



Increment 53 / 54 Science Symposium

Advanced Colloids Experiment (Temperature controlled) – ACE-T9

PI: Professor David W.M. Marr – Colorado School of Mines (CSM)



Presented by:

Dr. William V. Meyer (*a.k.a.* Bill Meyer)

ACE NASA Project Scientist

USRA at NASA GRC, Tel: (216) 433-5011, Email: William.V.Meyer@NASA.Gov

ACE NASA Project Manager: Ron Sicker, Tel.: (216) 433-6498

ZIN-Technologies ACE Project Manager: Kelly Bailey, Tel: (440) 625-2251

ZIN-Technologies Science Lead: John Eustace, Tel: (440) 625-2244

July 11-13, 2017





ACE-T9 Science Team



David Marr (PI)
CSM

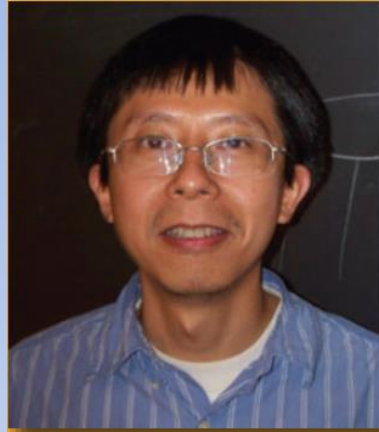

Ning Wu (Co-I)
CSM



Michael Solomon (Co-I)
UMich



Tao Yang
CSM



Fuduo Ma
CSM

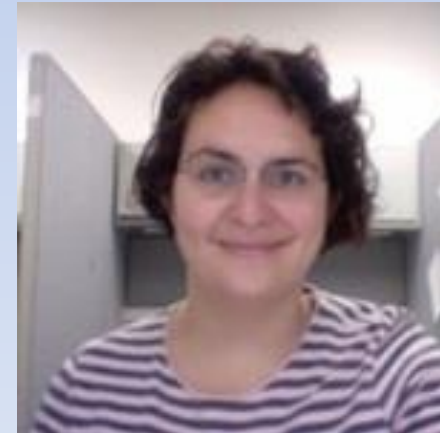

Laura Colón-Meléndez
UMich



ACE-T9 Science Team Contact Information



Professor David W.M. Marr (PI) [Department Head]
451B Alderson Hall
Chemical and Biological Engineering Dept.
Colorado School of Mines
Golden, CO 80401-1887
Office Tel / Fax: (303) 273-3720 / (303) 273-3730
Email: dmarr@mines.edu

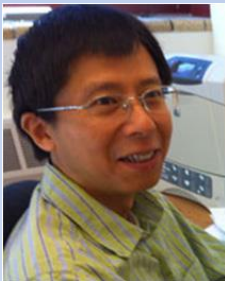

Professor Ning Wu (Co-I)
441 Alderson Hall
Chemical Engineering Dept.
Colorado School of Mines
Golden, CO 80401-1887
Office Tel / Fax: (303) 273-3720 / (303) 273-3730
Email: ningwu@mines.edu



Professor Michael Solomon (Co-I)
Chemical Engineering; Macromolecular Science and Engineering
Associate Dean for Academic Programs and Initiatives, Rackham Graduate School
University of Michigan
NCRC B10-A151
Office Tel: (734) 764-3119
Email: mjsolo@umich.edu

ISS Increments 53 and 54 Science Symposium

Advanced Colloids Experiment - Temperature controlled – (ACE-T9):
David W. M. Marr and Ning Wu, Colorado School of Mines (CSM);
Michael Solomon, University of Michigan (UMich)

- Science Background and Hypothesis
- Investigation goals and objectives
- Measurement approach
- Importance and reason for ISS
- Expected results and how they will advance the field
- Earth benefits/spin-off applications

Science Background and Hypothesis – 1/2

The ACE-T9 experiment involves the imaging, folding, and assembly of complex colloidal molecules within a fluid medium. The colloidal molecules include long rigid and semi-flexible colloidal chains, colloidal dimers with anisotropic surface properties, lock and key colloids, and metallodielectric Janus spheres. The fluid medium is an aqueous solution with different salt concentrations. These so-called “colloidal molecules”, are vital to the design of advanced functional materials. In the microgravity environment, we will first test the microscopy imaging capability of those colloidal molecules in a fluidic environment. Once successful, [in later experiments] we will further study the folding dynamics of single colloidal chains where the chain architecture can be varied systematically and the monomer-solvent interaction can be tuned by varying salt concentrations. Furthermore, by tuning the balance between electric double layer repulsion and hydrophobic attraction on both colloidal dimers and lock-and-key particles, we aim to study the assembly of those colloidal molecules into complex three-dimensional structures and measure the binding equilibrium constants. This set of experiments will not only prepare us for future studies using the electric-field cell (ACT-E), but also provide insight into the relation between particle shape, colloidal interaction, and structure.

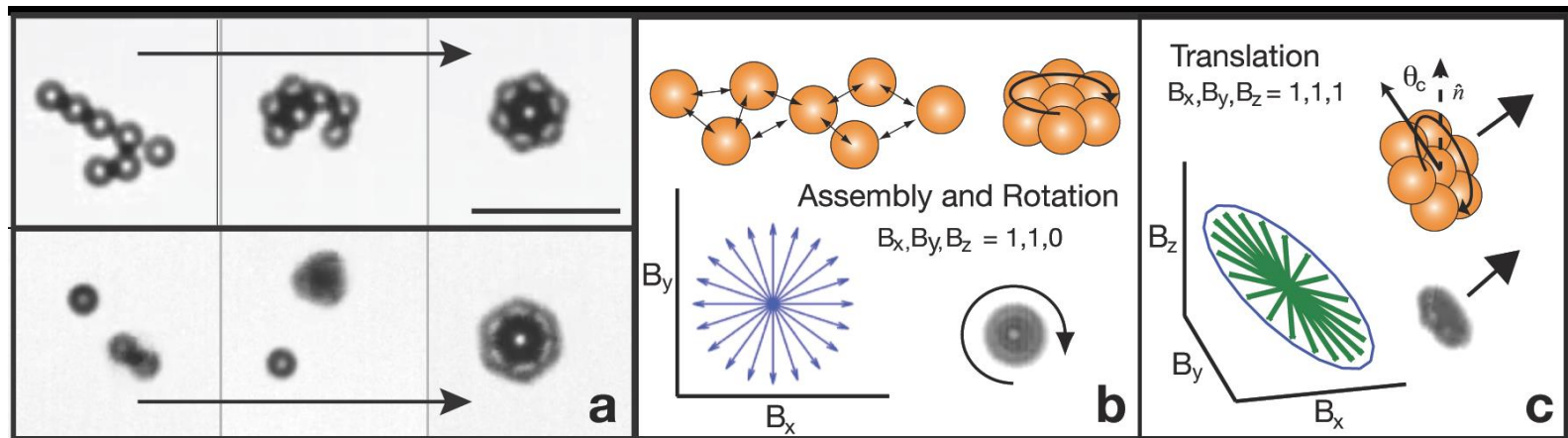

Science Background and Hypothesis – 2/2

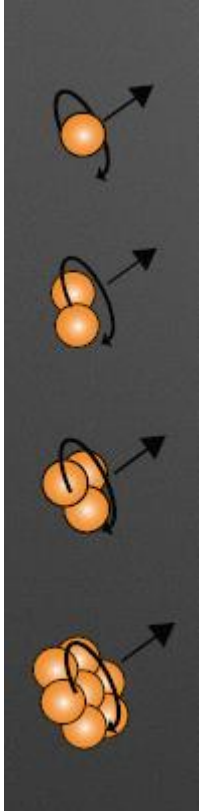

Fundamental science and colloidal engineering can be pursued and understood directly at a particle level.

Microscopy enables scientists to directly observe what is happening at a colloid particle level - one no longer requires a theoretical model to hope to connect macroscopic experimental observations to microscopic ones (as when observing experiments at the size scale seen with a photograph or with your eye in the laboratory).

In addition, many 2-D colloids structures created on Earth form 3-D structures in microgravity where sedimentation and jamming become insignificant.

Investigation goals and objectives

In ACE-T9, the imaging capability, folding dynamics, and assembly behavior of linear colloidal chains, colloidal dimers, and lock-and-key particles are studied by the combination of a proper design of particle architecture and tunable colloidal interactions (*e.g.*, double layer repulsion and hydrophobic attraction). In the case of colloidal chains, for example, the single chain dynamics should sensitively depend on the chain flexibility and monomer-solvent interactions. Under the microgravity environment, we hope to observe qualitative three-dimensional, real time dynamics of single colloidal chains (using pre-confocal - bright field and fluorescent microscopy; and if available and working we would use confocal microscopy for appropriate samples). We also aim to observe three-dimensional structures assembled from colloidal dimers and lock-and-key particles and to measure the binding equilibrium constants that are impossible to measure in earth experiments due to the effect of sedimentation.



Pumps

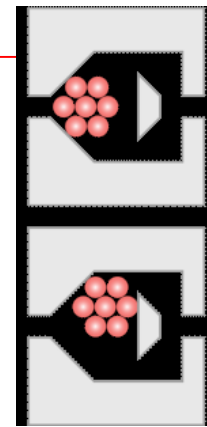
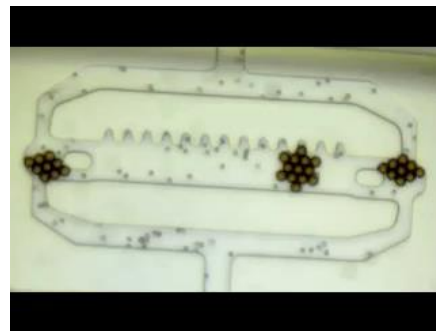

Valves

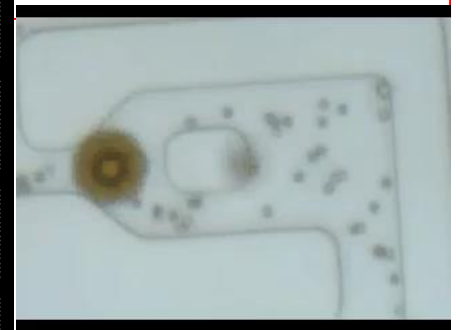

Measurement approach – 1/16

We will be using a flight-hardened Commercial-Off-The-Shelf (COTS) microscope

[pictured on next page]

and an

ACE-T sample module

[pictured later]

Measurement approach – 2/16

Light Microscopy Module (LMM) in the Fluid Integrated Rack (FIR)

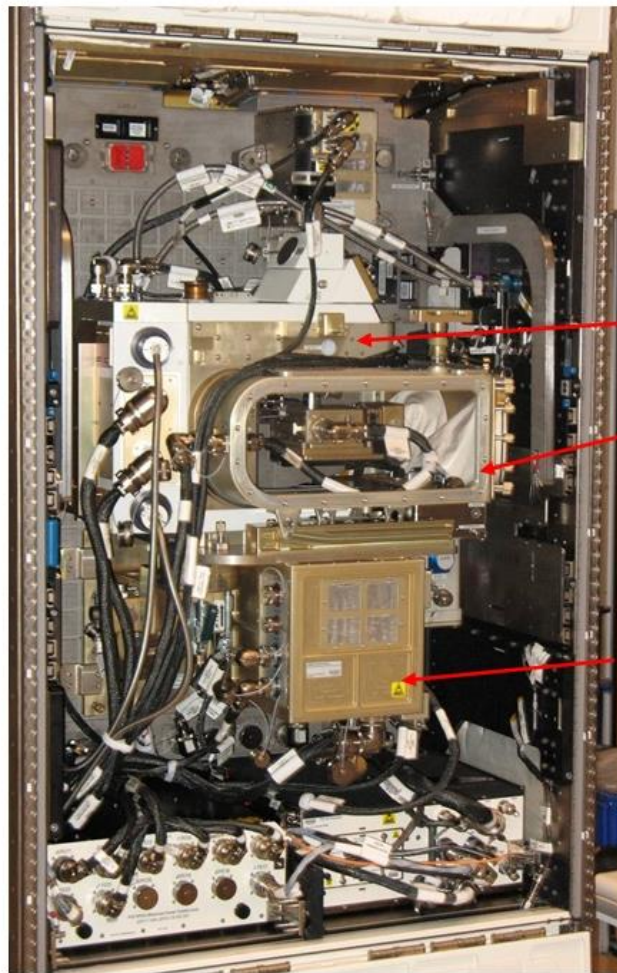

LMM in the Closed Position or Operating Configuration

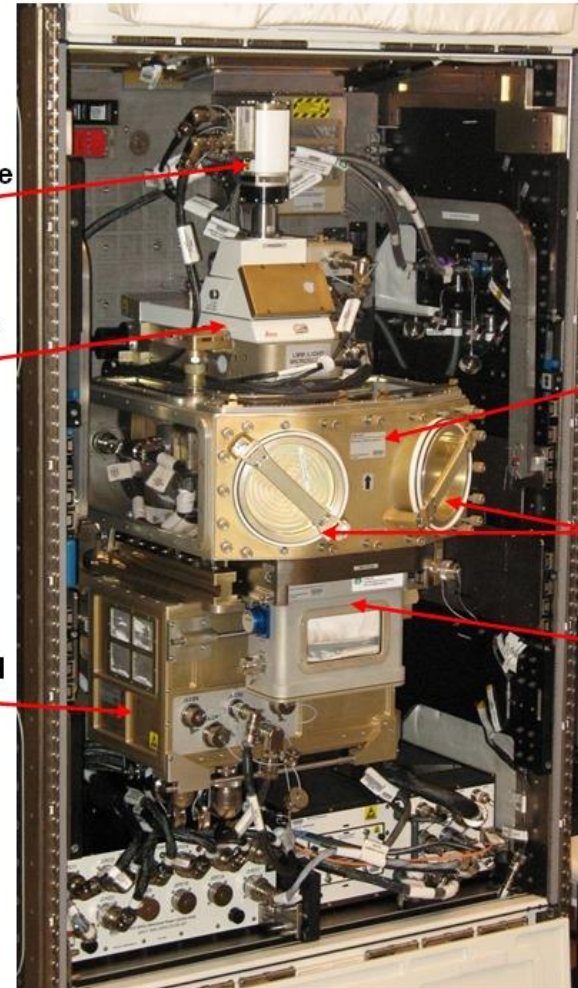

LMM in the Open Position or Installation/Service Configuration

Monochrome Camera

Microscope

Auxiliary Fluids Container (AFC) – Left Side

LMM Control Box

Auxiliary Fluids Container AFC - Front

Glove ports

Equipment Transfer Module (ETM)

Measurement approach – 3/16

LMM Implementation Philosophy

Philosophy: Maximize the scientific results by utilizing the existing LMM capabilities. Develop small sample modules and image them within the LMM

Payload specific and multi-user hardware customizes the FIR in a unique laboratory configuration to perform research effectively.

Light Microscopy Module



FCF Fluids Integrated Rack

- Power Supply
- Avionics/Control
- Common Illumination
- PI Integration Optics Bench
- Imaging and Frame Capture
- Diagnostics
- Environmental Control
- Data Processing/Storage
- Light Containment
- Active Rack Isolation System (ARIS)

Payload Specific Hardware

- Sample Cell with universal Sample Tray
- Specific Diagnostics
- Specific Imaging
- Fluid Containment

Multi-Use Payload Apparatus

- Test Specific Module
- Infrastructure that uniquely meets the needs of PI experiments
- Unique Diagnostics
- Specialized Imaging
- Fluid Containment



Measurement approach – 4/16

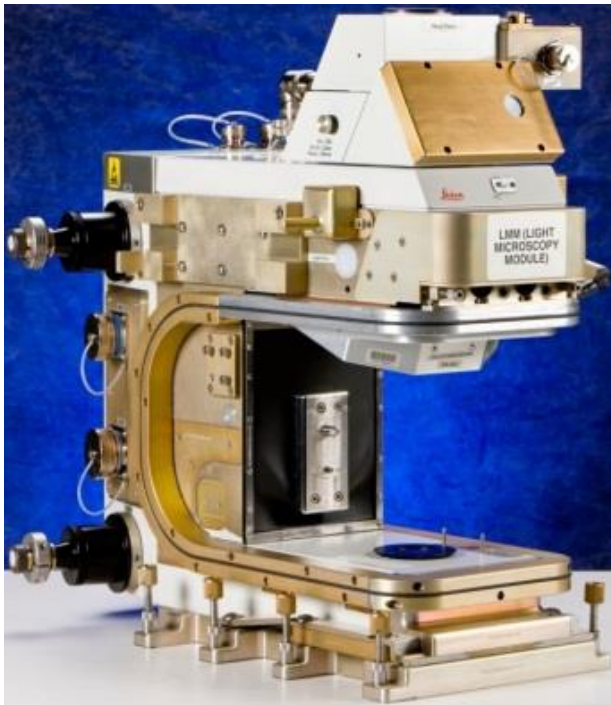

Light Microscopy Module
(LMM)

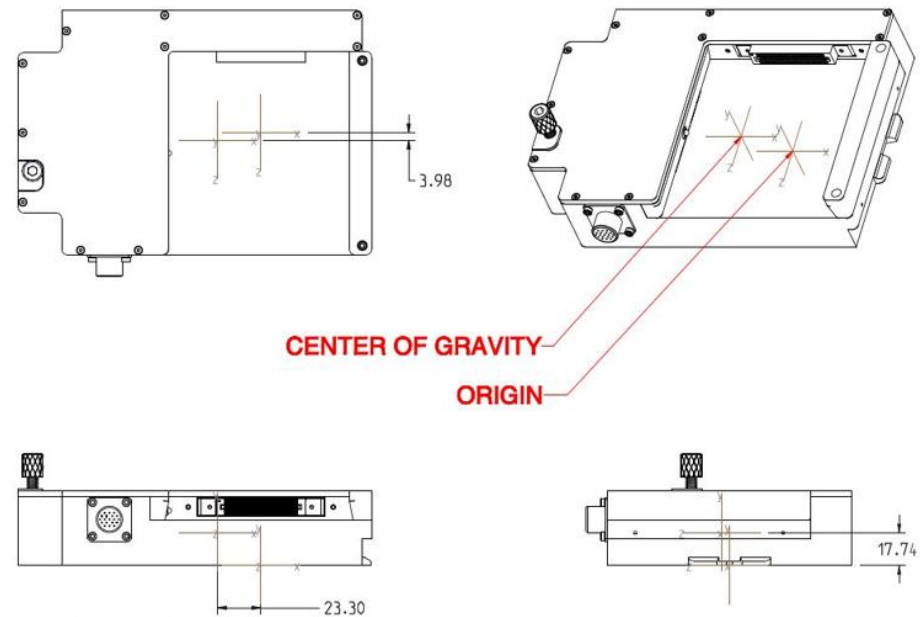
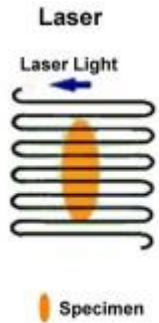
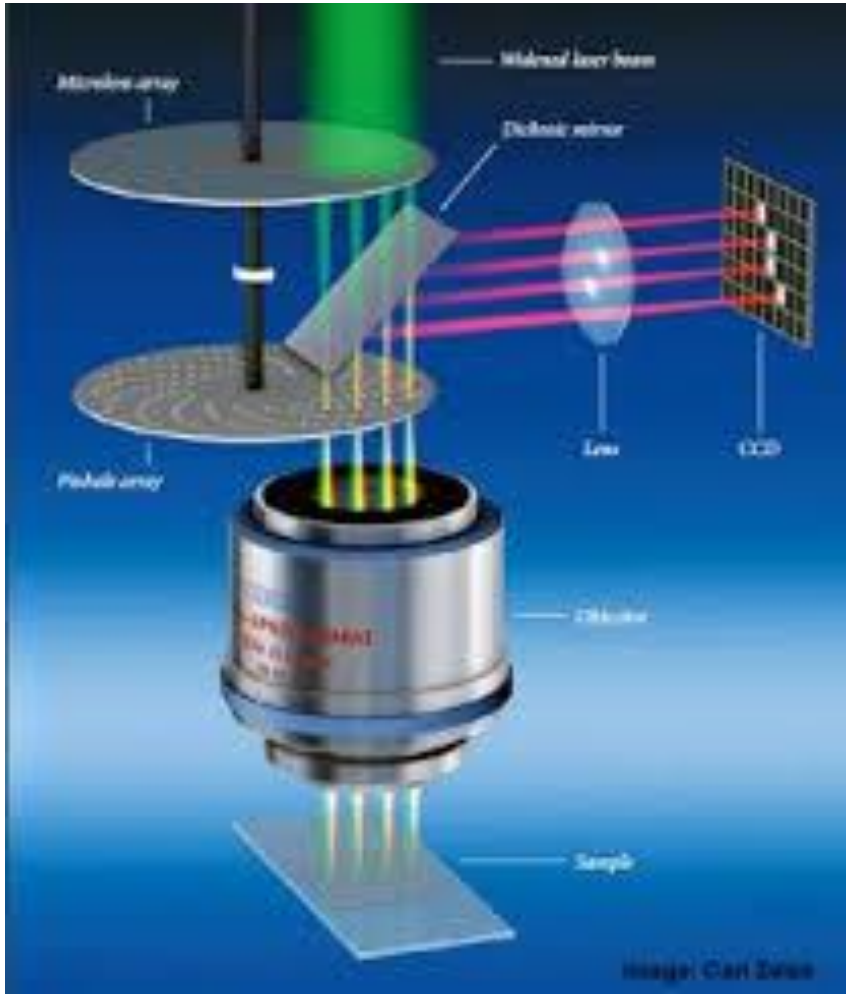

Figure 1: Center of Mass for ACE-T

ACE Sample Assembly with
Removable ACE-T Sample Tray
that will contain a row of 3
temperature controlled
capillary cells

Measurement approach – 5/16



Measurement approach – 6/16

The difference between traditional and confocal microscopy

Focus 50 μm below cover slip

Traditional microscopy doesn't see through objects well; out-of-focus light obscures in-focus light



Particles on top are easily imaged

Focus 200 μm below (near bottom of well)

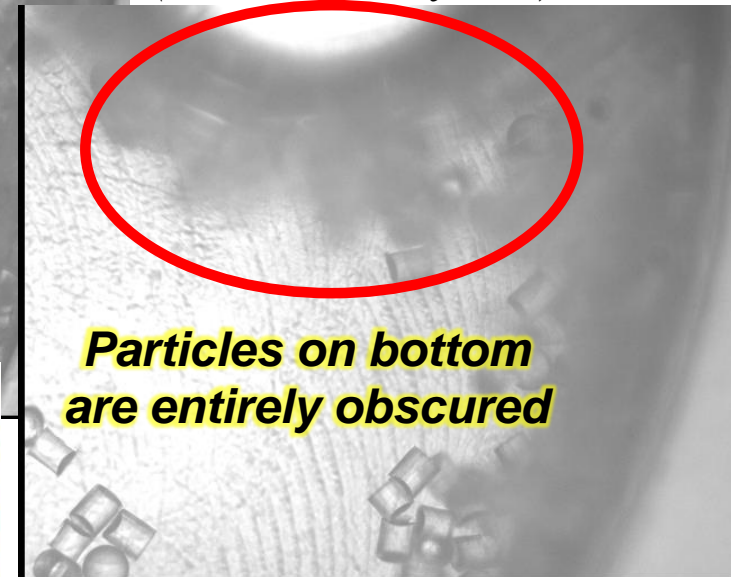

Particles on bottom are entirely obscured

Confocal microscopy rejects out-of-focus light, to look through semi-transparent objects

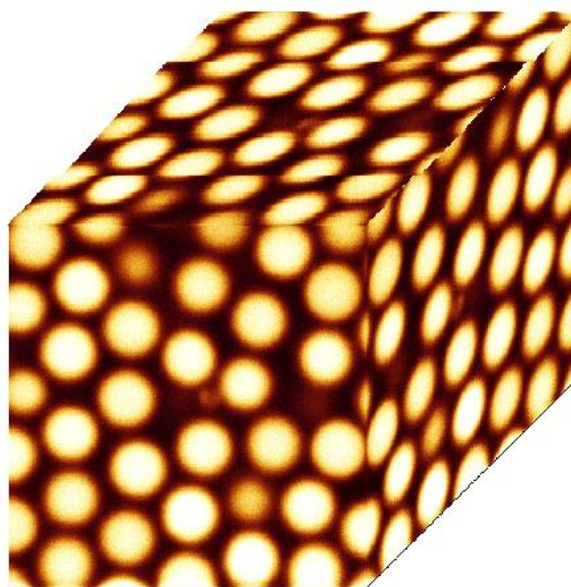

3D image is built out of 2D XY sections while stepping through Z axis.

Measurement approach – 7/16

Mechanical Design Highlights

- Modular sample assemblies
- Allows for multiple sample configurations.
 - Easier Sample replacement
 - Decreased “ACE-T” up-mass in comparison to ACE-H

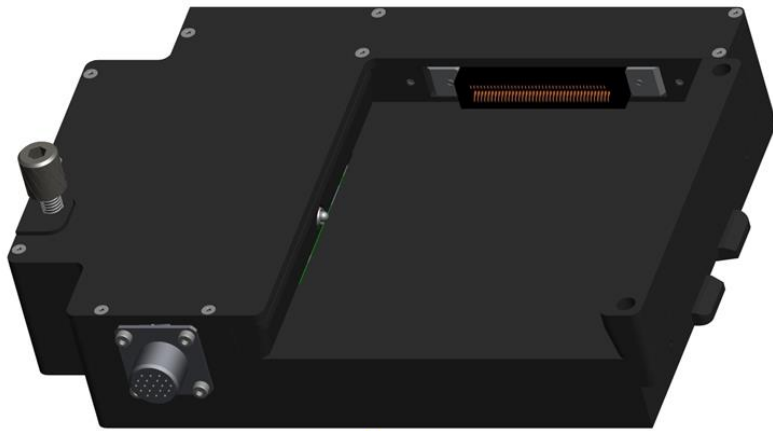

Measurement approach – 8/16

Mechanical Design Highlights

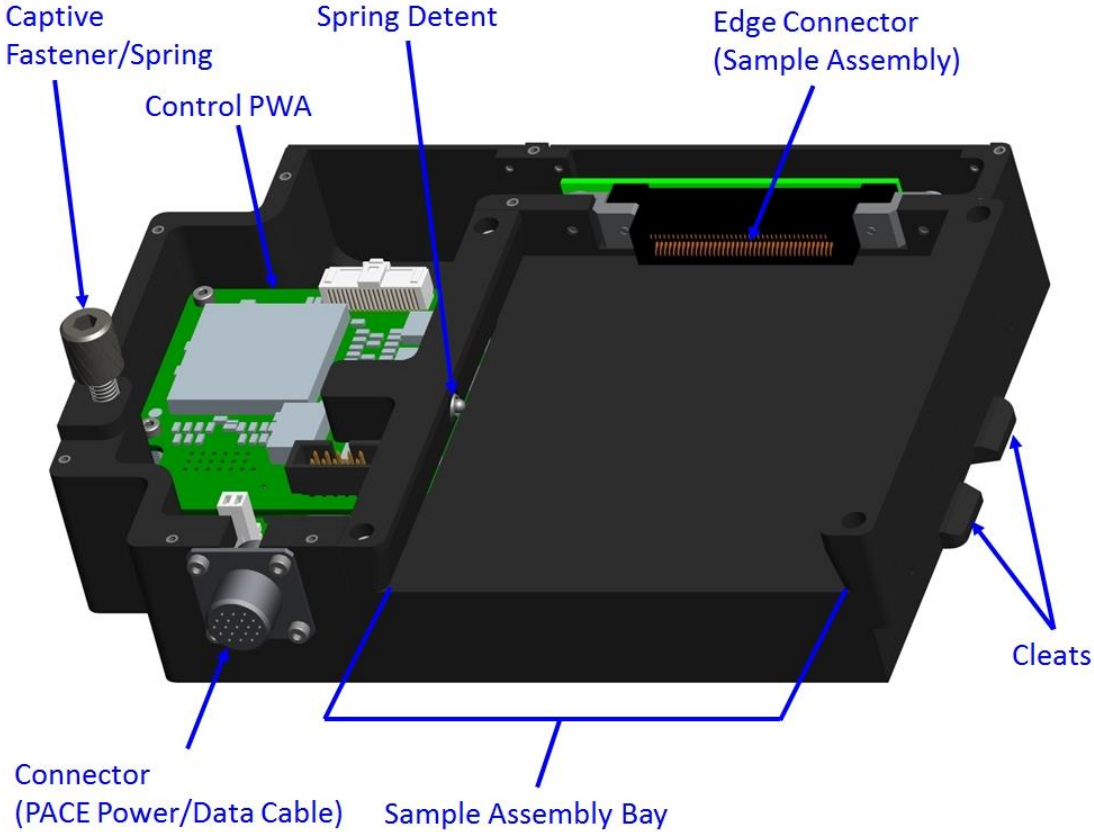

Measurement approach – 9/16

Mechanical Design Highlights

- In-situ mixing (details in electrical section)
- Black Hard Anodize Surface Coat
 - Reduction of any errant light within the AFC
 - Increased wear resistance

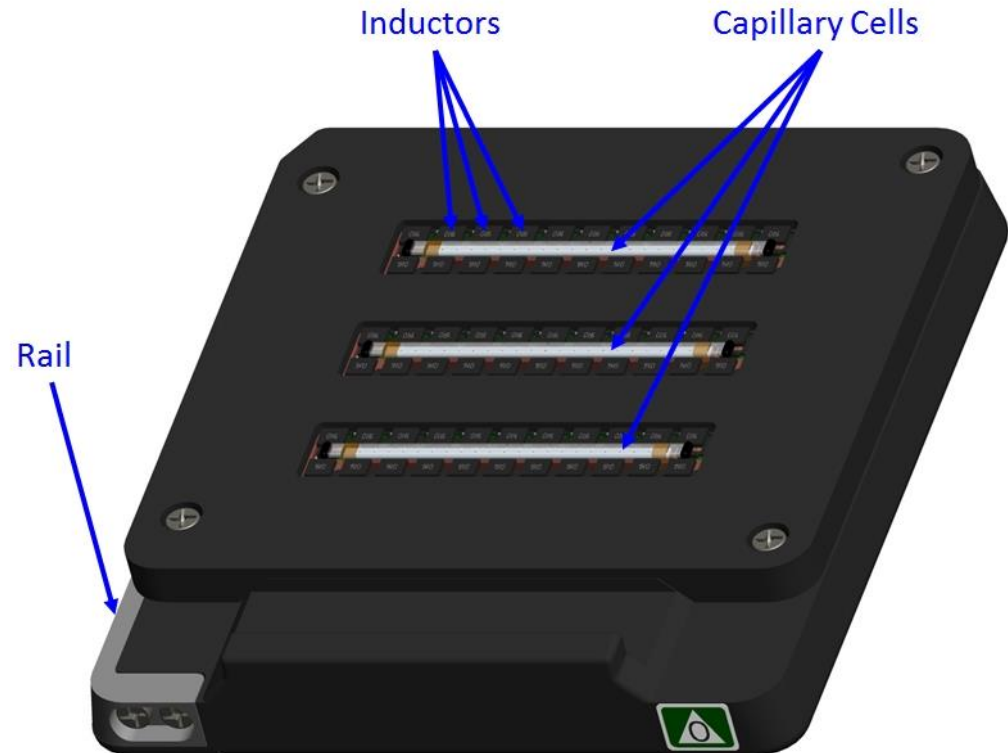

Measurement approach – 10/16

Mechanical Design Highlights

Capillary cell

- Purchased through VitroCom.com
- Material
 - Borosilicate (3520-050)
 - Fused Silica by request (3520S-050)
- COTS
- 50mm length
- Reference Marks
 - Secondary Process to ease positional awareness

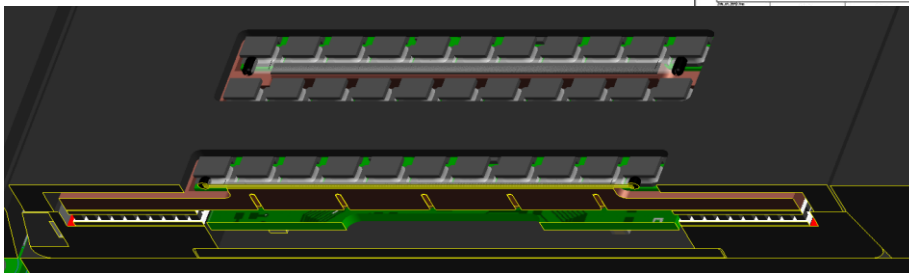
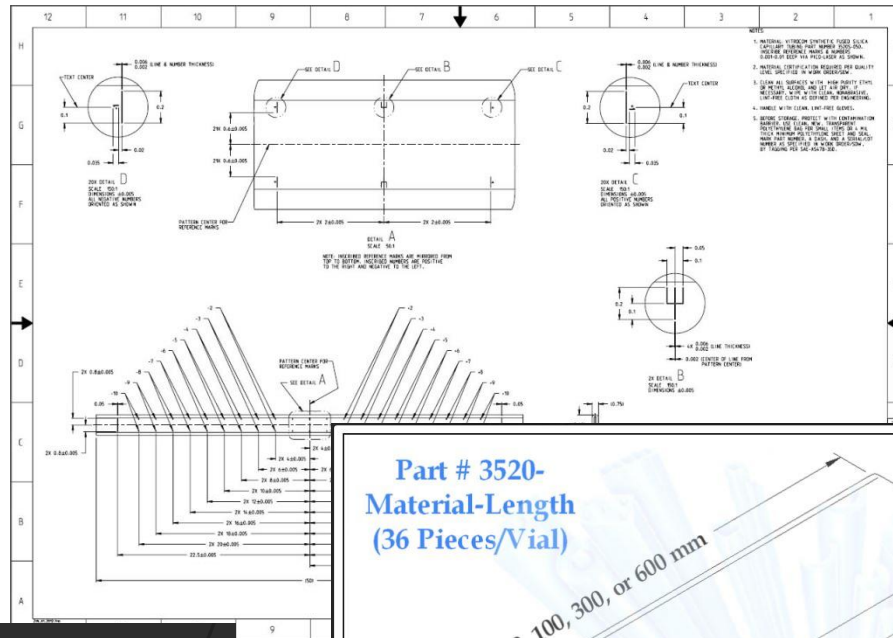

**Part # 3520-
Material-Length
(36 Pieces/Vial)**

TOLERANCES	LENGTH (mm)	
ID +/- 10 %	50 +2 / -0	300 +10 / -0
Wall +/- 20 %	100 +4 / -0	600 +20 / -0

**VITROCOM
TECHNICAL GLASS**

Two capillary cells surrounded by inductors that are used for walking a turning stir-bar for sample mixing.

Measurement approach – 11/16

Temperature gradient option

- Thermal bridge
 - Material: Copper
 - Bridges thermal energy between TEM's
 - Constrains Thermistor Positioning
 - Thermal symmetry across X and *Y Axis

*When set-points are equal

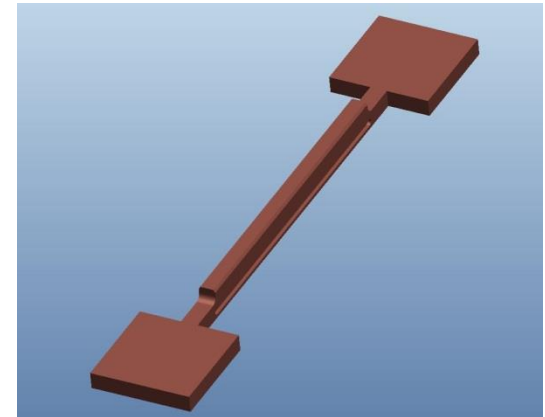
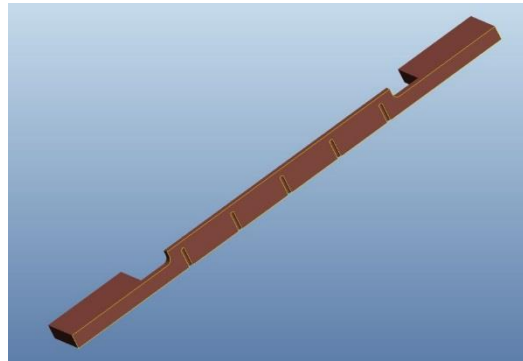

Bonus information: ACE-T, in general, will enable temperature control that can either be linear across the capillary - or a temperature gradient across the capillary. A temperature gradient will form a density gradient! You can now march through a phase diagram using a single capillary and have a common error bar for all measurements.

Hard Sphere Equilibrium Phase Diagram

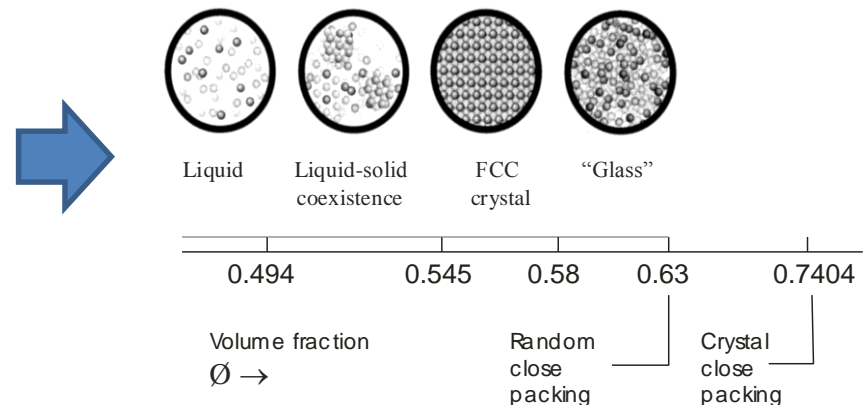

Measurement approach – 12/16

Operational Requirements [nasa.gov]: Defines constraints and requirements necessary to complete the investigation (number of subjects or observations, spacing of observations, downlink of data, return of samples, etc.).

- Two experiment modules. One experiment module (each module contains three capillary cells) is expected to run for one week. Microscopic observation is expected to require 1–4 days (the actual duration will depend upon the number of z-scans that are needed to determine the chain dynamics and assembled structures).
- Inspect each capillary for air bubbles using a low magnification objective. Switch observation area or capillary if air bubbles exceed allowable size.
- Use balance of experiment time, *i.e.*, the rest of the week, to analyze data, re-write scripts, adjust parameters, *etc.*
- The number of capillaries per experiment is limited by:
 1. Observation position repeatability: the need to return to the same Region of Interest (ROI), *i.e.*, single chains and particle crystallite – or to maintain XYZ coordinates during an experiment – implies maintaining one capillary position. If this requirement takes an excessive amount of time, find a solution. For example, images can be registered in post-processing via port or stir bar location, or pattern of particles stuck to bottom of cover slip.

Measurement approach – 13/16

Operational Protocols [nasa.gov]: Descriptive overview of the investigation on orbit procedures.

General experiment steps (imaging and dynamics of single colloidal chain), capillary 1-2:

1. Inspect the samples.
2. Mix the sample in sample module using the in-situ mixer for 1 minute(s).
3. Define XY offsets.
4. Experiment on one capillary using the 100x oil (or 63x air) objective;
5. Adjust camera parameters using 2.5x objective and bright field.
6. Survey capillary(s) at 2.5x, scanning in the X direction over a range of at least 10 millimeters. Determine bubble locations and possible primary (and secondary) Regions of Interest (ROI). If the 2.5x objective is difficult to switch in and out with the 100x oil objective, then find ROI capillary cells before using 100x oil objective. Select primary locations away from stir bar or bubble. There will be about (9) 800 x 800 micron areas within the capillary strip. The number of areas may increase once usage of the flight capillary cell design is available to test.
7. Using 100x oil objective (or 63x air) objective, find a single colloidal chain in the field of view.
8. Focus on the inner surface of the bottom glass capillary, it is closest to the objective.
9. Take one image at each of the z-depth and scan over the thickness of the glass capillary (e.g., twenty z-depths over 100 microns). The z-scanning rate should be set as fast as possible, potentially 5 -10 frames per second. No pixel binning, 8 bits per pixel (highest supported), full frame images. The number (e.g., 20 here) of z-depths depends on the chain lengths, conformation, monomer size, and thickness of glass capillary.
10. Repeat the z-scan of the same colloidal chain over 30 minutes.
11. Find another colloidal chain by moving the stage in x-y direction.
12. Repeat steps 8-11.
13. To obtain statistically meaningful data, at least ten colloidal chains in one capillary should be imaged. This calculates to at least ~400 minutes for one capillary.
14. Complete upon evaluation by PI.

(continued)

Measurement approach – 14/16

Operational Protocols [nasa.gov]: Descriptive overview of the investigation on orbit procedures. (continued)

General experiment steps (self-assembly of Janus dimers), capillary 3-4:

Scheme 1: One end of the capillary is held at $T=31.5^{\circ}\text{C}$ and the other end is at $T= 36.5^{\circ}\text{C}$.

1. Inspect the sample.
2. Mix the sample for 5 minutes.
3. Adjust camera parameters using 2.5x objective and bright field.
4. Survey the capillary at 2.5x, scanning in the X direction over the whole range of the capillary. Determine bubble locations and possible primary (and secondary) Regions of Interest (ROI). There will be about (9) 800 x 800 micron areas within the capillary strip. The number of areas may increase once usage of the flight capillary cell design is available to test.
5. Use 63x air objective, Survey the capillary. Make sure that no or only a few aggregates are present. If necessary, mix the sample using magnet for 5 minutes again and repeat steps 3-4.
6. Set the temperature to 36.5°C (ramp rate $1^{\circ}\text{C}/\text{min}$) for one end of the capillary and 31.5°C for the other end of the capillary (5 cm long). The temperature gradient is $\sim 1^{\circ}\text{C}/\text{cm}$.
7. Start $x=0.5$ cm from one end of the capillary ($T=31.5^{\circ}\text{C}$).
8. Focus on the region of interest, where clusters or aggregates of particles are being formed. Acquire images at least 5 frames per second. If three-dimensional structures are formed, take one image at each of the z-depth (every 2 microns) and scan over the whole thickness of the structures.
9. Scan other regions of interest along $y=0-2\text{mm}$. Acquire images at 1 frame per second for 5 minutes per region of interest. Obtain structures of different types, which are representative in the cell.
10. Scan $x=0.75$ cm from one end of the capillary ($T=31.5^{\circ}\text{C}$), repeat steps 8-9.
11. Repeat 12 along x for every 0.25 cm until reaching the other end of the capillary ($T=36.5^{\circ}\text{C}$).
12. Complete upon evaluation by PI.

(continued)

Measurement approach – 15/16

Operational Protocols [nasa.gov]: Descriptive overview of the investigation on orbit procedures. (continued)

Scheme 2: T=35°C, T = 34°C, and T=33.2°C uniformly across the capillary

1. Inspect the samples.
2. Mix the sample for 5 minutes.
3. Define XY offsets (assembly alignment per ACE-M-1 method).
4. Adjust camera parameters using 2.5x objective and bright field.
5. Survey capillary(s) at 2.5x, scanning in the X direction over a range of at least 10 millimeters. Determine bubble locations and possible primary (and secondary) Regions of Interest (ROI). If the 2.5x objective is difficult to switch in and out with the 100x oil objective, then find ROI capillary cells before using 100x oil objective. Select primary locations away from stir bar or bubble. There will be about (9) 800 x 800 micron areas within the capillary strip. The number of areas may increase once usage of the flight capillary cell design is available to test.
6. Experiment on one capillary using 100x oil objective (or 63x air) objective, Survey the capillary. Make sure that no or only few aggregates are present. If necessary, mix the sample using magnet for 5 minutes again and repeat steps 4-5.
7. Set the temperature to 35°C (ramp rate 1°C/min) for the whole capillary.
8. Focus on the region of interest, where clusters or aggregates of particles are being formed. Acquire images at least 5 frames per second. If three-dimensional structures are formed, take one image at each of the z-depth (every 2 microns) and scan over the whole thickness of the structures.
9. Once the temperature reaches 35 °C, continue to acquire images at 1 frame per second for one hour.
10. Scan other regions of interest and acquire images at 1 frame per second for 5 minutes. Obtain structures of different types, which are representative in the cell.
11. Set the temperature to 34.0 °C (ramp rate 0.1°C/min) for the whole capillary.
12. Repeat steps 8-10.
13. Set the temperature to 33.2 °C (ramp rate 0.1°C/min) for the whole capillary.
14. Repeat steps 8-10.
15. Complete upon evaluation by PI.

(continued)

Measurement approach – 16/16

Operational Protocols [nasa.gov]: Descriptive overview of the investigation on orbit procedures. (continued)

General experiment steps (imaging and assembly of lock and key particles), capillary 5-6:

1. Inspect the sample.
2. Mix the sample using BCAT drill magnet for 5 minutes.
3. Define *XY* offsets.
4. Adjust camera parameters using 2.5x objective and bright field.
5. Survey the capillary at 2.5x, scanning in the X direction over a range of at least 10 millimeters. Determine bubble locations and possible primary (and secondary) Regions of Interest (ROI). Select primary locations far away from stir bar or bubble. There will be about (9) 800 x 800 micron areas within the capillary strip. The number of areas may increase once usage of the flight capillary cell design is available to test.
6. Use 63x air objective. Survey the capillary. Make sure that no or only a few aggregates are present. If necessary, mix the sample using magnet for 5 minutes again and repeat steps 4-5.
7. Focus on the region of interest, where particles are bonded. Acquire images at least 5 frames per second. If three-dimensional structures are formed, take one image at each of the z-depth (every 2 microns) and scan over the whole thickness of the structures.
8. Repeat step 6. To obtain statistically meaningful data, at least 5 regions in one capillary should be imaged.
9. Repeat the steps 6-7 for day 2 and day 4.
10. Complete upon evaluation by PI.

The imaging goal is to observe (1) real-time and three-dimensional particle centroid positions of colloidal chains and colloidal molecules over both short (30 minutes) and long period (one week); (2) assembled structures and to resolve particle centroid positions for colloidal dimers and lock-and-key particles. For short-time imaging, the video should be taken with 5 fps over 30 minutes. For both cases, the x-y positions of particles should be determined with less than 5% error (with respect to particle diameter). The z-positions should be determined within 1 micron. For fluorescence imaging, lamp should be shuttered between image sets to prevent sample bleaching.

Importance and reason for ISS

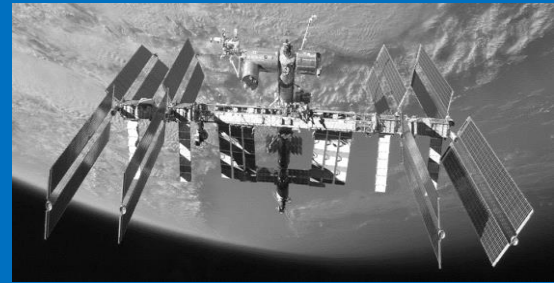

- Nature assembles relatively simple atomic and molecular building blocks into well-defined structures of exquisite complexity and functionality. Scientists and engineers desire a similar capability to produce advanced functional materials efficiently, however, the difficulty in characterizing molecular processes *in situ* greatly limits our current understanding. Although decades of study using colloids as molecular mimics have shed significant light, the range of particles employed to date has been limited to relatively simple symmetries. We remain far from accessing the full diversity of fundamentally and technologically-relevant phases due to a limited control of intrinsic colloidal interactions and a reliance on non-directed assembly. To push beyond these limitations, we need to develop colloidal building blocks that better model natural molecules with varying composition, complex architecture, and external field-responsive interactions.
- In ACE-T9, the imaging capability, folding dynamics, and assembly behavior of linear colloidal chains, colloidal dimers, and lock-and-key particles are studied by the combination of a proper design of particle architecture and tunable colloidal interactions (e.g., double layer repulsion and hydrophobic attraction). In the case of colloidal chains, for example, the single chain dynamics should sensitively depend on the chain flexibility and monomer-solvent interactions. Under the microgravity environment, we hope to observe qualitative three-dimensional, real time dynamics of single colloidal chains (using pre-confocal - bright field and fluorescent microscopy; and if available and working we would use confocal microscopy for appropriate samples). We also aim to observe three-dimensional structures assembled from colloidal dimers and lock-and-key particles and to measure the binding equilibrium constants that are impossible to measure in earth experiments due to the effect of sedimentation.

Expected results and how they will advance the field

- This work will test the imaging capability for large and complex colloidal molecules.
- It will also probe the combined impacts of particle shape and colloidal interactions on assembly. Understanding this will lead to improved control of non-covalent assembly of molecules, efficient tailoring of lattice symmetries, and scalable processing of nano-structured materials.

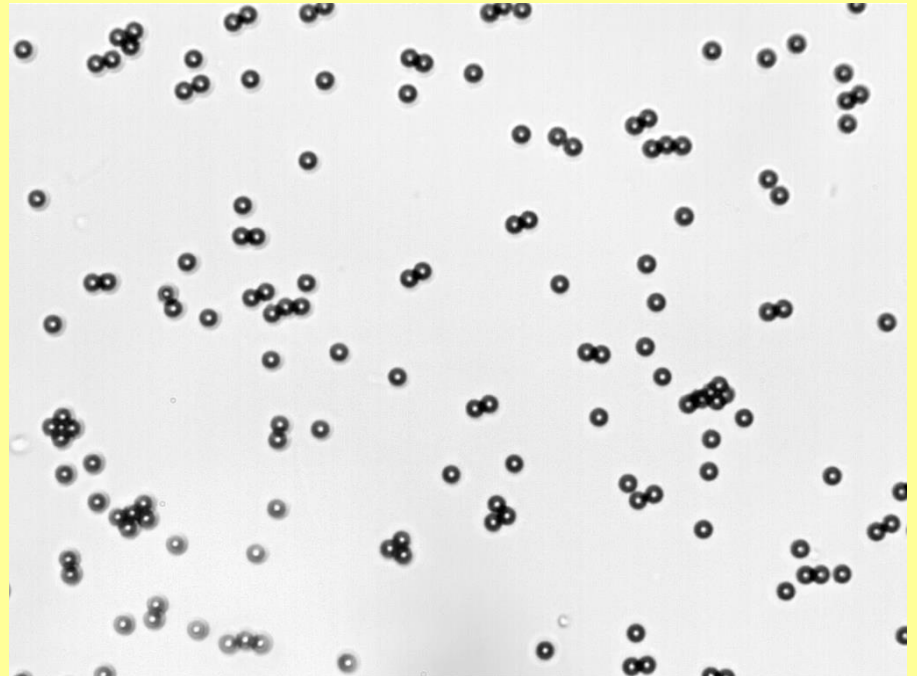



Front-cover of Langmuir



June 13, 2017 Volume 33, Number 23

pubs.acs.org/Langmuir

LANGMUIR

The ACS journal of fundamental interface science

Rolling
Microlassos
Used for
Cargo Delivery

ACS Publications
Most Trusted. Most Cited. Most Read.

www.acs.org

This article just got published on the front-cover of Langmuir. This is ground-based work by David Marr, Ning Wu, *et al.* related to the upcoming ACE-T9 and ACE-E3 NASA flight experiments.

June 13, 2017

Volume 33, Issue 23

Pages 5613-5974

About the Cover: Cover image by Brad Baxley. Linear chains of superparamagnetic colloidal particles linked via flexible polymer bonds form lassos in the presence of a rotating magnetic field. When the field is canted relative to the surface, lassos translate via a rolling mechanism similar to wheels. [We demonstrate here that lassos can be used to move \[micron-sized\] cargo without the need for chemical attachment and roll at substantial velocities with excellent spatial control. In addition, once the target destination is reached, cargo can be readily released with field removal, leaving the lasso available for reuse.](#) For more information, see "Magnetic Microlassos for Reversible Cargo Capture, Transport, and Release" by Tao Yang, Tonguc O. Tasci, Keith B. Neeves, Ning Wu, and David W. M. Marr (DOI: 10.1021/acs.langmuir.7b00357).

Earth benefits/spin-off applications

In-situ manipulation of anisotropic interactions and dynamic pathways, based on rational colloidal particle design and proper use of external fields, could lead to crystalline and aperiodic structures beyond those seen in nature. With the wide variety of attributes that characterize anisotropic interactions, we will probe previously inaccessible regions of complex phase space. Our studies will move significantly beyond hard spheres and towards experimental models appropriate for studying fundamental questions associated with complex symmetries. Results from this study will lead to improved control of non-covalent assembly of molecules, efficient tailoring of lattice symmetries, and the scalable processing of nano-structured materials. The development of new colloidal molecules and their associated assembled structures have considerable technological impact as well. Such structures will generally lead to arrays with reduced symmetry and enhanced directionality. They can interact with a broad range of electromagnetic radiation in unique ways and can exhibit collective photonic, plasmonic, mechanical, electronic, or magnetic properties that are not manifested at the level of single particles. As a result, they have significant potential as next-generation functional materials.

ACE-T9

Increment 53/54 Science Symposium

BACKUP SLIDES

ACE-T9 samples

Well #	Capillary Cell Contents
1 [~SPX-12] Particle Media [1 st flight]	0.02%, rigid magnetic chains, composed of Dynabead M450 Epoxy, diameter 4.5 micron 1%, 4-arm polyethylene glycol tetra-maleimide, Mw=10, 000 98.98%, deionized water
2 [~SPX-12] Particle Media [1 st flight]	0.02%, flexible magnetic chains, composed of Dynabead M450 Epoxy, diameter 4.5 micron 1%, 4-arm polyethylene glycol tetra-maleimide, Mw=40, 000 98.98%, deionized water
3 [SPX-13] Particle Media [2 nd flight]	0.5 %, symmetric polystyrene-platinum dimers, radius of one lobe is ~1.5 micron, ratio of the radii between two lobes is ~1.0; Constituents: polystyrene, platinum, gold, 3-Mercaptopropionic acid 35.0%, 2,6 lutidine 64.7%, deionized water
4 [SPX-13] Particle Media [2 nd flight]	0.5%, asymmetric polystyrene-platinum dimers, radius of one lobe is ~1.5 micron, ratio of radii between two lobes is ~1.5; Constituents: polystyrene, platinum, gold, 3-Mercaptopropionic acid 35.0%, 2,6 lutidine 64.5%, deionized water
5 [SPX-13] Particle Media [2 nd flight]	24.64%, RBITC dyed, 3-trimethoxysilyl propyl methacrylate lock particles, 2.4 µm diameter 4.96%, Fluoresbrite® YG carboxylate polystyrene spheres, 1.75 µm diameter 0.0006%, sodium chloride 0.1% , polyethylene oxide Mv 600,000 g/mol 0.0625%, Pluronic F108 (poly(ethylene oxide) – block – poly(propylene oxide) – block-poly(ethylene oxide), Mn ~ 14,600) 0.0125%, tetramethylammonium hydroxide 70.22%, deionized water
6 [~SPX-12] Particle Media [1 st flight]	27.72%, RBITC dyed, 3-trimethoxysilyl propyl methacrylate lock particles, 2.4 µm diameter 3.72%, Fluoresbrite® YG carboxylate polystyrene spheres, 1.75 µm diameter 0.006%, sodium chloride 0.1%, polyethylene oxide Mv 600,000 g/mol 0.0625%, Pluronic F108 (poly(ethylene oxide) – block – poly(propylene oxide) – block-poly(ethylene oxide), Mn ~ 14,600) 0.0125%, tetramethylammonium hydroxide 68.379%, deionized water

ACE-T9 Success Criteria

Complete success is the achievement of all of the science requirements. This means that there will be sufficient information to provide a crosscheck of all data and calculated factors. Processing, manipulation and characterization of the samples in micro-gravity are as important as the measurements during the experiments themselves. e.g., sample homogenization is essential to conduct of any of the flight experiments. This allows for the homogenization of the crystallites or any structures formed from phase separation or gelation that have occurred in 1g before launch, and provides a proper starting point in micro-g.

Success Level	Accomplishment
Minimum Success	<ul style="list-style-type: none">• Homogenize completely at least 40% of the complete set of samples, and observe the time evolution with (using pre-confocal - bright field and fluorescent microscopy; and if available and working we would use confocal microscopy for appropriate samples) imaging for several days to weeks, depending on rates of change determined in real-time as data is downlinked to earth (these cannot be predicted accurately ahead of time in the 1g environment).• Have sufficient data (both in terms of frequency and duration) from microscopy of sufficient quality to observe, characterize and quantify the rates of growth of structures formed as a result of the physical process of interest in microgravity, including but not limited to crystallization, phase separation and gelation. The behavior cannot be predicted ahead of time, often new mechanisms can be observed whose presence is masked on earth by the presence of gravity.• We hope that these processes will generate new structures formed in microgravity, that may direct further earthbound studies and inspire new directions for materials synthesis and fundamental physics understanding.
Significant Success	<ul style="list-style-type: none">• Accomplish the above for 50% of the different types fluid samples launched.
Complete Success	<ul style="list-style-type: none">• Accomplish the above for all launched samples, with multiple runs to repeat the experiment and assess reproducibility.



Microgravity Justification

- Formation of colloidal structures is profoundly affected by gravity via sedimentation processes. Chaikin and Russel have already demonstrated this effect in space experiments exploring the simplest of all entropic transitions, the hard-sphere liquid-solid phase transition.
- Sedimentation causes particles to fall so rapidly that there is insufficient time for particles to explore the full phase space of positions and velocities that are required for thermodynamic assembly processes. A substantial particle concentration gradient arises in the earthbound sample.

$$h = \frac{kT}{\Delta\rho V g}$$

h = gravitational height

kT = Thermal Energy of system

$\Delta\rho$ is the density difference between the particles and the background fluid

V is the particle volume

g is the gravitational acceleration

h ranges from a few microns for the case of polystyrene in water to a fraction of a micron for most of the other particles we consider. Our particles are usually of order 1 micron in diameter.



Microgravity Justification

(continued)

- In addition, the shear forces of fluid flow due to the sedimenting particles is often sufficient to break structures that are forming thermodynamically.
- The solvents we plan to use (such as water) are restricted by various factors, for example by our need to fix the colloidal structures in space. Almost all of the particles of future interest are either too heavy or too light compared to water.
- Sample equilibration often requires ~1 to 12 hours. Structure growth sometimes continues for one to two more weeks after the initiation process. These processes are too slow for a drop tower or an airplane.
- Space station or space shuttle provides an environment where microgravity is sustained long enough to allow these experiments to be conducted. The samples can be homogenized, and then allowed to develop in the microgravity environment. Their structures and optical properties can be measured. For most samples we are contemplating, the density mismatch between particle and background fluid is large (e.g. $> 1.1 \times$). Microgravity dramatically reduces these differences and permits true equilibrium processes to occur.