

UNIVERSITÉ DU QUÉBEC À MONTRÉAL

**RÉGULATION ET ÉTUDES DE FONCTION
DE FACTEURS DE TRANSCRIPTION MADS-box ASSOCIÉS
À LA VERNALISATION CHEZ LE BLÉ (*Triticum aestivum* L.)**

THÈSE
PRÉSENTÉE
COMME EXIGENCE PARTIELLE
AU DOCTORAT EN BIOLOGIE

PAR
NDJIDO ARDO KANE

Décembre 2007

UNIVERSITÉ DU QUÉBEC À MONTRÉAL
Service des bibliothèques

Avertissement

La diffusion de cette thèse se fait dans le respect des droits de son auteur, qui a signé le formulaire *Autorisation de reproduire et de diffuser un travail de recherche de cycles supérieurs* (SDU-522 – Rév.01-2006). Cette autorisation stipule que «conformément à l'article 11 du Règlement no 8 des études de cycles supérieurs, [l'auteur] concède à l'Université du Québec à Montréal une licence non exclusive d'utilisation et de publication de la totalité ou d'une partie importante de [son] travail de recherche pour des fins pédagogiques et non commerciales. Plus précisément, [l'auteur] autorise l'Université du Québec à Montréal à reproduire, diffuser, prêter, distribuer ou vendre des copies de [son] travail de recherche à des fins non commerciales sur quelque support que ce soit, y compris l'Internet. Cette licence et cette autorisation n'entraînent pas une renonciation de [la] part [de l'auteur] à [ses] droits moraux ni à [ses] droits de propriété intellectuelle. Sauf entente contraire, [l'auteur] conserve la liberté de diffuser et de commercialiser ou non ce travail dont [il] possède un exemplaire.»

Remerciements

À la mémoire du professeur Papa Abdourahmane Kane, mon père.

Des remerciements infinis à ma mère, à ma femme et à ma fille

À toute ma famille. À la mémoire de Seyni.

À ma belle famille

À mon directeur de recherche, le Pr Fathey Sarhan.

À mes collègues et à tout le personnel présent et passé du laboratoire.

Aux membres du jury de thèse, aux collaborateurs et aux évaluateurs anonymes.

À mes maîtres et enseignants du Sénégal

À Mme Martine (Assistante programme 1^{er} cycle du département des sciences biologiques de l'UQAM 1995-1999) et à Mme Hélène Durand-Nadeau (Services des Étudiants étrangers).

À mes amis d'enfance.

À mes amis de Montréal et de partout à travers le monde.

À tous ceux et celles que je n'ai pas pu citer, vous êtes dans mon cœur.

Je dédie ce travail à ma mère pour son acharnement pour la réussite de ses enfants

Table des matières

Liste des figures	vii
Liste des tableaux.....	x
RÉSUMÉ	XI
INTRODUCTION ET REVUE DE LITTÉRATURE.....	1
1 LA FLORAISON	1
1.1 Importance de la floraison	1
1.2 Étapes de la floraison	2
2 VOIES DE CONTRÔLE DE LA FLORAISON	2
2.1 Relation génétique entre les basses températures et la floraison	2
2.1.1 <i>Acclimatation au froid et vernalisation</i>	2
2.1.2 <i>Génétique de la voie de vernalisation</i>	4
2.1.2.1 <i>Chez Arabidopsis</i>	4
2.1.2.2 <i>Chez les céréales</i>	6
2.2 Relation génétique entre la lumière et la floraison	7
2.2.1 <i>Le signal photopériodique</i>	7
2.2.2 <i>Génétique de la voie de photopériode</i>	8
2.2.2.1 <i>Chez Arabidopsis</i>	8
2.2.2.2 <i>Chez les céréales</i>	9
2.3 Autres voies de régulation de la floraison.....	12
2.3.1 <i>Voie autonome</i>	12
2.3.2 <i>Régulation épigénétique</i>	13
2.3.4 <i>Régulation hormonale</i>	15
3 LES FACTEURS DE TRANSCRIPTION MADS-BOX	16
3.1 Définition.....	17
3.2 Classification.....	18
3.2.1 <i>Les facteurs MADS-box de type I</i>	19
3.2.2 <i>Les facteurs MADS-box de type II</i>	20
3.2.3 <i>Les facteurs MADS-like</i>	20
3.3 Fonctions.....	21

3.3.1	<i>Chez les végétaux</i>	21
3.3.2	<i>Chez les animaux</i>	23
PROBLÉMATIQUE		25
OBJECTIFS		28
RÉSULTATS ET DISCUSSIONS		30
I. TAVRT-2, A MEMBER OF THE STMADS-11 CLADE OF FLOWERING REPRESSORS, IS REGULATED BY VERNALIZATION AND PHOTOPERIOD IN WHEAT		31
Abstract		33
Introduction.....		34
Results.....		37
<i>Identification and molecular characterization of TaVRT-2</i>		37
<i>Mapping of the TaVRT-2 gene</i>		38
<i>Expression of TaVRT-2 in parental and near-isogenic lines (NILs) of wheat differing at the Vrn-A1/vrn-A1 locus</i>		38
<i>Influence of photoperiod on TaVRT-1 and TaVRT-2 expression in cereals</i>		40
Discussion		43
Materials and Methods.....		48
Table		52
Figures and legends.....		54
Literature cited		68
Supplemental data		74
II. TAVRT-2 REPRESSES THE TRANSCRIPTION OF THE WHEAT VERNALIZATION GENE TAVRT-1.....		80
Abstract		82
Introduction.....		83
Results.....		86
<i>TaVRT-2 binds the CArG motif present in the TaVRT-1 promoter</i>		86
<i>TaVRT-2 represses TaVRT-1 promoter activity in vivo</i>		87

<i>TaVRT-2, TaVRN2 and TaVRT-1 are expressed in the same cells of the shoot apical meristem and young leaves</i>	88
<i>Photoperiod affects flowering time and regulates the expression of vernalization genes</i>	89
<i>TaVRT-2 delays flowering in Arabidopsis</i>	90
Discussion	91
Experimental procedures	97
Table	103
Figures and legends.....	104
References list.....	123
Supplemental material.....	130
III. VERNALIZATION GENES IN WINTER CEREALS	132
Summary	134
Introduction.....	135
The model system <i>Arabidopsis</i>	136
Genetics of vernalization in cereals	138
Identification of vernalization genes in wheat.....	140
Future prospects	144
Figure and legend.....	146
References list.....	148
IV. PHYLOGENETIC AND MOLECULAR ANALYSES OF MADS-BOX GENES IN HEXAPLOID WHEAT	157
Abstract.....	159
Introduction.....	160
Results.....	163
<i>Identification of MADS-box genes in hexaploid wheat</i>	163
<i>Phylogenetic analysis</i>	164
<i>Chromosome mapping</i>	170
<i>Expression profiling during vernalization and photoperiod responses</i>	171
Discussion	174
Materials and Methods.....	180

Tables	184
Figures.....	188
Supplemental data.....	198
References.....	217
V. INTERACTION NETWORK OF PROTEINS ASSOCIATED WITH ABIOTIC STRESS	
RESPONSE AND DEVELOPMENT IN WHEAT.....	227
Abstract	229
Introduction.....	230
Materials and Methods.....	234
Results and Discussion	238
<i>Two-hybrid screen</i>	238
<i>Bimolecular fluorescent complementation experiments (BiFC)</i>	239
<i>Properties of the interaction network</i>	241
Tables	244
Figures.....	252
Literature Cited	256
Supplemental material.....	268
CONCLUSION	270
BIBLIOGRAPHIE GÉNÉRALE	277

Liste des figures

Figure 1: Voies de régulation de la transition d'un état végétatif à un état reproductif chez <i>Arabidopsis thaliana</i>	11
Figure 2: Régulation de la floraison par les modifications épigénétiques au niveau de FLC	14
Figure 3: Organisation structurale des facteurs de transcription MADS-box.....	18
Figure 4: Modèle d'expression des gènes MADS-box	22

Article I

I-Figure 1: Alignment of TaVRT-2 with related MADS-box proteins from other species	55
I-Figure 2: Unrooted phylogenetic tree illustrating the relationship between TaVRT-2 and other major MADS-box regulatory proteins in monocots and dicots	57
I-Figure 3: Mapping of the TaVRT-2 homologous genes on wheat group-7 chromosomes	59
I-Figure 4: Expression of TaVRT and COR genes during low temperature exposure in parental and near-isogenic lines of wheat	61
I-Figure 5: Expression of TaVRT-2 at different developmental stages of wheat	63
I-Figure 6: Expression of TaVRT genes in Norstar wheat and their orthologues in Dicktoo barley in response to low temperature and photoperiodic regimes.....	65
I-Figure 7: Schematic representation of the constructs used in the protein-protein interaction studies in yeast	67

Article II

II-Figure 1: Characterization of the <i>TaVRT-1</i> promoter	106
II-Figure 2 : <i>TaVRT-1</i> promoter activity <i>in vivo</i>	108

II-Figure 3: Effect of TaVRT-2, TaVRN2 and TaVRT-1 on <i>TaVRT-1</i> promoter activity <i>in vivo</i>	111
II-Figure 4: <i>In situ</i> RNA hybridization analysis of <i>TaVRT-2</i> , <i>TaVRN2</i> and <i>TaVRT-1</i> expression	113
II-Figure 5: Effect of photoperiod on flowering and gene expression.....	116
II-Figure 6: <i>TaVRT-2</i> overexpression in <i>Arabidopsis</i>	118
II-Figure 7: Effect of TaVRT-2 overexpression on the accumulation of flowering-associated transcripts	120
II-Figure 8 : Hypothetical model of the regulation of TaVRT-1 expression in winter wheat	122

Article III

III-Figure 1: Proposed model for the activation of TaVRT-1/VRN1 in wheat	147
--	-----

Article IV

IV-Figure 1: Identification of MADS-box genes in hexaploid wheat	189
IV-Figure 2: Phylogenetic analysis of wheat MADS-box MIKC proteins.....	191
IV-Figure 3: Phylogenetic analysis of StMADS11-like sequences.....	193
IV-Figure 4: Phylogenetic analysis of SOC1-like sequences	195
IV-Figure 5: Expression of wheat MADS-box genes in response to vernalization and photoperiod	197
IV-Figure S 1: Relationships between members of the MADS-box type II genes from wheat, rice and <i>Arabidopsis</i>	201
IV-Figure S 2: Sequences comparison between unassigned wheat MADS-box genes and selected SRF-like sequences from rice and <i>Arabidopsis</i>	203

Article V

V-Figure 1: Representative BiFC of selected interaction pairs uncovered by two-hybrid screening	244
---	-----

V-Figure 2: A) Network view of the abiotic stress-related interacting wheat proteins
and B) Proteins involved in three- and four-protein interaction loops245

Liste des tableaux

Article I

I-Table 1: Protein-protein interactions between candidates that could be associated with the floral induction pathway	52
I-Table S1: Biochemical and physical characteristics of the TaVRT-2 protein	74
I-Table S2: MADS-box proteins used in the phylogenetic analysis.....	75
I-Table S3: Wheat MADS-box proteins used in protein-protein interaction studies in yeast	76
I-Table S4: List of primers used to generate the different constructs in the protein-protein interaction studies	77
I-Table S5: Control constructs used in protein-protein interaction studies in yeast ...	79

Article II

II-Table 1: TaVRT-2 interactors identified by yeast interaction screening	103
II-Table S1: Primers used for the different experiments on the characterization of the wheat TaVRT-2 gene	130
II-Table S1 (continued).....	131

Article IV

IV-Table 1: List of MADS-box in hexaploid wheat	184
IV-Table 2: Mapping of 20 wheat MADS-box genes.....	186

Article V

V-Table 1: Proteins used as initial baits in yeast two-hybrid screening.....	244
V-Table 2: Proteins interactions data.....	245
V-Table 1: Proteins pairs confirmed by BIFC.....	250
V-Table 4: Criteria for high confidence interaction scoring.....	251

RÉSUMÉ

La floraison, une des étapes cruciales du cycle de vie des plantes, est influencée par les facteurs environnementaux tels que la température et la durée d'ensoleillement. La majorité des espèces végétales évoluant en zones tempérées ont fort avantageusement développé des mécanismes d'adaptation leur permettant de mieux synchroniser leur développement en condition de basses températures et de courte durée d'ensoleillement. En réponse au stress causé par une longue exposition aux basses températures, les plantes induisent un processus nommé vernalisation qui consiste à induire une floraison précoce chez les plantes sensibles. Cette capacité à promouvoir la floraison peut également être acquise selon la sensibilité de chaque plante par une longue ou courte exposition de lumière (photopériode). Ces mécanismes d'adaptation favorisent une floraison au moment opportun et assurent une bonne reproduction.

Chez *Arabidopsis*, des analyses génétiques et moléculaires ont démontré que l'expression de nombreux gènes était modulée en réponse aux variations de basses températures et de lumière afin de bien synchroniser la transition florale. La plupart des gènes ayant un rôle majeur dans la régulation de la floraison en réponse aux variations de températures et de lumière code pour des protéines conservées chez les eucaryotes et impliquées dans divers aspects du développement et la reproduction des espèces : les facteurs de transcription de type MADS-box. D'ailleurs, toutes les voies de régulation de la floraison chez *Arabidopsis* convergent vers un répresseur central, le gène *FLC* (*Flowering locus C*) qui code pour un facteur de transcription de type MADS-box.

Chez les céréales, aucun homologue de *FLC* n'est, à ce jour, identifié et très peu de gènes MADS-box ont une fonction connue. Afin de pousser la caractérisation des gènes MADS-box chez les céréales et d'élucider leurs rôles lors de la régulation de la floraison, l'identification de cette famille de gènes a été entreprise chez le blé. Le blé hexaploïde a été choisi comme modèle d'étude à cause de sa grande variabilité de réponses face aux stress, ce qui lui confère une grande résistance et aptitude à pousser dans des zones où le climat et les saisons sont variables. De plus, il est plus intéressant au niveau agronomique, nutritif et économique qu'*Arabidopsis*. Par contre, ce choix s'accompagne d'un grand défi du fait de la taille et de la complexité du génome du blé, mais également des caractéristiques structurales et évolutives de la famille de gènes MADS-box.

Pour ces raisons, une approche génomique combinant des outils bioinformatiques et des études moléculaires a été utilisée. L'identification d'ADNc de MADS-box chez le blé hexaploïde, par recherche de bases de données, par PCR ou criblage de banques, montre que plus d'une cinquantaine de facteurs MADS-box sont codés par ses génomes. En général, ces facteurs présentent une grande conservation de structures et de fonctions durant l'évolution chez les angiospermes.

Une analyse moléculaire sommaire de membres de la famille MADS-box, en réponse à la vernalisation et à la photopériode, a permis d'identifier et d'associer un de ces facteurs, nommé TaVRT-2, à la régulation de la floraison. En réponse à la vernalisation, l'ARNm de TaVRT-2 s'accumule seulement durant la phase végétative du blé d'hiver et ce profil est inversement proportionnel à celui du gène majeur de vernalisation *VRNI/TaVRT-1*. Ce résultat suggérait que TaVRT-2 pouvait retarder la transition florale en réprimant l'expression de *TaVRT-1* ou bien que *TaVRT-1* induisait la floraison après la répression de *TaVRT-2*. Or, les études génétiques indiquaient que l'accumulation de *TaVRT-1* était un des événements les plus tardifs dans l'induction de la floraison. De plus, les études d'interactions protéiques indiquent que TaVRT-2 est capable de former des hétérodimères, surtout avec TaVRT-1. Enfin, la présence au niveau de son promoteur d'un élément *cis* spécifique au MADS-box suggérait plutôt que TaVRT-2 régule négativement l'expression de *TaVRT-1*. Toutes ces données soutenaient l'hypothèse que TaVRT-2 est un régulateur négatif de *TaVRT-1* et donc de la transition florale chez le blé. Grâce à des études de liaisons *in vitro* et par expression transitoire *in vivo*, il est démontré que la protéine TaVRT-2 réprime la transcription du gène *TaVRT-1* en se liant directement sur le promoteur et probablement en recrutant d'autres facteurs importants. Des études chez des plantes transgéniques confirment que TaVRT-2 est capable de retarder la floraison et qu'il est impliqué dans la voie autonome de régulation de la floraison.

Le clonage des gènes MADS-box de blé a permis de voir que les acteurs majeurs impliqués dans la régulation de la vernalisation sont différents entre espèces monocotylédones et dicotylédones. En ce sens, l'identification de TaVRT-2 constitue une contribution importante dans l'étude des mécanismes de régulation de la floraison. L'implication de TaVRT-2 dans les voies de régulation de la floraison (vernalisation, photopériode et autonome) démontre qu'il est un répresseur central de la floraison chez les céréales à l'instar de FLC chez *Arabidopsis*. Ces résultats montrent à quel point une meilleure compréhension des mécanismes d'adaptation des plantes face aux changements environnementaux peut contribuer à une bonne synchronisation de la floraison et du développement chez les céréales. En perspective, cette étude offre des avenues intéressantes sur le plan de l'amélioration des stratégies agricoles et de l'augmentation de la productivité céréalière.

Mots clés : blé hexaploïde, facteurs de transcription, MADS-box, floraison, vernalisation, photopériode.

INTRODUCTION ET REVUE DE LITTÉRATURE

1 La floraison

1.1 Importance de la floraison

Les plantes occupent une place essentielle pour la planète de par leur diversité (famille, espèces, genre, etc.), leur apparence (forme, structure et couleur) et leur mode de reproduction et de développement. Ces caractéristiques sont utilisées dans l'alimentation, l'agriculture et l'économie ou dans le confort de la population mondiale (horticulture ou encore la construction des maisons, etc.). L'importance des plantes dans la vie de tous les jours n'est pas à prouver, encore moins celle de la floraison puisque cette dernière permet la formation de nouveaux individus, la multiplication végétative et sexuée et la diversité génétique des espèces. La floraison est donc une étape décisive du cycle de vie des plantes. Les saisons et les conditions environnementales en perpétuel changement ont une grande influence sur cette étape, d'où l'importance pour les plantes de ne pas confondre une fluctuation passagère des facteurs environnementaux. C'est pour cela que les plantes ont acquis durant leur évolution la capacité de moduler leur système endogène (physiologie cellulaire ou expression génique) pour bien évaluer la durée d'un stress et ne pas induire une fausse réponse de développement. L'aptitude à moduler des mécanismes de régulation assure une bonne synchronisation des différentes phases de la floraison en réponse aux conditions saisonnières et environnementales.

1.2 Étapes de la floraison

La floraison est caractérisée par une phase végétative, une phase juvénile, une phase de transition et une phase reproductive. La phase végétative correspond à une étape où le méristème apical commence à former le bourgeon terminal au sein duquel la différenciation florale aura lieu (Simpson *et al.*, 1999). La phase appelée transition florale correspond au passage de la phase végétative à la phase reproductive qui est une phase de différenciation de l'inflorescence marquée par le gonflement de l'apex au niveau de la zone axiale du méristème (Simpson *et al.*, 1999). Le méristème d'inflorescence, après avoir donné une tige et des feuilles modifiées, se transforme en méristème floral qui donnera la fleur. L'étape la plus critique de ce cycle est celle de la transition florale durant laquelle la plante acquiert la capacité d'induire la floraison.

Les plantes peuvent être classifiées selon la longueur des phases de développement. Les variétés dites annuelles germent, fleurissent et meurent durant la même année. Les graines des variétés d'hiver germent durant l'automne et leur croissance est ralentie durant tout l'hiver, attendant que les conditions du milieu soient favorables (printemps ou au début de l'été) pour fleurir. De nombreuses céréales sont des variétés d'hiver, mais une espèce donnée peut avoir deux génotypes (printemps et hiver) : c'est le cas pour l'orge, le seigle et le blé. Certaines variétés d'hiver, lorsque semées au printemps, forment une rosette de feuilles pendant le premier été et passent l'hiver sous cette forme, une pousse fleurie au cours de la seconde année : ces plantes sont dites alors bisannuelles.

2 Voies de contrôle de la floraison

2.1 Relation génétique entre les basses températures et la floraison

2.1.1 Acclimatation au froid et vernalisation

Pour survivre dans les conditions de stress causées par les basses températures, les végétaux supérieurs des zones tempérées n'ont pas juste besoin de développer des

mécanismes pour s'adapter au froid, elles ont besoin aussi de fleurir au moment opportun et de se reproduire avec succès. Pour cela, certaines plantes tolérantes ont acquis des mécanismes qui pallient les effets nuisibles du froid sur le développement. Ces mécanismes sont l'acclimatation au froid et la vernalisation.

Une brève exposition aux basses températures entraîne chez certaines plantes une acclimatation au froid et une plus grande capacité à tolérer le gel. Dans la nature, les mécanismes d'acclimatation au froid débutent avec la perception du froid à l'automne. Deux phases caractérisent l'acclimatation au froid: d'abord, le rajustement de métabolites et des fonctions cellulaires en réponse aux fluctuations de température; ensuite, l'induction des mécanismes menant à la tolérance au gel (Thomashow, 1999). Durant l'hiver, les plantes tolérantes au froid ajustent leur métabolisme cellulaire afin de poursuivre leur cycle de vie et de pouvoir supporter les conditions extrêmes du climat. Les modifications physiologiques, métaboliques et géniques impliquées dans l'acclimatation au froid et la tolérance au gel ont fait l'objet de plusieurs articles de synthèse (Pearce, 1999; Thomashow, 1999; Breton *et al.*, 2000; Xin et Browse, 2000) et ne seront pas détaillées dans cette revue de littérature.

Par contre, une longue période d'exposition au froid, naturelle ou artificielle, induit un processus distinct de l'acclimatation au froid et qui est nommé vernalisation. La vernalisation est définie comme étant l'acquisition ou l'accélération de la capacité à fleurir suite à un traitement prolongé au froid (Chouard, 1960). Certaines plantes sont indifférentes de la longue exposition au froid pour induire leur floraison. D'autres manifestent un besoin facultatif, ou absolu du froid pour avancer leur temps de floraison. La vernalisation n'initie pas directement la floraison, mais elle agit sur les processus biochimiques des cellules en division du méristème apical (Lang 1965). Il est fondamental de mentionner que l'état de vernalisation chez une plante est stable jusqu'à la prochaine génération, ce qui indique qu'une plante a la capacité de « mémoriser » son état de vernalisation et d'induire une floraison avancée lorsque les conditions du milieu s'y prêteront.

Donc, il existe une relation quantitative entre la durée de traitement au froid et la rapidité d'induction de la floraison. Cette réponse quantitative est prononcée et généralement saturable, atteignant un point auquel une exposition plus prolongée au froid ne mène pas à l'accélération additionnelle de la floraison (Napp-Zinn, 1987; Fowler *et al.*, 1996a). Certains écotypes d'*Arabidopsis* atteignent la réponse maximale à la vernalisation ou le temps d'exposition au froid requis pour acquérir la compétence à fleurir après 4 à 8 semaines (Michaels et Amasino, 2000). Par comparaison, le point de saturation de la vernalisation chez le blé d'hiver est maximal à 49 jours de traitement au froid (Fowler *et al.*, 1996b). Cette réponse est en outre progressive et peut refléter l'accumulation progressive d'un activateur floral ou la diminution d'un répresseur ou les deux réponses de manière synergique. Toutes les études sur les MADS-box depuis leur identification ont permis de montrer que l'induction de la floraison et la détermination des organes floraux étaient sous le contrôle de facteurs exogènes (saison et environnement) et endogènes (génétiques et métaboliques). La température et la lumière ont été identifiées comme les deux principaux facteurs qui influencent plus l'induction de la floraison puisqu'elles jouent sur l'activité des facteurs endogènes.

2.1.2 Génétique de la voie de vernalisation

2.1.2.1 Chez *Arabidopsis*

Des écotypes naturels et des mutants montrant une diminution de la réponse à la vernalisation ont été identifiés chez *Arabidopsis*. La majorité de ces écotypes naturels et mutants sont des écotypes d'hiver et ils fleurissent tardivement sans vernalisation (phénotype tardif). Des études de croisements entre phénotypes précoce (pas de réponse à la vernalisation) et tardif ont permis d'associer la réponse à la vernalisation avec la présence d'un locus monogénique, appelé *FRIGIDA (FRI)* (Burn

et al., 1993; Lee *et al.*, 1993; Koornneef *et al.*, 1994). Le locus *FRI*, associé à la floraison tardive, porte un caractère dominant et son action peut être supprimée par une période d'exposition au froid (Napp-Zinn, 1987). Localisé sur le chromosome 4 chez *Arabidopsis*, ce locus porte un seul gène (Johanson *et al.* 2000) qui code pour une protéine de fonction inconnue. *FRI* agit de façon synergique avec un autre gène sur le locus *FLOWERING LOCUS C (FLC)* pour réprimer la transition florale. Le gène porté par le locus *FLC* est localisé sur le chromosome 5 chez *Arabidopsis* et code pour un facteur de transcription de type MADS-box (Lee *et al.*, 1993; Burn *et al.*, 1993; Koornneef *et al.*, 1994). *FLC* a été identifié comme le principal répresseur de cette transition florale (Michaels et Amasino, 1999; Sheldon *et al.*, 2000a). Le niveau d'expression de son ARN messager (*ARNm*) et celui de sa protéine augmente chez les écotypes d'hiver. Cette association entre *FLC* et la vernalisation a permis de démontrer que le niveau d'accumulation de *FLC* diminue proportionnellement avec le temps d'exposition au froid. Ce niveau d'accumulation de *FLC* est aussi corrélé avec la répression de la transition florale. *FLC* joue un rôle central dans la réponse à la vernalisation bien que la caractérisation de sa régulation grâce à des mutants *flc* suggère que le niveau d'accumulation de *FLC* seul ne suffit pas pour expliquer la réponse à la vernalisation (Michaels et Amasino, 2001; Scortecci *et al.* 2001).

Il existe d'autres loci récessifs *vrn1*, 2, 4 et 5 associés à la vernalisation chez *Arabidopsis* (Chandler *et al.*, 1996). Les gènes responsables des mutations *vrn1* et *vrn2* ont été clonés. *VRN1* code pour une protéine qui se lie à l'ADN (Levy *et al.*, 2002) tandis que *VRN2* code pour une protéine homologue à celles en doigt-de-zinc (Gendall *et al.*, 2001). *VRN1* a des fonctions durant la vernalisation et dans la régulation de la floraison. Cette évidence vient du fait que la mutation *vrn1* seule entraîne un phénotype tardif qui n'est pas dû à une forte accumulation de *FLC*. De plus, une surexpression de *VRN1* induit une floraison précoce qui n'est pas non plus en rapport avec l'accumulation de *FLC* (Levy *et al.*, 2002). Dans les deux cas, les changements de l'expression de *VRN1* ont comme conséquence les changements de l'expression des inducteurs sous-jacents de la voie florale (Levy *et al.*, 2002). Des

fonctions similaires sont associées à la mutation *vrn2* ; la perte de la protéine VRN2 affecte seulement la seconde phase de la répression florale. Donc, la protéine VRN2 n'est pas essentielle pour la répression de la transition par FLC, mais elle semble stabiliser la répression une fois que le traitement au froid est arrêté (Gendall *et al.*, 2001).

2.1.2.2 Chez les céréales

Chez plusieurs céréales, les variations dans la réponse à la vernalisation et de la sensibilité à la basse température sont principalement contrôlées par l'action de deux loci appelés *Vrn1* et *Vrn2*. Ils sont totalement différents des loci *Vrn1* et *Vrn2* d'*Arabidopsis*. Chez le blé hexaploïde, le locus *Vrn1* est présent sur le groupe de chromosomes 5 et identifié *Vrn-A1*, *Vrn-B1* et *Vrn-D1* (Law *et al.*, 1976; Sutka et Snape, 1989; Roberts, 1990; Galiba *et al.*, 1995). Chez l'orge, il est porté sur le chromosome 5H et identifié *Vrn-H1* (Laurie *et al.*, 1995). Chez le seigle, *Vrn-R1* est sur le chromosome 5R (Plaschke *et al.*, 1993). Chez le blé, la présence du locus *Vrn-A1* est dominante sur les autres loci de vernalisation (Galiba *et al.*, 1995; Dubcovsky *et al.*, 1998). De plus, la présence d'un seul locus *Vrn1* dominant est suffisante pour induire une floraison sans une nécessité de vernalisation (Shindo et Sasakuma, 2002). Donc, *Vrn1* est le locus le plus déterminant pour la réponse à la vernalisation chez les céréales. Dernièrement, les travaux de notre équipe de recherche (Danyluk *et al.*, 2003) appuyés parallèlement par d'autres études (Yan *et al.*, 2003; Murai *et al.*, 2003) décrivaient le clonage et la caractérisation du gène *VRN1* qui confère la réponse de la vernalisation et qui régule la transition florale chez les céréales. Le gène *VRN1* code pour une protéine appartenant à la famille de facteurs de transcription MADS-box connue pour contrôler divers aspects du développement.

Le second locus lié à la vernalisation est *Vrn2*. Chez l'orge, *Vrn2* (initialement nommé *Sh2*) est localisé sur le chromosome 4HL (Laurie *et al.*, 1995). Chez le blé *T. monoccocum*, il est localisé au niveau du long bras du chromosome 5, sur un locus

portant 6 autres gènes et un pseudogène (Yan *et al.*, 2004). Le caractère associé au locus *VRN2* a été relié à la présence de deux de ces gènes nommés *ZCCT1* et *ZCCT2*. L'expression du gène *ZCCT2* a été quantifiée par qRT-PCR et n'a pas été détectée alors que celle du gène *ZCCT1* montre une diminution durant la vernalisation. L'expression de *ZCCT1* est opposée à celle de *VRN-A1* (*TaVRT-1*) chez le blé d'hiver. Également, l'inhibition de l'expression de *ZCCT1* par interférence à l'ARN (RNAi) a été associée à une induction précoce de la floraison chez le blé (Yan *et al.*, 2004). Ces travaux ont montré que *ZCCT1* est le gène fort probablement responsable du caractère de vernalisation associé au locus *Vrn2* et leurs auteurs en ont conclu que *ZCCT1* est *VRN2* (Yan *et al.*, 2004).

Le clonage des gènes de vernalisation chez le blé (*VRN1* et *VRN2*) et chez *Arabidopsis* (*FLC* et *FRI*) indique que différents acteurs semblent réguler la floraison en réponse au froid chez les angiospermes, ce qui laisse supposer que l'adaptation des céréales face au stress causé par le froid est due à un système complexe multigénique et à des mécanismes différents de ceux identifiés chez les espèces dicotylédones.

2.2 Relation génétique entre la lumière et la floraison

2.2.1 Le signal photopériodique

Comme pour la réponse à la vernalisation, il existe une variation naturelle pour la sensibilité à la lumière. Dès le début du 20^{ème} siècle, les scientifiques ont montré que la floraison, chez une grande variété de plantes, pouvait être contrôlée par des signaux saisonniers qui assurent que la floraison se passe au temps de l'année le plus propice à la reproduction. La durée d'ensoleillement journalier d'une plante ou photopériode est un indicateur fiable du changement de saisons. La plupart des plantes se sert de la durée du jour pour déterminer les étapes de leur développement (Searle et Coupland 2004). Cette réponse à la photopériode dépend non seulement de la durée, mais aussi de l'intensité et de la qualité de la lumière. Elle catégorise les

espèces en plantes à jours longs qui induisent leur floraison lorsque la durée de lumière est longue, ou bien en plantes à jours courts qui ne peuvent fleurir que lorsque les jours sont courts. Il existe aussi des plantes à jours indifférents chez lesquelles la photopériode n'a aucun effet sur l'induction de la floraison.

Peu importe la catégorie de plantes, il reste que la perception de la photopériode a lieu au niveau des feuilles et que la floraison est induite au niveau du méristème. Depuis plus d'un siècle, des études de physiologie ont débattu de l'existence d'un signal universel de floraison appelé « florigène » migrant dans la plante (par le système vasculaire) et changeant le méristème d'un état végétatif à un état reproductif. Toutefois, aucune étude n'a clairement identifié la nature (hormone, métabolite, gène ou protéine) du florigène.

2.2.2 Génétique de la voie de photopériode

2.2.2.1 Chez *Arabidopsis*

Les études génétiques de l'influence de la photopériode sur la floraison ont permis de mettre en évidence que ce sont des photorécepteurs qui perçoivent la lumière au niveau des feuilles. Chez *Arabidopsis*, les premiers détecteurs impliqués dans la sensibilité à la photopériode et à la qualité de la lumière sont les phytochromes et les cryptochromes. Cinq gènes qui codent pour des phytochromes (PHYA à PHYE) et deux qui codent pour des cryptochromes (CRY1 et CRY2) ont été identifiés (Reed *et al.*, 1993; Somers *et al.*, 1998). Les clonages de *CRY1* et *CRY2* (Tei *et al.*, 1997; Guo *et al.*, 1998) et de *PHYA* et *PHYB* (Somers *et al.*, 1998; Jarillo *et al.*, 2001; Kim *et al.*, 2002) ont démontré que ces photorécepteurs sont impliqués dans le contrôle de la floraison.

Tous les signaux qui dépassent les phytochromes et les cryptochromes convergent vers le gène *CONSTANS* (*CO*) qui code pour une protéine similaire aux

facteurs de transcription à doigts de zinc. Des mutants *co* fleurissent plus lentement que les plantes sauvages lorsqu'ils sont exposés à des jours longs. Chez les plantes transgéniques, la surexpression de *CO* induit une floraison très précoce (Onouchi *et al.*, 2000; Samach *et al.*, 2000). Chez les écotypes sauvages d'*Arabidopsis*, le gène *CO* est régulé par l'horloge interne de la plante. L'ARNm de *CO* n'est pas exprimé à tout moment de la journée. En jours longs, il est rapidement exprimé pendant la journée, sa protéine est alors stabilisée dans le noyau où elle active l'expression d'autres gènes. Par contre, en jours courts, l'ARNm de *CO* est produit seulement la nuit, sa protéine est produite la nuit et est rapidement dégradée (Valverde *et al.*, 2004). Donc, la floraison d'*Arabidopsis* a lieu pendant les jours longs au printemps et au début de l'été via le contrôle de l'expression de *CO* (transcrit et protéine) par la lumière.

Des études récentes ont démontré qu'une des cibles directes de *CO* était le gène *FLOWERING LOCUS T* (*FT*, Tadaka et Goto, 2003; Wigge *et al.*, 2005; Yoo *et al.*, 2005). Dans la feuille et dans la tige, l'ARNm de *FT* est induit sous l'effet de la lumière (via *CO*). Au niveau du méristème, *FT* est négativement régulé par la température (via *FLC*) (Searle *et al.*, 2006). Le gène *FT* code pour une protéine homologue des inhibiteurs de kinases RAF (Kardailsky *et al.*, 1999; Kobayashi *et al.*, 1999) présente dans le noyau et dans le cytoplasme (Abe *et al.*, 2005) d'où possiblement il coordonnerait l'expression de gènes inducteurs de la floraison. Pour ces raisons, *FT* est pressenti comme un bon candidat pour être le signal de floraison (Teper-Bamnolker et Samach, 2005). Sa caractérisation chez d'autres espèces permettra d'élucider sa fonction exacte.

2.2.2.2 Chez les céréales

Chez les céréales, il existe aussi cette variation naturelle pour la sensibilité à la photopériode. Certains génotypes peu ou pas sensibles à la photopériode initient leur floraison sans condition de durée d'exposition de lumière alors que les génotypes

sensibles nécessitent une durée courte ou longue pour initier le développement floral. Par exemple, le riz et le maïs fleurissent en jours courts alors que la majorité des variétés de blé et d'orge fleurissent en jours longs. Se basant de cette sensibilité à la photopériode chez les céréales, des analyses génétiques ont permis d'identifier les loci contrôlant la réponse à la photopériode. Ces loci (*Ppd-A1*, *Ppd-B1* et *Ppd-D1*) sont respectivement situés sur le chromosome 2A, 2B et 2D (Laurie, 1997). Le locus le plus déterminant pour la réponse à la photopériode est *Ppd-A1* ; ses effets les plus visibles sont l'accélération de la floraison et le développement de l'épillet en jours courts.

D'autres parties du génome chez le blé (chromosomes 6B et 7BS) ont été identifiées comme étant impliquées dans la réponse de photopériode (Laurie *et al.*, 1995). D'ailleurs, un gène appelé *HEADING DATE 1 (HD1)* a été identifié sur le chromosome 6 du blé et il code pour une protéine homologue à CO d'*Arabidopsis* (Yano *et al.*, 2000; Nemoto *et al.*, 2003). À l'opposé de CO, HD1 favorise la floraison en jours courts, mais il retarde la floraison en jours longs chez les céréales. Ceci constitue une évidence de plus de l'existence d'une part de diverses réponses face aux facteurs environnementaux et d'autre part de différents mécanismes de régulation entre les espèces.

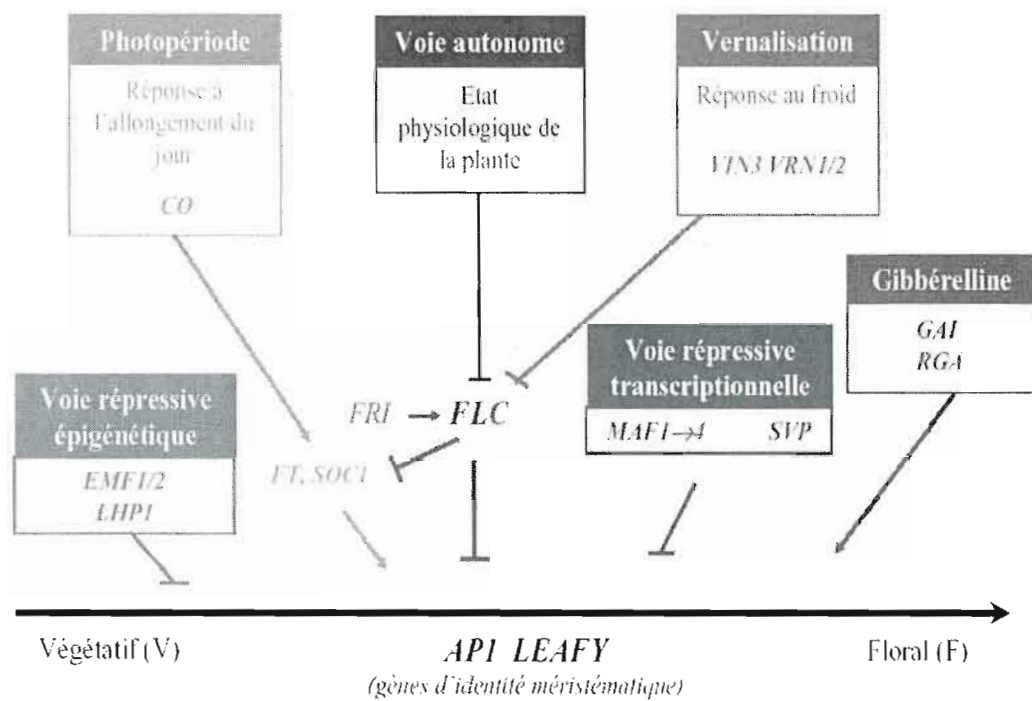

Figure 1: Voies de régulation de la transition d'un état végétatif à un état reproductif chez *Arabidopsis thaliana*
(voir le texte pour la description).

2.3 Autres voies de régulation de la floraison

L'illustration des voies de régulation de la floraison (figure 1) montre bien qu'il existe, outre la vernalisation et la photopériode, d'autres mécanismes qui régulent le temps de floraison. Ces voies peuvent agir de façon synergique sur les parties de la plante (feuilles ou apex du méristème) qui transmettent le ou les signaux qui initient le développement et la reproduction.

2.3.1 Voie autonome

Les plantes ont dans leur bagage génétique l'information pour induire les stades développementaux et reproductifs lorsque les conditions endogènes (l'âge et la taille de l'appareil végétatif) le permettent. Cette régulation interne est nommée voie autonome, car elle est indépendante des conditions exogènes (climat, nutriments). La caractérisation de cette voie chez *Arabidopsis* a permis l'identification de six gènes qui codent pour des protéines impliquées dans la régulation par défaut de la floraison : FCA (Macnight *et al.*, 1997), FY (Simpson *et al.*, 2003), FLD (He *et al.*, 2003), FVE (Ausin *et al.*, 2004), FPA (Schomburg *et al.*, 2001) et LD (Lee *et al.*, 1994; Aukerman *et al.*, 1999). FPA et LD possèdent des motifs de facteurs de transcription (Schomburg *et al.*, 2001; Aukerman *et al.*, 1999), mais leurs fonctions dans cette voie sont encore inconnues. FCA et FY forment un complexe protéique qui empêche la stabilité de l'ARNm de FLC et qui induit de fait la floraison par une régulation posttranscriptionnelle (dérépression) de FLC (Amasino, 2003; Simpson *et al.*, 2003). Quant aux protéines FLD et FVE, elles sont impliquées dans la régulation du promoteur de *FLC* par des mécanismes de condensation de la chromatine appelés régulation épigénétique (figure 2).

2.3.2 Régulation épigénétique

La régulation épigénétique fait référence aux modifications ou aux facteurs qui ne sont pas codifiés par la séquence d'ADN. Dans ce type de régulation, la forme de la chromatine change alors que la séquence nucléotidique de l'ADN n'est aucunement modifiée. Selon la forme euchromatinienne ou hétérochromatinienne, la régulation épigénétique détermine de façon très coordonnée quel(s) gène(s) activer ou inhiber. Comme voie de régulation de la floraison, elle nécessite l'intervention de multiples enzymes qui causent des modifications posttraductionnelles de type méthylation, acétylation, phosphorylation ou ubiquitination. Des modifications sur les acides aminés présents au niveau de l'extrémité N terminale des histones vont avoir pour conséquence une augmentation ou, *a contrario*, une diminution de l'accessibilité des facteurs de régulation géniques. C'est par de telles modifications (figure 2) que l'expression du gène *FLC* serait régulée de façon positive par FLD et FVE ou bien négative par d'autres protéines telle que VERNALIZATION INSENSITIVE 3 (VIN3; Sung et Amasino, 2004) impliquées dans la régulation de la floraison chez *Arabidopsis*. Suite à une longue exposition au froid, le niveau d'expression de FLC (ARNm et protéine) reste très faible chez les plantes traitées, et ce, malgré un arrêt de l'exposition et une remontée de la température à des conditions inductibles de floraison (Sung et Amasino, 2004). Ceci indique que les cellules des plantes vernalisées sont mitotiquement stables et « gardent en mémoire » qu'elles ont rempli cette nécessité de vernalisation et que, lorsque les conditions s'y prêteront, elles induiront la floraison.

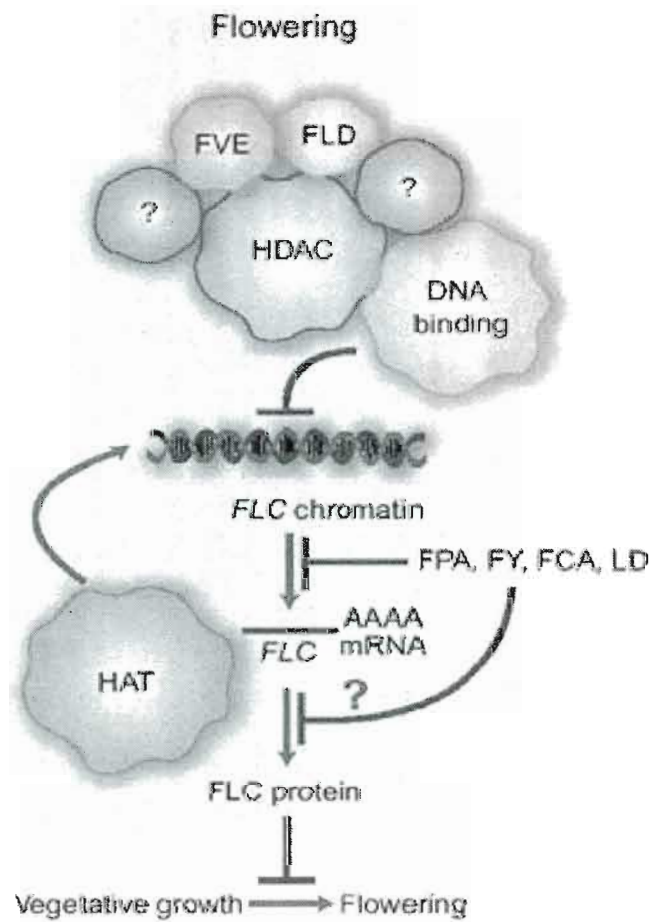

Figure 2: Régulation de la floraison par les modifications épigénétiques au niveau de FLC

HDAC = complexe histone deacetylases, HAT= Histones acétyltransférases (tiré d'Amasino, 2004a).

2.3.3 Régulation transcriptionnelle

2.3.3.1 Voies de répression

En fait, des facteurs de transcription autres que FLC auraient des rôles dans la régulation de la floraison. Des études ont montré que d'autres protéines MADS-box jouaient des rôles similaires sinon synergiques à FLC. Les mutants des gènes qui codent pour les protéines MADS AFFECTING FLOWERING (MAF, Ratcliffe *et al.*, 2003) FLOWERING LOCUS M (FLM, Scortecci *et al.*, 2001), et SHORT VEGETATIVE PHASE (SVP, Hartmann *et al.*, 2000) fleurissent de façon précoce comme les mutants *flc*. Certains, à la différence des mutants *flc*, sont sensibles à la photopériode, mais pas à la vernalisation.

2.3.3.2 Voies d'activation

En plus de CO, FT ou encore API, d'autres régulateurs au niveau transcriptionnel induisent la transition florale : GIGANTEA (GI, Park *et al.*, 1999), LEAFY (LFY, Weigel *et al.*, 1992) ou par exemple AGL20 ou SOC1 (SUPPRESSOR OF OVEREXPRESSION OF CO 1). La mutation de ces gènes ralentit ou bloque la transition florale. Le gène *AGL20* code aussi pour un facteur de transcription MADS-box (Lee *et al.*, 2000) dont l'expression est positivement régulée par la vernalisation. Sa surexpression active la phase reproductive en supprimant l'effet combiné de *FRI* et *FLC*. De plus, *AGL20* est régulé par la voie photopériodique sous l'action directe de *CO* et aussi par la voie autonome par la répression de *FLC* (Hepworth *et al.*, 2002).

2.3.4 Régulation hormonale

Plusieurs hormones dérivant de la voie de biosynthèse des terpènes, selon leur dose, stimulent ou inhibent divers aspects du développement et de la croissance des

tissus végétaux. Mais ce sont surtout les gibbérellines (GAs) qui sont connues pour jouer des rôles dans l'induction de la floraison.

Les GAs stimulent la prolifération des cellules au niveau du méristème et activent, conjointement avec des protéines nucléaires, l'expression des gènes régulant la transition florale (Sun et Gubler, 2004). Les mutants des enzymes de la voie de biosynthèse des GAs montrent un phénotype à floraison précoce ou bien à floraison tardive accompagné d'un nanisme. Chez certaines espèces comme la carotte, la voie des GAs peut substituer celle de la vernalisation.

L'acide abscissique (ABA) est, comme les GAs, produit dans la voie de biosynthèse des terpènes. Par contre, il renverse l'effet des hormones de stimulation de croissance (GAs, cytokinines, auxine, éthylène) dans plusieurs tissus. L'inhibition de la croissance et le maintien de la dormance de bourgeons sont les effets les plus saisissants de l'ABA. Cependant, son rôle dans l'induction de la floraison reste mal connu. Des études récentes ont identifié la protéine FCA comme le récepteur probable de cette molécule et elles montrent que l'application exogène (d'une forme active) de l'ABA avait pour conséquence de briser l'interaction de FCA avec FY, causant ainsi une stabilité (augmentation) de FLC et un retard de la floraison (Razem *et al.*, 2006). Cette découverte donne une idée du rôle de l'ABA dans la régulation de la floraison et ouvre sans aucun doute des avenues nouvelles à la recherche de régulateurs de la floraison.

3 Les facteurs de transcription MADS-box

Les études sur la croissance et le développement des plantes ont permis de montrer que le contrôle de la transcription de gènes constitue une autre stratégie de réponse face aux impacts des stress abiotiques. Il n'est donc pas étonnant de constater que les plantes allouent une grande portion de leur génome aux facteurs de

transcription: plus 1500 gènes ont été identifiés chez *Arabidopsis thaliana* (Riechmann *et al.*, 2000) et chez le riz (Goff *et al.*, 2002). Ces facteurs de transcription sont généralement des protéines qui activent ou répriment l'expression de gène(s) en se liant à l'ADN. Selon le type de domaine de liaison à l'ADN, les facteurs de transcription eucaryotiques sont classés en plusieurs grandes familles. Au cours des dix dernières années, il a été démontré que les facteurs de transcription de la famille MADS-box jouent un rôle majeur dans le contrôle génétique de la transition florale et du développement et de la réponse à la vernalisation.

3.1 Définition

MADS désigne l'acronyme des premiers membres identifiés de cette famille : M pour le gène de levure *MINICHROMOSOME MAINTENANCE 1* (Ammerer, 1990), A pour *AGAMOUS* chez *Arabidopsis* (Yanofsky *et al.*, 1990), D pour *DEFICIENS* chez *Antirrhinum* (Sommer *et al.*, 1990) et S pour *SERUM RESPONSE FACTOR* chez l'humain (Norman *et al.*, 1988). Leur organisation structurale identifie, en plus du domaine MADS, une région intermédiaire (I), un domaine K et les extrémités N et C terminales (Figure 3).

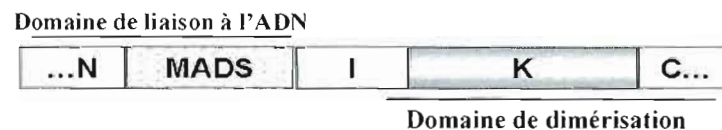

Figure 3: Organisation structurale des facteurs de transcription MADS-box

L'extrémité N terminale est à prédominance hydrophile et une partie de cette région serait nécessaire à la spécificité de liaison sur l'ADN (Shore et Sharrocks, 1995). Le domaine MADS est composé en moyenne de 56 à 60 résidus d'acides aminés disposés en paire d'hélices alpha antiparallèles. Il reconnaît une séquence spécifique de liaison à l'ADN appelée motif CArG. La région I code pour un domaine très variable d'environ 30 acides aminés. Le domaine K code pour une région conservée de 70 acides aminés formant une structure enroulée sur elle-même comme celle retrouvée dans la kératine, d'où le nom K-box. Il contient une α -hélice amphipatique capable de dimériser avec un autre domaine K. Il est absent chez l'humain et les levures et serait à l'origine d'une divergence phylogénique entre les types I et II chez les MADS-box de plantes (Alvarez-Buylla *et al.*, 2000). L'extrémité C terminale est la moins conservée chez cette famille de gènes MADS-box. Région à prédominance hydrophobe, elle est indispensable pour la liaison à l'ADN (Shore et Sharrocks, 1995). L'extrémité C terminale pourrait être impliquée dans l'activation de la transcription ou la formation de complexes multimériques entre facteurs de transcription.

3.2 Classification

Le séquençage et l'annotation complète du génome d'*Arabidopsis* ont permis d'identifier plus d'une centaine de membres possibles de facteurs de transcription MADS-box : 104 facteurs (De Bodt *et al.*, 2003a; Martinez-Castilla et Alvarez-Buylla 2003), 105 (Kofuji *et al.*, 2003) et 107 (Parenicova *et al.*, 2003). Le séquençage et l'annotation des gènes de riz ont permis d'identifier 71 membres appartenant à cette famille (Goff *et al.*, 2002). Toutefois, ce nombre de gènes MADS-box chez le riz pourrait augmenter une fois l'annotation du génome complétée. Il est connu que ces gènes possèdent des variants, ce qui contribuerait à réviser le nombre exact de membres de cette famille chez les céréales.

L'identification et l'annotation de nombreux gènes MADS-box chez différentes espèces d'angiospermes, gymnospermes et mousses ont conduit à quatre classifications. Toutes les quatre distinguent deux types de gènes selon leur organisation structurale: les gènes de type I, constitués généralement d'un exon unique, ne possèdent pas de domaine K et les gènes de type II caractérisés justement par ce domaine et qui comptent en moyenne 7 à 8 exons (Alvarez-Buylla *et al.*, 2000; De Bodt *et al.*, 2003a). La première classification des gènes MADS-box (Alvarez-Buylla *et al.*, 2000) suggère qu'une duplication d'un gène ancestral avant la divergence entre plantes et animaux est à l'origine des types I et II. Cette classification est basée sur la similarité de séquence au niveau de la structure des domaines MIKC et de l'absence du domaine K chez le type I. Par la suite, trois autres classifications ont été quasi simultanément proposées. Parenicova et collaborateurs (2003) classent les gènes MADS-box en 5 groupes selon leurs relations phylogénétiques du domaine conservé. Ils distinguent les types M α , M β , M γ , M δ et MIKC. Seuls les types M δ et MIKC possèderaient le domaine K. La troisième classification, proposée par Kofuji et collaborateurs (2003), distingue en plus du type I deux sous-groupes dans le type MIKC qui diffèrent selon leurs structures exons/introns. La dernière classification proposée est basée sur la présence ou l'absence de motifs conservés au niveau des extrémités N et C terminales. Elle distingue 3 sous-classes M, N et O pour le type I, le groupe MIKC du type II et un nouveau groupe appelé MADS-like (De Bodt *et al.*, 2003a).

3.2.1 Les facteurs MADS-box de type I

Les gènes MADS-box de type I sont caractérisés par la présence d'un exon unique (possiblement le résultat d'un épissage ou d'une transcription inverse) qui code pour une protéine dont le domaine MADS est conservé, mais qui ne contient pas de vrai K-box. Chez les plantes, ils sont très peu étudiés. Aucun mutant phénotypique n'a été rapporté pour de ce type de gène ne facilitant pas leur caractérisation au

niveau fonctionnel. De Bodt et collaborateurs (2003 a et b) proposent que cette absence de mutant serait due au fait que les gènes de type I auraient évolué soit en pseudogènes inactifs soit en rétrotransposons ou transposons inactifs. Peut-être aussi que les gènes de type I auraient des fonctions, complexe ou mineures, au cours de la croissance et du développement des plantes. Des travaux sur l'expression des gènes MADS-box de type I par RT-PCR (Parenicova *et al.*, 2003) montrent que leurs transcrits sont peu exprimés, qu'ils sont fort possiblement exprimés sous des conditions particulières, dans certains tissus ou à différents stades de développement.

3.2.2 Les facteurs MADS-box de type II

La sous-famille des gènes MADS-box de type II représente près de la moitié des gènes MADS-box annotés, soit 40 sur 107 chez *Arabidopsis* (Parenicova *et al.*, 2003) et 39 membres sur 71 chez le riz (Goff *et al.*, 2002; De Bodt *et al.*, 2003a). Les facteurs MADS-box de type II sont les plus étudiés, plus d'une vingtaine de mutants de gènes de cette sous-famille a été caractérisée. L'analyse génétique à l'aide de mutants indique que les gènes MADS-box de type II jouent des rôles majeurs dans divers processus de développement de la plante. L'abondance et la distribution de leurs transcrits font qu'ils sont faciles à suivre par l'étude d'expression et à retracer dans les bases de données publiques d'ESTs (expressed sequences tags). Nombreux sont les gènes de type II qui sont dupliqués ou qui possèdent des variants. Le nombre de jonctions exon-intron (en moyenne 7 à 8) présent au niveau structural expliquerait la variabilité de fonction de ces facteurs. Souvent, les protéines MADS-box de type II font partie de complexes protéiques homodimériques et/ou hétérodimériques.

3.2.3 Les facteurs MADS-like

Les facteurs MADS-like sont dénombrés à 20 membres et sont classés pour le moment dans un nouveau groupe pour les raisons suivantes : i) au niveau de la région N terminale, ils divergent très fortement des gènes des types I et II; ii) au niveau de la structure C terminale, ils ne possèdent pas les régions conservées caractéristiques de

tous les autres MADS-box (De Bodt *et al.*, 2003a et b). Aucun homologue de gènes MADS-like n'a été rapporté ni par l'annotation actuelle du génome de riz, ni chez les autres espèces monocotylédones.

3.3 Fonctions

3.3.1 Chez les végétaux

Les gènes MADS-box sont des gènes homéotiques qui jouent des rôles essentiels dans la transition florale et dans la transduction des signaux vers le méristème en développement (Johansen *et al.*, 2002). Sans doute les fonctions les plus connues des facteurs MADS-box sont la formation et la détermination des organes floraux. Un modèle dit « quartet model » ABCE ou ABCDE (Jack, 2001; Pelaz *et al.*, 2001; Theissen, 2001) explique comment les facteurs MADS-box régulent l'acquisition et l'identité florale. Selon ce modèle (figure 4), l'ensemble des organes d'une fleur est déterminé par les fonctions de trois classes de gènes : une classe A représentée par les gènes *APETALA 1* et *2* (*API*, *AP2*), une classe B représentée par la famille *APETALA 3 / PISTILLA* (*AP3/PI*) et une classe C représentée par la famille *AGAMOUS* (*AG*). Les gènes de classe ABC ne sont pas suffisants pour permettre le développement des feuilles. Trois autres gènes *SEPALLATA* (*SEPI*, *2* et *3*) MADS-box dits de classe E sont impliqués dans ce modèle. Chez les triples mutants *SEP*, les pièces florales se transforment qu'en sépales, ce qui indique que l'interaction des gènes *SEP* avec les gènes des classes A, B et C est essentielle pour déterminer l'identité des étamines (classe D) et des ovules (classe E). À l'exception du gène *AP2*, tous les gènes impliqués dans la différenciation des organes floraux codent pour des facteurs MADS-box.

En plus de leurs fonctions au niveau de la régulation de la floraison et de l'architecture florale (Immink *et al.*, 1999; Michaels et Amasino 1999; Sheldon *et al.*, 2000b; Hartmann *et al.*, 2000; Samach *et al.*, 2000; Ratcliffe *et al.*, 2001), les facteurs

MADS-box joueraient des rôles redondants durant le développement des plantes (Black et Olson, 1998). Ils sont également impliqués au niveau de la formation et du mûrissement des fruits (Mandel et Yanofsky 1995 ; Vrebalov *et al.*, 2002), au niveau du contrôle de l'architecture des racines (Zhang et Forde 1998), et de l'abscision (Mao *et al.*, 2000). D'ailleurs, les membres de cette large famille sont particulièrement ciblés dans les programmes visant à mieux domestiquer les espèces d'intérêts agronomiques.

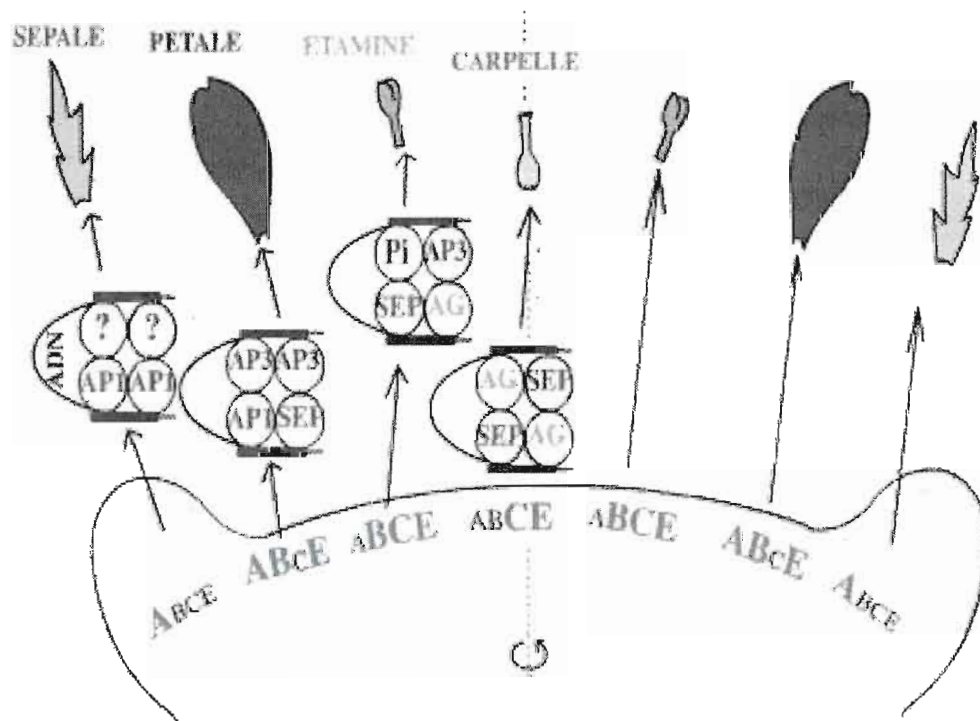

Figure 4: Modèle d'expression des gènes MADS-box

Selon le modèle ABCE (Pelaz *et al.*, 2001), les gènes *SEPALLATA* (*SEP*) sont nécessaires au bon développement des organes floraux : pour la formation complète d'un sépale, l'expression des gènes de classe A est nécessaire, mais pour la formation d'un pétale, l'expression des gènes des classes A, B et E est nécessaire. Pour la formation des organes floraux, l'expression des gènes des classes B, C et E est nécessaire pour donner une étamine alors que pour former un carpelle, les gènes des classes C, D et E doivent être exprimés. Ce modèle d'expression des gènes MADS-box s'applique aux espèces monocotylédones, excepté que les organes impliqués seraient les palea, les lemnes, les lodicules, les étamines et les ovules.

3.3.2 Chez les animaux

Chez les eucaryotes autres que les plantes, les gènes MADS-box jouent des rôles biologiques similaires, c'est-à-dire des rôles lors la croissance et du développement des organismes (Shore et Sharrocks, 1995). Chez la levure, le rôle de *MCMI* dans la détermination du type de cellules de levure est très bien caractérisé. *MCMI* joue un rôle essentiel dans la spécificité cellulaire et la régulation de la transcription de nombreux gènes codant pour des métabolites essentiels tels que l'arginine. En coopération avec différents facteurs associés, *MCMI* réprime ou active la transcription de beaucoup de gènes impliqués dans divers aspects de la croissance, du métabolisme (y compris celui de l'arginine), de la spécialisation et du cycle cellulaire de la levure. Chez la drosophile les facteurs MADS-box interviennent dans la différenciation et le développement de muscles viscéraux et cardiaques (Black et Olson, 1998). Chez l'humain, chez la souris et chez *Xenopus*, les gènes *SRF* ou *MEF-2* (*MYOCYTE ENHANCER FACTOR-2*), qui sont des facteurs MADS-box de type I (les seuls caractérisés de ce sous-groupe chez les animaux), interviennent dans les processus de morphogenèse et de myogenèse des cellules squelettiques, cardiaques et musculaires lisses (Olsen *et al.*, 1995). Les facteurs MEF (*MEF2A*, *MEF2B*, *MEF2C* et *MEF2D*) régulent des facteurs de croissance et des gènes précoces impliqués dans

la spécificité des muscles cardiaques, une mutation des facteurs MEF-2A entraîne une hypertrophie des ventricules et d'autres pathologies cardiaques (Xu *et al.*, 2006). Chez la souris, le facteur MEF-2C est nécessaire particulièrement au développement cranofacial (Verzi *et al.*, 2007). Enfin, chez l'humain, un polymorphisme de ces facteurs MEF a été récemment associé à la maladie d'Alzheimer (Gonzalez *et al.*, 2007).

PROBLÉMATIQUE

Au Canada et dans les autres régions à climat tempéré, l'hiver peut paraître sans conséquence pour les cultures. Or, bien au contraire, les conditions climatiques hivernales affectent la floraison et la reproduction des plantes, et donc la productivité de plusieurs cultures. La sensibilité aux basses températures chez plusieurs céréales (blé, orge) et le raccourcissement de la durée du jour ont été identifiés comme étant les facteurs causant le plus de dommages et de pertes de productivité dans les pays à climat tempéré. Le Canada, sixième pays producteur de blé et quatrième exportateur mondial (données de la FAO, 2003), enregistre chaque année des pertes agricoles chiffrées en centaines de millions de dollars selon le rapport 2001-2002 de la commission canadienne du blé (www.cwb.ca). Ces pertes sont majoritairement les conséquences des conditions difficiles de l'environnement.

Les basses températures (froid ou gel) et la lumière affectent tous les stades de développement d'une plante et d'une manière très complexe. La réponse des plantes face au stress causé par ces deux facteurs environnementaux dépend de la durée et de la période d'exposition, de la variabilité de sa sévérité et des interactions avec d'autres facteurs endogènes. Pour survivre et se développer dans ces conditions de stress, les plantes n'ont pas juste besoin de développer des mécanismes pour s'adapter au froid. Elles ont besoin aussi de fleurir et de se reproduire avec succès. Pour cela, certaines plantes ont acquis au cours de l'évolution des mécanismes qui leur permettent de bien synchroniser leur floraison en fonction des changements des facteurs environnementaux. En milieu naturel, de tels mécanismes ont lieu durant l'automne lorsque les plantes sont exposées aux basses températures : des changements physiologiques et géniques se mettent en place pour leur permettre de s'adapter au froid et de mieux tolérer les périodes de gel de l'hiver. Durant cette période d'adaptation au froid, les plantes retardent leur transition florale jusqu'au

printemps pour induire leur floraison au moment propice et compléter leur reproduction durant l'été.

En général, les mécanismes qui régulent la floraison sont mieux connus chez la plante modèle *Arabidopsis thaliana*. Les analyses génétiques et moléculaires chez *Arabidopsis* ont indiqué l'existence de plusieurs voies interdépendantes qui régulent la floraison (Mouradov *et al.*, 2002 ; Simpson *et al.*, 1999 ; Henderson *et al.*, 2003). Les voies de vernalisation et de photopériode répondent aux signaux environnementaux tandis que la voie autonome et l'induction de la floraison par les gibbérellines (GAs) intègrent l'état développemental endogène de la plante. La voie autonome et celle de la vernalisation induisent la floraison par la répression du gène *FLC* qui agit en tant que répresseur central de la transition florale. Les voies de la photopériode et des GAs convergent, via *FLC*, vers les intégrateurs floraux communs tels que *FT* et *SOC1/AGL20* qui, à leur tour, régulent les gènes floraux *LFY* et *API* (Simpson *et al.*, 1999).

Les céréales constituent des plantes modèles toutes aussi intéressantes qu'*Arabidopsis* pour comprendre la régulation de floraison et l'adaptation des espèces en milieu tempéré. Par exemple, le blé possède un large spectre d'adaptation vis-à-vis des facteurs environnementaux et c'est l'une des espèces céréalières les plus tolérantes aux basses températures. De plus, pour des études moléculaires sur la régulation de la floraison, il existe une gamme de lignées génétiques ou isogéniques ayant des variations naturelles pour les réponses à la vernalisation et à la photopériode. Chez les espèces céréalières, les allèles de vernalisation (*Vrn*) et de photopériode (*Ppd*) sont connus et bien caractérisés aux niveaux physiologique et génétique. Au niveau moléculaire, aucun gène de vernalisation ou de photopériode n'a été clairement identifié comme régulateur positif ou négatif de la floraison parce que les allèles qui confèrent ces réponses sont généralement épistatiques (effet d'un allèle sur un allèle), pléiotropiques (effet multiples) et récessifs. Cependant, Yano et collaborateurs (2000) rapportaient le clonage du gène *HEADING DATE 1 (HD1)* chez le riz qu'ils ont associé à la régulation de la floraison par la photopériode. Trois

ans plus tard, ces résultats ont été étayés chez le blé par Nemoto et collaborateurs (2003) qui montrent, qu'à l'opposé de son homologue *CO* d'*Arabidopsis*, *HDI* favorise la floraison en jours courts et retarde la floraison en jours longs chez les céréales. Malgré cette caractérisation de fonction, le mode d'action de HD reste inconnu. En 2003, notre groupe rapportait une découverte majeure au niveau moléculaire qui consistait au clonage d'un gène associé à la transition florale chez le blé hexaploïde. Ce gène, nommé *TaVRT-1*, code pour une protéine MADS-box appartenant au clade des régulateurs transcriptionnels de la floraison et de la détermination des organes floraux (Danyluk *et al.*, 2003). L'expression de son ARNm chez différents génotypes et lignées quasi-isogéniques de blé, aussi bien que chez l'orge, a été associée à la réponse à la vernalisation, à la photopériode et la tolérance au gel chez les céréales (Danyluk *et al.*, 2003). Ce gène a été cartographié dans la région génique qui détermine la réponse à la vernalisation chez *T. aestivum* (Danyluk *et al.*, 2003) et *T. monoccoccum* (Yan *et al.*, 2003). Par la suite, des analyses de cultivars de blé de printemps et d'hiver ont suggéré que la variation allélique de la réponse à la vernalisation serait due à des séquences régulatrices au niveau du promoteur du gène *VRN1* (Yan *et al.*, 2003). Ensemble, ces études ont permis d'établir que *TaVRT-1* est le gène majeur *VRN1* qui régule la transition florale et qui détermine la variation allélique conférant la réponse à la vernalisation chez le blé.

En dépit de toutes ces découvertes, l'étude des voies de régulation de la floraison chez les céréales en reste à ses balbutiements en comparaison avec celle chez *Arabidopsis*. Par défi scientifique et pour des considérations agronomiques et économiques, il est opportun de poursuivre la caractérisation moléculaire des voies de régulation de la floraison chez des espèces autre qu'*Arabidopsis*. Cela permettra de valider les voies déjà connues mais aussi de voir si des divergences existent entre les espèces. Une meilleure compréhension des voies de régulation de la floraison et des réponses des plantes face aux stress environnementaux peut être avantageuse dans une perspective d'augmenter la productivité des espèces céréalières en zones tempérées.

OBJECTIFS

Le premier objectif de la recherche a été l'identification de gènes de type MADS-box impliqués dans la réponse de la vernalisation et le contrôle de la floraison chez le blé. Chez *Arabidopsis*, toutes les voies de régulation de la floraison identifiées convergent vers un seul clade de gènes MADS-box (*FLC* et *MAF*), désigné FLC-like. Tous agissent comme répresseurs de la floraison et codent pour des facteurs de transcription MADS-box. Chez tous les écotypes annuels d'hiver d'*Arabidopsis* analysés, *FLC* est le seul régulateur négatif dont l'expression (ARNm et protéine) est suffisante pour réprimer la floraison. L'induction de la floraison est proportionnelle à la durée de vernalisation dont l'effet est de réduire le niveau de *FLC* au plus bas. Chez les céréales, aucun gène orthologue à *FLC* ou à un des gènes *MAF* n'a été identifié. Ces gènes *FLC*-like sont-ils présents chez le blé ou est-ce qu'un autre clade de gènes MADS-box joue des rôles similaires? L'isolation des gènes de la famille MADS-box chez le blé permettrait de répondre aux questions soulevées par l'absence des ces gènes *FLC*-like chez les espèces monocotylédones.

Le second objectif a été l'étude de la régulation du gène de vernalisation *TaVRT-1*. A l'opposé de *FLC*, *TaVRT-1* intègre les voies de régulation (vernalisation, photopériode et autonome) pour promouvoir la floraison chez les céréales. L'accumulation de son ARNm étant un des événements les plus tardifs qui déclenche la transition florale, force était de supposer qu'un régulateur négatif retarde cette accumulation et donc la réponse à la vernalisation. La présence au niveau du promoteur de de *TaVRT-1* d'un élément de liaison à l'ADN spécifique aux facteurs MADS-box suppose que ces facteurs sont les régulateurs directs de la transcription de *TaVRT-1*. Les gènes MADS-box impliqués dans la réponse à la vernalisation et montrant un profil similaire à celui de *FLC* lors de la vernalisation ont été particulièrement ciblés pour une caractérisation fonctionnelle. Grâce à leurs

propriétés connues (structure et fonction conservées), une approche génomique intégrant des analyses phylogénétique et moléculaire a pu être envisagée pour le clonage des gènes de blé qui codent pour des protéines MADS-box.

L'étude des gènes MADS-box impliqués dans la régulation de la floraison chez le blé peut aider à mieux connaître les réponses adaptatives des céréales en zones tempérées. Une bonne connaissance des mécanismes qui régulent les différentes voies de floraison peut être utile dans un effort de maximiser le potentiel de rendement des cultivars de céréales dans les zones tempérées.

RÉSULTATS ET DISCUSSIONS

Les résultats sont présentés et discutés sous forme d'articles, de chapitre de livre et de manuscript. Les versions finales sont disponibles en ligne ou chez les éditeurs.

I. *TaVRT-2*, a member of the StMADS-11 clade of flowering repressors, is regulated by vernalization and photoperiod in wheat

Ndjido A. Kane¹, Jean Danyluk¹, Guylaine Tardif², François Ouellet¹, Jean-François Laliberté², Allen E. Limin³, D. Brian Fowler³, and Fathey Sarhan^{1*}

¹ Département des Sciences Biologiques, Université du Québec à Montréal, Case Postale 8888, Succursale Centre-ville, Montréal, Québec, Canada H3C 3P8

² INRS - Institut Armand-Frappier, 531 boulevard des Prairies, Laval, Québec, Canada H7V 1B7

³ Department of Plant Sciences, University of Saskatchewan, Saskatoon, Saskatchewan, Canada S7N 5A8

Résultats publiés dans le journal « *Plant physiology* 138 (4) : 2354-63. Epub 2005 Jul 15 »

Contribution

J'ai participé dans toutes les étapes d'expérimentation et de rédaction de l'article sous la supervision et le soutien de mon directeur FS et l'assistance de JD. J'ai réalisé l'identification, le clonage et les analyses de séquence du gène *TaVRT-2*. J'ai effectué les études d'expression et de localisation chromosomique de *TaVRT-2*. J'ai été impliqué dans les études phylogénétiques. DBF et AL ont fourni les matériels végétaux. GT et JFL ont effectué les études d'interactions protéiques. Tous les auteurs ont participé à la rédaction de l'article.

TaVRT-2, membre de la famille de répresseurs de floraison, est régulé par la vernalisation et la photopériode chez le blé

Résumé

Durant l'hiver, la transition d'une phase végétative à une phase reproductive chez les céréales d'hiver est retardée au printemps jusqu'à ce que les conditions favorables de croissance s'y prêtent. Ce retard chez ces espèces dites bisannuelles est modulé par les conditions de basse température par le processus nommé vernalisation. Les bases moléculaires et génétiques de l'interaction entre les facteurs environnementaux et la transition florale sont encore mal connues. Cependant, l'identification récente du gène du blé *TaVRT-1* a fourni une occasion de pousser la caractérisation au niveau moléculaire de la régulation du temps de floraison chez les céréales. Dans cet article, il est décrit la caractérisation d'un autre gène, appelée *TaVRT-2*, probablement impliqué dans la voie de floraison chez le blé. D'abord, les analyses moléculaires et phylogénétiques indiquent que ce gène code pour un facteur de transcription MADS-box qui appartient à un groupe de régulateurs négatifs de la floraison chez plusieurs espèces. Ensuite, le profil d'expression de *TaVRT-2*, chez des lignées quasi-isogéniques pour le caractère de vernalisation et chez différents génotypes ayant une variation naturelle de la réponse à la vernalisation et à la photopériode, est associé à la transition florale : son transcrit s'accumule plus en jours courts et pendant la phase végétative chez les génotypes d'hiver. Par contre, il est réprimé par vernalisation à un niveau bas qui permet la transition à la phase reproductrice. Finalement, les études d'interactions protéiques indiquent que *TaVRT-2* a une grande affinité pour former des hétérodimères avec les protéines codées par deux gènes importants de vernalisation chez le blé, *TaVRT-1/VRN-1* et *VRN-2*. Tous ces résultats soutiennent l'hypothèse que *TaVRT-2* est un régulateur négatif de la transition florale chez le blé.

Abstract

The initiation of the reproductive phase in winter cereals is delayed during winter until favorable growth conditions resume in the spring. This delay is modulated by low temperature through the process of vernalization. The molecular and genetic bases of the interaction between environmental factors and the floral transition in these species are still unknown. However, the recent identification of the wheat *TaVRT-1* gene provides an opportunity to decipher the molecular basis of the flowering time regulation in cereals. Here we describe the characterization of another gene, named *TaVRT-2*, possibly involved in the flowering pathway in wheat. Molecular and phylogenetic analyses indicate that the gene encodes a member of the MADS-box transcription factor family that belongs to a clade responsible for flowering repression in several species. Expression profiling of *TaVRT-2* in near-isogenic lines and different genotypes with natural variation in their response to vernalization and photoperiod showed a strong relationship with floral transition. Its expression is upregulated in the winter genotypes during the vegetative phase and in photoperiod-sensitive genotypes during short days, and is repressed by vernalization to a level that allows the transition to the reproductive phase. Protein-protein interactions studies revealed that *TaVRT-2* interacts with proteins encoded by two important vernalization genes (*TaVRT-1/VRN-1* and *VRN-2*) in wheat. These results support the hypothesis that *TaVRT-2* is a putative negative regulator of the floral transition in wheat.

Introduction

Flowering is one of the most crucial developmental programs that plants use to ensure survival and reproductive success. The timing of this process is under the control of several interdependent pathways (reviewed in Mouradov *et al.*, 2002; Simpson and Dean 2002; Henderson *et al.*, 2003). The photoperiod and vernalization pathways respond to environmental signals while the autonomous and gibberellin (GA) dependent pathways integrate the endogenous developmental state of the plant. In the model system *Arabidopsis*, the effect of low temperature (LT) on flowering time was found to be mediated in part by FLOWERING LOCUS C (*AtFLC*), a MADS-box protein that delays floral transition (Michaels and Amasino, 1999). Recent evidence indicates that *AtFLC* functions in part by directly repressing the expression of the *Arabidopsis* gene *SUPPRESSOR OF CONSTANS 1* (*AtSOC1*) (reviewed in Boss *et al.*, 2004), which encodes a MADS-box protein that accelerates flowering. Interestingly, the *AtSOC1* gene was also shown to be the target of *CONSTANS* (*AtCO*) (Hepworth *et al.*, 2002). The convergence of *AtCO* and *AtFLC* at the promoter of *AtSOC1* could be one mechanism by which photoperiodic and cold signaling pathways, respectively, are integrated to ensure an appropriate seasonal control of flowering time (Hepworth *et al.*, 2002). Different regions of the *AtSOC1* promoter have been found to mediate activation by *AtCO* under long day photoperiod and repression by *AtFLC*, which is itself negatively regulated by vernalization (Hepworth *et al.*, 2002).

In winter cereals, flowering is delayed during winter until the favorable growth conditions of spring. This delay allows plants to fulfill their vernalization requirement, an important trait in winter growth habit cereal species. The recent cloning and characterization of *Vrn-A^m1* from *Triticum monococcum* (Yan *et al.*, 2003) and *TaVRT-1* from *T. aestivum* (Danyluk *et al.*, 2003) provides an opportunity to unravel the molecular basis of the floral inductive pathway in cereals. Expression

profiling and genetic analysis of *VRN-1/TaVRT-1* showed that transcript accumulation is associated with the vernalization response, the transition from vegetative to reproductive phase, the expression of cold-regulated (*COR*) genes, and the degree of freezing tolerance (FT). The gene encodes a MADS-box protein that belongs to the AP1/SQUA-like clade of transcriptional regulators whose members have been implicated in functions such as determining inflorescence meristem identity and flower development. It is becoming apparent that variations detected in different *VRN-1* alleles of temperate cereals are important for specifying vernalization requirement (Yan *et al.*, 2003; Yan *et al.*, 2004a; Beales *et al.*, 2005; Fu *et al.*, 2005). However, the exact molecular mechanisms involved in the interaction between environmental factors and allelic variants at the *Vrn-1* locus remain unknown.

Several other components of the floral pathway identified in *Arabidopsis* seem to have functional equivalents in cereals. The genes underlying the rice flowering time QTLs *Hd1*, *Hd3a* and *Hd6* are closely related to the *Arabidopsis* genes *AtCO*, *FLOWERING LOCUS T (AtFT)* and α subunit of protein kinase *CK2 (AtCK2 α)* respectively, and their products play key roles in the photoperiodic flowering pathway (Yano *et al.*, 2000; Takahashi *et al.*, 2001; Izawa *et al.*, 2002). In addition, a *SOC1*-like gene from rice, *OsSOC1*, can complement the *Arabidopsis soc-1* mutant and promote flowering (Tadege *et al.*, 2003) while overexpression of *OsGI*, a rice orthologue of the *Arabidopsis* photoperiod pathway gene *GIGANTEA (AtGI)*, was shown to regulate the expression of the downstream genes *OsCO* and *OsFT* (Hayama *et al.*, 2003).

There are, however, differences between the components of the flowering pathway in cereals and *Arabidopsis*. *FLC*-like genes have so far been identified only in the Brassicaceae (Becker and Theißen, 2003), and the recent identification of the floral repressor *Vrn-A^m2* gene in *T. monococcum* showed that it encodes a substantially diverged member of a zinc finger family of transcription factors present only in temperate cereal species (Yan *et al.*, 2004b). These observations raise the question whether similar interactions of transcriptional activator/repressor proteins

regulate flowering time in cereals as has been shown in *Arabidopsis*. To understand these interactions and identify the genes involved in the floral inductive pathways in cereals, we pursued molecular analysis of other MADS-box genes found in the FGAS (Functional Genomics of Abiotic Stress, a Genome Canada project) wheat EST database. Expression profiling, bioinformatics analysis, phylogenetic and genetic studies revealed that a MADS-box gene, which we have named *TaVRT-2*, encodes a potential repressor of the floral inductive pathway in hexaploid wheat. The putative function of this gene in the control of the transition from vegetative to reproductive phase in wheat is discussed.

Results

Identification and molecular characterization of *TaVRT-2*

To identify components of the regulatory network involved in the vernalization pathway in hexaploid wheat, we selected MADS-box genes by homology-based search of the FGAS wheat EST collection. Expression profiling of 7 MADS-box genes revealed that 3 of them, including the previously published *TaVRT-1* gene (Danyluk *et al.*, 2003), were differentially regulated by LT (data not shown). One of the other two genes showed an inverse pattern of expression relative to that of *TaVRT-1* in that the level of expression is high during the early stage of LT exposure but starts to decline towards the vegetative/reproductive transition point. This decrease is concomitant with the increase in expression observed for *TaVRT-1*. This suggests possible interactions between the two genes and could indicate that their products act in an opposite manner in the flowering inductive pathway. This gene was therefore named *TaVRT-2* (*Triticum aestivum* vegetative to reproductive transition gene-2).

The *TaVRT-2* gene encodes a predicted protein of 226 amino acids (Table S1). A search in public databases for conserved domains in the *TaVRT-2* protein revealed an MIKC structure (M = MADS domain, I = intervening region, K = K-box and C = C-terminal domain), a conserved bipartite nuclear targeting sequence in the MADS domain, and several putative phosphorylation sites (Fig. 1). Sequence comparison with several MADS-box proteins from monocots and dicots revealed that *TaVRT-2* is homologous to MADS-box proteins from the *StMADS11*-like clade (Carmona *et al.*, 1998; Becker and Theißen, 2003). *TaVRT-2* shows 96% amino acid sequence identity with its reconstructed orthologue from *Hordeum vulgare* (named *HvVRT-2*), 77% with two proteins from *Zea mays* (*ZmM19* and *ZmM26*), 73% with a protein from *Oryza sativa* (*OsMADS22*), and 51% with the Short Vegetative Phase protein

from *Arabidopsis thaliana* (*AtSVP*), the closest predicted homolog from dicot species (Table S2).

A phylogenetic analysis was performed using several members of the AP1/SQUA-, FLC-, *StMADS11*- and AG-like clades, the latter being used as an outgroup. The results of this analysis classified *TaVRT-2* into the *StMADS11*-like regulators clade (Fig. 2). Transcription factors of this clade have been associated with the repression of transition of the shoot apex from the vegetative to the reproductive phase (Carmona *et al.*, 1998; Becker and Theißen, 2003).

Mapping of the *TaVRT-2* gene

To determine the location of *TaVRT-2* in relation to *TaVRT-1*, we performed a DNA gel blot analysis on ditelocentric chromosome lines of hexaploid wheat (cv Chinese Spring). The results show that *TaVRT-2* is located on the short arms of chromosomes 7A and 7B, as indicated by the missing bands in lines 7AL and 7BL (Fig. 3A). The ditelocentric 7DL line was unavailable but since no bands were missing in the 7DS line, it was likely that the D genome copy was on the short arm of chromosome 7D. The presence of a copy of *TaVRT-2* on the 7D chromosomes was confirmed by the data obtained when the group-7 nullisomic-tetrasomic lines were examined (Fig. 3B). Together, these results show that *TaVRT-2* is located on the short arms of the group-7 chromosomes in each of the three genomes of hexaploid wheat.

Expression of *TaVRT-2* in parental and near-isogenic lines (NILs) of wheat differing at the *Vrn-A1/vrn-A1* locus

To determine if *TaVRT-2* expression is associated with the vernalization response in cereals, northern blot analyses were performed using two wheat genotypes having different responses to vernalization and different degrees of FT. We used the *WCS120* and *TaVRT-1* genes as markers to determine the relationship

between the expression of *TaVRT-2*, vernalization and developmental stages in cereals. Previous studies had identified *WCS120* as a cold-specific gene likely involved in FT (Limin *et al.*, 1997) and *TaVRT-1* as a marker of the transition from the vegetative to the reproductive phase (Danyluk *et al.*, 2003). The results show that the *TaVRT-2* transcript level remains low and stable in spring wheat Manitou during LT exposure (Fig. 4A). Together with the low level of *TaVRT-2* expression, the spring genotype shows constitutive expression of *TaVRT-1* and lower levels of *WCS120* transcript. In contrast, the *TaVRT-2* transcript level in winter wheat Norstar is higher than in spring Manitou early in the vegetative phase, and this expression level remains for 35 days of LT exposure (Fig. 4B). This period is associated with higher *WCS120* transcript levels and increased FT compared to spring Manitou (Danyluk *et al.*, 2003). Towards the floral transition point, *TaVRT-2* is down-regulated to a very low level while *TaVRT-1* starts to accumulate (Fig. 4B). After this transition, *WCS120* transcript levels decrease and FT is gradually lost.

Since the *TaVRT-2* regulation appears to be associated with the vernalization saturation point, we also investigated its accumulation profile in the previously described Manitou/Norstar reciprocal NILs for the *Vrn-A1* locus (Limin and Fowler 2002). In these two sets of NILs, the recessive winter habit allele (*vrn-A1*) in Norstar was replaced with the dominant spring allele (*Vrn-A1*) from Manitou (to produce 'spring Norstar NIL'), and the spring allele in Manitou was replaced with the winter allele from Norstar (to produce 'winter Manitou NIL'). In the spring habit plants (spring Manitou and spring Norstar NIL), the *TaVRT-2* gene shows similar low levels of constitutive expression (Fig. 4A, C, E). In contrast, the *TaVRT-2* transcript level is higher in winter habit plants (winter Norstar and winter Manitou NIL) until 35 days of LT exposure, after which point it decreases to the low level observed in the spring habit plants (Fig. 4 B, D, F). A clear inverse relationship is observed in the expression patterns of *TaVRT-1* and *TaVRT-2* after 35 to 49 days of LT exposure (vernalization). This expression pattern corresponds in time to the period of vernalization saturation after which the plant has achieved competence to flower. Analyses of several spring

and winter genotypes confirmed that the accumulation of *TaVRT-2* is higher in winter cultivars, which require a vernalization period (data not shown). Overall, these results suggest that a higher level of *TaVRT-2* expression is required to maintain winter wheat cultivars in the vegetative growth phase, and that there is a possible interrelationship between *TaVRT-1* and *TaVRT-2*, where one may be repressing the expression of the other (discussed below).

To study the expression of the two *TaVRT* genes in the reproductive tissues, we used wheat inflorescences at different development stages. The results show that *TaVRT-2* is weakly or not expressed whereas *TaVRT-1* is highly expressed at all stages (Fig. 5). The *TaVRT-2* expression pattern is in agreement with that of most of the other members of the *StMADS11* clade, which is restricted to vegetative tissues (Becker and Theißen, 2003). Further northern blot analysis demonstrated that *TaVRT-2* transcripts accumulate preferentially in the aerial part of wheat plants compared to roots (data not shown).

Influence of photoperiod on *TaVRT-1* and *TaVRT-2* expression in cereals

Norstar winter wheat and photoperiod-sensitive spring Dicktoo barley plants were grown under short or long day conditions at 4°C for 98 days to determine the effect of photoperiod on *TaVRT-1* and *TaVRT-2* expression in association with flowering competency and FT. Norstar winter wheat shows a higher accumulation of *TaVRT-2* transcripts under long day and to a lesser extent under short day at 14 and 35 days of LT exposure (Fig. 6A). At these time points, Norstar plants are still in the vegetative phase and development has not reached the double ridge stage, the morphological indicator of flowering competence (Danyluk *et al.*, 2003). In photoperiod-sensitive spring Dicktoo barley, *HvVRT-2* (the *TaVRT-2* orthologue) is expressed at higher levels under short days at 14, 35 and 56 days of LT exposure, and is down-regulated after 77 days (Fig. 6B). Interestingly, the double ridge formation and reproductive phase initiation occurs at 70 days of LT under short day conditions

(Fowler *et al.*, 2001; Danyluk *et al.*, 2003). On the other hand, *HvVRT-2* is expressed at low levels during long day LT treatments (Fig. 6B), where Dicktoo barley has already entered the reproductive stage. These data also provide further evidence of the inverse relationship between *TaVRT-1* and *TaVRT-2* expression and flowering capacity in wheat and barley (Fig. 6A, B), and suggest that *TaVRT-2* up-regulation is associated with the maintenance of plants in the vegetative phase.

Protein-protein interactions

Proteins involved in the same biological process frequently form complexes, and members of the MADS-Box family are known to form specific homodimers and heterodimers (Davies *et al.*, 1996; Favaro *et al.*, 2003; Immink *et al.*, 2003). To determine if *TaVRT-2* can interact with itself or with other proteins involved in the flowering pathway, we used the yeast two-hybrid system. Fusion constructs were made with the GAL4 binding domain (BD) and GAL4 activation domain (AD) using various MADS proteins (Fig. 7). The results show that *TaVRT-2* can homodimerize as well as heterodimerize with *TaVRT-1* (AP1/SQUA clade), *Ta57H08* (*SlMADS11* clade) and *Ta73C21* (TM3/SOC1 clade) (Tables 1 and S3). Additional assays showed that *TaVRT-1* can also homodimerize and heterodimerize with five other wheat MADS-box proteins with a similar apparent affinity while the *TaVRT-1/TaVRT-2* pair shows a higher apparent affinity (Tables 1 and S3).

The *VRN2* gene, which encodes a zinc finger protein that acts as a flowering repressor, was recently identified in diploid wheat (Yan *et al.*, 2004b). The significant epistatic interactions observed between *VRN1* and *VRN2* indicated that these two genes act in the same pathway. The *VRN-2* cDNA was thus cloned from hexaploid wheat (unpublished data) and used in the yeast two-hybrid studies to determine if it has any affinity with the two *TaVRT* proteins. The results show that *VRN2* has a higher apparent affinity with *TaVRT-2* than with *TaVRT-1* (Table 1). The interaction of the *TaVRT* proteins with another wheat zinc-finger protein, *TaHD1*, was also tested and the results indicate that the proteins interact with each other, but with a

lesser apparent affinity (Table 1). Together, these data indicate that *TaVRT-2* interacts with several transcription factors involved in flowering control and vernalization in wheat and suggest that the transition to the reproductive phase could be mediated by complex protein-protein interactions.

Discussion

We have characterized a wheat MADS-box gene, *TaVRT-2*, that has an expression pattern opposite to that of the previously identified *TaVRT-1* gene, a key gene that regulates the vegetative to reproductive phase transition in hexaploid winter wheat (Danyluk *et al.*, 2003). While *TaVRT-1* is located in the phenotypically defined *Vrn-A1* region on chromosome 5A, *TaVRT-2* was mapped to the short arm of the group-7 chromosomes. In Triticeae, the latter chromosomes have not been found to carry major genes affecting flowering time and have therefore often been overlooked in this regard. A survey of the literature, however, reveals that this chromosome group is in fact highly involved in the continuous variation of flowering time found in nature. QTLs associated with ear emergence, vernalization, heading date and photoperiod sensitivity have been located on the group-7 chromosomes in wheat and barley (Bezant *et al.*, 1996; Sourdille *et al.*, 2000; Boyko *et al.*, 2002; Baum *et al.*, 2003; Shindo *et al.*, 2003). The mapping of *TaVRT-2* and *HvVRT-2* to group 7 chromosomes suggests that they may be involved in these QTLs. However, direct experimental evidence is needed for verification of such an association.

Phylogenetic analysis has positioned *TaVRT-2* in the *StMADS11*-like clade. Members of this clade are expressed strictly in vegetative organs and seem to have an ancestral function in the maintenance of vegetative phase or in the timing of the transition from vegetative to reproductive phase (Becker and Theißen, 2003). In *Arabidopsis*, the two *StMADS11*-like genes *SVP* and *AGL24* act in an opposite manner in the floral transition, despite their close phylogenetic relationship. *SVP* is a negative regulator of flowering because its inactivation causes early flowering (Hartmann *et al.*, 2000) whereas *AGL24* acts as a promoter of flowering because loss-of-function plants show a late flowering phenotype (Yu *et al.*, 2002). In *Antirrhinum*, the *StMADS11*-like gene *INCO* is also capable of repressing flowering when overexpressed (Masiero *et al.*, 2004). Therefore, the higher levels of *TaVRT-2*

transcripts found to be associated with the vegetative growth phase in winter habit wheat or short day photoperiod sensitive barley is in line with functions such as maintaining vegetative growth or repressing the transition to the reproductive phase.

The inverse expression pattern between *TaVRT-2* and *TaVRT-1* suggests that *TaVRT-2* could suppress *TaVRT-1* transcription or that, inversely, *TaVRT-1* could suppress *TaVRT-2*. Since *TaVRT-2* belongs to the clade of genes encoding suppressors of flowering and because *TaVRT-1* appears to shortcut the vernalization process (Fu *et al.*, 2005), it seems logical that *TaVRT-2* may be suppressing *TaVRT-1* transcription in winter habit genotypes by interaction with the recessive winter allele. This allele is believed to be the ancestral type (Yan *et al.*, 2003), and it is possible that the spring allele may have arisen from mutational changes affecting its susceptibility to the possible repressor effect of *TaVRT-2*. Alternatively, we cannot rule out the possibility that once induced, *TaVRT-1* could either directly or indirectly repress *TaVRT-2* expression seen in the winter wheat genotypes. This suppression is associated with vernalization saturation and competence to flower (Limin and Fowler, 2002) which is coincidental with *TaVRT-1* up-regulation (Danyluk *et al.*, 2003). In the spring habit genotypes *TaVRT-1* is constitutively expressed at a high level and *TaVRT-2* is down-regulated. However, the decrease in *TaVRT-2* may also be caused by other factors. Induction of genes from the AP1/SQUA clade (such as *TaVRT-1*) is believed to be one of the furthest downstream events in the flowering pathway in plants (Mouradov *et al.*, 2002; Becker and Theißen, 2003). Genes from this clade were shown to be important in determining inflorescence meristem identity and flower development. Once these proteins are induced, the plant is committed to reproductive growth and it is likely that integration of most developmental and environmental signals have taken place. Therefore, factors involved in regulation of the vegetative/reproductive transition such as members of the *StMADS11* clade should become redundant and likely to be down-regulated by their upstream regulators. Further identification of genes involved in wheat floral transition will be necessary to establish the full extent of these interactions.

Although the evidence seems to suggest that most of the members from the *SlMADS11*-like clade function in repressing the transition to the reproductive phase, their exact roles in the flowering pathway remain unclear. Recently, double mutant analyses in *Arabidopsis* have shown that *AtSVP* is positioned in the same pathway as another MADS-box gene, *FLOWERING LOCUS M (AtFLM)* (Scortecci *et al.*, 2003). These genes were shown to interact with the photoperiod pathway downstream of *AtGI* and *AtCO* (Scortecci *et al.*, 2003). If similar regulatory networks exist in cereals, this could explain the higher expression of *TaVRT-2/HvVRT-2* in long day grown winter wheat and short day grown photoperiod sensitive barley, where a high level of repression would be required to maintain plants in the vegetative stage. Thus, in dicot and monocot species, genes such as *AtSVP* and *TaVRT-2* may have a similar function in the repression of flowering by integrating photoperiodic signals. *Arabidopsis* has at least one additional photoperiodic pathway (*AtCO* that converges on the promoter of the *AtSOC1* gene) that may offer plants the observed variation in photoperiod sensitivity necessary for environmental adaptation. The significance of this interplay in determining flowering time (adaptation) should not be underestimated in wheat because of the importance in maintaining up-regulation of the LT tolerance genes, a requirement of which is the extension of the vegetative state (Mahfoozi *et al.*, 2001; Danyluk *et al.*, 2003). Although the evidence suggests that some members of the *SlMADS11* clade may function in a parallel photoperiodic pathway that plays a role in timing the transition to the reproductive phase, it is not yet known how they exert their molecular action.

A possible mode of action can be proposed for *TaVRT-2* that is based on common properties of MADS-box proteins and from information gained from this and previous studies. Available wheat genomic sequence data indicates the presence of a CArG-box (a MADS-box binding motif) in the promoter of *Vrn-1 (TaVRT1)* in all winter wheat genotypes tested (Yan *et al.*, 2003; Yan *et al.*, 2004a; Beales *et al.*, 2005; Fu *et al.*, 2005; our unpublished results). Analysis of promoter and gene sequences of different alleles of *Vrn-1* revealed that spring accessions contain either

1) a deletion or insertion in the vicinity of this CArG-box, suggesting that these variations could interfere with the regulation mediated by this motif; or 2) a deletion of a conserved 440 bp sequence in the first intron which suggests that the regulation of *VRN-1* expression is complex and may involve multiple regulatory elements. We speculate that the *Vrn-1/TaVRT-1* CArG-box could be bound by a homodimer of *TaVRT-2*, thereby contributing to repressing its expression. VRN-2, a dominant repressor of flowering identified in *T. monococcum* (Yan *et al.*, 2004b), is a zinc finger protein that is unlikely to directly bind the CArG-box but which interacts strongly with *TaVRT-2*. Therefore, VRN-2 may exert its repressor effect by first binding unidentified elements in the first intron and/or by being recruited by *TaVRT-2*. Once bound to the CArG-box, the complex composed of these two factors and possibly others would repress the expression of the *VRN-1/TaVRT-1* gene and result in vegetative growth. After vernalization of winter wheat genotypes, the expression of *VRN-2* is repressed and levels of *TaVRT-2* transcripts decrease. This would lead to a reduction of a functional repressive complex, allowing expression of *VRN-1/TaVRT-1* and the switch to the reproductive phase. In spring varieties of wheat, mutations in the promoter or intron of *Vrn-1* alleles could preclude the binding of the repressors and other transcription factors, and this in turn would result in a constitutive expression of *VRN-1/TaVRT-1* and flowering competence.

The significance of *TaVRT-2* interaction with *TaVRT-1*, a member of the AP1/SQUA clade, is an intriguing question that has arisen from this study. Specific homo- and heterodimerisation has been reported for a few MADS-box proteins from various plant species (Davies *et al.*, 1996; Moon *et al.*, 1999; Pelaz *et al.*, 2001, Immink *et al.*, 2003). These studies have demonstrated that protein-protein interactions and formation of complexes are at the basis of MADS-box transcription factor function (Messenguy and Dubois, 2003). Other members of the *StMADS11* clade have also been found to interact with proteins of the AP1/SQUA clade in petunia (Immink *et al.*, 2003), rice (Fornara *et al.*, 2004), *Antirrhinum* and *Arabidopsis* (Masiero *et al.*, 2004). Therefore, the interaction between members of

these two clades may represent an evolutionary conserved property that is important for their function. Recently, de Folter et al. (2005) have proposed that *AtAP1* (*TaVRT-1*) could serve as a hub between the flower induction pathway interacting proteins such as *AtSVP*, *AtSOC1* and *AtAGL24*, and the floral organ identity proteins. It could be speculated that *TaVRT-2* homodimerization during the early stages of LT exposure in winter wheat, when other high affinity MADS proteins are unavailable for interaction, could lead to a complex that can repress flowering. With the induction of *TaVRT-1*, there could be a preference for heterodimerization and consequently a change of function. In support of this, genetic and transgenic studies in *Antirrhinum* and *Arabidopsis* have led to the proposal that the INCO homodimer acts as a repressor of flowering whereas the INCO/SQUA heterodimer acts as an activator (Masiero et al., 2004). However, this might not represent a general property for this clade of proteins since *AtSVP* does not homodimerize (Masiero et al., 2004). Such differences may be based on non-identical conservation of homodimerization capacity of MADS-box proteins in plants following the appearance and evolution of heterodimerization capacity in angiosperms (Kaufmann et al., 2005). This suggests that there will be differences among the interactions of transcriptional activator/repressor MADS-box proteins that regulate flowering time in plants. Overall, the expression data and identification of the physical association of *TaVRT-2* with *TaVRT-1* and *VRN-2* further our knowledge of the regulation of flowering transition in temperate cereals.

Materials and Methods

Plant materials and growth conditions

Two spring cultivars of hexaploid wheat (*Triticum aestivum* L.; cv Glenlea and Manitou) and four winter cultivars (cv Absolvent, Fredrick, Monopole and Norstar) were used in the initial comparative gene expression studies. For detailed gene expression analyses, the non-hardy spring habit wheat cv Manitou, the very cold-hardy winter habit wheat cv Norstar, and two reciprocal near-isogenic (NILs) wheat lines that differ in vernalization requirement were used. The reciprocal NILs were produced using the cultivars Manitou (dominant *Vrn-A1* allele) and Norstar (recessive *vrn-A1* allele) as described previously (Limin and Fowler, 2002). After four backcrosses, heterozygous plants were selected and selfed. Homozygous lines (*vrn-A1/vrn-A1* and *Vrn-A1/Vrn-A1*) with theoretically 96.9% of the recurrent parent genome were recovered. This procedure produced a spring growth habit Norstar with the *Vrn-A1* allele of Manitou and a winter habit Manitou with the *vrn-A1* allele of Norstar. Ditelocentric (DT) chromosome lines and the group-7 nullisomic-tetrasomic series (NT) of Chinese Spring wheat were used to locate and confirm the presence of *TaVRT-2* homoeologues on chromosome arms of each of the 3 genomes.

The experimental design for these studies was a 4 (genotypes) x 11 (acclimation periods) factorial in a two replicate randomised complete block design. All NILs and parental material were evaluated for eleven LT exposure periods (0, 7, 14, 21, 28, 35, 42, 49, 56, 77, and 98 days). Growth conditions for plants were as previously described (Limin and Fowler, 2002; Danyluk *et al.*, 2003). For photoperiod studies, Norstar winter wheat and Dicktoo barley were grown for 13 days at 20°C under either long day (20h) or short day (8h) photoperiod, transferred at 4°C under identical photoperiods, and then sampled at regular intervals for RNA extraction.

Identification and molecular characterization of *TaVRT-2*

A cDNA library was prepared from an mRNA mixture from cold-acclimated and non-acclimated crown and leaf tissues of cv Norstar. For cDNA synthesis, the SuperScript Plasmid System with Gateway Technology and Cloning Kit (Invitrogen) was used, except that the precipitation steps without yeast carrier tRNA were replaced by the QIAquick PCR purification procedure (QIAGEN). The cDNAs were directionally cloned into the pCMV.SPORT6 vector with the *Sa*I adaptor (GTCGACCCACGCGTCCG) on the 5' end and the *Not*I primer-adaptor (GCGGCCGCCC(T₁₅)) on the 3' end.

All the MADS-box genes present in the FGAS wheat EST database were completely sequenced using the CEQTM 2000 DNA Analysis System (Beckman) and analyzed by northern blotting (Danyluk *et al.*, 2003) to determine their expression patterns. One of these genes was found to be cold-regulated and its expression pattern was associated with the vernalization response. This gene, named *TaVRT-2*, was selected for detailed molecular characterization.

For Southern analysis, genomic DNA was extracted by the CTAB (cetyltrimethyl-ammonium-bromide) method from several wheat cytogenetic lines in the Chinese Spring background. In the ditelocentric lines, the long or short arms of a specific chromosome pair are missing. For example, DT7AL represents a line where only the long arms of the 7A pair are present (therefore the short arms are missing). In the nullisomic-tetrasomic lines, a pair of chromosomes is missing but the loss is compensated by the homoeologous chromosome pair from another genome. For example, the N7A/T7B line is missing the chromosome pair 7A and there are two pairs of 7B. Genomic DNA (5 µg) was digested with *Dra*I and separated overnight using a FIGE mapper (Bio-Rad). A gene-specific *TaVRT-2* probe lacking the MADS domain was amplified with *Pfx*-polymerase (Invitrogen) using the primers: 5'-ATTCAAAGAACCTGGGGAAATCTG-3' and 5'-TCCAAGGTAACGCTAGTTTCAGGGATA-3'. Blotting and probe hybridizations were performed as previously described (Danyluk *et al.*, 2003). All filters were

washed at high stringency (0.1X SSC, 0.1% SDS) and exposed to Molecular Imager FX screens (Bio-Rad) and to X-ray films (Kodak BioMax-MS).

Phylogenetic analysis

The amino acid sequences of *TaVRT-2* and several other MADS-box sequences from dicots and monocots were aligned using CLUSTAL X v1.83 (Thompson *et al.*, 1997) with the following parameters: gap opening penalty of 10.00, gap extension penalty of 0.20 and substitution scoring matrix Gonnet. A distance matrix was computed from the alignment using the Protdist program under the model JTT (Jones *et al.*, 1992). Using several members of the AP1/SQUA-, FLC-, *StMADS11*- and AG-like clades (Table S2), a tree was computed with the Neighbor program using the Neighbor-Joining method (Saitou and Nei, 1987) and then adjusted manually. The same analysis was repeated under 1000 bootstrap replicates to assess the reliability of branches. The extended-majority rule consensus tree was created by the Consense program. All the programs used to generate the trees were from the PHYLIP package v-3.6 (Felsenstein, 1989).

Yeast two-hybrid analysis

Protein interaction assays were performed with the GAL4 yeast two-hybrid system (CLONTECH). The *Saccharomyces cerevisiae* strains used were AH109 (*MAT α* , *trp1*, *leu2*), which contains the *ADE2*, *HIS3*, *lacZ* and *MEL1* reporter genes, and Y187 (*MAT α* , *trp1*, *leu2*), which contains the *lacZ* and *Mel1* reporters. All the reporter genes in the two strains are under the control of their own GAL4-responsive promoter. The vectors used for the protein-protein interaction assays were pGADT7 (activation domain fusion; AD) and pGBKT7 (binding domain fusion; BD). The cDNAs encoding the proteins tested were PCR-amplified (Tables S3 and S4) then fused in frame with the GAL4 AD- or BD-encoding vector using the Gap repair technique. The recombinant pGBKT7 and pGADT7 constructs were introduced in Y187 and AH109, respectively. Following conjugation between haploids cells (Kaiser

et al., 1994), diploid cells were spread in triplicate on selective medium (SD/Galactose/Raffinose without adenine, leucine, tryptophan and uracil, and supplemented with 10 mg/L X-GAL (5-bromo-4-chloro-3-indolyl- β -D-galactopyranoside). β -galactosidase specific activity was determined using ONPG (*o*-nitrophenyl- β -D-galactopyranoside; Sigma) as a substrate (Rose *et al.*, 1990).

Distribution of Materials

Upon request, all novel materials described in this publication will be made available in a timely manner for non-commercial research purposes, subject to the requisite permission from any third-party owners of all or parts of the material.

Acknowledgments

We are grateful to Dr. P. Gulick (Concordia University) for critical reading and suggestions on the manuscript, Dr. C. Chauve (UQÀM) and M. Pelletier for help with the phylogenetic analysis, and G. Cormack, A. O. Diallo, and G. Schellhorn for technical help.

Table**I-Table 1: Protein-protein interactions between candidates that could be associated with the floral induction pathway**

The interactions between several wheat MADS-box and other flowering proteins were investigated using the yeast two-hybrid assay. β -galactosidase specific activity was determined using ONPG (o- nitrophenyl- β -D-galactopyranoside) as a substrate. Data is an average of two experiments performed in triplicate. Autoactivation control results are presented in Table S5. The terms BD and AD refer to the GAL4 Binding Domain and Activating Domain, respectively.

GAL4 BD and AD fusions	β -GAL activity (nmol/min/mg of protein)
BD-VRN-2 + AD- <i>Ta</i> VRT-2	85 \pm 5
BD- <i>Ta</i> VRT-2 + AD- <i>Ta</i> VRT-2	73 \pm 6
BD- <i>Ta</i> VRT-1 + AD- <i>Ta</i> VRT-2	73 \pm 4
BD- <i>Ta</i> 31K05 + AD- <i>Ta</i> VRT-2	not tested
BD- <i>Ta</i> 57H08 + AD- <i>Ta</i> VRT-2	110 \pm 9
BD- <i>Ta</i> 42G17 + AD- <i>Ta</i> VRT-2	29 \pm 3
BD- <i>Ta</i> 45G05 + AD- <i>Ta</i> VRT-2	25 \pm 3
BD- <i>Ta</i> 73C21 + AD- <i>Ta</i> VRT-2	47 \pm 1
BD- <i>Ta</i> VRT-1 + AD- <i>Ta</i> VRT-1	21.3 \pm 0.7
BD- <i>Ta</i> VRT-2 + AD- <i>Ta</i> VRT-1	61 \pm 4
BD- <i>Ta</i> 31K05 + AD- <i>Ta</i> VRT-1	23.2 \pm 0.4
BD- <i>Ta</i> 57H08 + AD- <i>Ta</i> VRT-1	22.7 \pm 0.3
BD- <i>Ta</i> 42G17 + AD- <i>Ta</i> VRT-1	17.3 \pm 0.3
BD- <i>Ta</i> 45G05 + AD- <i>Ta</i> VRT-1	18.3 \pm 0.2
BD- <i>Ta</i> 73C21 + AD- <i>Ta</i> VRT-1	24.8 \pm 0.7
BD-VRN-2 + AD-VRN-2	12.4 \pm 0.3
BD- <i>Ta</i> VRT-2 + AD-VRN-2	98 \pm 3
BD- <i>Ta</i> VRT-1 + AD-VRN-2	50 \pm 4
BD- <i>Ta</i> VRT-2 + AD- <i>Ta</i> HD1	33 \pm 3
BD- <i>Ta</i> VRT-1 + AD- <i>Ta</i> HD1	20 \pm 4

Figures and legends

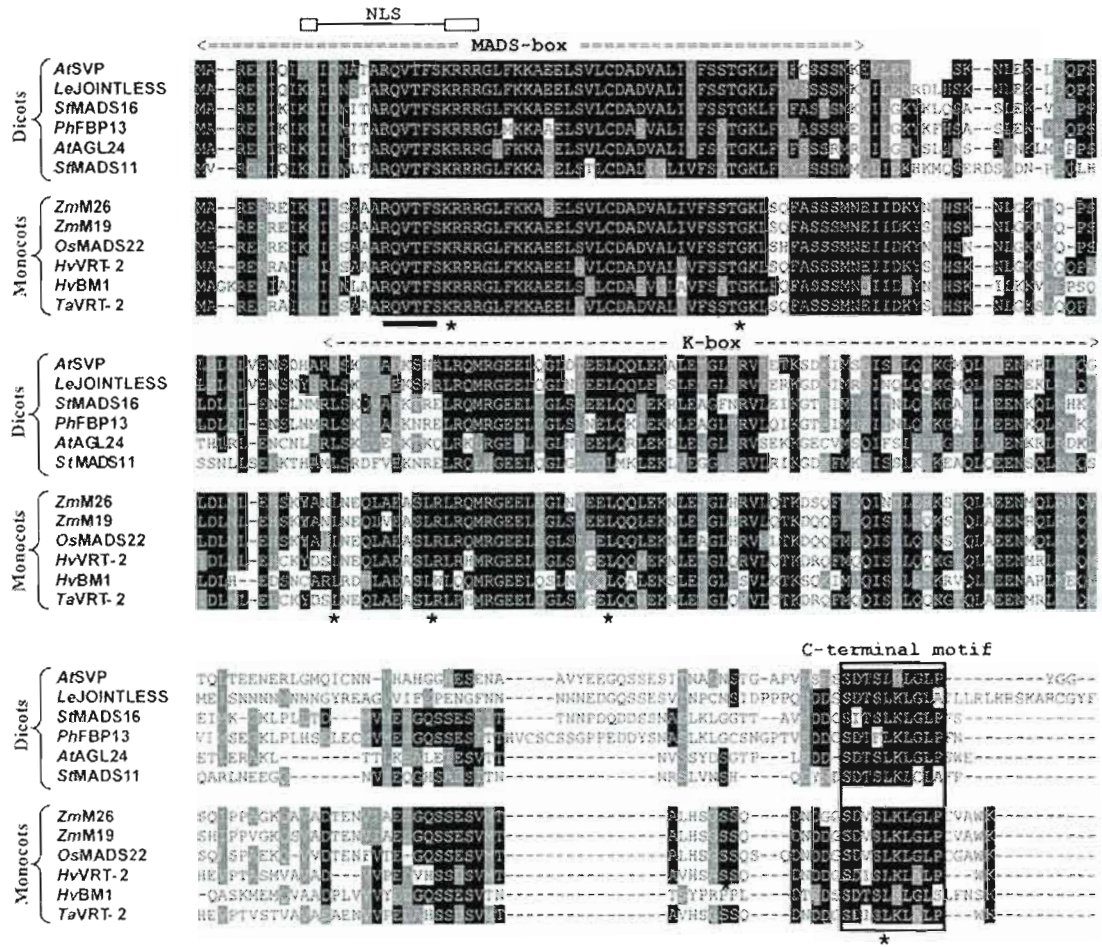

I-Figure 1: Alignment of TaVRT-2 with related MADS-box proteins from other species

The deduced amino acid sequence of proteins from *Triticum aestivum* (TaVRT-2), *Oryza sativa* (OsMADS), *Zea mays* (Zmm19, Zmm26), *Hordeum vulgare* (HvVRT-2, HvBM1), *Solanum tuberosum* (StMADS16, StMADS11), *Petunia x hybrida* (PhFBP13), *Arabidopsis thaliana* (AtAGL24, AtSVP) and *Lycopersicon esculentum* (LeJOINTLESS) were aligned using Clustal W (gap opening = 10.00 and gap extension = 0.10). Accession numbers are given in Table S2. The double and single dash bars indicate the location of the MADS and K boxes, respectively. The arrow indicates the TaVRT-2 nuclear localization signal (NLS) identified by PSORT (Nakai and Horton, 1999). The bar indicates the potential phosphorylation site (QVTFS) for calmodulin-dependent protein kinases (Carmona *et al.*, 1998). The asterisk represents other predicted phosphorylation sites using ScanProsite (Gattiker *et al.*, 2002). A conserved C-terminal motif found in these proteins is boxed. Black shading indicates identical residues in at least 4 proteins, grey boxes are similar residues, and dashes indicate gaps introduced to optimize the alignment.

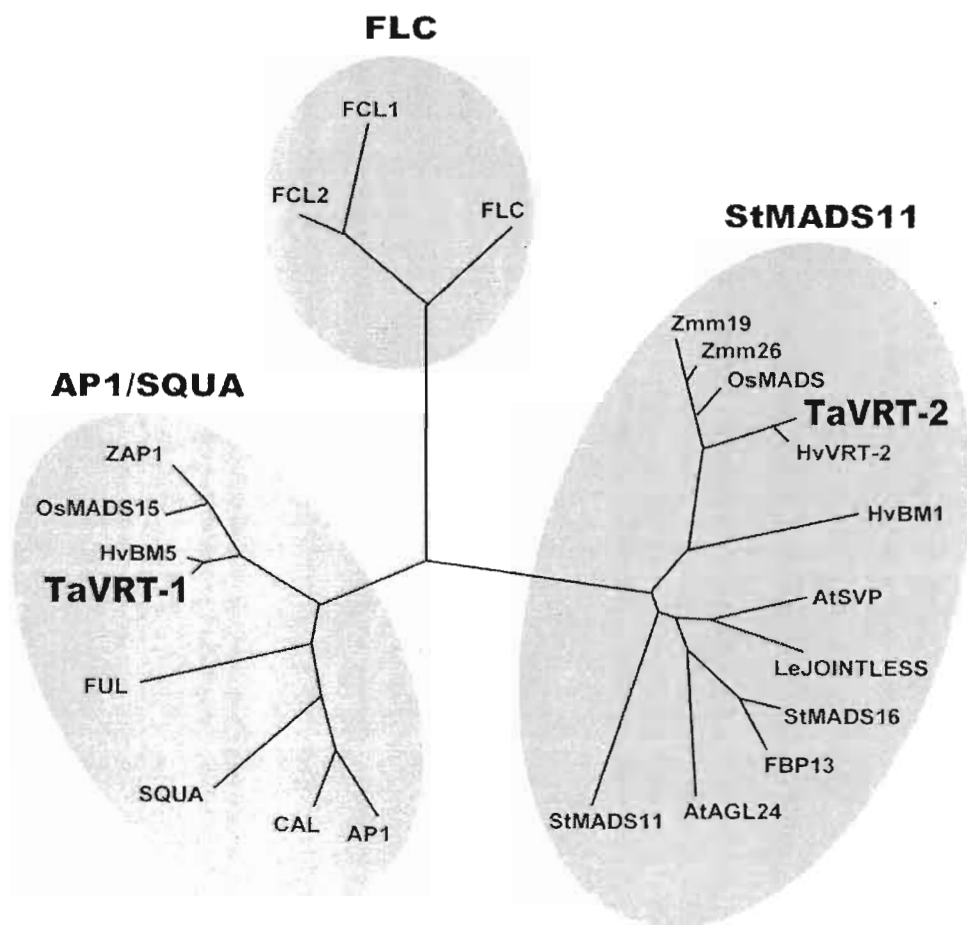

I-Figure 2: Unrooted phylogenetic tree illustrating the relationship between TaVRT-2 and other major MADS-box regulatory proteins in monocots and dicots

The full-length sequence of *TaVRT-2* and several sequences from the AP1/SQUA, FLC, *S/MADS11* and AG clades were aligned using Clustal X v1.83 as described in Materials and Methods. Only three clades are represented. Branch lengths are proportional to the number of amino acid substitutions.

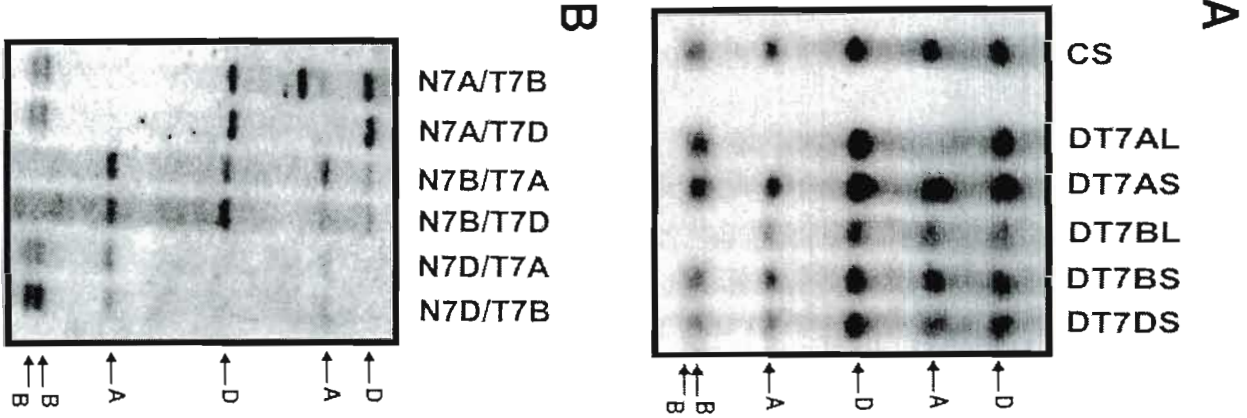

I-Figure 3: Mapping of the TaVRT-2 homologous genes on wheat group-7 chromosomes

DNA blot analysis of *Dra*I-digested genomic DNA from ditelocentric (A) and nullisomic-tetrasomic lines (B) of hexaploid wheat (cv Chinese Spring) hybridized with a *TaVRT-2* specific probe. The arrows indicate which of the A, B or D genome contributes to the bands seen on the blots.

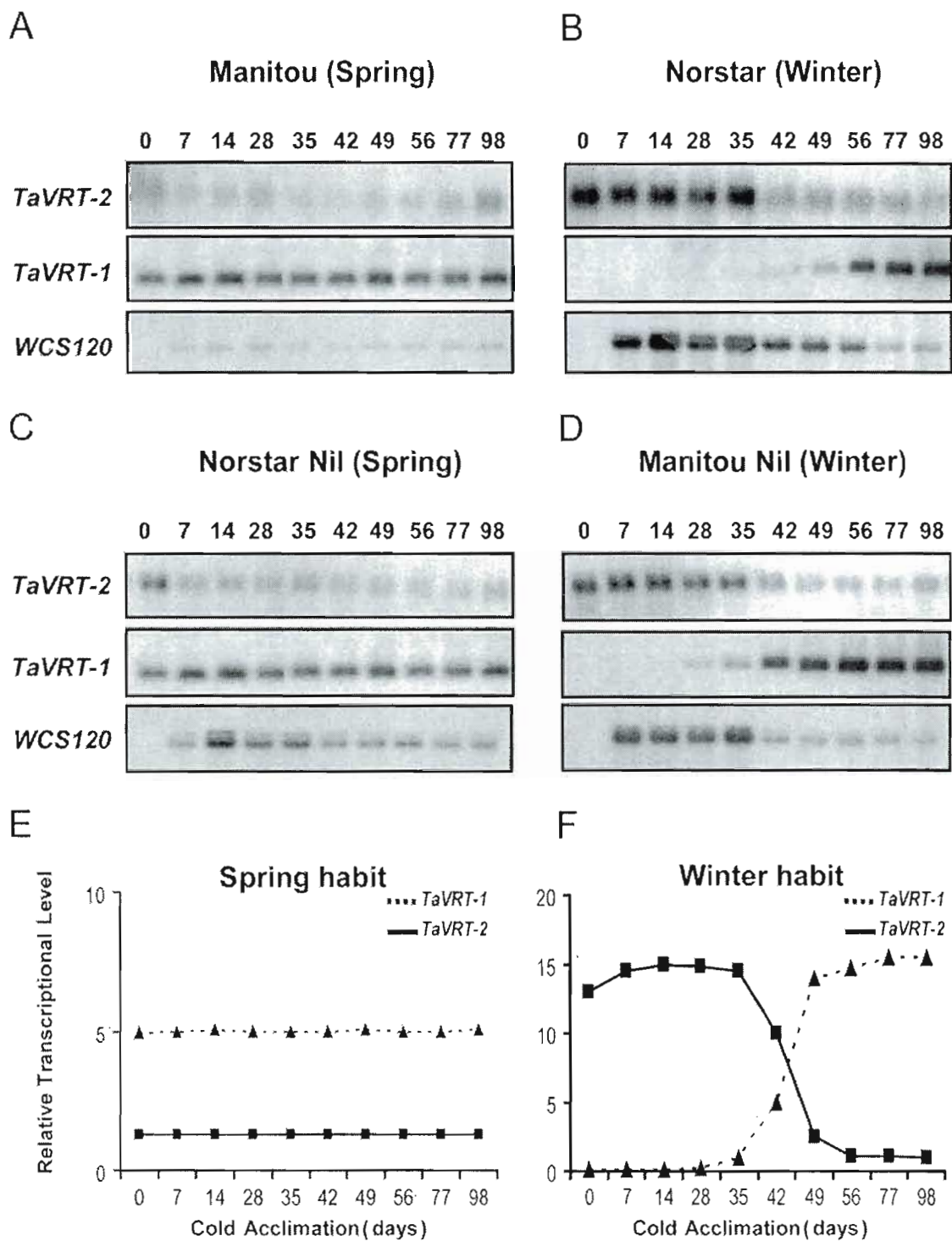

I-Figure 4: Expression of TaVRT and COR genes during low temperature exposure in parental and near-isogenic lines of wheat

Parental lines spring Manitou (A) and winter Norstar (B), and near-isogenic lines spring Norstar (C) and winter Manitou (D), were exposed for the indicated period (in days) at LT, then RNA was extracted for northern blot analyses. Blots were first hybridized with a *TaVRT-2* specific probe, then with a specific *TaVRT-1* probe and finally with a *WCS120* probe. Panels A to D are scanned X-ray films. The same blots were also exposed to a phosphor screen which was scanned in a Molecular Imager FX (Bio-Rad) for densitometric measurement. Values are expressed as relative arbitrary units of the *TaVRT* genes accumulation in spring (E) and winter (F) parental genotypes.

Inflorescences

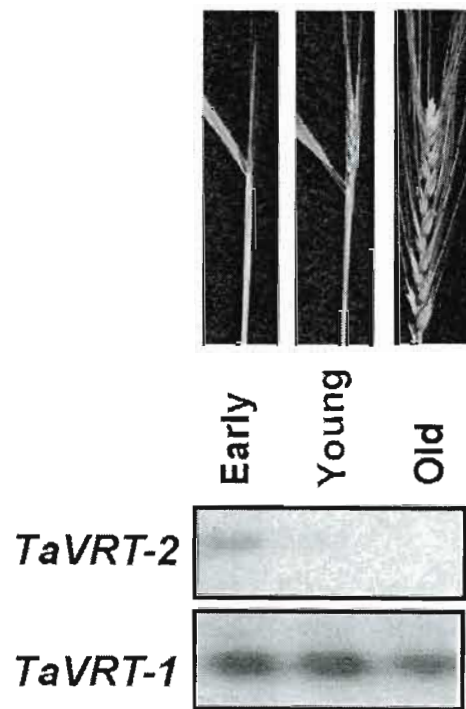

I-Figure 5: Expression of TaVRT-2 at different developmental stages of wheat

RNA gel blot analyses were performed with specific *TaVRT-2* and *TaVRT-1* probes using RNA extracted from wheat inflorescences (early = very young spike dissected out of the stem, young = boot stage of development during emergence, old = fully emerged spike and florets).

A

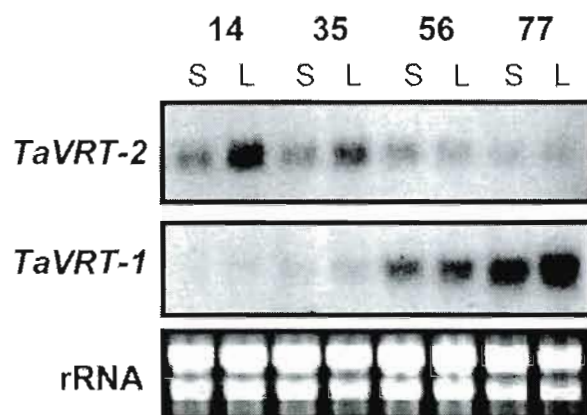

B

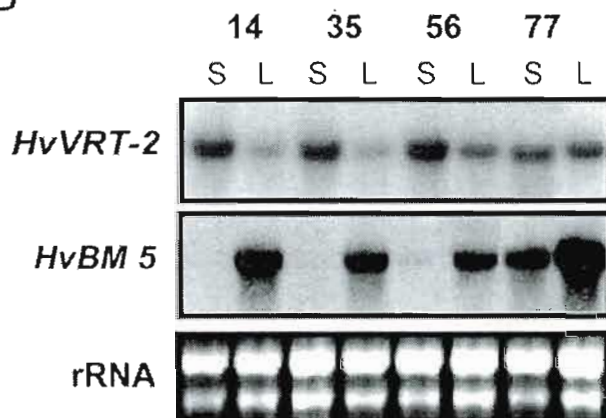

I-Figure 6: Expression of TaVRT genes in Norstar wheat and their orthologues in Dicktoo barley in response to low temperature and photoperiodic regimes

Norstar winter wheat (A) and photoperiod-sensitive spring barley plants (B) were grown at 4°C under short-day (S) or long-day (L) photoperiod for the indicated number of days, and RNA blot analyses were performed as described in Figure 4. Under these growth conditions, flowering competence based on final leaf number is reached by day 49 under both S and L photoperiod conditions in Norstar (Mahfoozi *et al.*, 2001). In long-day grown Dicktoo barley, the morphological indicator of flowering competence, double ridge formation, is present at the start of treatment (0 day LT) while in short-day grown barley, it appears after 70 days of LT exposure (Danyluk *et al.*, 2003).

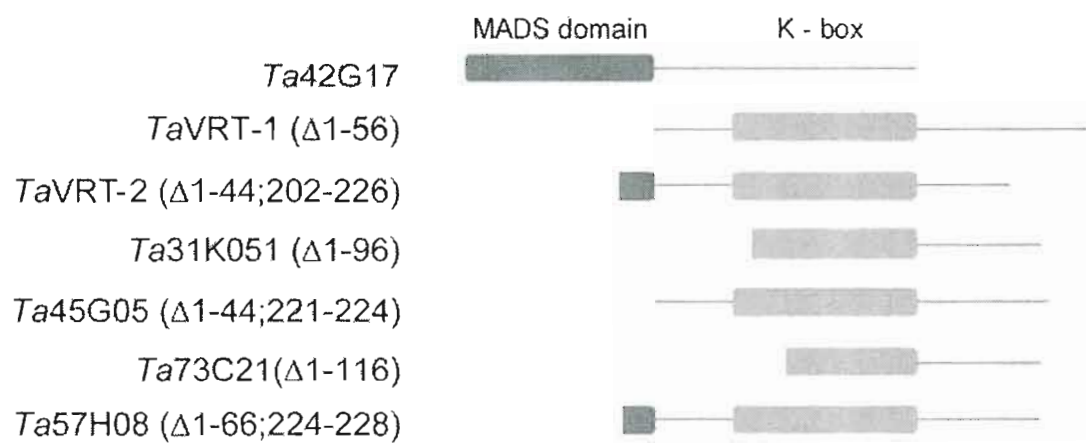

I-Figure 7: Schematic representation of the constructs used in the protein-protein interaction studies in yeast

Except for *Ta42G17*, the MADS domain was deleted to avoid toxicity to the yeast strain used.

Literature cited

- Baum M, Grando S, Backes G, Jahoor A, Sabbagh A, Ceccarelli S (2003) QTLs for agronomic traits in the Mediterranean environment identified in recombinant inbred lines of the cross 'Arta' x *H. spontaneum* 41-1. *Theor Appl Genet* 107: 1215-1225
- Beales J, Laurie DA, Devos KM (2005) Allelic variation at the linked *AP1* and *PhyC* loci in hexaploid wheat is associated but not perfectly correlated with vernalization response. *Theor Appl Genet* 110 (6) : 1099-107.
- Becker A, Theissen G (2003) The major clades of MADS-box genes and their role in the development and evolution of flowering plants. *Mol Phylogenet Evol* 29: 464-489
- Bezant J, Laurie D, Pratchett N, Chojecki J, Kearsey M (1996) Marker regression mapping of QTL controlling flowering time and plant height in a spring barley (*Hordeum vulgare* L.) cross. *Heredity* 77: 64-73
- Boss PK, Bastow RM, Mylne JS, Dean C (2004) Multiple pathways in the decision to flower: enabling, promoting, and resetting. *Plant Cell* 16 Suppl: S18-31
- Boyko E, Kalendar R, Korzun V, Fellers J, Korol A, Schulman AH, Gill BS (2002) A high-density cytogenetic map of the *Aegilops tauschii* genome incorporating retrotransposons and defense-related genes: insights into cereal chromosome structure and function. *Plant Mol Biol* 48: 767-790
- Carmona MJ, Ortega N, Garcia-Maroto F (1998) Isolation and molecular characterization of a new vegetative MADS-box gene from *Solanum tuberosum* L. *Planta* 207: 181-188

- Danyluk J, Kane NA, Breton G, Limin AE, Fowler DB, Sarhan F (2003) TaVRT-1, a putative transcription factor associated with vegetative to reproductive transition in cereals. *Plant Physiol* 132: 1849-1860
- Davies B, Egea-Cortines M, de Andrade SE, Saedler H, Sommer H (1996) Multiple interactions amongst floral homeotic MADS-box proteins. *EMBO J* 15: 4330-4343
- de Folter S, Immink RG, Kieffer M, Parenicova L, Henz SR, Weigel D, Busscher M, Kooiker M, Colombo L, Kater MM, Davies B, Angenent GC (2005) Comprehensive interaction map of the *Arabidopsis* MADS-box transcription factors. *Plant Cell* 17 (5) : 1424-1433.
- Favaro R, Pinyopich A, Battaglia R, Kooiker M, Borghi L, Ditta G, Yanofsky MF, Kater MM, Colombo L (2003) MADS-box protein complexes control carpel and ovule development in *Arabidopsis*. *Plant Cell* 15: 2603-2611
- Felsenstein J (1989) PHYLIP - Phylogeny Inference Package (Version 3.2). *Cladistics* 5: 164-166
- Fornara F, Parenicova L, Falasca G, Pelucchi N, Masiero S, Ciannamea S, Lopez-Dee Z, Altamura MM, Colombo L, Kater MM (2004) Functional characterization of *OsMADS18*, a member of the *API/SQUA* subfamily of MADS-box genes. *Plant Physiol* 135: 2207-2219
- Fowler DB, Breton G, Limin AE, Mahfoozi S, Sarhan F (2001) Photoperiod and temperature interactions regulate low-temperature-induced gene expression in barley. *Plant Physiol* 127: 1676-1681
- Fu D, Szucs P, Yan L, Helguera M, Skinner JS, von Zitzewitz J, Hayes PM, Dubcovsky J (2005) Large deletions within the first intron in *VRN-1* are associated with spring growth habit in barley and wheat. *Mol Gen Genomics* 273: 54-65

- Gattiker A, Gasteiger E, Bairoch A (2002) ScanProsite: a reference implementation of a PROSITE scanning tool. *Appl Bioinformatics* 1: 107-108
- Hartmann U, Hohmann S, Nettesheim K, Wisman E, Saedler H, Huijser P (2000) Molecular cloning of SVP: a negative regulator of the floral transition in *Arabidopsis*. *Plant J* 21: 351-360
- Hayama R, Yokoi S, Tamaki S, Yano M, Shimamoto K (2003) Adaptation of photoperiodic control pathways produces short-day flowering in rice. *Nature* 422: 719-722
- Henderson IR, Shindo C, Dean C (2003) The need for winter in the switch to flowering. *Annu Rev Genet* 37: 371-392
- Hepworth SR, Valverde F, Ravenscroft D, Mouradov A, Coupland G (2002) Antagonistic regulation of flowering-time gene *SOC1* by CONSTANS and FLC via separate promoter motifs. *EMBO J* 21: 4327-4337
- Immink RG, Ferrario S, Busscher-Lange J, Kooiker M, Busscher M, Angenent GC (2003) Analysis of the petunia MADS-box transcription factor family. *Mol Gen Genom* 268: 598-606
- Izawa T, Oikawa T, Sugiyama N, Tanisaka T, Yano M, Shimamoto K (2002) Phytochrome mediates the external light signal to repress FT orthologues in photoperiodic flowering of rice. *Genes Dev* 16: 2006-2020
- Jones DT, Taylor WR, Thornton JM (1992) The rapid generation of mutation data matrices from protein sequences. *Comput Appl Biosci* 8: 275-282
- Kaiser C, Michaelis S, Mitchell A (1994) *Laboratory Course Manual for Methods in Yeast Genetics*. Cold Spring Harbor Laboratory Press, New York,

Kaufmann K, Melzer R, Theißen G (2005) MIKC-type MADS-domain proteins: structural modularity, protein interactions and network evolution in land plants. *Gene* 347: 183-198

Limin AE, Danyluk J, Chauvin LP, Fowler DB, Sarhan F (1997) Chromosome mapping of low-temperature induced *Wcs120* family genes and regulation of cold-tolerance expression in wheat. *Mol Gen Genet* 253: 720-727

Limin AE, Fowler DB (2002) Developmental traits affecting low-temperature tolerance response in near-isogenic lines for the vernalization locus *Vrn-A1* in wheat (*Triticum aestivum* L. em Thell). *Ann Bot-London* 89: 579-585

Mahfoozi S, Limin AE, Fowler DB (2001) Influence of vernalization and photoperiod response on cold hardiness in winter cereals. *Crop Science* 41: 1006-1011

Masiero S, Li MA, Will I, Hartmann U, Saedler H, Huijser P, Schwarz-Sommer Z, Sommer H (2004) *INCOMPOSITA*: a MADS-box gene controlling prophyll development and floral meristem identity in *Antirrhinum*. *Development* 131: 5981-5990

Messenguy F, Dubois E (2003) Role of MADS-box proteins and their cofactors in combinatorial control of gene expression and cell development. *Gene* 316: 1-21

Michaels SD, Amasino RM (1999) *FLOWERING LOCUS C* encodes a novel MADS domain protein that acts as a repressor of flowering. *Plant Cell* 11: 949-956

Moon YH, Kang HG, Jung JY, Jeon JS, Sung SK, An G (1999) Determination of the motif responsible for interaction between the rice APETALA1/AGAMOUS-LIKE9 family proteins using a yeast two-hybrid system. *Plant Physiol* 120: 1193-1204

- Mouradov A, Cremer F, Coupland G (2002) Control of flowering time: interacting pathways as a basis for diversity. *Plant Cell* 14 Suppl: S111-S130
- Nakai K, Horton P (1999) PSORT: a program for detecting the sorting signals of proteins and predicting their subcellular localization. *Trends Biochem Sci* 24: 34-35
- Pelaz S, Gustafson-Brown C, Kohalmi SE, Crosby WL, Yanofsky MF (2001) APETALA1 and SEPALLATA3 interact to promote flower development. *Plant J* 26: 385-394
- Rose MD, Winston F, Hieter P (1990) *Methods in yeast genetics*. Cold Spring Harbor Laboratory Press, New York,
- Saitou N, Nei M (1987) The neighbor-joining method: a new method for reconstructing phylogenetic trees. *Mol Biol Evol* 4: 406-425
- Scortecci K, Michaels SD, Amasino RM (2003) Genetic interactions between *FLM* and other flowering-time genes in *Arabidopsis thaliana*. *Plant Mol Biol* 52: 915-922
- Shindo C, Tsujimoto H, Sasakuma T (2003) Segregation analysis of heading traits in hexaploid wheat utilizing recombinant inbred lines. *Heredity* 90: 56-63
- Simpson GG, Dean C (2002) *Arabidopsis*, the Rosetta stone of flowering time? *Science* 296: 285-289
- Sourdille P, Snape JW, Cadalen T, Charmet G, Nakata N, Bernard S, Bernard M (2000) Detection of QTLs for heading time and photoperiod response in wheat using a doubled-haploid population. *Genome* 43: 487-494
- Tadege M, Sheldon CC, Helliwell CA, Upadhyaya NM, Dennis ES, Peacock WJ (2003) Reciprocal control of flowering time by OsSOC1 in transgenic *Arabidopsis* and by FLC in transgenic rice. *Plant Biotechnology J* 1: 361-369

Takahashi Y, Shomura A, Sasaki T, Yano M (2001) *Hd6*, a rice quantitative trait locus involved in photoperiod sensitivity, encodes the alpha subunit of protein kinase CK2. *Proc Natl Acad Sci USA* 98: 7922-7927

Thompson JD, Gibson TJ, Plewniak F, Jeanmougin F, Higgins DG (1997) The CLUSTAL_X windows interface: flexible strategies for multiple sequence alignment aided by quality analysis tools. *Nucleic Acids Res* 25: 4876-4882

Yan L, Helguera M, Kato K, Fukuyama S, Sherman J, Dubcovsky J (2004a) Allelic variation at the VRN-1 promoter region in polyploid wheat. *Theor Appl Genet* 109: 1677-1686

Yan L, Loukoianov A, Blechl A, Tranquilli G, Ramakrishna W, SanMiguel P, Bennetzen JL, Echenique V, Dubcovsky J (2004b) The wheat *VRN2* gene is a flowering repressor down-regulated by vernalization. *Science* 303: 1640-1644

Yan L, Loukoianov A, Tranquilli G, Helguera M, Fahima T, Dubcovsky J (2003) Positional cloning of the wheat vernalization gene VRN1. *Proc Natl Acad Sci USA* 100: 6263-6268

Yano M, Katayose Y, Ashikari M, Yamanouchi U, Monna L, Fuse T, Baba T, Yamamoto K, Umehara Y, Nagamura Y, Sasaki T (2000) *Hdl*, a major photoperiod sensitivity quantitative trait locus in rice, is closely related to the *Arabidopsis* flowering time gene *CONSTANS*. *Plant Cell* 12: 2473-2484

Yu H, Xu Y, Tan EL, Kumar PP, (2002) *AGAMOUS-LIKE 24*, a dosage-dependent mediator of the flowering signals. *Proc Natl Acad Sci USA* 99: 16336-16341

Supplemental data

I-Table S1: Biochemical and physical characteristics of the TaVRT-2 protein

Parameter	Value
Length	226 aa
Molecular Weight (m.w)	25188.17 ka
Molar Extinction coefficient	8610
1 A _[280] corr. to	2.93 mg/ml
A _[280] of 1 mg/ml	0.34 AU
Isoelectric Point	5.74
Charge at pH 7	-4.69

I-Table S2: MADS-box proteins used in the phylogenetic analysis

Proteins	Genbank Accession Number
<i>Am</i> SQUA (DEFH68)	CAC86007
<i>At</i> AG	NP_567569
<i>At</i> AGL24	CAB79364
<i>At</i> AP1	AAF27070
<i>At</i> CAL	AAC67506
<i>At</i> FCL1	AAG43854
<i>At</i> FCL2	AAG43855
<i>At</i> FLC	AAN04056
<i>At</i> FUL	NP_568929
<i>At</i> SVP	AAG24508
<i>Hv</i> BM1	CAB97349
<i>Hv</i> VRT-2*	BI958127, BQ469990, BQ665233, CA592072, BJ452447 and BJ459993
<i>Le</i> JOINTLESS	AAG09811
<i>Os</i> MADS15	AAF19048
<i>Os</i> MADS22	BAD93335
<i>Os</i> MADS47	CAC29335
<i>Ph</i> FBP13	AAK21250
<i>St</i> MADS11	AAB94006
<i>St</i> MADS16	AAB94005
<i>Ta</i> VRT-1	AAP33790
<i>Ta</i> VRT-2	DQ022679
<i>Zm</i> AP1	AAB00081
<i>Zm</i> M19	CAD23409
<i>Zm</i> M26	CAD23439

The asterisk indicates a reconstructed sequence.

I-Table S3: Wheat MADS-box proteins used in protein-protein interaction studies in yeast

Proteins	Genbank Accession Number	Arabidopsis Orthologue
<i>TaVRT-2</i>	DQ022679	(SVP-like) <i>SlMADS-11</i>
<i>TaVRT-1</i>	AAP33790	API (API/SQUA)
<i>Ta42G17</i>	CV765258	AGL79/FUL (API/SQUA)
<i>Ta45G05</i>	CV765903	AGL12 (AGL12)
<i>Ta57H08</i>	CV769487	(SVP-like) <i>SlMADS-11</i>
<i>Ta73C21</i>	CV772064	AGL14 (TM3/SOC1)
<i>Ta31K05</i>	CV762849	(SVP-like) <i>SlMADS-11</i>

I-Table S4: List of primers used to generate the different constructs in the protein-protein interaction studies

BD and AD indicate GAL4 Binding and GAL4 Activation Domain, respectively.

Fusion gene	Vector	Oligonucleotides
<i>TaVRT-1</i>	BD	5'TGATCTCAGAGGAGGACCTGTTCTCCACCGAGTCATGTATG3' 5'TTATGCTAGTTATGCGGCTCAGCCGTTGATGTGGCT3'
<i>TaVRT-1</i>	AD	5'AACGCAGAGTGGCCATTA TTCTCCACCGAGTCATGTATG3' 5'GCCGAGGCGGCCGACATG TCAGCCGTTGATGTGGCT3'
<i>TaVRT-2</i>	BD	5'TGATCTCAGAGGAGGACCTGCTCGTCGTCTTCTCCTCCAC3' 5'TAGCTAGTTATGCGGCCGCGCCGTCATCACAGAGTCAGA3'
<i>TaVRT-2</i>	AD	5'AACGCAGAGTGGCCATTA CTCGTCGTCTTCTCCTCCAC3' 5'GCCGAGGCGGCCGACATG GCCGTCATCACAGAGTCAGA3'
<i>Ta42G17</i>	BD	5'TGATCTCAGAGGAGGACCTGAACCACCGAGAAAGACGAGA3' 5'TAGCTAGTTATGCGGCCGCGGAAGAGTGTGGCATCAGCAG3'
<i>Ta45G05</i>	BD	5'TGATCTCAGAGGAGGACCTGATCATCATCTTCTCCGCACA3' 5'TAGCTAGTTATGCGGCCGCCATCTCTGAGCCCCTACAA3'
<i>Ta73C21</i>	BD	5'TGATCTCAGAGGAGGACCTGATCGAGGACCGGACGAG3' 5'TAGCTAGTTATGCGGCCGCTCCCTTACCAACTACAAGTAGCA3'
<i>Ta57H08</i>	BD	5'TGATCTCAGAGGAGGACCTGATCGACAAGTACAGCACGCATT3' 5'TAGCTAGTTATGCGGCCGCGCAGGGCAATCCTAATTTCA3'
VRN-2	BD	5'TGATCTCAGAGGAGGACCTGGTCCATGTCATGCGGTTT3' 5'TAGCTAGTAGTTATGCGGCCGCATAGGGCAAAGCTGGAGATG3
VRN-2	AD	5'AACGCAGAGTGGCCATTA GTCCATGTCATGCGGTTT3' 5'GCCGAGGCGGCCGACATGCGCATAGGGCAAAGCTGGAGATG3
<i>TaHDI</i>	BD	5'TGATCTCAGAGGAGGACCTAACCTTTTGGAGAACGAAGCTG3' 5'TAGCTAAGTTATGCGGCCGCATGTGGTCTCCTCATGCTC3'
Universal Recombination Vector-BD	BD	5'GGCGAGCCGCCATCATGGAGGAGCAGAAGCTGATCTCAGAGG AGGACCTG3' 5'GGCGAGCCGCCATCATGGAGGAGCAGAAGCTGATCTCAGAGG AGGACCTG3'
Universal Recombination Vector-AD	AD	5'AGTGAATTCCACCCAAGCAGTGGTATCAACGCAGAGTGGCCAT TA3' 5'ATGGATCCCGTATCGATGCCACCCCTCTAGAGGCCGAGGCCGC CGACATG3'

I-Table S5: Control constructs used in protein-protein interaction studies in yeast

Crude yeast extracts were prepared and β -GAL activity was determined as described in Materials and Methods. Data is an average of two experiments performed in triplicate. BD and AD indicate GAL4 Binding and GAL4 Activation Domain, respectively.

AD and BD constructs	β-galactosidase activity (nmol/min/mg protein)
AD- <i>Ta</i> VRT-1(Δ 1-56) + pGBKT7	2.2 \pm 0.1
AD- <i>Ta</i> VRT-2 (Δ 1-44;202-226) + pGBKT7	7.8 \pm 0.6
AD-VRN-2 (Δ 1-2/201-212) + pGBKT7	2.0 \pm 0.3
BD- <i>Ta</i> VRT-1(Δ 1-56) + pGADT7	1.4 \pm 0.9
BD- <i>Ta</i> VRT-2 (Δ 1-44;202-226) + pGADT7	3.3 \pm 0.1
BD- <i>Ta</i> β 1K05 (Δ 1-96) + pGADT7	2.2 \pm 0.3
BD- <i>Ta</i> 57H08 (Δ 1-66/224-228) + pGADT7	1.2 \pm 0.6
BD- <i>Ta</i> 42G17 + pGADT7	2.4 \pm 0.8
BD- <i>Ta</i> 45G05 (Δ 1-44;221-224) + pGADT7	3.1 \pm 0.5
BD- <i>Ta</i> 73C21 (Δ 1-11) + pGADT7	1.4 \pm 0.1
BD-VRN-2 (Δ 1-2/201-212) + pGADT7	7.4 \pm 0.7
BD- <i>Ta</i> HD1 + pGADT7	8.0 \pm 3.0

II. *TaVRT-2* represses the transcription of the wheat vernalization gene *TaVRT-1*

Ndjido Ardo Kane, Zahra Agharbaoui, Amadou Oury Diallo, H el ene Adam, Yoko Tominaga, Fran ois Ouellet and Fathey Sarhan*

D epartement des Sciences Biologiques, Universit e du Qu ebec  a Montr eal, Case Postale 8888, Succursale Centre-ville, Montr eal, Qu ebec, Canada H3C 3P8

R esultats publi es dans *The Plant Journal*, volume 51(4): 670-80. Epub 2007 Jun 22.
Note : une partie (figures 6 et 7) a  et e publi ee dans un autre article (Adam et al. 2007, Adam, H., Ouellet, F., Kane, N.A., Agharbaoui, Z., Major, G., Tominaga, Y., and Sarhan, F. (2007). Overexpression of *TaVRN1* in *Arabidopsis* promotes early flowering and alters development. *Plant Cell Physiol.* 48:1192-206).

Contribution

J'ai particip e dans toutes les  etapes d'exp erimentation et de r edaction de l'article sous la direction de FS. J'ai r ealis e l'identification, le clonage et les analyses de s equence promotrice de *TaVRT-1*, la production des prot eines recombinantes de *TaVRT-2* ainsi que les exp eriences de retard sur gel. ZA a dirig e et r ealis e les  etudes d'expression transitoire et de production des plantes transg eniques et je l'ai assist e dans les  etapes de clonage, de ph enotype et de caract erisation mol eculaire. Avec AOD, j'ai conduit et r ealis e les exp eriences pour les  etudes d'expression des g enes par RT-PCR. J'ai contribu e avec YT aux exp eriences de RT-PCR chez *Arabidopsis* et aux exp eriences de d eveloppement de l'apex chez le bl e. J'ai assist e HA et YT dans les exp eriences d'hybridation in situ (pr eparation des tissus et design des sondes sp ecifiques). J'ai clon e les g enes *TaVRT-1* et *TaVRT-2* dans les vecteurs de recombinaison pour le criblage dans la levure. Tous les auteurs ont activement particip e  a la r edaction de l'article.

TaVRT-2 réprime la transcription du gène de vernalisation *TaVRT-1*

Résumé

Chez le blé hexaploïde, *VRN1/TaVRT-1* et *TaVRN2* déterminent l'habitude de croissance (printanière ou hivernale) et le temps de floraison. En outre, nous avons découvert que le facteur de transcription MADS-box TaVRT-2, semblable en quelque sorte à TaVRN2, est également associé à la réponse de vernalisation. Cependant, le lien entre ces trois gènes/protéines au niveau moléculaire restait inconnu. Dans cet article, nous prouvons que TaVRT-2 agit en tant que répresseur direct de la transcription du gène *TaVRT-1*. La protéine TaVRT-2 lie le motif de CARG présent dans la région promotrice du gène *TaVRT-1* et réprime son activité *in vivo*. En revanche, la protéine TaVRN2 ne lie pas la région promotrice *TaVRT-1* ; elle n'a aucun effet direct sur son activité *in vivo*, mais elle peut augmenter l'effet de répression de TaVRT-2, suggérant qu'un complexe de répresseur régule l'expression de *TaVRT-1*. Dans des conditions normales, les transcrits des gènes *TaVRT-2*, *TaVRN2* et *TaVRT-1* s'accumulent dans le méristème apical et dans les jeunes feuilles. Leur profil d'expression durant la vernalisation supportent que TaVRT-2 et TaVRN2 sont les répresseurs de la transition florale alors que TaVRT-1 est l'activateur de cette phase. Chez le blé de printemps (qui ne nécessite pas de vernalisation pour fleurir), le gène *TaVRT-2* s'exprime à 20°C en jours court et la floraison est retardée, indiquant que le gène de vernalisation *TaVRT-2* est réglé indépendamment des basses températures. Une surexpression de *TaVRT-2* chez *Arabidopsis* dérègle l'expression de nombreux gènes de développement et retarde la floraison jusqu'à 10 jours chez les plantes transgéniques. Ce résultat, bien que dans un système hétérologue, supporte une fois de plus que la protéine TaVRT-2 est capable de retarder la floraison chez les plantes vernalisables.

Abstract

In wheat, VRN1/TaVRT-1 and VRN2/TaVRN2 determine the growth habit and flowering time. In addition, the MADS-box transcription factor VEGETATIVE TO REPRODUCTIVE TRANSITION-2 (TaVRT-2) is also associated with the vernalization response in a manner similar to TaVRN2. However, the molecular relationship between these three genes and their products is unknown. Using transient expression assays in *Nicotiana benthamiana*, we show that TaVRT-2 acts as a repressor of *TaVRT-1* transcription. TaVRT-2 binds the CArG motif in the *TaVRT-1* promoter and represses its activity *in vivo*. In contrast, TaVRN2 does not bind the *TaVRT-1* promoter and has no direct effect on its activity, but it can enhance the repression effect of TaVRT-2. This suggests that a repressor complex regulates the expression of *TaVRT-1*. In winter wheat, *TaVRT-2*, *TaVRN2* and *TaVRT-1* transcripts accumulate in the shoot apical meristem and young leaves, and temporal expression is consistent with TaVRT-2 and TaVRN2 being repressors of floral transition while TaVRT-1 is an activator. Unvernalized spring wheat under short day photoperiod accumulates *TaVRT-2* and shows delay in flowering, suggesting that *TaVRT-2* is regulated independently by photoperiod and low temperature. Overexpression of *TaVRT-2* in *Arabidopsis* alters the expression of three flowering genes and delays flowering by over 10 days. The data presented suggest that TaVRT-2, in association with TaVRN2, represses the transcription of *TaVRT-1* and delays flowering.

Introduction

Vernalization, the exposure to low temperature (LT) to promote flowering, is an adaptive mechanism that plants use to cope with LT stress and survive extreme winter conditions. A vernalization requirement results in a delay in flowering by postponing the transition from the vegetative to the reproductive phase, and thus prevents damage to the LT-sensitive flowering meristem when temperatures drop below the freezing point. Similarly, the day length sensitivity (or photoperiod response) regulates the developmental switch under short-day (SD) or long-day (LD) conditions. Plants sensitive to both responses synchronize successful flowering with seasons by expressing various regulatory genes at different levels and moments in time (Fowler *et al.*, 1996; Fowler *et al.*, 2001; Reeves and Coupland, 2000).

In *Arabidopsis*, flowering results from the integration of the vernalization and photoperiod responses, and environment-independent pathways such as the autonomous and gibberellin pathways (Levy and Dean, 1998). Interactions between the vernalization and photoperiod responses have been studied using natural variants and mutants, which led to the identification of several flowering-associated genes involved in both responses (for reviews, see Amasino, 2005; Searle and Coupland, 2004; Simpson *et al.*, 2003). Additional molecular studies have revealed that the vernalization response in *Arabidopsis* is regulated by two major loci, *FRIGIDA (FRI)* and *Flowering Locus C (FLC)* (Michaels and Amasino, 1999). No genes corresponding to *FRI* or *FLC* were found in species outside of the *Brassicaceae* family (Hecht *et al.*, 2005; Lee *et al.*, 2005), suggesting that the components of the vernalization process have diverged after the evolutionary split of this family from other angiosperms.

In wheat, the vernalization requirement determines the growth habit. Spring varieties do not respond to vernalization whereas winter varieties have an absolute vernalization requirement. This response is regulated by at least two key genes,

TaVRT-1 and *TaVRN2* (unrelated to the *Arabidopsis VRN* genes; Gendall *et al.*, 2001; Levy *et al.*, 2002), which control the genetic response to vernalization in cereals. The *TaVRT-1* gene (also identified as *TaVRT1* or *WAP1*) encodes a MADS-box transcription factor that belongs to the *Arabidopsis* AP1/SQUA clade, and is associated with floral transition and LT tolerance in cereals (Danyluk *et al.*, 2003; Murai *et al.*, 2003; Yan *et al.*, 2003). The *TaVRN2* gene encodes a zinc finger-CCT domain transcription factor (*ZCCT*) that was reported as a dominant flowering repressor in wheat (Yan *et al.*, 2004b). Another wheat MADS-box gene, *TaVRT-2*, belongs to the *StMADS11* clade of flowering repressors and its expression is regulated by vernalization (Kane *et al.*, 2005). Like *TaVRN2*, *TaVRT-2* transcripts accumulate during the vegetative phase and decline towards the transition to the reproductive phase. It was suggested that the presence of *TaVRN2* and *TaVRT-2* transcripts early during LT exposure could reduce or delay the expression of *TaVRT-1* (Kane *et al.*, 2005). When the vernalization requirement is fulfilled, *TaVRN2* and *TaVRT-2* transcripts are down-regulated concomitantly with the accumulation of *TaVRT-1* transcripts, and flowering is initiated provided the photoperiod requirement is met.

It is not known how the three genes interact at the molecular level during vernalization and how they regulate flowering time. It was suggested that a DNA-binding motif specific to MADS-box proteins in the *TaVRT-1* promoter and a large insertion in the first intron of this gene could be potential regulatory sites that confer the vernalization response in cereals (Fu *et al.*, 2005; Yan *et al.*, 2004a). *TaVRN2* has been assumed to be a negative regulator of *TaVRT-1* expression (Yan *et al.*, 2004b) but available evidence argues against the fact that *TaVRN2* is a direct repressor of *TaVRT-1* transcription. First, *TaVRN2* encodes a zinc finger protein and bioinformatics analyses did not reveal any consensus zinc finger binding sites in the *TaVRT-1* promoter region. Second, the absence of *TaVRN2* does not always result in the upregulation of *TaVRT-1* in non-vernalized plants grown under SD conditions,

suggesting the existence of another repressor of *TaVRT-1* expression (Dubcovsky *et al.*, 2006).

Our previous study suggested that TaVRT-2 could be a major player in the regulation of the transition from the vegetative to reproductive phase in wheat (Kane *et al.*, 2005). The present study was initiated to determine the function of this protein and how it regulates and interacts with other major vernalization genes. The results demonstrate that TaVRT-2 binds the *TaVRT-1* promoter and represses its activity *in vivo*, and that the repression is enhanced by TaVRN2.

Results

TaVRT-2 binds the CArG motif present in the *TaVRT-1* promoter

To investigate the regulation of *TaVRT-1* expression, we isolated and sequenced a 1 kb genomic DNA fragment covering 820 bp upstream of the 5'UTR from six hexaploid winter and spring cultivars that differ in their vernalization requirement (Figure 1a). Sequence analysis indicated that there are few polymorphisms between the different cultivars and that there is a 17 bp deletion found only in the promoter from the spring cultivar Manitou. It is thus unlikely that polymorphisms can explain the difference in *TaVRT-1* expression between the winter and spring cultivars. All the isolated promoters possess a non-canonical CArG motif with the CCTCGTTTTGG sequence, a motif that is a binding site of MADS-box transcription factors. We hypothesized that TaVRT-2 could regulate *TaVRT-1* expression through its binding to this CArG motif. To confirm this, electrophoresis mobility gel shift assays (EMSA) were carried out using the TaVRT-2 recombinant protein and promoter fragments with an intact, deleted or mutated CArG motif (Figure 1b,c). A clear shift is observed with the intact CArG motif and is competed out when nonradioactive promoter fragments are used. When the CArG motif or flanking sequences are mutated or absent, or when a truncated TaVRT-2 protein lacking the MADS domain is used, no shift is observed (Figure 1c and data not shown). Although no consensus zinc finger binding site was found in the *TaVRT-1* promoter, the TaVRN2 protein was also tested in EMSA and no shift was observed (data not shown). Together, these results indicate that TaVRT-2 physically and specifically binds the CArG motif of the *TaVRT-1* promoter via its MADS domain, and could thus be a *trans*-acting element that regulates transcription of *TaVRT-1* during vernalization in wheat.

TaVRT-2 represses *TaVRT-1* promoter activity *in vivo*

To characterize the interaction between TaVRT-2 and the *TaVRT-1* promoter *in vivo*, we adapted the transient expression system based on the agroinfiltration of *Nicotiana benthamiana* leaves (Voinnet *et al.*, 2003). To optimize the procedure, we infiltrated plants at different developmental age with an *Agrobacterium* strain carrying the *TaVRT-1_{PROM}:GFP* reporter construct consisting of the GFP gene under the control of the *TaVRT-1* promoter. After infiltration and a two-day recovery period, plants were exposed for various periods to either control (24°C) or LT (4°C) conditions, then confocal microscopy was used to assess *TaVRT-1* promoter activity as reflected by the level of green fluorescent protein (GFP) fluorescence. The results indicate that the *TaVRT-1* promoter is more active in older plants (28 day-old) and that the activity is induced by LT (4°C) (Figure 2). The highest activity was obtained when 28 day-old plants were infiltrated then exposed to LT for 8 days, therefore these conditions were used for subsequent experiments. These results were surprising since *Nicotiana* species are not responsive to vernalization and cold acclimate only to a limited degree. It is possible that the GFP transcript and/or protein is more stable under these conditions. Most importantly, these data show that *Nicotiana* possesses the elements required for *TaVRT-1* promoter activity and that this approach is suitable for our study.

To determine if the physical interaction between TaVRT-2 and the *TaVRT-1* promoter can influence *TaVRT-1* expression, plants were co-infiltrated with the reporter construct and with effector constructs carrying the corresponding cDNAs under the control of the CaMV 35S promoter (Figure 3a). RT-PCR analyses confirmed that all the effector constructs are expressed properly in the agroinfiltrated leaves (Figure 3b). In contrast to the results obtained when the reporter construct is used alone (Figure 3c, panel 1), a significant decrease in GFP fluorescence is observed in plants co-infiltrated with the *TaVRT-2* construct (Figure 3c, panel 2), indicating that TaVRT-2 represses *TaVRT-1* promoter activity. On the other hand,

when *TaVRN2* is used as an effector, no decrease in GFP fluorescence is observed indicating that *TaVRN2* has no direct influence on *TaVRT-1* promoter activity (Figure 3c, panel 3). When both the *TaVRT-2* and *TaVRN2* constructs are co-infiltrated, GFP fluorescence is lower compared to plants where *TaVRT-2* alone is used as effector (Figure 3c, compare panels 2 and 4). Co-infiltration of *Nicotiana* leaves with the *TaVRT-1* effector construct does not result in a fluorescence level different from what is observed when no effector is used, suggesting that *TaVRT-1* has no effect on its own promoter under the conditions used (Figure 3c, panel 5). Finally, when *TaVRT-2* and *TaVRT-1* are coexpressed, the level of GFP fluorescence is similar to what is observed when *TaVRT-2* alone is used, indicating that *TaVRT-1* cannot compete the repression effect of *TaVRT-2* (Figure 3c, panel 6). To better assess the accumulation of the GFP reporter protein, a western blot analysis was performed on protein extracts prepared from the agroinfiltrated leaves. The data obtained support the GFP fluorescence data shown in Figure 3c. Interestingly, in leaves co-infiltrated with the *TaVRT-2* and *TaVRN2* effector constructs, the GFP protein is barely detectable indicating that *TaVRN2* can enhance the repression effect of *TaVRT-2*. Taken together, these results show that *TaVRT-2* directly represses *TaVRT-1* promoter activity *in vivo* under our experimental conditions.

***TaVRT-2*, *TaVRN2* and *TaVRT-1* are expressed in the same cells of the shoot apical meristem and young leaves**

Northern blot analyses had shown that *TaVRT-2* is expressed during the vegetative phase while *TaVRT-1* is expressed at and after the transition to the reproductive phase (Danyluk *et al.*, 2003; Kane *et al.*, 2005). To determine the spatial and temporal expression of *TaVRT-2*, *TaVRN2* and *TaVRT-1* during vernalization and floral transition of wheat, *in situ* hybridization experiments were performed. The transcripts accumulation was monitored in longitudinal sections of shoot apical meristem (SAM) and young leaves at different developmental stages and times of LT

acclimation (Figure 4). In winter wheat, which requires vernalization, *TaVRT-2* and *TaVRN2* transcripts are present in cells of SAM and young leaves during the vegetative phase, while *TaVRT-1* transcript is barely detectable. After the vernalization requirement is fulfilled, (after 49 days of LT treatment), *TaVRT-2* transcript is still present but not *TaVRN2*, while *TaVRT-1* is detected in the same cells. In spring wheat, which does not require vernalization to initiate flowering, *TaVRT-2* and *TaVRN2* transcripts are not detected during the LT treatment nor at any developmental stage (data not shown). Taken together, the results indicate that *TaVRT-2*, *TaVRN2* and *TaVRT-1* transcripts accumulate in the same cells of the SAM and young leaves but show specific expression patterns according to the developmental stage. *TaVRT-2* and *TaVRN2* transcripts accumulate preferentially during the vegetative phase whereas *TaVRT-1* transcripts accumulate towards the transition to the reproductive phase.

Photoperiod affects flowering time and regulates the expression of vernalization genes

To study the effect of photoperiod independently of the responses to LT exposure, plants were grown under LD or SD conditions at 20°C and flower development was monitored by observing the differentiation of the main stem shoot apices (Figure 5a). Under LD conditions, spring wheat flowers rapidly while under SD conditions, spikelet formation is delayed. The double ridge appears after 3-4 weeks and the apical meristem differentiates into spikelet and floret meristems with glume primordia within 22 weeks. In contrast, non-vernalized winter wheat remains in the vegetative phase whether grown under LD or SD conditions.

RT-PCR analyses were performed to determine if the delay in flowering observed under SD is associated with differential gene expression. The results show that *TaVRT-2* and *TaVRN2* transcripts accumulate in both spring and winter wheat at

least until 70 days of growth (Figure 5b). *TaVRT-1* transcripts are slightly detected in spring wheat but not in winter wheat, suggesting that *TaVRT-1* expression is down-regulated by the presence of products encoded by *TaVRT-2* and/or *TaVRN2* transcripts. When plants grown for 70 days under SD are shifted to LD conditions for 28 days, the *TaVRT-2* transcript level decreases whereas *TaVRN2* transcripts remain at the same level and *TaVRT-1* transcripts begin to accumulate. Together, the data in Figure 5 indicate that *TaVRT-2* and *TaVRT-1* expression is regulated by photoperiod independently of LT, and that the delay in flowering observed in spring wheat under SD could be due to the high level of *TaVRT-2* transcripts.

TaVRT-2* delays flowering in *Arabidopsis

To investigate the role of *TaVRT-2* in modulating flowering time, transgenic *Arabidopsis* plants expressing *TaVRT-2* under the control of the CaMV 35S promoter were produced. Among the hemizygous T1 lines showing a delayed flowering time phenotype under LD conditions, 19 lines were randomly selected, brought to the T2 generation, and the flowering time phenotype was again assessed. Finally, four lines were selected based on the strength of their phenotype and brought to the T3 generation. The L1 and L5 lines flower 7 to 10 days later than the control line while lines L17 and L23 flower 15-days later than the control lines (Figure 6a). The delay in flowering time is measured by the number of rosette leaves at time of bolting (Figure 6b). In addition to their flowering phenotype, lines L17 and L23 have shorter siliques compared to control plants (Figure 6a). Lines L17 and L23 have higher *TaVRT-2* transcript levels compared to lines L1 and L5 (Figure 6c), indicating that the extent of flowering delay is associated with the level of transcript accumulation. To determine the impact of overexpressing *TaVRT-2* in *Arabidopsis*, we have measured the accumulation level of 7 flowering-associated genes using RT-PCR. The results show that the expression of FCA and FY decreases while FLC increases in the transgenic plants (Figure 7).

Discussion

Selective pressure during domestication and modern breeding of wheat resulted in a complex flowering mechanism modulated by photoperiod and vernalization. In spring wheat, the *TaVRT-1* allele is dominant and the plants have the competence to flower without any environmental stimuli. In contrast, winter wheat possesses a recessive *TaVRT-1* allele and requires vernalization to flower. Negative regulators of the transition from vegetative to reproductive phase ensure that *TaVRT-1* transcription is kept at a low level during winter, therefore delaying floral transition and preventing damages to the cold-sensitive flowering meristem. The expression of photoperiod-responsive genes is modulated to trigger the development of flowers when the inductive day length conditions are met. *TaVRT-1* is a positive regulator that triggers the transition from the vegetative to the reproductive phase (Yan *et al.*, 2003), whereas *TaVRN2* is a negative regulator (Yan *et al.*, 2004b). Decreasing the level of *TaVRN2* transcripts by RNA interference resulted in transgenic wheat plants that accumulate high levels of *TaVRT-1* transcripts and flower 40 days earlier than wild type plants. However, the down-regulation of *TaVRN2* in cultivars that show natural mutation or deletion of this gene is not always correlated with an increased accumulation of *TaVRT-1* transcripts and concomitant flowering initiation (Dubcovsky *et al.*, 2006). This indicates that there is another negative regulator of *TaVRT-1* expression.

Regulation of vernalization-responsive genes by photoperiod

In contrast to spring wheat, winter wheat acquires flowering competence only after a long-term exposure to LT conditions. In both growth habit cultivars, floral induction is accelerated under LD conditions (Danyluk *et al.*, 2003; Dubcovsky *et al.*, 2006; Fowler *et al.*, 2001). The development of the spikelet meristem into the terminal spikelet is delayed in spring wheat plants grown at normal temperature (20°C) under SD, possibly because a high level of *TaVRT-2* transcripts is maintained

under these conditions. Similar effects on meristem differentiation were observed in transgenic rice plants expressing *OSMADS22*, the *TaVRT-2* homologue in rice (Sentoku *et al.*, 2005). When spring wheat is shifted to LD conditions, *TaVRT-2* transcript levels decrease even though plants are not exposed to LT. This indicates that *TaVRT-2* expression is modulated independently by LT and photoperiod.

During the course of domestication, spring varieties have been selected for cultivation under LD conditions to accelerate flowering and harvest. It is possible that LD photoperiod triggers specific signals to downregulate *TaVRT-2* and initiate flowering. Interestingly, *TaVRT-2* maps to the short arms of group 7 chromosomes in a region associated with QTLs involved in ear emergence, photoperiod and heading date (Kane *et al.*, 2005, and references therein). More recently, the *TaVRT-2* homologue in barley was associated with a photoperiod-responsive QTL (Szucs *et al.*, 2006). Overall, these data suggest that *TaVRT-2* may contribute to these QTL effects and that the *TaVRT-2* protein may play a role in the integration of photoperiod and vernalization signals.

Regulation of *TaVRT-1* expression

The *TaVRT-2*, *TaVRN2* and *TaVRT-1* transcripts accumulate in the SAM and young leaves. These tissues were identified as the perception sites of vernalization and floral initiation in wheat (Yong *et al.*, 2003), sugar beet (Crosthwaite and Jenkins, 1993), *Arabidopsis* (Searle *et al.*, 2006; Sung and Amasino, 2004), and ryegrass (Petersen *et al.*, 2006). The fact that the three genes are expressed in the same active cells, albeit at different developmental stages in some cases, indicates that interactions between the encoded proteins could be required to modulate the vernalization signal as well as the photoperiod response to properly time flowering in wheat.

TaVRT-1 and *TaVRT-2* encode MADS-box transcription factors. These factors bind specific sites called CArG boxes in the promoter regions of their target genes, resulting in the activation or repression of gene expression. The presence of a CArG

motif in the *TaVRT-1* promoter suggested that MADS-box proteins can regulate its activity. In addition, wheat varieties having a deletion in the CArG motif of the *TaVRT-1* promoter show increased levels of *TaVRT-1* transcripts (Dubcovsky *et al.*, 2006). Our expression studies of several wheat MADS-box genes indicated that only three genes, including *TaVRT-1* and *TaVRT-2*, are associated with the vernalization response (Danyluk *et al.*, 2003; Kane *et al.*, 2005); N. Kane *et al.* unpublished results). *In vitro* binding assays and *in vivo* transient expression analyses showed that TaVRT-2 binds the CArG motif in the *TaVRT-1* promoter and represses its activity. In contrast, TaVRN2 does not bind and does not activate the *TaVRT-1* promoter by itself. This demonstrates that TaVRT-2 can act as a direct repressor of *TaVRT-1* expression. In addition, we cannot rule out the possibility that TaVRT-2 and/or TaVRN2 could bind to the first intron of *TaVRT-1* gene. Bioinformatics analysis of the 2.8 kb first intron indicated the presence of a CArG motif (CTAATATATG), but this motif falls outside of the 440 bp region that was suggested to be a putative vernalization-responsive regulatory region (Dubcovsky *et al.*, 2006).

Members of the MADS-box family often homodimerize or combine with other MADS-box or other transcriptional regulators to achieve functional diversity and control key developmental events (Immink and Angenent, 2002; Riechmann *et al.*, 1996). Intriguingly, protein-protein interaction studies indicated that in addition to their homodimerization capacity, TaVRT-1 and TaVRT-2 have high affinity with each other (Kane *et al.*, 2005). It is possible that in addition to regulating *TaVRT-1* transcription, TaVRT-2 may be required to titrate out the TaVRT-1 protein by protein-protein interaction to prevent floral transition. As the level of TaVRT-2 decreases towards vernalization saturation, TaVRT-1 accumulates and could form heterodimers with other partners that would activate *TaVRT-1* expression or stabilize its protein. A similar mechanism involving API-like and SVP-like proteins has been proposed for *Antirrhinum majus* (Masiero *et al.*, 2004) and *Lolium perenne* (Petersen *et al.*, 2006). Positive or negative auto-regulatory feedback loops have been proposed as a common mechanism to regulate expression of MADS-box genes (de Folter and

Angenent, 2006; Egea-Cortines *et al.*, 1999). It is possible that a TaVRT-1 heterodimer may bind the CArG-motif in its own promoter for positive auto-regulation once the level of TaVRT-2 protein is down. Such a mechanism of auto-regulation was suggested for the *TaVRT-1* orthologue in barley (Trevaskis *et al.*, 2006) and other MADS-box genes involved in the flowering process (de Folter *et al.*, 2005; de Folter and Angenent, 2006). However, our transient expression assays showed that there is no increase in *TaVRT-1* promoter-dependent GFP expression when the *TaVRT-1* effector construct is used alone or with *TaVRT-2*. In a recent study, Ciannamea *et al.* (2006) demonstrated that the vernalization gene *LpMADS1* from *Lolium perenne*, a homologue of *TaVRT-1*, interacts with *LpMADS10*, a homologue of *TaVRT-2*. A yeast one hybrid screen and gel retardation assays were used to show that the promoter region containing a CArG motif is bound by an LpMADS1-LpMADS10 heterodimer. This higher order protein complex only binds efficiently to the promoter element from the winter variety. Based on these data, it was suggested that *LpMADS1* (*TaVRT-1*) is regulated by a higher order complex according to the quartet model.

Another property of MADS-box proteins is their capacity to allow the formation of multicomponent regulatory complexes with proteins that are not MADS-box factors (de Folter and Angenent, 2006). There is a possibility that once bound to the *TaVRT-1* promoter, TaVRT-2 may recruit other proteins that activate or repress *TaVRT-1* transcription. A yeast two-hybrid interaction screen and bimolecular fluorescent complementation assays revealed that TaVRT-2 interacts with a floral homeotic AP2 protein, a putative RING-H2 zinc finger protein, a C3H2C3 ring-finger protein-like, a protein homologous to a 26S proteasome regulatory subunit, and a helicase-like protein (Table 1 and Tardif *et al.*, 2007). Both heterochromatin modification and ubiquitination of target proteins have been identified as epigenetic regulatory mechanisms of vernalization and early stages of plant development, respectively (Amasino, 2004; Ausin *et al.*, 2004; Kim *et al.*, 2004; Serrano *et al.*, 2006). Therefore, there is a possibility that these proteins could, by their interaction

with TaVRT-2, modify higher-order complexes that ensure a coordinated regulation of *TaVRT-1* expression.

TaVRT-2 is a flowering repressor

Overexpression of *TaVRT-2* in *Arabidopsis* delays flowering time. The closest TaVRT-2 homologues from the MADS-box family are SVP (SHORT VEGETATIVE PHASE) in *Arabidopsis* (Hartmann *et al.*, 2000) and INCOMPOSITA (INCO) in *Antirrhinum* (Masiero *et al.*, 2004). The overexpression of *SVP* or *INCO* in *Arabidopsis* and *Antirrhinum* also results in a delay in flowering time. In addition, floral morphogenesis is affected in these transgenic plants, where flowers show leaf-like features such as branched trichomes on sepals, petals and carpels, and sepaloid petals (Masiero *et al.*, 2004). No such effects were seen in the *TaVRT-2*-overexpressing plants. The delay in flowering may result from a modulation of the expression of downstream genes or by titration of proteins that positively regulate floral transition. A similar mechanism was reported for the flowering repressors SVP (Gregis *et al.*, 2006; Hartmann *et al.*, 2000) and FLC (Searle *et al.*, 2006) in *Arabidopsis*. It could be argued that the results obtained for the *TaVRT-2*-overexpressing *Arabidopsis* plants (delay in flowering) do not necessarily reflect the function of TaVRT-2 in wheat. However, overexpression of another wheat MADS-box gene, *TaVRT-1*, produces an early flowering phenotype in *Arabidopsis* (unpublished data). This indicates that the two MADS-box genes lead to opposite phenotypes when ectopically expressed in *Arabidopsis*, suggesting that the effect on flowering is specific for these genes.

RT-PCR analyses revealed that overexpressing *TaVRT-2* in *Arabidopsis* alters the expression of at least three flowering time genes. During floral development of *TaVRT-2* transgenic plants, the mRNA level of *FCA* and *FY* decreases whereas the level of *FLC* increases. This is consistent with flowering regulation by the autonomous pathway. In wild type plants, genes of the autonomous pathway such as *FCA* and *FY* induce flowering by reducing the level of the repressor *FLC* at both the

mRNA and protein levels. This suggests that the delay in flowering observed in the transgenic *TaVRT-2*-overexpressing plants is due to the accumulation of FLC via the autonomous pathway.

Based on our data, we propose a hypothetical model of *TaVRT-1* regulation in winter wheat (Figure 8). *TaVRT-2* and *TaVRN2* accumulate during the vegetative phase. *TaVRT-2* directly binds the CArG box of the *TaVRT-1* promoter and represses its activity. This repression effect is enhanced or stabilized by *TaVRN2*. Upon vernalization, *TaVRT-2* and *TaVRN2* levels decline, allowing the gradual accumulation of *TaVRT-1* which leads to the transition from vegetative to reproductive phase. LD conditions maintain *TaVRT-1* in an upregulated state and promote flowering.

Experimental procedures

Plant material and growth conditions

Six varieties of hexaploid wheat (*Triticum aestivum* L.) including three spring habit cultivars (Concorde, Glenlea, Manitou) and three winter habit cultivars (Cheyenne, Absolvent, Norstar) were grown in environmentally-controlled growth chambers as previously described (Danyluk *et al.*, 2003). Briefly, seedlings were germinated for 2 weeks under long day (LD, 16h) photoperiod at 20°C and kept under LD or transferred under short day (SD, 8h) photoperiod as indicated in the figure legends. For cold treatment, germinated plants were transferred at 4°C under LD conditions as indicated in the figure legends.

Cloning of cDNAs and promoters

The isolation of cDNAs from winter wheat Norstar was described previously (Danyluk *et al.*, 2003; Kane *et al.*, 2005). The *TaVRT-1* promoter region of the A genome was PCR-amplified from genomic DNA of several wheat cultivars using specific primers: 5'-CTGGTCGGTATACACGCACAGCACAGTACCCCTA-3' and 5'-GCGCCCCATCTCCGCTCGAGAACC-3'. Promoter sequences were determined then analyzed using Plant-CARE (Lescot *et al.*, 2002), Genomatix Promoter Database (<http://www.genomatix.de/products/GPD/index.html>), and PLACE (Higo *et al.*, 1999).

Electrophoresis mobility shift assays (EMSA)

The full length *TaVRT-2* coding region and a truncated version lacking the MADS domain (IKC) were cloned in the pENTR4 vector then transferred to the pDEST15 vector by recombination using the Gateway technology (Invitrogen; for primers, see Table S1). The resulting plasmids pDEST15-TaVRT-2 and pDEST15-TaVRT-2IKC were independently transformed into *Escherichia coli* BL21-A1 to

express GST-fusion proteins. The proteins were purified on GST·Bind affinity resin (Novagen) and used in EMSA to determine their binding affinity towards the *TaVRT-1* promoter. Sense and complementary oligonucleotides corresponding to wild type and mutated CARG motif region were annealed and radiolabelled with [γ - 32 P] ATP (Amersham) to generate double-stranded probes (Figure 1b). DNA binding reactions were performed in a total volume of 20 μ l of buffer (10 mM Tris-HCl pH 7.5, 4% glycerol, 20 mM KCl, 20 mM dithiothreitol) containing 1 μ M of polydI.dC, 0.2% (v/v) Triton X-100, 2 ng ($\sim 5 \times 10^4$ CPM) of probe, and 10, 50 or 100 ng of the recombinant GST-tagged proteins. The binding specificity was assessed by competition with a 10, 100 or 200-fold excess of unlabelled double-stranded oligonucleotides. Binding reaction mixtures were incubated for 15 min at room temperature and then resolved by electrophoresis on a 4% nondenaturing polyacrylamide gel, prepared in 0.5X TBE, at 100 V for 90 min. The gels were dried, exposed to K screens and the signal was detected with a Personal Molecular Imager FX System (Bio-Rad).

Transient expression by agroinfiltration of *Nicotiana benthamiana*

Four binary constructs based on pBin19 or pGreenII0029 were generated for transient expression assays. The primers used for cloning are indicated in Suppl. Table 1. The *TaVRT-1prom:GFP* reporter plasmid contained the *mGFP_{er}* gene under the control of the *TaVRT-1* promoter, and the effector constructs contained the *TaVRT-2*, *TaVRN2* or *TaVRT-1* genes under the control of the CaMV 35S promoter. The plasmids were independently transformed into *Agrobacterium tumefaciens* strain EHA105. The transformed *Agrobacteria* were used individually or in combination to infiltrate intact leaves of *Nicotiana benthamiana* according to Voinnet *et al.* (2003). To enhance transient expression of the transgenes, *Agrobacteria* carrying the p19 suppressor of PTGS were included along with the binary vectors carrying the other gene constructs. Plants at different developmental stages and various post-infection conditions were tested to determine the optimal conditions for maximal GFP

accumulation. Images of GFP expression were acquired 10 days post-infiltration using an MRC1024 confocal system with a Nikon Eclipse TE300 inverted microscope, and analyzed using the LaserSharp software (Bio-Rad).

***In situ* RNA hybridizations**

Wheat plants were grown to various developmental stages and used for *in situ* RNA hybridization. Specific probes corresponding to *TaVRT-2*, *TaVRN2* and *TaVRT-1* transcripts were PCR-amplified using primers containing the T7 RNA polymerase initiation site (Table S1). These PCR fragments were used as templates for synthesis of antisense digoxigenin-labelled riboprobes, using the UTP-DIG (Roche) and T7 MAXIscript (Ambion) kits. Each amplification product was tested by Southern blotting to confirm the specificity of the probe (data not shown).

The plant parts containing the shoot apical meristems (SAM) and young leaves were fixed for 8 h at 4°C in fixation buffer (4% paraformaldehyde, 0.1 M phosphate buffer, pH 7.0), dehydrated through a graded series of ethanol and butanol dilutions, embedded in Paraplast plus (Paraplast X-Tra, Oxford Labware) and sectioned to 7 µm with a microtome. Tissue sections were de-paraffinized with xylene, rehydrated through an ethanol series, and then pre-treated with Proteinase K (0.1 U/mL) in 100 mM Tris-HCl pH 7.5 at 37°C for 15 min. Digestions were stopped by washing with PBS+0.2% glycine and then twice with PBS for 2 min each. After dehydrating in ethanol baths, hybridizations were performed at 42°C overnight with 0.2 µg/mL of the digoxigenin-labelled RNA probes in hybridization solution (50% formamide, 2X SSC, 4X Denhardt's, 20% dextran sulfate, 2 mg/mL tRNA). After hybridization, slides were washed in 2X SSC at 50°C for 45 min and twice in 1X NTE (1 mM Tris-HCl, 0.5 M NaCl, 1 mM EDTA, pH 7.5) at 37°C for 2 min each. An RNase A digestion (20 µg/mL in NTE) was carried out for 30 min at 37°C and stopped by washing with NTE at 37°C. Final washes were done with 2X SSC, 1X SSC and 0.5X SSC for 15 min each at 50°C prior to rinsing in PBS. For signal detection, samples were incubated in 10% Blocking Reagent (Roche) prepared in

PBS for 1 h and then for 30 min in Blocking Reagent containing anti-DIG alkaline phosphatase-conjugated Fab fragment antibody (Roche) diluted 1:500. After 3 washes for 10 min in PBS, tissues were equilibrated in detection buffer (100 mM Tris-HCl pH 9.5, 100 mM NaCl, 50 mM MgCl₂) for 15 min prior to incubating in the same buffer supplemented with 0.2 mM nitroblue tetrazolium (NBT) and 0.2 mM 5-bromo-4-chloro-3-indolyl phosphate (BCIP). Images were captured on a Leica Laborlux-S microscope using a Nikon Coolpix 4500 digital camera.

Overexpression of *TaVRT-2* in *Arabidopsis*

A *Pro*_{35S}:*TaVRT-2* construct was generated (for primers, see Table S1) then transformed in *A. tumefaciens* for transformation of *Arabidopsis thaliana* ecotype Columbia by floral-dipping (Clough and Bent, 1998). Transformants were selected on medium containing MS salts and vitamins supplemented with 50 mg/L kanamycin, and resistant T1 seedlings were transferred to soil and grown to maturity under LD conditions (16h photoperiod) at 24/20°C (day/night). Wild-type Columbia and plants transformed with pBIN19 (*Pro*_{35S}:*GUS*) were used as controls. Transgenic lines showing a late flowering phenotype were selected to produce homozygous lines. Flowering time was measured as the number of rosette leaves produced on the main shoot at time of bolting, expressed as means ± SEM. Seedlings were grown for 2 weeks in MS agar and transferred to SD or LD conditions at 20°C. For each treatment, a minimum of 16 plants from each line was used and the experiment was repeated twice.

Molecular analyses

For western blot analysis of transient assays tissues, an anti-GFP antibody (Clontech) was used. For nucleic acids analyses, genomic DNA and total RNA were isolated from aerial parts (wheat), agroinfiltrated leaves (*N. benthamiana*), or leaves (*Arabidopsis*) using DNAzol or TRIzol reagents following the manufacturer's instructions (Invitrogen). Northern blot hybridizations were performed using a

TaVRT-2-specific probe lacking the MADS-domain. For RT-PCR, total RNA was subjected to reverse transcription using the SuperScript™ II Reverse Transcriptase (Invitrogen) according to the manufacturer's recommendations. Primers were designed to specifically amplify the wheat *TaVRT-2*, *TaVRN2*, or *TaVRT-1* transcripts. (Table S1). PCR amplification products were analyzed by electrophoresis on 1% agarose/ethidium bromide gels.

Yeast interaction screen

An interaction screen was performed in yeast using the GAL4 two-hybrid system and GATEWAY technology (Invitrogen). To generate the bait construct, the pENTR4 vector containing the truncated *TaVRT-2* cDNA (lacking the MADS domain) was transferred to pDEST32 (GAL4 binding domain fusion; Invitrogen) by LR recombination and selected clones were sequenced to verify the integrity of the construct. The interaction library was generated from a mix of 4 mRNA populations purified from aerials parts of winter wheat (cv Norstar) (Library 5, Houde *et al.*, 2006): 1 cm crown sections after 30 days of vernalization, 1 cm vernalized crown sections that were exposed to flower inducing conditions for 11 days, different developmental stages of spike formation (5 to 50 mm) before emergence from the leaf (dissection required), and different developmental stages of spike and seed formation after emergence from the leaf (visible). The corresponding cDNAs were cloned in pCMVSPORT6 to generate the original libraries, which were then transferred to pDEST22 (GAL4 activation domain fusion; Invitrogen) by LR recombination. Screening was carried out in the yeast strain MaV203 that contains three GAL4-inducible reporter genes (*HIS3*, *URA3*, *lacZ*). Interactors were re-tested by two-hybrid assays, sequenced, and identified by homology-based search.

Acknowledgements

We thank Karine Tremblay and Geneviève Major for technical assistance, and all lab members for helpful discussions. This work was supported by grants from the Natural Sciences and Engineering Research Council, Genome Canada and G enome Qu ebec.

Table

II-Table 1: TaVRT-2 interactors identified by yeast interaction screening

Interactor	Accession number	Putative function
AP2 floral homeotic protein	AY702957.1	flower organ identity
early light inducible protein (ELIP)	AB019617.1	photosynthesis
heat shock HSP101protein	AAF01280.1	posttranslational modification and protein turnover
alpha subunit of translation elongation factor 1, EF-1 alpha	EB714177	translation, ribosomal structure and biogenesis
remorin 1	EB714178	plant-specific plasma membrane/lipid raft-associated proteins
C ₃ H ₂ C ₃ RING-finger protein-like	EB714180	mediated protein-protein interactions
Wali6	AAC37417.1	genes induced by aluminum in wheat
cold-responsive LEA/RAB-related COR protein	AAF68628.1	cold response
putative helicase SK12W	EB714181	heterochromatin modification
chlorophyll a/b binding protein	EB714182	chlorophyll binding, photosynthesis
26S proteasome regulatory subunit 4 homolog	NP_910447.1	proteasome pathway
ice recrystallization inhibition protein 1 precursor	AAX81542.1	freezing tolerance
putative AP2 domain	EB714184	abiotic stress and hormone response
RING-H2 finger protein	AAP80615	ubiquitination pathway, plant defense

Figures and legends

(a)

```

CHEYENNE      GGGCCAGATCCCTTTAAAACCCCTCCCCCTGCCGGAATCCTCGTTTTGGCC TGGCCA
ABSOLVENT     GGGCCAGATCCCTTTAAAACCCCTCCCCCTGCCGGAATCCTCGTTTTGGCC TGGCCA
NORSTAR       GGGCCAGATCCCTTTAAAACCCCTCCCCCTGCCGGAATCCTCGTTTTGGCC TGGCCA
GLENLEA       GGGCCAGATCCCTTTAAAACCCCTCCCCCTGCCGGAATCCTCGTTTTGGCC TGGCCA
CONCORDE      GGGCCAGATCCCTTTAAAACCCCTCCCCCTGCCGGAATCCTCGTTTTGGCC TGGCCA
MANITOU       GGGCCAGATCCCTTTAAAACCCCTCCCCCTGCCGGAATCCTCGTTTTGGCC TGGCCA
              TATA-box                               CArG motif

CHEYENNE      TCCTCCCTCTCCTCCCTCTCTTCACCTCAGTCCCTCACCCAAACAACCTGATAGCCATG
ABSOLVENT     TCCTCCCTCTCCTCCCTCTCTTCACCTCAGTCCCTCACCCAAACAACCTGATAGCCATG
NORSTAR       TCCTCCCTCTCCTCCCTCTCTTCACCTCAGTCCCTCACCCAAACAACCTGATAGCCATG
GLENLEA       TCCTCCCTCTCCTCCCTCTCTTCACCTCAGTCCCTCACCCAAACAACCTGATAGCCATG
CONCORDE      TCCTCCCTCTCCTCCCTCTCTTCACCTCAGTCCCTCACCCAAACAACCTGATAGCCATG
MANITOU       TCCTCCCTCTCCTCCCTCTCTT-----CCAAACAACCTGACAGCCATG

CHEYENNE      GCTCCGCCGCC TCGCCTCCGCCTGCCAGTCGGAGTAGCCGTCGCCGTCGCCGGTGT
ABSOLVENT     GCTCCGCCGCC TCGCCTCCGCCTGCCAGTCGGAGTAGCCGTCGCCGTCGCCGGTGT
NORSTAR       GCTCCGCCGCC TCGCCTCCGCCTGCCAGTCGGAGTAGCCGTCGCCGTCGCCGGTGT
GLENLEA       GCTCCGCCGCC TCGCCTCCGCCTGCCAGTCGGAGTAGCCGTCGCCGTCGCCGGTGT
CONCORDE      GCTCCGCCGCC TCGCCTCCGCCTGCCAGTCGGAGTAGCCGTCGCCGTCGCCGGTGT
MANITOU       GCTCCGCCGCC TCGCCTCCGCCTGCCAGTCGGAGTAGCCGTCGCCGTCGCCGGTGT

CHEYENNE      GGAGGGTAGGGGCGTAGGGTTGGCCCGGTTCTCGAGCGGAGATG
ABSOLVENT     GGAGGGTAGGGGCGTAGGGTTGGCCCGGTTCTCGAGCGGAGATG
NORSTAR       GGAGGGTAGGGGCGTAGGGTTGGCCCGGTTCTCGAGCGGAGATG
GLENLEA       GGAGGGTAGGGGCGTAGGGTTGGCCCGGTTCTCGAGCGGAGATG
CONCORDE      GGAGGGTAGGGGCGTAGGGTTGGCCCGGTTCTCGAGCGGAGATG
MANITOU       GGAGGGTAGGGGCGTAGGGTTGGCCCGGTTCTCGAGCGGAGATG
    
```

(b)

```

CArG intact
CTGCCGGAATCCTCGTTTTGGCCATC
GACGGCCTTAGGAGCAAAACCGGACGGTAG

CArG mutated
CTGCCGGAATATCGTTTTATCCTGGCCATC
GACGGCCTTATTAGCAAAATAGGACCGGTAG
    
```

(c)

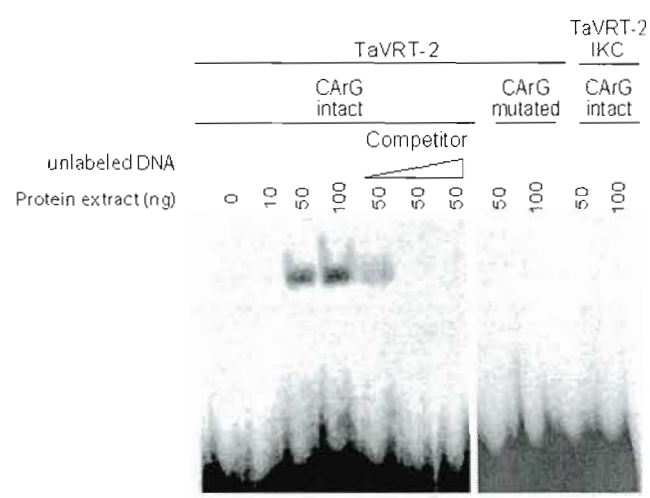

II-Figure 1: Characterization of the *TaVRT-1* promoter

(a) Sequence alignment of *TaVRT-1* promoters isolated from winter (cv Cheyenne, Absolvent, Norstar) and spring (cv Glenlea, Concorde, Manitou) wheat varieties that differ in their vernalization requirement. The putative TATA-box and a CArG motif are indicated. The 5' UTR, determined by comparing the available cDNA sequences with the genomic sequence, is underlined and the ATG translation initiation codon is indicated in bold. (b) Double-stranded oligomers used in the DNA-binding assays. (c) Electrophoretic mobility shift assays (EMSA). Different concentrations of recombinant full length (*TaVRT-2*) or truncated (*TaVRT-2IKC*; no DNA-binding domain) proteins were incubated with ³²P-labeled oligomers containing an intact or mutated CArG motif. Binding specificity was confirmed by competition with a 10, 100 and 200-fold excess of unlabeled oligomer containing an intact CArG motif.

14 day-old plants



24°C

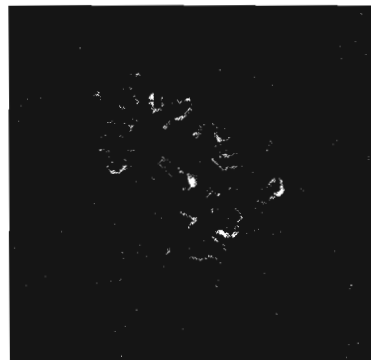

4°C

28 day-old plants

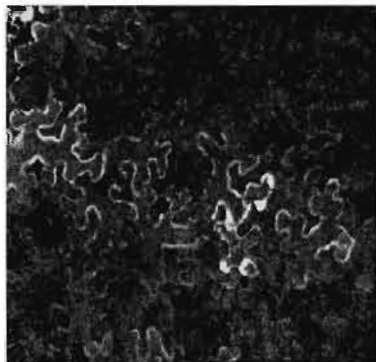

24°C

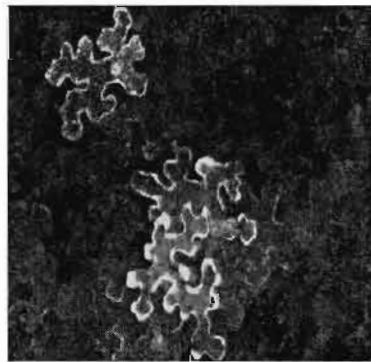

4°C

II-Figure 2 : *TaVRT-1* promoter activity *in vivo*

Intact leaves from 14 and 28-old *Nicotiana benthamiana* plants were infiltrated with *Agrobacterium* strains carrying the *Pro_{TaVRT-1}:GFP* reporter construct. After a recovery period of 2 days at 24°C, the leaves were either kept at 24°C or transferred to 4°C for 8 days. GFP fluorescence was then detected in leaf epidermal cells 10 days post-infection by laser scanning confocal microscopy. The data shown are representative from at least three independent experiments (n = 16 plants). Bar, 60 µm.

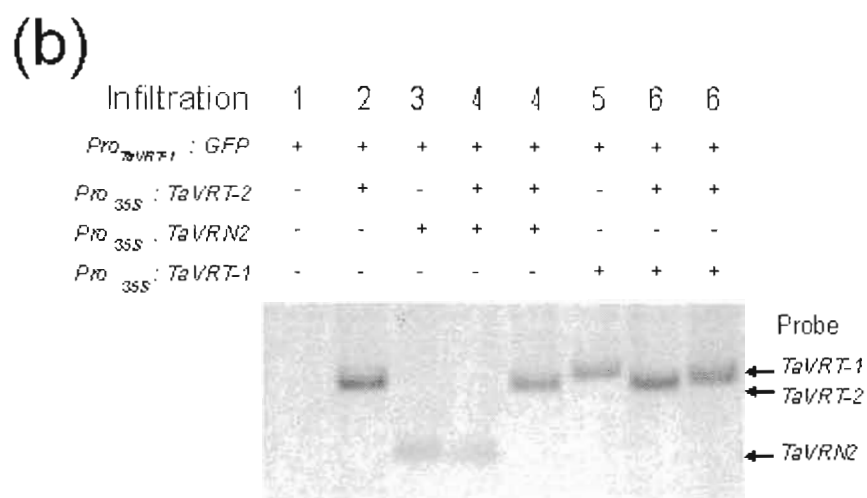
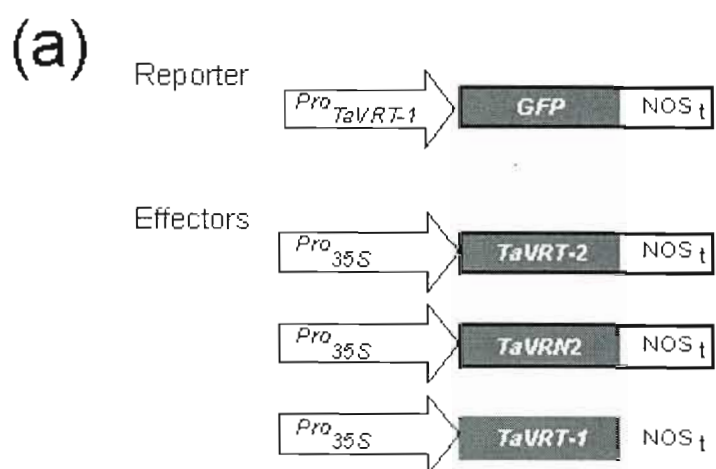

(c)

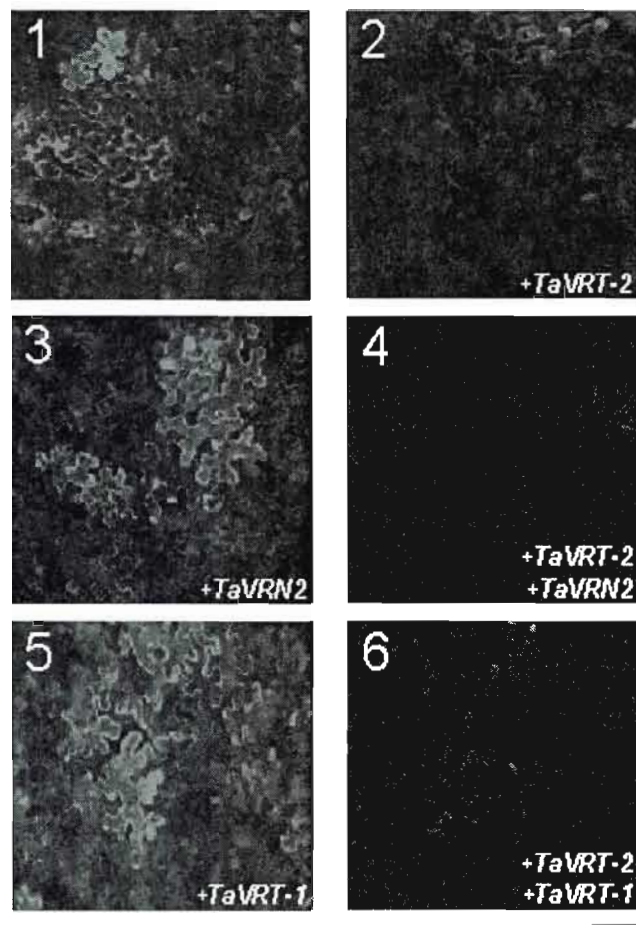

(d)

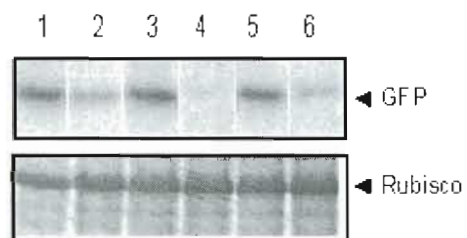

II-Figure 3: Effect of TaVRT-2, TaVRN2 and TaVRT-1 on *TaVRT-1* promoter activity *in vivo*

(a) Reporter and effector constructs used in the transient assays. *Pro_{TaRT1}*, *TaVRT-1* promoter; *Pro_{35S}*, promoter from the cauliflower mosaic virus; GFP, green fluorescent protein; NOST, nopaline synthase terminator. (b) *Nicotiana benthamiana* intact leaves were infiltrated with *Agrobacterium* strains carrying the reporter construct with or without effector constructs. RNA was extracted and used in RT-PCR analysis to confirm that the constructs used are expressed. When two effector constructs were co-infiltrated with the reporter construct, RT-PCR reactions were carried out independently. Infiltration numbers refer to panels shown in c. (c) GFP fluorescence was detected in leaf epidermal cells 7 days post-infection by laser scanning confocal microscopy. Effectors used: none (panel 1), TaVRT-2 (panel 2), TaVRN2 (panel 3), TaVRT-2 and TaVRN2 (panel 4), TaVRT-1 (panel 5), TaVRT-2 and TaVRT-1 (panel 6). The data shown are representative from at least three independent experiments (n = 16 plants). Bar, 60 μ m. (d) Immunoblot analysis of GFP protein accumulation in the agroinfiltrated *Nicotiana* leaves. Lane numbers correspond to the infiltrated samples shown in c. Soluble proteins were separated by SDS-PAGE, transferred to PVDF and an anti-GFP antibody was used to detect GFP. The CBB-stained RUBISCO large subunit show equal loading. The same results were obtained with proteins extracted from 2 independent infiltrations.

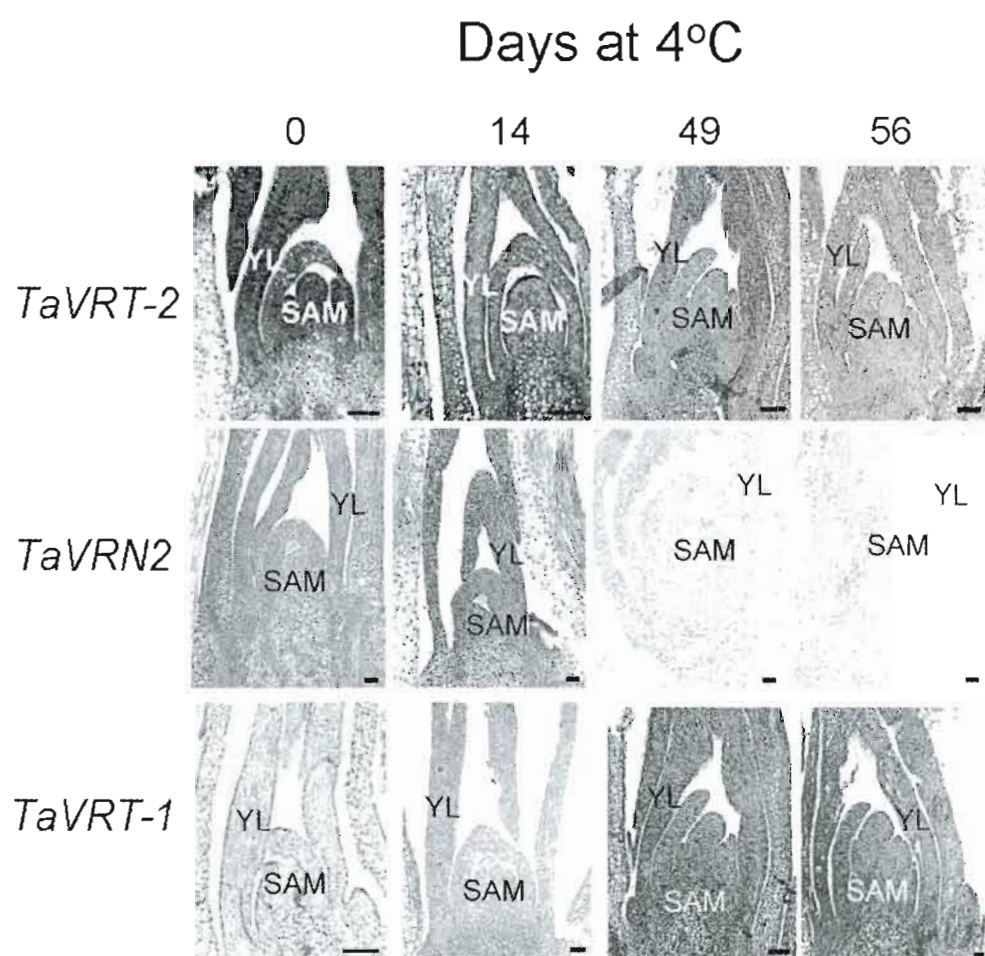

II-Figure 4: *In situ* RNA hybridization analysis of *TaVRT-2*, *TaVRN2* and *TaVRT-1* expression

The region containing the shoot apical meristem (SAM) and young leaf (YL) tissues was sampled from winter wheat before (0) and after 14, 49 and 56 days of cold exposure. Longitudinal sections were hybridized with specific digoxigenin-labeled antisense RNA probes corresponding to the *TaVRT-2*, *TaVRN2* and *TaVRT-1* transcripts. Bars, 0.1 mm.

(a)

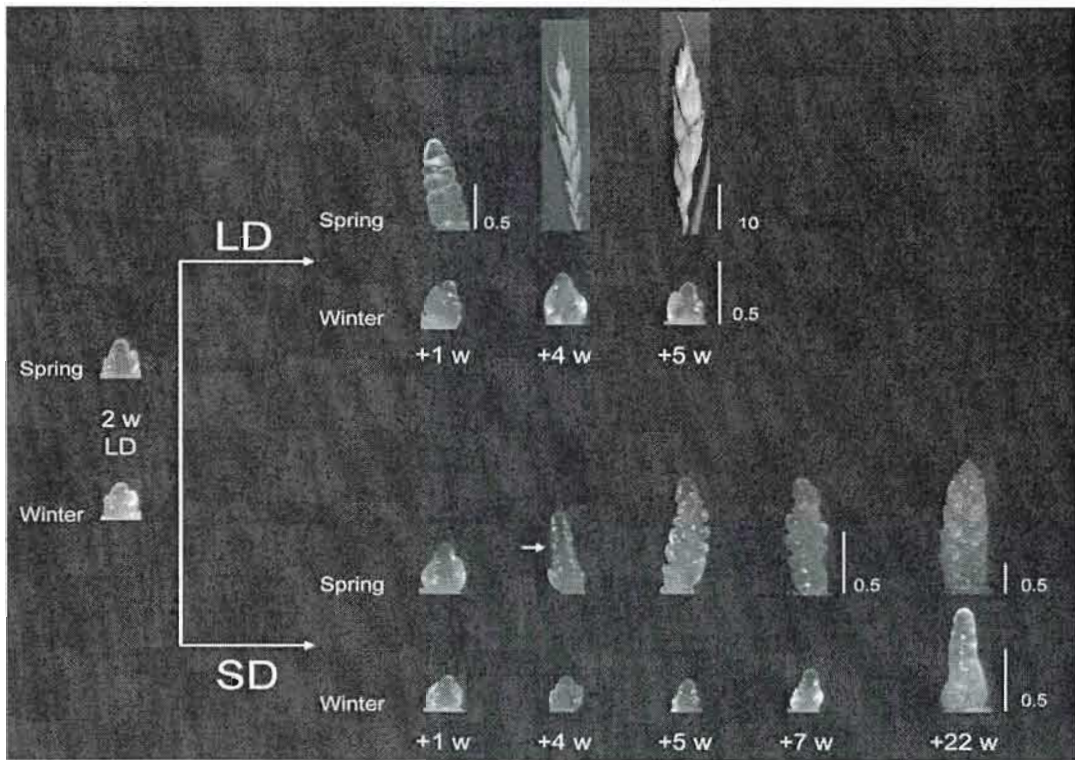

(b)

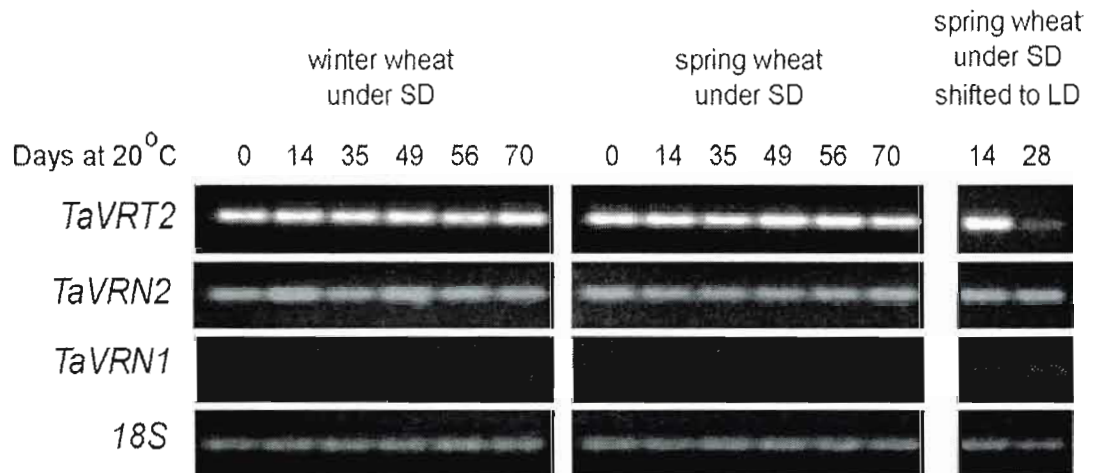

II-Figure 5: Effect of photoperiod on flowering and gene expression

(a) Effect on apex development. After two weeks of germination at 20°C, spring and winter wheat plants were either kept under long day (LD) photoperiod or shifted to short day (SD) conditions. The main stem shoot apices were dissected and photographed. Arrow, double ridge. Scale bars are indicated in mm. (b) Effect on *TaVRT-2*, *TaVRN2* and *TaVRT-1* expression. Total RNA was extracted from aerial parts and transcripts levels were measured by RT-PCR. Winter and spring wheat were grown under SD conditions at 20°C for a period up to 70 days. In addition, spring wheat plants grown for 70 days under SD were shifted to LD conditions and sampled after 14 and 28 days. Total RNA was extracted from aerial parts before (14d) and after (28d) ear emergence. *18S* rRNA was used as internal control.

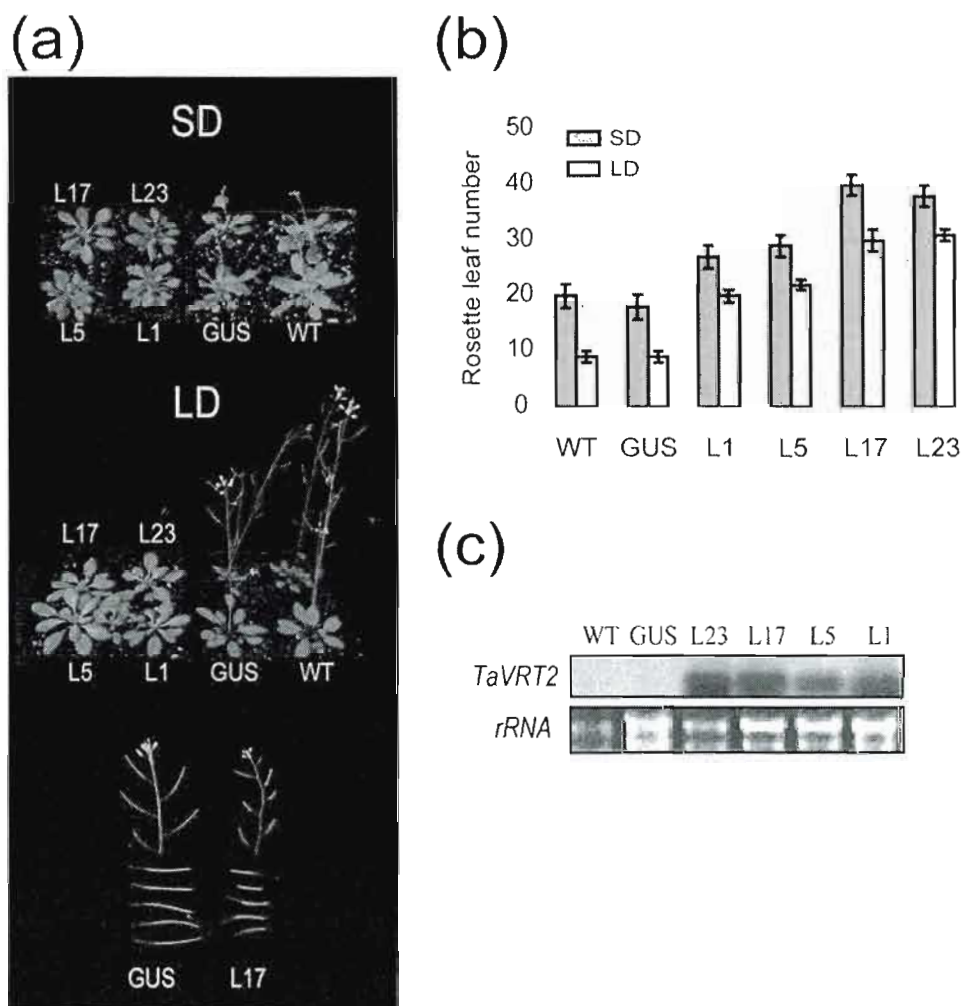

(Adam et al. 2007)

II-Figure 6: *TaVRT-2* overexpression in *Arabidopsis*

(A) Phenotypic effect of *TaVRT-2* overexpression. Wild type (WT) and transgenic plants expressing β -glucuronidase (GUS) or *TaVRT-2* (L1 to L23) were grown for 34 days under short day (SD) or long day (LD) conditions. Lower panel, comparison of silique size between the GUS and L17 lines. (B) Number of rosette leaves at time of bolting, expressed as means \pm SEM (n=20). (C) Northern blot analysis of control and *TaVRT-2*-overexpressing lines.

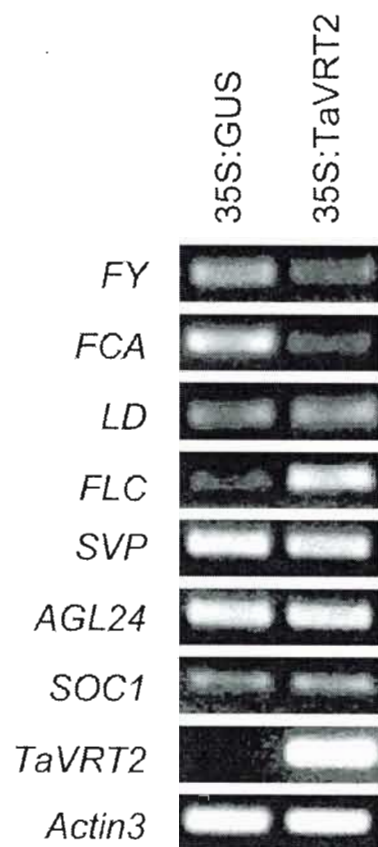

(Adam et al. 2007)

II-Figure 7: Effect of TaVRT-2 overexpression on the accumulation of flowering-associated transcripts

Total RNA was extracted from leaves of 15 day-old transgenic *Arabidopsis* plants grown under LD conditions at 20°C and transcript levels were measured by RT-PCR. *TaVRT-2* and *Actin3* were used as controls. Each experiment was repeated three times using RNA prepared from two biological samples of each line, and only results from L17 are presented.

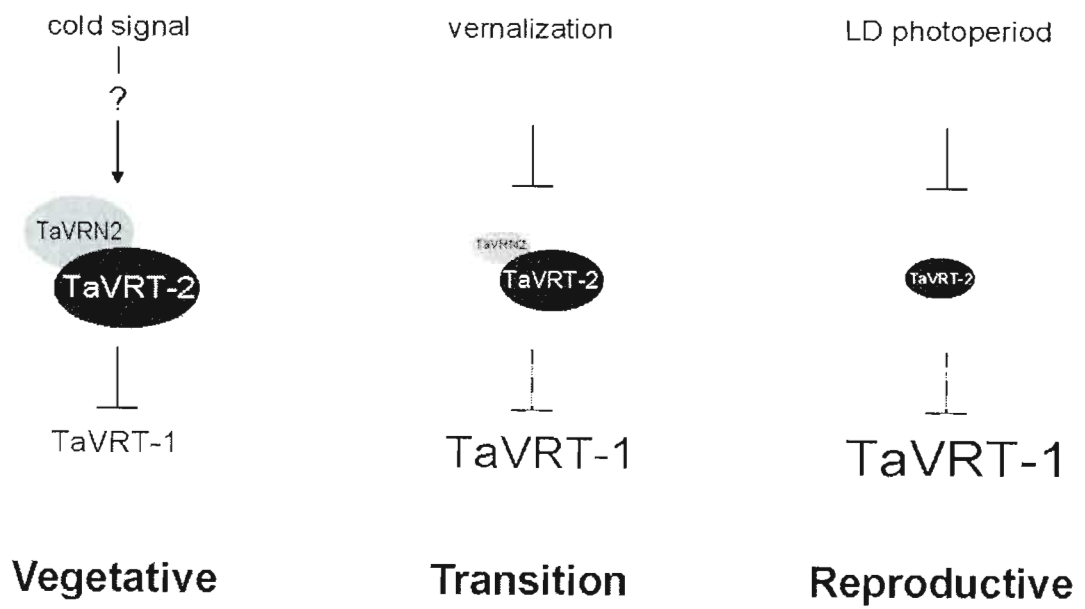

II-Figure 8 : Hypothetical model of the regulation of TaVRT-1 expression in winter wheat

During the vegetative phase, the TaVRT-2/TaVRN2 complex represses *TaVRT-1* transcription. Around vernalization saturation, the *TaVRT-2* and *TaVRN2* transcripts are downregulated and the levels of corresponding proteins decrease. This allows for the derepression of *TaVRT-1* expression, and the accumulation of TaVRT-1 protein triggers the transition from vegetative to reproductive phase. Once vernalization saturation is achieved, a long day (LD) photoperiod contributes to the downregulation of *TaVRT-2* and to the flower development.

References list

Adam, H., Ouellet, F., Kane, N.A., Agharbaoui, Z., Major, G., Tominaga, Y., and Sarhan, F. (2007). Overexpression of *TaVRN1* in *Arabidopsis* promotes early flowering and alters development. *Plant Cell Physiol.* 48:1192-206.

Amasino, R. (2004) Take a cold flower. *Nat. Genet.*, 36, 111-112.

Amasino, R.M. (2005) Vernalization and flowering time. *Curr. Opin. Biotechnol.*, 16, 154-158.

Ausin, I., Alonso-Blanco, C., Jarillo, J.A., Ruiz-Garcia, L., and Martinez-Zapater, J.M. (2004) Regulation of flowering time by FVE, a retinoblastoma-associated protein. *Nat. Genet.*, 36, 162-166.

Ciannamea, S., Kaufmann, K., Frau, M., Tonaco, I.A., Petersen, K., Nielsen, K.K., Angenent, G.C., and Immink, R.G. (2006) Protein interactions of MADS box transcription factors involved in flowering in *Lolium perenne*. *J. Exp. Bot.*, 57, 3419-3431.

Clough, S.J. and Bent, A.F. (1998) Floral dip: a simplified method for *Agrobacterium*-mediated transformation of *Arabidopsis thaliana*. *Plant J.*, 16, 735-743.

Crosthwaite, S.K. and Jenkins, G.I. (1993) The role of leaves in the perception of vernalizing temperatures in sugar-beet. *J. Exp. Bot.*, 44, 801-806.

Danyluk, J., Kane, N.A., Breton, G., Limin, A.E., Fowler, D.B., and Sarhan, F. (2003) TaVRT-1, a putative transcription factor associated with vegetative to reproductive transition in cereals. *Plant Physiol.*, 132, 1849-1860.

- de Folter, S. and Angenent, G.C. (2006) *trans* meets *cis* in MADS science. *Trends Plant Sci.*, 11, 224-231.
- de Folter, S., Immink, R.G., Kieffer, M., Parenicova, L., Henz, S.R., Weigel, D., Busscher, M., Kooiker, M., Colombo, L., Kater, M.M., Davies, B., and Angenent, G.C. (2005) Comprehensive interaction map of the *Arabidopsis* MADS box transcription factors. *Plant Cell*, 17, 1424-1433.
- Dubcovsky, J., Loukoianov, A., Fu, D., Valarik, M., Sanchez, A., and Yan, L. (2006) Effect of photoperiod on the regulation of wheat vernalization genes *VRN1* and *VRN2*. *Plant Mol. Biol.*, 60, 469-480.
- Egea-Cortines, M., Saedler, H., and Sommer, H. (1999) Ternary complex formation between the MADS-box proteins SQUAMOSA, DEFICIENS and GLOBOSA is involved in the control of floral architecture in *Antirrhinum majus*. *EMBO J.*, 18, 5370-5379.
- Fowler, D.B., Breton, G., Limin, A.E., Mahfoozi, S., and Sarhan, F. (2001) Photoperiod and temperature interactions regulate low-temperature-induced gene expression in barley. *Plant Physiol.*, 127, 1676-1681.
- Fowler, D.B., Limin, A.E., Wang, S.Y., and Ward, S.W. (1996) Relationship between low-temperature tolerance and vernalization response in wheat and rye. *Can. J. Plant Sci.*, 76, 37-42.
- Fu, D., Szucs, P., Yan, L., Helguera, M., Skinner, J.S., von Zitzewitz, J., Hayes, P.M., and Dubcovsky, J. (2005) Large deletions within the first intron in *VRN-1* are associated with spring growth habit in barley and wheat. *Mol. Genet. Genomics*, 273, 54-65.

Gendall, A.R., Levy, Y.Y., Wilson, A., and Dean, C. (2001) The *VERNALIZATION 2* gene mediates the epigenetic regulation of vernalization in *Arabidopsis*. *Cell*, 107, 525-535.

Gregis, V., Sessa, A., Colombo, L., and Kater, M.M. (2006) *AGL24*, *SHORT VEGETATIVE PHASE*, and *APETALA1* redundantly control *AGAMOUS* during early stages of flower development in *Arabidopsis*. *Plant Cell*, 18, 1373-1382.

Hartmann, U., Hohmann, S., Nettesheim, K., Wisman, E., Saedler, H., and Huijser, P. (2000) Molecular cloning of *SVP*: a negative regulator of the floral transition in *Arabidopsis*. *Plant J.*, 21, 351-360.

Hecht, V., Foucher, F., Ferrandiz, C., Macknight, R., Navarro, C., Morin, J., Vardy, M.E., Ellis, N., Beltran, J.P., Rameau, C., and Weller, J.L. (2005) Conservation of *Arabidopsis* flowering genes in model legumes. *Plant Physiol.*, 137, 1420-1434.

Higo, K., Ugawa, Y., Iwamoto, M., and Korenaga, T. (1999) Plant *cis*-acting regulatory DNA elements (PLACE) database: 1999. *Nucl. Acids Res.*, 27, 297-300.

Houde, M., Belcaid, M., Ouellet, F., Danyluk, J., Monroy, A.F., Dryanova, A., Gulick, P., Bergeron, A., Laroche, A., Links, M., McCarthy, L., Crosby, W.L., and Sarhan, F. (2006) Wheat EST resources for functional genomics of abiotic stress. *BMC Genomics*, 7, 149.

Immink, R.G. and Angenent, G.C. (2002) Transcription factors do it together: the hows and whys of studying protein-protein interactions. *Trends Plant Sci.*, 7, 531-534.

Kane, N.A., Danyluk, J., Tardif, G., Ouellet, F., Laliberte, J.F., Limin, A.E., Fowler, D.B., and Sarhan, F. (2005) *TaVRT-2*, a member of the *StMADS-11* clade of flowering repressors, is regulated by vernalization and photoperiod in wheat. *Plant Physiol.*, 138, 2354-2363.

- Kim, H.J., Hyun, Y., Park, J.Y., Park, M.J., Park, M.K., Kim, M.D., Kim, H.J., Lee, M.H., Moon, J., Lee, I., and Kim, J. (2004) A genetic link between cold responses and flowering time through *FVE* in *Arabidopsis thaliana*. *Nat. Genet.*, 36, 167-171.
- Lee, J.H., Cho, Y.S., Yoon, H.S., Suh, M., Moon, J., Lee, I., Weigel, D., Yun, C.H., and Kim, J.K. (2005) Conservation and divergence of FCA function between *Arabidopsis* and rice. *Plant Mol. Biol.*, 58, 823-838.
- Lescot, M., Dehais, P., Thijs, G., Marchal, K., Moreau, Y., Van de Peer, Y., Rouze, P., and Rombauts, S. (2002) PlantCARE, a database of plant *cis*-acting regulatory elements and a portal to tools for *in silico* analysis of promoter sequences. *Nucl. Acids Res.*, 30, 325-327.
- Levy, Y.Y. and Dean, C. (1998) Control of flowering time. *Curr. Opin. Plant Biol.*, 1, 49-54.
- Levy, Y.Y., Mesnage, S., Mylne, J.S., Gendall, A.R., and Dean, C. (2002) Multiple roles of *Arabidopsis* VRN1 in vernalization and flowering time control. *Science*, 297, 243-246.
- Masiero, S., Li, M.A., Will, I., Hartmann, U., Saedler, H., Huijser, P., Schwarz-Sommer, Z., and Sommer, H. (2004) *INCOMPOSITA*: a MADS-box gene controlling prophyll development and floral meristem identity in *Antirrhinum*. *Development*, 131, 5981-5990.
- Michaels, S.D. and Amasino, R.M. (1999) *FLOWERING LOCUS C* encodes a novel MADS domain protein that acts as a repressor of flowering. *Plant Cell*, 11, 949-956.
- Murai, K., Miyamae, M., Kato, H., Takumi, S., and Ogihara, Y. (2003) WAP1, a wheat APETALA1 homolog, plays a central role in the phase transition from vegetative to reproductive growth. *Plant Cell Physiol.*, 44, 1255-1265.

Petersen, K., Kolmos, E., Folling, M., Salchert, K., Storgaard, M., Jensen, C.S., Didion, T., and Nielsen, K.K. (2006) Two MADS-box genes from perennial ryegrass are regulated by vernalization and involved in the floral transition. *Physiol. Plant.*, 126, 268-278.

Reeves, P.H. and Coupland, G. (2000) Response of plant development to environment: control of flowering by daylength and temperature. *Curr. Opin. Plant Biol.*, 3, 37-42.

Riechmann, J.L., Krizek, B.A., and Meyerowitz, E.M. (1996) Dimerization specificity of *Arabidopsis* MADS domain homeotic proteins APETALA1, APETALA3, PISTILLATA, and AGAMOUS. *Proc. Natl. Acad. Sci. USA*, 93, 4793-4798.

Searle, I. and Coupland, G. (2004) Induction of flowering by seasonal changes in photoperiod. *EMBO J.*, 23, 1217-1222.

Searle, I., He, Y., Turck, F., Vincent, C., Fornara, F., Krober, S., Amasino, R.A., and Coupland, G. (2006) The transcription factor FLC confers a flowering response to vernalization by repressing meristem competence and systemic signaling in *Arabidopsis*. *Genes Dev.*, 20, 898-912.

Sentoku, N., Kato, H., Kitano, H., and Imai, R. (2005) *OsMADS22*, an *StMADS11*-like MADS-box gene of rice, is expressed in non-vegetative tissues and its ectopic expression induces spikelet meristem indeterminacy. *Mol. Genet. Genomics*, 273, 1-9.

Serrano, M., Parra, S., Alcaraz, L.D., and Guzman, P. (2006) The *ATL* gene family from *Arabidopsis thaliana* and *Oryza sativa* comprises a large number of putative ubiquitin ligases of the RING-H2 type. *J. Mol. Evol.*, 62, 434-445.

Simpson, G.G., Dijkwel, P.P., Quesada, V., Henderson, I., and Dean, C. (2003) FY is an RNA 3' end-processing factor that interacts with FCA to control the *Arabidopsis* floral transition. *Cell*, 113, 777-787.

Sung, S. and Amasino, R.M. (2004) Vernalization in *Arabidopsis thaliana* is mediated by the PHD finger protein VIN3. *Nature*, 427, 159-164.

Szucs, P., Karsai, I., von Zitzewitz, J., Meszaros, K., Cooper, L.L., Gu, Y.Q., Chen, T.H., Hayes, P.M., and Skinner, J.S. (2006) Positional relationships between photoperiod response QTL and photoreceptor and vernalization genes in barley. *Theor. Appl. Genet.*, 112, 1277-1285.

Tardif, G., Kane, N.A., Adam, H., Labrie, L., Major, G., Gulick, P., Sarhan, F., and Laliberte, J.F. (2007) Interaction network of proteins associated with abiotic stress response and development in wheat. *Plant Mol. Biol.* 63:703-18.

Trevaskis, B., Hemming, M.N., Peacock, W.J., and Dennis, E.S. (2006) *HvVRN2* responds to daylength, whereas *HvVRN1* is regulated by vernalization and developmental status. *Plant Physiol.*, 140, 1397-1405.

Voinnet, O., Rivas, S., Mestre, P., and Baulcombe, D. (2003) An enhanced transient expression system in plants based on suppression of gene silencing by the p19 protein of tomato bushy stunt virus. *Plant J.*, 33, 949-956.

Yan, L., Helguera, M., Kato, K., Fukuyama, S., Sherman, J., and Dubcovsky, J. (2004a) Allelic variation at the *VRN-1* promoter region in polyploid wheat. *Theor. Appl. Genet.*, 109, 1677-1686.

Yan, L., Loukoianov, A., Blechl, A., Tranquilli, G., Ramakrishna, W., SanMiguel, P., Bennetzen, J.L., Echenique, V., and Dubcovsky, J. (2004b) The wheat *VRN2* gene is a flowering repressor down-regulated by vernalization. *Science*, 303, 1640-1644.

Yan, L., Loukoianov, A., Tranquilli, G., Helguera, M., Fahima, T., and Dubcovsky, J. (2003) Positional cloning of the wheat vernalization gene *VRN1*. *Proc. Natl. Acad. Sci. USA*, 100, 6263-6268.

Yong, W.D., Xu, Y.Y., Xu, W.Z., Wang, X., Li, N., Wu, J.S., Liang, T.B., Chong, K., Xu, Z.H., Tan, K.H., and Zhu, Z.Q. (2003) Vernalization-induced flowering in wheat is mediated by a lectin-like gene *VER2*. *Planta*, 217, 261-270.

Supplemental material

II-Table S1: Primers used for the different experiments on the characterization of the wheat TaVRT-2 gene

Primers used for the generation of constructs to express the recombinant full length or truncated TaVRT-2 proteins. The restriction enzyme cutting sites used for cloning are underlined.

<i>TaVRT-2-F</i>	5'- TCCACCATGGCGCGGGAGA -3'
<i>TaVRT-2-R</i>	5'- GCGAATTCTTACTTCCAAGGTAACGCTAGTTTCA -3'
<i>TaVRT-2(IKC)-F</i>	5'- TCCACCATGGACGAGATCATTGACAAGTATAGTA -3'
<i>TaVRT-2(IKC)-R</i>	5'- GAATTCTTACTTCCAAGGTAACGCTAGTTTCAGG -3'

Primers used for the generation of constructs used in the transient expression assays. The restriction enzyme cutting sites used for cloning are underlined.

Reporter construct	
<i>TAVRT-1-XT F2</i>	5'-CAAGCTTTATACACGCACAGCACAGTACCC-3'
<i>TaVRT-1-XT R2</i>	5'-AGTCTAGACGCTCGAGAACCGGGCCA-3'
Effector constructs	
<i>TaVRT-2-XT F1</i>	5'-TAAGCTTATGGCGCGGGAGAG-3'
<i>TaVRT-2-XT R1</i>	5'-AGAATTCTTACTTCCAAGGTAACGCTAGTTTC-3'
<i>TaVRN2-XT F1</i>	5'-CGGATCCTATGTCCATGTTCATGCGGTTTGT -3'
<i>TaVRN2-XT R1</i>	5'-AGGAATTCTTTACCGGAACCATCCGAGGTGA -3'
<i>TAVRT-1-XT F1</i>	5'-TAAGCTTATGGGGCGCGGGAAGGTGCA-3'
<i>TAVRT-1-XT R1</i>	5'-AGAATTCTCAGCCGTTGATGTGGCTAACCA-3'

Primers used for RT-PCR analyses of transcripts expressed in *Nicotiana benthamiana* and in wheat.

<i>TaVRT-2</i> forward	5'-GTGGCCGTTGCCGAAGCTGAAAAT-3'
<i>TaVRT-2</i> reverse	5'-CGCGCCATGCAAATGGAGACATAAAACGA-3'
<i>TaVRN2</i> forward	5'-CGTGAGCACCAGTTCTTCGCCC-3'
<i>TaVRN2</i> reverse	5'-GTGAGCCATGTGTCCGGCCGCC-3'
<i>TaVRT-1</i> forward	5'-GCTGAAGGGCTTCCAGCCCATATAAG-3'
<i>TaVRT-1</i> reverse	5'-TACATGGTAAATTGAGCCCAGCTGGG-3'
<i>18S</i> forward	5'-AGTTAAAAGCTCGTAGTTGGACCT-3'
<i>18S</i> reverse	5'-GTTTATGGTTGAGACTAGGACGGTA-3'

II-Table S2 (continued)

Primers used for the generation of probes for the *in situ* RNA hybridizations. The T7 or SP6 RNA polymerase-binding sites are underlined.

<i>TaVRT-2T7S1</i>	5'-GCGAAATTAATACGACTCACTATAGGGCGAA
<i>TaVRT-2T7AS1</i>	5'-GCGAAATTAATACGACTCACTATAGGGCGAA
<i>TaVRN2SP6S1</i>	5'-TACGATTTAGGTGACACTATAG
<i>TaVRN2SP6AS1</i>	5'-TACGATTTAGGTGACACTATAG
<i>TaVRT-1T7S1</i>	5'-GCGAAATTAATACGACTCACTATAGGGCGAA
<i>TaVRT-1T7AS1</i>	5'-GCGAAATTAATACGACTCACTATAGGGCGAA

Primers used for the generation of the *Pro*_{35S}:*TaVRT-2* construct used to transform

Arabidopsis. The restriction enzyme cutting sites used for cloning the cDNA in pBIN19 mgfp-ER are underlined.

<i>TaVRT-2-XT F2</i>	5'-CTCTAGATATGGCGCGGGAGAG -3'
<i>TaVRT-2-XT R2</i>	5'-GAGCTCTCTTCCAAGGTAACGCTAGT -3'

Primers used for RT-PCR analyses of *TaVRT-2*-overexpressing *Arabidopsis* plants.

<i>FCA</i> forward	5'-AATGTACCTGGACCGAGCATACT-3'
<i>FCA</i> reverse	5'-CTGCTGAACTTGTTGTGGTTGTTG-3'
<i>FY</i> forward	5'-GCCAACCTGATAATTTCCAACCAT-3'
<i>FY</i> reverse	5'-ATGGAACCTGGAAGAGGCTGTTTA-3'
<i>LD</i> forward	5'-CTTGATGAACGAAGAATTGCTGCT-3'
<i>LD</i> reverse	5'-AACTTCGACCCTTTCTTCAACCTG-3'
<i>FLC</i> forward	5'-CGGTTGAAATCAAATCCAAAACA-3'
<i>FLC</i> reverse	5'-CACACGAATAAGGTACAAAGTTCATCA-3'
<i>SVP</i> forward	5'-GAAGGAAGTCCTAGAGAGGCATAAC-3'
<i>SVP</i> reverse	5'-CGTTAGTAATAGACTCCGACGACTG-3'
<i>AGL24</i> forward	5'-GAATGAGAGACATATTGGGAAGGTA-3'
<i>AGL24</i> reverse	5'-AAGTGTCGGAGTCATCCTCAAG-3'
<i>SOC1</i> forward	5'-ACCATAGATCGTTATCTGAGGCAT-3'
<i>SOC1</i> reverse	5'-GAAGAACAAGGTAACCCAATGAAC-3'
<i>TaVRT-2</i> forward	5'-GGACCGCAATTCATGCAACA-3'
<i>TaVRT-2</i> reverse	5'-TCCTGCGAGCTTCCCGAATG-3'
<i>Actin3</i> forward	5'-GGCTCCAAGCAGCATGAAGATCAA-3'
<i>Actin3</i> reverse	5'-TGGCGGTGCTTCTTCTCTGAAAAAT-3'

III. Vernalization genes in winter cereals

Ndjido A. Kane, Jean Danyluk and Fathey Sarhan*

Département des Sciences Biologiques, Université du Québec à Montréal, Case Postale 8888, Succursale Centre-ville, Montréal, Québec, Canada H3C 3P8.

Publié comme chapitre de livre en 2006 par CAB International. Cold Hardiness in Plants: Molecular Genetics, Cell Biology and Physiology (Éds T.H.H. Chen et al., 2006)

Tous les auteurs ont contribué à l'élaboration et à la rédaction des différentes parties du manuscrit. J'ai écrit la première version, JD et FS ont produit la version finale.

Les gènes de vernalisation chez les céréales

Résumé

L'exposition aux basses températures est l'un des facteurs environnementaux les plus limitant pour la croissance, la productivité et la distribution géographique des espèces végétales. Les plantes natives des régions tempérées ont développé des mécanismes adaptatifs au cours de leur évolution qui les aident à faire face à une exposition aux basses températures et à survivre durant les périodes extrêmes d'hiver. L'acclimatation au froid permet à une plante d'ajuster sa croissance et son métabolisme en fonction de l'exposition aux basses températures et de protéger pendant l'hiver ses structures et fonctions essentielles. Les plantes qui ont un cycle de floraison sur deux années (bisannuelles) perçoivent l'hiver durant la première année et retardent la floraison. Ceci empêche les dommages du méristème floral pendant l'hiver et accélère la floraison au printemps. Ce processus est nommé vernalisation et il est différent de l'acclimatation au froid.

Summary

Low temperature is one of the most severe abiotic stress factors limiting plant growth, productivity and distribution. Plants native to temperate regions have developed two major evolutionary adaptive mechanisms that help them to cope with low temperature stress and survive extreme winter conditions. Cold acclimation allows hardy winter plant to adjust growth and metabolism to low temperature and to protect critical cell structures during winter. Over-wintering plants sense the upcoming winter and delay flowering by postponing the transition from the vegetative to the reproductive phase. This delay is known as vernalization and prevents the damage of the LT-sensitive flowering meristem during winter and accelerates flowering in spring. Both cold acclimation and vernalization are important traits regulated through complex genotypic and environmental interactions.

Introduction

Plants native to regions with a winter season have evolved the ability to time the transition from vegetative growth to flowering. This evolutionary adaptation allows plants to flower under favourable environmental conditions for sexual reproduction. The initiation and timing of this transition is determined by seasonal changes of the two main environmental cues, temperature and photoperiod. The term vernalization describes the period of low temperature (LT) exposure that is necessary for these plants to acquire the capacity or accelerate their ability to enter the reproductive phase (Chouard, 1960). Once vernalization or flowering competency is achieved, plants will initiate reproductive development only under appropriate photoperiod conditions in the spring.

During the period of growth at LT many physiological, biochemical and metabolic functions are altered in the plant (reviewed in Guy, 1999; Thomashow, 1999; Breton *et al.*, 2000). This cold acclimation (CA) period allows plants to develop efficient freezing tolerance (FT) mechanisms required to survive the winter months. One of these mechanisms is the accumulation of cold-regulated / late embryogenesis abundant (COR/LEA) proteins that are believed to promote the development of FT by protecting cellular components (Thomashow, 1999). In cereals the development of maximum FT is known to be associated with COR/LEA protein accumulation and the vernalization saturation point (Fowler *et al.*, 1996a, b; Danyluk *et al.*, 2003). The transition from vegetative to reproductive growth phase can be perceived as a critical switch that initiates the down regulation of LT-induced genes (Fowler *et al.*, 1996a, b, 2001; Mahfoozi *et al.*, 2001a, b; Danyluk *et al.*, 2003). As a result, full expression of cold hardiness genes only occurs in the vegetative phase and plants in the reproductive phase have a limited ability to cold acclimate. In addition, plants that are still in the vegetative phase have the ability to re-acclimate following periods of exposure to warm temperatures while plants in the reproductive phase only

have a limited ability to do so (Mahfoozi *et al.*, 2001b). These studies indicate that there is a close genetic linkage between vernalization and CA, and suggest that developmental genes also act to control genes affecting the expression of LT-induced genes associated with the acquisition of FT. By understanding the genetics involved in controlling the duration of vernalization and the timing of the switch to the reproductive phase, additional candidates would be available for breeding new varieties with delayed transition to the reproductive stage, thus increasing the period of stress resistance.

Plant species display a wide range of responses to vernalization. Some like the biennial cabbage (*Brassica oleracea*) have an obligate vernalization requirement while others like winter wheat display a quantitative vernalization requirement. Studies on the growth habit of wheat cultivars have shown that spring genotypes have a very mild response or no response at all to vernalization compared to winter genotypes that continue reducing their final leaf number up to the point of vernalization saturation (49 days of LT exposure) (Fowler *et al.*, 1996a, b). Vernalization is a trait that evolved independently in flowering plants as they radiated into regions with a winter season (Amasino 2004). Recent work in plants is revealing that differences in vernalization requirement do not necessarily imply fundamental modifications in the mechanisms that control flowering. Before reviewing the advances in our understanding of vernalization in wheat, we will briefly summarize the knowledge gained by studying flowering control in *Arabidopsis*.

The model system *Arabidopsis*

The genetic and molecular analyses of *Arabidopsis* have revealed the existence of several interdependent pathways controlling flowering (reviewed in Mouradov *et al.* 2002; Simpson and Dean 2002; Henderson *et al.*, 2003). The photoperiod and vernalization pathways respond to environmental signals while the autonomous and

gibberellin (GA) dependant pathways integrate the endogenous developmental state of the plant. Both the autonomous and vernalization pathways promote flowering by repressing the *FLOWERING LOCUS C (FLC)* gene that acts as a repressor of flowering. Subsequently, the photoperiod and GA pathways in combination with *FLC* levels (from autonomous/vernalization pathway integration) converge on the common flowering pathway integrators *FT*, *SUPPRESSOR OF OVEREXPRESSION OF CO 1 (SOC1/AGL20)* and *LEAFY (LFY)* that regulate floral initiation genes such as *APETALA1 (API)* (Simpson and Dean, 2002).

Ecotypes of *Arabidopsis* display a natural variation in vernalization requirement (Burn *et al.*, 1993, Clarke and Dean, 1994; Koornneef *et al.*, 1994). The two main genes that were shown to display allelic variation in *Arabidopsis* ecotypes are *FRIGIDA (FRI)* and *FLC* (Johanson *et al.*, 2000; Michaels and Amasino, 1999). Winter annual ecotypes contain dominant alleles of *FRI* and *FLC* that delay flowering while spring ecotypes carry null and weak alleles of *FRI* and *FLC*, respectively (Michaels *et al.*, 2003). Molecular cloning of *FRI*, which encodes a plant-specific gene of unknown biochemical activity, revealed that *FRI* strongly enhanced *FLC* transcript levels (Johanson *et al.*, 2000). The *FLC* gene encodes a transcription factor of the MADS-box family whose expression alone is sufficient to repress flowering (Michaels and Amasino, 1999; Sheldon *et al.*, 1999). The effect of vernalization is to promote flowering through an epigenetic down-regulation of *FLC* mRNA levels, thereby antagonizing *FRI* function (Michaels and Amasino, 1999; Sheldon *et al.*, 1999). The extent of this reduction is proportional to the duration of vernalization and is closely correlated with flowering time (Gendall *et al.*, 2001).

With the advancement of EST and genomic sequencing projects in plants, it became apparent that *FLC*-like genes were specifically found in the *Brassicaceae*. This indicated that other vernalization responsive plants would at least contain some differences in the signaling pathways controlling the transition to the reproductive stage. The use of mutagenic approaches in *Arabidopsis* has lead to the identification of many genes involved in the flowering pathway in plants. Information gained from

such studies were invaluable to us in choosing a more targeted approach to identifying genes associated with the floral switch in species less amenable to transformation studies like wheat.

Genetics of vernalization in cereals

Wheat is one of the leading food crops grown worldwide and is of great economic and nutritional importance. In an effort to maximize yield potential of wheat cultivars in diverse environments, extensive physiological and genetic studies have been undertaken since the beginning of the 20th century with the goal of uncovering the allelic variation that fine tunes the life cycle for an appropriate flowering time control (Chouard, 1960; Lang, 1965; Law, 1966; Pugsley, 1972; Klaimi and Qualset, 1974; Maystrenko, 1980; Stelmakh, 1993; Bezant *et al.*, 1996; Law and Worland, 1997; Dubcovsky *et al.*, 1998; Sourdille *et al.*, 2000). Chromosome substitution line analysis in wheat has shown that the genetic control of flowering time is complex with nearly all homoelogenous groups involved (Worland *et al.* 1987; Law *et al.* 1993; Laurie *et al.*, 1995; Bullrich *et al.*, 2002). These studies have revealed that distinct sets of genes regulate adaptive mechanisms allowing cereals to properly time flowering: i) the vernalization response genes (*Vrn*) that regulate flowering using LT; ii) the photoperiod response genes (*Ppd*) that regulate flowering using day length; iii) and the earliness *per se* genes that influence the rate of development. Vernalization and photoperiod genes play important regulatory roles in the growth and development of winter cereals. By contrast with vernalization requirement and photoperiod sensitivity, earliness *per se* genes are environment-independent. In addition, genes from all three systems have shown pleiotropic effects on other aspects of plant growth and development. These features build in an added variability that ensures that the energy demanding processes of flowering and setting seed is well timed to ensure survival of the species.

In the last 2 decades, much of the efforts are being directed to precise QTL mapping and identification of the corresponding genes. The most studied alleles conferring the vernalization requirement are the *Vrn* loci found on chromosomes 5 of wheat (Law *et al.*, 1993; Law and Worland 1997). In hexaploid wheat (*Triticum aestivum* L. 2n x 6 = 42), *Vrn-1* loci occur as a set of homeologous genes named *Vrn-A1*, *Vrn-B1*, and *Vrn-D1* that map to identical regions of the group 5 chromosomes (Galiba *et al.*, 1995; Dubcovsky *et al.*, 1998; Iwaki *et al.*, 2001; McIntosh *et al.*, 2003;). Orthologous genes have been mapped in diploid wheat (*T. monococcum*, *Vrn-A^{m1}*), barley (*Hordeum vulgare*, *Vrn-H1*) and rye (*Secale cereale* *Vrn-R1*) (Dubcovsky *et al.*, 1998, Laurie et al 1995, Galiba *et al.*, 1995; Plaschke *et al.*, 1993). Alleles at the *Vrn-A1* locus appear to have a predominant effect in reducing the vernalization requirement compared to those on other *Vrn* loci (Snape *et al.*, 1985, Shindo *et al.*, 2003). For example, cultivars with *Vrn-A1* do not require vernalization at all; whereas those with *Vrn-B1* and *Vrn-D1* require vernalization for 15 to 30 days, and cultivars recessive for all of these genes require 45 to 60 days of vernalization (Shindo *et al.*, 2003). The *Vrn-1* loci have also been the ones most associated with FT. Recently, an isogenic line containing recessive copies of all *vrn-1* loci in a spring Manitou background showed a higher accumulation of *cor/lea* genes and development of FT than the parental spring line (Limin and Fowler, 2002; Danyluk *et al.*, 2003), suggesting a genetic link between vernalization requirement and a higher capacity for developing stress tolerance. In addition, these studies revealed that the *vrn-A1* locus does not act alone in determining the transition from the vegetative to the reproductive phase confirming the importance of continuing the identification of loci controlling the duration of the vegetative phase (Snape *et al.*, 2001).

A locus showing an epistatic interaction with *Vrn-A^{m1}* in diploid wheat was mapped to the distal region of chromosome 5A^{mL} (Dubcovsky *et al.*, 1998; Tranquilli and Dubcovsky, 2000). The dominant winter allele, designated *Vrn-A^{m2}*, was shown to delay flowering only in the presence of *vrn-A^{m1}*. Allelic variation at the *Vrn-2* loci has been observed in barley but not in hexaploid wheat. In the latter, *Vrn-2* would

only be able to determine a spring habit if the three *Vrn-2* loci are simultaneously homozygous for the recessive spring alleles which certainly can be predicted to occur at a lower probability.

Other loci affecting the transition to flowering have been reported in the literature but they remain less characterized. Genes sensitive to vernalization in wheat have been identified on chromosome 3B (Miura and Worland, 1994), and group 1 and 6 chromosomes (Law et al.; 1998; Islam-Faridi *et al.*, 1996). Furthermore, markers associated the QTL for ear emergence on 7HS have been located to the physical consensus map of wheat (Boyko *et al.*, 2002) along with a possible vernalization locus. A QTL for heading time was located on chromosome 7BS in a doubled haploid population of wheat (Sourdille *et al.*, 2000), a region that may correspond to a QTL for earliness *per se*. RFLP markers with significant linkage to heading date and photoperiod sensitivity have also been located to all group-7 chromosomes of wheat (Shindo *et al.*, 2003). In barley, RFLP markers with highly significant additive effects for ear emergence time were found on both the long and short arms of chromosome 7H in a spring habit cross (Bezant *et al.*, 1996). Baum et al (2003) also reported finding a major QTL for days to heading on chromosome 7H. The extensive allelic variation that has been reported in cereal species is probably at the basis of their adaptive capabilities.

Identification of vernalization genes in wheat

The identification and characterization of genes underlying adaptive traits in cereals is a prerequisite for understanding how they may be used in manipulating growth habit and/or vernalization response to achieve a better timing of flowering in wheat and other temperate cereals. Natural variation, mutation analyses and molecular characterization have identified the MADS-box family members as important floral regulators in *Arabidopsis* and other plants. To evaluate the possibility

that this group is involved in the floral pathways of cereal plants, our group initially concentrated on determining if any were associated with the vegetative to reproductive transition in wheat. What follows is a review on the recent developments on the characterization of these and related genes.

TaVRT-1/VRN-1

TaVRT-1 encodes a MADS-box protein and belongs to the AP1/SQUA-like clade of transcriptional regulators (Danyluk *et al.*, 2003) whose members have been implicated in functions such as determining inflorescence meristem identity and flower development. Mapping studies localized this gene to the *Vrn-1* regions of homeologous group 5 chromosomes, regions that are associated with vernalization and FT in wheat. The level of expression of *TaVRT-1* is positively associated with the vernalization response and transition from vegetative to reproductive phase. Comparisons among different wheat genotypes, near-isogenic lines, and cereal species, which differ in their vernalization response, indicated that the gene is inducible only in those species that require vernalization, whereas it is constitutively expressed in spring habit genotypes. These expression studies suggested that *TaVRT-1* is a key developmental gene in the regulatory pathway that controls the transition from the vegetative to reproductive phase in cereals. At the same time, the genetic evidence that *TaVRT-1* is a *VRN1* gene from hexaploid wheat appeared with the positional cloning of the *Vrn-A^m1* gene from *T. monococcum* (Yan *et al.*, 2003). Allelic variation was found between the spring and winter accessions of tested diploids. Analysis of promoter sequences revealed that spring accessions contained a deletion encompassing a putative MADS-box protein binding site (CArG-box) near the transcription start site. Subsequently, allelic variation was investigated in the promoter and first intron of *VRN1* in polyploid wheat (Yan *et al.*, 2004b; Fu *et al.*, 2005). These studies have indicated that the regulation of *VRN1* expression is complex and may involve multiple regulatory elements. Most of the polyploid wheat varieties containing a dominant spring *Vrn-A1* allele were characterized by an

insertion or deletion in the vicinity of the CArG-box in the promoter suggesting that these could interfere with the regulation mediated by this motif. The remaining *Vrn-A1* and spring *Vrn-B1* and *Vrn-D1* alleles did not show any polymorphism in the promoter region when compared with their corresponding recessive alleles. However, analysis of these spring alleles revealed important deletions in the first intron. These alleles were all missing a 440 bp region showing a high conservation between wheat and barley. This suggests that the DNA segment contains putative regulatory elements important for the vernalization requirement (Yan et al. 2004b). Further experiments will be necessary to identify the putative vernalization-responsive regulatory regions in these alleles.

These molecular studies have revealed that the spring/winter growth habit of temperate cereals is being controlled mainly by genetic variability of the *VRN1* locus which encodes an orthologue of *Arabidopsis API1*. Thus, these relatives appear to function in promoting flowering in both species; whereas the genes that underlie the allelic variation in vernalization sensitivity in both species are different. In addition, because the winter allele is believed to be the ancestral type, these studies revealed that spring alleles have undergone independent mutational changes affecting their responsiveness to vernalization (Yan *et al.*, 2004b; Fu et al. 2005; Beales *et al.*, 2005). This created different variants that may alone or in different combination provide an adaptive advantage in certain conditions.

VRN-2

The dominant repressor of flowering, *Vrn-A^m2*, was recently identified by positional cloning in *T. monococcum* (Yan et al. 2004a). The gene encodes a substantially diverged zinc finger protein that is specifically found in temperate cereals, indicating that it evolved fairly recently. The *Vrn-A^m2* gene is down-regulated by vernalization and shows an opposite expression profile to *Vrn-A^m1*. The *vrn-A^m2* spring alleles were found to contain either deletions of the gene or a mutated version that is hypothesized to hinder its capacity for protein-protein interaction and function

(Yan *et al.*, 2004a). Therefore, loss of function through either the presence of spring alleles or the reduction of transcript levels by RNA interference resulted in the promotion of flowering in wheat (Yan *et al.*, 2004a). With the cloning of this gene, allelic variation at the *VRN1* and *VRN2* loci are able to explain 46 of the 49 spring habits tested in *T. monococcum*. This suggests that other less known loci conferring spring habit will be found in the coming years. The identification of these central genes in the vernalization pathway in wheat provides an opportunity to begin deciphering the molecular basis of the floral inductive pathway in cereals. These studies will eventually reveal how differences in controlling vernalization requirement in plants impact other floral signalling pathways.

TaVRT-2

In preliminary expression profiling of several wheat MADS-box genes, one showed an inverse pattern of expression relative to that of *TaVRT-1* in that the level of expression was high during the early stage of vernalization but started to decline towards the vegetative/reproductive transition point (Kane *et al.*, 2005). This gene was named *TaVRT-2* to underline this close association with *TaVRT-1*. Molecular and phylogenetic analyses indicate that *TaVRT-2* encodes a member of the *StMADS11*-like clade of genes responsible for flowering repression in several species. Expression profiling of this gene using near-isogenic lines and different genotypes with natural variation in their response to vernalization and photoperiod showed a strong relationship with floral transition and photoperiod. In *Arabidopsis*, the *StMADS11*-like member, Short Vegetative Phase (SVP), was shown to interact with the photoperiod pathway (Hartmann *et al.*, 2000).

Protein-protein interactions studies revealed that *TaVRT-2* can form homodimers and interacts with proteins encoded by the vernalization QTLs (*TaVRT-1/VRN-1* and *VRN-2*) of wheat. The *StMADS11*-like genes have been found to interact with proteins of the AP1/SQUA clade in several species (Immink *et al.*, 2003; Fornara *et al.*, 2004; Masiero *et al.*, 2004). Therefore, the interaction between

members of these two clades may represent an evolutionary conserved property that is important for their function. In addition, a shift between homo- and heterodimer formation was proposed to mediate a change in function for a member of this clade (Masiero *et al.*, 2004). Overall these results support the notion that TaVRT-2 is part of the flowering pathway in wheat integrating developmental and environmental signals resulting in the vegetative / reproductive transition. In the proposed model (Figure 1), TaVRT-2 binds to the CArG box present in winter *VRN1* promoters while VRN2 binds unidentified elements in the first intron and/or interacts with TaVRT-2. Within this context, the expression of the *VRN1* gene is repressed and the result is vegetative growth. After vernalization, the expression of *VRN2* is repressed and levels of *TaVRT-2* diminished. This leads to expression of *TaVRT-1/VRN1* and the switch to the reproductive phase. Increased quantities of TaVRT-1/VRN1 would then favor heterodimer formation with TaVRT-2, and a shift in function. The physical association of TaVRT-1, TaVRT-2 and VRN-2 may then be at the basis of the regulation of flowering transition in temperate cereals.

Future prospects

An appropriate flowering time of cereals exposed to a wide range of environments is achieved by complex interactions of quantitative traits controlled by many genes. To date, only a limited number of traits have been identified at the molecular level from those reported to contain some genetic variability in temperate cereals. It is essential to increase our knowledge of these traits in the coming years through 1) their detailed genetic mapping and positional cloning; 2) the use of approaches targeting the characterization of genes associated with floral pathways in other plants. This will increase our knowledge of the full complement of variations that plants may have evolved for fine-tuning the life cycle to a target environment.

Breeding of cereal varieties better adapted to specific environments would maximize yield potential and minimize risks from stress exposure.

One interesting question that can be asked is how is vernalization genetically linked to the development of FT. Vernalization requirement enables winter wheat cultivars to maintain the expression of *cor/lea* genes at higher levels and for a longer period than in spring cultivars (Fowler *et al.*, 1996a, b; Danyluk *et al.*, 2003). The delay in the transition from the vegetative to the reproductive phase produces increased FT that is sustained for a longer period of time. This observation also explains why a high level of FT has not been observed in spring habit cultivars. Because LT gene expression is only up-regulated when the plant is in the vegetative phase, the genetic potentials of spring habit cultivars are not given an opportunity to be fully expressed leaving the impression that the spring habit *Vrn-1* allele has a dominant pleiotropic effect for frost susceptibility (Fowler *et al.*, 1999). Although the two developmental pathways, vernalization and CA, respond to the same environmental cue, no molecular information is yet available to indicate how they are linked. Evidence from mutant analyses in the model system *Arabidopsis* is indicating that some genes may be playing a role in both pathways. The first gene, *HOS1*, functions as a negative regulator of flowering and LT-responsive gene transcription (Lee *et al.*, 2001). It encodes a novel plant protein with a RING finger motif that was never previously associated with these developmental pathways. The second is the autonomous pathway gene *FVE* (Kim *et al.*, 2004), and it negatively regulates the CBF/DREB pathway and positively flowering. Whether these genes play a similar role in temperate cereals will depend when these functions evolved. Understanding this link may allow a more effective manipulation of both FT and vernalization to produce cereal varieties with higher and more sustained tolerance to stress.

Figure and legend

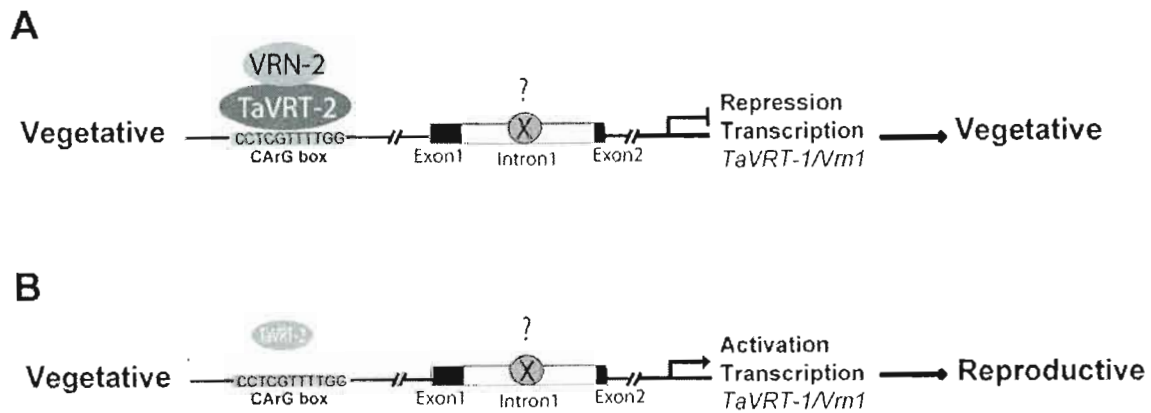

III-Figure 1: Proposed model for the activation of TaVRT-1/VRN1 in wheat

(A) During vernalization TaVRT-2, a MADS-box protein, binds to the CArG box in the *TaVRT-1/Vrn1* promoter and interacts with VRN2, a zinc finger protein. In addition, VRN2 or another factor (?) binds conserved sequences in the first intron. This complex at the *TaVRT-1/Vrn1* gene leads to repression of the reproductive phase.

(B) After vernalization, VRN2 and TaVRT-2 levels are repressed and none of these factors are bound to the promoter. This leads to expression of *TaVRT-1/Vrn1* and transition to the reproductive stage.

References list

- Amasino R (2004) Vernalization, competence, and the epigenetic memory of winter. *Plant Cell* 16: 2553-2559
- Baum M, Grando S, Backes G, Jahoor A, Sabbagh A, Ceccarelli S (2003) QTLs for agronomic traits in the Mediterranean environment identified in recombinant inbred lines of the cross 'Arta' x *H. spontaneum* 41-1. *Theor Appl Genet* 107: 1215-1225
- Beales J, Laurie DA, Devos KM (2005) Allelic variation at the linked AP1 and PhyC loci in hexaploid wheat is associated but not perfectly correlated with vernalization response. *Theor Appl Genet* 110 (6):1099-107
- Bezant J, Laurie D, Pratchett N, Chojecki J, Kearsey M (1996) Marker regression mapping of QTL controlling flowering time and plant height in a spring barley (*Hordeum vulgare* L.) cross. *Heredity* 77: 64-73
- Breton G, Danyluk J, Ouellet F, Sarhan F (2000) Biotechnological applications of plant freezing associated proteins. *Biotechnol Annu Rev* 6: 59-101
- Bullrich L, Appendino L, Tranquilli G, Lewis S, Dubcovsky J (2002) Mapping of a thermo-sensitive earliness per se gene on *Triticum monococcum* chromosome 1A(m). *Theor Appl Genet* 105: 585-593
- Burn JE, Bagnall DJ, Metzger JD, Dennis ES, Peacock WJ (1993) DNA methylation, vernalization, and the initiation of flowering. *Proc Natl Acad Sci U S A* 90: 287-291
- Boyko E, Kalendar R, Korzun V, Fellers J, Korol A, Schulman AH, Gill BS (2002) A high-density cytogenetic map of the *Aegilops tauschii* genome incorporating

retrotransposons and defense-related genes: insights into cereal chromosome structure and function. *Plant Mol Biol* 48: 767-790

Chouard P (1960) Vernalization and its relations to dormancy. *Annu Rev Plant Physiol* 11: 238

Clarke JH, Dean C (1994) Mapping FRI, a locus controlling flowering time and vernalization response in *Arabidopsis thaliana*. *Mol Gen Genet* 242: 81-89

Danyluk J, Kane NA, Breton G, Limin AE, Fowler DB, Sarhan F (2003) TaVRT-1, a putative transcription factor associated with vegetative to reproductive transition in cereals. *Plant Physiol* 132: 1849-1860

Dubcovsky J, Lijavetzky D, Appendino L, Tranquilli L (1998) Comparative RFLP mapping of *Triticum monococcum* genes controlling vernalization requirement. *Theor. Appl. Genet.* 97: 968-975

Dubcovsky JM, Luo C, Zhong GY, Bransteitter R, Desai AJ, Kilian A, Kleinhofs A, Dvorak J (1996) Genetic map of diploid wheat, *Triticum monococcum* and its comparison with maps of *Hordeum vulgare* L. *Genetics*. 143: 983-999

Fornara F, Parenicova L, Falasca G, Pelucchi N, Masiero S, Ciannamea S, Lopez-Dee Z, Altamura MM, Colombo L, Kater MM (2004) Functional characterization of OsMADS18, a member of the AP1/SQUA subfamily of MADS-box genes. *Plant Physiol* 135: 2207-2219

Fowler DB, Breton G, Limin AE, Mahfoozi S, Sarhan F (2001) Photoperiod and temperature interactions regulate low-temperature-induced gene expression in barley. *Plant Physiol* 127: 1676-1681

Fowler DB, Limin AE, Ritchie JT (1999) Low-temperature tolerance in cereals: Model and genetic interpretation. *Crop Sci* 39: 633

Fowler DB, Chauvin LP, Limin AE, Sarhan F (1996a) The regulatory role of vernalization in the expression of low-temperature induced genes in wheat and rye. *Theor Appl Genet* 93: 554-559

Fowler DB, Limin AE, Wang S-Y, Ward SW (1996b) Relationship between low-temperature tolerance and vernalization response in wheat and rye. *Can J Plant Sci* 76: 37-42

Fu D, Szucs P, Yan L, Helguera M, Skinner JS, von Zitzewitz J, Hayes PM, Dubcovsky J (2005) Large deletions within the first intron in VRN-1 are associated with spring growth habit in barley and wheat. *Mol Genet Genomics* 273 (1):54-65

Galiba G, Quarrie SA, Sutka J, Morgounov A, Snape JW (1995) RFLP mapping of vernalization (*Vrn1*) and frost resistance (*Fr1*) genes on chromosome 5A of wheat. *Theor Appl Genet* 90: 1174-1179

Gendall AR, Levy YY, Wilson A, Dean C (2001) The VERNALIZATION 2 gene mediates the epigenetic regulation of vernalization in *Arabidopsis*. *Cell* 107: 525-535

Guy C (1999) Molecular responses of plants to cold shock and cold acclimation. *J Mol Microbiol Biotechnol* 1: 231-242

Hartmann U, Hohmann S, Nettesheim K, Wisman E, Saedler H, Huijser P (2000) Molecular cloning of SVP: a negative regulator of the floral transition in *Arabidopsis*. *Plant J* 221: 351-360

Henderson IR, Shindo C, Dean C (2003) The need for winter in the switch to flowering. *Annu Rev Genet* 37: 371-392

Hepworth SR, Valverde F, Ravenscroft D, Mouradov A, Coupland G (2002) Antagonistic regulation of flowering-time gene *SOC1* by *CONSTANS* and *FLC* via separate promoter motifs. *EMBO J* 21: 4327-4337

Immink RG, Ferrario S, Busscher-Lange J, Kooiker M, Busscher M, Angenent GC (2003) Analysis of the petunia MADS-box transcription factor family. *Mol Genet Genomics* 268: 598-606

Islam-Faridi MN, Worland AJ, Law CN (1996) Inhibition of ear-emergence time and sensitivity to day-length determined by the group 6 chromosomes of wheat. *Heredity* 77: 572-580

Iwaki K, Nishida J, Yanagisawa T, Yoshida H, Kato K (2001) Genetic analysis of *Vrn-B1* for vernalization requirement by using linked dCAPS markers in bread wheat (*Triticum aestivum* L.). *Theor Appl Genet* 104: 571-576

Johanson U, West J, Lister C, Michaels S, Amasino R, Dean C (2000) Molecular analysis of *FRIGIDA*, a major determinant of natural variation in *Arabidopsis* flowering time. *Science* 290: 344-347

Kane NA, Danyluk J, Tardif G, Laliberté J-F, Limin AE, Fowler DB, Sarhan F (2005). *TaVRT-2*, a member of the *StMADS-11* clade of flowering repressors, is regulated by vernalization and photoperiod in wheat. *Plant Physiol.* 138 (4): 2354-63

Koornneef M, Blankenstijn-de Vries H, Hanhart C, Soppe W, Peters T (1994) The phenotype of some late-flowering mutants is enhanced by a locus on chromosome 5 that is not effective in the *Landsberg erecta* wild type. *Plant J* 6, 911-919

Kim HJ, Hyun Y, Park JY, Park MJ, Park MK, Kim MD, Kim HJ, Lee MH, Moon J, Lee I, Kim J (2004) A genetic link between cold responses and flowering time through FVE in *Arabidopsis thaliana*. *Nat Genet* 36: 167-171

Klaimi YY, Qualset CO (1974) Genetics of heading time in wheat (*Triticum aestivum* L.) II. The inheritance of vernalization response. *Genetics* 76: 119-133

Lang A (1965) Physiology of flower initiation. In *Encyclopedia of Plant Physiology*, W. Ruhland, ed (Berlin: Springer-Verlag), pp. 1371–1536

Laurie DA, Pratchett N, Bezant JH, Snape JW (1995) RFLP mapping of five major genes and eight quantitative trait loci controlling flowering time in a winter x spring barley (*Hordeum vulgare* L.) cross. *Genome* 38: 575-585

Law CN, Suarez E, Miller TE, Worland AJ (1998) The influence of the group 1 chromosomes of wheat on ear-emergence times and their involvement with vernalization and day length. *Heredity*, 80: 83–91.

Law CN, Worland AJ (1997) Genetic analysis of some flowering time and adaptive traits in wheat. *New Phytol* 137: 19-28

Law CN, Dean C, Coupland G (1993) Genes controlling flowering and strategies for their isolation and characterization. In BR Jordan, ed, *The Molecular Biology of Flowering*, CAB International, Oxford, pp 47-68

Law CN, Wolfe MS (1966) Location of genetic factors for mildew resistance and ear emergence time on chromosome 7B of wheat. *Ed 8* pp 462-472

- Limin AE, Fowler DB (2002) Developmental traits affecting low-temperature tolerance response in near-isogenic lines for the Vernalization locus Vrn-A1 in wheat (*Triticum aestivum* L. em Thell). *Ann Bot (Lond)* 89: 579-585
- Mahfoozi S, Limin AE, Fowler DB (2001a) Developmental regulation of low-temperature tolerance in winter wheat. *Annals of Botany* 87: 751-757
- Mahfoozi S, Limin AE, Fowler DB (2001b) Influence of vernalization and photoperiod responses on cold hardiness in winter cereals. *Crop Sci* 41: 1006-1011
- Masiero S, Li MA, Will I, Hartmann U, Saedler H, Huijser P, Schwarz-Sommer Z, Sommer H (2004) INCOMPOSITA: a MADS-box gene controlling prophyll development and floral meristem identity in *Antirrhinum*. *Development* 131: 5981-5990
- Maystrenko, O. I (1980) Cytogenetic study of the growth habit and ear-emergence time in wheat (*Triticum aestivum* L.). 1, 267-282. Moscow, In: Well-Being of mankind and genetics. Proc 14th Int Congress of Genetics.
- McIntosh RA, Devos KM, Dubcovsky J, Morris CF, and Rogers WJ. 2003. Catalogue of gene symbols for wheat: Supplement
- Michaels SD, He Y, Scortecci KC, Amasino RM (2003) Attenuation of *FLOWERING LOCUS C* activity as a mechanism for the evolution of summer-annual flowering behavior in *Arabidopsis*. *Proc Natl Acad Sci U S A* 100: 10102-10107
- Michaels SD, Amasino RM (1999) *FLOWERING LOCUS C* encodes a novel MADS domain protein that acts as a repressor of flowering. *Plant Cell* 11: 949-956

Miura H, Worland AJ (1994) Genetic control of vernalization, day-length response and earliness *per se* by homoeologous group-3 chromosomes in wheat. *Plant Breeding* 113, 160-169

Mouradov A, Cremer F, Coupland G (2002) Control of flowering time: interacting pathways as a basis for diversity. *Plant Cell* 14 Suppl: S111-S130

Plaschke J, Xie DX, Koebner RMD, Gale MD (1993) RFLP mapping of genes affecting plant height and growth habit in rye. *Theor Appl Genet* 85: 1049-1054

Pugsley AT (1972) Additional genes inhibiting winter habit in wheat. *Euphytica* 21: 547-552

Rajeevan MS, Lang A (1993) Flower-bud formation in explants of photoperiodic and day-neutral *Nicotiana* biotypes and its bearing on the regulation of flower formation. *Proc Natl Acad Sci U S A* 90: 4636-4640

Samach A, Onouchi H, Gold SE, Ditta GS, Schwarz-Sommer Z, Yanofsky MF, Coupland G (2000) Distinct roles of CONSTANS target genes in reproductive development of *Arabidopsis*. *Science* 288: 1613-1616

Sheldon CC, Burn JE, Perez PP, Metzger J, Edwards JA, Peacock WJ, Dennis ES (1999) The FLF MADS-box gene: a repressor of flowering in *Arabidopsis* regulated by vernalization and methylation. *Plant Cell* 11: 445-458

Shindo C, Sasakuma T, Watanabe N, Noda K (2002) Two-gene systems of vernalization requirement and narrow-sense earliness in einkorn wheat. *Genome* 45: 563-569

Shindo C, Tsujimoto H, Sasakuma T (2003) Segregation analysis of heading traits in hexaploid wheat utilizing recombinant inbred lines. *Heredity* 90: 56-63

Simpson GG, Dean C (2002) *Arabidopsis*, the Rosetta stone of flowering time? Science 296: 285-289

Simpson GG, Gendall AR, Dean C (1999) When to switch to flowering. Annu Rev Cell Dev Biol 15: 519-550

Snape JW, Butterworth, K., Whitechurch, E., Worland AJ (2001) Waiting for fine times: genetics of flowering time in wheat. Euphytica 119: 185-190

Snape JW, Law CN, Parker BB, Worland AJ (1985) Genetical analysis of chromosome 5A of wheat and its influence on important agronomic characters. Theor. Appl. Genet. 71, 518-526

Sourdille P, Snape JW, Cadalen T, Charmet G, Nakata N, Bernard S, Bernard M (2000) Detection of QTLs for heading time and photoperiod response in wheat using a doubled-haploid population. Genome 43: 487-494

Stelmakh AF (1993) Genetic effect of *Vrn* genes on heading date and agronomic traits in bread wheat. Euphytica 65: 53-60

Sung S, Amasino RM (2004) Vernalization and epigenetics: how plants remember winter. Curr Opin Plant Biol 7: 4-10

Thomashow MF (1999) Plant cold acclimation: Freezing tolerance genes and regulatory mechanisms. Annu Rev Plant Physiol Plant Mol Biol 50: 571-599

Tranquilli G, Dubcovsky J (2000) Epistatic interaction between vernalization genes *Vrn-Am1* and *Vrn-Am2* in diploid wheat. J Hered 91: 304-306

Worland AJ, Gale MD, Law CN (1987) Wheat genetics. In F.G.H. Lupton, ed. *Wheat breeding*, p. 135. London, Chapman and Hall

Yan, L., Helguera, M., Kato, K., Fukuyama, S., Sherman, J., and Dubcovsky, J. (2004a) Allelic variation at the *VRN-1* promoter region in polyploid wheat. *Theor. Appl. Genet.*, 109, 1677-1686.

Yan, L., Loukoianov, A., Blechl, A., Tranquilli, G., Ramakrishna, W., SanMiguel, P., Bennetzen, J.L., Echenique, V., and Dubcovsky, J. (2004b) The wheat *VRN2* gene is a flowering repressor down-regulated by vernalization. *Science*, 303, 1640-1644.

Yan, L., Loukoianov, A., Tranquilli, G., Helguera, M., Fahima, T., and Dubcovsky, J. (2003) Positional cloning of the wheat vernalization gene *VRN1*. *Proc. Natl. Acad. Sci. USA*, 100, 6263-6268.

IV. Phylogenetic and molecular analyses of MADS-box genes in hexaploïd wheat

Ndjido A. Kane, Amadou O. Diallo, Jean Danyluk and Fathey Sarhan^{*}

(Manuscript)

¹ Département des Sciences biologiques, Université du Québec à Montréal, Case Postale 8888, Succursale Centre-ville, Montréal, Québec, Canada H3C 3P8

^{*} To whom correspondence should be addressed.

Footnotes

Key words: Hexaploïd wheat, MADS-box protein, flowering, vernalization, photoperiod.

Running Title: "MADS-box genes in hexaploïd wheat".

Contribution

J'ai participé dans toutes les étapes d'expérimentation sous la supervision de FS et JD. J'ai été impliqué dans l'identification, le clonage et les analyses de séquence des gènes MADS-box avec AOD et JD. J'ai réalisé les analyses bioinformatiques et phylogénétiques, le design des sondes spécifiques et les études par RT-PCR des gènes MADS-box. J'ai rédigé cette version du manuscrit.

Analyses phylogénétiques et moléculaires des gènes MADS-box chez le blé

Résumé

La floraison, une des étapes les plus cruciales dans le cycle de vie des plantes, est sous le contrôle de facteurs saisonniers et environnementaux. Dans les zones tempérées, la basse température et la durée d'ensoleillement déterminent principalement les moments propices pour fleurir. Il a été démontré que les gènes de la famille MADS-box jouent des rôles importants dans la régulation génétique de l'induction florale et dans divers aspects du développement. En dépit d'une bonne caractérisation des gènes de MADS-box chez *Arabidopsis* et le riz, très peu de membres de cette famille ont une fonction connue chez le blé. Dans cet article, des études bioinformatiques et moléculaires ont permis d'identifier au moins 55 différentes séquences de gènes qui codent pour des protéines MADS-box. Toutes ces protéines possèdent des orthologues chez *Arabidopsis*, excepté dans les clades FLC-, AGL15- et GGM13/TT16-like. Les gènes de MADS-box de blé sont présents sur tous les génomes, cependant certains sont groupés dans des régions géniques (QTLs) qui déterminent la réponse à la vernalisation et à la photopériode. Les études d'expression de gènes indiquent que les transcrits régulés de façon différentielle en réponse à la vernalisation et en condition de jours longs sont ceux des clades StMADS11- et SOC1-like, ce qui suggère que ces gènes jouent des fonctions principales au cours de la floraison. En revanche, d'autres gènes s'expriment principalement au niveau des tissus embryogéniques et des épis, suggérant des fonctions durant l'embryogenèse et le développement de l'endosperme chez le blé.

Abstract

Flowering, one of the most crucial steps in a plant life cycle, is under the control of environmental cues. In temperate zones, low temperature (LT) and light duration mainly determine the process. MADS-box genes constitute a family that plays important roles in diverse aspects of development including the genetic control of floral induction. This family is well characterized in *Arabidopsis* and rice compared to wheat. To address this lack of information, we identified and characterized several members of the MADS-box family in wheat. Diverse cloning approaches indicated that wheat genomes express at least 55 nonredundant MADS-box genes which can be classified into 11 clades. Phylogenetic analysis revealed that the FLC-, AGL15-, and GGM13/TT16-like clades contain no representatives from wheat. However, one clade, named OsMADS32, seems to be specific to monocots. Mapping studies revealed that wheat MADS-box genes are scattered on all chromosomes, but some are clustered in QTL regions controlling the vernalization and the photoperiod responses. Expression studies revealed that transcripts differentially regulated by LT and long-day conditions belong to StMADS11- and SOC1-like clades, suggesting that genes of these clades are involved in flowering control mechanisms. In contrast, transcripts of the unclassified MADS-box genes are predominantly expressed in embryos and spikes, predicting potential functions during embryogenesis and endosperm development in wheat.

Introduction

The most characterized genes playing major roles throughout plant development belong to the MADS-box family. These genes encode transcriptional factors involved in diverse biological functions in eukaryotes (Shore, P. and Sharrocks, A. D. 1995). It has been demonstrated that members of this family are key players in gene networks that control the transition from the vegetative to the reproductive phase (Borner, R. et al. 2000, Danyluk, J. et al. 2003, Kane, N. A. et al. 2005, Levy, Y. Y. et al. 2002, Michaels, S. D. and Amasino, R. M. 1999). Some MADS-box genes are flowering time genes that repress or promote the floral transition depending on environmental or endogenous factors (cold, day-length, and plant age) (Hartmann, U. et al. 2000, Michaels, S.D. and Amasino, R. 1999, Sheldon, C.C. et al. 1999, 2000). Flowering time genes exert their function by influencing meristem identity genes that control the transition from inflorescence to floral meristems. Others MADS-box genes work as organ identity genes during the ontogeny of flowers that led to establishment of the ABCDE model in floral development (Jack, T. 2001; Theissen, G. 2001). This model describes how floral organ identity of different classes, called A, B, C, D, and E genes, provide different homeotic functions: A for sepals, A+B+E for petals, B+C+E for stamens, C+E for carpels, and D for ovules (Pelaz, S. et al. 2000, Theissen, G. 2001).

The accessibility of the complete genome sequences of *Arabidopsis thaliana* and rice (*Oryza sativa*) has allowed the annotation of 107 and 71 MADS-box genes, respectively (Goff, S. A. et al. 2002, Parenicova, L. et al. 2003, Riechmann, J. L. et al. 2000). It was proposed that MADS-box genes evolved from a common ancestor and formed two lineages referred to as type I and type II (or MIKC) which differ in the MADS domain and in the overall protein structure (Alvarez-Buylla, E. R. et al. 2000). The amino acid sequence of type I genes has a higher homology to SRF (Serum Response Factor)-like proteins whereas type II proteins are more related to MEF 2

(Myocyte Enhancer Factor 2)-like proteins. Type I proteins do not possess the characteristic dimerization domain called the K-box which is present in all type II MADS proteins. Type I genes represent 68/107 and 30/71 of the MADS genes in *Arabidopsis* and rice, respectively, but little is known about their functions. In contrast, MADS-box type II genes have been extensively studied. There are 39 and 40 MIKC class genes in *Arabidopsis* and rice, respectively (Lee, S. et al. 2003, Parenicova, L. et al. 2003) and these include genes acting in the control of flowering time (FLOWERING LOCUS C [FLC], SUPPRESSOR OF OVEREXPRESSION OF CONSTANS1 [SOC1], SHORT VEGETATIVE PHASE [SVP]), floral meristem identity, floral organ identity, fruit formation, ovule identity and root development (references in (Becker, A. and Theissen, G. 2003, Kofuji, R. et al. 2003, Parenicova, L. et al. 2003)). Based on expression patterns similarities and highly related functions, these genes are subdivided into 13 clades termed AG-, SEP/AGL2-, AGL6-, AGL12-, AGL15-, AGL17/ANR1-, DEF/AP3-, FLC-, GGM13/TT16-, GLO/PI-, AP1/SQUA-, StMADS11/SVP-, and SOC1/TM3- like (Becker, A. and Theissen, G. 2003, Parenicova, L. et al. 2003, Purugganan, M. D. et al. 1995). Inside each lineage, there are particularities providing evidence that MADS-box genes have undergone duplications to form large subfamilies in *Arabidopsis* and in rice.

In wheat, several genes encoding putative MADS-box proteins were identified. Their mRNAs have differential expression patterns in various organs at different developmental stages (Danyluk, J. et al. 2003, Kane, N. A. et al. 2005, Trevaskis, B. et al. 2003, Ciaffi, M et al. 2005, Zhao, T. et al. 2006, Zhao, X.Y. et al. 2006). However, very few MADS-box genes in wheat have known function. In the present study, we identified 55 MADS-box genes that were expressed in hexaploid wheat. Phylogenetic and molecular analyses indicated a broad conservation of MADS-box gene sequences and functions between wheat and previously described models rice and *Arabidopsis*. The StMADS11- and SOC1-like genes particularly seem to evolve between monocots and dicots and probably achieving novel functions during wheat adaptability to LT. In contrast, some other MADS-box genes not clearly classified

into type I and II lineages might functions during embryogenesis and endosperm development in wheat.

Results

Identification of MADS-box genes in hexaploid wheat

To initiate this project, available MADS-box protein sequences were used for data mining of the NCBI databases in search of wheat homologs. Wheat mRNAs and ESTs were assembled using the CAP3 sequence assembly program (<http://deepc2.psi.iastate.edu/aat/cap/cap.html>) into virtual mRNAs encoding putative MADS box proteins. These sequences were used as query to search for their closest relatives in *Arabidopsis* and rice genomes. To increase chances of identification of MADS-box genes in wheat, we used a strategy combining data mining, cDNAs libraries screening and PCR amplification as previously described (Houde, M. et al. 2006, Badawi, M. et al. 2007). The results allowed the isolation of 40 complete cDNA encoding putative MADS-box (Table I). Based on the identity and homology at the nucleic acid level (95% percent identity and a 30 overlap cut-off), these expressed sequences represented 29 different MADS-box genes (Table I).

Recently, 42 cDNAs encoding putative MADS-box in hexaploid wheat were reported (Zhao, T. et al. 2006). A close analysis of these expressed sequences revealed that they correspond to 31 nonredundant genes. Additionally, 2 genes (*m7* and *TaMADS1*) from hexaploid wheat were previously characterized (Ciaffi, M et al. 2005, Zhao, X. Y. et al. 2006). To be consistent with the previous nomenclature (Zhao, T. et al. 2006), identical gene names from wheat were conserved. Thus, new genes were named from *TaAGL43* to *TaAGL82* (Table S1) and *m7* and *TaMADS1* were renamed *TaAGL83* and *TaAGL84*. To differentiate between homeologous copies, an analysis of all identified MADS-box cDNA sequences from hexaploid was completed. The result indicated that only 7 MADS-box sequences have been identified in common by this study and by Zhao, T. et al (2006). Together, this

analysis indicated that at least 55 nonredundant genes are expressed in hexaploid wheat (Table I, figure 1).

Phylogenetic analysis

To distinguish wheat MADS-box type I and type II members, structure of protein sequences were analysed by screening databases of protein families, domains and functional sites as described in the experimental procedures. The analysis (data not shown) revealed that five proteins encoded by *TaAGL12*, *TaAGL22*, *TaAGL59* (same as *TaAGL33*), *TaAGL63* (same as *TaAGL41*) and *TaAGL42* did not contain a K-box inside their structural organisation. This was consistent with previous findings that recognized the five genes as unassigned genes (Zhao, T. et al. 2006). Concurrently, the results indicate that *TaAGL17* and three newly identified genes (*TaAGL65*, *TaAGL68*, and *TaAGL79*) did not contain the K-box.

Phylogenetic tree of MADS-box from wheat, rice and *Arabidopsis* was constructed using the highly conserved MADS domain. The results (figure S1) showed that the MADS domain present in *TaAGL17* is closely related to the MEF-2 sequence and it is classified into the *AGL17* clade as previously reported (Zhao, T. et al. 2006). In contrast, the unrooted tree in figure S2 showed that the MADS domain sequence of unassigned wheat MADS-box genes are closely related to the SRF-like sequence of rice. Based on the lineages classification, it could be presumed that these MADS-box genes might encode for type I genes. Unfortunately, little information is available about these types of MADS-box and no clear functions of such genes have yet been reported in plants.

Subsequently, the wheat type II MADS-box sequences was aligned to generate a tree that illustrates their evolutionary relationship. The results (figure 2) showed that 47 MADS-box type II genes of wheat are subdivided into 11 clades. The general

features of wheat MADS-box genes in each clade are summarized in the following paragraphs.

AP1/SQUA-like

The AP1/SQUA-like clade regroups three distinct subfamilies of genes: APETALA 1 (AP1-like), CAULIFLOWER (CAL-like) and FRUITFULL (FUL-like). These genes determine the specification of A-class functions in the flower development model. Five sequences were identified in wheat (*TaAGL10*, *TaVRT1*, *TaAGL29*, *TaAGL44* and *TaAGL52*). *TaVRT-1* and *TaAGL44* were classified into AP-like sub-class in cereals, which is consistent with previous studies (Danyluk, J. et al. 2003, Yan et al. 2003, Murai, K. et al. 2003). *TaAGL29* and *TaAGL52* are in the CAL-like sub-class while *TaAGL10* is the only member found into FUL-like sub-class.

DEF/AP3- and GLO/PI -like

DEFICIENS (DEF) and GLOBOSA (GLO) of *Antirrhinum* are the first members of these clades identified in *Antirrhinum* (Sommer, H. et al. 1990, Trobner, W. et al. 1992) and their orthologues found in *Arabidopsis* are APETALA3 (AP3) and PISTILATA (PI), respectively. In wheat, four DEF/AP3-like (*TaAGL35*, *TaAGL50*, *TaAGL51* and *TaAGL74*) and two GLO/PI-like (*TaAGL26* and *TaAGL49*) sequences were identified. This is not surprising because several paralogues of DEF/AP3-like and GLO/PI-like have been found in many other angiosperm genomes (Kramer, E.M. et al. 1998, Kramer, E.M. and Irish, V.F., 1999, Munster, T. et al. 2001). A well-known feature of these proteins is their ability to interact with other MADS-box proteins capable of binding to CArG-box sequences as heterodimer and to form regulatory complex of proteins. It has been shown that PI forms a heterodimer with AP3, capable of binding to CArG-box sequences. This heterodimer binds AP1 or SEP3 to form a ternary complex that could be responsible for the

regulation of the genes involved in the flower development (Honma, T. and Goto, K. 2001).

AG-like

The AGAMOUS (AG-like) genes control the specification of C and D functions. There are four different AG-like genes in the *Arabidopsis* genome (Yanofsky, M.F. et al. 1990, Ma, H. et al. 1991, Rounsley, S.D. et al. 1995). AGAMOUS was the first class C floral homeotic gene ever cloned (Yanofsky, M.F. et al. 1990). It has been suggested that the ancestral function of these genes is to specify reproductive organs and to distinguish them from non-reproductive organs (Winter, K. U. et al. 2002). In wheat, four different sequences *TaAGL31*, *TaAGL39*, *TaAGL55* and *TaAGL56* were related to the AG-like clade.

SEP/AGL2-like

The SEPALLATA (SEP1/AGL2, SEP2/AGL4 and SEP3/AGL9) or AGAMOUS-like 2 (AGL2-like) genes determine the specification of E function (Mandel, M.A. and Yanofsky, M.F. 1995, Pelaz, S et al. 2000). This clade counts 4 members in *Arabidopsis* and 8 in rice. However, ten wheat SEP-like sequences were recognized. *TaAGL83* and *TaAGL84* (formerly *m7* and *TaMADS1*, respectively) have been isolated from spike/spikelet tissues (Ciaffi, M. et al. 2005, Zhao, X.Y. et al. 2006). Seven sequences were identified in cDNAs libraries prepared from leaves and roots of different development stages (seedling stage, tillering stage, jointing stage and heading stage) (Zhao, T. et al. 2006). Under our experimental conditions, only one cDNA (*TaAGL53*) was amplified from leaves and crowns tissues. This distribution of wheat SEP-like sequences is consistent with the fact that these genes play their function during the formation of the floral meristem organs.

AGL6-like

No function of AGL6-like genes has been reported yet. In *Arabidopsis*, two genes *AGL6* and *AGL13* are present in this clade and they are expressed in floral organs and ovules, respectively. In wheat, only one gene of this clade (*TaAGL37*) was isolated under our experimental conditions. However, there is a high probability that another member of this clade is present in wheat because the clade is ancestral and widely distributed and conserved in angiosperms: Os02g45770.1 and Os04g49150.1 (figure 1), ZAG3 and ZAG6 in maize (Mena, M. et al. 1995), and GGM9 and GGM11 in ancestor species gymnosperms (Winter, K. U. et al. 2002).

AGL12-like

AGL12 is the only subfamily member from *Arabidopsis*. Few AGL12-like MADS-box genes have been isolated from eudicot, from rice (OsMADS26) and other monocot species (Becker, A. and Theissen, G. 2003). In wheat, three cDNAs (*TaAGL32*, *TaAGL64* and *TaAGL78*) within AGL12-like clade were recognized. The function of AGL12-like subfamily genes was not yet determined.

GGM13/TT16-like

The first clade member, GGM13, was found in the gymnosperm *G. gnemon* (Becker, A. et al. 2002). The GGM13/TT16-like genes are assumed to represent the sister group of the B genes including the DEF/AP3-like and GLO/PI-like genes, and their gymnosperm orthologues (Becker, A. et al. 2002). The only member from the *Arabidopsis* genome, TT16 also named AGL32, is required for proper development and pigmentation of the seed coat (Nesi, N. et al. 2002). Three genes were found in rice, but no sequence from wheat was identified.

SOC1/TM3-like

All SOC1/TM3-like genes are involved in floral transition (Becker, A. and Theissen, G. 2003). Our phylogenetic analysis of SOC1/TM3-like showed that 3 members are recognized in wheat that contrast with 6 members found in *Arabidopsis*.

This could be indicative that this clade lost some members in monocots or amplified in dicots. Because SOC1-like genes in cereals are more closely related to each other than with those of *Arabidopsis* (figure 4), it appeared that an amplification of members of this clade has occurred in dicots rather than a loss of members in monocots. This indicated that SOC1-like genes have evolved separately in dicots after the split with monocots. On the other hand, sequences of SOC1/TM3-like clade were detected in gymnosperms, suggesting that this family is even older than the split between gymnosperms and angiosperms. Therefore, it appears that the SOC1/TM3-like genes constitute an ancestral clade with conserved structures and functions.

AGL17-like

There are four different AGL17-like genes in the *Arabidopsis* genome, AGL16, AGL17, AGL21, and ANR1. ANR1 is the only AGL17-like gene for which a mutant phenotype is known. Transgenic plants in which ANR1 expression was blocked no longer responded to nitrate-rich zones in the soil by lateral root proliferation (Zhang, H. and Forde, B.G. 1998). This revealed that ANR1 is a key component of the signal transduction chain by which nitrate stimulates lateral root proliferation. Clade members have also been identified in rice, maize and here in wheat (*TaAGL6* and *TaAGL17*).

FLC-like

No wheat MADS-box genes homologous to *Arabidopsis* FLC-like clade (FLC and MAF genes) were found, which is consistent with the fact that this clade is absent in monocots (Becker, A. and Theissen, G. 2003, Hecht, V. et al. 2005, Izawa, T. et al. 2003). However, it is possible that close homologues of these genes might be expressed at very low level and therefore failed to be identified from wheat cDNAs libraries.

AGL15-like

The AGL15-like (AGL15 and AGL8) genes are preferentially expressed during embryogenesis and seed development (Perry, S.E. et al. 1996). AGL15 also accumulates transiently in shoot apices of seedlings, in flowers and leaf primordia of *Arabidopsis* (Fernandez, D.E. et al. 2000). However, their function remains unclear. No wheat MADS-box genes homologous to *Arabidopsis* AGL15-like clade were found. This clade might be absent in monocots as FLC-like genes (Becker, A. and Theissen, G. 2003, Hecht, V. et al. 2005, Izawa, T. et al. 2003).

StMADS11/SVP-like

Members of this clade were first isolated from *Solanum tuberosum* (StMADS11 and StMADS16, Carmona et al., 1998) and after from *Arabidopsis* (SVP and AGL24, Hartmann *et al.*, 2000; Michaels *et al.*, 2003). Nine wheat sequences are grouped in the StMADS11-like clade of genes. The phylogenetic analysis in figure 2 indicated that in wheat one singleton gene (*TaAGL48*) and two clusters of genes are clearly rooted inside three distinct subclasses. The comparison between *TaAGL60* and *TaAGL81* indicated that their proteins identities are 94%, suggesting that they are not product of the same gene. When comparing proteins encoded by genes of the second cluster (here identified VRT2-like), it appeared that TaVRT-2, TaAGL46, TaAGL36 and TaAGL47 correspond to different variants of the same protein (TaAGL47 and TaVRT-2). On the contrary, TaVRT-2 seems distinct from TaAGL77. Both mRNAs showed 95% similarities, but their proteins shared just 85% of identity, indicating that *TaVRT-2* and *TaAGL77* might be diverged genes. Thus, another phylogenetic analysis was conducted using the 5 close members of winter wheat Norstar StMADS11-like (*TaAGL48*, TaVRT-2, TaAGL77, TaAGL60 and TaAGL81) and all published proteins from the clade. The new tree (figure 3) identified again three distinct subclasses in all monocots wheat, barley, ryegrass, maize and rice comprising each one member at least. In dicots, three subclasses identified SVP-like, AGL24-like and StMADS11-like were also recognized.

A new clade of MADS-box genes in monocot

This clade was named OsMADS32-like (Zhao, T. et al. 2006) after the first clade member (*OsMADS32* also termed *Os01g52680.1*) that has been identified in rice. This clade include three sequences from wheat (*TaAGL62*, *TaAGL15* and *TaAGL58*) that have no orthologues in *Arabidopsis* genome (figure 2, figure S1). Closest homologues in dicots belong to the A- and B-class genes and putative orthologues of these genes have been identified in maize, the basal angiosperm *Asarum europaeum* and in gymnosperms (Munster, T. et al. 2001, Winter, K. U. et al. 2002).

Chromosome mapping

The map position of MADS-box genes in wheat genomes was used to discriminate between homeologues (copies of genes) as well to discover whether any of them could be linked to known QTLs having an effect on flowering time. The map position of several MADS-box sequences was determined by Southern blot analysis. Specific probes and a series of cytogenetic stocks of the wheat cultivar Chinese Spring were used to map genes to bins corresponding to chromosomal deletion regions. All the results presented in Table II indicated that members of the family are scattered through all three genomes and 7 chromosomes of wheat. There is a particular clustering of MADS-box gene mapped in the short arm of group 7 chromosomes (Table II). In several *Triticeae* species, this region carries a vernalization locus (*Vrn5*) and is associated with QTLs of photoperiod, heading time and earliness *per se* (Goncharov, N. P. 2003, Kane, N. A. et al. 2005). Mapping results presented are consistent with previously reported data (Danyluk, J. et al. 2003, Kane, N. A. et al. 2005, Szucs, P. et al. 2006) indicating that a number of MADS-box sequences are located on or very close to a bin allocation of linked markers that determine growth habit and flowering time in cereals.

Expression profiling during vernalization and photoperiod responses

In hexaploid wheat, *TaVRT-1* and *TaVRT-2* have been characterized in response to vernalization and photoperiod (Danyluk, J. et al. 2003, Kane, N. A. et al. 2005). During vernalization, the expression profile of their transcripts was inversely proportional. *TaVRT-2* transcript accumulation was associated with the vegetative phase while *TaVRT-1* accumulation determined the transition to the reproductive phase. Here, the focus was on the clades of genes that are not yet characterized in wheat and those that are known to play a role in flowering control in other species. The expression pattern of these genes is presented in figure 5.

Unassigned MADS-box genes

RT-PCR analyses of *TaAGL59* (same as *TaAGL33*), *TaAGL65*, *TaAGL68*, *TaAGL75* and *TaAGL79* genes were performed (figure 5A). No expression of *TaAGL75* and *TaAGL79* genes were detected in the aerial parts of leaves while *TaAGL59*, *TaAGL65* and *TaAGL68* were constitutively expressed in these tissues. Both *TaAGL65* and *TaAGL59* were constitutively expressed in wheats regardless of the photoperiod conditions, but transcripts expression of *TaAGL65* was weak whereas *TaAGL59* is highly expressed. In the case of *TaAGL68*, its transcript was reduced in winter wheat during vernalization under LD conditions.

OsMADS32-like

TaAGL62 and *TaAGL58* transcripts were highly expressed in embryos (data not shown). This was consistent with previous studies of other genes in the same clade (*TaAGL14* and *TaAGL15*) (Zhao, T. et al. 2006). *TaAGL58* was barely PCR-amplified after 40 cycles while *TaAGL62* was not detected in LT-treated leaves. qRT-PCR analysis using specific primers of *TaAGL62* indicated that *TaAGL62* is

upregulated in winter wheat under both LD and SD, but the ratio is 4-fold higher under LD (figure 5E). The differential expression of *TaAGL62* and *TaAGL58* in embryos and leaves suggested that the genes of this clade are expressed very early or under specific conditions of wheat development.

StMADS11-like

RT-PCR analyses of *TaAGL48* (same as *TaAGL11*), *TaAGL77*, *TaAGL60* and *TaAGL81* were performed with *TaVRT-2* (*TaAGL66*) as gene expression control (figure 5C). No expression of *TaAGL77* and *TaAGL81* genes was detected under our experimental conditions. However, *TaAGL60* and *TaAGL48* are constitutively expressed in both spring and winter genotypes. *TaAGL60* transcript accumulated to a higher level in winter than in spring wheat. The same pattern was observed under LD and SD photoperiod. In contrast, *TaAGL48* transcript is positively regulated by LD photoperiod and by vernalization in winter wheat. This pattern indicated that *TaAGL48* is similarly regulated as *TaVRT-1*, but inversely to *TaVRT-2* during the vernalization under LD. It is not surprising that two genes evolutionally close show inverse expression pattern. The *Arabidopsis* StMADS-11 genes *SVP* and *AGL24* showed inverse expression and function. *TaVRT-2* has been shown to be a negative regulator of flowering and since other members of the clade did not show any particular regulation in wheat under our experimental conditions, we thus presumed that *TaAGL48* may be a functional equivalent of *AtAGL24*.

SOC1/TM3

Previous gene expression studies reported that *TaAGL1* (same as *TaAGL82* of Norstar) is expressed in primary root tips, leaves, developing seeds and whole spikelet, suggesting that *TaAGL1* might have similar expression pattern than *Arabidopsis AtSOC1* (Zhao, T. et al. 2006). However, RT-PCR analyses performed on cDNA prepared from vernalized and unvernallized leaves showed that *TaAGL82* is not differentially regulated (upregulation) during the vernalization of wheat.

TaAGL82 is constitutively expressed in spring and winter wheats regardless of the photoperiod conditions (figure 5D). Similarly, the gene *TaAGL7* is constitutively expressed in vegetative as well as in reproductive tissues during LT treatment and no differential pattern was observed when plants were grown under LD or SD photoperiods (figure 5D). On the other hand, expression studies of *TaAGL54* during the vernalization treatment revealed that the gene is barely detected by RT-PCR in both spring and winter wheat genotypes. This indicated that the level of expression of this gene is very low in these tissues. To further characterize this gene in winter wheat, qRT-PCR analysis was performed using specific primers and the results indicated that *TaAGL54* is upregulated during vernalization (figure 5F). Moreover, this upregulation is 3-fold higher under LD than under SD conditions. Together, the expression studies of SOC-like genes of wheat indicated that *TaAGL54* has a similar gene expression pattern as *AtSOC1*.

Taken together, the expression analyses revealed that most of the MADS-box transcripts from flowering regulators clades were constitutively expressed in the aerial parts of spring and winter wheat. They were more expressed in winter wheat than in spring wheat, suggesting that they might play a role during winter wheat development during LT periods. On the contrary, some of the uncharacterized MADS-box genes were not detected in those young leaves and they were particularly abundant in wheat embryos and endosperms tissues.

Discussion

Identification and location of MADS-box genes in wheat genomes

Common wheat, *Triticum aestivum*, contains three pairs of genomes originated by inter-specific hybridization of three diploid species, *T. urartu*, *Aegilops speltoides*, and *A. tauschii*. For geneticists and molecular biologists, the first challenge using hexaploid wheat is to differentiate between copies of the same gene (orthologues) and recently duplicated genes on the same genome (paralogues).

In this study, comparative approaches were used to distinguish between wheat MADS-box homeologous genes. All sequences analysed were from hexaploid wheat and then were treated arbitrary as duplicates if they were > 95% identical at the DNA level with 30 overlap cut-off. Sequences analysis led to the identification of 55 nonredundant MADS-box genes. In addition, 12 partial cDNAs have been identified from FGAS EST database or by PCR (data not shown). Virtual mRNAs were also reconstructed from initial data mining, but they failed to be amplified under our experimental conditions. Therefore, it is apparent that the wheat genomes encode more MADS-box proteins than the 55 members identified so far.

Chromosomal location of the genes revealed that MADS-box genes are scattered in wheat genomes, some closely related genes are mapped in different group chromosomes. For example, the StMADS11-like genes *TaAGL48* and *TaVRT-2* were located on chromosomes, 6 and 7 respectively. In contrast, a few MADS-box genes are located on two or more distinct genomes possibly with re-arrangements of chromosomes between genomes. Another interesting data out of the genomic location is the cluster of MADS-box genes mapped in the short arm of group 7 chromosomes. For instance, the coincidence of this cluster with vernalization and photoperiod QTLs suggests that the MADS-box genes in that region are potential candidates as flowering time genes in *Triticeae* species. The association of *TaVRT-2* with

vernalization and photoperiod QTL effects was already demonstrated in barley (Szucs, P. et al. 2006), confirming this association in wheat or other plant having a vernalization requirement.

Classification of wheat MADS-box genes

In addition to MADS-box type I and Type II (MIKC) genes, *Arabidopsis* and rice genomes carry numerous genes that are identified as pseudogenes and/or retrotransposons (Nam, J. et al. 2003, 2004). MADS-box Type I genes are classified into classes M, N and O on the basis of the presence of conserved motifs in the C-terminal region of their proteins (De Bodt, S. et al. 2003). However, it was suggested that they have experienced a rapid birth-and-death evolution in both species (Nam, J. et al. 2004). Given that the unassigned wheat genes did not contain the K-box inside their structural organization, we initially thought that they could be MADS-box type I genes. However, the amino acids alignment of their proteins with those of type I from rice and *Arabidopsis* showed that none of the wheat unassigned genes possesses the conserved motifs in the C-terminal region. In addition, it appeared from the rooted tree of the alignment that unassigned wheat genes are regrouped inside one subclass, suggesting that they could be monophyletic. Therefore, one may conclude that these wheat genes are not MADS-box type I or type II genes as described in both model plants rice and *Arabidopsis*. Subsequently, we considered the possibility that the unassigned wheat genes might be pseudogenes, i.e. incomplete and non-functional (no longer expressed) MADS-box genes. However, our data clearly show that they are expressed, particularly in embryos and endosperms tissues. Therefore, they are not pseudogenes and further identification and characterization will be necessary to better classify these wheat genes inside the lineages of MADS-box genes family.

A new clade of MADS-box MIKC genes in monocot

The recognition of *OsMADS32*-like genes is indicative that some MADS-box may have co-evolved in cereals species or after monocots and dicots split. Closest homologues of *OsMADS32*-like clade belong to the A- and B-class genes and putative orthologues of these genes have been identified in the monocot *Zea mays*, the basal angiosperm *Asarum europaeum*, the eudicot *Petunia hybrida* and in gymnosperms (Munster, T. et al. 2001, Winter, K. U. et al. 2002). Expression studies revealed that these classes of genes are mainly detected in female and male reproductive organs (Becker et al, 2002), suggesting that they play important roles during the evolution of the reproductive structures in seed plants. In wheat, the *OsMADS32*-like gene is expressed predominantly in spikes which carry reproductive organs. This is consistent with the fact that, during flower evolution, expressions of A- and B-class genes remain in reproductive organs. Therefore, members of the *OsMADS32*-like clade are candidate genes to further explore the evolution and function of reproductive organs in seed plants.

StMADS11-like genes in wheat

Phylogenetic analysis showed that StMADS11-like genes of cereals compared to dicots are more closely related to each other and all monocots carry at least one member of this clade. Interestingly, the presence of extra genes is more obvious in wheat and provides evidence that genes of this clade have undergone some duplication after divergence from the last common ancestor between monocots and dicots. It is assumed duplications gave rise to genes with restricted patterns of expression probably recruited to specialized functions in either reproductive or vegetative structures (Trevaskis, B. et al. 2007). Gene expression studies of members of the StMADS11-like clade in response to vernalization and photoperiod and their map position close to QTL regions controlling flowering suggest that the StMADS-

like genes might acquire specialized functions during wheat development and adaptability to LT.

In wheat and barley, StMADS11-like genes are associated with the delay formation of floral meristems indicating that these genes play an important role to repress floral development during winter, possibly to counteract induction of flowering by vernalization (Trevaskis, B. et al. 2007). Ectopic expression of StMADS11-like genes is consistent with inhibition of floral organ development and reversion of the floral meristem (Trevaskis, B. et al. 2007, Ciannamea, S. et al, 2006). It was also presumed that the primary function of StMADS11-like genes in cereals is to determine meristem identity (Trevaskis, B. et al. 2007). However, overexpressing VRT2-like in *Arabidopsis* delay flowering (Kane, N.A. et al. unpublished results), indicating that specialized functions have apparently evolved within the genes clade.

SOC1-like genes are ancient and regulated by vernalization and photoperiod

A bunch of SOC1-like sequences was identified in gymnosperms (references in (Becker, A. et al. 2003). This provides evidence that SOC1-like genes family is even older than the split between gymnosperms and angiosperms. The presence of less members in monocots than in *Arabidopsis* is an indication of gene amplification in *Arabidopsis* rather than a loss of genes in monocots. It appears, therefore, that SOC1-like genes constitutes a clade with ancestral functions. Expression studies of the SOC1-like family reveal that the genes are mainly expressed in non-floral organs, even those that are involved in the floral transition (Becker, A. et al. 2003, Zhao, T. et al. 2006). In *Arabidopsis*, *AtSOC1* transcript gradually increase during development and is up-regulated by vernalization (Lee et al, 2000; Samach et al, 2000). In rice, the functional equivalent of *AtSOC1* (*OsMADS50*) is expressed in vegetative tissues, and this expression is elevated at the time of floral initiation (Tadege, M. et al. 2003). Intriguingly, within the wheat genes, only *TaAGL54* is regulated by vernalization and LD photoperiodic treatments. These relationships suggest that *TaAGL54* might be a

functional equivalent of *AtSOC1*, i.e. integrating signals from the flowering pathways (vernalization and photoperiod) and promoting flowering in a dose-dependent manner (Borner, R. et al. 2000, Moon, J. et al. 2003, Samach, A. et al. 2000).

MADS-box genes evolution and functions

Apart from the single example in *Petunia* (Vandenbussche et al. 2003), genes of the FLC-like clade (FLC and the MAF genes) could not be found outside the *Brassicaceae* (Becker, A. and Theissen, G. 2003, Hecht, V. et al. 2005, Izawa, T. et al. 2003). It is possible that close homologues of these genes might be absent in monocots. Otherwise, they may be expressed at very low level and therefore failed to be identified in cDNAs libraries or EST databases. The absence of FLC-like in monocots is interesting in light of the importance of the functions of these genes in *Arabidopsis*. It raises the question of which genes integrate adaptive mechanisms to regulate flowering. The StMADS11-like clade is ancient and represents flowering genes that are regulated by vernalization and photoperiod. Because FLC-like genes are completely unrepresented or absent in the monocots species, we consider that StMADS11-like genes might regulate flowering in monocots in a similar manner that FLC-like genes function in dicots. *TaVRT-2* is a flowering repressor and the expression of this gene is regulated by vernalization, photoperiod and apparently through the autonomous pathway (Kane, N.A. et al. unpublished results). These characteristics of *TaVRT-2* are more similar to those of FLC than SVP (although SVP is a dominant repressor of flowering, its gene is not regulated by vernalization and photoperiod and overexpression of close orthologues doesn't delay flowering, (Trevaskis, B. et al. 2007, Ciannamea, S. et al, 2006)). Thus, *TaVRT-2* is a genuine candidate to play FLC-like functions in monocots. Another interesting result from the gene expression survey comes from the pattern of *TaAGL48*, suggesting that *TaAGL48* may be a functional equivalent of *AtAGL24*.

In conclusion, data reported here reveal that multiple MADS-box genes are functional in wheat. In general, a broad conservation of MADS-box gene sequences and functions during angiosperms evolution is observed. Members of the clade of genes tend to share similar expression profile and highly related functions (Theissen *et al.*, 2000). Therefore, it is reasonable to assume that MADS-box genes play important roles in mechanisms that govern wheat development and response to environmental stresses. The results presented here suggest that MADS-box genes that determine the floral organs identity through the ABCDE model are relatively conserved between wheat, rice and previously described model dicots, although a few minor variations of certain genes is observed (for example TaVRT-1 versus API of the API-like clade, the latter determines the floral organs identity in dicots while the first regulates the vernalization response in cereals). On the other hand, the existence of MADS-box genes in monocots that was not detected in dicots, and *vice versa*, is a sign that the conservation and functions of these genes in the plant kingdom are far from elucidation. The absence FLC-like in monocots is interesting in light of the important functions of such genes in *Arabidopsis*. It raises the question of which genes in cereals can integrate adaptive mechanisms to regulate flowering, in a similar manner to dicot FLC.

Materials and Methods

Plant materials and growth conditions

Two genotypes of hexaploid wheat (*Triticum aestivum* L. AABBDD x 7 = 42 chromosomes) having different vernalization requirement were grown in environmentally-controlled growth chambers as previously described (Kane, N.A. et al. 2005). Briefly, seedlings were germinated for 2 weeks under long day (LD, 16h) or short day (SD, 8h) photoperiod at 20°C. For LT treatment, plants grown for 14 days at 20°C under either LD or SD photoperiod were transferred at 4°C under identical photoperiods. For photoperiod studies, plants were always kept at 20°C under identical photoperiod.

Data mining, library construction and gene isolation

The procedures for the construction of the 5 wheat cDNA libraries used in this study were described in detail previously (Houde, H. et al. 2006; Badawi, M. et al. 2007). Briefly the five libraries (L2–L6) were prepared from the following pooled mRNA populations: (L2) aerial parts (leaf and crown) from control and long-term cold acclimated wheat (1–53 days); (L3) root tissue from control, cold-acclimated and salt stressed wheat; (L4) aerial parts of dehydration stressed wheat; (L5) crown tissue during vernalization and different developmental stages of spike and seed formation in wheat; (L6) crown and leaf tissues from wheat after short exposures to LT in the light and in the dark.

To initiate this project, available MADS-box protein sequences were used for data mining of the NCBI NR and EST databases in search of wheat homologs. Wheat mRNAs and ESTs were assembled using the Cap3 sequence assembly program (<http://deepc2.psi.iastate.edu/aat/cap/cap.html>) into virtual mRNAs encoding putative MADS box proteins. These sequences were used as query to search for their closest

relatives in the *Arabidopsis* and rice genomes. Details of the screening and PCR isolation were described (Badawi, M et al. 2007).

Phylogeny analyses

A phylogenetic reconstruction of MADS-box family were performed using the MADS domain (60 amino acids) from *Arabidopsis*, rice and wheat sequences. Phylogenetic analysis of the wheat MADS-box MIKC proteins was performed using the MADS domain, I region and K-box while phylogenetic analyses of StMADS11- and SOC1-like were conducted using full-length amino acid sequences. All alignments of MADS-box amino acid sequences were performed using ClustalW with the following parameters: gap opening penalty of 10.00, gap extension penalty of 0.20 and BLOSUM protein weight matrix. To construct reliable trees, all have been manually corrected and resubmitted to multiple alignments. To better visualize the relationship of wheat MADS-box genes, only one copy of each gene was included in each analysis. If a copy is isolated from two different cultivars, only the one from Norstar was used in the analysis.

Analysis of MADS-box protein sequences

The analysis of shared motifs among the wheat MADS-box protein sequences was performed using the MEME version 3.0 (Bailey, T. L. and Elkan, C. 1994) as previously reported (Parenicova, L. et al. 2003). The InterProScan (<http://www.ebi.ac.uk/InterProScan/>, (Quevillon, E. et al. 2005)) and the NCBI conserved domain search (<http://www.ncbi.nlm.nih.gov/Structure/cdd/wrpsb.cgi>, (Marchler-Bauer, A. et al. 2005)) were also used to support the results obtained through the MEME analysis.

Chromosomal location

A series of cytogenetic stocks of the wheat cultivar Chinese Spring were obtained from the Wheat Genetics Resources Center, Kansas State University, USA

(Endo, T. R. and Gill, B. S. 1996, Sears, E. R. 1954, Sears, E. R. 1966). The series included 19 nullisomic-tetrasomic lines, 23 ditelosomic lines and 96 deletion lines.

Leaf tissues was collected (5g) from four week old plants grown in growth chambers, freeze-dried and ground in 50 ml centrifuging tubes with the help of 2mm glass beads using a high speed shaker. Fifteen micro-grams of genomic DNA from 138 wheat lines used in this study was digested with the restriction enzyme *Dra I* for 4 hours at 37°C in the presence of RNase A (0.03 µg/reaction).

For hybridizations, probes were PCR-amplified using specific primer sets (Table S2) and 100 ng purified DNA fragment was labelled with α -³²P using a random primer labelling kit following the manufacturer's instructions (Invitrogen). The filters were hybridized, washed at high stringency and exposed to BioMax MS, X-Ray film through a BioMax TranScreen HE intensifying screen (Rochester, New York) for 1 to 10 days depending on the signal strength.

Expression analyses

RT-PCR analyses were carried out as previously described (Kane, N.A. et al.2007). Specific primers were designed to amplify MADS-box transcripts (Table S3). Assays were repeated twice and PCR amplification products were analyzed by electrophoresis on 1% agarose/ethidium bromide gels. For qRT-PCR, analyses were carried out as previously described (Badawi, M et al. 2007). Primers were specifically designed to monitor the expression of each selected gene. Fluorescent TaqMan-MGB probes as well as the non-fluorescent primers (Table S4) were designed using the combination of Primer Express Software Version 2.0 (Applied Biosystems) and Primer3 input (primer www.cgi v 0.2).

Acknowledgements

We thank Lasantha Ubayasena and Graham Scoles for the chromosomal location studies. This work was supported by grants from the Natural Sciences and Engineering Research Council, Genome Canada and Génome Québec.

Tables

IV-Table 1: List of MADS-box in hexaploid wheat

Gene ID	Cultivar	cDNA (bp)	Protein (a.a)	GI Number	Comments	Reference
TaAGL1	Nongda	908	219	ABF57914	MIKC	Zhao, T. et al. 2006
TaAGL3	Nongda	796	227	ABF57931	MIKC	Zhao, T. et al. 2006
TaAGL4	Nongda	878	225	ABF57940	MIKC	Zhao, T. et al. 2006
TaAGL5	Nongda	805	227	ABF57946	MIKC	Zhao, T. et al. 2006
TaAGL6	Nongda	911	232	ABF57913	MIKC	Zhao, T. et al. 2006
TaAGL7	Nongda	1000	230	ABF57947	MIKC	Zhao, T. et al. 2006
TaAGL10	Nongda	1146	267	ABF57915	MIKC	Zhao, T. et al. 2006
TaAGL11	Nongda	924	228	ABF57916	MIKC	Zhao, T. et al. 2006
TaAGL12	Nongda	714	176	ABF57951	U	Zhao, T. et al. 2006
TaAGL13	Nongda	972	226	ABF57917	MIKC	Zhao, T. et al. 2006
TaAGL15	Nongda	705	196	ABF57945	MIKC	Zhao, T. et al. 2006
TaAGL17	Nongda	402	100	ABF57952	MIKC	Zhao, T. et al. 2006
TaAGL22	Nongda	473	104	ABF57949	U	Zhao, T. et al. 2006
TaAGL23	Nongda	1036	263	ABF57924	MIKC	Zhao, T. et al. 2006
TaAGL24	Nongda	799	231	ABF57925	MIKC	Zhao, T. et al. 2006
TaAGL26	Nongda	877	209	ABF57927	MIKC	Zhao, T. et al. 2006
TaAGL27	Nongda	986	236	ABF57928	MIKC	Zhao, T. et al. 2006
TaAGL28	Nongda	951	247	ABF57929	MIKC	Zhao, T. et al. 2006
TaAGL29	Nongda	1158	247	ABF57930	MIKC	Zhao, T. et al. 2006
TaAGL31	Nongda	980	252	ABF57948	MIKC	Zhao, T. et al. 2006
TaAGL32	Nongda	828	229	ABF57934	MIKC	Zhao, T. et al. 2006
TaAGL33	Nongda	579	167	ABF57950	U	Zhao, T. et al. 2006
TaAGL35	Nongda	635	167	ABF57953	MIKC	Zhao, T. et al. 2006
TaAGL36	Nongda	841	228	ABF57936	MIKC	Zhao, T. et al. 2006
TaAGL37	Nongda	993	259	ABF57937	MIKC	Zhao, T. et al. 2006
TaAGL38	Nongda	921	222	ABF57938	MIKC	Zhao, T. et al. 2006
TaAGL39	Nongda	959	273	ABF57939	MIKC	Zhao, T. et al. 2006
TaAGL40	Nongda	683	224	ABF57954	MIKC	Zhao, T. et al. 2006
TaAGL41	Nongda	560	152	ABF57941	U	Zhao, T. et al. 2006
TaAGL42	Nongda	696	166	ABF57942	U	Zhao, T. et al. 2006
TaAGL43	Norstar	1181	245	*	MIKC, TaVRT-1	This study
TaAGL44	Norstar	1184	245	*	MIKC	This study
TaAGL45	Norstar	877	209	*	WPI-2	This study
TaAGL46	Norstar	1113	228	*	MIKC	This study
TaAGL47	Norstar	823	190	*	MIKC	This study
TaAGL48	Norstar	877	228	*	MIKC	This study
TaAGL49	Norstar	928	208	*	MIKC	This study
TaAGL50	Norstar	959	229	*	MIKC	This study
TaAGL51	Norstar	1004	201	*	MIKC	This study

IV-Table 1 (continued)

Gene ID	Cultivar	cDNA (bp)	Protein (a.a)	GI Number	Comments	Reference
TaAGL52	Norstar	701	222	*	MIKC	This study
TaAGL53	Norstar	1215	246	*	MIKC	This study
TaAGL54	Norstar	1075	222	*	MIKC	This study
TaAGL55	Norstar	1090	254	*	MIKC	This study
TaAGL56	Norstar	1083	254	*	MIKC	This study
TaAGL58	Norstar	923	196	*	MIKC	This study
TaAGL60	Norstar	870	226	*	MIKC	This study
TaAGL62	Norstar	1031	237	*	MIKC	This study
TaAGL63	Norstar	833	152	*	U	This study
TaAGL64	Norstar	1106	224	*	MIKC	This study
TaAGL65	Norstar	841	167	*	U	This study
TaAGL66	Norstar	1068	226	*	MIKC, TaVRT-2	This study
TaAGL67	Norstar	1049	196	*	MIKC	This study
TaAGL68	Norstar	825	166	*	U	This study
TaAGL74	Norstar	1053	275	*	MIKC	This study
TaAGL75	Norstar	641	165	*	U	This study
TaAGL77	Norstar	1023	235	*	MIKC	This study
TaAGL79	Norstar	887	184	*	U	This study
TaAGL81	Norstar	859	227	*	MIKC	This study
TaAGL82	Norstar	919	223	*	MIKC	This study
TaAGL83	CS	640	201	CAE53894	MIKC, m7	Ciaffi, M. et al. 2005
TaAGL84	PH 82-2-2	961	252	AAQ11687	MIKC, TaMADSI	Zhao, X.Y. et al. 2006

ORF = open reading frame (CDs)

bp = base pair

a.a = amino acid

* = sequences are presented in supplement and will be submitted to GenBank.

MIKC = MADS, Intervening, K-box and C-terminal

U = unassigned to MADS-box type I and II

Nongda = Nongda 3338

CS = Chinese Spring

IV-Table 2: Mapping of 20 wheat MADS-box genes

Gene ID	Chromosomal location	
	Arm	Bin
TaAGL74	1AS	C-1AS1-0.47
	1BS	C-1BS10-0.50
TaAGL63	1AL	1AL1-0.17-0.61
	1BL	1BL6-0.32-0.47
	1DL	1DL2-0.41-1.00
TaAGL49 (WPI-1)	1AL	1AL1-0.17-0.61
	1BL	1BL1-0.47-0.69
	1DL	1DL2-0.41-1.00
	3AL	3AL5-0.78-1.00
	3BL	3BL7-0.63-1.00
	3DL	3DL2-0.27-0.81
TaAGL56 (WAG)	1AS	1AS1-0.47-0.86
	1BS	C-1BS10-0.50
	3AS	3AS4-0.45-1.00
	3BS	3BS1-0.33-0.57
TaAGL50 (WAP3)	2AL	C-2AL1-0.85
	2BL	2BL2-0.36-0.50
	2DL	2DL3-0.49-0.76
TaAGL78	2AL	C-2AL1-0.85
	2BL	C-2BL2-0.36
	2DL	C-2DL3-0.49
TaAGL67	3AL	3AL3-0.42-0.78
	3BL	3BL2-0.22-0.50
	3DL	3DL2-0.27-0.81
TaAGL75	3AL	3AL5-0.78-1.00
	3DL	3DL2-0.27-0.81
TaAGL65	3AL	3AL5-0.78-1.00
	3BL	3BL7-0.63-1.00
	3DL	3DL3-0.81-1.00

IV-Table 2 (continued)

Gene ID	Chromosomal location	
	Arm	Bin
TaAGL68	3AL	3AL5-0.78-1.00
	3BL	3BL7-0.63-1.00
	3DL	3BL2-0.27-0.81
TaAGL81	4AS	4AS3-0.76-1.00
	4BL	C-4BL5-0.71
	4DL	4DL13-0.56-0.71
TaAGL54	4BL	4BL1-0.86-1.00
	4DL	4DL13-0.56-0.71
TaVRT-1	5AL	<i>VRN1</i> locus
TaAGL48	6AL	6AL8-0.90-1.00
	6BL	6BL5-0.36-0.40
	6DL	6DL1-0.47-0.68
TaAGL51	7AL	7AL1-0.39-0.71
	7BL	7BL2-0.33-0.48
	7DL	7DL5-0.30-0.61
TaAGL64	7A	undetermined
	7D	undetermined
TaAGL62	7AS	7AS5-0.59-0.89
	7BS	7BS1-0.27-1.00
	7DS	7DS5-0.36-0.61
TaAGL77	7AS	7AS5-0.59-0.89
	7BS	7BS1-0.27-1.00
	7DS	7DS5-0.36-0.61
TaAGL66 (TaVRT-2)	7AS	7AS5-0.59-0.89
	7BS	7BS1-0.27-1.00
	7DS	7DS5-0.36-0.61
TaAGL53	7AS	C-7AS8-0.45
	7BS	C-7BS1-0.27
	7DS	C-7DS5-0.36

Figures

A

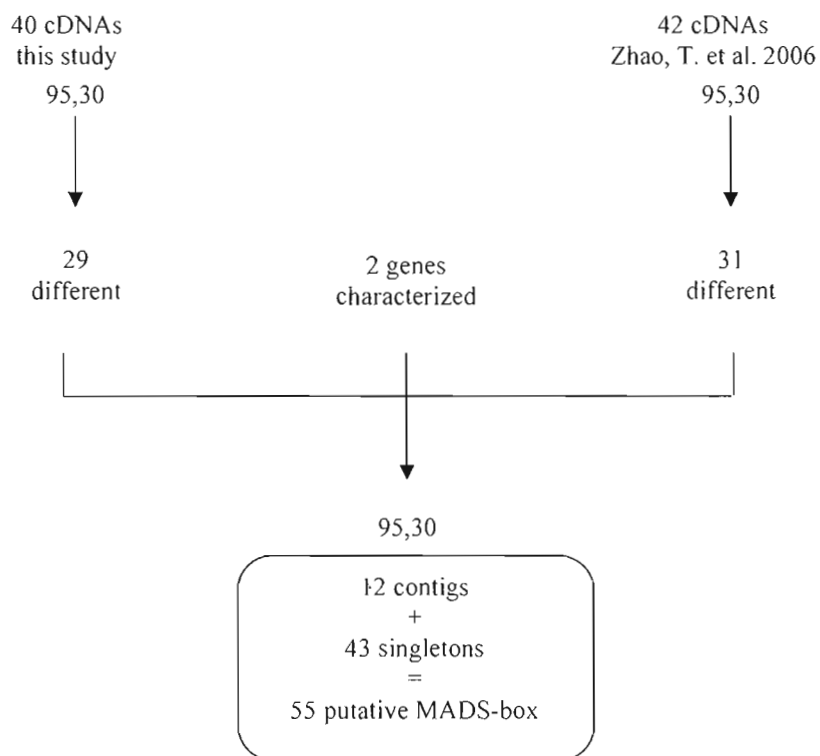

B

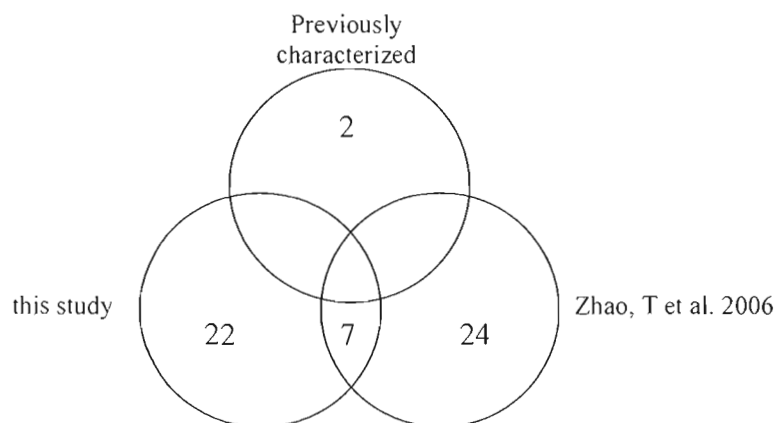

IV-Figure 1: Identification of MADS-box genes in hexaploid wheat

A) Flowchart for sequence assembly and B) Diagram summarizing the distribution of genes isolated from this study and by others.

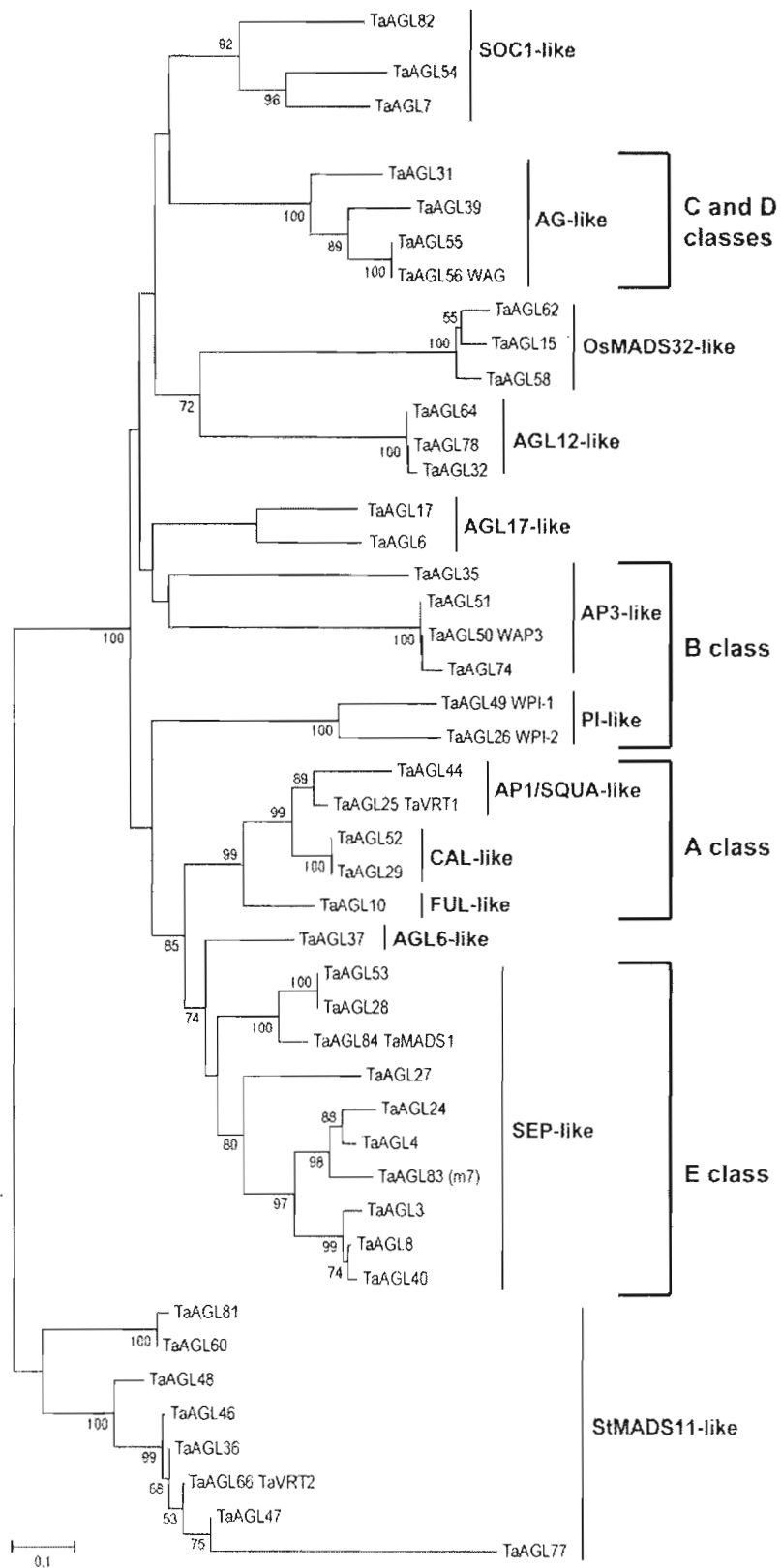

IV-Figure 2: Phylogenetic analysis of wheat MADS-box MIKC proteins

An alignment of the MADS domain, I region and K-box was generated using ClustalW with the multiple alignment parameters gap penalty 10, gap extension penalty 0.2 and BLOSUM protein weight matrix. The accession numbers for the sequences used are listed in the Table I. The tree was constructed with the Neighbor Joining (NJ) algorithm included in the MEGA 3.1 program package (Kumar, S. et al. 2004) with the Poisson correction, complete deletion of gaps, and 500 bootstrap replications. Numbers beside each branch are percentages of the bootstraps (<50% were omitted). Classification of subfamilies was according to previous annotation (Parenicova, L. et al. 2003). Wheat members are indicated in bold. The scale bar indicates the number of amino acid substitutions per site.

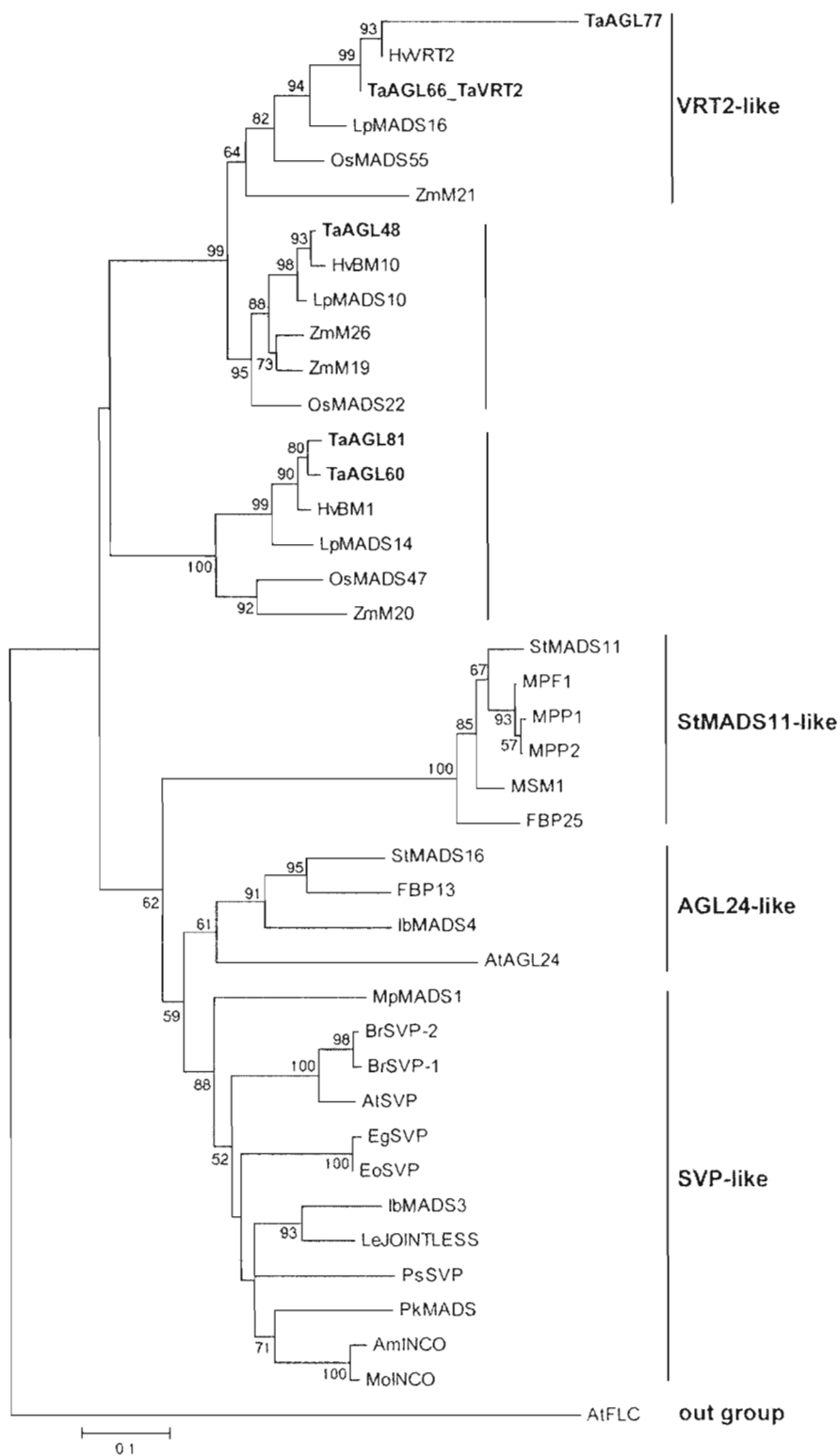

IV-Figure 3: Phylogenetic analysis of StMADS11-like sequences

The StMADS11-like proteins were aligned using default parameters of ClustalW included in the program MEGA 3.1 (Kumar, S. et al. 2004), manually corrected and used to construct the Neighbor-Joining (NJ) tree with the Poisson correction, complete deletion of gaps, and 500 bootstrap replications. Numbers beside each branch are percentages of the bootstraps (<50% were omitted). Wheat members of the clade are indicated in bold. The consensus tree is rooted with FLC from *Arabidopsis*. The scale bar indicates the number of amino acid substitutions per site.

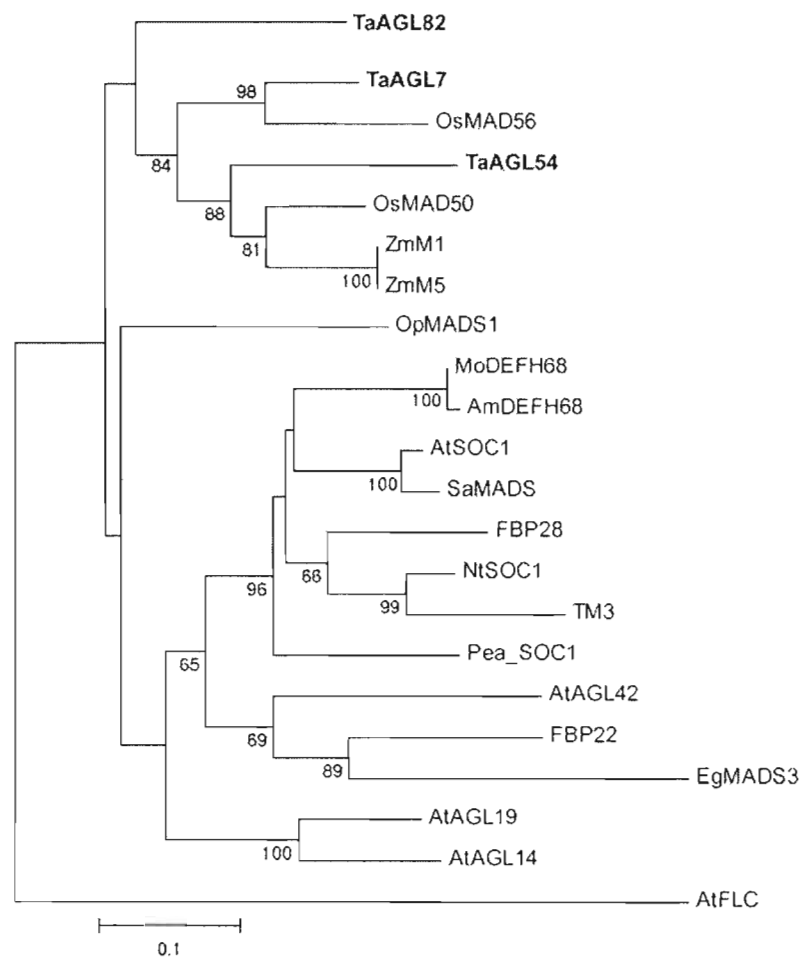

IV-Figure 4: Phylogenetic analysis of SOC1-like sequences

Methods to generate the tree and legend are as that of figure 3.

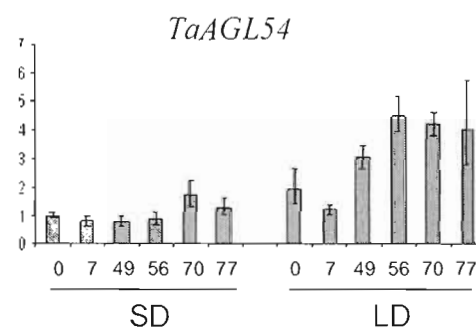
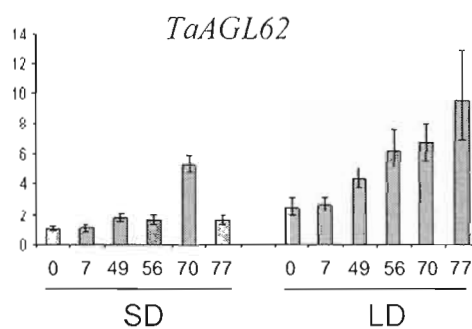
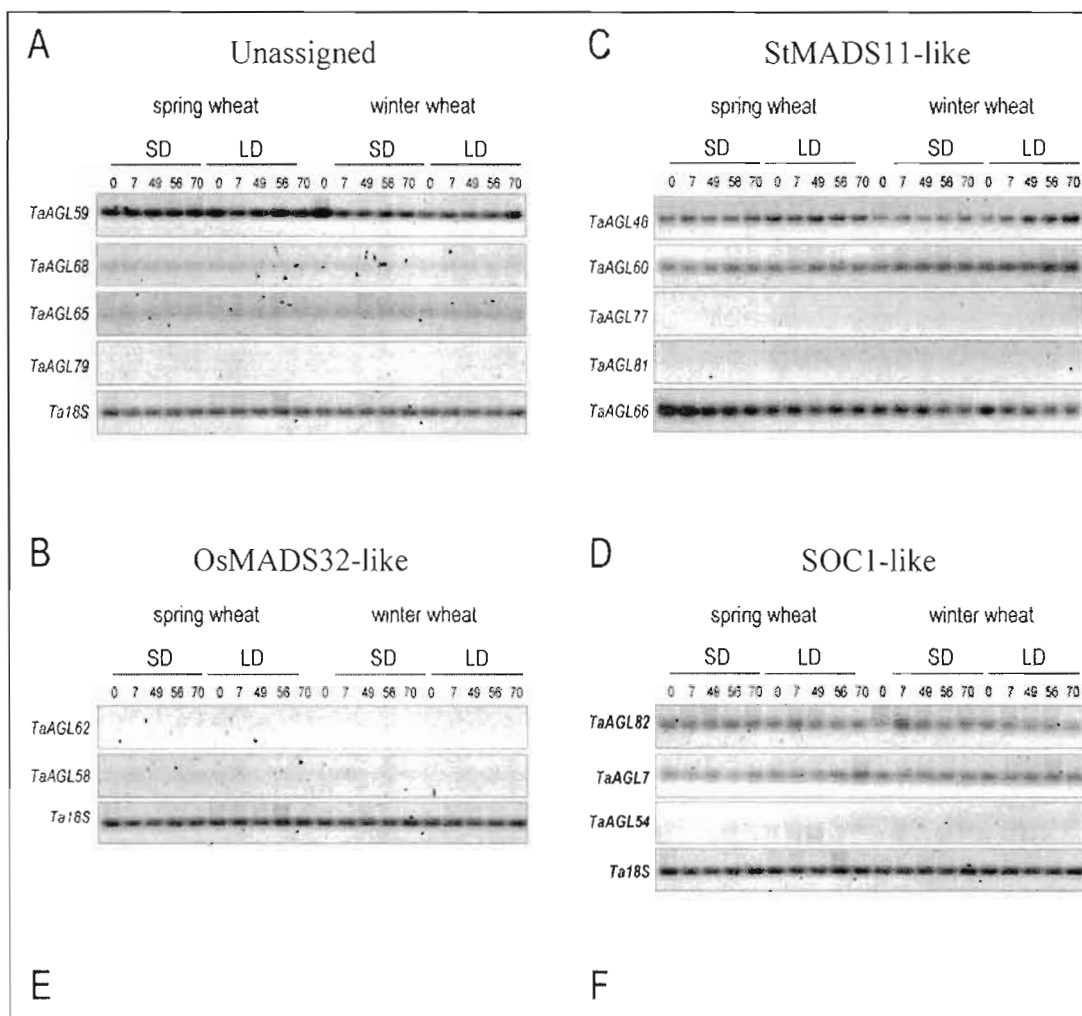

IV-Figure 5: Expression of wheat MADS-box genes in response to vernalization and photoperiod

RT-PCR of wheat MADS-box (A), OsMADS32-like (B), StMADS11-like (C) and SOC1-like (D) in response to vernalization and photoperiod conditions in spring and winter wheat.

qRT-PCR of *TaAGL62* (E) and *TaAGL54* (F) in response to vernalization and photoperiod conditions in winter wheat.

Supplemental data

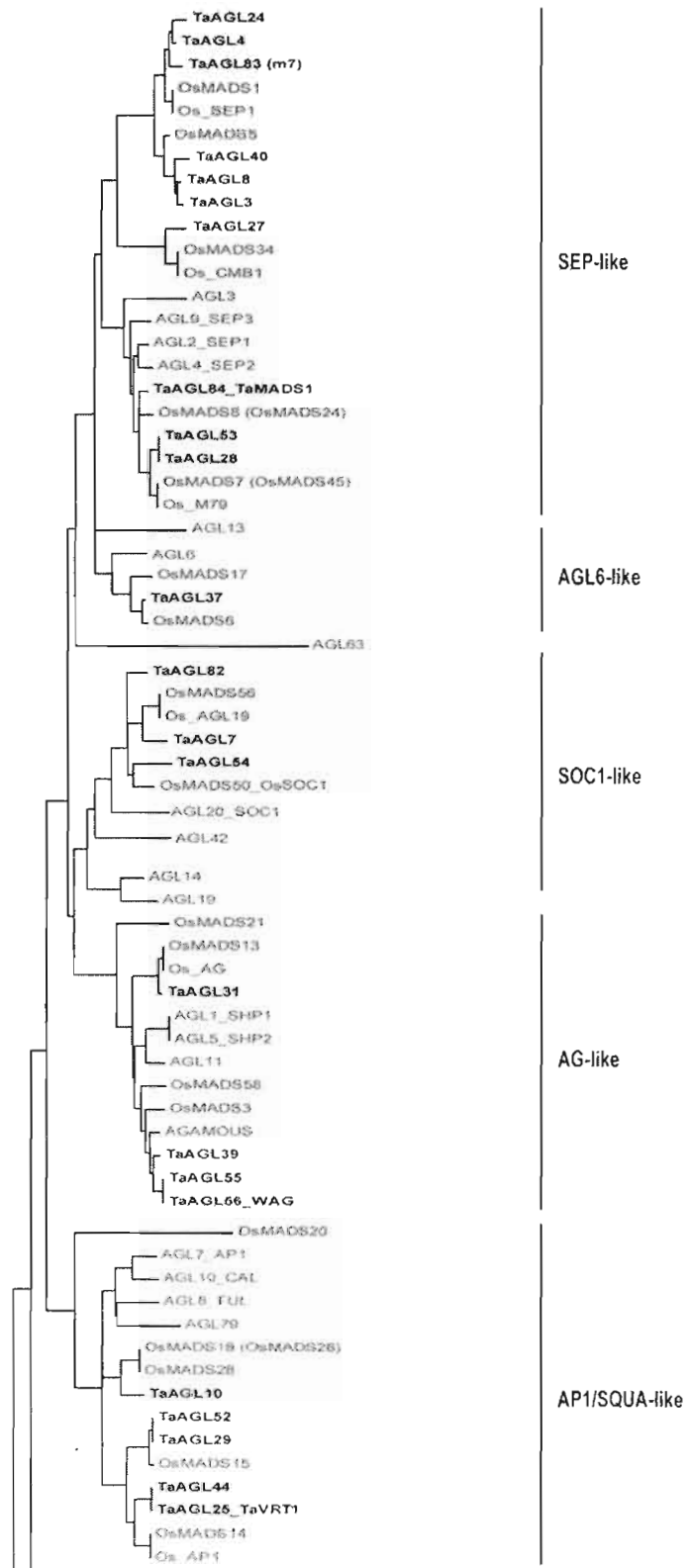

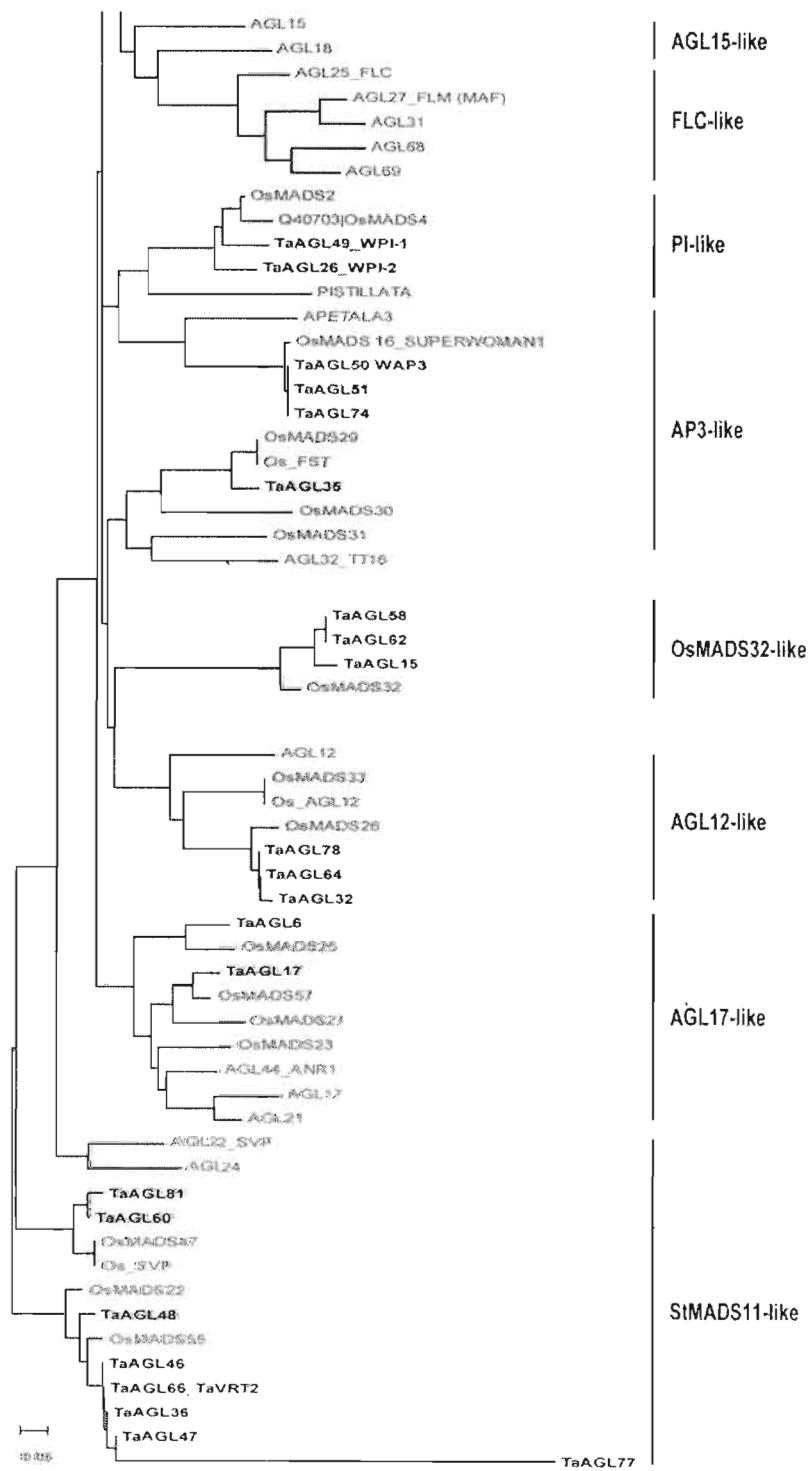

IV-Figure S 1: Relationships between members of the MADS-box type II genes from wheat, rice and Arabidopsis

An alignment of the MADS domain was generated using ClustalW with the multiple alignment parameters gap penalty 10, gap extension penalty 0.2 and BLOSUM protein weight matrix. The accession numbers for the sequences used are presented in the supplemental (not presented here). The tree was constructed with the Neighbor Joining (NJ) algorithm included in the MEGA 3.1 program package (Kumar, S. et al. 2004) with the p-distance, complete deletion of gaps, and 500 bootstrap replications. MADS-box sequences of wheat (black bold), rice (red) and Arabidopsis (blue) are highlighted.

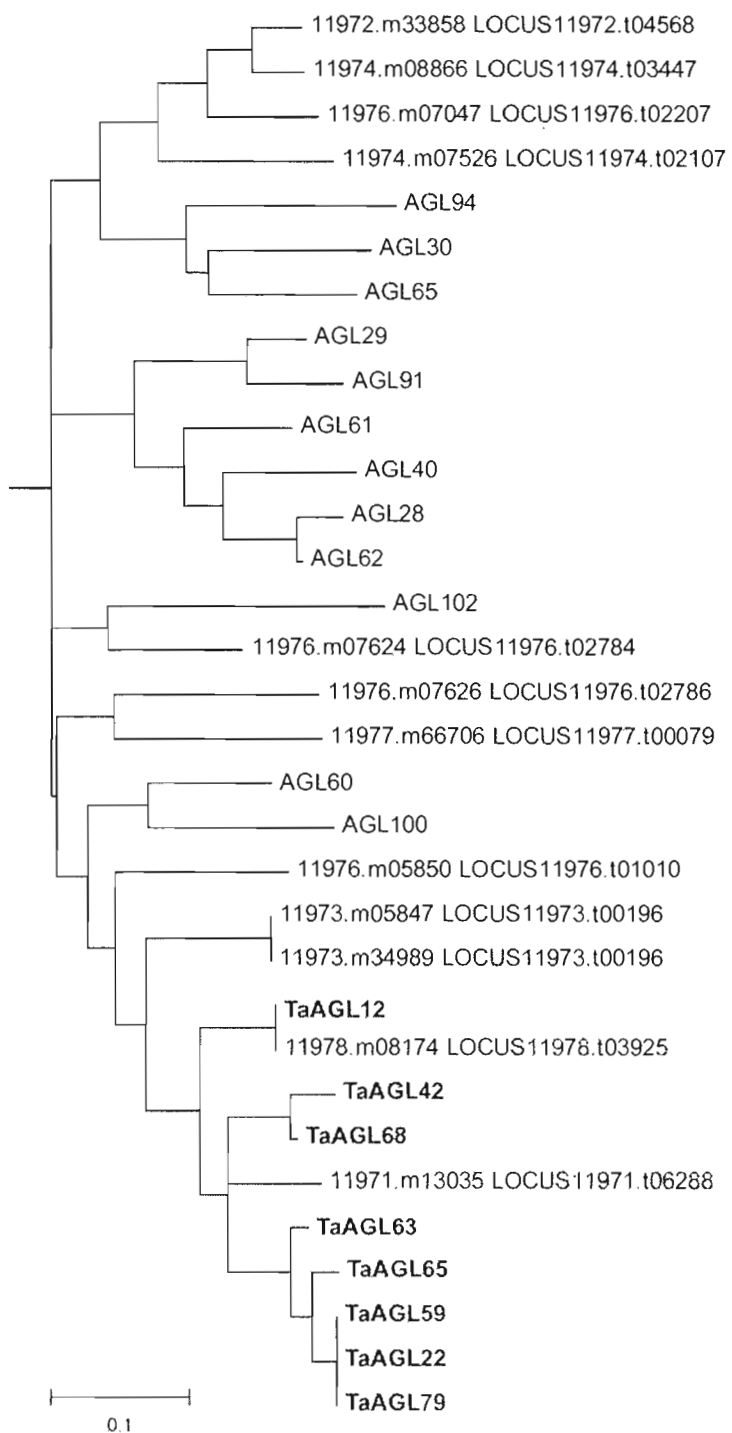

IV-Figure S 2: Sequences comparison between unassigned wheat MADS-box genes and selected SRF-like sequences from rice and *Arabidopsis*.

Methods and legend are as that of figure S1.

Sequences of MADS-box cDNAs isolated from wheat Norstar (TaAGL43 to TaAGL82).

>TaAGL43 clone MM2, 1181bp CDs complete, mRNA 162...896
 TCCTCCCTCTCCTCCCCTCTCTTCCACCTCACGTCCTCACCCAACCACCTGATAGCCATGGCTCCGCC
 GCCTCGCCTCCGCCTGCGCCAGTCGGAGTAGCCGTCGCGGTCTGCCGGTGTGGAGGGTAGGGGCGTA
 GGGTTGGCCC GGTTCTCGAGCGGAGATGGGGCGGGGAAGGTGCAGCTGAAGCGGATCGAGAACAAGA
 TCAACCGGCAGGTGACCTTCTCCAAGCGCCGCTCGGGGCTTCTCAAGAAGGCGCACGAGATCTCCGTG
 CTCTGCGACGCCGAGGTCGGCCTCATCATCTTCTCCACCAAGGAAAGCTCTACGAGTTCTCCACCGA
 GTCATGTATGGACAAAATTCTTGAACGGTATGAGCGCTATTCTTATGCAGAAAAGGTTCTCGTTTCAA
 GTGAATCTGAAATT CAGGGAAACTGGTGT CACGAATATAGGAAACTGAAGGCGAAGGTTGAGACAATA
 CAGAAATGTCAAAAGCATCTCATGGGAGAGGATTTTGAATCTTTGAATCTCAAGGAGTTGCAGCAACT
 GGAGCAGCAGCTGGAAAGCTCACCGAAACATATCAGATCCAAGAAGAACCAACTTATGCACGAATCCA
 TTTCTGAGCTT CAGAAGAAAGAGAGGT CACTGCAAGAGGAGAATAAAGTTCTCCAGAAGGAACTCGTG
 GAGAAGCAGAAGGCCCATGTGGCGCAGCAAGATCAAACCTCAGACTCAAACCAGCTCTTCATCTTCTC
 CTTCATGCTGAGGGATGCTCCCCCTGCCGCAAATACCAGCATTTCATCCAGCGGCAACAGGCGAGAGGG
 CAGAGGATGCGGCAGTGCAGCCG CAGGCCACCCCGGACGGGGCTTCCACCGTGGATGGTGAGCCAC
 ATCAACGGGTGAAGGGCATCCAGCCCATA CAGGCGTACTATT CAGTAGAGGGTAACAAGTTGCACCCG
 CCAGCTGGTGTATGTTGCGGTTGCTAGCACGCCTGACCCCTTGGAGGGGAAAGGAAAAGAAATCAG
 AGTAAAGTAGCAAGCTGCAGCGATGTGTATATTTCACTTTGTCCACCTCAGTTTCCCTCCCAGCTGGG
 CTGAGATGGCTGTACGAGTAATTTACCATGTAATCTATATGTAGCTTGAGTGATGAATTTTCAAGTTT
 CCATGAAAAAAAAAAAAAAAAAAAAA

>TaAGL44 clone MM3, 1184bp CDs complete, mRNA 162...899
 TCCTCCCTCTCCTCCCCTCTCTTCCACCTCACGTCCTCACCCAACCACCTGATAGCCATGGCTCCGCC
 GCCTCGCCTCCGCCTGCGCCAGTCGGAGTAGCCGTCGCGGTCTGCCGGTGTGGAGGGTAGGGGCGTA
 GGGTTGGCCC GGTTCTCGAGCGGAGATGGGGCGGGGAAGGTGCAGCTGAAGCGGATCGAGAACAAGA
 TCAACCGGCAGGTGACCTTCTCCAAGCGCCGCTCGGGGCTTCTCAAGAAGGCGCACGAGATCTCCGTG
 CTCTGCGACGCCGAGGTCGGCCTCATCATCTTCTCCACCAAGGAAAGCTCTACGAGTTCTCCACCGA
 GTCATGTATGGACAAAATTCTTGAACGGTATGAGCGCTATTCTTATGCAGAAAAGGTTCTGTTTCAA
 TGAATCTGAAATT CAGGGGAAACTGGTGT CACGAATATAGGAAACTGAAGGCGAAGGTTGAGACAATA
 CAGAAATGTCAAAAGCATCTCATGGGAGAGGATTTTGAATCTTTGAATCTCAAGGAGTTGCAGCAACT
 GGAGCAGCAGCTGGAAAGCTCACTGGAAACATATCAGATCCAGGGAAGAACCAACTTATGCACGAATC
 CATTCTGAACTTCAAAAAAGGAAAGGTCACTGGCAGGAGGAAAATAAAGTTCTCCAAAAGGAACTC
 GTGGAGAAGCAGAAGGCCCATGTGGCGCAGCAAGATCAAACCTCAGCCTCAAACCAGCTCTTCATCTTC
 TTCTTCATGCTGAGGGATGCTCCCCCTGCCGCAAATACCAGCATTTCATCCAGCGGCAACAGGCGAGA
 GGGCAGAGGATGCGGCAGTGCAGCCG CAGGCCACCCCGGACGGGGCTTCCACCGTGGATGGTGAGC
 CACATCAACGGGTGAAGGGCATCCAGCCCATA CAGGCGTACTATT CAGTAGAGGGTAACAAGTTGCAC
 CGGCCAGCCTGGTGTATGTTGCGGTTGCTAGCACGCCTGACCCCTTGGAGGGGAAAGGAAAAGAAAT
 CAGAGTAAAGTAGCAAGCTGCAGCGATGTGTATATTTCACTTTGTCCACCTCAGTTTCCCTCCCAGCT
 GGGCTGAGATGGCTGTACGAGTAATTTACCATGTAATCTATATGTAGCTTGAGTGATGAATTTTCAAG
 TTTCCATGAAAAAAAAAAAAAAAAAAAAA

>TaAGL45 clone MM4, 1039bp CDs complete, mRNA 40...729
 CGGCGCCGAGCAGCTGGGAGCGGTT CAGGCGGGT CAGATGGCGCGGAGAGGCGGGCGATACGGCG
 GATAGAGAGCGCGGCGCGGCAGGTGACCTTCTCCAAGCGAGGCGGGGCTGTTCAAGAAGGCCG
 AGGAGCTCGCCGTGCTCTGCGACGCCGACGTCGCGCTCGTCTTCTCCTCCACCGGCAAGCTCTCC
 CAGTTCCGACAGTCCAGTATGAACGAGATCATTGACAAGTATAGTACTCATTCAAAGAACCTGGGGAA
 ATCCGATCAGCAGCCGGCTATTGATTTAAATTTAGAGCACTGCAAGTATGACAGTTTGAATGAACAAC
 TCGCGGAAGCAAGCCTTCGACTTAGACGCATGAGAGGTGAGGAACTTGACGGACTGAGTGTGGTGAG
 TGGCAGCAGATGAAAAAGAATCTGAAAA CAGGATTGCAGAGGGTGCTTTGTACAAAGGATCGGCAATT

CATGCAACAAATCAATGACCTGCAACAAAAGGGAACACAGCTGGCAGAGGAAAATATGCGCTTGAAAA
 ACCAAATGCATGAGGTGCCAACTGCTAGCATGGTGGCCGTTGCCGATGCCGATGCCGAAAATGTTGTC
 CCTGATGATGTTTCATTCATCAGACTCTGTGATGACGGCAGTACATTCGGCAAGCTCGCAGGACAATGA
 CGACGGTTCCTGATATATCCCTGAAACTAGCGTTACCTTGGAAAGTAAGAGCCGTGGGGAGACCATGACC
 AGTTGAGGGAGTTGCCTTGGTAGAGAGAAGATGTCAAATGCTATGGAGACTCACTCCAAGATAGGCTG
 ACTGGAATGATCCCATAGTAGAAGCCAGATCAGTTTAAACCCTATCGAGTTGTGTCGTTTTATGTCTC
 CATGTGCACGGCGCAGTTGTCCACCTTTGTGCCTGAGTATTCAGTCACTGAACTTGTAGCGTATCCTC
 TTAATCTCTAGCGACATGTATCATTTCGTGCAAACTATGTATGTATCTGCCGCGGCTATGTGTACTTAT
 TTTAGAGAAGTGTATGGCC

>TaAGL46 clone MM5, 1113bp CDs complete, mRNA 107...793

ATCTAGCCAGCCGGTGCTCCTTTGTTTGTGGTTCGTGCGGCTGAGCAGGAGGGAGGAGGACGAC
 GGCGCCGAGCAGCTGGGAGCGGTTTCAGGCGGGTCGAGATGGCGCGGGAGAGGCGGGCGATACGGCGG
 ATAGAGAGCGCGGCGGCGGCGGAGGTGACCTTCTCCAAGCGGAGGCGCGGGCTGTTCAAGAAGCCGA
 GGAGCTCGCCGTGCTCTGCGACGCCGACGTGCGGCTCGTCTTCTCCTCCACCGGCAAGCTCTCCC
 AGTTCGCCAGCTCCAGTATGAACGAGATCATTGACAAGTATAGTACTCATTCAAAGAACCCTGGGGAAA
 TCCGATCAGCAGCCGGCTATTGATTTAAATTTAGAGCACTGCAAGTATGACAGTTTGAATGAACAACT
 CGCGGAAGCAAGCCTTCGACTTAGACGCATGAGAGGTGAGGAACTTGACGGACTGAGTGTCCGTGAGT
 TGCAGCAGATGGAAAAGAATCTTGAAACAGGATTGCAGAAGGTGCTTGGTACAAAGGATCGGCAATTC
 ATGCAACAAATCAATGACCTGCAACAAAAGGGAACACAGCTGGCAAAAGAAAATATGCGCTTGAAAA
 CCAAATGCATGAGGGGCCAACTGCTAACATGGTGGCCGTTGCCGATGCCGATGCCGAAAATGTTGTCC
 CTGATGATGTTTCATTCATCAGACTCTGTGATGACGGCAGTACATTCGGCAAGCTCGCAGGACAATGAC
 GACGGTTCCTGATATATCCCTGAAACTAGCGTTACCTTGGAAAGTAAGAGCCGTGGGGAGACCATGACGA
 GTTGAGGGAGTTGCCTTGGTAGAGAGAAGATGTCAAATGCTATGGAGACTCACTCCAAGATAGGCTGA
 CTGGAATGATCCCATAGTAGAAGCCAGATCAGTTTAAACCCTATCGAGTTGTGTCGTTTTATGTCTCC
 ATGTGCACGGCGCAGTTGTCCACCTTTGTGCCTGAGTATTCAGTCACTGAACTTGTAGCGTATCCTCT
 TAATCTCTAGCGACATGTATCATTTCGTGCAAACTATGTATGTATCTGCCGCGGCTATGTGTACTTAT
 TATGAGAAGTGTATGGCGCCGTTCT

>TaAGL47 clone MM6, 823bp CDs complete, mRNA 103...675

CACGGTTGTTTGTGTTGTTGCTTGTGCGGCTGAGCAGGAGGAGGAGGAGGACGGCGGCGCCGGG
 GCGGTCGAGAGCGGTTTCAGGCAGGGCCGATCGAGATGGCGCGGGAGAGGCGGGCGATACGGCGGATAG
 AGAGCGCGGCGGCGGCGGAGGTGACCTTCTCCAAGCGGAGGCGCGGGCTGTTCAAGAAGGCCGAGGAG
 CTCGCCGTGCTCTGCGACGCCGACGTGCGGCTCGTCTTCTCCTCCACCGGCAAGCTCTCCCAGTT
 CGCCAGCTCCAGTATGAACGAGATCATTGACAAGTATAGTACTCATTCAAAGAACCCTGGGGAAATCTG
 ATCAGCAGCCGGCTATTGACTTAAATTTAGAGCACTGCAAGTATGACAGTTTGAATGAACAACTCGCA
 GAAGCAAGTCTTCGACTTAGACACATGAGAGGTGAGGAACTTGACGGACTGAGTGTCCGTGAGTTGCA
 GCAGATGGAAAAGAATCTCGAAAAGGATTGCAGAGGGTGTCTTGTACaAAGGACCGGCAATTCATGC
 AACAAATCAGTGACCTCCAACAAAAGGGAACGCAGCTGGCAaAAGAAAATATGCGCTTGAAAAACCCA
 ATGCATGAgGgGCCACTGGTTcCCcCGGgGGGCCGTTGCCCAAACCTGAAATGTTGTCCCTGAAaAgG
 CcATTCaTCTGACTCTGgGATGACGGCATAcATTTcGgAaAActTcCAGgAaAATGATGACGGTTcT
 GAatTTCCCTGGAActAACGTTcCCTTGaAAAaAGGACCGgGGGgAaAACCCTTGAATTTCCCTGG
 TAAAAA

>TaAGL48 clone MC14F1L7-9, 1101bp CDs complete, mRNA 127...813

AGTGAGCCGCGCCAGCACGGTATTCGAGCCTGCCTGCCTCGGCGCGGGCGGGTGAGAGAG
 GGGGAGGGGGCGGGGAGATCGATCGGTTCGGTTCGGTTCGGGAGAGAGAAGGAGGAGACCGCATCGGG
 AGCGAGGGGAGATAAAGCGGATAGAGAGCGCGGCGGCGGAGGTACCTTCTCCAAGCGCCGCCGG
 GGCCCTTCAAGAAGGCCGAGGAGCTCTCCGCTCTGCGACGCCGACGTGCGGCTCATCGTCTTCTC
 CTCCACCGCAAGCTTTCCAGTTCGCCAGCTCCAGTATGAATGAGATCATCGACAAGTACAGCACGC
 ATTTCAAGAACCCTGGGGAAAACAGACCAGCCTGCTCTTGACTTGAACCTTAGAGCATAGCAAGTATGCA
 AATTTGAACGATCAGCTTGCAGAAGCTAGTCTTCGACTAAGACAGATGAGAGGTGAGGAGCTTGAGGG

GTTGAGTGTGATGAACTCCAGCAGTTGGAGAAAAACCTAGAAACTGGTCTGCACAGGGTGCTTCAGACAAAAGATCAACAATTCTTGGAACAGATAAATGAACTGCATCGAAAGAGTTCACAGCTGGCAGAGGAGAACATGAAACTAAGGAACCAAGTAGGCCAGATTCCAACAGCTGGCAAGCTAGTGGTTGCTGATACTGAAATATTGTTGCTGAAGATGGACAGTCTCGGAATCCGTCATGACTGCATTACACTCCGGAAGCTCACAGGATAATGATGATGGTTCTGATGTTTCCCTGAAATTAGGATTGCCCTGCCCTCCCGTGGAAAG**TAA**CAACGGTTGTCGTCGGTTCGGTTCCTCATGGAGCTGCAGCATCAGTGAAGAAGCTCTTGGGGTTATGGATAAACCTGGGCTGCAATAATCCTGCGGCGGAAGCGAGATCAGTTAACCTGATTTATCATCCTTGTGGCTGCATGATGTGATGTCCCCGTTTTAACTGTTGGTGTGGTGTAGGACCTTGACTAACTTTTAGAGCTACCTGATGTTTCATCGTTGTTGACACTATCCATGTTATGTATGTACCATGCCGGTATCTTAGATTATGCTCTATAAAAAAAAAAAAA

>TaAGL49 clone MC10F1L6-19, 979bp CDs complete, mRNA 121...747
 CCAAGCGTCCACACTCCACAGAGACAAGGGAGGAGGAGAGGGAGGAGTCCCTCTGGGTCTGGGTCTTG
 GGTGCTCCTGGGTCTCTTTCTTTCTTCCCGGCGAGCGAGCAGCTTGTTGAGAT**GGGG**CGCGGGAAGA
 TCGAGATCAAGAGGATCGAGAACTCGTCCAACCGCCAGGTGACCTTCGCCAAGCGCCGGGCCGGGCTG
 GTGAAGAAGGCCCGCGAGATCGGCGTCTCTGCGACGCCGAGGTGCGGCGTGCATCTTCTCCAGCGC
 CGGCAAGCTCTACGACTTCTGGACGCCAAGACCACGCTGCCGAGGATCTTGGACAAGTACCAGACCA
 ACTCCGGCAAGATCCTCTGGGATGAGAAGCACAAGAGCATCAGCGCCGAGATCGACAGGGTGAAGAAG
 GAGAACGACAACATGCAGATCGAGCTCAGGCATATGAAAGGCGAGGATGTGAACTCCCTGCAGCCCAA
 GGAGCTGATCGCCATCGAGGAGGCGCTCACCAACGGCCAGACCAACCTCAGGGACAAGATGATGGACC
 ACTGGAAGATGCACAGGAGGAATGAGAAGATGCTGGAGGAGGAGCACAAGCTGCTGGCTCTGAGGATG
 CACCAGCAGGACGACCTGAGCAGCGGCATGAGGGAGATGGAGCTCGGGTACCATCAGGGTAGGGATTT
 CACTTCCAGATGCCGTTACCTTCCGGCTGCAGCCAGCCACCCCAACTTGCAGGAAGACAAG**TAGG**
 CCACCGAATCCTGCCACGGCCTGTGTCAACTGAAGCTCCTTACCTGCAGGCCACAACCTGCCAGCTTC
 AATTTCTTGTGCAACCTTAAAAATGTATCTTCTTTTTCATGTCTGGCTTGATGAACTTAACAGCGCT
 AGTTGGTTCACAGCACATAACTTTAACTAAGACAGTTCCTGTCCCTGTCAAGATGCTTGTATAATTGC
 TGCTTAAAAAAAAAAAAAAAAAAAAAAAAA

>TaAGL50 clone MC21F1L7-85, 1075bp CDs complete, mRNA 127...816
 CCTCTCTCCCCCATACTCTTTCTTCTCCACCCGTCGCTGCGTCGGCCGACCTAGCTAGCCAGCTCG
 CTCGCTCGCGGTGGCGCGCGGATTGCGGGTTCGGAGGAGGTGGATCGGGCGGCGGAGAT**GGGG**CGGG
 GGAAGATCGAGATAAAGCGGATCGAGAACGCCACAACAGGCAGGTGACCTACTCCAAGCGCCGGTGC
 GGGATCATGAAGAAGGCGCGGGAGCTCACCGTGCTCTGCGACGCCAGGTGCCCATCATCATGTTCTC
 CTCCACCGCAAGTACCACGAGTTCTGCAGCACCGGCACCGACATCAAGGGGATCTTTGACCGCTACC
 AGCAGGCATCGGGACCAGCCTGTGGATCGAGCAGGTATGAGAATATGCAGCGCAGCTGAGCCATCTC
 AAGGACATCAATCGGAACCTGCGCACCGAGATCAGGCAAAGGATGGGTGAAGATCTGGACCGCTGGA
 GTTCGAGGAGCTGCGCAGCTTGTAGCAAAATGTGATGCCGCTCTCAAGGAGGTTGCCAGAGGAAGT
 ATCATGTGATCACACGCAGACTGAAACCTACAAGAAGAAGGTGAAGCACTCCAGGAGGCATACAAG
 AATCTGCAGCAGGAGCTGGGTATGCGCGAGGACCCGGCGTACGGGTTCTGTGGACAACCCGGCTGCGGG
 CGGGTGGGACGGCGTGGCAGCGGTGGCGATGGGCGGCGGCTCGGCGGCGGACATGTACGCCTTCCGCG
 TGGTCCCAGCCAGCCCAACCTGCACGGCATGGCCTACGGCGGCTCCCACGACCTGCGCCTCGGCT**TAA**
 TCGATCACTTCGATCGCTCCTACTAGCTTATATATCAAGTGATCGATCAAGTTACCACAATAAGAAAA
 AAATCTGTGTGTTTGTATTTGTGAAATGCTGTGATCGATGATGCCTTATCTCGGTCTCGTGCACATG
 AGTCAGTTCAATGTGTAATTAACGCCGTAGTGCTCGACTGTGTATTGTATTGTATGATCTGCTATGAC
 TTTGGTTGTGAGCTACTTTGCCAGTACTATAATATATTTTGGTAAAAAAAAAAAA

>TaAGL51 clone MC21F1L7-88, 1004bp CDs complete, mRNA 127...732
 CCTCTCTCCCCCATACTCTTTCTTCTCCACCCGTCGCTGCGTCGGCCGACCTAGCTAGCCAGCTCG
 CTCGCTCGCGGTGGCGCGCGGATTGCGGGTTCGGAGGAGGTGGATCGGGCGGCGGAGAT**GGGG**CGGG
 GGAAGATCGAGATAAAGCGGATCGAGAACGCCACAACAGGCAGGTGACCTACTCCAAGCGCCGGTGC
 GGGATCATGAAGAAGGCGCGGGAGCTCACCGTGCTCTGCGACGCCAGGTGCCCATCATCATGTTCTC
 CTCCACCGCAAGTACCACGAGTTCTGCAGCACCGGCACCGACATCAAGGGGATCTTTGACCGCTACC

AGCAGGCCATCGGGACCAGCCTGTGGATCGAGCAGTATGAGAATATGCAGCGCACGCTGAGCCATCTC
 AAGGACATCAATCGGAACCTGCGCACCGAGATCAGGCAAAGGATGGGTGAAGATCTGGACGCGCTGGA
 GTTCGAGGAGCTGCGCGACCTTGAGCAAAATGTGATGCCGCTCTCAAGGAGTTCCAGAGGAAGT
 ATCATGTGATCACCACACAGACTGAAACCTACAAGAAGAAGGTGAAGCACTCCAGGAGGCATACAAG
 AATCTGCAGCAGGAGCTGGGTATGCGCGAGGACCCGGCGTACGGGTTCGTGGACAACCCGGCTGCGGG
 CGGGTGGGACGGCATGGCCTACGGCGGCTCCCACGACCTGCGCCTCGGCT**TAAT**CGATCACTTCGATCG
 CTCCTACTAGCTTATATATCAAGTGATCGATCAAGTTACCACAATAAGAAAAAAATCTGTGTGTTTG
 TATTTGTGAAATGCTGTGATCGATGATGCCTTATCTCGGTCTCGTGACATGAGTCAGTTCAATGTGT
 AATTAACGCCGTAGTGCTCGACTGTGTATTGTATTGTATGATCTGCTATGACTTTGGTTGTGAGCTAC
 TTTGCCAGTACTATAATATATTTTGGTACTTTGTGAAAAAAAAAAAAAAAAAAAA

>TaAGL52 clone MC26F1L1-108, 701bp CDs complete, mRNA 33..701
 AAGAGCCGACAGCTAGATCGCGAAATCAGGAT**ATGGGT**CGCGCAAGGTGCAGCTGAAGCGGATAGAG
 AACAAAGATAAAATCGGCAGGTGACCTTCTCCAAGCGCCGCAACGGGCTCCTGAAGAAGGCGCACGAGAT
 CTCCGTCCTCTGTGACGCGGAGGTGCGCGTCATCGTCTTCTCCCCAAAGGCAAGCTCTATGAGTACG
 CCACCGACTCCAGCATGGACAAAATTCTTGAACGTTATGAGCGTACTCTTATGCTGAAAAGGCTCTT
 ATTTACAGTGAATCTGAAAGTGAGGGAAATTGGTGCCACGAATACAGGAACTTAAGGCGAAGATTGA
 GACCATACAAAAATGTACAAGCACCTCATGGGAGAGGATCTGGATTCTCTGAATCTCAAAGAACTCC
 AACAACTGGAGCAGCAGCTGGAGAGTTTATTGAAGCACATCAGATCGAGAAAGAGCCATCTTATGATG
 GAGTCCATTTCTGAGCTACAGAAGAAGGAGAGGTCACTGCAGGAGGAGAACAGGCCCTACAGAAGGA
 ACTGGTGGAGAGGCAGAAGGCGGCGGCCAGCAGGCAGCAGCAGCAGCAACAACAACAATGCAGT
 GGGAGACCAAGCCAGACCACCATAACCCATAACCAAAACCAACCCCAAGCCAGACCAGCTCATCA
 TCTTCCAGTTTCATGATG**TAG**

>TaAGL53 clone MC58R1L1-122, 1215bp CDs complete, mRNA 208..948
 CCCTGCACCCATCATCTCTCGCTTTAATCCCTACCAGGCCAGCCAGCTGCCTGCCTGCCTGCCTCCTCC
 CCACCCCTTATCTTCCCTCCCTCCTCTCCCTTCTTGCTACGAGTAGTACGCTTGGTGGTGGTGGTGG
 TGGTGGTGGTGTGTATGGTTGCTGCAGCATAGCCAGGGACGGGGAAGGTGGAGGAAGCAGCGGAGTCA
 GCC**ATGGGG**GAGGGGAGGGTGGAGCTGAAGCGGATCGAGAACAAGATCAACCGCCAGGTACCTTCGC
 CAAGCGCAGAACCGCCTGCTCAAGAAGGCCTACGAGTCTCCGTGCTGTGCGACGCCGAGGTCGCGC
 TCATCGTCTTCTCCAACCGCGCAAGCTCTACGAGTCTGCAGCACCCAGAGCATGACGAAGACACTC
 GACAAGTATCAAAAATGCAGTTATGCAGGACCTGAAACTACTGTGCAGAACCGAGAAAATGAGCAACT
 GAAAAACAGCCGAATGAGTACCTGAAAATAAAGGCACGGGTTGATAATTTACAGCGAACACAAAGGA
 ATTTGCTTGGTGAAGATCTTGATTATTAGGCATAAAAGAGCTCGAGAGCCTTGAGAAGCAACTCGAT
 TCATCCTTGAAGCACATTCGAACAACAAGGACACAACATATGGTTGACCAATTGACAGAACTCCAGAG
 AAGGGAACAATGTTTTTCAGAGGCGAATAAATGTCTTCAATAAAAATGGAGGAGAGCAACCAGGTTT
 ATGGGCAGCAGCTCTGGGAGCACAACAACAATGTACTGGGCTATGAACGTCAGCCGGAAGTGCAGCCG
 CCGATGCACGGCGGCAATGGATTTTTCCACCCCTTGATGCTGCTGGTGAACCCACACTTCACATAGG
 GTACCTCCTGAGTCCATGAGTAACTCATGCATGACAACCTTTCATGCCCCGTTGGTTGCCT**TGATTGA**
 AGACGGCGAAGAAAGTGCAGAAGAATAAGTATATACGTGGCACCCGGCCGGCCGATATATGCATGTAT
 ACTACTTCGAGTGATGGATTATTCCAGTCAAGATCCTCAATTATTTGCGTGCAACTTTTGTGTGATG
 AAAACTTCAGAACCTGTATTTGATGCTCAACATTATTGTGTTACTGCATGTAAGATCATACATTG
 TATTACTAGAGTGGCTATGCGTGATGATATTTTCCCTTACCTCTAAAAAAAAAAAAAAAA

>TaAGL54 clone MC58R1L8-127, 1075bp CDs complete, mRNA 272..940
 ACGCGTCCGCGACTGGAGCACGAGGACACTGACATGGACTGAAGGAGTAGAAAAGATCCCTTCTCTCC
 TCGCGTGGGTGGGCTGGGGTTTTCCACTTTTCGCCCTCCCCTCGCCGCCCAATTAGGATAACAGTGC
 CCACATTTTATTTACCTCTCCCCCTCTCTTATTTGTGTTTCCGTTCCGTCAGGCCGCTGATCGGAGGAG
 GGAGATTTTCTGGTTTGGTTTGGTTTCCGATTTAGATTGTTGTTGGTGGGAGAAGAGAAGGGGGGAAAA
TGGTGCGGGGGAAGACGCAGATGAAGCGGATAGAGAACCCGACGAGCCGGCAGGTGACCTTCTCCAAG
 CGCCGCGGCGGCTGCTGAAGAAGGCCTTCGAGCTCTCCGTCTCTGCGACGCGGAGGTCGCGCTCGT
 CGTCTTCTCCCCCGCGGAGGCTCTACGAATTCCGCGAGCTCCAGCATGAAGAACAACAATTGAACGTT

ATAAGACAGTCACAAAGGATAATTTGGGCAGACAGACCGGTACAGCAAGATATAGAGAAAGTAAAAGCT
 GATGCTGAGGGCTTGTCAAAGAAGCTTGATGCTCTTGAAGCTTGCAAAGCAAACTTTTGGGCCAAAA
 TTTGGAAGAAATGCTCTATTGAAGAAGCTGCAAAGCTTAGAGGTCAAAATTGAAAGAAGCCTTCTAGGCA
 TCAGGGCAATGAAGACTCGGCGGTTGAAAGAGCAGCTCTCTACGTTGAGGCAGAAGGAGATGAAGTTG
 CGGCAGGACAATGAAGAAGCTATATAGCCAGTGCCAGAAGGAACAGCACTCTGCGTTGGAGGCGGCCGC
 GCCCCCTGCTCCGGCGACCTTGGCGGCGCTCCCTGCTCCAGTGACCCCTGGCGGAGCAGGGCCAGCAGG
 TGGTGGATGTGGAGACGGATCTATTTCTTGGATTGCCCGGCACCGGCCGCTCC**TGAG**ATT**CAGG**CAGG
 CTGACAACGCCTGAGAAAAATGCCAGAATAAGCTGGCAATGGAGTTGCAAGCAGCAGCAGGCAATGG
 ATGCGGACGGCTATAGATATAATATAAACCCCTGTGCAGCGGAAACCTCGAGAGT

>TaAGL55 clone MC18R1L1-143, 1090bp CDs complete, mRNA 105...869
 CCGGGATATCGTCGACCCACGCGTCCGATCCCATCTCTCTCCGCCACGAAACACAAACATGCAGATA
 CTCAACGAGCAGCTGGCTGCACCATCCACAGGCCTA**ATGGT**GAAAGGAGTCTGCGTCCCCGGGGTCCGGG
 GTCGGGATCGGCAGGGGGGGCTGCTGAGAAGATGGGGAGAGGGAGGATCGAGATCAAGCGCATCGAGA
 ACACCAGAACCCGGCAGGTACCTTCTGCAAGCGCCGCAACGGCCTCCTGAAGAAGGCGTACGAGCTC
 TCGTGCTCTGCGACGCCGAGGTGGCGCTCATCGTCTTCTCCGGCCGCGGGCGCCTCTACGAGTACTC
 CAACAACAGCGTGAAAACAACATTGAGAGATAACAAGAAGGCAACAAGTGACACCTCCAGCGCTGGTA
 CAGTCGCAGAGATCAATGCCAGCACTACCAGCAGGAATCTGCGAAGCTGAAGCAGCAGATAACCACC
 TTGCAGAACTCCAACAGGACTTAATAGCCGATACAATGGCCACCATGAGCCACAGACACCTGAAGCA
 GCTGGAGGGAAGGCTGGACAAAGGCTAGGAAAGATTAGAGCAAGAAAGAACGAATTACTATGCGCTG
 AAATTGAGTACATGCAGAGAAGGGAAATGGAGCTGCAGAATAACAACCTTCTTCTTGGGGAAAAAGTA
 GCTGAGACTGAAAGGGGGCAACAGCAGACGTTGAAACATGATGGGGGCGGCTTCGACATCGAATGAGTA
 CGAGCAAAATATGATCCATTGTGATCCGAGAACCTTCTGCAGTTCAACTTCATGCAGCAGCACCCCTC
 AGTACTGCTCCAGCAGGAGGACCGAAAAAGTTTCAACTCAGTTGGAAGG**TGAT**GGATGCATCCATGC
 ATAGCTGTGTCGTCTCTCATTTACCTTCAAGTGAGATTGAAGCTACATATATCCGTGATATATAACTA
 GAACTTGATGAATGTGTGATTTCTATACGCGACAATCGACTTTATCCTATAATTAAGGCTTGGCC
 ACACCAGTCAATGTATCCATATGTATTGTGATGGTACTACTTAATTTTCTCAGTGCAACTCAGGTAC
 TC

>TaAGL56 clone MC47R1L7-140, 1018bp CDs complete, mRNA 96...860
 CCGGGATATCGTCGACCCACGCGTCCGTCTAGCGCCACGAAACACAAACATGCAGATACTCAACGAG
 CAGCTGGCTGCACCATCCACAGGCCTA**ATGGT**GAAAGGAGTCTGCGTCCCCGGGGTCCGGGCTCAGGATC
 GCCAGGGGGGGCTGCCGAGAAGATGGGGAGAGGGAGGATCGAGATCAAGCGCATCGAGAACACCACGA
 ACCGGCAGGTACCTTCTGCAAGCGCCGCAACGGCCTCCTGAAGAAGGCGTACGAGCTCTCGGTGCTC
 TGCGACGCCGAGGTGGCGCTCATCGTCTTCTCCGGCCGCGGGCGCCTCTACGAGTACTCCAACAACAG
 CGTGAAAGCAACCATTGAGAGATACAAGAAGGCAACAAGTGACACCTCCAGCGCTGGTACAGTCGCAG
 AGATCAATGCCAGCACTACCAGCAGGAATCTGCGAAGCTGAAGCAGCAAATAACCACCTTCAGAGAAC
 TCCAACAGGACTCTAATAGGCGATACAATGGCCACCATGAGCCACAGAGACCTGAAGCAGCTGGAGGG
 AAGGCTGGACAAAGGCTAGGAAAGATTAGAGCAAGAAAGAACGAATTACTATGCGCTGAAATTGAGT
 ACATGCAGAGAAGGGAAATGGAGCTGCGGAATAACAACCTTCTTCTTGGGGAAAAAGTAGCTGAGACT
 GAAAGGGGGCAACAGCAGACGTTGAAACATGATGGGGGCGGCTTCGACATCGAATGAGTACGAGCAAAA
 TATGATCCATTGTGATCCGAGAACCTTCTGCAGTTCAACTTCATGCAGCAGCAGCCTCAGTACTACT
 CCCAGCAGGAGGACCGCAAAAGTTTGAACCTCAGTTGGAAGG**TGAT**GGATGCATCCATGCATAGCTGTG
 TCGTCTCTCATTTACCTTCAAGTGAGATTGAAGCTATATAGATATCCGTGAGATATAACTAGAACTTC
 CATGAATGTGTGATTTCTATACGCGACAATCAACTTTATCCATAATTAAGGCTTGGCCACACC

>TaAGL57 clone MC29F1, 705bp CDs complete, mRNA 134...634
 ACGCGTCCGCCACGCGTCCGCGACTGGAGCACGAGGACACTGACATGGACTGAAGGAGTAGAAAACCT
 CCCGTTACCCCTAACAAACCACCGAGATACAAAAACAGAGCGAGAGACGAGCGGGCCGGTGGGG**ATG**
 GCGCGGCGGGGGCTGTTGAGCTGCGGCGGATCGAGGACCGGACGAGCCGGCAGGTGCGCTTCTCCAA
 GCGCCGCGGGGGCTTCAAGAAGGCGTTCGAGCTCGCGGTCTCTGCGACGCCGAGGTGCGGCTGC
 TCGTCTTCTCCCCCGGGGAAGCTCTACGAGTACGCTCCTCCAGCATTGAAGGTACATATGATCTC

TATCAGAGATTTGCAGGAGCTGGAACGAACTTGAATGGAGGCGATGCAAGTAGCAACAATGATGGTGA
 TCCTTCAAACATACAGTCAACGCTTAAAGAGATCGCTTCCTGGTCTATTCAAACAATGCTGATGTCT
 CAGATGCTAATAAGCTAGAGAACTGGAGAACTCCTGACAGATGCTTTGAGGAATACAAAATCCAAG
 AAGATGTCGGCGCAACAAAATAGCGGGGCAGGCACGAGTGGCGAGAACGCCAATGGTCTTAGGGGAAA
 GAAGAAGCGAGGAAGGACT**TGAGAG**CAGTCATGTGGTGTGTCTGCATTTGGTACAAGCAATGCTCTGT
 TTCTTGATGCAACACTCTTCCCCAG

>TaAGL58 clone MC51R1L1, 923bp CDs complete, mRNA 140...730
 CCGGGATTTTGTGACCCACGCGTCCGCGACTTGAGCCCAGGACTCTGACATGGACTGAAGGAGTAG
 AAACGGTCCGCTGCGCGTGGCGAGTTGGGAAGAAGCCTTGCTGCCCGAGGGGGGAAACGGGC
 GAGAT**GGGGG**GAGGGCGCAGCGAGATAAAGAGGATCGACAACCCACGCAGCGCCAGTCCACCTTCTA
 CAAGCGCAGGGACGGCCTCTTCAAGAAGGCCCGGGAGCTCGCCGTCCTTTGCGACGCCGACCTCCTCC
 TCCTCCTTCTCCGCCTCCGGCAAGCTCTACCAGTACCTCGCGCCACCGTCCCCCTCTGTCAAGGAG
 TTCGTCGAGAGGTACGAGGCTTCGAGGCACACCAAAGTTTGGTCCGACATCCGCCAGGAGAGGCGCCG
 CGAGCTGGAGAAGGTGGCCAAGATGTGCGACCTCTTGGAGAAGGAACTGAGGTTTCATGACGGTGGACG
 ACGGGGAGCGGTACACGGTCCGCTCGCTGGCGGCGCTGGAGCACAACCTGGAGGCGGCCATGCACAAG
 GTGCGCTCCGAGAAGGACCGCAAGATCGGCGGCGAGATGAGCTACCTCGAGAACATGATCAGGGGGAA
 ACAAGCGGAGCGCTACGGTCTGTGTGACAAGCTCGCTCATGCTCAGAGCCTCAAGGTCGTTGAAGGTG
 GATCCACCTCGCTGAACAACGGCCTGGACCTCAAACCTGGATTCAACT**AGGA**ACGGGTGAAAGCTTCT
 GGCCGTGGGGTTCTGCTCTAGTGTGCTTTTGGAGCTCGAGTGTATGTCAGGTTGAAATATTCTGCAA
 TTTCCTTCGAAGGGATTGTATGAACTTGTAAAGAGACCACTGTCTTATGAGATGTTTGGCTTAGGCTGG
 ACTGGGCTGTGCGTTGTACCTCCAATAGGTGGAATGTGA

>TaAGL59 clone MCBJ313725R1, 867bp CDs complete, mRNA 162...641
 GGGACCCCTGACCTTGGGCTGAAAGGAGTAGAAAACACTTTTTTCCCTGAACACCCCCGACCCCTTTT
 CCATCCACCGAGATAAAACCCGGGAGAAGAGACTCAAGAGAGACACGAGGGGAAAGGCGGAGGAGAGGA
 CGAGGCTGGTGGGAAAACCTGGGGG**ATGG**CGCGCGCGGGCGTGTGGAGCTGCGGCGGATCGAGGACC
 GGACGAGCCGGCAGGTGCGCTTCTCCAAGCGCCGCGCGGGGCTCTTCAAGAAGGCCCTTCGAGCTCGCG
 GTCCTCTGCGACGCCGAGGTCTCGCTGCTCGTCTTCTCCCCCGCCGCGAGGCTTACGAGTACGCCTC
 CTCCAGCATAAGAAGGTACATATGACCGCTATCAGGCATTTGCAGGAGCCGGAAAGGAGTGAATGAAC
 CCGTGTCAAGTAACAACAATGATGGAGATCCTTCAAATATACAGTCAAGGCTTGAAGAGATTACTTCC
 TGGTCTCTTCAAAAACAATGCTGATAACTCAGATGCTAATGAGCTAGAGAACTGGAGAACTACTGAC
 AGATGCTTTGAAGAATACAAAATCCAAGAAGATGTTGGCGCAACAAAATAGCGATGCCGGCACTAGTG
 CGAGCGCGGGAACCTCAGAAGGACT**TGAG**CAGCCATGTGATGTGCATGCATTTGGTTCAAGCAAAGC
 TCTGTGGCTGATGCCACACTCTTCCCCAGTTACTGAAAGAGTTGTGTTTGAAGGTGCAGCAAAGGCA
 CGAGGGGCAAATTCATAAAAAGGGCGGTGGGTTAACACCAACAGTGTGTGTGTGGGTGTGCTTGT
 AAGTTATCTGTTGCTTGTCTGTTGCCTTACCTTTTTGTGCTTTGCCAAGGC

>TaAGL60 clone MC61R1, 870bp CDs complete, mRNA 139...819
 CCCGGGATATTTGTGCAACCCACGCTTCCGCGACTGGAGCCCAGGACACTGACATGGACTGAAGGAG
 TAGAAAGCCGCCCGCCGAGATCTATTGCAACACCTCGACTGTGGGGAGGGGAACCAAGGGGGGGGGA
 GGAT**GGGGG**AAGAGGGAGAGGATTGCGATACGGAGGATCGAGAATCTGGCGGCGAGGCAGGTCACC
 TTCTCGAAGCGCCGGAGGGGCTCTTCAAGAAGGCCGGGGAGCTCTCCATCCTATGCGACGCCGAGGT
 CGGCCTCGCCGTCTTCTCCGCCACCGCAAGCTCTTCCAGTTCGCCAGCTCCAGCATGAACCAGATTA
 TTGATCGGTATAACTCTCATTCCAAGATACTTAAGAAAGCAGACGAGCCATCTCAGCTGGATTTGCAT
 GAGGACAGCAATTGTGCAAGACTAAGGGACGAGCTTGCAGAAGCAAGCCTCTGGCTCCAGCAGATGAG
 AGGAGAGGAGCTCCAGAGCTTGAACGTCAGAGCTTCAAGGCCCTAGAGAAGAGCCTCGAGTCCGGGC
 TCGGCTCCGTTCTGAAAACCAAGAGCCAAAAGATCATGGACAGATCAGCGAGCTAGAAAAGAAAGAGG
 GTGCAACTGATAGAGGAAAACGCAAGGCTAAAGGAGCAAGCGTCCAAGATGGAGATGCAAGTCCGCCG
 TGATTACCGGGTGTATGAGGAAGGACAGTCATCTGAGTCCGTACGAACACGTCGTATCCGCGCC
 CTCCCCTCGACACCGAGGACAGCTCCGATACCTCTCTCAGGCTCGGATTACCACTCTACAACCTCGAAG
TGATTGGCTGGAAATTATCCGAAGCAAAGTGATGCTTGGTACGACAAGCTCCT

>TaAGL61 clone MC46F1, 975bp CDs complete, mRNA 165...755
 TCCACGCACCATCACAGTAGAGCAGAGACCTAGTCGCTCGCGCGGCGGGCAATCCAAACCTTTCTCT
 TATTCTTGCAAGGTCTCGGAAACGGAAAGGCCCTGCTCCGCTGCGCGTTTGCAGAGTTTGGGAAGAAG
 CCTTGCCTGCCGAAGGGGAAAACGAG**ATGGGGCGAGGGCGCAGCGAGATAAAGAGGATCGACAACC**
 CCACGCAGCGCCAGTCCACCTTCTACAAGCGCAGGGACGGCCTCTTCAAGAAGGCCCGGGAGCTCGCC
 GTCCTCTGCGACGCCGACCTCCTCCTCCTCCTCTTCTCCGCCTCCGGCAAGCTCTACCAGTACCTCGC
 GCCACCGTCCCCTCTGTCAAGGAGTTTGTGAGAGGTACGAGGCTGCAACGCACACCAAAGTTTGGT
 CCGACATCCGCCAGGAGAGGGCGCGCCGAGCTGGAGAAGGTGGCCAAGATGTGCGACCTCTTGAGAAG
 GAGCTGAGGTTTCATGACGGTGGACGACGGGGAGCAGTACACGGTGCCGTGCGTGGCGGCGCTGGAGCA
 CAACCTGGAGGCGGCCATGCACAAGGTGCGCTCCGAGAAGGACCGCAAGATCGGGGGCGAGATGAGCT
 ACCTCGAGAACATGATCAGGGGGAAAACAAGCTGAGCGCTACGGCCTATGTGACAAGCTCGCTCATGCT
 CAGAGCCTGAAGGTCGTGGAAGGCGGATCCACCTCGCTGAACAACGGTCTGGACCTCAAACCTGGATT
 CAAC**TAG**GaAACGGGGTGAAAGCTTCTGGCCGTGGGGTTCTGCTCTAGTGTgGCTGTTGAGCTCGAGT
 GTTATGTCAGGGTCAAATATTCTGCAATTTCCtTTCGAAGGGATTGTATGAACTTTGTAAAaAAG
 ACCACTGGTCTTATGaAAATGTTTGGCTTAAGGCTGGAcTGGGGCTGTGCTTTTGTACCTCCaATAGG
 GGGAAATGtGGAAaACCAGTTCCA

>TaAGL62 clone MC44F1L1, 1031bp CDs complete, mRNA 178...891
 TTACATCCCTCTCCTCCACTCACCAGCACAGTAGAGCAGAGAGCTAGTCGCTCGCGCGGGCAATCCAA
 ACCTTTCCCTATTCTTGCAAGGTCTCGGAAACGGAAAGGCCCTGCTCCGCTGCGCGTTTGCAGAGTTT
 GGGAAAGAAGCCTTGCTGCCGAGGGGGGAAAACGGGCGAG**ATGGGGCGAGGGCGCAGCGAGATAAAG**
 AGGATCGACAACCCACGCAGCGCCAGTCCACCTTCTACAAGCGCAGGGACGGCCTCTTCAAGAAGGC
 CCGGGAGCTCGCGTCTCTGCGACGCGACCTCCTCCTCCTCCTCTTCTCCGCCTCCGGCAAGCTCT
 ACCAGTACCTCGCGCCACCGTCCCCTCTGTCAAGGAGTTCGTGAGAGGTACGAGGCTTCGAGGCAC
 ACCAAAGTTTGGTCCGACATCCGCCAGGAGAGGGCGCGGAGCTGGAGAAGGTGGCCAAGATGTGCGA
 CCTCTTGAGAAGGAAGTCTGAGGTTTCATGACGGGTGGACCGACGGGGAGCGGTACACGGTGCCGTGCG
 TGGCGGCGCTGGAGCACAACCTGGAGGCGGCCATGCACAAGGTGCGCTCCGAGAAGGACCGCAAGATC
 GGCGGCGAGATGAGCTACCTCGAGAACATGATCAGGGGGAAAACAAGCGGAGCGCTACGGTCTGTGTGA
 CAAGCTCGCTCATGCTCAGAGCCTCAAGGTCGTTGAAGGTGGATCCACCTCGCTGAACAACGGCCTGG
 AACCTCAAACCTGGATTCAACTAGGAAACGGGTGAAAGCTTCTGGCCGTGGGGTCTGCTCTAGTGGTT
 GCTTTTGAAGTCAAGTGTATGTCAGGTTGAAAATATTCTGCAATTTCTTCAAGGGATTGTATGAA
 CTTG**T**AAGAGACCACTGTCTTATGAGATGTTTGGCTTAGGCTGGACTGGGCTGTGCGTTGTACCTCCA
 ATAGGTGGAATGTGATACCAGTCCAGTATTGCAATAATGTAGTTAACGGTCACCTTATGCTCTAAAAA
 AAAAAAAAAA

>TaAGL63 clone MC32R1L1, 833bp CDs complete, mRNA 264...764
 GAGCGGATAACAATTTACACAGGAAACAGCTATGACCATTAGGCCTATTTAGGTGACACTATAGAAC
 AAGTTTGTACAAAAAGCAGGCTGGTACCCGGTCCGGAATTTCCCGGGATATCGTCGACCCCACGCGT
 CCGCCCACGGTGCCGACCCGAGCCAGAGTTCCCCTCCCCGCCTCGCACCGCCCCGTACACTCCGTT
 ACCCCTAACAAACCACCGAGATACAAAAACAGAGCGAGAGACGAGCGGCGGCGGTGGGG**ATGG**CGCGG
 CGCGGGCGTGTGAGCTGCGGCGATCGAGGACCGGACGAGCCGGCAGGTGCGCTTCTCCAAGCGCCG
 CGCGGGGCTCTTCAAGAAGGCGTTCGAGCTCGCGTCTCTGCGACCGGAGGTGCGCTGCTCGTCT
 TCTCCCCCGCCGGAAAGCTTACGAGTACGCCTCCTCCAGCATTGAAGGTACATATGATCTCTATCAG
 AGATTTGCAGGAGCTGGAACGAACCTGAATGGAGGCGATGCAAGTAGCAACAATGATGGTGATCCTTC
 AAACATACAGTCAACGCTTAAAGAGATCGCTTCTGGTCTATTCAAACAATGCTGATGTCTCAGATG
 CTAATAAGCTAGAGAACTGGAGAACTCCTGACAGATGCTTTGAGGAATACAAAATCCAAGAAGATG
 TCGGCGCAACAAAATAGCGGGGACGGCACGAGTGGCGAGAACGCCAATGGTCTTAGGGGAAAGAAGAA
 GCGAGGAAGGACT**TG**AGAGCAGTCATGTGGTGTGTCTGCATTTGGTACAAGCAATGCCTCTGTTCTCTG
 ATGCAACACTCTTCCCC

>TaAGL64 wef045wellG05, 1106bp CDs complete, mRNA 157...831

>TaAGL70 clone MC8F1L7-18, 1134bp CDs complete, mRNA
138...530,661...840

TGAGTTCCTCGTGGGTTCTGGGTTCTTGGGTGCTCCTGGGTTCTTCTTTCTTTCTTCCC GGCGAGCGA
GCAGCTTGTTGAGATGGGGCGCGGGAAGATCGAGATCAAGAGGATCGAGAACTCGTCCAACCGCCAGG
TGACCTTCGCCAAGCGCCGGGCCGGGCTGGTGAAGAAGGCCCGCGAGATCGGCGTGCTCTGCGACGCC
GAGGTCGGCGTCTGTCATCTTCTCCAGCGCCGGCAAGCTCTACGACTTCTGGACGCCCAAGACCACGCT
GCCGAGGATCTTGGAGAAGTACCAGACCAACTCCGGCAAGATCCTCTGGGATGAGAAGCACAAGAGCA
TCAGCGCCGAGATCGACAGGGTGAAGAAGGAGAACGACAACATGCAGATCGAGCTCAGGCATATGAAA
GGCGAGGATGTGAACTCCCTGCAGCCCAAGGAGCTGATCGCCATCGAGGAGGCGCTCACCAACGGCCA
GACCAACCTCAGGGACAAGATGATGGACCCACTGGAAGATGCACAGGAGGAATGTATGGACACTAAAT
TTACCACTGCGCTTTGCATTTCTTCTGTACACCATGGAGTTTCTTGAAGAAGAATTTTGATCTTTTT
TTGGCAAAGAAAATTCTGATCATGCTCCTCCTTTGTGATTTACCACAGGAGAAGATGCTGGAGGAGGA
GCACAAGCTGCTGGCTTTGAGGATGCACCAGCAGGACGACCTGAGCAGCGGCATGAGGGAGATGGAGC
TCGGGTACCATCAGGGTAGGGATTTCACTTCCCAGATGCCGTTACCTTCCGGCTGCAGCCAGCCAC
CCCAACTTGCAGGAAGACAAGTAGGCCATCGAATCCTGCCGTGGCCTGTGTGAAGCTGAAGCTCCTCTA
CCTGCAGGTCACAACTGCTAGCTTCAATTTCCGTGTGCAACCTTAAATGTATCTTCTTTTCATGTCT
GGCCTGATGAACTTAAACCCGCTAGTTGCTTCCCAACACATAACTTTTAACTAAGACAGTTCTGTCC
CTGTCAAGATGCTTGTATAATTGCTGCCTATCCTGATTACAGTGTGTCTTGTAGTGATGATGGCCAA
GGTGCGAAAGTAACAAAGTTTGATGTGAATGCCAAAAAAAAAAAAA

>TaAGL71 clone MC8F1L7-17, 983bp CDs complete, mRNA 76...702

GAGTCTCTGGGTCTGGGTCTTGGGTGCTCCTGGGTCTTCTTTCTTTCTTCCC GGCGAGCGAGCAGCT
TGTTGAGATGGGGCGCGGGAAGATCGAGATCAAGAGGATCGAGAACTCGTCCAACCGCCAGGTGACCT
TCGCCAAGCGCCGGGCCGGGCTGGTGAAGAAGGCCCGCGAGATCGGCGTGCTCTGCGACGCCGAGGTC
GGCGTCTGTCATCTTCTCCAGCGCCGGCAAGCTCTACGACTTCTGGACGCCCAAGACCACGCTGCCGAG
GATCTTGGAGAAGTACCAGACCAACTCCGGCAAGATCCTCTGGGATGAGAAGCACAAGAGCATCAGCG
CCGAGATCGACAGGGTGAAGAAGGAGAACGACAACATGCAGATCGAGCTCAGGCATATGAAAGGCGAG
GATGTGAACTCCCTGCAGCCCAAGGAGCTGATCGCCATCGAGGAGGCGCTCACCAACGGCCAGACCAA
CCTCAGGGACAAGATGATGGACCACTGGAAGATGCACAGGAGGAATGAGAAGATGCTGGAGGAGGAGC
ACAAGCTGCTGGCTTTGAGGATGCACCAGCAGGACGACCTGAGCAGCGGCATGAGGGAGATGGAGCTC
GGGTACCATCAGGGTAGGGATTTCACTTCCCAGATGCCGTTACCTTCCGGCTGCAGCCAGCCCAAC
CAACTTGCAGGAAGACAAGTAGGCCATCGAATCCTGCCGTGGCCTGTGTGAAGCTGAAGCTCCTCTACC
TGCAAGCCACAAGTCTAGCTTCAATTTCCGTGTGCAACCTTAAATGTATCTTCTTTTCATGTCTGG
CCTGATGAAACTTAAACCCGCTTAgTTGCTTCCCAACACATAACTTTTAACTAAGACAGTTCTGTCC
CTGTCAAGATGCTTGTATAATTGCTGCCTATCCTGATTACAGTGTGTCTTGTAGTGATGATGGCCAA
GGTGCGAAAGTAACAAAAAAAAAAAAAAAAA

>TaAGL73 clone MC42F1L1, 1192bp CDs complete, mRNA 199...882

TCCTCTCTTTTCGATCCCTCCTTCCATCCGTCCCCATCGCATCGCAACCGCCGCATCGGCGAGTGAG
CCGCGCAGCACGGTGCTCCGAGCCTGCCTCCCTGGGCGAGCCTCGGCGCGGGCGGTGGCGGGGTGAG
AGAGGGGGAGGGGGCGAGGAGATCGATCGGTCCGTCCGGCTCGGAGAGAGGGACGCGACCGATGGCG
CGGGAGCGGAGGGAGATAAAGCAGATAGAGAGCGCGCGGCGCGGCAGGTCACCTTCTCCAAGCGCCG
CCGGGGCTCTTCAAGAAGGCCGAGGAGCTCTCCGTCTCTGCGACGCCGACGTCGCGCTCATCGTCT
TCTCCTCCACCGCAAGCTCTCCCAGTTCCGAGCTCCAGTATGAATGAGATCATCGACAAGTACAGC
ACGCATTCTAAGAACCTGGGGAAAAACAGACCAACCTGCTCTTGACCTGAACTTAGAGCATAGCAAGTA
TGCAAAATTTGAACGATCAGCTTGCAGAAGCTAGTCTTGAATAAGACAGATGAGAGGTGAGGAGCTTG
AGGGGTTGAGTGTGATGAACTCCAGCTGTTGGAGAAAAACCTAGAACTGGTCTGCACAGGGTGCTT
CAGACGAAAGATCAACAATTCTTGGAAACAGATAAATGAACATGCATCGAAAGAGTTACAGCTGGCAGA
GGAGAACATGAACTAAGGAACCAAGTAGGCCAGATTTCCAACAGCTGGCAAGCTAGTGGTTGCTGATA
CCGAAAAATGTTGTTGCTAAGGGACAGTCTCGGAATCCGTCATGACTGCATTACACTCTGGAAGCTCA
CAGGATAATGATGATGGTTCCGATGTTTCCCTGAAATTAGGATTGCCCTGCCTTCCATGGAAGTAACG

ACAGTTGCCGTCCGTTTCGGTTCCTCATGGAGCTGCAGCATCAGTGGAGAAGCTCTTGGGGTTATGGAC
 AAACCTGGGCTGCAATAATCCTGCGGCGGAAGCGAGATCAGTTAACCTGATTTTATCATCCTTGTGGCT
 GCATGATGCGATGTCCCGTTTTAACTGTTGGTGTGTTGCTAGGATCTTGAC^{*}TAAACTTTTAGAGCTAC
 CTGATGTTTCATCGTTGTTGACACTATCCATGTTATGTATGTACCATGCCGGTATCTTAGATTATGCTC
 TATAAATACATGTCTTGGTCAGAAAAAAAAAAAAA

>TaAGL74 clone MC65F1L7-101, 1053bp CDs complete, mRNA 129..956
 CGATCTCCCTCCTTCTCGCCATTTCTTCTCCAACGCTCGCTGAGTCGGTCGACCTAGCTAGCCAGCT
 CGCCCGCTCGCGGTGGCGCGCGGATTGCGGGGTGCGAGGAGGTGGATCGACCGGCGGAGATGGGGCG
 GGGGAAGATCGAGATAAAGCGGATCGAGAACGCCACCAACAGGCAGGTGACCTACTCCAAGCGCCGGT
 CGGGGATCATGAAGAAGGCGCGGGAGCTCACCGTGCTCTGCGACGCCAGGTGCGCATCATCATGTTT
 TCCTCCACCGGCAAGTACCACGAGTTCTGCAGCACCGGCACCGACATCAAGGGGATTTTGTACCGCTA
 CCAGCAGGCCATCGGGACCAGCCTGTGGATCGAGCAGTATGAGAATATGCAGCGCACGCTGAACCATC
 TCAAGGACATCAACCGGAACCTGCGCACCGAGATCAGGCAAAGGATGGGTGAAGATCTGGACGCGCTG
 GAGTTCGAGGAGCTGCGCGACCTTGAGCAAAATGTGATGCCGCTCTCAAGGAGTTTCGCCAGAGGAA
 GTATCATGTGATCACACGCAGACTGAAACCTACAAGAAGAAGGTGAAGCACTCCAGGAGGCATACA
 AGAATCTGCAGCAGGAGCTGGGCATGCGCGAGGAAACCGGCTACGGTTCTGTGACAACCCGCGGCG
 GGCGGTTGGGATGGCGTGGCGCGGGCGGGGGAACCGGGGCACCGGGGGCAATGGGCGCGGCTC
 GGCGCCGACATGTACCCCTTCCGCGTGGTCCCAGCCAGCCCAACCTGCCACGGAATGGCCTACGGC
 GGCTCCACGACCTGCGCCTCGGCTAATCGATCATCTCAATCGCTCCTACTACCTTATAGTATATCAA
 GTGATCGATCAAGTGGTTCAAGTTACCACAATAAAAAAAAAATCTGTGTGCTTGTATTGTACATGTT
 GTGATCGATGATGCCTTATGTGGTCTTCTGTGCACATGATTCAATGTGTAATTAACGCCGTAG
 TGCTCGACTGTGTATTGTATTGTAAAAAAAAAA

>TaAGL75 clone MC29F1L1-3, 641bp CDs complete, mRNA 133..630
 ACGCGTCCGCCACGCGTCCGCGACTGGAGCACGAGGACACTGACATGGACTGAAGGAGTAGAAAAC
 CCGTTACCCCTAACAACCACCGAGATACAAAAACAGAGCGAGAGACGAGCGGCGGCCGGTGGGGATGG
 CGCGGCGCGGGCGTGTGAGCTGCGGCGGATCGAGGACCGGACGAGCCGGCAGGTGCGCTTCTCCAAG
 CGCCGCGCGGGGCTCTTCAAGAAGGCGTTTCGAGCTCGCGGTCTCTGCGACGCCGAGGTGCGCTGCT
 CGTCTTCTCCCCCGCCGGGAAGCTCTACGAGTACGCCTCCTCCAGCATTGAAGGTACATATGATCTCT
 ATCAGAGATTTGAGGAGCTGGAACGAACTTGAATGGAGGCGATGCAAGTAGCAACAATGATGGTGAT
 CCTTCAAAACATACAGTCAACGCTTAAAGAGATCGCTTCTGGTCTATTCAAAACAATGCTGATGTCTC
 AGATGCCTATAGGCTAGAGAAACTGGAGAACTCCTGACAGATGCTTTTGAGAATACAAAATCCAAGA
 AGATGTCTGCGCACAAAATAACCGGGGCAGGCACGAATGGCGAGAACGCCATGGTCTTAGGGAAAGA
 AGAACCGAGGAAGGATGAAAGCATTCTGT

>TaAGL76 clone MC29F1L1-2, 734bp CDs complete, mRNA 162..663
 CCGAGATATCGTTCGACCCACGCGTCCGCCCACGCGTCCGCCCACGCGTCCGCGACTGGAGCACGAGGA
 CACTGACATGGACTGAAGGAGTAGAAAACCTCCGTTACCCCTAACAACCACCGAGATACAAAACAGAG
 CGAGAGACGAGCGGCGGCCGGTGGGGATGGCGCGGCGCGGGCGTGTGAGCTGCGGCGGATCGAGGAC
 CGGACGAGCCGGCAGGTGCGCTTCTCCAAGCGCCGCGGGGCTCTTCAAGAAGGCGTTCGAGCTCGC
 GGTCTCTGCGACGCCGAGGTGCGCTGCTCGTCTTCTCCCCCGCCGGGAAGCTCTACGAGTACGCCT
 CCTCCAGCATTGAAGGTACATATGATCTCTATCAGAGATTTGAGGAGCTGGAACGAACTTGAATGGA
 GGCGATGCAAGTAGCAACAATGATGGTGATCCTTCAAAACATACAGTCAACGCTTAAAGAGATCGCTC
 CTGGTCTATTCAAAACAATGCTGATGTCTCAGATGCTAATAAGCTAGAGAAACTGGAGAACTCCTGA
 CAGATGCTTTGAGGAATACAAAATCCAAGAAGATGTGCGGCAACAAAATAGCGGGGCAGGCACGAGT
 GCGGAGAACGCCAATGGTCTTAGGGGAAAGAAGAAGCGAGGAAGGACTTGAGAGCAGTCATGTGGTGT
 GTCTGCATTTGGTACAAGCAATGCTCTGTTTCTGATGCAACACTCTTCCCCAG

>TaAGL77 clone MCBj230548R1, 1023bp CDs complete, mRNA 158..865
 CCCCCGGCCCCGGGGCCCCCTTTGGGTTTGGTTTGGGTTTGGTTTGGTTCCGGGGCGGCCCTTGAAC
 CCAGGAAGGAAGGGGAAGGAAGGAACCGGCCGGCCCCCGGAGGCCAGGCTTGGGAAGCCGGTTTCCA

GGCCAGGGGCGGAATCCCAGAA**ATGGGCGCCGGGAAGAAGGCCCGGGCCAATACCGGCCGGATAAGAAG**
 CCGCGGCCGGCCCCGGCCAGGTGACCTTTCTTCCAAAGCCGGGAGGGCGCCGGGCTGTTCAAGAAAGG
 CCCGAGGAGCTCGCCGTGCTTCTGCGACGCCGACGTGCGGCTCGTCTTTCTTCCACCGGGCAA
 GCTCTCCCCAGTTCCGCCAGCTCCCAGTATGAACGAGATCATTGACAAGTATAGTACTCATTCAAAGAA
 CCTGGGGAAATCTGATCAGCAGCCGGCTATTGATTTAAATTTAGAGCACTGCAAGTATGACAGTTTGA
 ATGAACAACCTCGCAGAAGCAAGTCTTCGACTTAGACACATGAGAGGTGAGGAACTTGACGGACTGAGT
 GTCGGTGAGTTGCAGCAGATGGAAAAGAATCTCGAAACAGGATTGCAGAGGGTGTCTTGTACAAAGGA
 CCGGCAATTCATGCAACAATTAGTGACCTCCAACAAAAGGGAACACAGCTGGCAGAGGAAAAATATGC
 GCTTGAAAAACCAATGCATGAGGTGCCAACTGCTAGCACGGTGGCCGTGCGGAAGCCGAAAATGTT
 GTCCCTGAAGATGCTCATTCTGACTCTGTGATGACGGCAGTACATTCGGGAAGCTCACAGGACAA
 TGATGACGGTTCTGATATATCCCTGAAACTAGCGTTACCTTGGAAAGT**AAGGACCGTGGGGAGGCCACC**
 CTGAGTTGCCTTGGTAGAGAGAAGATGTGAAATGCTATGGGGAATCACTCCAAGATAGGCTGGCTGGA
 ATGATCCCATAGTAGAAGCCAGATCAGTTTAACCCGATCGAGTTGTCGTTTTATGTCTCCGTTTGCAC
 GGC

>TaAGL78 clone MC87 (contig R1 and F1), 1061bp CDs complete, mRNA
 220...918

ACGCGTCCGCGACTGGAGCACGAGGACACTGACATGGACTGAAGGAGTAGAAAAACCAGGACAGTAGT
 CTCACATAGAGAGAGCTGCAAGGGTGAACCGCAGCAACCTCGAAGCTAGTCCAAACTAGTGGAAAGGT
 TGTGTGCAATCCATCATCTTCTTCGTCTCTCCATCTACCCCTTATCAATCATCCACCCATCCATCCAT
 CCATCATCATCATCC**ATGGCGAGAGGCAAGGTCCAGCTCTGGCGCATCGAGAACCCCGTCCACCGGCA**
 GGTACCTTCTGCAAGCGCCGCGCAGGGCTCCTCAAGAAGGCCAGGGAGCTCTCTGTCTCTGCGACG
 CCGACATCGGCATCATCATCTTCTCCGCACACGGCAAGCTCTACGACCTCGCCACCACCGGAACCATG
 GATGGGCTGATCGAGAGGTACAAGAGTGCCAGTGGAGAAGGCATGACCGGCGACGGCTGCGGCGACCA
 GAGAGTGGACCCAAAGCAGGAGGCAATGGTGTGAAACAAGAAATAGACCTTCTGCAGAAGGGACTGA
 GGTACATTTATGGAAACAGGGCAAATGAGCACATGAATGTTGACGAGCTGAATGCCCTGGAAAGGTAC
 TTGAAATATGGATGTTCAACATCCGCTCCGCAAAGATGCAGATAATGATTCAGAGATCCAGGCACT
 GAAGACAAGATTTTATATGCAGGAGGGCATGTTGAAAGCTGCCAACGAAATCTCCAGGAAAGG
 TACCGATTATAGTAGAACAGCATGGACTGATCGACGTAGGCATGACTATAGCAGATCAGCAGAATGGG
 CATTTTAGTACAGTCCCAATGTTAGAGGAGATCACTAACCCACTGACTATACTAGTGGCTATTCTAC
 TTGTAGGGGCTCAGAGATGGGCTATTCTTCT**GATGGTAATAACGCCCTGAGGGACTATTATTAGTGT**
 GTAATATGGTGGTTAATATTTAACAAAGCTTGCTTTACGTATGATTTGCTCCGGTACTACTCTGTAAT
 ATTTATATAGGCCATATTCCTCAGGAGTGCCTTAAGGCC

>TaAGL79 clones TaAGL84,87,89,92 887bp CDs complete, 97...627

CGGGATATCGTCCGACCCACGCGTCCGCGACTGGAGCACGAGGACACTGACATGGACTGAAGGAGTAGA
 AAAGGACGAGGCTGGTGGGGA**ACTGGGGATGGCGCGGCGGGCGTGTGGAGCTGCGGCGGATCGAGG**
 ACCGGACGAGCCGGCAGGTGCGCTTCTCAAGCGCCGCGGGGCTCTTCAAGAAGCCCTTCGAGCTC
 GCGGTCTCTGCGACGCCGAGGTCTCGTGTCTCGTCTTCTCCCCCGCGCAGGCTCTACGAGTACGC
 CTCTCCAGCATAGAAGGTACATATGACCGCTATCAGGCATTTGCAGGAGCCGGAAAGGACGTGAATG
 AACCCGGTGAAGTAACAACAATGATGGAGATCCTTCAAATATACAGTCAAGGCTTGAAGAGATTACT
 TCCTGGTCTCTTCAAAAACAATGCTGATAACTCAGATGCTAATGAGCTAGAGAACTGGAGAAACTACT
 GACAGATGCTTTGAAGAATACAAAATCCAAGAAGATGTTGGCGCAACAAAAATAGCGATGCCGGCACT
 AGTGCAGCGGGCGGAACTCCAGAAGGACTTGAGCAGCCATGTGATGTGCATGCATTTGGTTCAAGCA
 AAGCTCTGTGGCT**GATGCCACACTCTTCTCCAGTTACTGAAAGAGTTGTGTTTGAAGGTGCAGCAA**
 AGGCACGAGGGGCAAATTCATAAAAAGGGCGGTGGGTTAACACCAACAGTGTGTGTGGGTGTGTCC
 TTGTTAAGTTATCTGTTGCTTGTCTGCTTACCTTTTGTGCTTTGCCAAGGCTGTGTGTGATGC
 TCAGATTAACATATCAGTCTGTTGTGAGTCTTATATACGCAGCTGAGTGAGAAAAAAAAAAAAAAAAAAA
 AAA

>TaAGL80 clone MC78R1, 942bp CDs incomplete

CCGGCTTTCAACCCGGAAGGAAGGGAGGAAGGAAGAAAGGGCCGGCCCCGGGGCGGTTCCAAAAACC
 GTTTCAGGCCCGGGCGGGATTCCAAGAATGGCCCGGAAAAGGCCGGGGCGATACCGGCCGATAAAAAG
 AGCCCCGGCGGCCCGGCCAGGTGGCCTTCTCCAAGCGGAGGGCCCCGGGCCCTTTTCAAGAAAAGCCC
 AGGAGCTCGCCGTGGTCTGcGACGCCGACGTGCGCTCGTCTCTTTTTCTCCCCCGCAAGCTCTC
 CCCAGTTCGCCAGCTCCAGTATGAACGAGATCATTGACAAGTATAGTACTCATTCAAAGAACCTGGGG
 AAATCTGATCAGCAGCCGGCTATTGACTTAAATTTAGAGCACTGCAAGTATGACAGTTTGAATGAACA
 ACTCGCAGAAGCAAGTCTTCGACTTAGACACATGAGAGGTGAGGAACCTGACGGACTGAGTGTGGTG
 AGTTGCAGCAGATGGAAAAGAATCTCGAAAACAGGATTGCAGAGGGTGCCTTGTACAAAGGACCGGCAA
 TTCATGCAACAAATCAGTGACCTCCAACAAAAGGGAACGCAGCTGGCAGAGGAAAATATGCGCTTGAA
 AAACCAAATGCATGAGGTGCCAACTGTTAGCACGGTGGCCGTTGCCGAAGCTGAAAAATGTTGTCCCTG
 AAGATGCTCATTCTGACTCTGTGATGACGGCAGTACATTCGGGAAGCTCGCAGGACAAATGATGAC
 GGTCTGATATATCCCTGAAACTAGCGTTACCTTGAAAATAAGGACCGTGGGGAGACCACCTTGAGTT
 GCCTTGGTAGAGAGAAGATGTGAAATGCTATGGAGAATCACTCGAAGATAGGCTGACTGGAATGATCC
 CATAGTAGAAGCCAGATCAGTTAACCTGATCGAGTTGTGTTTTATGTCTCCATTTGC

>TaAGL81 clone MC60R1-2, 859bp CDs complete, mRNA 42...731

GATGGGCAGGAAGGGGAACCAAGGGGGGGAGGGGAAGGAATGGCCGGGGAAGAAGGAAGAGGAT
 TGCCGATTCGGAGGATCGAGAATTCTGGCGGCAGGCAGGTCCCCTTCTCCAAGCGCCGGCCGGGG
 CCTTTTCAAGAAGGCCGAGGAGCTCTCCATCCTCTGCGACGCCGAGGTGGCCTCGCCGCTTCTCCG
 CCACCGCAAGCTCTTCCAGTTCGCCAGCTCCAGCATGAACCAGATTATTGACCGGTATAACTCTCAT
 TCCAAGATACTTAAGAAAAGCAGACGAGCCATCTCAGCTGGACTTGCATGAGGACAGCAATTGTGCAAG
 ACTAAGCGACGAGCTTGCAGAAGCAAGCCTCTGGCTCCAGCAGATGAGAGGAGAGGAGCTCCAGAGCC
 TGAACGTCAGCAGCTTCAAGCCCTAGAGAAGAGCCTCGAGTCCGGGCTCGGCTCCGTTCTGAAAACC
 AAGAGCCAAAAGATCATGGACCAGATCAGCGAGCTAGAAAATAAGAGGGTGCAACTGATAGAGGAAAA
 CGCAAGGCCAAAGGAGCAAGCGTCCAAGATGGAGATGCAGGTCCGCCGCTGATTACCGGTGGTGTACG
 AGGAAGACAGTCGTCTGAGTCCGTCACGAACACGTCGTATCCGCGCCCTCCCCTCGACACCGAGGAC
 AGTCCGATACGTCTCTCAGGCTCGGATTACCACTCTTCAACTCAAAGTGATTGGCTGGAATATATCT
 GAAGCAAAGTTGCTTGGTCAACAAGCTCCTGAATCGAACCGCGCGCTGCATCGAATAAACAGTTTG
 AGTGCCTGGATGATGTGTGTAATCTAAAAGAAGGCTGGCTTC

>TaAGL82 clone MC69F1L7-1, 919bp CDs complete, mRNA 163...831

GCCTCCCCCTCGTCTCTCCAGATCCGCCCGTCCGTCGATCCATGGCGCCGTCGTCGCCGGCGGGC
 GGCGGTGGCGGAGGGAGACGAGCAGCAGCAGCAGATCGTGGCGGGCGGGCGGCCAAGAAGG
 GCGCGGGAAGAGGGCCGGCGGAGATGCGGGCGGATCGAGGACGCCACCAGCCGCGAGGTGACCTTC
 TCCAAGCGCCGGAGCGGGCTGCTCAAGAAGGCCTTCGAGCTGGGCGTCTCTGCGACGCCGAGGTGCG
 CCTCATCGTCTTCTCCCCCGCGCCGCTCTACGAGTACGCTCCGCGCCAGATTTGCAGAAAACGA
 TTGATCGTATCTGAACCACACAAAAGGGACATCTGCCAATGAGAAAACGTTGAGCAACCAGCTGCT
 GGCGTCCAGATGTGTAGATCCGAAGCTACCGCCTTGAAGCACAAGATAGACGCAATTGAGGCATACCA
 GAGGAAGCTATCTGGAGAAGGACTGGGGTCTGTTTCGGCCATGAGCTGCAAGAGCTGGAGCTGCAGC
 TGGAGAAGAGCCTAAGCTGCATCCGGCAAAAAGAAGCAACAGAAAATGCTGGATAAAAATCTTGGAGCTG
 AAGGAGAAGGAGAGAAAGCTGTTGACGGAGAACGTGGTGTCTCCGCGAGGAGTACAAGGCGCTGCCTCT
 GCTAGAGCTGGCCACTGCTGCTGCTGCTGAAAGATCGCCTGACGGCGCCGGAGCTGAAGAAGCTGAGG
 AGGACGAcCGGCGCTGCATTTACATGGAAGTGAAGACTGAAcCTGGTCATTGGAAAGGCCCGGGT
 TTCGTTCTaActTAGCAGCAGTAaAAAAATTGATTTGAATAAAATtTGCTCCAATCCA tTGAAGAAT
 CGATGCAAAAAATCCAATCAAATtTGTTTGTTC

References

- Alvarez-Buylla, E.R., Pelaz, S., Liljegren, S.J., Gold, S.E., Burgeff, C., Ditta, G.S., Ribas, d.P., Martinez-Castilla, L., and Yanofsky, M.F. (2000) An ancestral MADS-box gene duplication occurred before the divergence of plants and animals. *Proc. Natl. Acad. Sci. U.S.A.* 97:5328-5333.
- Badawi, M., Danyluk, J., Boucho, B., Houde, M., and Sarhan, F. (2007) The CBF gene family in hexaploid wheat and its relationship to the phylogenetic complexity of cereal CBFs. *Mol. Genet. Genomics* 277:533-554.
- Becker, A., Kaufmann, K., Freialdenhoven, A., Vincent, C., Li, M.A., Saedler, H., and Theissen, G. (2002) A novel MADS-box gene subfamily with a sister-group relationship to class B floral homeotic genes. *Mol. Genet. Genomics* 266:942-950.
- Becker, A. and Theissen, G. (2003) The major clades of MADS-box genes and their role in the development and evolution of flowering plants. *Mol. Phylogenet. Evol.* 29:464-489.
- Becker, A., Saedler, H., and Theissen, G. (2003) Distinct MADS-box gene expression patterns in the reproductive cones of the gymnosperm *Gnetum gnemon*. *Dev. Genes Evol.* 213:567-572.
- Borner, R., Kampmann, G., Chandler, J., Gleissner, R., Wisman, E., Apel, K., and Melzer, S. (2000) A MADS domain gene involved in the transition to flowering in *Arabidopsis*. *Plant J.* 24:591-599.
- Carmona, M.J., Ortega, N., and Garcia-Maroto, F. (1998) Isolation and molecular characterization of a new vegetative MADS-box gene from *Solanum tuberosum* L. *Planta* 207:181-188.

Ciaffi,M., Paolacci,A.R., D'Aloisio,E., Tanzarella,O.A., and Porceddu,E. (2005) Identification and characterization of gene sequences expressed in wheat spikelets at the heading stage. *Gene* 346:221-230.

Ciannamea,S., Kaufmann,K., Frau,M., Tonaco,I.A., Petersen,K., Nielsen,K.K., Angenent,G.C., and Immink,R.G. (2006) Protein interactions of MADS box transcription factors involved in flowering in *Lolium perenne*. *J.Exp.Bot.* 57:3419-3431.

Danyluk,J., Kane,N.A., Breton,G., Limin,A.E., Fowler,D.B., and Sarhan,F. (2003) TaVRT-1, a putative transcription factor associated with vegetative to reproductive transition in cereals. *Plant Physiol* 132:1849-1860.

De Bodt,S., Raes,J., Florquin,K., Rombauts,S., Rouze,P., Theissen,G., and Van de,P.Y. (2003) Genomewide structural annotation and evolutionary analysis of the type I MADS-box genes in plants. *J.Mol.Evol.* 56:573-586.

Endo,T.R. and Gill,B.S. (1996) The Deletion Stocks of Common Wheat. *J Hered* 87:295-307.

Fernandez,D.E., Heck,G.R., Perry,S.E., Patterson,S.E., Bleecker,A.B., and Fang,S.C. (2000) The embryo MADS domain factor AGL15 acts postembryonically. Inhibition of perianth senescence and abscission via constitutive expression. *Plant Cell* 12:183-198.

Goff,S.A., Ricke,D., Lan,T.H., Presting,G., Wang,R., Dunn,M., Glazebrook,J., Sessions,A., Oeller,P., Varma,H., Hadley,D., Hutchison,D., Martin,C., Katagiri,F., Lange,B.M., Moughamer,T., Xia,Y., Budworth,P., Zhong,J., Miguel,T., Paszkowski,U., Zhang,S., Colbert,M., Sun,W.L., Chen,L., Cooper,B., Park,S., Wood,T.C., Mao,L., Quail,P., Wing,R., Dean,R., Yu,Y., Zharkikh,A., Shen,R., Sahasrabudhe,S., Thomas,A., Cannings,R., Gutin,A., Pruss,D., Reid,J., Tavtigian,S.,

Mitchell,J., Eldredge,G., Scholl,T., Miller,R.M., Bhatnagar,S., Adey,N., Rubano,T., Tusneem,N., Robinson,R., Feldhaus,J., Macalma,T., Oliphant,A., and Briggs,S. (2002) A draft sequence of the rice genome (*Oryza sativa* L. ssp. japonica). *Science* 296:92-100.

Goncharov,N.P. (2003) Genetics of growth habit (spring vs winter) in common wheat: confirmation of the existence of dominant gene *Vrn4*. *Theor.Appl.Genet* 107:768-772.

Hartmann,U., Hohmann,S., Nettesheim,K., Wisman,E., Saedler,H., and Huijser,P. (2000) Molecular cloning of *SVP*: a negative regulator of the floral transition in *Arabidopsis*. *Plant J.* 21:351-360.

Hecht,V., Foucher,F., Ferrandiz,C., Macknight,R., Navarro,C., Morin,J., Vardy,M.E., Ellis,N., Beltran,J.P., Rameau,C., and Weller,J.L. (2005) Conservation of *Arabidopsis* flowering genes in model legumes. *Plant Physiol* 137:1420-1434.

Honma,T. and Goto,K. (2001) Complexes of *MADS*-box proteins are sufficient to convert leaves into floral organs. *Nature* 409:525-529.

Houde,M., Belcaid,M., Ouellet,F., Danyluk,J., Monroy,A.F., Dryanova,A., Gulick,P., Bergeron,A., Laroche,A., Links,M.G., MacCarthy,L., Crosby,W.L., and Sarhan,F. (2006) Wheat EST resources for functional genomics of abiotic stress. *BMC.Genomics* 7:149.

Izawa,T., Takahashi,Y., and Yano,M. (2003) Comparative biology comes into bloom: genomic and genetic comparison of flowering pathways in rice and *Arabidopsis*. *Curr.Opin.Plant Biol.* 6:113-120.

Jack,T. (2001) Plant development going *MADS*. *Plant Mol.Biol.* 46:515-520.

Kane,N.A., Danyluk,J., Tardif,G., Ouellet,F., Laliberte,J.F., Limin,A.E., Fowler,D.B., and Sarhan,F. (2005) TaVRT-2, a member of the StMADS-11 clade of flowering repressors, is regulated by vernalization and photoperiod in wheat. *Plant Physiol* 138:2354-2363.

Kofuji,R., Sumikawa,N., Yamasaki,M., Kondo,K., Ueda,K., Ito,M., and Hasebe,M. (2003) Evolution and divergence of the MADS-box gene family based on genome-wide expression analyses. *Mol.Biol.Evol.* 20:1963-1977.

Kramer,E.M., Dorit,R.L., and Irish,V.F. (1998) Molecular evolution of genes controlling petal and stamen development: duplication and divergence within the APETALA3 and PISTILLATA MADS-box gene lineages. *Genetics* 149:765-783.

Kramer,E.M. and Irish,V.F. (1999) Evolution of genetic mechanisms controlling petal development. *Nature* 399:144-148.

Kumar,S., Tamura,K., and Nei,M. (2004) MEGA3: Integrated software for Molecular Evolutionary Genetics Analysis and sequence alignment. *Brief.Bioinform.* 5:150-163.

Lee,H., Suh,S.S., Park,E., Cho,E., Ahn,J.H., Kim,S.G., Lee,J.S., Kwon,Y.M., and Lee,I. (2000) The AGAMOUS-LIKE 20 MADS domain protein integrates floral inductive pathways in Arabidopsis. *Genes Dev.* 14:2366-2376.

Lee,S., Jeon,J.S., An,K., Moon,Y.H., Lee,S., Chung,Y.Y., and An,G. (2003) Alteration of floral organ identity in rice through ectopic expression of OsMADS16. *Planta* 217:904-911.

Lee,S., Kim,J., Han,J.J., Han,M.J., and An,G. (2004) Functional analyses of the flowering time gene OsMADS50, the putative SUPPRESSOR OF OVEREXPRESSION OF CO 1/AGAMOUS-LIKE 20 (SOC1/AGL20) ortholog in rice. *Plant J.* 38:754-764.

- Levy, Y.Y., Mesnage, S., Mylne, J.S., Gendall, A.R., and Dean, C. (2002) Multiple roles of Arabidopsis VRN1 in vernalization and flowering time control. *Science* 297:243-246.
- Ma, H. (1998) Flowering time: from photoperiodism to florigen. *Curr. Biol.* 8:R690-R692.
- Mandel, M.A. and Yanofsky, M.F. (1995) The Arabidopsis AGL8 MADS box gene is expressed in inflorescence meristems and is negatively regulated by APETALA1. *Plant Cell* 7:1763-1771.
- Mandel, M.A., Gustafson-Brown, C., Savidge, B., and Yanofsky, M.F. (1992). Molecular characterization of the Arabidopsis floral homeotic gene APETALA1. *Nature* 360, 273-277.
- Marchler-Bauer, A., Anderson, J.B., Cherukuri, P.F., DeWeese-Scott, C., Geer, L.Y., Gwadz, M., He, S., Hurwitz, D.I., Jackson, J.D., Ke, Z., Lanczycki, C.J., Liebert, C.A., Liu, C., Lu, F., Marchler, G.H., Mullokandov, M., Shoemaker, B.A., Simonyan, V., Song, J.S., Thiessen, P.A., Yamashita, R.A., Yin, J.J., Zhang, D., and Bryant, S.H. (2005) CDD: a Conserved Domain Database for protein classification. *Nucleic Acids Res.* 33:192-196.
- Mena, M., Ambrose, B.A., Meeley, R.B., Briggs, S.P., Yanofsky, M.F., and Schmidt, R.J. (1996) Diversification of C-function activity in maize flower development. *Science* 274:1537-1540.
- Michaels, S.D. and Amasino, R.M. (1999) FLOWERING LOCUS C encodes a novel MADS domain protein that acts as a repressor of flowering. *Plant Cell* 11:949-956.

Michaels,S.D., Ditta,G., Gustafson-Brown,C., Pelaz,S., Yanofsky,M., and Amasino,R.M. (2003) AGL24 acts as a promoter of flowering in Arabidopsis and is positively regulated by vernalization. *Plant J.* 33:867-874.

Moon,J., Suh,S.S., Lee,H., Choi,K.R., Hong,C.B., Paek,N.C., Kim,S.G., and Lee,I. (2003) The SOC1 MADS-box gene integrates vernalization and gibberellin signals for flowering in Arabidopsis. *Plant J.* 35:613-623.

Munster,T., Wingen,L.U., Faigl,W., Werth,S., Saedler,H., and Theissen,G. (2001) Characterization of three GLOBOSA-like MADS-box genes from maize: evidence for ancient paralogy in one class of floral homeotic B-function of grasses. *Gene* 262:1-13.

Murai,K., Miyamae,M., Kato,H., Takumi,S., and Ogihara,Y. (2003) WAP1, a wheat APETALA1 homolog, plays a central role in the phase transition from vegetative to reproductive growth. *Plant Cell Physiol* 44:1255-1265.

Nam,J., dePamphilis,C.W., Ma,H., and Nei,M. (2003) Antiquity and evolution of the MADS-box gene family controlling flower development in plants. *Mol.Biol.Evol.* 20:1435-1447.

Nam,J., Kim,J., Lee,S., An,G., Ma,H., and Nei,M. (2004) Type I MADS-box genes have experienced faster birth-and-death evolution than type II MADS-box genes in angiosperms. *Proc.Natl.Acad.Sci.U.S.A* 101:1910-1915.

Parenicova,L., de Folter,S., Kieffer,M., Horner,D.S., Favalli,C., Busscher,J., Cook,H.E., Ingram,R.M., Kater,M.M., Davies,B., Angenent,G.C., and Colombo,L. (2003) Molecular and phylogenetic analyses of the complete MADS-box transcription factor family in Arabidopsis: new openings to the MADS world. *Plant Cell* 15:1538-1551.

Pelaz,S., Ditta,G.S., Baumann,E., Wisman,E., and Yanofsky,M.F. (2000) B and C floral organ identity functions require SEPALLATA MADS-box genes. *Nature* 405:200-203.

Pelaz,S., Gustafson-Brown,C., Kohalmi,S.E., Crosby,W.L., and Yanofsky,M.F. (2001) APETALA1 and SEPALLATA3 interact to promote flower development. *Plant J.* 26:385-394.

Perry,S.E., Nichols,K.W., and Fernandez,D.E. (1996) The MADS domain protein AGL15 localizes to the nucleus during early stages of seed development. *Plant Cell* 8:1977-1989.

Purugganan,M.D., Rounsley,S.D., Schmidt,R.J., and Yanofsky,M.F. (1995) Molecular evolution of flower development: diversification of the plant MADS-box regulatory gene family. *Genetics* 140 :345-356.

Quevillon,E., Silventoinen,V., Pillai,S., Harte,N., Mulder,N., Apweiler,R., and Lopez,R. (2005) InterProScan: protein domains identifier. *Nucleic Acids Res.* 33:W116-W120.

Riechmann,J.L., Heard,J., Martin,G., Reuber,L., Jiang,C., Keddie,J., Adam,L., Pineda,O., Ratcliffe,O.J., Samaha,R.R., Creelman,R., Pilgrim,M., Broun,P., Zhang,J.Z., Ghandehari,D., Sherman,B.K., and Yu,G. (2000) Arabidopsis transcription factors: genome-wide comparative analysis among eukaryotes. *Science* 290:2105-2110.

Rounsley,S.D., Ditta,G.S., and Yanofsky,M.F. (1995) Diverse roles for MADS box genes in Arabidopsis development. *Plant Cell* 7:1259-1269.

Samach,A., Onouchi,H., Gold,S.E., Ditta,G.S., Schwarz-Sommer,Z., Yanofsky,M.F., and Coupland,G. (2000) Distinct roles of CONSTANS target genes in reproductive development of Arabidopsis. *Science* 288:1613-1616.

Sears,E.R. (1954) *The Aneuploids of Common Wheat*. (Columbia, MO.: University of Missouri Agricultural Experiment Station,), pp. 1-58.

Sears,E.R. (1966) Nullisomic-tetrasomic combinations in hexaploid wheat. Oliver & Boyd, ed (Edinburgh: R. Riley and K. R. Lewis), pp. 29-45.

Sheldon,C.C., Burn,J.E., Perez,P.P., Metzger,J., Edwards,J.A., Peacock,W.J., and Dennis,E.S. (1999) The FLF MADS box gene: a repressor of flowering in Arabidopsis regulated by vernalization and methylation. *Plant Cell* 11:445-458.

Sheldon,C.C., Rouse,D.T., Finnegan,E.J., Peacock,W.J., and Dennis,E.S. (2000) The molecular basis of vernalization: the central role of FLOWERING LOCUS C (FLC). *Proc.Natl.Acad.Sci.U.S.A* 97:3753-3758.

Shore,P. and Sharrocks,A.D. (1995) The MADS-box family of transcription factors. *Eur.J.Biochem.* 229:1-13.

Sommer, H., Beltran, J.P., Huijser, P., Pape, H., Lonig, W.E., Saedler, H., and Schwarz-Sommer, Z. (1990). Deficiens, a homeotic gene involved in the control of flower morphogenesis in *Antirrhinum majus*: the protein shows homology to transcription factors. *EMBO J.* 9, 605-613.

Szucs,P., Karsai,I., von Zitzewitz,J., Meszaros,K., Cooper,L.L., Gu,Y.Q., Chen,T.H., Hayes,P.M., and Skinner,J.S. (2006) Positional relationships between photoperiod response QTL and photoreceptor and vernalization genes in barley. *Theor.Appl.Genet* 112:1277-1285.

Tadege,M., Sheldon,C.C., Helliwell,C.A., Upadhyaya,N.M., Dennis,E.S., and Peacock,W.J. (2003) Reciprocal control of flowering time by OsSOC1 in transgenic Arabidopsis and by FLC in transgenic rice. *Plant Biotechnol.J.* 1:361-369.

Theissen,G., Becker,A., Di Rosa,A., Kanno,A., Kim,J.T., Munster,T., Winter,K.U., and Saedler,H. (2000) A short history of MADS-box genes in plants. *Plant Mol.Biol.* 42:115-149.

Theissen,G. (2001) Development of floral organ identity: stories from the MADS house. *Curr.Opin.Plant Biol.* 4:75-85.

Tranquilli,G. and Dubcovsky,J. (2000) Epistatic interaction between vernalization genes *Vrn-Am1* and *Vrn-Am2* in diploid wheat. *J Hered.* 91:304-306.

Trevaskis,B., Tadege,M., Hemming,M.N., Peacock,W.J., Dennis,E.S., and Sheldon,C. (2007) Short Vegetative Phase-Like MADS-Box Genes Inhibit Floral Meristem Identity in Barley. *Plant Physiol* 143:225-235.

Trobner,W., Ramirez,L., Motte,P., Hue,I., Huijser,P., Lonngig,W.E., Saedler,H., Sommer,H., and Schwarz-Sommer,Z. (1992) GLOBOSA: a homeotic gene which interacts with DEFICIENS in the control of *Antirrhinum* floral organogenesis. *EMBO J.* 11:4693-4704.

Vandenbussche,M., Zethof,J., Souer,E., Koes,R., Tornielli,G.B., Pezzotti,M., Ferrario,S., Angenent,G.C., and Gerats,T. (2003) Toward the analysis of the petunia MADS box gene family by reverse and forward transposon insertion mutagenesis approaches: B, C, and D floral organ identity functions require SEPALLATA-like MADS box genes in petunia. *Plant Cell* 15:2680-2693.

Weigel, D., and Meyerowitz, E.M. (1994). The ABCs of floral homeotic genes. *Cell* 78, 203-209.

Winter,K.U., Saedler,H., and Theissen,G. (2002) On the origin of class B floral homeotic genes: functional substitution and dominant inhibition in Arabidopsis by expression of an orthologue from the gymnosperm Gnetum. *Plant J* 31:457-475.

Xiong,L. and Zhu,J. (2001) Abiotic stress signal transduction in plants: Molecular and genetic perspectives. *Physiologia Plantarum* 112:152-166.

Yan,L., Loukoianov,A., Tranquilli,G., Helguera,M., Fahima,T., and Dubcovsky,J. (2003) Positional cloning of the wheat vernalization gene VRN1. *Proc.Natl.Acad.Sci.U.S.A* 100:6263-6268.

Yanofsky, M.F., Ma, H., Bowman, J.L, Drews, G.N., Feldmann, K.A., and Meyerowitz, E.M. (1990). The protein encoded by the Arabidopsis homeotic gene *agamous* resembles transcription factors. *Nature* 346, 35-39.

Zhao,T., Ni,Z., Dai,Y., Yao,Y., Nie,X., and Sun,Q. (2006) Characterization and expression of 42 MADS-box genes in wheat (*Triticum aestivum* L.). *Mol.Genet Genomics* 276:334-350.

Zhao,X.Y., Cheng,Z.J., and Zhang,X.S. (2006) Overexpression of TaMADS1, a SEPALLATA-like gene in wheat, causes early flowering and the abnormal development of floral organs in Arabidopsis. *Planta* 223:698-707.

Zhang,H. and Forde,B.G. (1998) An Arabidopsis MADS box gene that controls nutrient-induced changes in root architecture. *Science* 279:407-409.

V. Interaction network of proteins associated with abiotic stress response and development in wheat

Guylaine Tardif¹, Ndjido Ardo Kane², H  l  ne Adam², Louise  tte Labrie¹, Genevi  ve Major², Patrick Gulick³, Fathey Sarhan² and Jean-Fran  ois Lalibert  ^{1*}

1. Institut Armand-Frappier, Institut national de la recherche scientifique, 531 boulevard des Prairies, Laval, Qu  bec, Canada H7V 1B7

2. D  partement des sciences biologiques, Universit   du Qu  bec    Montr  al, CP 8888, Succursale Centre-ville, Montr  al, Qu  bec, Canada H3C 3P8

3. Department of Biology, Concordia University, 7141 Sherbrooke W., Montr  al, Qu  bec, Canada H4B 1R9

Publi   dans *Plant Molecular Biology*, volume 65 (5): pp703-718.

Contribution

Ma participation a   t   d'identifier et de cloner des g  nes candidats de vernalisation ou associ      la floraison chez le bl  . J'ai effectu   leur clonage dans des vecteurs de recombinaison pour le criblage dans la levure. J'ai   galement particip   dans la r  daction et les id  es de discussion de l'article.

Réseau d'interaction de protéines associées aux stress abiotiques et au développement chez le blé

Résumé

Le blé, une des récoltes les plus adaptées aux facteurs abiotiques, est considéré en dépit de sa complexité génétique comme un excellent modèle pour étudier les stress issus des variations environnementales. En réponse aux expositions aux basses températures, les plantes natives des zones tempérées régulent l'expression de plusieurs gènes soit à la hausse ou à la baisse. Afin de mieux comprendre la fonction des gènes impliqués dans ces processus adaptatifs, le système du double hybride GAL4 de levure a été utilisé pour dresser une carte d'interaction de protéines « interactome » associées à différentes réponses abiotiques et au développement chez le blé. L'interactome est composé de 73 protéines, générant 97 paires d'interactions selon les critères de confiance établis. Vingt et une interactions ont été confirmées *in planta* par complémentation (BiFC). La caractéristique principale de cet interactome est que presque toutes les protéines sont reliées d'une façon directe ou indirecte. L'interactome indique également la présence de complexes multimériques de protéines impliquées dans la régulation de la floraison. Ces complexes, en plus de fournir des informations primaires, mettent en exergue la dynamique et les connexions possibles entre les facteurs de transcription impliqués dans les réponses abiotiques.

Abstract

Wheat is the most widely adapted crop to abiotic stresses and considered an excellent system to study stress tolerance in spite of its genetic complexity. Recent studies indicated that several hundred genes are either up- or down-regulated in response to stress treatment. To elucidate the function of some of these genes, an interactome of proteins associated with abiotic stress response and development in wheat was generated using the yeast two-hybrid GAL4 system and specific protein interaction assays. The interactome is comprised of 73 proteins, generating 97 interactions pairs. Twenty-one interactions were confirmed by bimolecular fluorescent complementation in *Nicotiana benthamiana*. A confidence-scoring system was elaborated to evaluate the significance of the interactions. The main feature of this interactome is that almost all bait proteins along with their interactors were interconnected, creating a spider web-like structure. The interactome revealed also the presence of a “cluster of proteins involved in flowering control” in three- and four-protein interaction loops. This network provides a novel insight into the complex relationships among transcription factors known to play central roles in vernalization, flower initiation and abscisic acid signaling, as well as associations that tie abiotic stress with other regulatory and signaling proteins. This analysis provides useful information in elucidating the molecular mechanism associated with abiotic stress response in plants.

Introduction

Plants have evolved to survive under a wide range of environmental conditions and they display large genetic variation for tolerance to stresses such as freezing, drought, salinity, heavy metals, high light, and increased atmospheric CO₂. Tolerant plants cope with harsh environmental conditions through adaptive mechanisms that are genetically programmed and that result in the production of a wide array of substances needed to protect the plants and ensure their survival. Wheat (*Triticum aestivum*) is one of the two major cereals worldwide, with the production of over 627 million tones in 2004 (<http://faostat.fao.org/>). It is grown over a large range in latitudes under both rain fed and irrigated conditions and thus in conditions subjected to environmental stresses. Bread wheat is among the most cold tolerant crop species and winter wheat cultivars are markedly more freezing tolerant than spring cultivars. The control of flower induction is a key element that distinguishes these classes of cultivar types and is intimately linked to cold tolerance. The signalling pathways that regulate flowering, vernalization and stress responses have been extensively studied in the model species *Arabidopsis thaliana*.

Numerous mutants that affect flower induction have been characterised and relationships between components of signalling and regulatory pathways have been determined by epistasis. In wheat, key genes regulating flower induction in relation to vernalization, *Vrn1/TaVRT1*, *Vrn2* and *TaVRT2* have been identified recently (Danyluk *et al.*, 2003; Yan *et al.*, 2004; Kane *et al.*, 2005). These genes belong to transcription factor gene families and have homologs in *A. thaliana*. Though members of these gene families have been shown to play central roles in the regulation of flowering in *A. thaliana*, it is not possible to determine orthology relationships between the wheat and *A. thaliana* genes by sequence similarity alone. It is also likely that the signalling pathways in the two species are not identical, for

example the genes controlling the requirement for vernalization in wheat and *A. thaliana* are not orthologous (Yan *et al.*, 2003; Yan *et al.*, 2004).

Genomic studies in crop species have facilitated all aspects of the study of the molecular biology. Large-scale genomic sequencing in rice and *A. thaliana* and EST sequencing in other important species has accelerated the identification of genes based on sequence similarity to gene of known function. Large-scale gene expression studies by microarray analysis have identified many genes that are associated with the environmental stress responses. Protein-protein interaction studies can give critical insight into the components of signalling and regulation of the cold stress response and flower induction. Such an approach is especially important in crop species in which extensive mutant stocks are not available and in which it is difficult to establish gene interaction relationships through epistasis. It can delineate components of signalling and regulation networks by the identification of the direct interaction partners of regulatory proteins and identify proteins that may not be identified by changes in their mRNA levels.

Light perception and temperature sensing are key elements in the plants response to environmental stress. Secondary messengers such as Ca^{2+} , calmodulin (CaM), cAMP, cGMP, cADP-ribose, inositol 1,4,5-triphosphate (IP3) and reactive oxygen species (ROS) have been implicated in signalling in the stress response. These secondary messengers relay the stress signal by the intermediary of transducer kinases and phosphatases to appropriate transcription factors, which act as positive or negative expression regulators of target genes. This re-programming of gene expression is needed for cell damage repair and prolonged abiotic stress protection [for reviews on this subject, see (Mahajan and Tuteja 2005; Xiong *et al.*, 2002)].

Recently, there has been a number of extensive studies using microarrays of gene regulation during abiotic stress of *A. thaliana* (Hannah *et al.*, 2005; Lee *et al.*, 2005), rice (Rabbani *et al.*, 2003; Yamaguchi *et al.*, 2004), potato (Rensink *et al.*, 2005) and wheat (Gulick *et al.*, 2005). These studies indicated that several hundred genes are either up or down-regulated in response to stress. A large number of these

genes encode regulatory factors such as protein kinases, transcription factors, ubiquitin ligases, GTP and calcium binding proteins or are involved in chromatin modification or posttranscriptional regulation. Several genes involved in the biosynthesis of plant hormones, such as abscisic acid (ABA), gibberellic acid and auxin, are also regulated by stress.

However, not all abiotic stress-related gene products may be transcriptionally regulated, and the co-ordinated regulation of genes is only suggestive of interactions. Protein-protein interactions are likely to play an important role in response to abiotic stress, in the signal transduction cascade for example. Therefore, compiling the interaction network will provide a novel perspective on how cells perceive and transducer stress signals to trigger the genetic system responsible for appropriate plant response.

The yeast two-hybrid system is a powerful tool for the identification of protein associations that can be applied to high-throughput detection of interactions across the entire proteome of an organism. The generation of accurate cellular protein interaction networks is an ongoing process. Proteome-wide studies for model organisms such as *Helicobacter pylori* (Rain *et al.*, 2001), *Saccharomyces cerevisiae* (Ito *et al.*, 2001; Uetz *et al.*, 2000), *Caenorhabditis elegans* (Li *et al.*, 2004) and *Drosophila melanogaster* (Giot *et al.*, 2003), in addition to *Homo sapiens* (Rual *et al.*, 2005; Stelzl *et al.*, 2005), have been performed. However, there are few studies on protein interaction mapping in plants. One study showed a densely connected network of interactions between and within family members of the 3-aa loop extension (TALE) homeodomain proteins (Hackbusch *et al.*, 2005). The interaction map of the *A. thaliana* MADS-box transcription factors has been investigated and revealed regulatory loops providing links between flower organ development and floral induction (de Folter *et al.*, 2005). The hallmark of these networks is that practically all proteins are linked to each other, a characteristic of small-world networks. Another property is that the number of links per protein is non-uniform (i.e. scale-free), with the great majority of proteins with only a few connections along with

the presence of “hubs” in which proteins are highly connected. This scale-free topology is linked to the robustness of interaction networks, being largely insensitive to random removal of single proteins but sensitive to removal of “hubs”. Although large interactome maps establish only “scaffold” information of protein-protein interactions without describing the dynamics of interaction, they nevertheless provide unique resources for further functional studies and the identification of key proteins.

The goal of this study is to initiate an interactome of proteins associated with abiotic stress response and development in wheat. A certain number of proteins known to play an important role in these processes were chosen as initial baits for the screening of interactors coded by cDNA libraries, or were directly tested with specific proteins whose candidacy for interaction was suggested by investigations in model species. In addition, selected putative interactors were subsequently reconfigured as baits for a second round of screening. Certain interactions were confirmed *in planta* by bimolecular fluorescent complementation (BiFC). The significance of the generated interactome of 73 proteins, with 97 links between them is discussed.

Materials and Methods

Yeast growth conditions

The *S. cerevisiae* strains used in this study are Y187 *MATá* and AH109 *MATa*. Yeast cells were grown on standard YPD [1% (w/v) yeast extract (Difco), 2% (w/v) Bacto peptone (Difco), 2% (w/v) dextrose] or YNB [0,67% (w/v) yeast nitrogen base without amino acids (Difco) supplemented with the appropriate amino acids (Sigma) and containing 2% dextrose or 1% raffinose/2% galactose]. The yeast strains were transformed using the modified lithium acetate method (Gietz et Woods 2001).

Wheat cDNA libraries

For the cold acclimation and developmental cDNA library, seeds of *Triticum aestivum* L cv Nostar were germinated in water-saturated vermiculite for 7 days under an irradiance of 200 $\mu\text{mol}\cdot\text{m}^{-2}\cdot\text{sec}^{-1}$. The temperature was maintained at 20°C with a 15-hr photoperiod under a relative humidity of 70%. At the end of this period, non-acclimated plants were sampled and frozen. Cold acclimation was performed by subjecting germinated seedlings to a temperature of 4°C with a 12-hr photoperiod for one, 23 and 53 days.

RNA from aerial parts (i.e. crown and leaf) were isolated using the Tri reagent (Sigma) from seven day non-acclimated plants and 1, 23, and 53 day cold-acclimated plants, and pooled. For the dehydration stress cDNA library, seeds were germinated in water-saturated vermiculite for seven days under an irradiance of 200 $\text{mol m}^{-2} \text{sec}^{-1}$. The temperature was maintained at 20°C with a 15h photoperiod under a relative humidity of 70%. At the end of this period, plants were removed from vermiculite and incubated at 20°C on the table without water for 1, 2, 3 and 4 days and then sampled. In parallel, seeds were germinated in a water-saturated mix (50% black earth and 50% ProMix) for seven days under an irradiance of 200 $\text{mol m}^{-2} \text{sec}^{-1}$. The temperature was maintained at 20°C with a 15h photoperiod under a relative humidity

of 70%. After this period watering of plants was stopped. Four time points were sampled during a two week period; the first after wilting was observed and the last two weeks later, consisting of live crown and stem tissue (leaf tissue was yellow and not included in sampled material). RNA from aerial parts from these time points were isolated using the Tri-reagent (Sigma) and pooled. The “SuperScript plasmid System” (Invitrogen) was used for cDNA synthesis. The library was produced in pEXPAD-502 (Invitrogen).

Two-Hybrid Analysis

Two-hybrid analyses using the dehydration library were performed with the GAL4 yeast two-hybrid system. The dehydration library was sub-cloned in pDEST22 prey vector by Gateway cloning and introduced into *S. cerevisiae* strain AH109 (*MATa trp1, leu2* which contains *ADE2, HIS3, lacZ* and *MEL1* reporter genes, each of which uses a distinct GAL4-responsive promoter). Bait-coding cDNAs were PCR amplified with specific primers (see supplementary material) and cloned in pDEST32 bait vector (Invitrogen) by homologous recombination in *S. cerevisiae* strain Y187 (*MAT α fn trp1, leu2*, which contains the *lacZ* and *Mel1* reporters under the control of two distinct GAL4-responsive promoters). Yeast cells were grown and transformed as previously described (Gietz et Woods 2001). Diploid cells between Y187 (bait) and AH109 (wheat cDNA library containing 106 clones) were obtained by conjugation. Yeast colonies containing putative interactors were selected on medium containing SD/Galactose/Raffinose without adenine, leucine, tryptophane and uracil, supplemented with 10mg/L of 5-Bromo-4-Chloro-3-indolyl- β -D-galactopyranoside (X- β -Gal) (VWR) Blue colonies were picked after six days at 30°C. The prey-coding genes were identified by sequencing. Interaction was confirmed by a second round of two-hybrid analysis with β -Galactosidase (*LacZ*) assay on solid medium (Dumay *et al.*, 1999).

The cold acclimated and development library was screened according to the Gateway ProQuest Two hybrid system instructions (Invitrogen) - 2,5x10⁶ clones were screened using this library. The interaction data was displayed using the yEd Graph editor (<http://www.yworks.com/>).

Agroinfiltration

The backbone of the fusion vector used for Bi-molecular fluorescence complementation was pGreen-0029 vector (Hellens *et al.*, 2000), which was modified in the following manner. The multiple cloning site (MCS) was removed by digestion with *KpnI* and *NotI* followed by filling up of overhangs and ligation. The 35S cassette (http://www.pgreen.ac.uk/JIT/pGreen0000_fr.htm) was then inserted into the *StuI* site within the right border of the T-DNA. The 2 μ TRP1 gene for yeast DNA replication was amplified by PCR using specific primers (see supplementary material) and introduced by homologous recombination in the *HpaI*-linearized vector following transformation of yeast strain Y187. The Ntgfp5 (1-471) and Ctgif5 (472-714) were amplified from pBinmgfp5-ER (Haseloff *et al.*, 1997) with specific primers (see supplementary material), and inserted into the *SmaI*-linearized above described modified pGreen-0029 vector by homologous recombination. The resulting plasmids were identified as pGreen-35SNtGFP5 or pGreen-35S-CtGFP. Genes of interest were amplified by PCR using specific primers (see supplemental data) and introduced into the yeast strain Y187 for homologous recombination with the appropriate BiFC vector. Each construct was analysed by PCR and sequenced.

Agrobacterium tumefaciens strain AGL1 transformed with the appropriate BiFC vector was grown at 30°C in L-broth supplemented with 50 g ml⁻¹ of kanamycin and 50 g ml⁻¹ of ampicillin to stationary phase. Bacteria were sedimented by centrifugation at 5000 g for 15 min at room temperature and resuspended in 10 mM MgCl₂ and 150 g ml⁻¹ acetosyringone. Cells were left in this medium for 3h to overnight at room temperature. The abaxial air space of leaves from four-week-old *Nicotiana benthamiana* plants were infiltrated (Voinnet *et al.*, 2003). The P0 protein

of beet western yellows virus was used to suppress posttranscriptional gene silencing. Co-infiltration of *Agrobacterium* strains containing the BiFC constructs and the P0 silencing plasmid was carried out at OD600 of 0,5 : 0,5: 0,5. Epidermal cell layers of tobacco leaves were assayed for fluorescence 3-5 days after infiltration. *N. benthamiana* plants were incubated in environmental growth chamber under long days (16 h light/8 h dark) at 20°C. Wide field fluorescence imaging was carried out on Nikon E800 upright equipped with a Radiance 2000 BioRad laser. Excitation was with BioRad laser at 515 +/- 15 nm longpath. Image analysis was carried out with Photoshop 7.0.

Results and Discussion

Two-hybrid screen

The protein-protein interaction map was generated using the yeast two-hybrid GAL4 system using a combination of library screens and specific protein interaction assays. Proteins that were selected as baits for the initial screening of a wheat cDNA library are listed in Table I. These proteins are transcription factors or signal transduction components that have been shown to be associated with stress responses, vernalization and/or flower development. In each case, baits were tested for auto-activation prior to screening. Conjugation mating between the yeast strain harbouring the bait plasmid with yeasts harbouring the prey cDNA plasmids was performed. Only colonies positive for all three reporter genes (i.e. growth on plates lacking adenine as well as histidine, and expression of x-alpha Gal activity) were retained. Positive colonies were picked and the prey genes were sequenced. Prey plasmids were isolated and tested in a series of control two-hybrid interaction assays. When available, the full-length cDNA of the putative interactor was preferentially used. Only preys showing beta-galactosidase activity with the bait and not with control proteins were retained. Ten preys having a high potential for involvement in abiotic stress response or development were reconfigured as baits for another round of library screening. Equally, specific protein interaction assays were performed using the same experimental criteria as for a library screen.

The interaction data for the library screening and specific protein interaction is shown in Table II. Twenty proteins were configured as baits (i.e. ten proteins listed in Table I and ten resulting from preys that were reconfigured as baits) and 63 preys were identified, generating 97 interaction pairs. Of those interaction pairs, 18 were from specific protein-protein interactions. The biological significance of the interactions was evaluated by searching the PubMed and Google Scholar literature

databases for co-occurrence of prey and bait protein names, or for association of prey protein names with abiotic stress, signal transduction or gene expression regulation. None of the interactions were previously reported in the literature, as expected from the paucity of protein interaction data for wheat. For 16 interaction pairs, there was previous evidence for similar association in plant or animal cells. For example, MADS-box transcription factors have been shown to form homo- and heterodimers (de Folter *et al.*, 2005), and tubulin interaction with phospholipase C and kinases has been reported (Popova *et al.*, 1997; Carman *et al.*, 1998). In several instances, the prey protein was associated with abiotic stress response (13 occurrences). Equally, many prey proteins were involved in signal transduction (e.g. immunophilin, G protein alpha subunit, MAPK phosphatase; 12 occurrences), or gene expression regulation (e.g. TaHD, VRN-2, Elongin C, RNA polymerase II 36 kDa subunit; 16 occurrences).

It is worthy to note that the library screening using MADS-box proteins as bait did not identify other MADS-box proteins as prey. The most likely explanation is that the cDNAs encoding these factors are of very low abundance in the libraries. Another possibility is some interaction might be mediated by another protein, or DNA. Finally, some MADS-box proteins may require post-translational modifications for interaction, which do not take place in yeast.

Bimolecular fluorescent complementation experiments (BiFC)

Selected interaction pairs uncovered by the yeast two-hybrid screen and by specific protein interaction assay were further tested for *in planta* association by BiFC (Bracha-Drori *et al.*, 2004; Walter *et al.*, 2004). In this assay the green fluorescent protein (GFP) is split into two non-overlapping N-terminal (GNter) and C-terminal (GCter) fragments. The GNter fragment is fused to the N-terminal end of one binding protein, while the GCter fragment is fused to the C-terminal end of the corresponding partner. Both fusions are expressed concomitantly in *N. benthamiana*

by agro-infiltration, and reconstitution of a fluorescing GFP chromophore examined by confocal microscopy four days later. The interactions selected for BiFC assays were chosen a priori for their presumed biological significance and in several cases were based on some prior knowledge of interaction in signalling pathways. Twenty-one interaction pairs were tested, and all proved to be positive. Table III lists these interactions, as well as the predominant cellular site of interaction (i.e. cytoplasm and/or nucleus). Each protein fusion was tested against a control non-interacting protein fusion to ascertain that the observed fluorescence was not the result of non-specific interaction. Figure 1 provides representative confocal micrographs of interacting pairs that were tested. For example, reconstitution of GFP fluorescence was obtained by co-expression of TaVRT-1/VRN-1 and TaVRT-2, and was observed predominantly in the nucleus (panel A). No GFP fluorescence was detected by co-expression of either protein with the complementing non-fused GFP fragment (data not shown) or by expression of one partner with non-interacting partners (e.g. TaVRT-1/VRN-1 or TaVRT-2 with PR-1) (panel B). TaVRT-1/VRN-1 showed cytoplasmic localisation following homodimerization (panel C), which was confirmed when TaVRT-1/VRN-1 was fused to the complete GFP (panel D). The necessity of dimerization for nuclear localisation was reported for plant MADS-box proteins (McGonigle *et al.*, 1996; Immink *et al.*, 2002), as well as for other transcription factors (Spit *et al.*, 1998; Chida *et al.*, 1999). The transit from the cytoplasm to nucleus would then be part of the mechanism for the regulation of TaVRT-1/VRN-1 activity. However, BiFC experiments showed that dimerization does not always lead to nuclear localisation. TaFCA-A1 interaction with TaVRT-2 showed both nuclear and cytoplasmic localisation (Panel E), but for most cases interaction was found to be taking place in the cytoplasm (e.g. VRN-2 and TaVRT-2, panel F).

Properties of the interaction network

To evaluate the significance of the interactions, a confidence-scoring system based on Stelzl *et al.*, (2005) was elaborated (Table IV). A quality point was given for each fulfilled criterion and the interactions were classified into categories of low (1 quality point), medium (2 quality points) and high confidence (3-4 quality points). The first criterion is that a protein-protein interaction was of higher confidence if it was able to activate several reporter genes in a reproducible manner. In our study, all the reported twohybrid interactions activated four reporter genes, and were re-assayed for specific interactions. This is justified because several studies provide evidence that interactions that are detected with three independent reporters can be reproduced significantly more easily than interactions identified only with two reporters (Vidalain *et al.*, 2004). The reliability of this criterion was recently confirmed by Rual *et al.*, (2005) and Stelzl *et al.*, (2005) who showed that interacting pairs that activated three or four reporter genes had a higher verification rate by co-purification or co-immunoprecipitation than interaction pairs that activated only two reporter genes. A second confidence criterion was confirmation by BiFC. Although selection of a given interaction pair for BiFC was not a random choice and this assay was not applied to all interaction pairs, this criterion nevertheless adds to the likelihood that the tested protein pairs interact *in planta*. Three and four-protein-interaction loops were also used as criteria for high confidence interaction scoring since these motifs are features of many biological complexes as well as pathways (Goldberg et Roth 2003; Wuchty *et al.*, 2003; Yeager-Lotem *et al.*, 2004). The last confidence criterion is that proteins with similar cellular function are more prone to interact with each others (Stelzl *et al.*, 2005). Our analysis revealed that 54 interactions involved proteins with the same general process in cells (e.g. regulation of gene expression, signal transduction or response to abiotic stress), or with linked processes (e.g. regulation of gene expression with signal transduction or response to abiotic stress).

The interaction data for the library screen and specific protein interaction data is shown in Figure 2A. On average, proteins in the network had 2.4 interaction partners. Proteins involved in three- and four-protein interaction loops are highlighted in Figure 2B.

An interesting aspect of the interactome is the presence of a “flowering protein interaction cluster” represented in three- and four-protein interaction loops. This multiprotein complex contains several proteins known to be involved in flower regulation (e.g. TaVRT-1/VRN-1, TaVRT-2, VRN-2, TaAP2, TaHd and TaFT). It will thus be interesting to investigate if flowering is controlled, at least in part, by a dynamic physical interaction among transcription factors known to be inducer or repressor of flower development. Furthermore, the interaction network shows the presence of another, overlapping, three and four-protein interaction loops composed of signal transduction factors [e.g. two phospholipases C, a receptor-like protein kinase, a GTP-binding protein (possibly a noncanonical G protein), α -tubulin and TaTIL]. All of these proteins were shown to be involved in abiotic stress. For instance, transcript levels for the phosphoinositide-specific phospholipase C (PI-PLC) has been observed to rise rapidly in *A. thaliana* following a cold shock (Vergnolle *et al.*, 2005). Activation of PI-PLC by G proteins and various protein kinases has been widely reported in mammalian studies [for a review see (Rhee 2001)]. Tubulins along with a variety of associated proteins constitute microtubules. In the case of cold-tolerant wheat, it was observed that microtubules partially depolymerised prior to the formation of cold-stable microtubules (Abdrakhamanova *et al.*, 2003). TaTil is a lipocalin, whose transcript level has been shown to rise during cold response (Frenette-Charron *et al.*, 2002; 2005). Again, it will be interesting to investigate if signal transduction following abiotic stress is dependent on such protein-protein interactions.

This protein interaction network offers a novel insight into the cascades of protein interactions going from the cell surface to the nucleus during abiotic stress response. It provides a unique resource for further functional studies and the identification of the signalling pathways. This interaction map is currently static, and

eventually the dynamics of this interactome will need to be considered to address where and when interactions take place and how they are regulated.

Acknowledgement

We thank Dr. Jean Danyluk for the cDNAs libraries construction, Jean-Benoît F. Charron for providing the lipocalin genes. This work was supported by Genome Canada and Genome Québec grants to JFL, PG and FS.

Tables

Table 1 Proteins used as initial bait in two-hybrid screening

Initial bait	Evidence for involvement in abiotic stress and/or development	Ref.
TaVRT-1/VRN-1 AY280870	MADS-box transcription factor; member of the AP1 subfamily; associated with vegetative to reproductive transition in cereals following vernalization.	Danyuk et al. 2003
TaVRT-2 DQ022679	MADS-box transcription factor; member of the SIMADS-11 subfamily of flowering repressors; regulated by vernalization and photoperiod in wheat.	Kane et al. 2005
TaTIL AAL75812	True lipocalin; transcript induced by low temperature; possible role against stress damage.	Frenette-Charron et al. 2002; 2005
TaCHL CK159974	Chloroplastic lipocalin; transcript induced by low temperature; repressed by heat shock; possible role against stress damage.	Frenette-Charron et al. 2005
TaFCA-A1 AAP84415	Homologue to the barley abscisic acid-binding protein ABA-P1 and to <i>A. thaliana</i> FCA; involved in flowering.	Razem et al. 2006
Small Ran-related GTP-binding protein AF433653	Involved in signal transduction; transcript regulated differently in spring and winter wheat.	Gulick et al. 2005
TaGBI (GTP binding protein) DQ489316	Involved in signal transduction; transcript regulated differently in spring and winter wheat.	Gulick et al. 2005
Inorganic pyrophosphatase CD862876	Transcript regulated differently in spring and winter wheat.	Gulick et al. 2005
Receptor-like protein kinase AF085168	Involved in signal transduction; transcript regulated differently in spring and winter wheat.	Gulick et al. 2005
Calcium binding EF-hand protein DR733548	Involved in signal transduction; transcript regulated differently in spring and winter wheat.	Gulick et al. 2005

Table 2. Protein-protein interaction data

Bait	Prey	Published co-occurrence of prey with bait, with abiotic stress, signal transduction or gene expression regulation	Ref.
Calcium binding EF-hand protein ^a DR733548 Elongin ^b CV765696	TaGA1 (G protein alpha subunit) ^c AB090158	Heterotrimeric G protein are involved in several signal transduction pathways.	Hossain et al. 2003
	Histone H2B ^{c,d} P27807		
	60S Ribosomal protein L9 ^c BQ806898 Translation elongation factor 1-alpha ^c AF479046		
Immunophilin ^b X86993	Metallothionein-like protein ^c L11879	Metallothionein functions in both metal chaperoning and scavenging of reactive oxygen species.	Mir et al. 2004
	Pathogenesis related protein 1 ^{c,d} AF384143	Involvement in cold adaptation is inferred from activation of the pepper basic PR-1 gene promoter after exposure of plant at 4°C.	Hong et al. 2005
	Peroxidase ^c X56011	Injury to plants imposed by cold exposure is associated with oxidative damage at the cellular level. Correlation between active oxygen detoxifying enzymes and chilling tolerance has been noted.	Yoshimura et al. 2004
Inorganic pyrophosphatase ^c C.D862876	Cold acclimation induced protein ESI2-1 ^c AY666013	Gene expression is induced during cold acclimation.	Gulick, unpublished
	Glycosyltransferase ^c AJ969052	Accumulation of zeatin <i>O</i> -glycosyltransferase in <i>Phaseolus vulgaris</i> and <i>Zea mays</i> was observed following cold stress.	Li et al. 2000
Lipid transfer protein 3 ^b AY226580	60S Ribosomal protein L9 ^c BQ806898		
	S-adenosylmethionine decarboxylase ^c CK209496	Differential expression of transcript upon low temperature treatment has been reported for a cold resistant rice genotype.	Pillai and Akiyama 2004
	Glutathione S-transferase ^{c,d} CV781641	Abiotic stress alters transcript profile and activity of glutathione S-transferase.	Anderson and Davis 2004
	Polygalacturonase ^c CA638207	Two <i>Brassica napus</i> polygalacturonase inhibitory protein genes are expressed at different levels in response to biotic and abiotic stresses.	Li et al. 2003
β -Ketoacyl-acyl carrier protein synthase ^b DR740728 Pathogenesis related protein 1 ^b AJ007348	Unknown protein 3 ^c DR736877		
	Vacuolar targeting receptor ^{c,d} AAF80450		
	Phosphoinositide-specific phospholipase C ^c DR741524	Changes in phospholipase C activity affect the expression of a large number of cold regulated genes in <i>A thaliana</i> .	Vergnolle et al. 2005
	Fructan 1-exohydrolase ^{c,d} CAD56806	Expression analysis of a chicory fructan 1-exohydrolase gene revealed complex regulation by cold.	Michiels et al. 2004
	Glycosyltransferase ^c AJ969052	Accumulation of zeatin <i>O</i> -glycosyltransferase in <i>Phaseolus vulgaris</i> and <i>Zea mays</i> was observed following cold stress.	Li et al. 2000
	Cold acclimation induced protein ESI2-1 ^c AY666013	Gene expression is induced during cold acclimation.	Gulick, unpublished
	Unknown protein 1 ^c CD931572		
	Wheat etiolated seedling root ^c DN829250		

Table 2 continued

Bait	Prey	Published co-occurrence of prey with bait, with abiotic stress, signal transduction or gene expression regulation	Ref.
Receptor-like protein kinase ^a <i>AF085168</i>	Phosphatidylglycerol specific phospholipase C ^c <i>CK206104</i> α -Tubulin 3-3 ^c <i>DQ435660</i>	Changes in phospholipase C activity affect the expression of a large number of cold regulated genes in <i>A. thaliana</i> . Microtubules participate in the cold stress response and in adaptation to low temperatures; binding and phosphorylation of tubulin by G protein-coupled receptor kinases have been reported.	Vergnolle et al. 2005 Nyporko et al. 2003; Carman et al. 1998
Small Ran-related GTP-binding protein ^a <i>AF433653</i>	unknown protein 2 ^c <i>CV779217</i> Cold acclimation induced protein ESI2-1 ^c <i>AY666013</i> Unknown protein 1 ^c <i>CD931572</i>	Gene expression is induced during cold acclimation.	Gulick, unpublished
Ta31K05 ^b (SVP-like SrMADS-11) <i>CV762849</i>	Pathogenesis related protein 1.1 ^c <i>AJ007348</i>	Very similar to <i>AF384143</i> . Involvement in cold adaptation is inferred from activation of the pepper basic PR-1 gene promoter after exposure of plant at 4°C.	Hong et al. 2005
Ta45G05 ^b <i>AGL12DR741518</i>	Fructan 1-exohydrolase ^c <i>CAD56806</i> α -Tubulin 3-3 ^c <i>DQ435660</i> Fructose-biphosphate aldolase ^c <i>BE216994</i> Protein tyrosine phosphatase ^c <i>CV772785</i>	Expression analysis of a chicory fructan 1-exohydrolase gene revealed complex regulation by cold. Microtubules participate in the cold stress response and in adaptation to low temperatures. A tyrosine-specific protein phosphatase is encoded by a stress-responsive gene in <i>A. thaliana</i> .	Michiels et al. 2004 Nyporko et al. 2003 Xu et al. 1998
Ta57H08 ^b (SVP-like SrMADS-11) <i>CV769487</i>	Thiamine biosynthesis protein ^c <i>CV763653</i> Thiol protease aleurain ^c <i>CV778706</i> Calmodulin TaCaM3-1 ^c <i>AAC49584</i> Ferredoxin-NADP(H) oxidoreductase ^c <i>CAD30025</i> Plastid ribosomal protein CL9 ^c <i>AAM92711</i> Sigma related factor ^c <i>NP 197800</i>	Calmodulin(CaM) is an important intermediate of calcium-mediated signal transduction; binds also wheat immunophilin. Scavenger of free oxygen radicals.	Liu et al. 2003; Kurek et al. 2002 Krapp et al. 1997
Ta73C21 ^b (AGL14 TM3/SOC1) <i>CV772064</i>	Plastocyanin precursor SGT1 ^c <i>CA625601</i>		
TaCHL (chloroplast lipocalin) ^d <i>CK159974</i>	Endopeptidase ATP-B chain ^c <i>CV780642</i> Glu-tRNA amidotransferase A ^c <i>DR738631</i> High mobility protein ^c <i>CAA77641</i> β -Ketoacyl-acyl carrier protein synthase ^c <i>DR740728</i> Lipid transfer protein 3 ^c <i>AY226580</i> 40S ribosomal p525 ^c <i>CD930290</i> Rubisco small unit ^c <i>X00235</i>	Involved in fatty acid synthesis. A lipid transfer protein gene was shown to be differentially regulated by abiotic stress and ABA.	Abbadi et al. 2000 Wu et al. 2004

Table 2 continued

Bait	Prey	Published co-occurrence of prey with bait, with abiotic stress, signal transduction or gene expression regulation	Ref.
TaFCA-A1 ^a (Abscisic acid-binding protein like) AA184415	Lipoxygenase ^d U32428	Lipoxygenases are involved in stress responses and are modulated by ABA.	Melan et al. 1993
	MAP kinase phosphatase ^c AJ666016	Negative regulator of mitogen-activated protein kinase, which is involved in ABA signal transduction.	Xiong et al. 2002; Meskiene et al. 1998
	Solanum pollinated pistil (SPP30) ^f AL819796	Coded by conserved gene in evolutionarily distant organisms; predicted to have an important role in development.	Lantin et al. 1999
	Sucrose-6F-phosphate phosphohydrolase ^c AY029159	Pulls the sucrose synthesis reaction pathway in the direction of net sucrose synthesis; sucrose is an osmoprotectant.	Lunn et al. 2000
TaGB1 (GTP binding protein) ^a DQ489316	TaVRT-2 ^{c,d} DQ022679	Putative repressor of flowering during vernalization.	Kane et al. 2005
	Cold acclimation induced protein ES12-1 ^c AY666013	Gene expression is induced during cold acclimation.	Gulick, unpublished
	Phosphatidylglycerol specific phospholipase C ^c CK206104	Changes in phospholipase C activity affect the expression of a large number of cold regulated genes in <i>A. thaliana</i> .	Vergnolle et al. 2005
	Phosphoinositide-specific phospholipase C ^c DR741524	Changes in phospholipase C activity affect the expression of a large number of cold regulated genes in <i>A. thaliana</i> .	Vergnolle et al. 2005
	Polygalacturonase ^c CA638207	Polygalacturonases have been connected with processes of cell expansion as well as fruit ripening, abscission, pathogen defence and water deficit.	Hadfield and Bennett 2005; Bray 2004
TaTIL ^a AAL75812	Phosphatidylglycerol specific phospholipase C ^c CK206104	Changes in phospholipase C activity affect the expression of a large number of cold regulated genes in <i>A. thaliana</i> .	Vergnolle et al. 2005
	Phosphoinositide-specific phospholipase C ^c DR741524	Changes in phospholipase C activity affect the expression of a large number of cold regulated genes in <i>A. thaliana</i> .	Vergnolle et al. 2005
	Putative plastid ribosomal protein c19 ^c AAM92711		
TaVRT 1/VRN-1 ^a AY280870	Acetylornithine transaminase ^c BT009428		
	Cyanate lyase ^c CV766454		
	Cytochrome P450-like protein ^{c,d} BQ170524	Cytochrome P450 is involved in abiotic stress response.	Narusaka et al. 2004
	Elongin ^{c,d} CV765696	Elongin complex is involved in regulation of transcription elongation by RNA polymerase II.	Gerber et al. 2005
	FK506-binding protein immunophilin ^{c,d} X86903	Immunophilins are involved in signal transduction as well as in development and stress responsiveness.	Romano et al. 2004; Romano et al. 2005
	Flowering locus T (TaFT) ^c AY705794	Positive regulator of flower development.	Kojima et al. 2002
	Solanum pollinated pistil-like (SPP30) ^f AL819796	Coded by conserved gene in evolutionarily distant organisms; predicted to have an important role in development.	Lantin et al. 1999
	Ta42G17 ^c CV765258	Heterodimerization of MADS-box proteins is a well known phenomenon.	de Folter et al. 2005
	Ta45G05 ^c CV765903	Heterodimerization of MADS-box proteins is a well known phenomenon.	de Folter et al. 2005
	Ta57H08 ^c CV769487	Heterodimerization of MADS-box proteins is a well known phenomenon.	de Folter et al. 2005
Ta73C21 ^c CV772064	Heterodimerization of MADS-box proteins is a well known phenomenon.	de Folter et al. 2005	
Ta31K05 ^c CV762849	Heterodimerization of MADS-box proteins is a well known phenomenon.	de Folter et al. 2005	

Table 2 continued

Bait	Prey	Published co-occurrence of prey with bait, with abiotic stress, signal transduction or gene expression regulation	Ref.
TaVRT-2 ^d Q022679	TaHd1 ^c AB094490.	Homologous to CONSTANS, which promotes flowering of <i>A. thaliana</i> in response to long photoperiods	Nemoto et al. 2003
	TaMC44 ^d Submitted to Genebank	APETALA3-like protein; Heterodimerization of MADS-box proteins is a well known phenomenon.	de Folter et al. 2005
	TaVRT-1/VRN-1 ^c AY280870	Homodimerization of MADS box proteins is a well known phenomenon.	de Folter et al. 2005
	TaVRT-2 ^d Q022679	Heterodimerization of MADS-box proteins is a well known phenomenon.	de Folter et al. 2005
	VRN-2 ^c AY485975	Zinc-finger transcription factor shown to be an important repressor of flowering; down regulated during vernalization.	Yan et al. 2004
	AP2 domain containing protein ^d EB714184	Ethylene Responsive Element Binding Protein (EREBP) AP2 family member; is involved in regulation of low-temperature responsive genes.	Xue 2003
	DNA-directed RNA polymerase II 36 kDa polypeptide A ^{c,d} AL820054	Component of transcription machinery.	
	Ferredoxin-NADP(H) oxidoreductase ^{c,d} CAD30025	Scavenger of free oxygen radicals.	Krapp et al. 1997
	Floral homeotic protein ^d EB714175	Homologue in Arabidopsis is known to be involved in floral organ identity and development.	Jofuku et al. 1994
	Ice recrystallization inhibition protein 1 precursor ^d AAY81542	Gene expression is induced during abiotic stress and jasmonic acid or ethylene treatment.	Tremblay et al. 2005
	Immunophilin ^d X86903	Immunophilins are involved in signal transduction as well as in development and stress responsiveness.	Romano et al. 2004; Romano et al. 2005
	LEA/RAB-related COR protein cold-responsive ^d AAF68628	Gene expression is inducible by cold.	Tsuda et al. 2000
	Peroxidase ^c X56011	Injury to plants imposed by cold exposure is associated with oxidative damage at the cellular level. Correlation between active oxygen detoxifying enzymes and chilling tolerance has been noted.	Yoshimura et al. 2004
	RING-H2 finger protein ^d AAP80615	RING zinc-finger proteins play important roles in the regulation of development in a variety of organisms.	Xu and Quinn 2003
	Ta42G17 ^c CV765258	Heterodimerization of MADS-box proteins is a well known phenomenon.	de Folter et al. 2005
Ta45G05 ^c CV765903	Heterodimerization of MADS-box proteins is a well known phenomenon.	de Folter et al. 2005	
Ta57H08 ^c CV769487	Heterodimerization of MADS-box proteins is a well known phenomenon.	de Folter et al. 2005	
Ta73C21 ^c CV772064	Heterodimerization of MADS-box proteins is a well known phenomenon.	de Folter et al. 2005	
TaHd1 ^c AB094490.	Homologous to CONSTANS, which promotes flowering of <i>A. thaliana</i> in response to long photoperiods	Nemoto et al. 2003	

Table 2 continued

Bait	Prey	Published co-occurrence of prey with bait, with abiotic stress, signal transduction or gene expression regulation	Ref.
	TaVRT-1/VRN-1 ^a AY280870	Heterodimerization of MADS-box proteins is a well known phenomenon.	de Folter et al. 2005
	TaVRT-2 ^c DQ022679	Homodimerization of MADS box proteins is a well known phenomenon.	de Folter et al. 2005
	Translation elongation factor 1 Alpha subunit ^e EB71477		
	Ubiquitin-like protein 8 ^c CV765891	An interaction between calreticulin and ubiquitin-like nuclear protein in rice has been reported. Calreticulin is a major Ca ²⁺ -sequestering protein and plays a role in cold acclimation.	Sharma et al. 2004
	VRN-2 ^c AY485975	Zinc-finger transcription factor shown to be an important repressor of flowering; down regulated during vernalization.	Yan et al. 2004
	Wali6 ^b AAC37417	Gene expression is inducible by aluminium.	Richards et al. 1994
»Tubulin 3-3 ^b DQ435660	Phosphatidylglycerol-specific phospholipase C ^c CK206104	Changes in phospholipase C activity affect the expression of a large number of cold regulated genes in Arabidopsis; interaction with PLC in mammalian cells was observed.	Vergnolle et al. 2005; Popova et al. 1997
	Glycosyltransferase ^c AJ969052	Accumulation of zeatin O-glycosyltransferase in <i>Phaseolus vulgaris</i> and <i>Zea mays</i> was observed following cold stress.	Li et al. 2000

^a Bait listed in Table 1

^b Initially found as prey, reconfigured as bait

^c Interaction uncovered by two-hybrid dehydration cDNA library screening

^d Second-round confirmation of interaction was done with full-length cDNA

^e Interaction uncovered by specific protein two-hybrid assay

^f Interaction uncovered by BiFC

^g Interaction uncovered by two-hybrid cold acclimated and developmental cDNA library screening

Table 3 Protein pairs confirmed by BiFC

Nt-GFP	Ct-GFP	Predominant cellular localization
TaFCA-A1	TaVRT-2	cytoplasm and nucleus
TaGB1 (GTP binding protein)	Cold acclimation induced protein	cytoplasm
Pathogenesis-related protein 1	PG-phospholipase C	cytoplasm
	PI-phospholipase C	cytoplasm
Receptor-like protein kinase	Cold acclimation induced protein	cytoplasm
Ta45G05	Immunophilin	cytoplasm
α Tubulin	PG-phospholipase C	cytoplasm
TaTILA	α -Tubulin	cytoplasm
TaVRT-1/VRN-1	α Tubulin	cytoplasm
TaVRT-2	PG-phospholipase C	cytoplasm
	Lipid transfer protein 3	cytoplasm
	immunophilin	cytoplasm
	Elongin	nucleus
	Ta31K05	cytoplasm
	Ta57H08	cytoplasm
	TaVRT-1/VRN-1	cytoplasm
VRN-2	TaVRT-2	nucleus
VRN-2	MADS-MC44	cytoplasm
	Immunophilin	cytoplasm
	TaVRT-1/VRN-1	cytoplasm
	TaVRT-2	cytoplasm

Table 4 Criteria for high confidence interaction scoring

Confidence criteria	Number of interactions fulfilling criteria
1 Interaction activating all four reporter genes	93
2 Interaction confirmed by BiFC	21
3 Interaction present in three- or four-protein interaction loop	37
4 Interaction where partner proteins share same or linked function	44

Figures

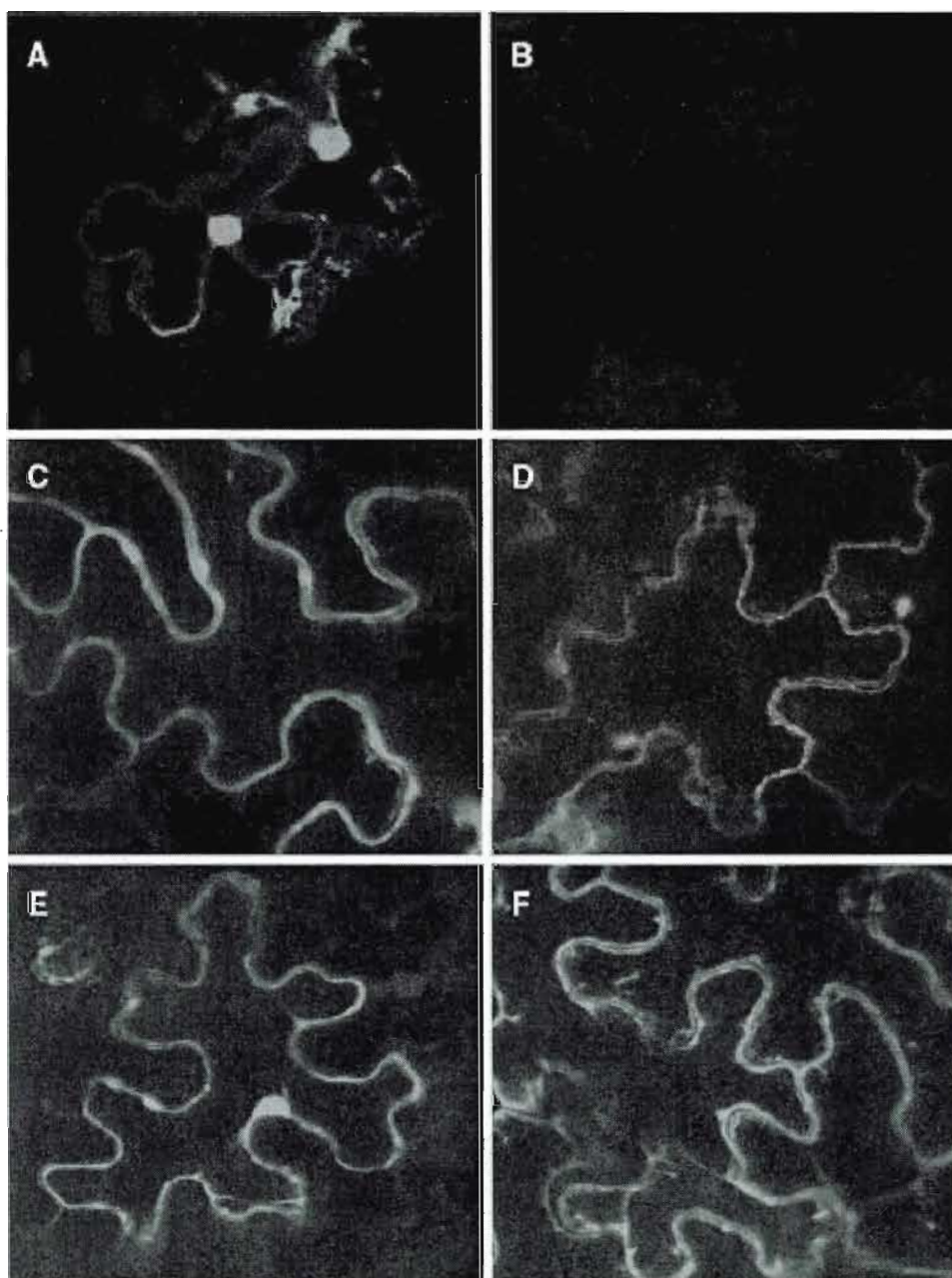

V-Figure 1: Representative BiFC of selected interaction pairs uncovered by two-hybrid screening

N. benthamiana leaves were agroinfiltrated with *A. tumefaciens* suspensions containing plasmids coding for: A) ntGFP-TaVRT-1 and TaVRT-2-ctGFP; B) ntGFP-TaVRT-1 and PR-1-ctGFP; C) ntGFP-TaVRT-1 and TaVRT-1-ctGFP; D) TaVRT-1-GFP; E) ntGFP-TaFCA and TaVRT-2-ctGFP; F) ntGFP-VRN-2 and TaVRT-2-ctGFP. Reconstitution of fluorescing GFP chromophore was examined by confocal microscopy four days later.

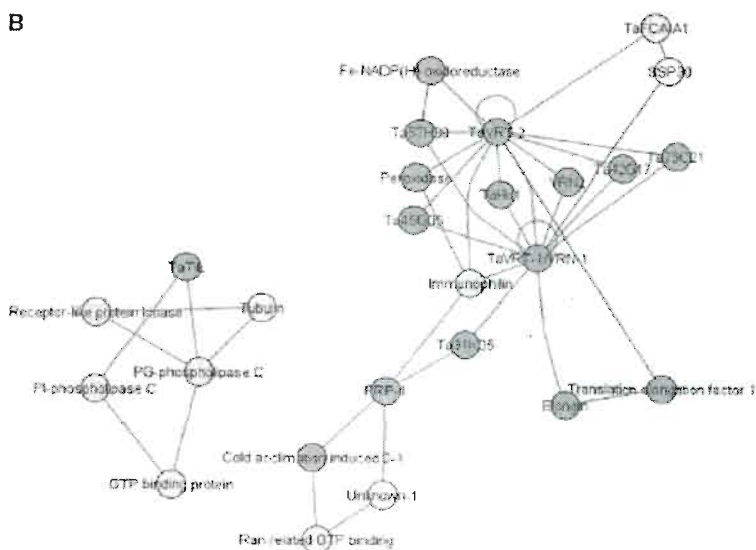
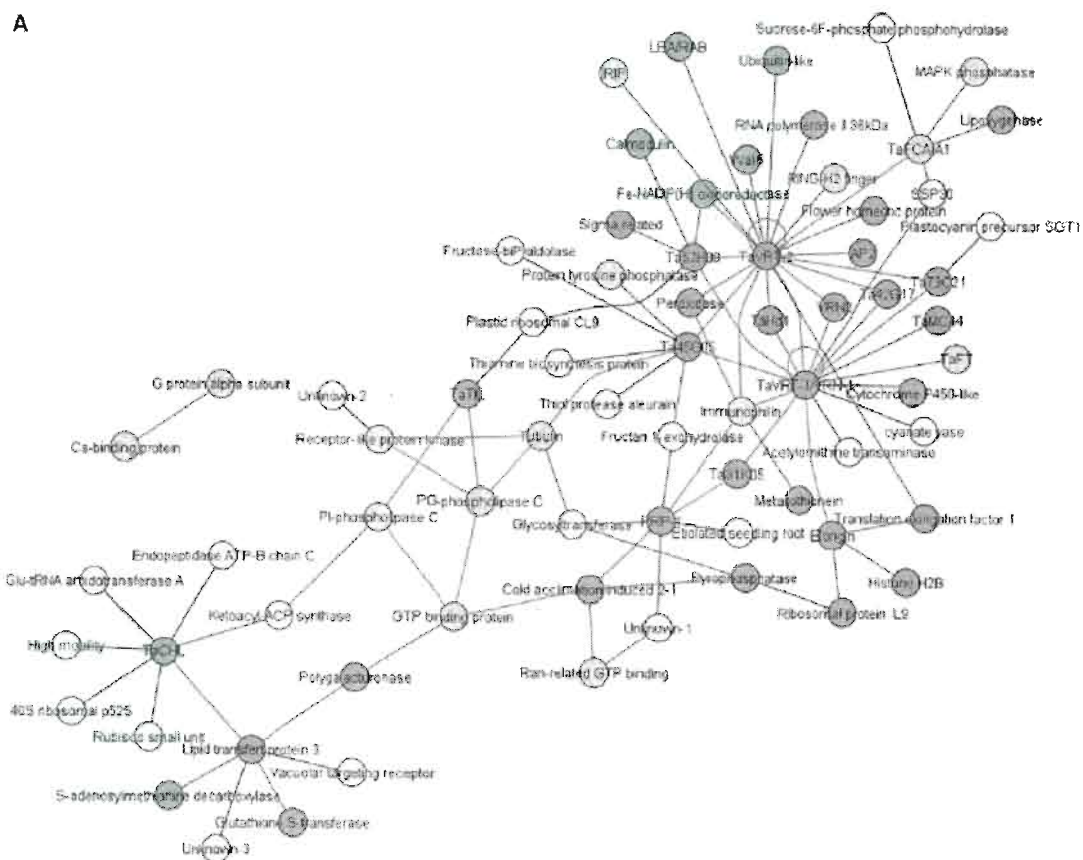

V-Figure 2: A) Network view of the abiotic stress-related interacting wheat proteins and B) Proteins involved in three- and four-protein interaction loops

Circles depicted in green: protein involved in regulation of gene expression; yellow: protein involved in signal transduction; blue: protein involved in abiotic stress response; white: unclassified. Interactions connecting the nodes are represented by color-coded lines according to their confidence scores. Black: low confidence; Blue: medium confidence; Red: high confidence.

Literature Cited

Abbadi A, Brummel M, Spener F (2000) Knockout of the regulatory site of 3-ketoacyl-ACP synthase III enhances short- and medium-chain acyl-ACP synthesis. *The Plant Journal* 24: 1-9

Abdrakhamanova A, Wang QY, Khokhlova L, Nick P (2003) Is microtubule disassembly a trigger for cold acclimation? *Plant Cell Physiol* 44: 676-686

Anderson JV, Davis DG (2004) Abiotic stress alters transcript profiles and activity of glutathione S-transferase, glutathione peroxidase, and glutathione reductase in *Euphorbia esula*. *Physiol Plant* 120: 421-433

Bracha-Drori K, Shichrur K, Katz A, Oliva M, Angelovici R, Yalovsky S, Ohad N (2004) Detection of protein-protein interactions in plants using bimolecular fluorescence complementation. *Plant J* 40: 419-427

Bray EA (2004) Genes commonly regulated by water-deficit stress in *Arabidopsis thaliana*. *J. Exp. Bot.* 55: 2331-2341

Carman CV, Som T, Kim CM, Benovic JL (1998) Binding and phosphorylation of tubulin by G protein-coupled receptor kinases. *J. Biol. Chem.* 273: 20308-20316

Chida K, Nagamori S, Kuroki T (1999) Nuclear translocation of Fos is stimulated by interaction with Jun through the leucine zipper. *Cell Mol Life Sci* 55: 297-302

Danyluk J, Kane NA, Breton G, Limin AE, Fowler DB, Sarhan F (2003) TaVRT-1, a putative transcription factor associated with vegetative to reproductive transition in cereals. *Plant Physiol.* 132: 1849-1860

de Folter S, Immink RG, Kieffer M, Parenicova L, Henz SR, Weigel D, Busscher M, Kooiker M, Colombo L, Kater MM, Davies B, Angenent GC (2005) Comprehensive interaction map of the Arabidopsis MADS Box transcription factors. *Plant Cell* 17: 1424-1433

Dumay H, Rubbi L, Sentenac A, Marck C (1999) Interaction between yeast RNA polymerase III and transcription factor TFIIC via ABC10alpha and tau131 subunits. *J Biol Chem* 274: 33462-33468

Frenette Charron JB, Breton G, Badawi M, Sarhan F (2002) Molecular and structural analyses of a novel temperature stress-induced lipocalin from wheat and Arabidopsis. *FEBS Lett* 517: 129-132

Frenette Charron JB, Ouellet F, Pelletier M, Danyluk J, Chauve C, Sarhan F (2005) Identification, expression, and evolutionary analyses of plant lipocalins. *Plant Physiol* 139: 2017-2028

Gerber M, Tenney K, Conaway JW, Conaway RC, Eissenberg JC, Shilatifard A (2005) Regulation of heat shock gene expression by RNA Polymerase II elongation factor, elongin A. *J. Biol. Chem.* 280: 4017-4020

Gietz RD, Woods RA (2001) Genetic transformation of yeast. *Biotechniques* 30: 816-820

Giot L, Bader JS, Brouwer C, Chaudhuri A, Kuang B, Li Y, Hao YL, Ooi CE, Godwin B, Vitols E, Vijayadamar G, Pochart P, Machineni H, Welsh M, Kong Y, Zerhusen B, Malcolm R, Varrone Z, Collis A, Minto M, Burgess S, McDaniel L, Stimpson E, Spriggs F, Williams J, Neurath K, Ioime N, Agee M, Voss E, Furtak K, Renzulli R, Aanensen N, Carrola S, Bickelhaupt E, Lazovatsky Y, DaSilva A, Zhong J, Stanyon CA, Finley RL Jr, White KP, Braverman M, Jarvie T, Gold S, Leach M, Knight J, Shimkets RA, McKenna MP, Chant J, Rothberg JM (2003) A Protein Interaction Map of *Drosophila melanogaster*. *Science* 302: 1727-1736

Goldberg DS, Roth FP (2003) Assessing experimentally derived interactions in a small world. *Proc Natl Acad Sci U S A* 100: 4372-4376

Gulick PJ, Drouin S, Yu Z, Danyluk J, Poisson wheat responding to low temperature. *Genome* 48: 913-923

Hackbusch J, Richter K, Muller J, Salamini F, Uhrig JF (2005) A central role of *Arabidopsis thaliana* ovate family proteins in networking and subcellular localization of 3-aa loop extension homeodomain proteins. *Proc Natl Acad Sci U S A* 102: 4908-4912

Hadfield KA, Bennett AB (2005) Polygalacturonases: many genes in search of a function. *Plant Physiol.* 117: 337-343

Hannah MA, Heyer AG, Hinch DK (2005) A global survey of gene regulation during cold acclimation in *Arabidopsis thaliana*. *PLoS Genet* 1: e26

Haseloff J, Siemering KR, Prasher DC, Hodge S (1997) Removal of a cryptic intron and subcellular localization of green fluorescent protein are required to mark transgenic *Arabidopsis* plants brightly. *Proc Natl Acad Sci U S A* 94: 2122-2127

Hellens RP, Edwards EA, Leyland NR, Bean S, Mullineaux PM (2000) pGreen: a versatile and flexible binary Ti vector for Agrobacterium-mediated plant transformation. *Plant Mol Biol* 42: 819-832

Hong JK, Lee SC, Hwang BK (2005) Activation of pepper basic PR-1 gene promoter during defense signaling to pathogen, abiotic and environmental stresses. *Gene* 356: 169-180

Hossain MS, Koba T, Harada K (2003) Cloning and characterization of two full-length cDNAs, TaGA1 and TaGA2, encoding G-protein alpha subunits expressed differentially in wheat genome. *Genes Genet Syst* 78: 127-138

Immink RGH, Gadella TWJ Jr, Ferrario S, Busscher M, Angenent GC (2002) Analysis of MADS box protein-protein interactions in living plant cells. *Proc Natl Acad Sci USA* 99: 2416-2421

Ito T, Chiba T, Yoshida M (2001) Exploring the protein interactome using comprehensive two-hybrid projects. *Trends in Biotechnology* 19: S23-S27

Jofuku KD, Boer B, Montagu MV, Okamoto JK (1994) Control of Arabidopsis Flower and Seed Development by the Homeotic Gene APETALA2. *Plant Cell* 6: 1211-1225

Kane NA, Danyluk J, Tardif G, Ouellet F, Laliberte JF, Limin AE, Fowler DB, Sarhan F (2005) TaVRT-2, a member of the StMADS-11 clade of flowering repressors, is regulated by vernalization and photoperiod in Wheat. *Plant Physiol* 138: 2354-2363

Kojima S, Takahashi Y, Kobayashi Y, Monna L, Sasaki T, Araki T, Yano M (2002) Hd3a, a rice ortholog of the Arabidopsis FT gene, promotes transition to flowering downstream of Hd1 under short-day conditions. *Plant Cell Physiol.* 43: 1096-1105

Krapp AR, Tognetti VB, Carrillo N, Acevedo A (1997) The role of ferredoxin-NADP⁺ reductase in the concerted cell defense against oxidative damage - studies using *Escherichia coli* mutants and cloned plant genes. *Eur J Biochem* 249: 556-563

Kurek I, Dulberger R, Azem A, Tzvi BB, Sudhakar D, Christou P, Breiman A (2002) Deletion of the C-terminal 138 amino acids of the wheat FKBP73 abrogates calmodulin binding, dimerization and male fertility in transgenic rice. *Plant Mol Biol* 48: 369-381

Lantin S, O'Brien M, Matton DP (1999) Fertilization and wounding of the style induce the expression of a highly conserved plant gene homologous to a *Plasmodium falciparum* surface antigen in the wild potato *Solanum chacoense* Bitt. *Plant Mol Biol* 41: 115-124

Lee B, Henderson DA, Zhu J-K . The Arabidopsis cold-responsive transcriptome and its regulation by ICE1. *Plant Cell* 17: 3155-3175

Li R, Sosa JL, Zavala ME (2000) Accumulation of zeatin O-glycosyltransferase in *Phaseolus vulgaris* and *Zea mays* following cold stress. *Plant Mol Biol* 32: 295-305

Li R, Rimmer R, Yu M, Sharpe AG, S₊guin-Swartz G, Lydiate D, Hegedus DD (2003) Two *Brassica napus* polygalacturonase inhibitory protein genes are expressed at different levels in response to biotic and abiotic stresses. *Planta* 217: 299-308

- Li S, Armstrong CM, Bertin N, Ge H, Milstein S, Boxem M, Vidalain PO, Han JD, Chesneau A, Hao T, Goldberg DS, Li N, Martinez M, Rual JF, Lamesch P, Xu L, Tewari M, Wong SL, Zhang LV, Berriz GF, Jacotot L, Vaglio P, Reboul J, Hirozane-Kishikawa T, Li Q, Gabel HW, Elewa A, Baumgartner B, Rose DJ, Yu H, Bosak S, Sequerra R, Fraser A, Mango SE, Saxton WM, Strome S, Van Den Heuvel S, Piano F, Vandenhaute J, Sardet C, Gerstein M, Doucette-Stamm L, Gunsalus KC, Harper JW, Cusick ME, Roth FP, Hill DE, Vidal M (2004) A map of the interactome network of the metazoan *C. elegans*. *Science* 303: 540-543
- Liu H-T, Li B, Shang Z-L, Li X-Z, Mu R-L, Sun D-Y, Zhou R-G (2003) Calmodulin is involved in heat shock signal transduction in wheat. *Plant Physiol.* 132: 1186-1195
- Lunn JE, Ashton AR, Hatch MD, Heldt HW (2000) Purification, molecular cloning, and sequence analysis of sucrose-6F-phosphate phosphohydrolase from plants. *Proc Natl Acad Sci U S A* 97: 12914-12919
- Mahajan S, Tuteja N (2005) Cold, salinity and drought stresses: An overview. *Archives of Biochemistry and Biophysics* 444: 139-158
- McGonigle B, Bouhidel K, Irish VF (1996) Nuclear localization of the Arabidopsis APETALA3 and PISTILLATA homeotic gene products depends on their simultaneous expression. *Genes Dev* 10: 1812-1821
- Melan MA, Dong X, Endara ME, Davis KR, Ausubel FM, Peterman TK (1993) An Arabidopsis thaliana lipoxygenase gene can be induced by pathogens, abscisic acid, and methyl jasmonate. *Plant Physiol.* 101: 441-450.

Meskiene I, Bogre L, Glaser W, Balog J, Brandstotter M, Zwerger K, Ammerer G, Hirt H (1998) MP2C, a plant protein phosphatase 2C, functions as a negative regulator of mitogen-activated protein kinase pathways in yeast and plants. *Proc Natl Acad Sci USA* 95: 1938-1943

Michiels A, Van Laere A, Van den Ende W, Tucker M (2004) Expression analysis of a chicory fructan 1-exohydrolase gene reveals complex regulation by cold. *J. Exp. Bot.* 55: 1325-1333

Mir G, Domenech J, Huguet G, Guo W-J, Goldsbrough P, Atrian S, Molinas M (2004) A plant type 2 metallothionein (MT) from cork tissue responds to oxidative stress. *J. Exp. Bot.* 55: 2483-2493

Narusaka Y, Narusaka M, Seki M, Umezawa T, Ishida J, Nakajima M, Enju A, Shinozaki K (2004) Crosstalk in the responses to abiotic and biotic stresses in *Arabidopsis*: Analysis of gene expression in *cytochrome P450* gene superfamily by cDNA microarray. *Plant Mol Biol* 55: 327-342

Nemoto Y, Kisaka M, Fuse T, Yano M, Ogihara Y (2003) Characterization and functional analysis of three wheat genes with homology to the CONSTANS flowering time gene in transgenic rice. *The Plant Journal* 36: 82-93

Nyporko AY, Demchuk ON, Blume YaB (2003) Cold adaptation of plant microtubules: structural interpretation of primary sequence changes in a highly conserved region of [alpha]-tubulin. *Cell Biology International* 27: 241-243

Pillai MA, Akiyama T (2004) Differential expression of an S-adenosyl-L-methionine decarboxylase gene involved in polyamine biosynthesis under low temperature stress in *japonica* and *indica* rice genotypes. 271[2], 141-149

Popova JS, Garrison JC, Rhee SG, Rasenick MM (1997) Tubulin, Gq, and phosphatidylinositol 4,5-bisphosphate interact to regulate phospholipase C β 1 signaling. J Biol Chem 272: 6760-6765

Rabbani MA, Maruyama K, Abe H, Khan MA, Katsura K, Ito Y, Yoshiwara K, Seki M, Shinozaki K, Yamaguchi-Shinozaki K (2003) Monitoring Expression Profiles of Rice Genes under Cold, Drought, and High-Salinity Stresses and Abscisic Acid Application Using cDNA Microarray and RNA Gel-Blot Analyses. Plant Physiol. 133: 1755-1767

Rain JC, Selig L, De Reuse H, Battaglia V, Reverdy C, Simon S, Lenzen G, Petel F, Wojcik J, Schachter V, Chemama Y, Labigne A, Legrain P (2001) The protein-protein interaction map of *Helicobacter pylori*. Nature 409: 211-215

Razem FA, El-Kereamy A, Abrams SR, Hill RD (2006) The RNA-binding protein FCA is an abscisic acid receptor. Nature 439: 290-294
Rensink W, Iobst S, Hart A, Stegalkina S, Liu J, Buell C (2005) Gene expression profiling of potato responses to cold, heat, and salt stress. Functional et Integrative Genomics 5: 201-207

Rhee SG (2001) Regulation of phosphoinositide-specific phospholipase C. Annu Rev Biochem 70: 281-312

Richards KD, Snowden KC, Gardner RC (1994) *wali6* and *wali7* - Genes Induced by Aluminum in Wheat (*Triticum aestivum* L.) Roots). Plant Physiol. 105: 1455-1456

Romano P, Gray J, Horton P, Luan S (2005) Plant immunophilins: functional versatility beyond protein maturation. *New Phytologist* 166: 753-769

Romano PGN, Horton P, Gray JE (2004) The Arabidopsis Cyclophilin Gene Family. *Plant Physiol.* 134: 1268-1282

Rual JF, Venkatesan K, Hao T, Hirozane-Kishikawa T, Dricot A, Li N, Berriz GF, Gibbons FD, Dreze M, Ayivi-Guedehoussou N, Klitgord N, Simon C, Boxem M, Milstein S, Rosenberg J, Goldberg DS, Zhang LV, Wong SL, Franklin G, Li S, Albala JS, Lim J, Fraughton C, Llamosas E, Cevik S, Bex C, Lamesch P, Sikorski RS, Vandenhaute J, Zoghbi HY, Smolyar A, Bosak S, Sequerra R, Doucette-Stamm L, Cusick ME, Hill DE,

Roth FP, Vidal M (2005b) Towards a proteome-scale map of the human protein-protein interaction network. *Nature* 437: 1173-1178

Sharma A, Isogai M, Yamamoto T, Sakaguchi K, Hashimoto J, Komatsu S . A novel interaction between calreticulin and ubiquitin-like nuclear protein in rice. *Plant Cell Physiol.* 45[6], 684-692. 2004.

Spit A, Hyland RH, Mellor EJC, Casselton LA (1998) A role for heterodimerization in nuclear localization of a homeodomain protein. *Proc Natl Acad Sci U S A* 95: 6228-33

Stelzl U, Worm U, Lalowski M, Haenig C, Brembeck FH, Goehler H, Stroedicke M, Zenkner M, Schoenherr A, Koeppen S, Timm J, Mintzlaff S, Abraham C, Bock N, Kietzmann S, Goedde A, Toksoz E, Droege A, Krobitsch S, Korn B, Birchmeier W, Lehrach H, Wanker EE (2005a) A human protein-protein interaction network: a resource for annotating the proteome. *Cell* 122: 957-68

Stelzl U, Worm U, Lalowski M, Haenig C, Brembeck FH, Goehler H, Stroedicke M, Zenkner M, Schoenherr A, Koeppen S, Timm J, Mintzlaff S, Abraham C, Bock N, Kietzmann S, Goedde A, Toksoz E, Droege A, Krobitsch S, Korn B, Birchmeier W, Lehrach H, Wanker EE (2005b) A human protein-protein interaction network: a resource for annotating the proteome. *Cell* 122: 957-68

Tremblay K, Ouellet F, Fournier J, Danyluk J, Sarhan F (2005) Molecular characterization and origin of novel bipartite cold-regulated ice recrystallization inhibition proteins from cereals. *Plant Cell Physiol.* 46: 884-891

Tsuda K, Tsvetanov S, Takumi S, Mori N, Atanassov A, Nakamura C (2000) New members of a cold-responsive group-3 *Lea/Rab*-related *Cor* gene family from common wheat (*Triticum aestivum* L.). *Genes Genet Syst* 75: 179-88

Uetz P, Giot L, Cagney G, Mansfield TA, Judson RS, Knight JR, Lockshon D, Narayan V, Srinivasan M, Pochart P, Qureshi-Emili A, Li Y, Godwin B, Conover D, Kalbfleisch T, Vijayadamodar G, Yang M, Johnston M, Fields S, Rothberg JM (2000) A comprehensive analysis of protein-protein interactions in *Saccharomyces cerevisiae*. *Nature* 403: 623-7

Vergnolle C, Vaultier M-N, Taconnat L, Renou J-P, Kader J-C, Zachowski A, Ruelland E. (2005) The cold-induced early activation of phospholipase C and D pathways determines the response of two distinct clusters of genes in *Arabidopsis* cell suspensions. *Plant Physiol.* 139:1217-1233

Vidalain P-O, Boxem M, Ge H, Li S, Vidal M (2004) Increasing specificity in highthroughput yeast two-hybrid experiments. *Methods* 32:363-370

Voinnet O, Rivas S, Mestre P, Baulcombe D (2003) An enhanced transient expression system in plants based on suppression of gene silencing by the p19 protein of tomato bushy stunt virus. *Plant J* 33: 949-56

Walter M, Chaban C, Schutze K, Batistic O, Weckermann K, Nake C, Blazevic D, Grefen C, Schumacher K, Oecking C, Harter K, Kudla J (2004) Visualization of protein interactions in living plant cells using bimolecular fluorescence complementation. *Plant J* 40: 428-38

Wu G, Robertson AJ, Liu X, Zheng P, Wilen RW, Nesbitt NT, Gusta LV (2004) A lipid transfer protein gene BG-14 is differentially regulated by abiotic stress, ABA, anisomycin, and sphingosine in bromegrass (*Bromus inermis*). *J Plant Physiol* 161: 449-58

Wuchty S, Oltvai ZN, Barabasi AL (2003) Evolutionary conservation of motif constituents in the yeast protein interaction network. *Nat Genet* 35: 176-9

Xu Q, Fu H-H, Gupta R, Luan S (1998) Molecular characterization of a tyrosine-specific protein phosphatase encoded by a stress-responsive gene in *Arabidopsis*. *Plant Cell* 10: 849-858

Xu R, Quinn Li Q (2003) A RING-H2 zinc-finger protein gene *RIE1* is essential for seed development in *Arabidopsis*. *Plant Mol Biol* 53: 37-50

Xue G-P (2003) The DNA-binding activity of an AP2 transcriptional activator HvCBF2 involved in regulation of low-temperature responsive genes in barley is modulated by temperature. *The Plant Journal* 33: 373-383

Yamaguchi T, Nakayama K, Hayashi T, Yazaki J, Kishimoto N, Kikuchi S, Koike S (2004) cDNA microarray analysis of rice anther genes under chilling stress at the microsporogenesis stage revealed two genes with DNA transposon Castaway in the 5'-flanking region. *Biosci Biotechnol Biochem* 68: 1315-23

Yan L, Loukoianov A, Blechl A, Tranquilli G, Ramakrishna W, SanMiguel P, Bennetzen JL, Echenique V, Dubcovsky J (2004) The wheat VRN2 gene is a flowering repressor down-regulated by vernalization. *Science* 303: 1640-4

Yan L, Loukoianov A, Tranquilli G, Helguera M, Fahima T, Dubcovsky J . Positional cloning of the wheat vernalization gene VRN1. *PNAS* 100[10], 6263-6268. 2003.

Yeger-Lotem E, Sattath S, Kashtan N, Itzkovitz S, Milo R, Pinter RY, Alon U, Margalit H (2004) Network motifs in integrated cellular networks of transcription-regulation and protein-protein interaction. *Proc Natl Acad Sci U S A* 101: 5934-5939

Yoshimura K, Miyao K, Gaber A, Takeda T, Kanaboshi H, Miyasaka H, Shigeoka S (2004) Enhancement of stress tolerance in transgenic tobacco plants overexpressing *Chlamydomonas* glutathione peroxidase in chloroplasts or cytosol. *The Plant Journal* 37: 21-33

Supplemental material

Table S1: Sequences of the oligonucleotides used for the two rounds for homologous recombination in the pDEST32 or pDEST22 two hybrid vectors

Gene	Oligo's sequence
TaVRT-1/VRN-1	5'TGTACAAAAAGCAGGCCACCGAGTCATGTATG3' 5'TGTACAAGAAAGCTGGGTTTGGCTCACCCTTGATGTGGCT3'
TaVRT-2	5'GTTTGTACAAAAAGCAGGCCCTCGTCCTTCTCCTCCAC3' 5'TGTACAAGAAAGCTGGGTTTACCAAAGAGCGACTTGAA3'
Ta31K05	5'TTGTACAAAAAGCAGGTTGAACBACAGCTTGCAG3' 5'TGTACAAGAAAGCTGGGTTTACTTCTCCCTCCAAAAA3'
Ta45G05	5'TTGTACAAAAAGCAGGATCATCATCTTCTCCGCACA3' 5'TGTACAAGAAAGCTGGGTTCCATCTCTGAGCCCTACAA3'
Ta57H08	5'TTGTACAAAAAGCAGGATCGACAAGTACAGCACGCAAT3' 5'TGTACAAGAAAGCTGGGTTGCAGGGCAATCCTAATTTCA3'
Ta73C21	5'TTGTACAAAAAGCAGGATCGAGGACCCGGACGAG3' 5'TGTACAAGAAAGCTGGGTTTCCCTTACCAACTACAAGTAGCA3'
Elongin	5'TTGTACAAAAAGCAGGAAGGAGGAGCAGCAGGAG3' 5'TGTACAAGAAAGCTGGGTTGGCCAAAGCTGTTAAGTCCAG3'
Immunophilin	5'TTGTACAAAAAGCAGGGGGGACGGGTGATCTGTCTAA3' 5'TGTACAAGAAAGCTGGGTTTGTACCCAGGATCACGAAAGC3'
TaFCA-A1	5'TTGTACAAAAAGCAGGATGCACTGGGGCAGCGACCCG3' 5'TGTACAAGAAAGCTGGGTTTCAACTTTTCCAAGAACGCT3'
Small Ran-related GTP-binding protein	5'TTGTACAAAAAGCAGGGCGCTGCCGAACCAAGAAC3' 5'TGTACAAGAAAGCTGGGTTCTACTGATCAGATCGTCAT3'
TaGB1 (GTP binding protein)	5'TTGTACAAAAAGCAGGGGAGCACGACCGCCGCC3' 5'TGTACAAGAAAGCTGGGTTTAAAGCTGAAAACGTTGA3'
Inorganic pyrophosphatase	5'TTGTACAAAAAGCAGGGCTGGAGAAGCTGATGGAA3' 5'TGTACAAGAAAGCTGGGTTTCACTTCCCTAAGCCCTCCA3'
Receptor-like protein kinase	5'TTGTACAAAAAGCAGGCCAATTCAAAGATAAACTGGGT3' 5'TGGGTCGAAAGAACATGTAATGGCCAGCTTCTTACTGT3'
Calcium binding EF-hand protein	5'TTGTACAAAAAGCAGGGCGGATCCGGCGACAATCA3' 5'TGTACAAGAAAGCTGGGTTCACTCGCGACGTTGTAT3'
α-Tubulin 3-3	5'TTGTACAAAAAGCAGGATGAGGGAGTGCATCTCCAT3' 5'TGTACAAGAAAGCTGGGTTTACTGAAACAGGAAATGG3'
TaTNL	5'TTGTACAGGCGAGCGCGGCCAAGAGAGCGGG3' 5'TGTACAAGAAAGCTGGGTTTACCAAAGAGCGACTTGAA3'
TaCHL	5'TTGTACAAAAAGCAGGCCCGCATGAATTCAGATGCT3' 5'TGTACAAGAAAGCTGGGTTACACTTCGGCCGAGCTTCT3'
Lipid transfer protein 3	5'TTGTACAAAAAGCAGGGCGGCAAGGAGTCTGCTC3' 5'TGTACAAGAAAGCTGGGTTCACTCAGCCATACGGAC3'
Pathogenesis related protein 1	5'TTGTACAAAAAGCAGGGCGGCAAAAGAAAGACTACGA3' 5'TGTACAAGAAAGCTGGGTTGTCCATAGAAAGCTCATT3'
β-Ketoacyl-acyl carrier protein synthase	5'TTGTACAAAAAGCAGGAGAACGCCGGCTGCGGCTG3' 5'TGTACAAGAAAGCTGGGTTTCAGTTAAACCAAGGAGA3'
TaFT	5'TTGTACAAAAAGCAGGATGGCCGGTAGGGATAGGSA3' 5'TGTACAAGAAAGCTGGGTTTCAATGTACATCCTCCTGC3'
TaHD	5'TTGTACAAAAAGCAGGAACCTTTGGAGAAGCAAGCTG3' 5'TGTACAAGAAAGCTGGGTTATGTGGTCTCCTCATGCTC3'
VRN-2	5'TTGTACAAAAAGCAGGATGTCATGTCAATGCGGTTT3' 5'TGTACAAGAAAGCTGGGTTCTACTGGAACCATCCGAGGT3'
Universal vector pDEST32-GATEWAY	5'TCTTACTTACTTACCGCCATCAAGCCATTTGTACAAAGAAAGTGGGT3' 5'GACTGTATCTGTCGCGAGTCCAAACAAAGTTTGTACAAAAAGCAAGGCT3'
Universal vector pDEST22-GATEWAY	5'CGGAAGAGAGTAGTAACAAAGGTC3' 5'AGCCGACAACCTTGATTGGAGAC3'

Table S2: Sequences of the oligonucleotides used for the two rounds of PCR for homologous recombination in the pG35S-NtGFP5 or pG35S-CtGFP5 for BIFC vectors (pGREEN modified)

Gene	Oligo's sequence
TaFCA-A1-NtGFP5	5'TTGAGAGGACAGCCCAAGCATGCAACCGGGCAGCGAACC3' 5'GAAATTGGCTTTGATGCCGTTCAACTTTTCCAAGAACGCT3'
Receptor-like protein kinase - NtGFP5	5'TTGAGAGGACAGCCCAAGCATGCAACCGGGCAGCGAACC3' 5'GAAATTGGCTTTGATGCCGTTAAGCTGAAAACGTTGA3'
Ta45G05-NtGFP5	5'TTGAGAGGACAGCCCAAGCATGGGAGAGGCAAGSTCCA3' 5'GAAATTGGCTTTGATGCCGTTGAAAGATAGCCCATCTCTG3'
Pathogenesis related protein 1-NtGFP5	5'TTGAGAGGACAGCCCAAGCATGCAACCGGGCAGCGAACC3' 5'GAAATTGGCTTTGATGCCGTTGCCATAGAAAAGGCTCATT3'
Receptor-like protein kinase-NtGFP5	5'TTGAGAGGACAGCCCAAGCATGCAACCGGGCAGCGAACC3' 5'GAAATTGGCTTTGATGCCGTTAATGGCCAGCTTCTTACTGT3'
TaCHL -NtGFP5	5'TTGAGAGGACAGCCCAAGCATGCAACCGGGCAGCGAACC3' 5'GAAATTGGCTTTGATGCCGTTTACCAAGAGCGCACTTGA3'
TaVRT-1/VRN-1-NtGFP5	5'TTGAGAGGACAGCCCAAGCATGGCTCCGCCGCCGCCGCC3' 5'GAAATTGGCTTTGATGCCGTTTACACAATGCTCATATTTG3'
TaVRT-2-NtGFP5	5'TTGAGAGGACAGCCCAAGCATGGCCCGGGAGAGGCGGGC3' 5'GAAATTGGCTTTGATGCCGTTAAGCTTACCTTGGAAAG3'
VRN-2-NtGFP5	5'TTGAGAGGACAGCCCAAGCATGTCATGTCATGCGGTTT3' 5'GAAATTGGCTTTGATGCCGTTCTACTGGAACCATCCGAGGT3'
NtGFP5	5'TCTATAAAGGAAGTTCAATTTCAATTTGGAGAGGACAGCCCAAGC3' 5'TTGGACAACCTCCAAGTGAAGAAAGTTTCTCTCTTACTCAT3'
Immunophilin-CtGFP5	5'ACATGGCATGGATGAACTATGGGGACCGGTGATCTGTCTAA3' 5'TTTGTAGAGAGAGACTGGTGTGTACCAGGATCAAGAAAGC3'
TaVRT-2-CtGFP5	5'ACATGGCATGGATGAACTATGGCCCGGGAGAGGCGGGC3' 5'TTTGTAGAGAGAGACTGGTGAAGTACGCTTACCTTGGAAAG3'
Cold acclimation induced protein ESI2-1-CtGFP5	5'ACATGGCATGGATGAACTATGGGGAGCAGAGCTCATCG3' 5'TTTGTAGAGAGAGACTGGTGGATAGCTAGCATGGCGT3'
PG-phospholipaseC-CtGFP5	5'ACATGGCATGGATGAACTATGGGGACCCAGCGTTCCGAG3' 5'TTTGTAGAGAGAGACTGGTGGAGAGGCGGCTCCCTCCGAG3'
PI-phospholipaseC-CtGFP5	5'ACATGGCATGGATGAACTATGGGCCACCGCTTCCGCGAA3' 5'TTTGTAGAGAGAGACTGGTGGCCATCAGCTATGTAAG3'
α -Tubulin 3-3-CtGFP5	5'ACATGGCATGGATGAACTATAGAGGAGTGCATCTCGAT3' 5'TTTGTAGAGAGAGACTGGTGGATAAACCAGATAGCATG3'
TaVRT-1/VRN-1-CtGFP5	5'ACATGGCATGGATGAACTATGGCTCCGCCGCCGCCGCC3' 5'TTTGTAGAGAGAGACTGGTGTACACAATGCTCATATTTG3'
MADSMC 14-CtGFP5	5'TCATTGGAGAGGACAGCCCAAGCATGGCCCGGCTCGCTTCCCTTA3' 5'TGGCTTTGATGCCGTTCTTGTCTCCACGGGAGGCAAGGCA3'
MADSMC44-CtGFP5	5'TCATTGGAGAGGACAGCCCAAGCATGGGGCGAGGGCGCAGCA3' 5'TGGCTTTGATGCCGTTCTTGGTTGAATCCAAGSTTTGAGGT3'
Lipid transfert protein 3-CtGFP5	5'ACATGGCATGGATGAACTATGGCTCGTCTCAACAGCAA3' 5'TTTGTAGAGAGAGACTGGTGGTAGCTCAACATCGTATGA3'
Elongin-CtGFP5	5'ACATGGCATGGATGAACTATAAGGAGGAGCACGAGGAG3' 5'TTTGTAGAGAGAGACTGGTGGCCAAAGCTGTTAAGTCCAG3'
Ta31K05-CtGFP5	5'ACATGGCATGGATGAACTATTTGAACBATCAGCTTGCAG3' 5'TTTGTAGAGAGAGACTGGTGTACTTCTCTCCGCTCCAAAA3'
Ta57H08-CtGFP5	5'ACATGGCATGGATGAACTATGCCAGCTCCAGTATGAATGA3' 5'TTTGTAGAGAGAGACTGGTGTACTTCCATGGAAGGCAAG3'
CtGFP5	5'GTTTGTAAACAGCTGGGATTACACATGGCATGGATGAACTAT3' 5'TGGAGAAAATAGAGAGAGATAGATTTGTAGAGAGAGACTGGTGS

CONCLUSION

La génomique chez le blé

Un projet international (www.wheatgenome.org) vise à séquencer le génome de blé dans le but de déchiffrer l'information codée par chacun des chromosomes et de déterminer la fonction biologique des gènes. L'approche génomique utilisée dans notre recherche n'est qu'une façon différente d'atteindre ces objectifs, mais à une échelle plus modeste. Elle s'est particulièrement limitée à la famille de gènes MADS-box. Au début du projet, très peu de gènes codant des facteurs MADS-box, encore moins leurs fonctions, étaient identifiés chez blé. La revue de littérature et les résultats présentés dans cette étude montrent que plus d'une cinquantaine de facteurs MADS-box différents sont codés par les génomes du blé. Pourtant, se fiant à la taille de ces génomes (17 000 kilopaires de bases au total), estimée à quarante fois celle du génome de riz et cent vingt fois celle du génome d'*Arabidopsis*, il est tentant de supposer que le nombre de facteurs ou gènes MADS-box présents chez le blé devrait être supérieur à celui des autres génomes. Avec tous les génomes séquencés, la preuve a été apportée qu'aucune corrélation n'existe entre la taille et le nombre de gènes d'un génome.

Le défi suivant l'identification des gènes MADS-box était de déterminer leurs fonctions biologiques, particulièrement celles en rapport avec la vernalisation. Les difficultés auxquelles nous faisons face étaient issues même de nos choix, à savoir:

- a) le modèle d'étude : la complexité (polyploïdie) du génome de blé constitué d'environ 80% de séquences répétitives, n'a pas facilité l'identification de gènes polycistroniques (7-8 exons en moyenne) qui codent pour les facteurs MADS-box.
- b) la famille de gènes à l'étude : à cause de la grande conservation de leurs séquences, le séquençage des gènes MADS-box et leur analyse se devaient d'être

minutieuse afin de différencier les copies d'un gène d'avec les homologues en séquences.

- c) la propriété des facteurs de transcription MADS-box : ces facteurs peuvent être à la fois des régulateurs positifs et négatifs en formant des dimères, des trimères et tétramères. La formation de tels complexes multimériques représente des sommes de possibilités de fonctions pour les facteurs MADS-box.
- d) généralement, les gènes de vernalisation sont pléiotropiques, c'est-à-dire qu'ils ont des effets sur d'autres aspects de la croissance et du développement des plantes. De plus, il est difficile de distinguer un gène de vernalisation d'un gène impliqué dans les mécanismes d'acclimatation au froid pour plusieurs raisons : d'abord ce sont là deux mécanismes d'adaptation causés par le même stress, les basses températures; ensuite le locus qui confère la réponse à la vernalisation (*Vrn-1*) et celui qui confère une meilleure capacité de tolérance au gel (*Fr-1*) co-ségrègent dans la même région chromosomique; enfin, il existe une relation épistatique entre les allèles qui confèrent la réponse à la vernalisation qui fait que l'effet d'un gène sur un allèle peut être masqué par celui d'un gène porté par un autre allèle. Pour toutes ces raisons, la caractérisation d'un gène de vernalisation, tel que *TaVRT-2*, est en soi une avancée majeure.

Divergences dans la régulation de la floraison entre le blé et *Arabidopsis*

Le locus dominant qui retarde la floraison par la vernalisation chez les *Brassicaceae*, *FLC*, serait absent chez les céréales. Chez ces derniers, le locus clairement identifié qui aurait cette dominance pour la vernalisation et qui retarde la floraison est *TaVRN2*, bien qu'il soit muté ou absent chez certains génotypes nécessitant la vernalisation. L'absence de *TaVRN2* dans les dicotylédones et celle de *FLC* dans les monocotylédones prouve que : i) les acteurs majeurs des mécanismes génétiques régulant la transition florale chez ces espèces sont différents; ii) une similitude entre protéines ne signifie pas automatiquement conservation au niveau de

la fonction. D'ailleurs, l'absence de *FLC* chez les céréales suggère qu'un autre MADS-box pourrait être le répresseur principal de la floraison.

TaVRT-2 est-il l'orthologue de FLC chez les céréales ?

Une analyse sommaire de la famille MADS-box chez le blé identifie *TaVRT-2* comme un candidat véritable pour jouer les fonctions de *FLC* chez les céréales. En effet, la caractérisation de *TaVRT-2* indique que son transcrit, comme celui de *FLC* chez *Arabidopsis*, est régulé par la vernalisation, la photopériode et la voie autonome chez le blé. Comme pour *FLC*, une régulation épigénétique ou une méthylation au niveau du promoteur du gène *TaVRT-2* est possible, ce qui encourage à poursuivre une recherche dont l'objectif principal sera l'étude de régulation de la transcription de *TaVRT-2*. L'hypothèse en sera que plusieurs régulateurs impliqués dans la structure et la modélisation de la chromatine activeraient ou inhiberaient le gène *TaVRT-2* au niveau de son promoteur.

Qui, de TaVRT-1, TaVRN2 et TaVRT-2, induit la floraison ?

C'est *TaVRT-1* qui détermine si une plante sensible aux basses températures est annuelle (pas ou peu de nécessité de vernalisation) ou bisannuelle (nécessité absolue de vernalisation). *TaVRT-1* porté par le locus dominant s'exprime de façon constitutive et à des niveaux suffisamment élevés pour induire une floraison sans la nécessité de vernalisation. Par contre, lorsque *TaVRT-1* est porté par le locus récessif, son expression est masquée (ou limitée) par *TaVRT-2* et *TaVRN2*. La vernalisation, en diminuant le niveau de *TaVRT-2* et celui de *TaVRN2*, permet à la plante d'accumuler *TaVRT-1* à des niveaux suffisamment élevés pour être capable d'induire une floraison lorsque les conditions (de photopériode et de développement) s'y prêtent.

Comment le gène *TaVRT-1* est-il régulé?

Cette question a été récurrente dans les discussions avec mon directeur ou encore avec les évaluateurs de nos articles. L'intrigue venait du fait que les résultats présentent d'une part une interaction protéine-protéine entre TaVRT-1, TaVRT-2 et TaVRN2 (articles II), et d'autre part une régulation de l'expression du gène *TaVRT-1* par TaVRT-2 et TaVRN2 (article III).

Pourtant, les résultats étayaient que les messagers de ces trois gènes sont exprimés dans les mêmes tissus méristématiques et les protéines codées par ces gènes sont des facteurs de transcription capables de former des dimères tout en liant des régions régulatrices d'ADN. Pour ces évidences, le fait que leurs protéines interagissent ensemble (il est vrai, dans la levure) et que TaVRN2 et TaVRT-2 répriment conjointement la transcription de *TaVRT-1* n'est pas en soi un résultat surprenant. Ce postulat est plutôt à la base de notre modèle de régulation de la réponse à la vernalisation chez les plantes bisannuelles. Ce modèle propose que durant la phase végétative, un complexe de répresseurs (entre autres TaVRT-2 et TaVRN2) se crée et garde le niveau d'expression de *TaVRT-1* relativement bas pour que la floraison n'ait pas lieu durant cette période (qui équivaldrait dans la nature à tard l'automne et au début de l'hiver). Durant la phase de transition (début du printemps), ce complexe répresseur se désagrège (possiblement par ubiquitination, voir discussion et tableau des interactions en annexe), pour laisser place à un complexe d'activateurs de floraison. Or, selon nos résultats, une surexpression de *TaVRT-1* après la transition florale requiert une exposition en jour long pour que la plante entre en phase reproductive et complète son développement (durant l'été). Ces résultats laissent supposer que la voie photopériodique régule ce complexe activateur et aussi que des facteurs qui le composent interagissent avec TaVRT-1. D'après nos résultats, d'autres facteurs MADS-box (annexe VI), TaHD1 ou encore TaFT (Tominaga *et al.*, communication personnelle), sont surexprimés en jour long chez le

blé d'hiver et interagissent avec *TaVRT-1*. Donc, ce sont là des facteurs pressentis pour être des régulateurs majeurs dans le complexe activateur de la floraison.

Il faut reconnaître que le modèle qui est proposé n'est qu'une possibilité parmi d'autres voies de régulation de *TaVRT-1*. Du fait que *TaVRT-1* est porté par un locus, d'autres types de régulations sont possibles, d'où l'importance de poursuivre des études portant : i) sur la dynamique et la taille des complexes protéines au niveau des régions régulatrices de *TaVRT-1* ; ii) sur la régulation au niveau intronique de *TaVRT-1*; iii) sur les modifications au niveau de la structure et de la condensation de la chromatine.

Perspectives

L'alimentation humaine et animale se fonde principalement sur les produits agricoles dérivés en grande partie des espèces de récolte. Le blé, le riz, l'orge et le seigle sont les récoltes les plus importantes pour l'agriculture. Pour satisfaire les besoins en alimentation d'ici 2050, d'une façon sensible et soutenable, il est important d'améliorer les cultures et les stratégies agricoles, d'augmenter la productivité agricole, et de prédire la survie des plantes face aux irrégularités des saisons et des perturbations dues au réchauffement de notre planète. D'ailleurs, un des principaux objectifs des programmes d'agriculture des céréales cible la régulation de la floraison sous des conditions environnementales particulières ou lors d'une saison précise. Pour mieux agir et pour augmenter le rendement absolu tout en offrant la sécurité et la qualité des produits alimentaires, il faut comprendre et pouvoir manipuler les traits quantitatifs et qualitatifs (QTLs) d'intérêts agronomiques.

La génomique des plantes, à la base, adresse ces défis. Avec l'avènement des nouvelles technologies en génétique et l'utilisation d'approches et d'outils moléculaires, les scientifiques sont en mesure d'identifier les gènes conférant la dominance ou la récessivité de caractères qui régulent la floraison. Cette approche génomique, au point de vue pratique et économique (temps, énergie), est plus

intéressante et à privilégier. Elle permet de caractériser de nombreux gènes de régulation de la réponse aux stress environnementaux et de développer des marqueurs moléculaires associés ou responsables des effets des déterminants génétiques. Par conséquent, l'identification de TaVRT-2 et de son interaction avec les gènes *TaVRT-1* et *TaVRN2* (qui déterminent le temps de floraison) est prometteuse dans une perspective agro-alimentaire et économique.

La littérature et les résultats présentés permettent de déposer les conclusions suivantes :

- Les facteurs MADS-box de blé constituent une large et importante famille de facteurs de transcription dont les séquences et les fonctions sont conservées chez les angiospermes. Seuls certains gènes *a priori* auraient évolué ou se seraient spécialisés après la divergence entre espèces monocotylédones et dicotylédones, ce qui pourrait s'expliquer en partie par la sélection (naturelle ou assistée) et par l'adaptation du blé à ses environnements.
- L'identification de TaVRT-2 est une découverte majeure dans le domaine de la vernalisation et l'étude des facteurs de transcription MADS-box. Nous avons démontré que TaVRT-2 réprime la transcription du gène majeur de la vernalisation *TaVRT-1*. Dès lors, TaVRT-2 devient un acteur important dans la voie de régulation de la floraison chez les céréales. La caractérisation actuelle de TaVRT-2 soulève encore de nombreuses questions. Des plantes transgéniques ayant une réponse à la vernalisation et où l'expression du gène *TaVRT-2* est inhibée sont en cours de production. Leurs analyses apporteront sans nul doute des éléments de réponse quant à la fonction précise de TaVRT-2 chez le blé.
- L'étude des interactions possibles entre différentes protéines impliquées dans les réponses aux stress abiotiques et/ou régulant le temps de floraison chez les céréales

donne une vue des complexes protéiques impliqués dans les réponses aux stress environnementaux, dans la régulation de la floraison et dans le développement. Bien évidemment, des études *in vivo* sont requises pour évaluer la dynamique et la signification de telles interactions chez le blé.

Toutes ces conclusions contribuent à asseoir quelques bases moléculaires de la vernalisation chez les céréales et ainsi pouvoir envisager des études plus poussées et complexes dans cette voie de contrôle de la floraison chez les céréales.

Bibliographie générale

Abbadi, A., Brummel, M., and Spener, F. (2000). Knockout of the regulatory site of 3-ketoacyl-ACP synthase III enhances short- and medium-chain acyl-ACP synthesis. *Plant J.* : 24: 1-9.

Abe, M., Kobayashi, Y., Yamamoto, S., Daimon, Y., Yamaguchi, A., Ikeda, Y., Ichinoki, H., Notaguchi, M., Goto, K., and Araki, T. (2005). FD, a bZIP protein mediating signals from the floral pathway integrator FT at the shoot apex. *Science* 309:1052-6.

Abdrakhamanova, A., Wang, Q.Y., Khokhlova, L., and Nick, P. (2003). Is microtubule disassembly a trigger for cold acclimation? *Plant Cell Physiol* 44: 676-86.

Adam, H., Ouellet, F., Kane, N.A., Agharbaoui, Z., Major, G., Tominaga, Y., and Sarhan, F. (2007). Overexpression of *TaVRNI* in *Arabidopsis* promotes early flowering and alters development. *Plant Cell Physiol.* 48:1192-206.

Anderson, J.V., and Davis, D.G. (2004). Abiotic stress alters transcript profiles and activity of glutathione S-transferase, glutathione peroxidase, and glutathione reductase in *Euphorbia esula*. *Physiol Plant* 120: 421-33.

Alvarez-Buylla, E.R., Liljegren, S.J., Pelaz, S., Gold, S.E., Burgeff, C., Ditta, G.S., Vergara-Silva, F., and Yanofsky, M.F. (2000). MADS-box gene evolution beyond flowers: expression in pollen, endosperm, guard cells, roots and trichomes. *Plant J.* 24: 457-66.

- Amasino, R.M. (2003). Flowering time: a pathway that begins at the 3' end. *Curr. Biol.* 13:670-2.
- Amasino, R.M (2004a). Take a cold flower. *Nat. Genet.* 36: 111-2.
- Amasino, R. (2004b). Vernalization, competence, and the epigenetic memory of winter. *Plant Cell* 16: 2553-9.
- Ammerer, G. (1990). Identification, purification, and cloning of a polypeptide (PRTF/GRM) that binds to mating-specific promoter elements in yeast. *Genes Dev.* 4: 299-312.
- Aukerman, M.J., Lee, I., Weigel, D., and Amasino, R.M. (1999). The *Arabidopsis* flowering-time gene LUMINIDEPENDENS is expressed primarily in regions of cell proliferation and encodes a nuclear protein that regulates LEAFY expression. *Plant J.* 2:195-203.
- Ausin, I., Alonso-Blanco, C., Jarillo, J.A., Ruiz-Garcia, L., and Martinez-Zapater, J.M. (2004). Regulation of flowering time by FVE, a retinoblastoma-associated protein. *Nat. Genet.* 2:162-6.
- Baum, M., Grando, S., Backes, G., Jahoor, A., Sabbagh, A., and Ceccarelli, S. (2003). QTLs for agronomic traits in the Mediterranean environment identified in recombinant inbred lines of the cross 'Arta' x *H. spontaneum* 41-1. *Theor Appl Genet* 107: 1215-25.
- Beales, J., Laurie, D.A., and Devos, K.M. (2005). Allelic variation at the linked AP1 and PhyC loci in hexaploid wheat is associated but not perfectly correlated with vernalization response. *Theor Appl Genet* 110:1099-107.

Becker, A., and Theissen, G. (2003). The major clades of MADS-box genes and their role in the development and evolution of flowering plants. *Mol. Phylogenet. Evol.* 29, 464-89.

Bezant, J., Laurie, D., Pratchett, N., Chojecki, J., and Kearsey, M. (1996). Marker regression mapping of QTL controlling flowering time and plant height in a spring barley (*Hordeum vulgare* L.) cross. *Heredity* 77: 64-73.

Black, B.L., and Olson, E.N. (1998). Transcriptional control of muscle development by myocyte enhancer factor – 2 (*MEF-2*) proteins. *Annu. Rev. Cell Dev.* 14: 167-96.

Bracha-Drori, K., Shichrur, K., Katz, A., Oliva, M., Angelovici, R., Yalovsky, S., and Ohad, N. (2004). Detection of protein-protein interactions in plants using bimolecular fluorescence complementation. *Plant J* 40: 419-27.

Bray, E.A. (2004). Genes commonly regulated by water-deficit stress in *Arabidopsis thaliana*. *J. Exp. Bot.* 55: 2331-41.

Breton, G., Danyluk, J., Ouellet, F., and Sarhan, F. (2000). Biotechnological applications of plant freezing associated proteins. *Biotechnol. Annu. Rev.* 6: 59-101.

Bullrich, L., Appendino, L., Tranquilli, G., Lewis, S., and Dubcovsky, J. (2002). Mapping of a thermo-sensitive earliness per se gene on Triticum monococcum chromosome 1A(m). *Theor Appl Genet* 105: 585-93.

Burn, J.E., Smyth, D.R., Peacock, W.J., and Dennis, E.S. (1993). Genes conferring late flowering in *Arabidopsis thaliana*. *Genetica* 90: 147-55.

Boyko, E., Kalendar, R., Korzun, V., Fellers, J., Korol, A., Schulman, A.H., and Gill, B.S. (2002). A high-density cytogenetic map of the *Aegilops tauschii* genome incorporating retrotransposons and defense-related genes: insights into cereal chromosome structure and function. *Plant Mol Biol* 48: 767-90.

Dumay, H., Rubbi, L., Sentenac, A., and Marck, C. (1999). Interaction between yeast RNA polymerase III and transcription factor TFIIC via ABC10alpha and tau131 subunits. *J Biol Chem* 274: 33462-8.

Carman, C.V., Som, T., Kim, C.M., and Benovic, J.L. (1998). Binding and phosphorylation of tubulin by G protein-coupled receptor kinases. *J. Biol. Chem.* 273: 20308-16.

Carmona, M. J., Ortega, N., and Garcia-Maroto, F. (1998). Isolation and molecular characterization of a new vegetative MADS-box gene from *Solanum tuberosum* L. *Planta* 207: 181-8.

Chandler, J., Wilson, A., and Dean, C. (1996). *Arabidopsis* mutants showing an altered response to vernalization. *Plant J.* 10: 637-44.

Chouard, P. (1960). Vernalization and its relations to dormancy. *Annu. Rev. Plant Physiol.* 11: 191-237.

Ciannamea, S., Kaufmann, K., Frau, M., Tonaco, I. A., Petersen, K., Nielsen, K. K., Angenent, G. C., and Immink, R. G. (2006). Protein interactions of MADS box transcription factors involved in flowering in *Lolium perenne*. *J.Exp.Bot.* 57: 3419-31.

- Chida, K., Nagamori, S., and Kuroki, T. (1999). Nuclear translocation of Fos is stimulated by interaction with Jun through the leucine zipper. *Cell Mol. Life Sci.* 55: 297-302.
- Clarke, J.H., and Dean, C. (1994). Mapping *FRI*, a locus controlling flowering time and vernalization response in *Arabidopsis thaliana*. *Mol. Gen. Genet.* 242: 81-9.
- Clough, S. J. and Bent, A. F. (1998). Floral dip: a simplified method for *Agrobacterium*-mediated transformation of *Arabidopsis thaliana*. *Plant J.* 16, 735-43.
- Crosthwaite, S. K. and Jenkins, G. I. (1993). The role of leaves in the perception of vernalizing temperatures in sugar-beet. *J.Exp.Bot.* 44: 801-6.
- Danyluk, J., Kane, N.A., Breton, G., Limin, A.E., Fowler, D.B., and Sarhan, F. (2003). TaVRT-1, a putative transcription factor associated with vegetative to reproductive transition in cereals. *Plant Physiol.* 132:1849-60.
- Davies, B., Egea-Cortines, M., de Andrade, S. E., Saedler, H., and Sommer, H. (1996). Multiple interactions amongst floral homeotic MADS box proteins. *EMBO J.* 15: 4330-43.
- De Bodt, S., Raes, J., Van de Peer, Y., and Theissen, G. (2003a). And then there were many: MADS goes genomic. *Trends Plant Sci.* 10: 475-83.
- De Bodt, S., Raes, J., Florquin, K., Rombauts, S., Rouze, P., Theissen, G., and Van de Peer, Y. (2003b). Genomewide structural annotation and evolutionary analysis of the type I MADS-box genes in plants. *J. Mol. Evol.* 5: 573-86.

de Folter, S., Immink, R. G., Kieffer, M., Parenicova, L., Henz, S. R., Weigel, D., Busscher, M., Kooiker, M., Colombo, L., Kater, M. M., Davies, B., and Angenent, G. C. (2005). Comprehensive interaction map of the *Arabidopsis* MADS box transcription factors. *Plant Cell* 17, 1424-33.

de Folter, S. and Angenent, G. C. (2006). *trans* meets *cis* in MADS science. *Trends Plant Sci.* 11: 224-31.

Dubcovsky, J., Loukoianov, A., Fu, D., Valarik, M., Sanchez, A., and Yan, L. (2006): Effect of photoperiod on the regulation of wheat vernalization genes *VRN1* and *VRN2*. *Plant Mol.Biol.* 60: 469-80.

Dubcovsky, J., Lijavetzky, D., Appendino, L., and Tranquilli, G. (1998). Comparative RFLP Mapping of *Triticum monococcum* genes controlling vernalization requirement. *Theor. Appl. Genet.* 97:968-75.

Dubcovsky, J.M., Luo, C., Zhong, G.Y., Bransteitter, R., Desai, A.J., Kilian, A., Kleinhofs, A., and Dvorak, J. (1996). Genetic map of diploid wheat, *Triticum monococcum* and its comparison with maps of *Hordeum vulgare* L. *Genetics*: 143:983-99.

Egea-Cortines, M., Saedler, H., and Sommer, H. (1999). Ternary complex formation between the MADS-box proteins SQUAMOSA, DEFICIENS and GLOBOSA is involved in the control of floral architecture in *Antirrhinum majus*. *EMBO J.* 18:5370-9.

Favaro, R., Pinyopich, A., Battaglia, R., Kooiker, M., Borghi, L., Ditta, G., Yanofsky, M. F., Kater, M. M., and Colombo, L. (2003). MADS-box protein complexes control carpel and ovule development in *Arabidopsis*. *Plant Cell* 15:2603-11.

Fornara, F., Parenicova, L., Falasca, G., Pelucchi, N., Masiero, S., Ciannamea, S., Lopez-Dee, Z., Altamura, M.M., Colombo, L., Kater, M.M. (2004). Functional characterization of OsMADS18, a member of the AP1/SQUA subfamily of MADS-box genes. *Plant Physiol* 135: 2207-19.

Fowler, D. B., Breton, G., Limin, A. E., Mahfoozi, S., and Sarhan, F. (2001). Photoperiod and temperature interactions regulate low-temperature-induced gene expression in barley. *Plant Physiol.* 127: 1676-81.

Fowler, D.B., Limin, A.E., and Ritchie, J.T. (1999). Low-temperature tolerance in cereals: Model and genetic interpretation. *Crop Sci* 39: 633.

Fowler, D.B., Chauvin, L.P., Limin, A.E., and Sarhan, F. (1996a). The regulatory role of vernalization in the expression of low-temperature-induced genes in wheat and rye. *Theor. Appl. Genet* 93: 554-9.

Fowler, D.B., Limin, A.E., Wang, S-Y., and Ward, R.W. (1996b). Relationship between low-tolerance and vernalization response in wheat and rye. *Crop Sci.*: 626-33.

Frenette-Charron, J.B., Breton, G., Badawi, M., and Sarhan, F. (2002). Molecular and structural analyses of a novel temperature stress-induced lipocalin from wheat and *Arabidopsis*. *FEBS Lett* 517: 129-32.

Frenette-Charron, J.B., Ouellet, F., Pelletier, M., Danyluk, J., Chauve, C., and Sarhan, F. (2005). Identification, expression, and evolutionary analyses of plant lipocalins. *Plant Physiol* 139: 2017-2028.

- Fu, D., Szucs, P., Yan, L., Helguera, M., Skinner, J. S., von Zitzewitz, J., Hayes, P. M., and Dubcovsky, J. (2005). Large deletions within the first intron in *VRN-1* are associated with spring growth habit in barley and wheat. *Mol.Genet.Genomics* 273: 54-65.
- Galiba, G., Quarrie, S.A., Sutka, J., and Morgounov, A. (1995). RFLP Mapping of the vernalization (*Vrn1*) and frost resistance (*Fr1*) genes on chromosome 5A of wheat. *Theor. Appl. Genet.* 90: 1174-79.
- Gendall, A.R., Levy, Y.Y., Wilson, A., and Dean, C. (2001). The VERNALIZATION 2 gene mediates the epigenetic regulation of vernalization in *Arabidopsis*. *Cell* 107: 525-35.
- Gerber, M., Tenney, K., Conaway, J.W., Conaway, R.C., Eissenberg, J.C., and Shilatifard, A. (2005). Regulation of heat shock gene expression by RNA Polymerase II elongation factor, elongin A. *J. Biol. Chem.* 280: 4017-20.
- Gietz, R.D., and Woods, R.A. (2001). Genetic transformation of yeast. *Biotechniques* 30: 816-20.
- Gio, L., Bader, J.S., Brouwer, C., Chaudhuri, A., Kuang, B., Li, Y., Hao, Y.L., Ooi, C.E., Godwin, B., Vitols, E., Vijayadamodar, G., Pochart, P., Machineni, H., Welsh, M., Kong, Y., Zerhusen, B., Malcolm, R., Varrone, Z., Collis, A. Minto, M., Burgess, S., McDaniel, L., Stimpson, E., Spriggs, F., Williams, J., Neurath, K., Ioime, N., Agee, M., Voss, E., Furtak, K., Renzulli, R., Aanensen, N., Carrolla, S., Bickelhaupt, E., Lazovatsky, Y., DaSilva, A., Zhong, J., Stanyon, C.A., Finley, R.L.Jr., White, K.P., Braverman, M., Jarvie, T., Gold, S., Leach, M., Knight, J., Shimkets, R.A., McKenna, M.P., Chant, J., and Rothberg, J.M. (2003). A Protein Interaction Map of *Drosophila melanogaster*. *Science* 302: 1727-36.

Goldberg, D.S., and Roth, F.P. (2003). Assessing experimentally derived interactions in a small world. *Proc Natl Acad Sci U S A* 100: 4372-6.

Goff, S.A., Ricke, D., Lan, T.H., Presting, G., Wang, R., Dunn, M., Glazebrook, J., Sessions, A., Oeller, P., Varma, H., Hadley, D., Hutchison, D., Martin, C., Katagiri, F., Lange, B.M., Moughamer, T., Xia, Y., Budworth, P., Zhong, J., Miguel, T., Paszkowski, U., Zhang, S., Colbert, M., Sun, W.L., Chen, L., Cooper, B., Park, S., Wood, T.C., Mao, L., Quail, P., Wing, R., Dean, R., Yu, Y., Zharkikh, A., Shen, R., Sahasrabudhe, S., Thomas, A., Cannings, R., Gutin, A., Pruss, D., Reid, J., Tavtigian, S., Mitchell, J., Eldredge, G., Scholl, T., Miller, R.M., Bhatnagar, S., Adey, N., Rubano, T., Tusneem, N., Robinson, R., Feldhaus, J., Macalma, T., Oliphant, A., and Briggs, S. (2002). A draft sequence of the rice genome (*Oryza sativa* L. ssp. japonica). *Science* 296: 92-100.

Gonzalez, P., Alvarez, V., Menendez, M., Lahoz, C.H., Martinez, C., Corao, A.I., Calatayud, M.T., Pena, J., Garcia-Castro, M., and Coto, E. (2007). Myocyte enhancing factor-2A in Alzheimer's disease: genetic analysis and association with MEF2A-polymorphisms. *Neurosci Lett.* 411(1):47-51.

Gregis, V., Sessa, A., Colombo, L., and Kater, M. M. (2006). AGL24, SHORT VEGETATIVE PHASE, and APETALA1 redundantly control *AGAMOUS* during early stages of flower development in *Arabidopsis*. *Plant Cell* 18: 1373-82.

Gulick, P.J., Drouin, S., Yu, Z., Danyluk, J., Poisson, G, Monroy, A.F., and Sarhan, F. (2005). Transcriptome comparison of winter and spring wheat responding to low temperature. *Genome* 48: 913-23.

Hackbusch, J., Richter, K., Muller, J., Salamini, F., and Uhrig, J.F. (2005). A central role of *Arabidopsis thaliana* ovate family proteins in networking and subcellular localization of 3-aa loop extension homeodomain proteins. *Proc Natl Acad Sci U S A* 102: 4908-12.

Hadfield, K.A., and Bennett, A.B. (2005). Polygalacturonases: many genes in search of a function. *Plant Physiol.* 117: 337-43.

Hannah, M.A., Heyer, A.G., and Hinch, D.K. (2005). A global survey of gene regulation during cold acclimation in *Arabidopsis thaliana*. *PLoS Genet.* 1: 26.

Hartmann, U., Hohmann, S., Nettekoven, K., Wisman, E., Saedler, H., and Huijser, P. (2000). Molecular cloning of SVP: a negative regulator of the floral transition in *Arabidopsis*. *Plant J.* 4: 351-60.

Haseloff, J., Siemering, K.R., Prasher, D.C., and Hodge, S. (1997). Removal of a cryptic intron and subcellular localization of green fluorescent protein are required to mark transgenic *Arabidopsis* plants brightly. *Proc Natl Acad Sci U S A* 94: 2122-27.

Hellens, R.P., Edwards, E.A., Leyland, N.R., Bean, S., and Mullineaux, P.M. (2000). pGreen: a versatile and flexible binary Ti vector for *Agrobacterium*-mediated plant transformation. *Plant Mol Biol* 42: 819-32.

He, Y., Michaels, S.D., and Amasino, R.M. (2003). Regulation of flowering time by histone acetylation in *Arabidopsis*. *Science* 302:1751-4.

Hepworth, S.R., Valverde, F., Ravenscroft, D., Mouradov, A., and Coupland, G. (2002). Antagonistic regulation of flowering-time gene *SOC1* by CONSTANS and FLC via separate promoter motifs. *EMBO J.* 21: 4327-37.

Hecht, V., Foucher, F., Ferrandiz, C., Macknight, R., Navarro, C., Morin, J., Vardy, M. E., Ellis, N., Beltran, J. P., Rameau, C., and Weller, J. L. (2005). Conservation of *Arabidopsis* flowering genes in model legumes. *Plant Physiol.* 137: 1420-34.

Higo, K., Ugawa, Y., Iwamoto, M., and Korenaga, T. (1999). Plant *cis*-acting regulatory DNA elements (PLACE) database. *Nucl.Acids Res.* 27: 297-300.

Hong, J.K., Lee, S.C., and Hwang, B.K. (2005). Activation of pepper basic PR-I gene promoter during defense signaling to pathogen, abiotic and environmental stresses. *Gene* 356: 169-180.

Hossain, M.S., Koba, T., and Harada, K. (2003). Cloning and characterization of two full-length cDNAs, TaGA1 and TaGA2, encoding G-protein alpha subunits expressed differentially in wheat genome. *Genes Genet Syst* 78: 127-138.

Houde, M., Belcaid, M., Ouellet, F., Danyluk, J., Monroy, A. F., Dryanova, A., Gulick, P., Bergeron, A., Laroche, A., Links, M., McCarthy, L., Crosby, W. L., and Sarhan, F. (2006). Wheat EST resources for functional genomics of abiotic stress. *BMC Genomics* 7: 149.

Immink, R.G., Hannapel, D.J., Ferrario, S., Busscher, M., Franken, J., Lookeren-Campagne M.M., and Angenent, G.C. (1999). A petunia MADS box gene involved in the transition from vegetative to reproductive development. *Development* 126: 5117-26.

Islam-Faridi, M.N., Worland, A.J., and Law, C.N. (1996). Inhibition of ear-emergence time and sensitivity to day-length determined by the group 6 chromosomes of wheat. *Heredity* 77: 572-80.

Ito, T., Chiba, T., and Yoshida, M. (2001). Exploring the protein interactome using comprehensive two-hybrid projects. *Trends in Biotechnology* 19: 23-7.

Iwaki, K., Nishida, J., Yanagisawa, T., Yoshida, H., and Kato, K. (2002). Genetic analysis of *Vrn-B1* for vernalization requirement by using linked dCAPS markers in bread wheat (*Triticum aestivum* L.). *Theor Appl Genet* 104: 571-6.

Jack, T. (2001). Relearning our ABCs: New twists on an old model. *Trends Plant Sci.* 6: 310-16.

Jarillo, J.A., Capel, J., Tang, R.H., Yang, H.Q., Alonso, J.M., Ecker, J.R., and Cashmore, A.R. (2001). An *Arabidopsis* circadian clock component interacts with both CRY1 and PHYB. *Nature* 410: 487-90.

Jofuku, K.D., Boer, B., Montagu, M.V., and Okamoto, J.K. (1994). Control of *Arabidopsis* Flower and Seed Development by the Homeotic Gene *APETALA2*. *Plant Cell* 6: 1211-25.

Johansen, B., Pedersen, L.B., Skipper, M., and Frederiksen, S. (2002). MADS-box gene evolution-structure and transcription patterns. *Mol. Phylogenet. Evol.*: 458-80.

Johanson, U., West, J., Lister, C., Michaels, S., Amasino, R., and Dean, C. (2000). Molecular analysis of *FRIGIDA*, a major determinant of natural variation in *Arabidopsis* flowering time. *Science* 290: 344-7.

Kane, N. A., Danyluk, J., Tardif, G., Ouellet, F., Laliberte, J. F., Limin, A. E., Fowler, D. B., and Sarhan, F., 2005: *TaVRT-2*, a member of the StMADS-11 clade of

flowering repressors, is regulated by vernalization and photoperiod in wheat. *Plant Physiol.* 138, 2354-63.

Kim, H. J., Hyun, Y., Park, J. Y., Park, M. J., Park, M. K., Kim, M. D., Kim, H. J., Lee, M. H., Moon, J., Lee, I., and Kim, J. (2004). A genetic link between cold responses and flowering time through *FVE* in *Arabidopsis thaliana*. *Nat.Genet.* 36: 167-71.

Kim, H-J., Kim, Y-K., Park, J-Y., and Kim, J. (2002). Light signalling mediated by phytochrome plays an important role in cold-induced gene expression through the C-repeat/dehydration responsive element (C/DRE) in *Arabidopsis thaliana*. *Plant J.* 29: 693-704.

Klaimi, Y.Y., and Qualset, C.O. (1974). Genetics of heading time in wheat (*Triticum aestivum* L.) II. The inheritance of vernalization response. *Genetics* 76: 119-33.

Kofuji, R., Sumikawa, N., Yamasaki, M., Kondo, K., Ueda, K., Ito, M., and Hasebe, M. (2003). Evolution and divergence of the MADS-box gene family based on genome-wide expression analyses. *Mol Biol Evol.* 12:1963-77.

Koornneef, M., Blankestijn-de-Vries, H., Hanhart, C., Soppe, W., and Peeters, T. (1994). The phenotype of some late-flowering mutants is enhanced by a locus on chromosome 5 that is not effective in the Landsberg erecta wild-type. *Plant J.*: 911-9.

Krapp, A.R., Tognetti, V.B., Carrillo, N., and Acevedo, A. (1997). The role of ferredoxin-NADP+ reductase in the concerted cell defense against oxidative damage - studies using *Escherichia coli* mutants and cloned plant genes. *Eur J Biochem* 249: 556-63.

Kurek, I., Dulberger, R., Azem, A., Tzvi, B.B., Sudhakar, D., Christou, P., and Breiman, A. (2002). Deletion of the C-terminal 138 amino acids of the wheat FKBP73 abrogates calmodulin binding, dimerization and male fertility in transgenic rice. *Plant Mol Biol* 48: 369-81.

Lang, A. (1965). Physiology of flower initiation. In *Encyclopedia of Plant Physiology*, vol. XV/1, Ed. A. Lang, Berlin: Springer-Verlag, pp. 1380-536.

Lantin, S., O'Brien, M., and Matton, D.P. (1999). Fertilization and wounding of the style induce the expression of a highly conserved plant gene homologous to a *Plasmodium falciparum* surface antigen in the wild potato *Solanum chacoense* Bitt. *Plant Mol Biol* 41: 115-24.

Laurie, D.A., Pratchett, N., Bezant, J.H., and Snape, J.W. (1995). RFLP mapping of five major genes and eight quantitative trait loci controlling flowering time in a winter x spring barley *Hordeum vulgare* (L.) cross. *Genome* 38: 575-85.

Law, C.N., Suarez, E., Miller, T.E., and Worland, A.J. (1998). The influence of the group 1 chromosomes of wheat on ear-emergence times and their involvement with vernalization and day length. *Heredity*: 80: 83-91.

Law, C.N., and Worland, A.J. (1997). Genetic analysis of some flowering time and adaptive traits in wheat. *New Phytol* 137: 19-28.

Law, C.N., Dean, C., and Coupland, G. (1993). Genes controlling flowering and strategies for their isolation and characterization. In BR Jordan, ed, *The Molecular Biology of Flowering*, CAB International, Oxford, pp 47-68.

- Law, C.N., Worland, A.J., and Giorgi, B. (1976). The genetic control of ear-emergence time by chromosomes 5A and 5D of wheat. *Heredity* 36: 49-58.
- Law, C.N., and Wolfe, M.S. (1966). Location of genetic factors for mildew resistance and ear emergence time on chromosome 7B of wheat. *Ed.* 8, pp 462-72.
- Lee, B., Henderson, D.A., and Zhu, J-K. (2005) . The *Arabidopsis* cold-responsive transcriptome and its regulation by ICE1. *Plant Cell* 17: 3155-75.
- Laurie, D.A. (1997). Comparative genetics of flowering time. *Plant Mol. Biol.* 35:167-77.
- Lee, I., Bleecker, A., and Amasino, R. (1993). Analysis of naturally occurring late flowering in *Arabidopsis thaliana*. *Mol. Gen. Genet.* 237: 171-6.
- Lee, J. H., Cho, Y. S., Yoon, H. S., Suh, M., Moon, J., Lee, I., Weigel, D., Yun, C. H., and Kim, J. K. (2005). Conservation and divergence of FCA function between *Arabidopsis* and rice. *Plant Mol.Biol.* 58: 823-38.
- Lee, H., Suh, S.S., Park, E., Cho, E., Ahn, J.H., Kim, S.G., Lee, J.S., Kwon, Y.M., and Lee, I. (2000). The AGAMOUS-LIKE 20 MADS domain protein integrates floral inductive pathways in *Arabidopsis*. *Genes Dev.* 14: 2366-76.
- Lescot, M., Dehais, P., Thijs, G., Marchal, K., Moreau, Y., Van de Peer, Y., Rouze, P., and Rombauts, S. (2002). PlantCARE, a database of plant *cis*-acting regulatory elements and a portal to tools for *in silico* analysis of promoter sequences. *Nucl.Acids Res.* 30: 325-7.

Levy, Y.Y., Mesnage, S., Mylne, J.S., Gendall, A.R., and Dean, C. (2002). Multiple roles of *Arabidopsis* VRN1 in vernalization and flowering time control. *Science* 297: 243-6.

Levy, Y. Y., and Dean, C. (1998). Control of flowering time. *Curr.Opin.Plant Biol.* 1: 49-54.

Limin, A.E., and Fowler, D.B. (2002). Developmental traits affecting low-temperature tolerance response in near-isogenic lines for the Vernalization locus Vrn-A1 in wheat (*Triticum aestivum* L. em Thell). *Ann Bot (Lond)* 89: 579-85.

Li, R., Sosa, J.L., and Zavala, M.E. (2000). Accumulation of zeatin O-glycosyltransferase in *Phaseolus vulgaris* and *Zea mays* following cold stress. *Plant Mol Biol* 32: 295-305.

Li, R., Rimmer, R., Yu, M., Sharpe, A.G., Swartz, G., Lydiate, D., and Hegedus, D.D. (2003). Two *Brassica napus* polygalacturonase inhibitory protein genes are expressed at different levels in response to biotic and abiotic stresses. *Planta* 217: 299-308.

Li, S., Armstrong, C.M., Bertin, N., Ge, H., Milstein, S., Boxem M, Vidalain PO., Han, JD., Chesneau, A., Hao, T., Goldberg, D.S., Li, N., Martinez, M., Rual, J.F., Lamesch, P., Xu, L., Tewari., M., Wong, S.L., Zhang, L.V., Berriz, G.F., Jacotot, L., Vaglio, P., Reboul, J., Hirozane-Kishikawa, T., Li, Q., Gabel, H.W., Elewa, A., Baumgartner, B., Rose, DJ., Yu, H., Bosak, S., Sequerra, R., Fraser, A., Mango, S.E., Saxton, W.M., Strome, S., Van Den Heuvel, S., Piano, F., Vandenhaute, J., Sardet., C., Gerstein, M., Doucette-Stamm, L., Gunsalus, K,C., Harper, J.W., Cusick, M.E., Roth, F.P., Hill D.E., and Vidal, M. (2004). A map of the interactome network of the metazoan *C. elegans*. *Science* 303: 540-3.

Liu, H-T., Li, B., Shang, Z-L., Li, X-Z., Mu, R-L., Sun, D-Y., and Zhou, R-G. (2003). Calmodulin is involved in heat shock signal transduction in wheat. *Plant Physiol.* 132: 1186-95.

Lunn, J.E., Ashton, A.R., Hatch, M.D., and Heldt, H.W. (2000). Purification, molecular cloning, and sequence analysis of sucrose-6F-phosphate phosphohydrolase from plants. *Proc Natl Acad Sci U S A* 97: 12914-9.

Mahajan, S., and Tuteja, N. (2005). Cold, salinity and drought stresses: An overview. *Archives of Biochemistry and Biophysics* 444: 139-58.

Mahfoozi S, Limin AE, Fowler DB (2001a) Developmental Regulation of Low-temperature Tolerance in Winter Wheat. *Annals of Botany* 87: 751-7.

Mahfoozi S, Limin AE, Fowler DB (2001b) Influence of Vernalization and Photoperiod Responses on Cold Hardiness in Winter Cereals. *Crop Sci* 41: 1006-11.

Mandel, M.A., and Yanofsky, M.F. (1995) The *Arabidopsis* AGL8 MADS box gene is expressed in inflorescence meristems and is negatively regulated by APETALA1. *Plant Cell* 7: 1763-71.

Mao, L., Begum, D., Chuang, H.W., Budiman, M.A., Szymkowiak, E.J., Irish, E.E., and Wing, R.A. (2000). JOINTLESS is a MADS-box gene controlling tomato flower abscission zone development. *Nature* 406: 910-3.

Martinez-Castilla, L.P., and Alvarez-Buylla, E.R. (2003). Adaptive evolution in the *Arabidopsis* MADS-box gene family inferred from its complete resolved phylogeny. *Proc. Natl. Acad. Sci.* 100: 13407-12.

Masiero, S., Li, M. A., Will, I., Hartmann, U., Saedler, H., Huijser, P., Schwarz-Sommer, Z., and Sommer, H. (2004) *INCOMPOSITA*: a MADS-box gene controlling prophyll development and floral meristem identity in *Antirrhinum*. *Development* 131: 5981-90.

Maystrenko, O. I. (1980). Cytogenetic study of the growth habit and ear-emergence time in wheat (*Triticum aestivum* L.). 1, 267-82. Moscow, In: Well-Being of mankind and genetics. Proc 14th Int Congress of Genetics.

McIntosh, R.A., Devos, K.M., Dubcovsky, J., Morris, C.F., and Rogers, W.J. (2003). Catalogue of gene symbols for wheat: 2003 Supplement.

McGonigle, B., Bouhidel, K., and Irish, V.F. (1996). Nuclear localization of the *Arabidopsis* APETALA3 and PISTILLATA homeotic gene products depends on their simultaneous expression. *Genes Dev* 10: 1812-21.

Melan, M.A., Dong, X., Endara, M.E., Davis, K.R., Ausubel, F.M., and Peterman, T.K. (1993). An *Arabidopsis thaliana* lipoxygenase gene can be induced by pathogens, abscisic acid, and methyl jasmonate. *Plant Physiol.* 101: 441-50.

Meskiene, I., Bogre, L., Glaser, W., Balog, J., Brandstotter, M., Zwerger, K., Ammerer, G., and Hirt, H (1998). MP2C, a plant protein phosphatase 2C, functions as a negative regulator of mitogen-activated protein kinase pathways in yeast and plants. *Proc Natl Acad Sci USA* 95: 1938-43.

Messenguy, F., and Dubois, E. (2003). Role of MADS box proteins and their cofactors in combinatorial control of gene expression and cell development. *Gene* 316: 1-21.

Michaels, S. D., He, Y., Scortecci, K. C., and Amasino, R. M. (2003). Attenuation of *FLOWERING LOCUS C* activity as a mechanism for the evolution of summer-annual flowering behavior in *Arabidopsis*. *Proc Natl Acad Sci U S A* 100: 10102-7.

Michaels, S.D., and Amasino, R.M. (2001). Loss of flowering locus *C* activity eliminates the late-flowering phenotype of *frigida* and autonomous pathway mutation but not responsiveness to vernalization. *Plant Cell* 13: 935-41.

Michaels, S.D., and Amasino, R.M. (2000). Memories of winter: Vernalization and the competence to flower. *Plant Cell Environ.* 23: 1145-53.

Michaels, S.D., and Amasino, R.M. (1999). *FLOWERING LOCUS C* encodes a novel MADS domain protein that acts as a repressor of flowering. *Plant Cell*: 949-56.

Michiels, A., Van Laere, A., Van den Ende, W., Tucker, M. (2004). Expression analysis of a chicory fructan 1-exohydrolase gene reveals complex regulation by cold. *J. Exp. Bot.* 55: 1325-33.

Mir, G., Domenech, J., Huguet, G., Guo, W-J., Goldsbrough, P., Atrian, S., Molinas, M. (2004). A plant type 2 metallothionein (MT) from cork tissue responds to oxidative stress. *J. Exp. Bot.* 55: 2483-93.

Miura, H., and Worland, A.J. (1994). Genetic control of vernalization, day-length response and earliness *per se* by homoeologous group-3 chromosomes in wheat. *Plant Breeding* 113: 160-9.

Mouradov, A., Cremer, F., and Coupland, G. (2002). Control of flowering time: interacting pathways as a basis for diversity. *Plant Cell* 14 Suppl: S111-30.

Moon, Y. H., Kang, H. G., Jung, J. Y., Jeon, J. S., Sung, S. K., and An, G. (1999). Determination of the motif responsible for interaction between the rice APETALA1/AGAMOUS-LIKE9 family proteins using a yeast two-hybrid system. *Plant Physiol* 120: 1193-204.

Murai, K., Miyamae, M., Kato, H., Takumi, S., and Ogihara, Y. (2003). WAP1, a wheat APETALA1 homolog, plays a central role in the phase transition from vegetative to reproductive growth. *Plant Cell Physiol*. 44:1255-65.

Murai, K., Murai, R., and Ogihara, Y. (1998). Wheat MADS box genes, a multigene family dispersed throughout the genome. *Genes Genet. Syst.* 72: 317-21.

Napp-Zinn, K. (1987). Vernalization. Environmental and genetic regulation. Manipulation of flowering. Éd. J.G. Atherton, Butterworth, London, pp 123-32.

Narusaka, Y., Narusaka, M., Seki, M., Umezawa, T., Ishida, J., Nakajima, M., Enju, A., and Shinozaki, K. (2004). Crosstalk in the responses to abiotic and biotic stresses in *Arabidopsis*: Analysis of gene expression in *cytochrome P450* gene superfamily by cDNA microarray. *Plant Mol Biol* 55: 327-42.

Nemoto, Y., Kisaka, M., Fuse, T., Yano, M., and Ogihara, Y. (2003). Characterization and functional analysis of three wheat genes with homology to the CONSTANS flowering time gene in transgenic rice. *Plant J.* 36:82-93.

Norman, C., Runswick, M., Pollock, R., and Treisman, R. (1988). Isolation and properties of cDNA clones encoding SRF, a transcription factor that binds to the c-fos serum response element. *Cell* 55: 989-1003.

- Nyporko, A.Y., Demchuk, O.N., and Blume, Y.B. (2003). Cold adaptation of plant microtubules: structural interpretation of primary sequence changes in a highly conserved region of [alpha]-tubulin. *Cell Biology International* 27: 241-3.
- Olsen, E.N., Perry, M., and Schulz, R.A. (1995). Regulation of muscle differentiation by the MEF2 family of MADS-box transcription factors. *Dev. Biol.* 172: 2-14.
- Onouchi, H., Igeno, M.I., Perilleux, C., Graves, K., and Coupland, G. (2000). Mutagenesis of plants overexpressing CONSTANS demonstrates novel interactions among *Arabidopsis* flowering-time genes. *Plant Cell* 12: 885-900.
- Parenicova, L., De Folter, S., Kieffer, M., Horner, D.S., Favalli, C., Busscher, J., Cook, H.E., Ingram, R.M., Kater, M.M., Davies, B., Angenent, G.C., and Colombo, L. (2003). Molecular and phylogenetic analyses of the complete MADS-box transcription factor family in *Arabidopsis*: new openings to the MADS world. *Plant Cell* 15: 1538-51.
- Park, D.H., Somers, D.E., Kim, Y.S., Choy, Y.H., Lim, H.K., Soh, M.S., Kim, H.J., Kay, S.A., and Nam, H.G. (1999). Control of circadian rhythms and photoperiodic flowering by the *Arabidopsis* GIGANTEA gene. *Science* 285: 1579-82.
- Pearce, R.S. (1999). Molecular analysis of acclimation to cold. *Plant Growth Regul.* 29: 47-76
- Pelaz, S., Ditta, G.S., Baumann, E., Wisman, E., and Yanofsky, M.F. (2001). B and C floral organ identity functions require *SEPALLATA* MADS-box genes. *Nature* 405: 200-203.

Petersen, K., Kolmos, E., Folling, M., Salchert, K., Storgaard, M., Jensen, C. S., Didion, T., and Nielsen, K. K., 2006: Two MADS-box genes from perennial ryegrass are regulated by vernalization and involved in the floral transition. *Physiol.Plant.* 126: 268-278.

Plaschke, J., Börner, A. Xie, D.X., Koebner, R.M.D., Schlegel, R., and Gale, M.D. (1993). RFLP mapping of genes affecting plant height and growth habit in rye. *Theor. Appl. Genet.* 85: 1049-54.

Pillai, M.A., and Akiyama, T. (2004). Differential expression of an S-adenosyl-L-methionine decarboxylase gene involved in polyamine biosynthesis under low temperature stress in *japonica* and *indica* rice genotypes. 271: 141-9.

Popova, J.S., Garrison, J.C., Rhee, S.G., and Rasenick, M.M. (1997). Tubulin, Gq, and phosphatidylinositol 4,5-bisphosphate interact to regulate phospholipase C β 1 signaling. *J Biol Chem* 272: 6760-5.

Pugsley, A.T. (1972). Additional genes inhibiting winter habit in wheat. *Euphytica* 21: 547-552

Purugganan, M. D., Rounsley, S. D., Schmidt, R. J., and Yanofsky, M. F., 1995: Molecular evolution of flower development: diversification of the plant MADS-box regulatory gene family. *Genetics* 140: 345-56.

Rabbani, M.A., Maruyama, K., Abe, H., Khan, M.A., Katsura, K., Ito, Y., Yoshiwara, K., Seki, M., Shinozaki, K., and Yamaguchi-Shinozaki, K. (2003). Monitoring Expression Profiles of Rice Genes under Cold, Drought, and High-Salinity Stresses and Abscisic Acid Application Using cDNA Microarray and RNA Gel-Blot Analyses. *Plant Physiol.* 133: 1755-67.

Rajeevan, M.S., and Lang, A. (1993). Flower-bud formation in explants of photoperiodic and day-neutral *Nicotiana* biotypes and its bearing on the regulation of flower formation. *Proc Natl Acad Sci U S A* 90: 4636-40.

Rain, J.C., Selig, L., De Reuse, H., Battaglia, V., Reverdy, C., Simon, S., Lenzen, G., Petel, F., Wojcik, J., Schachter, V., Chemama, Y., Labigne, A., Legrain, P. (2001). The protein-protein interaction map of *Helicobacter pylori*. *Nature* 409: 211-5.

Ratcliffe, O.J., Nadzan, G.C., Reuber, T.L., and Riechmann, J.L. (2001). Regulation of flowering in *Arabidopsis* by an FLC homologue. *Plant Physiol.* 126:122-32.

Razem, F.A., El-Kereamy, A., Abrams, S.R., and Hill, R.D. (2006). The RNA-binding protein FCA is an abscisic acid receptor. *Nature* 439: 290-4.

Reed, J.W., Nagpal, P., Poole, D.S., Furuya, M., and Chory, J. (1993). Mutations in the gene for the red/far-red light receptor phytochrome B alter cell elongation and physiological response throughout *Arabidopsis* development. *Plant Cell* 5: 147-57.

Reeves, P. H. and Coupland, G. (2000). Response of plant development to environment: control of flowering by daylength and temperature. *Curr Opin. Plant Biol.* 3: 37-42.

Rhee, S.G. (2001). Regulation of phosphoinositide-specific phospholipase C. *Annu Rev Biochem* 70: 281-312.

Richards, K.D., Snowden, K.C., and Gardner, R.C. (1994). *wali6* and *wali7* - Genes Induced by Aluminum in Wheat (*Triticum aestivum* L.). *Plant Physiol.* 105: 1455-6.

Riechmann, J.L., Heard, J., Martin, G., Reuber, L., Jiang, C., Keddie, J., Adam, L., Pineda, O., Ratcliffe, O.J., Samaha, R.R., Creelman, R., Pilgrim, M., Broun, P., Zhang, J.Z., Ghandehari, D., Sherman, B.K., and Yu, G. (2000). *Arabidopsis* transcription factors: genome-wide comparative analysis among eukaryotes. *Science* 290: 2105-10.

Riechmann, J. L., Krizek, B. A., and Meyerowitz, E. M. (1996). Dimerization specificity of *Arabidopsis* MADS domain homeotic proteins APETALA1, APETALA3, PISTILLATA, and AGAMOUS. *Proc.Natl.Acad.Sci.USA* 93: 4793-8.

Roberts, D.W.A. (1990). Identification of loci on chromosome 5A of wheat involved in control of cold hardiness, vernalization, leaf length, rosette growth habit, and height of hardened plants. *Genome* 33: 247-59.

Romano, P., Gray, J., Horton, P., and Luan, S. (2005). Plant immunophilins: functional versatility beyond protein maturation. *New Phytologist* 166: 753-69.

Romano, P.G.N., Horton, P., and Gray, J.E. (2004). The *Arabidopsis* Cyclophilin Gene Family. *Plant Physiol.* 134: 1268-82.

Rual, J.F., Venkatesan, K., Hao T., Hirozane-Kishikawa, T., Dricot, A., Li N., Berriz, G.F., Gibbons, F.D., Dreze, M., Ayivi-Guedehoussou, N., Klitgord, N., Simon, C., Boxem, M., Milstein, S., Rosenberg, J., Goldberg, D.S., Zhang, L.V., Wong, S.L., Franklin, G., Li, S., Albala, J.S., Lim, J., Fraughton, C., Llamasas, E., Cevik, S., Bex, C., Lamesch, P., Sikorski, R.S., Vandenhaute, J., Zoghbi, H.Y., Smolyar, A., Bosak, S., Sequerra, R., Doucette-Stamm, L., Cusick, M.E., Hill, D.E., Roth, F.P., and Vidal, M. (2005b). Towards a proteome-scale map of the human protein-protein interaction network. *Nature* 437: 1173-8.

Samach, A., Onouchi, H., Gold, S.E., Ditta, G.S., Schwarz-Sommer, Z., Yanofsky, M.F., and Coupland, G. (2000). Distinct roles of CONSTANS target genes in reproductive development of *Arabidopsis*. *Science* 288: 1613-6.

Schomburg, F.M., Patton, D.A., Meinke, D.W., and Amasino, R.M. (2001). FPA, a gene involved in floral induction in *Arabidopsis*, encodes a protein containing RNA-recognition motifs. *Plant Cell* 6:1427-36.

Scortecci, K.C., Michaels, S.D., and Amasino, R.M. (2001). Identification of a MADS-box gene, FLOWERING LOCUS M, that represses flowering. *Plant J.* 26: 229-36.

Searle, I., and Coupland, G. (2004). Induction of flowering by seasonal changes in photoperiod. *EMBO J.* 23: 1217-22.

Searle, I., He, Y., Turck, F., Vincent, C., Fornara, F., Krober, S., Amasino, R.A., and Coupland, G. (2006). The transcription factor FLC confers a flowering response to vernalization by repressing meristem competence and systemic signaling in *Arabidopsis*. *Genes Dev.* 20: 898-912.

Sentoku, N., Kato, H., Kitano, H., and Imai, R. (2005). *OsMADS22*, an *StMADS11*-like MADS-box gene of rice, is expressed in non-vegetative tissues and its ectopic expression induces spikelet meristem indeterminacy. *Mol.Genet.Genomics* 273: 1-9.

Serrano, M., Parra, S., Alcaraz, L. D., and Guzman, P. (2006). The *ATL* gene family from *Arabidopsis thaliana* and *Oryza sativa* comprises a large number of putative ubiquitin ligases of the RING-H2 type. *J.Mol.Evol.* 62: 434-45.

Sharma, A., Isogai, M., Yamamoto, T., Sakaguchi, K., Hashimoto, J., and Komatsu, S. (2004). A novel interaction between calreticulin and ubiquitin-like nuclear protein in rice. *Plant Cell Physiol.* 45: 684-92.

Sheldon, C.C., Finnegan, E.J., Rouse, D.T., Tadege, M., Bagnall, D.J., Helliwell, C.A., Peacock, W.J., and Dennis, E.S. (2000a). The control of flowering by vernalisation. *Curr. Opin. Plant Biol.* 3: 418-22.

Sheldon, C.C., Rouse, D.T., Finnegan, E.J., Peacock, W.J., and Dennis, E.S. (2000b). The molecular basis of vernalization: The central role of *Flowering Locus C (FLC)*. *Proc. Natl. Acad. Sci.* 97: 3753-8.

Shindo C, Tsujimoto H, and Sasakuma T (2003) Segregation analysis of heading traits in hexaploid wheat utilizing recombinant inbred lines. *Heredity* 90: 56-63.

Shindo, C., and Sasakuma, T. (2002). Genes responding to vernalization in hexaploid wheat. *Theor. Appl. Genet.* 104: 1003-10.

Shindo C, Sasakuma T, Watanabe N, and Noda K (2002) Two-gene systems of vernalization requirement and narrow-sense earliness in einkorn wheat. *Genome* 45: 563-9.

Shore, P., and Sharrocks, A.D. (1995). The MADS-box family of transcription factors. *Eur. J. Biochem.* 229: 1-13.

Simpson, G.G., and Dean, C. (2002). *Arabidopsis*, the Rosetta stone of flowering time? *Science* 296: 285-9.

Simpson, G.G., Gendall, A.R., and Dean, C. (1999). When to switch to flowering. *Annu Rev Cell Dev Biol* 15: 519-50.

Snape, J.W., Butterworth, K., Whitechurch, E., and Worland, A.J. (2001). Waiting for fine times: genetics of flowering time in wheat. *Euphytica* 119: 185-90.

Snape, J.W., Law, C.N., Parker, B.B., and Worland, A.J. (1985). Genetical analysis of chromosome 5A of wheat and its influence on important agronomic characters. *Theor. Appl. Genet.* 71: 518-26.

Somers, D.E., Delvin, P.F., and Kay, S.A. (1998). Phytochromes and cryptochromes in the entrainment of *Arabidopsis* circadian clock. *Science* 282: 1488-94.

Sommer, H., Beltran, J.P., Huijser, P., Pape, H., Lonig, W.E., Saedler, H., and Schwarz-Sommer, Z. (1990). Deficiens, a homeotic gene involved in the control of flower morphogenesis in *Antirrhinum majus*: the protein shows homology to transcription factors. *EMBO J.* 9: 605-13.

Sourdille, P., Snape, J.W., Cadalen, T., Charmet, G., Nakata, N., Bernard, S., and Bernard, M. (2000). Detection of QTLs for heading time and photoperiod response in wheat using a doubled-haploid population. *Genome* 43: 487-94.

Spit, A., Hyland, R.H., Mellor, E.J.C., and Casselton, L.A. (1998). A role for heterodimerization in nuclear localization of a homeodomain protein. *Proc Natl Acad Sci U S A* 95: 6228-33.

Stelmakh, A.F. (1993). Genetic effect of *Vrn* genes on heading date and agronomic traits in bread wheat. *Euphytica* 65: 53-60.

Stelzl, U., Worm, U., Lalowski, M., Haenig, C., Brembeck, F.H., Goehler, H., Stroedicke, M., Zenkner, M., Schoenherr, A., Koeppen, S., Timm, J., Mintzlaff, S., Abraham, C., Bock, N., Kietzmann, S., Goedde, A., Toksoz, E., Droege, A., Krobitsch, S., Korn, B., Birchmeier, W., Lehrach, H., and Wanker, E.E. (2005a). A human protein-protein interaction network: a resource for annotating the proteome. *Cell* 122: 957-68.

Sung, S., and Amasino, R.M. (2004). Vernalization in *Arabidopsis thaliana* is mediated by the PHD finger protein VIN3. *Nature* 427:159-64.

Sun, T.P., and Gubler, F. (2004). Molecular mechanism of gibberellin signaling in plants. *Annu. Rev. Plant. Biol.* 55:197-223.

Sutka, J., and Snape, J.W. (1989). Location of a gene for frost resistance on chromosome 5A of wheat. *Euphytica* 42: 41-2.

Szucs, P., Karsai, I., von Zitzewitz, J., Meszaros, K., Cooper, L. L., Gu, Y. Q., Chen, T. H., Hayes, P. M., and Skinner, J. S. (2006). Positional relationships between photoperiod response QTL and photoreceptor and vernalization genes in barley. *Theor. Appl. Genet.* 112: 1277-85.

Takada, S., and Goto, K. (2003). Terminal flower 2, an *Arabidopsis* homolog of heterochromatin protein1, counteracts the activation of flowering locus T by constans in the vascular tissues of leaves to regulate flowering time. *Plant Cell* 15:2856-65.

Tardif, G., Kane, N. A., Adam, H., Labrie, L., Major, G., Gulick, P., Sarhan, F., and Laliberte, J. F. (2007). Interaction network of proteins associated with abiotic stress response and development in wheat. *Plant Mol. Biol.* 63 (5) : 703-18.

Teper-Bamnolker, P., and Samach, A. (2005). The flowering integrator FT regulates SEPALLATA3 and FRUITFULL accumulation in *Arabidopsis* leaves. *Plant Cell* 17:2661-75.

Theissen, G. (2001). Development of floral organ identity: stories from the MADS house. *Curr. Opin Plant Biol.* 4: 75-85.

Thomashow, M.F. (1999). Role of cold-responsive genes in plant freezing tolerance. *Plant Physiol.* 118: 1-8.

Tranquilli, G., and Dubcovsky, J. (2000). Epistatic interaction between vernalization genes Vrn-Am1 and Vrn-Am2 in diploid wheat. *J Hered* 91: 304-6.

Tremblay, K., Ouellet, F., Fournier, J., Danyluk, J., and Sarhan, F. (2005). Molecular characterization and origin of novel bipartite cold-regulated ice recrystallization inhibition proteins from cereals. *Plant Cell Physiol.* 46: 884-91.

Tsuda, K., Tsvetanov, S., Takumi, S., Mori, N., Atanassov, A., and Nakamura, C. (2000). New members of a cold-responsive group-3 Lea/Rab-related Cor gene family from common wheat (*Triticum aestivum* L.). *Genes Genet Syst* 75: 179-88.

Uetz, P., Giot, L., Cagney, G., Mansfield, T.A., Judson, R.S., Knight, J.R., Lockshon, D., Narayan, V., Srinivasan, M., Pochart, P., Qureshi-Emili, A., Li, Y., Godwin, B., Conover, D., Kalbfleisch, T., Vijayadamodar, G., Yang, M., Johnston, M., Fields, S., and Rothberg, J.M (2000). A comprehensive analysis of protein-protein interactions in *Saccharomyces cerevisiae*. *Nature* 403: 623-7.

Valverde, F., Mouradov, A., Soppe, W., Ravenscroft, D., Samach, A., and Coupland, G. (2004). Photoreceptor Regulation of CONSTANS Protein in Photoperiodic Flowering. *Science* 303: 1003.

Vergnolle, C., Vaultier, M-N., Taconnat, L., Renou, J-P., Kader, J-C., Zachowski, A., and Ruelland, E. (2005). The cold-induced early activation of phospholipase C and D pathways determines the response of two distinct clusters of genes in *Arabidopsis* cell suspensions. *Plant Physiol.* 139:1217-33.

Verzi, M.P., Agarwal, P., Brown, C., McCulley, D.J., Schwarz, J.J., and Black, B.L. (2007). The transcription factor MEF2C is required for craniofacial development. *Dev Cell.* 4:645-52.

Vidalain, P-O., Boxem, M., Ge, H., Li, S., and Vidal, M. (2004). Increasing specificity in highthroughput yeast two-hybrid experiments. *Methods* 32:363-70.

Voinnet, O., Rivas, S., Mestre, P., and Baulcombe, D. (2003). An enhanced transient expression system in plants based on suppression of gene silencing by the p19 protein of tomato bushy stunt virus. *Plant J* 33: 949-56.

Vrebalov, J., Ruezinsky, D., Padmanabhan, V., White, R., Medrano, D., Drake, R., Schuch, W., and Giovannoni, J. (2002). A MADS-box gene necessary for fruit ripening at the tomato ripening-inhibitor (*rin*) locus. *Science* 296: 343-6.

Walter, M., Chaban, C., Schutze, K., Batistic, O., Weckermann, K., Nake, C., Blazevic, D., Grefen, C., Schumacher, K., Oecking, C., Harter, K., and Kudla, J. (2004). Visualization of protein interactions in living plant cells using bimolecular fluorescence complementation. *Plant J* 40: 428-38.

Weigel, D., Alvarez, J., Smyth, D.R., Yanofsky, M.F., and Meyerowitz, E.M. (1992). LEAFY controls floral meristem identity in *Arabidopsis*. *Cell* 69: 843-59.

Wigge, P.A., Kim, M.C., Jaeger, K.E., Busch, W., Schmid, M., Lohmann, J.U., and Weigel, D. (2005). Integration of spatial and temporal information during floral induction in *Arabidopsis*. *Science* 309:1056-9.

Worland, A.J., Gale, M.D., and Law, C.N. (1987). Wheat genetics. In F.G.H. Lupton, ed. *Wheat breeding*, p. 135. London, Chapman and Hall.

Wu, G., Robertson, A.J., Liu, X., Zheng, P., Wilen, R.W., Nesbitt, N.T., and Gusta, L.V. (2004). A lipid transfer protein gene BG-14 is differentially regulated by abiotic stress, ABA, anisomycin, and sphingosine in bromegrass (*Bromus inermis*). *J Plant Physiol* 161: 449-58.

Wuchty, S., Oltvai, Z.N., and Barabasi, A.L. (2003). Evolutionary conservation of motif constituents in the yeast protein interaction network. *Nat Genet* 35: 176-9.

Xin, Z., and Browse, J. (2000). Cold comfort farm: the acclimation of plants to freezing temperatures. *Plant Cell Environ.* 23: 893-902.

Xu, J., Gong, N.L., Bodi, I., Aronow, B.J., Backx, P.H., and Molkenin, J.D. (2006). Myocyte enhancer factors 2A and 2C induce dilated cardiomyopathy in transgenic mice. *J Biol Chem.* 281(14):9152-62.

Xu, Q., Fu, H-H., Gupta, R., and Luan, S. (1998). Molecular characterization of a tyrosine-specific protein phosphatase encoded by a stress-responsive gene in *Arabidopsis*. *Plant Cell* 10: 849-58.

Xu, R., and Quinn, L.Q. (2003). A RING-H2 zinc-finger protein gene *RIE1* is essential for seed development in *Arabidopsis*. *Plant Mol Biol* 53: 37-50.

Xue, G-P. (2003). The DNA-binding activity of an AP2 transcriptional activator HvCBF2 involved in regulation of low-temperature responsive genes in barley is modulated by temperature. *Plant J.* 33: 373-83.

Yamaguchi, T., Nakayama, K., Hayashi, T., Yazaki, J., Kishimoto, N., Kikuchi, S., Koike, S. (2004). cDNA microarray analysis of rice anther genes under chilling stress at the microsporogenesis stage revealed two genes with DNA transposon Castaway in the 5'-flanking region. *Biosci Biotechnol Biochem* 68: 1315-23.

Yan, L., Helguera, M., Kato, K., Fukuyama, S., Sherman, J., and Dubcovsky, J. (2004a) Allelic variation at the *VRN-1* promoter region in polyploid wheat. *Theor. Appl. Genet.*, 109, 1677-1686.

Yan, L., Loukoianov, A., Blechl, A., Tranquilli, G., Ramakrishna, W., SanMiguel, P., Bennetzen, J.L., Echenique, V., and Dubcovsky, J. (2004b) The wheat *VRN2* gene is a flowering repressor down-regulated by vernalization. *Science*, 303, 1640-1644.

Yan, L., Loukoianov, A., Tranquilli, G., Helguera, M., Fahima, T., and Dubcovsky, J. (2003) Positional cloning of the wheat vernalization gene *VRN1*. *Proc. Natl. Acad. Sci. USA*, 100, 6263-6268.

Yano, M., Katayose, Y., Ashikari, M., Yamanouchi, U., Monna, L., Fuse, T., Baba, T., Yamamoto, K., Umehara, Y., Nagamura, Y., and Sasaki, T. (2000). *Hdl*, a major photoperiod sensitivity quantitative trait locus in rice, is closely related to the *Arabidopsis* flowering time gene *CONSTANS*. *Plant Cell* 12: 2473-84.

Yanofsky, M.F., Ma, H., Bowman, J.L., Drews, G.N., Feldmann, K.A., and Meyerowitz, E.M. (1990). The protein encoded by the *Arabidopsis* homeotic gene *agamous* resembles transcription factors. *Nature* 346:35-9.

Yeger-Lotem, E., Sattath, S., Kashtan, N., Itzkovitz, S., Milo, R., Pinter, R.Y., Alon, U., and Margalit, H. (2004). Network motifs in integrated cellular networks of transcription-regulation and protein-protein interaction. *Proc Natl Acad Sci U S A* 101: 5934-39.

Yoo, S.K., Chung, K.S., Kim, J., Lee, J.H., Hong, S.M., Yoo, S.J., Yoo, S.Y., Lee, J.S., and Ahn, J.H. (2005). *CONSTANS* activates *SUPPRESSOR OF OVEREXPRESSION OF CONSTANS 1* through *FLOWERING LOCUS T* to promote flowering in *Arabidopsis*. *Plant Physiol.* 139:770-8.

Yoshimura, K., Miyao, K., Gaber, A., Takeda, T., Kanaboshi, H., Miyasaka, H., Shigeoka, S. (2004). Enhancement of stress tolerance in transgenic tobacco plants overexpressing *Chlamydomonas* glutathione peroxidase in chloroplasts or cytosol. *Plant J.* 37: 21-33.

Yu, H., Ito, T., Wellmer, F., and Meyerowitz, E. M. (2004). Repression of *AGAMOUS-LIKE 24* is a crucial step in promoting flower development. *Nat.Genet.* 36: 157-61.

Zhang, H., and Forde, B.G. (1998). An *Arabidopsis* MADS box gene that controls nutrient-induced changes in root architecture. *Science* 27: 407-9.