

WESTERN LEDGE REEF WRECK: THE ANALYSIS AND RECONSTRUCTION OF
THE LATE 16TH-CENTURY SHIP OF THE SPANISH EMPIRE

A Dissertation

by

PIOTR TADEUSZ BOJAKOWSKI

Submitted to the Office of Graduate Studies of
Texas A&M University
in partial fulfillment of the requirements for the degree of

DOCTOR OF PHILOSOPHY

May 2012

Major Subject: Anthropology

WESTERN LEDGE REEF WRECK: THE ANALYSIS AND RECONSTRUCTION OF
THE LATE 16TH-CENTURY SHIP OF THE SPANISH EMPIRE

A Dissertation

by

PIOTR TADEUSZ BOJAKOWSKI

Submitted to the Office of Graduate Studies of
Texas A&M University
in partial fulfillment of the requirements for the degree of

DOCTOR OF PHILOSOPHY

Approved by:

Chair of Committee,	Donny Hamilton
Committee Members,	Kevin Crisman
	Wayne Smith
	David Woodcock
Head of Department,	Cynthia Werner

May 2012

Major Subject: Anthropology

ABSTRACT

Western Ledge Reef Wreck: the Analysis and Reconstruction of the late 16th-century
Ship of the Spanish Empire.

(May 2012)

Piotr Tadeusz Bojakowski, B.A., University of Nevada, Reno

Chair of Advisory Committee: Dr. Donny L. Hamilton

The Western Ledge Reef Wreck, discovered and later excavated in Bermuda between 1989 and 1991, is a prime example of Iberian shipbuilding within a broader Atlantic context. Operating during the late 16th-century, arguably one of the most fascinating periods of Spanish maritime history, the ship epitomizes the culture and technology identified with the celebrated fleets of the *Carrera de Indias*. By combining the new and previously unavailable data with that of the original reports, this dissertation outlines the structural details of this small utilitarian vessel which plowed the Atlantic Ocean between Spain and the Spanish America. Regarded as one of the better preserved Iberian shipwrecks in the New World, the hull timbers were disassembled and raised to the surface for detailed recording and analysis; the most comprehensive being the study and reconstruction presented in this dissertation. This data not only illustrates the transition from late medieval ship construction founded on the unempirical and intuitive style of local shipwrights to that of the geometrically- and scientific-rooted Renaissance design philosophy, but also to a frame-led assembly sequence. The hull remains and

associated cultural material excavated from the site prove to be an important 16th- and 17th-century collection of Spanish and New World origin, which collectively reinforce the notion that the Western Ledge Reef Wreck was on its homebound course when it sunk among treacherous Bermuda reefs sometime between 1560 and 1600.

DEDICATION

To my late grandpa for giving me the inspiration to pursue the dreams; to my parents for providing the opportunities; to my wife, Katie, for making sure I endure.

ACKNOWLEDGEMENTS

This dissertation would never be possible without the guidance and support of numerous people and organizations. First, I would like to thank my wife, Katie, who learned about the Western Ledge Reef Wreck while working in Bermuda in 2006. She not only suggested this project to me as a dissertation topic, but also provided much-needed assistance in collecting the data. Her help, hard work, and continuous encouragement made all the difference. Together with our two amazing children, Zofia and Michał, Katie has been the guardian of my sanity during the long process of writing this manuscript.

Second, I would like to express my sincere gratitude to all of the members of my doctoral committee: Donny Hamilton (chair), Kevin Crisman, Wayne Smith, and David Woodcock. They have given me their time, expertise and unfailing support. Without these professors and the classes I took from them at Texas A&M University, I would not be capable of conducting this or any other research. They opened my eyes to tremendous opportunities and ideas in archaeology, conservation, and preservation of our maritime heritage. Today, I am proud to say that Donny Hamilton, the most humble, kind and pragmatic person I know, has been my mentor and greatest supporter throughout the graduate career. Thank you for taking me under your wings Donny!

A special acknowledgement must be given to Gordon Watts who excavated the Western Ledge Reef Wreck (1989-1991) and granted me the permission to conduct the final analysis and reconstruction of this shipwreck. I want to express my appreciation to

the National Museum of Bermuda (NMB), its executive director (Edward Harris), and staff (Elena Strong, Jane Downing, and Andrew Harris) for giving me the permission for this research and unlimited access to the shipwreck material, documentation, and artifacts. The NMB generously provided me with free accommodation, equipment, office space, and logistical support while working in Bermuda.

I want to thank Fred Hocker who was involved in the project from the start and took time to discuss the excavation process and shipwreck structure with me. He shared his enthusiasm to finish this important project. Fred's extensive comments greatly improved this work. I also want to thank all the friends from various parts of the world who have helped me throughout all these years.

This dissertation was generously funded by the Institute of Nautical Archaeology (INA), Center for Maritime Archaeology and Conservation (CMAC), Texas A&M University, George Bush Presidential Library Foundation, and Association for Preservation Technology (APT). Thanks to the scholarships, grants, and awards from these institutions, I was able to continue the research and writing.

I wish my late grandpa, Tadeusz, could be with me today. When he was just 13 years old, WWII broke out in Poland and wreaked havoc on many of his dreams. His formal education was over. After the war, he could not go back to school as he had to rebuild his life and work to provide for the family. He loved to read, especially historical literature, and most of what I learned in my childhood about history I learned from him. He always presented me with the true history and not the communist version of the nonsense they taught us at school. He was the force behind persuading my parents to

allow me to pursue my dreams, even those most irrational. I know he has been watching after me providing the strength when I needed it the most. He must be so proud!

Finally, there are no words to describe the gratitude and love I have for my parents, Michał and Elżbieta. They gave me everything and bailed me out too many times to count...

TABLE OF CONTENTS

	Page
ABSTRACT.....	iii
DEDICATION.....	v
ACKNOWLEDGEMENTS.....	vi
TABLE OF CONTENTS.....	ix
LIST OF FIGURES.....	xii
LIST OF TABLES.....	xxi
CHAPTER	
I INTRODUCTION.....	1
1.1 Research Objectives and Parameters.....	1
1.2 Research Questions.....	3
1.3 Methodological Considerations.....	12
1.4 Conclusion.....	17
II LATE 16 th - EARLY 17 th -CENTURY SPAIN AND THE TRANSATLANTIC <i>CARRERA DE INDIAS</i>	20
2.1 The Spanish Empire under Philip II and Philip III.....	20
2.2 The Ships of the Spanish <i>Carrera de Indias</i>	26
2.3 The Routes to the New World.....	42
2.4 Bermuda: <i>Demonium Insula</i>	49
III HISTORY OF THE SITE, EXCAVATION, AND GEOGRAPHY OF BERMUDA.....	66
3.1 The “Malpas Wreck”.....	66
3.2 The Western Ledge Reef Wreck (IMHA-3).....	74
3.3 Excavation, Recovery, and Initial Analysis.....	81

CHAPTER	Page
3.4	Continuing Research on the Western Ledge Reef Wreck: 2007 to 2010..... 88
3.5	The Geography, Geology, and Climate of Bermuda..... 95
IV	DESCRIPTION AND ANALYSIS OF THE HULL STRUCTURE.. 103
4.1	Wood Analysis..... 105
4.2	Methodology of the Timber Catalog..... 109
4.3	The Geometry and Units of Measurements..... 113
4.4	The Ship Fasteners..... 116
4.5	The Principal Timbers: The Keel and Stern Assembly..... 132
4.6	The Framing..... 171
4.7	Garboards and Planking..... 206
4.8	The Internal Structure of the Ship..... 222
4.9	The Unidentified, Unassigned, or Miscellaneous Timbers..... 254
V	RECONSTRUCTION OF THE WESTERN LEDGE REEF WRECK HULL REMAINS..... 268
5.1	The Length of Keel..... 269
5.2	The Design of the Master Frame..... 281
5.3	The Maximum Breadth..... 295
5.4	The Height of the Main Deck..... 307
5.5	Modification of Frames Forward and Aft of the Master Frame..... 310
5.6	The Stern, Stem, and Maximum Length..... 322
5.7	The Tonnage..... 333
VI	ANALYSIS OF SELECTED ARTIFACTS FROM THE WESTERN LEDGE REEF WRECK..... 345
6.1	Introduction to the Artifact Analysis..... 345
6.2	Ceramic Artifacts..... 349
6.3	Faunal and Floral Artifacts..... 362
6.4	Metal Artifacts..... 372
6.5	Conclusion..... 375

CHAPTER		Page
VII	CONCLUSION	381
7.1	Did the Western Ledge Reef Wreck Sink During the Late 16 th -century?.....	382
7.2	Was the Western Ledge Reef Wreck Sailing Under the Spanish Flag?.....	385
7.3	Do the Western Ledge Reef Wreck Hull Remains Represent “Atlantic Vessel” (Iberian-Atlantic) Model?.....	387
7.4	Can the Design Method and Assembly Sequence of the Western Ledge Reef Wreck be Identified, and Correlated with the Shipbuilding Treatises of the Period?.....	392
7.5	Can the Western Ledge Reef Wreck be Positively Identified as a Specific Ship Type?.....	398
	WORKS CITED.....	405
	APPENDIX 1.....	430
	APPENDIX 2.....	432
	APPENDIX 3.....	435
	APPENDIX 4.....	437
	APPENDIX 5.....	455
	APPENDIX 6.....	458
	VITA.....	478

LIST OF FIGURES

	Page
Figure 2.1	European dominions inherited by Philip II (c. 1556)..... 21
Figure 2.2	Pie chart showing three major ship types: nao, <i>navío</i> , and galleon, by percentage, as registered in <i>Libros de Registro</i> between 1550 and 1600..... 30
Figure 2.3	Artistic representation of a nao at anchor..... 34
Figure 2.4	Example of the armed or naval <i>patache</i> (<i>pataxo de guerra</i>)..... 36
Figure 2.5	Example of a galleon from the map of China in the <i>Atlas</i> of Gerardus Mercator..... 39
Figure 2.6	Graph showing Spanish ships by type built in the Basque province of Gipuzkoa during the 16 th and 17 th centuries..... 40
Figure 2.7	Spanish sailing routes to and from New World..... 44
Figure 2.8	Spanish sailing within Caribbean Sea and Gulf of Mexico..... 46
Figure 2.9	Example of a biennial sailing schedule for the <i>Nueva España flota</i> from Spain to Veracruz..... 48
Figure 2.10	1511 map showing the island of Bermuda; <i>De Orbe Novo Décades Cum Legatione Babylonica</i> by Pedro Mártir de Anglería..... 51
Figure 2.11	The 16 th -century map of Azores..... 56
Figure 2.12	1603 map of Bermuda by Diego Ramierez..... 58
Figure 3.1	Location of the site..... 67
Figure 3.2	Selected artifacts from Malpas collection..... 69
Figure 3.3	One of the <i>versos</i> found near the Malpas Wreck..... 69
Figure 3.4	Cast iron cannon inscribed with the year 1577 and weight mark 500, found near the Malpas Wreck..... 70

	Page
Figure 3.5	Photograph of the salvage work carried out on the Malpas Wreck... 72
Figure 3.6	Photograph of the Malpas Wreck showing the full extent of the preserved hull..... 73
Figure 3.7	Site plan of the Western Ledge Reef Wreck site..... 76
Figure 3.8	Exposed hull remains of the Western Ledge Reef Wreck (IMHA-3) 80
Figure 3.9	The grid system used to record the Western Ledge Reef Wreck during the 1990 and 1991 ECU field seasons..... 84
Figure 3.10	Using the grid system to photograph the Western Ledge Reef Wreck during the 1990 and 1991 ECU field seasons..... 84
Figure 3.11	The dismantling of the Western Ledge Reef Wreck during the 1991 ECU field season..... 85
Figure 3.12	The raising of the Western Ledge Reef Wreck timbers during the 1991 ECU field season..... 85
Figure 3.13	Cleaning the timbers of the Western Ledge Reef Wreck timbers at the Bermuda Maritime Museum during the 1991 ECU field season. 87
Figure 3.14	Recording the timbers of the Western Ledge Reef Wreck timbers at the Bermuda Maritime Museum during the 1991 ECU field season.. 87
Figure 3.15	Piotr Bojakowski checking the measurements of the timbers in 2007 against the drawings produced in 1991..... 90
Figure 3.16	Piotr Bojakowski creating a 1:1-scale drawing of a timber to check for distortion and shrinkage against the drawings produced in 1991..... 90
Figure 3.17	One of the wet storage vats with shipwreck timbers at the NMB..... 93
Figure 3.18	The extent of the reefs surrounding Bermuda..... 98
Figure 4.1	Site plan showing three major sections of the site..... 104
Figure 4.2	Graph showing visual tree-ring count for selected timbers..... 107

	Page
Figure 4.3	View of the tree-rings along the bow face cut along the central section of the keel..... 108
Figure 4.4	Designations and locations of major structural timbers..... 111
Figure 4.5	Assortment of fasteners..... 122
Figure 4.6	Example of a clenched wrought iron spike from the Western Ledge Reef Wreck..... 126
Figure 4.7	Preserved section of a wrought iron bolt with clenched tip..... 128
Figure 4.8	Partly preserved forelock bolt..... 128
Figure 4.9	Overview of two types of caulking cuts..... 131
Figure 4.10	Example of a partly preserved treenail with a V-shaped caulking cut and caulking material..... 131
Figure 4.11	Overview of the preserved keel..... 133
Figure 4.12	Selected cross-sections of the keel: A. Profile at the master frame (FR M), B. Profile at 173cm aft of the bow face cut..... 137
Figure 4.13	View of the starboard face of the central section of the keel, near forward cut..... 139
Figure 4.14	Two examples of various forms of rabbets: A. Square rabbet in the form of a recess, B. Rabbet in the form of chamfered upper side of the keel 142
Figure 4.15	Hypothetical transition from the rabbet in the form of chamfer to the rabbet in the form of square recess as the garboard transitions from the midship into the bow and stern extremities of the keel..... 146
Figure 4.16	Two types of scribe marks discovered on the keel..... 149
Figure 4.17	Overview of the lower stern assembly (A), and a fragment of the upper stern assembly (B)..... 149

	Page
Figure 4.18 Stern knee.....	153
Figure 4.19 Preserved sternpost.....	156
Figure 4.20 Preserved forward faces of the stern floor timbers (crotches).....	159
Figure 4.21 “X” symbol carved on the forward face of most aft crotch.....	162
Figure 4.22 Hypothetical reconstruction of the lowest level of the construction ribbands.....	164
Figure 4.23 Preserved fragments of portside aft planking.....	165
Figure 4.24 Preserved starboard aft planking.....	167
Figure 4.25 A small section of the upper stern.....	170
Figure 4.26 Overview of the preserved framing timbers.....	172
Figure 4.27 Schematic arrangement between the master floor timber and first futtocks.....	174
Figure 4.28 Example of the dove-tail mortise on the port side of floor timber A..	174
Figure 4.29 Intervals between consecutive pair of nails along the keel.....	177
Figure 4.30 Intervals between consecutive bolts along the keel.....	177
Figure 4.31 Series of preserved floor timbers, asterisk (*) indicates those with the mortises.....	179
Figure 4.32 Relationship between sided and molded for a group of central floor timbers.....	180
Figure 4.33 Arcs of the floor timber of the master frame.....	182
Figure 4.34 Adze and axe marks along the forward face of the floor timber A....	184
Figure 4.35 Isometric representation of preserved futtocks.....	186

	Page
Figure 4.36	Arc of the aft portside first futtock of the master frame..... 189
Figure 4.37	Inboard end of the deteriorated portside first futtock of third frame aft (FR 3 P1) showing knots and original branches..... 190
Figure 4.38	Geometric design of the master frame from the 16 th -century Basque whaleboat, <i>chalupa</i> no. 1, from Red Bay..... 195
Figure 4.39	Geometric design of the master floor timber from the Western Ledge Reef Wreck..... 197
Figure 4.40	Visual representation of the changing radii of the floor arc..... 198
Figure 4.41	Curve of the changing radii of the floor arc of the Western Ledge Reef Wreck compared against selected <i>graminho</i> gauges of the period..... 200
Figure 4.42	Graph showing rising and narrowing of the central floor timbers.... 202
Figure 4.43	Preserved floor timber from the group of rising frames (FR 7 and FR 8) looking forward..... 205
Figure 4.44	Preserved Planking..... 207
Figure 4.45	Possible combinations of the butt joint fastening patterns found on the preserved planks..... 211
Figure 4.46	Visual representation of the readjustment between the keel and the garboards based on table 4.9..... 214
Figure 4.47	A fastening pattern as exemplified by garboards and first strakes in between frame C (FR C) forward and fifth frame (FR 5) aft..... 217
Figure 4.48	The preserved keelson (KN 1/1) in four views..... 223
Figure 4.49	Mast step mortise displaying disparity between the forward and aft sections along its bottom surface..... 225
Figure 4.50	Schematic view of the underside of the extant keelson..... 225

	Page
Figure 4.51	Wood between the notches showing reverse-triangle or chevron-shaped finish..... 228
Figure 4.52	Hypothetical central keelson and mast step assembly..... 229
Figure 4.53	Hypothetical keelson composed of three timbers..... 231
Figure 4.54	A bolt impression with a countersink on the top face of the keelson/mast step..... 233
Figure 4.55	Schematic overview of the mast step from the Contarina 1 shipwreck..... 236
Figure 4.56	Schematic overview of the keelson with expanded mast step from the Western Ledge Reef Wreck..... 237
Figure 4.57	Positions of the two bilge pumps based on a research model: A) the main bilge pump, B) a potential second bilge pump..... 240
Figure 4.58	Simplified view of the keelson, buttresses and ceiling planks showing the position of the second bilge pump..... 240
Figure 4.59	Example of the first starboard buttress..... 242
Figure 4.60	Overview of the site with the keelson/ mast step assembly, filler boards (bilge boards) covering the spaces between buttresses, and spaces indication possible location of foot wales..... 244
Figure 4.61	Detail of the mast step assembly showing thin longitudinal boards (bilge boards) covering the spaces between the buttresses..... 246
Figure 4.62	Overview of the preserved ceiling planks..... 247
Figure 4.63	Square cut away in the limber board (CSL 2/1) indicating possible location of the second (portside) bilge pump..... 249
Figure 4.64	Arrangement between the buttresses and the first ceiling strakes on both sides of the mast step..... 251

	Page
Figure 4.65	Simplified view of the preserved timber with marked positions of potential foot wales..... 253
Figure 4.66	Graph representing the distribution of foot wale fasteners: red line shows center-to-starboard wale fasteners, blue line: center-to-portside wale fasteners..... 255
Figure 4.67	Hypothetical reconstruction of the midship section, cutaway view just forward of the master frame..... 257
Figure 5.1	Research half-model based on the selected preserved timbers..... 271
Figure 5.2	Graduated scale facilitating the positioning of the stern knee and stern post along the aft portion of the keel..... 272
Figure 5.3	Positioning of the preserved sections of the stern planking and the two guiding battens..... 274
Figure 5.4	Schematic overview of the mend along the second starboard strake (PS 1) and the two stern planks..... 275
Figure 5.5	Proportions of a four-decked nao of Fernandez's design..... 277
Figure 5.6	Graphical representation of the ratios between the master frame and the bow and stern extremities of the keel..... 279
Figure 5.7	Proportions after Baker's design..... 280
Figure 5.8	Preserved master frame showing the geometry and measurements taken for reconstructing the design: (a) center of the floor arc, (b) center of the bilge arc..... 282
Figure 5.9	Schematic view of the master frame based on Pre Theodoro's design..... 285
Figure 5.10	The master frame for a Portuguese four-decked nao as illustrated by Manoel Fernandez..... 287
Figure 5.11	Schematic view of the master frame based on Fernandez's design... 289

	Page
Figure 5.12	Schematic view of the master frame based on Baker’s design..... 290
Figure 5.13	Pythagorean relationship between the radius of the floor arc and the maximum beam of Baker’s “Greek” mould..... 291
Figure 5.14	Graph showing the relationship between increasing maximum breadth and radii of the floor arc based on Baker’s geometry of the “Greek” mould, and other moulds analyzed..... 293
Figure 5.15	Comparison between the “Greek” mould and the three-arc method by replacing the curved floor with flat floor..... 294
Figure 5.16	Schematic view of the master frame of <i>chalupa</i> no.1 296
Figure 5.17	Chart displaying the radii of the first (floor arc) to the horizontal width of the curved floor (the chord of the floor arc), and the ratio of the radii of the first (floor arc) to the second or bilge arc..... 301
Figure 5.18	Hypothetical design of the master frame of the Western Ledge Reef Wreck based on the Baker’s description of the “Greek” midship mould..... 305
Figure 5.19	Outline of the hypothetical master frame of the Western Ledge Reef Wreck..... 306
Figure 5.20	Example of narrowing and rising mechanism described by Lavanha..... 311
Figure 5.21	Decrease in radii of the floor arc (from the master frame to the fifth frame aft) provided a mechanism by which the turn of the of the Western Ledge Reef Wreck was narrowing and rising..... 312
Figure 5.22	Examples of modifications of the master frame: A) <i>joba</i> , <i>espalhamento</i> , or <i>trebuchet</i> method, B) <i>balisa</i> with corrective adjustment of <i>concomo</i> , C) “hauling down” the futtocks..... 314
Figure 5.23	Analysis of the line scribed along the keel..... 319
Figure 5.24	Position of the tail frames based on Oliveira’s drawing..... 321

	Page
Figure 5.25	Ship's proportions by Lavanha..... 324
Figure 5.26	Hypothetical reconstruction of the stern..... 324
Figure 5.27	Proportions of the stem as illustrated by Lavanha..... 327
Figure 5.28	Hypothetical reconstruction of the stem..... 327
Figure 5.29	Hypothetical reconstruction of the total length of the ship (<i>eslora</i>) at the level of main deck..... 328
Figure 5.30	Graph showing the proportions for comparable ships..... 331
Figure 5.31	Ship types resisted by the officers of <i>Casa de Contratación</i> in the <i>Libros de Registro</i> between 130 and 170 <i>toneladas</i> 340
Figure 6.1	Common forms of Iberian ceramics..... 351
Figure 6.2	Distribution of ceramics by percentage..... 352
Figure 6.3	Forms of olive jars..... 354
Figure 6.4	Olive jar rim fragment..... 356
Figure 6.5	Degraded majolica fragment..... 356
Figure 6.6	Rim fragment of Green Bacín (Green <i>Lebrillo</i>)..... 361
Figure 6.7	Pie chart showing the variability of organic and mineral artifacts by percentage..... 363
Figure 6.8	Sketch of the chainplate assembly before concretion and wood removal..... 376
Figure 7.1	Conception of the overall ship in relation to the preserved framing timbers, keel, stern knee, and stern post..... 393

LIST OF TABLES

	Page
Table 1.1	Summary of the features associated with “Atlantic vessel” and Iberian-Atlantic tradition..... 7
Table 2.1	Primary and Secondary Ship Types in the <i>Libros de Registro</i> 31
Table 2.2	Iberian Primary and Secondary Ship Types (130-150 <i>toneladas</i>) in the <i>Libros de Registro</i> 41
Table 2.3	Ships Lost Near Bermuda between 1551 and 1622..... 60
Table 3.1	Comparison of the Malpas Wreck and Western Ledge Reef Wreck (IMHA-3) Dimensions and Scantling..... 79
Table 4.1	Visual tree-ring count of selected timbers..... 107
Table 4.2	Key to timber designations..... 112
Table 4.3	Basque fastener dimensions based on the shipment of nails and dowels for ships in 1582..... 117
Table 4.4	Fasteners and fastener impressions found on the Western Ledge Reef Wreck..... 120
Table 4.5	Changing chamfer as measured along available cross-sections on the portside and starboard of the keel..... 143
Table 4.6	Radii of the large floor arc for a series of central frames..... 198
Table 4.7	Rising and narrowing of the central floor timbers..... 202
Table 4.8	Dimensions of the planking based on Basque shipbuilding contracts. 209
Table 4.9	Readjustment between the keel and the garboards..... 213
Table 4.10	Depths of the keelson and mast step notches..... 228

	Page
Table 4.11	Wood economy calculations..... 237
Table 4.12	Distances from the center axes of the ship to the portside (Port) and starboard (Stbd.) foot wale fasteners; diameters of the fasteners..... 256
Table 5.1	Selected ratios between the master frame and the bow and stern extremities of the keel..... 278
Table 5.2	Statistical ratios between the length of keel and the maximum breadth and the depth of hold to the upper deck for Iberian ships below and above the 200 <i>tonelada</i> mark..... 297
Table 5.3	Selected ships from the Basque shipbuilding contracts..... 297
Table 5.4	Key parameters of the master frame within a group of corresponding designs..... 299
Table 5.5	Range of maximum breadths of the Western Ledge Reef Wreck's master frame by the way of ratios of the maximum breadth to the horizontal length of the curved floor obtained from a group of corresponding designs..... 299
Table 5.6	The relationships between the known parameters of the Western Ledge Reef Wreck's master frame and the parameters of the other midship moulds within a group of corresponding designs..... 302
Table 5.7	Length of keel in relation to the range of heights between the decks. 309
Table 5.8	Proportions for the length of the overhang and height of stern based Fernandez's four-decked nao..... 325
Table 5.9	The proportions between the total length and maximum breadth, and between the depth of hold and maximum breadth within a group comparable ships..... 332
Table 5.10	Comparison of Spanish tonnage measurements..... 335
Table 5.11	Hypothetical tonnage of the Western Ledge Reef Wreck and 16 th -century Spanish formulas..... 335

	Page
Table 5.12	Comparison of major dimensions between the Western Ledge Reef Wreck and <i>Santo Crucifijo</i> of Burgos..... 337
Table 6.1	A complete list of artifacts (by category) recovered from the Western Ledge Reef Wreck site between 1989 and 1991..... 346
Table 6.2	Ceramic material from the Western Ledge Reef Wreck site after applying research criteria..... 352
Table 6.3	Unglazed coarse earthenware material selected for the study..... 354
Table 6.4	The faunal remains..... 365
Table 6.5	The floral remains divided based on geographical origin..... 367
Table 6.6	Metal material selected for the study..... 373
Table 7.1	Dating Chart of the Western Ledge Reef Wreck..... 384
Table 7.2	Characteristic features of Atlantic vessel and Iberian-Atlantic tradition as related to the Western Ledge Reef Wreck..... 388

CHAPTER I

INTRODUCTION

1.1 RESEARCH OBJECTIVES AND PARAMETERS

From Columbus's first voyage in 1492 to the rapid subjugation of the newly discovered lands, to the avaricious extraction and transportation of gold and silver to the creation of a vast transoceanic dominion, Spain would have accomplished little without sailing vessels. The Spanish fleet, a body comprised of loosely defined and interchangeably used merchant and naval ships, became de facto a vehicle by which imperial power and commerce proliferated throughout the 16th century and beyond. While merely possessing ships capable of crossing the ocean was not enough to build and sustain such a realm (a case in point being the Norse voyages to North America), they were a significant factor in Spain's overall success.¹ These prosaic and often times underappreciated workhorses, the ships of Empire, created what John Parry characterized as "the maritime life-line" or *Carrera de Indias* linking Spain and Spanish America into one coherent system.²

While scholars debate the 16th-century rise and the 17th-century decline of the Spanish Empire, little is still known about the structure and role of various ships during the period in question. Some of the factors which marked the beginning of the ebb were progressive deforestation, technological backwardness, decay of domestic shipbuilding,

¹This dissertation follows the style of *American Journal of Archaeology (AJA)*.

and inability to compete with the foreign, primarily Dutch, economically-built ships. In addition, other factors can be found in mercantilist obstructions related to the devaluation of silver imported in enormous quantities from the New World, which in turn impeded not only Spanish export industries, but also naval construction and exploitation of ships.³ It is important not to exaggerate the overall scope of the decline; the Spanish Empire, as a political and cultural entity, did not just crumble. What had changed was the world, primarily the European world, surrounding it.⁴

Thousands of Spanish ships crossed the ocean lured by the riches of the New World. Although a number of them inevitably sunk, only a few have been discovered or rediscovered in modern times. Only a fraction of these have made their way into the archaeological and historical literature. Thus, our knowledge of Iberian ships and shipbuilding of the late 16th- and early 17th-centuries, and indeed those prior to and after that period, comes from a handful of examples.

This dissertation examines the Western Ledge Reef Wreck, a 16th-century Spanish ship lost upon its return voyage amongst the treacherous Bermuda reefs. This small vessel functioned within the *Carrera de Indias* system participating in the complex historical processes shaping the world on either side of the ocean. Building on current archaeological, documentary, and iconographic knowledge of Iberian ships of the greater Atlantic sphere, this dissertation analyzes the vessel's timber remains and reconstructs its structure to expand our understanding of the technology and diversity of ships which were vital in maintaining the empire. By probing the shipbuilding practices and construction methods, level of craftsmanship, timber usage and the technological

conservatism that accumulated over time, this dissertation looks at the Western Ledge Reef Wreck as a microcosm of the transformation that took place in the rich cultural zone of Atlantic Europe.

1.2 RESEARCH QUESTIONS

The structural timbers of the Western Ledge Reef Wreck and its associated artifacts were excavated between 1989 and 1991, but the hull remains were neither scientifically analyzed nor reconstructed; this resulted in limited use of this important archaeological material for further comparative study.⁵ Yet, in contrast with other Iberian shipwrecks found in the Caribbean and the Gulf of Mexico, the Western Ledge Reef Wreck is set apart not only due to its high level of timber preservation, but also because the remains were disassembled, raised from the bottom piece by piece, and transported to the laboratory for recording. This dissertation provides a final analysis of the preserved structure and a reconstruction of the vessel as part of wider investigation into the nature and evolution of late 16th- and early 17th-century shipbuilding philosophy. Some of the research questions found in this dissertation might appear repetitious to a reader. As this is a continuous research project which began more than two decades ago, the main objective was to avoid taking the original suppositions for granted; each research question had to be handled independently, and in a methodical way.

RESEARCH QUESTION 1: Did the Western Ledge Reef Wreck sink during the late 16th century?

At the time of the original excavations the project archaeologists tentatively concluded that the Western Ledge Reef Wreck sank sometime during the second half of the 16th century.⁶ However, the association of the Western Ledge Reef Wreck with artifacts of uncertain provenience raised periodically by the salvors created confusion. This is especially significant in the case of a cannon with the year 1577 engraved slightly forward of the touchhole.⁷ If one accepts this artifact as belonging to this shipwreck, the date should also be used as a *terminus post quem*. This, in turn, would indicate that the Western Ledge Reef Wreck sunk sometime after 1577. In the opinion of the author, however, there is an inherent risk to combining isolated and unprovenienced objects raised by salvors with the artifacts scientifically excavated from the shipwreck.

Acknowledging that the interpretation of the temporal data from any unidentified shipwreck is tainted by a degree of speculation, a decision was made to apply a conservative approach. The analysis excluded not only the objects which were salvaged, but also all those for which the provenience was uncertain.

Establishing a temporal range for the sinking of the Western Ledge Reef Wreck serves as a starting point for further research and allows for a more precise comparative study between the Western Ledge Reef Wreck and other contemporary shipwrecks, perhaps providing a more precise glimpse into the evolution of various technological features.

RESEARCH QUESTION 2: Was the Western Ledge Reef Wreck sailing under the Spanish flag?

To address this research question, the author will apply an identical methodology used for the first research question and exclude objects raised by the salvors and those of uncertain provenience. Based on the ship's structure and associated artifacts, as well as the fact that it was found in Bermuda, the original excavators tentatively postulated that the remains represented a Spanish ship that sank on its return voyage from the New World.

The importance of origin and nationality of the ship stems from the basic principle that the research and reconstruction of such a complex man-made structure cannot be devoid of inquiry into the culture of the people behind it. The question of nationality is rarely unambiguous, due to the cosmopolitan nature of seafaring. Moreover, the question of nationality should not be confused with the probable place where the ship was built. A case in point is the English-built but Dutch operated "Pipe Wreck" found in Monte Cristi Bay, Dominican Republic.⁸ If it can be established that the Western Ledge Reef Wreck sailed under the Spanish flag, it would indicate that the ship might have left Seville with one of the yearly convoys of the *Carrera de Indias* and never returned. If this was the case, then the ship was likely recorded in the registers of the *Casa de Contratación* (the House of Trade), the question will facilitate the identification of a range of ship candidates based on the date of sinking. In addition, it will provide socio-political context for this dissertation, elucidating the role of Bermuda within the Spanish transatlantic system of fleets.

RESEARCH QUESTION 3: Do the Western Ledge Reef Wreck hull remains represent an “Atlantic vessel” (Iberian-Atlantic) model?

Over the years, nautical research has shed light on some of the features associated with Iberian shipwrecks. In a preliminary study, Thomas Oertling identified eleven unique structural characteristics or traits of 16th- and 17th-century Iberian-Atlantic ships (table 1.1).⁹ As many of the individual features are found on other non-Iberian ships, for example on English vessels, the traits must be viewed collectively.¹⁰ They provide a theoretical foundation for the “Atlantic vessel” and the Iberian-Atlantic tradition.¹¹ Even though these concepts have faced some criticism and perhaps invite a major revision in order to incorporate a large body of new data, the framework even in its current form proves to be a valuable tool. It assists in a difficult process of tentatively identifying and describing Iberian-built ships of greater Atlantic provenience.

For a shipwreck to be considered part of this tradition, it would have a number of pre-assembled, and in essence pre-designed, central frames. Within this group of frames, the floor timbers and first futtocks would be scarfed to each other with trapezoidal (or more precisely dovetail) mortise-and-tenon joints, and then horizontally fastened with nails and trenails. These frames would be completely assembled as units prior to being fastened to the keel. The shipwreck should have carvel planking secured to the frames with a combination of nails and trenails at each plank-frame intersection. The aft extremity of the keel would be scarfed to the heel, an intermediate timber which provides a transition between the keel and the sternpost. The heel would also be scarfed to the sternpost. Atop the heel, the shipwreck would have a single stern knee functioning

Table 1.1: Summary of the features associated with “Atlantic vessel” and Iberian-Atlantic tradition. (after Oertling 2004, 130 (table 9.1).)

11 Characteristics Of Iberian Ships Of Atlantic Provenience	
FEATURES	
	A Group of Pre-assembled Frames
	Carvel Planking Fastened to Frames with Nails and Treenails
	Sternpost Scarfed to the Heel
	Single Stern Knee
	Y-shaped Stern frames (Crotches) tabbed to Stern Knee
	Keelson Notched to Fit Over the Floor Timbers
	Mast Step Formed Within the Expanded Keelson
	Buttresses and Stringers (Foot Wales)
	Ceiling Finished with Filler Boards
	Rigging With Chainplate assemblies
	Flat Transom

as rising deadwood. A number of stern frames would be fashioned as Y-shaped crotches and secured to the stern knee through a system of tabs which resemble single or double mortise-and-tenon joints.¹²

Within the Iberian-Atlantic tradition, one of the most unique design aspects is certainly the keelson and mast step assembly. The bottom surface of the keelson should be notched to fit over the corresponding floor timbers. The mast step should be fashioned as an expanded central section of the keelson timber, and resemble a large rectangular box. Such a mast step would be laterally supported by a number of wedge-shaped buttresses, which would be further reinforced by longitudinal bilge stringers or foot wales. A section on one or both sides of the keelson and mast step assembly would be carved away to accommodate one or more bilge pumps. The shipwreck would have ceiling planks extending just above the ends of the floor timbers. These planks should be finished with transverse filler boards. Although rigging rarely preserves on the shipwrecks, such an example would have chainplates with pear-shaped iron strop and chain attached to a bolt. Finally, an Iberian-Atlantic shipwreck would have a flat transom with a sternpost proud of the transom face.¹³

If the Western Ledge Reef Wreck hull remains exhibit structural characteristics consistent with this model, it should be considered an integral part of the Iberian-Atlantic typology. As a secondary consideration, this dissertation investigates the potential differences between Western Ledge Reef Wreck and the overarching model. Likewise, this research question addresses the possibility of a temporal evolution of hull design and construction. However, if analysis determines that the vessel does not belong

to the Atlantic-Iberian tradition, the hull remains should be excluded from the typology as defined and a new model established.

RESEARCH QUESTION 4: Can the design method and assembly sequence of the Western Ledge Reef Wreck be identified, and correlated with shipbuilding treatises of the period?

The other concepts, design and assembly sequence, must also be addressed when reconstructing a ship. While the design process is more conceptual, it implies a thought process behind the form of a ship. The assembly is the mechanical and detail oriented way of putting the structural elements together. Often times, the assembly sequence utilizes a range of pre-designed features, such as a group of central pre-designed frames, to facilitate the goal of constructing the final product.

A body of Spanish, Portuguese, Italian and English shipbuilding sources from between 1570 and 1620 were consulted to decipher these complex processes. Although hull design varied little in its key concepts across the geographical and temporal spectrum in question, differences existed and played a role in shaping the traditional shipbuilding on a local level. Shipwrights, largely a cosmopolitan crowd, exported their knowledge, as evidenced by Venetians employed in English dockyards.¹⁴ As more shipwrecks are excavated and systematically studied, one may ponder the extent of influence and role of these foreign experts. According to Richard Barker, the three most important and highly correlated aspects to examine are the form and proportions of the

hull and frame moulding, the geometrical shape of the midship frame, and the timbers used in the construction of a vessel.¹⁵

After basic dimensions and overall proportions are established, another consideration requiring in depth analysis is the assembly sequence. Straddling the technological gap between shell-first and frame-first construction, the Western Ledge Reef Wreck should be treated as a fascinating intermediate approach wherein a number of pre-designed frames were assembled and immediately followed by a few planks and ribbands before more frames and more planks could be added.

Granted that the design of the Western Ledge Reef Wreck can be identified, the data from this research question will form the theoretical base to compare to the descriptions and illustrations from the relevant shipbuilding treatises of the period. It will also support identification of the assembly sequence; hence, it will provide the basis for accurate reconstruction. As the treatises are the dominant sources of shipbuilding knowledge, they are a focal point for this research which aims at understanding the building methodology in light of prevailing shipbuilding theory.

RESEARCH QUESTION 5: Can Western Ledge Reef Wreck be positively identified as a particular ship type?

Building upon the knowledge acquired by answering the prior research questions, this dissertation will examine whether or not it is feasible to place this shipwreck within any known ship typology. Two most recognized Iberian ship types of the period are naos

and galleons, but there were also other such as *caravelas*, *navíos*, *pataches*, *barcas*, *urcas* or *zabras* to name a few.

First, this dissertation will investigate the remains of the Western Ledge Reef Wreck in terms of parallels with other contemporary shipwrecks. Second, it will weigh the analyzed and reconstructed material against two major bodies of data related to the diverse ship types of the late 16th and early 17th century. One of the best published sources is the study by José Luis Casado Soto.¹⁶ It examines the ships of the Spanish fleet that participated in the Armada Campaign of 1588. Another equally important and meticulously compiled catalog is the one by Huguette and Pierre Chaunu.¹⁷ This text comprises of a register of the ships participating in the transatlantic convoys of *Carrera de Indias*.

A significant limitation of this research question stems from fact that the technical knowledge regarding different Iberian ship types is largely nonexistent. Archeological remains of 16th- and 17th-century vessels rarely show any meaningful preservation above the turn of the bilge; hence, their reconstructed proportions between the maximum breadth, the keel, and the overall length, or the tonnage rating, are equivocal at best. The same can be said about pictorial evidence. Katie Custer Bojakowski identified in her dissertation a striking disconnect between actual shipwreck remains and conjecture about the upper works, which is almost always based on artistic representations. Incautious use of iconography has led to a skewed impression about the archaeological material.¹⁸

If the preserved structure of the lower hull of the Western Ledge Reef Wreck allows for reliable reconstruction, there is a chance to match this data with known historical documentary or iconographic sources and identify the ship type it represents. This, in turn, will provide much better understanding of the singularities of various types, and possibly facilitate similar identifications of other shipwrecks in the future. If such identification of the Western Ledge Reef Wreck is unachievable, the data gathered throughout this research will contribute yet another well-studied example until more shipwrecks are found, and collectively contribute to answering the question of a unique ship type.

1.3 METHODOLOGICAL CONSIDERATIONS

Three major lines of evidence will be incorporated into the study. First, the timber remains will be compared against typologically analogous shipwrecks. Second, the archaeological data will be reviewed in light of contemporary historical literature, including a historiography of shipbuilding treatises of the period. Last, but not least, the reconstruction will be supplemented by a careful investigation of contemporaneous ship illustrations, specifically those that accompanied shipbuilding treatises.

The three chronologically oldest comparative shipwrecks excavated in European waters are the 14th-century Corpo Santo Wreck, mid-15th century Ria de Aveiro A Wreck, and late 15th- or early 16th-century Cais do Sodr  Wreck from Portugal.¹⁹ As a group, these small local craft display several important characteristics associated with later fully developed Atlantic ships. A notable 14th-century Mediterranean example is

Contarina I, from the Po River delta, Italy.²⁰ Within a group of other comparative Mediterranean shipwrecks, there is the 14th-century Culip VI Wreck found off the coast of Catalonia, Spain, which displays construction related carved numerals on the floor timbers, the 15th-century Cavalaire Wreck excavated in France, the early 16th-century Villefranche Wreck (or Villefranche-sur-Mer Wreck) tentatively identified as the Genoese carrack *Lomellina*, and the especially intriguing stern section of the late 16th-century Calvi I Wreck excavated off the island of Corsica, France.²¹

Further 15th- and early 16th-century examples of Iberian-type vessels found in English waters include the Cattewater, Rye A, and Studland Bay Wrecks.²² Of these, only the Studland Bay Wreck undisputedly represents the shared and unique features of Iberian-Atlantic tradition.²³ Increasingly, this shipwreck shows a convergence of numerous local traditions and symbolizes much larger diversity of Atlantic shipbuilding methods. As pointed out by Brad Loewen no study can proceed without looking at the English 700-ton carvel-built dedicated warship *Mary Rose*.²⁴ Even though most of the floors and futtocks show distinct overlaps or meet with a type of scarf, very few of these timbers are permanently fastened to each other.²⁵ Recent investigations into the English-built “Gresham Ship” excavated in England and the B&W 7 Wreck discovered in Denmark significantly broaden the ramifications of familiar yet unique Atlantic methods.²⁶ Notably, the floor timbers of the “Gresham Ship” are joined to the first futtocks through double or single non-trapezoidal joints.²⁷

To date, perhaps the most significant early 16th-century Iberian ships lost in the New World are the Highborn Cay Wreck excavated in the Bahamas and the Molasses

Reef Wreck excavated in the Turks and Caicos Islands.²⁸ The Highborn Cay Wreck had a well-preserved keelson with the characteristic expanded mast step, six laterally placed buttresses, and foot wales.²⁹ The poorly preserved Molasses Reef Wreck provided little in terms of hull construction; however, meticulous analysis by Donald Keith supplied a plethora of data related to contemporary ship fasteners.³⁰ There is the scattered material from the three vessels of the ill-fated 1554 fleet.³¹ Here, of particular interest is the preserved stern assembly from a nao identified as *San Esteban*.³² There are also the mid-16th-century Emanuel Point Wrecks (Emanuel Point I Wreck being a larger and Emanuel Point II Wreck a smaller vessel) found in Pensacola Bay, Florida, which have yielded new and exciting evidence to archaeologists and researchers alike.³³

Three better preserved New World examples are the Basque ships (designated 24M, 27M, and 29M) sunk beneath the waters of the Red Bay, Labrador, Canada; the largest of the three (the shipwreck designated as 24M) was tentatively identified as the galleon *San Juan of Pasajes* (sunk in 1565).³⁴ Due to its importance and unmatched preservation, a decision was made not only to excavate and fully record it, but also to carry out an impressive analysis and reconstruction. In addition, the site yielded at least four other smaller craft, three confidently identified as *chalupas* and one tentatively as a *barco*.³⁵ Equally well preserved as the Red Bay (24M) Wreck, but neither analyzed nor reconstructed, are the late 16th-century remains of the Angra D Wreck discovered during the construction of a marina in 1992-1995, in Angra Bay on the island of Terceira, Azores, Portugal.³⁶ Measuring 35 m in length and about 8.1 m in maximum beam, the remains of Angra D Wreck are one of the most remarkable, but regrettably far from

being published, 16th-century Iberian examples known to author. Found during the same survey are the remains of Dutch-built Angra C, which have produced intriguing comparative information.³⁷ In addition, investigation of the late 17th-century Portuguese Navy frigate *Santo Antonio de Tanna* sunk in the old harbor of Mombasa, Kenya, provides confirmation of technological trends.³⁸

In an attempt to accurately reconstruct the hull of the Western Ledge Reef Wreck, the archaeological data will be reviewed in light of the seminal navigational and shipbuilding treatises from the second half of the 16th and early 17th century. Starting from the Italian sources, these will include the manuscript authored by Pre Theodoro de Nicolò and entitled: “Instructione sul modo di fabricare galere,” and to a lesser extent selected excerpts from earlier sources such as *Fabrica di galere*, the Timbotta manuscript, and *Visione di Drachio*.³⁹ For Spanish sources, the study will include Juan Escalante de Mendoza’s *Itinerarios de Navegación* dated to 1575 and Diego Garcia de Palacio’s *Instruccion Nauthica* dated to 1587, both of which contain diagrams and detailed ship proportions.⁴⁰ Similarly, a great deal of comparative data related to early 17th-century shipbuilding can be gathered by reviewing the writings of Tomé Cano of 1611 and the collection of Spanish shipbuilding *Ordenanzas* compiled during the reign of Philip III.⁴¹ These will be supplemented by seminal analyses of primary sources, particularly the study of Basque shipbuilding contracts by Michael Barkham, research into the ships of Spanish Armada of 1588 by Casado Soto, and Chaunu and Chaunu’s painstaking review of ship registers from Spanish transatlantic convoys.⁴²

Within the large body of Portuguese sources, the most significant are the *Liuro da Fabrica das Naus* by Fernando Oliveira dated to 1580s, the early 17th-century *Livro Primeiro de Architectura Naval* by João Baptista Lavanha, and superbly illustrated text by Manoel Fernandez, *Livro de Traças de Carpintaria*, dated to 1616.⁴³ The author's study of facsimiles of the original Portuguese texts will be supplemented by the corresponding research published by João da Gama Pimentel Barata.⁴⁴

Finally, this dissertation will take the advantage of English manuscripts. The first and most distinguished is certainly the "*Fragments of Ancient English Shipwrighty*" written by the royal master shipwright Mathew Baker and subsequently annotated by John Wells.⁴⁵ Containing what Richard Barker eloquently phrased as "a marvelous mixture of what was work at the frontiers of technology" of the era, the manuscript includes a collection of drawings, plans, and descriptions explaining geometric design.⁴⁶ Two other quite similar manuscripts with miscellaneous proportions are the Newton Manuscript and the Scott Manuscript.⁴⁷

As a group, this comprehensive data will form the basis for exploring Renaissance culture and ideology as they relate to geometrically-based and scientifically-rooted methods used by contemporary shipwrights. It will provide a connection between the archaeology and history of ships.

1.4 CONCLUSION

Ship reconstruction is inherently complicated by the fact that most shipwrecks, including Western Ledge Reef Wreck, consist of fragmentary hull remains from below the waterline. Through the combination of data procured from archaeological, documentary, and iconographic lines of evidence, this dissertation will analyze and reconstruct the Western Ledge Reef Wreck, establishing its role in Iberian maritime history of the Atlantic. It will review the temporal window of the sinking, inquire into the culture of the people by understanding its origin and nationality, and investigate its association with broader Iberian-Atlantic shipbuilding tradition, the philosophy behind its design, and the assembly sequence. This dissertation will also attempt to engage in a difficult task of identifying the possible ship type represented by the remains of the Western Ledge Reef Wreck. Even though the story of this ship spans more than 400 years, two continents, and a remote island in the middle of the Atlantic Ocean, the shipwreck deserves a thorough analysis and a final closure.

ENDNOTES

-
- ¹ Diamond (2005, 221-47) eloquently elucidates the case of the Norse.
- ² For the discovery and early voyages see Morison 1942; Parry 1966, 117.
- ³ Flynn 1979, 198; Hamilton 1954, 224.
- ⁴ Case argued in Kamen 1978.
- ⁵ Watts 1993a, 1993b; Watts et al. 1994; Morris 1993.
- ⁶ Watts 1993a; Morris 1993; Watts et al. 1994; Franklin 1993.
- ⁷ Watts 1993a, 115-6.
- ⁸ Hall 1996.
- ⁹ The list of original 12 traits can be found in Oertling 2001, 234 (Table A).
- ¹⁰ For example see Auer and Firth 2007.
- ¹¹ Oertling 1989a; 2001, 238; 2004.
- ¹² Oertling 1989a; 2001, 238; 2004.
- ¹³ Oertling 1989a; 2001, 238; 2004.
- ¹⁴ Barker 2003a, 35.
- ¹⁵ Barker 2001, 213.
- ¹⁶ Casado Soto 1988.
- ¹⁷ Chaunu and Chaunu 1955.
- ¹⁸ Custer Bojakowski 2011.
- ¹⁹ Alves et al. 2001a, 2001b, 2001c; Alves and Rieth 2005; Rodrigues et al. 2001.
- ²⁰ Occioni-Bonaffons and Gregoretti 1901; Bonino 1978; Beltrame 2009.
- ²¹ Nieto Prieto 1989; Palou et al. 1998; Burlet and Palou 1998; Delhay 1998; Guérout et al. 1989; Villié 1994.
- ²² Redknap 1984, 1985; Lovegrove 1964; Ladle 1993; Thomsen 2000.
- ²³ Thomsen 2000, 83.
- ²⁴ Loewen 2001.
- ²⁵ Marsden and Collins 2003; Marsden and McElvogue 2009.
- ²⁶ Auer and Firth 2007; Lemee 2006, 271-82.
- ²⁷ Auer and Firth 2007, 229.
- ²⁸ Oertling 1986, 1989b; Smith 1993; Smith et al. 1985; Keith 1984, 1985, 1987; see also Oertling 1989c; Steffy 1994, 133.
- ²⁹ Oertling 1989b.
- ³⁰ Keith 1987; Oertling 1989c.
- ³¹ Arnold 1976, 1978; Arnold and Weddle 1978; McDonald and Arnold 1979.
- ³² Rosloff and Arnold 1984.
- ³³ Smith 1994, 2001; Smith et al. 1995, 1998; Cook 2009; Worth 2009.
- ³⁴ Grenier 1988, 2001; Grenier et al. 2007.
- ³⁵ Grenier et al. 2007, 4: 309-80.
- ³⁶ Garcia and Monteiro 2001; Crisman and Garcia 2001.
- ³⁷ Phaneuf 2003.
- ³⁸ Darroch 1986; Jordan 2001; Fraga 2007.
- ³⁹ Lane 1934, 1992; Anderson 1988, 1925; Bellabarba 1988; Drachio and Lehmann 1992.
- ⁴⁰ Escalante de Mendoza 1985; Palacio 1587, 1986.
- ⁴¹ Cano and Dorta 1964; Rodríguez Mendoza 2008.
- ⁴² Barkham 1981; Casado Soto 1988; Chaunu and Chaunu 1955.
- ⁴³ Oliveira 1991; Guerreiro and Domingues 2000; Domingues 2001; Fernandez 1995.; note that Portuguese shipbuilding treatises were accessed online at: <http://nadi.tamu.edu/treatises.html>
- ⁴⁴ Pimentel Barata 1989.
- ⁴⁵ Baker c. 1580.
- ⁴⁶ Barker 1986.

⁴⁷ Barker 1994; for the list of English manuscripts and documentary sources of the period please refer to Adams 2003, 132 (Table 5b).

CHAPTER II:

LATE 16TH- EARLY 17TH-CENTURY SPAIN AND THE TRANSATLANTIC*CARRERA DE INDIAS*

2.1 THE SPANISH EMPIRE UNDER PHILIP II AND PHILIP III

In mid-16th century, a well-educated and obsessively religious Philip II (1556-1598) inherited an impressive dominion from his father, Carlos I of Spain (also Holy Roman Emperor Charles V). It combined Spain, the Duchy of Milan, the Kingdoms of Naples, Sicily, and Sardinia, with suzerainty over Burgundy, Franche Comté, the Low Countries and the rapidly expanding possessions in New World (fig. 2.1).¹ Although widespread, the focal point of Philip's empire was the Atlantic; a *status quo* which was altered only after the opening of a Pacific route in 1570s and annexation of Portugal with its Asian commercial outposts in 1580.²

Territorial conquest and the subjugation of relatively complex societies were arguably among the most important factors characterizing Spanish interests in the New World.³ Yet, one of the most significant motives behind the expansion was the search for precious metals. Despite the marvelous stories, the yield of gold quickly proved disappointing and Spaniards moved to the predatory extraction of silver from the famous Mexican and Peruvian mines.⁴ Since the extraction of silver-rich deposits required a considerable capital investment, the process was heavily dependent on impressment of native inhabitants. It was not until 1554, however, when a new amalgamation technique using mercury and salt produced a satisfactory increase in silver output.⁵

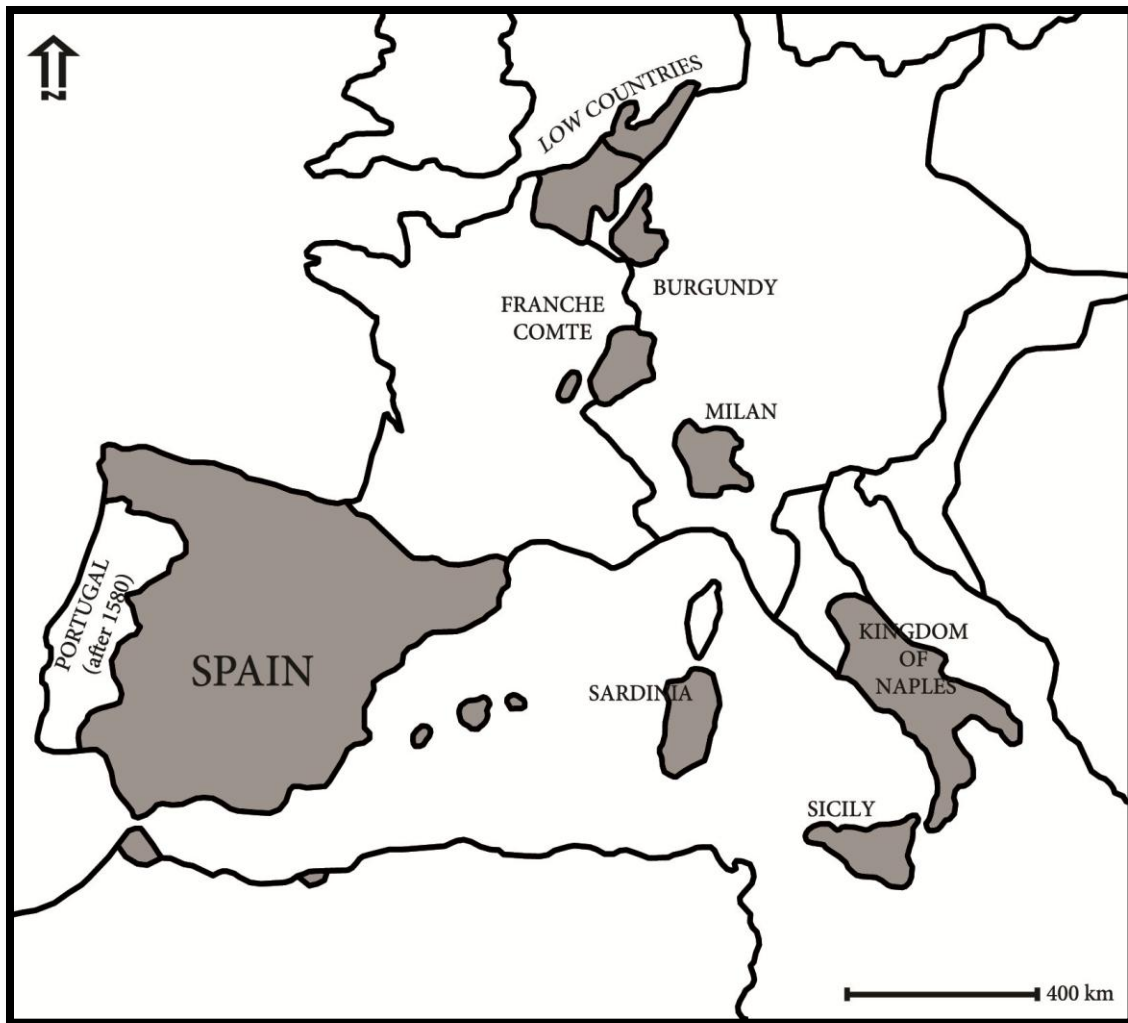

Figure 2.1: European dominions inherited by Philip II (c. 1556).

Significantly, for the overwhelming success of the enterprise, Philip II's sophisticated bureaucratic machinery allowed him to have an ample control over the Old and the New World. As revealed by an anecdote, he not only read all the government dispatches, but also managed to add a personal touch by correcting, modifying, or extensively annotating a majority of the manuscripts. As historians continue to analyze the multitude of written records produced during his reign, one could only wonder how this busy monarch found the time to leave his mark on so many of them. Ultimately, Philip's religious devotion dictated that the efforts on either side of the ocean were conducted and justified in the name of the God.⁶

Under Philip II, the world witnessed an unprecedented expansion of Spanish commercial and naval power. After the annexation of Portugal, the united Iberian merchant marine likely constituted the largest fleet in Europe, perhaps in the World, surpassing in tonnage even the pervasive Dutch.⁷ Even if Braudel's calculations of 600,000 to 700,000 tons of European merchant shipping in 1600 are somewhat amplified, it is prudent to say that the Iberian ships accounted for nearly half of that.⁸

On the naval front, there was not only the Lepanto of 1571, with a significant contribution of Spanish galleys, but also a celebrated engagement against England, which Spaniards quixotically named "Invincible" Armada of 1588. Regardless the disastrous outcome of the latter, which in the past had been largely distorted by nationalistic prejudice, the simple fact that such campaign could be planned, organized, and launched is unprecedented.⁹ Even in the face of Spanish debacle, Philip II did not give up and by 1592 had a new fleet of forty galleons under construction, while the New

World bases were refortified against English incursions. As a measure of true Spanish maritime potentials, Philip sent two more Armadas against England, one in 1596 and another one in 1597. As previously, both of these were dispersed by storms.¹⁰ Although all these grandiose efforts revived the shipbuilding industry, the economic stimulus was short lived. The late 16th-century Spain saw a challenge to its maritime supremacy from the Dutch, English, and to a lesser degree the French.¹¹

The aggressive foreign policy began by Philip II shifted with ascendancy of his son, Philip III, to the throne of Spain in 1598. Unlike his father, Philip III did not possess the same indefatigable energy for warfare, attention to bureaucratic details, and nuances of politics. After the prolonged period of wars with France, England and exhaustive campaigns in the Low Countries which drained the imperial coffer and forced consecutive defaults, the reign of the new monarch brought a period of relative stability.¹² The year of his inauguration, 1598, Philip III signed a peace with France. In 1604, after yet another disastrous invasion attempt, he made a successful peace with James I of England. Among important declarations England guaranteed termination of the unanimous support for the Republic of the Seven United Netherlands (or Provinces), a policy adamantly supported by the previous monarch, Elizabeth I. This, in turn, opened a path for further negotiations between Spain and the rebellious Netherlands. The resulting Twelve Year's Truce was brokered by the kings of England and France and signed in 1609.¹³ This highly equivocal agreement was widely considered a humiliation for Spain. The Dutch not only gained religious and political freedom, but could now navigate and engage in trade without restrictions which gave rise to an ambitious

shipbuilding program and economic prosperity.¹⁴ Although officially agreed to by both parties, unofficially it was unacceptable to Spain and the armistice was disregarded beyond the European waters.¹⁵

This relative stability in Europe allowed Philip III to divert some of the resources to the New World and Asia. He managed to launch a long anticipated campaign against pirates, foreign traders, and scores of interlopers continually encroaching onto Spanish interests in the overseas possessions. To encourage local participation in the scheme, the crown issued a decree by which Spanish colonists were allowed to capture and confiscate goods from interlopers, as well as to execute them if justified.¹⁶

Philip III was determined not only to defend the empire built by his predecessors, but also to enforce the Spanish monopoly for trade and colonization of the New World. Upon the urging of Martin de Aròztegui, secretary for the navy, he conceded that the key element to the integrity and wealth of his realm was a powerful fleet. This included the quality, size, and strength of the dedicated naval ships used to protect the convoys. It also meant that the individual merchantman ought to be as seaworthy and powerful as their naval counterparts to be used interchangeably if such need arose.¹⁷

In order to prevent a palpable decline in Iberian shipbuilding, which would threaten the empire as a whole, Philip III introduced strict controls over shipbuilding industry, establishing a system of state subsidies and a policy of leasing private vessels to the navy.¹⁸ Certainly, not all ships could qualify to be included in the program. Those that did had to be built in accordance with the royal guidelines known as *Ordenanzas para la fábrica de navíos de guerra y mercantes* (Ordinances for the construction of war

and merchant ships), which collectively constituted a major piece of maritime legislation of the era. Issued for the first time in 1607, the rules and proportions of the *Ordenanzas* were subsequently revised and somewhat improved in 1613 and again in 1618. Both times, the improvements of the 1607 *Ordenanza* came about upon requests by the shipwright and merchant communities which viewed the original regulations as severely deficient.¹⁹

In addition to the legislative effort, Philip III continued the operation of the reorganized *Armada del Mar Océano*, albeit in much reduced numbers. This *Armada* was divided into three independent squadrons responsible for defending Spanish merchantmen along the European trading routes, including: the Strait of Gibraltar, the stretch between Azores and mainland Spain, and the English Channel. He created *Armada de Nápoles* to protect his Italian possessions and Spanish Mediterranean coast. He also aimed at setting up a permanent Caribbean fleet, *Armada de Barlovento*, but continual lack of funds delayed the project beyond the time of his reign.²⁰

Regardless the extensive list of programs, nothing could divert a general economic downturn in the 1620s. This, combined with the onset of the Thirty Year's War in 1618 and termination of the truce with the Netherlands in 1621, produced a major threat to Spain and its Empire. As Philip IV (1621-1665) began his reign, "the golden age in literature and fine arts and the silver age in money (during the 16th century)" were over, and Spain entered a bronze age (during the 17th century) taking an increasingly secondary role in European politics.²¹ The pendulum swung and by the

1660s Spanish hegemony crashed while England emerged as the new world power, taking over the command of the oceans.²²

2.2 THE SHIPS OF THE SPANISH *CARRERA DE INDIAS*

Acquisition of New World domains meant Spain had to develop and maintain transatlantic trade routes, an obligation which necessitated building, operating, manning, and provisioning a large number of oceanic ships. Since American silver was vital to finance Philip II's bellicose foreign policy and European goods were essential to the New World colonists, an elaborate network rapidly developed.²³

Early on, the largely private enterprise was controlled by establishing the Royal institution of the *Casa de Contratación* (the House of Trade), located in Seville, by the Cedula of 1503.²⁴ In addition to normal regulatory and administrative duties, the office was to license the ships and levy taxes on goods, primary precious metals, imported from the New World. After 1521, it also collected a tax called *avería*.²⁵ It is generally accepted that the introduction of the tax, charged in addition to normal custom duties, coincided with the increase in the French hostilities against returning Spanish merchant ships in the Atlantic, a conflict that lasted until the signing of the peace treaty of Cateau-Cambrésis in 1559. To bolster the defenses, the king ordered the *Casa de Contratación* to designate four to five warships to escort the returning merchantmen. The *avería* was levied on all the goods transported by the convoy to finance their defense. Inbound cargo was taxed at a rate three times that of outbound cargo. The tax steadily increased from a mere one or two percent to about six or seven percent at the end of the 16th century, and

to an outrageous 35.5 percent in 1632.²⁶ As an evidence of misplaced priorities and a broken and abused fiscal system, in that same year the king also asked for the *avería* on the inbound cargo to be paid in advance. This, in essence, only reinforced what historians Chaunu and Chaunu accurately termed as a “psychosis of fraud” at every level that plagued the Spanish commerce throughout the period.²⁷

To accommodate the ever increasing volume of shipping and to protect precious cargoes against pirates and privateers alike, Spanish ships were ordered to sail in formal convoys accompanied by a naval escort as early as 1537.²⁸ The crown also issued specific instructions about the ships, sailors, and sailing to the Indies in ordinances of 1536 and 1543.²⁹ Each year one large fleet left Seville for the New World; upon reaching the Caribbean it split into two parts, each protected by a warship. One convoy sailed for *Nueva España* (Viceroyalty of New Spain), while the other sailed for *Tierra Firme* (Viceroyalty of New Granada).³⁰ The fleet was accompanied by at least two dedicated naval ships: a *capitana*, or a flagship, which traditionally lead the convoy, and *almiranta*, or vice-flagship, sailing in the rear.³¹ In principal, this system persisted until the mid-16th century when the tremendous pressure by the booming transatlantic commerce and ineffectiveness in protecting the merchantmen postulated a revision to the Spanish maritime transport policy. Merchants despised the convoys not only because taxation forced them to carry the financial burden of defense, but also because it forced them to bring merchandise at the same time as their competitors putting the pressure on the supply and depressing prices.³²

The Spanish naval hero, Admiral Pedro Menéndez de Avilés, is credited with first separating the yearly convoy into two independent fleets in 1555. Although simple in concept, the planning and implementation of this operation was not easy to resolve, and a modified system was developed between 1561 and 1564.³³ Once it finally took effect, it persisted in largely unchanged form throughout the 17th century.³⁴ The key elements of the new strategy included fortification of the fleet's main ports in the New World, introduction of naval patrols in the vulnerable locations where the fleets began and ended the voyages (particularly near the Caribbean and Azores), and creation of a system of two scheduled convoys protected by squadrons of dedicated warships and smaller dispatch vessels.

Due to rather idealistic nature of the plan and heavy emphasis on expensive defenses, its implementation as a whole became unaffordable, to say the least. The Spanish treasury could not support financing full-time naval patrols based in Caribbean. The number of ships guarding the returning fleets fluctuated depending on the political situation and availability, while the sailing schedule was far from being strict.³⁵ Estimates also suggest that between 1550 and 1600 only about 53% of the ships that left Seville sailed to the New World in convoys, 17% were permitted to make a solitary passage, while the data for the remaining 31% is unavailable. The lack of this data on almost a third of all ships crossing the Atlantic is a limiting factor in researching ships and shipwrecks of the *Carrera de Indias*.³⁶

The most extensive body of data related to ships indisputably participating in the convoys are the *Libros de Registro* (Books of Register) meticulously maintained by the

officers of the *Casa de Contratación*. According to the *Libros*, the ship which by far appears most frequently throughout the second half of the 16th century (1550 to 1600) is a nao, the workhorse of the *Carrera de Indias* (fig. 2.2, table 2.1). Overall, the *Libros de Registro* include a total of 216 combinations of ship designations, with most of them being simply variations of the same ship type but with different spelling, while others carrying proper typological meaning. For example, in certain contexts the words nao and *navío*, and less frequently the word *nave*, were used interchangeably and refer to “a ship.” In other contexts, these same words indicate certain ship types, albeit the *navío* usually implies a smaller vessel than the nao. Both nao and *navío* are generally associated with poorly understood merchantmen-class vessels.³⁷ Based on rather limited sources detailing the structure of the naos, these are often described as seaworthy full-rigged ships capable of making extended round trip voyages.³⁸

In iconography, the naos were depicted heaving large rounded hulls capable of accommodating large quantities of cargo, a high projecting forecastle, a large sterncastle often with galleries, and low-cut waist (fig. 2.3).³⁹ In addition to ships designated in the *Libros de Registro* simply as naos, some of them are also being defined by their origin as *biscayan, francea, inglesa, irlandesa, italiana, or portuguesa*; signifying that even the officers of the *Casa de Contratación* were aware of these regional differences. In terms of capacity, more than 90% of all the ships designated as naos fall into an extremely broad range from as small as 30 *toneladas* to as large as 1088 *toneladas*; the most frequently occurring tonnage (mode) is 120 *toneladas*.⁴⁰

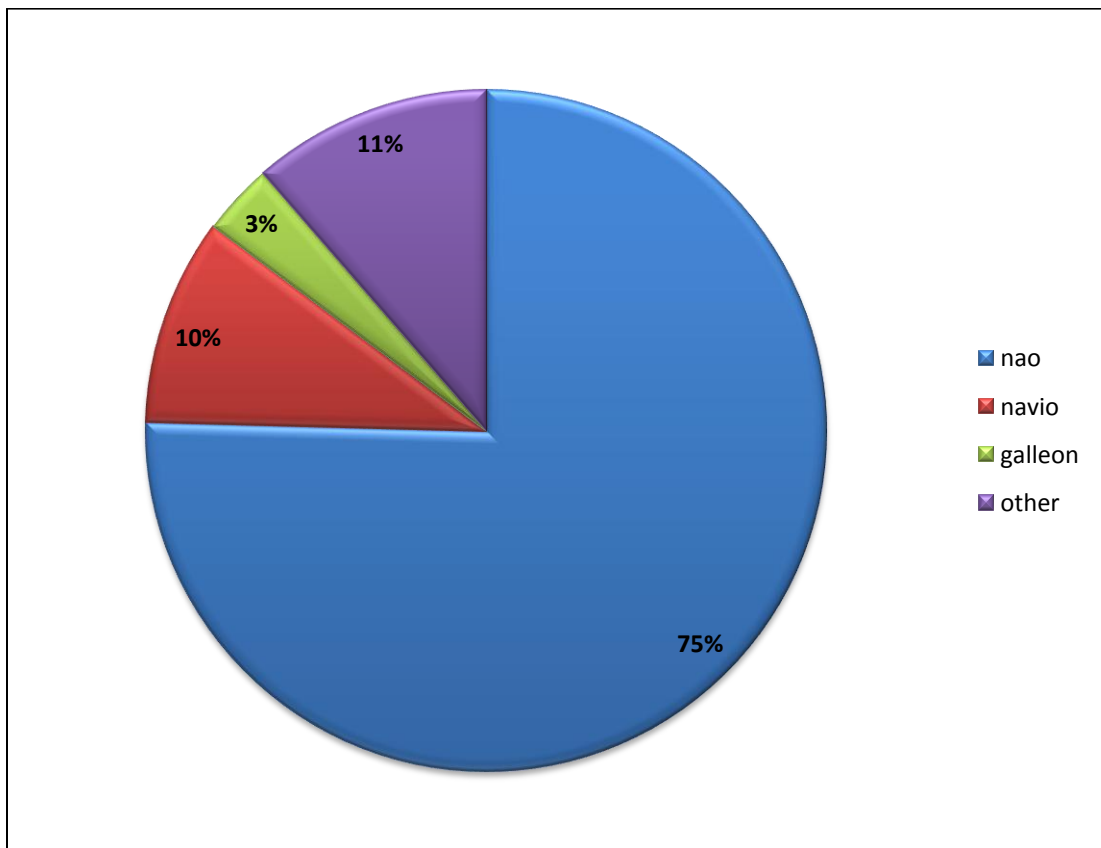

Figure 2.2: Pie chart showing three major ship types: nao, *navío*, and galleon, by percentage, as registered in *Libros de Registro* between 1550 and 1600. (after Chaunu and Chaunu 1955, 2: 444-595, 3: 6-63, 4: 8-109.)

Table 2.1: Primary and Secondary Ship Types in the *Libros de Registro*. (after Chaunu and Chaunu 1955, 2: 444-595, 3: 6-563, 4: 8-109.)

Ship Type	Number	Date Range	Tonnage Range	Tonnage Mode
Barco				
Luengo	2	1586-1587	50	50
Portuguese	1	1594	30	30
Bergatin				
NA	4	1555-1556	140	140
Biscayan	1	1555	130	130
Caravela				
NA	69	1550-1598	50-600	80
Pequena	1	1560	70	70
Portuguese	4	1565-1597	60-140	60
Caravelilla	4	1563-1564	70	70
Cochapin				
NA	2	1558-1561	120	120
Felibote				
NA	95	1591-1600	35-320	130
Fregata				
NA	82	1573-1600	60-300	80
Fregata Frances	1	1596	50	50
Fregata Inglesa	1	1600	135	135
Galeaza				
NA	21	1557-1586	200-700	600
Galeazetta				
NA	1	1557	130	130

Table 2.1 (Continued)

Ship Type	Number	Date Range	Tonnage Range	Tonnage Mode
Galleon				
NA	205	1550-1600	120-1259	600
Biscayan	11	1594-1598	300-835	300
French	2	1587-1588	600	600
English	1	1597	150	150
Portuguese	2	1599-1600	260	260
Galeoncete				
NA	1	1599	100	100
Galera(e)				
NA	9	1578-1595	100-200	100
Galizabra				
Biscayan	7	1589-1591	150	150
Gallega				
NA	21	1579-1600	35-500	400
Lancha				
Barco	2	1598	20	20
Nao				
NA	4,551	1550-1600	30-1088	120
Biscayan	235	1554-1600	40-750	300
French	29	1581-1600	20-1096	70
English	17	1584-1599	45-350	120
Irish	1	1598	160	160
Italian	3	1597-1599	260-270	270
Portuguese	46	1577-1600	60-600	150
Nave				
NA	2	1550-1551	350	350

Table 2.1 (Continued)

Ship Type	Number	Date Range	Tonnage Range	Tonnage Mode
Navio				
NA	593	1550-1600	40-600	100
Biscayan	6	1591-1594	100-120	100
French	8	1557-1598	40-100	70
English	3	1563-1594	120-150	120
Portuguese	24	1550-1597	50-400	120
Patache				
NA	119	1562-1600	30-140	60
Portuguese	3	1589-1596	50-120	120
Zabra	1	1589	125	125
Saetia				
NA	12	1578-1595	80-200	80
Urca				
NA	81	1550-1600	50-700	300
Urqueta	1	1558	200	200
Zabra				
NA	18	1588-1600	30-300	80

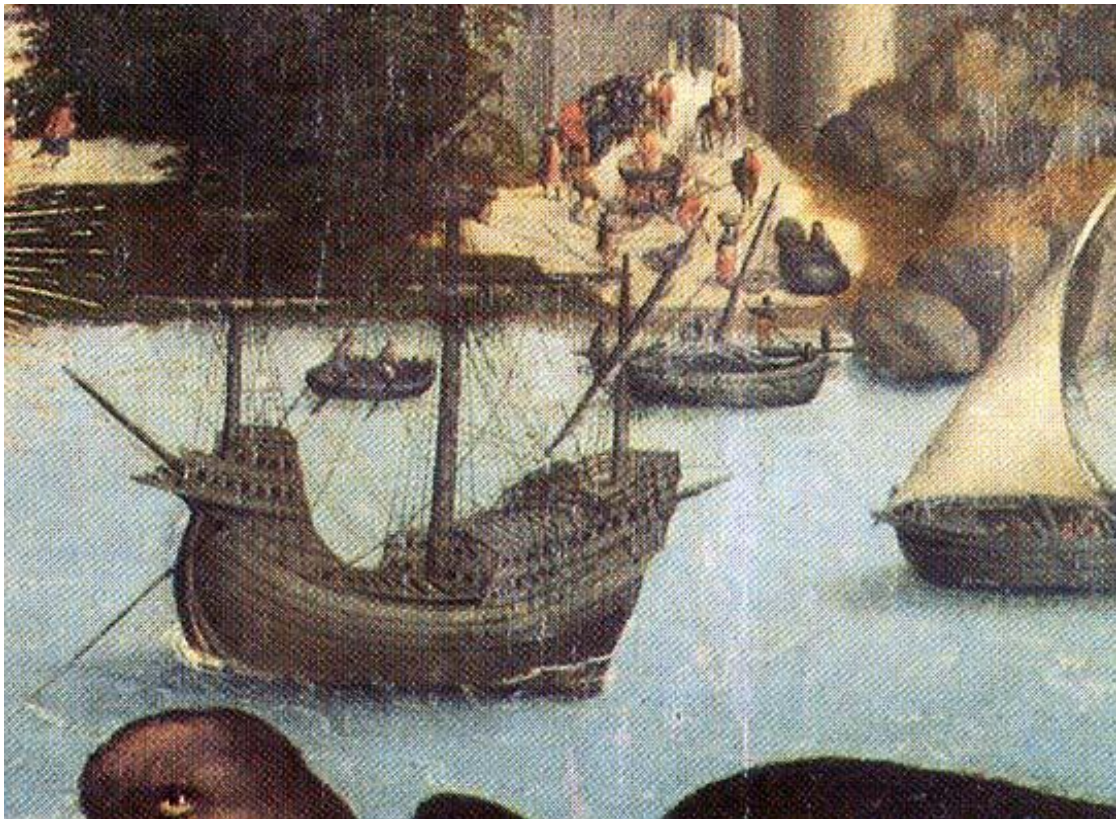

Figure 2.3: Artistic representation of a nao at anchor. (Martins 2001, 209.)

The majority of the *navíos* appear to be generic merchantmen while larger ones could also be used as warships.⁴¹ Only a few are classified by their respective function within the convoys as *navíos de aviso* (dispatch ships), *navíos patache* (also spelled *pataxe* or *pataxo*) (tenders), or *navíos* operating as a vaguely defined variety of *fregatas*.⁴² The order of Diego Flores de Valdes, captain-general of the *Tierra Firme* fleet in 1572, established the minimal size of the escort for each fleet as one armed *patache* (tender) sailing by the *capitana*, and one by the *almiranta* (fig. 2.4).⁴³ The primary role of *pataches* was to carry instructions and orders among vessels of the convoy, monitor the areas where the fleet would navigate, scout for potential shoals and pirates, and sail ahead to notify the next port of the incoming fleet. Sometimes these were also used to collect low-volume but high-value goods at ports along the main route, for example the *pataches* sailing with the *Tierra Firme* fleet could be employed to collect pearls from Isla de Margarita.⁴⁴ As indicated by Chaunu and Chaunu, any small vessel could be used to fulfill the *patache* function with more than 95% of them having a tonnage of less than 100 *toneladas* and the mode of 60 *toneladas*.⁴⁵

The Ordinances of 1591 also stipulated that each fleet should be accompanying with three to four *navíos de aviso*.⁴⁶ Although similar to *pataches* and often times used interchangeably, the *navíos de aviso* were not considered a proper part of the naval squadron. As the cost of operating them was born exclusively by the king, *navíos de aviso* were allowed to sail either in convoys or independently, carrying government and private documents. In essence, these were among very few ships legally permitted to sail

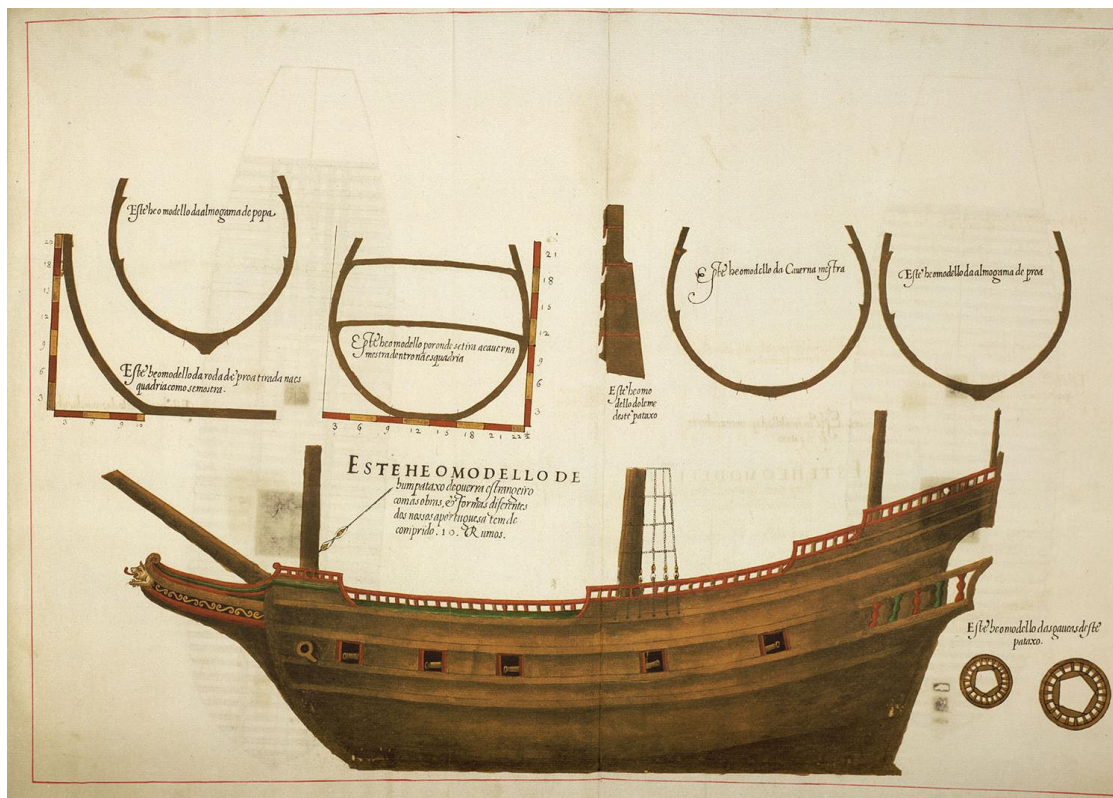

Figure 2.4: Example of the armed or naval *patache* (*pataxo de guerra*). (Fernandez 1616, fol, 112.; accessed at: <http://nabl.tamu.edu/treatises.html>)

across the Atlantic apart from the scheduled fleets.⁴⁷ If they sailed with the fleet, once it reached New World and officials had exchanged their government, financial, and legal correspondence, the *navíos de aviso* loaded the consignment and promptly return. En route to Spain, the ships also carried the most current information on the progress and condition of the fleet to the various ports they visited. Although both the *pataches* and the *navío de aviso* were prohibited from carrying any freight, as not to distract the crews from their duties, selected cargo could be exempt. While the *pataches de la Margarita* were assigned to carry pearls, the *navío de aviso* were allowed to carry the red dyestuff known as cochineal.⁴⁸ Although the preferred capacity was no more than 100 *toneladas*, the requirements of the mission or the availability of vessels that could sail to the New World could necessitate the use of ships in excess of 150 *tonelada*.⁴⁹ Based on the *Libros de Registro*, the tonnage of *navíos* range anywhere from 40 to 600 *toneladas* and the mode is 100 *toneladas*.⁵⁰

In addition to *naos*, the *Libros de Registro* include a large number of ships designated as *galeones* (eng. galleons), which denote vessels larger than 250 *toneladas* (a tonnage consistent with 99% of all galleons from the records). These ships, glorified by tradition and overwhelming nationalistic symbolism, are even more enigmatic than the *naos*.⁵¹ It is a common supposition that the Spanish galleons were employed in some naval capacity. These, however, were not dedicated warships but rather multi-purpose vessels.

Sources indicate that the same vessel could have been called galleon and a *nao* by the same document, and could function as a warship, merchantmen, or a whaler at

various times in its career.⁵² The same Admiral Pedro Menéndez de Avilés credited with developing the system of two yearly convoys in the 1560s advocated lengthening the galleon's keel to beam ratio to increase their seaworthiness, thus contributing to the development of a "classic" Spanish galleon shape. Based on iconography textual evidence, these ships had low set-back forecastle, a high and narrowing sterncastle with half-deck, quarter-deck, and often a poop-deck, a longer slicker profile and a beak-head protruding below the bowsprit (fig. 2.5).⁵³ Between 1550 and 1600, the tonnage for the galleons ranges from 120 to 1259 *toneladas* and the mode is 600 *toneladas*.⁵⁴

Within the group of less common ship types, which encompasses the remaining 11% of vessels analyzed, the *Libros de Registro* names the *lanchas*, *chalupas*, *charuas*, *barcos*, *pataches*, *bergantines*, *caravelas*, *caravelillas*, *corchapines*, *pinazas*, *fregatas*, *galeras*, *galeazas*, *galeazetteas*, *galeazillas*, *gallegas*, *galizabras* and *zabras*. As for various foreign-built ships, it also mentions *saetias* and *tartanas*, as well as Northern European ships such as *felibotes*, *felibotes ou galeoncete* (also simply referred to as *galeoncetes*) and *urcas*.⁵⁵

Ships of the the *Carrera de Indias* listed in the *Libros de Registro* correlate quite well with the ship types produced in one of the Basque Provinces, Gipuzkoa, during the 16th and 17th centuries.⁵⁶ As indicated by Odriozola Oyarbide in his historical overview of the shipbuilding industry in this small region, it epitomized larger trends in many ways; the five most commonly built ships during the 16th century were naos, galleons, *zabras*, *chalupas*, and *pinazas*, respectively.⁵⁷ However, during the 17th century, there was a slight reversal with the number of galleons significantly exceeding the naos,

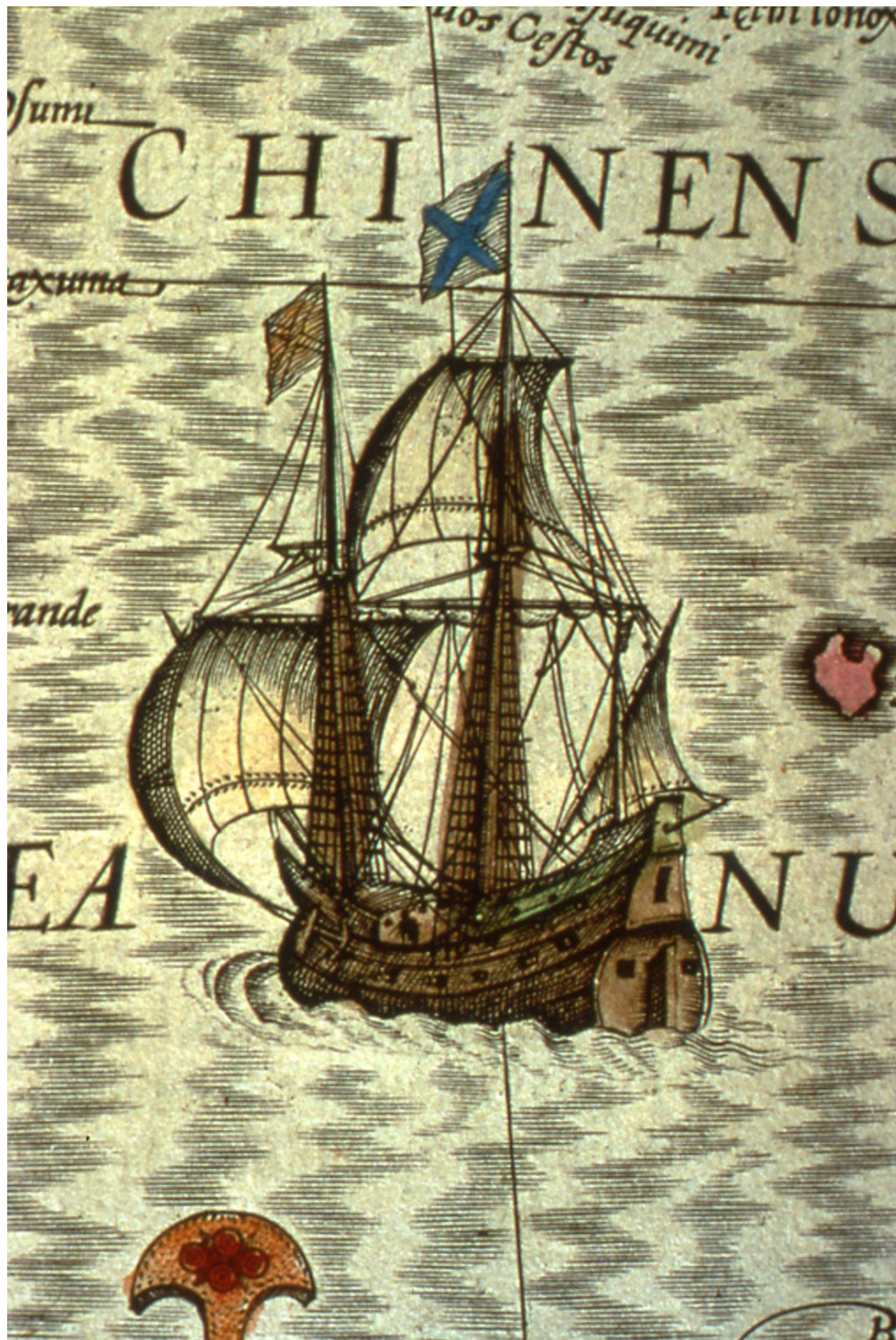

Figure 2.5: Example of a galleon from the map of China in the *Atlas* of Gerardus Mercator. (Amsterdam, 1630)

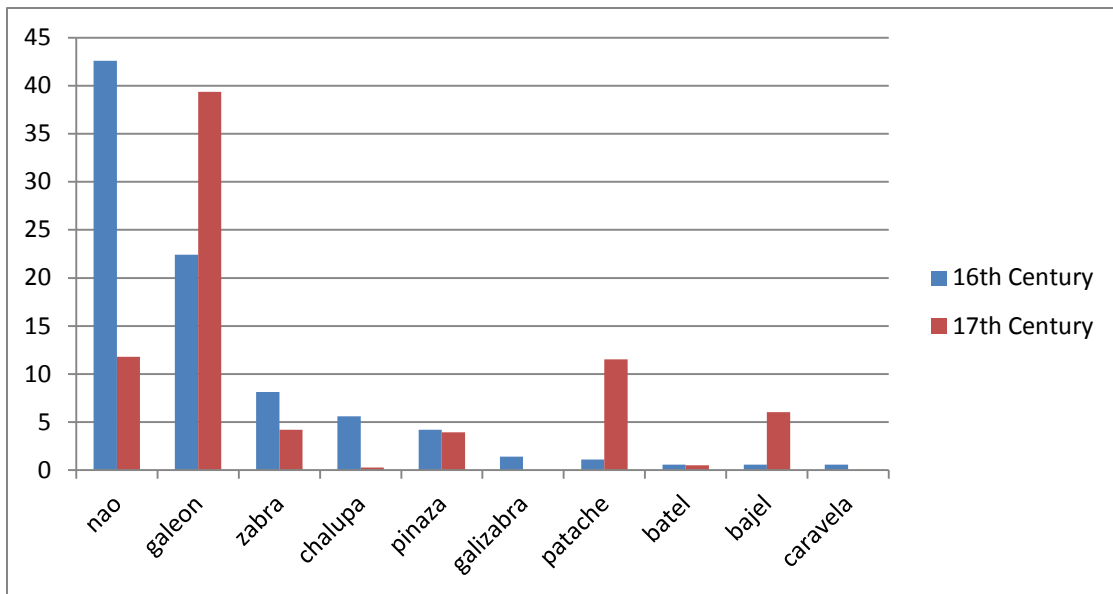

Figure 2.6: Graph showing Spanish ships by type built in the Basque province of Gipuzkoa during the 16th and 17th centuries. (after Oyarbide 1998, 105-7.)

Table 2.2: Iberian Primary and Secondary Ship Types (130-150 *toneladas*) in the *Libros de Registro*. (after Chaunu and Chaunu 1955, 2: 444-595, 3: 6-563, 4: 8-109.)

Ship Type	Number	Date Range	Tonnage Range	Tonnage Mode
Caravela				
NA	69	1550-1598	50-600	80
Portuguese	4	1565-1597	60-140	60
Fregata				
NA	82	1573-1600	60-300	80
Galeon				
NA	205	1550-1600	120-1259	600
Galera(e)				
NA	9	1578-1595	100-200	100
Galizabra				
Biscayan	7	1589-1591	150	150
Gallega				
NA	21	1579-1600	35-500	400
Nao				
NA	4,551	1550-1600	30-1088	120
Biscayan	235	1554-1600	40-750	300
Portuguese	46	1577-1600	60-600	150
Navio				
NA	593	1550-1600	40-600	100
Portuguese	24	1550-1597	50-400	120
Patache				
NA	119	1562-1600	30-140	60
Zabra				
NA	18	1588-1600	30-300	80

followed by *pataches*, *bajels*, and *zabras*.⁵⁸ Since Gipuzkoa shipyards targeted contracts for ships built specifically for the *Carrera de Indias*, Spanish Navy and long-distance fishing off Newfoundland, the large increase in construction of galleons (almost 17% increase) and *pataches* (10% increase) suggests that the demand for these two ship types must have had significantly expanded among 17th century ship buyers (fig. 2.6 and table 2.2).

2.3 THE ROUTES TO THE NEW WORLD

Despite some drawbacks, the new system of *Carrera de Indias* was a major achievement. As indicated by Chaunu and Chaunu, the fleet bound for *Nueva España* typically left Spanish Seville sailing down the Guadalquivir River to the Atlantic Ocean in June.⁵⁹ First it took a southerly course utilizing so-called Portuguese Trades, which blow from between north-east and north-west off the western coast of the Iberian Peninsula, and to a lesser degree a north-easterly *harmattan* wind, blowing hot and dry air from northern African deserts.⁶⁰ Sailing along the east coast of Africa, the convoy called a port at the Canary Islands, where the fleet stopped to re-provision. The islands were notorious for illicit trade, embarking unregistered cargo, and ships which joined the convoy without an official license.⁶¹ From there, the fleet continued south-west into a zone of prevailing north-easterly trade winds, known by the more romantic Spanish name *alisios*, and currents which supplied the ships with a steady push on a course due west.⁶² Sailing this course across the Atlantic, the convoy entered the Caribbean through one of the three major passages in the Lesser Antilles. Upon reaching the Caribbean Sea

some of the ships separated to visit the islands of Hispaniola, Puerto Rico, Jamaica, and Cuba as well as the mainland territories of Honduras, Guatemala, Yucatán and the coast of Campeche and Tobasco.⁶³ The main body of the fleet continued to its final destination entering the port of Veracruz anytime between August and September. On average, the first leg of the voyage from Seville to Canary Islands took about two weeks. From there it took about a month to cross the Atlantic to the Lesser Antilles, and yet another month to reach Veracruz (fig. 2.7).⁶⁴

Likewise, the *Tierra Firme* fleet typically left Spain in March and followed the same well established course to the Caribbean via a convenient resting stop at Canary Islands. After reaching the Lesser Antilles, the fleet kept to the south-west sailing along islands off the northern coast of South America such as Trinidad, Isla de Margarita and Cubagua. These were destinations for some of the smaller vessels. The fleet entered the port of Cartagena de Indias sometime at the end of May.⁶⁵

Upon the arrival, the captain-general hastened dispatches for Panama, and from there to Peru. These carried orders for the Viceroy to send the yearly silver quota and other goods north. Once these precious cargos reached Pacific side of the Isthmus, they had to be carried by the mule trains across the land to the Caribbean port of Nombre de Dios, which after 1592 was replaced by Portobelo. From there, the squadron of dedicated warships, or *galeones de la plata* (silver galleons), would take the valuable consignment back to Cartagena. The silver galleons sailing alongside merchantmen for *Tierra Firme* convoy also earned it the label *galeones*.⁶⁶ Typically, a voyage from Spain

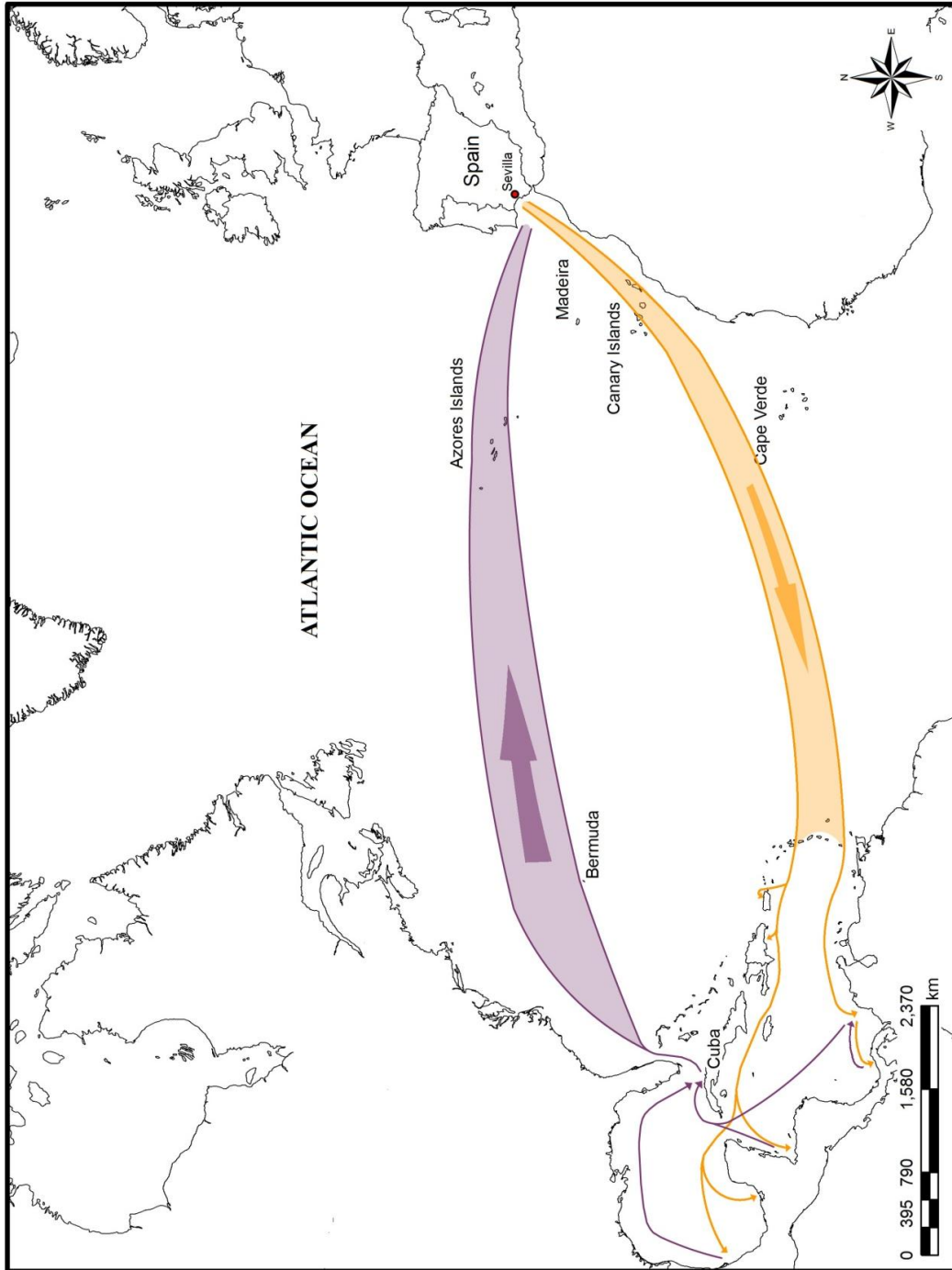

Figure 2.7: Spanish sailing routes to and from New World. (after Chaunu and Chaunu 1955, 7: 20-1.)

to Cartagena took about two and a half to three months, and from there about a week to Portobelo and a week to come back (fig. 2.8).⁶⁷

After about eight months in the Indies, both fleets assembled in Havana, Cuba, which was the premier commercial and naval center of the Spanish Empire in the New World. According to contemporaries, the city was not only considered to be “the best port in the World,” but also the “throat” of the Indies.⁶⁸ The *Nueva España flota* usually left Veracruz in early May. It sailed north, then east following the northern coast of Gulf of Mexico, and finally headed south along the west coast of Florida to Havana. The combined *Tierra Firme galeones* typically left Cartagena in mid-June, headed directly for Yucatán Channel and then east along the northern coast of Cuba.⁶⁹ Estimates suggest that it took about nine to ten days to reach a rendezvous point from Veracruz and about fifteen days from Cartagena.⁷⁰ After a stop in Havana to refit and victual before the long transoceanic stretch, the *flota* and *galeones* strived to depart before August, a schedule dictated by the onset of the hurricane season.⁷¹ Due to tremendous logistical difficulties associated with coordinating the movement of ships, it was uncommon to have one large retouring convoy. During the late 16th century the homebound fleets merged only fourteen times, though this rate greatly improved in the 17th century.⁷² When both fleets managed to sail for Spain together and were joined by heavily armed galleons of the *Tierra Firme*, the convoy was known as the *Armada de la Guardia de la Carrera de las Indias* (armada for the protection of the Indies route).⁷³ This naval squadron would include about eight large galleons, three auxiliary *pataches* and a special contingent of 1,100 seamen and 908 soldiers.⁷⁴

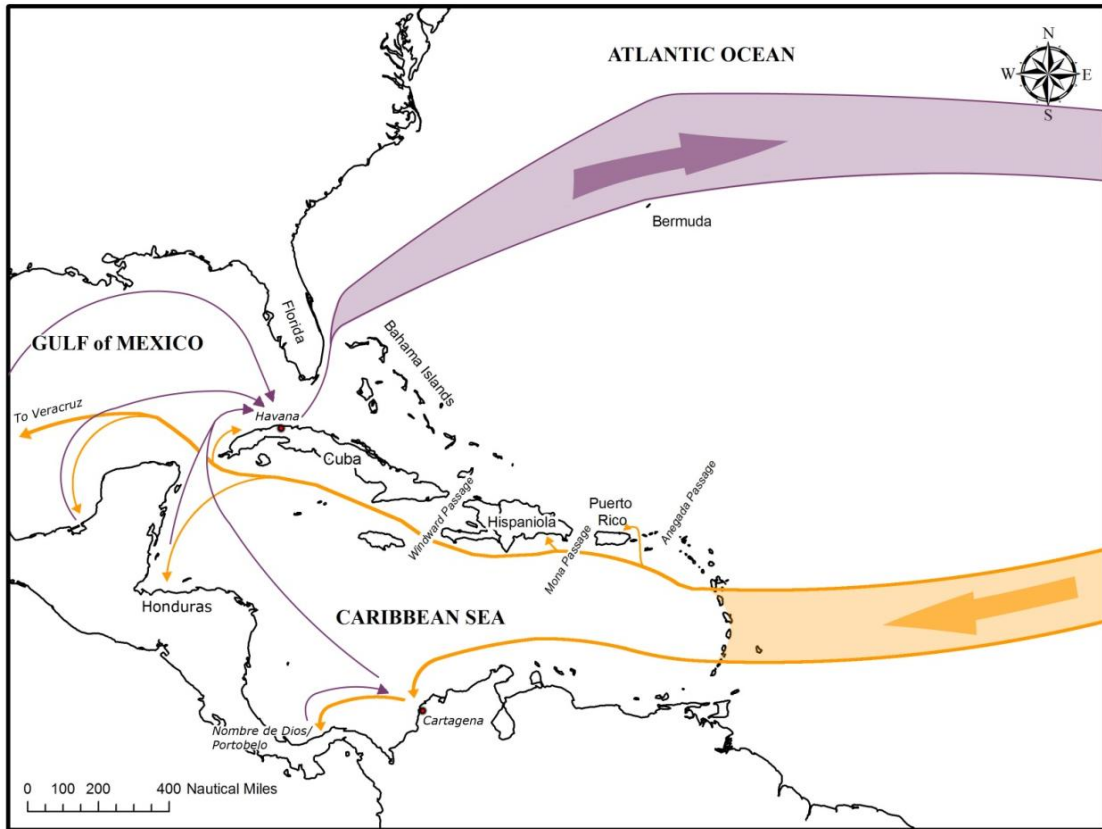

Figure 2.8: Spanish sailing within Caribbean Sea and Gulf of Mexico. (after Chaunu and Chaunu 1955, 7: 20-1.)

Combined or not, the fleets usually left Havana in early summer heading for the Straits of Florida with its strong headwinds and dangerous shoals, and then north along the coast utilizing the energy of the Gulf Stream. After clearing the last reefs of the Bahamas, the course was changed to north-east to reach Bermuda, which was typically accomplished in seven to ten days.⁷⁵ From there, Westerlies could be found for the fast Atlantic crossing to the Azores, with a stopover on the island of Terceira after about two to two and a half weeks of sailing, and then back to Spain (fig. 2.9).⁷⁶ This group of small islands was of paramount importance for safeguarding the *Carrera de Indias* route, as most of the attacks by pirates and privateers occurred between the Azores and the mainland Spain. Since the yearly schedule of fleets was well known, it was easier for the enemies to simply wait in the vicinity of the islands than to find the fleets in the middle of the ocean. To mitigate constant danger, the returning ships were joined in the Azores by one of the naval squadrons belonging to the *Armada del Mar Océano*. The system of scheduled fleets, protected by the galleons of *Armada de la Guardia* and joined by the *Armada del Mar Océano* when closer to home, proved effective. Over the course of 130 years the entire returning fleet was captured only once by enemies, the Dutch, at Matanzas Bay, Cuba.⁷⁷

The first determinant for long-range voyages between Spain and the Indies was the system of favorable winds and currents which in essence flow in the North Atlantic in almost a clockwise pattern. The discovery of this system, largely credited to Columbus, transformed the Atlantic from an intimidating body of water on the edge of the known world into the ocean of opportunities.⁷⁸ The second and equally important

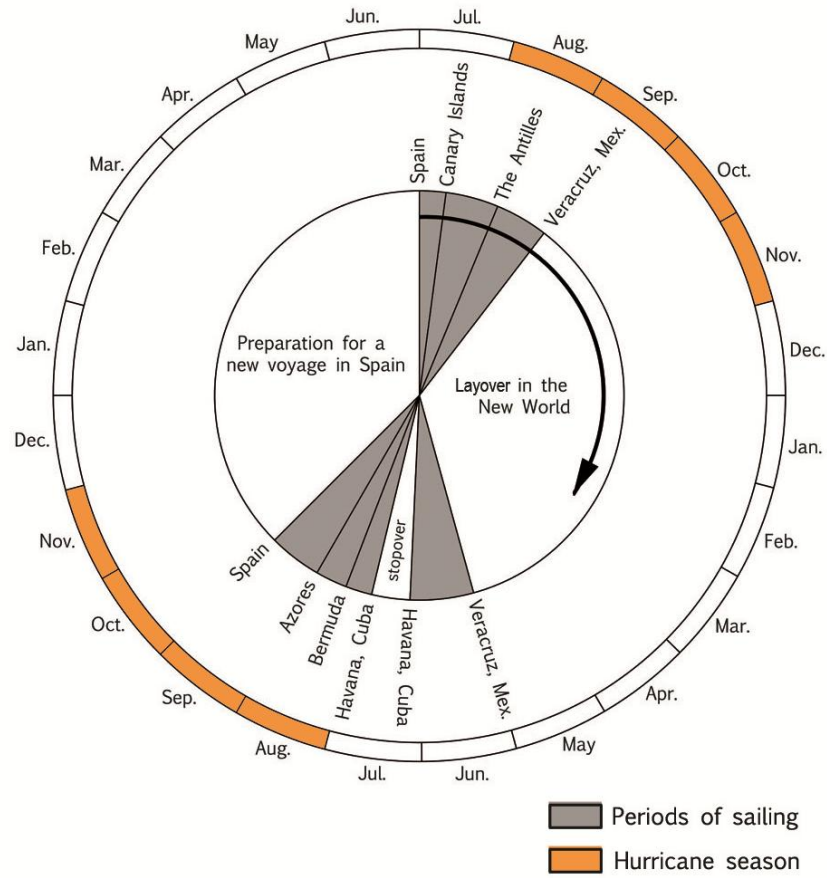

Figure 2.9: Example of a biennial sailing schedule for the *Nueva España flota* from Spain to Veracruz. (after Chaunu and Chaunu 1955, 7: 25.)

determinant for long-range voyages in the era of crude navigational equipment, dead reckoning, and inability to determine longitude at sea was the reliance on well-established waypoints.⁷⁹ Outbound, the fleets followed a southern route sailing from Spain to Canary Islands and then to Lesser Antilles, at which point the course was altered for either Cartagena or Veracruz. Inbound, the fleets gathered in Havana and from there they followed a northern route sailing near Bermuda to the Azores, and then back to Spain.⁸⁰

2.4 BERMUDA: *DEMONIUM INSULA*

*O brave new world...*⁸¹

Bermuda was one of the most distinctive waypoints in the Spanish system of navigation. According to three major studies on the early history of island, it was discovered by Juan Bermúdez de Palos, master of the carvel *La Garza*, during his return voyage from Hispaniola in 1505.⁸² Six years later, in 1511, *La Bermuda* was featured for the first time on an anonymous map, *Seno Mejicano*; it was reproduced as an insert to one of the earliest editions of a book entitled *De Orbe Novo Décades Cum Legatione Babylonica* by Pedro Mártir de Anglería, a leading chronicler at the Spanish court (fig. 2.10).⁸³ The anonymous cartographer mistakenly positioned Bermuda at the same longitude as the Canary Islands, an understandable error since the longitude could not be reliably measured until the 18th century. As far as the latitude, it was almost exact and

corresponded with what was labeled on the map as *El Estrecho* (The Strait), today known as the Strait of Gibraltar. Bermuda was known by two names, *La Garza* (also spelled *Garça*), after the ship, and *La Bermuda*, after the captain, Juan Bermúdez, who discovered it. Spanish captain and chronicler Gonzalo Fernández de Oviedo (y Valdés) sailed near the island in 1515, with the intention of leaving live pigs for potential shipwreck survivors. Although contrary winds prohibited him from make a landfall, he recorded that at the latitude of the island was 33° north, and that it was the furthest island known in the world. Oviedo also reported that *La Bermuda* was 12 leagues in length, 6 leagues in breadth, and about 30 leagues in circumference. As we know today, the size was erroneously magnified by about a third.⁸⁴

Bermuda geographical position, which coincided with prevailing winds and currents, made the archipelago a crucial navigational marker for almost all traffic coming back from the New World. The group of over 150 small islands and islets was the only such point of reference in this part of the Atlantic Ocean.⁸⁵ Although pushed by the Gulf Stream, the ships had to frequently struggle against opposing northerly winds within the Straits of Florida. Upon clearing the Bahamas, ships could evade such northerlies by staying close to the wind on the portside tack and altering their course to north-east, which in essence took them directly to the latitude of Bermuda. As they knew its approximate location, pilots used the islands to readjust the position of the ships and find a zone of reliable Westerlies, which prevailed north of the latitude of 35°.⁸⁶

The strategic considerations and growing number of ships retouring from the Indies produced an urgent need to take a close look at the archipelago. In 1525, the

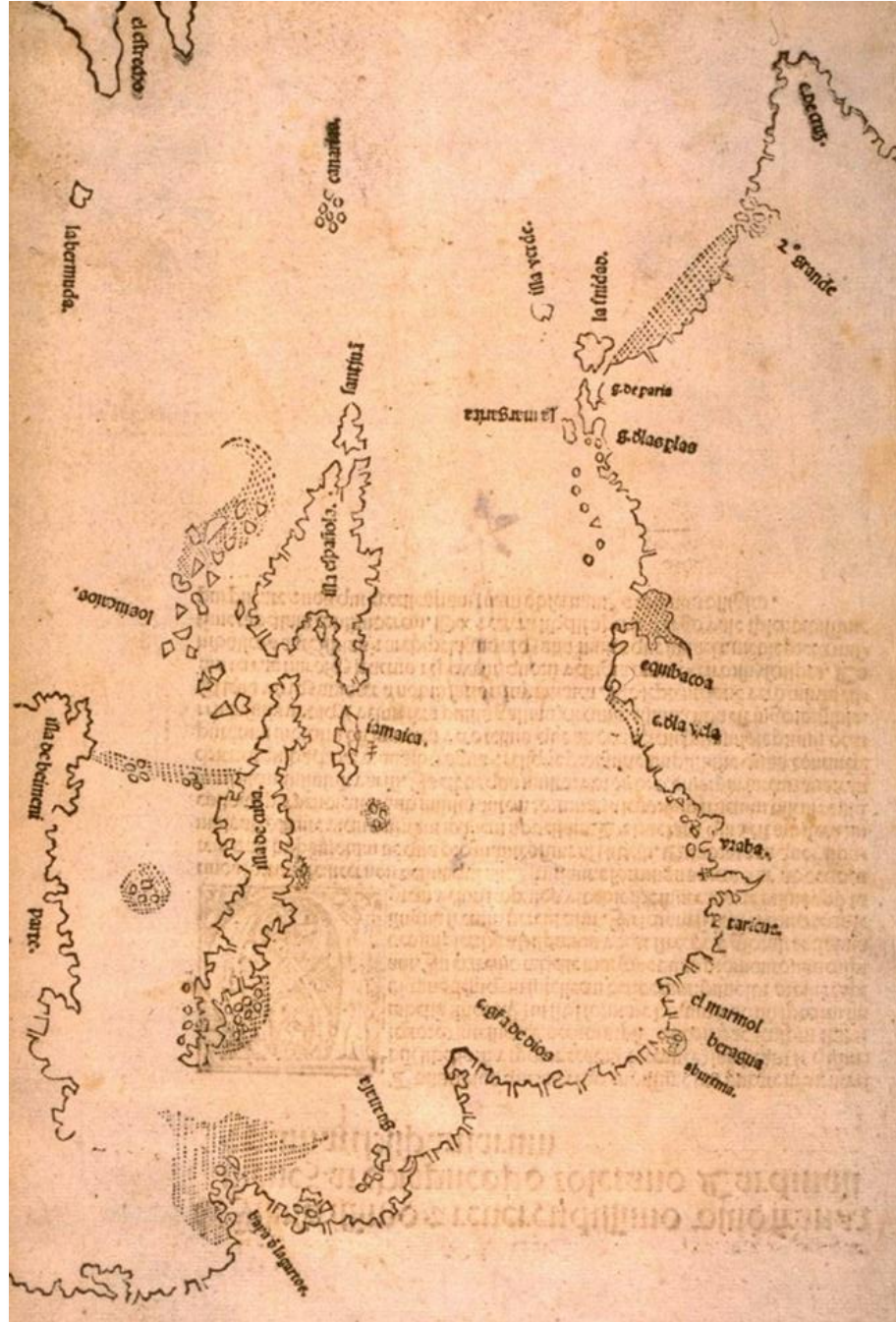

Figure 2.10: 1511 map showing the island of Bermuda; *De Orbe Novo Décades Cum Legatione Babylonica* by Pedro Mártir de Anglería.

crown commissioned Estevão Gomez, Portuguese Azorean in Spanish service, to search for an easy passage through North America in temperate latitudes as well as to survey and map Bermuda.⁸⁷ Unfortunately, Gomez's original map did not survive; a poor quality copy was included as a part of the manuscript known as *Islario general de todas las islas del mundo* written by Santa Cruz, a chief cosmographer at the *Casa de Contratación*, in 1542. Notable, Santa Cruz's *Mapamundi* published in the same manuscript included *La Bermuda* marked as a group of islands.⁸⁸

Two years later yet another Portuguese Azorean, Fernando Camelo, proposed to colonize the islands. According to the stipulations of the official license issued in 1527, Camelo was required to begin the colonization within a year and settle Bermuda with at least 20 people, exclusively Spanish citizens, within four years. After this period, the jurisdiction would be transferred directly to the Spanish crown, with the provision that Camelo could retain the position of the governor and captain general of the colony for life. Even though the scheme seemed appealing, it is unknown why the effort was never launched.⁸⁹ Quinn suggests a potential explanation might be that the Spaniards were unwilling to occupy the small and resource deficient Bermuda, especially in the light of Cortés's contemporary achievements in Mexico.⁹⁰ With the exception of occasional shipwrecks, the Spanish activity and potential interest in the archipelago was revived only in 1587, when a Basque, Pedro de Aspide, petitioned to the crown for a license to sail to Bermuda in search for pearl fisheries, which he hoped to be found there. It is unknown if such request was ever granted.⁹¹ Although colonization and

commercialization were ineffectual, the location of this small group of islands continued playing a strategic role within the system of *Carrera de Indias*.

The stretch between the Bahamas and Bermuda was deemed particularly perilous for sailing vessels and the islands acquired a mystical aura as a fanciful place of enchantment and haunting by devils.⁹² For example, the *Mappa Mundi* authored by celebrated Sebastian Cabot and dated to 1544 carried a description of Bermuda as “ya, de demonius.” In a letter to King James I, the Earl of Northampton explained that the Spaniards were so afraid of the place and amazed by the frequency of the hurricanes that they dubbed it “Demonium Insula.”⁹³ Although navigational problems could be mitigated, at least to a certain degree, the Atlantic storms were largely unpredictable even after following a timetable delineated in the Royal Ordinances or *Instrucciones*.⁹⁴ The hurricane season, which usually lasted from August till November, proved so menacing that the Spanish naval hero don Fadrique de Toledo claimed “to delay the departure from Havana beyond August was to tempt God.”⁹⁵ Despite the Royal and divine warnings, the timing of the convoys remained variable, and some disasters at sea were unavoidable even within the best organized fleet.

Since the individual ships often lacked experienced pilots and skilled seamen, books on navigation aimed at providing information to facilitate a safe return. One of the earliest such examples was a book written by Alonso de Chaves between 1519 and 1538 and known by its short title *Espejo de Navegantes*. Chaves described three possible sailing routes that a pilot could take while sailing from the Florida Strait. To sail north of Bermuda, one should sail east by north-east 240 leagues out of the strait and then 100

leagues east. To sail for Bermuda, one should sail east by north-east 230 leagues and then 100 leagues east. Finally, to sail south of Bermuda, one should sail east by north-east 220 leagues out of the strait and then 100 leagues east. Although the text did not elaborate on these routes, Chaves indicated that the second one would put a ship directly on the reefs extending west off Bermuda and should be avoided.⁹⁶ In 1575, Juan Escalante de Mendoza, an experienced sailor and later captain himself, printed one of the most comprehensive treatises on navigation to the Indies. In reference to Bermuda, he stated that after leaving the Florida Strait the preferred route was to sail east by north-east to the latitude of 35° north and from there east for the Azores. Mendoza explained that passing Bermuda to the north was the most prudent because of the contrary winds, hurricanes, calms, and water shoots that tended to occur to the south. It is possible that the rationale behind this approach was that if the hurricanes strike, they usually come from south. Thus, by sailing south of Bermuda, the winds would drive the ship onto the reefs and rock. By sailing north, however, the winds would drive the ship away from the islands and into the open ocean.⁹⁷

Finally, there were also more detailed navigational instructions, perhaps based on the directives issued by the *Casa de Contratación* to those in charge of the convoys. According to an excerpt from one such example by Baltasar Vellerino de Villalobos and dated to 1592:

“...From Havana to the Azores Islands there are two navigational routes. Upon leaving the Bahamas Channel, the one route is used when the winds and currents drive the ship to the northeast and the other when the winds and currents do not allow this route to be followed.

When the weather is good, sail from Havana in the morning just before first light with the land breezes assisting the departure. Having left El Morro, turn with the land

breezes until they stop midday or until the sea breezes pick up. Stay along the coast, so that when night comes, land is within sight and Havana is to the lee. The sea between Havana and the Bahamas will be crossed quickly because of the currents that flow directly towards the channel. It is important to sail this route at night with care and vigilance and keeping a constant watch for land, for islets, and reefs around Cabeza de los Martiros which are sand banks (Cay Sal Banks).

Upon maneuvering around these islets and Cabeza de los Martiros, sail north northeast along the coast of Florida, but not too close. On this course, sail to the 28 1/2° latitude which is the exit of the Bahamas Channel.

The route to follow is to sail from Havana when the winds are strong and adverse, as the winds in the navigation tend to be. Under no circumstances sail west, but tack as best as possible along the coast to the Bay of Matanzas. To the northeast is the entrance to the Bahamas Channel. If the winds make a northerly tack impossible, with extreme vigilance and care, tack back and forth to windward in search of the channel.

Take heed that while beating windward to find the entrance to the Bahamas Channel, search for the coast of Florida. Sail with care because of the reefs, shoals, rocks, and the convergence of the waters from the Old Channel (Santaren Channel).

To sail from the channel without making port at Havana, sail within sight of the Totugas (Dry Tortugas). Between the Tortugas and the Cayos Axiauga (Florida Keys) there is a passage where all ships from the entire World can pass. Sail to windward, around the coast and the keys, into the channel.

Having left the Bahams Channel in the 28 1/2° latitude, in order to sail east northeast, the course should be east by northeast, due to the northwesterly declination of the compass. Continue this route until reaching the 39° latitude. At this point Bermuda will be to the south.

Upon arriving at the 39° latitude, sail east by south east. Due to northwesterly declination of the compass, the course will be east, Following this course until the fleur-de-lis lines up the Pole. At this point the islands of Flores will be near. Continue this route for Flores and the other islands of the Azores Islands, which are Corvo, Faial, Pico, San Jorge, Graciosa, Terceira, San Miguel, and Santa Maria... ” (fig. 2.11)⁹⁸

As evident, the passage reveals that the navigation between Havana and Azores was well established up to a degree of latitude and Bermuda functioned within the system as an important reference point. Navigational instructions also warned against any attempts to approach Bermuda due to its extensive shallow reefs, to stay clear of the islands for at least one league, and to be constantly aware of the ships' latitude, bearing, and sounding.⁹⁹

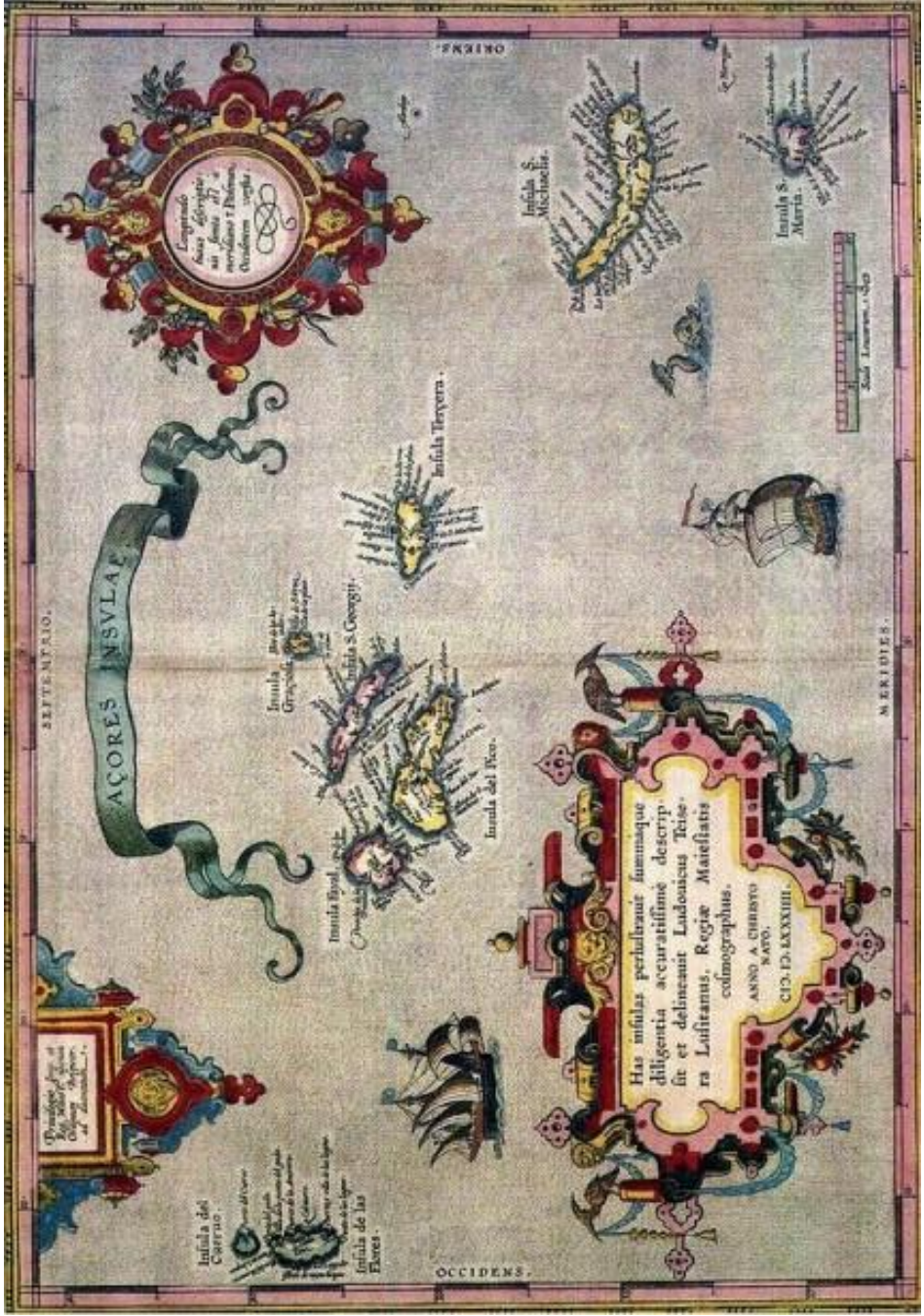

Figure 2.11: The 16th-century map of Azores. (after Luis Teixeira map of the Azores, c. 1584, Teixeira et al. 1993)

These late 16th-century records provide surprisingly little in terms of the actual description of the archipelago, especially after excluding information copied from the earlier sources. For instance, the manual circulated as a manuscript and published by Juan López de Velasco in 1571 indicated only the well-known facts related to the position of Bermuda at 33° latitude, the lack of inhabitants, or its general flatness with one dominant hill. The manual also stated that Bermuda had an abundance of seabirds and fish, and it could be sighted on the retouring passage.¹⁰⁰ A 1583 manuscript written by Franco Manuel offered the simple advice to stay away from the islands altogether and sail further north to the latitude of 34° before attempting to change the course due east for Azores.¹⁰¹

One of the earliest surviving and most esteemed maps of Bermuda was produced by Diego Ramirez, a captain of a *Tierra Firme* galleon returning as a part of the Armada under the command of captain-general, Luis Fernandez de Cordoba, in 1603.¹⁰² During a hurricane, Ramirez's ship separated from the fleet and became stranded on the sandy bank near the northern entry to Bermuda's Great Sound, an area known today as the Spanish Point. Although largely undamaged, the vessel had to remain in Bermuda for twenty two days to undergo necessary repairs while the captain and his pilot, Hernando Muniz, surveyed the archipelago in a ship's boat. They produced a detailed map of the islands, brief descriptions of the fauna and flora, available water sources, and the physical conditions at the most suitable anchorages: at the Great Sound, Castle Harbour, and St. George's Harbour (fig. 2.12).¹⁰³

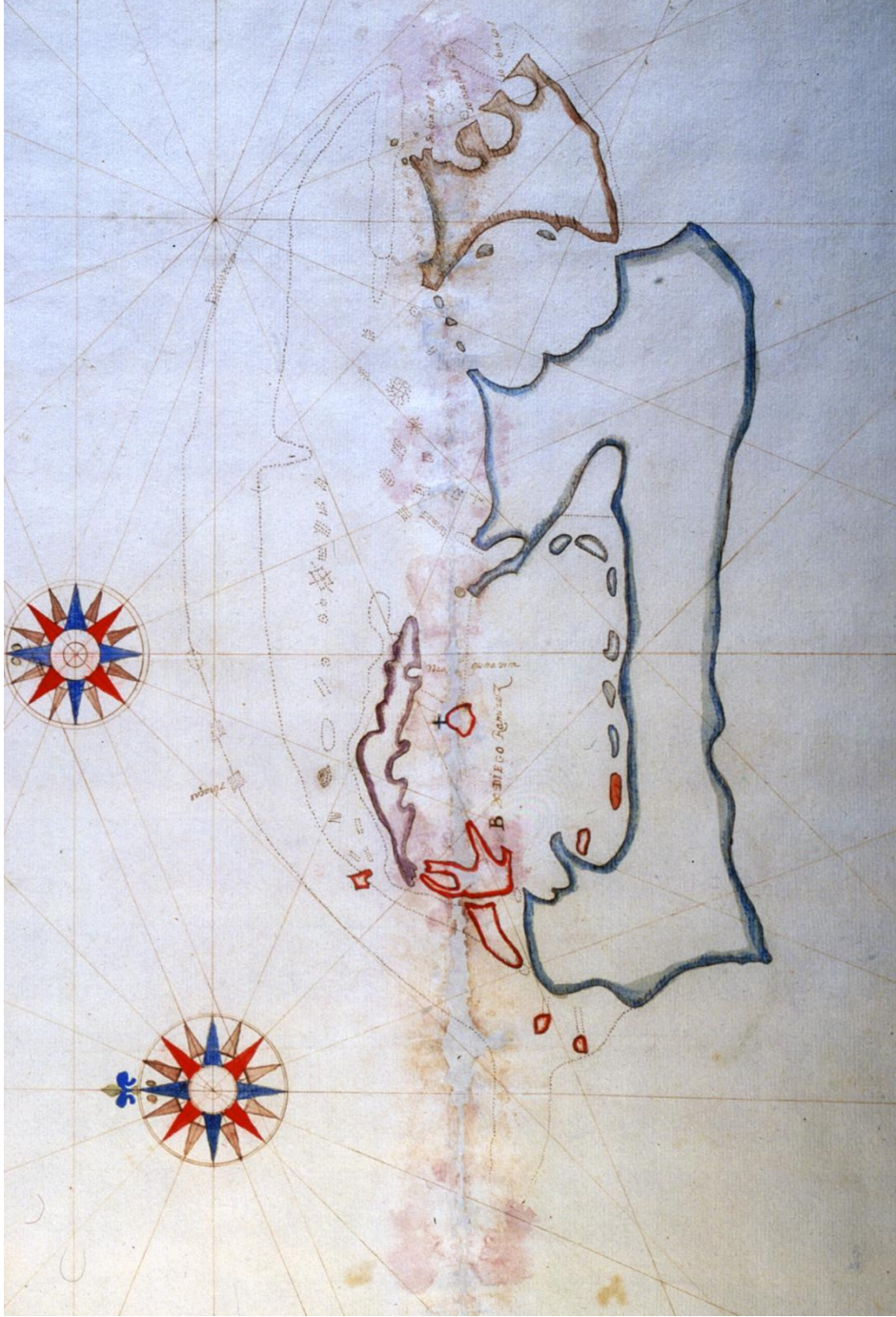

Figure 2.12: 1603 map of Bermuda by Diego Ramirez. (Archivo General de Indias, Seville)

Another description often times issued together with the navigational instructions to the pilots sailing to Indies was this late 16th-century excerpt. Here, previously mentioned Villalobos provided basic information about the archipelago sailing conditions stating that:

“... (Bermuda)...is located in the middle of the ocean not close to anything. One should deviate from that latitude and location, always keeping a wide berth. Certainly many naos have been lost while sailing in those parts without knowing where nor how they perished. The shoals of the island would have consumed them(...)

(...) One usually sailed south of the island saying that to the north of the island is where the demons were stirring up large storms. This error lasted a long time. Experience showed that this was incorrect. It is the opinion of all the experienced mariners that it is better to sail to the north of the island due to favorable conditions found there. This should always be followed unless strong winds cause one to sail south of the island. In the winter strong winds can be found in that latitude and it is better not to sail too far north. Only in the summer and with good weather should one sail to the south. The navigation should be done this way.”¹⁰⁴

Despite all the safeguards and warnings put in place for the convoys, Chaunu and Chaunu noted 17 ships lost on the treacherous Bermuda reefs before 1600s. Of these, 13 shipwrecks occurred in September 1591, an especially devastating year (table 2.3).¹⁰⁵ In contrast, Quinn cautiously estimated over thirty ships of different nationalities lost near Bermuda before 1600s , with at least several crews managing to salvage enough materials and use native cedars to build new vessels and escape to report their ordeals.¹⁰⁶ This was more than enough to leave a profound impression on mariner’s collective memory, producing numerous superstitions. One myth held that the archipelago could disappear on occasion and then suddenly reappear only to lure sailors to an inevitable disaster.

Table 2.3: Ships Lost Near Bermuda between 1551 and 1622. (after Chaunu and Chaunu 1955, 6b: 972-3 (Table 666. Les Bermudes)).

Ships Lost Near Bermuda Between 1551 and 1622			
Year	Month	N	Total Tonnage
1551	April	1	400
1579	November	2	1050
1591	September	13	4480
1596	July	1	320
1605	July	1	200
1614	unknown	1	150
1622	September	4	1916
Total:		23	

With the exception of shipwrecks and their occasional survivors, the island stayed uninhabited until the famous English supply ship *Sea Venture*, under the command of Captain Christopher Newport, wrecked there in 1609.¹⁰⁷ Interestingly, the news of the event did not circulate in Spain until 1611 at which time it was already too late.¹⁰⁸ By 1612, the first group of fifty to sixty English colonists arrived in “these Islands of the Bermudos” onboard the *Plough*.¹⁰⁹ Even though Alonso Pérez de Guzmán, Duke of Medina Sidonia, adamantly lobbied the Spanish king, Philip III, and the Council of War to send a military contingent and remove English heretics from Bermuda, the idea never materialized.¹¹⁰ English settlers under the leadership of the first governor, Richard Moore, not only remained in Bermuda, but also developed it into one of the most successful British overseas territories. Bermuda was transformed, in essence, from inaccessible, mysterious and foreboding Isle of Devils into safe, rich, and balmy haven for Englishmen and other colonists. What happened after 1612 is, however, another chapter in the history of the island and that of the Atlantic world.¹¹¹

Regardless the island’s lack of natural resources and inability or perhaps unwillingness of Spain and Portugal to colonize it throughout the 16th and early 17th centuries, Bermuda was preeminent within the system of navigation between the New World and Spain. It was during this period that the Spanish Empire witnessed tremendous political and economical changes, which effectively set the ground for its decline. Once distant and insulated, the New World quickly became open and assessable by ships of various types and sizes. These ships of the Spanish fleet system were the most advanced expressions of human technological ingenuity of the era. They provided a

crucial link transporting goods and settlers to the New World and bringing such desperately needed silver back to the Spanish royal coffer. They also were responsible for exchange of information, ideas, and knowledge among the fringes of the Empire. The unique geographical position of the island of Bermuda within the Spanish *Carrera de Indias* and the extensive system of reefs extending far into the ocean transformed the island into a resting ground for numerous homebound vessels. To understand better the unique circumstances surrounding the wrecking of one such ship, we need to know more about the location, history of the site, and prior research on the Western Ledge Reef Wreck.

ENDNOTES

-
- ¹ Hume 1927, 2-3.
- ² For an excellent review of the Portuguese maritime history see Boxer 1969.
- ³ Scammell 1981, 301-2.
- ⁴ Flynn 1979, 197.
- ⁵ Brading and Cross 1972, 546, 552, 576-77.
- ⁶ Gayarré 1866, 23-4.
- ⁷ Usher 1967, 211-2.
- ⁸ Quoted in Braudel 1981, 363.
- ⁹ See Martin and Parker 1999; Fernández-Armesto 1988.
- ¹⁰ Fernández-Armesto 1988, 269-70.
- ¹¹ Scammell 1981, 301-69.
- ¹² Watson and Thomson 1783, 2-3.
- ¹³ Dufau et al. 1824, 382-4, 405-7.
- ¹⁴ Grattan and Hawthorne 1901, 243-7.
- ¹⁵ Goodman 1997, 15-6.
- ¹⁶ Phillips 1986, 17.
- ¹⁷ Goodman 1997, 10.
- ¹⁸ Ibid., 9-11.
- ¹⁹ Rodríguez Mendoza 2008.
- ²⁰ Phillips 1986, 15-7; Goodman 1997, 10-1.
- ²¹ Hamilton 1938, 178.
- ²² Ibid; Goodman 1997, 29.
- ²³ Scammell 1981, 326-7; Parry 1966, 117.
- ²⁴ Moses 1898, 27-67.
- ²⁵ Barney 1998, 4; Phillips 1986, 9.
- ²⁶ Chaunu and Chaunu 1955, 6a: 414-21.
- ²⁷ Chaunu and Chaunu 1955, 1: 121-2; Phillips 1986, 192.
- ²⁸ Goodman 1997, 3; Smith 1988, 85.
- ²⁹ Phillips 1986, 10; the concept of highly regulated convoys was not an original Spanish idea since the Venetian galleys were organized into regularly scheduled fleets, the *mudue* or *mude*, more than two centuries earlier, for discussion related to the Venetian convoys see Lane 1963, 180-1.
- ³⁰ Fernández Duro 1876, 167-8.
- ³¹ Smith 1988, 85-6.
- ³² Walton 1994, 51.
- ³³ Haring 1918, 158; Walton 1994, 48-9.
- ³⁴ Goodman 1997, 3.
- ³⁵ Ibid., 3-4; Walton 1994, 49.
- ³⁶ Chaunu and Chaunu 1955, 6a: 404-6.
- ³⁷ Clayton 1976, 236-7.
- ³⁸ Smith 1993, 46.
- ³⁹ Phillips 1993, 230.
- ⁴⁰ Chaunu and Chaunu 1955, 2: 444-595, 3: 6-563, 4: 8-109.
- ⁴¹ Clayton 1976, 236-7.
- ⁴² Chaunu and Chaunu 1955, 1: 316-8; Clayton 1976, 237.
- ⁴³ Juárez 1997, 262.
- ⁴⁴ Chaunu and Chaunu 1955, 1: 317; Veitia Linage 1977, 271; Juárez 1997, 260-1.
- ⁴⁵ Chaunu and Chaunu 1955, 1: 317, 2: 444-595, 3: 6-563, 4: 8-109.
- ⁴⁶ Juárez 1997, 263.
- ⁴⁷ Ibid., 262; Veitia Linage 1977, 271.

-
- ⁴⁸ Lee 1951, 214; Sanz and Pérez 1979, 32-8, 570-3.
- ⁴⁹ Veitia Linage 1977, 331-6; Manera Regueyra 1981, 402; Juárez 1997, 260-7.
- ⁵⁰ Chaunu and Chaunu 1955, 2: 444-595, 3: 6-563, 4: 8-109.
- ⁵¹ Custer Bojakowski 2011, 59-63.
- ⁵² Phillips 1993, 231; Grenier et al. 2007.
- ⁵³ Phillips 1993, 231-2; Custer Bojakowski 2011, 102-8.
- ⁵⁴ Chaunu and Chaunu 1955, 4: 74-5.
- ⁵⁵ Chaunu and Chaunu 1955, 1: 317, 4: 74-75.
- ⁵⁶ See Oyarbide 1998.
- ⁵⁷ *Ibid.*, 105-6.
- ⁵⁸ *Ibid.*, 106-7.
- ⁵⁹ Chaunu and Chaunu 1955, 7: 24.
- ⁶⁰ Cornell 1998, 34.
- ⁶¹ Padron 1955, 288.
- ⁶² Cornell 1998, 24.
- ⁶³ Chaunu and Chaunu 1955, 1: 318-9.
- ⁶⁴ Chaunu and Chaunu 1977, 232-3, 7: 24-5; Walton 1994, 51; Juárez 1997, 240-1; Lugo-Fernandez et al. 2007, 27-8.
- ⁶⁵ Chaunu and Chaunu 1955, 1: 318-9.
- ⁶⁶ Walton 1994, 51-3; Juárez 1997, 242; Phillips 1986, 11-2, 4.
- ⁶⁷ Chaunu and Chaunu 1955, 7: 24.
- ⁶⁸ Fuente and Pino 1996, 95.
- ⁶⁹ Chaunu and Chaunu 1955, 7: 20-4.
- ⁷⁰ *Ibid.*, 7: 24-5; Rodríguez Mendoza 2008, 25.
- ⁷¹ Chaunu and Chaunu 1955, 7: 24-5; Phillips 1986, 12-3; Walton 1994, 53-4.
- ⁷² Phillips 1986, 13.
- ⁷³ Parry 1966, 134; Juárez 1997, 244-5.
- ⁷⁴ Goodman 1997, 3.
- ⁷⁵ Parry 1966, 135.
- ⁷⁶ Quinn 1989, 1-2.
- ⁷⁷ Phillips 1986, 3-7; Goodman 1997, 4.
- ⁷⁸ Fernández-Armesto 2006, 64.
- ⁷⁹ Juárez 1997, 237-45.
- ⁸⁰ Hasler 1961, 118.
- ⁸¹ *The Tempest*, Act 5, scene 1, 183
- ⁸² Quinn 1989; Bream 1990; Barreiro-Meiro 2002.
- ⁸³ Barreiro-Meiro 2002, 13; Anglería 1511; Winsor 1886, 109-13.
- ⁸⁴ Barreiro-Meiro 2002, 7-8; Brockman 2009, 13; Valdés and Ríos 1851; as far as the geographical position, the parallel of 32° 20' passes directly through Bermuda. Based on the Spanish league of 4.2 km, the size of the island is about 8.5 by 0.8 leagues.
- ⁸⁵ Cornell 2001, 145.
- ⁸⁶ Quinn 1989, 2-3.
- ⁸⁷ *Ibid.*, 6; Bream 1990, 17-8.
- ⁸⁸ Delgado-Aguilera and Cruz 1918.
- ⁸⁹ Bream 1990, 18-9.
- ⁹⁰ Quinn 1989, 6.
- ⁹¹ *Ibid.*, 12.
- ⁹² Walton 1994, 61; Chaunu and Chaunu 1955, 8: 577-9.
- ⁹³ Brockman 2009, 15.
- ⁹⁴ See Rodríguez Mendoza 2008, 30; Spain 1943.
- ⁹⁵ Phillips 1986, 11.

⁹⁶ Chaves et al. 1983, 160-2.

⁹⁷ Escalante de Mendoza 1985.

⁹⁸ Quoted in Villalobos 1984, fol.185-6.

⁹⁹ Spanish league = 4.2 km or about 2.3 nautical miles. AGI, *Contratación* 4889, fol. 2; AGI, Santo Domingo 272, fol. 1

¹⁰⁰ Quinn 1989, 11; Velasco 1971, 90.

¹⁰¹ Quinn 1989, 11.

¹⁰² Chaunu and Chaunu 1955, 4: 164-7.

¹⁰³ Quinn 1989, 12-4; Wilkinson 1950, 53-7.

¹⁰⁴ Quoted in Villalobos 1984, fol.185-6.

¹⁰⁵ Chaunu and Chaunu 1955, 6: 972-3.

¹⁰⁶ Quinn 1989, 3.

¹⁰⁷ *Ibid.*, 14.

¹⁰⁸ Wilkinson 1950, 52.

¹⁰⁹ Quinn 1989, 16-7; Wilkinson 1958, 56-9.

¹¹⁰ Wilkinson 1950, 61.

¹¹¹ For the post 17th-century history of Bermuda refer to Craven 1990; Jarvis 2010.

CHAPTER III:

HISTORY OF THE SITE, EXCAVATION, AND GEOGRAPHY OF BERMUDA

3.1 THE “MALPAS WRECK”

As with so many shipwrecks which perished in the waters surrounding Bermuda, the history behind the one discussed in this dissertation is puzzling. In 1964, after one of the autumn storms that frequent this Atlantic archipelago, two local Bermudians, Douglas Roberts and Kenneth Stark, and an American, Dick Bouchard, encountered a conglomeration of ceramic objects during one of their sport dives. These objects were easily identified as intact Spanish olive jars, partly exposed at the base of a large coral head. The artifacts had settled inside a protected sand hole of approximately 22 m by 30 m surrounded on the south, east, and west by coral patch reefs at the depth of 8 m to 10 m. Although the site was located only about a half a nautical mile (about 1 km) inside the Western Reef barrier, and hence it was open to ocean swells, and about five nautical miles (9.3 km) of the west coast of Bermuda, it was relatively well protected from destructive surges and currents (fig. 3.1). After an assessment conducted over several trips to the site, the divers realized that they had discovered not only distinctively Iberian ceramics, but also a large ballast pile concealing ship timbers. At the time, Spanish shipwrecks inevitably carried the mental image of marvelous treasures, particularly New World gold and silver. To capitalize on their highly promising find, the three divers formed a partnership with two other Bermudians, Brian Malpas and Donald Canton, and

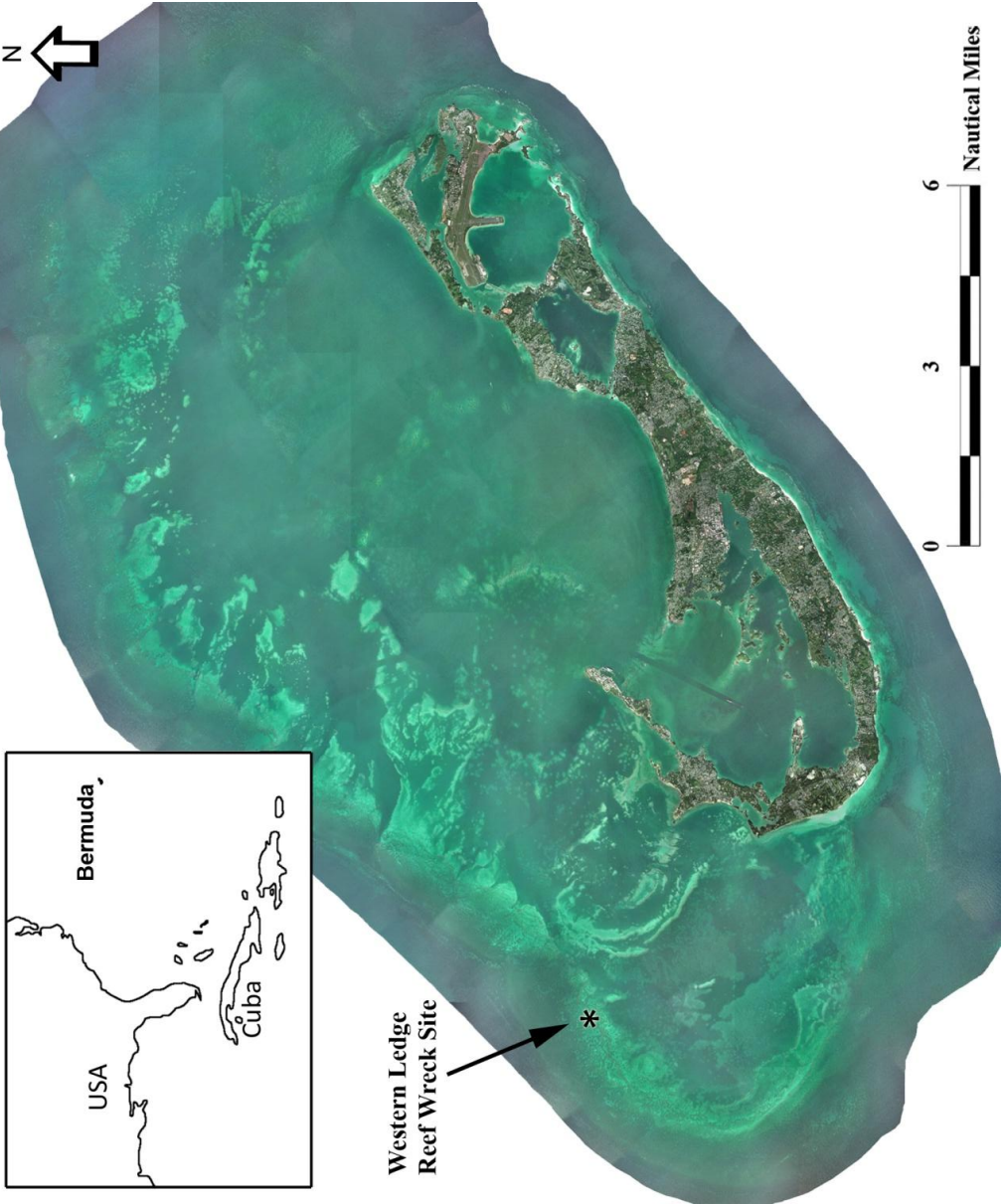

Figure 3.1: Location of the site. (satellite image of Bermuda courtesy of NMB; modified by P. Bojakowski)

registered the site under the names of Roberts and Canton. The group also applied for and was granted an official wreck license to salvage the site; they operated intermittently between mid-1960s and 1970s.¹

Although largely undocumented, this legally permitted operation (based on Bermuda's Wreck and Salvage Act of 1959) produced several significant finds, kept by Malpas, forming his extensive personal collection (fig. 3.2).² These include at least twelve intact olive jars, fragments of *majolica* and Columbian Plain ceramics, twelve heavily encrusted silver coins which could not be identified or dated, a total of seven pieces of ship's ordnance, iron and lead round shot of different caliber, three anchors, a ship's bell, three sounding leads, a jade amulet, a bosun's whistle, and numerous other smaller pieces (see Appendix 1). Reportedly, all the ship's ordnance was found in one large pile with no evidence of gun carriages and not on top of the hull remains, suggesting that these could have been jettisoned by the crew. Out of the original seven, only four guns have survived, including two wrought-iron swivel *versos* and two cast iron muzzle-loading cannons; they were donated by Malpas to the Bermuda Maritime Museum (BMM) in 1991 (fig. 3.3).³ Due to the fact that one of the recovered cast iron cannons had the number 500 and the year 1577 inscribed slightly forward of the touchhole, the general site was often referred to as the "1577 Wreck" (fig. 3.4). This was an alternative name to the Malpas Wreck.⁴



Figure 3.2: Selected artifacts from Malpas collection. (photo courtesy of NMB)

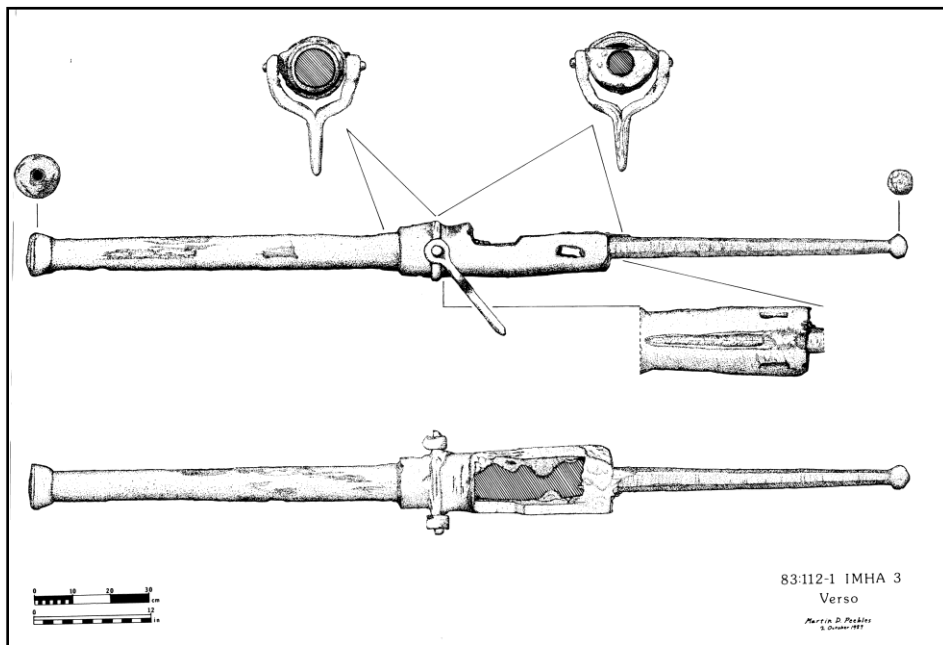

Figure 3.3: One of the *versos* found near the Malpas Wreck. (Watts 1993a, 117.; drawn by Martin D. Peebles)

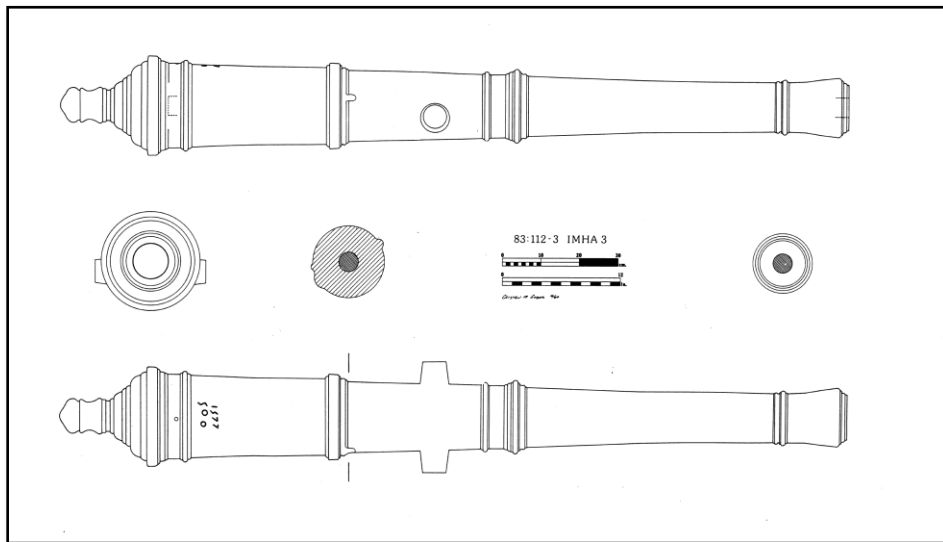

Figure 3.4: Cast iron cannon inscribed with the year 1577 and weight mark 500, found near the Malpas Wreck. (Watts 1993a, 115.; drawn by Cristen M. Gober)

Today, there are only six known photographs of the salvage operation: two of the shipwreck, one of the anchors, and three of the cannons. These were taken by Emory Kristof and featured in two issues of *National Geographic* magazine.⁵ The BMM inquired about obtaining a copy of all the photographs, particularly archival ones which were taken at the site but not published; as of the summer of 2010, the response of the National Geographic Society was that these old records could not be located. If a complete photographic record was found, it could clarify some of the confusion related to the shipwreck and the site as a whole.

Malpas claimed that he and his associates exposed the entire extant section of the shipwreck, constituting a rectangle approximately 10 m long by 5 m wide. The structure appeared to represent part of the starboard side of the hull, including a preserved fragment of the stem (fig. 3.5). The section was comprised of at least 19 framing timbers preserved from the turn of the bilge to the level of the second futtocks and possibly beyond. On average, these had roughly square cross-sections. Based on the relative scale of the photographs they measured between 21 cm and 27 cm molded width. Although the framing timbers showed distinct overlapping between the futtocks, the pattern was quite vague. Significantly, Malpas indicated that he never found evidence of dovetail scarfs joining the framing elements. Other exposed timbers included a few ceiling planks, a possible stringer, and about five external planks (fig. 3.6). Except some limited weekend excavations, Malpas and Canton were not concerned about the structural details of the vessel but rather in combing the vicinity of the wreck as well as the sand underneath the timbers for artifacts, which when encountered they occasionally raised.⁶



Figure 3.5: Photograph of the salvage work carried out on the Malpas Wreck.
(Peterson 1977, 728.)



Figure 3.6: Photograph of the Malpas Wreck showing the full extent of the preserved hull. (Benchley 1971, 116-7.)

With the permission of the original license holders, the Malpas Wreck was included as a part of the investigation of Bermuda “treasure” shipwrecks led by Edward (Teddy) Tucker and Mendel L. Peterson. They worked on the site in the mid-1970s. After further dismantling the structural timbers, they soon abandoned the site, recognizing what Malpas previously described as an absence of anything of pecuniary value. Although the ship sunk en route to Spain, the common consensus was that it could not have carried any New World treasures as neither salvors nor occasional treasure hunters ever locate any. The extensive use of the propwash technique and continuous exposure to the elements, winter storms, and occasional hurricanes over twenty years left the wreck largely demolished with no identifiable structure.

The Malpas Wreck was not the only sunken vessel in the vicinity. As indicated by Tucker, and later verified by the author, the surrounding reefs carry evidence of at least two more shipwrecks.⁷ One is tentatively identified as Dutch and associated with Rhenish stoneware, thin ballast bricks, and chunks of coal; the other one is probably English and associated with copper alloy bolts and small scraps of Muntz metal sheathing.

3.2 THE WESTERN LEDGE REEF WRECK (IMHA-3)

The site was relocated in September 1988 by archaeologists unaware of the previous work. During a survey of the Western Ledge Flats conducted by the staff and volunteers associated with the Institute of Maritime History and Archaeology (IMHA) at the BMM, two prominent ballast piles were located. One of the piles measured about 17

m in length and consisted of an elongated and slender wall of stones. Running along a north-south line, it defined the western boundary of the site. Reportedly, this pile was re-deposited to the present location by Malpas and his associates who worked on the Malpas Wreck in the north-eastern portion of the sand hole.⁸ The second smaller pile measured about 7 m by 5 m; the concealed hull timbers were partly uncovered, clearly the result of recent salvage. A forward section of the keelson with evidence of expanded mast step, short fragments of the ceiling planks, two or three buttresses, a few visible floor timbers and partial first futtocks were exposed along the western portion of the pile (fig. 3.7). These timbers, together with the scattered artifacts such as olive jar fragments, stoneware sherds, concreted iron fastenings, and rigging components, tentatively indicated an Iberian vessel of roughly late 16th- or early 17th-century provenience. Although a small section of the midship was exposed, the majority of the structure remained undisturbed as evidenced by the large intact portion of the ballast pile.⁹ This new shipwreck was designated in the museum records as IMHA-3 (Institute of Maritime History and Archaeology wreck number three).

Significant for the understanding the site, IMHA-3 was not the wreck originally discovered and worked on by Malpas and his associates, which by that time had been completely destroyed. According to the report, six test pits were dredged up to a depth of 2.5 m below surface but no articulate wreck structure of the Malpas Wreck was discovered. All that survived were concreted iron artifacts, ballast stones, and shattered fragments of hull timbers.¹⁰ In contrast to the Malpas Wreck, the IMHA-3 Wreck

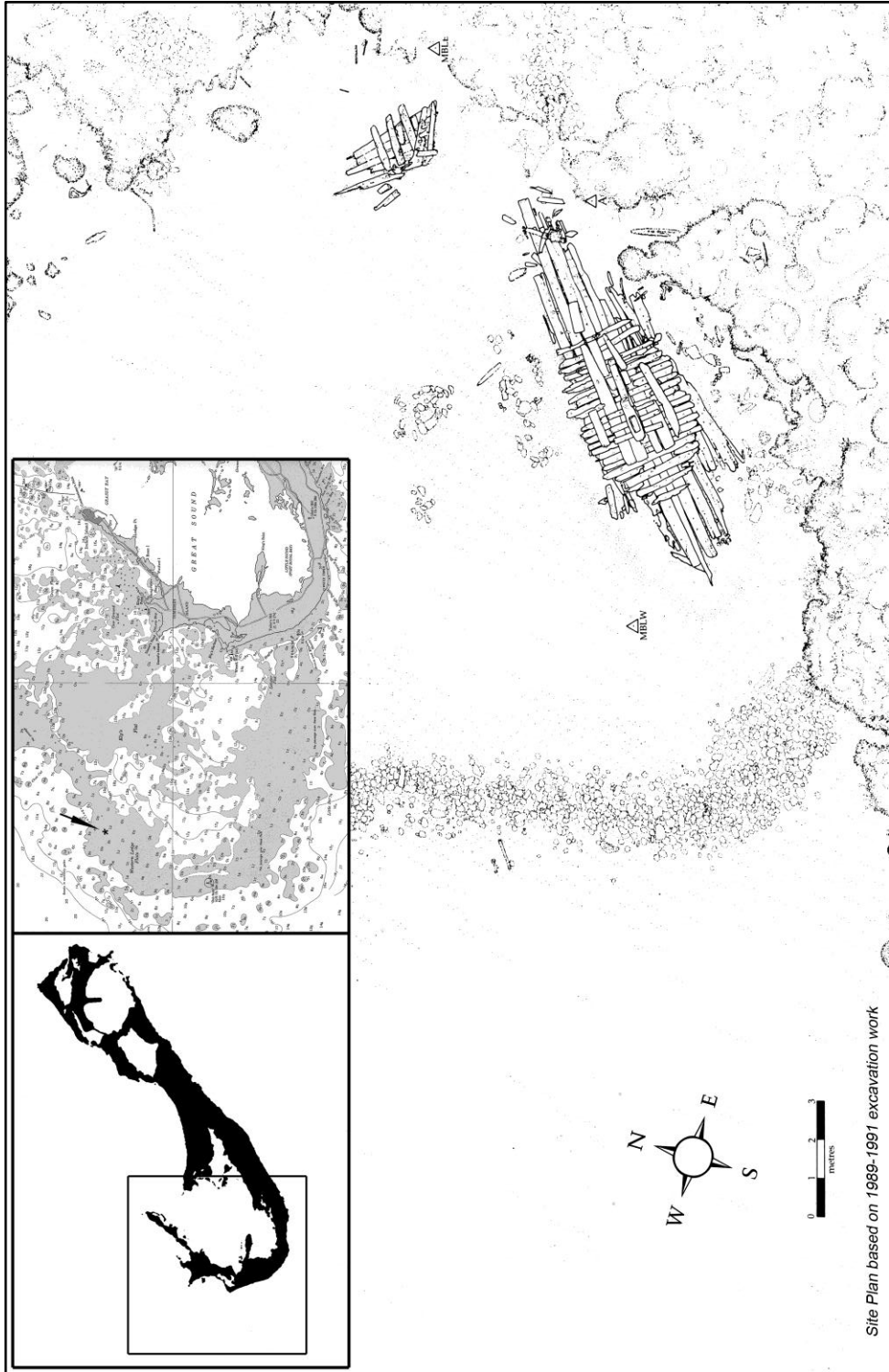

Figure 3.7: Site plan of the Western Ledge Reef Wreck site. (after Watts 1993b, 35.)

found during the survey appeared to be a well-preserved lower hull of a smaller vessel. Due to spatial proximity, however, confusion arose over time; investigators supposed a tentatively identified starboard section of the Malpas Wreck and a bottom section of newly discovered IMHA-3 Wreck could be parts of one and the same vessel.¹¹ This suggestion surfaced from time to time in conversations, but could never be validated. The fact that these were two separate shipwrecks sharing the same sand hole was finally confirmed by the author in a series of interviews with Malpas, Tucker, Dr. Philippe Rouja, and Anson Nash conducted between 2007 and 2011, review of the original survey journals, notes, drawings, and sketches from 1988 and 1989, and detailed analyses of large prints of the original photographs of both shipwrecks, which were digitally remastered in a professional studio (refer to fig. 3.5, fig. 3.6).

This conclusion is supported by four critical pieces of evidence. First, the overall dimensions of the extant section of the Malpas Wreck were larger than what was evident from studying the bottom hull of the smaller IMHA-3 Wreck, producing a notable discrepancy in size between the two. Second, the scantling of the Malpas Wreck framing timbers was on average between 4 cm and 8 cm larger than the scantling of even the most robust floor timbers of the IMHA-3 Wreck. If the former in fact represented only a side of the ship and the latter the very bottom, this would suggest that the cross-sections of the first and second futtocks had to be larger than the cross-sections of the floor timbers, a complete deviation from all accepted rules of framing. Third, the average frame spacing of the Malpas Wreck, (in essence a product of scantling), was on average 17.4 cm larger than the spacing measured on the IMHA-3 Wreck. Finally, a striking

confirmation was that the section of the Malpas Wreck and the bottom of the IMHA-3 Wreck included their respective turn of the bilge, making one of them redundant. In other words, it was structurally impossible to match a starboard side of the former, which was preserved from just below the turn of the bilge to the level of the second futtocks, with the bottom hull of the latter, which was preserved from the keel to the port and starboard turn of the bilge (table 3.1). It is important to emphasize that with the exception of Iberian artifacts raised over the years by the salvors, there was no structural evidence on the timbers corroborating with any degree of confidence the nationality or shipbuilding tradition of the Malpas Wreck. This further reinforces the notion that these two should be treated as separate shipwrecks.

Confirming that IMHA-3 and the Malpas Wreck were separate vessels was an important step forward, and clarified much about this enigmatic site. However the presence of two shipwrecks in the same sand hole tremendously complicated the subsequent research; the author could not disregard the fact that the salvage of the Malpas Wreck inevitably impacted the IMHA-3 Wreck. Because the artifacts were generally similar to those from IMHA-3, it was difficult to prove beyond a reasonable doubt which shipwreck produced the artifacts. Although artifacts are extremely helpful in interpreting partial ship remains, their value in this case may be questionable. As such, the author made a decision to exclude from this study all artifacts of uncertain provenience, which in essence included all object designated as surface finds and those raised before the 1989 field excavation.

Table 3.1: Comparison of the Malpas Wreck and Western Ledge Reef Wreck (IMHA-3) dimensions and scantling.

	Malpas Wreck	IMHA-3
Overall Dimensions		
Length of the preserved framed area	~10 m	4.5 m
Breadth of the preserved framed area	~4.9 m	3 m
Total number of visible framing timbers per side	18-19	24-26
Average Scantling of the Framing Timbers		
Sided width	24.7 cm	16 cm
Molded Thickness	Unknown	18 cm
Spacing	52.9 cm	35.5 cm



Figure 3.8: Exposed hull remains of the Western Ledge Reef Wreck (IMHA-3). (photo courtesy of NMB)

Upon completion of the 1988 survey, the partly exposed midship of IMHA-3 was photographed and sketched. Based on the uncovered mast step assembly and coarse earthenware sherds recovered from undisturbed ballast, the structure was tentatively identified as belonging to the 16th century Iberian tradition, although it could be dated as late as the 17th century. The vessel was well-preserved from the main mast step forward and aft based on the overall length of the unexcavated ballast pile. This assessment prompted the BMM director, Dr. Edward C. Harris, to broker an agreement with the original permit holders allowing systematic scientific excavation of the site by an international team of archaeologists.

The salvors agreed to waive their rights to the site knowing that it was barren of any valuables, a fact that they have repeatedly emphasized.¹² The project was initially lead by Kaea Morris and Holly Holland, but in mid-summer of 1989 it was transferred to Dr. Gordon Watts and a team from the East Carolina University (ECU) Program in Maritime Studies, who conducted excavations on the site for two seasons (fig. 3.8).¹³ Since the true identity of the shipwreck was unknown, they dubbed it the “Western Ledge Reef Wreck,” after its location.¹⁴

3.3 EXCAVATION, RECOVERY, AND INITIAL ANALYSIS

In 1989, archaeologists surveyed the site and surrounding reefs with hand-held metal detectors, and then proceeded with the controlled removal of stones from the ballast pile to uncover just enough of the hull to determine its construction characteristics. Using dredges and standard archaeological recording equipment, the

team slowly removed the overburden covering the timbers, mapped encountered artifacts and created a detailed site plan. Concurrently, the team made an effort to record the stratigraphy of the ballast pile, which could potentially help in establishing provenience for some of the artifacts.

The evidence suggested that as the ship sank it settled on a sloping coral foundation. At the time of the excavation, this foundation was covered by only 20 cm of sand along the southern edge of the site. There, the ship's floor timbers and broken first futtocks forward of the mast step were located immediately underneath the sand surface. These were significantly more deteriorated than the timbers aft of the mast step which were covered by thicker layer of sediment.

The surface of the ballast pile, referred to here as level one, consisted of polished river pebbles measuring anywhere from 10 cm to 20 cm in diameter, although a few larger ones were present as well. In addition to stones, level one incorporated small coral fragments, coarse-grained coral sand, concretions with remnants of iron fasteners and earthenware ceramic sherds.¹⁵ Level two, lying beneath the surface material, was distinguished by darker fine-grained sand mixed with small wood fragments, more concretions, and dark brown organic matter. The majority of the ballast stones were of the same size as those from the level above. However, these were darker in color and provisionally identified as a type of basalt. This level continued to the surface of the timbers. A number of larger stones measuring between 40 cm and 50 cm in diameter clustered around the keelson. These were interpreted as part of the permanent ballast of the ship. Level three consisted of the shipwreck structure, fine-grained sand and loose

clay-like sediment in between the timbers. The timbers were covered with a quantity of small rocks averaging 3cm in diameter and lumps of grey-white flint. The ballast pile contained only a small number of artifacts, the majority of which came from the level three. In contrast to the surface finds, which had been disturbed during the salvage of the Malpas Wreck, the artifacts in level three could be reliably associated with the IMHA-3 shipwreck.¹⁶

While the most significant artifact of the project was the ship itself, other finds included a large collection of concreted iron fastenings, as well as earthenware and stoneware ceramics. Organic samples included bamboo, coconut shells, olive pits, walnut shells, and possibly tobacco. The faunal remains were sparse but consisted of a number of domestic mammal species such as pigs, cows, or goats, as well as birds, fish, and rats. At the same time sediment samples were taken from between the keel and keelson, and wood samples from all the major timbers and treenails. Most of these samples were subsequently sent out for analysis.¹⁷

While searching the vicinity of the hull's main section, archaeologists discovered a preserved stern assembly whose scantling appeared consistent with the rest of the uncovered structural timbers of IMHA-3. The stern section lay on its starboard side on a gentle slope directly to the north-east of the ballast pile. It was covered only by a thin layer of sand showing signs of recent disturbance.¹⁸

Over the course of two summers, in 1990 and 1991, the timbers were uncovered and recorded using a three tiered 1 meter grid system erected over the hull and the stern assembly (figs. 3.9 and 3.10). The position of the grid was oriented to the

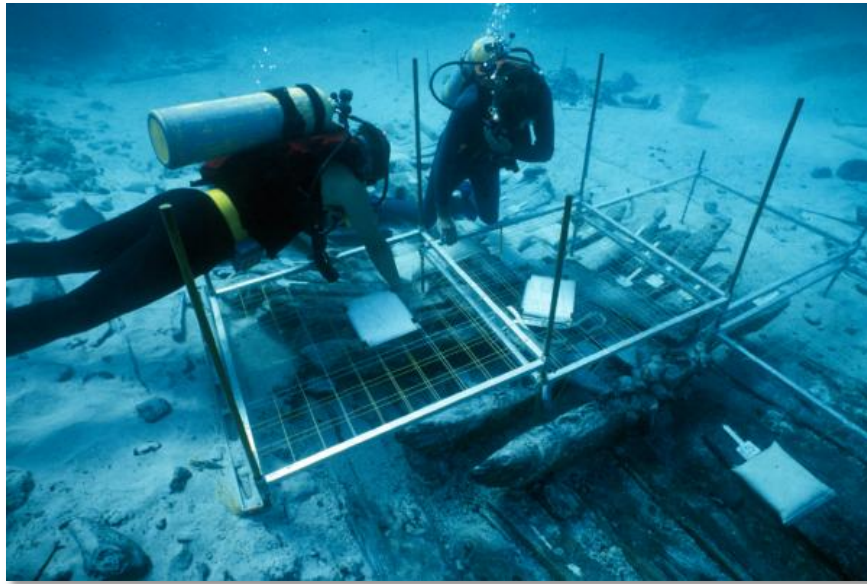

Figure 3.9: The grid system used to record the Western Ledge Reef Wreck during the 1990 and 1991 ECU field seasons. (photo courtesy of NMB)



Figure 3.10: Using the grid system to photograph the Western Ledge Reef Wreck during the 1990 and 1991 ECU field seasons. (photo courtesy of NMB)



Figure 3.11: The dismantling of the Western Ledge Reef Wreck during the 1991 ECU field season. (photo courtesy of NMB)



Figure 3.12: The raising of the Western Ledge Reef Wreck timbers during the 1991 ECU field season. (photo courtesy of NMB)

baselines. Drawing from the vast experience of archaeologists from Parks Canada, who worked on a similar archeological project in Red Bay, Labrador, the decision was made to recover the hull. In 1991, the timbers were raised to the surface and transported to the BMM facilities for further study, recording, and subsequent conservation and display. Once the ceiling planks and large keelson, which locked the floor timbers together, were detached and lifted, the remaining elements could be easily freed. These included curiously shaped buttresses, floor timbers and partial first futtocks, which had to be separated from each other along the dovetail joints. The external planking was disassembled by working from outboard towards the keel, while the garboards were extracted from the keel by cutting the planks in three places. In order to make the keel more manageable for lifting it was cut into three roughly 3 m long pieces (figs. 3.11 and 3.12). The entire process of disassembling the wreck was videotaped by Roy Laurence. This recording included every aspect of the project, from the uncovering of the timbers to the taping of the donation of the timbers to the BMM by Canton and Malpas. Once the ship timbers reached the BMM, they were cleaned, photographed, documented, and drawn at 1:1 scale on polyester film, generally known by its brand name *Mylar*TM.

The team managed to complete as many as six drawings per day, depending on the size of the timber, number of sides drawn, cross-sections taken, and the amount of cleaning involved (figs. 3.13 and 3.14). Upon completion of the recording process, the timbers were placed inside wet storage tanks for initial desalinization. Shortly thereafter further progress of the project was delayed and then completely discontinued; thus, the final analysis of the hull structure and conservation of the timbers remained unfinished.



Figure 3.13: Cleaning the timbers of the Western Ledge Reef Wreck timbers at the Bermuda Maritime Museum during the 1991 ECU field season. (photo courtesy of NMB)



Figure 3.14: Recording the timbers of the Western Ledge Reef Wreck timbers at the Bermuda Maritime Museum during the 1991 ECU field season. (photo courtesy of NMB)

According to the preliminary analysis produced by Brad Loewen, the Western Ledge Reef Wreck was a relatively small vessel of between 117.8 to 190.8 *toneladas*, and probably in the 140 to 180 *tonelada* range.¹⁹ Hypothetically, it had an elongated narrow stern and a short rounded bow. Estimates suggested that the total length of the flat keel was between 12.35 m to 13.50 m, with the higher value supported by the framing pattern and the plan of the starboard planking. Its greatest beam was between 5.06 m and 6.06 m. Since the length of the keel was theoretically proportional to the maximum beam and the depth of hold, it was estimated that such ship could reach 18.52 m to 23.45 m in length between perpendiculars with the rake of the sternpost of about 62°.²⁰ This, in turn, implied that it had two full decks with the main deck between 4.02 m and 4.31 m above the ceiling, and the first deck, or the orlop, about 1.72 m below the main. Loewen also proposed that this vessel might have had a typical three-masted ship rig with a lateen-rigged mizzen mast and square-rigged main mast and fore mast. Nonetheless, a two-masted all lateen rigged configuration could not be entirely rejected.²¹

3.4 CONTINUING RESEARCH ON THE WESTERN LEDGE REEF WRECK: 2007 TO 2010

The author's strong interest in Iberian shipbuilding philosophy within larger Atlantic sphere let him to requesting permission from Gordon Watts (the 1989-1991 primary investigator) and Edward Harris (executive director of the BMM, currently the National Museum of Bermuda) to conduct research, a final analysis, and reconstruction

of the Western Ledge Reef Wreck. In 2007, the Institute of Nautical Archaeology (INA) sponsored a team that visited the museum to evaluate the condition of the timbers and study the excavation records. The documentary materials reviewed ranged from the first 1988 survey to the final 1991 excavation season, timber recovery, and post-excavation timber recording. This included newspaper articles, notes, reports, personal and official correspondence, dive-logs, sketches, field photographs, and drawings. The INA team created an inventory of more than 130 individual timber drawings. To facilitate further analysis and research, Harris agreed to a temporary loan of the data related to the Western Ledge Reef Wreck site, which permitted the transport of the original and collated materials to the Conservation Research Laboratory (CRL) at Texas A&M University.

During the 2007 field season the team began assessing the physical condition of the IMHA-3 timbers stored in three concrete wet storage tanks on the museum grounds (figs. 3.15 and 3.16). The level of external timber deterioration was evaluated using a 2 mm stainless steel pin. Even though it was a subjective method, the pin tests proved to be an expedient way to assess the approximate degradation level of the waterlogged wood. Depending on the timber surface, the pin measurements ranged consistently between 10 mm and 12 mm. To evaluate the level of internal timber deterioration, core samples were taken with an incremental wood borer. These samples are currently awaiting further chemical tests; hence, they could not be included in this dissertation. Regardless of the outcome of this dissertation's analysis, conservation of the timber



Figure 3.15: Piotr Bojakowski checking the measurements of the timbers in 2007 against the drawings produced in 1991.



Figure 3.16: Piotr Bojakowski creating a 1:1-scale drawing of a timber to check for distortion and shrinkage against the drawings produced in 1991.

remains is a completely separate project that will require an extensive research and financial commitment from the interested institutions.

In 2008, the author personally verified the geographical position of the site, which was incorrectly stated on Malpas and Canton's wreck license, as no "true salvor" in Bermuda would provide the correct coordinates to the government. As recorded by the author, the Western Ledge Reef Wreck site is located at: N 32° 19' 23.3" W 64° 57' 38.9". During the same summer, analysis of the extant hull timbers continued, supplemented by historical and archival research. The latter focused on a collection of registers and letters spanning a period from 1508 to about 1614 that the NMB acquired from the *Archivo General de Indias* (AGI), Seville, initially gathered by Jonathan Bream.²² Even though the importance of Bermuda for Spanish authorities during the 16th century was limited and references to the island scarce, this invaluable collection encompasses excerpts from the navigational instructions, official orders, and letters concerning the fleets, ships, crews, and cargos related to Bermuda or presumably lost in the vicinity of the islands. As such, these materials provided the author not only an excellent geopolitical background for the period, but also a direct link between Iberian seafaring, ships, shipwrecks and Bermuda.

While reviewing the large body of historical and archival data, the author came across a document indicating a potential candidate for the identity of the Western Ledge Reef Wreck. Based on the location, time period, tentative size of the vessel, and artifact assemblage, one of the best matches with the shipwreck was *Santa Lucia*, a *navío de aviso* under the command of Juan Lopez which sunk near Bermuda in 1584.²³ It was

reported that immediately after wrecking, some of *Santa Lucia*'s crew reached dry land on improvised rafts built from parts of the ship. They found seven survivors of yet another Spanish shipwreck that had happened in 1582. Together, they constructed a boat from materials salvaged from the ship and the abundant local Bermudian cedar, and sailed back to Puerto Plata, Hispaniola. Once there, they returned the government documents that *Santa Lucia* carried to Pedro Rengifo de Angulo, warden of the fortress. A year later, these documents reached Seville on board a dispatch ship of the returning *Nueva España* fleet. They were accompanied by a letter from Pedro de Arana, which revealed the fascinating adventure of Captain Juan Lopez and the unfortunate fate of his ship.²⁴

The lack of other suitable candidates is by itself not enough to prove beyond reasonable doubt the identity of the ship.²⁵ Historical research shows that it is relatively easy to find registers of ships leaving and returning to Seville. What is difficult, in fact most of the time impossible, is to match the names and tonnages of these ships with data obtained from an actual shipwreck in an unequivocal manner. As such, the author is of the opinion that no matter how fascinating the story of *Santa Lucia* might appear to general public, any association with the Western Ledge Reef Wreck cannot be substantiated.

The second phase of the project, conducted at Corange Conservation Laboratory (CCL) at NMB, involved analysis of the remaining hull timbers, which were still stored in water vats at the lab (fig. 3.17). Due to advancements in our understanding of 16th-century Iberian shipbuilding and a much larger body of comparative and published



Figure 3.17: One of the wet storage vats with shipwreck timbers at the NMB.

materials, elements such as the keel, keelson, garboards and other planking, frames and futtocks, as well as the extant fragments of the stern assembly could be reviewed in new light. Some of the original drawings were either incomplete or missing, and had to be redrawn or revised. The opportunity to combine the original drawings produced in 1991 with direct observations and analyses of the timbers answered numerous questions, both verifying and disproving previous suppositions. It also allowed verification and detailed measurement of numerous features, predominantly wooden treenails and impressions of metal fasteners, which were inadequately recorded in the past. As such, this portion of the project constituted a crucial element of the timber evaluation for an accurate ship reconstruction.

In addition, the team revisited the Western Ledge Reef Wreck site. Over the course of two days the team conducted a limited underwater survey of the site and surrounding reefs. This survey significantly helped to understand the nature of the wrecking, character of the site, and geography of Bermuda's extensive Western Reefs. Although well-known among Spanish pilots for the menace they posed, these reefs were oftentimes impossible to avoid.²⁶ For a ship powered only by sails and caught in a sudden storm or early hurricane, there was no escape.

3.5 THE GEOGRAPHY, GEOLOGY, AND CLIMATE OF BERMUDA

WHERE the remote Bermudas ride,
 In the ocean's bosom unespied,
 From a small boat, that rowed along,
 The listening winds received this song :

"What should we do but sing His praise
 That led us through the watery maze,
 Unto an isle so long unknown,
 And yet far kinder than our own ?
 Where He the huge sea-monsters wracks,
 That lift the deep upon their backs ;
 He lands us on a grassy stage,
 Safe from the storms, and prelate's rage. (...) ²⁷

-Andrew Marvel

Andrew Marvell could not be more accurate in describing Bermuda as seen through the eyes of first English shipwreck survivors. Today, even though most people have heard about this tiny speck of land located in the Atlantic Ocean, it is frequently misidentified with the Caribbean Region, of which it is neither geographically nor culturally a part. Bermuda is located at 32° 19' 15" north and 64° 31' 20" west as recorded at the Commissioner's House, in the former Royal Naval Dockyard. This means the archipelago lies about 700 nautical miles (1,296 km) north of the nearest Caribbean island, 495 nautical miles (917 km) east of Cape Hatteras, North Carolina, and 3,039 nautical miles (5,628 km) southwest of London, England. This relative isolation places Bermuda among such unique oceanic islands like Hawaii, Seychelles, Galapagos, Azores, or Cape Verde, to name the most significant examples.

Another frequently repeated misconception is to identify Bermuda as a single island, perhaps since it is customary to refer to a singular "Bermuda." In reality it is an archipelago of about 150 islands and islets.²⁸ Some sources indicate that there are more

than 365 islands, islets, rocks, banks, and shoals constituting Bermuda.²⁹ Only seven are considered principal islands; they are connected by bridges and causeways and extend for about 35.4 km (about 22 miles) in length by 3.2 km (about 2 miles) in width at the widest point. Starting from the northwest, these are St. George's Island, St. David's Island, the Main Island, Somerset Island, Watford Island, Boaz Island, and Ireland Island; the last being a home to the National Museum of Bermuda. The total area of Bermuda is slightly over 50 km² (20 sq miles) with the population of almost 65,000 people according to 2009 World Bank estimates.³⁰

Bermuda forms what is often described as a fish-hook shape extending northeast to southwest at the top of an extinct submarine volcano which rises more than 4,000 m from the bottom of the ocean. Originating some 100 million years ago, the eroded volcanic foundation was over time covered by thin layer of limestone and limy sandstone, and further broadened by the growth of the coral colonies. As visible from the ocean, Bermuda appears to have three distinct layers: the pinkish-white sand of the beaches, the grayish weathered limestone rocks in the middle, and capped with lush green vegetation along the hills, the highest one being only 80 m (260 feet) above sea level.

The proximity of the North American continent does not influence the climate of the archipelago as much as the powerful Gulf Stream. By providing a continuous influx of warm water from the Gulf of Mexico, it creates a unique environment for the growth of the most northern coral reefs in the Atlantic Ocean.³¹ In the stretch between New Jersey and Bermuda the velocity of the Gulf Stream is constant at 4 knots, but the flow

decreases in the vicinity of Bermuda.³² In order for corals to survive, the water temperature has to be no less than 18° C (65° F) and no more than 36° C (96° F), with the optimal conditions provided by moving water that brings oxygen and food ranging between 25° C (77° F) and 30° C (86° F). Current climatic conditions of Bermuda are borderline for the development and growth of coral reefs, as water temperature during the winter fluctuates around 18° C (65° F).³³ If such trend continues and the water temperature drops below that mark for even a short continuous period, the present growth of corals and related reef organisms will be significantly reduced, and in extreme cases terminated. Bermuda reefs often grow in circular patches 100 m to 800 m in diameter and form a broad and rather irregular surface ranging from 18 m (59 feet) to about 1 m (3.28 feet) in depth. Some of the coral heads are right at or slightly above the sea level during the low tides.³⁴ Overall, there are more than twenty coral species residing in Bermuda. The most common include mustard hill corals (*Porites astreoides*), brain corals (*Diploria labyrinthiformis*), fire corals (*Millepora alcicornis*), as well as numerous sea rods and sea fans (e.g. *Rhipidogorgia flatbellum*, *Plexaura flexuosa*, or *Eunicea grandis*).³⁵ Since the reefs extend up to 9 nautical miles (about 17 km) in some places, they present a considerable obstacle for any ship approaching from the sea (fig. 3.18).³⁶

In addition to supporting the coral reefs, the Gulf Stream is also responsible for the fact that Bermuda is evergreen; even in January and February, the two coldest months of the year, the majority of the trees do not lose their leaves and spring flowers

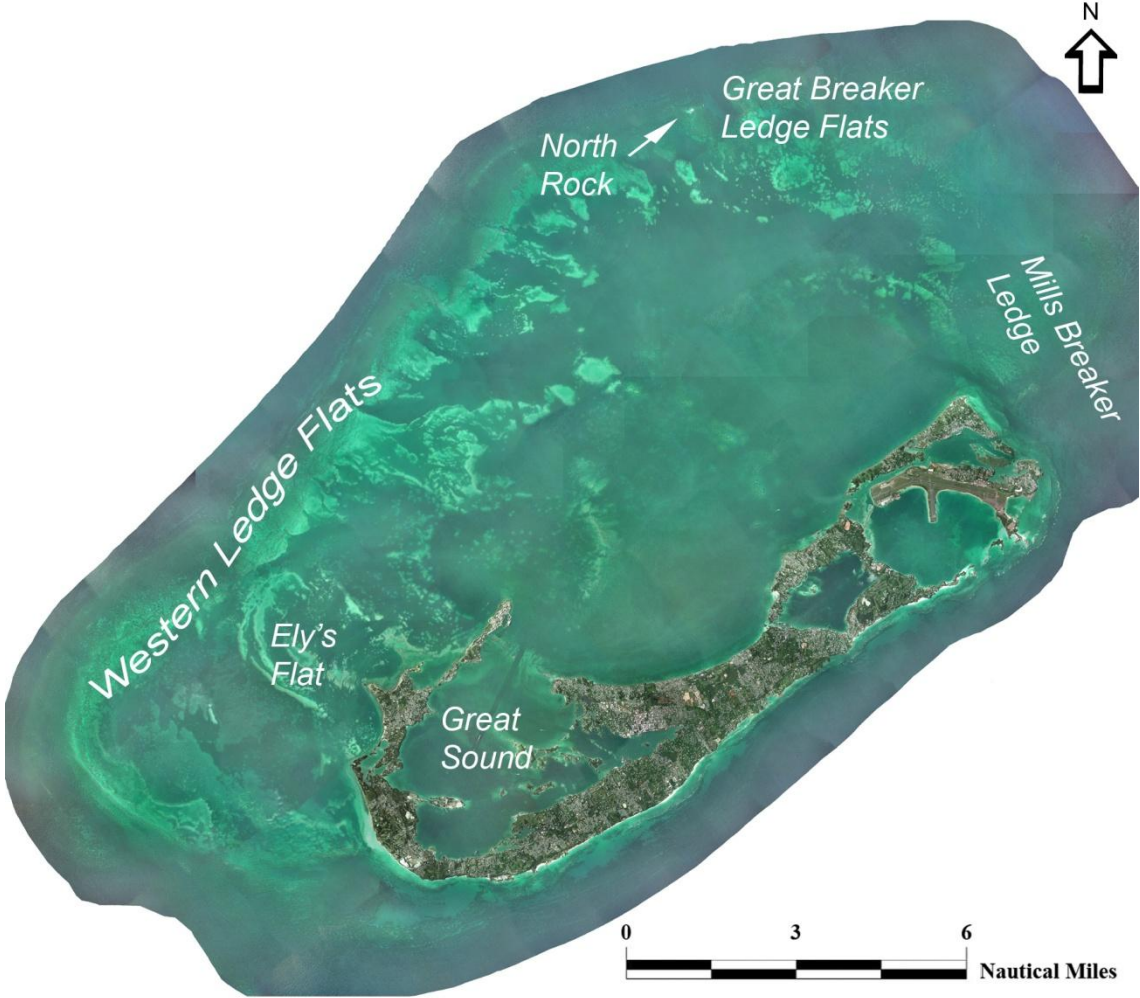

Figure 3.18: The extent of the reefs surrounding Bermuda. (satellite image of Bermuda
courtesy of NMB)

can be seen. Today, the most common trees are casuarina pines (*Casuarina sp.*), which were planted to replace the endemic Bermuda cedars (*Juniperus bermudiana*) which were obliterated by two scale insects accidentally introduced between mid-1940s and 1950s. Nonetheless, due to tremendous public effort the cedars are slowly growing back.³⁷ Other endemic plant species are the Bermuda palmetto (*Sabal bermudana*), Bermuda Olivewood (*Cassine laneana*), a blue-eyed grass commonly called bermudiana or Bermuda iris (*Sisyrinchium bermudiana*), and a maidenhair fern (*Adiantum bellum*).

As far as animal life is concerned, the most recognized are cahow birds (*Pterodroma cahow*), also known as Bermuda petrel and previously thought to be extinct. Bermuda has no endemic mammals and only one native reptile, a lizard known as the skink (*Plestiodon longirostris*).³⁸ Finally, the predominant fish found inside the reefs are Bermuda blue angelfish (*Holacanthus bermudensis*), surgeonfish (*Acanthurus sp.*), parrotfish (*Scarus sp.* and *Sparisoma sp.*), groupers (*Mycteroperca sp.*), coney (*Cephalopholis fulva*), grey snappers (*Lutjanus griseus*), hogfish (*Lachnolaimus maximus*), moray eels (*Gymnothorax sp.*), barracudas (*Sphyraena sp.*), or jacks (*Carangoides sp.*).³⁹

The geographical position of Bermuda, between tropical easterlies and temperate westerlies, is another factor behind its balmy climate with the average annual air temperature of 21.3° C (70.3° F). The average temperature for February, the coldest month of the year, is 19° C (67° F) and the average for August, the hottest month, is 30° C (86° F).⁴⁰ South of the island, the Trade Winds push the air south-west towards the equator, whereas north of them, the Westerlies blow towards northern Europe and the

Arctic. Being located at the intersection of these two Atlantic wind systems and at the ridge of a powerful sub-tropical high pressure with the center near the Azores Islands, Bermuda is at the convergence zone. In other words, the weather is whimsical with alternating beautiful sunny days and sudden squalls or rain showers. The most common wind directions are from the south, south-west, and west. The Bermuda-Azores high is most prominent in July producing stable summer weather and minimal precipitation.⁴¹

Contrary to popular beliefs, Bermuda experiences hurricanes only sporadically as most of these systems move west into Florida and the Gulf of Mexico or pass in between Bermuda and the east coast of the United States. During the so-called hurricane season, statistically defined as the period from June 1st to November 30th, some of them do turn to the east. When that occurs, the hurricane generally approaches the archipelago from south-southeast or southwest. Although the most severe ones tend to occur in October, by the time they reach the latitude of Bermuda they significantly weaken, changing into tropical depressions.⁴² Nonetheless, some particularly powerful hurricanes come in the vicinity of the island as the case was in 2010 when the largest Atlantic hurricane as measured by the gale diameter, “Igor,” blew the roof off the cottage where the author stayed with his family.

Integrating the geographical, geological, biological, and climatic factors; Bermuda has been and still is considered one of the most treacherous places for sailing vessels. First of all, the small size of the archipelago and its isolation in the vast expanses of the Atlantic Ocean creates problems for navigation. Bermuda’s reputation is also perhaps influenced by approximately 15° of westerly magnetic variation and the

manufactured mystery of the Bermuda Triangle.⁴³ In the most recent history, there were at least two cases when a British freighter and an American aircraft missed the island altogether and had to retrace their courses.⁴⁴ One can only ponder how this could happen in the age of satellite driven global positioning system. Secondly, there are the notorious, albeit quite exquisite, Bermuda coral reefs. Known among Spanish and later English pilots for the menace they posed, these reefs were oftentimes impossible to avoid. If a ship such as Western Ledge Reef Wreck powered only by sails was caught off the western end of the island in a sudden squall or a hurricane it would inevitably be driven onto the reefs; there was little room for error.

ENDNOTES

-
- ¹ Breck 1965, 3; Malpas, November 11, 2010, personal communication.
- ² Only very recently Malpas donated and loaned his collection to the Bermuda Maritime Museum (BMM).
- ³ In 2010, Bermuda Maritime Museum (BMM) was transformed into National Museum of Bermuda (NMB), incorporating BMM.
- ⁴ Breck 1965, 3; Malpas, November 11, 2010, personal communication; Tucker, February 18, 2011, personal communication.
- ⁵ Benchley 1971, 95, 116-7; Peterson 1977, 722.
- ⁶ Malpas, November 11, 2010, personal communication.
- ⁷ Tucker, February 18, 2011, personal communication.
- ⁸ Malpas, November 11, 2010, personal communication; Morris 1990, 63.
- ⁹ Morris 1990, 63.
- ¹⁰ *Ibid.*, 64; Malpas, November 11, 2010, personal communication; Tucker, February 18, 2011, personal communication.
- ¹¹ Morris 1990, 64; 1993, 59; Watts 1993a, 104-6;
- ¹² Malpas, November 11, 2010, personal communication; Tucker, February 18, 2011, personal communication.
- ¹³ Hocker, May 29, 2008, personal communication; Watts 1993a.
- ¹⁴ Watts 1993a, 1993b; Morris 1993.
- ¹⁵ Morris 1990, 64.
- ¹⁶ *Ibid.*
- ¹⁷ Watts 1993a, 105-6.
- ¹⁸ Morris 1990, 65.
- ¹⁹ Loewen 1991, 1-8; Morris 1993, 66-8; Watts 1993a; Casado Soto 1988, 67-70.
- ²⁰ Barkham 1981, 2-13.
- ²¹ Loewen 1991, 3.
- ²² Bream 1987.
- ²³ Broadwater et al. 1991.
- ²⁴ *Ibid.*
- ²⁵ Bojakowski 2009.
- ²⁶ AGI, *Contratación* 4889, fol. 2; AGI, *Contratación* 4890, fol. 1; AGI, Santo Domingo 272, fol. 1
- ²⁷ Marvell and Aitkin 1892, 39-40.
- ²⁸ This dissertation follows generally accepted way of referring to Bermuda as a singular island.
- ²⁹ Jackson 1988, 8-9.
- ³⁰ Voegeli and Voegeli 1977, 1-2; Jackson 1988, 8-9; World Bank (2011) provides up-to-date statistical data for Bermuda.
- ³¹ Jackson 1988, 9-11; Voegeli and Voegeli 1977, 1-3.
- ³² Rossby and Gottlieb 1998, 5-9.
- ³³ Jackson 1988, 10-1.
- ³⁴ Scoffin 1972, 1280.
- ³⁵ Bardach 1959, 77.
- ³⁶ Stanley and Swift 1967, 677-8; Ober 1928, 24.
- ³⁷ Voegeli and Voegeli 1977, 3; Jackson 1988, 19.
- ³⁸ Watson et al. 1965, 70-4; Wulff et al. 1981, 358.
- ³⁹ Bardach 1959, 80-5.
- ⁴⁰ Voegeli and Voegeli 1977, 2; Jackson 1988, 13.
- ⁴¹ Watson et al. 1965, 49-57; Jackson 1988, 13-4.
- ⁴² Voegeli and Voegeli 1977, 9; Watson et al. 1965, 65-8; Jackson 1988, 14-5.
- ⁴³ Voegeli and Voegeli 1977, 33; Kusche 1975.
- ⁴⁴ Brockman 2009, 16.

CHAPTER IV: DESCRIPTION AND ANALYSIS OF THE HULL STRUCTURE

The Western Ledge Reef Wreck currently consists of 125 individual hull timbers and timber fragments. Collectively, these elements account for approximately 13% of the original hull structure (see Appendix 2). The timbers were primarily distributed in three regions: the lower main hull (labeled A on the site plan), the lower stern assembly (B), and the upper transom (C) (fig. 4.1). The first and most substantial section (A) included the bulk of the well-preserved remains of the bottom hull of the ship. The remains were comprised of a large section of the keel, the central and aft portion of the keelson with an expanded mast step supported laterally by six buttresses, fourteen floor timbers (including nine exhibiting characteristic dovetail mortises), twenty-one heel ends of the first futtocks, portside and starboard central garboard planks, a total of eight other planks, limber boards and four ceiling planks, as well as numerous loose or unidentified pieces. The bow was missing; it likely separated along the scarf and was destroyed by wave action. The second section or lower stern assembly (B) was originally found about 2.5 m north of the main hull. It included the highly deteriorated vertical and horizontal arms of the stern knee with an attached fragment of the sternpost, three Y-shaped aft floor timbers (crotches), small fragments of the three first futtocks, hooding ends of the aft portside planks, short fragments of five starboard planks, and the concreted remnants of two gudgeon straps. The third and final section (C) is perhaps the most deteriorated of all and comprises elements of the upper transom assembly. It includes a fragment of the

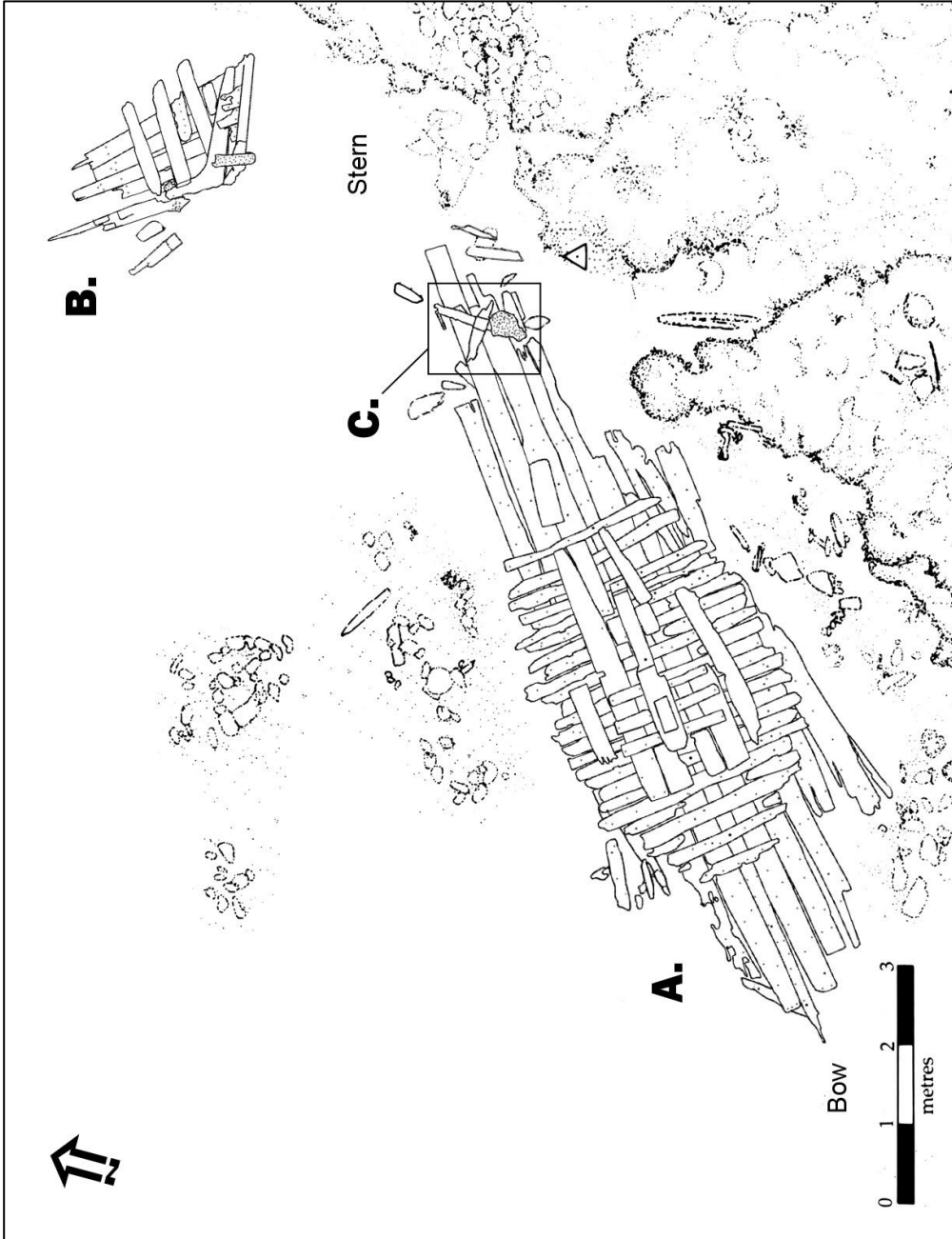

Figure 4.1 : Site plan showing three major sections of the site. (after Watts 1993b, 35 (Fig. 17).)

upper sternpost with a heavily concreted gudgeon strap and small impressions of diagonal transom planking with their respective fastenings.

4.1 WOOD ANALYSIS

In 1990, seven wood samples were taken from the Western Ledge Reef Wreck's hull for identification by Peter Warnock at Texas A&M University.¹ These included samples from one of the buttresses, keelson, ceiling, two floor timbers, and two treenails. With the exception of one of the treenails, which appeared to be an isolated surface find identified as birch (*Betula sp.*), all the other samples were oak. The wood was identified as a generic white oak (*Quercus sp.*), a category of hardwood which is comprised of several species.² At the time of the analysis, the samples could not be taken with certainty to the species level. These results and lack of adequate dendrochronological sequences for the Iberian oak species demonstrate that it is unlikely that the timbers from the shipwreck could be used for dating purposes. It is doubtful that the location of the forests from which the vessel's timbers were harvested from can be established. Other organic samples taken from the site for analysis consisted of balanoid fragments, otherwise known as common barnacles identified as *Megabalanus tintinnabulum*.³ Since this is a rather cosmopolitan species and has been widely distributed around the world particularly by ships, they are not a good indicator of the geographical provenience of where the voyage of the Western Ledge Reef Wreck began.

The hull timbers were analyzed by the author to understand the tree curvatures and tree-ring patterns as related to the forestry practices and ages of the individual

timbers. The research conducted over the course of 2008 and 2009 field seasons revealed that the extant floor timbers and first futtocks were fabricated from quality compass timbers whose grains closely matched the final desired form. At the same time, the keel, garboards, and other planks were fabricated from long straight specimens, which, judging by their sheer extant lengths, must have towered among the highest trees in the forest. As shown in table 4.1 (fig. 4.2), the trees for the Western Ledge Reef Wreck came from a fast-grown stock with an average age of about 37.5 years when felled (fig. 4.3). Based on the visual tree-ring count, these timbers displayed a high degree of age correlation with the timbers used to produce the hull of the Red Bay (24M) Wreck.⁴ In either case, these were not randomly selected trees, but rather the products of well managed forests characterized by highly developed husbandry standards. The trees were not only trained to the shapes required by the shipbuilding industry, as evidenced by the wide curvatures of the floor timbers and narrow curvatures of the first futtocks; they were also grown and harvested in an exceptionally intense way to maximize forest productivity. Although such resources are in essence renewable, by the late 16th and early 17th centuries demand for ships began surpassing the supply of Iberian forests. One commonly cited indication of such pressure is the overall decline in the quality of ship timbers.⁵ Overall, the evidence gathered from the Western Ledge Reef Wreck's timbers does not support this hypothesis as the shipwreck displays quality material throughout the structure.

Table 4.1: Visual tree-ring count of selected timbers.

Minimum Visual Tree-Ring Count		
Timber	Designation	Years
Keel	KL (central)	45
Garboards	PSG F/1	44
	PPG A/1	37
Planks	PS 1 F/1	25
Floor Timbers	FR M	30
	FR B	32
	FR 4	42
	FR 5	52
Futtocks	FR 3 P/1	36
	FR 1 S/1	32
		ave.: 37.5
		stdev.: 8.2
		range: 25-52

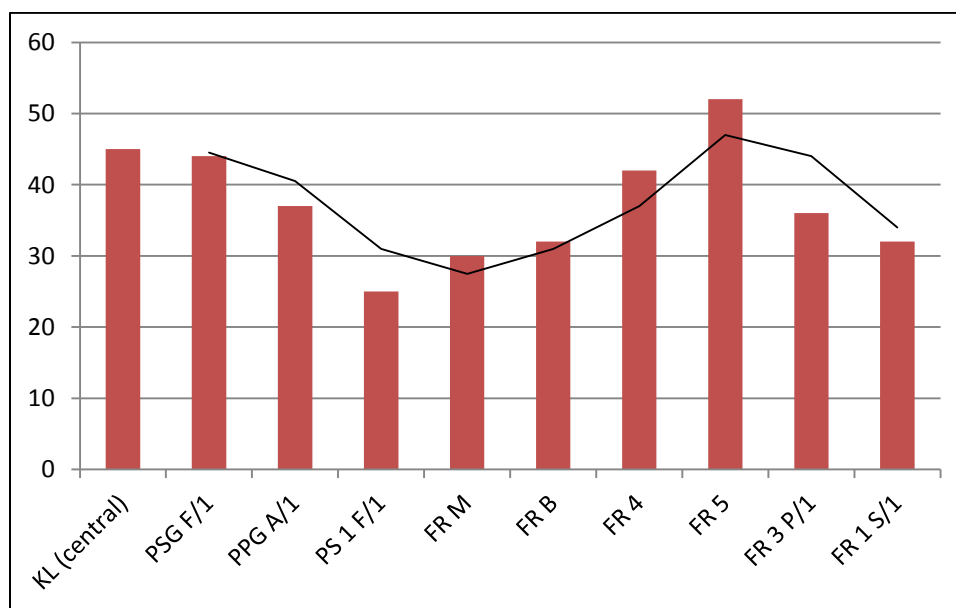

Figure 4.2: Graph showing visual tree-ring count for selected timbers.



Figure 4.3: View of the tree-rings along the bow face cut along the central section of the keel. (photo curtsey of NMB)

4.2 METHODOLOGY OF THE TIMBER CATALOG

As the timber catalog goes through a plethora of data, it follows a well-established standards and shipbuilding sequence.⁶ The catalog starts with the principal timbers, the keel and the posts, which form the backbone of a ship. Notably, in the case of the Western Ledge Reef Wreck only the stern survived the wrecking event and it is here presented as the stern assembly. For the clarity, known timber fragments, particularly the keel and external planking which were cut into smaller sections to facilitate lifting during the 1991 excavation season, are grouped and described as continuous units. Next, the catalog moves to framing timbers, which were labeled based on their relationship to the readily identifiable midship frame at the widest section of the hull. As this frame marks neither the middle of the keel nor the middle of the ship, it is designated throughout this dissertation the master frame and labeled “FR M.” Forward, the frames are labeled with consecutive capital letters of the alphabet (e.g. FR A, FR B, FR C, etc.); while aft, they are labeled with consecutive numbers (e.g. FR 1, FR 2, FR 3, etc.). In addition, differentiation is made between the floor timbers, which are labeled the same as the frames, and the portside and starboard first futtocks associated with the suffix P1 or S1 respectively (e.g. “FR 1 P1” indicates the portside first futtock of the first frame located aft of the master frame, while “FR D S1” indicates the starboard first futtock of the frame D located forward of the master frame). Since no framing timber above the level of the first futtocks survived, there is no need to introduce such labels.

Next, the catalog describes the garboards and other external planking, and continues into the internal structure of the ship, all of which are differentiated based on

the side of the ship. Although the garboards are effectively the first strakes of the vessel, these are described in the text simply as garboards (e.g. “PPG” indicates the portside garboard and “PSG” the starboard garboard); while the second strakes of the vessel are described as the first strakes above the level of the garboards (e.g. “PP1” indicates the first portside strake and “PS1” the first starboard strake above the garboard). Unless otherwise stated in the text, the last section of the catalog incorporates all the timbers that could not be assigned to known structural elements of the ship and those for which an exact position was undetermined. The key explanatory designations of the various hull timbers are presented in figure 4.4 and table 4.2. Furthermore, the catalog is accompanied by extensive timber analysis and comparative research.

Two lines of evidence were utilized throughout this research. The primary source was a set of 1-to-1-scale timber drawings on polyester and acetate films completed in the fall of 1991; these illustrations were accompanied by observation forms and photographs.⁷ Following the highest standards, the procedure to produce the 1:1-scale drawings was the application of the technique developed for recording the hull remains of the shipwrecks at Red Bay Project in Labrador, Canada.⁸ This data was supplemented by further research and analysis of the original Western Ledge Reef Wreck’s timbers, which had been stored in a waterlogged state in three vats on the NMB grounds. Although substantially deteriorated, these structural members still provided the author with a great deal of invaluable data and served as a benchmark for further interpretations and reconstruction. In order to verify the level of accuracy, the original drawings were compared against a sample of representative timbers from the tanks; the drawing all

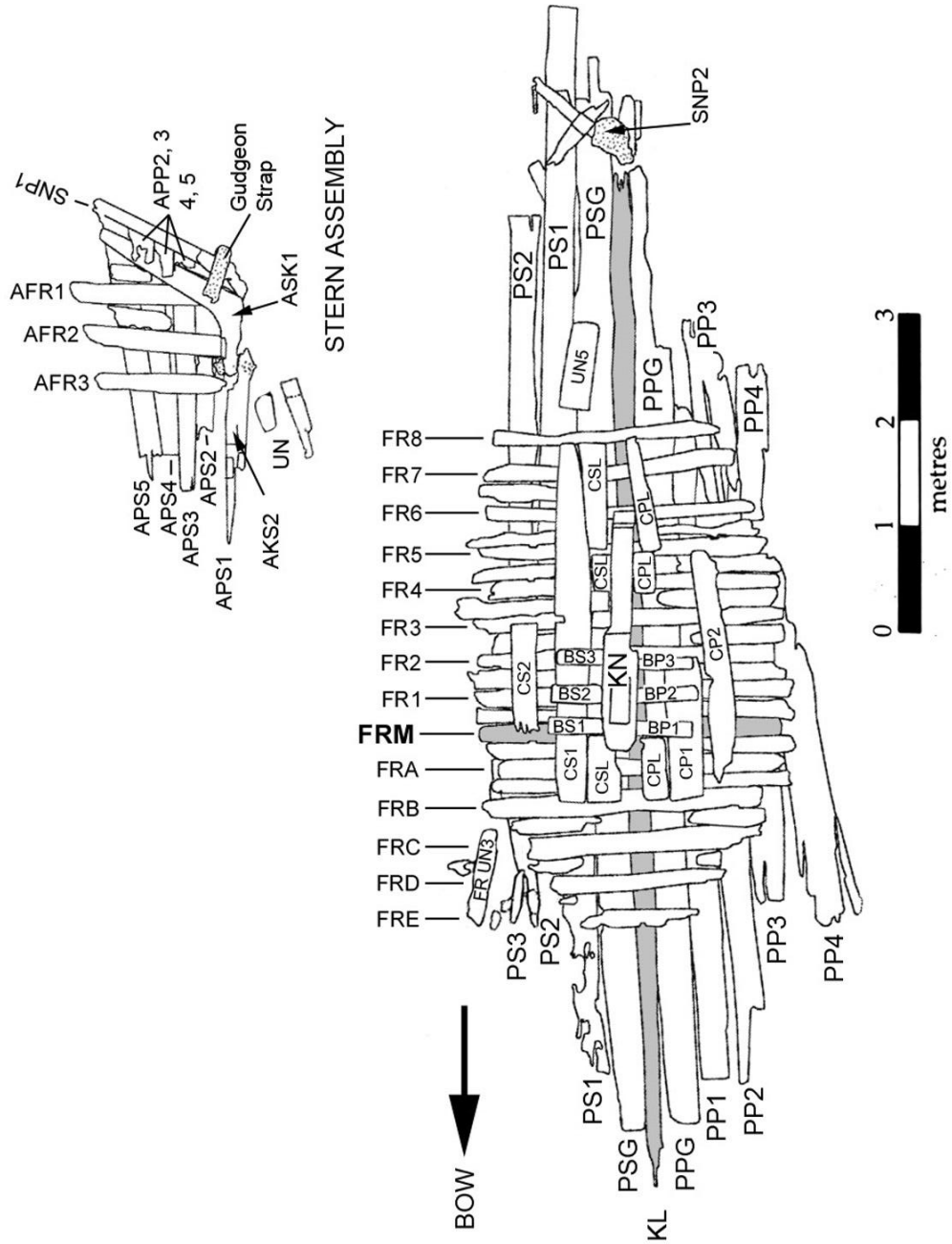

Figure 4.4: Designations and locations of major structural timbers.

Table 4.2: Key to timber designations.

Timber Labeling Key	
Designation Code	Name
AFR	After Frames
APP	Aft. Planking Portside
APS	Aft. Planking Starboard
ASK	After Stern Knee
BP	Port Buttress
BS	Stbd. Buttress
CP	Ceiling Portside
CPL	Ceiling Portside Limberboard
CS	Ceiling Starboard
CSL	Ceiling Starboard Limberboard
FR	Frames
KL	Keel
KN	Keelson
PP	Planking Portside
PPG	Planking Portside Garboard
PS	Planking Starboard
PSG	Planking Starboard Garboard
SNP	Sternpost Upper Part
UN	Unidentified

rated uniformly high in quality and precision.

In the case of timbers for which the drawings were either incomplete or missing, they were re-drafted following the same established procedure. This was necessary for both portside and starboard garboards and outer planking, which were originally drawn in one view, the inboard surface, and only in a scale of 1-to-5. It was of the utmost importance for the research and analysis that all of the timber drawings followed a uniform format. These were displayed in all three views, including a profile, and in 1-to-1 scale. The ability to combine the original and new drawings with direct observations of the timbers allowed the author to answer numerous questions, verifying or disproving some of the previously formed hypotheses. It also allowed for the measurement of numerous new features whose details were not registered before. This predominantly included surface angles, chamfers, and bevels, as well as wood and metal fastener impressions. Overall, this descriptive catalog and analysis of the hull structure constituted a key element of the timber evaluation required for accurate ship research and reconstruction.

4.3 THE GEOMETRY AND UNITS OF MEASUREMENT

To discover geometric principles behind the design of the ship's framing system, the following methodology was applied. It began with scaling down the original 1-to-1 drawings into 1-to-10 scale and modeling them in Rhinoceros[®], a particularly capable and accurate 3-D modeling software.⁹ Researchers working on the *Mary Rose* used transparent overlays of different circles and arcs to identify the underlying geometry.

Rhinoceros[®] made it possible to analyze even the most complex curvatures directly on the screen; the radii and the centers of each arc could then be found with unusual precision.¹⁰ Using this approach, it soon became apparent that the frames of the Western Ledge Reef Wreck follow the geometry of tangentially related arcs with progressively smaller radii. This is characteristic of the system known from English sources as “hauling down.” The Rhinoceros[®] software was also instrumental in research related to the lower stern assembly, as well as in discovering the relationships between individual structural elements and their overall correlation to the rest of the ship’s hull.

Following scientific standards, the units of measure used throughout the description and analysis of the hull structure of the Western Ledge Reef Wreck are in the metric system. To determine the units of measurement originally used to manufacture the timbers as well as design and construct the ship, four common Iberian standards were tested. These were the Basque *codo de ribera* (57.46 cm), Spanish *codo de vara (de Castilla)* (55.73 cm) and its close equivalent *codo de Málaga* (55.91 cm), as well as the Portuguese *rumo* (154 cm) and its subdivision, the *palmo de goa* (25.6 cm).¹¹ Since the true place of origin of the vessel is unknown, an attempt was made to compile all the recorded timber measurements in metric and convert them into relevant Iberian standards with the assumption that at least one should provide a meaningful dividing factor. Across the board, the most accurate results were obtained with the northern Spanish, or more specifically the Basque unite of *codo de ribera*, for which the average discrepancy within the sample was less than 0.07 *codo de ribera*. According to the 16th century norms, the unit equaled to 2 *pies* and 1 *dedo*, or in other words 33 *dedos* (e.g. 1

codo de ribera = 2 *pies* + 1 *dedo* = 33 *dedos*, or 0.57468 m) (see Appendix 3).¹² One of the best examples of the suitability of this unit for analysis and reconstruction of the Western Ledge Reef Wreck is the horizontal distance between the inboard edges of the dovetail mortises; a distance defined as the floor. On each corresponding floor timber the distance consistently measures about 172 cm, which after the conversion equals 3 *codo de ribera*.

Such results hardly came as a surprise. During the late 16th century, the *codo de ribera* was established as a principal shipbuilding standard throughout Spain, notable with the exception of southern province of Andalusia which continued using *codo de Málaga* for ships designated for the West Indies.¹³ By the official decree of 1590, Filipe II standardized the methodology of measuring ships and accepted a *codo de ribera* of 33 *dedos* in place of former and slightly shorter *codo castellano* (*codo de Castilla*), also known as *codo de vara* of 32 *dedos*. Soon, *codo de ribera* became wide spread eventually received the status of *codo real* (*del Rey*) or *codo regio* (the royal *codo*).¹⁴ When working with the antiquated units, a close attention must be paid to the designation associated with various *codos*, since Spanish provinces, sometimes even cities, measured the unit differently.

Paramount to understanding the timber scantling and construction of the ship, these findings complicate research into the origin of the Western Ledge Reef Wreck. Although it is highly plausible that the vessel could have been built in the greater Basque region of northern Spain, the metrology alone cannot confirm such a notion. Within this catalog, as the case would be with the 16th-century shipbuilding contracts or the early

17th-century *Ordenanzas*, the units of *codo de ribera* are simply designated as *codo(s)* and used as applicable to provide an alternative, and often times more appropriate, measurement standard to the metric system.¹⁵

4.4 THE SHIP FASTENERS

Following the morphology established by Keith in the study of the large number of fasteners recovered from the Molasses Reef Wreck, this catalog cannot be completed without reviewing this important category.¹⁶ As indicated by historical sources, the quantity and variety of fasteners used in the construction of 16th-century Iberian vessels is impressive. For example, the list produced by Barkham is of particular value, providing not only the functions, but also the dimensions for all 12 different types of nails (table 4.3).¹⁷

Other sources are equally significant in listing the spare nails and spikes taken onboard for long voyages. For example, the spare nails and spikes purchased by Bartolomé Carreño for the *capitana* of the 1552 fleet sailing for the New World included: “2000 clout nails; 400 tacks (*tachuelas*); 1150 nails and scupper nails; 700 small nails; 10 spikes with rings for fastening (forelock bolts); 173 nails for battening.”¹⁸ Thirty-five years later, in 1587, Diego Garcia de Palacio pointed out that: “a ship-owner, most prudently, ought to always carry many more spare things than is necessary, as they are of such benefit and give satisfaction on any occasion, but in case this cannot be done, I shall make known some things, without which one cannot easily depart; and they are: (...); four thousand sheathing -nails; two thousand scantling-nails; two thousand bottom-

Table 4.3: Basque fastener dimensions based on the shipment of nails and dowels for ships in 1582. (Barkham 1981, 32 (table 4).)

	Length (cm)	Diameter (cm)
Round Bolts		Head to Middle
<i>escoa</i> bolts	46.5	2.2 to 1.7
<i>escoa</i> bolts	18	2 to 1.5
bolts for the sides	35.2	2 to 1.5
half deck bolts	28.6	1.5 to 1.2
Square Nails		Head to Middle
spikes to <i>enbarascar</i>	44	2.1 to 1.5
smaller spikes to <i>enbaracar</i>	38.8	1.8 to 1.4
spikes for large wales	29.9	1.6 to 1.4
spikes for small wales	26.6	1.6 to 1.3
spikes for the sides	23.7	1.5 to 1.1
spikes for the half deck	20.5	1.3 to 1.0
decking spikes	15.6	2.1 to 0.8
round-house spikes	17	1.0 to 0.8

nails; one thousand (nails) for the ship's sides; one thousand medium side-nails; 500 pointed drift-bolts; 20 forelock bolts; 50 clinch rings; 50 forelocks; (...)."¹⁹ Notably, 96% of all the bolts from the list were pointed drift-bolts and only 4% were forelock bolts.

In the catalog, the fasteners associated with the Western Ledge Reef Wreck are divided into three categories based on the material from which they were manufactured: wrought iron, copper, and wood. These are further subdivided based on the function, morphology, and relative size. The group of copper fasteners includes one type of small square tacks or nails, and one type of nail. The group of wrought iron fasteners includes tacks or sheathing nails; two, perhaps three, types of nails; and three types of spikes; as well as two types of bolts. Due to a number of concretions containing natural molds of complete iron fasteners that could be cast with epoxy resin, this study includes the dimension taken from the casts as well as dimensions obtained from fastener impressions recorded in the timbers. The group of wooden fasteners includes only treenails that survived in the frames and planking.

Nails and Spikes

The wrought iron nails and spikes associated with the Western Ledge Reef Wreck constitute the largest and most diverse category of fasteners. Morphologically, the nails are defined as slender fasteners of square or octagonal shanks with a fine-drawn or flat point.²⁰ Spikes are defined as large, square shank tapering nails.²¹ Although the

epoxy casts of a few preserved natural molds were available, the limited number of samples prohibits a detailed description of manufacturing methods.

Throughout the preserved structure of the ship, a total of 492 nail and spike impressions were located. In addition, 53 nail and spike concretions were recorded during the excavations and later conserved and identified in the lab. Without exceptions, all impressions and epoxy casts are square-shanked. This is quite consistent with documentary evidence and other Iberian shipwrecks, (notably the Padre Island Wrecks, the Molasses Reef Wreck, and Red Bay Wreck), where round nails are present but uncommon.²² Although 16th-century shipbuilding contracts rated nails based on the number per unit of weight (e.g. 4 large nails per pound or 20 small nails per pound, etc.), this catalog must depart from such classification.²³ Here, the nails and spikes are divided into 5 basic varieties based on the relative size of the shank. These are further subdivided based on the morphology and dimensions of the head, estimated minimum length, and probable function, if such function could be established (table 4.4).

Little is known about the tacks or sheathing (filling) nails associated with fastening the lead strips protecting the caulking material along the Western Ledge Reef Wreck's planking seams. The available information gathered by analyzing the edges of the timbers is restricted to four 5 mm square shank impressions loosely spaced 24 cm to 34 cm apart. Although the artifact database includes two entries cataloged as iron tacks, the epoxy casts are missing; hence, the author could not personally review these objects. Based on the database description, the tacks had square shanks measuring about 6 mm and narrowing to a point, and round heads of about 16 mm to 20 mm in radius. Overall,

Table 4.4: Fasteners and fastener impressions found on the Western Ledge Reef Wreck.

Dimensions and Morphology of the Fasteners						
Fasteners	Shank Morphology	Shank Dimensions (mm)	Head Morphology	Head Dimensions (mm)	Est. minimum Length (mm)	% of the Total
Tacks	square	4 to 6	round?	20	45	0.8%
Nails (small)	square	4 to 6	rectangular	12 x 9	40	2%
Nails	square	6 to 9	"rose-headed"	15	90	2%
			unknown		160	3%
Spikes	square	10 to 12	square	20	160	22%
			round	30 to 40	180	69%
Spikes (large)/ small bolts	square	~ 15				1%
		~ 20				1%
Subtotal #:						492
Bolts	round	20 to 26	round	45 to 50	400	33%
		27 to 29				67%
Subtotal #:						15
Treenails	round	26 to 30			240 to 320	252
Subtotal #:						252

Table 4.4 (Continued)

Association of Fasteners with Known Structural Members	
Fastener	Association
Tacks (Sheathing nails)	uncertain, possibly fastened the lead strips protecting the caulking material
Nails (small)	found in the filler board and buttresses
Nails	possibly internal structure; impressions found in the keel (keel to the floor timbers)
Spikes	internal structure; possibly stern planking; hooding ends; keel to framing; planking to framing
Spikes (large)/small bolts	keelson; wales
Bolts	keel; framing; keelson; stern assembly
Treenails	pre-assembled frames; planking to frames

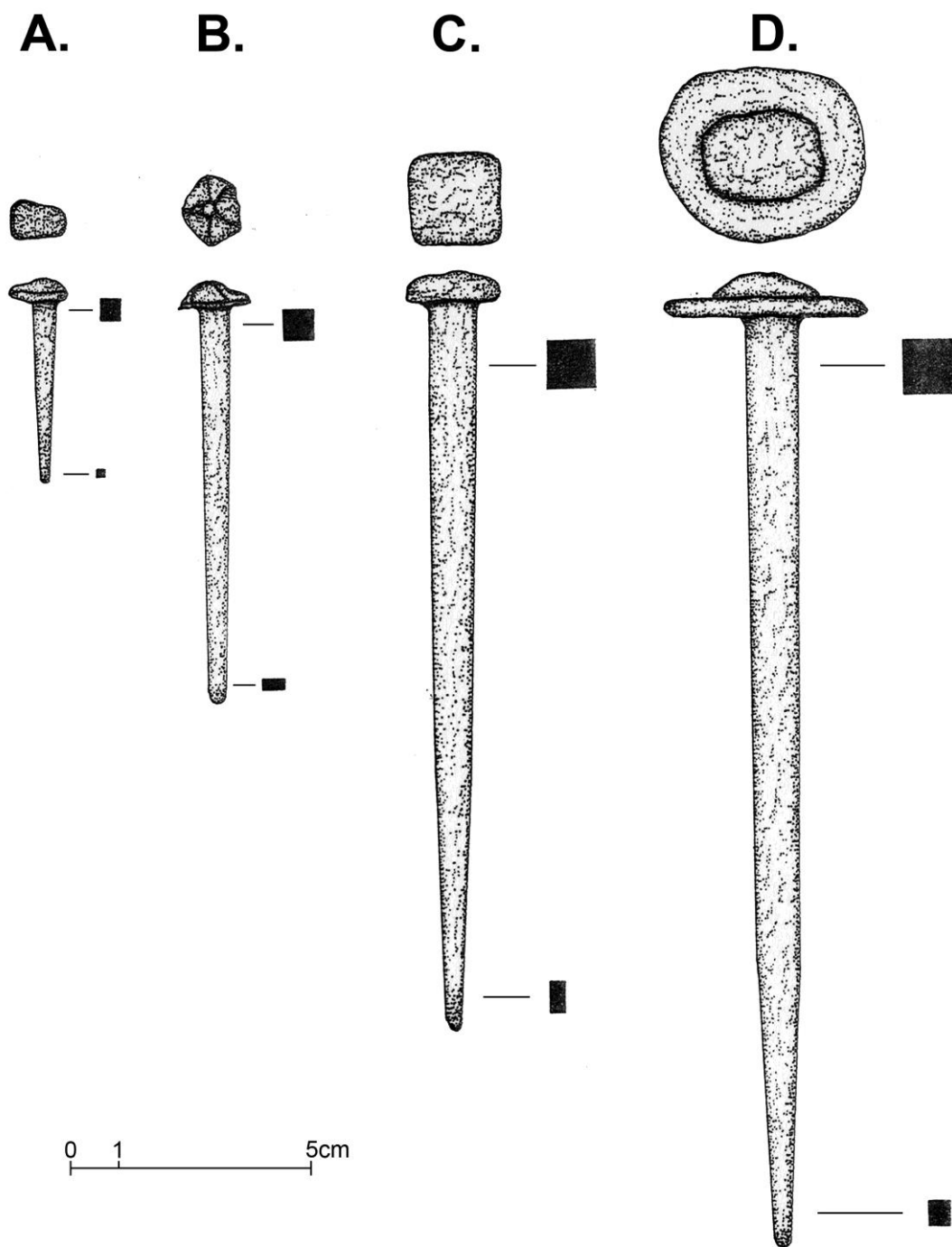

Figure 4.5: Assortment of fasteners. A. 90:55-TT5-2/9; B. 89:35-TT1-1/11; C. 90:55-TT5-2/14B; D. 89:35-I16-I-3/8B).

they measured 45 mm to 55 mm length. Except for a tentative head morphology, which has been impossible to validate, it is unclear how the tacks differed from the next category of fasteners described here as small nails.

The first variety of small nails have shanks between 3 mm and 6 mm thick (averaging 5 mm), square to rectangular heads and measure between 40 mm and 55 mm in length (fig. 4.5: A.). Based on the correlation between surviving specimens and impressions, these nails could represent a variety used to fasten filler boards to the top surfaces of the buttresses. The small square nails recovered from Padre Island Wreck (41 KN 10) were of corresponding shape and size.²⁴

The second variety of small nails has shanks between 6 mm and 9 mm thick, and averaging 7.5 mm. As exemplified by an epoxy cast (fig. 4.5: B.), one such nail measures 9.2 cm in length and has a flat point and a distinctive “rose-head” with five hammered facets spreading out and down from a central point. Although the function is uncertain at present, a number of impressions of corresponding size range were found throughout the internal structure of the ship and along both sides of the keel at frame stations FR B, FR C, FR D, FR E, and FR G. These represent a departure from the otherwise standard and generally larger keel-to-floor timbers spikes. Since the impressions form a clear pattern and are associated with square notches carved in the keel to countersink their heads, we can hypothesize that they represent replacements for original fasteners that, for some unknown reason, had to be removed.

Unfortunately, the lack of distinct or otherwise measurable head impressions prohibits broad generalization. For example, we cannot exclude a possibility that the

nails in the keel and those finished with “rose-heads” represent two different types sharing only common shank dimensions. Hence, they are differentiated in the catalog primarily by function.

The third variety of nails includes two groups; all having shanks between 10 mm and 12 mm thick (averaging 11.6 mm) and length ranging from 15 cm to at least 22 cm. Collectively, these can be classified as spikes and constitute the most common kind of fasteners found on the shipwreck, representing more than 90% of all the recorded impressions. The first group of spikes, associated with preserved casts and impressions in wood, is characterized by 20 mm by 20 mm square head and rectangular-drawn point measuring 7 mm by 3.2 mm (fig. 4.5: C.). They are short and do not exceed 160 mm in length. As for the usage, they were found securing stern planking to the crotches and plank hooding ends to the sternpost rabbet, as other more traditional planking spikes would have been too long. They could have also been used to fasten most of the internal elements of the ship including the ceiling planks and buttresses.

Similar in shank cross-section, the second group of spikes had fine drawn points and distinctive round, (or nearly round), add-on heads measuring between 30 mm and 40 mm in diameter (fig. 4.5: D.). The impressions of these spikes were found along both sides of the keel at the frame stations: FR A, FR M, FR 1, FR 2, FR 3, FR 4, FR 5, FR 6, FR 7, and FR 8. They were driven from below and employed as more traditional fasteners between the keel and the floor timbers. The round-headed impressions of square spikes are also associated with fastening planking to the frames. Since the spikes were used as temporary fasteners before the treenails were installed, it is assumed that

their purpose was to provide an extra safeguard preventing the planks from lifting. Notably, at least two long wrought iron spikes recovered from the Western Ledge Reef Wreck were clenched over, resembling a technique used to fastening caravel and clinker planks to the frames on a small Basque *chalupa* excavated in Red Bay (fig. 4.6).²⁵

The fourth and fifth varieties are large spikes with shanks measuring about 15 mm and 20 mm, respectively. Perhaps due to their size they might be more appropriately referred to as small bolts. They are the least represented throughout the ship. They have unknown head morphology and are identified exclusively from limited shank impressions. These impressions include an isolated spike reinforcing the scarf in the keelson, one anomalous impression found in the ceiling plank (CS 1), and three impressions associate with nonextant foot wales. The latter are located along the top surface of the floor timber FR A (port side), FR M (starboard), and FR 7 (port side). The 20 mm across spikes include only five impressions, all associated with fastening the now missing foot wales to the floor timbers. These are located along the top surface of the floor timbers FR C (starboard), FR A (starboard), FR 1 (port side and starboard), and FR 7 (starboard).

Copper Tacks and Nails

There were nine preserved copper alloy fasteners. These are subdivided in the database into tacks and nails. Tacks are small, measuring only about 22 mm to 24 mm in length. They are characterized by square shafts 1.5 mm to 2 mm across, sharp points, and round heads of between 5 mm and 6 mm in diameter. Nails are roughly twice the

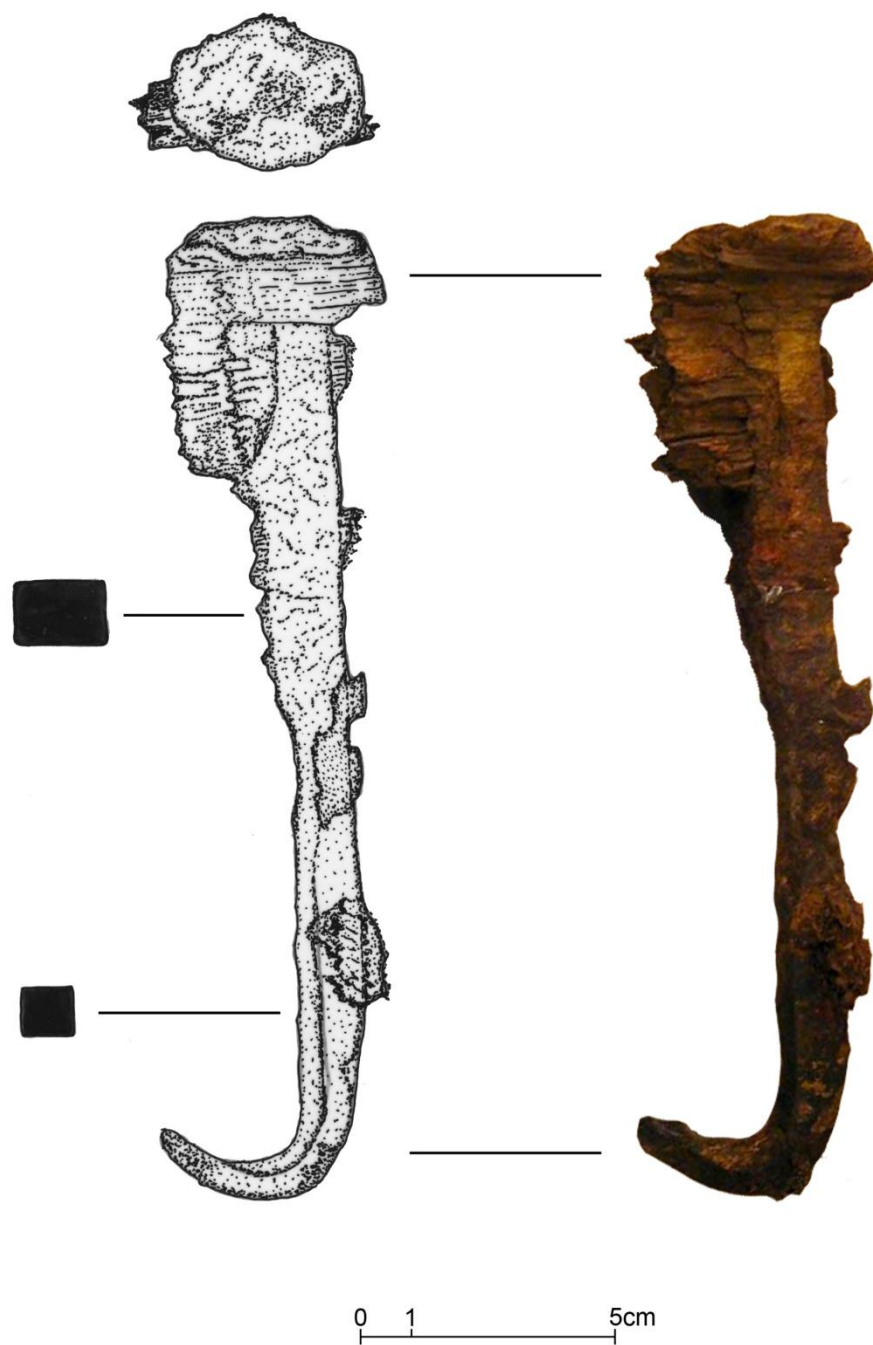

Figure 4.6: Example of a clenched wrought iron spike from the Western Ledge Reef Wreck. (90:55-J17-I-3/19)

size of tacks having 3.4 mm to 6 mm thick square shafts with heads of about 7 mm to 9 mm square. Overall, they measure between 53 mm to 55 mm in length. Since both types of copper alloy fasteners were found loose, their exact function is unknown. It is possible that high copper prices would prevent shipwrights from using these types of fasteners for ordinary structural purposes. If in fact copper tacks and nails belonged to the ship, we could speculate, at best, that they might have fulfilled one of many decorative functions which would be consistent with the interpretation of small brass tack in the collection from the site of 1554 fleet or they could be associated with a bilge pump assembly.²⁶

Bolts

Bolts represent the longest and most distinct of the wrought iron fasteners. Based on the impressions left in the timbers, 12 bolt locations were identified on the Western Ledge Reef Wreck. In addition, three bolts, including a single forelock bolt, were recovered as natural molds during the excavations and analyzed by the author. Bolts are characterized by round or slightly oval shanks and wide add-on heads.²⁷

Like the bolts from the Molasses Reef Wreck collection, those studied here fell into two size groups, with the differentiation based on the maximum shank diameter.²⁸ The first group includes those that measure 26 mm or less, while the second includes those that measure between 26 mm and 29 mm (refer to table 4.4). One of the preserved bolts from the first group measure 49 cm in length, 25 mm in diameter and has clenched tip (fig. 4.7).



Figure 4.7: Preserved section of a wrought iron bolt with clenched tip (00:057-009) (one scale unit equals 10 cm).



Figure 4.8: Partly preserved forelock bolt (00:057.013).

Upon closer examination, a few of the impressions indicate the presence of a forelock bolt type. These are associated with countersunk heads located outboard and impressions of about 50 mm diameter rings inboard. As illustrated by a poorly preserved and broken epoxy cast of a forelock bolt, its extant shank diameter is about 25 mm, while the forelock slot measures 17 mm in length by 4 mm in width (fig. 4.8). Both types of bolts were driven into pre-drilled holes; this is based on the evidence of a mistakenly produced partial hole in floor timber A (FR A) which had to be drilled from the inside of the structure. These holes could be drilled and the bolts inserted and secured only after most of the hull timbers, particularly the keel, both stem and sternpost, frames, keelson, and possibly some planking, were assembled. As such, they functioned as a permanent fixture binding the keel and keelson through the floor timbers, as well as the heel, stern knee, and the sternpost.

Treenails

The final category of fasteners comprises of long, shaved, wooden pegs, which in shipbuilding are referred to as treenails. The recorded specimens measured between 26 mm and 30 mm in diameter and could be divided into two length groups. The first includes 20 treenails which horizontally fastened the floor timbers to the first futtocks within the group of pre-assembled central frames. Their minimum length equals the combined sided widths of both of the floor timber and first futtock, averaging 32 cm. The second group includes 237 recorded treenails fastening the planks to the frames. Their minimum length equals the combined plank thickness and frame molded

thickness, averaging 24 cm. In addition, there is also an isolated treenail found in the keel measuring 22 cm in length. After the timbers were positioned and held in place with wrought-iron fasteners, treenails were hammered into the pre-drilled holes and then cut flush with the timbers at both ends. This suggests that they were more permanent than iron nails.

Another interesting aspect of the treenails associated with the lower planks is the presence of black residue, possibly pitch or tar. It appears that before being inserted, the treenails were covered with some unidentified resinous substance perhaps as a measure against leaking. In addition, a 65% of treenails found on the Western Ledge Reef Wreck were also caulked, but not wedged, in a similar fashion as those from the *Mary Rose*.²⁹ With wedging, a wooden wedge, plug, or peg is driven into a treenail from outboard, inboard, or from both sides. The outboard ends (the heads) of the treenails from the Western Ledge Reef Wreck, however, were split in a narrow V-shape almost at a right angle to the run of the planks. These caulking cuts formed either a single line or two perpendicular lines resembling a cross. The cuts were slightly expanded by being tightly packed with what appeared to be a type of fibrous material similar to oakum (fig. 4.9). Based on the investigation of a sample of treenails that could be removed from the planks, the depth of the caulking cuts is quite inconsistent and ranges anywhere from 5 mm to about 20 mm (9% to 36%, respectively, of the average planking thickness) (fig. 4.10). These depths are only slightly shallower than the depths of the caulking scars at the plank edges, which suggests that both were done by the same group of workers as a part of the same process. It is unknown, however, why only some and not all the

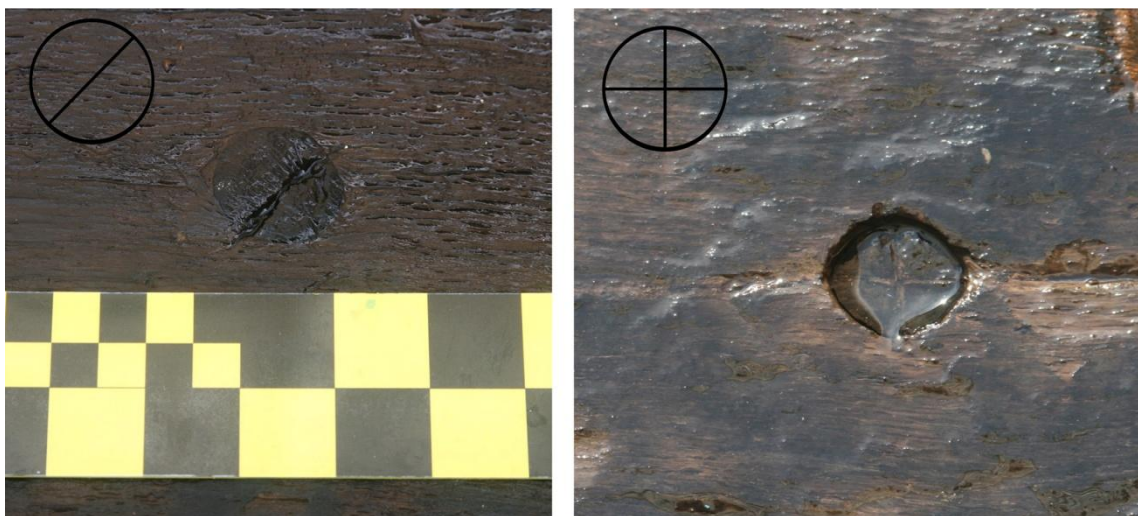

Figure 4.9: Overview of two types of caulking cuts.



Figure 4.10: Example of a partly preserved treenail with a V-shaped caulking cut and caulking material.

treenails are caulked. Likewise, it is also unknown if this procedure was restricted only to the underwater section of the hull or continued above the waterline.

4.5 THE PRINCIPAL TIMBERS: THE KEEL AND STERN ASSEMBLY

Keel

The backbone of the ship, the keel (*quille*), was hewn from a single oak log (fig. 4.11). Its bow and stern extremities are badly deteriorated; both were broken off sometime during the wrecking and subsequently damaged by shipworms. The top surface of the keel is flat along its entire length. As a result of wear suffered during the vessel's life and the wrecking process, the keel's extensively deteriorated bottom seemed rounded at first; careful observations, however, reveal that it originally must have been flat. In cross-section, the central section of the keel can be described as having an irregular hexagonal shape, reminiscent of the midship section of the keel of the *Mary Rose* (fig. 4.12).³⁰

Cut into three shorter pieces to facilitate lifting during the 1991 excavation season, the total preserved length of the keel is 9.32 m.³¹ The molded height fluctuates between 15 cm and 22 cm, while the sided width is between 17 cm and 23 cm; both dimensions generally narrow towards the extremities. Due to deterioration of the keel, the author could not fully verify if the narrowing was intentional or the result of the underwater burial and preservation of the timber. Out of the two dimensions, the sided width of the forward end of the keel appears to be narrowing in more deliberate manner.

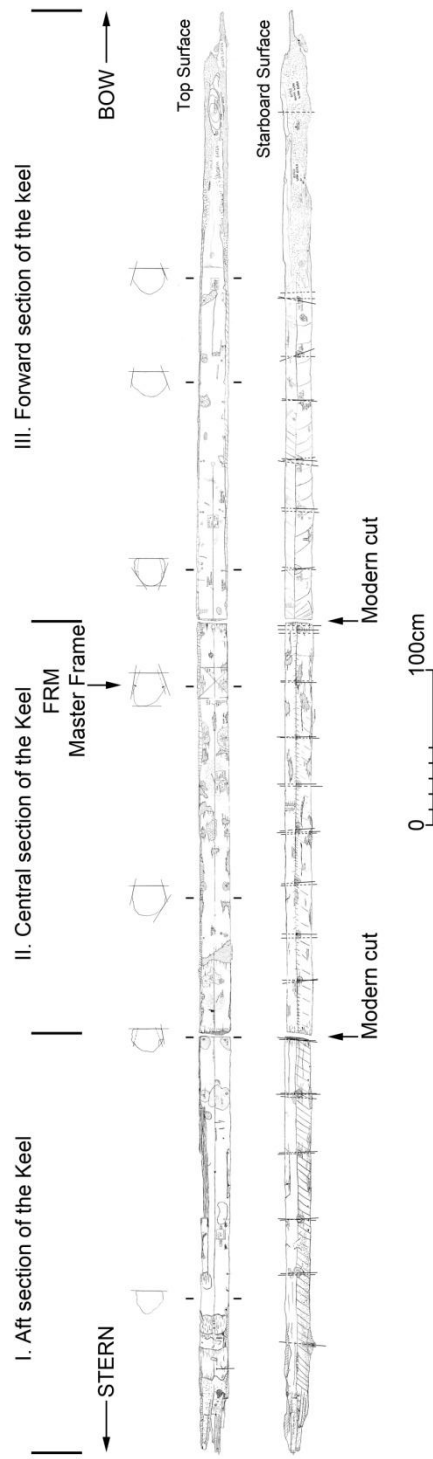

Figure 4.11: Overview of the preserved keel. (91-13-D2; 91-18-D2; 91-17-D1)

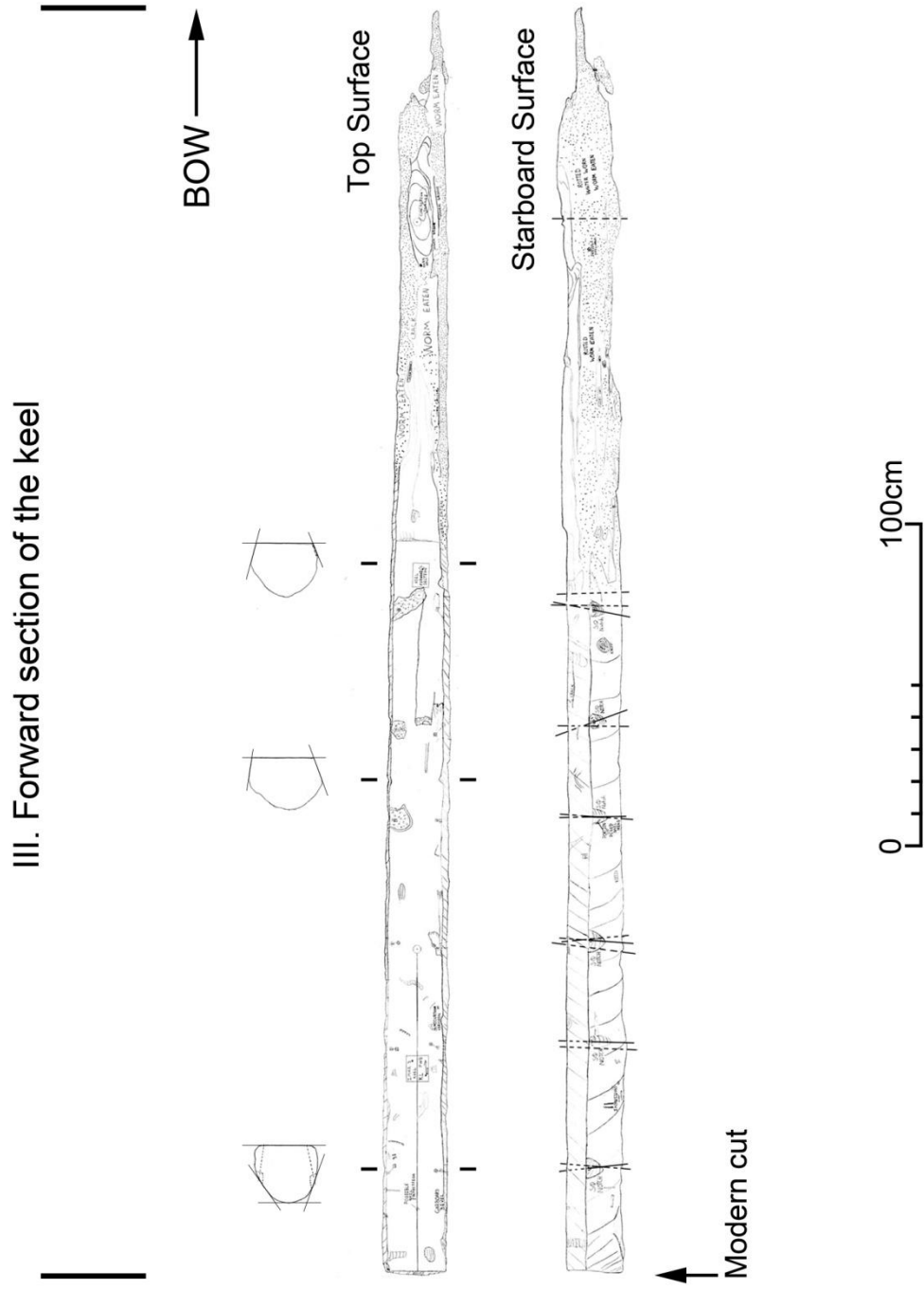

Figure 4.11(Continued)

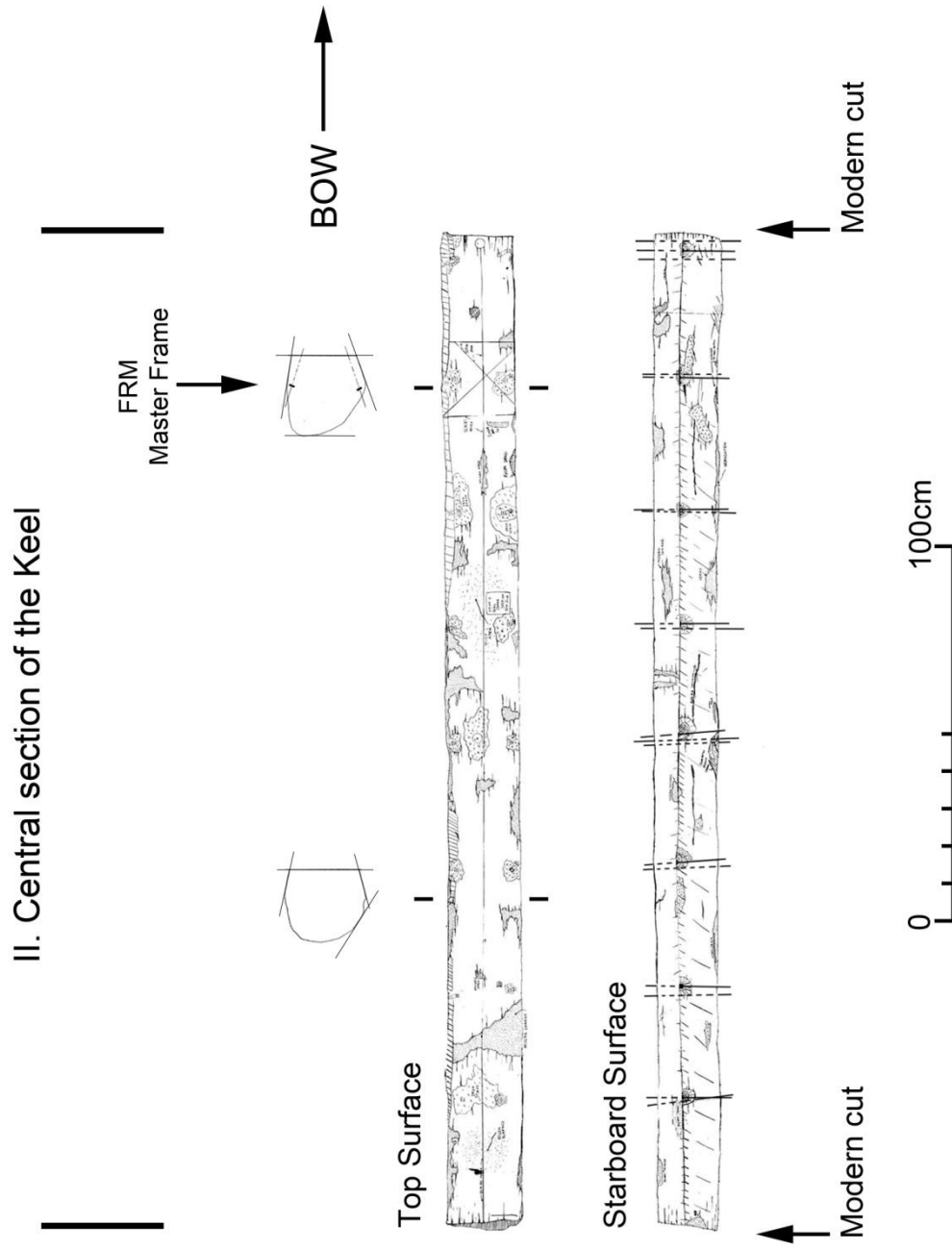

Figure 4.11(Continued)

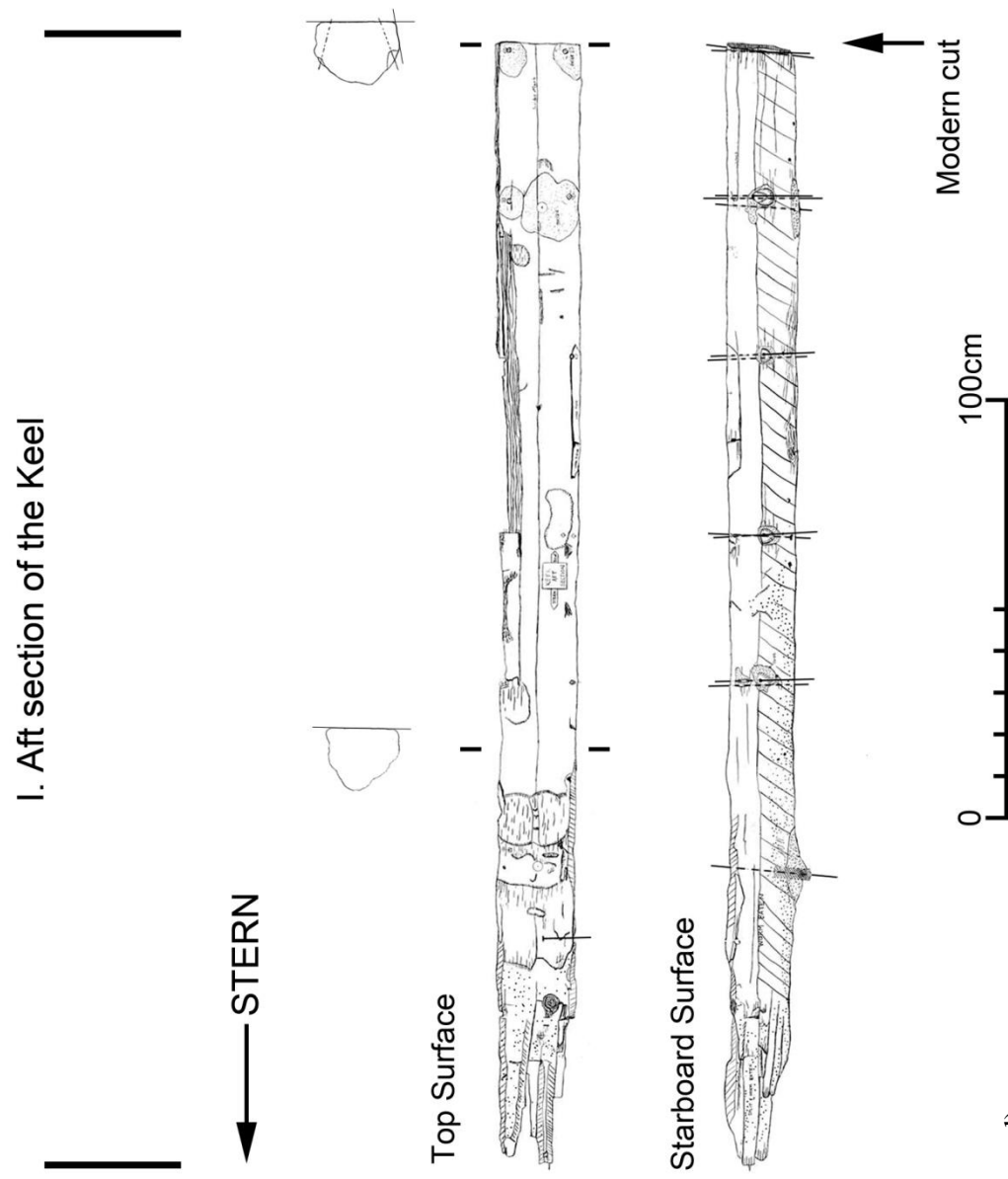

Figure 4.11(Continued)

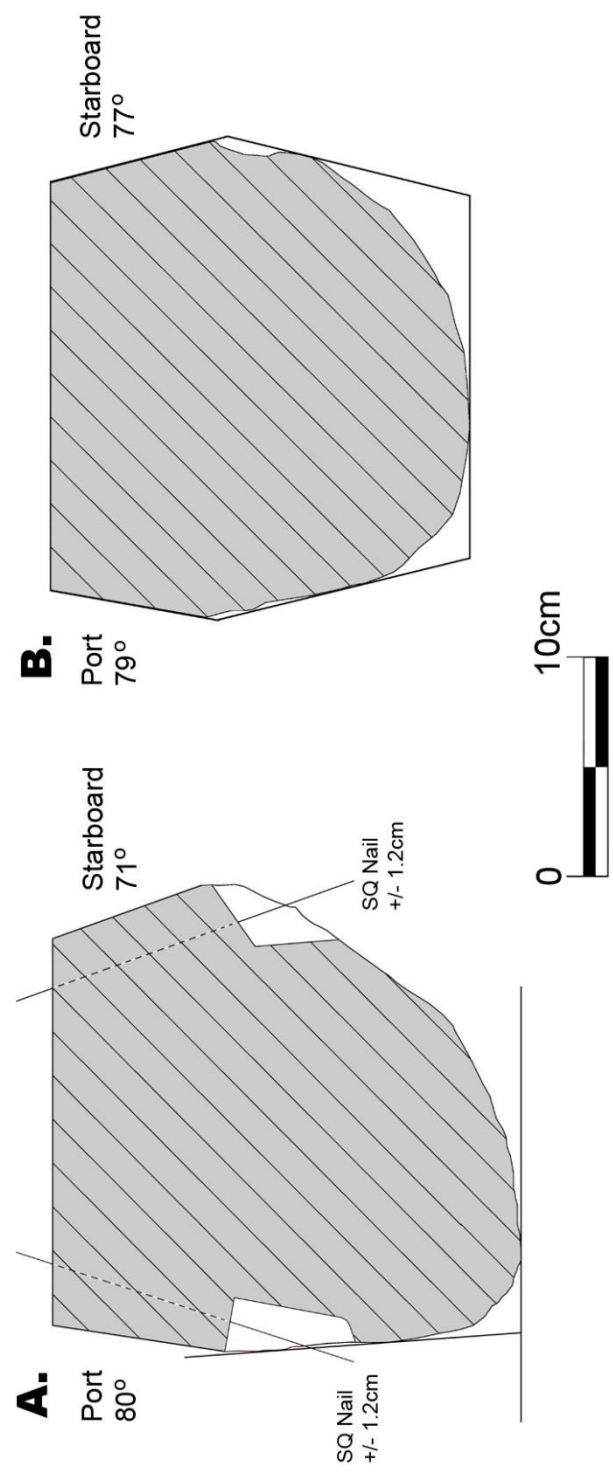

Figure 4.12: Selected cross-sections of the keel: A. Profile at the master frame (FR M), B. Profile at 173 cm aft of the bow face cut. (91-18-D2)

At the vicinity of the master frame, where both dimensions are well preserved, the keel measures about 22 cm by 22 cm. However, the width of the upper surface on which the master frame rested is only 17.6 cm.

The port and starboard sides of the keel are divided into upper and lower chamfered surfaces. Together with the top and bottom surfaces they form the previously described hexagonal shape. Along the central section of the keel, the lower edge of the upper side surface on the port side shows distinct caulking lines associated with extensive shipworm damage. Moreover, both port and starboard lower side surfaces exhibit series of notches whose function was to protect the heads of the nails fastening the keel to the floor timbers. The notches are semi-circular and appear to be carved with a hatchet. At the widest portion of the keel, they measure up to 2.5 cm in depth (fig. 4.13). In addition, a number of notches along the portside forward section of the keel exhibit distinct square impressions inside otherwise semi-circular notches. Although none of the fasteners survived, it is suggested that these could have been produced by nails with square heads or washers.

Bow End

Heavily deteriorated and *Teredo* worm-eaten, the forward extremity of the extant keel shows evidence of a keel-stem scarf. Along the underside of the keel, about 39 cm before of the last extant bolt hole at the bow (the location is associated with the tenth frame forward of the master frame), there was a small fragment of wood fastened to the keel with a corroded, 35 mm, square bolt or spike. When discovered, this irregular fragment measured only 13 cm long by 4 cm thick and was interpreted as part of the

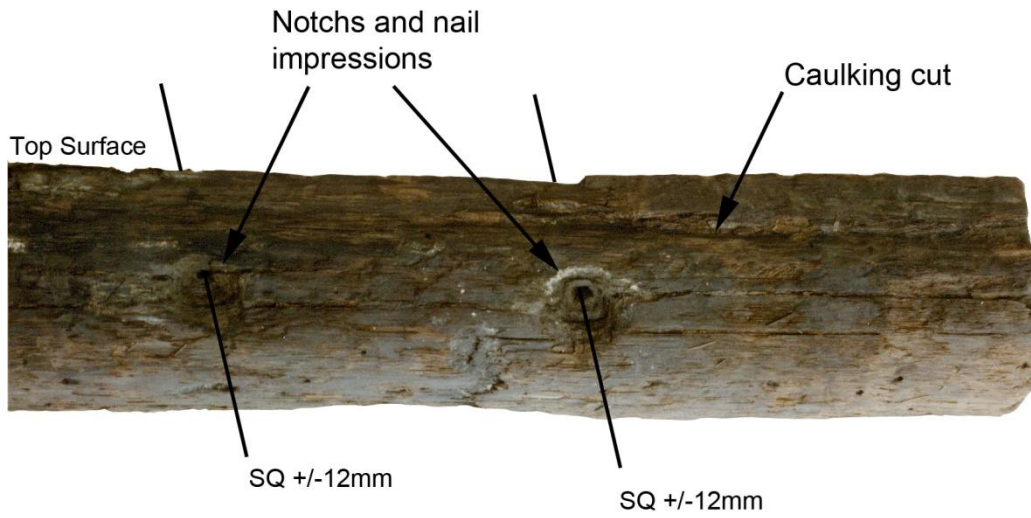

Figure 4.13: View of the starboard face of the central section of the keel, near forward cut. (photo courtesy of NMB)

original stem. Although the nature of this section of the keel prohibits making more precise claims, the joint resembles a flat horizontal scarf.

Stern End

At the stern extremity, the keel was violently torn away at the location of the fourteenth floor timber (FR 14). The top surface of the after section of the keel, a section associated with the very aft extant frame stations, has evidence of two, possibly three, shallow mortises. These are cut directly into the top flat surface of the keel and correspond with the locations of the twelfth, thirteenth, and possibly fourteenth frames (FR 12, FR 13, and FR 14). Since these did not survive, it is unknown if they could have been rising floors or they belonged to a group of Y-shaped stern crotches. If they were associated with rising floors, it is also likely that one of these frames could have been classified as a tail-frame during the construction of the ship. Collectively, the mortises along the after section of the keel appear to resemble the mortises found on the stern knee and give credence to the interpretation that the section where the keel broke off was originally in close proximity to the keel's heel and the stern knee of the ship.

The Rabbet

The preserved keel has neither a square rabbet in the form of a recess or groove to receive the edges of the garboards; nor is it sculpted, incorporating the garboards as the one found on the Red Bay (24M) Wreck.³² On the Western Ledge Reef Wreck, the garboards simply butt against chamfered upper sides of the keel. This design is analogous not only to those of the smaller vessels from the Red Bay, (including a whaleboat or *chalupa* no.1), but also to the midship section of the keel from the English

Mary Rose and *Sea Venture*, the Dutch Angra C Wreck, as well as the Iberian Angra D and *San Antonio* wrecks, amongst others (fig. 4.14).³³

As evident from the five successive cross-sections within the preserved segment of the keel timber, the chamfered surfaces are not symmetrical to each other and their angles gradually increase towards the stern. At the forward most cross-section, which corresponds with the location of the nonextant frame G (FR G), the portside angle is 74.5° while the starboard one is only 67.4° . Amidships, at the master frame (FR M), the portside angle is 80° and the starboard one is 71° . Finally, at the very aft cross-section, which corresponds with the location of the nonextant eleventh frame (FR 11), the portside angle cannot be reliably measured while the starboard one rises as high as 85.4° (table 4.5).

Since neither extremity of the keel survived where the garboards start turning into the posts, it is not feasible to fully test this evolving geometry. Nonetheless, it is apparent that the shape of the bottom hull was achieved by progressively increasing the vertical chamfer of the aft portion of the keel and by beveling the garboard edges at an inversely proportional angle. As none of these angles on either side of the keel is symmetrical to each other, these must have been fabricated independently using the judgment of an experienced craftsman rather than geometrical means. Unfortunately, the available data is not explicit if such readjustment between the keel and the garboards necessitated a transition of the chamfer into a square rabbet at the extremities, analogous to what was noted on the *Mary Rose*, the 16th-century eastern Mediterranean Yassiada Wreck, and the Basque *chalupa* no.1, or if the keel remained chamfered where it met the

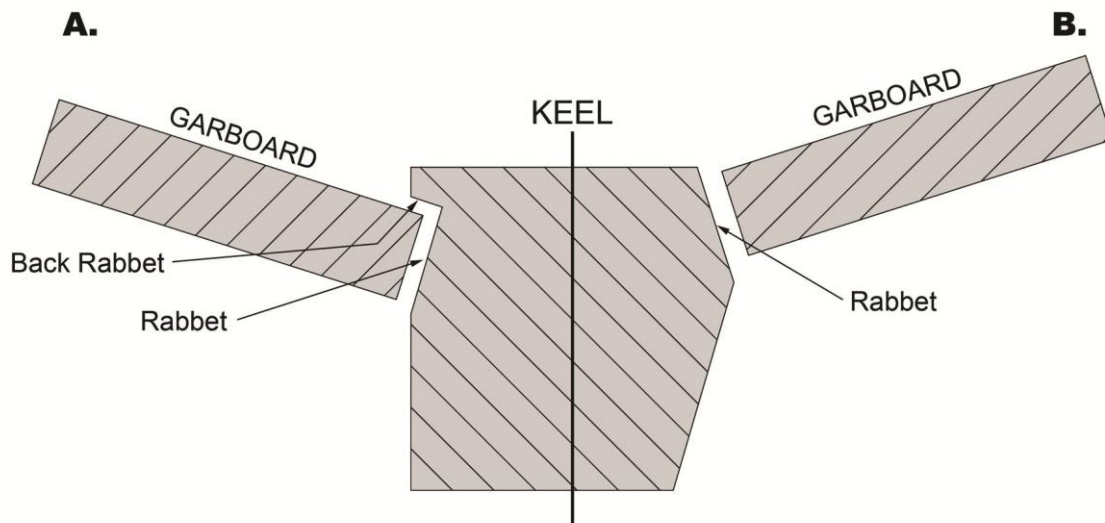

Figure 4.14: Two examples of various forms of rabbets: A. Square rabbet in the form of a recess, B. Rabbet in the form of chamfered upper side of the keel. (after Steffy 1994, 285 (fig. G-4); Curtis 1919, 28 (Figure-28).)

Table 4.5: Changing chamfer as measured along available cross-sections on the portside and starboard of the keel.

Chamfer of the Keel				
Frames	Chamfer (deg.)			Width of the top Surface (cm)
	Port	Starboard	Average	
FR G	74.5	67.4	71.0	17.9
FR F				
FR E	82.0	70.0	76.0	19.4
FR D				
FR C				
FR B				16.3
FR A				
FR M	80.0	71.0	75.5	17.6
FR 1				
FR 2				
FR 3				
FR 4	79.0	77.0	78.0	18.8
FR 5				
FR 6				
FR 7	84.5	78.5	81.5	17.3
FR 8				
FR 9				
FR 10				
FR 11	n/a	85.4		16.0

sternpost as was presumably the case on the *Angra D Wreck*.³⁴

To recapitulate, in the case of the Western Ledge Reef Wreck there is no indication that the garboards were attached prior to the framing. The rabbet is nothing more than a chamfered surface on each side of the keel. This chamfer had to be carved before the frames were positioned and secured in place, indicating that it was manufactured as a part of the keel's hewing. Although neither of the keel's extremities survived, the absence of a square rabbet in a form of a recess or groove to receive the garboards along the central section of the keel does not preclude its possible existence near the extremities. Amidships, the weight of the readjustment between the keel and the garboards lies on the keel. The chamfer is angled while the inboard edges on each of the garboards are neatly squared off (at or near 90°). Moving aft, however, the weight of the readjustment reverses. The chamfer becomes increasingly vertical and to compensate the inboard edges on each of the garboards become more acute. As defined by Manwayring "...rabbetting is the letting-in of the planks to the keel, which is little hollowed away, that the planks may join in the better, and closer to the hookes and the keel."³⁵ He continues the definition by emphasizing that "this is only used in the rake and run of the ship, and not in the flat floor..." indicating the absence of square rabbetting amidships.³⁶ Significantly, at least five other shipwrecks of very different nationality, geographical provenience, and shipbuilding tradition such as the 16th-century Ottoman *Yassiada*, English *Mary Rose*, Iberian-built Studland Bay Wreck, small Basque *chalupa*, or an early 17th-century English supply ship *Sea Venture* exhibit this particular approach to the readjustment between the keel and the garboards, which by analogy make an interesting

case for the Western Ledge Reef Wreck.³⁷ It can be hypothesized that the chamfered central section of the Western Ledge Reef Wreck's keel could have transitioned into somewhat square rabbeted surfaces at the very extremities; which, in turn, continued into rabbeted sternpost (fig. 4.15). Indeed, such transition would provide the strongest, smoothest, and most secure joint between the keel and the edges of the garboards. It is also supported by the dimensions of the stern knee.

Keel Fasteners

The floor timbers were fastened to the keel either with two square nails or a combination of two square nails and a round bolt. Although the fasteners corroded away, the impressions inside the notches carved along the sides of the keel show two types of nails being utilized. The first type was larger, had square shanks that varied between 10 mm and 12 mm, and round heads of about 25 mm to 30 mm in diameter. The second type was smaller, had square shanks measuring between 7 mm and 9 mm, and square heads known only as deteriorated impressions. In addition, a number of nails along the starboard central section of the keel had what appeared to be large, 35 mm to 37 mm diameter, round heads or perhaps washers (roves).

With the exception of a single starboard nail associated with the third floor timber (FR 3) aft, which was only partly driven in and then clenched over the keel, all the nails went through the keel and were inserted from below. The impressions left by the bolt's round shanks fell into two groups, those measuring between 23 mm and 26 mm, and those between 27 mm and 29 mm; while their round heads (or perhaps rings or roves) were about 50 mm. Although the majority of the bolts seem to be driven from

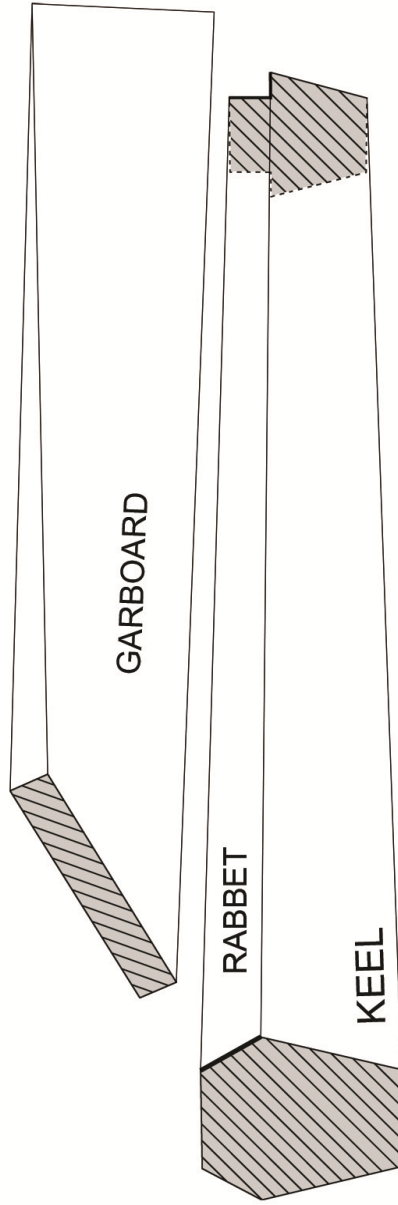

Figure 4.15: Hypothetical transition from the rabbet in the form of chamfer to the rabbet in the form of square recess as the garboard transitions from the midship into the bow and stern extremities of the keel.

above, the evidence related to the bolt at the third floor timber (FR 3) aft and those at the sternpost suggest otherwise. Because they were associated with countersinks along the underside of the keel and impression of washers along the top, these were most likely forelock bolts driven from below. In contrast to nails, bolts occurred at irregular intervals of every two, three, or four floor timbers. Based on the number of consecutive pairs of fasteners along the top surface, the extant keel had evidence of a total of 27, possibly 28, frame stations. Of these, 15 were fastened with 2 nails, 7 with 2 nails and an iron bolt, and the remaining 5 or 6 had unidentified pattern.

An interesting aspect of the keel's fastening system is the presence of an isolated, 3 cm diameter treenail cut flush with the top and bottom faces of the keel. It is located just forward of the master frame and about 9 cm aft of the floor timber A (FR A), with a slight offset to starboard. Since the treenail does not affix anything and perfectly corresponds with a partly finished drilled hole along the after face of the floor timber A, it seems to represent an assembly error. Evidently, a worker responsible for drilling the holes for the bolts, perhaps an unseasoned apprentice, misjudged the angle. Instead of drilling straight down through the keelson, the center of floor timber A, and the keel, the drill bit got skewed at floor timber A and went through the empty space between the master frame and floor timber A. To correct the mistake, a new hole had to be drilled, while the old one was plugged with a treenail. Such a mistake elucidates an important aspect of the construction sequence. After being positioned, each floor timber was fastened to the keel only with nails and part of the bottom was perhaps planked. The keelson was fashioned and placed atop the floor timbers. To finish, holes were drilled at

intervals through the keelson, floor timbers, and keel, and the internal structure was subsequently bolted through from above and below. Bolts were evidently intended as more permanent fasteners than nails.

Tool and Scribe Marks

The keel was hewn from a high quality straight oak timber. Based on a visual tree ring count, the timber was at least 45 year old when felled.³⁸ After being squared off with axes, the surfaces of the keel were adzed across the wood grains to attain the desired hexagonal shape. The top flat surface, which measured between 16 cm and 20 cm in sided width, exhibits two types of conspicuous and interrelated carpenter marks. The first type is a mark which designates the location of the master frame (FR M) and resembles a large square with two perpendiculars which effectively create an 'X' symbol (fig. 4.16). It was placed in a predetermined spot and scribed before the chamfer along both sides of the keel was cut. The second type is a longitudinal line scribed along the keel's centerline. Although severe deterioration prohibits determining its exact extent, evidence suggests that the line started at the location of the third bolt from the bow extremity and continued aft to the spot where the keel broke off. The preserved line spans a total of 17 floor timbers, including five bolted ones, and measures 565 cm or about 9.8 *codo* in length; however, its true length aft of the master frame is unknown.

The Stern

The remains of the Western Ledge Reef Wreck's stern were found in two large fragments, designated here as the lower and the upper stern (fig. 4.17). These were

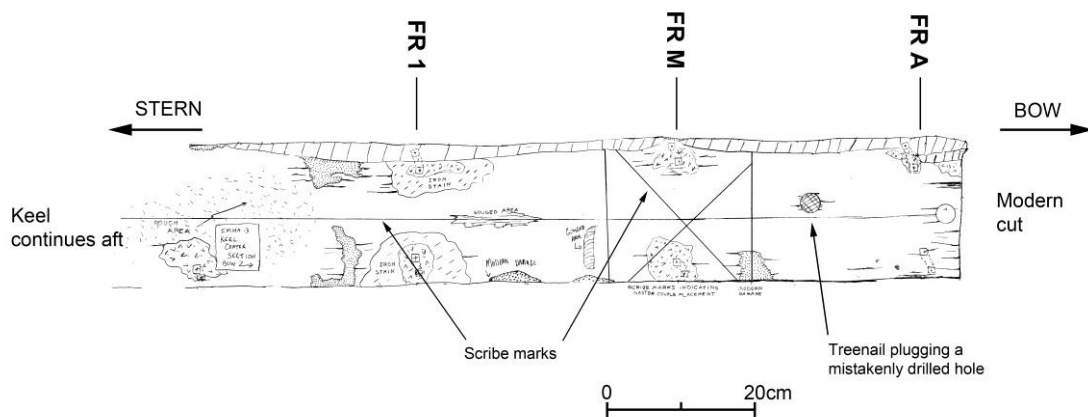

Figure 4.16: Two types of scribe marks discovered on the keel.

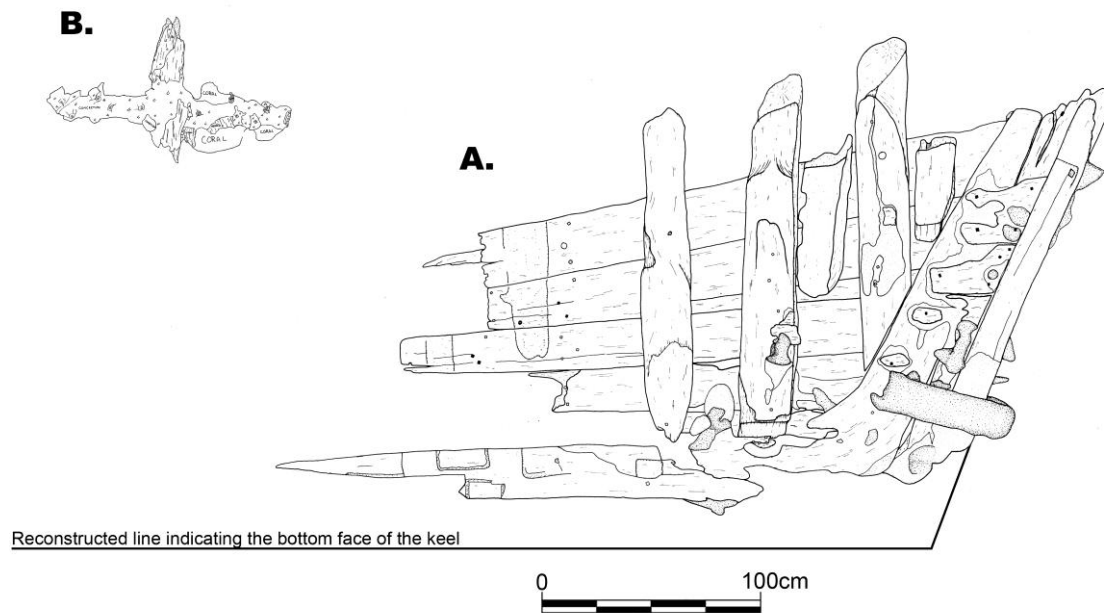

Figure 4.17: Overview of the lower stern assembly (A), and a fragment of the upper stern assembly (B). (after Watts 1993a, 113-4 (fig.13, fig.14))

separated, perhaps even torn away, from the main section of the hull sometime during the wrecking. The spot where the lower stern broke from the keel is quite similar to what was noticed on one of the Padre Island wrecks, *San Esteban* (1554). A hypothesis proposed by Arnold and Weddle blaming the ballast distribution for the breakage offers a possible explanation.³⁹ According to their hypothesis, to counter the weight of the large sterncastle, the ballast would have been concentrated mostly forward. For normal operation of a vessel, this would be an ideal balance; however, during the wrecking process it created a weak point somewhere at the merger of the stern assembly and the keel. This, in turn, caused the keel to snap and the stern assembly to separate.⁴⁰ Due to the fact that both lower and upper stern sections of the Western Ledge Reef Wreck were discovered forming two independent assemblies, these are analyzed in this dissertation individually.

The lower stern includes a highly deteriorated portion of the stern knee, a section of the sternpost with concreted remnants of two gudgeon straps, three Y-shaped floor timbers, fragments of three aft first futtocks, broken hooding ends of four portside planks, and short sections of five starboard planks including a stealer. Comparing this inventory with the 1989 timber catalog and photographs, there is a discrepancy in the number of the stern first futtocks. Although the original data indicated four first futtocks, a number that included a probable futtock associated with the most forward crotch (AFR 3), the new research excludes this timber from the total count. Due to its odd oval cross-section, lack of any fastener impressions, and rather loose and ambiguous association with the lower stern assembly, the timber has been interpreted as unidentified (UN 2)

and the total number of the stern first futtocks remains at three. In addition to the lower stern, much less substantial fragment of the upper stern assembly survived as well. It consists of a small section of the sternpost with a heavily concreted gudgeon strap and impressions of the portside and starboard diagonal transom planking.

Although separated from the main section of the hull some time during the wrecking, the general dimensions and characteristics of the lower stern assembly not only match those of the upper stern, found atop the main hull, but also constitute an integral part of the ship structure. Both the lower and upper stern assemblies conform to the size, proportions, and Iberian-Atlantic tradition of the rest of the hull. They share a common framing design, scantling, and spacing. They share the dimensions, morphology, and pattern of the fasteners. Lastly, the preserved stern planking is of consistent width and thickness, and produces a continuous strake with one of the midship planks. Overall, there is nothing to suggest that the lower or upper stern assemblies could have come from another and potentially larger shipwreck that sunk in the vicinity of the Western Ledge Reef Wreck.

The Lower Stern Assembly

The Stern knee

A badly damaged stern knee was recovered during the excavations. It not only reinforced the scarf between the keel and heel, but also the joint between the heel and the sternpost. In addition, the knee served as rising deadwood, creating a platform for at least five Y-shaped aft floor timbers referred to as the crotches. Although the dimensions

of the knee and the shape and design characteristics of the sternpost strongly suggest that the heel was originally present, there is no clear evidence of the scarf at the lower end of the sternpost. An alternative design in which the sternpost was originally longer and directly mortised to the keel, bypassing the heel, is known both from the presumably Iberian late 16th-century B&W 7 Wreck and the English *Sparrowhawk* (1626). This design cannot be entirely ruled out.⁴¹

Contrary to the stern assemblies of analogous Iberian examples, the stern knee associated with the Western Ledge Reef Wreck was fabricated from two timbers: one constituted a vertical arm (ASK 1) and the other one a horizontal arm (ASK 2) (fig. 4.18). These were scarfed together at the after end of the horizontal arm; the joint was further reinforced by a now completely corroded 25 mm diameter bolt. The vertical arm was attached to the sternpost with four bolts, while the horizontal arm exhibited evidence of being originally fastened to another fore-and-aft timber (either to the continuation of the keel, or to the keel's extension, the heel) with at least one, but likely more, bolts.

The extant vertical arm of the knee (ASK 1) extends for about 160 cm. Its molded height is 30 cm at the bottom narrowing to 14 cm at the top. The sided width also slightly narrows from 15 cm, along the forward face, to 12 cm, along the after face, matching the width of the rabbeted surface of the sternpost. The extant horizontal arm (ASK 2) measures 240 cm in length. Its maximum preserved molded height is about 22.6 cm, but it decreases to less than 5 cm at the deteriorated forward extremity. At the same time, its maximum preserved sided width is between 17 cm and 18 cm, perfectly

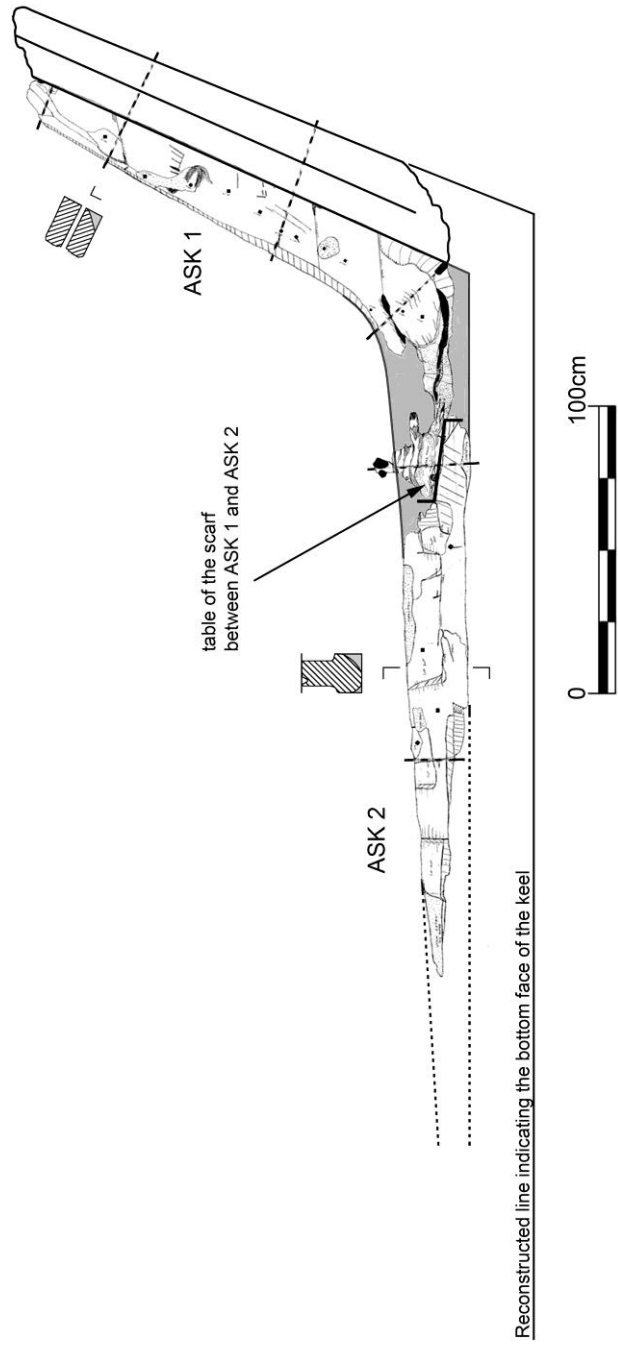

Figure 4.18: Stern knee. (ASK 1 and ASK 2) (91-13-10, 91-19-11, 91-12-D5)

matching the width of the top flat surface of the keel on which it must have originally rested. As described previously, the match between the knee and the top surface of the keel supports the notion that the keel could have been rabbeted at the stern extremity as the garboards were likely let into the keel to produce a smooth tapering at the run (the narrowing of the stern). The much better preserved upper surface of the horizontal arm slopes down towards the bow. Generally flat, the deteriorated bottom surface has a 5.4 cm deep recess and resemblances a diagonal scarf.

The vertical arm of the stern knee was manufactured from a large, naturally curved timber, with a grain that closely followed the shape of the finished piece. It was fastened to the sternpost with three iron bolts, although only two of them penetrated through the entire timber. Starting from the top, the diameters of the bolts are 16 mm, 20 mm, and 25 mm respectively. The arm was also fastened to the nonextant aft end of the heel or to the keel with a bolt measuring 20 mm. All of these fasteners were associated with large, 40 mm to 5 mm in diameter, shallow washer impressions found along the inner face of the arm, suggesting the use of the forelock bolts. In addition, the inboard edges of the upper arm appear to be beveled with adzes to reduce sharp corners.

The deteriorated horizontal arm of the knee was originally fastened to either the heel or the keel with at least two iron bolts measuring 22 mm and 28 mm, respectively, in diameter. The portside and starboard surfaces of the knee show evidence of numerous square nail impressions ranging in size from 9 mm to 15 mm. These were used to fasten the after ends of the planking and the gudgeon straps, both of which left distinct pressure marks. The square nails in the horizontal arm were also used to fasten at least five Y-

shaped crotches. Top surface of the horizontal arm of the knee was carved with four pairs of 3 cm to 4 cm deep notches into which the crotches were inserted and fastened, whereas the aftermost crotch was nailed directly onto the sloping vertical arm. Such solution to the design of the stern knee and the positioning of the crotches is well documented on the other 16th-century shipwrecks such as Red Bay (24M and 29M) wrecks, the Padre Island Wreck *San Esteban*, the likely Mediterranean-built Calvi I Wreck, and the English *Sparrowhawk*.⁴²

The Sternpost

The stern assembly included a fragment of the sternpost (SNP 1). When discovered, it measured 167 cm in length and was attached to the vertical part of the stern knee with two bolts. After careful detachment and analysis, the extant sternpost appeared to be square and measured 22 cm by 22 cm in cross-section, dimensions which closely match the average cross-section of the keel (fig. 4.19). Both the top and bottom ends of the extant sternpost have evidence of violent breakage. The top broke off right above the level of the second gudgeon, at almost the same location as the sternpost from the Red Bay (24M) Wreck.⁴³ By analogy, it is hypothesized that the breakage point could represent a level of the stern tuck where the fashion pieces were attached, a naturally weak spot along the post.

The lower end of the sternpost did not survive being torn away somewhere in the vicinity of the scarf with the heel or the keel. Due to the fact that neither the scarf nor the heel was preserved, the nature of the joint remains uncertain. Based on comparative research, the arrangement between the sternpost and the heel could resemble those found

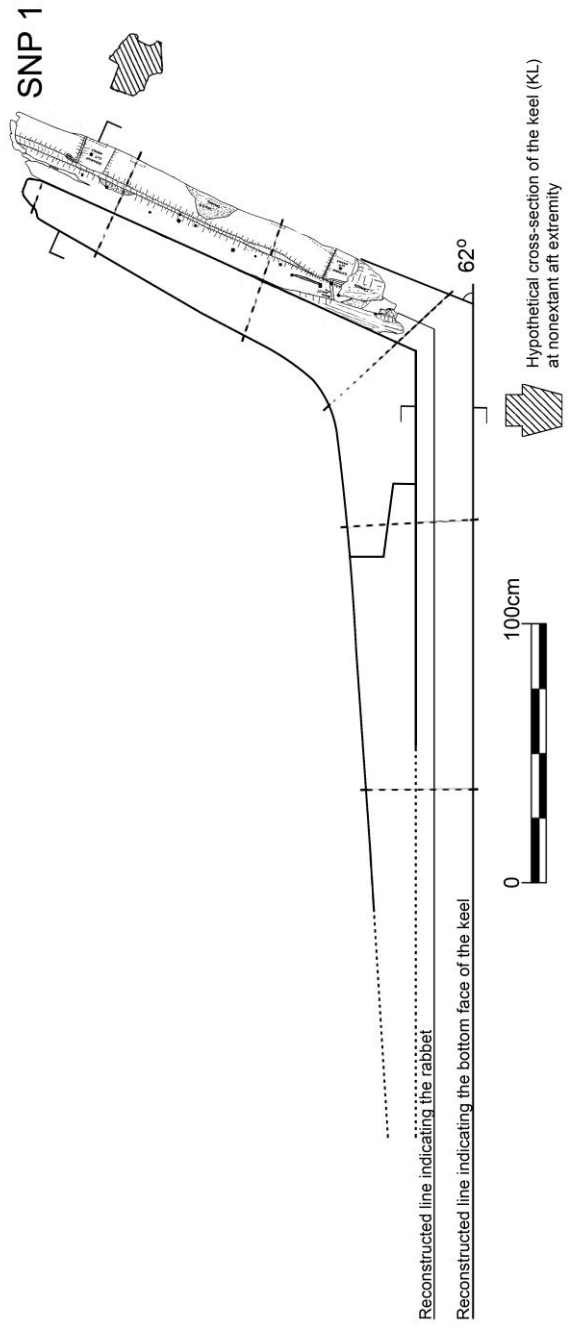

Figure 4.19: Preserved sternpost. (SNP 1) (91-10-D6, 91-20-D5)

on Red Bay (29M) Wreck or the Padre Island Wreck of *San Esteban*.⁴⁴ Alternatively, the original sternpost could also extend down along the after face of the knee and be scarfed directly to the very end of the keel, as with the case of *Sparrowhawk*, sunk in 1626.⁴⁵

It is estimated that the sternpost of the Western Ledge Reef Wreck rose at a 62° angle to the base of the keel. It is, by far, one of the furthest from vertical within the group of comparative shipwrecks, and closely parallels the 60° rake recorded for Emanuel Point I Wreck or the 65° rakes recorded for the Calvi I and the *San Esteban*.⁴⁶ The inboard face of the sternpost, the one adjacent to the vertical arm of the knee, is rabbeted to receive the hooding ends of the planking strakes. Along its length, the rabbet measures 4 cm in depth and extends for 10 cm aft. Beyond the rabbet, the sternpost sides are slightly chamfered as they transition to the flat external face.

The extant sternpost has evidence of two gudgeon straps. The heavily concreted lowest strap was still preserved under thick layers of concretion while the location of the second one could only be discerned from the pressure marks and fastening impressions. At the sternpost, the outer diameter of the gudgeon is about 12 cm. The width of the straps is between 13 cm to 15 cm narrowing to about 6 cm as they continue forward onto the planking to which they were once fastened with 10 mm to 14 mm square nails. Other nails, primarily those that fastened the hooding ends of the aft planking, were also square and followed a similar 10 mm to 12 mm range. The sternpost was pierced with two round bolts through which it was attached to the vertical arm of the knee. As they were associated with about 16 mm deep countersinks found along the outboard face of the sternpost and shallow impressions of possible washers inside, these are interpreted as

forelock bolts. It is evident that they must have been driven from the outside where their heads were completely countersunk in the sternpost timber, while their shanks were secured with a key over a washer from the inside.⁴⁷

At the vicinity both gudgeon straps, the outboard face of the sternpost shows elongated semi-circular notches measuring between 15 mm and 25 mm in depth. It seems that their main function was to provide space for unrestricted movement of the pintle and gudgeon assembly, hence the movement of the rudder. Since the very aft extremity of the keel, including potential heel, is absent, it is difficult to estimate the precise position of the lower strap. Nonetheless, it could not be lower than 45 cm above the baseline of the keel, while the distance between the lower and upper gudgeons was about 95 cm.

Stern Floor Timbers and Futtocks

The stern framing is represented by three floor timbers or crotches, and three poorly preserved fragments of the first futtocks (fig. 4.20). When excavated, the aftmost frame (AFR 1) was still resting directly on the vertical part of the stern knee to which it was fastened with a 12 mm square nail. The other two frames (AFR 2 and AFR 3) were loosely associated with the horizontal part of the stern knee to which they were once joined through a mortise-and-tenon system. The mortises were carved directly on each side of the knee, while the tenons projected from the foot of the crotches. After being assembled, the joints were reinforced with square nails driven from both sides. The distance between the center of AFR 3 and AFR 2 is about 37 cm, while between AFR 2 and AFR 1 it is 44 cm; both distances are consistent with the frame spacing noted at the

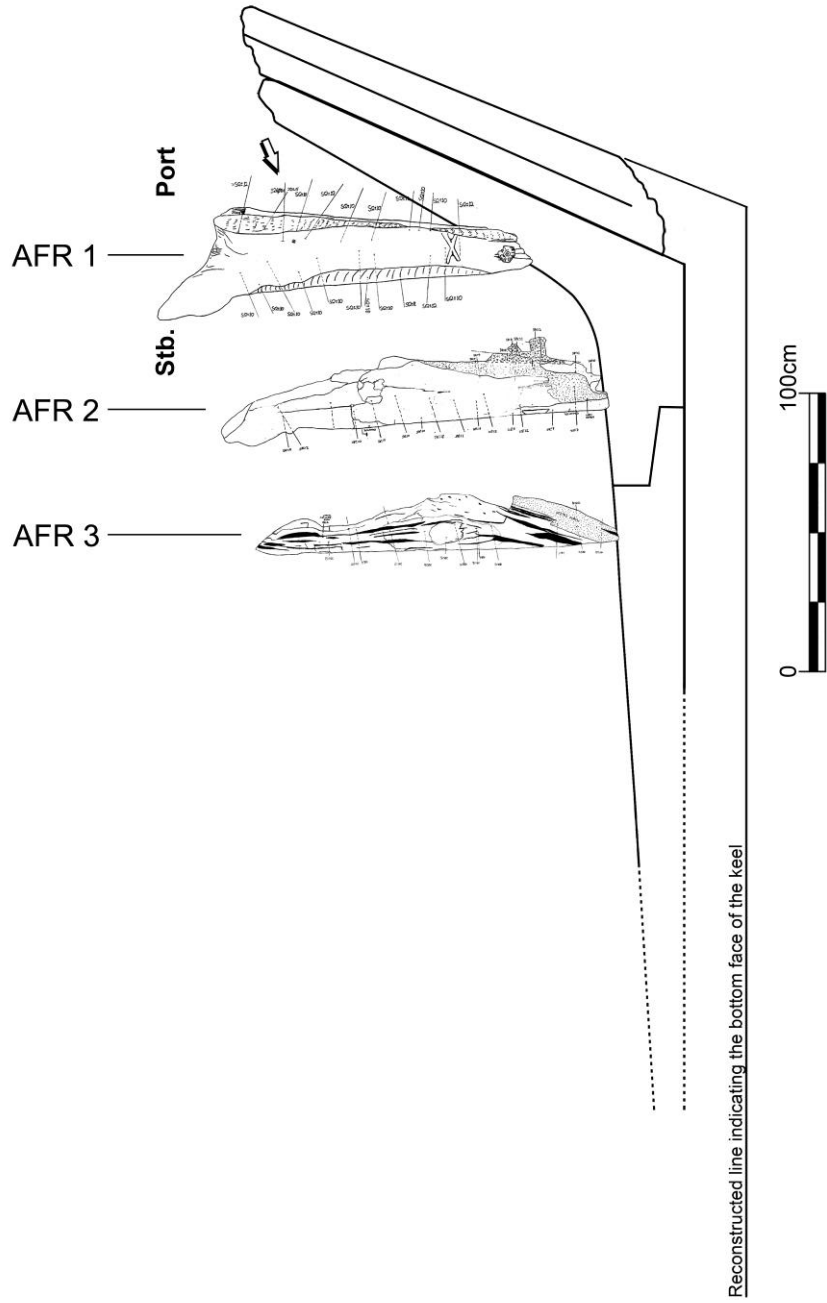

Figure 4.20: Preserved forward faces of the stern floor timbers (crotches). (AFR 1, AFR 2, AFR 3) (91-2-D8, 91-16-D2, 91-15-D1)

very aft extremity of the extant keel. Looking from the sternpost forward, the extant crotches reached about 130 cm in maximum height above the keel, and about 22 cm in sided width. Due to the absence of the entire port side of the assembly, the distance between the wrungheads could not be determined.

Following the rule governing the arrangement of the framing timbers between the master frame and the stern, the first futtocks are placed aft of the floor timbers. The aftermost crotch (AFR 1) is associated with the deteriorated heel end of the starboard first futtock (AFR 1 S1), while the second crotch from the stern (AFR 2) is associated with the fragmentary heel ends of both portside and starboard first futtocks (AFR 2 P1 and AFR 2 S1). The only dimension that these timbers provide is sided width, which ranges between 17 cm and 20 cm. Since the other dimensions are severely altered by timber deterioration, they are ambiguous. Unlike the dovetail mortise-and-tenon scarfed frames of the midship section of the vessel, the stern futtocks were not fastened to the crotches but only to the external planking with 8 mm to 15 mm square nails.

The wood used to manufacture the stern framing is of lesser quality than that used amidships. Some of the timbers have large knots, warped and twisted grains, and numerous natural waness, but they still follow sound shipbuilding standards. The stern floor timbers have been fashioned from the naturally grown crotches of trees. The futtocks, or at least what is preserved of them, appear to have been fashioned from either large roots or otherwise warped timbers marked by extensive branching. Interestingly, the wood grains of these timbers still run in the approximately correct direction, maximizing their strength. Since compass timbers that fit the shape dictated by the stern

of the ship are also some of the most difficult to find, the inner face of the starboard first futtock associated with the second crotch from the stern (AFR 2 S1) was shaped along the outside of a log near the original tree bark. This is the only timber found on the shipwreck that reveals evidence of the bark. The heel end of this first futtock is also sandwiched with the heel of the one opposite (AFR 2 P1), both being fastened to the external planking but not to each other. This coupling was almost indiscernible and was discovered only after the stern elements were disassembled. Due to extreme deterioration, no tool marks or surface details could be reliably recorded. The exception is the most aft crotch (AFR 1) which has what appears to be a large “X” symbol carved on its forward bottom face (fig. 4.21). At present, the significance of this symbol is known. At the foot of the crotches, the timbers were covered with black residue resembling pitch or tar and show evidence of V-shaped limber holes. This shape contrasts square-shaped limber holes found on the floor timbers amidships. Some of the crotches also display partial caulking marks at the location of the plank seams.

The crotches were fastened to the knee with either a combination of mortise-and-tenon joints reinforced by square nails or only with nails, but the first futtocks were fastened exclusively to the external planking. These are defined as “floating futtocks” and must have been installed only after ribbands and at least some of the planking was already in place. The nail impressions found in the framing are square and range from 8 mm to 15 mm. Other fasteners include three treenails, measuring 26 mm, 24.5 mm, and 30 mm, respectively, found in crotches (AFR 1, AFR 2, and AFR 3 respectively) as well

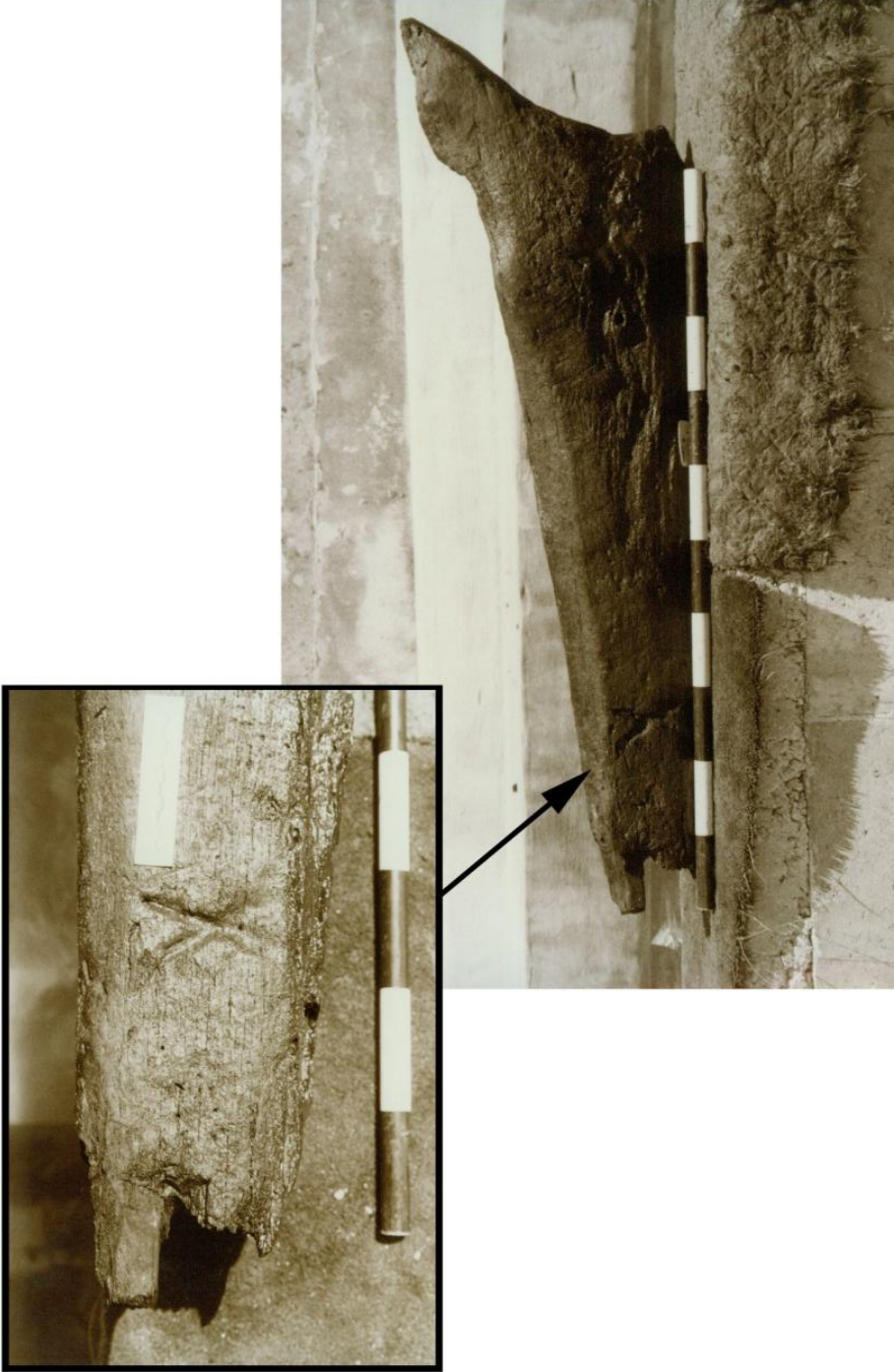

Figure 4.21: “X” symbol carved on the forward face of most aft crotch. (AFR 1) (photo courtesy of NMB)

as one treenail, measuring 23 mm in diameter found in the starboard first futtock of the aftmost crotch (AFR 1 S1).

The position of the treenail at AFR 3 could only be explained if it were plank-to-frame fastener. The nature, function, and position of the other treenails seem puzzling and could signify anomalous fasteners or plugs which mask the holes left by other fasteners. Analogous plugs found at the stern of the Red Bay (24M) Wreck suggest that these could have been associated with lowest level of the Western Ledge Reef Wreck's construction ribbands (fig. 4.22).⁴⁸

Stern Planking (Port and Starboard)

The extant planking of the lower stern assembly consists of extremely deteriorated remnants of three portside and five starboard planks. In addition to a small loose fragment that could have belonged to the second strake (APP 2), the portside planking seems to represent no more than the hooding ends of the third (APP 3), fourth (APP 4), and fifth (APP 5) strake respectively (fig. 4.23). Considering that the stern assembly was found separated from the rest of the hull, the strake numbering is tentative and relates solely to the stern. Due to their fragmentary nature, the recorded lengths of these extant planks are inconsequential; hence, only their width and thickness are provided here.

Collectively, they range between 29 cm (APP 5) and 36 cm (APP 3) in width and 5.6 cm in average thickness. The planks' hooding ends were seated inside a 4 cm deep sternpost rabbet to which they were fastened with 8 mm to 12 mm square nails. With the exception of APP 4, which exhibits a total of four nails, the general pattern consists of

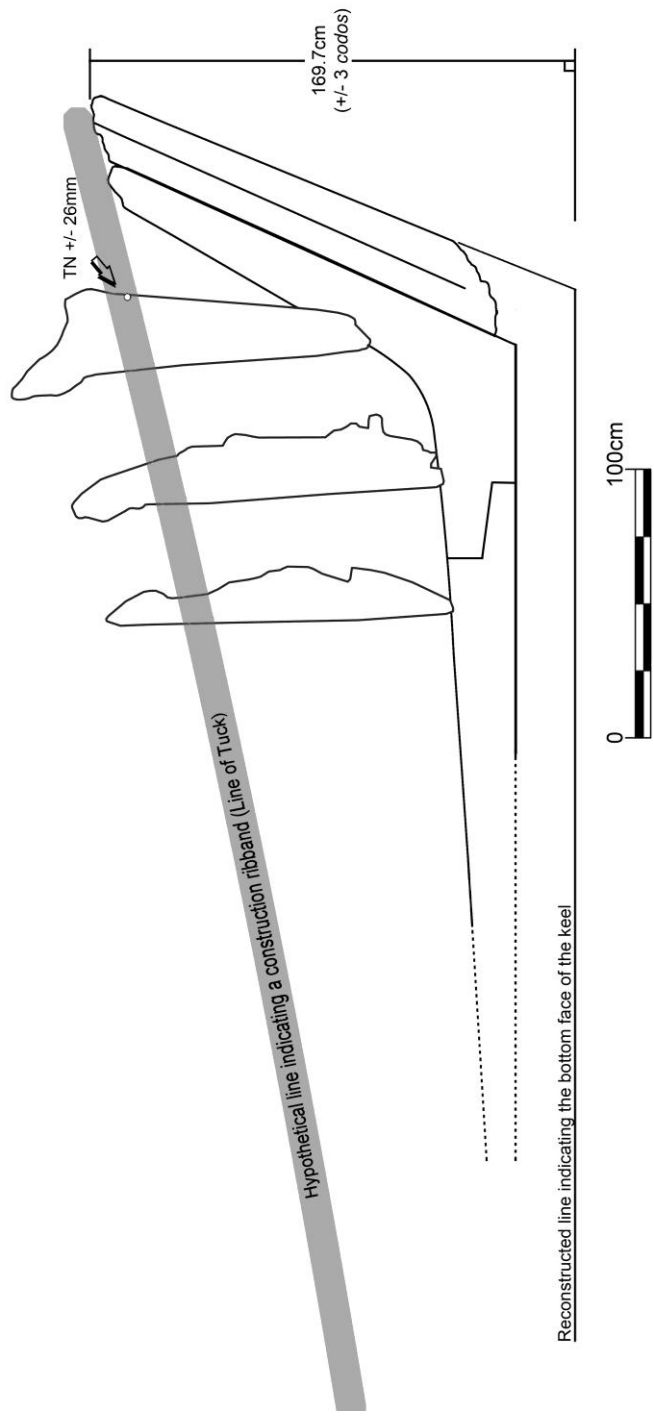

Figure 4.22: Hypothetical reconstruction of the lowest level of the construction ribbands.

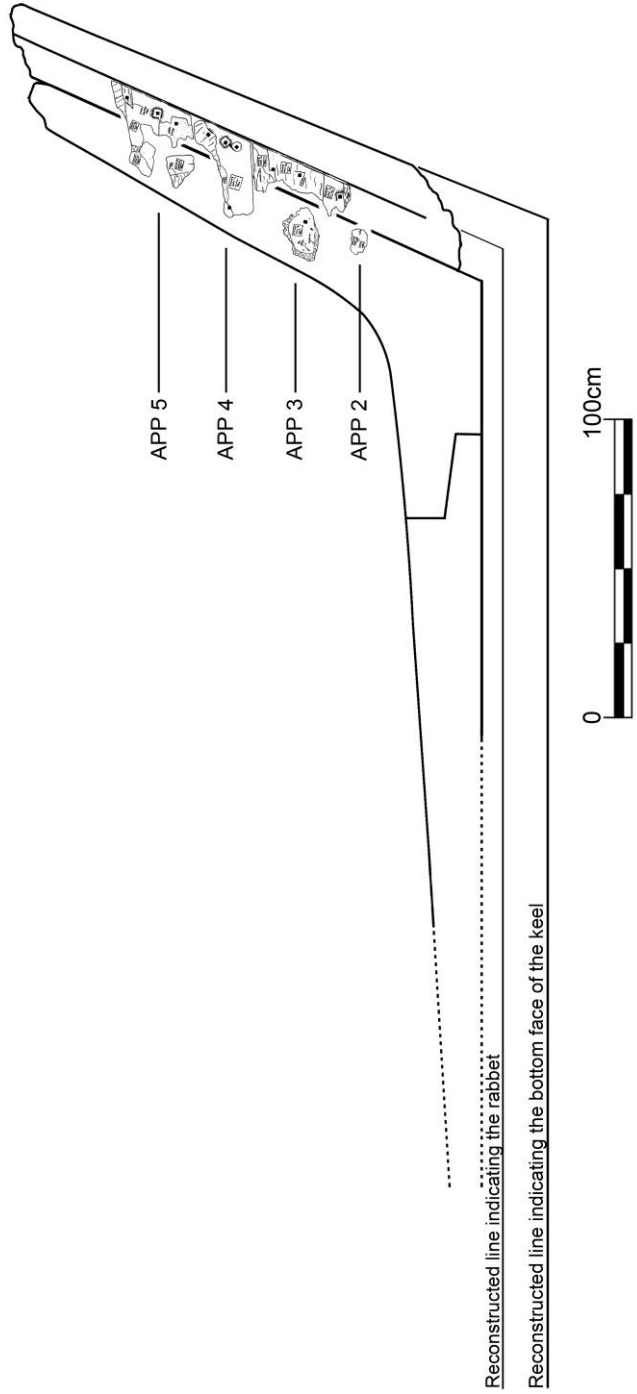

Figure 4.23: Preserved fragments of portside aft planking. (91-15-6)

three nails at each plank hooding end. Curiously, the very top nail at the hooding end of the APP 4 is driven from inside while the very bottom one is driven directly through a 34 mm diameter treenail or wooden plug. Since this treenail does not continue into the sternpost, it seems plausible to assume it was a repair or a knot plug. Another aspect of the fastening pattern is that some of the nails on each of the planks, usually the middle one of the three, are associated with shallow square gouged areas measuring about 3 cm by 3 cm. At present, the purpose of such countersinks is still unclear. Perhaps they facilitated the removal of a faulty nail or in some way protected the head of the fastener.

In contrast to the portside, the extant starboard planking is much better preserved. It consists of fragments of what can be defined as the first (APS 1), second (APS 2), third (APS 3), fourth (APS 4, which also includes a stealer APS 3A); and fifth (APS 5) strake (fig. 4.24). Starting from the bottom, the first and most deteriorated plank of the first strake is in two pieces (APS 1 1/1 and APS 1 1/2). These measure 26.8 cm and 52.8 cm in length by 9.9 cm and 12.8 cm in width respectively. The plank belonging to the second strake is also in two pieces (APS 2 1/1 and APS2 1/2); it was cut during the excavations, and hence it is presented here as a unit. It measures 176 cm in length by 25.7 cm in width at the hooding end, narrowing to 15.3 cm forward. At its after end, this plank exhibits an impression of the lower gudgeon strap. The section of the third strake (APS 3) represents what appears to be an intact plank. It is 243.6 cm long and 25.7 cm wide at the hooding end, narrowing to 14.6 cm at the forward butt joint, and is 5.3 cm in average thickness. Its inner surface reveals frame and square nail impressions representing at least five different frame stations, while the top and bottom edges are

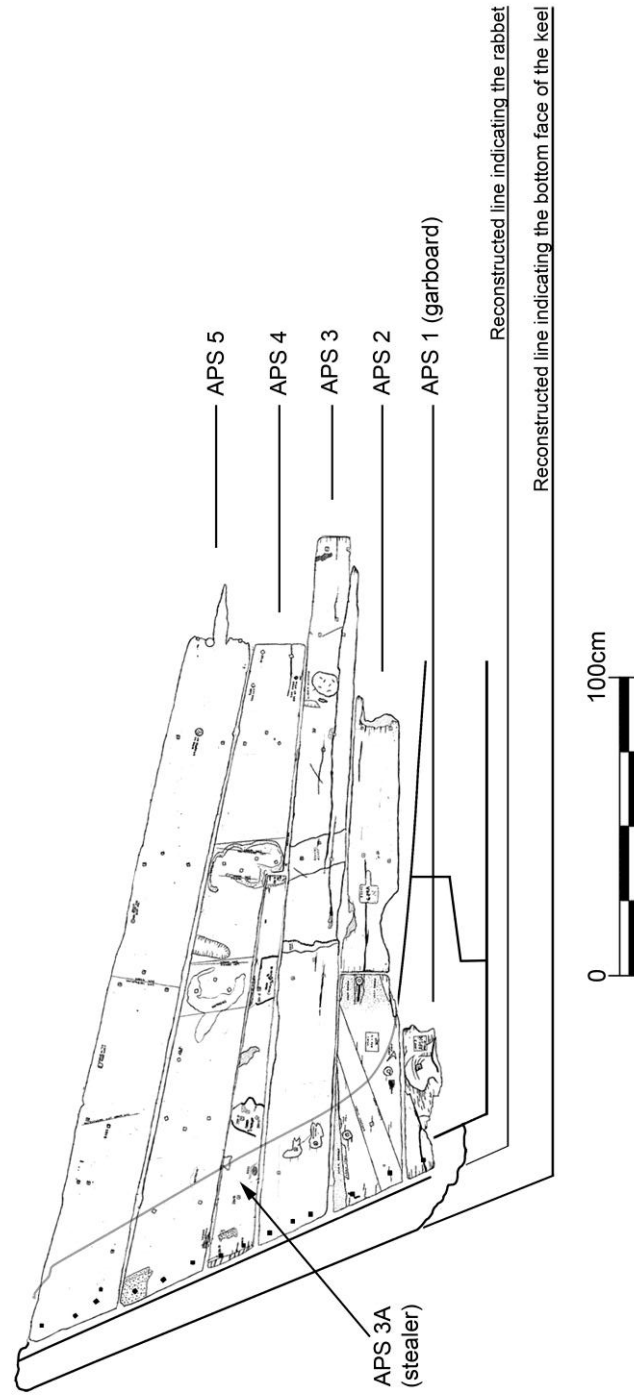

Figure 4.24: Preserved starboard aft planking. (91-12-D20, 91-14-D8/D9, 91-18-D5/D6, 91-18-D3, 91-9-D2)

beveled to allow tighter fit with the adjacent planks. The extant fragment of the fourth strake (APS 4) might represent yet another intact plank, although poor preservation of its forward extremity does not provide a conclusive answer. It measures 231.5 cm in length and 31.9 cm in width at the hooding end, narrowing to 17.4 cm at the forward end, and is 5.5 cm in average thickness. Similar to the strake directly below it, the inner surface of this plank contains frame and square nail impressions, as well as transverse saw marks. Along its bottom aft edge, there is a long recess in which a thick stealer plank (APS 3A) was inserted. The stealer extended from the sternpost to the third frame aft (AFR 3) and measured 135.7 cm in length, narrowed in width from 16.7 cm to 6.3 cm, and measured about 6.8 cm in thickness. Both top and bottom seam edges of the stealer were wedge-shaped. The final extant plank, the one estimated to be a part of the fifth strake (APS 5), is the longest and widest of the entire stern assembly. Even with its forward end broken along a plank-to-frame intersection, it still measures 267 cm in length, 33 cm wide at the hooding end, narrowing to 22.9 cm, forward; it was about 5 cm in thickness. With the exception of saw marks and nail impressions, no other surface details were preserved.

Collectively, the extant starboard planking is characterized by wide, 25 cm to 33 cm hooding ends that narrow significantly by at least 10 cm to 15 cm as the planks progress forward. In addition to narrowing, the top and bottom edges are beveled inboard. The inside surfaces carry distinctive pressure marks left by the framing and also exhibit transverse saw marks that together with the plank's cross-sections indicate flat-sawing. The average thickness of the planks is 5.5 cm, which is consistent not only with the thickness recorded for the portside, but also for the rest of the ship's planking. The

starboard hooding ends were seated inside a 4 cm deep sternpost rabbet to which they were fastened with 10 mm to 12 mm square nails. With the exception of the stealer and the first two bottom planks, the fastening of the hooding ends followed a pattern of three nails per plank at each frame and no treenails. Although deterioration limits precise measurements of the hooding ends, it appears that their thickness was slightly reduced as the planks entered the post. Moving forward into junctions between planks and frames, the fastening pattern becomes less apparent as these exhibit two, three, or even four iron nails per frame. In case of plank APS 5, two of its forward most nonextant frame stations are associated with an arrangement of a treenail and two iron nails. As evident from the other 16th-century Iberian shipwrecks, notably the Padre Island Wreck of *San Esteban*, the treenails, if present at the stern assembly, are a minority of fasteners.⁴⁹

The Upper Stern Assembly

Although disarticulated from the rest of the stern sometime during the wrecking, a small section of the upper stern (SNP 1/2) was discovered in association with the main hull (fig. 4.25). It consists of a fragment of the sternpost, a heavily concreted gudgeon strap, and small remnants of diagonal transom planking. The sternpost section measures about 73.5 cm in preserved length and about 14 cm in sided width. Inboard, both port and starboard surfaces have 4 cm deep rabbets, in which the remnants of fasteners and hooding ends of diagonal planking were originally found. The wrought iron gudgeon strap is preserved as a natural mold for about 113 cm; the angle between both its arms is about 150°. Nonetheless, this angle might deviate from the original angle, which cannot

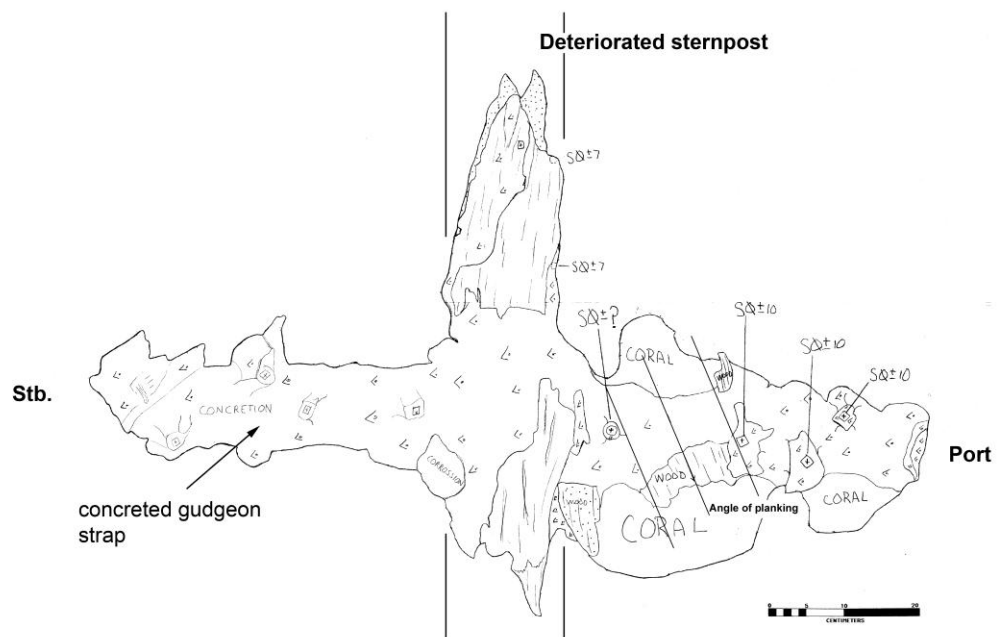

Figure 4.25: A small section of the upper stern. (SNP 1/2) (91-20-D5)
(scale equals 20 cm)

be reliably reconstructed due to the wrecking event and severe deterioration of the strap. The gudgeon strap has evidence of being fastened to the stern planking with 10 mm to 12 mm square nails. Since the impressions indicate that the planking was angled, it is evident that this strap must have been located directly on the transom.

4.6 THE FRAMING

Overview

Excluding the stern crotches and unassigned timbers, there are a total of 14 preserved frames within the central section of the Western Ledge Reef Wreck's hull. These comprise 14 floor timbers and the severely deteriorated heel ends of 21 first futtocks, 10 located on the portside, and 11 on the starboard. Due to underwater burial conditions, none of the framing elements above the level of the first futtock survived (fig. 4.26).

A group of nine central frames exhibit characteristic dovetail mortise-and-tenon joints or scarfs between the overlapping floor timbers and first futtocks.⁵⁰ Within this group, the largest frame, defined here as the master frame (FR M), is set apart as the only one with four scarfs corresponding to four first futtocks, two of them facing forward and two facing aft. Between the master frame and the stem of the vessel, the extant frames A, B, and C (FR A, FR B, and FR C) have scarfs facing forward; while between the master frame and stern, the first, second, third, fourth, and fifth frame (FR 1, FR 2, FR 3, FR 4, FR 5) have scarfs facing aft. The remaining five frames, namely

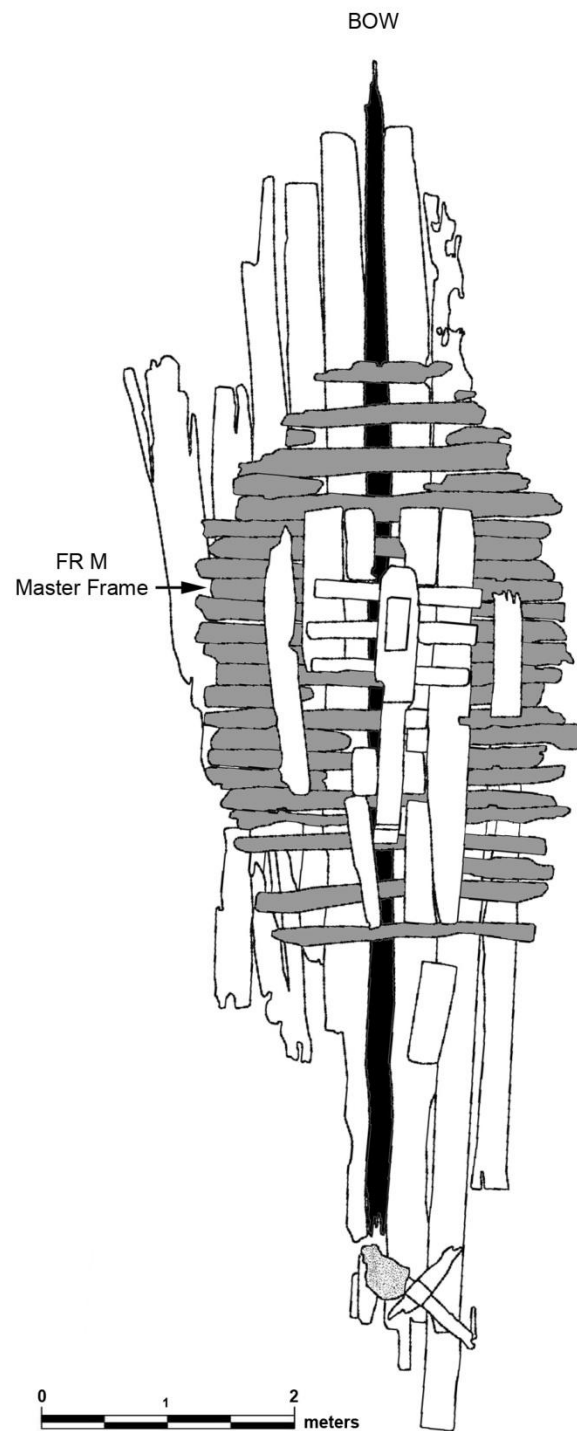

Figure 4.26: Overview of the preserved framing timbers.

forward frames D and E (FR D and FR E), and after frames six, seven and eight (FR 6, FR 7, FR 8) show similar overlapping between floor timbers and first futtocks.

However, the futtocks are not horizontally fastened to the floor timbers, but only held in place by being fastened directly to the outer planking. For the frames where overlaps between the floor timbers and first futtocks are preserved, these measure between 110 cm and 120 cm.

Dovetail Mortise-and-Tenon Joints

The group of nine central floor timbers and first futtocks are joined by dovetail mortise-and-tenon scarfs.⁵¹ Here, within a group of dovetail scarfed frames, the floor timbers have shallow mortises, measuring about 15 mm in depth; the first futtocks have complementary tenons, both of which were assembled and horizontally fastened to each other. At each joint, there was one treenail and two to four iron nails or spikes. This pattern also included a nail driven through a squared off tab carved at the lower end of the futtocks and a treenail set in a triangular countersink. Except on the master frame, the treenails are located outboard from the scarf and measure between 26 mm and 30 mm in diameter. The square iron spikes are located both inboard and outboard, and average 12 mm (fig. 4.27).

The scarfs have a basic trapezoidal shape with the inboard edge parallel to the vertical center line of the frame and the outboard edge angled (fig. 4.28). They are narrow and measure 6 cm to 8 cm on top, expanding to between 11 cm and 14 cm on the

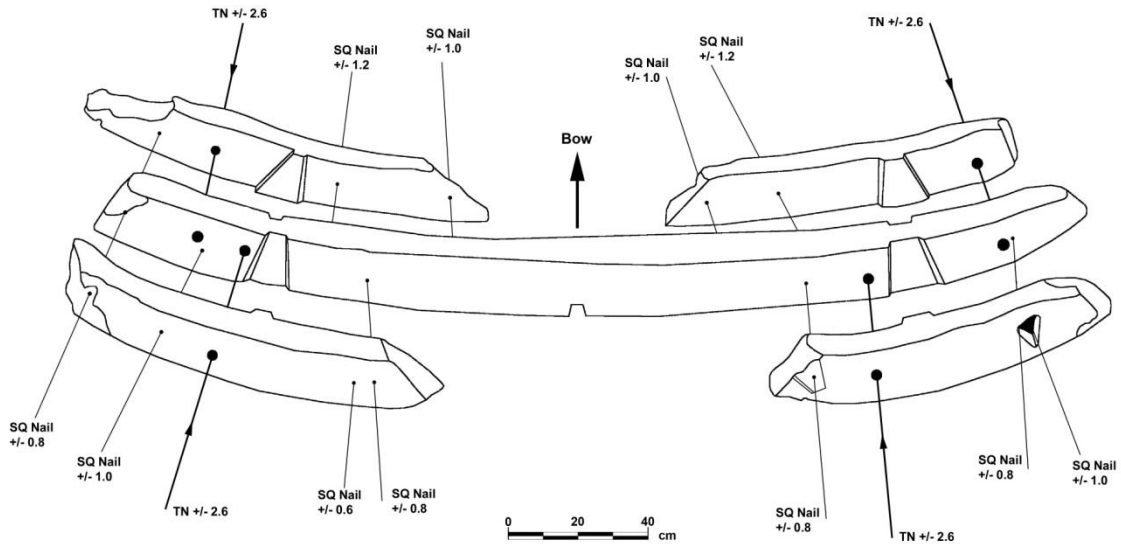

Figure 4.27: Schematic arrangement between the master floor timber and first futtocks.



Figure 4.28: Example of the dovetail mortise on the port side of floor timber A. (FR A)

bottom. Since the top is smaller than the bottom, these were put together by sliding the tenoned futtock into the mortised floor from below. The joint was first reinforced with the nails and subsequently treenails, for which holes had to be drilled across the adjoining timbers.

Based on this arrangement, it is evident that the treenails served as more permanent fasteners, a final step in the process of fastening and erecting a frame. This also indicates that these frames must have been completely assembled not only before being placed and fastened onto the keel, but also before external planking could be attached. Besides locking the floor timbers and futtocks together, the dovetail mortise-and-tenon scarfs also indicate the turn of the bilge. Notably, within a group of scarfed floor timbers, the horizontal distance from an inboard edge of a mortise to the opposite one is constant and measure about 172 cm, which is precisely 3 *codó*.

Assembly to the Keel

All of the extant frames are fastened to the keel with two 10 mm to 12 mm square nails driven from below. In addition, every third, fourth, or fifth frame, (the intervals vary), is bolted to the keel with a round bolt averaging 26.7 mm in diameter. Although the majority of these appear to be drift bolts driven from above, there is evidence of possible forelock bolts, notably one associated with the third floor timber aft (FR 3).

The frame interval or spacing, measured as the distance between the pairs of consecutive nails fastening the frames along the top surface of the keel, is remarkably

inconsistent. Averaging 35.5 cm, it sharply increases forward and aft of the master frame by irregular intervals or plateaus; a similar phenomenon was observed on the Red Bay (24M) Wreck.⁵² This can only partly be explained by the variation in the locations of nail impressions; the distribution shows a clear pattern of progressively increasing, albeit not in a strict linear fashion, intervals towards both extremities of the keel. Amidships, between the master frame (FR M) and the fifth frame aft (FR 5), spacing is the smallest and averages only 31.5 cm. Between the master frame (FR M) and forward frame F (FR F) it averages 36 cm. Beyond the midship section, the spacing erratically increases averaging 38 cm between the fifth and twelfth frame (FR 5 and FR 12) aft, and 50 cm at bow extremity (fig. 4.29). Conversely, the spacing measured as a distance between consecutive bolts (bolted frames) along the top surface of the keel is similarly inconsistent. The average distance from bolt to bolt measured along the top surface of the keel is about 163 cm, but it fluctuates from as low as 103.4 cm to as high as 170.5 cm. The number of unbolted floor timbers between the bolted ones is also erratic. Starting from the bow, there are two unbolted floor timbers between each set of bolted ones. Amidships, this ratio increases to three floor timbers; further aft to four, and finally, at the stern extremity, it decreases to three again (fig. 4.30). What this distribution potentially shows is that the bolts were not associated with any particular frames, but rather they were added in a semi-arbitrary manner to reinforce the whole structure only after the framing, internal timbers and possibly some planking were already in place.

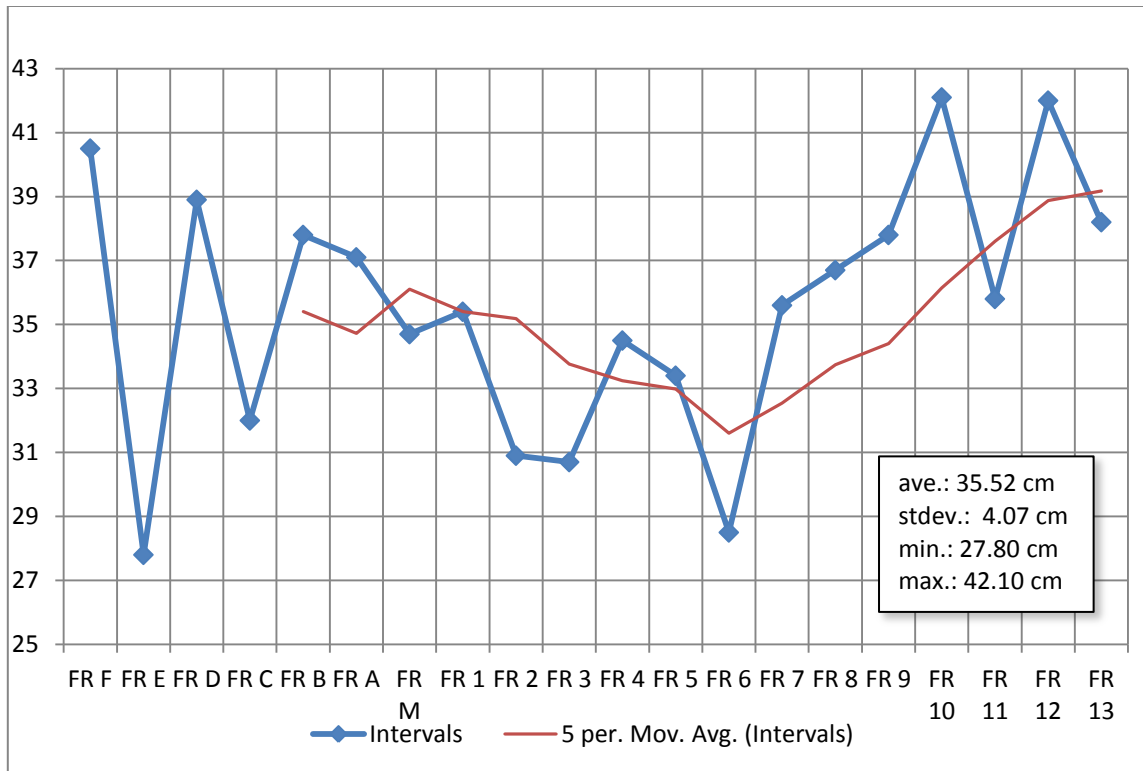

Figure 4.29: Intervals between consecutive pair of nails along the keel.

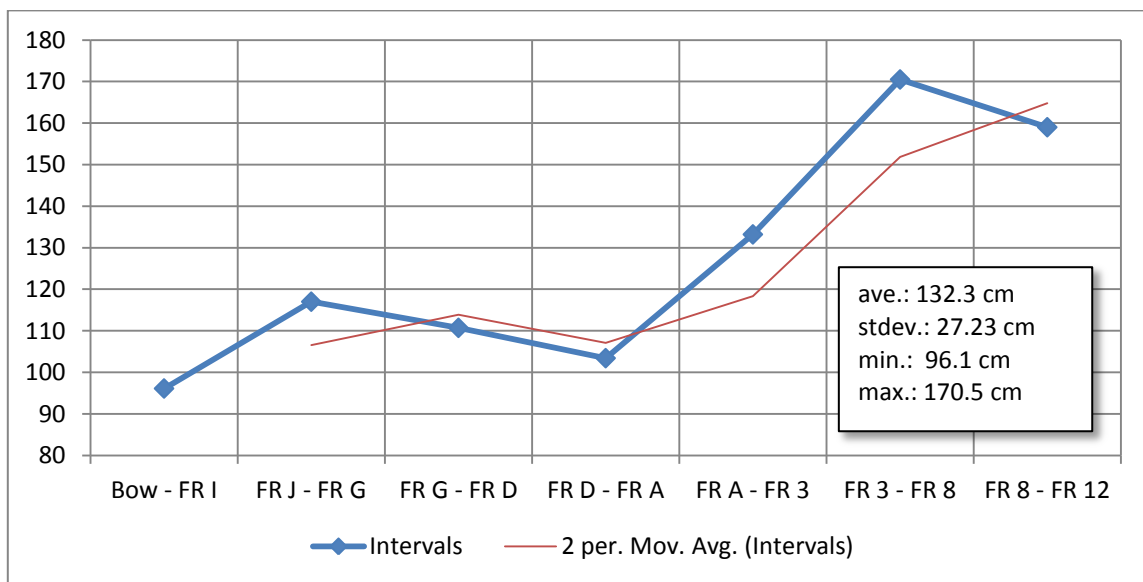

Figure 4.30: Intervals between consecutive bolts along the keel.

The Floor Timbers

General description

There are 14 preserved floor timbers within the wreck's main hull structure (fig. 4.31). When excavated they were still fastened to the keel and planking, and partly overlaid by the keelson and ceiling. The floor timbers are centered over the keel and relatively symmetrical athwartship with the geometrical centerline slightly offset to the portside. Square limber holes averaging 4.5 cm by 4.5 cm are carved into the underside of each floor timber at its lowest point. They do not follow any apparent pattern; some are in line with the centerline while others slightly offset.

The average sided width at the center of each floor timber is 16 cm, while the average molded height is 18 cm. Such dimensions place the Western Ledge Reef Wreck at the lower spectrum of the comparative 16th-century Atlantic shipwrecks, with a range of framing dimensions similar to the Highborn Cay Wreck and Molasses Reef Wreck.⁵³ With the exception of the master floor timbers (FR M) and the first frame aft (FR 1), the dimensions of all the others seem to be inversely proportional. In other words, the molded height increases towards the stern, while the sided width gradually declines (fig. 4.32). In extant breadth, the floor timbers range from 169 cm at the frame D (FR D) to 294.8 cm at the first frame (FR 1), with the latter representing a nearly intact member. Other essential dimensions are provided in Appendix 2. Although the mortises did not survive, FR C has evidence that they were once present but deteriorated over time.

Based on basic morphology, the floor timbers can be readily divided into nine scarfed (FR C, FR B, FR A, FR M, FR 1, FR 2, FR 3, FR 4, and FR 5) and five

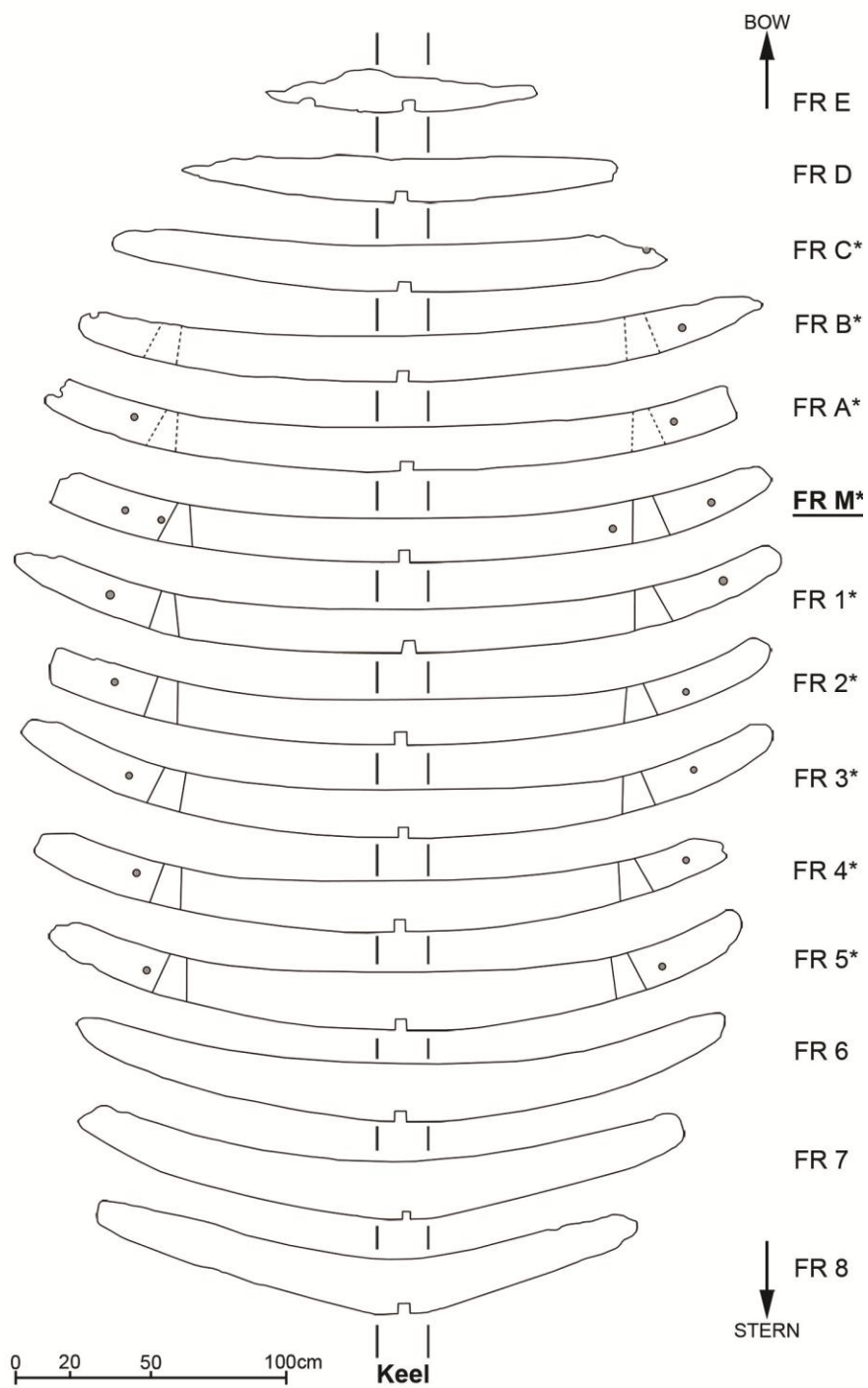

Figure 4.31: Series of preserved floor timbers, asterisk (*) indicates those with the mortises.

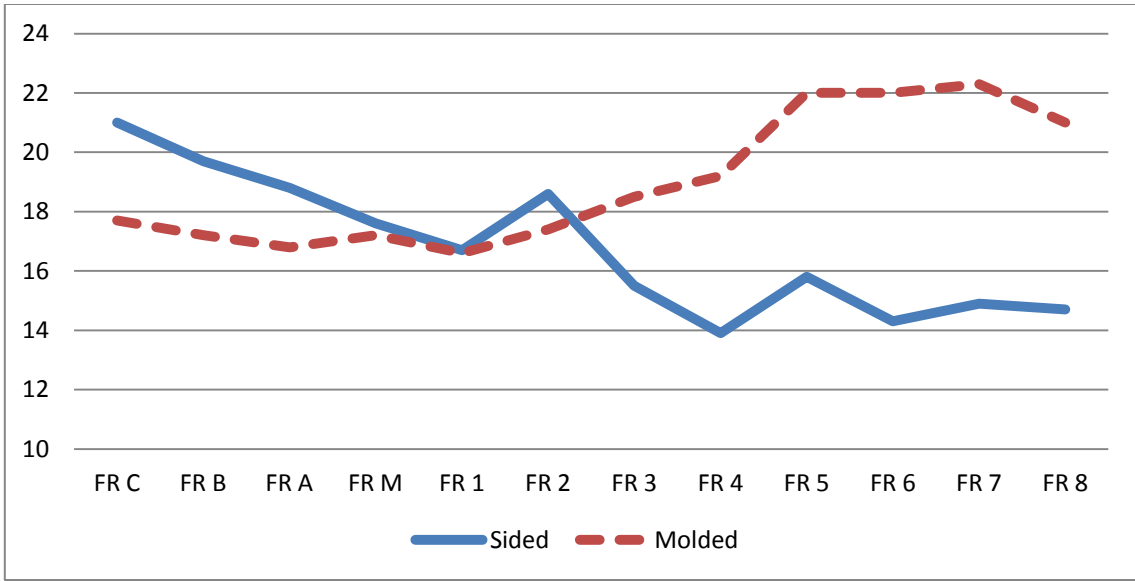

Figure 4.32: Relationship between sided and molded for a group of central floor timbers. (all dimensions in cm)

unscarfed floor timbers (FR E, FR D, FR 6, FR 7, and FR 8). By being placed in the proximity of the master frame (FR M), the former group denotes the nucleus of the midship, beyond which the latter group spreads forward and aft towards the posts. However, based on their design principles, two considerably different groupings emerge.

Comprising a total of 12 frames, the first group includes the master floor timber (FR M), three scarfed and two unscarfed forward floor timbers (FR A, FR B, FR C, FR D, and FR E), and five scarfed and one unscarfed aft floor timbers (FR 1, FR 2, FR 3, FR 4, FR 5, and FR 6). The major commonality here is that none of these have a section that can be defined as the straight horizontal floor. Instead, the extant floor timbers in this group follow the curvature of two tangent arcs. Between the well-defined port-to-starboard turn of the bilge they follow the outline of a single large arc. As they circumscribe what would otherwise be the floor of the vessel, the arc is referred here as the “floor arc.” Above the turn of the bilge, where the floor timbers overlap with the first futtocks, the wrungheads sharply rise up and follow an outline of a smaller arc, “the turn of the bilge arc.” For brevity, this arc is referred here as the “bilge arc” (fig. 4.33).

Where the first group terminates, the second one begins and extends forward and aft. It is represented by only two extant floor timbers (FR 7 and FR 8), which are defined as the “rising floor timbers” and are characterized by a central pedestal and basic straight upward-angling arms. Although preserved only aft, it is apparent that this group of floor timbers would originally extend in both directions as far as the V-shaped crotches at the bow and Y-shaped crotches at the stern. Despite the fact that the transition between the first and the second group could be tentatively identified, there is no unequivocal

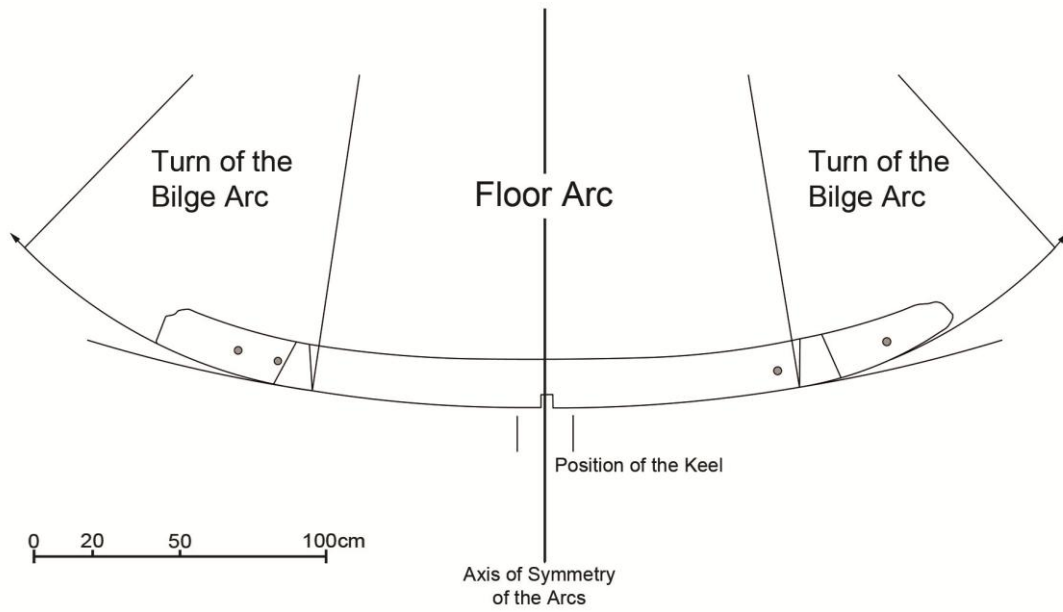

Figure 4.33: Arcs of the floor timber of the master frame.

evidence pointing the position of the so-called tail frames (*almogamas*), which were elemental in the process of ship design, as we know through the study of late 16th- and early 17th-century shipbuilding treatises.⁵⁴

Timber and Tool marks

The floor timbers were fabricated from compass timbers, with the wood grain generally following the sweeping curvature. Based on visual tree-ring count, the timbers came from 30 to 50 year old oaks. The timbers do not exhibit any scribe marks associated with the design process, the location of the turn of the bilge, or the placement of the dovetail mortises. Nonetheless, the floor timbers show numerous tool and saw marks.

The majority of the floor timbers appear to be squared off with broad axes. Fore-and-aft surfaces are evenly adzed diagonally or with the grain. Deviations from this pattern are associated with obstruction areas such as knots or dubbing for attaching the first futtocks. To help seat the planking, the outer surfaces received better quality workmanship and attention to detail. These surfaces were generally adzed across the grains with very regular long strokes producing smooth uniform surface. In the case of dovetail scarfed frames, some of the strokes continue across both the floor timber and the first futtock, providing yet another indication that these frames must have been pre-assembled and fastened to the keel before planking was installed. The inboard and outboard edges of the dovetail mortises were cut with axes, while the more-difficult-to-work interiors were adzed with deeper and shorter strokes (fig. 4.34).



Figure 4.34: Adze and axe marks along the forward face of the floor timber A. (FR A)

Some of the floor timbers, namely those of the fourth, fifth, sixth, and seventh frame aft (FR 4, FR 5, FR 6, and FR 7), exhibit saw marks along the fore-and-aft surfaces. These are diagonal to the grain and preserved in the very center of the timbers. Compared to the other floor timbers, these have the smallest sided widths and the largest molded heights. They are made of poor quality wood with large waness and extensive bows, and are associated with generally older oaks. Although generally compass timbers, they might have come from the tree trunks which were large enough to furnish two floor timbers side by side. This might explain a general disparity between poorer quality sawn floor timbers, and better quality floor timbers made from the individual trunks found at the very midship of the vessel. Regardless, it is impressive that oaks large enough to provide two floor timbers from a single trunk could be found. Other marks include what appears to be a large “X” symbol carved near the center of the forward surface of the fourth floor timber (FR 4), and saw and chisel marks associated with cutting the limber holes.

The Futtocks

General

Based on the updated inventory, there are 21 poorly preserved first futtocks associated with 10 floor timbers (fig. 4.35). These include 10 futtocks located on the port side and 11 on the starboard. With only minor variations, the futtocks average 16 cm by 16 cm; while the extant lengths range from 25 cm, for the port side first futtock of frame C (FR C P1), to no more than 138 cm, for the starboard first futtock of the frame three

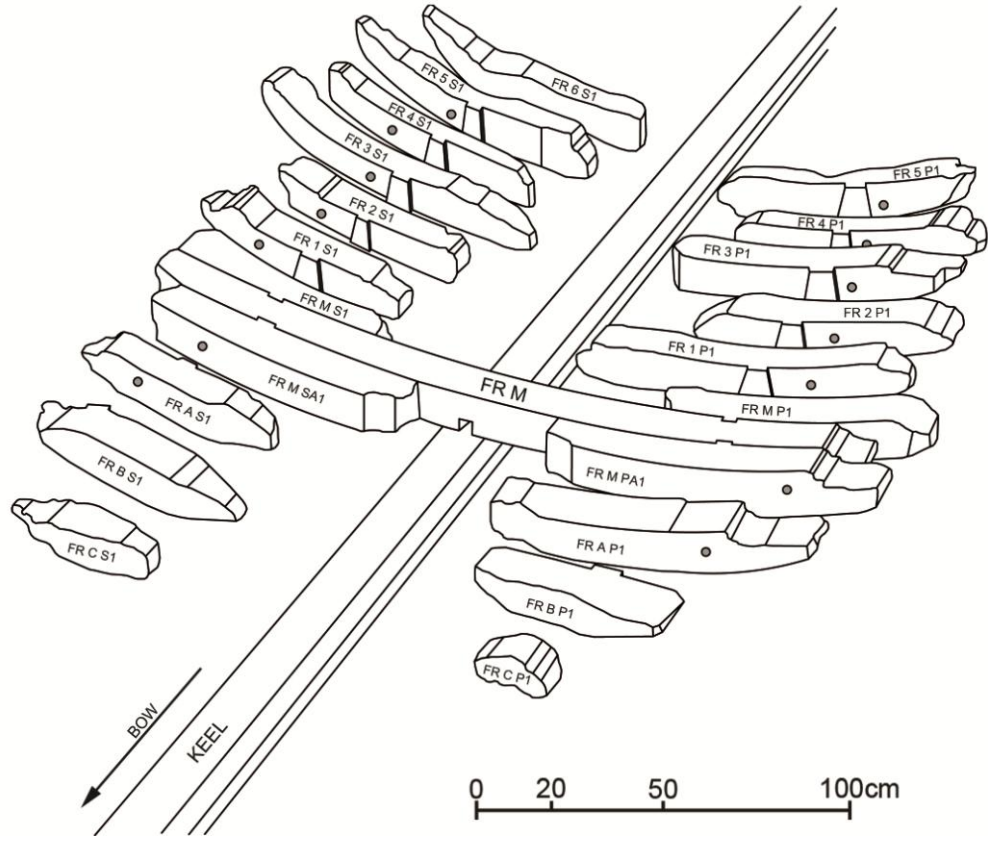

Figure 4.35: Isometric representation of preserved futtocks.

(FR 3 S1). Although most of the futtocks seem to be square in cross-section, at least one futtock (FR 1 S1) has a bevel on its upper corner along the forward facing surface (the surface opposite to the one adhering to the floor timber). Unfortunately, poor preservation prohibits from generalizing if beveling was a rule for all the futtocks or if they were simply square.

What is actually preserved does not include significantly more than the heel ends of the portside and starboard first futtocks, with only a few timbers, notably the portside futtock of the master frame extending beyond the level of the floor's wrungheads. Since this level also corresponds to the maximum height of the ballast pile, it is assumed that the unprotected futtocks above the ballast were damaged by post-sinking deterioration and shipworms. Although evidence is inconclusive, a competing explanation suggests that the futtocks were not only destroyed by deterioration and worms, but also by a possible salvage that might have taken place soon after the wrecking. This salvage hypothesis is inconclusive at present. Except the remnants of the first futtocks, no upper futtock timbers survive.

Groups

Like to the floor timbers, the extant first futtocks can be divided into two groups based on the presence or absence of the dovetail tenons. The first group includes 18 timbers, whose tenons fastened them horizontally to complementary mortises carved into the floor timbers. Together, these constituted part of the pre-designed and pre-assembled set of central frames. In contrast, the remaining three first futtocks are untenoned and not fastened to their associated floor timbers. As exemplified by the starboard first futtock of

the sixth frame (FR 6 S1), they do not even physically touch the floor timbers and were fastened only to the external planking. As such, these are defined as “floating futtocks” and must have been installed after the temporary ribbands and at least some of the external planking were already in place. In the absence of more sophisticated mathematical and geometrical methods, the floating futtocks provided a necessary flexibility to deal with the difficulties of designing the extremities of the ship.

Arcs

One of the most intriguing aspects of the Western Ledge Reef Wreck’s design is the changing geometry of the outer curves of the frames, which fall precisely at the turn of the bilge. Below the turn of the bilge, the floor timbers follow the curvature of large floor arcs; above, the geometry changes and the outer curve of the floors’ wrungheads and the lower ends of the first futtocks follow a different and much stronger arc, the bilge arc. Although poorly preserved, a group of tenoned first futtocks exhibits an especially pronounced transition with the constant radius of the bilge arc averaging 169 cm, which is about 3 *codo* (fig. 4.36). Based on the design geometry, these first futtocks must have belonged to one group. Since taking precise angular measurements along the outer surfaces of the remaining futtock was not possible, the radii of the bilge arcs beyond the first group could not be determined.

Tool Marks

The wood used to manufacture the first futtocks is of poorer quality than that used for the floor timbers. The surfaces, including the planking faces, are irregular with numerous large waness, knots, and visibly twisted grain. As the grain still follows the

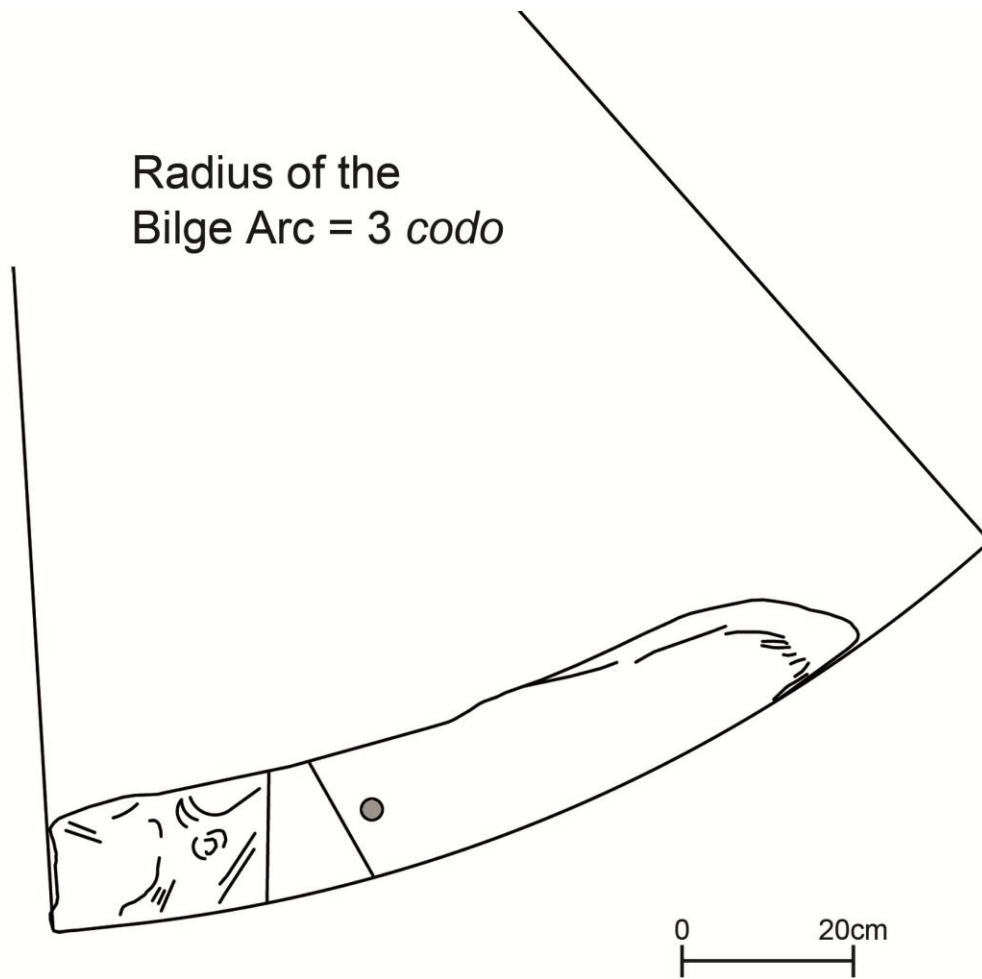

Figure 4.36: Arc of the aft portside first futtock of the master frame.



Figure 4.37: Inboard end of the deteriorated portside first futtock of third frame aft (FR 3 P1) showing knots and original branches.

general shape of the original timber, it is evident that these came from compass timbers as well. Despite the fact that the upper and most of the lower ends are broken off, the impression is that the futtocks are either tree roots or branches (fig. 4.37). Although any reliable calculations are problematic, the visual tree-ring count for a sample of futtocks reveals that the timbers came from 32 to 40 years old oaks. The first futtock tenons were first cut with axes, and then the adjacent surfaces were finished with adzes to produce a tight fit with the mortised floor timbers. The tool marks on other surfaces, generally associated with different adzing patterns, closely correspond with what was already noted for the floor timbers. Since most of the extant first futtocks are structural elements of the pre-assembled frames, both floor timbers and futtocks were worked on as units. Except their irregular surfaces and outlines, the short lengths and extreme deterioration of the three preserved floating futtocks prohibit from drawing any reliable conclusions related to their fabrication. The outboard planking surface of the starboard first futtock associated with the sixth frame aft (FR 6) has evidence of a treenail that might have plugged a hole left after removing a ribband fastener. Although inconclusive, the treenail measures 26 mm in diameter and it is the only one, out of five, that does not penetrate the full extent of the timber.

In addition, none of the extant first futtocks exhibit any other scribe marks, which could provide cognitive clues to manufacture or assembly process. The only exceptions are the lower ends of the master frame futtocks, which are finished with characteristic tabs, each with an impression of a 10 mm to 12 mm square nail in their center. As indicated in the study of the Red Bay (24M) Wreck, the presumed function of these nails

was to hold futtocks and floor timbers together before other frame fasteners, such as spikes and trenails, could be installed.⁵⁵

Analysis: The Frame Design

Group #1: Geometrically Designed Central Frames

The framing of the Western Ledge Reef Wreck can be divided into three groups. The first and most important is a group of central frames which include the master frame (FR M), five frames forward (FR A, FR B, FR C, FR D*, and FR E*), and six frames aft (FR 1, FR 2, FR 3, FR 4, FR 5, and FR 6*). Using the placement of the main mast as an indicator, the center of the fore-and-aft symmetry is located at the space between the master frame and the first frame, which splits the group exactly into six frames forward and aft. What is interesting, however, is the fact that out of these twelve frames only nine exhibit dovetail mortise-and-tenon joints between the floor timbers and first futtocks and remaining three do not. Yet, the entire group share congruent geometrical design principles. Within Iberian (or more specifically Basque) shipbuilding philosophy, they are referred to as the calculated frames (*maderas de cuenta*).

Contrary to the majority of the 16th- and 17th-century Atlantic examples and shipbuilding treatises, none of the floor timbers on the Western Ledge Reef Wreck have what can be defined as a straight horizontal floor.⁵⁶ Between the inboard edges of the dovetail mortises, corresponding to the turn of the bilge, the frames follow broad curvature of a single floor arc. Above the level of the turn of the bilge, the geometry

significantly changes and the wrungheads and overlapping heel ends of the first futtocks follow the curvature of much smaller bilge arc.

Both arcs are tangent, meaning their “touches” or contact points on the frame overlap and their respective centers are on the same straight line. Interestingly, the touch corresponding to the overlap between the floor arc and the bilge arc perfectly agree with the vertical inboard edge of dovetail mortise on each side of the frame. While this is true for the scarfed floor timbers, the same touch on the unmortised floor timbers from the group corresponds with the locations of the shallow iron nail impressions which could have been used to fasten temporary ribbands which assisted in shaping the extremities of the hull. In either case, a well-defined touch on either side of the frame is analogous to what English sources refer to as a surmark and Portuguese as an *acerto* or *covado*; its function was to control the overlap of the successive moulds.⁵⁷ Since the chord or a straight line between the surmarks should provide a meaningful controlling measurement, the horizontal distance of 3 *codo* from the inboard edge of one mortise (or nail) to the opposite one recorded on the Western Ledge Reef Wreck is a logical guide.

One of the closest archaeological parallels to the geometry of this framing system, perhaps the only such parallel to date, is the one found on the 16th-century Basque whaleboat, *chalupa* no. 1, from Red Bay.⁵⁸ With a total length of about 8.03 m (14 *codo*) and breadth of 1.92 m (3 1/3 *codo*), the *chalupa* had 19 unscarfed frames spaced 34 cm to 40 cm apart (averaging 37 cm). Although nuances of the system are peculiar to each shipwreck, the master frame was designed with three tangent arcs and no flat floor. The floor arc, measuring 5 *codo* in radius, extended out to the port and

starboard from the top-center of the keel. The bilge arc, measuring only 1 *codo* in radius, spanned the overlap between the floor timber wrungheads and the first futtocks. Finally, the futtock arc measuring 1 1/2 *codo* in radius, extended to point of maximum breadth (fig. 4.38).⁵⁹ Forward and aft of the midship, the master frame was used as a template. The frames were derived through a moulding process and hauling down the futtocks. By applying progressive rising and narrowing, clearly noticeable by analyzing a pivot point referred to as the *covado*, the shapes of the frames gradually evolved from large segments of circles at the midship to sharp V-shapes at the extremities of the hull.⁶⁰

Arcs of the Frames

The primary design component of the ship was the master frame. It was the only one from the group that was assembled with two forward and two aft facing first futtocks. It was positioned on the keel at the distinct and certainly pre-determined scribe mark resembling a large square with two perpendiculars. At its very center the floor timber was nearly square in cross-section and measured 17.2 cm in molded height, 17.6 cm in sided width, and the preserved breadth was 277.4 cm. Unlike the other frames, the master frame was found and recovered with remnants of both forward facing first futtocks still attached, thus the precision of the angular measurements taken along its outer surfaces was greatly enhanced. Extending from the inboard edge of a mortise to the opposite one (or from surmark to surmark) was the floor arc of about 10 *codo* in radius. The chord between the touches measured 3 *codo*, while the angle between the arms of the arc was 17.65°. The geometry changed for the remaining portion of the extant frame, meaning the wrungheads with the attached heel ends of the first futtocks, and followed

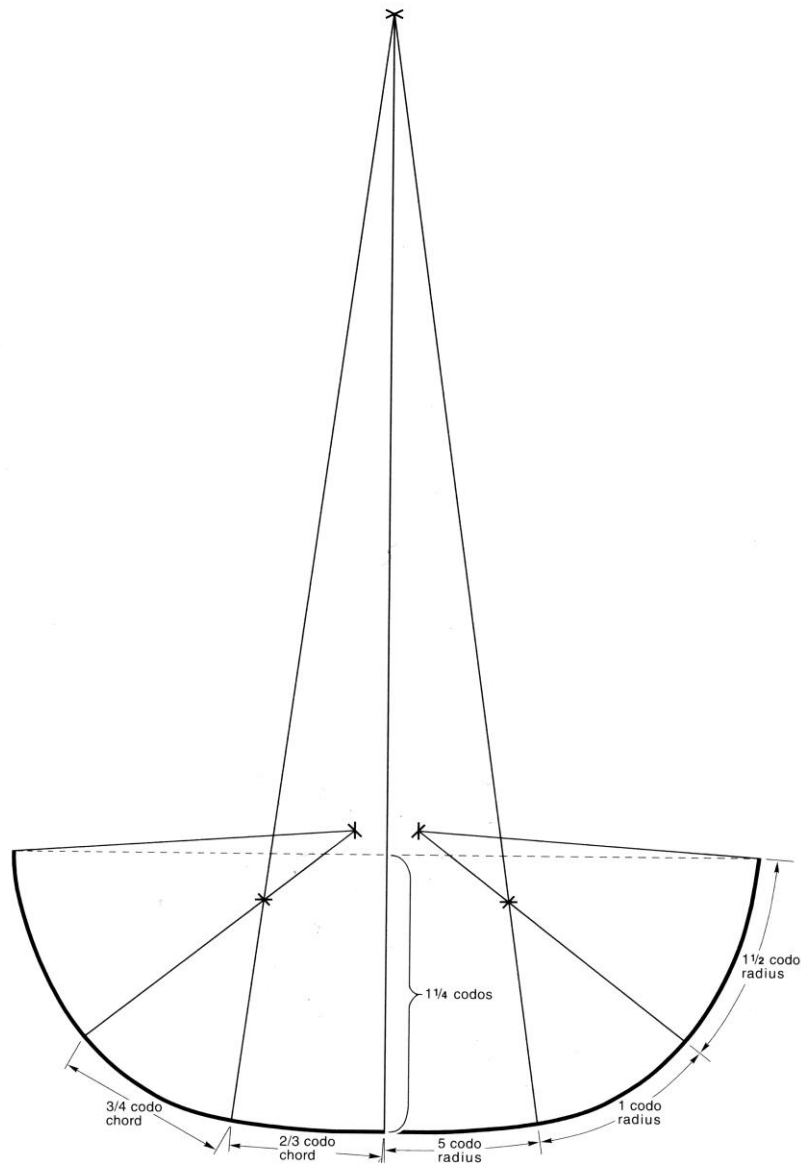

Figure 4.38: Geometric design of the master frame from the 16th-century Basque whaleboat, *chalupa* no. 1, from Red Bay. (Grenier, Bernier, and Stevens 2007, 4: 332 (fig. 22.20).)

the curvature of the tangent bilge arc, 3 *codó* in radius. Proportionally, the bilge arc was precisely 3-1/3 times less (3-1/3-to-1 ratio) than the floor arc (fig. 4.39).

Moving forward and aft from the master frame, the floor arc radii of the consecutive frames gradually decreased. Although individual increments varied between the master frame and frame E (the forward-most frame in the group), the overall decrease in radii was from 10 *codó* to 4 *codó*. At the same time, between the master frame and the sixth frame (the aftermost frame in the group), the decrease was from 10 *codó* to 4.5 *codó* (table 4.6). As illustrated in figure 4.40, the roughly parabolic-shaped curve obtained by plotting individual radii has two important characteristics. First, its geometric nature is deeply rooted in the science of mathematics and search for the perfect shape that could be calculated, hence repeated over and over again by a master shipwright. Second, it is not symmetrical fore-and-aft as split by the master frame located at its apex. Contrary to double-ended vessels, this apparent lack of symmetry signals an important innovation which likely played a role in the development of a concept known from English sources as the “cod’s head and mackerel’s tail” silhouette, an ideal shape to help the ship glide through the water like a fish.⁶¹

The plotted curve of the consecutive floor arcs from the Western Ledge Reef Wreck was tested against a number of *graminho* gauges or algorithms described in late 16th- and early 17th-century Iberian shipbuilding treatises.⁶² At the very apex, the section consisting of a master frame and one frame on each side of it, the change is minimal and only by about 0.5 *codó*. This portion of a ship was associated with the greatest breadth, which was set at the end of the forward third of the keel, a placement quite consistent

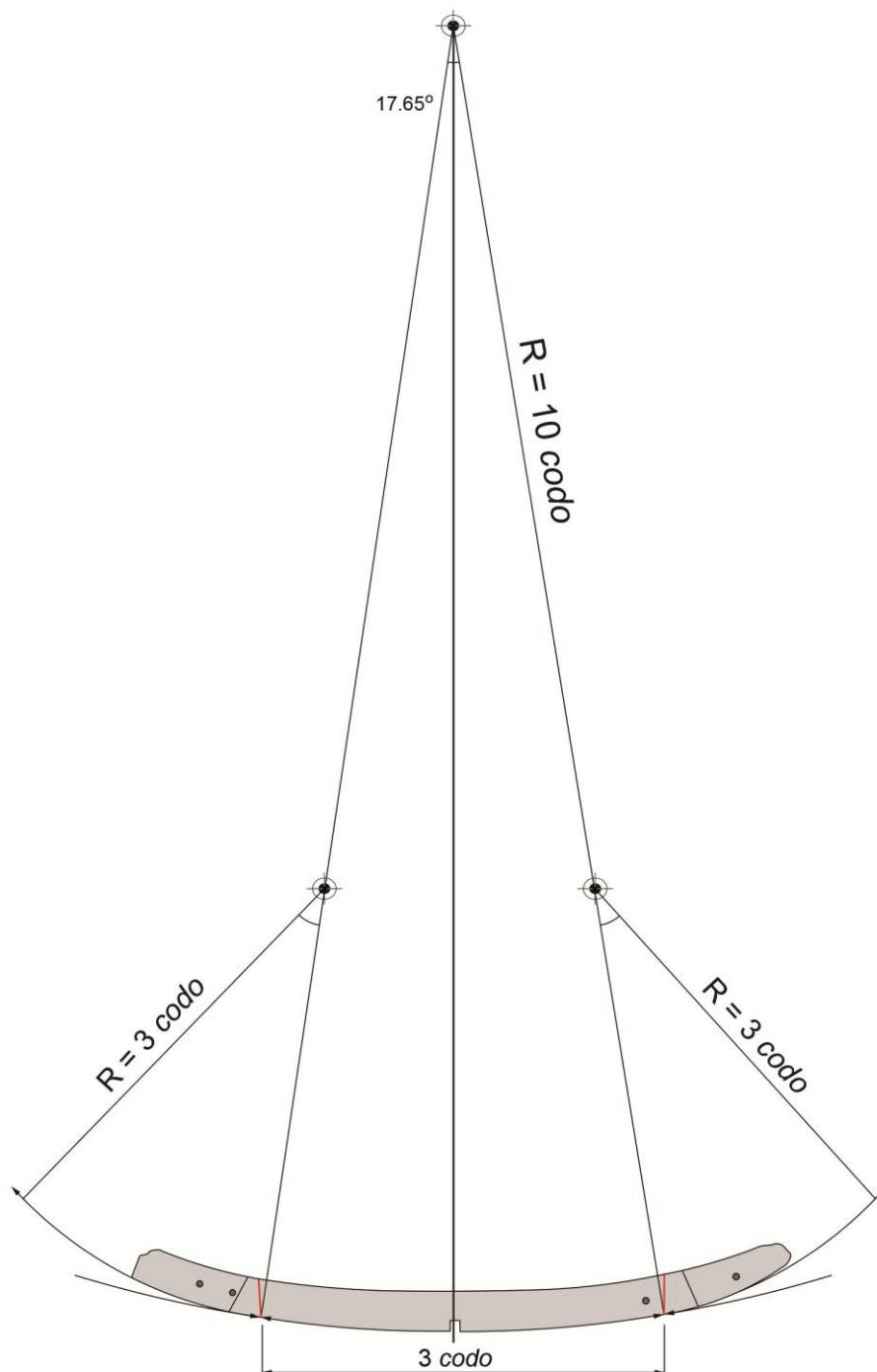
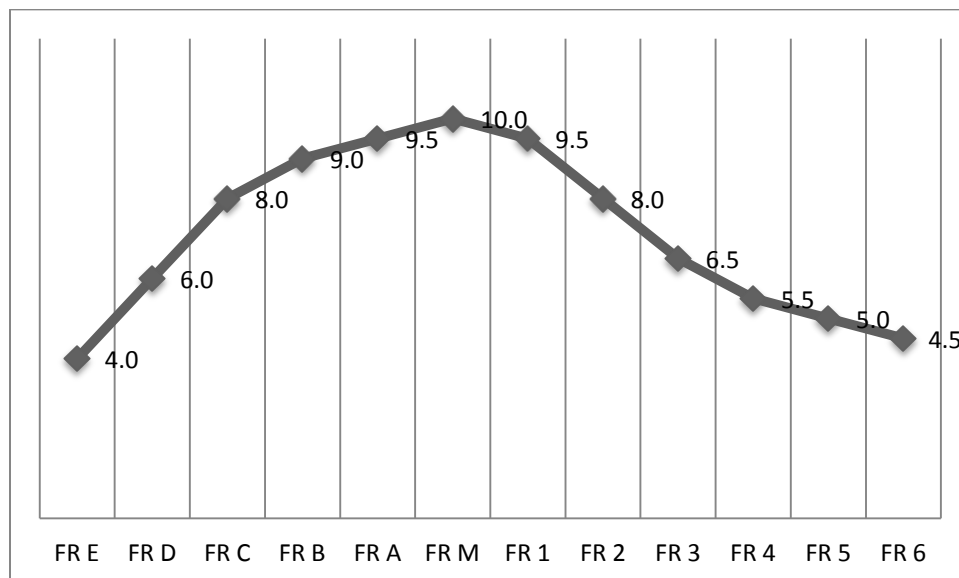

Figure 4.39: Geometric design of the master floor timber from the Western Ledge Reef Wreck.

Table 4.6: Radii of the large floor arc for a series of central frames.

Changing Radii of the Floor Arcs	
Frames	Radii (closest approx. to codo)
FR E	4.0
FR D	6.0
FR C	8.0
FR B	9.0
FR A	9.5
FR M	10.0
FR 1	9.5
FR 2	8.0
FR 3	6.5
FR 4	5.5
FR 5	5.0
FR 6	4.5

Figure 4.40: Visual representation of the changing radii of the floor arc. (all dimensions in *codos*)

with drawings in Baker's manuscript.⁶³ Forward of the master frame, the shape of the curve becomes concave, signifying a gradual transition into what probably was a full bow. To produce such curve, the best result was obtained by *graminho de brusca* (or *de saltareilha*), specifically the first formula of two cited by Castro ($N_{[i+1]} = N_i + [i - 1]$).⁶⁴ Aft of the master frame, the geometry reverses and after a short initial concave section the curve becomes convex indicating a rapid decline in increments and transition into an elongated narrowing stern. This curve appears to be a mirror image of one of the curves obtained also by the *graminho de brusca*; ⁶⁵ however, due to its reversed relationship at the point of the third frame (FR 3) aft, the specific mathematical formula could not be devised (fig. 4.41). It is quite plausible, however, that the section aft of the master frame was produced by two different functions of reverse nature. Although expressed specifically for round ships and galleys, the *brusca* or *saltareilha* method as used with the narrowing and rising was deemed compatible with the ribbands, producing a flowing transition between the central frames and the extremities along the tail-frames (*almogamas*).⁶⁶ It is suspected that this compatibility might also have been one of the reasons that the shipwrights selected this geometrical function to furnish a set of consecutive arcs for the floor timbers of the Western Ledge Reef Wreck.

Due to the poor preservation of the first futtocks in general, and short lengths of the measurable outboard surfaces in particular, the process of calculating the bilge arcs for the frames within this group was problematic. Combining this with the fact that the floor timbers and first futtocks were disassembled during the 1991 excavations produces a situation where the nuances of the adjustments between the two elements, such as

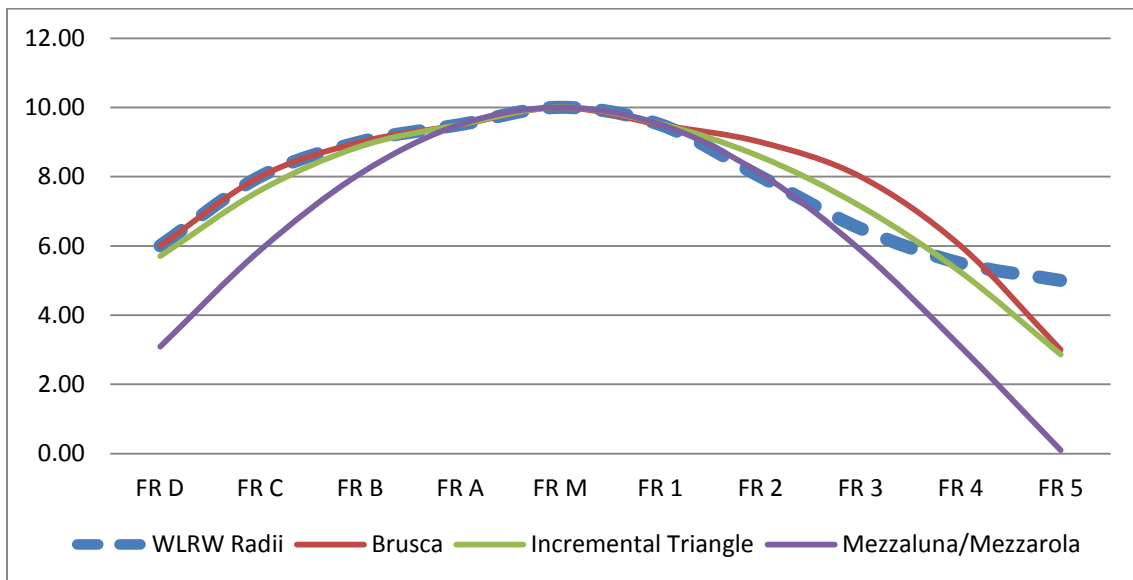

Figure 4.41: Curve of the changing radii of the floor arc of the Western Ledge Reef Wreck compared against selected *graminho* gauges of the period.

beveling or fairing the kinks for overlapping arcs, remain impossible to detect. Due to such limitations, the only option was to use the average radii of the wrungheads of the floor timbers and the average radii of the extant first futtocks. Hypothetically, they should be the same, as they were produced by flipping the same mould over and aligning it with the inboard edges of the mortises. The overall average for the wrungheads gave a result of 2.91 *codo* (at 0.12 *codo* standard deviation), while the average for the first futtocks was 2.94 *codo* (at 0.46 *codo* standard deviation); both being within 2% to 3% from a full 3 *codo*. By the closest approximation, which must take into the account limiting factors related to the underwater distortion, it is assumed that the bilge arc for the frame B to the fifth frame (FR B to FR 5) measured 3 *codo*. This arc was not only tangent to the floor arc, but also one of two arcs (bilge arc and futtock arc) defining the shapes of the first futtocks. Since nothing was preserved above the level of the wrungheads, neither the chord of the bilge arc nor the other arcs used in defining the shape of the frames could be detected.

Rising and Narrowing

Of all the diagnostic parameters, two, namely the location of the turn of the bilge and the radii of the floor arcs, appear to represent the mechanism by which the geometric modification of rising and narrowing was executed. To trace these changes, the rising was measured as a vertical distance, or height, from the floor's base line (the level of the top surface of the keel) to the turn of the bilge (table 4.7, fig. 4.42). Since the distance between the mortise inboard edges is constant throughout the floor timbers, the narrowing was devised as an evolving distance from the average center of the portside

Table 4.7: Rising and narrowing of the central floor timbers.

Narrowing and Rising (cm)		
Frames	Rising (incremental)	Narrowing (absolute)
FR B	1.3	-2.55
FR A	0.9	-1.25
FR M	0	0
FR 1	0.9	-1.3
FR 2	2.25	-2.95
FR 3	3.5	-4.25
FR 4	4.6	-5.35
FR 5	5.9	-6.9

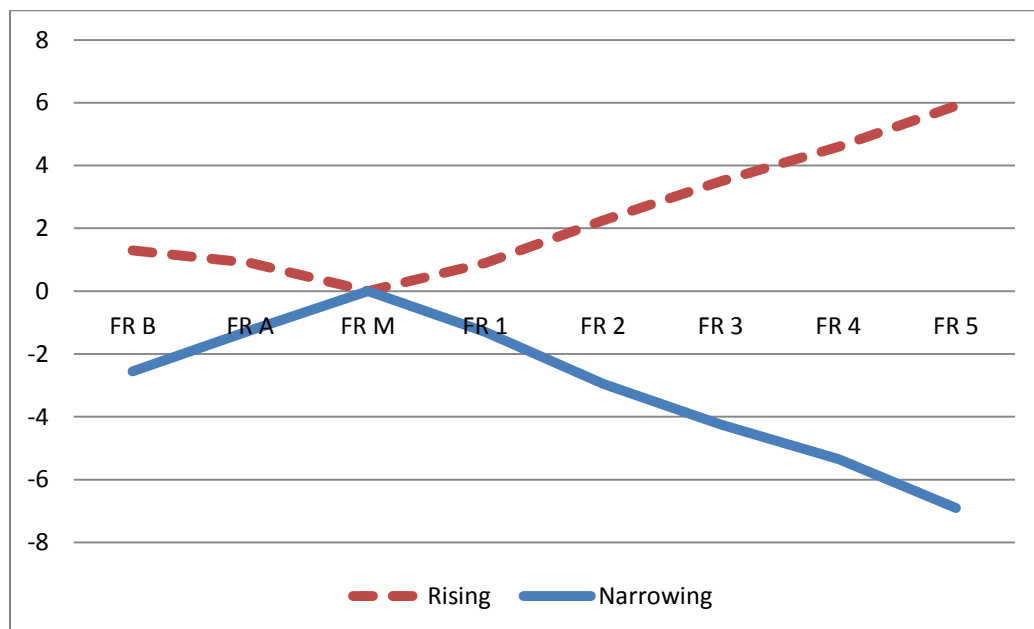

Figure 4.42: Graph showing rising and narrowing of the central floor timbers.

mortise to the average center of starboard one. Starting with the master frame only the rising was present and measured about 6.1 cm. Forward, the floor timbers from frame A and frame B (FR A and FR B) rise 7 cm and 7.4 cm in, respectively, and narrow by 1.25 cm and 2.55 cm in relationship to the master floor. Aft, the floor timbers of the first frame through fifth frame (FR 1 to FR 5) rise from 7 cm to 12 cm, respectively, and narrow by 1.3 cm to 6.9 cm in relationship to the master floor. Even though belonging to the same group, the floor timber of the frame C (FR C) and sixth frame (FR 6) follow a similar geometry. Unfortunately, the rising and narrowing for these two floor timbers could not be measured.

Group #2: Rising Frames

The second group of frames consists of only two poorly preserved floor timbers from the aft frames seven and eight (FR 7 and FR 8). These are relatively narrow, measuring 14.9 cm and 14.7 cm respectively in sided width. Nonetheless, they are among the thickest floor timbers on record measuring 22.3 cm and 21 cm in molded height. In breadth, the seventh floor timber (FR 7) extends for 234.4 cm and floor timber eight (FR 8) for about 208.4 cm.

The frames are fastened to the keel with two 10 mm to 12 mm square nails, while the eighth floor timber (FR 8) is additionally reinforced with a 26 mm bolt. These floor timbers are exclusively unmortised and lack any horizontal fasteners connecting them to the first futtocks. In addition, they are not defined by a large floor arc followed with a smaller tangent bilge arc. Instead, both arms of the floor timber are simply angled up from the flat central pedestal as a product of a readjustment called “rising of the floor.”

At the seventh floor timber (FR 7), the angle between the arms is about 155° , while at the eighth floor timber (FR 8) it narrows to 147° (fig. 4.43). Although two other potential floor timbers belonging to this group survived, their location within the hull is uncertain. Taken together, it appears that the rising floor timbers represent an entire category of frames which extends aft from the seventh frame (FR 7) to the beginning of the stern crotches, and for a number of frames forward of the group of calculated frames to the beginning of the stem crotches. Although no futtock associated with these frames survived, the lack of horizontal fasteners suggests a loose arrangement between the timbers indicative of so-called “floating futtocks.” Contrary to the first group, these frames were not erected as assembled units but rather in a step-by-step fashion in which the first futtocks were installed only after the temporary ribbands and at least some of the planking were already in place.

Group #3: Stem and Stern Frames

The third and final group included frames at the very bow and stern of the vessel, out of which only the latter are partly preserved and described in this chapter in section 4.5 (Stern Floor Timbers and Futtocks). Much like the second group of frames, the first futtocks of the third group are not horizontally fastened to the stern crotches but only to the external planking. As such, they could not be installed until ribbands and partial planking was secured in place.

Although evidence is limited, it is suggested that a treenail found in the aftermost crotch (AFR 1) could have been used as a plug associated with the lowest level of the construction ribbands delineating the rising line. This, together with the sternpost, which

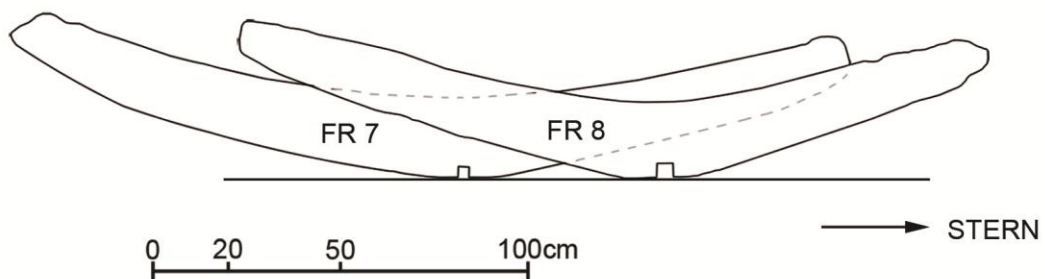

Figure 4.43: Preserved floor timber from the group of rising frames (FR 7 and FR 8) looking forward.

broke just below where the fashion pieces were attached, provides valuable information about the geometry of the Western Ledge Reef Wreck's lower hull to be explored for the reconstruction of the vessel.

4.7 GARBOARDS AND PLANKING

Including garboards, the Western Ledge Reef Wreck reveals portions of five portside and five starboard carvel strakes. These consist of two roughly complete central garboard planks, one on each side of the keel (PPG and PSG), and remnants of four consecutive port side (PP 1, PP 2, PP 3, PP 4) and three starboard planks (PS 1, PS 2, PS 3), as well as an additional loose starboard plank designated as unidentified (PS UN 1) (fig. 4.44). None of the strakes is preserved to its full length, nor is it represented by more than a single and rather poorly preserved plank. Like to the keel, both extant garboards and three of the longest planks were cut into shorter and more manageable sections as part of the timber lifting undertaken in 1991.⁶⁷ For the clarity of the description and analysis, the planks are presented here as continuous units.

Dimensions

The extant port side (PPG) and starboard (PSG) garboard planks measure 8.87 m and 9.49 m in length, respectively, and 5.5 cm in average thickness. Although their overall width vary between 34 cm and 36 cm, both garboards slightly taper towards their forward hooding ends and expand aft up to 37.6 cm on port and 39.5 cm on starboard. Apart from the garboards, there are four planks on each side of the keel. On the portside,

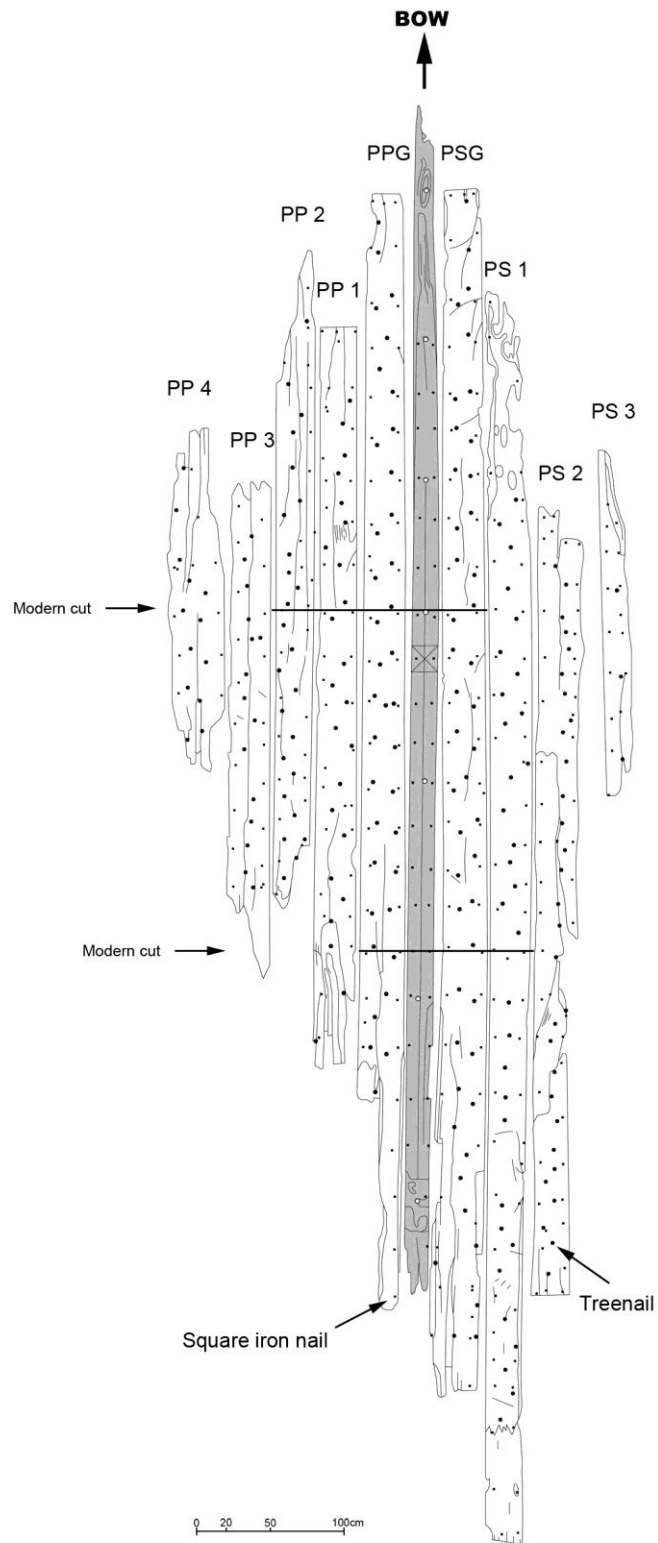

Figure 4.44: Preserved Planking.

the extant lengths range from 5.83 m for the plank of the first strake (PP 1) above the garboard, to 2.71 m, for the plank of the fourth strake (PP 4). With the exception of the latter, which measures 44 cm in average width, the planks stay between 29 cm and 36 cm in width, while their average thickness is 4.7 cm. On the starboard, the extant lengths range from as much as 9.82 m for the nearly complete plank of the first strake (PS 1) above the garboard, to as little as 1.07 m, the most deteriorated plank designated as unidentified (PS UN 1). These planks measure between 32 cm and 34 cm in width, and 4.8 cm in average thickness; the dimensions which are quite consistent with the specifications provided by the Northern Iberian or Basque wood supply contracts of the period (table 4.8).⁶⁸ As indicated by Barkham, the overall width of the planking ranges around 2/3 of a *codó*, with one reference to 1/2 a *codó* for deck planking, giving a range of about 37 cm to 28 cm.⁶⁹ On the Western Ledge Reef Wreck, the width of the extant garboards and planks stay between 36 cm and 27 cm, while the average thickness is 5.2 cm which translates into about 11 planks per *codó*.⁷⁰

Scarfs

The extant garboards (PPG and PSG) constitute almost complete central planks; their forward ends exhibit well preserved butt joints which once connected to the now nonextant forward garboard planks over the similarly nonextant frame J (FR J). Although the after ends of both garboards are broken, it appears that the starboard garboard was a complete plank with only its hood end missing. The fastening pattern of the butt joints constitutes three 7 mm to 12 mm somewhat vertically aligned square nails

Table 4.8: Dimensions of the planking based on Basque shipbuilding contracts. (after Barkham 1981, 22 (Table A.))

Dimensions of the Planking		
Number of Planks per <i>codo</i>	Plank Thickness (cm)	Plank Width
7	8	mainly 2/3 <i>codo</i> (about 38 cm) wide, also one reference to deck planking 1/2 <i>codo</i> (about 29 cm) wide
8	7	
9	6.22	
10	5.6	
11	5.09	
12	4.66	
13	4.3	
14	4	
15	3.75	

placed at the end of the portside plank, or three nails and a 27 mm diameter treenail along the end of the starboard one. Although no other garboard planks are preserved, the sheer length of the extant planks and the presence of the forward butt joints suggest that the strakes could have been made of at least three planks on each side.

Above the level of garboard, two planks of the first and second starboard strakes (PS 1 and PS 2, respectively) exhibit butt joints along their slightly narrowing after ends, while a plank of the first portside strake (PP 1) exhibits one along its forward end. Based on the count of the consecutive nonextant frame stations, the joint associated with PS 1 would fall over the nineteenth frame aft (FR 19) and the one associated with the PS 2 over the fourteenth frame aft (FR 14). Peculiarly, the latter frame station (FR 14) is precisely the point where the keel broke off during the wrecking. The joint associated with PP1 would fall over frame G forward (FR G). Consistent with the pattern found on the garboards, the butt joints of the starboard planks were fastened with three vertically aligned square nails equally distributed along the edge of the plank, while that of the portside plank with three nails and a treenail (fig. 4.45).

Planking Edges

Judging from the uniform profiles and lack of longitudinal curve or spile of the planks, their shapes were not dictated by the pre-conceived geometry of the hull as was the case with the spiled or arced edges of the bilge planks on the Red Bay (24M) Wreck.⁷¹ On the Western Ledge Reef Wreck, the planks were flat sawn having parallel longitudinal edges. Following the construction sequence, these were subsequently bent

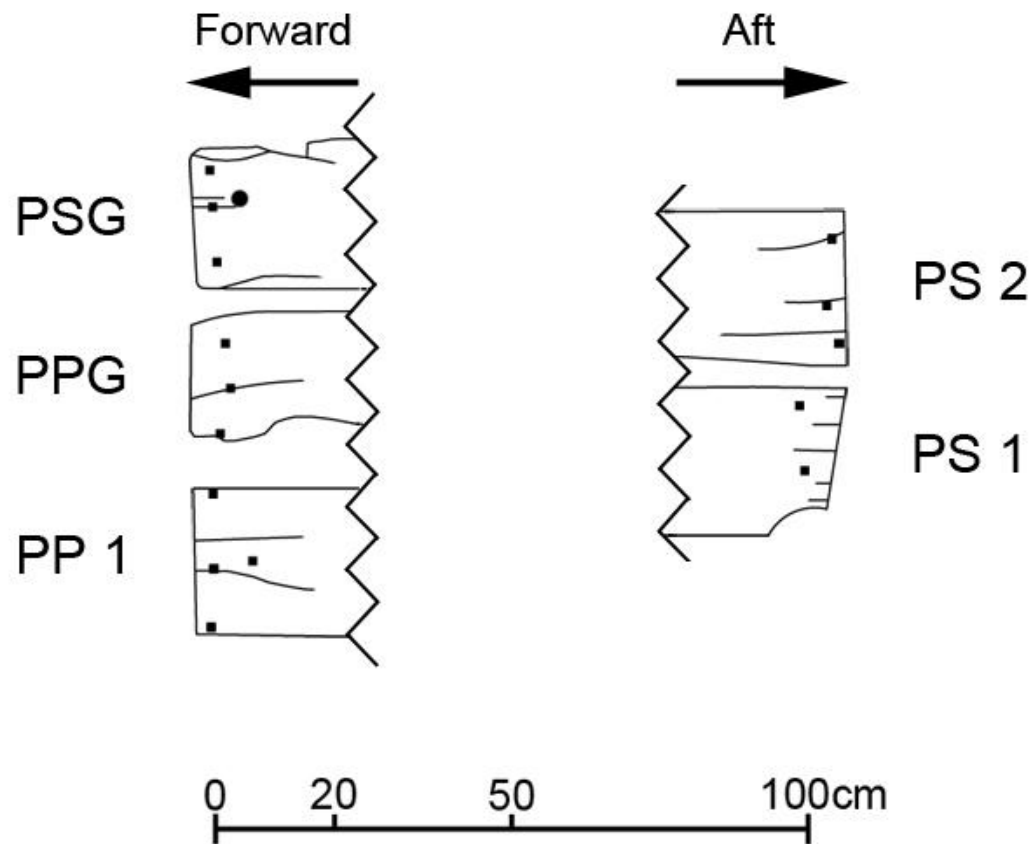

Figure 4.45: Possible combinations of the butt joint fastening patterns found on the preserved planks.

or forced to desired shape over the pre-erected central frames and tail-frames.

The lower edges of the garboards, those that butt against the chamfered upper sides of the keel, are beveled to produce a tight fit between the two. With the readjustment of the keel's chamfer, this bevel is responsible for the geometrical transition of the garboards from nearly horizontal amidships to vertical as they enter the posts. Between forward frames G and H (FR G and FR H) and the sixth and seventh frames aft (FR 6 and FR 7), the garboard's edges are square and measure about 90°. ⁷² Forward and aft of those locations, the transition becomes especially pronounced and the edges become increasingly beveled. As the modification progresses into the extremities of the vessel, the angle of the bevel significantly decreases to about 44° over the seventeenth frame (FR 17) aft on the starboard and 30° over the fourteenth frame (FR 14) aft on the portside. Noticeably, the garboard's bevels are not symmetrical port-to-starboard. This could indicate that these were carved independently and in relation to the similarly unsymmetrical chamfer of the keel, relying on the judgment of an experienced shipwright rather than empirical calculations (table 4.9 and fig. 4.46).

A section of the upper edge of the starboard aft garboard (PSG A1), which butts against a plank of the first starboard strake (PS 1), shows evidence of small (averaging 5 mm across) square nail or tack impressions. Although the morphology of these fasteners is unknown, their location along the outboard surface of the caulking scar could potentially be associated with securing lead strips which protected the caulking material. This would be a variation of the technique known from the wreck of *San Esteban* and especially akin to what was reported for the Boudeuse Cay Wreck. ⁷³ In the former

Table 4.9: Readjustment between the keel and the garboards. (in degrees)

	Frame	Chamfer of the Keel		Garboard Bevel with the Keel	
		Port	Stbd	PPG	PSG
Beveled Edge	FR I			80.5	
	FR H				
Square Edge, No Bevel	FR G	74.5	67.4		90*
	FR F			91	
	FR E	82	70		
	FR D				
	FR C				90**
	FR B				
	FR A			93	90
	FR M	80	71		
	FR 1				
	FR 3				
	FR 3				
	FR 4	79	77		
	FR 5				
	FR 6				
Beveled Edge	FR 7	84.5	78.5	81***	87
	FR 8				
	FR 9				
	FR 10				83
	FR 11		85.4	57.5	
	FR 12				
	FR 13				
	FR 14			30	
	FR 15				54
	FR 16				
	FR 17				44

*) No bevel, but only 13 mm caulking scar (V-shaped, about 48°)

***) No bevel, but only 32 mm caulking scar (V-shaped, about 63°)

****) Bevel and 20 mm caulking scar (outside, V-shaped, 51°)

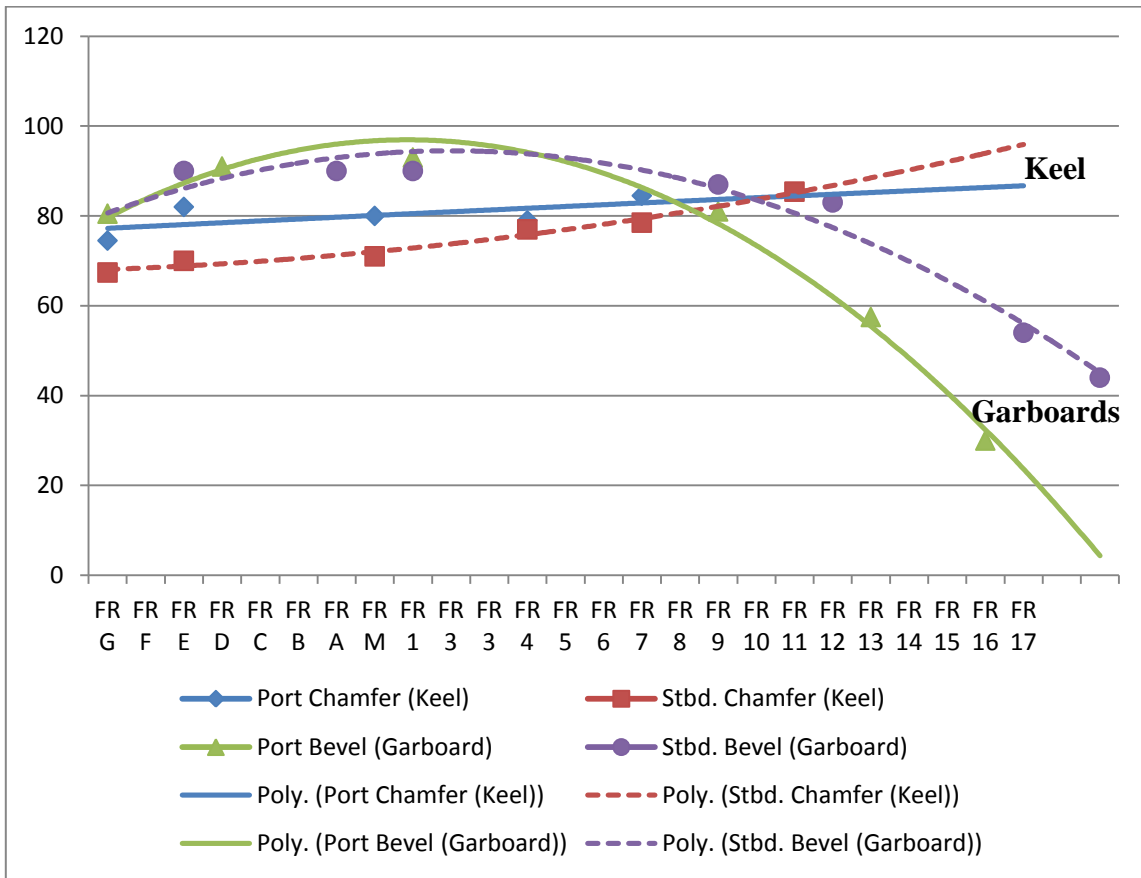

Figure 4.46: Visual representation of the readjustment between the keel and the garboards based on table 4.9.

example, the tacks holding the lead strips were driven into the caulking scars; on the latter, these were driven directly into both edges of the adjacent planks. It has been also suggested that tacks (or perhaps sheathing or filling nails) were used to securing lead hull patches on the Molasses Reef Wreck.⁷⁴

As pointed out by Oliveira, ships designed for long oceanic voyages had seams caulked with pitch and oakum and covered with lead plates nailed to the planking.⁷⁵ Although the tacks or sheathing (filling) nails did not survive, the caulking material identified as hemp (*Cannabis sativa*) with residues of pitch as well as crumbled and heavily oxidized lead strips were recovered during the excavations of the Western Ledge Reef Wreck. It appears that the caulking was oakum, which was produced from poorer grades of hemp fibers that were tarred.⁷⁶ The interpretation that the crumbled lead strips found on the shipwreck were used to secure caulking is only tentative, since lead would have had many other uses onboard a vessel. As explained by Garcia de Palacio, in addition to “two quarters of pitch, which weight twelve quintals; four barrels of tar; (and) 250 pounds of oakum; (...)” the ship should also carry “...a sheet of drawn lead...” as a spare for the voyage.⁷⁷ Due to severe deterioration of the plank edges, only limited sections of the caulking scars could be investigated in detail. The scars are shallow, V-shaped in cross-section, and between 13 mm and 32 mm (23% and 58%, respectively) of the average plank thickness.

Similar to the garboards, the lower and upper edges of the other hull planks are also slightly beveled. In order to produce an external skin along the curvature of large floor arcs, the plank edges had to be angled so they resembled a wedge. This approach to

planking frame-first carvel boats is ethnographically documented as recently as the 19th and early 20th centuries.⁷⁸ According to traditional Aegean boatbuilding, if the seams between consecutive planks are well angled, the amount of caulking is greatly reduced. Moreover, because of the radii of the large floor arcs are perpendicular to the grain of the planks, there is a danger that these may develop a shake when fastened. To prevent this, the Aegean shipwrights suggest adzing the insides of these planks so they perfectly fit the curvature of the floors, a feature consistent with what was discovered on the Western Ledge Reef Wreck lower planking.⁷⁹ It is also reminiscent of the archaeological remains of the 16th-century Studland Bay Wreck, whose planking assembly was characterized by tight fit and limited caulking.⁸⁰ This, in turn, implies a high degree of workmanship, attention to details and good quality timber selection available to produce these ships.

Fasteners

An interesting aspect of the ship's construction is the fact that the garboards are not fastened to the keel but, like the other planks, are secured only to the frames. Where garboards are attached to a frame, the fastening pattern is uniform and consists of a combination of two iron nails and two trenails. The nails are positioned 4 cm to 5 cm from the edges of the garboards along the centerline of the frames, while the trenails tend to alternate across this line. Above the level of garboards the uniformity diminishes. Although the pattern still includes two nails positioned near the edges of the planks, the number of trenails fluctuates between one and two (fig. 4.47). Combining this evidence with what was already discussed for the butt joints, it appears that the first phase of

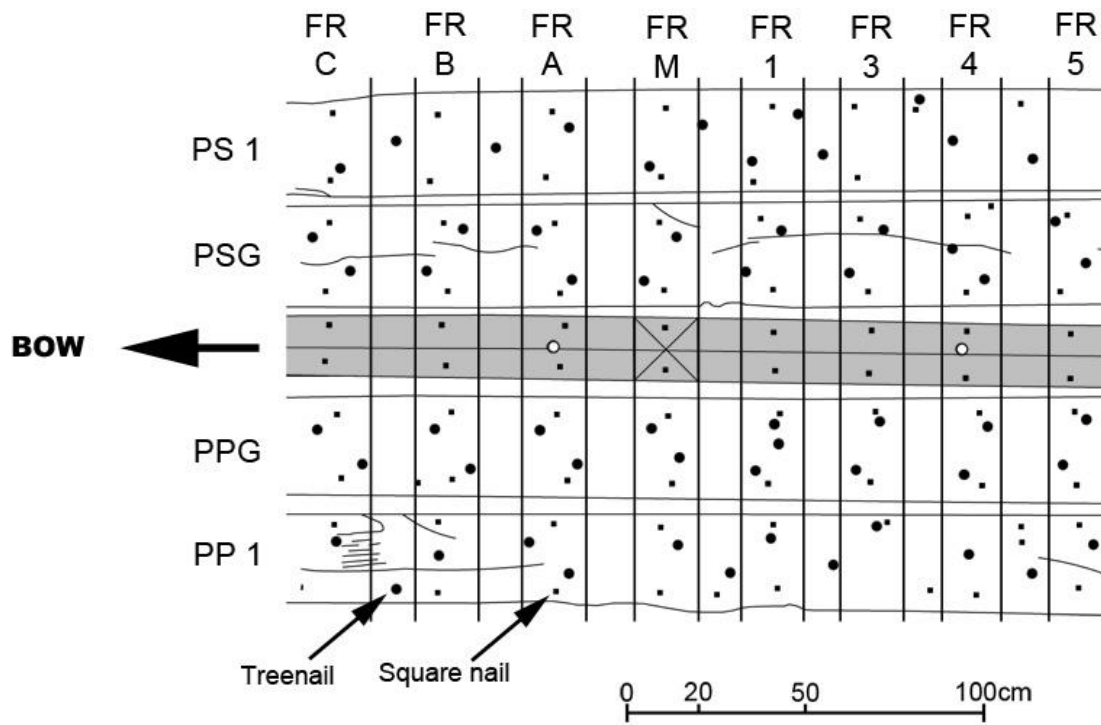

Figure 4.47: A fastening pattern as exemplified by garboards and first strakes in between frame C (FR C) forward and fifth frame (FR 5) aft.

planking the ship involved securing the planks with the nails, a sequence that began with the extremities and continued throughout the interior. After this was completed the carpenters could drill slightly angled holes through the planking and frames and drive treenails through. This suggests, the treenails were more permanent fixture.

The nails have square 10 mm to 12 mm shanks and round 30 mm to 40 mm heads, which were slightly countersunk into the planks. The treenails are well rounded, 26 mm to 30 mm in diameter, and covered with black unidentified substance, possibly pitch or tar. Both of the fastener types are consistent with the typical dimensions used by Iberian shipyards.⁸¹ Unless unidentified or completely missing, the majority of the preserved treenails fastening ship's garboards and lower planking to the frames are caulked from the outside. For more in-depth analysis of the treenails please refer to the section 4.4 of this dissertation.

Timber and Marks

The preservation of the planking is closely correlated with the proximity to the keel, which, in turn, is directly proportional to the thickness of the ballast pile and other overburden covering the site. While the garboards and the first strakes were relatively well protected, hence are represented by nearly complete planks, the strakes located further up are in progressively worse condition. The portside planks of the third (PP 3) and fourth (PP 4) strakes, but also the unidentified starboard plank (PS UN 1), are heavily damaged, extremely fragile, and show numerous cracks and broken pieces.

Upon visual count, the core and about 37 tree rings were identified on the portside garboard plank (PPG A/1), and an offset core and about 44 tree rings on the starboard garboard plank (PSG F/1). In addition, there were also at least 25 tree rings on the central section of the plank of the first starboard strake (PS 1 F/1). Collectively, the extant planks are flat sawn from long straight-grown oaks with only minimal, if any, noticeable branching. These were no doubt sizable quality specimens singled out specifically for the purpose of ripping down the garboards and planks. The saw marks, which are still discernible along sections of the inboard surfaces, are characterized by changing or readjusting angles associated with the so-called “pit-sawing” technique.⁸² Thus, they were sawn by hand rather than in some type of mill.

The term “pit-saw” is found only in English; in all other European languages, for instance the Spanish term *serrucho* or *serrucho braguero* – the “braced saw;” it refers to either the nature of the saw or the fact that it is used to split or part the logs or large balk. Dated to at least Roman times, the Early Modern framed or unframed saw variety used for ripping down planks was a two or three man device. It had a thick, long, tapering blade, and two handles, which could be disassembled if needed. After positioning a log or balk on trestles, one sawyer stood on the balk and two others worked below. These were commonly specialists belonging to a separate guild who traveled from job site to job site with their own equipment. Due to the sheer size of the balk, at least 20 cm in radius (40 cm in diameter) and 10 m in length in the case of the Western Ledge Reef Wreck’s garboards, and the way it was supported during the sawing process, the work could not be accomplished without at least a few interruptions.⁸³ Every time this

happened and the saw had to be repositioned inside the kerf, the blade left readily identifiable irregular marks on the planks.⁸⁴

Although the planks were sawn to shape, their inboard surfaces are visibly finished with adzes to create a smooth fit with the curvature of the frames. The use of shipbuilding adzes is not a novelty since it is typically associated with carvel construction techniques.⁸⁵ Where the planks intersect with the frames, the surfaces are also marked by distinct transverse pressure marks. After the assembly was completed and the planking securely fastened with both iron nails and treenails, their outboard surfaces were thoroughly charred as a measure to protect against shipworms. As evidenced by the uniformly deep black coverage of the planks, the charring, or perhaps even a complete careening, must have been done soon before the departure of the ship for home.

Analysis

The combination of iron nails and treenails as plank-to-frame fasteners was a hallmark of Iberian shipwrights, as the peninsula is interposed between Mediterranean, with its reliance on iron nails, and Northern Europe, dominated by treenails.⁸⁶ According to Oliveira, who endorsed this fastening method in his shipbuilding treatise, below the waterline, the treenails proved superior to nails made of iron.⁸⁷ Wood, however, has its own drawbacks, the biggest being a tendency of the treenails to leak. Granted that some of them did leak at some point, it was practically impossible to locate and fix the few defects, especially those that were covered by the ceiling.

Out of a variety of ways to tighten the treenails, one possibility was to simply make a kerf or two in their heads and drive strands of oakum into them. This technique was well known in English shipyards and associated with such well known shipwrecks as the 16th-century *Mary Rose* and “Gresham Ship” or the 17th-century *Sea Venture* and *Dartmouth*.⁸⁸ What is interesting, however, is that the treenails on the Western Ledge Reef Wreck followed the same method, which is unprecedented within the entire group of the comparative 16th- and 17th-century Iberian examples.⁸⁹

One way to explain it is to acknowledge the technique as a variation on the theme within the acceptable approaches to the Iberian shipbuilding, and hope that the future research will provide more comparative data. By accepting such explanation, we also consent that the caulking of the treenails was done as a part of normal Iberian or Basque shipbuilding procedure at the time of the construction. An alternative hypothesis is that the caulking of the treenails was a separate process, a fast and easy solution to repair a leaking ship. It is possible that during the operational life of the Western Ledge Reef Wreck, the ship sailed between Spain and England. During one of such voyages, its bottom became increasingly permeable. It was determined that the primary bilge pump could not deal with the problem alone, and that a major overhaul was needed. In addition to installing a second bilge pump, the ship was fully careened, which likely included recaulking the seams and treenails, as well as thoroughly charring the exterior planking.⁹⁰ Since the caulked treenails are unknown from Iberian contexts, there is a possibility that this was conducted in the English yard shortly before the ship’s voyage to the New World. However, this scenario remains conjectural at present.

4.8 THE INTERNAL STRUCTURE OF THE SHIP

Keelson and Mast Step

Out of all the preserved timbers, the keelson (*contraquilla, sobre quilla*) is not only the most prominent, but also one of the most representative structural members. By spanning the inside of the ship longitudinally and locking the floor timbers in place, it supplies great internal longitudinal strength. At the same time, by incorporating a mast step (*carlinga*) within its expanded central section, it provides robust support for the heel of the main mast, equally distributing the stresses of the rigging onto the floor timbers and throughout the inside of the vessel.

As illustrated in figure 4.48, the total preserved length of the keelson with the mast step, defined here as a single assembly, is 217 cm. Apart from the worm-eaten forward portion, the assembly constitutes nearly a complete mast step and after section of the keelson. Although its forward extremity deteriorated prior to the original excavations, careful observations of the pressure marks and the remnants of the fasteners reveal that this section was once present.

With the exception of a bilge pump sump cut on the keelson's port side just aft of the mast step mortise, the port and starboard sides of the assembly are symmetrical and centered over the keel. The top edges are beveled to reduce sharp corners, while the bottom surface is notched to fit over the corresponding floor timbers. The most forward end of the extant assembly corresponds with the location of the master frame (FR M) and it terminates over the sixth floor timber (FR 6) aft. The mast step itself spans three

Portside View

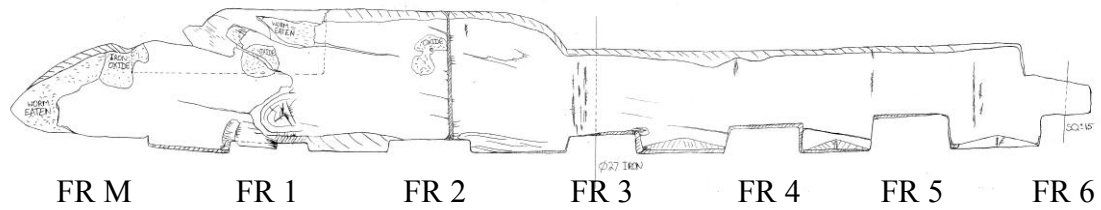

Top View

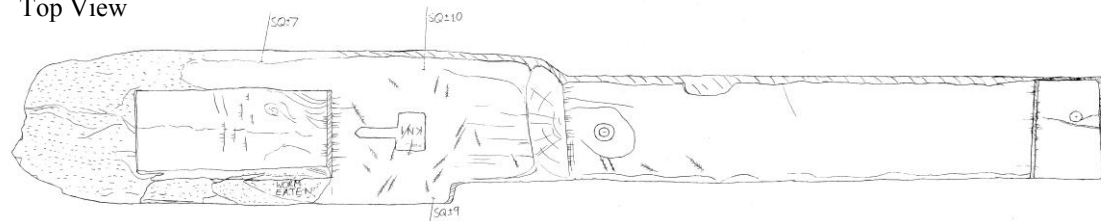

Starboard View

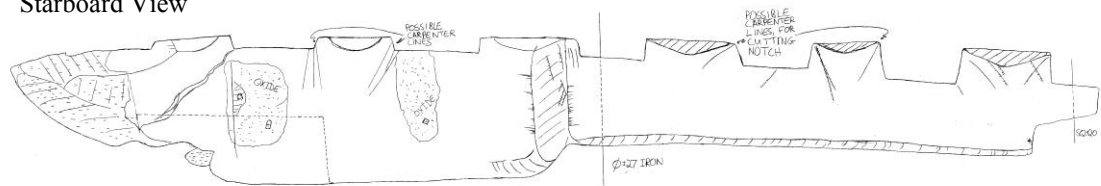

Bottom View

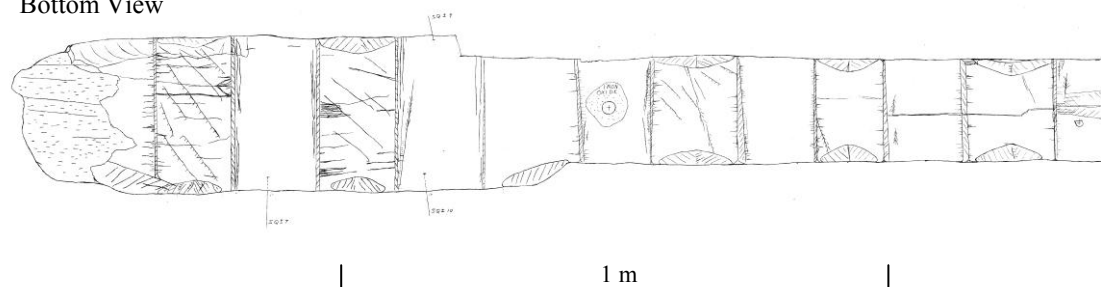

Figure 4.48: The preserved keelson (KN 1/1) in four views. (91-03-D3, 91-02-D6)

floor timbers (FR M, FR 1, FR 2), while the preserved section of the keelson spans four (FR 3, FR 4, FR 5, FR 6).

The Mast Step

Formed within an expanded central section of the keelson timber, the mast step resembles a large rectangular box with slightly tapering ends. By itself, it measures 115 cm in length, 32 cm in width, and 30 cm in height. Due to the deterioration of the entire forward section of the keelson, including a portion of the mast step, the tapering could only be identified along its after end. On the port side, there is a 4.3 cm deep cut away which originally housed the lower end of the bilge pump.

The mortise that received the heel of the main mast is carved into the upper surface of the mast step. The beginning of its elongated cavity corresponds with the end of the master frame (FR M) and its center is located over the first floor timber (FR 1) aft. The mortise measures 42 cm in length, 15 cm (at the bottom) expanding to 17 cm (at the top) in width, and about 14 cm in depth. Looking inside the mortise, there is a marked disparity between the forward and aft sections along its bottom surface. For about 22 cm, measuring from the after edge towards the center, the bottom surface is highly deteriorated. It displays numerous transverse adze-marks, several broken or otherwise chipped off pieces and black discoloration. In contrast, the remaining forward section of the bottom surface is clean and smooth, has only few barely visible marks and displays dark-brown still good quality wood (fig. 4.49). Even though no mast timber survived inside the mortise, such a striking discrepancy between the forward and aft sections of the bottom surface might be indicative of the positioning of the main mast. It is possible

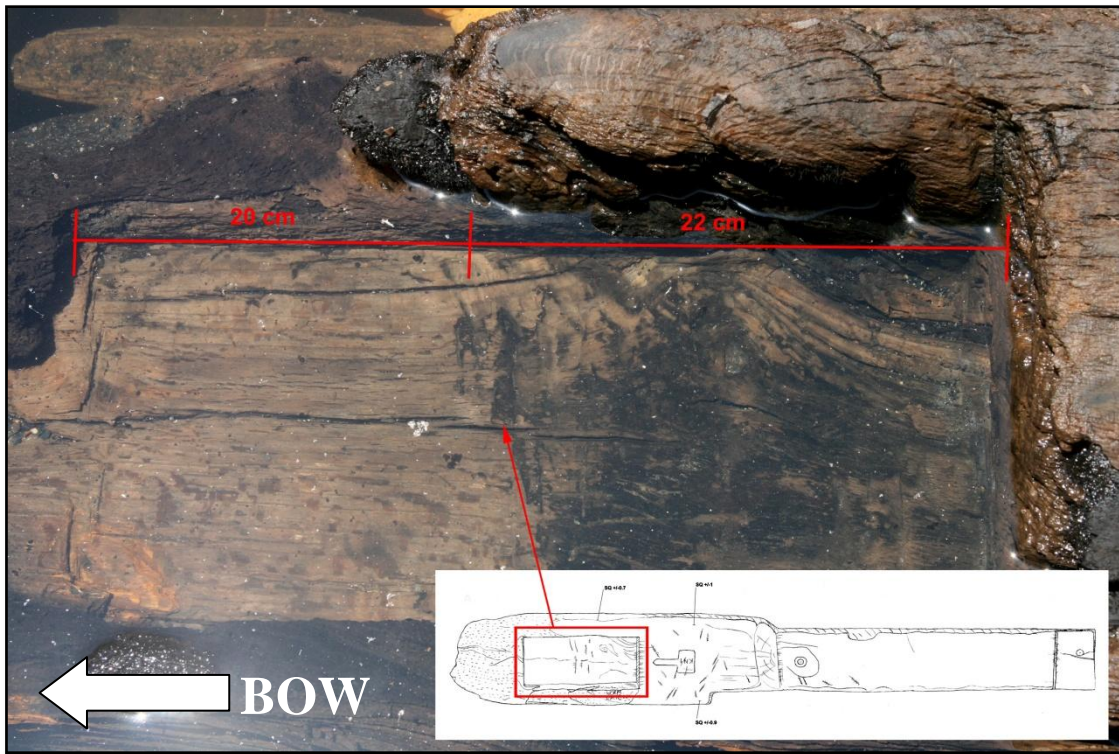

Figure 4.49: Mast step mortise displaying disparity between the forward and aft sections along its bottom surface.

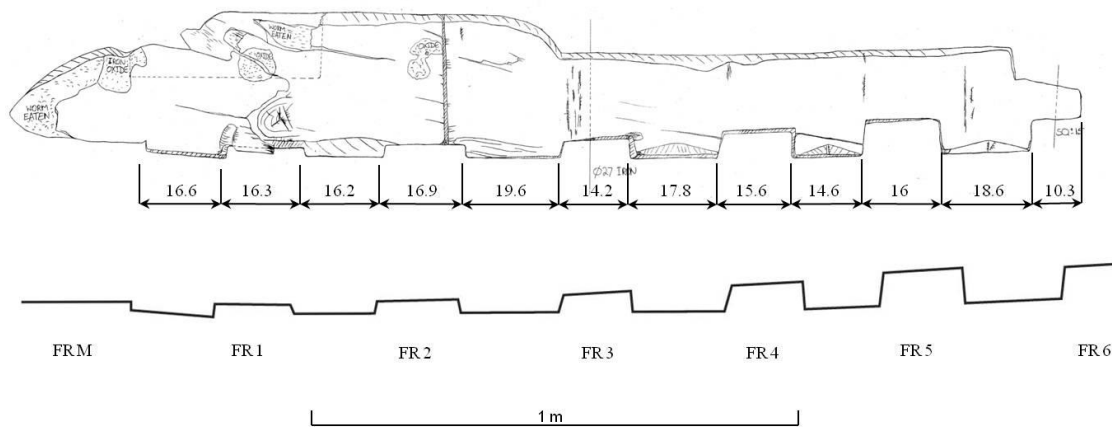

Figure 4.50: Schematic view of the underside of the extant keelson. (in cm)

that the mast was located along the aft section of the bottom, thus through the dynamic nature of the heel it wore down the surface of the mast mortise right underneath it. It is also possible that a wooden chock which locked the heel in place was located along the forward, much less deteriorated section of the mortise bottom. Although significant for understanding the overall proportions of the ship, this information alone is insufficient to reliably decipher the diameter of the main mast at the mortise.

The Keelson

The keelson portion of the assembly is preserved only abaft the mast step, while its forward section deteriorated completely prior to excavation. It measures about 107 cm in length, 20 cm to 21 cm in sided width, and 17 cm to 21 cm in molded height. Contrary to the keelson found on the Red Bay (24M) Wreck, which tapers towards each of its extremities, the keelson from the Western Ledge Reef Wreck stays square in the cross-section throughout its length.⁹¹

The keelson curves slightly up toward the stern while its underside is fashioned with the characteristic notches. As illustrated in figure 4.50, these have custom shapes which must have been adjusted on a one-by-one basis only after the floor timbers beneath the keelson were already in place. Only in this manner could the shipwrights achieve a close fit between the keelson's underside and the corresponding surfaces of floor timbers. The depths of these notches increase sequentially suggesting an attempt to keep the top surface of the keelson leveled over the rising floor timbers. The shallowest notches, those at the master frame and the first floor timber, measure only about 1.6 cm

in depth, while the deepest one, located at the aftermost extremity of the keelson, measures 7.4 cm (table 4.10).

On the starboard side, the wood between the notches shows curious linear cuts, possibly carpenter scribe marks. These may have served as guides in the fabrication process. Additionally, the outboard bottom corners of the wood between the notches are finished with reverse-triangle, or chevron-shaped bevels (fig. 4.51). Although the true function of these beveled edges is still unknown, it is assumed that they could reduce potential wood splitting, but also facilitated access to the space under the keelson for cleaning the bilge.

Careful observations reveal that the keelson originally extended forward beyond the mast step. Evidence comes in the form of a concreted iron bolt located in front of the mast step and protruding well above floor timber A (FR A). This bolt likely fastened the forward section of the keelson through the floor timber to the keel. Then, there is also the evidence of pressure marks present on the top surfaces of at least two, possibly three, floor timbers (FR B, FR C, and FR D) in front of the master frame. Since the widths of these marks perfectly correspond with the sided width of the keelson timber, we can assume that they were left by the forward section of the keelson. Since that section is missing, evidence of the pressure marks and fastener details between the master frame (FR M) and the floor timber D (FR D) were used to determine that the keelson's minimum hypothetical forward length should fall somewhere between 110 cm and 120 cm (fig. 4.52).

Table 4.10: Depths of the keelson and mast step notches.

Floor Timbers	FR M	FR 1	FR 2	FR 3	FR 4	FR 5	FR 6
Depth of notches (cm)	1.6	1.6	2.6	3.7	5	6.65	7.4



Figure 4.51: Wood between the notches showing reverse-triangle or chevron-shaped finish.

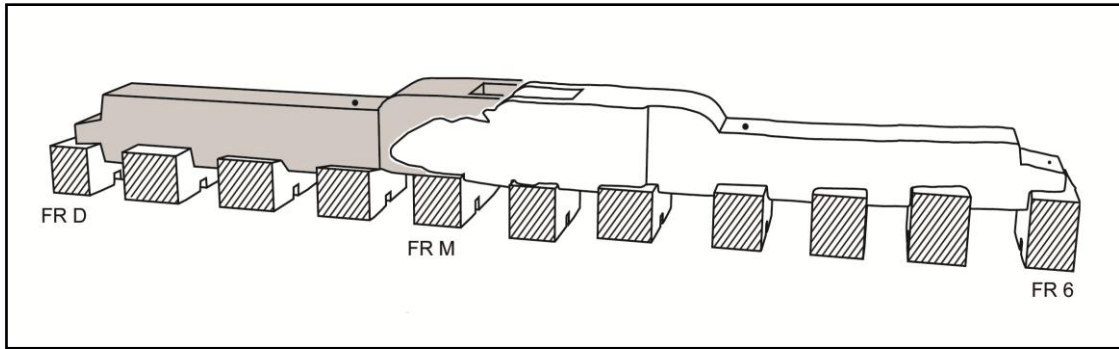

Figure 4.52: Hypothetical central keelson and mast step assembly.

The probable forward extent of the keelson appears to be roughly fore-and-aft symmetrical to the after section of the preserved assembly. The after end also terminates with a flat scarf, with a table length that measures 13.4 cm. The presence of such a scarf, as well as the unusually short length of the keelson and mast step assembly (even after incorporating a nonextant forward part), indicates that the keelson of the vessel was fashioned out of more than one timber.⁹² Spanning the interior of the vessel from post to post, the keelson was likely subdivided into three sections, for clarity referred here as the forward, central, and aft keelson timbers. Notably, the characteristics of the preserved keelson and mast step assembly associated with the Western Ledge Reef Wreck reveal that it could have represented only a central keelson with mast step timber (fig. 4.53). This design correlates well with what is known from other Iberian shipwrecks, particularly the Angra D Wreck and *Santo Antonio de Tanna*, among others (see Appendix 4).⁹³

The Fasteners

After being positioned, the keelson and mast step assembly was fastened through the floor timbers to the keel with round iron bolts and to a floor timber with a square nail. Based on the surviving concretions, the bolts were about 55 cm in length and had round heads and shanks. The first bolt fastened the now missing forward section of the keelson through floor timber A (FR A) to the keel. Judging from the dimensions of the impression, it measured about 23 mm in diameter. The second bolt fastened the extant after section of the keelson through the third floor timber (FR 3) to the keel, and was

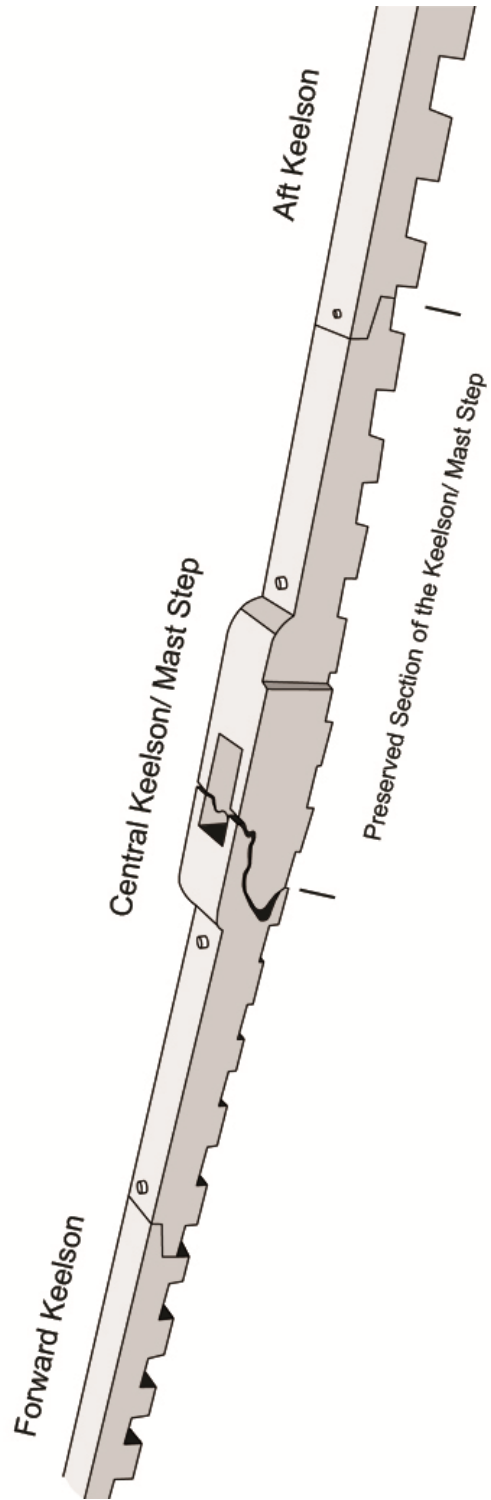

Figure 4.53: Hypothetical keelson composed of three timbers.

slightly larger, measuring about 28 mm in diameter. This bolt was driven from below where its head was countersunk into the keel; on top of the keelson its shank was associated with an impression of a 50 mm diameter washer over which the bolt would be locked (fig. 4.54). Based on evidence from other well-documented Iberian shipwrecks, particularly from the collection of fasteners from the Molasses Reef Wreck, it is likely that this was a forelock bolt.⁹⁴ Lastly, the after end of the keelson associated with a flat scarf was secured to the top of the sixth floor timber (FR 6) with a single square spike, which based on impression measured about 15 mm.

Timber/Tool Marks

Exhibiting only one small knot on the portside face of the mast step, the extant keelson timber appears to be manufactured from a good quality oak with no major defects. Its bottom surface along its aftermost extremity has a large longitudinal crack that extends for about 44 cm which must have developed during the wrecking process. Overall, the fabrication of the Western Ledge Reef Wreck's keelson and mast step assembly is reminiscent of what was already observed for the Red Bay shipwrecks.⁹⁵ The timber was likely squared off with axes, which left prominent marks on the bottom and side surfaces, and was finished to shape with adzes. Adze marks are evident on the top surface of the mast step and inside of the mast mortise, while the sump for the bilge pump was cut with an axe. Along the top surfaces of both keelson and the mast step, the corners or edges along the entire assembly are slightly beveled. The underside exhibits characteristic notches cut with axes. On the starboard side of the after section of the keelson, the wood between the notches has distinct linear markings identified as

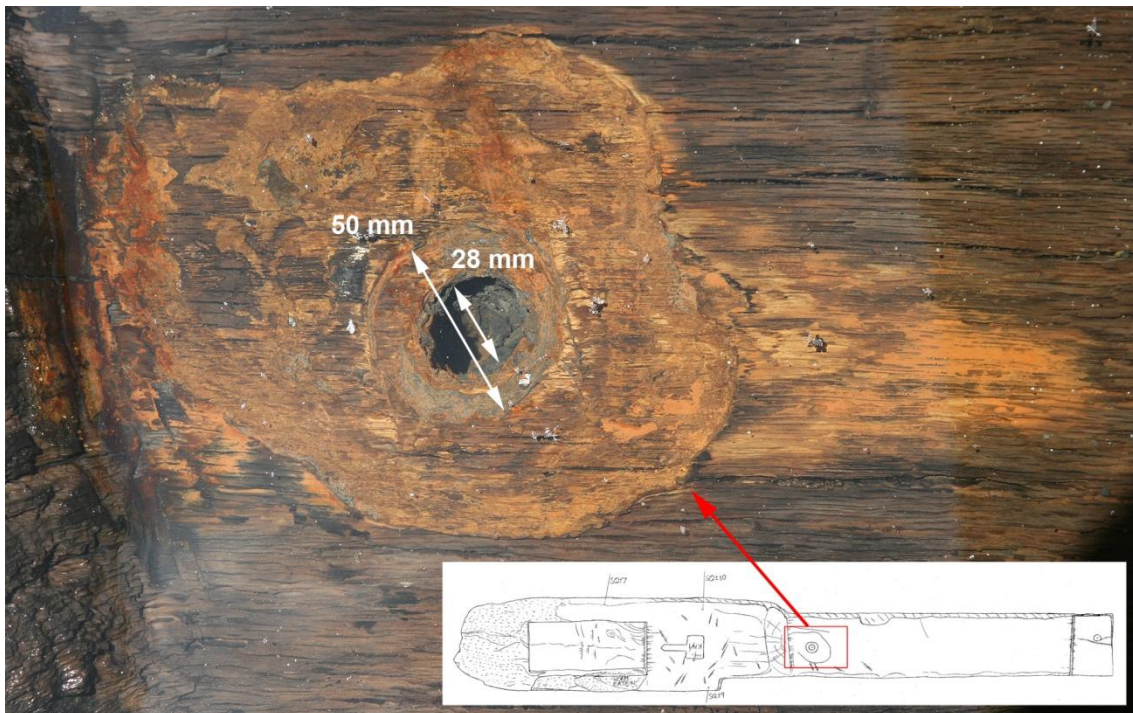

Figure 4.54: A bolt impression with a countersink on the top face of the keelson/mast step.

carpenter marks. These could have been used as guides for the correct cutting of the notches. Additionally, the outboard corners of the wood between the notches are finished with chevron-shaped bevels.

Analysis

At first glance, the design of the Western Ledge Reef Wreck's complete keelson assembly follows the same basic principles as those defined for the Iberian-Atlantic concept and illustrated by well-preserved shipwreck examples.⁹⁶ Complications arise, however, when one tries to interpret some of the nuances of the efficiency of wood usage, especially, the approach to the keelson's fabrication. In contrast to Mediterranean concept, which early on developed around a highly economical keelson with composite mast step made out numerous interlocking parts, showcased on the Contarina 1 and Villefranche-sur-mer wrecks and the much later on French light frigate *La Belle*, the broadly defined Atlantic world pursued a different path.⁹⁷ Utilized in one form or another on the Viking craft, cogs, and later on larger English and Iberian ships, the keelson incorporated a large expanded mast step. On the Western Ledge Reef Wreck, it was manufactured from three timbers scarfed end to end.⁹⁸

To illustrate the principal differences behind the design of the keelson and mast step in Mediterranean (in the Adriatic region) and Atlantic (along northern coast of Spain and perhaps further north), a closer look should be given to the Contarina 1 Wreck, with its recently reviewed dating, and Western Ledge Reef Wreck.⁹⁹ As explained later in this dissertation (see Chapter V), both vessels are of similar overall

dimensions but different rigging configuration; the former being a two-masted lateener while the later most likely a three-masted full-rigged ship.

The keelson of the Contarina 1 Wreck, extending the entire length of the ship, was manufactured out of six scarfed pieces. It was laid down flat on the floor timbers, to which it was nailed from above. Within the keelson, Contarina 1 had two identical mast steps measuring about 125 cm in length by 32 cm in width. These were assembled out of four independent elements, two longitudinal mast step partners and two chocks enclosing the structure forward and aft, that produced, in essence, a box. Each assembly was laterally supported by six buttresses, three on the portside and three on the starboard.¹⁰⁰ Much like another Adriatic vessel known as the Logonovo boat or the small Portuguese Ria de Aveiro A Wreck, the buttresses were fashioned as upward curving extensions of the floor timbers.¹⁰¹ In addition, photographs from Contrina 1 revealed that the mast steps were likely horizontally bolted, or perhaps treenailed, through at least the forward and aft buttresses (fig. 4.55).

Although the full extent of the keelson from the Western Ledge Reef Wreck is unknown, it is evident that instead of wasting yet another majestic oak to produce a keelson with a mast step out of a single timber, a design prominent on the Red Bay (24M) Wreck, the shipwrights of the Western Ledge Reef Wreck fabricated it out of three, much shorter, scarfed together pieces.¹⁰² The keelson was notched to fit over corresponding floor timbers, while all the edges were beveled. It was fastened through the floor timbers to the keel with bolts and spikes. The preserved main mast step was carved or sculpted as a unit within an expanded central section of the keelson. It

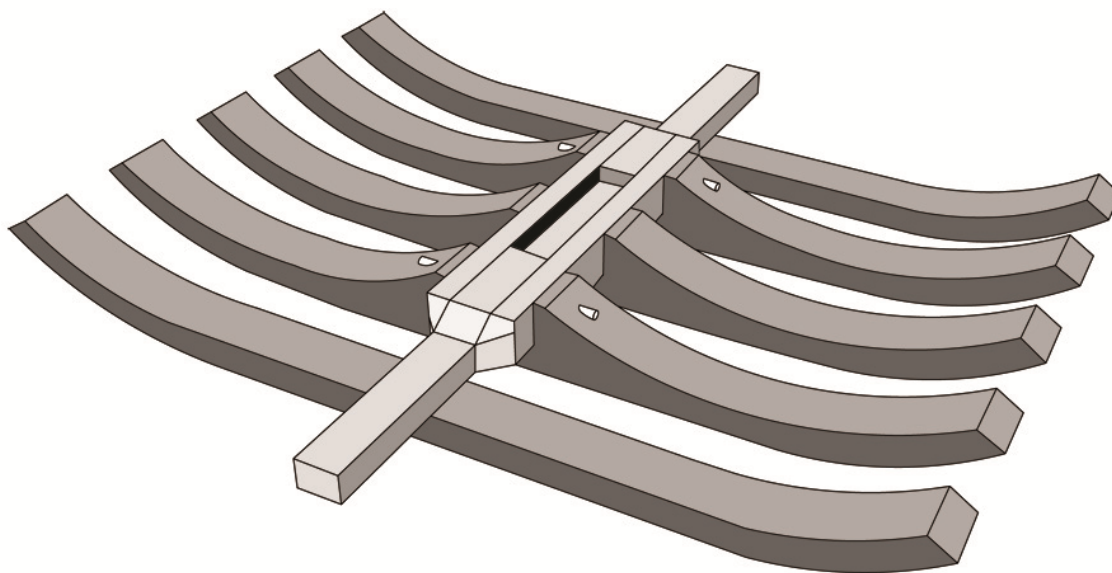

Figure 4.55: Schematic overview of the mast step from the Contarina 1 shipwreck.
(modified after Regia Deputazione di Storia Patria 1901, Photograph VI, VII, VIII.)

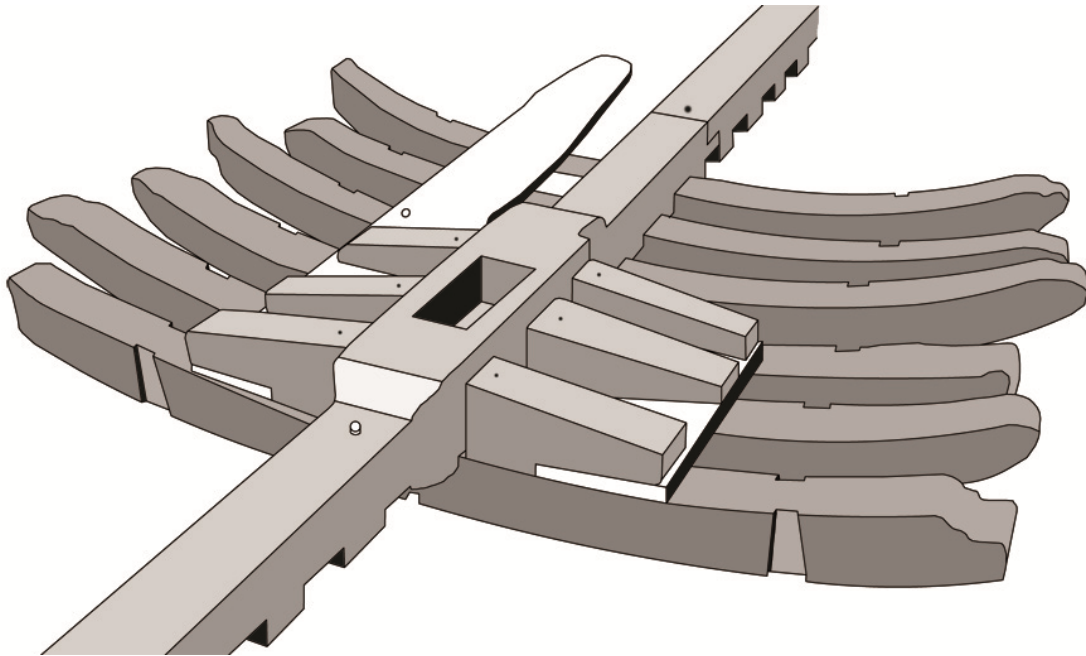

Figure 4.56: Schematic overview of the keelson with expanded mast step from the Western Ledge Reef Wreck.

Table 4.11: Wood economy calculations.

Timber	Volume in 1:1 (cm ³)	Volume in 1:1 (m ³)	Dry Weight (kg)*
KN 1/1	111681.93	0.1117	85
Minimum Log	331700.77	0.3317	226
	Difference:	0.22	141
	% of Material Lost:	66%	62%

* based on the average seasoned dry oak density of 760 kg/m³

measured 115 cm in length by 32 cm in width, the dimensions quite analogous to the Contarina 1 Wreck. It was also laterally supported by six buttresses, three on the portside and three on the starboard. However, these were fashioned as independent wedge-like timbers nailed to the mast step, ceiling planks, and foot wales (fig. 4.56).

Upon review of both designs, one aspect becomes apparent, namely a remarkable difference in the efficiency of wood usage. While the shipwrights of the Contarina 1 utilized smaller timbers skillfully shaped to form a box-like mast step, the team working on the Western Ledge Reef Wreck still required a substantial piece of oak. Based on the dimensions of the preserved keelson with an expanded mast step (KN 1/1), the hypothetical minimum oak log was reconstructed. Excluding the sapwood or any excess wood that had to be removed during a standard manufacturing process as well as a natural taper of the trunk, both of which could not be accounted for, the smallest radius of the log must have been about 22 cm (44 cm in diameter). Since the volume of the extant keelson with expanded mast step (KN 1/1) is estimated to about 0.1117 m³ and the minimum volume of the log needed to manufacture such assembly is about 0.3317 m³, the total volume of discarded wood would comprised about 66% of the original log (table 4.11). In other words, such a log would be of similar dimensions to those used for the keel and planking, and demonstrates that the shipwrights were not significantly affected by the shrinking wood supply of the later part of the 16th century.¹⁰³

In contrast to the framing, for which trees were given required shapes 50 or more years prior to the assembly, there was plenty of room for innovation the keelson and mast step, especially because the Iberian shipwrights must have been aware of other

designs used throughout Mediterranean region.¹⁰⁴ Although we can only hypothesize, it almost seems that these shipwrights were simply unwilling to change their traditional concept and carried on by perfecting what might strike us as uneconomical use of their resources. Such inability to adapt could also be a reason, albeit one of many, why the Iberian shipbuilding marked by its conservatism declined while the Dutch, after a series of rapid improvements and refinements, flourished in the early 17th century.¹⁰⁵

The Bilge Pumps

Although none of the components survived, the keelson with mast step assembly shows evidence of one, or possibly two, bilge pump sumps (fig. 4.57). The presence of two bilge pumps was regulated by one of the edicts issued by Philip II in 1552. As a safety precaution, it required that the new ships should be fitted with two pumps and not just one.¹⁰⁶

The seating of the main pump was located on the port side of the mast step directly abaft the mast mortise. The pump tube would have rested on the portside garboard between the second (FR 2) and third (FR 3) frame. Contrary to the semi-circular sumps known from other 16th-century Iberian shipwrecks, this 4.3 cm deep sump resembles a square step and was manufactured by simply cutting out a corner of the mast step with an axe.¹⁰⁷

Evidence suggests that the Western Ledge Reef Wreck had a second bilge pump. This one was positioned on the starboard, in the opening between the third (FR 3) and fourth (FR 4) frame. One of the limber boards (CSL 2/1) covering this space has a

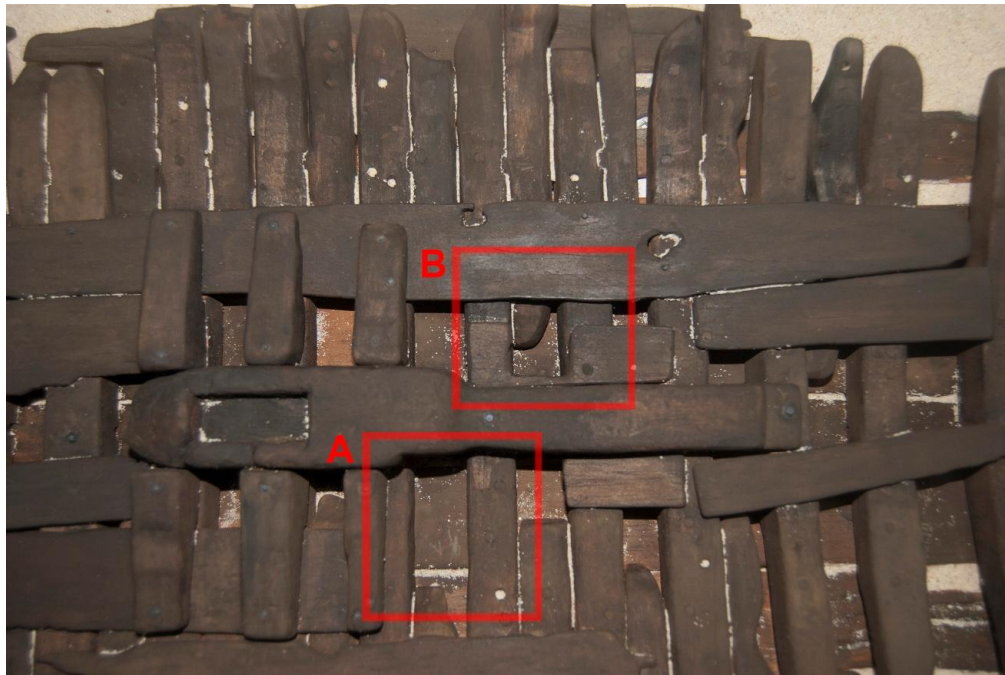

Figure 4.57: Positions of the two bilge pumps based on a research model: A) the main bilge pump, B) a potential second bilge pump.

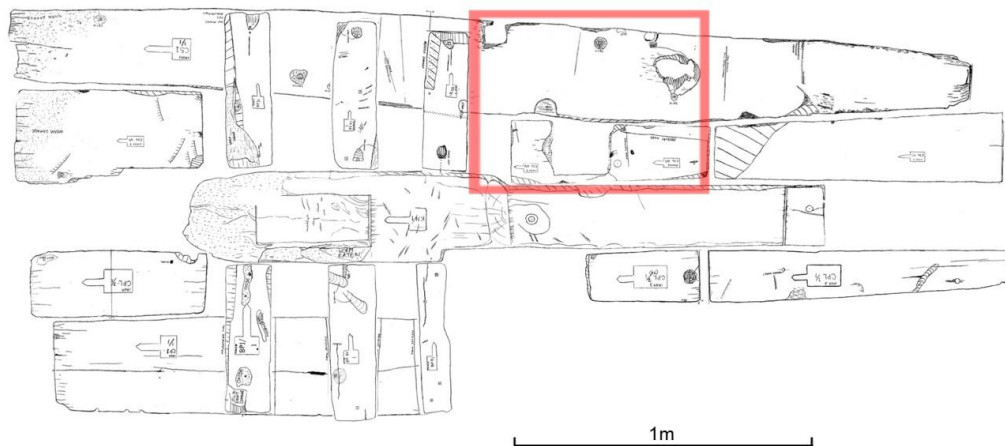
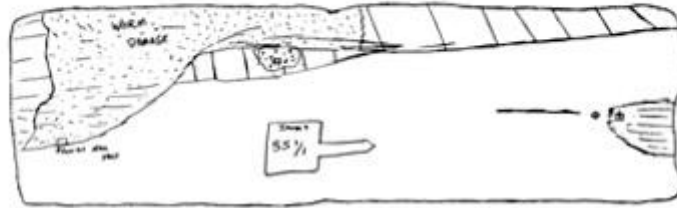

Figure 4.58: Simplified view of the keelson, buttresses and ceiling planks showing the position of the second bilge pump.

distinct 19 cm by 19 cm cut away associated with one or possibly two mortises located on the first starboard ceiling plank (CS 1). The much better preserved forward mortise is square, carved along the outboard face of the plank, and measures about 7 cm by 7 cm. The second, and more tentative, is located in the center of the plank and corresponds with a highly deteriorated hole. Although evidence is limited, it is likely that the large cut away could have originally served as a sump while the mortises could have been used to support posts from the structure that protected the second bilge pump (fig. 4.58).

This configuration would match a similar arrangement for one of the two bilge pumps found on the 17th-century Stonewall Wreck, an English-built vessel of moderate size in the Spanish service.¹⁰⁸ Since the arrangement of the second bilge pump deviates in so many respects from rather standard first pump, it is suspected that the second was simply a spare, or added much later during the service of the vessel, potentially as an alternative to a broken first pump or to deal with extensive leaking.¹⁰⁹ As discovered during the excavation, the bilge in the vicinity of the main pump was filled with thick organic muck corroborating the notion that it was either not cleaned for a prolonged period of time, or that the pump was not working.¹¹⁰ Overall, the presence of two bilge pumps is not uncommon on Iberian shipwrecks, as exemplified by the Emanuel Point I Wreck, Red Bay (27M and 29M) Wrecks, Angra D Wreck, or *Santo Antonio de Tanna*.¹¹¹

Top Face



Forward Face

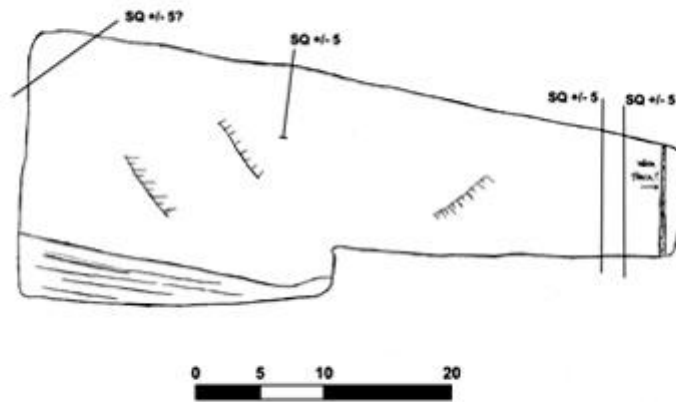

Figure 4.59: Example of the first starboard buttress. (BS 1)
(scale in cm)

The Buttresses

The Western Ledge Reef Wreck's mast step was laterally supported by six wedge-shaped buttresses (*taquetas*); three on the port side and three on the starboard. With the exception of the aftermost portside buttress (BP 3), whose somewhat reduced dimensions are dictated by the proximity to the main bilge pump, the buttresses are uniform in size. On average, they measure about 52 cm in length, and 15 cm to 16 cm in width. Inboard, where the buttresses rest against the mast step sides, they are 20 cm to 22 cm in height, while outboard, they taper to between 7 cm and 9 cm (fig. 4.59).

Adzed to a roughly triangular shape, the bottom surface of each buttress has a conspicuous rebate. For the first 19 cm to 24 cm inboard, the bottom face is flat and the buttresses rest directly on top of the floor timbers. Then, they have a rebate about 4 cm deep and the remaining 27 cm to 34 cm of their undersides overlay the first ceiling strake. In this arrangement, the first set of port (BP 1) and starboard (BS 1) buttresses rests over the master frame (FR M); the second set (BP 2 and BS 2) over the first floor timber (FR 1); and the third set (BP 3 and BS 3) over the second floor timber (FR 2). It must be emphasized that the arrangement between the buttresses and the first ceiling planks (CP 1 and CS 1), which perfectly fit into the notches cut in the undersides of the buttresses, is unparalleled in any other such arrangement found within the group of the 16th- and 17th-century Iberian shipwrecks. Although they gave solid lateral support for the mast step, the final outboard support for the buttresses was provided by the stringers, referred here as foot wales. Since these reinforcing timbers did not survive, excavation

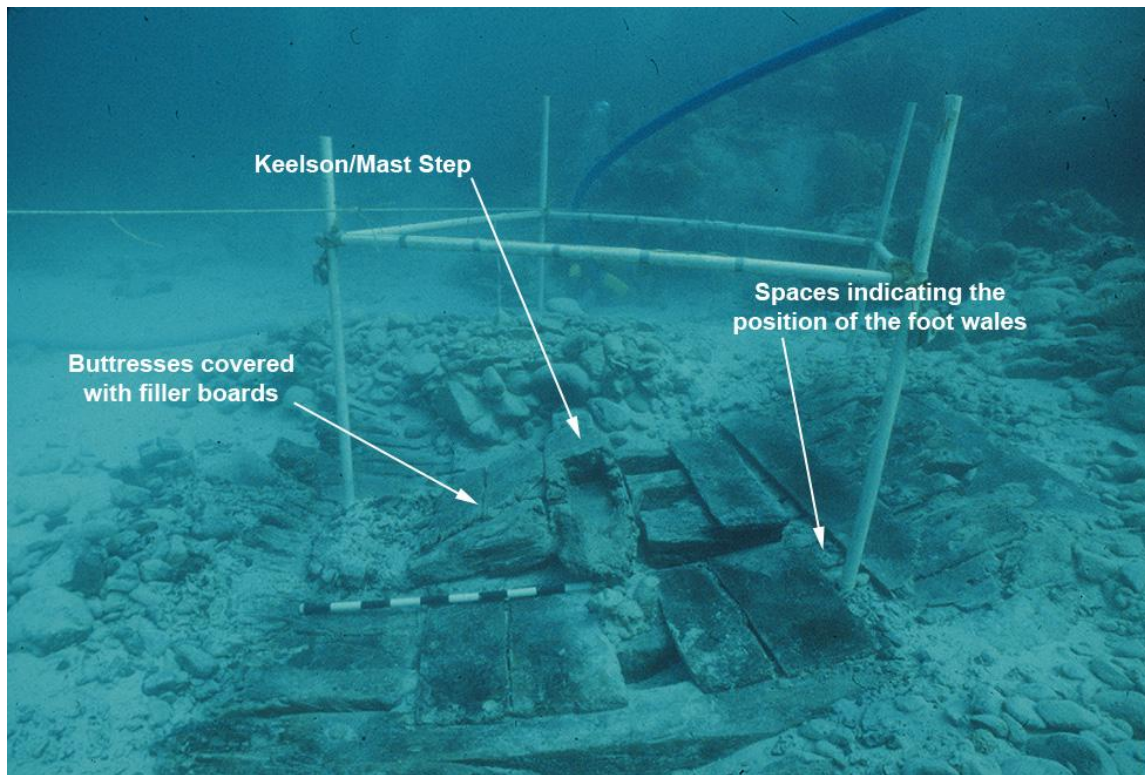

Figure 4.60: Overview of the site with the keelson/ mast step assembly, filler boards (bilge boards) covering the spaces between buttresses, and spaces indication possible location of foot wales.

photographs, ceiling plank spacing, and fastening patterns were used to discern their original presence (fig. 4.60).

The buttresses are fastened to both the mast step and the first starboard and port side ceiling planks (CP 1 and CS 1) with square nails, which based on nail impressions ranged from 5 mm to 12 mm across. Alternatively, as exemplified by both the second (BP 2) and the third (BP 3) portside buttresses, they were fastened to the foot wales with 5 mm to 7 mm square nails. Analogous to *Angra D Wreck*, the spaces between the buttresses were originally covered with thin longitudinal boards (or bilge boards), which in the case of the Western Ledge Reef Wreck consisted of two boards on each side (fig. 4.61).¹¹² The nailing pattern indicates that these were lightly fastened to the top of the buttresses with square nails ranging from 3 mm to 10 mm, thus, the boards could be easily removed as needed. Based on the observation that top surfaces of the buttresses do not exhibit older or otherwise anomalous nail impressions in addition to the ones already fastening the covering boards, it is suspected that these were never removed. Combining this evidence with the fact that the bilges were full of rich organic muck could also indicate that they were never opened for cleaning.

Internal Planking

The preserved elements of the internal planking consist of limber boards, common ceiling planks, and short boards covering the spaces between buttresses. Each side of the ship was lined with limber boards covering the bilges. These were followed by planks of the first ceiling strake, which slid into the notches under the buttresses, and

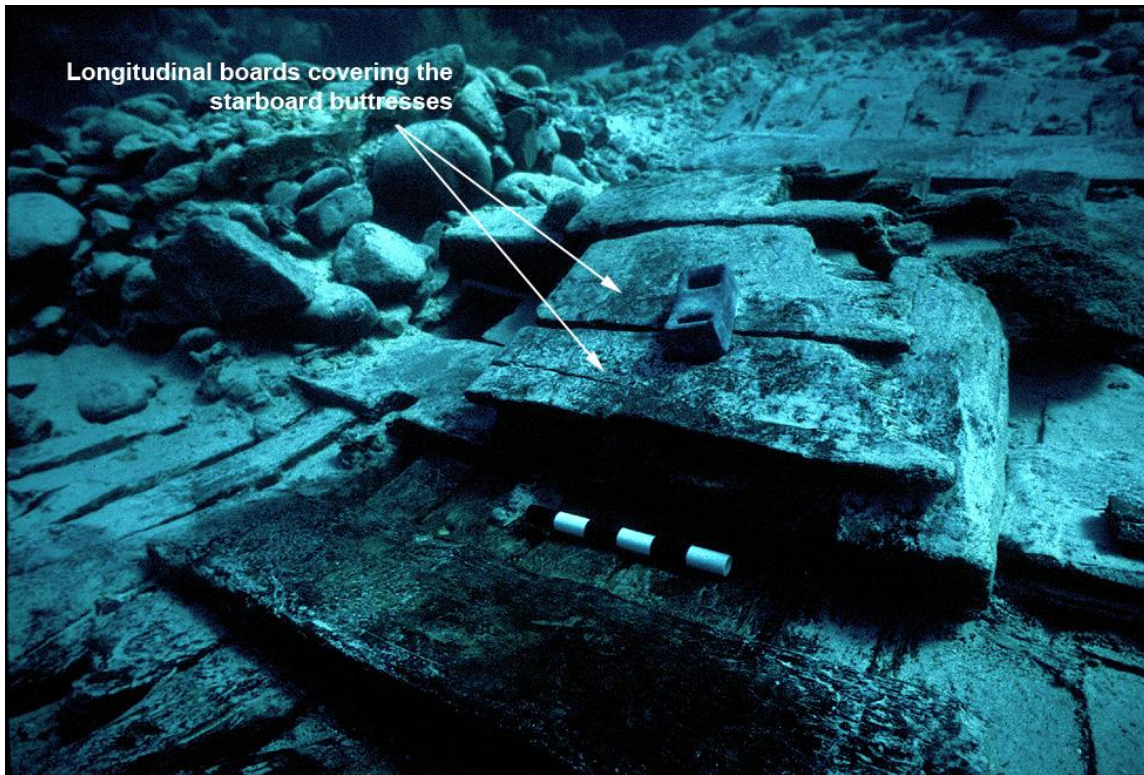

Figure 4.61: Detail of the mast step assembly showing thin longitudinal boards (bilge boards) covering the spaces between the butresses.

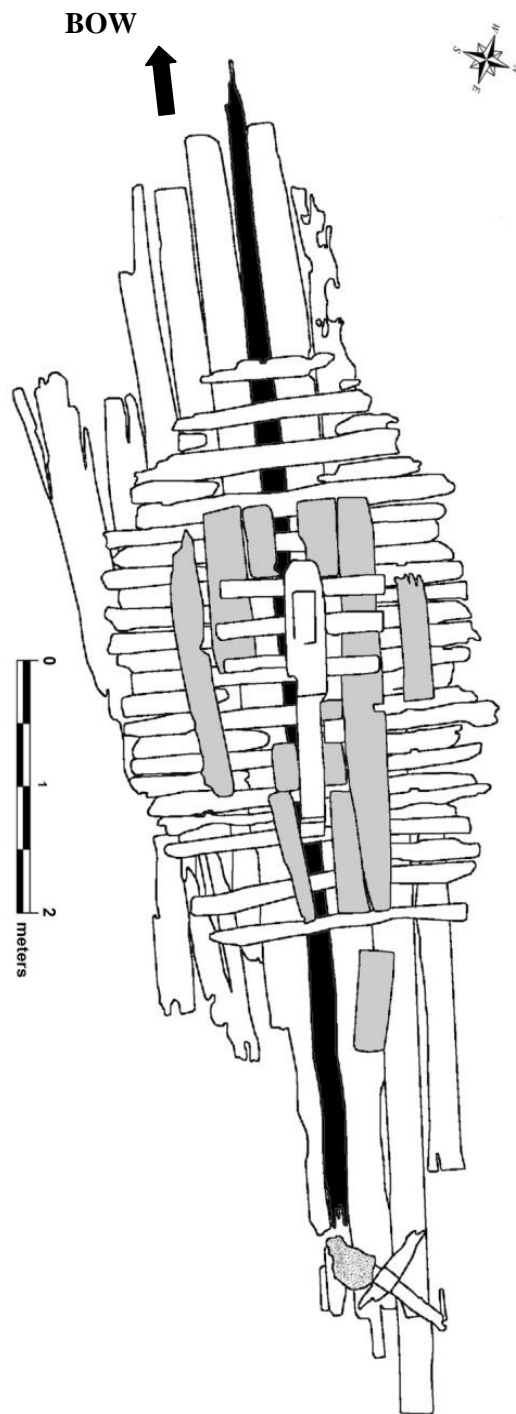

Figure 4.62: Overview of the preserved ceiling planks. (marked in grey)

further up by planks of the second ceiling strake (fig. 4.62). Although not preserved, the spaces between the first and the second ceiling strakes were originally reinforced by robust stringers, referred here as the foot wales. Moreover, the spaces between consecutive buttresses were covered with thin boards. These ran longitudinally, two on each side of the ship. Out of the four boards present during the 1989 excavation season, one is currently unaccounted for with all its data missing. Due to the deterioration of the ship, the internal members could not be reconstructed to the full extent.

Limber Boards

The limber boards, which are placed along both sides of the keelson and cover the bilges, consist of short individual planks. Although only one plank forward and two planks aft of the buttresses survived, the limber boards would have originally spanned the entire length of the keelson. The length of the extant portside boards is 60.8 cm (CPL 3/1), 39 cm (CPL 2/1), and 104.2 cm (CPL 1/1), respectively; while the length of the extant starboard planks is 64.2 cm (CSL 3/1), 68.4 cm (CSL 2/1), and 99.6 cm (CSL 1/1). In width, they measure 23 cm forward narrowing to 17.7 cm aft on port, and 32.6 cm forward narrowing to about 24 cm aft on starboard.

The limber boards were not fastened to any other timbers, hence, they could be easily removed to gain access to the bilges for maintenance and cleaning. As mentioned previously, one of the starboard limber boards (CSL 2/1) has a distinct square cut away, which corresponds with one or possibly two mortises in the first starboard ceiling plank (CS 1). Although tentative, this configuration, which is already known from a similarly designed square cut sump openings on of the Red Bay (27M) Wreck likely indicates the

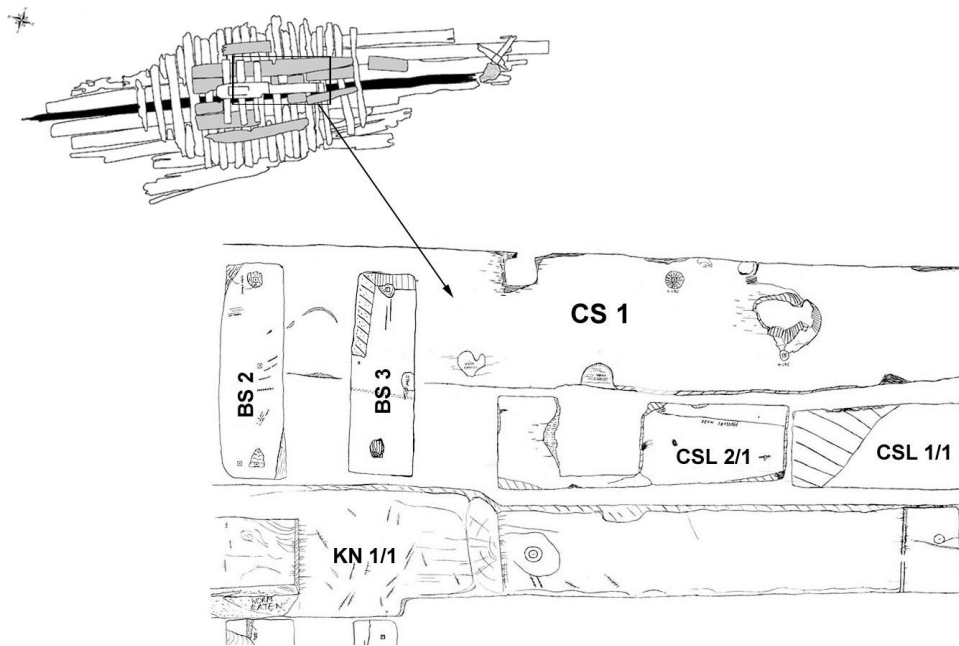

Figure 4.63: Square cut away in the limber board (CSL 2/1) indicating possible location of the second (portside) bilge pump. (not to scale)

location of a second bilge pump (fig. 4.63).¹¹³ Based on the visible marks, it is also evident that the limber boards were flat sawn and then adjusted on a one-by-one basis with adzes to fit into the irregular spaces, a task that was done only after the internal members of the ship were already in place.

Ceiling Planks (including UN 5)

Outboard of the limber boards lay two strakes of the flat sawn ceiling, (*tabla del soler, del granel*) made up of two planks on the portside (CP 1 and CP 2) and three planks on the starboard (CS 1, CS 2, and including UN 5). As illustrated in figure 4.64, a unique aspect of the internal structure is that the planks of the first ceiling strakes on both sides of the keelson fit into the notches carved into the undersides of the buttresses.

The first portside ceiling plank measured 132 cm in length, 33 cm in width, and 3.1 cm in average thickness. Although the evidence is scarce, it was fastened to the upper face of the starboard arm of the first floor timber (FR 1) with two 10 mm to 14 mm square nails. The first starboard ceiling, the longest extant internal plank, measured 332 cm in length, between 19 cm and 33 cm in width, and 3.6 in average thickness. It was fastened to the upper face of the portside arm of the master frame (FR M) with one 12 mm square nail. Since the fastener impressions were found directly under the buttresses, it is clear that these planks must have been installed first. Only after they were secured in place, could the buttresses be inserted and fastened to both the mast step and the ceiling.

The second ceiling planks are extremely fragile, have no surface or edge details fully preserved and they lack any fastener impressions. The second portside plank

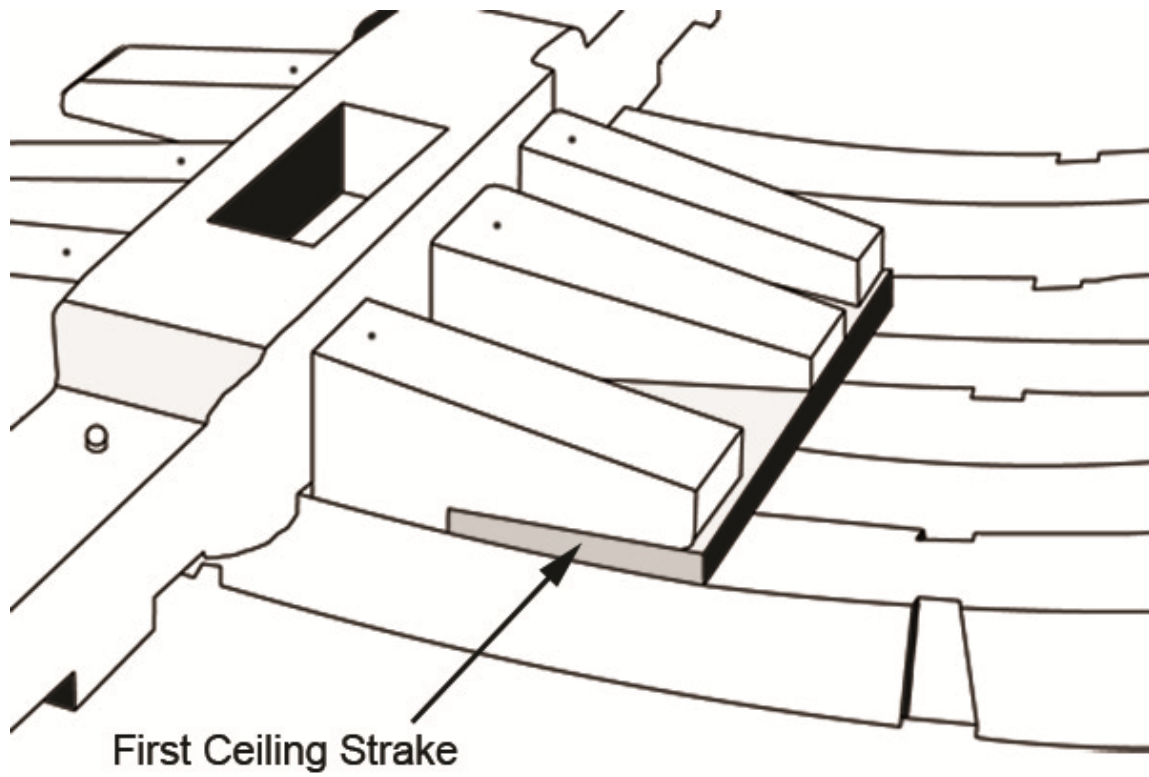

Figure 4.64: Arrangement between the buttresses and the first ceiling strakes on both sides of the mast step. (not to scale)

(CP 2), the most deteriorated of the group, measures 201 cm in length, about 24 cm in width, and 2.6 cm in average thickness. The preserved fragment of the second starboard plank (CS 2) measures 103 cm in length, 22.4 cm in width, and up to 5.7 cm in average thickness, making it significantly thicker than the adjacent ceiling. Based on these dimensions and the inability to precisely position it within the ship, it is possible that the plank designated CS 2 could represent a bilge clamp, a timber that clamped the floor wrungheads and first futtocks together (as seen on the Red Bay 24M Wreck).¹¹⁴ This interpretation, however, is tentative. Collectively, the average width of the ceiling planks is 26 cm or about 1/2 a *codo*; while the average thickness is 3.73 cm, a number which translates into about 15 planks per *codo*.¹¹⁵

Except for loose association with the J-16 square during the 1989 excavation season, the last plank (UN 5) is designated as unidentified. Originally, it was found loose at the aftermost section of the starboard internal hull. The plank had only very faint fastener impressions and measured 79 cm in length by 29 cm in width. Based on general characteristics, it was interpreted as being either one of the limber boards or part of the common ceiling.

Foot Wales

Due to poor preservation of the internal structure of the ship, the stringers, timbers technically described as the foot wales (*cingla, singla, palmejar*), did not survive.¹¹⁶ Extrapolating from evidence, including excavation photographs, the spacing between the first and second ceiling planks, and most of all the pattern of fasteners along the upper surfaces of the floor timbers, the original presence of these internal

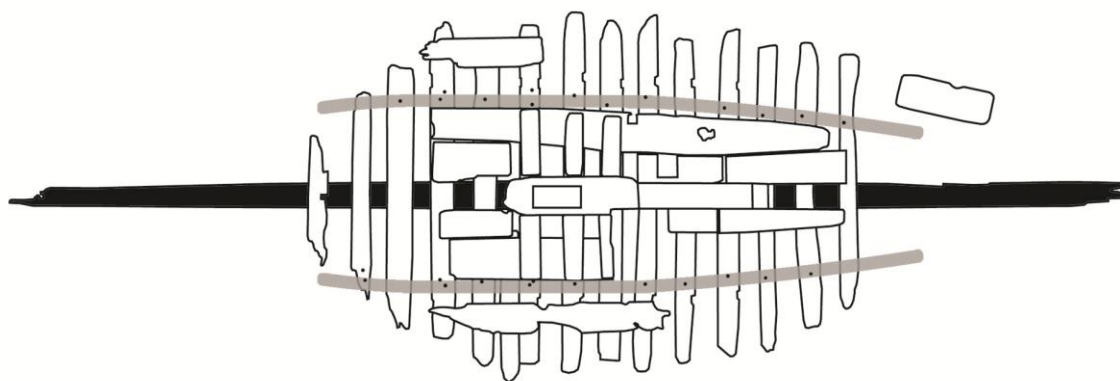

Figure 4.65: Simplified view of the preserved timber with marked positions of potential foot wales. (not to scale)

reinforcements was discerned (fig. 4.65). Outboard of the first ceiling planks and slightly inboard of the dovetail mortise-and-tenon joints of the central framing, the top surfaces of the frames exhibit a row of fasteners running fore-and-aft along each side of the ship. These consist of common 10 mm to 12 mm nails and more sporadic larger 15 mm to 20 mm spikes (fig. 4.66; table 4.12).

Based on this pattern, it appears that these fasteners could have secured the now missing foot wales to the frames; this bond in effect reinforced not only the buttresses, but also the overlaps between floor timbers and first futtocks. Although the dimensions of the foot wales are unknown, the minimum width would have varied between 14 cm and 16 cm, while the minimum thickness was at least 5 cm. With the exception of the Cattewater Wreck, which had neither foot wales nor buttresses, the internal assembly of the Western Ledge Reef Wreck follows characteristic shipbuilding methodology associated with the vessels built along the Atlantic coast of Iberian Peninsula (fig. 4.67).¹¹⁷

4.9 THE UNIDENTIFIED, UNASSIGNED, OR MISCELLANEOUS TIMBERS

The catalog contains 23 timbers designated during the excavation as unknown or unassigned (prefix - "UN"). Since the current research began, the author managed to positively identify some of the structural elements, while identification of others has been unattainable. In either case, the inability to assign proper provenience, orientation, and location to these timbers within the ship's hull and on the site plan obliges us to

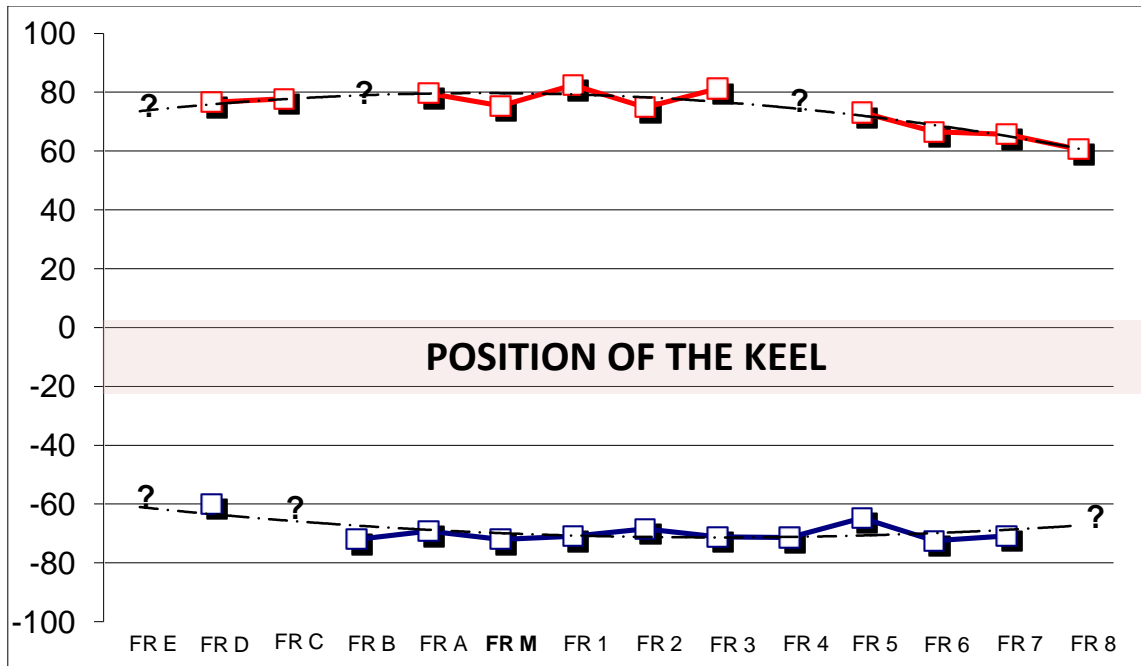

Figure 4.66: Graph representing the distribution of foot wale fasteners: red line shows center-to-starboard wale fasteners, blue line: center-to-portside wale fasteners.

Table 4.12: Distances from the center axes of the ship to the portside (Port) and starboard (Stbd.) foot wale fasteners; diameters of the fasteners.

FASTENERS ASSOCIATED WITH POSSIBLE FOOT WALES				
Frames	Center-to-Stbd Wale Fastener	Center-to-Port Wale Fastener*	Stbd SQ Nails/Spikes (mm)	Port SQ Nails/Spikes (mm)
FR E			?	?
FR D	76.6	-59.9	13	11
FR C	77.8		20	?
FR B		-72	?	12
FR A	79.6	-69.2	20	15
FR M	75.4	-72	15	12
FR 1	82.4	-71	20	20
FR 2	74.8	-68.4	12	10
FR 3	81.2	-71.2	10	12
FR 4		-71.4	?	12
FR 5	73.1	-64.8	12	12
FR 6	66.5	-72.5	12	10
FR 7	65.7	-70.8	20	15
FR 8	60.6		12	?

*) For the purpose of the graph, the distances from the center to the portside wale are presented as negative numbers

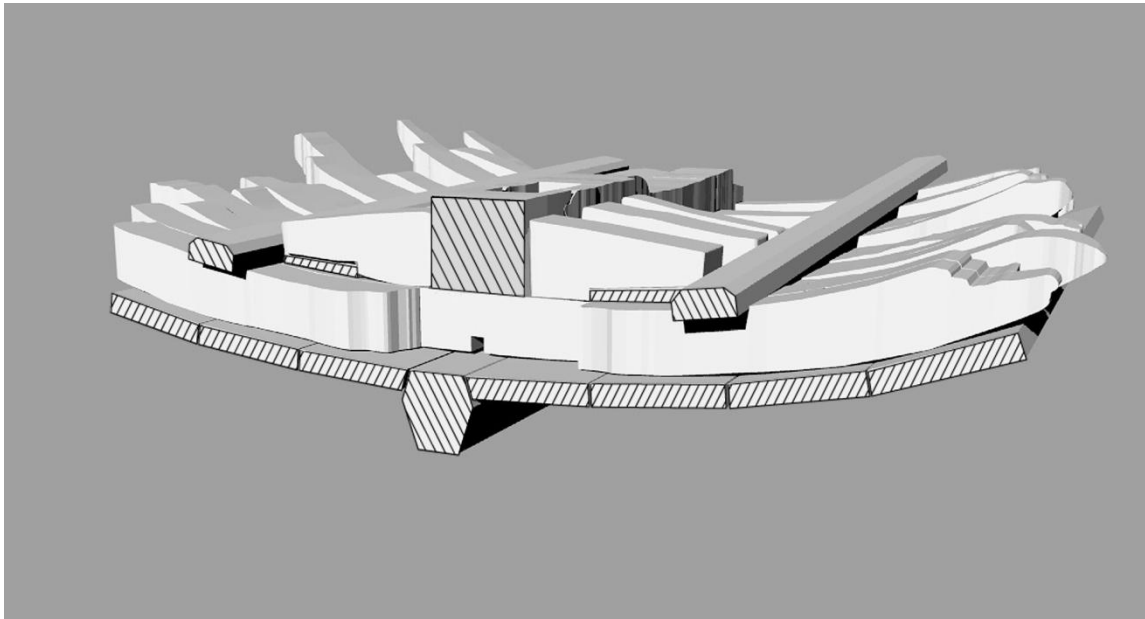

Figure 4.67: Hypothetical reconstruction of the midship section, cutaway view just forward of the master frame. (not to scale)

group them under this section. Unless stated otherwise, these are presented here based on their tentative identification.

Floor Timbers

Unidentified frame one (FR UN 1), unidentified frame four (FR UN 4), and unidentified timber twelve (UN 12) are tentatively associated with the ship's floor timbers. Although poorly preserved, their distinctive shapes and characteristics indicate that unidentified frame one (FR UN 1) and unidentified frame four (FR UN 4) could have belonged to a group of rising floor timbers aft of the dovetail scarfed series, while unidentified timber twelve (UN 12) could have belonged to the corresponding group forward.

Originally fastened to the keel with 2 iron nails, unidentified frame one (FR UN 1) represents an almost complete floor timber associated with the group located between the scarfed floor timbers and stern crotches. It measures about 213 cm in breadth, 21.5 cm in molded height, and 12 cm in sided width. The center of the floor is fashioned as a flat pedestal with a square limber hole. From there, two arms extend up at 133° angle. Along the outboard surfaces, the frame-to-planking fastening pattern consists of a combination of square nails and treenails. Interestingly, two of the treenails that extend the entire thickness of the timber have square nails driven into them from the inside. In addition, the timber does not have evidence of any horizontal fasteners connecting its arms to potential first futtocks.

A second floor timber, unidentified frame four (FR UN 4), appears to belong to the same group of frames associated with the after section of the keel. It is represented by a starboard arm with its port side missing. It measures 117 cm in extant breadth, 29 cm in modeled height, and 22 cm in sided width. It consistently exhibits a flat central pedestal with impressions of the square nails which once fastened it to the keel and a partial square limber hole. If the limber passage was centered over the keel, a mirror projection of the nonextant portside arm would produce a 126° angle in between the two halves. This, in turn, suggests that the unidentified frame four (FR UN 4) must have been located further aft than unidentified frame one (FR UN 1). The outboard frame-to-planking fastening pattern includes 12 mm square nails and treenails. Overall, the floor timber appears to be manufactured from lower quality wood with a large natural wane along the centerline, a defect that could have been responsible for its eventual breakage.

Compared to the previous two, the gentle curvature of timber unidentified timber twelve (UN 12) is reminiscent of the floor timbers of frames D and E (FR D and FR E) forward. It extends for about 119 cm and measures 12.6 cm in molded height by 14.6 cm in sided width. Although none of the surfaces provide much reliable data, the center of the timber still exhibits a partial 4 cm deep limber hole, while the inboard surface has a separate small fragment of broken board, possibly part of a ceiling plank, still nailed into it. The fastener impressions include square nails and treenails. Interestingly, the bottom or planking surface has an additional 22 mm diameter empty treenail hole, which does not penetrate the entire thickness of the timber.

Futtocks

Found scattered at different areas of the site, the inventory contains nine unidentified framing timbers (FR UN 2, FR UN 3, FR UN 5, FR UN 6, UN 3, UN 4, UN 13, UN (P) F19 IV/2, UN FR19 IV/3) tentatively identified as futtocks. Due to their fragmentary nature and lack of evidence related to their position within the hull, these could not be assigned to any particular group; they are documented here as generic futtock timbers. Based solely on the cross-sectional dimensions, these are divided into two broad groups.

The first group includes the unidentified framing timbers (FR UN 5, UN 3, UN 4, UN 13, UN (P) F19 IV/2). These measure about 10 cm by 10 cm in maximum cross-section and extend from 53 cm to 110 cm in length. They are characterized by more severe deterioration and irregular shapes of the surfaces, which in some cases still follow the geometry of large arcs. Unfortunately, none the arced surfaces could be measured with any degree of confidence. Where surfaces are preserved, the timbers exhibit a familiar pattern of square iron nails and treenails, including some which do not penetrate the entire thickness of the timbers. Most of the fasteners are located along what appears to be the outboard surfaces.

The second group of framing timbers (FR UN 2, FR UN 3, FR UN 6, UN FR19 IV/3) is characterized by larger cross-sectional dimensions. They average 17 cm in sided width, 13 cm in molded height, and measure between 39 cm and 98 cm in extant length. Although broken at both ends; the timbers exhibit numerous surface details, areas of natural waney, knots, and generally twisted grains suggesting rather poor quality wood.

In one case, the unidentified extant frame six (FR UN 6) appears to be cut off from the rest of the futtock with an axe. Collectively, these exhibit a consistent pattern of square iron nail impressions and treenails along slightly curved outboard surfaces. With the exception of unidentified frame three (FR UN 3), which was found on the starboard side of the hull in the vicinity of the floors D and E; the provenience of these timbers could not be established.

Stern Crotch or Futtock

Unidentified timber fifteen (UN 15) could represent a highly deteriorated stern crotch. It measures 22 cm by 12.4 cm, with the former dimension taken along the surface with the fasteners; and 98 cm in extant length. It is broken at both ends, with one of the possible arms entirely missing. Surfaces are degraded with numerous cracks, gouged areas, and concretion build-ups. The fasteners, which are present in a row only on one surface, are 9 mm to 11 mm square nails and an isolated treenail.

Sternpost Fragment

Although largely concreted and uneven, unidentified timber one (UN 1) is tentatively identified as a fragment of the upper sternpost with remnants of diagonal planking still attached. One of its surfaces exhibits a row of square nails to which diagonally placed remnants of shorter and thinner boards were originally attached.

Ceiling Plank (UN 5)

Found on top of the starboard planking just aft of the eighth frame (FR 8), unidentified timber five or C (UN 5, also labeled as UN (C)) represents a rectangular board, most likely a complete plank of one of the ceiling strakes. It measures 79 cm in length and 29 cm in width. Although the fasteners have corroded away, impressions suggest that this plank was once secured with three square nails placed along its centerline.

UN 2

Based on the excavation notes from 1989, this timber was discovered loosely associated with the starboard planking of the lower stern assembly. Overall, it is slightly curved and extends for about 93 cm. It has an unusual oval cross-section, 19 cm at its maximum diameter, which is reminiscent of a log. Both top and bottom ends are sawn off while the timber is crudely fashioned with large natural waney and sapwood still present. The timber also lacks any fastener impressions or concretions.

UN 6, UN 7, UN 8, UN 9, UN 10, UN 11 and UN 16

These timbers as a group could represent deteriorated fragments of external planks or ceilings. They measure from as little as 27 cm to as much as 63 cm in length, and from 7 cm to 12 cm in width. Although they generally have a rectangular shape, all the edges are deteriorated or broken. In the case of the timber UN 16, the dimensions are slightly larger and the plank measures 73 cm in length by 19 cm in width. It also

displays unusual pressure and adze marks along one of the surfaces. When fastener impressions are preserved, they are exclusively 12 mm square nails. At this stage, it is impossible to relate these timbers to the rest of the hull structure.

ENDNOTES

¹ Warnock 1990.

² See Panshin and Zeeuw 1970, 569-72.

³ See Henry and McLaughlin 1986.

⁴ Grenier et al. 2007, 3: 270-2.

⁵ For the discussion refer to Goodman 1997, 68-76.

⁶ The catalog used in the dissertation follows the methodology established by Steffy 1994, 205-13.

⁷ Watts 1993a, 110-1; among other designations, a drafting polyester film is commonly known by its brand name mylar®.

⁸ Grenier et al. 2007, 1: 113-48.

⁹ For the information related the software, its applications, and capabilities refer to the manufacture's website located at <http://www.rhino3d.com/>. For this analysis, the author used an educational version.

¹⁰ For the methodology used to study the Mary Rose refer to Marsden and McElvogue 2009, 36-7.

¹¹ Casado Soto 1988, 60-7, 288; Grenier et al. 2007, 3: 16-8; Martin 1977; Trueba 1988.

¹² Casado Soto 1988, 67.

¹³ Grenier et al. 2007, 3: 17; Casado Soto 1988, 288.

¹⁴ Grenier et al. 2007, 3: 17.

¹⁵ See Rodríguez Mendoza 2008.

¹⁶ Keith 1987, 157-70.

¹⁷ Barkham 1981, 29-33.

¹⁸ Arnold and Weddle 1978, 233.

¹⁹ Palacio 1986, 138.

²⁰ Keith 1987, 164-7; Arthur and Ritchie 1982, 252-3.

²¹ McCarthy 2005, 72-3.

²² Grenier et al. 2007, 4: 99.

²³ Barkham 1981, 30.

²⁴ Arnold and Weddle 1978, 232 (Figure. 22, e).

²⁵ Grenier et al. 2007, 4: 346.

²⁶ Arnold and Weddle 1978, 232-4.

²⁷ Although not from the Western Ledge Reef Wreck, the author found at least one example of a bolt with hemispherical upset head produced by hammering. The bolt is part of the museum's collection from the wreck tentatively known as *San Pedro*. Discovered in 1950 by Edward (Teddy) Tucker and Robert Canton, the shipwreck was tentatively identified as 320-ton Spanish nao *San Pedro* lost near Bermuda in 1596. Among other items recovered from the shipwreck, the NMB collection includes a well-preserved iron forelock bolt. It measures 505 mm in length and about 29 mm in diameter near the head narrowing to 22 mm by 15 mm at the tip. The head is not added-on but rather upset and measures 43 mm by 51 mm. At the tip the forelock slot measures 27 mm in length by 7 mm in width. A large collection of artifacts from *San Pedro* is located at the NMB.

²⁸ Keith 1987, 157-70.

²⁹ Marsden and McElvogue 2009, 77, 9 (Figure. 5.8, A).

³⁰ Ibid., 81-2 (Sheet F4).

³¹ Watts 1993a, 110.

³² Grenier et al. 2007, 3: 35-40.

³³ Curtis 1919, 27-8; Grenier et al. 2007, 1: 201-12, 4: 323-5; Marsden and McElvogue 2009, 81-2 (Sheet F4); Adams 1985, 287-9; Phaneuf 2003, 56-7, 148 (Figure 37); Garcia and Monteiro 1998, 431-47; Crisman and Garcia 2001. In addition, the surviving section of the keel from the Spanish shipwreck, *San Antonio*, which sunk in Bermuda in 1621, was investigated by the author in August 2010. The extant keel measured about 37 cm in molded height by 37 cm in sided width, but the width of the top surface on which the frames were positioned was only about 17 cm to 18 cm, almost identical to Western Ledge Reef

Wreck. Along the midship section, the keel upper side surfaces were visibly chamfered, while at the stern the chamfer transitioned into a square rabbet. Unfortunately, no garboards were preserved.

³⁴ Marsden and McElvogue 2009, 81-2; Labbe 2010, 41; Grenier et al. 2007, 4: 323-5; Garcia and Monteiro 1998, 431-47; Crisman and Garcia 2001, 8 (Figure. 9).; Detailed drawing of the Angra D stern assembly is on file at the Nautical Archaeology Program, New World Lab, Texas A&M University.

³⁵ Manwayring 1972, 81.

³⁶ Ibid.

³⁷ Labbe 2010, 41; Marsden and McElvogue 2009, 81-2; Thomsen 2000, 70; Grenier et al. 2007, 4: 323-5; Adams 1985, 286 (Figure 10), 2877-9; this technique was also likely used along the keel of Padre Island wreck, *San Esteban* (1554) see Rosloff and Arnold 1984; the author also interviewed Dr. Cemalettin Pulak, Dr. Jonathan Adams, and used extensive comments by Dr. Donny Hamilton.

³⁸ Loewen 1991, 15; the observations by Loewen (1991, 15) were verified and further researched by the author during the fieldwork in summer of 2010.

³⁹ Arnold and Weddle 1978, 380-1.

⁴⁰ Ibid.

⁴¹ Lemee 2006, 273-4; Adams 2003, 122-3 (Figure 5.9).

⁴² Grenier et al. 2007, 1: 208-9, 3: 44-45; Rosloff and Arnold 1984; Villié 1994, 19-25; Adams 2003, 122-3.

⁴³ Grenier et al. 2007, 3: 43-4.

⁴⁴ Ibid., 1: 208; Rosloff and Arnold 1984.

⁴⁵ Adams 2003, 122-3.

⁴⁶ Smith et al. 1995, 66; Villié 1994, 82; Rosloff and Arnold 1984, 291-3; Grenier et al. 2007, 3: 48.

⁴⁷ See Rosloff and Arnold 1984, 289-95; McCarthy 2005, 69-70.

⁴⁸ Grenier et al. 2007, 3: 79-80.

⁴⁹ Rosloff and Arnold 1984, 293.

⁵⁰ Although the largest frame or section of the vessel is usually termed the midship frame, it is not always located at the center of the keel or at mid-length between perpendiculars. Since this is also the case on the Western Ledge Reef Wreck, the largest frame is defined here as the mast frame.

⁵¹ Oertling 2001, 235; 2004, 129-30.

⁵² Grenier et al. 2007, 3: 59.

⁵³ Ibid., 3: 57 (Table 14.2.2).

⁵⁴ Rieth 1996a, 119-24.

⁵⁵ Grenier et al. 2007, 3: 71-2.

⁵⁶ See Marsden and McElvogue 2009, 36-43; Grenier et al. 2007, 3: 90-3.

⁵⁷ Barker 1991, 63-6.

⁵⁸ Grenier et al. 2007, 4: 309-80.

⁵⁹ Ibid., 4: 330.

⁶⁰ Ibid., 4: 331-4.

⁶¹ Lane 1992, 35-53; Adams 2003, 106-8; Baker c. 1580.

⁶² See Pimentel Barata 1989, 2: 181-8; Castro 2007.

⁶³ Kirsch 1990, 118; Baker 1958, 32.

⁶⁴ Pimentel Barata 1989, 184-5; Castro 2007, 150.

⁶⁵ Pimentel Barata 1989, 184-5.

⁶⁶ Castro 2007, 151.

⁶⁷ Watts 1993a, 110.

⁶⁸ Barkham 1981, 22 (Table A).

⁶⁹ Ibid.

⁷⁰ Ibid.

⁷¹ Grenier et al. 2007, 3: 37, 104.

⁷² The bevel is measured as the angle between the flat outboard surface of the plank and the edge, which originally formed a seam with the keel.

-
- ⁷³ Rosloff and Arnold 1984, 293; Blake and Green 1986, 6-7; although similar lead strips were found between some of the planks of the Molasses Reef Wreck, the exact method of how they were held in place could not be determine, see Keith 1987, 153-4.
- ⁷⁴ Keith 1987, 168.
- ⁷⁵ Blake and Green 1986, 7.
- ⁷⁶ Ash 1948, 162.
- ⁷⁷ Palacio 1986, 138.
- ⁷⁸ Daminiadis 1991.
- ⁷⁹ *Ibid.*, 99-100.
- ⁸⁰ Thomsen 2000, 75.
- ⁸¹ Barkham 1981, 32 (Table. 4).
- ⁸² Underhill 1983, 165-75.
- ⁸³ The dimensions of a log which could accommodate both garboards side by side were hypothetically reconstructed by the author using Rhinoceros© 3-D modeling software (<http://www.rhino3d.com/>)
- ⁸⁴ Goodman 1966, 131-40; Mercer 1975, 21-5; Underhill 1983, 172.
- ⁸⁵ Bill 1994, 157.
- ⁸⁶ Although related bibliography is extensive, for basic discussion related to Mediterranean plank-to-frame fastening pattern of the period see McCarthy 2005, 44-7; Guérout et al. 1989, 60-6; Martin 1979, 29-30. For discussion related to Northern European plank-to-frame fastening pattern of the period see McCarthy 2005, 56-7; Marsden and Collins 2003, 94; Marsden and McElvogue 2009, 77; Adams 1985, 292; Martin 1978, 47-8 (Figure 21). For a general dissection related to Iberian-Atlantic plank-to-frame fastening pattern refer to Oertling 2001; 2004, 130-1.
- ⁸⁷ Oliveira 1991, 151.
- ⁸⁸ McCarthy 2005, 64-5; Marsden and McElvogue 2009, 77; The treenail caulking pattern found on the late 16th-century 'Gresham Ship' appears to be identical to what was found on the Western Ledge Reef Wreck, see Auer and Firth 2007, 229. Although the majority of the treenails were neither wedged nor caulked, a few showed distinct caulking cuts, see Adams 1985, 292. In addition, the heads of the treenails on the *Dartmouth* were caulked with oakum inserted into triangular or criss-cross cuts, see Martin 1978, 47-8.
- ⁸⁹ Oertling 2001; 2004, 130-1.
- ⁹⁰ A description of the process of careening based on the late 17th-century Portuguese manuscript can be found in Barker 1997.
- ⁹¹ Grenier et al. 2007, 3: 152-3.
- ⁹² See Smith 1993, 66.
- ⁹³ Garcia and Monteiro 1998, 442-3; Crisman and Garcia 2001; Fraga 2007, 133-4; Marsden and McElvogue 2009, 83-4.
- ⁹⁴ Keith 1987, 161-3.
- ⁹⁵ Grenier et al. 2007, 1: 209-10, 3: 155.
- ⁹⁶ See Oertling 2001, 2004; Grenier et al. 2007, 1: 201-12, 3: 152-7.
- ⁹⁷ Bonino 1978, 13-5; Beltrame 2009; Guérout et al. 1989, 72-5; Grieco 2003, 19, 29 (Figure 12).
- ⁹⁸ Roberts 1990, 124-5; Weski 1999, 370-1; Lahn 1992, Blatt 19; Marsden and McElvogue 2009, 95; Garcia and Monteiro 1998, 442.
- ⁹⁹ Beltrame 2009.
- ¹⁰⁰ *Ibid.*, 413.
- ¹⁰¹ *Ibid.*; Alves et al. 2001b, 2001c.
- ¹⁰² Grenier et al. 2007, 3: 152-4.
- ¹⁰³ Goodman 1997, 68-76.
- ¹⁰⁴ See discussion in Loewen 2000.
- ¹⁰⁵ Clayton 1976, 243.
- ¹⁰⁶ Casado Soto 1991, 99.
- ¹⁰⁷ Oertling 1996, 16-20.
- ¹⁰⁸ Watts 2003, 66-83.

¹⁰⁹ See Oertling 1989d, 589-90.

¹¹⁰ Morris 1990, 64.

¹¹¹ Smith 1994, 15; Garcia and Monteiro 1998, 443; Fraga 2007, 135; Grenier et al. 2007, 1: 211.

¹¹² Garcia and Monteiro 1998, 440, 3.

¹¹³ Grenier et al. 2007, 1: 205.

¹¹⁴ *Ibid.*, 3: 161.

¹¹⁵ Barkham 1981, 22.

¹¹⁶ According to Steffy (1994, 271), foot wales are those thick longitudinal strakes of ceiling which run over the scarfs between the floor timbers and first futtocks (at or near the turn of the bilge) on each side of the vessel.

¹¹⁷ Redknap 1985, 42; Steffy 1994, 133-4; Oertling 2004, 132-3.

CHAPTER V

RECONSTRUCTION OF THE WESTERN LEDGE REEF WRECK HULL REMAINS

*“A Most Excellent Mannor for the Building of Shippes”*¹

When the work with the multitude of preserved structural elements began, it was apparent that in order to reconstruct the basic dimensions and form of the Western Ledge Reef Wreck one would have to revert to the principles of reversed engineering, or more appropriately, “reverse naval architecture.”² Piece by piece, the timbers, timber fragments, evidence of the assembly, and methods of construction were combined to make more deliberate, albeit only hypothetical, determinations into the design of a complete vessel. Contrary to quite relaxed rules governing the design of modern ships made of epoxy or steel, the form of the earlier wooden craft was bound by many limitations. A wooden plank can only be bent so far before it breaks.

Although the process began much earlier, the Iberian naval architecture of the 16th and early 17th centuries was marked by important developments. Shipwrights began a slow departure from an unempirical and intuitive style, and implementing, at least to some extent, ship designs based on mathematical and geometrical means. As these were largely based on proportions and logic, as opposed to pure art, it is possible to recreate the processes even if only small section of the bottom hull survived.³ By amalgamating the archaeological data with large body of documentary shipbuilding sources written

before 1620, the possibility of reconstructing the Western Ledge Reef Wreck became a reality.⁴

5.1 THE LENGTH OF THE KEEL

The three most important parameters which had to be defined before the construction of a new ship could begin were the length of keel (*quilla*), the maximum breadth (*manga*), and the depth of hold from the height of the main deck (*puntal*). In addition to these key measurements, the shipwright had to define and adhere to a set of proportions and geometrical rules delineating the extremities of the hull, the shape of the master frame, and the mechanism of projecting other frames forward and aft.

The first objective was to define the length of keel. According to the 16th-century Basque shipbuilding contracts, its length was measured from the middle of the keel-stem scarf to the sternpost rabbet.⁵ By reviewing the available data from the hull catalog presented in chapter IV, section 4.5, it was evident that the preserved section of the keel measured 9.32 m in length and about 22 cm by 23 cm in maximum recorded cross-section. Critical for the reconstruction, its forward extremity was identified as a portion of the original keel-stem scarf. What was much less complete was the aft extremity, which broke off sometime during the wrecking. Nothing survived in between the stern assembly and the central section of the hull. In order to reconstruct this missing section and determine the total length of the original keel of the ship, the author tested a hypothesis originally proposed by Loewen.⁶ In short, the hypothesis states that two

fragments, namely the preserved keel and the stern assembly, could be connected through properly faired runs of the starboard strakes.

To reconstruct this section, the 1:10 scale timber drawings were analyzed with a graphic program Photoshop®. In addition, the same drawings were used to build a computer model with Rhinoceros® 3-D modeling software. Both methods proved imperfect in conceptualizing complex curvature of the stern section of the vessel. There was also a lingering question related to the physical properties of the original material, which could not be accurately accounted for on the computer screen. To overcome some of these limitations, a traditional plank-on-frame research half-model was developed based on the preserved structural members of the starboard side of the hull (fig. 5.1).⁷ The scale was set at 1:10, providing a large enough working platform to increase the reliability of plank fairing. The keel, framing timbers, stern knee, and sternpost were all fabricated from pine. The planking was made of poplar. After laying down the keel, which was purposefully extended aft beyond the area of actual preservation, the extant floor timbers were glued at the intervals matching the original nail impressions. Since the primary question of this reconstruction was the location of the stern knee and the sternpost, which could approximate the length of the keel aft, these two elements were attached with temporary clamps so they could be easily shifted along the graduated scale representing intervals of 10 centimeters (1 cm in 1:10 scale of a model) (fig. 5.2). Next, the preserved sections of the stern planking and the battens were added. The first

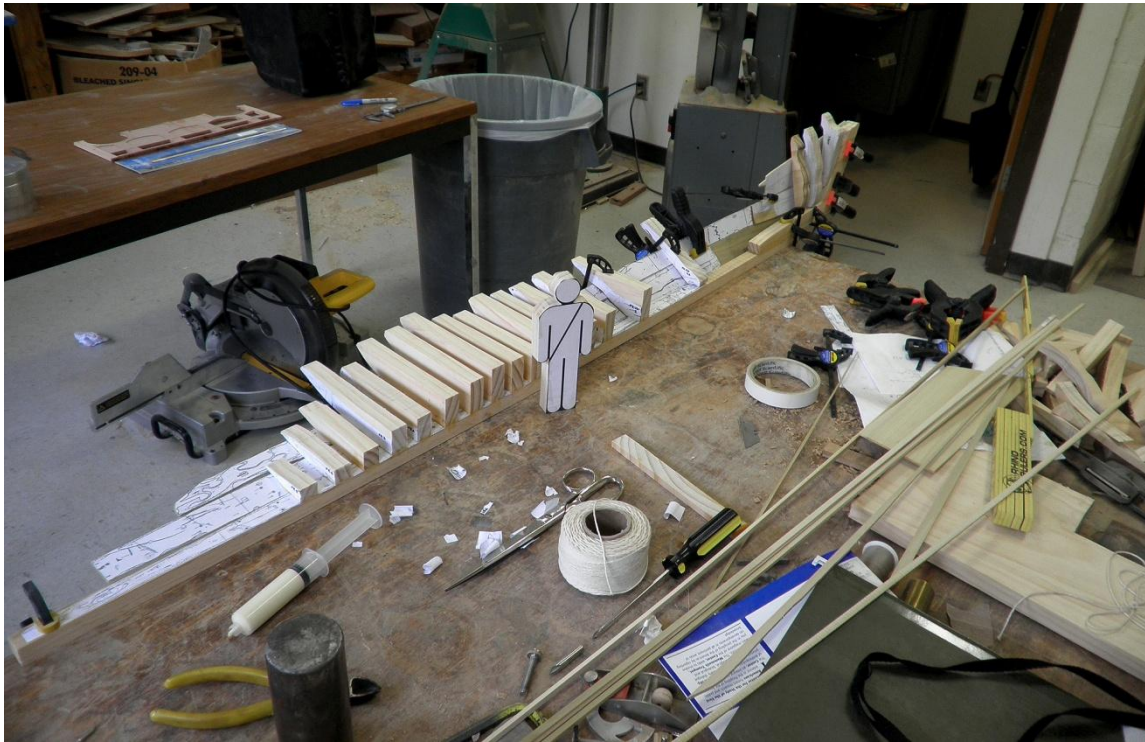

Figure 5.1: Research half-model based on the selected preserved timbers.

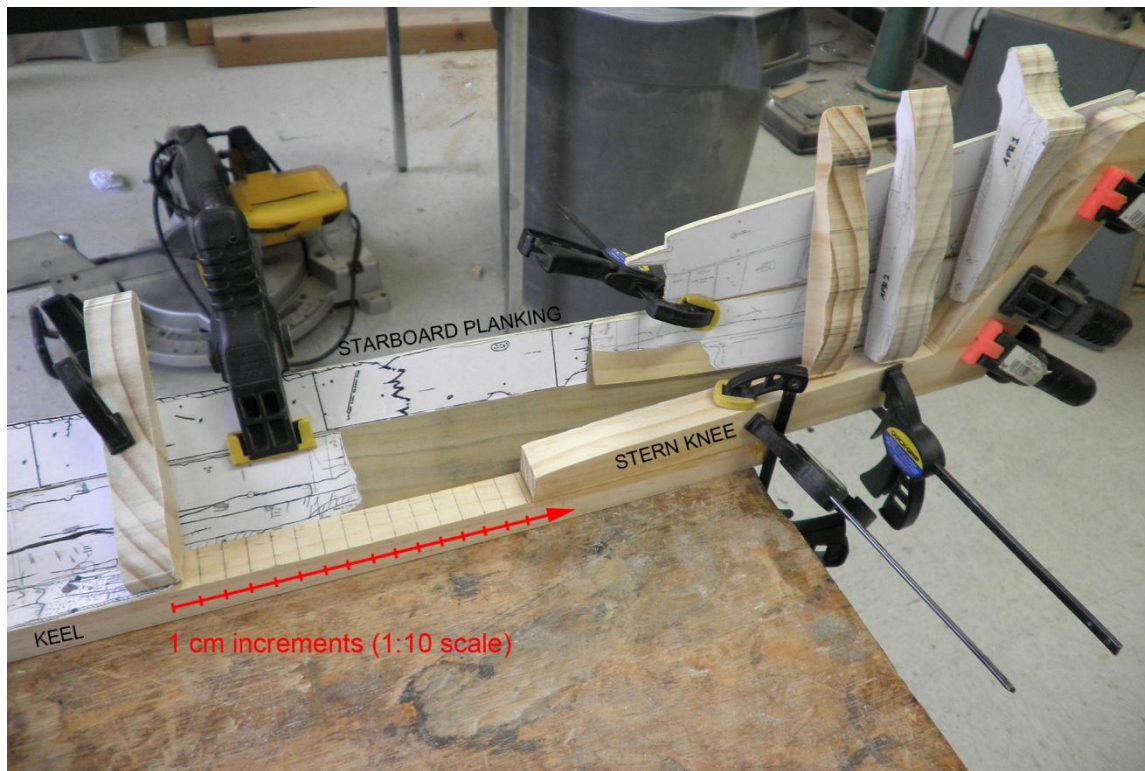

Figure 5.2: Graduated scale facilitating the positioning of the stern knee and stern post along the aft portion of the keel.

batten corresponded with the top edge of the first strake (the garboard) and the second one with the top edge of the second strake. The run of the second batten also matched the location of the inner edge of the mortise at the master frame. This produced preliminary shape of hull, which could be further faired and readjusted (fig. 5.3).

To test the hypothesis of a possible mend between one of the starboard stakes and the preserved stern planking, the battens were replaced with the extant garboard and the rest of the starboard was planked. These were glued to the frames as to match the majority of fastener locations. Even though the planks were repeatedly readjusted, a perfect match between all fastener impressions was unfeasible. By bending the planks over the preserved frames, the best mend was achieved by butting the second starboard strake (PS 1) with the two stern planks designated as APS 2 and APS 3. These planks were not only the second and third starboard stakes, they were also originally found still fastened to the sternpost rabbet (fig. 5.4). Although other arrangements were carefully tested, the preserved evidence did not support alternative solutions to the run of the planks between the midship and the sternpost rabbet. By butting the PS 1, whose location within the ship was well established, with the APS 2 and APS 3 at the stern, the total length of the keel was recreated. The keel was extended down from the presumed keel-stem scarf to the sternpost rabbet providing an approximate length of 135 cm (in 1-to-10 scale of the model). After converting it to 1-to-1 scale, the total length of the keel measured 13.5 m, or about 23 1/2 *codos*.

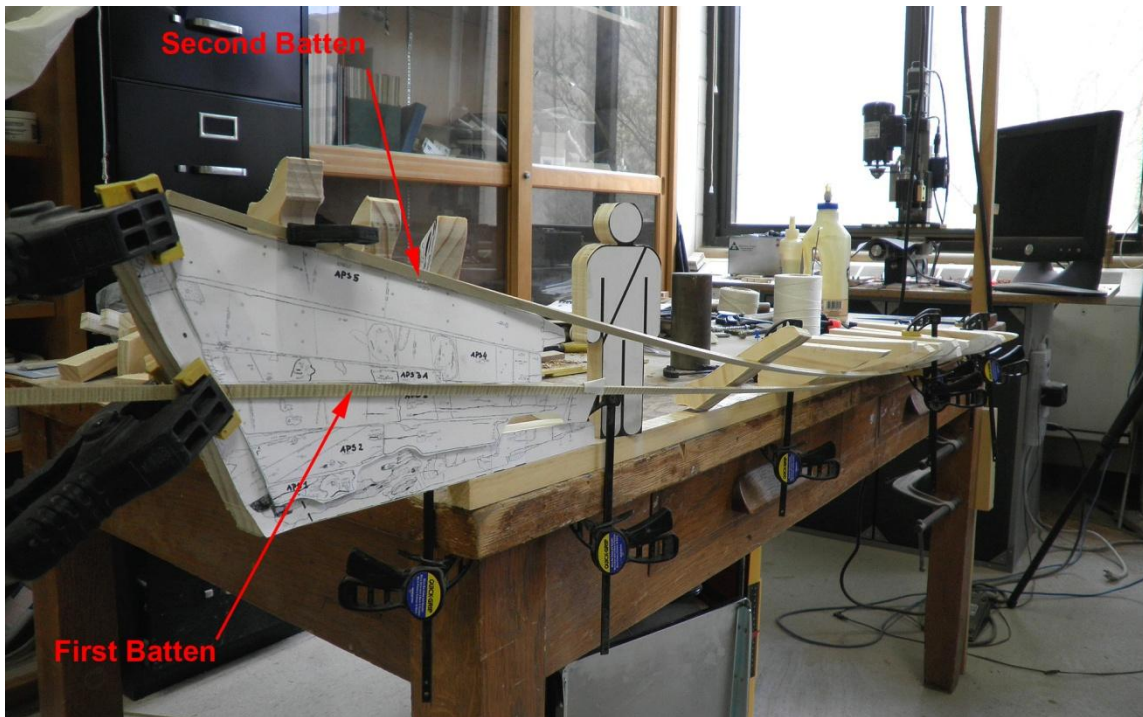

Figure 5.3: Positioning of the preserved sections of the stern planking and the two guiding battens.

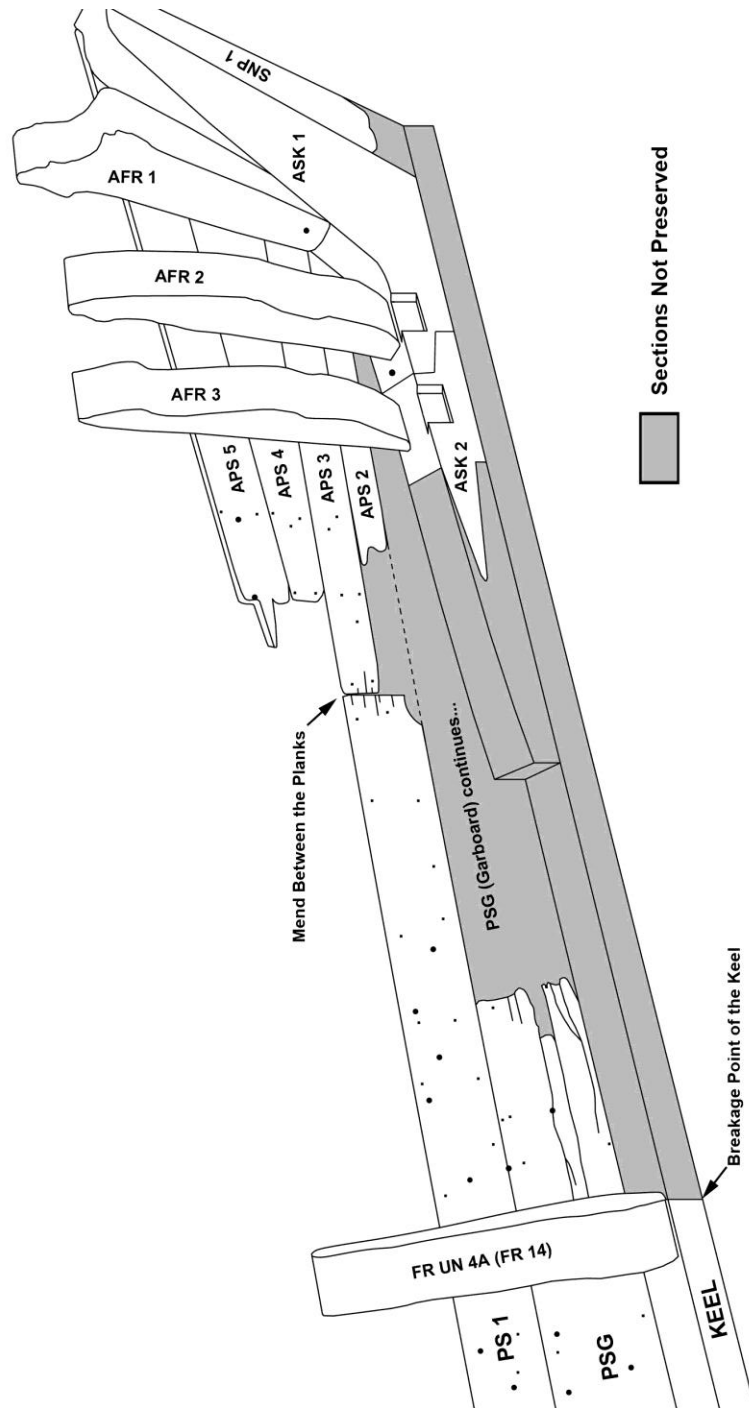

Figure 5.4: Schematic overview of the mend along the second starboard strake (PS 1) and the two stern planks. (APS 2 and APS 3) (not to scale)

The center of the master frame on the reconstructed keel was located 4.3 m, or about 7 1/2 *codos*, abaft the keel-stem scarf and 9.2 m, or about 16 *codos*, forward of the sternpost rabbet. In other words, 0.321 (slightly less than one-third) of the length of keel was located forward, while 0.679 (about two-thirds) was abaft. By comparison to the Red Bay (24M) Wreck, on which the master frame was located at about 0.428 (about three-seventh) of the keel length from the keel-stem scarf, the one from the Western Ledge Reef Wreck was approximately 0.109 or 11% closer to the forward extremity of the keel.⁸ This position, at or near the end of the forward third of the keel, corresponds well with the Iberian and English designs known from the shipbuilding treatises of the period. Taking a close look at Ferandez's drawing, the master frame splits the keel of a large four-decked nao into 0.328 forward and 0.672 abaft (fig. 5.5).⁹ According to Oliveira, it splits the keel of 18 *rumos* in length into 0.364 forward and 0.636 abaft.¹⁰ Whereas according to Barker's calculations of several designs, the keel is split into 0.362 forward and 0.638 abaft on three out of six profiles, and 0.308 forward 0.692 abaft, 0.368 forward 0.632 abaft, and 0.388 forward 0.612 abaft on the remaining three.¹¹ One of the Baker's illustrations presents rising and narrowing lines and body projection showing a keel split into 0.333 forward and 0.667 abaft (table 5.1).¹²

Scatter chart (fig. 5.6) puts these two ratios, explaining the position of the master frame on the keel, in perspective. The variables are inversely correlated; as the value of one increases, the value of the other decreases. Notably, the scatter graph illustrates a particularly close correlation among the ratios of the Western Ledge Reef Wreck, the Ferandez's illustration of a nao, and one of the Baker's drawings (fig. 5.7). Evidently,

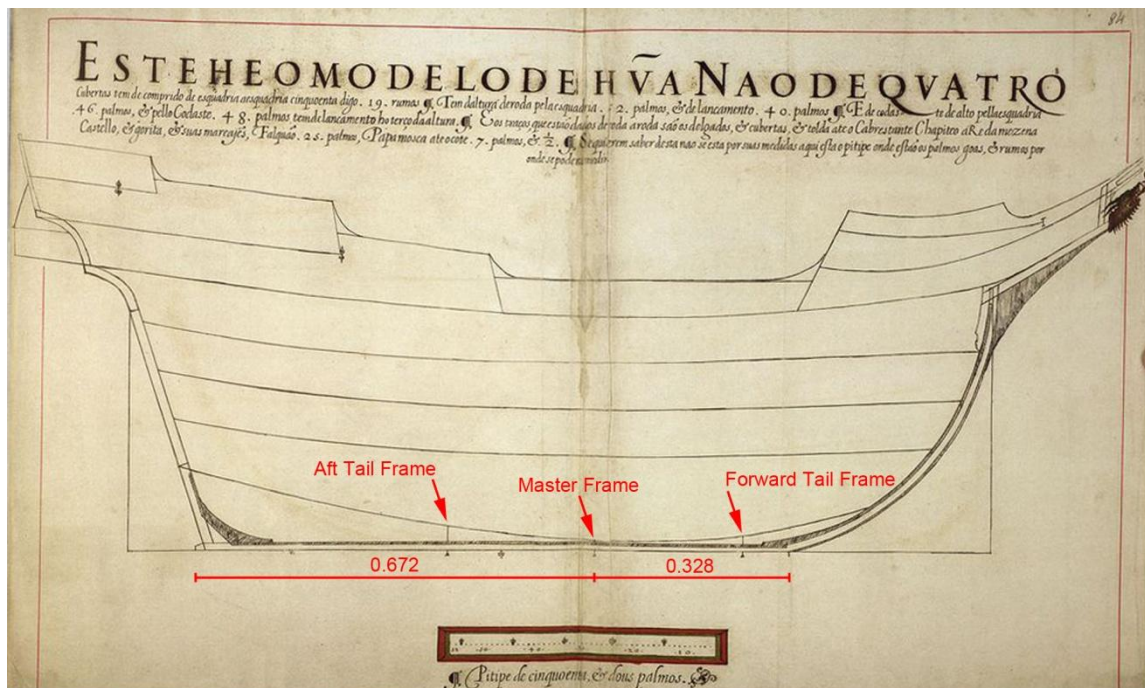

Figure 5.5: Proportions of a four-decked nao of Fernandez's design. (modified after Fernandez 1616, fol. 84., accessed at: <http://nndl.tamu.edu/treatises.html>)

Table 5.1: Selected ratios between the master frame and the bow and stern extremities of the keel. (after Baker c. 1580; Baker 1954, 270; Fernandez 1995, fol. 84; Grenier et al. 2007, 3: 38; Oliveira 1991, fol. 99.)

Position of the Master Frame on the Keel		
	From the Bow	From the Stern
Baker no.2	0.308	0.692
WLRW	0.321	0.679
Fernandez (fol. 84)	0.328	0.672
Baker no. 5 (fol. 21)	0.333	0.667
Baker no.1	0.362	0.638
Oliveira (fol. 99)	0.364	0.636
Baker no.3	0.368	0.632
Baker no.4	0.388	0.612
Red Bay (24M)	0.428	0.572

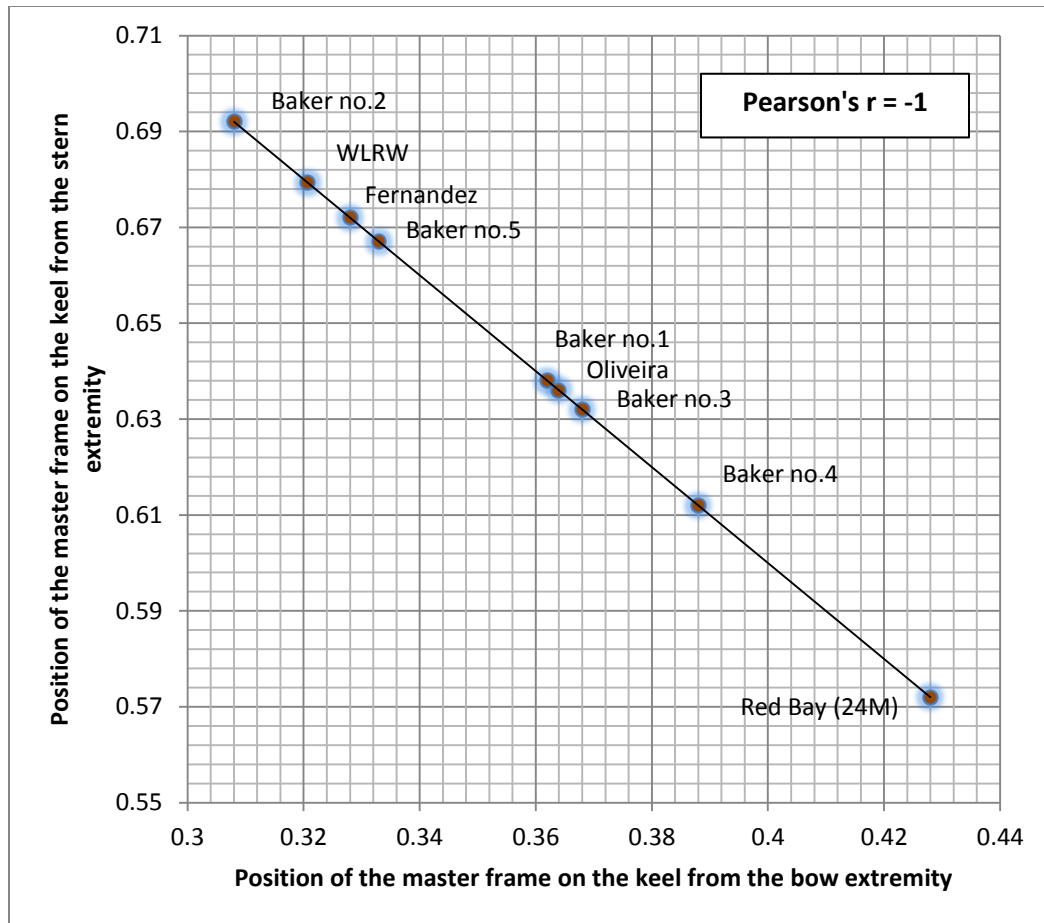

Figure 5.6: Graphical representation of the ratios between the master frame and the bow and stern extremities of the keel. (after Table 5.1)

Baker was not satisfied with a single set of proportions and extensively experimented in an effort to find the most optimal positions of the master frame on the keel, as related to proper trim, stability and best sailing qualities. In Baker's own words:

*“yf the same senter hade ben set on the mydest of the keel then the shipp wold have draw ase much water afore at the forefoot as abaft at the tuke. now foreasmuch as the sentur is moved forod ... the shipp will hange astarne as all shipp doth hose flower lyeth before the mydest of the keel. nowe to know what this shipp will draw abaft more then afore, worke be the ruell of proportion ...”*¹³

5.2 THE DESIGN OF THE MASTER FRAME

As previously noted in chapter IV, section 4.6, the extant master frame was comprised of an entire floor timber and four deteriorated heel ends of the forward and aft facing first futtocks. The master frame did not have a straight horizontal floor. Quite contrary, a section of the timber between the inboard edges of the port and starboard dovetail scarfs (surmarks) was curved. When measured, this section followed an outline of a single floor arc of 10 *codos* in radius. The horizontal distance between such defined surmarks, which constituted a chord of the floor arc stretching from one to the other touch, measured 3 *codos*. Above the level of the scarfs, the geometry changed and the floor timber's wrungheads together with the overlapping heel ends of the first futtocks followed the outline of a smaller bilge arc. At each preserved frame, this arc was tangent to the floor arc and remained constant, measuring 3 *codos* in radius. In other words, for every *codo* of the small bilge arc there was 3 1/3 *codos* of the large floor arc (1-to-3.333 ratio). In addition to the radii, the preserved elements provided enough evidence to discern the precise locations of the centers of the respective arcs (fig. 5.8).

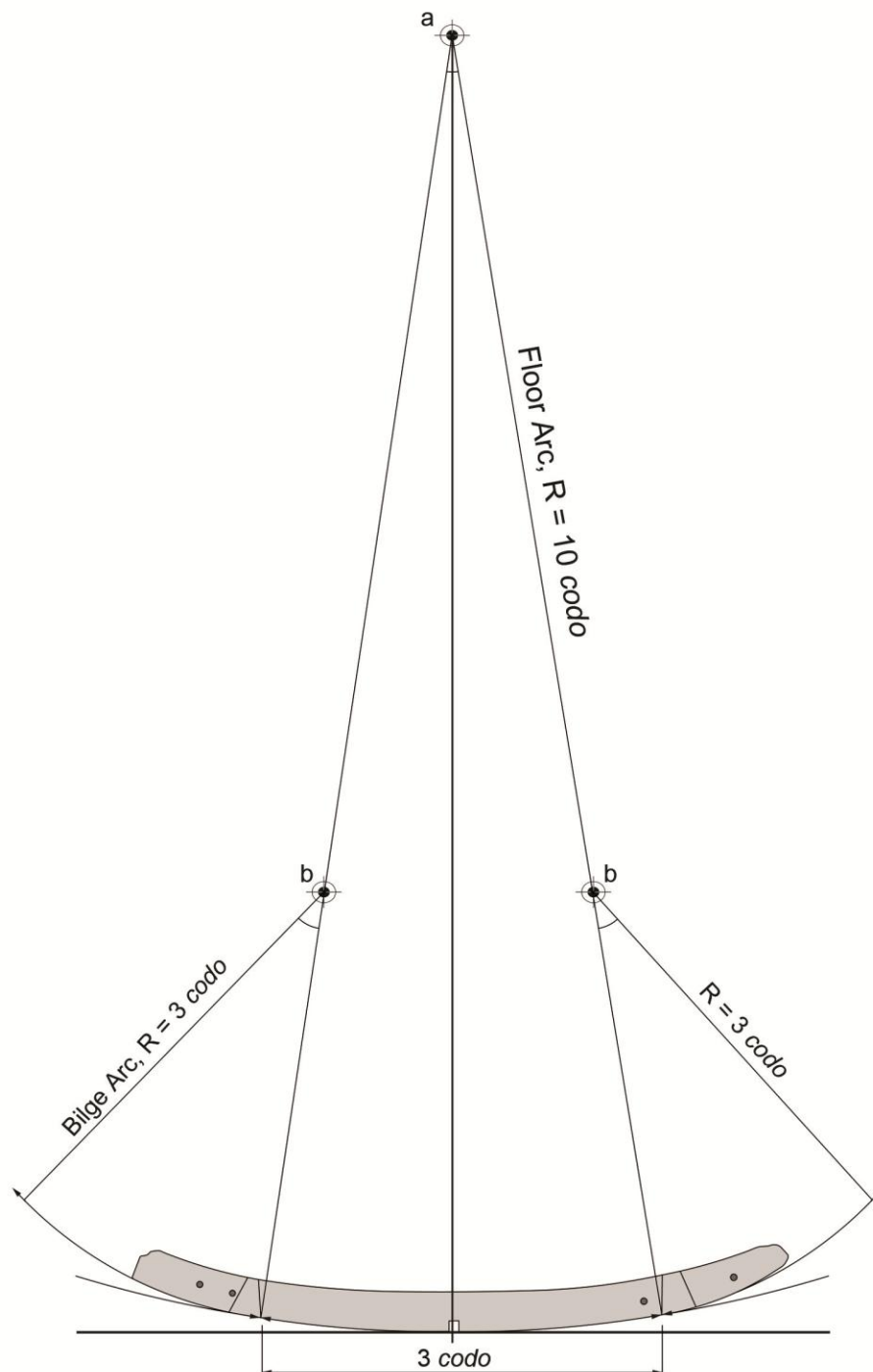

Figure 5.8: Preserved master frame showing the geometry and measurements taken for reconstructing the design: (a) center of the floor arc, (b) center of the bilge arc.

Anchoring the study in 16th- and 17th-century shipbuilding treatises, it appears that a curved floor was featured only in a handful of sources. Venetian examples of midship moulds, particularly one for a galleon and one for a merchantman, were described by Pre Theodoro de Nicolo at around 1550s.¹⁴ Portuguese example of so-called “oval” mould came from a superbly illustrated text by Manoel Fernandez dated to 1616.¹⁵ Yet another Mediterranean example presumably collected during the developmental voyage to Chios in 1552 was Mathew Baker’s “Greek” mould.¹⁶ A somewhat similar concept to the one presented by Baker was also found in the Newton Manuscript as well as in the Scott Manuscript.¹⁷ In addition, there was a known reconstruction, or perhaps an attempt to reconstruct a midship frame with a curved floor of the early 16th-century English ship, *Mary Gonson*.¹⁸ However, lack of appropriate explanation of the applied geometrical principles, particularly the reasoning behind using a curved versus flat floor, made this frame of little use in this research.¹⁹ To author’s best knowledge, the only excavated and well-studied 16th-century archaeological example of an Iberian vessel with curved floor and corresponding frame geometry is the Basque whaleboat, *chalupa* no. 1, from the Red Bay.²⁰

Pre Theodoro de Nicolo (mid-16th century)

A skillful foreman ship carpenter in the Venetian Arsenal, for brevity referred to as Pre Theodoro, provided a number of designs based on a curved floor. The one of particular interest here is a mould for a large merchantman or *nave*. According to the specifications, the ship was to have a keel of 10 *passos* (about 17.4 m)²¹ and depth of

hold to the main deck of 11 1/2 feet. Judging from the drawing, the mould was designed with four tangent arcs and a system of controlled widths placed at key vertical locations. Starting from the bottom, the width of the floor (*fondi*) equaled 7 feet, at 3 feet above the keel (*trepìè*) the width was 13 1/2 feet, and at 6 feet above the keel (*sepiè*) it was 17 1/2 feet, while at the deck level the maximum beam (*bocha*) was 20 feet.²² Comparing the width of the floor to the maximum beam, the ratio equaled 1-to-2.9; thus, for each venetian foot of the floor there was almost 3 feet of beam. Notably, what is defined in the manuscript as the floor or *fondi* appears to indicate the entire horizontal width from one touch between the floor arc and bilge arcs to the other one.²³ This is of great importance to reconstructing the master frame from the Western Ledge Reef Wreck, and reinforces the notion that the 3 *codos* distance between the touches of the floor and bilge arcs is indeed the floor. Within the system of tangent arcs of the Venetian *nave*, the touch between the floor and bilge arcs fell precisely at the spot marking the end of the floor at the width of *fondi* (marked on the drawing with a conspicuous “X” symbol); while the touch between the bilge and futtock arcs at the spot marking the width of *sepiè*. Although explanation is rather limited, it appears that the process of producing the required shape of the mould was governed by a system of adjustable horizontal widths at fixed vertical spots (*fondi*, *trepìè*, *sepiè* and *bocha*) (fig. 5.9). Curiously, within the context of the midship mould based entirely on sectors of different circles, a term “Mediterranean round-ship” takes a new and quite interesting meaning.

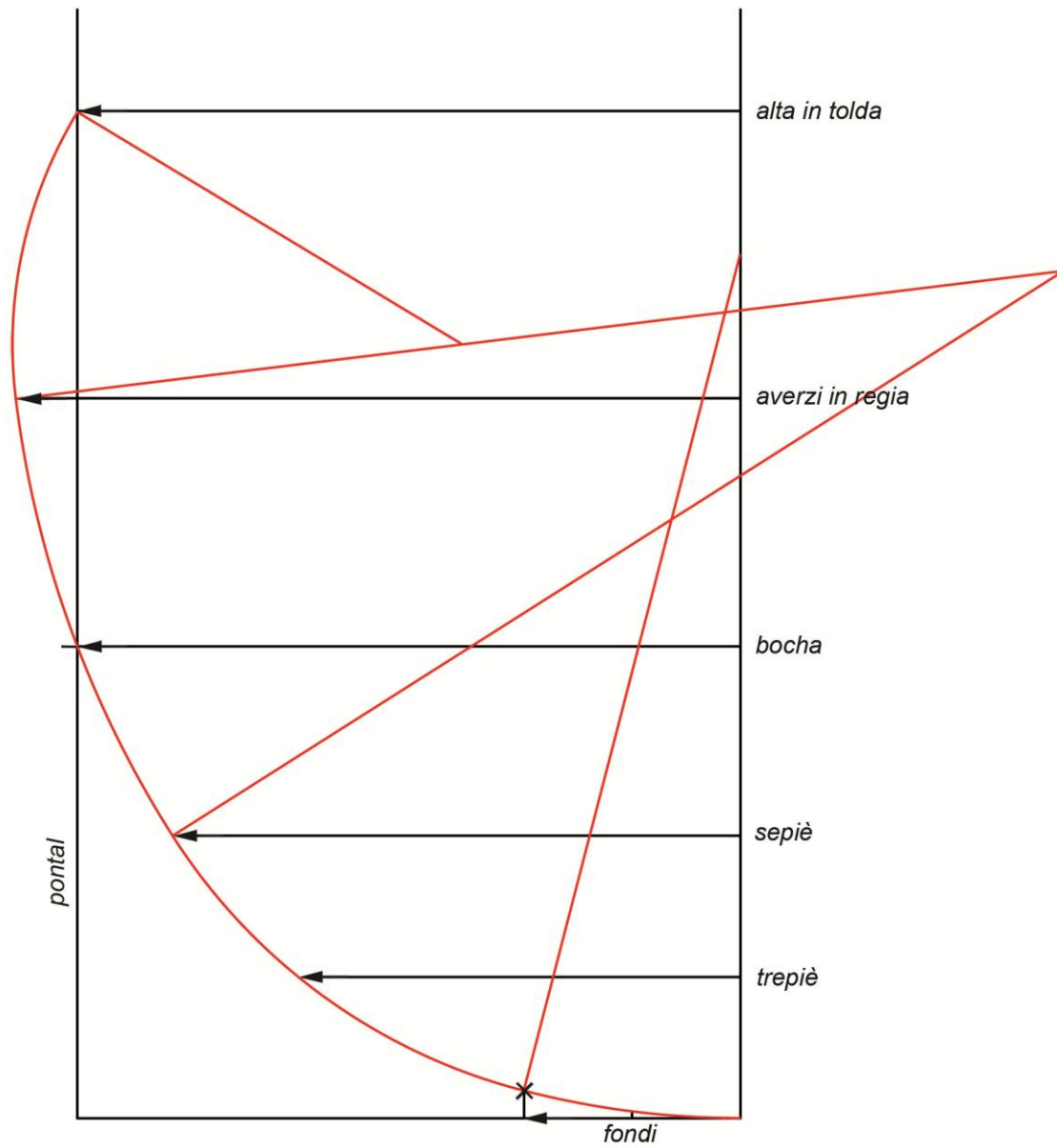

Figure 5.9: Schematic view of the master frame based on Pre Theodoro's design. (after Lane 1934, 47 (Fig. 7).)

Manoel Fernandez (1616)

As presented by Fernandez, the midship mould for a large four-decked nao is unlike any other design in the manuscript, both in term of artistic technique and the level of details.²⁴ The mold was intended for a ship of 19 *rumos* (about 29.26 m)²⁵ of keel and 56 *palmos de goa* (14.33m) of maximum breadth, and included the heights to all four decks. In addition, some of the most exquisite details inform about the centers, labeled as *rols*, of the bilge and futtock arcs, and the breadth of the curved floor marked directly on the frame with two conspicuous vertical lines (fig. 5.10). Graphic analysis in Rhinoceros® 3-D modeling software indicates that the mould was based on a system of five tangent arcs; hence, it is rather curious why the centers of only two are provided by the author of the manuscript. The only feasible explanation could be that these are of special, albeit enigmatic, importance to the design.

Starting from the bottom, the horizontal distance of the curved floor, the chord, measured 15 *palmos de goa*, which was about four times less than the maximum breadth (1-to-4 ratio). The radius of the large floor arc has been calculated to about 40 *palmos de goa* while the radius of prominently displayed and marked bilge arc was two times smaller, measuring 20 *palmos de goa* (1-to-2 ratio). Further up along the mould, the futtock arc as measured from its center was as long as the maximum breadth of the mould. In contrast to the Venetian system of adjustable widths at key vertical locations, the mould contains offsets marked at four constant levels, or every 7 1/2 *palmos de goa*, along the perpendicular.²⁶ It is worth noting that the lowest offset, which according to the inscription on the drawing equals 9 1/2 *palmos de goa*, corresponds precisely with

the touch of the bilge and futtocks arcs.²⁷ Since the text does not provide any explanation of how the system was used in practice, a comparison between the Pre Theodoro's Venetian and Fernandez's Portuguese concepts is to large extent unattainable (fig. 5.11).

Mathew Baker (late 16th-century)

Contrary to Fernandez's drawing, Baker's midship mould and detailed description conveyed even deeper understanding of the geometric processes. This, however, should not be a surprise since Baker was a well-traveled expert in the art of shipwrightry.²⁸ As revealed in the opening sentence of the description, the mould has clear Mediterranean roots, being used by the Greeks for their merchant ships called *screatse*.²⁹ It has been reported that this 16th-century vessel of about 100 tons burthen might be similar to the Turkish *skryasas*, square-rigged Italian *schirazzo*, or what Venetians called *esquiracces*.³⁰ Among the relevant information, there is a maximum breadth of the mould of 40 feet (about 12.2 m) and depth of hold of 10 feet (about 3 m). Nonetheless, the unusually large number for the breadth appeared to be corrupted and according to Barker's interpretation should read only 20 feet (about 6 m) (fig. 5.12).³¹

Of primary importance to the reconstruction of Western Ledge Reef Wreck, the manuscript provides step by step instructions of how to locate the centers and the radii of the tangent arcs. Since the process is based on geometry, there is a strong positive correlation between the maximum breadth of the mould and the radius of the floor arc. In other words, an increase in the maximum breadth brings about a proportional increase in the radius and vice versa (fig. 5.13). Using simple Pythagorean relationship, Baker's

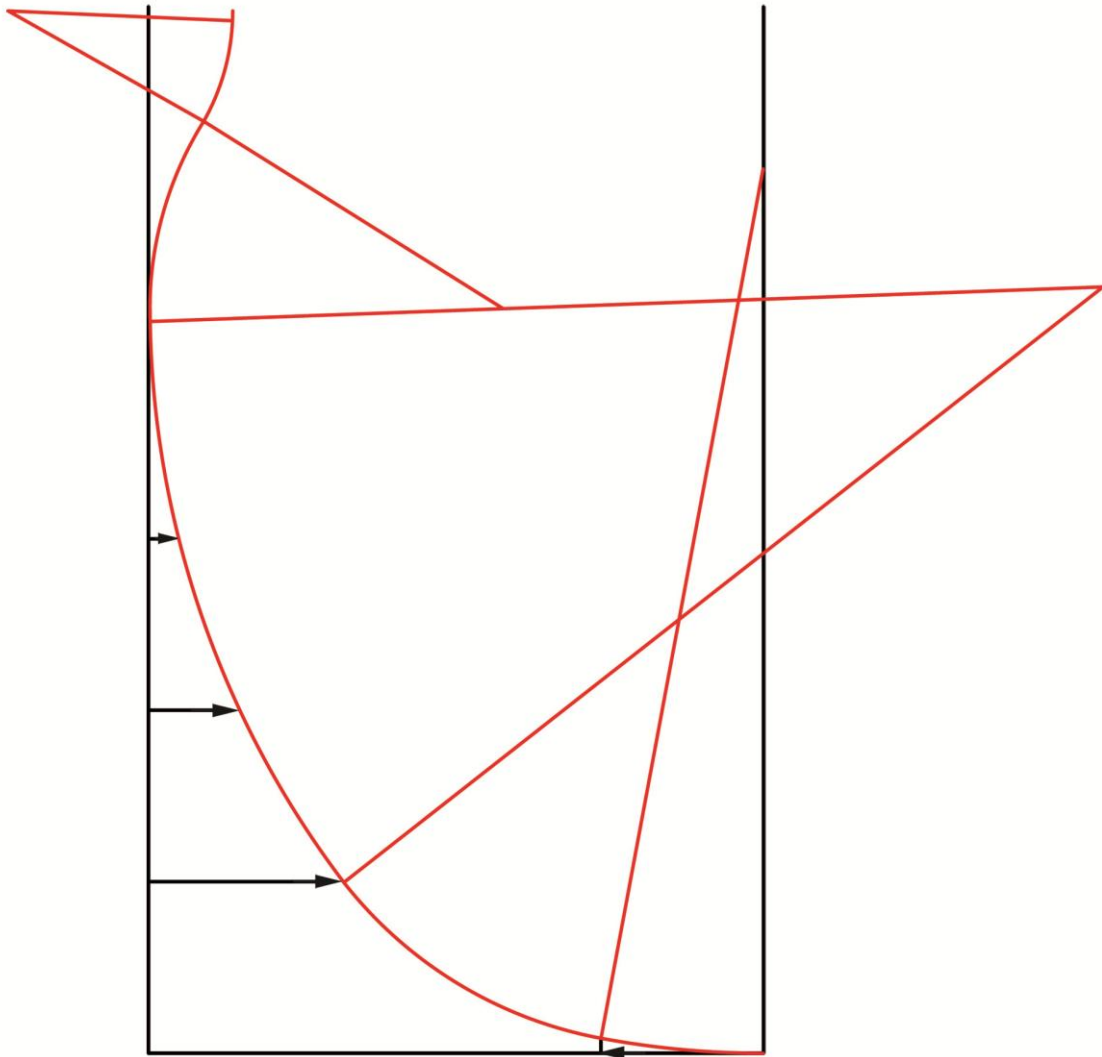

Figure 5.11: Schematic view of the master frame based on Fernandez's design. (after Fernandez 1995, fol. 83.)

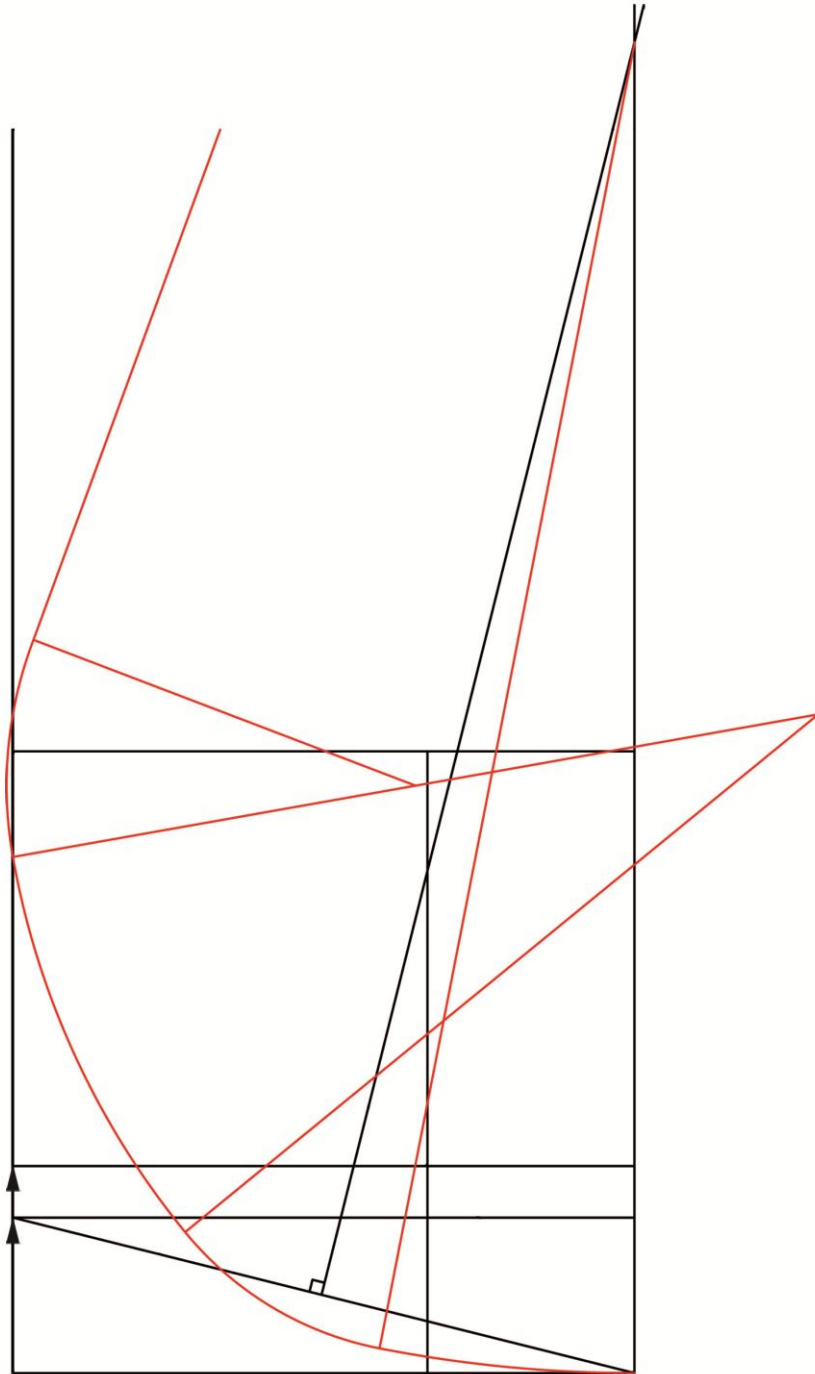

Figure 5.12: Schematic view of the master frame based on Baker's design. (after Baker c. 1580, fol. 12.)

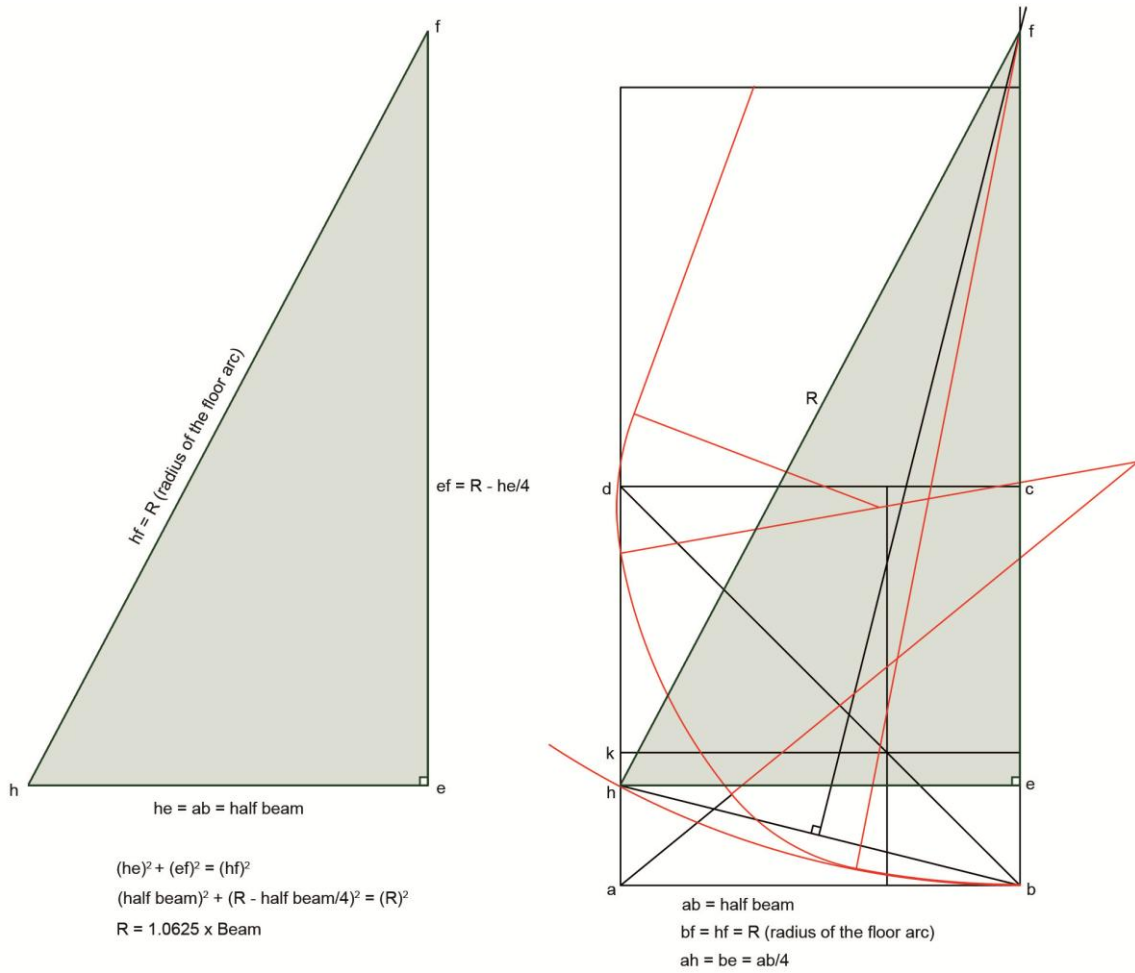

Figure 5.13: Pythagorean relationship between the radius of the floor arc and the maximum beam of Baker's "Greek" mould. (modified after Baker c. 1580, fol. 12.)

geometry of “Greek” mould allows for a formula to be devised whereas the maximum breadth equals 1.0625 times the radius of the floor arc [Radius (Floor Arc) = 1.0625 x Beam] (fig 5.14).

As a result, a 20 feet maximum breadth of the Baker’s “Greek” mould necessitates a 21 1/4 feet radius of the floor arc. Proportionally, this large arc is about four times smaller than the bilge arc, and about two-thirds smaller than the futtock arc. Interestingly, the curved floor seems to be delineated by projecting a parallel to the vertical axes of the mould though the center of the bilge arc, and not through the touch of the floor and bilge arcs as is the case in other examples. Except for the curved floor based on a large floor arc, the basic characteristics of the subsequent arcs do not deviate much from Baker’s familiar three-arc method (fig. 5.15). What is unique, however, is the fact that the description of the “Greek” mould neither mentions the Venetian system of horizontal widths at key vertical locations, nor Fernandez’s system of offsets along the perpendicular.

Basque *Chalupa* no. 1

Found flattened underneath the stern of the Red Bay (24M) Wreck, *chalupa* no.1, the best preserved out of three whaleboats, measured 8.03 m (14 *codos*) in length between perpendiculars, 1.92 m (3 1/3 *codos*) in maximum breadth, and 0.72 m (1 1/4 *codos*) in height from the top of the keel to the sheer line. Contrary to a group of mortise-and-tenon scarfed frames on the Western Ledge Reef Wreck, all of the *chalupa*’s frames are unscarfed.³² Based on detailed analysis by Ryan Harris and Loewen, the master

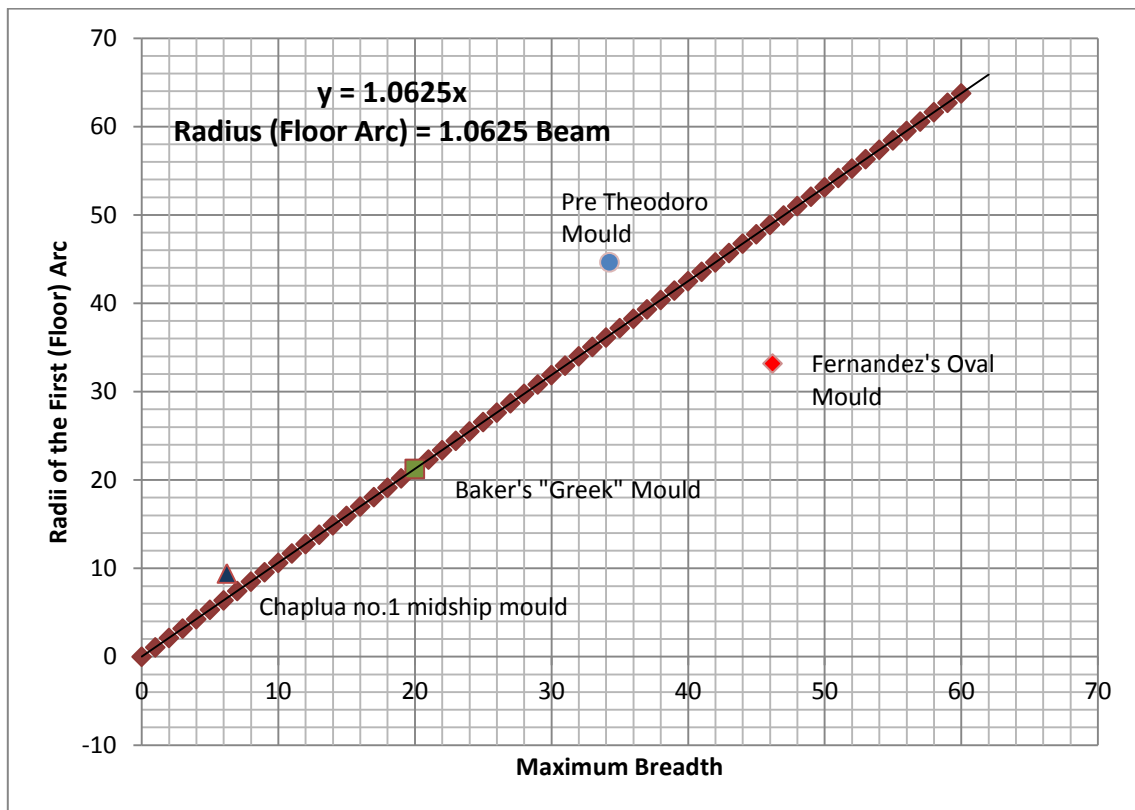

Figure 5.14: Graph showing the relationship between increasing maximum breadth and radii of the floor arc based on Baker's geometry of the "Greek" mould, and other moulds analyzed.

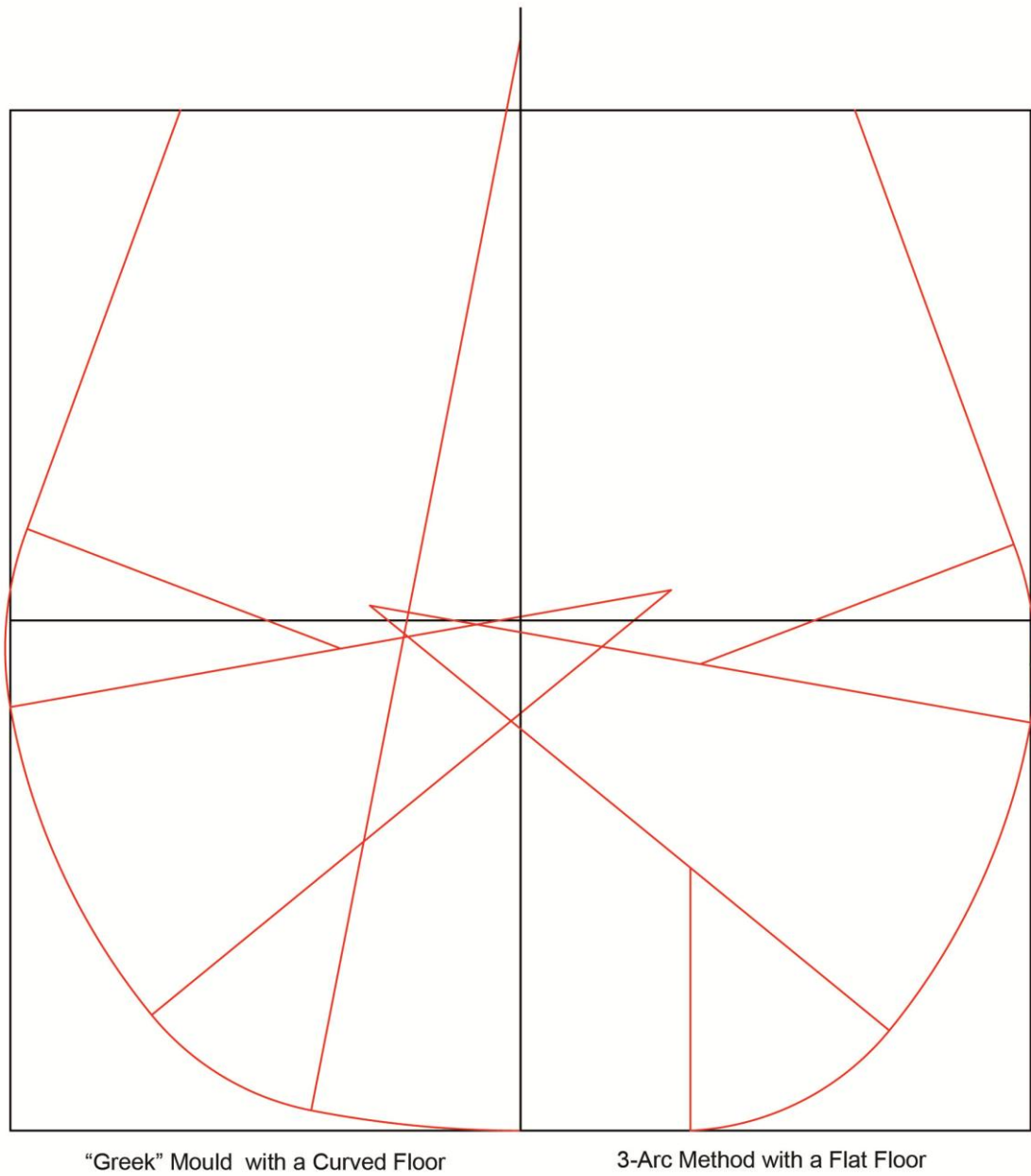

Figure 5.15: Comparison between the "Greek" mould and the three-arc method by replacing the curved floor with flat floor.

frame is positioned exactly in the middle between the posts and follows the geometry of three tangent arcs.³³ The horizontal distance of the curved floor, functioning as a chord, measures $1 \frac{1}{3}$ *codo* and is about two and a half times less than the maximum breadth (1-to-2.6 ration). The radius of the first arc, the floor arc, is 5 *codos*, while the radius of the second arc, the bilge arc, is 1 *codo*. In other words, for every *codo* of the small bilge arc there are five *codos* of the relatively large floor arc (1-to-5 ratio). Finally, the third arc, the futtock arc, measures $1 \frac{1}{2}$ *codo* in radius, extending to the maximum breadth of the vessel (fig. 5.16).³⁴ Although the ratios are significantly larger, the geometric concept behind the *chalupa*'s master frame generally resembles Baker's "Greek" mould.

5.3 THE MAXIMUM BREADTH

In order to determine the key dimensions of the master frame, namely the maximum breadth (*manga*) and the depth of hold to the height of the main deck (*puntal*), the primary approach was to relate the known parameters of the Western Ledge Reef Wreck to statistically devised ratios between the length of keel and the maximum breadth and the depth of hold. According to Barkham, who based his findings on eight ships below 200 *toneladas* and seven above that mark built between 1545 and 1602, these ratios varied little throughout the analyzed contracts.³⁵ Within the first group, for every *codo* of keel there was, on average, 0.41 *codo* of beam and 0.29 *codo* of height. Within the second group, the proportions increased by about 20% to 30%, thus for every *codo* of keel there was 0.52 *codo* of beam and 0.41 *codo* of height (table 5.2).³⁶ Since it is unlikely that the tonnage rating of the Western Ledge Reef Wreck exceeded 200

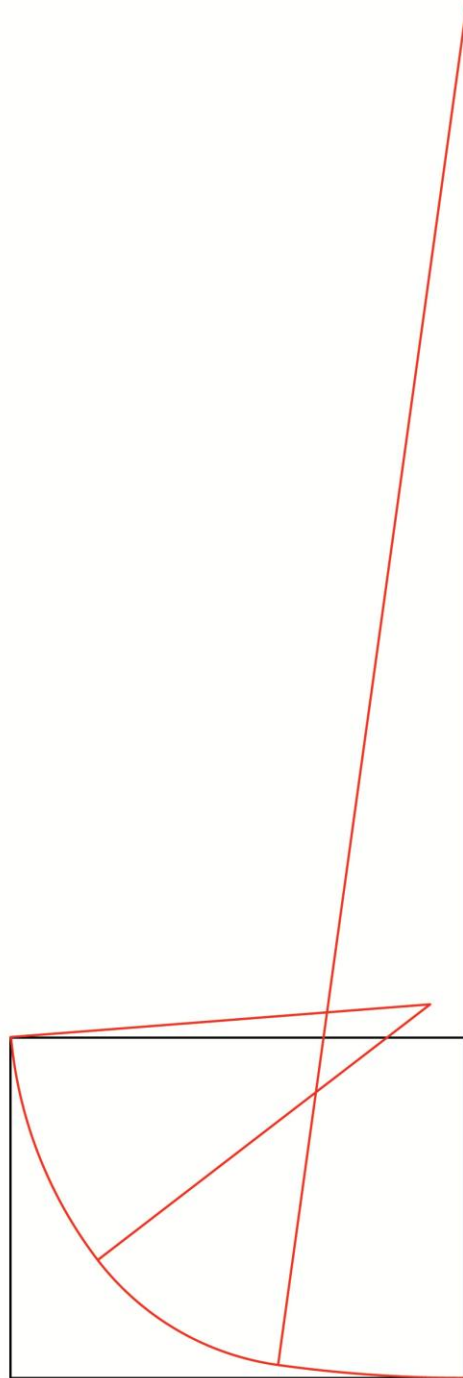

Figure 5.16: Schematic view of the master frame of *chalupa* no.1. (after Grenier et al. 2007, 4: 332 (Figure 22.20).)

Table 5.2: Statistical ratios between the length of keel and the maximum breadth and the depth of hold to the upper deck for Iberian ships below and above the 200 *tonelada* mark. (after Barkham 1981, 2.)

Length of keel to Maximum breadth to Depth of hold			
Ship's Tonnage	Given Keel Length	Maximum Breadth	Depth of Hold
< 200 <i>toneladas</i>	1.00	0.41	0.29
> 200 <i>toneladas</i>	1.00	0.52	0.41

Table 5.3: Selected ships from the Basque shipbuilding contracts. (after Barkham 1981, 2 (List I).)

Dimensions (in <i>codos</i>) of Corresponding Ships from the Contracts				
Year Built	Type	Given Keel Length	Maximum Breadth	Depth of Hold
1579	Galleon	23	10	7
1579	Nao	23	10	7

toneladas, its maximum formulated beam would equal 9.6 *codos* with a depth of hold of 6.8 *codos*. According to the stipulations provided in the contracts, the beam was taken at the widest point of the vessel on the inside of the planking. Similarly, the depth of hold was measured from the floor of the hold (ceiling) to the top of the beams of the upper deck.³⁷ Interestingly, these dimensions closely correspond with the measurement for two ships, a *nao* and a *galleon* from contracts dated to 1579 (table 5.3).³⁸

The second approach to determine the key dimensions was to relate the known width of the curved floor (chord of the floor arc) from the Western Ledge Reef Wreck to the ratio of the maximum breadth to the width of the floor obtained from the analyses of corresponding designs. In addition to the four previously described examples, the analysis was expanded to include a ratio of the maximum breadth to the width of the floor at the mid-mortises, locations of the touches between the bilge and futtock arcs, from the Red Bay (24M) Wreck. Even though the master frame of the Red Bay (24M) Wreck did not follow the geometry of a large floor arc, the design characteristics of tangent arcs and the association between the mortises and the turn of the bilge appear analogous; hence, it is a suitable source of comparative data.³⁹ As illustrated in tables 5.4 and 5.5, the resulting hypothetical maximum breadth of the Western Ledge Reef Wreck could range from as little as 7.7 *codos* (based on Chalupa's ratio of 2.6) to 11.2 *codos* (based on Fernandez's ratio of 3.7), averaging 9.3 *codos*.

Although each design was unique in its own way, the relationship between the known parameters of the master frame of the Western Ledge Reef Wreck and the corresponding parameters of the other midship moulds with a similar basic geometric

Table 5.4: Key parameters of the master frame within a group of corresponding designs.

	Greek	WLRW	Fernandez	Pre Theodoro	Red Bay (24M)	Chalupa no.1
units:	<i>feet</i>	<i>codos</i>	<i>pg</i>	<i>V. feet</i>	<i>codos</i>	<i>codos</i>
Max. Breadth	20	N/A	56	20	13.15	3.34
Horizontal Length of the Curved Floor (Chord of the Floor Arc)	6.66	3	15	7	4	1.3
Max. Breadth-to-Horizontal Length of Curved Floor	3.0	N/A	3.7	2.9	3.3	2.6

Table 5.5: Range of maximum breadths of the Western Ledge Reef Wreck's master frame by the way of ratios of the maximum breadth to the horizontal length of the curved floor obtained from a group of corresponding designs.

Range of the Max. Breadth of the WLRW (in codo)	
Ratios	Max. Breadth
w/ <i>Chalupa</i> No. 1 ratio of 2.6	7.7
w/ Pre Theodoro ratio of 2.9	8.6
w/ Geek ratio of 3.0	9.0
w/ Red Bay ratio of 3.3	9.9
w/ Fernandez ratio of 3.7	11.2
Average:	9.3

concept is evident and presents some important analytical implications for further analysis. The scatter chart displays two variables, the first one being the radii of the first or floor arc as compared to the horizontal width of the curved floor (the chord of the floor arc), and the second one being the ratio of the radii of the first or floor arc to the second or bilge arc (fig. 5.17). The Western Ledge Reef Wreck ratios of 3.33-to-1 and 3.33-to-1, respectively, closely match the ratios of Baker's "Greek" mould (3.19-to-1 and 3.96-to-1); both being somewhat smaller than the ratios for *chalupa* no.1 (3.85-to-1 and 5-to-1) and larger than either the ratios of Fernandez's (2.67-to-1 and 2-to-1) or Pre Theodoro's (1.86-to-1 and 1.4-to-1) moulds (table 5.6).

There is a strong positive correlation between these two variables; as the values of one of them increase, the values of the other one also increase. As compared to the Western Ledge Reef Wreck, the *chalupa*'s ratios allow for much smaller bilge arc in relation to a given floor arc and a shorter chord of the floor arc, the Baker's ratios allow for only marginally smaller bilge arc and relatively matching chord of the floor arc, while the Fernandez's and Pre Theodoro's ratios allow for significantly larger bilge arcs in relation to floor arcs and longer chords of the floor arc.

Based on the fact that the frame shows particularly strong correlation with the "Greek" midship mould, a theoretical exercise was performed to recreate the master frame of the Western Ledge Reef Wreck by amalgamating the preserved parameters as analyzed by the author and the original description from the Baker's shipbuilding treatises. First, "as in all moulds," the design must commence by drawing a bounding rectangle **ABCD**.⁴⁰ Using a 10 *codo* radius of the floor arc, which based on the

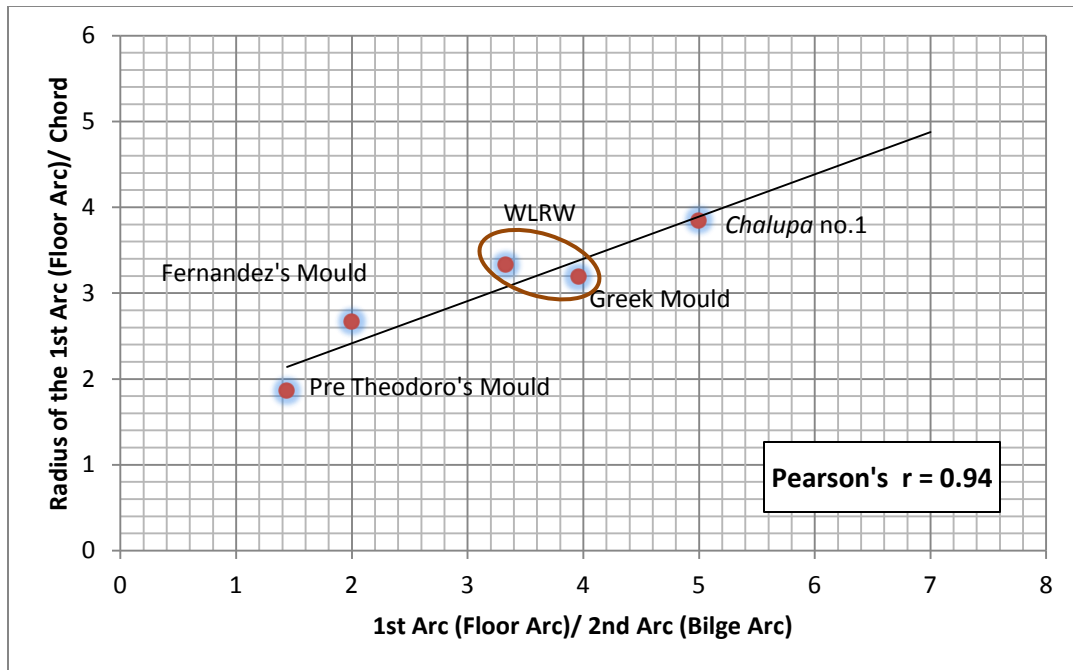

Figure 5.17: Chart displaying the radii of the first (floor arc) to the horizontal width of the curved floor (the chord of the floor arc), and the ratio of the radii of the first (floor arc) to the second or bilge arc.

Table 5.6: The relationships between the known parameters of the Western Ledge Reef Wreck's master frame and the parameters of the other midship moulds within a group of corresponding designs.

	Greek		WLRW		Fernandez		Pre Theodoro		Red Bay (24M)		Chalupa no.1	
	Units:	feet	codos	pg	v. feet	codos	pg	v. feet	codos	pg	v. feet	codos
Max. Breadth		20	?	56	20	13.15	56	20	13.15	56	20	3.34
Length of Curved Floor (Chord of Floor Arc)		6.66	3	15	7	3.3*	15	7	3.3*	15	7	1.3
Radius of Floor Arc		21.25	10	40	13	n/a	40	13	n/a	40	13	5
Radius Bilge Arc		5.37	3	20	9	4.5	20	9	4.5	20	9	1
Radius of Floor Arc/ Chord of Floor Arc		3.19	3.33	2.67	1.86	n/a	2.67	1.86	n/a	2.67	1.86	3.85
Max. Breadth/ Radius of Floor Arc		0.94	?	1.40	1.54	n/a	1.40	1.54	n/a	1.40	1.54	0.67
Radius of Floor Arc/ Radius Bilge Arc		3.96	3.33	2.00	1.44	n/a	2.00	1.44	n/a	2.00	1.44	5.00

*) Measured as the width of the floor at the mid-mortises

previously cited formula [Radius (Floor Arc) = 1.0625 x Beam] is correlated with the maximum breadth between perpendiculars, the width of the bounding rectangle is about 9.5 *codos*. At the same time, the height of such rectangle is set out as half of that or 4.75 *codos*. It must be emphasized that the height of the rectangle **ABCD** does not correspond to the height of hold, and it is used solely for construction purposes. Second, the rectangle **ABCD** should be divided in half with a vertical line **EG** as only a half of the mould needs to be geometrically represented. Then, a quarter of a half beam should be taken, which results in about $1 \frac{1}{5}$ *codos*, and this distance is marked on the line **BC** at the point **h**. From this point, a first parallel line to the baseline **AB** is drawn. The second parallel line is set out as a third of the height **BC**, or about $1 \frac{3}{5}$ *codos*, and drawn from the point **k**. Third, two other lines have to be drawn within the rectangle **ABCD**, one from **E** to **h** and one from **E** to **C**.⁴¹

Following Baker's description, the center of the first arc, the floor arc, is located by extending a perpendicular from the middle of the line **Eh** to where it crosses the centerline **EG** producing nearly a perfect 10 *codos* radius (10.09 *codos* according to the formula). Due to different proportions between the first and second arcs, the center **p** of the second arc, a bilge arc of 3 *codos* in radius, is readily positioned as a tangential continuation of the floor arc. Next, the center of the third arc, the futtock arc, is positioned on the line projecting from the **B** through **p**. By graphic experimentation with different radii, the most suitable value producing a fair curve is set out as $6 \frac{1}{2}$ *codos*, which is proportionally consistent with the relationship between the floor and futtock arcs of the "Greek" mould. The center of the fourth arc, the breadth arc, is arbitrarily

positioned at the intersection of the line delineating the curved floor and set out at about $3 \frac{1}{3}$ *codos* radius. Finally, the mould is finished with straight inward-angling line so the breadth at **R** equals two-thirds of the maximum breadth between perpendiculars (fig. 5.18).⁴²

Two important aspects of this mould construction should be emphasized. The first one relates to a system of horizontal controls, specifically to the distance between the port and starboard touches of both bilge and futtock arcs. Granted that a control at this location existed, a precise 7 *codos* breadth can be produced by simply extending the chord of the bilge arc and reducing the chord of the futtock arc by only 4.5° . This breadth could have functioned as the second consecutive level of horizontal controls above the 3 *codos* breadth between the touches of the floor and bilge arcs (the chord of the floor arc). The second aspect relates to the fact that the maximum breadth of the mould slightly exceeds the breadth between perpendiculars; a feature quite consistent not only with most of the period illustrations, but also with the evidence from the Red Bay (24M) Wreck whose maximum breadth was not nicely rounded 13 *codos* but rather 13.15 *codos*.⁴³ Since the official breadth of the Western Ledge Reef Wreck is unknown, it is accepted that the maximum breadth of the theoretically recreated master frame of the ship is consistent with $9 \frac{3}{5}$ (9.6) *codos*, as measured at extreme spots on the mould (fig. 5.19). As evident, this breadth gives a perfect match with the maximum breadth from Barkham's formula, attesting to its accuracy.

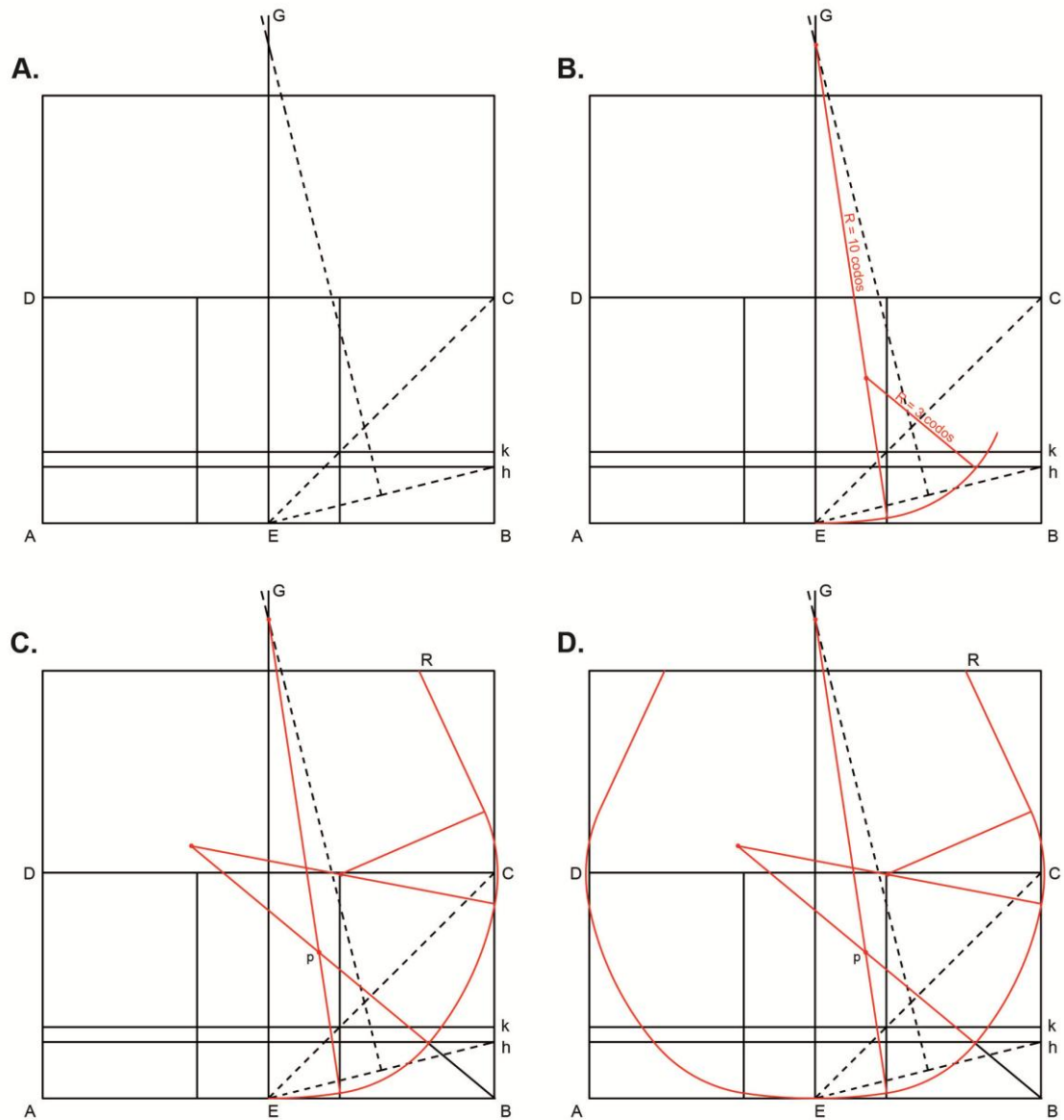

Figure 5.18: Hypothetical design of the master frame of the Western Ledge Reef Wreck based on the Baker's description of the "Greek" midship mould. (modified after Baker c. 1580, fol. 12.)

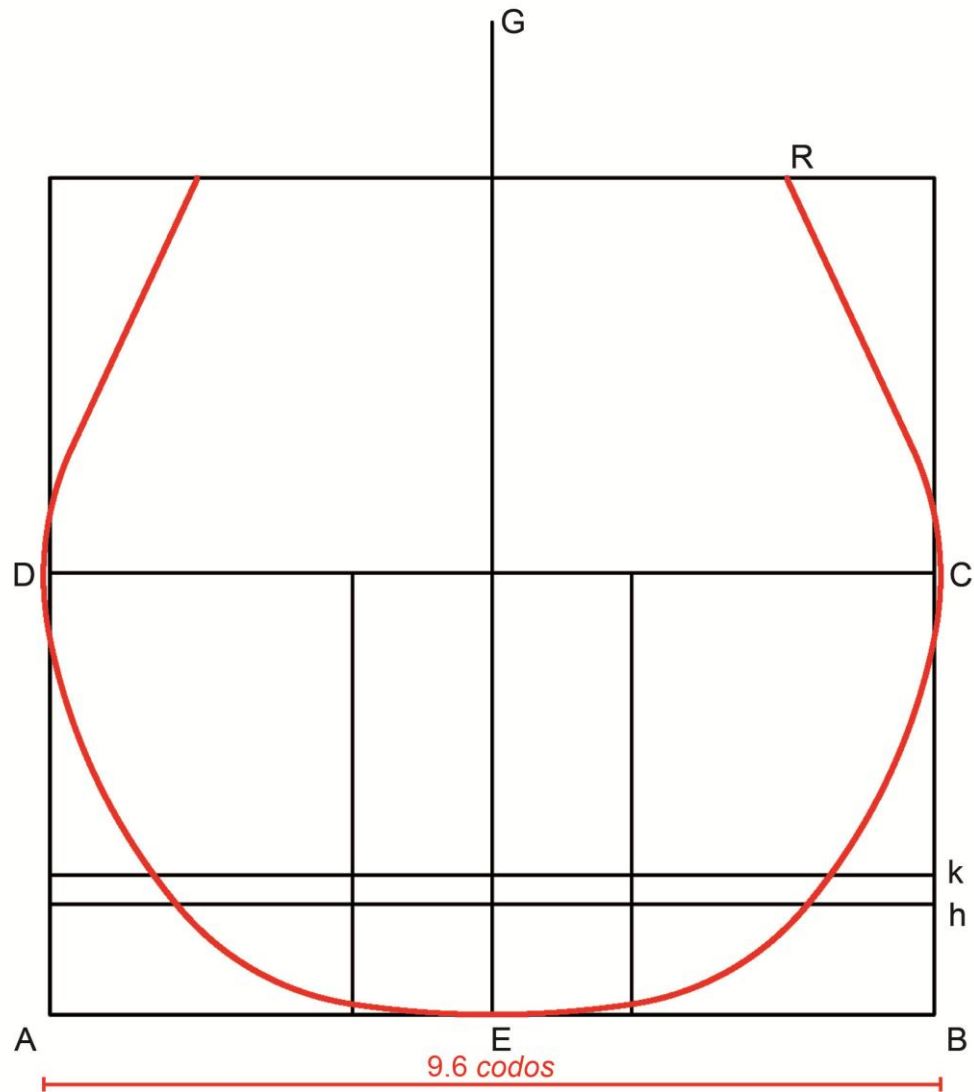

Figure 5.19: Outline of the hypothetical master frame of the Western Ledge Reef Wreck.

5.4 THE HEIGHT OF THE MAIN DECK

Traditionally, all decks were located at standard intervals corresponding to the space occupied by tiers of Andalusian *pipas*, half *tonelada* casks.⁴⁴ As described by Palacio, a 400 *tonelada* vessel would have 11 1/2 *codos* depth in hold; it was 4 1/2 *codos* (three tiers of *pipas*) high from the keel to the top of the orlop deck beams (*primeros baos*, or *baos vacios*),⁴⁵ 3 *codos* (two tiers of *pipas*) high to the first deck (also a gun deck), and another 3 *codos* (two tiers of *pipas*) high to the upper deck (*puente*), which was also the main deck. The final *codo* was added by the thickness of the beams, deck planking, and boarding nets, if the ship carried them. In contrast, a smaller 150 *tonelada* vessel would have 8 *codos* depth in hold; it was 3 *codos* high from the keel to the top of the orlop deck beams, 2 *codos* high to the first deck, and 3 *codos* high to the upper deck (the main deck). Notably, Palacio measured depth of hold from the top of the keel to the highest deck of the ship.⁴⁶

This method of measuring depth of hold was also supported by another contemporaneous Spanish author, Juan Escalante de Mendoza, as well as modern study of the Basque shipbuilding contracts by Barkham.⁴⁷ Both authors concluded that the depth of hold (*puntal*) was measured as a vertical distance from the floor of the hold (the ceiling) to the main deck of the ship, a method also accepted for the reconstruction of the Western Ledge Reef Wreck.⁴⁸ Since nothing was preserved above the level of the floor timber's wrungheads and the overlapping heel ends of the first futtocks, reverse engineering was of no use. Here, the only available approach was to apply previously cited statistical formula developed based on the Basque contracts.⁴⁹ Using Barkham's 1-

to-0.29 ratio between the length of keel and the depth of hold from the main deck for the ships below 200 *toneladas*, the keel of $23 \frac{1}{2}$ *codos* would necessitate a depth of about 6.8 *codos*. This also indicates that the ship must have had only one deck, the main deck, above the level of the lower deck beams associated with the orlop deck (table 5.7).

The intervals between the consecutive decks were further reinforced by the conservatism of the shipbuilding industry, specifically by the shapes and dimensions of the available timbers.⁵⁰ Contrary to the English ships (e.g. *Mary Rose*) of the period, the Iberian ships had clearly defined levels of framing timbers.⁵¹ Even though ships could vary in maximum breadth, the intervals between the decks stayed relatively constant.⁵²

Evidenced by the Red Bay (24M) Wreck, the height as measured from the ceiling to the top of the orlop beams was 4 *codos*, the height of the first deck (the main deck) was 3 *codos*, while the height of the second deck (the upper deck) was another 3 *codos* (4-3-3 *codo* intervals).⁵³ For Palacio's 400 *tonelada* ship the same intervals read $4 \frac{1}{2}$ -3-3, while his smaller 150 *tonelada* vessel measured 3-2-3 between the decks.⁵⁴ Although these intervals could be marginally increased by $\frac{1}{2}$ *codo* to $1 \frac{1}{2}$ *codo* for larger ships and dedicated warships, it is reasonable to assume that the Western Ledge Reef Wreck, with its formulated depth of hold of 6.8 *codos*, would have had a standard 4 *codos* high orlop deck and 3 *codos* high main deck. This puts its hypothetical depth of hold to the main deck (*puntal*) at 7 *codos*, as measured from the ceiling.

Table 5.7: Length of keel in relation to the range of heights between the decks. (after Barkham 1981, 11.)

Heights Between the Decks (in <i>codos</i>)				
Keel Lengths	Lower Beams	First Deck	Second Deck	Third Deck
25 - 28	4 - 4.5	7 - 7.5	10 - 10.5	NA
28 - 32.5	4 - 5.33	7.5 - 9.5	11 - 12	14.75 - 15.5

5.5 MODIFICATION OF FRAMES FORWARD AND AFT OF THE MASTER FRAME

After establishing the geometric shape and the overall dimensions of the master frame, the next step was to find the mechanism by which other frames could be projected forward and aft. Contrary to frames characterized by a flat floor, where both the narrowing of the flat section and the rising of the turn of the bilge had to be calculated and carefully controlled throughout the group, the modification found on the Western Ledge Reef Wreck was simplified (fig. 5.20).⁵⁵

By gradually decreasing only one variable, the radii of the consecutive floor arcs, the turn of the bilge was raised and the frame narrowed as a natural consequence. Due to their tangent relationships, the progressively smaller radii of the floor arcs triggered an inboard and upward movement of the other arcs and the entire frame was transformed (fig. 5.21). Although the amount of the narrowing and rising could be calculated within a group of preserved framing timbers, it was inconsequential to the shipwrights working on the Western Ledge Reef Wreck. In essence, the only thing that could be controlled was the radii of the floor arc.

Since the modification followed an evolving curve, the amount of narrowing and rising rapidly increased from one frame to the next, hence, it had to be compensated for. This was particularly significant for narrowing, which if left unchecked could cause a drastic reduction in the hull's breadth at the waterline undermining the overall stability of the vessel.⁵⁶ Based on the interpretation of the documentary sources of the period, two mechanisms were known to bring the flare of the futtocks under control. Although

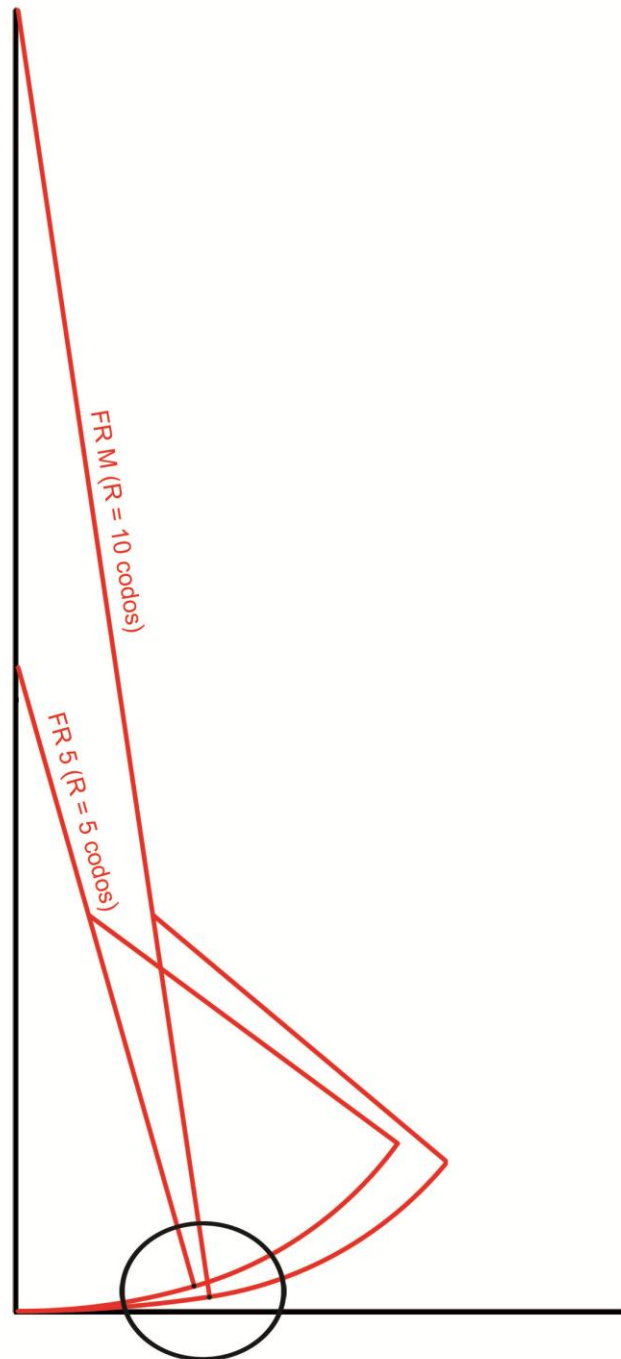

Figure 5.21: Decrease in radii of the floor arc (from the master frame to the fifth frame aft) provided a mechanism by which the turn of the bilge of the Western Ledge Reef Wreck was narrowing and rising.

conceptually different, both used a master “mould” which functioned as a loosely defined template in devising the other frames forward and aft in a process dubbed as “whole moulding.”⁵⁷

The first mechanism of controlling the flare of the futtocks was known exclusively from the English sources as “hauling down,” and involved adjusting the chords of tangent bilge and futtock arcs by gradually moving or “hauling” the touch between the two downward.⁵⁸ The second mechanism is primarily associated with Southern Iberian and Mediterranean sources and called *joba* (in Spanish), *espalhamento* (in Portuguese), or *trébuchet* (in French); it involved tilting the futtock outboard from a pivot point located at the turn of the bilge.⁵⁹ There is also a third mechanism, or rather a variation of the previous one, known in Portuguese as *balisa*. Similarly to *joba* or *espalhamento*, it involved not only tilting the futtock outboard, but also applying a corrective adjustment, *concomo*, to the chord of the bilge arc which echoed the “hauling down” modification.⁶⁰ In other words, the key distinction among the three lay in the shape of the bilge. While the “hauling down” produced a faire and perfectly circular bilge, the *joba* or *espalhamento*, but also the *balisa* with subsequent *concomo* “developed a kink at the fulcrum point.”⁶¹ Unlike the tangent arcs of “hauling down”, the tilting of the futtocks associated with the other two mechanisms resulted in reaching the limits of geometrical relationships (fig. 5.22).

Following Barker and Loewen assumption that “it ought to be possible to distinguish frames moulded in the ‘English’ method of pure arcs, and frames where the futtock frames have been rotated about a centre other than the centre of the arc of the

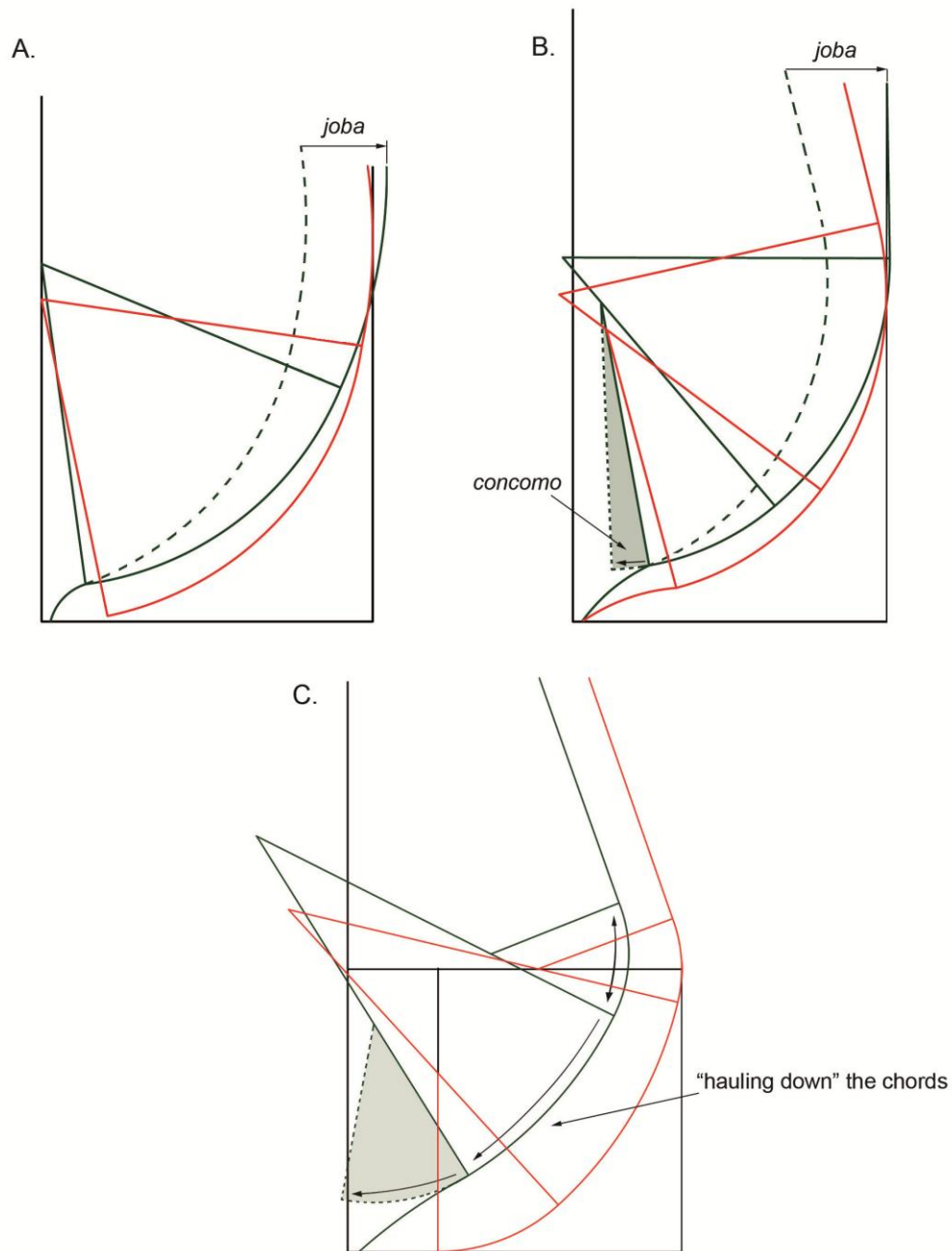

Figure 5.22: Examples of modifications of the master frame: A) *joba*, *espalhamento*, or *trebuchet* method, B) *balisa* with corrective adjustment of *concomo*, C) "hauling down" the futtocks. (modified after Barker 1991; Barker 2003a; Fernandez 1995, fol. 71; Fernandez 1995, fol. 103-104; Loewen 2001, 243-6; Rieth 1996a; Rieth 2000.)

mould, by *trebuchet*, *espalhamento*, or *joba*, (...) even if the hull only remains up to the bilge;” the available evidence from the Western Ledge Reef Wreck was carefully investigated.⁶² It has been shown that both the floor timbers, including their wrungheads, and the preserved first futtocks were circumscribed by perfectly circular arcs with no identifiable “kink.” Assuming that such kink could have been simply faired out during the assembly, it has also been shown that the relationships between the arcs remained tangent throughout the framing, which by itself precluded a corrective tilting. All the evidence associated with the fore-and-aft framing modification points towards the “hauling down” mechanism. With the exception of a large floor arc, the system used for the Western Ledge Reef Wreck is analogous with the three-arc concept and its fore-and-aft modifications known from such well-preserved archaeological examples like the Basque Red Bay (24M) Wreck and the English *Mary Rose*.⁶³ Indeed, it is another Iberian shipwreck like the Red Bay (24M) Wreck which does not follow the methods as described in Iberian shipbuilding treatises of the period. This provides a link with the broader Atlantic and Basque shipbuilding culture rather than the Southern Iberian or Mediterranean region.⁶⁴ However, it is still puzzling how to reconcile the “hauling down” method known exclusively from the English contexts with the “Greek” midship mould of eastern Mediterranean origin without venturing a guess that both perhaps shared a common ancestry which emerged somewhere along the northern coast of Spain.

The Distribution of Frames

Based on the reconstructed keel length, the center of the scribe-mark marking the location of the master frame fell approximately at the end of the forward third of the keel. Although only 19 frames survived that could be positively positioned, the keel with the reconstructed stern assembly could accommodate a total of 36 or 37 frames: 11 or 12 forward of the master frame, and 24 aft. Unfortunately, the deterioration of the forward extremity of the keel and the absence of the bow assembly prevented a precise count of frames forward of the master frame, including those that must have been located on the stem. Of all the preserved framing elements, the majority of the floor timbers were found in their original positions still fastened to the keel; the research model facilitated positioning of the two originally labeled as unidentified. The timber FR UN 1 appeared to be the tenth floor timber aft (FR 10) of the master frame, and timber FR UN 4A appeared to be the fourteenth floor timber aft (FR 14).

The framing of the Western Ledge Reef Wreck formed three distinct groups. The first was a group of central geometrically designed frames, sub-divided into two categories. The first category included the preassembled frames, characterized by the presence of the dovetail mortise-and-tenon scarfs between the floor timbers and the first futtocks. The second included the unmortised frames with floating futtocks fastened only to the planking. Due to narrow spacing between the frames, all the structural components in the first category had to be completely assembled prior to being placed and fastened to the keel. As frames in the second category had floating futtocks, the floor timbers had to

be fastened to the keel first, while the futtocks were installed only after the temporary ribbands and some of the planking was already in place.

The second group of frames, continuing from the first group to the stem and stern crotches, was similarly unmortised and characterized by floating futtocks. These did not follow any geometric function, but rather the arms of the floor timbers were angled up from the flat central pedestal. The third group included the frames, or crotches, defining the narrow extremities of the ships. The vessel's entry was characterized by V-shaped and the run by Y-shaped crotches. As mentioned previously, the structural components for the second and third group of frames were erected in a controlled step-by-step fashion in which the first futtocks were installed only after the temporary ribbands and selected planking was already assembled.

As the shape of the bottom hull gradually evolved from the perfectly round master frame to the V-shaped and Y-shaped crotches, so did the rising and narrowing of the floor line.⁶⁵ Although both modifications could be traced within the first group of central frames, for which the floor timbers were largely preserved, the lack of framing elements from the second and third groups with reliable shape and position limited any attempts to determine rising and narrowing. Likewise, the small number of preserved floor timbers and absence of most of the futtocks above the level of the turn of the bilge were the primary factors in the inability to produce the set of lines for the Western Ledge Reef Wreck with any degree of confidence. The author wanted to avoid a misunderstanding made by others, where the ship lines were recreated solely based on

documentary sources of the period diverging, in essence, from the theoretical and archaeological data.⁶⁶

Hypothetical Position of the Tail Frames

The second scribe-mark visible on the keel was a line running fore-and-aft along the center of the timber. Although the preserved line spanned a total of 17 frames and measured 564 cm ($9 \frac{4}{5}$ *codos*) in length, it appeared that it originally extended farther aft. In addition to controlling the athwartship symmetry of the consecutive frames, it could also facilitate the correct adjustment and tilt for the floating futtocks. This application of line scribed along the keel's length is ethnographically well documented for the construction of Western Indian Ocean *būm*-type vessels.⁶⁷

When analyzed graphically together with the reconstructed length of keel of $23 \frac{1}{2}$ *codos*, a new relationship is apparent. A circle with its center exactly in the middle of the keel and a radius equal to the distance between the middle of the keel and the forward known extent of the line produces a symmetrical division. The keel is split into about 5 *codos*, $13 \frac{1}{2}$ *codos*, and 5 *codos* intervals. As for the group of pre-designed calculated frames, these are located within the forward half of such delineated circle (fig. 5.23).

By extending forward and aft beyond the group of central pre-designed calculated frames, it can also be hypothesized that the end points of the line could have been used to define the placement of the tail frames (*almogamas*). This key but still poorly understood shipbuilding concept relates to the boundaries of the calculated

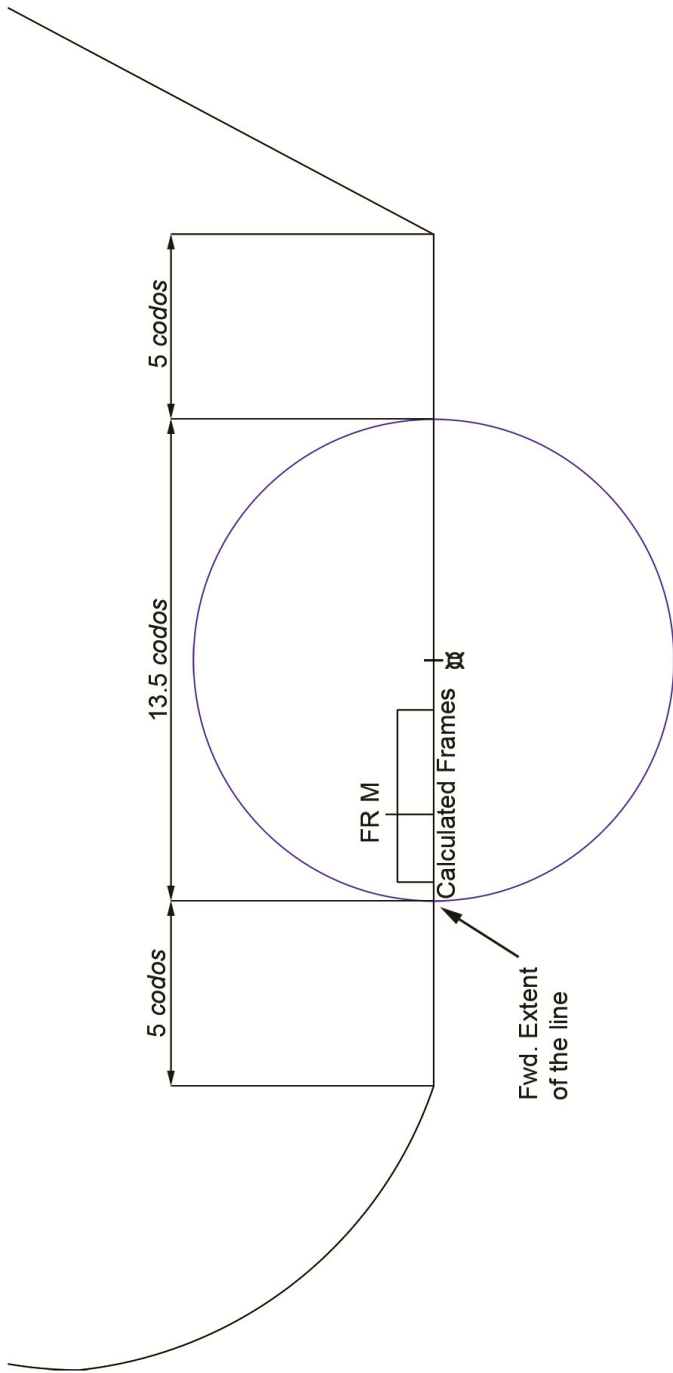

Figure 5.23: Analysis of the line scribed along the keel.

frames and the mechanism of shaping the extremities of the ship.⁶⁸ Although devoid of any detailed rules, the majority of the 16th-and 17th-century Iberian treatises indicate somewhat symmetrical distribution of these frames forward and aft of the master frame.⁶⁹ These documents do not describe the distribution of frames between the tail frames and the posts. By analyzing the preserved section of the line scribed on the keel of the Western Ledge Reef Wreck, such defined distribution is far from symmetrical.

An alternative solution to the placement of the tail frames is illustrated by Baker (refer to fig. 5.7).⁷⁰ Here, the tail frames are neither symmetrical as related to the master frame, nor to the maximum extent of the keel or the total length of the ship. According to the numbering which starts with the master frame being frame zero, the forward one is precisely the tenth frame, while the aft one is thirteenth. This position of the forward tail frame puts it at the proximity of the keel-stem scarf, a position consistent with Oliveira's drawing (fig. 5.24).⁷¹ Converting available information into proportional relations, a second hypothesis could be proposed. In this scenario, the forward tail frame on the Western Ledge Reef Wreck would be associated with the nonextant frame J (FR J), which was also the first bolted frame from the bow, while the aft tail frame would be associated with the similarly nonextant sixteenth frame (FR 16). Notably, these two frame stations marked the exact extent of the preserved starboard garboard plank (PSG) and partly preserved portside garboard plank (PPG) supporting the notion that their forward butt ends were fastened over the hypothetical forward tail frame, frame J (FR J). Although inconclusive, it is suspected that the aft butt end of at least the starboard garboard plank (PSG) was fastened over the hypothetical aft tail frame, sixteenth frame

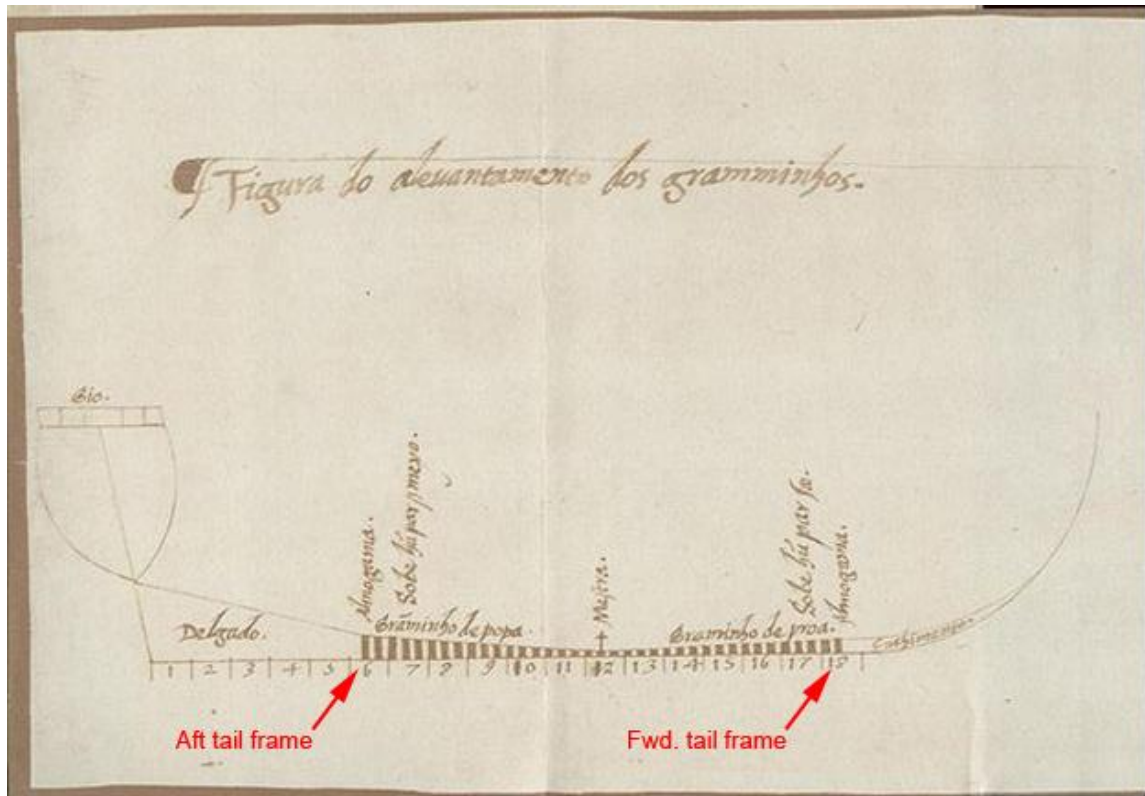

Figure 5.24: Position of the tail frames based on Oliveira's drawing. (after Oliveira 1991, fol. 99; the treaties accessed at <http://nadi.tamu.edu/treatises/BrowseTreaty?author=oliveira>)

(FR 16) aft. As these garboard planks must have been fastened to the pre-designed central framing quite early in the construction sequence, most likely before the extremities of the ship were framed, the locations of these two tail frames would provide easy anchor points for their butt ends. In addition, these frames would also facilitate the assembly of the other forward and aft garboard planks, finishing both strakes without delaying the sequence. Otherwise, the central garboard planks, fastened only to the central framing at that stage, would have their respective ends hanging unsupported; hence, the shipwrights would not be able to take advantage of the strakes to support the floor timbers and define the shapes of the extremities. Due to the lack of concrete archaeological evidence within the preserved structure of the Western Ledge Reef Wreck as well as the ambiguity of the documentary shipbuilding sources of the period, there is nothing to support one hypothesis over the other. As such, the concept of tail frames remains enigmatic until more comparative data emerges in the future.

5.6 THE STERN, STEM, AND MAXIMUM LENGTH

Contrary to the length of keel, the maximum breadth, and the depth of hold, which all must have been defined before the work on a new ship commenced, the overall length of the ship was considered extrinsic. In practice, it was derived only as a function of the length of keel and the way stem and stern overhangs developed during the construction.⁷² Based on the preserved evidence, the rake of the sternpost measured 62°. As previously noted (refer to chapter IV, section 4.5), this acute angle was one of the furthest away from vertical within a group of comparative examples, and could indicate

larger overall proportions between the length of keel and the total length of the hull. Following the historical research, Loewen proposed that there could also be a relationship between the rake and the number of decks. In this hypothesis, the closer the sternpost was to vertical, the more decks a vessel would have. Reversing this logic, the sharp angle of the Western Ledge Reef Wreck's sternpost seems to be consistent with a low number of decks, perhaps only two.⁷³

Stern

Since the shipbuilding treatises of the period did not yield a uniform formula governing the length of the stern overhang, the reconstruction effort concentrated on calculating the height of the sternpost above the keel's baseline. As illustrated by Lavanha, this height was expressed as a fraction (about $2/5$ of the length of the keel) (fig. 5.25, table 5.8).⁷⁴ These proportions were further corroborated by the geometry prescribed by Fernandez, and verified on the preserved example of the Red Bay (24M) Wreck.⁷⁵ Granted that the height of the sternpost was in fact $2/5$ of the length of the keel and the rake was 62° , the sternpost of the Western Ledge Reef Wreck must have extended for approximately $9 \frac{2}{5}$ *codos* above the keel's baseline and had a 5 *codos* overhang (fig. 5.26).

Stem

At the other extremity of the ship, the stem was not preserved; hence, it had to be hypothetically derived based on the proportions associated with analogous examples.

Table 5.8: Proportions for the length of the overhang and height of stern based on Fernandez's four-decked nao. (after Lavanha 1996 (commentary by R. Barker), 201.)

Length of the Overhang and Height of Stern Based on the Keel Length of 105 pg*			
	Length of the Overhang (pg)	Length of the Overhang/ Length of Keel	Height of stern/ Length of Keel
Lavanha	12	1/9	2/5
Fernandez	13	1/8	2/7
Oliveira #1	9	n/a	1 in every 4 1/2
Oliveira #2	9	n/a	1/5
Oliveira #3	10	n/a	2/9
Livro Nautico	11	1/9	1/4
Marcos Cerveira de Aguilar	11	1/9	1/4

*) pg = palmo de goa =25.6 cm

According to Fernandez, the general rule governing the overhang at the bow was directly correlated with the tonnage and the number of decks.⁷⁶ Other small variations depended on the character of the vessel, with higher and fuller bows commonly associated with naval ships and slightly lower ones associated with merchantmen. Single-decked ships of 80 to 100 *toneladas* had a bow overhang calculated to 1/4 of the length of keel; while two-decked ships ranging from 150 to 200 *toneladas* and two or three-decked vessels ranging from 150 to 300 *toneladas* had their overhang calculated at 1/4 to 1/3 of the keel length.⁷⁷ Similar proportions for the overhang of the stem, of 1/3 of the length of keel, were described and illustrated by Lavanha, who also supplied two other important parameters necessary in devising the arc of the bow.⁷⁸ The first one was the height of the stem above the baseline of the keel calculated to 1/2 of the keel's length, and the second one was a control point on the arc itself produced by a quadrant. The center of such quadrant was located at the intersection of the ship's baseline and bow's perpendicular, while its radius equaled 4/9 of the 5/6 of the height of the stem; the remaining 1/6 of the height being circumscribed by the offset arc of the bow (fig. 5.27).⁷⁹

Since it was unlikely that the tonnage of the Western Ledge Reef Wreck could have exceeded 200 *toneladas*, the overhang at the bow was assigned to 1/3 of the length of keel or 7 5/6 *codos*, while the height was 1/2 of the length of keel, or 11 3/4 *codos*. Hypothetically, a circular arc connecting such pre-defined control points had a radius of 11 2/3 *codos* (fig. 5.28).

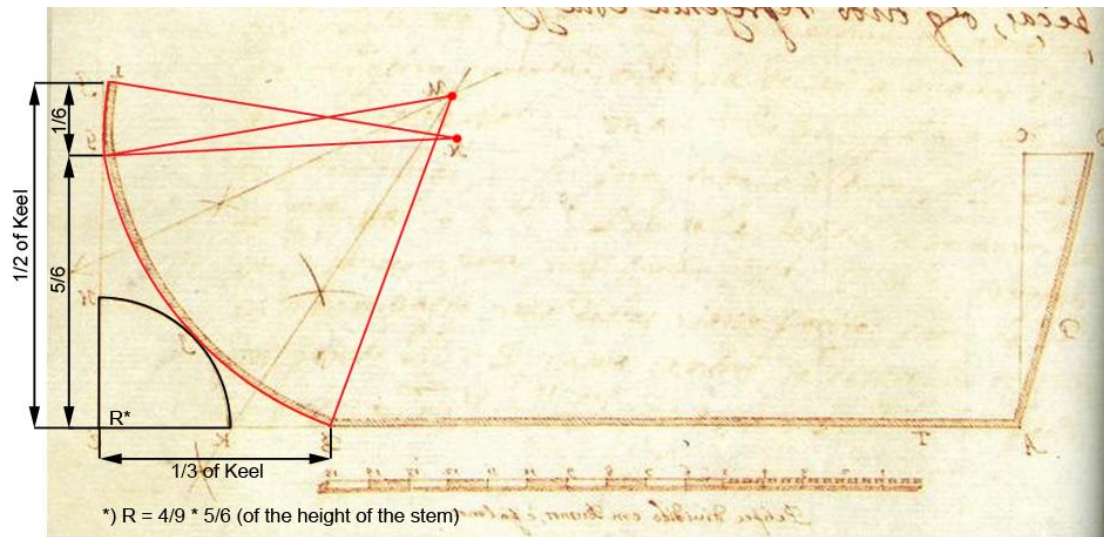

Figure 5.27: Proportions of the stem as illustrated by Lavanha. (modified after Lavanha 1996, accessed at: <http://nndl.tamu.edu/treatises/BrowseTreaty?author=lavanha>, fol. 57.)

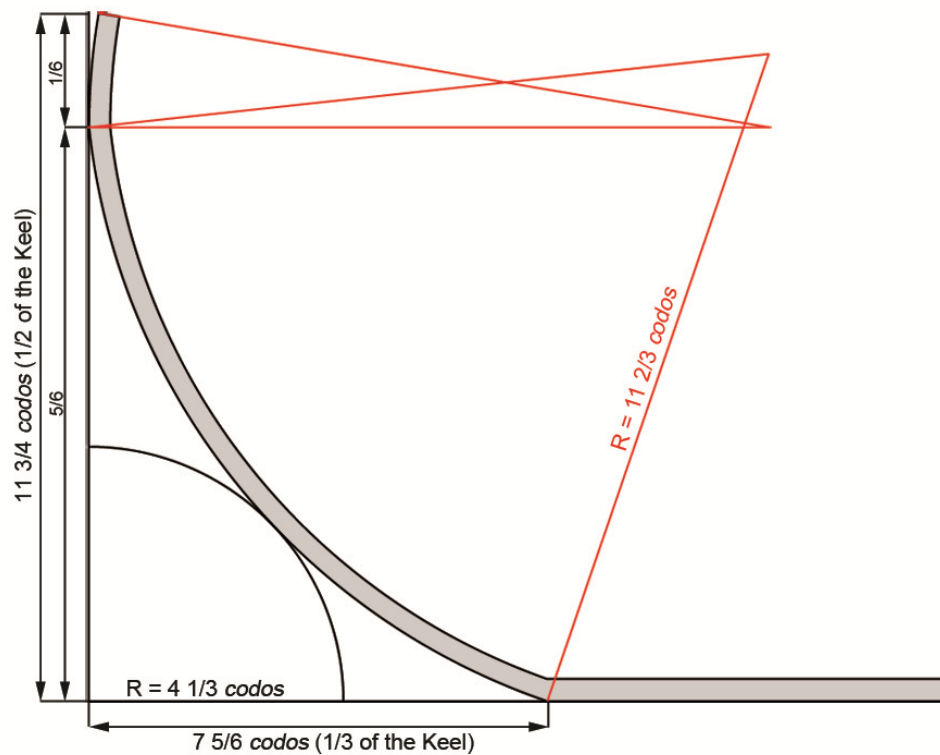

Figure 5.28: Hypothetical reconstruction of the stem

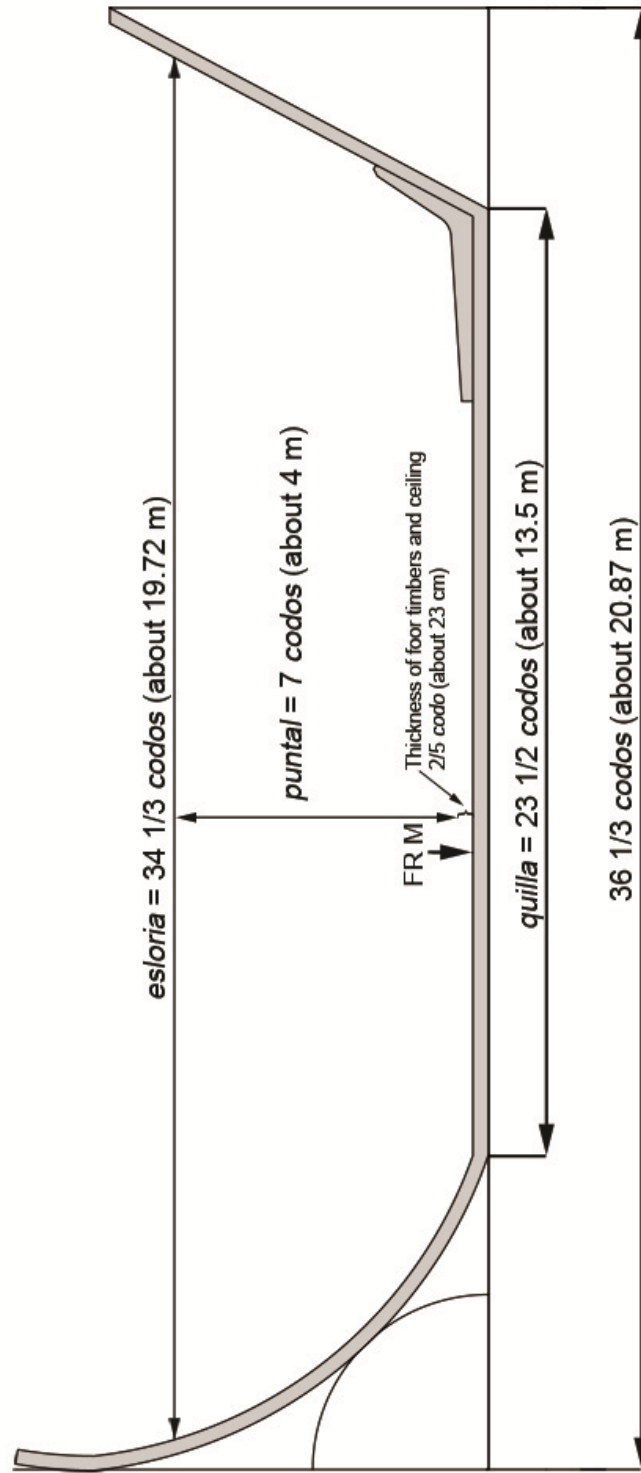

Figure 5.29: Hypothetical reconstruction of the total length of the ship (*eslora*) at the level of main deck.

By adding the length of keel to the length of the overhangs at both extremities of the hull, the Western Ledge Reef Wreck measured $36 \frac{1}{3}$ *codos* (about 20.87 m) between the perpendiculars. Nonetheless, this estimate is not what the contracts would call the total length of the ship (*esloria*). As indicated by the lawsuit involving *San Cristobal* of 500 *toneladas*, the actual total length was taken explicitly along the main deck of the ship from the post to post.⁸⁰ Based on the characteristics of the master frame of the Western Ledge Reef Wreck, particularly the height to the main deck at about $7 \frac{2}{5}$ *codos* above the baseline of the ship (7 *codos* above the ceiling), it is estimated that the total length (*esloria*) was about $34 \frac{1}{3}$ *codos* (approximately 19.72 m) (fig. 5.29).

Granted that the official dimensions commensurate with $23 \frac{1}{2}$ *codos* keel (*quilla*), $9 \frac{3}{5}$ *codos* maximum breadth (*manga*), 7 *codos* depth of hold to the main deck (*puntal*) and $34 \frac{1}{3}$ *codos* total length (*esloria*); the Western Ledge Reef Wreck was $\frac{3}{4}$ times longer than it was wide (ratio of 3.57-to-1), and about $\frac{5}{7}$ as deep in the hold as it was wide (ration of 0.73-to-1). To put these proportions into a perspective, the ratios were compared against measurements from the 1st Committee of Santander for the galleons of the *Armada de la Guarda de la Carrera de Indias* of 1581 (particularly the galleons of Pedro Menéndez de Avilés design); measurements from the Committee of Seville for the galleons of the *Armada de la Guarda de la Carrera de Indias* of 1581; measurements from the 2nd Committee of Santander for the galleons of the *Armada de la Guarda de la Carrera de Indias* of 1581; and a large body of ships that took part in the Spanish Armada Campaign of 1588.⁸¹ Although the galleons represented especially diverse group with ratios ranging from as high as 3.85-to-1 (length-to-breadth) for a

foreign-built Florentine galleon from the Armada of 1588, to as low as 3.33-to-1 for galleons of the *Armada de la Guarda* based on the Committee of Seville of 1581. At the same time, the group of galleons ranged from 0.58-to-1 to 0.68-to-1 (depth of hold-to-breadth) respectively. Only the smaller Castilian galleons (*Galeones menores de Castilla*) and *pataches* provided a match. These were as long as the Western Ledge Reef Wreck but shallower with the average ratios of 3.60-to-1 and 0.63-to-1, and 3.54-to-1 and 0.66-to-1, respectively.⁸² Contrary to the galleons, the naos as a group were considerably shorter for a given beam, averaging only 3.08-to-1 (length-to-breadth); hence, they could not be compared side-by-side the Western Ledge Reef Wreck. The only exception here was the nao *La Manuela*, with ratios of 3.48-to-1 and 0.67-to-1, which again indicate a slightly shorter and shallower vessel. Interestingly, *La Manuela*, with the largest length to beam ratio among all the naos of the Spanish Armada, was not Iberian but rather an impressed English-built vessel, suggesting perhaps a major proportional disparity between the ships from these two Atlantic zones.⁸³ As for the smaller auxiliary ships of the Armada of 1588, three Sevillian *navíos* had average ratios of 3.57-to-1 and 0.71-to-1, respectively, while four Zumayan *zabras* had ratios of 3.75-to-1 and 0.48-to-1. In other words, for a given beam, the *navíos* were only marginally shorter and as deep in the hold as the Western Ledge Reef Wreck, while the *zabras* were longer and shallower.⁸⁴ As illustrated in figure 5.30 (table 5.9), the proportions between the total length and maximum breadth, and between the depth of hold and maximum breadth placed the Western Ledge Reef Wreck in the vicinity of the cluster with galleons, *pataches*, and a nao (*La Manuela*). Although the Western Ledge Reef Wreck

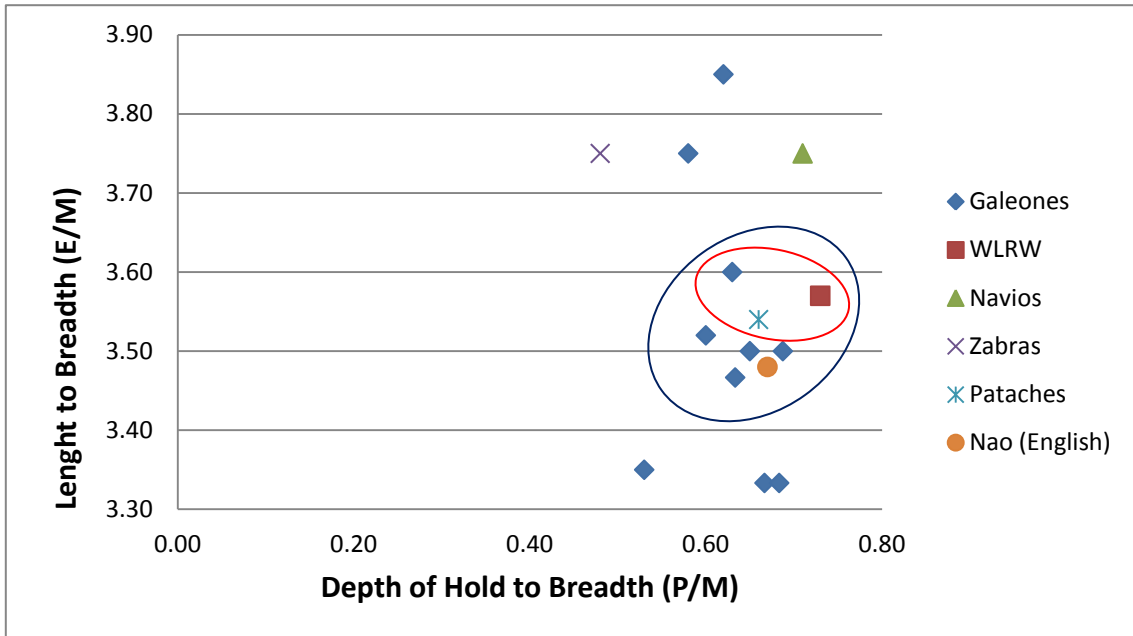

Figure 5.30: Graph showing the proportions for comparable ships. (after Table 5.9)

Table 5.9: The proportions between the total length and maximum breadth, and between the depth of hold and maximum breadth within a group of comparable ships. (after Casado Soto 1988, 186-226; Mendoza 2008, 170-2 (Table. 2, 3, and 4).)

Ship Types	E (Length)/ M (Breadth)	P (Height to main deck)/ M (Breadth)
Galeon de Florencia	3.85	0.62
Galeon frances	3.75	0.58
Navios de Sevilla	3.75	0.71
Zabras	3.75	0.48
Galeones menores de Castilla	3.60	0.63
Western Ledge Reef Wreck (WLRW)	3.57	0.73
Pataches	3.54	0.66
1st Committee of Santander (Galeone de Pedro Menéndez 1568)*	3.52	0.60
Galeon mayor de Castilla	3.50	0.65
2nd Committee of Santander Capitana and Almiranta (1581)**	3.50	0.69
Nao <i>La Manuela</i> (English)	3.48	0.67
2nd Committee of Santander Other Galleons (1581)**	3.47	0.63
Galeones de Portugal	3.35	0.53
Committee of Seville Capitana and Almiranta (1581)***	3.33	0.67
Committee of Seville Other Galleons (1581)***	3.33	0.68

*) after Mendoza 2008, 170 (Table. 2)

***) after Mendoza 2008, 172 (Table. 4)

****) after Mendoza 2008, 171 (Table. 3)

was Iberian-built, a relative association with English vessel could demonstrate the use of more progressive ship's proportions in line with Baker's manuscript of the period.

Within a group of galleons, the Western Ledge Reef Wreck also showed a distinct affinity to the smaller Castilian galleons. Even by expanding this analysis to include ship's measurements provided by the Ordinances of 1607, 1613 and 1618 does not diametrically alter the grouping.⁸⁵ The reconstructed proportions of the Western Ledge Reef Wreck consistently place it in the vicinity of galleons, *galeoncetes*, *navíos*, and *pataches* (see Appendix 5).

The proportions of the Western Ledge Reef Wreck appear to depart from the traditional Basque *as, dos, tres* (1:2:3) rule of breadth to keel to length found in numerous Spanish and Portuguese shipbuilding treatises of the period. Instead, they are consistent with a 2:5:7 ratio. In 1575, Juan de Escalante de Mendoza proposed that the Basque rule should be modified as to produce more streamlined hulls with proportions that adapted to be adept to the demands of the trans-Atlantic voyages.⁸⁶ This meant that for a given keel length, a ship such as the Western Ledge Reef Wreck would be narrower and longer overall than its equivalent built according to *as, dos, tres* rule, the qualities which undeniably would enhance its speed potential.

5.7 THE TONNAGE

Despite the inherent difficulties in interpreting the 16th- and 17th-century Iberian tonnage measurements, this reconstruction follows a seminal study that compared *toneladas* of cargo capacity (burthen), to the registry tonnage for the Red Bay (24M)

Wreck.⁸⁷ By adjusting the registry tonnage to include the usable space above the main deck, which simply implied increasing it by 20%, it was shown that both concepts gave identical results.⁸⁸

Notably, a *tonelada* could indicate either weight, as two Andalusian *pipas* (originally *pipas de vino*, casks of wine or water) of 27 1/2 *arrobas* (436 liters) each, equaled in weight to one *tonelada*; or volume, as eight Basque cubic *codos de ribera* (1.5183 m³) also equaled one *tonelada*.⁸⁹ Regional differences required conversion between the units; for instance, an Andalusian *tonel* or *tonel macho* had to be increased by approximately 20% to be comparable with a Basque *tonelada*. However, calculations for the commercial shipping between Spain and the Indies were normalized after 1590 (table 5.10).⁹⁰

A *tonelada* based on eight cubic *codos de ribera* became analogous with a *tonel* and a *tonel macho*, and formed the base for calculating taxes for different classes of merchandise per *tonelada de buque*, or cargo space. For example, the regulations of *Casa de Contratación* stated that ten sacks of chinaware amounted to a *tonelada*, as did five *botijas* of wine, or 22 1/2 *quintales* of iron, amongst numerous other categories of products.⁹¹

Keeping in mind all the limitations, the formulated rating or registry tonnage of the Western Ledge Reef Wreck at the time of building would have yielded about 136.9 *toneladas*. This was based on traditional calculations which multiplied the overall length (*esloria*) by half the beam (*manga/2*) by the depth in hold (*puntal*). Then, the total was reduced by five percent (x 0.95) to account for the entrance and run, and the resulting

Table 5.10: Comparison of Spanish tonnage measurements. (after Casado Soto 1988, 70.)

Basque <i>tonel</i> = <i>tonel macho</i> = <i>tonelada</i> of 8 cubic codos de ribera = 1.5183 m ³
Andalusian <i>tonel</i> = <i>tonelada</i> of cargo = <i>tonel</i> of 8 cubic codos de Castilla = 1.3844 m ³

Table 5.11: Hypothetical tonnage of the Western Ledge Reef Wreck and 16th-century Spanish formulas.

Tonnage Calculation			
Registry Tonnage	Actual Cargo Capacity		
<i>toneladas</i>	<i>toneladas + 20% refaçión</i>	<i>toneles</i>	<i>toneles machos</i>
136.9	164.2	149.2	141.8

Cargo Capacity			
<i>toneles machos + 20%</i>	<i>pipas</i>	Liters*	Metric Tons
170.1	328.5	143207.2	143.2

*) 1 liter = 1 kilogram

space lost in the hold. This amount was divided by eight to convert to *toneladas* of 8 cubic *codos de ribera*. To calculate the actual cargo capacity (burthen), which was also applied when a ship was chartered by the Crown to serve in some naval capacities, a customary 20 percent was added to the registry tonnage (addition known as *refaçión*).⁹² For the Western Ledge Reef Wreck, this would have yielded approximately 164.2 *toneladas*. Converting this to Andalusian *pipas* of 27 1/2 *arrobas* or 436 liters capacity each, the burthen would equal 331 *pipas* or about 143.2 metric tons (table 5.11).

Taken together, two lines of evidence related to a potential type of ship come to light. Upon reviewing previously mentioned ships of the Spanish Armada of 1588, only one vessel appeared to be comparable with the reconstructed dimensions and tonnage of the Western Ledge Reef Wreck. Within the reorganized squadron of auxiliary “*Pataches y Zabras*,” there was a ship called *Santo Crucifijo* of Burgos. Built in 1583, it measured about 35.7 *codos* in total length, 9.7 *codos* in maximum breadth, and 6 *codos* in depth of hold; while its tonnage was about 150 *toneladas* (table 5.12).⁹³ Significantly, this tonnage rating was more than twice the average tonnage of all the other ships classified as *pataches* or tenders in the fleet (generally ranging between 55 and 75 *toneladas*), a sufficient difference to justify the 1587 inventory describing *Santo Crucifijo* as a galleon appointed to serve as a *patache*.⁹⁴ Although this, by itself, does not prove that the Western Ledge Reef Wreck was a galleon- or a *patache*-type, it is a second verification, after the proportions between the length and breadth and between the depth of hold and breadth, of a viable connection. Within the entire body of rather diverse Spanish fleet of 124 ships, out of which 31 (25%) were classified as one of the auxiliary types and 20

Table 5.12: Comparison of major dimensions between the Western Ledge Reef Wreck and *Santo Crucifijo* of Burgos. (after Casado Soto 1988, 220-1.)

Western Ledge Reef Wreck vs. <i>Santo Crucifijo</i>		
Name	<i>Santo Crucifijo</i>	WLRW
Type	galleon	?
Construction Region	Cantabrian	?
Construction Date	1583	?
Esloria (L)	35.7	34.3
Manga (B)	9.7	9.6
Puntal (D)	6	7
Toneladas	150	136.9
Toneles Machos	127	141.8
E/M (L/B)	3.68	3.57
P/M (D/B)	0.62	0.73

(16%) classified as galleons, *Santo Crucifijo* is the only one with closely matching dimensions and proportions to the Western Ledge Reef Wreck.⁹⁵ Since, as Loewen noted, a tonnage range between 130 and 180 *toneladas* was considered anomalous for the 16th-century Basque shipbuilding, and proportionally, the Western Ledge Reef Wreck bore resemblance to a group of small Castilian galleons, the association with a galleon-built vessel type appears striking.⁹⁶

Additional evidence related to potential ship types based on tonnage range is found by analyzing an immense body of data provided by Chaunu and Chaunu (refer to chapter II, section 2.2, table 2.1).⁹⁷ Since the true nature or function of the Western Ledge Reef Wreck is unknown, the search criteria were expanded to include all those ship between 130 *toneladas* (the lower end of the registry tonnage) and 170 *toneladas* (the upper end of the cargo capacity or burthen). The bracketing was introduced as a way to compensate for potential unknowns and errors in the reconstruction calculations. Within a group of the ships that left Seville for the New World between 1550 and 1600, there are a total of 289 vessels of four distinct types. Of these, the most numerous were naos, constituting 92.4% (N=267) of the sample. They are designated either as generic naos or as naos *biscayan*, naos *portuguese*, or naos *gallega*. The second largest category are *navíos* constituting 2.8% (N=8) of the sample and include either generic *navíos* or *navíos* designated as naos *biscayan*. Although inconclusive, this could signify that the difference between the naos and *navíos* was rather fluid, both representing a broad merchantmen-type class of ships. The third category are an even more obscure type, described as *galizabras*, (likely a fusion of galley and *zabra*), constituting 1.4% (N=4) of

the sample. Explained by Veitia Linage, *zabras* were small ships of between 100 and 200 tons used for fishing and privateering, and subsequently replaced by frigates.⁹⁸ The remaining ship types include a single *patache* and other unknown ships, which constitute 0.3% (N=1) and 3.1% (N=9), respectively (fig. 5.31).

To conclude the reconstruction of the Western Ledge Reef Wreck, the ship had $23 \frac{1}{2}$ *codos* keel (13.5 m), $9 \frac{3}{5}$ *codos* maximum breadth (5.5 m), and $34 \frac{1}{3}$ *codos* total length (19.7 m). These dimensions were consistent with more progressive 2:5:7 (maximum breadth : keel : total length) ratio advocated by Juan de Escalante de Mendoza for the Atlantic vessels.⁹⁹ The formulated depth of hold to the main deck (*puntal*) was about 7 *codos* (4 m), which meant that the Western Ledge Reef Wreck had two decks: 4 *codos* (2.3 m) high orlop deck, and 3 *codos* (1.7 m) high main deck. As for the proportions, the ship was $3 \frac{4}{7}$ times longer than it was wide (3.57-to-1), and about $\frac{5}{7}$ as deep in the hold as it was wide (0.73-to-1). Although the tonnage was calculated and produced a range between 136.9 *toneladas* (registry tonnage) and 164.2 *toneladas* (cargo capacity or burthen) (or 143.2 metric tons), this by itself was not enough to prove ship's type. Assuming that the Western Ledge Reef Wreck sailed to the New World in one of the yearly convoys and was recorded by the officers of the *Casa de Contratación* in the registers, there is a considerable statistical possibility that it was a merchantman-type vessel consistent with a *nao* or *navío*. Yet, there is nothing in the data to conclusively dismiss a possibility that the ship could have been a *patache*. Finally, we should also make a note of the fact that a staggering number of ships, about 48% of the vessels of the period, were permitted to make solitary passages or their voyages did not

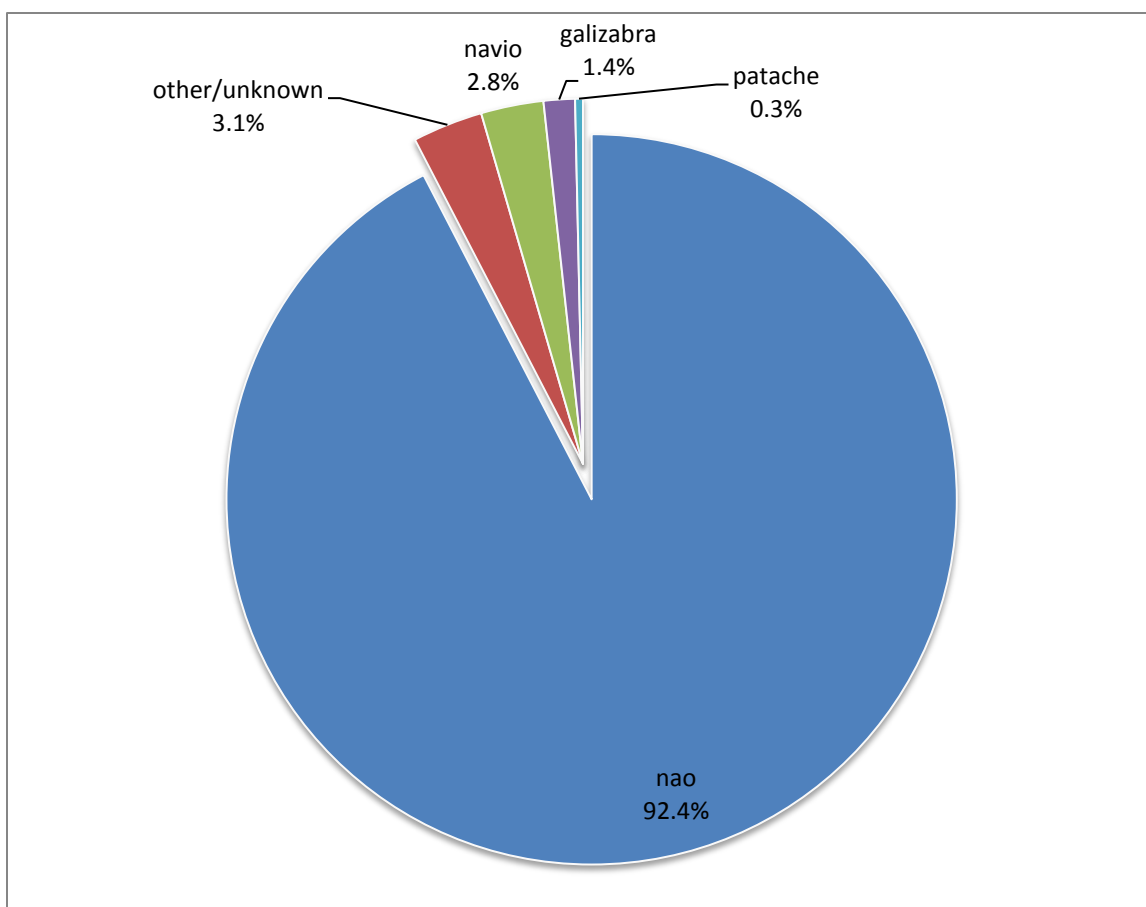

Figure 5.31: Ship types resisted by the officers of *Casa de Contratación* in the *Libros de Registro* between 130 and 170 toneladas.

make into the *Casa de Contratación* registers at all. As such, the Western Ledge Reef Wreck may well be a small galleon or some other unnamed Iberian type.¹⁰⁰ Although the available data provides a range of possibilities, the ambiguity of ship type nomenclature significantly limits the extent of search for a definite answer.

ENDNOTES

-
- ¹ Anonymous MS., ‘A Most Excellent Mannor for the Building of Shippes,’ Scott Collection, Institution of Naval Architects, London; Baker 1954, 266.
- ² Lemee 2006, 97.
- ³ See the analysis and reconstruction by Palou et al. 1998; Rieth 2003.
- ⁴ See Marsden and McElvogue 2009, 35.
- ⁵ For the discussion related to *quilla* (keel) versus *quilla limpia* (clean keel) refer to Barkham 1981, 4-6.
- ⁶ See Loewen 1991, 6.
- ⁷ The plank-on-frame model was built with help and expertise of Glenn Grieco at the Ship Model Laboratory < <http://nautarch.tamu.edu/model/> >, Nautical Archaeology Program, at Texas A&M University; Also see Steffy 1994, 221-5; Rieth and Burlet 1988.
- ⁸ Grenier et al. 2007, 3: 38.
- ⁹ Fernandez 1995, fol. 84.
- ¹⁰ Oliveira 1991, fol. 99.
- ¹¹ Baker 1954, 270; Baker c. 1580.
- ¹² Baker c. 1580, fol. 21
- ¹³ Baker c. 1580, fol. 23.
- ¹⁴ Lane 1934, 24-9; for the original manuscript refer to Pre Theodoro.
- ¹⁵ A term “oval” in reference to the design of the master frame was coined by Pimentel Barata 1989, 1: 184-90; Fernandez 1995, fol. 83.
- ¹⁶ Baker c. 1580, fol. 10-2; Barker 2003b, 74-5.
- ¹⁷ Barker 1994.
- ¹⁸ Anderson 1960, 218.
- ¹⁹ Barker 2003b, 75; 1985.
- ²⁰ Grenier et al. 2007, 4: 309-80.
- ²¹ 1 *passa* = 5 feet (venetian) = 1.74 meter; or 1 Venetian foot = 348.0 mm
- ²² Lane 1934.
- ²³ Bellabarba 1993, 278.
- ²⁴ Fernandez 1995, fol. 83.
- ²⁵ 1 *rumo* = 6 *palmo de goa* = 1.546 meter
- ²⁶ Barker 2003b, 74-5; Pimentel Barata 1989, 1: 186 (Fig. 8).
- ²⁷ Fernandez 1995, fol. 83.
- ²⁸ Johnston 1994, 107-65.
- ²⁹ Baker c. 1580, fol. 12.
- ³⁰ Johnston 1994, 128-9; Barker 2003b, 74; Hakluyt 1903, 71-6.
- ³¹ Barker 2003b, 74-5.
- ³² Grenier et al. 2007, 4: 319-22, 25.
- ³³ Ibid., 4: 329-35.
- ³⁴ Ibid., 4: 330-1.
- ³⁵ Barkham 1981, 1-3.
- ³⁶ Ibid.
- ³⁷ Ibid., 7-13.
- ³⁸ Ibid., 2.
- ³⁹ Grenier et al. 2007, 3: 83.
- ⁴⁰ Baker c. 1580, fol. 12.
- ⁴¹ Ibid.
- ⁴² Ibid.
- ⁴³ Grenier et al. 2007, 3: 261-2.
- ⁴⁴ Barkham 1981, 8-13; Casado Soto 1988, 289-91 (Appendix 9); Grenier et al. 2007, 3: 258; all see Palacio 1587, fol. 90.

-
- ⁴⁵ A term *baos vacios* or “empty beams” was used if the orlop deck was not planked. Notably, the word “orlop” is a contraction of the Dutch word *overlopen*, and literally means an overlap, see Campbell 1956, 4.
- ⁴⁶ Palacio 1986, 115; Laanela 2008, 84 (table 5.1).
- ⁴⁷ Barkham 1981, 2, 8-13; Escalante de Mendoza 1985, 39; also see Fernández Duro 1881.
- ⁴⁸ Barkham 1981, 2, 8-13; Escalante de Mendoza 1985, 39; also see Fernández Duro 1881.
- ⁴⁹ Barkham 1981, 2.
- ⁵⁰ Grenier et al. 2007, 3: 258.
- ⁵¹ Refer to Loewen 2001.
- ⁵² Grenier et al. 2007, 3: 274-5.
- ⁵³ *Ibid.*, 3: 258.
- ⁵⁴ Laanela 2008, 84 (table 5.1).
- ⁵⁵ Lavanha 1996, 160-2; Loewen 2001, 243-6; Rieth 1996a, 125-32.
- ⁵⁶ Grenier et al. 2007, 3: 6.
- ⁵⁷ See Barker 1991, 2003a; Rieth 2000.
- ⁵⁸ For further reading refer to Barker 1991, 2003a; Loewen 2001, 243-6; Rieth 1996a, 2000.
- ⁵⁹ The term *joba* or its variation appears in Cano and Dorta 1964; Apestegui 1992; Gaztañeta e Iturrizalza et al. 1992; Apestegui 2001; Loewen 2001; Rieth 1996b.
- ⁶⁰ Fernandez 1995, fol. 10, 7, 103-4.
- ⁶¹ Loewen 2001, 245-6.
- ⁶² Barker and Loewen 2001.
- ⁶³ Loewen 2001; Grenier et al. 2007; Marsden and McElvogue 2009.
- ⁶⁴ Grenier et al. 2007, 3: 263-5.
- ⁶⁵ Baker c. 1580; According to Loewen (Grenier et al. 2007, 3:6.) the floor line and *flower line* might be alternative spellings; also see Baker 1954, 270; Grenier et al. 2007, 3: 6.
- ⁶⁶ Castro 2001, 221-2.
- ⁶⁷ For details refer to Agius 2002, 146-7; al-Hijji 2001, 44.
- ⁶⁸ Grenier et al. 2007, 3: 54; Rieth 1996a, 45-7, 99-102, 119-24.
- ⁶⁹ Cano and Dorta 1964; Palacio 1986; Fernandez 1995; also see Grenier et al. 2007, 3: 6-7; Rodríguez Mendoza 2008.
- ⁷⁰ Baker c. 1580, fol. 21.
- ⁷¹ Oliveira 1991, fol. 99; the facsimile of the original treatises can also be accessed on-line at <http://nabl.tamu.edu/treatises/BrowseTreaty?author=oliveira>
- ⁷² Barkham 1981, 6-7.
- ⁷³ Grenier et al. 2007, 3: 48-9.
- ⁷⁴ Lavanha 1996, fol. 57.
- ⁷⁵ Fernandez 1616, fol. 84; Grenier et al. 2007, 3: 43-4.
- ⁷⁶ Fernandez 1995, 152.
- ⁷⁷ *Ibid.*
- ⁷⁸ Lavanha 1996, 35-6 (fig.1), 149; see also the facsimile of the original treatises at <http://nabl.tamu.edu/treatises/BrowseTreaty?author=lavanha>, fol. 57.
- ⁷⁹ *Ibid.*, 149; Barata 1989, 1: 167-71.
- ⁸⁰ Barkham 1981, 6-7.
- ⁸¹ Rodríguez Mendoza 2008, 170-2 (Table. 2, 3, and 4); Casado Soto 1988, 186-226.
- ⁸² Casado Soto 1988, 193 (Table. Proporciones de los Galeones de la Gran Armada), 201 (Table. Proporciones de las Embarcaciones Auxiliares de la Gran Armada).
- ⁸³ *Ibid.*, 194-5, 221.
- ⁸⁴ *Ibid.*, 135.
- ⁸⁵ Rodríguez Mendoza 2008, 169-79.
- ⁸⁶ Escalante de Mendoza 1985; Fernández Duro 1880, 413-515; Phillips 1993.
- ⁸⁷ Grenier et al. 2007, 3: 299-310.

⁸⁸ The basic rule can be expressed as registry tonnage plus 20%, which equals the freight tonnage; for discussion see *Ibid.*, 3: 299-301.

⁸⁹ Veitia Linage 1977, 297-300; Casado Soto 1988, 67-71.

⁹⁰ Chaunu and Chaunu 1955, 1: 132-6; Casado Soto 1988, 67-71; Grenier et al. 2007, 3: 301-6; Trueba 1988, 52.

⁹¹ Stampa 1949, 13; Grenier et al. 2007, 3: 301-6.

⁹² Grenier et al. 2007, 3: 300; Casado Soto 1988, 69-70.

⁹³ Casado Soto 1988, 220-1.

⁹⁴ *Ibid.*, 200.

⁹⁵ *Ibid.*, 226; Lander 1977.

⁹⁶ Grenier et al. 2007, 3: 258.

⁹⁷ Chaunu and Chaunu 1955, 2: 444-595, 3: 6-563, 4: 8-109.

⁹⁸ Veitia Linage 1977, 272.

⁹⁹ Escalante de Mendoza 1985; Fernández Duro 1880, 413-515; Phillips 1993.

¹⁰⁰ Chaunu and Chaunu 1955, 6a: 404, 6.

CHAPTER VI:
ANALYSIS OF SELECTED ARTIFACTS FROM THE WESTERN LEDGE REEF
WRECK

6.1 INTRODUCTION TO THE ARTIFACT ANALYSIS

Aside from the single most important artifact, the ship remains themselves, the official National Museum of Bermuda (NMB) database contains a total of 2067 entries representing individual artifacts and artifact groups excavated from the Western Ledge Reef Wreck site between 1989 and 1991.¹ The management of the database is an ongoing project at the museum as some of the previously missing files and conservation records only recently resurfaced, located by the author and the museum staff. Overall, the collection comprises 1069 ceramic sherds, 9 glass pieces, as well as 448 organic and 9 inorganic artifacts from which a number of organic and inorganic samples were taken for further analyses and identification. The collection also contains 375 metal artifacts and concretions, of which 348 are ferrous while 27 are non-ferrous. There are 8 composite metal/organic and 2 composite metal/stone artifacts, as well as 147 stones, which are predominantly samples from the ballast pile (table 6.1). In other words, more than 70% of the entire assemblage consists of nonperishable ceramic and metal objects. As of now, all of these have received appropriate conservation treatment, including epoxy casting of numerous concretions, as well as preliminary analysis and interpretation.²

Table 6.1: A complete list of artifacts (by category) recovered from the Western Ledge Reef Wreck site between 1989 and 1991.

Artifact Variability on the WLRW Site		
Artifact Types	N	%
ceramics	1069	51.7%
glass	9	0.4%
organic	448	21.7%
inorganic	9	0.4%
metals:		
- ferrous	348	16.8%
- non-ferrous	27	1.3%
composites:		
- metal/organic	8	0.4%
- metal/stone	2	0.1%
stone	147	7.1%
Total:	2067	100.0%

As described in the chapter III, section 3.1, site interpretation has been complicated by the presence of the other shipwrecks, primarily the “Malpas Wreck,” near the sand hole with the remains of the Western Ledge Reef Wreck. It must be emphasized that with the exception of a few photographs, nothing is known about the “Malpas Wreck.” As this shipwreck was heavily salvaged and its timbers destroyed prior to the discovery of the Western Ledge Reef Wreck, the credibility of finds associated with the site has been inevitably tainted, especially the surface finds tentatively associated with the Western Ledge Reef Wreck. For ethical and scientific reasons, the author opted against using these cultural objects as part of the historical record.

Unlike numerous other underwater archaeological sites which provide a unique uncontaminated context, the assemblage raised from the Western Ledge Reef Wreck had to be divided into two categories. The first contains the objects raised from the site during the systematic and scientific excavations directed by Watts, conducted between 1989 and 1991.³ The second contains the objects salvaged from the site under the wreck license issued to Canton and Malps between 1964 and the mid-1970s. In addition, the second category extends to all those objects which were excavated by Watts, but designed in the NMB database as surface finds. Such division was dictated not only by the inability to establish the provenience of the artifacts from the second group, as the surface finds could have come from either shipwreck, but also to challenge claims of the accurate dating of the Western Ledge Reef Wreck. The only possible way to preclude potential chronological confusion between the two shipwrecks was to disqualify everything of questionable nature.

Archaeologists realize the value of unprovenienced material and sometimes use it in their analyses or typologies, as with some ceramic examples from the salvaged 1733 fleet incorporated by John Goggin in his pioneering work on Spanish olive jars.⁴ However, during the course of research on the Western Ledge Reef Wreck only the archaeologically excavated objects were studied. This does not mean that the Canton and Malpas collection or the surface finds should not be researched and analyzed, quite the opposite is true. However, one must realize that the relationship of these objects with the Western Ledge Reef Wreck is equivocal, to say the least. Since the dating of shipwrecks often relies on a small quantity of ceramic sherds, individual coins, or other highly diagnostic objects, it is important to rule out all uncertainty and use only archaeologically excavated well-provisioned artifacts.

It must be emphasized that this chapter does not constitute a complete analysis of the artifact assemblage from the Western Ledge Reef Wreck site; a task which goes beyond the scope of this dissertation. By expanding on the preliminary interpretation and reevaluating of some of the recovered diagnostic artifacts, the aim is to answer the questions of nationality and date of the shipwreck. In addition, analysis should indicate the possible course of the voyage, in particular where the ship was sailing from and where it was heading to. Finally, both ferrous and non-ferrous metal artifacts are utilized throughout this dissertation to aid the reconstruction and interpretation of the ship structure.

6.2 CERAMIC ARTIFACTS

The study of the Western Ledge Reef Wreck ceramics was an integral part of this research generating some of the most important chronological information. In 1993 the collection was taken to the Florida Museum of Natural History in Gainesville, where it was studied and identified by the museum's staff. Unusual or otherwise difficult to identify pieces were personally verified by the museum's archaeological curator and chair, Dr. Kathleen Deagan.⁵ Overall, the original database included 1069 ceramics sherds, but after eliminating the pieces of questionable or uncertain provenance the assemblage decreased to 636. For example, the entire group of brown Cologne stoneware (dated to between 1530 and 1600) had to be omitted because all the sherds were found scattered above the wreckage, mixed with loose sand and corals. As their association with the shipwreck was very weak, there was suspicion that the stoneware could have come from another shipwreck. Following this criteria, one sherd of aboriginal earthenware, five sherds of coarse earthenware, two sherds of earthenware redware, 12 sherds of majolica, 54 fragments of Spanish olive jars, two sherds of stoneware, and five fragments of roofing tiles were also excluded for the analogous reason of being found on the surface.

The remaining group of 636 individual sherds was organized for the purpose of this study into large categories based on clay fabric, such as earthenware and stoneware, albeit 99.9% of the assemblage belonged to the former group. The analyzed earthenware was all coarse and further subdivided based on surface treatment, specifically the presence and absence of glaze, and other unique manufacturing techniques. The resulting

categories were: unglazed coarse earthenware (a category which included olive jars and redware) (N=488), tin-glazed coarse earthenware (a category commonly branded as majolica) (N=97), aboriginal coarse earthenware (N=41), lead-glazed coarse earthenware (N=3), and earthenware roofing tiles (N=2). Even though coarse earthenware is relatively soft and porous, it was an essential part of any supply list for Spanish 16th- and 17th-century ships.⁶ For example, a list of earthenware for the *Nuestra Señora de la Concepción*, a 300-ton *capitana* of the 1554 fleet, consisted of “funnels, jars, 3 dozen pitchers, 10 dozen plates and a like number of soup plates, as well as 8 dozen white plates, 4 dozen large bowls, and 6 white jars, contained in willow baskets.”⁷ The other categories analyzed included bricks (N=1), stoneware (N=1), and unidentified materials (N=3) (table 6.2). Of all the sherds under investigation, the overwhelming majority, almost 92% (N=584), were small body fragments while only about 6% (N=41) were fragments with diagnostic rims, bases, or both.

As noted by Marianne Franklin and further corroborated by the author, the most important parts of this assemblage were the well-defined fragments of wide bowls or basins known as *lebrillos* (N=4), sections of small straight-sided bowls known as *escudillas* (N=4), but especially the ubiquitous sherds of Spanish olive jars known, among other Spanish designations, as *botijas* (N=476) (fig. 6.1).⁸ Looking at figure 6.2, it is evident that the unglazed coarse earthenware, particularly olive jars, constitutes the single largest category, almost 77% of the total number of sherds. The second largest category is tin-glazed coarse earthenware (majolica) constituting slightly over 15%. Interestingly, the third largest category, about 6.5% of the total, is aboriginal (local

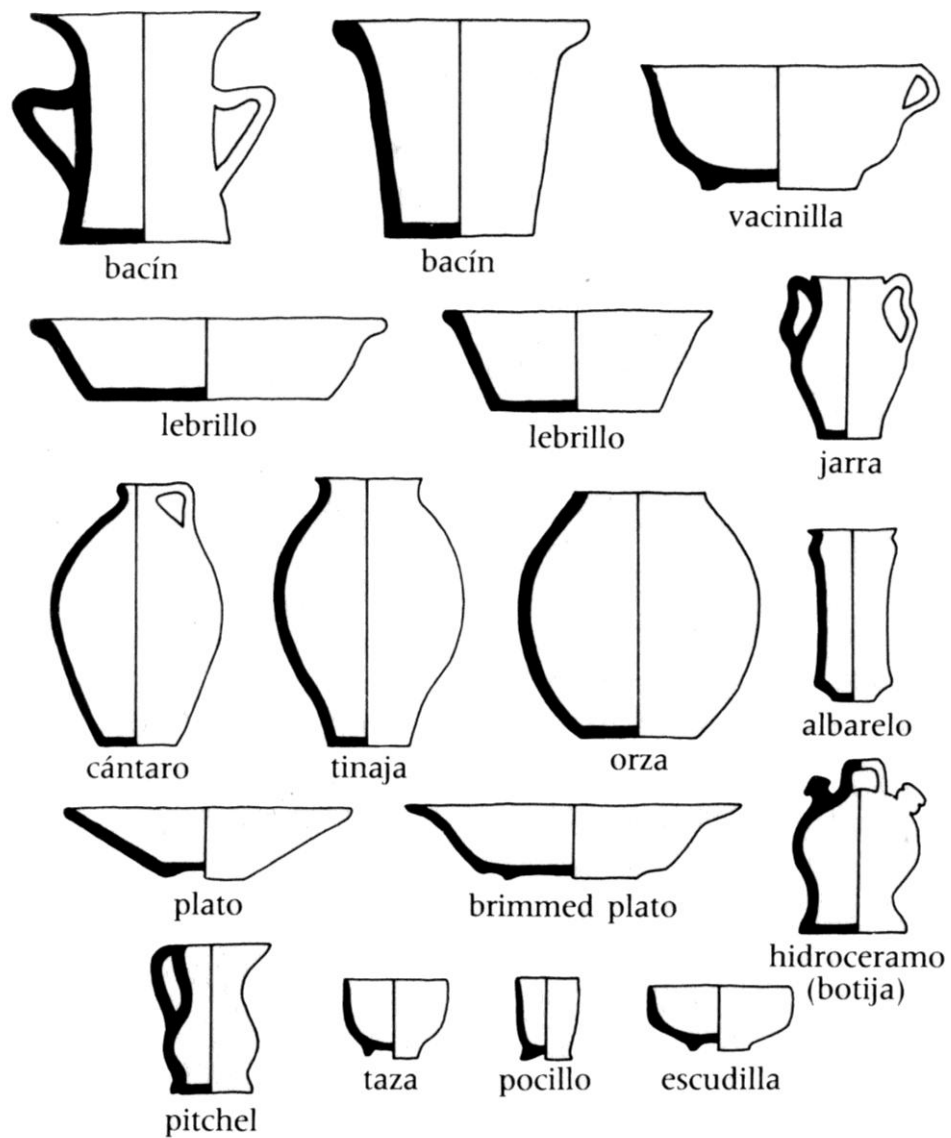

Figure 6.1: Common forms of Iberian ceramics. (after Deagan 1987, 27 (fig. 4.1).)

Table 6.2: Ceramic material from the Western Ledge Reef Wreck site after applying research criteria.

Ceramic Variability on WLRW		
Description	N	%
Unglazed Coarse Earthenware (Including Olive Jars and Redware)	488	76.73%
Tin-Glazed Coarse Earthenware	97	15.25%
Aboriginal Coarse Earthenware	41	6.45%
Lead-Glazed Coarse Earthenware	3	0.47%
Unidentified	3	0.47%
Earthenware Roofing Tiles	2	0.31%
Stoneware	1	0.16%
Bricks	1	0.16%
Total:	636	100.00%

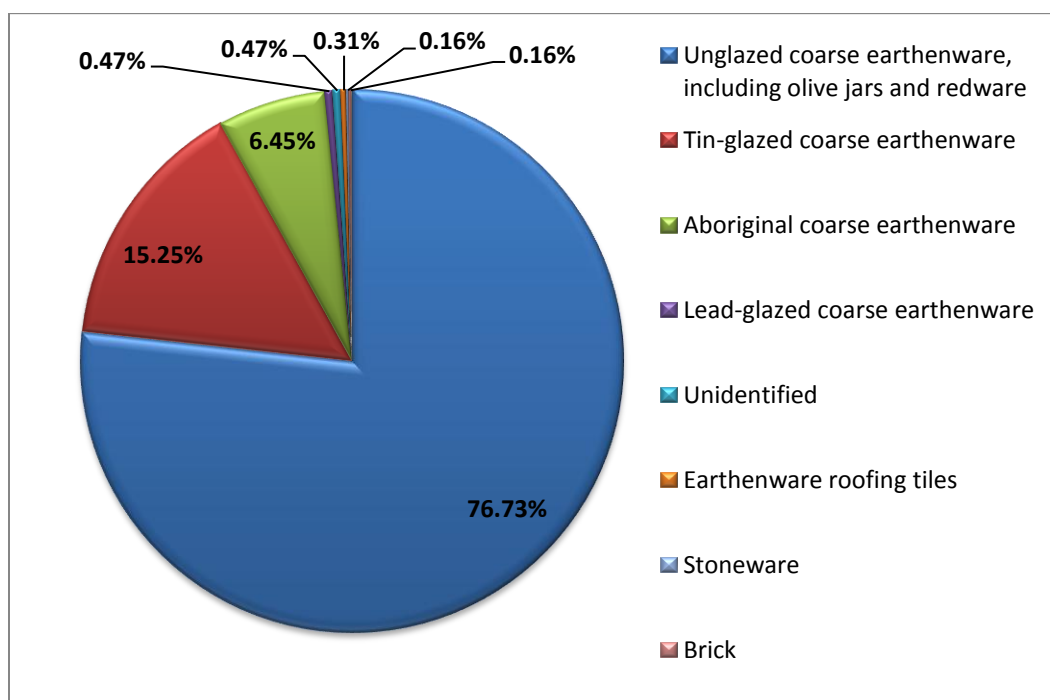

Figure 6.2: Distribution of ceramics by percentage. (based on table 6.2)

Caribbean) coarse earthenware. A simplified database with the ceramics from the Western Ledge Reef Wreck selected for the study based on the author's criteria is presented in the Appendix 5.

Unglazed Coarse Earthenware

Although olive jar sherds are numerous, they lack the unique characteristics of other ceramic types which facilitate more precise dating beyond broad temporal spectrum of up to 300 years. The 488 sherds excavated from the Western Ledge Reef Wreck comprised slightly over 75% of the entire coarse earthenware assemblage (table 6.3). Comparatively, olive jar sherds comprised about 47% of the total at the Molasses Reef Wreck site and 93% of the total at the 1554 Fleet wreck site (both 41WY3 and 41KN10).⁹

The olive jars can be defined as amphora-shaped Iberian shipping and storage vessels. They represented standard, mass produced, and inexpensive ceramic containers which proved irreplaceable for Spanish transatlantic commerce. In fact, the olive jars were so durable and available that archaeologists have often found them not only on numerous shipwrecks and terrestrial sites fulfilling their original function, but also as structural supports in roof vaults in the colonial homes, broken in floors, or as patio fills.¹⁰ Although traditionally referred to as olive jars, these vessels were regularly used for storing numerous other foodstuffs, including beans, chick peas, capers, olives in brine, and lard as well as liquids such as wine, olive oil, vinegar, or tar, among others.¹¹

Table 6.3: Unglazed coarse earthenware material selected for the study.

Ceramic Material From WLRW			
Unglazed Coarse Earthenware	Sherds	%	% of All Ceramics
Olive jars	478	97.95%	75.16%
Coarse earthenware	6	1.23%	
Coarse earthenware, redware	1	0.20%	
Other earthenware	3	0.61%	
Total:	488	100%	

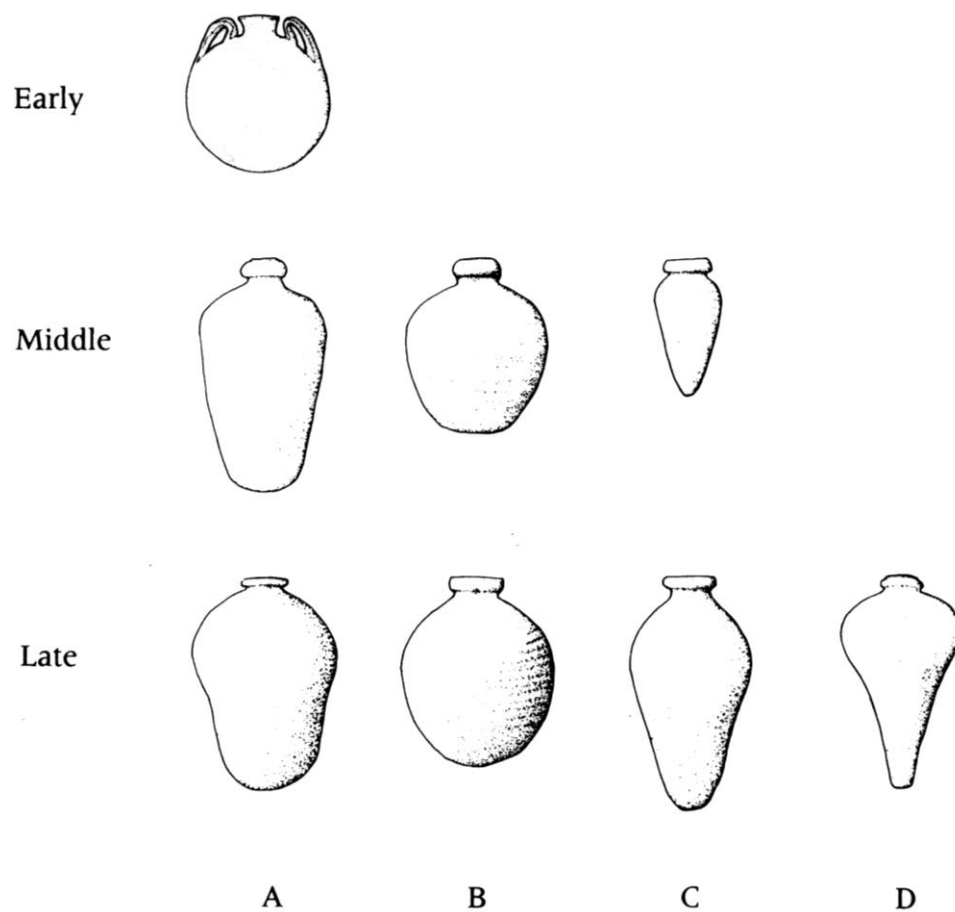

Figure 6.3: Forms of olive jars. (after Deagan 1987, 31; Goggin 1960, 28.)

The paste of the Western Ledge Reef Wreck sherds ranged from buff to pinkish-tan to gray. The majority had no glaze, and some displayed efflorescent salts leeching out on either the exterior or both exterior and interior. Nineteen sherds showed traces of pine resin or pitch on the interior or less commonly on the exterior, and five sherds had diagnostic green lead-glaze on the interior. The presence of the green glazing is difficult to interpret since it is unclear if it indicates certain content or reuse.¹²

According to Goggin, olive jars can be divided into three temporal styles: Early, Middle, and Late. While the Early style has only one shape, the Middle style can be further divided into three shapes: A, B, and C; whereas the Late style into four shapes: A, B, C, and D (fig. 6.3).¹³ However, Stephen James in his study proposed an alternative classification, identifying a fourth shape belonging to the Middle style in the assemblage of olive jars raised from two early 18th-century quicksilver wrecks, *Conde de Tolosa* and *Nuestra Señora de Guadalupe*.¹⁴ Regardless of the efforts to devise a comprehensive classification, the assemblage under the analysis had a limited number of diagnostic examples, and could not be taken to a shape level. On the Western Ledge reef Wreck site, there were 5 green lead-glazed body sherds and 2 rim fragments consistent with the Middle style and broadly dateable to between 1560 and 1800 (fig. 6.4).¹⁵ Although the assemblage also included a body sherd with conspicuous “nipple”, which bore some resemblance to the Early style, deterioration and its overall small size prohibited from substantiating this claim.

The collection included 10 sherds of other unglazed coarse earthenware ceramics. Of these, one sherd was identified as a body and rim fragment of *lebrillo*



Figure 6.4: Olive jar rim fragment (90:55-J16-2/12).



Figure 6.5: Degraded majolica fragment (89:35-TT1/16).

(basin) with an estimated diameter of the rim of about 36 cm, while another one was identified as body and rim fragment of an Iberian redware basin, with the estimated diameter of the rim of about 20 cm. The latter is of particular interest, since redware is the most common type of unglazed earthenware found at 16th and 17th century New World terrestrial sites, where it was oftentimes locally produced. The paste of the Western Ledge Reef Wreck redware was standard, resembling red-brick. Unfortunately, the popularity of this utilitarian ceramic type is also reflected in its temporal distribution, ranging from 1500 to 1750.¹⁶

Tin-Glazed Coarse Earthenware

Although the glaze was in poor condition after the years of underwater burial, the second largest group was identified as tin-glazed coarse earthenware, otherwise known as majolica. This ceramic type was considered the high end of earthenware up to the introduction of creamware by Josiah Wedgwood in 1762.¹⁷ Within the analyzed collection, 47 sherds were identified as Columbia Plain, a type of Spanish “Morisco ware” produced by Christianized Muslims (*Moriscos*) in the Spanish province of Andalusia, while 50 sherds were undiagnostic and categorized only as degraded majolica (fig. 6.5).¹⁸ The Columbia Plain ceramics came from one of the manufacturing centers in or around Seville and it could be described as a poor quality ware fabricated for lower levels of domestic market.¹⁹ It is not surprising, therefore, that it was the preferred type of pottery to outfit ship’s galley and used as tableware for the crew.²⁰ Noteworthy, the Columbia Plain ware was found on numerous Iberian shipwreck sites in the New World,

including Highborn Cay Wreck, Molasses Reef Wreck, St. John's Bahamas Wreck, or the Padre Island wrecks.²¹ In the Old World, it has been recovered from *La Trinidad Valencera*, one of the unfortunate casualties of Spanish Armada of 1588.²²

The paste of the Columbia Plain sherds from the Western Ledge Reef Wreck ranged from tan to yellow. The glaze was present both inside and outside and generally described as "gunmetal." According to Franklin, this color of glaze was an aberration from true enamel, likely caused by sulfide staining of the original white tin glaze under unique underwater deposition environment.²³ Within the Columbia Plain assemblage there were 12 bodies with flat bases identified as *escudillas*, one having an estimated rim diameter of 16 cm and base diameter of about 14 cm. There was also a body and rim of another *escudilla* with rim diameter of 16 cm, and two fragments of *platos* (plates). One *plato* had a rim diameter of about 24 cm, while the other one had an outer diameter of 28 cm.

This type of ware is the most common majolica found on the 16th and 17th century New World terrestrial and underwater sites. Unfortunately, as none of the sherds identified as *escudillas* could be placed within James Boone's chronology as Early (pre-1495), Middle (1495 to 1520) or Late (post-1520), it is assumed that the Western Ledge Reef Wreck's collection fall in the range from the 1490s all the way to 1650.²⁴

The few remaining tin-glazed coarse earthenware examples represent various heavily degraded majolica fragments. These include three sherds identified as *lebrillos* and two sherds as potential *escudillas*. Due to their extremely deterioration, they could neither be categorized beyond generic majolica nor dated.

Aboriginal Coarse Earthenware

The third largest category, by number of sherds, was low quality local Caribbean aboriginal coarse earthenware. As the assemblage constituted unglazed and undecorated grey body sherds with no identifiable characteristics, it was impossible to decipher their temporal distribution. Nonetheless, basic testing conducted by Keegan at the Florida Museum of Natural History pointed out inclusions of quartz or quartzite, narrowing the likely manufacturing center to the island of Hispaniola or perhaps one of the Windward Islands. Since this type of utilitarian ceramics was associated with the lowest socio-economic status, it must have been purchased or obtained through exchange by the crew from local potters along the way.²⁵ Noteworthy, a high percentage of aboriginal ware on board the Western Ledge Reef Wreck is consistent with the ceramic variability among terrestrial occupational sites. Even though shipwrecks and terrestrial sites are tricky to compare, aboriginal ceramics prevailed at both 16th-century Puerto Real, Haiti and St. Augustine, Florida; at the 17th-century Port Royal, Jamaica, slave-made African-Jamaica Yabba ware constituted about a third of all coarse ware analyzed.²⁶ Among shipwreck sites, the Molasses Reef Wreck assemblage included seven unidentified aboriginal sherds with gold inclusions.²⁷ In the case of the Western Ledge Reef Wreck, the presence of aboriginal material could indicate that the ship made a least one stop at the location where these ceramics were produced, or possibly, the vessel was sailing for a period of time within the Caribbean region to acquire such quantities of locally made inexpensive pottery.

Lead-Glazed Coarse Earthenware

Lead-glazing made coarse earthenware vessels less porous and more refined. It was represented on the Western Ledge Reef Wreck by two varieties. The first variety included two body sherds identified as El Morro ware. The second variety included a single, albeit highly diagnostic, rim fragment identified as Green Bacín (or Green *Lebrillo*) from a vessel with a reconstructed inner rim diameter of 14 cm (fig. 6.6). The paste of the El Morro material was red, the interior was covered with yellowish lead glaze, while the exterior had black discolorations of unknown origin. Being utilitarian and quite difficult of date due to irregularities in archaeological reporting, the median range for El Morro ware is between 1550 and 1770.²⁸ In contrast, the Green Bacín rim fragment was characterized by yellowish-cream paste and distinctive green glazing on both interior and exterior. This ceramic type is highly diagnostic and associated with 16th-century context. Deagan maintains that Green Bacín and Green *Lebrillo* have not been reported from any terrestrial or underwater sites after the end of the 16th century, providing a narrow temporal range between 1490 and 1600.²⁹ One of the well-known underwater sites with significant quantities of this ceramic was Molasses Reef Wreck, where Green Bacín and Green *Lebrillo* constituted 24% of all the sherds recovered.³⁰ Although most of the lead-glazed coarse earthenware, particularly Green Bacín and Green *Lebrillo*, had clear Spanish origin, during the late 16th-century Mexico established itself as a major New World production center. Other New World centers associated with El Morro ware were Puerto Rico, Puebla, or Havana.³¹

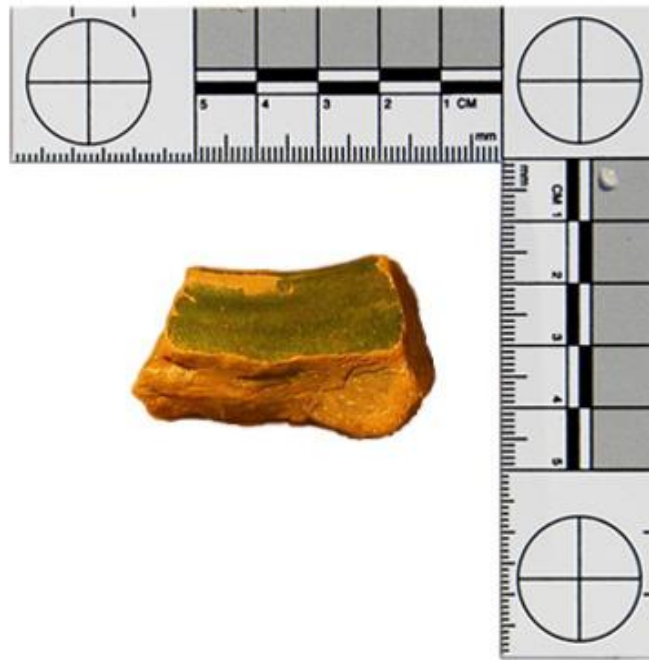

Figure 6.6: Rim fragment of Green Bacín (Green *Lebrillo*). (89:35-SS/30)

Roofing Tiles, Stoneware, Bricks, and Unknown

The remaining sherds, less than 1% of the entire ceramic collection, were identified as two fragments of earthenware roofing tiles, one sherd of stoneware, and a fragment of a brick. An additional three sherds were listed as unknown. With the exception of the stoneware, all these examples were undiagnostic and could not be used for dating. The dark brown stoneware, which might possibly be described as brown Cologne Stoneware, was not only poorly vitrified but also in such deteriorated state that no reliable identification could be permitted. Regardless, it is safe to say that this type of ceramic was manufactured in Europe, most likely northern Europe.

6.3 FAUNAL AND FLORAL ARTIFACTS

Constituting about 22% (N=457) of the entire collection of artifacts raised from the site, the faunal and floral remains provide an interesting outline of the possible itinerary of the Western Ledge Reef Wreck's voyage (fig. 6.7). In addition to a considerable amount of data recovered and analyzed in the field, a representative sample of both categories was sent for further tests and identification by archaeobotanist Lee Newsom from the Florida Museum of Natural History.³² At the same time, the faunal material was identified by Philip Armitage of Sanibel Island, Florida, and Elizabeth Wing of the Florida Museum of Natural History.³³ Unlike many of the ceramics and metal artifacts, the organic remains discussed here were well provenienced, as they were recovered from underneath the intact ballast pile, primarily from the sediment between the floor timbers. As such, their association with the shipwreck is remarkably strong. For

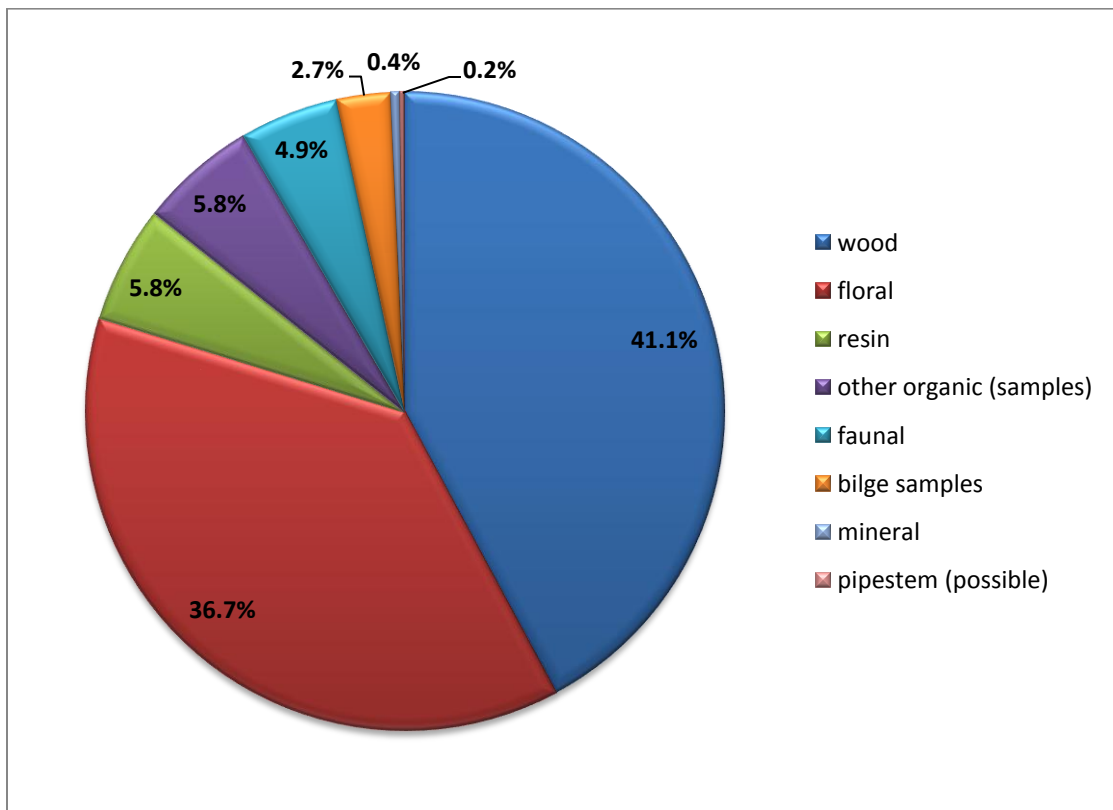

Figure 6.7: Pie chart showing the variability of organic and mineral artifacts by percentage.

a simplified table with the entries used in this study, refer to the Appendix 5. By no means is this a quantitative study of faunal and floral remains for the purpose of reconstructing the lifeway and subsistence practices on board the ship, which would be beyond the scope of this dissertation. The aim of this section is to provide a general overview on the animal and plant material present on the Western Ledge Reef Wreck at the time of sinking.

Fauna

The faunal remains constitute about 5% (N=22) of all the biological material recovered, ranging from bone fragments to shells to insect egg casings. As illustrated in table 6.4, the majority of the samples were identified as fragments of rib bones from domestic pig (*Sus sp.*). They display both old and more contemporary breaks, as well as evidence of butchery. The presence of pigs aboard the ship was anticipated, as they were part of standard 16th-century Spanish diet.³⁴ Other bone samples included domesticated cow; unidentified bones of either sheep, goat, or pig, which could not be taken to a species level; bird, most likely a chicken; fish; and edible oyster. Again, the dietary diversity evidenced by these samples reflects a common 16th-century Spanish consumption pattern, archaeologically identified from both land settlements and ships.³⁵

Noteworthy, the assemblage also included a previously broken and abraded part of lumbar vertebra from a white-tailed deer (cf. *Odocoileus virginianus*). Although the data related to historic white-tailed deer populations is imprecise, estimates suggest that it was one of the most abundant wild ungulate on the American continent, and was

Table 6.4: The faunal remains.

Identification	Part	N	%	Comments
Domestic pig				
Sus sp.	rib frags.	10	45%	4 frags. with recent knife marks; 6 broken in the past
Domestic Cattle				
Bos sp.	rib frag.	1	5%	anciently broken
White-tailed deer				
cf. <i>Odocoileus virginianus</i>	lumbar vertebra	1	5%	subspecies unknown; "anciently" broken/ abraded
Sheep, goat, or pig				
Unidentified sp.	long bone frag.	1	5%	anciently broken with no clear evidence of butchery
Bird				
Unidentified sp.	long bone frag.	1	5%	Possibly domestic chicken
Fish				
Unidentified sp.	vertebra	1	5%	
Rat				
cf. <i>Rattus</i> sp.	humerus, immature	1	5%	anciently broken
	pelvic bone	1	5%	
	rib, immature	1	5%	
	tibia	1	5%	anciently broken
Other:				
Oyster				
Unidentified sp.	shell	1	5%	likely as food
Insects				
Unidentified sp.	egg cases	1	5%	
	roach sacs	1	5%	
		22	100%	

incorporated quite early into Spanish colonial subsistence.³⁶ Since its habitat extends from southern Canada, throughout most of the Central and parts of South America, it is assumed that the operational theater of the Western Ledge Reef Wreck was not constrained to the Caribbean islands, but it must have visited the Spanish Main on at least one occasion during the voyage.³⁷ As emphasized by Franklin, the majority of bones were fragmentary and evidently butchered before the ship's demise. This suggests that the foodstuff had been already consumed by the crew.³⁸ Finally, the remaining samples belonged to two common ship vermin, rats and cockroaches, the scourge of the ship's holds; hence, their presence was predictable.

Flora

With almost 37% (N=165) of all the biological material classified as flora, the assemblage forms the second largest grouping (table 6.5). For the clarity of analysis, it is arranged here based on each plant's native habitat: Old World origin, New World origin, and either Old or New World origin. Although small volume of samples prohibited from taking some of the material to the species or subspecies level, the identification provided sufficient data for reliable, albeit generalized, assumptions as to the geographical extent of the voyage.

Old World

One of the most abundant species representing ship's victuals were whole and half pits of European (Common) olives (*Olea europaea*), a plant deeply rooted in the Mediterranean ecosystem, landscape, and culture.³⁹ Indeed, the olives and olive oil

Table 6.5: The floral remains divided based on geographical origin.

Identification	Part	N	%	Usage	Origin
Old World Species					
European Olive					
<i>Olea europaea</i>	Pits, Whole, Halves	93	56%	Foodstuff	Native to Mediterranean Region
Hemp					
cf. <i>Cannabis sativa</i>	Strands	16	10%	Ropes and Caulking	Native to Asia, Spread to Europe in Antiquity
Almond					
<i>Prunus dulcis</i>	Nut Shell, Frags.	3	2%	Foodstuff	Native to Mediterranean Region
Common Walnut					
<i>Juglans regia</i>	Nut Shell	1	1%	Foodstuff	Native to SE. Europe and Asia
New World Species					
Jerusalem Artichoke					
cf. <i>Helianthus tuberosus</i> *	Frag.	18	11%	Foodstuff	Native to N. America; Brought to Europe by 1599
American Chestnut					
<i>Castanea dentata</i>	Stem/Branch Frags.	3	2%	Unclear	Native to N. America; Brought to Europe by 1588
Pumpkin					
cf. <i>Cucurbita pepo</i>	Stem Frag.	1	1%	Foodstuff	Native to N. America; brought to Europe by 1587
Coconut					
<i>Cocos nucifera</i>	Hull Frags.	5	3%	Foodstuff	Native to Indo-Pacific Region, Reached Central America and Caribbean Prior to Spanish Colonization
Raintree/Liquorice					
Leguminosae, cf. <i>Cassia fistula</i>	Seed Pods	2	1%	Traditional Medicine	Numerous Species; Native to W. Caribbean, Africa, E. Asia

Table 6.5 (Continued)

Identification	Part	N	%	Usage	Origin
New/Old World Species					
Plum/Cherry					
Prunus sp.	Fruit Skin	1	1%	Foodstuff	Native to Europe, Asia, Americas Depending on species
Oak Acorn					
Quercus sp.	Hull Frags.	1	1%	Unclear	Native to Europe, Asia, Americas Depending on species
Other Plants					
Bamboo or sugar cane					
	Frag.	1	1%		
Tentatively ginger root					
	Frag.	1	1%		
Pine					
cf. Pinus sp.	Needle	1	1%		
Reed					
		1	1%		
Unidentified					
	Fruit Frag.	1	1%		
	Hull or Nut Seed	2	1%		
	Leaf Frag.	6	4%		
	Seed Pod	4	2%		
	Twig or Cane	1	1%		
	Vegetable Frag.	3	2%		
Total:		165	100%		

*) tentatively identified; possibly ginger, ground nut, or water lily

which they produce became a primary symbol of Spanish cultural identity and traditional diet that was transferred across the Atlantic. As all early efforts to cultivate olive trees in the New World were futile, which undoubtedly was quite dissatisfying to the Spanish colonists, the olives had to be imported and sold at an inflated price.

Although this important commodity would finally be cultivated in 1769, in a Mission just north of San Diego, California, it is clear that those found on the shipwreck were brought directly from Spain.⁴⁰ The almond (*Prunus dulcis*) and walnut (*Juglans regia*) supplemented the olives, and were distinctively native to the Old World as well.

Although they were likely stockpiled as foodstuffs for the duration of the voyage, both almonds and walnuts were considered luxury victuals distributed to the officers and crew only on a special occasions or as rewards.⁴¹ Another significant plant species present among the samples was true hemp (*Cannabis sativa*); it is easily confused with Manila fiber (*Musa textilis*), often referred to as hemp.⁴² The strong, lustrous, and very durable fibers from the inner bark of true hemp (*Cannabis sativa*) were traditionally the material of choice for ship ropes, cables, and oakum for caulking the seams.⁴³

New World

The second group of plants carried on board the ship is comprised of the species native to the New World prior to the Spanish colonization. Of these, the most abundant samples were tubers known as Jerusalem artichokes (cf. *Helianthus tuberosus*).

Although the samples gave a good match, Newsom stressed out that they also closely resembled ginger, ground nut, and even water lily, making the identification tentative.⁴⁴

Jerusalem artichokes are nutritious tuberous sunflower native to North American prairies

where they were used as foodstuff by the Indians.⁴⁵ Some biologists argue that in the wild state, Jerusalem artichokes originated in South America, perhaps in the area of today's Brazil or Peru, and then migrated north where they were domesticated.⁴⁶ During the late 16th century, these tubers were not only used as versatile dietary supplement, but also as the hog feed by the Spanish settlers.⁴⁷

Other New World provisions recovered from the shipwreck included samples identified as pumpkin (cf. *Cucurbita pepo*) and coconuts (*Cocos nucifera*). The pumpkin originated somewhere in between today's northern Mexico and western parts of Texas, and spread north and south during the pre-Columbian times.⁴⁸ Although somewhat ambiguously defined, it appears that the coconut evolved in the greater Indo-Pacific region and disseminated to South and Central America, as well as the Caribbean by floating. According to early Spanish chroniclers, particularly Oviedo y Valdéz, it was found on the west coast of Panama as early as 1526, and from there it was transferred to Mexico in 1539.⁴⁹ This was significant as the coconut became to be known not only for its nutritional value, but also for its quality oil.⁵⁰ Young and pliable stems of chestnut (*Castanea dentata*) could have been used for utilitarian purposes, such as withes suitable for binding casks.⁵¹

A few seed pods were identified as raintree or liquorice (cf. *Cassia fistula*), better known by its common Spanish name *cañafistula*. Although this plant has many different species growing worldwide, as an herbal medicine it reached Spain from the New World by 1569.⁵² It reflected a new and thriving export centered in Mexico of American plants and remedies widely sought after in Europe.⁵³ Noteworthy, there was about 12 pounds of

raintree (*cañafístula*) valued at 1,000 maravedís on a list of the medicines consigned to the officials of the Armada of 1549 under the Captain-General Diego López de las Roelas.⁵⁴ It was used as a moderate laxative, pain killer, to lessen fevers, and also in curing gout and rheumatism, amongst other real or imagined uses.⁵⁵

New and Old World

Finally, the ship also carried plants of more cosmopolitan nature which could not be used to narrow the geographical scope of the voyage. These included plum or cherry, hull fragment of oak acorn, bamboo or sugar cane, possible ginger root, pine needle, reed, as well as other unidentified fragments, seeds, leafs, twigs, or vegetables. As indicated by Franklin, acorns were both a dietary supplement and fodder for swine which, based on preserved bones, were present onboard.⁵⁶ Since these could not be identified, it is unclear which way they were traveling.

Other Organic Material

Other organic samples were either not analyzed or could not be identified due to their small size or severe deterioration and decomposition. Of these, there were samples of organic iron-rich muck recovered from the bilge of the ship from just underneath the middle portside buttress, slightly forward of the bilge pump, and below the ceiling. It consisted of a mixture of sand, clay, coal, possible ochre, wood chips, seeds, nuts, and bone fragments, all of which possibly indicating that the bilge in the vicinity of the pump was not cleaned for an extended period of time. Many of the samples were of unidentified resin, tentatively pitch. There was a single stem from a clay pipe. Some of

the more diagnostic wood fragments included various elements of barrels, such as head boards, staves, and hoops. There were also wooden wedges, dowels, and corks, as well as base fragment of a bowl and a head of a mallet.

6.4 METAL ARTIFACTS

The metal artifacts found on the Western Ledge Reef Wreck represent a collection of fasteners, rigging, and other ship elements or cargo; unlike ceramics, they do not narrow the chronological window for the sinking or the geographical scope of the voyage. Nonetheless, the collection is still invaluable in providing interesting comparative data, facilitating accurate reconstruction and interpretation of the ship structure. Using the database with 375 entries categorized as metals, which constituted about 18% of all artifacts recovered from the site, the assemblage was divided into copper alloys and iron. Upon applying similar methodology devised for ceramics and eliminating some of the most questionable or unprovenanced surface finds, as well as reanalyzing some of the categories and metal types, the assemblage under the analysis decreased to 93 objects (table 6.6). As the iron artifacts completely oxidized, leaving only molds in the encrustations, the objects in the museum collection are only those that were successfully cast with commercially available epoxy resin. As such, the museum database contains many more entries than are present in the physical collection of artifacts. Where appropriate, the author supplemented the information gathered from the database with the preserved artifacts stored or displayed at the NMB.

Table 6.6: Metal material selected for the study.

Copper or Bronze Material			
Description	Qty.	%	Type
Tacks	2		Small Tacks
Nails	7		Nails
Other Copper or Bronze	2		Unknowns
Subtotal:	11		
Lead Material			
Description	Qty.	%	Type
Sheathing Fragment	2		Lead
Subtotal:	2		
Iron Material			
Description	Qty.	%	Type
Tack	1	1%	90:55-TT5---2/25; 90:55-TT5---2/15; 90:55-J17-I-3/03; 90:55-I17-IV-1/01
Nails/Spikes	53	66%	Nails, Spikes, and Fragments
Ornamental Nail	1	1%	
Bolts	2	3%	
Forelock bolts	1	1%	
Chainplate w/ Forelock Bolt	1	1%	90:55-E18-I-0/01a
Chainplate	5	6%	Fragments
Gudgeon	4	5%	16 Fragments of Gudgeon Concretion
Strap	3	4%	Possibly From a Barrel
Shot	1	1%	
Unidentified/Other	8	10%	
Subtotal:	80	100%	
Total:	93		

Copper Alloys

As archeological metals can rarely be identified in accordance with modern metallurgical standards as bronze or brass, the first category contains all those metal alloys whose major component was copper. The assemblage comprises 13 artifacts which are further subdivided based on object type. There are seven nails, two tacks (or small nails), two pieces of copper sheeting or sheathing, and two unknown/unidentified objects. For the discussion on tacks and nails refer to chapter IV, section 4.4, of this dissertation. Out of the original four pieces of copper scraps, only two were found buried under the intact ballast, while two remaining ones were likely intrusive. Upon closer examination, it became clear that they were incorrectly identified in the past. Instead of deteriorated copper sheets or sheathing, these were highly oxidized and crumbling lead strips. In addition to numerous other functions of lead aboard a ship, it is hypothesized that these strips could have been used to watertight the seam between the deck planking or to protect the caulking material along the seams of the external planking.

Iron

The majority of the iron artifacts, about 71% (N=57), comprises ship fasteners such as bolts, spikes, nails, and tacks. These are discussed in detail in chapter IV, section 4.4, of this dissertation. It should be emphasized that the nature of the site prohibited recreating intra-site provenience, which could otherwise help differentiate between the fasteners used for the construction and those carried as spares. In addition to fasteners, the collection includes rigging elements such as a chainplate assembly with a forelock

bolt and another chainplate in five pieces, a lower gudgeon, a single ornamental nail, a possible small caliber shot (10mm in diameter), three fragments of straps, and eight other unidentified objects (fig. 6.8). Although poorly preserved, the wrought iron straps were initially interpreted as hoops for wooden barrels, from which fragments of individual staves and lids were also recovered. Based on comparison with iron barrel hoops from the wreck site of 1554 Fleet, the fragments analyzed here were twice as wide measuring 40 mm to 55 mm in width and 5 mm in thickness. In the lack of other evidence, the author is of an opinion that the initial interpretation that the iron straps functioned as barrel hoops is uncertain at best.

6.5 CONCLUSION

Overall, the material recovered from the Western Ledge Reef Wreck and that was selected for this analysis represents an important 16th and 17th-century collection of indisputable Spanish origin. Based on the two most numerous categories of ceramics, the unglazed coarse earthenware (primarily the Middle style olive jar rims), and the tin-glazed coarse earthenware identified as the Columbia Plain, the date range for sinking is from 1560 to 1650. Although tentative, a rim fragment of lead-glazed coarse earthenware known as Green Bacín or Green *Lebrillo* is instrumental in narrowing this range to between 1560 and 1600. This type of pottery is frequently encountered on the early-16th century sites and slowly disappears from the archaeological contexts towards the end of that period. Significantly, Green Bacín or Green *Lebrillo* pottery is completely absent from the 17th-century sites.⁵⁷ As this is not proof that such material could not

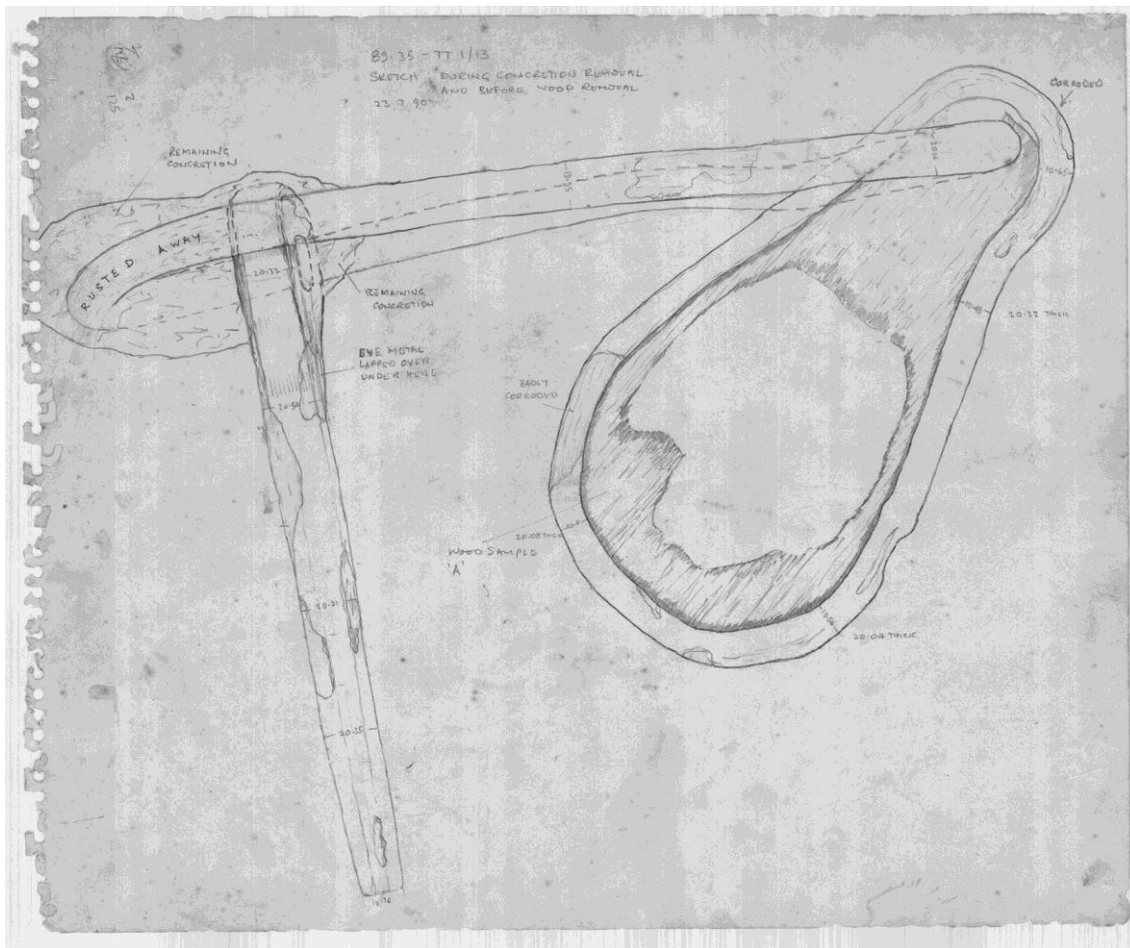

Figure 6.8: Sketch of the chainplate assembly before concretion and wood removal. (not to scale) (89:35-TT-1/13).

survive on a ship for a decade or so longer, the closing date of this range is somewhat tentative. In light of available data, however, we can conclude that Western Ledge Reef Wreck sunk on the Bermuda reefs no earlier than 1560 and no later than roughly 1600.

Except olive jars used for storage, which are universally found on any Iberian shipwreck, the collection includes a large number of tin-glazed earthenware crockery comprised of either degraded majolica or Columbia Plain. Being classified as a part of the Sevillian “Morisco ware,” this is the most common-grade of the utilitarian majolica associated with everyday use amongst the lower socio-economic strata of Spanish society. In addition, the assemblage includes a significant amount of local-Caribbean aboriginal coarse earthenware, which likely was manufactured in the region stretching from Hispaniola throughout the Windward Islands. This suggests a certain, albeit quite minimal, degree of contact with local populations, since the only chance to acquire this mediocre ware was at its source. At the 16th-century Spanish terrestrial occupational site of Puerto Real, Haiti (Area 35) aboriginal pottery was used for cooking and European ceramics were standard tableware. Here, we can argue that the same could be true for shipboard life.⁵⁸ Even though the Spanish transatlantic ships were instructed to be self-sufficient, there is a possibility that after making a passage or spending some time sailing in the region some of the Spanish pottery broke and had to be replaced. As a result of an inability or unwillingness to invest in anything of higher quality, cheap Spanish pottery was replaced or supplemented by equally cheap local pots.

Although the lack of evidence of potential cargo within the recovered cultural material might be misleading and should not be used to exclude a possibility that the

ship did, in fact, carry cargo items, it brings to light an interesting supposition. Within the entire group of vessels participating in transatlantic *Carrera de Indias*, there were only few ships that could afford the voyage without engaging in legal or illicit commerce. Among potential candidates, there were those ships functioning within the convoys as *pataches* (fleets tenders) or as *navíos de aviso* (dispatch ships). In either case, these ships still had to carry something to make their homebound voyage viable. In addition to letters and other government and private correspondence, *pataches* could be sent to collect low-volume but high-value goods such as pearls, while *navíos de aviso* were allowed to carry the red dyestuff cochineal. Unfortunately, none of these items was found during the excavations.

The potential absence of cargo comes as an interesting surprise, as the floral and faunal material clearly indicates that the ship made contact with both the Caribbean Islands and Spanish Main. In addition to olives, typically associated with traditional Spanish culture and diet, the ship carried other New and Old World foodstuffs and remedies. Collectively, these novel New World species are difficult to interpret, as they could have come from one central location, perhaps the area of New Spain, or numerous locations along the ship's route. Regardless, their presence on board and the location of the wreck site near Bermuda suggest that the Western Ledge Reef Wreck was on its return course when it sank.

ENDNOTES

-
- ¹ Watts 1993a.
 - ² Franklin 1993.
 - ³ Watts 1993a, 1993b; Morris 1993; Watts et al. 1994.
 - ⁴ Goggin 1960.
 - ⁵ Franklin 1993, 72.
 - ⁶ Rice 1987, 5.
 - ⁷ Arnold and Weddle 1978, 87.
 - ⁸ Franklin 1993, 73.
 - ⁹ Keith 1987, 350; Skowronek 1987, 104-6.
 - ¹⁰ Deagan 1987, 32; Marken 1994, 42.
 - ¹¹ Fairbanks 1972, 142; Martin 1979, 283; James 1985, 1-2.
 - ¹² James 1985, 41-2.
 - ¹³ Goggin 1960, 12-3.
 - ¹⁴ James 1985, 13-4 (Figure 2).
 - ¹⁵ Franklin 1993, 28-9, 34.
 - ¹⁶ Deagan 1987, 28-9, 37-8.
 - ¹⁷ Donachie 2001, 62.
 - ¹⁸ Deagan 1987, 55-7.
 - ¹⁹ Franklin 1993, 74.
 - ²⁰ Marken 1994, 141.
 - ²¹ Ibid., 143-4; Keith 1987, 363-5; also see Skowronek 1987; Malcom 1996.
 - ²² Martin 1979, 285-6.
 - ²³ Franklin 1993, 74.
 - ²⁴ Deagan 1987, 56-7; Boone 1984, 82-5; Marken 1994, 142-4.
 - ²⁵ Franklin 1993, 75; McEwan 1986.
 - ²⁶ McEwan 1986, 47 (Table 2); Donachie 2001, 50-1.
 - ²⁷ Keith 1987, 365-6.
 - ²⁸ Deagan 1987, 51.
 - ²⁹ Ibid., 48-9.
 - ³⁰ Keith 1987, 355.
 - ³¹ Deagan 1987, 47-8, 51.
 - ³² Franklin 1993, 77; also see correspondence with Lee A. Newsom (1993) on botanical analysis from the IMHA-3 Wreck on file at the National Museum of Bermuda, incorporating BMM.
 - ³³ Ibid., 80; also see unpublished report on the identification of the IMHA-3 faunal remains by Philip Armitage (1989-1990) on files at the National Museum of Bermuda, incorporating BMM; unpublished Report on the identification of the IMHA-3 faunal remains by Elizabeth Wing (1989-1990) on files at the National Museum of Bermuda, incorporating BMM.
 - ³⁴ Ibid.
 - ³⁵ Ibid., 80-1; McEwan 1986, 46-7; Palacio 1986, 137.
 - ³⁶ Leland et al. 2001, 2.
 - ³⁷ Ibid., 2-3.
 - ³⁸ Franklin 1993, 81.
 - ³⁹ Turrill 1951, 440-1.
 - ⁴⁰ Hartmann 1948, 345.
 - ⁴¹ Franklin 1993, 79; also see Reitz et al. 1985.
 - ⁴² Manila fiber (*Musa textilis*) is often referred to as hemp. However, it is a completely different plant from true hemp (*Cannabis sativa*). Manila fiber is also known by the Spanish name *abacá*.

⁴³ See Ash 1948, 158; for detailed analysis of planking seams and caulking refer to chapter IV, section 4.7, of this dissertation.

⁴⁴ Franklin 1993, 78.

⁴⁵ Whitford 1976, 30; Fernald and Kinsey 1958, 357-9.

⁴⁶ Lacaita 1919, 321-2.

⁴⁷ Franklin 1993, 78.

⁴⁸ Harshberger 1896, 890-1.

⁴⁹ Zizumbo-Villarreal and Quero 1998, 68-9.

⁵⁰ Franklin 1993, 78.

⁵¹ Ibid.

⁵² Foster 1953, 216.

⁵³ Arnold and Weddle 1978, 270; also see Schendel et al. 1968.

⁵⁴ Arnold and Weddle 1978, 270.

⁵⁵ Franklin 1993, 78.

⁵⁶ Ibid., 79.

⁵⁷ Deagan 1987, 49.

⁵⁸ McEwan 1986, 47.

CHAPTER VII

CONCLUSION

The late 16th century was a dynamic period for Spanish Empire and its shipbuilding industry. On the naval front, there was the battle of Lepanto in 1571, the Armada campaign of 1588, and numerous other smaller engagements of the Anglo-Spanish War. On the commercial front, there was the ever increasing volume of transatlantic and transpacific trade. Collectively these events were the cornerstone of Spanish imperial status and hence paramount to sustaining Spain's Empire. There was also the ecological factor, as the late 16th-century demand for ships to satisfy naval and commercial needs witnessed the first signs of timber shortage, deflected for a short while by broad reaching naval legislation.

Although within this context the small and highly utilitarian Western Ledge Reef Wreck might appear inconsequential, the analysis and reconstruction of the archaeological remains proved otherwise. Except for the three Basque whalers from the Red Bay, and that of *San Juan* in particular, only a small number of Iberian ship have been excavated and dated to the late 16th century. Likewise, the Western Ledge Reef Wreck was not only systematically excavated, but also disassembled and piece by piece raised to the surface for detailed recording in the lab; a process providing exemplary data which otherwise would be unavailable.

When the project began, a set of five research questions was proposed. These aimed at testing some of the original suppositions related to the dating and nationality of

the shipwreck which established the baseline. Careful analysis of the ceramics demonstrated that the vessel sank between 1560 and 1600 and had a predominantly Spanish crew. Despite concerns over site integrity tainted by prior salvage work, these results confirmed the initial expectations. The most significant research questions tested the compliance of the Western Ledge Reef Wreck with Iberian-Atlantic structural characteristics, the philosophical approach to design of major ship components, and the assembly sequence. Even though only a small percentage of the structure was preserved, the material showed that the ship was relatively new with no signs of reused or additional fastener impressions and timber repairs. The vessel was of reliable Iberian and Atlantic provenience. It was designed by adhering to geometrical rules and proportions known from contemporary shipbuilding treatises, and assembled with pre-designed frames, ribbands and planks in a step by step fashion. There was also the question, or rather an attempt, to combine the analyzed and reconstructed data from the Western Ledge Reef Wreck with a large body of historical sources in an effort to discover a ship type. Plagued by limitations in our knowledge of Spanish ships of the period, this dissertation established only a range of possible candidates.

7.1 DID THE WESTERN LEDGE REEF WRECK SINK DURING THE LATE 16TH CENTURY?

Although the timbers could not be dated by dendrochronological means, the analyzed cultural material from the Western Ledge Reef Wreck provides a temporal range for the sinking. This dating is also consistent with the original supposition of the

archaeologists working on the site between 1989 and 1991.¹ The correlation of the rims from the ubiquitous olive jars representing the Middle style (1560-1800) and fragments of tin-glazed *escudillas* and *platos* categorized as Columbia Plain (1490-1650) provided a range between 1560 and 1650. In other words, there is a high statistical probability that shipwreck sunk sometime between late 16th- and early 17th-century. A well-provenienced rim fragment belonging to lead-glazed earthenware known as Green Bacín or Green *Lebrillo*, dated to between 1490 and 1600, narrowed this range to between 1560 and 1600 (table 7.1). As reported by Deagan, this ceramics type has been absent from the post-16th-century contexts, including a number of well-studied 17th-century shipwreck sites, suggesting that it was manufactured only throughout the 16th century.² As the closing of this 40-year temporal window of sinking exclusively depends on a single sherd, it is statistically weak and the date should be treated with caution. Moreover, the author could not fully rule out the possibility that a few vessels or individual sherds of this 16th-century ware did not survive for a decade or two longer in the ship's bilge. In other words, the date 1560 associated with the introduction of the Middle style olive jars is used as a solid *terminus post quem*, while the date 1600 associated with terminal extent of the lead-glazed Green Bacín or Green *Lebrillo*, as a logical, albeit tentative, *terminus ante quem*. Dates based on small quantities of ceramics recovered from a catastrophic site with limited to no intra-site provenience are necessarily provisional. However, unless other serious questions preclude this interpretation, this provisional character should not distract from using the available data.

7.2 WAS THE WESTERN LEDGE REEF WRECK SAILING UNDER THE SPANISH FLAG?

In addition to its late 16th-century date, the cultural material from the Western Ledge Reef Wreck overwhelmingly indicates Spanish origin of the captain and the crew, once again supporting the original supposition.³ Except local-Caribbean low-grade aboriginal earthenware, which was probably obtained from the area extending between the island of Hispaniola throughout the Windward Islands, the collection included large quantities of olive jar sherds, redware, degraded majolica and Morisco ware including Columbia Plain, as well as lead-glazed earthenware. These can be divided into two categories: utilitarian storage containers such as olive jars and redware, and standard tableware such as various types of majolica. As both of these categories are of unmistakably Spanish provenience and particularly associated with the southern province of Andalusia, there is hardly a possibility that the Western Ledge Reef Wreck was sailing under a different flag during its final voyage.

Looking at the category of tableware, objects which would be used by the sailors on a daily basis, the most interesting aspect coming forth is the strong indication of low socio-economic status. The Morisco ware is represented by an austere, undecorated, and highly utilitarian grade most commonly used by the Spanish working class of the period. The presence and large overall percentage of aboriginal coarse earthenware further supports the notion of low socio-economic status, as only the cheapest Caribbean ware was acquired as a probable replacement or addition to the original and equally cheap

Spanish crockery. This, in turn, allows speculations that the ship had an analogous highly utilitarian and low cost operation.

Since neither Spanish nor Caribbean ceramics would bring any profit if shipped back to Spain, it appears that the cultural material from the site is characterized by the absence of objects which could be conclusively identified as cargo or trade goods. This, by itself, is insufficient to support the notion that the Western Ledge Reef Wreck did not carry such products. However, it is of consequence if combined with a possible utilitarian and low cost operation of the ship. Granted that only a few Spanish ship types could afford long transatlantic voyages without the financial rewards of commercial activities, the research focused on those vessels that were banned from carrying commercial goods. The two ships that fit this highly generalized description are the *pataches* (tenders) and *navíos de aviso* (dispatch vessels).

Based on floral and faunal evidence, the Western Ledge Reef Wreck made contact on a local level with the Caribbean islands and the Spanish Main. In addition to olives, almonds, and walnuts loaded in Spain in quantities that would suffice for the duration of the voyage, the ship also carried rare New World foodstuffs and remedies. While most of these species made their way to Europe sometime during the late 16th century, these novel colonial products must have been acquired from the local markets along the vessel's route. It is possible that all these plant and animal species were collected in Central America, specifically the area of the Viceroyalty of New Spain. However, due to statistically insignificant number of samples, one can only speculate if these species represent potential cargo or rather the foodstuff for the crew. Similarly, it is

ambiguous if they represent a single New World destination of the ship or a number of stops along the way.

7.3 DO THE WESTERN LEDGE REEF WRECK HULL REMAINS REPRESENT AN “ATLANTIC VESSEL” (IBERIAN-ATLANTIC) MODEL?

The Western Ledge Reef Wreck matches the eleven traits in Oretling’s model for Iberian ships of Atlantic provenience (table 7.2).⁴

First, Iberian-Atlantic vessel should have a number of pre-assembled central frames. The Western Ledge Reef Wreck has nine of those. They are characterized by the presence of shallow dovetail mortise-and-tenon scarfs at the overlap of the floor timbers and first futtocks. In addition to scarfs, each overlap is horizontally reinforced with iron nails or spikes and treenails. Since the minimum length of the extant treenails is nearly as much as the frame intervals, the process of assembling the futtocks to the floor timbers had to be completed prior to placing and fastening the frame to the keel. The final confirmation that these nine central frames were preassembled comes from the tool marks which indicate that the floor timbers and first futtocks were worked on as unit. Noteworthy, none of the remaining frames of the ship was pre-assembled.

Second, Iberian-Atlantic vessels should have carvel planking secured to the frames with a combination of nails and treenails. The Western ledge Reef Wreck has classic flat sawn, edge-to-edge carvel planking, bent or forced to shape over preassembled frames. These planks were ripped from long good quality oaks and are characterized by close fit and limited caulking. Each plank and frame intersection was

Table 7.2: Characteristic features of Atlantic vessel and Iberian-Atlantic tradition as related to the Western Ledge Reef Wreck. (after Oertling 2004, 130 (table 9.1).)

11 Characteristics Of Iberian Ships Of Atlantic Provenience			
FEATURES	Western Ledge Reef Wreck		
	PRESENT	ABSENT	UNKNOWN
Preassembled frames	Y (9)		
Planking (nails: treenails)	Y (2:2 & 2:1)		
Sternpost scarfed to the heel			X
Single stern knee	Y (2 timbers)		
Y-timbers tabbed to deadwood	Y		
Keelson notched over floors	Y		
Mast step in keelson	Y		
Buttresses and stringers	Y		
Ceiling/ filler boards			X
Rigging chainplate assemblies	Y		
Flat transom	Y		

secured with a combination of two iron nails and one or two treenails. The nails are positioned at the edges of the planks and along the centerline of the frames, while the treenails tend to alternate across that line. The large number of treenails is caulked from the outside. This is an original feature related to the planking assembly and has not been reported from any other Iberian-Atlantic example.

Third, Iberian-Atlantic vessels should have the after end of the keel scarfed to the heel, and the heel scarfed to the sternpost. Since the aft extremity of the keel did not survive, it is also unclear if the Western ledge Reef Wreck had the heel. However, the dimensions of both the stern knee and the sternpost strongly suggest that a heel might have been present. It is also plausible that the sternpost could have been longer and scarfed directly to the keel, an alternative solution known from contemporary shipwrecks.⁵ The available data does not provide an unequivocal answer.

Fourth, Iberian-Atlantic vessels should have a single stern knee functioning as rising deadwood. The Western ledge Reef Wreck has a stern knee. However, it is fashioned from two timbers functioning as horizontal and vertical arms. These were scarfed and fastened together along the horizontal arm and to the keel. Although a slight deviation, the stern knee of the Western Ledge Reef Wreck fits into the model as defined.

Fifth, Iberian-Atlantic vessels should have stern frames fashioned as Y-shaped crotches and secured to the stern knee through a system of tabs resembling single or double mortise-and-tenon joints. The Western ledge Reef Wreck has stern Y-shaped frames produced from the naturally grown crotches of the trees. These were scarfed to

the stern knee with a system of mortises and tenons. Mortises were cut along both sides of the knee, while the tenons into the bases of the crotches.

Sixth, Iberian-Atlantic vessels should have a keelson notched to fit over the corresponding floor timbers. The keelson from the Western ledge Reef Wreck is notched. The notches were custom cut to produce a close fit for maximum strength. The shallowest notches were present at the master frame and the first floor timber, while the deepest ones at the extremities. The entire keelson was also manufactured from at least three scarfed timbers.

Seventh, Iberian-Atlantic vessels should have a mast step fashioned as an expanded section of the keelson. The mast step from the Western ledge Reef Wreck is formed within the keelson's expanded central section. Overall, it resembled a large rectangular box with tapering ends and spanned a total of three floor timbers. The port side of the mast step directly abaft the mast mortise was cut into a square step for seating the main pump of the ship.

Eighth, the mast step of the Iberian-Atlantic vessels should be supported by a number of buttresses and longitudinal bilge stringers or foot wales. The Western ledge Reef Wreck has six roughly wedge-shaped buttresses; three on either side. The buttresses were fastened to the mast step and the first ceiling planks. They were also fastened to the stringers (foot wales), which provided the final outboard support for the mast step assembly.

Ninth, Iberian-Atlantic vessels should have ceiling planks extending just above the ends of the floor timbers where the last plank would be notched to accept short

transverse filler boards. Although the Western ledge Reef Wreck has poorly preserved ceiling, the transverse filler boards were not discovered during the excavation. This does not mean that the filler boards were not originally present on the ship. The available data does not provide a conclusive answer as to the compatibility with this feature of the model. Interestingly, the first strake of the ceiling fit perfectly into the rebates cut along the undersides of the buttresses. To date, the Western Ledge Reef Wreck is the only shipwreck with such arrangement; hence, it could signify a unique regional practice.

Tenth, the standing rigging of Iberian-Atlantic vessels should include chainplates with pear-shaped iron strop and chain attached to a bolt. The collection of rigging elements recovered from the Western Ledge Reef Wreck contained an example of such chainplate. The strop was pear-shaped and connected to a forelock bolt through a single link of chain. Inside the strop there was a remnant of a heart block.

Finally, the eleventh feature of Iberian-Atlantic vessels indicate that they should have a flat transom with a sternpost proud of the transom face. The lower stern and fragment of the preserved upper stern assembly from the Western Ledge Reef Wreck displayed diagonal planking and proud sternpost supporting the notion that the ship had a flat transom.

As evident from the summary, the Western Ledge Reef Wreck fully satisfies 9 out of 11 characteristics proving to be a legitimate Iberian-Atlantic vessel. Due to the poor preservation of the stern section of the ship, there is not enough evidence to determine if the sternpost was scarfed to the heel or directly to the keel. Likewise, absence of the hull remains above the turn of bilge prohibit validating if transverse filler

boards were originally present. Another original feature is the design of the stern knee made out of two timbers or the fastening pattern of hull planking with caulked treenails. Seen from the perspective of all the other key features, these idiosyncrasies are trivial and well within the overarching Iberian-Atlantic paradigm. In essence, they bear witness to a degree of regional variation or simply the ingenuity of individual shipwrights. As further Iberian shipwrecks come to light, it is important to continue the debate related to their structural characteristics and refine the current conceptual model.

7.4 CAN THE DESIGN METHOD AND ASSEMBLY SEQUENCE OF THE WESTERN LEDGE REEF WRECK BE IDENTIFIED, AND CORRELATED WITH SHIPBUILDING TREATISES OF THE PERIOD?

One of the most significant aspects of this dissertation was the research into the design and assembly sequence. Although both concepts are often times no more than conjecture, the preserved material from the Western Ledge Reef Wreck provided ample evidence. The ship measured $34 \frac{1}{3}$ *codo* (about 19.7 m) in total length, $9 \frac{3}{5}$ *codo* (5.5 m) in maximum breadth, 7 *codo* (4 m) in depth of hold, and it had a $23 \frac{1}{2}$ *codo* (13.5 m) long keel. At the time of building, the ship's registry yielded about 136.9 *toneladas*. However, its actual cargo capacity (burthen) was almost 164.2 *toneladas*, or about 143.2 metric tons (fig. 7.1).

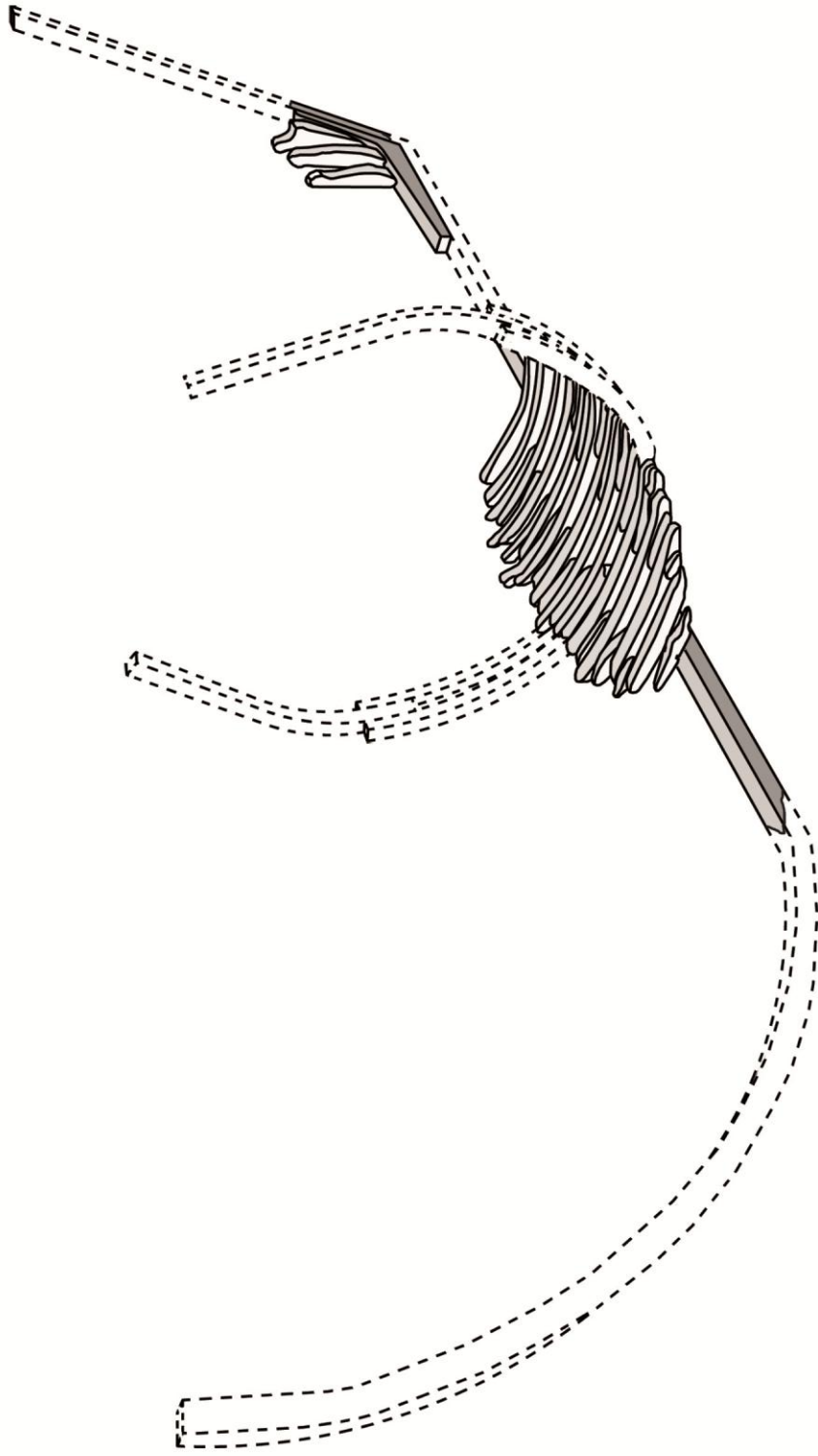

Figure 7.1: Conception of the overall ship in relation to the preserved framing timbers, keel, stern knee, and stern post (not to scale).

Design

The Western Ledge Reef Wreck the timbers came from intensely managed Basque woodlands with average age of nearly 40 years when felled. The keel and planking came from magnificent long straight oaks. The floor timbers were manufactured from large compass timbers whose grains generally followed the sweeping design arcs. Some of the lesser quality floors were manufactured from the tree trunks large enough to furnish two floor timbers sawn side by side. The compass timbers used to manufacture the first futtocks were also of lesser quality with numerous large waness, knots, and gnarled lower ends consistent with coppiced or pollarded stumps. By no means were these randomly selected oaks, but rather the products of controlled forestry practices. Being integral to the design process of Spanish ships, the influence of forestry impeded potential innovation and reinforced the conservatism within shipwright communities.

Set within these limitations, the Western Ledge Reef Wreck's master frame followed a methodology of four tangent arcs. Within this concept, one of the arcs delineated the curved floor while higher up the frame followed a familiar three-arc system that dictated the hull form of the Atlantic ships from at least early 16th century. On the Western Ledge Reef Wreck, consecutive moulds were aligned with the surmarks set at distinct intervals, while the chords of the arcs were regulated by a system of horizontal controls. This is only partly similar to the Venetian system of horizontal widths at key vertical locations. The design of the Western Ledge Reef Wreck's master frame closely resembled the "Greek" midship mould described by famous English

shipwright Mathew Baker at the turn of the 16th and 17th centuries. The Mediterranean ancestry of the mould was not limited to the Baker's description testifying to its use for small Greek merchantmen called *screatses*, it was also embedded, at least in principals, in the Mediterranean-inspired system of controls.⁶ Although the corresponding ratios differed, the geometry of the Western Ledge Reef Wreck's master frame also resembled the concept behind the master frame of a small Basque whaleboat excavated at Red Bay. In light of the still limited historical and archaeological comparative data, the master frame of the Western Ledge Reef Wreck might be seen as technological and cultural diffusion from the Mediterranean, rather than independent Basque development. During the second half of the 16th century, if not much earlier, this design was hardly a novelty. It was one of an array of design options available to shipwrights along the Spanish Atlantic seaboard and beyond.

Once the master frame was designed, the shipwrights used "whole molding" to shape subsequent frames, progressively narrowing the radii of the floor arc which affected the narrowing and rising of the turn of the bilge. Consequently, the chords of all tangent arcs of the frames were readjusted by being gradually moved downwards, indicative of the "hauling down" method. As this has been reported exclusively from English sources, its association with the Mediterranean "Greek" midship mould might appear confusing. Ultimately, the Western Ledge Reef Wreck demonstrates both methods can be compatible.

The design process is also illustrated by scribe marks found on the keel, particularly one pinpointing the position of the master frame. Setting the master frame at

the end of the forward third of the keel gave the vessel a full bow and elongated narrow stern, an ideal shape known in English treatises as the “cod’s head and mackerel’s tail.”⁷ Although their position on the keel could not be deciphered, the tail frames were instrumental in a process of creating the final shape of the hull. They also followed the “hauling down” mechanism. The frames beyond the central group of nine horizontally assembled ones were conceived with independent floating futtocks fastened only to the planking. The aim of floating futtocks was to provide necessary flexibility in dealing with complex curvatures of the extremities of the hull.

Assembly

Contrary to Hasslöf’s shell-first versus frame-first division or even more inclusive shell-based versus frame-based classification, the assembly sequence of the Western Ledge Reef Wreck is best described as frame-led or stepwise.⁸ After the keel was laid and both posts attached, a group of nine geometrically designed and fully assembled frames were placed and fastened to the keel. The floor timbers and futtocks belonging to this group were aligned at the surmarks and fastened with wrought iron nails. Next, the holes were drilled for the wood treenails which secured the joint. In such system, the nails might be viewed as more temporary fasteners before permanent and more superior treenails.

The sequence of framing began with the small number of preassembled frames and proceeded forward and aft. These guided or lead the evolving shape of the hull. Next, the other geometrically designed floor timbers, including the floor timbers for both

fore and aft tail frames, were positioned. At that point, longitudinal ribbands stretching from post to post were likely fastened along the turn of the bilge, followed by more ribbands higher up. These controls allowed for positioning and fairing the first futtocks. Since these futtocks were neither horizontally assembled nor made a physical contact with the corresponding floor timbers, they required a minimum of two ribbands. One placed along their lower ends and one along the upper. Simultaneously with the ribbands, garboards and some of the other intermediate planking must have been secured. These followed up being alternated with more first futtocks in a step-by-step fashion. Inside the hull, heavy stringers or foot wales could have been added along the turn of the bilge and some ceiling higher up to sandwich the overlaps between the framing timbers.

The Western Ledge Reef Wreck was not preserved above the turn of the bilge so the rest of the assembly sequence is only conjectural. The upper futtocks and planking advanced in a similar step-by-step manner. Once all the strakes were completed and temporarily nailed to the frames, the holes were drilled at the intersections treenails driven in. As such, the assembly of the Western Ledge Reef Wreck is quite analogous to other Iberian, English, or Dutch vessels in two key ways. The shape of its hull was dictated by a small number of pre-designed frames. Its form was also defined by longitudinal ribbands which created the complex curvatures and helped position the other framing elements without resorting to complex mathematics.

7.5 CAN THE WESTERN LEDGE REEF WRECK BE POSITIVELY IDENTIFIED AS A SPECIFIC SHIP TYPE?

Nomenclature for Iberian ships, particularly the smaller ones, is ambiguous. Although most of the Spanish ships were built as either naos or galleons, the same vessel could be designated by the *Casa de Contratación* as a nao during one voyage and as a galleon during the next one.⁹ This classification is further complicated by the fact that ship's designations often times associated with their function or size such as *navío* or *patache* were also quite lax and used interchangeably.¹⁰ As such, a ship built as a galleon could be designated as *navío* because of its small size, literally a "small ship," or as *navío de aviso* because of its function as a dispatch ship in the convoy. Since the Western Ledge Reef Wreck lacks associated historical sources, characteristic features above the waterline, or diagnostic artifacts which would conclusively pinpoint its potential type or function, the available data provides some interesting possibilities.

None of the cultural material associated with this highly utilitarian ship could be indisputably identified as the cargo. It is therefore possible that the Western Ledge Reef Wreck represented one of the ships known from the historical sources as being prohibited from engaging in commercial activities during the voyages. Two ships to fit this description are the *patache* (fleet's tender) or *navío de aviso* (dispatch vessel). The problem with this interpretation stems from the fact that absence of evidence of cargo is not evidence by itself. It might well be that the potential cargo or trade goods were originally present onboard prior to the wrecking but were salvaged, jettisoned, or otherwise dispersed by a number of environmental or human factors.

As nothing is known about the structure of *navío*-type ships, except perhaps their overall smaller tonnage and the notion that some were utilized as merchantmen, some as warships, while others as dispatch vessels, research concentrated on *pataches*, specifically the *pataches (pataxos) de guerra* (or armed *pataches*) illustrated in the Fernandez's shipbuilding treatise.¹¹ After comparing the structural characteristics related to the design of the master frame, curved versus flat floor, the position of the master frame on the keel, and the position of the main mast as related to the main mast step, the Western Ledge Reef Wreck significantly deviates from the drawings. Although this demonstrates that the Western Ledge Reef Wreck was probably not a *patache de guerra*, the sources are silent as far as possible similarities or difference between a *patache* functioning as a fleet's tender and *patache de guerra*, presumably functioning as a light warship. Likewise, there is no data to support a clear distinction between *pataches* and *navíos*.

A second hypothesis tested the relationship between the Western Ledge Reef Wreck and a standard Iberian merchantman-type ship, a *nao*, or presumably its smaller equivalent a *navío*. The premise here was that *navío* was simply a smaller version of a *nao*. Comparative analysis of the extant ship remains and shipbuilding treatises of the period indicates that the Western Ledge Reef Wreck's master frame design closely resembled the midship mould from the 16th-century Greek *screatse*.¹² Even though this vessel was an ordinary merchantman of about 100 tons burthen known throughout the Aegean and Adriatic, its affinity to Iberian merchantman-type ships is unclear, if such affinity ever existed. This is particularly well pronounced by looking at yet another small

Spanish boat which master frame followed the key principles of the “Greek” midship mould, but represented a known type of *chalupa* used for whaling. In essence, a design which the Greeks associated with a merchantman *screatse*, the Spaniards associated with something entirely different as far as the type and function.

The link between the Western Ledge Reef Wreck and merchantman-type ships was further tested against two ships designated as naos and illustrated in the Fernandez’s shipbuilding treatise.¹³ Of these, a larger four-decked nao with an “oval” midship mould appeared particularly similar, sharing not only a basic frame design, but also the characteristic curved floor and position of the master frame on the keel. These similarities were mitigated, albeit only to certain degree, by the fact that Fernandez’s “oval” mould allows for significantly different proportions between the arcs. Even taking a considerable size discrepancy into account, the similarities outweigh the differences. Given that the Fernandez’s large four-decked ship was undoubtedly a nao, the small two-decked Western Ledge Reef Wreck could be a scaled down version of the same ship. Here again the data to support such claim is extremely limited. This also raises a question about potential cut-off tonnage below which a nao would be already called a *navío*.

The hypothesis that the Western Ledge Reef Wreck was a nao or *navío* was further assessed by comparing its reconstructed tonnage range with ranges recorded for the late 16th-century ships of the *Carrera de Indias*. Overwhelmingly, more than 92% of the vessels ranging between 130 and 170 *toneladas* were classified in the documents as naos, a number that increased to 95% after including *navíos* into the count. No matter

how statistically significant, this interpretation has at least two drawbacks. It accounts neither for the remaining 5% of the ships of equivalent tonnage, including but not limited to *galizabras*, *pataches*, and other unknown types, nor for the fact that nearly half of all the ships making the passage to the New World were not registered in the official documents of the *Casa de Contratación*.¹⁴

Finally, the third hypothesis tested if Western Ledge Reef Wreck was a galleon or perhaps a galleon-built ship. Such a ship would be designed and built in accordance with galleon rules, but utilized or designated as something else. Basque shipbuilding contracts from 1579 describe two ships with analogous key dimensions: the length of keel, the maximum breadth, and height to upper deck.¹⁵ One of these was designated as a *nao* while the other as a galleon. This exposes the limitations of modern analysis of the past ship type nomenclature based on archaeological remains. It shows that the basic dimensions and tonnage of the Western Ledge Reef Wreck could equally relate to either a *nao* or galleon.

Regardless of these handicaps, the galleon hypothesis was further explored by converting the dimensions of the Western Ledge Reef Wreck into proportions (one expressed as total length of this ship to the maximum breadth, and the other one as the depth of hold to the maximum breadth) and comparing them against corresponding proportions gathered for the multitude of ship types participating in the Spanish Armada of 1588 and the *Armada de la Guarda de la Carrera de Indias*. Galleons matched the Western Ledge Reef Wreck's length-to-breadth ratio the best, specifically a group of smaller Castilian galleons (*galeones menores de Castilla*) from the Spanish Armada of

1588.¹⁶ Assigned to the squadron of “*Pataches y Zabras*,” one of the ships from the group was a 150-tonelada *Santo Crucifijo* of Burgos with dimensions and tonnage consistent with those of the Western Ledge Reef Wreck. Although *Santo Crucifijo* was assigned to serve as a *patache*, the 1587 inventory described it as a galleon. This was striking as *Santo Crucifijo* is the second factual example substantiating the galleon hypothesis, after the Basque contract of 1579. Notwithstanding, the best match for the depth of hold-to-breadth ratio was the group of Sevillian *navíos*.

Due to severe limitations of technical knowledge as related to the nuances of the hull structure of various Spanish ships of the period, the available data proved insufficient to positively match the Western Ledge Reef Wreck with a specific ship type known from the historical sources. At present, two most plausible candidates are either *nao/navío* with quite ambiguous distinction between the two, or a broadly defined galleon-type ship. Likewise, the available data did not elucidate a potential function the ship was performing during its last return voyage to Spain, perhaps a common merchantman, fleet’s tender, or an independent dispatch vessel sailing with letters.

Conclusion

Ship reconstruction is inherently complicated by the fact that most shipwrecks, including Western Ledge Reef Wreck, consist of fragmentary hull remains from below the waterline. Through the combination of data procured from archaeological, documentary, and iconographic lines of evidence, this dissertation analyzed and reconstructed a small utilitarian Spanish vessel, the Western Ledge Reef Wreck. It

established its role in Iberian maritime history of the Atlantic. It reassessed the temporal window of sinking and explored the culture of the people by understanding its origin and nationality. It analyzed its association with broader Iberian-Atlantic shipbuilding tradition, the philosophy behind its design, and the assembly sequence. This dissertation also engaged in the difficult task of identifying a potential ship type the remains could have represented.

Limitations in nautical archaeology are commonplace. Preservation level of the structural timbers and other artifacts, nature of work underwater, availability of comparative data, quality of historical sources and more; all play a role. Regardless, limitations should not distract from the importance of shipwreck research in general and completion of remarkable projects such as the Western Ledge Reef Wreck in particular. In addition to its standalone value, the project provided a significant data to be compared against known and prospective shipwrecks of the vibrant maritime zone of the Atlantic. As stated by late Richard Steffy, this is exactly the reason “why all wreck remains, no matter how sparse, should be documented carefully and published.”¹⁷

ENDNOTES

-
- ¹ Watts 1993a; Morris 1993; Watts et al. 1994; Franklin 1993.
² Deagan 1987, 48-50; Marken 1994.
³ Watts 1993; Morris 1993; Watts et al. 1994; Franklin 1993.
⁴ Oertling 2001, 234 (Table A); Oertling 2004, 130 (Table 9.1).
⁵ Lemee 2006, 273-4; Adams 2003, 122-3 (Figure 5.9).
⁶ Johnston 1994, 128-9; Barker 2003, 74; Hakluyt 1903, 71-6.
⁷ Baker c. 1580.
⁸ Hasslöf 1963, 163-4; Adams 2003, 48; Grenier et al. 2007, 3: 2-3.
⁹ Oyarbide 1998, 105-6; Phillips 1986, 14.
¹⁰ Barkham 1981, 1.
¹¹ Fernandez 1995, fol. 112-4.
¹² Johnston 1994, 128-9; Barker 2003, 74; Hakluyt 1903, 71-6.
¹³ Fernandez 1995, fol. 71, 83.
¹⁴ Chaunu and Chaunu 1955, 6a: 404, 6.
¹⁵ Barkham 1981, 2.
¹⁶ Casado Soto 1988, 193.
¹⁷ Steffy 1994, 218.

WORKS CITED

- Adams, J. 1985. "Sea Venture: A Second Interim Report - Part 1." *IJNA* 14(4):275-99.
- . 2003. *Ships, Innovation, and Social Change: Aspects of Carvel Shipbuilding in Northern Europe 1450–1850*. Stockholm Studies in Archaeology 24. Stockholm Marine Archaeology Reports, No. 3. Universitet Stockolm, Stockholm, Sweden.
- AGI, *Casa de Contratación*, 4889, fol. 2. Seville, Spain.
- AGI, *Casa de Contratación*, 4890, fol. 1. Seville, Spain.
- AGI, *Santo Domingo*, 272, fol. 1. Seville, Spain.
- Agius, D.A. 2002. *In the Wake of the Dhow: The Arabian Gulf and Oman*. Reading, UK: Ithaca Press.
- al-Hijji, Y.Y. 2001. *The Art of Dhow-Building in Kuwait*. London: London Centre of Arab Studies: in association with the Centre for Research and Studies on Kuwait.
- Alves, F., and É. Rieth. 2005. *Um Mergulho Na História: O Navio Do Século XV Ria De Aveiro A : Arqueologia Subaquática (Diving into History)*. Ílhavo: Museu Marítimo de Ílhavo.
- Alves, F., É. Rieth, and P. Rodrigues. 2001a. "The Remains of a 14th-Century Shipwreck at Corpo Santo and of a Shipyard at Praça Do Município, Lisbon, Portugal." In *International Symposium on Archaeology of Medieval and Modern Ships of Iberian-Atlantic Tradition: Proceedings*, edited by F. Alves, 405-26. Lisbon: Instituto Portugues De Arqueologia.
- Alves, F., É. Rieth, P. Rodrigues, M. Aleluia, R. Rodrigo, C. Garcia, and E. Riccardi. 2001b. "The Hull Remains of Ria De Aveiro A, A Mid-15th Century Shipwreck from Portugal: A Preliminary Analysis." In *International Symposium on Archaeology of Medieval and Modern Ships of Iberian-Atlantic Tradition: Proceedings*, edited by F. Alves, 317-45. Lisbon: Instituto Portugues De Arqueologia.
- Alves, F., P. Rodrigues, M. Aleluia, R. Rodrigo, C. Garcia, É. Rieth, and E. Riccardi. 2001c. "Ria De Aveiro A: A Shipwreck from Portugal Dating to the Mid-15th Century; a Preliminary Report." *IJNA* 30(1):12-36.

- Anderson, D. 1988. *The Spanish Armada*. London: Macdonald & Co. (in association with the National Maritime Museum).
- . 1925. "Italian Naval Architecture About 1445." *Mariner's Mirror* 11(2):135-63.
- . 1960. "The Mary Gonson." *Mariner's Mirror* 46(3):199-204.
- Anglería, P.M. de. 1511. *De Orbe Novo Decades Cum Legatione Babylonica*. Seville.
- Apestequi, C.C. 1992. "Aproximación a La Vida Y Obra De Antonio De Gaztañeta." In *Antonio De Gaztañeta, 1656-1728*, 39-102. Donostia, San Sebastián: Untzi Museoa [Museo Naval].
- . 2001. "Arquitectura Y Construcción Navales En La España Atlántica, El Siglo XVII Y Primera Mitad Del XVIII. Una Nueva Sistematización." In *International Symposium on Archaeology of Medieval and Modern Ships of Iberian-Atlantic Tradition: Proceedings*, edited by F. Alves, 163-212. Lisbon: Instituto Portugues De Arqueologia.
- Arnold, B.J. III. 1976. *Underwater Archaeological Magnetometer Survey and Site Test Excavation Project Off Padre Island, Texas*. Publication No. 3. Austin: Texas Antiquities Committee.
- . 1978. "The Flota Disaster of 1554." Paper read at 9th Conference on Underwater Archaeology, 3-8 January, 1978, San Antonio, TX.
- , ed. 1989. *Underwater Archaeology Proceedings from the Society for Historical Archaeology Conference*. Pleasant Hill, California: Society for Historical Archaeology.
- Arnold, B.J. III, and R.S. Weddle. 1978. *The Nautical Archaeology of Padre Island: The Spanish Shipwrecks of 1554*. New York: Academic Press.
- Arthur, E.R., and T.T. Ritchie. 1982. *Iron, Cast and Wrought Iron in Canada from the Seventeenth Century to the Present*. Toronto: University of Toronto Press.
- Ash, A.L. 1948. "Hemp: Production and Utilization." *Economic Botany* 2(2):158-69.
- Auer, J., and A. Firth. 2007. "The 'Gresham Ship': An Interim Report on a 16th-Century Wreck from Princes Channel, Thames Estuary." *Post-Medieval Archaeology* 41(2):222-41.

- Baker, M. c.1580. *Fragments of Ancient English Shipwrightry*. transcription by M.S. Robinson on file in the Nautical Archaeology Program library at Texas A&M University from an original MS in Pepysian Library, Magdalene College, Cambridge, PL 2820.
- Baker, W.A. 1954. "Early Seventeenth-Century Ship Design." *American Neptune* 14(4):262-77.
- . 1958. *The New Mayflower: Her Design and Construction*. Barre, MA: Barre Gazette.
- Barata, J. da G.P. 1989. *Estudos De Arqueologia Naval*. 2 vols. Lisbon: Imprensa Nacional-Casa da Moeda.
- Bardach, J.E. 1959. "The Summer Standing Crop of Fish on a Shallow Bermuda Reef." *Limnology and Oceanography* 4(1):77-85.
- Barker, R. 1985. "Blisters - a Venetian Bubble?" *Mariner's Mirror* 71(1):82-3.
- . 1986. "Fragments from the Pepysian Library." *Revista da Universidade de Coimbra* 32:161-78.
- . 1988. "Many May Peruse Us: Mould and Models in the Dockyards." *Centro de Estudos de História e Cartografia Antiga* 206:3-23.
- . 1991. "Design in the Dockyards, About 1600." In *Carvel Construction Technique: Fifth International Symposium on Boat and Ship Archaeology, Amsterdam 1988*, edited by R.H. Reinders and P. Kees, 61-9. Oxbow Monograph 12. Oxford: Oxbow Books.
- . 1994. "A Manuscript on Shipbuilding, Circa 1600, Copied by Newton." *Mariner's Mirror* 80(1):16-29.
- . 1997. "Careening for Good Soldiers in the Seventeenth Century." *Mariner's Mirror* 83(3):131-5.
- . 2001. "Sources for Lusitanian Shipbuilding." In *International Symposium on Archaeology of Medieval and Modern Ships of Iberian-Atlantic Tradition: Proceedings*, edited by F. Alves, 213-28. Lisbon: Instituto Portugues De Arqueologia.

- . 2003a. "Whole-Moulding: A Preliminary Study of Early English and Other Sources." In *Shipbuilding Practice and Ship Design Methods from the Renaissance to the 18th Century – A Workshop Report*, edited by H. Nowacki and M. Valleriani, 33-65. A Workshop Report. Preprint 245. Max Planck Institute for the History of Science.
- . 2003b. "A Venetian Ship Drawing of 1619." In *Shipbuilding Practice and Ship Design Methods from the Renaissance to the 18th Century - A Workshop Report*, edited by H. Nowacki and M. Valleriani, 67-77. A Workshop Report. Preprint 245. Max Planck Institute for the History of Science.
- Barker, R., and B. Loewen. 2001. "Raiding Lost Arcs." In *International Symposium on Archaeology of Medieval and Modern Ships of Iberian-Atlantic Tradition: Proceedings*, edited by F. Alves, 429. Lisbon: Instituto Portugues De Arqueologia.
- Barkham, M.M. 1981. *Report of 16th Century Spanish Basque Shipbuilding c.1550 to C.1600*. Manuscript Report Series, Number 422. Ottawa: Parks Canada.
- Barney, O.C. 1998. *El Riesgo En El Comercio Hispano-Indiano: Préstamos Y Seguros Marítimos Durante Los Siglos XVI a XIX*. México: Universidad Nacional Autónoma de México.
- Barreiro-Meiro, R. 2002. "The Bermuda Islands and Juan Bermudez." *Bermuda Journal of Archaeology and Maritime History* 13:7-18.
- Bass, G.F., ed. 1972. *A History of Seafaring: Based on Underwater Archaeology*. New York: Walker Publishing Company.
- . 1988. *Ships and Shipwrecks of the Americas: A History Based on Underwater Archaeology*. New York: Thames and Hudson.
- Bellabarba, S. 1988. "The Square Rigged Ship of the "Fabrica Di Galere" Manuscript." *Mariner's Mirror* 74(2):113-30.
- . 1993. "The Ancient Methods of Designing Hulls." *Mariner's Mirror* 79(3):274-92.
- Beltrame, C. 2009. "A New View of the Interpretation of the Presumed Medieval Po Delta Wrecks, Italy." *IJNA* 38(2):412-7.
- Benchley, P. 1971. "Bermuda: Balmy, British, and Beautiful." *National Geographic*, July, 93-120.

- Bill, J. 1994. "Ship Construction: Tools and Techniques." In *Cogs, Caravels, and Galleons: The Sailing Ship, 1000-1650*, edited by R. Gardiner and R.W. Unger, 151-9. London: Conway Maritime Press.
- Blake, W., and J. Green. 1986. "A Mid-XVI Century Portuguese Wreck in the Seychelles." *IJNA* 15(1):1-23.
- Bojakowski, P. 2009. "The Santa Lucia: Research into the Identity of the 16th-Century Western Ledge Reef Wreck, Bermuda." In *ACUA Underwater Archaeology Proceedings*, edited by E. Laanela and J. Moore, 227-234. Toronto, Canada: An Advisory Council on Underwater Archaeology.
- Bonino, M. 1978. "Lateen- Rigged Ships. New Evidence from Wrecks in the Po Delta (Italy) and Notes on Pictorial and Other Documents." *IJNA* 7(1):9-28.
- Boone, J.L. 1984. "Majolica Escudillas of the 15th and 16th Centuries: A Typological Analysis of 55 Examples from Qsar Es-Seghir." *Historical Archaeology* 18(1):76-86.
- Boxer, C.R. 1969. *The Portuguese Seaborne Empire, 1415-1825*. New York: A.A. Knopf.
- Brading, D.A., and H.E. Cross. 1972. "Colonial Silver Mining: Mexico and Peru." *Hispanic American Historical Review* 52(4):545-79.
- Braudel, F. 1981. *The Structures of Everyday Life: The Limits of the Possible*. Translated by S. Reynold. Vol. 1, Civilization and Capitalism, 15th-18th Century. New York: Harper & Row.
- Bream, J.W. 1987. "Archives of the Indies: Report of the Research Conducted May – June, 1987." Unpublished Report. Bermuda: Institute of Maritime History and Archaeology, Bermuda Maritime Museum.
- . 1990. "The Spanish Influence on Bermuda." *Bermuda Journal of Archaeology and Maritime History* 2:15-24.
- Breck, P. 1965. "Spanish Wreck Found Off Bermuda." *Bermuda Sun*, July 3, 1965.
- Broadwater, J.D., G.P. Watts, and J.W. Bream. 1991. "Is This the Santa Lucia?" *Bermuda Maritime Museum Quarterly*, Winter Issue, 18-9.
- Brockman, W.E. 2009. *Bermuda: Growth of a Naval Base*. Edited by W.R. Cooke. Bermuda: Bermuda Maritime Museum Press.
- Burlet, R., and H. Palou. 1998. *Culip VI*. Girona: Centre d'Investigacions Arqueològiques.

- Campbell, A.B. 1956. *Customs and Traditions of the Royal Navy: With Chapters on the Royal Marines, the Women's Royal Naval Service, Naval Decorations and Medals*. Aldershot, UK: Gale & Polden.
- Cano, T., and E.M. Dorta. 1964. *Arte Para Fabricar Y Aparejar Naos: 1611*. La Laguna: Instituto de Estudios Canarios.
- Carrell, T.L., ed. 1990. *Underwater Archaeology Proceedings from the Society for Historical Archaeology Conference*. Tucson, Arizona: Society for Historical Archaeology.
- Carus-Wilson, E.M. 1954. *Essays in economic history: reprints edited for the Economic History Society. Vol.1*. London: Edward Arnold.
- Casado Soto, J.L. 1988. *Los Barcos Españoles Del Siglo XVI Y La Gran Armada De 1588*. Vol. 4, Gran Armada. Madrid, España: Editorial San Martín.
- . 1991. "Atlantic Shipping in Sixteenth-Century Spain and the 1588 Armada." In *England, Spain and the Gran Armada 1585-1604*, edited by M.J. Rodriguez-Salgado and S. Adams, 95-133. Savage, MD: Barnes & Noble Books.
- Castellví, J.M., and X. Nieto. 1988. *Culip-IV: Un Vaixell En El Cap De Creus*. Girona: Centre d'Investigacions Arqueològiques.
- Castro, F.V. 2001. "The Pepper Wreck: A Portuguese Indiaman at the Mouth of the Tagus River." Ph.D. diss., Texas A&M University.
- . 2007. "Rising and Narrowing: 16th-Century Geometric Algorithms Used to Design the Bottom of Ships in Portugal." *IJNA* 36(1):148-54.
- Castro, F.V., and K. Custer, eds. 2008. *Edge of Empire: Proceedings of the Symposium "Edge of Empire" Held at the 2008 Annual Meeting of the Society for Historical Archaeology, Sacramento, CA*. Portugal: Caleidoscópico – Edição e Artes Gráficas, SA.
- Cederlund, C.O., ed. 1985. *Post-Medieval Boat and Ship Archaeology: Papers Based on Those Presented to an International Symposium on Boat and Ship Archaeology in Stockholm in 1982*. BAR International Series 256. Swedish National Maritime Museum, Stockholm, Report No. 20. Oxford: BAR
- Chaunu, H., and P. Chaunu. 1955. *Séville Et L'Atlantique, 1504-1650*. 8 vols. Paris: A. Colin.
- . 1977. *Séville Et L'amérique Aux XVIe Et XVIIe Siècles*. Paris: Flammarion.

- Chaves, A. de, P.C. Delgado, M.C. Domingo, and P.H. Aparicio. 1983. *Quatri Partitu En Cosmografía Práctica, Y Por Otro Nombre Espejo De Navegantes*. Madrid: Instituto de Historia y Cultura Naval.
- Clayton, L.A. 1976. "Ships and Empire: The Case of Spain." *Mariner's Mirror* 62(3):235-48.
- Cook, G.D. 2009. "Luna's Ships: Current Excavation of Emanuel Point II and Preliminary Comparisons with the First Emanuel Point Shipwreck." *Florida Anthropologist* 62(3-4):93-9.
- Cornell, J. 1998. *World Cruising Routes*. 4th ed. Camden, ME: International Marine.
- . 2001. *World Cruising Handbook*. 3rd ed. Camden, ME: International Marine/McGraw-Hill.
- Craven, W.F. 1990. *An Introduction to the History of Bermuda*. Second Edition ed. Bermuda: Bermuda Maritime Museum Press.
- Crisman, K.J., and C. Garcia. 2001. "The Shipwrecks of Angra Bay, 2000-2001." *INA Quarterly* 28(4):3-11.
- Curtis, W.H. 1919. *The Elements of Wood Ship Construction*. New York: McGraw-Hill.
- Custer Bojakowski, K. 2011. "Exploration and Empire: Iconographic Evidence of Iberian Ships of Discovery." Ph.D. diss., Texas A&M University.
- Daminiadis, K. 1991. "Planking up a Carvel Boat in the Aegean." In *Carvel Construction Technique: Fifth International Symposium on Boat and Ship Archaeology, Amsterdam 1988*, edited by R. H. Reinders and P. Kees, 97-102. Oxford: Oxbow Books.
- Darroch, A.C. 1986. "The Visionary Shadow: A Description and Analysis of the Armaments Aboard the Santo Antonio De Tanna." M.A. thesis, Texas A&M University.
- Deagan, K.A. 1987. *Artifacts of the Spanish Colonies of Florida and the Caribbean, 1500-1800*. Vol. 1: Ceramics, Glassware, and Beads. Washington, D.C.: Smithsonian Institution Press.
- Delgado-Aguilera, A.B.y, and A.d. Santa Cruz. 1918. *Islario General De Todas Las Islas Del Mundo. Por Alonso De Santa Cruz. Con Un Prólogo De D. Antonio Blázquez [with Atlas.]*. Madrid: Sociedad Geográfica Nacional.

- Delhaye, M. 1998. "L'épave Medieval De Cavalaire: Un Exemple De L'évolution Naval Architecturale Avant La Renaissance." *Itsas Memoria. Revista de Estudios Marítimos del País Vasco*. No. 2: 43-8. Donostia-San Sebastian: Untizi Museoa-Museo Naval.
- Diamond, J.M. 2005. *Collapse : How Societies Choose to Fail or Survive*. London: Allen Lane.
- Domingues, F.C. 2001. "Documents on Portuguese Naval Architecture (Late 16th-Early 17th Century) - A General Overview." In *International Symposium on Archaeology of Medieval and Modern Ships of Iberian-Atlantic Tradition: Proceedings*, edited by F. Alves, 229-32. Lisbon: Instituto Portugues De Arqueologia.
- Donachie, M.J. 2001. "Household Ceramics at Port Royal, Jamaica, 1655-1692: The Building 4/5 Assemblage." Ph.D. diss., Texas A&M University.
- Drachio, B.Q., and L.Th. Lehmann. 1992. *Visione Del Drachio*. Amsterdam: s.n.
- Dufau, P.-A., J.B. Duvergier, J. Guadet, and T.E. Evans. 1824. *History of the Political Institutions, of the Nations of Europe and America: With the Constitutions, Charters, and Fundamental Laws, by Which They Have Been, and Are Now Governed. From the French*. London: Black, Young, and Young.
- Escalante de Mendoza, J. 1985. *Itinerario De La Navegacion De Los Mares Y Tierras Occidentales, 1575*. Madrid: Museo Naval.
- Fairbanks, C.H. 1972. "The Cultural Significance of Spanish Ceramics." In *Ceramics in America*, edited by I.M.G. Quimby, 141-74. Charlottesville: University of Virginia Press.
- Fernald, M.L., and A.C. Kinsey. 1958. *Edible Wild Plants of Eastern North America*. New York: Harper.
- Fernández Duro, C. 1876. *Disquisiciones Nauticas / Duro, Casareo Fernandez. 1876-1881*. Madrid: Aribau.
- . 1880. *A La Mar Madera*. Madrid: Impr. de Aribau y c.a (sucesores de Rivadeneyra).
- . 1881. *Arca De Noé: Libro Sexto De Las Disquisiciones Náuticas*. Madrid: Imprenta, estereotípia y galvanoplástia de Aribau y Ca.
- . 1972. *La Armada Española Desde La Unión De Los Reinos De Castilla Y Aragón*. Madrid: Museo Naval.

- Fernandez, M. 1616. "Livro De Traças De Carpintaria." <http://nndl.tamu.edu/treatises.html>.
- . 1995. *Livro De Traças De Carpintaria*. Lisboa: Academia de Marinha.
- Fernández-Armesto, F. 1988. *The Spanish Armada: The Experience of War in 1588*. New York: Oxford University Press.
- . 2006. *Amerigo: The Man Who Gave His Name to America*. London: Weidenfeld & Nicolson.
- Flynn, D.O. 1979. "Silver and the Spanish Empire." In *Essays in Economic and Business History*, edited by J. H. Soltow, 197-211. East Lansing: Michigan State University.
- Foster, G.M. 1953. "Relationships between Spanish and Spanish-American Folk Medicine." *Journal of American Folklore* 66(261):201-17.
- Fraga, T.M. 2007. "Santo Antonio De Tanna: Story and Reconstruction." M.A. thesis, Texas A&M University.
- Franklin, M. 1993. "Description of Artifacts Assemblage Archaeologically Recovered from the Western Ledge Reef Wreck, Bermuda." *Bermuda Journal of Archaeology and Maritime History* 5:70-83.
- Fuente, A., and C.G.d. Pino. 1996. "Havana and the Fleet System: Trade and Growth in the Periphery of the Spanish Empire, 1550-1610." *Colonial Latin American Review* 5(1):95-115.
- Garcia, C., and P. Monteiro. 2001. "The Excavation and Dismantling of Angra D, a Probable Iberian Seagoing Ship, Angra Bay, Terceira Island, Azores, Portugal: Preliminary Assessment." In *International Symposium on Archaeology of Medieval and Modern Ships of Iberian-Atlantic Tradition: Proceedings*, edited by F. Alves, 431-47. Lisbon: Instituto Portugues De Arqueologia.
- Gardiner, R., and R.W. Unger, eds. 1994. *Cogs, Caravels, and Galleons: The Sailing Ship, 1000-1650, Conway's History of the Ship*. London: Conway Maritime Press.
- Gardiner, R. (series editor), and P. Bosscher (consultant editor), eds. 1993. *Heyday of Sail: The Merchant Sailing Ship 1650-1830, Conway's History of the Ship*. London: Conway Maritime Press.
- Gay, E.F. 1967. *Facts and Factors in Economic History*. New York: A.M. Kelley.
- Gayarré, C. 1866. *Philip II of Spain*. New York: W.J. Widdleton.

- Gaztañeta e Iturrilbalzaga, A.d., F.F. González, C.C. Apestegui, and F.M. García. 1992. *Arte De Fabricar Reales*. Barcelona: Lunwerg.
- Gilfillan, S.C. 1935. *Inventing the Ship*. Chicago: Cuneo Press.
- Goggin, J.M. 1960. *The Spanish olive jar: an introductory study*. New Haven: University Press Department of Anthropology.
- Goodman, D. 1997. *Spanish Naval Power, 1589-1665*. 1st ed. Cambridge: Cambridge University Press.
- Goodman, W.L. 1966. *The History of Woodworking Tools*. New York: D. McKay Co.
- Grattan, T.C., and J. Hawthorne. 1901. *Holland: The History of the Netherlands*. New York: Cooperative Publication Society.
- Grenier, R. 1988. "Basque Whalers in the New World: The Red Bay Wrecks." In *Ships and Shipwrecks of the Americas: A History Based on Underwater Archaeology*, edited by G.F. Bass, 69-84. London: Thames and Hudson Ltd.
- . 2001. "The Basque Whaling Ship from Red Bay, Labrador: A Treasure Trove of Data on Iberian Atlantic Shipbuilding Design and Techniques in the Mid-16th Century." In *International Symposium on Archaeology of Medieval and Modern Ships of Iberian-Atlantic Tradition: Proceedings*, edited by F. Alves, 269-93. Lisbon: Instituto Portugues De Arqueologia.
- Grenier, R., M.-A. Bernier, and W. Stevens, eds. 2007. *The Underwater Archaeology of Red Bay: Basque Shipbuilding and Whaling in the 16th Century*. 5 vols. Ottawa: Parks Canada.
- Grieco, G.P. 2003. "Modeling La Belle: A Reconstruction of a Seventeenth-Century Light Frigate." M.A. thesis, Texas A & M University.
- Guérout, M., É. Rieth, and J.-M. Gassend. 1989. *Le Navire Génois De Villefranche : Un Naufrage De 1516?*, *Archaeonautica* 9. Paris: Éd. du Centre national de la recherche scientifique.
- Guerreiro, I., and F.C. Domingues, eds. 2000. *Ars Nautica: Fernando Oliveira E O Seu Tempo: Humanismo E Arte De Navegar No Renascimento Europeu (1450-1650): Actas Da IX Reunião Internacional De História Da Náutica E Hidrografia*. Cascais, Portugal: Patrimonia.
- Guilmartin, J.F. 2002. *Galleons and Galleys*. Edited by K. John. London: Cassell & Co.

- Hakluyt, R. 1903. *The Principal Navigations, Voyages, Traffiques & Discoveries of the English Nation: Made by Sea or over-Land to the Remote and Farthest Distant Quarters of the Earth at Any Time within the Compasse of These 1600 Yeeres [Years]*. Glasgow: J. MacLehose and sons.
- Hall, J.L. 1996. "A Seventeenth-Century Northern European Merchant Shipwreck in Monte Cristi Bay, Dominican Republic." Ph.D. diss., Texas A&M University.
- Hamilton, E.J. 1938. "Revisions in Economic History: VIII.-the Decline of Spain." *Economic History Review* 8(2):168-79.
- . 1954. "The Decline of Spain." In *Essays in economic history: reprints edited for the Economic History Society. Vol.1*, edited by E.M. Carus-Wilson, 215-26. London: Edward Arnold Ltd.
- Haring, C.H. 1918. *Trade and Navigation between Spain and the Indies in the Time of the Hapsburgs*. Cambridge: Harvard University Press.
- Harshberger, J.W. 1896. "Is the Pumpkin an American Plant." *Science*, New Series 3 (77):889-91.
- Hartmann, H.T. 1948. "The Olive Industry of California." *Economic Botany* 2(4):341-62.
- Hasler, H.G. 1961. "Sailing the North Atlantic." *Journal of Navigation* 14:117-23.
- Hasslöf, O. 1963. *Wrecks, Archives and Living Tradition: Topical Problems in Marine-Historical Research*. London: Society for Nautical Research.
- Hedderwick, P. 1830. *Treatise on Marine Architecture, Containing the Theory and Practice of Shipbuilding*. Edinburgh.
- Henry, D.P., and P.A. McLaughlin. 1986. *The Recent Species of Megabalanus (Cirripedia, Balanomorpha) with Special Emphasis on Balanus Tintinnabulum (Linnaeus) Sensu Lato*. Leiden: Rijksmuseum van Natuurlijke Historie.
- Hocker, F.M., and C.A. Ward, eds. 2004. *The Philosophy of Shipbuilding: Conceptual Approaches to the Study of Wooden Ships*. College Station, TX: Texas A&M University Press.
- Hume, M.A.S. 1927. *Philip II of Spain*. London: Macmillan.
- Jackson, J.J. 1988. *Bermuda*. Newton Abbot: David & Charles.

- James, S.R. 1985. "The Analysis of the Conde De Tolosa and the Nuestra Señora De Guadalupe Olive Jar Assemblage." M.A. thesis, Texas A&M University.
- Jarvis, M. 2010. *In the Eye of All Trade: Bermuda, Bermudians, and the Maritime Atlantic World, 1680-1783*. Chapel Hill: Published for the Omohundro Institute of Early American History and Culture, Williamsburg, Virginia, by the University of North Carolina Press.
- Johnston, S.A. 1994. *Making Mathematical Practice: Gentlemen, Practitioners and Artisans in Elizabethan England*. University of Cambridge.
- Jordan, B. 2001. "Wrecked Ships and Ruined Empires: An Interpretation of the Santo Antonio De Tanna's Hull Remains Using Archaeological and Historical Data." In *International Symposium on Archaeology of Medieval and Modern Ships of Iberian-Atlantic Tradition: Proceedings*, edited by F. Alves, 301-16. Lisbon: Instituto Portugues De Arqueologia.
- Juárez, J.A.C. 1997. *El Régimen Jurídico De Las Armadas De La Carrera De Indias: Siglos XVI Y XVII*. México: Universidad Nacional Autónoma de México.
- Kamen, H. 1978. "The Decline of Spain: A Historical Myth?" *Past & Present* 81:24-50.
- Keith, D.H. 1984. "The Molasses Reef Wreck, Turks and Caicos Islands, B.W.I.: A Preliminary Report." *IJNA* 13(1):45-63.
- . 1985. "Analysis of Hull Remains, Ballast, and Artifact Distribution of a 16th Century Shipwreck, Molasses Reef, British West Indies." *Journal of Field Archaeology* 12(4):411-24.
- . 1987. "The Molasses Reef Wreck." Ph.D. diss., Texas A&M University.
- Kirsch, P. 1990. *The Galleon: The Great Ships of the Armada Era*. Annapolis, MD: Naval Institute Press.
- Kusche, L. 1975. *The Bermuda Triangle Mystery--Solved*. New York: Harper & Row.
- Laanela, E.E. 2008. "Instruccion Nautica (1587) by Diego Garcia De Palacio: An Early Nautical Handbook from Mexico." M.A. thesis, Texas A&M University.
- Labbe, M. 2010. "A Preliminary Reconstruction of the Yassiada Sixteenth-Century Ottoman Wreck." M.A. thesis, Texas A&M University.
- Lacaita, C.C. 1919. "The 'Jerusalem Artichoke.' (Helianthus Tuberosus.)" *Bulletin of Miscellaneous, Information (Royal Gardens, Kew)* 1919(9):321-39.

- Ladle, L. 1993. *The Studland Bay Wreck: A Spanish Shipwreck Off the Dorset Coast, Poole Museum Heritage Series No. 1*. Poole: Poole Museum Service.
- Lahn, W. 1992. *Die Kogge Von Bremen. Band I, Bauteile Und Bauablauf*. Hamburg: Kabel.
- Lander, R.J. 1977. "An Assessment of the Numbers, Sizes, and Types of English and Spanish Ships Mobilized for the Armada Campaign." *Mariner's Mirror* 63(4):359-64.
- Lane, F.C. 1934. "Venetian Naval Architecture About 1550." *Mariner's Mirror* 20(1):24-49.
- . 1963. "Venetian Merchant Galleys, 1300-1334: Private and Communal Operation." *Speculum* 38(2):179-205.
- . 1992. *Venetian Ships and Shipbuilders of the Renaissance*. Baltimore: Johns Hopkins University Press.
- Lavanha, J.B. 1996. *Livro Primeiro De Arquitectura Naval*. Lisboa: Academia de Marinha.
- Lee, R.L. 1951. "Cochineal in European Commerce, 1526-1625." *Journal of Modern History* 23(3):205-24.
- Leland, R.F, D.B. Zippin, and N.L. Fowler. 2001. "Effects of White-Tailed Deer (*Odocoileus virginianus*) on Plants, Plant Populations and Communities: A Review." *American Midland Naturalist* 146(1):1-26.
- Lemee, C.P. 2006. *The Renaissance Shipwrecks from Christianshavn: An Archaeological and Architectural Study of Large Carvel Vessels in Danish Waters, 1580-1640*. Edited by O. Crumlin-Pedersen. Vol. 6, *Ships and Boats of the North*. Roskilde: The Viking Ship Museum in Roskilde.
- Loewen, B. 1991. "Report and Discussion of Observations of IMHA-3: A Sixteenth Century Basque Vessel?" Unpublished Report. Bermuda: Bermuda Maritime Museum.
- . 1998. "The Red Bay Vessel. An Example of a 16th-Century Biscayan Ship." *Itsas Memoria. Revista de Estudios Maritimos del Pais Vasco*. No. 2: 193-99. Donostia-San Sebastian: Untzi Museoa-Museo Naval.

- . 2000. "Forestry Practices and Hull Design, Ca. 1400-1700." In *Ars Nautica: Fernando Oliveira E O Seu Tempo: Humanismo E Arte De Navegar No Renascimento Europeu (1450-1650)*, edited by I. Guerreiro and F.C. Domingues, 143-51. Cascais, Portugal Patrimonia.
- . 2001. "The Structures of Atlantic Shipbuilding in the 16th Century. An Archaeological Perspective." In *International Symposium on Archaeology of Medieval and Modern Ships of Iberian-Atlantic Tradition: Proceedings*, edited by F. Alves, 241-58. Lisbon: Instituto Portugues De Arqueologia.
- Lovegrove, H. 1964. "Remains of Two Old Vessels Found at Rye, Sussex." *Mariner's Mirror* 50(2):115-22.
- Lugo-Fernandez, A., D.A. Ball, M. Gravois, C. Horrell, and J.B. Irion. 2007. "Analysis of the Gulf of Mexico's Veracruz-Havana Route of La Flota De La Nueva España." *Journal of Maritime Archaeology* 2(1):1-62.
- Malcom, C. 1996. *St. John's Bahamas Shipwreck Project: Interim Report I: The Excavation and Artifacts 1991-1995*. Key West, Florida: Mel Fisher Maritime Heritage Society, Inc.
- Manera Regueyra, Don E. 1981. *El Buque En La Armada Española*. Spain: Silex.
- Manwayring, H. 1972. *The Seaman's Dictionary, 1644*. Menston, England: The Scolar Press.
- Marken, M.W. 1994. *Pottery from Spanish Shipwrecks, 1500-1800*. Gainesville: University Press of Florida.
- Marsden, P., and K.J. Collins. 2003. *Sealed by Time: The Loss and Recovery of the Mary Rose*. Edited by P. Marsden. Vol. 1, *The Archaeology of the Mary Rose*. Portsmouth, England: The Mary Rose Trust.
- Marsden, P., and D. McElvogue. 2009. *Mary Rose: Your Noblest Shippe: Anatomy of a Tudor Warship*. Edited by P. Marsden. Vol. 2, *The Archaeology of the Mary Rose*. Portsmouth, England: Mary Rose Trust.
- Martin, C., and G. Parker. 1999. *The Spanish Armada*. New York: Mandolin.
- Martin, C.J. 1977. "Spanish Armada Tonnages." *Mariner's Mirror* 63(4):365-6.
- . 1978. "The Dartmouth, a British Frigate Wrecked Off Mull, 1690." *IJNA* 7(1):29-58.

- . 1979. “La Trinidad Valencera: An Armada Invasion Transport Lost Off Donegal. Interim Site Report, 1971-76.” *IJNA* 8(1):13-38.
- . 1979. “Spanish Armada Pottery.” *IJNA* 8(4):279-302.
- Martins, A.A.S. 2001. *A Arqueologia Naval Portuguesa: (Séculos XIII a XVI): Uma Aproximação Ao Seu Estudo Ibérico*. Lisboa: Universidade Autónoma de Lisboa.
- Marvell, A., and G.A. Aitkin. 1892. *Poems and Satires of Andrew Marvell, Sometime Member of Parliament for Hull*. London: Lawrence & Bullen.
- McCarthy, M. 2005. *Ships' Fastenings from Sewn Boat to Steamship*. College Station: Texas A&M University Press.
- McDonald, D., and B.J.III Arnold. 1979. *Documentary Evidence for the Wreck of the New Spain Fleet of 1554, Publication No. 8*. Austin: Texas Antiquities Committee.
- McEwan, B.G. 1986. “Domestic Adaptation at Puerto Real, Haiti.” *Historical Archaeology* 20(1):44-9.
- Mercator, G., J. Hondius, Hermon Dunlap Smith Center for the History of Cartography, and Newberry Library. 1982. *Maps from the Mercator-Hondius Atlas: (Amsterdam, 1630)*. Chicago: Newberry Library.
- Mercer, H.C. 1975. *Ancient Carpenter's Tools: Together with Lumbermen's Joiners' and Cabinet Makers' Tools in Use in the Eighteenth Century*. New York: Horizon Press.
- Mintz, S.W., ed. 1960. *Papers in Caribbean Anthropology. Vol. 62*. New Haven: Yale University, Dept. of Anthropology.
- Morison, S.E. 1942. *Admiral of the Ocean Sea: A Life of Christopher Columbus*. Boston: Little, Brown and Co.
- Morris, J.W. 1993. “The Preliminary Analysis of the 16th Century Vessel Remains Recovered from the Western Ledge Reef, Bermuda.” *Bermuda Journal of Archaeology and Maritime History* 5:58-69.
- Morris, K.J. 1990. “The ‘1577 Shipwreck’ Project: A Preliminary Report.” In *Underwater Archaeology Proceedings From the Society for Historical Archaeology Conference*, edited by T.L. Carrell, 63-6. Tucson, Arizona: The Society for Historical Archaeology.
- Moses, B. 1898. *The Establishment of Spanish Rule in America*. New York: The Knickerbocker Press.

- Myers, M.D. 1987. "The Evolution of Hull Design in Sixteenth Century English Ships of War." M.A. thesis, Texas A&M University.
- Nieto Prieto, J., and J. Casas. 1989. *Excavacions Arqueològiques Subaquàtiques a Cala Culip I*. Girona: Centre d'Investigacions arqueològiques.
- Nowacki, H., and M. Valleriani. 2003. *Shipbuilding Practice and Ship Design Methods from the Renaissance to the 18th Century - A Workshop Report*. Preprint 245, Max Planck Institute for the History of Science.
- Ober, F.A. 1928. *A Guide to the West Indies, Bermuda and Panama*. 3rd. rev. ed. New York: Dodd, Mead.
- Occioni-Bonaffons, G., and U. Gregoret. 1901. "Sulla Scoperta Di Due Barche Antiche Nel Comune Di Contarina (Rovigo)." In *Miscellanea Di Storia Veneta*. Edited by Regia Deputazione di Storia Patria. Venezia: A Spese Della Societa.
- Oertling, T.J. 1984. "The History and Development of Ships' Bilge Pumps, 1500-1840." M.A. thesis, Texas A&M University.
- . 1986. "The Highborn Cay Wreck: Limited Excavations, Sept. 1-19, 1986." A Proprietary Report to the Ministry of Transport, Government of the Bahamas, BWI. College Station, TX.
- . 1989a. "The Few Remaining Clues." In *Underwater Archaeology Proceedings From the Society for Historical Archaeology Conference*, edited by B.J.III. Arnold, 100-3. Pleasant Hill, California: The Society for Historical Archaeology.
- . 1989b. "The Highborn Cay Wreck: The 1986 Field Season." *IJNA* 18(3):244-53.
- . 1989c. "Molasses Reef Wreck Hull Analysis: Final Report." *IJNA* 18(3):229-43.
- . 1989d. "A Suction Pump from an Early-16th-Century Shipwreck." *Technology and Culture* 30(3):584-95.
- . 1996. *Ships' Bilge Pumps: A History of Their Development, 1500-1900*. College Station: Texas A&M University Press.
- . 2001. "The Concept of the Atlantic Vessel." In *International Symposium on Archaeology of Medieval and Modern Ships of Iberian-Atlantic Tradition: Proceedings*, edited by F. Alves, 233-40. Lisbon: Instituto Portugues De Arqueologia.

- . 2004. “Characteristics of Fifteenth- and Sixteenth-Century Iberian Ships.” In *The Philosophy of Shipbuilding: Conceptual Approaches to the Study of Wooden Ships*, edited by F.M. Hocker and C.A. Ward, 129-36. College Station: Texas A&M University Press.
- Oliveira, F. 1991. *O Liuro Da Fabrica Das Naos*. Lisboa. Academia de Marinha.
- Oyarbide, L.O. 1998. “La Construcción Naval En Gipuzkoa. Siglos XVI-XVIII.” *Itsas Memoria. Revista de Estudios Marítimos del País Vasco*. No. 2: 93-146. Donostia-San Sebastian: Untizi Museoa-Museo Naval.
- Padron, F.M. 1955. *El Comercio Canario-Americano: (Siglos XVI, XVII, XVIII)*. Sevilla: Escuela de Estudios Hispano-Americanos de Sevilla.
- Palacio, D.G.d. 1587. *Instruccion Nauthica Para Navegar Por El Doctor Diego Garcia De Palacio*. Ed. fac. Madrid: Instituto de Cultura Hispanica.
- . 1986. *Nautical Instruction, 1587*. 1st. ed. Reprinted and translated into English by J. Bankston. Terranate Associates, Bisbee, AZ.: The Press.
- Palou, H., É. Rieth, M. Izaguirre, A. Jover, X. Nieto, M. Pujol, X. Raurich, and C.C. Apestegui. 1998. *Excavacions Arqueologiques Subaquatiques a Cala Culip VI, Vol. 2*. Girona: [Generalitat de Catalunya].
- Panshin, A.J., and C. De Zeeuw. 1970. *Textbook of Wood Technology*. 3rd ed. New York: McGraw-Hill.
- Parry, J.H. 1966. *The Spanish Seaborne Empire*. First American ed. New York: Alfred A. Knopf, Inc.
- Peterson, M.L. 1977. “Reach for the New World.” *National Geographic*, December, 724-67.
- Phaneuf, E. 2003. “Angra C, Une Épave Hollandaise En Contexte Açoréen Du XVIIIe Siècle.” M.Sc. thesis, Université de Montréal.
- Phillips, C.R. 1986. *Six Galleons for the King of Spain*. Baltimore: The John Hopkins University Press.
- . 1987. “Spanish Ship Measurements Reconsidered. The Instruccion Nautica of Diego Garcia De Palacio.” *Mariner's Mirror* 73(2):293-6.
- . 1993. “The Evolution of Spanish Ship Design from the Fifteenth to the Eighteenth Century.” *American Neptune* 53(4):229-38.

- . 2000. "Manuel Fernandez and His 1616 'Livro De Traças De Carpintaria'." *American Neptune* 60(1):7-29.
- Quimby, I.M., ed. 1972. *Ceramics in America*. Charlottesville: University of Virginia Press.
- Quinn, D.B. 1989. "Bermuda in the Age of Exploration and Early Settlement." *Bermuda Journal of Archaeology and Maritime History* 1:1-23.
- Redknap, M. 1984. *The Cattewater wreck: the investigation of an armed vessel of the early sixteenth century*. Oxford: BAR.
- . 1985. "The Cuttewater Wreck: A Contribution to 16th Century Maritime Archaeology." In *International Symposium of Boat and Ship Archaeology: Papers Based on those presented to an International Symposium on Boat and Ship Archaeology in Stockholm in 1982*, edited by O. C. Cederlund, 39-59. Report no. 20. BAR International Series 256. Stockholm: Swedish National Maritime Museum.
- Regia Deputazione di Storia Patria. 1901. *Miscellanea Di Storia Veneta*. 2nd ed. Vol. 7. Venezia: A Spese Della Societa.
- Reinders, R.H., and P.Kees, eds. 1991. *Carvel Construction Technique: Fifth International Symposium on Boat and Ship Archaeology, Amsterdam 1988*. Oxbow Monograph 12, Oxford: Oxbow Books.
- Reitz, E.J., M.C. Scarry, and D.J. Seifert. 1985. *Reconstructing Historic Subsistence with an Example from Sixteenth-Century Spanish Florida*. Glassboro, N.J.: Society for Historical Archaeology.
- Rice, P.M. 1987. *Pottery Analysis: A Sourcebook*. Chicago: University of Chicago Press.
- Rieth, É. 1985. "La Question De La Construction Navale a Franc-Board Au Ponant." *Neptunia* 160:8-21.
- . 1986. "Un Systeme De Conception Des Carenes De La Second Moitie Du XVIe Siecle." *Neptunia* 166:16-32.
- . 1996a. *Le Maître-Gabarit, La Tablette Et Le Trébuchet: Essai Sur La Conception Non-Graphique Des Carènes Du Moyen-âge Au XXIe Siècle*. Vol. 9, *Mémoires De La Section D'histoire Des Sciences Et Des Techniques*. Paris: Editions du CTHS.
- . 1996b. "A Propos Du Terme Espalhamento Chez Manoel Fernandes (1616)." *Neptunia* 203:33-40.

- . 2000. “La Méthode Moderne De Conception Des Carènes Du Whole-Moulding.” *Neptunia* 220:10-21.
- . 2003. “First Archaeological Evidence of the Mediterranean Moulding Ship Design Method, the Example of the Culip VI Wreck. Spain, XIIth-XIVth C.” In *Shipbuilding Practice and Ship Design Methods from the Renaissance to the 18th Century - A Workshop Report*, edited by H. Nowacki and M. Valleriani, 9-16. Preprint 245, Max Planck Institute for the History of Science.
- Rieth, É., and R. Burlet. 1988. “Essai De Restitution D'un Bâtiment De 400 Toneladas, D'après Diego García De Palacio (1587).” *Histoire & Mesure* 3(4):463-89.
- Rieth, É., and J. Paviot. 1989. “Un Compte De Construction De Caravelles Portugaises.” *O Arqueologo Portugues* IV (6/7):307-31.
- Roberts, O.T. 1990. “Shroudless in Scandinavia?” *IJNA* 19(2):123-7.
- Rodrigues, P., F. Alves, É. Rieth, and F. Castro. 2001. “L'epave D'un Navire De La Deuxieme Moitie De XVeme Sciecle/ Debut Du XVIeme, Trouvee Au Cais Do Sodre (Lisbonne). Note Preliminaire.” In *International Symposium on Archaeology of Medieval and Modern Ships of Iberian-Atlantic Tradition: Proceedings*, edited by F. Alves, 347-380. Lisbon: Instituto Portugues De Arqueologia
- Rodríguez Mendoza, B.M. 2008. “Standarization of Spanish Shipbuilding: Ordenanzas Para La Fabrica De Navios De Guerra Y Mercante - 1607, 1613, 1618.” M.A. thesis, Texas A&M University.
- Rodríguez-Salgado, M.J., and S. Adams. 1991. *England, Spain and the Gran Armada 1585-1604: Essays from the Anglo-Spanish Conferences, London and Madrid, 1988*. Savage, MD: Barnes & Noble Books.
- Rosloff, J., and B.J. III Arnold. 1984. “The Keel of the San Esteban (1554): Continued Analysis.” *IJNA* 13(4):287 - 96.
- Rosby, T., and E Gottlieb. 1998. “The Oleander Project: Monitoring the Variability of the Gulf Stream and Adjacent Waters between New Jersey and Bermuda.” *Bulletin of the American Meteorological Society* 79(1):5-18.
- Sanz, E.L., and D.R. Pérez. 1979. *Comercio De España Con América En La Época De Felipe II*. Vol. 1, *Los Mercaderes Y El Tráfico Indiano*. Valladolid: Diputación Provincial de Valladolid.
- Scammell, G.V. 1981. *The World Encompassed: The First European Maritime Empires C. 800-1650*. Berkeley and Los Angeles: University of California Press.

- Schendel, G., J.A. Amézquita, and M.E. Bustamante. 1968. *Medicine in Mexico: From Aztec Herbs to Betatrons*. Austin: University of Texas Press.
- Scoffin, T.P. 1972. "Fossilization of Bermuda Patch Reefs." *Science* 178(4067):1280-2.
- Skowronek, R.K. 1987. "Ceramics and Commerce: The 1554 Flota Revisited." *Historical Archaeology* 21(2):101-11.
- Smith, R.C. 1988. "Treasure Ships of the Spanish Main: The Iberian-American Maritime Empires." In *Ships and Shipwrecks of the Americas: A History Based on Underwater Archaeology*, edited by G. F. Bass, 85-106. New York: Thames and Hudson.
- . 1993. *Vanguard of Empire: Ships of Exploration in the Age of Columbus*. New York: Oxford University Press.
- . 1994. "The Ship at Emanuel Point: An Examination of Florida's Earliest Shipwreck." In *Underwater Archaeological Proceedings from the Society for Historical Archaeology Conference*, edited by R.P. Woodward and C.D. Moore, 14-8. Vancouver, British Columbia: Society for Historical Archaeology.
- . 2001. "The Emanuel Point Ship: A 16th-Century Vessel of Spanish Colonization." In *International Symposium on Archaeology of Medieval and Modern Ships of Iberian-Atlantic Tradition: Proceedings*, edited by F. Alves, 295-300. Lisbon: Instituto Portugues De Arqueologia.
- Smith, R.C., J. Spirek, J.R. Bratten and D. Scott-Ireton. 1995. *The Emanuel Point Ship: Archaeological Investigations, 1992-1995, Preliminary Report*. Tallahassee: Bureau of Archaeological Research, Division of Historical Resources, Florida Department of State.
- Smith, R.C., J.R. Bratten, J. Cozzi, and K. Plaskett. 1998. *The Emanuel Point Ship Archaeological Investigations 1997-1998*. Report on Investigations #68. Archaeology Institute. Pensacola: University of West Florida.
- Smith, R.C., D.H. Keith, and D. Lakey. 1985. "The Highborn Cay Wreck: Further Exploration of a 16th-Century Bahaman Shipwreck." *IJNA* 14(1):63-72.
- Spain. 1943. *Recopilacion de Leyes de los Reynos de las Indias, Mandadas Imprimir y Publicar por la Magestad Católica del Rey don Carlos II. Nuestro Señor. 4. impresion*. Madrid: Gráficas Ultra, s. a.
- Stampa, M.C. 1949. "Evolution of Weights and Measures in New Spain." *Hispanic American Historical Review* 29(1):2-24

- Stanley, D.J., and D. J. Swift. 1967. "Bermuda's Southern Aeolianite Reef Tract." *Science*, New Series 157(3789):677-81.
- Steffy, R.J. 1994. *Wooden Ship Building and the Interpretation of Shipwrecks*. College Station: Texas A&M University Press.
- Sutherland, W. 1711. *The Shipbuilder's Assistant, or Some Essays Towards Completing the Art of Marine Architecture*. London: Printed for R. Mount [and 2 others].
- Teixeira, L., S. Sider, and D.J. Boorstin. 1993. *Coastal Charts of the Americas and West Africa from the School of Luís Teixeira, Circa 1585, Facsimile Series (Fundação Calouste Gulbenkian), No. 1*. New York: Hispanic Society of America.
- Thomsen, M.H. 2000. "The Studland Bay Wreck, Dorset, UK: Hull Analysis." *IJNA* 29(1):69-85.
- Trueba, E. 1988. "Tonelaje Mínimo Y Arqueo De Buques En Sevilla (Siglo XVI)." *Revista de Historia Naval* 20:33-60.
- Turrill, W.B. 1951. "Wild and Cultivated Olives." *Kew Bulletin* 6(3):437-42.
- Underhill, R. 1983. *The Wood Wright's Companion: Exploring Traditional Woodcraft*. Chapel Hill: Univ. of North Carolina Press.
- Usher, A.P. 1967. "Spanish Ships and Shipping in the Sixteenth and Seventeenth Centuries." In *Facts and Factors in Economic History*, edited by E.F. Gay, 189-213. New York: Augustus M. Kelley.
- Valdés, G.F.d.O.y, and J. Amador de los Ríos. 1851. *Historia General Y Natural De Las Indias, Islas Y Tierra-Firme Del Mar Océano (1547)*. Madrid: Imprenta de la Real Academia de la Historia.
- Veitia Linage, J.d. 1977. *The Spanish Rule of Trade to the West-Indies, Containing an Account of the Casa De Contratacion, or India-House*. New York: AMS Press.
- Velasco, J.L.d. 1971. *Geografía Y Descripción Universal De Las Indias*. Madrid: Ediciones Atlas.
- Villalobos, B.V.d. 1984. *Luz De Navegantes: Donde Se Hallarán Las Derrotas Y Señas De Las Partes Marítimas De Las Indias, Islas Y Tierra Firme Del Mar Océano*. Madrid: Museo Naval de Madrid, Universidad de Salamanca.
- Villié, P. 1994. *Calvi I, De L'archéologie à L'histoire*. Paris: De Boccard.

- Voegeli, M., and P. Voegeli. 1977. *Yachtsman's Guide to the Bermuda Islands*. Bermuda: Island Press.
- Voertman, R.F. 1954. "The Sailing Ship Complex and the Decline of Iberian Maritime Enterprise." *American Journal of Economics and Sociology* 14(1):77-88.
- Walton, T.R. 1994. *The Spanish Treasure Fleets*. Sarasota, Florida: Pineapple Press.
- Warnock, P., Letter to Emma Titford, 2 November 1990. *Wood Samples from IMHA-3*. Bermuda: Bermuda Maritime Museum.
- Watson, R., and W. Thomson. 1783. *The History of the Reign of Philip the Third, King of Spain*, edited by W. Thomson. London: Printed for G. Robinson; J. Robson; and J. Sewell.
- Watson, W.J., J. Oliver, and C.H. Foggo. 1965. *A Geography of Bermuda*. London: Collins.
- Watts, G.P. 1993a. "The Western Ledge Reef Wreck: A Preliminary Report on Investigation of the Remains of a 16th-Century Shipwreck in Bermuda." *IJNA* 22(2):103-24.
- . 1993b. "A Decade of Shipwreck Research in Bermuda." *Bermuda Journal of Archaeology and Maritime History* 5:12-57.
- . 2003. "A Second Decade of Shipwreck Research in Bermuda." *Bermuda Journal of Archaeology and Maritime History* 14:61-147.
- Watts, G.P., J. Broadwater, J.W. Morris, and M. Franklin. 1994. "Final Report on IMHA-3: A Sixteenth-Century Spanish Wreck Off Bermuda." In *Underwater Archaeological Proceedings from the Society for Historical Archaeology Conference*, edited by R.P. Woodward and C.D. Moore, 47-62. Vancouver, British Columbia: Society for Historical Archaeology.
- Weski, T. 1999. "The Ijsselmeer Type: Some Thoughts on Hanseatic Cogs." *IJNA* 28(4):360-79.
- Whitford, P.C. 1976. "Jerusalem Artichoke: A Versatile Food and Cover Plant." *Wildlife Society Bulletin* 4(1):30-1.
- Wilkinson, H.C. 1950. "Spanish Intentions for Bermuda 1603-1615: As Revealed by Records in the Archives of the Indies, Seville, Spain." *Bermuda Historical Quarterly* 7(2):50-89.

- . 1958. *The Adventurers of Bermuda: A History of the Island from Its Discovery until the Dissolution of the Somers Island Company in 1684*. 2nd. ed. London: Oxford University Press.
- Wingood, A.J. 1982. "Sea Venture. An Interim Report on an Early 17th Century Shipwreck Lost in 1609." *IJNA* 11(4):333-47.
- . 1986. "Sea Venture Second Interim Report - Part 2: The Artifacts." *IJNA* 15(2):149-59.
- Winsor, J., ed. 1886. *Narrative and Critical History of America: Spanish Explorations and Settlements in America from the 15th to the 17th Century*. Vol. 2. Boston: Houghton, Mifflin.
- Woodward, R.P., and C.D. Moor, eds. 1994. *Underwater Archaeology Proceedings from the Society for Historical Archaeology Conference*. Vancouver, British Columbia: Society for Historical Archaeology.
- World Bank. 2011, 11 February. *Bermuda*. <http://data.worldbank.org/country/bermuda>.
- Worth, J.E. 2009. "Documenting Tristan De La Luna Fleet, and the Storm That Destroyed It." *Florida Anthropologist* 62(3-4):83-92.
- Wulff, B.L., M.F. Gable, and R.E. DeGoursey. 1981. "Island Ecology in Bermuda." *American Biology Teacher* 43(7):357-63.
- Zizumbo-Villarreal, D., and H.J. Quero. 1998. "Re-Evaluation of Early Observations on Coconut in the New World." *Economic Botany* 52(1):68-77.

Works Consulted

- Alves, F.J., ed. 2001. *International Symposium on Archaeology of Medieval and Modern Ships of Iberian-Atlantic Tradition: Proceedings ; Hull Remains, Manuscripts and Ethnographic Sources: A Comparative Approach; Centro Nacional De Arqueologia Náutica E Subaquática, Academia De Marinha, Lisbon - September 7th to 9th, 1998*. Lisboa: Instituto Português de Arqueologia.
- Anderson, R.C. 1920. "The Grace De Dieu." *Mariner's Mirror* 6(1):22-4.
- . 1959. "The Story of the Woolwich Ship." *Mariner's Mirror* 45(2):94-9.
- . 1988. "Jal's Memoire No.5 and the Manuscript Fabrica Di Galere." *Mariner's Mirror* 31(3):160-7.

- Anderson, R.C., and Ramola. 1963. *The Sailing-Ship: Six Thousand Years of History*. New York: W.W. Norton & Company.
- Bowen, F.C. 1940. *Conquest of the Seas: The History and Adventure of Sea and Ships*. 1st ed. New York: Robert M. McBride & Company.
- Bruseeth, J.E., and T.S. Turner. 2005. *From a Watery Grave: The Discovery and Excavation of La Salle's Shipwreck, La Belle*. College Station, TX: Texas A&M University Press.
- Costa, L.F. 1997 *Naus e Galeões na Ribeira de Lisboa*. Portugal: Patrimónia, Cascais.
- Crumlin-Pederson, O. 1991 "Ship Types and Sizes." In *Aspects of Maritime Scandinavia, A.D. 200–1200*, edited by O. Crumlin-Pederson, 69–82. Roskilde, Denmark: The Viking Ship Museum.
- . 1997. *Viking-Age Ships and Shipbuilding in Hedeby/Haithabu and Schleswig*. Vol. 2, *Ships and Boats of the North*. Roskilde: The Viking Ship Museum.
- Fix, P.D., and P.T. Bojakowski. 2008. "The Stabilization and Structural Reconstruction of Timber Remains from the Western Ledge Reef Wreck (IMHA-3)." Unpublished Report. College Station, TX: Center for Maritime Archaeology and Conservation.
- Friel, I. 1995. *Good Ship: Ships, Shipbuilding and Technology in England 1200-1520*. London: British Museum Press.
- Gardiner, J., and M.J. Allen, eds. 2004. *Before the Mast: Life and Death Aboard the Mary Rose*. Vol. 4, *Archaeology of the Mary Rose*. Portsmouth: The Mary Rose Trust.
- Howarth, D.A. 1981. *The voyage of the Armada: the Spanish story*. New York: Viking Press.
- Indruszewski, G. 1996. "A Comparative Analysis of Early Medieval Shipwrecks from the Southern Shores of the Baltic Sea." Ph.D. diss., Texas A&M University.
- Kamen, H. 2004. *Golden Age Spain*. Houndmills, Basingstoke, Hampshire: Palgrave Macmillan.
- Lavery, B. 1987. *Arming and Fitting of English Ships of War 1600-1815*. Annapolis: Naval Institute Press.
- McKee, A. 1982. *How we found the Mary Rose*. New York: St. Martin's Press

- Ordenanzas Para La Fábrica De Navíos De Guerra Y Mercantes. 1607. In *Colección De Documentos Y Manuscritos Compilados*, edited by M.F.d. Navarrete and Museo Naval (Spain). 1971, 23-I: 575-93. Nendeln, Liechtenstein: Kraus-Thomson.
- Ordenanzas Para La Fábrica De Navíos De Guerra Y Mercantes. 1613. In *Función Y Evolución Del Galeón En La Carrera De Indias*, edited by F. Serrano Mangas. 1992, 211-36. Colección Mar y América, 9. Madrid: Editorial MAPFRE.
- Ordenanzas Para La Fábrica De Navíos De Guerra Y Mercantes. 1618. In *Recopilacion De Leyes De Los Reynos De Las Indias: Mandadas Imprimir Y Publicar Por La Magestad Católica Del Rey Don Carlos II. Nuestro Señor. 4. Impresion*, edited by Spain Consejo de Indias (Spain). 1943, 340-362. Madrid: Gráficas Ultra, s. a.
- Pierson, P. 1999. *The history of Spain*. Westport, CT: Greenwood Press.
- Prynne, M.W. 1968. "Henry V's Grace Dieu." *Mariner's Mirror* 54(2):115-28.
- Ruiz, T.F. 2001. *Spanish society, 1400-1600*. Harlow, England: Longman.
- Salisbury, W. 1961. "The Woolwich Ship." *Mariner's Mirror* 47(2):81-90.
- The Mary Rose Trust. 2007. *The Mary Rose*.
<http://www.maryrose.org/index.html>.
- Unger, R. 1980. *The Ship in the Medieval Economy*. Montreal: McGill-Queens University Press.
- . 1981. "Warships and Cargo Ship in Medieval Europe." *Technology and Culture* 22(2):233-52.
- . 1997. *Ships and Shipping in the North Sea and Atlantic 1400-1800*. Brookfield, VT: Variorum/Ashgate.
- Williams, P. 2000. *Philip II*. Houndmills, Basingstoke, Hampshire [England]: Palgrave.

APPENDIX 1

ARTIFACTS FROM THE BRIAN MALPAS COLLECTION

On February 9th, 1991, Dr. Edward Harris, an executive director of the BMM, Robert Stenhoff, head of the BMM board, and Emma Titford, a conservator; met with Brian Malpas to review a collection of artifacts raised from the site before 1980s. These artifacts, currently belonging to Brian Malpas, represented a part of the finds discovered by Douglas Roberts, Dick Bouchard, Kenneth Stark, Brian Malpas, and Donald Canton, and raised from the Malpas Wreck. These included:

- 7 pieces of iron ordnance (2 versos and 2 cast iron muzzle-loading cannon were donated to the BMM)
 - 3 pieces disappeared in the past (all of unknown type)
 - 2 wrought-iron swivel guns (*versos*)
 - 1 cast iron muzzle-loading cannon (with a date 1577 and a number 500 cast slightly foreword of the touchhole)
 - 1 cast iron muzzle-loading cannon (plain)
- 12 olive jars of varying sizes (all intact)
- 4 olive jar necks
- 5 olive jar bases, one still with unidentified content
- 3 ceramic dishes (possibly Columbian Plainware), one heavily reconstructed
- 4 blue-glazed majolica bowl/dish
- 1 ceramic “loving cup” with four handles (one missing)

- 1 copper alloy (bronze/brass) bell, embossed with four “T” motifs
- 12 silver unidentifiable coins, heavily encrusted (the condition of the coins did not warrant successful conservation)
- 15-20 miscellaneous lead shot, average diameter 15mm
- 2 copper alloy buckles (from knee britches?)
- 1 whole coconut
- 2 coarse earthenware bowls
- 1 254 mm in diameter copper alloy ladle, with bottom missing
- 4 lead weights
- 1 sharpening stone
- 1 silver boson’s whistle, heavily encrusted
- 2 pairs of brass navigational dividers, one arm missing
- 1 concretion with mould of navigational dividers and at least 2 silver coins
- 1 jawbone (pig?)
- 1 bead of organic material, possibly a seek
- 1 unidentified organic seed
- 1 piece of jade, about 150 mm long with 2 small holes (possibly a neck ornament)
- 1 copper alloy drawer pull? (Unknown object; possible modern?)

APPENDIX 2

SCANTLING LIST OF PRESERVED TIMBERS (IN CENTIMETERS)

Scantling List			
Keel	Molded Height	Sided Thickness	Max Length
Keel	15 - 22	17 - 23	932
Keelson & Mast-Step	Depth	Width	Max Length
Keelson & Mast-Step Assembly	17 - 21	20 - 21	217
Keelson	17 - 21	20 - 21	107
Mast-Step	30	32	115
Mast-Step	Depth	Width	Max Length
Mast-Step Mortise	14	15- 17	42
Butresses	Depth (Inboard-Outboard)	Width	Max Length
1st Port Butress (BP 1)	8.86 - 20.7	15.6	51.5
2nd Port Butress (BP 2)	9 - 22.4	16.5	54.1
3rd Port Butress (BP 3)	8.27 - 21.9	10.6	51.7
1st Stbd Butress (BS 1)	8.8 - 21.5	16	53.6
2nd Stbd Butress (BS 2)	6.8 - 20.4	15.7	50.5
3rd Stbd Butress (BS 3)	7.2 - 20.3	15.5	47.7
Ceiling	Width Range (Aft-Fore)	Sided Thickness (Avg.)	Max Length
CSL (in 3 pieces)	24 - 32.6	3.36	99.6(A); 68.4(C); 64.2(F)
CS 1	18.8 - 32.7 (C) - 24.7	3.6	331.88
CS 2	22.44 (C)	5.69	102.75
CPL (3 pieces)	17.7 - 23	4	104.21(A); 39.1(C); 60.8(F)
CP 1	32.5 - 33.5	3.1	131.62
CP 2	25 - 22.3	2.6	200.7
Planking	Width Range	Sided Thickness (Avg.)	Max Length
PSG	34 - 49	5.83	949
PS 1	28.55 - 34	5.3	982
PS 2	25 - 32	4.53	621
PS 3	11.6	4.5	136
PS UN 1	12.55	n/a	107

Planking (continue...)	Width Range	Sided Thickness (Avg.)	Max Length
PPG	35 - 38	5.22	887
PP 1	27.5 - 34	5.34	583
PP 2	28.65 - 29	5	517
PP 3	30.38 - 36	3.75	391
PP 4	41.9 - 44	n/a	271
APS 1 1/1	9.9	n/a	27
APS 1 1/2	12.78	n/a	53
APS 2	15.34 - 22.92	4.8	176
APS 3	14.6 - 18.53	5.3	244
APS 3A	6.35 - 11.25	6.8	136
APS 4	17.4 - 25	5.5	231
APS 5	22.85 - 24	5.0	267
APP 2	n/a	n/a	n/a
APP 3	36	n/a	n/a
APP 4	19.5	n/a	n/a
APP 5	29	n/a	n/a
Stern Knee	Molded Height	Sided Thickness	Max Length
Horizontal Arm	5? - 22.6	17 - 18	240
Vertical Arm	14 - 30	12 - 15	160
Futtucks	Molded Height	Sided Thickness	Max Length
FR C (S1)	14?	13?	52
FR C (P1)	11?	12?	25
FR B (S1)	16	16	83
FR B (P1)	14?	17	68
FR A (S1)	15	13	79
FR A (P1)	16	16	115
FR M (S1)	17	16	102
FR M (P1)	16	15	124
FR M (SA 1)	14	14	101
FR M (PA 1)	15.4	17	104
FR 1 (S1)	16.3	16.3	94
FR 1 (P1)	15.5	14.7	131
FR 2 (S1)	14.6	17.6	85
FR 2 (P1)	15.5	16	103
FR 3 (S1)	15	18.6	138
FR 3 (P1)	15	16	120

Futtucks (continue...)	Molded Height	Sided Thickness	Max Length
FR 4 (S1)	14.4	11.3	107
FR 4 (P1)	16	16.5	108
FR 5 (S1)	18.9	14?	126
FR 5 (P1)	18.3	15.8?	109
FR 6 (S1)	16.3?	16.8?	113
Floor Timbers	Molded Height	Sided Thickness	Max Breadth
FR E	n/a	n/a	n/a
FR D	16.9	14.6?	169?
FR C	17.7	21	215?
FR B	17.2	19.7	265.8
FR A	16.8	18.8	268.7
FR M	17.2	17.6	277.4
FR 1	16.6	16.7	294.8
FR 2	17.4	18.6	277.5
FR 3	18.5	15.5	291.6
FR 4	19.2	13.9	267.9
FR 5	22	15.8	268.7
FR 6	22	14.3	250.5
FR 7	22.3	14.9	234.4
FR 8	21	14.7	208.4

*) (F) – Forward; (C) – Center; (A) - Aft

APPENDIX 3

SPANISH UNITS OF MEASUREMENT

Estado (tosa)	vara	codo (de ribera)	pie	dedo
1	2	3 1/2	7	112
	1	1 1/2	3	48

1 vara = 1 1/2 codo de ribera = 3 pies = 48 dedos [0.83578 m]

1 *codo de Castilla* = 2 pies = 32 dedos [0.5573 m]

1 *codo de ribera* = 2 pies + 1 dedo = 33 dedos [0.57468 m]

Estado (tosa) = 167.15 cm

Vara = 83.58 cm

Codo de ribera = 57.46 cm

Pie = 27.86 cm

Dedo = 1.74 cm

UNITS	Vara Castellana	Codo de vara	Codo de ribera	Pie de Burgos	Palmo	Pulgada Castellana	Dedo	Linea	METERS
Vara Castellana	1	1 1/2		3	4	36	48	432	0.8359
Codo de vara		1		2		24	32	288	0.5573
Codo de ribera			1				33		0.5746
Pie de Burgos (de Castilla)				1	1 1/3	12	16	144	0.2786
Palmo					1	9	12	108	0.209
Pulgada Castellana						1	1 1/3	12	0.0232
Dedo							1	9	0.0174
Linea								1	0.0019

UNITS	Codo de ribera	Pie de ribera	Pulgada de ribera	METERS
Codo de ribera	1	2	24	0.5746
Pie de ribera		1	12	0.2873
Pulgada de ribera			1	0.0239

APPENDIX 4

KEELSON AND MAST STEP SCATTER PLOTS

Following the example of Red Bay (24M) Wreck, a theoretical concept was explored by which the dimensions of the mast step could reflect the overall dimensions of the vessel.¹ Based on the hypothesis, the maximum breadth of the ship controlled the diameter of the main mast at the deck level. Since the diameter of the main mast at the deck was proportional to its diameter at the mast step, it is reasonable to assume that the maximum breadth of the ship was also indirectly correlated with the dimensions of the mast step and mast step mortise. Since Iberian ships were built using geometric proportions, the three basic dimensions of the mast step (length, width, and depth) for a group of pertinent Iberian-Atlantic shipwrecks were analyzed and tested using statistical software SPSS 12 (table A-4.1).

Mast Step

By looking at the scatter plot of the mast step length-to-width and mast step length-to-depth, a rising left to right pattern is indicative of a positive correlation (fig. A-4.1). In other words, the increase in the length of the mast step will trigger a proportional increase in the other two dimensions. The results indicate that Western Ledge Reef Wreck is closely correlated with Red Bay (24M) Wreck, Angra D, and Rye A, rather than with the Highborn Cay Wreck or *Santo Antonio de Tanna*.

Table A-4.1: A group of pertinent Iberian-Atlantic shipwrecks used in the statistical analysis of the mast step.

Name of the Wreck	Date	Preserved Length (m)	Aft Keelson		
			L (m)	W (cm)	H (cm)
Ria de Aveiro A (RIA A)	1440s	3.50	3.5	13	12.5
Cuttewater (CATWT)	1530s	5.20	0.7	27	22
Rye A (RYE A)	early 16th c.	5.48		39	30
Highborn Cay (HBCY)	early 16th c.	8.15	5.9	21-16	17
Cais do Sodre (CASO)	early 16th c.	10.30	10.3	27	26
Emanuel Point (EMPT)	1559	19.20		22	34
San Juan (SJUAN)	1565	9.97	8.39	20-32	19-21
Western Ledge Reef Wreck (WLRW)	late 16th c.	2.2	1.07	21	20
Angra D (ANGRA D)	late 16th c.	23.00	~7.5	22-25	25
Santo Antonio de Tanna (ST ANT)	1678	26.50		30	30

Table A-4.1 (Continued):

Name of the Wreck	Mast Step			Mast Mortise		
	L (m)	W (cm)	H (cm)	L (cm)	W (cm)	D (cm)
Ria de Aveiro A (RIA A)						
Cuttewater (CATWT)	0.75	54	40		33	15
Rye A (RYE A)	1.45	52	46	56	25	18
Highborn Cay (HBCY)	2.25 (est)	40	25	65	15-17	14.5
Cais do Sodre (CASO)						
Emanuel Point (EMPT)						
San Juan (SJUAN)	1.55	40	30	75	18	16
Western Ledge Reef Wreck (WLRW)	1.15	31.6	30	40	16	14
Angra D (ANGRA D)	1.75	42	32	61	20	
Santo Antonio de Tanna (ST ANT)	4	70	30	48	21	16

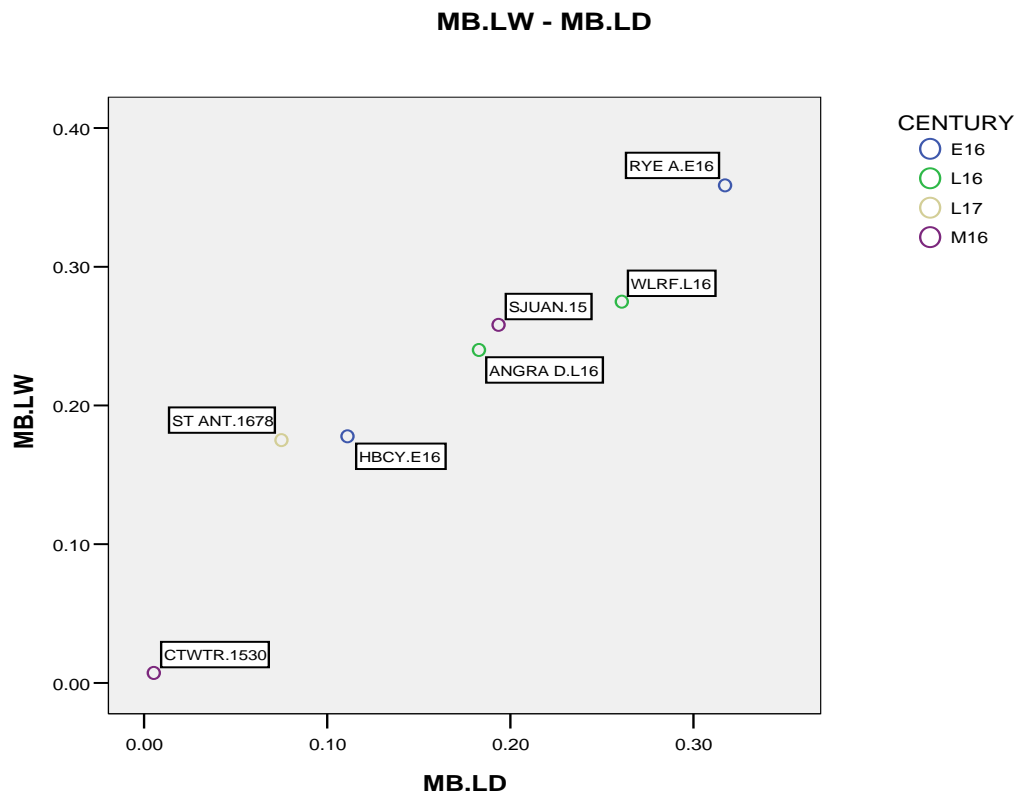

Figure A-4.1: Scatter plot of the mast step length-to-width and mast step length-to-depth.

By looking at the scatter plot in the figure A-4.2 (the mast step length-to-width and mast step width-to-depth), the data is more spread out in comparison to the previous plot (fig. A-4.1). A positive correlation still exists, but it is a weak one. In other words, the width of the mast step is not as strongly correlated to the other two dimensions. Western Ledge Reef Wreck is still more closely correlated with Red Bay (24M) Wreck and Angra D, as well as with the Rye A, than with the Highborn Cay Wreck, *Santo Antonio de Tanna*, or Cattewater Wreck.

By looking at the scatter plot of the mast step length-to-depth and mast step width-to-depth, the sharply rising slope again indicates a strong positive correlation of these data sets (fig. A-4.3). It also reconfirms what the previous two scatter plots (fig. A-4.1 and fig. A-4.2) already displayed. It indicates that the deeper the mast step, the longer and wider it is. Even though the Western Ledge Reef Wreck is set somewhat apart, it is still closer correlated with Rye A, Red Bay (24M) Wreck, and Angra D, than with the Highborn Cay Wreck, *Santo Antonio de Tanna*, or the Cattewater Wreck.

Finally, by combining all three proportional dimensions, the 3-variable scatter plot is produced. By looking at the three proportions collectively, the mutual positive correlation is evident. Although these mast steps were built to conform to different sizes, the previous scatter plot graphs (fig. A-4.1, fig.A-4.2, fig.A-4.3) show that certain groups of mast steps conformed to similar proportions. The 3-variable scatter plot

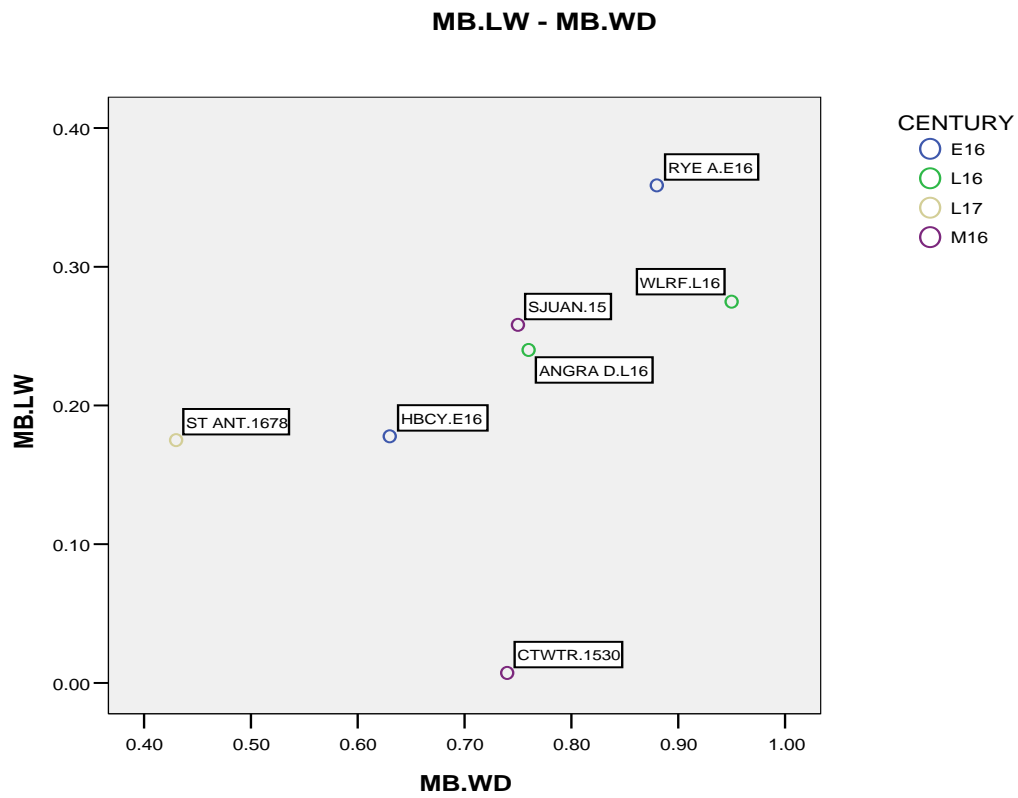

Figure A-4.2: Scatter plot of the mast step length-to-width and mast step width-to-depth.

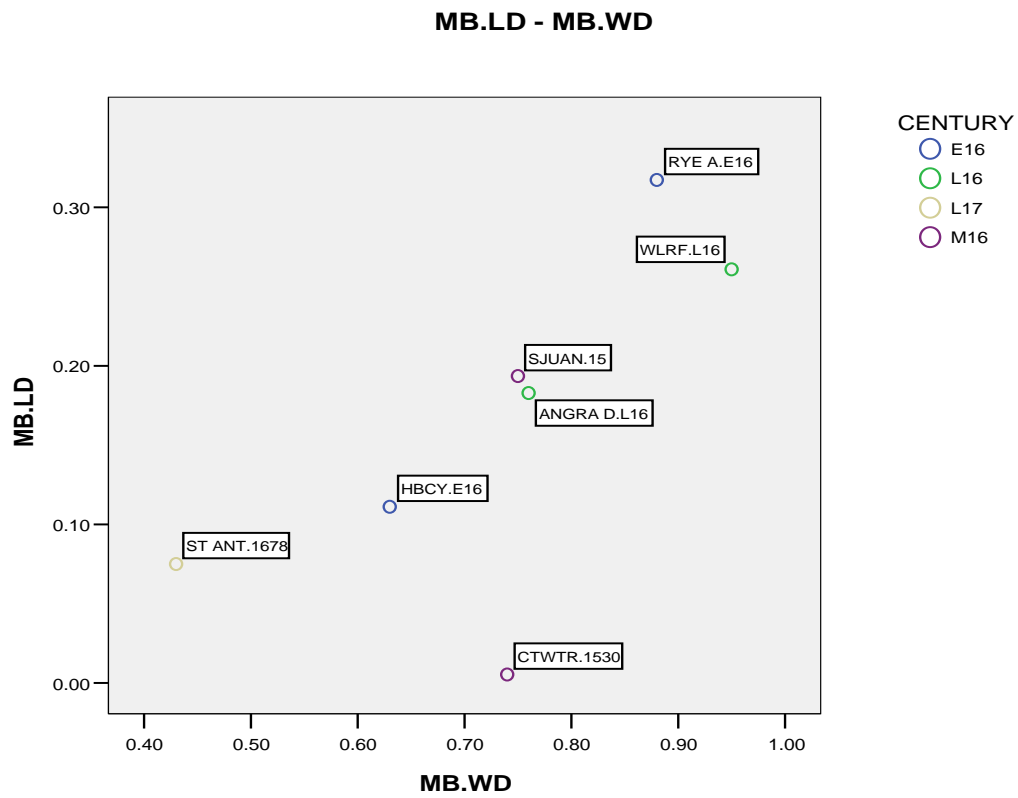

Figure A-4.3: Scatter plot of the mast step length-to-depth and mast step width-to-depth.

Mast Box Scatter Plot

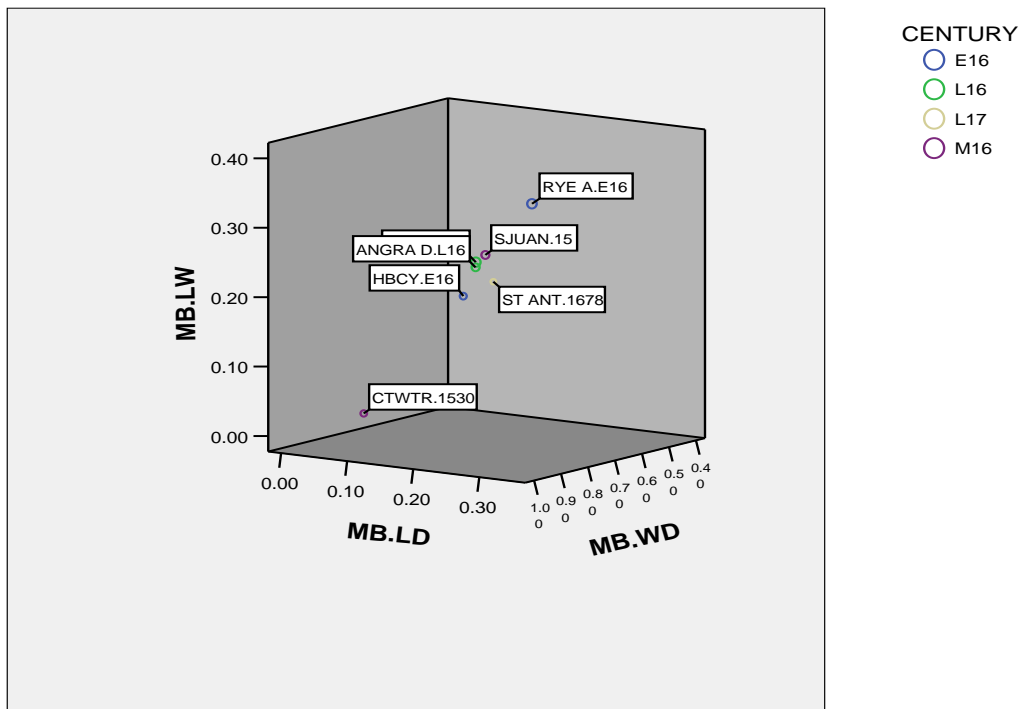

Figure A-4.4: Variable scatter plot of the mast step length-to-width, mast step length-to-depth, and mast step width-to-depth.

(fig. A-4.4) supports these groupings. It also indicates a close relationship between the mast step of the Western Ledge Reef Wreck and Angra D. The label for the Western Ledge Reef Wreck is in fact right underneath that of the Angra D and the circle markers are overlapping. In other words, this analysis shows a significant statistical correlation between the two mast steps.

Mast Step Mortise

Since the mast mortise is an integral part of the mast step, it is reasonable to assume that it might also be directly related to its overall dimensions. Following the theoretical concept for the mast step, the same proportional dimensions (length, width, and depth) were statistically evaluated for the mast step mortise.² Here again, the goal was to test a statistical relationship among the mast step mortises within a group of Iberian-Atlantic shipwrecks.

As illustrated by the scatter plot of the mast mortise length-to-width and mast mortise length-to-depth, the proportional relationships between the mast step mortise dimensions are controlled by the mortise length (fig. A-4.5). The plot shows the data set as a whole is not correlated; rather, it forms two groups. The first one comprises the Red Bay (24M) Wreck and the Highborn Cay Wreck, which are closely correlated to each other; while the second one comprises the *Santo Antonio de Tanna* and Rye A. Although slightly distant, the Western Ledge Reef Wreck proportions for the mast step mortise length seem to be more closely related with the later grouping. Finally, the Angra D and Cattewater wrecks are completely separated from the rest.

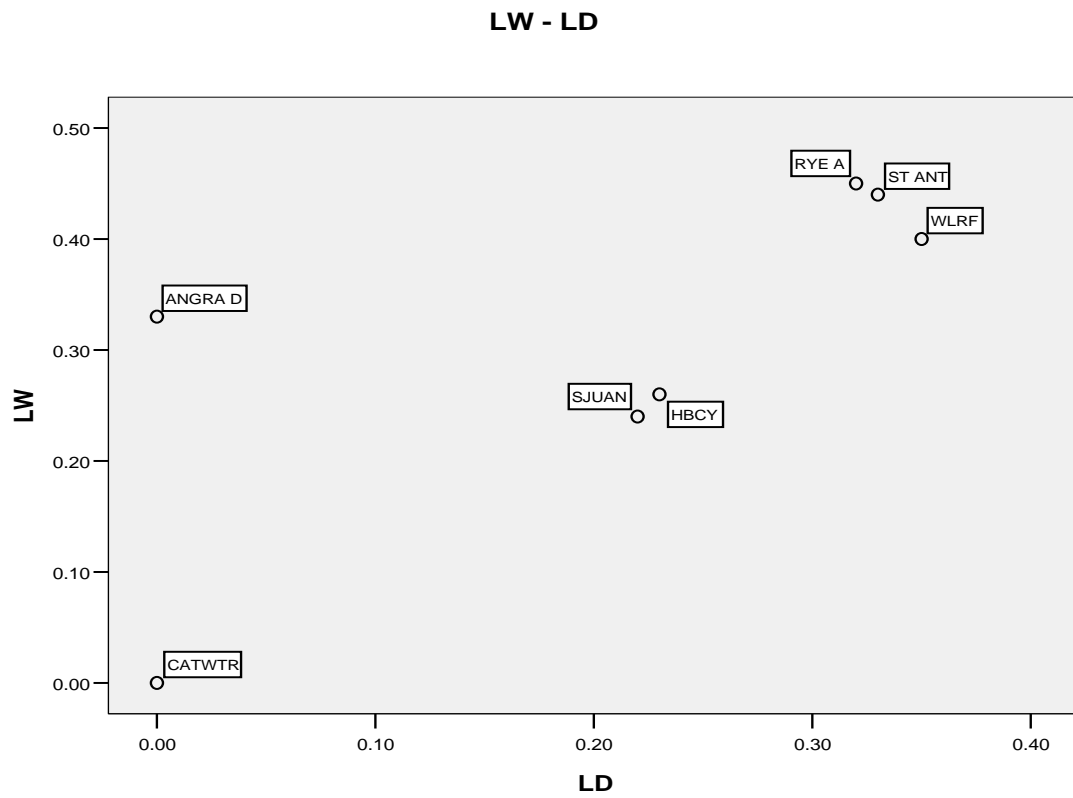

Figure A-4.5: Scatter plot of the mast mortise length-to-width and mast mortise length-to-depth.

By looking at the scatter plot of the mast mortise length-to-width and mast mortise width-to-to-depth, the data set is not correlated (fig. A-4.6). What is interesting is the fact that the same two groupings still hold. Base on proportional relationships controlled by the width, the Red Bay (24M) Wreck and Highborn Cay Wreck form one group, while the *Santo Antonio de Tanna* and Rye A form the other one. Here again, Western Ledge Reef Wreck seems to fluctuate in between these two groups being somewhat closer the later.

By looking at the scatter plots of the mast step mortise length-to-depth and mast step mortise width-to-depth (fig. A-4.7), the proportional relationships for the mast step mortise depths for the Red Bay (24M) Wreck and Highborn Cay Wreck still form a group. The *Santo Antonio de Tanna* and Rye A are still in the other group, while the Western Ledge Reef Wreck is somewhat in their proximity.

The next scatter plot (fig. A-4.8) combines all three measurements: mast step mortise length-to-width, length-to-depth, and width-to-depth, into the 3-variable scattered plot. Comparing the dimensions of the 2-variable scatter plots, the shipwrecks consistently grouped as follows: Red Bay (24M) Wreck and Highborn Cay Wreck into one group, *Santo Antonio de Tanna* and Rye A Wreck into the second group, while Western Ledge Reef Wreck somewhat within proximity to the latter. Comparing the dimensions of the 3-variable scatter plot, it is interesting to note that, without exceptions, it fully reconfirms these groupings.

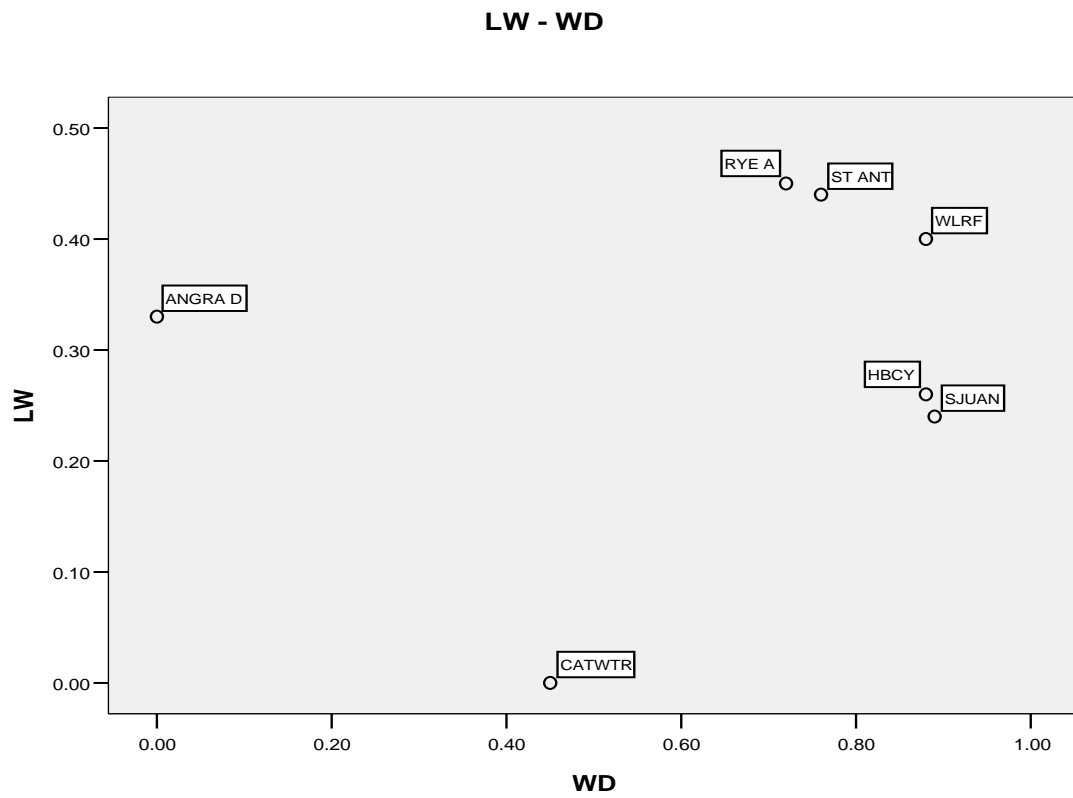

Figure A-4.6: Scatter plot of the mast mortise length-to-width and mast mortise width-to-to-depth.

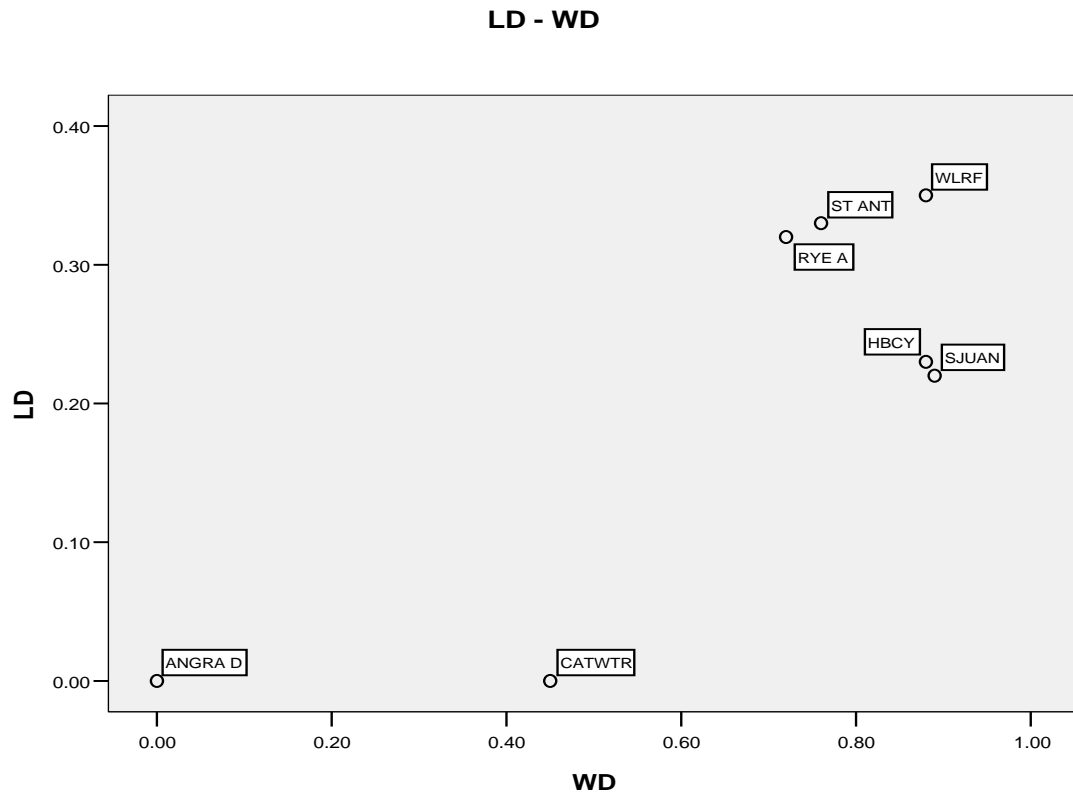

Figure A-4.7: Scatter plot of the mast step mortise length-to-depth and mast step mortise width-to-depth.

MAST MORTISE

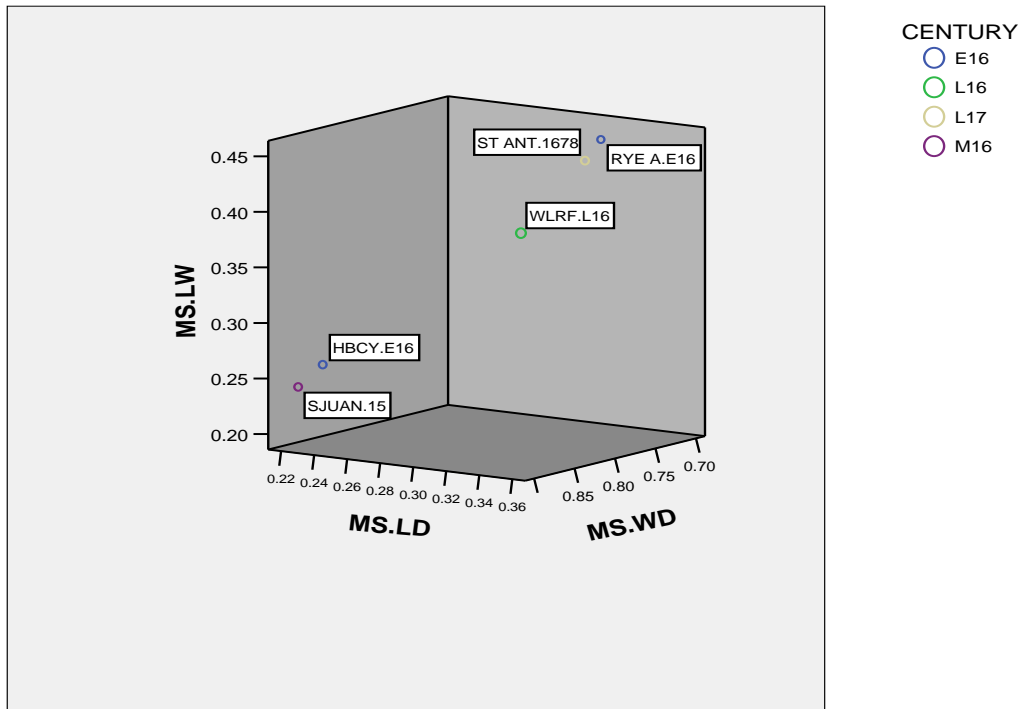

Figure A-4.8: Variable scatter plot of the mast step mortise length-to-width, mast step mortise length-to-depth, and mast step mortise width-to-depth.

Finally, to look at these relationships from a broader perspective, the mast step length and mast mortise length were compared against the mast step width and mast mortise width (fig. A-4.9). From a statistical point of view, these data sets are not correlated. What is significant, however, is the fact that mast step to mast mortise proportions for Western Ledge Reef Wreck place this assembly closer to the Rye A and Angra D, than to any other shipwreck. To look at the data from yet another angle, all three proportions between the mast step and mast mortise: length-to-length, width-to-width, depth-to-depth, were combined into the 3-variable scatter plot and compared to each other. As evident from the plot, Western Ledge Reef Wreck and the Rye A dimensions are still the most correlated, with the other wrecks scattered around them. In other words, the patterns here are weak (fig. A-4.10).

To summarize, it appears that the Western Ledge Reef Wreck standard mast step housed relatively small mast mortise. Measuring only 40 cm, this mortise was the shortest out of the all recorded mortise lengths. It also appears that the proportions used in manufacturing the mast step as well as in carving the mast mortise of the Western Ledge Reef Wreck seem to be more closely related to the proportions found on the Rye A vessel, Angra D, and *Santo Antonio de Tanna*, rather than on the Highborn Cay Wreck or Red Bay (24M) Wreck.

Although interesting, the presented here results are still preliminary being hindered by numerous unknowns due to problems of missing or unavailable data. The fact remains that the statistical test using scatter plots within a small data set should

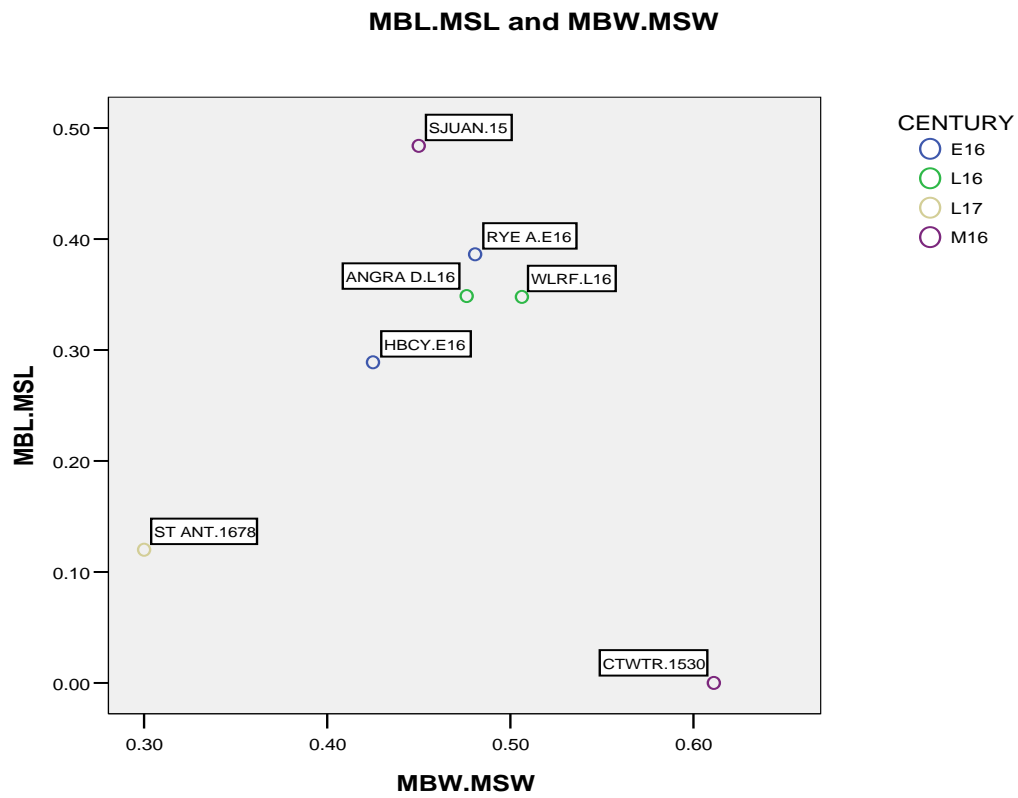

Figure A-4.9: Mast step length-to-mast mortise length vs. mast step width-to-mast mortise width.

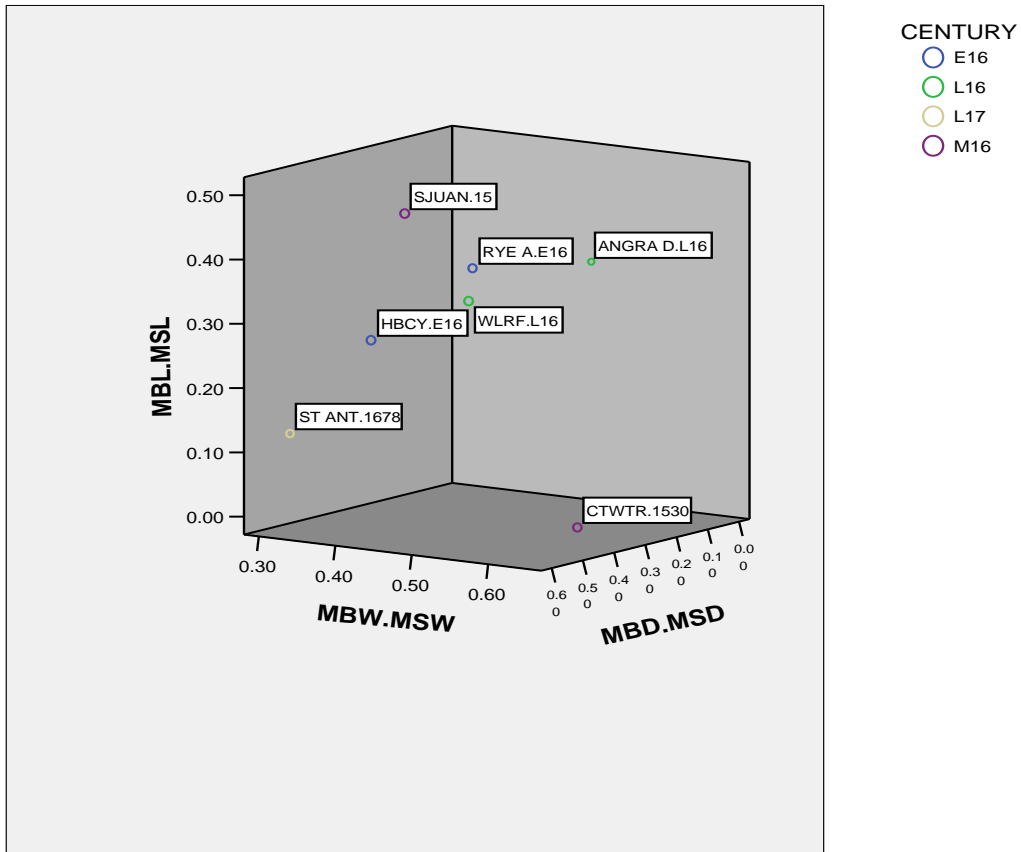

Figure A-4.10: Mast step length-to-mast mortise length; Mast step width-to-mast mortise width; mast step length-to-mast mortise length; mast step depth-to-mast mortise depth.

only be interpreted with caution. Looking at the broad picture, these analyses indicate that there is a consistent relationship between the proportions of the mast steps and the mast mortises of the shipwrecks within the respective groupings. Unfortunately, looking at the fine details numerous of these relationships disappear. With further evidence, for instance based the keel and framing proportions, it might be possible to discover the full extent of these relationships. In isolation, the Western Ledge Reef Wreck mast step and mortise dimensions do not answer some of the more complex questions.

ENDNOTES

¹ See Grenier et al. 2007, 3: 156.

² Ibid.

APPENDIX 5

PROPORTIONS OF VARIOUS IBERIAN SHIP TYPES BASED ON SELECTED
SOURCES (SORTED BY E/M)

Source	Ship Type	E (Length)/ M (Breadth)	P (Depth of Hold)/ M (Breadth)
1618 ordinances	14. Navío	3.09	0.48
Arana's Six Galleons	<i>Felipe</i>	3.11	0.47
Arana's Six Galleons	<i>Reyes</i>	3.14	0.47
1618 ordinances	13. Navío	3.14	0.48
Arana's Six Galleons	<i>Begona</i>	3.15	0.47
Arana's Six Galleons	<i>Baptista</i>	3.15	0.47
1618 ordinances	12. Navío	3.15	0.48
1613 ordinances	9. Galleon	3.20	0.50
1618 ordinances	11. Navío	3.24	0.47
Arana's Six Galleons	<i>Sebastian</i>	3.24	0.48
Armada of 1588	<i>Galeon particular</i>	3.25	0.62
Arana's Six Galleons	<i>Santaigo</i>	3.26	0.47
1613 ordinances	8. Galleon	3.27	0.50
1618 ordinances	10. Navío	3.28	0.47
1618 ordinances	9. Navío	3.29	0.47
1613 ordinances	7. Galleon	3.30	0.50
1618 ordinances	8. Navío	3.31	0.47
1613 ordinances	6. Galleon	3.33	0.50
Committee of Seville	Capitana and Almiranta	3.33	0.67
Committee of Seville	Other Galleons	3.33	0.68
Armada of 1588	<i>Galeones de Portugal</i>	3.35	0.53
1618 ordinances	7. Navío	3.37	0.47
1607 ordinances	8. Galleon	3.41	0.52
1613 ordinances	5. Galleon	3.42	0.50
1607 ordinances	5. Galleon	3.42	0.53
1618 ordinances	6. Navío	3.43	0.46
1607 ordinances	7. Galleon	3.43	0.52
1607 ordinances	4. Galleon	3.44	0.53

Source	Ship Type	E (Length)/ M (Breadth)	P (Depth of Hold)/ M (Breadth)
1607 ordinances	6. Galleon	3.45	0.53
1613 ordinances	4. Galleon	3.46	0.50
1618 ordinances	4. Navío	3.46	0.46
1618 ordinances	5. Navío	3.46	0.46
1607 ordinances	1. Galleon	3.47	0.53
2nd Committee of Santander	Other Galleons	3.47	0.63
Armada of 1588	<i>Nao La Manuela (English)</i>	3.48	0.67
1613 ordinances	3. Galleon	3.50	0.50
Armada of 1588	<i>Galeon mayor de Castilla</i>	3.50	0.65
2nd Committee of Santander	Capitana and Almiranta	3.50	0.69
1st Committee of Santander	Galeon de Pero Menéndez 1568	3.52	0.60
1607 ordinances	3. Galleon	3.53	0.54
Armada of 1588	<i>Pataches</i>	3.54	0.66
1618 ordinances	3. Navío	3.55	0.45
1613 ordinances	2. Galleon	3.55	0.50
1607 ordinances	2. Galleon	3.56	0.55
WLRW	unknown	3.57	0.73
1607 ordinances	2. Galeoncete	3.57	0.54
1607 ordinances	3. Navío	3.58	0.54
1618 ordinances	2. Navío	3.60	0.45
Armada of 1588	<i>Galeones menores de Castilla</i>	3.60	0.63
1613 ordinances	1. Galleon	3.61	0.50
1607 ordinances	2. Navío	3.64	0.55
Fábrica de Navíos	Patches (average)	3.64	0.42
Fábrica de Navíos	Galleons (average)	3.67	0.50
1613 ordinances	3. Navío	3.67	0.50
1607 ordinances	1. Galeoncete	3.69	0.54
Armada of 1588	<i>Zabras</i>	3.75	0.48
1613 ordinances	2. Navío	3.75	0.50
Armada of 1588	<i>Galeon frances</i>	3.75	0.58
Armada of 1588	<i>Navios de Sevilla</i>	3.75	0.71
1613 ordinances	1. Navío	3.77	0.45
1618 ordinances	1. Navío	3.78	0.44

Source	Ship Type	E (Length)/ M (Breadth)	P (Depth of Hold)/ M (Breadth)
1607 ordinances	1. Navío	3.80	0.55
Armada of 1588	<i>Galeon de Florencia</i>	3.85	0.62
1613 ordinances	3. Patache	3.88	0.45
1613 ordinances	2. Patache	4.00	0.44
1613 ordinances	1. Patache	4.22	0.47
Armada of 1588	<i>Galeoncetes de Portugal</i>	4.58	0.37

Sources Cited:

Principal Measurements of Arana's Galleons (Phillips 1986, 229 (Table I.))

Measurements for the ships of Armada of 1588 (Casado Soto 1988, 186-226.)

Measurements provided in the *Diálogo entre un vizcaíno y un montañés sobre la fábrica de navíos* (Mendoza 2008, 169 (Table. 1).)

Measurements from the 1st Committee of Santander for the galleons of the Armada de la Guarda de la Carrera de Indias – 1581 (Mendoza 2008, 170 (Table. 2).)

Measurements from the Committee of Seville for the galleons of the Armada de la Guarda de la Carrera de Indias – 1581 (Mendoza 2008, 171 (Table. 3).)

Measurements from the 2nd Committee of Santander for the galleons of the Armada de la Guarda de la Carrera de Indias – 1581 (Mendoza 2008, 172 (Table. 4).)

Measurements provided by the 1607 ordinances (Mendoza 2008, 173 (Table. 5).)

Measurements provided by the 1613 ordinances (Mendoza 2008, 174 (Table. 6).)

Measurements provided by the 1618 ordinances (Mendoza 2008, 179 (Table. 11).)

APPENDIX 6

CATALOG OF THE SELECTED ARTIFACTS

ARTEFACT CATALOG				
Ceramics	Qty.	Finds Number	Type	Comments
Olive Jar	1	89:35-I16-I-3/05	Body	
Olive Jar	1	89:35-I16-I-3/06	Body	
Olive Jar	1	89:35-I16-I-3/07	Body	
Olive Jar	128	89:35-I16-I-3/09	Body	Resin on Int.
Olive Jar	1	89:35-I16-I-3/10&14	Body	Resin on Int.
Olive Jar	1	89:35-I16-I-3/11	Body	Resin on Int.
Olive Jar	1	89:35-I16-I-3/12	Body	Resin on Int.
Olive Jar	1	89:35-I16-I-3/13	Body	Resin on Int.
Olive Jar	1	89:35-I16-I-3/15	Body	Resin on Ext.
Olive Jar	1	89:35-I16-I-3/16	Body	Resin on Int.
Olive Jar	1	89:35-I16-I-3/17	Body	Resin on Ext.
Olive Jar	1	89:35-I16-I-3/18	Body	
Olive Jar	1	89:35-I16-I-3/19	Body	
Olive Jar	1	89:35-I16-I-3/20	Body	Resin on Int.
Olive Jar	1	89:35-I16-I-3/21	Body	Resin on Int.
Olive Jar	1	89:35-I16-I-3/22	Body	
Olive Jar	1	89:35-I16-I-3/23	Body	Resin on Int.
Olive Jar	1	89:35-I16-I-3/24	Body	
Olive Jar	1	89:35-I16-I-3/25	Body	
Olive Jar	1	89:35-I16-I-3/27	Body	Resin on Int.
Olive Jar	1	89:35-I16-I-3/28	Body	Resin on Int.
Olive Jar	1	89:35-I16-IV-1/01	Body	
Olive Jar	1	89:35-I16-IV-1/02	Body	
Olive Jar	1	89:35-I16-IV-2/06	Body	
Olive Jar	1	89:35-I16-IV-2/08	Body	
Olive Jar	1	89:35-I16-IV-2/09	Body	Green Glaze on Int.
Olive Jar	2	89:35-I16-IV-3/19	Body	
Olive Jar	1	89:35-I16-IV-3/23	Body	
Olive Jar	1	89:35-I16-IV-3/24	Body	
Olive Jar	1	89:35-I16-IV-3/25	Body	
Olive Jar	1	89:35-I16-IV-3/27	Body	
Olive Jar	1	89:35-I16-IV-3/28	Body	
Olive Jar	1	89:35-I16-IV-3/29	Body	
Olive Jar	1	89:35-I16-IV-3/30	Body	
Olive Jar	1	89:35-I16-IV-3/31	Body	
Olive Jar	1	89:35-I16-IV-3/32	Body	
Olive Jar	1	89:35-I16-IV-3/33	Body	

Ceramics	Qnt.	Finds Number	Type	Comments
Olive Jar	1	89:35-I16-IV-3/42	Body	
Olive Jar	1	89:35-I16-IV-3/43	Body	
Olive Jar	1	89:35-I16-IV-3/50	Body	
Olive Jar	1	89:35-I16-IV-3/51	Body	
Olive Jar	1	89:35-J16-I-2/05	Body	
Olive Jar	1	89:35-J16-I-2/09	Body	
Olive Jar	1	89:35-J16-I-2/10	Body	
Olive Jar	1	89:35-J16-I-2/11	Body	
Olive Jar	1	89:35-J16-I-2/12	Body	
Olive Jar	1	89:35-J16-I-3/11	Body	
Olive Jar	1	89:35-J16-I-3/12	Body	
Olive Jar	1	89:35-J16-I-3/13	Body	
Olive Jar	1	89:35-J16-I-3/14	Body	
Olive Jar	1	89:35-J16-I-3/15	Body	
Olive Jar	1	89:35-J16-I-3/16	Body	
Olive Jar	1	89:35-J16-I-3/17	Body	
Olive Jar	1	89:35-J16-I-3/18	Body	
Olive Jar	1	89:35-J16-I-3/31	Body	
Olive Jar	1	89:35-J16-I-3/32	Body	
Olive Jar	1	89:35-J16-I-3/33	Body	
Olive Jar	1	89:35-J16-I-3/34	Body	
Olive Jar	1	89:35-J16-I-3/35	Body	
Olive Jar	1	89:35-J16-I-3/36	Body	
Olive Jar	1	89:35-J16-I-3/38	Body	
Olive Jar	1	89:35-J16-I-3/39	Body	
Olive Jar	1	89:35-J16-I-3/40	Body	
Olive Jar	1	89:35-J16-I-3/41	Body	
Olive Jar	1	89:35-J16-I-3/42	Body	
Olive Jar	1	89:35-J16-I-3/43	Body	
Olive Jar	1	89:35-J16-I-3/44	Body	
Olive Jar	1	89:35-J16-I-3/45	Body	
Olive Jar	1	89:35-J16-I-3/46	Body	
Olive Jar	1	89:35-J16-I-3/47	Body	
Olive Jar	1	89:35-J16-III-1/01	Body	
Olive Jar	1	89:35-J16-IV-2/02	Body	
Olive Jar	1	89:35-J16-IV-2/03	Body	
Olive Jar	1	89:35-J16-IV-2/04	Body	
Olive Jar	1	89:35-J16-IV-2/06	Body	
Olive Jar	1	89:35-J16-IV-2/07	Body	
Olive Jar	1	89:35-J16-IV-2/08	Body	
Olive Jar	1	89:35-J16-IV-2/09	Body	
Olive Jar	1	89:35-J16-IV-3/29	Body	
Olive Jar	1	89:35-J16-IV-3/30	Body	
Olive Jar	1	89:35-J16-IV-3/57	Body	
Olive Jar	1	89:35-J16-IV-3/58	Body	

Ceramics	Qnt.	Finds Number	Type	Comments
Olive Jar	1	89:35-J16-IV-3/59	Body	
Olive Jar	1	89:35-SS--1/06	Body	
Olive Jar	1	89:35-SS--1/28	Body	
Olive Jar	1	89:35-TT1--/06	Body	
Olive Jar	1	89:35-TT1--/17	Body	Green Glaze on Int.
Olive Jar	1	89:35-TT1--/19	Body	
Olive Jar	1	90:55-E17-II-0/01	Body	
Olive Jar	1	90:55-E17-II-0/02	Body	
Olive Jar	1	90:55-E17-II-0/03	Body	
Olive Jar	1	90:55-E17-II-0/04	Body	Resin on Int.
Olive Jar	1	90:55-E17-II-0/05	Body	Resin on Int.
Olive Jar	1	90:55-E17-II-0/06	Body	Resin on Int.
Olive Jar	1	90:55-E17-II-0/08	Body	
Olive Jar	10	90:55-E17-II-0/09	Body	
Olive Jar	1	90:55-I16-III-2/02	Body	
Olive Jar	1	90:55-I16-III-2/03	Body	
Olive Jar	1	90:55-I16-III-2/04	Body	
Olive Jar	1	90:55-I16-III-2/05	Body	
Olive Jar	1	90:55-I16-III-2/06	Body	
Olive Jar	1	90:55-I16-III-2/07	Body	
Olive Jar	1	90:55-I16-III-2/08	Body	
Olive Jar	1	90:55-I16-III-2/09	Body	
Olive Jar	1	90:55-I16-III-2/13	Body	
Olive Jar	4	90:55-I16-III-2/16	Body	
Olive Jar	4	90:55-I16-III-2/17	Body	
Olive Jar	4	90:55-I16-III-2/18	Body	
Olive Jar	4	90:55-I16-III-2/19	Body	
Olive Jar	1	90:55-I16-III-2/21	Body	
Olive Jar	1	90:55-I16-III-2/22	Body	
Olive Jar	1	90:55-I16-III-2/23	Body	
Olive Jar	1	90:55-I16-III-2/24	Body	
Olive Jar	1	90:55-I16-III-2/25	Body	
Olive Jar	1	90:55-I16-III-2/26	Body	
Olive Jar	1	90:55-I16-III-2/27	Body	
Olive Jar	1	90:55-I16-III-2/28	Body	
Olive Jar	1	90:55-I16-III-2/29	Body	
Olive Jar	1	90:55-I16-III-2/30	Body	
Olive Jar	1	90:55-I16-III-3/02	Body	
Olive Jar	1	90:55-I16-III-3/03	Body	
Olive Jar	1	90:55-I16-III-3/04	Body	
Olive Jar	1	90:55-I16-III-3/05	Body	
Olive Jar	1	90:55-I16-III-3/06	Body	
Olive Jar	1	90:55-I16-III-3/07	Body	
Olive Jar	1	90:55-I16-III-3/08	Body	

Ceramics	Qnt.	Finds Number	Type	Comments
Olive Jar	1	90:55-I16-III-3/09	Body	
Olive Jar	1	90:55-I16-III-3/11	Body	
Olive Jar	1	90:55-I17-I-1/09	Body	
Olive Jar	1	90:55-I17-I-2/05	Body	
Olive Jar	1	90:55-I17-I-2/06	Body	
Olive Jar	1	90:55-I17-I-2/07	Body	
Olive Jar	1	90:55-I17-I-2/08	Body	
Olive Jar	1	90:55-I17-I-2/11	Body	
Olive Jar	1	90:55-I17-I-2/19	Body	
Olive Jar	1	90:55-I17-II-1/11	Body	
Olive Jar	1	90:55-I17-II-1/12	Body	
Olive Jar	1	90:55-I17-III-3/05	Body	
Olive Jar	1	90:55-I17-IV-1/04	Body	Resin on Int.
Olive Jar	1	90:55-I17-IV-1/06a	Body	
Olive Jar	1	90:55-I17-IV-2/03	Body	
Olive Jar	1	90:55-I17-IV-2/04	Body	
Olive Jar	12	90:55-I17-IV-3/07-08	Body	Resin on Int.
Olive Jar	1	90:55-I17-IV-3/18	Body	
Olive Jar	1	90:55-J16-II-1/02	Body	
Olive Jar	1	90:55-J16-II-1/03	Body	
Olive Jar	1	90:55-J16-II-2/04	Body	
Olive Jar	1	90:55-J16-II-2/10	Body	
Olive Jar	1	90:55-J16-II-2/11	Body	
Olive Jar	1	90:55-J16-II-2/12	Body	
Olive Jar	1	90:55-J16-II-3/01	Body	
Olive Jar	1	90:55-J16-II-3/07	Body	
Olive Jar	1	90:55-J16-II-3/08	Body	
Olive Jar	1	90:55-J16-II-3/09	Body	
Olive Jar	1	90:55-J16-II-3/10	Body	
Olive Jar	1	90:55-J16-II-3/11	Body	
Olive Jar	1	90:55-J16-II-3/12	Body	
Olive Jar	1	90:55-J16-II-3/13	Body	
Olive Jar	1	90:55-J16-II-3/14	Body	
Olive Jar	1	90:55-J16-II-3/26	Body	
Olive Jar	1	90:55-J16-II-3/27	Body	
Olive Jar	1	90:55-J16-II-3/28	Body	
Olive Jar	1	90:55-J16-II-3/29	Body	
Olive Jar	1	90:55-J16-II-3/30	Body	
Olive Jar	1	90:55-J16-II-3/31	Body	
Olive Jar	1	90:55-J16-II-3/32	Body	
Olive Jar	1	90:55-J16-II-3/33	Body	
Olive Jar	1	90:55-J16-II-3/34	Body	
Olive Jar	1	90:55-J16-II-3/35	Body	
Olive Jar	1	90:55-J16-II-3/36	Body	
Olive Jar	1	90:55-J16-II-3/37	Body	

Ceramics	Qnt.	Finds Number	Type	Comments
Olive Jar	1	90:55-J16-II-3/38	Body	
Olive Jar	1	90:55-J16-II-3/39	Body	
Olive Jar	1	90:55-J16-II-3/70	Body	Green Glaze on Int.
Olive Jar	1	90:55-J16-II-3/71	Body	
Olive Jar	1	90:55-J16-II-3/72	Body	Green Glaze on Int.
Olive Jar	1	90:55-J16-II-3/73	Body	
Olive Jar	1	90:55-J16-II-3/74	Body	
Olive Jar	1	90:55-J16-II-3/75	Body	
Olive Jar	18	90:55-J16-II-3/82	Body	
Olive Jar	1	90:55-J16-II-3/82.5	Body	
Olive Jar	1	90:55-J16-III-2/01	Body	
Olive Jar	19	90:55-TT5---2/02	Body	
Olive Jar	19	90:55-TT5---2/04	Body	
Olive Jar	19	90:55-TT5---2/06	Body	
Olive Jar	19	90:55-TT5---2/07	Body	
Olive Jar	19	90:55-TT5---2/08	Body	
Olive Jar	19	90:55-TT5---2/09	Body	
Olive Jar	1	89:35-TT1--/18	Body	Green Glaze on Int.
Olive Jar	1	90:55-E17-II-0/07	Body w/ "Nipple"	Resin on Int.
Olive Jar	1	90:55-J16-II-3/82.5b	Rim	
Olive Jar	1	90:55-I17-I-2/03&04	Body	
Olive Jar	1	90:55-J16-II-2/03	Rim	
Pipestem (Possible)				
Pipestem (Possible)	1	89:35-I16-I-1/02	pipestem (possible)	
Earthenware, Redware				
Earthenware, Redware	1	90:55-E17-II-0/13	Body/Rim	Rim D. 20cm
Earthenware	1	89:35-SS--1/39	Base (Flat)	
Earthenware	1	89:35-I16-I-3/26	Body	Resin on Int.
Earthenware	1	91:73--- #01	Body	
Earthenware	1	90:55-I16-III-3/01	Body/Rim	Lebrillo, Rim D. 36cm
Earthenware	1	90:55-I16-IV-3/12	Unknown	
Earthenware	1	90:55-J16-II-3/02	Unknown	
Earthenware	1	89:35-I15-III-3/21	Unknown	
Earthenware	1	89:35-I16-IV-3/40	Unknown	
Earthenware	1	89:35-J16-IV-3/60	Unknown	
Majolica, Columbia Plain				
Majolica, Columbia Plain	12	90:55-E17-II-0/11	Base/Body (Flat)	Escudilla, D. 16cm, Base D. 14cm

Ceramics	Qty.	Finds Number	Type	Comments
Majolica, Columbia Plain	12	89:35-I16-I-3/30	Body	
Majolica, Columbia Plain	12	89:35-I16-I-3/31	Body	
Majolica, Columbia Plain	1	89:35-I16-IV-3/44	Body	
Majolica, Columbia Plain	1	89:35-SS--1/24	Body	
Majolica, Columbia Plain	1	89:35-SS--1/27	Body	
Majolica, Columbia Plain	1	90:55-I17-IV-2/05	Body	
Majolica, Columbia Plain	1	89:35-SS--1/26	Body	
Majolica, Columbia Plain	1	90:55-I17-IV-3/06	Body/Rim	Unknown, Rim D. 26-28cm
Majolica, Columbia Plain	1	89:35-SS--1/31	Body/Rim	Escudilla, D. 16cm
Majolica, Columbia Plain	1	90:55-I17-I-2/21	Rim	Plato, D. 24cm
Majolica, Columbia Plain	1	90:55-I17-I-2/20	Rim	Unknown, D. 20cm
Majolica, Columbia Plain	1	89:35-I15-III-3/23	Base/Body (Flat)	Plato, Outer D. 28cm
Majolica, Columbia Plain	1	89:35-I15-III-3/22	Base/Body (Ring)	Unknown, Base D. 6-8cm
Majolica, Degraded	1	89:35-I16-IV-3/41	Base/Body	Lebrillo or Plato (Unbrimmed)
Majolica, Degraded	1	89:35-I15-III-3/01	Base/Body (Flat)	Lebrillo or Plato
Majolica, Degraded	12	90:55-E17-II-0/12	Base/Body (Flat)	Escudilla
Majolica, Degraded	1	89:35-TT1--/16	Body	Unknown
Majolica, Degraded	1	89:35-I15-III-3/03	Body	Unknown

Ceramics	Qty.	Finds Number	Type	Comments
Majolica, Degraded	1	89:35-I15-III-3/04	Body	Unknown
Majolica, Degraded	1	89:35-I15-III-3/05	Body	Unknown
Majolica, Degraded	1	89:35-I15-III-3/19	Body	Unknown
Majolica, Degraded	1	89:35-I15-III-3/20	Body	Unknown
Majolica, Degraded	1	89:35-J16-I-3/82	Body	Unknown
Majolica, Degraded	1	89:35-SS--1/35	Body	Unknown
Majolica, Degraded	1	90:55-H17-IV-1/05	Body	Unknown
Majolica, Degraded	1	90:55-J16-II-3/15	Body	Unknown
Majolica, Degraded	1	90:55-J16-II-3/25	Body	Unknown
Majolica, Degraded	19	90:55-TT5---2/05	Body	Unknown
Majolica, Degraded	1	90:55-TT5---2/10	Body	Unknown (Prob. Escudilla)
Majolica, Degraded	1	90:55-J16-II-3/18	Body	Unknown
Majolica, Degraded	1	89:35-SS--1/36	Body	Unknown
Majolica, Degraded	1	89:35-I15-III-3/02	Rim	Lebrillo, Inner D. 28cm
Majolica, Degraded	1	89:35-SS--1/33	Rim	Unknown, Outer D. 12cm
Majolica, Degraded	1	89:35-SS--1/34	Rim	Unknown, Outer D. 12cm
Aboriginal Earthenware				
Aboriginal Earthenware	1	89:35-I16-I-3/29	Body	
Aboriginal Earthenware	1	89:35-SS--1/37	Body	
Aboriginal Earthenware	1	90:55-J16-III-3/01	Body	
Aboriginal Earthenware	19	90:55-TT5---2/03	Body	
Aboriginal Earthenware	19	90:55-TT5---2/01	Body	

Ceramics	Qty.	Finds Number	Type	Comments
Lead Glazed, El Morro	1	89:35-J16-I-3/83	Body	Yellow Lead Glaze Int.
Lead Glazed, El Morro	1	90:55-J16-II-3/82.5c	Body	Yellow Lead Glaze Int.
Green Basin/Green Lebrillo	1	89:35-SS--1/30	Rim	Green Lead Glaze Int. & Ext.
Earthenware Roofing Tile	1	89:35-TT1--/21	Tile	Tile
Earthenware Roofing Tile	1	89:35-TT1--/20	Tile	Tile
Stoneware	1	89:35-SS--1/25	Body	Dk. Brown Glaze on Ext.
Brick	1	89:35-I16-IV-2/11	Brick	Brick
Unidentified	1	89:35-I16-I-3/14	Unknown	
Unidentified	1	89:35-I16-IV-3/26	Unknown	
Unidentified	1	90:55-I17-I-1/10	Unknown	
TOTAL:	636			

Glass	Qty.	Finds Number	Type	Comments
Glass	1	89:35-J16-I-3/23	Body Sherd	Emerald
Glass	1	89:35-I16-IV-1/05	Sherd, Sq. Edge	Emerald
Glass	1	90:55-J17-II-1/01	Sherd	Clear
Glass	1	90:55-J17-I-3/20	Body Sherd	Dark Green
Glass	1	89:35-G17-III-0/01	Bottle Base	Dark Green
Glass	1	90:55-I17-I-1/02	Body Sherd	Dark Green
Glass	2	89:35-I16-IV-1/06	Body Sherd	Dark Olive
Glass	1	89:35-I16-IV-2/10	Body Sherd	Olive Green
TOTAL:	9			

Inorganic Objects	Qty.	Finds Number	Type	Comments
Coal	3	89:35-J16-IV-3/63-65	n/a	Organic Muck, Sand, Wood Chips, Seeds, Nuts, and Bone
TOTAL:	3			

Metals (Non-Ferrous)	Qty.	Finds Number	Type	Comments
Copper Alloy	1	89:35-J16-IV-3/09	Nail Frag.	
Copper Alloy	1	90:55-I17-I-2/10	Nail Frag.	
Copper Alloy	1	90:55-I17-I-2/12	Nail Frag.	
Copper Alloy	1	90:55-I17-I-2/13	Nail Frag.	
Copper Alloy	1	90:55-J16-II-2/09	Nail Frag.	
Copper Alloy	1	90:55-J16-II-3/16	Nail Frag.	
Copper Alloy	1	90:55-I16-III-2/01	Nail Frag.	
Copper Alloy	1	90:55-I17-I-2/02	Tack	
Copper Alloy	1	90:55-I17-II-1/13	Tack	
Copper Alloy	1	89:35-I16-IV-3/21	Copper Scrap	
Copper Alloy	1	89:35-TT1--/14	Copper Scrap	
TOTAL: 13				
Lead	1	89:35-SS--1/29	Lead Sheaving Fragment	
Lead	1	90:55-I17-I-2/09	Lead Sheaving Fragment	

Metals (Ferrous)	Qty.	Finds Number	Type	Comments
Iron	1	90:55-F17-II-0/01a	Bolt	
Iron	1	90:55-F17-II-0/01b	Bolt	
Iron	1	90:55-F17-II-0/01c	Forelock Bolt	
Iron	1	89:35-TT1--/13	Chainplate	
Iron	1	90:55-E18-I-0/01a	Chainplate	
Iron	1	90:55-E18-I-0/01b	Chainplate	
Iron	1	90:55-E18-I-0/01c	Chainplate	
Iron	1	90:55-E18-I-0/01d	Chainplate	
Iron	1	90:55-E18-IV-0/01	Chainplate	
Iron	1	91:73---/LOWER GUDGEON A	Gudgeon	
Iron	1	91:73---/LOWER GUDGEON B	Gudgeon	
Iron	1	91:73---/LOWER GUDGEON C	Gudgeon	
Iron	1	91:73---/LOWER GUDGEON D	Gudgeon	
Iron	1	90:55-TT5---2/19	Nail/Spike	

Metals (Ferrous)	Qnt.	Finds Number	Type	Comments
Iron	1	89:35-TT1---1/11	Nail/Spike	
Iron	1	90:55-TT5---2/14	Nail/Spike	
Iron	1	89:35-I16-I-3/08b	Nail/Spike	
Iron	1	89:35-I16-IV-2/03	Nail/Spike	
Iron	1	89:35-J16-III-1/02	Nail/Spike	
Iron	1	89:35-TT1--/08a	Nail/Spike	
Iron	1	90:55-G19-IV-0/02	Nail/Spike	
Iron	1	90:55-G19-IV-O /03	Nail/Spike	
Iron	1	90:55-H17-IV-1/07B	Nail/Spike	
Iron	1	90:55-I16-III-3/13	Nail/Spike	
Iron	1	90:55-I16-III-3/14	Nail/Spike	
Iron	1	90:55-I17-I-1/06	Nail/Spike	
Iron	1	90:55-I17-I-1/07	Nail/Spike	
Iron	1	90:55-I17-I-2/01	Nail/Spike	
Iron	1	90:55-I17-I-2/15	Nail/Spike	
Iron	1	90:55-I17-I-2/16	Nail/Spike	
Iron	1	90:55-I17-I-2/17	Nail/Spike	
Iron	1	90:55-I17-I-2/22	Nail/Spike	
Iron	1	90:55-I17-II-1/01	Nail/Spike	
Iron	1	90:55-I17-II-1/04	Nail/Spike	
Iron	1	90:55-I17-II-1/08	Nail/Spike	
Iron	1	90:55-I17-II-1/09	Nail/Spike	
Iron	1	90:55-I17-II-1/10	Nail/Spike	
Iron	1	90:55-I17-III-2/08	Nail/Spike	
Iron	1	90:55-I17-III-2/10	Nail/Spike	
Iron	1	90:55-I17-III-2/14	Nail/Spike	
Iron	1	90:55-I17-IV-1/03	Nail/Spike	
Iron	1	90:55-I17-IV-2/07	Nail/Spike	
Iron	1	90:55-I17-IV-2/08	Nail/Spike	
Iron	1	90:55-I17-IV-3/02	Nail/Spike	
Iron	1	90:55-I17-IV-3/17	Nail/Spike	
Iron	1	90:55-J16-II-3/06	Nail/Spike	
Iron	1	90:55-J17-I-1/03 (possibly labled j17-i-0/3)	Nail/Spike	
Iron	1	90:55-J17-I-1/04	Nail/Spike	
Iron	1	90:55-J17-I-1/05	Nail/Spike	
Iron	1	90:55-J17-I-1/09	Nail/Spike	
Iron	1	90:55-TT5---2/23	Nail/Spike	
Iron	1	91:73---/ASK/1-1	Nail/Spike	
Iron	1	91:73---/MASTER COUPLE-EO#1,FLOOR 1,PORT	Nail/Spike	
Iron	1	91:73---/PPI-A7	Nail/Spike	
Iron	1	90:55-I16-II-2/02	Nail/Spike	
Iron	1	90:55-I17-I-1/03	Nail/Spike	

Metals (Ferrous)	Qty.	Finds Number	Type	Comments
Iron	1	90:55-I17-I-1/04	Nail/Spike	
Iron	1	90:55-I17-I-1/05	Nail/Spike	
Iron	1	90:55-I17-II-1/07	Nail/Spike	
Iron	1	90:55-I17-IV-1/02	Nail/Spike	
Iron	1	90:55-I17-IV-2/01	Nail/Spike	
Iron	1	90:55-I17-IV-2/01 B	Nail/Spike	
Iron	1	90:55-I17-IV-2/02	Nail/Spike	
Iron	1	90:55-J16-II-1/01	Nail/Spike	
Iron	1	90:55-J16-II-1/04	Nail/Spike	
Iron	1	90:55-J16-II-1/06	Nail/Spike	
Iron	1	90:55-J17-I-1/03a (two labels thus, a give Jan 93)	Ornamental Nail	
Iron	1	91:73---/ASK-1/3	Shot	
Iron	1	90:55-E18-IV-0/02	Strap	
Iron	1	90:55-G 19-IV-0/01	Strap	
Iron	1	90:55-I17-II-1/02	Strap	
Iron	1	90:55-I17-IV-1/01	Tack	
Iron	1	89:35-I16-I-0/01	Unknown	
Iron	1	89:35-I16-I-3/02	Unknown	
Iron	1	89:35-I16-IV-0/01	Unknown	
Iron	1	90:55-E17-III-0/02	Unknown	
Iron	1	90:55-I16-III-1/01	Unknown	
Iron	1	90:55-I17-I-1/08	Unknown	
Iron	1	90:55-I17-III-2/04	Unknown	
Iron	1	90:55-J16-II-3/04	Unknown	
TOTAL:		80		

Organics	Qty.	Finds Number	Type	Comments
Bilge	1	90:55-J16-II-3/69		
Bilge	1	90:55-J16-II-3/80		
Bilge	1	90:55-J16-III-3/03		
Bilge	1	90:55-J15-IV-3/01		
Bilge	1	90:55-J16-II-3/50		
Bilge	1	90:55-J16-II-3/51		
Bilge	1	90:55-J15-IV-3/02		
Bilge	2	90:55-J16-I-3/01		
Bilge	2	90:55-J16-I-3/02-03		
Bilge	1	90:55-J16-II-3/68		

Organics	Qnt.	Finds Number	Type	Comments
Faunal, Bone	1	89:35-J16-IV-3/56	Bird (Unidentified), Long Bone	
Faunal, Bone	1	90:55-J16-II-3/78	Bos sp. (Domestic Cattle), Rib	
Faunal, Bone	1	90:55-I16-IV-3/01	Fish (Unidentified), Vertebra	
Faunal, Bone	1	90:55-I17-IV-3/01	Odocoileus Virginianus (White-Tailed Deer), Lumbar Vertebra	
Faunal, Bone	1	90:55-J16-II-3/19	Rattus sp. (Rat), Humerus	
Faunal, Bone	1	89:35-J16-IV-3/53	Rattus sp. (Rat), Pelvic Bone	
Faunal, Bone	1	89:35-J16-IV-3/55	Rattus sp. (Rat), Rib, Immature	
Faunal, Bone	1	89:35-J16-IV-3/54	Rattus sp. (Rat), Tibia	
Faunal, Bone	1	89:35-SS--1/40	Sheep/Goat/Pig Unident, Long Bone	
Faunal, Bone	2	89:35-I16-I-3/01	Sus sp. (Domestic Pig), Rib	
Faunal, Bone	1	89:35-I16-IV-3/48	Sus sp. (Domestic Pig), Rib	
Faunal, Bone	1	89:35-I16-IV-3/49	Sus sp. (Domestic Pig), Rib	
Faunal, Bone	1	89:35-I16-IV-3/52	Sus sp. (Domestic Pig), Rib	
Faunal, Bone	1	89:35-J16-I-3/30	Sus sp. (Domestic Pig), Rib	
Faunal, Bone	1	90:55-E17-II-0/15	Sus sp. (Domestic Pig), Rib	
Faunal, Bone	1	90:55-I16-III-3/10	Sus sp. (Domestic Pig), Rib	
Faunal, Bone	1	90:55-J16-III-3/02	Sus sp. (Domestic Pig), Rib	

Organics	Qty.	Finds Number	Type	Comments
Faunal, Bone	1	90:55-J16-II-2/01	Sus sp. (Domestic Pig), Rib	
Faunal, Insect Egg Cases	1	90:55-J16-II-3/40	Unidentified	
Faunal, Oyster Shell	1	90:55-J16-II-3/48	Oyster (Possibly a Pearl Oyster Shell)	
Faunal, Roach Sacs	1	91:73-FR1 P/1 sample--/	Unidentified	
Fiber	1	91:73---/PPG CTR Seam Organic Sample	Tentatively Hemp & Pitch	
Fiber	1	91:73---/Keel Aft Caulk Sample	Tentatively Hemp & Pitch	
Fiber	1	91:73---/SNP 1/1 port organic sample	Tentatively Hemp & Pitch	
Fiber	1	91:73---/un14 organic sample	Cannabis sativa (Hemp)	
Fiber	1	90:55-J16-II-3/66	Cannabis sativa (Hemp)	
Fiber	1	91:73---/ASK-1/2	Unidentified	
Fiber, Rope	1	89:35-J16-I-3/24	Cannabis sativa (Hemp), Rope Fragment	
Fiber, Rope	2	89:35-J16-IV-2/11-12	Cannabis sativa (Hemp), Rope Fragment	
Fiber, Rope	4	89:35-J16-IV-3/11	Cannabis sativa (Hemp), Rope Fragment	
Fiber, Rope	4	89:35-J16-IV-3/12	Cannabis sativa (Hemp), Rope Fragment	
Fiber, Rope	1	89:35-J16-IV-3/17	Cannabis sativa (Hemp), Rope Fragment	
Fiber, Rope	4	91:73---/rope fragments	Cannabis sativa (Hemp), Rope Fragment	
Fiber, Rope	1	90:55-J16-II-3/03	Cannabis sativa (Hemp), Rope Fragment	
Fiber, Rope	1	89:35-I16-IV-2/14	Cannabis sativa (Hemp), Rope Fragment	
Fiber, Rope	1	91:73---/JB1-rope fragment	Cannabis sativa (Hemp), Rope	

Organics	Qnt.	Finds Number	Type	Comments
Floral	2	89:35-J16-IV-3/50-51	Prunus dulcis (Almond), Nut Shell	
Floral	5	89:35-J16-I-3/92-96	Prunus dulcis (Almond), Two Fragments; Plum or Persimmon, Unidentified (One Fruit Skin); Castanea dentata (American Chestnut), Two Fragments	
Floral	1	89:35-J16-IV-3/24	Bamboo or Sugar Cane	
Floral	1	89:35-SS--1/38	Castanea dentata (American Chestnut), Stem/Branch	
Floral	1	90:55-I17-I-1/01	Cocos nucifera (Coconut), Fragment	
Floral	1	90:55-J16-II-3/21	Cocos nucifera (Coconut), Fragment	
Floral	1	90:55-J17-II-3/21	Cocos nucifera (Coconut), Fragment	
Floral	1	89:35-J16-I-3/25	Cocos nucifera (Coconut), Fragment	
Floral	1	90:55-I17-I-2/18	Cocos nucifera (Coconut), Fragment	
Floral	1	89:35-J16-I-3/02	Unidentified Fruit	
Floral	1	90:55-I17-IV-2/16	Tentatively Ginger Root	
Floral	1	91:73-FRØSF/1 sample--/	Unidentified Hull or Nut Seed	
Floral	1	89:35-I16-I-3/32	Unidentified Leaf	
Floral	5	91:73-FRØSF/1 sample--/	Unidentified Leaf	
Floral	1	90:55-J16-II-3/83	Unidentified Nut Shell	

Organics	Qty.	Finds Number	Type	Comments
Floral	3	89:35---/A	Olea europaea (European Olive), Pit	
Floral	2	89:35-J16-IV-3/31-32	Olea europaea (European Olive), Pit	
Floral	1	90:55-J16-I-3/04	Olea europaea (European Olive), Pit	
Floral	1	91:73---/FR5 s/1 olive pit	Olea europaea (European Olive), Pit	
Floral	1	91:73---/FRA s/1 olive	Olea europaea (European Olive), Pit	
Floral	5	-FR1/01--/olive pits	Olea europaea (European Olive), Pit	
Floral	32	89:35-J16-I-3/50-81	Olea europaea (European Olive), Pit	
Floral	17	89:35-J16-IV-3/33-49	Olea europaea (European Olive), Pit	
Floral	32	89:35-J16-I-3/50-81b	Olea eropaea (European Olive), 17 pits; Quercus sp. (Oak Acorn), Hull, One Fragment	
Floral	1	91:73-FRØSA/1 Sample--/	Pine Needle	
Floral	1	90:55-J16-II-3/20	Reed	
Floral	12	90:55-I17-IV-3/07-08 sample	Helianthus tuberosus (Jerusalem Artichoke), Fragments	
Floral	1	89:35-I16-IV-3/05	Helianthus tuberosus (Jerusalem Artichoke), Fragments; Possibly Ginger, Ground Nut or Waterlily	

Organics	Qty.	Finds Number	Type	Comments
Floral	1	89:35-J16-I-3/49	Helianthus tuberosus (Jerusalem Artichoke), Fragments; Possibly Ginger, Ground Nut or Waterlily	
Floral	1	89:35-J16-IV-3/10	Helianthus tuberosus (Jerusalem Artichoke), Fragments; Possibly Ginger, Ground Nut or Waterlily	
Floral	1	89:35-J16-I-2/06-08	Helianthus tuberosus (Jerusalem Artichoke), Fragments; Possibly Ginger, Ground Nut or Waterlily	
Floral	1	91:73--from 1 stbd strake sample--/	Helianthus tuberosus (Jerusalem Artichoke), Fragments; Possibly Ginger, Ground Nut or Waterlily	
Floral	1	90:55-J16-II-3/91	Helianthus tuberosus (Jerusalem Artichoke), Fragments; Possibly Ginger, Ground Nut or Waterlily	
Floral	1	89:35-I16-IV-2/07	Unidentified Seed Pod	
Floral	1	90:55-I17-IV-3/10	U/N Seed Pod	

Organics	Qty.	Finds Number	Type	Comments
Floral	2	89:35-TT1--/02	Leguminosae. cf. Cassia fistula (Rain Tree, Liquorice), One Segment of Pod	
Floral	2	89:35-TT2--/02	Leguminosae. cf. Cassia fistula (Rain Tree, Liquorice), One Segment of Pod	
Floral	1	89:35-TT1--/15	Unidentified Seed Pod	
Floral	1	91:73-FRA 0/1 sample--/	Unidentified Seed Pod or Husk	
Floral	1	89:35-SS--1/21	Cucurbita pepo (Pumpkin), Basal Portion of Stem	
Floral	1	91:73-FRA 0/1 sample--/	Unidentified Twig or Cane	
Floral	1	90:55-J16-II-3/22	Unidentified Vegetable	
Floral	1	90:55-J16-II-3/23	Unidentified Vegetable	
Floral	1	90:55-J16-II-3/41	Unidentified Vegetable	
Floral	1	90:55-J16-II-3/77	Juglans regia (European Walnut), Nut Shell	
Mineral	1	90:55-J16-II-3/84	Clay	
Mineral	1	89:35-J16-IV-3/08	Ochre Residues	
Other Organic	10	91:73-FR2/s1 sample--/	Organic (Sample)	
Other Organic	10	91:73-FRA 0/1 sample--/	Organic (Sample)	
Other Organic	1	90:55-I17-IV-2/18 sample	Organic (Sample)	
Other Organic	1	91:73---/FR3 P/1 sample	Organic (Sample)	
Other Organic	1	91:73---/PP4 sample	Organic (Sample)	

Organics	Qnt.	Finds Number	Type	Comments
Other Organic	1	91:73---/PS1 FR1 sample	Organic (Sample)	
Other Organic	1	91:73---/ps2 4-x-1991 sample	Organic (Sample)	
Resin	1	89:35-J16-I-3/37	Unidentified Resin	
Resin	1	90:55-J16-II-3/81	Unidentified Resin	
Resin	1	89:35-I16-i-3/09-29	Unidentified Resin	
Resin	1	89:35-I16-i-3/09-29b	Unidentified Resin	
Resin	1	90:55-E17-II-0/01-10 sample	Unidentified Resin	
Resin	1	89:35-J16-I-2/17	Unidentified Resin	
Resin	4	89:35-J16-I-3/19-22	Unidentified Resin	
Resin	8	89:35-J16-I-3/84-91	Unidentified Resin	
Resin	1	89:35-J16-IV-3/52	Unidentified Resin	
Resin	1	90:55-I16-III-2/14	Unidentified Resin	
Resin	2	90:55-I17-IV-1/05	Unidentified Resin	
Resin	1	90:55-I17-IV-3/15	Unidentified Resin	
Resin	1	90:55-J16-II-3/24	Unidentified Resin	
Resin	1	91:73---/Resin sample	Unidentified Resin	
Resin	1	89:35-I16-IV-3/17	Unidentified Resin	
Wood	1	90:55-I17-III-3/06	Bark	
Wood	1	90:55-J16-II-3/49	Bark	
Wood	1	90:55-J16-II-3/76	Bark	
Wood	1	90:55-J16-II-1/05	Barrel Head	
Wood	2	89:35-J16-IV-2/13	Barrel Hoops	
Wood	12	89:35-J16-IV-2/14	Barrel Hoops	
Wood	3	89:35-J16-IV-3/04-06	Barrel Hoops	
Wood	4	89:35-J16-IV-3/11-14	Barrel Hoops	
Wood	4	89:35-J16-IV-3/13	Barrel Hoops	
Wood	4	89:35-J16-IV-3/14	Barrel Hoops	
Wood	4	89:35-I16-IV-3/55-58	Barrel Staves	

Organics	Qnt.	Finds Number	Type	Comments
Wood	2	89:35-SS--1/17-18	Barrel Staves	
Wood	1	91:73 ---/wooden bowl base	Bowl Base	
Wood	1	91:73---/002 (caulking mallet)	Caulking Mallet Head	
Wood	1	90:55-I17-III-2/09	Cork	
Wood	1	90:55-I15-IV-3/01	Cork	
Wood	1	90:55-I17-II-1/03	Dowel	
Wood	1	90:55-I17-IV-3/19	Dowel	
Wood	1	91:73-FRA P/1--/	Iron/Wood	
Wood	31	90:55-I17-I-2/23C	Planking Frag.	
Wood	3	89:35-I16-IV-3/34-36	Treenails	
Wood	2	89:35-I16-IV-3/46-47	Treenails	
Wood	3	90:55-I16-III-2/20	Treenails	
Wood	3	91:73---/Wooden Peg	Treenails	
Wood	1	89:35-J16-IV-3/61	Wedge	
Wood	1	90:55-I17-II-2/14	Wood	
Wood	1	90:55-I17-III-3/01	Wood	
Wood	1	90:55-I17-III-3/02	Wood	
Wood	2	89:35-I15-III-3/17	Wood	
Wood	1	89:35-I15-III-3/18	Wood	
Wood	1	89:35-I16-I-0/	Wood	
Wood	1	89:35-I16-IV-2/02	Wood	
Wood	1	89:35-I16-IV-3/02	Wood	
Wood	5	89:35-I16-IV-3/06-10	Wood	
Wood	4	89:35-J16-I-2/13-16	Wood	
Wood	1	89:35-J16-I-3/01	Wood	
Wood	2	89:35-J16-I-3/03-04	Wood	
Wood	5	89:35-J16-I-3/05-09	Wood	
Wood	1	89:35-J16-I-3/10	Wood	
Wood	4	89:35-J16-I-3/26-29	Wood	
Wood	1	89:35-J16-I-3/48	Wood	
Wood	2	89:35-J16-III-0/01-02	Wood	
Wood	1	89:35-J16-IV-3/19	Wood	
Wood	1	89:35-J16-IV-3/25	Wood	
Wood	1	89:35-J16-IV-3/28	Wood	
Wood	2	89:35-SS--1/22-23	Wood	
Wood	1	89:35-SS--1/32	Wood	
Wood	1	89:35-TT2--/01	Wood	
Wood	1	90:55-I16-II-0/01	Wood	
Wood	1	90:55-I16-II-2/04	Wood	
Wood	1	90:55-I16-II-2/05	Wood	
Wood	1	90:55-I16-III-2/11	Wood	
Wood	1	90:55-I16-III-3/15	Wood	
Wood	1	90:55-I17-I-2/14	Wood	

Organics	Qty.	Finds Number	Type	Comments
Wood	1	90:55-I17-III-2/13	Wood	
Wood	1	90:55-I17-IV-3/03	Wood	
Wood	1	90:55-I17-IV-3/14	Wood	
Wood	2	90:55-J16-II-2/02	Wood	
Wood	1	90:55-J16-II-2/05	Wood	
Wood	1	90:55-J16-II-2/07	Wood	
Wood	1	90:55-J16-II-2/08	Wood	
Wood	1	90:55-J16-II-2/09	Wood	
Wood	3	90:55-J16-II-3/04	Wood	
Wood	1	90:55-J16-II-3/05	Wood	
Wood	1	90:55-J16-II-3/17	Wood	
Wood	6	90:55-J16-II-3/42-47	Wood	
Wood	1	90:55-J16-II-3/79	Wood	
Wood	1	90:55-J16-III-2/02	Wood	
Wood	1	90:55-J17-I-1/06	Wood	
Wood	1	90:55-J17-I-1/08A	Wood	
Wood	1	90:55-J17-I-3/04	Wood	
Wood	1	90:55-J17-I-3/05	Wood	
Wood	1	90:55-J17-I-3/08	Wood	
Wood	1	90:55-J17-II-1/02	Wood	
Wood	1	90:55-J16-II-3/67	Wood	
Wood	1	90:55-J17-I-1/01	Wood	
Wood	1	90:55-J17-I-1/02	Wood	
Wood	1	91:73-from UN5 sample--/	Wood	
Wood	15	91:73---/wood samples	Wood	
Wood	1	89:35-TT1--/01	Wood Sheave	
Wood	1	89:35-J16-IV-3/62	Wood Worked	
Total:	449			

VITA

Name: Piotr Tadeusz Bojakowski

Address: 1 The Keep, National Museum of Bermuda
Sandys, MA01
Bermuda

Email Address: bojakus@tamu.edu

Education: Management and Marketing; Akademia Ekonomiczna, Krakow,
Poland, 1999

B.A., Anthropology, University of Nevada, Reno, 2001

Ph.D., Nautical Archaeology, Texas A&M University, College
Station, 2012

Employment: GIS Technician, Nevada Bureau of Mines and Geology,
University of Nevada, Reno, 2001

GIS Specialist, Biological Resources Research Center, University
of Nevada, Reno, 2002-2005

Research Assistant, Nautical Archaeology Program, Department
of Anthropology, Texas A&M University, Supervisor: Dr. Donny
L. Hamilton, 2005-2010

Archaeologist/Conservator, National Museum of Bermuda,
Bermuda, 2010-present