



## Strathprints Institutional Repository

Ross, K. and Bowers, R. and , NHS Quality Improvement Scotland (Funder) (2009) *Best practice statement: use of ankle-foot orthoses following stroke*. In: British Association of Prosthetists and Orthotists Annual Conference, 2010-03-05 - 2010-03-07, Bolton, UK.

Strathprints is designed to allow users to access the research output of the University of Strathclyde. Copyright © and Moral Rights for the papers on this site are retained by the individual authors and/or other copyright owners. You may not engage in further distribution of the material for any profitmaking activities or any commercial gain. You may freely distribute both the url (<http://strathprints.strath.ac.uk/>) and the content of this paper for research or study, educational, or not-for-profit purposes without prior permission or charge.

Any correspondence concerning this service should be sent to Strathprints administrator: <mailto:strathprints@strath.ac.uk>



Ross, K. and Bowers, R. (2009) Best practice statement 'Use of ankle-foot orthoses following stroke. In: British Association of Prosthetists and Orthotists Annual Conference, 5-7 March 2010, Bolton, UK.

<http://strathprints.strath.ac.uk/16661/>

Strathprints is designed to allow users to access the research output of the University of Strathclyde. Copyright © and Moral Rights for the papers on this site are retained by the individual authors and/or other copyright owners. You may not engage in further distribution of the material for any profitmaking activities or any commercial gain. You may freely distribute both the url (<http://strathprints.strath.ac.uk>) and the content of this paper for research or study, educational, or not-for-profit purposes without prior permission or charge. You may freely distribute the url (<http://strathprints.strath.ac.uk>) of the Strathprints website.

Any correspondence concerning this service should be sent to The Strathprints Administrator: [eprints@cis.strath.ac.uk](mailto:eprints@cis.strath.ac.uk)

ankle-foot orthoses

stroke

AFO

ankle-foot orthoses

stroke

AFO

stroke

ankle-foot orthoses

Best Practice Statement ~ August 2009

**Use of ankle-foot orthoses following stroke**

stroke

NHS Quality Improvement Scotland is committed to equality and diversity. We have assessed this Best Practice Statement for likely impact on the six equality groups defined by age, disability, gender, race, religion/belief and sexual orientation. For a summary of the equality and diversity impact assessment, please see our website ([www.nhshealthquality.org](http://www.nhshealthquality.org)). The full report in electronic or paper form is available on request from the NHS QIS Equality and Diversity Officer.

© NHS Quality Improvement Scotland 2009

ISBN 1-84404-58-6

First published August 2009

You can copy or reproduce the information in this document for use within NHSScotland and for educational purposes. You must not make a profit using information in this document. Commercial organisations must get our written permission before reproducing this document.

[www.nhshealthquality.org](http://www.nhshealthquality.org)

## Contents

Introduction	2	Appendix 1: Literature review	29
Key principles of best practice statements	2	Appendix 2: Anatomical planes	37
Supporting implementation	2	Appendix 3: Fundamental mechanical and biomechanical principles	38
Key stages in the development of best practice statements	3	Appendix 4: Biomechanics of normal gait	39
Best practice statement: Use of ankle-foot orthoses following stroke	4	Appendix 5: Biomechanical effects of stroke on gait	40
Best practice statement development	4	Appendix 6: Biomechanical effects of AFOs	41
Stroke	4	Appendix 7: Tuning AFOs	43
Mobility problems	5	Appendix 8: Footwear	44
Format of statement	11	Appendix 9: Ankle-foot orthosis screening and fitting/review tools	45
Section 1: Service planning, access to services and clinical governance	12	Appendix 10: Orthotic referral form	46
Section 2: Screening and referral	14	Glossary	47
Section 3: Patient assessment and indications for different AFOs	17	References	51
Section 4: Biomechanical effects of AFOs	22	Who was involved in developing this best practice statement	55
Section 5: Non-biomechanical effects of AFOs	24		
Section 6: Review, monitoring and follow-up	26		

## Introduction

NHS Quality Improvement Scotland (NHS QIS) leads the use of knowledge to promote improvement in the quality of healthcare for the people of Scotland and performs three key functions:

- providing advice and guidance on effective clinical practice, including setting standards
- driving and supporting implementation of improvements in quality, and
- assessing the performance of the NHS, reporting and publishing findings.

In addition, NHS QIS also has central responsibility for patient safety and clinical governance across NHSScotland.

### Key principles of best practice statements

A series of best practice statements has been produced within the Practice Development Unit of NHS QIS, designed to offer guidance on best and achievable practice in a specific area of care. These statements reflect the current emphasis on delivering care that is patient-centred, cost-effective and equitable. They reflect the commitment of NHS QIS to sharing local excellence at a national level.

Best practice statements are produced by a systematic process, outlined on page 3, and are underpinned by a number of key principles.

- They are intended to guide practice and promote a consistent, cohesive and achievable approach to care. Their aims are realistic but challenging.
- They are primarily intended for use by registered nurses, midwives, allied health professionals, and the staff who support them, but will also be of relevance to medical professionals.
- They are developed where variation in practice exists and seek to establish an agreed approach for practitioners.

- Responsibility for implementation of these statements rests at local level.

Best practice statements are periodically reviewed, and if necessary, updated in order to ensure the statements continue to reflect current thinking with regard to best practice.

This best practice statement is also accessible electronically via the NHS QIS website ([www.nhshealthquality.org](http://www.nhshealthquality.org)).

### Supporting implementation

Comments on best practice statements are very much welcomed. We are always keen to hear from anyone who has been involved with using the statements in their own area of practice. In particular, we would like to hear about specific successes or challenges relating to implementation and impact on quality of care provision.

Any information provided will be used to inform the next review of the statement.

Please forward any comments to: [qis.bestpracticestatements@nhs.net](mailto:qis.bestpracticestatements@nhs.net)

**Privacy note:** We will only use your email details to reply to your comment. Your address will not be passed on to any third parties.

### Key stages in the development of best practice statements

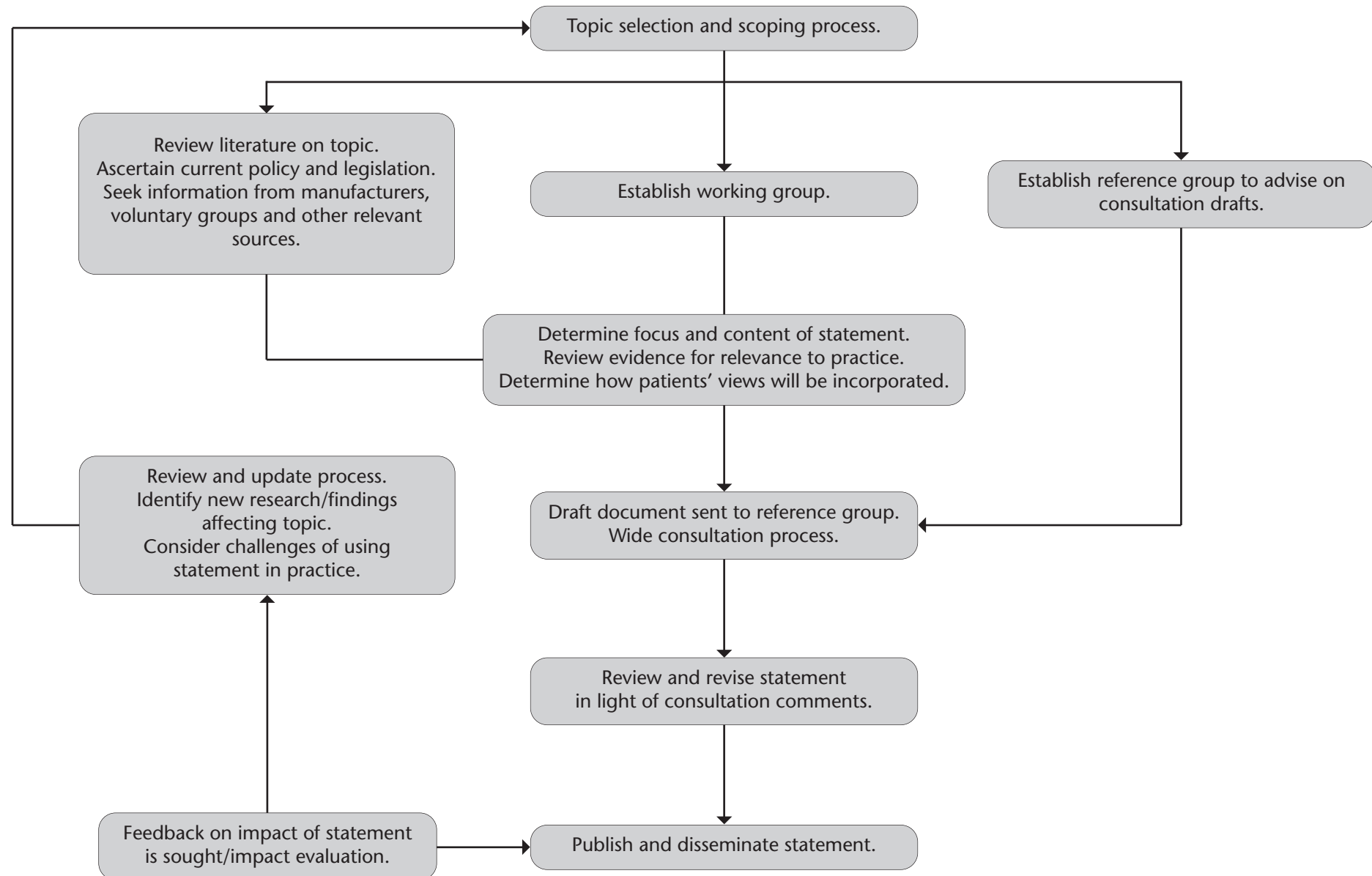

## Best practice statement: Use of ankle-foot orthoses following stroke

### Best practice statement development

NHS QIS and a specialist advisor from the National Centre for Prosthetics and Orthotics at the University of Strathclyde have worked in collaboration with a multidisciplinary group of relevant specialists to produce this best practice statement. Allied health professionals (AHPs) across Scotland identified the use of AFOs following stroke in adults as a clinical improvement priority<sup>1</sup>. Orthotic intervention following stroke has been recognised as a treatment option for many years, but there is wide variation in current practice, and a lack of evidence-based research to determine the optimal rehabilitation programme for individuals following stroke.

**“To me it is not even there, you know what I am saying, I don’t feel it or anything like that, I feel as if it is part of me. It is like putting on a pair of shoes or putting on my glasses so that I can see...you put your glasses on to see, put your splint on to walk and that is it...it is just a natural thing.”**

**AFO user, speaking of the AFO**

In order to inform the development of this best practice statement, a comprehensive literature review was carried out on the effects of AFOs following stroke (see Appendix 1). In addition, two surveys were conducted. People who have used AFOs following stroke were consulted (via questionnaire) about their experiences, and clinicians involved in stroke rehabilitation were consulted about their experience and attitudes to the use of AFOs following stroke. Existing information from interviews with patients, obtained as part of service evaluation, was also used.

The opportunity to be involved in the development of this best practice statement was open to all professionals with an interest in stroke rehabilitation, and expressions of interest were widely sought through the stroke managed clinical networks (MCNs) and all the relevant professional networks. A multidisciplinary reference group, which also included patient representation, has reviewed draft versions of this document, as part of a wide consultation process.

A Steering Group has advised and overseen the project throughout.

This best practice statement endorses the principles and recommendations contained in the ‘Report of a Consensus Conference on the Orthotic Management of Stroke Patients’ published by the International Society for Prosthetics and Orthotics (ISPO) in 2004<sup>2</sup>. Where recommendations within this document are supported by evidence from the scientific literature, appropriate references have been provided and are indicated by a superscript number. Where such references are not provided, the recommendations should be taken as representing the ‘expert opinion’ of the working group who developed this best practice statement.

It is hoped that the inclusion of additional information on the indications for different types of AFOs, the biomechanics of normal and pathological gait, and the biomechanical effects of orthotic intervention (see Appendices 2–8) within this best practice statement will help the reader to understand the principles that underpin the use of AFOs, and their role in stroke rehabilitation.

### Stroke

A stroke has been defined by the World Health Organisation as “rapidly developing clinical signs of focal and at times global disturbance of cerebral function, lasting more than 24 hours or leading to death, with no apparent cause other than that of vascular origin”<sup>3</sup>. Stroke is the most



frequent cause of severe adult disability in Scotland, with over 70,000 individuals living with stroke and its consequences, such as hemiplegia<sup>4</sup>. Each year there are approximately 8,500 new diagnoses of stroke in Scotland<sup>5</sup>.

Of those who survive an acute stroke, it is estimated that about 40% remain dependent upon other people for their daily activities. The after-effects of a stroke often include speech deficits, depression, neuropsychological disorders, functional difficulties and mobility problems.

**“It (the AFO) is a good thing I think they should do it for everybody.”**

**Partner of stroke patient fitted with an AFO**

### **Mobility problems**

Hemiplegic gait is slow and stiff, with poorly co-ordinated movements, and a high energy demand<sup>6-9</sup>. This often results in a loss of confidence and independence for the patient. Many of the mobility challenges faced by stroke patients are present in stance phase, in addition to a drop foot in swing phase which poses an obvious trip hazard (see Appendix 5).

Many mobility problems can be improved by the use of a suitable ankle-foot orthosis, which is “an orthosis which encompasses the ankle joint and the whole or part of the foot”<sup>10</sup>. An orthosis is “an externally applied device used to modify the structural and functional characteristics of the neuromuscular and skeletal systems”<sup>11</sup>.

AFOs are currently fitted by a variety of healthcare professionals including orthotists, doctors, physiotherapists, occupational therapists and nurses. An orthotist is “a person who, having completed an approved course of education and training, is authorised by an appropriate national authority to design, measure and fit orthoses”<sup>11</sup>. The Health Professions Council regulates orthotists (and all other AHPs) in the United Kingdom.

## Ankle-foot orthoses

### Key points

- AFOs may be prefabricated or custom made.
- All AFO prescription and design must be based on biomechanical deficit and clearly identified functional objectives.
- An AFO can have an effect in stance phase as well as swing phase.
- An AFO provides direct control of the ankle and foot.
- An AFO can provide indirect control of the knee and hip, and hence the trunk.
- Solid AFOs, when combined with footwear, should not position the tibia at 90° to the ground (ie vertical). The tibia should incline forward approximately 10° to optimise kinetics and kinematics at the knee and hip.
- Solid AFOs should be 'tuned' by the addition or removal of small heel wedges, in order to adjust the inclination of the tibia to optimise gait for each individual patient. For some patients, this is a highly sensitive process.
- The presence of sensory neuropathy or tissue viability issues does not contraindicate the use of an intimately fitting AFO provided the fit is optimal.
- Intimately fitting thermoplastic AFOs may be inappropriate if severe fluctuating oedema is not well managed.
- AFOs should be regarded as an adjunct to therapy, not a replacement.
- AFOs may help avoid the development of abnormal patterns, or prevent such patterns becoming established, and should therefore be considered for early intervention rather than as last resort.
- Additional therapeutic, pharmaceutical or surgical interventions may be required to optimise AFO function.
- The design and positioning of any straps should be carefully considered with regard to the upper limb function of the patient.

An AFO is a device worn on the lower part of the leg to provide direct control of the motion and alignment of the ankle and foot. Regardless of whether an AFO is prefabricated (off-the-shelf) or individually custom made, it must be prescribed according to the patient's neurobiomechanical deficit<sup>2, 12, 13</sup>, and the functional outcome desired. Although prefabricated AFOs are available in a range of sizes and designs, the limitations of these designs mean that they may not be able to adequately address all issues of a patient's individual size, shape and neurobiomechanical deficit. Custom-made AFOs can be individually designed so that they provide an intimate fit, and can match the specific neurobiomechanical requirements of each patient, leading to improved outcomes.

When adequately stiff, either prefabricated or custom-made AFOs can prevent plantarflexion of the foot in swing phase, reducing the risk of tripping. By preventing plantarflexion, they may also help inhibit extensor thrust in the lower limb. Many prefabricated AFOs are insufficiently stiff to resist plantarflexion in stance phase, leading to significant gait problems for the patient. Additionally, following a stroke, many patients develop complex triplanar deformities in the subtalar and midtarsal joints of the foot. To control these deformities, it is important that the AFO fits intimately, and crucially that it applies corrective forces to the appropriate areas of the lower part of the leg and foot comfortably<sup>14</sup>. As no prefabricated AFO can achieve this, a custom-made AFO is indicated in these cases.

When neurobiomechanically designed, well-fitted and optimally aligned, custom-made AFOs can provide indirect control of the knee and hip during the stance phase of gait, by controlling the alignment and motion of the foot and ankle, and optimising the alignment of the ground reaction force (GRF) vector to the knee and hip joints<sup>14</sup> (See Appendix 6). The combination of the direct and indirect effects of an AFO can decrease the biomechanical challenge facing the patient, thereby reducing the required neuromuscular response and improving mobility.

It is important that AFOs should be regarded as an adjunct to therapy rather than as a replacement, and that AFO use should be seen as part of an integrated package of care. For example, an appropriate AFO can be beneficial during therapy sessions by modifying the biomechanical challenge facing the patient. In the same way, the use of pharmacological interventions to moderate the effects of increased tone can enhance the function of an AFO, and may even be a necessary prerequisite to successful AFO fitting.

While the referral for an AFO may be made by any qualified healthcare professional, the actual design specification of the AFO, based on individual patient needs should be the responsibility of the orthotist<sup>2</sup>.

**“Because it is helping me so much I would like to think everybody got that chance, you know what I am saying, but I know not everybody gets that chance, and I think (as) somebody that has come on really well, I think that the opportunity should be given to everybody that has had a stroke.”**

**AFO user, speaking of her AFO**

## Prefabricated AFOs

### Key points

- Prefabricated AFOs should be prescribed based on biomechanical deficit and clearly identified functional objectives rather than convenience.
- Prefabricated AFOs are primarily of benefit in improving swing phase.
- Prefabricated AFOs are of limited value in the presence of complex gait abnormalities or deformities.
- Prefabricated AFOs may be utilised as temporary or assessment devices, but should be used with caution.
- Prefabricated AFOs take no account of gastrocnemius shortening, which can develop quickly after a stroke.



**Figure 1:** Prefabricated posterior leaf spring AFO

A number of prefabricated AFO designs are available in a limited range of sizes. The most common prefabricated design is the posterior leaf spring (PLS) (Figure 1). Due to their design limitations, prefabricated AFOs are primarily of benefit in improving swing phase clearance, but only in patients with low tone. They are less successful in cases where tone is high, where there is significant mediolateral instability at the foot, or where there are stance phase problems affecting the knee and hip.

Many prefabricated AFOs lack the intimacy of fit and the stiffness necessary to control complex deformity or instability of the foot and ankle (Figure 2). They also take no account of any gastrocnemius shortening, which is common following a stroke.



**Figure 2:** Prefabricated 'Toe-off'® AFO

Prefabricated AFOs are often used for early mobilisation before a custom-made orthosis can be provided, or as part of an assessment when a custom-made AFO is being considered. The function of prefabricated AFOs may be significantly different from that of a definitive custom-made orthosis and can mislead the clinician to draw the conclusion that AFOs are of little or no value, when in fact an optimally designed and fitted custom-made AFO could be extremely beneficial<sup>2</sup>.

Disappointing experience of using a prefabricated AFO may also prejudice the patient with regards to accepting future orthotic treatment.

## Custom-made AFOs

### Key points

- Custom-made AFOs are indicated in the presence of the complex gait abnormalities often associated with stroke.
- Custom-made AFOs offer best control of triplanar foot deformity.
- Custom-made AFOs should be designed to take account of gastrocnemius shortening, so that knee extension is not compromised during gait.
- Prescription of custom-made AFOs should be based on neurobiomechanical deficit and based on clearly identified functional objectives.
- The design specification of custom-made AFOs is the responsibility of an orthotist.
- The orthotist is responsible for fitting, alignment, delivery and initial review of custom-made AFOs, with subsequent reviews the shared responsibility of the multidisciplinary team.

Custom-made AFOs are most appropriate for control of significant triplanar foot deformity, and if knee or hip problems are present<sup>2, 12</sup>. When appropriately designed and well fitted, they can be extremely effective in the management of the complex gait abnormalities often encountered following stroke. It is important that they are designed to accommodate any gastrocnemius shortening, (ie made in a plantarflexed alignment if necessary). This is because if the AFO holds the foot in a more dorsiflexed position than that which can be achieved with the knee extended, the orthosis will actually limit knee extension, thereby impacting negatively on hip and knee control. Wedges must be added under the heel of the AFO to compensate for plantarflexion and to optimise function (see Appendix 7).

A thorough physical and neurological examination and an assessment of gait will identify the biomechanical challenges facing the patient. Functional objectives can then be established. This should take place within the multidisciplinary team environment. At this stage, the need for any adjunct therapeutic, pharmacological and/or surgical interventions to facilitate AFO provision or to optimise the effect of the AFO may also be identified. Thereafter, and based on these findings, the

orthotist should be responsible for the design specification, fitting, alignment, delivery and initial review of custom-made AFOs. Ongoing reviews are essential to maintain the orthosis in a serviceable condition, and to monitor the effectiveness of the intervention in response to any changes in condition of the patient which may require modification of treatment. Where practical, such reviews should be conducted within the multidisciplinary team environment.

There are many designs of custom-made AFOs including:

- 1 posterior leaf spring (PLS) AFO
- 2 hinged or articulated AFO (HAFO)
- 3 solid AFO
- 4 ground reaction AFO (GRAFO) or floor reaction AFO (FRAFO).

## Indications for different AFOs



Figure 3: Custom-made PLS

### 1) Posterior leaf spring

This flexible orthosis is similar to many prefabricated AFOs designs, and can be made from a range of materials (Figure 3). The PLS AFO is only indicated in cases where there is isolated dorsiflexor weakness, ie simple swing phase problems (drop foot). It is not appropriate when there is any significant problem of high tone or spasticity, any significant mediolateral instability of the foot, or the need for orthotic influence on the knee and/or the hip<sup>2, 12</sup>. These very specific prescription criteria will exclude many stroke

patients, who have increased tone, supination of the foot, knee hyperextension, and/or hip flexion and retraction.



Figure 4: Hinged AFO

### 2) Hinged or articulated AFO

There are a number of mechanical ankle joints which may be incorporated into HAFOs to allow or assist motion in one direction while preventing or limiting motion in another (Figure 4). Typically, hinged AFOs block plantarflexion at 90°. A HAFO that allows dorsiflexion should only be considered when an adequate range of dorsiflexion is already present. Specifically, there should be adequate length in the gastrocnemius to allow approximately 10° dorsiflexion with the knee fully extended<sup>12, 14</sup>. It is important that this

range of dorsiflexion should be achievable without any spastic catch in the plantarflexors<sup>15, 16</sup>, and without undue resistance due to tone. Even if adequate dorsiflexion range is present, HAFOs may be inappropriate in the presence of moderate to severe mediolateral instability of the foot. This is because the space needed for the ankle joints makes HAFOs fit less well than solid ankle designs.



Figure 5: Solid AFO

### 3) Solid AFO

Solid AFOs prevent all motion at the foot and ankle (Figure 5). They are indicated when there is high tone or spasticity in the plantarflexors, a gastrocnemius contracture, significant mediolateral instability of the foot and/or a need for the AFO to influence the knee or hip<sup>2, 12</sup>. The stiffness of a solid AFO is influenced by material choice and thickness, and the location of the trim lines (edges) which should be anterior to the malleoli. Reinforcements (eg carbon fibre inserts) may be incorporated at the ankle section of a solid AFO to increase stiffness. Flexing, or

'buckling', of the AFO should not be tolerated as a way of allowing stance phase progression, as this will compromise mediolateral control of the foot. Instead, stance phase progression can be improved by 'tuning' the solid AFO, a process which is essential to optimise the alignment of the ground reaction force (GRF) vector to the knee and hip joints<sup>12, 14</sup> (see Appendices 6 and 7).



Figure 6: Floor reaction AFO

### 4) Ground reaction orthosis

A GRAFO is a form of solid AFO which is designed to maximise the indirect orthotic control of knee flexion during stance phase (Figure 6). To have this effect on the knee, a GRAFO must be very stiff and must be optimally aligned so as to ensure that the ground reaction force is in front of the knee in mid to late stance, generating an external knee extension moment<sup>14</sup> (see Appendices 3 and 6). A specific design feature of the GRAFO is a plastic pretibial shell close to the knee, which helps prevent excessive tibial progression. Fixed deformity in any of the three anatomical planes

(see Appendix 2) or the presence of dynamic contracture of the knee and/or hip will compromise the effectiveness of a GRAFO.

## Summary

From a biomechanical perspective, the designs of AFO described in this section are the most appropriate to address the functional impairments most commonly encountered following stroke. In the absence of any sagittal plane problem, or where it is not possible to successfully fit these designs, there may be other orthotic options, eg silicone AFOs, supramalleolar AFOs (SMOs) and conventional metal AFOs, that should be considered with caution. This decision should be made within the multidisciplinary team, in partnership with the patient.

**“I think before he got the splint, he had three or four months in the house without the splint when the physio came but he was depressed and fed up, but obviously after a stroke you are going to feel like that anyway, but because he was not able to walk normally it was really getting him down, but then when he started getting that splint he seen (sic) like a huge difference and his quality of life improved.”**

**Partner of AFO user**

## Format of statement

The statement is divided into six sections:

- Service planning, access to services and clinical governance
- Screening and referral
- Patient assessment and indications for different AFOs
- Biomechanical effects of AFOs
- Non-biomechanical effects of AFOs
- Review, monitoring and follow-up.

Key points preceding each section highlight the core principles that are reflected throughout the statements. Each section contains a table corresponding to the what, why and how of best practice, ie the statement, the reason for the statement and how to achieve the statement or how to demonstrate that it is being achieved. Key challenges for implementation are identified for each section.

## How can the statement be used?

This best practice statement can be used in a variety of ways:

- as a guide to best practice
- as a basis for developing and improving care
- to promote a consistent and cohesive approach to care
- to stimulate learning among multidisciplinary teams involved in stroke rehabilitation
- to inform effective multidisciplinary team working and enhance partnerships with patients, carers and relevant others
- to serve as a measure of quality in stroke rehabilitation, and
- to stimulate ideas and priorities for research.

## Section 1: Service planning, access to services and clinical governance

### Key points

- The use of AFOs should be considered in the management of patients with mobility problems following stroke.
- All patients with mobility problems following a stroke should have timely and equitable access to specialist orthotic services.
- Orthotists should be involved in the planning, provision and review of stroke services.
- A client-centred approach to goal setting should be adopted.
- Orthotists should be included within stroke rehabilitation teams and should contribute to assessment for orthoses and the establishment of treatment objectives.



Statement 1	Reason for statement	How to demonstrate statement is being achieved
1 (a) The use of AFOs should be considered in the management of patients with mobility problems following stroke.	A body of evidence exists (see Appendix 1) that late use of AFO is beneficial, and that early use may also be beneficial <sup>2</sup> .	Data should be collected on numbers of patients with mobility problems following stroke. The numbers of new referrals for assessment for AFO following stroke should be audited. The numbers of new AFO prescriptions following stroke should be audited. A survey of clinicians should be conducted to investigate referral trends.
1 (b) All patients with mobility problems following a stroke should have timely access to specialist orthotic services.	The use of orthoses may support early mobilisation. Orthotic intervention should be considered at the most appropriate time. Access to orthotic services should be equitable.	Data on numbers of patients with mobility problems following stroke should be collected. The time points post stroke of patient referrals to orthotic services should be audited.
1 (c) Orthotists should be involved in the planning, provision and review of stroke services.	At present, orthotics is typically not represented in stroke MCNs or service redesign planning groups.	There should be evidence of orthotist involvement in all stroke MCNs within Scotland.
1 (d) A client-centred approach to goal setting should be adopted. Once AFO intervention is agreed, there is a need to have patient and multidisciplinary team (MDT) discussion to ensure an holistic approach to care.	Intervention goals, aims and objectives are often set by clinicians. Client involvement should ensure optimum prescription and best use of the AFO.	There should be evidence of implementation of SIGN guideline 64 <sup>4</sup> . There should be a clear statement in healthcare record of patient input to goal setting. AFO use should be audited.
1 (e) Orthotists should be included within stroke rehabilitation teams and should contribute to assessment for orthoses and the establishment of treatment objectives.	MDT approach is accepted as best practice. Orthotic care cannot effectively be provided in isolation <sup>2</sup> .	There should be evidence of orthotist involvement in MDT meetings and clinical governance meetings.

### Key challenges

- For NHS boards to include orthotists in the planning, provision and review of stroke services to increase effectiveness.
- To increase the availability of orthotists to specialist stroke services.
- To ensure timely and equitable access for patients to orthotic services.
- Delivering timely orthotic services to patients in remote rural settings.
- Recognition of the need for MDT working and communication.
- Redesign of stroke services to allow open access for patients to orthotic services.

## Section 2: Screening and referral

### Key points

- When considering orthotic intervention post stroke, referral by other professionals should take the form of a request for combined assessment, rather than a prescription.
- A standardised screening tool should be used to identify those for whom AFO use may be beneficial.
- Any member of the MDT can refer a patient for orthotic assessment at any stage post stroke.
- All professional staff involved in stroke rehabilitation should be able to recognise the presence of a mobility problem and be aware of the AFO screening tool.
- Referrals should be made using a nationally agreed orthotic referral form.
- AFOs should be considered very early in non weight-bearing patients for contracture prevention or positioning.
- As soon as the patient is medically stable, an AFO should be considered for use when the patient is able to bear weight.

**“Intervening at an early stage to address the biomechanical challenges facing patients with stroke is the right way to go and may make recovery less of a challenge.”**

**Healthcare professional**

Statement 2	Reason for statement	How to demonstrate statement is being achieved
2 (a) When considering orthotic intervention post stroke, referral should take the form of a request for combined assessment, involving a specialist orthotist and specialist physiotherapist, rather than a prescription.	This is a recommendation of the International Society for Prosthetics and Orthotics (ISPO) consensus conference <sup>2</sup> .	The nature of referrals for orthotic intervention should be audited.
2 (b) A standardised screening tool should be used to identify those for whom AFO use may be beneficial (see Appendix 9).	The use of a standardised screening tool will ensure that no patient who may benefit from AFO provision is overlooked.	A completed screening tool should be evident in the healthcare record.
2 (c) Any member of the MDT can refer a patient for orthotic assessment. Referral/re-referral can be made at any stage post stroke (inpatient or outpatient).	This is a recommendation of the ISPO consensus conference <sup>2</sup> . All healthcare professionals should consider the use of AFOs in assisting patients to be as functionally independent as possible.	There should be a clear statement in the healthcare record of the professional initiating the referral, and the time point following stroke.
2 (d) All healthcare professionals involved in stroke rehabilitation should be able to recognise the presence of a mobility problem. All professional staff involved in stroke rehabilitation should be aware of the AFO screening tool (see Appendix 9).	This is a recommendation of the ISPO consensus conference <sup>2</sup> . All healthcare professionals should consider the use of AFOs in assisting patients to be as functionally independent as possible.	A completed AFO screening tool should be evident in the healthcare record.
2 (e) Referrals for orthotic assessment should be made using a nationally agreed standardised orthotic referral form (see Appendix 10).	There should be standardisation of referrals.	A completed orthotic referral form should be evident in the healthcare record.
2 (f) AFOs should be considered very early in non weight-bearing patients for contracture prevention or positioning.	Orthoses can be used in combination with physiotherapy for minimising the development of contractures or deformities in the early or acute phase <sup>2</sup> .	The healthcare record should include information on the presence of contracture and of any AFO intervention.

Statement 2 (continued)	Reason for statement	How to demonstrate statement is being achieved
<p>2 (g) As soon as the patient is medically stable, an AFO should be considered for use in weight-bearing when a neurobiomechanical abnormality is present.</p>	<p>The ISPO consensus conference report<sup>2</sup> recognised the potential benefits that can be extrapolated from the literature on orthotic management of cerebral palsy<sup>17</sup>, namely to:</p> <ul style="list-style-type: none"> <li>• encourage balanced standing,</li> <li>• provide ankle stability, promote postural alignment,</li> <li>• maintain range of motion at the ankle, and</li> <li>• support early mobilisation.</li> </ul> <p>AFO use improves weight-bearing through the affected leg<sup>18-21</sup>.</p>	<p>The healthcare record should include information on the presence of any neurobiomechanical abnormality, any AFO intervention and the time point post stroke.</p> <p>Referral rates and time point post stroke should be audited.</p> <p>The referral practices of clinicians should be monitored by surveys.</p>

### Key challenges

- To ensure healthcare professionals implement the AFO screening tool.
- To equip all MDT members with the knowledge of indications for use of AFOs.
- For NHS boards to include orthotists as part of the core MDT
- To evaluate the tools.
- To address the differing beliefs of MDT members about the value of orthotic intervention.

### Section 3: Patient assessment and indications for different AFOs

#### Key points

- The orthotist should contribute to MDT assessment and the establishment of agreed treatment objectives in partnership with the patient.
- Assessment for an AFO should be undertaken jointly by a specialist orthotist and specialist physiotherapist.
- AFO design specification should be the responsibility of an orthotist, and must be based on sound biomechanical principles and a clear statement of desired functional outcomes.
- Caution must be exercised when using prefabricated AFOs.
- Custom-made AFOs should be regarded as the 'gold standard' when dealing with complex gait problems or deformities.
- Different AFO designs have very specific prescription criteria.
- Tuning is essential for all solid AFOs.
- Information should be provided to patients in accessible formats.
- Footwear is a key component for successful orthotic management.

Statement 3	Reason for statement	How to demonstrate statement is being achieved
<p>3 (a) The orthotist should contribute to MDT assessment and the establishment of agreed treatment objectives.</p>	<p>This is a recommendation of the ISPO consensus conference<sup>2</sup>.                      Education programmes provide orthotists with the essential patient assessment and prescription skills required.                      The Health Professions Council states that orthotists are responsible for all aspects of supplying orthoses for patients.                      An NHS QIS survey of clinicians found that assessment for AFO was conducted jointly in less than 50% of cases.</p>	<p>There should be a clear statement in the healthcare record of orthotist involvement in assessment and the setting of treatment objectives.</p>
<p>3 (b) AFO design specification (prescription) should be based on sound biomechanical principles and a clear statement of desired functional outcomes.</p>	<p>This is a recommendation of the ISPO consensus conference<sup>2</sup>.                      At present, some AFO prescription appears to be based on inadequate biomechanical knowledge.</p>	<p>There should be a clear statement of desired functional outcomes and AFO specification evident in the healthcare record.</p>
<p>3 (c) While assessment for an AFO should be undertaken jointly by a specialist orthotist and specialist physiotherapist, the AFO design specification (prescription) should be the responsibility of the orthotist.</p>	<p>Education programmes provide physiotherapists and orthotists with the essential assessment skills required.                      Education programmes provide orthotists with the essential design specification skills required.                      This is a recommendation of the ISPO consensus conference<sup>2</sup>.                      The Health Professions Council states that orthotists are responsible for all aspects of supplying orthoses for patients.</p>	<p>There should be evidence in healthcare record of MDT input to assessment and agreement of desired functional outcomes.                      There should be a clear statement in the healthcare record that the design specification of the AFO (prescription) has been made by the orthotist.                      Prescription practices of clinicians should be monitored by surveys.</p>
<p>3 (d) Orthotists should be recognised as specialists with responsibility for casting, scanning, measurement, fitting and alignment, and initial orthotic review.                      Orthotists should be included in the ongoing review of patients by the MDT.</p>	<p>This is a recommendation of the ISPO consensus conference<sup>2</sup>.                      Undergraduate and post-qualification education programmes provide orthotists with the essential clinical skills required.                      The Health Professions Council states that orthotists are responsible for all aspects of supplying orthoses for patients.                      Liability for any detrimental effects of the AFO, and future follow-up lies with the individual who prescribes and delivers the device.</p>	<p>There should be a clear statement in the healthcare record that orthotists are involved in casting, scanning, measurement, fitting and alignment, and initial orthotic review.                      There should be a clear statement in the healthcare record that orthotists are included in long-term follow-up of patients by the MDT.</p>

Statement 3 (continued)	Reason for statement	How to demonstrate statement is being achieved
3 (e) Prefabricated AFOs are of limited value in stroke rehabilitation.	<p>This is a conclusion of the ISPO consensus conference<sup>2</sup>. These orthoses lack the closeness of fit and the stiffness necessary to control complex deformity or instability of the foot and ankle.</p> <p>Note:</p> <ul style="list-style-type: none"> <li>• Manufacturer's liability for prefabricated AFOs is only valid if they remain unaltered and are fitted in accordance with the manufacturer's instructions.</li> <li>• Supply of any orthosis places responsibility on the provider to ensure appropriateness of prescription, fit and review.</li> </ul>	<p>The use of prefabricated AFOs should be audited against their prescription criteria (see Prefabricated AFOs on page 8). Prescription practices should be monitored by surveys.</p>
3 (f) Caution must be exercised when considering use of prefabricated AFOs as evaluation orthoses.	<p>This is a recommendation of the ISPO consensus conference<sup>2</sup>. The function of a prefabricated AFO may be significantly different from that of a definitive custom-made orthosis, and may mislead the clinician to conclude that orthotic treatment is of little or no value, when an optimally designed and fitted AFO could be extremely beneficial<sup>2</sup>.</p> <p>A bad experience of an inappropriate AFO may prejudice the patient with regards to future orthotic treatment, leading to poor compliance.</p> <p>Liability for any detrimental effects of the AFO, and future follow-up lies with the individual who fits and delivers the device.</p>	<p>The use of prefabricated AFOs should be audited against their prescription criteria (see Prefabricated AFOs in Background). Prescription practices should be monitored by surveys.</p>
3 (g) PLS AFOs should only be considered for swing phase problems.	<p>This is a recommendation of the ISPO consensus conference<sup>2</sup>. The PLS AFO has very specific indications, namely isolated dorsiflexor weakness, no significant mediolateral instability at the ankle, no significant tone/spasticity, and no need for orthotic influence on hip and knee<sup>2,12</sup>.</p>	<p>The use of PLS should be audited against their prescription criteria (see Indications for different AFOs on page 10). Prescription practices should be monitored by surveys.</p>
3 (h) AFOs that permit ankle dorsiflexion (either due to the presence of mechanical ankle joints or the flexibility of the design) are inappropriate in the presence of gastrocnemius shortening.	<p>This is a recommendation of the ISPO consensus conference<sup>2</sup>. In the presence of gastrocnemius shortening, dorsiflexion occurs at the expense of knee extension, with detrimental effect on hip and knee kinetics<sup>12,14</sup>.</p> <p>There is no evidence that free dorsiflexion in an AFO increases gastrocnemius length.</p>	<p>The use of HAFOs and flexible AFO designs should be audited against their prescription criteria (see Indications for different AFOs on page 10). Prescription practices should be monitored by surveys.</p>

Statement 3 (continued)	Reason for statement	How to demonstrate statement is being achieved
<p>3 (i) Gastrocnemius shortening must be accommodated in the AFO.</p> <p>The angle of dorsiflexion/plantarflexion in the AFO should be achievable without undue resistance due to tone ('dynamic contracture').</p> <p>If a plantarflexion contracture is present, the AFO should be set in plantarflexion and wedged to achieve optimal alignment (see Appendix 7).</p>	<p>Failure to accommodate plantarflexion contracture has a detrimental effect on hip and knee kinetics<sup>12, 14</sup>.</p> <p>An AFO that positions the ankle in more dorsiflexion than can be achieved with the knee extended will actually limit knee extension in stance, and will adversely affect knee and hip kinetics<sup>14</sup>.</p>	<p>There should be a clear statement in the healthcare record of angle of dorsiflexion achievable with knee extended (gastrocnemius length).</p> <p>The angle of dorsiflexion/ plantarflexion in the AFO should be audited against gastrocnemius length.</p> <p>Prescription practices in the presence of plantarflexion contracture should be monitored by surveys.</p>
<p>3 (j) Solid AFOs should be used when there is significant tone, significant deformity in the ankle and foot and/or a need for orthotic influence on the knee and/or hip.</p>	<p>The design characteristics of custom-made solid AFOs make these the ideal AFO for addressing these issues<sup>2, 12</sup>.</p>	<p>The use of solid AFOs should be audited against their prescription criteria (see Indications for different AFOs on page 10).</p> <p>Prescription practices should be monitored by surveys.</p>
<p>3 (k) Tuning is essential for all solid AFOs (see Appendix 7).</p>	<p>The neurobiomechanical effects of a solid AFO can be greatly enhanced by tuning<sup>12, 14</sup>.</p> <p>Provision of a solid AFO without tuning can introduce further neurobiomechanical challenges to patients.</p> <p>Tuning can prevent excessive knee flexion or hyperextension in midstance, and improve extension of the hip during stance<sup>14</sup>.</p> <p>Tuning can improve the smoothness of the gait pattern.</p>	<p>The use of tuning should be audited against prescription of solid AFOs (see Appendix 7).</p> <p>Clinical practices should be monitored by surveys.</p>
<p>3 (l) A GRAFO should be considered when knee flexion control cannot be achieved with a solid AFO.</p> <p>Caution: GRAFOs are not indicated when there is a significant contracture at the knee and or hip or significant rotational deformity of the leg.</p>	<p>The design characteristics of GRAFOs make these the ideal AFO for addressing severe knee flexion instability when control cannot be achieved with a solid AFO.</p>	<p>The use of GRAFOs should be audited against their prescription criteria (see Indications for different AFOs on page 10).</p> <p>Prescription practices should be monitored by surveys.</p>
<p>3 (m) As part of a self-management role, AFO users should be provided with clear instructions of how and when to use their AFO.</p>	<p>An NHS QIS survey of AFO users found that approximately 50% of respondents indicated that they did not get any information about the AFO and approximately 40% felt they did not receive clear information.</p>	<p>There should be evidence in the healthcare record that information regarding use of AFO has been provided in format(s) appropriate to the needs of service users.</p>



Statement 3 (continued)	Reason for statement	How to demonstrate statement is being achieved
3 (n) The characteristics of the patient's footwear and fastenings are taken into account when prescribing an AFO.	Footwear is a key component of successful orthotic management (see Appendix 8). Changing the heel and sole characteristics of footwear used with an optimally aligned AFO can negatively affect gait.	There should be clear statements in the healthcare record: <ul style="list-style-type: none"> <li>• of the footwear being recommended for use with the AFO</li> <li>• that information on appropriate footwear has been provided to patients, and</li> <li>• that new footwear has been brought to review appointments for approval.</li> </ul>
3 (o) Prescription footwear is not always necessary to accommodate an AFO.	If the AFO is an intimate fit and the patient's footwear is of the correct size and an appropriate design, prescription footwear should not be required.	There should be a clear statement in the healthcare record of the reason for prescription footwear being recommended. The provision of prescription footwear should be monitored.

### Key challenges

- To ensure that prescribers refer for combined assessment, rather than providing a detailed prescription.
- To involve orthotists as an integral part of stroke rehabilitation teams.
- To raise the awareness of the potential benefits of having the AFO specification determined by orthotists.
- To ensure that use of prefabricated AFOs is appropriate.
- To ensure appropriate levels of orthotist involvement in specialist stroke services.
- To address issues relating to clinical note keeping and sharing.
- To increase recognition of the need for MDT working and communication.
- To provide training on orthotic assessment, prescription, optimising fit and tuning solid AFOs.
- To develop and utilise national orthotic patient information leaflets in a variety of formats, including aphasia friendly format, and in a range of languages.
- To address the complexity of conducting audit of individual prescription practices.

## Section 4: Biomechanical effects of AFOs

### Key points

- An AFO can positively influence the alignment and motion of the foot and ankle in stance and in swing.
- The use of an AFO can have a positive effect on the motion and alignment of the knee and hip joints in stance.
- An AFO can have a positive effect on the temporal and spatial parameters of gait (eg velocity, cadence, step length).
- Contracture management should be considered to enhance the effectiveness of an AFO.
- Management of tone and/or spasticity should be considered to enhance the effectiveness of an AFO.

**“Why do we expect people with neurological impairment to deal with greater biomechanical challenges than the rest of us have to address, with fewer physical resources at their disposal?”**  
Healthcare professional

Statement 4	Reason for statement	How to demonstrate statement is being achieved
<p>4 (a) An AFO can positively influence the alignment and motion of the foot and ankle in both swing and stance. An AFO may have more impact on stance than on swing.</p>	<p>This is a statement made by the ISPO consensus conference<sup>2</sup>. (See Appendices 1 and 6.)</p>	<p>There should be clear statements in the healthcare record of:</p> <ul style="list-style-type: none"> <li>• whether the AFO has been prescribed to influence the alignment and motion of the foot and ankle in swing and/or in stance, and</li> <li>• the effect of the AFO in swing and/or in stance.</li> </ul>
<p>4 (b) The use of an AFO can have a positive effect on the alignment and motion of the knee and hip joints in stance.</p>	<p>There is evidence for beneficial effect on AFOs on the knee<sup>7, 22</sup>. Evidence can be extrapolated from the literature on the orthotic management of cerebral palsy that AFOs can have a positive effect at the knee and hip<sup>2, 17</sup>. (See Appendices 1 and 6.)</p>	<p>There should be clear statements in the healthcare record of:</p> <ul style="list-style-type: none"> <li>• whether the AFO has been prescribed to influence the alignment and motion of the knee and/or hip in stance, and</li> <li>• the effect of the AFO on the alignment and motion of the knee and/or hip in stance.</li> </ul>
<p>4 (c) An AFO can have a positive effect on the temporal and spatial parameters of gait (eg velocity, cadence, step length).</p>	<p>(See Appendix 1.) This is a conclusion of the ISPO consensus conference<sup>2</sup>.</p>	<p>There should be a clear statement in healthcare record of the effect that the AFO is having on temporal and spatial parameters.</p>
<p>4 (d) Contracture management by means of physiotherapy, pharmacological and/or surgical interventions should be considered to enhance the effectiveness of an AFO.</p>	<p>A contracture at any joint of the lower limb may limit the effectiveness of an AFO by compromising alignment of the ground reaction force<sup>2, 14</sup>.</p>	<p>There should be a clear statement in the healthcare record that appropriate measures have been taken to manage functional problems related to contractures.</p>
<p>4 (e) Management of tone and/or spasticity by means of physiotherapy, pharmacological and/or surgical interventions should be considered to facilitate AFO provision or enhance AFO effectiveness.</p>	<p>Altered tone or spasticity may limit the effectiveness of an orthosis by compromising GRF alignment<sup>2, 14</sup>.</p>	<p>There should be a clear statement in the healthcare record that appropriate measures have been considered to manage functional problems related to tone and/or spasticity.</p>

### Key challenges

- To raise awareness of the biomechanical effects of AFOs within the MDT.
- To address issues relating to clinical note keeping and sharing.
- To ensure that patients have access to surgical management of contractures.
- To ensure that patients have access to pharmacological interventions.

## Section 5: Non-biomechanical effects of AFOs

### Key points

- The ultimate aim of using AFOs with people who have had a stroke is to improve mobility and quality of life.
- Quality of life indicators should be used to assess treatment outcomes in stroke rehabilitation.
- Appropriate intervention with an AFO can improve/facilitate increased independence of patients following stroke.
- Using AFOs to facilitate independent ambulation can have beneficial psychological effects.

“No matter where you have your stroke,  
you should have the same access to good  
orthotic intervention.”

Orthotist

Statement 5	Reason for statement	How to demonstrate statement is being achieved
5 (a) Quality of life indicators should be used throughout treatment interventions (including AFO prescription) following stroke.	<p>The aim of treatment should be to improve the quality of life of a person who has had a stroke.</p> <p>An AFO prescription is a direct intervention that can influence function and quality of life in stroke patients.</p>	There should be a clear statement in the healthcare record that appropriate quality of life outcome measures are being used in clinical practice.
5 (b) The use of an AFO following stroke can improve patients independence, mobility, self-care, health and wellbeing.	<p>Results from an NHS QIS survey of AFO users indicated that approximately:</p> <ul style="list-style-type: none"> <li>• 85% of respondents managed better on their own with the AFO</li> <li>• 69% felt that the AFO helped them get out and meet people</li> <li>• 84% reported better confidence levels, and</li> <li>• 96% felt walking was easier using an AFO.</li> </ul>	There should be a clear statement in the healthcare record of the effect of an AFO on quality of life indicators.
5 (c) Using AFOs to facilitate independent ambulation can have beneficial psychological effects.	<p>Results from an NHS QIS survey of AFO users indicated that approximately:</p> <ul style="list-style-type: none"> <li>• 58% reported an AFO takes away their distress</li> <li>• 68% reported an AFO takes away fear of falling</li> <li>• 82% reported that the AFO improved their confidence, and</li> <li>• 64% reported that the AFO made them feel better about themselves.</li> </ul>	There should be a clear statement in the healthcare record of the effect of an AFO on quality of life indicators.

### Key challenges

- To ensure quality of life outcome measures are implemented in stroke rehabilitation assessment.
- To identify and disseminate nationally the most appropriate quality of life measures for use when investigating the effect of AFOs.
- To develop standardised assessment tools and data collection.

## Section 6: Review, monitoring and follow-up

### Key points

- All patients who have been prescribed an AFO should be routinely reviewed at timely intervals.
- Following provision of an AFO, an early review appointment should take place (within 4 weeks).
- AFOs with ankle joints should be reviewed at least once every 6 months.
- As part of a self-management role, AFO users should be provided with clear, written instructions of how and when to use their AFO.
- As part of a self-management role, AFO users should be provided with clear, written instructions of how and when to contact their orthosis provider for a review of their AFO.
- Where there has been a change in AFO prescription, there should be access to further therapy.
- Discontinuation of AFO use should not be recommended without MDT consultation.

Statement 6	Reason for statement	How to demonstrate statement is being achieved
<p>6 (a) All patients who have been prescribed an AFO should have regular routine planned reviews of their orthosis and footwear to assess fit, function and appropriateness for continued use.</p>	<p>There is significant potential for change in patients' condition over time, posing risk of skin lesions/discomfort.</p> <p>There is potential for change in the functional status of the patient, which may indicate a need for change in prescription.</p> <p>The appropriateness of footwear must be assessed to ensure that changes in footwear have no adverse effect on AFO function.</p> <p>All AFOs should be checked to ensure function and structural integrity are maintained.</p> <p>This is recommended by guidelines for orthotic review<sup>23</sup> and SIGN guideline 64<sup>4</sup>.</p> <p>Stroke is a long-term condition that requires regular monitoring.</p>	<p>There should be a clear statement in the healthcare record that the patient has been reviewed in line with guidelines for orthotic review<sup>23</sup>.</p> <p>Reviews should be audited against guidelines for orthotic review<sup>23</sup>.</p> <p>There should be a clear statement in the healthcare record of the fit and function of the AFO and footwear, and the structural integrity of the AFO.</p>
<p>6 (b) Following provision of an AFO, an early review appointment should take place (within 4 weeks).</p>	<p>An early review appointment is necessary to assess the appropriateness of fit of the AFO, to ensure comfort and to verify that functional objectives are being met.</p>	<p>There should be a clear statement in the healthcare record that the patient has been reviewed in line with guidelines for orthotic review<sup>23</sup>.</p> <p>First review appointments should be audited against guidelines for orthotic review<sup>23</sup>.</p> <p>There should be a clear statement in the healthcare record of the fit and function of the AFO.</p>
<p>6 (c) All orthoses should be subject to regular review. For HAFOs (those with ankle joints), the interval between reviews should be no longer than 6 months.</p>	<p>This is due to the risk of load-bearing joints becoming worn or developing a problem at their attachments to the orthosis which may increase the risk of failure and hence potential injury to the patient.</p> <p>This is in line with guidelines for orthotic review<sup>23</sup>.</p>	<p>There should be a clear statement in the healthcare record that the patient has been reviewed in line with guidelines for orthotic review<sup>23</sup>.</p> <p>Reviews should be audited against guidelines for orthotic review<sup>23</sup>.</p>
<p>6 (d) Patients/carers should be given clear instructions, in an appropriate and accessible format, on how to inspect their orthosis and report immediately any signs of wear and tear (particularly wear or loosening of joints or fastenings) and advised on the need for regular review to ensure structural integrity of the AFO.</p> <p>The responsibility to attend review appointments should lie with the patient or carer, as long as they are deemed competent.</p>	<p>This is in line with self-management role and the guidelines for orthotic review<sup>23</sup>.</p>	<p>There should be a clear statement in the healthcare record that information regarding the need for regular review appointments has been given to patient/carer in format(s) appropriate to the needs of service users and that reviews have been regularly initiated and attended.</p>

Statement 6 (continued)	Reason for statement	How to demonstrate statement is being achieved
<p>6 (e) As part of a self-management role, patients or carers should be provided with clear instructions in an appropriate format regarding how and when to contact their orthosis provider for ongoing orthotic management.</p>	<p>An NHS QIS survey of AFO users indicated approximately 43% of respondents were not sure who to contact if they had a problem with their AFO.</p>	<p>There should be a clear statement in the healthcare record that information regarding procedures for accessing services has been provided in format(s) appropriate to the needs of service users.</p>
<p>6 (f) Patients having an annual health check under local enhanced service contracts should be screened for gait difficulties and referred to either physiotherapy or orthotics for further assessment and targeted intervention if required.</p>	<p>The local enhanced contract for stroke in primary care is designed to screen stroke patients for new or worsening problems as part of ongoing long-term management.</p>	<p>There should be a clear statement in the healthcare record of screening by the primary care team and onward referral if appropriate.</p>

### Key challenges

- To address issues relating to clinical note keeping and sharing.
- To ensure that delivery and checkout of an AFO is conducted by an orthotist.
- To ensure that an early initial review is conducted by an orthotist.
- To implement regular orthosis review as part of stroke services long-term management plan.
- To provide orthotic patient information in a variety of formats, including an aphasia-friendly format and in a range of languages.



## Appendix 1: Literature review

### Methodology

A robust and thorough literature review was conducted to provide evidence for this best practice statement.

The search was not limited to any study type, and was run in the following databases:

- Medline
- EMBASE
- CINAHL
- AMED
- RECAL Legacy, and
- the Cochrane Library.

The search terms included:

- AFO
- orthosis
- orthotics
- splints
- stroke
- hemiplegia, and
- hemiparesis.

This search was supplemented by hand-searching reference lists and checking various websites (eg the TRIP database, the Scottish Intercollegiate Guidelines Network (SIGN) and the National Institute for Health and Clinical Excellence (NICE)).

The following research questions were developed and answered according to the best available evidence:

1 What are the effects of AFOs on the temporal and spatial parameters of gait?

2 What are the effects of AFOs on the ankle and foot?

3 What are the effects of AFOs on the knee?

4 What are the effects of AFOs on the hip?

5 What effect do AFOs have on the metabolic and cardiopulmonary cost of walking?

6 What effect do AFOs have on muscle activity and muscle length?

7 How do AFOs affect function and ability?

8 What are the benefits of tuning AFOs?

9 What are the perceptions of AFO users regarding orthotic treatment?

The search yielded 330 papers, and their suitability for inclusion was assessed by three reviewers. Papers were excluded if:

- they were abstracts
- they were not in the English language
- they were not related to the use of AFOs in adult stroke patients, and
- they had been conducted on mixed pathologies without sub-group analysis of the stroke patients.

Papers that reported on experimental AFO designs were also excluded, as the interventions are not currently able to be reproduced in clinical practice. Case studies were excluded as it is not possible to draw conclusions from this type of evidence.

A total of 27 studies (producing 29 publications) met the inclusion criteria, and these varied in size and quality. Three reviewers independently evaluated and extracted the data from these studies. The reviewed studies were categorised by study design:

- one systematic review of lower level evidence<sup>24</sup>
- two reasonable randomised controlled trials that resulted in three publications<sup>25-27</sup>
- 12 randomised crossover studies of various size and quality<sup>18-22, 28-34</sup>
- one retrospective cohort study<sup>35</sup>

- nine very small trials (with no randomisation) that produced 10 papers<sup>7, 36-44</sup>, and
- two small case series<sup>45, 46</sup>.

The systematic review by Leung and Moseley<sup>24</sup> included a comprehensive search of the literature, and provided a useful narrative summary of the results. The included studies were of varying quality and the authors highlighted the need for well-designed trials in this area. The studies included in the Leung and Moseley review have been presented separately in the following overview, and the various issues with their methodology have been taken into consideration.

The majority of the studies identified for this overview used a randomised crossover design, eg assessing the immediate effects of an AFO compared with no AFO (with the order of intervention being randomised). There is a lack of studies into the effects of AFO use in the longer term. While a randomised crossover design is reasonable to investigate the effects of AFO intervention, there are a number of limitations with the reviewed studies that should be noted. Sample size was often small, details of the randomisation method were rarely given and selection bias could not always be ruled out. Many papers provided inadequate information on the clinical details of the subjects and specification of the AFO.

It should be noted that retrospective cohort studies, small non-randomised trials and case series are particularly prone to biases, and their results should be treated with caution.

## Research questions

### 1 What are the effects of AFOs on the temporal and spatial parameters of gait?

#### Summary of evidence

- A variety of AFO designs, particularly those that block plantarflexion, can improve the temporal and spatial parameters of gait.
- Walking speed can be increased.

- Greatest improvement in speed is seen when the AFO is inclined forward.
- Cadence can be increased.
- Step length can be increased.
- Stride length can be increased.
- Gait symmetry can be improved, with increase in single support on the affected side and decrease in double support.

#### Speed

In a questionnaire conducted alongside a randomised crossover study, 96% of subjects rated speed as more important than quality of walking<sup>33</sup>.

Statistically significant increases in speed have been reported using a variety of AFO designs, including metal solid AFOs<sup>7, 22, 29</sup> plastic solid AFOs<sup>29, 31, 32, 40</sup>, custom laminated solid AFOs<sup>20</sup>, prefabricated PLS AFOs<sup>18, 21, 30, 32</sup>, HAFOs<sup>31-33, 46</sup>, a metal articulated 'Valens' AFO<sup>41</sup>, a 'Chignon' carbon fibre AFO<sup>28</sup>, and a 'Toe-off' ® carbon fibre AFO<sup>37</sup>. These studies were randomised crossover trials<sup>18, 20-22, 28-33</sup>, very small trials with no randomisation<sup>7, 37, 39-41</sup> or small case series<sup>46</sup>.

The sagittal plane alignment of solid AFOs is important. Statistically significant improvements in speed have been reported using a metal solid AFO set in 5° dorsiflexion, but not in 5° plantarflexion<sup>7</sup>. In another study, similar statistically significant increases in speed were reported with both metal and plastic solid AFOs set at 10° inclination<sup>29</sup>. One randomised control trial (producing two publications) using a plastic solid AFO with 5° anterior tilt reported a small and statistically insignificant improvement in speed<sup>25, 26</sup>. In one randomised crossover study, a statistically significant increase in speed was reported using a metal solid AFO, but not with a plastic AFO, with the authors attributing this to the greater stiffness in the metal design<sup>22</sup>.

One randomised crossover study reported statistically significant improvements in self-selected walking speed using a prefabricated PLS in subjects who were less than 6 months post stroke, but not in those more

than one year post stroke<sup>21</sup>. A further randomised crossover trial<sup>34</sup> showed no improvement using a PLS, although the use of this type of AFO may be questioned in a group of patients described as “severely impaired”. While a PLS had no significant effect on speed in one very small trial with no randomisation, the addition of an inhibitor bar led to a statistically significant improvement in speed in subjects with tonic toe flexion reflex<sup>43</sup>. In addition, a very small study reported a statistically insignificant improvement in speed with a PLS and a dynamic AFO (DAFO) with a plantarflexion stop<sup>44</sup>. A further very small study<sup>36</sup> reported no change in speed with Air Stirrup<sup>®</sup>, conventional AFOs with plantarflexion stop, or solid AFOs at 90° and at 5° dorsiflexion.

Statistically significant increases in speed have been reported with shoes only, compared to barefoot gait<sup>41</sup>.

### Cadence

A statistically significant increase in cadence has been reported using a custom laminated solid AFO<sup>20</sup>, a metal ‘Valens’ AFO blocking plantarflexion<sup>41</sup>, and a HAFO with 90° plantarflexion stop<sup>33</sup>. In one very small study (n=3), cadence was slightly improved using a DAFO with plantarflexion stop<sup>44</sup>. Two studies using a prefabricated PLS reported increase in cadence in subjects less than 6 months post stroke<sup>18, 21</sup> (with the improvement being statistically significant in one study<sup>21</sup>) but no improvement in those more than 12 months post stroke<sup>21</sup>. While a further study using PLS<sup>43</sup> found no significant effect on cadence, there was a statistically significant increase in subjects with tonic toe flexion reflex by the addition of an inhibitor bar to the orthosis. One study<sup>28</sup> found no change in cadence using a prefabricated PLS or a ‘Chignon’ carbon fibre AFO. These studies were all randomised cross-over studies, retrospective cohort studies or very small trials (with no randomisation).

### Step and stride length

Statistically significant increases in step length have been demonstrated by a number of randomised crossover studies, using metal and plastic solid AFOs at 90°<sup>22</sup>, solid AFOs and HAFOs<sup>31</sup>, prefabricated PLS<sup>18</sup>, and a very small study using an Air Stirrup<sup>®</sup>, a conventional AFO that blocked

plantarflexion, and a solid AFO at 90° and at 5° dorsiflexion<sup>36</sup>. Increased step length was also noted in a small case series on HAFOs<sup>46</sup>, but not in a larger follow-up randomised crossover study<sup>33</sup>. One randomised crossover study<sup>34</sup> showed no improvement in step length using a PLS, although the authors acknowledged that the study may have been underpowered.

Statistically significant increases in stride length have been demonstrated by a number of randomised crossover studies using a custom laminated solid AFO<sup>20</sup>, a HAFO with a 90° plantarflexion stop<sup>31, 33</sup>, solid AFOs<sup>31</sup>, an articulated ‘Valens’ AFO<sup>41</sup> and a prefabricated PLS<sup>18</sup>. Improvement in stride was reported in a very small trial using a DAFO that blocked plantarflexion and a prefabricated PLS<sup>44</sup>. A further very small trial<sup>43</sup> also reported that a PLS had no significant effect on stride length, but that the addition of an inhibitor bar led to a statistically significant improvement in subjects with tonic toe flexion reflex.

One randomised crossover study<sup>28</sup> reported no change in stride length using a ‘Chignon’ carbon fibre AFO or a prefabricated PLS. There is some evidence that a statistically significant increase in stride length can be brought about by the use of shoes only compared to barefoot walking<sup>41, 45</sup>.

Statistically significant improvements in gait symmetry were reported in two very small studies, one using HAFOs with a 90° plantarflexion stop<sup>38</sup> and another using an AFO that was not described<sup>40</sup>. Improvements have also been reported in a small case series using HAFOs<sup>46</sup>, and a very small study investigating a ‘Valens’ AFO<sup>42</sup>, both blocking plantarflexion at 90°.

### Single and double support time

A statistically significant decrease in double support was reported in very small trials using a ‘Valens’ articulated AFO which blocked plantarflexion<sup>42</sup>, and a custom-made solid AFO<sup>39</sup>. A non-statistically significant improvement was reported in a randomised crossover study on PLS<sup>18</sup>. Additionally, a very small trial reported an increase in single support using a DAFO with a plantarflexion stop and a prefabricated PLS<sup>44</sup>, with the greater improvement noted with the DAFO.

## 2 What are the effects of orthoses on the ankle and foot?

### Summary of evidence

- Ankle kinematics can be improved in AFOs that block plantarflexion.
- Very few studies address the issue of correction of foot deformity.

### Ankle kinetics and kinematics

Two randomised crossover studies reported improvements in ankle kinematics<sup>22, 28</sup>. Statistically significant improvements in equinus were reported using both plastic and conventional AFOs<sup>22</sup>, with the greater improvement with the conventional AFO being attributed to increased stiffness of this device. Propulsion was improved by both orthoses. Statistically significant improvements in equinus have also been reported using a 'Chignon' carbon fibre AFO, and to a lesser extent with a prefabricated PLS<sup>28</sup>.

Statistically significant improvements in equinus were also reported in a number of small studies. One reported that a conventional AFO with a plantarflexion stop and a solid AFO set at 90° or at 5° dorsiflexion performed better than an Air Stirrup<sup>® 36</sup>, with similar improvements having been reported using a HAFO with a plantarflexion stop<sup>38</sup>. A reduction in equinus was reported with a 'Valens' AFO which blocked plantarflexion at 90°<sup>41, 42</sup>, as was improvement in the second peak of the ground reaction force in late stance<sup>41</sup>. Although it did not specifically report on ankle kinematics, one small trial that reported a statistically significant improvement in knee kinetics using a rigid metal AFO in 5° dorsiflexion illustrates the important relationship between prevention of stance phase equinus and control of knee hyperextension<sup>7</sup>.

No papers were identified that addressed the issue of ankle kinetics.

### Foot alignment

Only two small trials were identified that made explicit reference to control of the varus foot. In one trial, the varus was reduced but not fully corrected by the Air Stirrup<sup>® 36</sup>, an improvement that was not evident with a solid AFO which raises questions over the fit of this orthosis. In the other trial<sup>44</sup>, patients favoured the improved equinovarus control

associated with the intimate fit provided by a DAFO blocking plantarflexion, rather than a prefabricated PLS AFO. This is not surprising as a PLS is not designed for this purpose (see Indications for different AFOs).

## 3 What are the effects of AFOs on the knee?

### Summary of evidence

- There is little evidence for AFO effect on the knee.
- There is a suggestion that to influence knee hyperextension, an AFO should be inclined forward and sufficiently stiff.
- Evidence may be extrapolated from the literature on cerebral palsy.

Two randomised crossover studies failed to show any significant effect on knee kinematics using a metal AFO, a 'solid' plastic AFO<sup>22</sup>, a 'Chignon' AFO or a PLS<sup>28</sup>. One very small trial<sup>7</sup> reported a statistically significant improvement in hyperextension using a rigid metal AFO in 5° dorsiflexion, but not in 5° plantarflexion. In one study<sup>22</sup>, a metal AFO brought about statistically significant improvements in knee kinetics, while a plastic AFO showed no improvement, presumably as it was insufficiently stiff. Evidence exists in the literature on cerebral palsy for a beneficial effect of AFO use on knee kinetics and kinematics, which may be extrapolated to stroke<sup>17</sup>.

## 4 What are the effects of AFOs on the hip?

### Summary of evidence

- Only one study addresses the issue of AFO effect on the hip.
- There is no evidence for improvement in hip kinematics using an AFO.
- Evidence may be extrapolated from the literature on cerebral palsy.

Only one randomised crossover study<sup>22</sup> made any reference to effect of an AFO on the hip, reporting that neither a metal AFO nor a plastic AFO had any effect on hip kinematics. Evidence exists in the literature in cerebral palsy for the beneficial effect of AFO use on hip kinetics and kinematics, which it may be possible to extrapolate to stroke<sup>17</sup>.

## 5 What effect do AFOs have on the metabolic and cardiopulmonary cost of walking?

### Summary of evidence

- There is limited evidence from a very small number of studies that the use of AFOs can improve the metabolic and cardiopulmonary cost of walking.

A randomised crossover study<sup>29</sup> demonstrated a statistically significant reduction in oxygen consumption using both metal and plastic AFOs at 10° forward inclination, with the plastic AFO having a greater effect. A further randomised crossover study<sup>28</sup> demonstrated a decrease in mechanical external work and energy cost of gait with a 'Chignon' carbon fibre AFO and a prefabricated PLS. A very small trial reported statistically significant reductions in energy cost, with no significant effect on energy consumption or other cardiopulmonary parameters using a custom non-articulated plastic AFO<sup>39, 40</sup>. Although another small trial<sup>37</sup> reported a slight increase in oxygen consumption using a carbon fibre 'Toe-Off'® AFO, this was associated with an increase in speed and a statistically significant decrease in energy cost, with no change in heart rate.

## 6 What effect do AFOs have on muscle activity and muscle length?

### Summary of evidence

- There is some evidence from a single randomised control study that early use of AFOs may prevent plantarflexion contracture.
- There is limited evidence from a few very small trials that AFOs may be able to affect muscle activity.

One randomised controlled trial<sup>27</sup> reported that wearing AFOs at night in the first 2–3 weeks post stroke was as effective as therapy using a tilt table in preventing plantarflexion contracture. As AFO use can be continued after discharge, this is a potentially useful approach to contracture prevention. Three small trials investigated the effect of AFOs on muscle activity. Use of an articulated 'Valens' AFO resulted in an

increase in vastus lateralis activity and a reduction in tibialis anterior activity, with an associated reduction in varus<sup>42</sup>. While the magnitude of plantarflexor activity remained unchanged, the timing improved. In a further small trial using the same AFO design<sup>41</sup>, eight of 19 patients reported a reduction in clonus during gait. No significant change in thigh muscle electromyography (EMG) was reported using a custom plastic non-articulated AFO<sup>39</sup>.

## 7 How do AFOs affect function and ability?

### Summary of evidence

- AFOs can improve static and dynamic balance.
- AFOs can improve weight distribution.
- There is no evidence that AFOs can improve the ability to rise from a sitting position (sit-to-stand).
- There is some evidence that AFOs may improve performance in ascending and descending stairs.

### Balance and weight distribution

Four randomised crossover studies investigated the effect of a variety of AFO designs on balance impairment and weight distribution<sup>18-21</sup> concluding that AFO use can lead to statistically significant improvements in weight distribution and in static and dynamic balance. The orthoses under investigation in these studies ranged from a low temperature thermoplastic anterior AFO to a prefabricated PLS and a custom laminated AFO. The two PLS studies<sup>18, 21</sup> reported improvements only in subjects within 6 months after a stroke. However, there was no reported improvement in the Berg Balance Scale<sup>47</sup> in either group. While use of a low temperature thermoplastic anterior AFO brought about improvements in dynamic mediolateral stability and weight bearing through the affected leg, the absence of any significant effect on the postural sway index, postural symmetry or maximal balance range in the sagittal plane may be due to a lack of stiffness in this AFO design<sup>19</sup>. Additionally, a small trial<sup>38</sup> demonstrated a reduction in step width during gait using HAFOs.

### Sit to stand

Only one randomised crossover study<sup>21</sup> addressed the issue of the effect of AFOs on the ability of patients to rise from a sitting position (sit-to-stand), and this reported no beneficial effect from a prefabricated PLS.

### Stair climbing

Two randomised crossover studies investigated the effect of AFOs on negotiating stairs. One study<sup>29</sup> found that both metal and plastic AFOs set at 10° forward inclination brought about a statistically significant improvement in stair performance. There was no significant difference between AFO designs, possibly due to the small sample size. In the other study<sup>30</sup>, a prefabricated non-articulated plastic AFO led to a statistically significant improvement in performance on the 'timed up-and-go' plus stairs test<sup>48</sup>.

### Additional outcome measures

The small improvements identified using the ambulation category of the Sickness Impact Profile<sup>49</sup> in one randomised controlled trial<sup>25</sup> may suggest that this instrument is insensitive to changes of the magnitude conferred by solid plastic AFOs. However this lack of effect may also be explained by the fact that this study had a high non-compliance rate and a high number of complaints from participants, suggesting that the design and fit of the AFOs were not optimal. One randomised crossover study<sup>34</sup> showed an improvement in the Functional Ambulation Category<sup>50</sup> using a PLS. A retrospective cohort study<sup>35</sup> suggests that the Chedoke-McMaster Stroke Impairment Instrument<sup>51</sup>, the Berg Balance Scale<sup>47</sup> and the Functional Independence Measure<sup>52</sup> (stairs and walking component) may be useful in identifying those patients most likely to require AFO intervention following stroke. Improvements in the Perry and Garrett Walking Handicap Scale<sup>53</sup> were reported in one very small trial on custom non-articulated AFOs<sup>39</sup>. A further small trial<sup>41</sup> reported an increase in Rivermead Motor Scores<sup>54</sup> using a 'Valens' AFO.

## 8 What are the benefits of tuning AFOs?

### Summary of evidence

- No studies were identified that addressed the issue of AFO tuning post stroke.
- Evidence of benefit may be extrapolated from the literature on cerebral palsy.

While there is nothing in the literature on tuning AFOs following stroke *per se*, one randomised crossover study<sup>29</sup> reports similar outcomes with both metal and plastic AFOs set to 10° dorsiflexion, despite differences in their construction. A very small trial<sup>7</sup> demonstrates the increased benefits of an AFO set in 5° dorsiflexion, as compared to 5° plantarflexion. Both of these papers support the emerging evidence in the literature on AFO use in cerebral palsy<sup>17</sup> that tuning can enhance the function of AFOs in the treatment of neurological conditions.

## 9 What are the perceptions of AFO users regarding orthotic treatment?

### Summary of evidence

- There is some evidence that AFO use is perceived as beneficial by users.

Five studies<sup>30, 31, 33, 34, 41</sup> investigated the views of AFO users.

One study used a visual analogue scale to evaluate the effect of a prefabricated plastic AFO<sup>30</sup>, and reported a statistically significant improvement in confidence by 70% of subjects, and a reduction in difficulty while performing the tasks under investigation (gait, timed up-and-go test<sup>55</sup>, timed up-and-go and stairs test<sup>48</sup>) by 65%. Using the Functional Ambulation Category<sup>50</sup> questionnaire, another study reported that 96% of subjects found a HAFO with 90° plantarflexion stop comfortable, and felt that they walked better with the orthosis<sup>33</sup>. The HAFO was considered easy to put on and take off by 64% of subjects, with 56% able to do this independently. Although 92% were unconcerned by the appearance of the AFO, 24% found it heavy. In this study, walking speed was rated as more important than walking quality by 96% of participants.

A third study<sup>34</sup> reported that while using a PLS, 45% of subjects felt that they could take weight better through the affected leg. In addition 40% felt they could advance the weak leg more easily, 55% felt improved confidence, 40% felt that safety was improved and 14% felt improvement in limping. In another study<sup>31</sup> three of the four subjects reported that they felt less exertion using a HAFO or a solid AFO, assessed using the BORG Rating of Perceived Exertion<sup>56</sup>.

The perceptions held by AFO users regarding their orthosis are very important and should be sought, but they are infrequently reported in the literature. If the views of patients are to be of value, it is important to ensure that they have been provided with the most appropriate AFO for their circumstances, otherwise inappropriate prescription may understandably have an adverse effect on responses.

### Observations on the literature review

There is evidence that AFOs can confer a number of beneficial effects when used in the rehabilitation of people who have had a stroke. However, before clinicians can attempt to make use of this evidence, there are a couple of very important questions that must be addressed.

- Are the patients to be treated the same as (or similar to) the study patients?
- Can the orthotic intervention in the study be accurately reproduced?

The reviewed papers have a number of limitations. Unfortunately, many failed to provide important clinical details about the subjects in the study. Clinicians appreciate the critical importance of many interrelated factors when prescribing and fitting AFOs, including joint range of motion, contracture, muscle strength, tone and spasticity. Many papers failed to provide adequate information on these factors. If dorsiflexion (to 90° for example) can only be achieved with the knee flexed due to contracture or hypertonus in the gastrocnemius, then an AFO that positions the ankle at this angle will actually limit knee extension. It was disappointing to note that a number of studies reported that subjects were provided with AFOs that held the ankle at 90° (neutral) when

clearly there was dynamic contracture present. Similarly, when a PLS or HAFO is used in cases like this, any dorsiflexion that occurs can only do so at the expense of knee extension. Ignoring gastrocnemius shortening in this way is inevitably detrimental to the kinetics and kinematics at the knee and at the hip. Proximal contractures, whether true or dynamic, also have a profound influence on outcomes, particularly contractures in the biarticular muscles.

Many studies provided inadequate information on the orthosis being investigated, making reproduction of the intervention a challenge. In one study, the orthosis was only described as an AFO. A large percentage of the reviewed papers failed to explicitly state the angle of plantarflexion or dorsiflexion of the orthosis, and very few specifically mentioned how well the orthosis controlled the subtalar joint or the midtarsal joint. In general, there appeared to be little or no attempt to quantify 'fit', which underpins optimal orthotic treatment and information on fitting complications and rejection rates was rarely provided.

The results of a number of studies into the effects of solid AFOs may have been compromised by the fact that these 'solid' AFOs were able to deflect into dorsiflexion (and perhaps even plantarflexion). As AFOs buckle, the closeness of their fit is inevitably affected, with detrimental consequences on the alignment of unstable subtalar and midtarsal joints, and as a result, on comfort. In addition, the ability of the solid AFO to influence knee and the hip kinetics and kinematics by manipulation of the ground reaction force is also compromised. Buckling to a more dorsiflexed position may adversely affect knee and hip extension in the presence of a true or a dynamic gastrocnemius contracture.

Many of the studies investigated the use of a PLS, an orthosis whose function is primarily to improve swing phase clearance, when clearly many stroke patients face significant challenges throughout stance phase where the PLS has minimal influence. Many studies reported improvements with this design of orthosis. Increased or additional improvements could be realised with an optimally designed and fitted AFO.

Due to the lack of detail provided in some studies, it is difficult to know whether the AFOs investigated fully matched the functional deficit of the subjects. While improvements in certain gait parameters have been reported, it may be that other important aspects of gait have not been addressed. For example, while improvements in sagittal plane kinetics and kinematics have been reported using conventional metal and leather AFOs, their design means that they are unable to adequately address triplanar foot deformity, which is common after stroke.

Although footwear is a key component influencing the biomechanical effect of the AFO, few studies provided adequate information on footwear modifications or important footwear characteristics, such as the effective heel height, ie the difference between the thickness of the heel and the sole. Even if the effective heel height is correct, should the heel be insufficiently stiff, control of knee hyperextension will be compromised.

Knowledge of these footwear characteristics, combined with the angle of plantarflexion or dorsiflexion of the AFO, are essential to appreciate the resulting tibial inclination angle of the device. This is a critical issue when considering whether AFOs are appropriately tuned. The angle of tibial inclination is only rarely mentioned in the literature.

In summary, there are a number of reported benefits for patients from using an AFO after a stroke. The evidence for AFO use can only be strengthened by further research in this area. To ensure that future research has best influence on clinical practice, it is important that comprehensive and explicit information is routinely provided on research methodology, the characteristics of the subjects being studied, and the orthotic intervention under investigation.



## Appendix 2: Anatomical planes

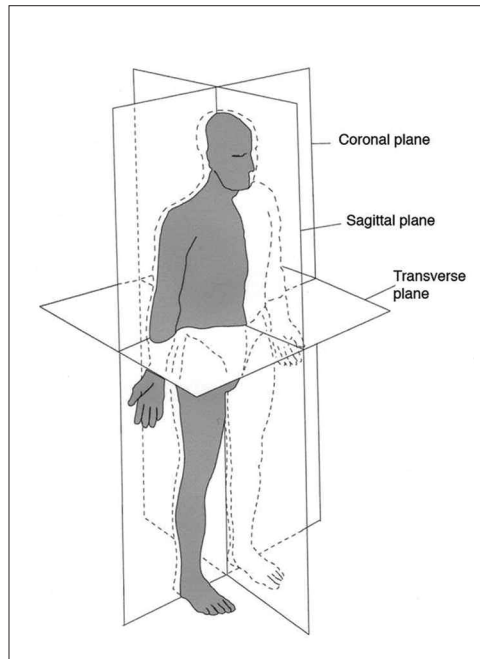

Figure 7: Anatomical planes

Medical and allied health professionals often refer to the movement of body segments in terms of the three anatomical planes, the sagittal plane, the coronal plane and the transverse plane (Figure 7). These three planes are imaginary lines – vertical or horizontal – drawn through an upright body.

The use of the terms sagittal, coronal and transverse aids description of the position or movement of a specific body part.

Term	Definition
Coronal (frontal) plane	The coronal plane divides the body into front and back sections (ie as if viewed from the front).
Sagittal plane	The sagittal plane divides the body into left and right sides (ie as if viewed from the side).
Transverse plane	The transverse plane divides the body into top and bottom halves (ie as if viewed from above).

### Appendix 3: Fundamental mechanical and biomechanical principles

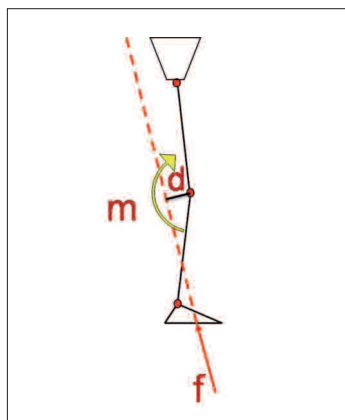

Figure 8: External moment caused by ground reaction force

There are a few basic but very important mechanical and biomechanical principles that must be understood to appreciate how AFOs can influence the static and dynamic control of the lower limb. The first of these is Newton's third law, which states that for every action, there is an equal and opposite reaction. This means that during stance the weight of the body acting downwards creates an equal and opposite force acting upwards. This is known as the ground reaction force (GRF). The GRF has a point of application on the sole of the foot, a magnitude, a line of action and a direction, which all vary in a fairly repetitive fashion during gait.

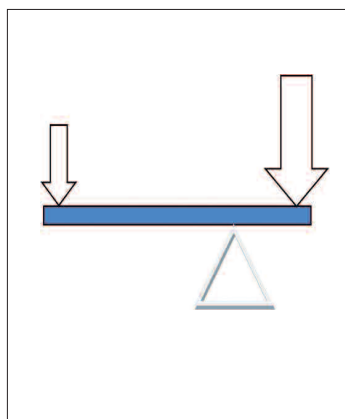

Figure 9: Moment equals force times distance

If the GRF passes at a distance from the centre of a joint, it creates a turning effect known as an external moment<sup>14</sup> (Figure 8). The size of this moment ( $m$ ) depends on the magnitude of the force ( $f$ ), and its perpendicular distance from the joint ( $d$ ), ie  $m=f \times d$ . If the external moment (in this case a knee flexion moment) is to be resisted, an opposing internal extension moment must be created (by the quadriceps). If the GRF is far from the joint (ie 'd' in the equation is large), the external moment it creates will be large, and as a consequence, so will the internal moment required to resist motion. If an adequate

internal moment cannot be created, an orthosis may be required to provide joint control and improve gait.

Orthoses control joints by applying systems of forces that create moments. As the size of any moment is the product of force and distance, the forces applied can be reduced if they are applied as far away from the joint as possible (Figure 9). In practice, the lever arm is limited by the length of the anatomical segments involved or by other considerations such as tissue intolerance to pressure.

It is also important that the orthosis should apply force ( $f$ ) over as large an area ( $a$ ) as possible in order to reduce tissue pressure ( $p$ ), which is equal to force divided by area ( $p = f/a$ ).

These fundamental mechanical principles underpin all orthotic practice.

## Appendix 4: Biomechanics of normal gait

A gait cycle can be divided into two phases, stance and swing. Each phase has different episodes. Stance phase may be described as having five episodes: namely initial contact, loading response, midstance, terminal stance and preswing. Swing phase consists of initial swing, midswing and terminal swing. Five prerequisites for normal walking have been described. In order of importance, these are stability in stance, foot clearance in swing, prepositioning of the foot in terminal swing, adequate step length and conservation of energy<sup>57</sup>.

The branch of biomechanics that studies motion (including joint angles and segment flow) is known as kinematics. The branch of mechanics concerned with the effects of forces on motion is called kinetics. Consideration of both kinematics and kinetics is necessary to understand the biomechanical aspects of normal gait, stroke gait, and the effect of AFOs. Rather than attempt to describe the kinematics and kinetics of gait in absolute detail, a few key issues will be addressed.

### Kinematics

Rather than considering joint kinematics, it can be clinically useful to focus on leg segment kinematics<sup>14</sup>. It is important to recognise that at midstance the tibia is not vertical, but slightly inclined forward, remaining almost stationary while the femur advances. By terminal stance the tibia and the femur are similarly inclined forward. While it is commonly assumed that at 'push-off' in terminal stance the ankle is plantarflexing, it is actually held almost rigid, in a slightly dorsiflexed position by isometric activity of the plantarflexors. The ankle only begins to plantarflex in preswing as the leg is being unloaded and the opposite foot has contacted the ground.

### Kinetics

In clinical practice, consideration of the external moments arising from the alignment of the ground reaction force (GRF) can be a successful strategy<sup>14</sup>. Because of the generally close alignment of the GRF

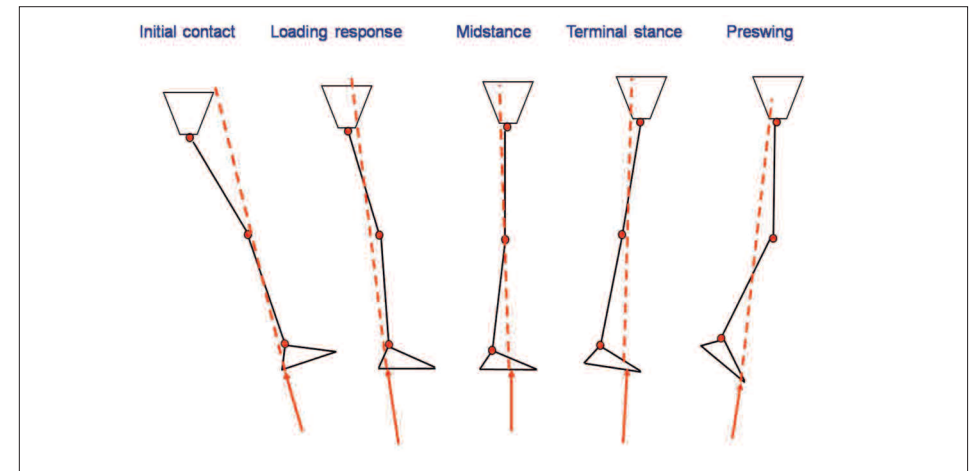
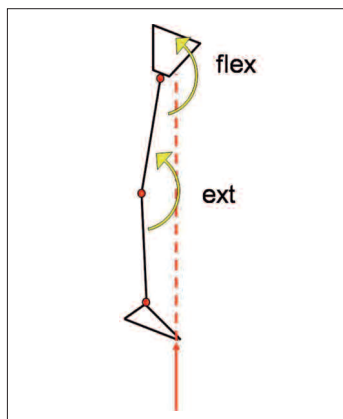

Figure 10: Stance phase kinetics

(indicated by the dotted line) to the joints throughout stance, the external moments created are small, and as a consequence the neuromuscular response is minimised (Figure 10). This contributes to the energy efficiency of gait. It can also be seen that the GRF passes either side of the joints of the leg throughout stance, alternating the moments between flexion and extension. This requires transfer in neuromuscular response, which is also facilitated by the close alignment of the GRF to the joints.

A very important kinetic feature occurs during the second half of stance, when forward inclination of the femur enables GRF alignment anterior to the knee and posterior to the hip, simultaneously extending and stabilising both joints without the need for knee and hip extensor muscle activity<sup>14</sup>. It is important that there is adequate range of motion in the knee and the hip to enable this. While the stability of the joints of the lower limb is fundamental for a safe and effective stance phase, it is also a prerequisite for achieving adequate step length in the opposite leg.

## Appendix 5: Biomechanical effects of stroke on gait



**Figure 11:** Abnormal knee and hip kinetics

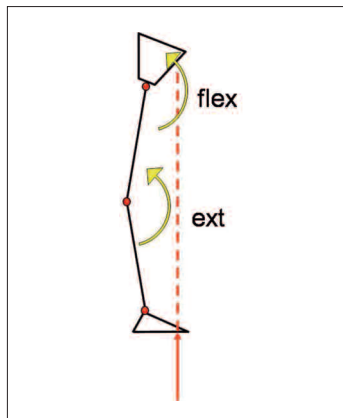

**Figure 12:** Abnormal knee and hip kinetics

Following a stroke, the foot frequently adopts a plantarflexed position, not only in swing phase but often throughout stance phase as well. This may be due to the presence of increased plantarflexor tone, inappropriate plantarflexor activity or a plantarflexion contracture. Regardless of its cause, persistent plantarflexion in stance resists forward progression of the tibia, so the knee is more posteriorly placed than normal.

A further consequence of persistent plantarflexion is a lack of weight bearing through the heel. This means that the GRF, as indicated by the dotted line, is located at the forefoot throughout stance rather than progressing smoothly from heel to toe, and therefore passes further in front of the knee than normal<sup>14</sup> (Figures 11 and 12). The combination of posterior placement of the knee and anterior placement of the GRF leads to the creation of an excessive knee extension moment that can lead to hyperextension. Because the knee is excessively stable in this alignment, it becomes difficult to initiate flexion at the end of stance. The presence of knee hyperextension during gait is common following stroke and should not be ignored.

If this is not addressed it will progress to laxity in the ligaments of the knee, instability and increasing deformity.

In addition, the plantarflexed foot position causes the GRF to pass in front of the hip, creating an external flexion moment that leads to hip flexion and retraction<sup>14</sup> (Figures 11 and 12). When the GRF remains in front of the hip in mid to late stance, the patient experiences a hip flexion moment at a stage in gait where there is normally a hip extension moment. As a consequence they must attempt to use the hip extensor muscles at a stage when these muscles would normally be inactive. This places an abnormal and significant demand on the neuromuscular system, which may be beyond the patient's capability. As a result, the stability of the limb may be compromised, and the patient may have difficulty bearing weight through the affected leg.

## Appendix 6: Biomechanical effects of AFOs

### Direct biomechanical effects

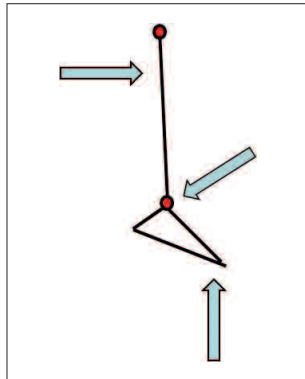

**Figure 13:** Force system to prevent equinus

Provided they are adequately stiff, AFOs can prevent plantarflexion of the foot in swing phase and improve ground clearance, reducing the risk of tripping. They do this by applying a system of three forces to the posterior calf, the plantar surface of the foot near the metatarsal heads, and the dorsum of the foot near the ankle joint<sup>14</sup> (Figure 13). In some cases the shoe is able to provide adequate force at the dorsum of the foot, but where there is increased tone an ankle strap should be considered. This should be positioned so that it applies the force at approximately a 45° angle. An ankle strap



**Figure 14:** Single ankle strap

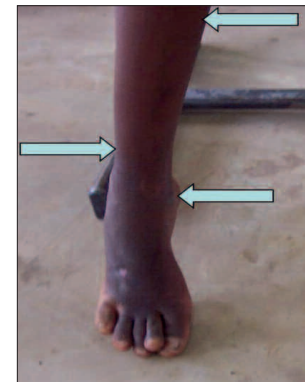

**Figure 15:** Figure-8 ankle strap

may also help maintain the foot in the correct position in the AFO while the shoe is being applied. Ankle straps should be non-elasticated for efficient force transmission, and may take the form of a single strap (Figure 14) or a 'figure-8' crossover strap (Figure 15). The

design and location of the ankle strap is influenced by the upper limb function of the wearer.

Supination of the foot affects the subtalar joint and the midtarsal joint, and the AFO must control both simultaneously. At the subtalar joint, hindfoot inversion is controlled by forces applied to the medial aspect of



**Figure 16:** Force system to prevent hindfoot inversion

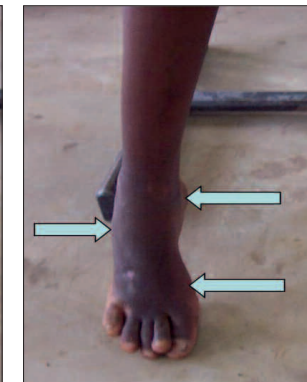

**Figure 17:** Force system to prevent forefoot adduction

the heel (calcaneus), the area above the lateral malleolus, and at the medial aspect of the proximal calf<sup>14</sup> (Figure 16). At the midtarsal joint, internal rotation of the forefoot (adduction) is controlled by the application of forces to the medial heel (calcaneus), the lateral midfoot (midtarsal

joint) and along the first metatarsal shaft<sup>14</sup> (Figure 17). Full correction of supination is important as if it is not addressed this foot position may contribute to the generation of increased varus moments at the knee, which can lead to ligamentous laxity (lateral collateral ligament) and increasing varus deformity over time.

In the presence of deformity that is not fully correctable, wedging should be added to the underside of the AFO.

To be successful, all these forces must be applied in a way that respects the underlying anatomy. Careful shaping of the AFO to match the contours of the underlying skeletal structures ensures comfort while controlling deformity. In addition, the forces should be applied as far apart as practical, to maximize lever arms, and over large areas to reduce pressure.

Traditionally, orthotic control of the varus (supinated) foot has been addressed using a conventional metal and leather AFO with a lateral T-strap tightened around the medial upright of the calliper. This is a simplistic and inadequate approach to the management of complex triplanar deformity. Close-fitting plastic AFOs that apply appropriate corrective forces are more successful.

## Indirect biomechanical effects

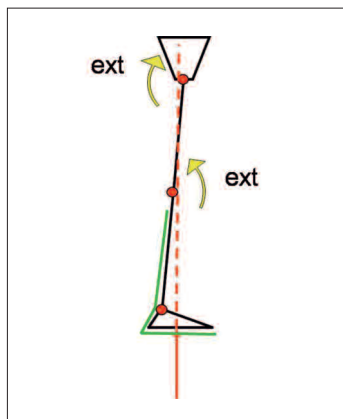

**Figure 18:** Biomechanical effect of AFO

By controlling the alignment and motion of the ankle joint, an AFO can realign the GRF in stance in a way that positively influences its relationship to both the knee and the hip<sup>14</sup> (Figure 18). It does this by realigning the tibia to a more normal position of approximately 10° forward inclination. It also ensures that the entire plantar surface of the foot bears weight, rather than just the lateral forefoot, which means that the GRF is moved posteriorly. The combination of posterior placement of the GRF and anterior placement of the knee ensures that the GRF now passes closer to the knee, therefore reducing the external knee extension moment and improving knee alignment. The fact that the GRF is now only slightly anterior to the knee creates an appropriate extension moment for knee stability, while facilitating knee flexion for swing phase. In cases of knee flexion instability, an AFO that successfully blocks dorsiflexion, such as a solid AFO or ground reaction AFO (GRAFO), can align the ground reaction force (GRF) in front of the knee in this way thereby aiding knee stability.

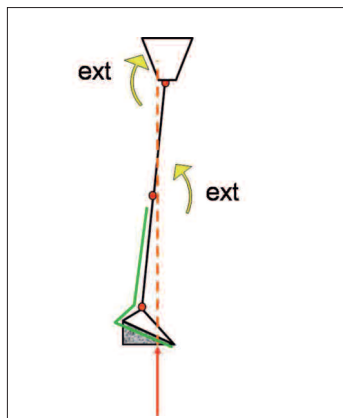

**Figure 19:** Wedge to accommodate plantarflexion

With the tibia maintained in this alignment the femur can also incline forward approximately 10° and the hip joint can be moved anteriorly, without knee hyperextension which would be the case if the tibia was vertical. The combination of anterior placement of the hip and posterior

placement of the GRF means that the abnormal external flexion moment at the hip can be reduced or even replaced with an external extension moment, which is normal in the second half of stance. Manipulation of the GRF in this way means that the hip extensor muscles are no longer required to be active at this stage, and the demand on the neuromuscular system is made more normal, improving both control and stability<sup>14</sup>.

This may suggest that AFOs should position the ankle in 10° dorsiflexion, but this is not the case. The heel height of the shoe will increase the inclination of the AFO (and therefore the tibia), so even an angle of 90° in the AFO will often result in an appropriate angle of tibial inclination. In cases where the gastrocnemius is short, it is essential that the AFO positions the ankle in an appropriate degree of plantarflexion (ie no more dorsiflexed than the position that can be achieved with the knee fully extended), if knee extension is not to be limited by the orthosis<sup>14</sup> (Figure 19). Thereafter, wedges under the heel of the AFO are employed to achieve an appropriate amount of tibial inclination, which should be individually determined for each patient (see Appendix 7).

## Appendix 7: Tuning AFOs

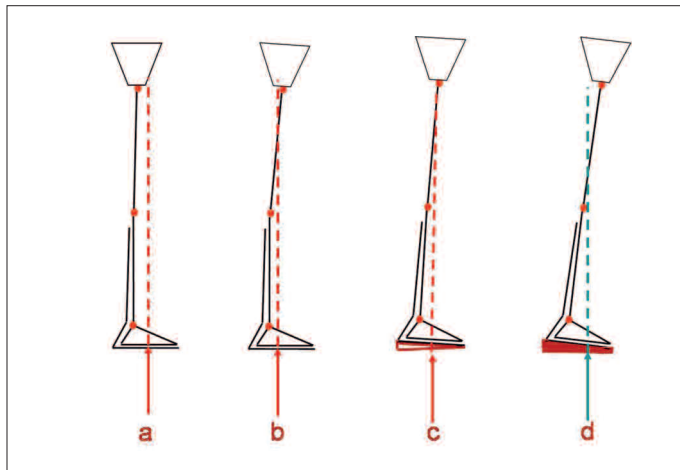

Figure 20: Tuning an AFO

AFOs is important to optimise their effect on gait. The angle of tibial inclination of the solid AFO is adjusted by adding or removing wedges under the heel to make what may be clinically significant kinetic changes at the knee and hip (Figure 20). When the AFO positions the tibia in a vertical alignment (position a) the GRF cannot be simultaneously aligned in front of the knee and behind the hip, unless the knee hyperextends (position b), which is undesirable. Progressively adding wedges under the heel (positions c and d) can optimise GRF alignment at both joints.

Tuning a solid AFO is as important as aligning a prosthesis for a lower limb amputee, and may be critical in the presence of neurological impairment such as seen following stroke. Clinical experience indicates that neurological conditions such as stroke are very sensitive to small changes of perhaps only a few degrees in the alignment of their AFO, or to small changes to the design of the footwear. In an average sized adult, the introduction of a 5mm heel wedge will increase the angle of tibial inclination by about 2°, and moves the hip forward approximately

Tuning a solid AFO involves adjusting the angle of tibial inclination of the AFO or modifying the characteristics of the footwear to make clinically significant differences to the alignment of the ground reaction force at the knee and hip. Individual tuning of solid

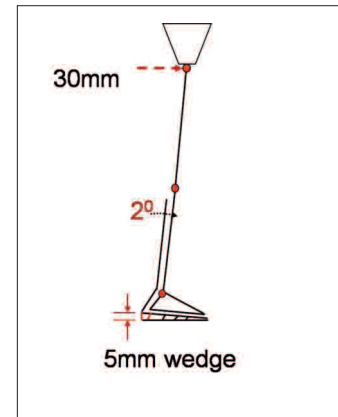

Figure 21: Effect of tuning on the hip joint

30mm, demonstrating that small changes to the SVA can bring about greater changes at the proximal joints<sup>14</sup> (Figure 21).

Under ideal circumstances, tuning is conducted using a gait analysis system that allows visualization of the GRF, but these systems are rarely available in routine clinical practice. Tuning can be performed visually without specialised gait analysis equipment, but can sometimes be difficult when gait is observed at normal speed. In clinical settings where instrumented gait analysis is unavailable, observational analysis by a skilled MDT, with or without the use of

video recording, complemented by a structured analytical approach and an awareness of biomechanical principles can facilitate assessment and understanding of gait problems. Slow-motion video recording can be particularly useful to assist in the interpretation of kinematic features, eg to confirm thigh inclination in late stance, which is necessary for optimal GRF alignment.

When using a tuned AFO the patient may require additional gait training to be able to derive maximum benefit. It should also be recognised that the addition of wedges in this way effectively increases the length of the affected leg, so some compensation for leg length in the form of a raise on the opposite leg may be required.

## Appendix 8: Footwear

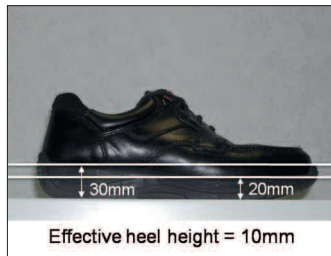

**Figure 22:** Effective heel height of shoe

Footwear should be regarded as an integral component of orthotic management. The thickness, stiffness, contour, and width of both heel and sole are important. The effective heel height (the difference in thickness between the heel and sole) influences the angle of tibial inclination (Figure 22). If the heel is too soft, tibial progression may be inadequate and the knee may hyperextend. A wide heel helps improve mediolateral stability.

the AFO. Occasionally there may be a need to go up one size on the affected side, but it should be remembered that wearing a shoe that is too big may constitute a trip hazard. Custom-made footwear should only be necessary in the presence of severe fixed foot deformity, or co-existing problems that cause sensory impairment.

Putting footwear on and off may be more difficult when wearing an AFO, so footwear with a low opening may be helpful, as may a long handled shoehorn. Ideally, the AFO should be applied before the footwear to ensure that the foot is correctly located within the orthosis. Consideration should be given to the design and position of shoe fastenings, with Velcro® closures likely to be easier to manage.

Patients should be advised that changing their footwear may have a detrimental effect on their walking unless the new and the old footwear have identical characteristics. Patients should be encouraged to bring new footwear to review appointments to have its suitability evaluated by the orthotist or by the AHP involved in the provision of the AFO.

While additional footwear modifications are rarely necessary if the AFO has been appropriately designed, fitted and aligned, external footwear modifications may be helpful in the presence of a fixed deformity. These can often be added to the patient's own footwear, and should not automatically be regarded as an indication for prescription footwear.

Prescription footwear should not be required if the AFO fits intimately and if the footwear is the correct size and is of an appropriate design. Removing the insole and/or stretching the shoe may help accommodate



## Appendix 9: Ankle-foot orthosis screening and fitting/review tools

**POST STROKE: ANKLE-FOOT ORTHOSIS SCREENING TOOL**

Please circle answers below as appropriate.

Functional impairment noted	
Walking	Y/N
Sit to stand	Y/N
Stand to sit	Y/N
Transfers	Y/N
ADL	Y/N
Level of mobility	
Non-ambulatory	Y/N
Walking with abnormal pattern – independently	Y/N
Walking with abnormal pattern – with assistance of 1 person	Y/N
Walking with abnormal pattern – with assistance of 2 persons	Y/N
Please indicate which walking aid is used (if any)	
Walking pattern	
Swing phase (affected leg off the ground)	
Can swing phase be initiated satisfactorily? (ie can patient easily lift foot off of the floor?)	Y/N
Can the patient clear the ground <b>safely</b> when bringing their affected leg through to take a step?	Y/N
Does the patient swing their leg out to the side when stepping?	Y/N
Initial contact (when affected foot hits the ground)	
Heel contact?	Y/N
Foot flat contact?	Y/N
Forefoot contact?	Y/N
Mid stance (weightbearing on affected leg)	
Foot and ankle position	
Foot flat on floor?	Y/N
Does the patient go over on unstable ankle?	Y/N
Lower leg leaning back?	Y/N
Lower leg leaning forward?	Y/N
Knee position	
Neutral/slightly flexed/flexed/hyperextended	N / SF / F / H
Hip/pelvic position	
Hip flexed / retracted?	Y/N
Late stance (just before leg leaves the ground)	
Heel off achieved?	Y/N
Knee neutral/flexed/hyperextended	N / F / H
Hip flexed/retracted?	Y/N
Other factors	
Sensory Impairments	Y/N
Proprioceptive Impairments	Y/N
Neglect/Inattention	Y/N
Altered tone	Y/N
Cognitive Impairment	Y/N

**If any of the shaded answers are circled then referral to combined physiotherapy/orthotics clinic is recommended.**

Form completed by: \_\_\_\_\_

Designation: \_\_\_\_\_

Date of assessment: \_\_\_\_\_

Action taken: \_\_\_\_\_

Referral to joint assessment clinic:  No further action:

**POST STROKE: ANKLE-FOOT ORTHOSIS FITTING/REVIEW TOOL**

Please circle answers (Y or N) below as appropriate.

AFO design (to be checked with AFO off patient)	
Does the AFO meet the functional objectives agreed during assessment?	Y/N
Does the alignment of the AFO match the patient's optimal joint alignments?	Y/N
If a solid AFO, does the orthosis incline (lean slightly forward) when in the shoe?	Y/N
AFO fit (to be checked with AFO on patient)	
Is the alignment of the talocrural joint optimally controlled within the AFO?	Y/N
Is the alignment of the subtalar joint optimally controlled within the AFO?	Y/N
Is the alignment of the midtarsal joint optimally controlled within the AFO?	Y/N
Are straps designed and positioned correctly to control the ankle joint?	Y/N
Is there adequate clearance for bony prominences whilst maintaining an intimate fit?	Y/N
Does the patient report discomfort while wearing the AFO?	Y/N
Does skin marking persist following removal of the AFO?	Y/N
AFO alignment/function (to be checked while walking)	
Does the AFO enable appropriate swing phase clearance?	Y/N
Does the patient make initial contact with the heel?	Y/N
Does the AFO buckle at mid to late stance? (if a solid AFO/GRAFO)	Y/N
Does the AFO have the desired effect on knee alignment?	Y/N
Does the AFO have the desired effect on hip alignment?	Y/N
Footwear	
Is the footwear appropriate and in good repair?	Y/N
Does the AFO fit inside the footwear without causing discomfort?	Y/N
Have the appropriate modifications been made to the footwear if necessary?	Y/N
State of repair	
Are the straps in good repair?	Y/N
Are rivets in good repair?	Y/N
Is the plastic in good condition?	Y/N
Are edges smooth?	Y/N
Are any pads if present in good repair?	Y/N
Are ankle joints if present in good repair?	Y/N
Patient's opinion	
Is the patient satisfied with the AFO?	Y/N

**If any of the shaded answers are circled then referral to combined physiotherapy/orthotics clinic is recommended.**

Form completed by: \_\_\_\_\_

Designation: \_\_\_\_\_

Date of assessment: \_\_\_\_\_

Action taken: \_\_\_\_\_

Referral to joint assessment clinic:  No further action:

Please see the NHS Quality Improvement Scotland website ([www.nhshealthquality.org](http://www.nhshealthquality.org)) to download a Word version of these tools to save and use electronically, or to print and complete by hand.

## Appendix 10: Orthotic referral form

<b>NHS Board Details</b>																					
<b><u>ORTHOTIC REFERRAL FORM</u></b>																					
<table style="width: 100%; border-collapse: collapse;"> <tr> <td style="width: 50%; border-right: 1px solid black; padding: 2px;"><b>CHI Number</b></td> <td style="padding: 2px;">Referrer-print name</td> </tr> <tr> <td style="border-right: 1px solid black; padding: 2px;">Unit Number</td> <td style="padding: 2px;">Signature</td> </tr> <tr> <td style="border-right: 1px solid black; padding: 2px;">Surname</td> <td style="padding: 2px;">Referral source</td> </tr> <tr> <td style="border-right: 1px solid black; padding: 2px;">Date of Birth</td> <td style="padding: 2px;">Contact Details</td> </tr> <tr> <td style="border-right: 1px solid black; padding: 2px;">Address</td> <td style="padding: 2px;">Consultant</td> </tr> <tr> <td style="border-right: 1px solid black; padding: 2px;">Postcode</td> <td style="padding: 2px;">Outpatient <input type="checkbox"/> Inpatient <input type="checkbox"/></td> </tr> <tr> <td style="border-right: 1px solid black; padding: 2px;">Telephone number</td> <td style="padding: 2px;">Planned Discharge Date <input type="checkbox"/></td> </tr> <tr> <td style="border-right: 1px solid black; padding: 2px;">Mobile Number</td> <td></td> </tr> <tr> <td style="border-right: 1px solid black; padding: 2px;">E-mail address</td> <td></td> </tr> <tr> <td style="border-right: 1px solid black; padding: 2px;">Registered GP</td> <td></td> </tr> </table>	<b>CHI Number</b>	Referrer-print name	Unit Number	Signature	Surname	Referral source	Date of Birth	Contact Details	Address	Consultant	Postcode	Outpatient <input type="checkbox"/> Inpatient <input type="checkbox"/>	Telephone number	Planned Discharge Date <input type="checkbox"/>	Mobile Number		E-mail address		Registered GP		<p style="text-align: center; margin-top: 0;"><i>INSERT LABEL HERE</i></p> <p style="text-align: center; margin-top: 10px;">practice code</p>
<b>CHI Number</b>	Referrer-print name																				
Unit Number	Signature																				
Surname	Referral source																				
Date of Birth	Contact Details																				
Address	Consultant																				
Postcode	Outpatient <input type="checkbox"/> Inpatient <input type="checkbox"/>																				
Telephone number	Planned Discharge Date <input type="checkbox"/>																				
Mobile Number																					
E-mail address																					
Registered GP																					
<p><b><u>Special needs</u></b></p> <p>Patients weight</p> <p>Communication difficulties</p> <p>Medical alert</p> <p>Interpreter required? <input type="checkbox"/> Dialect? <input type="checkbox"/></p> <p>Transport required? No <input type="checkbox"/> 1 man <input type="checkbox"/> 2 man <input type="checkbox"/> Wheelchair <input type="checkbox"/> Accompanied <input type="checkbox"/></p> <p>Diabetic Yes <input type="checkbox"/> No <input type="checkbox"/> Unknown <input type="checkbox"/></p>																					
<p><b><u>Relevant History and Diagnosis</u></b></p>  <p><b><u>Presenting Problem</u></b></p>  <p><b><u>Objectives of treatment</u></b></p> <table style="width: 100%; border-collapse: collapse;"> <tr> <td style="width: 33%;">Control Pain <input type="checkbox"/></td> <td style="width: 33%;">Immobilise <input type="checkbox"/></td> <td style="width: 33%;">Control specific joint movement <input type="checkbox"/></td> </tr> <tr> <td>Correct deformity <input type="checkbox"/></td> <td>Protect joint <input type="checkbox"/></td> <td>Accommodate fixed deformity <input type="checkbox"/></td> </tr> <tr> <td>Relieve weight <input type="checkbox"/></td> <td>Prevent ulceration <input type="checkbox"/></td> <td>Enhance Mobility <input type="checkbox"/></td> </tr> </table> <p><b><u>Other Relevant Information</u></b></p>  		Control Pain <input type="checkbox"/>	Immobilise <input type="checkbox"/>	Control specific joint movement <input type="checkbox"/>	Correct deformity <input type="checkbox"/>	Protect joint <input type="checkbox"/>	Accommodate fixed deformity <input type="checkbox"/>	Relieve weight <input type="checkbox"/>	Prevent ulceration <input type="checkbox"/>	Enhance Mobility <input type="checkbox"/>											
Control Pain <input type="checkbox"/>	Immobilise <input type="checkbox"/>	Control specific joint movement <input type="checkbox"/>																			
Correct deformity <input type="checkbox"/>	Protect joint <input type="checkbox"/>	Accommodate fixed deformity <input type="checkbox"/>																			
Relieve weight <input type="checkbox"/>	Prevent ulceration <input type="checkbox"/>	Enhance Mobility <input type="checkbox"/>																			
<p><b><u>Current medication</u></b></p>  																					
<p>Assessed priority of referral</p> <p>Date referral received <span style="float: right;">Referral type</span></p>																					

This form was designed by the NHS QIS prosthetics and orthotics practice development network.

Please see the NHS Quality Improvement Scotland website ([www.nhshealthquality.org](http://www.nhshealthquality.org)) to download a Word version of these tools to save and use electronically, or to print and complete by hand.

## Glossary

### **abduction**

Movement of the limb away from the midline (when applied to movement in the coronal plane).

### **adduction**

Movement of the limb towards the midline (when applied to movement in the coronal plane).

### **AFO**

Ankle-foot orthosis; an orthosis which encompasses the ankle joint and the whole or part of the foot.

### **AHP**

Allied health professional

### **cadence**

Number of steps taken per minute.

### **Chignon AFO**

A type of carbon fibre AFO.

### **circumduction**

A combination of movements of the leg in a circular motion involving abduction, flexion and adduction at the hip joint.

### **closed chain motion**

Movement taking place when the foot is bearing weight.

### **coronal plane**

The coronal plane divides the body into front and back sections (see Appendix 2: Anatomical planes).

### **DAFO**

Dynamic AFO (a type of supramalleolar AFO).

### **dorsiflexion**

Movement of the foot upwards (true flexion).

### **double support**

The period of gait when both feet are in contact with the ground.

### **EMG**

electromyography (the recording of electrical activity from a muscle).

### **eversion**

The movement of the sole of the foot away from the midline in the coronal plane; this results in 'valgus' alignment.

### **extension moment**

A turning effect tending to cause a joint to extend.

### **external moment**

A turning effect produced by an external force.

### **flexion moment**

A turning effect tending to cause a joint to flex.

### **foot/forefoot abduction**

In the foot, abduction refers to movement in the transverse plane away from the midline.

### **FRAFO**

Floor reaction AFO (see indications for different AFOs).

### **GRAFO**

Ground reaction AFO; this is synonymous with floor reaction AFO (see indications for different AFOs).

**GRF**

Ground reaction force (see Appendix 3: Fundamental mechanical and biomechanical principles).

**HAFO**

Hinged AFO (see indications for different AFOs).

**hyperextension**

Greater than normal range of extension (knee hyperextension is also referred to as 'recurvatum').

**initial contact**

The point in gait when the foot makes first contact with the floor.

**initial swing**

The point at which the limb leaves the floor.

**internal moment**

A turning effect caused by the actions of muscles or other anatomical structures.

**inversion**

Movement of the sole of the foot towards the midline in the coronal plane; results in 'varus' alignment.

**isometric contraction**

Muscle contraction with no change in length (associated with stabilisation of a joint).

**ISPO**

International Society for Prosthetics and Orthotics

**kinematics**

The branch of biomechanics that studies motion (including joint angles and segment flow).

**kinetics**

The branch of mechanics concerned with the effects of forces on motion.

**loading response**

The phase in gait immediately after initial contact when the limb accepts body weight and the shock of impact is absorbed.

**MCN**

Managed clinical network

**MDT**

Multidisciplinary team

**midstance**

The midpoint of the stance phase when the limb advances over the stationary foot.

**midswing**

The point in gait where the swinging limb passes the supporting limb.

**midtarsal joint**

The midfoot articulation between the talus and navicular medially, and the calcaneus and cuboid laterally.

**neurobiomechanics**

The combination and/or interaction of biomechanical and neurological factors.

**NHS QIS**

NHS Quality Improvement Scotland

**NICE**

National Institute for Health and Clinical Excellence

**orthosis**

An externally applied device used to modify the structural and functional characteristics of the neuromuscular and skeletal systems.

**orthotics**

The science and art involved in treating patients by the use of an orthosis.

**orthotist**

A person who, having completed an approved course of education and training, is authorised by an appropriate national authority to design measure and fit orthoses.

**plantarflexion**

Movement of the foot downwards (true extension).

**PLS**

Posterior leaf spring AFO (see indications for different AFOs).

**preswing**

The phase in gait where the limb begins to be unloaded in preparation for swing phase.

**retraction**

Lack of hip extension and abduction resulting in reduced forward propulsion of the pelvis over the weight-bearing leg during stance phase.

**rotation**

Movement of the lower limb in the transverse plane laterally (externally) or medially (internally).

**sagittal plane**

The sagittal plane divides the body into left and right sections (see Appendix 2: Anatomical planes).

**SIGN**

Scottish Intercollegiate Guidelines Network

**single support**

The period of gait when only one foot is in contact with the ground.

**stance phase**

The period of gait when the limb is in contact with the ground.

**subtalar joint**

The articulation between the talus and the calcaneus.

**subtalar joint pronation (closed chain)**

Triplanar motion involving plantarflexion, eversion and adduction (internal rotation) of the hindfoot; usually compensated by midtarsal joint supination (involving dorsiflexion, inversion and abduction (external rotation) of the forefoot).

**swing phase**

The period of gait when the limb is not in contact with the ground.

**talocrural joint**

The articulation between the tibia, fibula and talus.

**terminal stance**

The end of the stance phase, when the knee and hip are maximally extended.

**terminal swing**

The end of the swing phase, when the hip is flexed, the knee extended, and the ankle is at approximately 90° in preparation for initial contact.

**transverse plane**

The transverse plane divides the body into upper and lower sections (see Appendix 2: Anatomical planes).

**triplanar foot deformity**

Deformity of the foot (subtalar and midtarsal joints) with components in all three anatomical planes.

**tuning**

Adjusting the angle of tibial inclination of a solid AFO (with or without modification of footwear) to make clinically significant differences to the alignment of the ground reaction force at the knee and hip.

**Valens AFO**

A type of metal AFO of a conventional design.

**valgus**

Deviation of the distal portion of a joint away from the midline (in the foot this refers to subtalar joint eversion or pronation).

**varus**

Deviation of the distal portion of a joint towards the midline (in the foot this refers to subtalar joint inversion or supination).

**wedging**

The addition of wedges under the heel of an AFO to adjust the angle of tibial inclination (see Appendix 7: Tuning AFOs).

## References

- 1 NHS Quality Improvement Scotland. Together we can - Allied health professions clinical effectiveness and practice development network. 2006 [cited 2009 Jul 17]; Available from: [http://www.nhshealthquality.org/nhsqis/files/AHP%20\\_Report\\_April\\_06.pdf](http://www.nhshealthquality.org/nhsqis/files/AHP%20_Report_April_06.pdf)
- 2 Condie ME, Campbell JH, Martina JD. Report of a consensus conference on the orthotic management of stroke patients. Copenhagen: ISPO; 2004.
- 3 Hatano S. Experience from a multicentre stroke register: a preliminary report. *Bull World Health Organ.* 1976;54(5):541-53.
- 4 Scottish Intercollegiate Guidelines Network. Management of patients with stroke: rehabilitation, prevention and management of complications and discharge planning. 2002 [cited 2009 Jul 17]; Available from: <http://www.sign.ac.uk/pdf/sign64.pdf>
- 5 Scottish Intercollegiate Guidelines Network. Management of patients with stroke or TIA: assessment, investigation, immediate management and secondary prevention. 2008 [cited 2009 Jul 17]; Available from: <http://www.sign.ac.uk/pdf/sign108.pdf>
- 6 Bohannon RW. Comfortable and maximum walking speed of adults aged 20-79 years: reference values and determinants. *Age Ageing* 1997;26(1):15-19.
- 7 Lehmann JF, Condon SM, Price R, deLateur BJ. Gait abnormalities in hemiplegia: their correction by ankle-foot orthoses. *Arch Phys Med Rehabil.* 1987;68(11):763-71.
- 8 Olney SJ, Richards C. Hemiparetic gait following stroke. Part 1: characteristics. *Gait posture.* 1996 4(2):136-48.
- 9 Michael KM, Allen JK, Macko RF. Reduced ambulatory activity after stroke: the role of balance, gait, and cardiovascular fitness. *Arch Phys Med Rehabil.* 2005;86(8):1552-6.
- 10 International Organization for Standardization. Terms relating to external orthoses. ISO 8549-3:1989. Prosthetics and orthotics - vocabulary. Geneva, Switzerland: International Organization for Standardization; 1989.
- 11 International Organization for Standardization. General terms for external limb prostheses and external orthoses. ISO 8549-1:1989. Prosthetics and orthotics - vocabulary. Geneva, Switzerland: International Organization for Standardization; 1989.
- 12 Condie ME, Bowers RJ. Lower limb orthoses for persons who have had a stroke. In: Hsu J, Michael J, Fisk JR, editors. *Atlas of orthoses and assistive devices.* 4th ed. Philadelphia: American Academy of Orthopedic Surgeons; 2008. p. 433-40.
- 13 Bowers RJ. Non-articulated ankle-foot orthoses. In: Condie ME, Campbell JH, Martina JD, editors. *Report of a consensus conference on the orthotic management of stroke patients.* Copenhagen: ISPO; 2004. p. 87-94.
- 14 Meadows C, Bowers R, Owen E. Biomechanics of the hip knee and ankle. In: Hsu J, Michael J, Fisk JR editors. *Atlas of orthoses and assistive devices.* 4th ed. Philadelphia: American Academy of Orthopedic Surgeons; 2008. p. 299-309.
- 15 Boyd RN, Graham HK. Objective measurement of clinical findings in the use of botulinum toxin Type A for the management of children with cerebral palsy. *Eur J Neurol.* 1999 6 Suppl 4:S23-35.

- 16 Tardieu G, Shentoub S, Delarue R. A la recherche d'une technique de mesure de la spasticité. *Rev Neurol.* 1954;91(2):143-4.
- 17 Bowers RJ, Ross K. A review of the effectiveness of lower limb orthoses used in cerebral palsy. In: Morris C, Condie D, editors. *Recent developments in healthcare for cerebral palsy; implications and opportunities for orthotics.* Copenhagen: ISPO; 2009. p. 235-97.
- 18 Wang RY, Lin PY, Lee CC, Yang YR. Gait and balance performance improvements attributable to ankle-foot orthosis in subjects with hemiparesis. *Am J Phys Med Rehabil.* 2007;86(7):556-62.
- 19 Chen C, Yeung K, Wang C, Chu H, Yeh C. Anterior ankle-foot orthosis effects on postural stability in hemiplegic patients. *Arch Phys Med Rehabil.* 1999;80(12):1587-92.
- 20 Mojica JAP, Manakmura R, Kobayashi T, Handa T, Morohashi I, Watanabe S. Effect of ankle-foot orthosis (AFO) on body sway and walking capacity of hemiparetic stroke patients. *Tohoku J Exp Med.* 1988;156(4):395-401.
- 21 Wang RY, Yen L, Lee CC, Lin PY, Wang MF, Yang YR. Effects of an ankle-foot orthosis on balance performance in patients with hemiparesis of different durations. *Clin Rehabil.* 2005;19(1):37-44.
- 22 Gok H, Kucukdeveci A, Altinkaynak H, Yavuzer G, Ergin S. Effects of ankle-foot orthoses on hemiparetic gait. *Clin Rehabil.* 2003;17(2):137-9.
- 23 Scottish Executive Health Department. Guidelines for orthotic patient review: HDL(2001)16 [online]. 2001 [cited 2009 Jul 17]; Available from: [http://www.sehd.scot.nhs.uk/mels/HDL2001\\_16.htm](http://www.sehd.scot.nhs.uk/mels/HDL2001_16.htm)
- 24 Leung J, Moseley A. Impact of ankle-foot orthoses on gait and leg muscle activity in adults with hemiplegia: systematic literature review. *Physiotherapy.* 2003;89(1):39-55.
- 25 Beckerman H, Becher J, Lankhorst GJ, Verbeek ALM. Walking ability of stroke patients: efficacy of tibial nerve blocking and a polypropylene ankle-foot orthosis. *Arch Phys Med Rehabil.* 1996;77(11):1144-51.
- 26 Beckerman H, Becher J, Lankhorst GJ, Verbeek ALM, Vogelaar T. The efficacy of thermocoagulation of the tibial nerve and a polypropylene ankle-foot orthosis on spasticity of the leg in stroke patients: results of a randomized clinical trial. *Clin Rehabil.* 1996;10(2):112-20.
- 27 Robinson W, Smith R, Aung O, Ada L. No difference between wearing a night splint and standing on a tilt table in preventing ankle contracture early after stroke: a randomised trial. *Aust J Physiother.* 2008;54(1):33-8.
- 28 Bleyenheuft C, Caty G, Lejeune T, Detrembleur C. Assessment of the Chignon dynamic ankle-foot orthosis using instrumented gait analysis in hemiparetic adults. *Ann Readapt Med Phys.* 2008;51(3):154-60.
- 29 Corcoran PJ, Jepsen RH, Brengelmann GL, Simons BC. Effects of plastic and metal leg braces on speed and energy cost of hemiparetic ambulation. *Arch Phys Med Rehabil.* 1970;51(2):69-77.
- 30 de Wit DC, Buurke JH, Nijlant JM, Ijzerman MJ, Hermens HJ. The effect of an ankle-foot orthosis on walking ability in chronic stroke patients: a randomized controlled trial. *Clin Rehabil.* 2004;18(5):550-7.
- 31 Pavlik AJ. The effect of long-term ankle-foot orthosis use on gait in the poststroke population. *J Prosthet Orthot.* 2008;20(2):49-52.
- 32 Sheffler LR, Hennessey MT, Naples GG, Chae J. Peroneal nerve stimulation versus an ankle foot orthosis for correction of footdrop in stroke: impact on functional ambulation. *Neurorehabil Neural Repair.* 2006;20(3):355-60.



- 33 Tyson SF, Thornton HA. The effect of a hinged ankle foot orthosis on hemiplegic gait: objective measures and users' opinions. *Clin Rehabil.* 2001;15(1):53-8.
- 34 Tyson SF, Rogerson L. Assistive walking devices in nonambulant patients undergoing rehabilitation after stroke: the effects on functional mobility, walking impairments, and patients' opinion. *Arch Phys Med Rehabil.* 2009;90(3):475-9.
- 35 Teasell RW, McRae MP, Foley N, Bhardwaj A. Physical and functional correlations of ankle-foot orthosis use in the rehabilitation of stroke patients. *Arch Phys Med Rehabil.* 2001;82(8):1047-9.
- 36 Burdett RG, Borello-France D, Blatchly C, Potter C. Gait comparison of subjects with hemiplegia walking unbraced, with ankle-foot orthosis, and with Air-stirrup(TM) brace. *Phys Ther.* 1988;68(8):1197-203.
- 37 Danielsson A, Sunnerhagen KS. Energy expenditure in stroke subjects walking with a carbon composite ankle foot orthosis. *J Rehabil Med.* 2004;36(4):165-8.
- 38 Fatone S, Hansen AH. Effect of ankle-foot orthosis on roll-over shape in adults with hemiplegia. *J Rehabil Res Dev.* 2007;44(1):11-20.
- 39 Franceschini M, Massucci M, Ferrari L, Agosti M, Paroli C. Energy cost and gait assessment for hemiplegic walking: effects of an ankle-foot orthosis [sic]. *Eura Medicophys.* 2002;38(2):57-64.
- 40 Franceschini M, Massucci M, Ferrari L, Agosti M, Paroli C. Effects of an ankle-foot orthosis on spatiotemporal parameters and energy cost of hemiparetic gait. *Clin Rehabil.* 2003;17(4):368-72.
- 41 Hesse S, Leucke D, Jahnke MT, Mauritz KH. Gait function in spastic hemiparetic patients walking barefoot, with firm shoes, and with ankle-foot orthosis. *Int J Rehabil Res.* 1996;19(2):133-41.
- 42 Hesse S, Werner C, Matthias K, Stephen K, Berteau M. Non-velocity-related effects of a rigid double stopped ankle foot orthosis on gait and lower limb muscle activity of hemiparetic subjects with an equinvarus deformity. *Stroke.* 1999;30(9):1855-61.
- 43 Iwata M, Kondo I, Sato Y, Satoh K, Soma M, Tsushima E. An ankle-foot orthosis with inhibitor bar: effect on hemiplegic gait. *Arch Phys Med Rehabil.* 2003;84(6):924-7.
- 44 Dieli J, Ayyappa E, Hornbeak S. Effect of dynamic AFOs on three hemiplegic adults. *J Prosthet Orthot.* 1997;9(2):82-9.
- 45 Churchill AJ, Halligan PW, Wade DT. Relative contribution of footwear to the efficacy of ankle-foot orthoses. *Clin Rehabil.* 2003;17(5):553-7.
- 46 Tyson S, Thornton H, Downes A. The effect of a hinged ankle-foot orthosis on hemiplegic gait: four single case studies. *Physiother Theory Pract.* 1998;14(2):75-85.
- 47 Berg K, Wood-Dauphinee S, Williams J. The balance scale: reliability assessment with elderly residents and patients with an acute stroke. *Scand J Rehabil Med.* 1995;27(1):27-36.
- 48 Richards CL, Malouin F, Dean C. Gait in stroke, assessment and rehabilitation. *Clin Geriatr Med.* 1999;15(4):833-55.
- 49 Bergner M, Bobbitt RA, Carter WB, Gilson BS. The sickness impact profile: development and final revision of a health status measure. *Med Care.* 1981;19(8):787-805.
- 50 Holden MK, Gill KM, Magliozzi MR, Nathan J, Piehl-Baker L. Clinical gait assessment in the neurologically impaired: reliability and meaningfulness. *Phys Ther.* 1994;64(1):35-40.

- 51 Gowland C, Stratford P, Ward M, Moreland J, Torresin W, Van Hulleenaar S, et al. Measuring physical impairment and disability with the Chedoke-McMaster stroke assessment. *Stroke*. 1993;24(1):58-63.
- 52 Smith P, Hamilton BB, Granger CV. The FIM. New York: Research Foundation of the State University of New York; 1990.
- 53 Perry J, Garrett M, Gronley JK, Mulroy SJ. Classification of walking handicap in the stroke population. *Stroke*. 1995;26(6):982-9.
- 54 Lincoln NB, Leadbetter D. Assessment of motor function in stroke patients. *Physiotherapy*. 1979;65(2):48-51.
- 55 Mathias S, Nayak USL, Issacs B. Balance in elderly patients: The "Get up and Go" test. *Arch Phys Med Rehabil*. 1986;67(6):387-9.
- 56 Borg G. Psychophysical bases of perceived exertion. *Med Sci Sports Exerc*. 1982;14(5):377-81.
- 57 Gage JR, DeLuca PA, Renshaw TS. Gait analysis: principles and applications: emphasis on its use in cerebral palsy. *J Bone Joint Surg*. 1995;77(10):1607-23.

## Who was involved in developing the statement

### Specialist Clinical Advisor and Project Lead

**Roy Bowers** Orthotist, Senior Lecturer, National Centre for Prosthetics and Orthotics, University of Strathclyde

### Steering Group

**John Dennis** Physiotherapy Team Leader, NHS Greater Glasgow and Clyde

**June Lawrie** Physiotherapy Team Leader, NHS Greater Glasgow and Clyde

**Barry Meadows** Head of Neurobiomechanics, WESTMARC, NHS Greater Glasgow and Clyde

**Michelle Miller** Practice Development Project Co-ordinator, NHS QIS (until July 2009)

**Linsey Rodgers** Administration Support, NHS QIS

**Robbie Rooney** Orthotics Manager, NHS Lanarkshire

**Lynne Rowley** Orthotics Manager, NHS Forth Valley

**Mark Smith** Consultant Physiotherapist in Stroke, NHS Lothian

**Liz Stoddart** Patient Representative

**Claire Tester** Professional Practice Development Officer - AHPs, NHS QIS (Chair)

### Working Group

**John Lamb** Principal Orthotist/Service Manager, NHS Tayside

**Lynn McEwan** Senior Orthotist, NHS Grampian

**Anne McQueen** Specialist Orthotist, NHS Greater Glasgow and Clyde

**Karen Marshall** Senior Physiotherapist, NHS Greater Glasgow and Clyde

**Nicola Munro** Advanced Specialist Orthotist, NHS Greater Glasgow and Clyde

**Morag Nicoll** Senior Staff Nurse, Scottish Stroke Nurses Forum, NHS Lothian

**Lynn Robertson** Lead Physiotherapist for Stroke Rehabilitation, NHS Dumfries & Galloway

**Karyn Ross** Orthotist, Lecturer, National Centre for Prosthetics and Orthotics, University of Strathclyde

**Philip Rowe** Head of HealthQWest Programme; Professor of Rehabilitation Science

**Debbie Strang** Bobath Tutor, NHS Greater Glasgow and Clyde

**Lynne Taylor** Orthotist, NHS Tayside

A wide group of individuals, networks and organisations acted as a reference group during the consultation phases of the development process.

## **NHS Quality Improvement Scotland Support Team**

<b>Susan Baxter</b>	Health Services Researcher (until December 2008)
<b>Jason Kay</b>	Communications Officer
<b>Joanna Kelly</b>	Health Services Researcher
<b>Jeniffer Kibagendi</b>	Equality and Diversity Officer
<b>Karen McGeary</b>	Communications and Publications Co-ordinator
<b>Joyce Mouriki</b>	Senior Public Partnership Officer
<b>Suzanne Wilson</b>	Health Information Scientist

## **Acknowledgements**

NHS QIS wishes to acknowledge the contribution made to the development of this best practice statement by the many healthcare professionals who reviewed drafts of the document as part of the reference group, and the clinicians and users of AFOs who shared their experiences. We are also grateful to Joyce Martin of the National Centre for Prosthetics and Orthotics, University of Strathclyde for photographs and to Barry Meadows of WESTMARC, NHS Greater Glasgow and Clyde for diagrams used in the document. The support of Chest Heart and Stroke Scotland, the Stroke Managed Clinical Networks and the NHS QIS AHP networks is also greatly appreciated.



You can look at this document on our website. It is also available, if you ask:

- in electronic format
- in audio format
- in Braille
- in large print
- in community languages

## NHS Quality Improvement Scotland

Edinburgh Office

Elliott House, 8-10 Hillside Crescent, Edinburgh, EH7 5EA

Phone 0131 623 4300

Glasgow Office

Delta House, 50 West Nile Street, Glasgow G1 2NP

Phone 0141 225 6999

E-mail: [qis.bestpracticestatements@nhs.net](mailto:qis.bestpracticestatements@nhs.net) website: [www.nhshealthquality.org](http://www.nhshealthquality.org)