

See discussions, stats, and author profiles for this publication at: <https://www.researchgate.net/publication/242252922>

MODELS FOR COUPLING BRIDGE SUBSYSTEMS

Article

CITATIONS

0

READS

18

1 author:



Ghada Karaki

Birzeit University

7 PUBLICATIONS 22 CITATIONS

SEE PROFILE

All content following this page was uploaded by Ghada Karaki on 07 January 2015.

The user has requested enhancement of the downloaded file. All in-text references [underlined in blue](#) are added to the original document and are linked to publications on ResearchGate, letting you access and read them immediately.

MODELS FOR COUPLING BRIDGE SUBSYSTEMS

Ghada Karaki*

* *Graduiertenkolleg 1462*
Bauhaus-Universität Weimar
Berkaer Str. 9
99425 Weimar
E-mail: ghada.karaki@uni-weimar.de

Keywords: Bridges, Vehicular load, Elastomeric bearings, Dynamic analysis.

Abstract. *The evident advances of the computational power of the digital computers enable the modeling of the total system of structures. Such modeling demands compatible representations of the couplings of different structural subsystems. Therefore, models of dynamic interaction between the vehicle and the bridge and models of a bridge bearing, a coupling element between the bridge's superstructure and substructure, are of interest.*

This paper discusses some models for the coupling possibilities in bridge engineering. The emphasis is on modeling the coupling functionality rather than modeling the vehicle or the bridge bearing as individual entities.

1 INTRODUCTION

Models of structural systems are created to describe and/or explain observations of pre-existed structures, or to visualize and design new ones. There is no fix method or manual to steer the creation of a model, it is usually a subjective process controlled by the modeler himself.

Structures of interest in this paper are bridges. A bridge can be modeled through making different assumptions about its subsystems, the way they function, and how they react to environmental effects. Moreover, the area of interest is the effect of transient loads (moving heavy vehicles) on the bridge response. Under current design practice, separate models for the bridge's superstructure and substructure are used. The analyzed responses of the superstructure are applied as boundary conditions to the substructure which is analyzed accordingly. The feedback mechanism of the structural behavior between the different subsystems (loading, superstructure, bearing system, and substructure) is ignored. Such separation in modeling and analyses means that little attention is given to the load-structure interaction and the special structural components (e.g. the bridge bearings). However, if these interactions and components are not treated cautiously the bridge service life may be influenced and even failure may occur.

The study of vehicle-bridge interaction and its dynamic effect on bridge's superstructure have been studied and included in the design practice. For non-swinging bridges (e.g. beam bridges), the dynamic effects are taken into account by increasing the normal static design loads by a dynamic amplification factor [7]. However, new materials and improved design methods are introduced in the last years that may result in higher and more flexible bridges, thus highway bridges may become increasingly susceptible to vibration. Such dynamic loads on bridges continually degrade them and increase the necessity of regular maintenance [3].

In this paper, the concept of coupling in bridges and their varying modeling description is of interest. In order to assess the amount of dynamic loading transferred to the subsystems, or whether the different couplings may give different answers to the dynamic problem, a fundamental understanding of couplings and their parameters is required. Equally important, a systematic study is needed to ascertain the use and the compatibility of the bridge's couplings when modeling. The vehicle-bridge interaction and the bridge bearing models are presented within the paper. The emphasis is given to their functionality as bridge's couplings and the parameters influencing them.

2 COUPLING I: VEHICLE BRIDGE INTERACTION

The vertical load applied to the road surface by each tire of a heavy vehicle can be separated into two components: the static load due to weight, and a fluctuating component known as the dynamic tire load. The static load depends on the geometry and mass distribution of the vehicle. Dynamic tire loads are caused by vibration of the vehicle when it is excited by roughness of the road surface. Such loads generate additional dynamic stresses and strains in the road surface which are thought to accelerate its deterioration [2]. The loading model of a moving vehicle could be represented as a moving constant load, a harmonic moving load, or a system of moving masses.

The simplest way to tackle the problem involving the calculation of dynamic responses is to consider a simply supported beam. Although a simply supported beam model is not representative of bridges, but it embodies many of the important dynamic characteristics of a beam bridge [2].

In the following sections a description of these different models and their parameters and effects on the bridge's dynamic responses are presented. The solutions for the moving loads on a simply supported beam are adopted from the work of [5].

2.1 Transient Load Models

2.1.1 Constant Moving Load

The easiest way to model vehicle load is as a constant force moving at uniform speed. As mentioned before the solutions of [5] are presented. The main assumption of this model is that the mass of the moving load is small compared to the mass of the beam, as a result, only the gravitational effect of the load is considered. The following is the solution of the vertical deformation of a simply supported beam, $v(x, t)$,

$$v(x, t) = v_0 \sum_{j=1}^{\infty} \frac{1}{j^2[j^2(j^2 - \alpha^2)^2 + 4\alpha^2\beta^2]} \left[j^2(j^2 - \alpha^2) \sin j\omega t - \frac{j\alpha[j^2(j^2 - \alpha^2) - 2\beta^2]}{(j^4 - \beta^2)^{0.5}} e^{-\omega_b t} \sin \omega'_j t - 2j\alpha\beta(\cos j\omega t - e^{-\omega_b t} \cos \omega'_j t) \right] \sin \frac{j\pi x}{l}, \quad (1)$$

where v_0 is the static deflection at mid-span of the beam, α is the speed parameter, ω is the circular frequency of the beam, ω_b is the circular frequency of damping of the beam, ω_j is the circular frequency of j -th mode of vibration of the undamped beam, ω'_j is the circular frequency of j -th mode of vibration of the damped beam, l is the span of the beam, t is the time coordinate, and x is the length coordinate.

From the solution above, it is noticed that the main parameters affecting this model is the speed of the vehicle, the damping of the bridge, and the modal characteristics of the beam.

2.1.2 Harmonic Moving Load

The simplest way in considering the interaction between the irregularities of the road surface and the vehicle is to describe the gravitational load of the vehicle with a harmonic component. The harmonic load is described by [5],

$$P(t) = Q \sin \Omega t, \quad (2)$$

where Q is the amplitude of harmonic function and Ω is the circular frequency of a harmonic function.

This load is a fraction of the total gravitational load, consequently the solution of the beam response is combined with the derived solution, (1), of the previous section. Hence the additional parameter influencing this model is the frequency ratio between the bridge and the harmonic component of the applied load. This parameter embodies the coupling between the road surface and the load, which would be apparent in the local vibrational behavior of the bridge's dynamic

response. The solution due to the harmonic component for a simply supported beam is the following [5]

$$v(x, t) = v_0 \frac{Q \omega_1^2}{P \Omega^2} \frac{1}{\left(\frac{\omega_1^2}{\Omega^2} - 1\right)^2 + 4\left(\frac{\omega^2}{\Omega^2} + \frac{\omega_b^2}{\Omega^2}\right)} \left\{ \left[\left(\frac{\omega_1^2}{\Omega^2} - 1\right)^2 + 4\frac{\omega_b^2}{\Omega^2} \right]^{0.5} \sin(\Omega t + \varphi) \sin \omega t + 2\frac{\omega}{\Omega} (\cos \Omega t \cos \omega t - e^{-\omega_b t} \cos \omega_1 t) \right\} \sin \frac{\pi x}{l}, \quad (3)$$

where ω_1 is the circular frequency of the first mode of vibration and $\tan \varphi = -\frac{2\omega_b/\Omega}{\omega_1^2/\Omega^2 - 1}$.

2.1.3 Moving System of Masses

In this model the vehicle is treated as a single mass point. However, such idealization is not sufficient for modern vehicles, a differentiation of unsprung (m_1) and sprung masses (m_2) is needed. In this case, the structure is excited by a system of masses moving along it, Fig. 1.

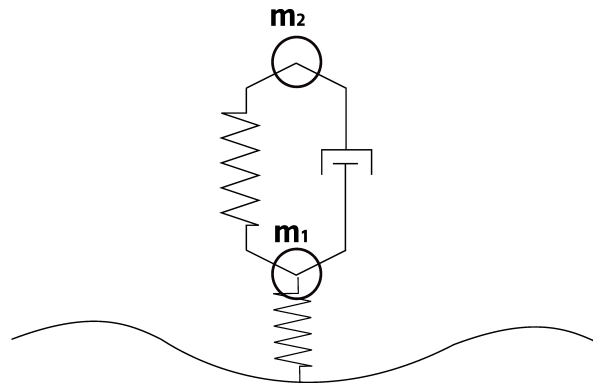

Figure 1: Moving mass model

The road surface irregularities, $\bar{r}(x)$, are assumed to vary harmonically along the span, Fig. 2, and are described by the following equation,

$$\bar{r}(x) = \frac{1}{2} \bar{a} \left(1 - \cos \frac{2\pi x}{l_a}\right), \quad (4)$$

where \bar{a} is the maximum depth of track unevenness and l_a is the length of road surface irregularities.

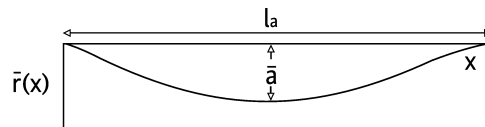

Figure 2: The road surface irregularities

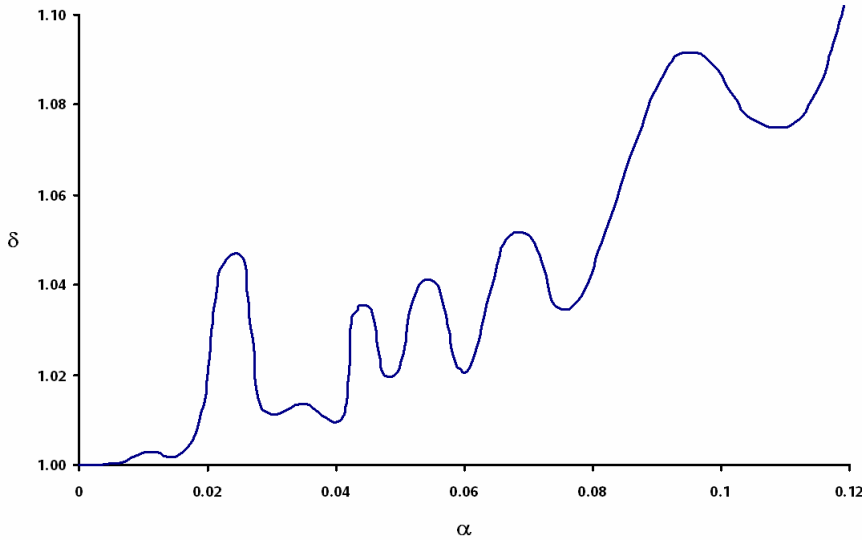

Figure 3: Effect of speed parameter (α) on the maximum dynamic deflection (δ) [5]

The force, \bar{R} , by which a moving system acts on a beam at the point of contact x_1 is found by [5]

$$\bar{R} = K[v_1(t) - v(x_1, t) - \bar{r}(x_1)], \quad (5)$$

where K is the spring stiffness of tires, $v_1(t)$ is the displacement of unsprung mass at time t , $v(x_1, t)$ is the beam vertical displacement at point x_1 at time t , and $\bar{r}(x_1)$ is the road surface irregularities at point x_1 .

The solution of this problem is fairly difficult compared to the previous models. A closed form solution is hard to find, therefore, numerical solutions are suggested for the vibrational differential equations of the system [5]. In introducing these solutions dimensionless parameters are of importance in defining the problem. These parameters are used later to understand the behavior of such models.

2.1.4 Influence of Different Parameters

In order to understand the importance of the dynamic tire forces on the bridge deck, it is necessary to predict accurately the primary responses of roads caused by fluctuating and moving axle loads. These responses of the bridge deck are known to depend on the speed of the vehicle as well as on the magnitude and frequency content of the loads. This section reviews the important parameters that influence the response of the bridge deck to vehicle loads.

- The effect of speed: At subcritical speeds, the maximum deflection at mid-span occurs during the passing of the load over the beam. Whereas at supercritical speeds, it is not noticed till the moving load leaves the beam, and the dynamic deflection is soon damped out by damped free vibration. Therefore, the cases of supercritical speeds are not of interest. Fig. 3 shows the effect of the speed parameter on the maximum dynamic deflection.
- The effect of frequency parameter of sprung mass: The frequency parameter is defined by the ratio of the sprung mass frequency and the bridge's natural frequency. In general the dynamic effects have a tendency to grow with the growing ratio, Fig. 4.

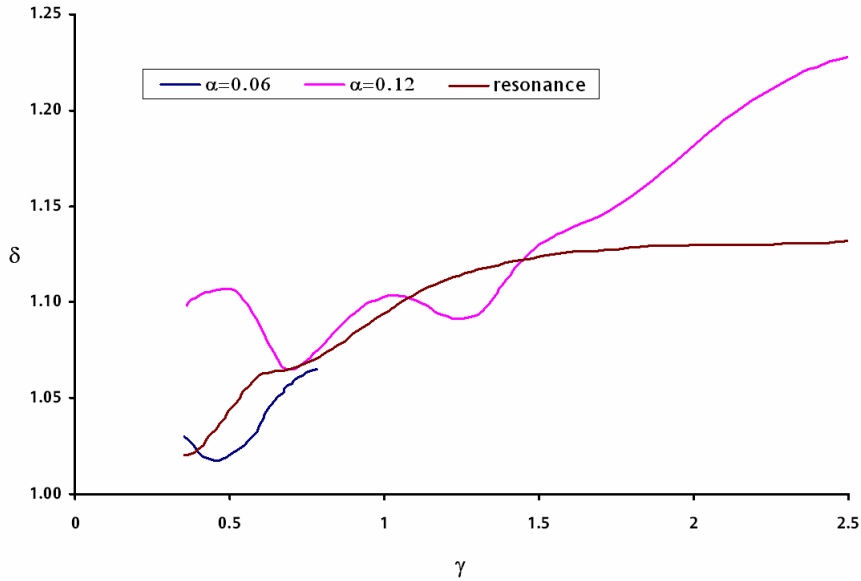

Figure 4: Effect of frequency parameter (γ) of sprung mass on the maximum dynamic deflection (δ) [5]

- The effect of the ratio between the weights of vehicle and beam: The dependency of the maximum dynamic deflection on this ratio is complicated, but generally it can be said that dynamic deflection grows with the growing ratio. This is noticed at high speeds, Fig. 5.
- The effect of beam damping: The dynamic deflection gradually falls away with growing damping values.
- The effect of vehicle damping: In general the dynamic deflection falls away with growing damping values.

2.2 Comparison Between the Different Models

The more complicated the model the more parameters included in defining the interaction problem. The point to be assessed here is whether the response of these models is influenced by the complexity. Fig. 6 shows a comparison between sprung mass model described in Sec. 2.1.3 and a combination between constant load model and harmonic load model in Sec. 2.1.2. The comparison is carried out using the maximum dynamic deflection with respect to the speed parameter, as it is valid for both models. A difference is noticed between both models within a certain range of speeds. This is a motivation to systematize when to use the simple or the complicated models, which is of significance in modeling.

2.3 Bridges are More Complicated

The solutions presented in the previous sections are for a simply supported beam. However, simply supported beam models are not representative for all beam bridges. On the whole, to study the dynamic response of bridges due to vehicular loading, more complicated configurations of beam bridges are considered and numerical models are used. These analytical solutions can be used as a basic step to validate a simple numerical model, and afterwards more detailed numerical models can be used for evaluation and assessment.

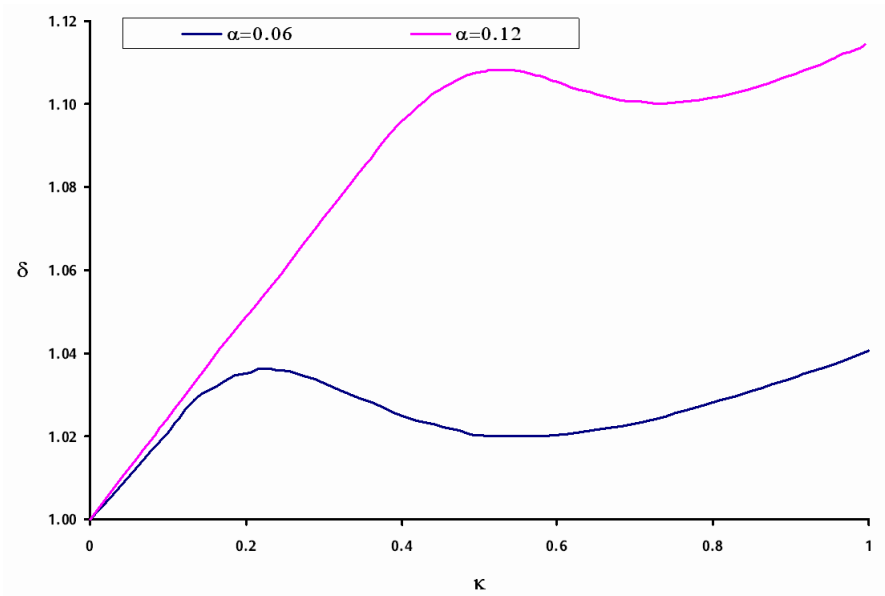

Figure 5: Effect of the ratio between the weights of the vehicle and the beam (κ) on the maximum dynamic deflection (δ) [5]

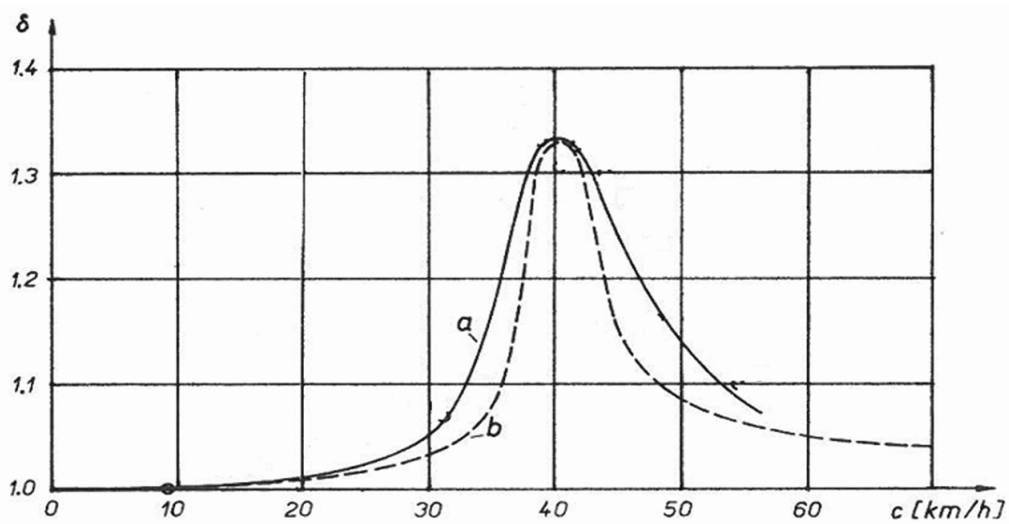

Figure 6: The maximum dynamic deflection in relation to the speed [5], (a) the sprung mass model and (b) the constant load model added to it a harmonic component

3 COUPLING II: BRIDGE BEARINGS- ELASTOMERIC BEARINGS

Elastomeric bearings are deformation bearings that consist of alternating elastomeric (rubber) layers bonded to intermediate steel plates.

3.1 Elastomeric Bearings Behavior

Elastomeric bearings are in general vertically stiff and horizontally flexible, which may lengthen the structure's period of vibration, thereby reducing the inertia forces that develop in the superstructure when considering dynamic analysis. The horizontal flexibility (shear stiffness) of an elastomeric bearing is detected by the total thickness of the elastomer, whereas the close spacing of the intermediate steel plates provides a large vertical stiffness (relative to shear). Therefore, elastomeric bearings are usually assumed rigid in the vertical direction. Accordingly the distribution of the bearing loads depends on the supported system and not on the bearing; vertical as well as horizontal bearing loads are assumed to be static, which means that the dynamic properties of the bearings become irrelevant. Nevertheless, elastomeric bearings provide some vertical elasticity and the elastomers provide some internal material damping that may be significant to consider in modeling.

3.2 Modeling Elastomeric Bearings

Elastomeric bearings are typically represented by a linear spring with constant stiffness considering only their axial degree of freedom, ignoring the fact that translational and rotational deformations are accommodated by elastomeric bearings and that such deformations interact with each other. The followings are some of the representations of the elastomeric bearings:

- Elastomeric bearing is represented numerically by independent linear springs in the directions of degrees of freedom (vertical, horizontal, and rotational). The interaction between the deformations and forces in the different directions of the elastomeric bearing is not accounted for in this model.
- A refined model considering such interaction between the components of the forces of the elastomeric bearing is presented by [8]. The followings are the relations to describe the additional forces corresponding to the deformations of the elastomeric bearings.
 - Horizontal restoring forces caused by shear deformation produces bending [8],

$$M = F_H \cdot d/2 = G \cdot A \cdot \tan \gamma' \cdot d/2, \quad (6)$$

where F_H is the horizontal restoring forces, d is the total thickness of the elastomeric bearing, G is the shear modulus of elastomeric bearing, γ' is the shear deformation, and A is the overall area of elastomeric bearing.

- Eccentricities combined with vertical forces cause additional bending [8],

$$M = F_V \cdot e = F_V \cdot \tan \gamma \cdot t_e, \quad (7)$$

where F_V is the vertical force, e is the load eccentricity from vertical axis, and t_e is the effective thickness of elastomer.

- Horizontal force resulting from the vertical load following the rotation of the bearing [8],

$$F_H = F_V \cdot \theta/2, \quad (8)$$

where θ is the rotational deformation of the elastomer.

A two node finite element is used to represent the elastomeric bearing, Fig. 7. This two dimensional finite element is described by a stiffness matrix relating nodal displacements and rotations to forces and moments considering the interaction of vertical, horizontal, and rotational loading [8].

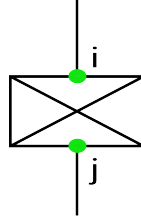

Figure 7: A two node element used in describing elastomeric bearing

$$\begin{Bmatrix} F_{x,i} \\ F_{y,i} \\ M_{z,i} \\ F_{x,j} \\ F_{y,j} \\ M_{z,j} \end{Bmatrix} = \begin{bmatrix} k_{xx} & 0 & 0 & -k_{xx} & 0 & 0 \\ 0 & k_{yy} & k_{32} & 0 & -k_{yy} & k_{32} \\ 0 & k_{32} & c_{mz} & 0 & -k_{32} & -c_{mz} \\ -k_{xx} & 0 & 0 & k_{xx} & 0 & 0 \\ 0 & -k_{yy} & -k_{32} & 0 & k_{yy} & -k_{32} \\ 0 & k_{32} & -c_{mz} & 0 & -k_{32} & c_{mz} \end{bmatrix} \cdot \begin{Bmatrix} u_{x,i} \\ u_{y,i} \\ \varphi_{z,i} \\ u_{x,j} \\ u_{y,j} \\ \varphi_{z,j} \end{Bmatrix} \quad (9)$$

The diagonal terms of the stiffness matrix describes the stiffness of the bearing in vertical, horizontal, and rotational directions (k_{xx} , k_{yy} , and c_{mz} , respectively). Whereas the off-diagonal term k_{32} is derived by [8] to take into account the interaction between the loading directions as explained previously

$$k_{32} = \frac{1}{2}(k_{xx} \cdot \Delta u_x + k_{yy} \cdot T), \quad (10)$$

where T is the total thickness of the elastomer.

- A detailed model of the elastomer material behavior is of necessity when modeling elastomeric bearing, especially in cases where complicated models for the vehicle-bridge interaction (Sec. 2.1.2 & Sec. 2.1.3) are used for the bridge's overall numerical model. Many material models have been suggested to model the elastomer that take into account the kinematic nonlinearity, the material nonlinearity, and the material inherent damping [10]. A general representation consists of parallel models for the hyperelastic, viscoelastic and elastoplastic behavior of the elastomer, Fig. 8.

The hyperelastic model describes the nonlinear elastic behavior of elastomer (rubber). The elastoplastic model includes the non-reversible strains of the elastomer under loading. The viscoelastic model describes the time dependent strain behavior of the elastomer, with such model the hysteretic loop is enclosed in the stress-strain relationship. The area of the hysteretic loop equals the energy loss during the loading cycle, which indicates the damping in the elastomer, Fig. 9. The inherent damping of the elastomer material may be of importance when transferring the dynamic effect of the moving vehicle from the superstructure (e.g. bridge's deck) to the substructure (e.g. bridge's pier).

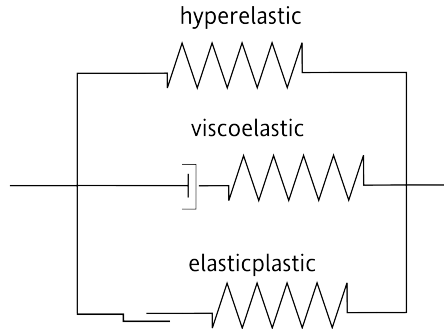

Figure 8: Schematic outline of parallel model

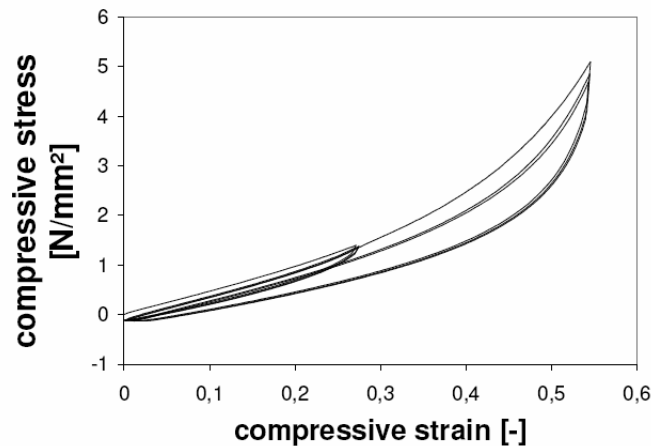

Figure 9: Elastomer behavior under cyclic loading [9]

4 FUTURE WORK

The models of the vehicle-bridge interaction do not take into account the actual boundary conditions offered by the bearings, therefore, an evaluation how the different parameters of these models affect the dynamic response of the bridge when considering models of bearings is to be done.

Another important aspect to consider is the performance of these couplings at high and low temperatures. The elastomeric bearings and the vehicle tires are affected by temperature changes. Considering their temperature dependent behaviors in assessing the dynamic loading and response is a type of coupling and of interest in bridges.

The above coupling models transfer the dynamic load to the tip of the bridge piers. The second step is to follow the transferred load and assess its dynamic component, its effect on the substructure and the soil boundary conditions. Furthermore, the feedback of the dynamic response of the soil to the substructure to the bearing to the deck is to be considered. Subsequently, a strategy will be developed and adopted to assess the performance of the different couplings

when considering the over-all bridge modeling in treating the dynamic response under transient loading.

5 CONCLUSION

In this paper two couplings in bridge structures are discussed, the vehicle-bridge interaction and the bridge bearing. The vehicle-bridge interaction may be described as a function connecting two sets of behavior. In this case, the coupling is embodied by mutual parameters that affect both systems. Whereas, the bridge bearings are elements used specifically to couple, in such elements the deformation and the transferred loads are used in characterizing the coupling.

In conclusion, the nature of these couplings is different, the influence of considering them is varying and the significance of using them is under study. However, the need to assess the amount of dynamic response transferred by or within these couplings is a common argument.

REFERENCES

- [1] [D. Cebon, *Handbook of Vehicle-road Interaction*. Taylor & Francis, New York, 1999.](#)
- [2] M. F. Green & D. Cebon, *Dynamic Interaction between Heavy Vehicles and Highway Bridges*, *Computers & Structures*, 62(2), 253–264, 1997.
- [3] M. F. Green & D. Cebon, *Dynamic Response of Highway Bridges to Heavy Vehicle Loads: Theory and Experimental Validation*, *Journal of Sound and Vibration*, 170(1), 51–78, 1994.
- [4] H. Eggert & W. Kauschke, *Structural Bearings*. Ernst & Sohn, Berlin, 2002.
- [5] L. Frýba, *Vibration of Solids and Structures under Moving Load*. Thomas Telford House, Third edition, London, 1999.
- [6] E. Hwang & A. S. Novak, *Simulation of Dynamic Load for Bridges*, *Journal of Structural Engineering*, 117(5), 1413–1434, 1991.
- [7] T. J. Memory, D.P. Thambiratnam & H. Brameld, *Free Vibration Analysis of Bridges*, *Engineering Structures*, 17(10), 705–713, 1995.
- [8] [R. Vogt, *Modeling of Bearings in Structural Systems for Bridges*, IABSE Symposium, Weimar, 93, 356–358, 2007.](#)
- [9] U. Freundt & R. Vogt, *Parameter identification for parallel hyperelastic - viscoelastic - elastoplastic models with damage for elastomeric materials and numerical example*, *Fourth European Conference of Constitutive Models for Rubber*, 335–340, 2005.
- [10] J. Yoshida, M. Abe, Y. Fujino & H. Watanabe, *Three-Dimensional Finite-Element Analysis of High Damping Rubber Bearings*, *Journal of Engineering Mechanics*, 130(5), 607–620, 2004.
- [11] [P. P. Xanthakos, *Theory and Design of Bridges*. John Wiley & Sons, Inc, 1994.](#)