

MEMORANDUM
 RM-4678-NASA
 SEPTEMBER 1965

GPO PRICE \$ _____

CSFTI PRICE(S) \$ _____

Hard copy (HC) 3rd _____

Microfiche (MF) _____

ff 653 July 65

THE MONITORING TASK IN AUTOMATED CHECKOUT OF SPACE VEHICLES

L. Chesler and R. Turn

FACILITY FORM 602

N 65 - 35 577	_____
(ACCESSION NUMBER)	(THRU)
<u>32</u>	_____
(PAGES)	(CODE)
<u>CR 3371</u>	_____ <u>05</u>
(NASA CR OR TMX OR AD NUMBER)	(CATEGORY)

PREPARED FOR:

NATIONAL AERONAUTICS AND SPACE ADMINISTRATION

The **RAND** Corporation
 SANTA MONICA • CALIFORNIA

MEMORANDUM
RM-4678-NASA
SEPTEMBER 1965

THE MONITORING TASK IN
AUTOMATED CHECKOUT OF SPACE VEHICLES

L. Chesler and R. Turn

This research is sponsored by the National Aeronautics and Space Administration under Contract No. NASr-21. This report does not necessarily represent the views of the National Aeronautics and Space Administration.

PREFACE

This Memorandum is a discussion of the monitoring task in automated checkout processes. It is part of a continuing study of man-computer compatibility in prelaunch checkout of space vehicles, performed under Contract NASr-21(08), the Apollo Checkout System Study, for the National Aeronautics and Space Administration.

The material presented in this study is primarily intended for use by the personnel, both at NASA Headquarters and the NASA centers, who are responsible for planning and implementing prelaunch operations and equipment for Apollo. Because of its general nature, however, the report should also be of interest to personnel in DoD and industry who are concerned with human monitoring of automated checkout or process control operations, or who are active in the information display field.

SUMMARY

This Memorandum deals with the roles that a human monitor may need to assume in automated checkout operations, describes his information requirements for performing selected monitoring tasks, and proposes a set of computer-driven information displays for increasing his effectiveness.

Participation of human monitors in an (even totally) automated checkout is essential in order to compensate for the limited capability of the checkout programs to detect incorrect test design, errors in checkout programs, and malfunctions in checkout equipment. A human monitor who has maintained context with the progress of the checkout may be able to detect such instances and take corrective action.

In the Memorandum the information requirements of a human monitor for effective participation are categorized and summarized, and the following set of information displays is suggested: a dynamic network display of test steps and their ordering, schematic displays of equipment under test with overlaid test data, matrix displays of current status of systems and equipment, and various text and graphical displays.

Questions concerning implementation of the proposed displays are considered, and it is concluded that current display devices would be adequate. Experimental results with a pilot program for one of the displays are used to indicate that data processing support required for maintaining and updating the display is not excessive. It is suggested that providing the monitor with means to regulate the rate of performing automated testing may greatly increase his ability to perform his task and may, in addition, impart to him a feeling of being in control of the checkout.

At present we have no experimental data concerning the effectiveness of the various displays in monitoring actual automated checkout processes. Accumulating this information for further study seems appropriate. If the displays proved to be effective as communication media for the monitor, they might also be useful in test design, writing, debugging or modifying test programs, and in on-line diagnostic and adaptive count-down operations.

CONTENTS

PREFACE	iii
SUMMARY	v
Section	
I. INTRODUCTION	1
II. MONITORING OBJECTIVES IN AUTOMATED CHECKOUT.	2
Maintaining Context.	4
Compensating for Controller Limitations.	6
Detecting Controller Errors.	9
Hazard Detection	12
Information Requirements for Various Monitoring Objectives	13
III. MAN-COMPUTER COMMUNICATION IN MONITORING	16
Information Extraction	16
Network Display.	17
Schematic Displays	23
Matrix Display	25
Graphic and Textual Display.	25
Uses of Display.	25
Checkout Rate Control.	27
IV. IMPLEMENTING THE DISPLAYS.	29
Display Devices.	29
Data Base.	30
Programming Implications	31
V. CONCLUSIONS.	33
Appendix	
AN OUTLINE FOR A NETWORK DISPLAY PROGRAM	35
REFERENCES.	47

I. INTRODUCTION

In previous publications on automated prelaunch checkout of advanced space vehicles⁽¹⁻⁵⁾ it has been pointed out that the ability to perform tests automatically does not free from further participation the test personnel whose tasks have been automated. Personnel are still needed to watch the progress of testing and to compensate both for possible incompleteness of the test programs and errors in their execution. Such participation of personnel is commonly referred to as "monitoring."

To date we have not found in the checkout literature any detailed or comprehensive discussions on the manned monitoring task and the associated man-computer communication requirements. In this Memorandum we attempt to fill that gap by investigating monitoring with respect to automated confidence testing in the prelaunch checkout of Apollo space vehicles. In particular, we wish to define the monitoring task, to identify reasons for and objectives to be obtained through monitoring, to establish the monitor's information requirements, and to discuss several basic information displays.

For our discussion, we have attempted to identify all plausible problems in automated confidence testing that may require monitoring. Not all of these, however, are equally likely or equally serious in a given test situation. Similarly, the particular application will determine if the monitoring task to be performed will be manual or automatic (whenever both are feasible). Finally, we are aware that many of the monitoring tasks we identify are performed routinely in current automated checkout systems. We believe, however, that our analysis of the monitoring task contributes to the understanding of its nature and that the suggested approaches to information display could lead to more effective monitoring.

II. MONITORING OBJECTIVES IN AUTOMATED CHECKOUT

It is useful to discuss the monitoring task in terms of a general feedback control system. The basic elements of this system are a "dynamic process" and a "controller" whose task is to maintain the process within specified boundaries. Figure 1 depicts such a system.

In certain control systems a secondary controller may be present. When the task of the secondary controller is to observe the course of the process and the performance of the primary controller, with the ability to override the primary controller and take direct control, we refer to the secondary controller as a "monitor." A system with a monitor is depicted in Fig. 2.

In monitoring automated confidence testing of space vehicles, the controller is a computer program, with its associated ground support equipment (GSE), and the monitor is a human operator (e.g., test engineer). The dynamic testing process consists of a series of test steps each of which involves generation and application of stimuli, measurement of responses, and evaluation of the responses on the basis of test criteria. In early checkout systems the performance of all these tasks was controlled by human operators. When the checkout process, in particular confidence testing, was automated, many of these control tasks were programmed. However, the responsibility for the correct and safe performance of the checkout still rests with the human operator. This fact, coupled with the rather limited capability of a computer program to handle unanticipated responses and the need of the human operator to be aware of the progress of the checkout and the state of the system, leads directly to the human operator's assumption of a monitoring position, i.e., he now observes the automatic execution of his previous job.

With verification of correct functioning of the prime equipment and completion of testing before a specified deadline as testing goals, the following specific objectives of monitoring can be identified: maintaining context, compensating for controller limitations, detecting controller errors, and detecting hazardous conditions.

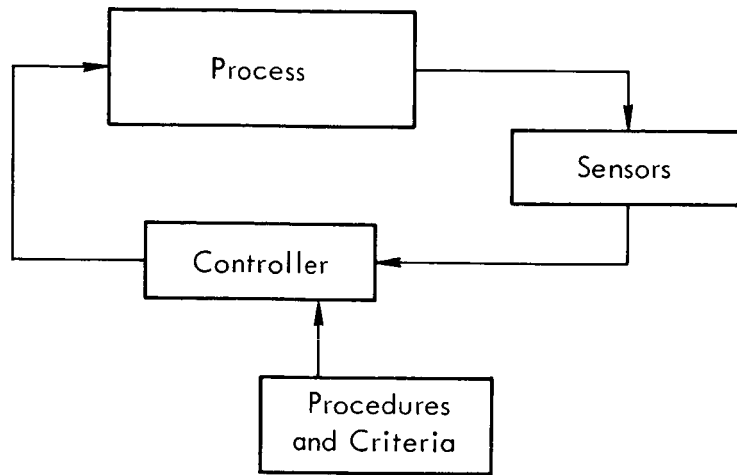

Fig.1 — Control system

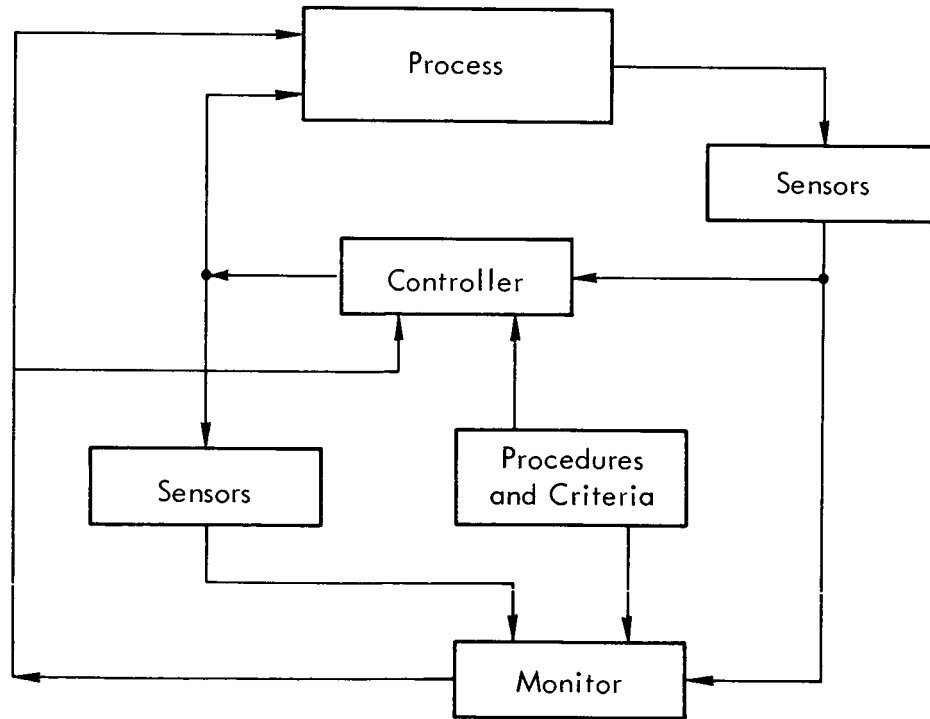

Fig.2 — Control system with monitor

MAINTAINING CONTEXT

Even if we assume that the controller (computer program) is capable of detecting all prime equipment malfunctions and that there are no chances for controller errors or undetected hazards, a requirement for monitoring still exists. It is necessary for the human operator to maintain context, to be aware of the progress of the testing so that he can plan ahead, learn about the behavior of the equipment and the controller, thus enhancing his ability to improve test procedures, and maintain his confidence in the effectiveness of automated testing.

Planning Ahead

The monitor needs to plan ahead in order to be prepared to take control of the checkout process at either a scheduled or an unscheduled point.

A scheduled assumption of control is associated with performing manual tests and various manual coordinating activities (e.g., initiating and terminating tests). In such cases the time, conditions, procedures for taking control, and subsequent control actions are all specified in the test program. The following information should be useful to the monitor:

- o An indication and identification of the forthcoming manual activity to alert the monitor
- o An estimation of the time until and duration of the required action
- o A description upon request (to refresh the monitor's memory) of the procedures for both taking control and performing the required actions.

An unscheduled assumption of control arises when a malfunction is detected and the diagnostic procedure must be performed by the monitor.* In this case the controller halts the testing process and informs the monitor, and the latter initiates a diagnostic procedure. In general,

*An unscheduled assumption of control also occurs when the monitor decides to override the computer to compensate for computer errors or limitations. This is discussed on p. 6.

the monitor can obtain all the information required for fault isolation after a "hold" has been initiated. However, there may be a few situations where useful observations could be made by the monitor only during testing.

After a malfunction has been detected prompt diagnostic action may be needed, and the monitor may not have sufficient time to obtain the required information in the routine manner. (For example, the physical processes under test may preclude maintaining lengthy holds without expensive recycling and significant loss of time.) In this situation the monitor would require the following:

- o Alerting information indicating those test steps where malfunctions requiring prompt diagnostic action may occur
- o For each such test step, a list of the likely causes of malfunctions and applicable diagnostic procedures
- o During the test, selected response data to facilitate fault diagnosis if a hold occurs.

Patterns giving clues to possible malfunctions and their causes (which would facilitate fault diagnosis) may be overlooked by the controller and thus would not be available to the monitor when a hold occurs. The monitor must try to identify these "suspicious" patterns by scanning information on current and past responses of the system, which he selects on the basis of his experience and ingenuity. A detected pattern may indicate an increased likelihood of certain malfunctions and alert the monitor to pay very close attention to tests being performed. This task is very similar to detecting "controller limitations," and the information requirements enumerated for the latter (on p. 9) are also applicable here.

Learning and Evaluation

A monitor may be interested in obtaining general information on the checkout process both to be aware of its characteristics and to be able to evaluate its performance (because he may be required to assess the value of new tests, procedures, and designs, and to provide explanations of physical phenomena that occur).

The information requirements for this activity are rather general, and the monitor may need to gain access to any information available to the controller during testing or to any previously compiled reference data. Such information should be presented to the monitor in a "fertile" manner, i.e., such as to stimulate insight and thought. For example, an observation of the flicker of a meter pointer may start the mind of an experienced observer along a line of thought that leads to the discovery of a previously unknown interaction. The monitor may also need to obtain permanent records of any information presented to him.

Finally, the monitor is still ultimately responsible for the checkout of his system. Even when automated testing is proceeding smoothly he needs a sense of contact with what is happening to maintain his confidence that the equipment is functioning properly and the checkout process is being performed correctly. For this purpose he should be presented information that depicts:

- o The status of the checkout--tests that have been completed, are presently being performed, and still remain to be performed
- o The status of the equipment under test
- o Time information--time of checkout start, current time, and predicted checkout completion time--for comparison with anticipated testing schedules.

COMPENSATING FOR CONTROLLER LIMITATIONS

The term "controller limitations" refers to the inability of the controller to recognize indications of malfunction or unusual behavior of the equipment under test. Failure to provide the controller with instructions for testing or criteria for recognizing a set of events and the limited capability of the controller to observe the behavior of all equipment at all times (or the unavailability of appropriate sensors) are the main causes of controller limitations.

The main reasons why the controller may not have been provided with the proper instructions are the following:

1. Errors were made in test specification and design, e.g., tests were omitted, or they failed to detect conditions they were intended to detect.

2. Occurrence of a set of events was considered improbable at the time of test design and provisions for their detection were omitted deliberately, e.g., on economic grounds.

3. Occurrence of a set of events was unanticipated at the test design time. For example, limited operational experience had not permitted their identification in systems where novel equipments and processes were integrated for the first time.

In order to deal with this part of the problem, the monitor may want to know the tests that have been used as the basis of judging the status of the equipment. This information, together with his knowledge of the performance of the system, should enable him to decide whether these tests provide sufficient evidence, i.e., whether some important tests may have been omitted. For example, the monitor might be presented with an electrical schematic diagram of the equipment under test, showing the location of test points, the stimuli applied, and the test responses. With this information, the monitor might decide that additional parameters (e.g., voltage, current) should be measured.

Inadequate test design may be the result of differences between the expected performance of a piece of equipment on which the test design is based and its actual performance during test. For example, a time delay may have been inserted in a test to permit a parameter to reach a steady state condition before making the measurement. If the transient behavior of the parameter was estimated incorrectly, the measurement may be invalid. In general, a monitor will not attempt to question the validity of a test unless he has reasons to suspect inadequacy, e.g., in cases of limited operational experience and equipment integrated for the first time.

One method that a monitor could use to establish the validity of a test is to establish the validity of underlying assumptions by comparing the assumed responses with actual responses. This implies that the monitor be supplied with information on the equipment and test design and the actual equipment responses. In cases where the amount of required information is great, it may be sufficient to present to the monitor only certain key descriptors on the response characteristics. For example, errors in some tests may be discovered simply by observing

that a variable is increasing or decreasing, that its rate of change is slow or fast, that it is periodic or aperiodic, etc.

Detection of certain malfunctions may be deliberately omitted from the test program in the interest of economy and on grounds that they are very improbable. It is possible, however, that the probability of certain of these events occurring increases during the checkout as a result of the occurrence of other "improbable" events (which themselves may not be malfunctions). To add to the effectiveness of the checkout, the monitor must look for the occurrence of these events. He can do this if he knows which improbable events were omitted and when they may occur during the checkout. Given this information he can look for clues hinting that the likelihood of one or more of such malfunctions has increased or that a malfunction actually has occurred. Often clues emerge only after information observed in different parts of the system at different times is combined into a pattern and regarded in the light of past experience. For example, the occurrence of certain malfunctions may increase the likelihood of other, additional malfunctions in related parts of the equipment.

The controller is not only limited by test deficiencies; it is limited in the capability to observe the behavior of equipments not directly under test. The controller may be unaware of interactions of equipment under test with other equipment and the propagation of malfunctions to other already tested systems.

A monitor would attempt to compensate for this type of controller limitation by observing the behavior of equipment he suspects might interact with the equipment under test, based on his knowledge and experience of potential interactions and subject to modification during the course of the test. The information required by the monitor for performing this task includes all known interactions between equipment, times when these interactions are more likely, and a description of the type and nature of malfunctions that could occur. Some of this information may be obtained from off-line simulations of the behavior and checkout of the prime equipment or from the monitor's observations during the checkout. (6)

Thus, the monitor's task in compensating for controller limitations is based on an initial suspicion that the likelihood of occurrence of those events that the controller is incapable of detecting is increasing. This suspicion is derived from the monitor's observations during the test, his general experience, and his knowledge of past system performance. It leads the monitor to hypothesize possible areas where undetected malfunctions may occur. The inherent vagueness of this task and the fact that it involves adapting to circumstances that arise after the start of the checkout preclude its automation except in very limited circumstances, such as detection of certain test design errors.

Besides observing specific responses of the system, the monitor may require additional reference information, in some cases finding it useful to have computational assistance from an on-line computer. The following specific information should be available on request to the monitor for this task:

- o Test design information: descriptions of test and equipment, pretest assumptions on response characteristics, functional flow diagrams
- o For a given piece of equipment: the tests required for its qualification, test status of its parameters, its malfunction and maintenance history, selected response data, a list of deliberately omitted tests and symptoms of associated malfunctions
- o Lists of known or suspected interactions between equipment, times of occurrence, malfunctions that might occur, their symptoms, and test points where symptoms may be observed.

DETECTING CONTROLLER ERRORS

By "controller errors" we mean departures of the controller (computer program) from planned tests. The main reasons for controller errors are:

- o Program errors: incorrect specification or sequencing of test steps in the control program; incorrect input data
- o Malfunctions in checkout equipment: incorrect operation of the checkout computer or the supporting test equipment.

The above error-causing events may occur in any part of the check-out program or equipment, at any time, and for very short duration. Detecting the occurrence of these events by human monitor is, therefore, exceedingly difficult, and the monitor should concentrate, instead, on the detection of their effects as manifested in incorrect performance of one or more of the following checkout tasks:

1. Test Selection--choosing the next test step for execution. The controller errors here mainly affect the sequence of test steps: they may be omitted or incorrectly selected. In both cases either incomplete testing, "hanging up" of the test program, or possible harm to the system may result.

2. Test Execution--performing the selected test step. The following kinds of controller errors may occur:

- (a) Commencing to execute the test step before all required initial conditions have been satisfied (e.g., all prerequisite tests may not have been completed). This might lead to interference with other tests performed on other systems, hazards, incomplete testing, and possible unpredictable responses.
- (b) Application of incorrect stimuli at inappropriate times or test points, or for a wrong duration, leading both to incomplete or no testing and damage either to the system under test or to other systems (some of which may already have been tested).
- (c) Measuring of responses at incorrect test points or with inappropriate sensors, perhaps causing incorrect evaluation of system performance.

3. Test Evaluation--comparing equipment responses with predetermined limits to establish the status of the particular equipment under test. Possible controller errors here are:

- (a) Comparing wrong responses with wrong criteria. The effect of this is incorrect evaluation.

- (b) Ignoring out-of-limits condition of responses and declaring the equipment operational.
- (c) Declaring the equipment "no-go" although all responses are within specified limits. (Usually the result of this is time wasted in attempted diagnostic testing or in repeating the test step.)

4. Test Assessment--determining the status of the checkout process on the basis of the results of test evaluation. Errors here are limited to:

- (a) Ignoring a "no-go" and continuing checkout of other equipment.
- (b) Halting checkout although all equipment is operational.

5. Hazard Detection. The controller errors here are mainly failing to detect or ignoring the existence of hazards that the program has been mechanized to recognize.

The monitor, in order to be able to recognize the effects of controller errors, needs to know both what the controller is doing and what the controller should be doing. Typical items of information needed are listed below:

- o Test step identification and instructions for performance: stimuli to be applied, test points, test duration, etc.; test points for response measurement, sensors to be used
- o Actual controller actions in performing the test step: stimuli applied, test points, etc., test points selected for response measurement, sensors used. Result of comparison of response with criteria.

The routine and completely specified nature of this task lends itself to automation, i.e., use of another computer to monitor the controller. Situations may, however, arise where a human monitor would have to detect controller errors directly.

HAZARD DETECTION

A hazardous condition in automated confidence testing exists when unexpected events such as controller errors, test design errors, equipment malfunctions, or unsafe test procedures occur that might lead to catastrophic events. These conditions are anticipated when they arise in conjunction with scheduled performance of a set of tests closely associated with a potentially catastrophic process (e.g., testing parts of ordnance firing circuits), but they may also be unanticipated, e.g., a controller error may unexpectedly lead to testing of RF circuits that maintain an RF beam for command destruct receivers.

When hazards are anticipated as part of normal testing, catastrophic events that may occur and the key sequences of events that lead to them are known. The task of the monitor in this situation is to observe whether the test process is following the planned sequence or has entered one such key sequence, and, if so, to take appropriate action to reduce the hazard level. For this task the following information could be presented to the monitor:

- o Alerting information--an indication that testing is entering a hazardous region
- o Description of key sequences toward catastrophic events, indication of steps in these sequences that the controller is scheduled to take, indication of steps actually taken, and magnitudes and critical values of certain key variables
- o Procedures for taking control and reducing the hazard level (to prepare the monitor to take control if available automatic backup procedures should fail).

In the case of unanticipated hazards, no alerting information may have been provided to the monitor, and his task now also will include hazard detection. Since all possible sequences to catastrophic events cannot be expected to be known, it is not sufficient to observe only those sequences already determined for anticipated hazards. As in detection of controller limitations, the monitor must first develop a "suspicion" of possible hazardous conditions and then observe selected information to verify his suspicions.

Information requirements of the monitor in this part of the hazard detection task are similar to those already listed for handling controller errors and limitations.

To handle hazards that arise in unsafe test procedures, e.g., personnel in close proximity to systems under test, a visual display of the test area may be adequate, as is presently done.

As soon as a hazardous condition has been detected, opportunities for its elimination exist, i.e., depending on the hazard level and whether it is anticipated, specific control options should be available. For example, it may be sufficient initially to stop further testing and maintain constant the established hazard magnitude. If that hazard magnitude is unacceptable, appropriate procedures for "backing off" to a lower hazard level can be chosen.

At high levels of hazards the monitor's only choice is to eliminate the hazard. In the case of lower hazard levels, he may choose to wait, but here the decision of when to apply controls is complicated by the following:

- o Various time periods during the existence of a hazard may be more or less suitable for its elimination, i.e., the costs of controls may vary over time, with higher hazard levels usually implying higher control costs
- o Time left in a given hazard level may be of uncertain duration, and the success in applying a control may be uncertain
- o Several hazard conditions may exist simultaneously, making it necessary to assign priorities, e.g., on the basis of the costs of associated catastrophic events.

INFORMATION REQUIREMENTS FOR VARIOUS MONITORING OBJECTIVES

In the previous section a number of monitoring objectives were discussed, and for each objective the associated monitoring tasks and their information requirements were described. Since some or all of these monitoring tasks may be performed simultaneously, the information presented for performing one task may be useful for performing another. To facilitate later discussion, Table 1 presents a summary of these

Table 1
 SUMMARY OF INFORMATION REQUIREMENTS FOR
 VARIOUS MONITORING OBJECTIVES

Type of Information	Maintaining Context	Controller Limitations	Controller Error Detection	Hazard Detection
<u>Program</u>				
Sequence and schedule of test steps	x	x	x	x
For each test step:				
Identification	x	x	x	x
Estimated duration	x	-	x	-
Alert indication for:				
Hazard	-	-	-	x
Prompt diagnostic action	x	-	-	-
Manual performance	x	-	-	-
Interaction	-	x	-	-
<u>Instruction</u>				
Initial conditions for test	-	-	x	-
Stimuli, test points	-	-	x	-
Test points for responses	-	x	x	-
Response evaluation criteria	-	x	x	-
Hazard detection criteria	-	-	-	x
<u>Response</u>				
Test measurements	x	x	x	-
Critical variables	-	-	-	x
<u>Status</u>				
Checkout	x	-	x	x
Equipment	x	x	x	x
<u>Reference</u>				
Equipment description				
Schematics and diagrams	x	x	-	-
Tests to qualify	x	x	-	-
Likely malfunctions, symptoms	x	x	-	-
Interactions with other equipment	x	x	-	-
Equipment history				
Performance	x	x	-	-
Malfunctions	x	x	-	-
Maintenance	x	x	-	-
Test design description	-	x	-	-
Deliberately omitted tests	-	x	-	-
Hazardous sequences	-	-	-	x
Procedures for taking control	x	-	-	x

requirements, classified into the following categories: (3,4)

- o Program information--specification of test objectives and listing of the test steps in the sequence they are to be performed
- o Instruction information--detailed instructions for performing a test step and evaluating the results
- o Response information--responses from the equipment under test
- o Status information--information depicting the operational readiness of the prime and checkout equipment and the progress of the checkout process
- o Reference information--information compiled both before the start of the checkout and during execution of test steps previous to the one currently performed. This information depicts the general nature and performance characteristics of the prime equipment, the checkout equipment, and the checkout process.

The information requirements presented in Table 1 should be fairly complete. They may seem quite extensive, however, when processed by a single monitor. In such a case, depending on the particular situation, decisions will have to be made as to which parts of the monitoring tasks are more important and which information items need to be presented in lieu of the complete list. In many cases the task of monitoring may be performed by several people, allowing a reduction in the amount of information processing required from a particular individual, e.g., while one person maintains context, another may detect controller limitations, and a third may detect hazards and controller errors.

In a particular checkout situation there may exist a number of specific monitoring tasks that may be performed automatically by a computer program. These are primarily tasks that either can be precisely formulated prior to testing or that require fast and accurate responses (e.g., periodic observation of system status, detecting certain controller errors, some aspects of hazard detection) or both. However, one class of monitoring task that is very difficult if not impossible to mechanize (and thus is inherently best suited for human performance) is that of compensating for controller limitations.

III. MAN-COMPUTER COMMUNICATION IN MONITORING

INFORMATION EXTRACTION

A human operator performs the monitoring tasks on the basis of information presented to him in messages at rates normally established by the controller, i.e., at the rate the control computer executes the test programs. If the monitor is to interact with the controller in real time or at least with minimum time delays, he must be able to extract the required information from the messages, perform the required mental data processing, and respond within the available time. Since this interval is usually short, all displays should be designed and messages composed so that information extractability* is increased.

To improve information extractability, the following characteristics of computer messages should be considered:

1. The type of message--graphic, text, or composite. The choice of message type is based on the planned use of the information, e.g., if controller actions are to be compared with required actions, a graphic message may lead to greater extractability by permitting faster comparisons than a message in text form.
2. Coding of information--different coding dimensions and alphabets permit different degrees of extractability, depending, of course, on the proficiency of the monitor. Among the usual coding dimensions are:
 - o Symbols--alphanumeric or abstract
 - o Geometric shapes
 - o Colors
 - o Position on display area
 - o Flash rate
 - o Length

*By extractability we mean the ease of obtaining useful information from a message.

3. Format of the message--structuring the message may permit faster selective extraction, e.g., presenting a list of items alphabetically, rather than in random order.
4. Redundancy in coding or in information--at times redundancy increases extractability, although excessive redundancy may lead to a loss of extractability.

The extraction time, the time required to obtain the desired information, is a measure of its extractability. Extraction time is affected by the amount of information that must be obtained, by the accessibility and legibility of the displayed message, by the vigilance of the monitor, and by his proficiency.

In specifying display designs for the monitor, we have attempted to increase extractability by using coding alphabets compatible with the monitor's proficiency and experience, by using formatting to permit selective extractability (e.g., permit anticipation of the display area where certain information will appear), and by presenting as much predictive and alerting information as feasible so that the processing task is reduced as much as possible to a simple, logical operation such as comparison.

Five basic types of display seem to be implied by the information requirements of monitors and our goal of extractability: network, schematic, matrix, graphic, and text.

NETWORK DISPLAY

A checkout program consists of a set of test steps so ordered that one step cannot be initiated until certain other steps have been completed or until specified constraints have been satisfied. This may be depicted graphically by a network of nodes, representing test steps, which are connected by line segments indicating their sequencing.

Representation of program information in this form presents the monitor with the following information:

- o Test steps to be performed
- o Test step relationships: steps that must precede others, steps that control others, and steps that may be performed simultaneously.

Additional nodes that do not represent actual test steps but rather such activities as preparation for tests or concluding operations may be incorporated in the network. Figure 3 depicts a two-dimensional network display. As partially shown there, the following specific information is associated with each node of the network:

1. Test identification--the number and name of the test and the parameters tested, coded by alphanumeric symbols.
2. System identification--name of the equipment and system being tested, coded either by alphanumeric symbol or the shape of the node.
3. State of the test step--whether the test has been completed, is in progress, has detected a malfunction, was aborted, is ready, etc. Here the color, shading, or design of the node could be used as coding dimensions.
4. Alerting information--indication that special attention should be given to the test and identification of the reason, e.g., hazard, prompt response required if malfunctioning, interaction with other tests, suspicious, etc. A flashing light at the node could indicate alert, and the flash rate could indicate urgency. Special symbols could be used to identify the reason for alert.
5. Duration of test--both expected and actual duration of the test step could be indicated by the length of the node, using an appropriate time scale, or by alphanumeric symbols.
6. Indices to more information--could refer the monitor by means of alphanumeric characters to text or graphical displays that could be requested.

Dynamic Behavior

During the checkout the monitor is interested in the progress of testing, i.e., which tests have been completed, which are currently in progress, and which are to be performed in the near future. It is, therefore, necessary to superimpose time information on the network display.

We propose to add the time information in the manner shown in Fig. 3, i.e., we establish the X-axis of the display area as the time axis and set up a "present time" line. The area to the left of

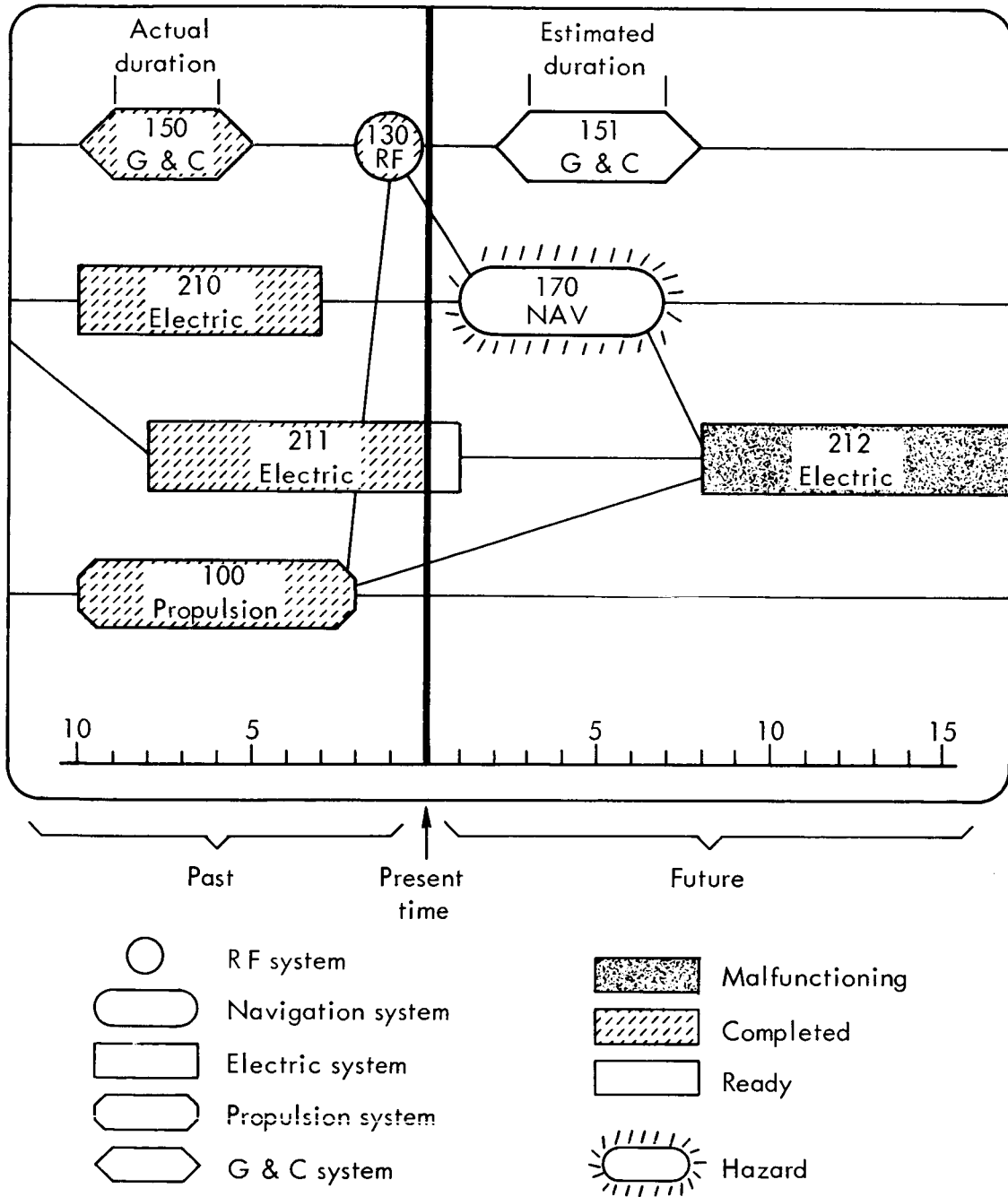

Fig.3 — Network display of program information

the present time line is the "past," and the area to the right is the "future." The length of the node indicates its duration on the chosen time scale--the length of a node in past time indicates actual duration, in future time estimated duration. Since the "present time" line is stationary, the network must move. Thus, a node is moved from the "future" to the "present" line, and from there it moves gradually into the "past" as it has been completed. The node of the past may be of different length than was estimated when it was in the future.

If the data processing required to maintain a network display such as depicted in Fig. 3 becomes excessive, it is possible to use a number of simpler network display versions that still would present much of the desired information. For example, the duration of a test step could be indicated digitally near its node, and the color coding could be replaced by alphanumeric symbols. In fact, a network display may even be presented in a tabular manner, as in Fig. 4. These changes, however, reduce the extractability of the displayed information; the interactions among nodes are more readily perceived in Fig. 3 than in Fig. 4.

A more complex version of the network display may be presented in a three dimensional perspective drawing, as shown in Fig. 5. The depth dimension would then be the time axis. Future nodes would move toward the monitor. The "present" line could either be at the very front of the display or recessed by a desired amount to permit display of some "past" nodes. Such a display would probably give the monitor a feeling analogous to that in driving an automobile.

Display Controls

The following control capability for the network display seems desirable:

- o Move the "present time" line on the display surface--permitting the monitor to look more in the "past" or more in the "future"
- o Remove nodes--permitting the monitor to eliminate from the network nodes that represent tests of no immediate interest

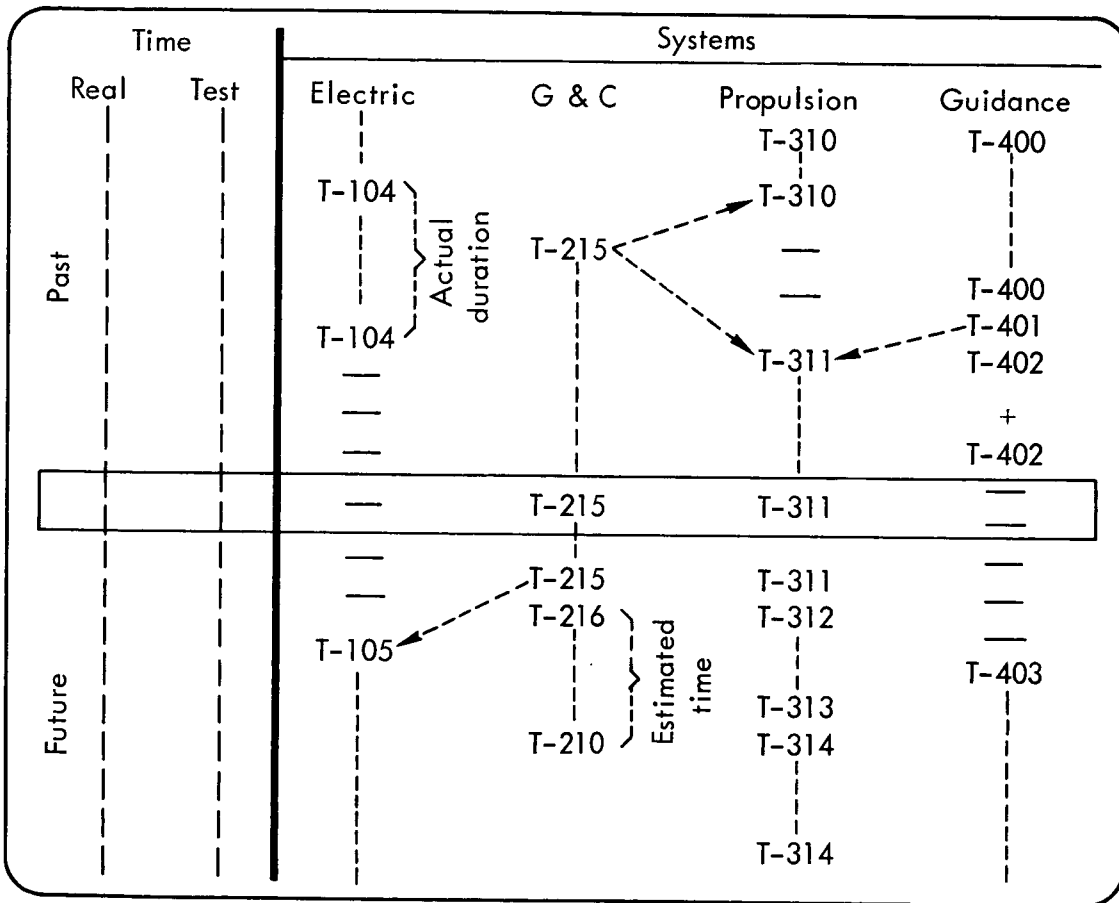

Fig.4 — Tabular display of a program network

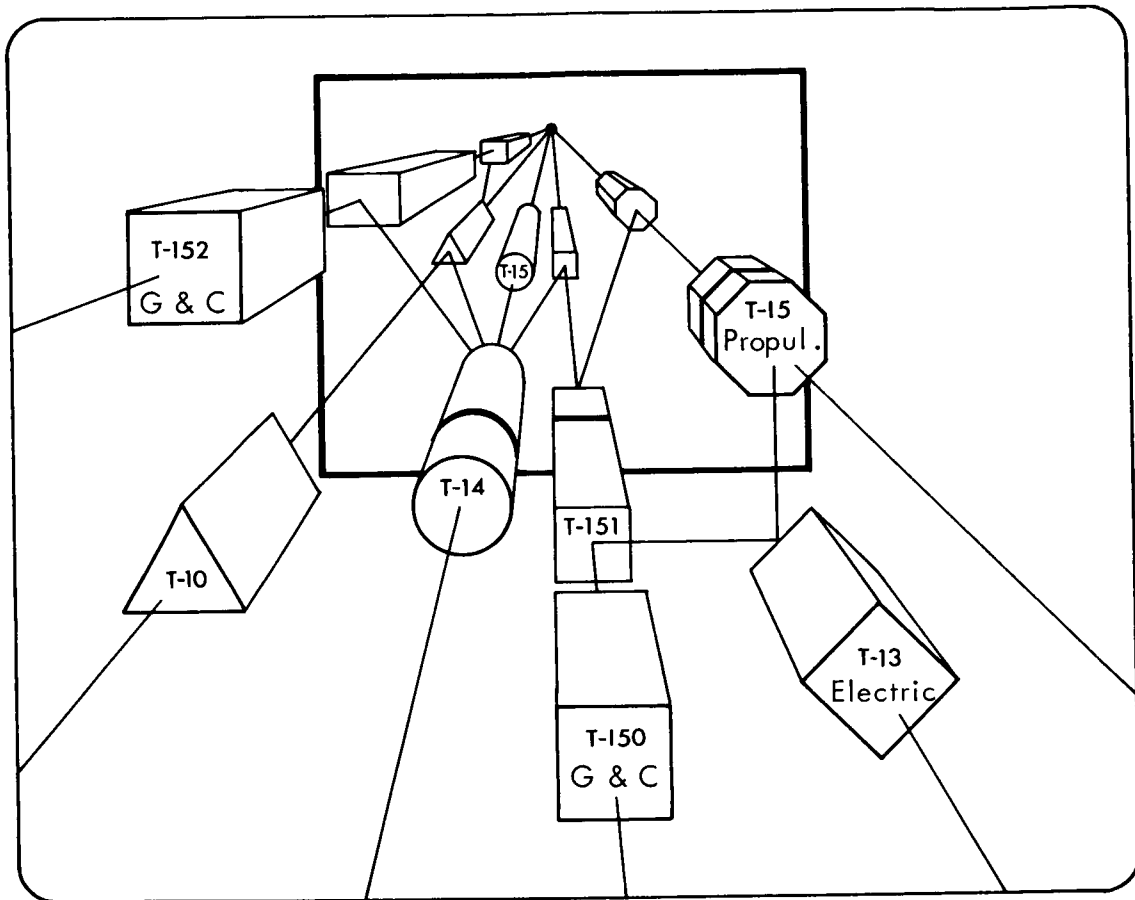

Fig.5 — Three-dimensional presentation of network display

- o Change time scale
- o Magnify or contract the network--permitting the monitor to choose the level of detail in representation of the program information, i.e., specify the set of test steps to be represented by a single node. (The ability to specify the level of detail for each separate system under test may be valuable.)

SCHEMATIC DISPLAYS

Schematic displays present a schematic diagram, in desired detail, of the equipment under test and superimpose on it the following test data:

- o Stimuli applied--type, magnitude, frequency and duration, indicated by alphanumeric coding and special symbols
- o Test points where stimuli are applied by color code
- o Equipment response--magnitude, frequency, delay from application of stimulus, rise time, etc., coded alphanumerically, or when required, a graph depicting the stimulus and the response could be plotted at an auxiliary display surface
- o Criteria for evaluation of the responses. (Response magnitude could also be shown here on a bar graph where the criteria have been indicated.)
- o Indices for use in retrieving additional information on the test and on the design of the equipment--its performance, and test and maintenance history.

This information is particularly useful to the monitor for compensating for controller limitations and for detecting controller errors. He can observe the test, assessing its adequacy, detect omission of tests, and find inappropriate evaluation criteria.

Figure 6 depicts a hypothetical schematic display.

For this type of display the controls that should be available are:

- o Magnification or contraction--choice of the level of detail
- o Removal of elements--elimination of insignificant detail
- o Use as a communication medium when requesting tests to be performed or in the modification and design of tests.

As in the case of network display, the last possibility proposes that the schematic diagram could be used as an essential part of a test design and monitoring language.

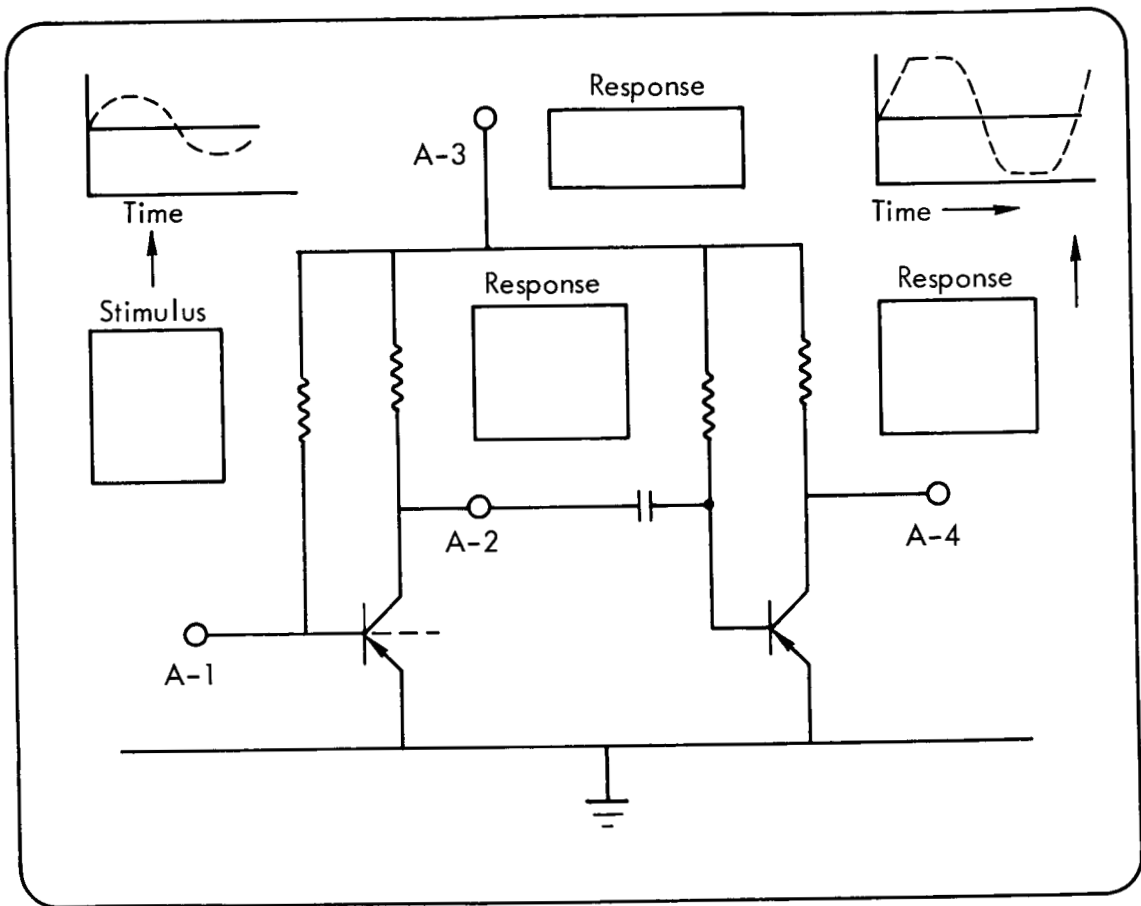

Fig.6 — Schematic display

MATRIX DISPLAY

Matrix displays, which present information in tabular or matrix form, can be used to relay equipment and system status information. For this purpose the matrix display is essentially a table whose rows list items (pieces of equipment or a system) and whose columns list the possible states of the items. The status of an item is indicated by an entry in the appropriate row and column. A status matrix could be presented in any level of detail and could be maintained and updated throughout the tests. When there are a large number of items it may be impractical to display the entire matrix. The monitor should have the capability to select the part of the matrix that depicts the status of equipment in which he is interested.

Matrix displays can also be used to depict equipment interactions: rows and columns of a matrix may be used to identify equipment, and whenever there is an interaction between equipment, an entry is made in the appropriate intersection of row and column.

GRAPHIC AND TEXTUAL DISPLAY

These are conventional, general purpose displays for presenting information supplementing that in the displays already enumerated. Graphic displays include among others, graphs of variables over a period of time and bar charts, which the monitor could use to detect unusual behavior. A special version of the graphic display is a televised presentation of the environment of the tested equipment for detecting personnel hazards.

The text display would be used to present information such as procedures and performance history either upon the monitor's request or automatically along with alert information.

USES OF DISPLAYS

Table 2 depicts the categories of information that can be presented by each of the displays described above to meet the information requirements for monitoring. Which of these displays will be available to a particular monitor depends on his role in the checkout

(i.e., whether he is a system test engineer, test conductor, etc.) and on the extent of the monitoring tasks he is performing.

Table 2

MONITORING INFORMATION AVAILABLE FROM DISPLAYS

Type of Information	Display				
	Network	Schematic	Matrix	Graphic	Text
Program	x	-	-	-	-
Instruction	-	x	-	-	x
Response	-	x	-	x	-
Status	x	-	x	-	-
Reference	x	x	x	x	x

In a typical monitoring situation at a system test engineer's level, the monitor would be presented continuously with both a matrix display of the status of his and related equipment and a network display of tests concerning this equipment. The network display would show the current checkout status, forthcoming tests, and would alert the monitor to various circumstances (hazard, manual control action). In addition the network display would also present limited historical information, such as references to past malfunctions, modifications, etc. When an alert situation arises or the monitor develops a suspicion concerning a piece of equipment or a test, he may request additional displays that present more detailed reference information.

In practice, however, there may exist many instances where checkout requirements or the modus operandi of the monitor do not conform with the "typical" situation described above. In order to permit effective monitoring, the display system should be sufficiently

flexible to permit changes of coding dimensions, formats, and type of information in the various basic displays. For example, a particular test engineer may prefer another type of coding than a flashing light for hazard indication.

CHECKOUT RATE CONTROL

Almost all of the monitoring tasks described in Sec. II require, at one time or another, extraction and processing of considerable amounts of information by the monitor as well as his readiness for instant response. Although network display provides predictive information concerning tests that should be closely observed, the automated rate of checkout may be too high to permit the monitor to be adequately prepared by the time such a test arrives. The test itself may also be executed too fast to permit its observation. In current checkout systems such situations can be resolved only by sacrificing some monitoring effectiveness or by reverting to totally manual step-by-step testing, thereby accepting the associated loss of speed.

We feel that a third alternative--the ability of the monitor to regulate the checkout rate over the interval from full speed to step-by-step--should be available. Given such a control feature, the monitor can adapt the checkout rate to circumstances as these arise. For example, a monitor may wish to slow down the checkout rate when he sees certain critical tests forthcoming, or he can speed up the rate during well established test sequences.

Certain psychological advantages derive with this capability--the monitor may now have a real feeling of "being in control" of the checkout process. (This feeling is usually lacking in current automated checkout systems, which permit either only full speed or manual modes of operation.)

Regulation of the checkout rate should be implemented not by attempting to change the internal timing of the checkout computer but rather by manipulating intervals between test steps and between individual actions within test steps. Any test step that must be

executed at a rate specified by the equipment under test must, of course, remain unaltered.

One scheme to implement checkout rate control would employ a control lever whose angle of rotation from a reference axis would be coded digitally. The operating program of the checkout computer would contain a "delay" instruction executed between test steps and actions. Each time the delay instruction is met the value of the control lever's current angle would be used as an indication of the desired delay; hence the delay between test steps and the speed of test performance would be a function of the position of the control lever. A monitor could thus regulate the checkout rate.

IV. IMPLEMENTING THE DISPLAYS

In this section we will turn our attention to the practical application of the proposed displays: what display devices are available, what data processing support is required, and what are the problems associated with programming such displays?

DISPLAY DEVICES

All the displays already discussed are characterized by the dynamic nature of the information presented--it is presented and changed synchronously with performance of the tests. This characteristic sets a ground rule for selecting display devices--they must permit real time updating of the displayed information and, in addition, must permit presentation of an adequate amount of predictive information.

Two classes of display devices suitable for individual viewers and for dynamic displays are computer-driven cathode ray tubes (CRTs) and electroluminescent panels (ELs). While EL panels of adequate size are currently still laboratory items, CRT display devices have been widely used, creating large amounts of operational experience. In particular, all current automated checkout systems for Apollo include computer-driven CRT displays. We have, therefore, chosen a CRT display device for our discussion of problems associated with presenting dynamic displays.* In particular, we chose the CRT characteristics as specified for the Kennedy Space Center automatic checkout system⁽⁷⁾ and listed in Table 3 (p. 36).

If displays are to be presented to monitoring groups, some of the projection techniques developed for military command and control systems

*In our discussion of network displays we pointed out the usefulness of color as a coding dimension (e.g., for indicating the operational status of the tests represented by nodes). At present CRT display devices with color capability have been built only for specific laboratory uses but should be available for general use in a few years. In the interim, other coding dimensions (e.g., shades of gray, levels of intensity, or special symbols) can be used.

may be applicable, although continuous motion of a network is hard to achieve because current projection devices require approximately 10 seconds of updating time.

Other conventional display devices--strip-charts, meters, etc.--are also required for continuous monitoring. These are particularly useful when compensating for controller limitations. The matrix display can use conventionally illuminated fixed messages arranged in an array.

DATA BASE

In Sec. III we indicated a number of categories of information that could be useful to monitor: program information, instruction information, status information, response information, and reference information.

Such static information exists essentially in two forms: coded in a physical medium for computer sensing or in a form where it can be read by the operator directly, i.e., in books, pamphlets, or slides. In all cases an extensive indexing scheme is required to tie the reference information together with given instances in checkout where it may be required. Much of this work is being done for the Apollo project by NASA contractors. For our discussion of the data processing requirement for monitoring, we will assume that such information is available on magnetic tapes or disks, or on slides, and that this information is adequately cross-indexed to the test steps.

Of particular importance is the organization of the data for network display. Program information must be previously arranged in the correct form with the nodes designated and links indicated so that they can be used directly to generate the appropriate shapes of nodes and the proper links. Then these data are moved from a large file to the display storage and from there with modifications (increased lengths of nodes, for example) into another file. Changes in test sequences or additions of new tests require that on-line changing of program information be easily accomplished, without having to relocate too many records. The Appendix presents one structure for network data that permits flexibility and yet compactness in terms of storage space required.

PROGRAMMING IMPLICATIONS

Programming of displays for monitoring follows the general pattern of programs written for real time processes--certain tasks must be performed within time intervals not controlled by the programmer. In monitoring the checkout process a number of stations would probably be involved, and most likely, several of these would have to be serviced by a single computer, i.e., time sharing of the computer among several stations has to be taken into account.

Network Displays

Here the part of the network displayed is moved at a rate proportional to real time. This movement is effected by continuous modification of the coordinates of the displayed items (nodes and links). Thus the general requirement is to update all the required coordinates within a specified time interval. Several parameters of the network display permit certain tradeoffs: smoothness of motion (number of unit distances that the network is moved per one updating cycle), time scale of the display (time units per unit distance), and the number of items displayed. Thus if the time required to update and move a given network one unit distance is too long relative to the time scale, the network may be made to move in a more discontinuous manner by advancing several unit distances at a time. Such discontinuous movement eventually makes the network appear to be "jumping" across the display surface, and thus might become sufficiently annoying to the monitor to make the display lose some of its usefulness.

In the Appendix we outline the structure of a moving network display program and discuss storage space and program time requirements. Some of these were obtained with the help of a small-scale network display program. We found, for example, that the storage space requirement for a 500-node and 1,000-link network is approximately 4,800 24-bit words, and that the time required to update a 20-node and 50-link network is less than 15 milliseconds on an IBM 7044 computer. On the basis of these figures we estimate that the maximum speed of moving the network on the display surface (512 points on a 12-inch axis) is 6.50 inches per second when the computer is entirely at the disposal of a single display

unit, and 0.42 inches per second if it is time shared among 16 display units and the display is moved in 0.1-inch jumps.

In the above discussion we have assumed that the data for displaying the network are sorted in a random access storage unit (e.g., magnetic cores). If a cycling storage unit such as a magnetic drum is available for the display, it may be possible to eliminate much of the updating time by using hardware instead of program to move the display. For example, if the drum surface is made to correspond with the display surface and the origin of the drum corresponds with the origin of the display sweep, it might be possible to use additional recording heads to physically move words on the drum into different locations when these words are not under the display output reading heads.

Other Displays

The schematic display, a composite of a schematic diagram of the equipment under test with the test results presented at the locations on the diagram where they are measured, might be implemented by projecting the schematic through the use of slides on the display surface and positioning the dynamic response data at appropriate locations. Data processing requirements for this are stored sets of display formats to correspond with the different layouts. The display program must select the slide to be projected, acquire the appropriate format, and generate the required coordinates for the response data. A program for this does not seem to offer any unusual problems.

Programs for presenting and maintaining matrix, graphic, and text displays are well known and require no specific discussion.

V. CONCLUSIONS

In this report we have examined the task of a human monitor in automated prelaunch checkout of space vehicles. We find that his main objectives are:

- o To maintain context with the progress of the checkout
- o To compensate for controller limitations
- o To detect controller errors
- o To discover hazardous conditions that are undetectable automatically.

To attain a selected set of monitoring objectives the operator must have real-time access to information regarding the status of the checkout process and the equipment under test, responses to tests, and reference information. Although it may be presented to the monitor in various ways, in order to increase the effectiveness of monitoring, the information should be presented:

- o In an extractable manner--such that the monitor could react to the presented information within a specified time interval
- o In a "fertile" manner--such as to permit the monitor to obtain additional insight and formulate hypotheses on the behavior of the equipment under test
- o Such that it includes predictive information, permitting the monitor to prepare for observing upcoming events.

A monitor should be provided with controls to:

- o Alter the checkout rate--for example, to reduce the checkout rate in order to observe execution of a particular test more effectively
- o Choose the information presented to him
- o Cause changes in the checkout program.

To facilitate presentation of information, the following types of visual displays are useful:

- o Moving network display--dynamic display of information describing the structure and status of the checkout process

- o Schematic display--presentation of stimulus and response information as overlays on the schematic diagram of the equipment under test
- o Matrix display--presentation of information on the operational status of the equipment and systems
- o Graphic and text displays--presentation of reference and derived response information.

Maintaining and updating the various monitoring displays places an additional burden on the checkout computers. In particular, the computing requirements for updating the moving network display increase in proportion with the required updating rate. If a number of such displays must be maintained, a computer may use most of its time for meeting the display requirements. There are several approaches to reduce possible excessive computer time requirements:

- o Use of a computer with high-speed arithmetic unit
- o Use of special purpose hardware for updating the display (e.g., a magnetic drum)
- o Use of group displays or units.

At present we have no experimental data concerning the effectiveness of the enumerated displays in monitoring of actual automated checkout processes. Accumulating this information seems to be a natural extension of this study. Other areas of study that might be considered include:

- o Use of the enumerated displays in diagnostic testing
- o Use of the displays as communication media for interacting with checkout programs, composing new programs, and debugging.

Appendix

AN OUTLINE FOR A NETWORK DISPLAY PROGRAM

We have outlined the programming of a moving network display for the purpose of obtaining data on which to base estimates of the required number of instructions, storage space, and time for moving a network a unit distance. In order to permit comparison with equipment already planned for Apollo checkout systems, we will assume that a CRT display unit similar to that specified for the Kennedy Space Center automated checkout system⁽⁷⁾ is available. Table 3 lists some of its pertinent characteristics.

PROGRAM DESCRIPTION

We will assume the network display to take the upper half of the 12 x 12 inch display area of the CRT, and that nodes are nominally one inch square, separated from each other at least one inch in the X and Y dimensions. Our display area can then accommodate three rows of nodes, with as many as 6 nodes per row. We will further assume that each node may contain 9 characters and can be flashed independently. Figure 7 depicts the display area, and Fig. 8 the construction of nodes and links when using the vector drawing capability of the display unit.

In Fig. 7, X_t denotes the "present" time line on the display and X_{t-K} identifies a "waiting" line, whose purpose is to hold the nodes at some convenient distance from X_t until they are "started."

Storage Structure

Each item to be displayed, a node or a link, is described by a two word record. A typical record is depicted in Fig. 9 and contains the following information:

<u>Word</u>	<u>Bit</u>	<u>Information</u>
1	1	0 indicates a node 1 indicates a link
	2-3	Row (Y-coordinate) of the item
	4-5	Node: shape code Link: row (Y-coordinate) of its terminus

Table 3

CHARACTERISTICS OF THE DISPLAY DEVICE

Character size:	height	0.2 in
	width	.15 in
	horizontal spacing	.085 in
	vertical spacing	.105 in
Maximum characters per line:		52
Maximum number of lines:		39
Vector drawing capability:		between any two points ^a
Maximum number of displayed vectors:		1000 connected 500 unconnected
Display area:		512 x 512 points, 12 x 12 inches
Special features:		photo pen cursor slide data mix capability TV capability
Buffer storage:		4996 24-bit words
Computer compatibility:		RCA 110A

^a This is a departure from the display device specified for the Kennedy Space Center; the latter specifies a maximum length of 2 inches for a vector. Vector drawing capability between any two points on a 12 x 12 inch display surface is, however, readily achievable.

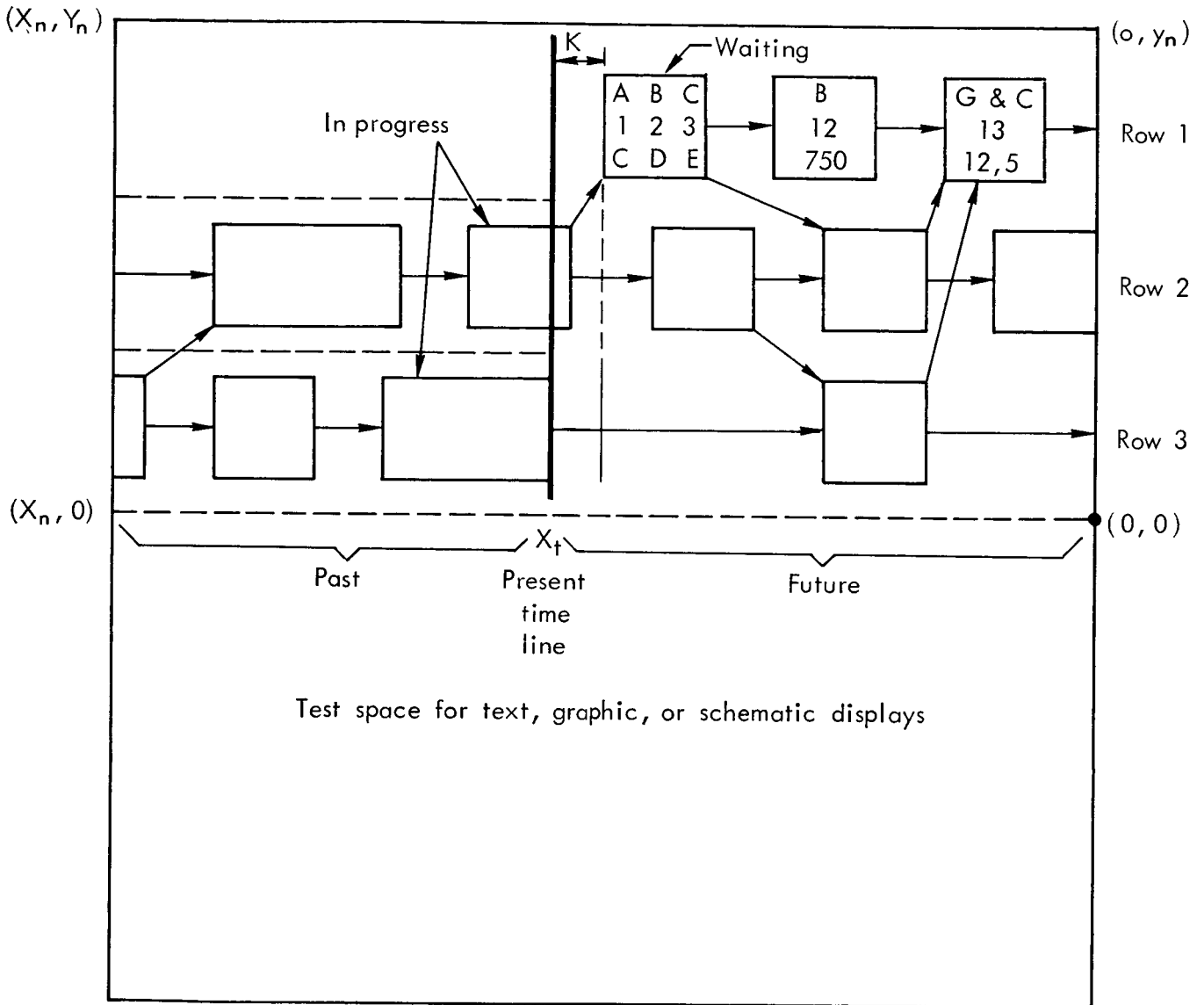

Fig.7 — Proposed use of 12 x 12-inch display area

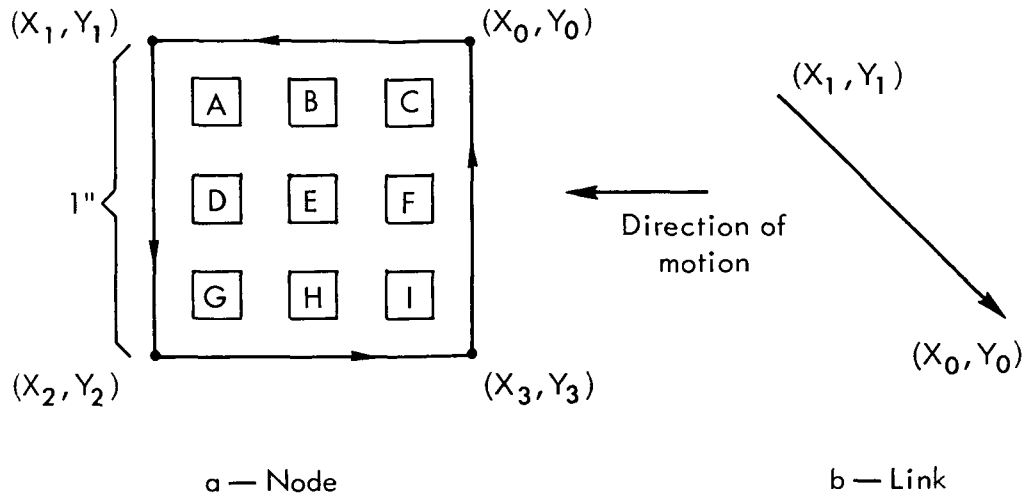

Fig.8 — Construction of node and link

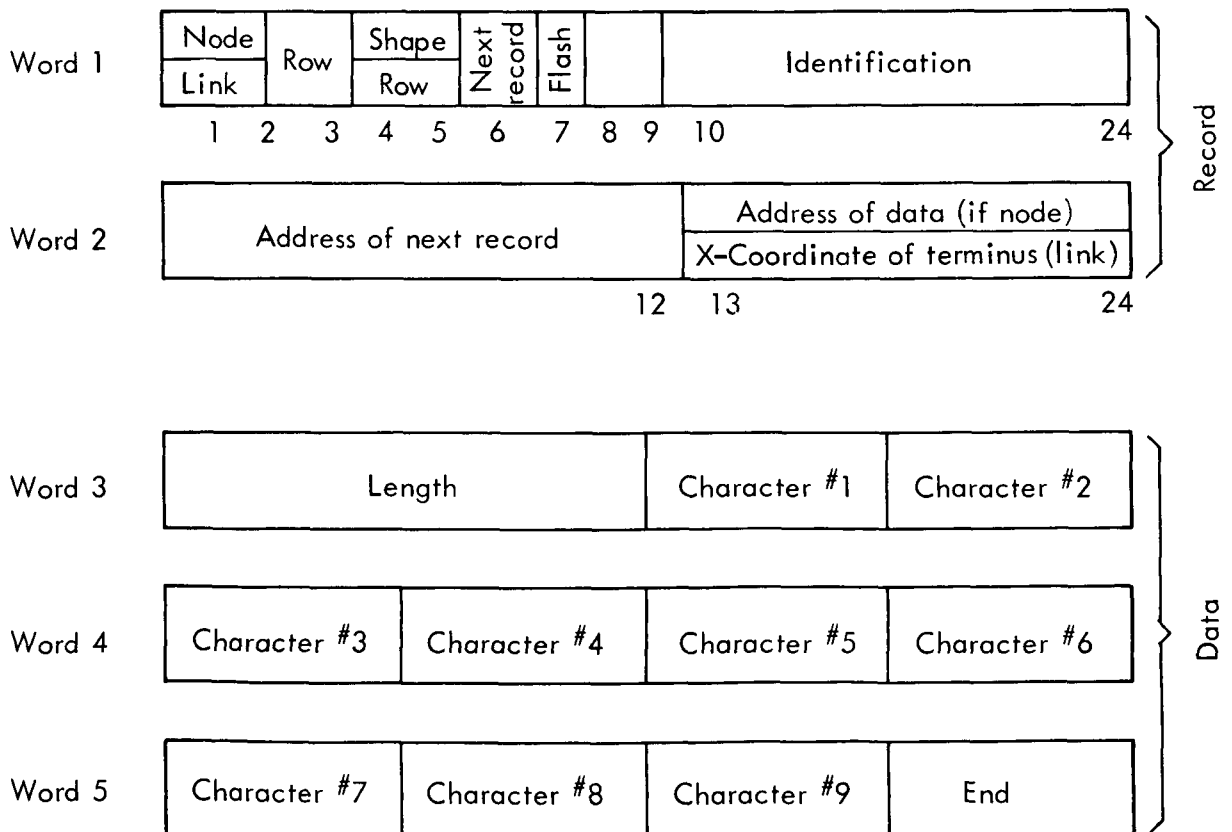

Fig.9 — Record for a node or link (in R-file)

<u>Word</u>	<u>Bit</u>	<u>Information</u>
	6	1 indicates that the next record is out of sequence
	7	1 indicates that the item should be flashed
	8-9	Vacant
	10-24	Identification of the item
2	1-12	Address of the next record if out of sequence
	13-24	Node: address of additional data (characters, duration) Link: X-coordinate of its terminus
3-5		Characters associated with the node (data)

All node or link records are in a "record file" (R-file), which, if large, may be partly in the core store and partly in the tape stores. Records are taken from the R-file when they must be displayed or analyzed, and at that time a corresponding display record is constructed and inserted in the "display file" (D-file).

A record in the D-file consists of as many words as required to generate the shape of the item to be displayed and to display the associated characters. Typically, a display record for drawing a square node and displaying 3 rows of 3 characters each requires 5 words for the square and 6 words for the characters (we assume that it is sufficient to specify the X- and Y-coordinates for the starting character of a row only, the other characters in the row being spaced automatically).

A D-file is depicted in Fig. 10. It contains the following information:

<u>Word</u>	<u>Bit</u>	<u>Information</u>
1	1	0 indicates "blinking" of the vector 1 indicates that the vector is unblanked
	2	"Mode": character, vector, or empty
	3	0 indicates no flash 1 indicates flash
	4-12	Y-coordinate of the origin of the item
	13-15	Vacant
	16-24	X-coordinate of the origin of the item

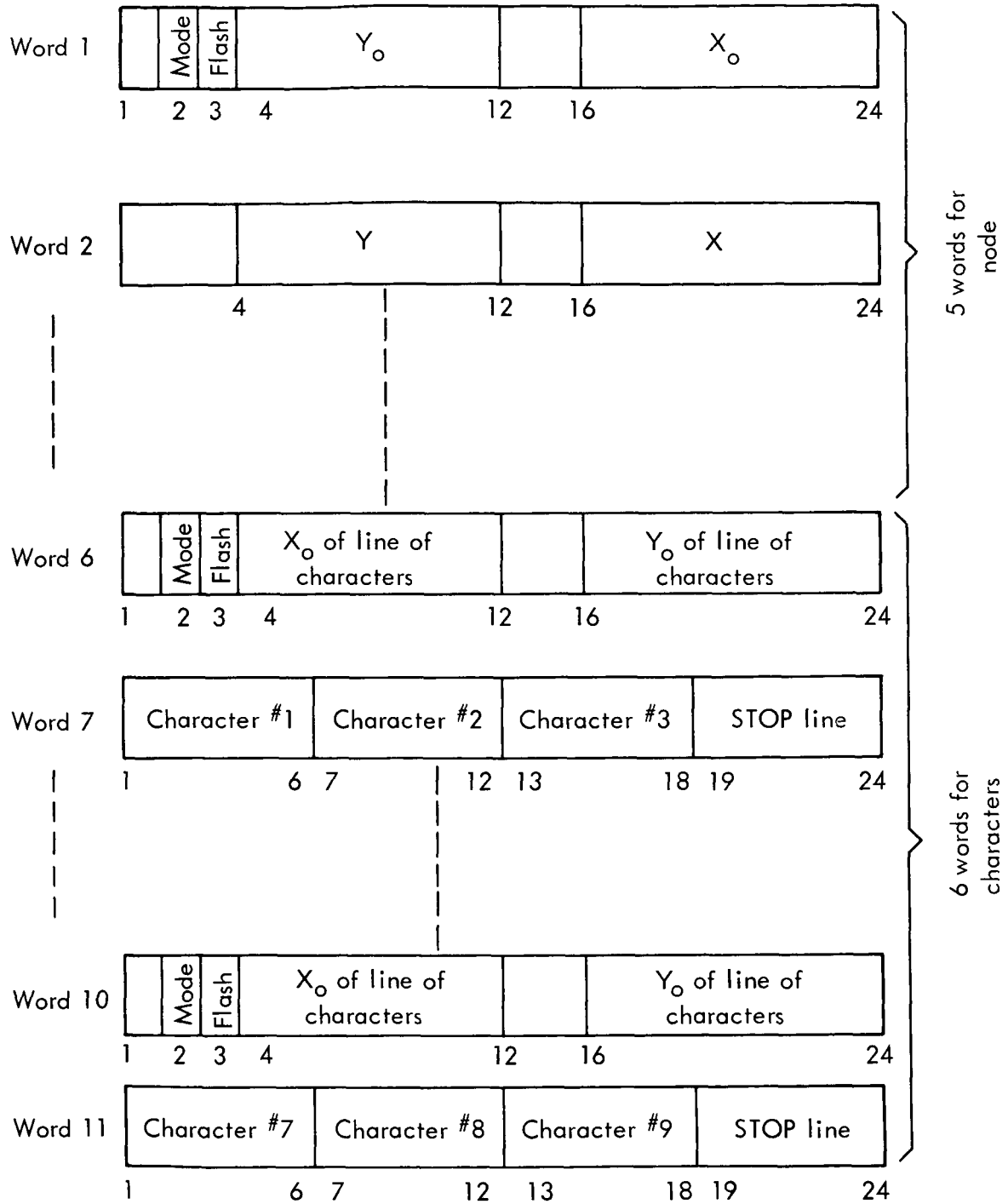

Fig.10— Typical display file (D-file) for a node

<u>Word</u>	<u>Bit</u>	<u>Information</u>
2		X- and Y-coordinates of the next point of the item
...
6		X- and Y-coordinates of the origin of the row of characters
7	1-6	Character #1
	7-12	Character #2
	13-18	Character #3
	19-24	Stop line symbol
8		X- and Y-coordinates of the next row
...
		etc.

D-file records are constructed on the basis of information obtained from analyzing the R-file records. During the operation of the program an item is moved on the display surface by incrementing the X-coordinates of all reference points of its D-file record.

Description of Program Operation

The general mode of operation of the network display program consists of modifying the X-coordinates in the D-file records (for motion in the X direction) synchronously with the time scale of the display. For example, if the unit distance on the display surface corresponds to 0.1 seconds, then each displayed node and vector must move a unit distance every 0.1 seconds.

There are a number of conditions that determine whether a displayed item (node or link) is actually moved, completely removed from display, or whether a new item is moved on the display. One of the following rules may apply:

- o If a node or a vector is entirely in the "past," all X-coordinates are modified
- o If a node or a vector is crossing the "present" time line, all X-coordinates are modified
- o If a node has crossed the present time line and the termination of the operation represented by it has not been signalled, only the X-coordinates of the leading edge are modified (i.e., the node grows in length)

- o If a node is stopped at the "waiting" line, its coordinates are not modified, and the entire row of nodes and vectors is "frozen"
- o If a node is in the "future" and the row is frozen, its coordinates are not modified
- o If a node is on the waiting line and receives a start signal, all its X-coordinates are modified by an increment K (the distance between the "present" time and "waiting" line)
- o If the X-coordinates of the trailing edge of a node are exactly equal to q (the minimum distance between the trailing edge and border of the display area), a new item (usually a link) is brought on the display surface for this row. To do this the next record for this row in the R-file must be obtained and analyzed, and a display record must be assembled for the D-file
- o If the node is in the "past" and the X-coordinates of the trailing edge are equal to N_x (the last point in the display surface), the display record of the corresponding node is removed from the D-file
- o In the case of a vector, the X-coordinate of a terminal is modified only if the row where the terminal is located is not frozen.

The basic operating cycle of the program consists then of taking display records from the D-file, determining which of the above rules to apply, and performing the indicated operations. Figure 11 depicts a gross flow chart of the organization of such a network display program.

Inclusion of control operations in the program, such as provisions for moving the present time line, removal of nodes, altering connections, etc., require inclusion of additional conditions. For example, if the present time line is moved right at the same rate as the network moves left, the net effect is to display more items in the "past," but to gradually remove items in the "future."

OPERATIONAL CHARACTERISTICS

Important characteristics determining the practicality of a program are the storage space required for the program and the data, and the execution time. In the following we attempt to make estimates of these characteristics for the network display program outlined in

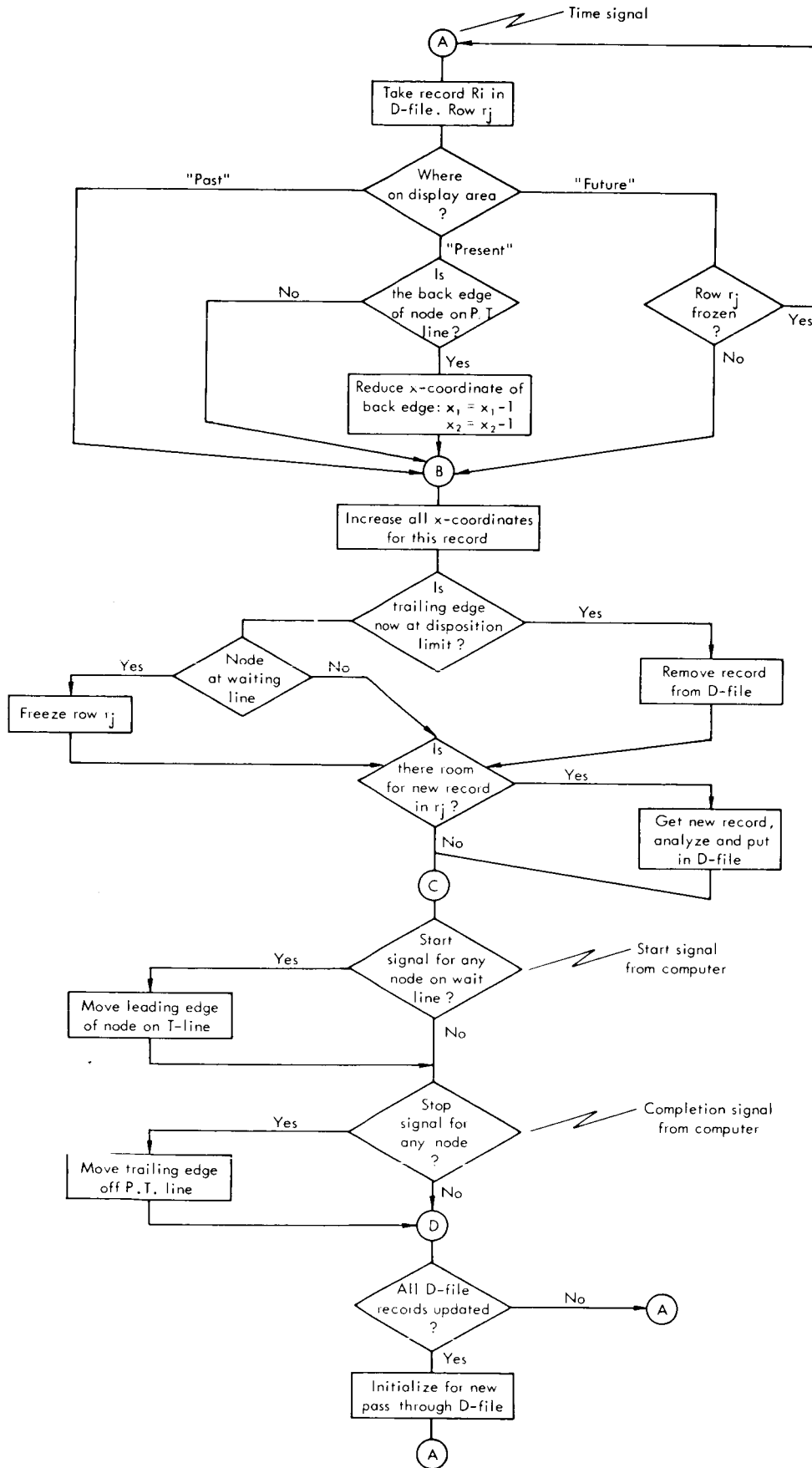

Fig. 11—Flow chart for program design

Fig. 11. We will make use of a "pilot program" for network display, written at RAND for the IBM 7040/44 computers.

Storage Space

The storage space required for the program is in the range of 500-700 words.

The storage space requirements for the network itself depend, of course, on the size of the network. In general, if N is the number of nodes and L the number of links, the record file (R-file) requires $5N + 2L$ words. If N_d and L_d are the maximum numbers of nodes and links that may be displayed simultaneously, the required size of the D-file is $11N_d + 2L_d$ words.

For example, if $N_d = 20$, $L_d = 50$, $N = 500$, and $L = 1,000$, the total storage space needed for the data is 4,820 words. In a practical situation, a part of the R-file may have to be maintained on tapes.

Program Execution Time

In discussing the time required to update the network display program, it is useful to define certain parameters:

T_u = Time required to move the entire displayed network, i.e., the time required to update the coordinates of all displayed items (independent of the number, K , of unit distances that the network is moved at a time).

T_r = Time scale of the X-axis, time units per unit distance.

M = Maximum number of unit distance that the display may be moved per updating cycle without adversely affecting the capability of a human monitor to follow the motion of the network (must be determined experimentally).

C_n = Number of computing cycles needed to update a node.

C_l = Number of computing cycles needed to update a link.

t_c = Time per cycle of the computer.

We chose to express the effort for updating a node and a link in terms of cycles on the grounds that the number of cycles per given instruction tends to be similar for most of the computers of a given

class (e.g., computers with bit-wise parallel transfers and arithmetic). In a serial computer cycle time is replaced by word time, which is a function of the word length and time per bit.

The time for moving the display, T_u , may now be expressed as $T_u = t_c (N_d C_n + L_d C_1)$. Since the display moves proportionally to real time, the inequality of $T_u < M T_r$ must be satisfied. If in addition the computer is time-shared so that it is available for updating the display only for a fraction F of the time, then the inequality must be modified to $T_u < (FM) T_r$.

For the program outlined in Fig. 11 and with the help of the pilot program we estimate that $C_n = 110$ and $C_1 = 80$. For a parallel computer similar to the IBM 7044, $t_c = 2$ microseconds. For $N_d = 20$, $L_d = 50$, we get $T_u = 2 (110 \times 20 + 80 \times 50) = 12,400$ microseconds. Assuming that M is 1, 2, and 4 (approximately .025, .05 and .1 inches) we can construct a table that, for various fractions of computer time available, shows the smallest T_r that can be used:

F	M	T_r /Unit Distance (microseconds)	Display Speed (in/sec)
1	1	15	1.66
1/2	2	15	1.66
1/4	4	15	1.66
1/8	4	30	0.830
1/16	4	60	0.415

For a serial computer with a one microsecond bit time of 24-bit word length and the same number of word times required as the cycle times given above, the T_u is 150 milliseconds. The smallest T_r is then 150 milliseconds (if the computer is entirely at the disposal of the display program), and maximum speed (for $M = 4$) is 0.67 inches per second.

REFERENCES

1. Mast, L. T., L. D. Amdahl, O. T. Gatto, and A. A. B. Pritsker, Growth of Automation in APOLLO Prelaunch Checkout: Vol. I Go/No-Go Testing, The RAND Corporation, RM 4160-NASA, July 1964.
2. Mast, L. T., L. D. Amdahl, O. T. Gatto, and A. A. B. Pritsker, Growth of Automation in APOLLO Prelaunch Checkout: Vol. II Go/No-Go Testing, The RAND Corporation, RM-4161-NASA, July 1964.
3. Pepler, R. D., and J. G. Wohl, Display Requirements for Prelaunch Checkout of Advanced Space Vehicles, The RAND Corporation, RM-4200-NASA, June 1964.
4. Pepler, R. D., and J. G. Wohl, Integration of Man and Computer in Prelaunch Checkout of Advanced Space Vehicles, The RAND Corporation, RM-4506-NASA, April 1965.
5. Mayper, V., Jr., "Programming for Automated Checkout," Datamation, Vol. 11, No. 4, April 1965, pp. 28-32, No. 5, May 1965, pp. 42-46.
6. Foster, R. W., "Future Test and Checkout Concepts for Space Booster Systems," Proceedings of Second Seminar on Automatic Checkout Equipment and Techniques, Battelle Memorial Institute, November 1963, pp. XII-1 - XII-22.
7. Sanders Associates, Inc., "Saturn V Operational Display System Program Specification," prepared for Marshall Space Flight Center under Contract NAS8-14009, Nashua, New Hampshire, April 2, 1965.