

Interim Report SS-2
NASA Grant NsG 609

**SURFACE PARAMETERS OF STANNIC OXIDE IN POWDER, CERAMIC,
AND GEL FORM BY NITROGEN ADSORPTION TECHNIQUES**

J. L. Rutledge
Solid State and Surface Studies Research Group

E. E. Kohnke
Project Supervisor, Physics Department

C. M. Cunningham
Project Supervisor, Chemistry Department

December 1965

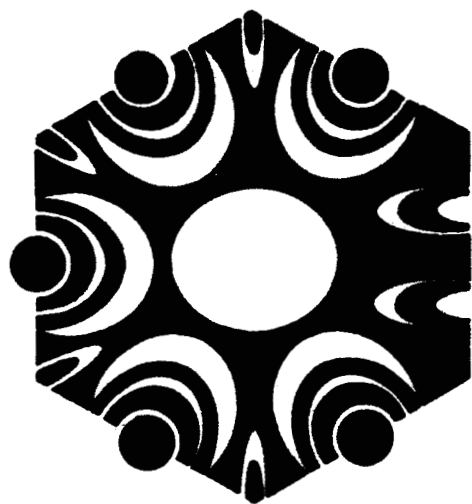

**RESEARCH
FOUNDATION**

**OKLAHOMA STATE
UNIVERSITY**

PREFACE

This report covers one aspect of a project being carried out under NASA Grant NsG-609 as an interdisciplinary activity in the Departments of Physics and Chemistry at Oklahoma State University. The project is entitled "Surface Parameters of Solids" and has as its principal research purpose an investigation of the feasibility of employing several non-traditional experimental techniques to provide new insight into the nature of solid surfaces. Principal investigators are Dr. E. E. Kohnke, Department of Physics and Dr. C. M. Cunningham, Department of Chemistry. Graduate students from both departments are involved in the total laboratory program.

The material contained in this report has been used by Mr. J. L. Rutledge, NASA Trainee, in partial fulfillment of the requirements for the degree Master of Science (Physics). His degree is to be awarded at the Spring Commencement, May 1966.

Mr. Rutledge is continuing work toward the Ph.D. degree within the framework of this project.

E. E. Kohnke and C. M. Cunningham
Project Supervisors

ABSTRACT

15778

A conventional gas adsorption apparatus employing 32 volumes differing by about 8 cm^3 in the calibrated bulb system has been constructed and used to measure the volume of nitrogen adsorbed as a function of pressure on three forms of SnO_2 --powder, ceramic and gel--at 78°K . The specific surface of each sample was calculated from each isotherm according to the B.E.T. equation and geometric considerations resulting in the following areas:

- 1) SnO_2 Powder (Reagent Grade) - $2.0 \text{ m}^2/\text{gm}$
- 2) SnO_2 Ceramic (Low Density) - $0.37 \text{ m}^2/\text{gm}$
- 3) SnO_2 Gel (Ion-free) - $173 \text{ m}^2/\text{gm}$

In addition, the adsorption isotherms have been analyzed to determine the nature of the surfaces with respect to pores and capillaries. For the ceramic specimen, a type II isotherm with no hysteresis indicates pore radii greater than 300\AA . The gel exhibited a type I isotherm with no hysteresis suggesting small capillaries of molecular dimensions (i.e., 20\AA). The powder sample exhibited a type II isotherm without hysteresis indicating that no significant number of small pores are present in each grain. A spherical particle model for the powder and a similar spherical pore model for the ceramic yielded particle and pore size consistent with the shapes and magnitudes of the measured isotherms.

Author

ACKNOWLEDGMENT

The author wishes to express his gratitude to Drs. E. E. Kohnke and C. M. Cunningham for initially suggesting the area of study and for their guidance during the investigation, to the National Aeronautics and Space Administration for sponsoring the research (NASA Grant NsG-609), to the National Aeronautics and Space Administration and the National Science Foundation for aid in the form of a traineeship and a fellowship, and to the Oklahoma State University Research Foundation for their administrative assistance. He is also indebted to H. Hall, W. Adkins, and E. Friedle for their help in design and construction of the apparatus. And, finally, the author wishes to recognize his wife Barbara as his inspiration and for her understanding during the course of the investigation.

TABLE OF CONTENTS

Chapter	Page
I. INTRODUCTION	1
II. THEORY OF PHYSICAL ADSORPTION.	3
III. EQUIPMENT DESIGN AND CONSTRUCTION.	14
IV. CALIBRATION AND EXPERIMENTAL PROCEDURES.	24
V. EXPERIMENTAL RESULTS	31
VI. CONCLUSION AND SUGGESTIONS FOR FURTHER WORK.	40
VII. PROPOSED EQUIPMENT DESIGN CHANGES.	44
BIBLIOGRAPHY	49
APPENDIX I	51
APPENDIX II.	53

LIST OF FIGURES

Figure	Page
1. Brunauer's and de Boer's Isotherms	10
2. Detail of complete adsorption apparatus.	15
3. Detail of Manometer.	17
4. Schematic of adsorption system	21
5. Nitrogen adsorption isotherm - powder.	32
6. Linear B.E.T. plot - powder.	33
7. Nitrogen adsorption isotherm - ceramic	34
8. Linear B.E.T. plot - ceramic	35
9. Nitrogen adsorption isotherm - gel	37
10. Linear B.E.T. plot - gel	38
11. Statistical thickness of adsorbed layers	39
12. Proposed gas burette cross section	46
13. Sketch of proposed gas transfer system	47
14. Metallographs of ceramic surface	54
15. Electron micrographs of colloidal (gel) particles.	57

CHAPTER I

INTRODUCTION

In recent years certain phenomena have appeared in electrical studies of solids which can only be explained by assuming the existence of electronic states located on the surfaces of the various materials. Subjects of investigation have included contacts and metal-semiconductor junctions¹, conductivity as a function of ambient atmosphere², surface conductivity³, photoconductivity⁴, etc. In recent work on the metal oxides it has been assumed that at least some of their properties are dependent upon surface states affected by chemisorbed hydrogen and oxygen.^{2,5}

It is the purpose of the study reported here to investigate parameters, particularly surface area and geometry, which should be related to these phenomena. The method used is the measurement of the physical adsorption of nitrogen on surfaces of interest. This is dependent upon both surface area and geometry and is a basic tool in the study of catalysts. Further work will attempt to utilize these results simultaneously with an electronic analysis of the material's behavior in order to determine what correlations exist.

In this preliminary work an adsorption apparatus has been constructed which is capable of measuring B.E.T. surface areas on samples whose electronic properties may be analyzed. The material selected for study is stannic oxide as there is a concerted local effort to

analyze its electronic structure in both crystalline and ceramic form.^{6,7,8,9} In addition, stannic oxide is a large band gap semiconductor which exhibits a marked response to ambient atmosphere. In the study of this material it has been necessary to assume a surface potential barrier model, which presumably is dependent upon oxygen chemisorption, to explain observed effects.⁹ In ceramic form the surface area of this material may be controlled to a certain extent during preparation and may also be measured independently. Samples of this nature should exhibit surface effects in varying degrees and as the surface area decreases the electronic properties should tend toward those of the pure crystalline substance.

As a principal result of this study, the surface area has been determined for three forms of stannic oxide (powder, ceramic, and gel) and certain inferences made as to their pore structure. Models of configuration which should be indicative of pore structure are in agreement with measured values. Though the gel may not be suitable for electronic study it should exhibit the same crystalline structure as the other samples and in addition it has a large surface area which makes it a convenient sample for surface studies by gas adsorption and I-R absorption techniques. It should be possible to make certain inferences from this type of study which will be valid for the other specimen forms.

In addition, modifications to the apparatus are proposed which will increase its accuracy, decrease its physical size, improve its ease of operation, decrease its cost and simplify its detail. These modifications are not restricted to this particular piece of apparatus, but should be applicable to any design of this nature.

CHAPTER II

THEORY OF PHYSICAL ADSORPTION

As early as 1777 it was noticed that when carbon is mixed with a gas a reduction of total volume occurs. Shortly thereafter, in 1791, a colored liquid was made clear by filtering through charcoal. Until the beginning of the twentieth century, however, very little quantitative work was done on this phenomenon although it had obtained by that time the name adsorption.

There are two closely related phenomena of this nature, adsorption and absorption. The first refers to the adsorbate (the substance being taken up) becoming attached to the surface of an adsorbent, while absorption occurs when the adsorbate actually penetrates into the adsorbent. This latter does not imply that adsorption occurring in pores of the adsorbent is an absorption phenomenon. In general, the adsorbate may be either a liquid or a gas. This study is primarily concerned with gas adsorption upon solid surfaces.

In principle, it is possible to divide adsorption into two separate classes, physical adsorption and chemical adsorption, though frequently it is impossible to determine which class characterizes a given system. The primary criterion for distinguishing the two entails the heat of adsorption.¹⁰ In physical adsorption the heat of adsorption is roughly comparable to the heat of liquefaction of the gas. Chemical adsorption is characterized by much larger heats of adsorption,

roughly comparable to heats of chemical reactions. The validity of this distinction lies in the fact that most systems fall readily into one or another of the two classes. For such systems one finds that physical adsorption is reversible while chemical adsorption is not. This property is often used to distinguish the two phenomena.

Of primary interest is the nature of the surface of the adsorbent. Physical adsorption is well characterized from a theoretical viewpoint. Hence the analysis of physical adsorption is used to determine a surface area and structure which are also considered to be valid for the less well understood chemical adsorption phenomena.

In order to characterize physical adsorption the theory must account for the dependence of the amount of gas adsorbed upon pressure and temperature. The earliest attempts utilized Henry's law which had been developed for the solution of gases in liquids. According to Henry's law the amount of gas adsorbed at constant temperature is proportional to the pressure. This law appears to be valid at ordinary temperatures and low pressures.¹⁰

Later, Langmuir developed an adsorption equation. Necessary and sufficient assumptions for the theoretical development of this isotherm are: molecules are adsorbed as discrete units on discrete sites and there is no lateral interaction between adsorbate molecules. The resulting isotherm is $\theta = bp/1+bp$ where θ is the fraction of the sites occupied, b is a constant at each temperature and p the pressure. At low pressures this reduces to Henry's law.

The next major advance in the theory of adsorption occurred in 1938 with the development of the B.E.T. equation by Brunauer, Emmett and Teller. Their result is of great practical utility as it involves

only two parameters and is applicable to the majority of measured isotherms. As its use is currently accepted as the best means of determining surface area of porous solids it is used in this study to evaluate the surface area of the samples.

It is possible to theoretically derive the B.E.T. adsorption equation by several techniques. However, the kinetic method¹⁰ is most easily understood without the background required by the more elegant statistical methods.

In the kinetic derivation it is assumed that each gas molecule in the second or higher layers is adsorbed directly upon a gas molecule below it. On a microscopic scale a certain portion of the surface of the adsorbent is covered. Molecules forming the second layer are adsorbed vertically upon the molecules of the first layer. The second layer is similarly covered in part by the third layer, etc. Hence, on a microscopic scale the adsorbed gas exists in vertical piles. In addition, all interaction between adjacent piles is neglected.

In order to characterize adsorption on this picture it is convenient to define $S_0, S_1, S_2, \dots, S_i, \dots$ as the areas covered by 0, 1, 2, ... adsorbed layers. The $\sum S_i$ is the area of the adsorbent, A . At equilibrium the rates of adsorption and evaporation from the i th layer must be equal, i.e.,

$$a_i P S_{i-1} = b_i S_i e^{-E_i/RT} \quad (1)$$

The adsorption rate is proportional to the number of molecules striking the lower level per second and thus proportional to its area and the pressure, P , in the gas phase. The rate of evaporation is proportional to the area of the layer and depends exponentially upon the binding

energy and the temperature. a_i and b_i are the constants of proportionality.

The volume of gas adsorbed is given by:

$$v = v_o \sum_{i=0}^{\infty} i S_i, \quad (2)$$

where v_o is the volume of gas required to cover a unit area with a monolayer of gas.

The relative volume of gas adsorbed is given by:

$$\frac{v}{Av_o} = \frac{v}{v_m} = \frac{\sum_{i=0}^{\infty} i S_i}{\sum_{i=0}^{\infty} S_i}, \quad (3)$$

where v_m is the volume of gas required to cover the surface A with a monolayer.

In order to further reduce this equation it is necessary to assume:

$$E_1 = \text{constant for the total surface} \quad (4)$$

$$E_2 = E_3 = \dots E_i = E_L = \text{Heat of liquification of adsorbate} \quad (5)$$

$$b_i/a_i = \text{constant. } (i = 2, 3, 4, \dots). \quad (6)$$

To simplify notation it is possible to define

$$y = a_1/b_1 Pe^{E_L/RT}. \quad (7)$$

Thus,

$$S_1 = yS_o. \quad (8)$$

Similarly, defining

$$X = \frac{a_i}{b_i} Pe^{E_L/RT} \quad (9)$$

one obtains

$$S_i = XS_{i-1} = X^{i-1}S_1 = yX^{i-1}S_0 = CX^iS_0, \quad (10)$$

where

$$C \equiv y/X = \frac{a_1}{b_1} \frac{b_i}{a_i} e^{(E_1 - E_L)/RT} \quad (11)$$

Inserting these relations into Equation 3 one obtains:

$$\frac{v}{v_m} = \frac{\sum_{i=0}^{\infty} iX^i}{\{1 + C \sum_{i=1}^{\infty} X^i\}} \quad (12)$$

Utilizing the familiar sum of a geometric series one recognizes that

$$\sum_{i=1}^{\infty} X^i = \frac{X}{1-X}, \quad (13)$$

$$\frac{d}{dX} \sum_{i=1}^{\infty} X^i = \sum_{i=1}^{\infty} iX^{i-1} = \frac{d}{dX} \frac{X}{1-X} = \frac{1}{(1-X)^2} \quad (14)$$

and

$$\frac{X}{(1-X)^2} = \sum_{i=1}^{\infty} iX^i \quad (15)$$

These relations allow reduction of Equation 12 to:

$$\frac{v}{v_m} = \frac{C \frac{X}{(1-X)^2}}{1 + \frac{CX}{1-X}} = \frac{CX}{(1-X)(1-X+CX)} \quad (16)$$

By considering the case when the surface is thickly covered and recognizing that the problem is identical with vaporization from the liquid phase, it is possible to evaluate X more precisely. In gas-liquid

equilibrium, rates of condensation and evaporation are equal. Therefore,

$$a_i P_o^S = b_i S e^{-E_L/RT} \quad (17)$$

where P_o is the vapor pressure of the adsorbate at temperature T .

Therefore,

$$X = \frac{a_i}{b_i} P_o^{E_L/RT} = \frac{P}{P_o} \quad (18)$$

Equation 16 then becomes the simple or "infinite form" of the B.E.T. equation, namely:

$$v = \frac{v_m CP/P_o}{(1 - P/P_o)(1 + (C-1)P/P_o)} \quad (19)$$

In use, this equation is plotted in linear form,

$$\frac{P/P_o}{v(1-P/P_o)} = \frac{1}{v_m C} + \frac{C-1}{v_m C} P/P_o, \quad (20)$$

which makes it possible to graphically evaluate v_m . Letting S be the slope of the graph and I its intercept, it is readily shown that

$$v_m = \frac{1}{I + S} \quad (21)$$

One wishes to characterize the surface of the adsorbent by its area which makes it necessary to assume a molecular size and some sort of packing of the gas molecules on the surface. The majority of work in this area utilizes as a measure of v_m the unit of cm^3 of gas at S.T.P. The accepted "area" of a nitrogen molecule is 16.2 \AA^2 . Various packings then allow the conversion factor to range from

$$A = 4.36 v_m \text{ to } A = 4.38 v_m, \quad (22)$$

where A has the units M^2 .

It is to be noted that the derivation makes several assumptions, all of which have been questioned. Many papers have been written in criticism of the theory but the general consensus of opinion is that the B.E.T. areas are reasonably valid.^{10,11} In addition, over a restricted pressure range, all major types of isotherms are fitted by the two parameter equations. Thus it is of great practical utility and remains, to date, the standard method for measurements of surface area of solid materials.

One of the major assumptions of the B.E.T. theory is that the surface of the adsorbent is uniform. This is not likely to be the case.^{10,11} In addition, the theory does not take into account the possibility that a portion of the surface is composed of fine pores which fill at a certain pressure and then contribute no longer to the adsorption process at higher pressures. As a consequence, the isotherms are valid in general only over a relative pressure range from 0.05 to 0.30. The deviation at higher pressures is attributed mainly to pore or capillary effects.¹⁰ The nature of these pores has become a major area of study.^{12,13,14}

Pores and capillaries often cause the isotherm to deviate significantly from an isotherm of the same material in a nonporous state. Brunauer classified commonly observed isotherms into five categories (Fig. 1a).¹⁵ Langmuir attributed the type I isotherm to mono-layer adsorption. Types II and III are the normally expected isotherms on nonporous materials. Type II is most frequent and is associated with a higher heat of adsorption than the rare type III. Types IV and V are characteristic of porous adsorbents.¹⁰ It is to be noted that types IV and V exhibit a steep portion at pressures above $0.5 P_0$.

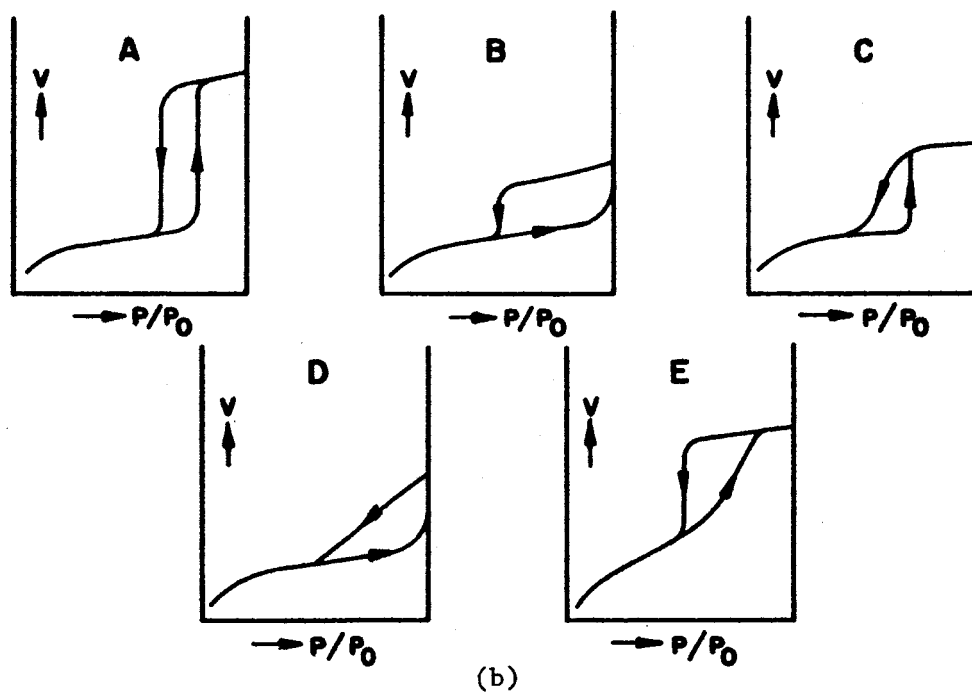
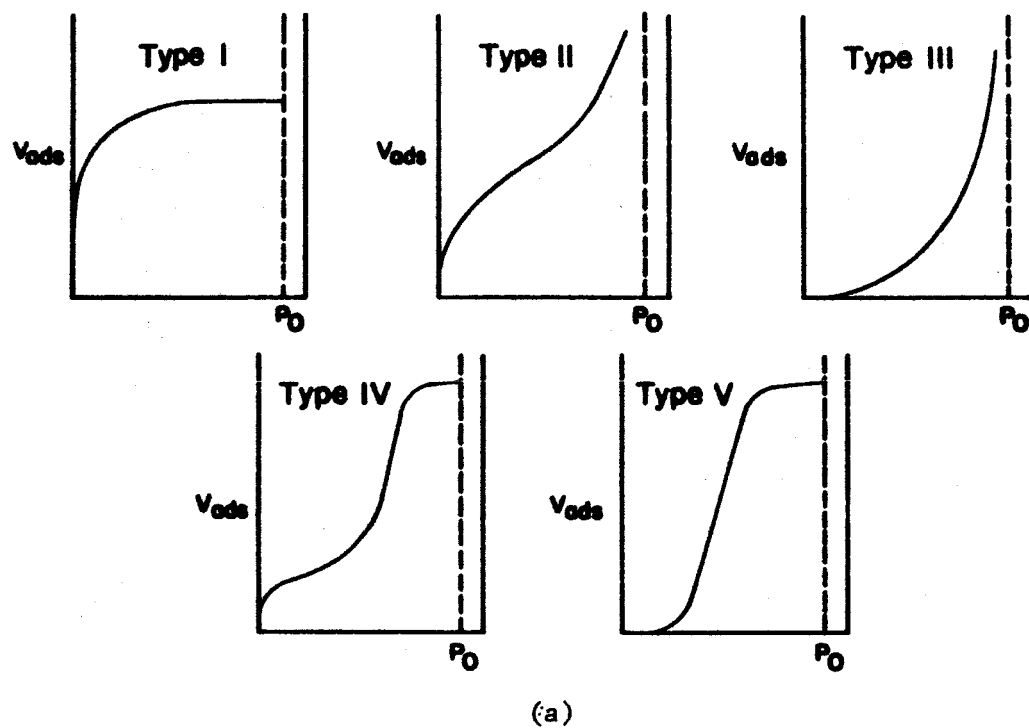

Figure 1. Brunauer's and de Boer's Isotherms.

These steep rises are attributed to the filling of pores.¹² In addition, de Boer has classified five types of isotherms with a steep portion in either the adsorption or desorption branch (Fig. 1b). He discusses a number of pore shapes and indicates how each characteristic shape affects the appearance of the isotherm. All five of these isotherms are steep at high relative pressures (i.e., above 0.5) and show hysteresis.

It is possible to analyze such isotherms and determine to some extent the nature of the pores.^{12,13,16} Such an analysis is based upon the Kelvin equation which implies that the pressure at which a substance liquefies is greatly lowered if the liquid surface has a highly concave curvature. The analysis assumes that after a few layers of molecules are adsorbed on the walls of a small pore they meet and form such a meniscus. At this point the mechanism for filling the pores changes to one of liquefaction. The liquid is mobile and fills almost immediately the entire pore resulting in the appearance of a steep rise in the adsorption isotherm. On desorption the pores empty by evaporation from the liquid surface instead of from higher adsorbed layers. Since the mechanisms of adsorption and desorption are different, porous solids with such pores exhibit hysteresis. It is the nature of this hysteresis which is analyzed to determine pore shape and size distribution. In such an analysis, pores with radii larger than 300\AA are neglected as a great many layers would be required for formation of a liquid surface.¹³

In general, as the pore diameter increases, the pressure at which the isotherm becomes steep increases. The type pores just discussed are referred to as transition type pores as the mechanism of filling changes during the process of adsorption.

In addition to transition type pores it is generally recognized that very fine capillaries exist which exhibit no hysteresis.^{14,17} In these pores two effects occur which make a liquid interface form at extremely low pressures. The two involve pores of such a small diameter that an adsorbate molecule interacts with a much larger area of the adsorbent than it would if the wall were flat. This results in a much tighter binding to the surface and explains the initially high energy of adsorption found in many cases. This stronger interaction causes preferential adsorption in the neck of the pore and enough layers of adsorbed gas are bound to form a liquid interface. The process of filling them appears as liquefaction on a highly concave meniscus. These pores are of molecular dimensions and no method has been developed for determining their size.

As is to be expected, the steep part of the isotherm occurs at very low pressure. Once the pores are filled there is very little free surface left for further adsorption and thus the adsorption isotherm appears flat at higher pressures. This mechanism, therefore, may also account for type I isotherm, without assuming mono-molecular adsorption. There are other properties associated with this type isotherm which in certain cases make the mono-molecular hypothesis untenable. It most frequently occurs with carbons of high surface area in the order of $2000 \text{ M}^2/\text{gm}$. This high a surface area would require that each carbon atom contribute 4 \AA^2 to the total surface which seems unreasonable. It is to be noted that graphite with a much lower surface area exhibits the expected type II isotherm.

In summary, the B.E.T. equation can be applied to all five types of isotherms in order to calculate the mono-molecular volume and hence

the surface area, although its applicability to the type I isotherm is to be strongly questioned. The expected isotherm for porous solids with no pores less than 300 Å radius or nonporous solids is Brunauer's type II. The type I isotherm may be associated with capillary condensation in pores of molecular dimensions or mono-molecular adsorption.

CHAPTER III

EQUIPMENT DESIGN AND CONSTRUCTION

An adsorption apparatus must be capable of measuring an amount of gas, allowing it to come in contact with a sample then determining the amount of gas remaining in the gas phase. In addition, it must be able to change the pressure by altering some parameter such as volume or amount of gas in order to determine a series of points as a function of pressure. In order to utilize the B.E.T. equation provisions must be made for simultaneously observing the vapor pressure of the adsorbate in addition to volume of gas adsorbed and pressure. In order to analyze other properties of the sample such as pore structure it is necessary to obtain adsorption data over a range of pressures from nearly zero to the vapor pressure of the adsorbate (i.e., around atmospheric pressure for nitrogen adsorption at 78° K).

To meet these demands it is necessary for the apparatus to fulfill certain requirements. Such an apparatus will consist of two major components, the adsorption system (containing a gas burette, sample chamber and manometer, (Figs. 2 & 3) and associated equipment (for evacuating the system, filling it with purified gas, isolating the system, vapor pressure measuring device, etc.).

In addition, the apparatus should have as small a free volume as possible and freedom from leaks. Provisions must be made to heat the sample for outgassing and then to reduce its temperature to the

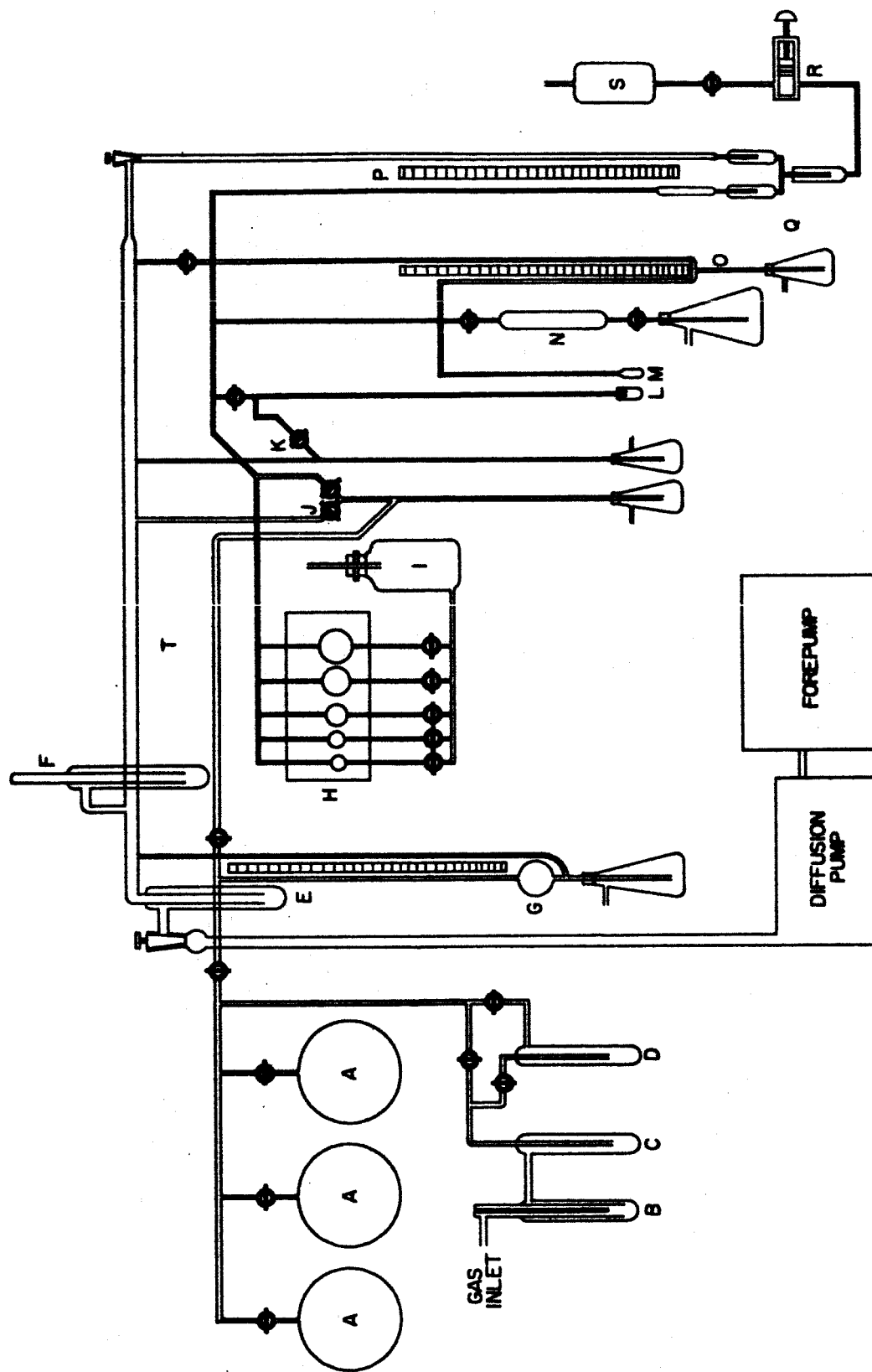

Figure 2. Detail of complete adsorption apparatus.
(Legend on page 16)

LEGEND FOR FIGURE 2

- A. Gas storage bulbs
- B. Hot copper trap (350°C)
- C. Cold trap (78°K)
- D. Silica gel trap
- E. Cold trap (78°K)
- F. Cold cathode vacuum gauge
- G. Toeppler pump
- H. Gas burette
- I. Mercury reservoir for burette
- J. Isolation stopcock for filling burette
- K. Isolation stopcock for evacuating sample
- L. Sample bulb
- M. Vapor pressure cold bulb
- N. Pressurizing pump for vapor pressure device
- O. Vapor pressure manometer
- P. Constant volume manometer
- Q. Filter bulbs for main manometer
- R. Level adjust for constant volume manometer
- S. Mercury reservoir for constant volume manometer
- T. High vacuum manifold

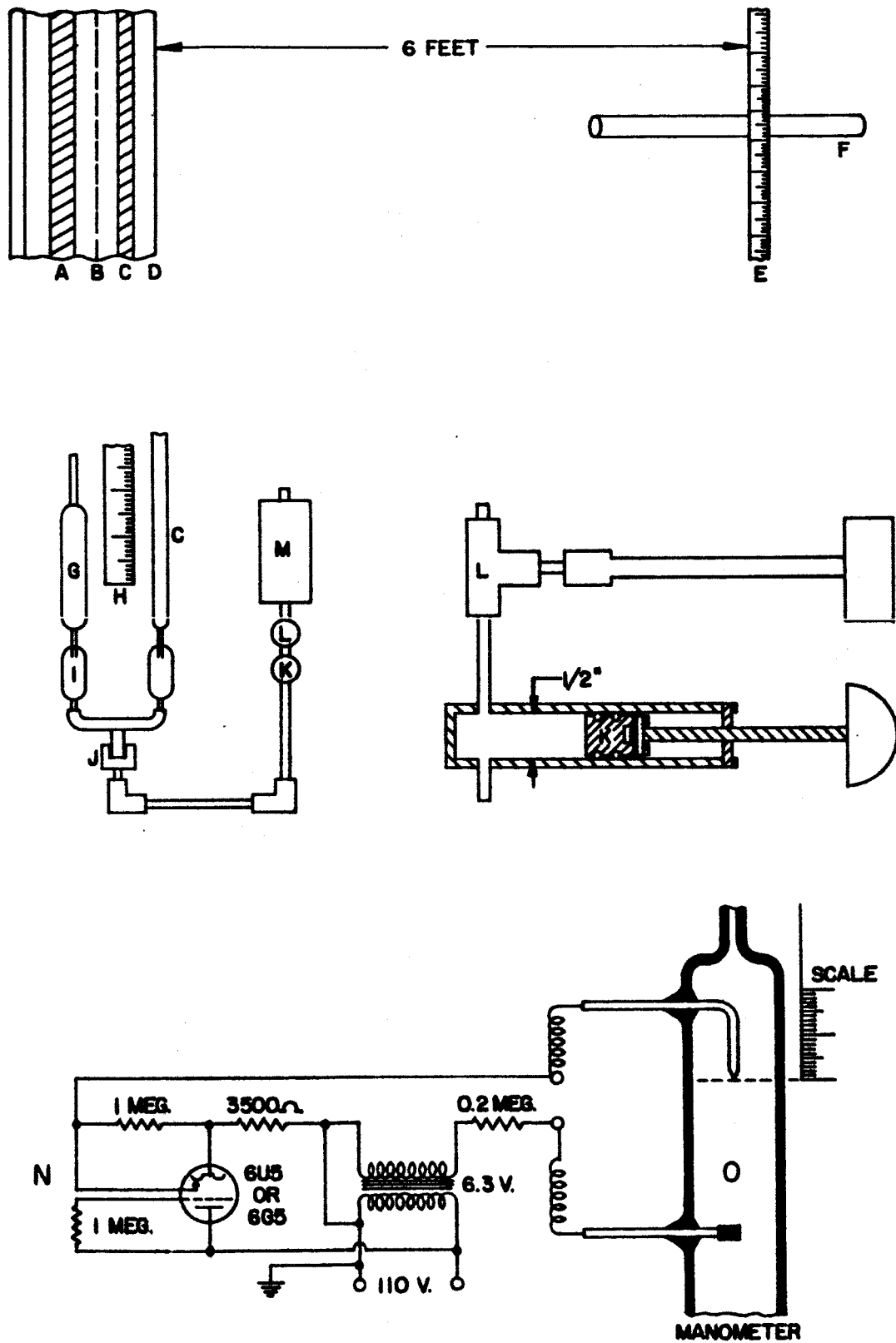

Figure 3. Detail of Manometer.

(Legend on Page 18)

LEGEND FOR FIGURE 3

- A. Fluorescent light bulb
- B. Movable slotted slide
- C. Manometer tube
- D. Glass front to manometer case
- E. Cathetometer meter bar
- F. Cathetometer telescope
- G. Tungsten contacts
- H. Manometer meter bar
- I. Filter bulbs
- J. Glass to stainless steel seal (wax)
- K. Piston pump
- L. SS valve (Whitey)
- M. SS mercury reservoir
- N. Electronic level indicator
- O. Constant volume manometer reference leg

temperature desired for the isotherm. Since gas pressure depends strongly upon the temperature, thermometers must be placed at appropriate points. The temperature of the manometer must also be monitored as the measured pressure and must be corrected for temperature effects. As with all equipment, better results will be obtained if the design is kept as simple as possible.

Adsorption apparatus have been around for some time so it is advisable only to note those points which have been significantly altered from conventional design. A good reference for design and construction is Methods of Scientific Glass Blowing¹⁸ which covers design problems quite carefully.

The present design includes a gas handling system patterned after Constabaris, Singleton and Halsey;¹⁹ a nitrogen vapor pressure manometer, and a gas purification system after Anhorn and Barr.¹⁸ The manometer is of original design utilizing the reference indicator of Anhorn and Barr¹⁸ and suggestions by Cunningham.²⁰

Because Anhorn and Barr¹⁸ and Constabaris, Singleton and Halsey¹⁹ cover most of the details of design, most of their material is not reproduced here. The diagram of the complete apparatus (Fig. 2) and the following discussion contain sufficient information for the construction of a similar apparatus though the two references may be helpful.

The apparatus differs significantly from conventional design only in the gas burette and the manometer. These two components along with a discussion of tubing sizes and nitrogen vapor pressure "thermometer" are to be discussed.

The main feature differing from standard design is the gas

burette (Fig. 4). The standard design contains five or six calibrated bulbs connected so that the largest is filled, then the next largest, etc., until all are filled. This results in only six or seven points before the system must be recharged with gas. By placing the bulbs in parallel (i.e., so each may be filled or emptied independently of the others) it is possible with five bulbs to obtain 32 points. In the present apparatus the smallest bulb had a volume of nearly 8 cm^3 , the next a volume of 16 cm^3 , the third 32 cm^3 , the fourth 64 cm^3 , the fifth 128 cm^3 . This allowed the volume of the system to be reduced in steps of 8 cm^3 (i.e., 8, 16, 24, 32...). The volumes listed above are only approximate for purpose of simplicity. The actual volumes were 7.005, 15.529, 31.607, 66.884, and 125.822 cm^3 respectively. These volumes were evaluated by determining the mass of mercury required to fill the bulbs between two etched reference marks and calculating the volume from the density of mercury at the appropriate temperature. The accuracy of calibration is in the order of 0.01 cm^3 . The bulbs are contained in a water bath whose temperature is monitored by a thermometer.

The manometer (Fig. 3) is constructed so that the pressure side is always at the same level when readings are taken, thus maintaining a constant volume in the adsorption system. This level is indicated by an electron ray tube with contact to the mercury made by two tungsten feed-throughs. This device is patterned after Anhorn and Barr.¹⁸ The mercury is adjusted to approximately the proper level by changing the air pressure at the top of the stainless steel mercury reservoir. The mercury flow is then shut off by means of a valve and the small O-ring sealed piston is run in or out for the final adjustment as indicated on the electron ray tube.

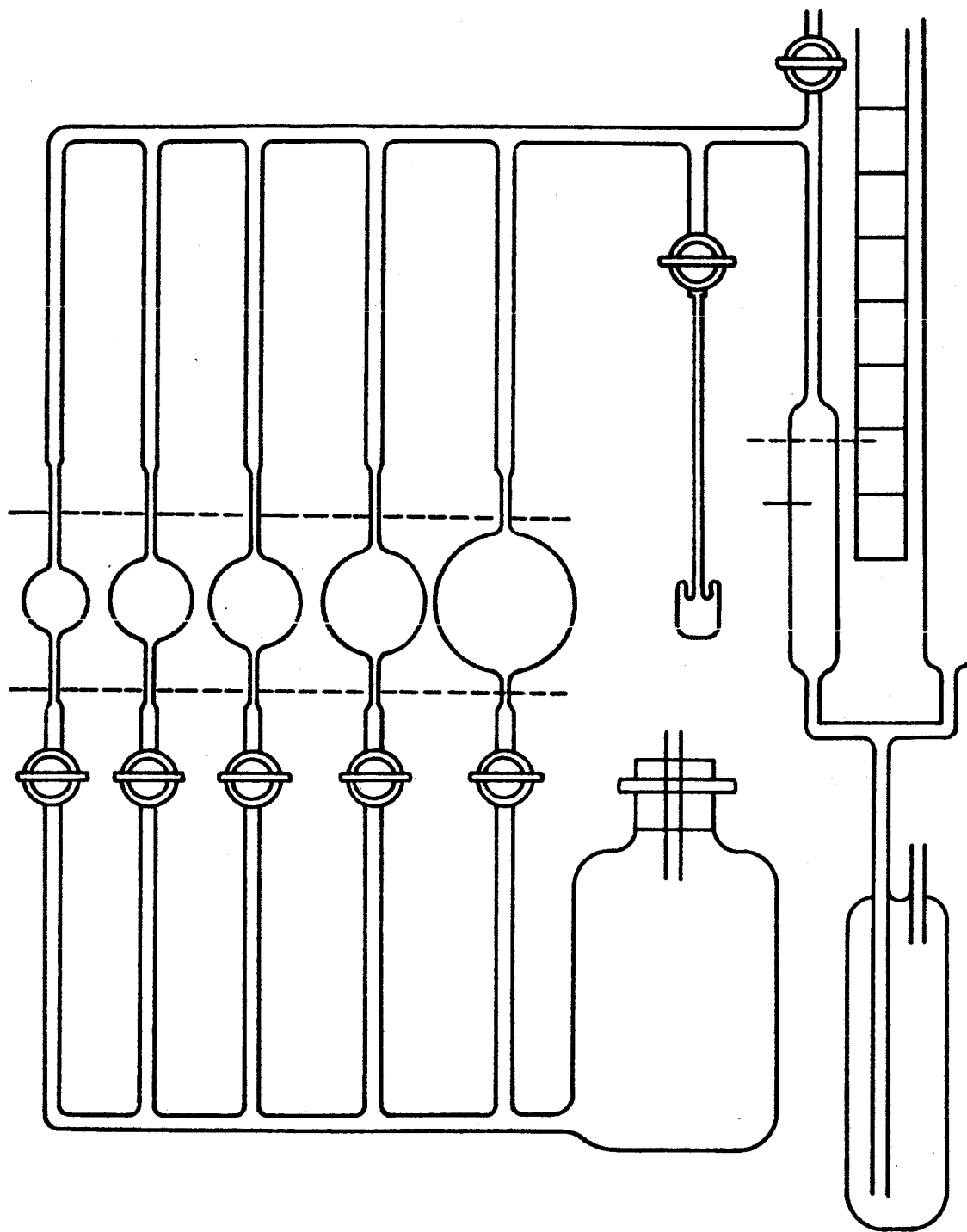

Figure 4. Schematic of adsorption system.

The complete manometer is enclosed in a wood case with a glass front. This case has a fluorescent light behind the mercury columns and a vertically movable slotted slide. In use this slide is positioned so that a narrow beam of light passes just over the mercury meniscus. The pressure is measured on a precision meter bar enclosed in the case. In addition, a cathetometer capable of reading to 0.001 cm is used to determine the height of the mercury above the index mark on the meter bar.

Both sides of the manometer are constructed of the same piece of 1/2" precision bore tubing to reduce capillary effects. The bulbs located below the manometer filter out floating impurities in the mercury.

The nitrogen vapor pressure "thermometer" is patterned after the design of Anhorn and Barr.¹⁸ It consists of a simple manometer, a bulb to pressurize the nitrogen with mercury, and a bulb located adjacent to the sample. By pressurizing the gas until it partially liquefies in the low temperature bulb the nitrogen vapor pressure may be read directly from the meter bar.

With the exception of the gas burette, the manometer and the sample bulb, the system is at room temperature. Thermometers are located at various points in order to be able to calculate volumes of gas in each component. As pretreatment of the sample includes heating under a vacuum to clean its surface, a small copper tube furnace of sufficient size to pass over the sample bulb is controlled by a variac. When this heater is in use, a mercury thermometer is hung adjacent to the sample bulb to monitor its temperature.

The main vacuum manifold is constructed of 1" diameter pyrex tubing.

The tubing in the adsorption system consists of 2 mm capillary to reduce the volume. The remaining tubing is nearly all 10 mm pyrex. The three gas storage bulbs are constructed from 6 liter Florence flasks.

CHAPTER IV

CALIBRATION AND EXPERIMENTAL PROCEDURES

Though at first sight an adsorption apparatus appears quite complicated (Fig. 2), it is quite simple in concept. The apparatus consists of several semi-isolated components each of which is simple in design and use. A gas purifying system consisting of a hot copper trap, a cold trap and a silica gel trap is connected directly with storage bulbs used for storing the prepared gas. Located between the storage bulbs and the adsorption system proper (Fig. 4) is a Toepler pump used to transfer the gas into the adsorption system. Much of the glass manifold is a high vacuum system used to evacuate each component of the apparatus and as a "zero pressure" reference for the two manometers. The adsorption system contains a gas burette, a sample bulb and manometer. In addition to these components an auxiliary manifold is used to raise or lower the mercury levels. For simplicity it is omitted from the detail drawing (Fig. 2).

A short study of the detail drawing along with the discussion in Chapter III should be sufficient for operation of the apparatus. Analyzing the data, however, could present some difficulties and it is the purpose of this chapter to clarify several points, introduce a convenient method of analysis, and present the concepts of certain corrections utilized.

In order to present a detailed discussion it is necessary to define

a system of units. To be consistent with other work of this nature it is advisable to measure volumes in cm^3 , pressure in cm of mercury, and temperatures in degrees Kelvin. With these units the most convenient unit for an amount of gas is cm^3 at S.T.P. (the amount of gas contained in a volume of 1 cm^3 at 76 cm pressure and $0^\circ\text{C}.$). Using this convention it is proper to speak of an amount of gas as a volume.

As the ideal gas law is normally valid at sub-atmospheric pressures and ordinary temperatures, nearly all of the system may be characterized by it. The only exception occurs with nitrogen gas at liquid nitrogen temperatures and it is possible to introduce a correction factor when necessary without disrupting the scheme of analysis as will be shown at the appropriate time. Utilizing the ideal gas law, the quantity, V , of gas at S.T.P. in a volume $V(i)$, at temperature $T(i)$ and pressure $P(i)$ is:

$$V = V(i) \frac{P(i)}{76} \frac{273.16}{T(i)} = (V(i) \frac{273.16}{76}) \frac{P(i)}{T(i)} \quad (1)$$

By defining the quantity $V(i) \frac{273.16}{76}$ as a volume factor, denoted $f(i)$, the volume of gas in "n" volumes may be written:

$$V = \sum_{i=1}^n f(i) \frac{P(i)}{T(i)} \quad (2)$$

It is now possible to express the volume of gas in the adsorption system provided sufficient information is known. As different portions of the system (Fig. 4) are at different temperatures it is necessary to consider it as several volumes: 1) the gas burette consisting of the five calibrated bulbs, 2) the connecting capillary to the manometer and the sample isolation stopcock (stopcock A), 3) the capillary between

stopcock A and the liquid nitrogen level in the sample dewar, and 4) the free volume in the sample bulb up to the liquid nitrogen level.

Volumes 1 and 2 are always connected, hence $P(1) = P(2)$.

Similarly $P(3) = P(4)$. With stopcock A open all pressures are identical. There may exist temperature gradients in some portion of each volume. These gradients, however, are either small enough to be neglected or the associated volume is small leading to a small error as in the case with V_3 where a temperature change of over 200°C exists. A small error in calculating $f(3)$ will be compensated for by calibration appearing as a change in the value of $f(4)$.

Throughout the course of an experiment the volumes remain unchanged except for $V(1)$ which is the independent variable. It is convenient to have a table of the 32 possible values of $f(1)$ with the associated bulb settings.

The data taken for both calibration and operation will fall in either of two classes: 1) A open or, 2) A closed with a known volume (possibly zero) of gas in $V(3)$ and $V(4)$. In the first case the volume of gas in the system for the i th point is given by:

$$V_i = \left(\frac{f_i(1)}{T_i(1)} + \frac{f(2)}{T_i(2)} + \frac{f(3)}{T_i(3)} + \frac{f(4)}{T_i(4)} \right) P_i. \quad (3)$$

In the second case the last two terms will be constants (possibly zero). In the case of nitrogen at liquid nitrogen temperatures it is necessary to correct the last term by multiplying it by

$$\left(1 + \frac{0.05 P_i}{76} \right)^{18}$$

For calibration after preparation of the sample and system

(outgassing, evacuating, cooling the sample to $\sim 78^{\circ}\text{K}$) the adsorption system with stopcock A closed is pressurized to about 2 cm of helium pressure and isolated. The volume of the burette is then varied in an appropriate manner and readings of pressure and temperature taken. (See Appendix I for a tabular method of taking data.) Stopcock A is then opened and the process repeated. This gives sufficient data for calibration and the analysis of this data is to be covered shortly.

The data for the adsorption isotherms is taken in a similar manner but with nitrogen instead of helium. In this case, however, a lower pressure may be necessary for initial points and it may be necessary to add more gas to the adsorption system in order to reach higher pressures. This latter is readily accomplished by closing stopcock A, adding gas to the burette, and taking a couple of points to determine the new volume of gas in volumes 1 and 2. In some cases hysteresis will occur and it will be necessary to approach each pressure from the proper direction. This is most easily accomplished by closing stopcock A while adjusting the burette then reopening it before taking readings. In addition, the nitrogen vapor pressure manometer must be in use in order that the vapor pressure be known at each point.

In analyzing the data it is necessary to correct the manometer to standard readings. This correction involves temperature, local gravity and meniscus effects. As both sides of the manometer are constructed of the same precision bore tubing to reduce meniscus effects to a minimum this particular correction is omitted.

The temperature correction is found to be:²¹

$$P'' = P' \left[1 + \frac{l(t-t_s) - m(t-t_m)}{l + m(t-t_m)} \right] \quad (4)$$

where:

t = temperature of scale and mercury in $^{\circ}\text{C}$

t_s = temperature to which scale is corrected

t_m = standard mercury temperature

l = coefficient of expansion of scale

m = volume of coefficient of expansion of mercury

P' = measured pressure

P'' = pressure corrected for temperature.

In addition, the above pressure is corrected to standard gravity by multiplying by:

$$\frac{979.746}{980.665} = \frac{\text{local gravity}}{\text{standard gravity}} \quad (5)$$

It is possible to combine these last two equations and construct a table for local conditions. The table will consist of the temperature and an associated correction factor which is multiplied with the measured pressure to give the true pressure. These correction factors range from 0.99543 at 20°C to 0.99359 at 31°C , and could feasibly be omitted without introducing significant error as in this case the gravity correction tended to compensate for the temperature deviation.

In the first part of the calibration data (helium used) the system is governed by Equation 3 with the last two terms on the right set equal to zero, i.e.,

$$V = \left(\frac{f_i(1)}{T_i(1)} + \frac{f_i(2)}{T_i(2)} \right) P_i = \text{constant}. \quad (6)$$

This equation may be rearranged to read

$$\frac{1}{P_i} = \frac{f_i(1)}{T_i(1)} \frac{1}{V} + \frac{f_i(2)}{T_i(2)} \frac{1}{V}. \quad (7)$$

If $T(2)$ remains constant, plotting $1/P_i$ against $f_i(1)/T_i(1)$ will result in a straight line whose slope is $1/V$, the volume of gas in the system. Obtaining $f(2)$ from this graph is difficult due to its small value. Actually $f(2)$ is obtained by either putting V back into Equation 6 for several data points and averaging the values of $f(2)$ calculated or by using Equation 6 written in the form

$$\frac{f_i(1)}{T_i(1)} P_i = V - \frac{f(2)}{T_i(2)} P_i. \quad (8)$$

Plotting $f_i(1)/T_i(1) P_i$ against P_i results in a straight line graph whose slope is $-f(2)/T_i(2)$ from which $f(2)$ may be extracted.

The quantity $f(3)$ must be calculated from geometrical data.

Equation 3 is then used to calculate $f(4)$ either directly or by plotting it in a form similar to Equation 8, i.e.,

$$\left(\frac{f_i(1)}{T_i(1)} + \frac{f(2)}{T_i(2)} + \frac{f(3)}{T_i(3)} \right) P_i = V - \frac{f(4)}{T_i(4)} P_i. \quad (9)$$

In this manner both $f(2)$ and $f(4)$ are determined and the calibration complete.

In analyzing the adsorption data the volume of gas in the system is determined with stopcock A closed. In the case of a recharge of gas the total volume of gas is given by the sum of the volumes in $V(1)$ and $V(2)$ and that gas in $V(3)$, $V(4)$ and V_{ads} where V_{ads} is the volume of gas adsorbed on the sample. In any case the volume of gas adsorbed, V_{ads} , is given by the difference between the total volume of gas placed in the system and the amount remaining in the gas phase for the i th point.

In calculating the volume of nitrogen in the sample bulb one is

again reminded that it is necessary to multiply the ideal gas volume by $[1 + \frac{.05}{76} P]$.

The data is normally presented as an isotherm with V_{ads} plotted against the relative pressure P/P_0 . The B.E.T. surface area is determined from a plot of $\frac{P/P_0}{V_{ads}(1-P/P_0)}$ against P/P_0 in accordance with Chapter III.

CHAPTER V

EXPERIMENTAL RESULTS

The B.E.T. area was determined and the nitrogen adsorption isotherms were analyzed for three samples prepared as indicated in Appendix I. As a check on the apparatus the B.E.T. area was determined for "Baymal" colloidal alumina obtained from DuPont. The calculated area of 265 $M^2/gm.$ agrees quite well with their stated value of 275 $M^2/gm.$ ²²

As measurements of this type are highly dependent upon final preparation it is felt necessary to cite with the results the details of the outgassing procedure.

The powder sample used was 7.81 gm of white SnO_2 powder. Final treatment of the sample before the adsorption run was heating to 200°C at 10^{-6} torr overnight. The sample yielded a type II isotherm at 78°K with no hysteresis (Fig. 5). Application of the B.E.T. equation was valid to a relative pressure of 0.20 (Fig. 6) and yielded a surface area of 1.99 $M^2/gm.$

The ceramic sample used consisted of four ceramic pellets as described in Appendix II. Its mass was 5.706 gm and it too was pretreated overnight at 200°C and 10^{-6} torr. This sample also exhibited a type II isotherm with no hysteresis (Fig. 7) at 78°K. The specific surface area derived via the B.E.T. method was 0.37 $M^2/gm.$ The B.E.T. plot appeared valid to relative pressures of 0.40 (Fig. 8).

The gel sample consisted of 0.131 gm of the white powder. Upon

NITROGEN ADSORPTION
ISOTHERM
 S_nO_2 POWDER (7.8 gm.) at 78°K

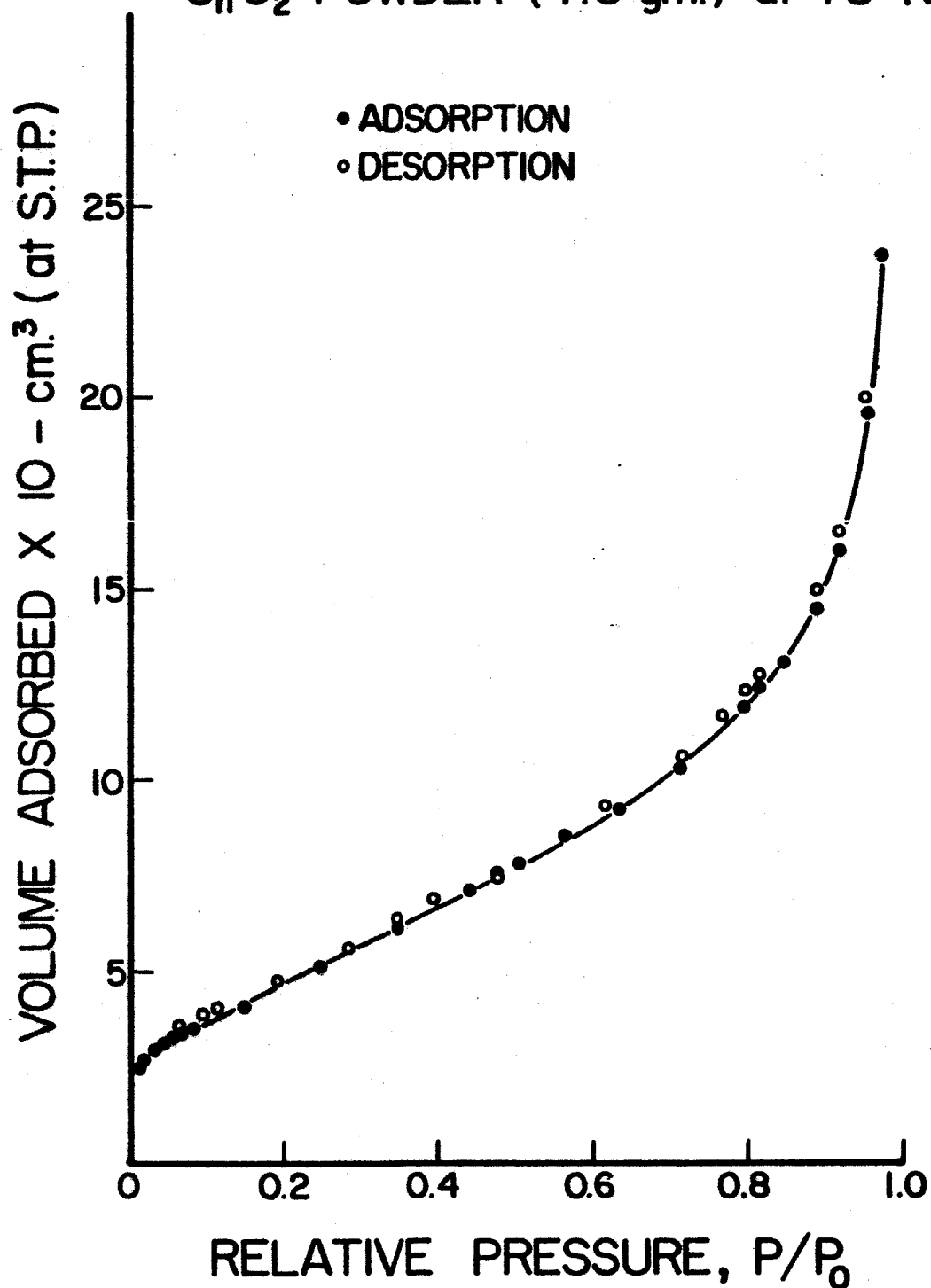

Figure 5. Nitrogen adsorption isotherm - powder.

BET LINEAR PLOT
FOR CALCULATION OF AREA
SnO₂ POWDER (7.8 gm.)

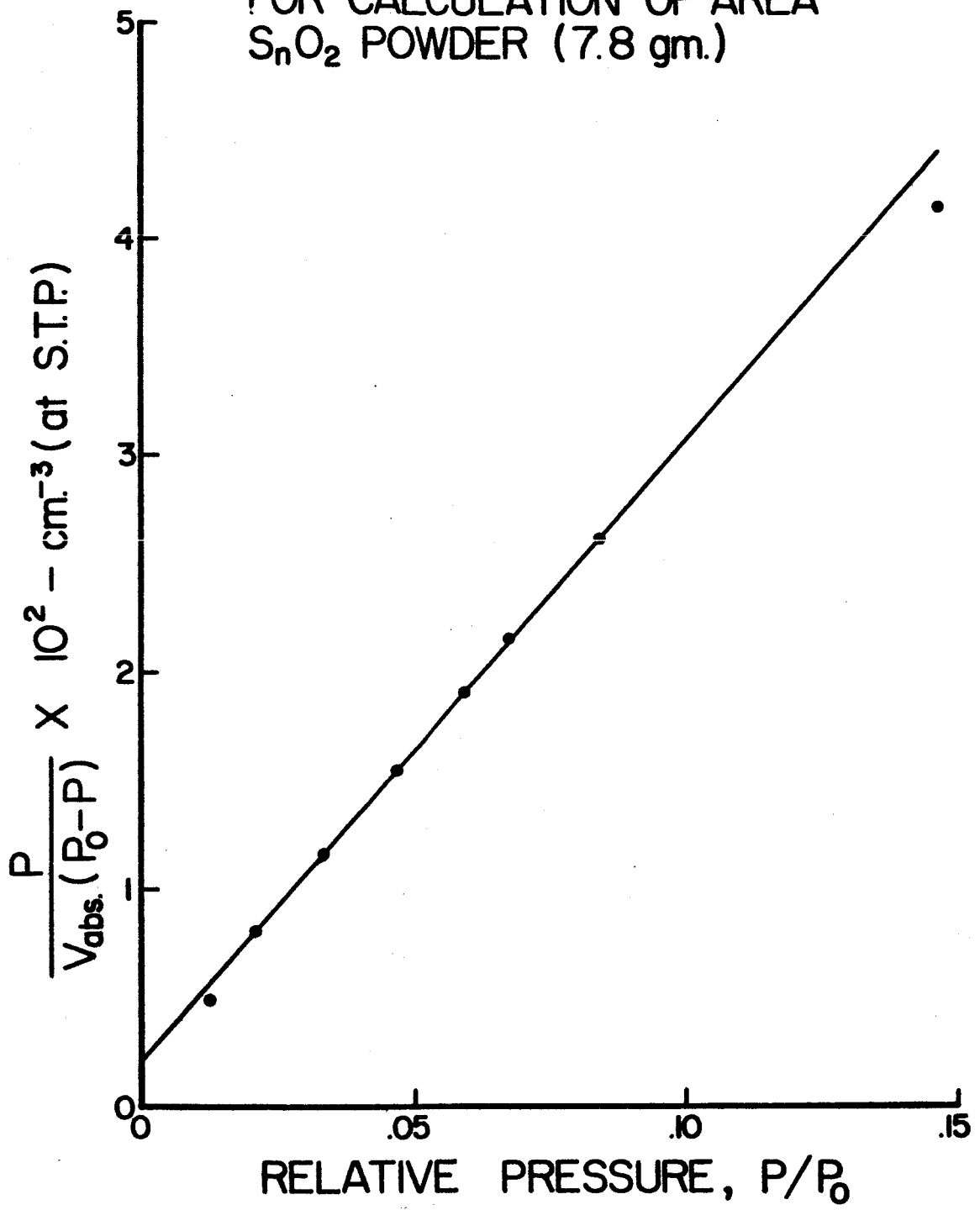

Figure 6. Linear B.E.T. plot - powder.

NITROGEN ADSORPTION
ISOTHERM
 S_nO_2 CERAMIC (5.7 gm.) at 78°K

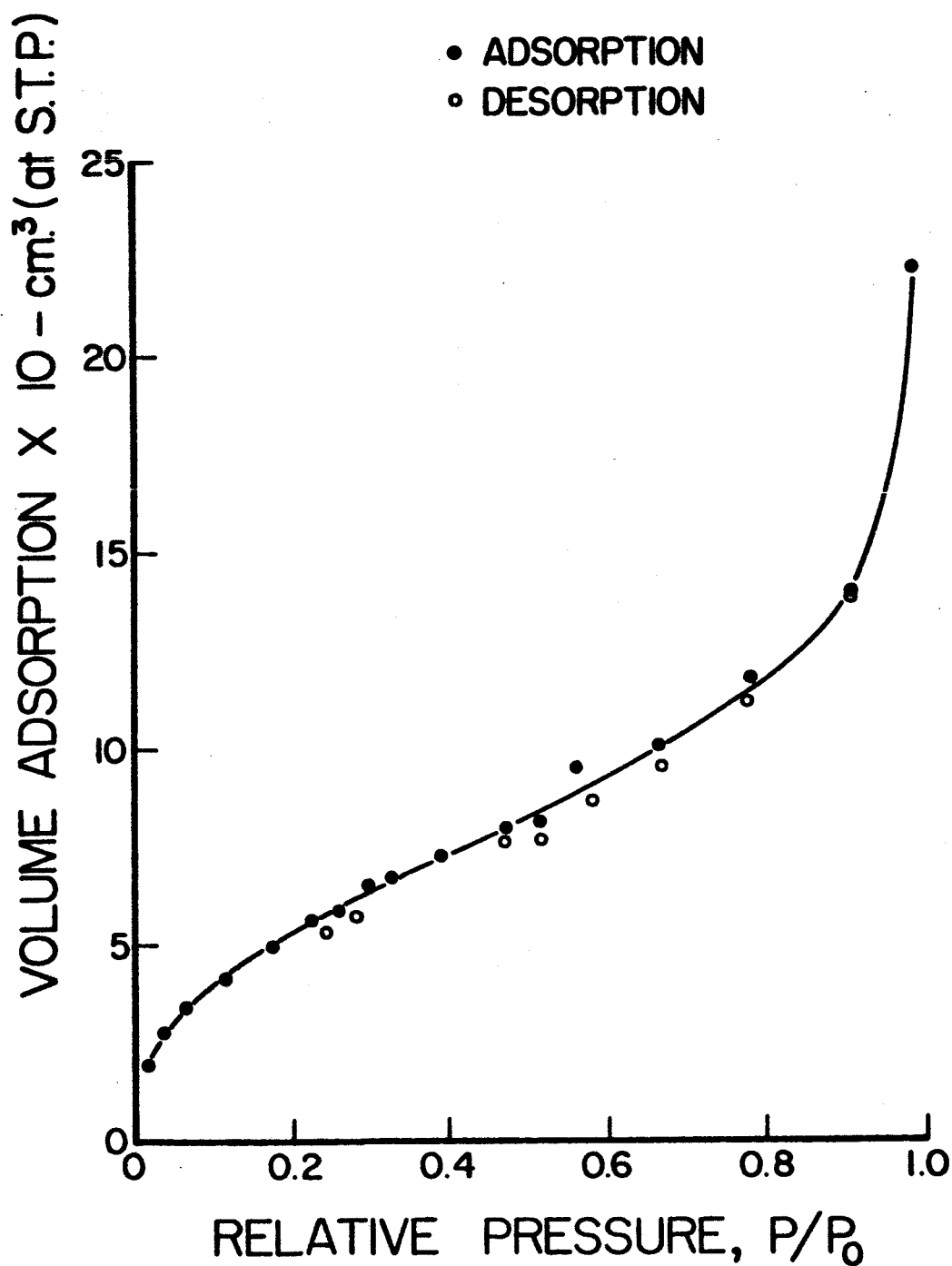

Figure 7. Nitrogen adsorption isotherm - ceramic.

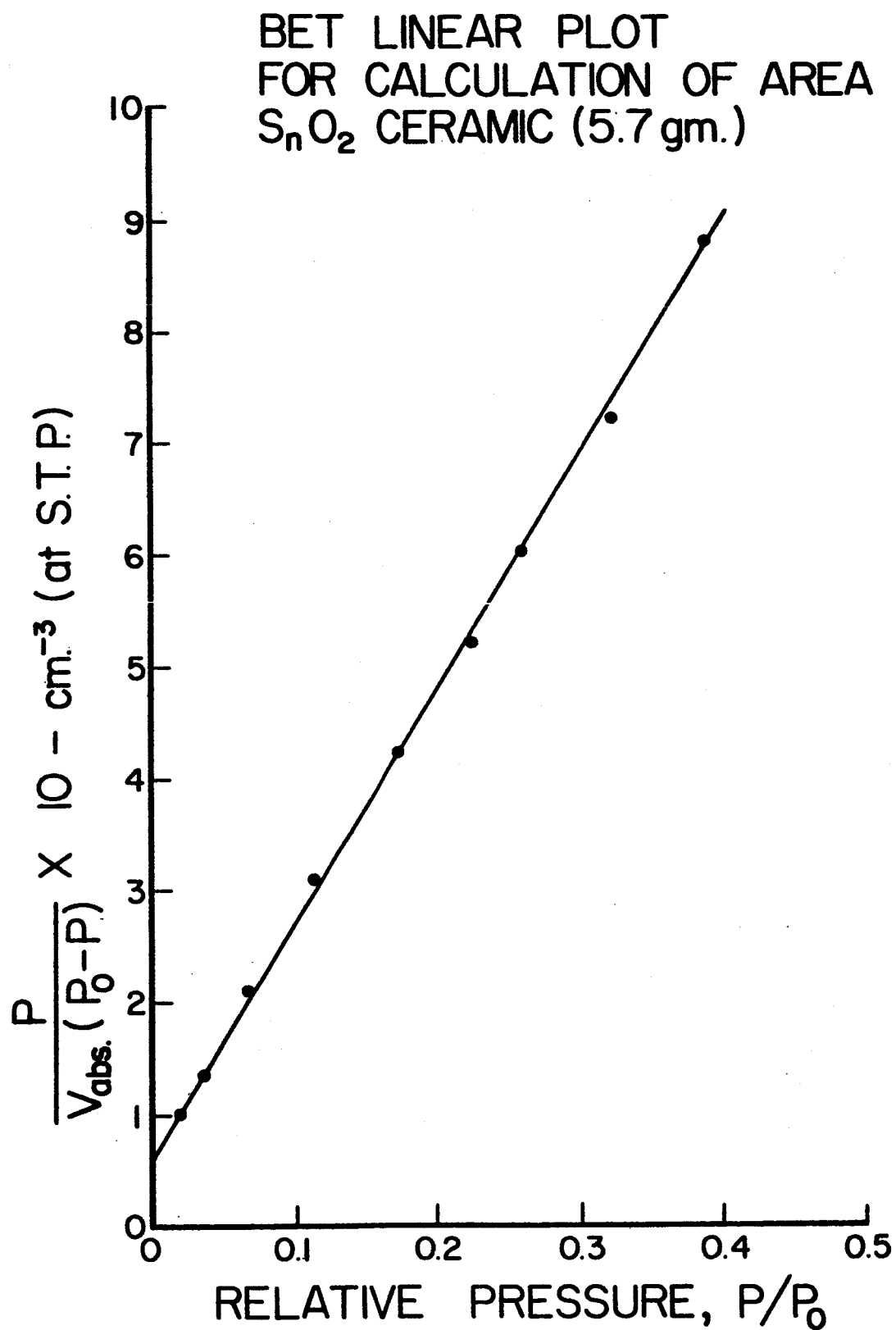

Figure 8. Linear B.E.T. plot - ceramic.

pretreatment at 220° under 10^{-6} torr the sample developed a yellow color. In contrast to the other samples the gel exhibited a type I or Langmuir isotherm at 78°K , again with no hysteresis (Fig. 9). The B.E.T. plot deviated from linearity at relative pressures above 0.20 (Fig. 10). The B.E.T. area was evaluated to be $173 \text{ M}^2/\text{gm}$ as compared to Goodman and Gregg's value of $172 \text{ M}^2/\text{gm}$ for similarly treated stannic oxide gel.¹⁷

In addition, the statistical thickness, v/v_m , of the adsorbed layers was calculated and plotted (Fig. 11). The powder and ceramic sample plots exhibited similar shapes and agreed fairly well in magnitude; whereas the gel plot deviated significantly, implying that the details of adsorption on the gel sample were considerably different.

In the ceramic and powder samples the type II isotherm with no hysteresis is taken to indicate an energy of adsorption greater than the heat of liquefaction and suggests that no significant number of pores exist with radii less than 300 \AA . The nature of the gel isotherm, on the other hand, may be reasonably attributed to the presence of pores of molecular dimensions.

On each sample three sets of data sufficient to obtain a B.E.T. area were taken. Two runs were normally required in preliminary work to determine what amounts of gas were required initially to yield points in the correct pressure range. The third run on each sample was taken with greater care and the complete isotherm obtained. The data from the two preliminary runs was then used as a check on the results of the third.

NITROGEN ADSORPTION
ISOTHERM
 S_nO_2 GEL (0.13 gm.) at 78°K

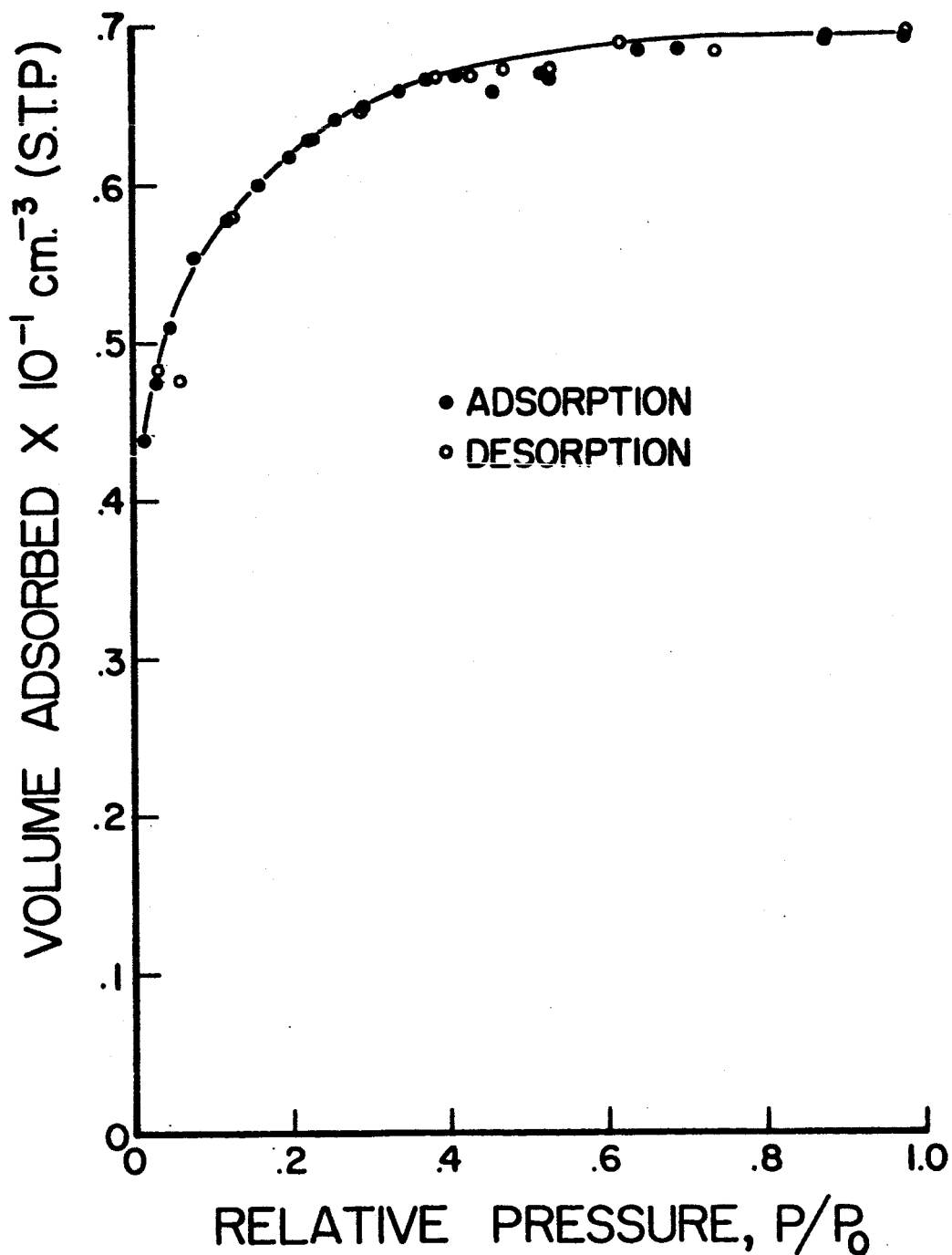

Figure 9. Nitrogen adsorption isotherm - gel.

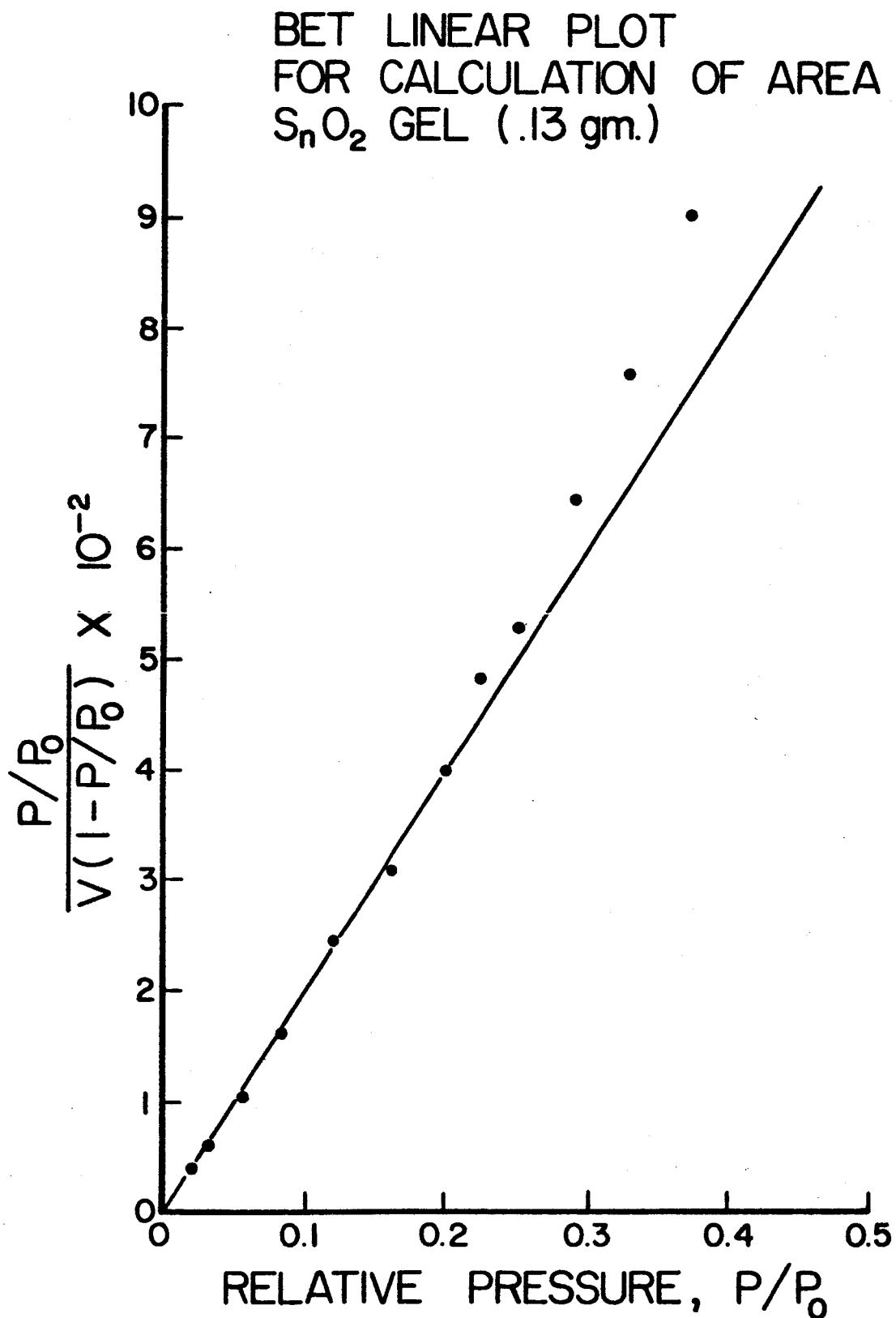

Figure 10. Linear B.E.T. plot - gel.

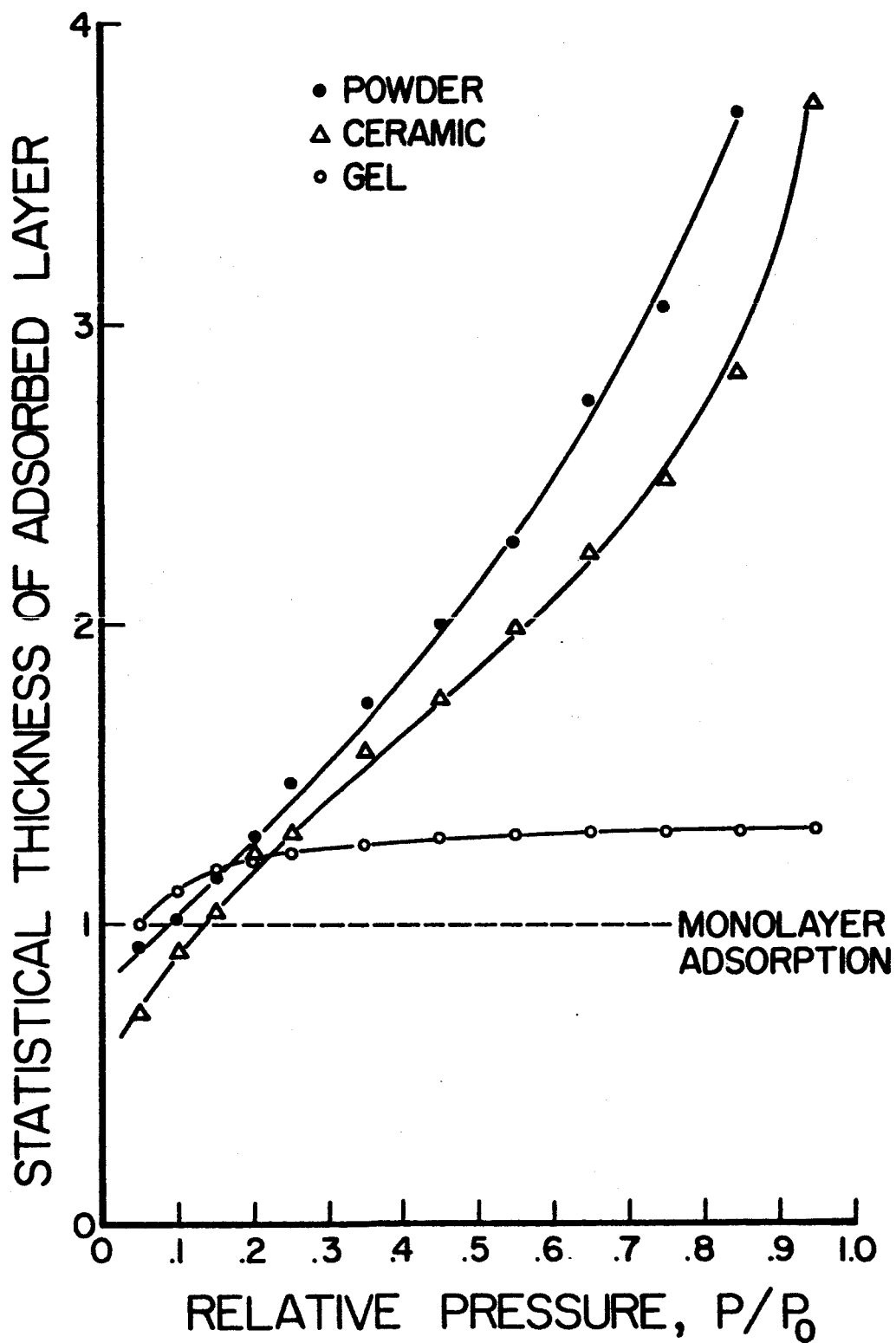

Figure 11. Statistical thickness of adsorbed layers.

CHAPTER VI

CONCLUSIONS AND SUGGESTIONS FOR FURTHER WORK

As emphasized earlier, the adsorption properties of the powder and ceramic samples appeared quite similar in nature. As they both exhibited a type II isotherm one must conclude that the adsorbate molecule "sees" a flat surface of uniform characteristics. In essence, a uniform surface could provide either a type II or type III isotherm behavior with the distinction between the two being the energy of adsorption. In the case of the type III isotherm, the adsorption energy is roughly equivalent to a heat of condensation, while the type II isotherm adsorption energy is somewhat greater resulting in a higher initial rise. In addition, the lack of hysteresis for both specimen forms indicates that the number of small pores is negligible.

Assuming that the individual powder particles are small nonporous bodies with fairly uniform surfaces, it is possible to calculate the diameter of small spheres required to give the measured surface area. Such a calculation gives as the relation between surface area and spherical radius the equation:

$$A = \frac{4.3 \times 10^{-7}}{r} ; \quad A \text{ in } \frac{M^2}{gm} , \quad r \text{ in } M \quad (1)$$

with 7 gm/cm^3 taken as the density of each particle. The measured surface area gives a value of 0.43 microns as the spherical particle diameter. This agrees well with the microscopically measured average

diameter of around 1.5 microns. This calculated diameter is in good agreement considering the simplicity of the spherical model.

In conclusion, the powder appears to consist of solid particles with uniform surfaces and little pore structure. As such it will be useful in further work as a "standard" surface.

The details of adsorption on the ceramic appear to be consistent with that of the powder. The lack of hysteresis indicates that no significant number of small pores with radii less than 300 Å exists. It is possible to assume the existence of spherical pores in this material and calculate the pore diameter required to give the measured surface. With this model the pore radius is given by:

$$r = \frac{3(1-X)}{PAX} , \quad (2)$$

where X is the relative density of the ceramic, P the true density of the material and A the measured area. This yields an effective radius of approximately 5000 Å which is consistent with the lack of hysteresis in the isotherm. This calculation, of course, contains the error of assuming all pores are spherical and are open to the surface of the sample.

Further work with ceramic samples is indicated since by proper formation techniques the surface area may be significantly altered on a sample which is suitable for electrical measurements. By producing a series of such samples, those electrical properties dependent upon the surface area may be detected. This information should be generally applicable to crystalline samples as the ceramic exhibits a normal isotherm.

Since the shape of the gel isotherm differs radically from that of

the powder or ceramic, one must conclude that an entirely different mechanism is responsible. There are at present two explanations for the type I or Langmuir isotherm--monolayer adsorption or condensation in fine capillaries. It is nearly impossible to believe that adsorption would occur only as a monolayer on a surface which in microscopic detail should be similar to a surface exhibiting multilayer adsorption. Hence, in this case, the capillary condensation picture of Pierce and Smith¹⁴ seems more reasonable. In this situation there is little credibility to such a parameter as surface area when calculated by the B.E.T. technique. Instead, one should speak of "adsorptive capacity" or some parameter related to its ability to adsorb (or condense) a specific gas.

At present the gel has not been used for direct electrical studies. As there is the possibility that it has different impurities than the powder, it would look worthwhile to attempt to grow crystals²³ or to make ceramics using the gel as a basic starting substance. Hopefully this could make it possible to isolate some electrical properties of stannic oxide which are dependent upon impurities.

The gel, as is normally expected of gels, is a good adsorbent. As such it will be useful in studies requiring a large amount of adsorbed material such as IR absorption and NMR measurements. In addition it may prove feasible to utilize it as a dessicant in studies involving stannic oxide as it will then not be necessary to have an impurity such as silica gel in the system.

It should now be possible to extend the results of the work to chemisorption studies and to get an indication of chemisorbed oxygen coverage which can be related to electrical properties. This in turn

should help clarify the dependence of electrical conductivity and other properties upon oxygen pressure and temperature.

CHAPTER VII

PROPOSED EQUIPMENT DESIGN CHANGES

As to be expected and probably hoped for, the construction and use of a new piece of apparatus often leads to new ideas in design. This has been the case during the course of this study. A major difficulty with the apparatus is the method of raising and lowering the mercury levels required for volume changes, manometry, and system isolation. This difficulty is due to the means of support of the mercury columns. In the present design the mercury is supported by air trapped inside a closed volume. Hence any sudden change of pressure inside the system allows the mercury levels to shift drastically. It would thus be advisable to support the mercury in another manner.

In essence one desires a method to force the mercury level upward or to allow it to fall. The simplest solution is to enclose the mercury in a container of variable volume. By decreasing the volume the mercury would be pumped upward. A bellows or a small piston pump constructed of the proper material will provide the necessary action.

It is proposed that all mercury levels in the system be supported by small piston pumps each actuated by a screw thread. In the present apparatus such a piston pump on the manometer has proven quite successful in an identical role. It consists of a stainless steel cylinder and a piston with vacuum grease sealed O-rings. Before installation of mercury this pump was evacuated to test for leaks and it was found that

the adsorption system could be maintained at 10^{-6} torr indefinitely. In use with mercury installed this pump has worked amazingly well.

Figure 12 is a cross section of a portion of the proposed gas burette. The calibrated bulb in this design has been changed from a spherical to a cylindrical shape to allow smaller total dimensions in the apparatus and to reduce the size of the stainless steel block from which the cylinders are to be machined. The figure also shows two cylinders, one for coarse changes in mercury level and one for fine. The calibrated bulb is completely enclosed in the water bath, the back of which is used as a mount for much of the adsorption system as illustrated in Figure 13.

Figure 13 gives the front view of the essential parts of the system. The vertical piston to the left replaces the Toepler pump without the use of any expensive mercury. This pump may also be used to charge the nitrogen vapor pressure monitoring system, again with a significant reduction in the amount of mercury required. Also illustrated are two piston-actuated mercury cut-offs which remove three stopcocks from the adsorption system. This part of the system is about 18 inches by 14 inches. In addition, a similar piston arrangement is proposed for the manometer.

As illustrated, the proposed system will require several vacuum tight mercury inert seals. For such seals "Apiezon W" wax has been used in the present manometer but it should also be possible to make them with an epoxy resin if it is sufficiently inert with respect to mercury.

In summary, the proposed modification should make possible a system with smaller dead space thus increasing the accuracy. The mercury

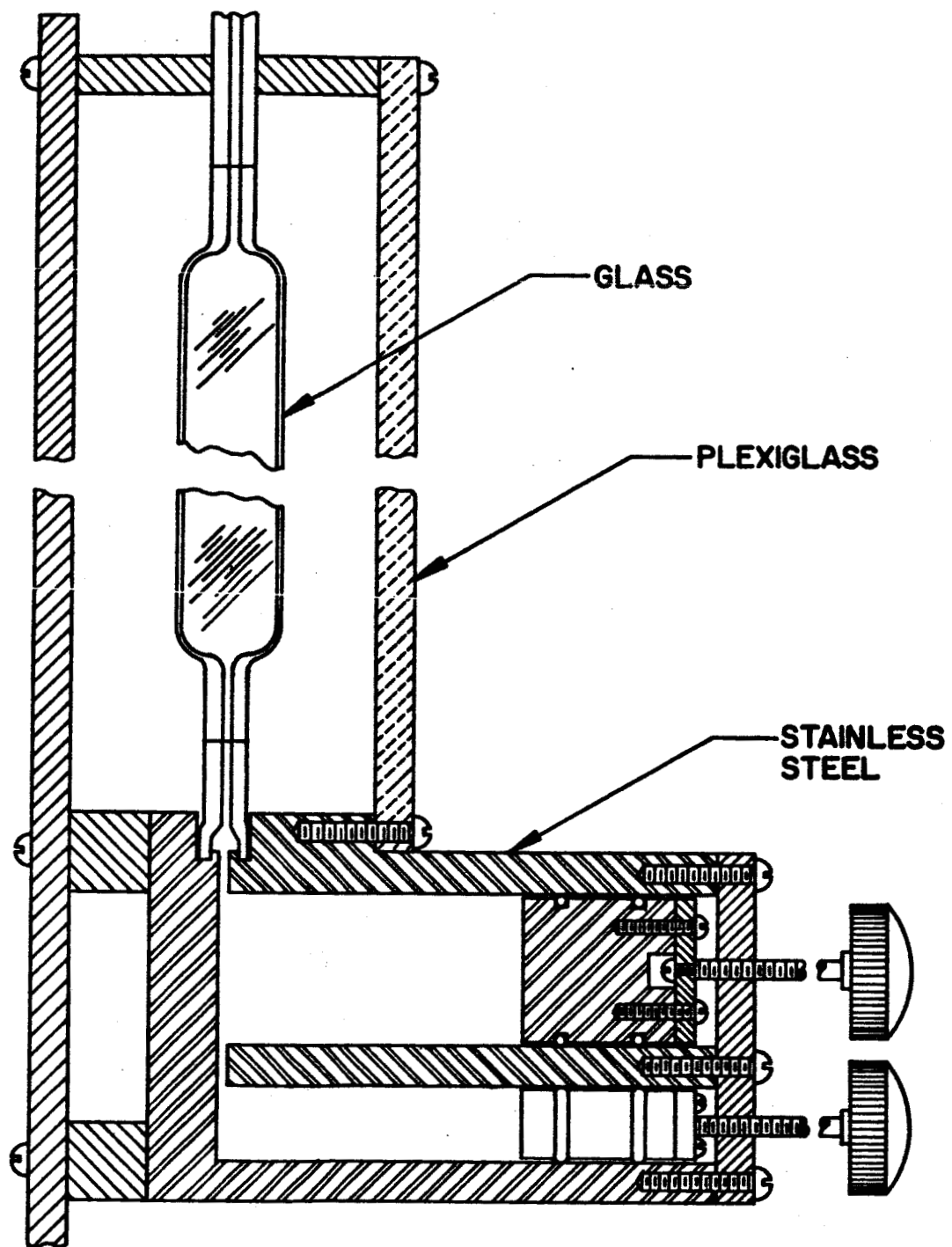

Figure 12. Proposed gas burette cross section.

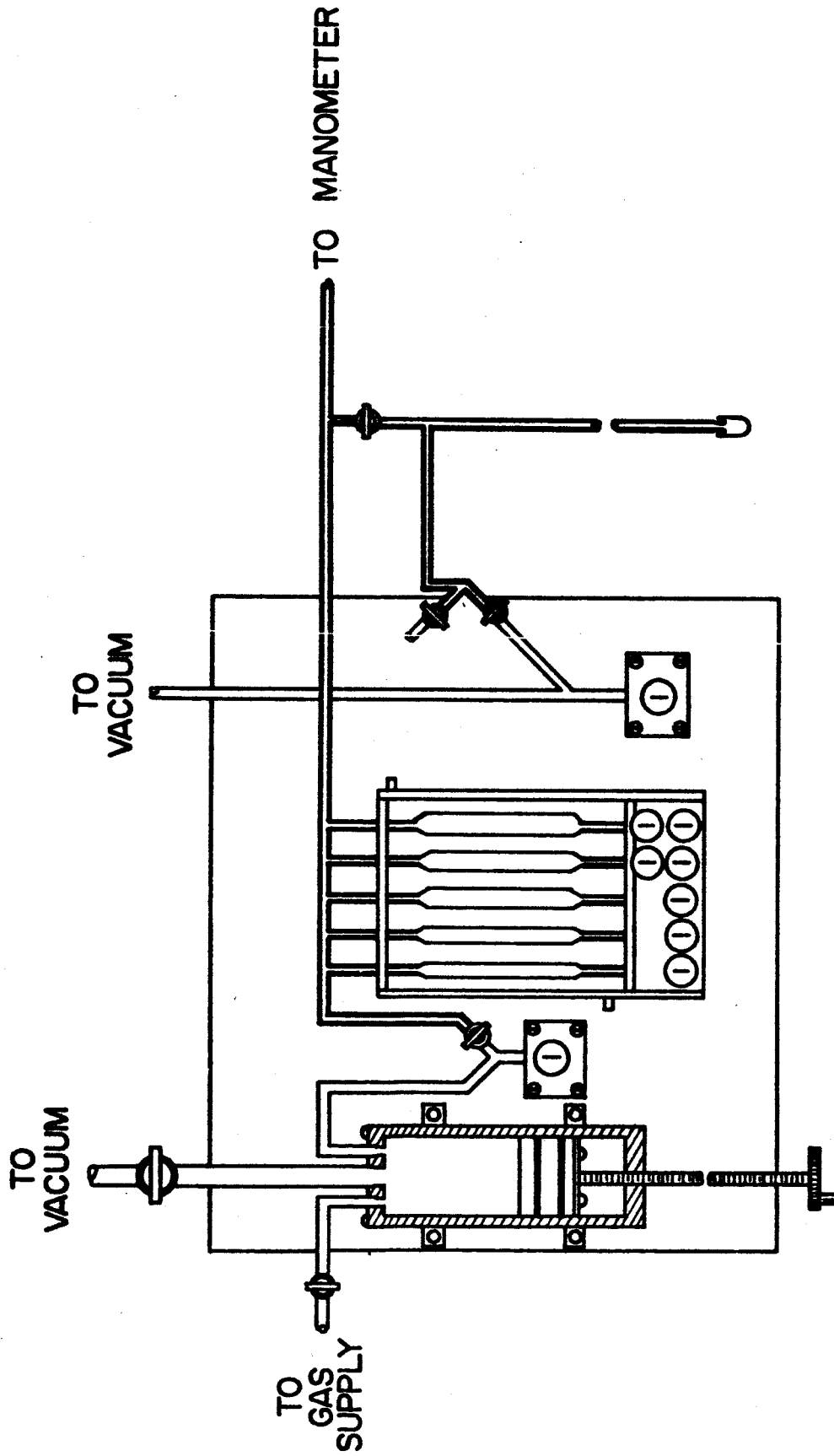

Figure 13. Sketch of proposed gas transfer system.

levels can be adjusted more accurately. The ease of operation should be greatly improved over the current design. The chance of accidental mercury spills is reduced tremendously thus giving a valuable safety factor. In addition, an auxiliary air pressure supply, a vacuum pump, a pressure-vacuum manifold, and several stopcocks will no longer be required. The quantity of mercury necessary for the apparatus will be reduced by two-thirds. The cost of the stainless steel components should be more than compensated for by the savings above illustrated.

BIBLIOGRAPHY

1. Bardeen, J., Phys. Rev. 71, 717 (1947)
2. Doerffler, W. and Hauffe, K., J. of Catalysis 3, 156 (1964)
3. Mowery, V. O., J. Applied Physics 29, 1753 (1958)
4. Zuev, V. A., Sachenko, A.V., and Tolpygo, K. B., Soviet Physics Solid State 6, 2535 (1965)
5. Cimino, A., Molinari, E., Cramarossa, F., and Ghersini, G., Journal of Catalysis 1, 275 (1962)
6. Kohnke, E. E., J. Phys. Chem. Solids, 23, 1557 (1962)
7. Houston, J. E., Unpublished Ph.D. dissertation O.S.U. (1965)
8. Matthews, H. E., Unpublished M.S. thesis O.S.U. (1965)
9. Kunkle, H. F., Unpublished Ph.D. dissertation O.S.U. (1965)
10. Young, D. M. and Crowell, A. D., Physical Adsorption of Gases, Butterworths, Washington, D.C. (1962)
11. Halsey, G., J. Chem. Phys. 16, 931 (1948)
12. deBoer, J. H., Proceedings of the Tenth Symposium of the Colston Research Society held in the University of Bristol, The Structure and Properties of Porous Materials, Butterworths, London (1958)
13. Barrett, E. P., Joyner, L. G. and Halenda, P. P., J. Am. Chem. Soc. 73, 373 (1951)
14. Pierce, C. and Smith, R. N., J. Phys. Chem. 57, 64 (1953)
15. Brunauer, S., The Adsorption of Gases and Vapors, Princeton Univ. Press, Princeton (1945)
16. Anderson, R. B., J. Catalysis 3, 50 (1956)
17. Goodman, J. F. and Gregg, S. J., J. Chem. Soc. 1162 (1960)
18. Barr, W. E. and Anhorn, V. J., Scientific and Industrial Glass Blowing and Laboratory Techniques, Insts. Pub. Co., Pittsburgh (1949)

19. Constabaris, G., Singleton, J. H., and Halsey, G. D. Jr., *J. Phys. Chem.* 63, 1350 (1959)
20. Cunningham, C. M., Personal Communication
21. International Critical Tables Vol. I, McGraw-Hill, New York (1926)
22. Bugosh, J., Brown, R. L., et al., *Ind. and Eng. Chem.* 1, 157 (1962)
23. Kunkle, H. F., and Kohnke, E. E., *J. Applied Phys.* 36, 1489 (1965)
24. Brauer, G., Handbook of Preparative Inorganic Chemistry Vol. I, Academic Press, New York (1963)
25. Taylor, H. S., and Glasstone, S., Treatise on Physical Chemistry, 3rd ed. D. Van Nostrand Co., New York (1951)

APPENDIX I

TABULAR FORM FOR TAKING AND ANALYZING DATA

As the experimental method requires a great deal of information it is helpful to take data in tabular form. It is convenient also to keep the analysis with the data. The tabulation method developed during the course of this study resulted in 27 columns each of which was used in taking and analyzing data. Listed below is the number of each column, what it contains and, if it is to be calculated, the manner of calculation. The underlined numbers refer to columns and imply that the value of that column for the point is to be used in calculation. For example, in column 17 $P_o = (\underline{13} - \underline{14})$ means the number to be inserted in that column is the vapor pressure of the adsorbate gas. The value is the difference in heights of the mercury levels in the vapor pressure manometer which are contained in columns 13 and 14.

<u>Column No.</u>	<u>Column Title</u>
1	Time
2	Remarks (A opened, closed; He, N ₂ etc.)
3	Bulb setting
4	Volume factor for bulbs, f(1) from tables
5	Bar pressure (Mark lower than level)
6	Bar mark on cathetometer
7	Mercury level on cathetometer
8	Liquid N ₂ level (keep within 1/2 inch of ref. pt.)

- 9 Temperature of room
- 10 Temperature of manometer
- 11 Temperature of burette
- 12 Temperature of sample ($^{\circ}\text{K}$)
- 13 P_o upper
- 14 P_o lower
- 15 Bar pressure = (5 + 7 - 6)
- 16 Absolute pressure = 15 x correction factor
- 17 $P_o = (\underline{13} - \underline{14})$
- 18 P_o corrected = 17 x correction factor
- 19 Absolute pressure correction for $V_4 = (1 + \frac{.05p}{76}) P$ to
compensate for deviation from ideal gas law
- 20 $V(1) = (\underline{4} \times \underline{16} \div (\underline{11} + 273.2))$ Volume of gas in
calibrated bulbs
- 21 $V(1) = \frac{f(2) \times \underline{16}}{273.2 + \underline{9}}$
- 22 $V(3) = f_{(3)} \times \underline{16} \div (\underline{9} + 273.2)$
- 23 $V(4) = f_{(4)} \times \underline{19} \div \underline{12}$
- 24 $\sum_{i=1}^4 V(i) = \underline{20} + \underline{21} + \underline{22} + \underline{25}$
- 25 $V_{ads} = Q - \underline{24}$ where Q is the volume of gas in the system
- 26 $P/P_o = (\underline{16} \div \underline{18})$
- 27 $\frac{P/P_o}{V_{ads} (1 - P/P_o)} = \frac{\underline{26}}{\underline{25} (1 - \underline{26})}$

APPENDIX II

SAMPLE PREPARATION

The stannic oxide (SnO_2) used in this study is prepared in three different forms which have greatly different surface properties.

As a base material commercial stannic oxide powder (Fisher certified reagent SnO_2 powder) is used. This is a fine white powder which has an average particle diameter estimated to be 1.5 microns. Powders of this size, assuming that each grain is non-porous, should appear as a "flat" surface to the adsorbate and should exhibit either a type II or type III isotherm, depending upon the heat of adsorption.

The second form under study is stannic oxide ceramic. This ceramic is prepared by making an acetone slurry of the powder, pressing it into pellets with pressures of around 10,000 p.s.i. and firing it at 1360°C for 19-20 hours.⁸ The resulting ceramic is a hard disk with 1/2 inch diameter and 1/8 inch thickness. It exhibits a slight pink color on the surface while the interior remains white. The pellet density is 4.6 gm/cm^3 compared to crystalline density of 7 gm/cm^3 . The surface area of ceramics is expected to decrease while the shape of the isotherm should be determined by pore structure. Micrographs of SnO_2 ceramic (Fig. 14) are indicative of this porous structure.

Stannic oxide gels were an object of study from 1915 to 1932 under the name of stannic acids and can be prepared by several methods.²⁴ The method used in preparing the gel closely parallels that of Goodman

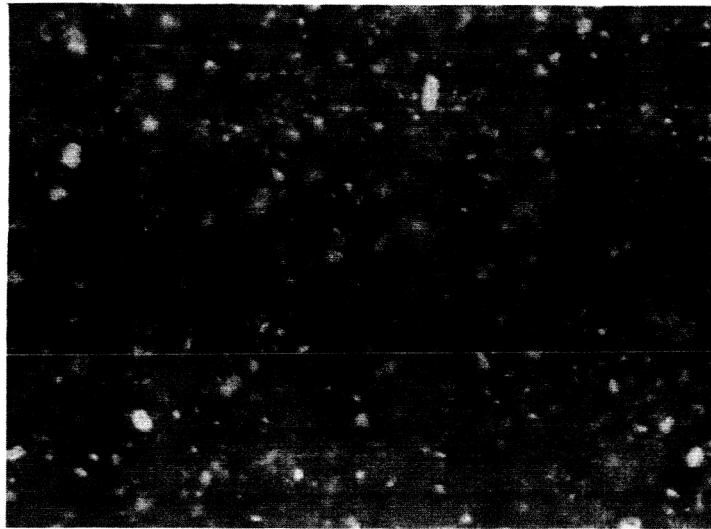

a) 500 X magnification

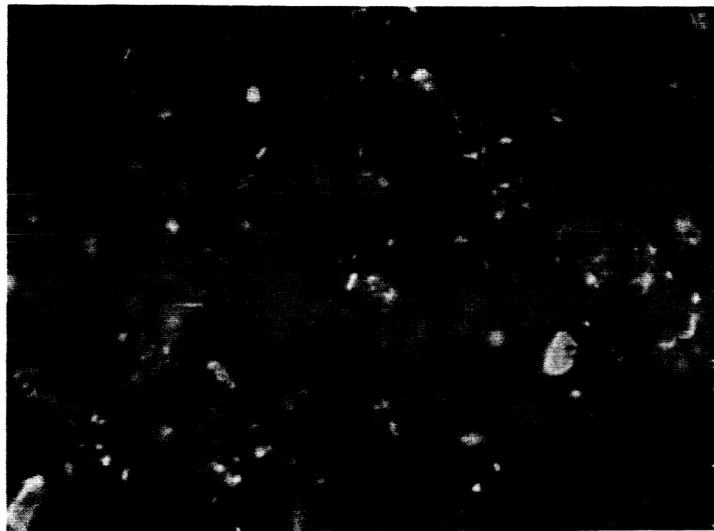

b) 1000 magnification

Figure 14. metallographs of ceramic surface

and Gregg.¹⁷ For its preparation metallic sodium is dissolved in excess ethyl alcohol. To the resulting sodium ethoxide in alcohol solution is added the proper amount of stannic chloride and refluxed for thirty hours, resulting in stannic tetra-ethylate in alcohol solution and sodium chloride precipitate which is next removed by filtering. The stannic tetra-ethylate is poured into an excess of distilled water at room temperature from which SnO_2 gel precipitates slowly. The preparation may be sketched in equation form as:

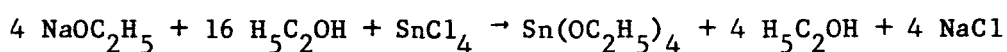
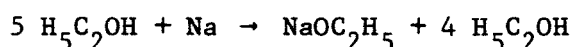

The liquid is then removed by siphoning and, after washing in distilled water, the precipitate is dried in air at room temperature.

Gels, in general, have a porous structure and exhibit a high surface area. Hence they are particularly valuable for use in the study of surfaces. As the nature of gels is not common knowledge it is appropriate to discuss shortly some of their properties.²⁵

Gels are coagulated colloids which may be a precipitate or a coherent, more-or-less elastic, solid enclosing part of the dispersion medium. Also included as gels are the dessicated products of the above.

If the gel has a high liquid content it is termed a jelly. If it has a low liquid content (dessicated bodies) it is called a xerogel. Included in the latter category are the hydrous oxides of aluminum, tin, iron, chromium and cerium which are formed by the electrolytic coagulation of hydrosols. A sol is a colloidal suspension of a solid in a

liquid. In the case of hydrosols the liquid is water.

Gel formation may be considered the result of precipitation of a sol. In this case conditions are changed so that the dispersed solute is no longer soluble. This may entail a temperature change, a solvent change or other methods. In order for the precipitate to have the characteristic gel properties (porous brush-heap structure) the precipitation material must maintain an affinity for the solvent. In precipitation the solvent acts to support the framework of the gel. When the solvent is later removed, the framework exhibits a finely porous structure. Conditions during precipitation must be controlled to prevent collapse of the framework. Thus, the final properties are highly dependent upon the shape of the colloidal particles and the conditions of precipitation.

Since gels have a fine porous structure they are expected to exhibit a high surface area, and the shape of the adsorption isotherm is expected to be dependent upon pore and capillary effects.

Electron micrographs (Fig. 15) of the SnO_2 gel particles indicate no predominate shape of the particles. The size of these particles ranges from 100 to 1000 \AA in diameter.

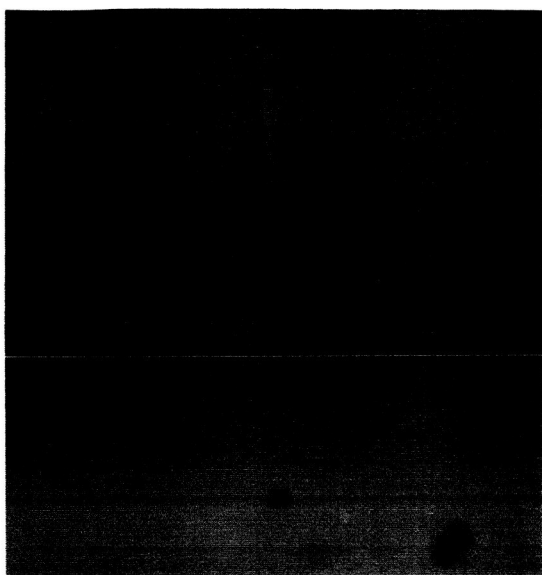

a) 13,000 X magnification
unshadowed

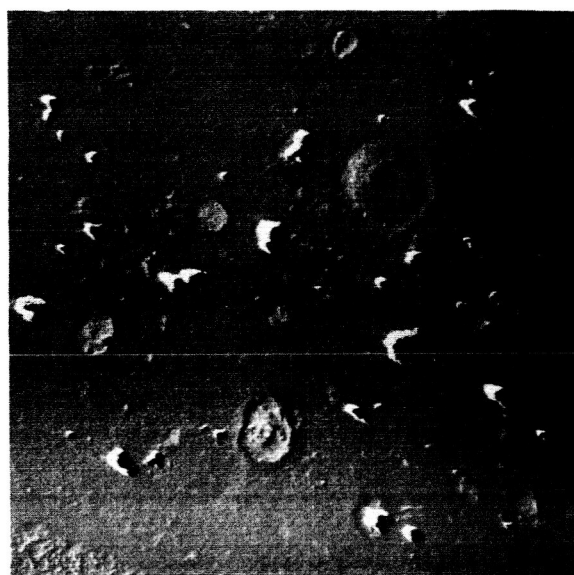

b) 13,000 X magnification
shadowed with chromium



e) 13,000 X magnification
shadowed with chromium



d) 13,000 magnification
shadowed with chromium

Figure 15. Electron micrographs of colloidal (gel) particles