

GENERAL DYNAMICS

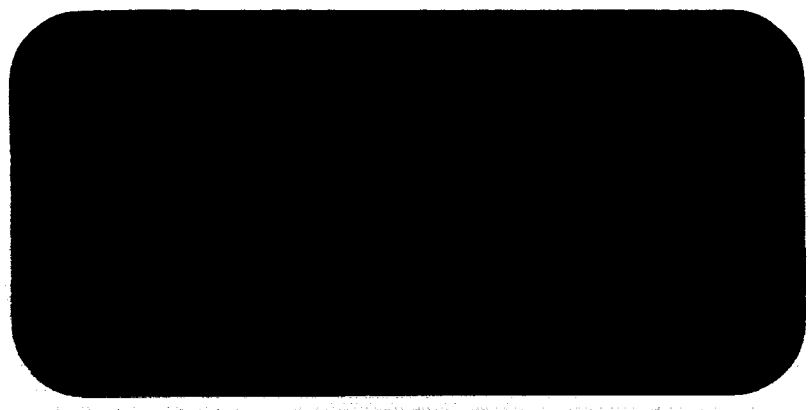

GPO PRICE \$ _____
 CFSTI PRICE(S) \$ _____
 Hard copy (HC) \$ 3.00
 Microfiche (MF) .75

ff 653 July 65

FACILITY FORM 502

1966-2687-7 (THRU) _____
 87 (PAGES) _____
 CR-75281 (NASA CR OR TMX OR AD NUMBER) _____
 1 (CODE) _____
 06 (CATEGORY) _____

INTERIM REPORT

THE SYNTHESIS AND UTILIZATION OF
LOW MOLECULAR WEIGHT OZONIDES FOR
AIR REVITALIZATION PURPOSES

NATIONAL AERONAUTICS and SPACE ADMINISTRATION

Contract No. NASw-559

for the period covering

August 14, 1964

to

October 14, 1965

by

Dr. A. W. Petrocelli
Dr. A. Capotosto, Jr.

Chemistry and Chemical Engineering Section
Research and Development Department

Approved:

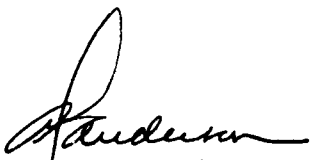
A. G. Anderson
Manager of Development Engineering

U413-65-204
November 14, 1965

TABLE OF CONTENTS

<u>SECTION</u>	<u>TITLE</u>	<u>PAGE</u>
OBJECTIVE		11
I. ABSTRACT		1
II. RESULTS OF EXPERIMENTAL STUDIES		2
2.1	Synthesis of Calcium Superoxide	2
2.1.1	Reaction of Calcium Hydroxide with Hydrogen Peroxide.	2
2.1.2	Reactions with Catalysts.	15
2.1.3	Reaction of Calcium Peroxide with Hydrogen Peroxide.	15
2.1.4	Reaction of Ethanolic Hydrogen Peroxide with Calcium Ethoxide.	17
2.1.5	Reaction of Calcium Peroxide with Ozone.	20
2.2	Reaction of Calcium Superoxide with Water Vapor.	24
2.3	Reactions of Air Revitalization Materials with Carbon Dioxide and Water Vapor.	30
2.3.1	Sodium Superoxide - Carbon Dioxide Reaction	34
2.3.2	Calcium Superoxide - Carbon Dioxide Reaction	45
2.4	Reaction of Sodium Superoxide with Carbon Monoxide.	50
2.5	Magnetic Susceptibility Studies.	53
2.5.1	The Gouy Method.	53
2.5.2	Theoretical Moments.	55
2.5.3	Curie Law and Curie - Weiss Law.	57
2.5.4	Experimental Studies and Results.	58
2.5.5	Discussion	63
III. SUMMARY		67
IV. CONCLUSIONS		71
V. RECOMMENDATIONS		72
VI. REFERENCES		75

OBJECTIVE

The objective of this program is to carry out a research and development study for the synthesis of calcium superoxide and the evaluation of the low molecular weight alkali metal ozonides and superoxides for air revitalization purposes.

ABSTRACT

26877

The synthesis and characterization of alkali and alkaline earth superoxides and ozonides has been continued. Various reaction schemes have been investigated in an effort to synthesize high-purity samples of calcium superoxide. Samples containing 40 - 60% calcium superoxide were consistently obtained from the reaction of aqueous hydrogen peroxide with solid calcium hydroxide which has been discussed in detail. The reaction of calcium hydroxide with water vapor has been characterized and its stoichiometry determined by the kinetic data obtained. Carbon dioxide absorption studies with sodium and calcium superoxides have been carried out and the observed respiratory quotients and reaction mechanisms have been discussed. Magnetic susceptibility measurements for potassium ozonide and superoxide, as well as calcium superoxide, have been obtained.

RESULTS OF EXPERIMENTAL STUDIES2.1 SYNTHESIS OF CALCIUM SUPEROXIDE

Work on contract No. NASw-559 was amended in order to emphasize studies of calcium superoxide, which has a number of advantages over other non-regenerative air revitalization materials. It has been recognized for years that although superoxides of potassium and sodium have been proven to have great potential as air revitalization materials in space cabins and for single unit self-contained breathing apparatus, calcium superoxide possesses inherent properties which make it a more reliable and useful air revitalization material than the alkali metal superoxides. Experience has shown that when alkali metal superoxides are used, inefficient utilization of superoxides can be a problem. The reason for this difficulty is related directly to a phenomenon which occurs in the course of the reaction of the superoxide with water vapor



where M = an alkali metal.

The alkali formed fuses at such a low temperature that the exothermicity of the reaction can be sufficient to cause these hydroxides to melt and fuse, forming clinkers of low porosity. Thus, water vapor is prevented from contacting the unreacted superoxide and reaction (1) is not completed. This problem is eliminated by substituting $Ca(O_2)_2$ for the alkali metal superoxides. The higher melting $Ca(OH)_2$ is formed which will not fuse at the temperatures produced by the reaction and the superoxide charge is

completely utilized with a minimum of reaction control. The melting point of KOH is 360°C, that of NaOH is 318°C, while Ca(OH)₂ decomposes at 580°C. In addition to this important advantage, the O₂ storage capacity of Ca(O₂)₂ is 37% greater than KO₂ and 7% greater than NaO₂.

To realize the advantages of this material in air revitalization systems, it became necessary to develop a method of synthesizing this compound in high purity. Early workers in this field succeeded in obtaining products containing only 1-10% Ca(O₂)₂. In 1959, purities as high as 40% were reported^{1*} and in 1962 both our laboratory² and R. R. Miller³ at Naval Reactors Laboratory reported synthesis of 50-60% pure Ca(O₂)₂. Its potential usefulness made it imperative that studies be undertaken to prepare higher purity calcium superoxide. The following text summarizes the studies made under this contract.

2.1.1 Reaction of Calcium Hydroxide with Hydrogen Peroxide

It has been demonstrated^{1,2} that alkali metal hydroxides will react with aqueous hydrogen peroxide to form the alkali metal peroxide dihydroperoxydate. Upon evaporation of excess water from this mixture, the latter compound disproportionates to form the superoxide. This scheme was investigated in an effort to prepare high purity calcium superoxide. The overall reaction path was visualized as:

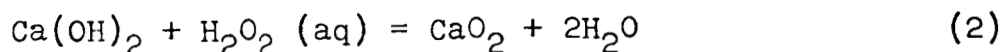

*These superscripts refer to publications listed in the back of this report.

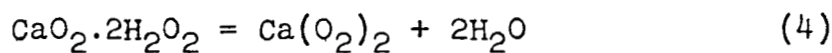
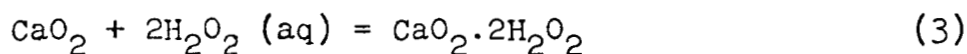

Various reaction parameters were investigated and shown to affect the yield of superoxide obtained. These parameters included:

- 1) Concentration of H_2O_2 solution,
- 2) Molar ratio of $\text{H}_2\text{O}_2/\text{Ca}(\text{OH})_2$,
- 3) $\text{H}_2\text{O}_2 - \text{Ca}(\text{OH})_2$ reaction temperature,
- 4) Temperature at which vacuum pumping is carried out, and
- 5) Length of vacuum pumping time.

The reaction was conducted in the apparatus shown in Figure 1. The most promising results were obtained from the following procedure. The aqueous hydrogen peroxide solution was rapidly added to a weighed, calcium hydroxide sample in a flat, open dish. The reaction was controlled by alternately immersing and withdrawing the reaction container from an ice bath. As soon as the more vigorous evolution of gas, the mixing step, had subsided, the reaction dish was quickly transferred to the vacuum desiccator. The elapsed time between the mixing step and the evacuation step was kept as short as possible. The reaction mixture was then evacuated to remove the water. Observations were made of the color, dryness, etc., of the sample and the pressure of the system monitored with time.

FIGURE 1. APPARATUS USED TO STUDY THE REACTION OF CALCIUM HYDROXIDE AND HYDROGEN PEROXIDE.

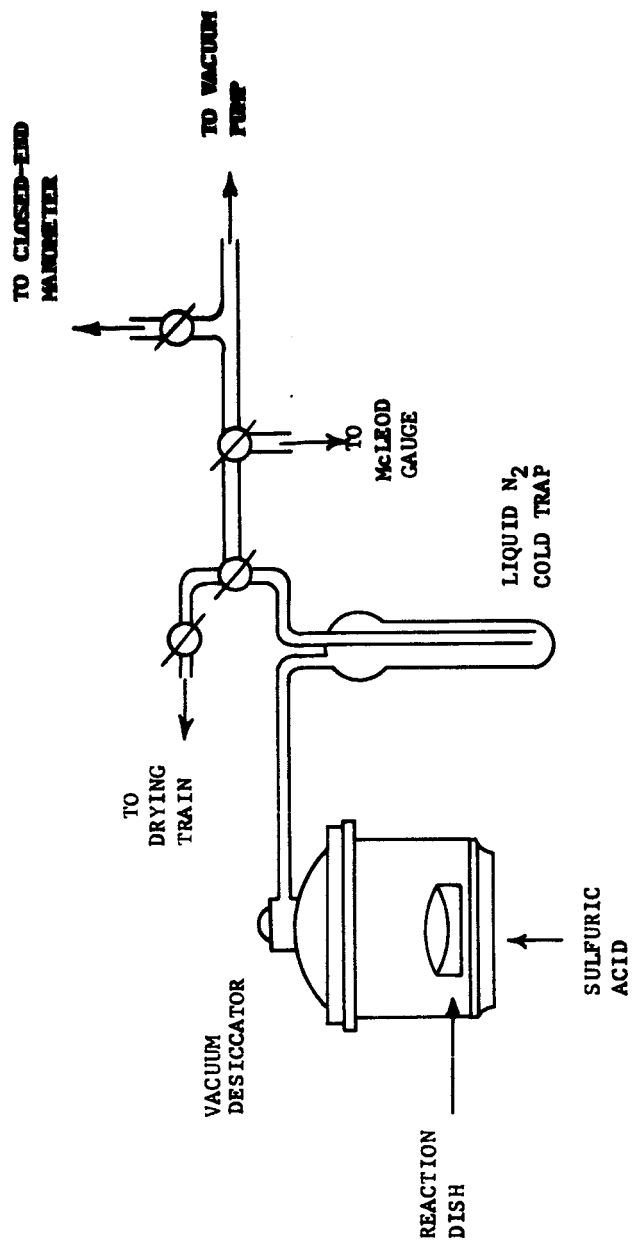

In the initial studies of this reaction, which used one gram samples of calcium hydroxide, a number of general correlations were observed:

- 1) H₂O₂ concentration - High yields of calcium superoxide were obtained using 50% to 87% aqueous solutions of H₂O₂. Use of more dilute H₂O₂ solutions apparently supplied excess water which could not be removed rapidly enough to prevent its reaction with the superoxide resulting in low superoxide yields.
- 2) Molar ratio H₂O₂/Ca(OH)₂ - The molar ratio of H₂O₂ to Ca(OH)₂ found to produce the best yields of Ca(O₂)₂ was 6.5:1.0. This amount of H₂O₂ represents an excess over what is required by the stoichiometry of reactions (1) and (2). The excess was required since some H₂O₂ was lost as a result of the heat generated in reaction with Ca(OH)₂.
- 3) Reaction temperatures - Best results were obtained when the Ca(OH)₂ - H₂O₂ reaction was caused to occur at temperatures near 0°C.
- 4) Vacuum pumping temperature - Decreases in Ca(O₂)₂ yield were found as the temperature of the disproportionation reaction was elevated above room temperature. Our best results were obtained in the temperature range of 0°C to room temperature.
- 5) Effect of pumping time on the product - The preliminary results of the studies of the effect of pumping time on the yield and purity of the calcium superoxide product revealed certain trends which are discussed below:

For preparations carried at room temperature, the period of vacuum desiccation was varied from 1 to 21 hours. After approximately one hour it appeared that all liquid had been removed. The yields of $\text{Ca}(\text{O}_2)_2$ were significantly lower in nearly all cases when pumping was discontinued before the end of 2-1/2 hours. Pumping resumed after about 5 hours appeared to have no significant effect on the yield of $\text{Ca}(\text{O}_2)_2$. In order to obtain information concerning the reaction mechanism, the pressure was monitored during the period of vacuum desiccation. The exact reaction conditions were not always the same. For example, temperature varied a few degrees and reactant weights varied from run to run. However, in all of these syntheses the same molar ratio of H_2O_2 to $\text{Ca}(\text{OH})_2$ was used (6.5:1) and the H_2O_2 was always 50% aqueous solution. Figure 2 illustrates the typical result when the pressure of the system, as monitored by the McLeod gauge, is plotted versus time. The following features were observed in most cases:

- a) Initially, a rapid decrease in system pressure was observed. During this period, water and some hydrogen peroxide were evolved. (Some hydrogen peroxide was found condensed in the cold trap.) After approximately thirty minutes, the sample appeared to be a damp, finely-divided tan solid. A short maximum appears in Figure 2 at this point.
- b) This maximum was followed by a gradual decrease in pressure for about 60 minutes of pumping. The solid, which

FIGURE 2. VARIATION OF PRESSURE WITH TIME
IN THE CALCIUM HYDROXIDE -
HYDROGEN PEROXIDE SYSTEM AT
ROOM TEMPERATURE.

1 gram $\text{Ca}(\text{OH})_2$,
5.6 ml 50% H_2O_2

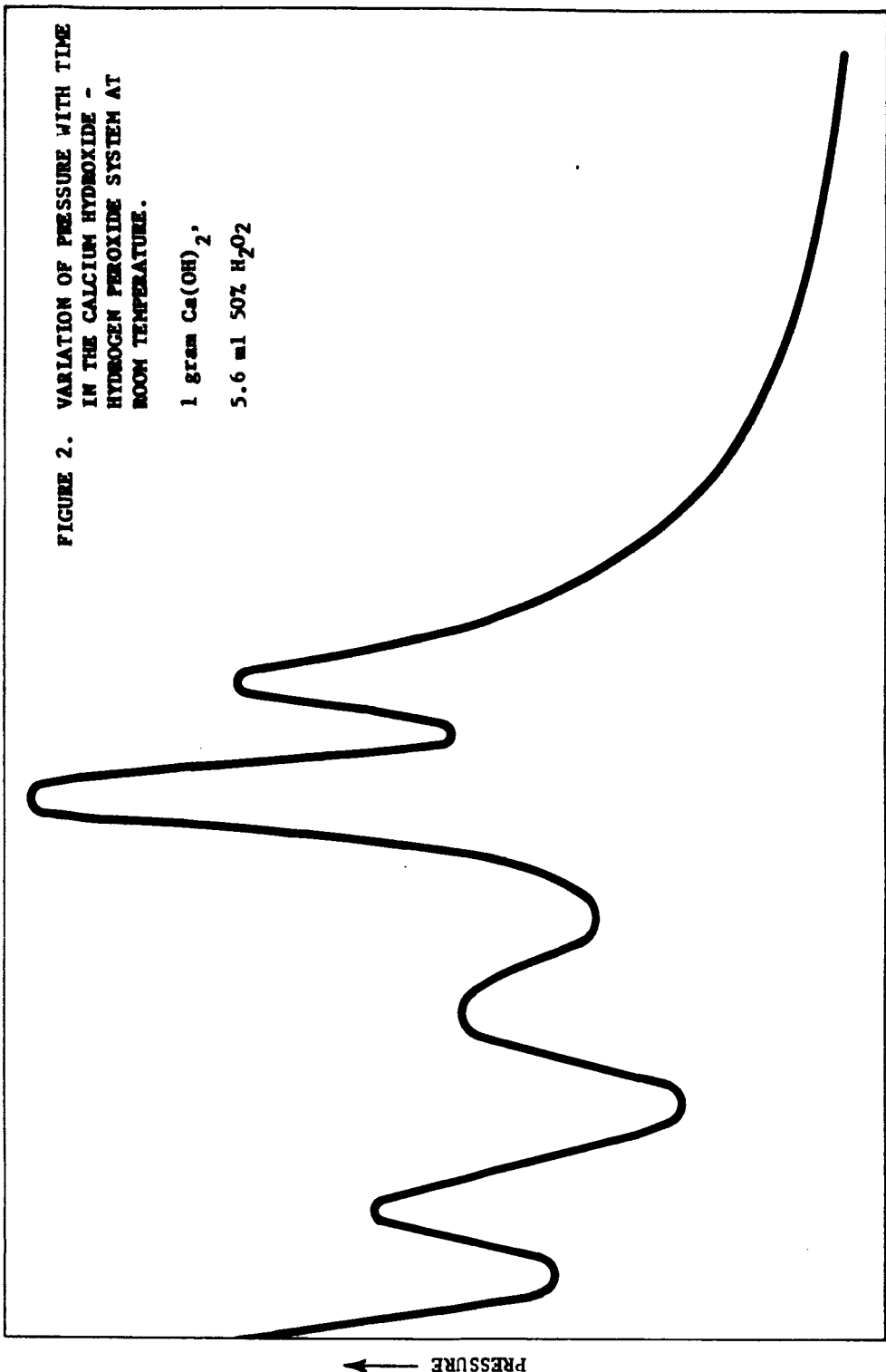

at this time was bone-white, then produced a gradual pressure rise of 1 mm. during the ensuing 25 minutes and gradually turned yellowish during this period.

c) After approximately 85 minutes a very rapid pressure rise of 30 mm. or more was momentarily achieved. The sample was seen to "erupt," presumably evolving a gas. This was followed by a rapid decrease in pressure, eventually approaching the limiting pressure of the pumping system.

Several attempts to isolate the product at the point of very rapid pressure rise (after about 85 minutes pumping) resulted in a product which when analyzed showed no active oxygen. Samples which had been pumped less than 85 minutes also showed no active oxygen. Unfortunately, it was not possible to remove a portion of the reaction mass periodically for analysis, while continuing the synthesis with the bulk of the material.

d) Four "pressure peaks" were usually found within a 2 to 5 hour pumping time. Further evacuation beyond the 5-hour limit did not result in any increase in superoxide yield.

e) The position of each "pressure peak" was not reproducible for successive experiments because the exact reaction conditions (temperature, reactant weights, pumping speed and efficiency, etc.) were not always the same. However, the third peak was usually the major peak and slight color changes associated with the vicinity of each peak were reproducible.

f) The trends outlined above are compatible with the disproportionation process already postulated in equation (3), if it is assumed that the major part of the disproportionation occurs after 85 minutes of pumping.

In the case of vacuum pumping at lower temperatures, the pumping time required for best superoxide yields was much longer than the 2 to 5 hours referred to above. Thus, at 0 - 10°C, a pumping period of approximately 13 hours was required for good superoxide yield. The relatively long period of evacuation would be expected since the rates of reaction, drying, and disproportionation should be slower at the lower temperature than at room temperature. In addition, the character of the pressure-time curves for the 0°C runs differed from that of the room temperature runs, as shown in Figure 3. Due to the experimental difficulties associated with the control of temperature and vacuum pumping rates, it was difficult to make a quantitative interpretation of the pressure-pumping time data. However, qualitatively it is useful for demonstrating the complexity of the mechanism involved in the disproportionation process.

Upon completion of the reaction, the products were removed from the desiccator in a dry box. The superoxide content was determined according to the method of Seyb and Kleinberg⁴. The peroxide content was then determined by titration with standard aqueous permanganate solution.

The data summarized in Table I for several syntheses confirms the trends discussed above. The procedure outlined above was

FIGURE 3. VARIATION OF PRESSURE WITH TIME
IN THE CALCIUM HYDROXIDE -
HYDROGEN PEROXIDE SYSTEM AT 0-10°C.

1 gram Ca(OH)_2
5.6 ml 50% H_2O_2

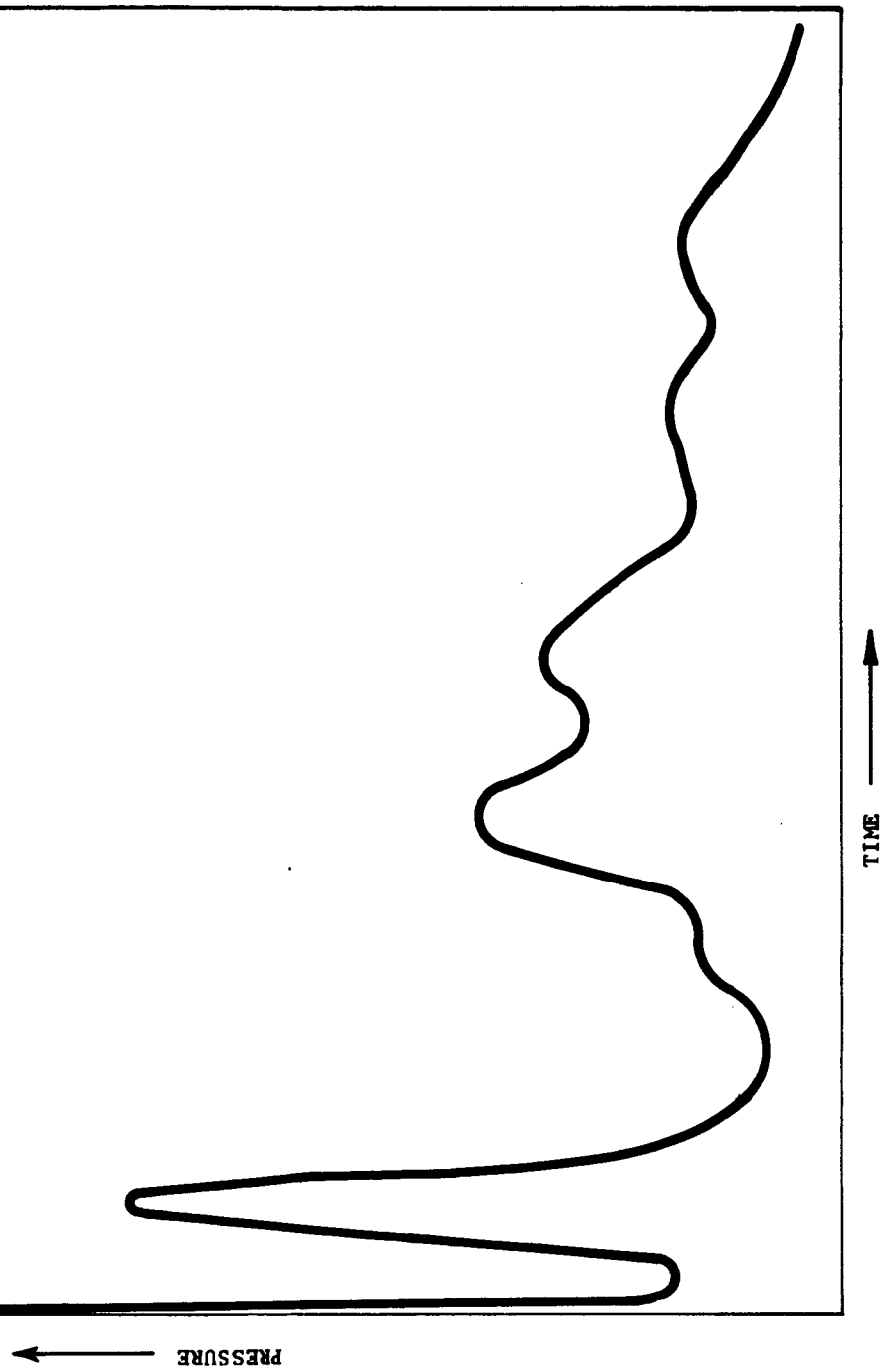

TABLE I
SUMMARY OF VARIOUS CALCIUM SUPEROXIDE SYNTHESSES

Reactants	Number of Runs	Weight Calcium Reactant (grams)	Mole Ratio H_2O_2 : Ca	Temperature $^{\circ}C$ Mixing Pumping	Pumping Time (Hours)	Calcium Superoxide Content (%)
$Ca(OH)_2 + 50\% H_2O_2$	9	1	6.5:1	0 R.T.	1.5-4	35.7
	3	1	6.5:1	0 5	10	44.9
	3	1	13:1	0 5	12	38.2
	4	1	6.5:1	0 $\left\{ \begin{array}{l} 0 \\ 27 \end{array} \right.$	$\left\{ \begin{array}{l} 1-4 \\ 1-4 \end{array} \right.$	40.2
	2	2	3:1	0 R.T.	2.5	17.8
	6	2	6.5:1	0 R.T.	8	53.7
	3	2	6.5:1	0 5	17	39.7
	4	5	6.5:1	0 R.T.	7	29.0
	3	5	6.5:1	0 5	12	36.8
	3	11	6.5:1	0 R.T.	7	9.4
	2	1	6.5:1	0 44	2.5	30.9
	2	1	6.5:1	0 78	2	9.4
	5	1	6.5:1	R.T. 78	2	8.1

TABLE I (Cont'd)

Reactants	Number of Runs	Weight Calcium Reactant (grams)	Mole Ratio $H_2O_2 : Ca$	Temperature $^{\circ}C$	Mixing Pumping (Hours)	Pumping Time (Hours)	Calcium Superoxide Content(%)
$Ca(OH)_2 + 87\%H_2O_2$	7	1	6.5:1	0	5	13	56.0
$Ca(OH)_2 + TiO_2 + 50\% H_2O_2$	3	1	6.5:1	0	R.T.	6	36.5
	3	1	6.5:1	0	5	12	48.2
$Ca(OH)_2 + CdO + 50\% H_2O_2$	4	1	6.5:1	0	R.T.	5	36.7
	2	1	6.5:1	0	5	10	48.3
$CaO_2 + 50\%H_2O_2$	9	1	6.5:1	R.T.	R.T.	5	46.8
	1	5	6.5:1	0	R.T.	9	8.8
$+87\%H_2O_2$	2	1	13:1	0	5	7	16.2
						21	54.7
$Ca(OEt)_2 (solid) + 50\%H_2O_2$	2	1	6.5:1	0	R.T.	16	19.1
	3	5	6.5:1	0	5	12	
					R.T.	15	
$Ca(OEt)_2$ dispersion + 50% ethanolic H_2O_2	8	1 gram Ca metal	← varied →				11.7
$CaO_2 + O_3$	7	3	-	-	R.T.	2.5-7	5.9
	2	2	-	-	-10	2.5	4.9

successful for the preparation of one gram batches of calcium superoxide at approximately 50% purity. However, for subsequent work in the characterization and chemical studies of calcium superoxide, it was necessary to improve the technique for scaling-up the reaction. Increasing the quantities of the initial reactants using the same apparatus and reaction dish resulted in a decrease in the superoxide content in the product, usually below 20% purity. The fact that the surface area of the reaction dish was held constant was probably the factor leading to the decrease in yield.

Studies were conducted using 2, 5, and 10 gram batches of calcium hydroxide and proportional amounts of hydrogen peroxide with the same experimental setup as described above, except as follows: A much larger desiccator was used and trap capacity was increased. The reaction dish was a commercially-available thick-walled specimen dish (I.D.: 200 mm, Ht: 80 mm, Cap: 1750 ml). The hydroxide sample, along with the hydrogen peroxide, was chilled at 0°C for at least 30 minutes prior to mixing. Under these conditions, the initial reaction was less vigorous and more controllable. Products containing approximately 30% calcium superoxide were consistently obtained with the 5 and 10 gram batches.

Although the yields in these studies were lower than could be obtained under normal operating conditions, these studies have confirmed that larger-scale preparations could be made with modest yields.

Better results were obtained when 11 ml. of 50% aqueous hydrogen peroxide was reacted with 2 grams of calcium hydroxide. The average purity was 53.7% calcium superoxide for 6 runs.

2.1.2 Reactions with Catalysts

The introduction of a catalyst (at the 1% level) with the calcium hydroxide prior to mixing of the reactants was also investigated in an effort to increase the yield of the reaction. The apparatus and procedure are the same as that discussed above for routine syntheses. The catalysts investigated were CdO and TiO₂ since heavy metal oxides are known to catalyze the decomposition of hydrogen peroxide. As shown in Table I, the superoxide content in the reaction product did not change significantly from the routine syntheses results. However, there do appear to be two advantages to the use of catalysts in this scheme. First, upon mixing, the reactions were less vigorous than those without catalyst. Secondly, it should be noted that the yields were consistent for each set of conditions. The use of catalysts, therefore, may tend to increase the reproducibility of a given process.

2.1.3 Reaction of Calcium Peroxide with Hydrogen Peroxide

Variations of the reaction scheme represented by reactions (2), (3), and (4) were investigated. The elimination of reaction (2) was considered by substituting calcium peroxide for the hydroxide as the starting material. It was anticipated that this step would decrease the amount of water to be removed. A decrease in the exothermicity of the initial reaction was also expected; thus, probably lessening the loss of hydrogen peroxide through thermal decomposition.

The reaction conditions which proved most promising with respect to the purity of the superoxide product obtained were repeated using calcium peroxide as the starting material. The reaction between 5.6 ml. of 50% hydrogen peroxide and one gram of calcium peroxide (6.5:1 mole ratio) at room temperature was relatively mild when compared to the reaction of $\text{Ca}(\text{OH})_2$ with H_2O_2 . The vigorous bubbling that normally occurred at this point in the previous studies was absent in these cases. Very little heat was evolved during this initial reaction as expected. The initial color of the mixture was yellow-tan which became lighter during the evacuation period. The first two runs at room temperature yielded products containing 36% calcium superoxide. Seven subsequent preparations ranged between 41 and 54% calcium superoxide (average 48.5%).

Two runs were also made in which one gram of calcium peroxide was reacted with 5.6 ml. of 87% hydrogen peroxide at 0°C . This mixture took place with little evidence of reaction or heat evolution. The vacuum desiccator was kept between 0 and 10°C during the evacuation step. The latter step was relatively short (7 hours) for the first run and the product contained only 16% calcium superoxide. In the second case, the reaction mixture was pumped for 20 hours and the product contained 55% calcium superoxide.

At this point it appears that no advantage was gained, in terms of superoxide yield, by substituting calcium peroxide for calcium hydroxide as the starting material in the synthesis procedure.

2.1.4 Reaction of Ethanolic Hydrogen Peroxide with Calcium Ethoxide

A second variation of the routine synthesis scheme called for the reaction of hydrogen peroxide with calcium ethoxide. A crucial step in the reaction schemes employed above for the synthesis of calcium superoxide has been the removal of water, in particular, that formed by the disproportionation step. To increase the yield of superoxide, a non-aqueous solvent was sought that would have a higher volatility than water. Ethanol was chosen because calcium metal could be readily dissolved in it to form the ethoxide. In the case of alkali metals, superoxides have been produced via the reaction of lithium hydroxide dissolved in ethyl alcohol with hydrogen peroxide.²² [CAUTION: Mixtures of hydrogen peroxide and ethanol (e.g., 40:60 mixture) can be explosive.⁵] Other precautions are noted in the following test as they apply.

Two paths were investigated. The first path was the dissolution of calcium metal in ethanol and recovery of the solid calcium ethoxide, followed by reaction of the latter with an ethanolic solution of hydrogen peroxide. It should be noted that this scheme was analagous to the calcium hydroxide - hydrogen peroxide reaction path. The experimental procedure was the same as described for that study. After the reaction had been vacuum pumped for 15 hours at room temperature, the dry, yellow product was recovered and analyzed for superoxide content. Two preparations employing 6 ml. of approximately 50% ethanolic hydrogen peroxide and 1 gram of calcium ethoxide yielded a product containing 15 to 30% calcium superoxide. When the reactants were precooled, then mixed in air, the reaction was controlled very easily before and during the early stages of the pumping step.

The second path involved the reaction of ethanolic hydrogen peroxide solutions with ethanolic solutions and dispersions of calcium ethoxide. When solution reactions were studied, approximately 1 gram of calcium metal was refluxed in ethanol at 80°C until dissolved. The apparatus is shown in Figure 4. The solution was filtered hot under nitrogen. While the reaction chamber was kept at 80°C, 25 ml. of approximately 50% hydrogen peroxide was added through the addition burette. When the peroxide solution met the refluxing calcium solution, the rate of ebullition increased as evidenced by vigorous bubbling. [CAUTION: This admixture can be explosive.] A yellow color appeared at the point of contact but disappeared rapidly as a white flux formed in that area. The peroxide solution was added slowly over a 15-minute period, and the entire reaction mixture refluxed for another 30 minutes. The heating mantle and the condenser were then removed and the ethanol evaporated by vacuum distillation. The whitish residue was pumped for 12 hours, then analyzed for superoxide content. Approximately 7% calcium superoxide was found in three products prepared in this manner.

In another series of runs, the calcium ethoxide solution was allowed to cool (a dispersion of the ethoxide in ethanol resulted) in a single-neck flask before addition of the peroxide solution. While stirring, 25 ml. of 50% ethanolic hydrogen peroxide were slowly added to the reaction mixture at about 5°C. [CAUTION: Again, this admixture may be explosive.] This addition was made in two minutes. The dispersed white solid became tannish in color after

FIGURE 4. APPARATUS FOR REACTION OF ETHANOLIC SOLUTIONS OF HYDROGEN PEROXIDE WITH CALCIUM ETHOXIDE - ETHANOL DISPERSIONS AND SOLUTIONS.

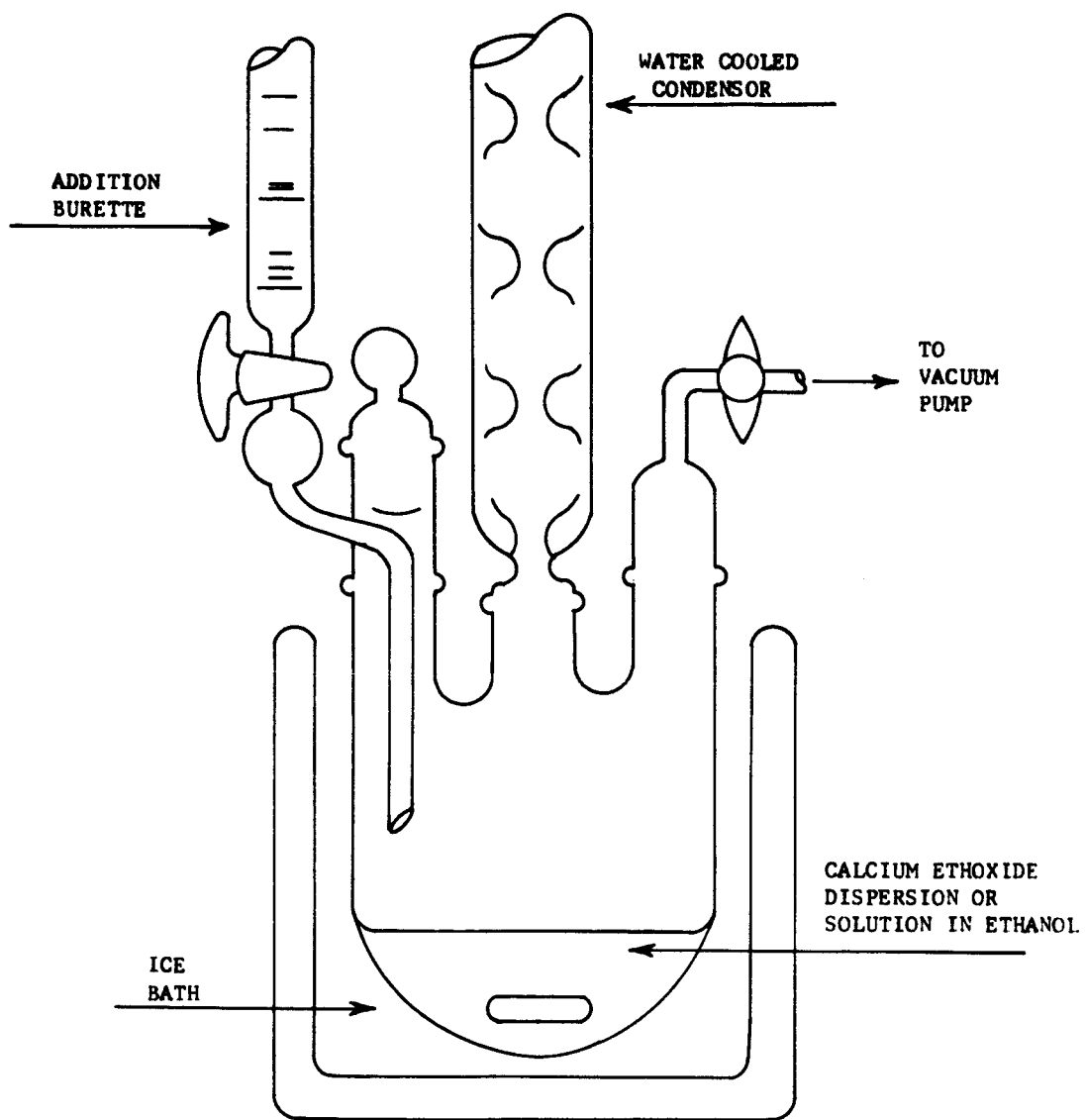

addition of the peroxide. The reaction flask was then placed on a rotary drying assembly but still maintained at 5°C. The ethanol was removed by vacuum distillation and the product pumped for 11 hours. The dry, powdered, off-white, solid product that was recovered contained about 15% calcium superoxide.

This synthesis approach cannot be recommended for production of high purity calcium superoxide at this time for the following reasons: the potential hazards involved in handling ethanol - hydrogen peroxide mixtures, the exotherm associated with the calcium ethoxide reaction with ~~these~~ mixtures and the low yields obtained.

2.1.5 Reaction of Calcium Peroxide with Ozone

Another synthesis scheme which was considered involved the reaction of calcium peroxide with gaseous ozone in anticipation of the reaction:

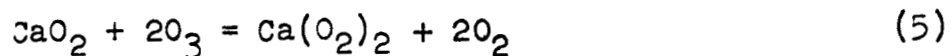

The apparatus used in this study is shown in Figure 5. The ozone concentration during the reaction was monitored by taking aliquot samples of the KI solution and titrating the liberated iodine with standard thiosulfate.⁶ The inlet ozone concentration was first determined by allowing the gaseous ozone-oxygen stream to bypass the reaction vessel. At time zero, the gaseous stream was diverted to pass upward through the weighed calcium peroxide sample. The reaction vessel was thermostated at about room temperature. Upon completion of the run, the reaction product was analyzed for superoxide and peroxide content. Typical results are shown in

FIGURE 5. APPARATUS USED TO STUDY THE REACTION OF CALCIUM PEROXIDE WITH OZONE.

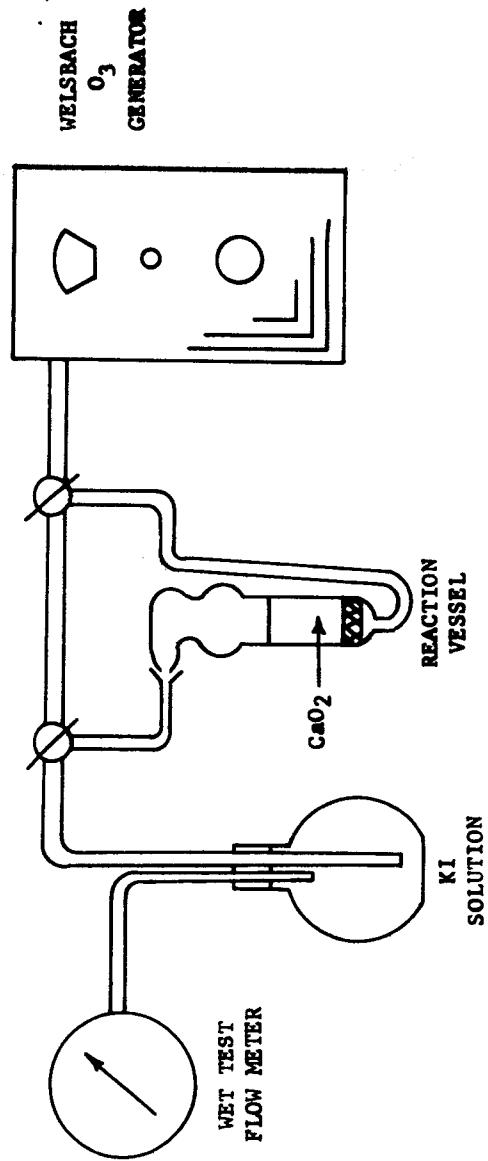
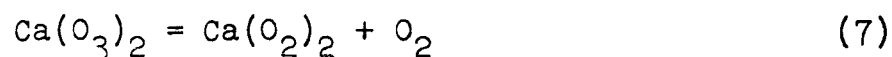
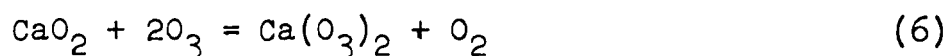

Figure 6 for the reaction of calcium peroxide and ozone at 23°C. At the start of the reaction, the ozone concentration decreased rapidly at a rate of about 0.60 min⁻¹. The rate then subsided as the reaction became diffusion controlled. Subsequently the exit ozone concentration approached that of the inlet gas stream, as shown for the 6.5 hour run, indicating that the reaction approached completion or some equilibrium state.

Samples that were ozonated for 2 or 6.5 hours contained 3 to 9.5% calcium superoxide. These results are not discouraging; calcium superoxide apparently was synthesized from the peroxide by reaction with ozone. The exact path of the reaction was not determined, although it is possible that calcium ozonide acts as an intermediate product which rapidly decomposes to the superoxide, accordingly:



On the basis of oxygen capacity, a 93% pure calcium superoxide product would be equivalent to 100% sodium peroxide. Since commercially-available sodium superoxide is about 92% pure, an 84% pure calcium superoxide material is all that would be required to compete with commercial sodium superoxide. Similarly, a 74% pure calcium superoxide material would be equivalent, on the basis of oxygen capacity, with 100% pure potassium superoxide sample.

However, in spite of the various approaches discussed above, samples containing more than 60% calcium superoxide could not be

FIGURE 6. VARIATION OF OZONE CONCENTRATION DURING REACTION WITH CALCIUM PEROXIDE.

○: 2.86 grams CaO₂
□: 2.69 grams CaO₂
ave. flow rate: 0.055 ft³/min.

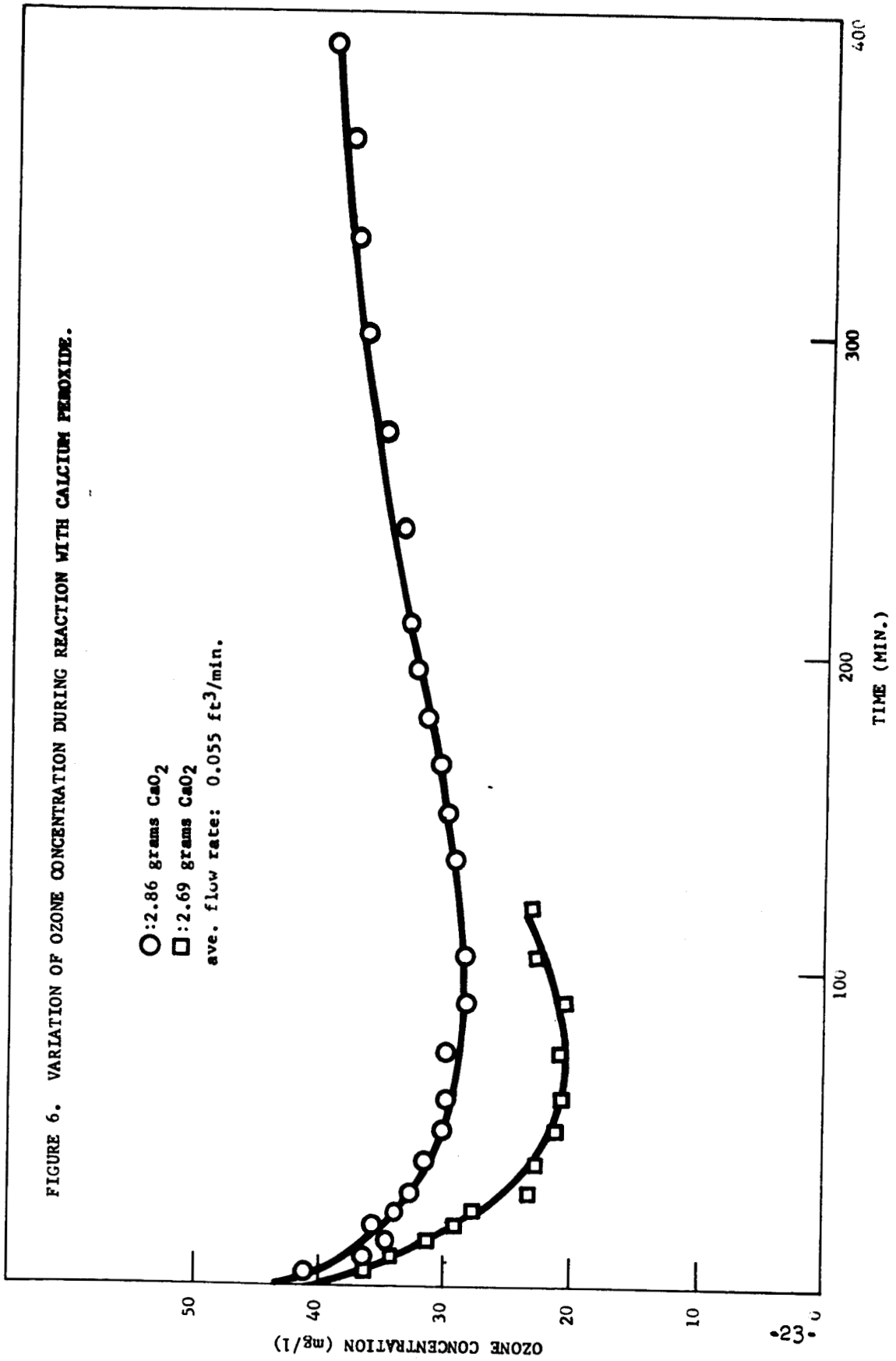

obtained consistently.

Thus the purity levels required to put calcium superoxide on an equivalent basis with the commercially-available alkali metal superoxides have not been achieved in these studies.

2.2 REACTION OF CALCIUM SUPEROXIDE WITH WATER VAPOR

One of the more important chemical properties of superoxides with respect to their use as air revitalization materials is their reaction with water vapor. Alkali metal superoxides normally react with water, either liquid or gaseous, to evolve oxygen and form the corresponding hydroxide, according to reaction (1). In the case of alkaline earth superoxides, such as calcium superoxide, the reaction is expected to proceed in an analogous manner:

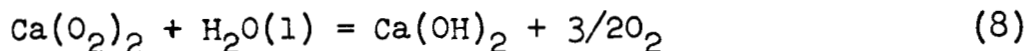

Kinetic studies of this reaction were carried out at two different temperatures, 24°C and 34°C, and at 100% relative humidity, to characterize this important air revitalization reaction and to verify or establish the stoichiometry of the reaction. The apparatus used in these studies has been described previously.⁷ The reaction chamber was charged with a powdered sample in the vial, stoppered, attached to a gas burette, and approximately 30 ml. water added through the side arm. When equilibrium had been attained, the sample was exposed to the water vapor and the volume of oxygen evolved was monitored with time. A number of runs using $\text{Ca(O}_2\text{)}_2$ were made at two different temperatures, 24°C and 34°C, and at 100% relative humidity. A typical run at 24°C

and 100% relative humidity for a 0.56 gram sample containing 49.5% calcium superoxide is shown in Figure 7. This reaction proceeded at a rate of 1.7 ml/gr/min. A typical run at 34°C and 100% relative humidity is shown in Figure 8. In this case the oxygen evolution rate was 3.2 ml/gr/min. The sample weight was 0.11 gram and contained 53.8% $\text{Ca}(\text{O}_2)_2$.

The characteristics of the reaction of water vapor and $\text{Ca}(\text{O}_2)_2$ differ considerably from the water vapor - alkali metal superoxide reaction. The product obtained by reacting $\text{Ca}(\text{O}_2)_2$ with water vapor is a white, powdery, dry-looking solid. In contrast, the reaction of KO_2 and NaO_2 with water vapor, under the same conditions, results in a very concentrated hydroxide solution. This result is, of course, to be expected from the high heat of fusion of $\text{Ca}(\text{OH})_2$ and, in fact, demonstrates one of the major advantages associated with the potential use of $\text{Ca}(\text{O}_2)_2$ in canister-type systems.

On the other hand, the total amount of oxygen evolved did not correspond to the stoichiometry of the liquidus water reaction. In addition, the dry, white, powdery product showed increased peroxide content over the starting material. For example, in one case the analysis of the sample before reaction with water vapor showed a superoxide content of about 52.8% and a peroxide content of 2.6%. After reaction the superoxide content was zero and the total peroxide content was 70%. Other data is summarized

FIGURE 7. VOLUME OF OXYGEN EVOLVED AT S.T.P. (ml) PER GRAM OF CALCIUM SUPEROXIDE PRODUCT DURING REACTION WITH WATER VAPOR AT 24° C AND 100% RELATIVE HUMIDITY.

VOLUME (ml)/GRAM

80

60

40

20

120

180

240

TIME (MIN.)

26

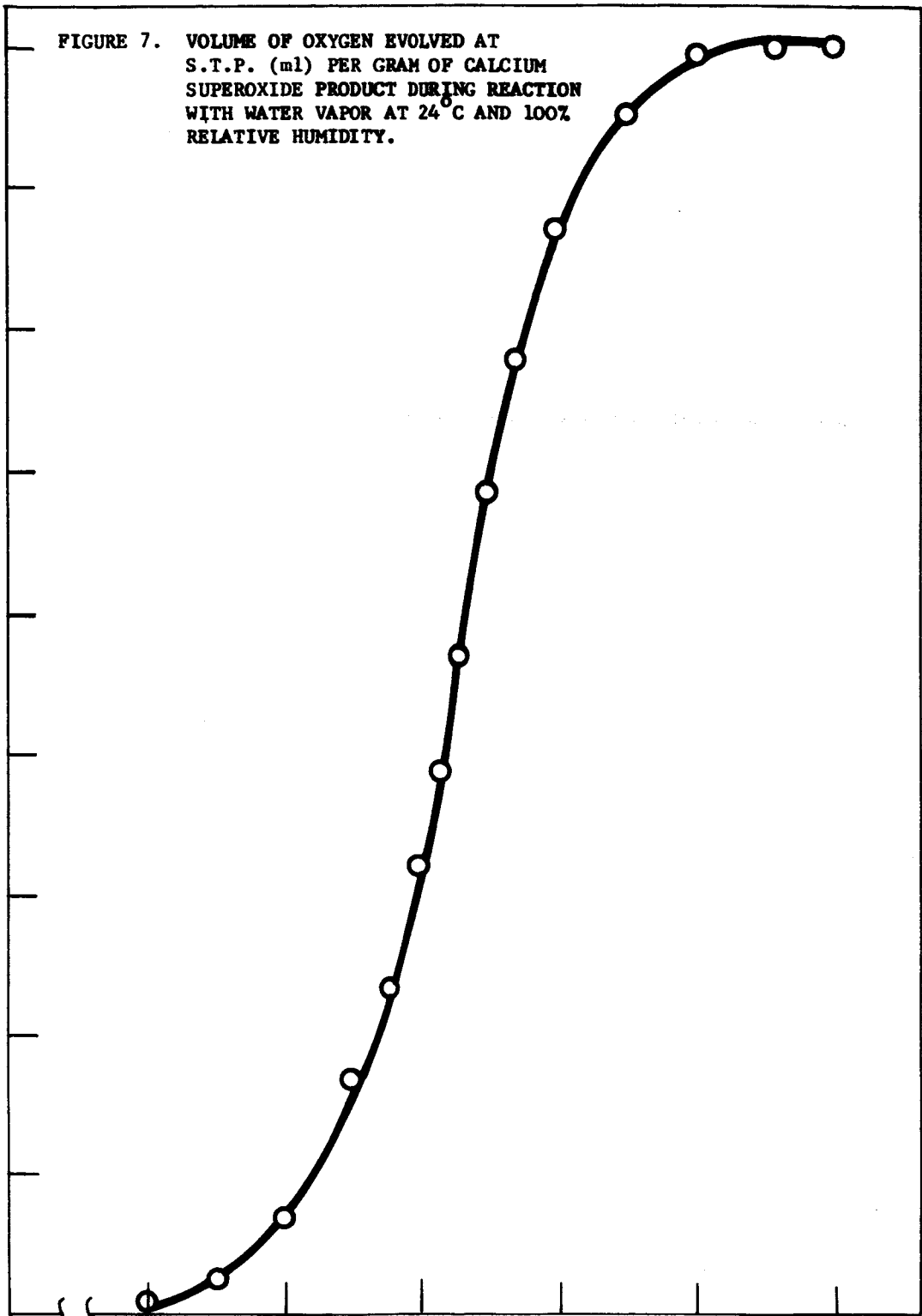
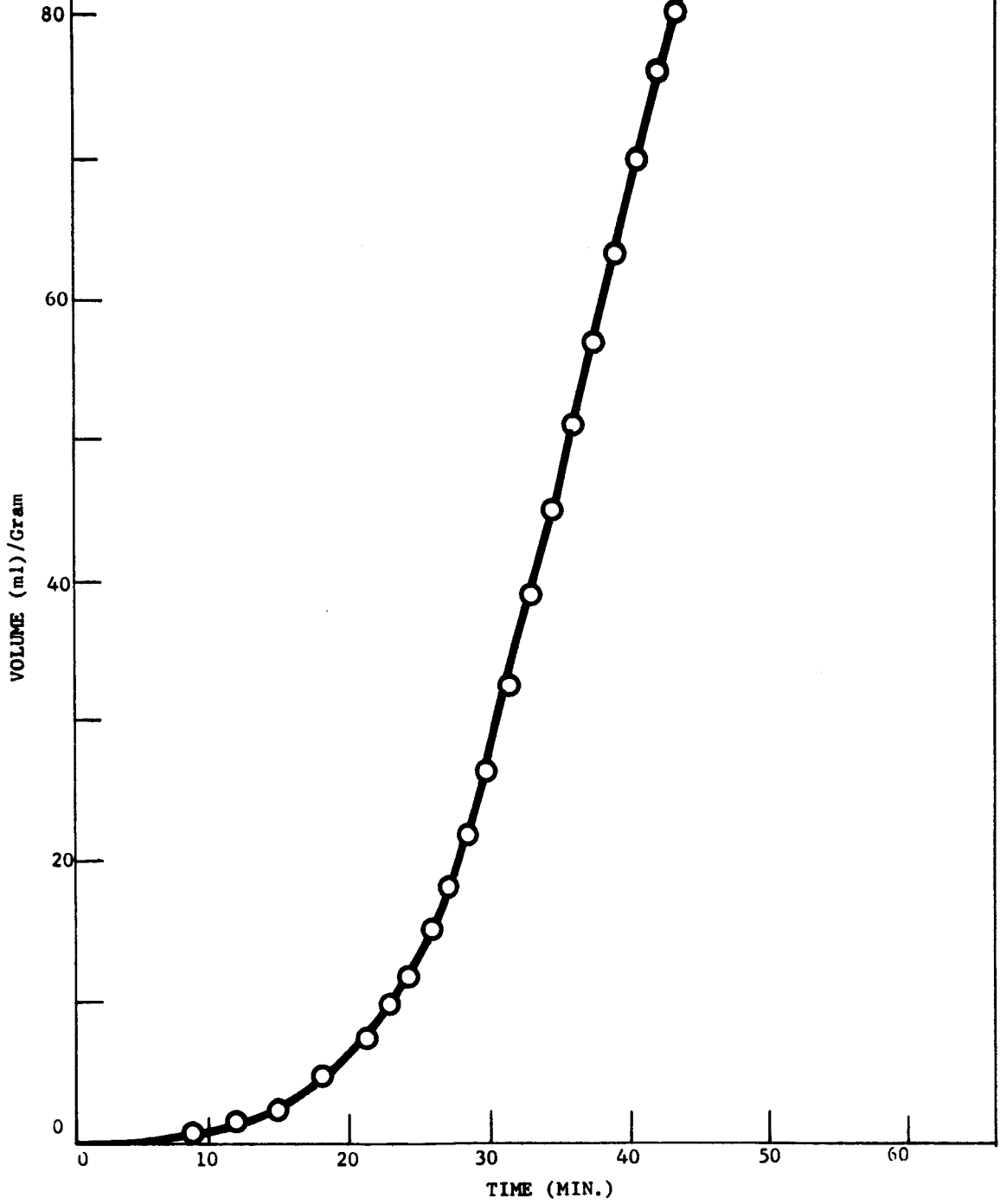
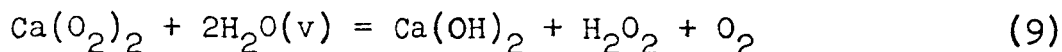

FIGURE 8. VOLUME OF OXYGEN EVOLVED AT S.T.P. (ml) PER GRAM OF CALCIUM SUPEROXIDE PRODUCT DURING REACTION WITH WATER VAPOR AT 34°C AND 100% RELATIVE HUMIDITY.



in Table II. It appears that the reaction of calcium superoxide with water vapor must proceed by one of the following paths:



or

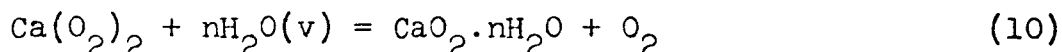

According to the stoichiometry of reaction (9), hydrogen peroxide would be formed. The formation of such a product would be difficult to justify because of the dryness of the reaction product. In addition, when the sample was washed with demineralized water and the filtrate tested for peroxide content with permanganate solution, the peroxide test was negative. Had liquidus hydrogen peroxide been formed, it would have been found at this point and the peroxide test would have been positive. Also, when samples containing 50% calcium superoxide were contacted with demineralized water, gas was evolved, and a white precipitate formed, either Ca(OH)_2 or CaO_2 . The precipitate was filtered off and dilute permanganate solution added dropwise to the filtrate. The permanganate solution was not decolorized, which indicates the lack of formation of hydrogen peroxide.

The evidence presented above and in Table II tends to favor reaction (10) as the better description of the reaction between calcium superoxide and water vapor. Mole ratios of oxygen evolved to calcium superoxide in the starting material varied between 1 and 2 for the study at 24°C, but never less than 1. At 34°C, the mole ratio was approximately one. Excess evolution of oxygen can be

TABLE II

SUMMARY OF DATA FROM KINETIC STUDIES OF THE
REACTION OF CALCIUM SUPEROXIDE AND WATER VAPOR AT 24°C
AND 34°C AND 100% RELATIVE HUMIDITY

<u>Sample</u>	<u>Weight (Grams)</u>	<u>Tempera- ture (°C)</u>	<u>Analysis (%)</u>			<u>Oxygen Evolved: Calcium Superoxide</u>
			<u>Ca(O₂)₂</u>	<u>CaO₂</u>		
			<u>Initial</u>	<u>Initial</u>	<u>Final</u>	
1	0.5386	24	43.6	15.0	31.1	1.11
2	0.7034	24	43.6	15.0	37.9	1.11
3	0.2585	24	58.2	5.2	35.3	1.68
4	0.3731	24	50.1	11.4	18.2	----
5	0.2205	24	52.6	8.4	29.0	1.46
6	0.3046	24	52.6	8.4	34.0	1.26
7	0.5613	24	49.5	12.0	33.0	1.17
8	0.3058	24	43.0	10.9	44.3	1.51
9	0.2703	24	70.8	0.0	31.4	1.86
10	0.2313	24	41.3	11.6	----	1.09
11	0.1657	24	55.0	3.0	34.8	1.09
1	0.6287	34	29.0	24.4	38.8	0.96
2	0.3435	34	29.0	24.4	33.1	1.00
3	0.5163	34	29.0	24.4	34.2	0.94
4	0.6680	34	34.8	24.6	33.6	0.97
5	0.11	34	53.8	----	----	0.79

attributed to partial decomposition of calcium peroxide by water vapor.^{8,9}

2.3 REACTIONS OF AIR REVITALIZATION MATERIALS WITH CARBON DIOXIDE AND WATER VAPOR

The importance of air revitalization materials, such as superoxides, depends upon the reactions of these compounds with carbon dioxide. As noted previously,⁷ extensive investigations have been made to study the reaction of carbon dioxide with alkali metal hydroxides, oxides, peroxides, superoxides, and ozonides. In all cases, water vapor plays a vital role in the reaction rate.^{7, 10, 11} The exact role of water in the reaction mechanism has not yet been clearly established.

In the case of superoxides, the overall reactions are written as:

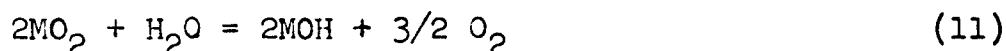

or

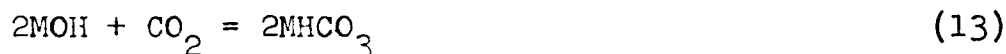

where M represents an alkali metal. In the case of ozonides, the reactions are the same, namely, the formation of the hydroxide which absorbs the carbon dioxide; only the stoichiometry varies. Kinetics of the reaction of potassium ozonide with carbon dioxide at various conditions of relative humidity have been reported.⁷

The custom-built apparatus designed for kinetic studies of the reaction of air revitalization compounds with carbon dioxide and water vapor is shown in Figure 9. The anticipated procedure called

FIGURE 9. APPARATUS TO STUDY THE REACTIONS OF AIR REVITALIZATION MATERIALS WITH CARBON DIOXIDE AND WATER VAPOR.

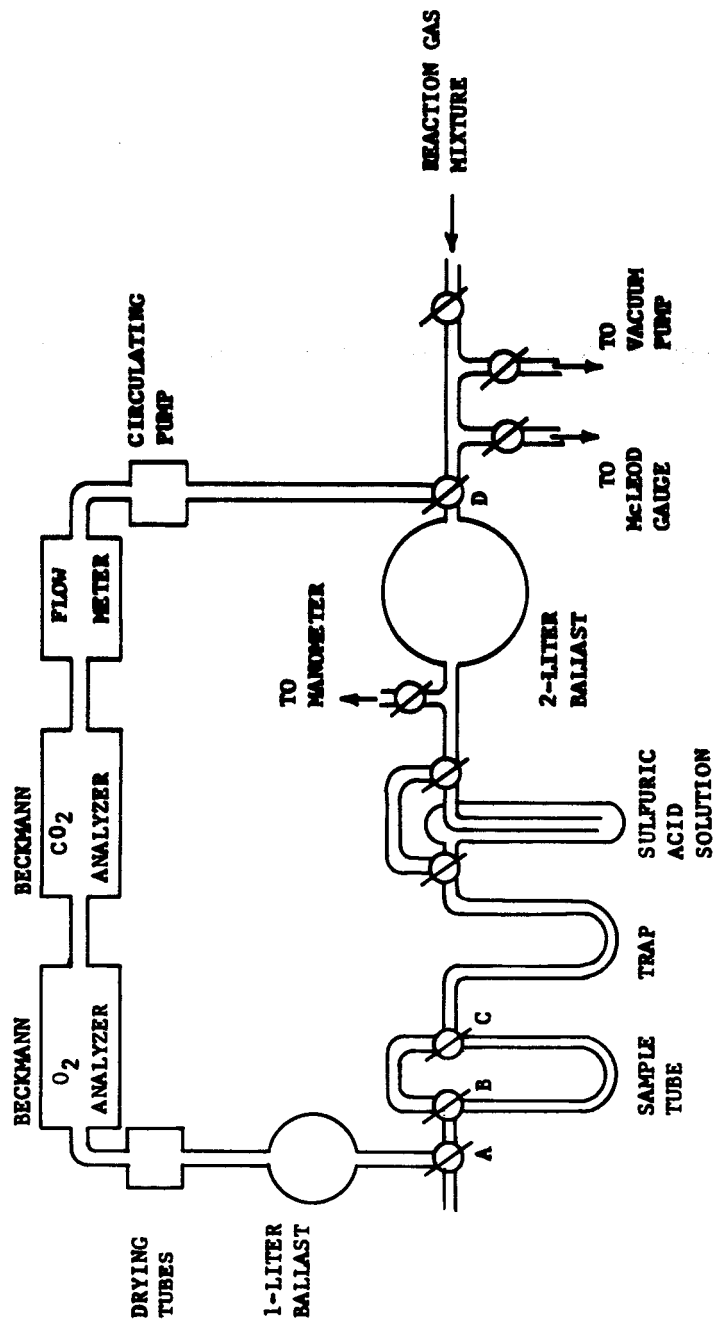

for the evacuation of the glassware between stopcocks A and D, excluding the flask containing the aqueous sulfuric acid solution for humidity control. During this time, calibrating gases were passed through the instruments at a flow rate to be used during the actual run (0.5 SCFH). The calibrating gases were dry N_2 and 5% CO_2 and 5% O_2 in N_2 . The sample was loaded into a U-tube in a dry box, inserted in the system, and also evacuated. Dewars were placed around the sample tube and the humidity control solution to maintain a constant temperature throughout the experiment. When the system was evacuated to about 0.1 mm, the reaction gas mixture (5% CO_2 in N_2) was let in to a positive pressure (later to occupy the void of the sample tube). The humidity control solution was introduced into the system and the gas circulated through the instruments (Beckman Infrared CO_2 Analyzer and Paramagnetic Oxygen Analyzer). When concentration equilibrium had been established, the gas was expanded into the sample tube by rapidly turning stopcocks B and C. The oxygen and carbon dioxide concentrations were monitored with time. An immediate small decrease in both concentrations was expected due to the expansion of the circulating gas into the evacuated sample tube. An increase in the O_2 concentration followed by a decrease in the CO_2 concentration was then expected as reactions (11) and (12) or (13) take place. However, in these preliminary studies, a drastic decrease in the CO_2 concentration from about 5% to 1% in the first minute of reaction time followed by an increase to about 4% in the next minute was observed. The oxygen concentration behaved oppositely; a sharp

increase followed by a sharp reduction. The concentrations then behaved as expected; the oxygen concentration rose slowly and the carbon dioxide concentration trailed off. The initial phenomena were attributed to the fact that the instruments did not see a representative sample of the entire gaseous system but only that portion which has just been in contact with the sample.

To establish a true baseline, to eliminate the change in concentration due to the change in pressure, and to overcome the initial phenomena described above, the following steps were taken. A ballast flask was inserted into the line between the sample tube and the instruments to allow the gases to mix prior to measurement of the concentrations of O_2 and CO_2 . The sample tube was charged under N_2 in a dry box. The sample tube was placed into the system but isolated along with the sulfuric acid solution while the glassware between stopcocks A and D was evacuated. After the instruments had been calibrated and the vacuum reduced to about 0.1 mm, the MacLeod gauge and the vacuum pump were isolated. The reaction gas mixture (5% CO_2 in N_2) was let in to atmospheric pressure and circulated through the instruments. It has been shown⁷ that potassium ozonide and superoxide do not react with dry CO_2 . Therefore, the sample tube, under N_2 was inserted in the circulating line. The reaction gas mixture was circulated until concentration equilibrium has been established, then allowed to pass through the humidity control solution of sulfuric acid. This time was taken as "zero time" for the kinetic study. The O_2 and CO_2 concentrations were monitored with time.

2.3.1 Sodium Superoxide - Carbon Dioxide Reaction

The reactions between sodium superoxide, carbon dioxide, and water vapor have been studied at room temperature and at 47.7%, 71.4%, and 100% relative humidity. Data for typical runs are summarized in Tables III and IV and illustrated in Figures 10, 11, and 12. The superimposition of these three figures emphasizes expected trends which are verified by the data given in Table III. For example, as the amount of water in the vapor phase is increased, for nearly equal weight samples, the oxygen released via reaction (11) is evolved in a shorter time. Although essentially the same time is needed for complete absorption of the carbon dioxide at each level of relative humidity, the absorption process takes place at a faster rate at the higher humidities. For example, when the water vapor-carbon dioxide mixture was circulated over equal weight samples of sodium superoxide at an average rate of 0.5 SCFH, the absorption of carbon dioxide was complete in about 360 minutes in all cases, whereas the oxygen evolution process was complete after 210, 165, and 150 minutes at the 47.7%, 71.4%, and 100% levels of relative humidity, respectively. The first-order kinetic rate constants for the evolution of oxygen and absorption of carbon dioxide for these relative humidity levels are also noted in Table III.

The percentage yields listed in Table III are for the following stoichiometric reaction:

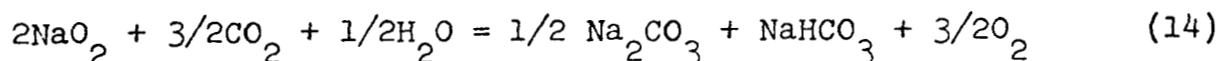

VOLUME (ml) OF CARBON DIOXIDE ABSORBED PER GRAM OF SODIUM SUPEROXIDE

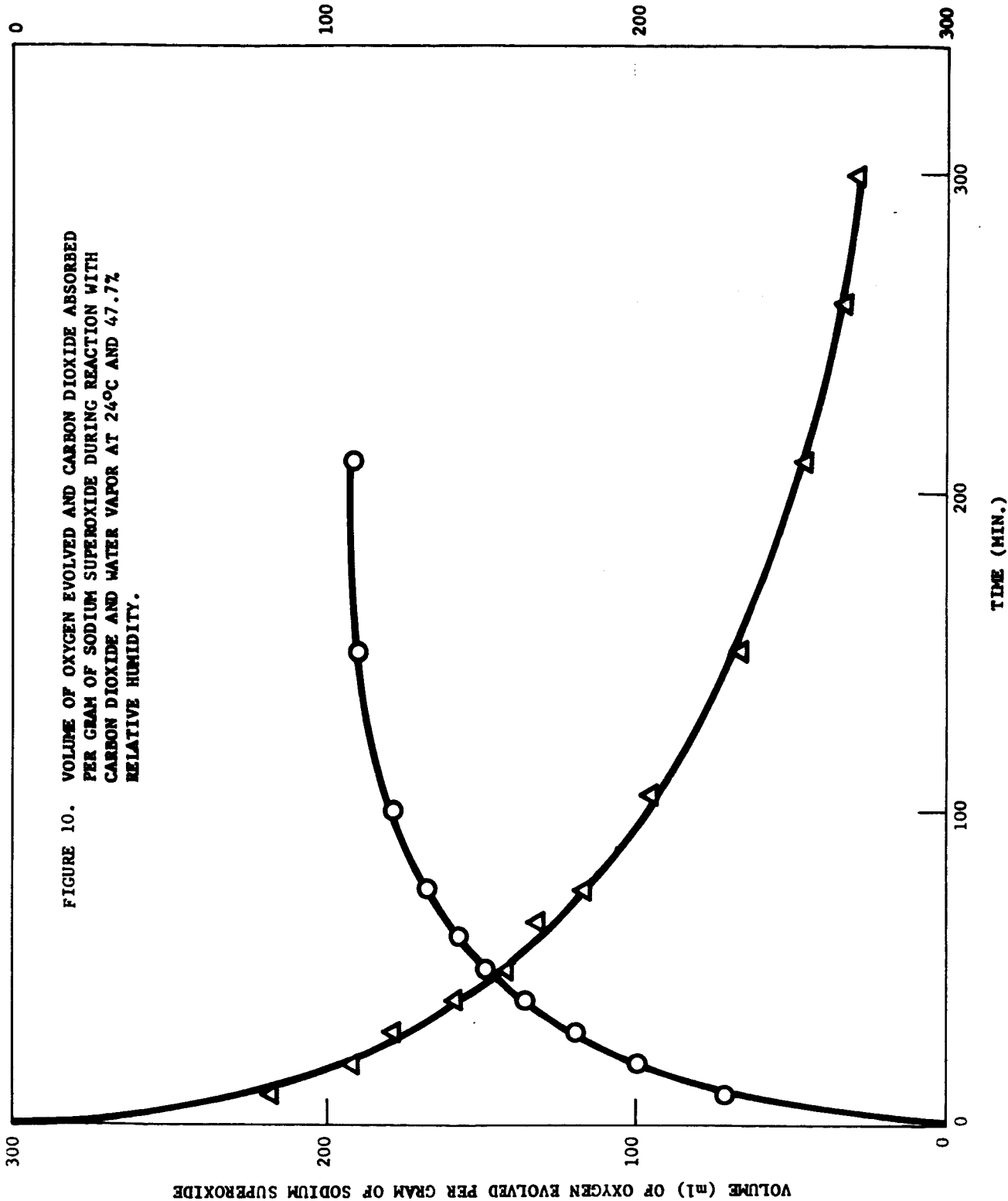
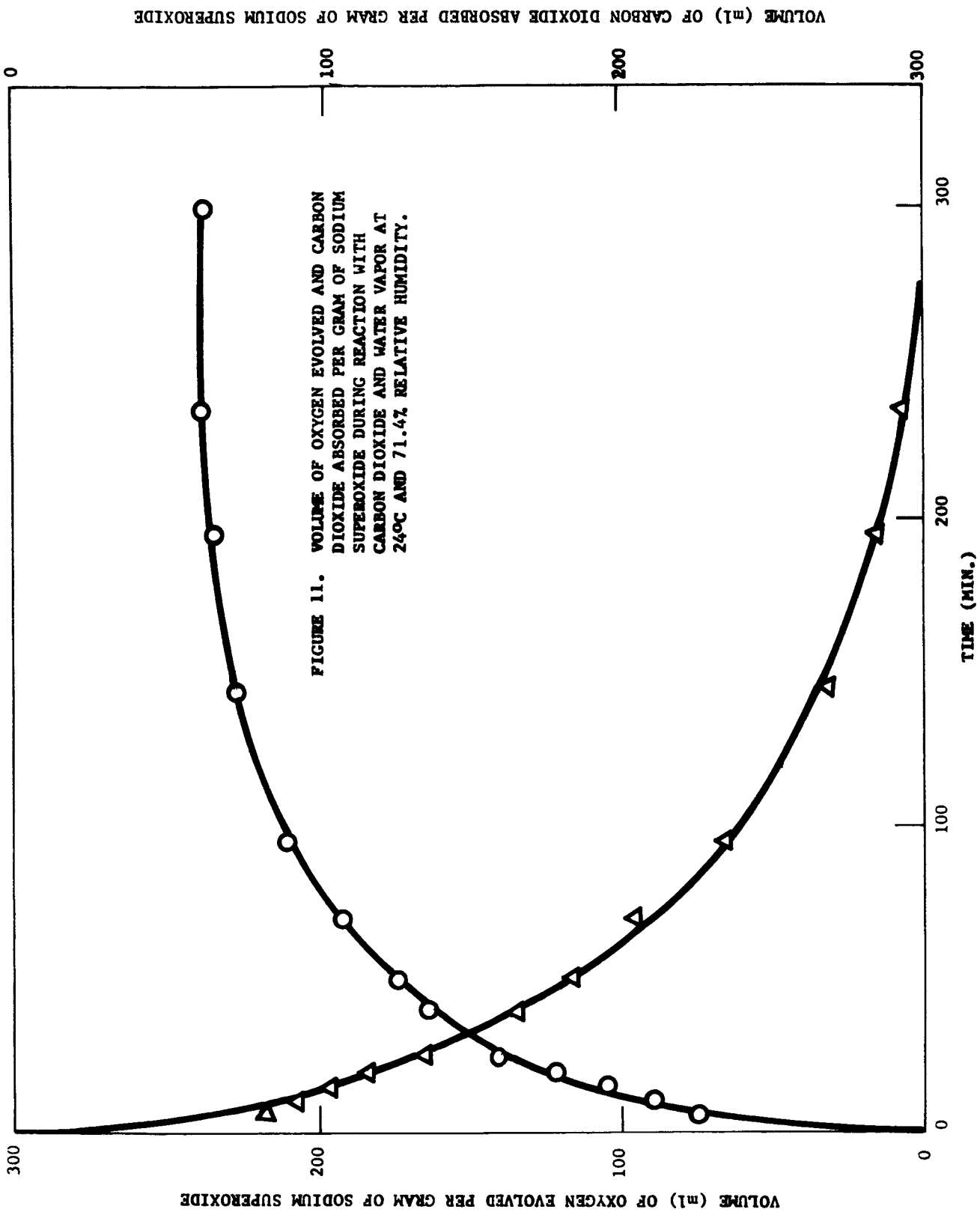

FIGURE 10. VOLUME OF OXYGEN EVOLVED AND CARBON DIOXIDE ABSORBED PER GRAM OF SODIUM SUPEROXIDE DURING REACTION WITH CARBON DIOXIDE AND WATER VAPOR AT 24°C AND 47.7% RELATIVE HUMIDITY.



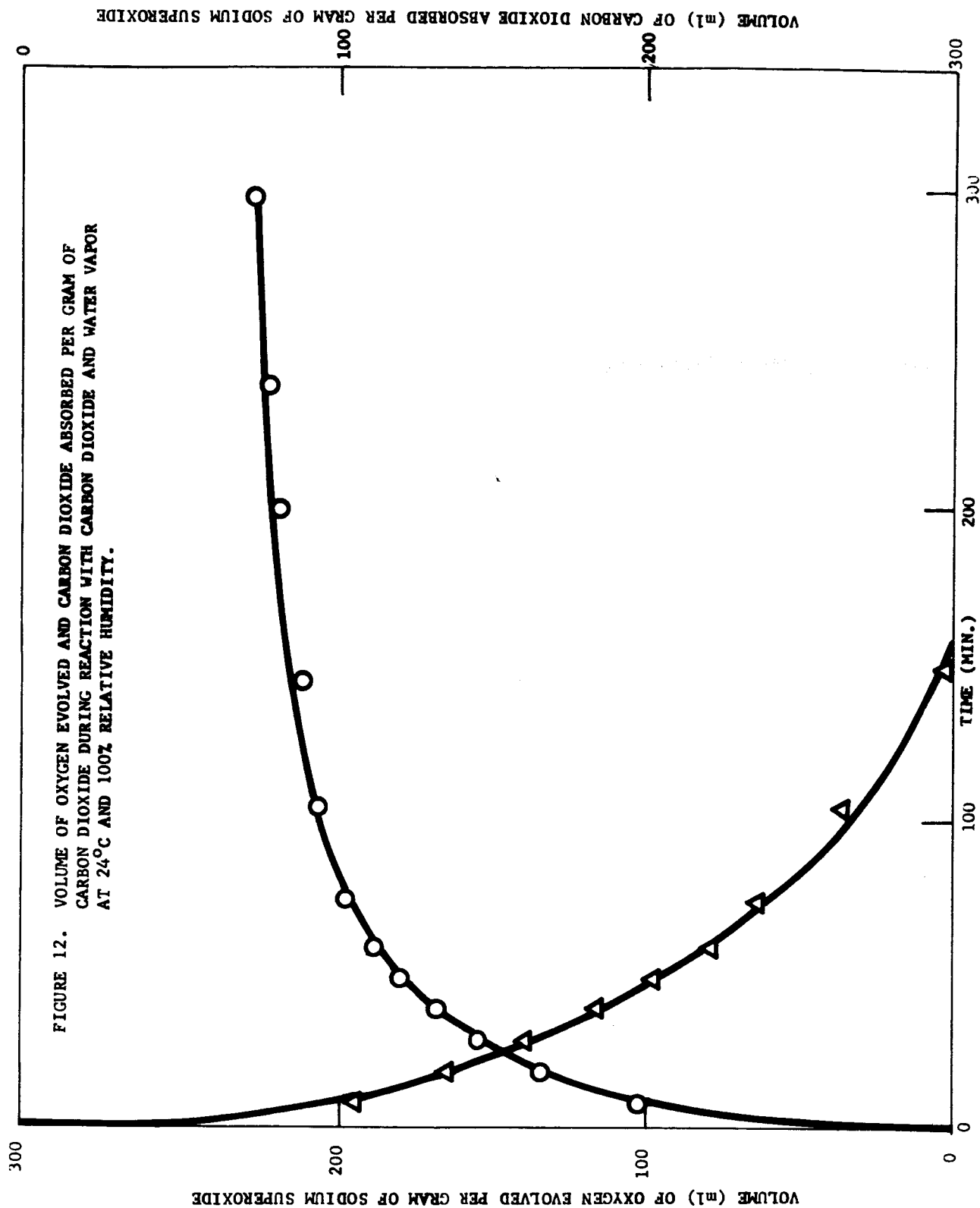

TABLE III

SUMMARY OF KINETIC DATA FOR REACTION OF
SODIUM SUPEROXIDE WITH CARBON DIOXIDE AND WATER VAPOR

Relative Humidity	Time to Completion		Volume (ml) per gram at completion		% of Theoretical		Rate Constant (min^{-1})	
	O ₂	CO ₂	O ₂ Evolved	CO ₂ Absorbed	O ₂	CO ₂	O ₂	CO ₂
47.7	210	360	192	275	62.8	90.0	.0095	.0055
71.4	165	300	235	300	76.9	98.2	.0096	.0060
100	150	360	240	309	78.6	101.1	.0101	.0071

TABLE IV

Summary of Data from Sodium Superoxide - Carbon Dioxide Studies

<u>Run No.</u>	<u>Relative Humidity (%)</u>	<u>Sample Weight (grams)</u>	<u>Average Respiratory Quotient</u>	<u>Final</u>
1	47.7	0.5689	1.2	1.5
2	47.7	0.5471	1.1	1.3
3	47.7	0.6410	1.0	1.3
4	47.7	0.5611	1.0	1.2
5	71.4	0.5185	1.1	1.2
6	71.4	0.4884	1.1	1.3
7	71.4	0.4568	1.1	1.3
8	71.4	0.4108	1.2	1.2
9	71.4	0.4308	1.0	1.1
10	100	0.5308	1.2	1.3
11	100	0.4886	1.3	1.4
12	100	0.4947	1.1	1.2
13	100	0.4694	1.1	1.3

Such a reaction is necessary because of the observed respiratory quotients (R.Q.) and the final observed volumes of CO_2 , both of which cannot be explained on the basis of equations (11), (12), and (13). The low yields of oxygen listed in Table III can be attributed to crusting of the surface during reaction with water vapor. A lesser degree of crusting was observed at the higher humidities as evidenced by the higher yields. Upon completion of the runs, the products were brought into contact with liquidus water. Slow gaseous evolution was observed and the crusted product did not dissolve readily.

The observed respiratory quotient values for this series of experiments varied from the 0.67 value predicted by reactions (11) and (12) and also from the 1.30 value predicted by reactions (11) and (13). The average and final R.Q. values observed at the various relative humidity levels are summarized in Table IV and plotted as a function of time for typical cases in Figures 13, 14, and 15. Reaction (14) best describes the state wherein the R.Q. would be near 1.0. However, the stoichiometry apparently favors bicarbonate formation as evidenced by the higher final R.Q. values. These results also serve to confirm and explain recent life support studies by the Boeing Company in which it was found that less auxiliary carbon dioxide scrubber material was required for a sodium superoxide system than expected on the basis of reactions (11) and (12). Thus, the product of the sodium superoxide - carbon dioxide - water vapor reaction is postulated to be a mixture containing bicarbonate as well as carbonate.

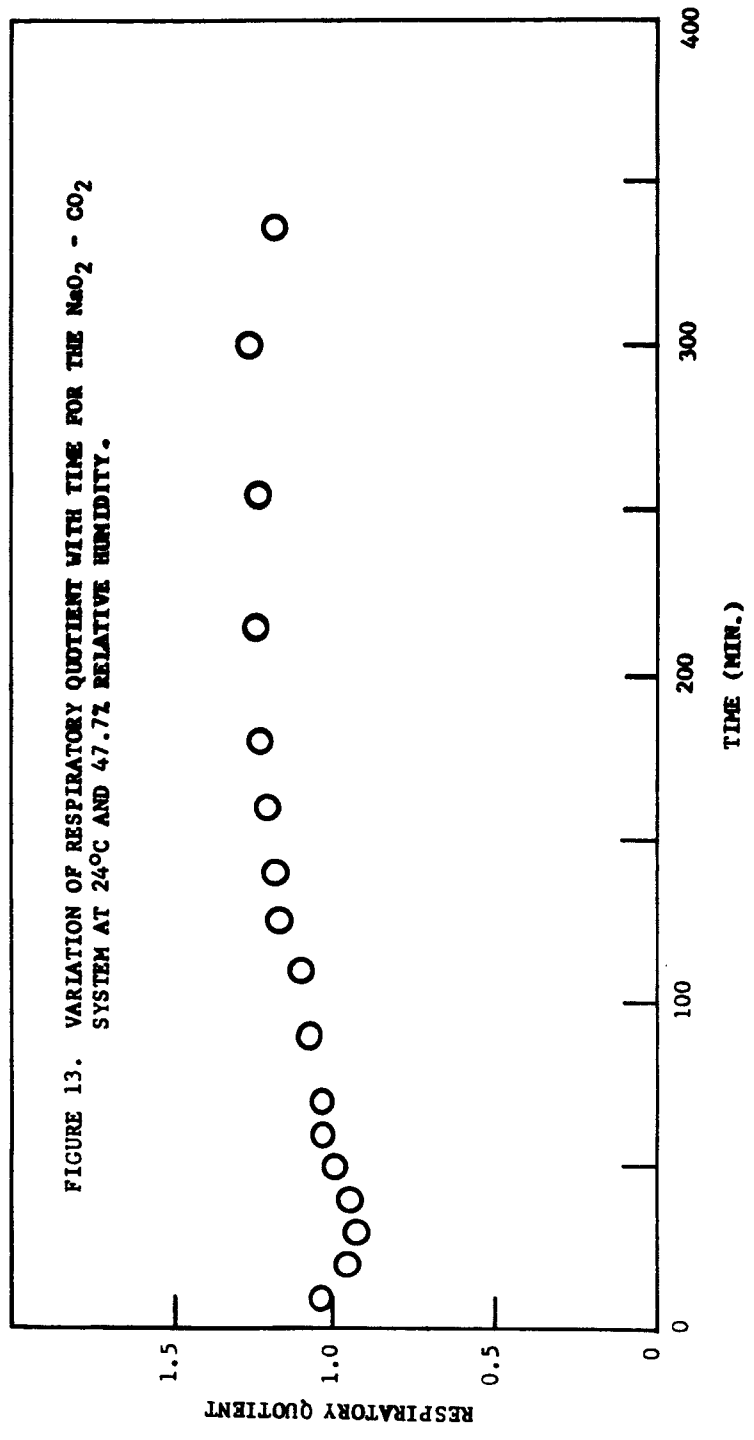

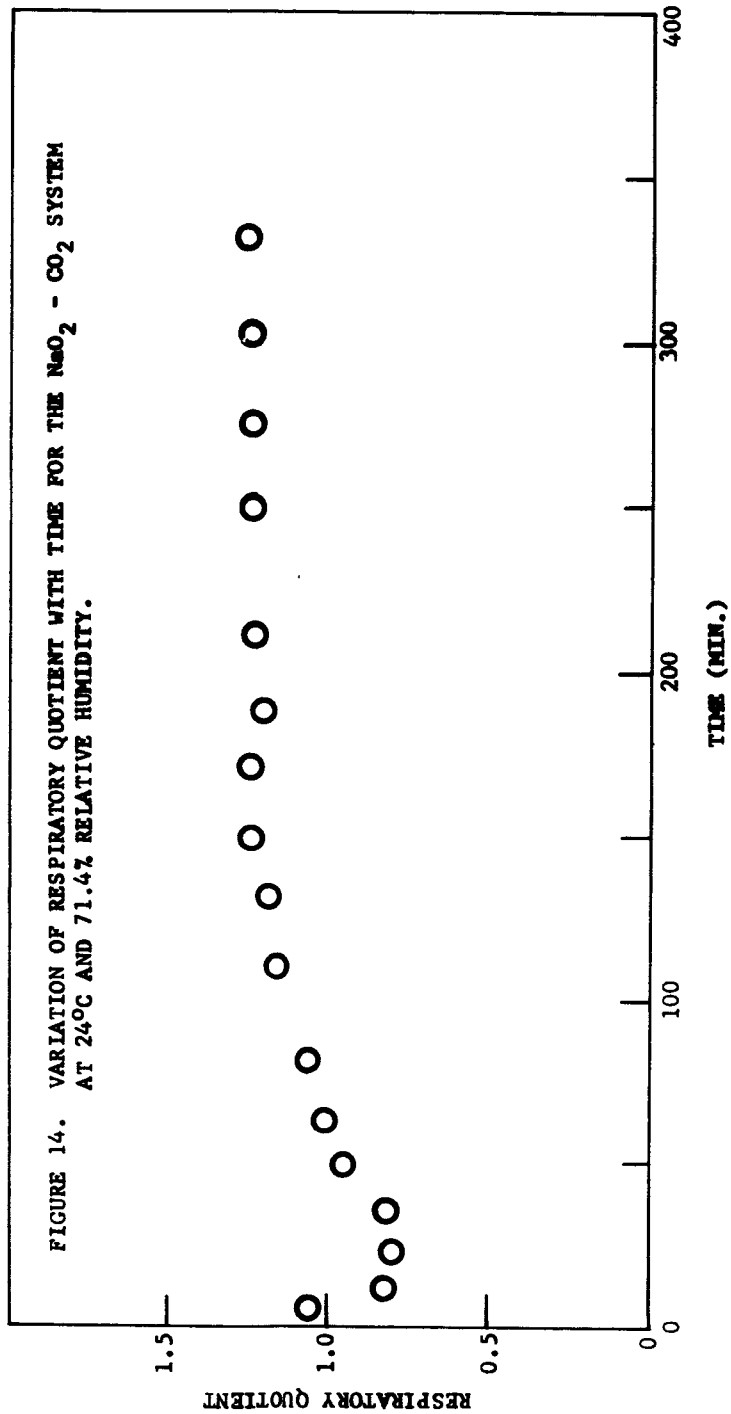

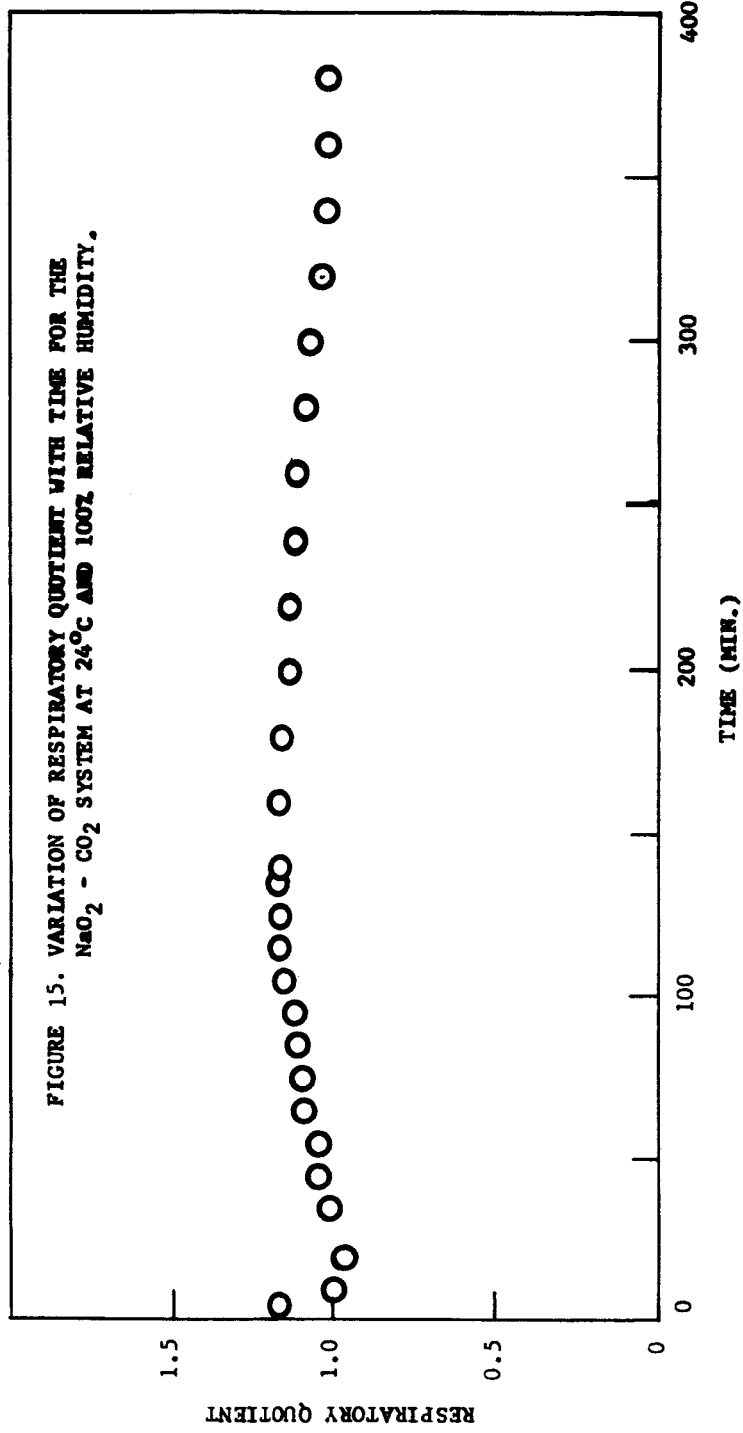

According to reaction (14), the respiratory quotient expected from the previously reported data would be 1.0. Table IV shows that an R.Q. near 1.0 was observed, but in some cases the R.Q. was greater. In all cases, the R.Q. increased toward the end of the run as carbon dioxide continued to be absorbed after the cessation of oxygen evolution. This lag in carbon dioxide absorption vs oxygen evolution is expected since it is known that carbon dioxide does not react with dry superoxide or hydroxide. Therefore, the initial reaction must be with water vapor, accordingly:

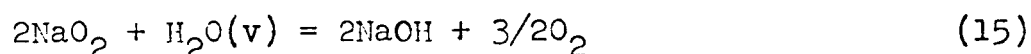

Simultaneously, the caustic is wetted and ionized,

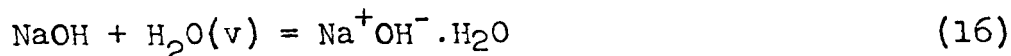

At pH values greater than 10, direct reaction of carbon dioxide with hydroxide predominates¹²:



However, the following reaction between the bicarbonate formed and the neighboring hydroxide occurs instantaneously:

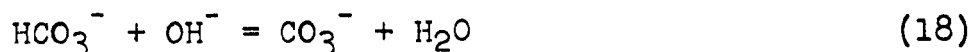

Therefore, early in the experiment, the R.Q. is governed by carbonate formation with values less than 1.0.

If carbonic acid (H_2CO_3) is in the gas stream as a result of the carbon dioxide bubbling through dilute acid solutions, it will be neutralized to the bicarbonate:

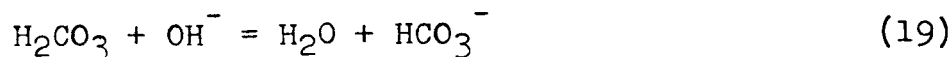

which will then react instantaneously according to reaction (18).

With time, reactions (15) through (18) proceed, the superoxide content diminishes, and the rate of oxygen evolution decreases. The rate of carbon dioxide absorption also decreases as the availability of caustic decreases and the product becomes crusted. The bicarbonate formed in reaction (17) sees less and less hydroxide to react with, the extent of reaction (18) decreases, the R.Q. favors bicarbonate formation and increases toward 1.33.

Values greater than 1.33 are probably due to the inefficient evolution of oxygen (ca. 75% in the case of the 71.4% relative humidity runs), i.e., underproduction of oxygen with respect to the efficient bicarbonate formation.

2.3.2 Calcium Superoxide - Carbon Dioxide Reaction

The reaction of calcium superoxide with carbon dioxide and water vapor has also been studied at room temperature and various levels of relative humidity. Typical results are illustrated in Figures 16 and 17 and summarized in Table V.

As was the case in the kinetic studies of the corresponding water reaction, these studies are complicated by the complex composition of the starting material and the dubious stoichiometries of the superoxide reactions. The data in Table V are varied enough so as not to enable a clear cut choice of stoichiometries. At the higher levels of relative humidity, the R.Q. remains between 0.75 and 1.1 during most of the experiment but rises to 1.3 and greater as carbon dioxide continues to be absorbed even after the evolution of oxygen is complete. The observations are confirmed in Figures 16

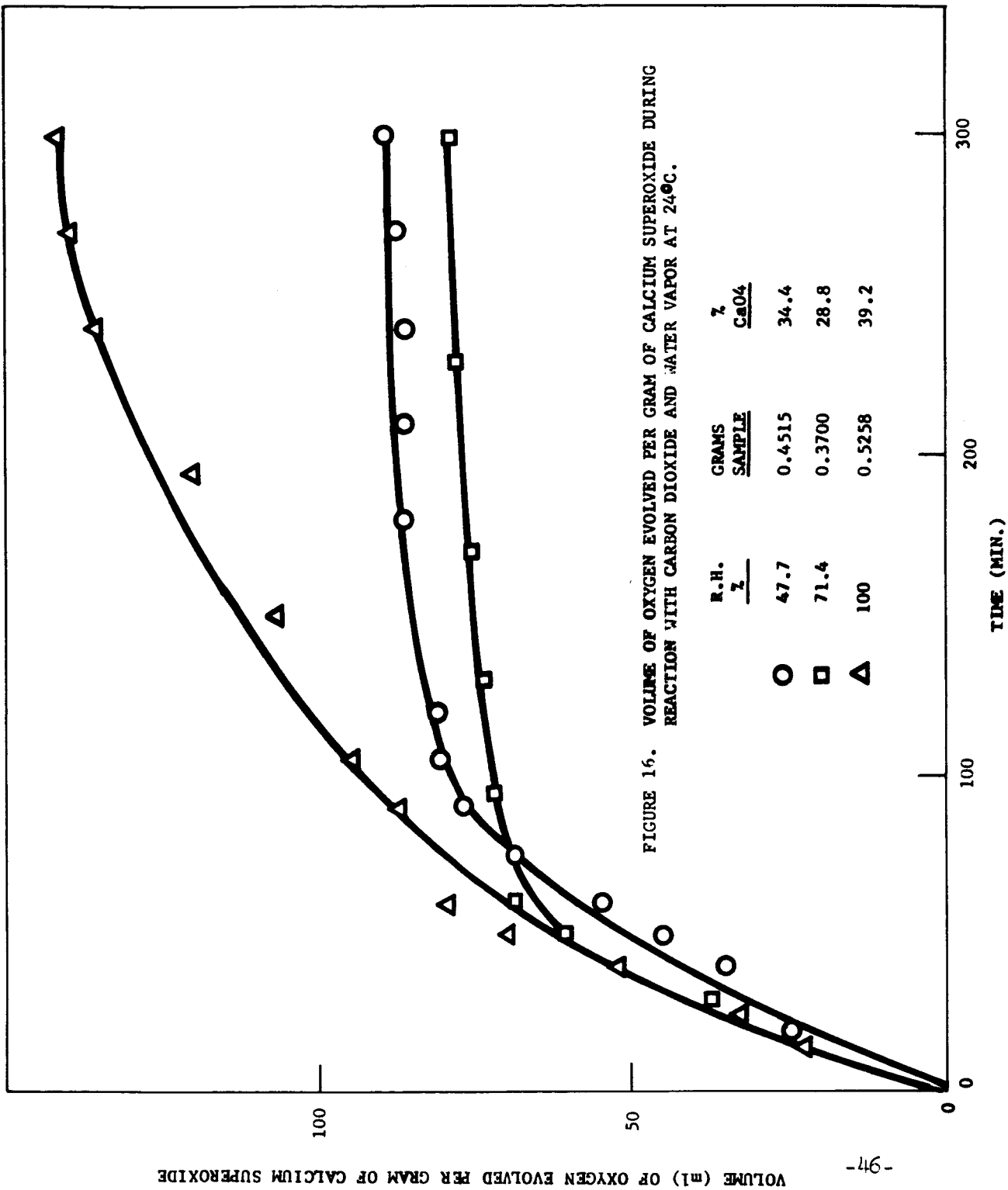

VOLUME (ml) OF OXYGEN EVOLVED PER GRAM OF CALCIUM SUPEROXIDE

FIGURE 17. VOLUME OF CARBON DIOXIDE ABSORBED PER GRAM OF CALCIUM SUPEROXIDE DURING REACTION WITH CARBON DIOXIDE AND WATER VAPOR AT 24°C.

	R.H. %	GRAMS SAMPLE	% CaO4
○	47.7	0.4515	54.4
□	71.4	0.3700	28.8
△	100	0.5258	39.2

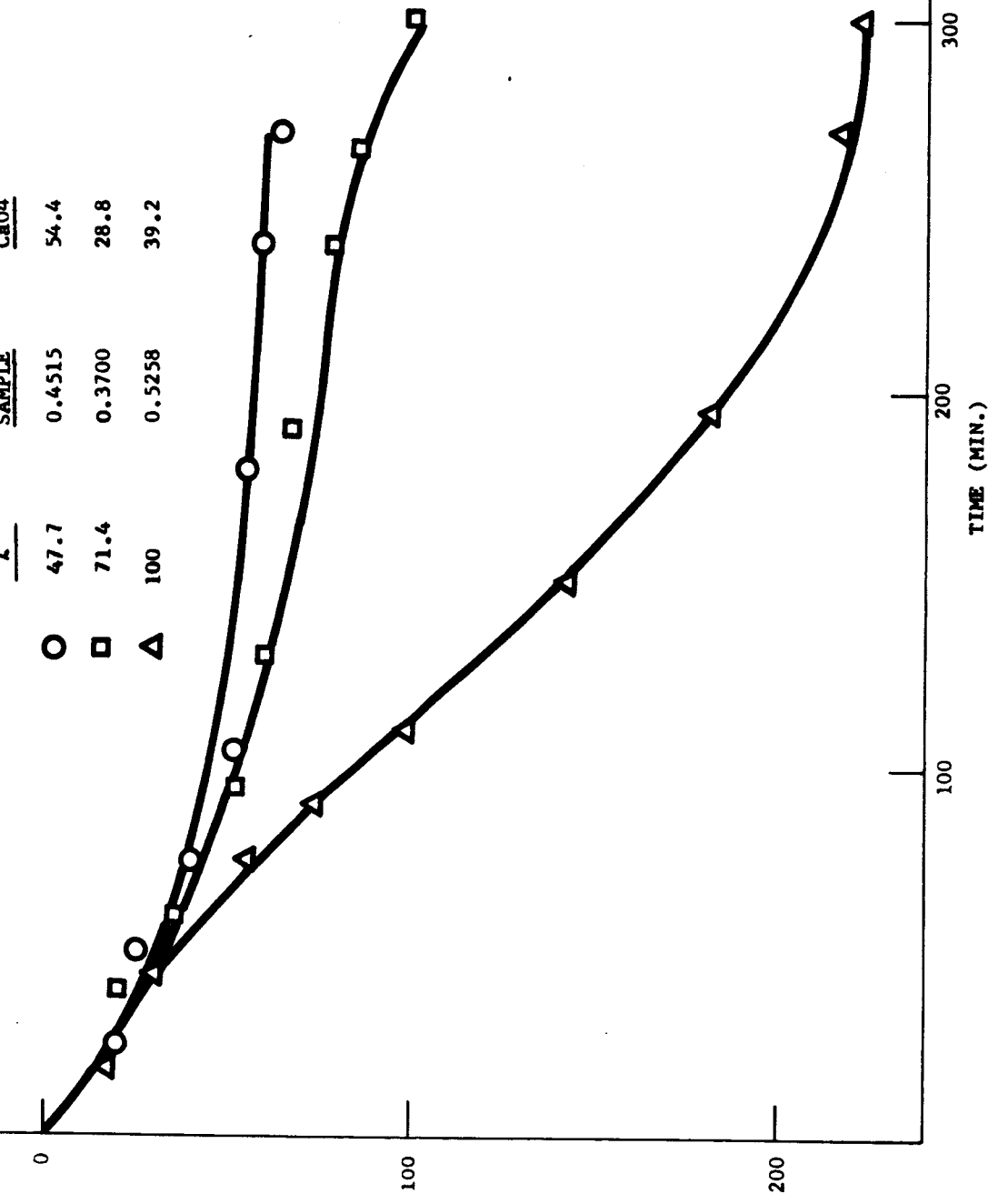

VOLUME OF CARBON DIOXIDE ABSORBED PER GRAM OF CALCIUM SUPEROXIDE

TABLE V

SUMMARY OF DATA FROM CALCIUM SUPEROXIDE - CARBON DIOXIDE
STUDIES AT ROOM TEMPERATURE

<u>Sample</u>	<u>Relative Humidity</u>	<u>Weight</u>	<u>Respiratory Quotient</u>		<u>Final Molar Ratio</u>	
			<u>Average</u>	<u>Final</u>	<u>O₂ /CaO₄</u>	<u>CO₂/CaO₄</u>
1	47.7	0.4515	0.71	0.75	1.19	0.87
2	47.7	0.5195	1.26	2.4	0.84	1.64
3	47.7	0.5060	0.86	1.3	0.92	0.80
4	47.7	0.4420	1.38	1.6	0.79	0.95
5	71.4	0.3700	0.75	1.33	1.26	1.7
6	71.4	0.5728	0.8	1.28	1.15	1.32
7	71.4	0.4691	1.10	1.3	1.19	1.8
8	71.4	0.4588	1.14	1.4	0.82	1.19
9	100	0.5258	0.94	1.6	1.78	2.87
10	100	0.4874	1.04	1.8	1.86	3.0

and 17 which show that there is a considerable lag in carbon dioxide absorption with respect to oxygen evolution. In addition, the experimental molar ratios of oxygen evolved and carbon dioxide absorbed to starting material, calcium superoxide, are not consistent. Some agreement with the water reaction data discussed above is obtained with respect to the O_2/CaO_4 molar ratio which lies apparently near 1 in most cases. Reactions (9) and (10) would then apply as the initial step for these studies. On the other hand, the CO_2/CaO_4 molar ratios ranging from about 1 to 3 are observed which do not correspond with the values expected from the postulated stoichiometries of reactions (9) and (10).

Evidently, these data do not truly depict the processes involved in the reactions of water vapor and carbon dioxide with calcium superoxide. In the above discussion, the roles of calcium peroxide and/or hydroxide, major constituents in the initial sample, were not taken into account. It is evident that the hydroxide will be wetted and absorb carbon dioxide. In previous discussions, it was pointed out that calcium peroxide will react with water vapor to evolve oxygen and the product capable of absorbing carbon dioxide. These side reactions can thus lead to an R.Q. value or a CO_2/CaO_4 mole ratio greater than expected in terms of only calcium superoxide.

It is probable, therefore, that the following reactions occur:

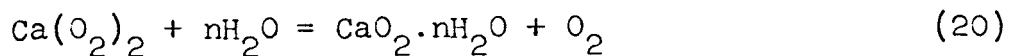

followed by:

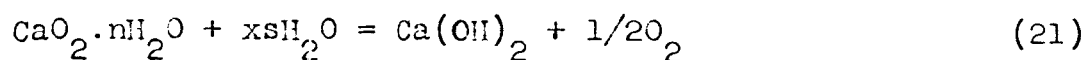

and

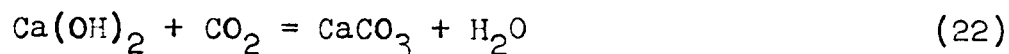

It is possible that the carbon dioxide reacts directly with the peroxide complex,

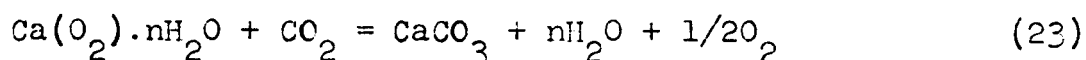

These reactions would yield an R.Q. value of 0.67. Reactions between the initial hydroxide and/or peroxide and the water vapor - carbon dioxide system could lead to higher observed R.Q. values.

2.4 REACTION OF SODIUM SUPEROXIDE WITH CARBON MONOXIDE

The reaction of air revitalization chemicals with carbon monoxide is of interest because Bogatkov, et. al.¹³, have confirmed the presence of carbon monoxide in the atmosphere of confined chambers inhabited by groups of smokers and non-smokers. After approximately ten days, the air of a test chamber inhabited by three persons contained 0.023 - 0.27 mg/l (23 - 27 ppm) of carbon monoxide. Tsentsiper and Tokareva¹⁴ have reported that sodium superoxide reacts with dry carbon monoxide only above 100°C to form the carbonate:

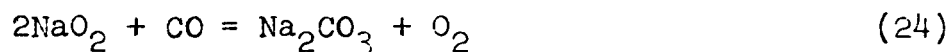

accompanied by the reaction:



The Russian investigators also report that potassium superoxide reacts with dry carbon monoxide to form the carbonate at only 95°C (14). In the presence of water vapor, the formation of sodium and potassium carbonate supposedly occurs at 95°C and 70°C, respectively.

The apparatus and procedure described above for the carbon dioxide studies was used to investigate the reaction of sodium superoxide with carbon monoxide. Carbon monoxide at 900 ppm in nitrogen was used as the sample gas. The Beckman CO₂ Infrared Analyzer was adapted to monitor carbon monoxide. This meter registered a blank absorption of 3 ppm/hr at room temperature, 100°C and 120°C. At these temperatures, blank responses for the oxygen meter were 0.12%/hr.

A blank determination was also made at 100°C and 120°C by circulating dry nitrogen gas over the sodium superoxide sample. The blank readings did not vary from those determined without a superoxide sample, thus indicating no significant thermal decomposition of the sample.

When carbon monoxide was introduced into the system at these temperatures and at 0% relative humidity, a change in the carbon monoxide concentration beyond that expected from the blank determinations was observed. Thus, a reaction between the superoxide and carbon monoxide is indicated. These results are illustrated in Figure 13. Assuming the Russian stoichiometry of reaction (24) as the expected equilibrium, then a total evolution of oxygen into the system of about 0.2% oxygen would be anticipated.

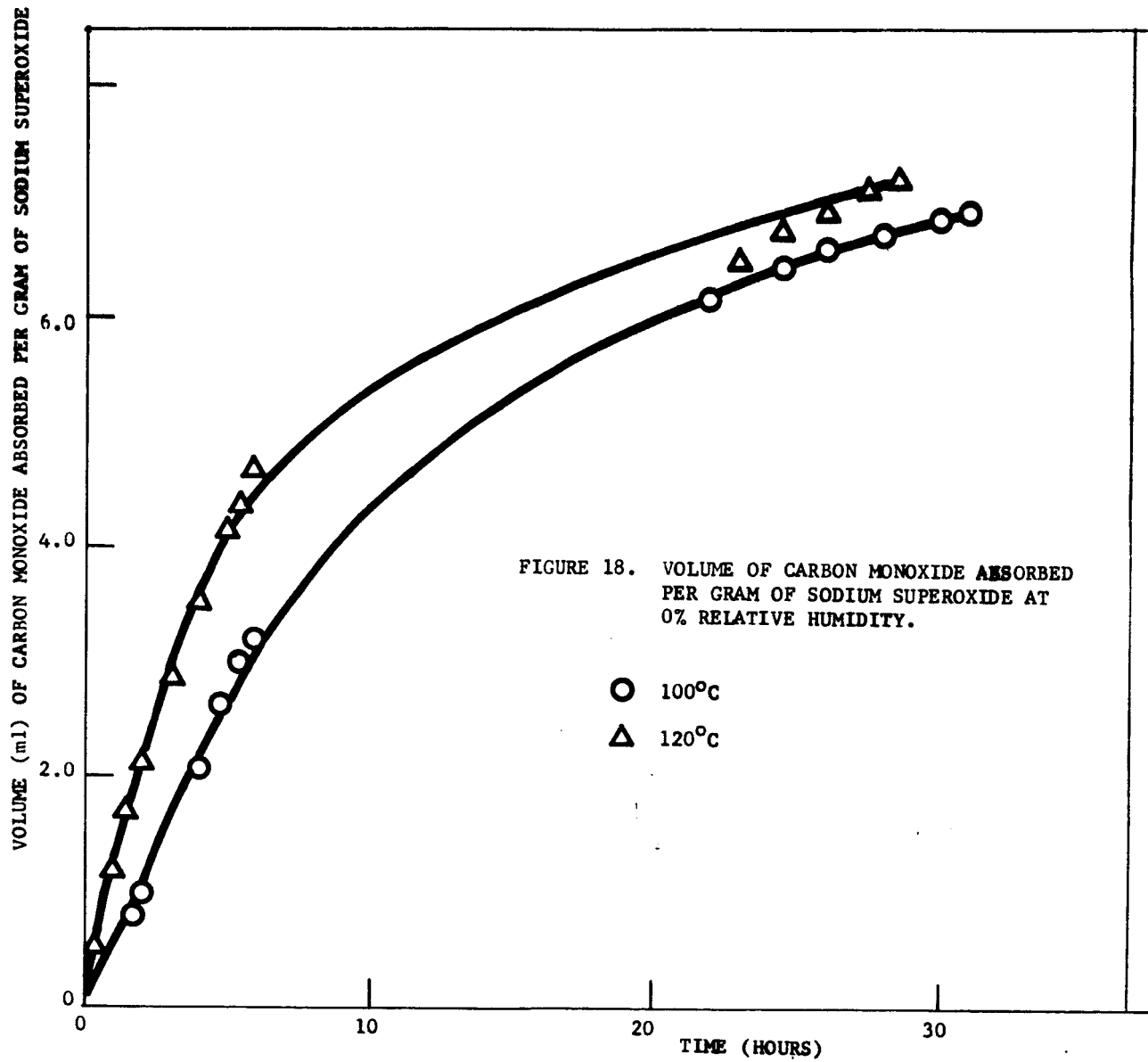

However, this change would be smaller than the total amount expected from the blank and this could not be detected with the present apparatus. Thus, the Russian stoichiometry cannot be verified at this time.

The absorption of carbon monoxide was not observed when these experiments were repeated at 100% relative humidity. These results contradict the Russian observations which indicated a lowering of the minimum reaction temperature with increased relative humidity.¹⁴

At room temperature and at 0 or 100% relative humidity, reaction of the superoxide with carbon monoxide was not observed.

On the basis of these studies it must be concluded that superoxides cannot be considered effective CO scrubbers at normal operating temperatures.

2.5 MAGNETIC SUSCEPTIBILITY STUDIES

Magnetic susceptibility studies of various air revitalization materials, in particular, calcium superoxide, were conducted in an effort to further characterize their structure and physical properties and to serve as an independent analytical check of their purity.

2.5.1 The Guoy Method

The Guoy method^{15, 16} is generally used for the determination of magnetic susceptibilities. This method is based on the property of paramagnetic substances to align themselves parallel to a homogeneous magnetic field and thus be drawn into the field. When a tube containing the sample is suspended in a magnetic field in

such a manner that the lower end of the tube is in a uniform field and the upper end in an inhomogeneous field, the downward magnetic force acting on the sample can be measured with an analytical balance. A diamagnetic substance aligns itself perpendicular to a homogeneous field and is repelled from an inhomogeneous field.

Under these conditions, a paramagnetic material develops a magnetic moment which is

$$KVH \quad (26)$$

where K is the susceptibility per unit of volume, V is the volume of the sample, and H is the field strength. Since the field gradient for a non-uniform field may be expressed as $\frac{\partial H}{\partial Z}$, then the sample will experience a linear displacing force, F, in the Z direction of

$$F = KVH \frac{\partial H}{\partial Z} \quad (27)$$

or

$$F = 1/2 \frac{KV \partial H^2}{\partial Z} = 1/2 KAH^2 \quad (28)$$

where A is the cross-sectional area of the sample. It follows that:

$$g \Delta m = 1/2 KAH^2 \quad (29)$$

where Δm is the change in weight measured on the analytical balance.

Rearranging,

$$K = \frac{2g \Delta m}{AH^2} \quad (30)$$

In practice the mass or gram susceptibility χ_g is generally a more

useful quantity than is the volume susceptibility K, and since,

$$\chi_g = \frac{K}{d} \quad (31)$$

where d is the sample density, it follows that

$$\kappa = \frac{m}{V} \chi_g \quad (32)$$

Since $AL = V$, where L is the length of sample, then

$$\chi_g = \frac{2g \Delta mL}{mH^2} \quad (33)$$

where m is the mass of sample. Equation (33) is the expression used in the present work to determine the gram susceptibilities of the test samples.

Mass susceptibilities determined in this manner are, in reality, sums of the paramagnetic and diamagnetic susceptibilities.

Diamagnetism is a universal property of matter and even a paramagnetic substance has an underlying diamagnetism. Generally speaking, if the test sample is very pure, corrections may be neglected with minor error because of the relatively small diamagnetic contributions.

2.5.2 Theoretical Moments

It is also possible, if an accurate chemical analysis of the sample is known, to obtain information relating to the number of unpaired electrons in the material, and in this way derive useful structural information pertaining to the material of interest.

Since an electron is a charged particle, it has a magnetic field associated with its motion. Thus, the existence of unpaired electrons in an atom or molecule gives rise to a permanent magnetic moment, μ_B , for the atom or molecule. This magnetic

moment results from the combined contributions of the resultant spin angular momentum (S) and the resultant orbital angular momentum (L) of the unpaired electrons. The effects cancel for all paired electrons, which, therefore, make no contributions to the magnetic moment of the system.

From wave mechanical considerations the permanent magnetic moment of a system containing unpaired electrons is related to S and L accordingly:

$$\mu_B = \sqrt{4S(S+1) + L(L+1)} \quad (34)$$

where μ is expressed in Bohr magnetons. Since the contribution due to the orbital motion of the electron is small compared to the contribution made by the spin motion, then equation (34) reduces to

$$\mu_B = 2 \sqrt{S(S+1)} \quad (35)$$

Since the number of unpaired electrons, n, equals 2S, the moment may be related directly to the number of such unpaired electrons by the expression:

$$\mu_B = \sqrt{n(n+2)} \quad (36)$$

Thus, the theoretical value of μ_B to be expected for a system with one unpaired electron is 1.73 Bohr magnetons. This value is also to be expected of superoxide compounds due to the presence of the one unpaired electron in the 3-electron bond of the superoxide ion. (In 1931 Pauling¹⁷ suggested that the superoxide ion is an O_2^- species having a 3-electron bond. Newman¹⁸

found experimentally that potassium superoxide is paramagnetic.) For two unpaired electrons, $\mu_B = 2.84$ Bohr magnetons.

2.5.3 Curie Law and Curie-Weiss Law

Equations have been derived which express the relationships between the permanent moment and the molar susceptibility of a system (the gram susceptibility, χ_g , times the molecular weight). In particular, there are two relationships used for the determination of the permanent moments from molar susceptibility data, the Curie Law and Curie-Weiss Law. The mathematical form of the Curie Law is:

$$\mu_{\text{eff}} = 2.84\sqrt{\chi_M T} \quad (37)$$

where χ_M is the molar susceptibility and T is the absolute temperature at which the measurement is made. The magnetic moment calculated by use of the Curie Law is referred to as the effective magnetic moment; this distinction being necessary since the Curie Law is not strictly obeyed in all cases.

In order to establish the best possible value for the magnetic moment of material, it is necessary to employ the Curie-Weiss Law:

$$\mu_B = 2.84\sqrt{\chi_M (T-\theta)} \quad (38)$$

where θ is known as the Weiss or Field Constant.

The Weiss constant arises largely from mutual interaction of molecular dipoles, or adjacent paramagnetic atoms, and large internal fields. Generally, θ is quite small with respect to T

and in such cases the value of μ_{eff} obtained by the use of the Curie Law is as reliable as experimental conditions will allow. However, it cannot be assumed that Θ is always negligible, and if the Θ has not been determined, then the moment calculated by the Curie Law must be reported as the "effective" magnetic moment. Large Weiss constants generally make their appearance in magnetically-concentrated substances, such as chromium sesquioxide. The Weiss constant is experimentally determined by measuring the susceptibility of the sample at various temperatures. However, this determination is not always easily carried out because allowances must be made for diamagnetism and temperature-constant paramagnetism which are important when Θ is very large.

From these arguments it is possible, as a first approximation, to calculate the moment of a material if the number of unpaired electrons is known as in equation (34) or, conversely, the experimentally-determined moment may be used to determine the number of unpaired electrons present.

2.5.4 Experimental Studies and Results

The magnetic studies conducted during this research were carried out according to the Gouy Method. Most of the samples were analyzed immediately after synthesis. Most of the measurements were made using an Atomic Laboratories, Inc., Model J research aluminum foil electromagnet (4-inch, flat, pole focus, 3/4-inch gap) and a solid-state current regulator built at Electric Boat. A few measurements were made using the electromagnet facility at

the University of Connecticut and a permanent magnet at Electric Boat. A diagram of the apparatus used to measure the magnetic susceptibility of solid samples is shown in Figure 19.

Pyrex glass tubes of uniform dimensions approximately 13 cm long with a 3 mm bore were filled in a P_2O_5 dry box under a dry nitrogen purge to a height of from 9 to 11 cm with the very finely-powdered sample. The sample was tamped down to ensure homogeneity and compactness. Each tube was fitted with a ground joint cap and a glass hook. The volume of each tube was previously determined by filling with mercury and weighing. Each tube also had an extra length of glass rodding joined to it at the bottom to cancel most of the diamagnetic susceptibility of the glass sample holder. Susceptibility blanks were also run on each tube filled with dry nitrogen at the amperages at which the samples were run to determine the calibration weight corrections for each tube.

The samples were then hung from the balance in the inhomogeneous part of the magnetic field with the bottom of the sample column at the exact center of the pole gap. Measurements were made at various field strengths and compared with each other to determine the presence of ferromagnetic impurities. Measured susceptibilities will vary inversely with the strength of the magnetic field if such impurities are present. One of the major disadvantages of the permanent magnet is that the field cannot be varied, and no indication of ferromagnetic impurities can be made.

FIGURE 19. APPARATUS FOR MEASUREMENT OF MAGNETIC SUSCEPTIBILITY BY THE GUOY METHOD.

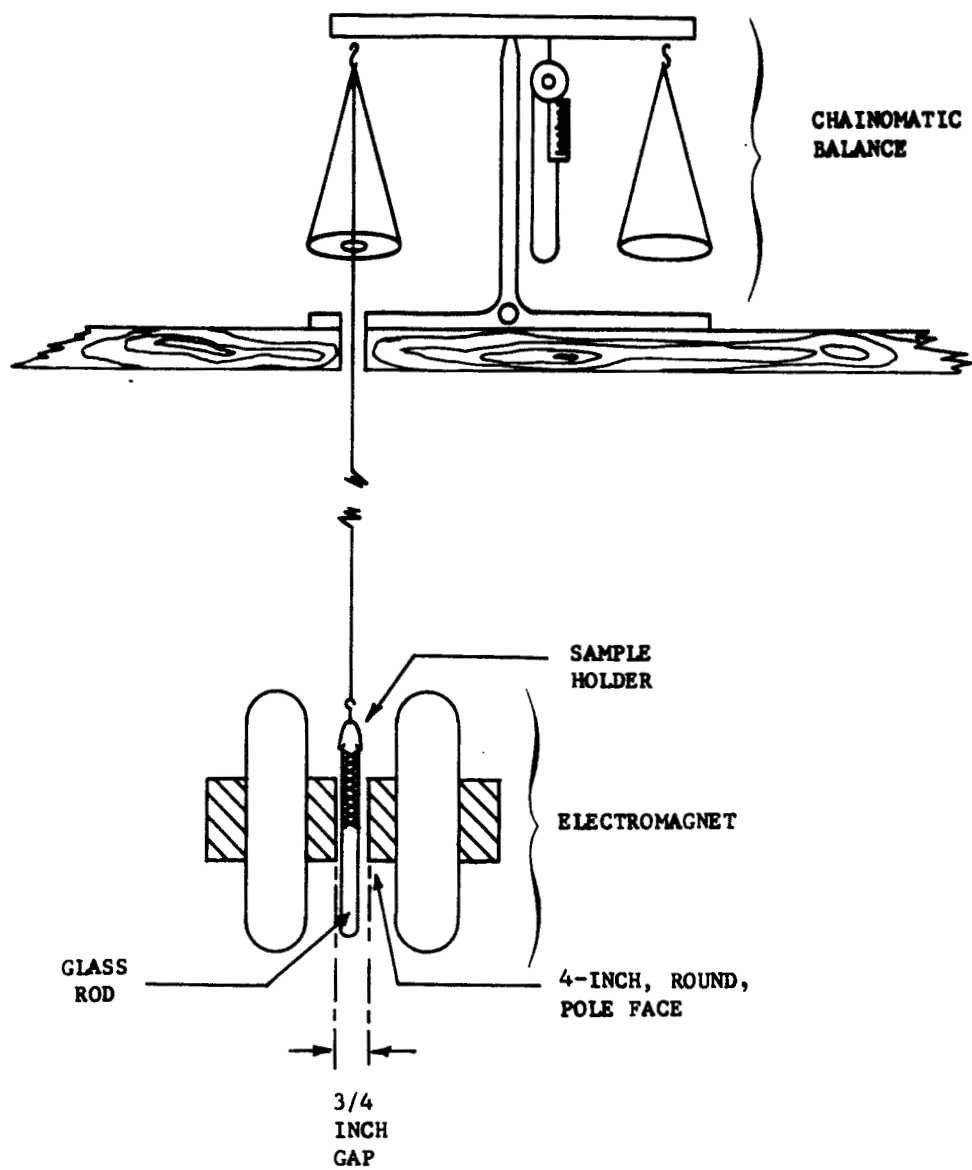

The field strength listed by the manufacturer for various amperages was verified by measuring the susceptibility of a known standard, Mohr's salt, according to the following expression¹⁹.

$$\chi_g = \frac{9500 \times 10^{-6}}{(T+1)} \quad (39)$$

where T is the absolute temperature. The results agreed with those values listed by Atomic Laboratories for the Model J electro-magnet with a pole gap of 3/4 inches. The field strength of the electromagnet could be varied continuously up to about 10,000 gauss, whereas the permanent magnet used in the initial studies was rated at 4890 gauss. To insure accuracy and reliability in subsequent calculations, the field strength was determined using Mohr's salt prior to the determination of the susceptibility of the unknown sample. Thus, at each amperage setting, two to three determinations of Δm were made for both the sample and the standard before the field strength was changed. Excellent precision was obtained in most cases.

Using the procedure and techniques described above, the magnetic susceptibilities of potassium superoxide and ozonide and calcium superoxide were determined. Average results are summarized in Table VI. For 84.7% KO_2 , a gram susceptibility of 24.10×10^{-6} c.g.s. units at $22.0^\circ C$ was obtained. Correspondingly, $\mu_{eff} = 2.02$ Bohr magnetons and $\mu_B = 2.07$, using the Weiss constant of Ehrlich²⁰, $\theta = 15^\circ C$. These results are in excellent agreement with those reported by Kazarnovskii²¹ and Ehrlich. Similarly,

TABLE VI

SUMMARY OF SUSCEPTIBILITY DATA AT 25°C
FOR AIR REVITALIZATION MATERIALS

<u>Compound</u>	<u>Formula</u>	<u>Susceptibility</u> <u>x 10⁶ c.g.s units</u>		<u>Magnetic Moment</u> <u>(Bohr Magnetons)</u>	
		<u>Gram</u>	<u>Molar</u>	<u>Effective</u>	<u>Permanent</u>
Potassium Ozonide	KO ₃	13.7	1200	1.69	-
Potassium Superoxide	KO ₂	24.1	1710	2.02	2.07 ^a
Calcium Superoxide	Ca(O ₂) ₂ ^b	23.64	2460	2.48	2.84 ^c

a. calculated using Weiss constant of $-15^{\circ}\text{K.}^{20}$

b. average of 13 runs, 42-83% Ca(O₂)₂.

c. calculated using Weiss constant of $-94^{\circ}\text{K.}^{20}$

for 68.8% KO_3 , $\chi_g = 12.94$ c.g.s. units at 25.0°C and $\mu_{\text{eff}} = 1.69$ agreed well with those reported by Kazarnovskii.

The procedure described above was also followed to obtain measurements for samples of calcium superoxide ranging in purity from 7% to about 70%. Immediately following the magnetic deflection, the sample was analyzed for superoxide content, according to the method of Seyb and Klimberg⁴. The data for a number of samples are summarized in Table VII. In a typical case, the measured gram susceptibility for a sample containing calcium superoxide was 12.71×10^{-6} c.g.s. units at 25°C as calculated using equation (33). To determine the susceptibility of calcium superoxide, the analysis of the sample and presence of impurities were considered. The contribution of CaO_2 , CaCO_3 , CaO , and H_2O impurities to the total susceptibility of the sample were ignored because of the negligible diamagnetism and lack of paramagnetic character.

2.5.5 Discussion

It is well established that the superoxide ion, O_2^- , contains a 3-electron bond with one unpaired electron¹⁷. Consequently, a theoretical value of $\mu_B = 2.84$ Bohr magnetons is expected for two unpaired electrons in a molecule. However, with many substances, the theoretical values for the permanent moment are not always attained, due largely to diamagnetism, large internal fields, and interaction between molecular dipoles; all of which factors often result in a relatively high negative value for the Weiss constant. The high Weiss constant for calcium superoxide obtained by Ehrlich

TABLE VII

SUMMARY OF MAGNETIC SUSCEPTIBILITY
MEASUREMENTS AT 25°C CALCIUM
SUPEROXIDE SAMPLES

Sample No.	Weight Sample (grams)	Analyses (%)		Gram Susceptibility ($\cdot 10^6$ c.g.s. units)
		Ca(O ₂) ₂	CaO ₂	
1	0.7649	67.2	0.0	12.9
2	0.7963	55.7	3.4	12.5
3	0.9840	54.3	5.0	12.7
4	0.8240	52.8	6.8	12.1
5	0.8118	46.2	10.0	10.3
6	0.7730	45.4	11.7	10.4
7	0.6804	42.2	14.0	12.7
8	0.7159	37.6	17.6	7.0
9	0.7357	33.9	16.6	6.5
10	0.5863	30.8	20.0	5.6
11	0.8595	29.2	0.0	5.1
12	0.7011	28.2	21.7	3.0
13	0.7442	20.8	0.0	3.3
14	0.9662	10.6	58.0	0.3
15	1.0753	6.9	68.4	0.4
(1	0.63	83.3	8.5	24.3
(2	0.52	75.0	13.3	16.0
(3	0.6702	53.8	2.6	12.6
* (4	0.5665	49.3	24.6	10.2
(5	-----	48.5	38.6	9.2
(6	0.5309	43.8	21.8	8.3
(7	0.8595	36.3	25.2	6.1
(8	0.5540	25.3	29.4	8.0
** (1	-----	4.5	95.5	0.8
(2	-----	2.7	97.3	0.5

*Data of Petrocelli and Chiarenzelli ²

**Date of Ehrlich ²⁰

(-94°K) seems to confirm these observations. This value fitted well in the results obtained experimentally in this lab. Figure 20 illustrates the variation of the measured gram susceptibility for samples containing calcium superoxide as a function of the percentage superoxide. Included in Figure 20 are data reported earlier by Petrocelli and Chiarenzelli² using a permanent magnet and those data reported by Ehrlich²⁰. Extrapolation of the observed gram susceptibilities as a straight line to 100% Ca(O₂)₂ led to a value of 24.6×10^{-6} c.g.s. units for the gram susceptibility. The molar susceptibility of the superoxide was then calculated to be 2561×10^{-6} c.g.s. units. The effective magnetic moment calculated from the Curie Law, equation (37), was found to be 2.43 Bohr magnetons. The permanent moment calculated from the Curie-Weiss Law, equation (38), using Ehrlich's Weiss Constant, $\theta = -94^\circ$, was found to be 2.84 Bohr magnetons. These moments are in excellent agreement with the theoretical value for two unpaired electrons, i.e., 2.84 Bohr magnetons.

FIGURE 20. MEASURED GRAM SUSCEPTIBILITY AS A FUNCTION OF COMPOSITION OF CALCIUM SUPEROXIDE AT 25°C.

□ extrapolated value 24.60

- PRESENT DATA
- DATA OF PETROCELLI & CHIARENZELLI⁽²⁾
- △ DATA OF ERLICH⁽²⁰⁾

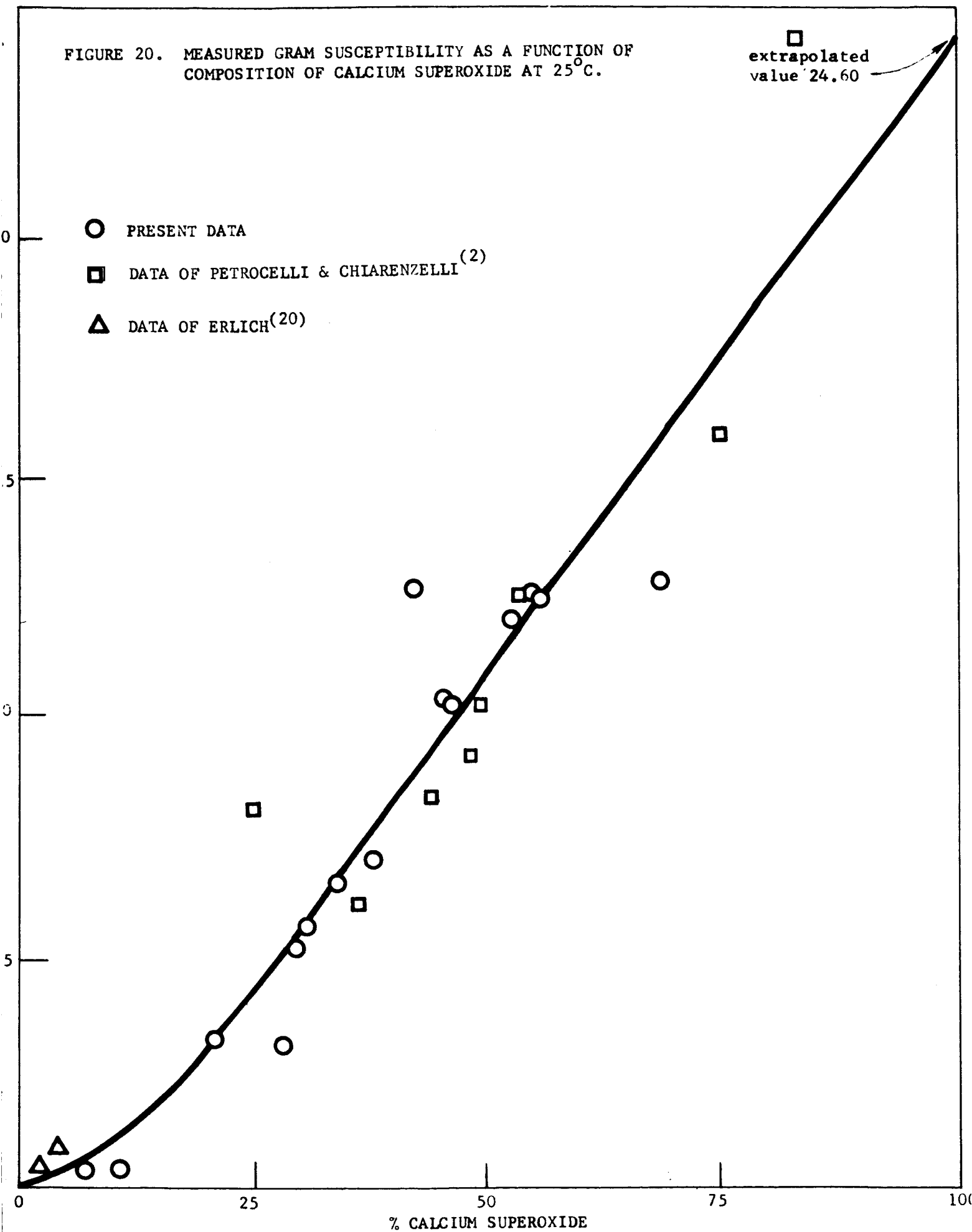

III

SUMMARY

The work accomplished under NASA contract NASw-559 is summarized as follows:

1) The reaction of aqueous hydrogen peroxide with calcium hydroxide on a small-scale was investigated in an effort to synthesize high purity calcium superoxide. Particular emphasis was placed in studying those reaction conditions necessary for optimum superoxide yield. High yields were obtained when 50 to 80% aqueous hydrogen peroxide was reacted in a 6.5:1 mole ratio with small quantities (circa one gram) of calcium hydroxide; the mixing step took place near 0°C and the reaction mixture evacuated for 4 to 13 hours at 0° to 25 C. Under these conditions, products were consistently obtained that contained 35 to 60% calcium superoxide.

When the initial reaction was carried out at 0°C with two grams of calcium superoxide and pumped at room temperature for 8 hours, the superoxide product averaged 54% purity.

Scale-up of the reaction conditions to 5-gram batches of calcium hydroxide resulted in products with lower superoxide activity. In these cases, samples that were approximately 30% pure with respect to calcium superoxide were synthesized.

The introduction of catalysts (TiO_2 and CdO) at the 1% level was investigated in an effort to increase the yield of the reaction and purity of the calcium superoxide product. The use of catalysts appeared to aid the experimenter in controlling the

vigorous reaction obtained upon mixing and also in obtaining more consistent yields. They did not, however, significantly change the yield of the hydroxide-hydrogen peroxide reaction.

2) The reaction of calcium peroxide with aqueous hydrogen peroxide was also investigated. No significant improvement in the calcium superoxide yield was observed.

3) The synthesis of calcium superoxide by the reaction of hydrogen peroxide with calcium ethoxide was investigated. When 50% ethanolic solutions of hydrogen peroxide were reacted with solid calcium ethoxide, products were obtained which contained approximately 20% calcium superoxide. When the peroxide solution was reacted with ethanolic dispersions of calcium ethoxide or with ethanolic solutions of calcium, samples containing from 7 - 15% calcium superoxide were recovered. Extreme caution was taken since the mixtures encountered in these studies were potentially explosive. Although calcium superoxide can be prepared in this manner, the procedure is not recommended.

4) The reaction of calcium peroxide with gaseous ozone was studied. These investigations proved successful in preparing calcium superoxide, but only in low yield, 3 - 10%, without promise of a quantitative separation.

5) Kinetic studies of the reaction of calcium superoxide with water vapor were carried out at 100% relative humidity. At 24°C, the reaction was shown to proceed at a rate of 1.7 ml/gram/min, whereas, at 34°C, the rate of oxygen evolution was 3.2 ml/gram/

min. This investigation concluded that the water vapor reacted with the calcium superoxide to form hydrated calcium peroxide and produce a molar equivalent of oxygen.

6) The reaction of sodium superoxide with carbon dioxide and water vapor was studied at room temperature and at 47.7, 71.4, and 100% relative humidity. In all cases, the respiratory quotient was observed to be near 1.0 indicating the formation of bicarbonate, as well as carbonate. With time, the R.Q. increases beyond 1.0 as complete conversion to bicarbonate is favored. A mechanism is offered to explain the formation of both carbonate and bicarbonate in the reaction mixture. These results substantiate and explain the excellent control of the R.Q. obtained in recent large-scale manned-chamber tests using sodium superoxide (23).

7) Kinetic studies were also carried out for the reaction of calcium superoxide with carbon dioxide and water vapor at room temperature and the same levels of relative humidity. The mechanism of oxygen evolution noted above for the reaction of the superoxide with water vapor was verified and that for the absorption of carbon dioxide discussed. The respiratory quotients were observed to vary between 0.75 and 2.4. This variation was due to the presence of calcium peroxide and calcium hydroxide, which complicated the carbon dioxide absorption process.

8) Magnetic susceptibility measurements were made according to the Guoy method on potassium superoxide and ozonide, and on calcium superoxide. The values obtained for the permanent moment of potassium ozonide (1.69 Bohr magnetons) and potassium superoxide (2.07 Bohr magnetons) are in excellent agreement with the

theoretical values expected, plus those previously reported in the literature. The molar susceptibility for calcium superoxide was calculated to be 2561×10^{-6} cgs units.

IV

CONCLUSIONS

It is concluded that the active chemicals most frequently considered for air revitalization purposes, sodium and potassium superoxides, offer the greatest potential for practical applications within the foreseeable future. Results obtained in recent successful engineering studies (23) employing sodium superoxide have been substantiated and explained as a result of the kinetic studies carried out in the course of this work on the reaction of alkali metal superoxides with water vapor and carbon dioxide.

The various schemes investigated for the synthesis of calcium superoxide point out the difficulties involved in the preparation of this compound. The reaction of calcium hydroxide or peroxide with aqueous hydrogen peroxide has been established as the most reliable means of preparing calcium superoxide. The parameters necessary for optimum yield have been established and indicate that the synthesis of better than 60% pure calcium superoxide will be extremely difficult.

The complexity of the reactions of calcium superoxide with carbon dioxide and water vapor, and the inability to prepare this compound in significantly pure form, confirm the opinion that it is not competitive with alkali metal superoxides at this time.

RECOMMENDATIONS

In view of the well-defined chemistry of sodium and potassium superoxides as air revitalization materials, it is recommended that these compounds be considered ready for use in such applications. For example, the reactions of these materials with water vapor and carbon dioxide in a semi-passive unit can be reliably controlled with proper flow rates and levels of relative humidity so as to maintain the desired respiratory quotient in closed environments such as space cabins. However, the use of these materials in small, self-contained, air revitalization units for use in space suits and the like would require that they be employed in cannister-type devices. The hope that calcium superoxide would help circumvent the crusting problem encountered in alkali metal superoxide-water vapor cannister reactions was not realized.

However, the possibility exists of taking advantage of the thermal decomposition characteristics of sodium superoxide or lithium peroxide for use in a back-pack reactor which would not require water vapor to produce oxygen. Such a reactor would be small, compact, easy to control, and suitable for "on-off" applications. The oxides products formed, either sodium oxide or lithium oxide, are both excellent carbon dioxide scrubbers in themselves. If one envisions a unit in which the superoxide or peroxide has been totally decomposed, the oxide formed would then be employed as a

carbon dioxide scrubber at normal operating temperatures. Since the exothermicity encountered in the superoxide-water vapor reaction has been circumvented, the product is not crusted or fused, and the carbon dioxide absorption process should occur efficiently with dry sodium or lithium oxide.

From an engineering point of view, the alkali metal superoxides are thermally stable, i.e., at normal operating temperatures, the dissociation pressure of oxygen is extremely low for the conversion of the superoxide to the oxide and oxygen. Nevertheless, reasonable temperatures are attainable at which these decompositions will occur quantitatively. Potassium superoxide will decompose to the oxide and oxygen at about 280 - 300°C. On the other hand, Shechter and Shakely have noted that sodium superoxide is "not thermally stable at 100°C." At this temperature, however, their early studies indicate that the rate is very slow. Petrocelli has shown that the use of pretreatment techniques or the use of a suitable catalyst can cause the thermal degradation of potassium superoxide to proceed to completion at 150°C. Thus, it is felt that similar techniques will lower the decomposition temperatures of sodium superoxide to an operable region.

Lithium peroxide would be another air revitalization compound of interest because it too will decompose thermally to the oxide and oxygen. Markowitz has noted that the decomposition occurs at 300°C but may be dependent upon surface area. It should be noted again that complete evolution of oxygen is a question of kinetics rather than thermodynamics, a situation which lends itself naturally to the use of catalysts.

Therefore, it is further recommended that investigation of the thermal decomposition characteristics of sodium superoxide and lithium peroxide be carried out.

VI

REFERENCES

1. Vol'nov, I. I., and V. N. Chamova, Zhur. neorg. khim. 5, 5222 (1960).
2. Petrocelli, A. W., and R. V. Chiarenzelli, GD/EB Final Report, U-413-62-219, December, 1962.
3. Miller, R. R., private communication.
4. Seyb, E., and J. Kleinberg, Anal. Chem. 23, 115 (1951).
5. Shanley, E. S., and J. R. Perrin, Jet Propulsion, 382 (1958).
6. Davis, I., ASTIA AD No. 267249, June 1961.
7. Petrocelli, A. W., and A. Capotosto, Jr., NASA CR-135, November, 1964.
8. Satterfield, C. N., and T. W. Stein, Ind. and Eng. Chem. 46, 1734 (1953).
9. Bulletin No. 7, Becco Chemical Division, Food Machinery and Chemical Corp.
10. Makarov, S., and S. Vol'nov, Izv. Akad. Nauk SSSR, 370 (1951).
11. Mel'nikov, A. Kh., et. al., Russ. J. Inorg. Chem. 7, 633 (1962).
12. Kern, D. M., J. Chem. Ed. 37, 14 (1960).
13. Bogatkov, P. I., Yu. G. Nefedov, and M. I. Poletayev, Voyenno-med. Zhur. 55, 37 (1961).
14. Tsentsiper, A. B., and S. A. Tokareva, Zhur. neorg. khim. 6, 2474 (1961).
15. Gouy, L. G., Compt. rend. 109, 935 (1889).
16. Selwood, P. W., Techniques of Organic Chemistry, Vol. I, Physical Methods, Part IV, 3rd edition, Weissberger, A., ed., Interscience Publishers, Inc., New York, 1960, pp 2873-2913.
17. Pauling, L., J. Am. Chem. Soc. 53, 3225 (1931).
18. Neuman, E., J. Chem. Phys. 2, 31 (1934).
19. Selwood, P.W., Magnetochemistry, 2nd edition, Interscience Publishers, Inc., New York, 1956.

20. Ehrlich, V. P., Zeit. anorg. khim. 252, 370 (1944).
21. Kazarnovskii, I. A., G. P. Nikol'skii, and T. A. Abletsova, Doklady Akad. Nauk, SSSR 64, 69 (1949).
22. Centnerszwer, M., and M. Blumenthal, Bull. Acad. Polon., A498 (1933).
23. The Boeing Co., NASA CR-134, November (1964).