

NASA CR-54981  
MRB5010Q3

Quarterly Report No. 3  
"RESEARCH AND DEVELOPMENT OF THE DRY TAPE BATTERY CONCEPT"  
9 December 1965 to 8 March 1966

Contract No. NAS3-7624

28 April 1966

For

NATIONAL AERONAUTICS AND SPACE ADMINISTRATION  
Lewis Research Center  
Cleveland, Ohio

Authors

John S. Driscoll, Project Leader  
Joseph J. Byrne  
David L. Williams

Technical Management  
NASA Lewis Research Center  
Cleveland, Ohio  
Space Power Division  
W. J. Nagle, Technical Manager

MONSANTO RESEARCH CORPORATION  
BOSTON LABORATORY  
Everett, Massachusetts 02149  
Tel: 617-389-0480

## SUMMARY

29083

Expanded magnesium was found to be superior to perforated magnesium in  $\text{AlCl}_3\text{-MgCl}_2/\text{ACL-85}$  static tests.

The effect of the atmosphere on the active chlorine content of the cathode was found to be minor up to 72 hours exposure. However, as much as 10% active chlorine loss was noted during the normal 3-4 minute delay between cell activation and load application. Lithium hypochlorite was found to be too soluble in aqueous solution for use as a depolarizer. Self-discharge occurred.

The effect of a large number of variables on nonaqueous ACL discharge characteristics was determined. The addition of proton donors to the cathode mix was ineffective. Attempts to pre-oxidize the acetylene black with ACL-85 and molecular chlorine were unsuccessful. Conducting additives were introduced into the cathode mix. It was found that acetylene black can be partially replaced by graphite. This should reduce the final system electrolyte requirements. Metallic additives were not effective. Electrolyte aging was found to severely affect ACL-70 decomposition in nonaqueous solution.

The  $\text{Li/LiClO}_4(\text{MF})/\text{CuF}_2$  system showed voltage and cathode efficiencies approaching 3.0 volts and 70% respectively, at 0.05 amp/in.<sup>2</sup>. Metallic additives, which might have made copper deposition more reversible, did not improve the performance of the system.

The use of limited amounts of electrolyte in static, nonaqueous tests improved the cathode efficiencies in the Li/ACL-70 cell. This is attributed to a decrease in ACL-70 solubility and the resulting reduction of self-discharge effects.

Short lengths (4 ft) of ACL-85 tape cathodes were prepared and evaluated dynamically. Problems were encountered with tape wet-out and adhesion to the current collector. Several modified current collectors were designed and fabricated in order to improve tape discharge characteristics.

*Author*

## TABLE OF CONTENTS

	<u>Page</u>
I. INTRODUCTION. . . . .	1
II. HIGH ENERGY COUPLE RESEARCH . . . . .	2
A. AQUEOUS ANODE RESEARCH. . . . .	2
B. AQUEOUS CATHODE RESEARCH. . . . .	2
1. Acid Pretreatment of Acetylene Black Conductor . . . . .	2
2. Effect of Aging in Ambient Atmosphere on Activity Retention of ACL-85 Tape Cathodes	2
3. Chemical Losses During Activation . . . . .	2
4. Addition of LiClO <sub>4</sub> to Electrolyte to Promote Wetting . . . . .	5
5. Inorganic Fibers as a Cathode Reinforcing Filler. . . . .	5
6. Lithium Hypochlorite Depolarizer. . . . .	5
C. NONAQUEOUS ANODE RESEARCH . . . . .	5
1. Lithium . . . . .	5
2. Lithium-Magnesium Alloy . . . . .	7
D. NONAQUEOUS CATHODE RESEARCH . . . . .	7
1. Effect of Variables on ACL Discharge Characteristics . . . . .	7
a. Effect of Acid. . . . .	7
b. Effect of Processing Variables. . . . .	7
c. Effect of Conducting Additives. . . . .	9
d. Effect of Trichlorotriazinetrione (ACL) Source. . . . .	11
e. Effect of ACL Structure . . . . .	11
f. ACL-70 Stability. . . . .	15
2. Dichlorobenzoquinonediimine Cathodes. . . . .	15
3. Inorganic Fluoride Cathodes . . . . .	15
a. Cupric Fluoride . . . . .	15
b. Silver Difluoride . . . . .	19
4. Determination of Cell Polarization by the Interrupter Technique . . . . .	19
5. Propylene Carbonate as an Electrolyte Solvent	21
6. Limited Electrolyte Experiments . . . . .	21

TABLE OF CONTENTS (Continued)

	<u>Page</u>
III. TAPE CELL CONFIGURATION. . . . .	24
IV. DYNAMIC TESTER MODIFICATION. . . . .	25
V. FUTURE PLANS . . . . .	27
A. AQUEOUS SYSTEMS. . . . .	27
B. NONAQUEOUS SYSTEMS . . . . .	27
VI. REFERENCES . . . . .	28

## LIST OF FIGURES

<u>No.</u>		<u>Page</u>
1	Expanded vs Punched Magnesium in Static Mg/AlCl <sub>3</sub> · MgCl <sub>2</sub> /ACL-85 Tests. . . . .	3
2	Comparison of Li-Mg Alloy (LA141) and Primary Mg in AlCl <sub>3</sub> (Acetonitrile) vs ACL-85 at 0.02 amp/in. <sup>2</sup> . . . . .	8
3	Discharge of Various Cathode Materials at 0.10 amp/in. <sup>2</sup> . . . . .	17
4	Oscilloscope Interrupted Voltage Trace of Li/LiClO <sub>4</sub> (MF)/ACL-70 Discharge at 0.1 amp/in. <sup>2</sup> . . . . .	20
5	Oscilloscope Interrupted Voltage Trace of Mg/1.5M AlCl <sub>3</sub> + 0.5M MgCl <sub>2</sub> (H <sub>2</sub> O)/ACL-85. Discharge at 0.5 amp/in. <sup>2</sup> . . . . .	22
6	Cathode Current Collector Designs . . . . .	26

LIST OF TABLES

<u>NO.</u>		PAGE
1	Effect of Short Term Aging on Activity Retention of ACL-85. . . . .	4
2	The Effect of Time Lapse Between Activation and Load Application on ACL-85 Activity Retention. . . . .	4
3	Mg/AlCl <sub>3</sub> ·MgCl·LiClO <sub>4</sub> /ACL-85 Tape Cells Discharged at 0.67 amp/in. <sup>2</sup> . . . . .	6
4	Discharge of ACL-85 Tape Cathodes Containing Silica-Alumina Fibrous Reinforcement. . . . .	6
5	Li/LiClO <sub>4</sub> (MF)/ACL-70 Cells With Pretreatment of Electrolyte or Carbon. . . . .	10
6	Li/MF/Trichlorotriazinetrione Cells. . . . .	12
7	Li/(MF)/ACL-70 Cells with Various Electrolytes . . . . .	13
8	Effect of LiClO <sub>4</sub> -Methylformate Aging on ACL-70 Active Chlorine Content. . . . .	16
9	Li/LiClO <sub>4</sub> (MF)/CuF <sub>2</sub> Cells with Cathode Additives. . . . .	18
A-1	Discharge Data of Various Cathodes in Excess Methyl Formate Versus Lithium Anodes. . . . .	29
A-2	The Effects of Conducting Additives on Li/LiClO <sub>4</sub> (MF)/ACL-70 Cells (Excess Electrolyte) . . . . .	30
A-3	Full Cell Discharges Using a Measured Volume of 1M LiClO <sub>4</sub> In Methyl Formate and a Measured Cell Pressure . . . . .	31

## I. INTRODUCTION

Early in this contract, a new aqueous tape couple, based on magnesium and trichlorotriazinetrione (ACL-85<sup>R</sup>) in acidic electrolyte, was developed. Static cells operated routinely at 2.4 volts and 0.5 amp/in.<sup>2</sup>. Cathode efficiencies were high (70-80%) but erratic. Energy densities in excess of 300 watt-hr/lb of tape system (excluding electrolyte) were obtained. The variations in cathode efficiencies were traced to the use of an acidic electrolyte, a necessity for high current densities. At low pH, chlorine evolution occurred reducing the available active chlorine content. A change to a different acidic electrolyte helped, but did not completely resolve this problem. It was determined that cathode decomposition could be avoided if neutral electrolytes were used. In addition, anode gassing was reduced. Lower current densities, however, were necessary with the neutral system because of concentration polarization effects. Sixty to seventy per cent cathode efficiencies were obtained at 2.0 volts and 0.05 amp/in.<sup>2</sup>.

Lithium and magnesium anodes were tested for compatibility with numerous nonaqueous electrolyte systems. As a result, the lithium work was emphasized. It was determined that only one chlorine atom was being utilized when ACL active chlorine compounds were used as nonaqueous oxidizing agents.

Emphasis during the third quarter was placed on nonaqueous cathode research, limited electrolyte studies, aqueous tape preparation, and dynamic test apparatus modification.

## II. HIGH ENERGY COUPLE RESEARCH

### A. AQUEOUS ANODE RESEARCH

Research in this area was limited this quarter to the determination of which type of magnesium (perforated or expanded) performed better in acidic electrolyte tests. These two types of magnesium were discharged statically against machine-made ACL-85<sup>®</sup> cathodes in  $\text{AlCl}_3\text{-MgCl}_2$  electrolyte. The tests were carried out using both the normal static test cell, and the dynamic apparatus (without tape movement). The discharge characteristics are shown in Figure 1.

In both test cells, the expanded magnesium was superior to perforated magnesium. This indicates that gas polarization is an important factor. We expect that as better cathodes are prepared, less electrolyte will be required, there will be less gas polarization, and better voltages will be obtained.

### B. AQUEOUS CATHODE RESEARCH

#### 1. Acid Pretreatment of Acetylene Black Conductor

It has been shown that drying the acetylene black conductor prior to cathode formulation cuts down ACL-85 activity loss during processing but does not eliminate it. These losses can be held to about seven per cent.

A nitric acid pretreatment of acetylene black was tried to clean the surface and also to improve electrolyte wet-out. The procedure consisted of a nitric acid wash, a water wash, and acetone rinse followed by vacuum drying at  $200^\circ\text{C}$  for 18 hours. No significant improvements in electrical performance or electrolyte wet-out properties were observed.

#### 2. Effect of Aging in Ambient Atmosphere on Activity Retention of ACL-85 Tape Cathodes

If absorbed water on acetylene black is an activated hydrolysis agent for ACL-85, then atmospheric moisture absorbed after tape processing may also be detrimental. A study of the effect of air aging on activity retention of ACL-85 (65 wt-%) tape cathodes indicated some activity loss after 72 hours' exposure to the atmosphere. Results are summarized in Table 1.

#### 3. Chemical Losses During Activation

The effect on electrochemical performance of decreasing the time lapse between activation and load application was evaluated. Conventional static cell test techniques involve wetting out the cell before enclosing it in the cell holder. Comparisons were made in which tapes were wet-out after enclosure in the cell,



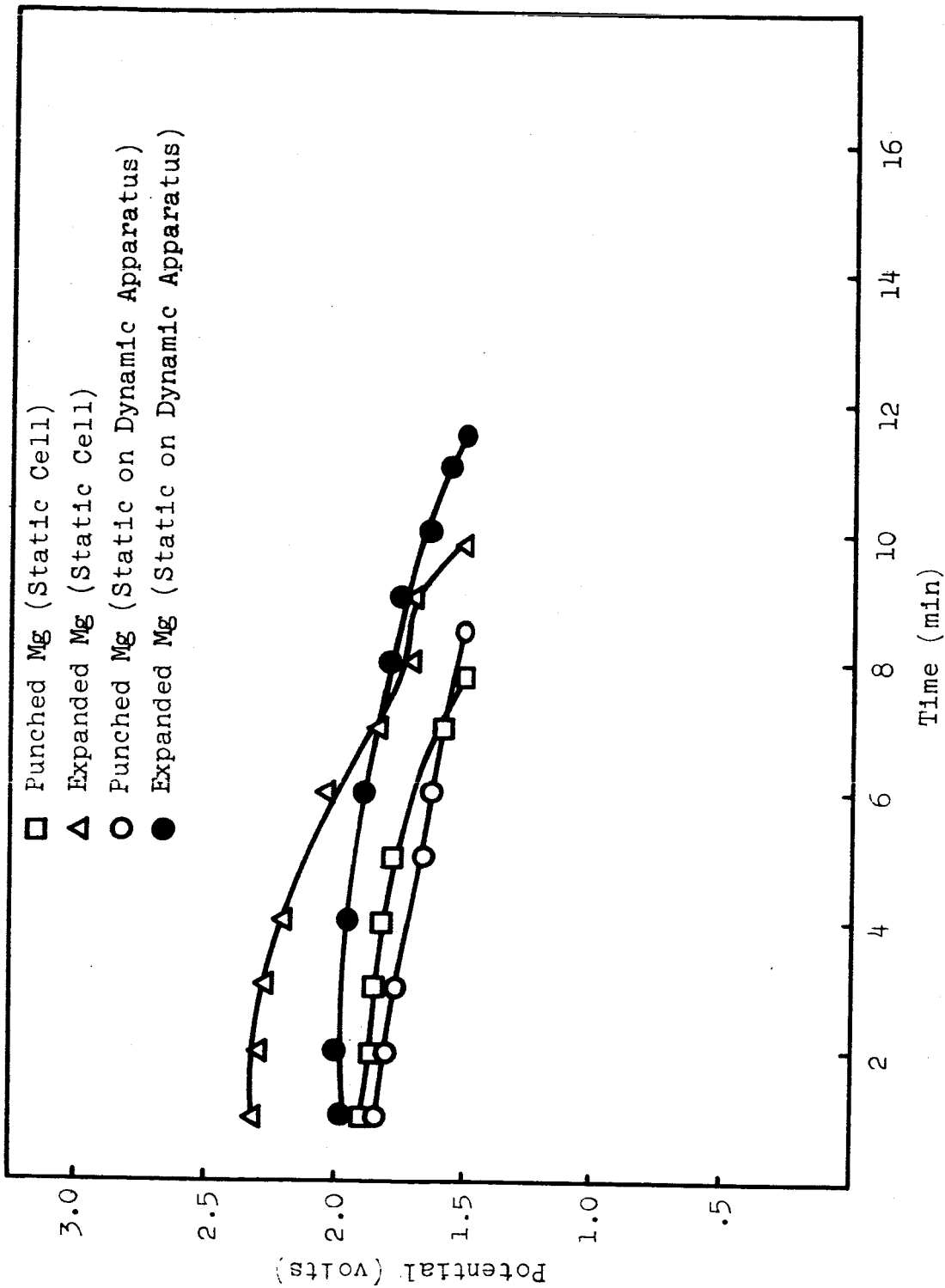

Figure 1. Expanded vs Punched Magnesium in Static Mg/AlCl<sub>3</sub>·MgCl<sub>2</sub>/ACL-85 Tests

Table 1

EFFECT OF SHORT TERM AGING ON ACTIVITY RETENTION OF ACL-85  
TAPE CATHODES

<u>Aging Time,</u> <u>hr</u>	<u>Per cent Original</u> <u>Activity Retained</u>	<u>Cathode Efficiency*</u> <u>on Discharge</u>
4	93,93	69,69
22	92,94,93	69,77,74
72	90,89,87	69,62,58
96	86,90	73,67

\* Based on analyzed ACL-85 content just prior to discharge.

Table 2

THE EFFECT OF TIME LAPSE BETWEEN ACTIVATION AND LOAD  
APPLICATION ON ACL-85 ACTIVITY RETENTION

Experimental Conditions: Cathode-65 wt% ACL-85, Anode-primary Mg  
Electrolyte-1.5M AlCl<sub>3</sub>·0.5M MgCl<sub>2</sub>  
Cell area- 3 inches<sup>2</sup>  
Current-1.5 amperes

<u>Cell No.</u>	<u>When Activated</u>	<u>Capacity</u> <u>amp-min.</u>	<u>Cathode Efficiency</u>
804502-1	Before enclosing	22	68
804502-3	After enclosing	19	77

saving several minutes in electrolyte contact time. A typical result is shown in Table 2 for two similar cells prepared from the same cathode batch.

From these experiments it would appear that some 10% chemical loss is incurred by a 3-4 minute delay between activation and load application. This would tend to support the supposition that dynamic testing should result in higher efficiencies.

#### 4. Addition of $\text{LiClO}_4$ to Electrolyte to Promote Wetting

Small amounts of a 2M lithium perchlorate solution were added to the aluminum chloride-magnesium chloride mixed electrolytes in an effort to promote wetting. Some wet out improvement was noted, but overall performance was unchanged. (Table 3).

#### 5. Inorganic Fibers as a Cathode Reinforcing Filler

A silica-alumina fiber (Fiberfrax<sup>®</sup>-Carborundum), was found to be a suitable cathode mix reinforcing agent. Results are shown in Table 4.

At high current drains, voltages and efficiencies are somewhat low, presumably owing to the nonconducting properties of the ceramic fiber. At low current drains (in neutral electrolyte) performance is good.

#### 6. Lithium Hypochlorite Depolarizer

A sample of  $\text{LiOCl}$  was received from Foote Mineral Company. The assay was 72%  $\text{LiOCl}$ , 22%  $\text{NaCl}$ , and 2.8%  $\text{H}_2\text{O}$ . Since  $\text{LiOCl}$  has a coulombic capacity of 54 amp-min/g, it is of considerable interest in both aqueous and non-aqueous research. Although this material is soluble in water, 80% of the active chlorine remained in the solution five minutes after the salt was dissolved.

Tapes were prepared with compositions similar to standard ACL-85 tapes. These were tested in  $\text{AlCl}_3 \cdot \text{MgCl}_2$  and  $(\text{MgClO}_4)_2$  electrolytes. Open circuit potential in acid was 2.7 volts, and in neutral solution was 2.5 volts. In both cases the cathode polarized rapidly and only 1.0 amp-min could be obtained above 1.5 volts in either electrolyte. The total capacities of the tapes were approximately 20 amp-minutes.

### C. NONAQUEOUS ANODE RESEARCH

#### 1. Lithium

Several methods for removing surface contamination from lithium ribbon anodes were studied this quarter. A methanol-benzene wash followed by a benzene rinse was suggested by the Foote Mineral Company. This method proved inferior to the methanol wash and scraping procedure that is currently used. A methanol wash and ethyl ether rinse was the best cleaning method

Table 3

Mg/AlCl<sub>3</sub>·MgCl·LiClO<sub>4</sub>/ACL-85 TAPE CELLS DISCHARGED  
AT 0.67 amp/in.<sup>2</sup>

<u>Cell</u>	<u>Cathode Efficiency (1.5 V cut-off)%</u>
Standard (No LiClO <sub>4</sub> )	62, 70
LiClO <sub>4</sub> Added	70, 59, 50, 76

Table 4

DISCHARGE OF ACL-85 TAPE CATHODES CONTAINING SILICA-ALUMINA  
FIBROUS REINFORCEMENT

Cathode Formulation: 65 wt-% ACL-85, 30% Acetylene black,  
5% Fiberfrax<sup>®</sup>

Anode: Primary magnesium

Cell: 3 in.<sup>2</sup> area with 4-mil dynel separator

	<u>Capacity</u> amp-min.	<u>Current</u> amp	<u>Electrolyte</u>	<u>Ave.</u> <u>Voltage,</u> volts	<u>Cathode</u> <u>Efficiency</u> %
80488-2	18	0.15	2M MgBr <sub>2</sub>	2.10	63
80488-3	16	0.15	2M MgCl <sub>2</sub>	2.10	70
80488-4	31	2.00	2M AlCl <sub>3</sub> ·0.5M HCl	2.30	57
80488-5	38	2.00	1.5M AlCl <sub>3</sub> ·0.5M MgCl <sub>2</sub>	2.20	63

discovered. We have delayed the use of this procedure until additional dry box facilities are available.

## 2. Lithium-Magnesium Alloy

The use of lithium alloy anodes might allow the use of advantageous electrolyte combinations that are incompatible with lithium metal alone.

A magnesium-lithium alloy (LA141A) was obtained from Brooks and Perkins, Inc. This material has a 1:2 atom ratio of Li/Mg. The material was tested versus ACL-85 in  $\text{AlCl}_3$  (1M in acetonitrile). A comparison test with primary magnesium showed no improvement for the alloy material (see Figure 2).

## D. NONAQUEOUS CATHODE RESEARCH

### 1. Effect of Variables on ACL Discharge Characteristics

#### a. Effect of Acid

Because of the beneficial effect of acid in ACL-85 aqueous discharges, attempts were made to include proton donors and Lewis acids in the nonaqueous tapes. An acid-washed carbon was used in a tape with  $\text{LiClO}_4(\text{MF})$ . The carbon was prepared by washing Shawinigan acetylene black in aqueous HCl. It is known that this treatment changes the wetting properties of carbon, and presumably HCl is adsorbed. Since the discharge data showed a deleterious effect for this carbon, no acid number was determined (Cell No. 81347 vs 81337). Pertinent discharge data are compiled in Table A-1.

Another ACL-85 cathode tape was discharged in methyl formate with a morpholinium hexafluorophosphate electrolyte. This electrolyte is known to be acceptable with lithium anodes, and the amine hydrogen would be a weak proton donor (such as in the  $\text{NH}_4^+$  ion). Again there was no improvement in discharge over that of the  $\text{LiClO}_4(\text{MF})$  system (Cell No. 81351).

An  $\text{AlCl}_3 \cdot \text{LiCl}$  electrolyte was prepared in methyl formate (MF) following the procedure of Chilton and Cook (ref. 1).  $\text{AlCl}_3$  was added to MF, followed by LiCl. The final concentration was 0.75M  $\text{AlCl}_3$  and 0.63M LiCl. This Lewis acid electrolyte appears to have improved the ACL-85 discharge (Cell No. 81352). There was only slight gassing noticed at open circuit. The final tape appeared too dry for effective operation. The addition of Lewis acids warrants further investigation for ACL cathode electrolytes.

#### b. Effect of Processing Variables

##### (1) Purification

Cathode processing variables are known to be important in the production of good tape cathodes. Purification procedures

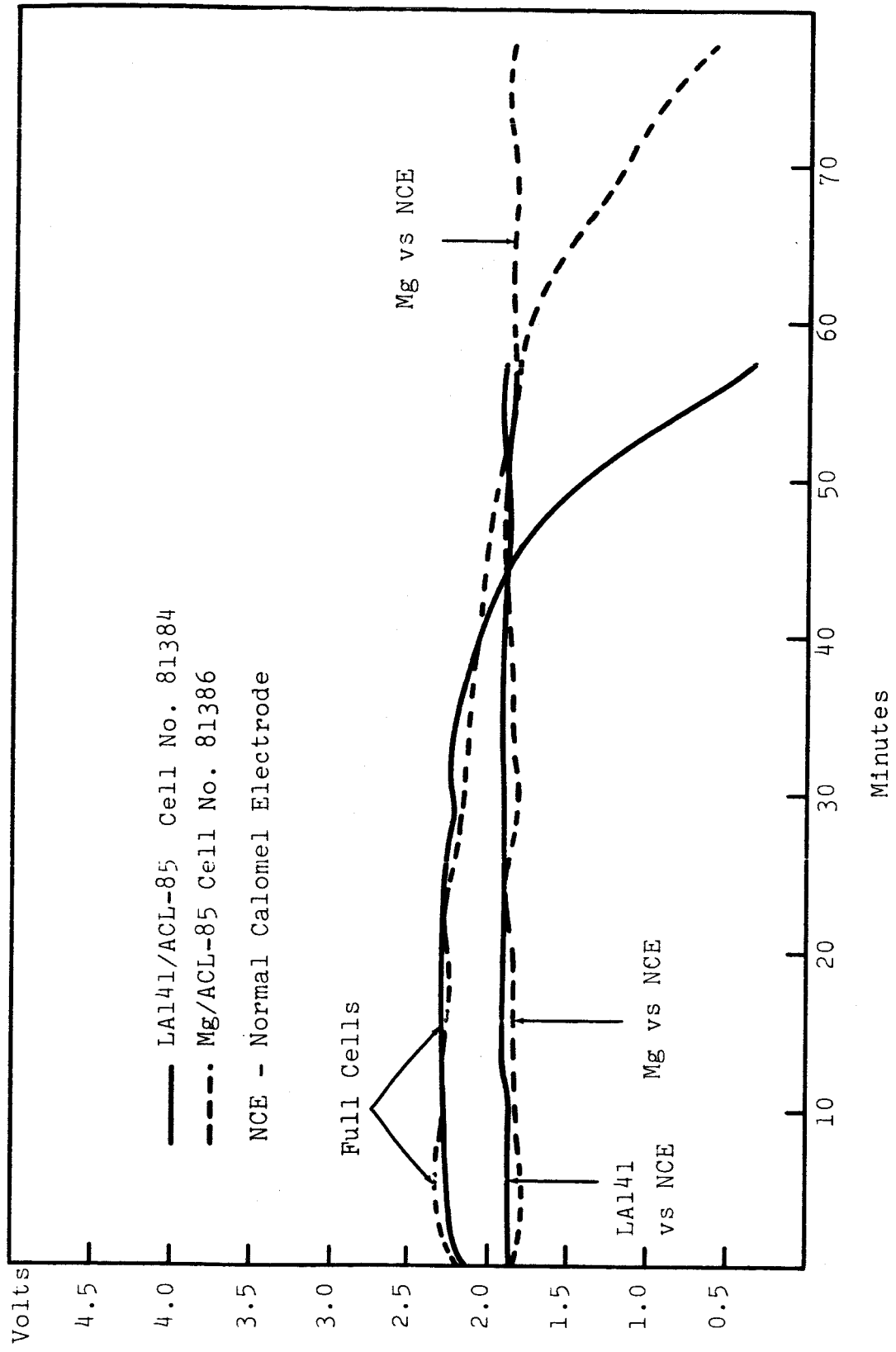

Figure 2. Comparison of Li-Mg Alloy (LA141) and Primary Mg in AlCl<sub>3</sub> (Acetonitrile) vs ACL-85 at 0.02 amp/in.<sup>2</sup>.

involving pre-oxidation of SAB with ACL-85 and treatment of electrolyte solutions with activated charcoal were carried out. The data are shown in Table 5.

Of these pre-treatments, electrolyte purification with charcoal is the only one which warrants further experimentation.

## (2) Chlorine Pre-treatment

A prechlorination of SAB and Darco G-60 with  $\text{Cl}_2$  gas was attempted in order to chlorinate any sites that might decompose ACL-70. SAB adsorbed 10% of its weight in chlorine, and Darco G-60 activated charcoal adsorbed 40% of its weight in chlorine. Methyl formate adsorbed 5.6% chlorine. These values were determined by iodimetric titration.

Elemental chlorine was found to poison the SAB, and the standard test showed 6% utilization of ACL-70 at  $>2.0$  volts. Chlorine adsorbed on Darco G-60 was mixed with SAB and discharged in a  $\text{Li}/\text{LiClO}_4(\text{MF})$  cell. At 0.1 amp/in. only 3 minutes capacity ( $\sim 5\%$ ) was obtained to a 2.0 v cut-off voltage.

### c. Effect of Conducting Additives

Shawinigan acetylene black (SAB) is our standard cathode carbon material. Its good electrical conduction properties, however, are accompanied by the need for a large amount of wet-out electrolyte. An attempt was made this quarter to replace some portion of the SAB with other types of lower density carbon supplied by the Cabot Company. It was hoped that the resulting decrease in the electrical conductivity of the cathode mix would be more than compensated for by reduced electrolyte requirements.

ACL-70 was tested using various types of carbon and graphite in the cathode mix. Various metal catalysts, supported on carbon, were also tried. Some of these were commercial preparations while others were prepared in this laboratory as metals supported on SAB.

The effect on the cathode performance of changing the amount of carbon fibers present was also studied.

The results of these tests are shown in Table A-2.

#### (1) Graphite

It is seen that micronized graphite can be used to partially replace SAB (Cell No. 85334 vs 85325). More work is planned in this area when electrolyte requirements are measured.

Table 5

Li/LiClO<sub>4</sub> (MF)/ACL-70 CELLS WITH PRETREATMENT OF ELECTROLYTE OR CARBON  
(C.D. = 0.10 amp/in.<sup>2</sup>, ACL-70 = 0.65 g, SAB = 0.35 g, C Fibers = 0.027 g)

Cell No.	Pretreatment	Capacities, amp-min					Total	%Utilization 2.0 v
		Initial	Final	>3.0 v	>2.5 v	>2.0 v		
85317	SAB w̄ LiClO <sub>4</sub> ·MF and dried	20.3	12.7	0.3	1.5	2.4	3.3	12
85318	SAB w̄ LiClO <sub>4</sub> ·MF·ACL-85 (not dried)	20.3	10.5	2.4	5.4	9.3	10.5	46
85315	LiClO <sub>4</sub> ·MF w̄ SAB	20.3	6.6	3.9	6.0	8.4	9.9	41
85316	LiClO <sub>4</sub> ·MF w̄ Darco G-60	20.3	4.9	4.2	8.1	10.5	11.7	52

MF = Methylformate

SAB = Shawinigan acetylene black



## (2) Carbon Fibers

Increasing the amount of carbon fibers improves the performance, although it may increase the electrolyte requirements of the cell (Cell No. 85328, 85325 vs 81364 Table A-1).

## (3) Other Types of Carbon

The Cabot carbon samples showed definitely inferior performance compared with SAB.

## (4) Catalysis with Noble Metals

Initial results (Quarterly Report No. 2) suggested that the ACL-70 reduction could be catalyzed by platinum. Many attempts at catalysis followed. It now appears that processing variables are more important than catalysis. The percentage utilization remains at 50% in all of these tests with ACL-70. The iodimetric titration on the spent tape, however, shows that all the capacity is not used.

The "initial capacity" value reported in Table 7 is that of the ACL-70 before blending with the carbon black. Separate iodine determinations have shown that the loss due to mixing is negligible. These cells are assembled from dry materials in the glove box.

### d. Effect of Trichlorotriazinetrione (ACL) Source

Monsanto ACL-85 <sup>®</sup> was compared to the competitive CDB-85 <sup>®</sup> product. Both materials were tested with catalyzed SAB. The data are shown in Table 6.

There is no apparent difference in performance between ACL-85 and CDB-85. Both are almost 100% trichlorotriazinetrione. CDB-85 has the smaller particle size. All of the results above are definitely superior to earlier experiments reported in our second quarterly report using non-catalyzed carbons.

### e. Effect of ACL Structure

Analysis of our past data indicates that the least ionic ACL compounds are the best cathode materials. Thus, ACL-70 is better than ACL-59, and ACL-59 will not discharge unless lithium ions are present in the electrolyte. The following activity order was determined from these data:

Table 6

Li/MF/TRICHLOROTRIAZINETRIONE CELLS

[C.D. = 0.10 amp/in.<sup>2</sup>, ACL-85 (CDB-85) = 0.65 g, SAB = 0.35 g, C. Fibers = 0.027 g]

Cell No.	Cathode	Electrolyte	Initial	Final	Capacity, amp-min				%Utilization >2.0 v
					>3.0 v	>2.5 v	>2.0 v	Electrochemical	
85303	ACL-85 Pt/C	LiClO <sub>4</sub>	27.0	7.4	3.9	5.4	6.6		24
85304	CDB-85 Pt/C	LiClO <sub>4</sub>	27.0	7.2	3.9	6.9	8.4		31
85309	ACL-85 Pd/C	LiClO <sub>4</sub>	27.0	6.5	4.5	6.0	8.4		31
85310	CDB-85 Pd/C	LiClO <sub>4</sub>	27.0	9.6	3.3	5.4	6.9		26
85312	ACL-85 Pd/C	KPF <sub>6</sub>	27.0	3.0	3.6	5.4	7.2		27
81390	ACL-85 Cl <sub>2</sub> /C	LiClO <sub>4</sub>	27.0	-	1.8	3.0	3.6		13

MF = Methyl formate

Table 7

L1/(MF)/ACL-70 CELLS WITH VARIOUS ELECTROLYTES  
 (C.D. = 0.10 amp/in.<sup>2</sup>, ACL-70/SAB = 65%)

Cell No.	Electrolyte in MF	Capacity, amp-min				#Utilization > 2.0 v	
		Initial	Final	>2.5	>2.0		
85321	1M LiClO <sub>4</sub> + 5%(MeO) <sub>2</sub> B	20.3	9.0	3.6	5.4	8.7	32
81400	1M AlCl <sub>3</sub> + 0.5M LiCl	20.3	4.2	0.0	0.0	3.0	4

MF = Methyl Formate

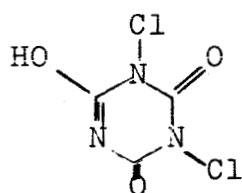

ACL-70

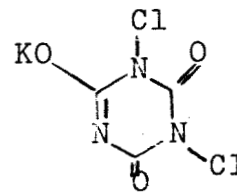
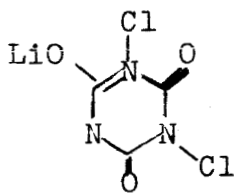

ACL-59

We suspected that electronically deactivated intermediates [such as (A) below] might be the cause of our ability to remove only one chlorine atom from either ACL-70 or ACL-85.

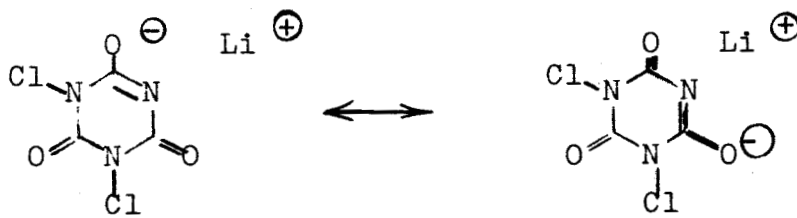

(A)

We have attempted to use Lewis acid coordinating agents to reduce this deactivation. Aluminum chloride reacted with lithium and was, therefore, unsatisfactory. Trimethylborate was found to be compatible with lithium. We hoped to form (B) by the addition of this compound to the electrolyte.

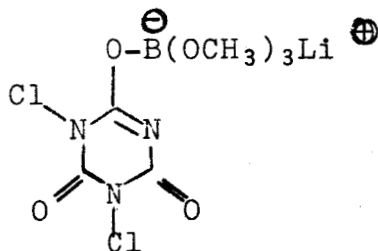

(B)

(B) was expected to discharge more readily than (A).

The results of the test indicate no improvement due to methyl borate addition (Table 7). A test with 1M AlCl<sub>3</sub> plus 0.5M LiCl in methyl formate showed no improvement (Cell No. 81400 vs 81364 Table A-1).

#### f. ACL-70 Stability

A study was made of ACL-70 decomposition in methyl formate-LiClO<sub>4</sub> electrolyte as a function of time. However, two batches of electrolyte were used and it is evident from the results that the decomposition rate is a function of electrolyte age. Very little decomposition occurred when the electrolyte was fresh. Severe decomposition occurred with old or contaminated electrolyte. Electrolyte left lightly capped on the bench-top for 48 hours showed some evidence of contamination. In these experiments 0.65 g of ACL-70, 0.35 g SAB, and 0.027 g of carbon fibers were slurried with 10 ml of 1M LiClO<sub>4</sub>-methyl formate for various periods of time. The results of the active chlorine analyses on these samples are shown in Table 8.

#### 2. Dichlorobenzoquinonediimine Cathodes

As mentioned in the second quarterly report, dichlorobenzoquinonediimine (DCBQDI) could be a better chlorine donor in nonaqueous solvents than ACL compounds. A sample of DCBQDI was prepared from phenylenediamine dihydrochloride and a sodium hypochlorite solution. The KI/I<sub>2</sub> analysis gives 0.0175 eq/g or 3.0 equivalents/mole for this product. Using this material in a cell similar to ACL, there was considerable capacity but poor voltage for the Li/LiClO<sub>4</sub> (MF)/DCBQDI cell (see Figure 3).

Dichlorobenzoquinonediimine was tested with LiCl·DMF electrolyte. The result was no better than that reported above.

#### 3. Inorganic Fluoride Cathodes

##### a. Cupric Fluoride

CuF<sub>2</sub> has approximately the same theoretical capacity (amp-hr/g) as ACL-70. Against lithium anodes, CuF<sub>2</sub> efficiencies were found to be higher and voltages lower than with ACL-70.

The Li/LiClO<sub>4</sub>/CuF<sub>2</sub> system (see Figure 3) showed voltages approaching 3 volts. Two tests (0.10 and 0.05 amp/in.<sup>2</sup>) gave efficiencies of 69% and 66% based on 100% active CuF<sub>2</sub> materials.

Metal additives were tested in the cathode to attempt to improve CuF<sub>2</sub> discharge rates. The approach was to include materials on which the plating of copper might be more reversible than on amorphous carbon. Copper, platinum black and graphite were tested as additives. The results are shown in Table 9. No improvement was noted.

Table 8

EFFECT OF  $\text{LiClO}_4$ -METHYLFORMATE AGING ON ACL-70 ACTIVE CHLORINE CONTENT

<u>ACL-70 Contact Time (min)</u>	<u>Electrolyte Age</u>	<u>Percent Initial Active Chlorine Remaining</u>
5	fresh	96
15	fresh	96
60	fresh	96
5	fresh+48 hr	93
5	old(>1 month)	85

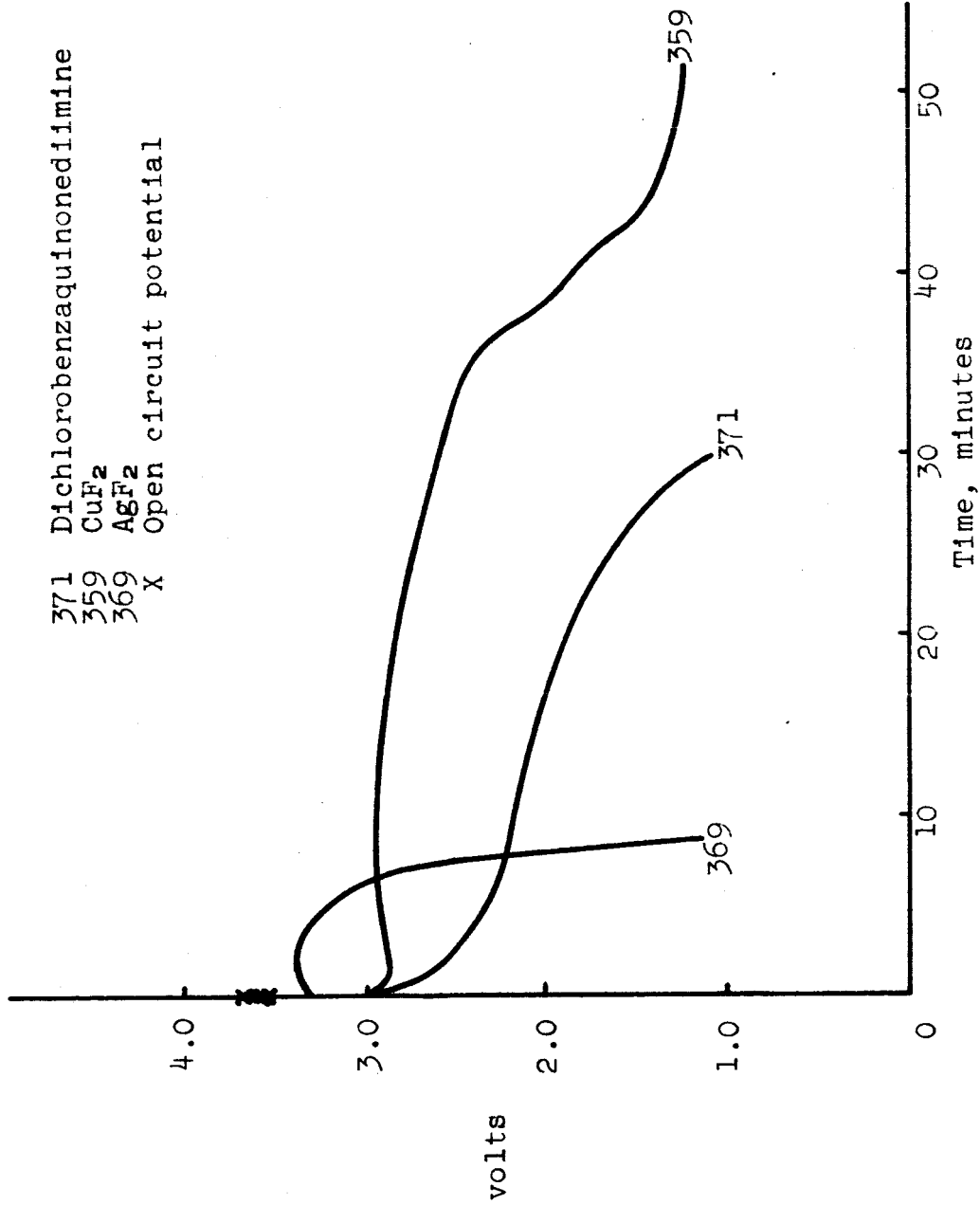

Figure 3. Discharge of Various Cathode Materials at 0.10 amp/in.<sup>2</sup>

Table 9

Li/LiClO<sub>4</sub>(MF)/CuF<sub>2</sub> CELLS WITH CATHODE ADDITIVES

(C.D. = 0.10 amp/in.<sup>2</sup>, CuF<sub>2</sub> = 0.50 g, SAB = 0.27 g, Carbon Fibers = 0.027g)

Cell No.	Additive	Capacities, amp-minutes				%Utilization 2.0 v
		Initial	>3.0 v	>2.5 v	>2.0 v	
81377	None	16.5	0.3	8.7	10.2	62
81384	Cu powder (0.27 g)	16.5	-	8.4	9.9	60
81385	Pt powder (0.027 g)	16.5	-	7.8	8.7	53
81383	Graphite (0.27 g)	16.5	-	9.0	9.9	60



Oscilloscope voltage interruption traces on  $\text{CuF}_2$  were similar to those obtained with ACL-70.

b. Silver Difluoride

$\text{AgF}_2$  was tested as a nonaqueous cathode component in a lithium cell. The  $\text{Li}/\text{AgF}_2$  open circuit potential was stable at 3.65 volts, but only 9 minutes' capacity could be obtained at 0.10 amp/in.<sup>2</sup> (Figure 3).  $\text{AgF}_2$  was apparently too soluble in the methyl-formate/lithium perchlorate electrolyte resulting in self-discharge of the cell.

4. Determination of Cell Polarization by the Interrupter Technique

The use of interrupter techniques to measure polarization of porous cathodes is complicated by the poorly defined electrode surface area and the fact that, on breaking the circuit, internal currents flow through the porous structure until concentration and potential gradients are equalized. However, we have analyzed the characteristics of a  $\text{Li}/\text{LiClO}_4$ , methyl formate/trichloro-isocyanuric acid cell using this technique.

The initial IR drop is about 0.1 v. (Figure 3). This is the IR loss due to the Li-electrolyte and carbon resistance. The IR builds up, however, so that within 0.5 second it is about 0.5 v. This is due to movement of the reaction interface deeper into the porous cathode. Finally, a gradual build-up of polarization is evident that is not an IR effect and instead is due to a concentration polarization.

This information on the discharge limitation is obtained by observing the potential decay when current is applied, and the potential recovery when the circuit is opened. The results are shown in Figure 4. These oscilloscope traces were photographed at various times during the constant current discharge of a  $\text{Li}/\text{LiClO}_4$  (MF)/ACL-70 cell. Analysis of these curves is open to question because internal currents can flow within a porous system when the external circuit is opened. However, from these oscillograms it appears that the IR of the system is approximately 0.1 volt and does not change during the discharge (this is the immediate polarization from OFF to ON). A resistance builds up during discharge, however, so that after about 0.5 second the IR becomes about 0.5 volt (this is the immediate polarization relaxation from ON to OFF). This effect also does not change much with increasing discharge time. This accounts for practically all of the polarization observed during

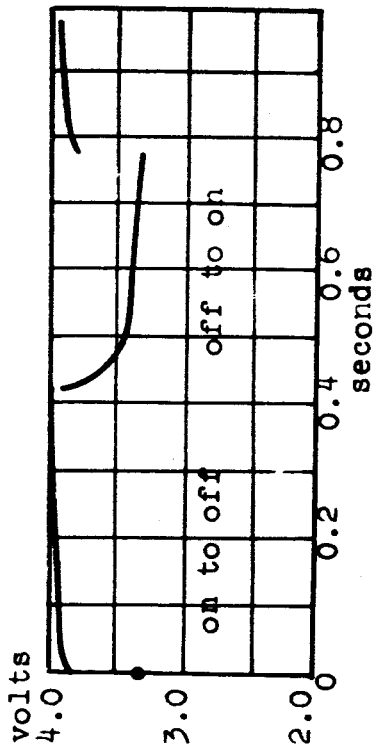

(1) 6 min. from start of discharge  
3.35 cell voltage

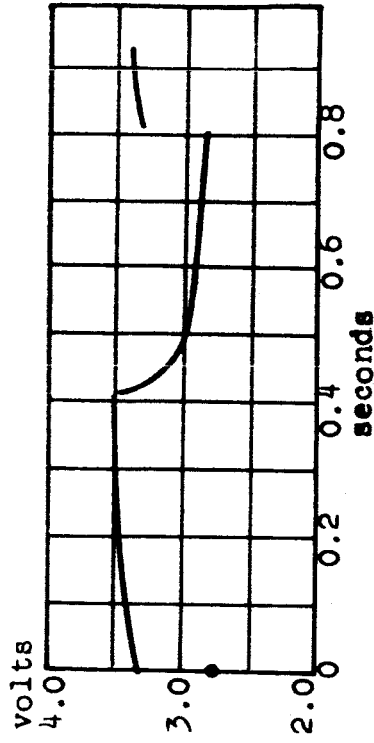

(2) 12 min., 2.85 volts

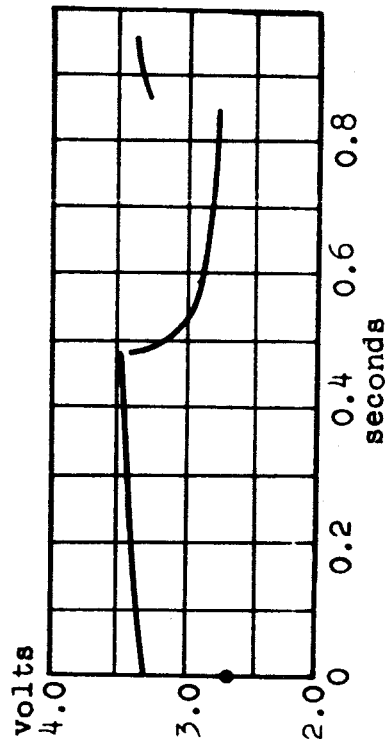

(3) 20 min., 2.75 volts

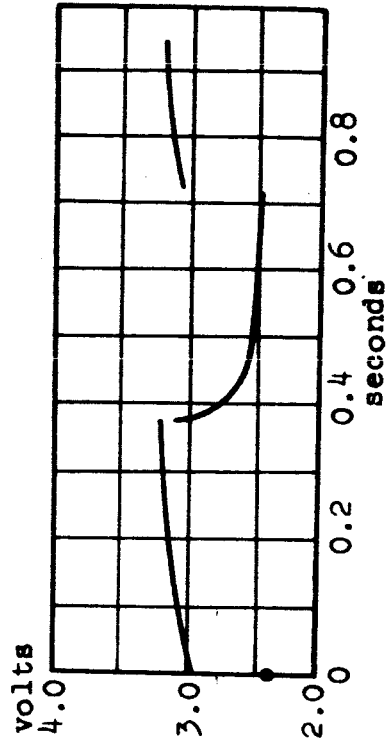

(4) 25 min., 2.40 volts

Figure 4. Oscilloscope Interrupted Voltage Trace of Li/LiClO<sub>4</sub>(MF)/ACL-70  
Discharge at 0.1 amp/in.<sup>2</sup>.

the first 5 minutes. The polarization that becomes more prevalent at increasing discharge times is slow to relax (be recovered) and is probably a concentration polarization.

Data on the aqueous system shows the same type of trace (Figure 5). However, the initial polarization (IR buildup) occurs very rapidly. Later in the discharge, the primary difference from the MF case is the fast recovery of the cell to almost the initial open circuit potential. This type of data is easily obtained during a discharge, and the OFF time of the cell is so small as to be inconsequential. We hope that as more cells are studied in this way a more positive analysis of polarizations can be achieved, and that this will aid us in designing better tape cells.

It was possible that precipitation of LiCl in MF was limiting the cathode discharge. Hence, the ACL-70 cell was tested with DMF·LiCl electrolyte. The current density of 0.10 amp/in.<sup>2</sup> was unobtainable because of lithium polarization.

#### 5. Propylene Carbonate as an Electrolyte Solvent

Propylene carbonate was tested as a solvent using LiClO<sub>4</sub> and AlCl<sub>3</sub>·LiCl as electrolyte salts. These were tested in Li/ACL-70 cells, and neither electrolyte could support more than 20 ma/in.<sup>2</sup> in these cells.

#### 6. Limited Electrolyte Experiments

Excess electrolyte has been used in almost all of the previously reported nonaqueous couple data. Attention was focused on chemical problems, and the effective utilization of cathode materials. The attainment of high energy densities, however, requires the strict use of a minimum amount of electrolyte. For this reason, some cells were discharged with minimum electrolyte volumes to see what effect this would have on cell performance.

Our most useful nonaqueous electrolyte solvent is methyl formate. The determination of the minimum electrolyte requirements in this case is very difficult since this compound boils at 32° C.

In our first approach to this study, an attempt was made to saturate the glove box with electrolyte vapor while the cell was discharged as usual. A minimum separator was used, and no reference electrode was included in the assembly. Electrolyte requirements were high. A bag cell was then designed and the cathode was pressed dry (without methyl formate) before being placed in the bag. The results of these tests are given in Table A-3. In these tests the pressure used to compress the test cell was also measured. In Table A-3, initial amp-minute capacities are calculated from the weight of electroactive compound used for the experiment. Efficiencies in excess of 50%

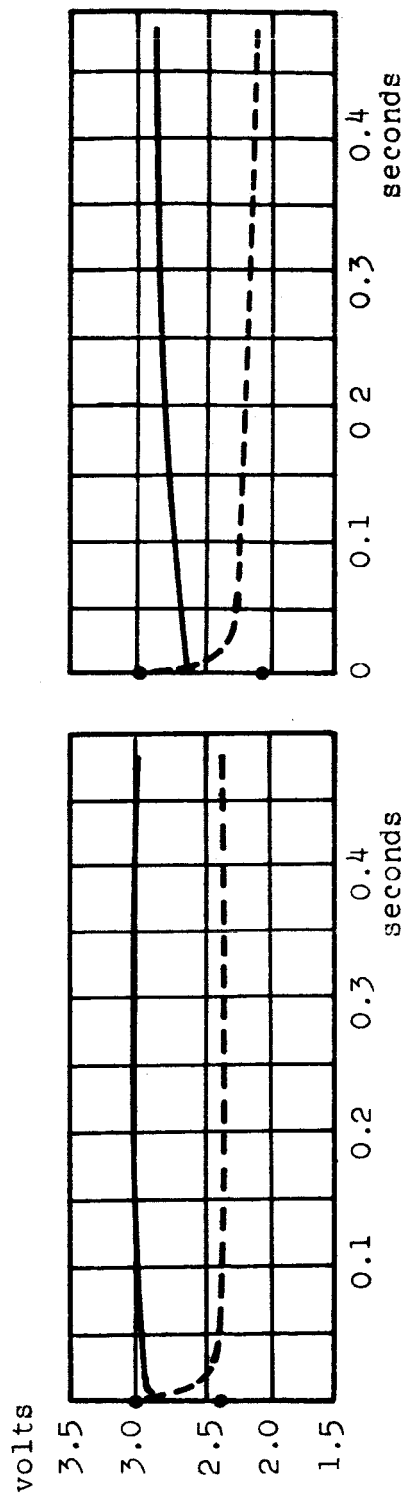

(1) 2 minutes from start of discharge (2) 14 minutes  
 2.42 volts, cell voltage 2.1 volts

Figure 5. Oscilloscope Interrupted Voltage Trace of  
 $\text{Mg}/1.5\text{M AlCl}_3 + 0.5\text{M MgCl}_2(\text{H}_2\text{O})/\text{ACL-85}$ .  
 Discharge at 0.5 amp/in.<sup>2</sup>.

have been obtained, and at the end of the test, active material still remained (based on iodimetric titration). In several tests, electrolyte was added during the run. The amount added is in parentheses.

The results of the tests thus far indicate that cathodic efficiencies are improved by using less electrolyte (Table A-3, 85346 vs Table A-1, 81364). It is possible that the low efficiencies obtained earlier were due to the solubility and chemical decomposition of ACL-70. With less electrolyte, less ACL-70 is soluble.

We feel that a number of variables may be important in the reduction of the amount of electrolyte necessary for most efficient cell operation. These variables include:

1. decreasing carbon content
2. replacing acetylene black with graphite
3. decreasing separator thickness
4. decreasing current density
5. adding electrolyte as needed
6. using increased test pressure
7. cathode formation pressure

Table A-3 shows the initial results of this study. It is evident that tape cells can be run with 80% ACL-70 (Cell No. 85354). Whether graphite can be used to replace some of the remaining carbon black has not been tested. It can be shown, however, that graphite does not reduce cell performance (Cell No. 85349). Cells can be run using only a 3 mil separator (Cell No. 85355) but the cathode efficiency is poor. Adding electrolyte incrementally, as needed, could be beneficial (Cell No. 85353). Because of evaporation losses (methyl formate bp. 32°C), the effect of the addition of small amounts of electrolyte is difficult to measure. Increasing the test pressure above 1 lb/in.<sup>2</sup> appears to offer no advantage to electrolyte requirements or to general performance (Cell No. 85353, 85358).

We believe that a more gas-tight cell must be designed before reliable data can be obtained. We intend to develop such a cell and to study the cathode processing variables and the optimum time and position for electrolyte addition.

The LiOCl test, (Cell No. 85348, Table A-3) was performed with the 72% active material received from Foote Mineral Company. This material was soluble in the electrolyte. Furthermore, 5 minutes after dissolving 0.1 g of this material in 5 ml of LiClO<sub>4</sub>(MF), only 70% of the active chlorine remained in solution. LiOCl reacted vigorously with dimethylformamide. From the above cell discharge it is evident that LiOCl is too soluble in LiClO<sub>4</sub>(MF). LiOCl may be useful in other electrolytes. In addition, other hypochlorites (NaOCl) might be used with LiClO<sub>4</sub>(MF). These combinations will be tried using a minimum electrolyte cell design.

### III. TAPE CELL CONFIGURATION

Prior to actual dynamic runs, a series of tests were conducted in which static data were taken utilizing the dynamic tester current collector plate. By measuring electrolyte and pressure requirements in this manner, we hoped to have a better estimate of variables for the moving tape experiments.

A major problem associated with previous dynamic experiments was the necessity for large electrolyte excesses to avoid tape-collector plate adhesion. With sufficient electrolyte to avoid sticking, the experimental energy densities were low. We feel that less electrolyte will be used when more coherent tapes are prepared and when the frictional forces are reduced. More coherent tapes can be made by forming denser tapes, and by using more binder and fibrous materials. A change in binder may be needed since PVF is somewhat soluble in acid. Smoother tape surfaces, a more friction-free collector head and less pressure on the tape during discharge will also aid dynamic performance.

Cathode tapes are being made by hand casting and by machine rolling. Both types of tapes adhere to the dynel separator fairly well. The machine-made tapes operate slightly better than the hand cast tapes.

We find that the smoothest and most coherent tapes are prepared by machine rolling with absorbant paper between the rollers and the cathode mix, and by using maximum pressure. Tape templates are also cut from blotting paper. Four-foot lengths have been made in this manner, and are now being tested.

The wetting of the tape with minimum electrolyte demands excellent tape wet-out properties, since the electrolyte must reach the separator, and since large pressures cannot be applied at the time of activation.

Several approaches can be taken to solve the wet-out problem. The first is to wet the electrode totally or partially through the anode side. Another approach is the addition of a wetting agent to the electrolyte or the cathode tape. Also, micro-encapsulation could solve the problem. The only method tried thus far has been the addition of a wetting agent (p-toluene-sulfonic acid) to the electrolyte. No improvement was evident from this single test.

At present we are testing tapes in static cells and analyzing the effect of cathode formation and testing pressures as functions of electrolyte type and volume, and the current density. Also we are studying optimum electrolyte placement as a function of time and position. This is being done in the static cell test using hypodermic electrolyte addition and in the dynamic test unit, using pump addition of electrolyte through the collector plates.

#### IV. DYNAMIC TESTER MODIFICATION

Early in the quarter a leak was detected in the dynamic tester current collector plate. The need to fix this malfunction led to a re-evaluation of the current collector geometry. Several new collector heads were designed and fabricated (Figure 5) to give versatility to the dynamic test assembly.

Two types of porous graphite plates have been fabricated. They allow electrolyte to seep into the cathode collector either at the front edge only (Figure 5a) or over the entire collector plate (Figure 5b). We hope that the diffusion process will give a better distribution of electrolyte than from holes in the collector plate.

A third collector plate design is shown in Figure 5c. In this design the current through each section can be measured individually. Also, the electrolyte feed to each section can be controlled individually. The advantage of the "L" shape design is that corrosive electrolytes do not interfere with electrical contacting. Separate contacts for voltage and current measurement are used to eliminate electrical contact voltage loss due to poor clip connections to the collector plate.

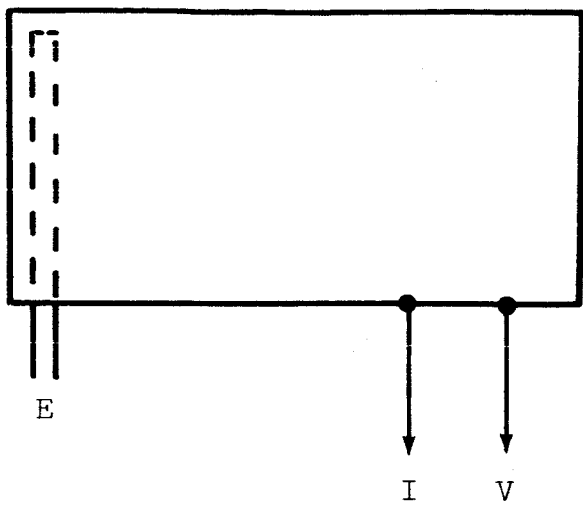

(5a) Porous Graphite

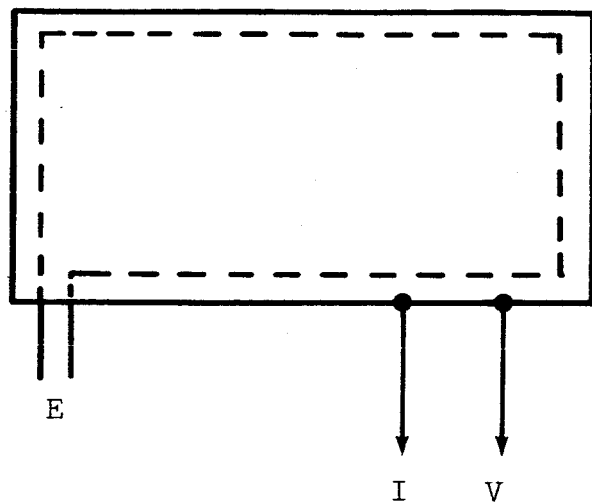

(5b) Porous Graphite

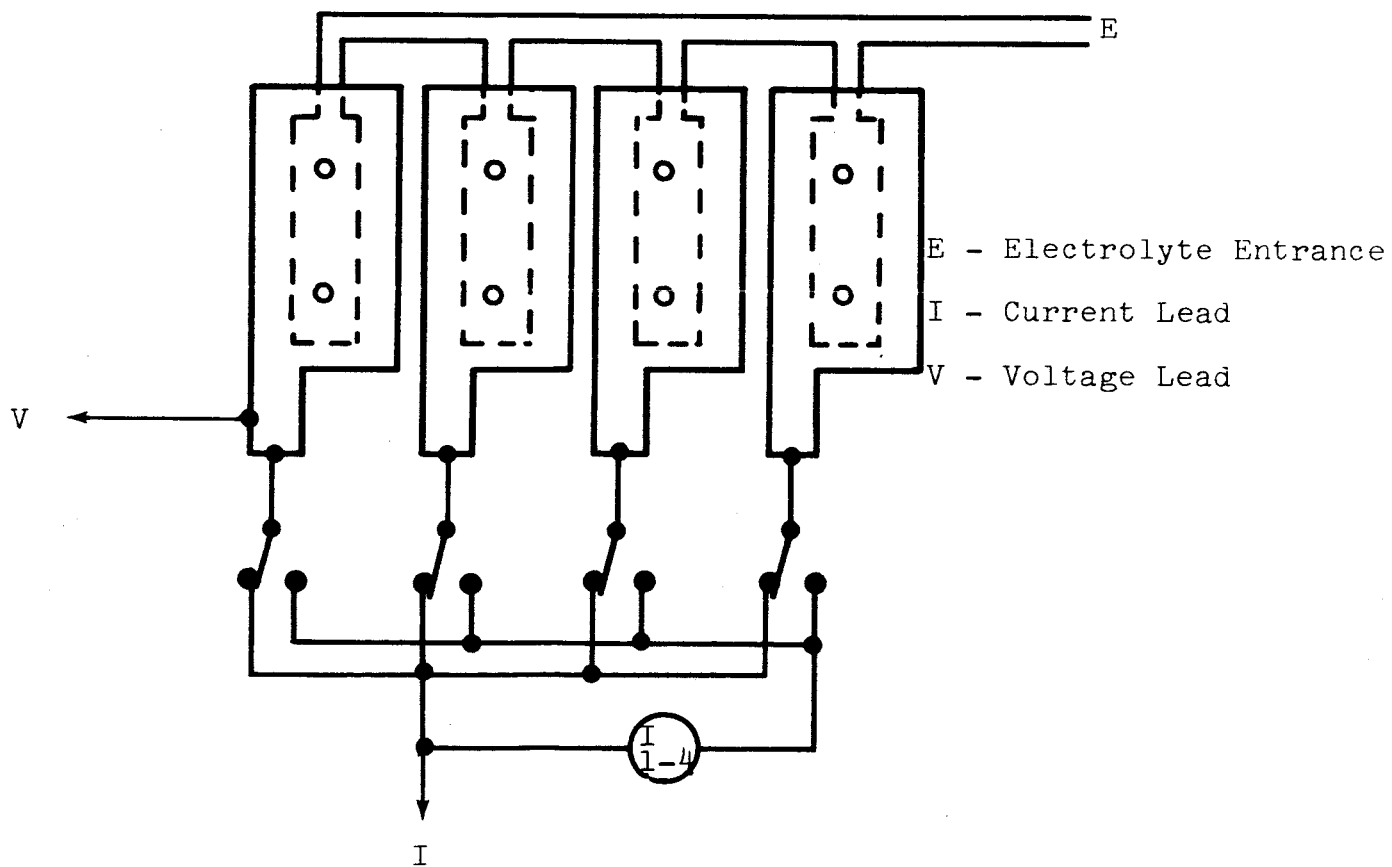

(5c) Drilled Impervious Graphite

Figure 6. Cathode Current Collector Designs



## V. FUTURE PLANS

### A. AQUEOUS SYSTEMS

1. Major emphasis during the fourth quarter will be placed on the preparation of an optimized dynamic tape system. The apparatus previously described (ref. 2) for the preparation of continuous  $\text{KIO}_4$  tape cathodes will be reactivated, and applied to the manufacture of smooth, coherent ACL-85 cathodes. In addition, a rotating disc current collector will be constructed in order to reduce the friction problems associated with pulling the cathode mix across a graphite collector plate.
2. Fluoboric acid ( $\text{HBF}_4$ ) will be tested as a possible acidic electrolyte.
3. A neutral electrolyte system (e.g.  $\text{MgCl}_2$ ) will be optimized for the Mg/ACL-85 couple. Offsetting the necessity of operating at low current density should be the advantages associated with the elimination of gassing at both the anode ( $\text{H}_2$ ) and cathode ( $\text{Cl}_2$ ).
4. Thin beryllium foil has been obtained. This material will be evaluated statically in KOH solution as a high energy anode material.
5. Carbon flocking (perpendicular addition of electrostatically charged carbon fibers to a tape separator) will be investigated as a method for the improvement of cathode integrity.
6. Liquid cathode studies will begin with the Mg/KBr/ $\text{Br}_2$  system.

### B. NONAQUEOUS SYSTEMS

1. Minimum electrolyte requirement work will continue in the Li/ $\text{LiClO}_4(\text{MF})/\text{ACL-70}$  and  $\text{CuF}_2$  systems. A new static test cell which will facilitate this work, has been constructed.
2. Lithium hypochlorite will be run vs lithium in KPF<sub>6</sub>-methyl formate electrolyte. Any KOCl formed may reduce the solubility of the oxidizing agent, and the subsequent self-discharge of the cell. Other hypochlorites containing cations compatible with lithium metal [ $\text{K}^+$ ,  $(\text{CH}_3)_4\text{N}^+$ ,  $\text{Ca}^{+2}$ ] will be obtained, if possible.
3. A 4:6 lithium-magnesium alloy will be tested with methanol, acetonitrile and water as electrolyte solvents.

## VI. REFERENCES

1. Chilton, J. E. and Cook, G. M., "New Cathode-Anode Couples Using Nonaqueous Electrolytes," Technical Documentary Report No. ASD-TDR-62-837 (1962).
2. B. A. Gruber, et al., "Development of the Dry Tape Battery Concept", NASA CR-347, Contract NAS3-4168, December 1965, p. 113.

Table A-1  
DISCHARGE DATA OF VARIOUS CATHODES IN EXCESS METHYL FORMATE VERSUS LITHIUM ANODES

65% Active Material in Cathode Mix  
3 in.<sup>2</sup> Electrode Area  
I = 0.10 amp/in.<sup>2</sup>

No.	System	Variation	amp-minute capacities					Cathode Weight(gm)	
			Initial	End	Electrochemical				
					>3.0v	>2.5v	>2.0v	Total	
<u>Comparison Data from 2nd Quarter</u>									
81337	L1/LiClO <sub>4</sub> (MF)/ACL-85		19.2	4.0	1.8	4.5	5.4	7.5	0.894
81342	L1/LiClO <sub>4</sub> (MF)/ACL-70		14.8	2.0	3.0	6.3	7.2	8.7	0.774
<u>Acids</u>									
81347	L1/LiClO <sub>4</sub> (MF)/ACL-85	SAB HCl wash	23.7	8.7	0	0	3.6	7.5	0.924
81351	L1/MPF <sub>6</sub> (MF)/ACL-85	MPF <sub>6</sub>	21.0	2.1		2.1	3.0	5.1	0.990
81352	L1/AlCl <sub>3</sub> ·LiCl(MF)/ACL-85	AlCl <sub>3</sub> ·LiCl	27.3		3.0	4.5	5.1	6.9	1.386
<u>Darco--ACL-70</u>									
81350	L1/LiClO <sub>4</sub> (MF)/ACL-70		16.1	2.8	3.3	6.0	7.2	8.7	0.916
81353	"	I/2	11.1	1.4	2.2	3.3	3.6	4.2	0.605
81355	"	week later	12.2	1.0	2.1	3.0	4.8	7.2	0.689
81354	L1/AlCl <sub>3</sub> ·LiCl(MF)/ACL-70	AlCl <sub>3</sub> ·LiCl	11.6	1.0	1.2	2.1	2.4	3.3	0.652
<u>Process Variables for Li/LiClO<sub>4</sub>(MF)ACL-70 Cells</u>									
<u>Without TCE and PVF</u>									
81357	Immediate Tests		19.4	4.1	4.5	8.4	9.9	12.0	1.027
81358	"		15.7	3.0	3.3	6.0	6.6	11.4	0.806
81366	"		16.2	4.9	3.6	5.7	6.3	8.1	0.881
81364	"	prep in Dry Box	20.7*	2.6	4.5(m)	6.9	7.8	9.3	1.027
81367	1 Day wait		13.9	3.5	2.7	6.0	6.6	7.8	0.747
<u>With TCE and PVF</u>									
81363	4 Days wait		16.1	3.6	3.6	7.5	8.7	9.9	0.875
81374	8 Day wait		17.2*	1.5	3.6	6.9	8.1	11.4	0.848
<u>With PVF, no TCE</u>									
81368	Immediate test		20.2*	5.1	3.9	6.9	8.7	9.9	1.000
<u>Dichlorobenzquinonediimine</u>									
81371	L1/LiClO <sub>4</sub> (MF)/DCBQDI		18.3*	0	-	0.6	5.1	9.6	1.028
<u>Cupric Fluoride**</u>									
81359	L1/LiClO <sub>4</sub> (MF)/CuF <sub>2</sub>		16.5		-	9.9	11.4		0.80
81361	"	I/2	16.5		2.2	9.6	10.8		0.80
<u>Silver Fluorides**</u>									
81360	L1/LiClO <sub>4</sub> (MF)/AgF <sub>2</sub>		11.0		-	-	-		0.80
81369	L1/KPF <sub>6</sub> (MF)/AgF <sub>2</sub>		11.0		1.8	2.1	2.4		0.80
81373	L1/KPF <sub>6</sub> (MF)/AgF		6.3		-	-	0.3		0.80

\* Based on chlorine analysis before tape preparation

\*\* Based on 100% active material

(m) Reached this value after initial lower values

TCE = Trichloroethylene

Table A-2  
 THE EFFECTS OF CONDUCTING ADDITIVES ON  $\text{Li/LiClO}_4(\text{MF})/\text{ACL-70}$  CELLS (EXCESS ELECTROLYTE)  
 (C.D. = 0.10 amp/in.<sup>2</sup>; ACL-70 = 0.65 g)

Cell No.	Conducting Additive (grams)		SAB	Initial	End	Capacities amp-min			Total	% Utilization >2.0 v
	Additive	OF				>3.0	>2.5	>2.0		
81382	Dixon	0.35	0.027	0.35	4.3	4.2	7.8	9.0	10.5	44
85305	Micro 6	0.35	0.027	0.35	3.4	4.5	6.9	9.9	11.7	49
85319	"	0.15	0.027	0.20	6.7	3.9	6.3	9.0	11.1	44
85320	"	0.20	0.027	0.15	5.5	4.2	7.5	9.9	11.4	49
85325	None	0.054	0.054	0.35	6.6	3.9	8.7	9.9	11.1	49
85328	None	0.10	0.10	0.35	3.9	4.8	8.7	10.2	10.8	50
85336	Micro 6	0.15	0.05	0.20	2.4	3.9	6.9	9.3	11.1	46
85334	"	0.20	0.05	0.15	2.7	3.9	6.9	8.7	10.5	43
81391	Pt/C Eng	0.17	0.027	0.17	-	5.1	8.4	9.3	11.7	46
85323	Pt/C Eng	0.17	0.027	0.17	-	3.6	6.6	8.1	10.2	40
81392	Pd/C MCB	0.17	0.027	0.17	-	0.6	1.5	2.1	3.0	10
81393	Ru/C Eng	0.17	0.027	0.17	-	5.1	7.2	8.7	10.5	43
81394	Rh/C Eng	0.17	0.027	0.17	-	3.3	5.1	8.4	10.2	41
81396	Pd Eng	0.035	0.027	0.35	-	4.2	7.5	8.7	10.5	43
81399	Pt/C MRC	0.35	0.027	-	5.2	4.2	6.9	8.7	10.5	43
85308	Pd/C MRC	0.35	0.027	-	-	3.6	5.4	6.9	9.0	34
85322	Vulcan XC-72R	0.35	0.027	-	-	3.0	4.8	6.6	9.0	32
85324	Sterling 11-82	0.35	0.027	-	11.7	-	0.3	0.6	0.9	3
85327	Exp. 4156-51	0.35	0.027	-	-	0.9	2.4	3.3	5.1	16

SAB--Nawminigan acetylene black  
 CF--Carbon fibers  
 Dixon--Graphite  
 Micro 6--Graphite  
 Eng.--Englehard catalyst  
 MCB--Matheson Coleman and Bell catalyst  
 M-C--Montanto Research Corp. catalyst  
 Vulcan XC-72R  
 Sterling 1182  
 Exp. 4156-51  
 Carbons from the Cabot Corporation

Table A-3  
 FULL CELL DISCHARGES USING A MEASURED VOLUME OF 1M LiClO<sub>4</sub> IN METHYL FORMATE AND A MEASURED CELL PRESSURE

Cell No.	Cathode Material Type %	Separator Thickness mils	Testing Pressure <sup>a</sup> lbs/in. <sup>2</sup>	Current Density amp/in. <sup>2</sup>	Electrolyte Volume ml (a)	Capacity, amp-min.		% Utilization at >2.0V			
						Initial	Final				
85346	ACL-70 62	6	1.0	0.10	4.0	20.3	5.4	7.5	10.5	11.4	56
85347	ACL-70 62	6	1.0	0.10	2.5	20.3	4.6	5.1	8.4	9.9	49
85349	ACL-70 62 (b)	6	1.0	0.10	2.5	20.3	5.6	3.0	9.0	10.8	53
85351	ACL-70 76	6	1.0	0.10	2.0 (0.5)	20.3	5.9	4.5	8.4	9.6	47
85352	ACL-70 81	3	1.0	0.10	2.0 (0.5)	20.3	8.4	3.0	4.5	6.9	34
85353	ACL-70 76	6	1.0	0.05	1.5 (0.5)	20.3	5.4	3.1	4.2	11.2	55
85354	ACL-70 81 (c)	6	8.0	0.10	1.6	20.3	7.0	3.6	7.8	9.0	44
85355	ACL-70 76	3	16.0	0.05	1.75 (0.25)	20.3	6.1	4.5	6.2	8.1	40
85357	ACL-70 67	6	16.0	0.10	1.75 (0.25)	25.2	5.1	3.9	6.9	8.0	32
85358	ACL-70 76	6	16.0	0.05	1.85	20.3	7.2	3.8	6.9	8.1	40
85356	ACL-85 81 (c)	6	16.0	0.10	1.75	27.0	7.2	1.8	1.8	6	6
85348	LiOCl 62	6	1.0	0.05	5.0	21.6	0.3			0	0
85344	CuF <sub>2</sub> 55	6	1.0	0.10	3.5	16.5	6.9	8.1	8.1	49	49
85345	CuF <sub>2</sub> 55	12	1.0	0.10	5.0	16.5	5.1	8.4	5.1	8.4	51

a Amount of electrolyte added during run in parenthesis.  
 b Cell contains 19% graphite  
 c Cell contains no carbon fibers

DISTRIBUTION LIST

Contract NAS3-7624

National Aeronautics + Space Administration  
Washington, D. C. 20546  
Attention: E. M. Cohn, Code RNW  
A. M. Greg Andrus, Code FC  
J. R. Miles, Code SL

National Aeronautics + Space Administration  
Goddard Space Flight Center  
Greenbelt, Maryland 20771  
Attention: Thomas Hennigan, Code 632.2  
Joseph Sherfey, Code 652  
Paul Donnelly, Code 636.2  
E. R. Stroup, Code 636.2

National Aeronautics + Space Administration  
Lewis Research Center  
21000 Brookpark Road  
Cleveland, Ohio 44135  
Attention: Library - Mail Stop 3-7  
N. D. Sanders - Mail Stop 302-1  
J. E. Dilley - Mail Stop 500-309  
R. L. Cummings - Mail Stop 500-201  
B. Lubarsky - Mail Stop 500-201  
H. J. Schwartz - Mail Stop 500-201  
W. J. Nagle - Mail Stop 500-201  
(2 copies)  
M. J. Saari - Mail Stop 500-202  
J. J. Weber - Mail Stop 3-19  
R. R. Miller - Mail Stop 500-202  
Report Control - Mail Stop 5-5  
\*V. F. Hlavin - Mail Stop 3-14

National Aeronautics + Space Administration  
Scientific + Technical Information Facility  
P. O. Box 5700  
Bethesda 14, Maryland  
Attention: NASA Representative  
(2 plus 1 reproducible)

National Aeronautics + Space Administration  
Marshall Space Flight Center  
Huntsville, Alabama 35812  
Attention: Philip Youngblood  
Richard Boehme - Bldg. 4487-BB  
M-ASTR-EC

\*Final Report Only

U.S. Army Research Office  
Box CM, Duke Station  
Durham, North Carolina  
Attention: Paul Greer  
Dr. Wilhelm Jorgensen

U.S. Army Research Office  
Chief, Rand D.  
Department of the Army  
3D442, The Pentagon  
Washington, D. C. 20546  
Attention: Dr. Sidney J. Mangram

U.S. Army Mobility Command  
Research Division  
Center Line, Michigan 48090  
Attention: O. Renius (AMSMO-RR)

National Aeronautics + Space Administration  
Manned Spacecraft Center  
Houston, Texas 77058  
Attention: William R. Dusenbury  
Propulsion + Energy Systems Br.  
Bldg. 16, Site 1  
Robert Cohen, Gemini Project Off.  
Richard Ferguson (EP-5)  
James T. Kennedy (EE-5)  
Forrest E. Eastman (EE-4)

National Aeronautics + Space Administration  
Ames Research Center-Pioneer Project  
Moffett Field, California 94035  
Attention: James R. Swain  
A. S. Hertzog  
Jon Rubenzer-Biosatellite Proj.

National Aeronautics + Space Administration  
Jet Propulsion Laboratory  
4800 Oak Grove Drive  
Pasadena, California 91103  
Attention: Aiji Uchiyama

U.S. Army Engineer R + D Labs.  
Fort Belvoir, Virginia 22060  
Attention: Dr. Galen Frysinger  
Electrical Power Branch  
SMOFB-EP

U.S. Army Engineer R + D Labs.  
Fort Monmouth, New Jersey  
Attention: David Linden (Code SELRA/PS)

U.S. Army R + D Liaison Group (9851 DV)  
APC 757  
New York, New York  
Attention: B. R. Stein

Commanding Officer  
U.S. Army Electronics R + D Labs.  
Fort Monmouth, New Jersey 07703  
Attention: Power Sources Division

Research Office  
Rand D. Directorate  
Army Weapons Command  
Rock Island, Illinois  
Attention: Mr. G. Riensmith, Chief

Army Materiel Command  
Research Division  
AMCRD-RSCM-T-7  
Washington, D. C.  
Attention: John W. Crellin

U.S. Army TRECOM  
Fort Eustis, Virginia 23604  
Attention: Leonard M. Bartone (SMOFE-ASE)

Office of the Deputy Commander AFSC for  
Aerospace Systems  
U.S.A.F.  
Los Angeles 45, California  
Attention: W. J. Bennison