

FZK-154

A STUDY OF SOME REACTOR SHIELDING PROBLEMS FOR SPACECRAFT APPLICATIONS

GPO PRICE \$ _____

CFSTI PRICE(S) \$ _____

Hard copy (HC) 3.00

Microfiche (MF) .75

ff 653 July 65

Work performed for
National Aeronautics and Space Administration
under the technical direction of
George C. Marshall Space Flight Center
Huntsville, Alabama

N66 31936

FACILITY FORM 602

(ACCESSION NUMBER)

114

(PAGES)

CR-76529

(NASA CR OR TMX OR AD NUMBER)

(THRU)

(CODE)

22

(CATEGORY)

NUCLEAR AEROSPACE RESEARCH FACILITY

GENERAL DYNAMICS | PORT WORTH

597-37072-R

GD

NUCLEAR AEROSPACE RESEARCH FACILITY

29 OCTOBER 1962

**A STUDY OF SOME REACTOR SHIELDING PROBLEMS
FOR SPACECRAFT APPLICATIONS**

**E. E. JONES
M. B. WELLS**

Contract No. NAS8-1573

**Work performed for
National Aeronautics and Space Administration
under the technical direction of
George C. Marshall Space Flight Center
Huntsville, Alabama**

ABSTRACT

31936

Machine programs for computing the single-scattered neutron and gamma-ray fluxes from radiators of reactor-powered spacecraft are described and some calculated results for typical unshielded SNAP-8-powered spacecraft are presented. Calculations to investigate the effect of uniform expansion of a direct-beam shield on the transmitted neutron dose rate in the absence of a scattering atmosphere are reported. The results of some Monte Carlo calculations performed by GD/FW and the Technical Research Group of Syosset, N. Y., to investigate the effects of shield-splitting on neutron transmission through direct-beam shields in the absence of a scattering atmosphere are discussed.

ACKNOWLEDGMENTS

The authors wish to express their thanks to Mr. L. W. McCleary and Mr. B. R. Uzzell for their help in performing some of the calculations described in this report and to Mr. D. G. Collins for helpful discussions on the use of the Monte Carlo Code K97.

TABLE OF CONTENTS

	<u>Page</u>
ABSTRACT	3
ACKNOWLEDGMENTS	4
LIST OF FIGURES	7
LIST OF TABLES	9
I. INTRODUCTION	11
II. RADIATOR SCATTERING	15
2.1 Methods of Calculation	15
2.1.1 Neutrons: IBM Procedure S06	15
2.1.2 Gammas: IBM Procedure S14	29
2.2 Calculations	34
2.2.1 Geometry of Radiator Systems	37
2.2.2 Source Terms	39
2.3 Results	41
2.3.1 Flux and Dose	41
2.3.2 Relative Importance of Radiator Regions	49
2.4 Discussion of Results	50
2.4.1 Limitations	50
2.4.2 General Observations	52
III. DIRECT-BEAM SHIELDING	53
3.1 Expanded-Shield Studies	53
3.1.1 Geometry	53
3.1.2 Source	54
3.1.3 Method of Calculation	54
3.1.4 Results	54
3.2 Split Shield Considerations	65

TABLE OF CONTENTS (cont'd)

	<u>Page</u>
IV. CONCLUSIONS AND RECOMMENDATIONS	73
4.1 Radiator Scattering	73
4.2 Direct-Beam Shielding	74
APPENDIX A - FORTRAN STATEMENTS FOR S06	75
APPENDIX B - INPUT AND OUTPUT FOR S06 SAMPLE PROBLEM	87
APPENDIX C - FORTRAN STATEMENTS FOR S14	93
APPENDIX D - INPUT AND OUTPUT FOR S14 SAMPLE PROBLEM	103
APPENDIX E - MACHINE OPERATING INSTRUCTIONS FOR PROCEDURES S06 AND S14	111
REFERENCES	117
DISTRIBUTION	119

LIST OF FIGURES

<u>Figure</u>		<u>Page</u>
1	Flat Configuration of 70-kwe SNAP-8 Interplanetary Spacecraft	12
2	Scattering Geometry	16
3	Format for Problem Data: Program S06	26
4	Format for Source Library: Program S06	27
5	Format for Cross-Section Library: Program S06	28
6	Format for Problem Data: Program S14	35
7	Format for Source Library: Program S14	36
8	Radiator Geometries Used in Calculations	38
9	Single-Scattered Neutron Spectra at Payload for Flat and Y Configurations	44
10	Direct-Beam Neutron Spectra at Payload for Flat and Y Configurations	45
11	Single-Scattered Gamma Spectra at Payload for Flat and Y Configurations	46
12	Direct-Beam Gamma Spectra at Payload for Flat and Y Configurations	47
13	Effect of Expanding 9-cm Polyethylene Shield: Plane Isotropic Source	55
14	Effect of Expanding 27-cm Polyethylene Shield: Plane Isotropic Source	56
15	Effect of Expanding 60-cm Polyethylene Shield: Plane Isotropic Source	57
16	Effect of Expanding 9-cm Polyethylene Shield: Plane Monodirectional Source	58
17	Effect of Expanding 27-cm Polyethylene Shield: Plane Monodirectional Source	59

LIST OF FIGURES (cont'd)

<u>Figure</u>		<u>Page</u>
18	Effect of Expanding 60-cm Polyethylene Shield: Plane Monodirectional Source	60
19	Transverse Neutron Leakage for Plane Isotropic Source	61
20	Transverse Neutron Leakage for Plane Monodirectional Source	62
21	Geometries for Configurations (1/2) and (1/3, 2/3)	69

NOTE:

The following pages were intentionally
left blank: 2, 10, 72, 76, 88, 94,
104, 110, 118 and 120.

LIST OF TABLES

<u>Table</u>		<u>Page</u>
I	Neutron Source Terms for Unshielded SNAP-8 Reactor	42
II	Gamma Source Terms for Unshielded SNAP-8 Reactor	43
III	Total Neutron Flux Above 0.33 Mev	48
IV	Gamma Dose Rates	48
V	Neutron Fluxes for Various Shield Configurations	67

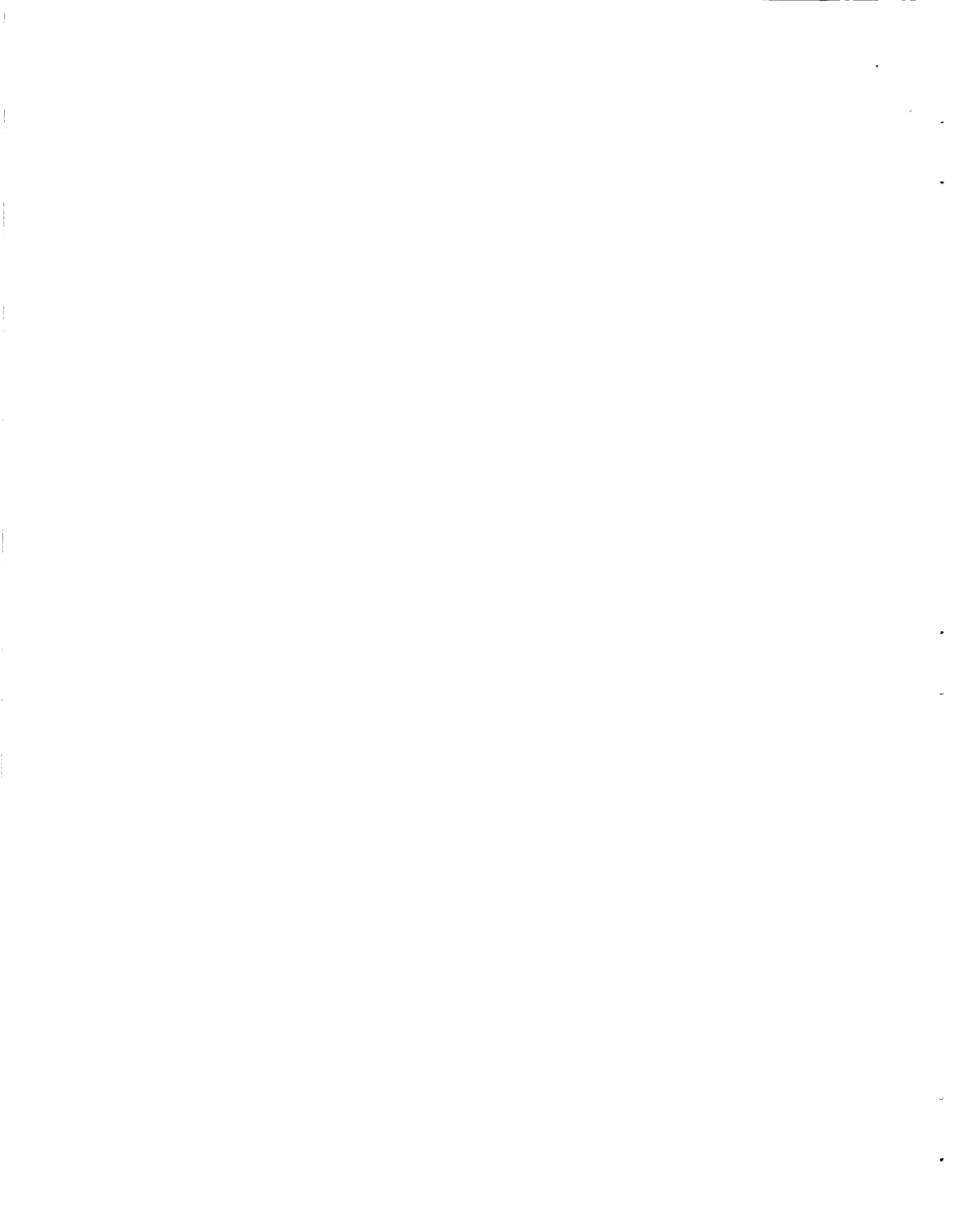

I. INTRODUCTION

A number of presently conceived spacecraft designs utilize small nuclear reactors as sources of power. In most of these designs, the reactor powers a turboelectric generating system which supplies electricity to an ion propulsion system and to secondary equipment, such as transmitters and various scientific instruments. An example of this type of spacecraft is shown in Figure 1. Other spacecraft designs utilize a device for direct conversion of heat to electricity. In some vehicles, such as an orbiting satellite, the reactor will be used only as a source of electricity and will not furnish power to a propulsion system. In any event, relatively large radiating surfaces, such as those shown in Figure 1, will be required to dispose of waste heat.

Because of the reactor and the radiators, various parts of the spacecraft may be exposed to high scattered-neutron and -gamma fluxes. It is important, with respect to the design of such spacecraft, to predict the magnitudes of these fluxes so that a shield configuration can be designed which will reduce the neutron and gamma fluxes to allowable levels. It is of particular importance to know the magnitude of these fluxes at such places as the payload and propellant tank.

Both the neutron and gamma fluxes at any point will consist of two components: (1) the flux transmitted along a "line of sight"

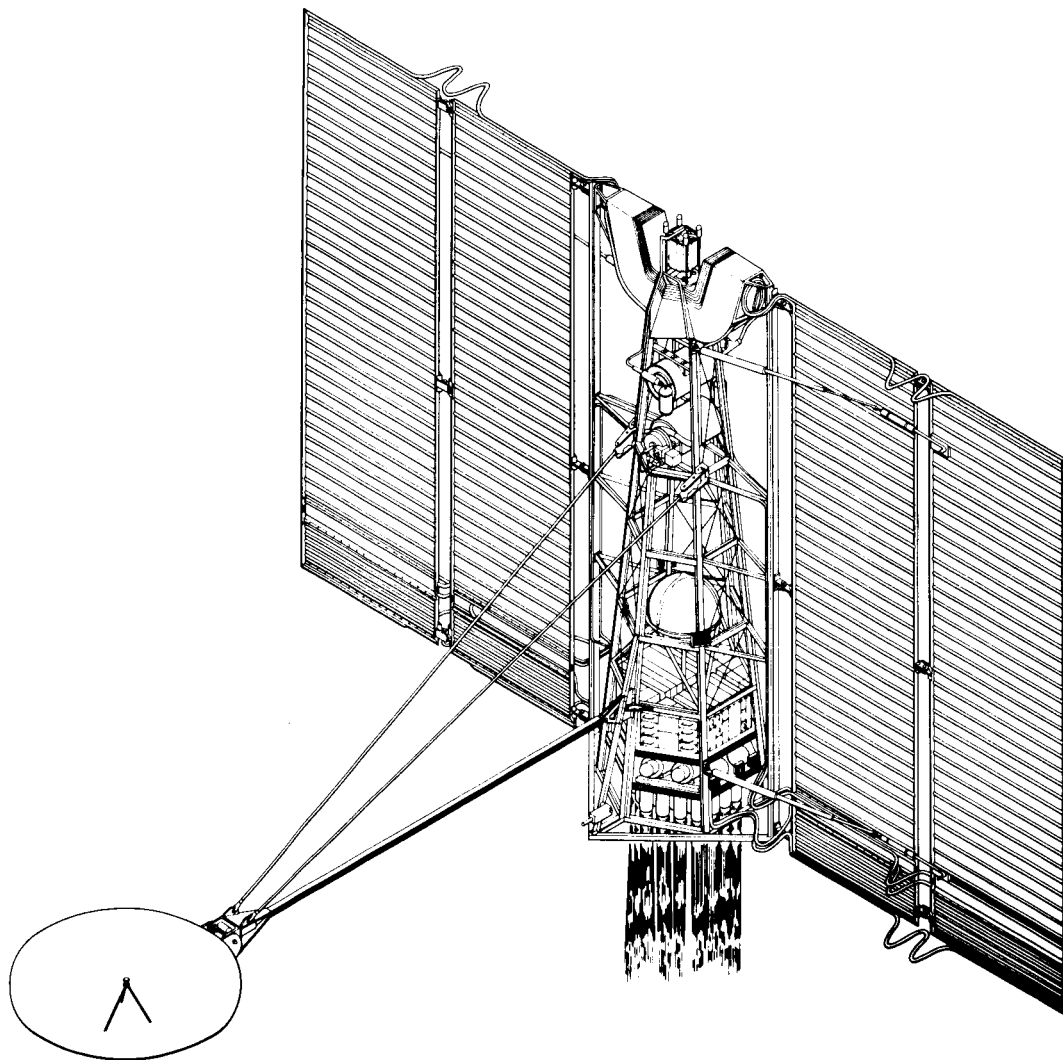

Figure 1. Flat Configuration of 70-kwe SNAP-8 Interplanetary Spacecraft

from source to detector (a component referred to as the "direct beam" and consisting of the uncollided flux plus that flux which is scattered within any material between the source and the detector) and (2) the flux scattered from the radiator surfaces and structural components. Although the total gamma flux would include a component due to neutron activation of the radiators and structural components, only those methods of calculating and shielding against the radiator-scattered and direct-beam fluxes are discussed in this report.

Particular effort has been directed toward setting up machine programs for calculating the radiator-scattered fluxes. The development and use of these programs are described and some results for typical spacecraft powered by unshielded SNAP-8 reactors are presented.

The problem of shielding against the direct-beam fluxes is considered from the standpoint of minimizing the required shielding by proper placement of the shield and by expanding or splitting the shield. In any case, the desired effect is to increase the transverse leakage of those neutrons and photons which scatter within the shield. Results of calculations performed at GD/FW to investigate the effects of shield expansion are presented and discussed. Calculations performed by the Technical Research Group at Syosset, New York to investigate the effects of shield placement and splitting are also discussed.

It should be pointed out that, thus far, this study has not been concerned with the actual design of specific shields, but has

been directed toward setting up methods of analysis and investigating some of the more important aspects of spacecraft reactor shielding. Recommendations are made for continuing this study in order to arrive at an integrated program for spacecraft reactor shield design and to evaluate presently conceived designs.

II. RADIATOR SCATTERING

Equations for calculating the radiator-scattered neutron and gamma fluxes are developed in this section. The IBM programs for calculating these scattered fluxes are described in terms of calculational procedure, data input, and data output. Results of some calculations for typical spacecraft configurations are also given.

2.1 Methods of Calculation

2.1.1 Neutrons: IBM Procedure S06

A FORTRAN program (S06) for calculating the neutron flux scattered from the radiators of reactor-powered spacecraft has been coded for the IBM-7090. This program is described below. The FORTRAN statements for S06 are given in Appendix A. Machine operating instructions are given in Appendix E. Input and output for a sample problem are given in Appendix B.

2.1.1.1 Derivation of Equation for Scattered Neutron Flux

It is assumed that the reactor can be represented by a point source, with the origin of the coordinate system at the source. A simple example of the geometry involved is shown in the accompanying sketch. In all cases, it is assumed that the radiator, source, and detector lie in the same plane.

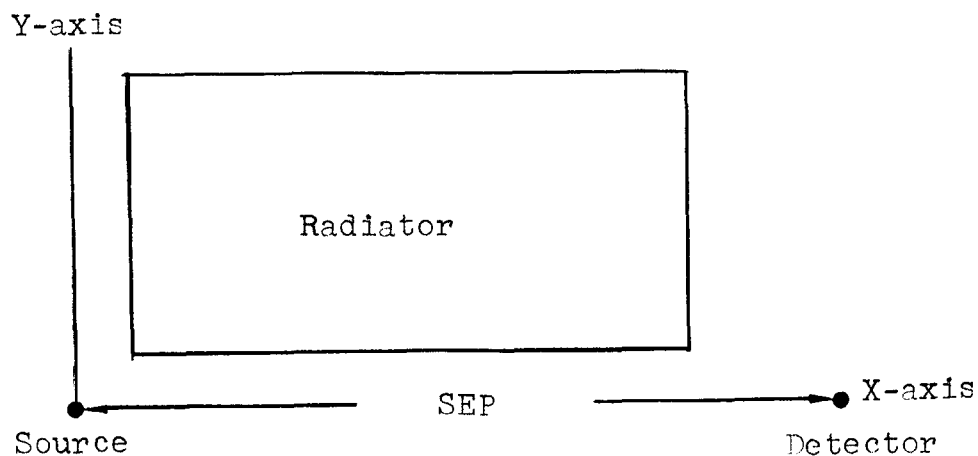

The radiator can be triangular or consist of rectangular and triangular sections. The base of each section must be parallel to the X axis. Each triangular section must be a right triangle with its area above its base, and the slopes of all hypotenuses must be equal and positive. This geometry was chosen because it lends itself to the analysis of systems such as the one illustrated in Figure 1 and those described in Reference 1.

To derive the expression for the scattered flux, consider the geometry illustrated in Figure 2. For the present, the source, detector, and radiator need not be in the same plane.

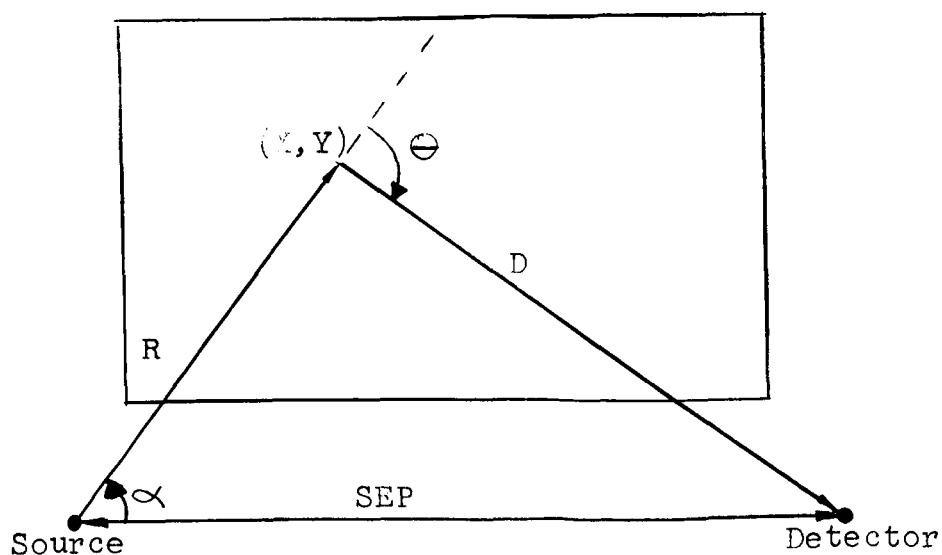

Figure 2. Scattering Geometry

Assume that the radiator is sufficiently thin so that the Z-dependence of the flux at any point in the radiator can be neglected. The flux in energy group L at the point (X,Y) is then given by $S(L,X,Y)$. It is important to note that in this formulation the source is represented by a point source, but that the source term, $S(L,X,Y)$, is calculated by considering the reactor core as a number of point sources distributed throughout the volume of the core.

Next, assume that all the neutrons at (X,Y) are traveling in the same direction. This assumption is consistent with the assumption of a point source and is feasible since the dimensions of the reactor core are small compared to R.

The number of group-L neutrons in the element of volume $dXdYdZ$ at X,Y,Z which undergo single-scatterings through the angle θ is given by

$$S(L,X,Y)\Sigma(L,\theta)dXdYdZ \text{ neutrons/sec-steradian,}$$

where

$\Sigma(L,\theta)$ = differential scattering cross section of the radiator for group-L neutrons in units of $\text{cm}^{-1}/\text{steradian}$.

Neglecting energy loss due to scattering, the number of group-L neutrons passing through an element of area dS , which is located at the position of the detector and oriented perpendicular to D, and resulting from single-scattering in $dXdYdZ$ is

$$S(L,X,Y)\Sigma(L,\theta)dXdYdZ e^{-\ell/\lambda(L)} \frac{dS}{D^2} \text{ neutrons/sec,}$$

where

l = slant distance in cm from the point (X,Y,Z) to the surface of the radiator, and

λ = mean free path in cm of group L neutrons in the radiator.

Assuming the radiator to be sufficiently thin, l will be so small compared to $\lambda(L)$ that the exponent may be neglected. The flux (or, more properly, the current) at dS will then be

$$\frac{S(L,X,Y)\Sigma(L,\theta)}{D^2} dXdYdZ \text{ neutrons/cm}^2\text{-sec.}$$

Since the detector is omnidirectional, the total single-scattered flux in energy group L is

$$\phi(L) = \int \int \int_{\text{volume}} \frac{S(L,X,Y)\Sigma(L,\theta)}{D^2} dXdYdZ \text{ neutrons/cm}^2\text{-sec.}$$

Since the integrand is independent of Z,

$$\phi(L) = t \int \int_{\text{area}} \frac{S(L,X,Y)\Sigma(L,\theta)}{D^2} dXdY \text{ neutrons/cm}^2\text{-sec,} \quad (1)$$

where t = thickness of radiator in cm.

It should be noted that Equation 1 has been derived without any assumptions with regard to the relative orientations of point source, radiator, and detector. As noted in Section 2.1.1, however, it will be assumed that all lie in the same plane and Equation 1 will be evaluated on that basis.

In formulating the expression for the scattered flux, the following assumptions were made:

1. Attenuation by the radiator can be neglected.
2. The neutron spectrum incident on the radiator can be represented by a number of discrete energy groups.
3. The scattered flux will consist only of single-scattered neutrons.
4. Energy loss due to scattering can be neglected.
5. The radiation leaking from the reactor can be treated as if emitted from a point source.

2.1.1.2 IBM Computational Procedure

Program SO6 numerically evaluates Equation 1 for any number of energy groups (values of L) from 1 to 15. Since it is desirable to know which sections of the radiator contribute most of the scattered flux, the radiator may be broken up into as many as 20 sub-areas and the flux from each sub-area calculated.

The source terms $S(L,X,Y)$ are supplied to the program as fluxes at points described by R and α about the source (see Fig. 2). The integral in Equation 1 is evaluated by a double application of Simpson's rule for each sub-area. The procedures for evaluating the two terms in the integrand of Equation 1 for a given X and Y are described below.

Source Term $S(L,X,Y)$. The values of (R,α) corresponding to (X,Y) are calculated in conventional fashion. The program then determines the input values of R and α between which the point (R,α) will lie (see sketch). By the use of linear interpolation with

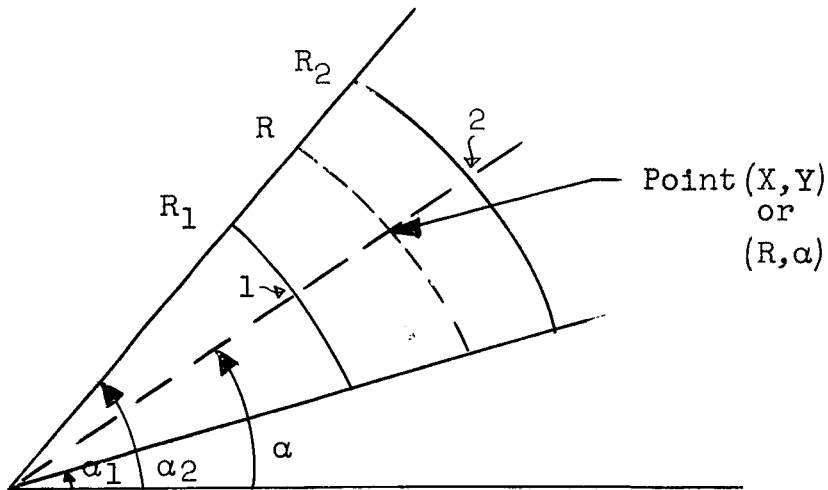

R_1 , R_2 , α_1 ,
and α_2 are
input values
of R and α .

respect to α , the source terms S_1 and S_2 at the points (1) and (2) are determined. The source term at (R, α) is then calculated by the expression

$$S(R, \alpha) = 1/2 (S_1 R_1^2 + S_2 R_2^2) / R^2. \quad (2)$$

Differential Scattering Cross Sections $\Sigma(L, \theta)$. The cosine of the scattering angle, θ , is calculated by the equation

$$\cos \theta = \frac{(\text{SEP})^2 - R^2 - D^2}{2RD}, \quad (3)$$

where $R = (X^2 + Y^2)^{1/2}$ and (4)

$$D = [R^2 + (\text{SEP})^2 - 2(\text{SEP})X]^{1/2}. \quad (5)$$

The differential scattering cross section in FORTRAN terminology is

$$\Sigma(L, \theta) = \sum_{\text{NU}=1}^{\text{NUMAX}} \text{ATOM}(\text{NU}) * \text{SIG}(L, \theta, \text{NU}), \quad (6)$$

where * denotes multiplication and

ATOM(NU) = nuclear density of element NU in radiator in
nuclei/cm³ (input);

$$\text{SIG}(L, \theta, \text{NU}) = \frac{\text{SIGEL}(L, \text{NU})}{4\pi} \sum_{LL=1}^{LLMAX} (2LL-1)F(\text{NU}, L, LL)P(LL, \cos\theta); \quad (7)$$

SIGEL(L, NU) = elastic scattering cross section of element NU for
group-L neutrons in barns (input);

F(NU, L, LL) = coefficients in Legendre expansion (input);

P(LL, cos θ) = Legendre polynomials (calculated by the program).

It should be noted that θ in Equation 3 refers to laboratory system coordinates, whereas most compilations of the coefficients F(NU, L, LL) are for scattering angles in the center-of-mass system. For most radiator materials, the mass number will be high enough to cause the error introduced in the results by use of the F(NU, L, LL)'s in the center-of-mass system in Equation 7 to negligible.

2.1.1.3 Code Description of Radiator Geometry

The radiator configuration is described in XY coordinates, with the origin of the coordinate system always located at the source. The detector then always lies on the X-axis, a distance SEP from the origin. A sub-area is described in FORTRAN by seven quantities:

XO(K) and YO(K) Coordinates of the lower left corner
of the sub-area K. No sub-area can
have coordinates (0,0).

NPX(K) and NPY(K) The number of points in the X and Y
meshes for integration. NPX(K) and
NPY(K) must all be odd integers.

KT(K) A control number denoting whether sub-area K is rectangular or triangular. (=0 for rectangle, =1 for triangle).

DELX(K) and DELY(K) Intervals between points in the X and Y meshes for sub-area K.

For a triangular sub-area, NPY(K) and DELY(K) will be put in as zero and their values will then be computed by the program as follows:

$$NPY = 3 + (I-1)2,$$

where I = the index number of a point in the X-mesh which will assume values of 1 through NPX(K).

and

$$DELY = \text{SLOPE}(X-XO)/(NPY-1),$$

where SLOPE = the slope of the hypotenuse of the triangular sub-area.

2.1.1.4 S06 Input Data

Definition of Input Quantities. The program input for a single problem will consist of (1) the problem data, (2) one library deck of source data, and (3) one to five libraries of cross-section data. A cross-section data library must be supplied for each element. Although up to 25 cross-section libraries may be loaded at the same time, a single problem can have a maximum of only five elements.

Only one source library can be read in at a time. If several problems are to be run in sequence, they must all use the same source library. All library data for a given sequence of problems must be read in before the problem decks are read in.

The quantities that comprise the problem data, the source-data library, and the cross-section data library are listed and defined below.

Problem Data

NA	Number of sub-areas (a positive integer).
NUMAX	Number of different nuclei which are treated as scatterers (a positive integer).
LLMAX1	The largest value of LLMAX which is to be used (a positive integer). LLMAX is defined under cross-section data.
NE	Number of energy groups (a positive integer). This must be the same in the problem data input, the source library, and all the cross-section libraries used in a particular problem.
SLOPE	Slope of hypotenuses of all triangular sub-areas in a particular problem (a decimal number).
SEP	Source-detector separation distance in cm (a decimal number).
YSLIB	Identification number of source library (a decimal number). Same digits appear in Columns 63 through 68 of source library cards.
THICK	Thickness of radiator in cm (a decimal number).
NPX(K)	Number of points in X-mesh for sub-area K (a positive integer: NA values).
NPY(K)	Number of points in Y-mesh for sub-area K (a positive integer: NA values).
KT(K)	Denotes rectangular (KT = 0) or triangular (KT = 1) sub-area (NA values).
XO(K)	X-coordinate of lower left corner of sub-area K in cm (a decimal number: NA values).
YO(K)	Y-coordinate of lower left corner of sub-area K in cm (a decimal number: NA values).

Problem Data (cont'd)

DELX(K) Interval between points in X-mesh of sub-area K in cm (a decimal number: NA values).

DELY(K) Interval between points in Y-mesh of sub-area K in cm (a decimal number: NA values).

ATOM(NU) Nuclear density of element NU in nuclei/cm³ (a decimal number with exponent: NUMAX values).

YLIB(NU) Library identification number of cross-section data library for element NU (a decimal number: NUMAX values).

Source Data

NE Defined under problem data.

MMAX Number of values of R for which source points are defined (a positive integer).

NMAX Number of values of α for which source points are defined (a positive integer).

R1(M) Values of R in cm at which sources are defined (a decimal number: MMAX values in increasing order).

ALPHA1(N) Values of α at which sources are defined; has units of degrees (a decimal number: NMAX values in increasing order).

S(L,M,N) Source terms (flux) for energy group L, radius R1(M), and angle ALPHA1(N) (a decimal number with exponent: NE · MMAX · NMAX values).

Cross-Section Data

LLMAX Number of terms in Legendre expansion of cross section (a positive integer).

NE Defined in problem data.

SIGEL(L) Total elastic scattering cross section for energy group L (a decimal number with exponent: NE values).

Cross-Section Data (cont'd)

F(L,LL) Group L coefficients in Legendre expansion of cross section (a decimal number with exponent: NE * LLMAX values).

Limits on Quantity of Input Data. The quantity of input data is limited by the following maximum values:

<u>Quantity Input</u>	<u>Maximum Value</u>
NA	20
NUMAX	5
LLMAX1	10
NE	15
MMAX	20
NMAX	20
LLMAX	10
NPX(K)	
Rectangular sub-area	99
Triangular sub-area	49
NPY(K)	99

Input Data Formats. Formats for preparing input data are shown in Figures 3 through 5. The first card of the problem deck contains no data. The first card of a source library has a 1 in Column 10. The first card of a cross-section library has a 2 in Column 10. With regard to entering the input on the data sheets, the following rules must be followed:

CONVAIR GENERAL DYNAMICS CORPORATION
 DEPARTMENT 6
 2700 W. 10TH AVE.
 DENVER, COLORADO 80202

DIGITAL COMPUTER DATA SHEET

CUSTOMER'S NAME: _____
 PHONE: _____
 PROJECT: _____
 SERIAL NUMBER: _____

PROBLEM TITL: **RADIATOR-SCATTERED NEUTRONS** WORK ORDER: **PROGRAM S06**

PROBLEM NO. _____

JOB NO. _____

CARD NO. _____

OFFICE NO. _____

REVISIONS

1	2	3	4	5	6	7	8	9	10	11	12	13	14	15	16	17	18	19	20	21	22
SEP	NA	NUMAX	LLMAX	NE	SLOPE																
	YSLIB	THICK																			
NPX(1)	NPX(a)																				
NPY(1)	NPY(a)																				
KT(1)	KT(a)																				
X0(1)	X0(a)																				
Y0(1)	Y0(a)																				
DELX(1)	DELX(a)																				
DELY(1)	DELY(a)																				
ATOM(1)	ATOM(a)																				
YLIB(1)	YLIB(a)																				

Figure 3. Format for Problem Data: Program S06

TITLE: RADIATOR-SCATTERED NEUTRONS PROGRAM S06

LAST DIGIT OF
CURRENT YEAR
DECK NO.
CARD NO.

1	2	3	4	5	6	7	8	9	10	11	12	13	14	15	16	17	18	19	20	21	22	23	24	25	26	27
RI(1)																										
ALPHA1(1)																										
S(1,1,1)																										
S(1,1,2)																										
S(1,1,NMAX)																										
S(2,1,1)																										
S(2,1,NMAX)																										
S(NE,1,1)																										
S(NE,1,NMAX)																										

00011 S06
0002
0003

Figure 4. Format for Source Library: Program S06

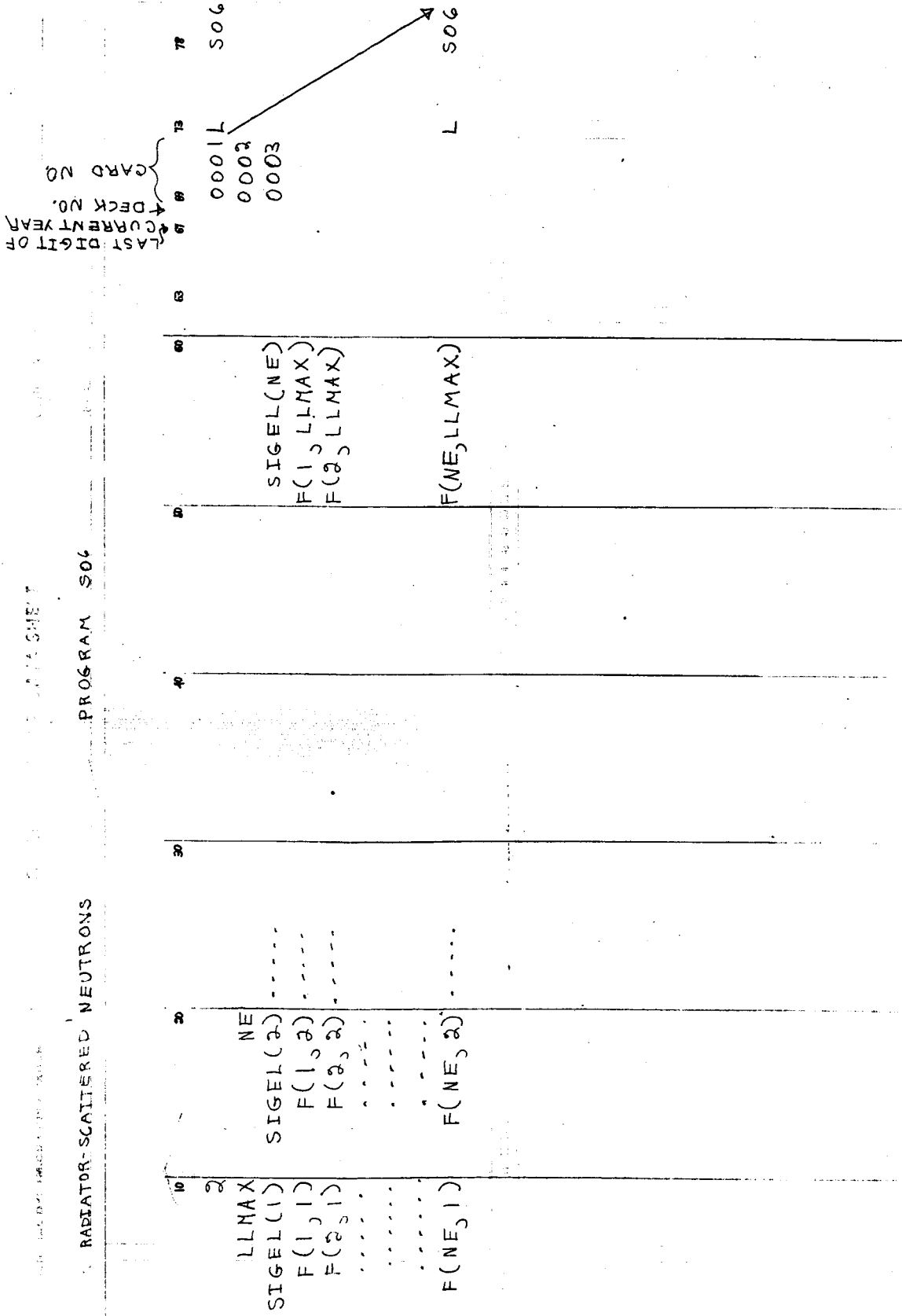

Figure 5. Format for Cross-Section Library: Program S06

1. Integers must end in the last column of a data field, i.e., Column 10, 20, 30, 40, 50, or 60.
2. A Decimal Number can end anywhere in the data field.
3. A Decimal Number with Exponent must end in the last column of a data field (2.5×10^6 would be $2.5 + 06$ or $.25 + 07$).

2.1.1.5 S06 Output Data

Output data from the program consists of the following:

1. Total flux at detector
2. Flux spectrum at detector
3. Flux from sub-areas
4. Fraction of total flux at detector from each sub-area
5. Flux spectrum at detector from each sub-area

With regard to the output data, the following should be noted:

1. If $S(L, X, Y)$ is in units of n/cm^2 -sec-Mev, then $SIGEL(L)$ and $F(L, LL)$ for each element are supplied for each energy $E(L)$; $\phi(L)$ is then the flux at the detector in units of n/cm^2 -sec-Mev and output items 1, 3, and 4 have no meaning.
2. If $S(L, X, Y)$ is in units of n/cm^2 -sec in energy group L , then $SIGEL(L)$ and $F(L, LL)$ for each element consist of their average values over energy group L ; $\phi(L)$ then has units of n/cm^2 -sec and all output items have meaning.

2.1.2 Gammas: IBM Procedure S14

A program, S14, has also been coded to calculate the radiator-scattered gamma flux. This program is described below. The FORTRAN statements are listed in Appendix C. Input and output for a sample problem are given in Appendix D. Machine operating instructions are given in Appendix E.

The geometry involved is the same as in the neutron program.

2.1.2.1 Derivation of Equation for Scattered Gamma Flux

In formulating the expression for the scattered gamma flux, the following assumptions were made:

1. Attenuation in the radiator can be neglected.
2. The gamma spectrum incident on the radiator can be represented by a number of discrete energy groups.
3. The scattered flux will consist of only single-scattered gammas.
4. An average energy can be assigned to each energy group, and this energy can be used in calculating the cross section for Compton scattering.
5. The radiation leaking from the reactor can be treated as if emitted from a point source.

With these assumptions, the scattered flux $\phi(L)$ in energy group L is given by

$$\phi(L) = t \iint_{\text{area}} \sum_{L'=1}^L \frac{S(L', X, Y)}{D^2} \Sigma(L', \theta) F(\theta, L' \rightarrow L) dXdY, \quad (8)$$

where $\phi(L)$ = scattered flux in energy group L in photons/cm²-sec;

t = thickness of radiator in cm;

S(L', X, Y) = flux in energy group L' incident on the radiator at the point (X, Y) in photons/cm²-sec;

D = distance from scattering point to detector in cm;

$\Sigma(L', \theta)$ = differential scattering cross section of radiator for group-L' photons in cm⁻¹/steradian;

F($\theta, L' \rightarrow L$) = "probability" that a group-L' photon which scatters through angle θ will end up in group-L. This will always be either zero or unity, depending on θ , L', and L.

2.1.2.2 IBM Computational Procedure

With the exception of $\Sigma(L',\theta)$ and $F(\theta,L' \rightarrow L)$, which are discussed below, the quantities in Equation 8 are calculated in the same manner as in IBM Procedure S06.

Differential Scattering Cross Section. The cosine of the scattering angle, θ , is calculated as in the neutron program (S06). The ratio of final to initial energy, $P(L)$, is then calculated by the equation

$$P(L) = 1 / [1 + \gamma_0(L)(1 - \cos\theta)], \quad (9)$$

where $\gamma_0(L) = E0(L)/0.51$, and

$E0(L)$ = average energy of group-L photons, in Mev.

The differential scattering cross section is then given by

$$\Sigma(L,\theta) = N_e \left(\frac{r_0^2}{2} \right) (P - P^2(1 - \cos^2\theta) + P^3), \quad (10)$$

where N_e = number of electrons per cm^3 in radiator,

r_0 = classical radius of electron, in cm.

Equations 9 and 10 are discussed in Reference 2.

$F(\theta,L' \rightarrow L)$. This quantity is not actually calculated. Instead, the final energy, $E1$, is calculated by

$$E1(L) = E0(L) P(L).$$

$E1$ is then successively compared with the lower-energy limits $E(L)$ of the energy groups, beginning with $L = 1$, until the group in which $E1$ lies is found. The group-L flux scattered from the point in question is then assigned to that particular group.

2.1.2.3 S14 Input Data

Definition of Input Quantities. The program input for a single problem will consist of (1) the problem data and (2) one library of source data. The library data for a given sequence of problems must be read in before the problem decks are read in. Only one source library may be read in at a time. Therefore, if several problems are to be run in sequence, they must all use the same source library.

The input quantities comprising the problem and library data are listed and defined as follows:

Problem Data

NA	Number of sub-areas (a positive integer).
NE	Number of energies (a positive integer). This must be the same in the problem data and source library.
SLOPE	Slope of the hypotenuses of all triangular sub-areas in a particular problem (a decimal number).
SEP	Source-detector separation distance, in cm (a decimal number).
YSLIB	Identification number of source library (a decimal number). Same digits as in Columns 63 through 68 of source library cards.
THICK	Thickness of radiator, in cm (a decimal number).
XNEL	Number of electrons per cm ³ in radiator (a decimal number with exponent).
NPX(K)	Number of points in X-mesh for sub-area K (a positive integer: NA values).
NPY(K)	Number of points in Y-mesh for sub-area K (a positive integer: NA values).

Problem Data (cont'd)

KT(K) Denotes rectangular (KT = 0) or triangular (KT = 1) sub-area (NA values).

XO(K) X-coordinate of lower left corner of sub-area K, in cm (a decimal number: NA values).

YO(K) Y-coordinate of lower left corner of sub-area K, in cm (a decimal number: NA values).

DELX(K) Interval between points in X-mesh of sub-area K, in cm (a decimal number: NA values).

DELY(K) Interval between points in Y-mesh of sub-area K, in cm (a decimal number: NA values).

Source Library

NE Defined under problem data.

MMAX Number of values of R for which source points are defined (a positive integer).

NMAX Number of values of α for which source points are defined (a positive integer).

R1(M) Values of R in cm at which sources are defined (a decimal number: MMAX values in increasing order).

ALPHA1(N) Values of α at which sources are defined; has units of degrees (a decimal number: NMAX values in increasing order).

EO(L) Average energy in Mev of group-L photons (a decimal number with exponent: NE values).

E(L) Lower energy bound of group L (a decimal number with exponent: NE values). It is important to note that E(L = NE) must always be zero, and the highest energy group must be Group 1.

S(L,M,N) Source term (flux) for energy group L, radius R1(M), and angle ALPHA1(N) (a decimal number with exponent: NE * MMAX * NMAX values).

Limits on Quantity of Input Data. The quantity of input data is limited by the following maximum values:

<u>Quantity Input</u>	<u>Maximum Value</u>
NA	20
NE	15
NMAX	20
MMAX	20
NPX(K)	
Rectangular sub-area	99
Triangular sub-area	49
NPY(K)	99

Input Data Formats. Formats for preparing input data are shown in Figures 6 and 7. The first card of the problem deck contains no data. The first card of a source library has a 1 in Column 10. The rules for entering input on data sheets are outlined in Section 2.1.1.

2.1.2.4 S14 Output Data

Output from the program consists of the following:

1. Total flux at detector.
2. Flux spectrum at detector.
3. Total flux and flux spectrum from each sub-area.
4. Fraction of total flux at the detector from each sub-area.

2.2 Calculations

Calculations have been carried out by use of the programs described above to determine the neutron and gamma fluxes scattered

JOB NO.	PROBLEM NO.	CARD NO.	LAST DIGIT OF CURRENT YEAR	PROGRAM	10	20	30	40	50	60	70	80
		00012	S14	RADIATOR-SCATTERED GAMMAS	NA	NE	SLOPE	SEP	YSLIB	THICK		
		0002			XNEL	NPX(2)	NPX(2)			NPX(NA)		
		0003			NPY(1)	NPY(2)	NPY(2)			NPY(NA)		
		0004			KT(1)	KT(2)	KT(2)			KT(NA)		
					XO(1)	XO(2)	XO(2)			XO(NA)		
					YO(1)	YO(2)	YO(2)			YO(NA)		
					DELX(1)	DELX(2)	DELX(2)			DELX(NA)		
					DELY(1)	DELY(2)	DELY(2)			DELY(NA)		
		2	S14									

Figure 6. Format for Problem Data: Program S14

RADIATOR-SCATTERED GAMMAS

PROGRAM S14

LAST DIGIT OF
CURRENT YEAR
DECK NO
CARD NO

10	20	30	40	50	60	70	80
1							
NE	M MAX	N MAX					
RI(1)	RI(2)				RI(M MAX)		
ALPHA(1)	ALPHA(2)				ALPHA1(N MAX)		
E(1)	E(2)			E(NE-1)	E0(NE)		
S(1,1,1)	S(1,2,1)				S(1, M MAX, 1)		
S(1,1,2)	S(1,2,2)				S(1, M MAX, 2)		
S(1,1,N MAX)	S(1,2,N MAX)				S(1, M MAX, N MAX)		
S(2,1,1)	S(2,2,1)				S(2, M MAX, 1)		
S(2,1,N MAX)	S(2,2,N MAX)				S(2, M MAX, N MAX)		
S(NE,1,1)	S(NE,2,1)				S(NE, M MAX, 1)		
S(NE,1,N MAX)	S(NE,2,N MAX)				S(NE, M MAX, N MAX)		

0001 L
0002
0003

S14

S14

Figure 7. Format for Source Library: Program S14

from the radiators of typical unshielded SNAP-8-powered spacecraft having rectangular- and triangular-shaped radiators. Results of these calculations are discussed in the subsections that follow.

2.2.1 Geometry of Radiator Systems

Two radiator configurations based on specifications given in Reference 1 were treated: the "flat" configuration shown on page 7 and the "Y" configuration shown on page 11. The flat configuration consists of two rectangular-shaped radiators lying opposite one another in the same plane, one on each side of the axis of the spacecraft. The Y configuration consists of three triangular-shaped radiators mounted radially about the spacecraft axis, each with the same axial position.

The geometries used in these calculations are shown in Figures 8a and 8b. Calculations were performed for a single radiator of each configuration, so that the total flux would then be twice the flux from a single radiator in the flat configuration and three times the flux from a single radiator in the Y configuration. The circled numbers in Figure 8 indicate the detector locations used in the calculations. Detector 1 coincides with the location of the scientific payload, Detector 2 with that of the ion-propulsion-system propellant tank.

For purposes of calculation, the radiators in both configurations were assumed to consist entirely of aluminum and to be 0.45-cm thick. (By the present method of calculation, the scattered flux is directly proportional to radiator thickness.)

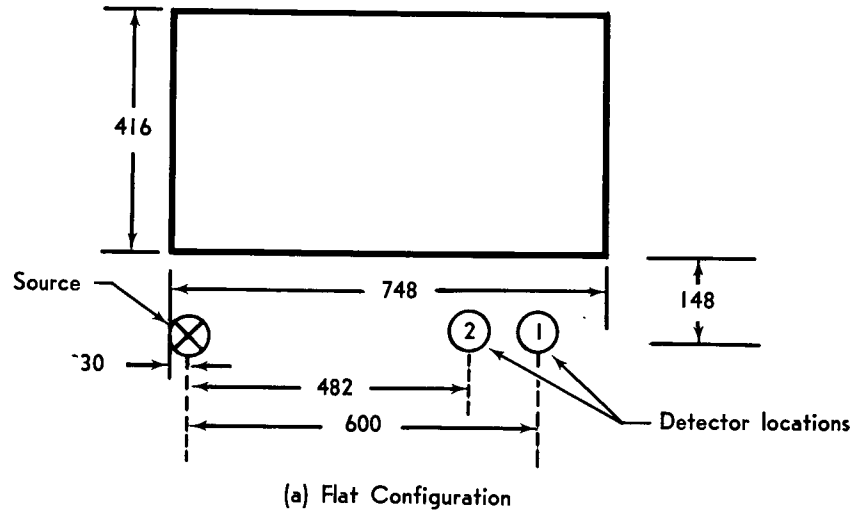

All dimensions in centimeters

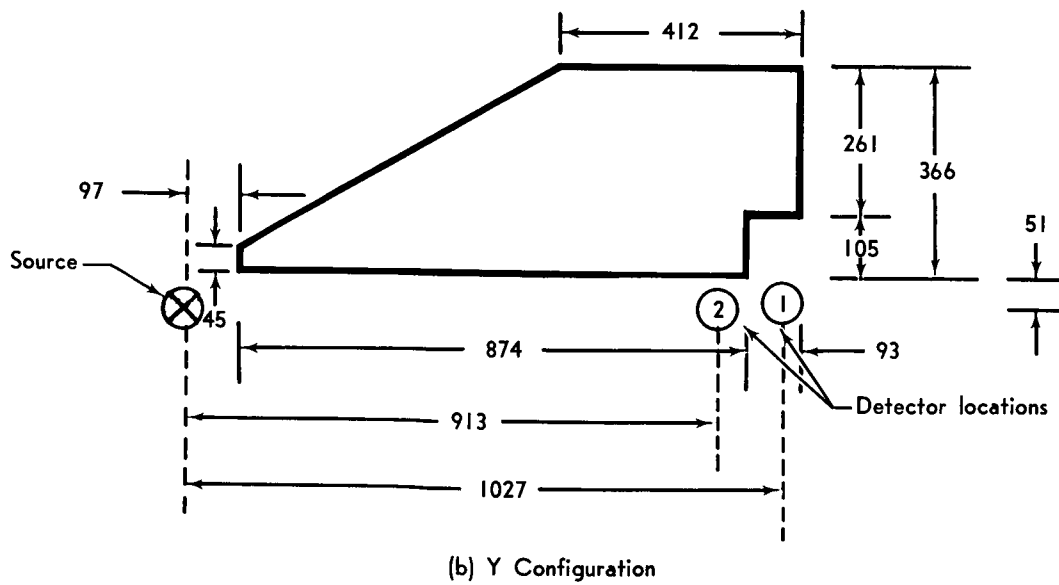

Figure 8. Radiator Geometries Used in Calculations

2.2.2 Source Terms

2.2.2.1 Method of Calculating

Both neutron and gamma source terms were obtained by use of the GD/FW shield penetration program, C-17 (Ref. 3). The reactor core was treated as a number of point sources. The output from this program consists of differential fluxes (particles/cm²-sec-Mev-power unit) and dose rates. However, the radiator-scattered gamma calculation (S14) requires that the source terms consist of fluxes (particles/cm²-sec-power unit) instead of differential fluxes. In order to use in the S14 program the gamma source data generated by the C-17 program, the following procedure was used:

1. The differential gamma spectrum at each radius and angle was normalized to the value at 0.25 Mev.
2. An average normalized spectrum was calculated from the normalized spectra obtained in Step 1. This was possible since the normalized spectra were all quite similar in shape.
3. The average normalized spectrum was then integrated over energy intervals to obtain relative group fluxes. The flux-weighted energy for each energy group was also calculated.
4. The group fluxes (photons/cm²-sec-watt) at each angle and radius were then obtained by multiplying the differential flux at 0.25 Mev for each angle and radius by the relative group fluxes calculated in Step 3.

The source terms required by the S06 program for the neutron calculations are the differential fluxes calculated by the C-17 shield penetration program. Since results obtained from the radiator-scattered neutron program (S06) were the scattered differential

fluxes at each detector, it was necessary to integrate these results over energy to obtain the total scattered fluxes.

The neutron and gamma source terms for an unshielded SNAP-8 reactor are given in Tables I and II.

2.2.2.2 Reactor Geometry and Composition

The composition and geometry of the unshielded SNAP-8 reactor, as used for input to the shield penetration program, were obtained from References 4 and 5 and are indicated below. Dimensions are in centimeters.

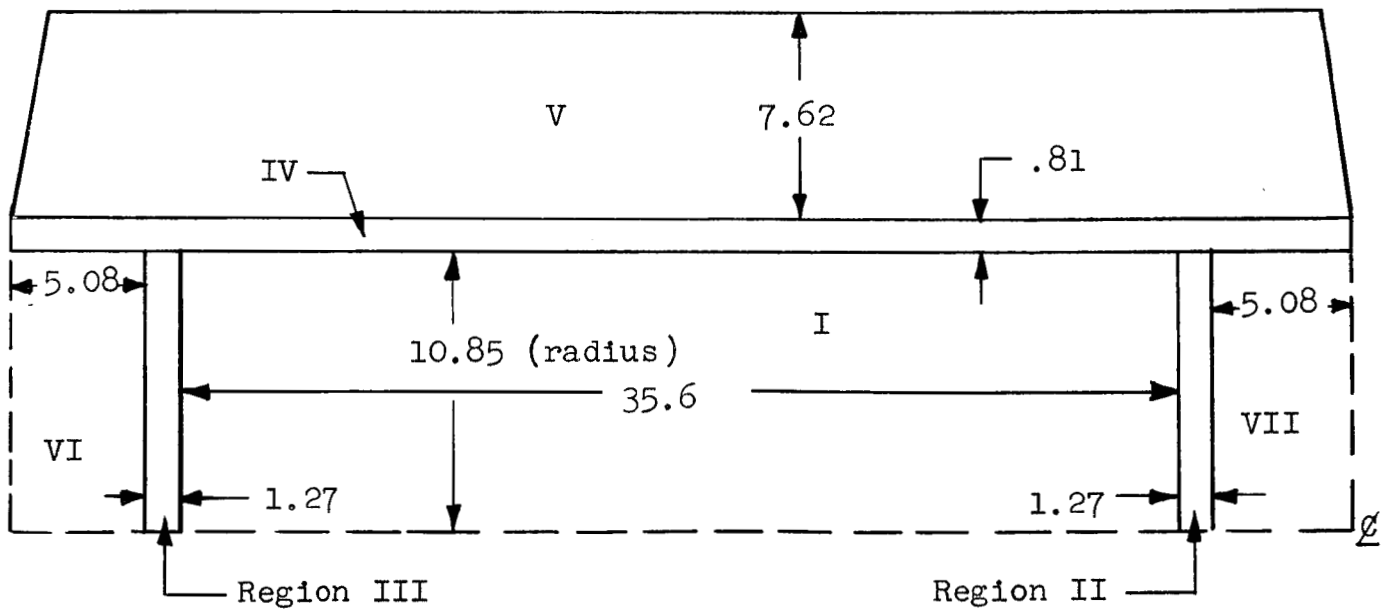

The Roman numerals indicate region numbers. The composition of each region is as follows:

<u>Region</u>	<u>Material</u>	<u>Density (gm/cm³)</u>
I (core)	NaK	0.0705
	H	0.0898
	Zr	4.82
	U-235	0.596
	Hastelloy-N	0.082
II, III, IV	Fe	8.0
V	Be	1.84
VI, VII	Al	0.74

2.3 Results

2.3.1 Flux and Dose

For an unshielded SNAP-8 reactor, the single scattered neutron and gamma spectra at the payload (Detector 1 in Figure 8) are given in Figures 9 and 11. For purposes of comparison, the unshielded direct-beam neutron and gamma spectra at the same detector positions are shown in Figures 10 and 12. The direct-beam spectra were obtained from the source data in Tables I and II. The integrated neutron fluxes and gamma dose rates are given in Tables III and IV. It should be pointed out that the unshielded dose rates and fluxes reported are those from a single radiator multiplied by 2 in the flat configuration and by 3 in the Y configuration. A reactor power of 600 kw thermal was assumed. The neutron elastic scattering cross sections and coefficients for the Legendre expansions for aluminum were taken from Reference 6.

TABLE I
 NEUTRON SOURCE TERMS FOR UNSHIELDED SNAP-8 REACTOR
 (neutrons/cm²-sec-Mev-watt)

α (deg)	R (cm)	Energy (Mev)									
		.33	1.0	2.0	3.0	4.0	6.0	8.0	10.0	14.0	18.0
0	24	2.72(6)	1.64(6)	1.02(6)	6.11(5)	3.55(5)	1.06(5)	3.18(4)	8.20(3)	2.54(2)	8.57(0)
	180	2.18(4)	1.32(4)	8.34(3)	5.12(3)	3.04(3)	9.43(2)	3.69(2)	1.14(2)	2.41(0)	7.48(-2)
	305	7.24(3)	4.38(3)	2.77(3)	1.71(3)	1.01(3)	3.16(2)	1.27(2)	4.00(1)	8.15(-1)	2.51(-2)
	650	1.53(3)	9.30(2)	5.89(2)	3.63(2)	2.16(2)	6.76(1)	2.77(1)	8.86(0)	1.76(-1)	5.36(-3)
	7000	1.32(1)	8.01(0)	4.33(0)	3.13(0)	1.87(0)	5.83(-1)	2.37(-1)	7.64(-2)	1.51(-3)	4.62(-5)
30	24	8.97(6)	2.57(6)	1.33(6)	2.76(5)	1.19(5)	2.82(4)	6.28(3)	1.35(3)	5.82(1)	1.92(0)
	180	9.43(4)	2.62(4)	1.35(4)	2.81(3)	1.22(3)	2.87(2)	6.31(1)	1.35(1)	5.73(-1)	1.86(-2)
	305	3.27(4)	9.08(3)	4.68(3)	9.69(2)	4.19(2)	9.87(1)	2.17(1)	4.62(0)	1.94(-1)	6.27(-3)
	650	7.14(3)	1.98(3)	1.02(3)	2.11(2)	9.14(1)	2.15(1)	4.72(0)	1.00(0)	4.24(-2)	1.37(-3)
	7000	6.16(1)	1.71(1)	8.99(0)	1.82(0)	7.88(-1)	1.85(-1)	4.07(-2)	8.62(-3)	3.66(-4)	1.18(-5)
60	24	6.83(6)	1.93(6)	9.90(5)	1.90(5)	8.30(4)	1.98(4)	4.44(3)	9.67(2)	4.28(1)	1.44(0)
	180	1.11(5)	3.15(4)	1.62(4)	3.06(3)	1.34(3)	3.22(2)	7.26(1)	1.59(1)	7.06(-1)	2.39(-2)
	305	3.92(4)	1.14(4)	5.70(3)	1.09(3)	4.72(2)	1.14(2)	2.58(1)	5.66(0)	2.53(-1)	8.57(-3)
	650	8.65(3)	2.45(3)	1.26(3)	2.41(2)	1.06(2)	2.54(1)	5.73(0)	1.26(0)	5.64(-2)	1.91(-3)
	7000	7.46(1)	2.11(1)	1.09(1)	2.08(0)	9.14(-1)	2.19(-1)	4.94(-2)	1.09(-2)	4.83(-4)	1.65(-5)
90	24	7.53(6)	2.20(6)	1.14(6)	2.27(5)	9.87(4)	2.38(4)	5.41(3)	1.19(3)	5.31(1)	1.81(0)
	180	1.42(5)	4.11(4)	2.14(4)	4.31(3)	1.86(3)	4.46(2)	1.01(2)	2.23(1)	9.99(-1)	3.42(-2)
	305	4.92(4)	1.43(4)	7.41(3)	1.49(3)	6.44(2)	1.54(2)	3.50(1)	7.70(0)	3.45(-1)	1.18(-2)
	650	1.08(4)	3.12(3)	1.62(3)	3.26(2)	1.41(2)	3.37(1)	7.64(0)	1.68(0)	7.52(-2)	2.57(-3)
	7000	9.31(1)	2.69(1)	1.40(1)	2.81(0)	1.22(0)	2.91(-1)	6.59(-2)	1.45(-2)	6.48(-4)	2.25(-5)
120	24	6.83(6)	1.93(6)	9.90(5)	1.90(5)	8.30(4)	1.98(4)	4.44(3)	9.67(2)	4.28(1)	1.44(0)
	180	1.11(5)	3.15(4)	1.62(4)	3.06(3)	1.34(3)	3.22(2)	7.26(1)	1.59(1)	7.06(-1)	2.39(-2)
	305	3.92(4)	1.14(4)	5.70(3)	1.09(3)	4.72(2)	1.14(2)	2.58(1)	5.66(0)	2.53(-1)	8.57(-3)
	650	8.65(3)	2.45(3)	1.26(3)	2.41(2)	1.06(2)	2.54(1)	5.73(0)	1.26(0)	5.64(-2)	1.91(-3)
	7000	7.46(1)	2.11(1)	1.09(1)	2.08(0)	9.14(-1)	2.19(-1)	4.94(-2)	1.09(-2)	4.83(-4)	1.65(-5)

TABLE II
 GAMMA SOURCE TERMS FOR UNSHIELDED SNAP-8 REACTOR
 (photons/cm²-sec-watt)

α (deg)	R (cm)	Energy Range (Mev)													
		9-10	8-9	7-8	6-7	5-6	4-5	3-4	2-3	1.5-2.0	1.0-1.5	.75-1.0	.50-.75	.25-.50	0-.25
0	24	1.79(3)	1.92(4)	3.40(4)	4.67(4)	8.12(4)	1.62(5)	4.51(5)	1.40(6)	1.39(6)	2.28(6)	1.81(6)	3.10(6)	7.53(6)	1.09(7)
	180	1.40(1)	1.50(2)	2.65(2)	3.65(2)	6.33(2)	1.27(3)	3.52(3)	1.09(4)	1.09(4)	1.78(4)	1.41(4)	2.42(4)	5.89(4)	8.50(4)
	305	4.61(0)	4.95(1)	8.75(1)	1.20(2)	2.09(2)	4.18(2)	1.16(3)	3.60(3)	3.59(3)	5.85(3)	4.68(3)	7.90(3)	1.94(4)	2.80(4)
	650	9.81(-1)	1.05(1)	1.86(1)	2.56(1)	4.45(1)	8.90(1)	2.47(2)	7.66(2)	7.65(2)	1.25(3)	9.93(2)	1.70(3)	4.13(3)	5.98(3)
	7000	8.45(-3)	9.10(-2)	1.60(-1)	2.21(-1)	3.83(-1)	7.67(-1)	2.13(0)	6.60(0)	6.55(0)	1.08(1)	8.65(0)	1.45(1)	3.55(1)	5.15(1)
30	24	4.37(2)	4.69(3)	8.29(3)	1.14(4)	1.98(4)	3.96(4)	1.10(5)	3.41(5)	3.40(5)	5.55(5)	4.42(5)	7.55(5)	1.84(6)	2.65(6)
	180	8.36(0)	8.97(1)	1.59(2)	2.18(2)	3.79(2)	7.59(2)	2.11(3)	6.53(3)	6.50(3)	1.07(4)	8.48(3)	1.45(4)	3.53(4)	5.10(4)
	305	2.97(0)	3.19(1)	5.64(1)	7.75(1)	1.35(2)	2.69(2)	7.49(2)	2.32(3)	2.31(3)	3.78(3)	3.00(3)	5.15(3)	1.64(4)	1.81(4)
	650	6.60(-1)	7.08(0)	1.25(1)	1.72(1)	2.99(1)	5.99(1)	1.66(2)	5.15(2)	5.15(2)	8.40(2)	6.68(2)	1.14(3)	2.78(3)	4.03(3)
	7000	5.70(-3)	6.11(-2)	1.08(-1)	1.49(-1)	2.58(-1)	5.17(-1)	1.44(0)	4.45(0)	4.43(0)	7.25(0)	5.78(0)	9.85(0)	2.40(1)	3.48(1)
60	24	9.47(2)	1.00(4)	1.78(4)	2.44(4)	4.24(4)	8.49(4)	2.36(5)	7.31(5)	7.30(5)	1.19(6)	9.48(5)	1.62(6)	3.93(6)	5.70(6)
	180	1.47(1)	1.58(2)	2.80(2)	3.85(2)	6.68(2)	1.34(3)	5.72(3)	1.15(4)	1.88(4)	1.49(4)	1.88(4)	2.55(4)	6.20(4)	8.98(4)
	305	5.15(0)	5.53(1)	9.78(1)	1.35(2)	2.33(2)	4.67(2)	1.30(3)	4.02(3)	4.00(3)	6.55(3)	5.23(3)	8.93(3)	2.17(4)	3.13(4)
	650	1.13(0)	1.21(1)	2.15(1)	2.95(1)	5.13(1)	1.03(2)	2.85(2)	8.83(2)	8.80(2)	1.44(3)	1.15(3)	1.96(3)	4.75(3)	6.88(3)
	7000	9.76(-3)	1.05(-1)	1.85(-1)	2.55(-1)	4.43(-1)	8.86(-1)	2.46(0)	7.62(0)	7.60(0)	1.24(1)	9.88(0)	1.69(1)	4.10(1)	5.95(1)
90	24	1.03(3)	1.09(4)	1.93(4)	2.66(4)	4.61(4)	9.23(4)	2.57(5)	7.94(5)	7.94(5)	1.30(6)	1.03(6)	1.76(6)	4.28(6)	6.20(6)
	180	1.78(1)	1.91(2)	3.38(2)	4.65(2)	8.08(2)	1.62(3)	4.49(3)	1.39(4)	1.39(4)	2.27(4)	1.80(4)	3.08(4)	7.48(4)	1.08(5)
	305	6.15(0)	6.60(1)	1.17(2)	1.60(2)	2.79(2)	5.58(2)	1.55(3)	4.80(3)	4.80(3)	7.80(3)	6.23(3)	1.07(4)	2.58(4)	3.75(4)
	650	1.35(0)	1.45(1)	2.56(1)	3.52(1)	6.11(1)	1.22(2)	3.40(2)	1.05(3)	1.05(3)	1.73(3)	1.36(3)	2.33(3)	5.65(3)	8.20(3)
	7000	1.16(-2)	1.25(-1)	2.21(-1)	3.03(-1)	5.27(-1)	1.05(0)	2.93(0)	9.07(0)	9.07(0)	1.48(1)	1.18(1)	2.01(1)	4.89(1)	7.08(1)
120	24	9.47(2)	1.00(4)	1.78(4)	2.44(4)	4.24(4)	8.49(4)	2.36(5)	7.31(5)	7.30(5)	1.19(6)	9.48(5)	1.62(6)	3.93(6)	5.70(6)
	180	1.47(1)	1.58(2)	2.80(2)	3.85(2)	6.68(2)	1.34(3)	5.72(3)	1.15(4)	1.88(4)	1.49(4)	1.88(4)	2.55(4)	6.20(4)	8.98(4)
	305	5.15(0)	5.53(1)	9.78(1)	1.35(2)	2.33(2)	4.67(2)	1.30(3)	4.02(3)	4.00(3)	6.55(3)	5.23(3)	8.93(3)	2.17(4)	3.13(4)
	650	1.13(0)	1.21(1)	2.15(1)	2.95(1)	5.13(1)	1.03(2)	2.85(2)	8.83(2)	8.80(2)	1.44(3)	1.15(3)	1.96(3)	4.75(3)	6.88(3)
	7000	9.76(-3)	1.05(-1)	1.85(-1)	2.55(-1)	4.43(-1)	8.86(-1)	2.46(0)	7.62(0)	7.60(0)	1.24(1)	9.88(0)	1.69(1)	4.10(1)	5.95(1)

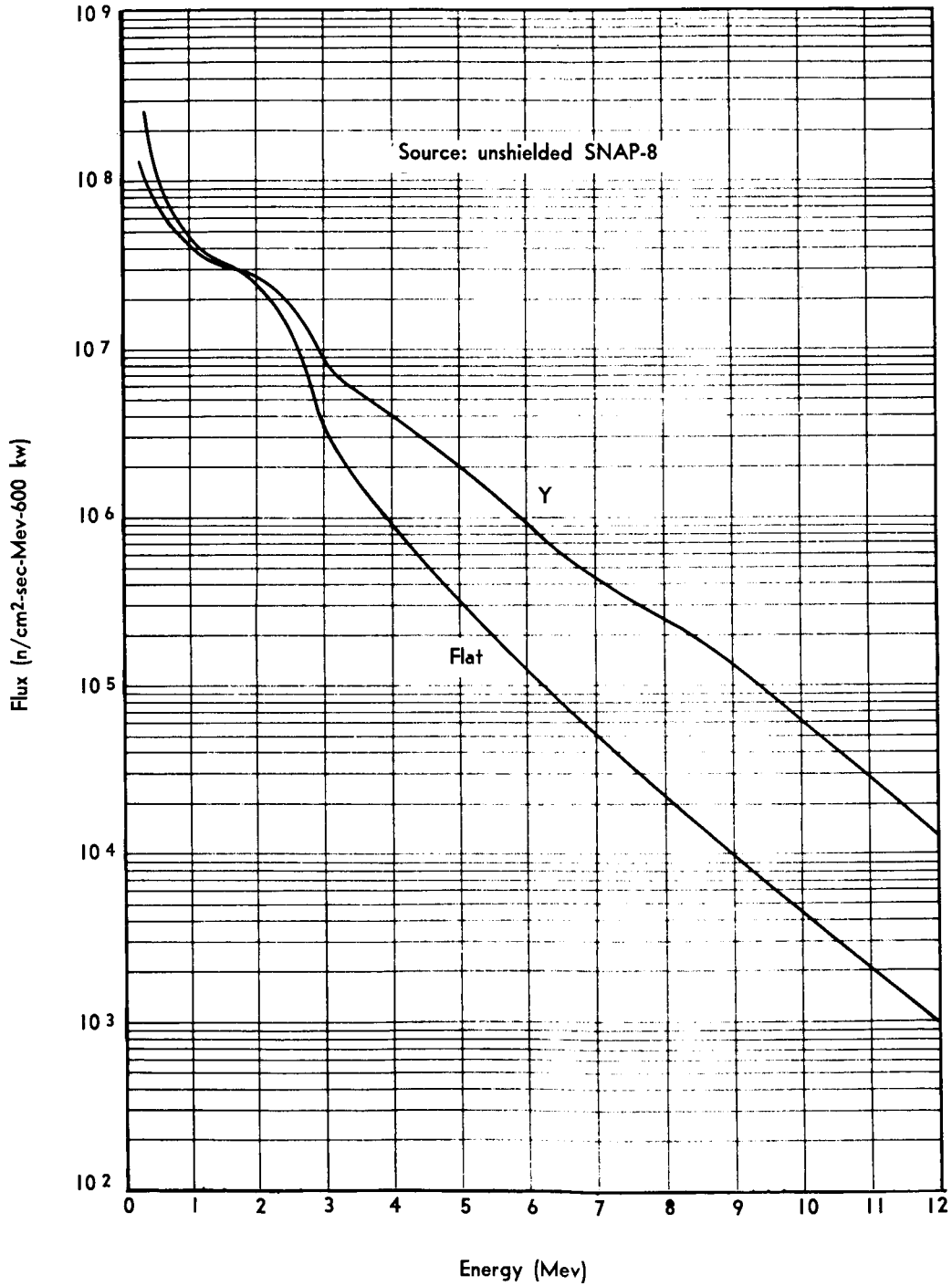

Figure 9. Single-Scattered Neutron Spectra at Payload for Flat and Y Configurations

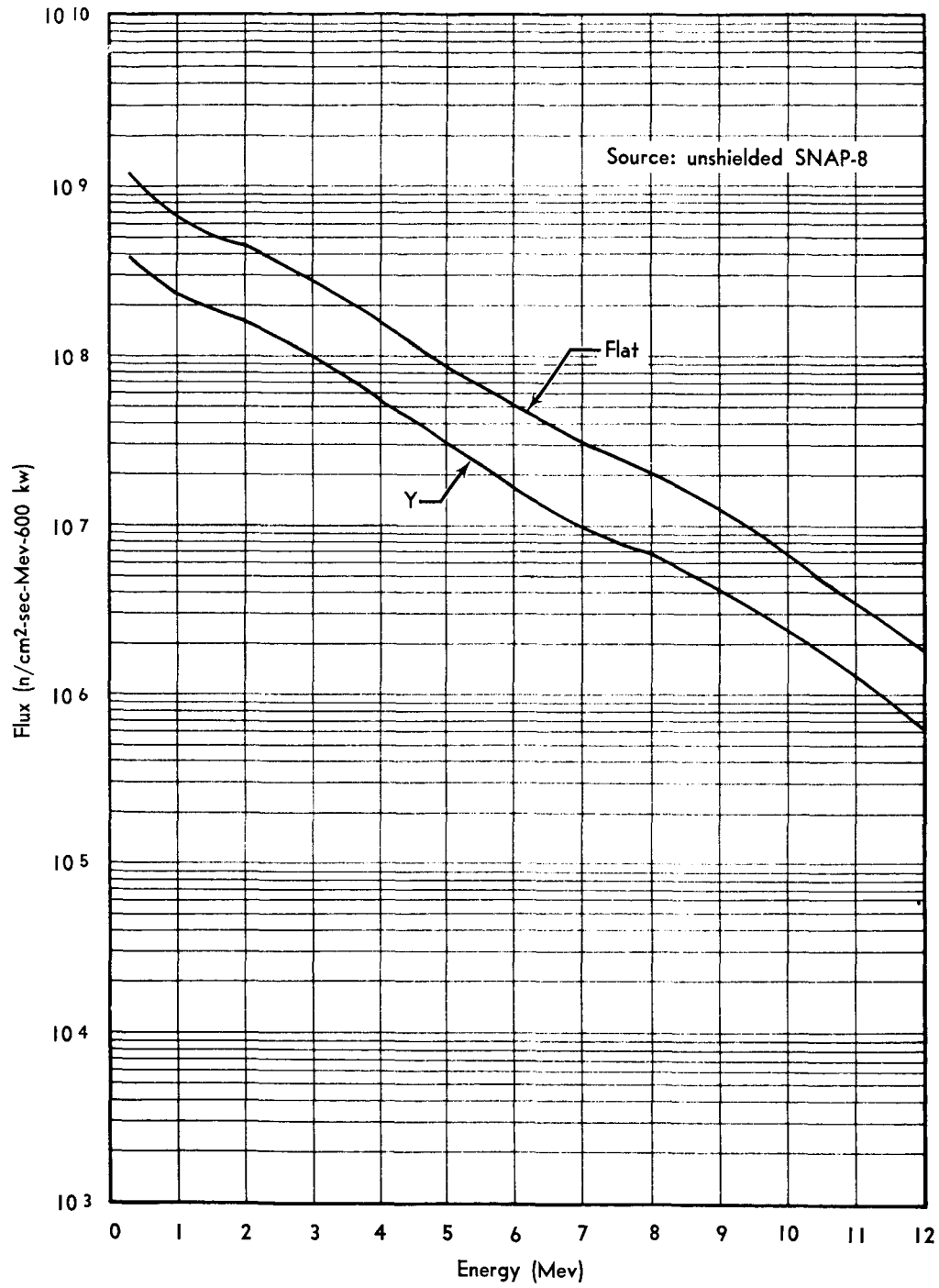

Figure 10. Direct-Beam Neutron Spectra at Payload for Flat and Y Configurations

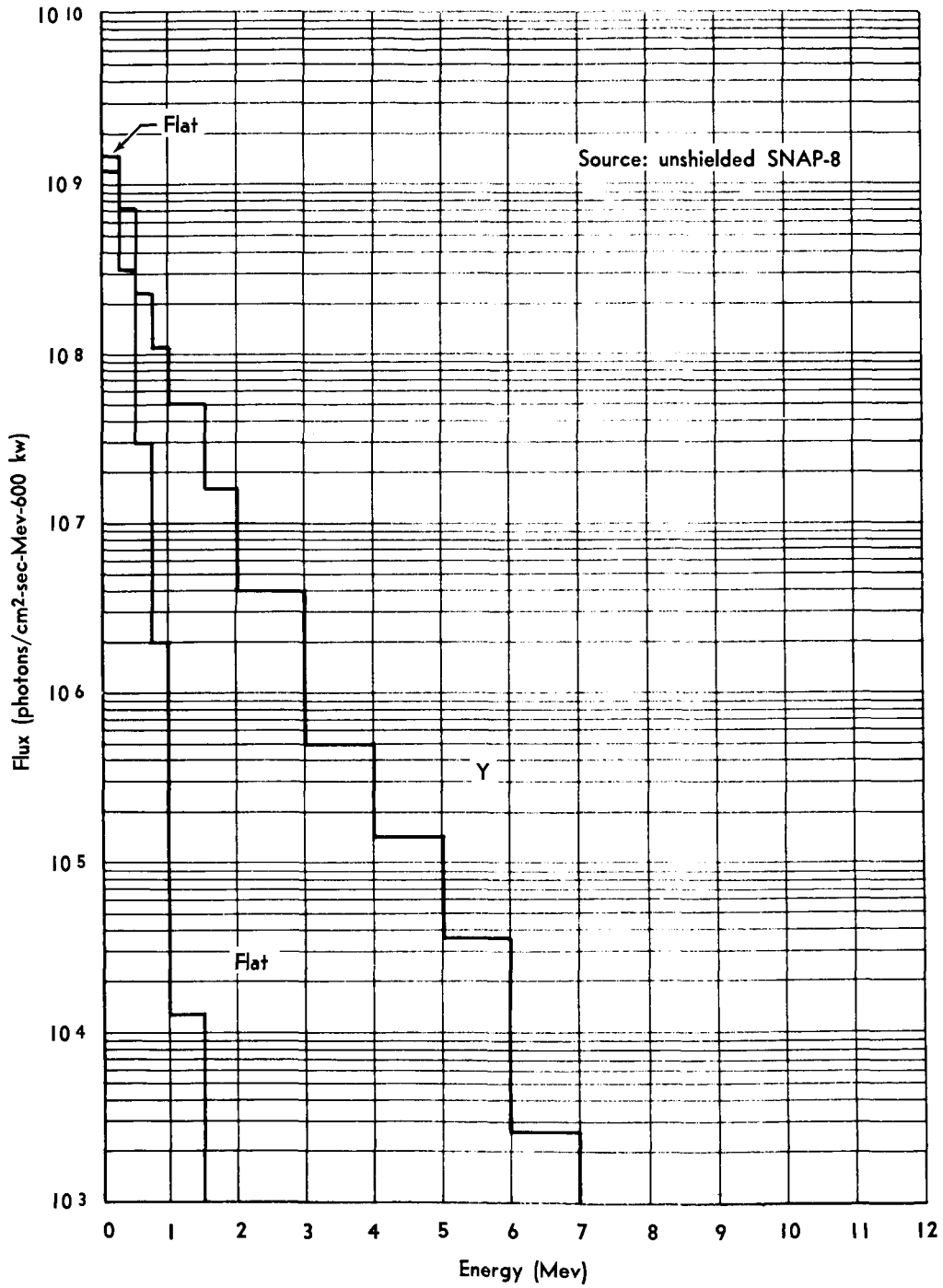

Figure 11. Single-Scattered Gamma Spectra at Payload for Flat and Y Configurations

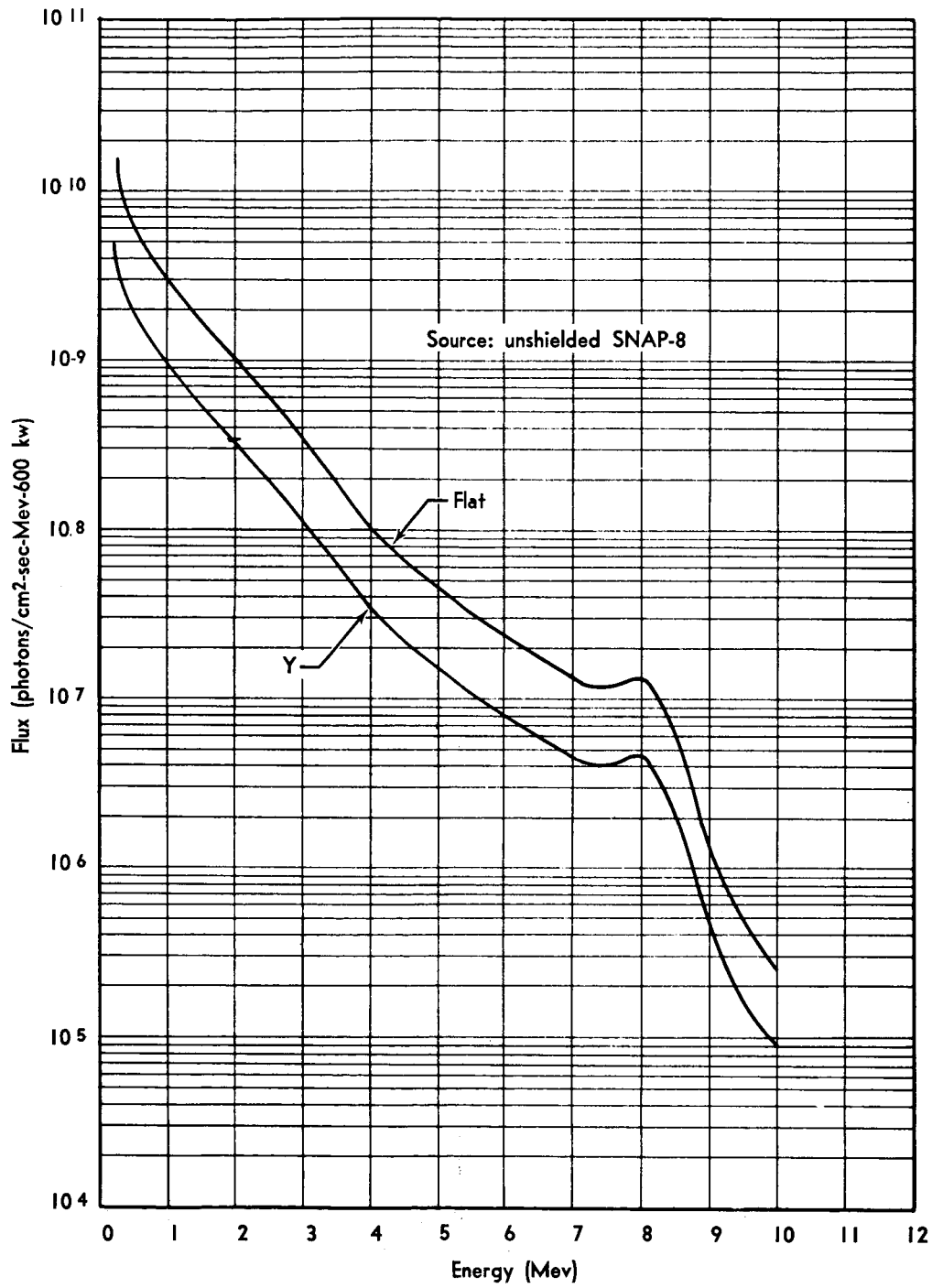

Figure 12. Direct-Beam Gamma Spectra at Payload for Flat and Y Configurations

TABLE III

TOTAL NEUTRON FLUX ABOVE 0.33 MEV
(neutrons/cm²-sec-600 kw)

	Flat Configuration	Y Configuration
At Payload		
Scattered	1.2×10^8	1.1×10^8
Direct Beam	2.6×10^9	8.9×10^8
At Propellant Tank		
Scattered	1.5×10^8	1.7×10^8
Direct Beam	4.0×10^9	1.1×10^9

TABLE IV

GAMMA DOSE RATES
(r/hr-600 kw)

	Flat Configuration	Y Configuration
At Payload		
Scattered	1.5×10^2	4.3×10^2
Direct Beam	1.3×10^4	4.3×10^3
At Propellant Tank		
Scattered	1.7×10^2	5.4×10^2
Direct Beam	2.0×10^4	5.4×10^3

The scattered gamma dose rates were obtained by the following expression:

$$\text{DOSE} = \sum_i f_i \phi_i,$$

where ϕ_i = group i gamma flux,

f_i = flux-to-dose conversion factor, approximated from the curve on page 19 of Reference 7.

The direct-beam dose rates were obtained from the C-17 shield penetration program results.

2.3.2 Relative Importance of Radiator Regions

Of interest is the relative importance of various segments of the radiator with regard to scattering. With the flat configuration divided into three equal areas, as shown below, the percentage of total scattered neutron flux above 0.33 Mev contributed by each area is as follows: area 1, 70%; area 2, 20%; and area 3, 10%. The percentage of scattered gamma dose rate contributed by each area is: for area 1, 73%; for area 2, 19%; and for area 3, 8%.

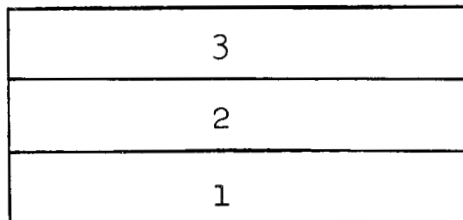

⊘

Next, consider the source-detector scattering surface arrangement shown below, where area A = area B.

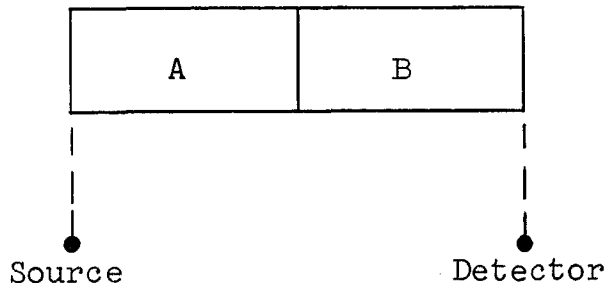

For an angular-independent source term that varies as $1/r^2$, it can be shown that the scattered fluxes contributed by areas A and B are equal. This is true because, for a given scattering "point" in area A, there will be a "point" in area B for which the scattering angle and geometric attenuation from source to detector will be equal to the scattering angle and total geometric attenuation, respectively, for area A.

2.4 Discussion of Results

2.4.1 Limitations

The most important limitations on the radiator scattering calculations are:

1. Neglect of attenuation in the radiator.
2. Consideration only of single scattering.
3. Uncertainties in the source terms, particularly the neutron source term.

The errors introduced by the first two limitations compensate each other to some degree. It is not certain that the effects of either are significant.

Attenuation is neglected because accounting for it would require either that the reactor be treated as a number of source points or that a detailed knowledge of the angular distribution of the radiation leaving the reactor surface be obtained and an integration performed over the surface of the reactor. The latter approach would be the better of the two but, at present, methods are not available which would give the necessary angular distribution of leakage radiation. It should be pointed out that, while the reactor is assumed to be a point source as far as the geometry involved in the scattering calculations is concerned, the source terms used in the scattering calculations were obtained by treating the reactor core as a number of point sources.

In using the shield penetration program (C17, Ref. 3) for calculating neutron fluxes from systems which consist of both hydrogenous and nonhydrogenous materials, one is faced with certain basic limitations inherent in the application of moments method data to neutron penetration calculations. The most important of these are:

1. Difficulty in choosing the proper reference material.
2. Uncertainties due to boundary effects.

This points out the importance of more sophisticated methods for determining neutron source terms.

A reasonable estimate of the error introduced by the assumptions and uncertainties discussed above cannot be made.

2.4.2 General Observations

From Reference 1, page 5, the total allowed radiation doses in the payload area are 10^{13} n/cm² and 10^9 ergs/gm(C) for neutrons and gammas, respectively. For a 10^4 -hour operating period, the maximum allowable neutron flux and gamma dose rate are then 2.8×10^5 n/cm²-sec and 10^3 r/hr, respectively. By comparing these numbers with those in Tables III and IV, one can see that, in the particular spacecraft treated in these calculations, it will be necessary to shield against both scattered and direct-beam neutrons. The gamma shielding required will depend on the gamma attenuation offered by the neutron shielding.

Since the scattering cross section for aluminum decreases with increasing neutron energy and its differential elastic scattering becomes highly anisotropic with increasing neutron energy, it is the low-energy neutrons leaking from the reactor that contribute most of the scattered flux. One can see this by comparing the shapes of the scattered and direct-beam neutron spectra, bearing in mind that energy loss due to scattering is negligible. This is fortunate, since it is easier to shield against low-energy neutrons than against those of high energy.

Conclusions and recommendations with regard to radiator scattering are discussed in Section 4.1 of this report.

III. DIRECT-BEAM SHIELDING

Shielding against direct-beam radiation has been studied from the standpoint of reducing the required shielding by either splitting or uniformly expanding the shield in order to increase the transverse leakage of radiation scattered within the shield. The effect of shield placement has also been considered. Results of Monte Carlo calculations performed at GD/FW to investigate shield expansion are presented, and the results of calculations performed by the Technical Research Group to study shield splitting are discussed. Thus far, the GD/FW study of direct-beam shielding has been confined to neutrons.

3.1 Expanded-Shield Studies

3.1.1 Geometry

The geometry for the expanded-shield calculations is shown below.

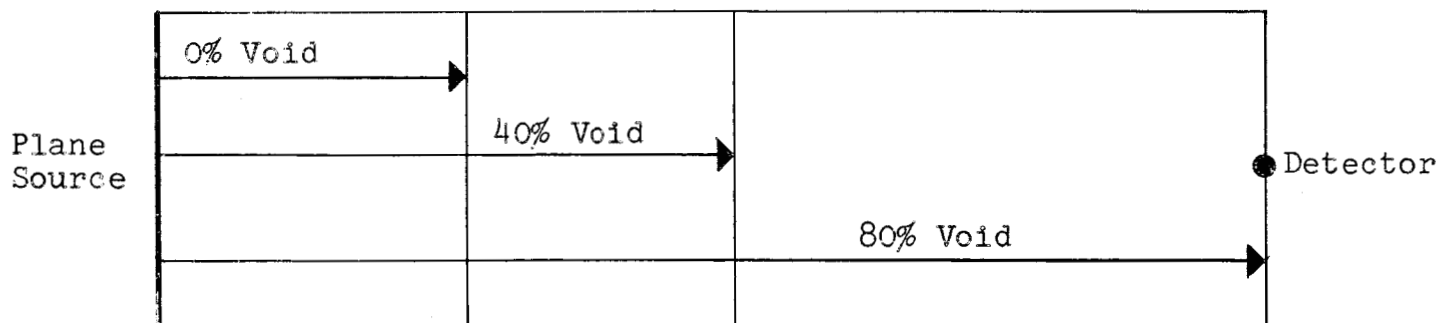

The shield was assumed to be a right circular cylinder of polyethylene, 12 inches in diameter, which was uniformly expanded until 40% and 80% void fractions were achieved. Initial shield thicknesses of 9, 27,

and 60 cm were considered. For each of these solid-shield thicknesses, the source-detector separation distance was assumed to be equal to the thickness of the shield when expanded to 80% void. The total mass of each shield was assumed to remain constant.

3.1.2 Source

The energy spectrum of the source was taken to be the same as that leaking from a typical nuclear rocket engine reactor. Although this spectrum differs considerably from that of the SNAP-8 reactor, the general conclusions drawn from this study should be applicable.

Two source angular distributions - isotropic and monodirectional - were treated.

3.1.3 Method of Calculation

IBM procedure K97, a Monte Carlo program, was used to make the calculations. A complete description of the calculational method is presented in Reference 8.

3.1.4 Results

Uncollided, scattered, and total dose rates per source neutron per second are presented in Figures 13 through 18 as a function of void percent for both source angular distributions and each initial shield thickness. The uncollided dose rates were calculated by conventional methods. The number of neutrons that leak from the side of the shield per source neutron as a function of void percent is shown in Figures 19 and 20 for a plane isotropic source and a plane monodirectional source, respectively.

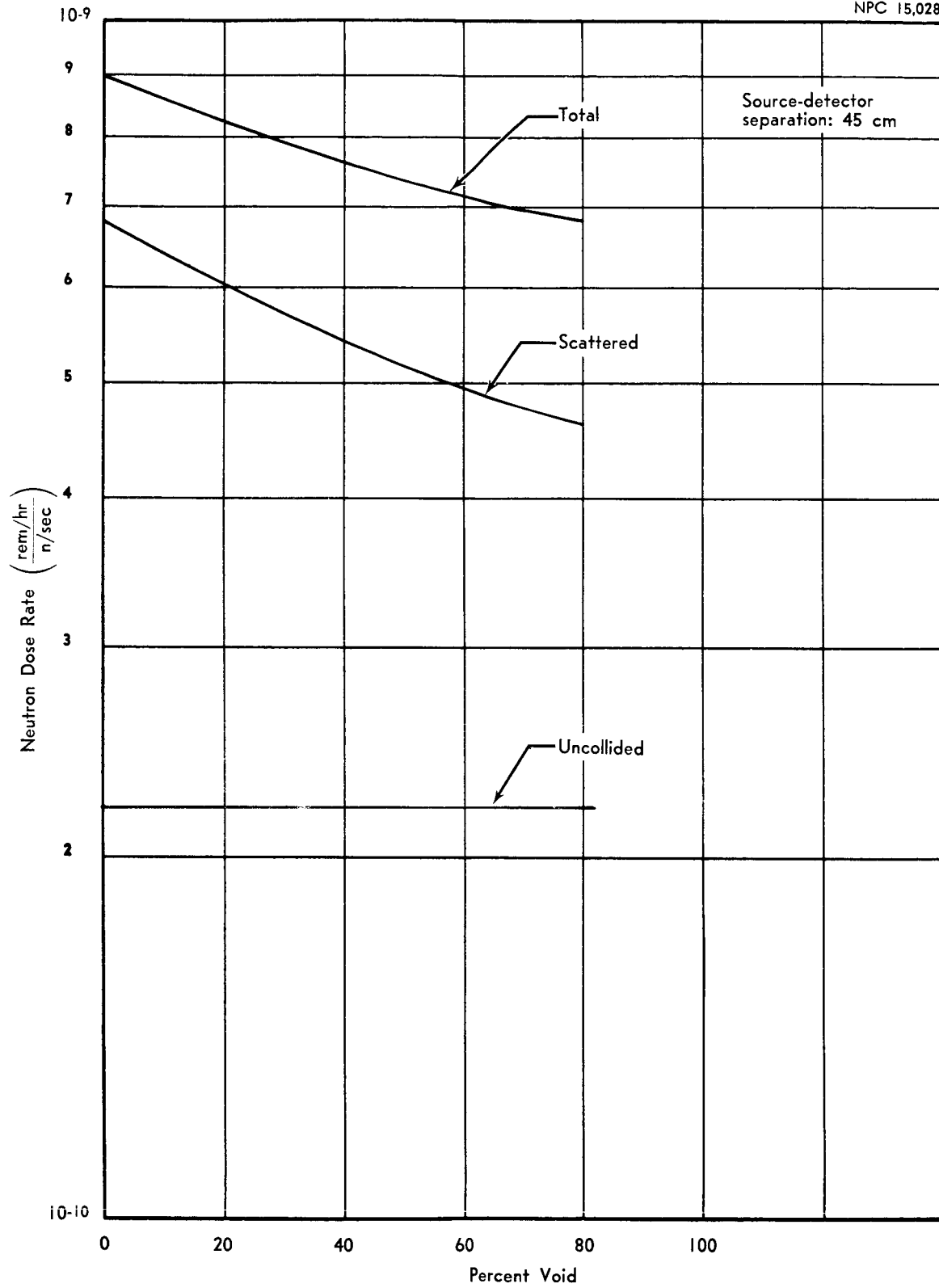

Figure 13. Effect of Expanding 9-cm Polyethelene Shield: Plane Isotropic Source

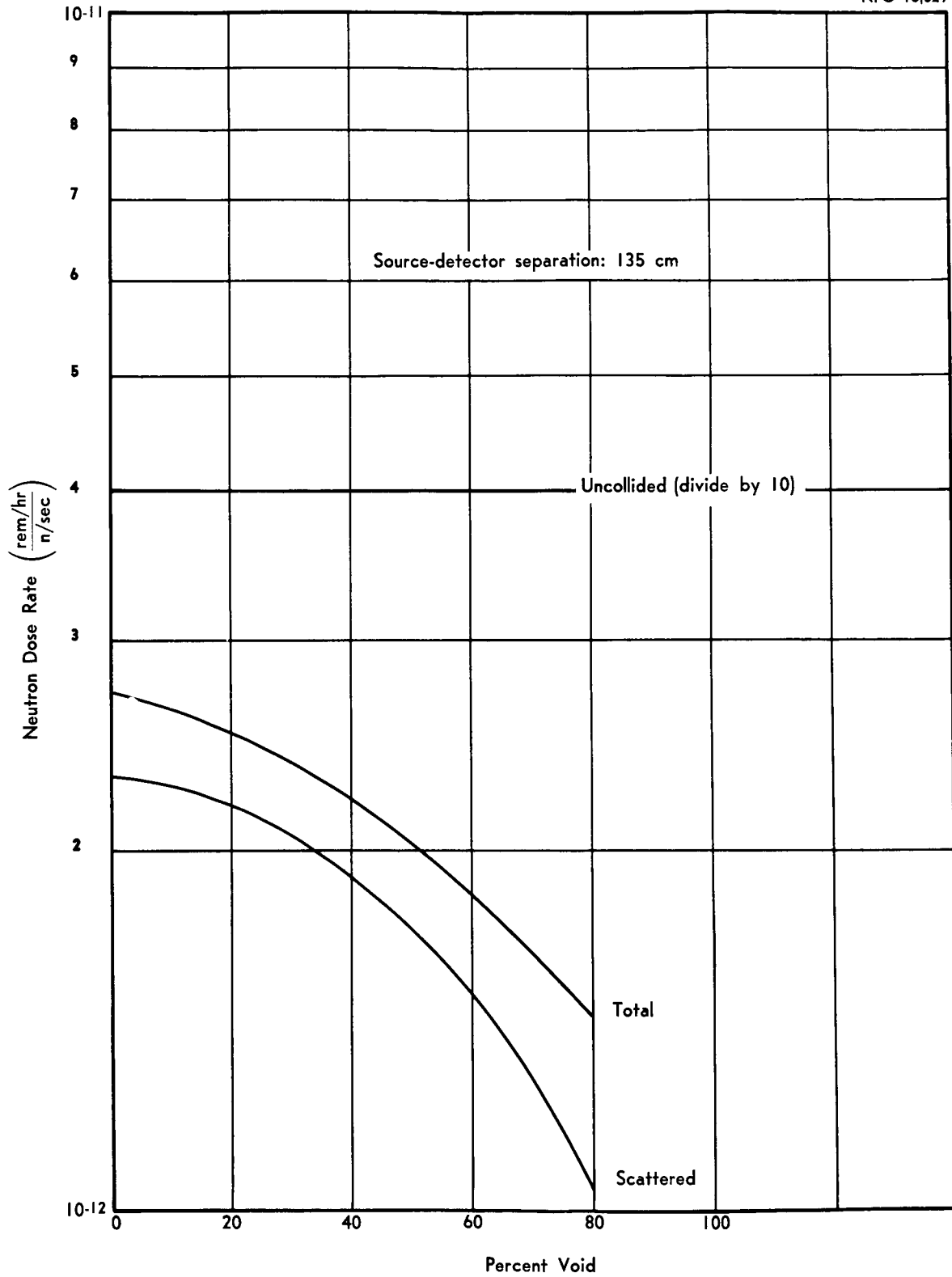

Figure 14. Effect of Expanding 27-cm Polyethelene Shield: Plane Isotropic Source

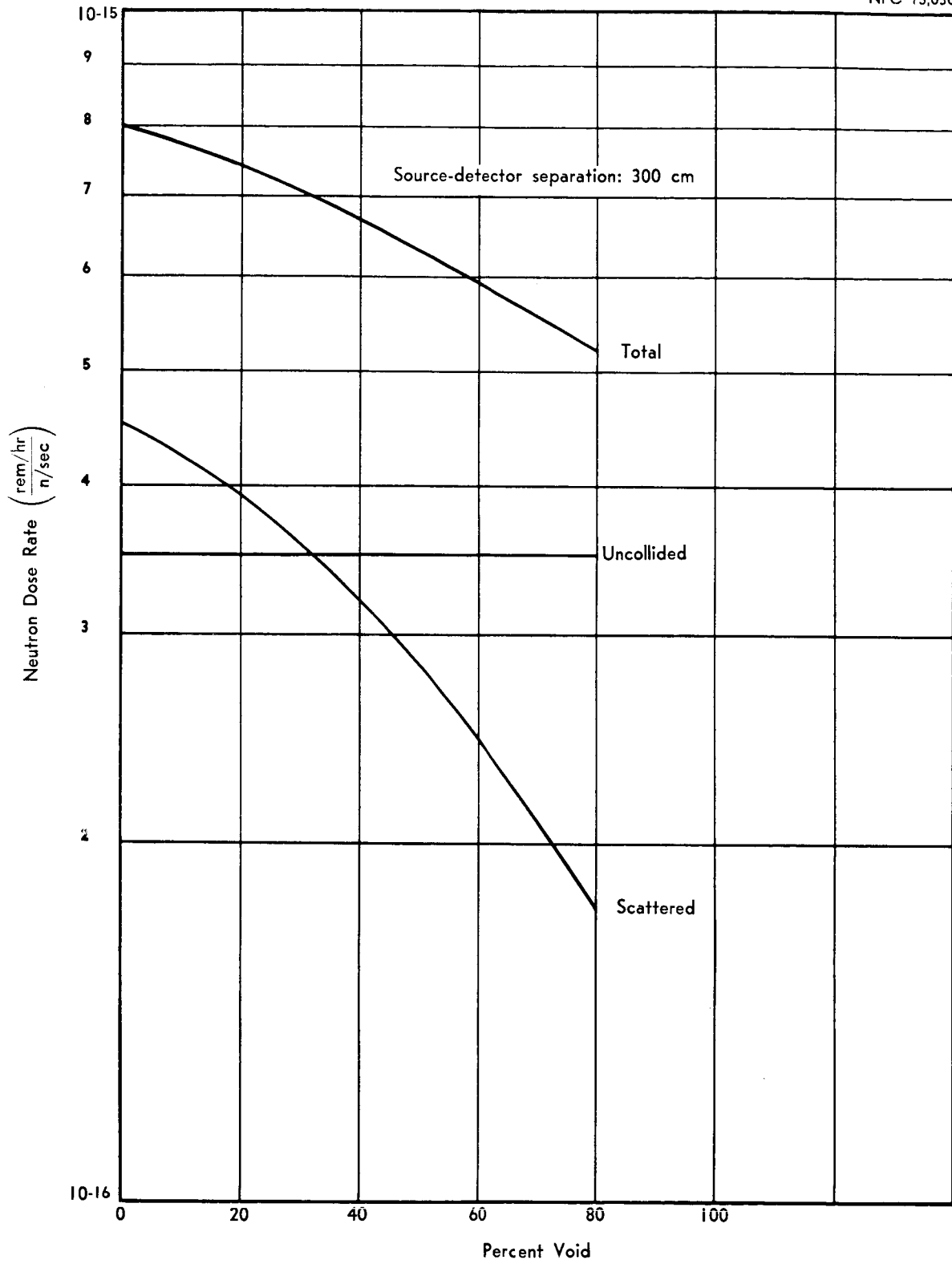

Figure 15. Effect of Expanding 60-cm Polyethylene Shield: Plane Isotropic Source

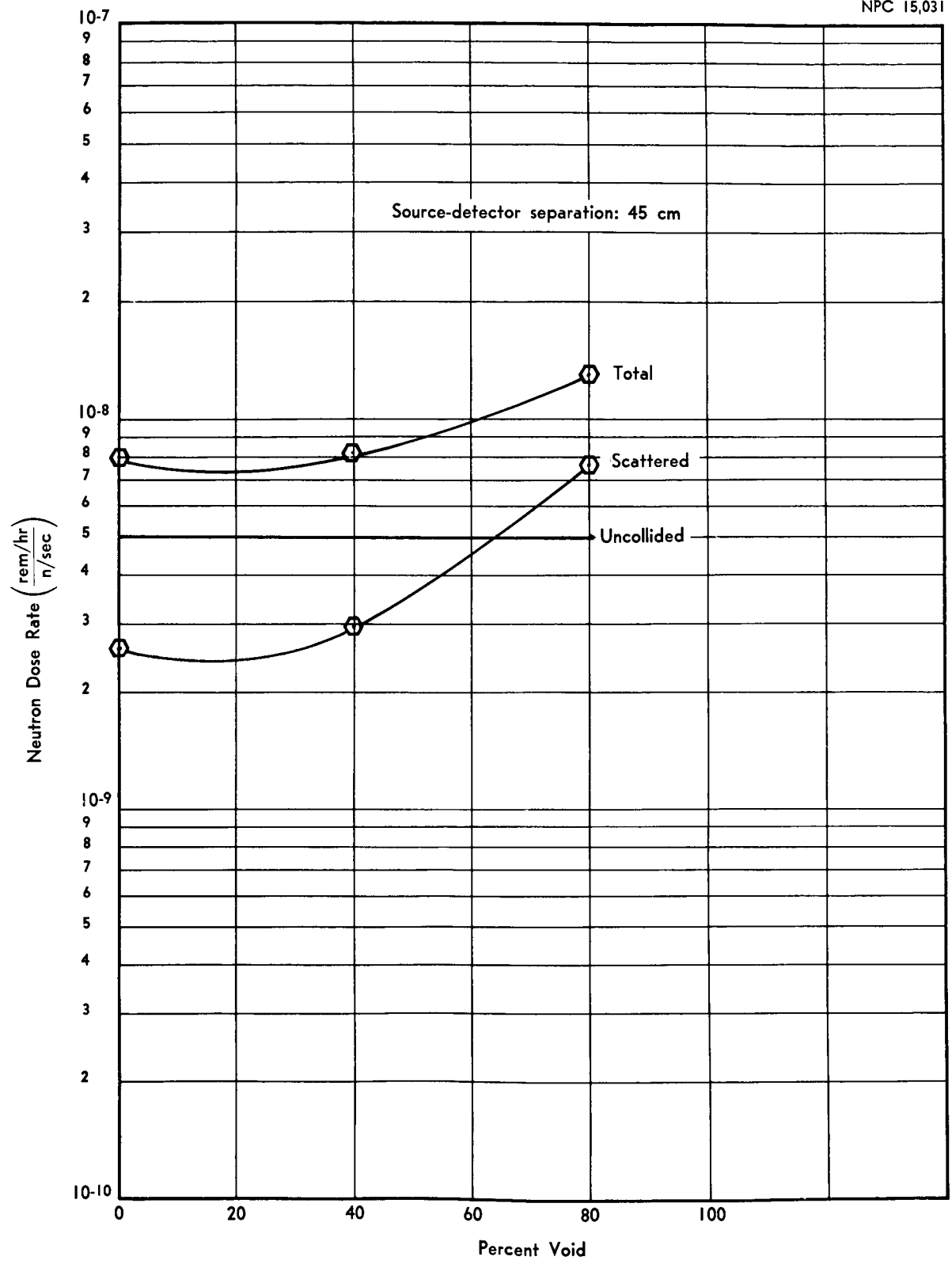

Figure 16. Effect of Expanding 9-cm Polyethelene Shield: Plane Monodirectional Source

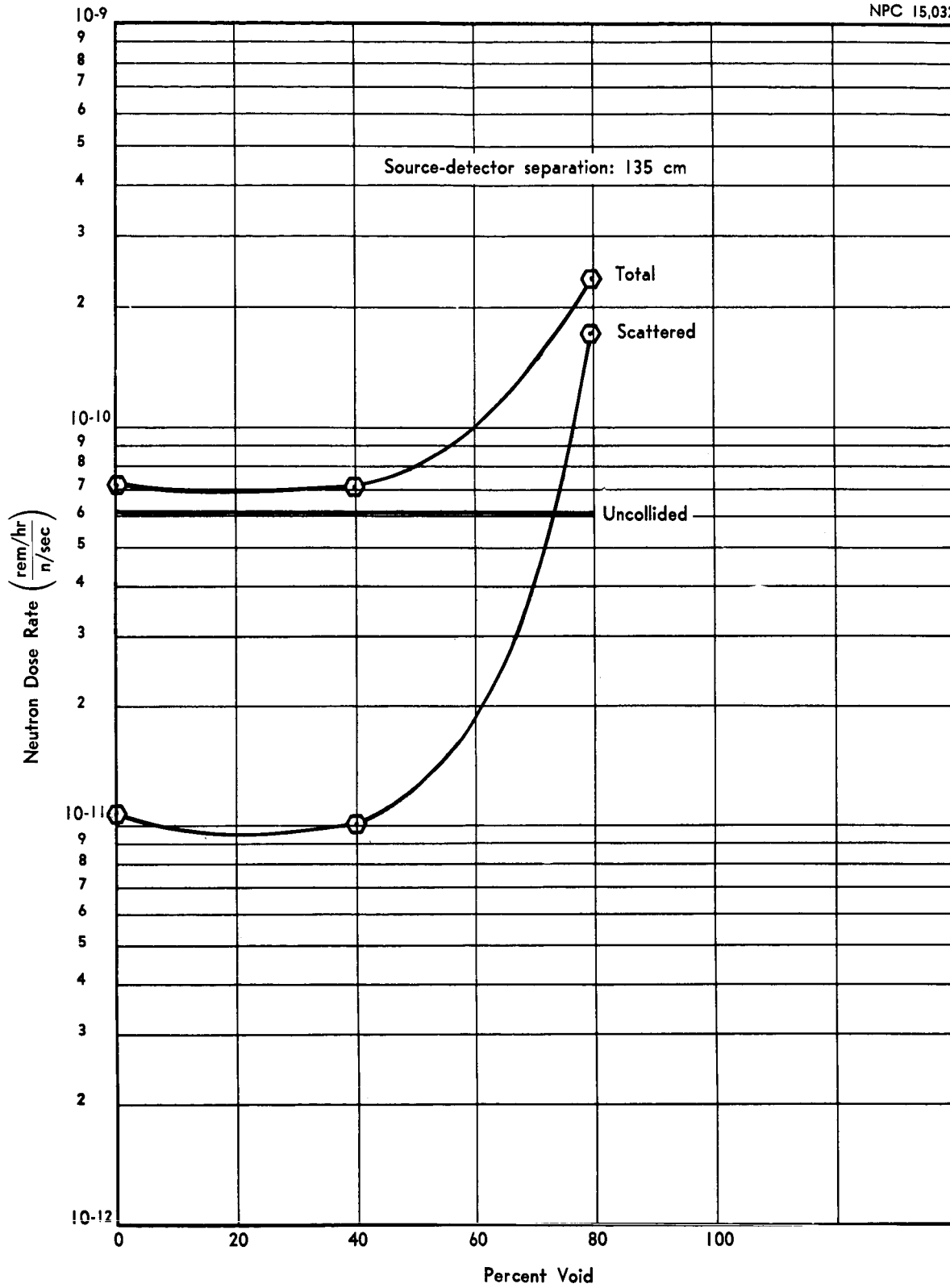

Figure 17. Effect of Expanding 27-cm Polyethelene Shield: Plane Monodirectional Source

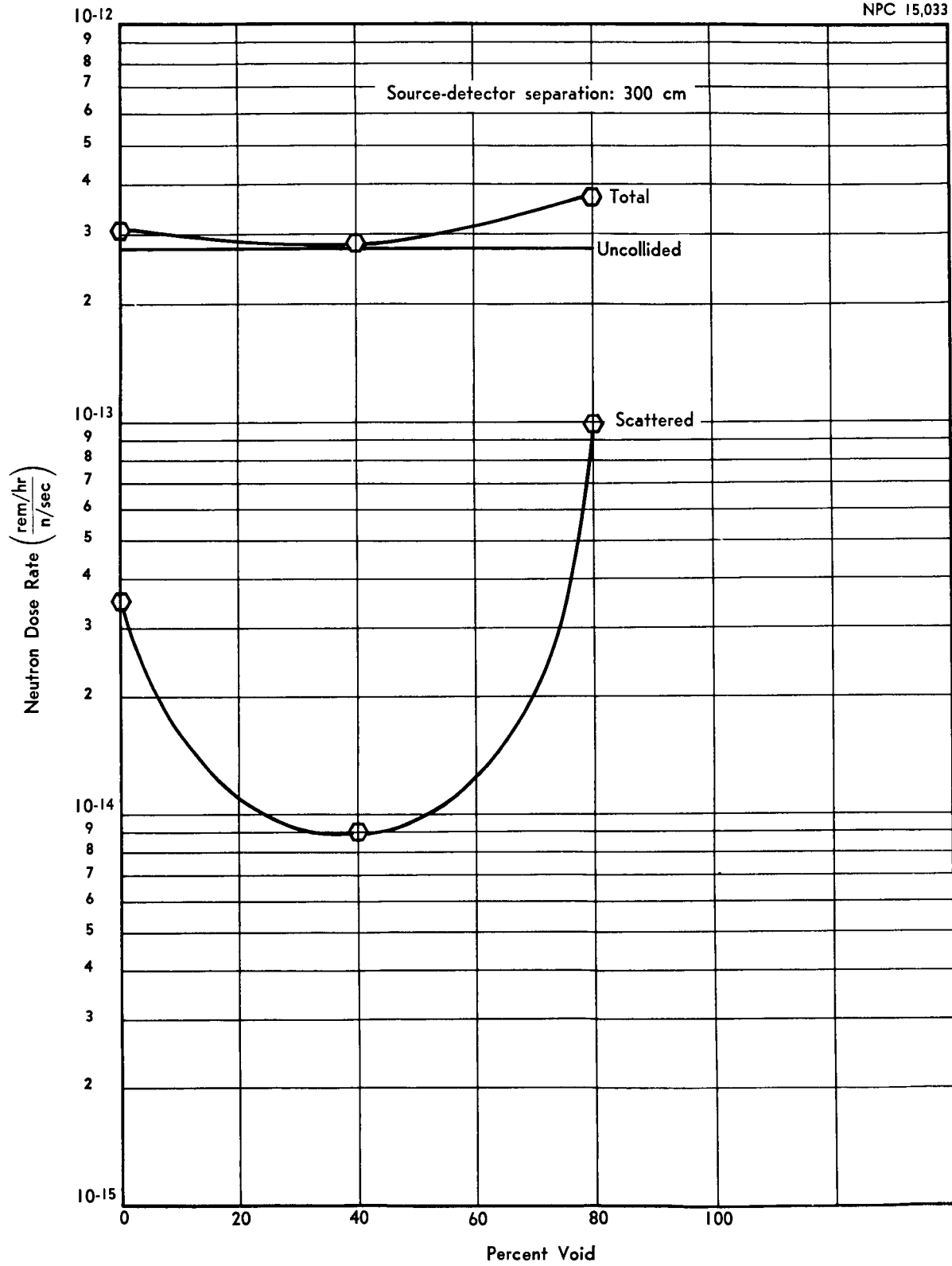

Figure 18. Effect of Expanding 60-cm Polyethylene Shield: Plane Monodirectional Source

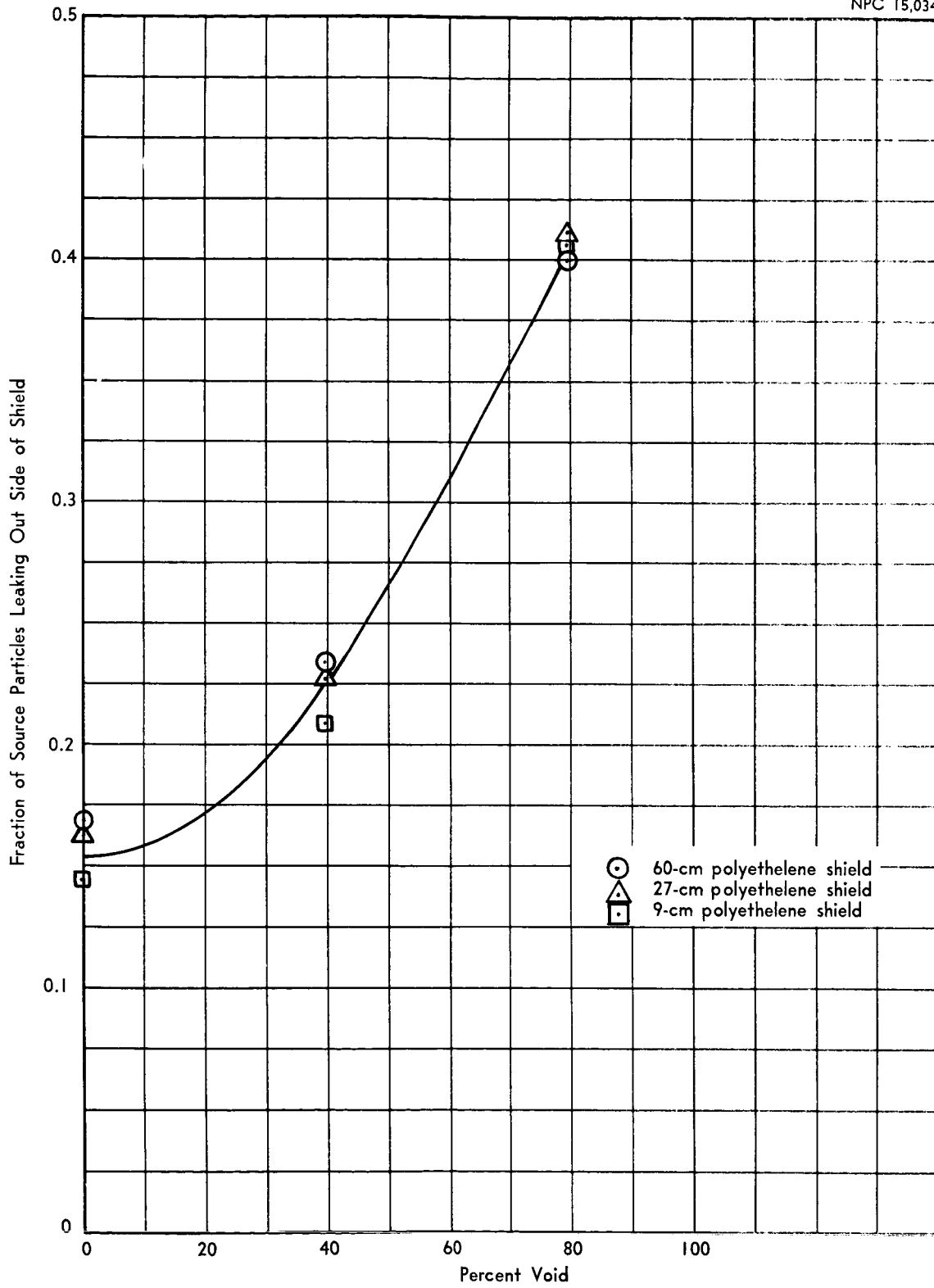

Figure 19. Transverse Neutron Leakage for Plane Isotropic Source

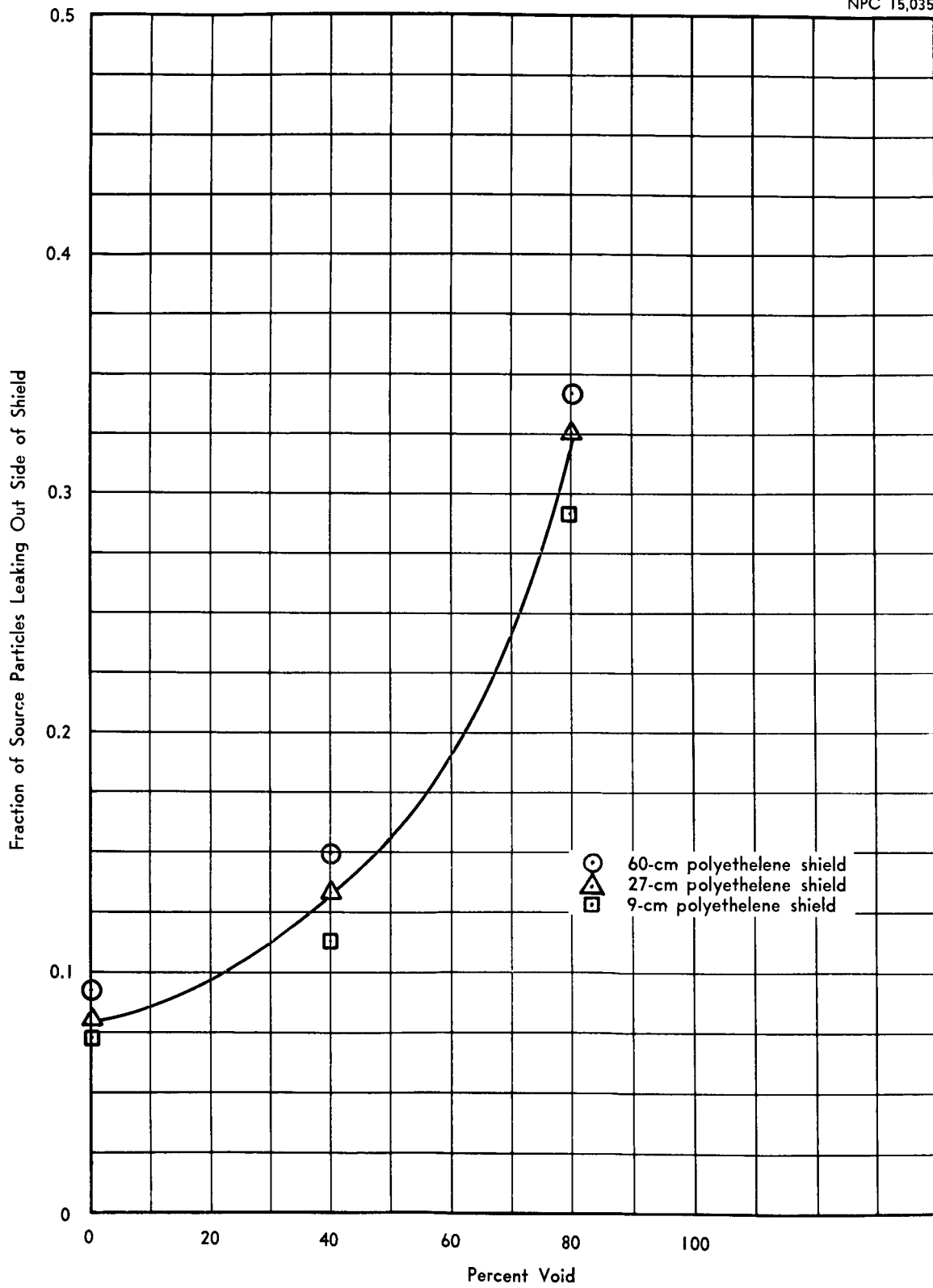

Figure 20. Transverse Neutron Leakage for Plane Monodirectional Source

Figures 13 through 15 indicate that the total dose rate from a plane isotropic source is reduced by expanding the shield. With an isotropic source the effectiveness of shield expansion is expected to be at a maximum when the source is located at the face of a hydrogenous material, since scattering is predominantly in the forward direction. If the source were located a large distance from the shield, the incident radiation would be more normal and the effect of expansion would be reduced.

The high magnitude of the uncollided dose rate relative to the total dose rate for the 60-cm case (Fig. 15) is felt to be caused by the source energy spectrum. For small thicknesses of polyethylene, the major contribution to the dose at the detector results from neutrons which originate at the source with energies of less than 5.0 Mev. A 40.0-cm thickness of polyethylene, however, removes most of those neutrons with energies below 5.0 Mev. Since the scattering cross section decreases as the energy increases, the uncollided dose rate becomes more important for polyethylene thicknesses greater than 40 cm. This latter effect would not be as noticeable for the SNAP-8 spectrum, since this spectrum is harder than that used in the calculation reported here.

Figures 16 and 17 indicate that, for shield thickness of 9 and 27 cm and for a monodirectional source, the effect of expanding the shield toward the detector is to increase the dose rate. This is because the effect of moving scattering points closer to the detector is greater than that of increasing the transverse leakage.

Figure 18 indicates that for a plain monodirectional source and a 60-cm shield thickness, the result of expanding the shield toward the detector is, first, to decrease and, then, to increase the scattered dose. This is probably due to the larger source-detector separation distance used in this case. With a 40% expansion, the fractional change in separation distance between scattering points closer to the source, where the scattering is highest, is less than that in the other cases which used shorter source-detector separation distances. The increase in transverse leakage due to a 40% expansion, therefore, compensates for the decrease in geometric attenuation, which results from moving scattering points closer to the source. With further expansion, the effect of moving the scattering points closer to the detector is greater than the increase in transverse leakage and the dose-rate increases. If the distance from shield to detector had been held constant and the shield expanded toward the source, the opposite effect would have been observed since the scattering points would be moving farther from the detector. This illustrates the importance of proper placement of the shield with respect to source and detector.

Figures 19 and 20 indicate that most of the increase in transverse leakage due to expansion is due to expansion of the first few mean free paths of the solid shield. This is especially true for the isotropic source, as can be noted by the fact that the data for the three shield thicknesses are quite close together.

Since those neutrons which leak from the side of the shield could reach the detector by scattering off radiators or other structure, it may be necessary to consider them in calculating the radiator-scattered dose rates for a composite shield configuration. The spectrum of neutrons leaking from the shield would be softer than the source spectrum, since neutrons from the shield would have undergone collisions in a moderating medium. The spectrum at the detector due to these neutrons would be even softer, as indicated by the discussion in Section 2.4.2.

The results just discussed indicate that it is possible to obtain significant reduction in neutron dose rate by expanding the direct-beam shield, but that the effect of expansion is dependent on several factors, the more important of which are angular distribution of source, initial (solid) shield thickness, and source-detector separation distance. The effect of expansion will also be dependent on other factors which were not specifically covered in this study. These would be shielding material, source energy spectrum, configurations of source and detector, ratio of source-detector separation distance to shield diameter, and shield placement. In actual design, one would consider the gamma dose rate and expansion in connection with splitting (i.e., breaking the shield into several sections and re-distributing these sections).

3.2 Split Shield Considerations

The results of a Monte Carlo study on the effect of splitting and placement of shadow shield configurations appropriate to manned

nuclear rocket and ion-propelled vehicles has been reported by Aronson et al. in Reference 9. In that study, the geometry of the source-shield-detector configuration was axially symmetric and consisted of the source, a disc; the shield, a set of cylinders placed end-to-end; and the detector, a cylindrical cavity. The study considered both hydrogenous and nonhydrogenous shields. On pages 21, 22, and 23 of Reference 9 are listed ten tentative conclusions which Aronson et al. had obtained from their Monte Carlo results. The first three of these conclusions are (1) the neutron flux transmitted through a nonhydrogenous shield can be reduced appreciably by splitting the shield into two or more segments, (2) the dose reduction factor increases as the ratio of the source-detector separation distance to the shield radius increases until the ratio is so large that the unscattered flux predominates in the dose, and (3) the dose reduction due to splitting the shield increases with the thickness of the shield, up to some limiting thickness.

These conclusions are based mainly on their Monte Carlo results for a carbon shield in which the shield thickness was four feet and the disc source was emitting neutrons with energies in the fission spectrum and in directions defined by a cosine distribution. The source-detector separation distance used in the carbon-shield problems of interest in this discussion was 75 feet and the shield radius was five feet. These problems were run for cases where (1) the shield was located midway between the source and detector,

(2) the shield was split into two equal segments with one segment located one-third the way from the source to the detector and the other segment two-thirds of the way, and (3) the shield split into four equal segments, with a segment located at $1/5$, $2/5$, $3/5$, and $4/5$ of the distance between the source and detector. The configurations for these problems are denoted as (1/2), (1/3, 2/3), and (1/5, 2/5, 3/5, 4/5), respectively. The results for each configuration are shown in Table V.

TABLE V
NEUTRON FLUXES FOR VARIOUS SHIELD CONFIGURATIONS

Configuration	Uncollided Flux (n/cm ² -sec)	Total Flux (n/cm ² -sec)
(1/2)	2.5×10^{-11}	2.4×10^{-10}
(1/3, 2/3)	1.92×10^{-11}	9.6×10^{-11}
(1/5, 2/5, 3/5, 4/5)	2.4×10^{-11}	7.9×10^{-11}

The results shown for Configuration (1/3, 2/3) are the average of the results given in Table 6 of Reference 9 for problems 62 and 62A. These results show that splitting the shield into two segments reduces the flux in the detector cavity by 60% and that splitting it into four segments reduces the flux by 67%.

The uncollided flux should be the same for all three configurations. A hand calculation performed later in this study to determine the direct-beam component gave 2.88×10^{-11} n/cm²-sec as the uncollided flux, so that the uncollided fluxes in Table V appear to be underestimates, especially that for Configuration (1/3, 2/3).

An examination of the geometries shown in Figure 21 for Configurations (1/2) and (1/3, 2/3) reveals that none of the neutrons incident on the shield in Configuration (1/2) will enter the shield at an angle greater than 16 deg. Similarly, there will not be any neutrons entering the shield of Configuration (1/3, 2/3) at angles greater than 23 deg. It appears, then, that the results for the mono-directional source, as described in Section 3.1.4, can be used to examine these configurations. These results indicate that expansion of the shield toward the source reduces the flux at the detector, and that expansion of the shield toward the detector increases the detected flux. In expanding the shield toward the detector, it was noted that the effect of an increase in shield transverse leakage was less than the effect of moving the scattering centers closer to the detector.

Another thing to note about the two configurations illustrated in Figure 21 is that twice as many source neutrons will enter the shield in Configuration (1/3, 2/3) as will enter the shield in Configuration (1/2). It is not evident that the additional transverse leakage that might be expected in Configuration (1/3, 2/3) over that in Configuration (1/2) will be great enough to overcome the effect of adding more source particles into the shield system and the effect of moving the scattering points in the second section of Configuration (1/3, 2/3) toward the detector.

In order to settle some of the questions raised on the magnitude of each of the effects just discussed, problems using the geometries

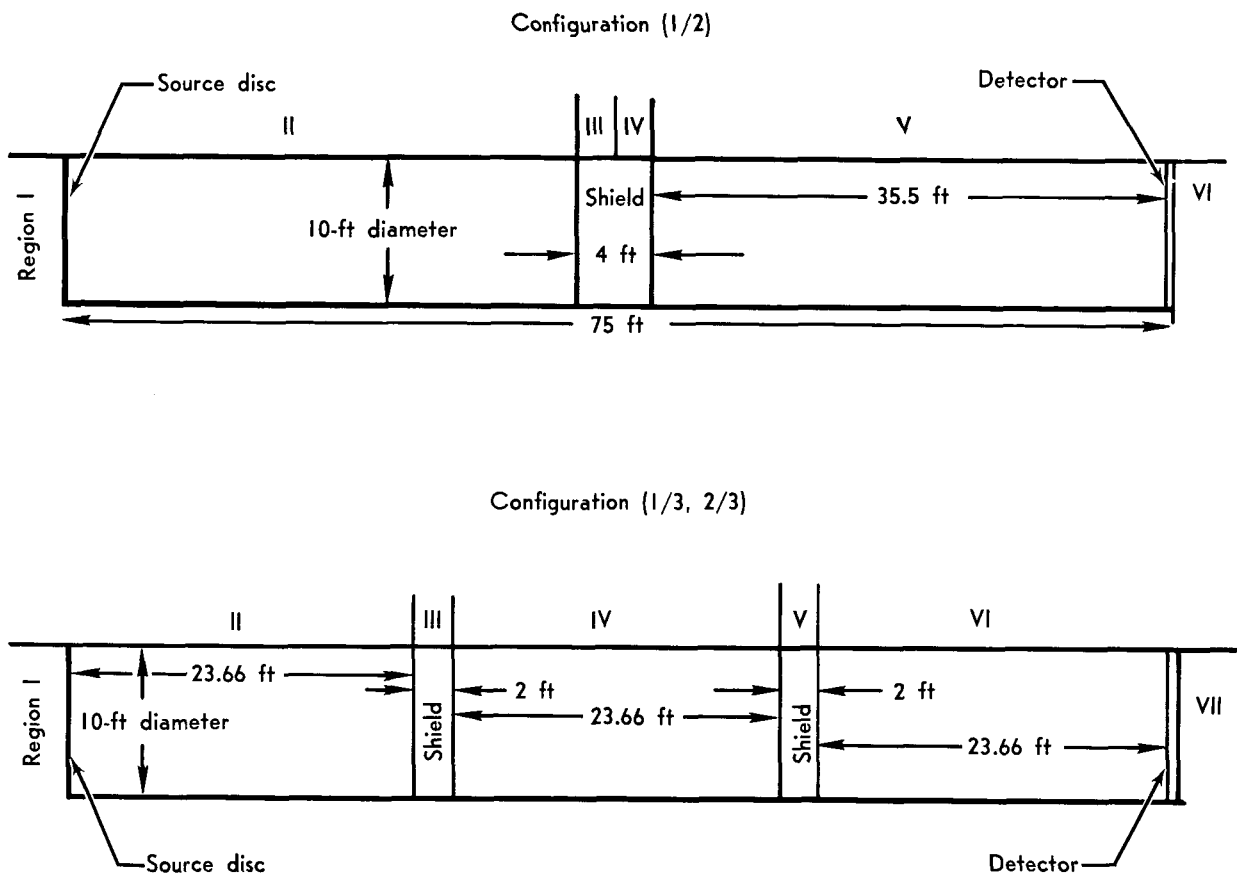

Figure 21. Geometries for Configurations (1/2) and (1/3, 2/3)

of Configurations (1/2) and (1/3, 2/3) were prepared and run on the General Electric Flexible Monte Carlo Code FMC-N (Ref. 10). The results of the FMC-N calculations gave 3.52×10^{-9} n/cm²-sec for Configuration (1/2) and 5.59×10^{-9} n/cm²-sec for Configuration (1/3, 2/3). It is to be noted that these fluxes are considerably higher than those given in Table V and that the flux in the detector cavity of Configuration (1/3, 2/3) is higher than that in the cavity of Configuration (1/2).

In addition to giving the total fluxes, the FMC-N code prints out the number current leaking out of the main geometry into outside regions. The flux estimator used in the FMC-N total flux calculations is based on the method of statistical estimation, whereas the current-leakage estimator is an analog estimator. These current-leakage results, normalized to one particle per second entering the shield, show that the leakage into Outside Regions III and IV of Configuration (1/2) is approximately the same as the leakage into Outside Regions III, IV, and V of Configuration (1/3, 2/3). The fraction of the neutron leakage into Outside Region VII of Configuration (1/3, 2/3) per neutron incident on the shield was about 80% of the leakage into Outside Region VI of Configuration (1/2).

Based on the fact that twice as many of the neutrons leaving the source will enter the first shield segment of Configuration (1/3, 2/3) as will enter the shield in Configuration (1/2), it was found that about 40% more neutrons will enter Outside Region VII of Configuration (1/3, 2/3) as will enter Outside Region VI of Configuration (1/2).

The ratio of the leakages into Outside Region VI of Configuration (1/2) and Outside Region VII of Configuration (1/3, 2/3) is approximately the same as the ratio obtained from the expectation fluxes in the detector cavities of both configurations.

The differences in the magnitudes of the fluxes computed by the use of FMC-N and those shown in Table V, as well as the fact that the FMC-N results do not support the conclusions given in Reference 9, are disturbing. Because of the importance of the problem of obtaining a minimum-weight reactor shield for spacecraft applications, it is recommended that further work be performed to investigate the concept of split shielding.

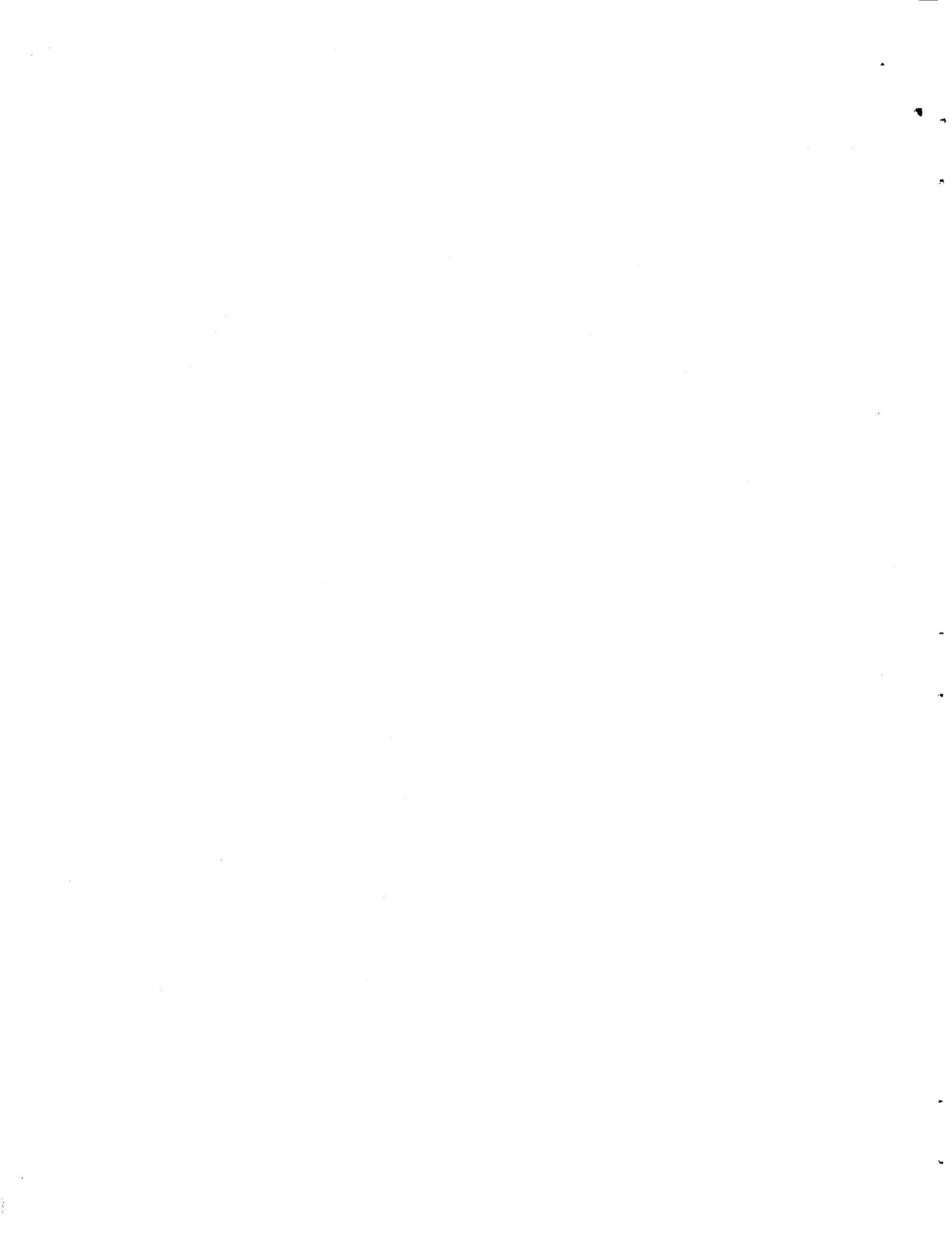

IV. CONCLUSIONS AND RECOMMENDATIONS

4.1 Radiator Scattering

For the particular type of spacecraft geometries treated in Section 2.4.2 of this report, it will be necessary to shield against the scattered neutrons as well as the direct-beam neutrons and gammas. The scattered neutrons, due to low-energy radiation leaking from the reactor, will be somewhat easier to shield against than the direct-beam neutrons. As can be seen from the results in Section 2.3.2, it will not be necessary for the reactor shield to be such that all parts of the radiator are shielded to the same degree. Considerable savings in weight can therefore be made by properly shaping the shield. It may also be possible to obtain a minimum-weight shield by placing shielding around the payload.

Since the scattered neutron flux is a significant component, improvements in the methods for calculating this component should be developed in order to remove some of the uncertainties discussed in Section 2.4.1.

With regard to the study of radiator scattering of neutrons, the following recommendations are made.

1. The effect of shielding should be considered. In particular, the possibility of obtaining a minimum-weight shield by proper shaping and placement should be investigated.
2. The methods of analysis should be improved by determining the importance of attenuation in the scattering calculations; if found to important, a method of including attenuation in the scattering calculations should be provided.

3. The development and use of improved methods for calculating neutron source terms should be considered.
4. Calculations should be performed to determine the secondary gamma fluxes due to neutron activation of the radiator. Program SO6 can be used in its present form to carry out these calculations for both prompt and decay gammas.

4.2 Direct-Beam Shielding

The following recommendations are made concerning the study of direct-beam shielding:

1. The effect of shield placement per se should be given further study.
2. The combined effects of splitting, expanding, and placement should be studied with realistic spacecraft geometries and SNAP reactor leakage spectra.
3. Direct-beam shielding should be considered in connection with radiator scattering, since the location of the direct-beam shielding could have a marked effect on the neutron flux incident on the radiators.
4. Effort should be directed toward resolving the apparent differences between TRG and GD/FW results for the split carbon shield discussed in Section 3.2. (This also points up the need for further study of shield-splitting, expansion, and placement.)

APPENDIX A
FORTRAN STATEMENTS FOR SO6

FORTRAN Statements for S06

```

*JOB 9242 86 JACK GRIGSBY (E E JONES 2895) S.N. 801184 0001 S06
* STRAP FORTRAN 0002 S06
* LIST8
CS06 JACK GRIGSBY (E E JONES 2895) 0003 S06
EZE EZE1 EZE2 EZE3 EOF EZE5 EZE1AEZE3 EZE4 EZE1AEZE5
DIMENSION 0004 S06
1SOURCE(15) ,PHIK(20) ,PHIK2(20) ,PHIL(15) ,PHI(20,15) , 0005 S06
C 0006 S06
2SUMLL(5) ,P(10) ,SX(100) ,SY(100) ,SIG(5) , 0007 S06
C 0008 S06
3R1(20) ,ALPHA1(20),F(25,15,10),X0(20) ,Y0(20) , 0009 S06
C 0010 S06
4DELX(20) ,DELY (20),ATOM(5) ,SIGEL(15,25),S(15,20,20), 0011 S06
C 0012 S06
5NPX(20) ,NPY(20) ,KT(20) ,LLMAX(25) ,YLIB(5) , 0013 S06
6XLIB(25),LBRD(5) 0014 S06
COMMON 0015 S06
1SOURCE ,PHIK ,PHIK2 ,PHIL ,PHI , 0016 S06
C 0017 S06
2SUMLL ,P ,SX ,SY ,SIG , 0018 S06
C 0019 S06
3R1 ,ALPHA1 ,F ,X0 ,Y0 , 0020 S06
C 0021 S06
4DELX ,DELY ,ATOM ,SIGEL ,S , 0022 S06
C 0023 S06
5NPX ,NPY ,KT ,LLMAX ,YLIB, 0024 S06
6XLIB ,L1 ,XLIBNO ,LIBNO ,XSLIB, 0025 S06
C 0026 S06
7LB ,YSLIB ,LBRD ,LBCK ,NU , 0027 S06
C 0028 S06
8L1 ,XID 0029 S06
C 0030 S06
COMMON 0031 S06
1NA ,X1 ,Y1 ,DX ,NX ,NE ,THICK,NX1 ,VI ,X , 0032 S06
C 0033 S06
2DY ,NY ,NYM ,XNY ,SLOPE,NY1 ,VJ ,Y ,ALPHA,RSQ , 0034 S06
C 0035 S06
3R ,DSQ ,SEP ,D ,THETA,FMU ,F1 ,PHIT ,FNPX ,XM , 0036 S06
C 0037 S06
4FNPY ,YM ,MMAX ,NMAX ,CON1 ,CON2 ,CON3 ,CON4 ,LLMAX1 ,XLL , 0038 S06
C 0039 S06
5NUMAX,SIGMA 0040 S06
C READ IN LIBRARY DATA 0041 S06
C 0042 S06
C 0043 S06
C 0044 S06
LB=0 0045 S06
CALL LIB1(L1) 0046 S06
GO TO (10 ,1000 ) ,L1 0047 S06
10 CALL LIB (3HS06 ,XLIBNO ) 0048 S06
C READ CONTROL CARD 0049 S06
READ 20, LIBNO 0050 S06
20 FORMAT (6I10) 0051 S06
IF (LIBNO) 900 , 900 , 30 0052 S06
30 GO TO (35 ,200 ) , LIBNO 0053 S06
C 0054 S06

```

FORTRAN Statements for S06 (Cont'd)

C	READ IN SOURCE LIBRARY (TYPE 1 LIBRARY)	0055 S06
C		0056 S06
	READ 40 ,NE ,MMAX , NMAX	0057 S06
	FORMAT (3I10)	0058 S06
	READ 45 , (R1(M) , M=1 ,MMAX)	0059 S06
	READ 45 , (ALPHA1 (N) , N=1 ,NMAX)	0060 S06
45	FORMAT (6F10.3)	0061 S06
C		0062 S06
	DO 50 L=1 , NE	0063 S06
	DO 50 N=1 , NMAX	0064 S06
	READ 60 , (S(L,M,N) , M = 1 , MMAX)	0065 S06
60	FORMAT (1P6E10.3)	0066 S06
50	CONTINUE	0067 S06
	XSLIB = XLIBNO	0068 S06
	GO TO 10	0069 S06
C		0070 S06
C	READ IN CROSS SECTION DATA (TYPE 2 LIBRARIES)	0071 S06
200	LB=LB+1	0072 S06
C		0073 S06
	XLIB(LB) = XLIBNO	0074 S06
	READ 210, LLMAX(LB) , NE	0075 S06
210	FORMAT (2I10)	0076 S06
	READ 220, (SIGEL(L,LB) , L=1, NE)	0077 S06
220	FORMAT (1P6E10.3)	0078 S06
C		0079 S06
	LLMAXX=LLMAX(LB)	0084 S06
	DO 230 L=1 , NE	0085 S06
	READ 225 , (F(LB , L , LL) , LL=1 , LLMAXX)	0086 S06
225	FORMAT (1P6E10.3)	0087 S06
230	CONTINUE	0087.1S06
	GO TO 10	0088 S06
C		0089 S06
C		0090 S06
C		0091 S06
C		0092 S06
	900 PRINT 910	0093 S06
	910 FORMAT (42H1 THE FOLLOWING LIBRARIES HAVE BEEN LOADED)	0094 S06
C		0095 S06
	PRINT 920 ,XSLIB ,(XLIB(I) , I=1 , LB)	0096 S06
920	FORMAT (1H0 , 6F10.0)	0097 S06
C		0098 S06
C	READ IN AND TEST PROBLEM CONTROL NUMBERS	0099 S06
C		0100 S06
	BACKSPACE 9	0101 S06
1000	CALL SETUP (3HS06 , XID)	0102 S06
	READ 20 ,LIBNO	0103 S06
C		0104 S06
C		0105 S06
C		0106 S06
	READ 320 , NA , NUMAX ,LLMAX1 ,NE ,SLOPE	0107 S06
320	FORMAT (4I10,F10.0)	0108 S06
C		0109 S06
	READ 330 , SEP , YSLIB ,THICK	0110 S06
330	FORMAT (E10.4 , E10.4 , F10.0)	0111 S06
C		0112 S06
	READ 340 , (NPX(K) ,K=1,NA)	0113 S06

FORTRAN Statements for S06 (Cont'd)

	READ 340 , (NPY(K) ,K=1,NA)	0114 S06
340	FORMAT (6I10)	0115 S06
	READ 340 ,(KT(K) ,K=1 ,NA)	0116 S06
	READ 350 ,(X0(K) ,K=1 ,NA)	0117 S06
	READ 350 ,(Y0(K) ,K=1 ,NA)	0118 S06
	READ 350 ,(DELX (K) ,K=1 ,NA)	0119 S06
	READ 350 ,(DELY (K) ,K=1 ,NA)	0120 S06
350	FORMAT (6F10.3)	0121 S06
	READ 360,(ATOM(NU) , NU=1, NUMAX)	0122 S06
360	FORMAT (6E10.4)	0123 S06
	READ 370, (YLIB (NU) ,NU=1 ,NUMAX)	0124 S06
370	FORMAT (6F10.3)	0126 S06
C		0127 S06
C		0128 S06
	IF (XSLIB - YSLIB) 9000 ,1100 ,9000	0130 S06
9000	PRINT 9010	0131 S06
9010	FORMAT (17H1 WRONG LIBRARY)	0132 S06
	CALL END 9	0134 S06
C		0135 S06
1100	LBCK =0	0136 S06
	DO 1160 I=1 , NUMAX	0137 S06
	DO 1150 J=1 , LB	0138 S06
C		0139 S06
	IF (XLIB(J) -YLIB(I)) 1150 ,1140 ,1150	0140 S06
1140	LBRD(I) = J	0141 S06
	LBCK =LBCK + 1	0142 S06
1150	CONTINUE	0143 S06
1160	CONTINUE	0144 S06
C		0145 S06
C		0146 S06
	IF (LBRCK -NUMAX) 9100 ,1200 ,9100	0147 S06
9100	PRINT 9110	0148 S06
9110	FORMAT (52H1 LIBRARIES LOADED DO NOT AGREE WITH THOSE REQUESTED)	0149 S06
C		0150 S06
C		0151 S06
1200	CALL SUB M	0152 S06
	PRINT 9250, PHIT	0153 S06
9250	FORMAT (29H TOTAL FLUX AT DETECTOR IS , 1P1E10.3)	0154 S06
C		0155 S06
	PRINT 9260	0156 S06
9260	FORMAT(43H0 FLUX SPECTRUM AT DETECTOR BY INCREASING L)	0157 S06
	PRINT 9270,(PHIL(L) ,L=1, NE)	0158 S06
9270	FORMAT (1H0,1P6E10.3)	0159 S06
C		0160 S06
	PRINT 9280	0161 S06
9280	FORMAT(43H0 TOTAL FLUX FROM SUB AREAS BY INCREASING K)	0162 S06
	PRINT 9290,(PHIK(K) ,K=1 ,NA)	0163 S06
9290	FORMAT (1H0,1P6E10.3)	0164 S06
C		0165 S06
	PRINT 9300	0166 S06
9300	FORMAT(39H0 FRACTION OF TOTAL FLUX FROM SUB AREAS)	0170 S06
	PRINT 9310 , (PHIK2(K) , K=1, NA)	0171 S06
9310	FORMAT (1H0,1P6E10.3)	0172 S06
C		0173 S06
	DO 9311 K=1 , NA	01731S06
	PRINT 9312 ,K	01732S06

FORTRAN Statements for S06 (Cont'd)

```

9312 FORMAT (36H0 FLUX BY INCREASING I FOR SUB AREA ,I2)
      PRINT 9313, ( PHI (K,L) , L= 1, NE )
9313 FORMAT (1H0,1P6E10.3)
9311 CONTINUE
      IF (SENSE SWITCH 2 ). 9315 , 9375
9315 PRINT 9320
9320 FORMAT (48H0 COORDINATES OF LOWER LEFT CORNER OF SUB AREAS )
      PRINT 9330
9330 FORMAT (37H0      K      XO(K)      YO(K)      )
      PRINT 9340, (K ,XO(K) ,YO(K) ,K=1 ,NA)
9340 FORMAT (1H0, 17 ,1F14.2 , 1F11.2)
      PRINT 9370 , SEP
9370 FORMAT (42H0 SOURCE DETECTOR SEPARATION DISTANCE IS ,1PE10.3 )
9375 GO TO 1000
      END
* STRAP FORTRAN
* LISTB
CS06SBM      JACK GRIGSBY (E E JONES 2895)
EZE  EZEC1 EZED2 EZED3 EOF  EZED5 EZEB1AEZEB3 EZEB4 EZEB1AEZEB5
      SUBROUTINE SUBM
      DIMENSION
1SOURCE(15) ,PHIK(20) ,PHIK2(20) ,PHIL(15) ,PHI(20,15) ,
C
2SUMLL(5) ,P(10) ,SX(100) ,SY(100) ,SIG(5) ,
C
3R1(20) ,ALPHA1(20),F(25,15,10),XO(20) ,YO(20) ,
C
4DELX(20) ,DELY (20),ATOM(5) ,SIGEL(15,25),S(15,20,20),
C
5NPX(20) ,NPY(20) ,KT(20) ,LLMAX(25) ,YLIB(5) ,
6XLIB(25),LBRD(5)
      COMMON
1SOURCE ,PHIK ,PHIK2 ,PHIL ,PHI ,
C
2SUMLL ,P ,SX ,SY ,SIG ,
C
3R1 ,ALPHA1 ,F ,XO ,YO ,
C
4DELX ,DELY ,ATOM ,SIGEL ,S ,
C
5NPX ,NPY ,KT ,LLMAX ,YLIB,
6XLIB ,L1 ,XLIBNO ,LIBNO ,XSLIB,
C
7LB ,YSLIB ,LBRD ,LBCK ,NU ,
C
8L1 ,XID
      COMMON
1NA ,X1 ,Y1 ,DX ,NX ,NE ,THICK,NX1 ,VI ,X ,
C
2DY ,NY ,NYM ,XNY ,SLOPE,NY1 ,VJ ,Y ,ALPHA,RSQ ,
C
3R ,DSQ ,SEP ,D ,THETA,FMU ,F1 ,PHIT ,FNPX ,XM ,
C
4FNPY ,YM ,MMAX ,NMAX ,CON1 ,CON2 ,CON3 ,CON4 ,LLMAX1 ,XLL ,
C

```

FORTRAN Statements for S06 (Cont'd)

	5NUMAX, SIGMA	0040 S06
	DO 9000 K=1 , NA	M042 S06
	X1=X0(K)	M043 S06
	Y1=Y0(K)	M044 S06
	DX=DELX(K)	M045 S06
	NX=NPX(K)	M046 S06
C	DO 8100 L=1,NE	M047 S06
	PHI(K,L)=0.0	M048 S06
8100	CONTINUE	M049 S06
C	CALCULATE SX FOR ALL I	M050 S06
C	SX(1)= THICK *DX/3.0	M051 S06
	SX(NX) =SX(1)	M052 S06
	NX1=NX-1	M053 S06
	DO 8200 I=2,NX1	M054 S06
	VI=I	M055 S06
	SX(I)=SX(1)*(MODF(2.0*(VI+1.0),4.0)+2.0)	M056 S06
8200	CONTINUE	M057 S06
C	DO LOOP FOR SUMMING OVER X	M058 S06
	NPXX=NPX(K)	M059 S06
	DO 8000 I=1,NPXX	M060 S06
	VI=I	M061 S06
	X=X1+(VI-1.0)*DX	M062 S06
C	GENERATE Y MESH	M063 S06
	IF(KT(K)-1) 7100 ,7200 ,7200	M064 S06
7100	DY=DELY(K)	M065 S06
	NY=NPY(K)	M066 S06
	GO TO 7300	M067 S06
C		M068 S06
7200	NY=3+(I-1)*2	M069 S06
	NYM=NY-1	M070 S06
	XNY=NYM	M071 S06
	DY=SLOPE*(X-X1)/XNY	M072 S06
	NPY(K) = NY	M073 S06
	GO TO 7300	M074 S06
C	CALCULATE SY FOR ALL J	M075 S06
7300	SY(1) =DY/3.0	M076 S06
	SY(NY) = SY(1)	M076.1S06
	NY1=NY-1	M077 S06
	DO 7400 J=2,NY1	M082 S06
	VJ =J	M083 S06
	SY(J) = SY(1) * (MODF(2.0 * (VJ+1.0), 4.0) + 2.0)	M083.1S06
7400	CONTINUE	M084 S06
	NPYY = NPY(K)	M085 S06
	DO 7000 J=1,NPYY	M086 S06
	VJ=J	M087 S06
	Y=Y1+(VJ-1.0)*DY	M088 S06
C		M090 S06
	IF (X) 7310, 7320 , 7330	M091 S06
7310	ALPHA = 90.0 + (ATANF (-X/Y)) * 57.296	M092 S06
	GO TO 7311	M093 S06
7320	ALPHA = 90.0	M094 S06
	GO TO 7311	M095 S06
		M095.2S06
		M095.3S06
		M095.5S06
		M095.6S06

FORTRAN Statements for S06 (Cont'd)

7330	ALPHA = (ATANF (Y/X)) * 57.296	M0958S06
	GO TO 7311	M0959S06
7311	RSQ =X**2 + Y**2	M096 S06
C	R =SQRTF(RSQ)	M097 S06
	CALL SUB1 (K,I,J)	M098 S06
	DSQ =RSQ + SEP**2 -2.0*SEP*X	M099 S06
C	SUB1 IS SOURCE CALCULATION	M100 S06
	D =SQRTF(DSQ)	M101 S06
	FMU = (SEP**2 - RSQ - DSQ) / (2.0*R*D)	M102 S06
	F1 = SX(I)* SY(J)/DSQ	M103 S06
C	IF (SENSE SWITCH 3) 7430 , 6000	M104 S06
7430	PRINT 7435 ,K ,I ,J	M106 S06
7435	FORMAT (44H0 X,Y,ALPHA,R,D,THETA,FMU, AND F1 FOR K I J ,I5,I5,I5)	M107 S06
	PRINT 7440 ,X,Y,ALPHA,R,D,THETA,FMU, F1	M108 S06
7440	FORMAT (1H0,1P8E10.3)	M109 S06
6000	CALL SUB2 (K,I,J)	M110 S06
C	SUB2 IS NEUTRON CALCULATION CONTAINS DO LOOP OVER ENERGY	M111 S06
7000	CONTINUE	M112 S06
8000	CONTINUE	M114 S06
9000	CONTINUE	M115 S06
C		M121 S06
C		M122 S06
C	CALCULATE TOTAL AND FRACTIONAL FLUXES	M123 S06
7425	PHIT =0.0	M124 S06
	DO 9100 K=1 , NA	M125 S06
	PHIK(K) =0.0	M126 S06
C		M127 S06
	DO 9050 L=1 , NE	M128 S06
	PHIK(K) =PHIK(K) +PHI(K,L)	M129 S06
9050	CONTINUE	M130 S06
C		M131 S06
	PHIT =PHIT + PHIK(K)	M132 S06
9100	CONTINUE	M133 S06
C		M134 S06
	DO 9150 K=1 ,NA	M135 S06
C		M136 S06
	PHIK2(K) = PHIK(K)/PHIT	M137 S06
9150	CONTINUE	M138 S06
	DO 9200 L=1 ,NE	M139 S06
C		M140 S06
	PHIL(L) =0.0	M141 S06
C		M148 S06
	DO 9175 K=1 , NA	M149 S06
C		M150 S06
	PHIL(L) = PHIL(L)+ PHI(K,L)	M151 S06
9175	CONTINUE	M152 S06
9200	CONTINUE	M153 S06
9207	RETURN	M154 S06
	END	M155 S06
*	STRAP FORTRAN	M156 S06
*	LIST8	M176 S06
CS06SB1	JACK GRIGSBY ,E E JONES 2895)	M177 S06
EZE	EZEC1 EZED2 EZED3 FOF EZED5 EZFR1AEZEB3 EZEB4 EZEB1AEZEB5	1001 S06
		1002 S06

FORTRAN Statements for S06 (Cont'd)

```

SUBROUTINE SUB1(K,I,J)
DIMENSION
1SOURCE(15) ,PHIK(20) ,PHIK2(20) ,PHIL(15) ,PHI(20,15) ,
C
2SUMLL(5) ,P(10) ,SX(100) ,SY(100) ,SIG(5) ,
C
3R1(20) ,ALPHA1(20),F(25,15,10),X0(20) ,Y0(20) ,
C
4DELX(20) ,DELY (20),ATOM(5) ,SIGEL(15,25),S(15,20,20),
C
5NPX(20) ,NPY(20) ,KT(20) ,LLMAX(25) ,YLIB(5) ,
6XLIB(25),LBRD(5)
COMMON
1SOURCE ,PHIK ,PHIK2 ,PHIL ,PHI ,
C
2SUMLL ,P ,SX ,SY ,SIG ,
C
3R1 ,ALPHA1 ,F ,X0 ,Y0 ,
C
4DELX ,DELY ,ATOM ,SIGEL ,S ,
C
5NPX ,NPY ,KT ,LLMAX ,YLIB,
6XLIB ,L1 ,XLIBNO ,LIBNO ,XSLIB,
C
7LB ,YSLIB ,LBRD ,LBCK ,NU ,
C
8L1 ,XID
COMMON
1NA ,X1 ,Y1 ,DX ,NX ,NE ,THICK,NX1 ,VI ,X ,
C
2DY ,NY ,NYM ,XNY ,SLOPE,NY1 ,VJ ,Y ,ALPHA,RSQ ,
C
3R ,DSQ ,SEP ,D ,THETA,FMU ,F1 ,PHIT ,FNPX ,XM ,
C
4FNPY ,YM ,MMAX ,NMAX ,CON1 ,CON2 ,CON3 ,CON4 ,LLMAX1 ,XLL ,
C
5NUMAX,SIGMA
IF (R-R1(1)) 20, 2 ,2
2 IF (ALPHA -ALPHA1(1)) 20,5,5
C
5 DO 10 M=1 ,MMAX
IF (R1(M)-R ) 10 ,40,40
10 CONTINUE
20 PRINT 30
30 FORMAT ( 48H A VALUE OF R1 OR ALPHA1 CALLS FOR EXTRAPOLATION)
PRINT 31,K,L,I,J
31 FORMAT (31H0 X,Y,R,ALPHA FOR K,L,I,J OF 4I5 )
PRINT 32, X,Y,R,ALPHA
32 FORMAT (1H0 ,1P4E10.3 )
PRINT 33
33 FORMAT (33H0 MIN AND MAX INPUT R AND ALPHA )
PRINT 34, (R1(1),R1(MMAX),ALPHA1(1),ALPHA1(NMAX) )
34 FORMAT (1H0 ,1P4E10.3)
CALL AUTO
40 DO 50 N=1 . NMAX

```

FORTRAN Statements for S06 (Cont'd)

```

IF (ALPHA1(N) -ALPHA)      50 ,60 ,60      1052 S06
50 CONTINUE                1053 S06
GO TO 20                    1054 S06
60 CON1 =(ALPHA-ALPHA1(N-1))/(ALPHA1(N)-ALPHA1(N-1)) 1055 S06
C                            1056 S06
DO 100 L=1 ,NE             1060 S06
CON3=S(L,M-1,N-1) +CON1*(S(L,M-1,N)-S(L,M-1,N-1)) 1061 S06
C                            1062 S06
CON4=S(L,M,N-1) +CON1*(S(L,M,N)-S(L,M,N-1)) 1063 S06
C                            1064 S06
SOURCE(L)=(CON3 * R1(M-1)**2+CON4 *R1(M)**2 ) / (2.0*R**2) 1065 S06
C                            1066 S06
100 CONTINUE              1066 S06
IF (SENSE SWITCH 4 )      65 ,110        1067 S06
C                            1068 S06
65 PRINT 70 , K , I , J   1069 S06
70 FORMAT (37H0 SOURCE$ FOR ALL L FOR K I AND J OF,15 ,15 ,15 ) 1070 S06
PRINT 75 , ( SOURCE(L), L=1 , NE ) 1071 S06
75 FORMAT ( 1P6E10.3)    1072 S06
C                            1073 S06
110 RETURN                1075 S06
END                          1076 S06
* STRAP FORTRAN           2001 S06
* LIST8
CS06SB2 JACK GRIGSBY (E E JONES 2895)      2002 S06
EZE EZE1 EZE2 EZE3 EOF EZE5 EZE1AEZEB3 EZE4 EZE1AEZEB5
SUBROUTINE SUB2 (K,I,J)
DIMENSION
1SOURCE(15) ,PHIK(20) ,PHIK2(20) ,PHIL(15) ,PHI(20,15) ,
C                            0004 S06
C                            0005 S06
C                            0006 S06
2SUMLL(5) ,P(10) ,SX(100) ,SY(100) ,SIG(5) ,
C                            0007 S06
C                            0008 S06
3R1(20) ,ALPHA1(20),F(25,15,10),X0(20) ,Y0(20) ,
C                            0009 S06
C                            0010 S06
4DELX(20) ,DELY (20),ATOM(5) ,SIGEL(15,25),S(15,20,20),
C                            0011 S06
C                            0012 S06
5NPX(20) ,NPY(20) ,KT(20) ,LLMAX(25) ,YLIB(5) ,
C                            0013 S06
6XLIB(25),LBRD(5)
COMMON
1SOURCE ,PHIK ,PHIK2 ,PHIL ,PHI ,
C                            0014 S06
C                            0015 S06
C                            0016 S06
C                            0017 S06
2SUMLL ,P ,SX ,SY ,SIG ,
C                            0018 S06
C                            0019 S06
3R1 ,ALPHA1 ,F ,X0 ,Y0 ,
C                            0020 S06
C                            0021 S06
4DELX ,DELY ,ATOM ,SIGEL ,S ,
C                            0022 S06
C                            0023 S06
5NPX ,NPY ,KT ,LLMAX ,YLIB,
C                            0024 S06
6XLIB ,L1 ,XLIBNO ,LIBNO ,XSLIB,
C                            0025 S06
C                            0026 S06
7LB ,YSLIB ,LBRD ,LBCK ,NU ,
C                            0027 S06
C                            0028 S06
8L1 ,XID
C                            0029 S06
C                            0030 S06
COMMON
1NA ,X1 ,Y1 ,DX ,NX ,NE ,THICK,NX1 ,YI ,X ,
C                            0031 S06
C                            0032 S06

```

FORTRAN Statements for S06 (Cont'd)

C	2DY ,NY ,NYM ,XNY ,SLOPE,NY1 ,VJ ,Y ,ALPHA,RSO ,	0033 S06
C	3R ,DSQ ,SEP ,D ,THETA,FMU ,F1 ,PHIT ,FNPX ,XM ,	0034 S06
C	4FNPY ,YM ,MMAX ,NMAX ,CON1 ,CON2 ,CON3 ,CON4 ,LLMAX1 ,XLL ,	0035 S06
C	5NUMAX,SIGMA	0036 S06
C	DIMENSION AND COMMON GO HERE	0037 S06
C	CALCULATE LEGENDRE COEFICIENTS FOR CROSS SECTION CALCULATION	0038 S06
C	P(1)=1.0	0039 S06
C	P(2)=FMU	0040 S06
C	IF (LLMAX) -2) 100 ,100 ,60	2041 S06
60	DO 70 LL= 3 ,LLMAX1	2042 S06
	XLL=LL	2043 S06
C	P(LL) =((2.0*XLL-3.0) * FMU * P(LL-1) -(XLL-2.0)*P(LL-2))/	2044 S06
	1 (XLL-1.0)	2045 S06
C	70 CONTINUE	2048 S06
C	DO LOOP OVER ENERGY	2049 S06
100	DO 900 L=1 , NE	2050 S06
C	CALCULATE MICROSCOPIC CROSS SECTIONS SIG (NU)	2051 S06
C	DO 800 NUP=1 ,NUMAX	2052 S06
	NU = LBRD(NUP)	2053 S06
C	SUMLL(NUP)=0.0	2055 S06
C	LLM= LLMAX(NU)	2056 S06
	DO 790 LL=1 ,LLM	2060 S06
	XLL=LL	2061 S06
C	SUMLL(NUP)=SUMLL(NUP)+(2.0*XLL-1.0)*F(NU,L,LL)*P(LL)/12.5664	2062 S06
790	CONTINUE	2063 S06
	SIG(NUP)= SIGEL(L,NU)* SUMLL(NUP)	2064 S06
800	CONTINUE	2065 S06
C	CALCULATE MACROSCOPIC CROSS SECTIONS	2066 S06
803	SIGMA =0.0	2067 S06
C	DO 810 NU=1 , NUMAX	2068 S06
	SIGMA = SIGMA + ATOM(NU) * SIG(NU)	2069 S06
C	810 CONTINUE	2070 S06
	PHI(K,L) = PHI(K,L)+SOURCE(L)*SIGMA *F1	2071 S06
C	IF (SENSE SWITCH 6) 801 , 900	2072 S06
801	PRINT 802 , K ,I ,J ,L ,SIGMA	2073 S06
802	FORMAT (26H0 K I J L AND SIGMA ,I5,I5,I5,I5,1P1E10.3)	2074 S06
	PRINT 815	2075 S06
815	FORMAT (29H0 PHI(K,L) SOURCE(L) AND F1)	2082 S06
	PRINT 820 ,PHI(K,L), SOURCE(L) . F1	2083 S06
820	FORMAT (1P3E10.3)	2084 S06
		2085 S06
		2086 S06
		2088 S06
		2092 S06
		2093 S06
		2094 S06
		2095 S06
		2089 S06
		2090 S06
		2091 S06
		20961S06
		20962S06
		20963S06
		20964S06



APPENDIX B

INPUT AND OUTPUT FOR SO6 SAMPLE PROBLEM

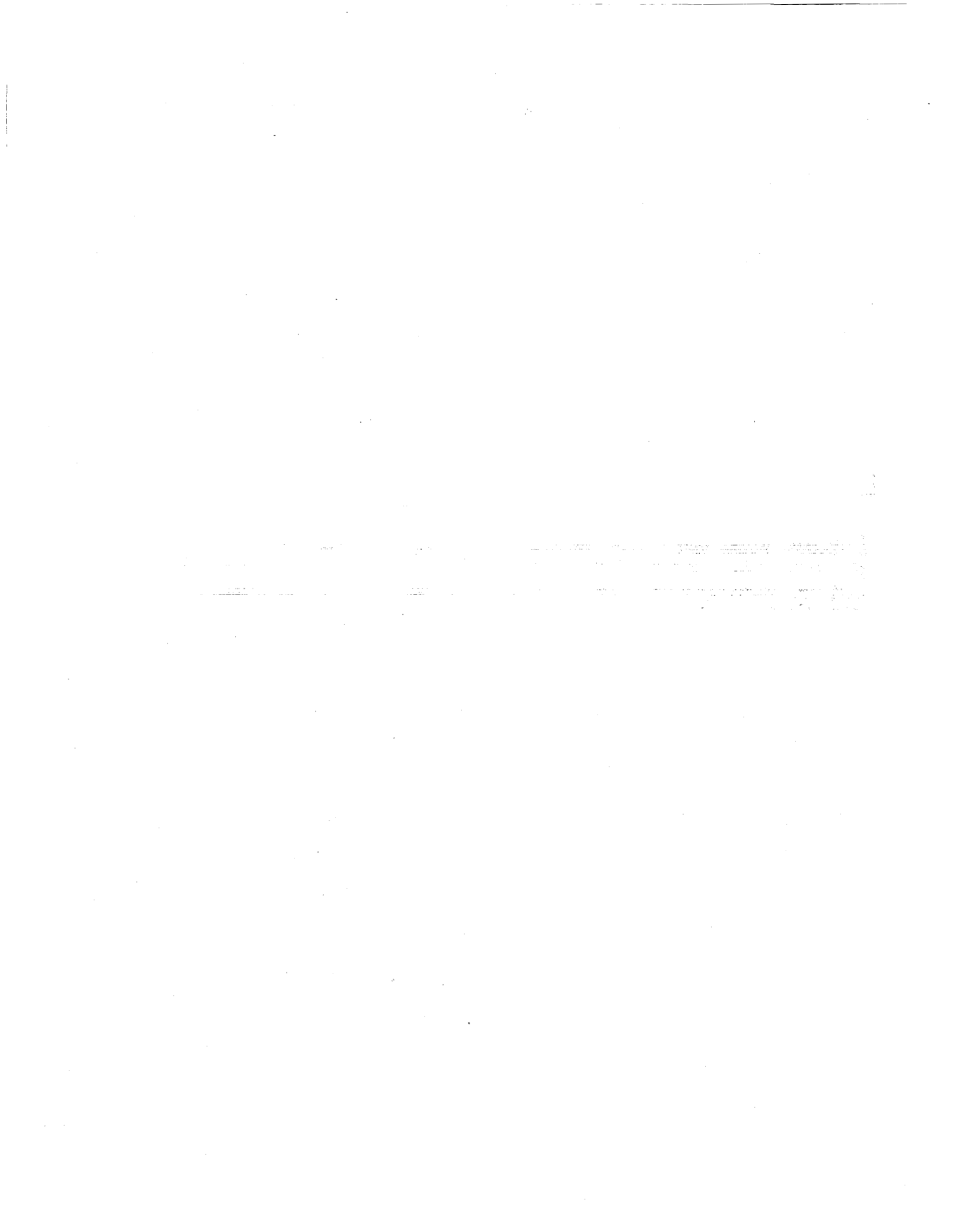

Problem Data for S06

6	1	9	10	0.58		53890100012	S06
913.0	509321.0	0.45				53890100022	S06
79	15	61	49	55	45	53890100032	S06
9	0	9	0	35	15	53890100042	S06
0	1	0	1	0	0	53890100052	S06
97.540	97.54	198.700	198.700	650.700	650.70	53890100062	S06
50.59	92.05	92.05	155.40	155.40	50.59	53890100072	S06
7.092	7.229	7.533	9.417	7.620	7.239	53890100082	S06
5.181	0.0	7.925	0.0	7.676	7.493	53890100092	S06
.0602+00						53890100102	S06
511223.0						53890100112	S06
						53890100122	S06

Source Library for S06

1				
10	5	5		
24.0	180.0	305.0	650.0	7000.0
0.0	30.0	60.0	90.0	120.0
2.72+06	2.18+04	7.24+03	1.53+03	1.32+01
8.97+06	9.43+04	3.27+04	7.14+03	6.16+01
6.83+06	1.11+05	3.92+04	8.65+03	7.46+01
7.53+06	1.42+05	4.92+04	1.08+04	9.31+01
6.83+06	1.11+05	3.92+04	8.65+03	7.46+01
1.64+06	1.32+04	4.38+03	9.30+02	8.01+00
2.57+06	2.62+04	9.08+03	1.98+03	1.71+01
1.93+06	3.15+04	1.11+04	2.45+03	2.11+01
2.20+06	4.11+04	1.43+04	3.12+03	2.69+01
1.93+06	3.15+04	1.11+04	2.45+03	2.11+01
1.02+06	8.34+03	2.77+03	5.89+02	4.33+00
1.33+06	1.35+04	4.68+03	1.02+03	8.79+00
9.90+05	1.62+04	5.70+03	1.26+03	1.09+01
1.14+06	2.14+04	7.41+03	1.62+03	1.40+01
9.90+05	1.62+04	5.70+03	1.26+03	1.09+01
6.11+05	5.12+03	1.71+03	3.63+02	3.13+00
2.76+05	2.81+03	9.69+02	2.11+02	1.82+00
1.90+05	3.06+03	1.09+03	2.41+02	2.08+00
2.27+05	4.31+03	1.49+03	3.26+02	2.81+00
1.90+05	3.06+03	1.09+03	2.41+02	2.08+00
3.55+05	3.04+03	1.01+03	2.16+02	1.87+00
1.19+05	1.22+03	4.19+02	9.14+01	7.88-01
8.30+04	1.34+03	4.72+02	1.06+02	9.14-01
9.87+04	1.86+03	6.44+02	1.41+02	1.22+00
8.30+04	1.34+03	4.72+02	1.06+02	9.14-01
1.06+05	9.43+02	3.16+02	6.76+01	5.83-01
2.82+04	2.87+02	9.87+01	2.15+01	1.85-01
1.98+04	3.22+02	1.14+02	2.54+01	2.19-01
2.38+04	4.46+02	1.54+02	3.37+01	2.91-01
1.98+04	3.22+02	1.14+02	2.54+01	2.19-01
3.18+04	3.69+02	1.27+02	2.77+01	2.39-01
6.28+03	6.31+01	2.17+01	4.72+00	4.07-02
4.44+03	7.26+01	2.58+01	5.73+00	4.94-02
5.41+03	1.01+02	3.50+01	7.64+00	6.59-02
4.44+03	7.26+01	2.58+01	5.73+00	4.94-02
8.20+03	1.14+02	4.00+01	8.86+00	7.64-02
1.35+03	1.35+01	4.62+00	1.00+00	8.62-03
9.67+02	1.59+01	5.66+00	1.26+00	1.09-02
1.19+03	2.23+01	7.70+00	1.68+00	1.45-02
9.67+02	1.59+01	5.66+00	1.26+00	1.09-02
2.54+02	2.41+00	8.15-01	1.76-01	1.51-03
5.82+01	5.73-01	1.94-01	4.24-02	3.66-04
4.28+01	7.06-01	2.54-01	5.63-02	4.85-04
5.31+01	9.99-01	3.45-01	7.52-02	6.48-04
4.28+01	7.06-01	2.53-01	5.63-02	4.85-04
8.57+00	7.48-02	2.51-02	5.36-03	4.62-05
1.92+00	1.86-02	6.27-03	1.37-03	1.18-05
1.44+00	2.39-02	8.57-03	1.91-03	1.65-05
1.81+00	3.42-02	1.18-02	2.57-03	2.22-05
1.44+00	2.39-02	8.57-03	1.91-03	1.65-05

5093210001L	S06
5093210002L	S06
5093210003L	S06
5093210004L	S06
5093210005L	S06
5093210006L	S06
5093210007L	S06
5093210008L	S06
5093210009L	S06
5093210010L	S06
5093210011L	S06
5093210012L	S06
5093210013L	S06
5093210014L	S06
5093210015L	S06
5093210016L	S06
5093210017L	S06
5093210018L	S06
5093210019L	S06
5093210020L	S06
5093210021L	S06
5093210022L	S06
5093210023L	S06
5093210024L	S06
5093210025L	S06
5093210026L	S06
5093210027L	S06
5093210028L	S06
5093210029L	S06
5093210030L	S06
5093210031L	S06
5093210032L	S06
5093210033L	S06
5093210034L	S06
5093210035L	S06
5093210036L	S06
5093210037L	S06
5093210038L	S06
5093210039L	S06
5093210040L	S06
5093210041L	S06
5093210042L	S06
5093210043L	S06
5093210044L	S06
5093210045L	S06
5093210046L	S06
5093210047L	S06
5093210048L	S06
5093210049L	S06
5093210050L	S06
5093210051L	S06
5093210052L	S06
5093210053L	S06
5093210054L	S06

00054

Cross-Section Library for S06

	2						5112230001L	S06
	9	10					5112230002L	S06
3.6+00	2.7+00	3.03+00	2.29+00	1.85+00	1.24+00		5112230003L	S06
0.86+00	0.67+00	0.69+00	0.85+00				5112230004L	S06
1.0+00	.082+00	.004+00	0.0+00	0.0+00	0.0+00		5112230005L	S06
0.0+00	0.0+00	0.0+00					5112230006L	S06
1.0+00	.256+00	.072+00	.004+00	0.0+00	0.0+00		5112230007L	S06
0.0+00	0.0+00	0.0+00					5112230008L	S06
1.0+00	.321+00	.115+00	.015+00	.004+00	0.0+00		5112230009L	S06
0.0+00	0.0+00	0.0+00					5112230010L	S06
1.0+00	.390+00	.175+00	.030+00	.015+00	.003+00		5112230011L	S06
0.0+00	0.0+00	0.0+00					5112230012L	S06
1.0+00	.449+00	.250+00	.049+00	.036+00	.013+00		5112230013L	S06
.003+00	0.0+00	0.0+00					5112230014L	S06
1.0+00	.530+00	.410+00	.182+00	.147+00	.062+00		5112230015L	S06
.022+00	.003+00	0.0+00					5112230016L	S06
1.0+00	.590+00	.482+00	.307+00	.242+00	.146+00		5112230017L	S06
.067+00	.016+00	0.0+00					5112230018L	S06
1.0+00	.622+00	.502+00	.365+00	.292+00	.208+00		5112230019L	S06
.112+00	.031+00	.006+00					5112230020L	S06
1.0+00	.680+00	.514+00	.422+00	.350+00	.288+00		5112230021L	S06
.201+00	.105+00	.036+00					5112230022L	S06
1.0+00	.709+00	.509+00	.432+00	.375+00	.305+00		5112230023L	S06
.237+00	.162+00	.077+00					5112230024L	S06

00024

Output for S06

GENERAL DYNAMICS/FORT WORTH S06 PROB 538901 DATE 8-27-62 PAGE 1

TOTAL FLUX AT DETECTOR IS 1.682+02

FLUX SPECTRUM AT DETECTOR BY INCREASING L

1.047+02 3.240+01 2.114+01 6.270+00 2.867+00 6.070-01

1.601-01 3.822-02 8.353-04 3.080-05

TOTAL FLUX FROM SUB AREAS BY INCREASING K

2.983+01 6.429+00 2.286+01 3.097+01 3.365+01 4.444+01

FRACTION OF TOTAL FLUX FROM SUB AREAS

1.774-01 3.823-02 1.359-01 1.841-01 2.001-01 2.643-01

FLUX BY INCREASING L FOR SUB AREA 1

1.639+01 6.335+00 4.624+00 1.438+00 7.393-01 2.152-01

6.789-02 1.763-02 4.380-04 1.674-05

FLUX BY INCREASING L FOR SUB AREA 2

4.196+00 1.240+00 7.973-01 1.367-01 5.075-02 6.988-03

7.371-04 8.219-05 1.122-06 4.058-08

FLUX BY INCREASING L FOR SUB AREA 3

1.318+01 4.763+00 3.363+00 9.595-01 4.581-01 1.056-01

2.620-02 5.727-03 1.007-04 2.981-06

FLUX BY INCREASING L FOR SUB AREA 4

2.075+01 5.672+00 3.526+00 7.056-01 2.747-01 3.544-02

4.572-03 6.658-04 1.700-05 8.611-07

FLUX BY INCREASING L FOR SUB AREA 5

2.457+01 5.242+00 2.886+00 6.687-01 2.419-01 3.184-02

6.982-03 1.689-03 4.209-05 1.650-06

FLUX BY INCREASING L FOR SUB AREA 6

2.561+01 9.145+00 5.942+00 2.362+00 1.102+00 2.120-01

5.376-02 1.243-02 2.363-04 8.523-06

APPENDIX C
FORTRAN STATEMENTS FOR S14



FORTRAN Statements for S14

```

*JOB  9247  86 JACK GRIGSBY (E E JONES 2895)  S.N. 801184      0001 S14
*      STRAP FORTRAN                                          0002 S14
*      LIST8                                                  S14
CS14      JACK GRIGSBY (E E JONES 2895)                      0003 S14
EZE      EZEC1 EZED2 EZED3 EOF  EZED5 EZEBlAEZEB3 EZEb4 EZEBlAEZEB5  S14
          DIMENSION                                          0004 S14
          1SOURCE(15), PHIK(20), PHIK2(20) , PHIL(15), PHI(20,15),SX(100), 0005 S14
C
          2SY(100)  , R1(20)  , ALPHA1(20),X0(20)  , YO(20)  , DELX(20), 0006 S14
C
          3DELY(20) , S(15,20,20),NPX(20) ,NPY(20) , KT(20)  , E0(15)  , 0007 S14
C
          4E(15)                                          0008 S14
          COMMON                                          0009 S14
          1SOURCE ,PHIK ,PHIK2 ,PHIL ,PHI ,SX ,SY ,R1 ,ALPHA1 ,X0, YO, 0010 S14
C
          2DELX ,DELY ,S      ,NPX ,NPY ,KT ,XLIB ,L1 ,XLIBNO ,LIBNO, 0011 S14
C
          3XSLIB ,LB ,XID  ,NA ,X1 ,Y1 ,DX ,NX ,NE ,THICK ,NX1, 0012 S14
C
          4VI ,X ,DY ,NY ,NYM ,XNY ,SLOPE ,NY1,VJ ,Y ,ALPHA ,RSQ , 0013 S14
C
          5R ,DSQ ,SEP,D ,FMU ,F1 ,PHIT ,FNPX ,FNPY , MMAX ,NMAX ,CON1 , 0014 S14
C
          6CON2 ,CON3 ,CON4 ,CON5 ,CON6 ,CON7 ,CON8 , CON9 ,RO ,CON10 , 0015 S14
          7SIGMA ,E1 ,E0 ,E ,XNEL 0016 S14
C
          READ IN LIBRARY DATA 0017 S14
C
          LB=0 0018 S14
          CALL LIB1(L1) 0019 S14
          GO TO (10 ,1000 ) ,L1 0020 S14
10 CALL LIB (3HS14 ,XLIBNO ) 0021 S14
C
          READ CONTROL CARD 0022 S14
          READ 20, LIBNO 0023 S14
20 FORMAT (6I10) 0024 S14
          IF (LIBNO) 900,900,35 0025 S14
C
          READ IN SOURCE LIBRARY (TYPE 1 LIBRARY ) 0026 S14
C
          35 READ 40 ,NE ,MMAX , NMAX 0027 S14
          40 FORMAT (3I10) 0028 S14
          READ 45 , (R1(M) , M=1 ,MMAX ) 0029 S14
          READ 45 , (ALPHA1 (N) , N=1 ,NMAX ) 0030 S14
          45 FORMAT (6F10.3) 0031 S14
          READ 360 ,(E0(L), L=1,NE) 0122 S14
360 FORMAT (6E10.4) 0123 S14
          READ 370 ,(E(L) ,L=1 ,NE) 0124 S14
          370 FORMAT (6E10.4) 0126 S14
C
          DO 50 L=1 , NE 0062 S14
          DO 50 N=1 , NMAX 0063 S14
          READ 60 , ( S(L,M,N) , M = 1 , MMAX ) 0064 S14
          60 FORMAT (1P6E10.3) 0065 S14
          50 CONTINUE 0066 S14
          0067 S14

```

FORTRAN Statements for S14 (Cont'd)

	XSLIB = XLIBNO	0068 S14
	GO TO 10	0069 S14
	900 PRINT 910	0093 S14
	910 FORMAT (42H1 THE FOLLOWING LIBRARIES HAVE BEEN LOADED)	0094 S14
C		0095 S14
	PRINT 920 ,XSLIB ,(XLIB(I) , I=1 , LB)	0096 S14
	920 FORMAT (1H0 , 6F10.0)	0097 S14
C		0098 S14
C	READ IN AND TEST PROBLEM CONTROL NUMBERS	0099 S14
C		0100 S14
	BACKSPACE 9	0101 S14
	1000 CALL SETUP (3HS14 , XID)	0102 S14
	READ 20 ,LIBNO	0103 S14
C		0104 S14
C		0105 S14
C		0106 S14
	READ 320 ,NA,NE,SLOPE,SEP,YSLIB,THICK	0107 S14
	320 FORMAT (2I10,4F10.0)	0108 S14
C		0109 S14
	READ 330 ,XNEL	0110 S14
	330 FORMAT (1P1E10.3)	0111 S14
C		0112 S14
	READ 340 , (NPX(K) ,K=1,NA)	0113 S14
	READ 340 , (NPY(K) ,K=1,NA)	0114 S14
	340 FOKMAT (6I10)	0115 S14
	READ 340 ,(KT(K) ,K=1 ,NA)	0116 S14
	READ 350 ,(XO(K) ,K=1 ,NA)	0117 S14
	READ 350 ,(YO(K) ,K=1 ,NA)	0118 S14
	READ 350 ,(DELX (K) ,K=1 ,NA)	0119 S14
	READ 350 ,(DELY (K) ,K=1 ,NA)	0120 S14
	350 FORMAT (6F10.3)	0121 S14
C		0127 S14
	RO =.000000000000000000000000079524 *XNEL	0151 S14
C		0128 S14
	IF (XSLIB-YSLIB) 9000 ,1200 ,9000	0130 S14
	9000 PRINT 9010	0131 S14
	9010 FORMAT (17H1 WRONG LIBRARY)	0132 S14
	CALL END 9	0134 S14
	1200 CALL SUB M	0152 S14
	PRINT 9250, PHIT	0153 S14
	9250 FORMAT (29H TOTAL FLUX AT DETECTOR IS , 1P1E10.3)	0154 S14
C		0155 S14
	PRINT 9260	0156 S14
	9260 FORMAT(43H0 FLUX SPECTRUM AT DETECTOR BY INCREASING L)	0157 S14
	PRINT 9270,(PHIL(L) ,L=1, NE)	0158 S14
	9270 FORMAT (1H0,1P6E10.3)	0159 S14
C		0160 S14
	PRINT 9280	0161 S14
	9280 FORMAT(43H0 TOTAL FLUX FROM SUB AREAS BY INCREASING K)	0162 S14
	PRINT 9290,(PHIK(K) ,K=1 ,NA)	0163 S14
	9290 FORMAT (1H0,1P6E10.3)	0164 S14
C		0165 S14
	PRINT 9300	0166 S14
	9300 FORMAT(39H0 FRACTION OF TOTAL FLUX FROM SUB AREAS)	0170 S14

FORTRAN Statements for S14 (Cont'd)

	PRINT 9310 , (PHIK2(K) , K=1, NA)	0171 S14
9310	FORMAT (1H0,1P6E10.3)	0172 S14
C	DO 9311 K=1 , NA	0173 S14
	PRINT 9312 , K	01731S14
9312	FORMAT (36H0 FLUX BY INCREASING L FOR SUB AREA ,12)	01732S14
	PRINT 9313, (PHI (K,L) , L= 1, NE)	01733S14
9313	FORMAT (1H0,1P6E10.3)	01734S14
9311	CONTINUE	01735S14
	IF (SENSE SWITCH 2) 9315 , 9375	01736S14
9315	PRINT 9320	0174 S14
9320	FORMAT (48H0 COORDINATES OF LOWER LEFT CORNER OF SUB AREAS)	0178 S14
	PRINT 9330	0179 S14
9330	FORMAT (37H0 K XO(K) YO(K))	0180 S14
	PRINT 9340, (K ,XO(K) ,YO(K) ,K=1 ,NA)	0181 S14
9340	FORMAT (1H0, I7 ,1F14.2 , 1F11.2)	0182 S14
	PRINT 9370 , SEP	0183 S14
9370	FORMAT (42H0 SOURCE DETECTOR SEPARATION DISTANCE IS ,1PE10.3)	0192 S14
9375	GO TO 1000	0193 S14
	END	0198 S14
*	STRAP FORTRAN	0199 S14
*	LIST8	M001 S14
CS14SRM	JACK GRIGSBY (E E JONES 2895)	S14
EZE	EZEC1 EZED2 EZED3 EOF EZED5 EZEB1AEZEB3 EZEB4 EZEB1AEZEB5	M002 S14
	SUBROUTINE SUBM	S14
	DIMENSION	M003 S14
	1SOURCE(15), PHIK(20), PHIK2(20) , PHIL(15), PHI(20,15),SX(100),	0004 S14
C		0005 S14
	2SY(100) , R1(20) , ALPHA1(20),XO(20) , YO(20) , DELX(20),	0006 S14
C		0007 S14
	3DELY(20) , S(15,20,20),NPX(20) ,NPY(20) , KT(20) , EO(15) ,	0008 S14
C		0009 S14
	4E(15)	0010 S14
	COMMON	0011 S14
	1SOUKCE ,PHIK ,PHIK2 ,PHIL ,PHI ,SX ,SY ,R1 ,ALPHA1 ,XO, YO,	0015 S14
C		0016 S14
	2DELX ,DELY ,S ,NPX ,NPY ,KT ,XLIB ,L1 ,XLIBNO ,LIBNO,	0017 S14
C		0018 S14
	3XSLIB ,LB ,XID ,NA ,X1 ,Y1 ,DX ,NX ,NE ,THICK ,NX1,	0019 S14
C		0020 S14
	4VI ,X ,DY ,NY ,NYM ,XNY ,SLOPE ,NY1,VJ ,Y ,ALPHA ,RSQ ,	0021 S14
C		0022 S14
	5R ,DSQ ,SEP,D ,FMU ,F1 ,PHIT ,FNPX ,FNPY , MMAX ,NMAX ,CON1 ,	0023 S14
C		0024 S14
	6CON2 ,CON3 ,CON4 ,CON5 ,CON6 ,CON7 ,CON8 , CON9 ,RO ,CON10 ,	0025 S14
	7SIGMA ,E1 ,EO ,E ,XNEL	0026 S14
	DO 9000 K=1 , NA	0027 S14
	X1=XO(K)	M042 S14
	Y1=YO(K)	M043 S14
	DX=DELX(K)	M044 S14
	NX=NPX(K)	M045 S14
C		M046 S14
	DO 8100 L=1,NE	M047 S14
	PHI(K,L)=0.0	M048 S14
		M049 S14

FORTTRAN Statements for S14 (Cont'd)

8100	CONTINUE	M050	S14
C	CALCULATE SX FOR ALL I	M052	S14
C	SX(1)= THICK *DX/3.0	M053	S14
	SX(NX) =SX(1)	M054	S14
	NX1=NX-1	M055	S14
	DO 8200 I=2,NX1	M056	S14
	VI=I	M057	S14
	SX(I)=SX(I)*(MODF(2.0*(VI+1.0),4.0)+2.0)	M058	S14
8200	CONTINUE	M059	S14
		M060	S14
C	DO LOOP FOR SUMMING OVER X	M061	S14
	NPXX=NPX(K)	M062	S14
	DO 8000 I=1,NPXX	M063	S14
	VI=I	M064	S14
	X=X1+(VI-1.0)*DX	M065	S14
C	GENERATE Y MESH	M066	S14
	IF(KI(K)-1) 7100 ,7200 ,7200	M067	S14
7100	DY=DELY(K)	M068	S14
	NY=NPY(K)	M069	S14
	GO TO 7300	M070	S14
C		M071	S14
7200	NY=3+(I-1)*2	M072	S14
	NYM=NY-1	M073	S14
	XNY=NYM	M074	S14
	DY=SLOPE*(X-X1)/XNY	M075	S14
	NPY(K) = NY	M076	S14
	GO TO 7300	M0761	S14
C	CALCULATE SY FOR ALL J	M077	S14
7300	SY(1) =DY/3.0	M082	S14
	SY(NY) = SY(1)	M083	S14
	NY1=NY-1	M0831	S14
	DO 7400 J=2,NY1	M084	S14
	VJ =J	M085	S14
	SY(J) = SY(1) * (MODF(2.0 * (VJ+1.0), 4.0) + 2.0)	M086	S14
7400	CONTINUE	M087	S14
	NPYY = NPY(K)	M088	S14
	DO 7000 J=1,NPYY	M090	S14
	VJ=J	M091	S14
	Y=Y1+(VJ-1.0)*DY	M092	S14
C		M093	S14
	IF (X) 7310, 7320 , 7330	M094	S14
7310	ALPHA = 90.0 + (ATANF (-X/Y)) * 57.296	M095	S14
	GO TO 7311	M0952	S14
7320	ALPHA = 90.0	M0953	S14
	GO TO 7311	M0955	S14
7330	ALPHA = (ATANF (Y/X)) * 57.296	M0956	S14
	GO TO 7311	M0958	S14
		M0959	S14
C		M096	S14
7311	RSQ =X**2 + Y**2	M097	S14
C		M098	S14
	R =SQRTF(RSQ)	M099	S14
	CALL SUB1 (K,1,J)	M100	S14
	DSQ =RSQ + SEP**2 -2.0*SEP*X	M101	S14

FORTRAN Statements for S14 (Conf'd)

C	SUB1 IS SOURCE CALCULATION		M102 S14
	D =SQRTF(DSQ)		M103 S14
	FMU = (SEP**2 - RSQ - DSQ) / (2.0*R*D)		M104 S14
	F1 = SX(I)* SY(J)/DSQ		M106 S14
C			M107 S14
	IF (SENSE SWITCH 3) 7430 , 6000		M108 S14
	7430 PRINT 7435 ,K ,I ,J		M109 S14
	7435 FORMAT (44H0 X,Y,ALPHA,R,D,THETA,FMU, AND F1 FOR K I J ,15,15,15)		M110 S14
	PRINT 7440 ,X,Y,ALPHA,R,D,THETA,FMU, F1		M111 S14
	7440 FORMAT (1H0,1P8E10.3)		M112 S14
	6000 CALL SUB2 (K,I,J)		M114 S14
C	SUB2 IS GAMMA CALCULATION CONTAINS DO LOOP OVER ENERGY		M115 S14
	7000 CONTINUE		M121 S14
	8000 CONTINUE		M122 S14
	9000 CONTINUE		M123 S14
C			M124 S14
C			M125 S14
C	CALCULATE TOTAL AND FRACTIONAL FLUXES		M126 S14
	7425 PHIT =0.0		M127 S14
	DO 9100 K=1 , NA		M128 S14
	PHIK(K) =0.0		M129 S14
C			M130 S14
	DO 9050 L=1 , NE		M131 S14
	PHIK(K) =PHIK(K) +PHI(K,L)		M132 S14
	9050 CONTINUE		M133 S14
C			M134 S14
	PHIT =PHIT + PHIK(K)		M135 S14
	9100 CONTINUE		M136 S14
C			M137 S14
	DO 9150 K=1 ,NA		M138 S14
C			M139 S14
	PHIK2(K) = PHIK(K)/PHIT		M140 S14
	9150 CONTINUE		M141 S14
	DO 9200 L=1 ,NE		M148 S14
C			M149 S14
	PHIL(L) =0.0		M150 S14
C			M151 S14
	DO 9175 K=1 , NA		M152 S14
C			M153 S14
	PHIL(L) = PHIL(L)+ PHI(K,L)		M154 S14
	9175 CONTINUE		M155 S14
	9200 CONTINUE		M156 S14
	9207 RETURN		M176 S14
	END		M177 S14
*	STRAP FORTRAN		1001 S14
*	LIST8		S14
CS14SB1	JACK GRIGSBY ,E E JONES 2895)		1002 S14
EZE	EZEC1 EZED2 EZED3 EOF EZED5 EZEB1AEZEB3 EZEB4 EZEB1AEZEB5		S14
	SUBROUTINE SUB1(K,I,J)		2003 S14
	DIMENSION		0004 S14
	1SOURCE(15), PHIK(20), PHIK2(20) , PHIL(15), PHI(20,15),SX(100),		0005 S14
C			0006 S14
	2SY(100) , R1(20) , ALPHA1(20),X0(20) , Y0(20) , DELX(20),		0007 S14
C			0008 S14

FORTRAN Statements for S14 (Cont'd)

```

3DELY(20) , S(15,20,20),NPX(20) ,NPY(20) , KT(20) , EO(15) ,      0009 S14
C
4E(15)                                                                0010 S14
COMMON                                                                0011 S14
1SOURCE ,PHIK ,PHIK2 ,PHIL ,PHI ,SX ,SY ,R1 ,ALPHA1 ,XO , YO,      0015 S14
C
2DELX ,DELY ,S ,NPX ,NPY ,KT ,XLIB ,L1 ,XLIBNO ,LIBNO,            0016 S14
C
3XSLIB ,LB ,XID ,NA ,X1 ,Y1 ,DX ,NX ,NE ,THICK ,NX1,              0017 S14
C
4VI ,X ,DY ,NY ,NYM ,XNY ,SLOPE ,NY1,VJ ,Y ,ALPHA ,RSQ ,          0018 S14
C
5R ,DSQ ,SEP,D ,FMU ,F1 ,PHIT ,FNPX ,FNPY , MMAX ,NMAX ,CON1 ,    0019 S14
C
6CON2 ,CON3 ,CON4 ,CON5 ,CON6 ,CON7 ,CON8 , CON9 ,RO ,CON10 ,      0020 S14
7SIGMA ,E1 ,EO ,E ,XNEL                                            0021 S14
IF (R-R1(1)) 20, 2 ,2                                              0022 S14
2 IF (ALPHA -ALPHA1(1)) 20,5,5                                     0023 S14
C
5 DO 10 M=1 ,MMAX                                                    0024 S14
IF (R1(M)-R ) 10 ,40 ,40                                          0025 S14
10 CONTINUE                                                         0026 S14
20 PRINT 30                                                         0027 S14
30 FORMAT ( 48H A VALUE OF R1 OR ALPHA1 CALLS FOR EXTRAPOLATION)  0028 S14
PRINT 31,K,L,I,J                                                  0029 S14
31 FORMAT (31H0 X,Y,R,ALPHA FOR K,L,I,J OF 415 )                  0030 S14
PRINT 32, X,Y,R,ALPHA                                             0031 S14
32 FORMAT (1H0 ,1P4E10.3 )                                         0032 S14
PRINT 33                                                            0033 S14
33 FORMAT (33H0 MIN AND MAX INPUT R AND ALPHA )                  0034 S14
PRINT 34, (R1(1),R1(MMAX),ALPHA1(1),ALPHA1(NMAX) )              0035 S14
34 FORMAT (1H0 ,1P4E10.3)                                         0036 S14
CALL AUTO                                                            0037 S14
40 DO 50 N=1 , NMAX                                                 0038 S14
IF (ALPHA1(N) -ALPHA) 50 ,60 ,60                                  0039 S14
50 CONTINUE                                                         0040 S14
GO TO 20                                                            0041 S14
60 CON1 =(ALPHA-ALPHA1(N-1))/(ALPHA1(N)-ALPHA1(N-1))             0042 S14
C
DO 100 L=1 ,NE                                                       0043 S14
CON3=S(L,M-1,N-1) +CON1*(S(L,M-1,N)-S(L,M-1,N-1))              0044 S14
C
CON4=S(L,M,N-1) +CON1*(S(L,M,N)-S(L,M,N-1))                      0045 S14
C
SOURCE(L)=(CON3 * R1(M-1)**2+CON4 *R1(M)**2 ) / (2.0*R**2)       0046 S14
C
100 CONTINUE                                                         0047 S14
IF (SENSE SWITCH 4 ) 65 ,110                                       0048 S14
C
65 PRINT 70 , K , I , J                                            0049 S14
70 FORMAT (37H0 SOURCES FOR ALL L FOR K I AND J OF,15 ,15 ,15 )  0050 S14
PRINT 75 , ( SOURCE(L), L=1 , NE )                                  0051 S14
75 FORMAT ( 1P6E10.3)                                              0052 S14
C

```

FORTRAN Statements for S14 (Cont'd)

110	RETURN	1075	S14
	END	1076	S14
*	STRAP FORTRAN	2002	S14
*	LISTS		S14
CS14S82	JACK GRIGSBY (E E JONES 2896)	2003	S14
EZE	EZEC1 EZED2 EZED3 EGF EZED5 EZEB1AEZEB3 EZEB4 EZEB1AEZEB5		S14
	SUBROUTINE SUB2 (K,I,J)	2004	S14
	DIMENSION	00041	S14
C	1SOURCE(15), PHIK(20), PHIK2(20) , PHIL(15), PHI(20,15),SX(100),	0005	S14
C	2SY(100) , R1(20) , ALPHA1(20),X0(20) , YO(20) , DELX(20),	0006	S14
C	3DELY(20) , S(15,20,20),NPX(20) ,NPY(20) , KT(20) , E0(15) ,	0007	S14
C	4E(15)	0008	S14
	COMMON	0009	S14
C	1SOURCE ,PHIK ,PHIK2 ,PHIL ,PHI ,SX ,SY ,R1 ,ALPHA1 ,X0 , YO,	0010	S14
C	2DELX ,DELY ,S ,NPX ,NPY ,KT ,XLIB ,L1 ,XLIBNO ,LIBNO,	0011	S14
C	3XSLIB ,LB ,XID ,NA ,X1 ,Y1 ,DX ,NX ,NE ,THICK ,NX1, .	0015	S14
C	4VI ,X ,DY ,NY ,NYM ,XNY ,SLOPE ,NY1,VJ ,Y ,ALPHA ,RSQ ,	0016	S14
C	5R ,DSQ ,SEP,D ,FMU ,F1 ,PHIT ,FNPX ,FNPY , MMAX ,NMAX ,CON1 ,	0017	S14
C	6CON2 ,CON3 ,CON4 ,CON5 ,CON6 ,CON7 ,CON8 , CON9 ,RO ,CON10 ,	0018	S14
C	7SIGMA ,E1 ,E0 ,E ,XNEL	0019	S14
C	DO LOOP OVER ENERGY	0020	S14
C	DO 600 L=1 ,NE	0021	S14
C		0022	S14
C	CALCULATE SIGMA	0023	S14
C	CON7 = E0(L)/0.51	0024	S14
C	CON6 = 1.0 / (1.0 + CON7*(1.0 - FMU))	0025	S14
C	SIGMA = RO * (CON6 - (CON6**2)*(1.0-FMU**2) + CON6**3) / 2.0	0026	S14
C	CALCULATE FINAL ENERGY	0027	S14
C	E1 = CON7*CON6 * 0.51	2029	S14
C		2030	S14
C	DETERMINE WHICH GROUP E1 LIES IN AND CALCULATE PHI	2031	S14
C		2032	S14
C	DO 610 LF= 1, NE	2033	S14
C		2035	S14
C	IF (E(LF)-E1) 620 , 620 , 610	2036	S14
610	CONTINUE	2038	S14
C		2040	S14
C		2042	S14
C		2054	S14
C		2055	S14
C		2056	S14
C		2057	S14
C		2058	S14
C		2059	S14
620	PHI (K,LF)= PHI (K,LF)+ SOURCE(L) * SIGMA * F1	2060	S14
C	IF (SENSE SWITCH 6) 630,600	2061	S14
630	PRINT 635	2062	S14
635	FORMAT (30H0 K I J L E1 SIGMA AND SOURCE)	2063	S14
C	PRINT 640 ,K,I,J,L,E1,SIGMA,SOURCE(L)	20631	S14
640	FORMAT (4I5,1P3E10.3)	20632	S14
C		20633	S14
		20634	S14
		20635	S14
		2064	S14

FORTRAN Statements for S14 (Cont'd)

600 CONTINUE
RETURN
END

2065 S14
2066 S14
2067 S14

00381

APPENDIX D
INPUT AND OUTPUT FOR S14 SAMPLE PROBLEM



Problem Data for S14

6	14	0.58	913.0	529621.0	0.45	56430300012	S14
0.782+24						56430300022	S14
79	15	61	49	55	45	56430300032	S14
9	0	9	0	35	15	56430300042	S14
0	1	0	1	0	0	56430300052	S14
97.54	97.54	198.70	198.700	650.7	650.700	56430300062	S14
50.59	92.05	92.05	155.40	155.4	50.590	56430300072	S14
7.092	7.229	7.533	9.417	7.620	7.2390	56430300082	S14
5.181	0.0	7.925	0.0	7.676	7.4930	56430300092	S14
						56430300102	S14

Source Library for S14

1							5296210001L	S14
14	5	5					5296210002L	S14
24.0	180.0	305.0	650.0	7000.0			5296210003L	S14
0.0	30.0	60.0	90.0	120.0			5296210004L	S14
9.34+00	8.25+00	7.51+00	6.43+00	5.43+00	4.39+00		5296210005L	S14
3.36+00	2.37+00	1.72+00	1.20+00	8.59-01	6.09-01		5296210006L	S14
3.45-01	1.17-01						5296210007L	S14
9.00+00	8.00+00	7.00+00	6.00+00	5.00+00	4.00+00		5296210008L	S14
3.00+00	2.00+00	1.50+00	1.00+00	7.50-01	5.00-01		5296210009L	S14
2.50-01	0.00+00						5296210010L	S14
1.79+03	1.40+01	4.60+00	9.81-01	8.45-03			5296210011L	S14
4.37+02	8.36+00	2.97+00	6.60-01	5.70-03			5296210012L	S14
9.36+02	1.47+01	5.15+00	1.13+00	9.76-03			5296210013L	S14
1.03+03	1.78+01	6.15+00	1.35+00	1.16-02			5296210014L	S14
9.36+02	1.47+01	5.15+00	1.13+00	9.76-03			5296210015L	S14
1.92+04	1.50+02	4.95+01	1.05+01	9.10-02			5296210016L	S14
4.69+03	8.97+01	3.19+01	7.08+00	6.11-02			5296210017L	S14
1.00+04	1.58+02	5.53+01	1.21+01	1.05-01			5296210018L	S14
1.09+04	1.91+02	6.60+01	1.45+01	1.25-01			5296210019L	S14
1.00+04	1.58+02	5.53+01	1.21+01	1.05-01			5296210020L	S14
3.40+04	2.65+02	8.75+01	1.86+01	1.60-01			5296210021L	S14
8.29+03	1.59+02	5.64+01	1.25+01	1.08-01			5296210022L	S14
1.78+04	2.80+02	9.78+01	2.15+01	1.85-01			5296210023L	S14
1.93+04	3.38+02	1.17+02	2.56+01	2.21-01			5296210024L	S14
1.78+04	2.80+02	9.78+01	2.15+01	1.85-01			5296210025L	S14
4.67+04	3.65+02	1.20+02	2.56+01	2.21-01			5296210026L	S14
1.14+04	2.18+02	7.75+01	1.72+01	1.49-01			5296210027L	S14
2.44+04	3.85+02	1.35+02	2.95+01	2.55-01			5296210028L	S14
2.66+04	4.65+02	1.60+02	3.52+01	3.03-01			5296210029L	S14
2.44+04	3.85+02	1.35+02	2.95+01	2.55-01			5296210030L	S14
8.12+04	6.33+02	2.09+02	4.45+01	3.83-01			5296210031L	S14
1.98+04	3.79+02	1.35+02	2.99+01	2.58-01			5296210032L	S14
4.24+04	6.68+02	2.33+02	5.13+01	4.43-01			5296210033L	S14
4.61+04	8.08+02	2.79+02	6.11+01	5.27-01			5296210034L	S14
4.24+04	6.68+02	2.33+02	5.13+01	4.43-01			5296210035L	S14
1.62+05	1.27+03	4.18+02	8.90+01	7.67-01			5296210036L	S14
3.96+04	7.59+02	2.69+02	5.99+01	5.17-01			5296210037L	S14
8.49+04	1.34+03	4.67+02	1.03+02	8.86-01			5296210038L	S14
9.24+04	1.62+03	5.58+02	1.22+02	1.05+00			5296210039L	S14
8.49+04	1.34+03	4.67+02	1.03+02	8.86-01			5296210040L	S14
4.51+05	3.52+03	1.16+03	2.47+02	2.13+00			5296210041L	S14
1.10+05	2.11+03	7.49+02	1.66+02	1.44+00			5296210042L	S14
2.36+05	3.72+03	1.30+03	2.85+02	2.46+00			5296210043L	S14
2.57+05	4.49+03	1.55+03	3.40+02	2.93+00			5296210044L	S14
2.36+05	3.72+03	1.30+03	2.85+02	2.46+00			5296210045L	S14
1.40+06	1.09+04	3.60+03	7.66+02	6.60+00			5296210046L	S14
3.41+05	6.53+03	2.32+03	5.15+02	4.45+00			5296210047L	S14
7.31+05	1.15+04	4.02+03	8.83+02	7.62+00			5296210048L	S14
7.94+05	1.39+04	4.80+03	1.05+03	9.07+00			5296210049L	S14
7.31+05	1.15+04	4.02+03	8.83+02	7.62+00			5296210050L	S14
1.39+06	1.09+04	3.59+03	7.65+02	6.55+00			5296210051L	S14
3.40+05	6.50+03	2.31+03	5.15+02	4.43+00			5296210052L	S14
7.30+05	1.15+04	4.00+03	8.80+02	7.60+00			5296210053L	S14
7.94+05	1.39+04	4.80+03	1.05+03	9.07+00			5296210054L	S14

Source Library for S14 (Cont'd)

7.30+05	1.15+04	4.00+03	8.80+02	7.60+00	5296210055L	S14
2.28+06	1.78+04	5.85+03	1.25+03	1.08+01	5296210056L	S14
5.55+05	1.07+04	3.78+03	8.40+02	7.25+00	5296210057L	S14
1.19+06	1.88+04	6.55+03	1.44+03	1.24+01	5296210058L	S14
1.30+06	2.27+04	7.80+03	1.73+03	1.48+01	5296210059L	S14
1.19+06	1.88+04	6.55+03	1.44+03	1.24+01	5296210060L	S14
1.81+06	1.41+04	4.68+03	9.93+02	8.55+00	5296210061L	S14
4.42+05	8.48+03	3.00+03	6.68+02	5.78+00	5296210062L	S14
9.48+05	1.49+04	5.23+03	1.15+03	9.88+00	5296210063L	S14
1.03+06	1.80+04	6.23+03	1.36+03	1.18+01	5296210064L	S14
9.48+05	1.49+04	5.23+03	1.15+03	9.88+00	5296210065L	S14
3.10+06	2.42+04	7.90+03	1.70+03	1.46+01	5296210066L	S14
7.55+05	1.45+04	5.15+03	1.14+03	9.85+00	5296210067L	S14
1.62+06	2.55+04	8.93+03	1.96+03	1.69+01	5296210068L	S14
1.76+06	3.08+04	1.07+04	2.33+03	2.01+01	5296210069L	S14
1.62+06	2.55+04	8.93+03	1.96+03	1.69+01	5296210070L	S14
7.53+06	5.89+04	1.94+04	4.13+03	3.55+01	5296210071L	S14
1.84+06	3.53+04	1.64+04	2.78+03	2.40+01	5296210072L	S14
3.93+06	6.20+04	2.17+04	4.75+03	4.10+01	5296210073L	S14
4.28+06	7.48+04	2.58+04	5.65+03	4.89+01	5296210074L	S14
3.93+06	6.20+04	2.17+04	4.75+03	4.10+01	5296210075L	S14
1.09+07	8.50+04	2.80+04	5.98+03	5.15+01	5296210076L	S14
2.65+06	5.10+04	1.81+04	4.03+03	3.48+01	5296210077L	S14
5.70+06	8.98+04	3.13+04	6.88+03	5.95+01	5296210078L	S14
6.20+06	1.08+05	3.75+04	8.20+03	7.08+01	5296210079L	S14
5.70+06	8.98+04	3.13+04	6.88+03	5.95+01	5296210080L	S14
					00080	

Output for S14

GENERAL DYNAMICS/FORT WORTH S14 PROB 564303 DATE 8-29-62 PAGE 1

TOTAL FLUX AT DETECTOR IS 4.798+02

FLUX SPECTRUM AT DETECTOR BY INCREASING L

0.	0.	0.	1.510-04	1.165-02	6.799-02
2.737-01	2.011+00	5.183+00	1.520+01	1.736+01	3.834+01
1.329+02	2.685+02				

TOTAL FLUX FROM SUB AREAS BY INCREASING K

9.832+01	1.024+01	6.852+01	5.376+01	6.740+01	1.816+02
----------	----------	----------	----------	----------	----------

FRACTION OF TOTAL FLUX FROM SUB AREAS

2.049-01	2.135-02	1.428-01	1.120-01	1.405-01	3.785-01
----------	----------	----------	----------	----------	----------

FLUX BY INCREASING L FOR SUB AREA 1

0.	0.	0.	1.510-04	1.151-02	6.374-02
2.300-01	1.511+00	3.173+00	7.489+00	5.808+00	1.115+01
2.800+01	4.089+01				

FLUX BY INCREASING L FOR SUB AREA 2

0.	0.	0.	0.	0.	0.
0.	4.261-04	1.256-02	2.464-01	4.631-01	8.175-01
3.874+00	4.830+00				

FLUX BY INCREASING L FOR SUB AREA 3

0.	0.	0.	0.	0.	0.
6.780-03	2.125-01	9.454-01	3.059+00	3.980+00	8.274+00
2.175+01	3.030+01				

FLUX BY INCREASING L FOR SUB AREA 4

0.	0.	0.	0.	0.	0.
0.	0.	1.169-02	5.019-01	1.612+00	4.126+00
1.908+01	2.843+01				

FLUX BY INCREASING L FOR SUB AREA 5

Output for S14 (Cont'd)

GENERAL DYNAMICS/FORT WORTH S14 PROB 564303 DATE 8-29-62 PAGE 2

0.	0.	0.	0.	0.	0.
0.	0.	1.190-07	1.726-02	2.261-01	1.551+00
1.209+01	5.351+01				

FLUX BY INCREASING L FOR SUB AREA 6

0.	0.	0.	0.	1.377-04	4.251-03
3.699-02	2.868-01	1.040+00	3.886+00	5.270+00	1.242+01
4.810+01	1.106+02				

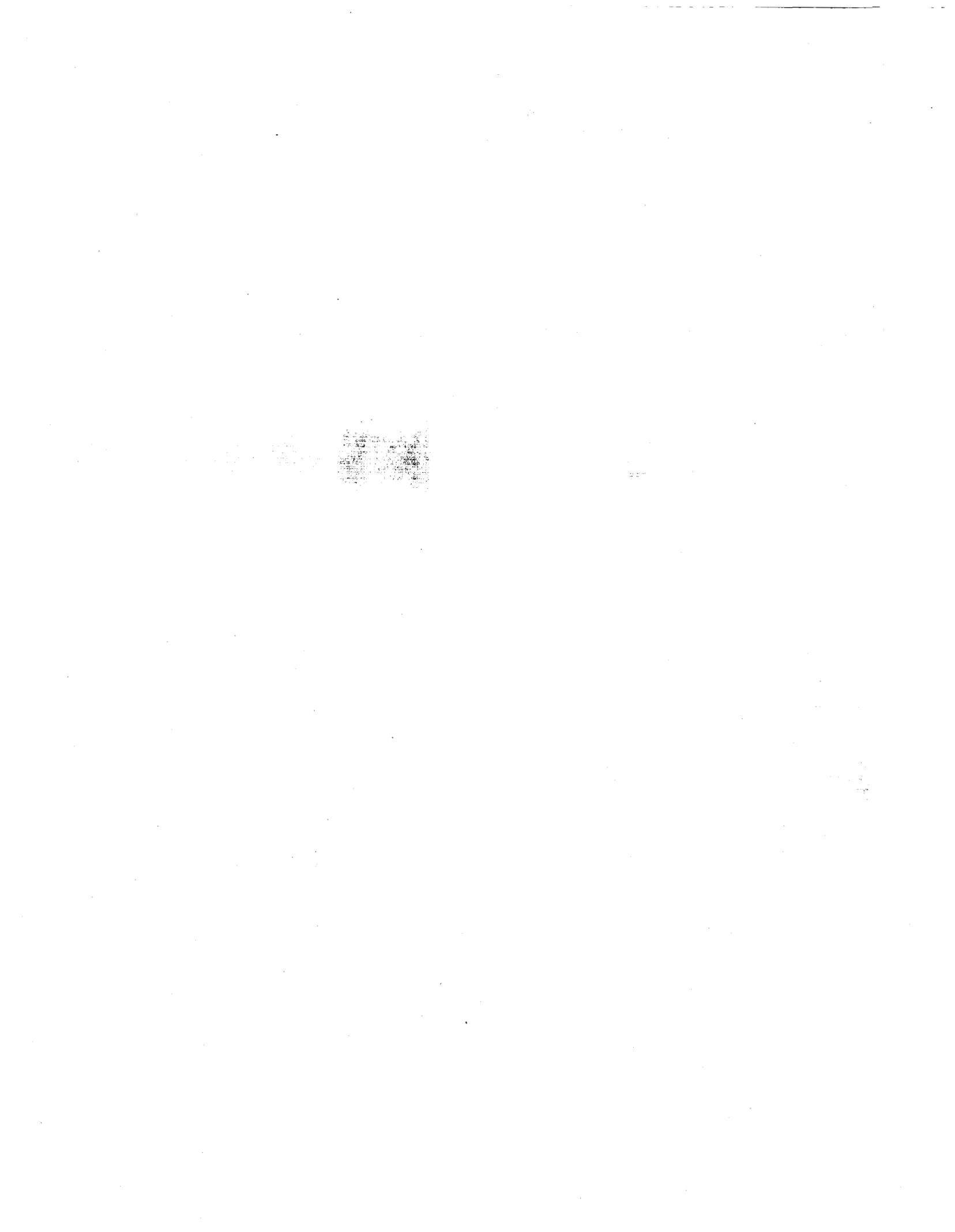

APPENDIX E
MACHINE OPERATING INSTRUCTIONS FOR PROCEDURES
S06 AND S14

APPENDIX E

MACHINE OPERATING INSTRUCTIONS FOR PROCEDURES S06 and S14

The computer codes S06 and S14 (procedures) are designed to run in STRAP, the GD/FW operating system for the IBM-7090. In the modified version of the 709/7090 FORTRAN System used at GD/FW, the STRAP System is read from the system tape and control transferred to it whenever a STRAP control card is encountered by either SIGNON or SCAN. At the end of a STRAP job, the FORTRAN Common I-O Package is stored and control returned to SIGNON.

A method by which computing installations other than GD/FW may run a computer code designed for use with STRAP as a standard execute job in the 709/7090 FORTRAN System has been developed. The job deck for running in this mode is composed of the following parts in the order listed:

1. DATE card and/or I.D. card compatible with the version of the 709/7090 FORTRAN System used by the installation running the job.
2. Any FORTRAN Monitor comment or PAUSE cards needed by the individual computing installation.
3. The STRAP control deck, which is numbered consecutively in Columns 73-75, beginning with 001, and has STRP2 in Columns 76-80 of each card. Card 001 is an EXQ control card.
4. The program binary deck for the computer code in question. This deck is numbered consecutively in Columns 73-76, beginning at 0001, and has the computer code identification in Columns 78-80 of each card.
5. Problem-data decks and library-data decks.

The following statements should convey to anyone familiar with the basic 709/7090 FORTRAN System all the information needed to run a STRAP job:

1. The job deck is written as a file on the input tape. When the FORTRAN Monitor reaches this file, control is transferred to the STRAP Monitor via the XEQ card, and the STRAP Monitor in turn transfers control to the specific computer code being run.
2. Tapes A1, A2, and A3 are the system, input, and output tapes in STRAP, just as in the FORTRAN system. B4 is written on by the FORTRAN Monitor and hence must not be filed protected.
3. Tape B1 is used as an intermediate tape.
4. The memory locations between (3)8 and (143)8 permanently reserved for the use of the FORTRAN Monitor are not used by STRAP procedures.
5. Programmed stops in STRAP procedures are preceded by a comment on the on-line printer.
6. The output added to tape A3 by STRAP jobs will not be followed by an end-of-file.
7. Upon completion of a STRAP run, the system tape on A1 is rewound, the FORTRAN Common I-O Package is read in, two Monitor records (DUMP and C-to-tape) are skipped on A1, and (LOAD) is called to bring in SIGNON.
8. Tapes are assigned in STRAP jobs according to the following table:

<u>Logical No. or Tape Function</u>	<u>Actual 7090 Tape Assignment</u>
1	B1
2	B2
3	B3
4	B4
5	B5
6	B6
7	A4
8	A5
9, READ	A2
10, PRINT	A3
11	A6
12	A5
SYSTEM	A1

The actual 7090 tape assignment corresponding to logical tape numbers 1, 2, 3, 4, 5, 6, 7, 11, or 12 may be altered by the using installation. The choice of tape units must, however, be limited to channels A, B, or C. The following is an octal listing of the STRAP tape unit table.

77643	000000000024		
44	2201	LOGICAL TAPE	1
45	2202		2
46	2203		3
47	2204		4
50	2205		5
. 51	. 2206		6
. 52	. 1204		7
. 53	. 1205		8
54	1202		9
55	1203		10
56	1206		11
57	1205		12
60	0000		13
61	0000		14
62	0000		15
63	0000		16
64	0000		17
65	0000		18
66	0000		19
77667	000000001201		20

The format of this table is identical to the FORTRAN unit table (IOU) in the FORTRAN library. It is assumed that anyone attempting to change the table will be familiar with standard FORTRAN usage of table (IOU). This table appears on a separate absolute binary card in both the STRP2 and STRPR2 near the end of the decks. Changes may be made by using installation on this card or by binary corrections inserted just before the last card of each deck. The 22 word/card standard binary format is used in each deck---columnar binary in STRP2 and row binary in STRPR2. The check-sum on the cards in both decks must be either correct or zero.

As an example, suppose it is desired to change the actual 7090 tape assignment of logical tape 3 from B3 to C1. Location 77746 would be changed from 2203 to 3201 in both the STRP2 and STRPR2 decks.

9. Recovery is initiated on STRAP procedures by loading from the on-line card reader the STRAP Recovery Deck (numbered consecutively in Columns 73-74 beginning at 01 with STRPR2 in Columns 75-80 of each card).
10. Whenever it appears that a problem on a STRAP procedure is unable to reach completion, or whenever it is desired for any reason to terminate the problem (not the job), then the following steps should be taken:
 - a. Place the computer in manual and wait until operation stops.
 - b. Place the machine in automatic.
 - c. Depress sense switch 1.
 - d. Load the STRAP Recovery Deck from the on-line card reader.
11. If it becomes necessary to interrupt a job being run, the operator should depress sense switch 1. Within 10 minutes of this step, the procedure should indicate by an on-line comment what action has been taken, and what steps must be taken to restart the procedure. In many procedures, the takedown action will consist of nothing more than skipping the problems not yet completed. If the latter alternative is taken, then the problems not processed should merely be rescheduled at a later time.

The following restrictions apply to the running of procedures S06 and S14 by the method outlined in this section:

1. Subroutine DATE (in the STRAP Control Deck) assumes that the current date is stored in cell (142)g in standard FORTRAN format. If local changes to the FORTRAN system have altered this standard, then subroutine DATE should be replaced by a subroutine which does the following:
 - a. Stores the current date in absolute cell (77777)g as an integer of the form:

$$(\text{MONTH}) \cdot 10000 + (\text{DAY OF MONTH}) \cdot 100 + (\text{LAST TWO DIGITS OF YEAR}).$$
 - b. Returns control to 1,4.

Subroutine DATE is on standard relocatable binary instruction cards near the beginning of the STRAP Control Deck.

2. Whenever a recovery or termination of a problem is executed, the following items should be noted:
 - a. The correct date may not appear on the remaining output of the job on which recovery was made.
 - b. Information retained between jobs in locations (3)8 - (143)8 will probably be lost.
 - c. When the job is complete, an on-line comment will be given directing the operator to reload the START card to begin the next job on the input tape.

Both procedures, S06 and S14, will give error prints in the event that one of the following situations exists:

1. The wrong source library has been loaded. This will cause the machine to stop after printing WRONG LIBRARY.
2. A calculated value of R or ALPHA does not fall within the range of input values of R1 or ALPHA1. This will cause the machine to go to the next problem after printing A VALUE OF R1 OR ALPHA1 CALLS FOR EXTRAPOLATION; the values of K, L, I, J, X, Y, R, ALPHA involved; and the maximum and minimum values of R1 and ALPHA1. K, L, I, and J are subscripts on sub-area, energy, mesh point in X mesh, and mesh point in Y mesh, respectively.

When the cross-section libraries loaded in procedure S06 do not agree with those called for in the problem deck, the following print out will be given: LIBRARIES LOADED DO NOT AGREE WITH THOSE REQUESTED.

REFERENCES

1. Beale, R. H., et al., Test Bed Configurations for the Flight Testing of SNAP-8 Powered Electric Propulsion Systems. Jet Propulsion Laboratory Technical Report 32-190 (November 1961).
2. Stephenson, R., Introduction to Nuclear Engineering. New York: McGraw-Hill Book Company (1954).
3. Peterson, D. M., Shield Penetration Programs C-17 and L-63. GD/FW Report FZK-9-170 (NARF-61-39T, December 1961).
4. Clark, F. H., Wogulis, S. G., and Davis, M. W., Physics Measurements of the SNAP Experimental Reactor. Atomic International Report NAA-SR-5619 (January 1961).
5. Diekamp, H. M., Bolent, R., and Welch, J. R., "Compact Reactors for Space Power." Nucleonics 19 (April 1961), 73.
6. Troubetzkoy, E. S., Fast-Neutron Cross Sections of Iron, Silicon, Aluminum, and Oxygen. Nuclear Development Corporation of America Report NDA 2111-3, Volume C (November 1959).
7. Rockwell, T., Reactor Shielding Design Manual. Atomic Energy Commission Report TID-7001 (March 1958).
8. Collins, D. G., A Monte Carlo Procedure for Calculating Penetration of Neutrons Through Straight Cylindrical Ducts. GD/FW Report MR-N-286 (NARF-61-33T, November 1961).
9. Aronson, R., et al., Effect of Shield Splitting and Placement in Nuclear Propelled Space Vehicles. Technical Research Group Report TRG-136-FR (March 1961).
10. Loechler, J. J., and McDonald, J. E., Flexible Monte Carlo Programs FCM-N and FMC-G, General Electric Flight Propulsion Laboratory Report APEX-702 (April 1961).

DISTRIBUTION

FZK-154 29 October 1962

Addressee

No. of Copies

H. E. Stern (M-RP-N)
Marshall Space Flight Center
Huntsville, Alabama

50