

1002.11
GT-4
MSC-G-R-65-3

~~CONFIDENTIAL~~

526 pp

31

GEMINI PROGRAM MISSION REPORT

GEMINI IV

(U)

unclassified

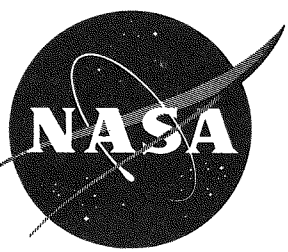

GROUP 4
DOWNGRADED
AT 3 YEAR INTERVALS;
DECLASSIFIED
AFTER 12 YEARS

~~CLASSIFIED DOCUMENT This material contains information affecting the National Defense of the United States within the meaning of the espionage laws, Title 18, U.S.C., Secs. 793 and 794, the transmission or revelation of which in any manner to an unauthorized person is prohibited by law.~~

JUNE 1965

NATIONAL AERONAUTICS AND SPACE ADMINISTRATION MANNED SPACECRAFT CENTER

~~CONFIDENTIAL~~

1352.1.1
IV

Hammurath

17

UNCLASSIFIED

CHANGE SHEET

FOR

GEMINI PROGRAM MISSION REPORT

GEMINI IV

(MSC-G-R-65-3)

CHANGE I

December 9, 1965



Charles W. Mathews
Manager, Gemini Program

Page 1 of 10 pages
(with enclosures)

Insert the attached enclosures, which are replacement pages or additional new pages, and make the indicated pen and ink changes. Upon incorporation of the changes, insert this CHANGE SHEET between the cover and title page, and enter your signature and the date in the spaces provided below.



Signature of person incorporating changes

6-22-66
Date

NATIONAL AERONAUTICS AND SPACE ADMINISTRATION

MANNED SPACECRAFT CENTER

HOUSTON, TEXAS

UNCLASSIFIED

UNCLASSIFIED

Pen-and-ink changes:

1. Page xii; Title of section 8.5: Change "magnetrometer" to "magnetometer".
2. Page xvii; Title of table 8-II: Change "Experiments" to "Experiment", and insert "4" after spacecraft.
3. Page xvii; Title of table 12-II: Insert "at 11:47 G.m.t." after "Reentry Weather Conditions".
4. Page 3-19; remark opposite item no. 76 in table 3-III: Reference should be made to item no. 43 instead of item no. 39.
5. Page 3-21; paragraph (a) in second column of table 3-IV, opposite "Stage I Structure": Change "capped" to "lapped".
6. Page 4-2; fourth line of fourth paragraph: Change "7.1.5" to "7.1.2".
7. Page 4-3; second line from top of page: "Reschuled" should be "rescheduled".
8. Page 4-7; first sentence of paragraph 4.3.1.2: Change "reference 2" to "reference 4".
9. Page 4-11; seventh line of second paragraph: Insert a minus sign preceding "6.9 nautical miles".
10. Page 5-3; first sentence of last paragraph of section 5.1.1.2.3: Change "Head-shield" to "Heat-shield".
11. Page 5-27; last sentence of second paragraph of section 5.1.6: Change actual time of retrofire to 97:40:00.70 g.e.t.
12. Page 5-34; ninth line from top of page: Add "and" after "testing".
13. Page 5-34; last sentence of paragraph 5.1.8.2.3: Delete the comma after "propulsion systems".
14. Page 5-70; Change figure number to 5.1-8.
15. Page 5-89; first sentence of second paragraph of section 5.2.3.2: Change "5.1-7" to "5.1-8".

UNCLASSIFIED

16. Page 5-94; second line following the table in paragraph 5.2.9.1: Add "LO to" preceding "LO + 50 seconds".

17. Page 5-97; last item in first column of table 5.2-I: Change "precent" to "percent".

18. Page 6-13; third line following the table in paragraph 6.3.3.3: Change "affort" to "afford".

19. Page 7-7; eighth line from top of page: Delete "of the" after "close-up".

20. Page 12-2; third line of last paragraph of section 12.2: Delete "at the time of reentry", and replace it with "at 11:47 G.m.t. (92:31:00 g.e.t.)".

21. Page 12-3; fifth line of paragraph 12.3.1.2: Change "UCM" to "VCM".

22. Page 12-10: Insert "rev. A" after the following STR numbers.

4002
4004
4005
4007

23. Page 12-14; title of table 12-II: Insert "at 11:47 G.m.t." after "Reentry Weather Conditions".

24. The following pages have been declassified as a result of a classification review. Please make the necessary corrections, citing Gemini Program Security Classification Guide (SCG 10-1) 3 June 1965 and this change sheet as the downgrading authorities.

UNCLASSIFIED

<u>Page</u>	<u>Original Classification</u>	<u>Revised Classification</u>
3-11	Confidential	Unclassified
4-3	"	"
4-4	"	"
4-6	"	"
4-8	"	"
4-9	"	"
4-10	"	"
4-11	"	"
4-12	"	"
4-13	"	"
4-16	"	"
4-17	"	"
4-18	"	"
4-22	"	"
4-25	"	"
4-26	"	"
4-31	"	"
5-12	"	"
5-17	"	"
5-18	"	"
5-19	"	"
5-20	"	"
5-21	"	"
5-24	"	"
5-25	"	"
5-26	"	"
5-27	"	"
5-65	"	"
5-72	"	"
5-77	"	"
5-78	"	"
5-79	"	"
5-108	"	"
5-109	"	"
5-110	"	"

The following attached pages are replacements or new pages.

<u>Page</u>	<u>Category</u>
12-11	Replacement
12-12	Replacement
12-12A	new
12-12B	new
12-12C	new
12-15	Replacement

UNCLASSIFIED

UNCLASSIFIED

12-11

<u>Number</u>	<u>System</u>	<u>Purpose</u>
4010 rev. A	Guidance and control	To remove, clean, and return the IMU and IMU electronics to the vendor for evaluation tests of the IGS, and possible re-use.
4011 rev. A	Environmental control	To determine the condition of the LiOH canister after the mission.
4012 rev. B	Instrumentation	To return the spacecraft 4 voice recorder cartridges to the vendor for evaluation, refurbishment, and possible re-use.
4013	Environmental control	To analyze a sample of the absorbent material removed from the cabin wall after flight.
4014	Communications	To demonstrate that the HF voice transceiver and HF whip antenna were not adversely affected by immersion.
4015 rev. A	Communications	To evaluate the voice quality of the voice transmission system.
4016	Structures	To determine why the flight crew had difficulty closing and latching the right-hand hatch.
4017	Crew station	To determine the chemical constituents of the film that was observed to be wiped off the left-hand window during EVA.
4018 rev. A	Experiments	To investigate and recommend design changes concerning flight crew comment that the sight reticle was not bright enough during the Gemini IV flight.
4019 rev. A	Crew station	To investigate the Gemini IV crew's report that the left-hand G.m.t. clock was not accurate.
4020 rev. A	Instrumentation	To investigate the condition of the mylar drive belt and inverter wire routing in the PCM tape recorder.

UNCLASSIFIED

Changed December 9, 1965

UNCLASSIFIED

<u>Number</u>	<u>System</u>	<u>Purpose</u>
4021	Structures	To perform postflight evaluation of the heat shield.
4022	Environmental control	To perform a failure analysis of the overboard urine dump system.
4023 rev. A	Crew station	To evaluate seals and determine the extent of damage incurred during flight as a result of stowing gear and removing gear from the center stowage box.
4024 rev. A	Propulsion	To investigate possible flight failure of the RCS thrust chamber assembly no. 5.
4025 rev. A	Environmental control	To establish the accuracy of inflight cabin humidity readings.
4026	Crew station	To inspect and test the 16-mm cameras to determine the cause of intermittent operation. To refurbish the 16-mm cameras for use on spacecraft 5, and to perform non-destructive analysis of parts removed during refurbishment.
4027	Instrumentation and recording	To install the PCM tape recorder in spacecraft 7 until a flight-rated recorder is available.
4028	Crew station	To ship both blood pressure reprogramming adapters to the spacecraft contractor for use as spacecraft 6 SST units and for use in spacecraft 7 stowage review.
4029	Electrical, and guidance and control	To conduct a failure analysis on those electrical/mechanical devices which could have prevented operation of thrust chamber assembly no. 9 during the flight.
4030	Crew station	To conduct further evaluation of the hand controller.

Changed December 9, 1965

UNCLASSIFIED

UNCLASSIFIED

12-12A

<u>Number</u>	<u>System</u>	<u>Purpose</u>
4031	Structure	To conduct further evaluation of the right-hand hatch latching handle and mechanism.
4032	Structure	To conduct further analysis of the right-hand and left-hand windows' optical transmission, reflection, and image degradation qualities. Also, to examine the windows under high magnification for meteoroid impacts.
4033	Instrumentation and recording	To conduct an analysis in order to determine why the PCM tape recorder stopped recording at 97:54:09 g.e.t. The contractor will subject the recorder to differential pressures to determine if the cover bows in and stops reel motion.
4034 rev. A	Guidance and control	To conduct a failure analysis of the guidance and control system to determine the cause of the inertial guidance system anomaly which occurred during the flight.
4035	Crew station	To remove and return biomedical tape recorders (serial nos. 001 and 009) to KSC for analysis and refurbishment.
4036	Crew station	To investigate the cause of metallic noise during operation of the biomedical tape recorders.
4037	Communications	To evaluate communications system anomalies of spacecraft 4 which occurred during extravehicular activity.
4038 rev. A	Sequential	To determine the acceptability of the retrofire relay panel.
4500	Environmental control	To evaluate moisture absorbent material used in the cabin.
4503	Electrical	To dry spacecraft wiring in preparation for failure analysis of IGS malfunction.

Changed December 9, 1965

UNCLASSIFIED

UNCLASSIFIED

<u>Number</u>	<u>System</u>	<u>Purpose</u>
4505 rev. A	Escape	To use ejection seats in spacecraft 5 for pad systems tests.
4508	Structure	To determine the composition of the residue on windows.
4509 rev. A	Environmental control	To investigate a problem reported to have occurred during the Gemini IV mission in which the command pilot was not able at times to get water to flow from drink dispenser, and to determine why the tube assembly has a crazed surface.
4511	Landing, escape, and recovery	To evaluate the tip of the MDF interconnect on the right-hand seat.
4512 rev. A	Electrical	To obtain the ampere-hours left in the batteries for comparison with the load analysis prediction.
4513	Landing, escape, and recovery	To evaluate the reason for the right-hand hatch actuator galling.
4517	Landing, escape, and recovery	To determine why the hoist loop door failed to jettison.
4518	Guidance and control, instrumentation and recording, coolant, and electrical	To make the necessary preparations for retest of the installed inertial guidance system in order to investigate the inflight anomaly.
4519 rev. B	Environmental control	To determine why the cabin temperature control valve which operated satisfactorily just prior to reentry was jammed after recovery.
4520	Instrumentation and recording	To determine the present condition of the PCM tape recorder and the reason for its stopping at approximately 2000-foot altitude during descent.
4522	Guidance and control, and electrical	To remove 6 inches of wire bundle for failure analysis.

UNCLASSIFIED Changed December 9, 1965

UNCLASSIFIED

12-12C

<u>Number</u>	<u>System</u>	<u>Purpose</u>
4523	Sequential, and instrumentation and recording	To investigate the manual retrofire and equipment adapter separation circuitry because of apparent non-operation during the mission.
4525	Overall	To remove ballast and ballast fittings from spacecraft 4 for possible re-use on later flights.
4526	Reentry control	To conduct an X-ray analysis, and compare char depth on RCS thrusters 5A and 5B.
4528	Ejection seat	To remove and ship ballast to vendor for possible re-use on other ejection seats.
4529	Structures	To remove additional plugs of heat shield material for further evaluation.

UNCLASSIFIED

Changed December 9, 1965

TABLE 12-III.- SUPPLEMENTAL REPORTS

Number	Report title	Responsible organization	Completion date	Text section reference and remarks
1	Launch Vehicle Flight Evaluation Report NASA Mission Gemini/Titan GT-4	SSD and contractor (Aerospace Corporation)	August 3, 1965	Section 5.2 Standing requirement
2	Launch Vehicle No. 4 Flight Evaluation	SSD and contractor (Martin Company)	July 18, 1965	Section 5.2 Standing requirement
3	MFSN Performance Analysis for GT-4 Mission	Goddard Space Flight Center	August 3, 1965	Section 6.3 Standing requirement
4	Gemini GT-4 IGS Evaluation - Trajectory Reconstruction	TRW Systems	July 18, 1965	Section 5.1.5 Standing requirement
5	Gemini GT-4 Ascent Post-flight Analysis Report	IBM Corporation	July 18, 1965	Section 5.1.5 Standing requirement
6 ^a	Analysis of Station-Keeping and Rendezvous Exercise	Flight Operations Directorate-Manned Spacecraft Center	July 18, 1965	Section 4.1

^aRequirement deleted

UNCLASSIFIED

Changed December 9, 1965

UNCLASSIFIED

12-15

UNCLASSIFIED

TABLE 12-IV.- INSTRUMENTATION DATA AVAILABILITY

Data description	
<p><u>Paper recordings</u></p> <p>Spacecraft telemetry measurements</p> <p>(Revolutions 1, 2, 3, 4, 7, 14, 15, 16, 17, 18, 27, 28, 29, 30, 31, 32, 42, 43, 44, 45, 46, 47, 48, 49, 57, 58, 59, 60, 61, reentry)</p> <p>GLV telemetry measurements (launch)</p> <p>Telemetry signal-strength recordings</p> <p>MCC-H and MCC-C plotboards (Confidential)</p> <p>Range safety plotboards (Confidential)</p> <p><u>Radar data</u> (Confidential)</p> <p>IP-3600 trajectory data</p> <p>MISTRAM</p> <p>Natural coordinate system</p> <p>Final reduced</p> <p>C-band</p> <p>Natural coordinate system</p> <p>Final reduced</p> <p>Trajectory data processed at MSC and GSFC (launch and orbital)</p> <p><u>Voice transcripts</u> (Confidential)</p> <p>Air-to-ground and onboard recorder</p> <p>Technical debriefing (on recovery ship)</p> <p><u>GLV reduced telemetry data</u> (Confidential)</p> <p>Engineering units versus time plots</p> <p>Vibration</p> <p>Power spectrum density plots</p> <p>g_{rms} plots</p> <p>Acoustical noise spectrum density plots (by one-third octave)</p>	<p><u>Spacecraft reduced telemetry data</u></p> <p><u>Engineering units versus time:</u></p> <p>Ascent phase</p> <p>DCS parameters (Confidential)</p> <p>Orbital phase</p> <p>Parameter tabulations (statistical) for revolutions 1, 3, 14, 16, 18, 30, 32, 46, 47, 48, 49, 51, 59, 60, 61, and 62</p> <p>System parameters excluding G and C for revolutions 1, 48, and 49</p> <p>Selected G and C parameters for revolutions 1, 43, 45, 46, 47, 48, 49, 61, and 62 (Confidential)</p> <p>Reentry phase</p> <p>System parameters excluding G and C</p> <p><u>Event tabulations</u></p> <p>Sequence of event tabulations versus time, including thruster firings for ascent, reentry, and revolutions 1, 2, 3, 4, 7, 14, 15, 16, 17, 18, 28, 29, 30, 31, 32, 36, 37, 44, 45, 46, 47, 48, 49, 51, 58, 59, 60, 61, and 62</p> <p><u>Special computations</u></p> <p>Ascent phase</p> <p>IGS computer word flow tag correction (Confidential)</p> <p>Special aerodynamic and guidance parameter calculations (Confidential)</p> <p>IGS computer simulation (Confidential)</p> <p>MISTRAM versus IGS velocity comparison (Confidential)</p> <p>Mod III radar versus IGS velocity comparison (Confidential)</p>

UNCLASSIFIED

UNCLASSIFIED

MSC-G-R-65-3

GEMINI PROGRAM MISSION REPORT

GEMINI IV

Prepared by: Gemini Mission Evaluation Team

Approved by:



Charles W. Mathews
Manager, Gemini Program

Authorized for Distribution:



George M. Low
Deputy Director

NATIONAL AERONAUTICS AND SPACE ADMINISTRATION

MANNED SPACECRAFT CENTER

HOUSTON, TEXAS

JULY 1965

UNCLASSIFIED

UNCLASSIFIED

NASA-S-65-6687

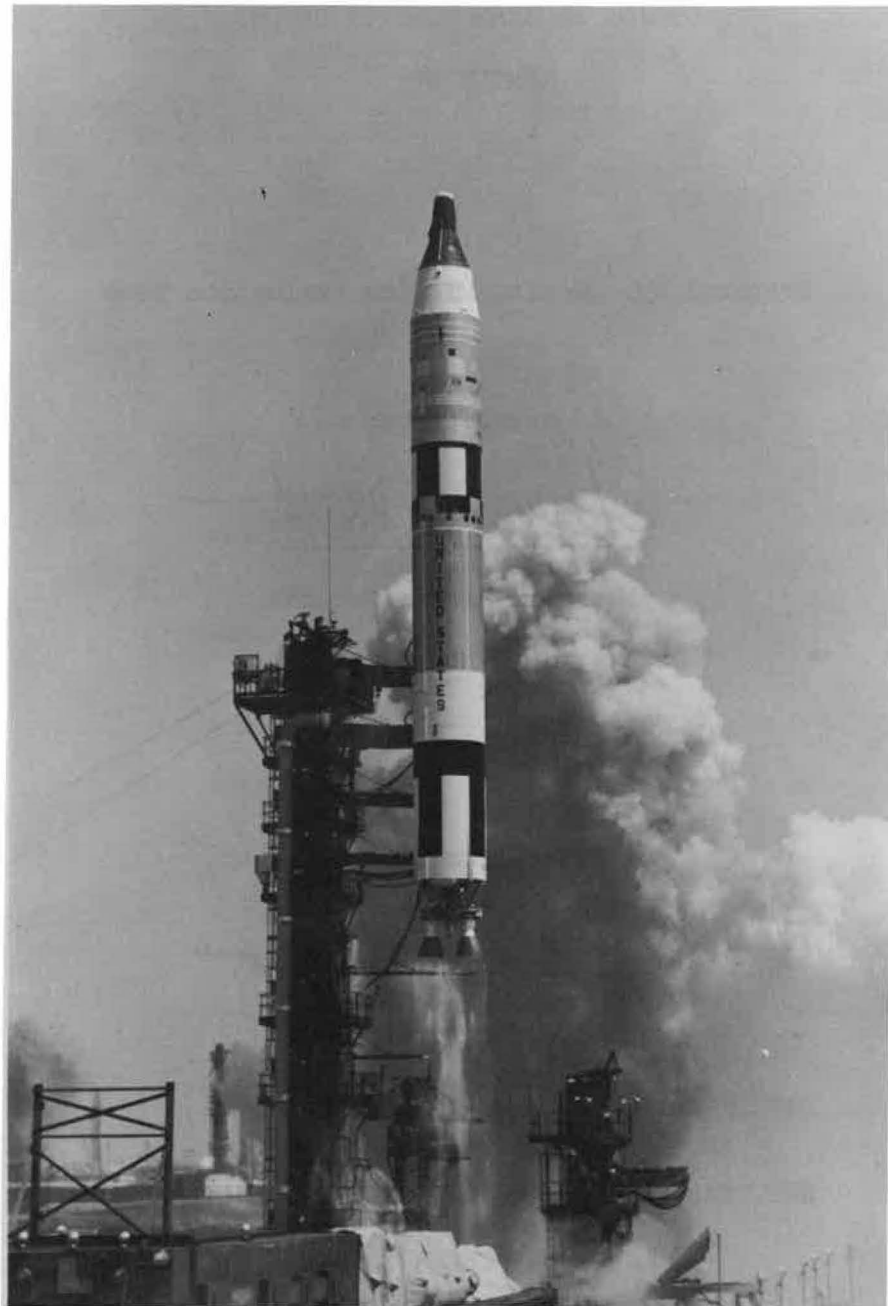

Gemini IV space vehicle at lift-off.

UNCLASSIFIED

MAJOR
SECTION
LOCATOR

Mission Summary	1.0
Introduction	2.0
Vehicle Description	3.0
Mission Description	4.0
Vehicle Performance	5.0
Spacecraft	5.1
Gemini Launch Vehicle	5.2
GLV-S/C Interface	5.3
Mission Support Performance	6.0
Flight Control	6.1
Network Performance	6.2
Recovery	6.3
Flight Crew	7.0
Flight Crew Performance	7.1
Aeromedical Analysis	7.2
Experiments	8.0
Conclusions	9.0
Recommendations	10.0
References	11.0
Appendix	12.0
Vehicle Histories	12.1
Weather Conditions	12.2
Flight Safety Reviews	12.3
Supplemental Reports	12.4
Data Availability	12.5
Postflight Inspection	12.6
Distribution	13.0

UNCLASSIFIED

CONTENTS

Section	Page
TABLES	xv
FIGURES	xviii
1.0 <u>MISSION SUMMARY</u>	1-1
2.0 <u>INTRODUCTION</u>	2-1
3.0 <u>VEHICLE DESCRIPTION</u>	3-1
3.1 GEMINI SPACECRAFT	3-1
3.1.1 Structure	3-1
3.1.2 Major Systems	3-1
3.1.2.1 Communications	3-1
3.1.2.2 Instrumentation and recording	3-2
3.1.2.3 Environmental control	3-2
3.1.2.4 Guidance and control	3-3
3.1.2.5 Time reference	3-4
3.1.2.6 Electrical	3-4
3.1.2.7 Propulsion	3-4
3.1.2.8 Pyrotechnic	3-4
3.1.2.9 Crew station furnishings and equipment	3-5
3.1.2.10 Landing	3-6
3.1.2.11 Postlanding and recovery	3-6
3.2 GEMINI LAUNCH VEHICLE	3-8
3.2.1 Structure	3-8
3.2.2 Major Systems	3-8
3.2.2.1 Propulsion	3-8
3.2.2.2 Flight control	3-9
3.2.2.3 Radio guidance	3-9
3.2.2.4 Hydraulic	3-9
3.2.2.5 Electrical	3-9
3.2.2.6 Malfunction detection	3-9
3.2.2.7 Instrumentation	3-9

UNCLASSIFIED

UNCLASSIFIED

Section		Page
	3.2.2.8 Range safety	3-9
	3.2.2.9 Ordnance separation	3-9
3.3	GEMINI IV WEIGHT AND BALANCE DATA	3-10
4.0	<u>MISSION DESCRIPTION</u>	4-1
4.1	ACTUAL MISSION	4-1
4.2	SEQUENCE OF EVENTS	4-5
4.3	FLIGHT TRAJECTORIES	4-6
	4.3.1 Spacecraft	4-6
	4.3.1.1 Launch	4-6
	4.3.1.2 Orbit	4-7
	4.3.1.3 Station keeping	4-7
	4.3.1.4 Reentry	4-10
	4.3.2 Launch Vehicle Second Stage	4-11
5.0	<u>VEHICLE PERFORMANCE</u>	5-1
5.1	SPACECRAFT PERFORMANCE	5-2
	5.1.1 Spacecraft Structure	5-2
	5.1.1.1 General	5-2
	5.1.1.2 Thermal environment	5-2
	5.1.1.3 Reentry aerodynamics	5-4
	5.1.1.4 Hatch closing and latching difficulty	5-4
	5.1.2 Communications Systems	5-5
	5.1.2.1 Ultra-high frequency voice communications	5-6
	5.1.2.2 High-frequency voice communications	5-7
	5.1.2.3 Radar transponders	5-7
	5.1.2.4 Digital command system	5-7
	5.1.2.5 Telemetry transmitters	5-8
	5.1.2.6 Antenna systems	5-8
	5.1.2.7 Recovery aids	5-8

UNCLASSIFIED

Section	Page
5.1.2.8 Voice tape recorder	5-8
5.1.3 Instrumentation and Recording System . . .	5-9
5.1.4 Environmental Control System	5-10
5.1.5 Guidance and Control Systems	5-12
5.1.5.1 Summary	5-12
5.1.5.2 IGS performance evaluation . . .	5-12
5.1.5.3 Control system performance evaluation	5-18
5.1.5.4 Anomalies	5-25
5.1.6 Time Reference System	5-27
5.1.7 Electrical System	5-28
5.1.8 Spacecraft Propulsion Systems	5-29
5.1.8.1 Orbital attitude and maneuver systems	5-29
5.1.8.2 Reentry control system	5-32
5.1.8.3 Retrograde rocket system	5-34
5.1.9 Pyrotechnic System	5-34
5.1.10 Crew Station Furnishings and Equipment . .	5-35
5.1.10.1 Crew station design and layout	5-35
5.1.10.2 Controls and displays	5-38
5.1.10.3 Space suits and accessories . . .	5-39
5.1.10.4 Extravehicular equipment	5-41
5.1.10.5 Pilots' operational equipment. . .	5-42
5.1.10.6 Pilots' personal equipment . . .	5-43
5.1.10.7 Bioinstrumentation system	5-45
5.1.11 Landing System	5-47
5.1.12 Postlanding and Recovery System	5-48
5.2 GEMINI LAUNCH VEHICLE	5-85
5.2.1 Airframe	5-85

UNCLASSIFIED

Section	Page
5.2.1.1	Longitudinal oscillation 5-85
5.2.1.2	Vibration environment 5-85
5.2.1.3	Acoustic environment 5-85
5.2.1.4	Structural loads 5-85
5.2.1.5	Post-SECO pulse 5-86
5.2.2	Propulsion 5-86
5.2.2.1	Stage I engine performance 5-86
5.2.2.2	Stage II engine performance 5-86
5.2.2.3	Propellant and autogenous system performance 5-86
5.2.2.4	Performance margin 5-87
5.2.3	Flight Control System 5-88
5.2.3.1	Stage I flight 5-88
5.2.3.2	Stage II flight 5-89
5.2.3.3	Post-SECO and separation rates 5-89
5.2.3.4	GLV tumble rates 5-89
5.2.4	Hydraulic System 5-90
5.2.4.1	Stage I primary system 5-90
5.2.4.2	Stage I secondary system 5-90
5.2.4.3	Stage II system 5-90
5.2.5	Guidance System 5-90
5.2.5.1	Programed guidance 5-90
5.2.5.2	Closed-loop guidance 5-90
5.2.6	Electrical System 5-92
5.2.7	Instrumentation System 5-92
5.2.7.1	Ground 5-92
5.2.7.2	Airborne 5-93
5.2.8	Malfunction Detection System 5-93
5.2.8.1	Engine MDS 5-93
5.2.8.2	Airframe MDS 5-94

UNCLASSIFIED

Section	Page
5.2.9	Range Safety and Ordnance 5-94
5.2.9.1	Flight termination system 5-94
5.2.9.2	Range safety tracking system 5-94
5.2.9.3	Ordnance 5-95
5.2.10	Prelaunch Operations and Aerospace Ground Equipment 5-95
5.3	SPACECRAFT - LAUNCH VEHICLE INTERFACE PERFORMANCE 5-117
6.0	<u>MISSION SUPPORT PERFORMANCE</u> 6-1
6.1	FLIGHT CONTROL 6-1
6.1.1	Prepermission Operation 6-1
6.1.1.1	Prepermission activities 6-1
6.1.1.2	Documentation 6-2
6.1.1.3	MCC/Network flight control operations 6-2
6.1.1.4	Countdown 6-2
6.1.2	Mission Operations Summary 6-3
6.1.2.1	Powered flight 6-3
6.1.2.2	Orbital 6-3
6.1.2.3	Reentry 6-5
6.2	NETWORK PERFORMANCE 6-6
6.2.1	MCC and Remote Facilities 6-6
6.2.2	Network Facilities 6-7
6.2.2.1	Remote sites 6-7
6.2.2.2	Computing 6-8
6.2.2.3	Communications 6-8
6.3	RECOVERY OPERATIONS 6-10
6.3.1	Recovery Force Deployment 6-10
6.3.2	Location and Retrieval 6-11

UNCLASSIFIED

Section	Page
6.3.3	Recovery Aids 6-12
6.3.3.1	UHF recovery beacon 6-12
6.3.3.2	HF transmitter 6-13
6.3.3.3	UHF transmitter 6-13
6.3.3.4	UHF survival radio (Voice and CW, 243.0 mc) 6-13
6.3.3.5	Flashing light 6-13
6.3.3.6	Flourescent sea marker 6-13
6.3.4	Postretrieval Procedures 6-14
6.2.5	Spacecraft RCS Deactivation 6-15
7.0	<u>FLIGHT CREW</u> 7-5
7.1	FLIGHT CREW PERFORMANCE 7-6
7.1.1	Activities 7-6
7.1.1.1	Prelaunch 7-6
7.1.1.2	Launch and insertion 7-6
7.1.1.3	Station-keeping maneuvers 7-6
7.1.1.4	Extravehicular activity 7-7
7.1.1.5	Crew station housekeeping 7-8
7.1.1.6	Operational checks 7-8
7.1.1.7	Control system and platform alinements 7-11
7.1.1.8	Retrofire and reentry 7-12
7.1.1.9	Recovery 7-13
7.1.1.10	Mission training and training evaluation 7-13
7.1.2	Pilots' report 7-16
7.1.2.1	Prelaunch 7-16
7.1.2.2	Powered flight 7-16
7.1.2.3	Insertion 7-17
7.1.2.4	Orbital phase 7-18
7.1.2.5	Preretrofire and retrofire 7-26
7.1.2.6	Reentry and landing 7-27
7.1.2.7	Postlanding 7-28
7.1.2.8	Systems operation 7-28
7.1.2.9	Visual observations 7-34
7.1.2.10	Postlanding 7-35

UNCLASSIFIED

UNCLASSIFIED

Section		Page
7.2	AEROMEDICAL	7-41
7.2.1	Preflight	7-41
7.2.1.1	Medical histories	7-41
7.2.1.2	Bioinstrumentation	7-41
7.2.1.3	Preflight tilt-table studies	7-42
7.2.1.4	Preflight diet	7-42
7.2.1.5	Preflight medical examination.	7-42
7.2.1.6	Miscellaneous preflight activities	7-43
7.2.1.7	Preflight denitrogenation	7-43
7.2.1.8	Sensoring, suiting, checkout, and suit purge	7-44
7.2.2	Inflight	7-44
7.2.2.1	Physiological measurements	7-44
7.2.2.2	Medical observations	7-45
7.2.3	Postflight	7-47
7.2.3.1	Recovery activities	7-47
7.2.3.2	Examinations	7-48
7.2.3.3	Tilt-table studies	7-48
7.2.3.4	Medical debriefing	7-49
8.0	<u>EXPERIMENTS</u>	8-1
8.1	EXPERIMENT D-8, RADIATION IN SPACE	8-2
8.1.1	Objective	8-2
8.1.2	Equipment	8-2
8.1.3	Procedure	8-2
8.1.4	Results	8-3
8.1.4.1	Active dose-rate indicators.	8-3
8.1.4.2	Passive dosimeters	8-5
8.1.5	Conclusions	8-6
8.2	EXPERIMENT D-9, SIMPLE NAVIGATION	8-7
8.2.1	Objective	8-7
8.2.2	Equipment	8-7

UNCLASSIFIED

Section		Page
	8.2.3 Procedure	8-7
	8.2.4 Results	8-7
	8.2.5 Conclusions	8-8
8.3	EXPERIMENT MSC-1, ELECTROSTATIC CHARGE	8-10
	8.3.1 Objective	8-10
	8.3.2 Equipment	8-10
	8.3.3 Procedure	8-10
	8.3.4 Results	8-10
	8.3.5 Conclusion	8-11
8.4	EXPERIMENT MSC-2, PROTON-ELECTRON SPECTROMETER	8-12
	8.4.1 Objective	8-12
	8.4.2 Equipment	8-12
	8.4.3 Procedure	8-12
	8.4.4 Results	8-12
	8.4.5 Conclusions	8-13
8.5	EXPERIMENT MSC-3, TRI-AXIS MAGNETOMETER	8-14
	8.5.1 Objective	8-14
	8.5.2 Equipment	8-14
	8.5.3 Procedure	8-14
	8.5.4 Results	8-14
	8.5.5 Conclusions	8-15
8.6	EXPERIMENT MSC-10, TWO-COLOR EARTH'S LIMB PHOTOGRAPHS	8-16
	8.6.1 Objectives	8-16
	8.6.2 Equipment	8-16
	8.6.3 Procedure	8-16
	8.6.4 Results	8-16
	8.6.5 Conclusions	8-17
8.7	EXPERIMENT S-5, SYNOPTIC TERRAIN PHOTOGRAPHY	8-18
	8.7.1 Objective	8-18
	8.7.2 Equipment	8-18
	8.7.3 Procedure	8-18
	8.7.4 Results	8-18
	8.7.5 Conclusions	8-19

UNCLASSIFIED

Section		Page
8.8	EXPERIMENT S-6, SYNOPTIC WEATHER PHOTOGRAPHY . . .	8-20
8.8.1	Objective	8-20
8.8.2	Equipment	8-20
8.8.3	Procedure	8-20
8.8.4	Results	8-20
8.8.5	Conclusions	8-21
8.9	EXPERIMENT M-3, INFLIGHT EXERCISER	8-22
8.9.1	Objective	8-22
8.9.2	Equipment	8-22
8.9.3	Procedure	8-22
8.9.4	Results	8-22
8.9.5	Conclusions	8-23
8.10	EXPERIMENT M-4, INFLIGHT PHONOCARDIOGRAM	8-24
8.10.1	Objective	8-24
8.10.2	Equipment	8-24
8.10.3	Procedure	8-24
8.10.4	Results	8-24
8.10.5	Conclusions	8-25
8.11	EXPERIMENT M-6, BONE DEMINERALIZATION	8-26
8.11.1	Objective	8-26
8.11.2	Equipment	8-26
8.11.3	Procedure	8-26
8.11.4	Results	8-26
8.11.5	Conclusions	8-27
9.0	<u>CONCLUSIONS</u>	9-1
10.0	<u>RECOMMENDATIONS</u>	10-1
11.0	<u>REFERENCES</u>	11-1
12.0	<u>APPENDIX</u>	12-1
12.1	VEHICLE HISTORIES	12-1
12.1.1	Spacecraft Histories	12-1
12.1.2	Gemini Launch Vehicle	12-1

UNCLASSIFIED

Section	Page
12.2 WEATHER CONDITIONS	12-1
12.3 FLIGHT SAFETY REVIEWS	12-2
12.3.1 Flight Readiness Review	12-2
12.3.1.1 Spacecraft	12-2
12.3.1.2 Extravehicular activity equipment	12-3
12.3.1.3 Launch vehicle	12-3
12.3.2 Mission Review	12-3
12.3.3 Flight Safety Review Board	12-4
12.4 SUPPLEMENTAL REPORTS	12-4
12.5 DATA AVAILABILITY	12-4
12.6 POSTFLIGHT INSPECTION	12-4
12.6.1 Spacecraft Systems	12-6
12.6.1.1 Structure	12-6
12.6.1.2 Environmental control system	12-6
12.6.1.3 Communications system	12-7
12.6.1.4 Guidance and control systems	12-7
12.6.1.5 Pyrotechnics	12-8
12.6.1.6 Instrumentation and recording system	12-8
12.6.1.7 Electrical system	12-8
12.6.1.8 Crew station furnishings and equipment	12-9
12.6.1.9 Propulsion system	12-9
12.6.1.10 Landing system	12-9
12.6.1.11 Postlanding recovery aids	12-9
12.6.1.12 Experiments	12-9
12.6.2 Continuing evaluation	12-10
13.0 <u>DISTRIBUTION</u>	13-1

UNCLASSIFIED

UNCLASSIFIED

xv

TABLES

Table		Page
3-I	GEMINI IV SPACECRAFT MODIFICATIONS	3-12
3-II	SPACECRAFT INSTRUMENTATION MEASUREMENTS	3-14
3-III	CREW STATION STOWAGE LIST	3-15
3-IV	GLV-4 MODIFICATIONS	3-21
4-I	SEQUENCE OF EVENTS	4-12
4-II	COMPARISON OF PLANNED AND ACTUAL TRAJECTORY PARAMETERS	4-14
4-III	COMPARISON OF ORBITAL ELEMENTS	4-15
4-IV	DETAILED LIST OF MANEUVERS DURING GEMINI IV STATION-KEEPING ATTEMPT	4-16
4-V	SUMMARY OF MANEUVERS MADE DURING GEMINI IV STATION-KEEPING ATTEMPT	4-18
5.1-I	GEMINI IV TEMPERATURE INSTRUMENTATION	5-49
5.1-II	REAL-TIME DATA RECEIVED BY TEL II	5-50
5.1-III	DELAYED TIME DATA FROM SELECTED STATIONS	5-51
5.1-IV	GUIDANCE AND CONTROL SUMMARY CHART	5-52
5.1-V	GUIDANCE ERROR AT SECO	5-56
5.1-VI	SUMMARY OF ASCENT GUIDANCE SYSTEM ERRORS	5-57
5.1-VII	PRELIMINARY ORBIT INJECTION PARAMETERS AT SECO+20 SECONDS	5-58
5.1-VIII	ANGULAR ACCELERATIONS DURING THE RCS SYSTEM TEST	5-59
5.1-IX	HORIZON SENSOR TRACK CHECK DATA	5-59
5.1-X	SEQUENTIAL EVENTS	5-60
5.1-XI	BLOWN FUSISTORS	5-60

UNCLASSIFIED

UNCLASSIFIED

Table		Page
5.2-I	PRE-BECO LOADS	5-97
5.2-II	PRELIMINARY STAGE I ENGINE PERFORMANCE PARAMETERS . .	5-98
5.2-III	PRELIMINARY STAGE II ENGINE PERFORMANCE	5-99
5.2-IV	STAGE I IGNITION DISPLACEMENTS AND RATES	5-100
5.2-V	PLANNED AND ACTUAL LAUNCH VEHICLE EVENT TIMES AND RATES	5-101
5.2-VI	MAXIMUM ATTITUDE ERRORS AND RATES	5-102
5.2-VII	POST-SECO RATES	5-103
5.2-VIII	GLV TUMBLE RATES	5-104
5.2-IX	GLV HYDRAULIC SYSTEM PERFORMANCE	5-105
5.2-X	COMPARISON OF PLANNED AND ACTUAL LAUNCH VEHICLE TRAJECTORY PARAMETERS	5-106
5.2-XI	GEMINI IV MALFUNCTION DETECTION SYSTEM SWITCHOVER PARAMETERS	5-107
6-I	GEMINI IV NETWORK CONFIGURATION	6-17
6-II	RECOVERY SUPPORT	6-17
7.2-I	PREFLIGHT MEDICAL STUDIES AND ASSOCIATED ACTIVITIES .	7-50
7.2-II	HEMATOLOGY-COMMAND PILOT	7-51
7.2-III	HEMATOLOGY-PILOT	7-52
7.2-IV	BLOOD VOLUME DETERMINATIONS (I_{125})	7-53
7.2-V	FOOD, WATER, AND SLEEP TABULATION	7-54
7.2-VI	POSTFLIGHT EVENTS AND MEDICAL ACTIVITIES	7-55
7.2-VII	POSTFLIGHT MEDICAL EXAMINATION PROTOCOL	7-56

UNCLASSIFIED

UNCLASSIFIED

xvii

Table		Page
7.2-VIII	SUMMARY CLINICAL EVALUATION	
	(a) Command Pilot	7-57
	(b) Pilot	7-58
7.2-IX	URINALYSES	
	(a) Command Pilot	7-59
	(b) Pilot	7-60
8-I	EXPERIMENTS ON GEMINI IV	8-28
8-II	EXPERIMENTS D-8 , DOSE RATES OF COSMIC RADIATION FOR SELECTED REVOLUTIONS OF SPACECRAFT OUTSIDE OF THE SOUTH ATLANTIC ANOMALY	8-29
8-III	PRELIMINARY RESULTS EXPERIMENT D-8 PASSIVE DOSIMETERS	8-30
8-IV	SUMMARY OF PHOTOGRAPHS OBTAINED FOR EXPERIMENT S-5. .	8-31
12-I	LAUNCH AREA ATMOSPHERIC CONDITIONS AT 15:21 G.m.t., JUNE 3, 1965	12-13
12-II	REENTRY WEATHER CONDITIONS AS MEASURED AT CAPE KENNEDY ON JUNE 7, 1965 ^{at 11:47 GMT}	12-14
12-III	SUPPLEMENTAL REPORTS	12-15
12-IV	INSTRUMENTATION DATA AVAILABILITY	12-16
12-V	SUMMARY OF PHOTOGRAPHIC DATA AVAILABILITY	12-18
12-VI	LAUNCH PHASE ENGINEERING SEQUENTIAL CAMERA DATA AVAILABILITY	12-19

UNCLASSIFIED

UNCLASSIFIED

FIGURES

Figure		Page
3-1	GLV-4 - Spacecraft 4 relationships	
	(a) Launch configuration	3-23
	(b) Dimensional axes and guidance coordinates	3-24
3-2	Spacecraft arrangement and nomenclature	3-25
3-3	Communication System	3-26
3-4	Major instrumentation components (reentry section)	3-27
3-5	Major instrumentation components (adapter section)	3-28
3-6	Environmental control system	3-29
3-7	Umbilical assembly and ventilation control module	3-30
3-8	G4C suit and extravehicular equipment	3-31
3-9	Ventilation control module	3-32
3-10	Maneuvering unit	3-33
3-11	Electrical power system	3-34
3-12	Reentry control system	3-35
3-13	Orbital attitude and maneuver system	3-36
3-14	Spacecraft controls and displays	3-37
3-15	Equipment stowage containers	3-38
4-1	Planned and actual mission with planned alternates included	4-19
4-2	Ground track for Gemini IV orbital mission	
	(a) Revolutions 1 through 4	4-20
	(b) Revolution 60 through landing	4-21

UNCLASSIFIED

Figure		Page
4-3	Time histories of trajectory parameters for Gemini IV launch phase	
	(a) Altitude and range	4-22
	(b) Space-fixed velocity and flight path angle	4-23
	(c) Earth-fixed velocity and flight path angle	4-24
	(d) Dynamic pressure and Mach number	4-25
	(e) Longitudinal acceleration	4-26
4-4	Time history of apogee and perigee altitudes for the Gemini IV mission after the station-keeping exercise	4-27
4-5	Time history of separation range, azimuth, and elevation between the spacecraft and the second stage during the station-keeping maneuver	4-28
4-6	Relative motion between the spacecraft and the second stage during station-keeping maneuvers	4-29
4-7	Accumulative effect of station-keeping maneuvers	4-30
4-8	Performance of maneuver thrusters	4-31
4-9	Spacecraft-second stage relative position	4-32
4-10	Spacecraft-second stage range and range rate	4-33
4-11	Time histories of trajectory parameters for Gemini IV mission reentry phase	
	(a) Latitude, longitude, and altitude	4-34
	(b) Space-fixed velocity and flight path angle	4-35
	(c) Earth-fixed velocity and flight path angle	4-36
	(d) Dynamic pressure and Mach number	4-37
	(e) Longitudinal acceleration	4-38
5.1-1	Cabin section shingle temperatures during reentry	5-61
5.1-2	RCS and R and R section shingle temperatures during reentry	5-62

UNCLASSIFIED

Figure	Page
5.1-3 Heat shield bondline temperatures during reentry . . .	5-63
5.1-4 Gemini IV atmospheric density comparisons	5-64
5.1-5 Preliminary angle of attack and lift-to-drag ratio	5-65
5.1-6 Gemini reentry flight Mach-Reynolds number environment	5-66
5.1-7 Schematic of hatch latching ratchet	5-67
5.1-8 Comparison of steering commands during launch with preflight value	
(a) Roll attitude error	5-68
(b) Yaw attitude error	5-69
(c) Pitch attitude error	5-70
5.1-9 Velocity comparisons	5-71
5.1-10 IGS error coefficient history	5-72
5.1-11 Spacecraft-stage II rates at separation	5-73
5.1-12 Horizon scan control mode performance	
(a) Sun interference with no loss of track	5-74
(b) Loss of track of horizon sensor due to sun interface	5-75
(c) Sun interference causing loss of control	5-76
5.1-13 Reentry roll rate, altitude, dynamic pressure, and RCS propellant consumption	5-77
5.1-14 Typical reentry time histories	5-78
5.1-15 Design curves of propellant consumption vs. roll rate and K_{PR} (roll-yaw coordination)	5-79
5.1-16 IGS power sequencing block diagram	5-80
5.1-17 IGS power sequence summary	5-81

UNCLASSIFIED

UNCLASSIFIED

Figure		Page
5.1-18	Spacecraft acceleration from aft thrusters	5-82
5.1-19	Gemini IV landing system performance	5-83
5.2-1	GLV-4 post-SECO rates	
	(a) Pitch rate	5-108
	(b) Yaw rate	5-109
	(c) Roll rate	5-110
5.2-2	Comparison of GLV stage I primary hydraulic pressures	5-111
5.2-3	Comparison of GLV stage I secondary hydraulic pressures	5-112
5.2-4	Space-fixed velocity in the region of SECO	
	(a) Launch vehicle guidance data	5-113
	(b) MISTRAM I range safety computer (IP-3600) data	5-114
5.2-5	Space-fixed flight-path angle in the region of SECO	
	(a) Launch vehicle guidance data	5-115
	(b) MISTRAM I range safety computer (IP 3600) data	5-116
6-1	Cape Kennedy Air Force eastern test range network stations	6-20
6-2	Gemini IV launch abort recovery force deployment . . .	6-21
6-3	Gemini IV landing zone force deployment	6-22
6-4	Details of primary landing area	6-23
6-5	Spacecraft 4 retrieval by U.S.S. Wasp	6-24
7.1-1	Summary flight plan	7-36
7.2-1	Tilt table studies	
	(a) Command pilot	7-61
	(b) Pilot	7-62

UNCLASSIFIED

UNCLASSIFIED

Figure		Page
7.2-2	Physiological measurements	
	(a) Command pilot	7-63
	(b) Pilot	7-64
7.2-3	Blood pressure record	7-65
8-1	Experiment D-8, spacecraft installation locations . . .	8-32
8-2	Experiment D-8, active dosimeters dose levels during passage through the South Atlantic anomaly	8-33
8-3	Experiment D-9, typical sextant measurements	8-34
8-4	Experiment MSC-10, typical earth's limb photos	8-35
8-5	Experiment S-5, typical synoptic terrain photograph	8-36
8-6	Experiment S-6, typical synoptic weather photograph	8-37
8-7	Experiment M-3, preliminary evaluation of exercise data	8-38
12-1	Spacecraft 4 test history at contractor facility . . .	12-22
12-2	Spacecraft 4 significant problem areas at contractor facility	12-23
12-3	Spacecraft 4 test history at Cape Kennedy	12-24
12-4	Spacecraft 4 significant problem areas at Cape Kennedy	12-25
12-5	GLV-4 history at Denver and Baltimore	12-26
12-6	GLV-4 history at Cape Kennedy	12-27
12-7	Variations of wind direction and velocity with altitude for launch area at 15:21 G.m.t., June 3, 1965	12-28
12-8	Variations of wind direction and velocity with altitude for reentry area at 19:00 G.m.t., June 7, 1965	12-29

UNCLASSIFIED

Figure		Page
12-9	Faulty escape system MDF interconnect	12-30
12-10	Sheared connector to R and R separation igniter	12-31

UNCLASSIFIED

THIS PAGE INTENTIONALLY LEFT BLANK.

UNCLASSIFIED

UNCLASSIFIED

1-1

1.0 MISSION SUMMARY

The second manned mission of the Gemini Program, Gemini IV, was launched from Complex 19 at Cape Kennedy, Florida, at 10:16 a.m. e.s.t. on June 3, 1965. The mission was successfully concluded on June 7, 1965, with the recovery of the spacecraft by the prime recovery ship, the aircraft carrier U.S.S. Wasp, at 27°44' N. latitude, 74°11' W. longitude at 2:28 p.m. e.s.t. This manned long-duration flight was accomplished 10 weeks after the three-orbit manned flight which qualified the Gemini spacecraft and systems for orbital flight. The spacecraft was manned by Astronaut James A. McDivitt, command pilot, and Astronaut Edward H. White II, pilot. The flight crew completed the 4-day mission in excellent physical condition, and demonstrated full control of the spacecraft and competent management of all aspects of the mission.

The major objectives of the Gemini IV mission were to demonstrate and evaluate the performance of the Gemini spacecraft systems for a period of approximately 4 days in space, and to evaluate the effects of prolonged exposure of the flight crew to the space environment in preparation for missions of longer duration. In addition, it was desired to demonstrate extravehicular activity, to conduct station keeping and rendezvous maneuvers with the expended Gemini launch vehicle (GLV) second stage, to demonstrate the capability to make significant inplane and out-of-plane maneuvers, to demonstrate orbital attitude and maneuver system (OAMS) capability to operate as a backup to the retrograde rocket system, and to execute eleven experiments.

All primary and secondary mission objectives were met with two exceptions. A decision was made late in the first revolution not to attempt the rendezvous with the expended Gemini launch vehicle second stage because the allotted propellants for the orbital attitude and maneuver system had been consumed during the station-keeping exercise with the second stage. A computer-controlled reentry was not flown because of an inadvertent alteration of the computer memory during revolution 48. This alteration occurred during an attempt to remove power from the computer following an apparent malfunction of the computer power-down circuitry.

Two other anomalies occurred which had no detrimental effect on the mission. The first was the loss of thrust from one aft-firing OAMS thruster during the rendezvous exercise. At the time of publication of this report, this discrepancy had not been explained. In addition, thruster 5 (pitch-up) on the reentry control system B-ring failed to operate during the reentry phase of the mission. Postflight inspection

UNCLASSIFIED

UNCLASSIFIED

of the thruster revealed a broken wire to an electrical connector between the attitude control electronics package and the solenoid valve on the thruster.

Some of the more important results of the 4-day Gemini IV mission from the standpoint of future Gemini missions were the successful demonstration of the spacecraft systems, the successful demonstration of extravehicular activity, and the information gained during station keeping with the expended second stage of the launch vehicle. The flight crew found the spacecraft design to be acceptable for flights of longer duration with only minor changes required to equipment, stowage methods, and procedures.

The Gemini launch vehicle performed satisfactorily in all respects. A wiring error in the erector system caused a 1 hour 15 minute hold at T-35 minutes. The launch vehicle had a slightly lofted first-stage trajectory; however, the changes to the guidance program after the GT-3 mission did decrease this condition from that experienced on previous flights.

For the first time, mission control was accomplished from the Mission Control Center, Houston. Some minor problems occurred; however, they did not deter from accomplishing the control in a satisfactory manner.

UNCLASSIFIED

2.0 INTRODUCTION

The first-order mission objectives for the Gemini IV mission were as follows:

(a) Evaluate the effects of prolonged exposure to the space environment of the two-man flight crew in preparation for missions of longer duration.

(b) Demonstrate and evaluate the performance of the Gemini spacecraft systems for a period of approximately 4 days in space.

(c) Evaluate previously developed procedures for crew rest and work cycles, eating schedules, and real-time flight planning for long duration flights.

The second-order mission objectives for the Gemini IV mission were as follows:

(a) Demonstrate extravehicular activity in space and evaluate attitude and position control using the hand-held propulsion unit or the tether line.

(b) Conduct station keeping and rendezvous maneuvers with the expended second stage of the Gemini launch vehicle.

(c) Conduct further evaluation of spacecraft systems as outlined in the inflight systems test objectives.

(d) Demonstrate the capability of the spacecraft and flight crew to make significant inplane and out-of-plane maneuvers.

(e) Demonstrate orbital attitude and maneuver system (OAMS) capability to operate as a backup for the retrograde rocket system.

(f) Execute the following experiments:

- (1) D-8, Radiation
- (2) D-9, Simple navigation
- (3) S-5, Synoptic terrain photography
- (4) S-6, Synoptic weather photography
- (5) M-3, Inflight exerciser

UNCLASSIFIED

- (6) M-4, Inflight phonocardiogram
- (7) M-6, Bone demineralization (nonflight participation)
- (8) MSC-1, Electrostatic charge
- (9) MSC-2, Proton electron spectrometer
- (10) MSC-3, Tri-axis magnetometer
- (11) MSC-10, Two-color earth's limb photographs

Because of the large volume of telemetry data provided the ground stations, selected portions of the data were reduced and evaluated, especially where problems were known to exist. These data included spacecraft-transmitted data and onboard data, biomedical data, ground-based radar data, and engineering photographic data. In evaluating the launch vehicle performance, all transmitted data were reduced and evaluated. The evaluations of spacecraft and launch vehicle data consisted of analyzing and comparing the data with those from all phases of ground tests. The results of these analyses are presented in this report.

More detailed analyses of the data are continuing as this report is being published. These analyses for the launch vehicle are overall performance and performance of the radio guidance system.

Analyses of spacecraft performance are continuing in the areas of performance of inertial guidance system, UHF and HF communications, and station keeping and rendezvous procedures.

Supplemental reports, listed in section 12.4, will be issued as required for a full report of those anomalies not resolved at the time of publication of this report.

The cooperation and contributions of the Space Systems Division of the Air Force in the preparation of the sections of this report concerning the performance of the launch vehicle are acknowledged.

UNCLASSIFIED

3.0 VEHICLE DESCRIPTION

The spacecraft designated 4 and the Gemini launch vehicle designated GLV-4 constituted the Gemini IV space vehicle. The major reference coordinates for the space vehicle are shown in figure 3-1. Section 3.1 of this report describes the spacecraft configuration, section 3.2 describes the GLV configuration, and section 3.3 provides space vehicle weight and balance data.

3.1 GEMINI SPACECRAFT

The structure and major systems of the spacecraft are basically the same as those used on the two previous missions. The general arrangement and nomenclature of the spacecraft systems are shown in figure 3-2. Descriptions of the major systems may be found in reference 1 and therefore are not repeated in this report; however, significant configuration changes effective with spacecraft 4 are discussed. Table 3-1 provides a summary of changes to the spacecraft 3 configuration which were incorporated in spacecraft 4.

3.1.1 Structure

The primary structure of spacecraft 4 was the same production configuration that was flight-tested on the three previous Gemini missions. No major structural modifications were made because successful performance was demonstrated on the previous flights in parallel with a comprehensive ground test program.

3.1.2 Major Systems

3.1.2.1 Communications.- The communication equipment installed in spacecraft 4 (fig. 3-3) was similar to the equipment installed in spacecraft 3 (described in refs. 1 and 2) except for the differences noted in the following paragraphs:

(a) Tracking subsystem: The S-band radar transponder, as installed in the adapter equipment section of spacecraft 3, was replaced by a C-band transponder (see fig. 3-3). Both the adapter and reentry assembly C-band transponders were tuned to the same assigned transmitting center frequency and receiving center frequency.

UNCLASSIFIED

(b) Antenna subsystem:

(1) The C-band antenna system was modified so that the C-band transponder in the reentry assembly could radiate only through the three helix antennas located in the reentry assembly, and the C-band transponder in the adapter assembly could radiate only through the adapter annular slot antenna.

(2) To remove the constraint on the use of high-frequency (HF) voice communications during orbital flight (a potential heating problem during reentry if the reentry assembly HF whip antenna does not retract), a similar HF whip antenna was installed in the adapter assembly. The reentry assembly HF antenna was extended only during the post-landing phase of the mission.

3.1.2.2 Instrumentation and recording.- The regular instrumentation and recording equipment, as installed in spacecraft 3, was also installed in spacecraft 4 with some additional instrumentation provided to furnish data on horizon sensor performance. The major components are illustrated in figures 3-4 and 3-5. A detailed description of this equipment is contained in references 1 and 2.

The spacecraft 4 biomedical instrumentation and recording equipment were similar to those used on the GT-3 mission (see ref. 2), except that time-correlation systems were incorporated. (See para. 3.1.2.5.)

Table 3-II lists the spacecraft parameters referred to in this report.

3.1.2.3 Environmental control.- The spacecraft 4 environmental control system (ECS) was basically the same as that employed on the GT-3 mission (ref. 2). The major changes incorporated in the spacecraft 4 ECS were as follows:

(a) The urine disposal system was modified so that urine could be dumped directly overboard through a heated line and solenoid valve. The capability for urine disposal through the launch-cooling heat exchanger was retained from the spacecraft 3 configuration as an alternate method.

(b) The drinking water capacity was increased by the installation of four water-storage tanks, as shown in figure 3-6, in the adapter instead of the one flown on GT-3.

(c) The CO₂ and odor absorber canister installed in the spacecraft 4 suit loop contained larger quantities of absorbent material consistent with long-duration mission requirements.

UNCLASSIFIED

Additional ECS equipment furnished for the extravehicular phase of the Gemini IV mission is described in the following paragraphs.

3.1.2.3.1 Umbilical assembly: The pilot was supplied with oxygen during extravehicular operation by a 25-foot umbilical assembly. The assembly also included a restraint tether and provisions for electrical connection of the pilot's voice communication and bioinstrumentation equipment to the spacecraft (see fig. 3-7). The umbilical was designed to supply oxygen from the spacecraft system to the suit at a nominal flow-rate of 9.0 lb/hr. Figure 3-8 illustrates the attachment of the umbilical assembly to the suit.

3.1.2.3.2 Ventilation control module (VCM): The VCM was provided to control the pilot's suit pressure and to supply oxygen in the event of an emergency involving the loss of the umbilical oxygen supply during extravehicular activity (EVA). The VCM was developed and fabricated at the NASA Manned Spacecraft Center (MSC) by the Crew Systems Division, Technical Services Division, and Engineering Division. The basic components of the VCM were Gemini ECS components which had already been qualified individually. Qualification at the assembly and system level was accomplished by testing at MSC.

A Gemini demand regulator was used to control suit pressure, and a Gemini egress-kit oxygen bottle contained the emergency oxygen supply. The high-pressure regulator and shut-off valve used to control the emergency oxygen supply were originally designed for use in the Mercury Program. The VCM components are shown schematically in figure 3-7. Figure 3-8 shows the VCM attached to the suit by means of a multiple gas connector (Y-connector) and a separate hose leading from the emergency bottle to the suit helmet, and figure 3-9 illustrates the configuration of the VCM.

3.1.2.3.3 Maneuvering unit: The maneuvering unit, shown in figure 3-10, was a simple hand-held cold-gas reaction jet device which employed two 1-pound tractor jets and one 2-pound pusher jet to provide the pilot with maneuvering capability during extravehicular operation. The unit consisted of two sections which were assembled by the pilot prior to egress. One section consisted of the propulsion unit assembly, while the other section consisted of two Gemini egress-kit oxygen bottles to provide propellant to the reaction jets. This unit was developed by the MSC Flight Crew Support Division and was fabricated by MSC Engineering Division and Technical Services Division.

3.1.2.4 Guidance and control.- Except for the following minor changes made as a result of anomalies evidenced in the analysis of GT-3 flight data, the guidance and control systems were identical to those installed in the GT-3 spacecraft (see refs. 1 and 2).

UNCLASSIFIED

(a) Three electronic modules in the inertial measuring unit (IMU) were redesigned.

(b) One module in the attitude control electronics (ACE) was redesigned.

In addition to these changes, a different computer operational program was incorporated (Math flow III Mod II - IBM no. 6444868 Revision B, issued March 10, 1965).

3.1.2.5 Time reference. - The time reference system installed in spacecraft 4 was unchanged from the configuration used on the previous flight (ref. 1), except for the inclusion of a time-correlation buffer which functioned as a conditioner for time-correlation signals supplied to the voice tape recorder (VTR) and the two biomedical tape recorders, and an additional G.m.t. clock installed on the command pilot's instrument panel.

3.1.2.6 Electrical. - The spacecraft 4 adapter equipment section contained a battery module rather than the fuel-cell module planned for use on future Gemini flights. The adapter battery module (fig. 3-11) contained six silver-zinc batteries to provide primary power until adapter equipment section separation; whereas, the spacecraft 3 adapter battery module contained three batteries for this purpose. Except for these changes and removal of the Z100 separation sensor switches, the spacecraft 4 electrical system configuration was the same as that of spacecraft 3.

3.1.2.7 Propulsion. - The spacecraft 4 propulsion systems (figs. 3-12 and 3-13) were essentially the same as those of spacecraft 3. Reference 1 provides a basic description of the system and reference 2 contains a description of changes incorporated in spacecraft 3. The significant differences between the configurations were as follows:

(a) The dummy orbital attitude and maneuver system (OAMS) thrust chamber assemblies (TCA's) 13, 14, 15, and 16 installed in spacecraft 3 were replaced with operational TCA's in spacecraft 4. (See fig. 3-13.)

(b) The B-package burst diaphragms which were not installed in the spacecraft 3 reentry control system (RCS) and OAMS were installed in spacecraft 4.

(c) Boundary-layer-cooled (long-life) TCA's were installed in spacecraft 4.

3.1.2.8 Pyrotechnic. - Spacecraft 4 contained the regular pyrotechnic devices as installed in spacecraft 3, along with the following additional devices or modifications:

UNCLASSIFIED

(a) A pyrotechnic-actuated door was installed to provide protection for the MSC-1 experiment sensor unit during launch.

(b) A pyrotechnic guillotine was provided to sever the magnetometer-boom locking-cable included in the MSC-3 experiment installation.

(c) Keyways were machined into the electrical connectors of the pyrotechnic cartridges to eliminate the possibility of improper installation.

(d) An aluminum breech and CTI cartridges were installed in the high-altitude drogue parachute mortar, whereas a steel breech and ORDO cartridge were installed in the spacecraft 3 drogue mortar.

(e) The unused pins on the electrical connectors to initiators were removed.

3.1.2.9 Crew station furnishings and equipment.-

3.1.2.9.1 Instrument panels and controls (fig. 3-14): The controls and displays of spacecraft 4 were the same as those of spacecraft 3 (see ref. 2) with the following exceptions:

(a) The attitude control and maneuver electronics (ACME) logic switches were relocated from the pedestal panel to the overhead switch/circuit breaker panel.

(b) The control switches for the RCS propellant shutoff valves were relocated from the pilot's panel to the pedestal panel.

(c) The fuel-cell purge switches and the reactant supply system (RSS) crossover switch were installed in the pilot's instrument panel, but were not operational because the fuel cell was not used.

(d) Other minor changes were made to switch positions and nomenclature.

3.1.2.9.2 Space suit: The space suits furnished for the Gemini IV mission were of the G4C configuration. The design of the G4C space suit is similar to that of the G3C suit used on the previous flight. The significant changes are as follows:

(a) Redundant entrance closures were provided instead of the single closures previously used. A redundant closure incorporates a pressure-sealing external zipper with a standard internal zipper.

UNCLASSIFIED

(b) The helmets were modified to accommodate a thicker pressure-sealing visor, and to accept the extravehicular overvisor (see fig. 3-8). The overvisor was used only by the pilot during extravehicular operation.

(c) A cover layer for thermal and micrometeoroid protection was provided for the pilot. A single layer cover layer for anti-snag protection was incorporated in the command pilot's suit.

(d) Thermal over-gloves were provided for the pilot. These gloves were designed to protect against conductive heat transfer during contact with the spacecraft or equipment.

3.1.2.9.3 Water and waste management systems: The drinking water and the urine disposal provisions in the crew station were similar to those of spacecraft 3 (ref. 2). However, the controls for the urine disposal system were modified to provide for direct overboard urine dumping as well as dumping through the launch-cooling heat exchanger. In addition, a light was installed on the water management panel to indicate "heater on" for the direct overboard urine dump system (see fig 3-14).

3.1.2.9.4 Ejection seat: The seat assemblies were essentially the same as those used on the GT-3 mission (ref. 2). Minor modifications to the seat were as follows:

(a) The retracting mechanism on the parachute risers was redesigned as a result of an anomaly on the previous flight.

(b) A safety pin was added to the ejection control handle to insure against inadvertent actuation.

(c) The egress-kit configuration was modified to a lower profile to provide more room for the crew members.

3.1.2.9.5 Stowage provisions: Containers for the stowage of flight crew equipment were installed as shown in figure 3-15. Table 3-III lists the equipment that was stowed in the containers.

3.1.2.10 Landing. - The landing equipment installed in spacecraft 4 was of the same configuration as that of spacecraft 3 with the exception of the pyrotechnic equipment which was changed as noted in paragraph 3.1.2.8. A description of the landing equipment is given in references 1 and 2. The spacecraft 4 landing-system deployment sequence was the same as that described in reference 2.

3.1.2.11 Postlanding and recovery. - No significant changes to the spacecraft 3 postlanding and recovery equipment were incorporated in the spacecraft 4 equipment other than modification of the recovery flashing

UNCLASSIFIED

UNCLASSIFIED

3-7

light wiring. On-off control of the light was provided by redesigning the recovery beacon control switch. Both the recovery beacon and flashing light operated with the switch in the upper position; only the recovery beacon operated with the switch in the lower position; and both the recovery beacon and flashing light were turned off with the switch in the center position. A general description of the postlanding and recovery equipment is given in references 1 and 2.

UNCLASSIFIED

UNCLASSIFIED

3.2 GEMINI LAUNCH VEHICLE

The configuration of GLV-4 was basically the same as that of the launch vehicles used on previous Gemini flights. A description of the GLV structure and major systems is given in reference 1, and minor changes incorporated for the GT-2 and GT-3 missions are given in references 1 and 2, respectively. Only the significant differences between GLV-3 and GLV-4 are discussed in this report. These differences are summarized in table 3-IV.

3.2.1 Structure

3.2.1.1 Stage I.- The following minor structural modifications were incorporated in stage I:

(a) The oxidizer feed line conduit was fabricated with butt-welded, circumferential joints instead of the lapped joints used on GLV-3.

(b) The stage I fuel tank aft skirt was modified to provide for remote charging of the oxidizer standpipe.

3.2.1.2 Stage II.- Insulation previously installed to reduce external protuberance heating on Gemini launch vehicles was removed from the stage II oxidizer tank forward skirt of GLV-4.

3.2.2 Major Systems

3.2.2.1 Propulsion.- The following modifications were incorporated in the GLV-4 propulsion system:

(a) The modification previously incorporated to suppress longitudinal oscillation instabilities (POGO) was revised in the following respects:

(1) A heat shield was added to the fuel-dampener assembly to protect the rotary potentiometer and bearing.

(2) The fuel-dampener-piston-shaft bearing material was changed from teflon to ceramic-filled teflon.

(3) The capability for automatic remote tuning of the oxidizer standpipe was added.

(b) Shields were added to all fuel-tank-level sensors to protect the prisms from autogenous gas contamination.

UNCLASSIFIED

3.2.2.2 Flight control. - The three-axis reference system (TARS) pitch program was changed to make it compatible with the Gemini IV mission requirements.

3.2.2.3 Radio guidance. - No modifications were required.

3.2.2.4 Hydraulic. - No modifications were required.

3.2.2.5 Electrical. - The following modifications were incorporated in the GLV-4 electrical system:

(a) Provisions for remote control of oxidizer standpipe charging or bleeding were added.

(b) A flashing beacon light system was added to stage II.

3.2.2.6 Malfunction detection. - Other than additional insulation applied to the stage I malfunction detection system and control harnesses in compartment 5, no modifications were required.

3.2.2.7 Instrumentation. - The following changes were incorporated in the instrumentation system:

(a) Instrumentation which provided 16 structural integrity measurements on GLV-3 was not installed on GLV-4.

(b) Instrumentation was installed in compartments 1 and 2 to provide sound pressure-level data.

(c) Provisions for monitoring radio guidance system (RGS) decoder discretes 2, 4, and 8 were added.

3.2.2.8 Range safety. - The destruct system circuitry was modified to prevent switch cycling in the event that both "set" and "reset" signals were inadvertently applied during testing. Otherwise, no additional modifications were required.

3.2.2.9 Ordnance separation. - No modifications were required.

~~CONFIDENTIAL~~

3.3 GEMINI IV WEIGHT AND BALANCE DATA

Weight data for the Gemini IV space vehicle are as follows:

Condition	Weight (including spacecraft), lb ^a	Center-of-gravity location, in ^b		
		Y	Z	X
Ignition	340 000	-.11	60.0	775
Lift-off	336 000	-.13	60.0	776
Stage I burnout (BECO)	85 000	-.60	60.0	440
Stage II start of steady-state combustion	73 400	-.40	60.05	344
Stage II burnout (SECO+20 sec)	13 300	-.21	60.10	296

^aWeights obtained from Aerospace Corporation.

^bX-axis reference in GLV station 0.000 (see fig. 3-1). Y-axis is referenced to the centerline of the vehicle. Z-axis is referenced to the waterline (60 in. below centerline) of the vehicle.

~~CONFIDENTIAL~~

UNCL

~~CONFIDENTIAL~~

Spacecraft weight and balance data are as follows:

Condition	Weight, lb	Center-of-gravity location, in. (a)		
		X	Y	Z
Launch, gross weight	7879.05	-1.29	-1.43	105.32
Retrograde	5432.44	0.05	-1.65	129.49
Reentry (0.05g)	4725.71	0.02	-1.58	135.21
Main parachute deployment	4415.30	0.02	-1.74	129.94
Touchdown (no parachute)	4305.05	0.02	-1.80	127.87

^aZ-axis reference was located 13.44 inches aft of the launch-vehicle-spacecraft mating plane (GLV station 290.265). The X- and Y-axes were referenced to the centerline of the vehicle.

~~CONFIDENTIAL~~

UNCLASSIFIED

TABLE 3-I.- GEMINI IV SPACECRAFT MODIFICATIONS

System	Significant changes incorporated in spacecraft 4 from the spacecraft 3 configuration
Reentry assembly structure	No significant change
Adapter assembly structure	No significant change
Communications	<p>(a) The S-band radar transponder was replaced by C-band transponder</p> <p>(b) The C-band antenna system was modified</p> <p>(c) A second HF whip antenna was installed (in the adapter assembly)</p>
Instrumentation	Additional instrumentation was installed to provide data on horizon sensor performance
Environmental control	<p>(a) A direct overboard urine dump system was installed</p> <p>(b) Four drinking water storage tanks were installed in the adapter</p> <p>(c) The CO₂ and odor absorber cannister contained increased quantities of LiOH and charcoal.</p>
Guidance and control	<p>(a) Math flow III Mod II was incorporated</p> <p>(b) Modules were redesigned in the IMU and ACE (minor circuit changes)</p>
Time reference	<p>(a) A time-correlation buffer was added to provide correlation time signals to VTR and biomedical tape recorders.</p> <p>(b) A G.m.t. clock was added to the command pilot's instrument panel.</p>

UNCLASSIFIED

TABLE 3-I.- GEMINI IV SPACECRAFT MODIFICATIONS - Concluded

System	Significant changes incorporated in spacecraft 4 from the spacecraft 3 configuration
Electrical	<p>The adapter battery module contained six silver-zinc batteries</p> <p>The Z100 separation sensor switches were removed</p>
Propulsion	<p>(a) The lateral thrusting OAMS TCA's were operational</p> <p>(b) B-package burst diaphragms were installed in the RCS and OAMS</p> <p>(c) Long-life TCA's were used</p>
Pyro-technics	<p>(a) Pyrotechnic devices were included with the MSC-1 and MSC-3 experiment equipment</p> <p>(b) An aluminum breech and CTI cartridges were installed in the high altitude drogue mortar</p> <p>(c) The unused pins on electrical connectors to initiators were removed</p>
Crew station furnishing and equipment	<p>(a) The instrument panels were modified</p> <p>(b) A G4C space suit was worn by each crew member</p> <p>(c) The urine disposal system controls were modified</p> <p>(d) Additional stowage containers were provided for food, operational equipment, experiment equipment, and waste</p> <p>(e) Minor modifications were made to the ejection seat system.</p>
Landing	No significant change
Post-landing and recovery	On-off control of the recovery flashing light was provided.

UNCLASSIFIED

TABLE 3-II.- SPACECRAFT INSTRUMENTATION MEASUREMENTS

Measurement	Description	Instrumentation Range	Type of data
AD01	Adapter shaped charge ignition	1 = fire	Delayed time
AD02 ^a	Equipment adapter separation	1 = separation	Delayed time
AD06 ^a	Manuel retrofire initiate	1 = fire	Delayed time
AD08	Retrorocket no. 3 fire	1 = fire	Delayed time
AD09	Retrorocket no. 2 fire	1 = fire	Delayed time
AD10	Retrorocket no. 4 fire	1 = fire	Delayed time
AE13 ^a	Parachute jettison	1 = jettison	Delayed time
PB05	Outer skin temperature - R&R section	70 to 1900° F	Delayed time
PC03	Outer skin temperature - RCS section	70 to 1900° F	Delayed time
PC04	Outer skin temperature - RCS section	70 to 1900° F	Delayed time
PD03	Outer skin temperature - cabin section	70 to 1900° F	Delayed time
PD04	Outer skin temperature - cabin section	70 to 1900° F	Delayed time
PD06	Outer skin temperature - cabin section	70 to 1900° F	Delayed time
PD07	Outer skin temperature - cabin section	^b -459 to 85° F	Delayed time
PD08	Outer skin temperature - cabin section	^b -459 to 85° F	Delayed time
FE11	Heat-shield ablation material bondline temperature	-55 to 1055° F	Delayed time
FE12	Heat-shield ablation material bondline temperature	-55 to 1055° F	Delayed time

^aNot received^bEffective range

UNCLASSIFIED

TABLE 3-III.- CREW STATION STOWAGE LIST

Operational Equipment

No.	Item	Quantity	Remarks	Container (a)
1	Flight plan filmstrip	1	Installed on flight plan display located on center instrument panel	
2	Flight booklets	2	Stowed with item no. 54	
3	Orbital path display assembly	1	Stowed with item no. 54	
4	Plastic bags (CF55056-1)	6	Stowed in pouch in right-hand aft food box	6
5	Plastic bags (CF55056-2)	14	Stowed in pouch in right-hand aft food box	6
6	Plastic bags (CF55056-3)	10	Stowed in pouch in right-hand aft food box	6
7	16-mm sequence camera	1	Stowed in fiber-glass container in center stowage box	7
8	16-mm sequence camera (for EVA photography)	1	Stowed in right-hand aft food box	6
9	16-mm film magazines (for item no. 7)	4	Two stowed in right-hand side food box. One stowed on camera (item no. 7)	3 7 & 10
10	16-mm film magazine (for item no. 8)	1	Stowed on camera (item no. 8)	6
11	Mounting bracket (for item no. 8)	1	Stowed on camera (item no. 8)	6
12	5-mm lens assembly (for item no. 8)	1	Stowed in pouch in right-hand aft food box	6
13	Insulation pouch (for item no. 8)	1	Stowed on camera (item no. 8)	6
14	25-mm lens assembly (for item no. 7)	1	Stowed with item no. 7	7
15	18-mm lens assembly (for item no. 7)	1	Stowed with item no. 7	7
16	75-mm lens assembly (for item no. 7)	1	Stowed with item no. 7	7

^aContainer locations are indicated in figure 3-15

UNCLASSIFIED

TABLE 3-III.- CREW STATION STOWAGE LIST - Continued

No.	Item	Quantity	Remarks	Container (a)
17	Mirror mounting bracket assembly (for item no. 7)	1	Stowed with item no. 7	7
18	16-mm camera bracket (for item no. 7)	1	Stowed on support mounted outboard of seat on left-hand sidewall	
19	70-mm Hasselblad camera with lens	1	Stowed in center stowage box	7
20	70-mm film magazines (CF55026-1)	5	One stowed with camera. Four stowed in left-hand side food box. (Two for experiments S-5 and S-6).	7 10
21	70-mm film magazine (CF55009-1)	1	Stowed in right-hand side food box (Experiment MSC-10)	3
22	Camera ring sight assembly	1	Stowed with item no. 19	7
23	Photographic event indicator	1	Stowed in right-hand circuit breaker fairing	1
24	35-mm Zeiss Contrarex camera	1	Stowed in container in center stowage box	7
25	35-mm camera film backs	3	Film backs, containing cassettes, stowed in center stowage box	7
26	Right-hand window bracket	1	Stowed on center food box door	5
27	200-mm lens with built-in filter	1	Stowed in pouch in right-hand aft food box	6
28	50-mm lens	1	Stowed in pouch in right-hand aft food box	6
29	Right-hand window bracket adapter	1	Stowed on center food box door	5
30	Right-hand window bracket adapter clamp	1	Stowed in center stowage box	7
31	Tape	10 feet	Stowed in post landing kit pouch (item no. 66)	12
32	Sextant and filter	1	Stowed in container in center stowage box (Experiment D-9)	7

^aContainer locations are indicated in figure 3-15

UNCLASSIFIED

TABLE 3-III.- CREW STATION STOWAGE LIST - Continued

No.	Item	Quantity	Remarks	Container (a)
33	Maneuvering unit	1	Stowed in item no. 64	7
34	Splash curtain clips	2	Stowed in item no. 66	12
35	Defecation bags	14	Six stowed in soft pouch in right-hand aft food box. Four stowed in each aft sidewall container.	6 4 & 9
36	Waste containers	4	Two stowed in left-hand side food box. Two stowed in right-hand side food box.	10 3
37	Personal hygiene towels	2	One stowed in each tissue dispenser	7
38	Inflight medical kit	1	Stowed in container mounted outboard of seat on left-hand sidewall	11
39	Ventilation control module (VCM) restraint straps	2	Stowed in pouch in right-hand aft food box	6
40	CO ₂ tapes	18	Nine stowed in each tissue dispenser	7
41	Food	8 man days	Stowed in left-hand aft food box	8
42	Inflator assembly (blood pressure)	1	Bulb, hose and two adapters stowed in right-hand side food box	3
43	Urine receiver and hose	1	Stowed in pouch in right-hand aft food box	6
44	Hose interconnects	3	One stowed in right-hand aft food box and one in each aft sidewall container	6 4 & 9
45	Ventilation control module	1	Stowed in left-hand side of right-hand footwell	
46	UCD clamps	1	Stowed in urine receiver pouch	6
47	Finger-tip-light batteries	4	Stowed in suit repair kit in right-hand aft food box (item no. 71)	6

^aContainer locations are indicated in figure 3-15

UNCLASSIFIED

TABLE 3-III.- CREW STATION STOWAGE LIST - Continued

No.	Item	Quantity	Remarks	Container (a)
48	Biomedical fitting removal wrench	1	Stowed in item no. 66	12
49	Blood pressure reprogramming adapter cables	2	One stowed in periscope container. One stowed in right-hand aft food box.	2 6
50	Inflight exerciser	1	Stowed in pouch in right-hand aft food box during launch (Experiment M-3)	
51	Voice tape recorder cartridges	15	One stowed in recorder Fourteen stowed in right-hand side food box in three belts	3
52	"Y" connectors	2	Stowed in pouch in right-hand aft food box	6
53	Swizzle stick	1	Stowed on overhead switch/circuit breaker panel switch guard	
54	Plot board	1	Stowed in collapsible cloth container on outboard side of instrument panel pedestal in left-hand footwell	
55	Lightweight headset	1	Stowed in right-hand aft sidewall container	4
56	Optical sight	1	Stowed under command pilot's instrument panel, forward of maneuver controller	
57	Hatch closing lanyard	1	Stowed in cloth pouch under pilot's instrument panel	
58	Humidity sensor	1	Stowed in pouch in right-hand aft food box	6
59	Utility dual electrical cord	1	Stowed in right-hand circuit breaker fairing	1
60	Umbilical hose	1	Stowed in pouch in right-hand aft food box	6

^aContainer locations are indicated in figure 3-15

UNCLASSIFIED

TABLE 3-III.- CREW STATION STOWAGE LIST - Continued

No.	Item	Quantity	Remarks	Container (a)
61	Umbilical hose pouch	1	Stowed in right-hand aft food box	6
62	Tissue dispenser	2	Stowed on top of center stowage container	7
63	Dry stowage bags	2	Stowed in left-hand side food box	10
64	Fiberglass container	1	Stowed in center stowage container	7
65	Postlanding kit assembly	1	Stowed in item no. 66 (Includes items no. 31, 34, 48, 67, 69, and 78)	12
66	Postlanding kit pouch	1	Stowed in left-hand circuit breaker fairing	12
67	Screw driver	1	Stowed in item no. 66	12
68	Umbilical guide	1	Stowed in pouch in right-hand aft food box	6
69	Wire, Belden, 20 AWG	10 feet	Stowed in item no. 66	12
70	Celestial display star chart	1	Stowed with item no. 54	
71	Suit repair kit assembly	1	Stowed in item no. 72 (includes items no. 73, 74, and 75)	6
72	Suit repair kit pouch	1	Stowed in right-hand aft food box	6
73	"O" ring, small	2	Stowed in item no. 72	6
74	"O" ring, large	2	Stowed in item no. 72	6
75	Lubricant	1 tube	Stowed in item no. 72	6
76	Water transfer adapter	1	Stowed with urine receiver and hose (item no. 39 43)	6

^aContainer locations are indicated in figure 3-15

UNCLASSIFIED

TABLE 3-III.- CREW STATION STOWAGE LIST - Continued

No.	Item	Quantity	Remarks	Container (a)
77	Utility electrical extension cord	1		
78	Allen key	1	Stowed in item no. 66	i2
Equipment Stowed on Space Suits				
1	Knife	2	One per crew member	
2	Surgical scissors	2	One per crew member	
3	Flight data display straps	2	One per crew member	
4	Launch day urine bags	2	One per crew member	
5	Wrist dams	2 sets	One set per crew member	
6	Visor cover	1	Stowed on pilot's helmet	
7	Flight booklet	1		

^aContainer locations are indicated in figure 3-15

UNCLASSIFIED

TABLE 3-IV.- GLV-4 MODIFICATIONS

System	Significant Changes Incorporated in GLV-4 From GLV-3 Configuration
Stage I Structure	<ul style="list-style-type: none"> (a) The Stage I oxidizer feed line conduit circumferential joints were changed from tapped joints to butt-welded joints. (b) Provisions were added to Stage I fuel tank aft skirt for remote charging of oxidizer standpipe.
Stage II Structure	External protuberance heating insulation was removed from the Stage II oxidizer tank forward skirt.
Propulsion	<ul style="list-style-type: none"> (a) The POGO installation was revised as follows: <ul style="list-style-type: none"> (1) A heat shield was added to the fuel dampener assembly to protect the potentiometer and bearing from heat. (2) The fuel dampener piston shaft bearing material was changed from teflon to ceramic-filled teflon. (3) The capability for remote charging of the oxidizer standpipe was added. (b) Shields were added to all fuel-tank-level sensors to protect prisms from autogenous gas contamination.
Flight Controls	(a) The TARS pitch program was revised to make it compatible with Gemini IV mission requirements.
Guidance	No significant change.
Hydraulics	No significant change.
Electrical	<ul style="list-style-type: none"> (a) Provisions were added for remotely controlling charging or bleeding of the oxidizer standpipe. (b) A flashing beacon light system was added to Stage II.

UNCLASSIFIED

UNCLASSIFIED

TABLE 3-IV.- GLV-4 MODIFICATIONS - Concluded

System	Significant Changes Incorporated in GLV-4 from GLV-3 Configurations
Malfunction Detection System Instrumentation Range Safety and Ordnance	No significant change. (a) Sixteen structural integrity measurements were removed. (b) Two sound pressure measurements were added (compartments 1 and 2). (c) Measurements were provided for monitoring RGS decoder discretes 2, 4, and 8. No significant change.

UNCLASSIFIED

UNCLASSIFIED

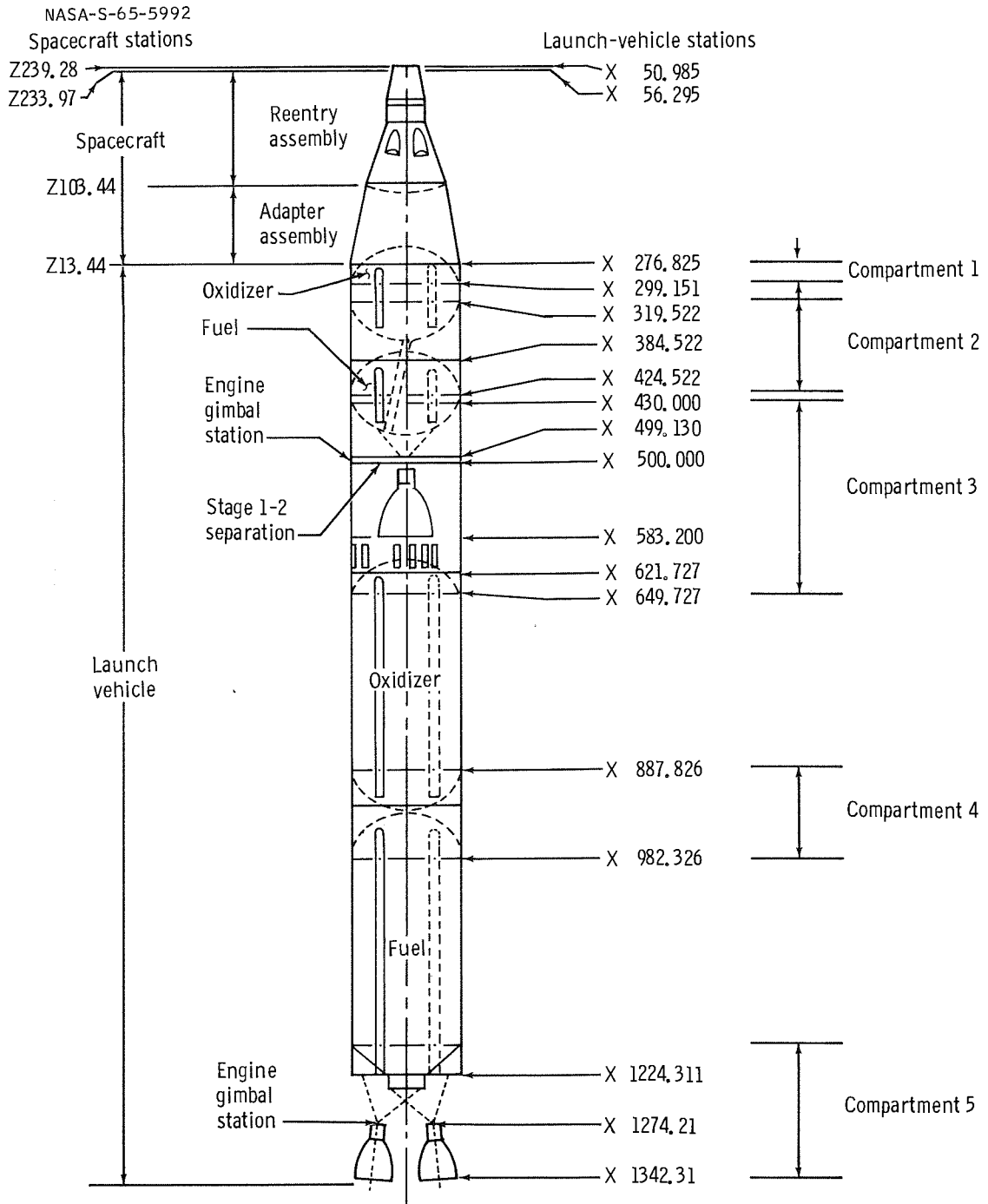

(a) Launch configuration

Figure 3-1. - GLV-4 - Spacecraft 4 relationships.

NASA-S-65-5998

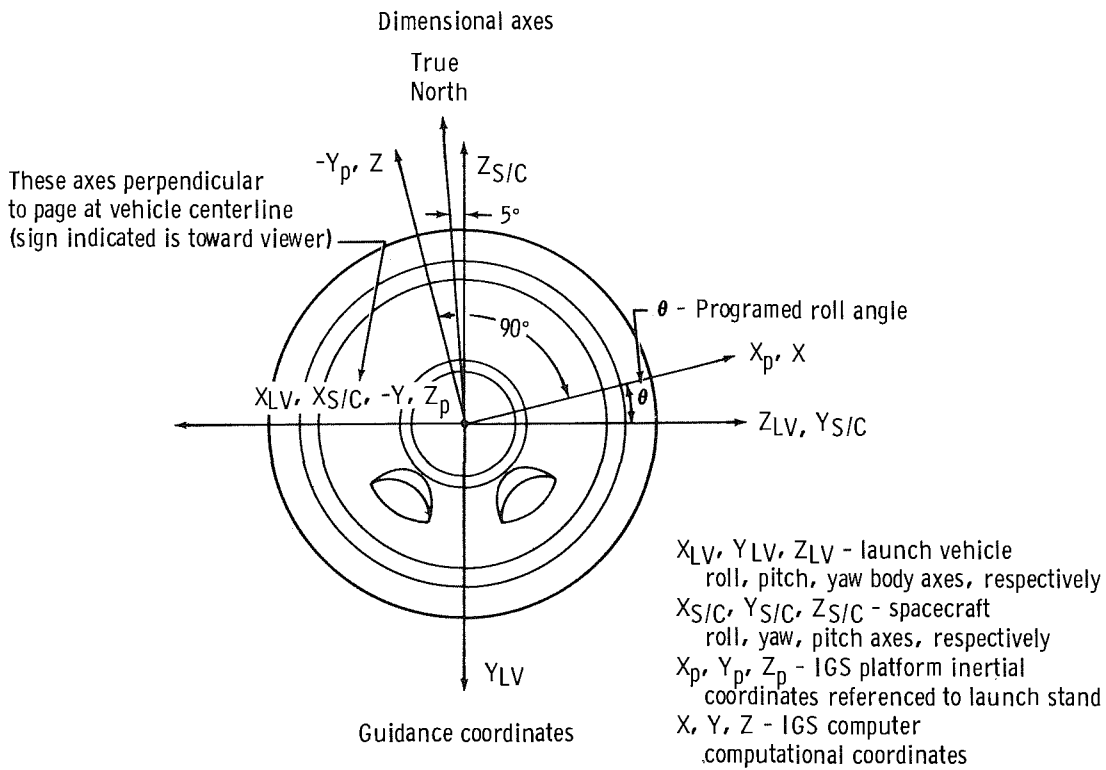
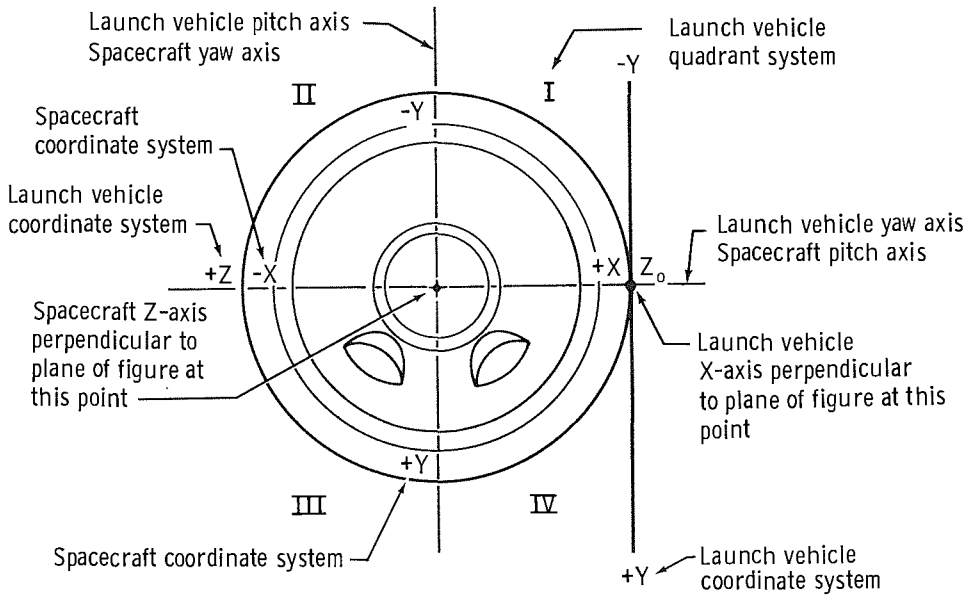

(b) Dimensional axes and guidance coordinates
 Figure 3-1. - Concluded.

NASA-S-65-3481

UNCLASSIFIED

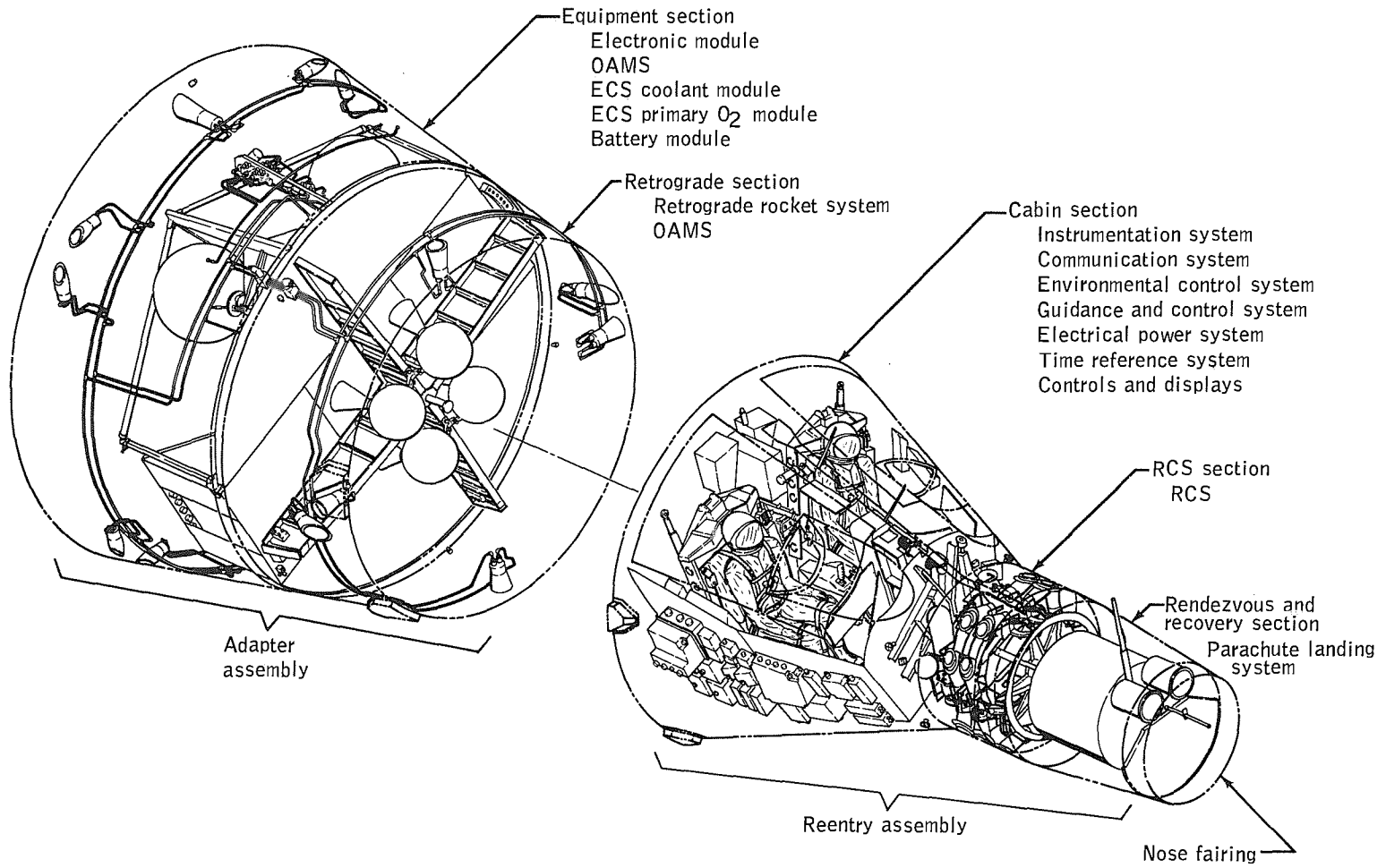

UNCLASSIFIED

Figure 3-2. - Spacecraft arrangement and nomenclature.

UNCLASSIFIED

UNCLASSIFIED

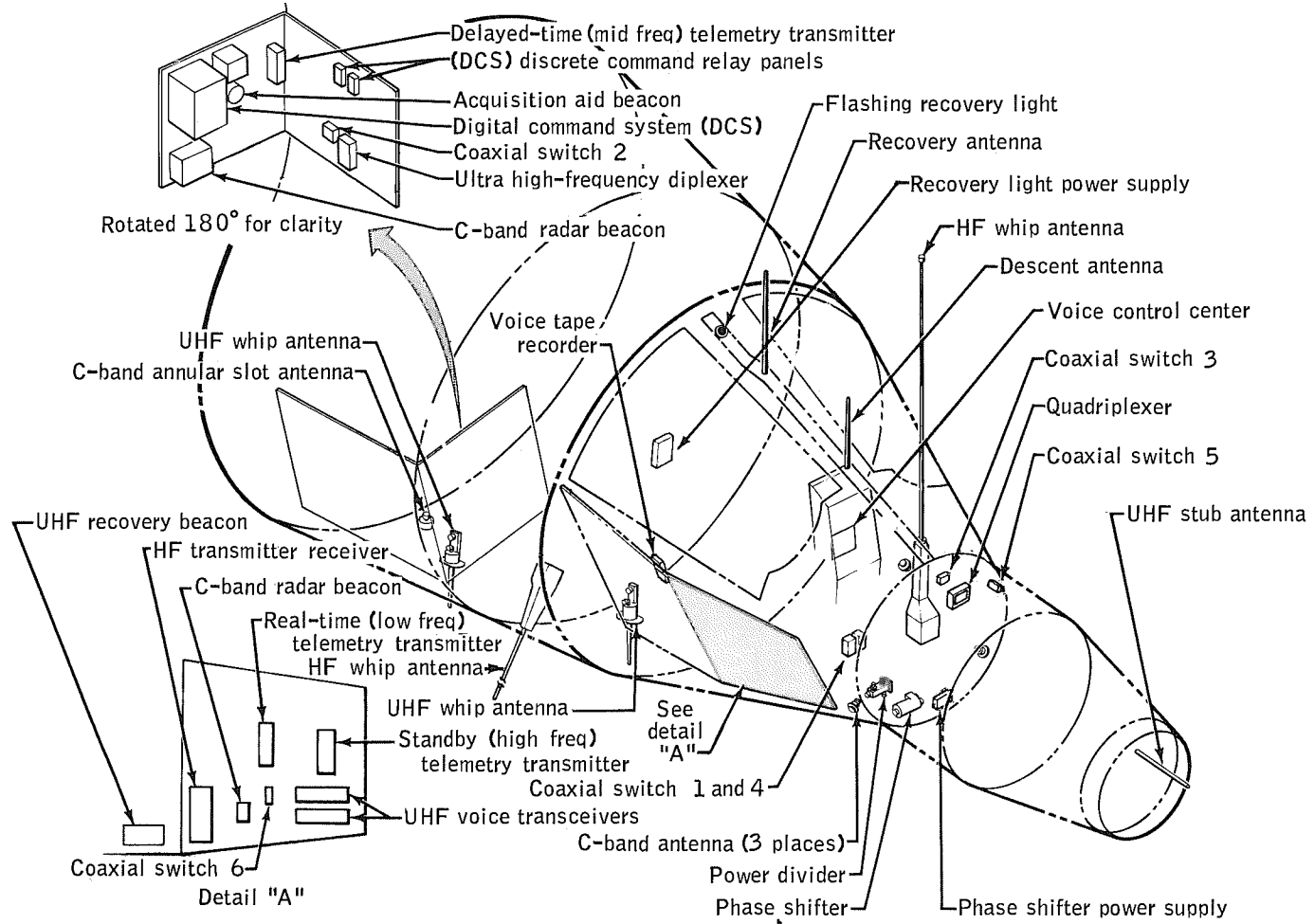

Figure 3-3. - Communication system.

NASA-S-65-3483

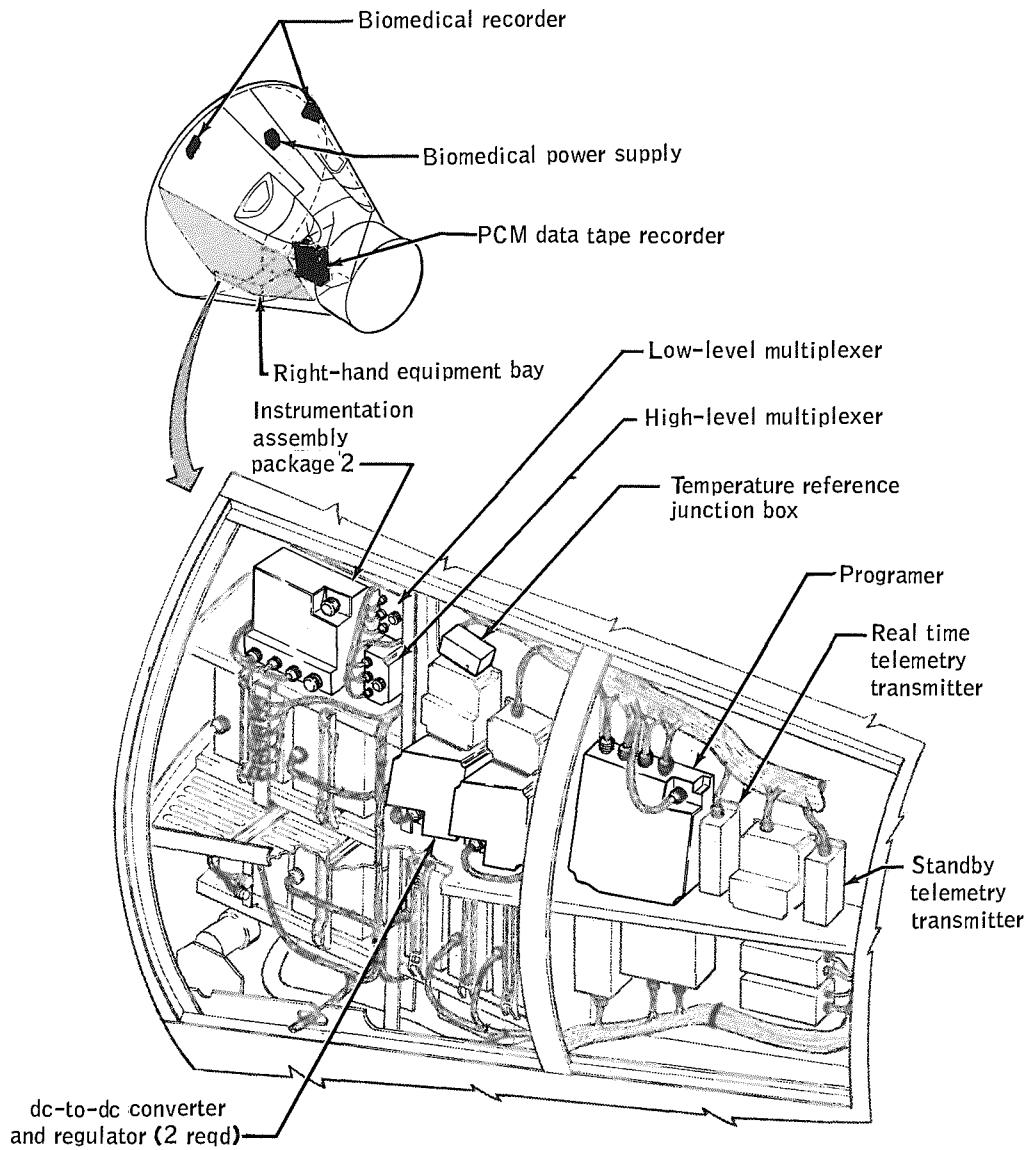

Figure 3-4. - Major instrumentation components (reentry section).

NASA-S-65-3484

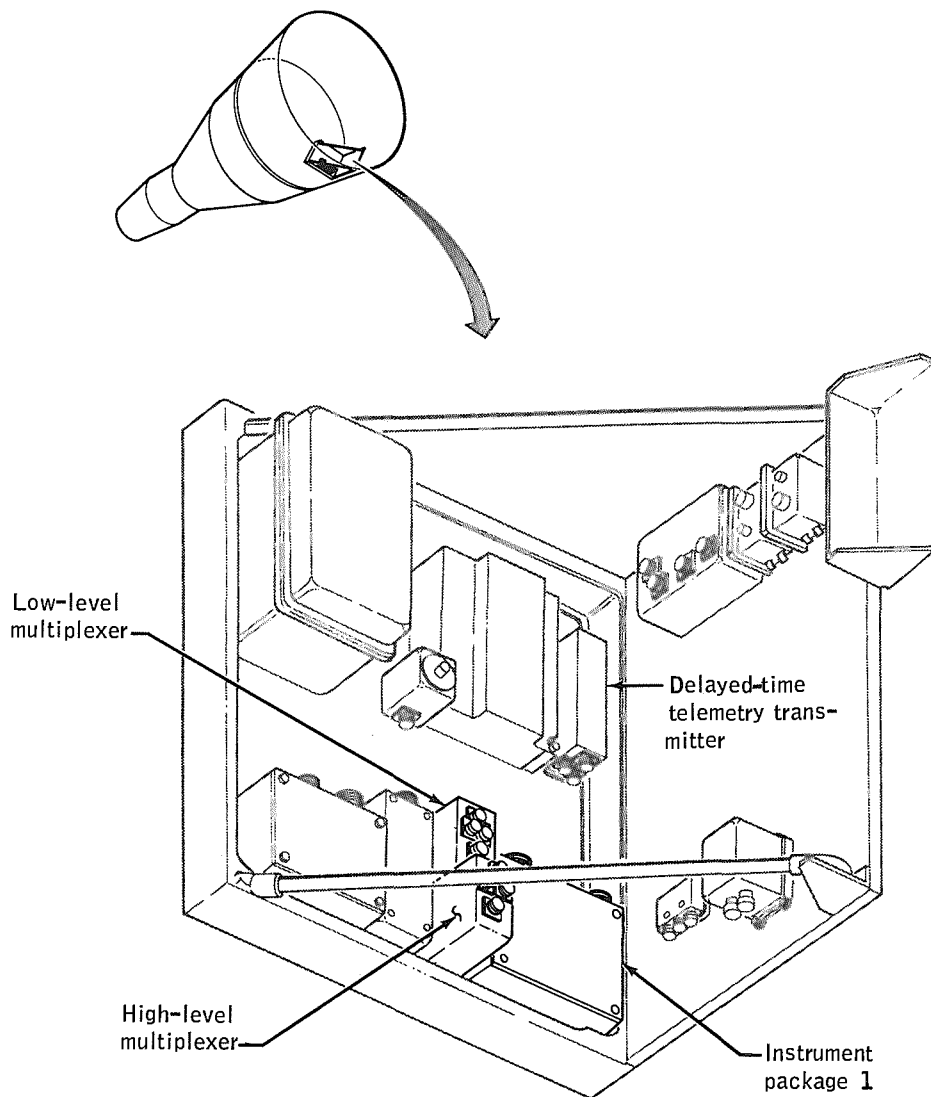
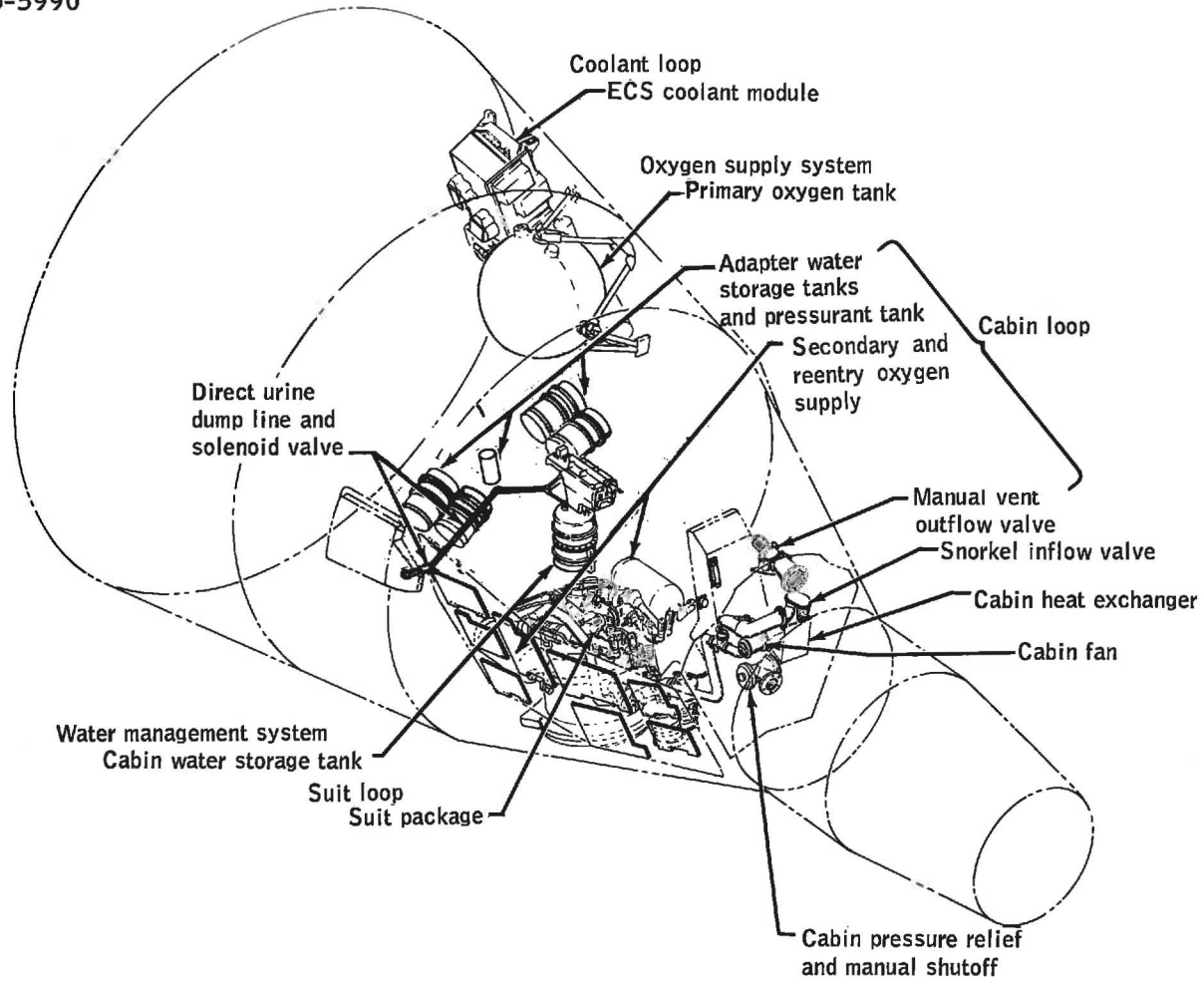

Figure 3-5. - Major instrumentation components (adapter section).

UNCLASSIFIED



UNCLASSIFIED

Figure 3-6. - Environmental control system

UNCLASSIFIED

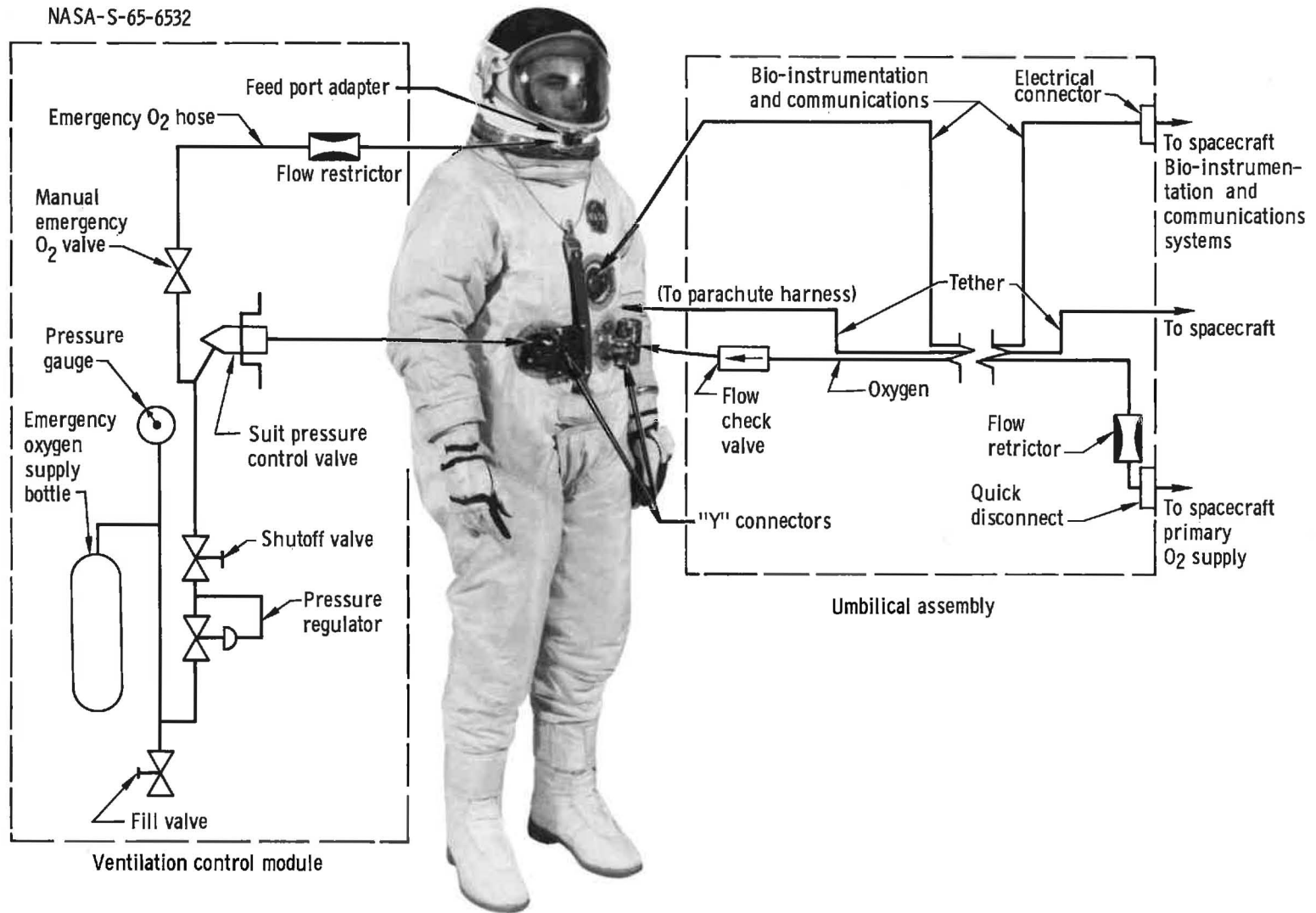

Figure 3-7. - Umbilical assembly and ventilation control module.

UNCLASSIFIED

NASA-S-65-6027



Figure 3-8. - G4C suit and extravehicular equipment.

UNCLASSIFIED

UNCLASSIFIED

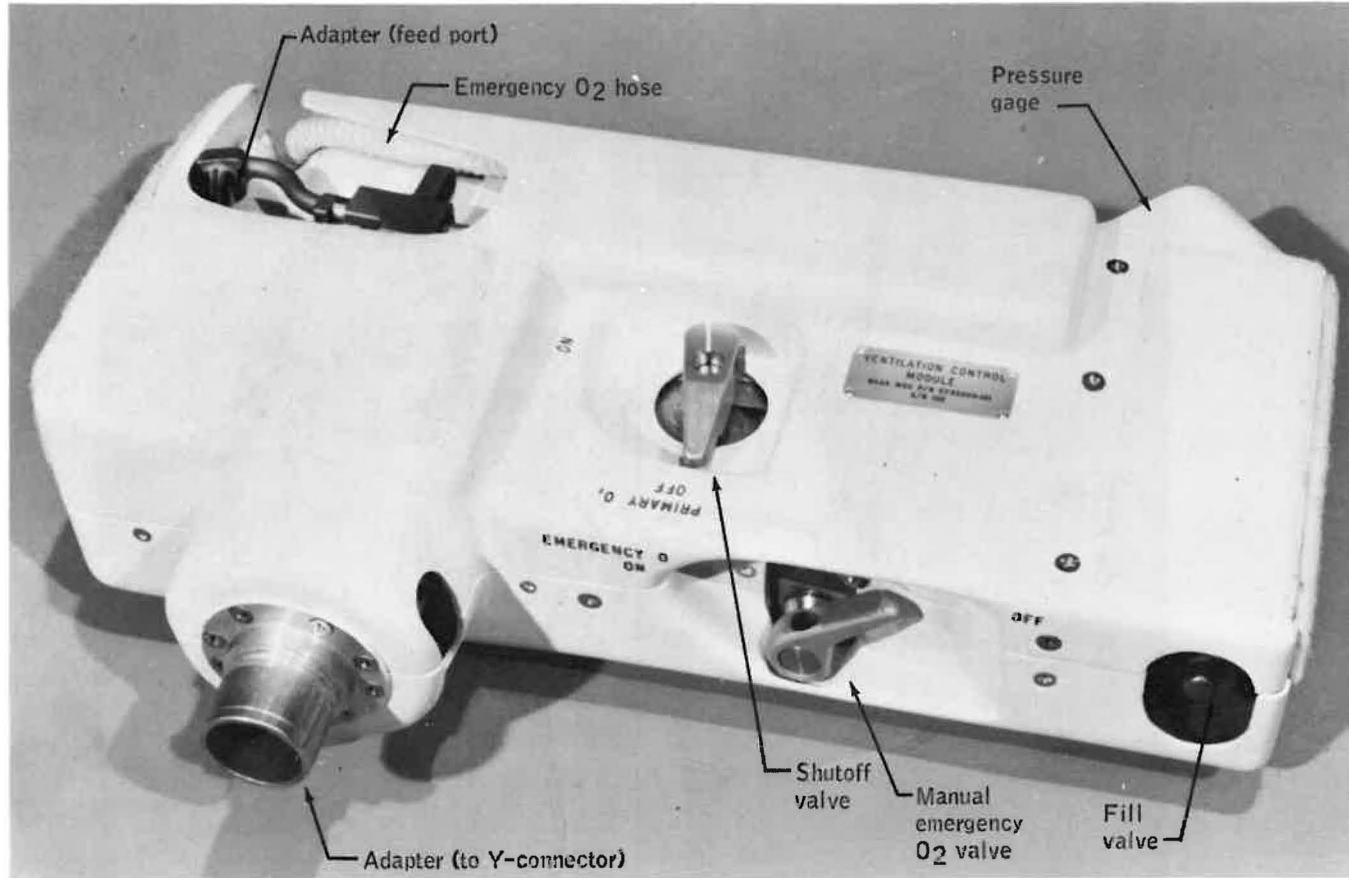
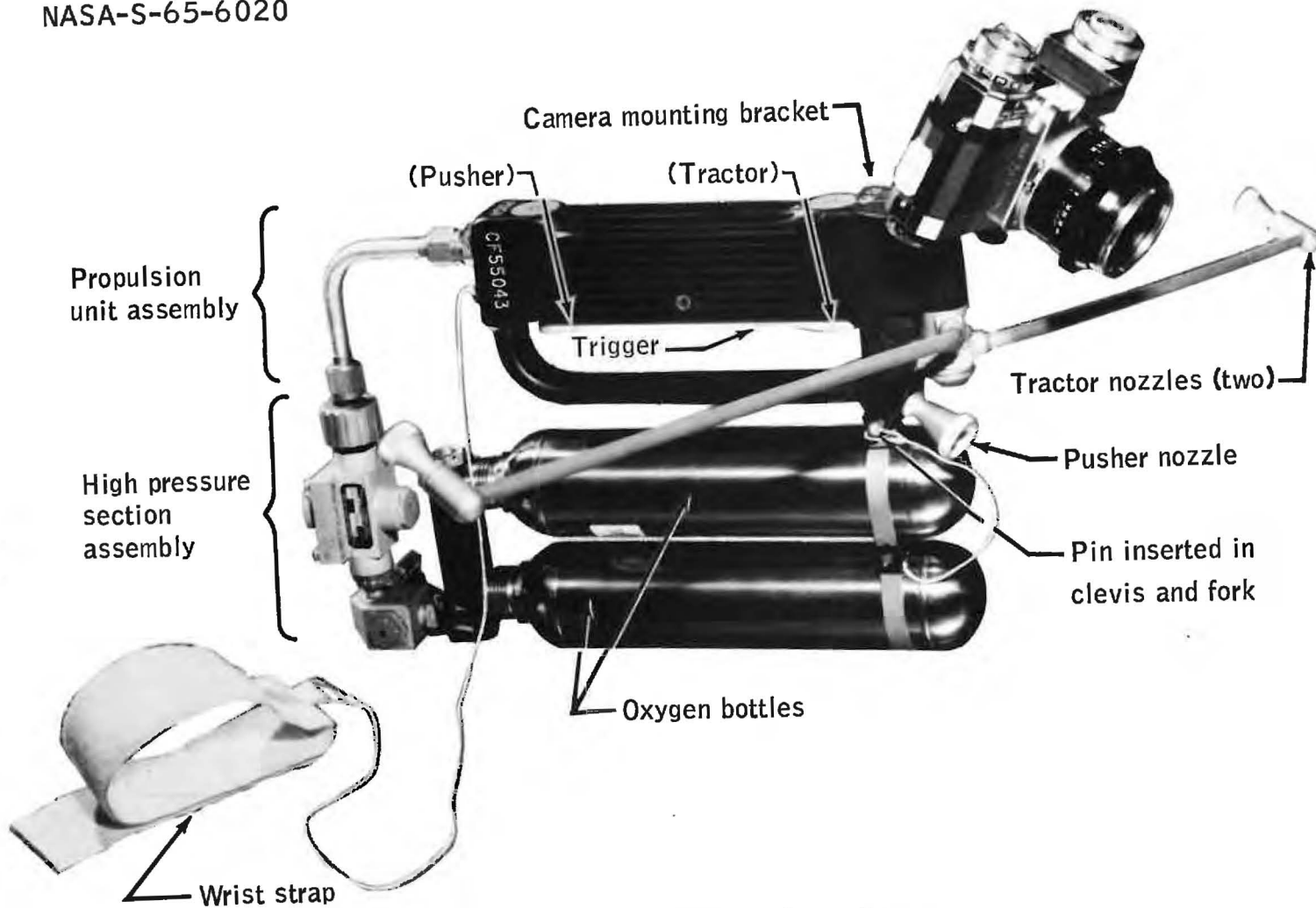

Figure 3-9. - Ventilation control module.

NASA-S-65-6020

UNCLASSIFIED



UNCLASSIFIED

Figure 3-10. - Maneuvering unit.

NASA-S-65-3485

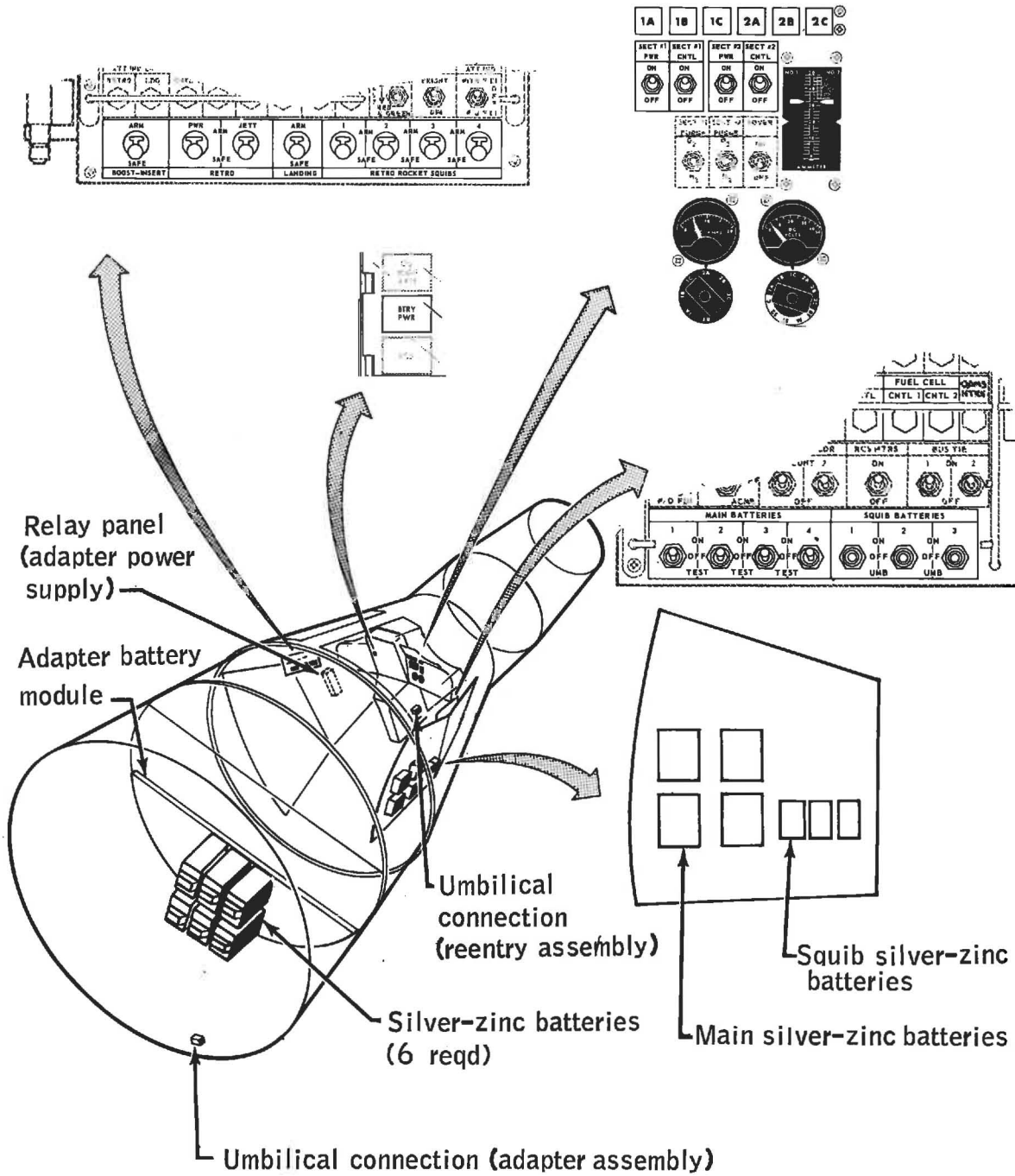
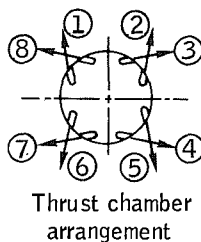
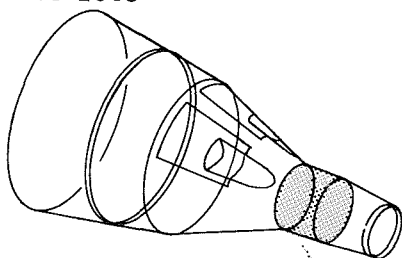

Figure 3-11. - Electrical power system.

NASA-S-65-1608



- | | | |
|---|---|------------|
| 5 | 6 | Pitch up |
| 1 | 2 | Pitch down |
| 3 | 4 | Yaw right |
| 7 | 8 | Yaw left |
| 3 | 7 | Roll right |
| 4 | 8 | Roll left |

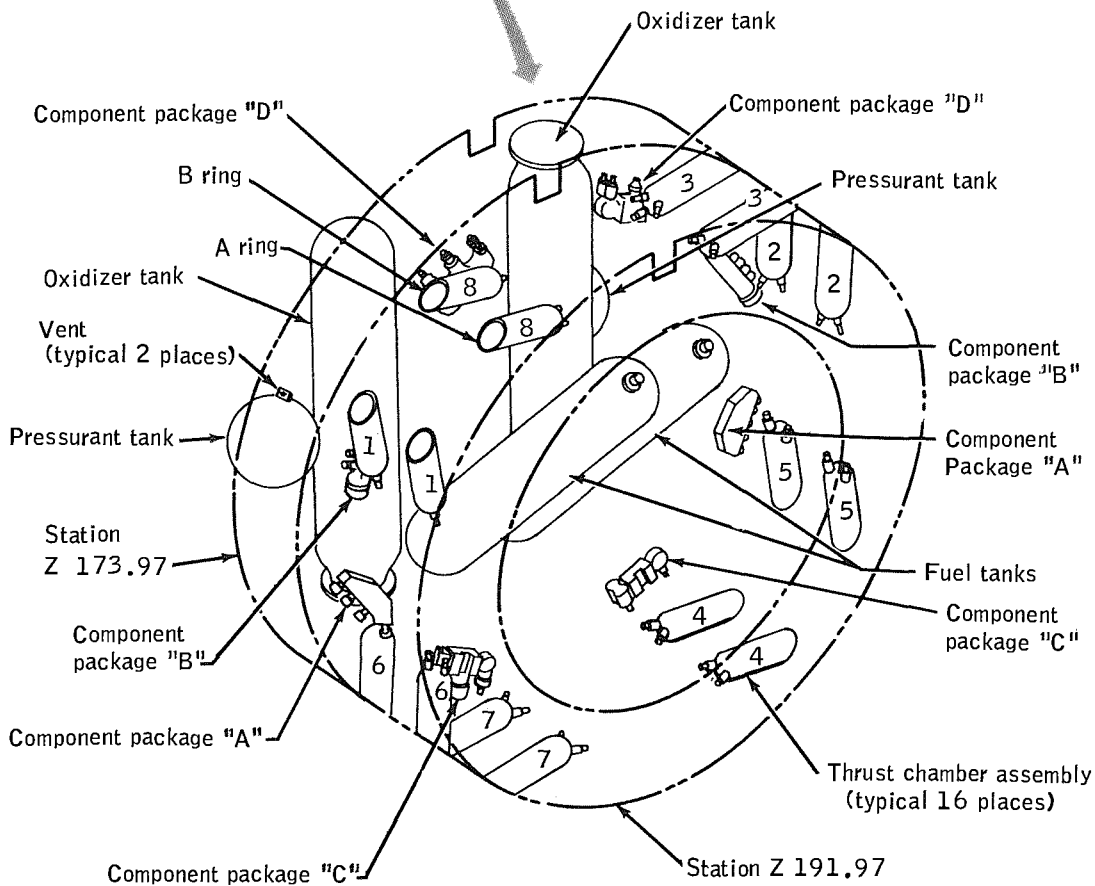

Figure 3-12. - Reentry control system

NASA-S-65-3486

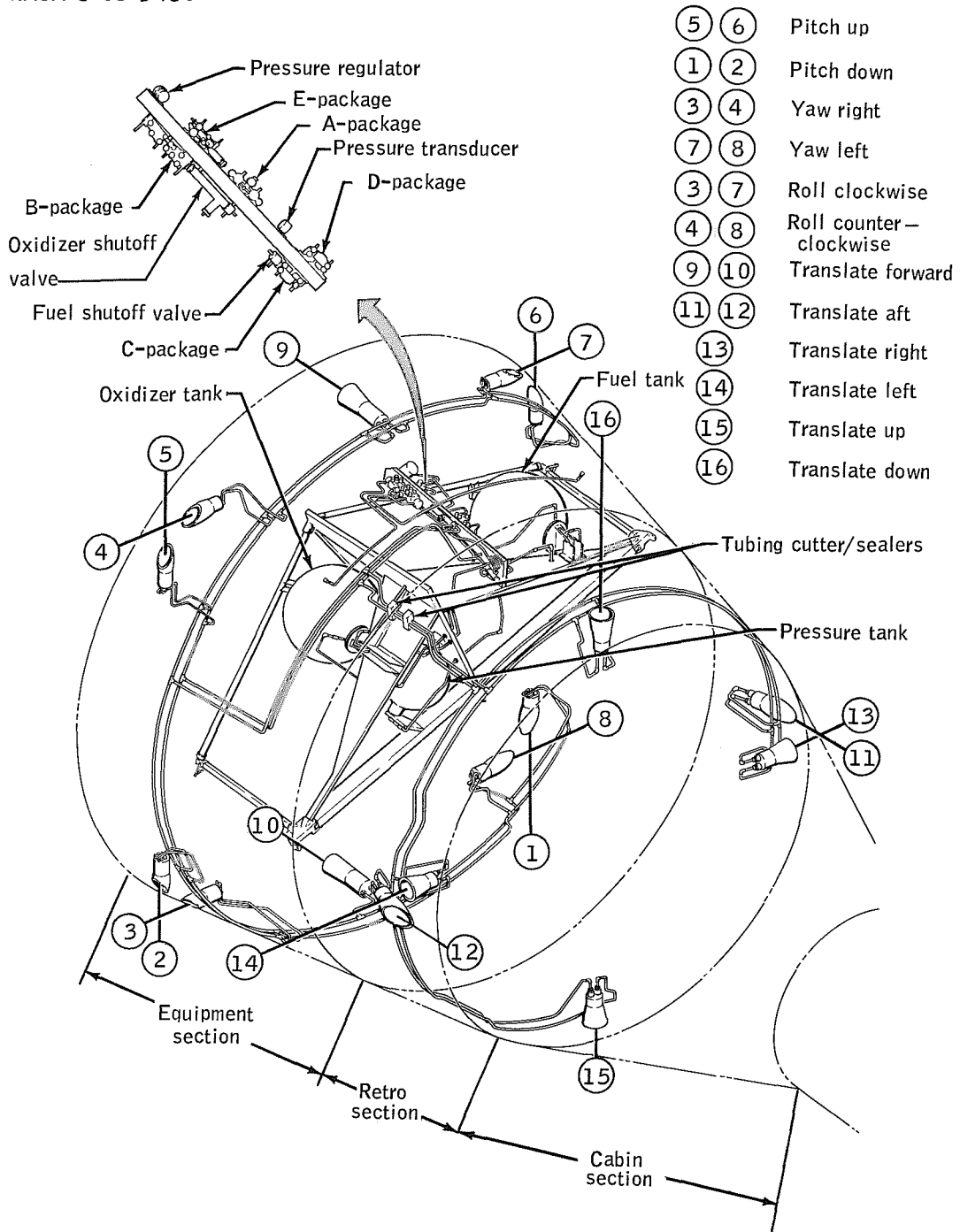
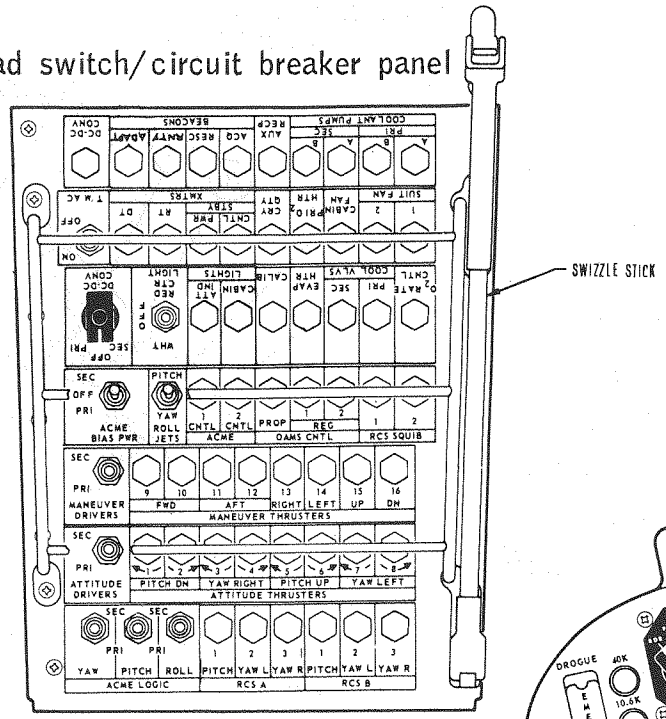

Figure 3-13. - Orbital attitude and maneuver system.

UNCLASSIFIED

Overhead switch/circuit breaker panel



Left switch/circuit breaker panel

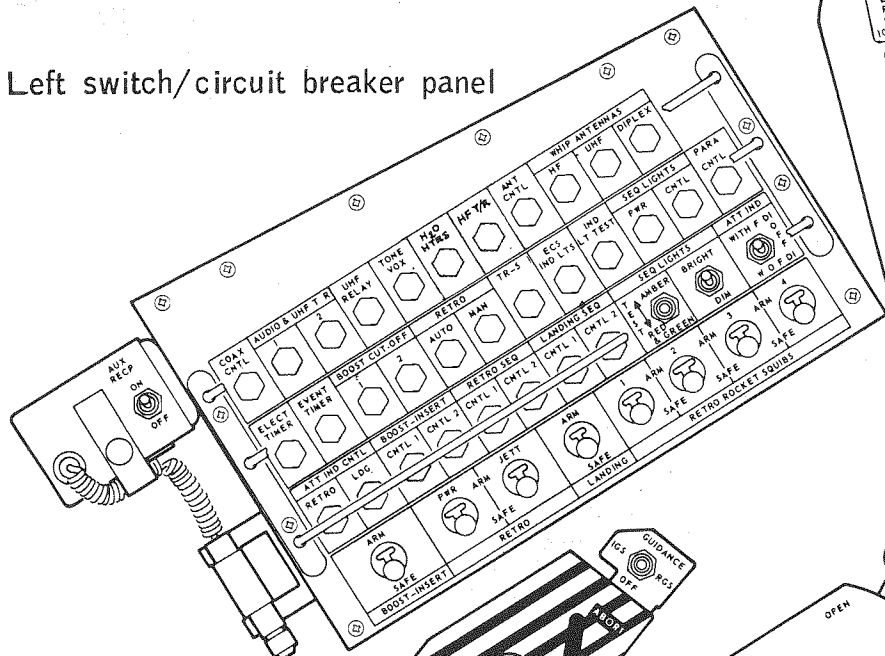

Center panel

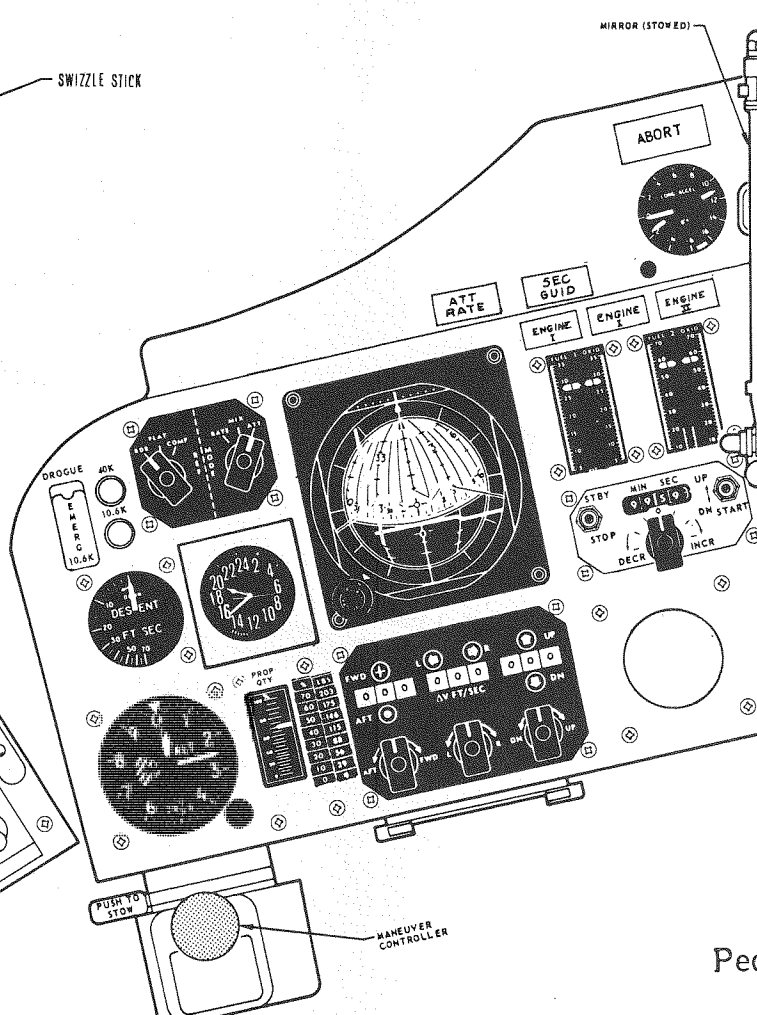
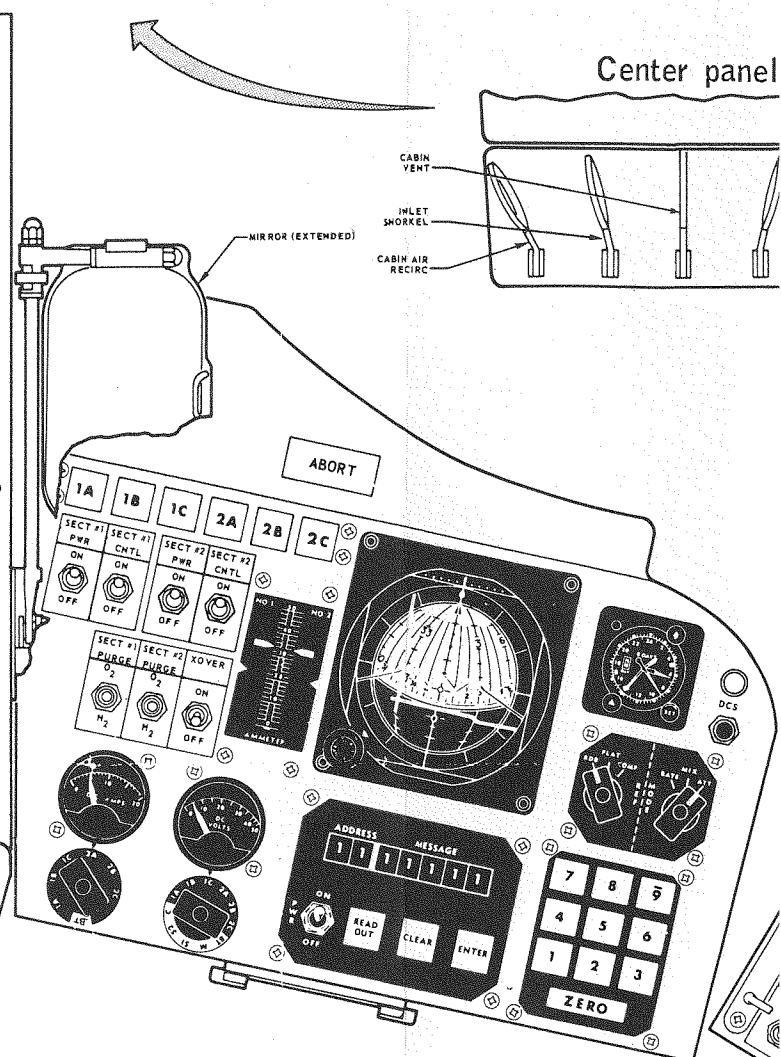

Command pilot's panel

Pedestal

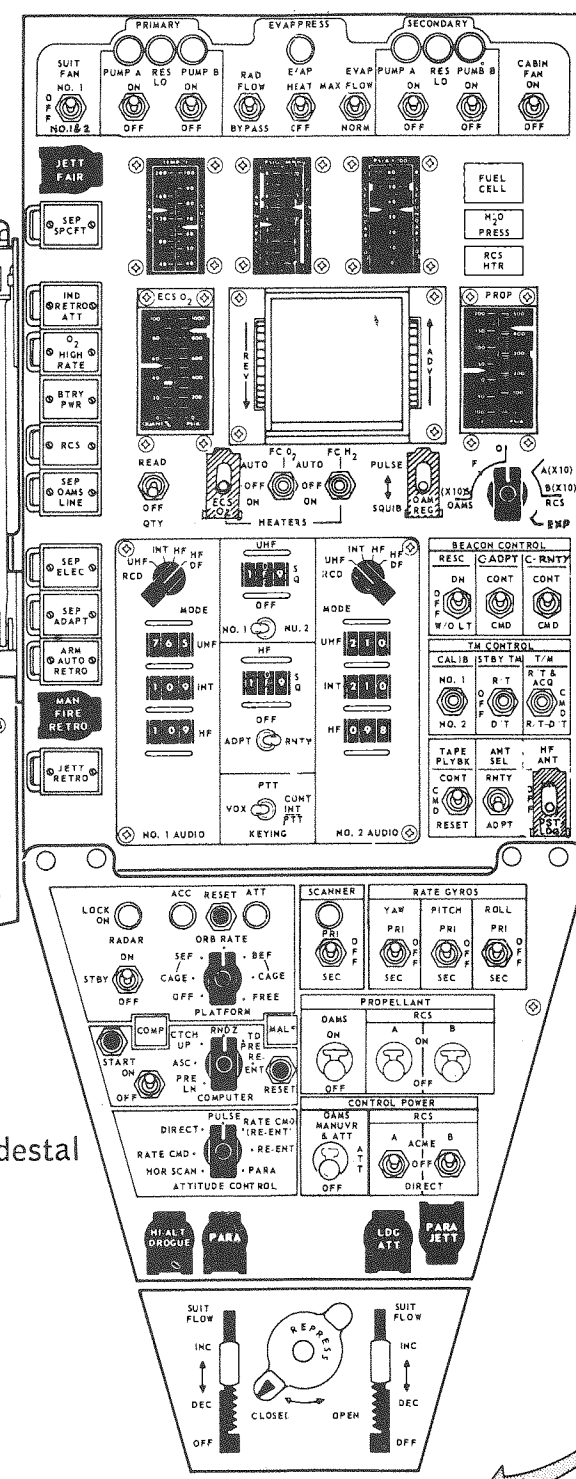

Pilot's panel

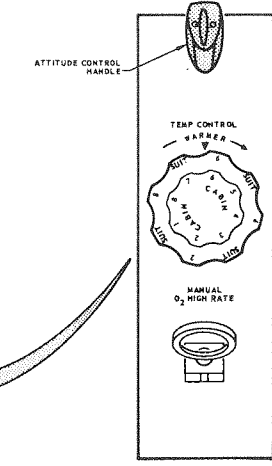

Center console

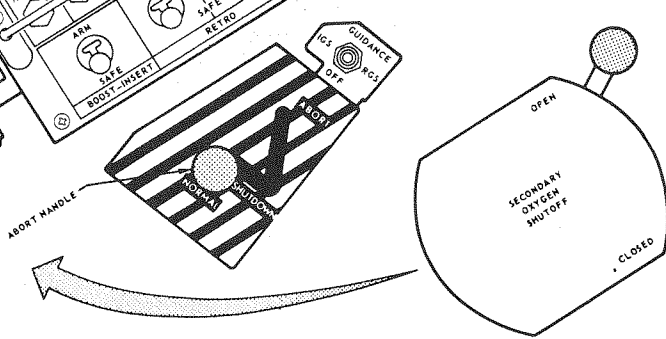

Figure 3-14. - Spacecraft controls and displays.

UNCLASSIFIED

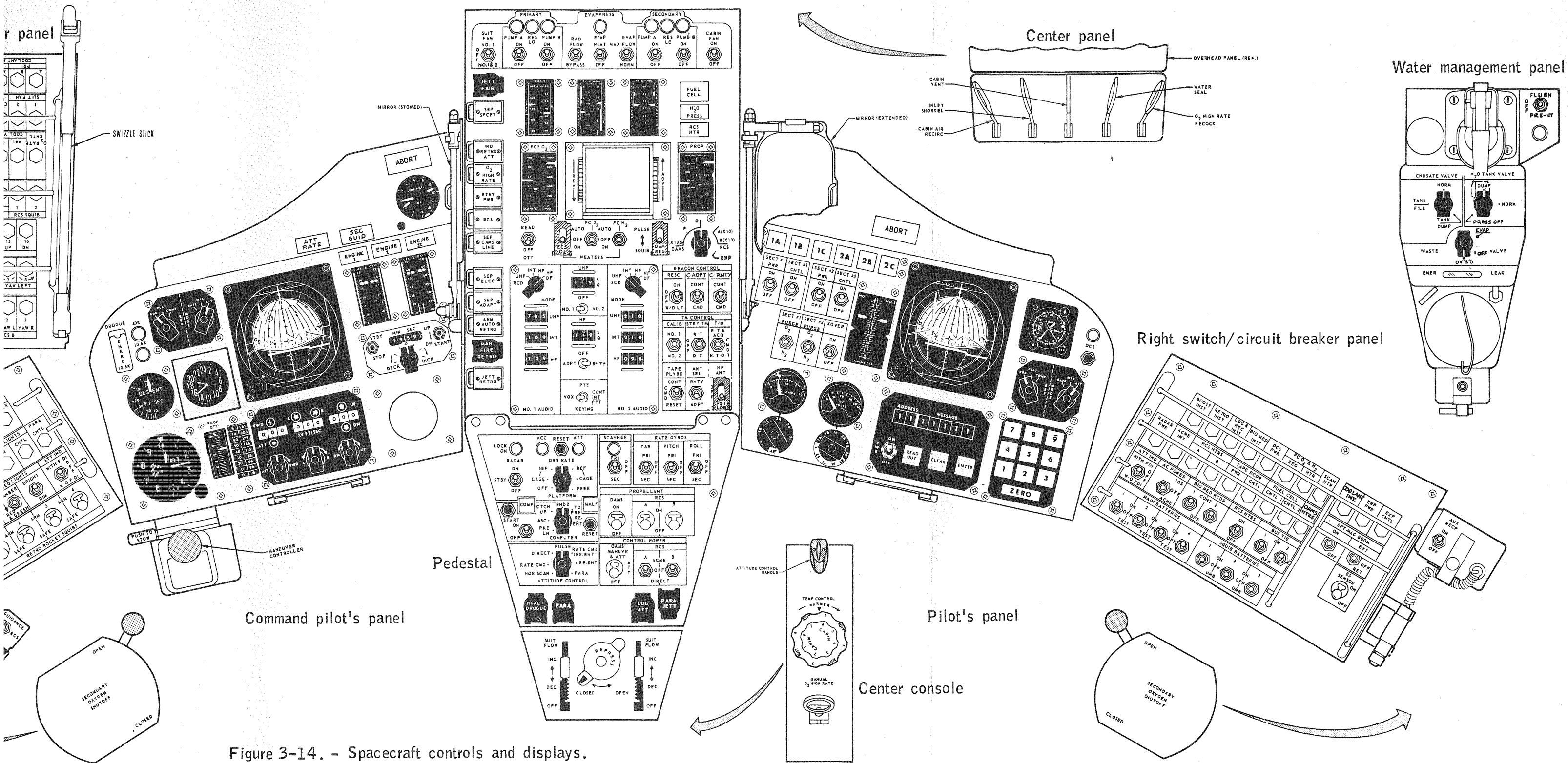
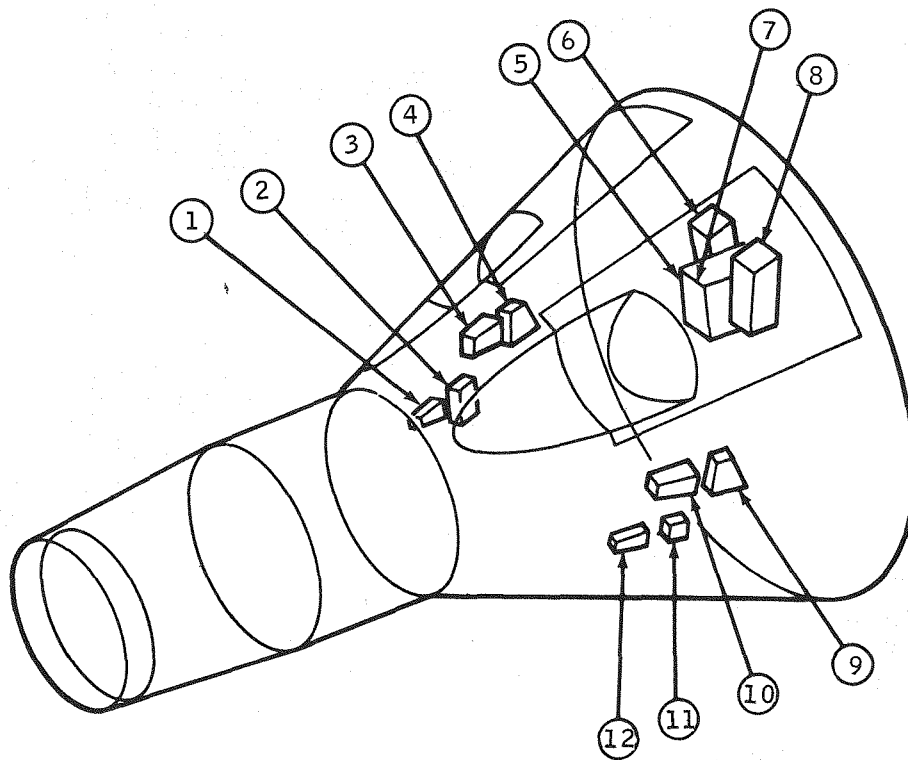

Figure 3-14. - Spacecraft controls and displays.

UNCLASSIFIED



- 1 - Right sidewall fairing container (on wall below R-H switch/circuit breaker panel).
- 2 - Container (for periscope viewer).
- 3 - Forward sidewall container (on wall below hatch sill).
- 4 - Aft sidewall container (on wall below hatch sill).
- 5 - Center stowage box door mount.
- 6 - Right aft food box.
- 7 - Center stowage box.
- 8 - Left aft food box.
- 9 - Aft sidewall container (on wall below hatch sill).
- 10 - Forward sidewall container (on wall below hatch sill).
- 11 - Pouch (on wall, adjacent armrest).
- 12 - Left sidewall fairing container (on wall below L-H switch/circuit breaker panel).

Figure 3-15. - Equipment stowage containers.

UNCLASSIFIED

4.0 MISSION DESCRIPTION

4.0

The comparison of the planned and actual mission is shown in block diagram form in figure 4-1; this diagram also includes planned alternates for the major mission phases. The detailed discussion of the mission is divided into the actual mission, sequence of events, and flight trajectories.

4.1 ACTUAL MISSION

Lift-off of Gemini IV occurred at 15:15:59.562 G.m.t., approximately 1.24 hours later than planned. The delay was due to faulty electrical wiring in the vehicle erector which prevented erector lowering (see sect. 5.2).

Telemetry data indicated that the vehicle rolled at the desired rate and to the desired flight azimuth. The first-stage flight was lofted because of slightly low pitch program rates and the first-stage thrust being higher than expected. However, the flight profile was within the 3σ trajectory boundary.

Staging was initiated at LO+152.43 seconds, and separation had begun by LO+153.14 seconds, approximately 1 second earlier than predicted. The stage II thrust was higher than nominal, and, as in stage I, engine shut-down occurred early. The lofted trajectory was corrected during radio guidance system (RGS) steering. Vehicle steering rates experienced a slight oscillation in pitch, yaw, and roll due to propellant sloshing. This oscillation damped out near SECO (see sect. 5.2).

The spacecraft separation occurred 31.8 seconds after SECO. The spacecraft aft-firing thrusters operated for 5 seconds. The elapsed time at completion of this maneuver was 369.7 seconds, and the inertial velocity was 25 746 ft/sec, which resulted in an elliptical orbit with a perigee of 87.6 nautical miles and an apogee of 152.2 nautical miles as compared with the planned nominal of 87 nautical mile perigee and 159 nautical mile apogee.

The GLV second stage was inserted into an orbit with a perigee altitude of 87.6 nautical miles and an apogee altitude of 150.1 nautical miles. Immediately following spacecraft separation, the command pilot initiated the station-keeping exercise. During station keeping, the flight crew made a total of 74 maneuvers within approximately 80 minutes and used 115 pounds of propellant. This amounted to a total velocity

UNCLASSIFIED

increment change of approximately 102 ft/sec. During the station-keeping exercise, the minimum separation distance between the two vehicles was approximately 0.3 nautical mile and the maximum separation distance was approximately 5.1 nautical miles.

At the end of the first revolution, the crew was instructed not to attempt any more station-keeping maneuvers. The decision to terminate the exercise was based on the fact that most of the propellant budget allocated to the exercise had been expended and the desired close-up station keeping had not been achieved. It was obvious that further attempts would seriously jeopardize the primary mission objective and could require cancellation of a number of secondary objectives. Maneuvers performed up to this time had resulted in a 90.4 by 159.9 nautical-mile orbit which was higher than planned both in perigee and apogee.

The flight crew then began preparations for the extravehicular activity (EVA) at approximately 01:40:00 g.e.t. which was about as scheduled. Preparations went smoothly, but the command pilot decided that due to the high level of activity required, the EVA should be delayed one revolution because the rendezvous attempt had been deleted and there was no need to maintain the close schedule as originally planned. This decision was approved by ground controlling personnel. The egress checklist was completely reverified during the next revolution with final checks occurring just prior to Carnarvon. Approval for depressurization and hatch opening was given over Carnarvon. Final egress preparations were made and the final approval for egress was transmitted during the pass over Hawaii.

The pilot egressed from the spacecraft at approximately 04:23:00 g.e.t. The egress was made using only the maneuvering gun and occurred without difficulty. Maneuvers with the gun were very successful (see section 7.1.3 for a detailed account of the EVA). The command pilot controlled attitude with the pulse mode during EVA. This mode was used primarily to insure that no thruster firings occurred while the pilot was in close proximity to an attitude thruster.

Pilot ingress started at about 04:46:00 g.e.t. which was nearly 10 minutes later than planned, and final hatch closure and repressurization were not completed until 05:06 g.e.t. The primary reason for this delay was the difficulty experienced with the hatch closure. As a result, the crew decided not to reopen the hatch to discard equipment as planned.

After EVA, the crew was instructed to assume drifting flight in order to conserve propellants. This mode of flight was maintained for approximately the next $2\frac{1}{2}$ days. During this period, the flight plan

UNCLASSIFIED

41102
~~CONFIDENTIAL~~

4-3

was continually updated as various operational checks and experiments were rescheduled, as required. The crew adjusted the planned sleep cycles to suit their needs, which also required a continual replanning of activities around these sleep periods. The ability to perform those experiments and checks which required the crew's monitoring of ground or terrestrial objects depended on the attitude that the spacecraft happened to be in at that time; consequently, many of the planned experiments and checks were rescheduled to a later period when fuel consumption was again allowed. At about 21 hours g.e.t., the first successful orbital navigation sighting was performed. The spacecraft was in a drifting mode of flight at that time. The crew was instructed to return to the normal flight plan at 22 hours g.e.t.

MSC experiments 2 and 3 were performed at 33 hours g.e.t. These were the first experiments or operational checks that were performed on this flight in a controlled attitude mode.

The orbital lifetime adjustment maneuver, planned for the 30th apogee, was deleted since orbital decay was only 72 percent of the expected decay. The orbit at this time was 88.5 by 151.3 nautical miles which provided an adequate orbital lifetime margin. A D-9 experiment run was substituted for the orbital lifetime adjustment maneuver. This run was accomplished with attitude control and marked the first time the experiment was performed with the aid of a controlled attitude. Another orbital adjustment maneuver was planned for the 45th apogee, but again evaluation showed that the necessary orbital lifetime requirements existed; therefore, the maneuver was deleted. The spacecraft was in an 87.2 by 145.6 nautical mile orbit at this time.

During the next 24-hour period, the crew performed various horizon sensor checks, Apollo orientation checks, and attitude thruster checks of simulated failures. At an elapsed time of 72 hours, the attitude control and maneuver electronics (ACME) was placed in the horizon scan mode; this mode was maintained for the next 15 hours. During this period, the MSC 2 and 3 experiments were run with the spacecraft in the small-end-forward (SEF) attitude, D-8 and D-9 runs were performed, and thruster plume photographs were attempted.

At approximately 75:45:43 g.e.t., the command pilot had trouble turning off the computer and the computer malfunction light came on. During the next several revolutions, various attempts were made to restore proper operation of the computer but none were successful. (See sect. 5.1.5.4 for details of the problem.)

Preretrograde preparations were started some 3 hours early, primarily because of the large amount of equipment and refuse that had to be stowed. Instructions were sent up from the MCC-H for an alternate

~~CONFIDENTIAL~~

4 NGL
~~CONFIDENTIAL~~

retrograde sequence; this alternate became necessary as a result of the malfunction in the inertial guidance system (IGS) which precluded use of the computer.

In revolution 62 at 97:28:02 g.e.t., a preretrograde orbital attitude and maneuvers system (OAMS) maneuver was initiated. The aft-firing thrusters were used and the maneuver lasted 2 minutes 41 seconds. The resulting velocity increment was 6 ft/sec greater than the planned value, and a theoretical perigee of 42.3 nautical miles resulted instead of the 45 nautical miles which had been planned.

Equipment adapter separation was commanded by the crew at 97:39:14 g.e.t. followed by automatic retrorocket firing at 97:40:01 g.e.t. Automatic retrofire was initiated by the sequential system about 1 second early and, in an attempt to correct for this early initiation, the command pilot held full-lift attitude for 21 seconds beyond the 400 000-foot altitude where the rolling reentry had been planned to begin. Spacecraft entry into communication blackout began at 97:44:59 g.e.t. and ended at 97:49:14 g.e.t.

The drogue parachute was deployed at 97:50:53 g.e.t., followed by pilot and main parachute deployment at 97:52:11 g.e.t. (See sect. 5.1.11 for detailed sequence.)

Landing occurred at 97:56:12 g.e.t. at 27:44 North latitude and 74:14 West longitude, as reported by the recovery ship. Recovery was prompt, and all phases occurred without difficulty (see sect. 6.3 for details).

~~CONFIDENTIAL~~

4.2 SEQUENCE OF EVENTS

The times at which major events were planned and executed are presented in table 4-I. All events were completed as scheduled or within the expected tolerances, indicating a satisfactory flight.

4.3 FLIGHT TRAJECTORIES

The planned launch and orbital trajectories are preflight calculated nominal trajectories from references 3 and 4, respectively. The preliminary actual trajectories are based on nominal outputs from the Real Time Computer Complex (RTCC) and attitudes and sequences as determined in the auxiliary computer room (ACR). The final actual trajectories are based on the Manned Space Flight Network tracking data and actual attitudes and sequences as determined by airborne instrumentation. The Patrick Air Force Base and 1959 ARDC model atmospheres were used for all trajectories except the final actual launch phase which used the atmosphere at the time of launch up to 25 nautical miles. The earth model for all trajectories contained geodetic and gravitational constants representing the Fischer Ellipsoid. A ground track of the first four and the last three revolutions is shown in figure 4-2. The launch, orbit, station-keeping exercise, and reentry curves are presented in figures 4-3 to 4-11.

4.3.1 Spacecraft

4.3.1.1 Launch. - The launch trajectory data shown in figure 4-3 are based on the output of the range safety impact prediction computer (IP 3600) and the Guided Missile Computer Facility (GMCF). The IP 3600 used data from the missile trajectory measurement system (MISTRAM), FPS-16, and FPQ-6 radars. The GMCF used data from the GE Mod III radar. Data from these tracking facilities were used during the time periods listed in the following table:

Facility	Time from lift-off, sec
IP 3600 (FPQ-6)	0 to 35
GMCF (GE Mod III)	35 to 358

The actual launch trajectory, as compared with the planned launch trajectory in figure 4-3, was slightly high in altitude and flight-path angle during stage I powered flight. After BECO the RGS corrected the trajectory and guided the second stage to a near-nominal insertion. The final actual conditions as compared with the preliminary actual solution are presented in table 4-II. The preliminary actual solution is based on integrating the GE Mod III guidance vector to spacecraft separation, and the final actual condition is based on integrating the Bermuda

vector backward through the orbital attitude maneuvering system (OAMS) activity and attitudes to separation. The preliminary velocity was within 1 ft/sec of the final, and the velocity as determined by the MISTRAM tracking radars was within 6 ft/sec of the final. See section 5.1.5.2.1 for a comparison of the IGS insertion parameters.

4.3.1.2 Orbit. - A comparison of the planned orbital lifetime in reference 4 is shown with the actual lifetime in figure 4-4. The actual lifetime was obtained by integrating the Antigua vector in revolution 18 back to the end of the station-keeping maneuvers in the first revolution, and forward to revolution 50. Lifetime after revolution 50 was obtained by integrating the Bermuda vector in revolution 61. Apparently, accumulated thruster activity during the third day raised perigee 1.2 nautical miles. Apogees obtained with the Antigua vector agreed throughout the 62 revolutions with the tracking data. Perigees, however, did not agree past revolution 50, and the Bermuda vector had to be used for the remainder of the flight to obtain tracking agreement.

The planned orbital decay required three lifetime adjustments to maintain the mission capability; however, the ballistic parameter ($W/C_D A$) and atmosphere density combination was less than expected and no maneuvers were required to maintain the mission lifetime. By keeping the $W/C_D A$ constant, an atmospheric K factor of 0.72 was required to simulate the actual lifetime.

A comparison of the orbital elements for each day is presented in table 4-III. The final actual orbital elements at insertion were based on the Bermuda vector before the station-keeping maneuvers. Preliminary actual orbital elements were measured over a spherical earth, whereas the final actual and planned elements were measured over an oblate earth. The spherical earth elements are approximately 0.8 nautical mile less.

4.3.1.3 Station keeping. - Time histories of separation range, azimuth, and elevation during the first revolution between the spacecraft and the second stage of the launch vehicle are shown in figure 4-5. Relative motion between the spacecraft and stage II is shown in figure 4-6. These parameters were calculated by simulating each vehicle's trajectory, utilizing the corrected IGS insertion vector as shown in section 5.1.5.2.1. An initial spacecraft - launch-vehicle separation velocity of 6 to 7 ft/sec was established through simulations during postflight evaluation. A 4.1-ft/sec velocity increment was applied to the spacecraft using the aft-firing thrusters, and a 2 to 3 ft/sec velocity increment was applied to the launch vehicle which may have been a result of the shaped-charge firing or the effect of the OAMS aft-firing thrusters impinging on the launch vehicle or a combination of both. If uncompensated, this velocity difference would build up to give a separation of approximately 17 nautical miles at the end of the first revolution. The relative trajectory

M N C L

~~CONFIDENTIAL~~

for this situation is shown in figure 4-7. The trajectory obtained from the simulation appears to be compatible with the following information available from the flight crew and from ground orbit determination.

- (a) At Canary Island (22 min g.e.t.), the crew was almost directly above stage II.
- (b) Stage II was never above the horizon (as viewed from the spacecraft).
- (c) Prior to Carnarvon (52 min g.e.t.) the two vehicles came back together within a minimum range of 0.3 nautical mile.
- (d) After darkness, stage II was well below and in front of the spacecraft.
- (e) At the time of the last maneuver, stage II was well below and in front of the spacecraft.
- (f) The final orbit obtained from the simulation agreed within 1.3 nautical miles of the actual orbit determined by ground tracking. A detailed list of all thrusts and attitudes is contained in table 4-IV, and a summary list of all maneuvers for each thruster is presented in table 4-V.

Two retrograde maneuvers were completed by 00:09:23 g.e.t. using the aft-firing thrusters and with the spacecraft in the BEF orientation (fig. 4-8). Prior to platform alinement, one additional small thrust was made with the aft-firing thrusters and a second with the up-firing thrusters. These four thrusts, totaling 5.1 ft/sec, were applied to reduce the separation rate and were greater than the separation velocity applied by the crew.

Figure 4-9 shows the principal velocity increments applied during the first 60 minutes of the station-keeping exercise. Also shown is the spacecraft attitude at the time of these thrusts.

Figure 4-7 illustrates the effectiveness of the thrusting history by showing the relative trajectory that would have resulted if thrusting had been terminated after several of the principal thrust periods. The range and range-rate time history for this period is shown in figure 4-10.

Review of these figures shows that the velocity increments applied through 00:09:21 g.e.t. succeeded in reducing the separation rate, but left a residual rate of 1.5 ft/sec away from the launch vehicle. As a result, the range from spacecraft to launch vehicle increased to 0.84 nautical mile and the range-rate increased to 6.5 ft/sec by

~~CONFIDENTIAL~~

00:30:25 g.e.t. when corrective action was initiated. From 00:30:25 g.e.t. to 00:35:58 g.e.t., thrusts were applied which cancelled the separation rate and produced a range rate of 2.4 ft/sec towards the launch vehicle. The resulting orbit would have passed within 2700 feet of the launch vehicle if no further thrusts had been applied.

Further thrusting was applied at 00:44:30 g.e.t. and at 00:55:55 g.e.t., which resulted in reducing the closest approach distance to 1800 feet. At this point (00:52:00 g.e.t.) a relative velocity of 8 ft/sec normal to the line of sight existed. This velocity propagated into a separation distance of 1.6 nautical miles and a separation rate of 17 ft/sec by the time corrective action was initiated at 01:05:30 g.e.t. The corrective thrust applied was insufficient and the separation distance continued to increase throughout the remainder of the first revolution as shown by figure 4-6. The application of velocity changes was further complicated during this time (01:04:00 g.e.t. through the end of revolution 1) because of the apparent failure of an aft-firing thruster. It appears that if a procedure had been followed that required the crew (1) to initially establish a clearly perceptible closing rate with the target at all times and (2) to again establish a perceptible closing rate any time the range became larger than several stage II lengths, then the closeup station-keeping goal could perhaps have been achieved. If these procedures had been followed for the thrusts applied in the first 24 minutes after separation, it appears that closeup station keeping would have been achieved using less fuel than that actually expended in attempting the task. The values of rates needed to be perceptible are very sensitive to the lighting conditions and can cause high propellant consumption if these lighting conditions are inadequate. The lighting conditions also limit how close to the target station keeping can be maintained with safety.

Figure 4-9 shows the effect of applying a correction which establishes a closing rate such that the target is intercepted. This plot shows how one thrust correction could theoretically achieve closure; however, in a flight case a number of successive thrusts approaching the one shown would be required because of the sensitivity of the trajectory to small corrections. This trajectory would in this case have placed the spacecraft below and behind the target which is desirable to allow nulling of the translation rates against an inertial background and provide effective corrections during closure with the target.

During the station-keeping exercise, the critical nature of rate determination was demonstrated. After separation, following the four thrusts back toward the launch vehicle, a rate of 1.5 ft/sec away from the stage II existed, whereas, a rate toward it should have been established. The range was approximately 1800 feet at this time. Later, at the point of closest approach, an 8-ft/sec rate existed, normal to the

~~CONFIDENTIAL~~

line of sight, which should have been removed. The range at this time was also 1800 feet; however, both vehicles were in darkness. The ability of a flight crew member to determine rates of the target even in daylight is considerably impaired without a stable background or familiar objects in the foreground. At night, the ability to determine rates depends on the relative distance between two reference lights if they are both visible. If only one light is visible, the flight crew member's judgement depends on his ability to measure the intensity of the light, and, if this one light is flashing, the task becomes very difficult. Therefore, it appears necessary to follow a procedure which requires that perceptible rates be established. In addition, the data from this flight confirm that a limit of separation for maintaining a close-up station-keeping exercise should be established which provides that relative rates remain low, yet perceptible. At the same time, total fuel consumption must stay reasonable. Figure 4-7 shows that the maneuvers conducted after 32 minutes on this flight were less successful than those before that time in maintaining a close-up station with the second stage of the launch vehicle. The data also indicate that any attempt after that time to achieve a close-up station would have required a significant period of time and a number of thrust periods.

Referenced to the computer coordinate system, the IVI indicated total ΔV expenditure from the time of entering the catch-up mode to the close of the station-keeping exercise was:

$$\begin{aligned} |\Delta V_X| &= 44 \text{ ft/sec} + +4 \text{ ft/sec} = 48 \text{ ft/sec} \\ |\Delta V_Y| &= 75 \text{ ft/sec} + -9 \text{ ft/sec} = 66 \text{ ft/sec} \\ |\Delta V_Z| &= 21 \text{ ft/sec} + +11 \text{ ft/sec} = 32 \text{ ft/sec} \end{aligned}$$

The first term for each component is the sum of the magnitudes of the applied ΔV 's along the respective axis. The second term is the accumulated ΔV over 4700 seconds due to accelerometer drift, resulting from a difference between input accelerometer bias terms and actual accelerometer bias.

4.3.1.4 Reentry. - The final and preliminary actual reentry phase of the trajectory is shown in figure 4-11. After the onboard computer was no longer operating, the decision was made to fly a zero lift reentry by rolling the spacecraft at 15 deg/sec instead of using the closed-loop reentry guidance described in reference 5.

The preliminary trajectory was determined by integrating the Carnarvon vector in revolution 62 through the planned preretrofire and retrofire sequences, and a rolling zero lift reentry to 100 000 feet,

~~CONFIDENTIAL~~

at which time full lift was applied until drogue parachute deployment. The final trajectory was obtained by integrating the Carnarvon vector in revolution 62 through the actual preretrofire sequence to retrofire, then integrating the California vector through actual retrofire and a rolling zero-lift reentry until drogue parachute deployment. Table 4-II contains a comparison of the planned, preliminary actual and final actual reentry dynamic parameters and landing.

The final landing point was 50 nautical miles short of the landing point predicted with preliminary solution. Dispersions in retrofire attitude, retrofire time, and OAMS thrust can account for this distance. The final actual landing point was achieved by integrating the California vector through the actual retrofire sequence using a 31° retrofire attitude as determined by telemetry rather than the planned 30° attitude. This additional 1° in attitude contributed 6.9 nautical miles to the landing dispersion. A 1.3-second early retrofire time contributed -3.1 nautical miles. In order to obtain the landing point by integrating the Carnarvon vector through the OAMS preretrofire maneuver and actual retrofire sequence, OAMS thrust had to be increased by 4.5 percent, resulting in an OAMS preretrofire maneuver ΔV of 134 ft/sec instead of 128 ft/sec (98 pounds average thrust from aft thrusters). This 4.5 percent increase in thrust contributed the remaining -40 nautical miles to the landing dispersion, and was verified by the agreement between the trajectory using this increase and the California vector taken between the OAMS preretrofire maneuver and the retrofire maneuver.

After reconstructing the reentry trajectory utilizing the apparent anomalies that caused the landing dispersion, communications blackout agreed with the recorded blackout times, and peak reentry deceleration agreed within 0.05g of the onboard telemetered deceleration. The altitude of parachute deployment sequences agreed with the actual deployment sequences in section 5.1.1.1, and touchdown was within 1.5 nautical miles of actual touchdown based on ship tracking radars and aircraft observers. These sequences confirm the validity of the reconstructed trajectory.

4.3.2 Launch Vehicle Second Stage

The second stage of the launch vehicle was inserted into an orbit with apogee and perigee altitudes of 150.1 and 87.6 nautical miles, respectively. The Gemini network tracking radars were able to skin track the second stage during its 2-day lifetime. The Merritt Island Launch Area (MILA) and Patrick radars tracked the second stage during its reentry on revolution 33, and reported multiple objects which indicate that the vehicle broke up during reentry. Estimated impact point was $12^\circ 24'$ North latitude and $31^\circ 06'$ West longitude.

UNCL

~~CONFIDENTIAL~~

TABLE 4-I.- SEQUENCE OF EVENTS

Event	Planned time, g.e.t.	Actual time, g.e.t.	Difference, sec
Launch phase, sec			
Stage I engine ignition signal (87FS1)	-3.40	-3.24	0.16
Stage I MDTCPs makes subassembly 1	-2.30	-2.39	-0.09
Stage I MDTCPs makes subassembly 2	-2.30	-2.34	-0.04
TCPS subassembly 1 and subassembly 2 make	-2.20	-2.28	-0.08
Lift-off (pad disconnect separation) (15:15:59.562 G.m.t.)	0	0	0
Roll program start	10.16	10.10	-0.06
Roll program end	20.48	20.40	-0.08
Pitch program rate no. 1 start	23.04	22.95	-0.09
Pitch program rate no. 1 end, no. 2 start	88.32	88.21	-0.11
Control system gain change no. 1	104.96	104.67	-0.29
IGS update sent	105.00	105.00	0.00
Pitch program rate no. 2 end, no. 3 start	119.04	118.66	-0.38
Stage I engine shutdown circuitry armed	144.64	144.20	-0.44
IGS update sent	145.00	145.00	0.00
Stage I MDTCPs unmake	153.29	152.40	-1.11
BECO (stage I engine shutdown (87FS2))	153.37	152.43	-0.94
Staging switches actuate	153.37	152.43	-0.94
Signals from stage I rate gyro package to flight control system discontinued	153.37	152.43	-0.94
Hydraulic switchover lockout	153.37	152.43	-0.94
Telemetry ceases, stage I	153.37	152.43	-0.94
Staging nuts detonated	153.37	152.43	-0.94
Stage II engine ignition signal (91FS1)	153.37	152.43	-0.94
Control system gain change	153.37	152.43	-0.94
Stage separation begin	154.07	153.14	-0.93
Stage II engine MDFJPS make	154.27	153.11	-1.16
Pitch program rate no. 3 ends	162.56	162.07	-0.49

~~CONFIDENTIAL~~

UNCL

~~CONFIDENTIAL~~

4-13

TABLE 4-I.- SEQUENCE OF EVENTS - Concluded

Event	Planned time, g.e.t.	Actual time, g.e.t.	Difference, sec
Launch phase, sec			
Radio guidance enable	162.56	162.03	-0.53
First guidance command signal (decoder output)	169.00	168.50	-0.50
Stage II engine shutdown circuitry armed	317.44	316.45	-0.99
SECO (stage II engine shutdown (91FS2))	335.82	333.75	-2.07
Redundant stage II shutdown	335.82	333.77	-2.05
Stage II MDFJPS break	336.12	333.91	-2.21
Spacecraft separation (shaped charge fired)	365.82 ^a	365.55	-0.27
OAMS on	365.82 ^a	364.71	-1.11
OAMS off	372.30 ^a	369.56	-2.74
Reentry phase, hr:min:sec			
Preretrofire maneuver initiate	97:28:02	97:28:02	0
Retrofire	97:40:02	97:40:01	-1
Retroadapter separate	97:40:47	97:40:47	0
Begin blackout	97:45:25	97:44:59	-26
End blackout	97:49:24	97:49:14	-10
Drogue deployment	97:50:58	97:50:53	-5
Pilot parachute deployment	97:52:40	97:52:11	-29
Landing	97:56:50	97:56:12	-38

^aThese times show the revised planned times which are different from the times shown in refs. 3 and 4 (which show spacecraft separation times at SECO+20 and an OAMS activity to get a spacecraft separation velocity of 10 ft/sec).

~~CONFIDENTIAL~~

~~CONFIDENTIAL~~

TABLE 4-II.- COMPARISON OF PLANNED AND ACTUAL TRAJECTORY PARAMETERS

Condition	Planned (a)	Actual	
		Preliminary (b)	Final (c)
SECO			
Time from lift-off, sec	335.8	(d)	333.8
Geodetic latitude, deg North	30.55	(d)	30.52
Longitude, deg West	72.07	(d)	72.21
Altitude, feet	530 838	(d)	531 202
Altitude, n. mi.	87.3	(d)	87.4
Range, n. mi.	460.1	(d)	453.2
Space-fixed velocity, ft/sec	25 668	(d)	25 659
Space-fixed flight-path angle, deg	0.01	(d)	0.09
Space-fixed heading angle, deg East of North	77.73	(d)	77.67
Spacecraft separation			
Time from lift-off, sec	355.8	363	365.6
Geodetic latitude, deg North	30.83	30.93	30.97
Longitude, deg West	70.59	70.08	69.88
Altitude, feet	531 097	532 961	532 349
Altitude, n. mi.	87.4	87.7	87.6
Range, n. mi.	538.5	563.2	573.8
Space-fixed velocity, ft/sec	25 756	25 742	25 743
Space-fixed flight-path angle, deg	0.0	0.10	0.07
Space-fixed heading angle, deg East of North	78.52	78.79	78.90
Maximum conditions			
Altitude, statute miles	185	184	184
Altitude, n. mi.	161	160	160
Space-fixed velocity, ft/sec	25 766	25 748	25 748
Earth-fixed velocity, ft/sec	24 449	24 433	24 433
Exit acceleration, g	7.3	(d)	7.6
Exit dynamic pressure, lb/sq ft	752	(d)	726
Reentry deceleration, g	6.8	7.8	7.7
Reentry dynamic pressure, lb/sq ft	426	498	493
Landing point			
Latitude, deg:min North	27:29	27:29	27:44
Longitude, deg:min West	73:25	73:21	74:14

^aThese trajectory parameters reflect the planned spacecraft separation conditions for SECO+20 as shown in reference 3 (published 1 month before launch date) and not the revised planned trajectory parameters for spacecraft separation at SECO+30.

^bThese trajectory parameters for spacecraft separation were determined in real time (within several seconds of the actual event) by the Real-Time Computer Complex (RTCC).

^cThese trajectory parameters for spacecraft separation were determined by postflight evaluation.

^dNot applicable.

~~CONFIDENTIAL~~

TABLE 4-III.- COMPARISON OF ORBITAL ELEMENTS

Revolution	Condition	Planned (a)	Actual	
			Preliminary (b)	Final (c)
Insertion	Apogee, n. mi.	158.5 161.0	152.7	152.2
	Perigee, n. mi.	87.0	86.9	87.6
	Inclination, deg	32.53	32.55	32.53
	Period, min	89.09	(d)	88.90
2 (after station- keeping)	Apogee, n. mi.	161.0	159.2	159.9
	Perigee, n. mi.	91.0	89.4	90.4
	Inclination, deg	32.53	32.58	32.53
	Period, min	89.09	89.05	89.08
18	Apogee, n. mi.	156.0	154.6	154.9
	Perigee, n. mi.	89.5	88.6	89.4
	Inclination, deg	32.53	32.56	32.53
	Period, min	89.03	88.95	88.97
33	Apogee, n. mi.	134.3	148.0	149.1
	Perigee, n. mi.	94.2	87.5	88.0
	Inclination, deg	32.53	32.57	32.53
	Period, min	88.77	88.80	88.83
52	Apogee, n. mi.	123.0	138.2	141.0
	Perigee, n. mi.	93.0	86.2	87.4
	Inclination, deg	32.53	32.55	32.53
	Period, min	88.50	88.58	88.62
61	Apogee, n. mi.	115.5	135.4	136.5
	Perigee, n. mi.	89.5	85.3	86.1
	Inclination, deg	32.53	32.56	32.53
	Period, min	88.24	(d)	88.53

^aThese orbital parameters reflect the planned trajectory and spacecraft separation velocity of 10 ft/sec at SECO+20 as shown in reference 4 (published 1 month before launch date) and not the revised planned trajectory and spacecraft separation velocity of 5 ft/sec at SECO+30.

^bThese orbital parameters of the spacecraft were determined in real time by the Real-Time Computer Complex (RTCC).

^cThese orbital parameters of the spacecraft were determined by postflight evaluation.

^dNot available.

UNCL
~~CONFIDENTIAL~~

TABLE 4-IV.- DETAILED LIST OF MANEUVERS DURING GEMINI IV STATION-KEEPING ATTEMPT

Time, (g. e. t.) min:sec	Thruster	Length of burn, sec	Pitch gimbal, deg	Yaw gimbal, deg	Roll gimbal deg
6:04.71	Aft	5	-	-	-
^a 6:05.55					
8:47.164	Aft	2.95	-	-	-
9:20.989	Aft	3.25	-	-	-
13:59.066	Up	.575	-	-	-
15:07.966	Up	.80	-	-	-
21:35.344	Aft	.457	255.852	18.684	151.236
23:59.42	Aft	.50	272.988	13.788	138.852
30:24.923	Up	3.45	313.39	348.136	359.524
30:28.873	Up	2.075	313.02	347.364	359.964
31:30.648	Aft	6.475	285.768	2.664	356.760
34:13.725	Aft	2.275	312.66	347.624	343.512
35:58.225	Aft	3.675	324.91	352.78	15.87
44:26.079	Aft	2.475	332.928	351.036	7.920
44:36.604	Aft	1.575	332.30	349.30	9.37
49:55.231	Aft	1.20	347.13	351.01	6.06
52:09.907	Up	1.50	331.86	350.85	19.03
52:12.907	Aft	2.175	331.58	350.58	19.53
54:23.608	Aft	2.975	315.792	353.916	354.924
55:53.759	Aft	2.975	302.37	346.26	59.50
59:46.310	Fwd	.80	261.56	6.70	83.19
64:29.937	Aft	2.40	262.152	2.052	131.292
66:15.463	Aft	1.275	281.304	355.896	128.592
66:23.988	Aft	1.20	280.68	356.01	128.07
67:47.889	Aft	3.475	277.704	.612	116.856
69:03.464	Aft	2.275	289.008	358.812	112.932
70:30.315	Aft	3.475	288.972	349.488	99.180
71:37.966	Aft	5.35	283.500	354.852	70.956
72:10.291	Aft	4.875	285.552	353.304	65.304
72:25.766	Aft	2.675	285.372	353.700	64.152
72:41.141	Aft	2.175	285.840	352.548	64.476
72:46.691	Aft	5.45	287.38	352.90	65.02
73:03.941	Aft	2.875	287.964	349.452	65.556

^aAt this time, explosive bolts were actuated.

~~CONFIDENTIAL~~

UNCL

~~CONFIDENTIAL~~

4-17

TABLE 4-IV. - DETAILED LIST OF MANEUVERS DURING GEMINI IV STATION-KEEPING ATTEMPT - Concluded

Time, (g.e.t.) min:sec	Thruster	Length of burn, sec	Pitch gimbal, deg	Yaw gimbal, deg	Roll gimbal, deg
73:16.741	Aft	4.85	287.99	348.63	66.38
73:37.866	Aft	1.90	289.188	345.744	68.976
73:48.166	Aft	2.20	289.7	346.78	69.91
74:05.042	Aft	3.174	291.43	345.77	72.83
74:22.092	Aft	3.575	293.83	347.99	73.42
74:35.067	Aft	2.80	294.228	348.30	73.008
74:50.267	Aft	3.675	295.884	350.100	72.180
74:56.617	Aft	5.35	297.180	348.804	71.532
75:42.517	Aft	5.27	291.06	2.628	1.044
75:50.067	Aft	5.75	292.644	.504	359.964
76:11.067	Aft	.80	291.06	356.04	1.224
76:12.767	Aft	4.275	291.04	355.70	1.27
76:44.218	Aft	1.775	291.204	354.672	3.024
76:53.343	Up	1.175	290.7	354.92	3.22
77:17.843	Aft	.40	293.58	353.412	1.944
77:19.018	Up	.50	294.59	353.34	2.51
77:29.543	Up	.775	300.41	352.45	3.70
77:30.518	Up	1.30	299.988	351.900	3.564
77:51.043	Aft	4.375	298.26	347.33	1.908
78:14.843	Up	1.10	291.14	350.37	348.916
78:51.344	Aft	4.075	298.224	349.452	329.580
78:59.069	Right, up	3.275/3.375	299.05	348.264	328.680
79:9.994	Up	4.15	297.412	347.14	327.19
79:10.194	Right	3.85	297.412	347.14	327.19
79:30.144	Up	1.375	297.792	349.128	325.764
79:33.894	Up	2.375	297.05	350.52	326.73
79:45.491	Up	7.15	296.62	350.83	350.56
80:29.644	Up	5.15	301.968	343.836	333.756
80:32.119	Aft	2.775	301.752	343.476	334.152
81:07.42	Up	1.20	304.03	347.12	341.536
81:08.995	Up	2.175	303.984	347.976	339.336
81:09.695	Right	1.375	302.7	348.9	337.03
82:03.145	Aft, up	3.975/3.875	306.22	342.18	336.312
82:47.27	Aft	.90	304.056	333.72	6.408
83:21.796	Aft	4.95	302.88	343.28	347.17
84:35.371	Up	3.475	311.868	344.988	326.376
84:59.371	Up	4.275	311.94	345.42	354.744
86:41.222	Right, up	1.075/1.374	309.7	348.00	353.36
86:46.297	Up	4.25	306.7	347.25	350.40

~~CONFIDENTIAL~~

1NCL

4-18

~~CONFIDENTIAL~~

TABLE 4-V. - SUMMARY ON THE MANEUVERS MADE DURING
GEMINI IV STATION-KEEPING ATTEMPT

Thruster	Number of burns	Total burn time of thruster, sec	Propellant, lb
Aft	46	142.299	
Forward	1	.80	
Left	0	0.00	
Right	4	9.575	
Up	23	57.450	
Down	0	0.00	
Total	74	210.124	115

~~CONFIDENTIAL~~

UNCLASSIFIED

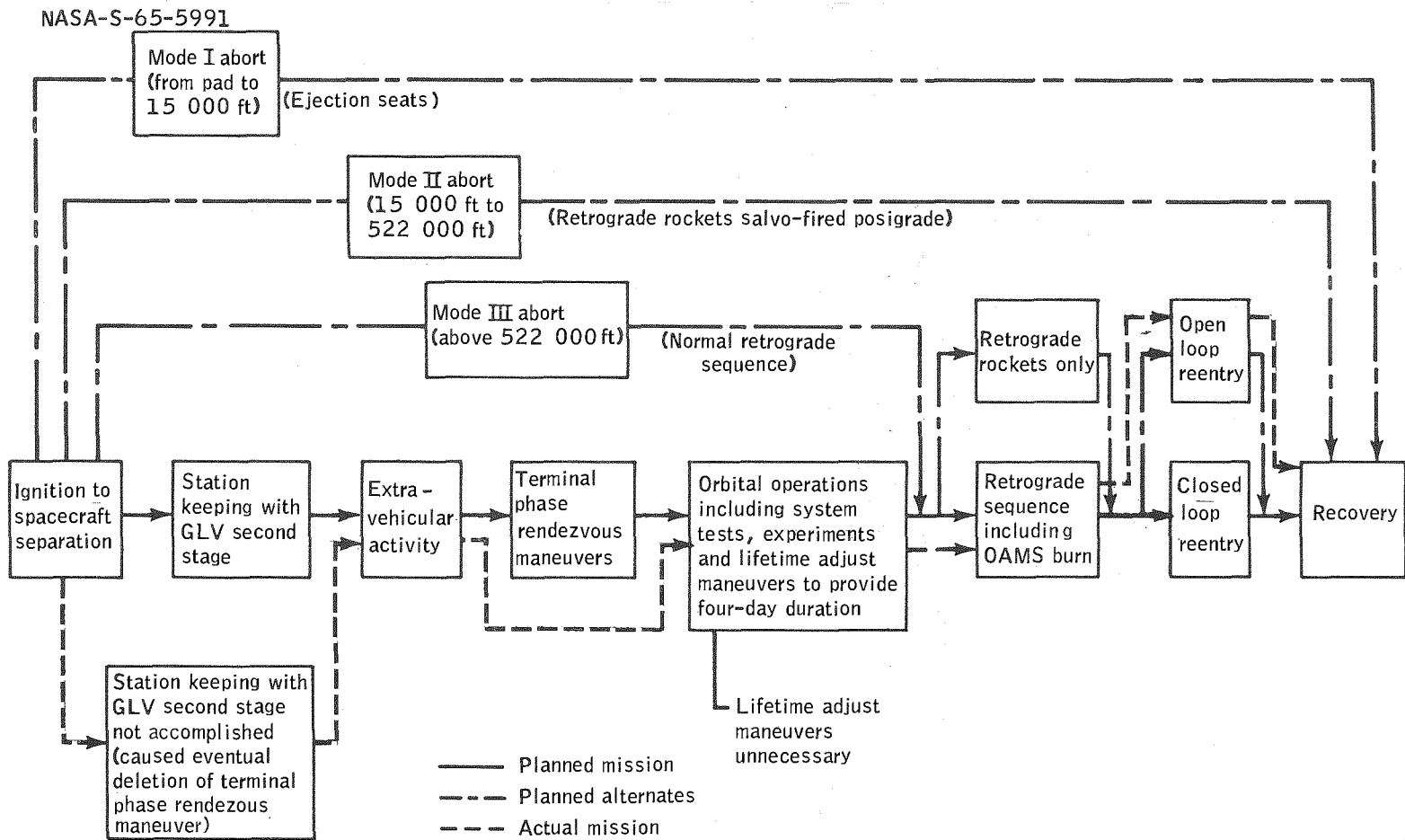

UNCLASSIFIED

Figure 4-1. - Planned and actual mission with planned alternates included.

UNCLASSIFIED

NASA-S-65-5994

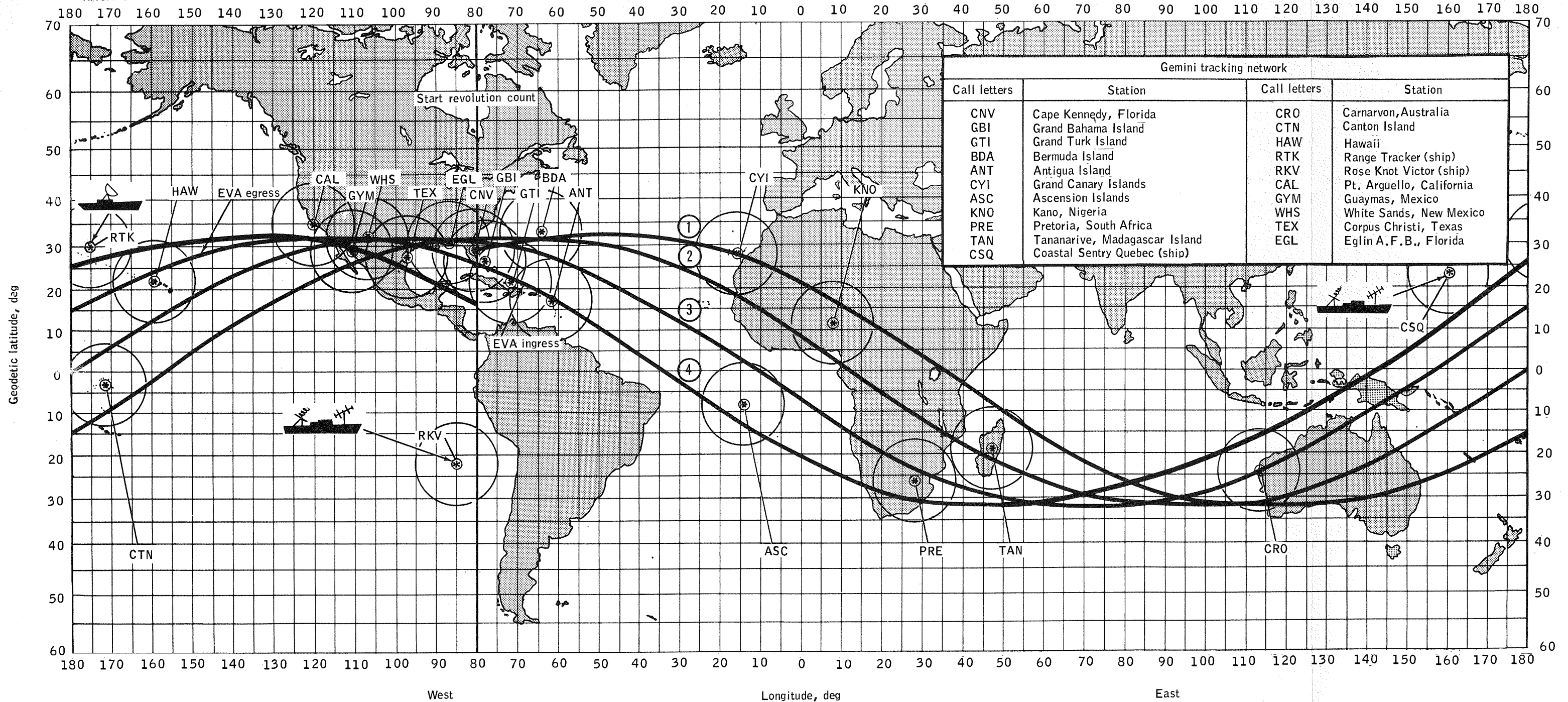

(a) Revolution 1 through 4.

Figure 4-2. - Ground track for the Gemini IV orbital mission.

UNCLASSIFIED

NASA-S-65-5995

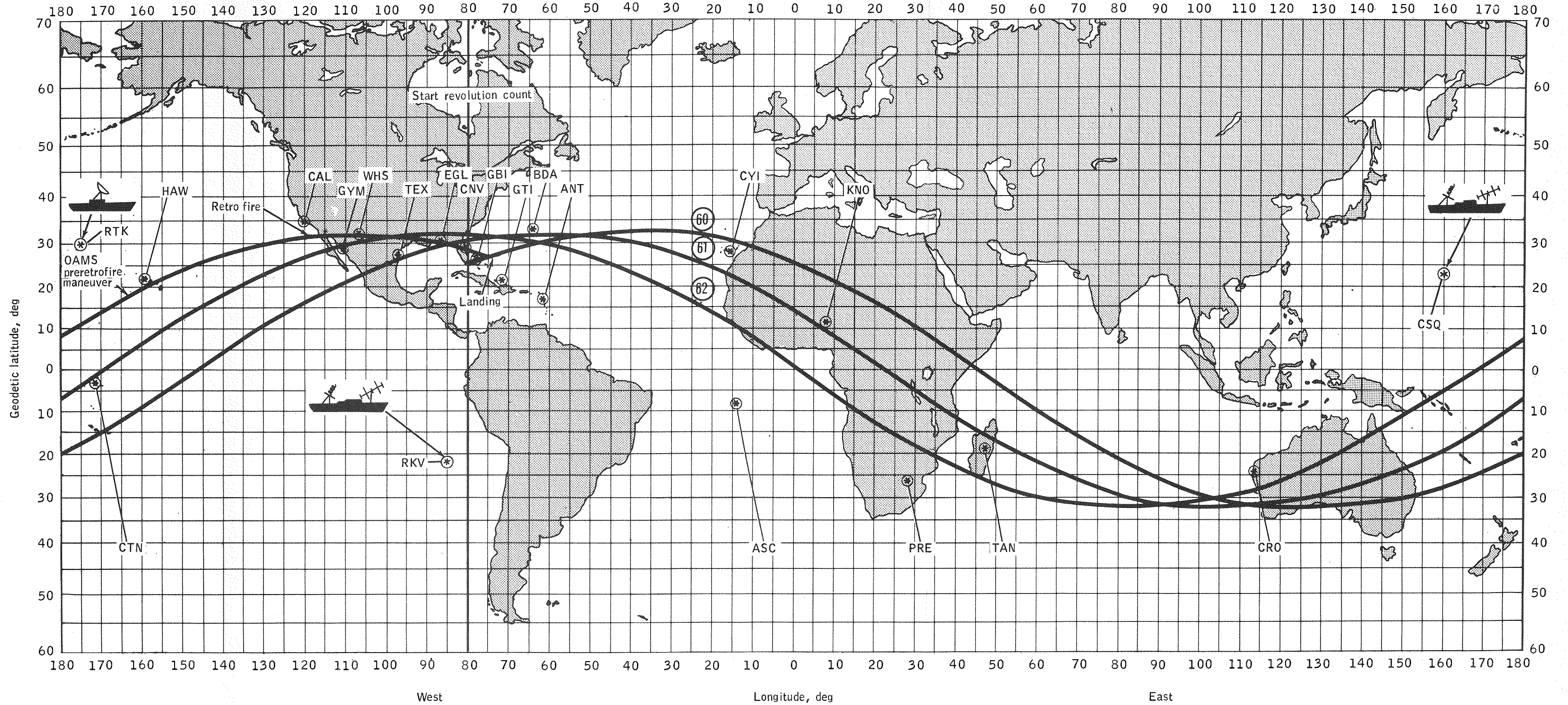

(b) Revolution 60 through landing

Figure 4-2.- Concluded.

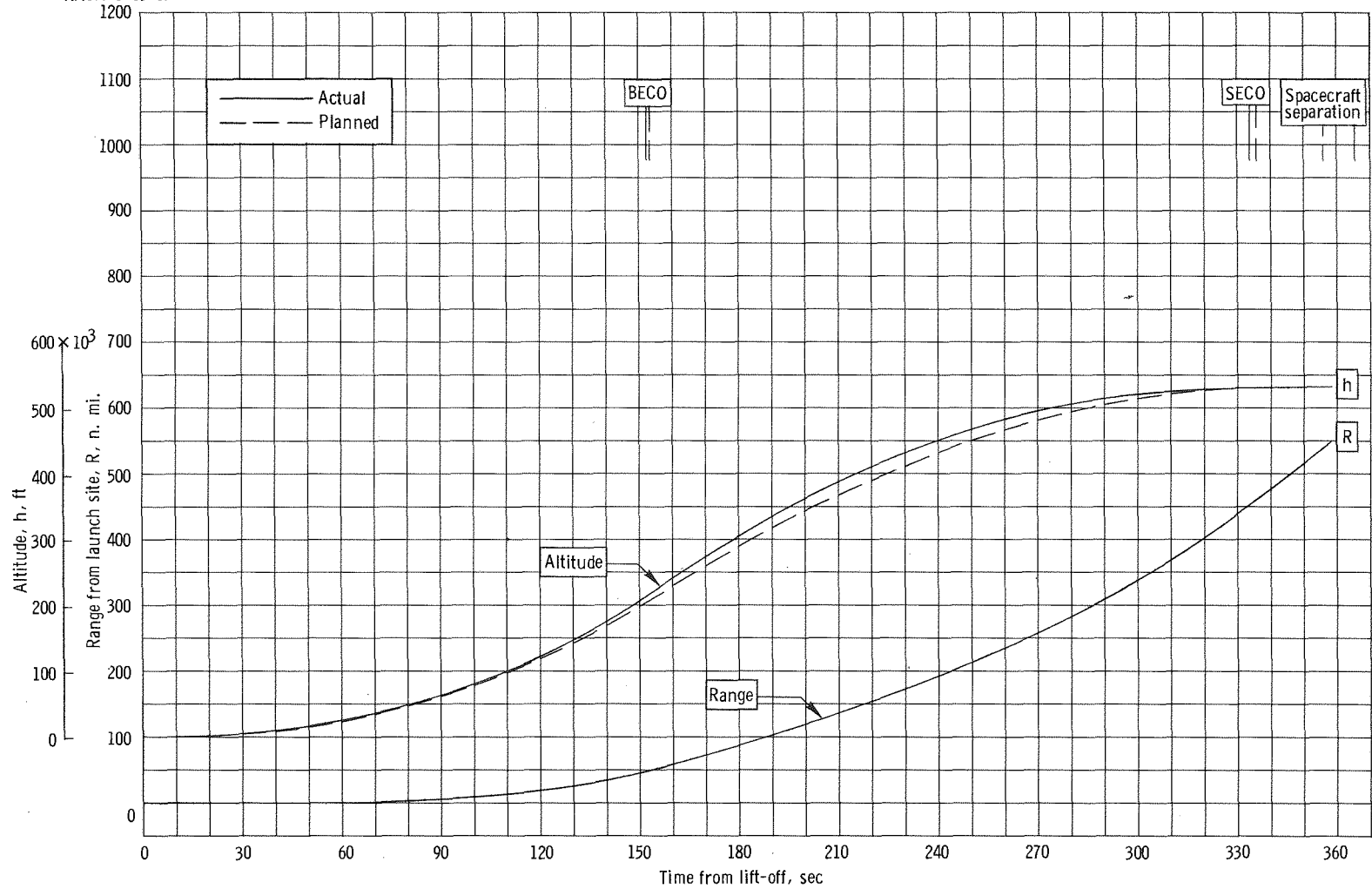

(a) Altitude and range.

Figure 4-3. - Time histories of trajectory parameters for Gemini IV mission launch phase.

CONFIDENTIAL

UNCL

CONFIDENTIAL

CONFIDENTIAL

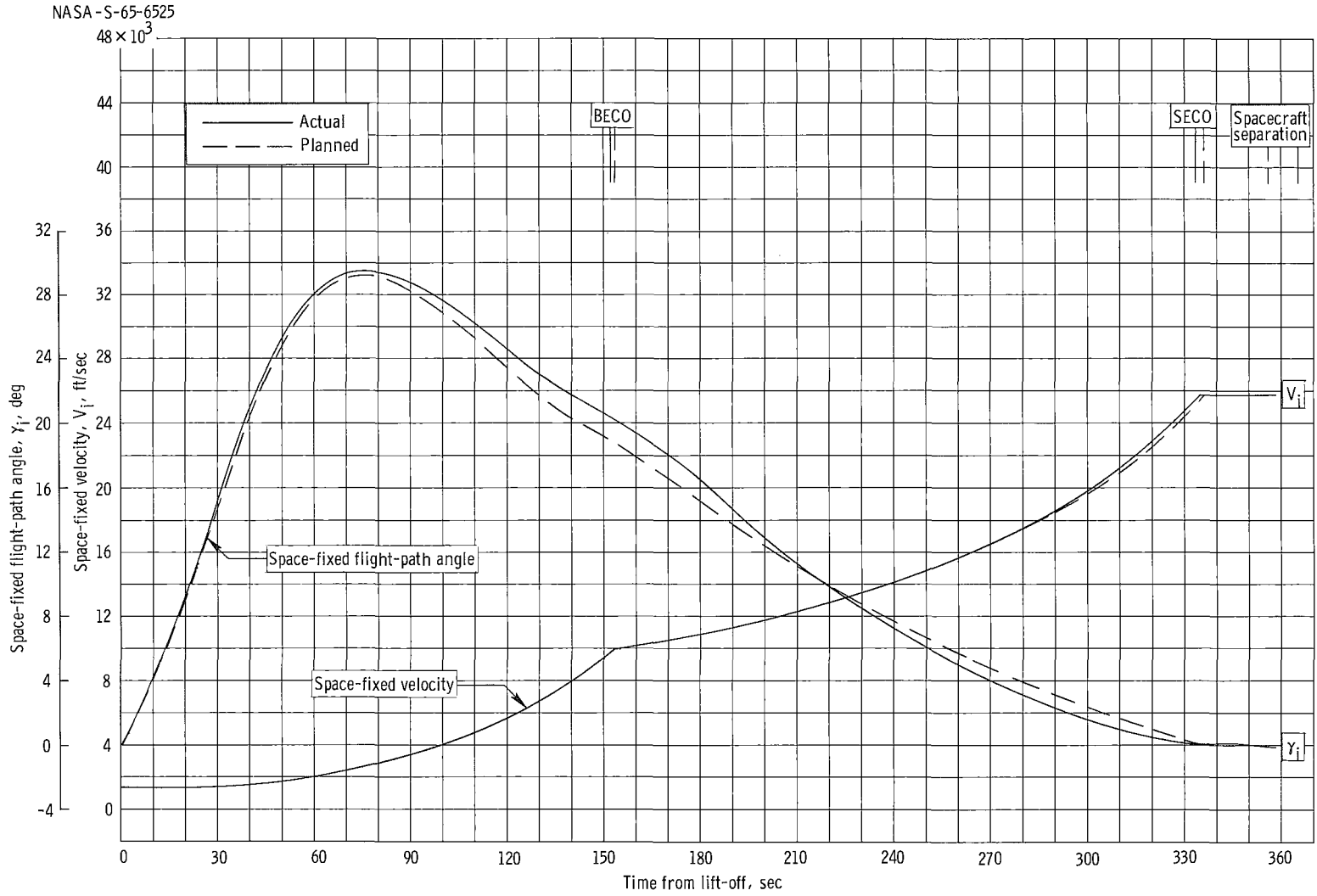

(b) Space-fixed velocity and flight-path angle.

Figure 4-3. - Continued.

CONFIDENTIAL

~~CONFIDENTIAL~~

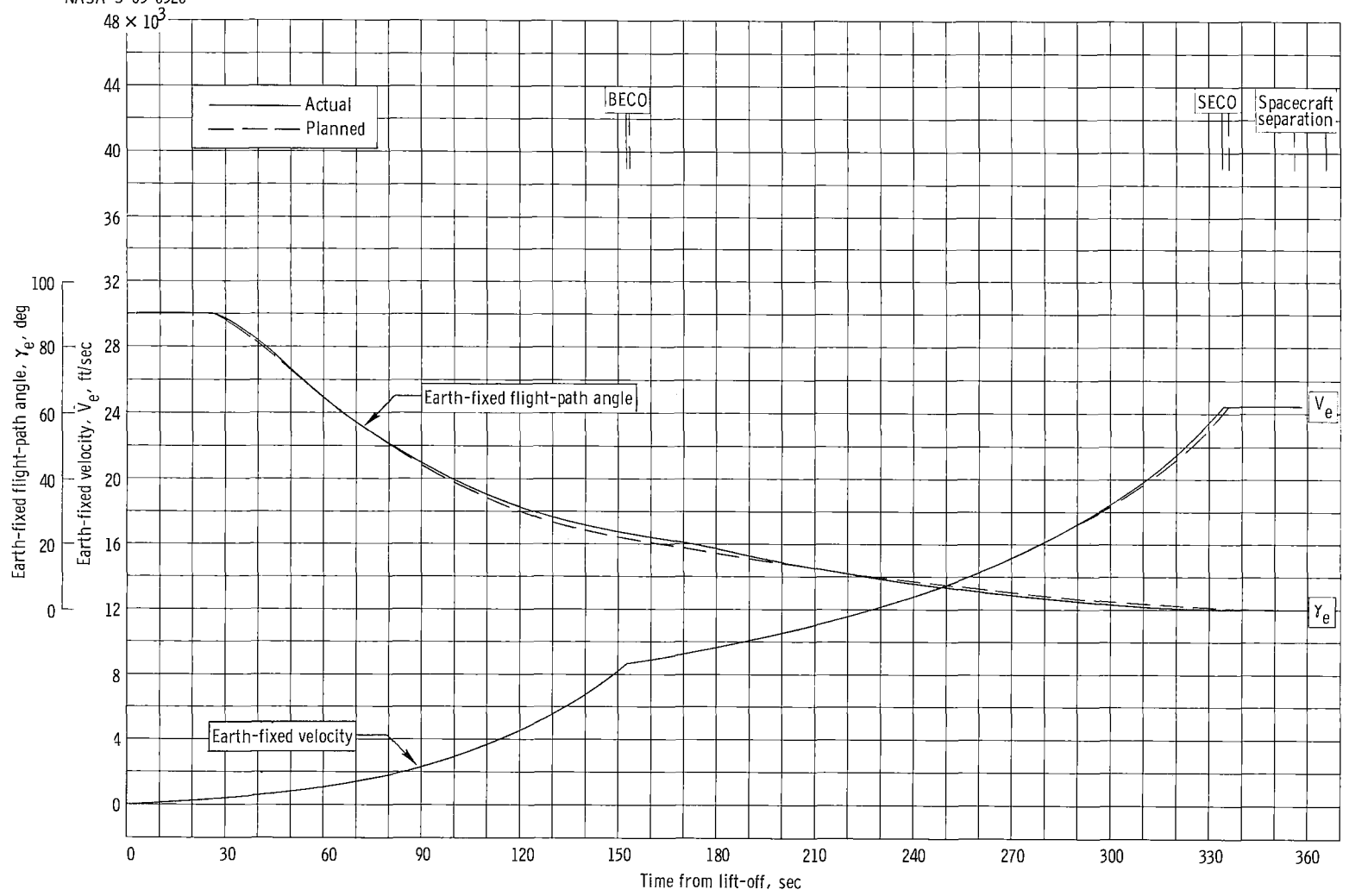

~~CONFIDENTIAL~~

(c) Earth-fixed velocity and flight-path angle.
Figure 4-3. - Continued.

CONFIDENTIAL

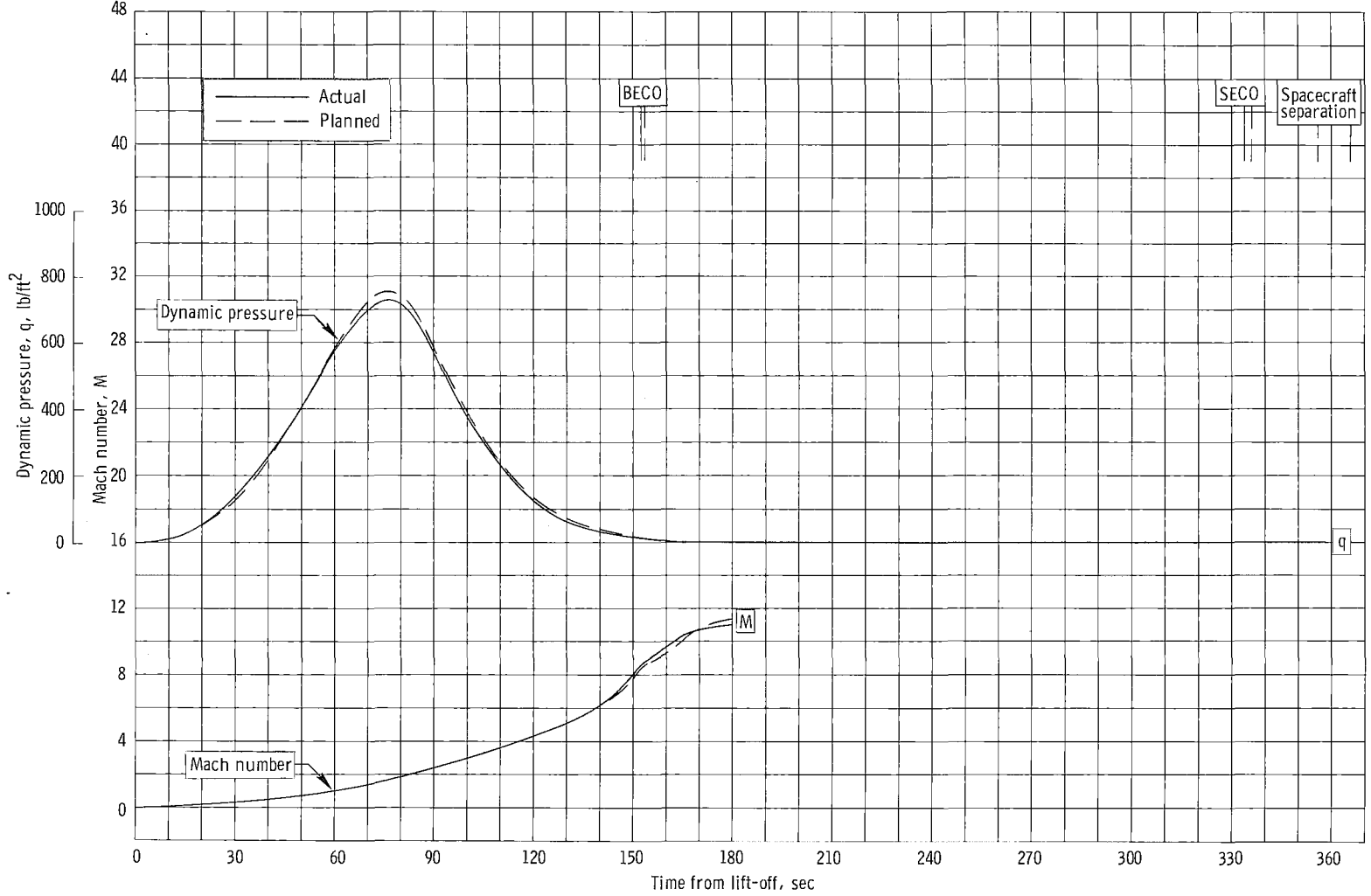

(d) Dynamic pressure and Mach number.

Figure 4-3. - Continued.

CONFIDENTIAL

UNCL

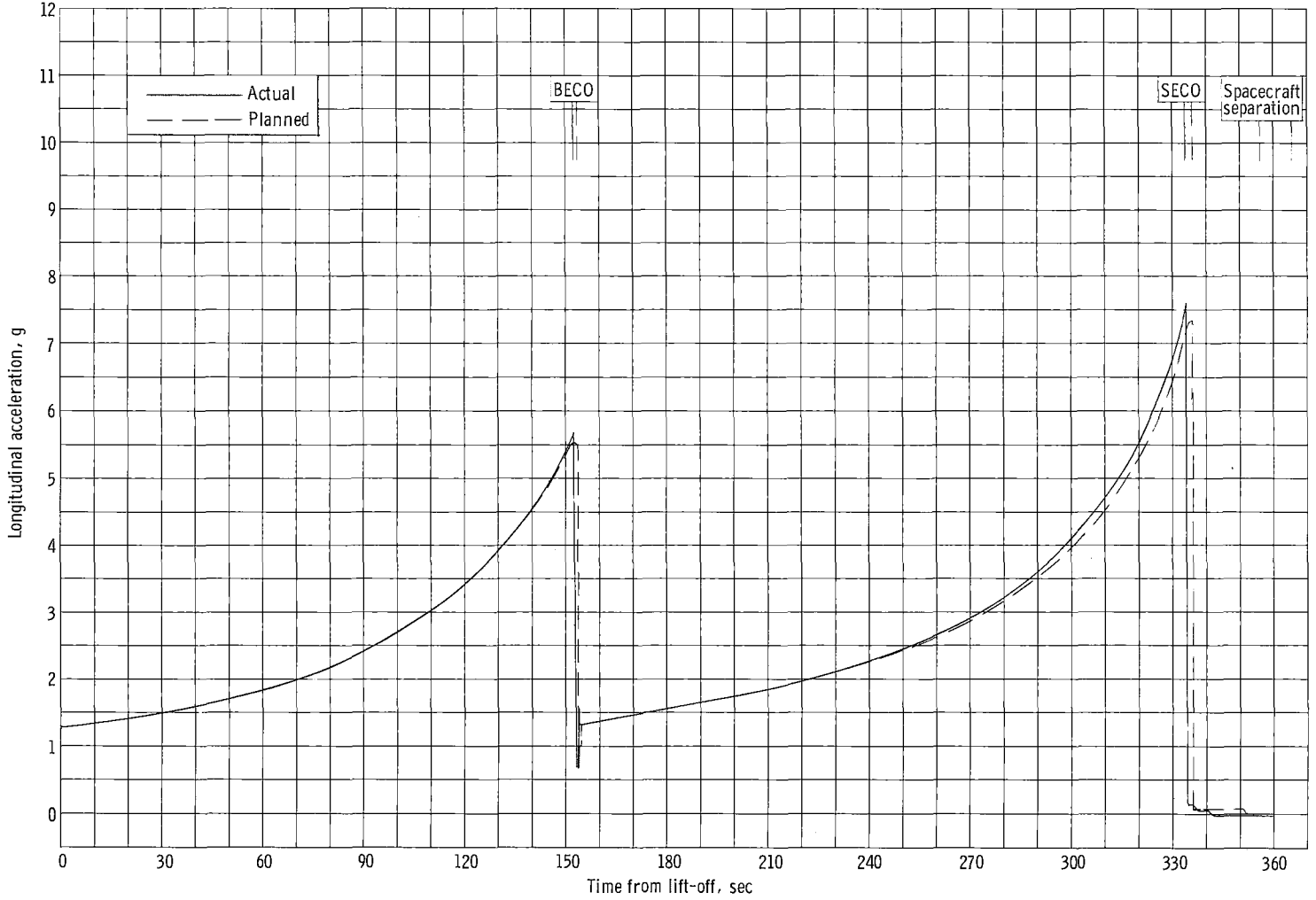

(e) Longitudinal acceleration.
Figure 4-3. - Concluded.

~~CONFIDENTIAL~~

~~CONFIDENTIAL~~

UNC

NASA-S-65-6516

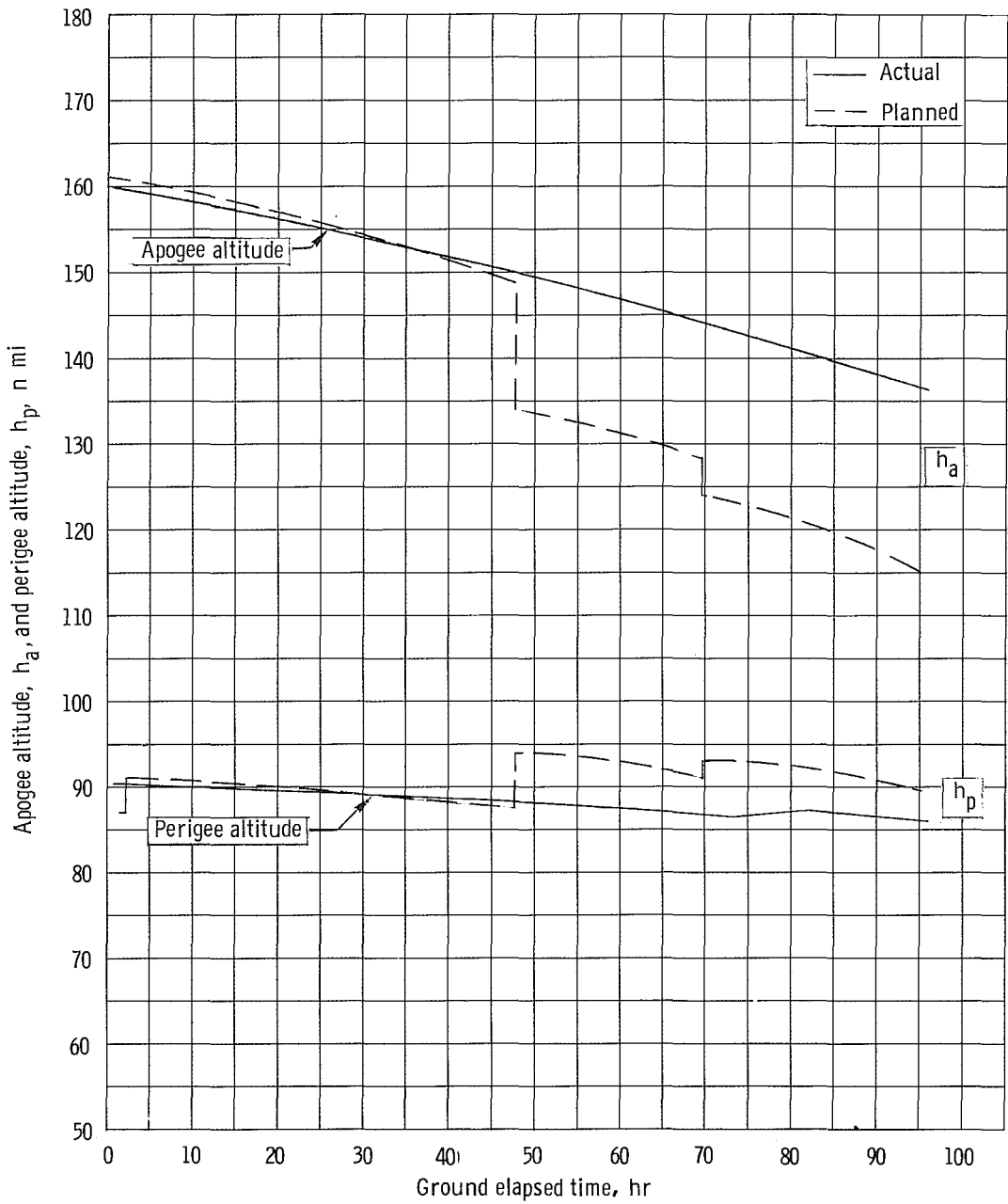

Figure 4-4. - Time history of apogee and perigee altitudes for the Gemini IV mission after the station keeping exercise.

UNCLASSIFIED

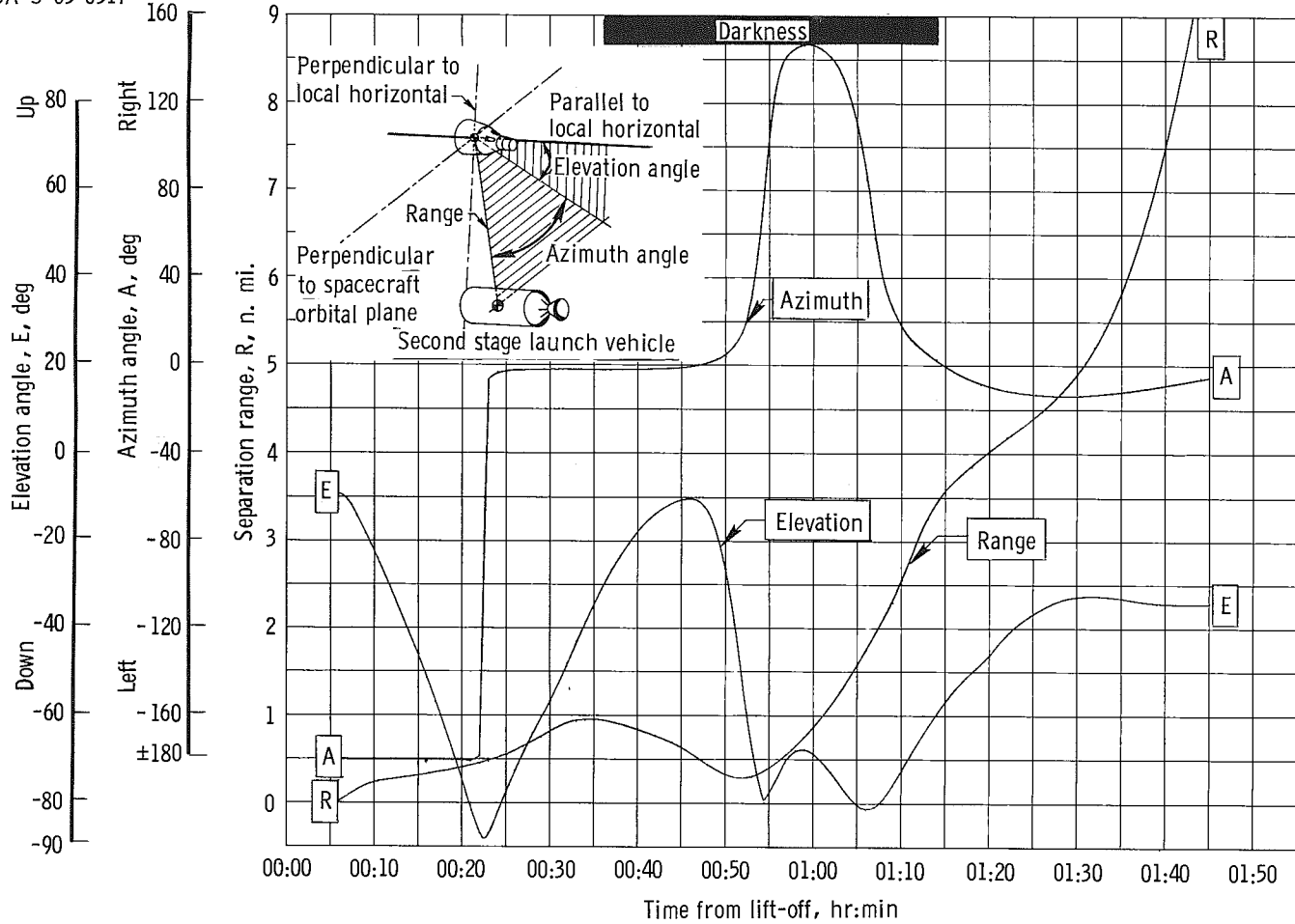

Figure 4-5. - Time history of separation range, azimuth, and elevation between the spacecraft and the second stage during the station keeping maneuvers.

UNCLASSIFIED

UNCLASSIFIED

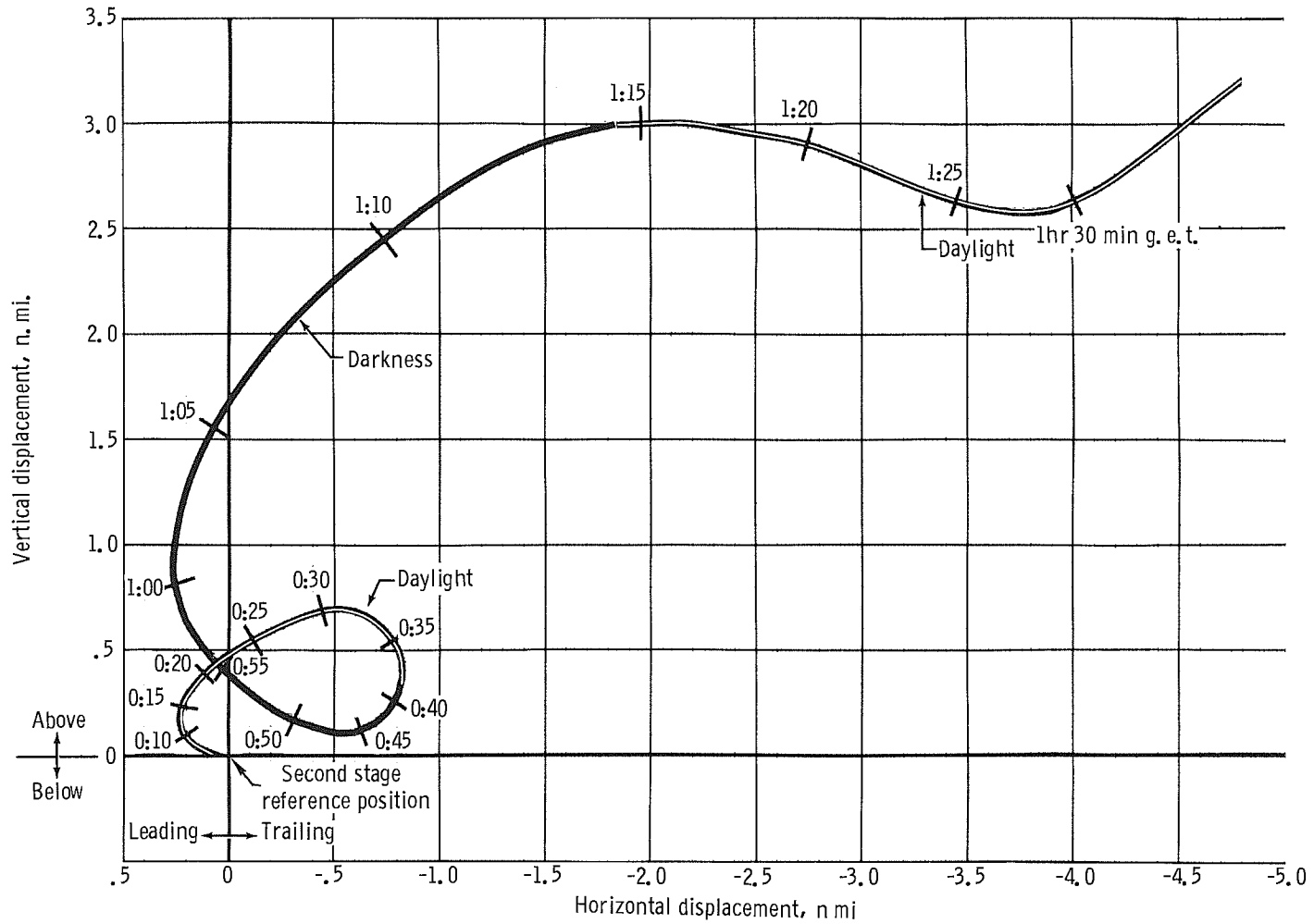

Figure 4-6. - Relative motion between the spacecraft and the second stage during station keeping maneuvers.

UNCLASSIFIED

UNCLASSIFIED

55:55-
g.e.t.

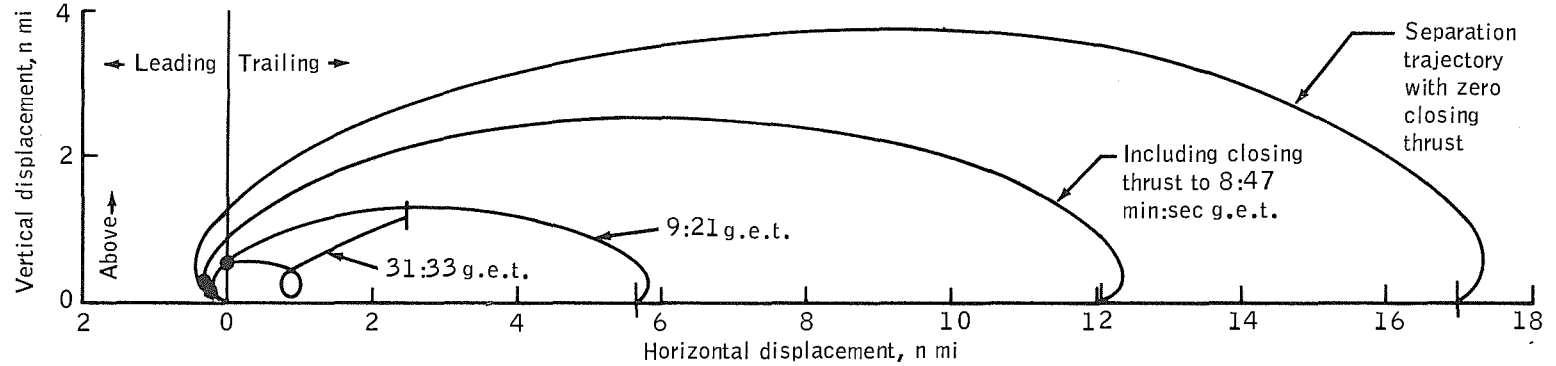
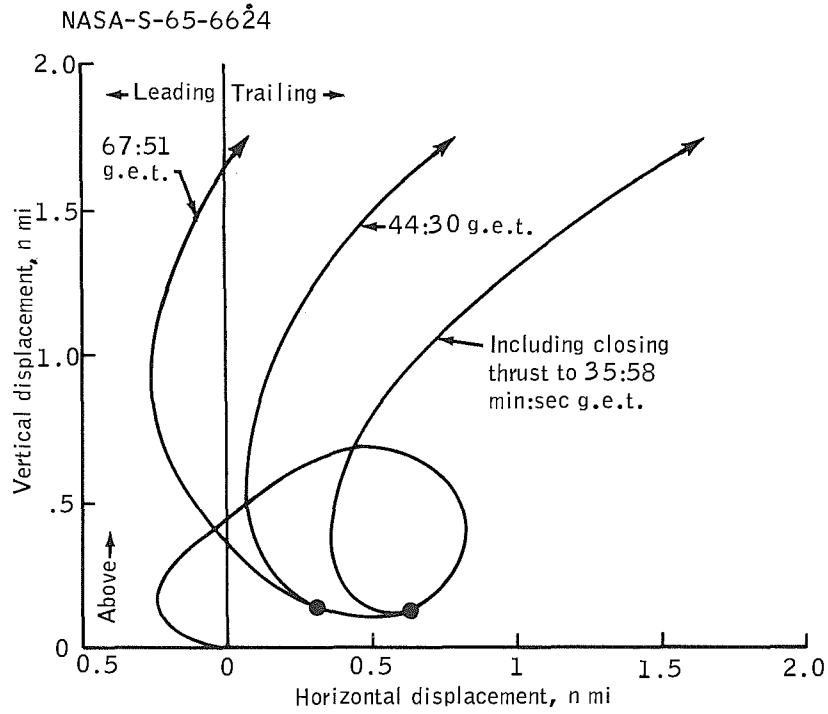

Figure 4-7. - Accumulative effect of station keeping maneuvers.

UNCLASSIFIED

UNC

~~CONFIDENTIAL~~

NASA-S-65-6549

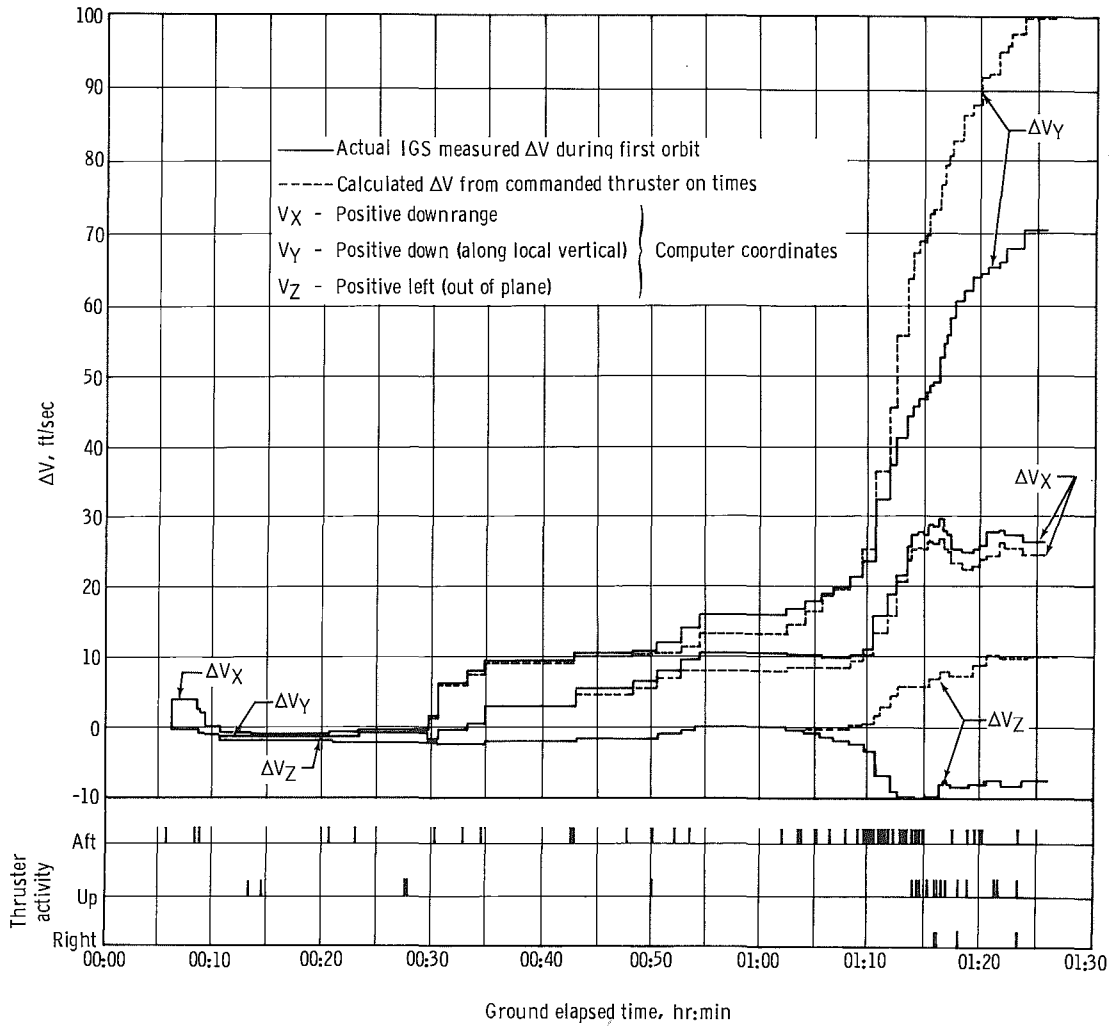

Figure 4-8. - Performance of maneuver thrusters.

~~CONFIDENTIAL~~

UNCLASSIFIED

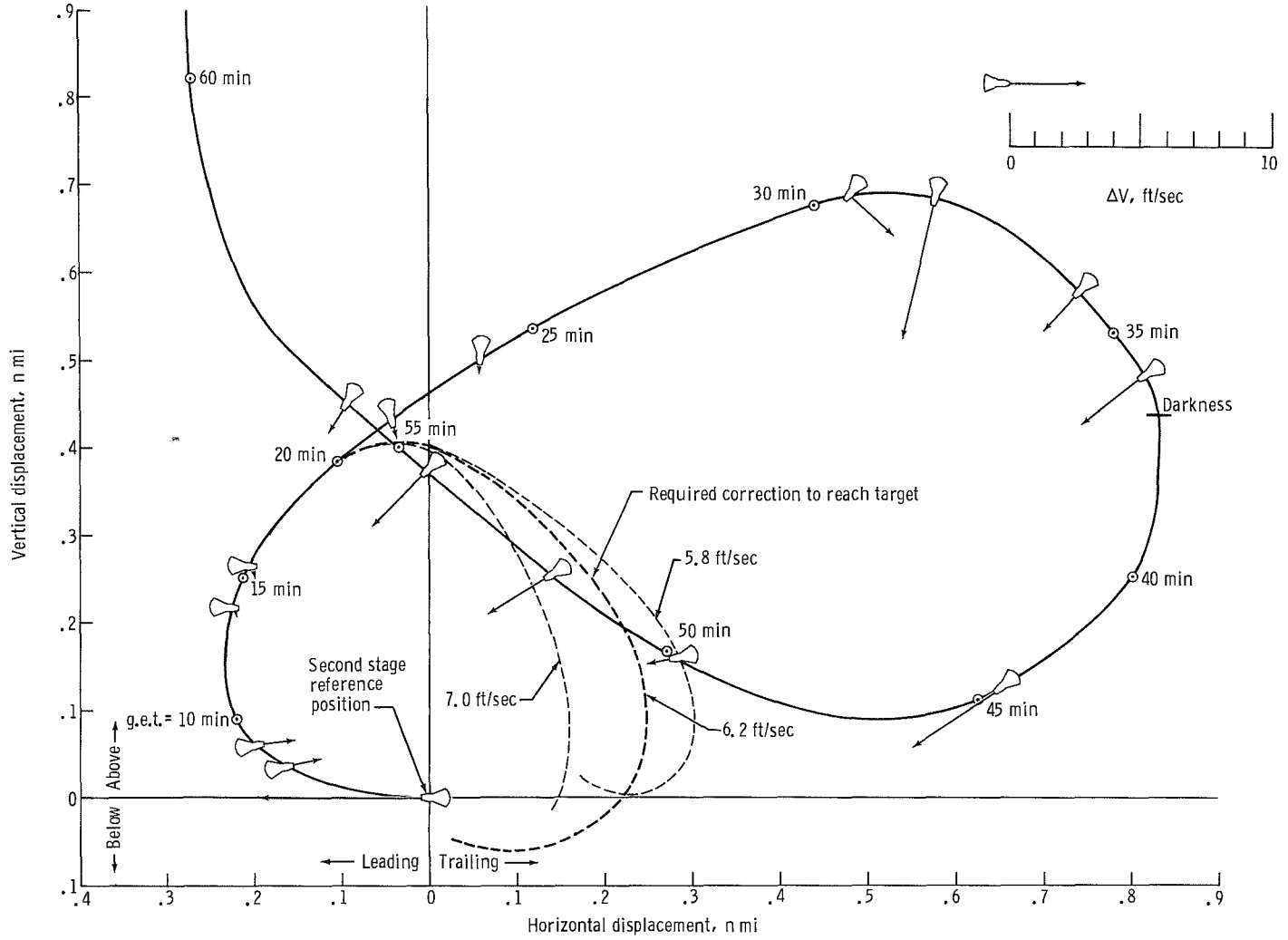
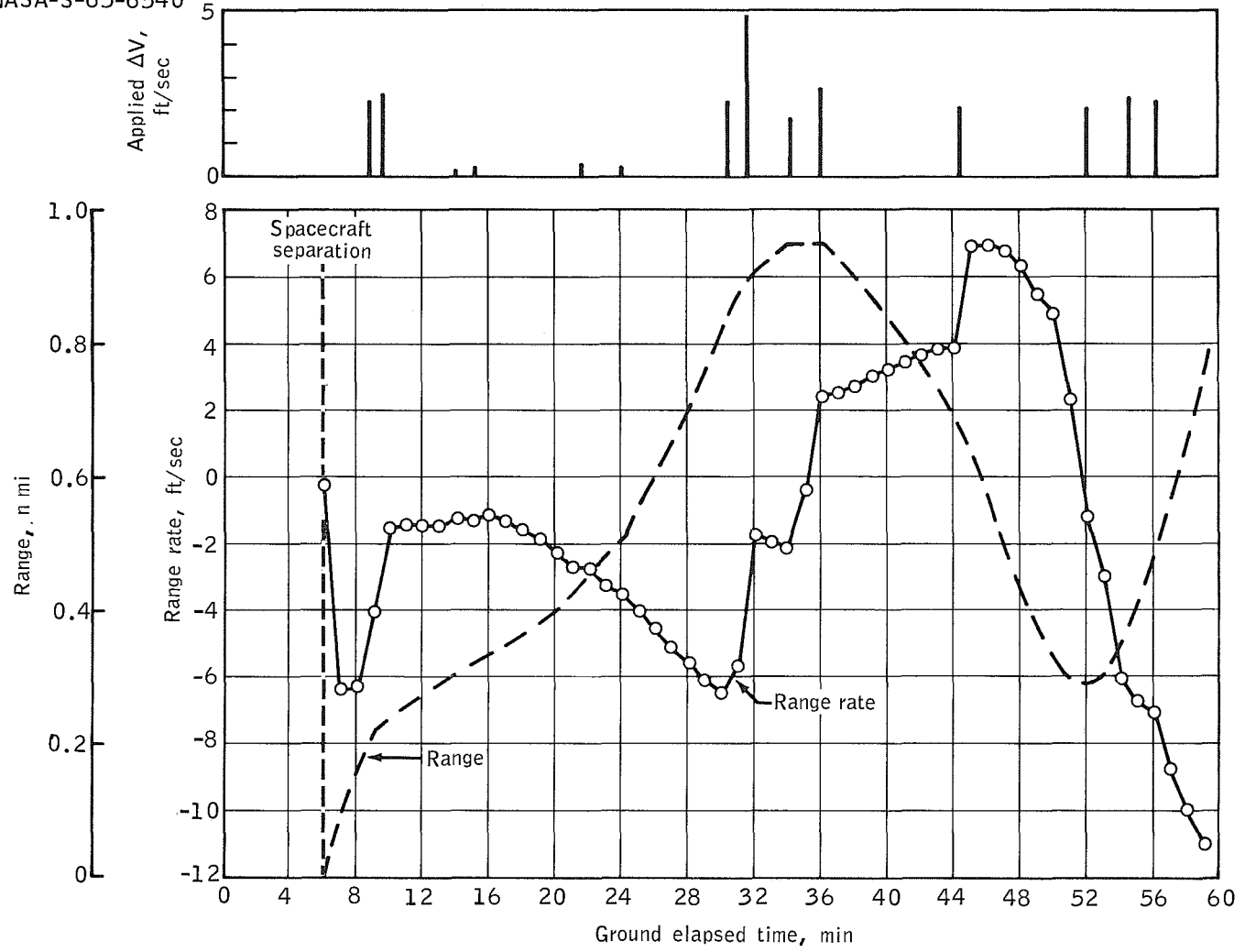

Figure 4-9. - Spacecraft-second stage relative position.

UNCLASSIFIED

NASA-S-65-6540



UNCLASSIFIED

UNCLASSIFIED

Figure 4-10. - Spacecraft - stage II range and range rate.

UNCLASSIFIED

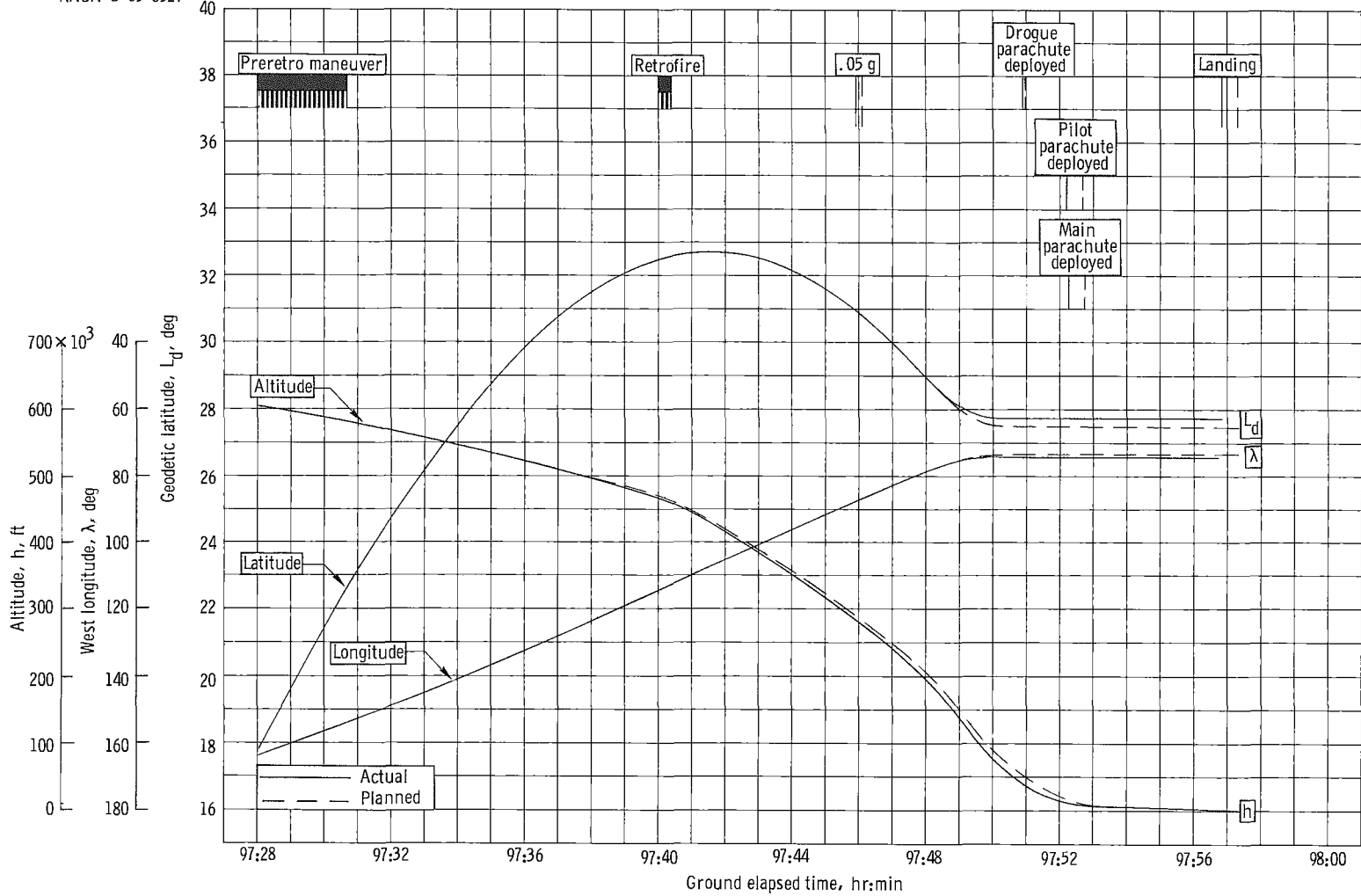

(a) Latitude, longitude, and altitude.

Figure 4-11. - Time histories of trajectory parameters for Gemini IV mission reentry phase.

UNCLASSIFIED

UNCLASSIFIED

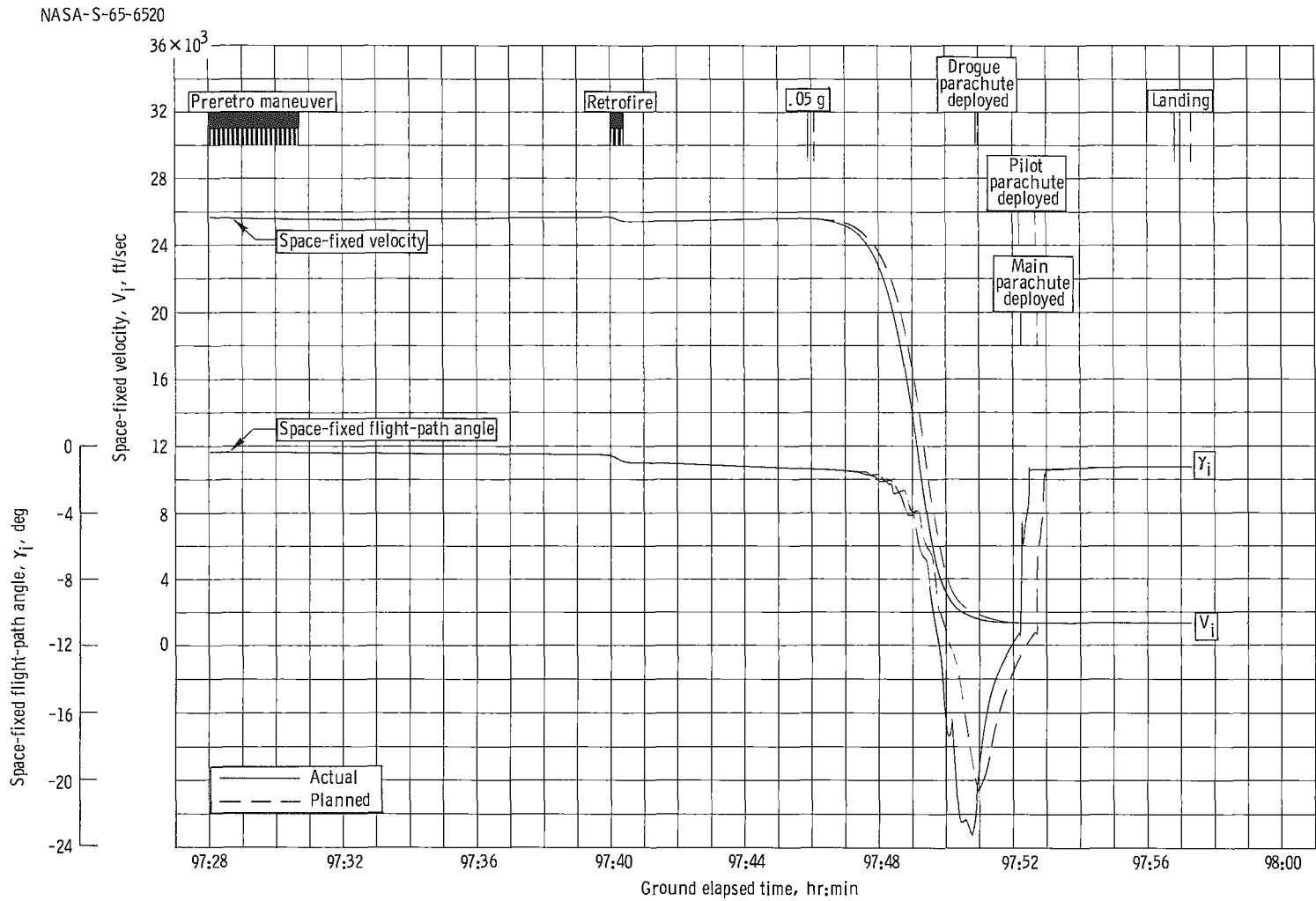

(b) Space-fixed velocity and flight-path angle.

Figure 4-11. - Continued.

UNCLASSIFIED

UNCLASSIFIED

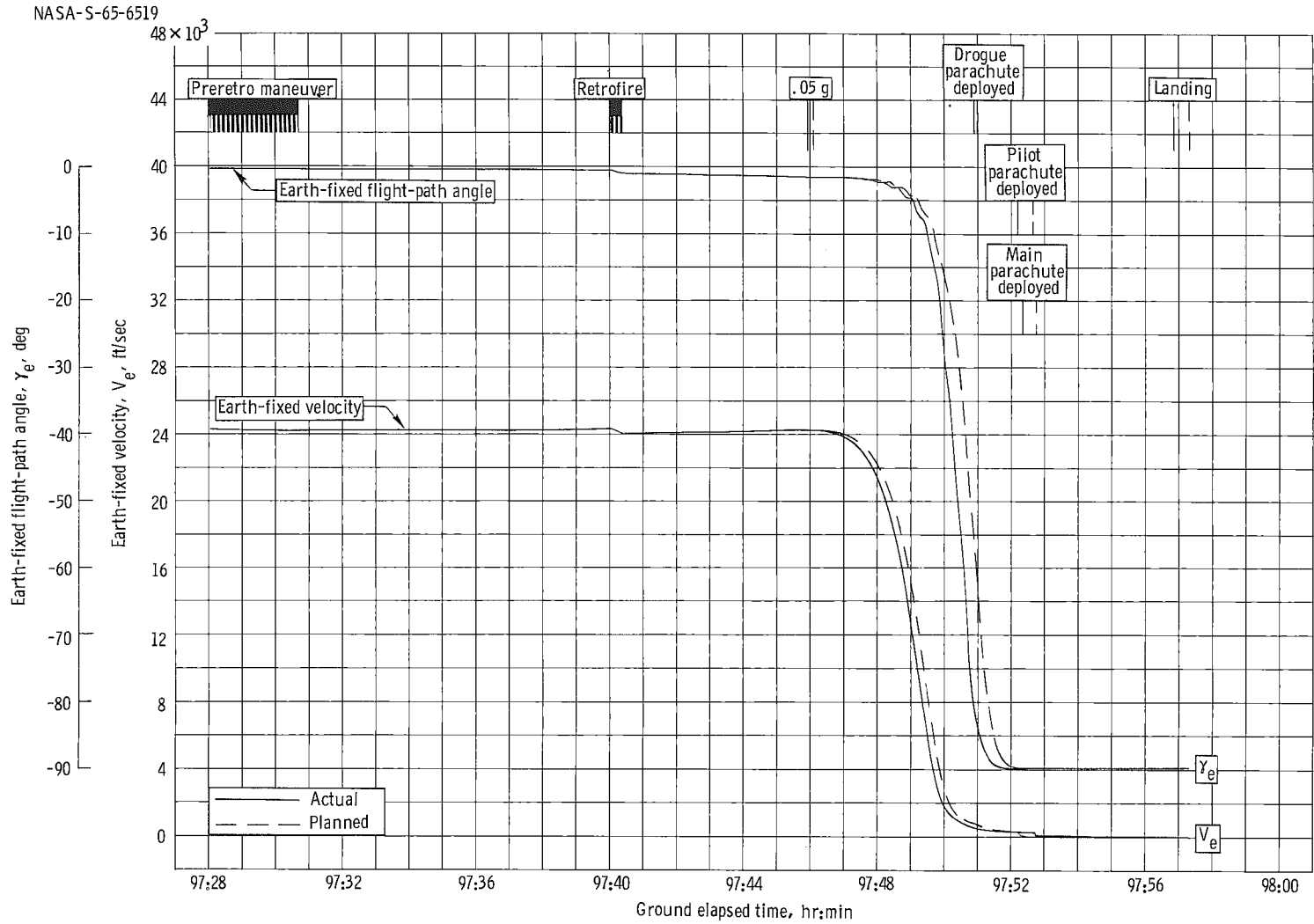

(c) Earth-fixed velocity and flight-path angle.

Figure 4-11. - Continued.

UNCLASSIFIED

UNCLASSIFIED

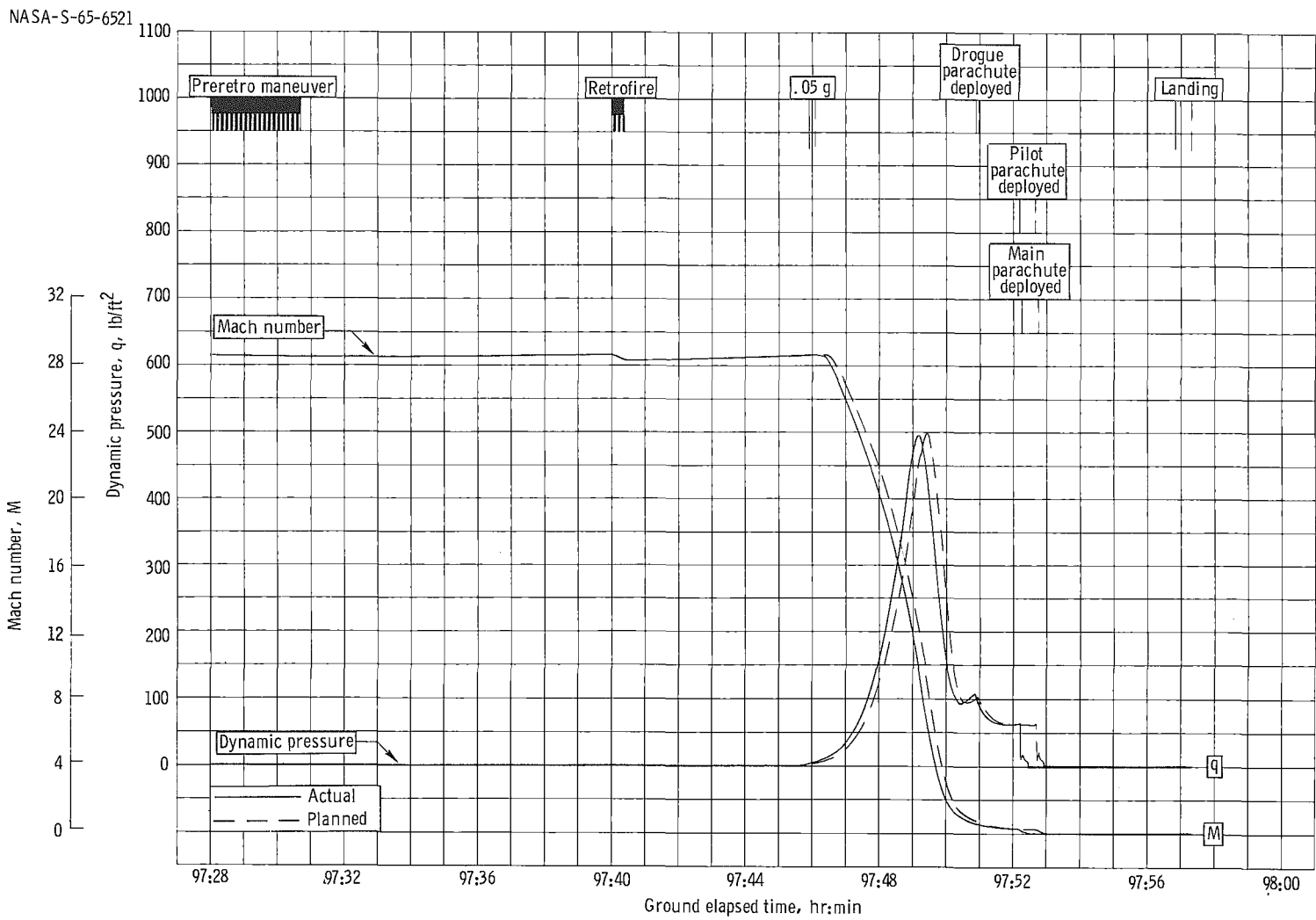

(d) Dynamic pressure and Mach number.

Figure 4-11. - Continued.

UNCLASSIFIED

UNCLASSIFIED

NASA-S-65-6518

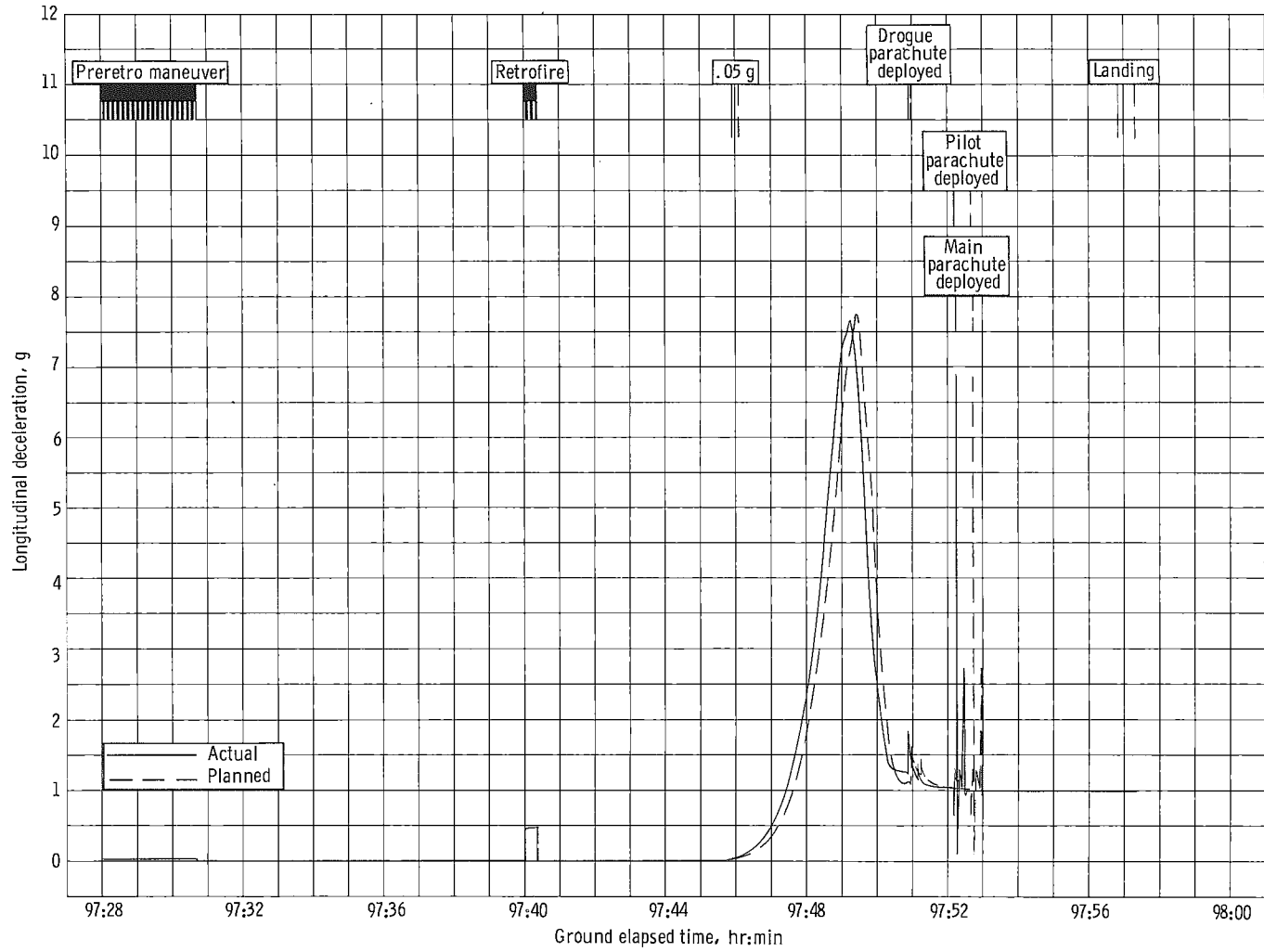

(e) Longitudinal deceleration.

Figure 4-11. - Concluded.

UNCLASSIFIED

5.0 VEHICLE PERFORMANCE

The second Gemini manned flight provided a large amount of new data with which to evaluate the performance of the spacecraft and its systems. The capability of equipment components to operate in orbit for periods of time up to the full 4-day duration of the mission was demonstrated. Several malfunctions of equipment did occur and are discussed in this report. These malfunctions did not cause early termination of the flight nor expose the crew to danger, thus again confirming the value of either redundant systems or suitable alternate equipment or procedures for all contingencies.

The Gemini launch vehicle performed satisfactorily in all respects and placed the spacecraft into a near-nominal orbital path.

Details of spacecraft performance are contained in section 5.1, and details of the launch-vehicle performance are contained in section 5.2 of this report.

5.0

UNCLASSIFIED

5-2

5.1 SPACECRAFT PERFORMANCE

5.1.1 Spacecraft Structure

5.1.1.1 General.- One anomaly in the operation of the spacecraft structural and mechanical system was the failure of the drive pawl spring return in the hatch operating mechanism to operate properly during extra-vehicular activity (EVA). The difficulty experienced by the pilot in closing the hatch is discussed in section 5.1.1.4. After the water landing, the hoist loop failed to deploy properly because of a mechanical interference of the cover door (see sec. 5.1.12 for details). In addition to these discussions of anomalies, section 5.1.1.2 presents thermal conditions, and section 5.1.1.3 presents the reentry aerodynamics.

5.1.1.2 Thermal environment.- The thermal environment to which the Gemini spacecraft 4 was exposed has been examined for the launch, orbital, and reentry phases of the mission. This evaluation is based on temperatures measured at the locations described in table 5.1-I.

5.1.1.2.1 Launch environment: The launch trajectory flown on Gemini IV was similar to that of previous Gemini flights, and the temperatures measured on these flights are comparable. The maximum measured launch temperature of 450° F occurred at 125 seconds after launch at station Z116.0 on the bottom centerline.

5.1.1.2.2 Orbit environment: The launch azimuth and time of lift-off resulted in an orbit with a geocentric angle between the sun and the spacecraft's orbital plane of 8° at that point in orbit where the spacecraft was nearest the sun. A geocentric angle of 0° between the spacecraft's orbital plane and the sun results in orbits of the highest temperatures, and the Gemini IV mission approached this condition.

In an effort to measure minimum temperatures in orbit, the polarity of sensors PD07 and PD08, located on the left and top sides of the cabin section, respectively, was reversed to enable temperatures below the reference value of 85° F to be recorded. The minimum orbital temperature of -85° F was recorded by sensor PD07 during revolution 3 while later revolutions showed a minimum value of -65° F. Sensor PD08 showed a minimum value of -55° F. Peak temperatures of approximately 200° F, 150° F, and 160° F were recorded from the sensors on the bottom of the cabin, reentry control system (RCS), and rendezvous and recovery (R and R) sections, respectively. The maximum orbital temperature of 200° F on the cabin section occurred during revolution 17 after temperatures had stabilized.

UNCLASSIFIED

5.1.1.2.3 Reentry environment: Because the onboard computer could not be used for reentry, Gemini IV followed a zero-lift reentry trajectory with manual guidance. This trajectory resulted in a reentry with thermal characteristics less severe than those of GT-2 but with higher heating than the lifting reentry of GT-3.

The maximum zero angle-of-attack stagnation-point heating rate was calculated as $57.8 \text{ Btu/ft}^2\text{-sec}$, nearly midway between the value of $71.8 \text{ Btu/ft}^2\text{-sec}$ calculated for GT-2 and $49.8 \text{ Btu/ft}^2\text{-sec}$ calculated for GT-3. Total reference stagnation-point heating was calculated as 8260 Btu/ft^2 . Total heating for GT-2 was 6670 Btu/ft^2 , and for GT-3 was 8650 Btu/ft^2 .

During maximum heating, the center-of-gravity offset on spacecraft 4 produced a trim angle of attack of 10° which agreed with pre-flight predictions. This calculated angle of attack also agrees with a visual clue provided by a 19-inch displacement of the apparent stagnation point from the center of the heat shield. For comparison, the trim angle of attack during maximum heating was 15° to 16° for GT-2 and 8° to 9° for GT-3.

Gemini IV temperatures were somewhat higher than those on GT-3 but much lower than those on GT-2, and no areas of high local heating were encountered. The maximum temperature on the cabin section was 1240° F , recorded by PDO3 located at station Z116 on the bottom centerline. This maximum value was expected from the type of reentry that was flown. Reentry cabin section temperature histories are shown in figure 5.1-1.

The peak temperature on the spacecraft beryllium shingles was 870° F , recorded by PCO3 on the RCS section bottom centerline. Reentry temperature histories on the beryllium shingles are shown in figure 5.1-2.

Heat-shield bondline temperatures are similar to those measured on the GT-3 mission. The maximum bondline temperature of 120° F was reached just before landing for sensor PE11 on the leeward edge. Transient heat-shield bondline temperatures are presented in figure 5.1-3.

5.1.1.2.4 Overall performance of structure and heat protection: Postflight inspection of the spacecraft indicated that all structure and heat protection were in excellent condition after the mission. Afterbody shingles were clean and undamaged but showed a slight discoloration in the area behind the most windward spacecraft-adaptor interconnect fairing.

A preliminary examination of the heat shield indicated the char depth to be approximately 0.25 inch. This depth is of the order of that

UNCLASSIFIED

measured on GT-3. The weight loss of the heat shield during reentry was 12.44 pounds, which is similar to that measured after previous flights. The surface has a white appearance over the entire shield, as was noted on GT-3. The postflight condition of the ablation shield is excellent.

5.1.1.3 Reentry aerodynamics.- The reentry aerodynamics were obtained from a flight data reduction program which utilized onboard attitude control maneuver electronics angular rate, inertial measurement unit synchro gimbal angle, and body-mounted accelerometer data. Earth referenced position data were obtained by a point-mass reentry-trajectory simulation derived from radar vector data from White Sands, Eglin, and Cape Kennedy. The use of position data from the simulation was necessary because of the lack of position data from the spacecraft onboard computer. The simulation employed the ARDC 1959 Model Atmosphere; whereas, the measured atmospheric density deviations at Eglin Air Force Base and at Cape Kennedy were those presented in figure 5.1-4. The trim angle of attack and lift-to-drag ratio obtained by using the simulated reentry and an offset center of gravity of 1.56 inches are presented in figure 5.1-5.

The spacecraft was ballasted for an intended center-of-gravity (c.g.) offset of 1.46 inches prior to the flight; the greater actual c.g. offset resulted from the decision not to jettison the extravehicular activity (EVA) equipment. The 1.56-inch offset for spacecraft 4 compares with 1.96 for spacecraft 2 and 1.43 for spacecraft 3. Hence, the Gemini IV reentry can be characterized as being between GT-2 and GT-3 in trim attitude, which is also the case with the Mach number and Reynolds number environment shown in figure 5.1-6.

The measured atmospheric densities are being employed to obtain refined aerodynamic coefficients.

5.1.1.4 Hatch closing and latching difficulty.- The flight crew reported difficulty in closing and latching the hatch after the EVA operation. They reported that the latching system's manual handle moved back and forth freely and that the gain pawl spring return mechanism failed. After moving the handle back and forth several times and manually working the gain pawl, the handle finally caught and the latch mechanism was driven overcenter, locking the hatch to the sill.

Postflight analysis of the spacecraft revealed that the drive pawl spring return was failing, which accounted for the free motion of the handle reported by the pilot. The gain pawl mechanism performed satisfactorily; however, quantitative measurements indicated that its spring return was also marginal in the "lock" position.

Failure of the pawl spring cartridge to operate properly had been experienced on Spacecraft 3 and 6 and corrective action had been taken. Figure 5.1-7 is a schematic diagram illustrating this portion of the

UNCLASSIFIED

hatch locking mechanism. In the case of the previous failures, it was determined that the spring-driven piston A was sticking in its cylinder and thus preventing it from rotating cam B to cause the ratchet pawl C to engage the drive gear D. The sticking was caused by excess dry film lubricant collecting between the piston and cylinder. The corrective action was to clean all excess lubricant from both the piston and the cylinder, and extensive testing showed no further tendency for the corrected article to fail.

This corrective action was taken on spacecraft 4. Also, in order to be as safe as possible and to be prepared for any formation of ice in the mechanism, the pilot was instructed in a method to manually assist the spring piston if necessary. This method consists in manually rotating the external selector handle which is on the same shaft as B and C in the direction to cause the pawl to engage the gear.

The postflight examination showed that the failure mode was not in the piston and cylinder which moved freely, but in excessive friction at point E where cam B slides on the face of piston A. The piston face was found to be rough and there was an accumulation of the dry film lubricant adhering to cam B at point E.

A redesign which completely eliminates sliding friction from the operation of the ratchet pawls is being incorporated on all future spacecraft.

In addition to the faulty pawl, the difficulty the Gemini IV flight crew experienced with the hatch closure was compounded because the space suits were pressurized higher than nominal, and the chest-mounted ventilation control module interfered with the motion of the latching handle. Also, the hatch resisted closing because the forces generated by new seals in the sill and the redesigned actuator seal were considerably higher than those in the zero-g flight tests, to which the flight crew were accustomed.

5.1.2 Communications Systems

The communications equipment for spacecraft 4 performed as designed with no failures evident at the time of preparation of this report; however, the flight crew reported that the communications performance was marginal during the first few revolutions. Data are still being examined, and several items of equipment are scheduled for further tests. The voice control center (VCC) is among these items. The flight crew reported before launch that their volume controls were set near the maximum, and there were several reported instances of garbled conversation received by the crew during flight. Because of various air-to-ground and ground network problems, voice communications were marginal in support of the

UNCLASSIFIED

mission. Performance of the various spacecraft communications subsystems is discussed in the succeeding paragraphs.

5.1.2.1 Ultra-high frequency voice communications.- The flight crew reported generally poor ultra-high frequency (UHF) voice communications during the first eight or nine revolutions. Later during the mission, and from the preretrograde through the postlanding phases, UHF communications were satisfactory. Signal-strength charts from Cape Kennedy appear normal during the first few revolutions. Levels were about 20 microvolts shortly after acquisition, increasing normally to about 250 microvolts, and dropping again to about 20 microvolts as the station pass was completed. Other data will be examined as they become available. Tests on the recovered flight equipment are not yet complete. Communications blackout caused by plasma attenuation during reentry occurred from 97:44:59 g.e.t. to 97:49:14 g.e.t., as determined from signal-strength data from the Mission Control Center, Cape Kennedy (MCC-C). Adequate communications during most of the extravehicular activity phase were shown on the signal strength chart from MCC-C Tel II. The strength was normal and in the range of 20 to 250 microvolts. There were a very few short-duration drop-outs during this time period. This situation is indicative of VOX mode continuous conversation between crew members, verified from the onboard voice transcripts, and is one which precludes reception of ground transmissions. During this period, from about 04:29:00 g.e.t. to about 04:40:00 g.e.t., the pilot's mode switch apparently was in the RECORD position. When the pilot's mode switch is in the RECORD position, his voice should be attenuated sufficiently by isolation pads to prevent modulation of the UHF transmitter. However, the pilot was heard on the ground, but at a lower volume level than the command pilot. The voice control center will be examined to determine why the pilot's voice was not attenuated. During the debriefing, the flight crew reported that they could not contact the ground during the early portion of the extravehicular activity (EVA) exercise. The record shows that from about 04:24:40 g.e.t. to 04:29:33 g.e.t., good UHF communications between the command pilot and the spacecraft communicator were remoted through Hawaii. From about 04:29:33 g.e.t. to 04:33:21 g.e.t., the spacecraft communicator could not reach the command pilot because the spacecraft was not over a station. After 04:33:21 g.e.t., the spacecraft communicator listened to the flight crew during the remainder of the extravehicular exercise. The spacecraft communicator tried to break into the conversation several times during this period without success because the spacecraft transmitter was almost continuously keyed. During this time, air-ground transmissions were remoted through MCC-C and Bermuda; the command pilot's voice quality was good, and the pilot's voice level was low as explained previously.

The flight crew reported that voice communications interrupted the sleeping periods of the crew members even though the volume controls were in the minimum position. Present design does not permit completely

UNCLASSIFIED

turning off the voice communications. This situation will be corrected for future flights.

5.1.2.2 High-frequency voice communications.- High-frequency (HF) voice communications equipment is included in the Gemini spacecraft for emergency purposes. No emergency use of the equipment was attempted during this mission; however, it was given special tests in both voice and direction finding (HF-DF) modes. Data examination at this time is not complete. The flight log indicates that limited results were achieved from the daytime tests, and no replies are noted for the night tests. A great many cases of radio frequency interference (RFI) were noted in the network station reports. Signal strengths were recorded intermittently and sometimes continuously on the HF frequency charts of most of the stations. These interfering signals were probably strong enough to degrade line-of-sight communications or even to preclude the weaker reflected transmissions that would be necessary in case of an emergency. For example, the chart from Bermuda, during the time that one of the HF transmission tests was to be recorded, showed overriding signal strengths which were annotated "Cape Com Tech" on the charts. This prevented any usable data from being recorded and very probably would have prevented emergency communication with the station. Further evaluation is dependent on Federal Communications Commission (FCC) and Department of Defense (DOD) support for signal strengths and direction bearing data in support of the HF-DF tests. The data will be examined when they become available.

5.1.2.3 Radar transponders.- Two C-band radar transponders were flown on spacecraft 4. A new and improved transponder was mounted in the adapter, and the original Gemini transponder was mounted in the reentry assembly to be used for the launch and reentry phases. One element of this antenna was phase-shifted to provide approximately 270° of roll coverage. The transponders performed satisfactorily throughout the mission. Teletypes, verbal reports, and some station logs were examined for evidence of abnormal operation. Hawaii and Canary Island stations reported intermittent tracking but only during revolutions 7 and 13, which indicates a ground-station problem. In several instances, extreme modulation appeared on the tracking station signal. This modulation did not cause loss of tracking and can be explained by the effect of drifting flight on antenna gain patterns. The Eglin Air Force Base station reported that it tracked the spacecraft transponder completely through reentry blackout. Several stations were programmed to skin-track the spacecraft at various intervals during the mission. Some stations, reporting through the network controller, reported limited success; however, a more complete evaluation is awaiting additional data.

5.1.2.4 Digital command system.- Satisfactory operation of the spacecraft digital command system is indicated by preliminary reports

UNCLASSIFIED

from network stations and flight-control personnel. No problems were experienced with the uplinking of real-time commands. Updates to the time reference system were successful. Stored program commands to the computer were repeated on several occasions because of lack of complete message verification. Reduced data showing commands transmitted, time, and message acceptance pulse will be examined as they become available.

5.1.2.5 Telemetry transmitters.- Telemetry transmitter operation was very satisfactory, as evidenced by the quality of the data received on the ground. The stand-by transmitter was not needed. The delayed-time transmissions of recorded data received at Cape Kennedy contained almost 100-percent usable data, even though many of the dumps were made during drifting flight. The real-time transmission of telemetry data was satisfactory throughout the mission. At this time, signal strengths are still being examined for evidence of antenna orientation fades.

5.1.2.6 Antenna systems.- There are good indications that all antennas deployed normally. The voice communications and the real-time telemetry were switched to the reentry, or UHF stub, antenna near the end of revolution 7. It is unfortunate that this switching was not done earlier in the flight because the UHF stub antenna would have provided better communications during periods in which the spacecraft was in a nose-down attitude. It is possible, and this mission appears to confirm, that the UHF stub antenna provides more complete coverage than the adapter antenna and, therefore, is more suitable for drifting flight. The adapter antenna for HF voice apparently deployed properly and the HF recovery antenna satisfactorily extended and retracted after landing.

5.1.2.7 Recovery aids.- With the possible exception of high-frequency direction finding (HF-DF), the recovery aids operated normally. The flashing light extended but was not turned on by the flight crew. The survival pack beacons were not used. The 243-megacycle recovery beacon was turned on after two-point parachute suspension. Its operation is covered more fully in the recovery report, section 6.3.3. The flight crew reported that HF-DF was used briefly after landing; however, it was not received by recovery forces in the landing area. This is to be expected because direct transmission on the water does not normally extend beyond 15 miles at this frequency because of ground wave attenuation. There are no reports of skip distance reception at this time. Network reports obtained from the Department of Defense describe the reception as "poor."

5.1.2.8 Voice tape recorder.- The spacecraft voice recorder functioned throughout the mission. Reproduction was good during the early and terminal phases of the flight. Excessive background noise, however, caused some tapes to be of marginal quality. The recorded level of the crew members' voices varied throughout the mission. During EVA, the

UNCLASSIFIED

recorded level of the pilot's voice was much higher than that of the command pilot. The tapes and the recorder are being returned to the vendor for evaluation.

The flight crew expressed dissatisfaction with the voice RECORD function being controlled by the mode select switch since it prevented simultaneous transmit and record by a given crew member and also caused confusion because of the need for frequent switching between the two positions. Also, the end-of-tape indicator light of the voice tape recorder is in a position where it cannot be readily seen by the crew. The short length of tape in a cartridge (enough for 1 hour of continuous recording) required frequent reloading, and the crew stated that this reloading detracted from more important tasks.

5.1.3 Instrumentation and Recording System

An examination of the real-time and delayed-time available data revealed only one anomaly during the mission. The pulse code modulation (PCM) tape recorder stopped recording during reentry at about 2000 ft altitude at 97:54:08 g.e.t. either because of a power interruption to the tape recorder or a failure of the PCM signal to the recorder. A check of the spacecraft wiring to the recorder will be made on a spacecraft test request (STR). Further investigation into all related areas is continuing in an attempt to resolve this problem.

There was a total of 279 parameters for this mission, and only one measurement, ADO2, equipment adapter separation, failed to give an indication. The real-time data received by the Cape Kennedy telemetry station number two (Tel II) for various phases of the mission are listed in table 5.1-II. From the columns of total losses and valid data, it can be seen that the real-time usable data is more than 97 percent of that receivable, except for revolutions 19 and 59 and the reentry blackout period. During the passes for revolutions 19 and 59, the look-angle, or tracking-elevation angle, was very low or close to the horizon.

The delayed-time data received by Tel II, Texas, Hawaii, and Antigua telemetry ground stations as well as the data recovered from the onboard PCM tape recorder are summarized in table 5.1-III. This represents 33 data dumps out of the 61 dumps actually made. It can be seen that the usable data exceeds 99.7 percent for all stations listed. The onboard PCM recorder had only 98.44 percent usable data; and this lower figure may be the result of bit-jitter caused by reentry vibrations, or it may have been the result of intermittent failure leading to the anomaly which resulted in no data being recorded during reentry after the spacecraft passed through an altitude of approximately 2000 feet.

UNCLASSIFIED

Overall, the instrumentation system performed exceptionally well during the Gemini IV mission.

5.1.4 Environmental Control System

The environmental control system (ECS) operated throughout the flight without any major problems. Only minor anomalies were experienced and are discussed herein.

The ventilation control module (chest pack) operated nominally throughout the extravehicular activity (EVA). Operation of the EVA equipment had no detrimental effect on the environmental control system (radiator or primary oxygen) even though the activity lasted nearly twice the originally planned period.

The primary oxygen tank pressure decayed from 935 psia to 835 psia shortly after spacecraft separation. The decay started 382 seconds after lift-off, and the pressure stabilized after an interval of 128 seconds. A greater and more rapid decay occurred in the reactant supply system (RSS) cryogenic tanks on the GT-2 flight. Ground testing since GT-2 has shown that this decay could be caused by temperature stratification within the tank and can be minimized by proper prelaunch procedures which were used on the Gemini IV mission. Oxygen temperature in the tank was measured for the first time on spacecraft 4. The temperature showed a decline approximately 12 seconds before the start of pressure decay, indicating that the condition was caused by stratification. The pressure decay caused no problem on spacecraft 4 and is not expected to cause problems on any future spacecraft if proper prelaunch procedures are continued.

The pressure in the primary oxygen vessel required venting from about 960 psi to 920 psi approximately every 4 hours during the flight. The pressure was vented manually through the oxygen high-rate valve or cabin-repressurization valve instead of automatically through the primary oxygen relief valve. This procedure was followed because the primary oxygen pressure transducer and the relief valve both have an upper limit of 1000 psi. If the pressure had been allowed to increase to relief pressure the gage needle would probably have been against the full-scale stop, and the crew could not have ascertained that the relief valve was functioning properly. The pressure transducer upper limit is being increased to 1200 psi on future spacecraft.

The pilot seemed to be slightly warm for most of the mission with a tendency toward discomfort during sleep periods, whereas the command pilot reported generally comfortable temperatures. This is a result of differences in the pressure suits, metabolic heat loads, and individual

UNCLASSIFIED

response to the environment. The pilot's suit had added insulation for extravehicular activity, which could reduce the cooling by heat transfer through the suit to the cabin. Also, because of the added bulk of the suit, the effort required for normal activity was increased, and therefore the metabolic heat load of the pilot was increased. The measured suit inlet temperature was generally between 50° and 55° F, which had been shown by ground testing to be adequate for normal activity with normal suit flow.

The relative humidity in the cabin varied from a low of 50 percent to a high of 63 percent. The humidity varied in different areas of the cabin and was highest in the vicinity of the open faceplates as expected. Preliminary analysis of the absorbent material located on the cabin walls showed negligible moisture absorption.

The cabin leakage rate was reported to be excessive early in the flight. Analysis of the data shows this report was incorrect. Cabin leakage was below the specified maximum throughout the flight.

The overboard urine dump system failed at approximately 92 hours g.e.t., during the eleventh dump cycle of the mission. The failure was an apparent line blockage. The backup mode of dumping through the launch cooling heat exchanger was used for the remainder of the mission (last half of the eleventh and the twelfth dumps). Investigation to date has revealed that the solenoid valve now opens only a very small amount. The system is being disassembled for detailed examination.

The flight crew reported eye irritation and ammonia odors during the flight and a nauseating odor after landing. The flame retardant used to treat the water absorbent material installed on the cabin walls was known to outgas small amounts of ammonia. This ammonia may have caused the eye irritation; however, the charcoal which was used in the ECS for odor removal is being analyzed for additional contaminants. The flame retardant is being changed for future spacecraft. The acrid odor in the spacecraft cabin after landing was later verified by the flight crew to be the same as that emanating from the heat shield.

The cabin coolant control valve was found to be stuck when the spacecraft was returned to Cape Kennedy. The flight crew reported that they had no problem with the valve. A failure analysis is being made.

The flight crew reported that gas was mixed with the water from the drinking water dispenser. This appears to be the result of inadequate prelaunch servicing procedures.

UNCL
~~CONFIDENTIAL~~

5.1.5 Guidance and Control System

5.1.5.1 Summary.- The guidance and control system functioned adequately throughout the flight except for two anomalies which may have to be corrected before the next flight. Table 5.1-IV contains a time sequence of test and operation events together with an indication of the function of each component during the tests.

The inertial guidance system (IGS) performed well during launch and for the first 75 hours of the flight. After the completion of the update and subsequent verification at the end of revolution 48, the crew reported they were unable to power down the computer using the on-off switch although the computer operation was satisfactory in other respects. During the next revolution it was decided to power down the computer by removing power from the IGS. The resulting out-of-sequence power-down caused several changes in the memory core of the computer. Although the computer appears to have been capable of powering down normally later in flight, normal computer operation could not be restored because of the memory alterations; therefore, the computer could not support the remaining mission phases.

Although the horizon sensor system functioned well during periods of the mission, the sensor dropped track one time while in the horizon scan mode because of the sun's being in the field of view. As a result, the vehicle tumbled and could not recover attitude control without assistance from the flight crew.

As a result of comparing IGS measured accelerations to commanded accelerations from thrust chamber assembly (TCA) signals, and investigating the effect of TCA firings on the attitude control system, it was determined that TCA 9 (top aft-firing OAMS) was apparently intermittent in operation. After examining the reasons for the high reentry rolling rate and checking the control system behavior during the reentry control system (RCS) rate command mode check, it became apparent that TCA 5 (left pitch-up RCS) was inoperative during checkout of the system and during reentry.

5.1.5.2 IGS performance evaluation.-

5.1.5.2.1 Ascent phase: The IGS pitch, yaw, and roll steering signals are shown in figure 5.1-8. Superimposed on this figure are the steering signals from the primary guidance system along with the upper and lower IGS extremes which were generated by assuming nominal operation of the primary guidance system. The differences in the steering commands resulting from IGS gimbal cross coupling are shown in the same figure. These differences are not considered an error but are nominal deviations resulting from basic differences between the "strap-down" and "gimbaled-inertial" references used in the two guidance systems. The

~~CONFIDENTIAL~~

following is a brief discussion of the steering signals with respect to first- and second-stage flight. The IGS performance during this period was excellent and showed no indication of the problems encountered on the previous two flights.

First stage - As shown in figure 5.1-8(a), the roll steering commands between the two guidance systems were different by 1.4° at BECO. About 0.1° of this difference was the result of initial bias between the two systems and another 0.1° was the result of the difference between the two roll programs. The gimbal cross-coupling contributed 0.7°, leaving 0.5° unexplained. This difference is representative of a 10 to 12 deg/hr linear drift which is reasonable for the launch-vehicle three-axis reference system (TARS) drift. The primary guidance roll attitude offset of 0.4° at lift-off and the drift to 1.0° at BECO again represent stage I engine misalignment. This was proven after staging when the commands were shifted to the stage II roll control nozzle, and the roll attitude command immediately shifted from 1.0° to 0°.

Figure 5.1-8(b) shows an initial difference in yaw steering of 0.1° to 0.2° between the two guidance systems. At BECO, the difference was 0.7° and the gimbal cross-coupling was about 1.0°. This left about 0.4° to 0.5° unexplained, which corresponds to a linear drift of about 10 deg/hr. Analysis indicates a 1.0 deg/hr drift and misalignment error maximum (discussed later in this section) from the IGS, leaving a TARS drift of 9 deg/hr. The 0.6° shift which occurred at BECO was a normal reaction to the yaw moment created by the stage II roll nozzle and an offset center of gravity.

At staging, there was a 1.1° difference between the two pitch steering commands as shown in figure 5.1-8(c). There was an initial bias of 0.1° to 0.2°, leaving about 1.0° which was probably a TARS or TARS-programmer drift. Either a TARS linear drift of 21 deg/hr or a TARS-programmer error in the torquing signal could explain the difference. The IGS was commanding a nose-down attitude after staging, just prior to RGS initiate, to correct for the high stage I trajectory.

Analysis of the inflight telemetry data indicated that both azimuth updates were received. The flight reconstruction simulation resulted in the following values of platform misalignment computer bias corrections.

Platform release, deg	0.03
After first update, deg	-0.14
After second update, deg	-0.13

This misalignment was within the specified 3σ value of 0.75°.

~~CONFIDENTIAL~~

Second stage - Although the difference between the two pitch steering commands was quite large (2.4° at LO+300 sec), the IGS command was a natural reaction to the high trajectory flown. The IGS was commanding the vehicle to a nose-down attitude to correct for its measurement of an excessive radial velocity of 25 ft/sec and an altitude that was high by 1000 feet. Postflight trajectory reconstructions have verified that the radial velocity was 25 ft/sec high and that the altitude at SECO+20 seconds was 1300 feet high.

The IGS yaw steering appeared to be quite normal until about LO+320 seconds. At this time, the command started to deviate until it had drifted a total of 1.0° at SECO. This behavior was probably the effect of the IGS misalignment in yaw. The steering command is derived by dividing the out-of-plane velocity by an effective time to go to SECO. The out-of-plane velocity was in error by 12 to 15 ft/sec; and, as the vehicle approached SECO, this ratio diverged as did the steering command.

After the gimbal cross-coupling was subtracted from the roll steering commands in stage II, the remainder of the difference between the two guidance systems was representative of a TARS linear drift of 10 deg/hr. This agreed well with the drift observed during stage I flight.

Postflight simulations of the ascent trajectory, using the actual accelerometer and gimbal angle data as inputs, show agreement in velocity to within less than $\frac{1}{2}$ ft/sec which indicates that the computer operated properly during the launch phase.

If switchover to IGS had occurred early in the stage II operation, the SECO conditions would have shown about the following differences from nominal: +4.6 ft/sec in velocity, $+0.009^\circ$ in flight-path angle, and +550 feet in altitude. With IGS steering, these insertion conditions would have resulted in a lower perigee and a higher apogee. The perigee would have been about 3600 feet lower and the apogee about 70 000 feet higher (approximately an 87 by 163.9 nautical-mile orbit).

The incremental velocity indicator (IVI) display, as actually computed by the onboard incremental velocity adjust routine (IVAR), was reconstructed by using IGS navigational and gimbal-angle data. The IVAR was programmed to include a desired insertion velocity based on an incremental velocity addition of 10 ft/sec at separation. However, the flight plan for this mission called for only 5 ft/sec. The crew reported readings of 20 ft/sec forward, 11 ft/sec right, and 2 ft/sec down, which were the approximate readings calculated near the end of the roll maneuver. The final values for the time to apogee (T_{ap}) and for the velocity

~~CONFIDENTIAL~~

to be applied at apogee (V_{gp}) as obtained through the data acquisition system (DAS) prelaunch mode were: (1) the T_{ap} reading at SECO+20 seconds was 2945.2 seconds which was the correct value, and (2) the V_{gp} at LO+512 seconds, when the computer was switched out of the ascent mode, was -0.8 ft/sec which was also the correct velocity change required to lower perigee to nominal. These comparisons validate the orbit insertion equations and the computer IVI interface.

If the IVAR had been followed on this flight and the correction had been made at SECO+20 seconds, a 25-ft/sec forward and a 12-ft/sec out-of-plane velocity would have been displayed in component form. Following a 10-ft/sec separation maneuver and nulling the pitch and roll attitude errors, the IVI's would have displayed 15 ft/sec forward and 7 ft/sec right. The out-of-plane velocity was 19 ft/sec; however, the IVAR limits the out-of-plane correction to one-half the in-plane correction. In this case, with the yaw attitude error nulled, the spacecraft would have been yawed 26.5° right, and the resultant correction of 17 ft/sec forward would have appeared on the fore and aft window. After driving this 17 ft/sec reading to zero, a 7-ft/sec correction to the out-of-plane velocity would have resulted. Assuming no other maneuvers, the resultant apogee would have been 164.3 nautical miles, including the effect of IGS navigational errors. At the time the IVI's are normally zeroed, V_{gp} would have read -0.5 ft/sec, and relatively no change would have been required at apogee to reach the desired perigee of 87 nautical miles.

Guidance error analysis -

Data quality - Telemetry data for the inertial measuring unit (IMU) evaluation were of excellent quality and were continuous throughout powered flight, except for a few single-point dropouts.

GE Mod III data were adequate for quick-look analysis; however, the data became very noisy at approximately LO+300 seconds because of the lower elevation look-angles on this flight. The quick-look missile trajectory measurement (MISTRAM) system data agree relatively well with the GE data in X and Z computer coordinates. The MISTRAM calibrate (p leg) channel was not functioning for the flight. Rate data, however, were available on all legs, and by using MISTRAM 10 K legs for zero setting, smooth MISTRAM data were obtained.

The IMU evaluation was based on velocity comparisons between the telemetered accumulated accelerometer count data, which were properly scaled and biased, and GE Mod III tracking data.

~~CONFIDENTIAL~~

The preliminary data acquired during ascent indicate that the accelerometer and pitch gyro malfunctions that occurred during GT-2 and GT-3 missions, respectively, did not occur on Gemini IV. The computer operation during ascent was normal.

The azimuth misalignment of -0.13° on Gemini IV was considerably less than the misalignments on GT-2 and GT-3, which were -0.29° and -0.52° , respectively.

Error analysis - Preliminary analysis of the indicated guidance system errors follows.

The major component of velocity error in the X_p -direction (down-range) appears to have been caused by a scale-factor shift. A good fit of the data (see fig. 5.1-9) is obtained using X_p scale-factor error of -141 ppm which caused a -3.5 ft/sec error. A bias of -37 ppm (computed from free-flight data) and the Y_p -gyro input axis unbalance accounted for the remainder of the velocity error.

The velocity error data in the Y_p (vertical axis) were noisy after $10+280$ seconds. However, the trend of the data indicates that the dominant error source was a gyro drift (see fig. 5.1-10). A g-sensitive-drift Y_p -gyro mass unbalance along the input axis is assumed to be the primary error source. A Z_p -gyro mass unbalance along the input axis of 0.45 deg/hr/g and an azimuth misalignment of -0.56 minute were assumed to be the major sources of the Z_p -velocity error (see fig. 5.1-10).

The indicated guidance-system errors at SECO, which were obtained from position and velocity comparisons using GE Mod III as a reference, are shown in table 5.1-V. In this table, the IMU error represents the error contributed by the accelerometer and gyro sources. The navigation error is the error resulting from various approximations within the airborne computer. The total guidance error represents total IGS error.

Estimates of indicated accelerometer and gyro error sources which account for the velocity error at SECO are given in table 5.1-VI. Preliminary estimates of sensors and tracker error coefficients obtained from an error coefficient recovery program are also shown in the table. This program is very sensitive to low-frequency noise, and the error sources and values must be reviewed to be consistent with engineering judgment and preflight data. The two mass unbalance terms which are the main velocity error contributors agree relatively well. An estimate of orbital injection parameters, total inertial velocity, inertial

~~CONFIDENTIAL~~

velocity components, and flight-path angles obtained from different sources are shown in table 5.1-VII.

The data presently available indicate that the IGS performed satisfactorily during ascent.

5.1.5.2.2 Orbital phase:

Platform alinements - The platform was caged blunt-end-forward (BEF) following the yaw turnaround after separation. At the initiation of BEF alinement, the platform axes were within 1° of the spacecraft axes. The spacecraft, in turn, had a 12° pitch-down and 1.8° roll-right orientation with respect to the local horizontal. Sensor and gimbal-angle data indicate essentially no pitch and roll errors at the termination of alinement. In addition, because the initial roll and yaw errors were small, good yaw alinement was achieved even though the alinement period was relatively short (6 min 29 sec). This good yaw alinement was substantiated by examining the data at 90° of orbital travel from alinement termination where a yaw error (if it had existed) would have propagated into a roll error. No appreciable roll error was observed. A pitch error of approximately 0.2° did exist at this time; however, this amount agrees with the predicted value which resulted from the difference in the platform orbital rate bias (246.4 deg/hr) and the actual orbital rate. Small-end-forward (SEF) alinement was initiated early in revolution 3 after the spacecraft had been in the orbit rate mode since the last alinement period. Each platform axis was again alined accurately.

SEF alinement was again initiated early in revolution 44 following a 25-minute warmup and 18-minute cage period. The platform had been off since early in revolution 5. At alinement initiation, the spacecraft had a 12° pitch-down and 14.3° roll-right orientation with respect to the local horizontal. At the end of the 16-minute 18-second alinement period, the pitch and roll alinement errors were less than 0.5° . However, examination of the data at approximately 90° of orbit travel from alinement termination indicates that there was a 6.3° roll platform misalinement with respect to the local horizontal. This would indicate that a 6.3° yaw misalinement existed at termination of alinement.

The platform was alined in the BEF mode for a 33-minute period prior to the OAMS preretrofire maneuver. Initial errors were already small from the alinement performed in the previous revolution. Since the flight crew held the spacecraft to small attitude limit cycles ($\pm 1^\circ$) with respect to platform nulls, the alinement accuracy was excellent. Alinement was again performed for a 6-minute period prior to retrofire. Again alinement was excellent.

4 N C L

~~CONFIDENTIAL~~

Computer operation - The computer was operated continuously from 30 minutes prior to lift-off until 02:52:00 g.e.t., and from that time until 75:46:00 g.e.t. it was turned on and off 12 more times. This accumulated a total of 6 hours 18 minutes of running time after launch. Updates were sent and verified during each "on" time. After completion of the 12th update at 75:46:00 g.e.t., the computer power switch was placed in the "off" position, but the computer failed to power-down. This anomaly is discussed in detail in section 5.1.5.4.

The catch-up mode was entered at 00:08:30 g.e.t. and the "start comp" button was pushed at 00:08:50 g.e.t. The computer was left in catch-up mode throughout the first revolution and provided information regarding platform alinement, spacecraft attitudes, and maneuvers used in station keeping.

With the spacecraft remaining in BEF, platform alinement began at 00:13:30 g.e.t. and ended at 00:20:00 g.e.t. There was a small up-firing thrust at the beginning of alinement and, about two-thirds of the way through, the spacecraft was pitched down 10°, yawed right 5°, and then returned to BEF for the final 80 seconds of alinement.

At the completion of alinement, the attitude control and maneuver electronics (ACME) was switched between rate command, direct, and pulse as required. Rate command was used during thrusting.

5.1.5.2.3 Reentry phase: The spacecraft attitudes during the preretrofire OAMS maneuver were held within an average of less than 1° in yaw, 1° in pitch, and 5° in roll.

Examination of inertial platform data indicates that the spacecraft attitudes were held to within 1° in pitch and roll with negligible variation in yaw during retrofire maneuver.

Because of the IGS anomaly and subsequent action which disabled the computer, no evaluation of the IGS during reentry is possible. Closed-loop guidance was not performed, and an open-loop zero-lift reentry technique was used. After retrofire a full-lift attitude was held until 97:42:52.5 g.e.t. at an approximate altitude of 400 000 feet, at which time a roll rate was established.

5.1.5.3 Control system performance evaluation.- The control system operated properly during all phases of the mission. Attitude and translation hand-controller commands and automatic mode commands were properly generated and transmitted to the thrusters. Rate deadbands were proper throughout. Control authority was adequate in the face of all disturbances encountered including those that resulted from attitude thruster failures and was marginal for apparent failure of the aft maneuver thruster.

~~CONFIDENTIAL~~

5.1.5.3.1 Separation: The separation maneuver was performed as planned with the firing of aft thrusters 9 and 10 for 4.9 seconds (see fig. 5.1-11). The separation shaped charge was fired 0.5 second after thrust initiate with attitude control in "direct." No attitude thrusters fired until the system was switched to "rate command" after 2.5 seconds. At this point the rates had increased to -0.84 , -0.53 , and -1.39 deg/sec in pitch, roll, and yaw, respectively. Rate command immediately damped and held the rates to near zero. The separation attitudes were -4° , 89° , and 2.5° in pitch, roll, and yaw, respectively. The "skewed" separation as reported by the flight crew was not apparent in the data; therefore, this effect must have been small, yet it was detectable by the crew.

5.1.5.3.2 Control mode checks: Two attitude-thruster checks were performed on this flight: one to determine control capability with an OAMS attitude thruster inoperative and the other to check RCS performance prior to retrofire. Both checks demonstrated adequate control with either actual or simulated thruster failures.

Attitude-thruster failure check - The attitude-thruster failure check, initiated at 70:05:00 g.e.t. was to determine the crew's ability to control the spacecraft attitudes with one attitude thruster failed. The direct mode was utilized and adequate control authority was demonstrated.

RCS operational check - Each RCS ring was exercised by firing pairs of thrusters for approximately 0.2 second using the rate-command mode. Abnormal operation was suspected by the flight crew when roll thruster activity was observed while testing in the pitch axis. The same phenomenon was reported in both rings; yet no roll motion was observed by the crew in subsequent direct mode tests. The body accelerations shown in table 5.1-VIII indicate that TCA 5B was not operating at this time. This can be seen in the almost 2 to 1 difference in pitch acceleration in rings A and B when thrusters 5 and 6 were fired. The failed thruster was also evidenced in the difference in roll coupling when pitch-up commands were initiated on ring A and then on ring B.

5.1.5.3.3 Horizon sensor operation: The horizon sensors were operated for approximately 33 hours during the flight. All but a few minutes of this time was on the primary system. In an attempt to provide information concerning the excessive loss of track anomaly reported during the GT-3 mission, extensive flight tests with special instrumentation were included in the Gemini IV flight plan. Proper operation was indicated during most of this time. Fifty-nine losses of track (scanner ignore light) were recorded in the 20 hours of data processed. Forty-eight of these losses were caused by maneuvers which exceeded the attitude limits, one by excessive body rates, seven by the sun entering the

A N C E

~~CONFIDENTIAL~~

field of view, and three during warmup and initial lock-on. Eight of the attitude losses and one sun loss were intentional. The number of losses of track when in the horizon scan mode is dependent on the yaw orientation which can place the sun in the field of view of the horizon sensor. In one loss because of the sun, the flight crew, by prearrangement, allowed the spacecraft to maneuver under control of the horizon scan mode to determine if control would be regained after it was lost. This occurrence, shown in figure 5.1-12(a), was preceded by a 22-minute period of long limit-cycle operation indicating excellent performance. As seen, the sensor lost track for 17 seconds (4 minutes after crossing from sunlight into umbra), regained track for 21 seconds, and then lost it again. At this time, the pitch thruster began firing intermittently causing the spacecraft to pitch down through 360° and tumble completely. Toward the end of the maneuver, the roll thrusters began firing which caused the spacecraft to exceed the roll limits before it reentered the pitch band preventing acquisition after one revolution. At this point the flight crew assumed control. The horizon scan mode was then again energized and proper operation was resumed. Figure 5.1-12(b) and (c) show the two other periods of operation with sun interference present. In the first period, the sensor "loss-of-track" light did not illuminate although spurious thruster firings occurred indicating intermittent loss of track. In the second period, track was lost and reacquired without flight crew assistance. The horizon scan mode operated satisfactorily for long periods exhibiting long limit-cycle periods (greater than 6 minutes), demonstrated low propellant consumption, and required insignificant electrical power.

The effects of the sun, moon, and OAMS thruster plumes on horizon sensor operation were determined. All checks were made utilizing the primary sensor with the platform in orbit rate and aligned. These checks were carried out in a manner that achieved the complete results desired in all but the thruster plume check. The checks were primarily performed in the pulse mode with the horizon sensor powered up except for the thruster plume check which was performed in the rate command mode. Intermittent use of the direct mode occurred when rate reversals were required to establish the desired attitude limits.

Sunset check - The spacecraft was oriented to the requested attitudes of 0° pitch, 0° roll, and yaw aligned to the sun. Initial alignment was accomplished utilizing the direct mode of control. The check was initiated with low rates in all axes although the attitudes had drifted slightly from the desired angles. A negative rate was established in yaw which was close to that desired. The first loss of track occurred at 68:41:52 g.e.t. and was the result of the sun, or, possibly, a combination of attitude and sun. No other loss of track was noted even though the sun was in the sensor field of view three times. The spacecraft attitudes and rates were maintained at the desired values.

~~CONFIDENTIAL~~

Moonrise check - The spacecraft was oriented to the proper attitudes to conduct the check at 68:59:27 g.e.t. The direct mode was used to stop and start the spacecraft yaw rates at the end of each 180° sweep. The moon should have been in or near the field of view four times during the 6 minutes 50 seconds required for this check. The spacecraft attitudes were maintained near the desired values. No loss of tracks was observed during this check.

Thruster plume check - The spacecraft was oriented to an attitude of -1°, 11°, and 77° in pitch, roll, and yaw, respectively. The desired attitude was -10°, -10°, and 90° in pitch, roll, and yaw, respectively. The plume check was initiated at 69:43:21 g.e.t. and terminated at 69:44:01 g.e.t. OAMS thruster number 11 was fired for 1.1 seconds at 69:43:35 g.e.t. The rates at the start of this test were very close to zero and changed to 0.3, 0.1, and 0.25 deg/sec in pitch, roll, and yaw, respectively. The observed rate changes in yaw and pitch were verified to be very close to the theoretical values for one maneuver thruster firing. The horizon sensor angles were observed to be 2° and 17° for roll and pitch, respectively. Because of the positive roll angle, the sensor was scanning the lower part of its field of view; therefore it is doubtful that the plume was in view of the sensor. Although no loss of track was observed, the test was probably inconclusive.

Horizon sensor track check - The horizon sensor track check was designed to determine the spacecraft attitude limits for operation of the horizon sensors. The horizon sensor track check was initiated at 69:43:00 g.e.t. and terminated at 70:06:00 g.e.t. The track check was not completed in accordance with the flight plan; however, the portion of the track check completed was adequate for the purpose intended.

The attitudes were maintained very well throughout the track check period; however, the rates for the most part, exceeded the desired $\frac{1}{2}$ deg/sec. The relatively high rates presented minor problems in analyzing the data because of lag in the horizon sensor system. The loss-of-track angle (unlock) and the track (lock) angles for both the telemetry data and the angles as observed by the flight crew are presented in table 5.1-IX. The angles at which the horizon sensor lost track indicated a much wider band of operation than expected (approximately 30°). The difference between the unlock and lock data supports the 3° to 5° difference between unlock and lock angles. The rather high rates at which some of the maneuvers were carried out made the unlock-lock angle band difficult to determine because of the inherent lag in the instrument.

5.1.5.3.4 Reentry phase: The performance of the control-system during the preretrofire OAMS maneuver and the retrofire maneuver was nominal with the control system operating in rate command and with all

~~CONFIDENTIAL~~

three rate gyros turned on. The control system had adequate control authority even though one B-ring thruster was not functioning, and, by not functioning, had introduced additional roll disturbances and decreased the yaw authority slightly. The system experienced duty cycles during retrofire as high as 30, 20, and 30 percent in pitch, roll, and yaw, respectively. The retrofire attitude was held accurately without difficulty. The procedure of operating the rate command system in all three axes during thrusting maneuvers results in more accurate attitude control, and, with monitoring, introduces minimum risk.

After retrofire, a full lift attitude was held until 97:42:52.5 g.e.t. when a 6.5 deg/sec roll rate was established. Figure 5.1-13 is a time history of gimbal roll rate and indicates that the roll rate gyro was turned off before the roll rate was established (44 sec). Figure 5.1-14 shows spacecraft attitudes, rates, and thrust activities for a 2-minute period during reentry. Figure 5.1-13 also shows the high RCS fuel usage during the high roll rate. The altitude reference curve on the figure was obtained from a zero lift reentry simulation using Eglin Air Force Base tracking station information. A study of the propellant consumption curve reveals four distinct regions of consumption rate.

During reentry an unexpected large roll rate was developed by means other than the roll thrusters. Ring A and ring B thruster commands indicate that the last roll commanded thruster activity occurred at 97:43:15 g.e.t. These roll rate commands entered were to establish the reentry roll rate and commanded thrusters 4 and 8 on both A-ring and B-ring which induced a negative roll rate of 6.5 deg/sec. Observation of figure 5.1-13 indicates that a roll acceleration existed throughout the remainder of the reentry even though no change in roll rate was commanded by the flight crew.

During the time period of 97:43:15 g.e.t. to 97:46:05 g.e.t., the roll rate increased from 6.5 deg/sec to 11.5 deg/sec. Pitch thrusters 5 and 6 were being used to null the pitch rate as the spacecraft was approaching the aerodynamic trim condition. Failure of pitch thruster 5 on the B-ring had the effect of inducing a roll acceleration of -2.4 deg/sec^2 . The pitch thrusters 5 and 6 were on for 2.6 ± 1.5 seconds during this time period. The time tolerance corresponds to a thruster off-on time uncertainty of ± 0.1 second (0.1-second data sample rate). With this pitch thruster "on" time and the roll acceleration associated with thruster 5 failure, the resulting increase in roll rate would have been $6.24 \pm 3.6 \text{ deg/sec}$ as compared to the actual observed increase of 5.0 deg/sec. Thrusters 5 and 6 were exercised from 97:40:56.0 g.e.t. to 97:40:56.3 g.e.t. and the pitch rate increased positively and the roll rate increased negatively. During the time from 97:40:57.9 g.e.t. to 97:40:58.3 g.e.t. only pitch thrusters 1 and 2

~~CONFIDENTIAL~~

were being exercised. The pitch rate increased negatively and the roll rate remained unchanged. This confirms that thruster 5 was still in-operative because a coupling effect was introduced between pitch and roll axes only when pitch thrusters 5 and 6 were commanded to fire.

During the time period of 97:46:05 g.e.t. to 97:48:00 g.e.t. the roll rate increased from 11.5 deg/sec to 17.5 deg/sec. Because the roll-rate gyro was turned off at approximately 97:42:18 g.e.t., no roll-rate information was introduced into the yaw-rate channel by means of the cross-over network. Therefore, the effect of off-setting the yaw-rate deadband as the roll rate increased was not present. The yaw rate intermittently exceeded the yaw deadband of 4 deg/sec, which had the effect of exercising yaw thrusters 7 and 8 to restore the yaw rate to within the yaw-rate deadband. The vertical center-of-gravity offset was approximately 1.56 inches with the extravehicular activity (EVA) gear stored. Because the yaw thrusters were mounted symmetrically about the geometrical center, and because the center of gravity did not coincide with the geometrical center, the firing of yaw thrusters 7 and 8 introduced a roll acceleration of approximately -1.07 deg/sec^2 . A $-2.25 \pm 2.03 \text{ deg/sec}$ increase in roll rate should have occurred during the measured thruster "on" time of 2.1 ± 1.9 seconds. Pitch thrusters 5 and 6 also contributed $1.2 \pm 0.48 \text{ deg/sec}$ because of the 0.5 ± 0.5 seconds "on" time during the same time period.

Between 97:48:00 g.e.t. and 97:50:52 g.e.t. the roll rate increased from 17.5 deg/sec to a maximum value of 65.4 deg/sec after which it decreased slowly to 57.0 deg/sec at drogue parachute deployment. The yaw rate was negative and exceeded the yaw-rate deadband of 4 deg/sec. The roll rate was reduced (fig. 5.1-13) because of increased aerodynamic damping when maximum dynamic pressure occurred between 97:49:05 g.e.t. and 97:49:25 g.e.t.

5.1.5.3.5 Control characteristics affecting the RCS propellant consumption: Because of the extensive operation of the RCS in various control modes during reentry, propellant supplies had been nearly depleted at the time of operating the motorized shut-off valves in both systems. The reasons for propellant consumption are discussed for each region of RCS use. It should be noted that fuel consumption, indicated by computations based on measured pressure and temperature, is not precise because of measurement and calibration inaccuracies, and fuel consumption measured by using TCA "on" times is inaccurate as a result of the estimation of weight and TCA DAS sample time; however, trends can be determined even though absolute values cannot be established.

At 97:34:00 g.e.t., the amount of propellant remaining for each of the RCS rings varied by approximately 1.5 pounds. This was probably caused by the single ring testing performed by the crew approximately

UNCL
~~CONFIDENTIAL~~

1 hour prior to that time, in which the B-ring was tested at greater length than the A-ring.

The relatively high consumption rate during the period between 97:35:00 g.e.t. and 97:41:00 g.e.t. was a direct result of the efforts of the flight crew in obtaining and holding the -30° retrofire pitch attitude. The TCA on-off indicators show a large amount of activity in the 4 minutes preceding retrofire as do the PCM gimbal angle and body rate data. The command pilot was apparently testing the response of the RCS and its ability to hold the retrofire pitch attitude.

The spacecraft descended from 450 000 feet to 180 000 feet from 97:41:00 g.e.t. to 97:48:18 g.e.t. The rate of propellant consumption decreased during this period, thus indicating a reduced amount of attitude-control activity. The spacecraft was in the heads-down position with little thruster activity necessary to maintain this attitude. At 97:43:15 g.e.t. two short bursts from thrusters 4 and 8 imparted a roll rate of -6.5 deg/sec to the spacecraft. After this initial roll was established, there was little thruster activity until 97:45:00 g.e.t. when the spacecraft began to trim in pitch and yaw because of its aerodynamic characteristics. At this time the command pilot began attempting to null the pitch rate, which the trimming moment was inducing, by firing thrusters 5 and 6. At 97:46:06 g.e.t. he ended his attempt to null this pitch rate and allowed the spacecraft to establish trim. Starting at 97:46:18 g.e.t., thruster activity was limited almost solely to the intermittent firing of yaw thrusters 7 and 8. There was a small amount of thruster activity in this region, thus verifying the observed reduction in propellant consumption rate.

Figure 5.1-13 indicates that a large roll rate of -23 deg/sec existed at 97:48:18 g.e.t. and aerodynamic coupling had caused a large yaw rate to build up corresponding to the high roll rate. The deadbands on the yaw-rate channel while in the reentry rate-command mode remained at ± 4 deg/sec instead of being displaced by an amount proportional to the roll rate because the roll rate gyro had been shut off. Because of the vertical center-of-gravity offset, firing of the yaw thrusters induced roll in the spacecraft's attitude. This roll was positive for yaw thrusters 3 and 4 and negative for yaw thrusters 7 and 8.

In the period from 97:46:00 g.e.t. to 97:48:18 g.e.t. the spacecraft roll rate began a slow increase, as did the yaw rate. The positive yaw rate deadband was occasionally reached in this area, causing a firing of yaw thrusters 7 and 8 to null the rate. These firings caused an increase in the roll rate. As the roll rate further increased, the yaw rate did likewise, thus decreasing the intervals between the firing of thrusters 7 and 8. The situation was finally reached at 97:48:18 g.e.t. when the roll rate became so large that the corresponding yaw rate exceeded its deadband, thus causing thrusters 7 and 8 to be fired continuously. The

~~CONFIDENTIAL~~

extremely high RCS fuel consumption rate after this time was a result of this continual firing of yaw thrusters 7 and 8 in attempting to damp the yaw rate, caused by the high roll rate, to within the ± 4 deg/sec deadband.

Figure 5.1-15 shows the effect of the roll-to-yaw coordination term (K_{pr}) and roll rate on fuel consumption, with $K_{pr} = 0$ and roll rate = 20 deg/sec. Figure 5.1-13 shows that the high consumption is coincident with combined high aerodynamic total pressure and rolling rate above 20 deg/sec. Figure 5.1-14 shows that the control system activity was low with low roll rate.

At 97:50:00 g.e.t. the propellant consumption rate decreased considerably. Yaw thrusters 7 and 8 were still firing at this time and continued firing until 97:50:35 g.e.t. Since the trim angle of attack varies with Mach number near drogue parachute deployment, oscillations were introduced even while on rate command or reentry rate-command mode. Because thruster firing was audible to the crew while the spacecraft was on the drogue parachute and the oscillations did not indicate any loss in control prior to and while the spacecraft was on the reefed drogue parachute, it is assumed that propellant depletion occurred while on the disreefed drogue parachute.

5.1.5.4 Anomalies.-

5.1.5.4.1 Computer-IGS power sequence anomaly: At the end of revolution 48, after verification of the computer digital command system (DCS) reentry quantities by Cape Kennedy, the command pilot encountered difficulty in turning off the computer. This was the first indication of a problem in the IGS. Figure 5.1-16 shows the elements of the IGS associated with the power sequencing. Figure 5.1-17 shows a time history for revolution 49 of quantities pertinent to this problem.

At 75:45:30 g.e.t. the spacecraft communicator requested that the computer be turned off. The telemetry data show no indication of computer turn off, although the flight crew cycled the computer on-off switch several times. At 75:45:35 g.e.t., the power switch was turned from IGS to ACME, whereupon the auxiliary computer power unit (ACPU) did not turn the computer off as it would normally do. Instead, the ACPU continued to supply power to the computer. Telemetry data show that the computer dc voltages assumed a new regulation level for 36 seconds then began to decay (see fig. 5.1-17). During this period the computer continued to operate properly as indicated by the digital acquisition system (DAS) data. The computer malfunction light was seen on the spacecraft but not on telemetry, indicating that the malfunction light was activated by the ACPU.

JNC

~~CONFIDENTIAL~~

At 75:46:57 g.e.t., the power switch was returned to IGS, and the computer dc voltages returned to normal. From this time until 75:48:18 g.e.t. cycling of the computer on-off switch was requested by the spacecraft communicator and was indicated by short duration level shifts on the computer attitude error signals. This cycling had no effect on the computer dc voltages levels, and the computer words continued to appear satisfactory on telemetry. Prelaunch and catch-up mode switch positions were tried and the computer functioned normally in all modes tested.

At 76:34:42 g.e.t., the power switch was again turned to ACME in an attempt to power down the computer and prevent spacecraft power drain. As before, the ACPU did not turn off the computer, and the computer dc voltages went to a new regulation level, held for 10 seconds, then began to decay. During the decay interval, the computer continued to operate normally until the 27.2 volt dc reached 20 volts and the 9.6 volt dc reached 7 volts. At that time (76:35:18 g.e.t.), the computer running light turned off, the computer malfunction light came on, and the computer telemetry data terminated. The computer dc voltage levels observed at that time were well below the permissible low limits of 25.84 and 8.83 volts dc, and a memory modification was suspected.

During the period from 77:09:22 g.e.t. to 77:10:50 g.e.t., the computer on-off sequence operated normally. The power switch was turned to IGS at 77:09:30 g.e.t. At 77:10:33 g.e.t. the computer was cycled down and a power up was then initiated using the computer on-off switch (77:10:37 g.e.t.). During these operations, all sequencing appeared normal. A memory modification was observed in the computer DAS data for this period evidenced by (1) improper flow tags were observed, and (2) time did not return to zero after the second turn on. An intermittent connection is believed present in the IGS elements related to the computer on-off circuit. This includes the computer, the IGS power supply, the ACPU, and spacecraft switches and wiring. Intensive testing is being performed on these elements. A verification of the computer memory after recovery indicated a number of modified memory locations. It is concluded that this modification probably occurred at the second ACPU drain (76:35:18 g.e.t.) because of the low dc voltages. Modification of the memory during the first ACPU drain cannot be definitely ruled out, although no modifications were revealed by examination of computer data in the interim period.

Approximately 0.4 second after drogue parachute deployment and 5 minutes 22 seconds prior to landing, a 12-amp current demand was placed on the spacecraft main dc power and lasted about 3 seconds (97:50:47.5 g.e.t. to 97:50:50.5 g.e.t.). At the start of this surge, the computer dc voltages dropped and the computer malfunction light went out. Testing of the IGS power supply has since isolated a short

~~CONFIDENTIAL~~

UNCL

~~CONFIDENTIAL~~

circuit which would account for this shutdown. This malfunction does not resemble the one experienced in revolution 49, and is not believed to be related, although this possibility is not being overlooked. Failure analysis of the IGS power supply has revealed two transistors and a fuse that failed in the computer voltage section. All of these could have caused a large current drain on the power supply such as the one indicated.

5.1.5.4.2 Horizon scan mode loss of control: During the mission, the horizon sensor system exhibited a number of loss of tracks due to the sun when a sunrise or sunset was within the field of view.

This loss in track results in the control system pulsing the attitude control thrusters which may move the horizon from the field of view and result in loss of control. The likelihood of this occurrence depends on the attitudes of the vehicle at the time of the loss of track.

5.1.6 Time Reference System

Data indicate that the electronic timer started approximately 16 milliseconds after lift-off and exhibited an elapsed time slow error of 1.162 seconds over the 4-day mission, which is well within specifications.

The flight crew reported that retrofire time (T_R) initiated by the electronic timer occurred 1 to 2 seconds early. This was based on observance of the T_R -5 minute and T_R -30 second lights and the ground countdown compared with the event timer and wrist watches. The flight controller reported that T_R was known to be at least $\frac{1}{2}$ second early, but no correction was necessary. Postflight evaluation of the initiation of retrofire indicates that retrofire occurred approximately 1.3 seconds early. The planned time was 97:40:02 g.e.t. and the actual time was 97:40:00~~70~~ g.e.t.

Data received from the Landing and Recovery Division, MSC, indicated that the right-hand G.m.t. and the left-hand g.e.t. clocks were indicating the same time when read on the carrier. The flight crew reported that the left-hand g.e.t. clock lost 4 to 5 seconds per day.

The time-correlation buffer operated normally as indicated by the time track on the onboard voice tapes.

~~CONFIDENTIAL~~

UNCLASSIFIED

5.1.7 Electrical System

The electrical power and sequential system performance was satisfactory during the mission. The main bus voltages and currents were within the limits of specification and predictions. Real-time accounting of electrical power showed that throughout the mission there was sufficient power to meet the remaining mission requirements with a margin of approximately 300 to 400 ampere hours. During the mission, the reentry batteries tested low in several battery tests. Performance of these batteries was nominal from the time they were placed on the main bus (T_R -5 minutes) until power shut-down after landing, which tends to confirm the supposition that the low test performance was due to the low battery temperatures (53° to 54° F).

The major electrical-sequential spacecraft events and times of occurrences are tabulated in table 5.1-X. Three event parameters were not received via telemetry: equipment adapter separation (AD02), manual retrofire (AD06), and parachute jettison (AE13). Sensor AD02 indicates a physical separation of 1.5 inches at any two of the three sensor locations. At the same time, and by another set of contacts on the same relay, power is sent to light the "adapter separation" green telelight. Although the telemetry signal was not received, the telelight did light green verifying the action of the separation sensors. Reviewing the telemetry shows that several synchronization drop-outs at the ground station were occurring during the period from 97:39:54.3 to 97:40:07.55 g.e.t. Event AD02 is just outside this region; therefore, its loss cannot be explained in this manner, but event AD06 does occur during this period and could have been part of the loss of data due to the synchronization problems. AE13 was not recorded because it is an on-the-water function, and the telemetry system had been turned off prior to the reported AE13 event time.

In GT-3, during the equipment-adapter separation sequence, several fusistors were blown as a result of slag formation in the cartridges during firing, which caused an electrical short circuit to the case of the pyro. A similar reaction occurred in Gemini IV during the equipment-adapter separation sequence, the retroadapter separation sequence, drogue parachute deployment, and parachute jettison. Table 5.1-XI identifies the blown fusistors. The squib batteries handled the added current very well with a transient minimum bus voltage of 20.75 volts.

The inertial guidance system (IGS) fuse block was recorded as dry during the postmission inspection. A special effort was made to insure that this fuse block did not leak because the fuses it contains were connected directly to the main bus. Leakage of salt water into this block would drain electrical recovery power. Other fuse blocks did leak salt water, but it is of little consequence since the sequential busses

UNCLASSIFIED

to which they were connected were not armed when the spacecraft was in the water.

5.1.8 Spacecraft Propulsion Systems

5.1.8.1 Orbital attitude and maneuver systems.-

5.1.8.1.1 Preflight: Propellant servicing of the orbital attitude maneuver system (OAMS) occurred on May 3 and 4, 1965. The loaded fuel and oxidizer quantities were 164.5 and 245.9 pounds, respectively. A helium pressurant loading of 3155 psi at 85° F was accomplished on May 25, 1965. At approximately T-15 minutes the OAMS was activated, and all attitude thrusters were static fired to confirm system operation.

5.1.8.1.2 Performance: All measured pressures and temperatures examined were satisfactory throughout the flight. Also, satisfactory system performance was reported by the flight crew. However, postflight examination of the flight data indicated that the performance of one of the aft-firing thrusters was variable during the course of the mission. This apparent anomaly is discussed in subsequent paragraphs.

Tables 4-IV and 4-V list the maneuver thrust chamber assembly (TCA) duty cycles during the first revolution. This usage, plus system tests during revolutions 45 and 62 and the retromaneuver, constitutes the total maneuver TCA activity during the flight.

5.1.8.1.3 Propellant utilization: In the first revolution, approximately 140 pounds of propellant were consumed while attempting station keeping with the launch vehicle's second stage. During the period between the first revolution and the OAMS retroburn, 57 pounds of propellant were consumed. The retromaneuver consumed 110 pounds, and subsequently 5 pounds were utilized. Twenty-five pounds of usable propellant, exclusive of gaging system inaccuracy contingencies, were computed to have remained within the system at equipment adapter separation. The remaining propellant was unusable, either entrapped within the system or in the form of excessive oxidizer loaded for system requirements. (The mixture ratio of the maneuver TCA's was a nominal 1.6, whereas the attitude TCA's mixture ratio was a nominal 0.7, thus using considerably less oxidizer per pound of fuel.)

5.1.8.1.4 Aft TCA anomaly: Calculation of the aft-firing thruster acceleration during station keeping, using DAS accelerometer pulse counts and thruster-on times as plotted in figure 5.1-18, shows that the acceleration dropped approximately 50 percent at 01:04:00 g.e.t. and indicates that one aft-firing TCA was inoperative.

UNCLASSIFIED

The aft-firing TCA's (9 and 10) functioned normally until 00:55:55 g.e.t. Pitch-up TCA's 1 and 2 fired as required to compensate for the pitch-down unbalance torque of approximately 16 ft-lb caused by the center-of-gravity offset and thruster misalignments. At 01:04:29 g.e.t. TCA's 9 and 10 were commanded, but a pitch-up unbalance torque of approximately 5 ft-lb above the control limits was detected using the pitch-rate gyro signal. This indicates that the OAMS attitude thrust levels were at the low end of the perceptible tolerance range. Pitch-down TCA's 1 and 2 fired throughout the forward-thrust maneuver indicating a large pitch-up unbalance torque. Maximum torques from the pitch-down TCA's (1 and 2) and the aft-firing TCA (10) are calculated to be -334 and +340 ft-lb, respectively. This difference of +6 ft-lb agrees well with +5 ft-lb seen in the pitch-rate signal and implies that TCA 9 did not fire. This condition existed for the next 12 forward-thrust maneuvers but appeared to change during the 13th firing at 01:13:37 g.e.t., and during subsequent forward maneuvers when the unbalance conditions decreased slightly. An explanation for this slight change in thrust is that propellant utilized during this phase of the mission shifted the center of gravity sufficiently to change the balance between the control and disturbance torques. No evidence of this malfunction of TCA 9 could be detected during the preretrofire OAMS maneuver during which the control system functioned normally.

The effect of the TCA 9 apparent failure is presented in figure 4-8. When TCA 9 apparently failed, the spacecraft axial acceleration was reduced and a pitch-up moment was introduced by the remaining aft-firing complementing thruster TCA 10. Since the attitude control was in the rate-command mode during this period, the reacting thrusters were activated to null the pitching moment. However, a force of 58 pounds, normal to the spacecraft X-axis, was introduced by the attitude thrusters. Because the spacecraft was oriented in a generally nose-down and rolled attitude during the thrusting period, the most significant effect was on ΔV_Y (up-down, spacecraft axial direction), with the RCS coupling effect appearing on ΔV_Z (right-left, out-of-plane direction). From 01:04:29 g.e.t., the time at which TCA 9 apparently malfunctioned, until the end of thrusting at 01:26:45 g.e.t., a ΔV_Y of 54.4 ft/sec was added in the down direction as opposed to an expected ΔV_Y of 87.5 ft/sec obtained by using the available thruster on-off times. During the same period, a ΔV_Z of 7.5 ft/sec was added as opposed to an expected ΔV_Z of 10 ft/sec in the opposite direction. In both cases, the differences are shown to be diverging, starting with the aft-firing thrust at 01:04:29 g.e.t.

Thus the flight crew experienced a relative in-plane line-of-sight ΔV of 33 ft/sec less than expected and relative out-of-plane ΔV of

UNCLASSIFIED

7.5 ft/sec during station-keeping period, complicating the task. If the IVI's had been used during the period of thrusting, an indication of the thruster malfunction would have been given to the flight crew.

During the OAMS retromaneuver, the thrust of the aft TCA's using the predelivery acceptance test data and spacecraft OAMS propellant temperatures and pressures measured in flight was determined to be 95 pounds for TCA's 9 and 10. In section 4.3.1 it is stated that an average thrust of 98 pounds was determined to be necessary to fit the OAMS preretro translation maneuver to the actual trajectory and known landing point. This indicates that not only were both aft-firing thrusters operating, but they were producing thrust in excess of that expected. In order for the TCA's to have produced this thrust along the spacecraft Z-axis, a regulated pressure of 319 psia would have had to exist instead of the indicated 303 psia. Although this error is within the overall accuracy of the instrumentation, it is not considered likely to have occurred. A small gradual shift of +6 psi in regulated pressure was noted throughout the mission from the initial revolution. This shift increased the regulated pressure to 306 ± 2 psia.

This type of anomaly, in which TCA operation varied from little or no thrust to excess thrust, has never been encountered in the extensive ground test program for these TCA's. Such a malfunction can only be attributed to interrupted propellant flow.

The most likely cause of interrupted propellant flow is that of failure to apply voltage across one or both propellant valves. Considering the design of the OAMS and analyzing the telemetered discrete data taken in flight leads to the conclusion that this could only have been a break in the continuous positive power source to the valves or an open wire in the circuitry to the negative spacecraft power source. In the Gemini system, ACME switches the negative side of all four aft-thruster valves (two in each thruster) at a common point, and because one aft thruster fired during this period, ACME can be eliminated as a source of this problem. Divided wiring in the adapter from the common switched point to each thruster cannot be eliminated as a source of the problem but since the adapter was separated and destroyed during reentry, it cannot be checked. The power wiring (positive) and circuit breakers in the reentry vehicle were checked after the flight and intermittent operation could not be induced or detected. However, power could have been inadvertently interrupted by an open circuit breaker. Although some circuit breakers were inadvertently operated by the crew during the mission, and this could explain the apparent malfunction, no data were taken on circuit-breaker operation; therefore, this possibility cannot be checked.

Incomplete valve actuation, contamination, or oxidizer flow-decay are other possible causes which might have decreased the TCA propellant

UNCLASSIFIED

flow. Partial valve actuation has never been encountered in ground testing. Contamination in the calibration orifice is not a very likely cause since the thrust subsequently returned to normal and remained satisfactory during the 160-second preretrofire maneuver. However, the possibility that any contamination later flushed through an orifice cannot be discounted. Similar arguments apply to contamination within the injector. Oxidizer flow decay has been experienced in tests conducted by the manufacturer. However, environments to which the spacecraft systems were exposed at this time in the mission were not the same as those required to produce decay at the vendor. Propellant line or valve freeze-up would halt flow to the chamber, but would not likely occur in the first revolution of the flight.

From the information and data available to the Mission Evaluation Team, it therefore appears impossible at this time to explain or resolve the apparently anomalous behavior of this system.

5.1.8.1.5 System tests: During revolution 45, TCA 8 was turned off, and an alternating yaw-roll maneuver was executed for an elapsed time of 26 seconds. The crew reported no difficulty with holding attitude during this maneuver.

The remaining maneuver TCA activity, exclusive of the first and last revolutions, occurred during revolution 44 in support of an horizon sensor check. For this check the forward TCA's were burned for 1.1 seconds.

5.1.8.2 Reentry control system. -

5.1.8.2.1 Preactivation: Fuel servicing of the A and B rings was completed May 3, 1965, with respective loadings of 15.86 and 16.0 pounds. Final oxidizer servicing of 20.2 and 20.26 pounds in the A and B rings, respectively, was completed on May 21, 1965. Both source pressure tanks were serviced with 3080 psig at 79° F on May 25, 1965.

Operationally, this mission differed from previous ones in that neither system was activated until required for reentry during the last revolution. System temperatures and pressures monitored throughout the mission were satisfactory. The TCA solenoids did cool sufficiently to trip the heater thermostats at an elapsed time of about 63 hours 40 minutes. The temperature stayed within the thermostat limits of 40° to 50° F for approximately 1 hour.

5.1.8.2.2 Performance: Activation of the reentry control system (RCS) A and B rings was accomplished by the crew between 96:34:00 g.e.t. and 96:35:00 g.e.t. During system checkout, all measured performance parameters appeared normal. However, the crew noted, during pitch-up test firings in the rate command mode, that a yaw-right thruster was

UNCLASSIFIED

also firing, which indicated that at least one pitch-up thruster was not firing and the resultant yaw-roll coupling was being corrected. Because the crew thought they observed this irregularity on both rings A and B but could not detect it in direct control mode, it was assumed that all TCA's were operating satisfactorily. The detection and effect on spacecraft control of the TCA nonoperative condition is discussed in sections 5.1.5.3.2 and 5.1.5.3.4. Results of the failure analysis conducted are discussed in section 5.1.8.2.3 which also presents preflight RCS verification tests.

Even with one TCA inoperative, the RCS fulfilled basic mission requirements. Final alinement of the spacecraft for retrofiring was achieved and held during all four retrorocket firings. TCA duty cycles, computed over 10-second time intervals, varied from 10 percent to a maximum of 45 percent during retrofire. Propellant depletion appears to have occurred unexpectedly sometime during or immediately after deployment of the drogue parachute. During deservicing, it was not possible to remove propellant from any of the four RCS tanks. Figure 5.1-13 presents a history of propellant consumed during reentry. The overall error of these computations is estimated to be a maximum of ± 3 pounds.

The curve points out a significant demand prior to equipment section separation. Use of the OAMS for attitude control during this time would have saved a total of 10 pounds, or 16 percent, of the RCS propellant. This quantity is commensurate with the TCA activity. For attitude control during retrofire approximately 1.6 pounds were utilized. Examination of consumption rates derived from this curve shows that the yaw left TCA's fired almost continuously over the 130-second interval between 97:48:14 g.e.t. and 97:50:22 g.e.t. Summation of TCA discreets indicated approximately 110 seconds of TCA burn time in this interval. This time and nominal TCA propellant flow rates were used to calculate propellant consumption. This results in a close correlation with propellant quantity depletion calculations made by using measured tank pressures and temperatures.

The precise time of depletion is difficult to establish because of inherent inaccuracies in the gaging system computations. At least some propellant was available during drogue parachute deployment because the crew reported hearing TCA's fire and tail off immediately after the motor-operated shut-off valves were closed at approximately 20 000 feet.

5.1.8.2.3 Pitch TCA failure: The results of a failure analysis conducted have revealed an open circuit in a connector between the attitude control and maneuver electronics (ACME) and the TCA 5 solenoid. The cause of the failure has been established as a broken wire in a connector. Subsequent postflight valve simultaneity and flow checks have verified proper operation of all TCA's of both rings. Final systems checks prior to launch verified continuity of the circuits involved.

~~CONFIDENTIAL~~

During a prelaunch test, the ACME-TCA electrical connection was interrupted for TCA simultaneity checks. No discrepancies were reported with either ring; however, because of the location in this circuit of the connector that failed, none should have been encountered in this test. The connection was reestablished and verified during a later prelaunch test. In this test, all TCA solenoid valves were actuated by using the spacecraft hand controller. Oxidizer-valve and fuel-valve actuations were individually verified by supplying gaseous nitrogen to the fuel side during one phase of testing⁴⁰⁸ the oxidizer side during another phase. All TCA valves operated satisfactorily, and no electrical connections were opened subsequent to this test. The above testing provided a satisfactory end-to-end functional verification check of the attitude control, electrical, and propulsion systems^X involved in the subsequent flight failure.

5.1.8.3 Retrograde rocket system. - At 97:40:00.7 g.e.t. ignition of retrorocket number 1 occurred, followed by the remaining motors in the normal firing sequence. Motor total burn times appeared nominal for the case temperatures encountered. One motor case temperature was measured, and it stabilized at approximately 47° F after 27 revolutions. The actual imparted spacecraft velocity decrement of 333.5 ft/sec compares well with the preflight estimate of 336.3 ft/sec.

5.1.9 Pyrotechnic System

On the basis of the successful mission and all available data concerning events related to it, it may be deduced that the pyrotechnic system performed all required functions in a satisfactory manner.

Because they have not yet been fully qualified for missions of longer than 4-days duration, a postflight evaluation of the ejection seat ballute deploy-release and the drogue mortar aneroid mechanisms was conducted. All four of these devices functioned within design limits. The test results are listed in the following table:

~~CONFIDENTIAL~~

Nomenclature	Arming force, lb	Design firing altitude, ft	Firing altitude, ft		
			Test 1	Test 2	Test 3
Right-hand drogue aneroid	55	5700 ± 600	5100	5375	5350
Left-hand drogue aneroid	58	5700 ± 600	5750	6000	5950
Right-hand ballute aneroid	55	7500 ± 700	8250	7375	8000
Left-hand ballute aneroid	53	7500 ± 700	7000	6975	6875

When the aneroid mechanisms were disassembled, corrosion was found on the blocking arms. This corrosion was a result of inadequate protection and can result in failure of the automatic feature of the aneroid.

During postflight removal of the mild detonating fuse (MDF) interconnect from the MDF manifold assembly on the right-hand ejection seat, the end of the interconnect was found to be loose. Visual inspection of the part did not indicate any damage. The MDF interconnect is being examined in an attempt to determine the cause and will be subsequently fired to determine if any performance degradation occurred.

The right-hand hatch actuator rod was galled and was dispositioned for failure analysis.

Simultaneously with retroadapter separation, the horizon sensors were jettisoned. The horizon sensor head was sighted by the pilot through the command pilot's window immediately following the jettison sequence. He reported this sighting at the time on the voice tape and identified the object as the "pump package." Subsequently, during a crew consultation the object was positively identified by the pilot as the horizon sensor head. During the GT-3 mission, the pilot reported this same sighting to have occurred at the same relative mission time (immediately after retroadapter separation). The GT-3 pilot's description of the object fits the horizon sensor head more accurately than the pump package.

5.1.10 Crew Station Furnishings and Equipment

5.1.10.1 Crew station design and layout. - The overall design of the crew station was satisfactory for the Gemini IV mission. The principal new requirements for the crew station in this mission were

UNCLASSIFIED

concerned with extravehicular egress and ingress, stowage of a large quantity of onboard equipment, and long-duration habitability. The flight crew accomplished these requirements successfully; however, they encountered the anomalies discussed in the following paragraphs.

5.1.10.1.1 Extravehicular egress and ingress: The crew station and the equipment provided for the extravehicular activity (EVA) were entirely adequate for the steps leading to the pilot's egress from the spacecraft. There were no anomalies encountered during the important preparatory phases of this operation. After the EVA, which is described in detail in section 7.1.2, the pilot had considerable difficulty in closing the hatch. This problem is covered in section 5.1.1. All other operations relating to the ingress such as removal of mounting fittings and keeping the hatch area clear of the umbilical, the lanyards, and other equipment during hatch closure were satisfactorily accomplished.

5.1.10.1.2 Stowage utilization: During the 4-day mission, the EVA and the large number of experiments dictated that all available stowage volume in the crew station be utilized. (See table 3-III and figure 3-15 for the launch stowage configuration.) It was planned to discard the EVA equipment early in the flight and to stow all wet waste in the right-aft stowage container, all loose equipment except photographic film in the left-aft container, and all film packs in the center container for reentry. This plan was carried out, except that the umbilical bag was retained because the crew elected not to jettison the EVA equipment in orbit. This large bag with the umbilical and other miscellaneous items was stowed in the pilot's foot well in orbit and during reentry. The flight crew indicated that the stowage concept using pouches attached to stowage lanyards with removable fasteners was a satisfactory design for the aft stowage boxes. The pilot also was able to use the side food box extension for orbital stowage. Dry trash was either stowed there or in the dry storage bags attached by velcro to the walls in the foot wells.

In orbit, nearly all the loose items were taken out of the boxes and attached to the walls with velcro. For this reason, substantial preparation time was required prior to reentry to stow all this equipment. No difficulty was encountered except with the umbilical bag.

5.1.10.1.3 Long duration habitability: The mission results indicate that the crew station was habitable for 4 days without significant adverse effects on the flight crew. During the first part of the mission, the cabin environment prevented the flight crew from sleeping adequately. There were traces of ammonia fumes in the cockpit during the first day, possibly caused by the absorbent lining on the cabin walls. The pilot had trouble sleeping because he was uncomfortably warm. The communication volume could not be turned low enough to eliminate all sound in the earphones. The noise of the attitude thrusters kept the flight crew from sleeping during the orbital attitude and maneuver system (OAMS)

UNCLASSIFIED

operation. The noise and pressure change associated with venting cabin pressure through the cabin vent valve was disturbing to the flight crew when they were asleep.

All of these problems were corrected by changes in equipment utilization or changes in procedures. The ammonia fumes apparently decreased in intensity. The flight crew operated both suit compressors together while the pilot was asleep to increase suit cooling. The pilot also kept his visor open while asleep. The communications noise was eliminated by disconnecting the space suit communications harness at the neck ring on the sleeping crew member. Each crew member attempted to minimize attitude thruster usage and cabin vent valve operation while the other crew member was asleep. These changes in equipment utilization coupled with flight-plan variations enabled the flight crew to sleep and operate satisfactorily for the remainder of the mission.

5.1.10.1.4 Crew furnishings: The ejection seats were not used in this mission except for support and restraint for the flight crew. The flight crew had no comfort problems during the prelaunch hold for 1 hour 15 minutes after flight crew ingress. After insertion into orbit, the pilot had great difficulty installing the drogue parachute mortar safety pins on the right seat. This difficulty was caused by the poor visibility and access to the pins, the small size of the pins, and the internal design of the mechanism in which the safety pins were inserted. A similar difficulty was encountered when the same safety pins were to be installed after landing. The flight crew also reported that the hoses from the seat to the space suit were not long enough for complete mobility within the cabin. This length was apparently a problem only when the pilot was attempting to install the drogue parachute safety pins.

5.1.10.1.5 Cabin lighting: The flight crew reported that the cabin lighting was satisfactory for the instrument panels, acceptable for the circuit-breaker panels, and poor for the water-management panel. The utility lights were not bright enough to be useful even with the clear lenses. Consequently, there was no satisfactory means of illuminating the water tank between the seats.

The flight crew also reported that when the sun was shining into the window on either side of the spacecraft, the pilot on that side was not able to see the instruments readily. This condition was noticed on launch as well as in orbit. The extra bright center light was not bright enough to counteract the effect of the sunlight.

5.1.10.1.6 Parachute suspension single-point release: The problem encountered in the GT-3 mission in which the command pilot broke his visor on the window frame at single point release was satisfactorily resolved for the Gemini IV mission. The pilots held their arms in front

UNCLASSIFIED

of their heads at the time of bridle release. No impact with the window frame or other adverse effect occurred.

5.1.10.2 Controls and displays. -

5.1.10.2.1 Flight controls: The attitude and the maneuver hand controls operated satisfactorily throughout the flight.

5.1.10.2.2 Non-flight controls: The range of volume control of the communications system was inadequate. It was impossible to turn the volume all the way down; and for launch, it was necessary for the command pilot to use nearly full volume. In the absence of a control to turn off the audio inputs to the space suit headsets, the flight crew disconnected their headsets when they wanted to sleep.

The controls for the voice tape recorder were reported by the flight crew to be inadequate. The location of the recorder on-off control on the voice control center (VCC) audio-mode-selector switches precluded use of the recorder when both crew members were set to transmit normally to the ground. Conversely, if either audio selector was set to record, the crew member on that side of the spacecraft was unable to transmit to the ground.

5.1.10.2.3 Displays: All displays in the crew station functioned normally during the mission. The command pilot reported that the decals on the face of the launch vehicle propellant tank pressure indicators were difficult to read. The parallax associated with the overlay decals on the face was objectionable, and the decals tended to cover the needles at the lower end of the meter scales.

The flight-plan roller display on the center instrument panel was not used as intended during the mission. The flight crew indicated that it did not provide any useful information, particularly in view of the change in flight plan soon after launch. All flight-plan information was obtained from the flight-data books and cards or from the flight director in the case of changes.

The readability of the right-hand G.m.t. clock was reported as unsatisfactory as on the previous flight. Conversely, the readability of the new left-hand G.m.t. clock was reported as good.

The flight crew stated that the lack of a legible elapsed time indicator to read mission elapsed time continuously through the mission was a serious shortcoming. Throughout the mission, there was constant confusion between G.m.t. and g.e.t. All preflight planning data provided to the flight crew were, by necessity, based on elapsed time. The lack of an elapsed time indicator and the poor readability of the G.m.t. clock required the crew to use wrist watches to keep track of both g.e.t.

UNCLASSIFIED

and G.m.t. As a result there were six clocks used in the spacecraft, in addition to the event timer and the time reference system which is not displayed to the crew.

There was no display in the cockpit to indicate the amount of drinking water remaining in the adapter supply nor was this information relayed to the flight controllers. Consequently, there was no means of keeping track of water consumption, other than by counting swallows. The poor illumination of the cabin water tank contributed to the problem.

The altimeter indicated -100 feet at landing impact. This error was attributed to the fact that the altimeter was not reset for the sea-level barometric pressure in the recovery area.

The warning light on the voice tape recorder was difficult to see because of its location outboard of the pilot's right arm rest. This particular area was used occasionally for temporary stowage of loose equipment which covered the light. When the pilot was asleep, this light was frequently blocked from the command pilot's view. As a result, the crew frequently failed to realize when a voice tape cartridge was expended.

5.1.10.3 Space suits and accessories.-

5.1.10.3.1 Basic space suit: The basic G4C space suit gave excellent performance during the normal and EVA phases of the mission. The flight crew reported that the space suits were free from pressure points, except that length between the knee and the heel of the pilot's suit was slightly short, and the command pilot's helmet innerliner rubbed the sides of his head. The remaining comfort aspects were satisfactory. The mobility of the flight crew in their suits was adequate in both the unpressurized and the pressurized condition.

Postflight inspection of the two suits showed leakage values to be well within normal limits. This shows that there were no meteoroid impacts of sufficient energy to affect the suit integrity. Additional tests for detecting meteoroid damage, if any, will be conducted in an attempt to map the impact zones and determine penetration depths.

Some corrosion of the main zippers was noted in the crotch area of both suits after the flight. This corrosion is attributed to exposure to urine. There was no effect on the structural integrity of the zippers.

The rubberized fabric wrist dams were used extensively throughout the flight to maintain arm ventilation with the gloves removed. These wrist dams were satisfactory for this purpose, and no difficulties were experienced in using them.

UNCLASSIFIED

The finger-tip lights on the command pilot's suit were unsatisfactory. Several of the lights were damaged, one light on the right hand burned out during the mission, and the switch on the left hand was intermittent. The pilot had newer finger-tip lights which incorporated a protective cover on each bulb. These lights worked well throughout the flight. The pilot's finger-tip lights were relocated to the vicinity of the first finger joint prior to the flight in an attempt to protect the lights from damage. This position caused discomfort on the finger joints; therefore, the preferred position for these lights is between the finger tip and the first joint and proper protection must be provided.

The blood-pressure port in the command pilot's suit would not retain the blood-pressure bulb properly throughout the flight. Inspection after the flight revealed that the retention ring within the port was worn and deformed. Postflight testing also confirmed the inflight problem. The plugs for the blood-pressure ports on both suits were removed prior to flight because of concern over trapped pressure inside the cuffs during EVA. This omission did not compromise the suit integrity since the blood-pressure cuff was sealed inside the suit. In addition, the suits were qualified for sudden decompression with the plugs removed.

Both pilots scratched their helmet visors extensively during the flight. This was partly due to the susceptibility of the plexiglass visor to scratching, as well as to rough edges in the spacecraft.

5.1.10.3.2 EVA accessories: The addition of the extravehicular cover layer worn by the pilot necessarily caused his mobility to be somewhat less than the command pilot's. When the pilot removed the EVA cover layer sleeves, his comfort and arm mobility were improved.

The pilot also reported that he was uncomfortably warm throughout the mission. Since the command pilot was comfortable and both space suits fit well, the EVA cover layer, more strenuous activities, and differences in individual responses to environment probably contributed to making the pilot too warm. Checks of the pressure drop in both suits had been made shortly before the mission and were found to be essentially identical.

The overvisors were difficult to raise and lower, and the sun visor occasionally slipped to the back of the helmet and rode against the headrest. The use of two overvisors added to the bulk of the helmet and complicated the visor operation. The overvisors were discarded in orbit at the time of ingress from EVA.

The two-piece thermal gloves having zippers in the hand pieces were removed and donned readily over the pressurized suit gloves. The pilot removed the thermal gloves when manipulating the hatch, the umbilical

UNCLASSIFIED

guide, the external camera on its mount, and the maneuvering unit. At no time during the EVA did the pilot find it necessary to hold on to the external surface of the spacecraft for more than a few seconds. He did not notice any indication of extreme surface temperatures, either hot or cold. The thermal gloves were satisfactory; however, the need for these gloves is under study.

5.1.10.3.3 Miscellaneous accessories: The microdot connectors used to connect the electrical and communication cables to the space suit were superior to the connectors previously used. The alignment marks on the connectors were not clearly visible.

The visor cover was useful in covering the eyes of the crew members when they were trying to sleep; however, the visor cover used on this mission was not sufficiently opaque.

5.1.10.4 Extravehicular equipment.-

5.1.10.4.1 Ventilation control module (VCM): Stowage and operation of the VCM for the extravehicular excursion were satisfactory. The pilot was able to unstow and attach the VCM without difficulty. While attached to the space suit, the VCM maintained the suit outlet pressure at 4.2 psia in the vacuum environment. The flow rate of 8.2 lb/hr was adequate for all normal EVA tasks at low work level. This flow rate did not keep the pilot cool during peak work levels, such as those which occurred while mounting the external camera, and during ingress. The command pilot observed that the pilot was perspiring profusely during and after EVA ingress.

The VCM restraint straps were satisfactory for holding the VCM in place on the pilot's chest during EVA. During hatch operation, the VCM straps were easily detached to permit moving the VCM out of the way of the hatch handle.

5.1.10.4.2 EVA umbilical: Removal from stowage and use of the umbilical during EVA were satisfactory. No problems were encountered in attaching the umbilical to the spacecraft or to the space suit connections. The design of the umbilical stowage bag was satisfactory, except that the bag and the strings were occasionally in the pilot's way. The umbilical was sufficiently flexible so that no torque or other undesirable force was imposed on the extravehicular pilot. Communications and bioinstrumentation were adequate using the umbilical. During ingress, the crew was able to pull the umbilical back into the cabin without difficulty. Subsequent stowage in the umbilical bag was satisfactory except that the crew was unable to stow the umbilical and bag in the aft stowage container.

UNCLASSIFIED

5.1.10.4.3 Umbilical guide: The umbilical guide was difficult to install on the hatch sill because the operation required the pilot to manipulate a small pip pin. After several attempts, the pilot was successful in mounting the guide. During the remainder of the EVA, it remained in place and retained the umbilical satisfactorily. During ingress, the pilot removed the guide and discarded it in orbit.

The pilot reported that having the umbilical attached to the guide on the hatch sill made it difficult for him to maintain a position in front of the spacecraft when controlling himself with the umbilical. The lack of an additional umbilical attachment on the nose of the spacecraft allowed the pilot to swing back to the adapter section occasionally. This situation was aggravated by the lack of handholds on any surface of the spacecraft except the open hatch.

5.1.10.4.4 Maneuvering unit: The hand-held maneuvering unit provided the pilot with an effective means of controlling his position and attitude while outside the spacecraft. Because of the limited duration of the propellant gas supply, the pilot was able to maneuver only about 4 minutes. During this time, he used the maneuvering unit for translation and stopping, for pitch and yaw maneuvers, and for stabilizing his attitude. He had no apparent difficulties in using the unit during the evaluation period. The 2-pound thrust level gave satisfactory control response when using the unit in the pulse mode.

The 35-mm camera mounted on the forward end of the maneuvering unit was difficult to operate because of its location. The position of the camera made it difficult to aim. In addition, the added bulk of the maneuvering unit made it more difficult to handle the camera.

5.1.10.4.5 Hatch-closing lanyard: The hatch-closing lanyard was satisfactory for stowage and for installation prior to EVA egress. When the hatch was opened, the lanyard limited the initial hatch opening travel properly. During ingress and hatch closure, the flight crew were required to subject this device to loads which they considered high compared with those imposed in training exercises.

5.1.10.5 Pilots' operational equipment.-

5.1.10.5.1 Still camera: The 70-mm still camera was used to obtain excellent photographs of the pilot during EVA from inside the spacecraft. One of the later 70-mm film packages for this camera failed to take up film properly. On this film package, only 10 out of 60 pictures were usable.

5.1.10.5.2 Sequence camera (16-mm): The 16-mm camera mounted external to the spacecraft during EVA functioned normally for the duration

UNCLASSIFIED

of the film magazine. The pictures taken with this camera using a 5-mm wide-angle (160°) lens gave excellent coverage of the pilot's initial EVA.

The other 16-mm camera was intermittent during the EVA and occasionally thereafter. Postflight investigation failed to identify the exact cause of the problem; however, a switch failure is suspected. Replacement of the switch and the switch actuator is planned before the camera is reused.

One 16-mm film pack had a slipping clutch, and no pictures were obtained from this pack.

5.1.10.5.3 Photo event indicator: The photo event indicator malfunctioned frequently when it was being used with the 70-mm still camera. It is believed that the cable fitting on the camera was too tight and interfered with the shutter operation.

5.1.10.5.4 Lightweight headset: Both crew members reported that the lightweight headset was unsatisfactory because of improper fit and resulting continuous need for adjustment.

5.1.10.5.5 Optical sight: The light intensity of the optical sight was found to be inadequate against a cloud background. The ground-tracking exercises on this mission demonstrated the need to be able to see the reticle against any earth or cloud background for tracking continuity.

5.1.10.5.6 Flight data books: The flight data books tended to come apart with use. The snap rings holding the pages together came unfastened several times. The pages also tended to tear loose from the rings because they were made from lightweight paper.

5.1.10.6 Pilots' personal equipment.-

5.1.10.6.1 Food: Thirty-one of the thirty-two meals carried on the spacecraft were consumed by the flight crew. They reported that the rehydratable and the bite-size food items were palatable and provided a varied diet. The flight crew considered the food to be one of the most important parts of the flight.

Eleven out of seventy rehydratable food bags leaked around the valves in the bags. Most of the bags that leaked contained orange drink. This leakage was unsatisfactory, although the crew managed to consume the contents of these bags in spite of the leaks.

Toast was included in several of the meals. The records revealed that the vendor had made the toast from the wrong type of bread. The

UNCLASSIFIED

toast was tested before the flight and found to be susceptible to crumbling, but the flight food had been packed. The flight crew was briefed before the flight to avoid the toast if there were any indication of crumbling; therefore, the crew did not open the toast. The only other items which crumbled were the peanut bars.

Very few meats were included in the menu because of previous problems of leakage with meat items. The crew commented that the bacon bites were exceptionally tasty and indicated that the inclusion of more meat items was desirable.

5.1.10.6.2 Drinking water dispenser: The water dispenser operated satisfactorily at the first of the flight, but later, the manually operated plunger valve stuck open. The flight crew had to pull the handle back to close the valve. This problem has been noted in several other spacecraft recently, and it is attributed to bending of the probe of the dispenser which caused the plunger to bind. The cause of bent probes is being investigated at this time.

The water dispenser hose was reported to have been deteriorated and susceptible to kinking. These discrepancies are also being investigated.

5.1.10.6.3 Urine collection device (UCD): The UCD's were worn by the crew inside their suits during the launch phase and until after EVA. The UCD's were then removed from the suits and dumped through the urine transport system without incident.

5.1.10.6.4 Urine transport system: The urine system was used approximately 14 times. Noticeable urine spillage occurred during these periods of use, although the crew controlled this spillage effectively by means of the hygiene towels and tissue. No free urine was allowed to remain in the cabin.

The urine spillage was caused by inadequate sealing at the entrance to the urine receiver. The problems with sealing relate to individual procedures as well as inherent design limitations. Sufficient information was gained from this flight to identify the problem clearly. A design investigation is being initiated to improve the sealing at the receiver entrance.

5.1.10.6.5 Defecation device: The defecation bags were used effectively by the crew on six occasions during the flight. Although they described the operation as difficult, both pilots were able to accomplish defecation without contaminating the suits, underwear, or spacecraft. The germicide was added to the bags without difficulty and the subsequent sealing and stowage were satisfactory.

UNCLASSIFIED

The one-sided paper provided with the defecation bags was unsatisfactory. The crew used the hygiene tissues in preference to the paper provided.

5.1.10.6.6 Personal hygiene items: The wet pads packed with the food were very useful for hygiene purposes. The two large hygiene towels were used primarily to control urine spillage. The tissues were found to be very useful for utility as well as hygiene purposes. The tissue dispenser zippers failed early in the flight; however, the dispenser design was otherwise good. In the postflight debriefing, the flight crew indicated that their 4-day growth of beard caused no significant discomfort. There was no indication of any need for a shaver.

5.1.10.6.7 Oral hygiene items: The oral hygiene chewing gum was used infrequently. One tooth brush was lost the first day, and the other was not used. The low utilization of these items did not have any noticeable effect on the crew.

5.1.10.6.8 CO₂ sensing tapes: The CO₂ sensing tapes were carried in flight but were not used.

5.1.10.6.9 Humidity sensor: The flight crew was provided with a battery-powered electronic hand-held humidity sensor for determining dry-bulb, wet-bulb, and wall temperatures within the spacecraft cabin. This device was utilized approximately every four revolutions during flight and approximately 30 minutes after each helmet or glove removal or visor opening. Relative humidity levels, as measured by this device, were approximately 62 percent throughout the flight. Cabin dry-bulb temperatures were recorded between 70° F and 79° F and wet-bulb temperatures were recorded between 50° F and 59° F throughout the mission.

5.1.10.6.10 Survival equipment: The only survival components utilized were the lifevests which were inflated by each crew member before recovery by helicopter. Both sets of vests inflated satisfactorily, although they were not used for flotation during the recovery phase.

5.1.10.7 Bioinstrumentation system. -

5.1.10.7.1 System description: The medical monitoring instrumentation flown on the Gemini IV mission consisted of a flight safety instrumentation package for each pilot, two experiment M-4 (phonocardiogram) instrumentation units, two blood-pressure reprogramer adapter interface electronics units, and two biomedical magnetic tape recorders. The flight safety package consisted of an oral temperature measuring system, blood-pressure measuring system, respiration rate and pattern device, and two electrocardiogram systems. The package was identical for each pilot.

UNCLASSIFIED

5.1.10.7.2 Data retrieved: All of the measurements were transmitted on a real-time basis. The electrocardiograms, respiration, and phonocardiogram measurements were continuous; the oral temperature and blood pressure, by nature of the method of measurements, were intermittent according to flight plan or by request of the medical monitors.

Two channels of electrocardiogram and one of respiration were measured on the pilot during the extravehicular activity (EVA). Other measurements, described in the previous paragraph, were interrupted while the EVA umbilical was in use.

Blood pressure was recorded by the pilot during reentry and by both flight crew members after landing by inserting a blood-pressure reprogrammer adapter in series with the electric umbilical of the space suit.

The two biomedical recorders ran on a preprogrammed basis and recorded electrocardiogram, respiration, and phonocardiogram data on a redundant basis with real-time transmission on the PCM telemetry. When the blood-pressure reprogrammer was used, blood-pressure measurements instead of phonocardiogram were recorded.

5.1.10.7.3 System operation: The command pilot reported difficulty in taking the blood-pressure measurement. The problem involved the mating of the blood-pressure bulb with the suit fitting, as described in paragraph 5.1.10.3.1.

After the biomedical tape recorders were removed from the spacecraft, the tapes were removed and inspected. The tape on recorder no. 2 was intact, and the excess was wound manually on the takeup reel. The tape from recorder no. 1 was wrinkled on about 20 percent of the circumference. Some of this tape was manually unwound and inspected, and the wrinkled area appeared to extend into the entire tape. The excess tape was then manually wound on the takeup reel. During this operation, it was noticed that the takeup reel was bent. Upon receipt of the reels from both recorders, a test was made using the bent reel in recorder no. 1. The tape was run through the transport for 3 days and removed. Upon inspection of the tape, it was again found wrinkled, but only on about 10 percent of the circumference. Also, at the end of the 3-day test, it was noticed that the transport had begun to squeak quite loudly. The two possible reasons for the wrinkled tape are: (1) the bent take-up reel, or (2) the takeup reel was not properly installed.

The tapes from the biomedical recorders have been analyzed by viewing the various channels on an oscilloscope. By this method, it has been determined that each parameter has been recorded on its assigned channel. The blood-pressure measurements made by using the blood-pressure reprogrammer were successful. The recorded data are now being converted to strip chart recordings.

UNCLASSIFIED

5.1.10.7.4 Postflight inspection: Inspection of the biomedical equipment has shown no anomalies other than in the pilot's harness and signal conditioners. These two items were damaged during removal. The command pilot's equipment was removed without damage and returned in good condition.

5.1.10.7.5 Summary: High-quality bioinstrumentation data were received in real time. The recorded data are now being reduced.

5.1.11 Landing System

The parachute landing system functioned as designed. All system events occurred within established tolerances and in the proper order as commanded by the crew. Figure 5.1-19 illustrates the major sequences with respect to ground elapsed time (g.e.t.) and pressure altitude as they occurred in flight.

On this flight, the drogue parachute was deployed at an altitude of 40 000 feet instead of the normal altitude of 50 000 feet. This delay contributed to the subsequent performance of the spacecraft while on the drogue. In addition, there is evidence that the RCS propellant was depleted unexpectedly during the latter stages of reentry and possibly prior to the spacecraft's reaching an altitude of 60 000 feet (see section 5.1.8). If this was the case, the RCS was not able to maintain stability during this period. As a result, the oscillations in pitch and yaw increased in magnitude from 50 000 feet down to 40 000 feet and continued to increase during the 16 seconds that the drogue parachute was in the reefed condition. Previous tests have shown that the reefed drogue parachute will prevent the spacecraft from tumbling, but will permit oscillations as high as $\pm 40^\circ$ to occur. Telemetry data indicate oscillations of $\pm 25^\circ$ in yaw at 40 000 feet, followed by a data loss during the critical reefed drogue period. Increased oscillations during this time are probable and were reported as severe by the flight crew. Following the disreef of the drogue parachute at approximately 31 500 feet, the oscillations damped quickly and remained at low magnitudes for the remainder of the descent.

Spacecraft 4 was subjected to another unusual condition at the time of drogue parachute deployment. The spacecraft was rolling at a rate of approximately 60 deg/sec when drogue parachute deployment was commanded. Subsequent to the deployment, this roll rate decreased until, at drogue parachute jettison, the rate was approximately 23 deg/sec. This condition appeared to have no detrimental effect on the overall system performance.

UNCLASSIFIED

5.1.12 Postlanding and Recovery Systems

Recovery photographs indicate that the UHF descent and recovery antennas, the recovery flashing light, and the sea dye marker satisfactorily deployed during the descent and landing phases of the mission. Shortly after landing, the crew successfully extended the HF antenna and later retracted it just prior to egress. The recovery hoist loop failed to deploy when the main parachute was jettisoned, but was later deployed manually by the recovery team. An investigation of this anomaly revealed that physical interference between the recovery-hoist-loop door and the phenolic filler in the parachute-bridle-stowage trough prevented the door from deploying. In three tests, a load of 64, 58, and 63 pounds, respectively, was required in addition to the spring force to open the door. Action has been initiated to inspect future spacecraft for the proper clearance of the recovery-hoist-loop door and preclude a recurrence of this anomaly. The operation and effectiveness of the recovery aids are covered in the communications and recovery-operations portions of this report.

UNCLASSIFIED

TABLE 5.1-I.- GEMINI IV TEMPERATURE INSTRUMENTATION^a

Parameter	Description	Location	Instrumentation range, °F	Accuracy, °F
PB05	R and R section outer skin	Z217, R03.2, BY	70 to 1900	±37
PC03	RCS section outer skin	Z189, R03.2, BY	70 to 1900	±37
PC04	RCS section outer skin	Z189, L _X , T03.0	70 to 1900	±37
PD03	Cabin section outer skin	Z116, R00.0, BY	70 to 1900	±37
PD04	Cabin section outer skin	Z163.4, R00.0, BY	70 to 1900	±37
PD06	Cabin section outer skin	Z131, R00.0, BY	70 to 1900	±37
PD07	Cabin section outer skin	Z135.9, L _X , T01.5	^b -459 to 85	±25
PD08	Cabin section outer skin	Z133.4, R02.6, TY	^b -459 to 85	±25
PE11	Heat-shield ablation material at bondline	B.L., R00.0, T39.0	-55 to 1055	±20
PE12	Heat-shield ablation material at bondline	B.L., R00.0, B29.3	-55 to 1055	±20

^aReference junction (MA24) ranged from 85° F during launch and revolutions 1, 2, and 3 to 70° F during later revolutions.

^bEffective range.

UNCLASSIFIED

UNCLASSIFIED

TABLE 5.1-II.- REAL-TIME DATA RECEIVED BY TEL II

Revolution	Total data received		Total losses		Usable data, percent
	Duration, sec	Total master frames	Master frames	Percent	
Launch	427	17 217	236	1.37	98.63
1	410	16 400	200	1.22	98.78
2	429	17 164	177	1.03	98.97
3	466	18 632	293	1.57	98.43
4	352	14 076	212	1.51	98.49
14	377	15 088	116	0.77	99.23
19	237	9 484	484	5.10	94.90
44	412	16 476	343	2.08	97.92
48	402	16 092	387	2.41	97.59
59	428	17 120	722	4.22	95.78
60	415	16 608	463	2.79	97.21
61	394	15 760	32	0.20	99.80
Preblackout 62	7	280	80	^a 28.58	^a 71.42
Postblackout 62	50	2 000	35	^a 17.40	^a 82.60

^aThese losses include intermittent reception associated with entering and leaving blackout.

UNCLASSIFIED

UNCLASSIFIED

TABLE 5.1-III. - DELAYED TIME DATA FROM SELECTED STATIONS

Station	Revolutions	Total data received		Total losses		Usable data, percent
		Duration, hr:min:sec	Prime subframes	Prime subframes	Percent	
Tel II	1, 2, 14, 15, 16, 17, 18, 29, 30, 31, 32, 44, 45, 46, 47, 48, 59, 60, 61	28:15:54	1 017 542	814	0.08	99.92
Texas	3, 19, 34, 49	06:30:03	234 037	125	0.05	99.95
Hawaii	7, 21, 22, 36, 37, 51, 52	09:27:38	340 580	875	0.26	99.74
Antigua	27, 42, 51	04:13:02	151 825	46	0.03	99.97
Onboard recorder	Last plus reentry	01:34:07	56 474	879	1.56	98.44
Total		50:00:45	1 800 459	2739	0.15	99.85

UNCLASSIFIED

UNCLASSIFIED

TABLE 5.1-IV.- GUIDANCE AND CONTROL SUMMARY CHART

Ground elapsed time, sec		Event	Component				Remarks
Planned	Actual		ACME	Computer	IMU	Horizon sensor	
10.16	10.10	Roll program start	IGS backup	Ascent	Free	Search (primary)	
20.48	20.40	Roll program end	IGS backup	Ascent	Free	Search (primary)	
23.04	22.95	No. 1 pitch rate start	IGS backup	Ascent	Free	Search (primary)	
88.32	88.21	No. 2 pitch rate start	IGS backup	Ascent	Free	Search (primary)	
104.96	104.67	No. 1 gain change	IGS backup	Ascent	Free	Search (primary)	
105.00	105.00	No. 1 IGS update	IGS backup	Ascent	Free	Search (primary)	
119.04	118.66	No. 3 pitch rate start	IGS backup	Ascent	Free	Search (primary)	
145.00	145.00	No. 2 IGS update	IGS backup	Ascent	Free	Search (primary)	
162.56	162.07	Termination of pitch program	IGS backup	Ascent	Free	Search (primary)	
335.82	333.75	SECO	IGS backup	Ascent	Free	Search (primary)	

UNCLASSIFIED

UNCLASSIFIED

TABLE 5.1-IV.- GUIDANCE AND CONTROL SUMMARY CHART - Continued

Ground elapsed time, hr:min:sec		Event	Component				Remarks
Planned	Actual		ACME	Computer	IMU	Horizon sensor	
00:05:56	00:06:05	Separation	Direct	Ascent	Free	Search	OAMS maneuver TCA 14 was fired for 1.4 sec prior to separation to damp GLV rates. The initial and final rates were: Pitch, +0.05 to -0.05 deg/sec; yaw, 0.37 to 0.01 deg/sec; roll, 0.45 to 0.18 deg/sec. The separation attitudes were: pitch, -4°; yaw, 2.5°; and roll, 89°. The aft TCA's 9 and 10 were on for 4.9 sec to provide the separation velocity. The disturbance torques from these TCA's were small, producing accelerations in pitch, yaw, and roll of -0.24, -0.2, and +0.14 deg/sec ²
	00:08:46	Station keeping	Direct pulse, rate command	Catch up	Free, orbit rate	Search	A temporary failure is indicated in TCA 9 at 64 minutes after lift-off. This was established by the decrease in acceleration from the aft pair and the effect on the pitch TCA's. The maximum acceleration with the pitch TCA's on was +0.06 deg/sec ² . The calculated pitch acceleration from TCA 10 is +4.18 deg/sec ² while that from pitch TCA's is -4.12 deg/sec ² .
	00:13:33	Platform alinement	Pulse	Catch up	SEF	Search	The platform was alined for 6 min 29 sec. A good alinement was achieved due to the small initial errors.
	04:23:00	EVA	Pulse		Orbit rate	Primary	Maximum attitude accelerations induced by the extravehicular activity were approximately 0.3 deg/sec ² .
	05:40:00	IGS "off"	Pulse	Off	Off	Off	

UNCLASSIFIED

UNCLASSIFIED

TABLE 5.1-IV.- GUIDANCE AND CONTROL SUMMARY CHART - Continued

Ground elapsed time, hr:min:sec		Event	Component				Remarks
Planned	Actual		ACME	Computer	IMU	Horizon sensor	
67:34:00	67:33:00	IGS power up	Pulse	Prelaunch	Free, cage, SEF, orbit rate	Primary	IGS powered up and indicated normal operation.
	68:17:17	Platform alinement	Pulse	Prelaunch	SEF	Primary	Alined for 16 min 48 sec. Approximately 6° yaw error remained at end.
68:38:00	68:41:00	Horizon sensor sunset check	Pulse, direct	Prelaunch	Orbit rate	Primary	The sun was swept three times. Loss of track occurred once at 68:41:51 g.e.t. The attitudes in pitch, yaw, and roll were 178°, -10°, and 182°, respectively. The yaw rate was -2.25 deg/sec. The actual loss of track lasted 11 sec, while the sensor ignore light remained on properly for 18 sec.
68:59:00	68:59:26	Horizon sensor moon check	Pulse, direct	Prelaunch	Oribit rate	Primary	The moon was swept through the field of view four times. No loss of track occurred.
69:06:00	69:06:00	Apollo night yaw orientation	Pulse, direct	Prelaunch	Orbit rate	Primary	The pilot visually oriented the spacecraft within a few degrees of the horizontal plane within the 2 min 20 sec stated in the pilot report.
69:42:00	69:43:20	Horizon sensor thruster plume check	Rate command	Prelaunch	Orbit rate	Primary	The forward maneuver engines were fired for 1 sec. During this time the horizon sensor did not lose track. The spacecraft attitudes in pitch, yaw, and roll were -10°, 86°, and +8°, respectively.

UNCLASSIFIED

UNCLASSIFIED

TABLE 5.1-IV.- GUIDANCE AND CONTROL SUMMARY CHART - Concluded

Ground elapsed time, hr:min:sec		Event	Component				Remarks																				
Planned	Actual		ACME	Computer	IMU	Horizon sensor																					
69:43:00	69:45:40	Horizon sensor track check	Pulse	Prelaunch	Orbit rate	Primary	The horizon sensor lost track at the following spacecraft attitudes: <table border="1"> <thead> <tr> <th>Test</th> <th>Pitch, deg</th> <th>Yaw, deg</th> <th>Roll, deg</th> </tr> </thead> <tbody> <tr> <td>Positive pitch</td> <td>+29</td> <td>0</td> <td>-8</td> </tr> <tr> <td>Negative pitch</td> <td>-29</td> <td>2</td> <td>2</td> </tr> <tr> <td>Positive roll</td> <td>0</td> <td>-2</td> <td>+35</td> </tr> <tr> <td>Negative roll</td> <td>-6</td> <td>+1</td> <td>-32</td> </tr> </tbody> </table> In general, the spacecraft rate was 0.5 deg/sec throughout and the sensor output saturated at 19°.	Test	Pitch, deg	Yaw, deg	Roll, deg	Positive pitch	+29	0	-8	Negative pitch	-29	2	2	Positive roll	0	-2	+35	Negative roll	-6	+1	-32
Test	Pitch, deg	Yaw, deg	Roll, deg																								
Positive pitch	+29	0	-8																								
Negative pitch	-29	2	2																								
Positive roll	0	-2	+35																								
Negative roll	-6	+1	-32																								
69:58:00	70:05:00	Attitude thruster failure check	Direct	Prelaunch	Orbit rate	Primary	Disturbance torques generated by the simulated failure were shown to be controllable.																				
	96:52:54	Platform alinement	Pulse	--	SEF	Primary	Alined for 33 min 14 sec. No errors noted.																				
97:04:00	96:35:40	RCS checkout	Rate command, direct	--	Orbit rate	Primary	Body accelerations during this test established the failure of RCS ring B thruster 5.																				
97:28:02	97:28:02	OAMS retrofire	Rate command	--	Orbit rate	Locked on (primary)	The maneuver lasted for 160.6 sec. Both aft-firing TCA's were again functioning properly. The disturbance accelerations in pitch, yaw, and roll were -0.38, -0.17, and +0.27 deg/sec ² , respectively.																				
	97:31:10	Platform alinement	Pulse	--	SEF	Primary	Alined for 6 min 18 sec. No errors noted.																				
97:40:02	97:40:01	Retrofire	Rate command	--	Free	Locked on (primary)																					
	97:42:31	400 000 feet	Rate command	--	Free	Jettisoned																					
97:50:58	97:50:53	Drogue parachute deployment	Rate command	--	Free	Jettisoned																					

UNCLASSIFIED

UNCLASSIFIED

UNCLASSIFIED

TABLE 5.1-V.- GUIDANCE ERROR AT SECO

	Position, ft			Velocity, ft/sec		
	X	Y	Z	\dot{X}	\dot{Y}	\dot{Z}
IMU error	150	-500	500	-4	-6	15
Navigation error	50	-100	-200	-3	+1	0
Total guidance error	200	-600	300	-7	-5	15

UNCLASSIFIED

TABLE 5.1-VI. - SUMMARY OF ASCENT GUIDANCE SYSTEM ERRORS

(This analysis is preliminary and assumes zero tracking errors)

	Accelerometer scale factor, ppm			Accelerometer bias ^a , g/ppm			Accelerometer quadratic nonlinearity, ppm/g			Accelerometer initialization error, ft/sec			Gyro misalignment, sec			Gyro mass unbalance along input axis, deg/hr/g			Gyro mass unbalance along spin axis, deg/hr/g			
	X	Y	Z	X	Y	Z	X	Y	Z	X	Y	Z	X	Y	Z	X	Y	Z	X	Y	Z	
Platform coordinates																						
Hand fit	-141	-10	-18	-37	-69	+59	(b)	(b)	(b)	(b)	(b)	(b)	(b)	(b)	-33	-.04	-.29	.45	-.17	-.29	-.5	
Error coefficient recovery program	(b)	(b)	(b)	(b)	(b)	(b)	-33.2	(b)	45.2	.64	-.27	(b)	(b)	(b)	-15	(b)	-.243	.44	(b)	(b)	(b)	
Specification values	360			300			300			.5			60			.5			.5			

^aValues computed from free-flight data.

^bNo significant errors attributed in the quantity and process indicated.

CONFIDENTIAL

CONFIDENTIAL

TABLE 5.1-VII.- PRELIMINARY ORBIT INJECTION PARAMETERS AT SECO +20 SECONDS

System	Inertial velocity, ft/sec	Inertial flight-path angle, deg	Inertial velocity components (computer coordinates), ft/sec		
			\dot{X}	\dot{Y}	\dot{Z}
Nominal	25 757	0.000233	25 359	4507	34
IGS	25 738	.058	25 347	4470	-24
STL preliminary BET	25 746	.043	25 353	4478	-36
STL MISTRAM 10 K	25 746	.043	25 353	4478	-36
STL MISTRAM 100 K	25 746	.04	25 352	4477	-36
STL GE Mod III	25 745	.049	25 353	4475	-36
Goddard GE Mod III	25 743	.09	--	--	--
MISTRAM (IP)	25 749	.06	--	--	--
Reconstructed from Bermuda first orbital pass	25 743	.07	--	--	--

~~CONFIDENTIAL~~~~CONFIDENTIAL~~

TABLE 5.1-VIII.- ANGULAR ACCELERATIONS DURING THE RCS SYSTEM TEST

Ring	TCA	Angular acceleration, deg/sec ²		
		Pitch	Roll	Yaw
B	5, 6	+2.1	-0.8	+0.02
A	5, 6	+3.9	+ .13	0
B	1, 2	-3.7	- .16	+ .03
A	1, 2	-3.6	- .18	0
A, B	5, 6	+5.3	- .65	- .45

TABLE 5.1-IX.- HORIZON SENSOR TRACK CHECK DATA

Starting attitude, deg			Maneuver	Unlock point, deg		Lock point, deg	
Yaw	Roll	Pitch		TM data	Pilot data	TM data	Pilot data
0	0	0	Pitch-up	33	33	29	30
			Pitch-down	29	28	26	22
			Roll-CW	33	40	21	35
			Roll-CCW	32	29	27	27
0	10	0	Pitch-up	43	40	48	35
			Pitch-down	31	28	22	21
0	0	10	Roll-CW	37	40	37	30
			Roll-CCW	37	30	30	28

UNCLASSIFIED

TABLE 5.1-X.- SEQUENTIAL EVENTS

Telemetry parameter	Event	Time, g.e.t. hr:min:sec
(a)	Spacecraft shape charge ignition	00:06:04.8
(a)	Spacecraft separation (sensor)	00:06:05.4
AD01	Adapter shape charge ignition	97:39:14.2
AD02	Adapter separation (sensor)	Not received
AD06	Manual retrofire	Not received
AD08	Retrorocket no. 3 fire	97:40:06.2
AD09	Retrorocket no. 2 fire	97:40:11.4
AD10	Retrorocket no. 4 fire	97:40:17.2
AE13	Parachute jettison	Not received

^aFrom Kennedy Space Center real-time 150 channel event recorder.

TABLE 5.1-XI.- BLOWN FUSISTORS

Fuse block identification	Fuse number	Application
F-AF	5-119	Drogue parachute guillotine
F-AG	5-122	Drogue parachute guillotine
F-C	4-14	Retro wiring Pyro switch H-1
F-G	4-23	Adapter equipment wiring Pyro switch F-1
F-Q	5-48	Parachute jettison (forward 2-2)

UNCLASSIFIED

NASA-S-65-6537

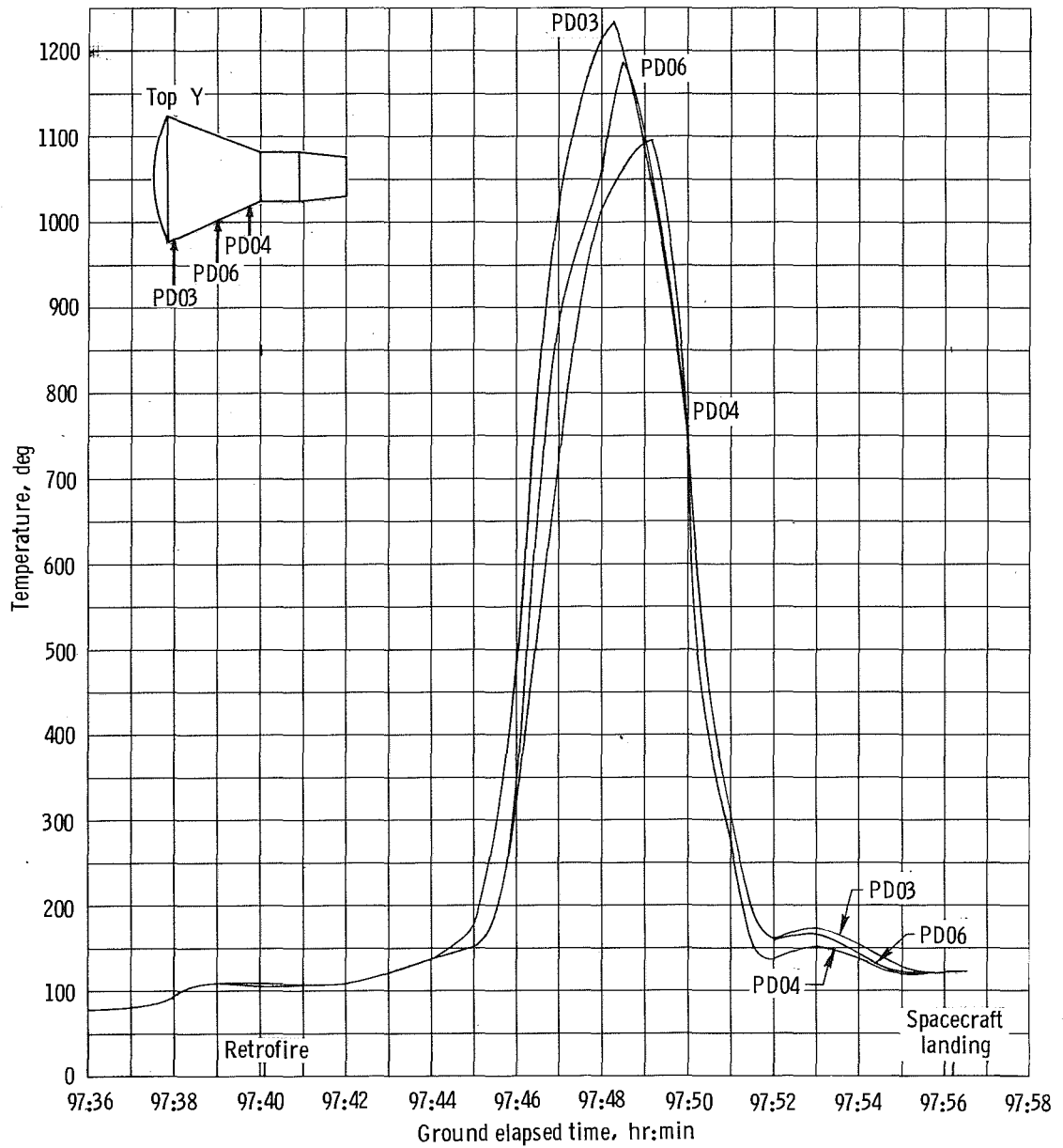

Figure 5.1-1. - Cabin section shingle temperatures during reentry.

NASA-S-65-6538

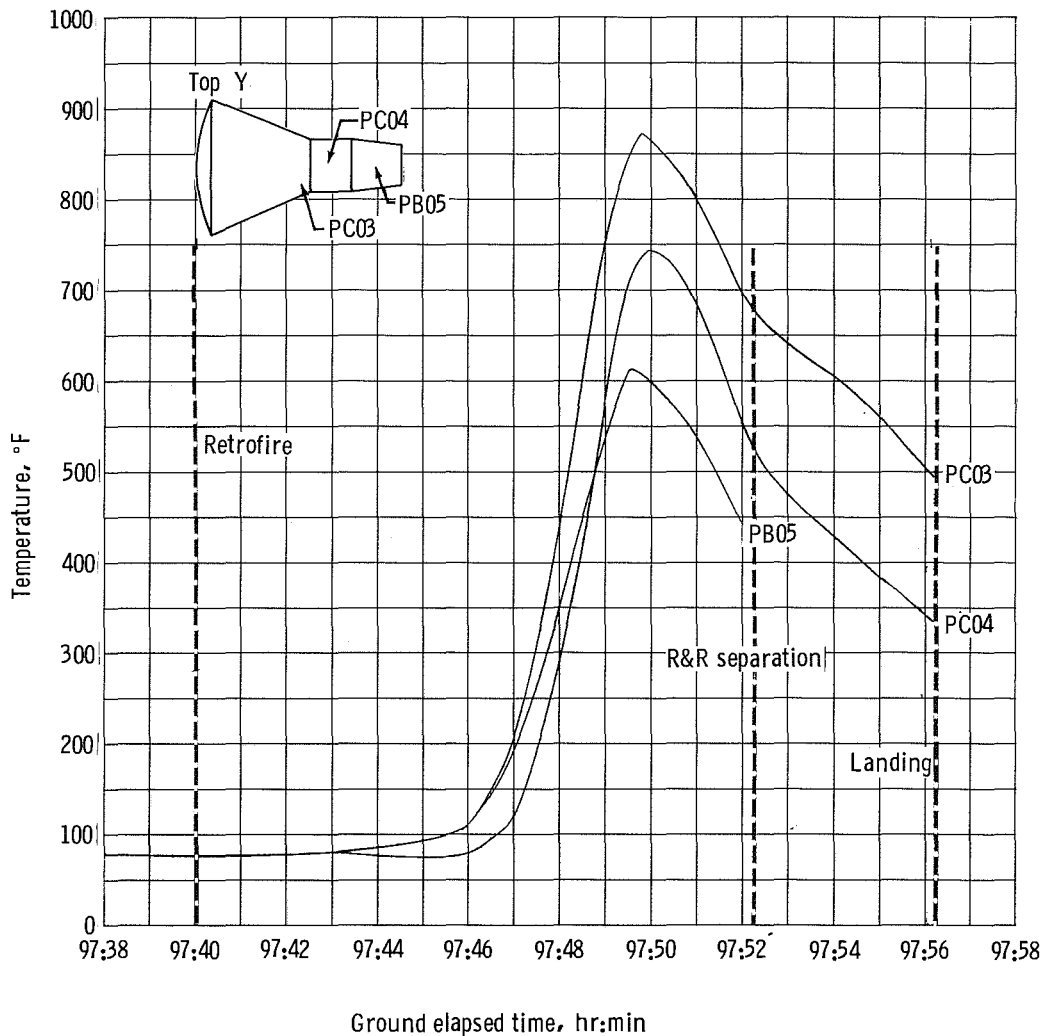

Figure 5.1-2. - RCS and R&R section shingle temperatures during reentry.

UNCLASSIFIED

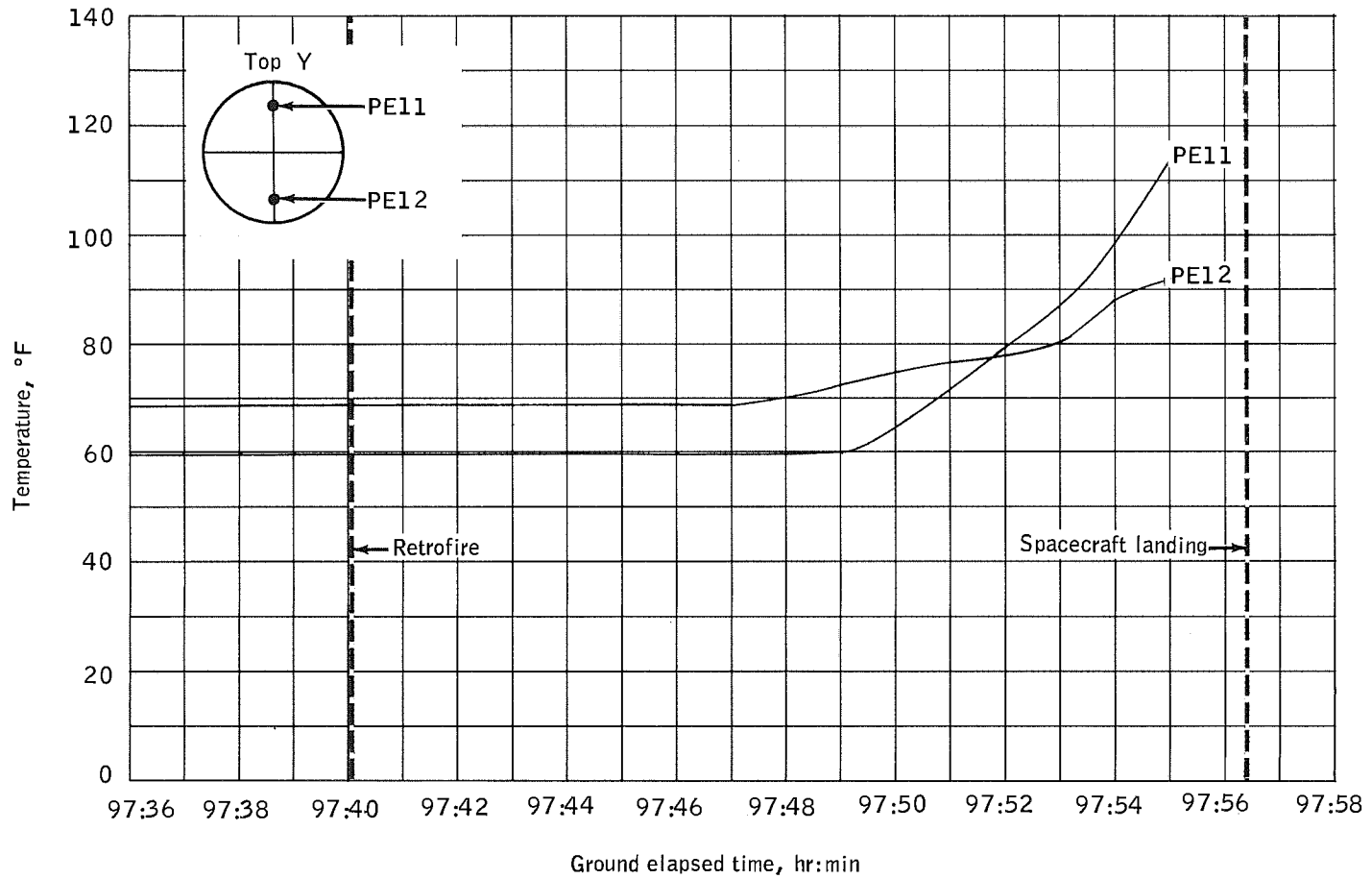

Figure 5.1-3 - Heat shield bondline temperatures during reentry.

UNCLASSIFIED

NASA-S-65-6028

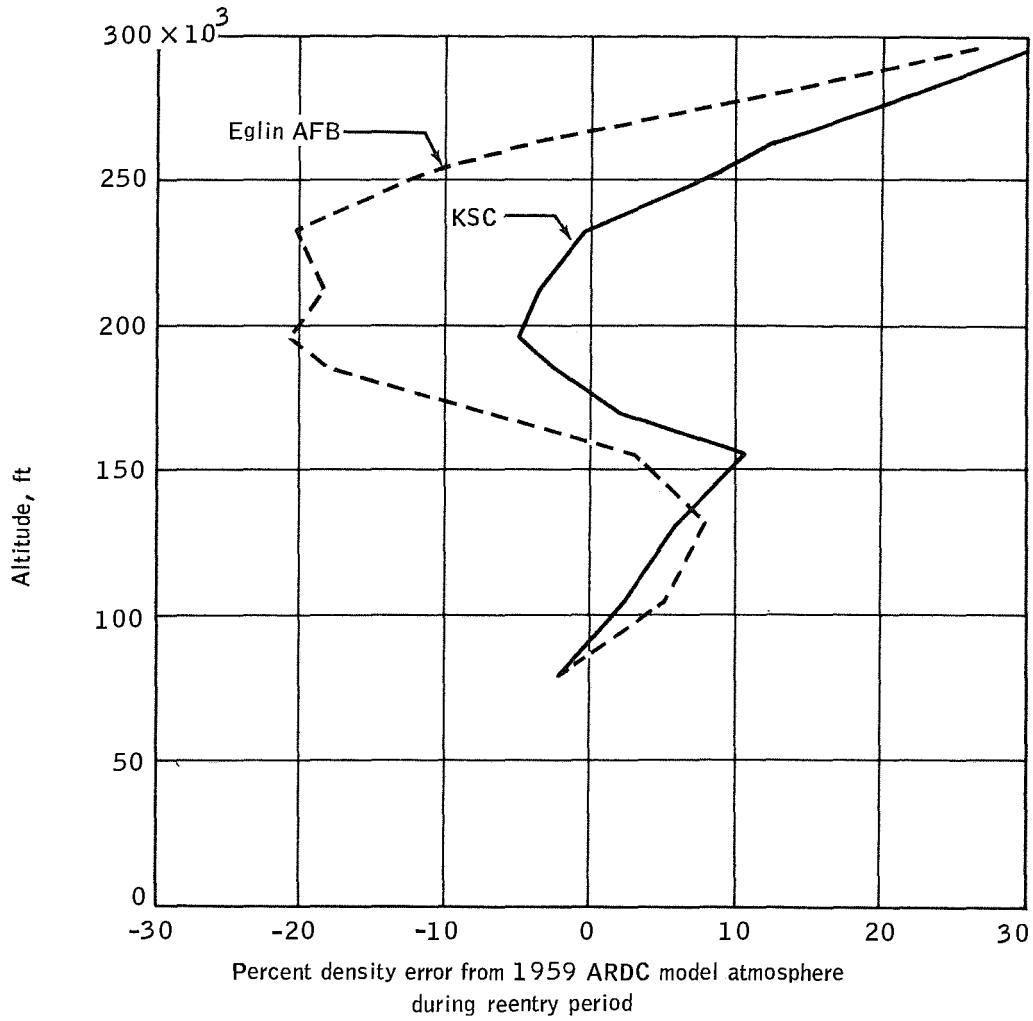

Figure 5.1-4.- Gemini IV atmospheric density comparisons.

CONFIDENTIAL

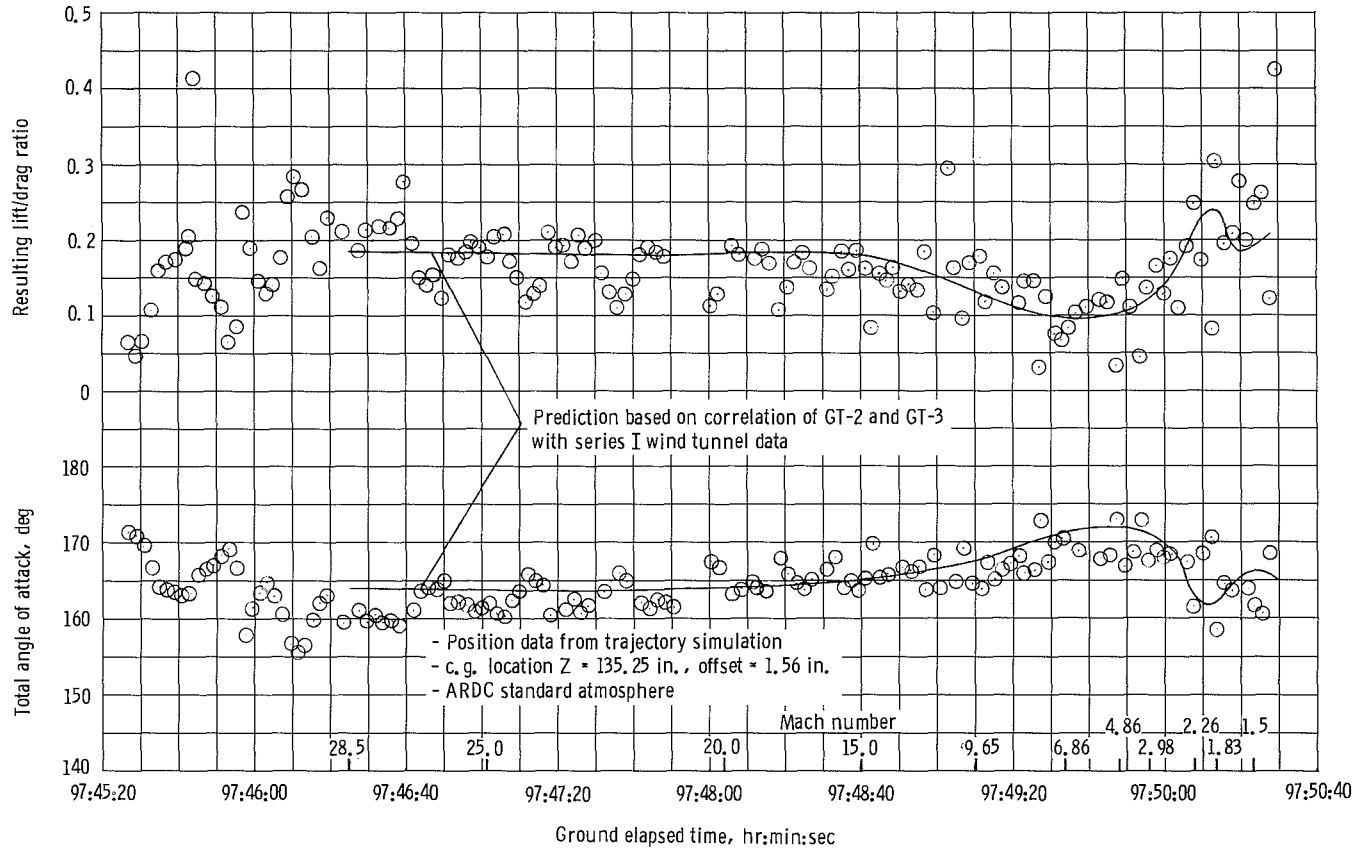

Figure 5.1-5. - Preliminary angle of attack and lift-to-drag ratio.

CONFIDENTIAL

4110

NASA-S-65-6029

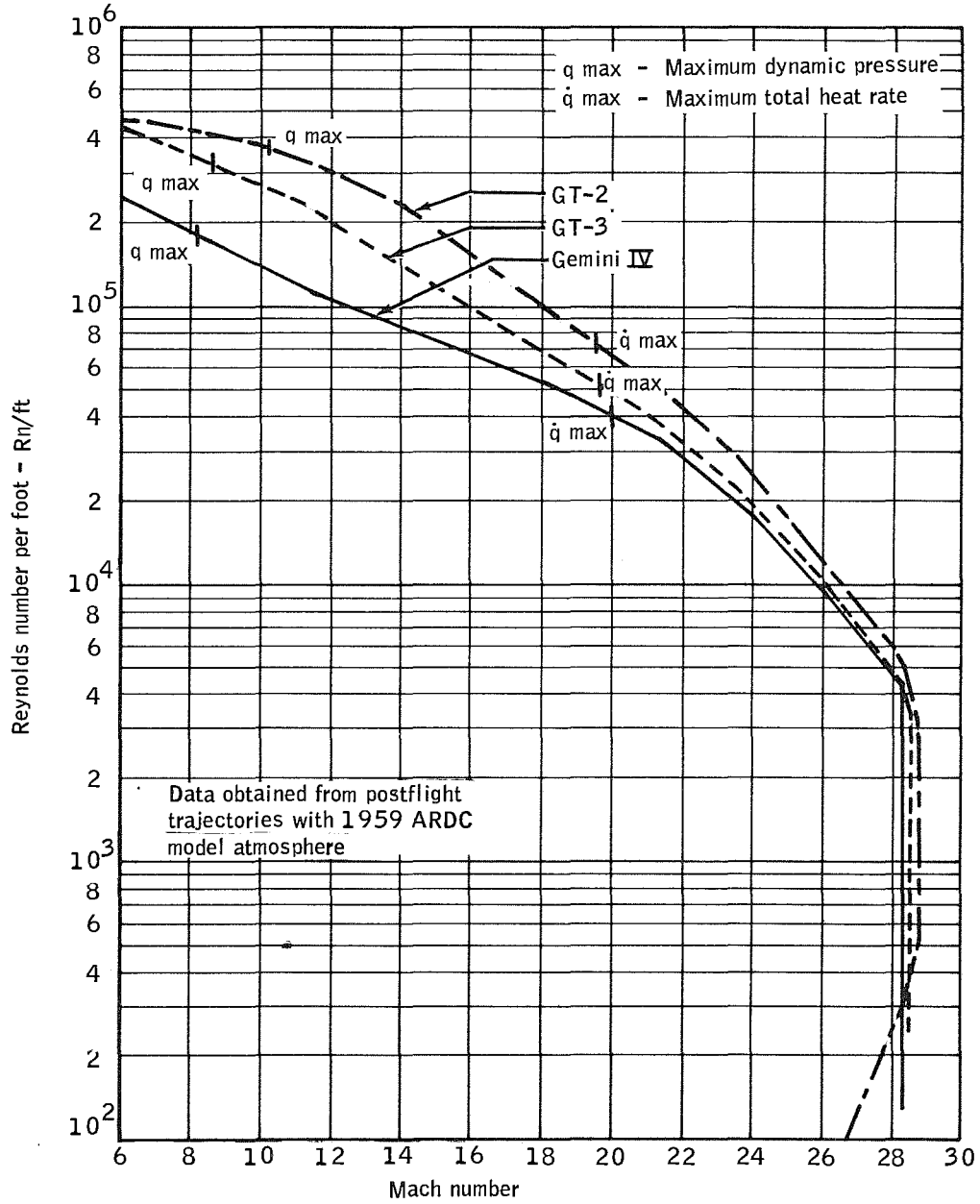

Figure 5.1-6. - Gemini reentry flight Mach - Reynolds number environments.

NASA-S-65-6782

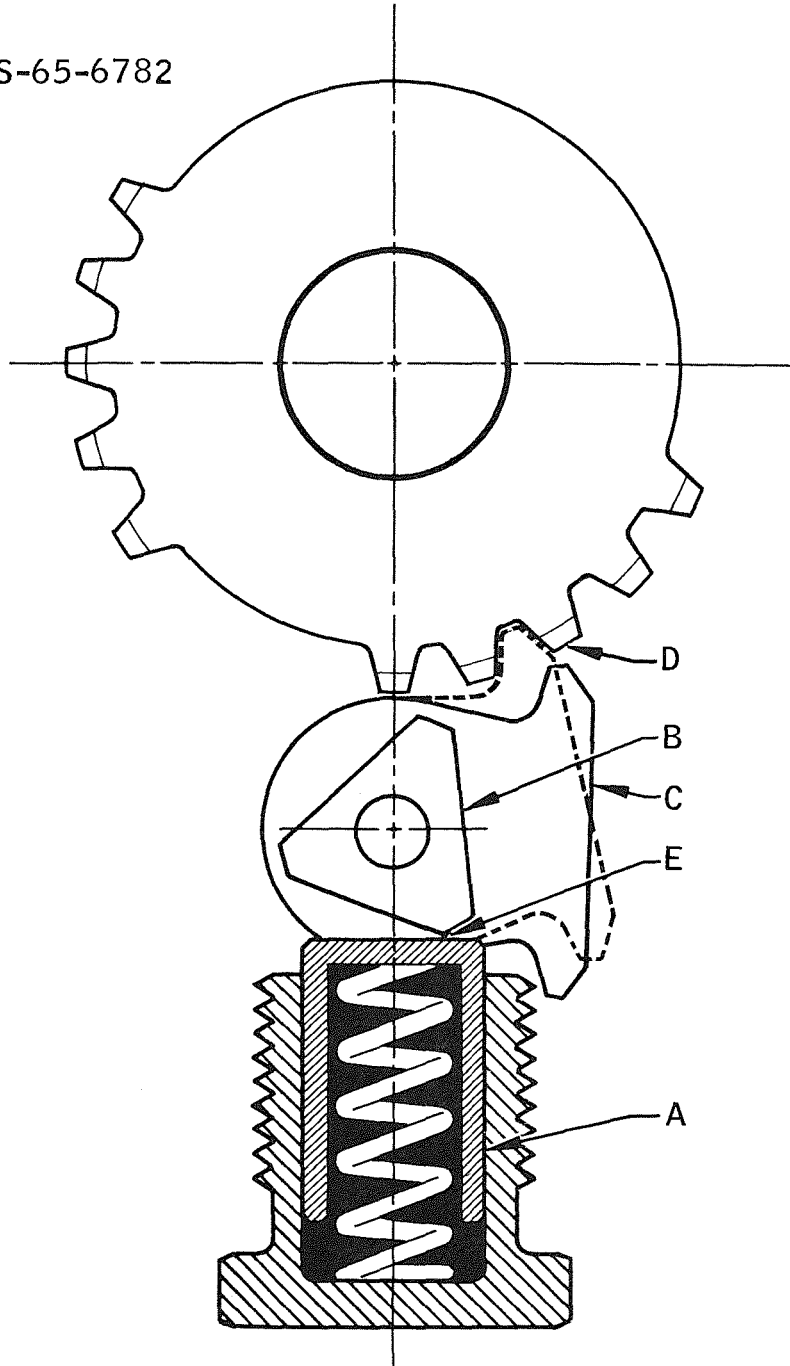
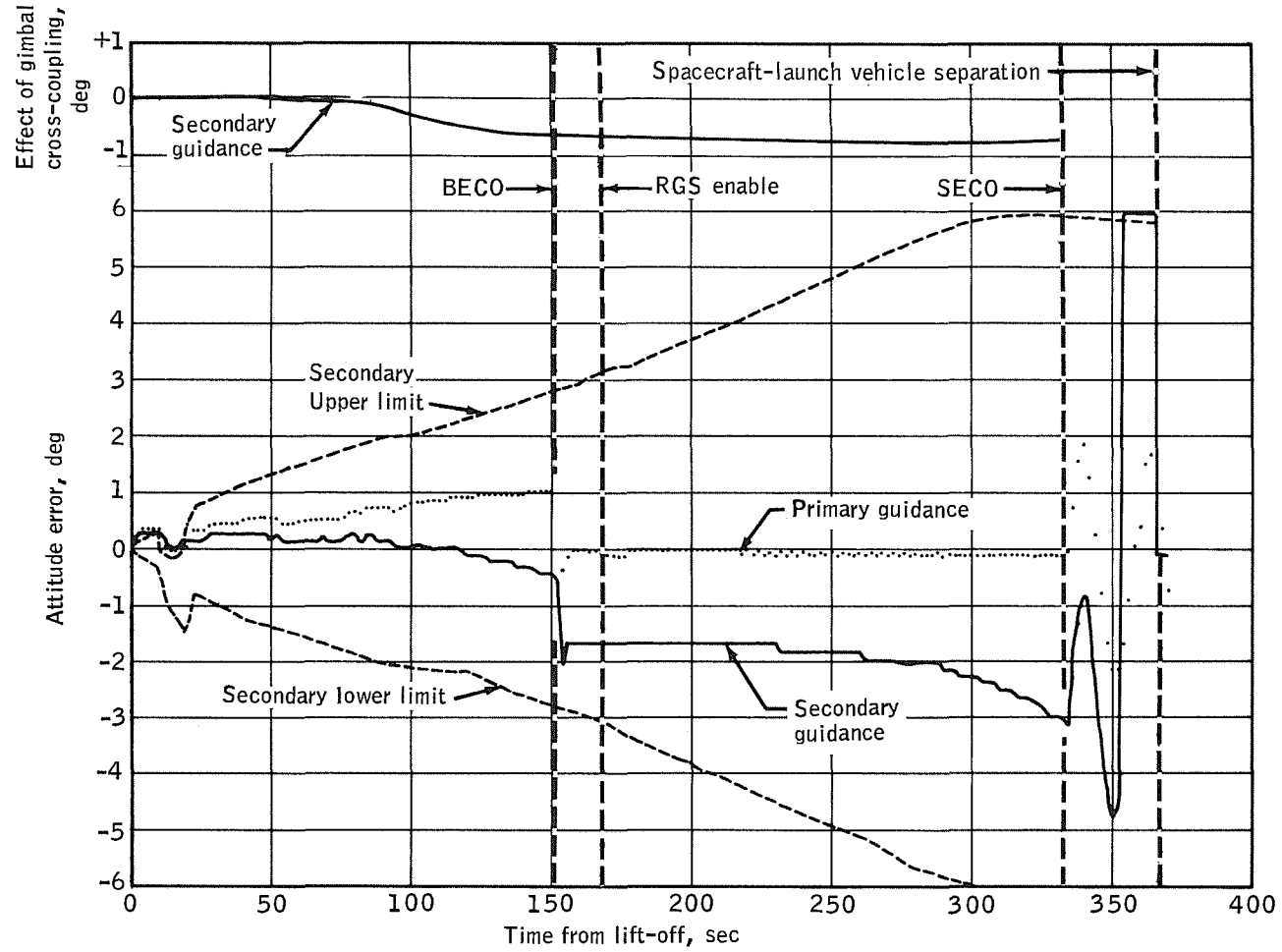

Figure 5.1-7. - Schematic of hatch latching ratchet.

CONFIDENTIAL

CONFIDENTIAL



(a) Roll attitude error

Figure 5.1-8. - Comparison of steering commands during launch with preflight value.

~~CONFIDENTIAL~~

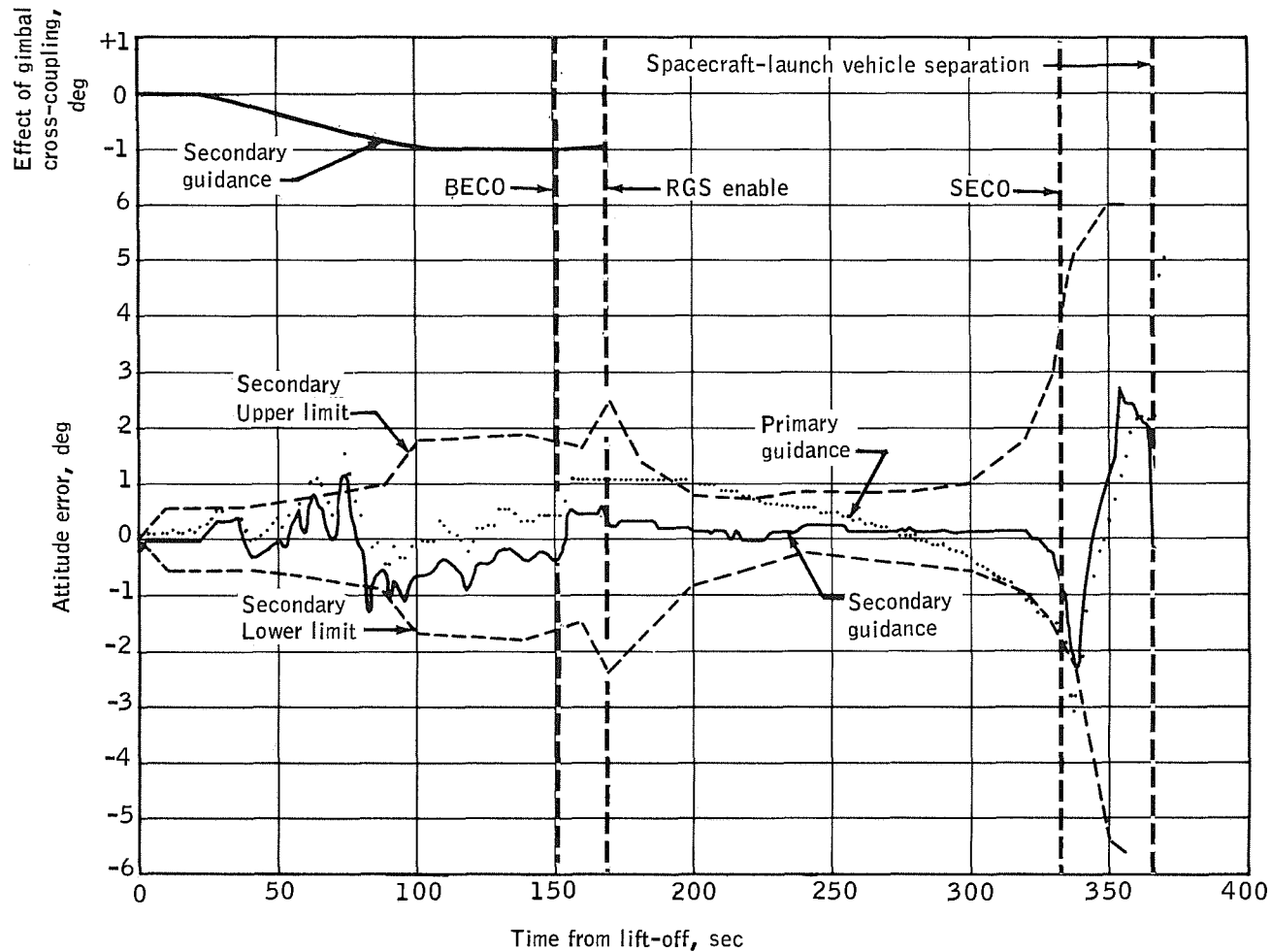

(b) Yaw attitude error
Figure 5.1-8. - Continued.

~~CONFIDENTIAL~~

CONFIDENTIAL

CONFIDENTIAL

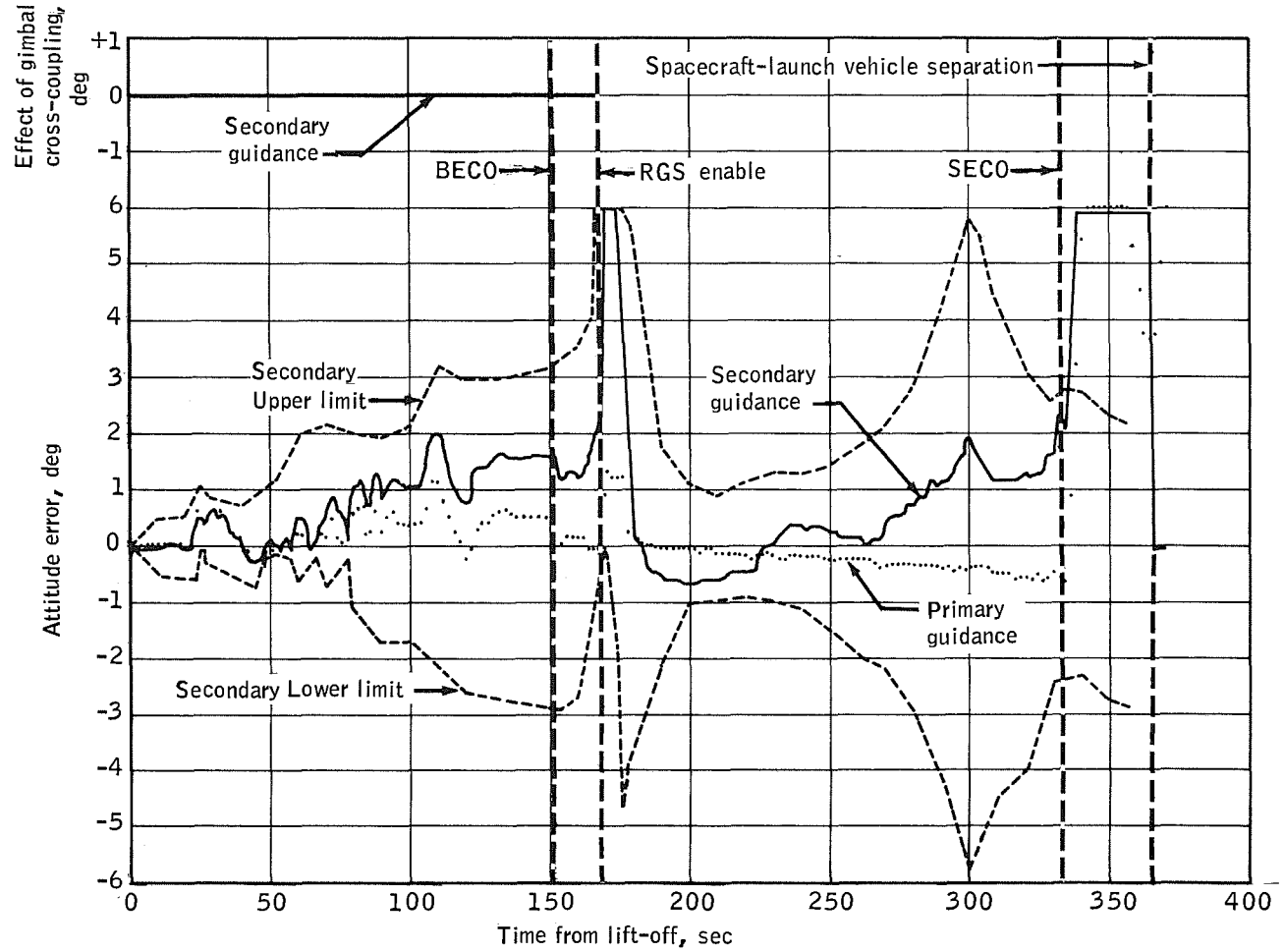

(c) Pitch attitude error
Figure 5.1.5-1. - Concluded.

NASA-S-65-6551

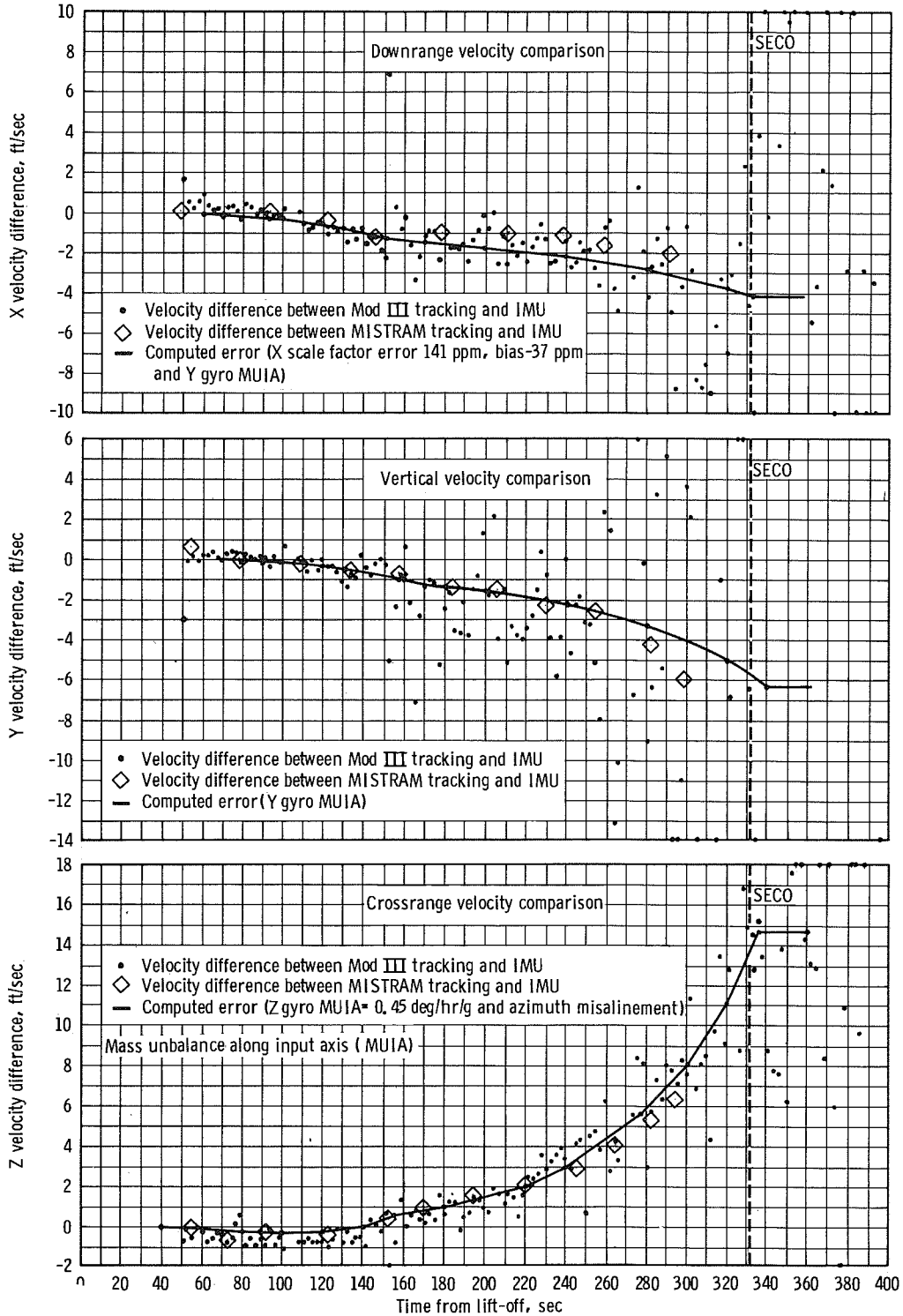

Figure 5.1-9. - Velocity comparisons.

NASA-S-65-6542

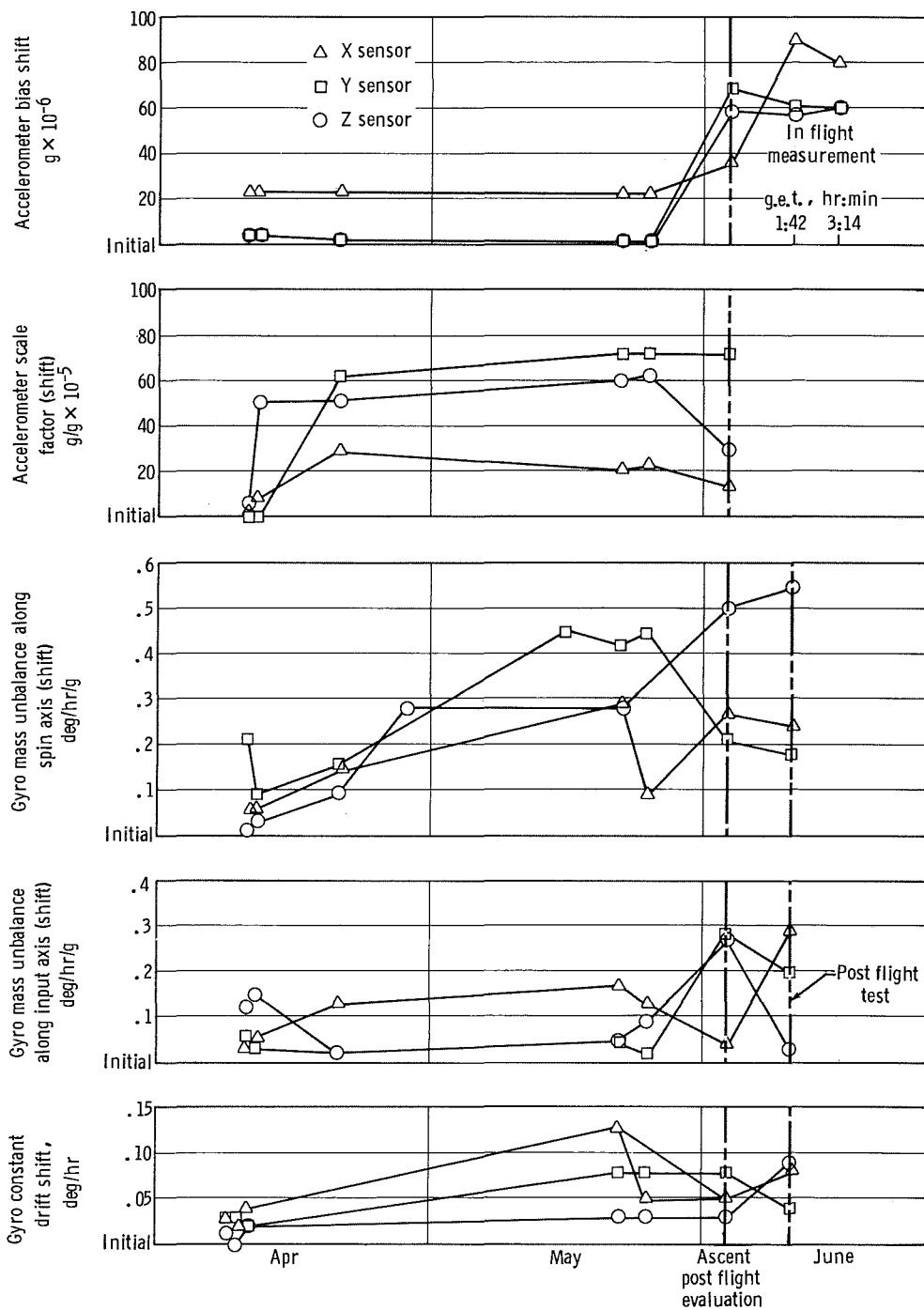

Figure 5.1-10. - IGS error coefficient history.

NASA-S-65-6541

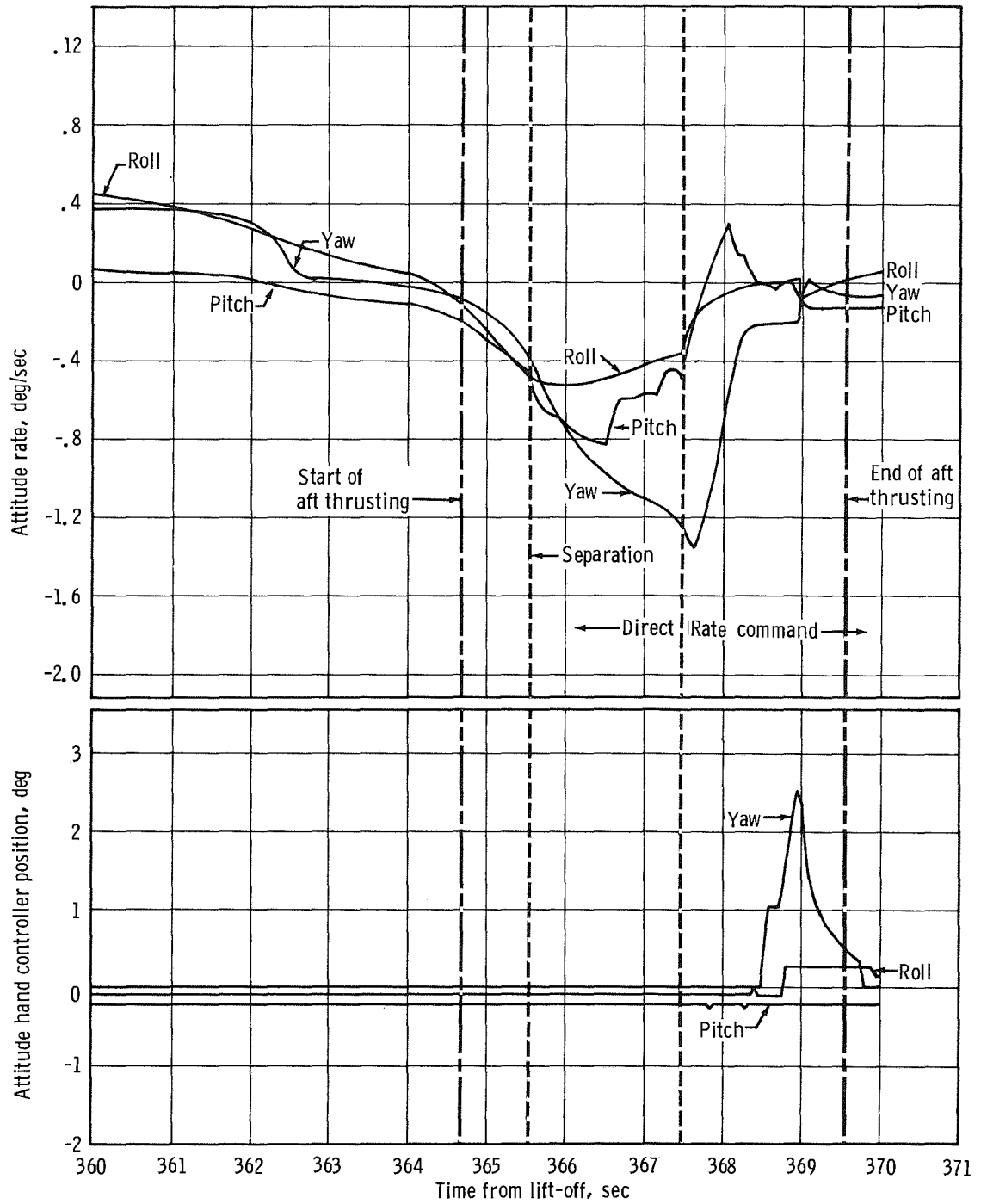
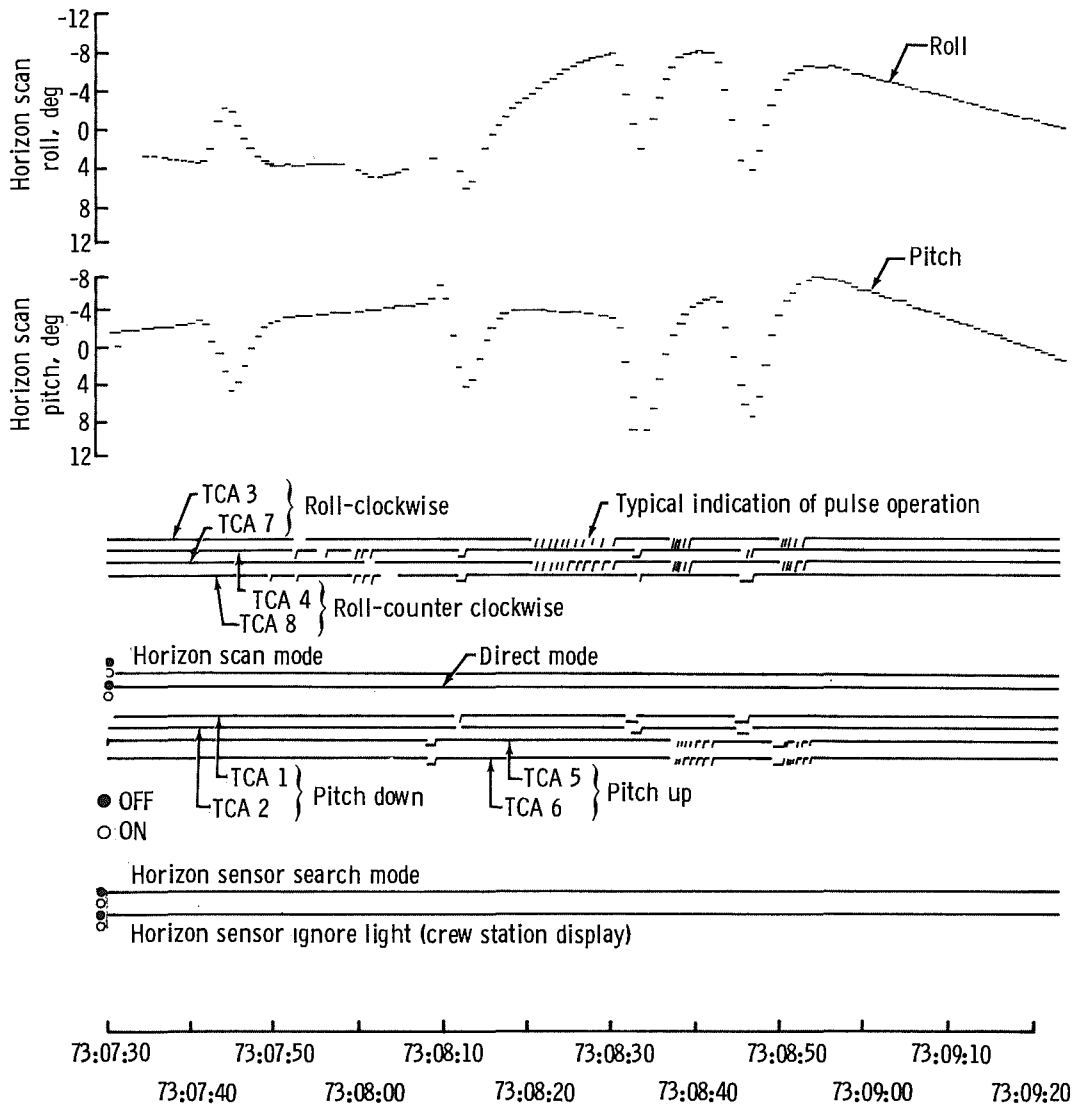

Figure 5.1-11. - Spacecraft - stage II rates at separation.

NASA-S-65-6552



(a) Sun interference with no loss of track.
Figure 5.1-12. - Horizon scan control mode performance.

NASA-S-65-6553

NASA-S-65-6553

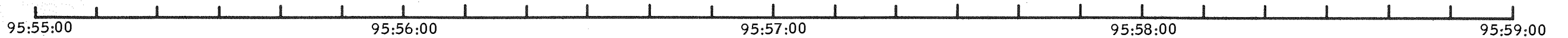
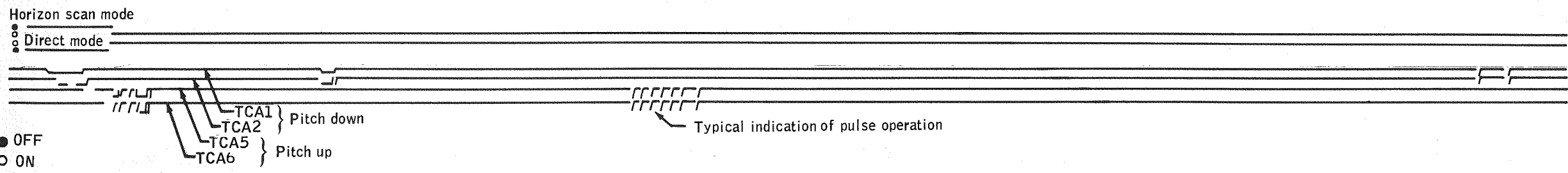
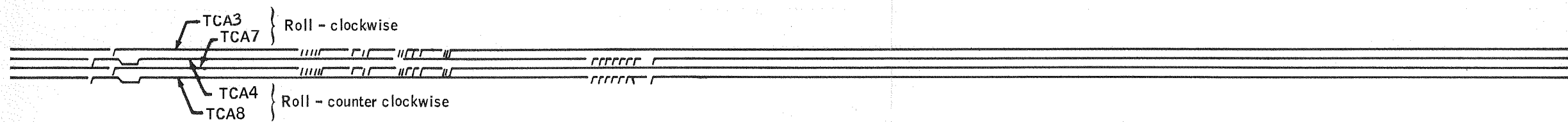
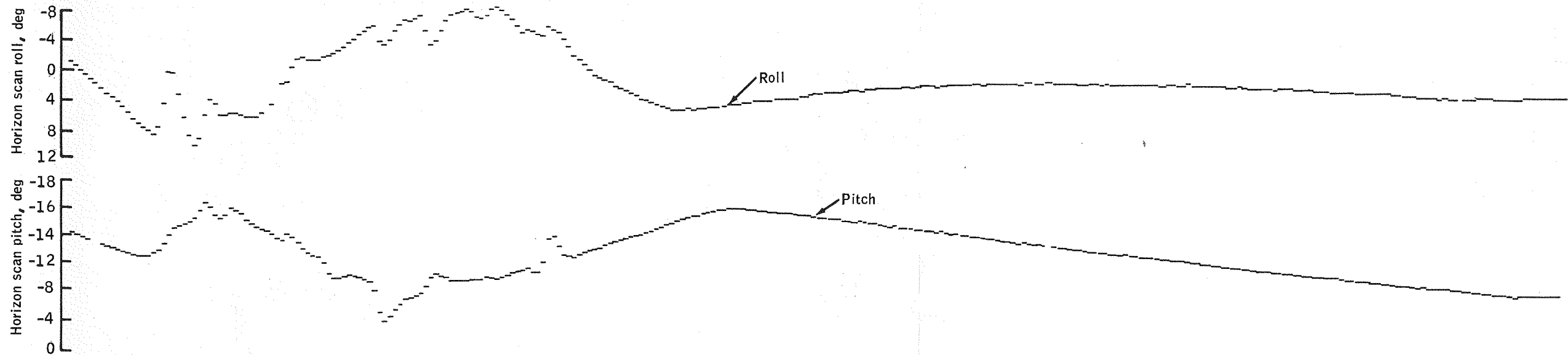

Ground elapsed time, hr:min:sec

(b) Loss of track of horizon sensor due to sun interference.
Figure 5.1-12. - Continued.

~~CONFIDENTIAL~~

NASA-S-65-6678

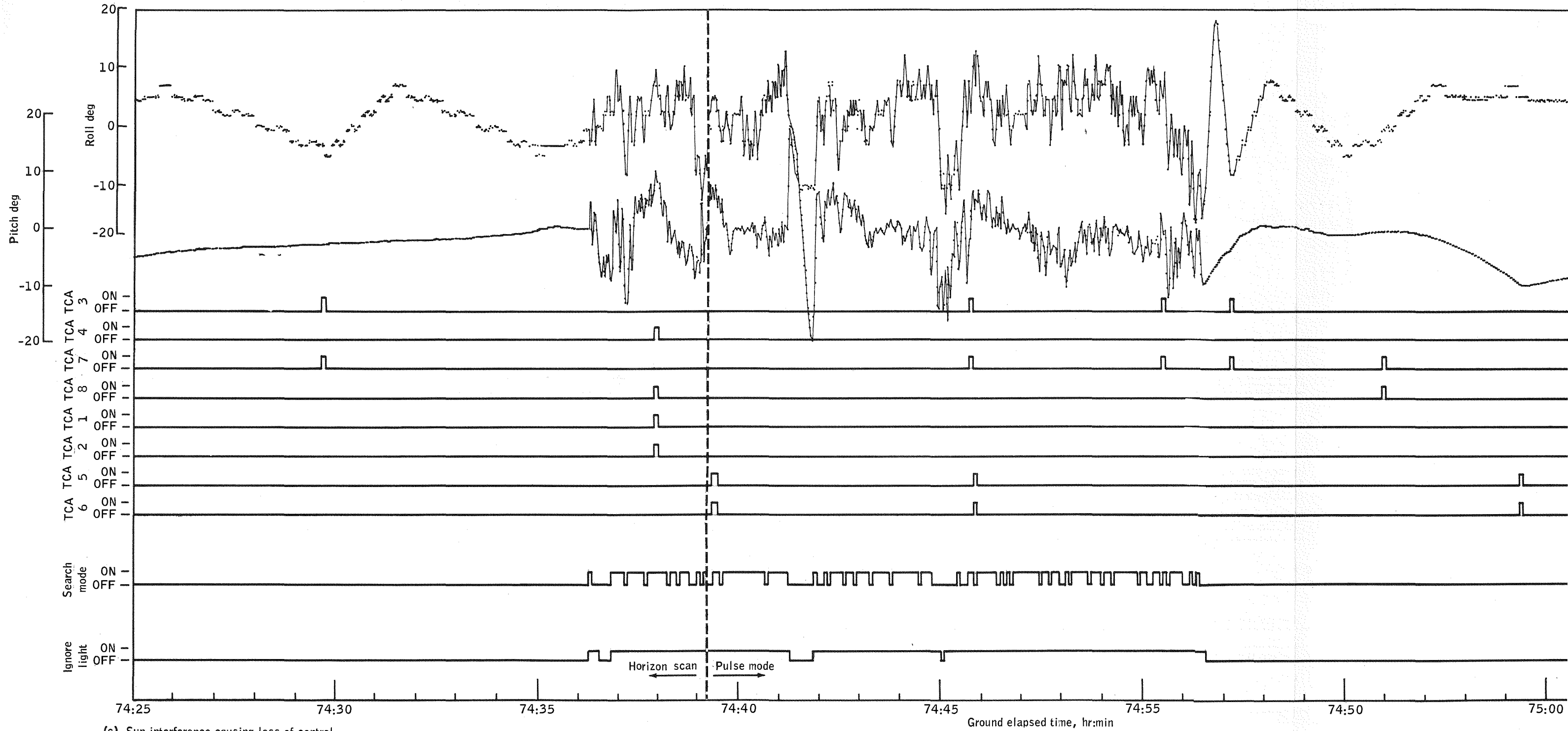

(c) Sun interference causing loss of control
Figure 5.1-12. - Concluded.

~~CONFIDENTIAL~~

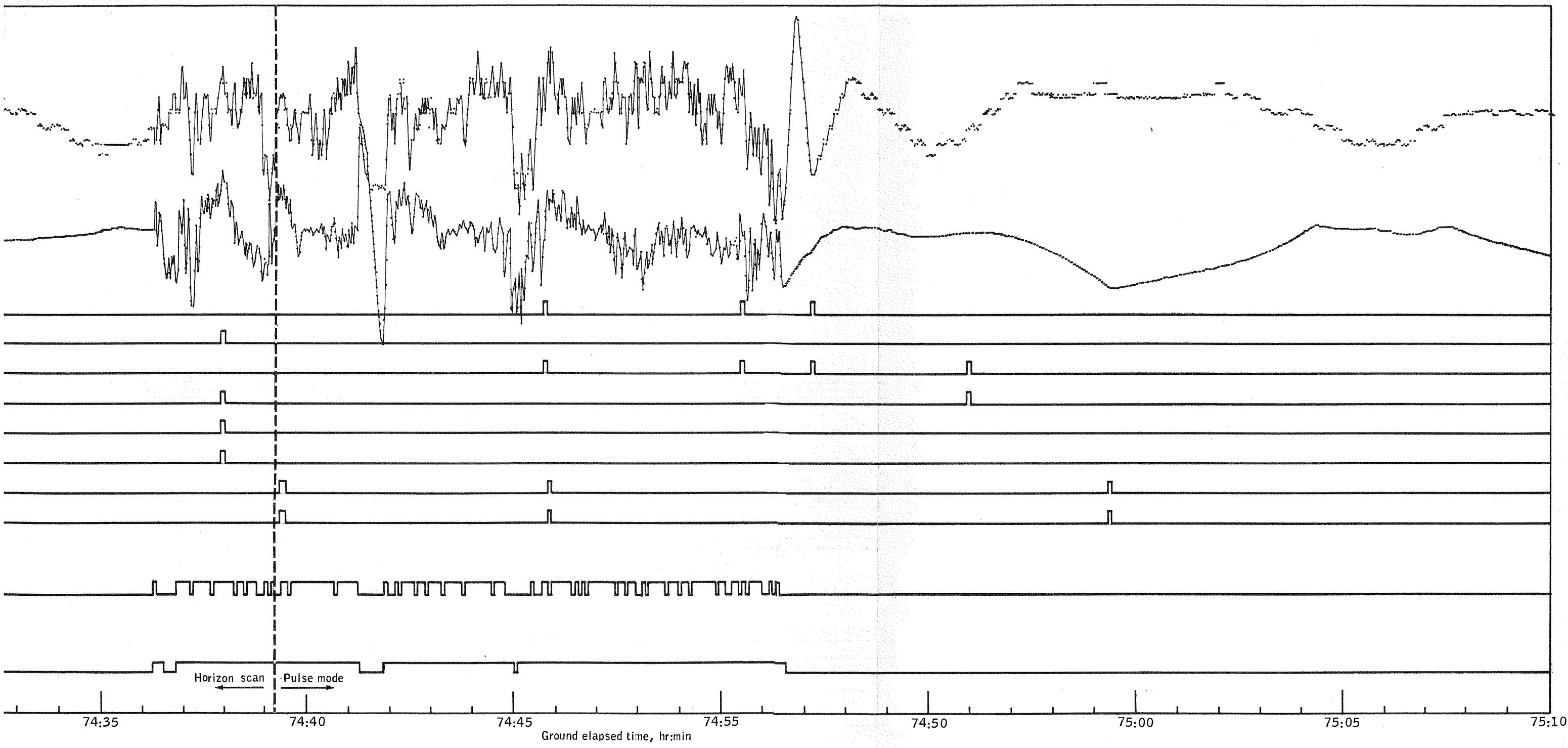

CONFIDENTIAL

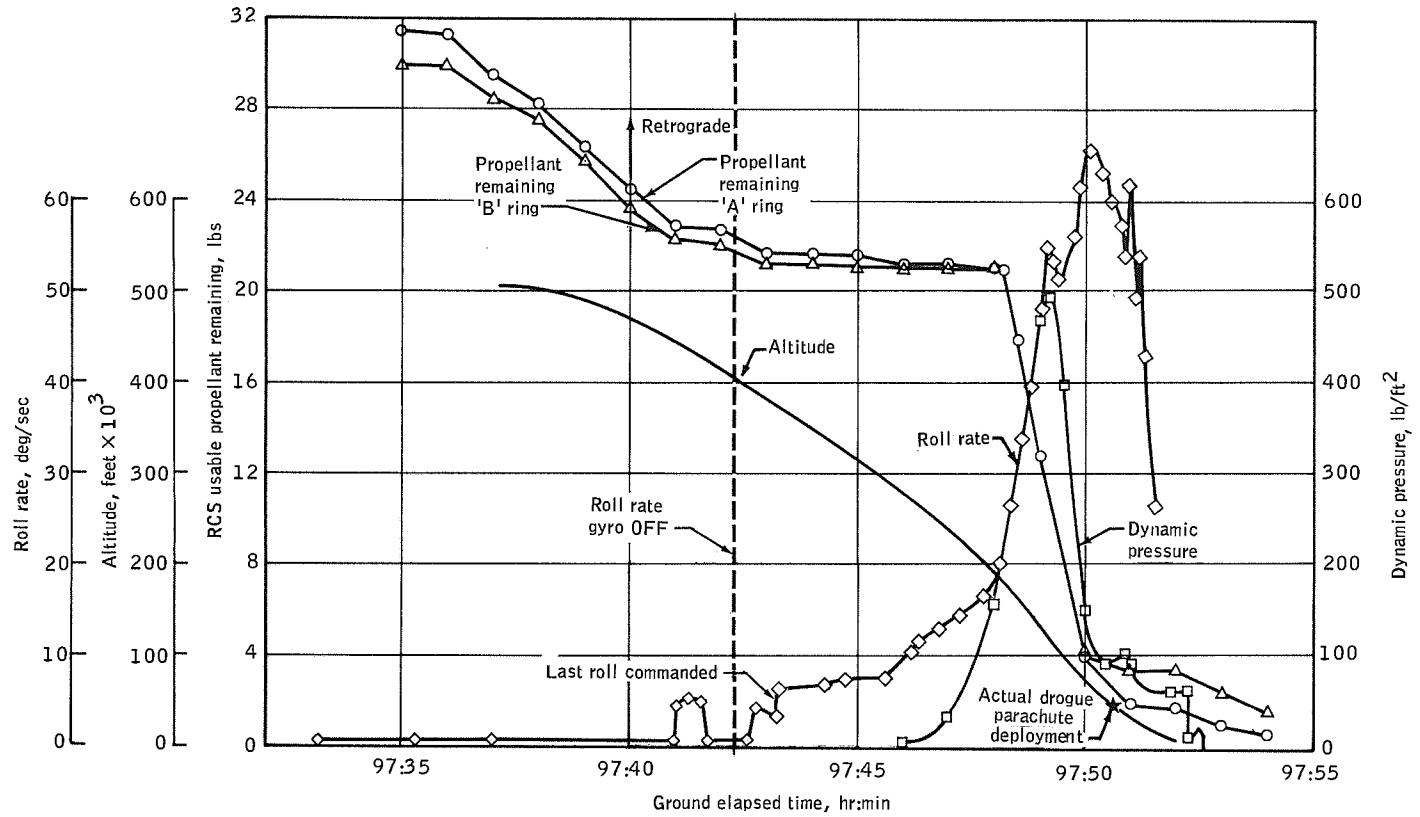

Figure 5.1-13. - Reentry roll rate, altitude, dynamic pressure, and RCS propellant consumption.

CONFIDENTIAL

JNCL

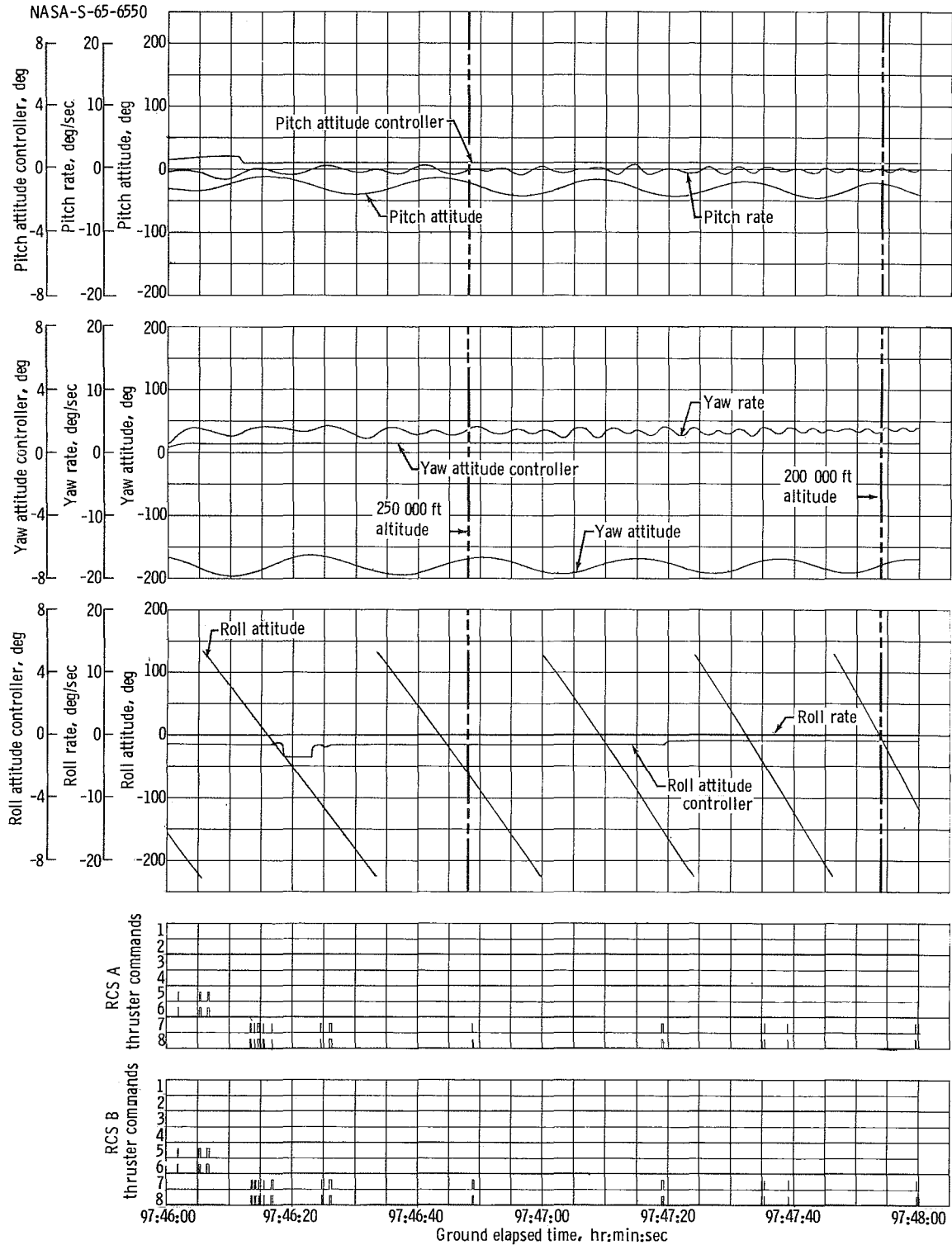
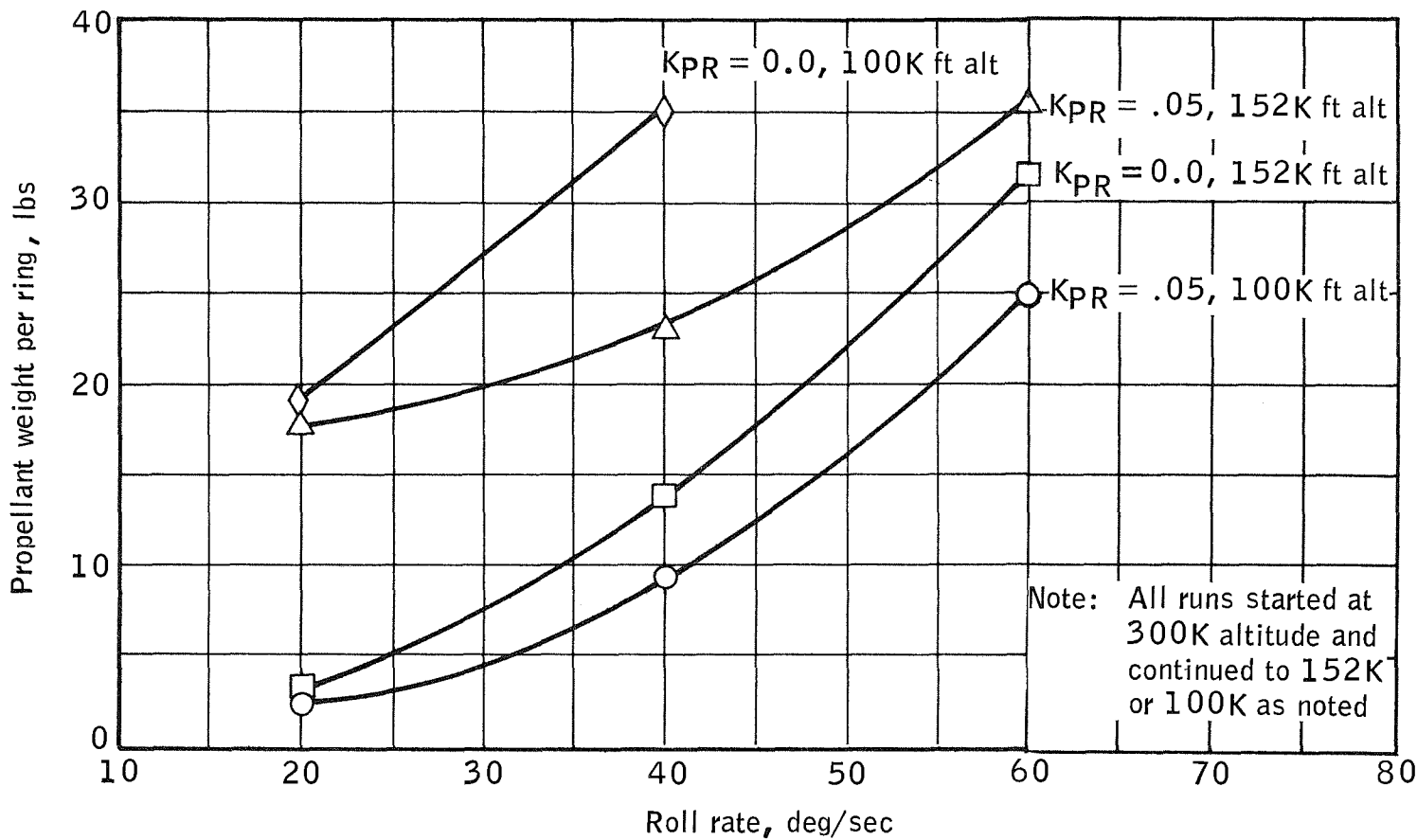

Figure 5.1-14. - Typical reentry time histories.

~~CONFIDENTIAL~~



~~CONFIDENTIAL~~

WMC

Figure 5.1-15. - Design curves of propellant consumption vs roll rate and K_{PR} (roll-yaw coordination).

UNCLASSIFIED

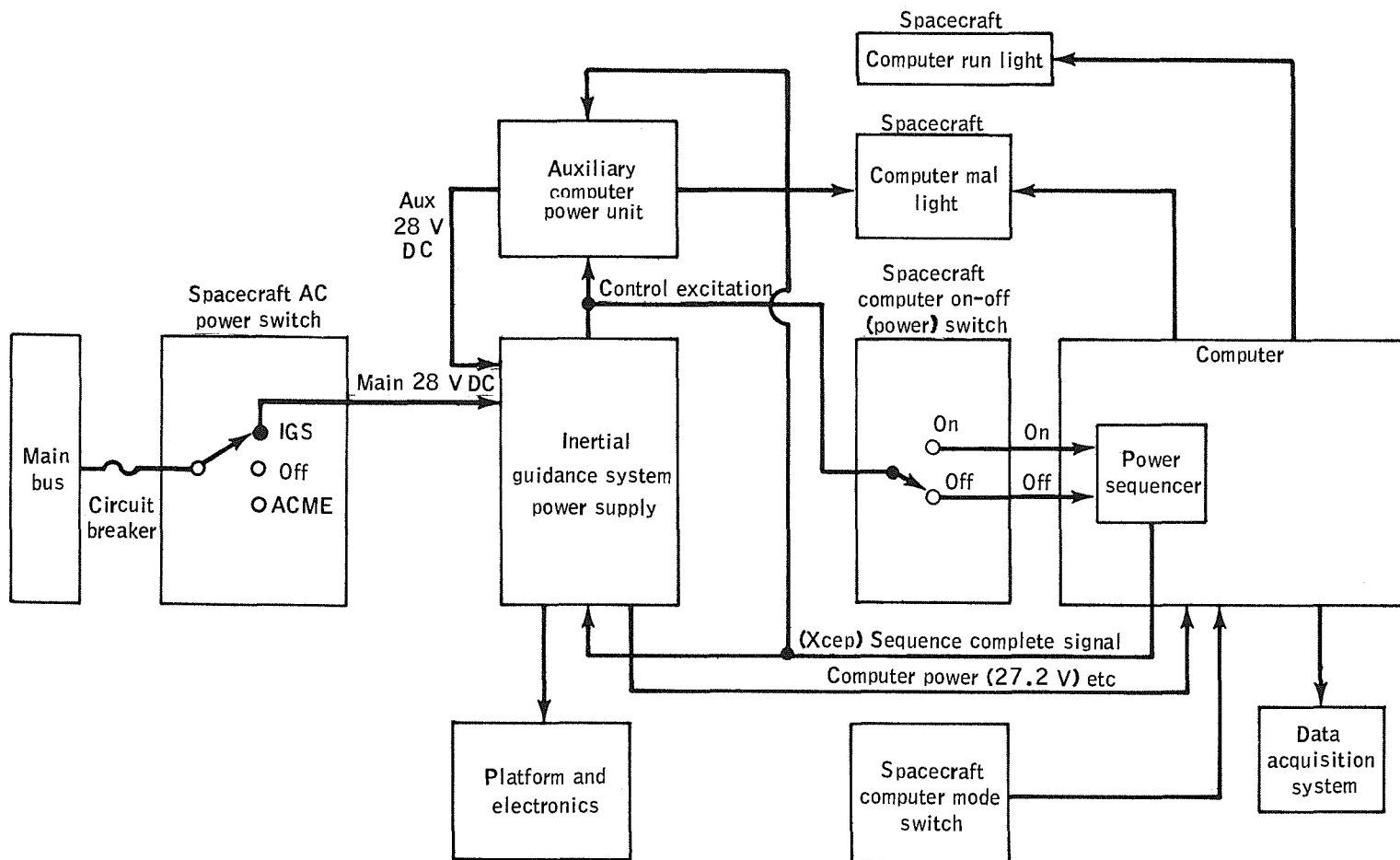

UNCLASSIFIED

Figure 5.1-16. - IGS power sequencing block diagram.

NASA-S-65-6514

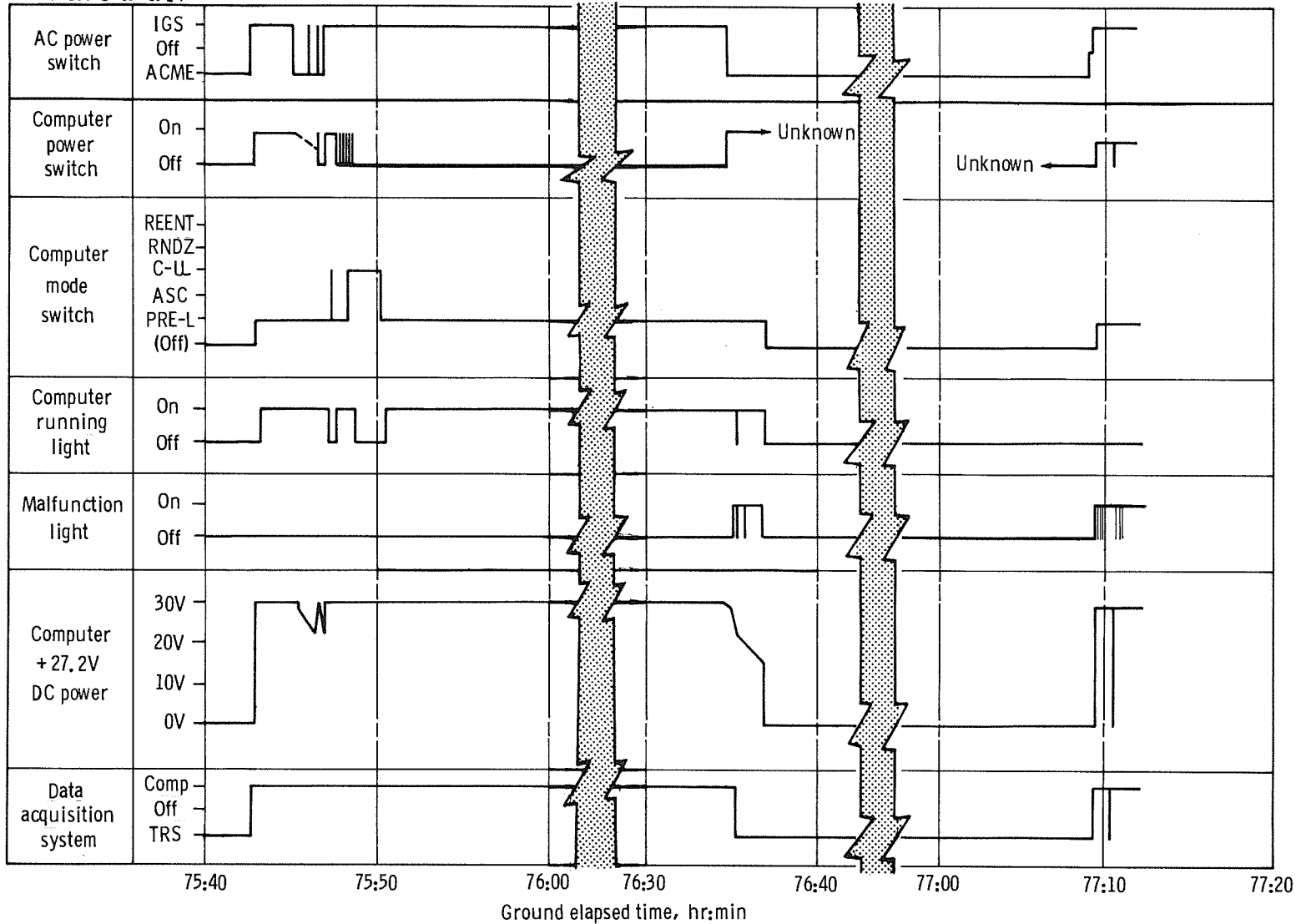

UNCLASSIFIED

UNCLASSIFIED

Figure 5.1-17. - IGS power sequence summary.

UNCLASSIFIED

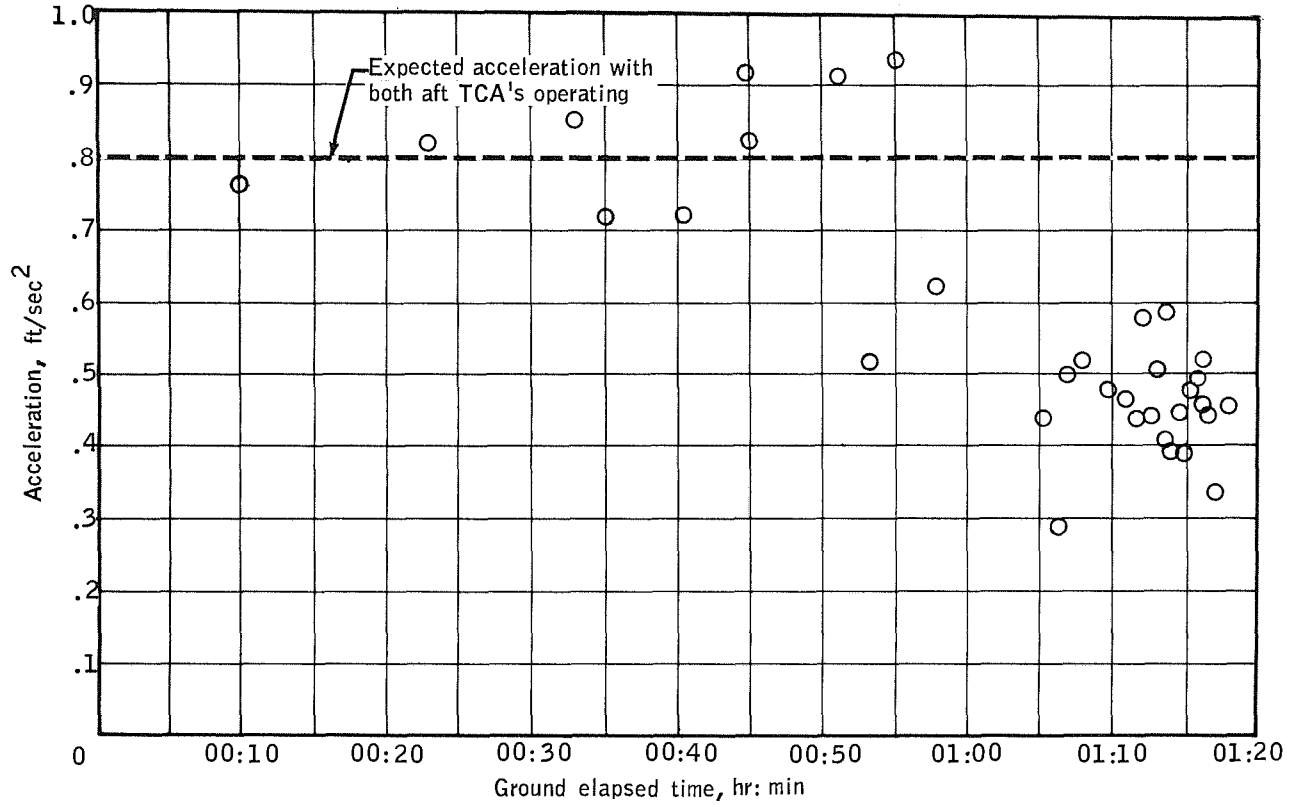

Figure 5.1-18. - Spacecraft acceleration from aft thrusters.

UNCLASSIFIED

NASA-S-65-6005

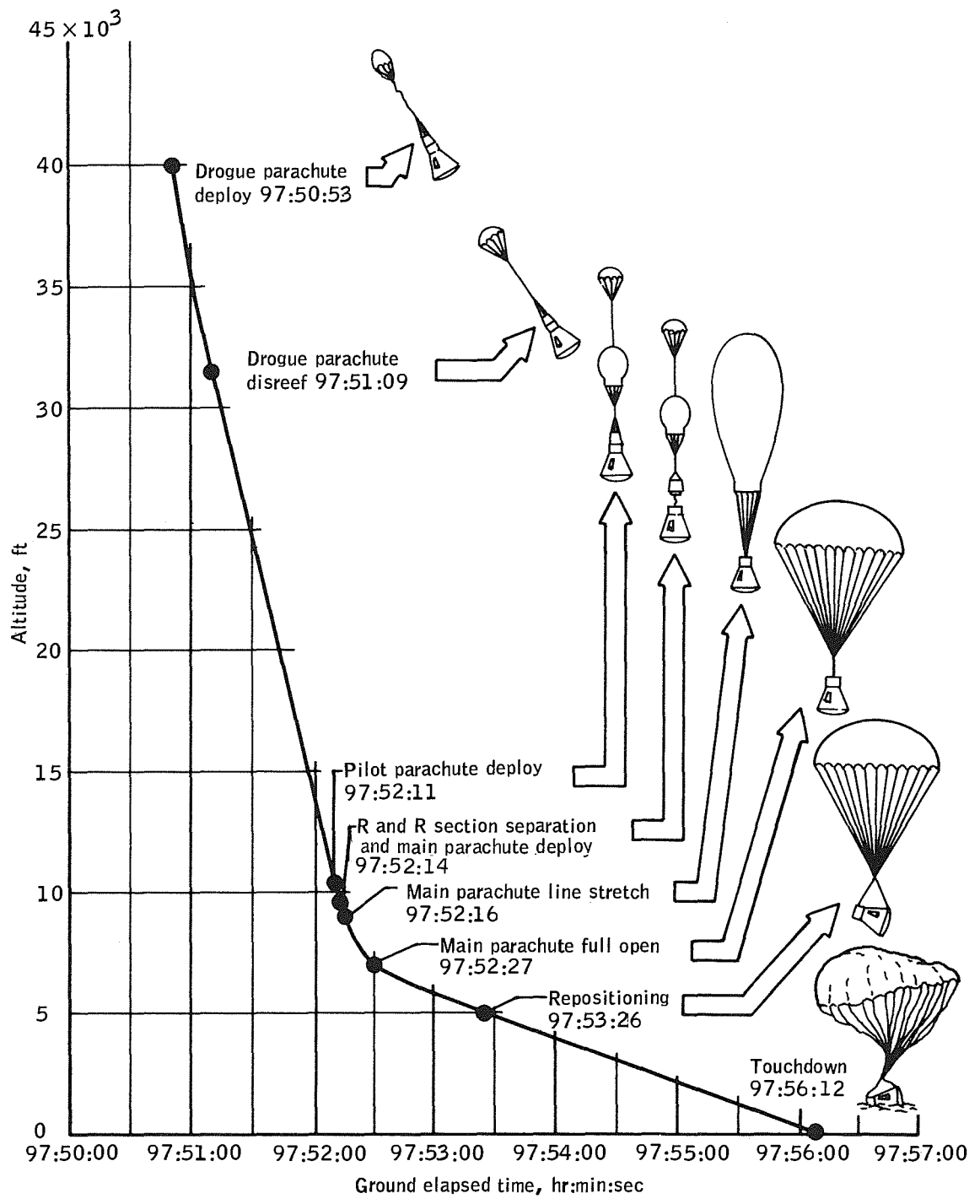

Figure 5.1-19. - Gemini IV landing system performance.

UNCLASSIFIED

THIS PAGE INTENTIONALLY LEFT BLANK.

UNCLASSIFIED

5.2 GEMINI LAUNCH VEHICLE PERFORMANCE

The performance of the Gemini launch vehicle was satisfactory in all respects. Two problems occurred in supporting facilities. The erector failed to lower on command, causing the only hold in the count-down, and the stage I fuel-vent topping-line umbilical disconnect failed to release properly. Although not a problem, but a matter of concern, was the large positive margin in payload as compared with preflight predictions.

5.2

5.2.1 Airframe

Gemini IV flight data indicate that airframe loading was well within the launch-vehicle structural capability and, except for the acoustic environment, the flight environment was within predicted limits.

5.2.1.1 Longitudinal oscillation. - Well-defined envelopes of longitudinal oscillation reached a peak amplitude at LO+121 seconds of $\pm 0.20g$ (filtered data) at the spacecraft-launch-vehicle interface with a response frequency of 11 cps.

5.2.1.2 Vibration environment. - Vibration environment on the radio guidance system (RGS) equipment was $2.1g_{rms}$, well below the qualification level of $14.3g_{rms}$.

5.2.1.3 Acoustic environment. - Sound pressure measurements indicate an overall level of 143.7 dB at compartment 2 as compared with 151 dB allowed and an overall level of 167 dB at compartment 1 as compared with 154 dB allowed. This excess is not considered critical since there is no equipment in compartment 1 and the vibration level in compartment 2 is well below qualification levels.

5.2.1.4 Structural loads. - Ground winds were approximately 6 mph during the countdown of Gemini IV, resulting in a combined static and dynamic bending moment of less than 2 percent of the vehicle bending capability. Structural loads shown in table 5.2-I are considered peak loads experienced by the launch vehicle and were computed for the pre-BECO condition.

The response of stage II fuel slosh during stage II flight was approximately double the magnitude experienced on previous flights. However, the equivalent axial load estimated for this response is only 400 pounds at station 276 and is not considered critical.

UNCLASSIFIED

5.2.1.5 Post-SECO pulse.- Post-SECO pulses, similar to those observed on GT-1 and GT-2, occurred at 3.14 and 10.83 seconds after SECO. These disturbances are evident on actuator deflection, rate gyros, and accelerometer data.

5.2.2 Propulsion

The performance of the stage I and II propulsion systems was satisfactory.

5.2.2.1 Stage I engine performance.- Table 5.2-II provides a comparison of preflight predicted and postflight reconstructed propulsion system operation and indicates excellent agreement. The largest dispersion was in engine mixture ratio (-1.34 percent). This decrease in mixture ratio (MR) resulted principally from colder propellant temperatures and fuel pump inlet pressures which were higher than expected. The minor shift in MR resulted in a fuel depletion shutdown with approximately 620 pounds of useful oxidizer remaining. Predicted mean outage was 567 pounds. The start transients of both subassemblies (SA1 and SA2) were of the predicted form and well within the range of Titan II experience. Shutdown transients were normal for a fuel exhaustion shutdown with chamber pressures of 115 psia and 105 psia for SA1 and SA2, respectively, at stage II ignition.

5.2.2.2 Stage II engine performance.- Table 5.2-III provides a comparison of preflight predicted and postflight reconstructed propulsion system operation and indicates good agreement. The stage II start transient exhibited a "false start" during the initial chamber pressure rise. This is the first time it has been noted in flight although it has occurred occasionally in ground tests. This "false start" lengthened the transient slightly but had no apparent effect on step or overshoot pressures which were 520 and 890 psia, respectively. Steady-state performance was nominal with the exception of a decrease in gas generator oxidizer injector pressure and turbine inlet temperature (T_{t_i}) at

L0+313 seconds. This occurrence is presently being investigated. As in the GT-3 mission, the shutdown sequence utilized both the redundant engine shutdown and pressure sequencing valve override relay. The shape of the shutdown transient was almost identical to that of GT-3. The postflight calculated shutdown total impulse of Gemini IV was 37 400 pound-seconds as compared with the $39\ 300 \pm 7000$ pound-seconds predicted.

5.2.2.3 Propellant and autogenous system performance.- The following table provides data on requested and loaded propellant weights for stages I and II.

UNCLASSIFIED

Component	Stage I		Stage II	
	Requested, lb	Actual, lb	Requested, lb	Actual, lb
Fuel	89 732	89 752	22 043	22 043
Oxidizer	172 084	172 094	38 517	38 517

The following table gives predicted and actual inflight propellant temperatures and indicates that inflight temperatures were lower than predicted.

Component	Stage I		Stage II	
	Predicted, °F	Actual, °F	Predicted, °F	Actual, °F
Fuel	49.0	43.5	45.0	42.8
Oxidizer	51.7	45.8	51.2	46.5

The general form of the inflight propellant temperature curve closely followed the predicted, but was displaced by the differences shown in the foregoing table.

A comparison of predicted and actual tank pressures indicates good agreement; however, an analysis of the stage II fuel autogenous data shows the pressurant orifice inlet temperature to be slightly high with a corresponding reduction in pressure. The temperature exceeded the predicted values by 40° F at 91FS2 -5 seconds. This minor anomaly is under investigation.

5.2.2.4 Performance margin.- At the Flight Safety Review the performance margin was predicted to be a negative 51 pounds, based on a launch at the beginning of the window. Real-time calculations performed during the launch countdown indicated this margin to be -35 pounds at lift-off. The performance margin is defined as the difference between the weight the GLV could insert into orbit in the presence of -3σ performance dispersions and the actual spacecraft weight. Postflight calculations indicate an achieved payload capability 270 pounds greater than the predicted nominal.

~~CONFIDENTIAL~~

The following table shows the comparison between the predicted nominal payload and the achieved capability.

Predicted nominal payload, lb ^a	Achieved payload capability, lb	Difference, lb
8472	8742	270

^aFor beginning of launch window.

5.2.3 Flight Control System

The flight control system operated in the primary mode and functioned satisfactorily. A revised pitch program was utilized on Gemini IV to compensate for high BECO altitudes on previous Gemini flights. The flight control system errors indicate a three-axis reference system (TARS) pitch program which was 1.76 percent low (combined rate and time) and a TARS gyro down-drift of 0.07° at BECO.

5.2.3.1 Stage I flight. - Ignition and lift-off transients were normal. Maximum actuator travel and rate gyro disturbance are listed in table 5.2-IV. The lift-off roll transient produced a rate of 0.77 deg/sec clockwise and was damped out within 1.5 seconds. At 10+2.1 seconds, the roll rate gyros indicated a vehicle disturbance that produced a counter-clockwise rate of 0.6 deg/sec. Vehicle displacement was 0.16°. This disturbance was damped out and corrected in 1.6 seconds. Also, a slight disturbance was noticed in the pitch and yaw axis. This disturbance was the result of abnormal release of the 2DFVT umbilical disconnect (see section 5.2.10).

The roll and pitch programs were properly executed; respective rates and times are presented in table 5.2-V. All TARS-initiated discrettes were initiated at their nominal times. Attitude errors were developed in response to wind disturbances and for the pitch and roll programs. The maximum vehicle attitude errors and rates are listed in table 5.2-VI.

Excellent correlation existed between the primary system and the secondary system up to maximum dynamic pressure (q max). The differences noted thereafter were caused primarily by axis cross-coupling effects, gyro drifts, and both inertial guidance system (IGS) and programmer errors.

~~CONFIDENTIAL~~

Staging was normal. The peak staging transients were as follows:

Axis	Rate, deg/sec	Displacement, deg
Pitch	-0.99	+0.43
Yaw	+0.77	+1.2
Roll	-2.58	-1.26

5.2.3.2 Stage II flight.- Radio guidance system (RGS) pitch and yaw steering was initiated at LO+168.5 seconds and proper response was observed. The fuel-oxidizer slosh disturbance had maximum rates of less than 0.25 deg/sec between LO+200 seconds and LO+320 seconds and damped out toward the end of flight.

The differences between primary and secondary attitude errors are shown in figures 5.1-8(a) to (c). The differences reflect the two different methods of determining steering commands in pitch and yaw only. The inertial guidance system (IGS) does not account for the effects on the gimbal angles of vehicle perturbations such as center-of-gravity shift and roll engine misalignment. Further discussion of the comparison between the primary and secondary systems is contained in section 5.1.5.

5.2.3.3 Post-SECO and separation rates.- The rates experienced at SECO resulted from the tail-off of the sustainer and roll nozzle thrust and the axial cross-coupling effects of the vehicle center of gravity and the roll thrust vector being offset from the vehicle centerline.

The rates for the 31.5-second flight period from SECO to separation are shown in figures 5.2-1(a) to (c). At LO+361.3 and 362.1 seconds, the spacecraft orbital attitude and maneuver system (OAMS) thrusters were fired in the vehicle pitch plane, which resulted in a slight change in rate. The maximum rates are listed in table 5.2-VII.

A disturbance was introduced to the second stage at spacecraft separation when the center of gravity shifted. Remaining rates, as shown in figures 5.2-1(a) to (c), resulted from the center-of-gravity shift and residual thrusts of the second-stage engine and roll nozzle.

5.2.3.4 GLV tumble rates.- Telemetry data from Bermuda indicate the GLV second stage continued to oscillate slowly in a cork-screw motion. Examination of the C-band radars while skin tracking the second stage reveals tumbling rates in the order of 25.4 deg/sec after the first

~~CONFIDENTIAL~~

revolution. Vehicle tumbling rates as recorded at skin-tracking sites are shown in table 5.2-VIII.

5.2.4 Hydraulic System

The hydraulic system operated satisfactorily. During start-up of the stage I system, the hydraulic pressure dropped to 2315 psia before recovery. This compares with a value of 2596 psia on GT-3. Recovery was prompt, indicating proper engine-driven pump compensator response. The launch-vehicle hydraulic system performance is shown in table 5.2-IX.

5.2.4.1 Stage I primary system.- The output of the stage I electric motor pump was automatically switched from the secondary system to the primary system 110 seconds before engine ignition, permitting a primary system verification. A comparison of the stage I primary hydraulic pressures obtained during the launch of GT-1, GT-2, GT-3, and Gemini IV is shown in figure 5.2-2.

5.2.4.2 Stage I secondary system.- The secondary system was checked using the electric motor pump in the period from T-180 to T-110 seconds. Comparison of the stage I secondary hydraulic pressures obtained during the launch of GT-1, GT-2, GT-3, and Gemini IV is shown in figure 5.2-3.

5.2.4.3 Stage II system.- Prelaunch checkout of the system was accomplished in the period from T-4 to T-3 minutes using the stage II electric motor pump. The hydraulic pressure peaked at 3690 psia within 2.0 seconds after engine ignition. A steady-state pressure of 3000 psia was reached within 8 seconds after engine ignition, decreasing to 2870 psia at SECO.

5.2.5 Guidance System

The vehicle was guided by the primary Mod III radio guidance system (RGS) which performed satisfactorily throughout the countdown and flight.

5.2.5.1 Programed guidance.- The programed guidance for the first 162.07 seconds after lift-off consisted of sequenced events as shown in table 5.2-X.

As discussed in section 4.0, a slightly lofted first-stage trajectory was flown. The errors at BECO (see table 5.2-X) were 75 ft/sec low in velocity, 6426.0 feet high in altitude, and 1.53° high in flight-path angle.

5.2.5.2 Closed-loop guidance.- The guidance system acquired the pulse beacon of the launch vehicle, tracked in the monopulse automatic

~~CONFIDENTIAL~~

mode, and was locked-on continuously from lift-off to LO+395.3 seconds. At this time, track went into a period of intermittent lock until loss of signal (LOS) at LO+410.0 seconds (76.25 seconds after SECO). The average received signal strength at the central station during second-stage operation was satisfactory. Rate lock was continuous, except for a momentary interruption at staging, from LO+43.6 seconds to LO+397.8 seconds (64.05 seconds after SECO).

Normal steering commands were issued, as planned, by the airborne decoder at LO+168.50 seconds. At this time, an initial 10-percent pitch-down steering command (0.2 deg/sec) was given for 0.5 second, followed by a 100-percent pitch-down steering command (2.0 deg/sec) for 7.58 seconds. The steering gradually returned to relatively small and varying pitch-down commands of 2.5 to 10.0 percent until SECO-2.5 seconds, at which time transmission of commands were terminated as planned. Yaw steering started at LO+168.50 seconds. The yaw commands were of very small magnitude, with the commands over the closed-loop portion of flight amounting to positive and negative rates of from 0.02 to 0.04 deg/sec (1 to 2 percent).

SECO occurred at LO+333.754 seconds which was 2.07 seconds earlier than planned, and at an elevation angle of 7.0° as compared with a planned elevation of 6.7° . The auxiliary sustainer engine cut-off (ASCO) signal was sent at LO+333.837 seconds via the range safety command transmitter.

The resultant SECO+20 second conditions were well within 3σ limits. The flight-path angle was 0.065° , the velocity was 25 743 ft/sec, and the altitude was 531 793 feet. Table 5.2-X shows that the flight-path angle was 0.066° high, the velocity was 13 ft/sec low, and the altitude was 696 feet high. Since tail-off was near nominal (see table 5.2-X), insertion errors were directly attributable to shutdown at SECO. Most of the error was due to the noise in the guidance data. At the end of tail-off, tumbling rates were -0.17 deg/sec yaw-right, and 0.18 deg/sec roll-clockwise.

The computing system, in conjunction with the RGS track, rate, and airborne systems, completed all prelaunch and launch operations in a normal and satisfactory manner. The inertial guidance system (IGS) updates were sent from the computer and verified by the buffer as follows:

Update sent, time from lift-off, sec	Update verified, time from lift-off, sec	Value, ft/sec
100.0	105.01	358.25
140.0	145.01	254.50

UNCLASSIFIED

These transmission times include the 5-second delay required by the spacecraft inertial guidance system and the digital command system verification by telemetry.

In figures 5.2-4 and 5.2-5, the velocity and flight-path angle are shown in the regions of SECO and tail-off. The launch-vehicle radio guidance system data and the range safety computer (IP 3600) data (MISTRAM I) are shown to illustrate the quality of the post-SECO data used for the orbital determination.

The redundant orbit determinations were quite adequate despite the Houston real-time computing complex buffer pool overflow. This caused partial loss of real-time data to the computer which resulted in slightly degraded real-time computations. The problem is currently being investigated.

5.2.6 Electrical System

The electrical system operated normally throughout both the first- and second-stage flight. No anomalies were noted in any of the electrical parameters. The current and voltage characteristics of both the accessory power supply (APS) and instrumentation power supply (IPS) dc busses were nominal. An average of 29 volts appeared on the IPS bus for a nominal load of 35 amperes during first-stage flight and 32.5 amperes during second-stage flight. Variation of load reflected the sequence of events at the proper times. The APS bus measured 29.8 volts for a load of 22.5 amperes and 19 amperes during stage I and stage II flight, respectively. An added fluctuating load due to the cycling TARS heaters caused the current to peak at 30 amperes. The ac power and the instrumentation power sources and supplies were nominal.

Two Gemini target docking adapter flashing lights were mounted 180° apart between the tanks on the second stage. Each light was powered by a squib-type battery. The lights were activated at SECO.

5.2.7 Instrumentation System

5.2.7.1 Ground.- All ground measurements performed as expected. Parameter assignments were 51 landline measurements on chart recorders, 16 measurements on magnetic tape, and 41 airborne (PCM) real-time measurements on chart recorders. The umbilical separation sequence, as monitored on ground instrumentation equipment, occurred as planned and was complete in 0.785 second.

UNCLASSIFIED

5.2.7.2 Airborne.- There were 230 measurements programed for Gemini IV and data acquisition was 100 percent for the flight. Pre-launch real-time telemetry monitor of the stage I (primary) pitch-rate gyro indicated a malfunctioned gyro, but review of the flight-control test set chart recorded verified proper gyro performance. The malfunction indication through the telemetry system was not considered factual, and no hold in the launch count was initiated. The apparent malfunction is considered attributable to a high resistance contact in the system between the signal-conditioner emitter follower and the input to the PCM encoder. This has been duplicated in laboratory tests. The erroneous indication corrected itself at T-3 seconds and remained valid throughout the flight. Data loss during the RF blackout at staging lasted for 330 milliseconds.

There was no indication of erratic tracking from Telemetry Building (Tel II) at Cape Kennedy Missile Annex during the ascent phase of Gemini IV, as there was during the flights of GT-2 and GT-3.

5.2.8 Malfunction Detection System

Performance of the malfunction detection system (MDS) during pre-flight checkout and flight was satisfactory. Flight data indicated that all MDS hardware functioned properly. MDS parameters are shown in table 5.2-XI.

5.2.8.1 Engine MDS.- The malfunction detection thrust chamber pressure switch (MDTCPS) actuation times have been evaluated. The stage I engine subassembly 1 and subassembly 2 (SA1 and SA2) switches actuated at 550 psia and 580 psia, respectively. The stage II malfunction detection fuel injector pressure switch (MDFJPS) pressure cannot be determined, because there is no analog telemetry channel of injector pressure. Switch actuation times and corresponding pressures were as follows:

Switch	Condition	Actuation time from lift-off, sec	Pressure, psia
Subassembly 1 MDTCPS	Make	-2.39	550
	Break	+152.40	545
Subassembly 2 MDTCPS	Make	-2.34	580
	Break	+152.38	530
Subassembly 3 MDFJPS	Make	+153.11	
	Break	+333.91	

UNCLASSIFIED

5.2.8.2 Airframe MDS.- The MDS rate switch package (RSP) performed properly throughout the flight. No vehicle overrates occurred from lift-off through spacecraft separation. The tank pressure transducers performed satisfactorily throughout countdown and flight.

5.2.9 Range Safety and Ordnance

The performance of all range safety and ordnance items was satisfactory.

5.2.9.1 Flight termination system.- Review of flight data indicated both receivers displayed unusually low signal strength at approximately LO+316 seconds. Telemetry data show that from LO+315.538 seconds to LO+316.289 seconds the input signal strength to each receiver was less than the 2-microvolt specification sensitivity of the receiver. The Gemini spacecraft command receivers do not show this loss of signal strength. Review of the ground transmitter operation disclosed no discrepancies which could account for this loss of signal strength. It is therefore concluded that this phenomenon is due to the pattern characteristics of the command antenna configuration of the Gemini launch vehicle. The data available indicate that a command could have been delayed for approximately 1 second as a result of this occurrence.

The following command facilities were used:

Time, sec	Facility
LO to LO+65	Cape 600-W transmitter and single helix antenna
LO+65 to LO+113	Cape 10-kW transmitter and quad helix antenna
LO+113 to LO+430	GBI 10-kV transmitter and ESCO steerable antenna

The ESCO steerable antenna at Grand Bahama Island (GBI) was driven by the Cape from ^{LO+}LO+50 seconds. The GBI FPS-16 radar steered the antenna from LO+50 seconds to LO+430 seconds. A range change in the radar at LO+295 seconds caused a slew of short duration and low magnitude.

5.2.9.2 Range safety tracking system.- Missile Trajectory Measurement (MISTRAM) System I was used as the primary source for impact prediction (IP) and provided accurate information through insertion. These data were selected for input to the IP for a total of 261.6 seconds.

UNCLASSIFIED

Prior to lift-off, an unlock of one receiver at the central site occurred. As a result, no calibrated rate data could be obtained from the west 100 K leg (P_2) and it was necessary to use data from the west 10 K leg (P_1) throughout the launch. The unlock was due to a faulty connector at the central site. During the first 100 seconds after lift-off, polarization track was intermittent, but track was stable after that period until handover to MISTRAM II at 10+381 seconds. Approximately 274 seconds of MISTRAM I data were reconstructable for postflight use.

5.2.9.3 Ordnance.- The performance of all ordnance items was satisfactory.

5.2.10 Prelaunch Operations and Aerospace Ground Equipment

The Gemini IV propellant loading and launch countdown was performed incorporating a new split-count procedure. The precount (T-660 minutes through T-40 minutes) started as scheduled at 2:00 p.m. e.d.t., June 2, 1965. During this period, flight controls, guidance, MDS, instrumentation, and spacecraft signals were checked out. The precount tests were successfully completed in 3 of the 4 hours scheduled.

The midcount period from T-15 hours to T-7 hours was established with a degree of flexibility for propellant loading and pad preparations. In expectation of a warm summer day, propellant loading was started at 9:00 p.m. e.d.t., following the prechill. Oxidizer loading was completed at 10:40 p.m. e.d.t.; both stages indicated well within limits at high-light. The total loads were completed using the oxidizer flowmeter references. Fuel loading started at 11:33 p.m. e.d.t. and was completed at 1:09 a.m. e.d.t., June 3, 1965. Stage I fuel loading was successful using the flowmeter reference. Stage II fuel loading was temporarily halted while a procedure was established to by-pass a leaking check valve. The stage II fuel indication was 6 pounds below tolerance at high-light; the ratio system was employed to complete the load.

From T-7 hours through T-4 hours, flight controls, guidance, instrumentation, and mechanical operations were performed.

The launch vehicle clock picked up the count at T-240 minutes. From this time through ignition, the launch-vehicle and spacecraft clocks were synchronized. At T-172 minutes, the oxidizer standpipe auto-bleed charge system was initiated. This was the first use of this system on Gemini, and the charge was successfully accomplished in 2 minutes. The flight disconnect was manually removed. At T-38 minutes neither the blockhouse automatic equipment nor the complex manual equipment could initiate erector lowering. Several attempts, using the manual controls, resulted

UNCLASSIFIED

in fail-safe stops. Investigation disclosed an overspeed indication. Further investigation of the circuits permitted the formulation of a procedure which permitted a safe erector lowering. The lowering problem resulted from a wiring error which occurred during troubleshooting after wet mock simulated launch (WMSL). After correcting a moisture problem in the leg lock-unlock micro-switches, two wires were restored incorrectly. As a result, the erector lowering logic was disturbed. The hold time for the erector problem was 1 hour 16 minutes. A review of the launch films indicates that the stage I fuel-vent topping-line umbilical disconnect (2DFVT) did not release as planned. Disconnect occurred by tension in the vent-topping line after the vehicle had lifted approximately 27 feet off the complex.

The damage to the complex was minimal and not as extensive as previous launches.

UNCLASSIFIED

TABLE 5.2-I.- PRE-BECO LOADS

Components of load	Launch vehicle station			
	276	320*	935	1188
Quasi-steady axial, lb	-33 800	-261 800	-422 300	-473 000
Quasi-steady lateral, lb	---	---	---	---
Dynamic axial, lb	±1 200	±8 700	±7 000	±5 300
Dynamic lateral, lb				
Stage II fuel mode	±600	±800	±500	±0
First structural mode	±700	±1 100	±1 100	±300
Third structural mode	±400	±400	±500	±300
Stage I engine mode	±800	±200	±3 900	±2 100
Total calculated load	-37 500	-273 000	-435 300	-481 000
Percent of ultimate design load	31.8	78.0	56.2	64.8

*Critical station

~~CONFIDENTIAL~~

TABLE 5.2-II.- PRELIMINARY STAGE I ENGINE PERFORMANCE PARAMETERS

Parameter	Preflight predicted	Postflight	Difference, percent
Thrust ^a (engine), lb	441 400	442 433	0.24
Thrust (engine, flight average) lb	465 068	467 870	0.60
Specific impulse ^a , $\frac{\text{lb-sec}}{\text{lb}}$	260.69	361.47	0.30
Specific impulse (flight average), $\frac{\text{lb-sec}}{\text{lb}}$	277.81	278.61	0.29
Engine mixture ratio ^a	1.9503	1.9280	-1.34
Engine mixture ratio (flight average).	1.9339	1.9083	-1.32
Oxidizer flow rate ^a , lb/sec	1 121.06	1 116.04	-0.45
Oxidizer flow rate (average between sensors), lb/sec	1 105.06	1 103.62	-0.13
Fuel flow rate ^a , lb/sec	1 121.06	1 116.04	-0.45
Oxidizer flow rate (average between sensors), lb/sec	1 105.06	1 103.62	-0.13
Fuel flow rate ^a , lb/sec	574.81	578.87	+0.71
Fuel flow rate (average between sensors), lb/sec	571.42	578.30	1.20
Burn time (87FS1 to 87FS2), sec	156.77	155.67	-0.70

^aStandard inlet conditions~~CONFIDENTIAL~~

TABLE 5.2-III.- PRELIMINARY STAGE II ENGINE PERFORMANCE PARAMETERS

Parameter	Preflight predicted	Postflight	Difference, percent
Thrust ^a (engine), lb	101 540	102 777	1.22
Thrust (engine, flight average), lb	101 718	103 103	1.36
Specific impulse ^b , $\frac{\text{lb-sec}}{\text{lb}}$	310.53	313.07	0.819
Specific impulse (flight average), $\frac{\text{lb-sec}}{\text{lb}}$	311.09	313.49	0.77
Engine mixture ratio ^b	1.7945	1.7742	-1.15
Engine mixture ratio (flight average)	1.7611	1.7497	-0.644
Oxidizer flow rate ^b , lb/sec	210.18	210.14	-0.019
Oxidizer flow rate (average between sensors), lb/sec	208.65	209.48	0.40
Fuel flow rate ^b , lb/sec	117.01	118.44	1.15
Fuel flow rate (average between sensors) lb/sec	118.48	119.72	1.05
Burn time (91FS1 to 91FS2), sec	182.45	181.32	-0.62

^aEngine thrust and specific impulse are exclusive of roll control nozzle thrust and autogenous weight flow

^bStandard inlet conditions

UNCLASSIFIED

TABLE 5.2-IV.- STAGE I IGNITION DISPLACEMENTS AND RATES

Actuator	Displacement	
	in.	sec
Pitch 1 ₁	-0.142	-2.44
Yaw/roll 2 ₁	+0.231	-2.44
Yaw/roll 3 ₁	+0.151	-2.44
Pitch 4 ₁	-0.040	-2.44
Axis	Rate	
	deg/sec	sec
Pitch (stage I)	+0.19	-0.28
Yaw (stage I)	+0.19	+0.10
Roll (stage I)	+0.58	+0.60

UNCLASSIFIED

TABLE 5.2-V.- PLANNED AND ACTUAL LAUNCH VEHICLE EVENT TIMES AND RATES

Event	Planned time from lift-off, sec	Actual time from lift-off, sec	Difference, sec	Planned rate, deg/sec	Actual rate, deg/sec	Difference, sec
Roll program start	10.16	10.10	-0.06	1.25	1.22	-0.03
Roll program end	20.48	20.40	-.08	1.25	1.22	-.03
Pitch program 1 start	23.04	22.95	-.09	-.709	-.69	-.019
Pitch program 1 end	88.32	88.21	-.11	-.709	-.69	-.019
Pitch program 2 start	88.32	88.21	-.11	-.516	-.50	-.016
Pitch program 2 end	119.04	118.66	-.38	-.516	-.50	-.016
Pitch program 3 start	119.04	118.66	-.38	-.235	-.25	+0.015
Pitch program 3 end	162.56	162.07	-.49	-.235	-.25	+0.15

UNCLASSIFIED

UNCLASSIFIED

UNCLASSIFIED

TABLE 5.2-VI.- MAXIMUM ATTITUDE ERRORS AND RATES

Axis	Attitude error, deg	Time from lift-off, sec
Pitch	+1.31 -0.256	108.2 64.0
Yaw	+1.623 -0.617	74.0 82.1
Roll	+1.101 0.0	141.0 10.6
Axis	Rates, deg/sec	Time from lift-off, sec
Pitch	-1.07 +0.38	82.6 0.41
Yaw	-0.66 +0.56	80.1 83.11
Roll	+1.61 -0.58	10.8 2.36

UNCLASSIFIED

TABLE 5.2-VII.- POST-SECO RATES

Axis	Parameter	Rate, deg/sec
Pitch	Maximum positive rate at SECO + 5 sec	1.3
	Maximum negative rate at SECO + 24 sec	-0.4
	Rate at spacecraft separation	.1
Yaw	Maximum positive rate at SECO + 8 sec	0.4
	Maximum negative rate at SECO + 2 sec	-.6
	Rate at spacecraft separation	-.1
Roll	Maximum positive rate at SECO + 4 sec	0.5
	Maximum negative rate at SECO + 12 sec	-.6
	Rate at spacecraft separation	.1

UNCLASSIFIED

TABLE 5.2-VIII. - GLV TUMBLE RATES

Station	Revolution	Period (sec)	Rate (deg/sec)
EGL	1/2	14.2	25.4
PAFB	1/2	14.2	25.4
EGL	2/3	13.4	26.9
PAFB	2/3	13.4	26.9
EGL	3/4	12.25	29.4
CRO	18	11.2	32.2
MILA	30/31	11.	32.7
MILA	31/32	11.	32.7

UNCLASSIFIED

TABLE 5.2-IX. - GLV HYDRAULIC SYSTEM PERFORMANCE

Time	Stage I primary system	Stage I secondary system	Stage II system
Hydraulic pressure			
Electric pump	3070 psia	---	---
Minimum	2310 psia	---	---
Maximum overshoot	3330 psia	3340	3690
Steady state	2980 psia	3050	3000
BECO/SECO	2840 psia	2870	2870
Fluid level			
Ignition	37 percent	34 percent	38 percent
BECO/SECO	51 percent	43 percent	42 percent
Fluid temperature			
Ignition	92 F	87 F	---
BECO/SECO	175 F	167 F	---

TABLE 5.2-X.- COMPARISON OF PLANNED AND ACTUAL LAUNCH
VEHICLE TRAJECTORY PARAMETERS

~~CONFIDENTIAL~~

~~CONFIDENTIAL~~

Condition	Planned	Actual	Difference
BECO			
Time from lift-off, sec	153.37	152.43	-0.94
Altitude, ft	208 024	214 450	6 426
Space-fixed velocity, ft/sec	9 922	9 847	-75
Space-fixed flight-path angle, deg	18.82	20.35	1.53
SECO			
Time from lift-off, sec	335.82	333.75	-2.07
Altitude, ft	530 838	531 202	364
Space-fixed velocity, ft/sec	25 667.9	25 659	-9
Space-fixed flight-path angle, deg0088	.089	.080
Yaw velocity, ft/sec	6.2	4.5	-1.7
SECO + 20			
Time from lift-off, sec	355.82	353.75	-2.07
Altitude, ft	531 097	531 793	696
Space-fixed velocity, ft/sec	25 756	25 743	-13
Space-fixed flight-path angle, deg	-.0007	.065	.066
Yaw velocity, ft/sec	0.0	0.0	0.0

TABLE 5.2-XI.- GEMINI IV MALFUNCTION DETECTION SYSTEM SWITCHOVER PARAMETERS

Parameter	Switchover setting	Maximum or positive	Time from lift-off, sec	Minimum or negative	Time from lift-off, sec
Stage I primary hydraulics	Shuttle spring (1500 psia equiv)	3320	-2.16	2280	-2.37
Stage I secondary hydraulics	None	3350	-2.68	2850	+152.0
Stage I tandem actuators					
No. 1 subassembly	±4.0	+0.45	+63.4	-0.51	+80.5
No. 2 subassembly 2 yaw/roll	±4.0	+0.92	+74.2	-0.73	+82.1
No. 3 subassembly 1 yaw/roll	±4.0	+0.35	+81.8	-1.20	+74.0
No. 4 subassembly 1 pitch	±4.0	+0.43	+80.1	-0.55	+63.2
Stage I pitch rate (+ = up, - = down)	+2.5 deg/sec -3.0 deg/sec	+0.2 deg/sec	+0.4	-1.0 deg/sec	+82.0
Stage I yaw rate (+ = right, - = left)	±2.5 deg/sec	+0.5 deg/sec	+83.2	-0.7 deg/sec	+80.5
Stage I roll rate (+ = clockwise, - = counterclockwise)	±20.0 deg/sec	+1.7 deg/sec	+10.7	-2.9 deg/sec	+152.8
Stage II pitch rate (+ = up, - = down)	±10.0 deg/sec	+4.0 deg/sec	+155.1	-2.1 deg/sec	+171 to 176.5
Stage II yaw rate (+ = right, - = left)	±10.0 deg/sec	+0.8 deg/sec	+153.8	-0.2 deg/sec	+155.7
Stage II roll rate (+ = clockwise, - = counterclockwise)	±20.0 deg/sec	+1.5 deg/sec	+153.9	-0.3 deg/sec	+155.4

UNCLASSIFIED

UNCLASSIFIED

NASA-S-65-6000

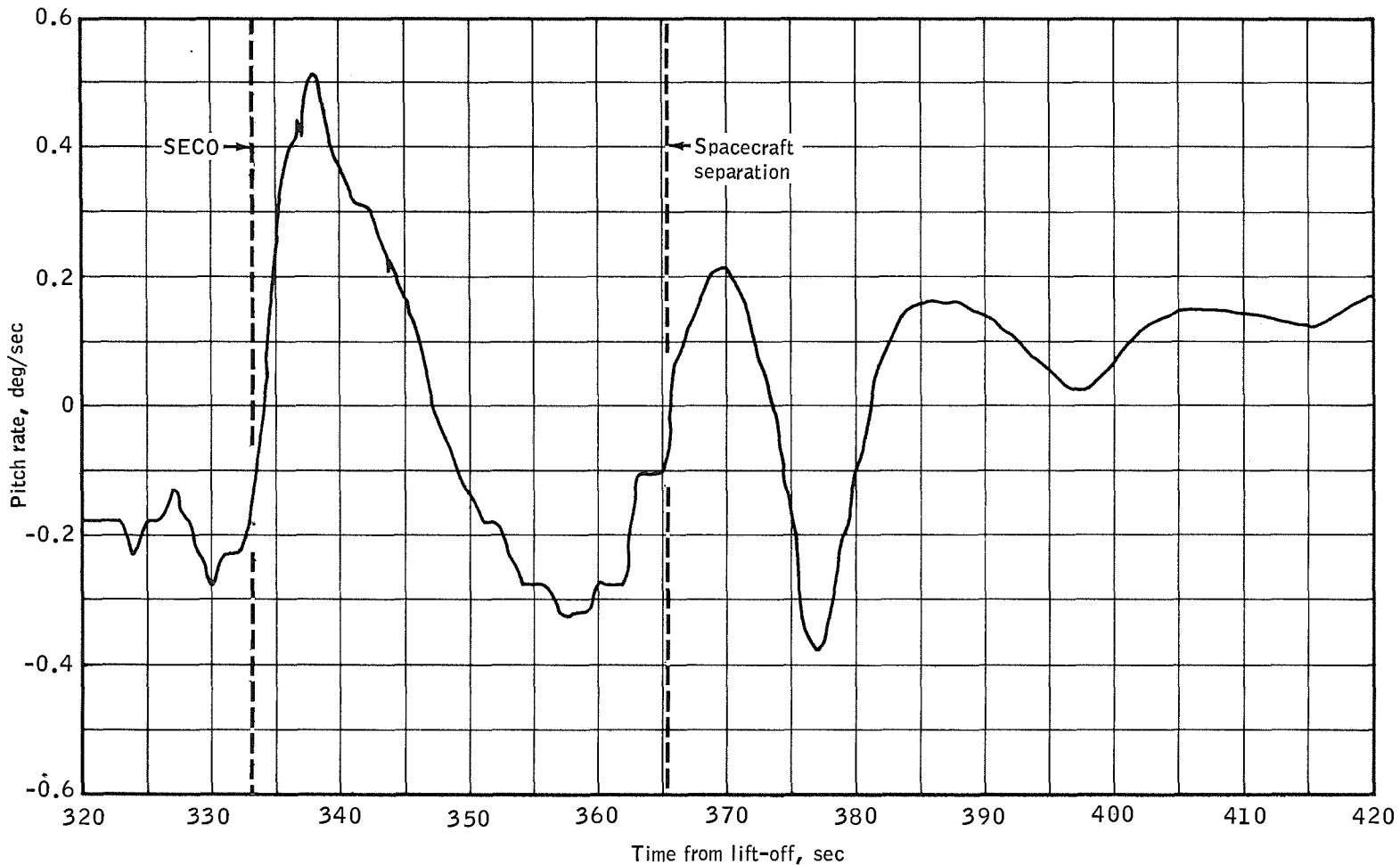

(a) Pitch rate.

Figure 5.2-1. - GLV-4 post SECO rates.

~~CONFIDENTIAL~~

~~CONFIDENTIAL~~

5-108

1 NCS

NASA-S-65-6003

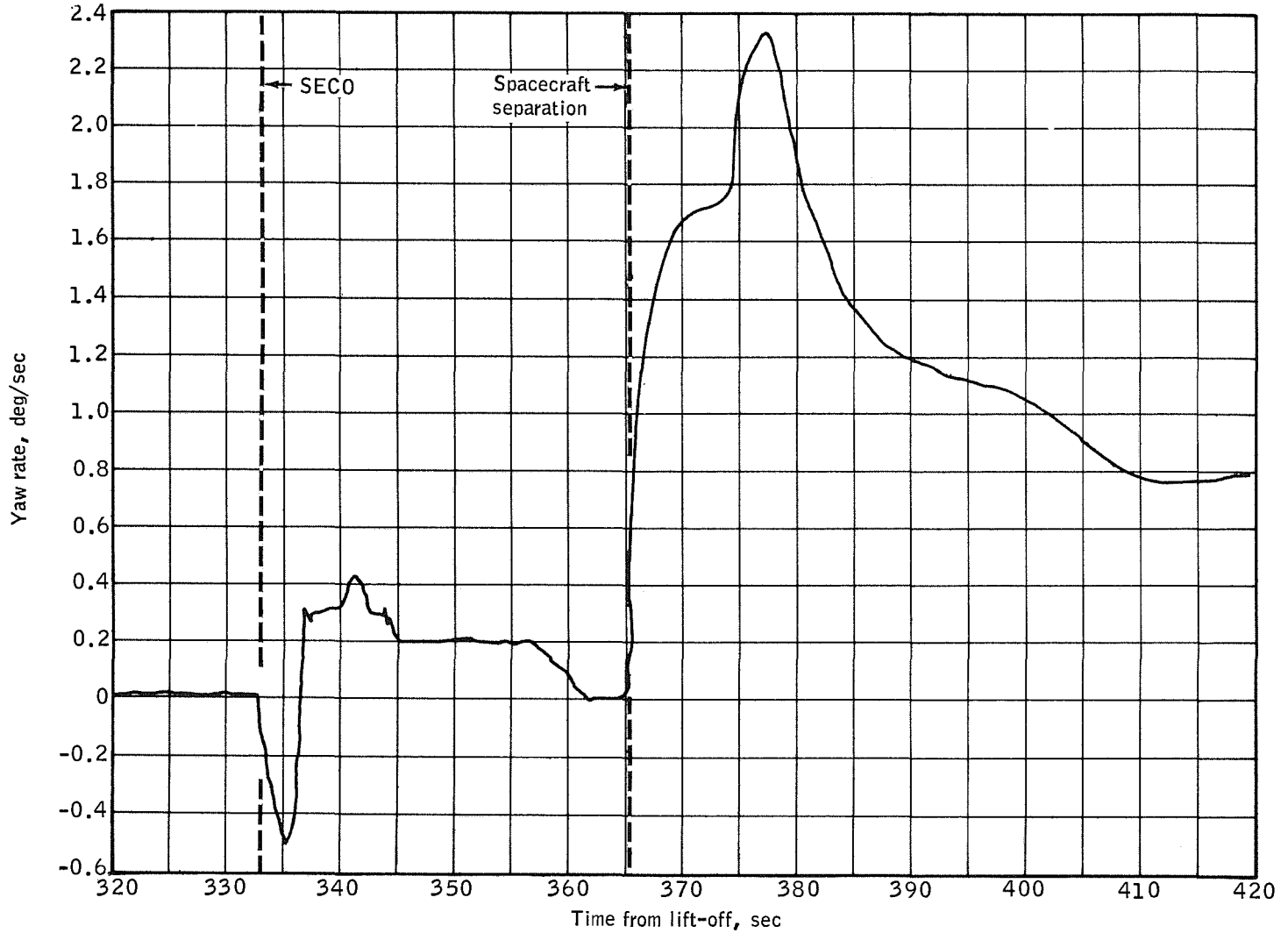

~~CONFIDENTIAL~~

~~CONFIDENTIAL~~

UNCL

(b) Yaw rate
Figure 5.2-1. - Continued.

~~CONFIDENTIAL~~

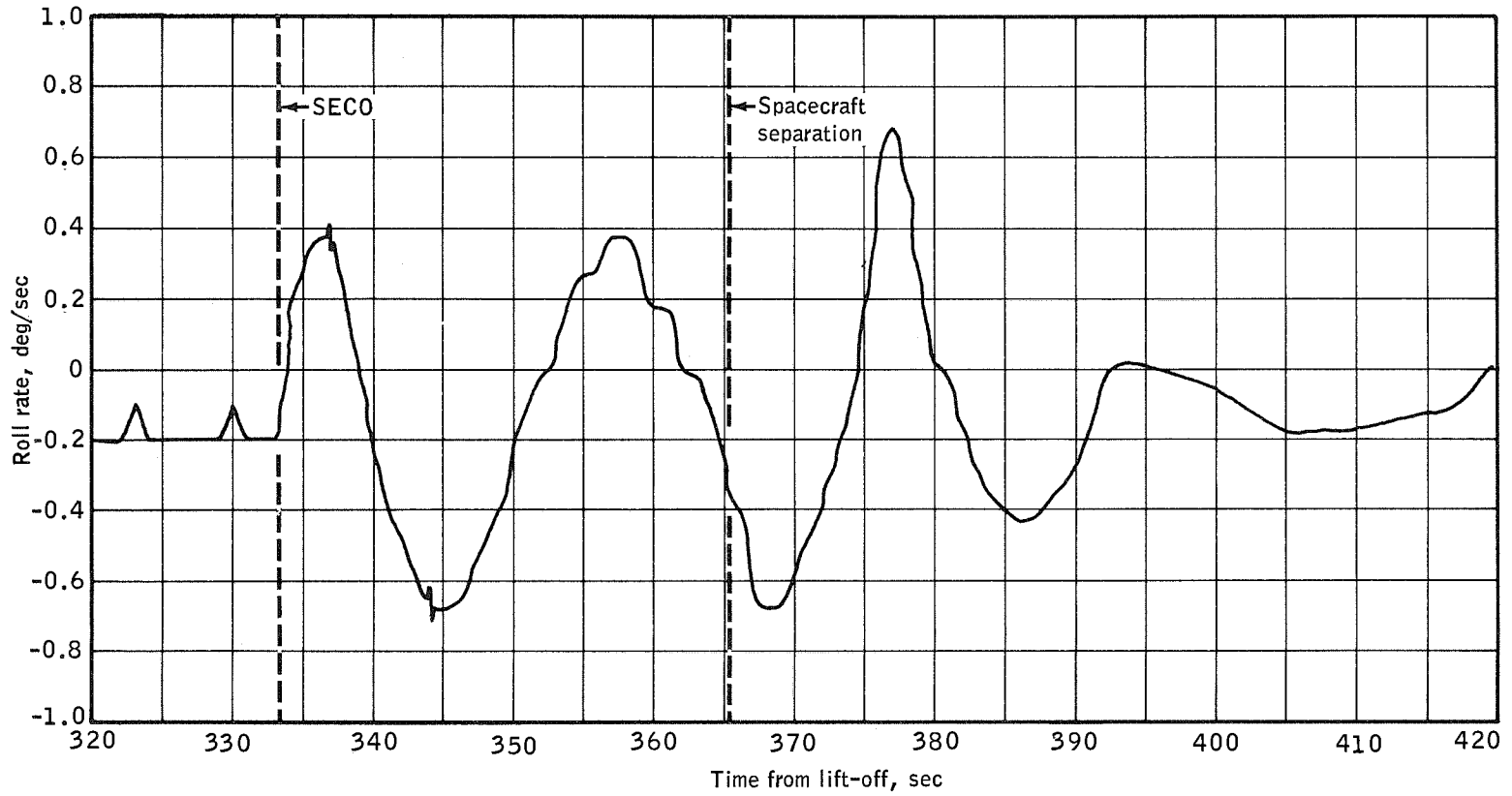

~~CONFIDENTIAL~~

UNCL

(c) Roll rate.

Figure 5.2-1. - Concluded.

UNCLASSIFIED

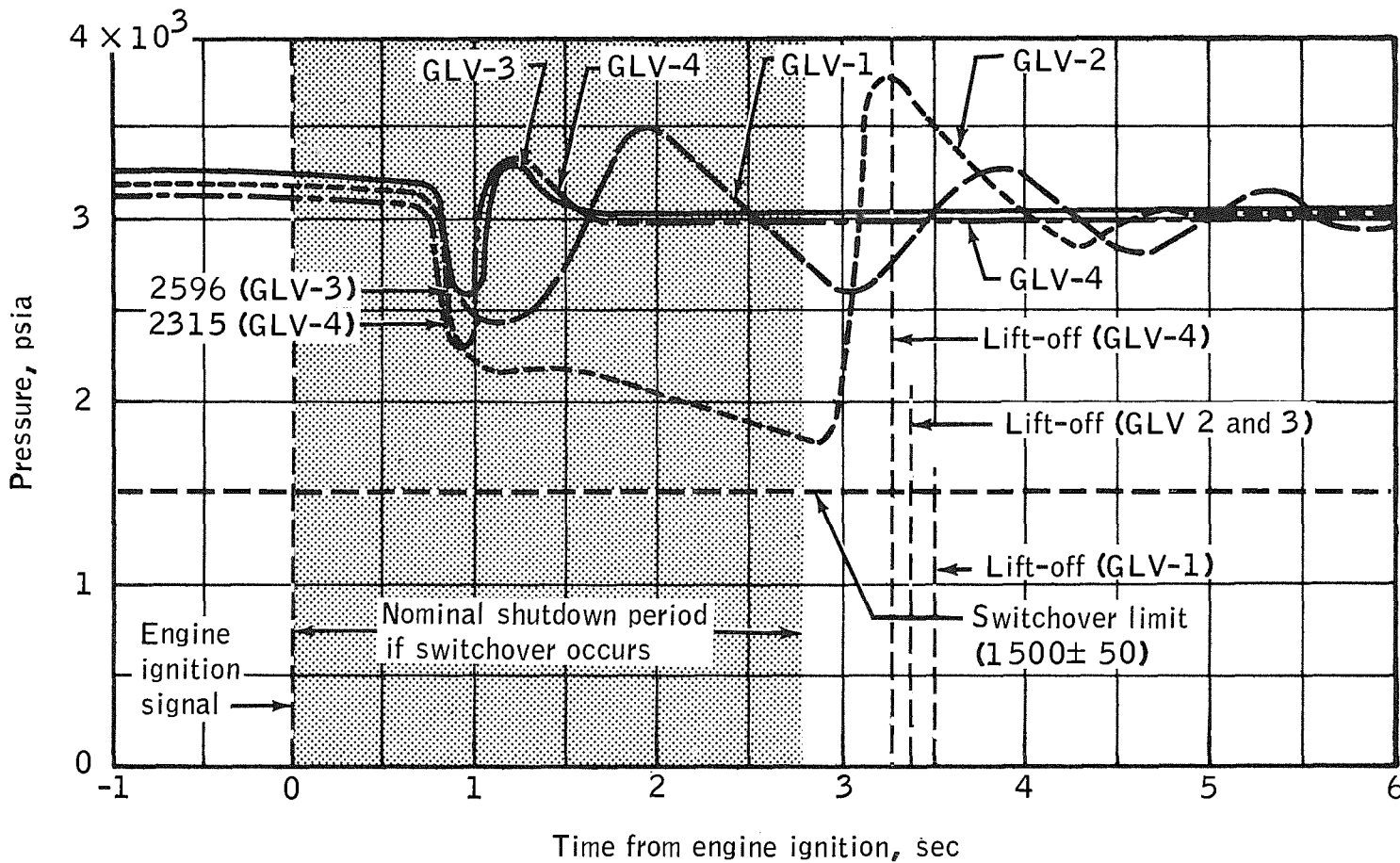

UNCLASSIFIED

Figure 5.2-2. - Comparison of GLV stage I primary hydraulic pressures.

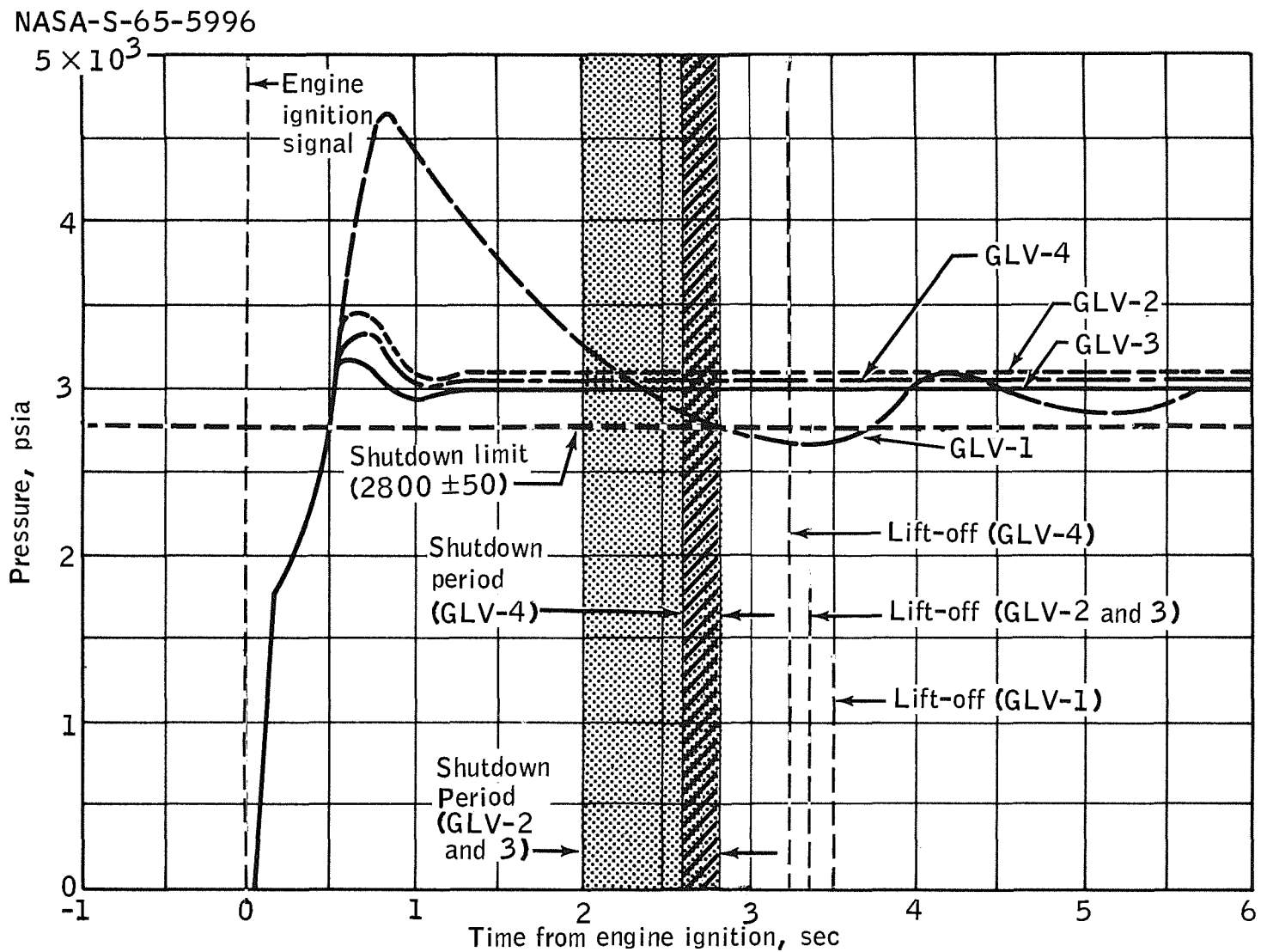
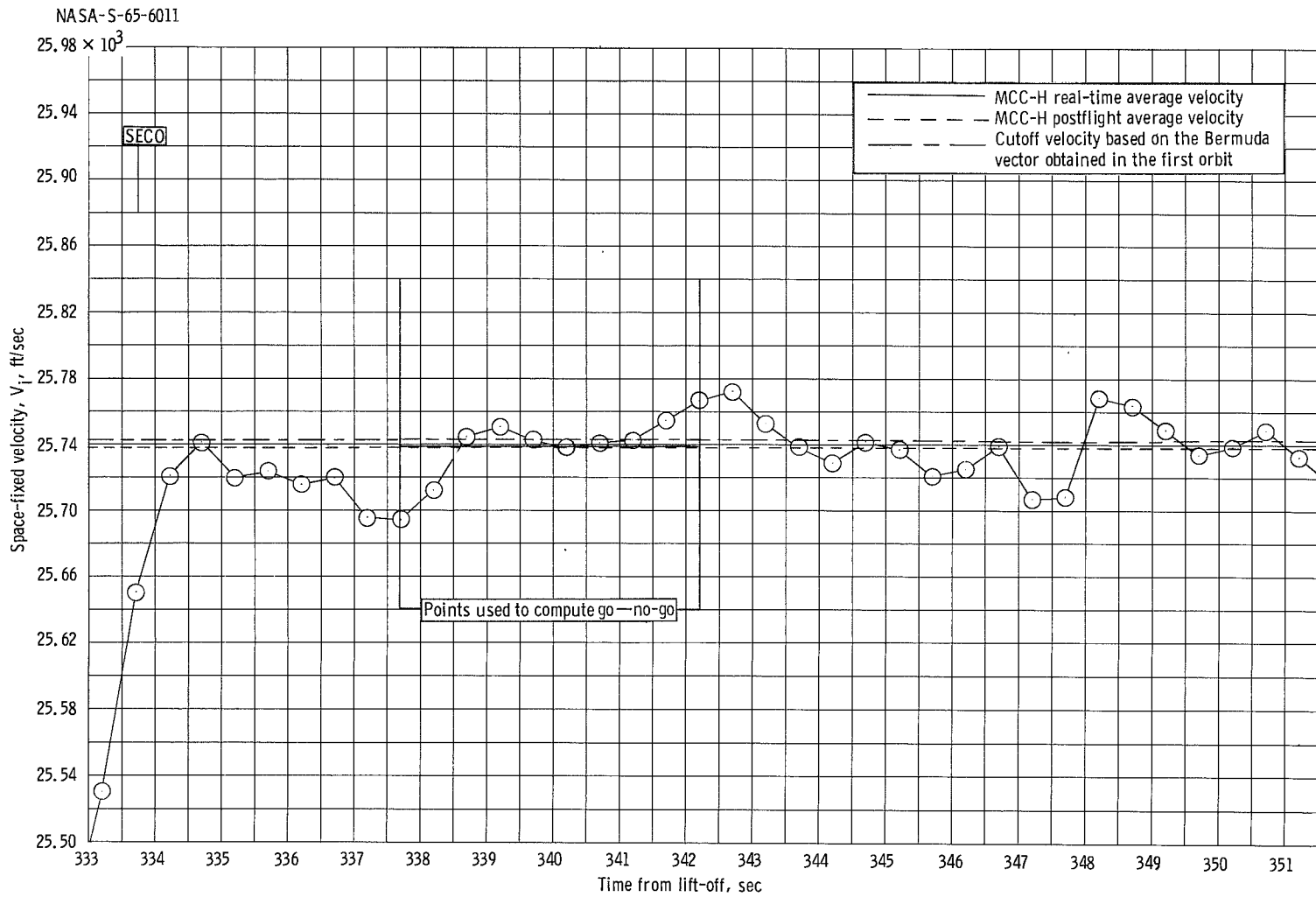

Figure 5.2-3. - Comparison of GLV stage I secondary hydraulic pressures.

~~CONFIDENTIAL~~



(a) Launch vehicle guidance data.

Figure 5.2-4.- Space-fixed velocity in the region of SECO.

~~CONFIDENTIAL~~

~~CONFIDENTIAL~~

~~CONFIDENTIAL~~

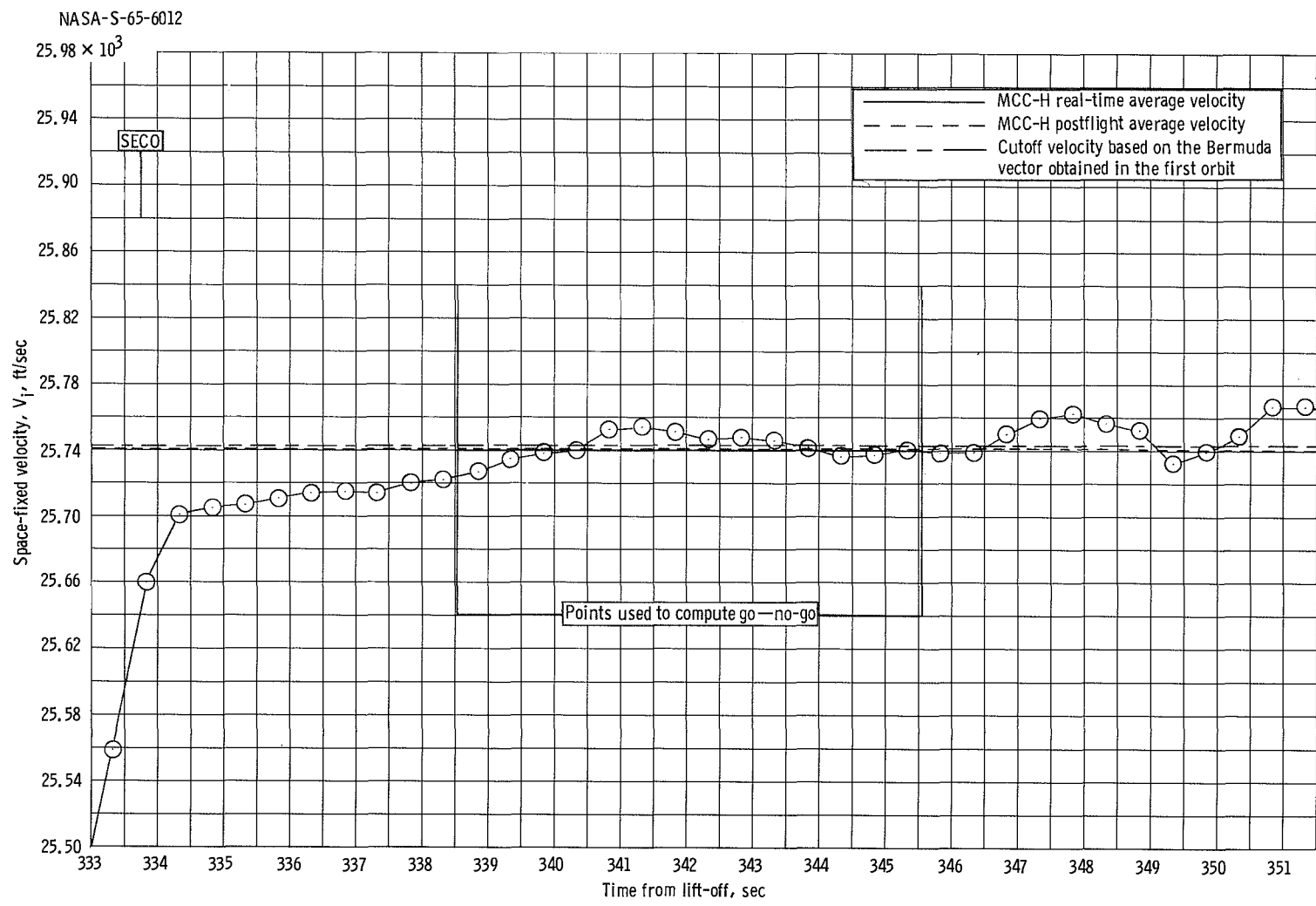

(b) MISTRAM I range safety computer (IP-3600) data.

Figure 5.2-4.- Concluded.

~~CONFIDENTIAL~~

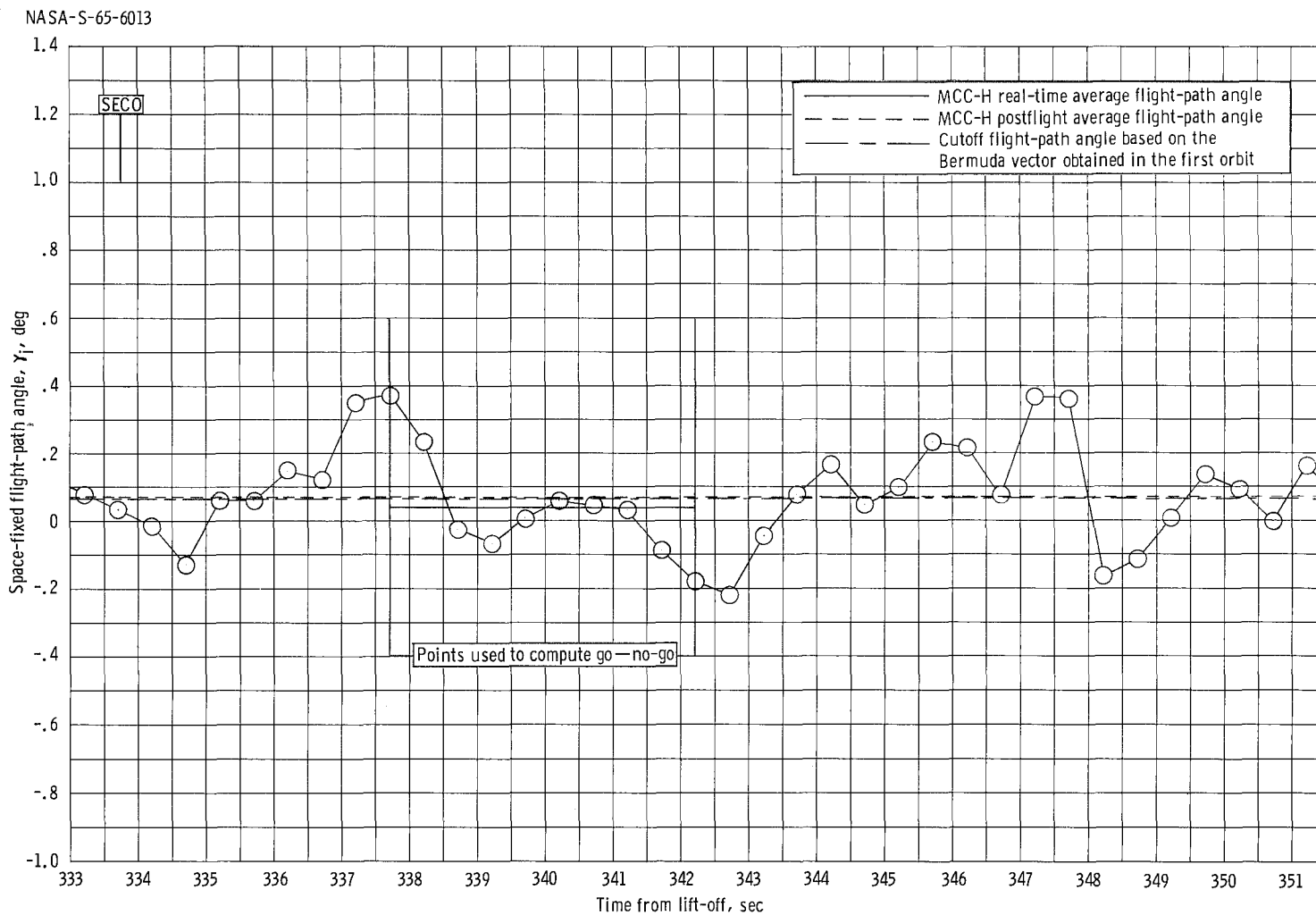

(a) Launch vehicle guidance data.

Figure 5.2-5.- Space-fixed flight-path angle in the region of SECO.

~~CONFIDENTIAL~~

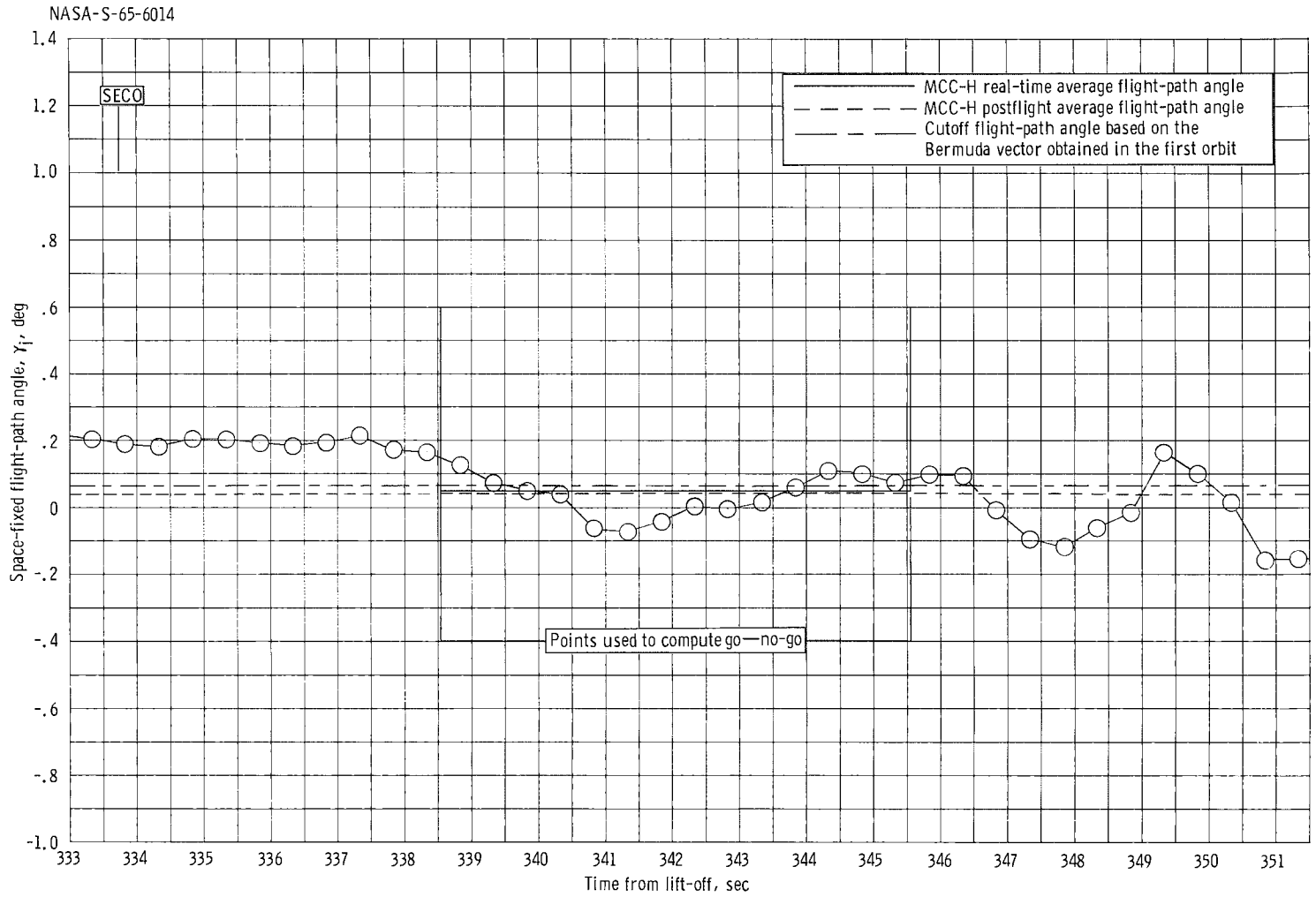

(b) MISTRAM I range safety computer (IP-3600) data.
Figure 5.2-5 - Concluded.

5.3 SPACECRAFT-LAUNCH-VEHICLE INTERFACE PERFORMANCE

The various aspects of the spacecraft-launch-vehicle interface, as defined by reference 6, performed within specification limits. The performance of the electrical and mechanical interfacing systems was derived from the overall performance of the launch vehicle and the spacecraft as determined from instrumentation and by observation of the crew.

Mechanical interface inspection before and after the last mating of the launch vehicle and spacecraft showed the configuration to be as specified by the interface drawings. The venting and sealing requirements of the spacecraft adapter and the skirt area of the launch vehicle were inspected and determined to be in accordance with the specification drawings.

The electrical circuitry on both sides of the interface performed nominally as indicated by the malfunction detection system (MDS) performance and the spacecraft inertial guidance system (IGS) steering signals.

5.3

UNCLASSIFIED

THIS PAGE INTENTIONALLY LEFT BLANK.

UNCLASSIFIED

6.0 MISSION SUPPORT PERFORMANCE

6.1 FLIGHT CONTROL

The Gemini IV mission marked a milestone in flight operations as it was the first mission controlled from the Mission Control Center (MCC-H) at the Manned Spacecraft Center, Houston, Texas. In addition to using MCC-H as the prime control center, the Mission Control Center at Cape Kennedy (MCC-C) was used to backup MCC-H during the launch phase of the mission. Certain critical positions at MCC-C were manned with flight controllers to provide the necessary support in the event that MCC-H lost the capability to effectively control the launch phase of the flight. Operational procedures were developed to take advantage of the backup control capability at Cape Kennedy to effect an efficient hand-over of control, should this have been required. In addition to MCC-C, the Goddard Space Flight Center (GSFC) computing and communications processing equipment was standing by to backup counterpart functions at MCC-H during the entire mission.

6.0

6.1

Three shifts of flight controllers were used each day in MCC-H. Care was taken in order to effect a smooth handover of control from team to team in order to assure continuity between shifts. The three-shift operation worked smoothly and proved to be a satisfactory method of providing continuous ground control and monitoring during the mission.

This portion of the report was written based on real-time observations, and may disagree with some of the detailed evaluations in other sections of the report that were derived from analysis of postflight records.

6.1.1 Prepermission Operations

6.1.1.1 Prepermission activities.- The flight control team activities in the prepermission phase consisted of MCC-H support to Launch Complex 19 and an extensive group of simulations. Support was provided to the pad on May 13, 1965, for wet mock simulated launch; on May 24 and 25 for final systems test; on May 29 for spacecraft simulated flight; and on June 3 for the launch countdown. Both MCC's supported the precount, midcount, and terminal countdown for wet mock simulated launch and the launch countdown. The pad support provided the flight controllers an opportunity to see live spacecraft and launch-vehicle telemetry prior to the mission, and allowed them to become familiar with the operational characteristics of the systems. In addition, a good checkout of the ground systems - spacecraft interface was accomplished during this activity.

UNCLASSIFIED

6.1.1.2 Documentation.- The documentation provided for the Gemini IV mission was satisfactory except that late changes in the flight plan caused numerous updates to be transmitted to the remote sites. Seventy-eight instrumentation support instructions (ISI's) were transmitted to the remote sites for this mission. As was expected, revisions to the flight plan were made and transmitted in real time, proving the ability of the network to respond to flight plan changes on short notice.

6.1.1.3 MCC/Network flight control operations.- The network went on mission status May 23, 1965. Subsequent to going on mission status, 24-hour-per-day communications coverage was provided by flight control at MCC-H. On May 26, a biomedical telemetry test and digital command system (DCS) loading test were performed with the network. On May 29, a DCS test and telemetry data flow test were conducted with Texas, MCC-C, and Bermuda. On June 1, the remote sites performed PCM telemetry patching, data flow, and calibration testing. Also, a DCS loading test was conducted using the GSFC computers.

6.1.1.4 Countdown.- MCC-H picked up the countdown at T-300 minutes with active flight controller participation. The MCC-C flight control team joined in the countdown at T-240 minutes. At T-300 minutes the multiple vehicle address on master digital command system (MDCS) no. 2 was intermittent in the Bermuda sector. The first DCS load sent to Carnarvon, Australia, during the T-260 trajectory run was not valid, but a second load was transmitted with no problem. At T-220, the MDCS no. 2 was having problems with the Bermuda and Texas sectors.

At T-189 minutes the time-to-go-to-retrograde (T_R) time was updated via the DCS using the value of 1:33:05 g.e.t., listed in the official countdown procedure. Because of a last minute change, this T_R time became invalid and had to be corrected by the pilot via the computer manual data insertion unit to 1:33:52 g.e.t.

At T-184 minutes, permission was given to open the oxidizer pre-valves, and at T-134 minutes the flight crew was directed to proceed with ingress as scheduled. At T-65 minutes, Kano, Nigeria; Tananarive, Madagascar; and Canton Island were weak on UHF air-to-ground remoting. At T-65 minutes, a Mission Rules review was conducted with the network including the final changes to the rules. At T-40, the MCC-H System B communications processor failed with a 5-minute estimate for repair.

At T-38 minutes, the crew was instructed to place the evaporator switch on the water management panel to the overboard position for the launch. At T-35 minutes, an estimated 20-minute hold was called because the erector would not lower. The hold continued for approximately 1 hour and 15 minutes. After the erector was successfully lowered, the count proceeded to ignition with no further delays. The MCC-C spacecraft

UNCLASSIFIED

communicator provided the final count and voice communications with the crew until lift-off. After lift-off, all communication with the crew was conducted by the MCC-H spacecraft communicator.

6.1.2 Mission Operations Summary

6.1.2.1 Powered flight.- The T-3 minute IGS update was transmitted to the spacecraft and verified by both the ground and the crew. After lift-off, stage I thrust was nominal, and the roll and pitch programs started on time. The cabin pressure began relieving properly and all systems were satisfactory except that the UHF voice reception was difficult to read. The stage I trajectory was slightly high, but the additional altitude was steered out by the radio guidance system in stage II flight. Stage II thrust was nominal and both guidance systems were in agreement. The IGS updates at 105 and 145 seconds after lift-off were received on time. At SECO, the following cut-off conditions were achieved, as indicated at MCC-H:

Data source	Velocity, ft/sec	Flight-path angle, deg
GE/Burroughs	25 739	+0.04
IP 3600	25 740	+0.05

The Bermuda high-speed data did not give a good solution at SECO. The MCC-C flight dynamics officer also declared a satisfactory insertion, as indicated by the GSFC computers.

6.1.2.2 Orbital.- After SECO, the spacecraft was separated with a 5 ft/sec burn. Using the cut-off vectors, the perigee was calculated to be 86.9 nautical miles, and the apogee 152.7 nautical miles. The crew was requested to switch to UHF-2 in order to improve voice communications. However, UHF-1 was tested over the Canary Islands and found to be working properly. Over Carnarvon, on the first pass, the spacecraft was given a GO for landing area 3-4. The spacecraft attempted closeup station keeping with the second stage of the launch vehicle during the first revolution; however, the crew was advised over Guaymas to discontinue the rendezvous attempt because the fuel allocated to the entire task had been expended. The continuous change in trajectory during the first orbit caused the retrofire information to vary with the orbit changes. The first estimate of propellant usage during the first revolution was 90 pounds, and it was later revised to 115 pounds after

UNCLASSIFIED

replaying the first orbit telemetry tapes. The OAMS propellant quantity remaining was continuously computed using an off-line computing facility. The accelerometer biases were checked at a number of points during the first revolution and over Guaymas during revolution 46. All checks determined this bias to be within the allowable error of .04 pulses/sec.

The extravehicular activity (EVA) was postponed for one orbit because the preparations by the crew took longer than anticipated. The crew was given permission to proceed with EVA over Hawaii during the third revolution, and the pilot was out of the spacecraft as they approached Guaymas. During the continental U.S. pass for the EVA, MCC-H was able to monitor telemetry and talk to the crew using air-to-ground remoting. Due to difficulty in closing the hatch, the cabin was not decompressed a second time in order to jettison the EVA gear.

The telemetry transmitter, tape dump, and C-band transponders were operated by ground command until shortly before mission termination. During revolution 60 over Carnarvon, the C-band transponder was placed in the continuous position to allow White Sands to practice tracking for reentry. The telemetry was switched to real-time and acquisition during the preretro check list for reentry. Tape dumps were accomplished once per revolution, and over the continental U.S. when possible.

During revolution 7, the primary O₂ tank pressure was observed to be rising. The decision was made to relieve the tank pressure into the cabin by selecting O₂ high-rate rather than venting the pressure overboard through the relief valve. The crew was told to relieve the pressure when it increased to values between 940 and 960 psi, which is below the tested relief valve actuation pressure (980 psi). Later in the mission, it was decided to use the cabin repressurization valve to relieve the excess tank pressure because application of O₂ high-rate caused discomfort to the sleeping crewman.

The UHF air-to-ground communications were degrading steadily until revolution 7 over Hawaii where a radio check was performed. The reentry and adapter antennas were used in several spacecraft attitudes, and the reentry stub antenna appeared to be the best. This antenna was used for essentially the remainder of the mission. Air-to-ground remoting through some of the stations was frequently marginal except for remoting through Bermuda, which was consistently good.

During the first 47 revolutions, the spacecraft computer memory was read and verified by MCC-H each time a preretro update was transmitted to the spacecraft. The preretro updates were uplinked only for the primary go-no-go areas. A command load for a landing area for each revolution was transmitted to a selected remote site; however, this

UNCLASSIFIED

load would only be uplinked to the spacecraft in the event of an imminent reentry. At the beginning of revolution 48, the spacecraft computer was turned on and loaded with the 51-4 reentry parameters from MCC-H. This load was not verified by MCC-H until the next revolution because of telemetry dropouts and loss-of-signal (LOS). When the attempt was made to turn the computer off on revolution 49, a momentary computer malfunction light was observed and the computer would not shutdown. Approximately 45 minutes later over Carnarvon, the power switch was placed to "ACME" and the main bus current showed a power drop to the computer "OFF" level. During later orbits, numerous attempts were made to restore all or part of the computer to normal operation, but they were not successful. In response to a theory that the computer had failed due to low temperature, the IGS power supply was left on for the remainder of the flight in an attempt to bring the temperature back up.

6.1.2.3 Reentry.- As a result of the spacecraft IGS malfunction, which precluded the use of the computer, it was necessary to fly an open-loop reentry. The decision was made to fly a zero-lift rolling reentry to reduce the probable landing area dispersions. The OAMS retroburn was planned to give a retrograde velocity of 128 ft/sec, and to have a duration of 2 minutes 40 seconds. This thrusting was planned to be accomplished on the basis of time since the computer was not able to drive the incremental velocity indicator (IVI) and provide a ΔV indication.

The Hawaii site gave the spacecraft a time hack for the initiation of the OAMS retroburn at a g.e.t. of 97:28:02. The duration of this burn was timed by Hawaii to be 2 minutes 41 seconds. A quick look at the telemetry recording indicated that the burn duration was 2 minutes 40.5 seconds. The spacecraft attitudes held within 2° throughout the thrusting. The crew was given a countdown to retrofire over Guaymas at a g.e.t. of 97:40:02. The retrofire was initiated automatically, and was reported by Guaymas to have occurred 1 second early. All four rockets fired, and the attitudes during retrofire were good at -30.8° pitch, 180° yaw, and 1.9° roll. The estimated blackout times, estimated landing area information, and recovery force information were passed to the crew by the MCC spacecraft communicator using air-to-ground remoting through Texas.

Telemetry data were solid throughout reentry, except during blackout, until an altitude of approximately 25 000 feet. Based on calculations made using real-time telemetry six pounds of propellant were used in each ring prior to retrofire and 4.5 pounds of propellant remained in each ring at the end of blackout. All of the RCS propellant was drained completely 5 seconds prior to drogue deployment. The suit inlet temperatures rose to 65° during the reentry, and the crew did not use O₂ high-rate flow.

UNCLASSIFIED

6.2 NETWORK PERFORMANCE

The network for the Gemini IV mission went on mission status May 23, 1965. Although numerous equipment problems were being experienced at that time, the network was ready to support the mission by launch day. There were no major network problems or significant losses of network support throughout the entire mission.

6.2.1 MCC and Remote Facilities

The network configuration for the Gemini IV mission and the type of support required for each station are indicated in table 6-I. Figure 4-2(a) (in section 4.0) shows the network, and figure 6-1 shows the locations of various network installations at Cape Kennedy. Aircraft which provided supplementary support but which were not a part of the normal network configuration are listed as follows:

Number of aircraft	Type of aircraft	Type of support	Location
1	C-54	Photographic	Launch area
2	F-4C	Photographic	Launch area
1	HC-97	Weather	Launch area
1	EC-121	Weather	Launch area
3	C-130	Telemetry	Reentry area
2	C-130	Voice Relay	Reentry area

Following a number of interface, local checkout, display, and remote-circuit tests, the network countdown began at T-430 minutes on June 3, 1965. Computer and data-flow integrated subsystem (CADFISS) testing and operational readiness and confidence testing (ORACT) were repeated during the mission when sites returned to the network from a standby condition.

UNCLASSIFIED

6.2.2 Network Facilities

Because of the length of the mission, no attempt is made to present coverage charts. Instead, performance is reported on a negative basis by system and site. In general, nominal and actual performance were equivalent for this mission.

6.2.2.1 Remote sites.-

6.2.2.1.1 Telemetry: An exercise was conducted to determine the duration of telemetry transmission from the launch vehicle. The exercise resulted in reception by the Canary Islands; however, the link on 244.3 megacycles was not observed during revolution 1 over Carnarvon or Texas, and the exercise was terminated after Texas loss-of-signal (LOS). Aeromedical remoting from all stations was of good quality and was acceptable to the mission operations control room (MOCR) surgeon. Both real-time and delayed telemetry were satisfactory with very infrequent drop-outs or serious loss of signal strength.

6.2.2.1.2 Radar: No major problems were experienced during the countdown. During the first day of the mission, it was discovered that the Pretoria and Ascension radars were using identification bits which were not compatible with the real-time computer complex (RTCC) program. The formats were modified and normal operation was resumed.

The launch-vehicle second stage was skin-tracked by several radars, and an accurate time and location were predicted. The launch-vehicle second stage reentered at the beginning of revolution 33 at 15.417° N. latitude and 33.836° W. longitude. Merritt Island Launch Area (MILA), Patrick AFB, and Grand Bahama Island held track until the second stage broke up. The spacecraft also was frequently skin-tracked by network radars.

Occasionally, tracking drop-outs occurred because of spacecraft attitudes during drifting flight, and some C-band data appeared to deteriorate during spacecraft delayed-time telemetry transmission. Some of the radar acquisition data did not take into account local terrain masking, and this caused some minor difficulty in acquisition. The Canary Islands (CYI) radar data had a position bias which is believed to be due to a site location error.

6.2.2.1.3 Acquisition aids: Both acquisition systems at Carnarvon experienced a boresight shift because of multipath problems caused by excessive rain water standing in the area. The condition prevailed for several hours.

6.2.2.1.4 Command: Four command sites were disabled during terminal countdown for short periods of time, but support was possible

UNCLASSIFIED

in all cases. Texas was disabled for 5 hours because of a faulty air valve which controls the switching of the RF to the antennas. The Carnarvon digital command system (DCS) B demodulator malfunctioned and was disabled for 35 minutes. This limited the DCS to a single transmission path. Module replacement and realinement of the demodulator corrected the problem.

One of the Coastal Sentry Quebec (CSQ) FRW-2 transmitters developed a teflon ring short which disabled one transmission path for 2 hours. The MCC-C data routing and error detection (DRED) equipment was disabled for 14 minutes. The cause was undetermined. During the spacecraft computer loading which occurred during the countdown, the output from one master digital command system (MDCS) in the MCC-H was not accepted by Cape Kennedy DRED equipment. Loading was shifted to the other system, and loading was then accomplished.

Mathematical analysis had indicated that interference was possible between the Trinidad radar and the Antigua DCS during simultaneous operation. However, twenty-seven commands were sent to the spacecraft during revolution 34 while the North American Air Defense Command (NORAD) Trinidad radar was tracking, and all commands were accepted without retransmission, indicating that this radar may be used on future Gemini missions.

The CSQ experienced a complete power failure for 7 minutes during revolution 20 with the result that DCS command loads were not accepted.

IGS updates, time-to-go-to retrofire (T_R), time-to-go-to equipment reset (T_X), and maneuver loads were regularly transmitted and verified without difficulty.

6.2.2.1.5 Missile trajectory measurement (MISTRAM) system: MISTRAM operation was nominal during the powered flight phase. Valkaria was active and Eleuthera passive. Valkaria used the "short-legs" data because of difficulty with the long base line systems.

6.2.2.2 Computing. - The remote site data processors (RSDP) and real-time computer complex (RTCC) performed very well. The MSC off-line computers in buildings 30 and 12 were disabled twice during the mission for 10 to 15 minutes because of MSC commercial power fading. The first instance, which occurred during the terminal count, was caused by lightning, and the second, which occurred during reentry, was caused by a transformer fault.

6.2.2.3 Communications. -

UNCLASSIFIED

6.2.2.3.1 Ground communications: A break in the Air Force Eastern Test Range (AFETR) subcable occurred near San Salvador on May 27, 1965, and the cable was not operational again until June 5, 1965. During this period, spacecraft communications were provided downrange via commercial cable. The wideband (40.8 Kc) telemetry capability could not be used, but seven selected telemetry channels were remoted via leased line from Antigua to Cape Kennedy. No remote command capability existed from Grand Turk Island or Antigua while the cable was out. Acquisition and radar data were provided without interruption.

Tananarive was plagued with local power outages and anticipated propagation problems. Presently programed new on-site power generating and communications equipment will improve operation at this site.

The Rose Knot Victor (RKV) communications were marginal because of propagation difficulties and HF interference with telemetry. Three different communications routes were available to the RKV and CSQ.

Communication quality in the MCC-H viewing room was poorer than in the mission operations control room (MOCR) or staff support rooms (SSR). The cause of this difficulty is believed to have been insufficient time for adequate checkout, testing, and adjustment of the viewing room equipment.

6.2.2.3.2 Air-to-ground: Air-to-ground communications were nominal throughout the mission and were degraded only because of ground communication difficulties. On-site equipment problems did not prevent air-to-ground operation when required. The air-to-ground remote keying failed to function properly on a number of occasions. Misalignment of equipment, procedural problems, and ground communication difficulties contributed to these malfunctions.

The scheduled HF testing was accomplished during several revolutions under both day and night conditions. Results of these tests are being evaluated.

6.2.2.3.3 Frequency interference: There were a number of RF interference reports during the count and flight phases of the mission. Although these instances are potential hazards, no loss of support resulted.

For a detailed evaluation of the spacecraft communication system's portion of the total communication system's performance, see section 5.1.2.

UNCLASSIFIED

6.3 RECOVERY OPERATIONS

6.3.1 Recovery Force Deployment

The four categories of planned landing areas designated for the Gemini IV mission are defined as follows:

(a) Primary landing areas (supported by an aircraft carrier and located in or near the West Atlantic zone).

(b) Secondary landing areas (East Atlantic, West Pacific, and Mid-Pacific zones, including those areas in the West Atlantic zone not supported by the carrier).

(c) Launch site landing area.

(d) Launch abort landing areas.

Data concerning the deployment of ships and aircraft in planned landing areas are provided in table 6-II. Figure 6-2 shows the deployment of ships and aircraft in the launch abort landing areas. Figure 6-3 illustrates the four worldwide landing zones and the ship support provided for each of the numbered landing areas listed in table 6-II.

The recovery forces were assigned positions in these areas so that any point in a particular area could be reached within specified access times. The ship and aircraft access times, which varied for the different areas, were based upon the probability of the spacecraft's landing within a given area and the amount of recovery support provided in that area. Access time is defined as the elapsed time between the preliminary establishment of the approximate spacecraft landing point and the positioning of the recovery ship alongside the spacecraft, or the installation of the flotation collar around the spacecraft by pararescuemen deployed by an aircraft. It should be emphasized that access time is primarily a planning parameter and is based upon favorable operating conditions. Weather data in the primary landing area during recovery are given in section 12.2.

Sixteen ships, 57 aircraft, 10 helicopters, and various small special vehicles were used for recovery support in the planned landing areas. Thirty-nine aircraft were deployed around the world on strip alert to provide contingency recovery support and support in the zones described in the preceding paragraphs.

Department of Defense (DOD) routine operational ships and aircraft were used for the recovery support. Special equipment, such as retrieval

UNCLASSIFIED

cranes for use aboard destroyers, airborne UHF electronic receivers, and spacecraft flotation collars, was furnished to the DOD by NASA. All recovery aircraft were equipped with UHF receivers to provide the aircraft with the capability to "home" on the spacecraft UHF location aids. These aircraft carried three-man pararescue teams equipped to parachute to the spacecraft and flight crew and render assistance. Twin turbine helicopters (type SH-3A) were provided on board the carrier to transport two three-man swimmer teams, flotation collars, and photographers to the spacecraft landing point within the primary landing area. Three fixed-wing carrier-based aircraft were specially configured for communications relay in the primary area. Also available were other carrier-based aircraft to assist search and rescue aircraft and to transport the "on-scene commander" to the spacecraft landing point, planned for 27°29' N., 73°21' W.

6.3.2 Location and Retrieval

The recovery forces were informed of flight progress throughout the mission. As the orbital ground tracks shifted, updated possible landing points were passed to all forces, and recovery ships altered positions accordingly. Early in revolution 62 of the flight, the prime recovery ship, CVS-18 (U.S.S. Wasp), was informed that the spacecraft retrograde rockets would be fired for a landing in area 63-1, the end-of-mission area, supported by the U.S.S. Wasp. All recovery forces providing support in this area were alerted and assumed their "on-station" positions as shown in figure 6-3.

6.3

The recovery forces were informed at 97:41 g.e.t. that retrofire was nominal and at 97:45 g.e.t. a calculated spacecraft landing position (CALREP) was received by the U.S.S. Wasp. This position, given as 27°44' N., 74°11' W., was approximately 48 nautical miles uprange from the position of the U.S.S. Wasp. Seven minutes later the MCC-H recovery control center reaffirmed the calculated landing position with a best estimate of the spacecraft landing position (DATUMREP). The U.S.S. Wasp radar tracked the spacecraft during reentry at a slant range of 330 nautical miles to landing. Upon receipt of the DATUMREP and evaluation of initial radar data, all recovery forces in area 63-1 began moving towards the predicted landing position (fig. 6-4). The uprange helicopter received a signal from the recovery beacon of the spacecraft while it was on the main parachute which indicated the spacecraft would land in the vicinity of the reported positions. The first visual sighting of the spacecraft was reported by the "on-scene commander" from an S-2E aircraft to be 27°44' N., 74°14' W., at about 97:56 g.e.t., shortly before spacecraft landing. Recovery helicopters with swimmers aboard were ordered to the scene and arrived over the spacecraft approximately 14 minutes after landing (fig. 6-4). The spacecraft flotation collar was attached at 98:16 g.e.t., at which time the crew began their egress.

UNCLASSIFIED

Both crew members egressed through the left hatch and into a raft provided by the swimmers. The crew members were retrieved from the raft and taken aboard the helicopter 34 minutes after landing. The recovery helicopter landed aboard the U.S.S. Wasp at 98:53 g.e.t. When the spacecraft was picked up, its position was 27°48.3' N., 74°23.2' W. The U.S.S. Wasp was alongside the spacecraft at 100:05 g.e.t. and had the spacecraft on the deck 7 minutes later (fig. 6-5). At this time, members of the recovery team began an examination of the spacecraft and started the postlanding procedures.

Aircraft pilots over the spacecraft immediately after landing reported sighting the main parachute near the spacecraft; however, the parachute sank prior to arrival of the swimmers. The rendezvous and recovery (R and R) section and drogue parachute were not sighted.

6.3.3 Recovery Aids

6.3.3.1 UHF recovery beacon. - Signals from the spacecraft recovery beacon were received by the various aircraft as follows:

Aircraft	Time, g.e.t., hr:min	Range, n. mi.	Receiver	Mode
Sinclair 52 (SH-3A)	97:54	25	SPP	CW
	97:54	25	SPP	Pulse
Sinclair 54 (SH-3A)	97:56	60	SPP	CW
	97:56	60	SPP	Pulse
Inkspot 3 (HC-97)	97:55	140	SPP	CW
	97:55	140	SPP	Pulse
Sinclair 64 (SH-3A)	97:58	30	ARA-25	-
EA-1F	97:53	35.	TN-179 ECM	-

Inkspot 3, the uprange search and rescue aircraft, acquired the beacon signal during parachute descent. The signal was lost shortly afterward and was regained only 20 miles from the spacecraft. The standby helicopter, Sinclair 57, equipped with a SARAH beacon, also reported intermittent signal reception from a range of 40 miles; however, the remainder of the SARAH equipped aircraft reported consistent good signal reception.

UNCLASSIFIED

6.3.3.2 HF transmitter.- The HF antenna was erected and lowered by the flight crew prior to egress. The flight crew reported making HF transmissions in the blind after landing. At the time of writing, HF-DF network results obtained by DOD were described as "poor". All recovery forces in the landing area submitted negative reports.

6.3.3.3 UHF transmitter.- Signals from the spacecraft transmitter were received by aircraft as follows:

Aircraft	Time, g.e.t., hr:min	Range, n. mi.	Receiver
Sinclair 52 (SH-3A)	98:01	10	ARA-25
Inkspot 3 (HC-97)	98:14	70	ARA-25
Sinclair 64 (SH-3A)	97:58	30	ARA-25
Omnibus (S-2E)	97:52	14	ARC-27
EA-1F	97:44	Unknown	ARC-27

The 70-mile range reported by Inkspot 3 may have been obtained from other aircraft over the spacecraft transmitting on 296.8 mc. The signal receptions by the S-2E and the EA-1F did afford DF information.

6.3.3.4 UHF survival radio (Voice and CW, 243.0 mc).- Not used.

6.3.3.5 Flashing light.- The spacecraft flashing light erected properly upon landing, but the light was not activated by the flight crew.

6.3.3.6 Fluorescent sea marker.- The sea-dye marker diffusion was profuse on landing and was easily observable by all recovery aircraft in the landing area. The maximum range reported was 15 nautical miles from an aircraft at an altitude of 15 000 feet. Dye was still being emitted in small quantities as the spacecraft was brought aboard the aircraft carrier approximately 2 hours after landing.

UNCLASSIFIED

6.3.4 Postretrieval Procedures

The spacecraft postretrieval procedures were performed as specified in reference 7. All data, film, and equipment were rushed to Cape Kennedy and Houston by special flights from the carrier. In addition to regular procedures, the equipment bays and skid well doors were opened for cleaning and equipment removal. The bays were flushed with fresh water, steamed, and air dried. The following items were removed from the spacecraft and washed in distilled water:

Item	Part number	Serial number
Computer	52-87710-7	105
Auxiliary computer power unit (ACPU)	52-87723-13	110
Inertial guidance system (IGS) static power supply	52-87717-67	322
Gimbal control electronics	52-87717-43	409
Inertial platform	52-87717-75	101
Inertial measuring unit (IMU) system electronics	52-87717-77	H8/202

This equipment was packed in special containers, flown to Patrick AFB, and delivered to the Gemini Program Office (GPO) representative. Post-retrieval operations proceeded in a normal orderly manner to completion.

Visual inspection of the spacecraft disclosed no excessive heating effects or physical damage. Other postretrieval observations follow.

(a) The heat shield was burned evenly with no apparent hot spots. (Scarred areas on the heat shield near the hoist loop were caused by swimmer equipment.)

(b) Both windows contained moisture between the glass layers, except for a very small strip around the periphery. Small amounts of a film were noted on the external surface of the windows.

UNCLASSIFIED

(c) The hoist loop door which normally opens when the main parachute is jettisoned failed to release even though the release pyrotechnics had detonated. The swimmers manually removed the door and returned it to recovery personnel aboard ship.

(d) At no time was there any evidence of propellant leakage.

(e) The spacecraft interior was exceptionally neat and all equipment was stowed.

(f) The heat-shield stagnation point appeared to be at about the same location as that on spacecraft 2. The spacecraft 4 heat shield was gray and black at recovery; whereas, the spacecraft 3 heat shield had a very white cast at landing. However, after several days of "drying out", the spacecraft 4 heat shield became quite white.

Prior to performing the postretrieval procedures, it was planned not to open the right hatch. Later, it became obvious that the right biomedical recorder could not be removed unless the right hatch was opened. The hatch was then torqued open requiring 37 in-lb to unlock. This hatch was later closed, but not locked, for spacecraft return to Cape Kennedy. Upon completion of all procedures, the left hatch was closed, requiring 380 in-lb to lock.

At 13:15 G.m.t. on June 10, 1965, the third day after recovery, the Gemini IV crew departed the U.S.S. Wasp (fig. 6-7), which was docked at Mayport Naval Station, and boarded an aircraft to return to Houston. The spacecraft was off-loaded from the U.S.S. Wasp at Mayport, at 14:30 G.m.t., June 10, 1965.

6.3.5 Spacecraft RCS Deactivation

After off-loading of the spacecraft at Mayport and before transporting the spacecraft back to Cape Kennedy aboard a C-130 aircraft, the spacecraft was transported by dolly to a previously selected, well isolated area where the reentry control system (RCS) was deactivated. It was desired by Kennedy Space Center safety personnel that the RCS be decontaminated of propellants to a level less than 300 parts-per-million prior to its arrival at Cape Kennedy and its subsequent transportation through and into populated work areas.

The landing safing team (IST) that was flown from Cape Kennedy to the Mayport Naval Station consisted of NASA and spacecraft contractor engineers and technicians. This team, with the required equipment, was responsible for deactivating the RCS according to the approved procedures given in reference 8, modified by Procedural Change Notice Number 1, dated June 9, 1965.

UNCLASSIFIED

Deactivation was begun at 15:30 G.m.t. (fig. 6-8). Normal safety procedures were observed throughout the operation. Upon receipt of the spacecraft, no indication of toxic vapors from any of the 16 RCS thrust chamber assemblies (TCA's) was obtained with a portable propellant vapor detector.

Before the pressurant in each ring was relieved to atmospheric pressure, the LST obtained pressure readings of this source pressure. Source pressure readings of 1150 psig and 1185 psig (ambient dry-bulb temperature of 81° F) were obtained from rings A and B, respectively. Regulator lock-up pressure readings of 295 psig were obtained for both rings. The pressures in each ring were then relieved to atmospheric pressure through test point 1. Immediately following the source pressurant draining operation, the pressurant upstream of the propellant bladders and downstream of the system C-package check valves was relieved through test points 4 and 6 by venting through separate scrubber units.

Following the above operations, nitrogen pressure of 50 psig was utilized to force the remaining usable propellants of both rings into the proper propellant holding containers. When these steps were accomplished, the propellant motorized valves were still in the closed position so that propellant loss would be minimized. At no time prior to or during the flushing operation did a propellant solenoid valve leak vapors or flush fluids such as might occur with a valve stuck partially open. All the RCS valves appeared to function normally.

No problems with any electrical components were encountered during this deactivation as were encountered during deactivation of spacecraft 2 and 3. Following completion of the deactivation, the spacecraft was transported to Cape Kennedy by C-130 aircraft, arriving there 12:35 G.m.t., June 11, 1965.

Analysis of liquid samples taken from each propellant system indicated that the oxidizer parts-per-million counts were well within the Kennedy Space Center safety limits; therefore, the spacecraft was made accessible for immediate postflight analysis.

The propellant-holding containers were taken to Cape Kennedy for weight analysis. Weight analysis of the container contents at Cape Kennedy indicated that no propellants were drained from either RCS ring.

UNCLASSIFIED

TABLE 6-I.- GEMINI IV NETWORK CONFIGURATION

	MISTRAM	C-band radar	SPANDAR	R and R TM	Real time TM display	Delayed time telemetry	Horizon sensor TM	GLDS	Remote site Data Processor	GLV TM	GLV command	Digital command system	Down range up link	Data routing and error detection	RF command	Voice	Teletype	Horizon sensor radar data	FC manned	Acquisition aid	TM RCV antenna	FC, A/G	Air-to-ground remoting
MCC-H					X	X	X	X	X	X		(X)				X	X	X	X			X	X
MCC-C				X	X	X	40.8	X	X	X		X		X		X	X		X	X	X	X	X
MILA	X																	X					
CNV				X						X	X		X		X			X			X		X
PAT		X																X					
GBI		X		X		X	40.8			(X)	X		X		X			X			X		X
GTI		X		X		X	40.8			(X)	X		X		X			X		X	X		X
BDA		X		X		X	2.0			(X)			X		X	X	X	X		X			X
CYI		X		X	X	X			X			X			X	X	X		X	X		X	X
KNO				X												X	X			X			X
TAN				X												X	X			X			X
CRO		X		X	X	X			X			X			X	X	X		X	X		X	X
CTN				X												X	X			X			X
HAW		X		X	X	X			X			X			X	X	X		X	X		X	X
GYM				X	X	X			X							X	X		X	X		X	X
CAL		X		X												X	X			X			X
TEX				X	X	X	2.0		X			X	X		X	X	X		X	X		X	X
WHS		X														X	X			X			
EGL		X														X	X			X			
ANT		X		X		X	40.8				X		X		X			X			X		X
ASC		X		X														X			X		X
CSQ				X	X	X			X			X			X	X	X		X	X		X	X
RKV				X	X	X			X			X			X	X	X		X	X		X	X
RTK		X		X												X	X			X			X
A/C				X		X																	X
WLP			X													X	X						
PRE		X																X					
VAL	X																						
ELU	X																						

(X) Master DCS
 (X) Record only

Approximate ship positions:
 RKV 21 S 85 W
 CSQ 23 N 160 E
 RTK 30 N 175 W

UNCLASSIFIED

TABLE 6-II.- RECOVERY SUPPORT

Landing area	Access time, hr		Support
	Aircraft	Ship	
Launch site: Pad Land Water (ejected) Water (spacecraft)	15 min		4 LARC (amphibious vehicle) 2 boats (40 and 50 feet long) with water salvage teams 1 LCU (large landing craft) with spacecraft retrieval capabilities 2 LVTR (amphibious vehicle with spacecraft retrieval capabilities) 3 M-113 (tracked land vehicle) 4 CH-3C (helicopters) (3 with rescue teams) 2 MSO (mine sweepers with salvage capabilities)
Launch abort: A B C D	 3 3 3	 3 3 3	1 ATF (deep water salvage ship) with spacecraft retrieval capability 1 CVS (aircraft carrier) with onboard aircraft capabilities 6 DD (destroyers) 1 AO (oiler) 7 aircraft on station (2 HC-97 and 5 HC-54)
West Atlantic (end-of-mission area 63-1)	1	4	1 CVS (aircraft carrier) from Area A, Station 4 5 JC-130 (3 telemetry and 2 communications relay) 6 SH-3A helicopters (3 location - 2 swimmer, 1 photo) 2 S-2E (on-scene commander and backup) 3 EA-1F (Navy communications relay - 1 primary, 2 backup) 1 EA-1E (radar search) 2 HC-97 (search and rescue)
Primary landing area: West Atlantic zone 1	1	4	1 CVS (aircraft carrier) from Area A with own aircraft (see end-of-mission area)

UNCLASSIFIED

TABLE 6-II.- RECOVERY SUPPORT - Concluded

Landing area	Access time, hr		Support
	Aircraft	Ship	
Secondary landing areas:			
West Atlantic zone 1	5	6	1 DD (destroyer) from Area A, Station 3
Mid-Pacific zone 4	5	6	1 DD (destroyer) (Southern zone) 1 AO (fleet oiler) (Northern zone)
East Atlantic zone 2	5	6	1 DD (destroyer) from Area C, Station 8 1 DD (destroyer) (1 from Area D, Station 9, supported special areas south of zone)
West Pacific zone 3	5	6	1 AO (oiler) from Area B, Station 7 3 DD (destroyers) (1 DD supported special areas south of zone)
Contingency	18		39 aircraft on strip alert at worldwide staging bases
Total (including MSO's)			16 ships, 10 helicopters, 57 aircraft

NASA-S-65-6024

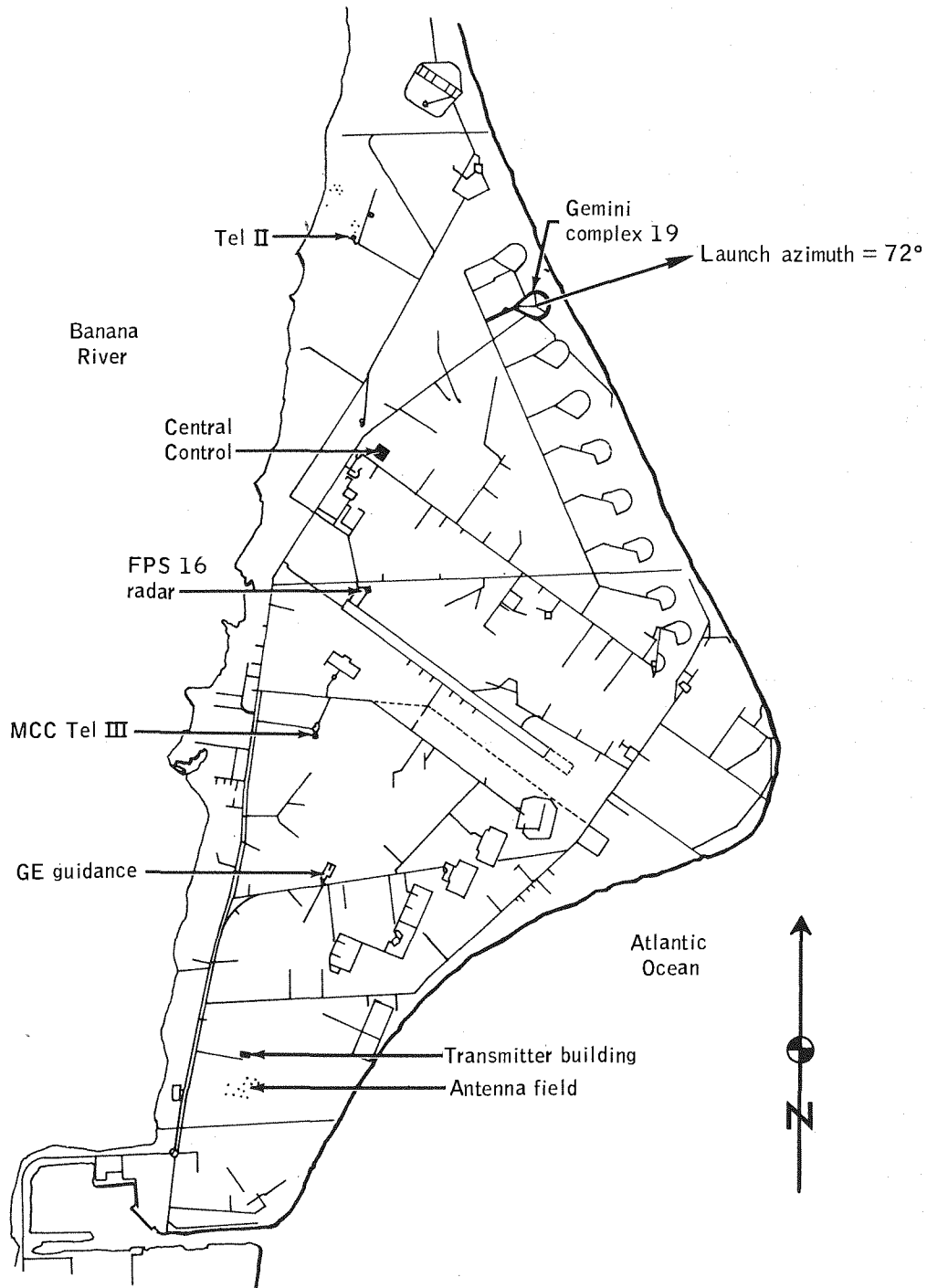

Figure 6-1. - Cape Kennedy Air Force eastern test range network stations

NASA-S-65-6023

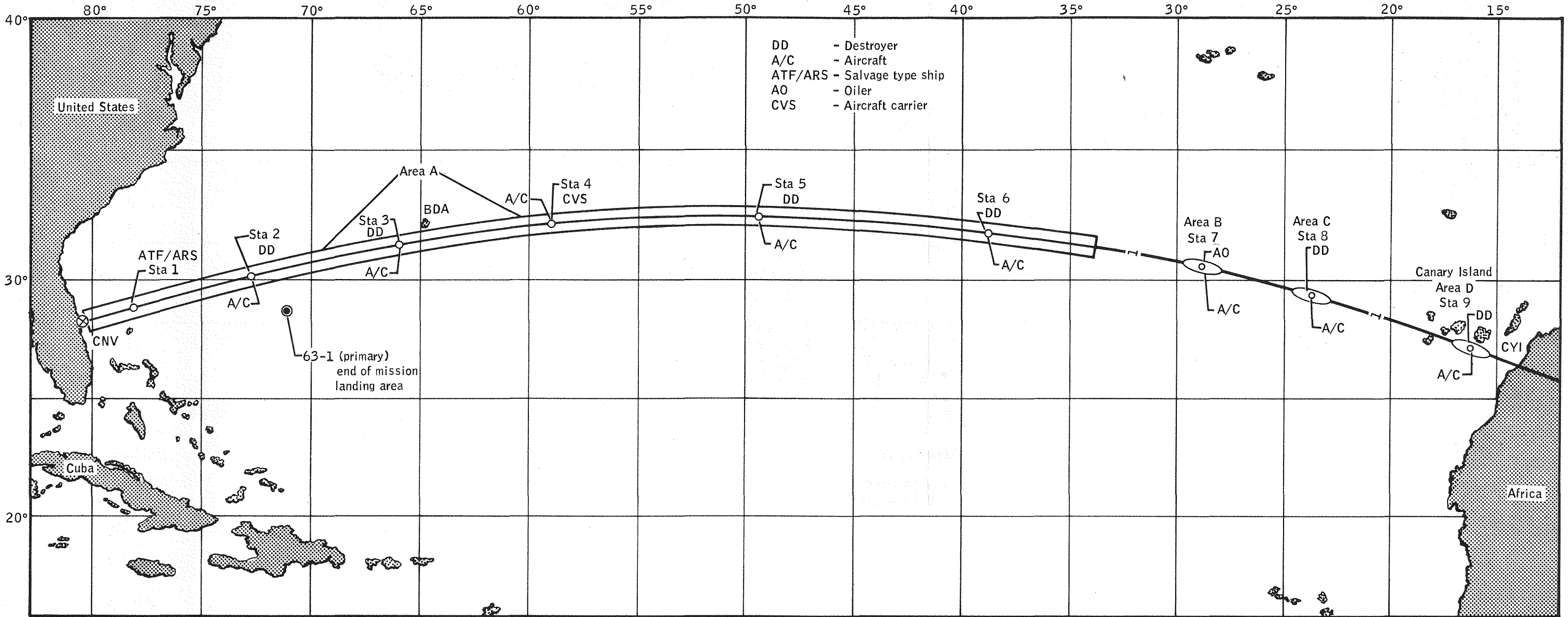
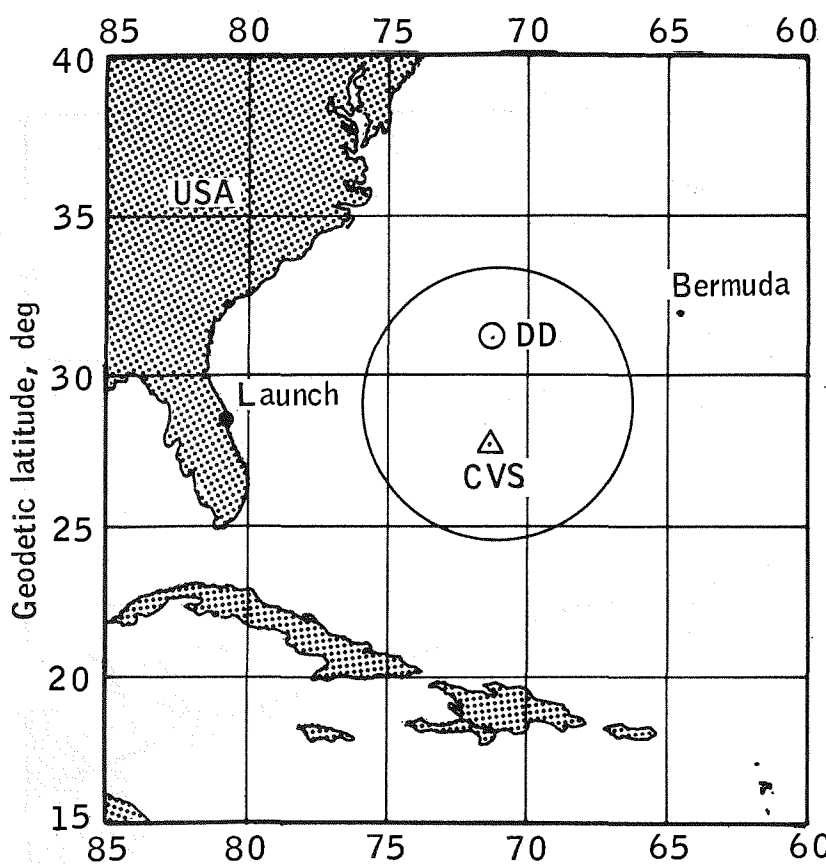

Figure 6-2. - Gemini IV launch abort recovery force deployment.

UNCLASSIFIED

NASA-S-65-6679



West Atlantic zone 1

Landing area coverage for revolutions:

<u>DD</u>		<u>CV</u>	
3	46	2	45
16	47	15	48
17	61	18	60
31	62	30	63
32		33	

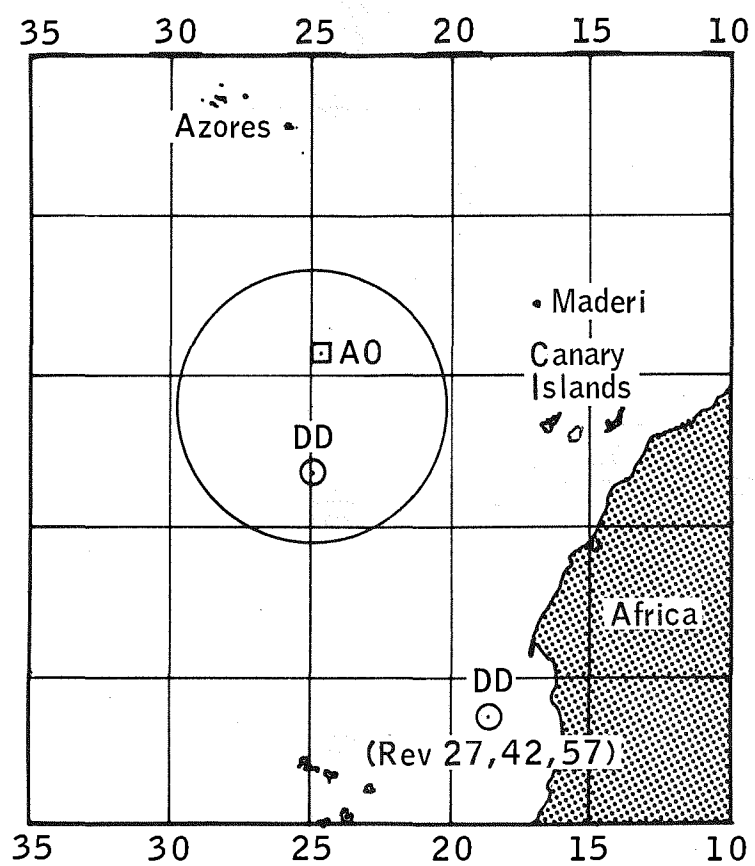

East Atlantic zone 2

Landing area coverage for revolutions:

<u>AO</u>		<u>DD</u>	
14	44	13	46
15	45	28	58
29	59	31	61
30	60	43	

NASA-S-65-6679

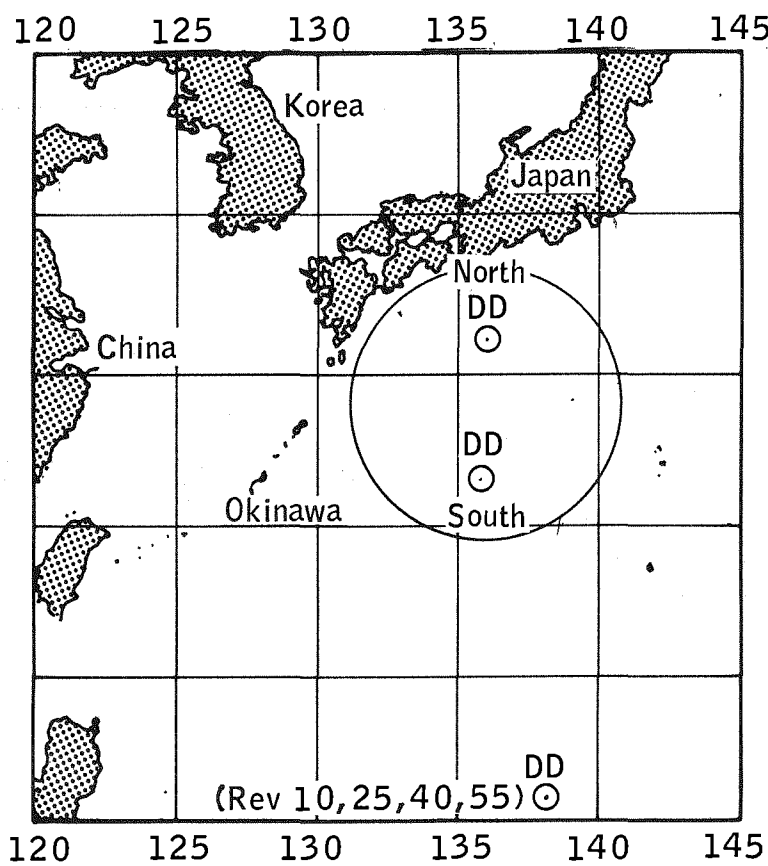

West Pacific zone 3

Landing area coverage for revolutions:

<u>DD-North</u>		<u>DD-South</u>	
7	37	6	36
8	38	9	39
22	52	21	51
23	53	24	54

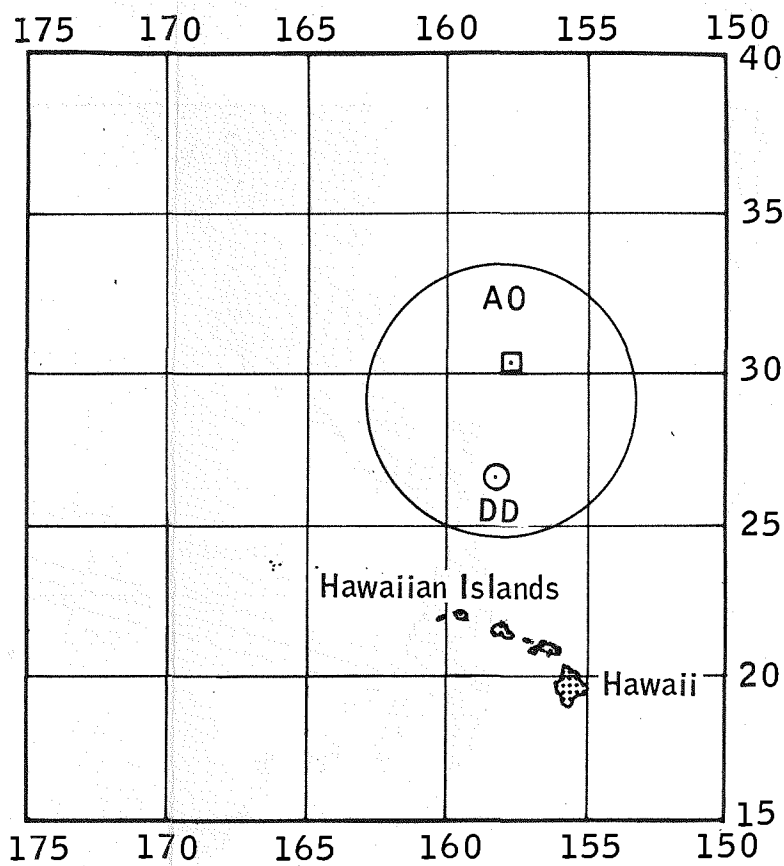

Mid Pacific zone 4

Landing area coverage for revolutions:

<u>AO</u>		<u>DD</u>	
4	35	6	
5	49	18	
19	50	21	
20	64	36	
34	65	51	
		66	

Figure 6-3. - Gemini IV landing zone force deployment.

UNCLASSIFIED

UNCLASSIFIED

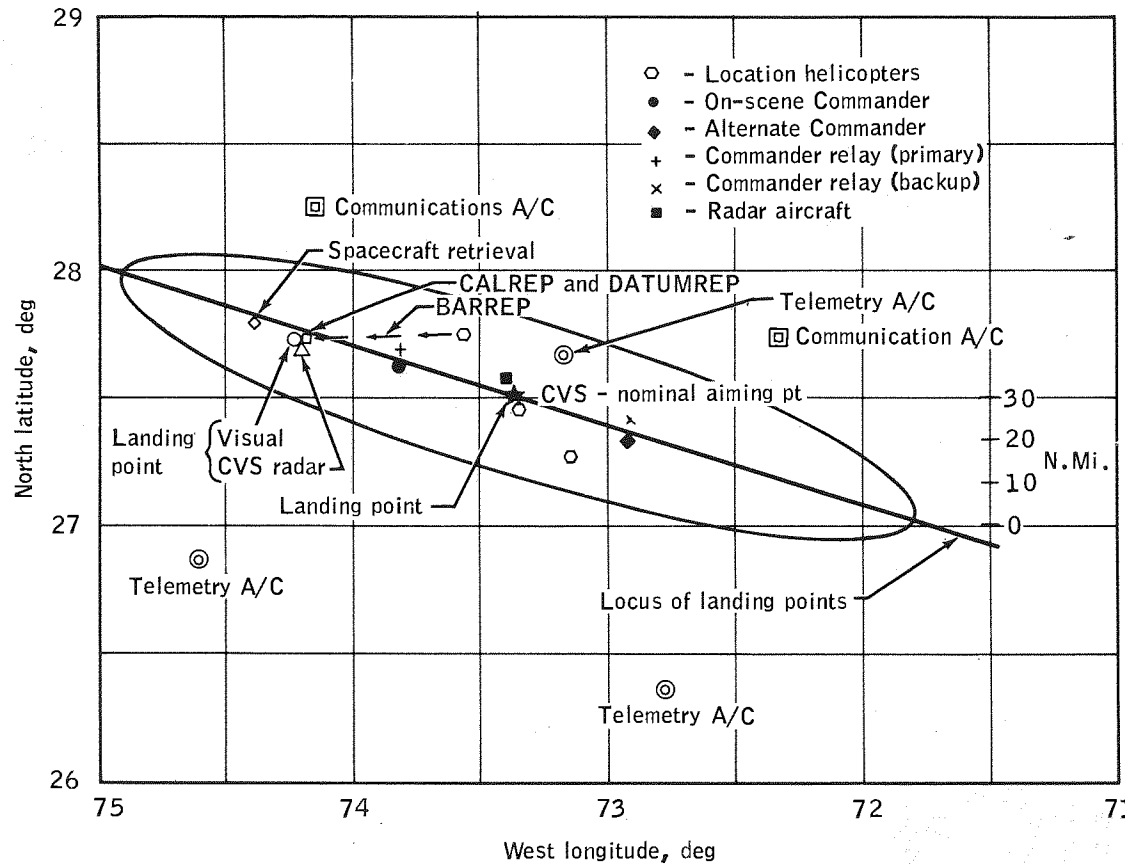

- A/C - Search and location aircraft
- CALREP - Calculated landing position based on data available shortly after retrofire
- DATUMREP - Best position estimate of spacecraft after landing
- BARREP - Report of DF signals from spacecraft
- CVS - Aircraft carrier (U.S.S. WASP)

Figure 6-4. - Details of Primary landing area.

UNCLASSIFIED

NASA-S-65-6616

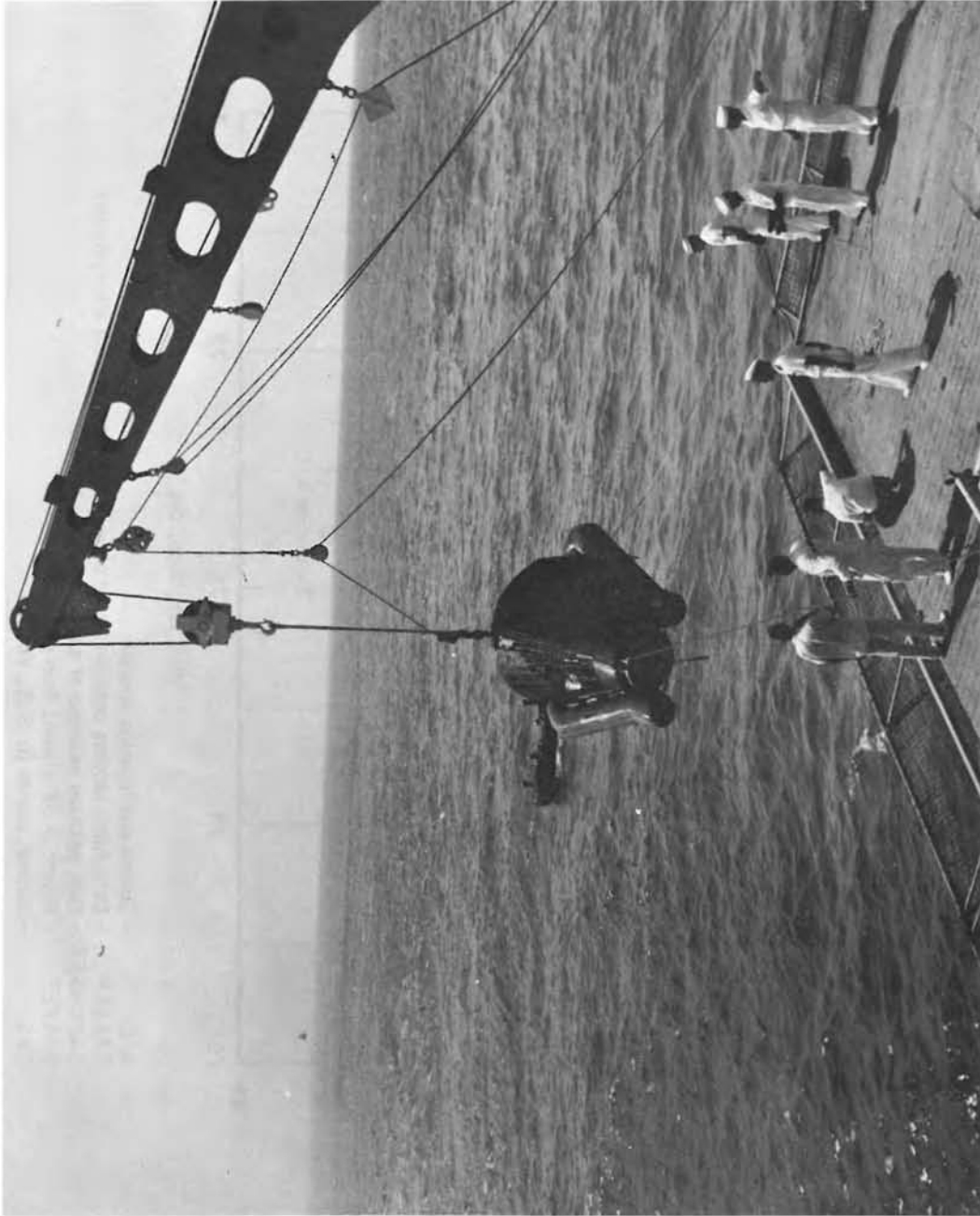

Figure 6-5. - Spacecraft 4 retrieval by USS Wasp.

UNCLASSIFIED

7-1

THIS PAGE INTENTIONALLY LEFT BLANK.

UNCLASSIFIED

NASA-S-65-6685



Astronaut James A. McDivitt, Command Pilot.

NASA-S-65-6686



Astronaut Edward H. White, II, Pilot.

UNCLASSIFIED

THIS PAGE INTENTIONALLY LEFT BLANK.

UNCLASSIFIED

7.0 FLIGHT CREW

The flight crew's activities during the mission and a summary of their preflight training are presented in section 7.1.1. Section 7.1.2 is a report by the flight crew of the most important aspects of the mission. The aeromedical analysis, divided into preflight, inflight, postflight phases, is presented in section 7.2.

7.0

7.1

UNCLASSIFIED

7.1 FLIGHT CREW PERFORMANCE

7.1.1 Activities

The crew activities outlined in the flight plan were tailored to mission objectives which were ambitious during the early revolutions. In order to accomplish extravehicular activity (EVA) and rendezvous maneuvers in the vicinity of the launch vehicle, it was necessary to plan this activity early in the flight because of the predicted differential orbital decay rates of the two vehicles. It was decided to perform station keeping with the launch vehicle during the first two revolutions rather than separate during the first revolution and perform visual rendezvous maneuvers during the second revolution concurrent with spacecraft systems tests and the EVA preparation.

The separation and maneuver and subsequent rendezvous maneuver were planned after EVA on the third and fourth revolutions, respectively.

Crew performance is discussed in the following paragraphs and crew training summary is included at the end of this section.

7.1.1.1 Prelaunch.- Prelaunch preparations proceeded smoothly, and the crew was ready for ingress at the scheduled time of T-100 minutes. The erector problem and resultant launch delay had no noticeable effect on crew readiness. During this period, the crew performed all required countdown functions and was waiting for lift-off.

7.1.1.2 Launch and insertion.- The flight crew verified lift-off by calling out that the event timer was "counting." Powered-flight events occurred on schedule and were confirmed by the crew as required. The crew was well prepared for launch, and no unexpected events occurred during this phase of the mission.

7.1.1.3 Station-keeping maneuvers.- The crew members' account of the station-keeping maneuvers is contained in section 7.1.2 of this report, and a detailed evaluation of the exercise is included in section 4.3.1.3. Therefore, the chronology will not be repeated here. The command pilot did not achieve close-up station keeping with the second stage of the launch vehicle, initially as a result of insufficient translation thrust application to effect a zero relative velocity or a closing velocity immediately after separation. The difficulty in nulling relative velocity was increased as a result of the earth's being viewed as a background rather than the sky. Also, a 3-ft/sec retrograde velocity which was not predicted prior to the flight was

UNCLASSIFIED

imparted to the launch vehicle as a result of the separation maneuvers. The difficulty in estimating range rate of a tumbling vehicle was an additional factor in the difficulty encountered in achieving close-up station keeping. In addition, the crew was required to perform this complex task immediately after insertion before they became accustomed to the new environment, and they were also required to align the platform which diverted their attention from the station-keeping tasks. All of these factors contributed to the failure of the close-up ~~of the~~ station-keeping exercise.

The preflight flight plan was essentially followed up to the time of terminating the station-keeping phase of the mission. Starting with the second revolution, the flight plan was revised because of the low fuel status and elimination of launch vehicle rendezvous in conjunction with EVA. Periodic flight-plan updates were made throughout the mission, depending primarily upon the current fuel status. The flight plan as revised and accomplished in the mission is presented in figure 7.1-1.

7.1.1.4 Extravehicular activity.- The flight crew began preparing for the pilot's egress at 01:35:00 g.e.t. The preparation began approximately 10 minutes earlier than planned because of the abandonment of launch-vehicle rendezvous, and was accomplished with direct reference to the egress preparation checklist. As the scheduled egress time approached during the second revolution, it was apparent to the flight crew that sufficient time was not available to perform the necessary tasks adequately; therefore, they requested that EVA be delayed until the following revolution.

Spacecraft depressurization and hatch opening were accomplished, and the pilot was given permission to exit the spacecraft over Hawaii. He left the spacecraft solely by use of the maneuvering gun and proceeded forward and slightly up from the spacecraft, maneuvering with no difficulty. The pilot used the same maneuvering technique as that used in training simulations, which proved to be very effective. As predicted, the pilot had some difficulty in attempting to position himself relative to the spacecraft by use of the umbilical alone. The umbilical had a tendency to position the pilot over the adapter section of the spacecraft.

The pilot had no difficulty in orientation during EVA and maneuvering by using the spacecraft as a reference. The command pilot maintained spacecraft orientation using pulse mode while the pilot was in sight. The command pilot did not attempt to stabilize the spacecraft while the pilot was out of sight to insure that no thruster firing would occur while the pilot was near the thrusters.

UNCLASSIFIED

Excellent photographic coverage was obtained during EVA by use of both a 16-mm sequence camera mounted on the adapter assembly by the pilot, and the 16-mm sequence camera operated by the command pilot. Additional still photographs were obtained by the command pilot with the 70-mm still camera. The still photographs with the 35-mm camera taken by the pilot were only partially successful because of the interference of the equipment lanyards and the umbilical.

The pilot was outside the spacecraft for approximately 22 minutes. He began to ingress before loss of signal at Bermuda (BDA) and completed ingress several minutes later after retrieving the umbilical and associated EVA equipment. The flight crew overcame hatch closing difficulties by using closing techniques practiced during training and experience gained in the altitude chamber tests at the spacecraft contractor's facility and zero-g flights in the KC-135 aircraft. The crew did not reopen the hatch to eject equipment because of the hatch closing difficulty.

7.1.1.5 Crew station housekeeping.- The mission objectives and the extended length of the Gemini IV flight required well-defined crew coordination together with rigorous crew station housekeeping. The assumption of spacecraft control and the changing of the command from one crew member to the other in relation to sleep-work cycles required considerable briefing and exchange of information to assure continuity of the mission and spacecraft status.

The flight crew were successful in adapting to the work cycle and were able to successfully accomplish assigned tasks throughout the mission. The flight crew were also able to overcome the problem of excessive stowage caused by retention of EVA equipment by using all available room in the foot well and systematically relocating items as required during flight.

The sleep periods were unsatisfactory because of the necessary changes to the flight plan, and this part of flight planning must be given more attention in future long-duration missions.

7.1.1.6 Operational checks.- Several operational checks and procedures were scheduled to be performed beginning in revolution 44 and ending in revolution 45. Those of importance from the standpoint of flight crew operations are discussed in the following paragraphs.

7.1.1.6.1 Night Apollo yaw orientation check: This operation required approximately 2 minutes 35 seconds from the time the rates were applied to completion of the check. Approximately 2 minutes 20 seconds were required for the command pilot to orient the spacecraft from an unusual position with small rates to retrofire attitude

UNCLASSIFIED

with zero rates. The recovery technique used by the command pilot was: first, find the horizon by going into roll; then pitch-down to determine direction of motion; roll heads up; and then pitch-up to retrofire attitude. Another technique would have been to pitch-down (if not already in this position) toward the earth to determine yaw, then orient directly to retrofire attitude. Final pitch and roll attitudes were quite exact; however, yaw attitude was approximately 20° away from that desired. The maneuver could have been done in a shorter time, if fuel conservation had not been required.

7.1.1.6.2 Attitude thruster failure check: The attitude thruster failure check was nominal. The rates were as expected and control of the spacecraft was similar to that which had been programmed into the Gemini mission simulator.

7.1.1.6.3 Apollo landmark investigations: Factors influencing the accomplishment of the Apollo landmark investigation were weather over the landmarks and fuel conservation requirements. The large propellant consumption during the first revolution initially limited this investigation to free drifting attitudes. Later in the mission, the flight crew were given several new landmarks to be investigated and spacecraft attitude control was then allowed. The pulse mode of control was used for the task with excellent results. The following paragraphs summarize the landmark investigations performed and the results of each.

Nile River intersection - This investigation was accomplished by the pilot during the free drifting portion of the mission. Identification of the photographs of this landmark are not completed. The spacecraft ground track was 92 nautical miles from the landmark at the closest point. The pilot reported that the landmark was very easy to find and that the charts provided were satisfactory for locating this type of landmark.

Agadir, Morocco; Wheelus Air Force Base, Libya; Alexandria, Egypt; and Dhahran, Saudi Arabia - These landmarks were given to the crew during the mission to test their ability to locate and track a series of landmarks appearing sequentially along the ground track. The pilot attempted the series and reported that the landmarks were so close together that there was not enough time between landmarks for necessary preparation. Sighting of Agadir, Morocco, was not attempted, and Dhahran, Saudi Arabia, and Wheelus Air Force Base, Libya, were overcast. Alexandria, Egypt, was acquired and photographed. The flight crew did not sight the Alexandria airport, although they had seen it on previous revolutions. Positive identification of this landmark has not yet been made on the photographs.

UNCLASSIFIED

El Paso, Texas - This landmark was a very difficult one to evaluate. The charts were not satisfactory for this type of landmark. The lack of water, white sands, or other contrasting colors on the charts precluded acquisition of the landmark before the spacecraft was directly over it. The crew therefore elected to locate and track another landmark since they had already used fuel to set up for this task. The crew tracked and photographed the channel between two sand spits on the Gulf of Mexico near Corpus Christi, Texas. This landmark was tracked approximately $\pm 30^\circ$ from the nadir point. The landmark was identified as the channel at the north end of Matagorda Club Island just south of Port O'Conner, Texas. The tracking was accomplished with excursions of 1° or less using the pulse mode of control.

Tel Aviv and Haifa, Israel - These landmarks were given to the crew during flight. The landmarks at closest approach were within 1° of each other. The pilot reported that this landmark was very easy to acquire and track. Haifa, Israel, which has more discernible geographic features, was located before Tel Aviv, Israel, and therefore tracked. The pilot reported seeing a small circular airport at Haifa. The crew reported that the onboard charts were satisfactory for this type of landmark and provided good contrast since the landmark was near a coast line. Photographs of Haifa were obtained.

Yuma, Arizona - The command pilot reported this landmark difficult to locate. The film indicates, however, that a good investigation was made. The command pilot first sighted the Salton Sea, then swept across and sighted El Centro and U.S. Highway 80, proceeded to the Colorado River, and then to Yuma. The airport was located with some difficulty and was tracked with less than 1° attitude excursions using the 16-mm camera with the 75-mm lens. The command pilot reported that the best landmark nearest Yuma was the Salton Sea, approximately 150 miles away.

Cairo, Egypt - This landmark had been observed previously by the crew prior to performing the investigation. The sequence of landmarks used to locate the Cairo International Airport was first to track the Mediterranean Sea and the Red Sea; the Suez Canal was then located and followed to the bottom of the Nile River delta and the airport. Although the tracking was within 1° of accuracy, the airport that was tracked does not appear to be the Cairo International Airport. The city of Cairo is not discernible on the film. It appears that the pilot was tracking the airport located at Bilbeis, approximately 20 nautical miles northeast of the Cairo airport. Another airport appeared at the bottom of the film during tracking and was tentatively identified as an airport near Shibin el Qanatir, approximately 11 nautical miles north-northeast of the Cairo airport. Although numerous color contrasts are available near this landmark, a lack of this

UNCLASSIFIED

information on the charts could easily have detracted from the desired landmark. A very large area of vegetation was seen on the film, which was not shown on the charts.

Basra, Iraq - Basra, Iraq, was reported to be a very easy landmark to identify, and the airfield was a very predominant feature. Charts were reported as satisfactory for this landmark. The command pilot tracked this airfield within 1° of accuracy although the film indicates that he actually tracked the Shaibah airfield, located approximately 12 miles southeast of the intended landmark. Landmark information on the onboard maps was not adequate to permit positive identification of the Basra airfield.

Landmark investigation summary - The onboard charts used were satisfactory for locating some, but not all, of the landmarks. More color contrast and aerial photographs used in conjunction with these charts would be helpful. The method of calling up landmark information was satisfactory. Surrounding landmark information used for locating a specific landmark was satisfactory for most of the targets, but could be improved. The reticle light intensity was too dim for day-time tracking of landmarks. Crew performance was very good. Multiple axis tracking using the pulse mode of control was usually performed within 1° of attitude accuracy.

7.1.1.7 Control system and platform alinements.-

7.1.1.7.1 Control system: Operation of the orbital attitude and maneuver system (OAMS) during the mission was nominal. Crew performance and technique in the use of different modes of operation throughout the orbital phase of the mission were very satisfactory. The flight crew used fuel very conservatively while performing experiments and operational checks with the pulse or direct modes of control. The spacecraft was controlled within a few degrees of intended attitudes and provided good results in all attempted operational checks and experiments. Landmarks were tracked to within 1° of accuracy using the pulse mode of control.

7.1.1.7.2 Platform alinement: The platform was alined on four different occasions during the flight. Alinement accuracies were excellent, particularly the first alinement after insertion and the final alinement for the end-of-mission OAMS retromaneuver and retrofire. A maximum error of 6° in yaw occurred during an alinement on the night-side of an orbit. This error probably occurred because other flight-plan activities interfered with the maneuver, and alinement was not considered critical for the test involved. This flight established quite definitely that a very accurate platform alinement can be accomplished (1° of error or less) during either day or night conditions,

UNCLASSIFIED

if the crew concentrates solely on the alinement maneuver. (See section 5.1.5.2.2 for details on platform alinement.)

7.1.1.8 Retrofire and reentry.- The preparation for the reentry phase of the flight began approximately 3 hours before retrofire and required all of the flight crew's time until this event. This was primarily due to the difficulty in getting all of the equipment stowed. Proper equipment stowage was achieved to prevent interference in case of post-reentry ejection, and all preretrofire checklists were completed. The crew accomplished a very good platform alinement considerable in advance of retrofire time.

The OAMS retromaneuver was initiated at 12 minutes prior to retrofire and continued for a period of 2 minutes 40 seconds. The command pilot held the spacecraft attitudes within 1° throughout this maneuver using the rate command control mode. The crew had no indication of the actual ΔV resulting because the computer was inoperative. (See section 4.3 for detailed results of the OAMS retromaneuver.)

The command pilot held the spacecraft within $\pm 1^\circ$ of proper retrofire attitude (180° yaw, -30° pitch) throughout the retrofire maneuver using the rate command mode and the flight director indicator. Pitch was maintained at near -31° for most of this maneuver, which, in conjunction with the 1.3-second time error (see section 5.1.6) resulted in approximately a 10-mile uprange error. (Section 4.3 gives a complete discussion on landing error.)

The crew was instructed to fly a rolling reentry because of the IGS malfunction which prevented the computer from being used for navigation. It was verified prior to communications blackout that the spacecraft would land approximately 50 miles short.

The reentry proceeded fairly smoothly using reentry rate command. The command pilot inserted a 15 deg/sec left roll after which he reported that he disengaged the roll rate gyro. (Ed note: The roll rate gyro was disengaged 44 seconds prior to setting up the roll rate.) The roll rate gradually increased throughout the reentry, reaching a maximum of 64 deg/sec at drogue parachute deployment. The command pilot made no further attempt to control the roll rate; however, the crew had no direct indication of the buildup in roll. The pilot did note that the upper right thruster was firing almost continuously throughout the reentry and correctly analyzed the thruster failure problem existing in the RCS system. (See section 5.1.8 for details on reentry control system operation.)

Pitch and yaw oscillation rates were fairly low until drogue parachute deployment. The crew reported that it appeared that the spacecraft would have remained stable without control inputs. They observed the retroadapter burn up during reentry and noted that it remained in a stable attitude.

UNCLASSIFIED

The crew were prepared for the single-point release as a result of the GT-3 crew experience. Both crew members had their shoulder harness locked, hands against the window, and head braced on the arm in preparation for this event. The crew reported that this operation was satisfactory.

7.1.1.9 Recovery. - The recovery operation proceeded quite smoothly. The crew were reasonably comfortable for the approximately 20 minutes they spent in the spacecraft after landing. All postflight crew functions were completed. Exit from the spacecraft and crew retrieval by the helicopter were performed without difficulty. Although the recovery operation was quite normal, the crew believed they would have been able to perform successful egress and recovery under much more severe recovery conditions.

7.1.1.10 Mission training and training evaluation. - The flight crew training was accomplished generally as planned and outlined in reference 9. Spacecraft familiarity and proficiency were obtained by crew participation in spacecraft systems tests and task simulation as described in the following paragraphs.

7.1.1.10.1 Spacecraft tests: Each member of the flight crew spent approximately 60 hours in spacecraft 4 during the major systems tests at the spacecraft contractor's facility and at Cape Kennedy.

7.1.1.10.2 Gemini mission simulator: The flight crew started training in the Gemini mission simulator on November 30, 1964. Each member of the prime crew spent approximately 130 hours in the mission simulator, and each of the backup crew spent approximately 105 hours. Approximately 30 hours of this training was accomplished by each member of the prime crew and backup crew wearing the Gemini pressure suits.

7.1.1.10.3 Special and part-task training activities: The flight crew completed several training programs to give them experience with as many of the space flight conditions as possible. Some of the more important training activities are described in the following paragraphs.

Parachute - Each flight crew member completed several parachute tows with attendant release and drop onto land and in the water to prepare them for a possible mode I abort simulation.

Egress training - The flight crew received spacecraft water egress practice in the flotation tank at Ellington AFB, Texas, and in the Gulf of Mexico using test spacecraft. Training consisted of briefings, films, demonstrations on use of egress and survival equipment, and practice in "shirt sleeves" as well as with full egress equipment.

UNCLASSIFIED

Centrifuge - The flight crew participated in two Gemini centrifuge programs conducted at the Naval Air Development Center, Johnsville, Pennsylvania. During these programs, the crew experienced launch and reentry acceleration profiles and controlled the spacecraft during normal and selected abort simulations.

Extravehicular activity (EVA) and zero gravity training - The flight crew made two trips to Wright-Patterson Air Force Base for zero-gravity flight training in the KC-135 aircraft. During these training flights, the crew practiced food and waste management, hatch opening and closing, and egress and ingress in pressurized Gemini suits. The pilot made an additional trip for further EVA training with an EVA suit. Familiarization with the EVA environmental control equipment was gained in the crew-station mock-up and in altitude-chamber work at MSC. Training in the operation of the hatch latching mechanism was accomplished during altitude chamber tests, zero-gravity flights, and personal inspection of the mechanism. In addition, a special briefing was given by systems engineers to the flight crew on the hatch latching mechanism design and operation, possible problem areas and malfunctions, and corrective actions necessary. Space propulsion training was accomplished during five sessions on the MSC frictionless platform which also included a simulation of tether line dynamics.

Engineering simulator at spacecraft contractor's facility - The command pilot developed and practiced visual rendezvous procedures on the engineering simulator at the spacecraft contractor's facility. This simulator, which provided a view of the target vehicle with a star background, was programmed for the last 6 miles of the rendezvous maneuver.

Launch abort training - Each flight crew member participated in three launch abort simulation programs on the moving-base simulator. This simulator permitted the flight crew to experience some of the vibration cues in conjunction with various abort situations and definition of optimum abort procedures for a wide variety of launch vehicle or spacecraft systems malfunctions.

Planetarium - The crew made three trips to the Morehead Planetarium, Chapel Hill, North Carolina, to review the entire celestial sphere, and, in particular, those portions near the orbital track. The primary purpose of this training was for backup spacecraft orientation and navigation in case of inertial platform or communications failure.

Briefings - The crew received formal systems briefing of 2 or more days each at Houston, Texas; St. Louis, Missouri; and Cape Kennedy, Florida. Two experiments briefings were conducted at MSC and a short experiments review was conducted at Kennedy Space Center. In addition,

UNCLASSIFIED

the crew participated in many informal systems briefings in conjunction with various training activities. Flight-plan reviews were conducted on a periodic basis throughout their preflight training program.

7.1.1.10.4 Evaluation of training: The flight-crew performance indicated a high level of proficiency in spacecraft systems knowledge, spacecraft operation, and accomplishment of planned mission objectives. The training received during the preflight period adequately prepared the flight crew to perform the critical activities associated with launch, orbital, and reentry phases. The extension of the EVA and the inclusion of the station-keeping exercise and rendezvous maneuvers with the second stage of the launch vehicle required the flight crew to accomplish additional training shortly before the flight.

Training for the EVA portion of the mission was adequate, and the crew was well prepared for this phase of the mission. They were able to cope with difficulties encountered with hatch closing as a result of thorough training.

No simulation training was accomplished to prepare the crew for the station-keeping exercise. The crews were briefed on the station-keeping procedure during the last days prior to flight. The resulting failure to achieve close-up station keeping indicates that the briefings were not an adequate substitute for training for this portion of the mission. Application of what was learned during the station-keeping exercise should greatly increase the probability of successful rendezvous and docking in the next rendezvous mission.

Although the rendezvous portion of the mission was not attempted, training was conducted for the rendezvous with the second stage of the launch vehicle using the rendezvous simulator at the spacecraft contractor's facility and the translation and docking trainer at MSC.

UNCLASSIFIED

7.1.2 Pilots' Report

7.1.2.1 Prelaunch.- The prelaunch training and crew participation in spacecraft testing progressed smoothly and logically. The medical examinations, however, appeared to be out of sequence. The F-2 day examination was a major one, while that on F-10 days was relatively minor. The major examination by its very nature causes discomfort and could prevent the crew's being ready for flight. In addition, this examination is time consuming in a period when time is very critical to flight preparation.

On the morning of the launch, the operations in the crew quarters and the transfer to the suiting area with the prebreathing equipment were satisfactory. The suiting and transfer to the oxygen system of the suit were accomplished with only minor breaks in the oxygen prebreathing. Transfer to the launch pad and ingress were also satisfactory. The cockpit procedures before launch went smoothly, except when one of the valves on the water management panel had to be repositioned after the hatches were closed. For this operation the command pilot had to loosen his straps, reposition the valve with the swizzle stick, and then resume his launch position in the spacecraft. The only interruption to the normal countdown procedure was the 1 hour 15 minute hold caused by the malfunctioning erector. This delay did not cause any excessive crew discomfort.

Preflight communications required the volume controls for both crew stations to be turned fully up. This caused some concern because the flight crew was communicating with a site only a short distance away and would shortly be required to use the same system from much greater ranges. Throughout the count, and especially during the hold, the crew was adequately informed of the status. During the last 3 minutes, the crew was receiving communications from three sources: the Spacecraft Conductor, the Booster Test Conductor, and the Cape Spacecraft Communicator. In addition, two unsynchronized countdowns were conducted between T-10 seconds and lift-off. As a result, there was an excessive amount of chatter, and the flight crew had difficulty in understanding all three communicators.

The only surprising occurrence in the countdown was the very loud noise and extreme vibrations associated with opening the prevalues of the launch vehicle.

7.1.2.2 Powered flight.- The flight crew could hear and feel the engines start; and although lift-off was very smooth, they could feel it. As the Gemini launch vehicle accelerated, the noise and vibration built up smoothly and then stopped abruptly as the vehicle attained supersonic speed. The vibrations at maximum dynamic pressure were

UNCLASSIFIED

somewhat greater than expected. Just before BECO, the command pilot noticed a very slight low-level longitudinal oscillation (POGO) effect, but it was not objectionable; the pilot did not notice the effect.

Although the sky was cloudless, it provided visual cues to the roll and pitch maneuver of the vehicle. The position of the sun relative to the window and moving shadows in the cockpit provided additional cues.

The clock started at lift-off, and the tank pressure gages changed slightly. The roll and pitch programs occurred as expected. The cabin vented at 5.5 psi, and the digital command system (DCS) updates were received on time. At BECO, which occurred normally and on time, the acceleration decreased rapidly but smoothly. Stage I separation, stage II ignition, and stage II powered flight were very smooth. The stage II fuel pressure remained high, and the oxidizer pressure dropped slowly until SECO, as expected.

During stage I flight, the rates and attitude errors remained very small. After BECO, at guidance initiate, the pitch-attitude error went full scale and was steered out quickly with very small rates as expected. Late in stage II flight, a very small rate oscillation of about $\pm \frac{1}{2}$ deg/sec appeared on the rate needles. It was obvious that the vehicle was not diverging, but the oscillation could be felt slightly. The pitch-attitude error needle began to deviate very late in powered flight, and at shut-down it was indicating less than 1° pitch-down. The maximum acceleration was 7.5g, but it was in no way objectionable.

7.1.2.3 Insertion.- After SECO, the Gemini launch vehicle rates were very low, about $\frac{1}{2}$ deg/sec or less. The command pilot fired two or three short bursts with the maneuver thrusters to damp these rates to even lower values. The crew could hear the lateral thrusters firing during this time. The IVI's counted up at SECO+20, and at SECO+30 a 5-second separation maneuver was performed. Although the crew attempted to separate straight ahead with no attitude control inputs, the spacecraft felt as if it separated asymmetrically with a rotational velocity. As on the GT-3 mission, the flight crew were unable to hear the aft-firing thrusters during separation. Later, the crew were unable to hear these thrusters when the IVI's were indicating definite operation. The crew rolled to a heads-up position, and because of the lack of time before turnaround, the crew read the IVI's in an arbitrary attitude rather than with the pitch-attitude needle nulled. The IVI readings were 20 ft/sec forward, 11 ft/sec right, and 5 ft/sec down. As soon as the crew was in an upright position, the turnaround began, and the fairings were jettisoned. During the turnaround, a great amount of debris was visible on all sides of the spacecraft. The insertion check

UNCLASSIFIED

list was started during turnaround and completed shortly thereafter. The 2-1 update was received, and the crew was informed that the orbit was 87 nautical miles at perigee and 153 nautical miles at apogee.

7.1.2.4 Orbital phase.-

7.1.2.4.1 Station keeping: After separation and turnaround, the launch-vehicle second stage came into view at 200 to 500 feet behind the spacecraft and to the left of a line pointing back along the spacecraft track. The second stage was clearly visible against the dark sky, and the flashing lights were also clearly visible. The engine skirt was visible and appeared to be intact. The flight crew pointed the spacecraft at the second stage and thrust for about 6 seconds. The crew did not have time to place the computer in catch-up mode before starting to thrust, but managed to place it there after about 2 or 3 seconds of thrust. The IVI's then counted up to 3 ft/sec. It appeared that the spacecraft and second stage were still separating; therefore, the crew thrust for an additional 4 or 5 seconds. At that time, it appeared that the relative velocity was zero, or that the spacecraft was closing slightly. The spacecraft was then approximately 600 or 700 feet from the launch vehicle, and the crew started to aline the platform. Shortly after the crew began the alinement, the launch vehicle started to drop down below the spacecraft and finally went out of sight. The crew then thrust down with the top thruster and waited about a minute more in the alining attitude. They then pitched down to sight the launch vehicle and found that it had dropped much further below than they had expected. It was difficult to see the launch vehicle against the earth background. The crew quickly returned to the alining attitude and placed the platform in orbit rate. The crew then retrothrust for about 3 seconds and pitched the spacecraft down again to reacquire the launch vehicle, which was approximately 1000 feet below the spacecraft. At this point, two choices were available: One choice was to retrothrust to a different orbit and to attempt a rendezvous; the other was to force the spacecraft toward the launch vehicle by using the orbital attitude and maneuver system (OAMS) to overcome the relative velocities resulting from the now different orbits. Because of the time constraints of the flight plan, the brute force method was selected. The launch vehicle stayed below the spacecraft at a range of approximately 1200 feet as the spacecraft entered darkness. The launch vehicle disappeared in seconds as it entered darkness, and the flashing lights became visible. The crew continued to thrust both at the launch vehicle and in retrograde with most of the thrusting being at the launch vehicle. Just prior to Carnarvon, the crew had finally forced the spacecraft to an altitude approximately the same as the launch vehicle at a close range. Both flashing lights were intermittently visible throughout the maneuvers, and the distance between these lights gave some reference for judging range and range rate. The spacecraft was obviously getting close to the launch vehicle, and the crew fired a short burst to decrease the closing velocities. At about

UNCLASSIFIED

that time, the launch vehicle tumbling, which had reached a rate of 40 to 50 deg/sec, caused one of the lights to disappear. After that time, the crew was forced to judge range and range rate by the brightness of the single visible flashing light. This was extremely difficult to do, and the crew did not have a good estimate of range until the launch vehicle passed into sunlight. At that time, the launch vehicle was approximately 2 miles away, and its outline was visible below the spacecraft. During this daylight phase, the launch vehicle passed over a background of water, clouds, and land and was difficult to see at ranges greater than 1 mile. In thrusting toward it, the crew found that they could not close on it with a reasonable amount of fuel, and the range appeared to increase. The crew reported to the flight controllers that they could only close on the launch vehicle by a major expenditure of fuel; therefore, they recommended abandoning the station-keeping activity. Shortly thereafter, the crew was told to abandon the exercise. At that time, the launch vehicle was below and ahead of the spacecraft at a range of approximately 3 miles. Section 4.3 contains a detailed discussion of the station-keeping exercise.

7.1.2.4.2 Extravehicular activity: The extravehicular activity (EVA) preparations started during the first revolution and continued into the second. As the crew approached the end of the checklist and the spacecraft neared Carnarvon, they realized that they had been rushing and although they could probably begin the EVA on schedule, they believed that the best decision was to delay the EVA for one revolution and to repeat the preparations more thoroughly. During the third revolution, the crew went back through the checklist item for item and completed it with about 15 minutes to spare. The permission to begin the EVA was given by the Carnarvon station, and the command pilot immediately started to depressurize the spacecraft. Depressurization was stopped at 2 psi for a final suit integrity check and then continued to a vacuum. The pilot opened the spacecraft hatch and mounted the outside 16-mm camera, mounted the umbilical guard on the hatch sill, and assembled the maneuvering unit and camera. Although these operations were relatively simple, they did demonstrate the capability of man in a pressurized suit to work effectively outside the spacecraft. These operations took 4 or 5 minutes, and shortly thereafter the Hawaii station gave the pilot permission to egress from the spacecraft. The pilot then turned on the outside 16-mm camera, and left it on until the film was expended. The pilot took special care to depart the spacecraft under the sole influence of the maneuvering unit. The pilot translated to a point 15 or 16 feet from the spacecraft and used the maneuvering unit to stop his motion. He spent the next 4 minutes in translating back and forth to the spacecraft two times and demonstrating various pitching and yawing maneuvers. The capability of using the maneuvering unit to move from one specific point to another was clearly demonstrated during this time. The control technique used with the maneuvering unit was short bursts of pulse mode. While the pilot was demonstrating controlled flight with the maneuvering

UNCLASSIFIED

unit, the command pilot maintained the spacecraft attitude fixed using the pulse control mode. This was done so that the command pilot would know exactly when the thrusters were firing so that no thrusting would be done while the pilot was near the thrusters.

The pilot used the spacecraft as a visual orientation reference. The three-dimensional spacecraft provided a satisfactory reference at all times and the pilot experienced no disorientation.

The pilot spent the rest of the time making general observations and investigating tether dynamics. The open hatch provided a center of operations and a few hand holds. From the beginning, it was obvious that the location of the tether attachment was not optimum for operations in front of the spacecraft. The attachment of the tether to the sill of the hatch tended to force the pilot to operate perpendicular to the hatch area rather than out in front of the spacecraft as was desired. Every time the pilot managed to maneuver to the front of the spacecraft, the tether carried him in a large arc up over the top of the spacecraft and back into the adapter area. It also became apparent that it was difficult for the pilot to push off at an angle from a surface. Not only did the spacecraft tend to pitch down under the force when the pilot was pushing off, but the general direction of the pilot's motion tended to be perpendicular to the surface. Although control with the tether was marginal, it was quite easy to return to the hatch area using it. At no time during the EVA activities did the pilot make any high velocity contacts with the spacecraft. All contacts were gentle. During brief contacts with the spacecraft surfaces, the pilot did not notice any extremes of temperature through his gloves. During most of the tether operation, the command pilot let the spacecraft drift to preclude firing the thrusters while the pilot was in the close vicinity of the thruster nozzles. The pilot made excursions to the full length of the tether on numerous occasions. He executed brisk push-offs from the spacecraft which resulted in spacecraft rates of up to 2 deg/sec. During the operations in a vacuum, both pilots noticed a definite decrease in suit temperature but the level was not uncomfortable. Vision through the three visors was excellent. The sun visor provided adequate and needed protection when the pilot looked into the sun while mounting the 16-mm camera. From that time on the visor was left down and offered no impairment to the remainder of the extravehicular activities.

The pilot examined the spacecraft and the adapter quite closely. The thermal tape and velcro piece placed on the adapter before launch were still intact. The adapter separation plane had a good cut, but the edges were somewhat rough.

Once the pilot brushed up against the left window and caused two apparent smears on it. From the inside, the smears looked like black

UNCLASSIFIED

paint; and from the outside, they had a smooth mirror-like surface. Later, the presence of a film and particles on the window could be detected when the sun shone on the window from certain angles. Evidently, the smears were actually areas on the window where the film had been brushed off.

While the pilot was outside the spacecraft, the VOX was constantly keying the transmitter and blocking the receiver. When the command pilot switched to continuous interphone and push-to-talk, the ground was able to give the order to return to the spacecraft. The preparations that the pilot had made to get ready for the EVA activities had to be made in reverse order to return to the spacecraft. He did these in a slow and deliberate, orderly fashion.

The suit was a little bulkier and stiffer than the pilot was accustomed to, and he needed a little extra time to get down and into the seat. The gain and the drive lever had been placed in the lock position; however, the hatch handle was loose and would not exert any torque. It was obvious that the normal method of pulling down on the canvas strap with the left hand and actuating the hatch handle with the right hand would not work. Instead, the gain pawl was actuated in conjunction with the hatch handle. With the command pilot using the bar and lanyard closing device, the pilot and the command pilot were able to close the hatch successfully. It is felt that the extensive training and briefing on the hatch aided materially in successfully coping with this malfunction. Section 5.1.1 contains a detailed discussion of this problem.

The following comments are made concerning the equipment used during EVA. The sun visor tended to rotate behind the helmet and get between the helmet and the head rest. In addition, the dual visor did not seem necessary; the sun visor alone would have been adequate. There was no tendency for the visor to cloud up. The ventilation control module operated properly as did the rest of the associated equipment. The flow to the suit was adequate, except for two times when the pilot tended to overheat: once when he was mounting the 16-mm camera and again during the spacecraft ingress.

7.1.2.4.3 Experiments: The following comments are given on the experiments. Section 8.0 contains a detailed discussion of the experiments.

MSC-1, Electrostatic charge - The electrostatic sensor was turned on and off as indicated in the flight plan or as directed by the ground.

MSC-2 and MSC-3, Proton-electron spectrometer and tri-axis fluxgate magnetrometer - The spectrometer-magnetrometer switch was turned on as indicated in the flight plan or as directed by the ground. The only

UNCLASSIFIED

problem was a lack of indication of boom extension. Since both experiments depended on this boom extending, it would have been desirable to have an indicator which showed proper extension.

MSC-10, Two-color Earth's limb photography - Nine and one-half runs were made. The event indicator did not properly trip the shutter of the camera and had to be removed during the experiment.

M-3, Flight exerciser - This experiment was conducted as scheduled, except that the command pilot felt that he was not getting enough exercise and requested permission to use the exerciser more frequently. The medical passes were made expeditiously and interfered very little with other spacecraft activities. Both pilots felt that the capacity and desire to do strenuous exercise decreased to a certain point and remained there for the rest of the flight. The pilots did a great deal of leg-stretching and back-stretching, combined with tensing of the legs and stomach muscles. They probably did this latter exercise much more frequently than they used the exerciser. The outside thin rubber layer of the exerciser broke at $6\frac{1}{2}$ hours; however, effectiveness of the unit did not decrease.

M-4, Inflight phonocardiogram - No inflight activities were associated with this experiment.

S-5 and S-6, Synoptic terrain and weather photography - This experiment was conducted as scheduled, and a great many interesting and significant terrain and weather photographs were obtained. One magazine jammed and, as a result, most of the frames in the magazine were lost.

D-8, Radiation - This experiment was conducted as planned. No problems were encountered.

D-9, Simple navigation with the sextant - The first time the sextant was unstowed, the light in the readout dial failed; therefore, the speed with which readings could be taken was greatly decreased. The first series of runs consisted of making star-to-horizon measurements in the daytime. It soon became apparent that making these measurements in the daytime was not feasible. In fact, viewing stars in the daytime was very difficult except for a few limited positions in which the sun was entirely blanked out. The stars could be viewed in both sunset and sunrise by blanking out the sun with the spacecraft, but during the daytime, reflections from the sun made it very difficult to view any stars. The stars selected for the night run were ones in which the angle between the star and the horizon was so great that it was impossible to measure the angle with the sextant through the Gemini window. Therefore, other sets of stars were selected, and measurements made more in the

UNCLASSIFIED

vicinity of 20° to 25°. The limitation of 20° to 25° is not only a window limitation, but also a limitation effected by the inside geometry of the spacecraft. In order to take more effective measurements, the pilot removed his helmet, but the limitation of 20° to 25° still applied. The horizon during the night was not well defined, and it was difficult to take precise measurements to it. Both the clear and the green filter provided satisfactory, usable horizons. The blue filter, however, was not suitable for nighttime viewing. Because the photo event indicator had such a large throw to actuate it, it is not considered to be a satisfactory, accurate timing device. The crew decided that star-to-horizon sextant measurements were not a simple task.

Apollo sextant - No star-to-stage II measurements were taken because the rendezvous was eliminated from the flight plan. It should be noted that the same limitations as stated above would apply here also. The task of measuring the angle between two stars using the same area of the window was accomplished with good repeatability.

7.1.2.4.4 Operational checks:

Relative humidity sensor check - Throughout the flight, the dry-bulb and wet-bulb temperatures were taken. The relative humidity remained close to 62 percent throughout the flight, which was much less than had been predicted. No difficulties were encountered in using this sensor. A satisfactory wall temperature was not obtained because the walls were well covered with the water absorbent padding.

Apollo landmark identification - It was possible to acquire and track prominent landmarks or features. With a few contrasting landmarks and a reasonable degree of familiarity with the area, good tracking can be obtained from about 20° to 30° before the vertical. Thorough pre-flight map study and several passes over the area make rapid landmark identification possible. Any amount of cloudiness greatly complicates the tracking problem and makes landmark identification very difficult. Pulse control was found to be very adequate for tracking. The charts provided to the crew were not detailed enough for target location; the most desirable landmark-identification aids are aerial photographs.

HF transmission-reception check - These checks were run as scheduled with a very low degree of success.

Orbital navigation check - Only a limited number of orbital navigation checks were made. On the other hand, considerable orbital navigation was done with the orbital plotter which was very similar to this check. Little difficulty was encountered in observing terrain features and updating the orbital plot.

UNCLASSIFIED

Apollo yaw orientation check - This test was conducted at night since that was considered to be the most difficult time to perform the test. The results showed that it was not too difficult to orient the spacecraft even at night. Therefore, the day check was omitted to save fuel. At night, the best technique was to pitch down immediately toward the earth. By observing the motion of the ground and the clouds, it was possible to determine the direction of flight quickly and then to orient the spacecraft to a retrofire attitude. By using the direct mode sparingly to save fuel, the required orientation was reached in approximately 2 minutes 20 seconds. The attitude was correct in pitch and roll, but 18° off in yaw. If fuel were not a consideration, this maneuver could be performed in approximately 1 minute 30 seconds. It should be noted that accurate yaw orientation at night, using just the stars, is a difficult task.

One attitude thruster failure check - This task was not difficult as long as the roll TCA's in the other axes were available. The rates could be damped out, and a desired yaw rate could be established. The check compared very closely with that performed in the simulator.

Horizon sensor track check - This test was performed as scheduled, except that the last two runs with pitch and roll were omitted because the sensor was checking out very well, and time and fuel were limited. The crew did discover that the sensor operating range was considerably broader than they had expected.

Horizon scanner check - The sensor check was run at sunset and moonset. During the sunset checks, the sensor ignore light would come on as the sun passed through the point directly in front of the sensor. The moon did not cause erratic operation in the horizon sensor mode. The forward-firing translational thrusters did not affect the operation of the sensor, nor did three-axis attitude inputs cause the scanner ignore light to come on. On the whole, the horizon sensor mode was satisfactory.

Zodiacal light check - The zodiacal light check was conducted as scheduled.

7.1.2.4.5 Eating, sleeping, and house keeping: Eating was a very important part of the flight activities, and the food provided was satisfactory. Both pilots became hungry about every 4 or 5 hours and would get a completely run-down feeling. As soon as they ate a meal, their energy would increase rapidly. The crew felt that they had to eat a reasonable amount regularly to function effectively. The bacon was so tasty that both pilots think more emphasis should be placed on packaging meats for space flight and particularly smoked meats. Two problems were associated with the food: the juice bags tended to leak,

UNCLASSIFIED

and the toast slices and peanut cubes crumbled. Several problems were associated with drinking water. It was quite easy to crimp the hose where it attached to the drinking water gun and shut off the flow of water. In addition, the hose appeared to be old and cracked. The drinking water gun stuck in the open position and had to be pushed to the closed position manually to shut off the flow of water. An excessive amount of air was mixed with the flow of water. This problem was apparent when the food bags were filled, because the bags contained approximately one-quarter air and three-quarters water and reconstituted food.

Sleeping was a definite problem during the flight. It was impossible to turn the radios completely off without disconnecting the helmet quick-disconnect, which was not an operationally satisfactory solution. Eventually, however, the quick-disconnect was disconnected during the command pilot's and pilot's rest period so that they could get adequate rest. The sudden noise associated with firing of the attitude thrusters was another disturbance during the rest periods. It was agreed that the 4-hour rest cycles were not satisfactory, and a more satisfactory cycle would be a 6-hour sleep period followed at some time later by a 2-hour nap. House keeping was a major effort during the flight, and it had to be conscientiously carried out. Early in the mission, it became apparent that there was not enough velcro around the spacecraft. The storage pouches along the center pedestal were very useful for storing the books, maps, and other miscellaneous items and were used continuously. Also, the large dry waste bags mounted on the outer side of the foot wells were very useful for storing miscellaneous objects and dry trash. All planned storage areas were usable, with the center box and side boxes being the most easily accessible. The right and left food boxes were accessible, but it took undesirable effort to get articles in and out of the boxes. The two rubber-topped refuse boxes were accessible with even more effort and were used at various times throughout the flight. The most useful storage area was underneath the command pilot's and pilot's legs. All EVA equipment was stored in this area throughout the entire flight. In fact, various other items such as the sextant, camera, and lenses were also stored in this area from time to time.

The defecation bags were quite satisfactory and were used on six different occasions. It is possible to use just one bag during a defecation and then use the paper to push the feces down into the bag. The plastic bag containing the disinfectant was too difficult to break. The special one-sided paper was not absorbent enough. The urine collection device was considered marginally acceptable. When a good seal in the device was obtained, the urine did not flow properly; and when a poor seal was effected, the urine flowed quite satisfactorily, but it also leaked excessively.

UNCLASSIFIED

7.1.2.4.6 Real-time flight planning: This flight was the first experience with real-time flight planning. There were a great number of changes to the flight plan, and they were made in an orderly manner. The changes required not only the ground, but also the flight crew participation to arrive at the best plan at the best time. Despite the success of the operation, some problems were encountered. The major problem was the use of two time systems - ground elapsed time and G.m.t. All flight planning had to be made in elapsed time to be meaningful; yet the official time for the mission was G.m.t. The two systems not only complicate the transmission of data in flight planning, but also confuse the reduction of data after the flight.

The only problem encountered in real-time flight planning was a conflict between the MSC-10 experiment and the horizon sensor sunset check. Both checks were accomplished satisfactorily, but the time interval between them was inadequate. The plan in the flight-plan roller was difficult to scan, while the flight plan in the flight booklet was easily accessible in its entirety. Easy access is necessary for proper flight planning. The flight-plan usefulness could be improved by changing the scale to 3 hours per card.

7.1.2.5 Preretrofire and retrofire.- The preparation for retrofire began 3 hours prior to the event. All of the equipment was stowed at the end of the first 2 hours, leaving both crew members free to concentrate on the final mission events. The platform was turned on approximately 1 hour 45 minutes before retrofire and was alined for approximately 45 minutes of this time. The preretrofire, T_R-36 , T_R-22 , and T_R-13 checklists were performed on time or ahead of time. The aft-firing translation thrusters were checked out satisfactorily. While checking ring B of the RCS, one thruster seemed to be malfunctioning, but further checks indicated that they were all operating properly. A complete discussion of this problem is found in section 5.1.8. At T_R-12 the OAMS retrofire was started. It was terminated in exactly 2 minutes and 40 seconds. It was quite easy to hold the attitudes to within $\pm 1^\circ$ with the rate command mode. The T_R-5 checklist was performed on time. At T_R-1 the crew performed the OAMS separation, electrical separation, and adapter separation. Each event was clear and distinct. The adapter separation was very loud and disturbed the spacecraft attitudes slightly. At T_R-30 , the crew armed the retrofire squibs and noticed that the event lights came on approximately 1 second early, indicating that the time reference system was 1 second ahead of the retrofire count. However, the crew elected to arm the automatic retrofire function so that both automatic and manual retrofire signals would be sent. The retrorockets fired 1 to $1\frac{1}{2}$ seconds early on the time reference system autofire signal. Once again,

UNCLASSIFIED

the rate command system provided excellent control, and the attitudes were held within $\pm 1^\circ$. The retroadapter was jettisoned at $T_R + 45$ seconds with a sharp report. The pilot observed the horizon sensor assembly through the command pilot's window shortly after the assembly was jettisoned.

7.1.2.6 Reentry and landing.- After the retroadapter was jettisoned the spacecraft was rolled to a heads-down position. At about $T_R + 3$ minutes 15 seconds, the rolling reentry began. The crew used reentry rate command with the roll gyro turned off. The roll gyro was turned off so that the hand controller did not have to be held deflected in roll for the entire reentry. Shortly thereafter, the retroadapter came into view. It was perfectly stable in a small end forward attitude. At $T_R + 5$ minutes the retroadapter started to burn, and then flames began coming up around the sides of the spacecraft. The spacecraft was rolling about its longitudinal axis at the beginning of reentry. As the aerodynamics began to take effect, the spacecraft began to roll about its trim axis, causing the spacecraft to reenter in a wide spiral. The crew were surprised that the nose of the spacecraft followed such a large circular path, indicating a large trim angle. The spacecraft was very stable during this period. The command pilot occasionally damped pitch and yaw within the rate deadbands of the reentry rate command. During this time, the command pilot noticed the steady-state yaw rate increasing slightly and heard the thrusters begin to fire more often. Roll inputs were then made through the attitude controller to decrease the roll rate, which, in turn, caused the steady-state yaw rate to decrease. Postflight data showed that the roll rate did indeed increase throughout the reentry due to a non-firing pitch thruster. A detailed discussion of this problem is found in section 5.1.8. This increased roll rate cross coupled into yaw and caused the steady-state yaw rate to increase to the limit of the deadband. This caused the yaw thrusters to fire. During this time, the acceleration level increased to $7\frac{1}{2}g$.

As the spacecraft passed through an altitude of 100,000 feet, the acceleration level was still at $4g$. The spacecraft continued in a stable spiral until drogue parachute deployment, when the spacecraft oscillated rapidly. The angle between the drogue risers and the spacecraft axis had amplitudes up to 40° . The control mode was changed from reentry rate command to rate command approximately 15 seconds after drogue parachute deployment. This was done to dampen the oscillations and to expend as much fuel as possible before impact and therefore to lessen the problem created by propellant fumes. Approximately 25 seconds after drogue parachute deployment, at an altitude of 28,000 feet, the rates began to dampen out. Shortly after this, the RCS propellant valves were turned off, and the rate command was left on to drain the fuel from the manifolds.

UNCLASSIFIED

The main parachute deployed smoothly with no torn panels. While in the single-point attitude, it was possible to see the drogue and pilot parachutes drifting down just above the spacecraft. After the pilot completed a blood-pressure recording, the spacecraft was oriented to the two-point attitude. The crew had been warned about the jolt at single-point release, and they had their arms against the window and their heads on their arms. Because of this preparation, the resulting jolt was not excessive. The local altimeter setting was not furnished prior to landing.

Water landing was somewhat more severe than the crew had expected. The spacecraft went under water and rolled to the left. The parachute was jettisoned immediately after landing, and the spacecraft immediately came to the surface. The inlet snorkel was closed at landing to keep out any RCS propellant fumes.

7.1.2.7 Postlanding.- The crew received excellent treatment on-board the carrier. The first one-half day was spent undergoing the postflight physical. Much of the second day was spent in medical debriefing and two tilt-table tests. The technical debriefing was not started until the evening of the second day and continued into the evening of the third day. Because of the large amount of time required for the medical debriefing and testing, an extra day was required to complete the technical debriefing.

7.1.2.8 Systems operation.-

7.1.2.8.1 Malfunction detection system: The malfunction detection system operated properly throughout the powered flight. It provided the command pilot with sufficient information to take the necessary actions during this period. There was one inadequacy of the instrumentation - the limit decals fixed to the outside of the glass on the tank pressure gages. If these decals had been made wide enough to completely obscure the limits painted on the gage face, they would have obscured the in-board needles; conversely, because the decals were made narrow enough to show the inboard needles of the gage, the obsolete limits on the gage face showed through. This situation was confusing since the gage face limits and the decal limits did not agree. A better marking of the launch vehicle MDS tank pressure limits is necessary.

7.1.2.8.2 Flight control: The prelaunch check of the OAMS system was adequate, and the actual thruster firing was easily detected from within the spacecraft. Pulse, direct, rate command, and horizon scan modes were used with the OAMS during the orbital phase of the mission. The pulse mode was used more than any of the other modes. It provided excellent control, not only for small attitude changes but also for ground-tracking tasks which required rather high spacecraft rates and

UNCLASSIFIED

large changes in attitude. It was very economical from the fuel standpoint, especially when attitude changes were planned and could be started well in advance. The direct mode was used sparingly. It provided positive authority and could accelerate the spacecraft rapidly. It worked well for large attitude changes that had to be accomplished quickly. The rate command system was only used during the control checks and translation thrusting. It provided excellent damping and control during these maneuvers. The horizon scan mode was used during almost the entire last day of the flight. It provided a modified attitude hold control mode. During this 24-hour period some extraneous pulses were heard when the sensor was pointing at the sun at sunset and sunrise. The control system actually lost control of the spacecraft only once.

The OAMS maneuver system was exercised thoroughly during the flight. The forward, aft, and lateral firing thrusters were used. Except for a short check with pulse and another with direct, rate command was the attitude control mode used throughout the translation maneuvers. Pulse and direct modes were adequate for short periods of thrusting, but rate command was far superior for attitude control during all translation thrusting maneuvers. Postflight data showed that one of the aft firing thrusters did not operate during a portion of the flight. With rate command attitude control, short periods of translation thrust, and using a moving out-the-window reference, this failure was not apparent. At no time did the crew hear the aft-firing thrusters; however, they could faintly hear the lateral- and forward-firing thrusters.

The RCS control modes used were pulse, direct, rate command, and reentry rate command. The RCS was activated approximately 1 hour prior to retrofire. No difficulties were experienced in activating the system. Pulse and direct appear to have slightly less authority with one ring, and slightly more with two rings than did the comparable OAMS modes. RCS rate command had a slightly greater rate deadband than did the OAMS mode. The rate command mode provided excellent damping and control during retrofire. Reentry rate command with the roll gyro turned off was used for reentry. This mode permitted manual damping with the rate deadband and automatic damping at the deadband limits except in roll. Section 5.1.8 contains a more detailed discussion of the spacecraft propulsion systems performance.

7.1.2.8.3 Inertial guidance system: All of the inertial guidance subsystems operated during the flight. The MDIU functioned properly at insertion when the pilot requested a read-out of the ΔV to be applied at first apogee to correct perigee. The IVI's read out the insertion parameters at SECO + 20 seconds and were used to count the ΔV during the station-keeping maneuver. These subsystems operated properly.

UNCLASSIFIED

The inertial measuring unit was used on three occasions during the flight: lift-off through $3\frac{1}{2}$ revolutions, at the end of the third day, and from preretrofire to landing. Approximately 25 minutes were required for the inertial measuring unit to warm up and start to cage on the two occasions that this was done. The attitude malfunction light came on and the ball started to cage at the same time. The malfunction light was reset immediately. During the alinement, the flight director indicator (FDI) needles appeared to function normally. The alined attitude was checked by looking out the window and appeared to be accurate.

The computer was operated continuously from prelaunch through the first two revolutions and intermittently throughout the flight until an elapsed time of 75 hours when an IGS system failure led to an alteration of the computer memory which prevented future use of the computer. The attitude errors were displayed by the FDI's from the computer during launch while the computer was in ascent mode. Shortly after insertion, the computer was switched to the catch-up mode. It appeared to have operated properly as it summed the ΔV applied during the station-keeping maneuver. After the second revolution, the computer was switched to prelaunch and then turned off. From this time on the computer was powered up only to receive updates from the ground. During the 75th hour of elapsed time the computer was powered up for an update. After the update, the computer and the IGS power were turned off. When the IGS power was turned off, the malfunction light came on, and it was noted that the computer running light was still on. The IGS power was turned on again and the malfunction light was reset. Several switch changes were made. One of these was a mode change with the computer power switch off but with the running light on. Telemetry data showed that the computer did change modes. Over Tananarive, instructions were received from the ground to place the computer power switch to on and to turn the ac power switch from IGS to ACME; this action was taken. The computer running light stayed on, and the malfunction light came on; then they dimmed appreciably and finally went out. Later efforts to make the computer operate properly were unsuccessful.

The DCS light illuminated when updates were sent and appeared to operate properly throughout the flight.

7.1.2.8.4. Propulsion: During the flight, some of the thrusters failed to fire. These occurrences are described in detail in sections 7.1.2.6 and 7.1.2.8.2.

The OAMS quantity indicator fluctuated very slowly throughout the flight. The average magnitude of these fluctuations was 2 percent, and the maximum was 4 percent.

UNCLASSIFIED

During orbital flight the RCS heater warning light came on intermittently over a period of 1 hour 45 minutes beginning at an elapsed time of approximately 65 hours. Actuating the RCS heaters extinguished the light.

7.1.2.8.5 Electrical systems: The electrical system operated satisfactorily throughout the flight. The voltage reading in the main batteries had dropped from 24 volts to slightly more than 22 volts by the end of the flight. It was interesting to note that in the minimum power configuration for drifting flight, the spacecraft required only 12 to 13 amperes. The crew received information on the electrical power usage from the ground just one time. At that time the crew were told that they had a 160 amp-hour margin over preflight calculations. Section 5.1.7 contains a more detailed discussion of the electrical system performance.

7.1.2.8.6 Communication: Communications throughout the flight were satisfactory except for the first 8 or 9 revolutions. During this time there was some difficulty with UHF, but the trouble seemed to be eliminated by switching to the reentry antenna. Later in the flight, however, the crew switched back to the adapter antenna, and the communications remained satisfactory. It should be noted that the command pilot's intercom volume and UHF had to be on the maximum setting to obtain satisfactory communications. The quality of the interphone and its operation was satisfactory throughout the flight. The HF radio did not work satisfactorily during any of the scheduled tests; however, it was used on a few station passes. The onboard voice tape recorder is unsatisfactory with respect to its operational capability: its 1-hour capability was too short, the light which indicated that all tape had been used was not in a position that could be seen, and the switch on the voice control panel did not provide satisfactory operation. On this flight, the crew had the capability to tape only 15 percent of the onboard conversation. The inability to turn the volume off on the HF, UHF, and intercom (as mentioned in section 7.1.2.4.5) was a serious deficiency. Section 5.1.2 contains a more detailed discussion of the communications systems performance.

7.1.2.8.7 The environmental control system: On the whole, the environmental control system operated satisfactorily. The most interesting point was that the relative humidity stayed at a fairly constant 62 percent throughout the flight. The cabin temperature remained approximately 75° F, except for a short period after insertion when it increased to 100° F. The cabin heat exchanger, in conjunction with the cabin fan, brought this temperature down to 80° F in about 20 minutes. The suit inlet temperatures stayed at about 52° to 54° F during most of the flight. The command pilot was comfortably cool at all times and was even a little too cool while he slept, but the pilot was warm through-

UNCLASSIFIED

out the entire flight. In fact, when the pilot went to sleep with his face-plate closed and the gloves on, he got so uncomfortably warm in about 1 hour 15 minutes that his sleep was interrupted. However, he discovered that when he slept with the face-plate open and both fans on, he did not become uncomfortably warm.

During launch, the cabin pressure rose to 5.5 psi and then slowly decreased to about 4.9 psi. The oxygen vent pressure had been set at 967 psi, which seemed to be in the operating range of the cryogenic oxygen system. As the pressure in the oxygen tank built up, the excess oxygen was bled into the cabin to prevent the cryogenic oxygen tank from venting. This excess oxygen, combined with the low setting of the cabin vent valve, caused numerous cabin ventings. After the cabin vented several times, and the pressure dropped 0.3 psi in less than a second, the crew decided that they should be fully suited before further cabin ventings. Therefore, maintaining an acceptable oxygen tank pressure required far too much time and effort.

During the EVA operations, the manual oxygen heaters were used twice and maintained the pressure satisfactorily. Neither pilot noticed any difference between the day and the night cycles in relation to temperature and comfort. Suit pulsing detected early in spacecraft testing occurred once during the flight. The configuration at that time was the face-plates closed, the recirculation valve closed, and both flow valves fully open. Both secondary oxygen bottles maintained their pressure throughout the flight. The normal overboard urine dump system operated satisfactorily until about 92 hours, when it failed in the middle of a dump. The rest of this dump and one more were expelled through the water evaporator.

After an elapsed time of about 6 hours, the pilot noticed a smell which he could not identify but which tended to keep him awake. Shortly thereafter both crew members noticed a burning sensation in their eyes, which increased in severity until approximately 30 hours. At this time, the eyes of both crew members were very red. The irritating sensation then decreased for the rest of the flight.

The crew wore the G4C pressure suit. The command pilot wore a suit with a standard cover layer. He was comfortable throughout the flight, and his mobility was adequate. The pilot wore the same type suit except with an EVA outer liner. He was warm throughout the flight and somewhat restricted in mobility, although his general comfort in the suit was satisfactory. Neither pilot had pressure points from the suit, but both had pressure points from the helmet. The gloves did not provide adequate feel. Section 5.1.4 contains a more detailed discussion of ECS performance.

UNCLASSIFIED

7.1.2.8.8 Sequential systems: No improper operations were detected in the sequential system.

7.1.2.8.9 Crew station: The interior spacecraft lighting was marginally adequate. The bright white center light helped to make rapid instrument reading possible. The front, side, and overhead panels were not well lighted but were satisfactory. The water management area between the seats was not satisfactorily lighted; the cabin water-tank level could not be seen with the auxiliary light or fingertip lighting. The auxiliary receptacle light was too dim; it should provide a strong, direct beam of light with an adjustable iris. The red panel lights were very useful and were used extensively during the night passes. In some orientations with respect to the sun, the sunlight was so bright that the instruments were very difficult to read.

Inadvertent switch throwing was not as much of a problem as had been anticipated. Switches were inadvertently thrown a very few times, and considering the length of the mission and the few switches that were actuated inadvertently, it was not an unsatisfactory situation. The flight plan roller in the center instrument panel was not used at all during the flight. This device is not easily rolled and presents such a limited amount of the flight plan that it was of no use during the flight. The Greenwich mean clock on the right-hand side was not satisfactory in any respect. The face was difficult to read, the two minute hands were confusing, and moveable indices tended to make the face even more crowded. The left-hand clock was very easily read, but it lost 4 or 5 seconds a day.

The lightweight headset would not stay on the head during activity in the spacecraft. The swizzle stick was used quite extensively; it proved to be quite useful in unstowing equipment and turning switches on and off. The star-charts were satisfactory. The orbit maps were quite easy to use. Although the timing became somewhat inaccurate, the maps were easy to update.

There was no gage to determine water usage or water remaining in the spacecraft or adapter section tanks. Such a gage is necessary to allow the crew to manage their water consumption adequately.

The zippers on both of the tissue containers pulled apart below the zipper plow.

The on-off switch on one of the 16-mm cameras operated intermittently throughout the flight. Sections of the filming of the EVA operation through the command pilot's window were lost as a result of this intermittent operation.

UNCLASSIFIED

The drogue pins were not satisfactory in any respect. The pin was small, difficult to handle and hard to reach. The hole cannot be seen and it is difficult to insert the pin into the hole.

Further remarks concerning storage are included in section 7.1.2.4.5 and section 5.1.10.

7.1.2.9 Visual observations.- The greatest impression was the clarity with which objects could be viewed, especially from directly overhead. Roads, canals, oil tanks, boat wakes, and airfields could be seen quite clearly. These items were especially easy to view if there was a good color contrast between them and their background. The lights of cities at night seemed to be very clearly defined. It was interesting to note that the moonlight did not obscure the stars as it does on earth. The moon appeared just as a bright light, and the stars close to it were easy to see. By using known fourth- and fifth-order magnitude stars as references, the crew observed stars down to the seventh order. It is felt that the coating on the window decreased the number and magnitude of stars that could be viewed. At an altitude of 40,000 feet on a dark night, more stars can be seen than were viewed through the spacecraft windows at night. Star viewing in the daylight was very difficult because of the reflections from the nose area of the spacecraft. A few stars were viewed by orienting the spacecraft very carefully, but as an operational procedure, viewing stars from the Gemini spacecraft in the daytime is very difficult. At sunset and sunrise the stars can be readily seen out one window. In fact, it was possible at this time to see complete darkness and stars out one window and bright sunlight out the other. At sunset and sunrise, particles from the spacecraft venting became very bright and reflected the sun's light as very bright light sources. In fact, one of the most beautiful sights of the flight was a urine dump at sunset. The sky would become full of tiny, bright light sources.

The planets seemed to increase in brightness as compared with seeing them from the ground. Venus was an especially striking view at sunset. What was assumed to be the Southern Lights were observed twice during the flight as vertical, parallel lights running in a snaking fashion below the spacecraft, and looked somewhat like a curtain of light. At one time, the airglow was noted to have a series of vertical lights reflected up through it. Also, a bright light source was noted flashing in the airglow layer on several occasions. This was not lightning. The two-band effect of the airglow was clearly observed. It appeared that the bright upper part was about one-third to one-fourth the thickness of the lower part. The airglow-layer had an apparent rise as the spacecraft passed from darkness to daylight. As soon as the spacecraft was in full daylight, the airglow layer disappeared.

UNCLASSIFIED

The shafting of zodiacal light prior to sunrise was observed on two occasions to occur 4 minutes 20 seconds prior to sunrise. It seemed to shaft up at an angle slightly to the right of the vertical.

Shooting stars or meteorites were observed on many occasions considerably below the orbital altitude as they fell and burned up in the atmosphere.

7.1.2.10 Postlanding.- Immediately after landing, the sea dye marker could be seen and the parachute was in the water to the left of the spacecraft. There were no apparent leaks and the RCS thrusters were steaming, but no fuel was observed. An acrid smell was detected immediately. The postlanding checklist was accomplished and the required blood pressures were recorded. The HF antenna was extended and an HF short count was given. The pilot removed his helmet and used the lightweight headset. The command pilot elected to leave his helmet on to avoid smelling the acrid odor in the spacecraft. An aircraft was overhead immediately and the crew was given the option of a 20-minute wait for a helicopter or a 1 hour 40 minute wait for spacecraft recovery. The crew elected to be picked up by the helicopter and decided to leave the spacecraft wearing their suits. The flotation collar was installed in about 20 minutes, and the crew was aboard the carrier U.S.S. Wasp in about 45 minutes after landing.

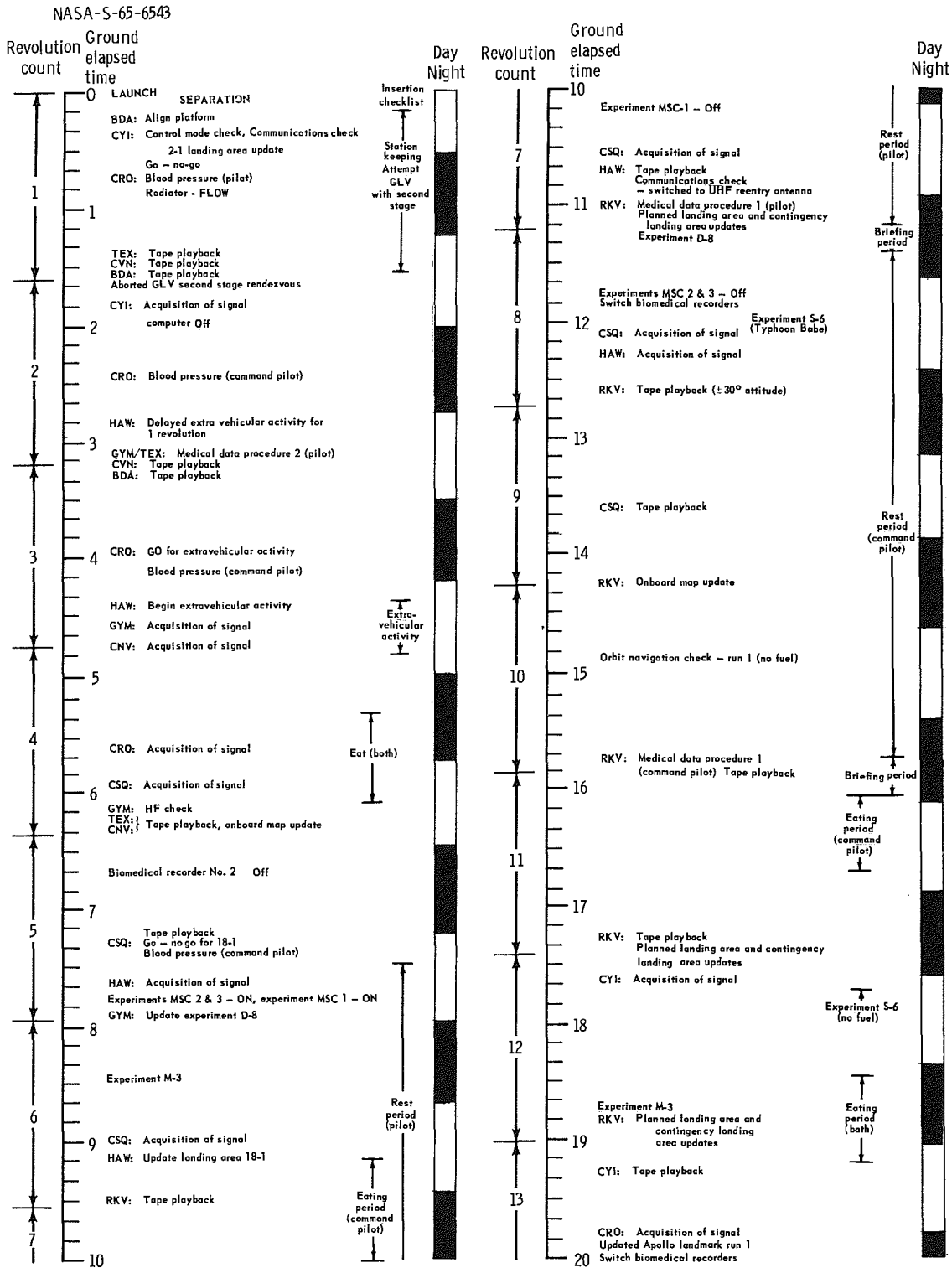

Figure 7.1-1.- Summary flight plan.

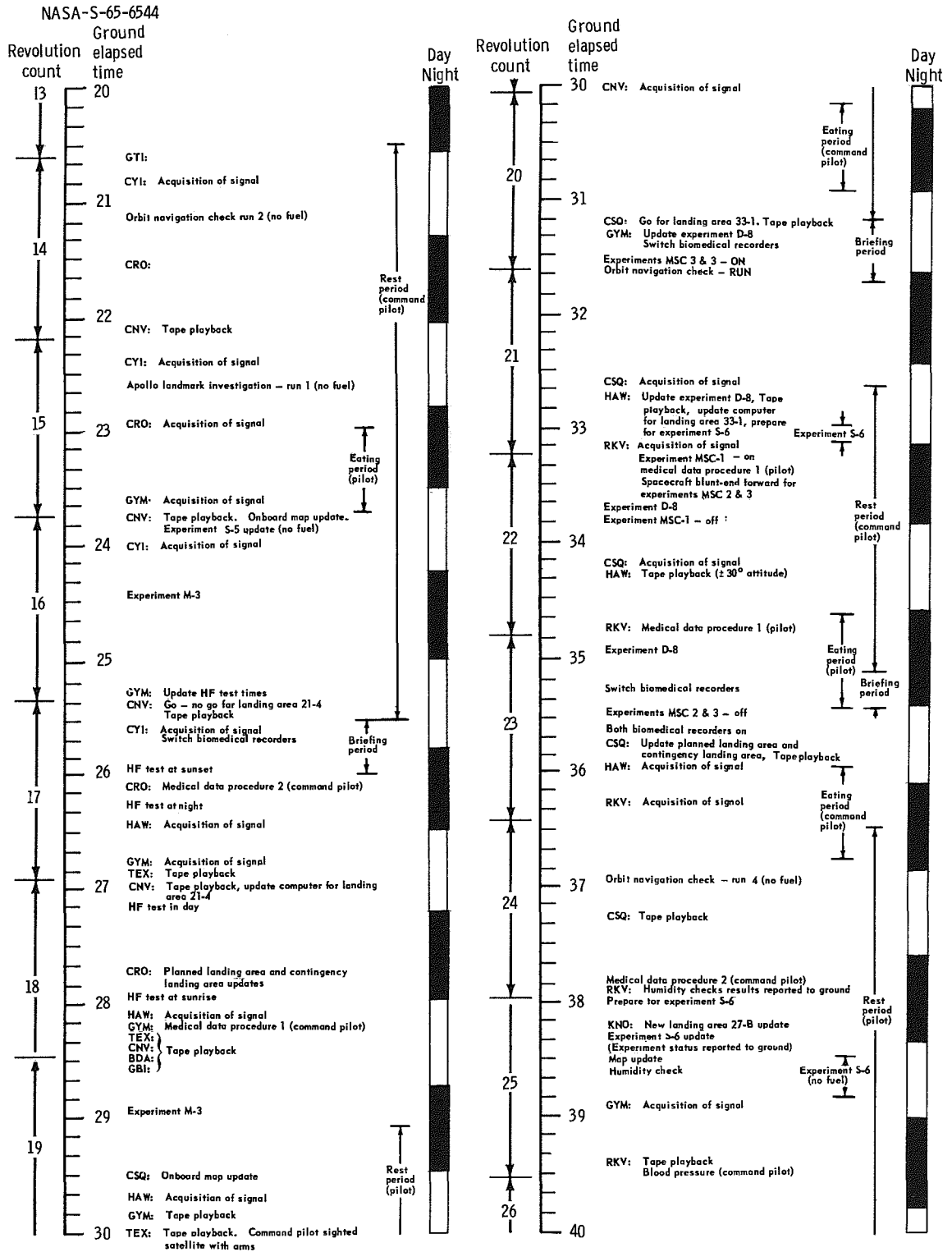

Figure 7.1-1.- Continued.

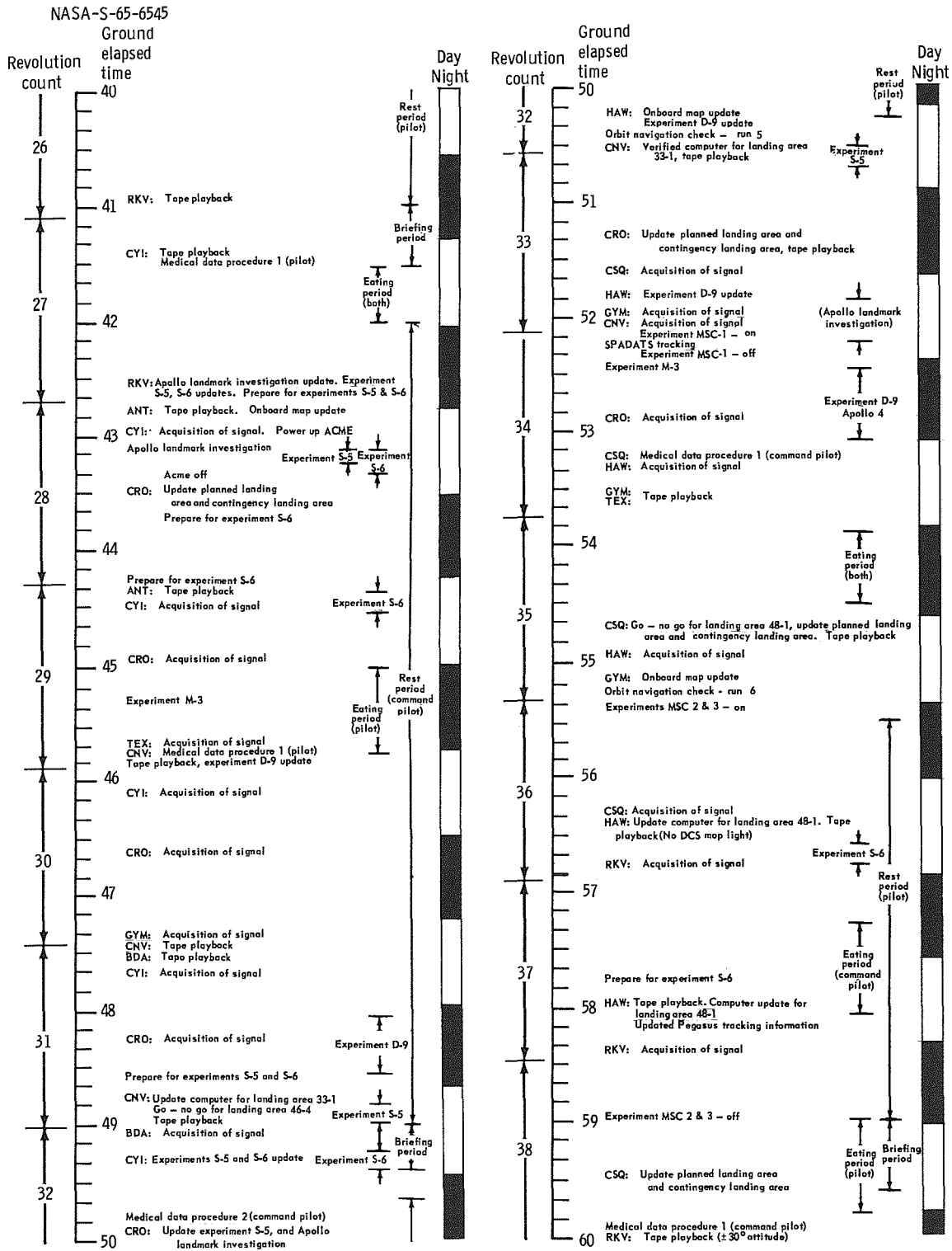

Figure 7.1-1.- Continued.

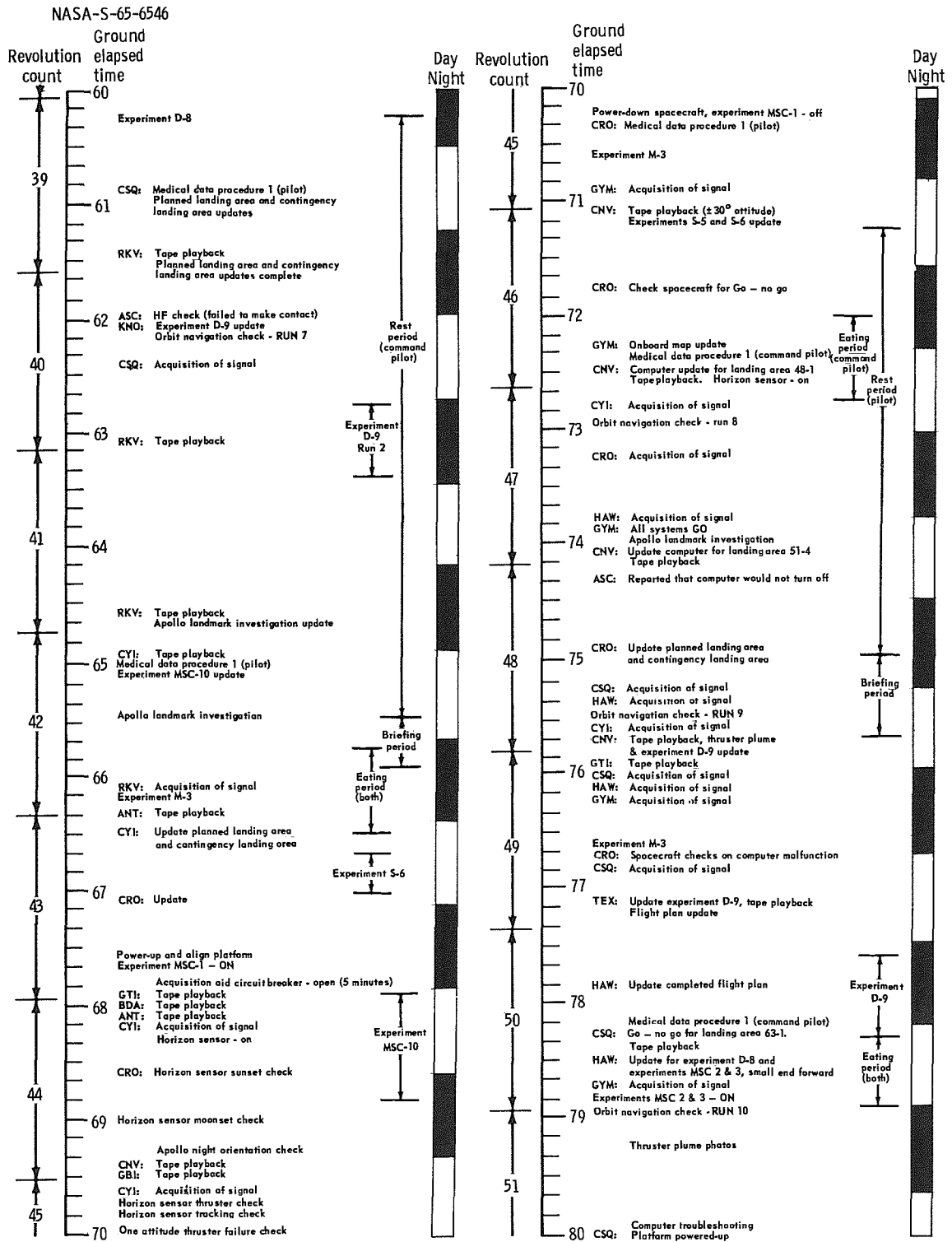

Figure 7.1-1.- Continued.

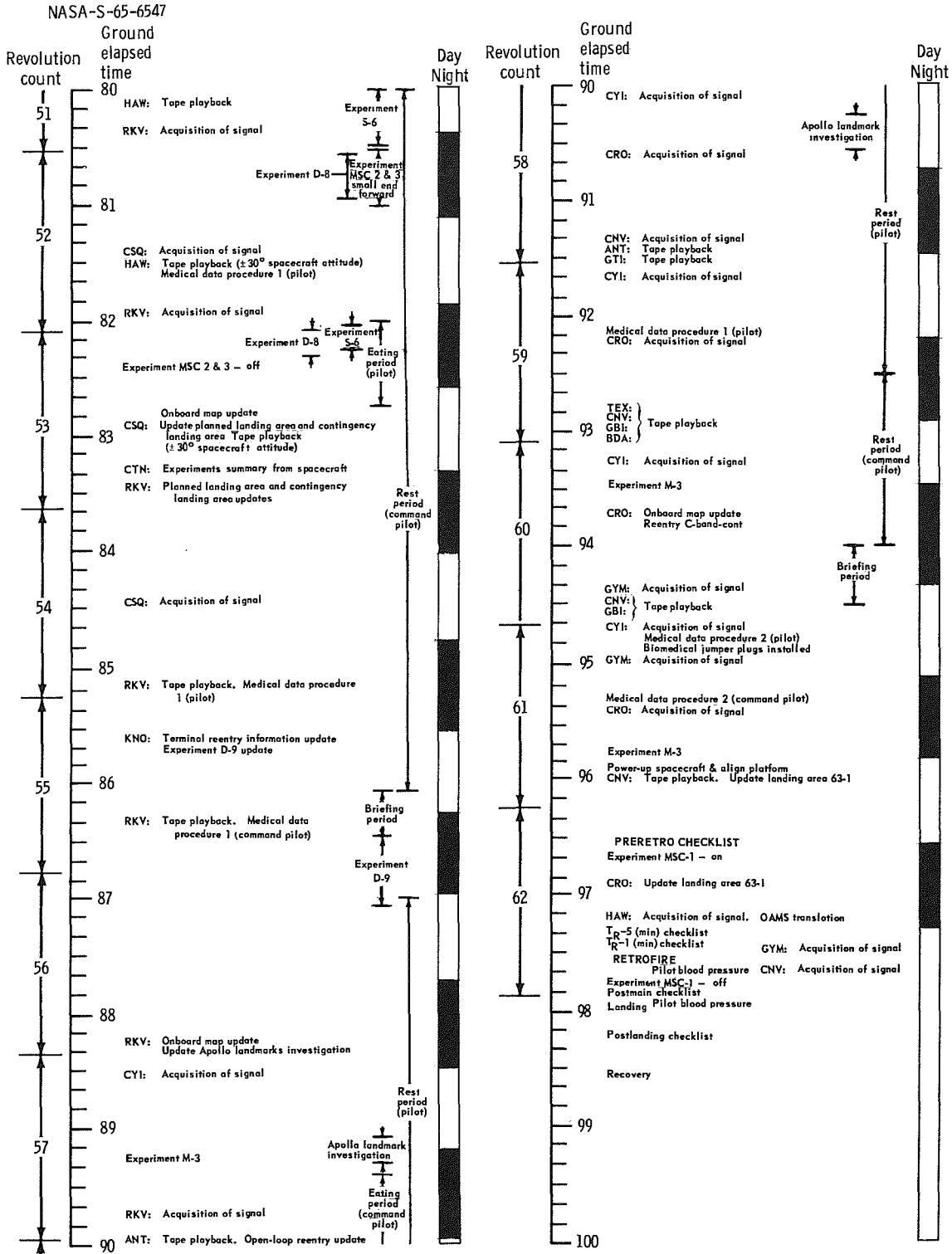

Figure 7.1-1.- Concluded.

7.2 AEROMEDICAL

One of the prime objectives of the Gemini IV mission was to observe what physiological effects, if any, a 4-day exposure to the space-flight environment would have on the flight crew. This was the first of three planned incremental increases in exposing man to flights of longer duration than that experienced by L. Gordon Cooper during MA-9 (34 hours). Unique opportunities were afforded to observe the two crewmen in pressurized suits while the cabin was at zero pressure for a period of approximately 1 hour, and to observe one crewman outside the spacecraft for 23 minutes.

These observations and data are presented by phase of flight, that is: preflight—all pertinent background data and activities to lift-off; inflight—all information and data received by telemetry and voice from lift-off to landing; and postflight—information and observations from medical examinations and debriefings. Data from the onboard biomedical tape recorders are unavailable at this time and will be presented in a supplemental report. This report will include some blood-pressure readings obtained during the reentry, descent, and a short period on the water.

Observations were also made of food and water management, the waste-collection system, the work/rest cycle, and general stowage and housekeeping. Results of the medical experiments are reported in section 8.

7.2

7.2.1 Preflight

7.2.1.1 Medical histories.— The medical histories from the flight crew consist of their service medical records, the record of the comprehensive medical examinations conducted at the time of their selection as astronauts, and the annual medical examinations for fitness for flying since that time. In addition, a considerable volume of data was collected on both the prime flight crew and backup crew during their participation in simulated flights, centrifuge training runs, and spacecraft system tests. The latter were conducted both at ground level and at simulated altitude in a vacuum chamber. A summary of the medical evaluations and the occasions on which baseline data were collected is presented in table 7.2-I. In preparation for this flight, the pilot of the prime crew using his extravehicular equipment participated in an altitude chamber test on May 20, 1965.

7.2.1.2 Bioinstrumentation.— For this flight, the bioinstrumentation harness consisted of two leads of electrocardiogram (sternal and

UNCLASSIFIED

axillary), impedance pneumogram, oral temperature using an oral thermistor, and a blood-pressure measuring system. In the M-4 medical experiment, a phonocardiogram microphone was placed on the anterior chest of the pilot just to the left of the sternum in the fourth interspace. This system was used on all those occasions noted in table 7.2-I. In connection with the tilt-table studies described in the following paragraph, strain gages were used to measure the difference which postural change made in the circumference of the calves of the prime crew.

7.2.1.3 Preflight tilt-table studies.- As shown in table 7.2-I, two paired tests and one single tilt-table test were conducted on the prime crew. Dates for the paired tests were selected so that they could be carried out before and after an occasion when the crew members would be relatively inactive for a period of 4 hours or more in connection with a Gemini mission simulator exercise. On both occasions, the flight crew members were engaged in launch and reentry simulations. A relatively new, saddle-type tilt table designed by the Crew Systems Division was used for all preflight and postflight tilt-table studies as this device had been used in all MSC's bedrest studies. Since there were no observed differences in the five preflight tilt-table tests, a single but representative preflight tilt record is shown in figure 7.2-1.

7.2.1.4 Preflight diet.- In view of the intention to decompress the cabin and engage in extravehicular activity on this flight, it was decided to have the flight crew limit themselves to a low-residue diet for 5 days prior to flight. The reasons for this decision were to minimize the possibility of abdominal discomfort upon reduction from a 5.2 psi cabin pressure to a 3.7 to 4.1 psi suit pressure and to obviate the necessity for breaking the integrity of the suit in order to dispose of body wastes until after the extravehicular activity (EVA). In order to afford the flight crew an opportunity for a subjective evaluation, a trial run on the low-residue diet was conducted from noon on May 17, 1965, through noon on May 20, 1965. The preflight diet had no apparent effect on the bowel habit of the command pilot. Initially, however, the bowel habit of the pilot was increased in frequency. By the end of the 5-day period, the pilot's bowel habit had returned to normal. The command pilot ate sparingly on flight morning, whereas the pilot ate his customary substantial meal.

7.2.1.5 Preflight medical examination.- An examination was conducted by a flight surgeon on F-9 days on both the prime and backup crew members. The command pilot of the prime crew was found to have a well localized infected laceration of the plantar surface of his right foot at the base of the great toe. In the course of gentle manipulation of the area, the abscess ruptured at the surface and purulent material drained out spontaneously. It was evacuated and treated with

UNCLASSIFIED

soaks and an antibiotic ointment. The pilot of the prime crew has had a long history of sinus arrhythmia (this is an intermittent irregularity which is physiologically normal) and has occasionally shown P-R intervals as high as 0.24 second. Both findings were consistently observed on each occasion that biosensors were used in connection with the previously mentioned tests. The cardiological findings during the course of these examinations were unchanged from what had been previously observed. There were no other findings worthy of special note in either member of the two crews. The F-2 day examination was conducted by the medical evaluation team which included an internist-cardiologist, ophthalmologist, otolaryngologist, neuropsychiatrist, and a flight surgeon. The infected laceration of the command pilot's right foot was found to be satisfactorily healed by that time. Hematological studies done in connection with the F-9 and F-2 day examinations are reported in tables 7.2-II and 7.2-III. The preflight blood-volume determination done in connection with the F-2 day examination using the radioactive iodinated serum albumin (RISA) technique is reported in table 7.2-IV. Both flight crew members were found to be medically fit for flight. Similarly, at the brief preflight physical examination conducted by the crew flight surgeons on launch morning, both members of the prime crew were found to be medically fit for flight.

7.2.1.6 Miscellaneous preflight activities.- The crew members moved into the astronauts' quarters in the Manned Spacecraft Operations (MSO) building on the evening of F-10 days. This afforded them the necessary privacy for study and preparation, and it minimized inadvertent exposure to communicable diseases. Prior to this time, there was some anxiety over the possibility of exposure to active cases of mumps in the immediate family of crewmen and in the families of close acquaintances. During testing, no abnormal skin or systemic reactions were found to be caused by the sensing agents or the onboard medications.

7.2.1.7 Preflight denitrogenation.- Because of the plans for EVA early in the flight, it was deemed advisable to have the crew pre-breathe with 100-percent oxygen on an open-loop system for 2 hours prior to flight. This was begun at 5:20 a.m. e.s.t., which was the time of departure from the MSO building. A portable gaseous oxygen source and an Al3A mask with a regulator were used for this purpose. Open-loop pre-breathing was continued during the application of the sensors and the suiting process and continued until 7:05 a.m. e.s.t., at which time both crewmen used portable ventilators to proceed from the pilot-ready room to the launch complex. The portable ventilators afforded 12 minutes of semiopen-loop breathing. An additional 12 minutes of semiopen-loop breathing were obtained in the spacecraft after cabin purge when the pilots' visors were open.

UNCLASSIFIED

7.2.1.8 Sensoring, suiting, checkout, and suit purge.- Great care was exercised in applying the biosensors in order to insure their continued function for the duration of the flight. Likewise, considerable care had to be taken to prevent dislodgement of the blood-pressure cuff and microphone when donning the pressure garment. During donning of the pressure garment, 100-percent oxygen was flowed at the maximum rate from the checkout console to obtain the best possible purge of nitrogen from the suit portion below the neck ring. For obvious reasons, particular care was taken to allow the suit technicians all the time necessary to insure a perfect attachment of the helmet after the suit portion had been carefully closed. Three minutes after closing the helmet visors, the concentrations of oxygen in the command pilot's and pilot's suits were 100 percent and 99.7 percent, respectively. Four minutes later, both suits measured 100-percent oxygen.

7.2.2 Inflight

The inflight portion of the aeromedical report includes the events from lift-off to spacecraft landing, an elapsed time of 97 hours 56 minutes.

7.2.2.1 Physiological measurements.- Physiological measurements obtained from the Gemini bioinstrumentation system which is described in section 5.1.10, as well as certain environmental parameters, were monitored by physicians at the Mission Control Center, Houston (MCC-H), and at various remote network tracking sites around the world. Analog biomedical data from Cape Kennedy (CNV), Bermuda (BDA), Antigua (ANT), Canary Islands (CYI), Carnarvon (CRO), Coastal Sentry Quebec (CSQ), Hawaii (HAW), Rose Knot Victor (RKV), Guaymas (GYM), and Texas (TEX) were also transmitted to MCC-H by means of voice/data lines. This allowed the MCC surgeon to observe the biomedical data which were available to the remote site surgeons either instantaneously or immediately after a pass. The quality of the analog data received at MCC-H was satisfactory for clinical analysis. Electrocardiograms and pneumograms for each crewman were recorded on an onboard biomedical tape recorder. The data recorded on the biomedical tape recorder are not available for analysis at the time of the publishing of this report.

7.2.2.1.1 Electrocardiograms: There were no changes in the electrocardiogram of either crewman as compared to baseline studies made prior to flight. The rates and patterns of the electrocardiograms remained within normal and expected limits. The rhythm showed expected sinus arrhythmias with some of the previously observed elongated P-R intervals in the pilot's ECG. Increases in the heart rate of both crew members were present, as expected, during dynamic portions of the flight. There were also periods of increased rate associated with various crew

UNCLASSIFIED

activities, such as the food and waste evaluation, the extravehicular activity (EVA), control of the spacecraft during maneuvers, and reentry.

7.2.2.1.2 Respiration: The respiratory rates as measured by the impedance pneumograph were within the expected range of normal for this crew. During the extravehicular activity, the expected increases in the respiratory rates of both crewmen were observed. The pilot's respiratory rate increased somewhat more than the command pilot's during this period of time; however, the pilot was doing considerably more work than the command pilot. The heart and respiration rates are shown in figure- 7.2-2.

7.2.2.1.3 Blood pressure: Numerous blood-pressure measurements were observed on each crewman. These were associated with planned exercise periods (experiment M-3, section 8) which were done four times each day by the pilot and two or three times a day by the command pilot. The command pilot had difficulty with the blood-pressure bulb because of an apparent misfit of the connector at the suit. This misfit was detected early in the flight. (See sec. 5.1.10.) The connector functioned satisfactorily in the crew ready room and in the spacecraft on the launch complex during normal system checks. Because of his persistence and through great effort, however, the command pilot was able to pump up his blood-pressure cuff and obtain readable blood-pressure values. All of the blood-pressure values obtained are believed to be valid. Early in the flight, systolic blood-pressure values were somewhat higher than preflight normals, but tended to decrease as the flight progressed. Values for the total flight can be found in figure 7.2-3. Prior to reentry, the pilot inserted a blood-pressure reprogrammer between the biomedical connector and the biomedical cable at the suit. This rerouted the blood-pressure signals from the telemetry transmitter to the onboard biomedical tape recorder.

7.2.2.1.4 Oral temperature: The oral temperature of both crew members was measured regularly during the medical data passes. No abnormal values were seen.

7.2.2.2 Medical observations.-

7.2.2.2.1 Environment: The environment remained within desirable thermal limits, and the relative humidity ranged from 50 percent to 63 percent throughout the flight. The command pilot was thermally comfortable at all times. The pilot continually felt warm while in the spacecraft except when both suit fans were on. This is believed to be due to the insulating effect of the EVA overgarment. He reported that he was coolest and most comfortable during EVA.

UNCLASSIFIED

The only significant medical problem which developed during the mission was eye, nose, and throat irritation which was noted after approximately 6 hours of flight. These symptoms were minimal on the pilot but marked in the command pilot. The dryness and irritation are believed to be caused partially by the dry oxygen environment but more probably by ammonia outgassing from diammonium phosphate fire retardant used on the methylcellulose sponge material on the spacecraft walls. The symptoms had subsided considerably after 36 hours of flight. This problem is discussed in section 5.1.4.

7.2.2.2.2 Food and water: A menu of 16 freeze-dehydrated meals was provided for each crew member during the flight. They ate all but one meal. They reported a noticeable "lift" in energy level shortly after eating. This benefit lasted for about 4 hours, although they felt hunger again 2 hours after eating probably as a result of the low amount of residue in the foods. The crew had no satisfactory method of measuring the drinking water consumed or remaining, and, therefore, they deliberately rationed water during the early part of the mission. They drank freely during the final day of flight. Such water rationing is contrary to accepted practices and would be unnecessary if an accurate measure of fluid intake were available in flight. A summary of the approximate caloric and fluid intakes is listed in table 7.2-V.

7.2.2.2.3 Waste: Waste elimination was carried out with a minimum of difficulty with the exception of urine leakage from the receptacle. Each crew member had three bowel movements during flight, all of which were soft.

7.2.2.2.4 Sleep: The command pilot estimated that he had only about $6\frac{1}{2}$ hours of good sound sleep during the entire flight. The pilot, whose normal habit is to fall asleep readily, slept somewhat more. Sleep periods were disturbed by radio communications, the ambient light, the sound and feel of the cabin pressure relieving, and the poundings felt from the thruster firings. On the advice of the MCC surgeon, an attempt was made to lengthen the sleep periods during the second half of the flight. This was moderately successful, and, although both crewmen were moderately fatigued, they felt prepared to manage the reentry. The total number of hours of attempted sleep is listed in table 7.2-V.

7.2.2.2.5 Extravehicular activities: The pilot experienced no medical difficulties during EVA. He was oriented at all times. He reported no falling sensation as he left the spacecraft and no thermal discomfort while outside the spacecraft. The comfort of the pressurized suit was not changed from the ground condition; however, he reported that the muscles in the back of his thighs became cramped while he was attempting to pull himself back into the spacecraft. He felt

UNCLASSIFIED

that the attenuation of light by the visors was correct for the brightness levels encountered outside the spacecraft. He reported that his vision seemed "clearer" during EVA, but no accurate measurement of visual acuity was made.

7.2.2.2.6 Reentry: The g forces of reentry caused no medical difficulty, although both crew members mentioned that their perception of the initial, rather low deceleration seemed an order of magnitude greater than the actual g loading of the spacecraft. Once the greater g loads of reentry began to build, they were felt by the flight crew to be of lower magnitude than experienced on the centrifuge. No visual disturbances were noted. When the spacecraft assumed the landing attitude, the crewmen were easily able to brace themselves and did not impact with any part of the spacecraft. Throughout the reentry, absolutely no symptoms indicative of hypotension were reported even though the crew made no specific effort to prevent symptoms as they felt no need to do this as per preflight instructions.

7.2.3 Postflight

Postflight medical information was gathered from the time of spacecraft landing until approximately 66 hours thereafter. These data were primarily obtained by clinical examinations. A verbal medical debriefing was conducted, and laboratory examinations of blood, urine, and feces were conducted. In addition, a bioinstrumentation system was used to record physiological measurements during the tilt procedures. Postflight deviations from the normal were limited to the following: (1) mild body fluid imbalance and dehydration, (2) moderate crew fatigue, and (3) transient, asymptomatic reduction in pulse pressure and elevation in heart rate during the tilt procedure.

7.2.3.1 Recovery activities.- Medical recovery activities were planned before the mission and were modified as dictated by the observed medical responses of the crew.

7.2.3.1.1 Planned recovery procedures: The Gemini IV medical activities were similar to those reported for the GT-3 mission, except that, because of the medical importance of this mission, the Medical Evaluation Team was deployed aboard the prime recovery vessel.

7.2.3.1.2 Narrative: The postflight medical activities of the crew are outlined in table 7.2-VI. With the prospect of rapid helicopter retrieval, the crew elected to remain in their flight suits and were picked up by helicopter using the horsecollar. Shortly after landing, the pilot became suddenly but minimally nauseated and vomited a small quantity of brownish (color of previously eaten food) fluid.

UNCLASSIFIED

This nausea was very rapid in onset and was entirely relieved by vomiting. No medication was used by either crew member during or after flight. Postflight egress through the hatch was relatively easy and the crew reported no symptoms when standing, while hanging on the hoist, or while standing for 20 seconds in the retrieving helicopter. The physician aboard the recovery helicopter reported that a brief examination revealed no medical abnormalities in the crew. Immediately following return to the aircraft carrier, the crew walked below decks to the ship's sick bay where the initial postflight medical examinations were performed. At no time during the recovery or postflight phase of the mission did the crew report any subjective symptoms indicative of hypotension.

7.2.3.2 Examinations.- A detailed examination was conducted in the ship's sick bay as soon as the crew came aboard the recovery carrier. The examination protocol is to be found in table 7.2-VII. With the exception of fluid and electrolyte changes and tilt-table responses, no significant abnormalities were noted during this examination. Specifically, there was no nosebleed as was erroneously reported in the press. These findings are summarized in tables 7.2-II, 7.2-III, 7.2-IV, 7.2-VIII, and 7.2-IX.

The command pilot exhibited a moderate skin reaction to the stomaseal tape. He also experienced moderate pruritus at all sensor sites for a short period after sensor removal. The pilot demonstrated a similar but milder skin reaction at the sensor sites. The crew's underwear was nearly saturated with perspiration, and the fabric in the genital area was stained because of leakage during urination. An analysis of the urine transport system is being conducted as mentioned in section 5.1.10. No skin reaction was present at this site. Skin turgor was good, and no maceration nor other abnormality was present.

7.2.3.3 Tilt-table studies.- A tilt-table procedure similar to that used on the GT-3 was employed for the Gemini IV mission. Significant modifications to the GT-3 tilt-table studies were as follows: use of a tilt table with modified saddle instead of the Stokes Litter, strain gages around both legs (maximum calf circumference) to sense increases in leg circumference, and continuous biomedical recording of tilt-table responses (2 channels of ECG, automatic blood pressure in place of the auscultatory method, impedance pneumograph, cardiometer, and time code generator). Five postflight tilt studies were done with each crewman. The first postflight tilt procedure revealed significant elevations of heart rate and narrowing of pulse pressure in response to a head-up tilt to 70° for 15 minutes. This response returned gradually to normal as seen in figure 7.2-1. The crew members' individual tilt-table responses were influenced both by a number of operational and environmental variables and by the tilting process

UNCLASSIFIED

itself. The cardiovascular responses are believed to have occurred because of physiologic alterations. Such changes did not in any manner compromise the crew's ability to function in the inflight or postflight phase of this mission.

7.2.3.4 Medical debriefing.- A verbal medical debriefing of the flight crew was conducted for most of the day after recovery aboard the U.S.S. Wasp. Because of the extravehicular activities, the attempted rendezvous, and the duration of the flight, many significant items were considered during this debriefing. No disorientation, breakoff phenomenon, or other untoward effects were noted during the mission. Vision and color perception were reported to be normal. The crew found it necessary to spend much of their time dealing with the routine functions of life, that is, eating, excreting, sleeping, and stowing used or soiled items. Details of these inflight functions have been discussed in section 7.2.2.

UNCLASSIFIED

TABLE 7.2-I.- PREFLIGHT MEDICAL STUDIES AND ASSOCIATED ACTIVITIES

Date, 1965	Activity	Medical study or support
March 3	Simulated flight (SST)	Examination before and after tests. Biosensors used during test.
March 24	Spacecraft checkout in altitude chamber, prime crew (SST)	Examination before and after tests. Biosensors used during test.
May 13	Wet mock simulated launch	Examination before test. Biosensors used during test.
May 18	Tilt-table tests 1 and 2 on prime crew	Biosensors and strain gages used.
May 20	Test of ventilation control module, umbilical and maneuvering unit in altitude chamber, pilot of prime crew	Examination before and after test. Biosensors used during test.
May 25	F-9 day medical examination by flight surgeon	Complete physical examination. Blood drawn for typing and cross matching.
May 28	Tilt-table tests	Biosensors and strain gages used during tests.
May 29	Simulated flight (Cape)	Examination before tests. Biosensors used during tests.
June 1	F-2 day medical examinations by medical evaluation team, tilt-table test 5	Comprehensive examinations, blood-volume studies, complete blood and urine studies.
June 3	Launch morning physical examination by flight surgeon	Final brief examination.

UNCLASSIFIED

TABLE 7.2-II.- HEMATOLOGY - COMMAND PILOT

Determination	Preflight		Postflight		
	Date, 1965 Time, e. s. t.	May 25 10:30 a.m.	June 1 8:15 a.m.	June 7 1:41 p.m.	June 7 9:00 p.m.
White blood cells /mm ³	9700	7 700	12 000	15 000	10 050
Neutrophiles, percent	60	54	78 (+2 bands)	64	63
Lymphocytes, percent	33	38	19	29	31
Monocytes, percent	5	4	0	6	3
Eosinophiles, percent	2	3	1	1	3
Basophiles, percent	0	1	0	0	0
Platelets/mm ³	Adequate	374 000	Adequate	Adequate	--
Red blood cells, millions/mm ³	5.3	5.93	6.18	5.91	--
Hematocrit, percent	46	44.0	41.0	45.0	--
Hemoglobin, gm/100 ml	14.4	14.5	14	--	--
Blood morphology	Normal	Normal	Normal	Normal	--
Sodium, mEq/l	142	144	143	144	--
Potassium, mEq/l	4.6	5.4	3.5	3.9	--
Chloride, mEq/l	105	108	106	103	--
Calcium, mgm percent	10.5	10.9	10.2	10.6	--
Phosphorus, mgm/100 ml	3.4	3.8	2.9	3.9	--
Glucose, mgm/100 ml (non-fasting)	92	102	127	98	--
Albumen, gm percent	4.9	4.9	4.5	4.9	--
Alpha 1, gm percent	0.2	0.2	0.2	0.2	--
Alpha 2, gm percent	0.5	0.5	0.6	0.7	--
Beta, gm percent	0.9	0.9	0.8	0.9	--
Gamma, gm percent	1.3	1.3	1.3	1.3	--
Total protein, gm percent	7.7	7.7	7.4	8.0	--

UNCLASSIFIED

UNCLASSIFIED

TABLE 7.2-III.- HEMATOLOGY - PILOT

Determination	Preflight		Postflight			
	Date, 1965 Time, e. s. t.	May 25 10:40 a. m.	June 1 8:25 a. m.	June 7 2:30 p. m.	June 7 9:30 p. m.	June 8 9:30 p. m. (approx.)
White blood cells /mm ³	7400	7 850	29 050	15 150	7350	9300
Neutrophiles, percent	62	49	88	74	66 (+1 band)	75
Lymphocytes, percent	34	44	10	16	23	19
Monocytes, percent	3	3	1	6	6	3
Eosinophiles, percent	0	3	1	1	3	3
Basophiles, percent	1	1	0	0	1	--
Platelets/mm ³	Adequate	308 000	Adequate	Adequate	--	Adequate
Red blood cells, millions/mm ³	5.17	5.14	5.58	5.72	--	4.75
Hematocrit, percent	45	43.5	44.0	44.0	42.0	45.0
Hemoglobin, gm/100 ml	15.3	15.5	15.0			15.9
Blood morphology	Normal	Normal	Normal	Normal	--	--
Sodium, mEq/l	140	143	141	141	--	--
Potassium, mEq/l	5.2	5.7	4.6	4.5	--	--
Chloride, mEq/l	106	107	106	102	--	--
Calcium, mgms percent	10.2	10.9	10.5	10.9	--	--
Phosphorus, mgm/100 ml	3.8	4.3	5.0	4.4	--	--
Glucose, mgm/100 ml (non-fasting).	77	100	146	87	--	--
Albumen, gm percent	4.5	5.0	4.8	4.6	--	--
Alpha 1, gm percent	0.1	0.2	0.2	0.2	--	--
Alpha 2, gm percent	0.5	0.4	0.8	0.5	--	--
Beta, gm percent	0.8	0.7	0.9	0.7	--	--
Gamma, gm percent	1.1	1.1	1.3	1.3	--	--
Total protein, gm percent	7.1	7.4	8.0	7.3	--	--

UNCLASSIFIED

UNCLASSIFIED

TABLE 7.2-IV.- BLOOD VOLUME DETERMINATIONS (I₁₂₅)

Command Pilot		
	Preflight June 1, 1965 8:30 a.m. e.s.t.	Postflight June 7, 1965 2:30 p.m. e.s.t.
Hematocrit, percent	43.0	41.0
Blood volume, cc estimated normal	5070	--
Actual blood volume, cc	5198	4820
Change in blood volume, preflight to postflight, cc: -378		
Plasma volume, cc estimated normal	2890	--
Actual plasma volume, cc	2962	2844
Change in plasma volume, preflight to postflight, cc: -118		

Pilot		
	Preflight June 1, 1965 8:45 a.m. e.s.t.	Postflight June 7, 1965 2:30 p.m. e.s.t.
Hematocrit, percent	44.3	44.0
Blood volume, cc estimated normal	5270	--
Actual blood volume, cc	6969	6059
Change in blood volume, preflight to postflight, cc: -910		
Plasma volume, cc estimated normal	2938	--
Actual plasma volume, cc	3885	3393
Change in plasma volume, preflight to postflight, cc: -492		

TABLE 7.2-V.- FOOD, WATER, AND SLEEP TABULATION

[The times reported for sleep are approximations as reported by the flight crew. Included in these times are periods of light sleep and rest.]

Day	Time, g.e.t.	Food, cal.		Water, cc						Sleep, hr	
		Command pilot	Pilot	Command pilot			Pilot			Command pilot	Pilot
				Drinking water	Water in food	Total	Drinking water	Water in food	Total		
1	T-0 to T+24 hr	944	2454	800	510	1310	720	1050	1770	7 $\frac{1}{2}$	7 $\frac{1}{2}$
2	T+24 to T+48 hr	1813	1797	405	780	1185	560	660	1220	7 $\frac{1}{2}$	7
3	T+48 to T+72 hr	2985	1674	900	1500	2400	760	900	1660	5	5
4	T+72 to T+96 hr	2411	3224	900	790	1690	1000	1200	2200	7	8 $\frac{1}{2}$
Totals		8153	9149	3005	3580	6585	3040	3710	6750	27	28

UNCLASSIFIED

UNCLASSIFIED

TABLE 7.2-VI.- POSTFLIGHT EVENTS AND MEDICAL ACTIVITIES

Date, 1965	Time, e. s. t.	Activity
June 7	12:12 p.m.	Spacecraft landing, 48 miles from U.S.S. Wasp
	12:22 p.m.	Crew decision to remain in suits for helicopter pickup.
	12:39 p.m.	Right hatch opened, egress began
	12:42 p.m.	Egress complete, helicopter pickup began
	12:50 p.m.	Helicopter pickup complete, departed for U.S.S. Wasp
	1:09 p.m.	Arrived aboard U.S.S. Wasp
	1:41 p.m.	Suits doffed, began initial medical evaluation
	4:50 p.m.	Completed initial medical evaluation
	6:30 p.m.	First postflight meal (low calcium)
	7:02 to 9:45 p.m.	Second tilt procedure and blood specimens
	10.30 p.m.	Sleep
June 8	8:30 a.m.	Awoke; breakfast
	10:00 to 11:50 a.m.	Third tilt procedure; medical debriefing
	1:00 to 4:00 p.m.	Medical debriefing
	7:19 to 9:30 p.m.	Fourth tilt procedure
	10:00 p.m.	Sleep
June 9	6:00 a.m.	Awoke; breakfast; technical debriefing
	2:55 to 4:37 p.m.	Fifth tilt procedure
	11:00 p.m.	Sleep
June 10	5:40 a.m.	Awoke; breakfast
	7:15 a.m.	Departed recovery ship

UNCLASSIFIED

TABLE 7.2-VII.- POSTFLIGHT MEDICAL EXAMINATION PROTOCOL

Examination	Duration, min	Command pilot, Minutes after arrival in sick bay	Pilot, Minutes after arrival in sick bay
X-ray ^a	30	0 to 30	50 to 80
Tilt	50	60 to 110	0 to 50
Otolaryngology	30	150 to 180	110 to 140
Neuropsychiatry	30	30 to 60	80 to 110
Ophthalmology	30	110 to 140	140 to 170
Medical	30	180 to 210	180 to 210
Audiometry	10	140 to 150	170 to 180

^aTime for X-ray includes: chest film (P.A. and left lat.), densitometry, blood sample, RISA, ECG, and RISA.

UNCLASSIFIED

TABLE 7.2-VIII.- SUMMARY CLINICAL EVALUATION

(a) Command pilot

	Preflight (launch site) June 1, 1965, 8:00 to 12:00 a.m. e.s.t.	Preflight (launch day) June 3, 1965, 4:00 a.m. e.s.t.	Postflight (shipboard) June 7, 1965, 3:00 p.m. e.s.t.	Postflight (shipboard) June 7, 1965, 8:00 p.m. e.s.t.
Body weight, lb	156	156.5	152	157
Temperature, oral, °F . . .	98.2	97.0	98.8	98.6
Respirations, breaths/min	16	10	16	20
Heart rate, beats/min . . .	72	72	82	86
Skin	Healed infected laceration, right foot.	Healed infected laceration, right foot.	Moderate reaction at biosensor sites, especially left axillary; otherwise clear.	No change. Lesion on right foot in satisfactory condition.
Comments	Normal	Fit for flight.	Thirsty, alert, oriented, cooperative, tired.	No change except less thirsty after drinking water freely.

UNCLASSIFIED

UNCLASSIFIED

TABLE 7.2-VIII.- SUMMARY CLINICAL EVALUATION - Concluded

(b) Pilot

	Preflight (launch site) June 1, 1965, 8:00 to 12:00 a.m. e.s.t.	Preflight (launch day) June 3, 1965, 4:00 a.m. e.s.t.	Postflight (shipboard) June 7, 1965, 1:03 p.m. e.s.t.	Postflight (shipboard) June 7, 1965, 7:02 p.m. e.s.t.
Body weight, lb	173	173	164 $\frac{1}{2}$	171
Temperature, oral, °F . . .	98.2	98.6	100.2	99.3
Respirations, breaths/min	15	12	18	18
Heart rate, beats/min . . .	70	64	96	84
Skin	Normal; no lesions.	Normal	Minimal reaction at biosensor sites; otherwise clear.	No change.
Comments	Well- conditioned normal man	Fit for flight.	Thirsty, alert, oriented, coopera- tive, tired.	No change except less thirsty after drinking water freely.

UNCLASSIFIED

UNCLASSIFIED

TABLE 7.2-IX.- URINALYSES

(a) Command pilot

Date, 1965 Time, e. s. t.	Preflight	Postflight				
	June 1 8:45 a.m.	June 7 3:50 p.m.	June 8 9:30 p.m.	June 8 5:00 p.m.	June 9 7:30 a.m.	June 10 noon
Color, appearance . . .	Yellow, clear	Straw	Amber	dark amber, clear	Straw, clear	Amber, clear
Specific gravity . . .	1.017	1.020	1.017	1.020	1.020	1.020
pH	6.4	6.0	6.0	5.0	5.0	5.0
Albumen, sugar, acetone, bile	Negative	Negative	Negative	Negative	Negative	Negative
Microscopic	0 to 1 white blood cell /hpf, rare epithelial cells, mucous thread	Few amorphous crystals, 1 to 2 white blood cells/hpf	2 to 3 white blood cells/hpf, occasional oxy- late crystals, mucous threads	3 to 4 white blood cells/hpf, rare red blood cells	1 to 2 white blood cells/hpf	Rare white blood cells, occasion- al oxylate crystals
Volume, cc	125	253	543	230	538	356

UNCLASSIFIED

UNCLASSIFIED

TABLE 7.2-IX.- URINALYSES - Concluded

(b) Pilot

Date, 1965 Time, e.s.t.	Preflight	Postflight*			
	June 1 9:00 a.m.	June 8 9:30 a.m.	June 8 3:00 p.m.	June 9 7:30 a.m.	June 10 3:00 p.m.
Color, appearance . . .	Yellow, clear	dark amber, clear	amber, clear	straw, clear	straw, clear
Specific gravity . . .	1.019	1.026	1.023	1.028	1.010
pH	5.0	5.0	5.0	5.0	6.0
Albumen, sugar, acetone, bile	Negative	Negative	Negative	Negative	Negative
Microscopic	0 to 1 white blood cell /hpf, rare epithelial cell. mucous threads	3 to 4 white blood cells/hpf, 1 to 2 red blood cells/hpf, occa- sional epithe- lial cells and mucous threads	3 to 4 white blood cells/hpf, 2 to 3 red blood cells/hpf, occa- sional epithe- lial cells and mucous threads	1 to 2 white blood cells/hpf, rare red blood cells/hpf	1 to 2 white blood cells/hpf, rare red blood cells/hpf, occa- sional epithe- lial cell
Volume, cc	80	530	127	640	175

*One specimen on June 8 discarded

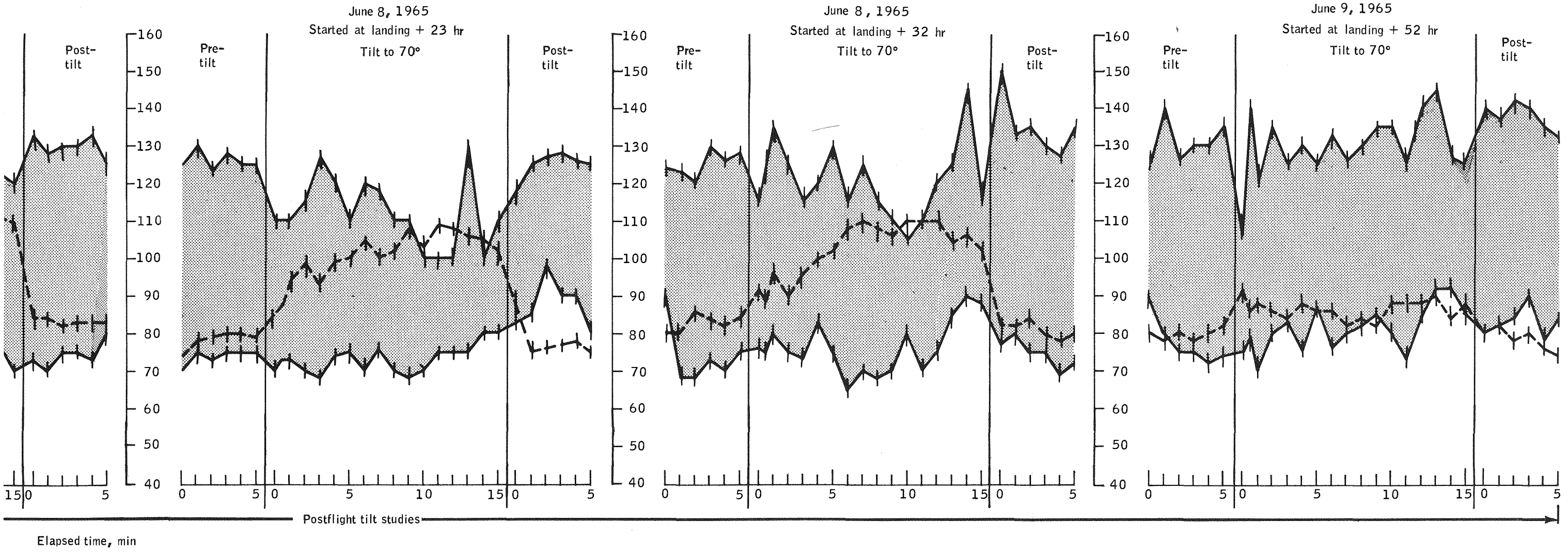

(a) Comand pilot.
Figure 7.2-1. - Tilt table studies.

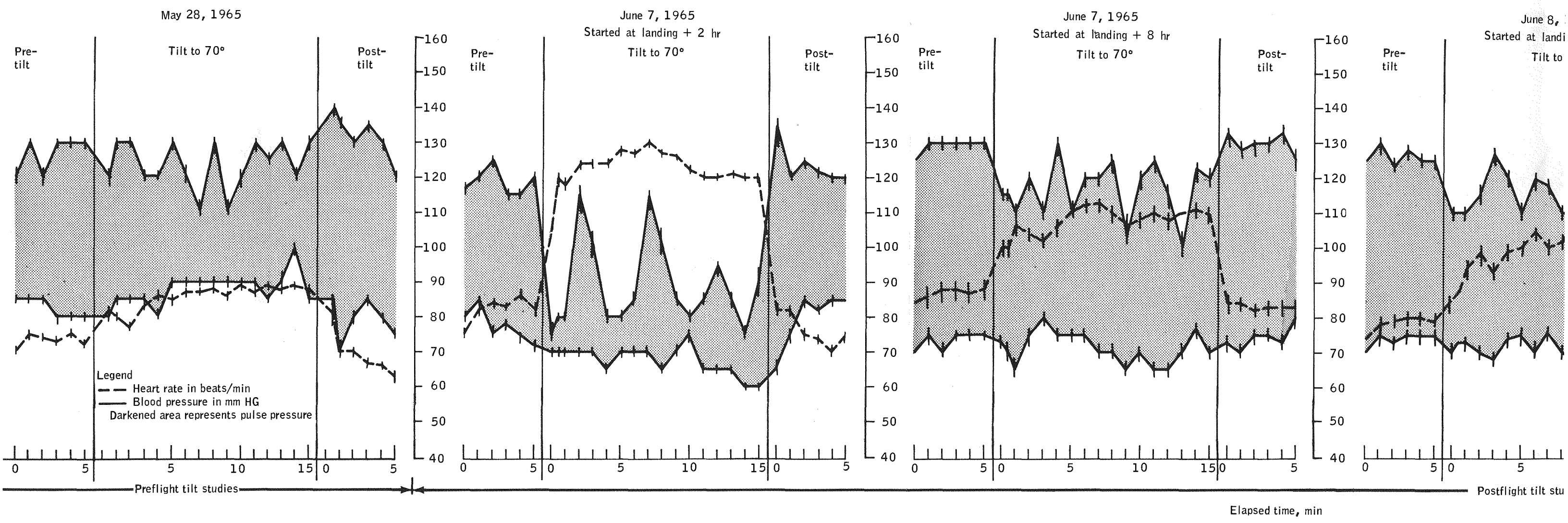

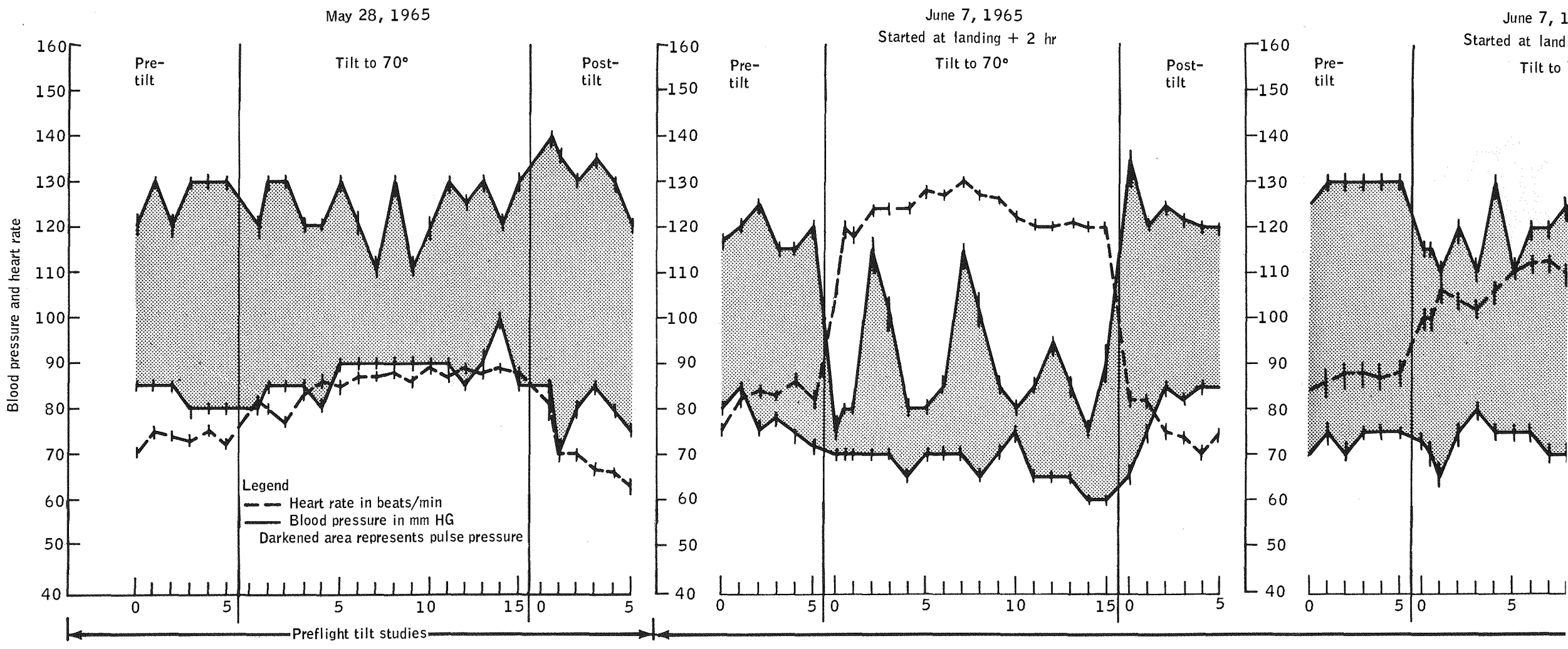

UNCLASSIFIED

NASA-S-65-6017

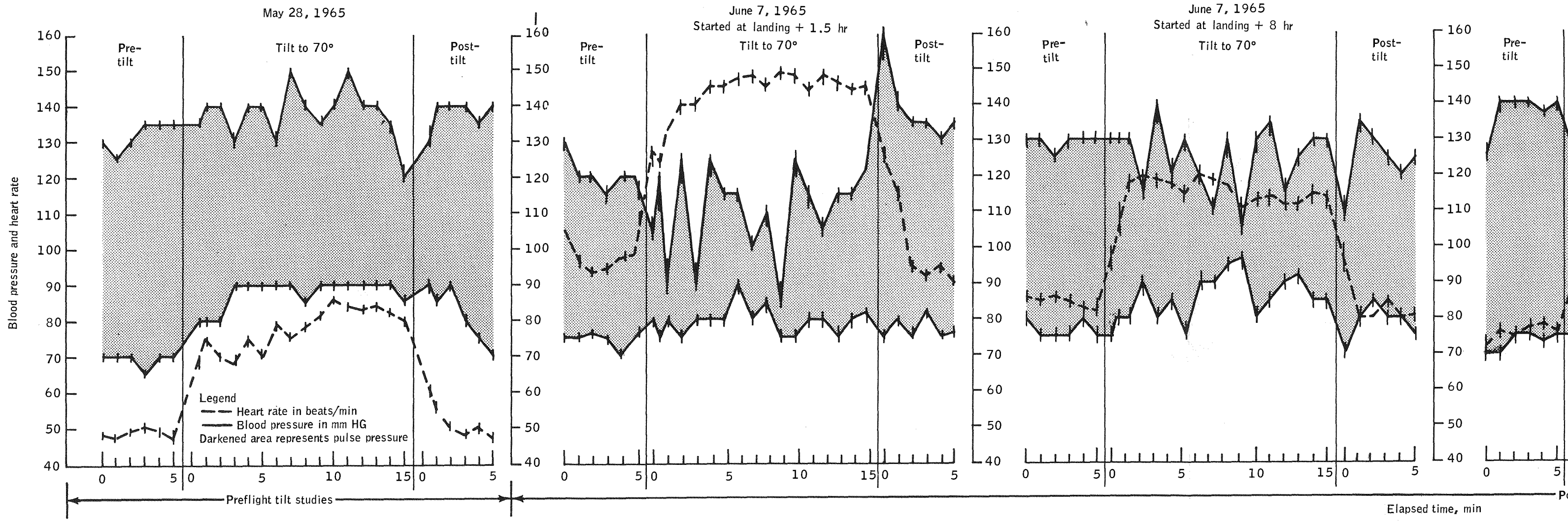

(b) Pilot.

Figure 7.2-1.- Concluded.

UNCLASSIFIED

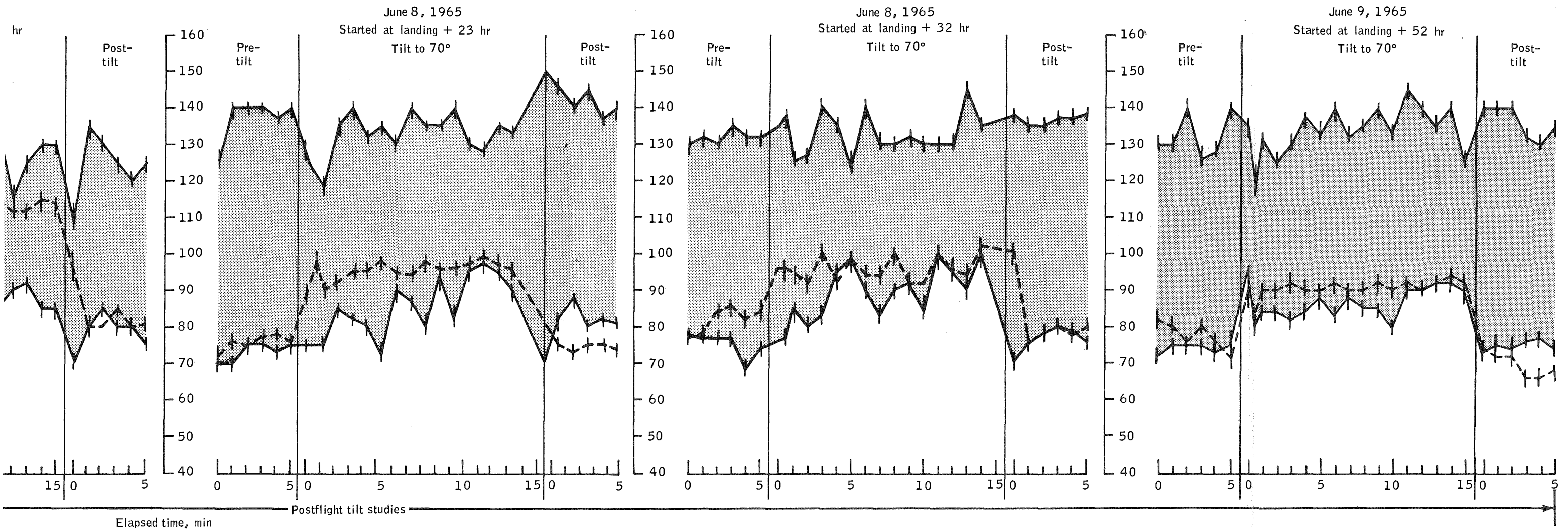

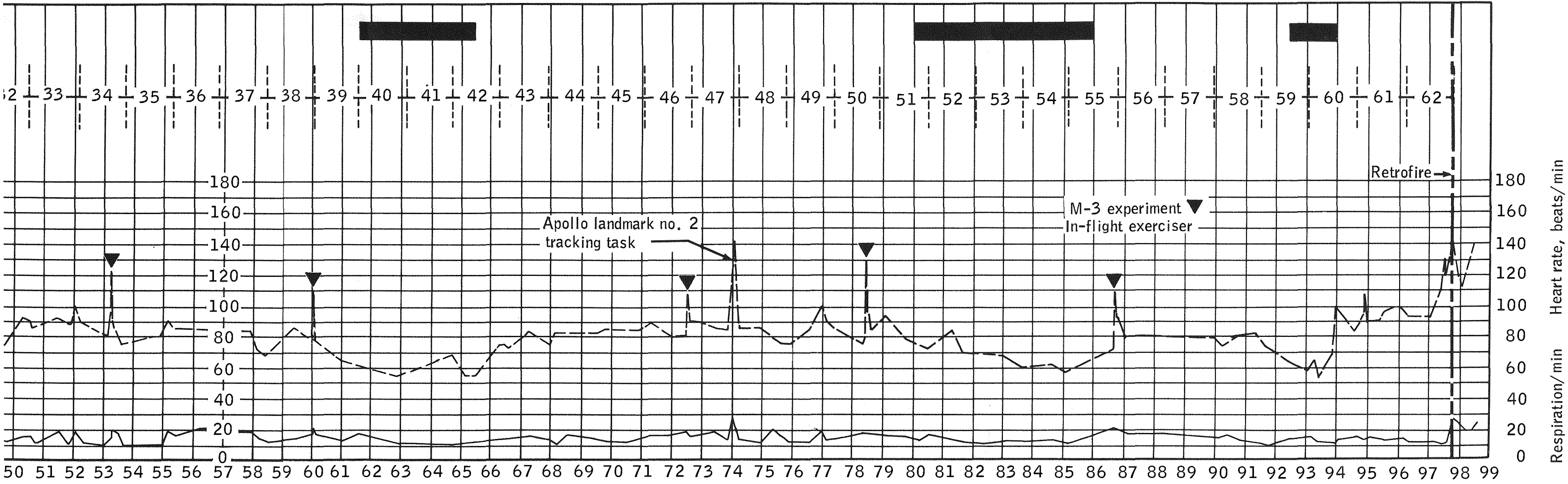

ed time, hr

(a) Command pilot.

Figure 7.2-2. - Physiological measurements

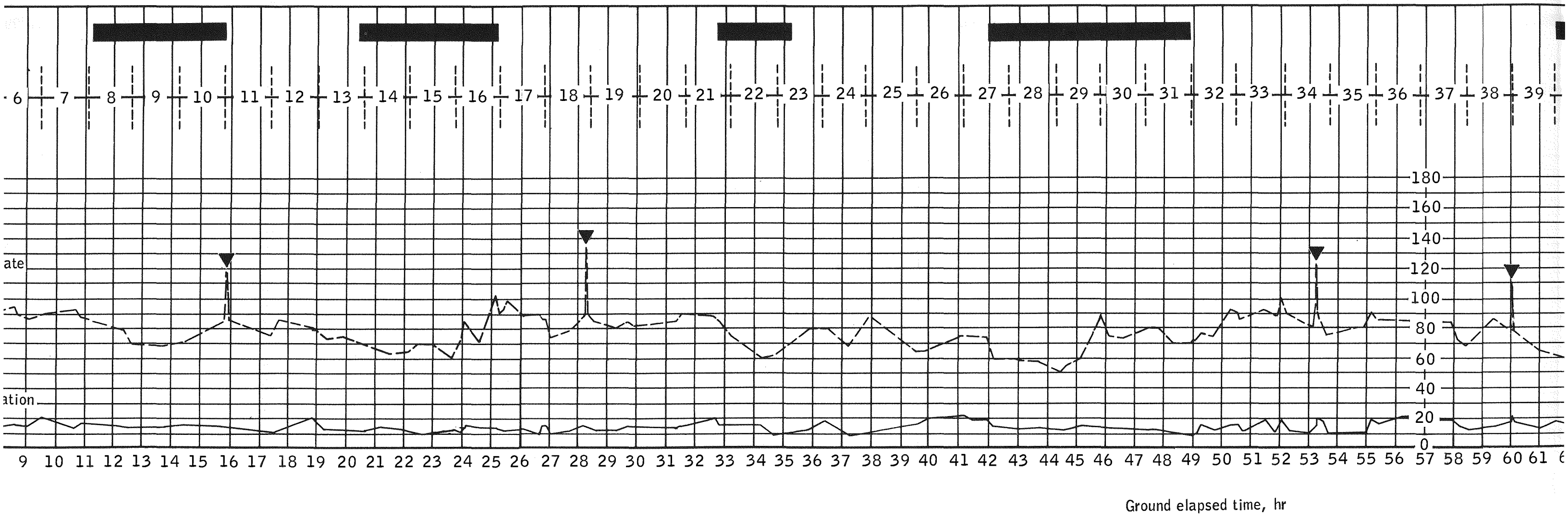

measurements

Ground elapsed time, hr

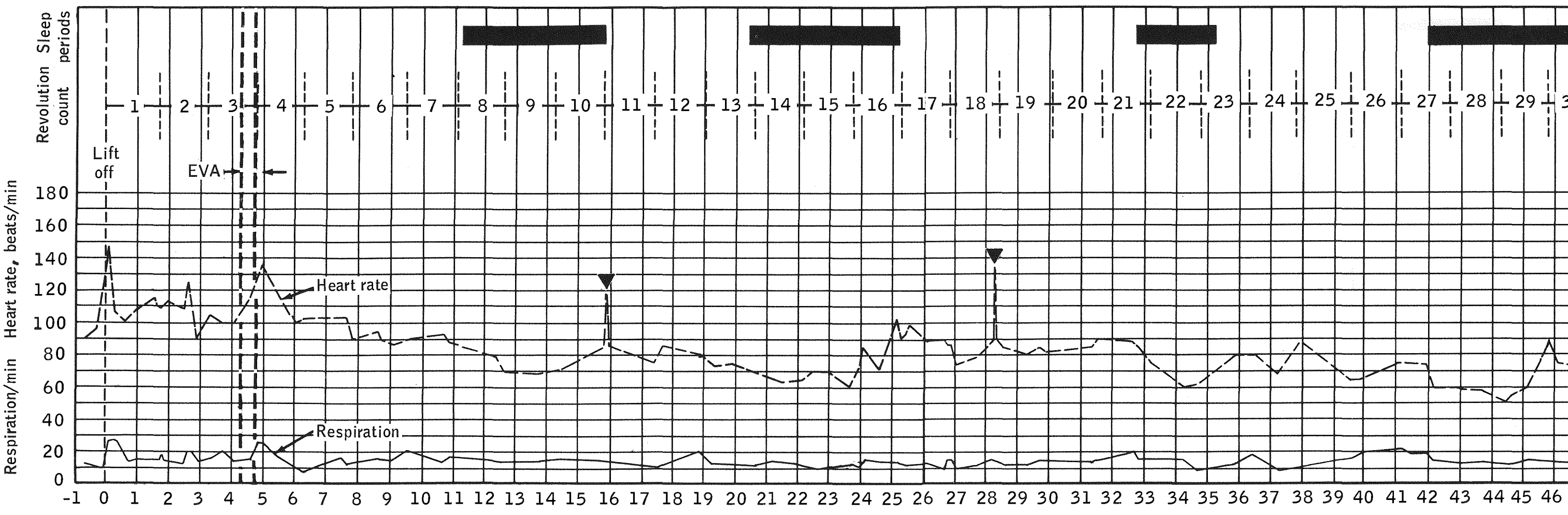

(a) Command pilot.

Figure 7.2-2. - Physiological measurements

UNCLASSIFIED

NASA-S-65-6504

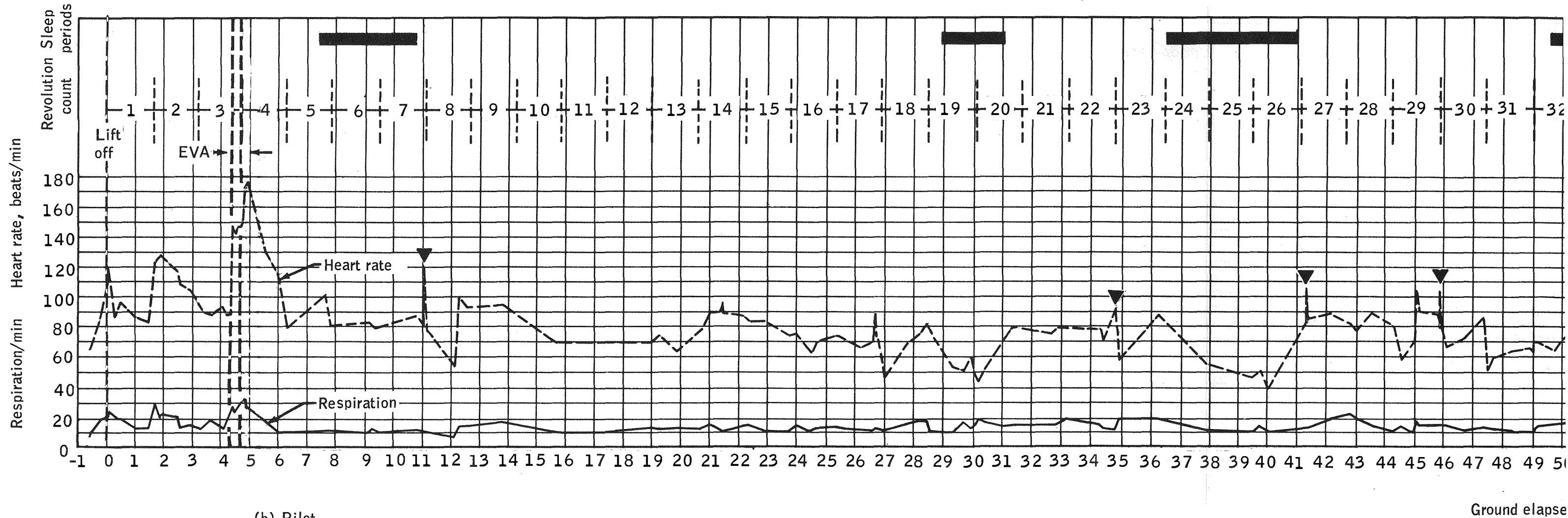

(b) Pilot.

Figure 7.2-2. - Concluded.

UNCLASSIFIED

Ground elapse

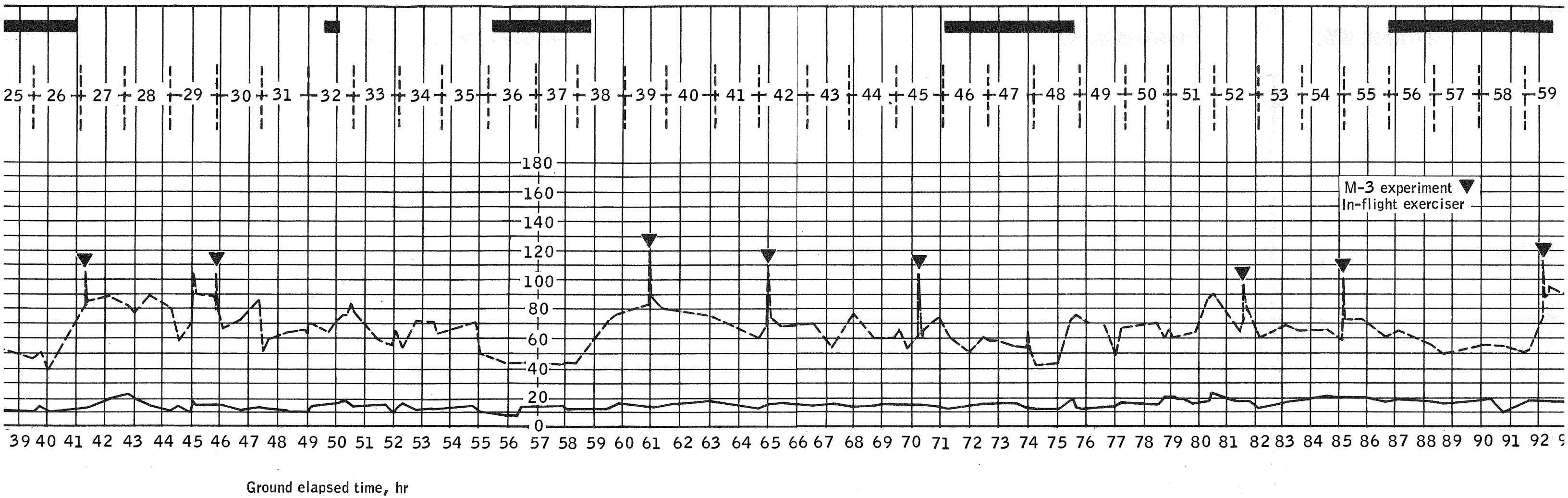

Ground elapsed time, hr

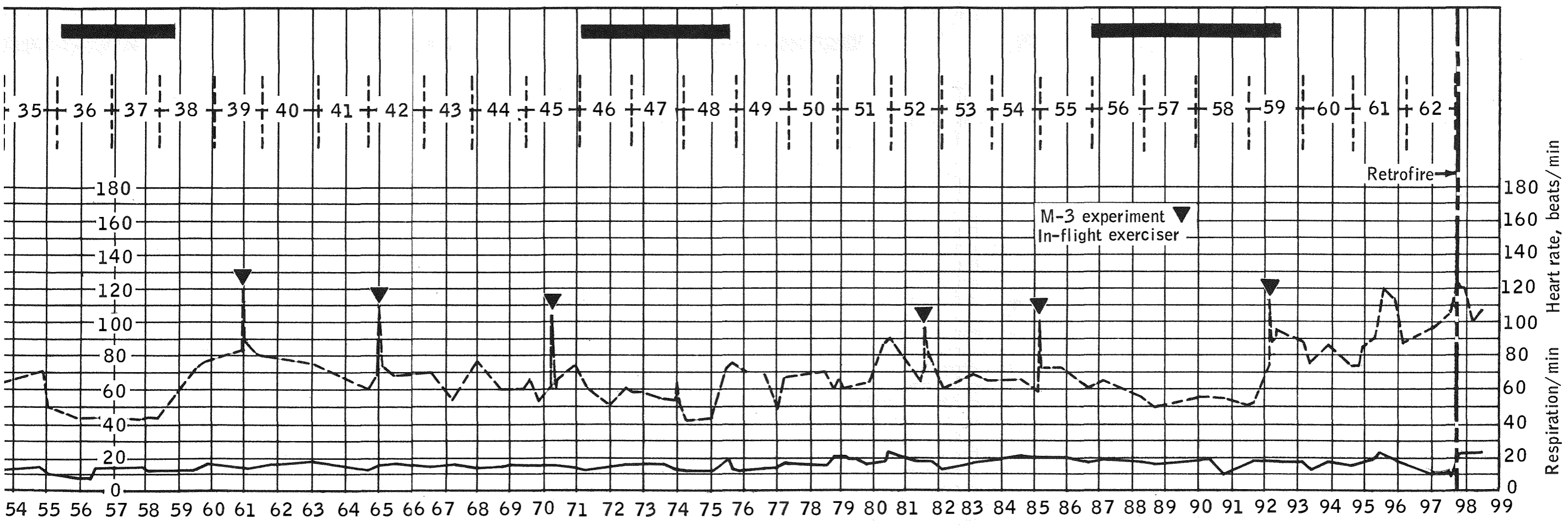

UNCLASSIFIED

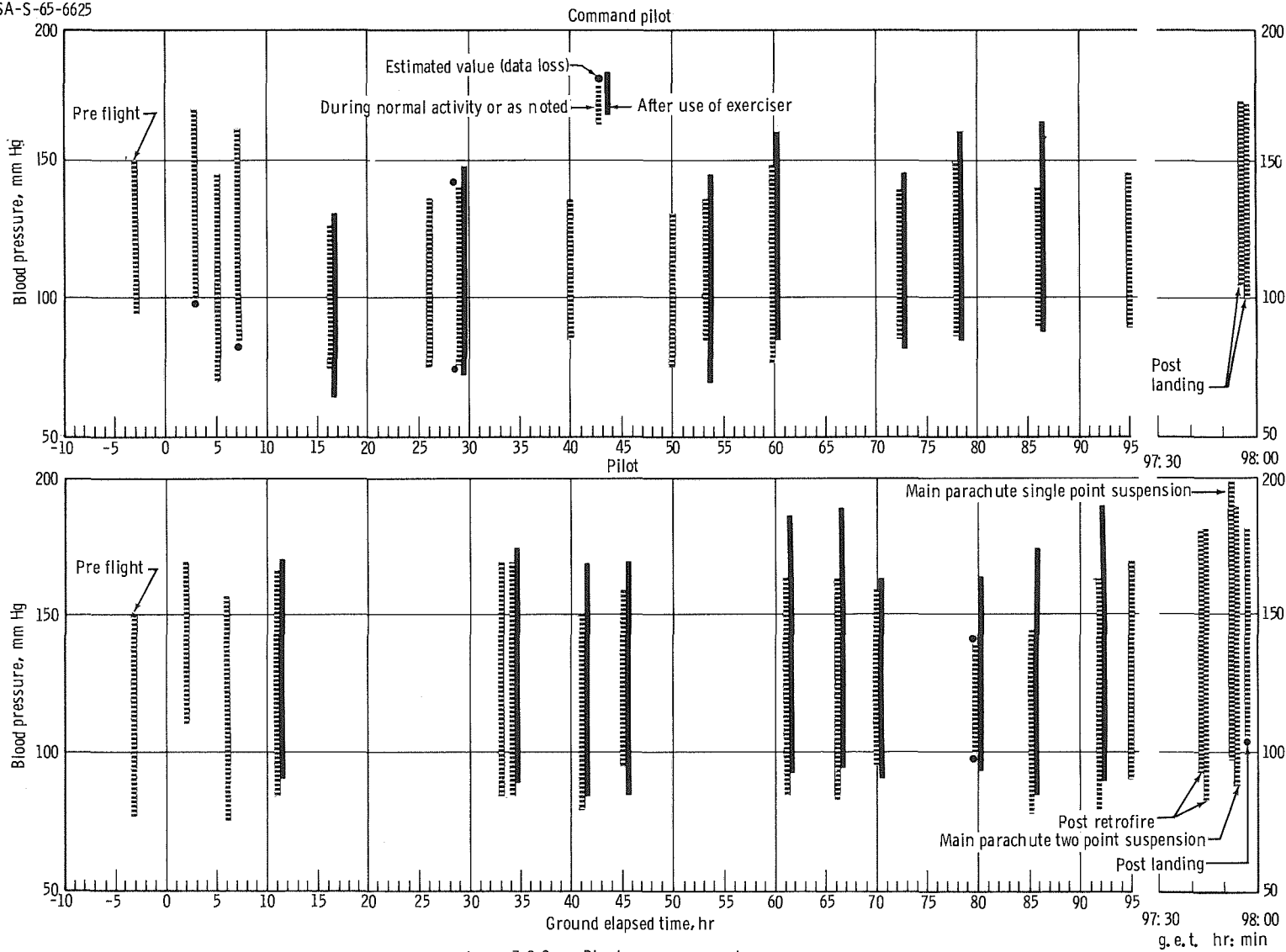

Figure 7.2-3. - Blood pressure record.

UNCLASSIFIED

UNCLASSIFIED

THIS PAGE INTENTIONALLY LEFT BLANK.

UNCLASSIFIED

8.0 EXPERIMENTS

Eleven scientific, medical, technological, and engineering experiments were conducted on the Gemini IV mission to extend man's knowledge of space and to develop further the ability to sustain life in the space environment. These experiments are listed in table 8-I. Detailed descriptions and additional information concerning the requirements and responsibilities necessary for the successful accomplishment of these experiments are presented in reference 6. Two originally scheduled experiments (D-1, Basic Object Photography, and D-6, Surface Photography) were deleted from this mission to permit conduct of the extravehicular activity. These two experiments will be conducted on a later Gemini mission.

Because of the nature of these experiments, only a preliminary evaluation of the experimental results can be presented in this report. In most cases, detailed evaluations and conclusions will be published in separate documents after all data for each experiment have been analyzed.

UNCLASSIFIED

8.1 EXPERIMENT D-8, RADIATION IN SPACECRAFT

8.1.1 Objective

The objective of Experiment D-8 was to describe qualitatively and quantitatively the absorbed radiation dose rate and total dose that penetrated the cabin of the Gemini 4 spacecraft. This includes determinations of ionizing and penetrating power of various types of radiation and their contribution to dose according to profile, type, time, and position within the cabin.

8.1.2 Equipment

The experimental equipment consisted of the two general types of dosimeters described in the following paragraphs.

8.1.2.1 Active dose rate indicators.- Two tissue-equivalent, current-mode ionization chamber instruments were used to measure the variation of absorbed dose rate inside the spacecraft cabin as a function of time.

8.1.2.2 Passive dosimeters.- Five passive dosimeters were used to measure the total radiation dose received at various locations inside the cabin. These units were installed in the spacecraft in the approximate locations shown in figure 8-1.

8.1.3 Procedure

The experiment commenced with the launch of the Gemini IV vehicle. At that time, both active instruments began normal operation and continued to monitor the radiation levels throughout the 4-day mission. During five passes through the central region of the South Atlantic anomaly, the sensor head of the portable active dosimeter was removed from its mount on the right hatch and placed at each of the following locations by the pilot for a period of 1 minute:

- (a) Against the chest, the sensor head covered with a glove
- (b) Between the legs in the area of the groin
- (c) Under the left armpit
- (d) In front of the cabin window
- (e) In front of the instrument panel about midway between the floor and the ceiling
- (f) On the floor of the spacecraft between the feet

UNCLASSIFIED

This measured the instantaneous radiation dose level as functions of position in the cabin and depth in the pilot, using portions of the pilot's body as a shield. The dose-rate level beneath the left hatch was obtained as a function of time from the fixed dosimeter and these data were used as a baseline from which to compare the measurements made by the portable unit.

The five passive dosimeters measured the total dose received during the mission and served two distinct functions:

(a) One unit was mounted in close proximity to the fixed active dosimeter to provide empirical correlations between the actual integrated dose as measured by that unit, and the energy dependent dose measured by the passive dosimeter.

(b) Four units were used to obtain values of integrated dose at other locations in the Gemini spacecraft. These areas included lightly shielded and heavily shielded positions.

8.1.4 Results

8.1.4.1 Active dose-rate indicators.- The active portion of Experiment D-8 is most conveniently discussed in terms of two general areas of interest: (1) experimental determination of the dose levels obtained outside of the South Atlantic anomaly (table 8-II), and (2) measurement of the radiation characteristics during spacecraft passage through the anomalous region of the inner radiation belt. The active dose-rate indicators functioned normally throughout the mission; and the five scheduled radiation level surveys within the cabin were performed by the pilot during anomaly passes of the spacecraft.

The principal contribution to the biological dose received by the flight crew outside of the South Atlantic anomaly was from cosmic radiation. The average, maximum, and minimum dose levels were measured approximately every 3 seconds during each revolution. The maximum and minimum dose levels were determined at the lowest or highest readings observed during at least a 1.0-minute period for each revolution. The average dose rate for all non-anomaly revolutions analyzed was 0.42 millirad/hour. Assuming a nominal period of 90 minutes for each revolution, the total accumulated tissue dose was approximately 13 millirads for a 20-revolution time span. The average daily radiation level received inside the cabin as a result of cosmic radiation was approximately 10 millirad/day. These radiation levels are very low and constitute a permissible magnitude. During the EVA, the right hatch remained open and the movable instrument was exposed to essentially a free-space radiation environment during a portion of revolution 3. The radiation

UNCLASSIFIED

levels measured by that instrument during this period did not exceed those obtained by the fixed unit, indicating the absence of softer or trapped corpuscular radiation in the regions of flight crew egress.

Data obtained during passage through the South Atlantic anomaly for revolutions 7, 36, and 37 were analyzed, and a rapid increase in the radiation levels within the Gemini spacecraft was observed. For revolution 7, a peak dose level of 363 millirad/hour was obtained for the fixed instrument, and a 107 millirad/hour peak level for the movable dosimeter. A dose level of over 300 millirad/hour was obtained for approximately 2.5 minutes during this passage through the anomaly. Figure 8-2 shows that a higher than normal radiation level existed for a period of 12 minutes during this revolution. The anomaly passage dose levels for revolution 37 are also shown in figure 8-2. Peak dose rates of 281 millirad/hour for the fixed instrument and 45 millirad/hour for the movable dosimeter were recorded. The duration of an increased radiation level during this passage was approximately 10 minutes.

The integrated tissue dose for anomaly passage during revolutions 7, 36, and 37 are presented as follows for both types of active dosimeters.

Revolution number	Fixed ionization chamber, millirads	Portable ionization chamber, millirads
7	34.0	10.0
36	13.0	4.0
37	25.0	4.0

The lower radiation levels obtained during revolution 36 indicate that this passage grazed the anomaly and failed to penetrate as deeply into the belt as the other two revolutions. The differences in the dose readings between the two types of active units appear to be a result of increased self-shielding of the movable unit. Because of the increased thickness of the stainless steel barrel of the sensing element and the greater shielding of the electronics package, there is a considerable reduction in the softer radiation reaching the movable sensing element. The fixed sensing element has less shielding and, therefore, has a much less restricted view of any omnidirectional radiation entering the spacecraft cabin. A conclusive discussion of these differences cannot be presented until the cabin radiation survey data for the experiment are available for analysis.

UNCLASSIFIED

8.1.4.2 Passive dosimeters.- All five flight dosimeters and a similar ground control unit were placed in a shielded aluminum container immediately after their preparation 5 days prior to launch. The flight dosimeters and the ground control unit remained together within this shielded container until approximately 26 hours before launch. At that time the flight items were installed in their assigned positions in the spacecraft. During and after spacecraft installation, extremely rigid controls were put into effect governing the location of all possible radiation sources in the launch area. This was required since the passive units were capable of detecting radiation doses as low as 5 millirads which could easily result from exposure to ground radiation sources near the launch area. The ground control unit was carried to the Manned Spacecraft Center, Houston, Texas, where the flight dosimeters were returned approximately 11 hours after termination of the mission. Therefore, for comparison purposes, the ground control unit was separated from the flight units for approximately 135 hours. The flight items and ground control unit were placed in the shielded shipping container and returned for evaluation to the Air Force Weapons Laboratory, Kirtland Air Force Base, New Mexico.

Each of the pocket ionization chambers and calcium fluoride detectors was checked for absolute accuracy, dose fading, and inherent leakage. The rate of fading of both the lithium and calcium fluoride dosimeters was considered negligible for the time duration of the mission and corrections for fading were not required.

The photoluminescent glass dosimeters of the needle type were carefully selected and the preflight dose on each needle was determined and recorded. Twelve of these dosimeters were inside the hatch-mounted passive unit. Analysis of the readings obtained with these dosimeters was beneath the threshold of sensitivity.

The lithium fluoride dosimeters contained in the passive units consisted of a small cylindrical teflon container filled with powdered lithium fluoride. Lithium fluoride powder containing predominantly lithium 6 will respond to ionizing radiation and neutrons, while the lithium 7 isotope has effectively zero neutron cross section. The difference in readings between these two types was used to determine the neutron component within the spacecraft cabin. In order to determine the practicality of this approach, the passive unit with both types of lithium isotopes was exposed to the fission spectrum of a pulsed neutron reactor. The data obtained indicated that no measurable neutron dose occurred within the limits of experimental error. This result is reasonable since the only neutrons expected in the spacecraft would be from secondary interactions resulting from high energy protons and would be extremely few in number for this mission.

UNCLASSIFIED

The preliminary results from the passive dosimeters are presented in table 8-III. The heavy particle detector and film emulsion packs that were on these units are being analyzed and the results are not available at the time of publication of this report.

8.1.5 Conclusions

Available data indicate Experiment D-8 successfully met the stated objective. Both passive and active dosimeter data indicate conclusively that no radiation hazard is associated with manned space operations at present Gemini altitudes. However, because of the rather high interior doses received during passages through the South Atlantic anomaly, it is evident that the Gemini spacecraft shielding is inadequate to completely stop trapped particles in a manner that would reduce the radiation levels to an acceptable magnitude for prolonged operations at higher orbital altitudes. The experiment also indicates the inadequacy of utilizing single passive elements to provide a true energy independent tissue radiation dose measurement when subjected to the complex spectrum of ionizing space radiation. The cumulative differences obtained between the passive and active instruments, and the active instruments themselves, indicate a need to extend the active portion of Experiment D-8 to cover depth dose measurements in order to define better the softness of the cabin interior radiation.

UNCLASSIFIED

8.2 EXPERIMENT D-9, SIMPLE NAVIGATION

8.2.1 Objective

The objective of Experiment D-9 was to achieve two basic goals:

(a) To gather information on the observable phenomenon which could be best used for autonomous space navigation (that is, a horizon and celestial object examination).

(b) To gather information on the use of a sextant-type device in an earth-orbiting vehicle and to define the man-sextant-vehicle interface problems involved in the use and application of this type of instrument for space navigation and rendezvous.

8.2.2 Equipment

The experimental equipment consisted of a first generation hand-held space sextant which was to be utilized for star-to-horizon, star-to-launch vehicle, and star-to-star measurements. The sextant contained neutral-density, blue-haze, and 5577Å filters to accentuate the horizons to be investigated during specific sightings.

8.2.3 Procedure

The experiment was scheduled to be conducted in two major phases. The Apollo portion of the experiment was to evaluate the man-spacecraft operational suitability of the space sextant, and to obtain quantitative data for accessing the limits of accuracy of the sextant for rendezvous-type measurements. The Air Force portion of the experiment consisted of studies of various star and horizon phenomena and specific star-to-horizon measurements to obtain data for postflight calculations and accuracy determinations of navigational positions.

8.2.4 Results

The actual conduct of these two phases was modified in flight because of spacecraft maneuver fuel limitations early in the mission, and because it was found that the selected stars were not visible on the daylight side of the revolutions. These flight-plan modifications eliminated the scheduled Apollo star-to-launch vehicle sightings and transferred all other sextant sightings to the nightside of the orbits. Movement of these sightings created other problems since the stars

UNCLASSIFIED

selected for the original star-to-horizon measurements were not all time-phased for the nightsides of the orbits and required the flight crew to deviate to a real-time type sighting.

Sextant sightings and observations were conducted by both flight crew members. Typical types of sightings are illustrated in figure 8-3. The number of sightings taken and other significant preliminary data are as follows:

Air Force sightings (star-to-horizon)	45
Apollo sightings (star-to-star)	47
Useful horizons	2 (natural earth and 5577 Å emission line)
Air Force	11
Apollo	6
Maximum sighting angle obtained	
Air Force	approximately 30°
Apollo	approximately 21°
Number of green horizon layers observed	2
Thickness of 5577 Å layer	approximately 2°40'
Star transit time	
Through green layer	49 $\frac{1}{2}$ sec
First sighting to top of green layer	3 min 23 sec
Type of data recording	written and voice tape
Type of sighting timing	manual and photo event timer

The number of sightings obtained for this experiment represent approximately one-fourth of the data points originally scheduled. Statistical evaluation of the star-to-horizon measurements is not currently possible because of the limited number of such sightings and loss of data from the spacecraft voice tapes. Valuable qualitative information was obtained on the availability of various observable phenomena: the utility of the Gemini spacecraft windows, the thickness of the various horizons and their upper boundaries, and the ability of man to make celestial sightings from an orbiting spacecraft.

The sextant performed satisfactorily except for the failure of the counter illumination light. This equipment malfunction caused no significant problems since the flight crew were able to read the counter with available cabin lighting.

8.2.5 Conclusions

Available data indicate that Experiment D-9 was a qualitative success. The lack of good statistical data limits the quantitative analysis

UNCLASSIFIED

concerning the accuracy of the sextant sightings. Important qualitative observations are as follows:

(a) The launch vehicle was visible in the daylight. This factor, in addition to the fact that stars are visible on the day side through a shaded window, appears to prove the feasibility of daylight optical rendezvous by using a sextant-type instrument.

(b) The stars were always visible on the night side and the launch vehicle lights were easily acquired when within range.

(c) The basic sextant concept utilized on this mission was proven feasible. There is now a requirement for operational flight checks to determine overall instrument-man accuracies.

(d) The utility of the different spacecraft windows apparently presented no significant differences in sextant operation.

(e) The observation of the thicknesses and the number of the various horizons used for sightings make it possible to determine the best horizon-filter combination under particular conditions.

(f) It is feasible for man to make celestial sightings from an orbiting spacecraft.

An investigation will be conducted to determine the cause of the sextant counter illumination light failure.

It is significant to note that good qualitative data were obtained because the flight crew adapted to the day-night change and modified and verified the flight plan for this experiment.

UNCLASSIFIED

8.3 EXPERIMENT MSC-1 ELECTROSTATIC CHARGE

8.3.1 Objective

The objective of Experiment MSC-1 was to obtain measurements that would define the electrostatic potential of a Gemini spacecraft during a typical mission.

8.3.2 Equipment

The electrostatic potential meter (EPM) measured the electric field terminating on the spacecraft in the immediate vicinity of the sensor unit. Electrolytic tank measurements, using a scaled-down spacecraft model, were made to determine the conversion from the electric field at the sensor unit to the actual spacecraft potential.

8.3.3 Procedure

The experiment was scheduled to be operated for seven different periods throughout the mission. These periods were selected to be coincident with the occurrence of one or more of the following conditions:

- (a) Extensive use of the orbital attitude and maneuver system (OAMS)
- (b) Spacecraft passing through the South Atlantic magnetic anomaly
- (c) Retrofire
- (d) Periods of good definition of the spacecraft orientation

8.3.4 Results

The data were not available in time to be evaluated for this report. However, quick-look EPM data were obtained for several operating periods and indicate the instrument was operating in the same manner as it did during the preflight tests. There was no indication of electrical or mechanical failure.

UNCLASSIFIED

8.3.5 Conclusion

Evaluation of the data will be accomplished as they become available. Correlations will be attempted between the spacecraft potential and spacecraft attitude, orientation, day-night cycles, ambient magnetic field, spacecraft transmitter operation periods, and OAMS and retrorocket firings.

UNCLASSIFIED

8.4 EXPERIMENT MSC-2, PROTON-ELECTRON SPECTROMETER

8.4.1 Objective

The objective of Experiment MSC-2 was to detect and measure the flux and energy of protons of energy $17 < E < 80$ Mev and electrons of energy $0.5 < E < 4.5$ Mev present throughout typical orbits on the Gemini IV mission, and especially within the South Atlantic geomagnetic anomaly. This anomaly is defined as the region bounded approximately by geodetic latitudes 15° S. and 55° S. and geodetic longitudes 30° E. and 60° W.

8.4.2 Equipment

The proton-electron spectrometer was located in the equipment adapter section on a support assembly fixed to the center of the equipment adapter section blast shield door.

8.4.3 Procedure

The experiments were activated four times during the mission. At each activation, the equipment was required to remain on for three consecutive revolutions during which the spacecraft passed through the South Atlantic anomaly.

8.4.4 Results

Analysis of preliminary data indicates the experimental hardware functioned normally. All parameters were within the limits of normal operation and responded as anticipated.

Preliminary examination of data from revolution 7 revealed that the proton flux outside the anomaly is extremely low, probably less than $5/\text{cm}^2\text{-sec}$. Likewise, the number of electrons encountered outside the anomaly in this revolution was very low. Radioactive thorium was present in the spacecraft structure where the spectrometer was located and introduced background into the measurement. This background made the exact number difficult to determine, but the flux was probably less than $5/\text{cm}^2\text{-sec}$.

Particle intensities within the anomaly were characterized by a relatively sharp increase in count rate at approximately 26° S. geodetic

UNCLASSIFIED

latitude and 56° W. geodetic longitude, and a further increase was observed at approximately 31° S. geodetic latitude and 40° W. geodetic longitude. The latter increase was followed by a relatively slow decay to background levels at about 30° S. and 9° E. The first increase occurred over a period of approximately 1 minute during which the electron flux increased to approximately $700/\text{cm}^2\text{-sec}$. Increase in proton flux was discernible but very small. The second increase occurred over a period of approximately 2 minutes and resulted in a peak electron flux of approximately $3 \times 10^4/\text{cm}^2\text{-sec}$ and proton intensity of approximately $50/\text{cm}^2\text{-sec}$. These peak values persisted for approximately 2 minutes, after which the proton count rates decreased smoothly over a period of approximately 4 minutes to background level. The electron intensity was not as sharply peaked as the proton intensity and decreased to background level over a period of approximately 8 minutes.

8.4.5 Conclusions

Due to limited data availability, it is not possible to determine what shape the energy spectra of the electrons and protons assume inside the anomaly. It is evident, as was expected, that both the proton and electron spectra are quite soft in the energy range measured.

Based on minimal preliminary data, it can be stated that the experimental equipment relayed information on proton and electron fluxes that was very close to the values expected. It appears at these altitudes that detectable intensities of protons and electrons exist only in the anomaly. The preflight arbitrary boundary of the anomaly seems to have proved realistic. Fluxes measured inside the region appear to be lower than expected, but this cannot be fully verified until additional data from the mission are analyzed in detail.

UNCLASSIFIED

8.5 EXPERIMENT MSC-3, TRI-AXIS MAGNETOMETER

8.5.1 Objective

The objective of Experiment MSC-3 was to determine the magnitude and direction of the geomagnetic field in the South Atlantic geomagnetic anomaly and to support Experiment MSC-2, Proton-Electron Spectrometer, with magnetic field line orientation with respect to the spectrometer.

8.5.2 Equipment

The tri-axis flux gate magnetometer equipment consisted of an electronics package, a sensor unit mounted on an extendable antenna boom, and an interconnecting cable between the two units.

8.5.3 Procedure

The sensor was extended on the boom after orbital insertion and remained in the extended position throughout the mission.

The experiment was activated four times during the mission. At each activation, the equipment was required to remain on for three consecutive revolutions during which the spacecraft passed through the South Atlantic anomaly.

8.5.4 Results

Preliminary data obtained from revolution 7 indicate that the experiment equipment operated normally in measuring the magnitude of the geomagnetic field while in orbital flight.

The average field intensity measured during 20 minutes of operating time between 90° W. to 30° E. longitude and 5° N. to 33° S. latitude was 25 500 gammas.

The field intensity predicted using McIlwain's computer codes was typically 25 000 gammas for the same geographic region at an altitude of 200 kilometers. Ephemeris data for revolution 7 of Gemini IV were not available at the time these data were analyzed. It was assumed that the orbital altitude was approximately 107 nautical miles (200 kilometers). The direction of the magnetic field lines appears to coincide with the magnitude values given for each component vector.

UNCLASSIFIED

8.5.5 Conclusions

Further analysis and comparison of data from revolution 7 with data from other revolutions must be made before final results for this experiment can be determined.

UNCLASSIFIED

8.6 EXPERIMENT MSC-10, TWO-COLOR EARTH'S LIMB PHOTOGRAPHS

8.6.1 Objectives

The objective of Experiment MSC-10 was to photograph the earth's limb on black and white film with a hand-held camera. The camera magazine had a two-color filter mosaic directly in front of the film, the central vertical portions being red-transmitting Wratten no. 92, and the side portions blue-transmitting Wratten no. 47B. The purpose of these filters was to allow measurement by microdensitometry of the excess elevation of the blue limb over the red. A series of photographs, taken with widely differing sun angles, was to indicate whether the high-altitude blue limb is a reliable sighting feature for use in future space-flight guidance and navigation. Earlier results from the Mercury-Atlas 9 flight indicated the need for these photographs to be taken periodically throughout the sun-lit portion of an earth orbit.

8.6.2 Equipment

The experiment equipment consisted of a 70-mm camera film magazine, modified to include the filter mosaic. This magazine was used with a 70-mm still camera also required for other experiments.

8.6.3 Procedure

The inflight photographic procedure, beginning at the end of the night portion of revolution 43, scheduled groups of three photographs to be taken in rapid succession at approximately 5-minute intervals throughout the succeeding daylight until sunset.

The photograph negatives of the earth's limb will finally be measured by microdensitometry, comparing the red and blue limbs by reference to an arbitrarily added horizontal line on the edge of the film. Each photograph affords two-limb comparison measurements, one on each side of the center barrier. The film has marked on its edges two series of step-wedge densitometric exposures, one red and one blue.

8.6.4 Results

The detailed schedule of operation for the experiment was generally followed as outlined in the flight plan. The earliest useful photographs were obtained soon after sunrise. Preliminary measurements of 6 of the 24 useful photographs have been made and reduced by quick-look procedures. Several typical photographs are shown in figure 8-4. The four upper

UNCLASSIFIED

photographs show intelligible features of the earth's surface and indicate some variety of blue-limb elevation above the red. The barrier in the center of each photograph is needed to hold the red gelatin filter in place. Photograph 14 was printed before the reference line was added. The enlargement of photograph 30 better illustrates the limb differences. Results of these preliminary measurements converted to blue limb excess elevations are as follows:

<u>Photograph no.</u>	<u>Blue limb excess elevation, km</u>
12	6.6
16	6.9
20	7.7
24	9.5
27	8.7
30	10.5

The limb elevation data refer to a point approximately one-half of the peak radiance of the limb. This conforms to the observing proposed procedure for Apollo navigation. The scattering angles increase regularly from the early, low numbered photographs to almost 180° for the latest ones taken near sunset.

8.6.5 Conclusions

Actual values of the limb radiance will not be available until the detailed micro-densitometry calculations have been completed.

UNCLASSIFIED

8.7 EXPERIMENT S-5, SYNOPTIC TERRAIN PHOTOGRAPHY

8.7.1 Objective

The objective of Experiment S-5 was to obtain high-quality color photographs of terrain features for geological and geographic purposes. The following two types of pictures were desired:

(a) Pictures of well-known areas, such as the United States, which could serve as standards for interpretation of lesser known areas.

(b) Pictures of remote regions, such as the central Sahara, which are poorly covered by existing photography.

8.7.2 Equipment

The experiment equipment consisted of a 70-mm camera film magazine. A total of five magazines loaded with color film was on board the spacecraft, each with a 55-frame capability. The equivalent of one magazine was allotted for Experiment S-5. A haze filter was also carried to be used at the discretion of the crew. These magazines were used with a 70-mm still camera also required for other experiments.

8.7.3 Procedure

Subject to fuel and power limitations, the crew was instructed to use the following procedure for terrain photography: First, United States and Mexico; second, Arabian peninsula and eastern Africa; and third, North Africa.

It was stressed to the crew that almost any pictures of the earth's surface were valuable, even if the experiment plan could not be followed exactly.

8.7.4 Results

Despite early fuel restrictions, the planned procedures were followed closely, and a large number of excellent color pictures were obtained. Approximately twice as many pictures were obtained as the experiment required, and some terrain photographs were obtained from each of the five magazines. Some photographic coverage was obtained of all desired areas.

UNCLASSIFIED

The most valuable series of photographs was taken systematically over the southern United States and Mexico. Complete overlapping coverage was secured from Baja California to central Texas, with intermittent coverage eastward to the Atlantic Ocean. These pictures are mostly vertically oriented, and the land areas west of central Texas are almost completely cloud free.

Other pictures were taken on several different revolutions. Fuel restrictions apparently prevented proper spacecraft orientation on some passes, but nearly all terrain pictures are of high quality and quite usable for scientific purposes. A summary of the photographs obtained is given in table 8-IV.

A detailed analysis of the terrain photographs has not been completed; however, preliminary comments are in order. Color rendition is generally excellent, especially in arid regions. Longer wavelengths - reds, yellows, and browns - are very distinct. The greens of vegetation did not register, except as shades of blue. However, many different shades of blue in shallow bodies of water, such as the Gulf of California, can be observed.

Ground resolution is remarkably high in view of the short (80-mm) focal length camera lens employed. Linear features, such as railroads and streets, on the order of 50 feet wide can be easily distinguished. For example, Route 54 can be traced into downtown El Paso, Texas, where it becomes Dyer Street, and many other streets in the residential districts can be delineated. This high ground resolution permits many other features to be identified. Open-pit mines in Arizona and oil fields in west Texas are very distinct. Figure 8-5 shows a typical synoptic terrain photograph of the upper end of the Gulf of California.

8.7.5 Conclusions

Experiment S-5 can be classified as a complete success. The photographs obtained will be of great value for geological studies. In addition to exhibiting good color rendition and high resolution, they include a wide variety of geological features. These include Pre-Cambrian massifs, Cenozoic volcanic fields, Paleozoic and Mesozoic folded mountains, and a wide variety of aeolian desert features such as seif dunes. Detailed study of the many photographs will require extensive analysis and evaluation.

UNCLASSIFIED

8.8 EXPERIMENT S-6, SYNOPTIC WEATHER PHOTOGRAPHY

8.8.1 Objective

One objective of this experiment was to obtain high-quality color photographs of a number of selected clouds and meteorologically interesting weather systems. A second objective of the experiment was to obtain photographs of areas being concurrently viewed by the TIROS in order to aid in interpretation of the high-altitude satellite television type photographs.

8.8.2 Equipment

The experiment equipment consisted of a 70-mm camera film magazine. Five magazines were on board the spacecraft, each with a 55-frame capability. The equivalent of one magazine was allotted for Experiment S-6. These magazines were used with a 70-mm still camera also required for other experiments.

8.8.3 Procedure

The crew was briefed immediately before launch on the types of weather systems existing at that time and those that should be photographed. During the mission, meteorologists from the U.S. Weather Bureau's National Weather Satellite Center used worldwide weather maps and TIROS pictures to select specific areas likely to contain various weather systems of interest. When operationally feasible, this information was communicated to the flight crew so they could locate and photograph these areas.

8.8.4 Results

Despite early fuel restrictions which prevented the crew from searching for desired cloud formations, over 100 excellent color photographs were obtained for this experiment. These photographs show cloud systems of all types, including such features as cellular cloud patterns, sun glint from ocean surfaces, extensive cloud layers in tropical disturbances, lines or "streets" of cumulus clouds over the oceans, and well developed thunderstorm areas. Figure 8-6 shows a typical synoptic weather photograph taken of Acklins Island in the Bahamas.

UNCLASSIFIED

8.8.5 Conclusions

Experiment S-6 can be classified as a complete success. The photographs obtained will be of great value for meteorological studies. Detailed study of the many photographs will require extensive analysis and evaluation and this information was not available for this report. When all data are available, comparisons will be made among a selection of the experiment photographs and corresponding TIROS views.

UNCLASSIFIED

8.9 EXPERIMENT M-3, INFLIGHT EXERCISER

8.9.1 Objective

The objective of Experiment M-3 was to assess cardiovascular reflex activity in response to a given physical workload (exercise) and to ascertain the general capacity of performing physical work under space-flight conditions.

8.9.2 Equipment

The inflight exerciser consisted of a pair of rubber bungee cords attached to a handle on one end and to a nylon strap at the other. A stainless steel stop-cable limited the stretch length of the rubber bungee cords and fixed the workload.

8.9.3 Procedure

The exercise periods were scheduled to consist of one pull per second for 30 pulls using the inflight exerciser. The exerciser used on the Gemini IV mission required 63 pounds to pull to a full extension of $10\frac{1}{2}$ inches. Seventeen exercise periods for the pilot and four for the command pilot were originally scheduled in the flight plan. The standard Gemini bioinstrumentation was used to record cardiovascular activity in support of this experiment.

8.9.4 Results

Available information indicates the flight crew exercised as scheduled. Also, the command pilot requested and received permission to perform additional exercise as he desired. At approximately 32 hours elapsed time, all type 2 medical data passes (blood pressure-temperature-no exercise) were upgraded to type 1 (blood pressure-exercise-blood pressure) and both pilots were given permission to perform unscheduled exercises. From available reports and data, it is estimated that both flight crew members exercised approximately the same amount during the mission.

During the 67th hour g.e.t., the pilot reported that the latex cover on the exerciser failed. This had no effect on the operation of the equipment or the experiment results, and the flight crew members

UNCLASSIFIED

continued to use the exerciser satisfactorily during the remainder of the mission.

Data from the biomedical recorder were not available at the time of this report. Mean heart rate and mean blood pressure values from preflight test procedures and telemetered type 1 medical data passes for both the command pilot and the pilot have been plotted in figure 8-7.

Preliminary data evaluation indicates little difference between heart rate responses to exercise during flight and those obtained during preflight tests for both flight crew members. This preliminary evaluation offers no evidence of cardiovascular reflex decrement.

Although the flight crew demonstrated their ability to perform physical work, both commented that they had no real desire to perform heavy, strenuous physical exercise. However, they indicated that periodic exercise is desirable throughout a long duration mission.

8.9.5 Conclusions

Available data indicate Experiment M-3 met the stated objective. Specific conclusions that can be made at this time are as follows:

- (a) Exercise periods should be programed in the mission flight for both flight crew members during their work (awake) cycle.
- (b) All medical data passes should include an exercise period.

UNCLASSIFIED

8.10 EXPERIMENT M-4, INFLIGHT PHONOCARDIOGRAM

8.10.1 Objective

The objective of Experiment M-4 was to measure the time interval between the electrical activation of the heart muscle (myocardium) and the onset of the muscular contraction of a man in space. This time interval is a measure of the functional status or fatigue-state of the muscle. This information will provide some insight into the functional cardiac status of flight crew members during prolonged space flight.

8.10.2 Equipment

The experiment equipment consisted of one transducer and an associated signal conditioner for each flight crew member. The signal conditioner was the same unit as that used for the operational electrocardiogram measurements. The transducer was applied to the chest wall on the sternum of each of the flight crew members on the Gemini IV mission. All heart sounds detected were transmitted through the harness wiring bundle to the biomedical recorder.

8.10.3 Procedure

The phonocardiogram signals were to be recorded on the appropriate biomedical recorder when it was operating. The data obtained were to provide information on the duration of mechanical systole and diastole, the duration of the time period between electrical and mechanical systole, and the duration of the complete heart cycle. In addition, the phase of isometric contraction was measured which included the electrical excitation period. From these measurements, an assessment of myocardial function will be made, particularly the effectiveness of cardiac contractility under conditions of space flight.

Selected portions of the data will be recorded at high chart speed for detailed analysis.

8.10.4 Results

At this time, the biomedical tape has not been processed. Post-flight evaluation of the experimental data cannot be performed until the data are available.

UNCLASSIFIED

8.10.5 Conclusions

Postflight determinations indicate that both phonocardiogram transducers were still in satisfactory operating condition. Recognizable phonocardiogram data were received at the Cape Kennedy ground station during the mission. However, since these data were not yet available for analysis, no conclusions can be made in this report.

UNCLASSIFIED

8.11 EXPERIMENT M-6, BONE DEMINERALIZATION

8.11.1 Objective

The objective of Experiment M-6 was to investigate the occurrence and degree of any bone demineralization resulting from prolonged space flights. Bone demineralization has been observed in humans during periods of inadequate calcium intake, during periods of immobilization such as bed rest, and during other situations involving physical inactivity.

8.11.2 Equipment

The equipment used in this experiment was a standard clinical X-ray machine, standard 8-inch by 10-inch X-ray films, and calibrated densitometric wedges.

8.11.3 Procedure

X-rays were made on the Gemini IV flight crew at Cape Kennedy, Florida, in accordance with the following schedule: (a) launch minus 10 days, (b) launch minus 48 hours, and (c) launch minus 220 minutes. Precise X-ray densitometric measurements were made of the heel bone (os calcis) of the left foot and the terminal bone of the little finger (fifth digit) of the left hand.

Three similar measurements were made after completion of the mission according to the following schedule: (a) as soon as possible after recovery, (b) approximately 24 to 72 hours after completion of the mission and prior to the flight crew's departure from the primary recovery vessel, and (c) at the NASA Manned Spacecraft Center, Houston, Texas, approximately 10 days after completion of the Gemini IV mission.

The data obtained will be compared to determine any bone demineralization that occurred during the mission.

8.11.4 Results

Comparison between the preflight and postflight X-rays, to the extent analyzed, indicates actual X-ray absorbancy changes occurred on both the foot (os calcis) and hand (fifth digit) of both flight crew members. The changes from the last preflight to the first postflight X-rays indicate a decrease in absorbancy of 8 to 10 percent for the os calcis. This decrease was expected from available bed-rest information.

UNCLASSIFIED

The X-ray absorbancy changes detected in the films of the hand require further evaluation, as such changes were not expected and considerably less ground baseline experimental data are available for comparison. Exercise performed by the flight crew had some effect on these changes. However, this variable can only be considered in a qualitative sense.

The reproducibility of the densitometric analysis of the X-rays of the os calcis is excellent (within 2 percent). The data on the X-rays of the hand are not complete but there is no reason to believe they will not be satisfactory.

The final postflight X-ray indicates that the observed decrease in os calcis absorbancy had not yet returned completely to preflight levels, but a gradual return is evident.

8.11.5 Conclusions

Available data and current analysis do not permit any conclusions to be reached at this time. All scheduled experimental X-rays have been completed. The preliminary results indicate the importance of continuing postflight observations. It is planned to take another X-ray of the Gemini IV flight crew at a later date to determine if their absorbancy rate has returned to normal. The results also indicate the importance of continuing these types of observations, especially for the longer Gemini missions.

TABLE 8-I.- EXPERIMENTS ON GEMINI IV

8-28

Experiment number	Experiment title	Principal experimenter	Sponsor
D-8	Radiation in Spacecraft	Research and Technology Division, Air Force Weapons Laboratory, Kirtland Air Force Base, New Mexico	Department of Defense
D-9	Simple Navigation	Research and Technology Division, Air Force Avionics Laboratory, Wright-Patterson Air Force Base, Ohio	Department of Defense
MSC-1	Electrostatic Charge	Radiation and Fields Branch, Advanced Spacecraft Technology Division, NASA-MSC, Houston, Texas	NASA Office of Manned Space Flight
MSC-2	Proton-Electron Spectrometer	Radiation and Fields Branch, Advanced Spacecraft Technology Division, NASA-MSC, Houston, Texas	NASA Office of Manned Space Flight
MSC-3	Tri-Axis Magnetometer	Radiation and Fields Branch, Advanced Spacecraft Technology Division, NASA-MSC, Houston, Texas	NASA Office of Manned Space Flight
MSC-10	Two-Color Earth's Limb Photos	Instrumentation Laboratory, Dept. of Aeronautics and Astronautics, MIT, Cambridge, Massachusetts	NASA Office of Manned Space Flight
S-5	Synoptic Terrain Photography	Theoretical Division, NASA-Goddard Space Flight Center, Greenbelt, Maryland	Office of Space Sciences
S-6	Synoptic Weather Photography	National Weather Satellite Center, U.S. Weather Bureau, Suitland, Maryland	Office of Space Sciences
M-3	Inflight Exerciser	Space Medicine Branch, Crew Systems Division, NASA-MSC, Houston, Texas	NASA Office of Manned Space Flight
M-4	Inflight Phonocardiogram	Space Medicine Branch, Crew Systems Division, NASA-MSC, Houston, Texas	NASA Office of Manned Space Flight
M-6	Bone Demineralization	Nelda Childers Stark Laboratory for Human Nutrition Research, Texas Women's University, Denton, Texas	NASA Office of Manned Space Flight

UNCLASSIFIED

UNCLASSIFIED

TABLE 8-II. - EXPERIMENT D-8, DOSE RATES OF COSMIC RADIATION
 FOR SELECTED REVOLUTIONS OF SPACECRAFT 4 OUTSIDE
 OF THE SOUTH ATLANTIC ANOMALY

Revolution number	Average dose rate, millirad/hour	Maximum observed dose rate, millirad/hour	Maximum observed dose rate, millirad/hour
1	0.65	2.00	0.35
2	.55	1.80	.35
3	.45	.75	< .10
14	.40	1.00	< .10
15	.40	.75	.20
16	.45	.80	.20
17	.50	1.00	.20
18	.45	1.00	.20
29	.38	.65	.15
30	.37	.65	< .10
31	.35	.75	< .10
32	.35	.75	.20
44	.50	.70	< .10
45	.45	1.00	< .10
46	.40	.80	.20
47	.35	.90	.11
48	.40	.75	< .10
59	.38	.75	.11
60	.35	.75	.10
61	.35	.75	.20

TABLE 8-III.- PRELIMINARY RESULTS OF EXPERIMENT D-8 PASSIVE DOSIMETERS

UNCLASSIFIED

Components	Passive dosimeters				
	Serial no. 111 ^a	Serial no. 112 ^a	Serial no. 113 ^a	Serial no. 114 ^a	Serial no. 115 ^a
Lithium fluoride (6) unshielded	50 ± 10		44 ± 19	85 ± 15	53 ± 18
Lithium fluoride (7) unshielded		52.5 ± 19.5	43 ± 12	50 ± 14	59 ± 14
Calcium fluoride unshielded		49.4 ± 6.1		57.9 ± 6.5	49.4 ± 4.7
Calcium fluoride unshielded	54.7 ± 7.0	47.1 ± 4.1	55.3 ± 5.4	55.7 ± 5.1	48.5 ± 6.1
Calcium fluoride shielded	53.6 ± 5.7	48.9 ± 3.8	49.0 ± 3.8	55.9 ± 5.9	
Pocket ionization chamber ^b	73	45	46	54	46.6
Toshiba glass	50 ± 15	45 ± 14	30 ± 9		35 ± 11

UNCLASSIFIED

^aAll exposure readings are in milliroentgens.

^bNo error estimates available at this time.

TABLE 8-IV.- SUMMARY OF PHOTOGRAPHS OBTAINED FOR EXPERIMENT S-5

Film identification	Number of terrain photographs	Areas covered	Remarks
Roll 3, magazine 8	47	Baja California, Arizona, New Mexico, west and central Texas	Systematic vertical photography; high percentage of overlap; excellent resolution and color
Roll 4, magazine 9	17	North Africa	Intermittent photography; some overlap; excellent quality
	4	Southeast United States	Some cloud cover; good resolution
	2	Mauritania	Richat structures
Roll 5, magazine 16	13	Arabian Peninsula, southwest Iran, Egypt, Mauritania	Intermittent photography; excellent geological detail; part of roll used for EVA
Roll 2, magazine 7	8	Key West, Fla., and Grand Bahama Islands, Nile Delta, Arabian Peninsula	Excellent color rendition of ocean areas; most of roll used for cloud photography
Roll 1, magazine 6	9	Nile River in southern Egypt, Saudi Arabia	Excellent quality; obliques; some overlap
--	1	Unknown - possibly southern Africa	This roll was jammed in magazine; damage negligible

UNCLASSIFIED

UNCLASSIFIED

UNCLASSIFIED

UNCLASSIFIED

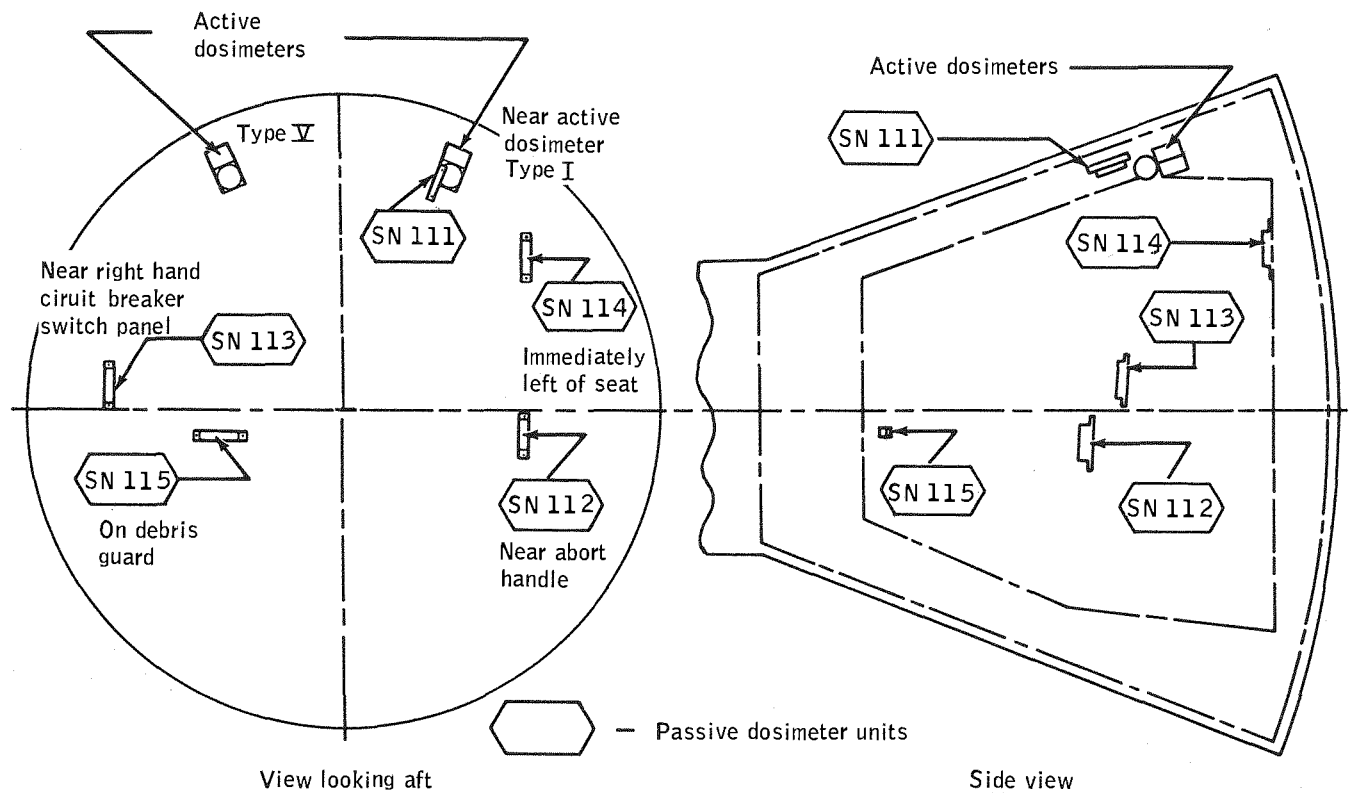

Figure 8-1. - Experiment D-8, spacecraft installation locations.

UNCLASSIFIED

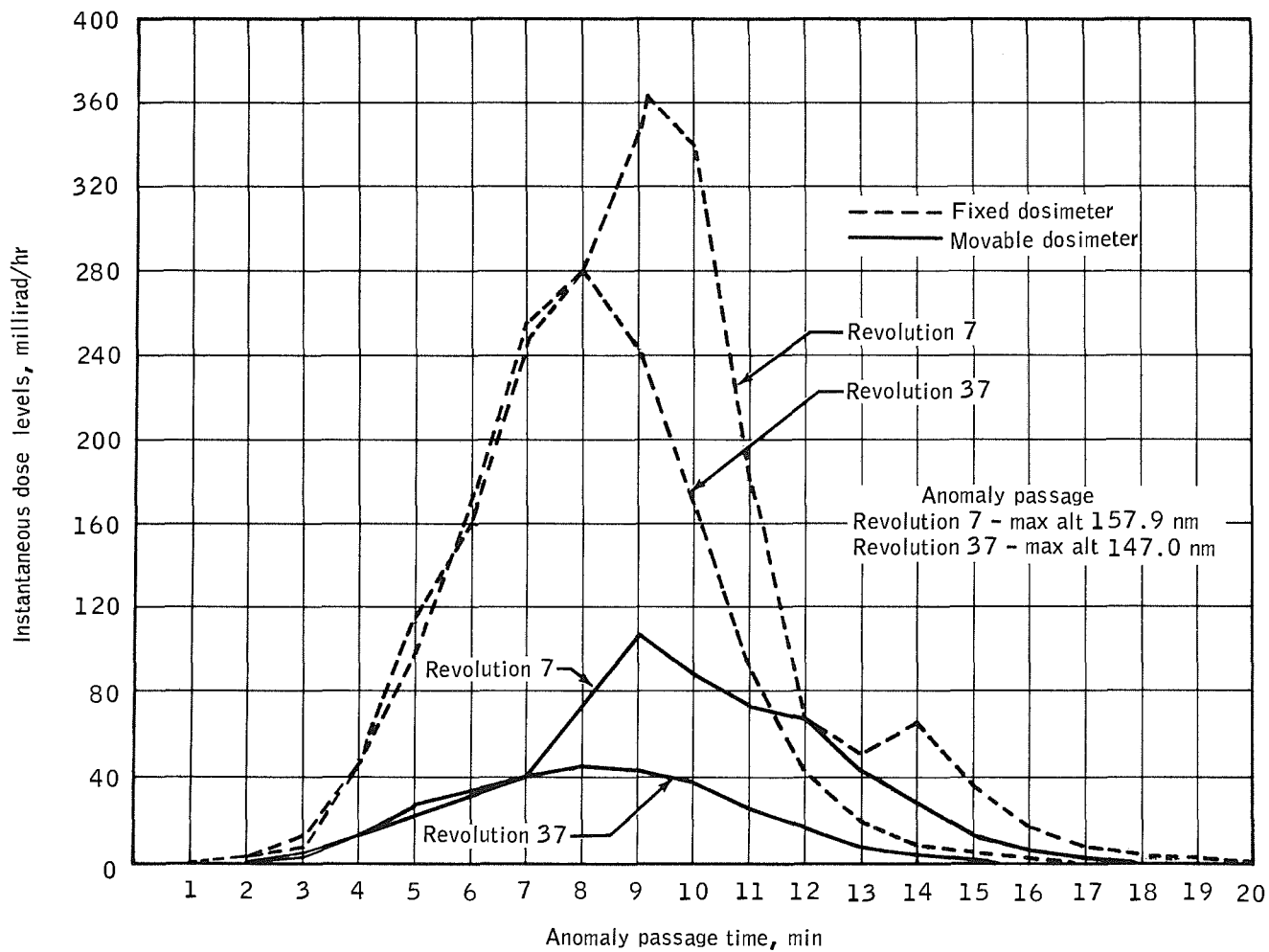

Figure 8-2. - Experiment D-8, active dosimeters dose levels during passage through the South Atlantic anomaly.

UNCLASSIFIED

NASA-S-65-6531

Star measurements to the night horizon through the 5577 Å green filter

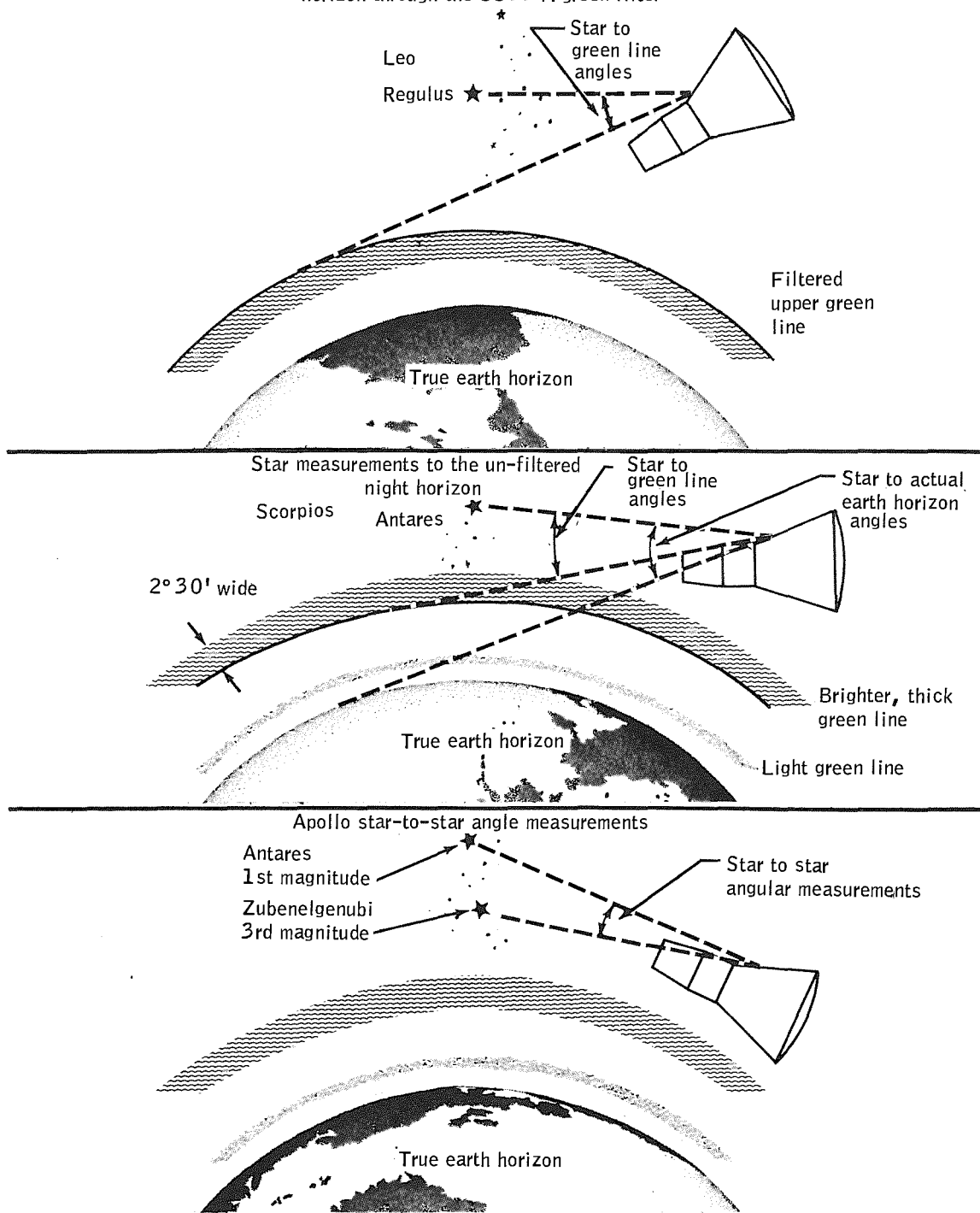
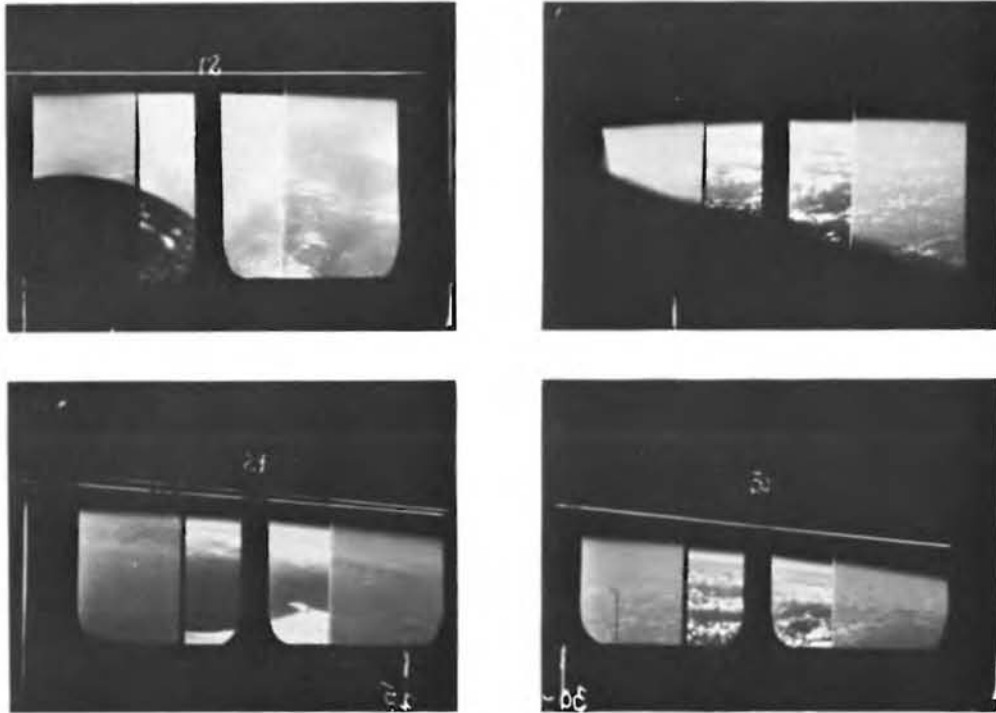

Figure 8-3. - Experiment D-9, typical sextant measurements.

NASA-S-65-6511



Enlargement of photo 30 showing blue limb elevation above the red limb

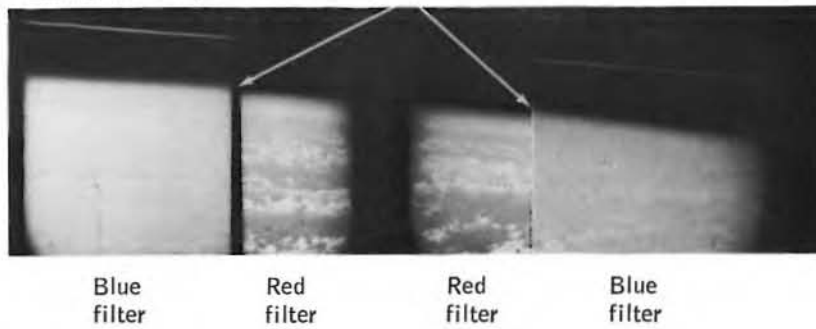

Figure 8-4. - Experiment MSC-10, typical earth's limb photos.

UNCLASSIFIED

NASA-S-65-6512



1. Cerro del Pinacate (volcanic field)
2. Satellitic volcanos
3. Great Sonora desert (sand dunes)
4. Bahía de Adair (bay)
5. Contact between mesozoic granite (to north) and schist (to south)
6. Area of mesozoic gneiss cut by north-trending fractures
7. Typical individual volcanos of the Pinacate field
8. Location of Puerto Peñasco, Sonora (town not visible)
9. Recent lava flows and volcanos

Figure 8-5. - Experiment S-5, typical synoptic terrain photograph.

UNCLASSIFIED

NASA-S-65-6533



View of Acklins Island in the Bahamas showing the deep (darker) water as contrasted to the lighter (shallower) water of the lagoon. Cumulus clouds are small over the water and larger over the sun-heated island. The light area at the left of the photograph is sun glint

Figure 8-6. - Experiment S-6, typical synoptic weather photograph.

NASA-S-65-6021

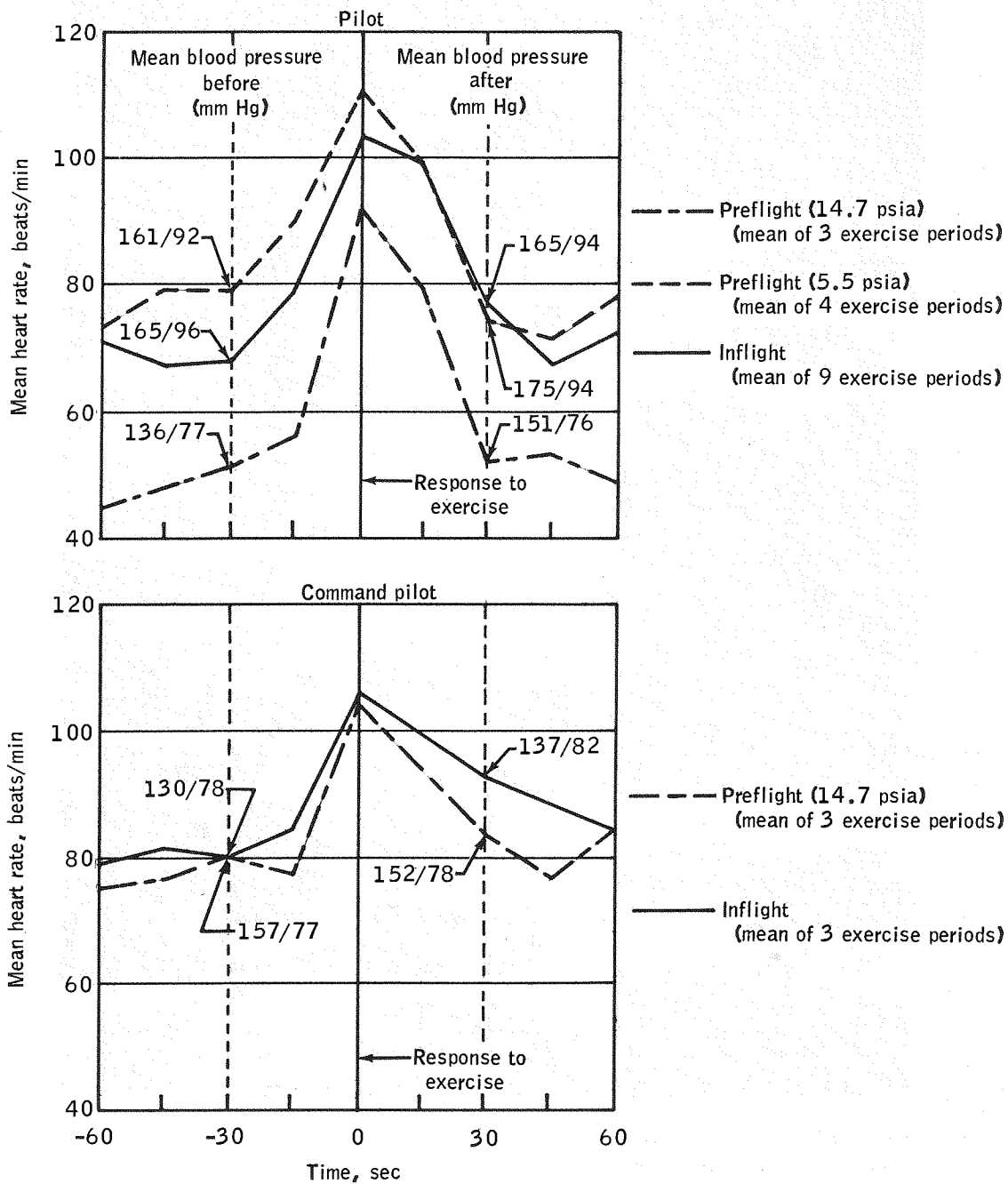

Figure 8-7. - Experiment M-3, preliminary evaluation of exercise data.

9.0 CONCLUSIONS

The performance of the spacecraft, launch vehicle, flight crew, and mission support was satisfactory for the Gemini IV mission. The objectives of the mission were met with only two exceptions: The close-up station-keeping exercise was not accomplished and consequently rendezvous with the launch-vehicle second stage was not attempted; and the controlled lifting reentry was not performed as a result of an inertial guidance system malfunction.

The flight contributed significantly to the knowledge concerning manned space flight, especially in the areas of long-duration flight, crew performance, and extravehicular activity. The Gemini spacecraft systems demonstrated the capability to support man on flights of up to 4 days.

The following conclusions were obtained from the evaluation of the Gemini IV mission.

1. The Gemini launch vehicle performed very satisfactorily and inserted the spacecraft into a nominal orbit. The launch-vehicle achieved-payload capability, however, was approximately 270 pounds greater than the predicted nominal.

2. The hatch-closure difficulty encountered by the pilot after the extravehicular activity resulted primarily from the failure of the hatch latching mechanism to operate normally. Although the hatch-closing lanyard was effective in pulling the hatch closed, this device was not designed to hold it closed.

3. Voice communications were not entirely satisfactory during this mission. Periods of satisfactory performance indicate that the spacecraft systems operated nominally; however, other problems were evidenced in operational procedures and ground station maintenance. In addition, the HF radio system did not provide an acceptable backup to the UHF system.

4. The crew members suffered irritation and inflammation of the tissue of their eyes, nose, and throat from a toxic substance which is assumed to have out-gassed from the water absorbent material or its additives.

5. During revolution 48, a malfunction in the inertial guidance system precluded normal computer shut-down. As a result of power-down attempts, the computer was forced through an uncontrolled voltage decay which altered the memory significantly. This memory alteration prevented the use of the computer for reentry.

UNCLASSIFIED

6. The reentry was conducted satisfactorily. The control system maintained adequate vehicle stability, and the attitude oscillations were controlled through the time of drogue-parachute deployment.

7. The propulsion system operated satisfactorily except for one thrust chamber assembly in the orbital attitude and maneuver system which apparently did not operate for approximately 9 minutes during the station-keeping exercise, and a thruster in the reentry control system which did not operate because of a failure in the electrical control circuitry. Neither of these malfunctions had a significant effect on the control of the spacecraft.

8. The crew station and space suits are suitable for orbital missions of 4 days or longer except for minor changes which are the subject of recommendations listed in section 10.

9. The food was suitable for orbital use. The leaking of the bags containing the rehydratable orange drink and the crumbling of the toast and peanut bars require correction. Exactly the right amount of food was carried on the mission.

10. The waste management system performed satisfactorily. Several minor problems are the subject for recommendations which are listed in section 10.

11. In some cases, fully representative flight-crew operational and experimental equipment was not available for practice in the mission simulator. As a result, the flight crew could not realize full pre-flight training in all aspects of the mission.

12. The flight plan did not provide the crew with adequate time for the many tasks which took place during the first revolutions, such as station keeping, platform alinement, and preparation for extravehicular activities.

13. It was demonstrated that extravehicular activity can be conducted as a routine part of manned space flight. The hand-held maneuvering unit was proved to be an effective means of controlling the pilot's position and attitude in free space. The three-dimensional spacecraft provided the pilot with a satisfactory visual reference during the extravehicular activity.

14. The selected point of the tether attachment to the spacecraft caused the pilot to translate to the adapter in nearly all attempts to maneuver without using the maneuvering unit during extravehicular activities.

UNCLASSIFIED

15. Star-to-horizon sightings from the Gemini spacecraft are more difficult than had been anticipated. Star viewing in the daytime is a difficult task.

16. With proper map and photograph study before the mission and some familiarity with the terrain, rapid landmark identification and good landmark tracking can be accomplished. Orbital navigation can be accomplished by using map updates provided by the ground, or by observing terrain features and updating the orbital plots from these observations.

17. The crew had difficulty in sleeping because the audio volume to the headset could not be turned off. In addition, the crew were disturbed by ambient light and noises associated with normal spacecraft operation.

18. Real-time flight planning is not difficult and may be employed when necessary.

19. Extravehicular activities and long-duration flights of up to 4 days have no adverse residual physical effects on man.

20. Available data indicate that the 11 experiments conducted during the mission were successful.

UNCLASSIFIED

THIS PAGE INTENTIONALLY LEFT BLANK.

UNCLASSIFIED

10.0 RECOMMENDATIONS

The following recommendations are made as a result of evaluating the Gemini IV mission.

1. A reevaluation should be made of the methods used to determine accurately the payload capability of the GLV.
2. Necessary action should be taken to insure that problems with the launch vehicle complex such as the erector malfunction and the umbilical disconnect do not reoccur.
3. A scheduled meeting of the appropriate NASA and MAC systems engineers with the flight crew should be conducted 1 week prior to the flight in order to review crew procedures for system operation as well as reduce the possibility of last minute changes.
4. A study should be made to determine the best points of tether attachment to the spacecraft when maneuvering with the tether line.
5. Adequate hand holds should be provided on the outside of the spacecraft for extravehicular activity.
6. The hatch latching mechanism must be modified or redesigned to a configuration which will preclude any malfunction of the type experienced on the Gemini IV mission before repeating any extravehicular activities.
7. The lanyard connected to the hatch should be strengthened to increase its effectiveness during any hatch closing operations in orbit.
8. Before repeating any extravehicular activities, the hatch closing device must be redesigned to act as a satisfactory method for holding the door closed in case of a failure in the normal latching device.
9. The hoist loop door should be tested as late as possible in the prelaunch preparations to insure its proper operation.
10. A study should be conducted to determine the necessary changes to make the communications system acceptable for manned space flight. Emphasis should be given to the poor HF performance.

10.0

UNCLASSIFIED

11. An independent and separate on-off control should be provided for the voice tape recorder.

12. The lightweight headset should be replaced with a headset which can be worn without discomfort and stay in proper mechanical adjustment.

13. The source of the eye irritation should be identified and eliminated.

14. Modifications should be initiated to improve the reliability of the power sequencing of the IGS and computer.

15. Reentry should be conducted in reentry rate command mode with all rate gyros activated to prevent divergence or undue magnitudes of rates.

16. The proper light pattern should be developed for a rendezvous target to provide adequate depth perception at night.

17. A legible digital display of ground elapsed time in hours, minutes, and seconds from zero to 99 hours should be provided for the crew.

18. Mission planning and operations should be conducted using ground elapsed time.

19. The ground personnel should provide more information to the flight crew on expendables.

20. A simplified means of safetying the ejection seat drogue mortar should be provided.

21. A positive means should be established for protecting the ejection seat aneroids from corrosion on long missions.

22. The intensity of the cabin utility lights should be increased.

23. The cause of the plunger binding in the water dispenser should be investigated and the necessary corrective action taken.

24. The required intensity of the reticle in the optical sight should be determined and corrective action taken.

25. Velcro should be placed on all cabin wall space readily accessible to the flight crew.

UNCLASSIFIED

26. Consideration should be given to providing a filter to prevent the direct sunlight from entering the cabin windows.
27. The altimeter setting for the recovery area should be determined and relayed to the flight crew prior to reentry.
28. A method of improving the readability of the launch vehicle tank pressure gages, which arose with the decals, should be implemented.
29. A drinking water quantity monitoring system should be provided.
30. The finger-tip lights incorporating protective covers on the bulbs should be used on all future Gemini space suits, and should be located between the first joint and the finger tip.
31. Steps should be taken to insure that the blood-pressure port and bulb fitting are properly sized to insure a good fit and will operate correctly for the entire mission.
32. The space suit overvisors should be redesigned to provide a single visor incorporating both visual and physical protection.
33. The method for holding the overvisor in position should be modified to permit raising and lowering the visor with one hand.
34. The urine receiver should be modified to prevent leakage.
35. Corrective action should be taken to prevent leakage of rehydratable food packages and the crumbling of all bite-size foods.
36. The food carried on future flights should be in no smaller proportion per man per day than on the Gemini IV mission.
37. More varieties of freeze dehydrated smoked meats should be developed.
38. Effort should be expended to develop an operational exercise method.
39. The mission simulators and trainers should receive increased attention to insure that up-to-date flight-type equipment is installed and that the crew station and stowage provisions are the same as the current spacecraft.
40. Training aids and simulators must duplicate exactly or have greater loads than the flight-type equipment for extravehicular activity training, and this training should be conducted with suit pressures of 4.5 psi differential.

UNCLASSIFIED

41. A means should be provided for turning off the audio in individual crew member's headsets and reducing the cabin ambient light level to aid the crew in getting better sleep.

42. Rest cycles should be revised to incorporate a 6-hour sleep period and a 2-hour nap period.

43. The comprehensive F-2 day and short F-10 day physicals should be exchanged.

44. The Cape spacecraft communicator should be the only person talking to the flight crew during the terminal count (T-3 minutes to lift-off).

45. Stricter measures should be enforced to insure that accidental exposure of the crew members to a communicable disease does not occur.

UNCLASSIFIED

11.0 REFERENCES

1. Gemini Mission Evaluation Team: Gemini Program Mission Report GT-2, Gemini 2. MSC-G-R-65-1, NASA Manned Spacecraft Center, February 1965.
2. Gemini Mission Evaluation Team: Gemini Program Mission Report GT-3, Gemini 3. MSC-G-R-65-2, NASA Manned Spacecraft Center, April 1965.
3. Aerospace Corporation: Systems Test Objectives for Gemini Launch Vehicle NASA Mission GT-4, TOR-469 (5126-80)-2 Amendment 1, 30 April 1965.
4. NASA Manned Spacecraft Center: Project Gemini Preflight Orbital and Reentry Trajectory Data for the Fourth Gemini-Titan Flight, MSC Internal Note 65-FM-62.
5. International Business Machines Corporation: Gemini Reentry Math Flow 3 and Math Flow 3 Mod I and Mod II Description. IBM No. 65-554-0044.
6. NASA Manned Spacecraft Center: Gemini Spacecraft/Launch Vehicle Interface Specification and Control Document, Report ISCD-1, Nov. 22, 1963 (as revised).
7. NASA Manned Spacecraft Center: Gemini Recovery Operations Manual for GT-4, 1965.
8. McDonnell Aircraft Corporation: Gemini Spacecraft Postflight RCS Deactivation, SEDR F-399, March 15, 1965.
9. NASA Manned Spacecraft Center: Preflight Training Plan for Second Manned Gemini Flight Crew, NASA Program Gemini Working Paper No. 5018, 1965.
10. Gordon C. Hrabal: Experiments for GT-4 Mission, NASA Program Gemini Working Paper No. 5023, NASA Manned Spacecraft Center, May 14, 1965.
11. McDonnell Aircraft Corporation: Project Gemini Postflight Inspection and Cleanup, Spacecraft 4. SEDR F498-4, 1965.

11.0

UNCLASSIFIED

THIS PAGE INTENTIONALLY LEFT BLANK.

UNCLASSIFIED

12.0 APPENDIX

12.1 VEHICLE HISTORIES

12.1.1 Spacecraft Histories

Spacecraft histories at the contractor facility are shown in figures 12-1 and 12-2, and at Cape Kennedy in figures 12-3 and 12-4. Figures 12-1 and 12-3 are summaries of activities with emphasis on spacecraft systems testing and prelaunch preparation. Figures 12-2 and 12-4 are summaries of significant, concurrent problem areas.

12.1.2 Gemini Launch Vehicle Histories

Gemini launch vehicle (GLV) histories at the contractor's facilities in Denver, Colorado, and Baltimore, Maryland, are shown in figure 12-5. The history of the launch vehicle at Cape Kennedy is shown in figure 12-6. Concurrent problem areas and significant manufacturing activities are shown with the GLV test and prelaunch preparation activities.

12.2 WEATHER CONDITIONS

The weather conditions in the launch area were satisfactory for all operations on the day of the launch. Visibility was unlimited in all directions from the Cape.

Surface weather observations in the launch area taken at T-5 hours were as follows:

Cloud coverage	Clear skies	
Wind direction, deg	060	
Wind velocity, knots	07	
Visibility, miles	10	
Pressure, in. Hg	30.08	
Temperature, °F	81	

12.0
12.1
12.2

UNCLASSIFIED

Dew point, °F	59
Relative humidity, percent	47

Weather observations taken aboard the U.S.S. Wasp located 27.44° N., 74.15° W., at the time of landing are as follows:

Cloud coverage	5/10 covered, alto cumulus and cirrus
Wind direction, deg	110
Wind velocity, knots	13
Pressure, in. Hg	30.26
Temperature, °F	81
Dew point, °F	75.8
Relative humidity, percent	80
Sea temperature, °F	79
Sea state	2 ft with 2- to 4-ft swells

Table 12-I presents the launch area atmospheric conditions at 15:21 G.m.t. (00:05:00 g.e.t.), and table 12-II provides weather data in the vicinity of Cape Kennedy ~~at the time of reentry~~. Figures 12-7 and 12-8 present the launch area and recovery area wind direction and velocity plotted against altitude.

** 11:47 GMT (12:31:00 g.e.t.)*

12.3 FLIGHT SAFETY REVIEWS

The flight readiness of the spacecraft and launch vehicle for the Gemini IV mission, as well as the readiness of all supporting elements, was determined at the Flight Readiness and Mission Review meetings noted in the following paragraphs.

12.3.1 Flight Readiness Reviews

12.3.1.1 Spacecraft.- The Flight Readiness Review for spacecraft 4 was held on May 15, 1965. Three open items required resolution prior to the spacecraft being approved for flight. They were:

UNCLASSIFIED

(a) End-to-end test of the HF antenna system prior to final systems test.

(b) RCS tank bladder pinching problem wherein the tank discharge assembly and tank outlet throat had insufficient clearance.

(c) Verification of the results of humidity tests on the drogue gun and ballute aneroids.

A complete satisfactory end-to-end test was conducted on the HF antenna system, and the system was found to be satisfactory. Also, the results of the humidity tests on the aneroid mechanisms were received and found to be acceptable. Investigation of the RCS tanks on spacecraft 4 concluded that the oxidizer tanks in both the A- and B-rings were suspected of having a pinched bladder, so the tanks were removed and replaced with ones having the proper clearance. With these and other minor system activities completed, the spacecraft was found ready for flight.

12.3.1.2 Extravehicular activity equipment.- A separate Flight Readiness Review was held on May 26, 1965, by the review board to consider only the equipment involved with the extravehicular activities scheduled for the mission. Discussion concerning the failure of the demand regulator during qualification of the ventilation control module (VCM) resulted in removal and X-ray of the demand regulators in the spacecraft (as they are identical) to ascertain proper blueprint configuration. The spacecraft regulators were found correct, reinstalled in the spacecraft, and the system properly retested. All hardware for the extravehicular activities was found to be properly qualified and flightworthy.

12.3.1.3 Launch vehicle.- On May 10, 1965, in Los Angeles, California, a technical review was held on the status of the Gemini IV launch vehicle. Members of the NASA-MSC Flight Readiness Review Board were present. The Air Force Space Systems Division, assisted by Aerospace personnel, compared differences between GLV-3 and GLV-4, reviewed the history, the qualification of hardware, and the testing and operations accomplished on GLV-4. All systems, except for two minor items under investigation at that time, were found ready for flight.

12.3.2 Mission Review

The Mission Review Board was convened on June 1, 1965. All elements reviewed their status and were found in readiness to support the launch and mission.

12.3

UNCLASSIFIED

12.3.3 Flight Safety Review Board

The Air Force Flight Safety Review Board met on June 2, 1965. Final confirmation had been made that the automatic oxidizer standpipe charging system was in operational readiness. The charging system is used to charge the oxidizer standpipe that reduces longitudinal oscillations (the POGO phenomenon) during first stage flight.

The results of flowmeter calibrations had been received establishing correlation between the launch vehicle propellant level highlights and the propellant system flowmeter readings. All launch vehicle and complex systems were ready, and the launch vehicle was committed to flight.

12.4 SUPPLEMENTAL REPORTS

Supplemental reports for the Gemini IV mission are listed in table 12-III. The format will conform to the external distribution format of the NASA or contractor organization preparing the report. Each report will be identified on the title page as being a Gemini IV supplemental report. Before publication, the supplemental reports will be reviewed by the cognizant Mission Evaluation Team (MET) Senior Editor, the Chief Editor, and the MET Manager, and will be approved by the Gemini Program Manager.

The same distribution will be made on the supplemental reports as that made on the Mission Report.

12.5 DATA AVAILABILITY

Tables 12-IV, 12-V, and 12-VI list the mission data which are available for evaluation. The trajectory and telemetry data will be on file at the Manned Spacecraft Center (MSC), Computation and Analysis Division, Central Metric Data File. The photographic data will be on file at the MSC Photographic Division.

12.6 POSTFLIGHT INSPECTION

The postflight inspection of the spacecraft 4 reentry assembly was conducted in accordance with reference 11 at the John F. Kennedy Space Center (KSC) from June 11 to June 25, 1965. The following items of

UNCLASSIFIED

equipment were removed from the spacecraft while on the recovery ship, and were dispositioned prior to arrival of the reentry assembly at Cape Kennedy.

<u>Part number</u>	<u>Nomenclature</u>	<u>Serial number</u>
52-87710-7	Computer	105
52-87717-43	Gimbal control electronics	409
52-87717-67	Inertial guidance system static power supply	322
52-87717-75	Platform	101
52-87717-77	Inertial measuring unit system electronics	H8/202
52-87723-13	Auxiliary computer power unit	110

The reentry assembly was received in good condition on June 11, 1965, without the rendezvous and recovery (R and R) section or the parachutes. The following list contains the discrepancies noted during the detailed inspection of the reentry assembly.

(a) The electrical connector to the left-hand mild detonating fuse (MDF) detonator at station Z192 had the bayonet pins sheared off and was hanging loose from the cartridge.

(b) A local heating wake in the area of the right-hand adapter interconnect fairing similar to the one on spacecraft 2 was noted.

(c) Hatch sill damage on the right-hand hatch sill consisting of a small dent on the lower corner in the area of the hinge was observed.

(d) Hatch seal and sill damage was found on the left-hand hatch midway between the forward and aft edges on the lower sill next to the hinge. The forward sill also was dented in approximately three spots.

(e) There were smudges on both spacecraft windows.

(f) The recovery-hoist-loop door did not jettison and was returned as loose equipment with the spacecraft.

(g) One ejection seat MDF interconnect cap was loose.

UNCLASSIFIED

- (h) There was no potting on some of the electrical terminal strips in the equipment bays.
- (i) No RCS propellants were returned with the spacecraft.
- (j) The urine dump system was inoperative.
- (k) The cabin temperature control valve was inoperative.
- (l) The right-hand hatch-actuator rod was galled.

12.6.1 Spacecraft Systems

12.6.1.1 Structure.- The overall appearance of the spacecraft structure was good. The external appearance suggested a heating environment somewhere between that of spacecraft 2 and spacecraft 3. The shingles and blankets exhibited more discoloration than those of spacecraft 3, but the discoloration was less than that exhibited on spacecraft 2. The heat shield appeared as expected. The stagnation point measured 19.4 inches from the centerline, as compared to 24.5 inches and 10 inches for spacecraft 2 and 3, respectively. This indicates that the angle of attack during reentry was also between that of spacecraft 2 and 3. Ten plugs were removed from the heat shield for analysis.

Various tests were run on the hatch, with emphasis on the latching mechanism, to investigate problems that were reported by the crew. Refer to section 5.1.1 for these results. This work was performed under spacecraft test request (STR) 4016. The hatch sill and seal exhibited some damage. Photographs indicate that this damage occurred during ground handling after the flight.

Residue similar to that noted on the windows of spacecraft 3 was again noted. These windows have been removed and are being analyzed according to STR 4508. The parts of the suit and EVA equipment that came in contact with the window will be examined for particles from the window according to STR 4017.

12.6.1.2 Environmental control system.- The external appearance of the environmental control system (ECS) bay was good, and no water was noted in the cavity. The crew reported the urine dump system inoperative after 92 hours. This item is being analyzed according to STR 4022, and preliminary results indicate a malfunction of the sole-noid dump valve.

UNCLASSIFIED

During the postflight inspection it was discovered that the cabin temperature control valve was stuck in position; however, the crew operated the valve just prior to reentry without any reported difficulty. This finding is under investigation according to STR 4519.

Upon investigating a report that the drinking water dispenser had kinked, it was found that its surface was crazed. This item is being analyzed according to STR's 4002 and 4509.

The lithium hydroxide canister is being evaluated according to STR 4011, primarily to determine its suitability for longer duration missions.

The cabin humidity sensor is being calibrated according to STR 4025 to determine the accuracy of the inflight readings.

12.6.1.3 Communications system.- The external appearance of all the communication equipment located in the equipment bays was good, and little evidence of corrosion was exhibited.

The HF antenna was tested according to STR 4014. The antenna extended and retracted satisfactorily when it was energized by an external power source. No water was found in the antenna case. The case was pressurized to 2 psig with an external gaseous nitrogen source, and the following flows were measured.

<u>Antenna configuration</u>	<u>Flow rate, cc/min</u>
As spacecraft was returned	0.0
Hydrogel in breather cartridge removed (by drilling out enough to allow air passage)	0.0
Extended approximately 6 in.	4300
Retracted and end-plug alined	1700

The HF transceiver and antenna were removed and dispositioned to the spacecraft contractor for further analysis according to STR 4014.

12.6.1.4 Guidance and control systems.- As a result of the inertial guidance system (IGS) malfunction, all removable equipment that could be associated with this failure was removed, cleaned aboard ship, and dispositioned to the appropriate vendors for failure analysis. Immediately after the arrival of the spacecraft at Cape Kennedy, and prior to its drying in the altitude chamber, the computer mode selector switch

UNCLASSIFIED

was tested. Proper circuit continuity was obtained in all positions. This work is being accomplished according to STR's 4000, 4006, 4009, and 4010. For further discussion and results, see section 5.1.5.

The attitude control maneuver electronics package is being cleaned and evaluated for possible reuse according to STR 4007.

12.6.1.5 Pyrotechnics.- Pyrotechnic resistance checks were performed on all actuated pyrotechnic cartridges. One cartridge registered a relatively low resistance, and the remaining cartridges indicated essentially open circuits.

The hatch actuators, rocket catapults, and seat pyrotechnic devices were removed and sent to the KSC pyrotechnics group for storage. One MDF interconnect had a loose end-cap, and was dispositioned for failure analysis according to STR 4511 (fig. 12-9).

The right-hand hatch-actuator rod exhibited galling and was dispositioned for failure analysis according to STR 4513.

The electrical connector to the left-hand MDF detonator at station Z192 was hanging loose. The three bayonet pins on the detonator had been sheared, allowing the electrical connector to become disengaged (fig. 12-10).

The postflight visual inspection of the wire-bundle guillotines, bridle-release mechanisms, detonators, and other pyrotechnics disclosed that all appeared to have functioned normally.

The ejection seat drogue and ballute aneroids were removed and actuation tests conducted according to STR 4000A.

12.6.1.6 Instrumentation and recording system.- The postflight inspection revealed two anomalies in this system. These were associated with the voice tape recorder cartridges, and with the wiring from the 400-cps inverter to the PCM tape recorder. The wiring is being investigated according to STR 4020. Three cartridges did not operate satisfactorily. On two of the cartridges, failure was evidenced only during rewinding after successful playback. The other cartridge was corroded; however, when it was removed, cleaned, and placed in a new cartridge, it provided good reproduction. The remaining equipment has been, or will be, dispositioned according to reference 11 and STR's 4001, 4004, and 4005. The equipment will be subjected to further cleaning and testing to determine its acceptability for reuse.

12.6.1.7 Electrical system.- The main and squib batteries were removed, and the discharge was controlled from 20 volts to 20.5 volts

UNCLASSIFIED

according to reference 11. The current leakage due to salt water immersion was checked and recorded in reference 11. The batteries and their terminals appeared unaffected by corrosion.

12.6.1.8 Crew station furnishing and equipment.- The appearance of the cabin interior was good. The recovery team reported the cabin to be clean and dry, and the equipment to be stowed in an orderly fashion. The absorbent material used in the spacecraft cabin appeared to be dry. Eight samples have been removed and will be tested according to STR's 4013 and 4500. The flight crew equipment has been dispositioned according to STR 4002 and 4003A. This equipment is being assessed for possible reuse.

The flight crew reported insufficient illumination of the optical sight. This sight is being investigated according to STR 4018 by the spacecraft contractor. The crew also reported that the left-hand G.m.t. clock was not accurate. The clock is being evaluated according to STR 4019.

The center stowage box seals are being examined according to STR 4023 to determine if any damage occurred due to stowing and unstowing the gear.

12.6.1.9 Propulsion system.- The RCS thrust chamber assemblies (TCA's) appeared normal. STR 4024 was written to investigate a failure associated with TCA 5. The failure was determined to be a faulty electrical circuit. The problem is still under investigation.

12.6.1.10 Landing system.- The single-point bridle-release mechanism and the main parachute forward and aft bridle-release mechanism appeared to have functioned normally.

12.6.1.11 Postlanding recovery aids.- The recovery team leader reported that the hoist-loop door had failed to open, and that the door was removed by a swimmer prior to the recovery of the spacecraft by the ship. STR 4517 was written to investigate the problem. Investigation showed that the retaining cable for both the hoist-loop door and recovery flashing light door had been severed by the pyrotechnic guillotine as designed. Further investigation revealed that the forward edge stiffener on the door had interfered with the edge of the phenolic parachute-bridle-trough filler. The door was replaced, and a spring scale attached to the door to measure the force required to remove the door. Two measurements were taken, and forces of 58 pounds and 62 pounds were required.

12.6.1.12 Experiments.- The Experiment D-8 active dosimeters were removed from the left-hand and right-hand hatches, and dispositioned

UNCLASSIFIED

to the Air Force experimenter at MSC Houston.

12.6.2 Continuing Evaluation

The following is a list of the approved spacecraft test requests (STR's) for the postflight evaluation:

<u>Number</u>	<u>System</u>	<u>Purpose</u>
4000 rev. A	Landing, escape, and recovery	To evaluate ejection seat, drogue, and ballute aneroids.
4001	Communications	To return the Gemini IV voice recorder and shock absorber to the vendor for evaluation and refurbishment.
4002 <i>rev A</i>	Crew station equipment	To remove flight crew equipment for evaluation and assessment for possible reuse.
4003 rev. A	Crew station equipment	To initiate and maintain control and accountability of the crew equipment returned to MSC Houston via the courier from the recovery ship.
4004 <i>rev A</i>	Instrumentation	To remove, clean, and return the instrumentation package no. 2 to the vendor for evaluation and possible reuse.
4005 <i>rev A</i>	Instrumentation	To remove, clean, and return the PCM telemetry system to the vendor for evaluation and possible reuse.
4006	Guidance and control	To remove, clean, and return the computer and ACPU to the vendor for failure analysis.
4007 <i>rev A</i>	Guidance and control	To remove, clean, and return the attitude and maneuver control electronics package to the vendor for evaluation and possible reuse.
4008	Electrical	To verify spacecraft 4 IGS circuitry.
4009	Guidance and control	To remove, clean, and return the IGS static power supply to the vendor for failure analysis.

UNCLASSIFIED

UNCLASSIFIED

12-11

<u>Number</u>	<u>System</u>	<u>Purpose</u>
4010	Guidance and control	To remove, clean, and return the IMU and IMU electronics to the vendor for evaluation tests of the IGS, and possible reuse.
4011	Environmental control	To determine the condition of the LiOH canister after the mission.
4012 rev. A	Instrumentation	To return the spacecraft 4 voice recorder cartridges to the vendor for evaluation, refurbishment, and possible reuse.
4013	Environmental control system	To analyze a sample of the absorbent material removed from the cabin wall after flight.
4014	Communications	To demonstrate that the HF voice transceiver and HF whip antenna were not adversely affected by immersion.
4016	Structures	To determine why the flight crew had difficulty closing and latching the right-hand hatch.
4017	Crew station equipment	To determine the chemical constituents of the film that was observed to be wiped off the left-hand window during EVA.
4018	Experiments	To investigate and recommend design changes necessary to overcome flight crew comment that the sight reticle was not bright enough during the Gemini IV flight.
4019	Crew station equipment	To investigate the Gemini IV crew's report that the left-hand G.m.t. clock was not accurate.
4020	Instrumentation	To investigate the condition of the mylar drive belt and inverter wire routing in the PCM tape recorder.
4021	Structures	To perform postflight evaluation of the heat shield.

UNCLASSIFIED

UNCLASSIFIED

<u>Number</u>	<u>System</u>	<u>Purpose</u>
4022	Environmental control	Failure analysis of the overboard urine dump system.
4023	Crew station equipment	To evaluate seals to determine the damage incurred during flight as a result of putting gear in and taking gear out of the center stowage box.
4024	Propulsion	To investigate possible flight failure of the RCS TCA 5.
4500	Environmental control system .	To evaluate moisture absorbent material used in the cabin.
4503	Electrical	To dry spacecraft wiring in preparation for failure analysis of IGS malfunction.
4508	Structure	To determine the composition of the residue on windows.
4509	Environmental control	To investigate a problem reported to have occurred during the Gemini IV mission in which the command pilot was not able at times to get water to flow from drink dispenser, and to determine why the tube assembly has a crazed surface.
4511	Landing, escape, and recovery	To evaluate the tip of the MDF interconnect on the right-hand seat.
4512	Electrical	To obtain the ampere-hours left in the batteries for comparison with the load analysis prediction.
4513	Landing, escape, and recovery	To evaluate the reason for the right-hand hatch actuator galling.
4517	Landing, escape, and recovery	To determine why the hoist loop door failed to jettison.
4519	Environmental control system	To determine why the cabin temperature control valve which operated satisfactorily just prior to reentry was jammed after recovery.

UNCLASSIFIED

TABLE 12-I.- LAUNCH AREA ATMOSPHERIC CONDITIONS
AT 15:21 G.m.t., JUNE 3, 1965

Altitude, ft	Temperature, °F	Pressure, lb/sq ft	Density, slugs/cu ft
0 × 10 ³	80.8	2126.1	2277.9 × 10 ⁻⁶
5	60.4	1782.3	1990.3
10	47.5	1485.1	1704.8
15	32.0	1232.0	1459.1
20	14.2	1015.2	1248.4
25	-.2	831.9	1054.9
30	-23.3	675.4	902.0
35	-43.6	542.8	760.1
40	-63.9	431.3	635.0
45	-76.9	339.2	516.4
50	-90.0	265.2	418.0
55	-93.1	205.9	327.4
60	-89.5	159.8	251.5
65	-79.6	124.9	191.3
70	-67.4	98.0	145.5
75	-56.9	77.5	112.2
80	-53.7	61.6	88.5
85	-52.2	49.1	70.1
90	-42.7	39.3	54.7
95	-37.8	31.3	43.3
100	-35.5	25.3	34.5
105	-27.2	20.3	27.4
110	-20.9	16.5	21.7
115	-18.0	13.4	17.5

UNCLASSIFIED

11:47 GMT

TABLE 12-II.- REENTRY WEATHER CONDITIONS AS MEASURED
AT CAPE KENNEDY ON JUNE 7, 1965

Altitude, ft	Temperature, °F	Pressure, lb/sq ft	Density, slugs/cu ft
0 × 10 ³	76.46	2128.83	2289.94 × 10 ⁻⁶
5	61.16	1786.94	1987.64
10	46.22	1490.99	1710.18
15	30.74	1236.40	1464.73
20	15.26	1019.20	1248.58
25	-1.48	834.57	1060.95
30	-21.46	677.72	901.27
35	-43.78	544.89	763.508
40	-67.18	432.53	642.24
45	-82.66	339.38	524.46
50	-95.62	263.78	422.209
55	-88.60	204.67	321.507
60	-86.08	159.35	248.36
65	-77.80	124.89	190.34
70	-67.72	98.16	146.10
75	-62.32	77.48	113.51
80	-60.16	61.40	89.45
85	-60.88	48.66	71.0.
90	-58.36	38.63	55.88
95	-43.96	30.70	43.07
100	-36.58	24.64	33.76
105			
110			
115			

UNCLASSIFIED

TABLE 12-III.- SUPPLEMENTAL REPORTS

Number	Report title	Responsible organization	Completion date	Text reference section and remarks
1	GLV Engineering Evaluation Report (Gemini IV)	SSD and contractor (Aerospace)	August 3, 1965	Section 5.2 standing requirement
2	Launch Vehicle No. 4 Flight Evaluation	SSD and contractor (Martin)	July 18, 1965	Section 5.2 standing requirement
3	Manned Space Flight Network Performance for the Gemini IV Mission	Goddard Space Flight Center	August 3, 1965	Section 6.3 standing requirement
4	Gemini IV Spacecraft Inertial Guidance System Evaluation	Space Technology Laboratories	July 18, 1965	Section 5.1.5 standing requirement
5	Gemini IV Spacecraft Guidance System Evaluation	International Business Machines Corporation	July 18, 1965	Section 5.1.5 standing requirement
6	Analysis of Station Keeping and Rendezvous Exercise	Flight Operations Directorate - MSC	July 18, 1965	Section 4.1

UNCLASSIFIED

UNCLASSIFIED

UNCLASSIFIED

TABLE 12-IV.- INSTRUMENTATION DATA AVAILABILITY

Data description	
<p><u>Paper recordings</u></p> <p>Spacecraft telemetry measurements (Revolutions 1, 2, 3, 4, 7, 14, 15, 16, 17, 18, 27, 28, 29, 30, 31, 32, 42, 43, 44, 45, 46, 47, 48, 49, 57, 58, 59, 60, 61, reentry)</p> <p>GLV telemetry measurements (launch)</p> <p>Telemetry signal-strength recordings</p> <p>MCC-H and MCC-C plotboards (Confidential)</p> <p>Range safety plotboards (Confidential)</p> <p><u>Radar data</u> (Confidential)</p> <p>IP-3600 trajectory data</p> <p>MISTRAM</p> <p>Natural coordinate system</p> <p>Final reduced</p> <p>C-band</p> <p>Natural coordinate system</p> <p>Final reduced</p> <p>Trajectory data processed at MSC and GSFC (launch and orbital)</p> <p><u>Voice transcripts</u> (Confidential)</p> <p>Air-to-ground and onboard recorder</p> <p>Technical debriefing (on recovery ship)</p> <p><u>GLV reduced telemetry data</u> (Confidential)</p> <p>Engineering units versus time plots</p> <p>Vibration</p> <p>Power spectrum density plots</p> <p>g_{rms} plots</p> <p>Acoustical noise spectrum density plots (by one-third octave)</p>	<p><u>Spacecraft reduced telemetry data</u></p> <p><u>Engineering units versus time</u></p> <p>Ascent phase</p> <p>DCS parameters (Confidential)</p> <p>Orbital phase</p> <p>Parameter tabulations (statistical) for revolutions 1, 3, 14, 16, 18, 30, 32, 46, 47, 48, 49, 51, 59, 60, 61, and 62</p> <p>System parameters excluding G and C for revolutions 1, 48, and 49</p> <p>Selected G and C parameters for revolutions 1, 43, 45, 46, 47, 48, 49, 61, and 62 (Confidential)</p> <p>Reentry phase</p> <p>System parameters excluding G and C</p> <p><u>Event tabulations</u></p> <p>Sequence of event tabulations versus time, including thruster firings for ascent, reentry, and revolutions 1, 2, 3, 4, 7, 14, 15, 16, 17, 18, 28, 29, 30, 31, 32, 36, 37, 44, 45, 46, 47, 48, 49, 51, 58, 59, 60, 61, and 62</p> <p><u>Special computations</u></p> <p>Ascent phase</p> <p>IGS computer word flow tag correction (Confidential)</p> <p>Special aerodynamic and guidance parameter calculations (Confidential)</p> <p>IGS computer simulation (Confidential)</p> <p>MISTRAM versus IGS velocity comparison (Confidential)</p> <p>Mod III radar versus IGS velocity comparison (Confidential)</p>

UNCLASSIFIED

TABLE 12-IV.- INSTRUMENTATION DATA AVAILABILITY - Concluded

Data description	
<u>Special computations - concluded</u> Orbit phase OAMS propellant remaining computations for revolutions 1, 2, 3, and 4 OAMS thruster activity computations for revolutions 1, 2, 3, 4, 61, and 62 RCS thruster activity computations for revolution 62 Experiment MSC-1 special processing for revolutions 1, 2, 30, and 62 Experiment MSC-2 special processing for revolutions 7, 37, and 51	Experiment MSC-3 special processing for revolutions 7, 37, and 51 D-8 experiment special processing for revolutions 7, 36, 37, 45, and 51 Reentry phase Lift-to-drag ratio and angle-of-attack calculations RCS propellant remaining computations RCS thruster activity computations Heat transfer rates

TABLE 12-V.- SUMMARY OF PHOTOGRAPHIC DATA AVAILABILITY

12-18

Mission phase	Number of still photographs	Motion picture film, footage
Launch and prelaunch	88	18 100
Recovery		900
Swimmer deployment and installation of collar	373	
Egress of flight crew	111	
Aircraft carrier		1 500
Loading of spacecraft and arrival of flight crew	400	
Inspection of spacecraft	82	
Mayport, Florida		600
General activities	15	
RCS deactivation	30	
Cape Kennedy postflight inspection		1 500
Exterior views of spacecraft	22	
Detail inspection views	76	
Onboard spacecraft		500
Extravehicular operation	29	
Experiment S-5, Synoptic Terrain Photography	125	
Experiment S-6, Synoptic Terrain Photography	107	
Experiment MSC-10, Two-Color Earth's Limb		
Photographs	28	
Apollo Landmark Experiment	35	
Miscellaneous general purpose photography	108	

UNCLASSIFIED

UNCLASSIFIED

TABLE 12-VI.- LAUNCH PHASE ENGINEERING SEQUENTIAL CAMERA DATA AVAILABILITY

Sequential film coverage item	Camera					
	Type	Size	Lens	Speed, frames/sec	Location	Presentation
1.2-31 1.2-32	Tracking	16-mm	40 in.	96	Cape Kennedy	Spacecraft centered in frame from lift-off to loss of vehicle
1.2-27 1.2-28	Fixed	16-mm	40-mm	400	Complex 19	Spacecraft upper and lower umbilical plugs showing disconnect
1.2-12 1.2-13	Fixed	16-mm	100-mm	200	Complex 19	Spacecraft centered in bottom of frame
1.2-32	Tracking	16-mm	40 in.	96	Cape Kennedy	Spacecraft centered in frame from lift-off to loss of vehicle
1.2-7 1.2-8	Fixed	16-mm	15-mm	24	Complex 19	Fuel-storage tanks to show possible leakage or spillage in the area
1.2-4 1.2-5 1.2-6	Fixed	16-mm	15-mm 15-mm 25-mm	24	Complex 19	General surveillance of space vehicle, launcher, and launcher stand
1.2-1 1.2-2 1.2-3	Fixed	16-mm	15-mm 15-mm 25-mm	24	Complex 19	Space vehicle, launcher, and launcher stand centered in frame; cameras remotely operated by Test Conductor in case of an emergency
1.2-20	Fixed	16-mm	10-mm	400	Complex 19	3D1E and 3D2E umbilical plugs
1.2-22	Fixed	16-mm	10-mm	400	Complex 19	1DOVT umbilical plug
1.2-23	Fixed	16-mm	10-mm	400	Complex 19	3B1E and associated umbilical plugs
1.2-24	Fixed	16-mm	10-mm	400	Complex 19	2B1E and associated umbilical plugs

UNCLASSIFIED

UNCLASSIFIED

TABLE 12-VI.- LAUNCH PHASE ENGINEERING SEQUENTIAL CAMERA DATA AVAILABILITY - Continued

UNCLASSIFIED

Sequential film coverage item	Camera					
	Type	Size	Lens	Speed, frames/sec	Location	Presentation
1.2-25	Fixed	16-mm	10-mm	400	Complex 19	Cable cutters
1.2-29	Fixed	16-mm	152-mm	400	Complex 19	Umbilical booms 3 and 4 to show umbilical and lanyard action following umbilical release.
1.2-14 1.2-15	Fixed	16-mm	15-mm 152-mm	400	Complex 19	Lower portion of space vehicle and A-frames to observe explosive bolt action and space vehicle first motion.
1.2-18 1.2-19	Fixed	16-mm	10-mm	400	Complex 19	Engine bells centered laterally.
1.2-16 1.2-17	Fixed	16-mm	10-mm	400	Complex 19	Engine area.
1.2-9 1.2-10 1.2-11	Fixed	16-mm	25-mm	400	Complex 19	Space vehicle centered in frame to show movement and vibration at launch.
1.2-33	Tracking	16-mm	20 in.	64	Cape Kennedy	Track from lift-off to loss of vehicle with space vehicle centered in frame throughout track.
1.2-34	Tracking	16-mm	40 in.	64	Cape Kennedy	Track from lift-off to loss of vehicle with space vehicle centered in frame throughout track; if any components fall from the vehicle during powered flight, track the falling debris.

UNCLASSIFIED

TABLE 12-VI.- LAUNCH PHASE ENGINEERING SEQUENTIAL CAMERA DATA AVAILABILITY - Concluded

Sequential film coverage item	Camera					
	Type	Size	Lens	Speed, frames/sec	Location	Presentation
1.2-35	Tracking	35-mm	120 in.	64	Cape Kennedy	Track from first acquisition to loss of vehicle; engine section centered until I/F ratio allows full space vehicle to be centered
1.2-36	Tracking		80 in.	64		
1.2-37	Tracking (IGOR)	70-mm	180 in.	30	False Cape	Track from first acquisition to loss of vehicle; engine section centered in frame until I/F ratio allows full space vehicle to be centered
1.2-38	Tracking (ROTI)	70-mm	360 in.	32	Cocoa Beach	
1.2-39	Tracking (IGOR)	35-mm	360 in.	32	Patrick Air Force Base Melbourne Beach	to show staging if event is recordable
1.2-40	Tracking (ROTI)	70-mm	500 in.	20		
	Tracking (airborne)	16-mm 35-mm	24 in. 32 in.	180 80	Cape Kennedy Area	Airborne photographic coverage of the launch sequence from specially configured aircraft for surveillance during the maximum aerodynamic pressure region
1.2-41	Tracking (BX-7 Image Enhancement System)		500-mm		Patrick Air Force Base	Track first acquisition to loss of vehicle to provide high altitude video coverage for transmission to MCC-Cape
1.2-42	Fixed	16-mm	25-mm	400	Cape Kennedy	3D10C and 3D20C umbilicals centered horizontally in top third of frame to show disconnect and clearness

UNCLASSIFIED

UNCLASSIFIED

UNCLASSIFIED

UNCLASSIFIED

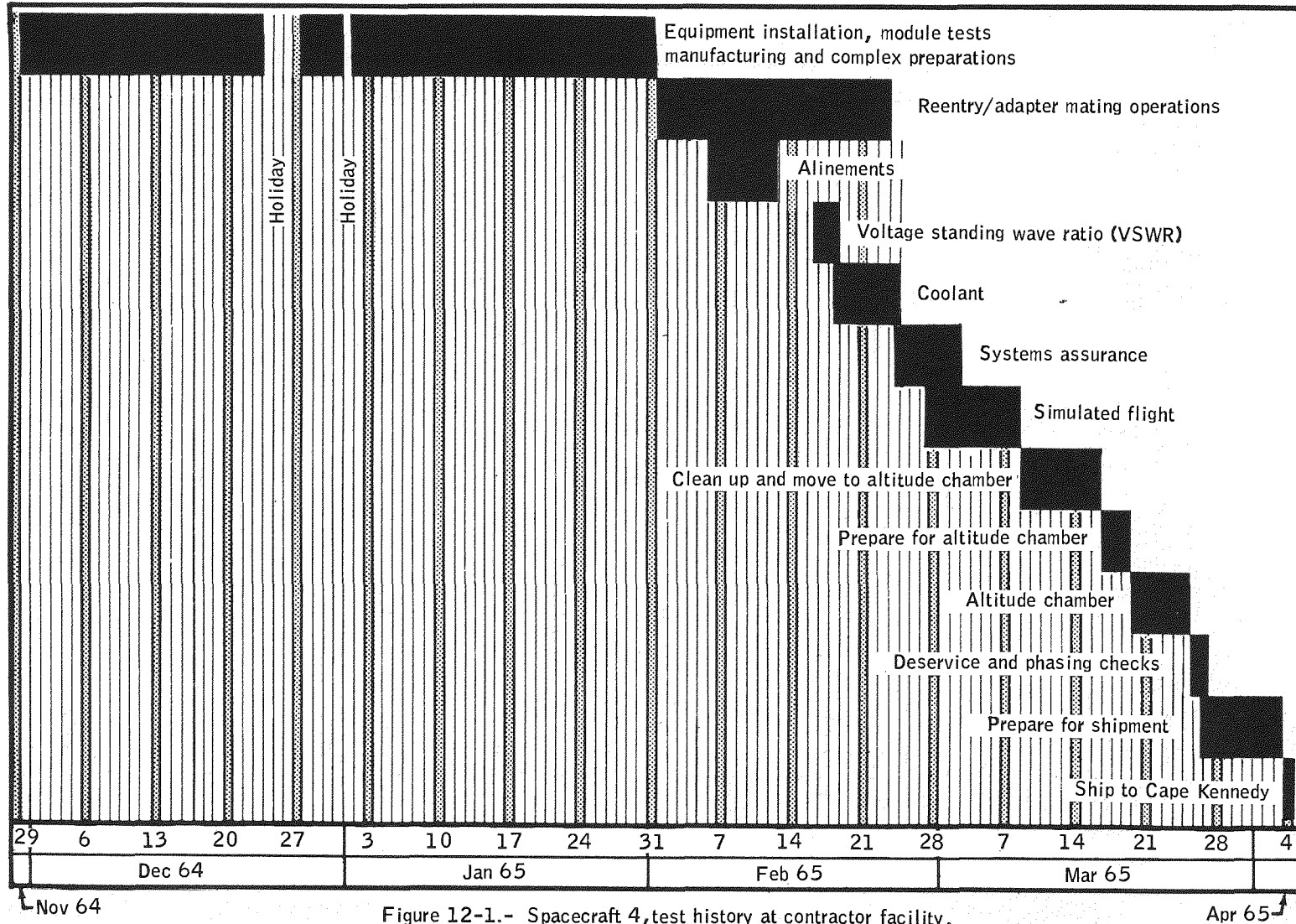
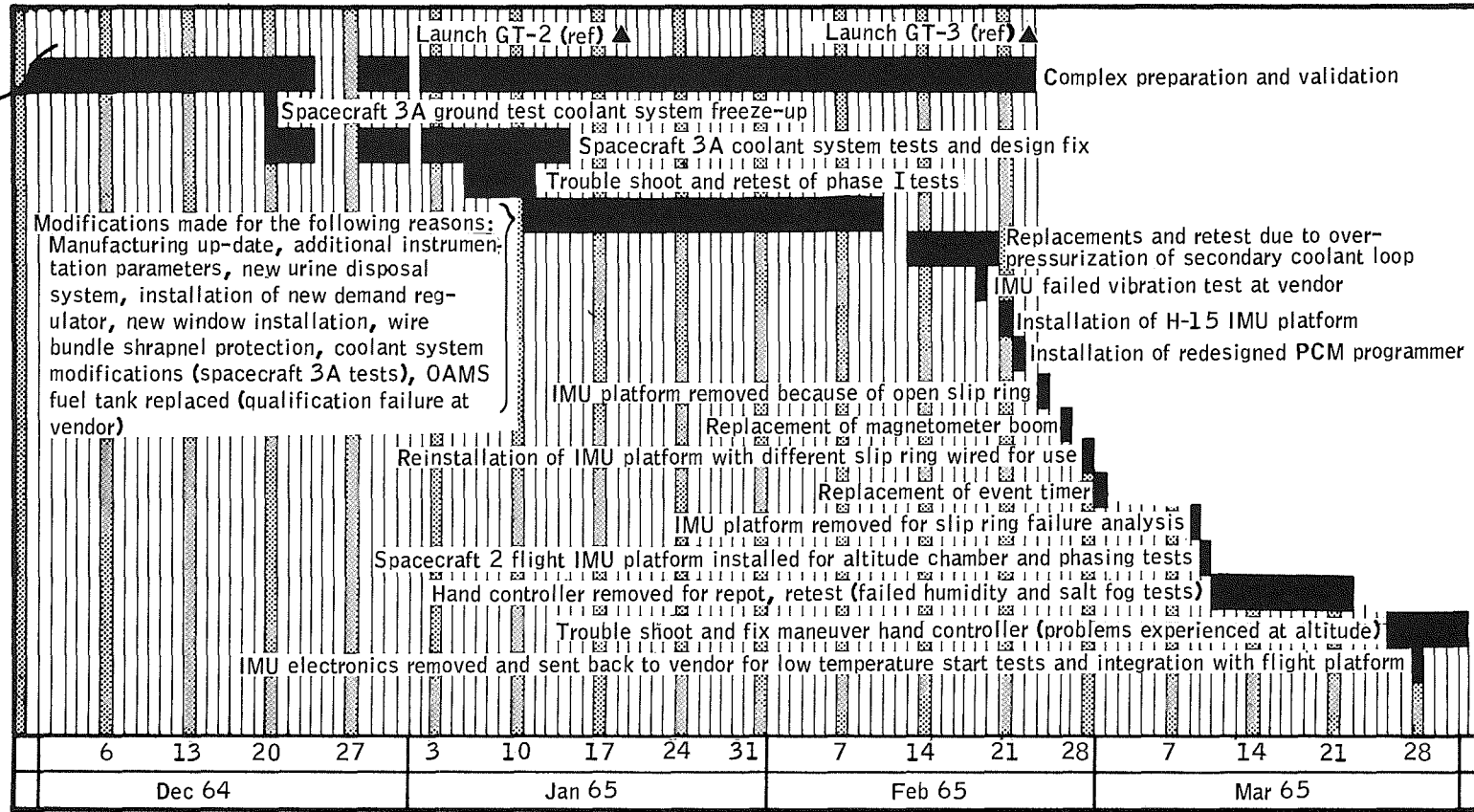

Figure 12-1.- Spacecraft 4, test history at contractor facility.

UNCLASSIFIED



UNCLASSIFIED

Figure 12-2. - Spacecraft 4 significant problem areas at contractor facility.

UNCLASSIFIED

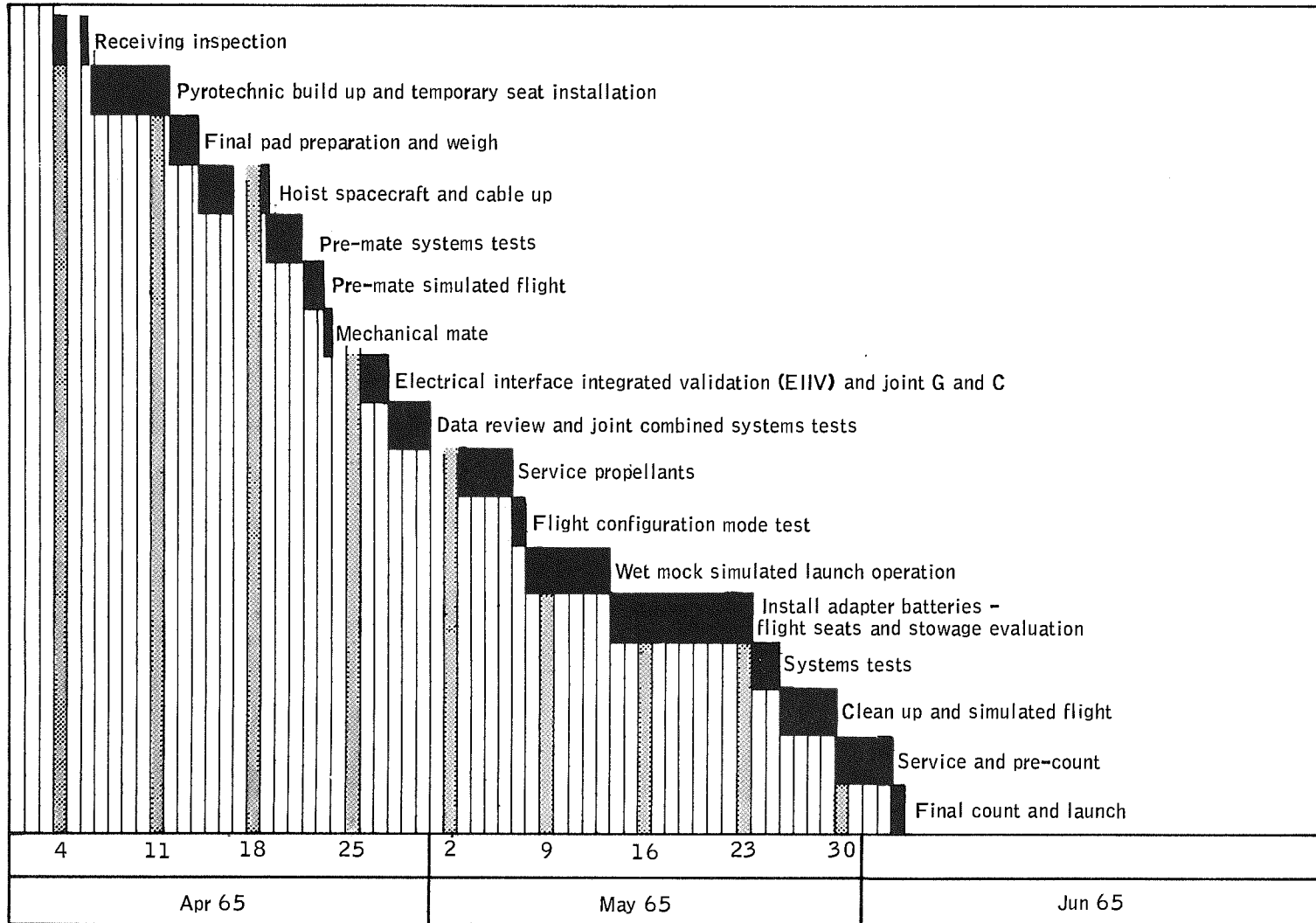

UNCLASSIFIED

Figure 12-3. - Spacecraft 4 test history at Cape Kennedy.

UNCLASSIFIED

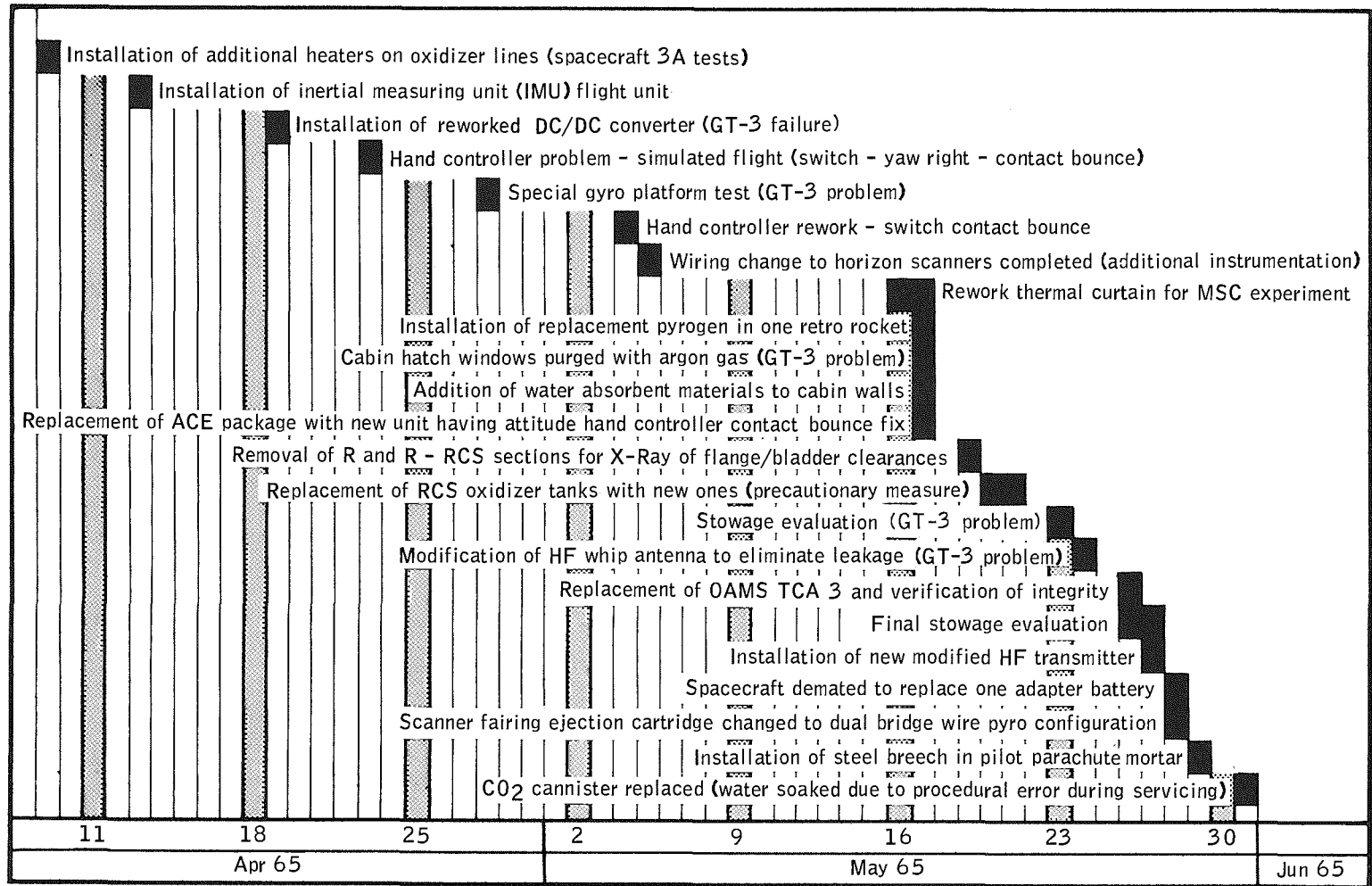

UNCLASSIFIED

Figure 12-4.- Spacecraft 4 significant problem areas at Cape Kennedy.

UNCLASSIFIED

UNCLASSIFIED

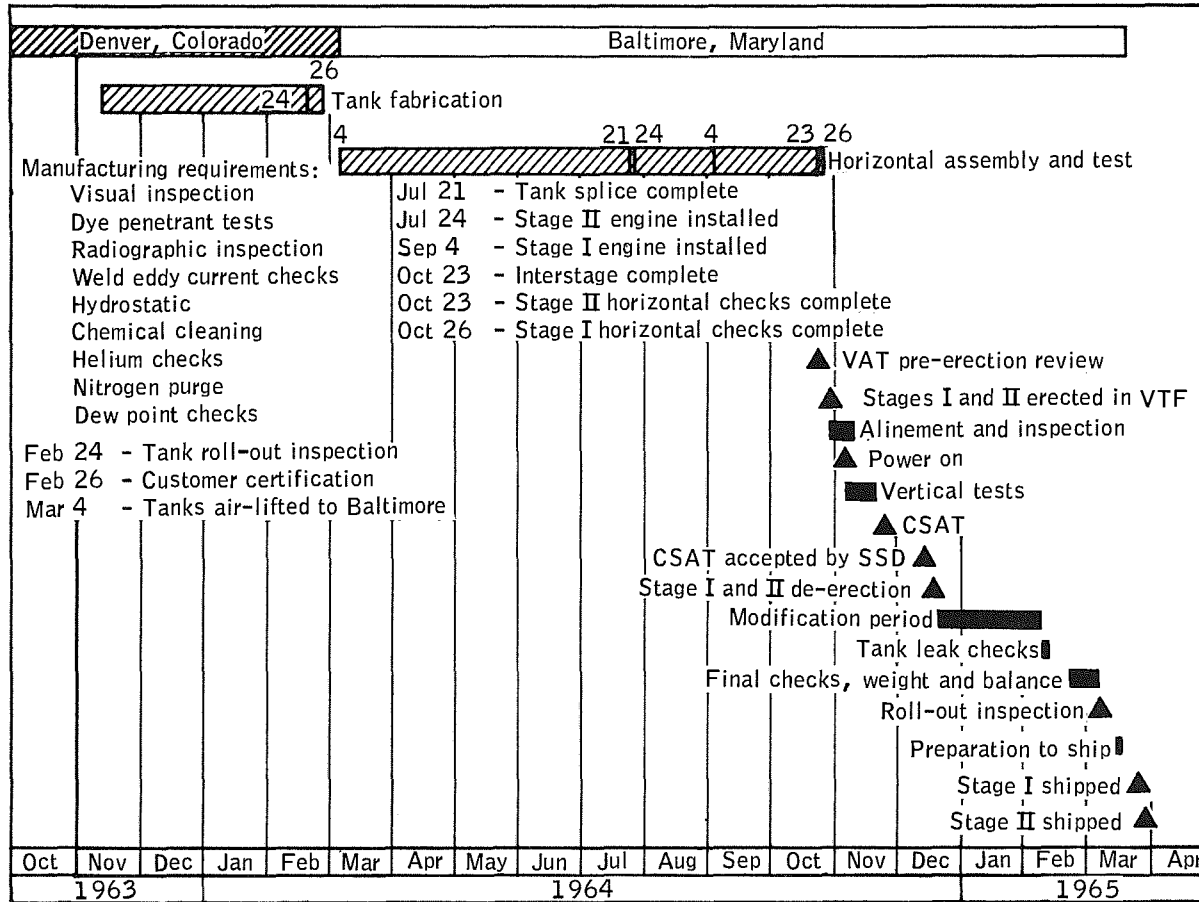
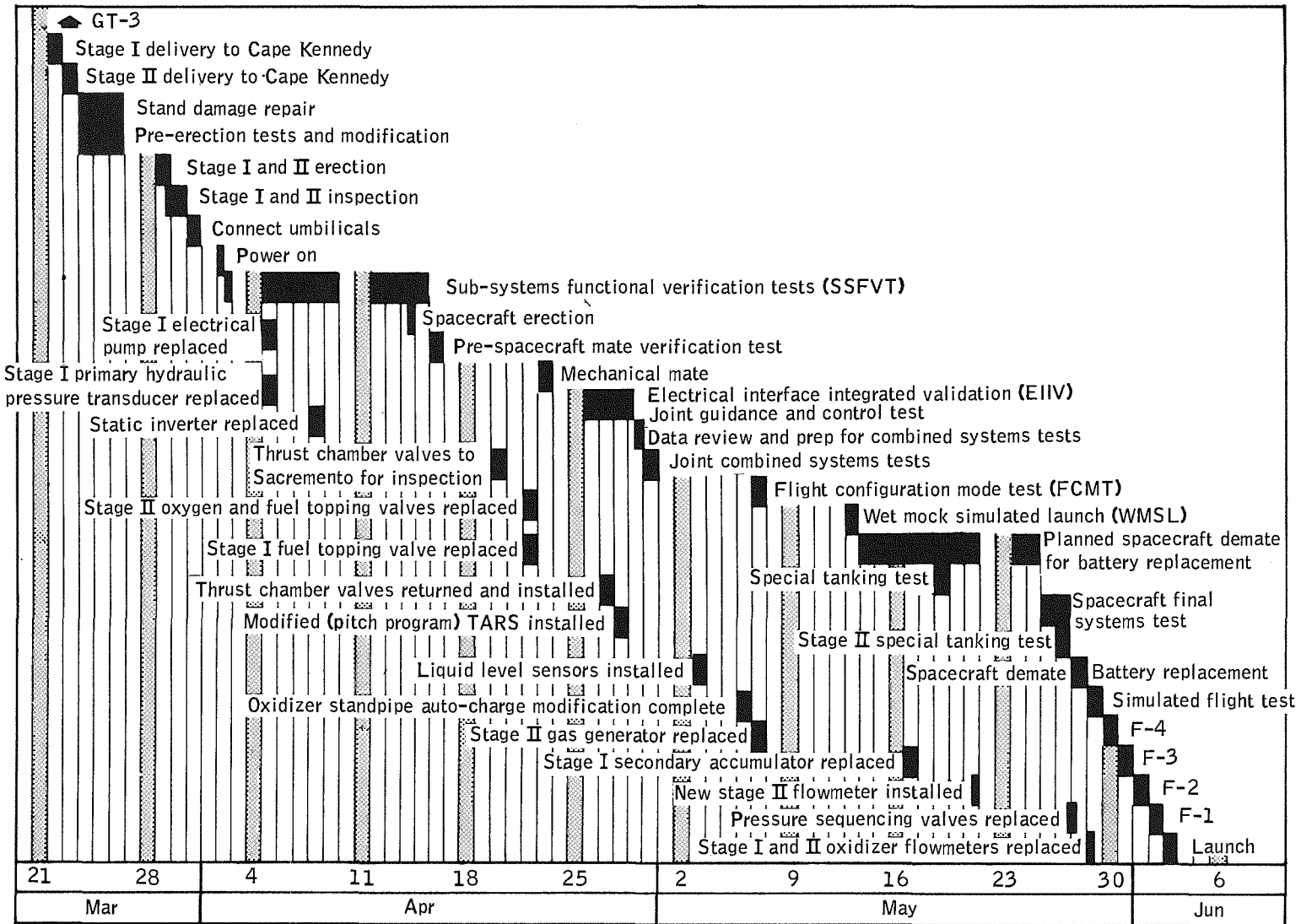

Figure 12-5. - GLV 4 history at Denver and Baltimore.

UNCLASSIFIED



UNCLASSIFIED

Figure 12-6. - GLV-4 history at Cape Kennedy.

UNCLASSIFIED

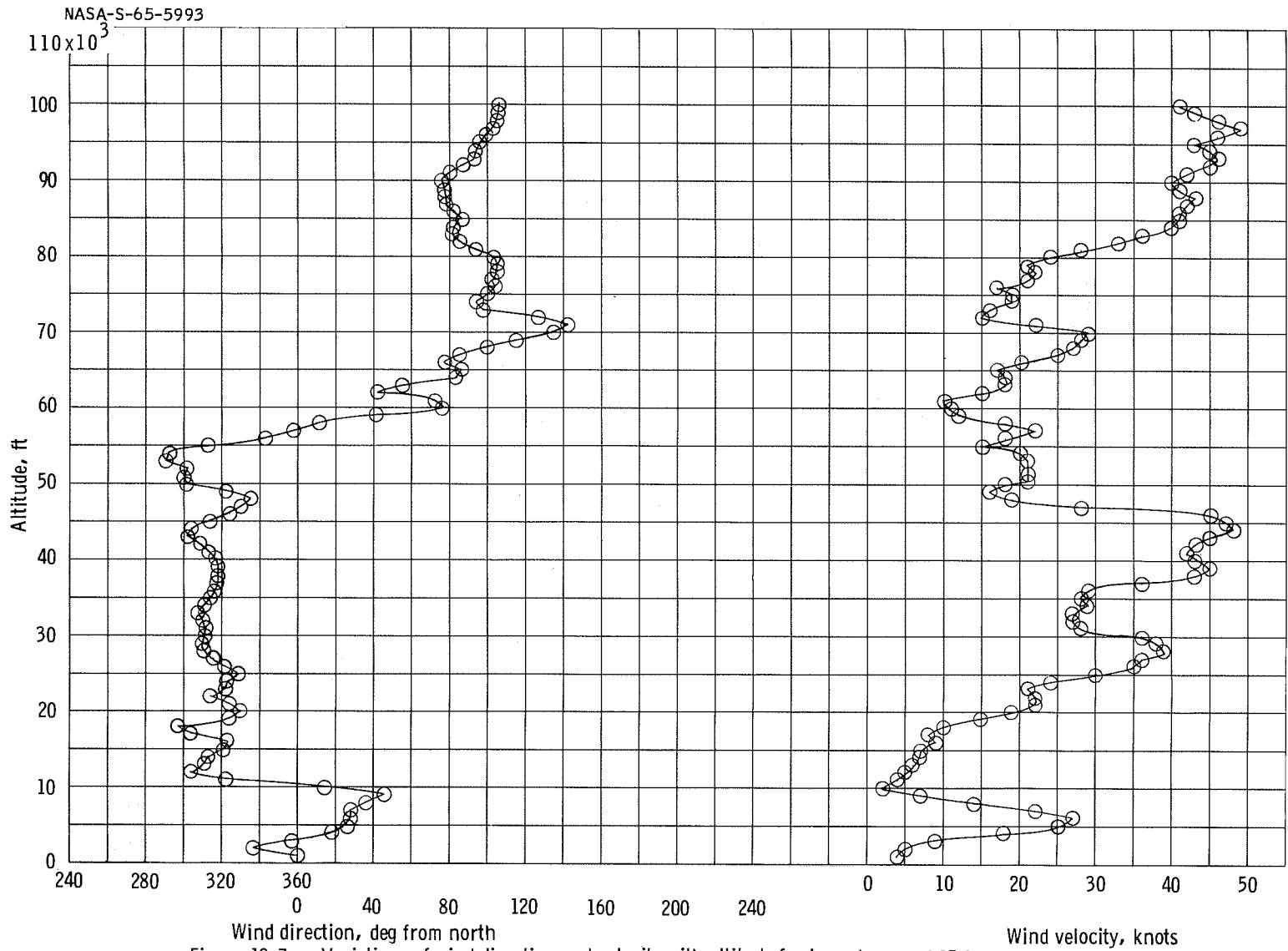

Figure 12-7. - Variations of wind direction and velocity with altitude for launch area at 15:21 Gmt, June 3, 1965.

UNCLASSIFIED

UNCLASSIFIED

NASA-S-65-6515

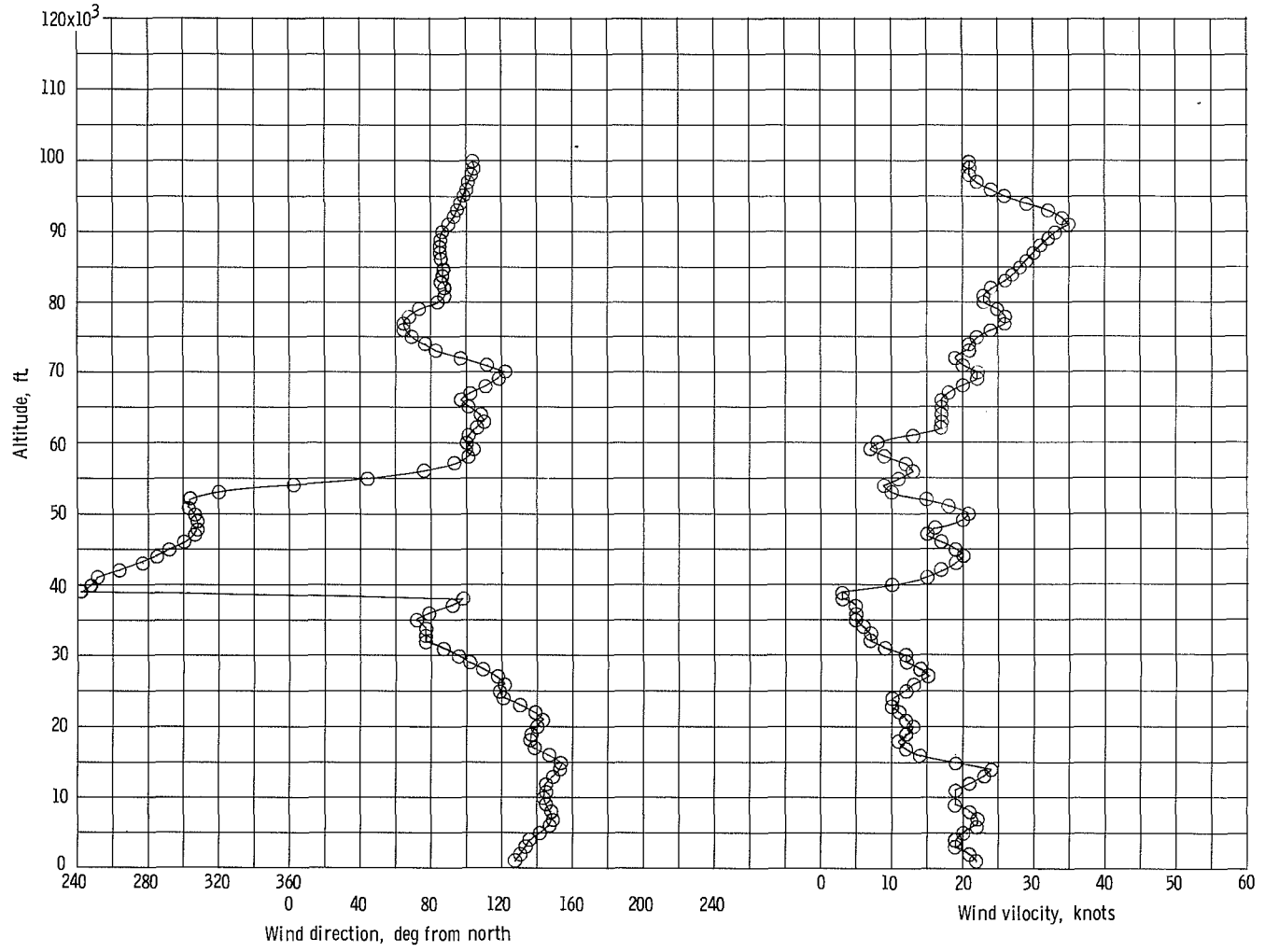

Figure 12-8 - Variation of wind direction and velocity with altitude for reentry area at 19:00 G. m. t., June 7, 1965.

UNCLASSIFIED

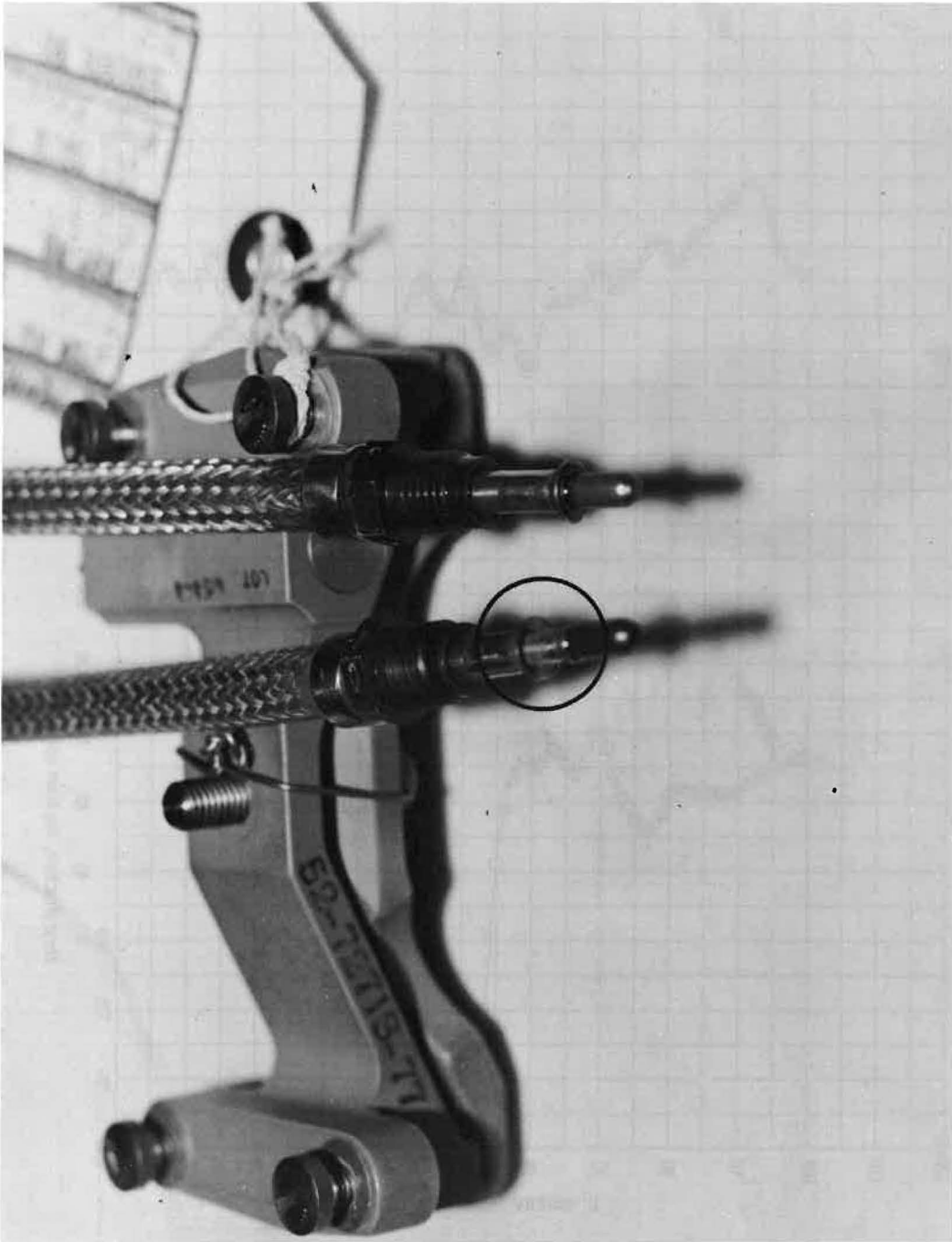

Figure 12-9. - Faulty escape system MDF interconnect.

NASA-S-65-6677



Figure 12-10 - Sheared connector to R and R separation igniter.

UNCLASSIFIED

THIS PAGE INTENTIONALLY LEFT BLANK.

UNCLASSIFIED

UNCLASSIFIED

13-1

13.0 DISTRIBUTION

<u>Addressee</u>	<u>Number of Copies</u>
NATIONAL AERONAUTICS AND SPACE ADMINISTRATION	
National Aeronautics and Space Administration Washington, D. C. 20546 Attention: Director, Gemini Program, MG	40
National Aeronautics and Space Administration Washington, D. C. 20546 Attention: Library, ATSS-6	6
National Aeronautics and Space Administration Manned Spacecraft Center Houston, Texas 77058	
Director, AA	1
Deputy Director, AB	1
Special Assistant to the Director, AC	1
Executive Assistant to the Director, AF	1
Chief of Center Medical Programs, AH	2
Legal Office, AL	1
Center Medical Office, AM	2
Flight Medicine Branch, AM2	2
National Aeronautics and Space Administration John F. Kennedy Space Center Kennedy Space Center, Florida 32899 Attention: Launch Site Medical Operations, HU	2
Public Affairs Office, AP	1
Flight Safety Office, AR	4
National Aeronautics and Space Administration John F. Kennedy Space Center Kennedy Space Center, Florida 32899 Attention: Flight Safety Office, HY	1

UNCLASSIFIED

13.0

UNCLASSIFIED

Assistant Director for Administration, BA	1
Mail and Records Management Branch, BF5	1
Forms and Publications Section, BF52	42
Procurement and Contracts Division, BG	1
Gemini and Flight Support Procurement Branch, BG61	1
Management Services Division, BM	1
Technical Information Preparation Branch, BM5	3
Technical Information Dissemination Branch, BM6	16
Assistant Director for Flight Crew Operations, CA	1
Astronaut Office, CB	5
Flight Crew Support Division, CF	11
Capt. Robert D. Mercer, CF32	1
National Aeronautics and Space Administration John F. Kennedy Space Center Kennedy Space Center, Florida 32899 Attention: Cape Simulator Operations Section, HW	1
Assistant Director for Engineering and Development, EA	8
Information Systems Division, EB	3
Crew Systems Division, EC	4
L. F. Dietlein, EC5	1
Rita M. Rapp, EC5	1
William J. Young, EC5	1
P. A. LaChance, EC6	1

UNCLASSIFIED

UNCLASSIFIED

13-3

Computation and Analysis Division, ED	3
Instrumentation and Electronic Systems Division, EE	5
Guidance and Control Division, EG	5
Charles Manry, EG33	1
Propulsion and Power Division, EP	3
Structures and Mechanics Division, ES	6
Advanced Spacecraft Technology Division, ET	5
Patrick E. Lafferty, ET32	1
James Marback, ET32	1
William D. Womack, ET32	1
Assistant Director for Flight Operations, FA	3
Flight Control Division, FF	7
Landing and Recovery Division, FL	4
Mission Planning and Analysis Division, FM	10
Flight Support Division, FS	4
Gemini Program Office, GA	10
Program Control, GP	7
Spacecraft, GS	8
Test Operations, GT	8
Vehicles and Missions, GV	8
Gemini Program Office Representative, GV2	1
Manned Spacecraft Center	
National Aeronautics and Space Administration	
c/o Martin Company	
Mail No. 388	
Baltimore, Maryland 21203	

UNCLASSIFIED

UNCLASSIFIED

Gemini Program Office Representative, GV3 Manned Spacecraft Center National Aeronautics and Space Administration c/o Lockheed Missiles and Space Company Sunnyvale, California 94086	1
Resident Manager, GM National Aeronautics and Space Administration c/o McDonnell Aircraft Corporation Post Office Box 516 St. Louis, Missouri 63166	5
National Aeronautics and Space Administration John F. Kennedy Space Center Kennedy Space Center, Florida 32899 Attention: Gemini Program Office Resident Manager, HS	1
Apollo Spacecraft Program Office, PA	6
Checkout and Test Division, PT	3
National Aeronautics and Space Administration White Sands Test Facility Post Office Drawer MM Las Cruces, New Mexico 88001 Attention: Manager, RA	1
National Aeronautics and Space Administration Ames Research Center Moffett Field, California 94035 Attention: Director, 200-1	1
National Aeronautics and Space Administration Ames Research Center Moffett Field, California 94035 Attention: Library, 202-3	5
National Aeronautics and Space Administration Ames Research Center Moffett Field, California 94035 Attention: Project Biosatellite, 201-2	1

UNCLASSIFIED

UNCLASSIFIED

13-5

National Aeronautics and Space Administration Electronics Research Center 575 Technology Square Cambridge, Massachusetts 02139 Attention: Director	1
National Aeronautics and Space Administration Flight Research Center Post Office Box 273 Edwards, California 93523 Attention: Director	1
National Aeronautics and Space Administration Flight Research Center Post Office Box 273 Edwards, California 93523 Attention: Library	5
National Aeronautics and Space Administration Goddard Space Flight Center Greenbelt, Maryland 20771 Attention: Director, 100	1
National Aeronautics and Space Administration Goddard Space Flight Center Greenbelt, Maryland 20771 Attention: Library, 252	5
National Aeronautics and Space Administration Goddard Space Flight Center Greenbelt, Maryland 20771 Attention: Chief, Manned Flight Operations Division, 550	1
National Aeronautics and Space Administration Goddard Space Flight Center Greenbelt, Maryland 20771 Attention: Dr. Paul D. Lowman	1
National Aeronautics and Space Administration Goddard Space Flight Center Liaison Representative, GSF-L c/o NASA Manned Spacecraft Center Houston, Texas 77058	1

UNCLASSIFIED

UNCLASSIFIED

National Aeronautics and Space Administration John F. Kennedy Space Center Kennedy Space Center, Florida 32899 Attention: GSFC Launch Operations	2
Jet Propulsion Laboratory 4800 Oak Grove Drive Pasadena, California 91103 Attention: Director, 180-905	1
Jet Propulsion Laboratory 4800 Oak Grove Drive Pasadena, California 91103 Attention: Library, 111-113	1
National Aeronautics and Space Administration John F. Kennedy Space Center Kennedy Space Center, Florida 32899	
Director, DIR	1
Deputy Director, DIR	1
Deputy Director, Launch Operations, HA	1
Library, GA72	5
Public Information Office, RB	1
Assistant Center Director for Launch Vehicle Operations, V	1
Assistant Center Director for Information Systems, E	1
Assistant Center Director for Spacecraft Operations, HG	5
Manager for Gemini Operations, HJ1	1
Inspection Division, HD	1
Test Conductor's Office, HE	1
Program Planning and Control Office, HB	3

UNCLASSIFIED

UNCLASSIFIED

13-7

Operations Support Plans and Programs Office, HC	4
National Aeronautics and Space Administration John F. Kennedy Space Center Liaison Representative, HALL3 c/o NASA Manned Spacecraft Center Houston, Texas 77058	1
National Aeronautics and Space Administration Langley Research Center Langley Station Hampton, Virginia 23365 Attention: Director, 106	1
National Aeronautics and Space Administration Langley Research Center Langley Station Hampton, Virginia 23365 Attention: Library, 185	5
National Aeronautics and Space Administration Langley Research Center Liaison Representative, RAA c/o NASA Manned Spacecraft Center Houston, Texas 77058	1
National Aeronautics and Space Administration Lewis Research Center 21000 Brookpark Road Cleveland, Ohio 44135 Attention: Director, 3-2	1
National Aeronautics and Space Administration Lewis Research Center 21000 Brookpark Road Cleveland, Ohio 44135 Attention: Library, 3-7	5
National Aeronautics and Space Administration George C. Marshall Space Flight Center Huntsville, Alabama 35812 Attention: Director, DIR	1
National Aeronautics and Space Administration George C. Marshall Space Flight Center Huntsville, Alabama 35812 Attention: Library, MS-1G	5

UNCLASSIFIED

UNCLASSIFIED

National Aeronautics and Space Administration George C. Marshall Space Flight Center Liaison Representative, RL c/o NASA Manned Spacecraft Center Houston, Texas 77058	1
National Aeronautics and Space Administration Pacific Launch Operations Office Post Office Box 425 Lompoc, California 93438 Attention: Director	1
National Aeronautics and Space Administration Wallops Station Wallops Island, Virginia 23337 Attention: Director	1
National Aeronautics and Space Administration Western Operations Office 150 Pico Boulevard Santa Monica, California 90406 Attention: Director	1
 DEPARTMENT OF DEFENSE	
Department of Defense Manager for Manned Space Flight Support Operations, DDMS Patrick Air Force Base, Florida 32925	3
Department of Defense Representative Liaison Officer, ZR2 c/o National Aeronautics and Space Administration Manned Spacecraft Center Houston, Texas 77058	1
Office of the Secretary of Defense Office of the Director of Defense Research and Engineering The Pentagon Room 3D-1085 Washington, D.C. 20330 Attention: Col. Robert A. Duffy	1

UNCLASSIFIED

UNCLASSIFIED

13-9

U. S. AIR FORCE

Commander, SSG Headquarters, Space Systems Division U. S. Air Force Systems Command Los Angeles Air Force Station Air Force Unit Post Office Los Angeles, California 90045	1
Deputy for Launch Vehicles, SSV Headquarters, Space Systems Division U. S. Air Force Systems Command Los Angeles Air Force Station Air Force Unit Post Office Los Angeles, California 90045	2
Chief, Agena Directorate, SSVA Headquarters, Space Systems Division U. S. Air Force Systems Command Los Angeles Air Force Station Air Force Unit Post Office Los Angeles, California 90045	1
Chief, Gemini Agena Division, SSVAT Agena Directorate Headquarters, Space Systems Division U. S. Air Force Systems Command Los Angeles Air Force Station Air Force Unit Post Office Los Angeles, California 90045	1
Director, Gemini Launch Vehicles, SSVL Headquarters, Space Systems Division U. S. Air Force Systems Command Los Angeles Air Force Station Air Force Unit Post Office Los Angeles, California 90045	5
Research and Technology Directorate, SSTR Headquarters, Space Systems Division U. S. Air Force Systems Command Los Angeles Air Force Station Air Force Unit Post Office Los Angeles, California 90045 Attention: Lt. Col. T. E. Mahoney, SSTR	1

UNCLASSIFIED

UNCLASSIFIED

Systems Program Director for Manned Orbital Laboratory, SSM Headquarters, Space Systems Division U. S. Air Force Systems Command Los Angeles Air Force Station Air Force Unit Post Office Los Angeles, California 90045 Attention: Deputy Director for Gemini B, SSMB	2
Commander, Detachment 2, ZR1 Headquarters, Space Systems Division U. S. Air Force Systems Command Field Office c/o National Aeronautics and Space Administration Manned Spacecraft Center Houston, Texas 77058	8
Commander, SCG Headquarters, U. S. Air Force Systems Command Andrews Air Force Base Washington, D. C. 20331 Attention: Office of Directorate of Plans and Programs, MSF-1	1
Commander, SCGR Headquarters, U.S. Air Force Systems Command Andrews Air Force Base Washington, D.C. 20331 Attention: Department of Defense Manager for Space Flight Support Operations	1
Commander, NRGV National Range Division (Patrick) U. S. Air Force Systems Command Patrick Air Force Base, Florida 32925	3
Commander, ETG Air Force Eastern Test Range U. S. Air Force Systems Command Patrick Air Force Base, Florida 32925	2
Commander, 6555th Aerospace Test Wing, DWG Space Systems Division U. S. Air Force Systems Command Patrick Air Force Base, Florida 32925	1

UNCLASSIFIED

UNCLASSIFIED

13-11

Chief, Gemini Launch Vehicle Division, DWD 6555th Aerospace Test Wing Space Systems Division U. S. Air Force Systems Command Patrick Air Force Base, Florida 32925	5
Chief, Patrick Test Site Office, RETPQC Quality Assurance Division Gemini Program U. S. Air Force Systems Command Post Office Box 4507 Patrick Air Force Base, Florida 32925	1
U. S. Air Force Systems Command/Air Training Command Office Liaison Representative, ZR3 c/o National Aeronautics and Space Administration Manned Spacecraft Center Houston, Texas 77058	1
Commander Headquarters, Air Rescue Service Military Air Transport Service United States Air Force Orlando Air Force Base, Florida 32813	3
Assistant for Manned Space Flight, AFRMO Headquarters, U. S. Air Force The Pentagon Room 4D330 Washington, D. C. 20330 Attention: Colonel Kenneth W. Schultz	1
SSTDG Space Systems Division U.S. Air Force Systems Command El Segundo, California Attention: Lt. Col. Theodore D. Little	1
U. S. NAVY Chief of Naval Operations The Pentagon Room 4E636 Washington, D. C. 20330	1

UNCLASSIFIED

UNCLASSIFIED

Commander-In-Chief, Atlantic Fleet Norfolk Naval Base Norfolk, Virginia 23511	1
Commander Cruiser-Destroyer Flotilla 4 Norfolk Naval Base Norfolk, Virginia 23511	3
Commander, Hawaiian Sea Frontier Code 34 Box 110 Fleet Post Office San Francisco, California 96610	3
U. S. GENERAL ACCOUNTING OFFICE	
U. S. General Accounting Office Liaison Representative, ZS1 c/o National Aeronautics and Space Administration Manned Spacecraft Center Houston, Texas 77058	1
U. S. WEATHER BUREAU	
Chief, Spaceflight Meteorological Group U. S. Weather Bureau Washington, D. C. 20235	1
Spaceflight Meteorology Group U. S. Weather Bureau c/o National Aeronautics and Space Administration Manned Spacecraft Center Houston, Texas 77058	1
Spaceflight Meteorology Group, WO U. S. Weather Bureau c/o National Aeronautics and Space Administration John F. Kennedy Space Center Cocoa Beach, Florida 32931	1
National Weather Satellite Center U. S. Weather Bureau Suitland, Maryland Attention: S. D. Soules and K. Nagler	2

UNCLASSIFIED

AEROJET-GENERAL CORPORATION

Mr. R. C. Stiff, Jr. 1
Vice President and Manager of the
Liquid Rocket Operations
Aerojet-General Corporation
Post Office Box 1947
Sacramento, California 95809

Mr. L. D. Wilson 1
Gemini Program Manager
Liquid Rocket Operations
Aerojet-General Corporation
Post Office Box 1947
Sacramento, California 95809

Mr. R. M. Groo 1
Aerojet-General Corporation
Eastern Test Range Office
Hangar U
Post Office Box 4425
Patrick Air Force Base, Florida 32925

AEROSPACE CORPORATION

Dr. Ivan A. Getting 3
President
Aerospace Corporation
Post Office Box 95085
Los Angeles, California 90045

Dr. Walter C. Williams 1
Vice President and General Manager of
Manned Systems Division
Aerospace Corporation
Post Office Box 95085
Los Angeles, California 90045

Mr. Bernhard A. Hohmann 10
Group Director, Gemini Launch Systems Directorate
Aerospace Corporation
Post Office Box 95085
Los Angeles, California 90045

UNCLASSIFIED

Mr. Leon R. Bush 1
Director, Systems and Guidance Analysis
Gemini Launch Systems Directorate
Aerospace Corporation
Post Office Box 95085
Los Angeles, California 90045

Mr. Newton A. Mas 6
Manager, Gemini Program
Aerospace Corporation
Post Office Box 4007
Patrick Air Force Base, Florida 32925

MARTIN COMPANY

Mr. V. R. Rawlings, Vice President 1
Mail No. 14
Martin-Marietta Corporation
Baltimore, Maryland 21203

Mr. W. D. Smith 8
Technical Director, Gemini Program
Mail No. 3134
Martin-Marietta Corporation
Baltimore, Maryland 21203

Mr. Bastian Hello 2
Program Director, Gemini
Mail No. 3070
Martin-Marietta Corporation
Baltimore, Maryland 21203

Mr. O. E. Tibbs, Vice President 1
Mail No. A-1
Canaveral Division
Martin-Marietta Corporation
Cocoa Beach, Florida 32931

Mr. J. M. Verlander 4
Gemini Program Director
Mail No. B-1605
Canaveral Division
Martin-Marietta Corporation
Cocoa Beach, Florida 32931

UNCLASSIFIED

UNCLASSIFIED

13-15

Mr. J. Donald Rauth, Vice President 1
Mail No. A-1-1
Denver Division
Martin-Marietta Corporation
Post Office Box 179
Denver, Colorado 80200

Mr. John J. Laurinec 1
Program Manager, Gemini
Mail No. C-222-103
Denver Division
Martin-Marietta Corporation
Post Office Box 179
Denver, Colorado 80200

Mr. Colin A. Harrison 1
Martin Company
1730 NASA Road 1
Suite 106
Houston, Texas 77058

McDONNELL AIRCRAFT CORPORATION

Mr. Walter F. Burke 25
Vice President and General Manager
Spacecraft and Missiles
McDonnell Aircraft Corporation
Lambert-Saint Louis Municipal Airport
Post Office Box 516
St. Louis, Missouri 63166

Mr. R. D. Hill, Jr. 5
Base Manager
McDonnell Aircraft Corporation
Post Office Box M
Cocoa Beach, Florida 32931

Mr. Frank G. Morgan 1
McDonnell Aircraft Corporation
1730 NASA Road 1
Suite 101
Houston, Texas 77058

UNCLASSIFIED

13-16

UNCLASSIFIED

MIT INSTRUMENTATION LABORATORY

Massachusetts Institute of Technology
Instrumentation Laboratory
Apollo Guidance Section
Cambridge, Massachusetts
Attention: Dr. Max Peterson

1

UNCLASSIFIED

MSC 5935-65