

# Final Report

## Development of HIGH VOLTAGE - HIGH CURRENT SWITCHES

by

H. N. Price

FACILITY FORM 602	N68-17073	
	(ACCESSION NUMBER)	(THRU)
	40	1
	(PAGES)	(CODE)
	CI-61519	09
	(NASA CR OR TMX OR AD NUMBER)	(CATEGORY)

prepared for

### NATIONAL AERONAUTICS AND SPACE ADMINISTRATION

CONTRACT NAS8-20526

GENERAL  ELECTRIC

Final Report  
Development of  
HIGH VOLTAGE - HIGH CURRENT SWITCHES

by

H. N. Price

Prepared for  
NATIONAL AERONAUTICS AND SPACE ADMINISTRATION

February 28, 1966

George C. Marshall Space Flight Center  
Huntsville, Alabama 35812

General Electric Company  
Tube Department  
Microwave Tube Business Section  
Schenectady, New York 12305

## TABLE OF CONTENTS

	Page
PURPOSE . . . . .	1
ABSTRACT . . . . .	2
FACTUAL DATA . . . . .	3
I. Introduction . . . . .	3
II. Tube Development . . . . .	4
A. Design Considerations and Preliminary Evaluations . . . . .	4
B. Tube Evaluation and Design Modification . . . . .	13
C. Final Tests . . . . .	22
DISCUSSION . . . . .	25
CONCLUSION . . . . .	28
APPENDIX I - Objective Technical Information . . . . .	29
APPENDIX II - Test Specifications . . . . .	31
APPENDIX III - ZR-7520 Final Acceptance Data . . . . .	33
APPENDIX IV - Contract Statement of Work . . . . .	35

## LIST OF ILLUSTRATIONS

Figure		Page
1	General Electric ZR-7520 20-Kilovolt Triggered Vacuum Gap (Front View) . . . . .	5
2	General Electric ZR-7520 20-Kilovolt Triggered Vacuum Gap (Top View) . . . . .	6
3	General Electric ZR-7520 20-Kilovolt Triggered Vacuum Gap (Bottom View) . . . . .	7
4	General Electric ZR-7520 20-Kilovolt Triggered Vacuum Gap (General Arrangement) . . . . .	8
5	Typical Vacuum Gap Trigger Mechanism . . . . .	9
6	General Electric ZR-7520 20-Kilovolt Triggered Vacuum Gap (Initial Design) . . . . .	11
7	Anode Mount, Body and Cathode Mount Subassemblies for General Electric ZR-7520 Triggered Vacuum Gap (Body Assembly is 4-1/2 Inches Outside Diameter). . . . .	12
8	Alternate Trigger Arrangement, ZR-7520 Triggered Vacuum Gap . . . . .	12
9	Oscillogram Showing Current Pulse through Sample Tube No. 1 when Tested in Capacitor-Discharge Circuit. (First Positive Current Pulse, Approximately 123,000 Amperes; Time Scale, 50 Microseconds per Centimeter). . . . .	14
10	Oscillogram Showing Capacitor Voltage versus Time During Discharge. (Note that Conduction Ceased after First Half-Cycle of Discharge Current. Initial Capacitor Voltage, +10 Kilovolts; Final Value, -5 Kilovolts; Time Scale, 50 Microseconds per Centimeter) . . . . .	19

Figure		Page
11	Oscillogram Showing Capacitor Voltage versus Time During Discharge. (Note that Conduction Ceased after Third Half-Cycle of Discharge Current. Initial Capacitor Voltage, +10 Kilovolts; Final Value, -1 Kilovolt; Time Scale, 50 Microseconds per Centimeter). . . . .	19
12	Body Assembly of General Electric ZR-7520, 20-Kilovolt Triggered Vacuum Gap, Showing Electrically Isolated Static Shield. . . . .	21
13	General Electric ZR-7520 20-Kilovolt Triggered Vacuum Gap Mounted in Test Equipment . . . . .	23

## PURPOSE

The subject contract, NAS8-20526, covers the development of a high voltage - high current switch with electrical characteristics equivalent to the Type GL-7703 Ignitron, but capable of operation in any position, while in motion, and under environmental conditions not suitable for ignitrons. The device is in the form of a triggered vacuum gap which combines the voltage hold-off capability of a vacuum tube with the conduction characteristics of a gas tube.

## ABSTRACT

This report describes the work performed under Contract No. NAS8-20526 for the development of a triggered vacuum gap with the essential characteristics of the GL-7703 capacitor-discharge Ignitron, but with the added advantage of being independent of operating position.

The development program included envelope and electrode design; trigger design and characteristics evaluation; construction and evaluation of development samples; life test; and construction, test, and delivery of final samples.

The resulting Triggered Vacuum Gap, ZR-7520, is capable of repetitive operation at the voltage, current, and energy levels appropriate to the intended application, and provides operation which is free from the environmental limitations imposed by mercury pool tubes.

## FACTUAL DATA

### I. INTRODUCTION

The triggered vacuum gap is a vacuum tube in the non-conducting state which demonstrates the electrical hold-off characteristics of vacuum space. During conduction, the gap becomes a vapor tube that conducts current through a metal vapor plasma. The vapor is provided by evaporation of the solid electrode material. In terms of metallurgy, the electrode materials are characterized by zone refining and vacuum melting, which provide metals free from gases and gas-generating impurities.

When current flow ceases, vapor generation ceases and the gap recovers its voltage hold-off characteristics. Therefore, the gap functions as a high-vacuum tube when it is inactive, and as a vapor tube during conduction.

The tube is triggered by hydrogen plasmoid injection. When the trigger gap is pulsed, a minute "puff" of hydrogen plasma (hydrogen ions, electrons, and hydrogen gas) is injected into the vacuum space. The interaction of this plasmoid with the gap electrodes causes the gap to break down. Cathode spots are then formed on the negative electrode, and conduction across the main gap is initiated. This entire triggering action occurs in a fraction of a microsecond.

The trigger configuration consists of a very small gap across a surface of a ceramic insulator. The main gap "cathode" electrode forms one electrode of this trigger gap, and at least one of the two trigger gap terminations consists of a quantity of a metal, such as titanium, impregnated with hydrogen. A voltage pulse across the gap initiates a spark between these surfaces, forming the hydrogen plasmoid.

Triggered vacuum gaps incorporating these features are suited to the proposed application for the following reasons:

1. Capable of being triggered over a range of voltage from a few hundred volts to many kilovolts
2. Require low trigger energies



3. Insensitive to operating position
4. Insensitive to normally experienced variations in ambient temperature, pressure, or humidity
5. High tolerance to nuclear radiation
6. Relatively small and compact.
7. Rapid triggering times of fractions of a microsecond
8. Recovery capability of 10 kilovolts per microsecond, and more

The subject contract covers the development of a triggered vacuum gap to meet the essential electrical characteristics of the Type GL-7703 capacitor-discharge Ignitron, especially as it pertains to the proposed metal-forming application at NASA, Huntsville, Alabama.

This gap, designated ZR-7520, is shown pictorially in Figures 1, 2, and 3. Figure 4 is a cross-sectional view. Designed with a ceramic-metal envelope, the tube is convection cooled and approximately 4-1/2 inches in diameter by 5-1/2 inches long. It weighs approximately 6 pounds. Electrically, it meets the objective ratings shown in Appendix I.

Work on the contract was conducted from June 29, 1965 to January 28, 1966. Details of the development program are contained in the following paragraphs.

## II. TUBE DEVELOPMENT

### A. Design Considerations and Preliminary Evaluations

The design of the initial samples was chosen after a careful review of potential alternates. In view of the repetitive operation characteristics of the ignitron that this design is to supplant, these considerations included electrode size and associated heat capacity, conductive heat paths, and external heat dissipation.

A typical trigger mechanism is illustrated in Figure 5. The mechanism consists of a ceramic rod coated with a layer of titanium impregnated with hydrogen. A voltage pulse across the groove which is cut in the titanium around the ceramic initiates a spark between the two titanium

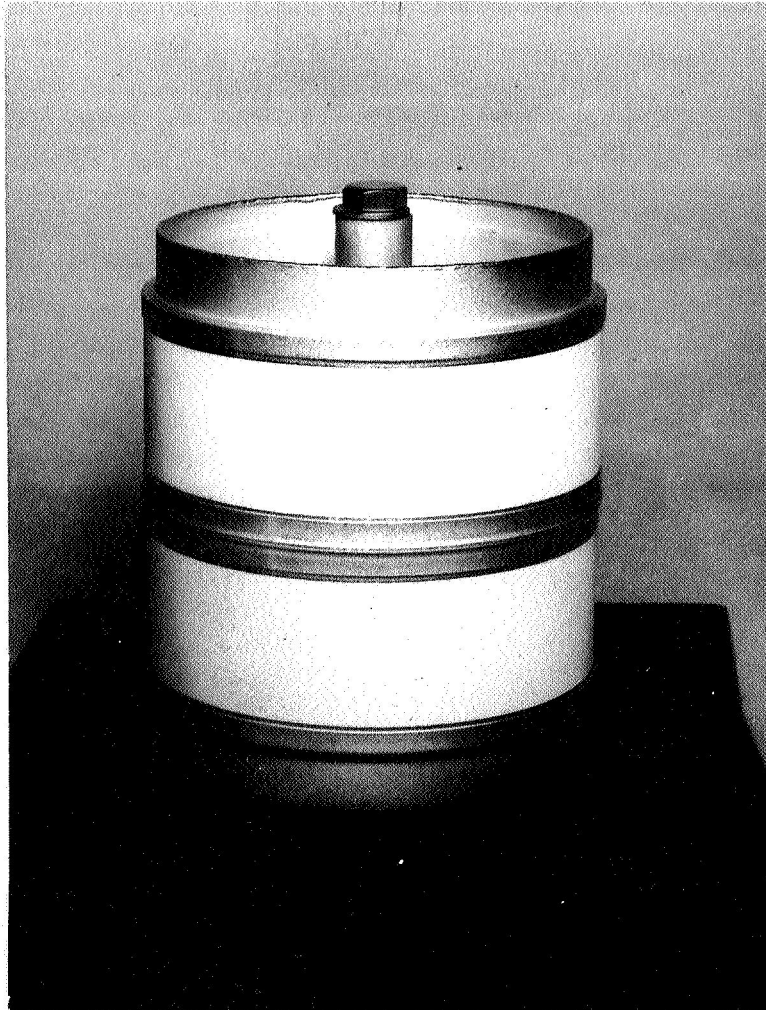

Figure 1 - General Electric ZR-7520 20-Kilovolt Triggered Vacuum Gap (Front View)

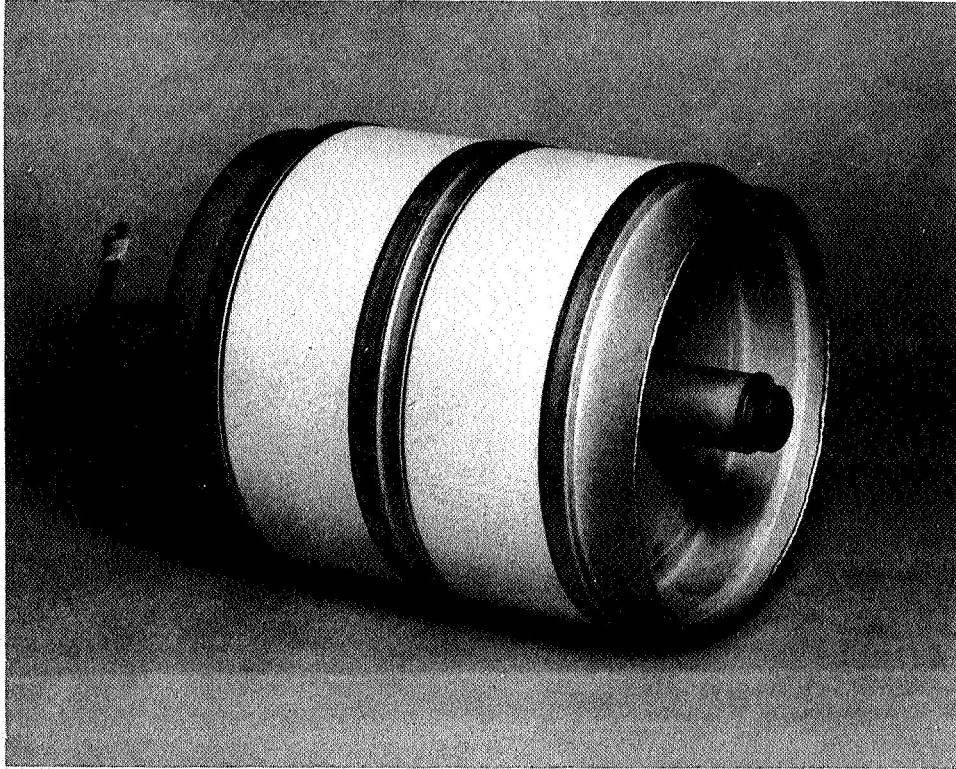

Figure 2 - General Electric ZR-7520 20-Kilovolt Triggered Vacuum Gap (Top View)

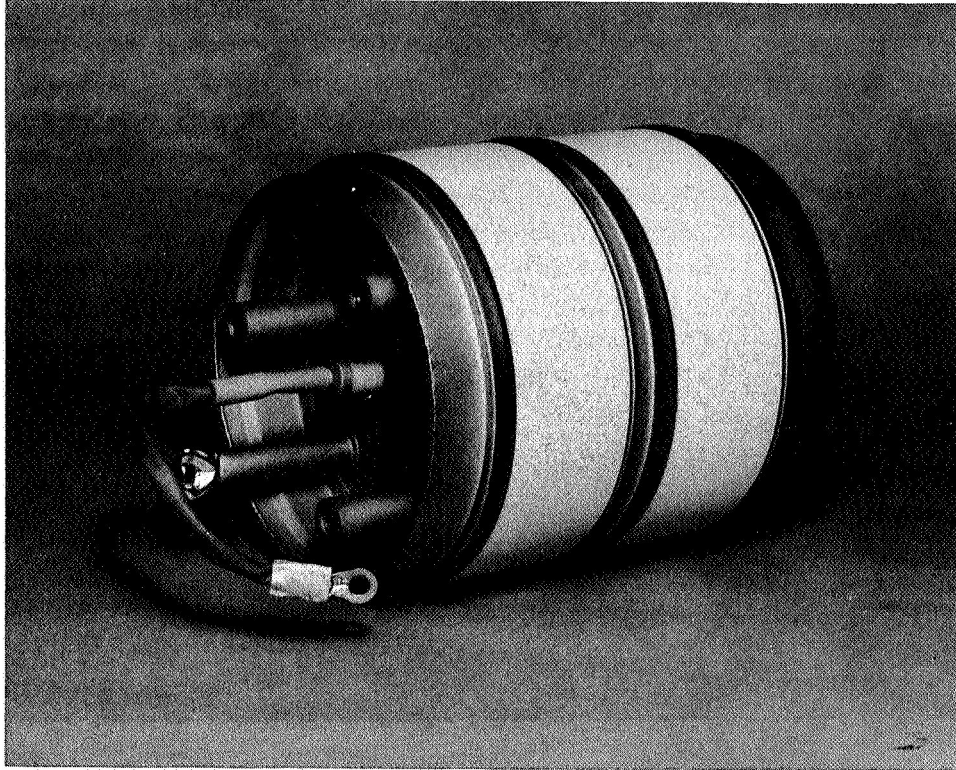

Figure 3 - General Electric ZR-7520 20-Kilovolt Triggered  
Vacuum Gap (Bottom View)

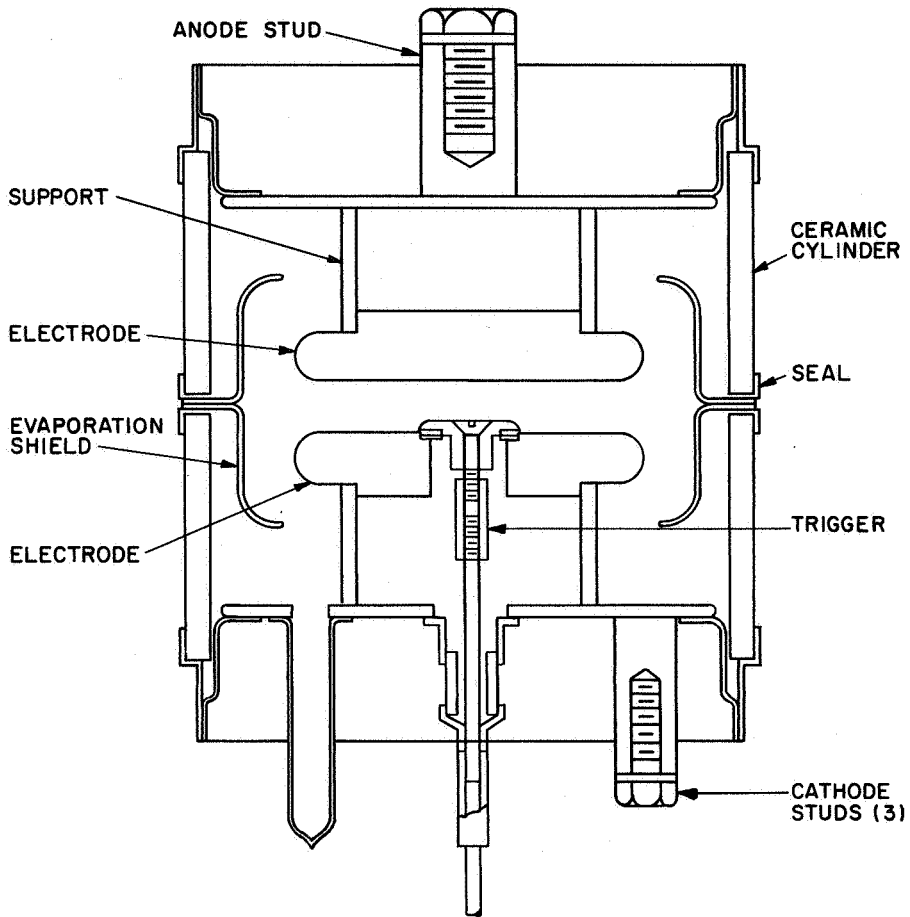

Figure 4 - General Electric ZR-7520 20-Kilovolt Triggered Vacuum Gap (General Arrangement)

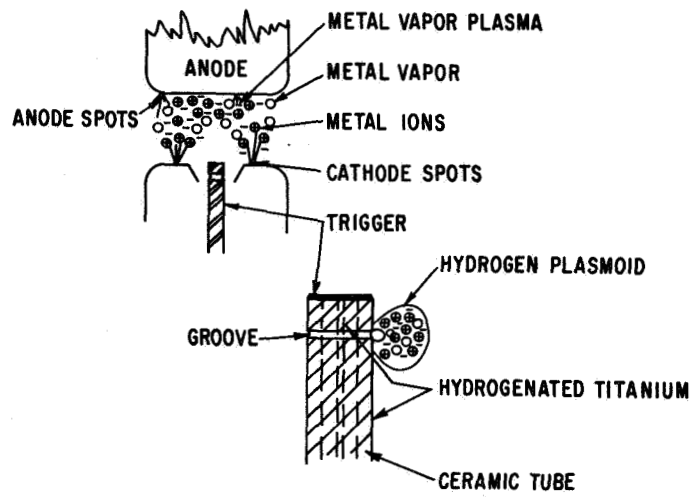

Figure 5 - Typical Vacuum Gap Trigger Mechanism

surfaces and forms the hydrogen plasmoid. This trigger is employed in some of the "crowbar" or circuit-protective gaps used for lighter circuit duty and requiring less frequent firing than necessary for the subject application. In the case of the ZR-7520, it was decided that ruggedization or isolation of the trigger function would be necessary to provide satisfactory life at the high currents, long pulses, and current reversals to be encountered. One such mechanism was conceived during work on Contract DA 28-043 AMC-00330(E) with the U.S. Army Electronics Command, Fort Monmouth, N. J., for a 350-kilovolt "Plasma-Injection Vacuum Energy Diverter (Crowbar)". This configuration consists of a ceramic wafer between a hydrogen-impregnated titanium metal washer and the cathode electrode. The electrode is appropriately recessed to provide the desired gap dimensions, and the whole trigger is protected by a vacuum-refined copper disc which covers the trigger mechanism. A spark from the impregnated washer to the cathode electrode provides the hydrogen plasmoid.

The design of the first sample (sample tube No. 1) is shown in the cross-sectional view of Figure 6. Figure 7 depicts the major subassemblies. The trigger mechanism described above is incorporated in this design. The electrodes are massive copper discs which are specially shaped to promote transfer of the arc to the outer edges, away from the trigger mechanism. They are supported from the headers by short, heavy-wall copper cylinders to provide heat transfer to the exposed surfaces. One anode and three cathode studs are provided for bolted connections and tube support. The trigger terminal has a flexible lead so that connections can be made to it without applying undue strain on the relatively small trigger seal.

A gap with this type of trigger in a glass envelope was made available from another program. It was fired approximately 150 times at 100 kilo-amperes with a rate of current rise so high that it definitely would have caused damage to a standard, unprotected trigger. The experiment was terminated embryonically by failure of the glass envelope for an irrelevant reason.

Another configuration, used previously in some experimental tubes, was planned for sample tube No. 2. It is shown in Figure 8. The hydride-coated ceramic rod normally employed in tubes for non-repetitive operation (crowbars) was used but isolated by molybdenum shields to protect it from the action of the main discharge.

A sample ZR-7512 tube from another program was constructed with this shielded-trigger arrangement. This tube was tested in a circuit

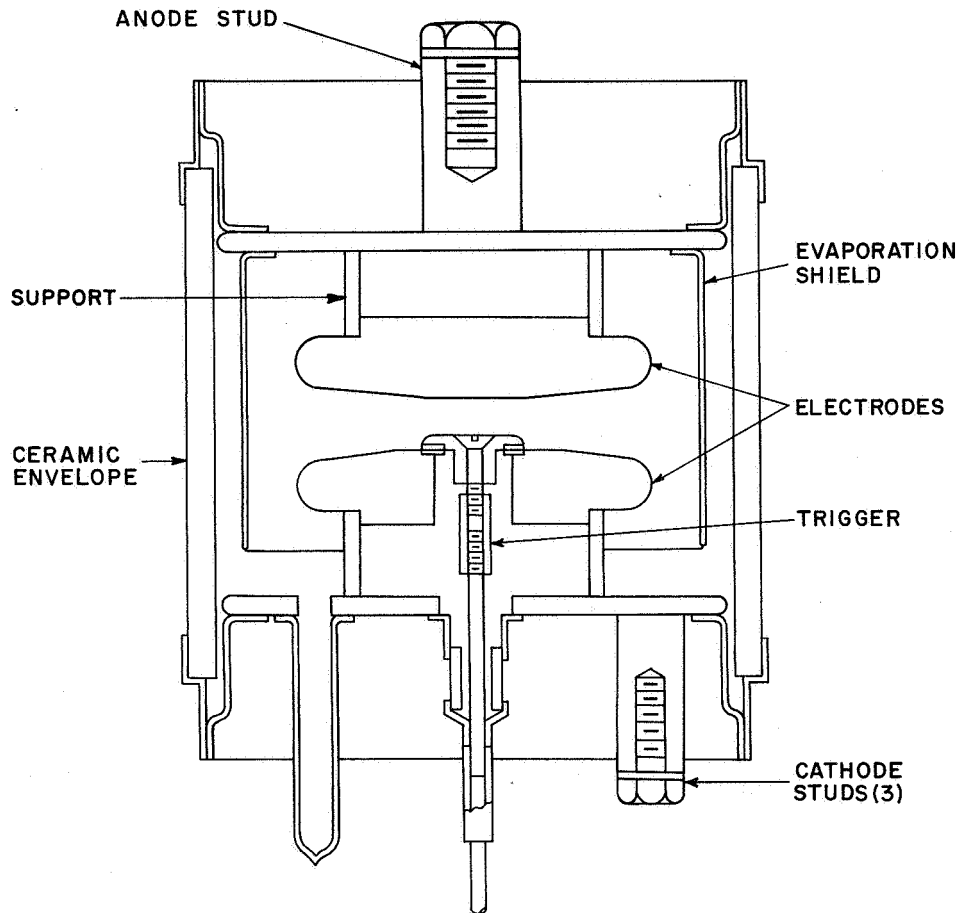

Figure 6 - General Electric ZR-7520 20-Kilovolt Triggered Vacuum Gap (Initial Design)



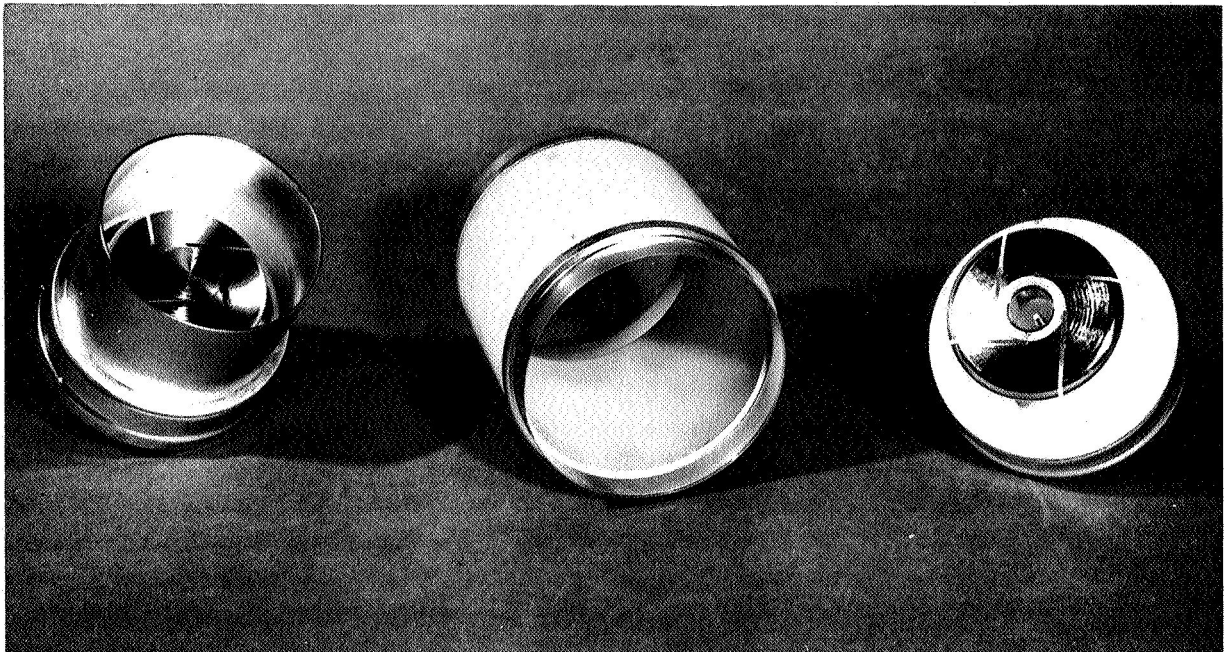

Figure 7 - Anode Mount, Body and Cathode Mount Subassemblies for General Electric ZR-7520 Triggered Vacuum Gap (Body Assembly is 4-1/2 Inches Outside Diameter)

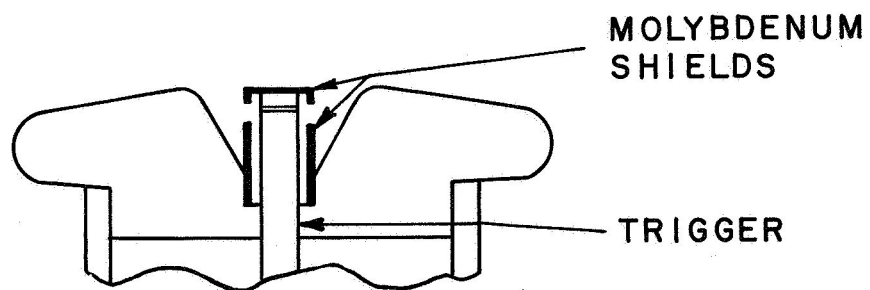

Figure 8 - Alternate Trigger Arrangement, ZR-7520 Triggered Vacuum Gap

providing a ringing discharge with a peak current of almost 100,000 amperes, a half-cycle width of 20 microseconds, and an 80-percent reversal. The initial firing characteristics were quite normal despite the additional shielding. After several dozen shots, a large percentage of which were made at approximately half the maximum peak current, the tube became difficult to fire. An autopsy indicated severe damage to the trigger and gross melting of the electrode surfaces. This configuration was not incorporated into sample tube No. 2 as planned, because of the superior performance of the mechanism used in sample tube No. 1, which was evaluated before No. 2 reached the final stages of manufacture.

The gross melting of the electrodes in the ZR-7512 tube was not judged to be a significant deterrent to proceeding with the ZR-7520 design, since the area of the electrodes in the latter design have about five times the surface area of the smaller tube, and improved performance was expected to result.

#### B. Tube Evaluation and Design Modification

Initially, the trigger in sample tube No. 1 fired reliably with the ignitor firing circuit of the GL-7703 Ignitron. With continued operation, the voltage required to cause trigger firing rose to seven or eight kilovolts.

The tube was tested in a capacitor-discharge circuit with 37 microfarads charged up to 20 kilovolts, and with no intentionally inserted resistance. The ringing current reached a peak of approximately 120,000 amperes at 20 kilovolts with a voltage reversal of approximately 83 percent, a ringing frequency of approximately 30 kilocycles, and a total charge transfer of 6.5 coulombs. The current pulse is shown in the oscillogram of Figure 9. Firings were conducted at a frequency of one every 30 seconds. Occasional prefires (voltage breakdowns without trigger impulses) occurred at various voltages during the charging cycle for the first hundred firings. No prefires were experienced thereafter. A direct-current hipot (stiff circuit) during the initial period indicated several static breakdowns at 25 to 30 kilovolts, and then quickly cleared until the tube would hold off voltages in excess of 50 kilovolts.

After approximately 300 firings at energy levels up to those previously described, the firing characteristics were unreliable. It was demonstrated that the tube could be fired at low voltage with sufficient trigger power, but at full voltage, occasional misfires occurred. At this time the tube could withstand 60 kilovolts on direct-current hipot (stiff circuit).

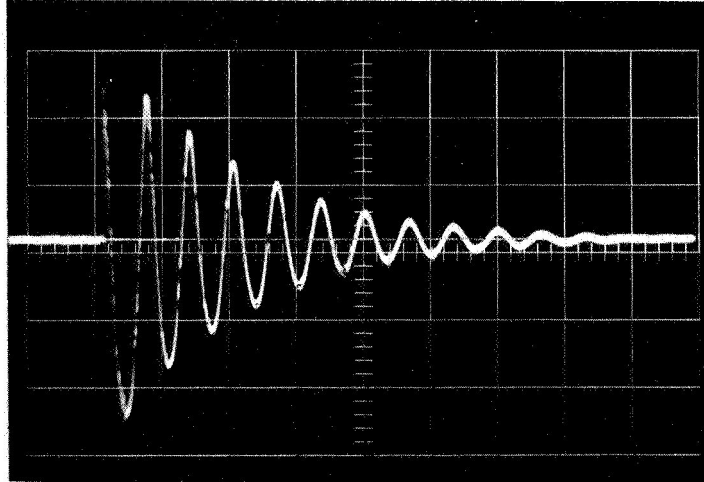

Figure 9 - Oscillogram Showing Current Pulse through Sample Tube No. 1 when Tested in Capacitor-Discharge Circuit. (First Positive Current Pulse, Approximately 123,000 Amperes; Time Scale, 50 Microseconds per Centimeter)

The cathode header was removed from the tube for examination. Electrode erosion was not excessive, but the electrostatic shielding was badly damaged in one location due to the formation of arcs between the shielding and the cathode header. At the time it appeared that these arcs resulted from the prefires that occurred in the initial test period. It was felt that such damage could be avoided by a graduated aging period, an evacuation schedule providing a reduction in residual hydrogen in the trigger, or a hydrogen adsorption reservoir. The trigger showed some damage, thus requiring a higher voltage to fire it.

A modified trigger assembly incorporating the same features and gap dimensions as before, with the exception of a ceramic washer 0.015-inch thick in place of its 0.045-inch counterpart, was substituted, and the tube was reassembled. The tube was then designated sample tube No. 1A. The initial trigger-firing characteristics were much more desirable than in the original construction. The trigger fired at approximately 300 volts on the rising trigger pulse.

The tube, after being re-exhausted, was tested in the capacitor-discharge circuit previously described. During the first 50 shots, a few pre-firings occurred at 10 kilovolts, but none thereafter. Misfiring that occurred after 200 additional shots was found to be caused by a faulty firing circuit.

A visit to Huntsville was made on September 21, 1965 to discuss engineering details. During this visit, it became clear that the test conditions reported above, although representative of rating sheet conditions, do not represent typical conditions of the GL-7703 Ignitron in the intended application. Consequently, the test circuit was modified (within the scope of available equipment) to more nearly represent the typical application of a single tube (four are normally used in parallel). Under these conditions, a 56-microfarad capacitor bank is charged to 20 kilovolts and discharged through a resistive and inductive circuit to give a discharge of 26,000 amperes with a 50-percent reversal and a ringing frequency of 5000 cycles per second. All subsequent tests were made under these conditions. Test results showed satisfactory operation after 5000 shots, after which the life test was discontinued in order to test sample tube No. 2.

The capacitor voltage was recorded on a strip chart recorder throughout the test. Three voltage breakdowns were recorded during the first 1800 shots, but none thereafter. Three misfires were indicated during the period when the trigger voltage was reduced to 3 kilovolts from 4 kilovolts (11

ohms resistance, 0.1 microfarad capacitance); one additional misfire was observed when the trigger supply was set at 2 kilovolts, 40 ohms, for some 85 shots. No misfires were indicated for the 1600 shots with a 4-kilovolt, 11-ohm trigger circuit, or the 2000 shots with a 2-kilovolt trigger circuit having no intentionally inserted resistance. The peak trigger currents, which are approximately the same in both cases, are between 300 and 350 amperes.

The test data taken before and after 5000 shots are given in Table I.

-----

Table I  
Life Test Data  
(Gap No. 1A)

<u>Item</u>	<u>Initial</u>	<u>5000 Shots</u>
1. D-c resistance, trigger electrode to cathode - $R_T$ (ohms)	infinite	500
2. Minimum trigger firing voltage (volts)	300	1300
3. Minimum anode firing voltage (volts), (2 kilovolts, 0.1 microfarad, zero resistance trigger)	<100	<100
4. Anode time delay after trigger fires (microseconds)	---	1 (approx)

The tube was hipotted in a stiff d-c circuit at this time. As the voltage was raised, the first breakdown occurred at 27 kilovolts and then, after a few additional breakdowns as the voltage was increased, the tube successfully withstood 60 kilovolts d-c.

Sample tube No. 2 was constructed with a modified version of the trigger used in No. 1. The copper disc shield over the trigger mechanism was increased in diameter, thus providing greater shielding of the trigger from the heat and vapor deposition from the arc.

It was felt that, as a result of the additional shielding of the trigger electrode, a higher level of hydrogen concentration would be permissible in the trigger without causing excessive release during conduction. A reduction in anode delay time and improved arc voltage characteristics were anticipated. The tube was exhausted to provide this greater concentration.

Initial tests on sample tube No. 2 fulfilled the expectations with regards to the modifications made. There were no voltage breakdowns, even during the first aging period of 50 shots, despite the higher level of hydrogen. The time for the initiation of the fall of anode voltage after the trigger fired was reduced to 0.2 microsecond at 5 kilovolts, although the anode fall-time itself was approximately 1 microsecond. The initial breakdown voltage on hipot was 45 kilovolts, and the tube held 60 kilovolts with very little aging. However, the minimum voltage at which the trigger fired was much higher than for sample tube No. 1A, being about 3 kilovolts. The life test was initiated using a 5-kilovolt, 11-ohm, 0.1-microfarad trigger. The life test was continued to 10,000 shots, at which point the tube became very difficult to fire. Complete tests were made after 4,000 shots and after 10,000 shots, with the results being shown in Table II.

-----

Table II  
Life Test Data  
(Gap No. 2)

<u>Item</u>	<u>Initial</u>	<u>4,000 Shots</u>	<u>6,000 Shots</u>	<u>10,000 Shots</u>
1. D-c resistance, trigger electrode to cathode - $R_T$ (ohms)	infinite	14	-	40,000
2. Minimum trigger firing voltage (volts)	3,000	750	-	2,300
3. Minimum anode firing voltage (volts), (5 kilovolt, 0.1-microfarad, 11-ohm resistance trigger)	75	200	200 (approx)	10,000
4. Anode time delay after trigger fires (microseconds), $E_{dc} = 10$ kilovolts	0.1	0.1	-	-

As mentioned previously, Figure 9 shows an oscillogram of the anode current in sample tube No. 1A in a circuit providing 123,000 amperes peak, 83-percent reversal, and a ringing frequency of approximately 30 kilocycles. This oscillogram shows sustained conduction through all current zeros and reversals down to very low currents. After the time the circuit was modified to give a ringing frequency of 5,000 cycles (necessarily at a lower peak current), extinction of anode current was experienced at various current nodes, statistically dependent upon the energy level.

Sample tube No. 1A experienced sustained conduction, as previously described, at full power throughout the life test. However, at 10 kilovolts (1/4 of the energy at full power) conduction was extinguished at current nodes varying from the first zero to the third. This is illustrated in the oscillograms shown in Figures 10 and 11, which show capacitor voltage.

Sample tube No. 2, probably by virtue of its lower hydrogen release during conduction, showed similar extinctions up to full power (20 kilovolts, 56 microfarads). The recorder chart of capacitor voltage indicated that conduction was extinguished at the end of the second half-cycle in a majority of the conduction periods during life, leaving the capacitor positively charged at the end of conduction. At other times, the conduction apparently went further, since the capacitor voltage was more nearly zero before the charging cycle began. These extinctions are due to the rapid recovery characteristics of this device and are inherent in it. In some applications excellent use is made of this characteristic, but it is of doubtful value in others.

Before complete assembly of sample tube No. 3, the "reservoir" for hydrogen in the trigger was highly loaded by firing the complete cathode mount to 700°C in pure, dry hydrogen. A getter or absorber for excess hydrogen (consisting of a nickel-mesh cylinder partially coated with titanium hydride) was fastened inside the tubulation near the cathode header. This location was chosen so that selective heating could be used during evacuation to "activate" the material and thus provide optimum absorption characteristics.

Pressure measurements indicated that the release of hydrogen was approximately normal during operation and that there was no active gettering of hydrogen. Despite the supposedly greater concentration of hydrogen in the trigger, however, a trigger power higher than normal was required to initiate anode conduction. This higher power requirement was probably caused by a design change which was made in the trigger geometry, resulting in a greater constriction of the trigger plasma.

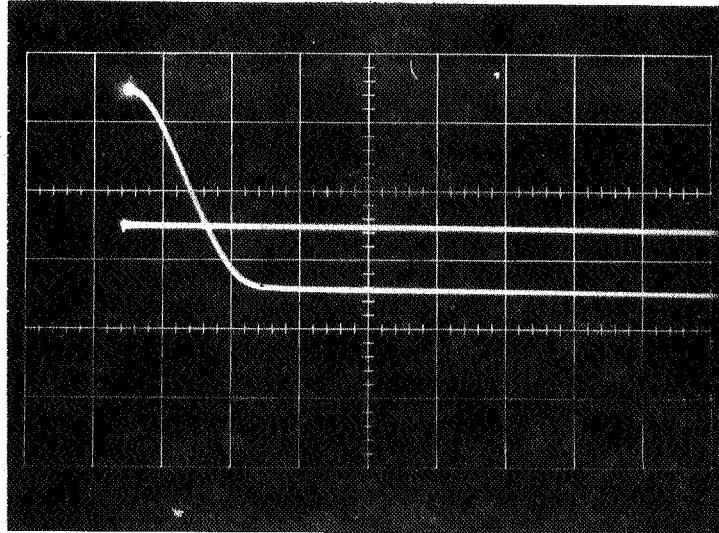

Figure 10 - Oscillogram Showing Capacitor Voltage versus Time During Discharge. (Note that Conduction Ceased after First Half-Cycle of Discharge Current. Initial Capacitor Voltage, +10 Kilovolts; Final Value, -5 Kilovolts; Time Scale, 50 Microseconds per Centimeter)

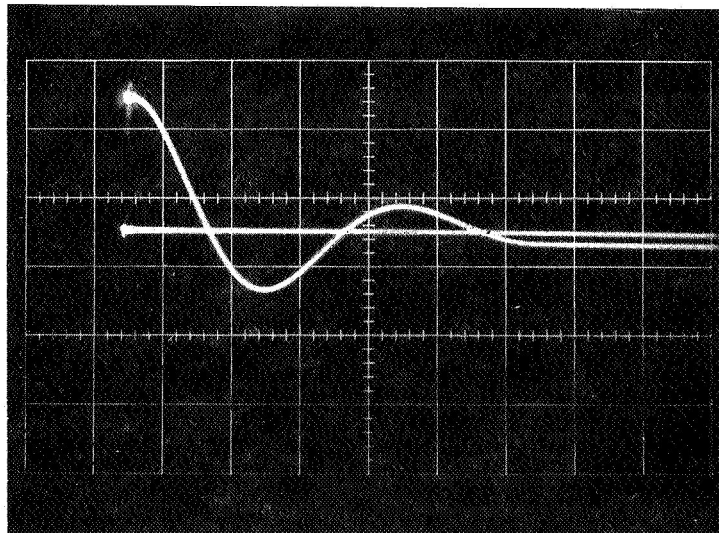

Figure 11 - Oscillogram Showing Capacitor Voltage versus Time During Discharge. (Note that Conduction Ceased after Third Half-Cycle of Discharge Current. Initial Capacitor Voltage, +10 Kilovolts; Final Value, -1 Kilovolt; Time Scale, 50 Microseconds per Centimeter)



When the cathode mount was removed to replace the modified trigger, it was noted that conduction had occurred between cathode header and shield, similar to that experienced in sample tube No. 2. To further shield this area from the plasma, and to reduce field stresses in this region, a copper ring was brazed to the copper shield before reassembly with the "normal" ZR-7520 trigger. This tube, sample tube No. 3A, performed satisfactorily at initial test. It has not been life tested because time was not available, and the subsequent isolated-shield design has eliminated the spurious conduction paths.

Sample tube No. 4 was constructed with an electrically isolated static shield shaped to perform the shielding functions described for sample tube No. 3. Its design is the final one, as shown in Figure 4. This shield is intended to eliminate spurious conduction paths and confine the discharge terminations to the electrode surfaces. The body assembly is shown in Figure 12. Header subassemblies are very similar to those shown previously (see Figure 7).

The electrically isolated static shield appeared to be beneficial in the elimination of spurious conduction paths. Although tests were made without the use of a coaxial tube mount, there is some indication that such a mount would contribute to the elimination of spurious conduction paths and, as in the case of GL-7703, this type of mount is recommended in the application of this tube.

In the initial construction of sample tubes No. 4 and 5, several attempts were made to reduce trigger power requirements. The trigger gap width in sample tube No. 4 was reduced by 25 percent to reduce its firing voltage. While the static resistance of the trigger gap was quite high, its breakdown was only a few hundred volts, indicating a very small effective spacing. The trigger fired easily but did not provide sufficient plasma for main-gap breakdown. This tube was rebuilt with the same gap spacing as used in the life test tubes and is now designated sample tube No. 4A. Satisfactory performance was then attained.

Sample tube No. 5 was constructed with the same narrow trigger gap as No. 4; in addition, the active hydrogen-bearing metal portion of the trigger mechanism was presaturated with hydrogen before assembly. This trigger shorted out during operation as a result of the narrow gap, and the distortion in the metal portion of the trigger due to hydrogen saturation. As in the case of sample tube No. 4, this tube has also been rebuilt with established spacings and is now designated sample tube No. 5A. Sample tube No. 6 was built similarly to Nos. 4A and 5A, and all were found to be satisfactory.

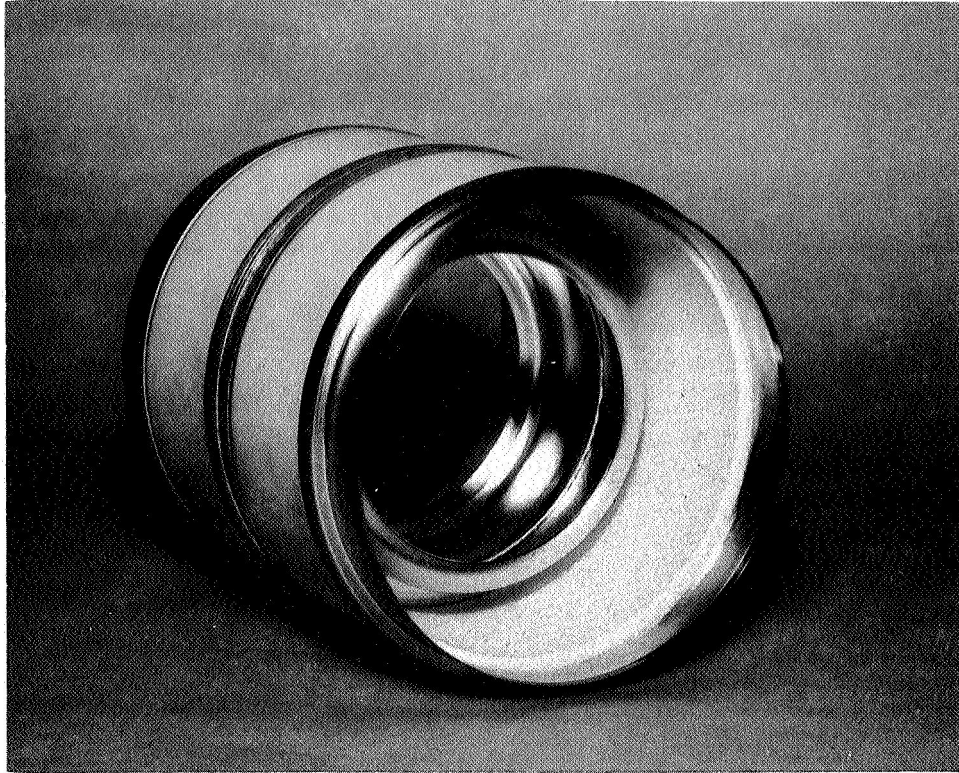

Figure 12 - Body Assembly of General Electric ZR-7520, 20-Kilovolt Triggered Vacuum Gap, Showing Electrically Isolated Static Shield

### C. Final Tests

Some indication was obtained during final testing that a wider trigger pulse was desirable to keep the trigger free from metallic deposits and to provide sufficient ionization to initiate conduction with a minimum of voltage oscillation during the plasma formative stages. This appears to be associated with closer proximity of the arc to the trigger electrode, with the elimination of spurious conduction paths in locations relatively remote from the trigger. Consequently the trigger capacitor was increased from 0.1 microfarads to 1.0 microfarads and tests were conducted with the modified circuit. A pulse transformer was used in the trigger circuit. The unloaded pulse was approximately 3 microseconds wide, and the short-circuit current was 340 amperes. The short-circuit current decayed to 200 amperes at 8 microseconds. Test data for these is shown in Table III.

-----

Table III

Initial Test Data for Gap Nos. 4A, 5A, and 6  
(Conditions as described in test specifications, Appendix II)

<u>Item</u>	<u>Units</u>	<u>Gap No. 4A</u>	<u>Gap No. 5A</u>	<u>Gap No. 6</u>
Trigger Resistance	Ohms	5,000	3,800	>10 <sup>6</sup> *
Trigger Firing Voltage	Volts	1,100	800	1000
Operation	-	OK	OK	OK
Anode Delay Time	Microseconds	<0.1	<0.1	<0.1
Minimum Anode Voltage	Volts	<200	<200	<200

---

\* Trigger resistance is usually very high until a few hundred shots have been fired.

-----

Final acceptance tests were made on sample tube Nos. 4A and 5A in accordance with the specifications prepared for this tube type, as shown in Appendix I. Figure 13 depicts the tube mounted in the test equipment. The capacitor bank, load resistor, inductance coil and instrumentation are shown. The rectifier is behind the back wall of the cage.

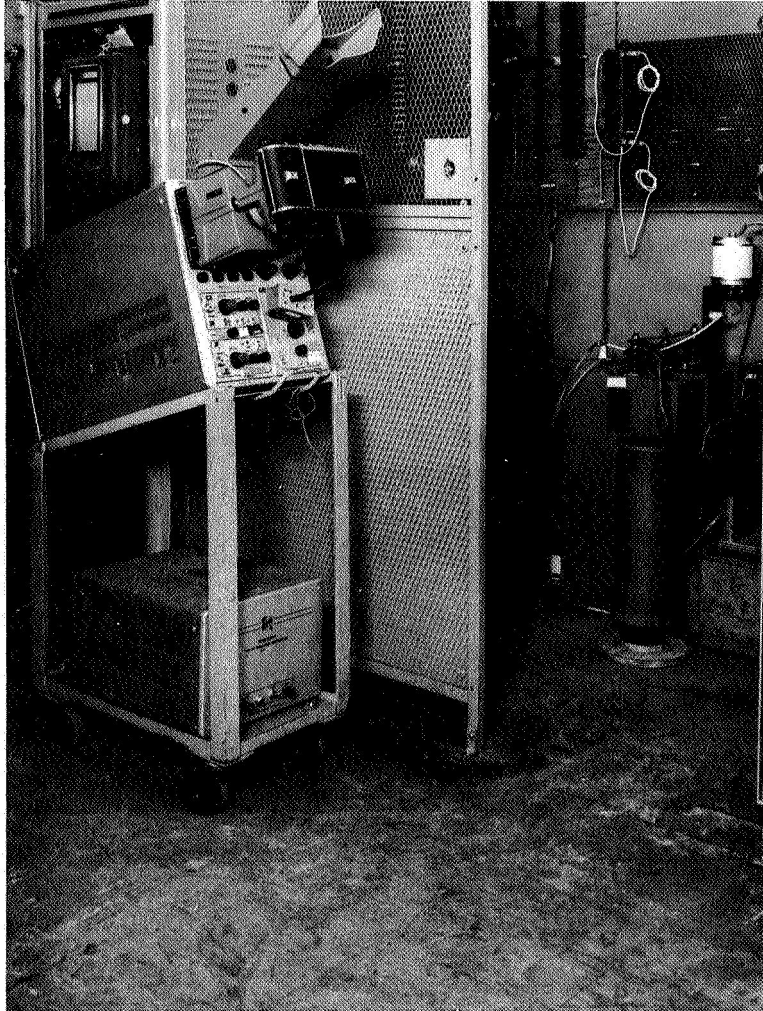

Figure 13 - General Electric ZR-7520 20-Kilovolt Triggered Vacuum Gap Mounted in Test Equipment

The tests were witnessed by Department of Defense (DOD) personnel as required by contractual terms. The test results are given in Appendix III together with the signature and seal of the DOD Inspector.

Sample tube No. 6 was provided as a spare in order to ensure that two samples would be available for shipment per contract. This tube, as well as life test sample tube No. 1A and tube No. 3A are in operable condition.

## DISCUSSION

In this discussion, reference is made by paragraph to the statement of work, Item B of Article I, of the subject contract. This reference is duplicated in Appendix IV.

The objective of the development program concerns a high-voltage, high-current switch with the characteristics outlined in the statement of work.

a. The switch should operate in any position. Since this gap is rigidly constructed entirely of solid parts, with no moving elements, it is capable of operation in any position and during accelerations and motion.

b. The switch should have the "equivalent electrical characteristics" of the Type GL-7703 Ignitron. The essential electrical performance of the Type GL-7703 Ignitron has been attained. The tube successfully withstands voltages in excess of 20 kilovolts, will pass at least 100,000 amperes peak current, and has the same general triggering characteristics. The trigger voltage and peak current requirements for reliable firing over a long life period were found to be somewhat higher than in the GL-7703.

One characteristic that was noted and is believed to be a fundamental characteristic (see development section of this report) is the gap's greater tendency to extinguish and return to the non-conducting state at points of zero current, progressing either from positive to negative or vice versa. This characteristic is considered advantageous in some applications but of doubtful value in others. Since the useful work is believed to be accomplished in the first one or two current half-cycles in the intended application, this characteristic would appear to be of little consequence.

c. The switch should have technical information data comparable to the GL-7703.

- (1) The ZR-7520 successfully withstands a peak anode voltage of 20 kilovolts, forward or inverse.

There is no equipment for testing either the GL-7703 or the ZR-7520 at the rated peak current value of 60,000 amperes, at a 1/2

cycle pulse width of 120 microseconds. This rating is derived from customer experience. It is anticipated that the ZR-7520 will pass this current but that its life will be foreshortened, especially with current reversal and the resulting increase in charge transfer. The initial life tests on the ZR-7520 were started at the 100,000-ampere, 20- $\mu$ sec pulse width condition, and approximately 500 shots were made on sample tube No. 1 and its modification, No. 1A. A visit to Huntsville disclosed that the typical operation there involved a much wider pulse at lower currents per tube and with approximately 50 percent reversal. The test circuit was modified accordingly, and all subsequent tests were made under these conditions, which are described in detail elsewhere in this report. All tests were made at the maximum discharge rate of two per minute.

- (2) The d-c short-circuiting service rating of the GL-7703 does not apply in the intended application and no tests were made. This is a derived rating in the case of the GL-7703; tests are not normally made and equipment is not available here.
- (3) The ignition requirements were found to be somewhat higher than for the GL-7703 in peak voltage and current; attempts to reduce them were not successful. Life tests were run with a very short trigger pulse width of less than one microsecond, but tests on the final design before acceptance tests were made indicated the need for a wider pulse; this was used in final tests as indicated on the tube specification sheet.
- (4) Since conduction in the ZR-7520 is not dependent upon mercury vapor as it is in the GL-7703, the operating temperature range is much wider. While no specific tests were made, it is expected that the tube will operate satisfactorily with convection cooling in any ambient temperature normally encountered either indoors or outdoors. If natural convection is impeded by the tube mounting, envelope temperature should not be allowed to exceed 200°C. The temperature rise in the envelope under maximum rated operating conditions is less than 50°C with natural convection cooling.

d. The tube is roughly comparable in size and weight to the GL-7703. As indicated in the proposal and during our visit to Huntsville, the basic design requires a somewhat larger diameter, and the tube is somewhat heavier.

e. Two tubes, Nos. 4A and 5A, were shipped January 26, 1966 under our Invoice No. 360-402.

f. The Objective Technical Information Sheet giving ratings, characteristics, and operating instructions is given in Appendix I.



## CONCLUSIONS

The Triggered Vacuum Gap, ZR-7520, resulting from this development program has the essential characteristics of the Type GL-7703 Ignitron and is capable of repetitive operation at the voltage, current, and energy levels of interest in the intended operation. It meets the objective of providing operation free from the environmental limitations imposed by the use of mercury tubes.

## Appendix I

### OBJECTIVE TECHNICAL INFORMATION ZR-7520 TRIGGERED VACUUM GAP

20 Kilovolts  
100,000 Amperes  
15,000 Joules

Fires at 500 Volts  
Ceramic Envelope

The ZR-7520 is a cold-cathode, vacuum, triggered-spark gap capable of switching 15,000 joules at high voltage. Unique design combines the desirable features of vacuum and gas devices. These include extremely wide voltage range, ease of triggering, high-voltage capability, rapid recovery time, stability of characteristics, and reliability.

Although capable of withstanding a hold-off voltage of 25 kilovolts indefinitely, the ZR-7520 will fire reliably at voltages as low as 500 volts. It will reliably switch non-repetitive high-current pulses with minimum delay and jitter in high-voltage circuits. Applications include "crowbars"\* and switching single-stored-electrical-energy systems into low-impedance loads, or energy-storage capacitors into resistive or inductive loads.

#### MECHANICAL

Mounting . . . . .	Any position
Net Weight . . . . .	6 lbs. Approx.

#### MAXIMUM RATINGS

Main Gap		
Operating Voltage . . . . .	500V to 20	Kilovolts
Hold-Off Voltage, Indefinite Time, minimum . . . . .	25	Kilovolts
Peak Current		
Unidirectional Pulse, maximum . . . . .	100,000	Amperes
Charge Conducted Through Gap per Operation**, maximum . . . . .	5	Coulombs
Discharge Rate, maximum . . . . .	2	Per Minute
Delay Time†, V app. = 5KV, maximum . . . . .	0.5	Microseconds
Interelectrode Leakage Resistance . . . . .	10,000	Megohms
Trigger Gap		
Typical Trigger Firing Circuit:		
Peak Voltage‡, minimum . . . . .	5	Kilovolts
Short-Circuit Current, minimum . . . . .	350	Amperes
Pulse Width, open circuit . . . . .	3	Microseconds

\*In a "crowbar" application, the gap acts as a short-circuiting switch to protect vulnerable high-voltage equipment by removing the direct-current supply voltage within tenths of a microsecond after initiation of the trigger-pulse. Unless the fault is self-clearing, the circuit must subsequently be opened in the usual manner.

\*\*This rating refers to the charge originating from the capacitor bank including the total charge transfer during ringing. For further information concerning "follow-through" current from the power supply in a given application, consult the General Electric Microwave Tube Business Section.

† From trigger-gap breakdown to main-gap breakdown.

‡ The voltage rise time should be as fast as is consistent with the firing speed and accuracy required. The trigger will fire typically at 1 to 3 kilovolts on the leading edge of the pulse.

#### OPERATING NOTES

When discharging or crowbaring energy-storage capacitors, repetitive firing for short periods may be necessary to maintain sufficiently low voltage to protect electrical equipment until the circuit is cleared. Restoration of power-supply voltage to maintain service continuity without circuit-breaker action after a self-clearing fault is feasible in a typical circuit by blocking the trigger pulse. This is due to the rapid deionization time and excellent voltage recovery capability of the ZR-7520. For further information consult the Microwave Tube Business Section, Bldg. 269, Schenectady, New York, FRanklin 4-2211, Extension 5-2353.

GENERAL ELECTRIC

A69087-72B155

REV. NO.	TITLE	CONT ON SHEET	SH NO.
	OUTLINE		
CONT ON SHEET	FIRST MADE FOR		
	ZR-7520		

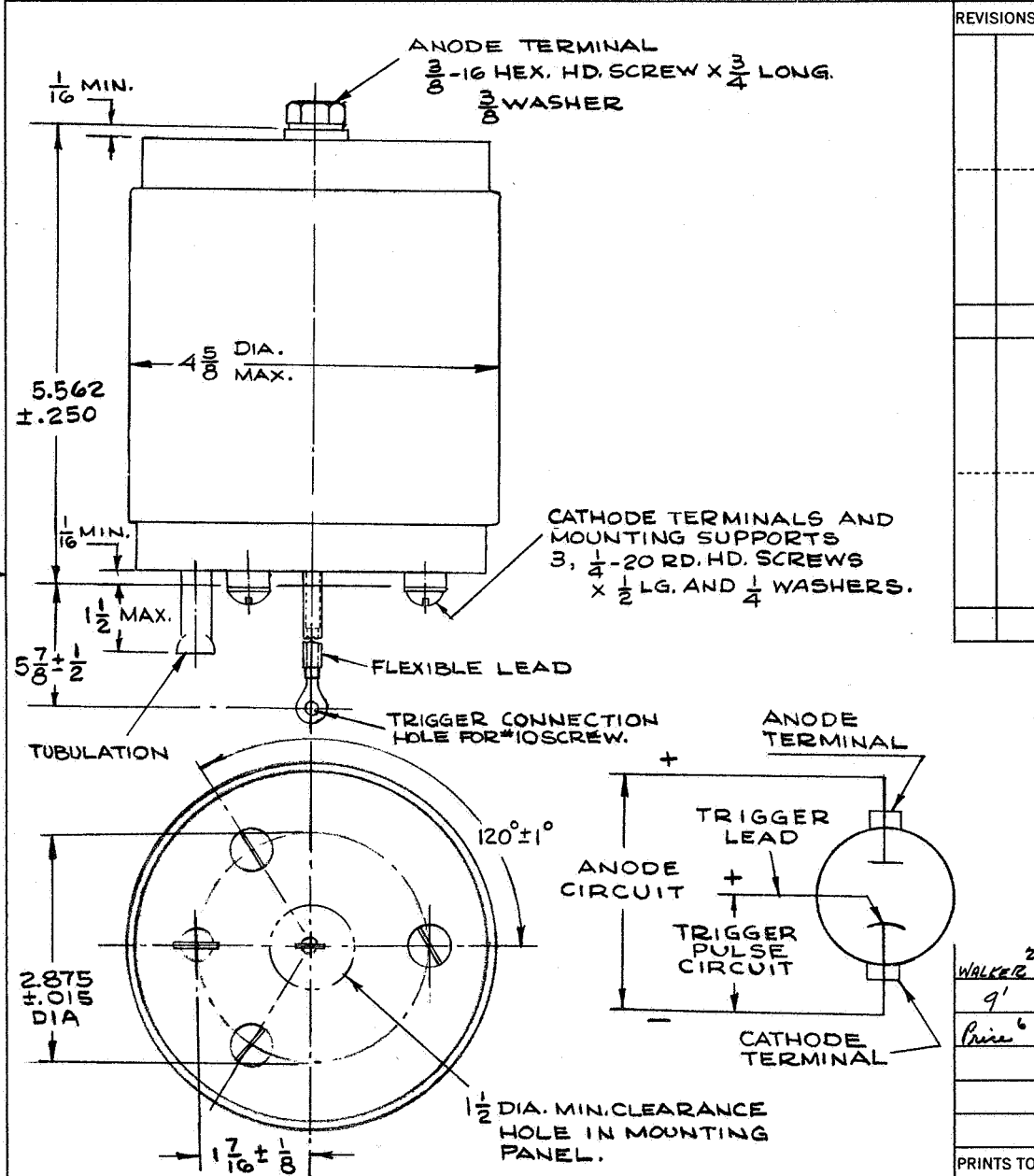

REVISIONS	

WALKER<sup>2</sup>

9'

Price<sup>6</sup>

PRINTS TO

MADE BY <i>Pandi JAN. 14, 1966</i>	APPROVALS <i>JN-13124</i>	DIV OR DEPT. MTBS	A-69087-72B155
ISSUED <i>JAN. 14, 1966 P</i>		LOCATION SCHDY	SH NO.

FF-803-WA (9-53)  
 PRINTED IN U. S. A.

CODE IDENT NO.

Appendix II  
 TEST SPECIFICATIONS  
 ZR-7520 Triggered Vacuum Gap

<u>Test</u>	<u>Conditions</u>	<u>Notes</u>	<u>Read</u>	<u>Limits</u>		<u>Units</u>
				<u>Min</u>	<u>Max</u>	
Trigger Resistance		1	$R_t$	100	-	ohms
Trigger Firing Voltage	$E_{tt} = 5KV$ dc min $i_t = 350A$ max $\frac{de}{dt} = 25000$ volts/ $\mu$ sec min (open circuit)	2	$e_t$	-	3.5	kilovolts
Operation 1	$E_{bb} = 20$ KV min 25 discharges	3, 4, 5	-	-	-	-
Anode Delay Time	Operation 1 $E_{bb} = 5$ KV	6	$\Delta t$	-	0.5	micro-seconds
Minimum Anode Voltage	Operation 1 $E_{bb} = 500$ V	7	-	-	-	-
Outline Dimensions	-	8	-	-	-	-

Symbols and Abbreviations

- $R_t$  = Trigger resistance
- $E_{tt}$  = Trigger power supply (condenser charging) voltage
- $e_t$  = Trigger instantaneous voltage
- $i_t$  = Instantaneous trigger current
- $C_t$  = Trigger circuit capacitance
- $E_{bb}$  = Anode power supply (condenser charging) voltage
- $\Delta t$  = Anode delay time
- $t$  = Time

NOTES

1. Measure trigger resistance with an ohmmeter.
2. Connect trigger circuit to trigger terminal and cathode. With an oscilloscope, measure voltage on rising trigger pulse at which tube trigger fires.

3. Trigger circuit shall consist of a condenser discharge circuit having the following constants:

$$E_{tt} = 5 \text{ KV dc } \pm 10\%$$

$$C_t = 1 \text{ microfarads nominal}$$

$$i_t = 350 \text{ ampere max peak}$$

4. Gap shall be operated at a rate of discharge every 30 seconds in a capacitor discharge circuit having the following constants:

$$E_{bb} = 20 \text{ KV dc min}$$

$$i_p = 26000 \text{ A } \pm 10\% \text{ peak}$$

$$\% \text{ Reversal} = (50 \pm 5)\%$$

$$t_{(1/2 \text{ cycle})} = 100 \text{ microseconds } \pm 10\%$$

The gap shall conduct at least one half cycle of current each discharge.

5. There shall be no voltage breakdown other than when gap is triggered. There shall be no failures to fire when triggered.
6. Delay time is the time between grid and anode breakdowns as evidenced by initiation of current or initiation of voltage fall.
7. The tube shall conduct at the anode voltage specified.
8. Tube dimensions shall be in accordance with Outline Drawing A69087-72B155 (see Appendix I).

Appendix III

ZR-7520 TEST DATA

TUBE #: 4A  
 OPER: H.N. PRICE  
 DATE: 1-18-66

TEST	UNITS	LIMIT		VALUE
		MIN.	MAX.	
TRIGGER RESISTANCE	Ohms	100	-	5000
TRIGGER FIRING VOLTAGE	<del>110</del> Volts	-	3.5	1100
OPERATION 1	-	-	-	OK
ANODE DELAY TIME	Microseconds	-	0.5	< 0.1
MINIMUM ANODE VOLTAGE		-	-	OK

  
 13 JAN. 66  
 M. Calli  
 CASQAA

ZR-7520 TEST DATA

TUBE #: 5A

OPER: H.N. PRICE

DATE: 1-18-66

TEST	UNITS	LIMIT		VALUE
		MIN.	MAX.	
TRIGGER RESISTANCE	Ohms	100	-	3800
TRIGGER FIRING VOLTAGE	<del>Kilo</del> Volts	-	3.5	800
OPERATION 1	-	-	-	O.K
ANODE DELAY TIME	Microseconds	-	0.5	<0.1
MINIMUM ANODE VOLTAGE	-	-	-	O.K

  
13 JAN. 66  
M. C. C. L. I.  
CASQAA

Appendix IV

CONTRACT STATEMENT OF WORK

(extracted from Contract NAS8-20526, Article 1, Item B)

Statement of Work

The Contractor shall conduct a program for the development of a high-voltage - high current switch with the following characteristics:

- a. The switch shall operate in any orientation thru 360 degrees.
- b. The switch shall have the equivalent electrical characteristics of the type 7703 ignitron.
- c. The following technical information should be used as a minimum requirement.

(1) CAPACITOR DISCHARGE RATINGS - Sinusoidal Pulse

Peak Anode Voltage, Maximum	
Forward (Volts)	20,000
Reverse (Volts)	20,000
Anode Current	
Peak (Amperes)	
1/2 Cycle Pulse Width 120 Microseconds	60,000
1/2 Cycle Pulse Width 20 Microseconds	100,000
Discharge Rate Maximum	2 per min.

(2) DC SHORT-CIRCUITING SERVICE

Peak Anode Voltage	
Forward (Volts)	20,000
Reverse (Volts)	20,000
Critical Starting Voltage, Min. (Volts)	100
Anode Current	
Peak (Amperes)	35,000
Average (Amperes)	0.25
Maximum Averaging Time (minutes)	1
Ionization Time (Microseconds)	0.5



(3) IGNITION REQUIREMENTS	MIN.	MAX.
Ignitor Voltage (Volts)		
Forward (Open Circuit)	1500	3000
Inverse	--	50
Ignitor Short Circuit Current (Peak Amperes)	200	250
Length of Firing Pulse, ( $\mu$ sec)	5	10

(4) COOLING REQUIREMENTS

Type of Cooling	Convection or Water Cooled Clamp
Mounting Clamp Tem. ( $^{\circ}$ C)	0 to 30
Anode Insulating Compound, Max. ( $^{\circ}$ C)	70

- d. The switch shall be of comparable size and weight to the 7703 ignition switch.
- e. The contractor shall deliver two (2) switches for testing and use by MSFC.
- f. The contractor shall write a technical information sheet containing the characteristics and instruction for use of the developed switch.