

C. N. : Smith 6574  
T.O. : Dr K. Ogilvie  
612

Final Report — PHASE III

# ANALYTICAL AND DEVELOPMENTAL INVESTIGATION OF ELECTRON STRIP MULTIPLIERS

CONTRACT NO. NAS5-9396

GPO PRICE \$ \_\_\_\_\_

CFSTI PRICE(S) \$ \_\_\_\_\_

Hard copy (HC) 306

Microfiche (MF) 65

ff 653 July 65

Prepared by

DONALD R. CONE  
SENIOR RESEARCH ENGINEER

STANFORD RESEARCH INSTITUTE  
MENLO PARK, CALIFORNIA

|                               |                    |           |
|-------------------------------|--------------------|-----------|
| FACILITY FORM 602             | <b>N 68-17831</b>  | (THRU)    |
|                               | (ACCESSION NUMBER) |           |
|                               | <u>46</u>          | (CODE)    |
|                               | (PAGES)            | <u>09</u> |
| <u>CR# 93246</u>              | (CATEGORY)         |           |
| (NASA CR OR TMX OR AD NUMBER) |                    |           |

For

NATIONAL AERONAUTICS AND SPACE ADMINISTRATION  
GODDARD SPACE FLIGHT CENTER  
GREENBELT, MARYLAND

*Final Report — PHASE III*

# **ANALYTICAL AND DEVELOPMENTAL INVESTIGATION OF ELECTRON STRIP MULTIPLIERS**

CONTRACT NO. NAS5-9396

*SRI Project 6281*

*December 1967*

*Prepared by*

DONALD R. CONE  
SENIOR RESEARCH ENGINEER

STANFORD RESEARCH INSTITUTE  
MENLO PARK, CALIFORNIA

*For*

NATIONAL AERONAUTICS AND SPACE ADMINISTRATION  
GODDARD SPACE FLIGHT CENTER  
GREENBELT, MARYLAND

## SUMMARY

---

### A. Objective

The object of this study was to provide a better understanding of the operational gain-fatigue mechanism in continuous-dynode electron multipliers.

### B. Scope

This effort encompassed the study of gain changes in electron multipliers as a function of their operational parameters and their environment, especially temperature, pressure, and residual-gas constituents. The basic environment was a room-temperature, vac-ion-pumped, ultra-high-vacuum (UHV) station operated at pressures below  $10^{-8}$  torr. Temperature excursions were from about  $0^{\circ}\text{C}$  to  $70^{\circ}\text{C}$ . The pressure was varied from  $10^{-9}$  torr to about  $10^{-4}$  torr. In addition to the normal vac-ion residual-gas environment, partial pressures of nitrogen, oxygen, argon, carbon dioxide, hydrogen, and air were introduced for varying time periods. Commercial and experimental continuous-dynode multipliers and a discrete-dynode multiplier, all with radioactive  $\beta$  source inputs, were operated simultaneously in close proximity to each other within the common vacuum environment, with comparable initial output currents.

The gain change was measured and evaluated as a function of operating time and other parameters over a period of eight months of essentially continuous operation. Postoperational electrical, optical, physical, and chemical analyses of the multipliers and collector electrodes were conducted.

### C. Conclusions

There is a rapid, and at least partially reversible gain change related to the cascade electron flux in the multiplier, the resistive-dynode surface temperature, and the constituency and pressure of the gaseous environment in the vicinity of the multiplier surface, apparently related to the corresponding changes in the physical and chemical equilibrium

state of the dynode surface. Both increases and decreases in gain exceeding one order of magnitude were observed in some cases.

There appears to be a long-term change in the surface composition of the dynode resistive surfaces due to electron-induced desorption of oxygen (and other gases), causing a chemical reduction of the surface that reduces the film resistance and the secondary-emission ratio of the surface. The rate of gain loss decreases with operating time, presumably because of the decreased population of releasable gases. Exposure of the surface to increased pressure of oxygen (and some other gases) apparently partially replenishes the depleted region, resulting in partial gain recovery.

#### D. Recommendations

1. The substantial effect on gain following introduction of modest partial pressures of oxygen and/or hydrogen gas to the multiplier operating environment should receive further study. If a controllable and beneficial effect on gain can be demonstrated, it should be possible to provide for continuous or periodic introduction of gas or gases to counteract the operational gain fatigue.

2. The complex surface chemistry apparently involved in the operational gain change of distributed-dynode multipliers should receive additional study.

The recently refined technique of using low-energy electron bombardment and analysis of the energy spectra of the resulting Auger electrons for detection and identification of microchemical surface changes is suggested as a suitable approach to obtain more quantitative information on the gain-change mechanism.

CONTENTS

---

|   |     |
|---|-----|
| SUMMARY . . . . .                             | ii  |
| A. Objective . . . . .                        | ii  |
| B. Scope . . . . .                            | ii  |
| C. Conclusions . . . . .                      | ii  |
| D. Recommendations . . . . .                  | iii |
| LIST OF ILLUSTRATIONS . . . . .               | v   |
| I    INTRODUCTION . . . . .                   | 1   |
| A. Purpose . . . . .                          | 1   |
| B. Scope . . . . .                            | 1   |
| C. Background . . . . .                       | 1   |
| D. Work Summary . . . . .                     | 2   |
| II   DISCUSSION . . . . .                     | 5   |
| A. Experimental Facility . . . . .            | 5   |
| B. Operational Results . . . . .              | 9   |
| 1. Gain vs Time Effects . . . . .             | 9   |
| 2. Thermal Effects . . . . .                  | 9   |
| 3. Interrupted Operation (Recovery) Effects   | 13  |
| 4. Environmental Pressure-Constituent Effects | 17  |
| 5. Post-run Analysis . . . . .                | 25  |
| a. Resistance . . . . .                       | 25  |
| b. Gain/Voltage Relationships . . . . .       | 25  |
| c. Optical Analysis . . . . .                 | 25  |
| d. Physical/Chemical Analysis . . . . .       | 25  |
| III  CONCLUSIONS                              |     |
| A. Long-Term Changes . . . . .                | 27  |
| B. Short-Term Changes . . . . .               | 27  |
| IV  RECOMMENDATIONS . . . . .                 | 29  |
| REFERENCES . . . . .                          | 30  |
| SUPPLEMENTARY BIBLIOGRAPHY . . . . .          | 31  |

DD Form 1473

LIST OF ILLUSTRATIONS

---

|           |  |         |
|-----------|--|---------|
| Fig. 1    | Electron Multiplier . . . . .                        | 3       |
| Fig. 2    | Film Patterns and Electron Trajectory . . . . .      | 3       |
| Fig. 3    | Multiple Multiplier Circuit . . . . .                | 6       |
| Fig. 4    | Multiplier Multiplier Test Configuration . . . . .   | 8       |
| Fig. 5    | Multiplier Output vs Time . . . . .                  | 10      |
| Fig. 6    | Multiplier Output vs Time & Environment . . . . .    | 11      |
| Fig. 7a/b | Gain - Temperature Effects . . . . .                 | 12 & 13 |
| Fig. 8    | Interrupted Operation Recovery and Decline . . . . . | 15      |
| Fig. 9    | Interrupted Operation Recovery and Decline . . . . . | 16      |
| Fig. 10   | Interrupted Operation Recovery and Decline . . . . . | 18      |
| Fig. 11   | Short-Time Gain-Pressure Relationships . . . . .     | 19      |
| Fig. 12   | Effect of Nitrogen Partial Pressure . . . . .        | 20      |
| Fig. 13   | Effect of Oxygen Partial Pressure . . . . .          | 23      |

## I INTRODUCTION

### A. Purpose

The purpose of this Phase III Study was to ascertain, by experiment and analysis, the principal cause or causes of operational gain fatigue in continuous-dynode electron multipliers.

### B. Scope

This effort encompassed the study of gain changes in electron multipliers as a function of their operational parameters and their environment, especially temperature, pressure, and residual-gas constituents. The basic environment was a room-temperature, vac-ion-pumped, ultra-high-vacuum (UHV) station operated at pressures below  $10^{-8}$  torr. Temperature excursions were from about  $0^{\circ}\text{C}$  to  $70^{\circ}\text{C}$ . The pressure was varied from  $10^{-9}$  torr to about  $10^{-4}$  torr. In addition to the normal vac-ion residual-gas environment, partial pressures of nitrogen, oxygen, argon, carbon dioxide, hydrogen, and air were introduced for varying time periods. Commercial and experimental continuous-dynode multipliers and a discrete-dynode multiplier, all with radioactive  $\beta$  source inputs, were operated simultaneously in close proximity to each other within the common vacuum environment, with comparable initial output currents.

The gain change was measured and evaluated as a function of operating time and other parameters over a period of eight months of essentially continuous operation. Postoperational electrical, optical, physical, and chemical analyses of the multipliers and collector electrodes were conducted.

### C. Background

The availability of small, lightweight, low-power, relatively simple electron multipliers capable of converting incoming energy packets (UV, X-ray, electron, ion, etc.) into highly amplified (gains in excess of  $10^6$ ) output pulses offers an appealing approach to upper-atmosphere and outer-space measurement and analysis problems. Where prolonged experiments are desired, the reliability and stability of such devices in the environment to be analyzed is a major concern. Of particular importance

is the decrease in gain observed in extended laboratory operation of these devices<sup>1,2</sup> \*.

SRI's microelectronics program required the development of an electron multiplier<sup>3</sup> that could withstand a 900°C vacuum bakeout; hence only refractory materials could be used in its fabrication. The device developed for this application consists of two identical, parallel-plane, optically polished, fused-silica strips, mounted to form a channel, as shown in Figs. 1 and 2. The inner or dynode surfaces of the channel are films prepared by codepositing aluminum oxide and molybdenum in proportions adjusted to yield the desired resistivity. The contact electrodes for the dynodes are molybdenum films, with a molybdenum tab facing the exit end of the channel serving as the collector. This device operates in a manner similar to commercially produced tubular or channel multipliers<sup>4,5</sup>, with comparable gains in excess of 10<sup>6</sup>. However, the parallel-strip configuration permits access to the resistive-dynode surface, a feature not readily available in the tubular devices.

The strip multiplier was fabricated with resistive-dynode materials different from those used in the tubular devices, and both tubular types used materials different from those typically used in discrete-dynode electron multipliers. Hence to study the operational gain change, it appeared appropriate to operate models of each of these types of devices simultaneously in a common controllable environment, to ascertain their respective responses, and to provide insight into the gain-change mechanism.

#### D. Work Summary

Four electron multipliers were prechecked, mounted on a common flange and placed in a vac-ion-pumped UHV station. Multiplier input excitation was by  $\frac{1}{4}$  millicurie radioactive  $\beta$  sources. The vacuum chamber was evacuated to  $< 10^{-8}$  torr pressure, and the output current (a direct indication of gain for a constant input) was measured continuously. The effects of temperature, pressure constituency of the gaseous environment, and interruptions of operating high voltage were measured throughout an eight-

---

\*References are listed at the end of the report.



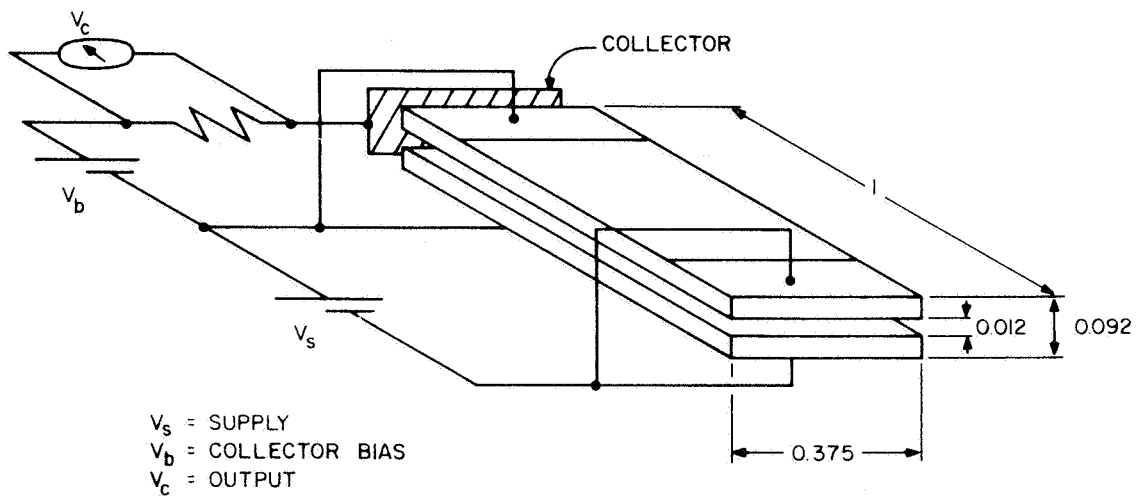

TA-6281-1

FIG. 1 ELECTRON MULTIPLIER

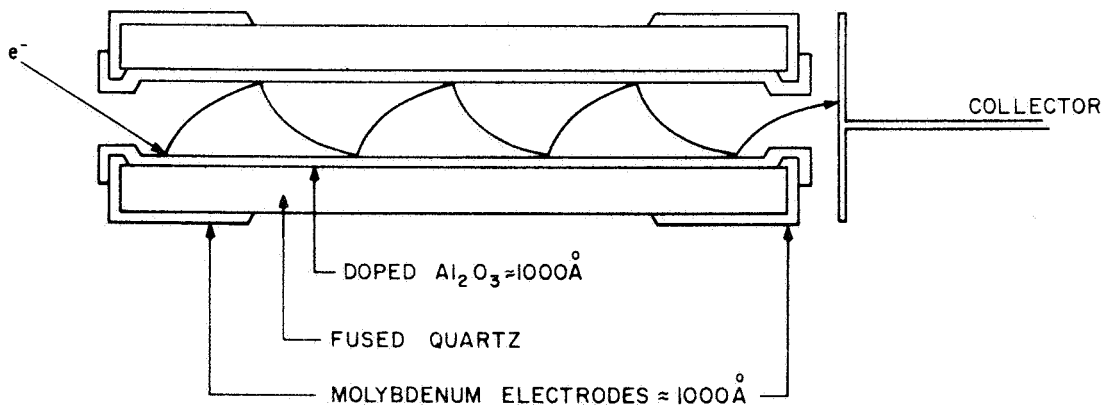

NOT TO SCALE  
TA-6281-2

FIG. 2 FILM PATTERNS AND ELECTRON TRAJECTORY

month period. Following the operational period the multipliers were subjected to visual, electrical, and physical/chemical analysis.

Concurrently, a literature survey was made and discussions were held with people knowledgeable in pertinent areas.

A preliminary hypothesis of the gain fatigue mechanism was developed and evaluated against the measured operational results.

## II DISCUSSION

### A. Experimental Facility

The UHV system used for this experiment was a 6-inch diameter by 12-inch long cylindrical stainless steel chamber with two 8-inch and five 2-3/4-inch copper gasketed ports; the ports provided adequate viewing-window and electrical feedthrough capability. The chamber was roughed in succession by a liquid-air-trapped mechanical pump and a liquid-air-cooled Vac-Sorb pump. A 50-liter/sec standard vac-ion pump and its related vacuum gauge were used for attaining and measuring ultra-high vacuum. Provision for heating the system was made by winding heating tapes around the main cylinder and the pumping port. An automatic controller permitted holding the temperature of the overall vacuum chamber within about  $\pm 1^\circ\text{C}$  of any desired setting higher than room temperature.

The input excitation for the multipliers was by  $\frac{1}{4}$  millicurie  $\text{Ni}^{63}$  radioactive  $\beta$  sources disposed near their respective input apertures. The effective input currents were on the order of  $10^{-14}$  to  $10^{-15}$  amps. The source/distance/input-aperture geometries and operating voltages of the respective multipliers were adjusted to provide about  $3 \times 10^{-9}$  amps of initial output current to the collector electrodes. Suitable "bias" voltages for the input sources and output electrodes were provided by dry batteries. Figure 3 is a functional diagram of the multiplier's operational circuitry.

The operating high voltages for the multipliers were provided by Northeast Scientific Corp. RE 5002 regulated high-voltage supplies. The output currents were measured by separate HP 425 dc microvolt ammeters (Nano ammeters). For most of the operational period, the output was continuously recorded by a multichannel chart recorder, fed from the microvolt ammeters. The high voltage was checked periodically using a Sensitive Research Corp. model ESH electrostatic voltmeter.

A thermocouple and thermal controller applying power to heater tapes around the vacuum chamber permitted controlling of the vacuum-system temperature to about  $\pm 1^\circ\text{C}$  at any desired setting above room temperature.

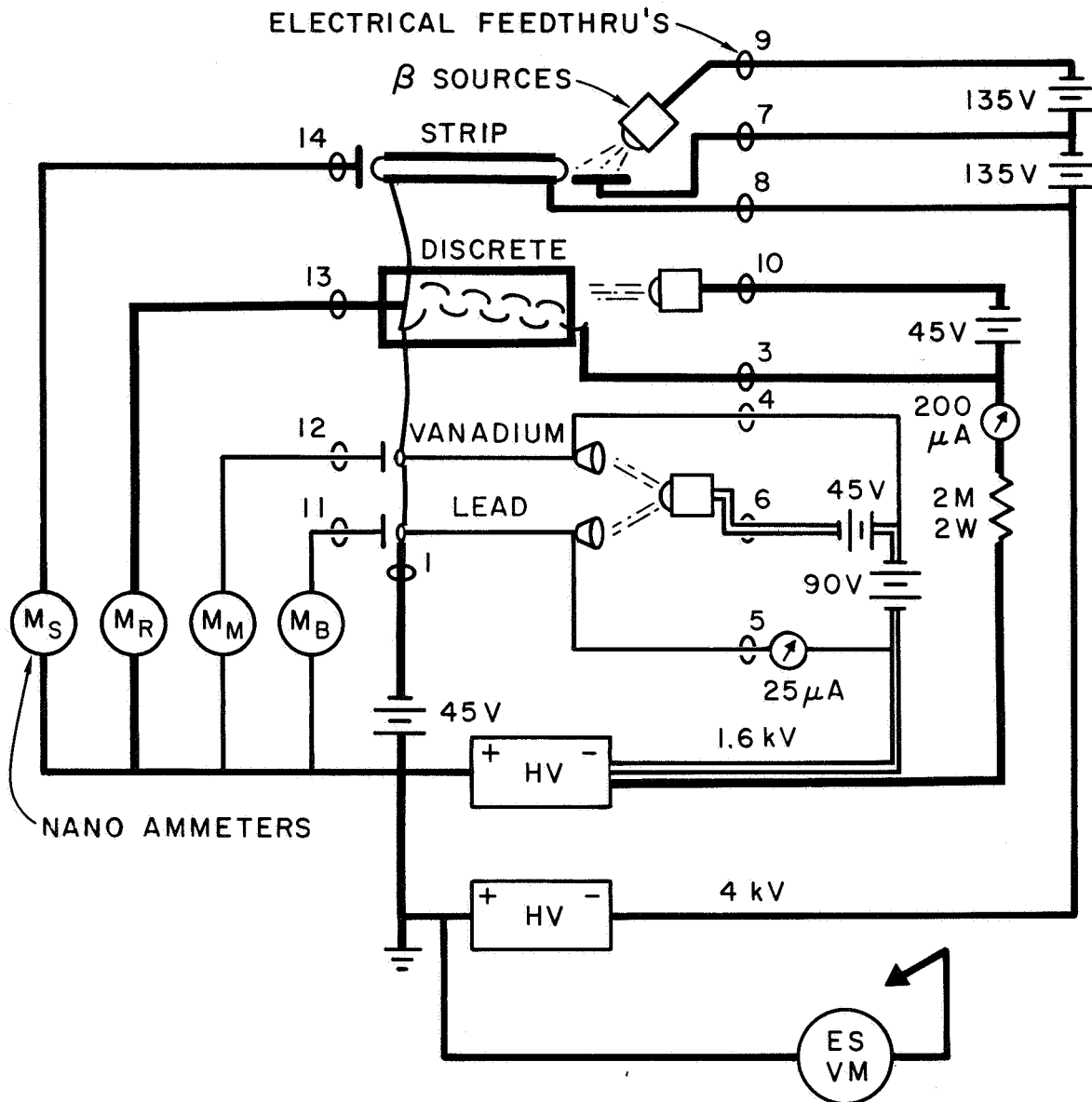

TB-6281-3

FIG. 3 MULTIPLE MULTIPLIER CIRCUIT

The upper limit was set by the maximum permissible temperature on the vanadium-phosphate-glass multiplier: 70° C operational; 100° C nonoperational.

A stainless steel gas manifold system connected through a needle valve to the vacuum station interior permitted the controlled introduction of selected gases into the system at pressures above the system base pressure of approximately  $1 \times 10^{-9}$  torr. The manifold system was purged by heating and pumping through a liquid-air-trapped vacuum system, and flushing the manifold with the selected gas several times prior to its introduction into the vacuum system.

Four electron multipliers were operated simultaneously in close proximity to each other within the vacuum system.

1. An SRI parallel-strip multiplier as described in Ref. 1 with molybdenum-alumina resistive dynode surfaces. This was an experimental high-resistivity device with a resistance of about  $10^{11} \Omega$ .
2. A commercial 14-stage discrete dynode multiplier with oxidized beryllium copper dynodes. Glass-encased precision  $1M\Omega$  resistors between dynodes provided the proper operating voltage distribution.
3. An early experimental model from a commercial supplier of a tubular multiplier with an internal coating of vanadium phosphate glass as the resistive dynode surface, and a resistance of  $\sim 10^{10} \Omega$ . This had an 0.05-inch I.D. and was formed into an 0.5-inch diameter helix.
4. A commercial tubular multiplier of lead oxide glass with a resistance of  $\sim 10^9 \Omega$ . This had an  $\sim 0.08$ -inch I.D. and was formed into a three-quarter circular arc of about 1-3/4-inch diameter.

Figure 4 is a photograph of the four multipliers mounted on a feedthrough port of the vacuum system.

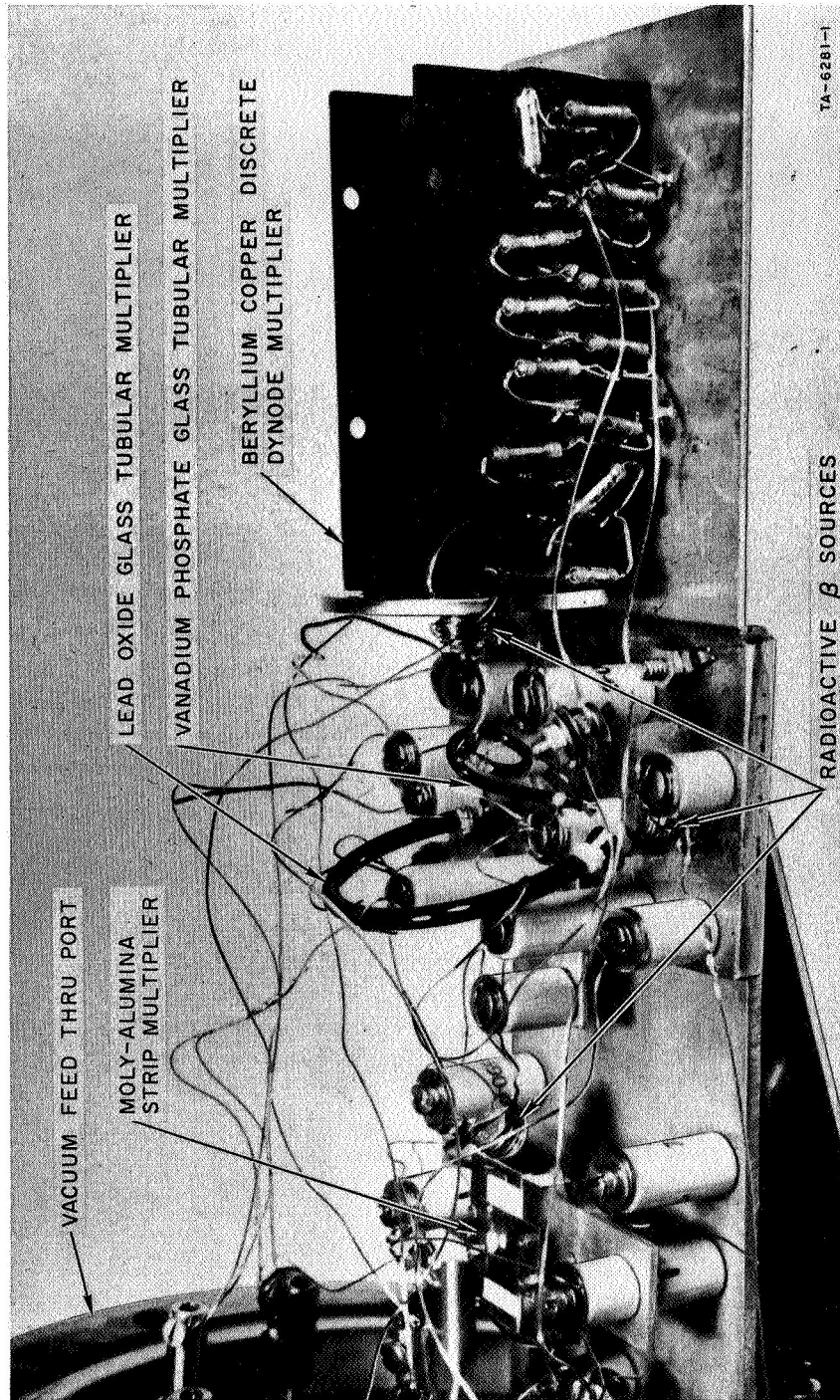

FIG. 4 MULTIPLE MULTIPLIER TEST CONFIGURATION

## B. Operational Results

### 1. Gain vs Time Effects

The four multipliers were individually prechecked, and then mounted and installed in the UHV station. The system was pumped to  $1 \times 10^7$  torr, and operation of the multipliers was rechecked, followed by a  $90^\circ\text{C}$  system bake for about 6 hours. On return to room temperature, the system pressure was less than  $1 \times 10^{-8}$  torr. The operating voltages were applied to the multipliers, and they were run continuously (except for a few brief periods occasioned by equipment malfunction or deliberate testing) for a period of 260 days. Figure 5 is an overly "smoothed" plot of the output current behavior of these multipliers during this period. Figure 6 provides a more detailed structure of the output current variation with time. A description of the environmental and operational situations that were applied and the resulting changes in output current are detailed in the following sections.

### 2. Thermal Effects

Figure 7 illustrates the output current resulting from multiplier operation at various temperatures in the range from below ambient room temperature to  $70^\circ\text{C}$ , the maximum allowable operational temperature for the vanadium-phosphate multiplier. The results for the  $\sim 0^\circ\text{C}$  period during the 22nd to 25th days are somewhat uncertain because of leakage currents and HV breakdown caused by moisture condensation on the multiplier leads immediately external to the vacuum system.

The moly-alumina strip and vanadium-glass tubular multipliers tended to increase in output with increasing temperature, while the lead-glass tubular device decreased. The output of the beryllium-copper discrete-dynode multiplier decreased with increasing temperature from room temperature to about  $50^\circ\text{C}$ , then increased. In almost all cases, when operational temperatures were repeated, the outputs were at a lower level than on the prior temperature exposures.

Prior to the sub-room-temperature exposure, gain of most of the multipliers was quite stable at a given temperature setting. Subsequently, the moly-alumina strip multiplier exhibited a marked decrease in gain during the controlled-temperature sequences.

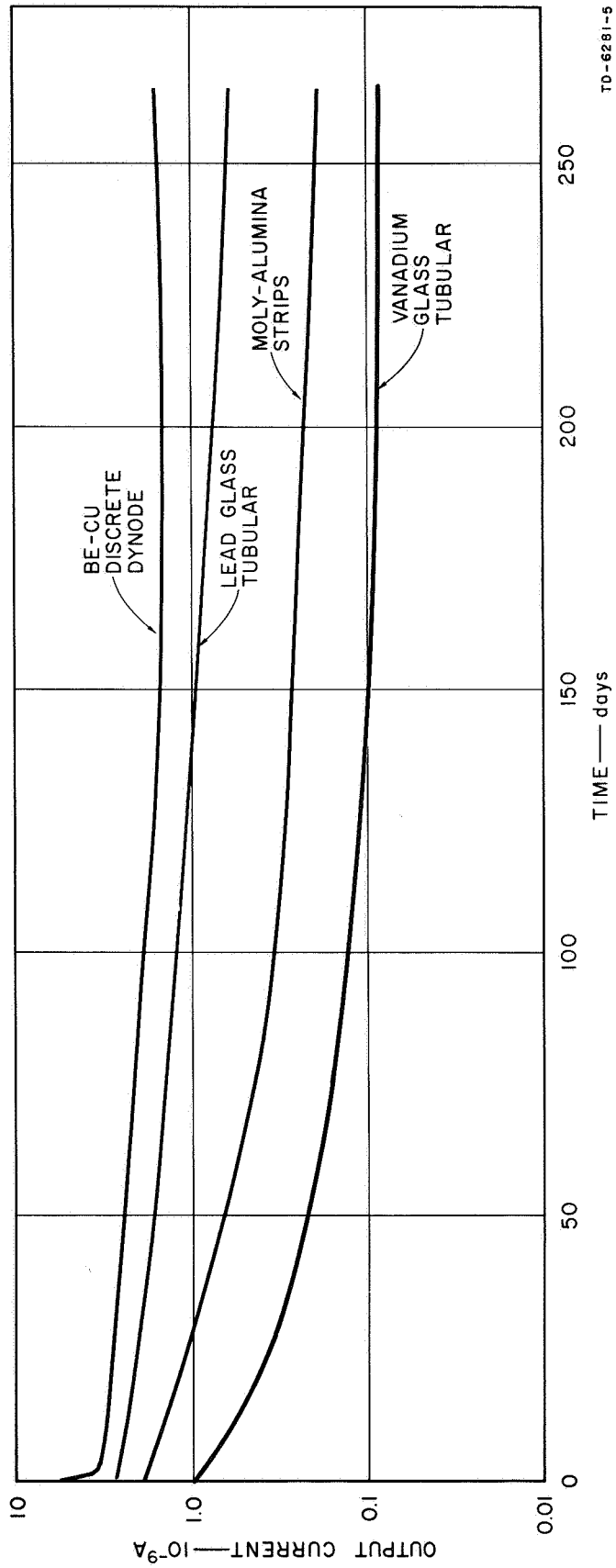

TD-6281-5

FIG. 5 MULTIPLIER OUTPUT vs. TIME



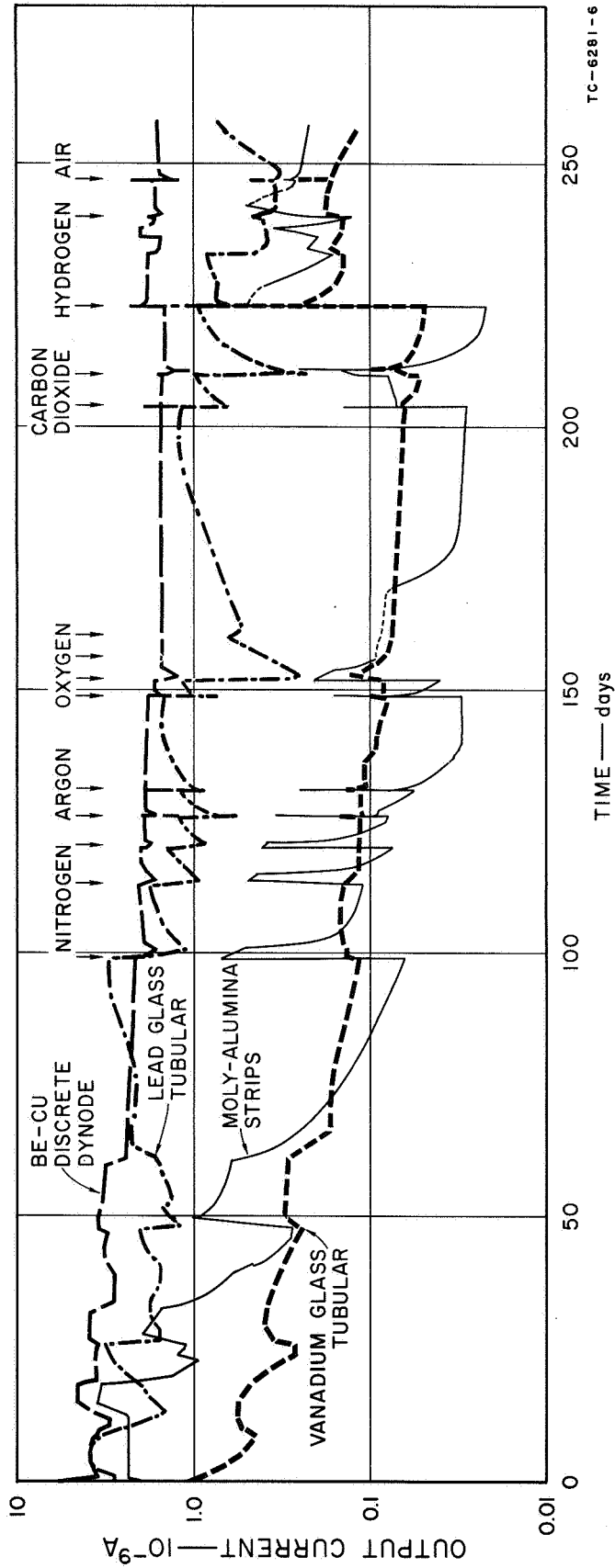
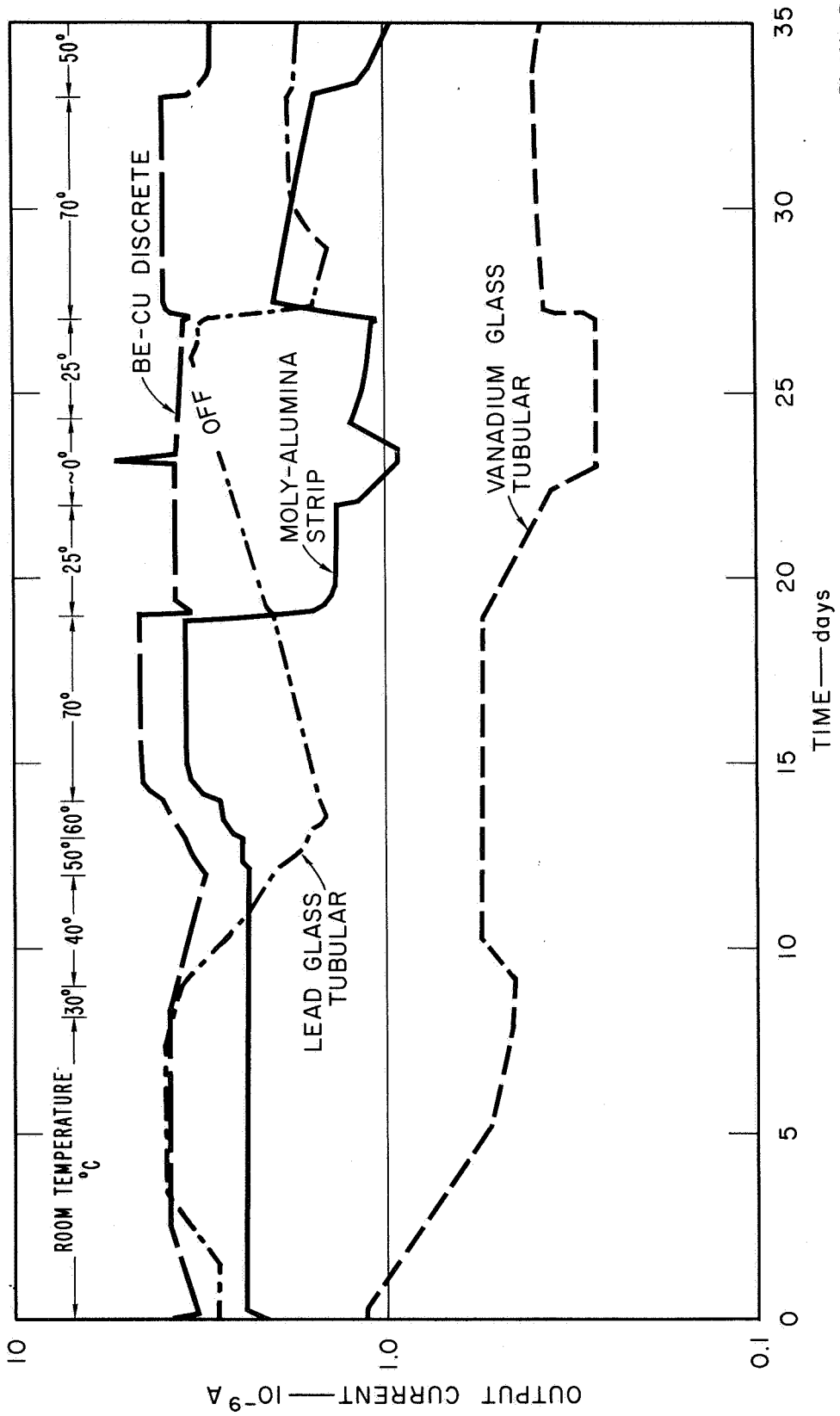
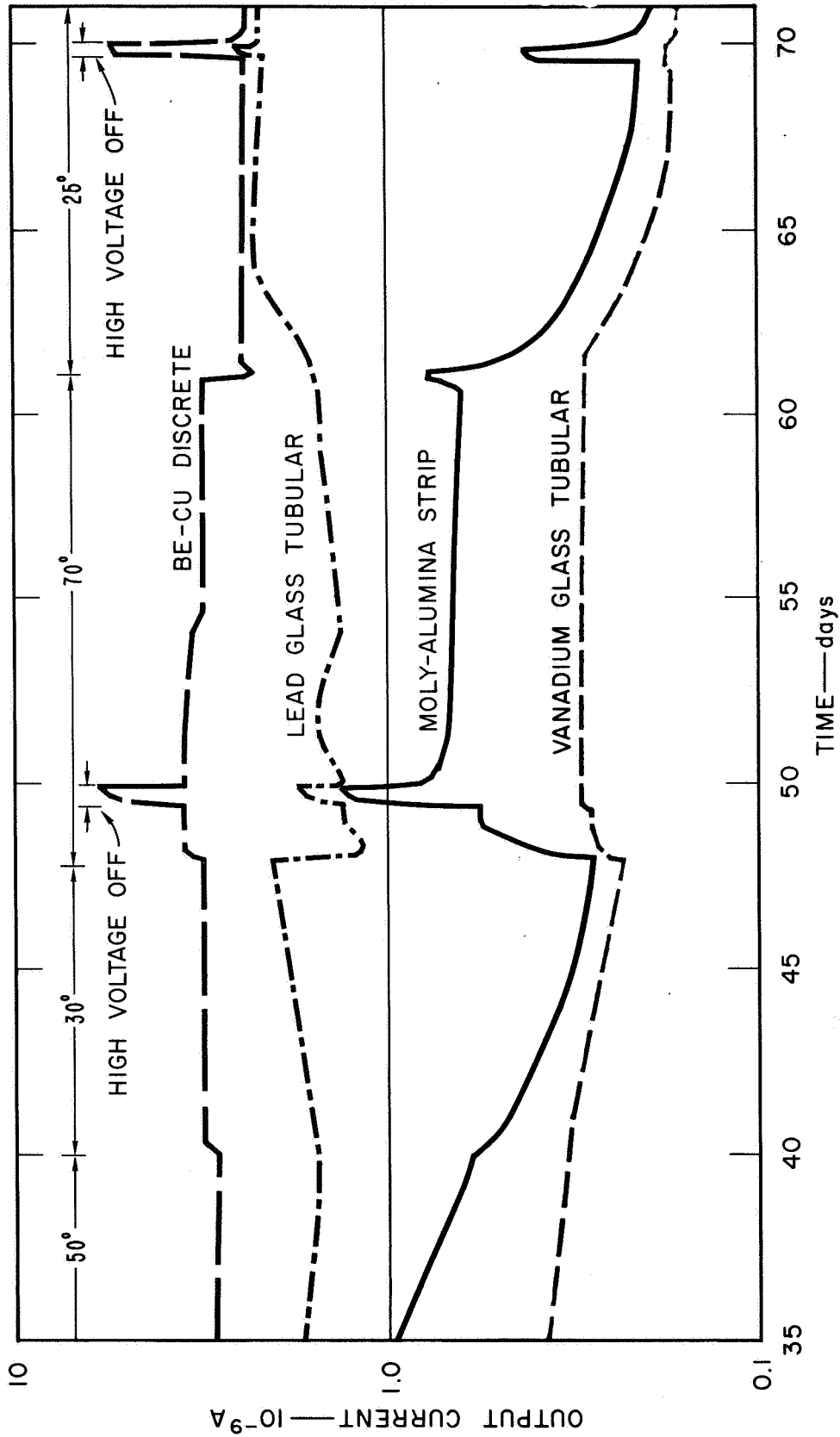

FIG. 6 MULTIPLIER OUTPUT vs. TIME & ENVIRONMENT



TC-6281-7

FIG. 7(a) GAIN — TEMPERATURE EFFECTS



TC-6281-8

FIG. 7(b) GAIN — TEMPERATURE EFFECTS

A final controlled-temperature variation near the end of the eight-month run showed no significant change in thermal effects from those noted at the start of the run.

### 3. Interrupted Operation (Recovery) Effects

At 1185 hours and again at 1668 hours, the high voltage to all units was turned off overnight (about 15 hours). Figure 7b roughly illustrates these periods. The "recovery" rate was not monitored, but the plot does show the magnitudes and gain fall-off rates for the various multipliers after reapplication of the operating voltage. The earlier run was at 70° C, the later one at 25° C. In both cases, the Be Cu discrete and lead-oxide tubular devices had dropped to their former operating level within one hour after turn-on; the moly-alumina strip unit decayed rapidly initially, but at a decreasing rate. In the 70° C run, that unit was still above the turn-off output current value 10 days later; for the 25° C run it took about 20 hours to resume its former value and decay rate. The latter run is illustrated in Fig. 8.

An earlier recovery test after only 150 hours of operation showed a recovery effect only in the Be Cu discrete-dynode multiplier. This appears reasonable, since at that time the moly-alumina strip and lead-oxide tubular units had not suffered any loss in output; the vanadium-glass unit never exhibited any significant recovery effect because of interrupted operation.

Figure 9 illustrates a typical cycle of the short-term recovery effects for the moly-alumina and Be Cu units at 25° C and 70° C. The multiplier voltages were cycled off, then on, during successive 20-minute periods. The high voltage was changed during successive "on" periods to provide output currents both above and below the established pretest levels, and the change in output current was monitored with time. The units were switched on briefly (20 -30 seconds) every 5 minutes during the "off" cycle to determine the potential operating level. The rate and magnitude of recovery of the Be Cu unit was substantially higher than for the moly-alumina device. For both units, the short-term rate of fall-off in gain (output current) following resumption of operation was significantly affected by the output current level. In fact, at a

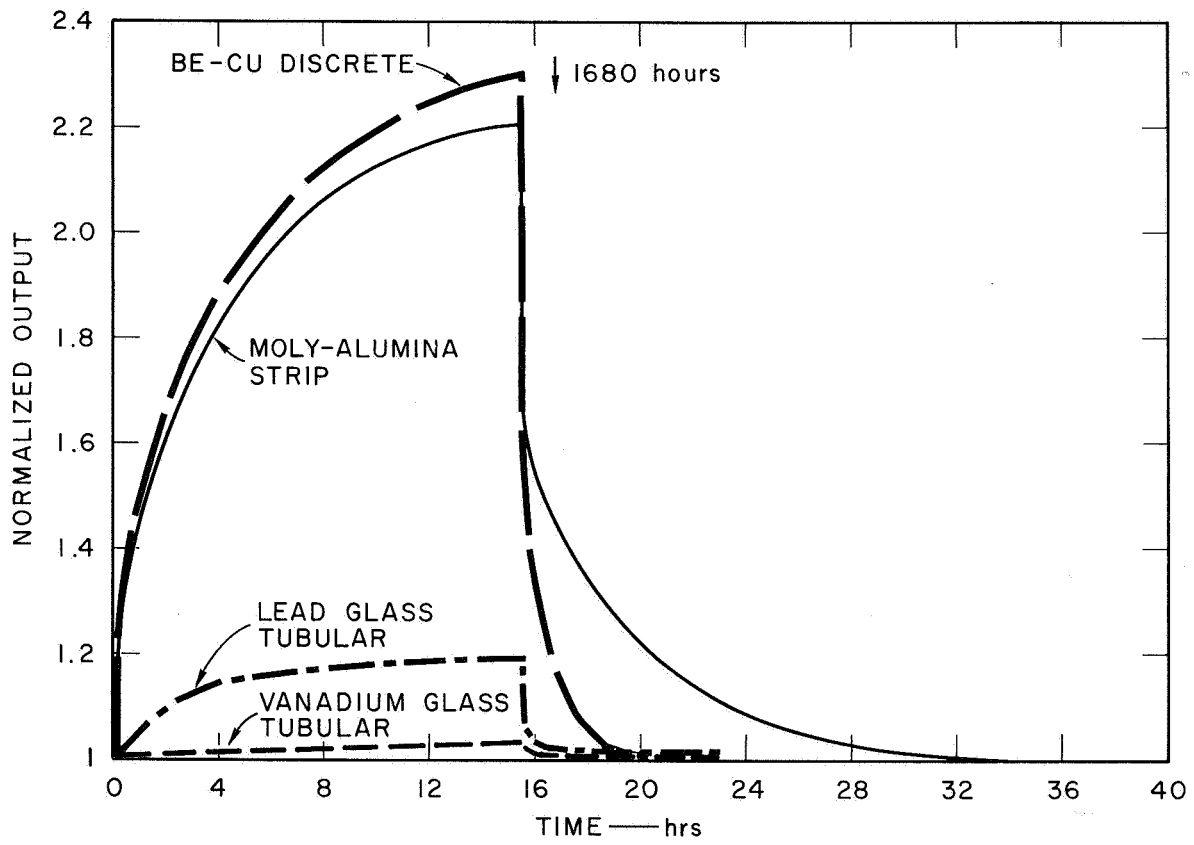

TB-6281-9

FIG. 8 INTERRUPTED OPERATION RECOVERY AND DECLINE

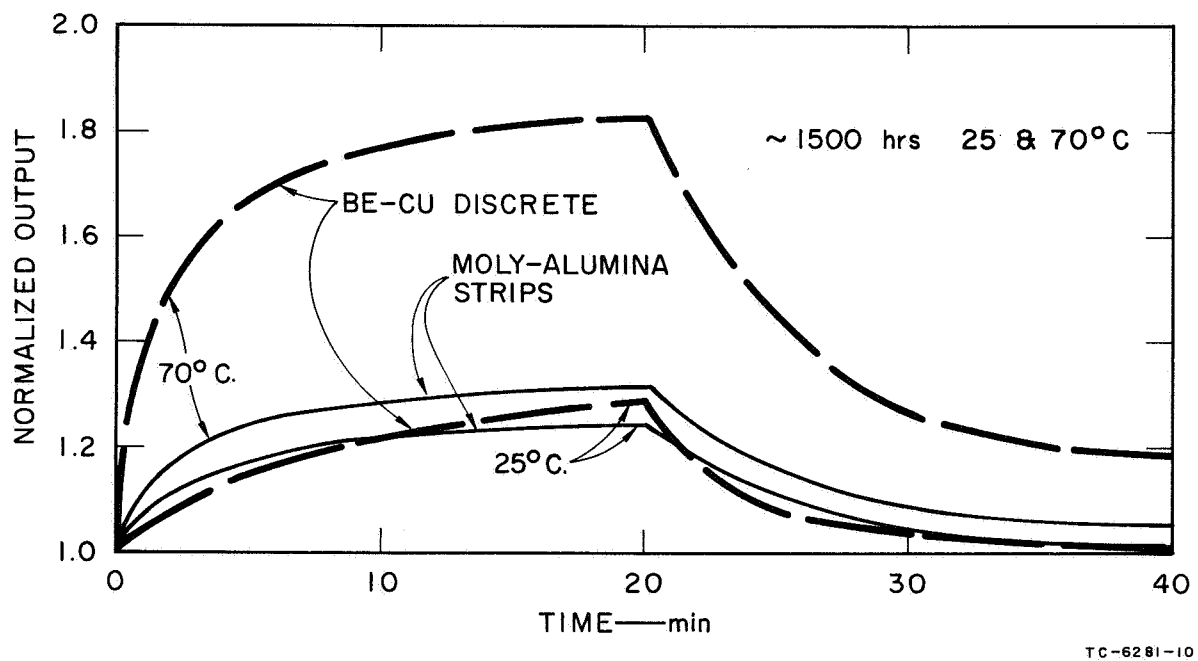

FIG. 9 INTERRUPTED OPERATION RECOVERY AND DECLINE

relatively low output current level, the moly-alumina multiplier showed an increasing output current during the "on" period. Thus, at least the short-term fatigue effect is clearly a function of the current level.

The short dashed lines of Fig. 10 show the modest increase in magnitude of the short-term interrupted-operation recovery effect after about  $7\frac{1}{2}$  months of operation. The magnitude of recovery does exhibit some direct relationship to the amount of long-term fatigue experienced.

#### 4. Environmental Pressure-Constituent Effects

At intervals during the extended multiplier operation, partial pressures of various gases (nitrogen, argon, oxygen,  $\text{CO}_2$ , hydrogen, and air) were introduced into the UHV system at pressures ranging from the pump base pressure of about  $1 \times 10^{-9}$  torr to as high as  $3 \times 10^{-4}$  torr. (The pressures recorded represent the actual vac-ion pressure gauge reading (ion current) without any attempt to correct the reading for the particular gaseous constituent involved).

Both short-term and long-term effects were noted. Brief exposures (seconds to a few minutes) to partial pressures up to  $3 \times 10^{-4}$  torr pressure readings resulted in essentially instantaneous and reversible increases in output current of about an order of magnitude. There was no noticeable effect below about  $1 \times 10^{-7}$  torr, and saturation appeared to be setting in at about  $2 \times 10^{-4}$  torr. Figure 11 illustrates the short-term reversible gain changes. For most of the introduced gases, the gain change of all the multipliers except that of the moly-alumina strip device fell within the narrow shaded band. The exceptions are noted on the figure. The output of the moly-alumina strip showed an initial peak in the low  $10^{-6}$  torr pressure range, then a decrease, followed by a fairly rapid increase in the  $10^{-4}$  torr region.

The introduced gases, in addition to being cycled rapidly through the pressure ranges reported above, also were sustained at pressures in the  $10^{-7}$  to  $10^{-6}$  torr range for varying periods of hours to study longer-term effects. Figure 12 illustrates the effect of the introduction of  $\text{N}_2$  to the UHV system. Before the valve was opened, the system base pressure was  $3.8 \times 10^{-8}$  torr. Nitrogen was introduced at such a rate

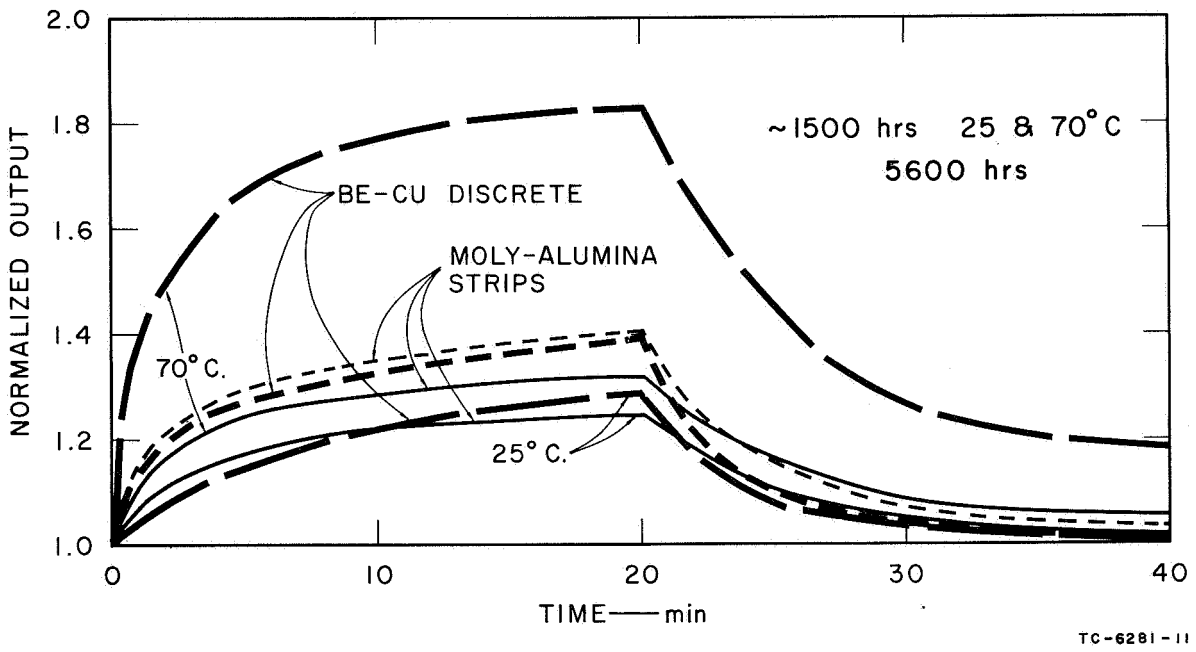
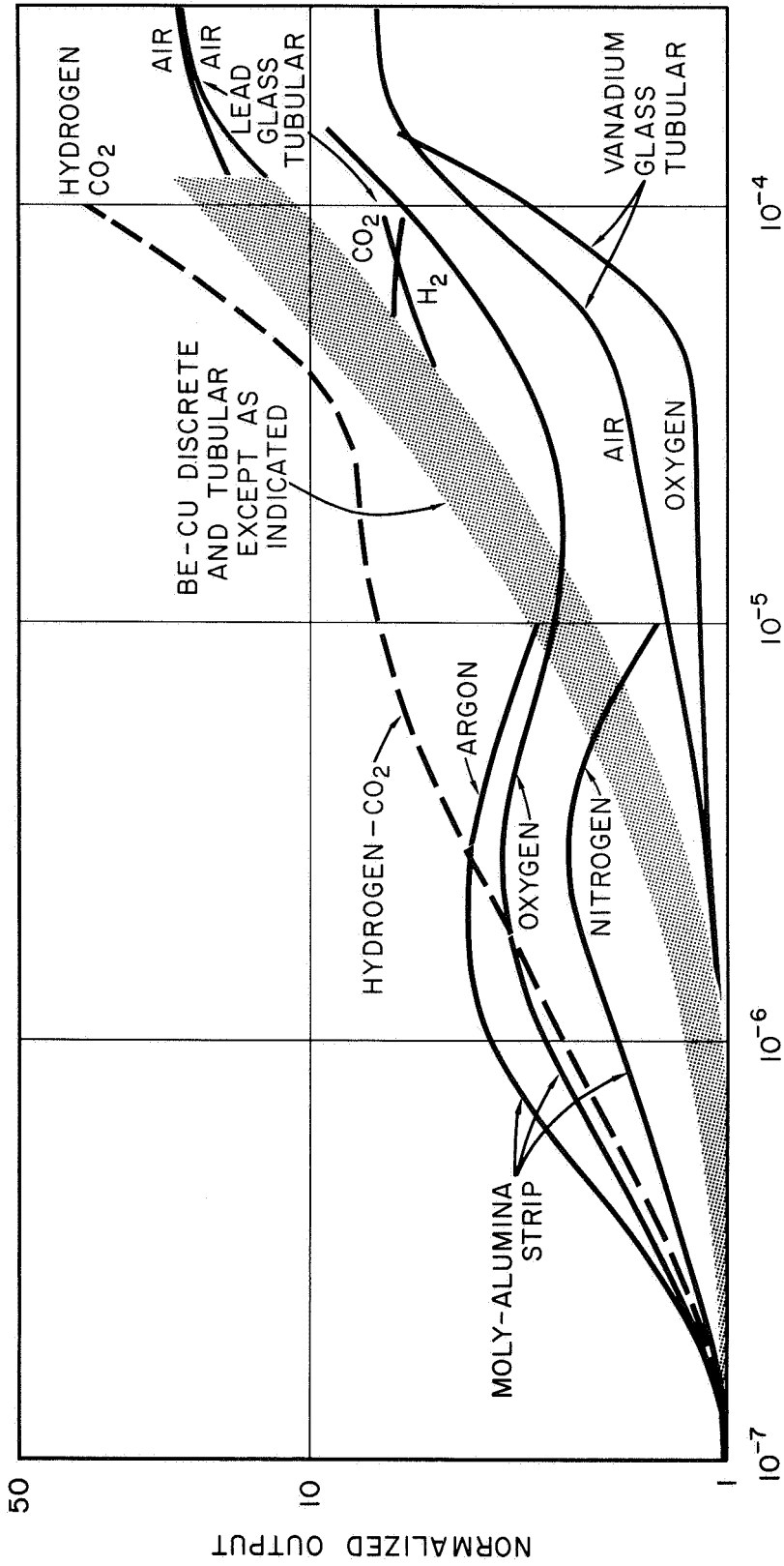

FIG. 10 INTERRUPTED OPERATION RECOVERY AND DECLINE





TD-6281-12

FIG. 11 SHORT-TIME GAIN-PRESSURE RELATIONSHIPS

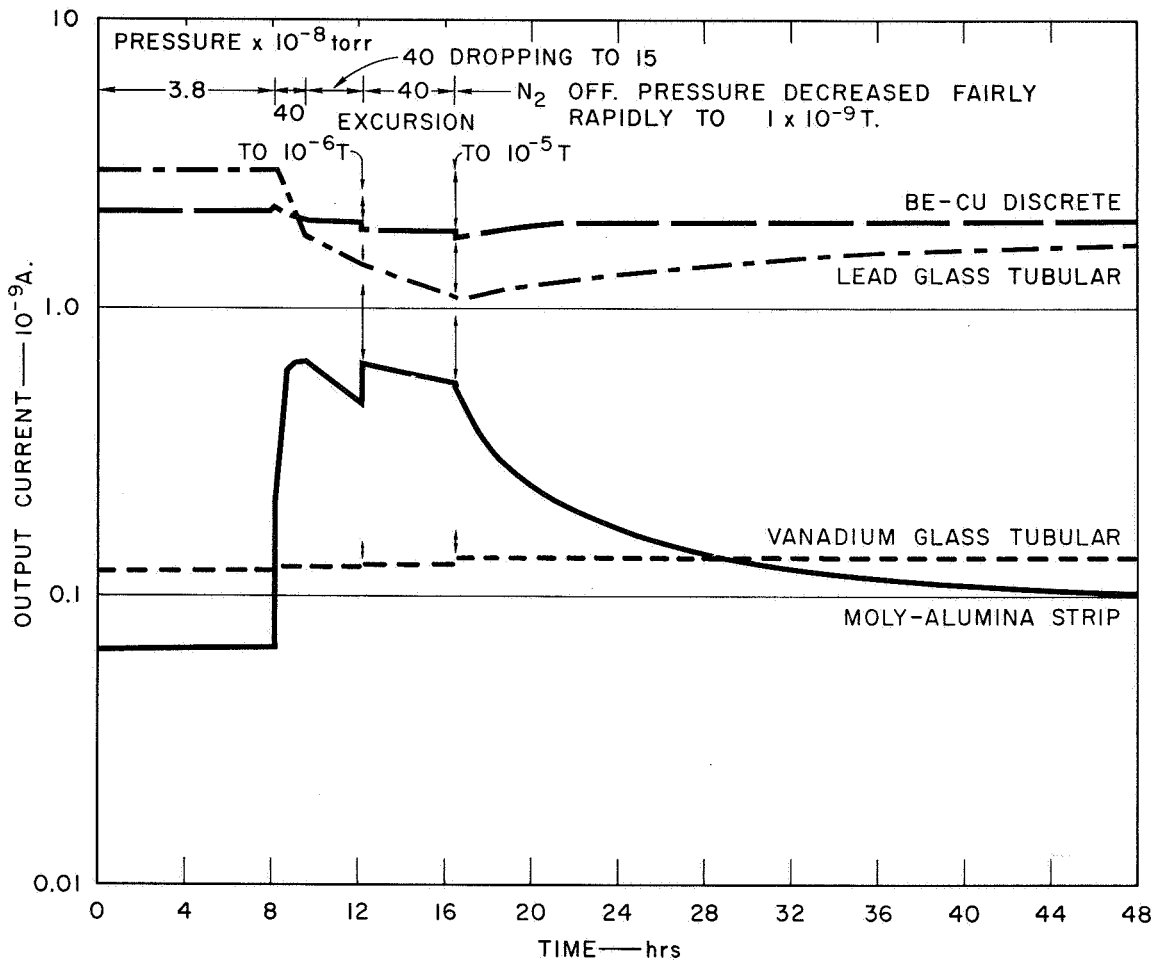

TC-6281-13

FIG. 12 EFFECT OF NITROGEN PARTIAL PRESSURE

that the vac-ion meter indicated  $4 \times 10^{-7}$  torr pressure. There was an immediate rise in the output of all four multipliers--substantial for the moly-alumina unit and small for the others. As operation continued at this pressure, the output of the moly-alumina device continued to rise rapidly, that of the lead-oxide unit dropped off substantially, and that of the Be Cu discrete-dynode unit dropped moderately, while the vanadium-glass device showed little change. Overnight, the vacuum-system pressure dropped from 4.0 to  $1.5 \times 10^{-7}$  torr. When it was restored to the  $4.0 \times 10^{-7}$  torr level, all devices again indicated a slight-to-moderate rise in output.

The vacuum-system pressure was next raised in steps to  $1 \times 10^{-6}$  torr and then restored to  $4 \times 10^{-7}$  torr, resulting in the rapid rise and fall of output as illustrated. Further operation at  $4 \times 10^{-7}$  torr resulted in stable output from the vanadium-glass and Be Cu discrete units, and decreasing output from the moly-alumina and lead-glass units.

The following day the devices were again pressure-cycled in steps, this time to  $1 \times 10^{-5}$  torr. All devices showed increasing output with pressure, except that the output of the moly-alumina strip unit peaked at about  $2 \times 10^{-6}$  torr and then fell off with further increase in pressure.

Subsequently, the inlet valve was closed, and the vacuum system pumped to a lower base pressure of about  $1 \times 10^{-9}$  torr. The output of the vanadium-glass multiplier continued unchanged; the other multiplier outputs changed toward their operational levels before nitrogen introduction, although at a much slower rate than for the initial change. A week later, none of the units had yet reached their pretest levels.

Two additional exposures to nitrogen partial pressure were conducted to determine the validity of the earlier  $N_2$  run and to ascertain whether the release of gases previously entrapped by the vac-ion pump had contributed significantly to the observed results. The latter possibility was of particular concern since the pump had been running steadily for about 2500 hours without cycling, and the base pressure reading had dropped by a factor greater than 30 (to about  $1 \times 10^{-9}$  torr) subsequent

to the initial N<sub>2</sub> introduction. The two additional nitrogen exposures produced results substantially similar to the initial run, indicating that evolved gas from the pump walls was probably not a significant factor.

Following the introduction of nitrogen, the inlet manifold was purged by pumping and heating, and the manifold system was flushed with argon several times. (This purging and flushing was done for each gas prior to its release into the UHV system). Then argon was introduced into the UHV system at various pressures in the 10<sup>-9</sup> to 10<sup>-4</sup> torr range.

The fast response to pressure change was illustrated in Fig. 11. With extended exposure to argon over a period of several hours in the 10<sup>-7</sup> torr range, there was very little change in output current from the Be Cu and vanadium-glass multipliers, and a modest increase in the moly-alumina device with almost instantaneous drop to the pre-argon level when the input was cut off. The output of the lead-glass multiplier dropped about a factor of 2 during the argon exposure and slowly regained its former level after several days of normal environment operation.

Following the argon test, oxygen was introduced into the system. As in the prior exposures of the multipliers to nitrogen and argon, there were both rapid and long-term effects, and the moly-alumina and lead-glass units exhibited greater long-term changes than the Be Cu and vanadium-glass units.

Figure 13 illustrates the long-term effect of oxygen on the various multipliers, the output of the moly-alumina device increasing and the output of the lead-glass unit decreasing with exposure. When the oxygen input was cut off, the output of the moly-alumina multiplier started dropping toward its earlier level, and the output of the lead-glass unit rose very slowly toward its pre-oxygen level.

Following the long-term oxygen exposure, the UHV system was operated for over 24 hours with an oxygen partial pressure of  $5 \pm 2 \times 10^{-8}$  torr, a pressure below the short-term threshold level. No change in output attributable to this exposure was noted.

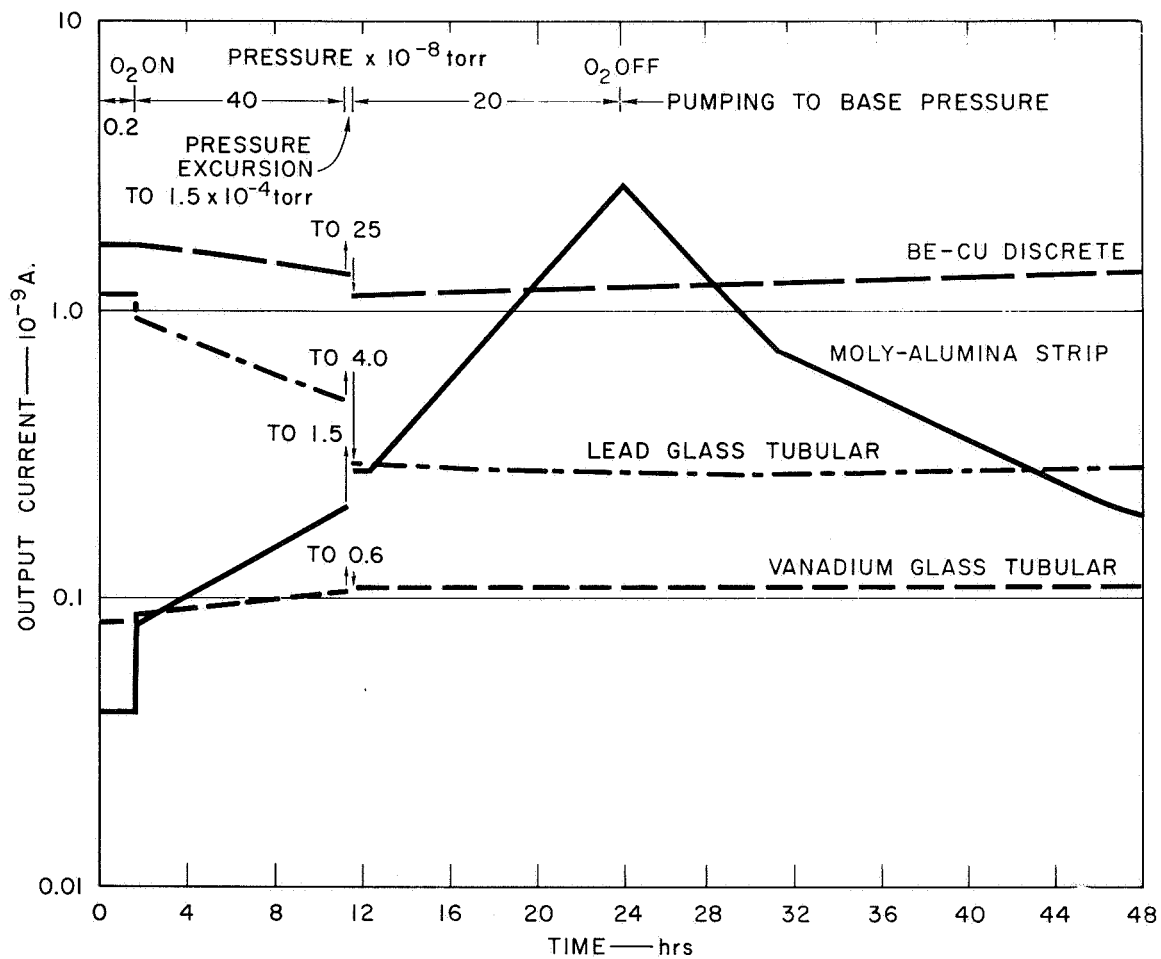

TC-6281-14

FIG. 13 EFFECT OF OXYGEN PARTIAL PRESSURE

Next, an attempt to determine the effect of nonoperational exposure to oxygen was initiated. First, the high voltage was turned off overnight and turned on the following morning. The output followed the expected recovery decay curve. The multipliers were operated throughout the day, and the high voltage was turned off again overnight. Oxygen was introduced at an initial pressure of  $4 \times 10^{-7}$  torr, above the previously established threshold level. The next morning, the oxygen supply was cut off, and after the pump had brought the UHV system pressure to  $2 \times 10^{-8}$  torr, the high voltage was reapplied. There was a moderate increase in the output of the moly-alumina multiplier and a decrease in the output of the lead-glass unit over that of the previous day, indicating that at least part of the effect causing gain change is independent of the presence of the cascade secondary electrons.

Exposure of the four multipliers to  $\text{CO}_2$  and hydrogen produced results very similar to those experienced earlier with nitrogen, argon, and oxygen. The multiplier output rises when the pressure is raised above about  $1 \times 10^{-7}$  torr, rising at an increasing rate up through  $10^{-4}$  torr. When the gas influx was sustained for 24 hours at pressures above the threshold level, the outputs of the Be Cu and lead-glass devices dropped initially, then tended to level off. The vanadium-glass multiplier output rose slightly. The current of the moly-alumina device rose and, for hydrogen, continued to rise slightly. For the  $\text{CO}_2$  exposure, the output of the device peaked after a few hours and then declined slightly. The maximum change was a factor of about 2 for the moly-alumina multiplier with hydrogen.

Prior to termination of the operational run, air was slowly introduced into the system through a liquid-nitrogen cold trap. The short- and long-term change in output current versus air partial pressure was measured, as had been done earlier with other gases. The results, not surprisingly, were similar to those obtained for nitrogen and oxygen. When the air partial pressure was extended beyond  $1 \times 10^{-4}$  torr, the rate of increase dropped off rapidly, approaching saturation at about  $2 \times 10^{-4}$  torr.

## 5. Post-run Analysis

a. Resistance. The resistance of all the distributed-dynode multipliers decreased during the extended operation; the moly-alumina device to about 50 percent, the lead-glass multiplier to 87 percent, and the vanadium-glass unit to 95 percent of their respective original values. The Be Cu discrete-dynode multiplier used separate glass-enclosed resistors, which did not change appreciably during the run.

There was no detectable variation of resistance gradient along the moly alumina resistive surface from input to output, although the base resistance of the strips was so high that the validity of this measurement is doubtful. This was the only device where the dynode surface was available for analysis without destruction of the multiplier.

b. Gain/Voltage Relationships. The slopes of the gain/voltage curves of the four multipliers following 6000 hours of operation were the same as the pre-operation slopes. Because of gain degradation, a higher voltage was required with the fixed input current, to provide a given value of output current. The ratios of final-to-initial voltage for  $1 \times 10^{-9}$  A output for the multipliers were:

- |                               |        |
|-------------------------------|--------|
| (1) Be Cu discrete            | 1:1.16 |
| (2) Lead and vanadium tubular | 1:1.22 |
| (3) Moly-alumina              | 1:1.37 |

c. Optical Analysis. After the operational period, the system was raised to atmospheric pressure, and the multipliers were removed for examination. The only visible change was a 1/64-inch by 1/4-inch dark streak, aligned with the exit aperture, on the moly-alumina multiplier collector. There were no comparable markings on the other collectors.

The surfaces of the moly-alumina strip dynode were examined under 600 $\times$  optical magnification. No noticeable variation between input and output surfaces was visible.

d. Physical/Chemical Analysis. The molybdenum collector electrodes of the continuous-dynode multipliers were subjected to analysis to see what films might have formed on the surfaces facing the exit apertures of the multipliers. Particular attention was directed to the dark streak opposite the moly-alumina unit.

These molybdenum electrodes were first evaluated nondestructively using X-ray diffraction and fluorescence. Lines were noted suggesting the presence of oxides of molybdenum, but not of other heavy elements.

The surfaces were next exposed to chemical solutions seeking to dissolve the surface layer. NaOH did completely dissolve the streak on the surface of the moly-alumina collector, and microscopic examination did not detect any particulate matter. Thus it was concluded that no significant amount of carbon was present.

Colorometric verification of the presence of oxides of molybdenum was carried out by the thiocyanate test. The resultant intense red was not decolorized by a reducing agent, indicating the presence of molybdenum.



### III CONCLUSIONS

#### A. Long-Term Changes

It is widely accepted that electron bombardment of surfaces causes the desorption of gas molecules--particularly oxygen--with the resultant chemical reduction of the surface. This effect appears to be a major cause of gain reduction in the multipliers. The "clean-up" apparently changes the effective work function of the surface and the yield of secondary electrons. The rate of chemical change should be related to the electron flux, to the proportion of oxides at or near the surface, and inversely to the supply of residual-oxygen molecules in the vacuum environment.

This would account for the sensitivity of gain degradation to the multiplier's output current density. The gradual depletion of oxides at or near the surface would cause the decrease in rate of gain loss with operating time. The substantial reduction in residual (replenishment) oxygen in an ultra-high vacuum system is consistent with the observed results of more rapid gain decay in UHV systems as compared to systems operating in the  $10^{-5}$  to  $10^{-7}$  torr range (although in poorly trapped oil-pumped systems there is a build-up of polymerized organics on the surface, which apparently is also detrimental to secondary emission). It also helps to partially explain the recovery of gain when the desorption-causing electron beam is reduced in intensity or cut off, changing the adsorption/desorption equilibrium point. This likewise is consistent with the experience of partial gain recovery when a system containing a multiplier is partially or fully exposed to atmosphere. The resistance change (decrease) in the three distributed-dynode multipliers is in the direction one would expect for a chemical reduction of the resistive material.

#### B. Short-Term Changes

The operational model, which seems to be reasonable supported by the experimental results and by some of the references and other listed

articles, is that of the resistive-dynode surface in physical and chemical equilibrium with its environment. The electrons propagating along and impacting the surface cause gas molecules at or near the surface to be desorbed at a rate proportional to the electron flux. The surface temperature and residual-gas pressure would affect the number of gas molecules adsorbed at or near the surface. Since the bulk of the impacting electrons are of relatively low energy (on the order of 100 eV) and arriving at very shallow angles, they will not penetrate very deeply; hence the production of secondaries will be highly dependant on the surface layer of material and on any gas molecules adhering to the surface.

#### IV RECOMMENDATIONS

1. The substantial effect on gain following introduction of modest partial pressures of oxygen and hydrogen gas to the multiplier's operating environment should receive further study. If a controllable and beneficial effect on gain can be demonstrated, it should be possible to provide for continuous or periodic introduction of gas to counteract the operational gain fatigue.

2. The complex surface chemistry, which is apparently involved in the operational gain change of distributed-dynode multipliers, should receive additional study.

A recently refined approach to the study of surface materials involves the use of a low-energy electron beam and analysis of the energy spectra of the resulting Auger electrons<sup>6,7</sup>. Detection and identification of a 1 percent monolayer of surface material is reported. Such a technique should permit quantitative evaluation of the complex surface microchemistry taking place on the resistive dynode surfaces. Since this technique utilizes a low-energy electron beam similar to the cascade electrons involved in multiplier operation, it should be possible to measure the secondary-emission ratio simultaneously with, or interspersed between measurements of the surface chemical composition, while closely simulating the operational situation of the continuous-dynode multiplier. Concurrent use of a closely coupled residual-gas analyzer sampling the gaseous environment near the multiplier resistive-dynode surface could provide additional helpful quantitative information.

#### REFERENCES

1. D. R. Cone, "Analytical and Developmental Investigation of Electron Strip Multipliers," Phase 1 Final Report, NASA Contract No. NAS5-9262, (November 1966).
2. Dr. D. L. Lind, NASA, GSFC (private communication).
3. C. A. Spindt and K. R. Shoulders, "A Bakeable Distributed-Dynode Electron Multiplier," Rev. Sci. Inst. Vol. 36, No. 6 (June 1965).
4. G. W. Goodrich and W. C. Wiley, "Continuous Channel Electron Multiplier," Rev. Sci. Inst., Vol. 33, p. 761 (1962).
5. J. Adams and B. W. Manley, "The Channel Electron Multiplier," Elec. Eng., (March 1965).
6. R. E. Weber, "Application of LEED Apparatus to the Detection and Identification of Surface Contaminants," a paper presented at the Conference on Photoelectric and Secondary Electron Emission, U. of Minn., August 29 - 30, 1967.
7. R. E. Weber and W. T. Peria, "Use of LEED Apparatus for the Detection and Identification of Surface Contaminants," J. Appl. Phys., Vol. 38, No. 11 (October 1967).

#### SUPPLEMENTARY BIBLIOGRAPHY

1. J. Adams and B. W. Manley, "Mechanism of Channel Electron Multiplication," IEEE Trans. Nuclear Sci., Vol. NS-13, No. 3, pp. 88-99 (June 1966).
2. D. A. Bryant and A. D. Johnstone, "Gain of a Channel Multiplier," Rev. Sci. Inst., Vol. 36, p. 1662 (1956).
3. R. F. Goff and C. F. Hendee, "Studies of the Secondary Electron Emission Yield, Energy and Angular Distribution from High Resistance Targets at Grazing Angles of Incidence," Bendix Research Laboratories, paper presented at 27th Annual Conf. on Phys. Electronics, M.I.T. (March 1967).
4. K. C. Schmidt and C. F. Hendee, "Continuous Channel Electron Multiplier Operated in the Pulse Saturated Mode", IEEE Trans. on Nuclear Sci., (June 1966).
5. D. S. Evans, "Low Energy Charged-Particle Detection Using the Continuous-Channel Electron Multiplier," Rev. Sci. Inst., Vol. 36, No. 3 (March 1965).
6. "Channel Electron Multipliers", Mullard Research Laboratories, Vacuum Physics Division.
7. G. A. Chuiko and A. M. Yakobson "The Fundamental Characteristics of High Lead Content Glass as a Material for a Continuous Dynode Secondary Electron Multiplier," Radio Electronics (April 1965).
8. G. E. Salser, "Rejuvenation of Electron Multipliers Used in Mass Spectrometers," Rev. Sci. Inst., Vol. 37, No. 5 (May 1966).
9. E. H. Eberhardt, "Noise in Photomultiplier Tubes," IEEE Trans. Nuclear Sci., Vol. NS-14, (April 1967).
10. G. M. de Munari, G. Mambriani, and F. Guisiano, "Secondary Emission of AgMgOCs Dynodes and its Dependence on the Temperature," Rev. Sci. Inst., Vol. 38, No. 4 (April 1967).
11. F. Hoffert, J. Paulus, and J. P. Adloff, "Influence de la Nature et de l'Énergie D'un Multiplicateur d'Électrons utilisé en Spectrométrie de Masse", Revue de Physique Appliquée, Vol.1, (March 1966).
12. L. Lesensky, D. K. Das, and C. R. McGeoch, "Long Life Cold Cathode Studies for Crossed-Field Tubes," Progress Report 1, U.S. Army Electronics Command, Ft. Monmouth, N. J. Contract DA 28-043 AMC-01698(E) (April 1966).

13. L. Lesensky, "Long Life Cold Cathode Studies for Crossed-Field Tubes," Raytheon Prog. Report 2, U.S. Army Electronics Command, Ft. Monmouth, N.J., Contract DA 28-043 AMC-01698(E) (August 1966).
14. L. Lesensky and C. R. McGeoch, "Long Life Cold Cathode Studies for Crossed-Field Tubes," Raytheon Prog. Report 3, U.S. Army Electronics Command, Ft. Monmouth, N.J. Contract DA 28-043 AMC -01698(E) (October 1966).
15. L. Lesensky and C. R. McGeoch, "Long Life Cold Cathode Studies for Crossed-Field Tubes," Raytheon Prog. Report 4, U.S. Army Electronics Command, Ft. Monmouth, N.J., Contract Da 28-043 AMC-01698(E) (February 1967).
16. P. W. Palmberg, "Secondary Emission Studies on Ge and Na-Covered Ge", J. Appl. Phys., Vol. 38, No. 5 (April 1967).
17. D. R. Sandstrom, J. H. Leck and E. E. Donaldson, "Electron-Bombardment Desorption of Carbon Monoxide Adsorbed on Tungsten," J. of Appl. Phys. Vol. 38, No. 7 (June 1967).
18. G. E. Moore, "Dissociation of Adsorbed CO by Slow Electrons," J. Appl Phys., Vol. 32, No. 7 (July 1961).
19. P. A. Redhead, "Interaction of Slow Electrons with Chemisorbed Oxygen," Canadian J. of Phys. Vol. 42, p. 886 (1964).
20. P. Wargo and W. G. Shepherd, "Electron-Bombardment-Induced Dissociation of Alkaline Earth Oxides," Phys. Rev., Vol. 106, No. 4 (May 1957).
21. K. W. Böer, "Adsorption and Desorption of Oxygen in the Ultrahigh Vacuum Range and its Influence on Electrical Properties of CdS," Tech. Report 7, U.S. Army Res. Office, Durham North Carolina, Contract DA-31-124 ARO(D)-173.
22. W. H. Wright, "Aging and Rejuvenation of Electron Multipliers", Rev. Sci. Inst. Vol. 38, No. 12 (December 1967)

UNCLASSIFIED

Security Classification

## DOCUMENT CONTROL DATA - R &amp; D

*(Security classification of title, body of abstract and indexing annotation must be entered when the overall report is classified)*

|   |  |   |                      |
|---|--|---|----------------------|
| 1. ORIGINATING ACTIVITY (Corporate author)<br>Stanford Research Institute<br>333 Ravenswood Avenue<br>Menlo Park, California 94025  |  | 2a. REPORT SECURITY CLASSIFICATION<br>UNCLASSIFIED  |                      |
|   |  | 2b. GROUP<br>N/A  |                      |
| 3. REPORT TITLE<br>ANALYTICAL AND DEVELOPMENTAL INVESTIGATION OF ELECTRON STRIP MULTIPLIERS   |  |   |                      |
| 4. DESCRIPTIVE NOTES (Type of report and inclusive dates)<br>Final Report—Phase III   |  |   |                      |
| 5. AUTHOR(S) (First name, middle initial, last name)<br>Donald R. Cone  |  |   |                      |
| 6. REPORT DATE<br>December 1967   |  | 7a. TOTAL NO. OF PAGES<br>39  | 7b. NO. OF REFS<br>7 |
| 8a. CONTRACT OR GRANT NO.<br>NAS5-9396  |  | 9a. ORIGINATOR'S REPORT NUMBER(S)<br>SRI Project 6281<br>Final Report—Phase III   |                      |
| b. PROJECT NO.  |  | 9b. OTHER REPORT NO(S) (Any other numbers that may be assigned this report)   |                      |
| c.  |  |   |                      |
| d.  |  |   |                      |
| 10. DISTRIBUTION STATEMENT  |  |   |                      |
| 11. SUPPLEMENTARY NOTES   |  | 12. SPONSORING MILITARY ACTIVITY<br>National Aeronautics and Space Administration<br>Goddard Space Flight Center<br>Greenbelt, Maryland |                      |
| 13. ABSTRACT<br><p>The object of this study was to provide a better understanding of the operational gain fatigue mechanism in continuous dynode electron multipliers.</p> <p>The effort encompassed the study of gain changes in electron multipliers as a function of their operational parameters and their environment, especially temperature, pressure, and residual-gas constituents. The basic environment was a room-temperature, vac-ion-pumped, ultra-high-vacuum (UHV) station operated at pressures below <math>10^{-6}</math> torr. Temperature excursions were from about <math>0^{\circ}\text{C}</math> to <math>70^{\circ}\text{C}</math>. The pressure was varied from <math>10^{-9}</math> torr to about <math>10^{-4}</math> torr. In addition to the normal vac-ion residual-gas environment, partial pressures of nitrogen, oxygen, argon, carbon dioxide, hydrogen, and air were introduced for varying time periods. Commercial and experimental continuous-dynode multipliers and a discrete-dynode multiplier, all with radioactive <math>\beta</math> source inputs, were operated simultaneously in close proximity to each other within the common vacuum environment, with comparable initial output currents.</p> <p>The gain change was measured and evaluated as a function of operating time and other parameters over a period of eight months of essentially continuous operation. Postoperational electrical, optical, physical, and chemical analyses of the multipliers and collector electrodes were conducted.</p> <p>There was a rapid, and at least partially reversible gain change related to the cascade electron flux in the multiplier, the resistive dynode surface temperature, and the constituency and pressure of the gaseous environment in the vicinity of the multiplier surface, apparently related to the corresponding changes in the (primarily) physical equilibrium state of the dynode surface. Both increases and decreases in gain exceeding an order of magnitude were observed in some cases.</p> <p>There appears to be a long term change in the surface composition of the dynode resistive surface due to electron induced desorption of oxygen (and other gases), causing a chemical reduction of the surface that reduces the film resistance and the secondary-emission ratio of the surface. The rate of gain loss decreases with operating time, presumably because of the decreased population of releasable gases. Exposure of the surface to increased pressure of oxygen (and some other gases) apparently partially replenishes the depleted region, resulting in partial gain recovery.</p> |  |   |                      |

DD FORM 1473 (PAGE 1)

1 NOV 65

S/N 0101-807-6801

UNCLASSIFIED

Security Classification

14

KEY WORDS

Multiplier  
 Electron Multiplier  
 Strip Multiplier  
 Distributed Dynode Multiplier  
 Multiplier Gain Fatigue  
 Multiplier Environmental Effects  
 Multiplier Fatigue Mechanisms

| LINK A |    | LINK B |    | LINK C |    |
|--------|----|--------|----|--------|----|
| ROLE   | WT | ROLE   | WT | ROLE   | WT |
|        |    |        |    |        |    |