

NATIONAL AERONAUTICS AND SPACE ADMINISTRATION

Technical Report 32-1168

*Periodic Orbits in the Restricted Three-Body Problem
With Earth-Moon Masses*

R. A. Broucke

Approved by:



W. G. Melbourne, Manager
Systems Analysis Research Section

JET PROPULSION LABORATORY
CALIFORNIA INSTITUTE OF TECHNOLOGY
PASADENA, CALIFORNIA

February 15, 1968

TECHNICAL REPORT 32-1168

**Copyright © 1968
Jet Propulsion Laboratory
California Institute of Technology
Prepared Under Contract No. NAS 7-100
National Aeronautics & Space Administration**

Acknowledgments

Special thanks are due Dr. A. Deprit for his guidance in the elaboration of the author's doctoral dissertation at the University of Louvain, Belgium, in February 1963 on the subject of periodic orbits in the earth-moon system. Professor Deprit was chairman of the author's dissertation committee, and it can truly be said that without his continuous and enthusiastic support this work would probably never have been terminated successfully. Several fruitful conversations with Professor Deprit since 1963 on the subject of periodic orbits are also gratefully acknowledged.

The author also wishes to thank Univac Brussels for allowing generous access to the USSC 90 computer for many orbit computations in 1961 and 1962 during the early part of this work.

PRECEDING PAGE BLANK NOT FILMED.

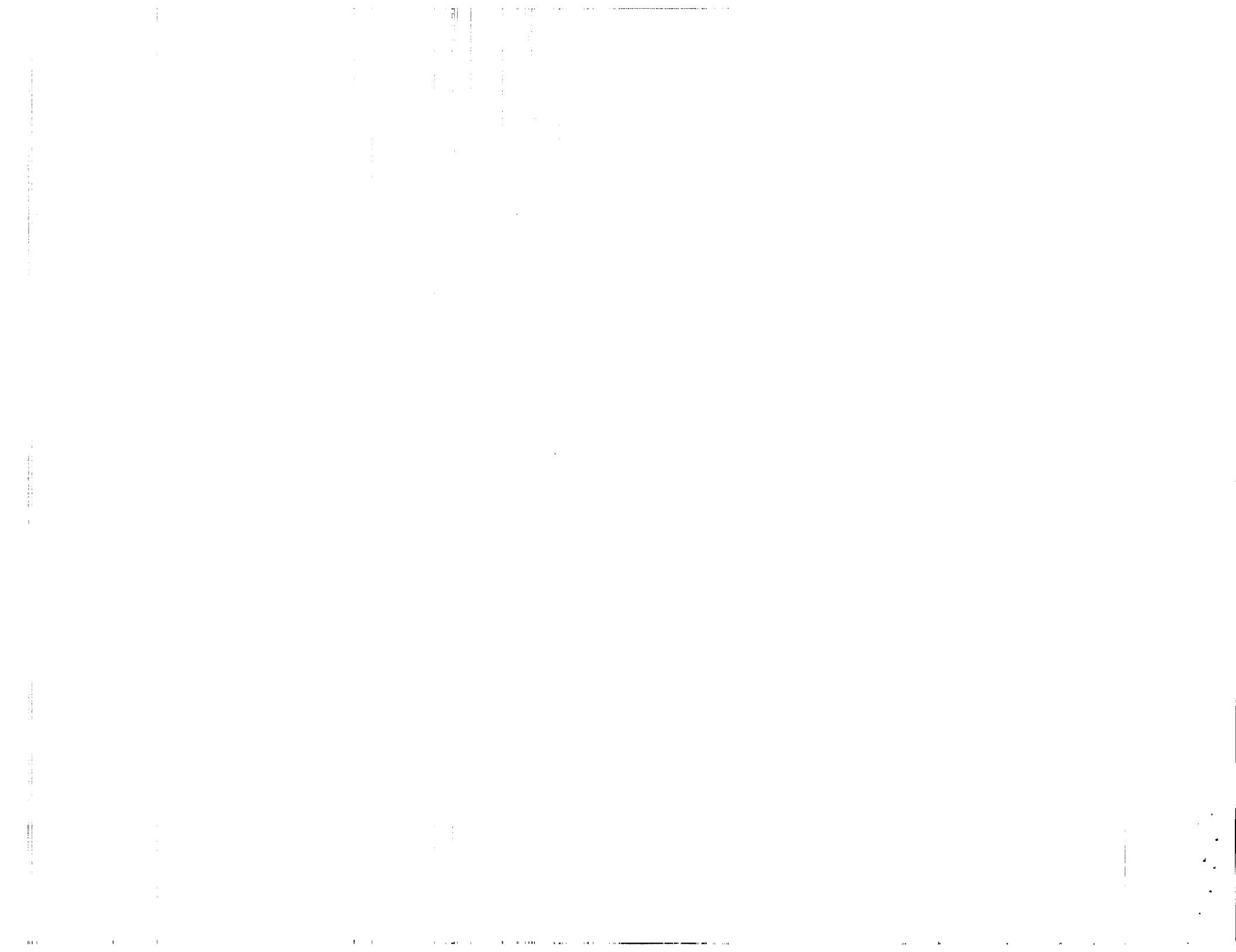

Contents

I. Introduction	1
II. Equations of Motion	3
A. Definition of the Problem	3
B. Equations of Motion with Rectangular Coordinates	3
C. The Lagrangian and Hamiltonian Functions of the Restricted Three-Body Problem	4
D. Equations of Motion With Polar Coordinates	6
E. Equations of Motion With Biradial Coordinates	7
III. Equipotential Surface and Equilibrium Points	7
A. The Equipotential Surface	7
B. The Five Equilibrium Points	10
C. Variational Equations in the Neighborhood of the Equilibrium Points	12
D. Solutions in the Neighborhood of L_4 and L_5	12
E. Solutions in the Neighborhood of L_1 , L_2 , and L_3	14
IV. Periodic Orbits	15
A. Symmetric Periodic Orbits	15
B. The Search for Periodic Orbits	17
C. Discussion of Results	21
V. Classification of Families of Periodic Orbits	23
A. Family G of Periodic Orbits Around L_1	24
B. Family I of Periodic Orbits Around L_2	26
C. Family J_1 of Periodic Orbits Around L_3	27
D. Family A_1 of Retrograde Periodic Orbits Around m_1	40
E. Family BD of Direct Periodic Orbits Around m_1	41
F. Family E_1 of Direct Periodic Orbits Around m_1 and m_2	60
G. Family F of Retrograde Orbits Around m_1 and m_2	65
H. Family C of Retrograde Periodic Orbits Around m_2	65
I. Families H_1 and H_2 of Direct Orbits Around m_2	71
References	91

Contents (contd)

Tables

1. Initial conditions for family G of periodic orbits around L_1	28
2. Initial conditions for family I of periodic orbits around L_2	32
3. Initial conditions for family J_1 of periodic orbits around L_3	36
4. Initial conditions for family A_1 of retrograde periodic orbits around m_1	45
5. Initial conditions for family BD of direct periodic orbits around m_1	51
6. Initial conditions for family E_1 of direct periodic orbits around m_1 and m_2	62
7. Initial conditions for family F of retrograde periodic orbits around m_1 and m_2	66
8. Initial conditions for family C of retrograde periodic orbits around m_2	74
9. Initial conditions for family H_1 of direct periodic orbits around m_2	82
10. Initial conditions for family H_2 of direct periodic orbits around m_2	85

Figures

1. Equipotential lines	8
2. Equipotential lines through the equilibrium points	9
3. Syzygial potential line and partial $\partial E_0(x, 0)/\partial x$	10
4. Function $\alpha(y'_0)$ for $x_0 = -1.6$ and $x_0 = -1.5$	18
5. Diagram (x_0, y'_0) for some families of periodic orbits	19
6. Diagram (x_0, y'_0) for some families of periodic orbits	20
7. Branchings between families A_1, G, J_1, BD	22
8. Typical trajectories in family G of periodic orbits around L_1	25
9. Energy diagram of family G	26
10. Stability evolution of family G	26
11. Typical trajectories in family I of periodic orbits around L_2	30
12. Energy diagram of family I	35
13. Stability evolution of family I	35
14. Typical trajectories in family J_1 of periodic orbits around L_3	39
15. Energy diagram of family J_1	40
16. Stability evolution of family J_1	40
17. Typical trajectories in family A_1 of retrograde periodic orbits around m_1	42
18. Energy diagram of family A_1	44
19. Stability evolution of family A_1	44

Contents (contd)

Figures (contd)

20. Typical trajectories in family BD of direct periodic orbits around m_1	56
21. Energy diagram of family BD	59
22. Evolution of periodic collision orbits in family BD	59
23. Stability evolution of family BD	59
24. Typical trajectories in family E_1 of direct periodic orbits around m_1 and m_2	60
25. Energy diagram of family E_1	61
26. Stability evolution of family E_1	61
27. Typical trajectories in family F of retrograde orbits around m_1 and m_2	64
28. Energy diagram of family F	65
29. Stability evolution of family F	65
30. Typical trajectories in family C of retrograde periodic orbits around m_2	72
31. Energy diagram of family C	73
32. Stability evolution of family C	73
33. Typical trajectories in family H_1 of direct periodic orbits around m_2	78
34. Typical trajectories in family H_2 of direct periodic orbits around m_2	80
35. Energy diagrams of families H_1 and H_2	89
36. Stability evolution of family H_1	90
37. Stability evolution of family H_2	90

Abstract

A systematic numerical investigation has been made of symmetric periodic orbits in the restricted three-body problem with two dimensions and with earth-moon mass ratio. Several thousands of periodic orbits have been obtained by numerical integration and have been classified in families. The present report describes 1811 periodic orbits, which are contained in 10 of the most important families. They represent most of the simpler forms of periodic orbits that are symmetric with respect to the syzygy axis.

In order to have reasonable assurance of the consistency of our classification, the orbits of each family have been computed with a somewhat greater than usual density, as compared with many other publications on this subject. However, no mathematical proofs are given here for the subdivision into families.

The report contains an elementary theoretical introduction to the restricted three-body problem preceding the description of the orbits and their stability. Tables with the numerical data of the orbits have also been included.

Periodic Orbits in the Restricted Three-Body Problem With Earth-Moon Masses

I. Introduction

The restricted three-body problem has long been of special interest in celestial mechanics, not only in the study of configurations of natural bodies in the solar system, but because it is one of the simplest nonintegrable dynamical systems. In recent years, with the launching of artificial satellites in the earth-moon system and in the solar system, applications in astronautics have generated renewed interest in the restricted three-body problem, and the availability of extremely fast computers in the last 10 years has made it feasible to undertake the complex computations required in a study of the problem.

The work presented here is part of a systematic numerical investigation of the restricted three-body problem as a model for the motion of a satellite in the earth-moon system. A large number of periodic orbits were numerically computed, and then an attempt was made to classify them in continuous sets, or families.

The general aspects of periodic orbits in the restricted three-body problem are well known, chiefly through the work of Stromgren's group at Copenhagen (Ref. 1), and

that of Moulton (Ref. 2), and Darwin (Ref. 3), among others. Stromgren's work, which started around the beginning of this century and extended over a period of forty years, produced no more than a hundred periodic orbits, but this was sufficient to discover the essential qualitative properties of the physiognomy of the problem.

One of the motivations for the present study of the restricted three-body problem with a small earth-moon mass ratio was that in the works of Stromgren, Darwin, and Moulton, all of the periodic orbits were computed with a larger mass ratio than the critical mass ratio, and that much less numerical work has been done with a mass ratio that is smaller than the critical value. It has been well established that the restricted three-body problem depends upon one single variable parameter: the mass ratio μ . One of the most important features of the restricted problem is the existence of a so-called critical mass ratio ($\mu = 0.0385$). This value of μ is a separation between stability and instability for the equilateral equilibrium points. This fact is of critical importance because the solutions of the problem behave in a completely different way on each side of the critical mass ratio. All the known applications in the solar system correspond to mass ratios below the critical value.

For this reason, it was thought that a systematic study of the problem with a small mass ratio would be worthwhile, with the value $\mu = 0.012155$ for the earth-moon system. In this study, earth is taken as the larger of the primaries, the moon as the smaller one, and the terms "geocentric" and "selenocentric" are used for convenience.

In the evolution of the present work, it became clear that the solutions of the problem with the small earth-moon mass ratio behave in a completely different way than the solutions obtained with equal masses by Stromgren. Certain features prevail for all mass ratios, but others do not cross over the borderline of the critical mass ratio.

Another distinguishing characteristic of the problem with a small mass ratio is that it is in the neighborhood of one with a known analytical solution: the case $\mu = 0$, or the two-body problem referred to rotating axes. One of the approaches in the search for periodic orbits in the present study was to use the initial conditions for the two-body problem to find good approximations of the initial conditions for the periodic orbits in the three-body problem. Theoretically, it should be possible to start from the known solution for $\mu = 0$ and make an analytical continuation study for positive values of μ . This method has been effectively used by many authors, notably by Poincaré (Ref. 4) among the earlier workers, and by Wintner (Ref. 5), Barrar (Ref. 6), and Arenstorf (Ref. 7) in more recent theoretical investigations.

The initial experimental material given here may be useful to begin studying the theoretical aspects of the problem, or may serve to illustrate numerically theoretical work that has already been done, and eventually confirm or disprove some points.

This report, which represents only a small fraction of the work done in this investigation, presents the results of the computation of 1811 periodic orbits. More of the results of this study will be presented in future reports. The periodic orbits described in this report have been classified into nine families that have a known origin, with one supplementary family included that shows certain similarities to one of the other nine. Because of the tremendous number of existing periodic orbits, only the simpler forms were analyzed and the investigation of a family was terminated when the forms of the orbits became too complicated. Thus, among the 10 families of periodic orbits described, only three have a known origin and end, a natural termination has not been found for six families, and in one family, neither the origin nor

the end is known. Although no mathematical proof is given for the classification of families used here, from the large number of periodic orbits computed and analyzed for each family, it has been established with reasonable certainty that each is a continuous set, as far as the values of the initial abscissa, the Jacobi constant, and the half-period are concerned.

The basis of this work was numerical integrations performed with fast electronic computers. The results are thus subject to some accuracy limitations related to the characteristics of the numerical methods used (the degree of the method, for instance) and also to the characteristics of the computers used (word length, for instance). Several integrations were carried out, using different integration methods and several computers as well. The classical fourth-order Runge-Kutta method was used for all of the first integrations. An Adams-Moulton predictor-corrector method was used in several integrations, but this was later replaced by the Steffensen recurrent power series (Ref. 8). All final computations were done with a fully regularized program in double precision, using Runge-Kutta and recurrent power series integration. The regularization enabled the computation of several hundreds of collision orbits, but this part of the investigation will be the subject of a future report.

This study was started in Belgium in May 1960, and in 1961 and 1962, a vast amount of numerical work was done with a Univac USSC 90 computer at Univac Brussels. The speed of the USSC 90 was 1.4 seconds per integration step (Runge-Kutta) in floating-point arithmetic and 0.45 seconds per step in fixed-point arithmetic. About 390 periodic orbits were obtained during that period and later described in the author's doctoral dissertation submitted at the University of Louvain, Belgium (Ref. 9). This work has since been extended both in precision and in volume at the Jet Propulsion Laboratory on an IBM 1620 and an IBM 7094. The work at JPL was started in 1964, but was interrupted several times before completion. On the IBM 1620, the speed was 10 seconds per step, and on the 7094, a speed of 0.002 seconds per integration step was obtained.

Sections II and III of this report are an elementary introduction to the restricted three-body problem and develop the equations of motion used in the analysis of the periodic orbits. The principal results of the numerical investigation are discussed in Section IV. Section V describes the classification of families of periodic orbits and lists the initial conditions for each family.

II. Equations of Motion

A. Definition of the Problem

The so-called "restricted" three-body problem is a particular case of the "general" three-body problem. In the general three-body problem, there are three point-masses with nonzero values m_1 , m_2 , m_3 , which attract each other according to the classical Newtonian gravitation law. The problem consists in finding the motion of the three masses as a function of the time t , when the positions and velocities at the initial time are given.

In the restricted three-body problem, one of the masses, say m_3 , is supposed to be zero or infinitely small compared with the other two masses, in such a way that m_3 is moving under the action of m_1 and m_2 , but does not perturb the two-body motion of m_1 and m_2 . In the restricted problem, the motion of m_1 and m_2 around their center of mass is given, and the motion of m_3 has to be determined as a function of the initial conditions. In the problem studied here the masses m_1 and m_2 are supposed to be moving in circular orbits and the satellite m_3 in the plane of the motion of m_1 and m_2 . This particular problem is known as the planar circular restricted three-body problem.

All the work has been done with a mass ratio m_1/m_2 which is close to the earth/moon mass ratio: $m_1/m_2 = 81.27$. We have also used a system of canonical units: the units of length and time are chosen in such a way that some of the constants of the problem take a simple value. We have used the notation $m_1 = 1 - \mu$, and $m_2 = \mu$, so that $m_1 + m_2 = +1$, and in our case $\mu = 1/82.27$. The unit of length is taken equal to the constant distance of m_1 and m_2 . With this choice the circumferences described by m_1 and m_2 have the respective radii μ and $1 - \mu$. We take the unit of time in such a way that the two masses m_1 and m_2 have an angular velocity ω equal to $+1$. With these units Kepler's third law for the motion of m_1 and m_2 is satisfied:

$$\omega^2 |m_1 m_2|^3 = g(m_1 + m_2) = +1 \quad (1)$$

and the universal gravitation constant g has the value $+1$.

B. Equations of Motion with Rectangular Coordinates

We can refer the problem to a fixed rectangular coordinate system with the origin at the center of mass. Let (ξ, η) be the coordinates of the satellite m_3 in this coordinate system. We can always take the coordinate system in such a way that at the instant $t = 0$, m_1 and

m_2 are on the ξ -axis, at the abscissa $(-\mu)$ and $(1 - \mu)$. At any time, the coordinates of the masses m_1 and m_2 are then

$$\begin{aligned} \xi_1 &= -\mu \cos t, & \xi_2 &= (1 - \mu) \cos t, \\ \eta_1 &= -\mu \sin t, & \eta_2 &= (1 - \mu) \sin t \end{aligned} \quad (2)$$

The distances r_1 and r_2 between the satellite m_3 and the two main masses m_1 and m_2 are given by

$$\begin{aligned} r_1^2 &= (\xi - \xi_1)^2 + (\eta - \eta_1)^2 \\ r_2^2 &= (\xi - \xi_2)^2 + (\eta - \eta_2)^2 \end{aligned} \quad (3)$$

The differential equations for the satellite's motion are then

$$\begin{aligned} \frac{d^2 \xi}{dt^2} &= -(1 - \mu) \frac{\xi - \xi_1}{r_1^3} - \mu \frac{\xi - \xi_2}{r_2^3} = -\frac{\partial V}{\partial \xi} \\ \frac{d^2 \eta}{dt^2} &= -(1 - \mu) \frac{\eta - \eta_1}{r_1^3} - \mu \frac{\eta - \eta_2}{r_2^3} = -\frac{\partial V}{\partial \eta} \end{aligned} \quad (4)$$

where V is the potential energy:

$$V = -\frac{1 - \mu}{r_1} - \frac{\mu}{r_2} \quad (5)$$

We now introduce a coordinate system that is rotating about the center of mass with the uniform angular velocity $+1$. Let (x, y) be the coordinates of the satellite m_3 in this new rotating frame. We can convert from the fixed coordinate system to the rotating coordinate system by

$$\begin{aligned} \xi &= x \cos t - y \sin t \\ \eta &= x \sin t + y \cos t \end{aligned} \quad (6)$$

The coordinates for m_1 and m_2 in this new system are

$$x_1 = -\mu, \quad y_1 = 0, \quad x_2 = 1 - \mu, \quad y_2 = 0 \quad (7)$$

The coordinates (x, y) shall be called "synodical" as opposed to the "sidereal" coordinates (ξ, η) .

The distances r_1 and r_2 are given by the expressions

$$\begin{aligned} r_1^2 &= (x - x_1)^2 + y^2 \\ r_2^2 &= (x - x_2)^2 + y^2 \end{aligned} \quad (8)$$

and the new differential equations for the motion are

$$\begin{aligned} \frac{d^2x}{dt^2} - 2\frac{dy}{dt} - x &= -(1 - \mu)\frac{x - x_1}{r_1^3} - \mu\frac{x - x_2}{r_2^3} = -\frac{\partial V}{\partial x} \\ \frac{d^2y}{dt^2} + 2\frac{dx}{dt} - y &= -(1 - \mu)\frac{y}{r_1^3} - \mu\frac{y}{r_2^3} = -\frac{\partial V}{\partial y} \end{aligned} \quad (9)$$

We see that the complete formulation of the problem depends upon one single variable parameter: the mass ratio μ . In all cases μ shall be taken between the limits 0 and 1/2.

C. The Lagrangian and Hamiltonian Functions of the Restricted Three-Body Problem

The equations of motion in the fixed coordinate system (ξ, η) can be derived from the Lagrangian (where the accents represent time-derivatives)

$$\begin{aligned} L &= \frac{1}{2}(\xi'^2 + \eta'^2) + \left(\frac{1 - \mu}{r_1} + \frac{\mu}{r_2}\right) \\ &= \frac{1}{2}(\xi'^2 + \eta'^2) - V \end{aligned} \quad (10)$$

By defining the canonical moments (p_ξ, p_η) conjugated with the coordinates (ξ, η) by $p_\xi = \xi'$, $p_\eta = \eta'$, we can derive the Hamiltonian

$$\begin{aligned} H &= \frac{1}{2}(p_\xi^2 + p_\eta^2) - \left(\frac{1 - \mu}{r_1} + \frac{\mu}{r_2}\right) \\ &= \frac{1}{2}(p_\xi^2 + p_\eta^2) + V \end{aligned} \quad (11)$$

and the canonical equations of motion

$$\begin{aligned} \frac{d\xi}{dt} &= p_\xi, & \frac{dp_\xi}{dt} &= -\frac{\partial V}{\partial \xi}, \\ \frac{d\eta}{dt} &= p_\eta, & \frac{dp_\eta}{dt} &= -\frac{\partial V}{\partial \eta} \end{aligned} \quad (12)$$

In the rotating coordinate system (x, y) , the Lagrangian takes the form

$$\begin{aligned} L &= \frac{1}{2}(x'^2 + y'^2) + \frac{1}{2}(x^2 + y^2) + (xy' - yx') \\ &\quad + \frac{1 - \mu}{r_1} + \frac{\mu}{r_2} \end{aligned} \quad (13)$$

With this Lagrangian are associated the canonical momenta

$$p_x = \frac{\partial L}{\partial x'} = x' - y, \quad p_y = \frac{\partial L}{\partial y'} = y' + x \quad (14)$$

and the Hamiltonian

$$H = \frac{1}{2}(p_x^2 + p_y^2) + (yp_x - xp_y) - \left(\frac{1 - \mu}{r_1} + \frac{\mu}{r_2}\right) \quad (15)$$

In this rotating frame the system of canonical equations takes the form

$$\begin{aligned} \frac{dx}{dt} &= p_x + y, & \frac{dp_x}{dt} &= p_y - \frac{\partial V}{\partial x}, \\ \frac{dy}{dt} &= p_y - x, & \frac{dp_y}{dt} &= -p_x - \frac{\partial V}{\partial y} \end{aligned} \quad (16)$$

We can notice now that the Lagrangian and Hamiltonian in the rotating coordinate system have a large advantage over those in the fixed (sidereal) coordinate system, for the reason that in the synodical frame the time t is not explicitly present in both functions. In the sidereal frame, both functions contain the time t in the distances r_1 and r_2 , through the variable coordinates of m_1 and m_2 .

In the preceding coordinate systems we always took the center of mass at the origin, but in the following developments we shall use two other rotating coordinates that are derived from the rotating barycentric system by a simple x -translation. In one system the origin is at the largest mass m_1 and we shall call this system geocentric. In the other system, the median system, the origin is in the middle of both masses.

1. The Median Rotating Coordinate System (X, Y).

We define the median coordinates by the equations

$$x = X + x_0, \quad y = Y, \quad x_0 = \frac{1}{2} - \mu \quad (17)$$

where x_0 is the distance between the center of mass and the middle of both masses m_1 and m_2 . We can then obtain the Lagrangian

$$L = \frac{1}{2}(X'^2 + Y'^2) + (XY' - YX') + x_0Y' + \frac{1}{2}(X^2 + Y^2) + x_0X + \frac{1}{2}x_0^2 + \left(\frac{1-\mu}{r_1} + \frac{\mu}{r_2}\right) \quad (18)$$

The canonical momenta are

$$p_x = X' - Y, \quad p_y = Y' + X + x_0 \quad (19)$$

and the corresponding Hamiltonian is

$$H = \frac{1}{2}(p_x^2 + p_y^2) + (p_xY - p_yX) - x_0p_y - \left(\frac{1-\mu}{r_1} + \frac{\mu}{r_2}\right) \quad (20)$$

We see that the preceding Lagrangian has two terms, $(1/2)x_0^2$ and x_0Y' , which are without effect on the equations of motion and we can thus neglect these terms in the Lagrangian. We have then to define the canonical momenta by

$$p_x = X' - Y, \quad p_y = Y' - X \quad (21)$$

and the Hamiltonian becomes

$$H = \frac{1}{2}(p_x^2 + p_y^2) + (p_xY - p_yX) - \left(\frac{1-\mu}{r_1} + \frac{\mu}{r_2}\right) - x_0X \quad (22)$$

We see that instead of having a term x_0p_y in the Hamiltonian, we now have a term x_0X . We shall generally prefer to use the Hamiltonian with the term x_0X , which is of zero-degree in the momenta, rather than the Hamiltonian with one more first-degree term x_0p_y , because of the fact that the term x_0X can be formally included in the potential terms.

2. The Geocentric Rotating Coordinate System (X, Y).

We define the geocentric coordinates by the translation:

$$x = X - \mu, \quad y = Y \quad (23)$$

We obtain the Lagrangian

$$L = \frac{1}{2}(X'^2 + Y'^2) + (XY' - X'Y) + \frac{1}{2}(X^2 + Y^2) - \mu X + \left(\frac{1-\mu}{r_1} + \frac{\mu}{r_2}\right) \quad (24)$$

where again two terms are neglected: $-\mu Y'$ and $\mu^2/2$. The canonical momenta here are

$$p_x = X' - Y, \quad p_y = Y' + X \quad (25)$$

and the Hamiltonian becomes

$$H = \frac{1}{2}(p_x^2 + p_y^2) + (p_xY - p_yX) - \left(\frac{1-\mu}{r_1} + \frac{\mu}{r_2}\right) + \mu X \quad (26)$$

Besides this geocentric formulation, centered at m_1 , we could also make a "selenocentric" formulation, centered at m_2 . The only difference in the result is that in the Hamiltonian and the Lagrangian, we have a term $+(1-\mu)X$ instead of the term $-\mu X$, the selenocentric coordinates being defined by

$$x = X + (1-\mu), \quad y = Y \quad (27)$$

The geocentric equations of motion corresponding to the Lagrangian Eq. (24) have the explicit form

$$\begin{aligned} X'' - 2Y' - (X - \mu) &= -(1-\mu)\frac{X}{r_1^3} - \mu\frac{X-1}{r_2^3} \\ Y'' + 2X' - Y &= -(1-\mu)\frac{Y}{r_1^3} - \mu\frac{Y}{r_2^3} \end{aligned} \quad (28)$$

It may also be worthwhile to mention that these geocentric synodic equations of motion can be obtained in a different way, which has considerable theoretical interest in perturbation theories; that is, we use the well-known heliocentric equations of motion for the planets around the sun. In our application, we consider the

earth as being the central body and the moon as the perturbing body. In a rectangular coordinate system (ξ, η) having the earth as origin, but having a fixed inertial orientation, the planetary equations for the satellite are

$$\xi'' = \frac{\partial}{\partial \xi} \left(\frac{1-\mu}{r_1} \right) + \frac{\partial R}{\partial \xi} = -(1-\mu) \frac{\xi}{r_1^3} - \mu \left(\frac{\xi - \xi_2}{r_2^3} + \xi_2 \right) \quad (29)$$

$$\eta'' = \frac{\partial}{\partial \eta} \left(\frac{1-\mu}{r_1} \right) + \frac{\partial R}{\partial \eta} = -(1-\mu) \frac{\eta}{r_1^3} - \mu \left(\frac{\eta - \eta_2}{r_2^3} + \eta_2 \right)$$

where R is the perturbing function

$$R = \mu \left[\frac{1}{r_2} - (\xi \xi_2 + \eta \eta_2) \right] \quad (30)$$

The equations of motion (29) separate very well the terms contributed by the earth $(1-\mu)$ from the moon's contribution (μ) . This presentation is especially interesting when μ is small, that is, when the moon is truly a perturbation to a two-body problem trajectory. The connection between the equations of motion (29) and the equations of motion (28) could also be made through the rotation from the inertial to the synodical orientation:

$$\begin{aligned} \xi &= X \cos t - Y \sin t \\ \eta &= X \sin t + Y \cos t \end{aligned} \quad (31)$$

D. Equations of Motion With Polar Coordinates

The polar coordinate system is derived from the rotating geocentric coordinate system (X, Y) , but it could as well be developed from the barycentric or selenocentric coordinate system.

The polar coordinates (r, ϕ) are related to the geocentric rotating coordinates (X, Y) by

$$\begin{aligned} X &= r \cos \phi \\ Y &= r \sin \phi \end{aligned} \quad (32)$$

The Lagrangian with the variables (r, ϕ) has the form

$$\begin{aligned} L &= \frac{1}{2} (r'^2 + r^2 \phi'^2) + r^2 \phi' \\ &+ \left[\frac{1}{2} r^2 - \mu r \cos \phi + \left(\frac{m_1}{r_1} + \frac{m_2}{r_2} \right) \right] \end{aligned} \quad (33)$$

and the corresponding Lagrangian equations of motion are

$$\begin{aligned} (r'' - r\phi'^2) - 2r\phi' - r + \left(\mu \cos \phi + \frac{\partial V}{\partial r} \right) &= 0 \\ (2r'\phi' + r\phi'') + 2r + \left(-\mu \sin \phi + \frac{\partial V}{r\partial \phi} \right) &= 0 \end{aligned} \quad (34)$$

We can easily recognize the physical meaning of the different terms in the preceding equations.

The first equation in (34) gives components along the radius vector, while the second equation gives the tangential components:

$$\begin{aligned} (r'' - r\phi'^2, 2r'\phi' + r\phi'') &= \text{acceleration components} \\ (-r, 0) &= \text{centrifugal force components} \\ (-2r\phi', 2r') &= \text{components of the Coriolis force, with magnitude twice the magnitude of the velocity} \end{aligned}$$

The canonical momenta derived from the Lagrangian are related to r' and ϕ' by

$$\begin{aligned} p_r &= r' \\ p_\phi &= r^2 (\phi' + 1) \end{aligned} \quad (35)$$

The Hamiltonian can then be written in the form

$$H = \frac{1}{2} \left(p_r^2 + \frac{1}{r^2} p_\phi^2 \right) - p_\phi + \mu r \cos \phi + V \quad (36)$$

It is also possible to find the Hamiltonian in (r, ϕ) directly from the Hamiltonian in (X, Y) by a canonical extension. We use the generating function

$$W(r, \phi, p_x, p_y) = r \cos \phi p_x + r \sin \phi p_y \quad (37)$$

and define the moments by

$$\begin{aligned} p_r &= \frac{\partial W}{\partial r} = \cos \phi p_x + \sin \phi p_y \\ p_\phi &= \frac{\partial W}{\partial \phi} = -r \sin \phi p_x + r \cos \phi p_y \end{aligned} \quad (38)$$

The inverse transformation can be obtained by

$$\begin{aligned} p_x &= \frac{1}{r} (r \cos \phi p_r - \sin \phi p_\phi) \\ p_y &= \frac{1}{r} (r \sin \phi p_r + \cos \phi p_\phi) \end{aligned} \quad (39)$$

as far as $r \neq 0$. We obtain then by direct substitution the same Hamiltonian as in Eq. (36).

E. The Equations of Motion With Biradial Coordinates

In this section, equations of motion are developed with (r_1, r_2) as principal variables. The variables (r_1, r_2) are related to the median synodical coordinates (X, Y) by

$$\begin{aligned} r_1^2 &= \left(X + \frac{1}{2}\right)^2 + Y^2, & 2X &= (r_1^2 - r_2^2), \\ r_2^2 &= \left(X - \frac{1}{2}\right)^2 + Y^2, & 4Y^2 &= 2S - 4X^2 - 1 \end{aligned} \quad (40)$$

where

$$S = r_1^2 + r_2^2$$

Then

$$\begin{aligned} X' &= r_1 r_1' - r_2 r_2' \\ 2YY' &= (1 + 2X) r_1 r_1' + (1 + 2X) r_2 r_2' \end{aligned} \quad (41)$$

and we can express the Lagrangian in (r_1, r_2, r_1', r_2') . We find the result

$$\begin{aligned} L &= \frac{A}{2} (r_1'^2 + r_2'^2) + Br_1' r_2' + \phi_1 r_1' + \phi_2 r_2' \\ &+ \frac{1}{8} (2S - 1) + x_0 X - V \end{aligned} \quad (42)$$

where the four following auxiliary functions have been introduced:

$$\begin{aligned} A &= \frac{r_1^2 r_2^2}{Y^2}, & B &= \frac{r_1 r_2}{2Y^2} (1 - S), \\ \phi_1 &= \frac{1}{4Y} [2X - (2S - 1)] r_1 \\ \phi_2 &= \frac{1}{4Y} [2X + (2S - 1)] r_2 \end{aligned} \quad (43)$$

The canonical moments (p_1, p_2) associated with the variables (r_1, r_2) are then defined by the equations

$$\begin{aligned} p_1 &= \frac{\delta L}{\delta r_1'} = Ar_1' + Br_2' + \phi_1 \\ p_2 &= \frac{\delta L}{\delta r_2'} = Br_1' + Ar_2' + \phi_2 \end{aligned} \quad (44)$$

and if the determinant $A^2 - B^2 = A$ is not zero, we can solve for r_1' and r_2' :

$$\begin{aligned} r_1' &= (p_1 - \phi_1) - \frac{B}{A} (p_2 - \phi_2) \\ r_2' &= -\frac{B}{A} (p_1 - \phi_1) + (p_2 - \phi_2) \end{aligned} \quad (45)$$

After a few simplifications we can then find the corresponding Hamiltonian

$$\begin{aligned} H &= \frac{1}{2} (p_1^2 + p_2^2) - \frac{1 - r_1^2 - r_2^2}{2r_1 r_2} p_1 p_2 \\ &+ \frac{Y}{2} \left(\frac{p_1}{r_1} - \frac{p_2}{r_2} \right) + V - x_0 X \end{aligned} \quad (46)$$

The variables (r_1, r_2) have a fundamental disadvantage in that the correspondence between the pairs (r_1, r_2) and (X, Y) is not a one-to-one correspondence. However, we develop the Hamiltonian in the variables (r_1, r_2) as an intermediate step to more sophisticated variables used mainly for regularizing purposes.

III. Equipotential Surface and Equilibrium Points

A. The Equipotential Surface

In the preceding section, two important formulations of the restricted three-body problem have been given: the "sidereal" or inertial system and the "synodical" or rotating system. The fundamental difference can be seen in the Lagrangian and in the Hamiltonian functions. In the sidereal system these two functions contain the time explicitly, whereas in the synodical system the time is not explicitly in these functions. We have for the same problem a nonconservative formulation and a conservative formulation. Thus, the conservative Lagrangian (Eq. 13) with synodical coordinates corresponds to the well-known first integral called the energy integral or Jacobi integral:

$$E = \frac{1}{2} (x'^2 + y'^2) - \frac{1}{2} (x^2 + y^2) - \frac{1 - \mu}{r_1} - \frac{\mu}{r_2} \quad (47)$$

If we use the canonical momenta instead of the velocity components, the energy equation can be written, according to Eq. (15),

$$E = \frac{1}{2}(p_x^2 + p_y^2) + (yp_x - xp_y) - \frac{1-\mu}{r_1} - \frac{\mu}{r_2} \quad (48)$$

There is, however, another interesting form for the energy integral, which shows some connection with the two-body problem. The synodical energy E may be expressed as a function of the sidereal coordinates (ξ, η) used in the beginning of Section II and connected to (x, y) by Eq. (6). We find then for the synodical energy

that,

$$E = \left[\frac{1}{2}(\xi'^2 + \eta'^2) - \left(\frac{m_1}{r_1} + \frac{m_2}{r_2} \right) \right] - [\xi\eta' - \eta\xi'] \quad (49)$$

The two brackets in Eq. (49) contain the sidereal energy and the sidereal angular momentum, respectively. In the two-body problem these two quantities are two constants of the motion, but in the restricted three-body problem, neither one is constant; only their difference is, as the Jacobi integral states.

We shall now consider points with zero kinetic energy, that is, with zero velocity relative to the rotating system

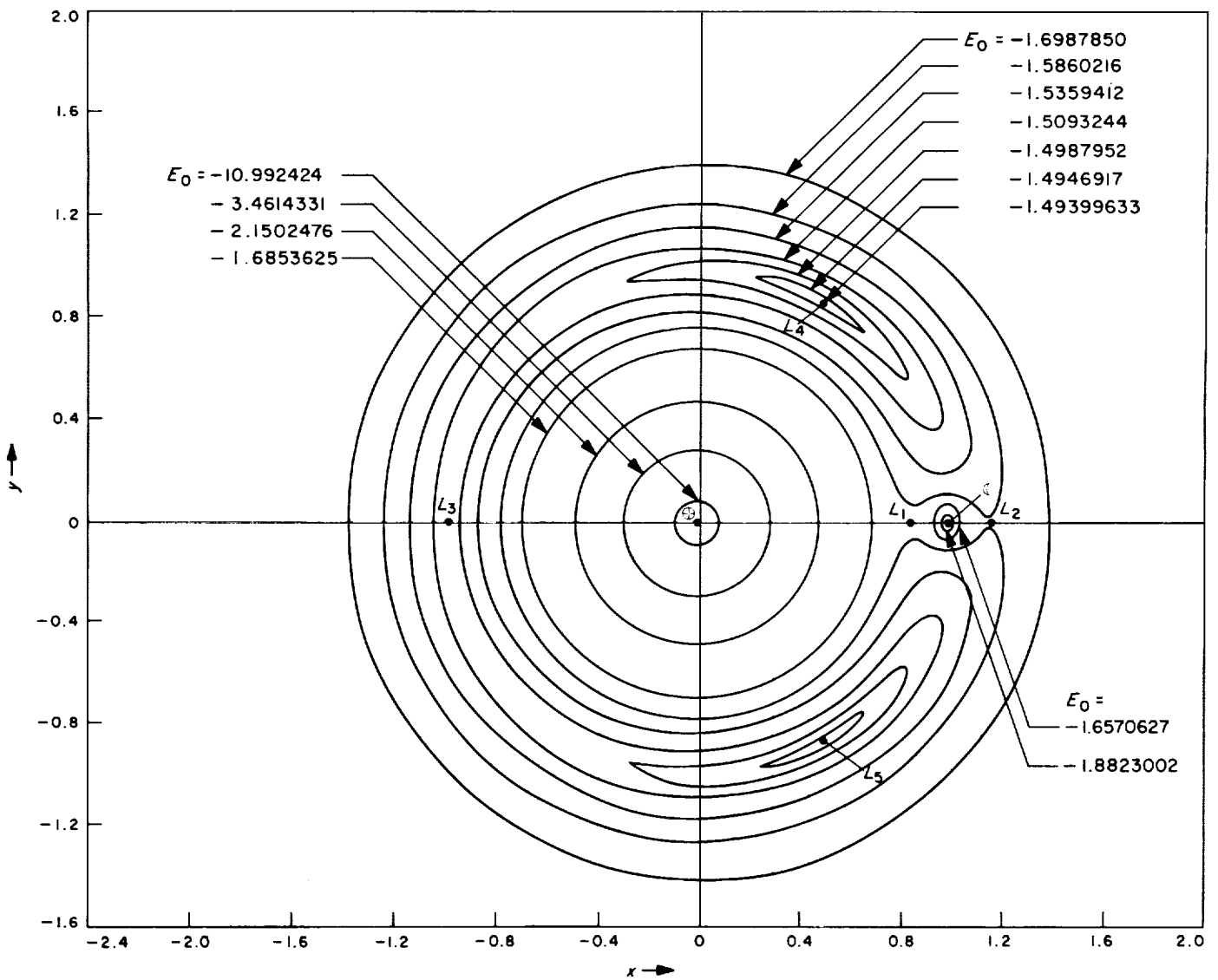

Fig. 1. Equipotential lines

of axes. This allows us to study the remaining part E_0 of the energy E . For zero velocities, Eq. (47) gives

$$-\frac{C}{2} = E_0 = V - \frac{1}{2}(x^2 + y^2) \quad (50)$$

Equation (50) may also be written with (r_1, r_2) instead of the variables (x, y) :

$$-2E_0 = C = (1 - \mu)\left(r_1^2 + \frac{2}{r_2}\right) + \mu\left(r_2^2 + \frac{2}{r_1}\right) - \mu(1 - \mu) \quad (51)$$

We have used here two different notations for the energy constant. We call E_0 the energy constant and C the Jacobi constant. Equation (51) gives E_0 (or C) as a function of x and y , or r_1 and r_2 . We can thus consider Eq. (51) as defining a surface in a three-dimensional space (x, y, E_0) . If we take E_0 as constant, we obtain an "equipotential" section of this surface. We have computed several equipotential lines (Fig. 1 and 2) for different values of E_0 , but all for the earth-moon mass ratio. Figure 3 shows a "vertical" section of this surface going through the $m_1 - m_2$ line, corresponding to the earth-moon mass ratio. The equipotential lines are important because they define regions of the (x, y) -plane, which the satellite with given energy E can attain or not. To compute the

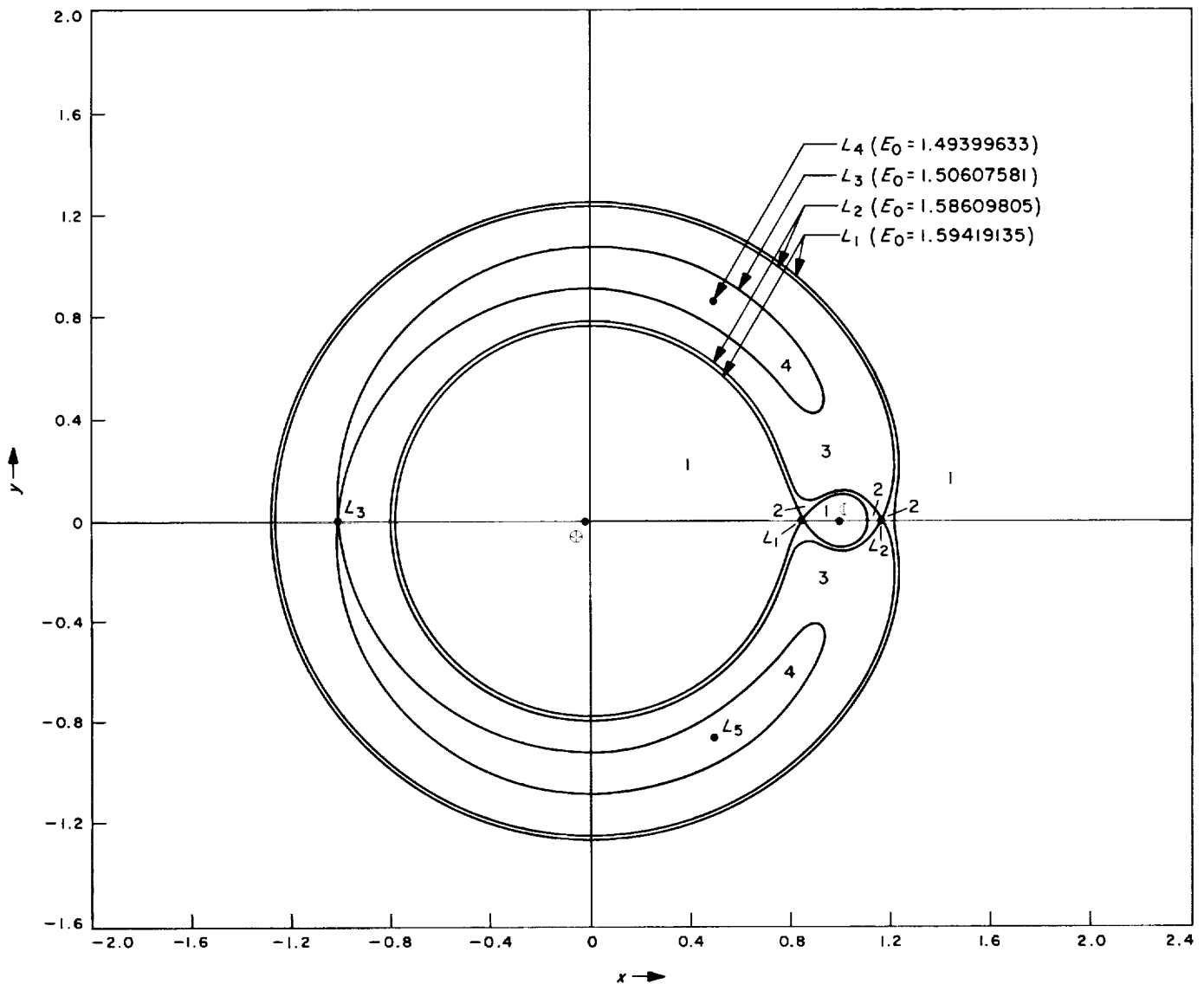

Fig. 2. Equipotential lines through the equilibrium points

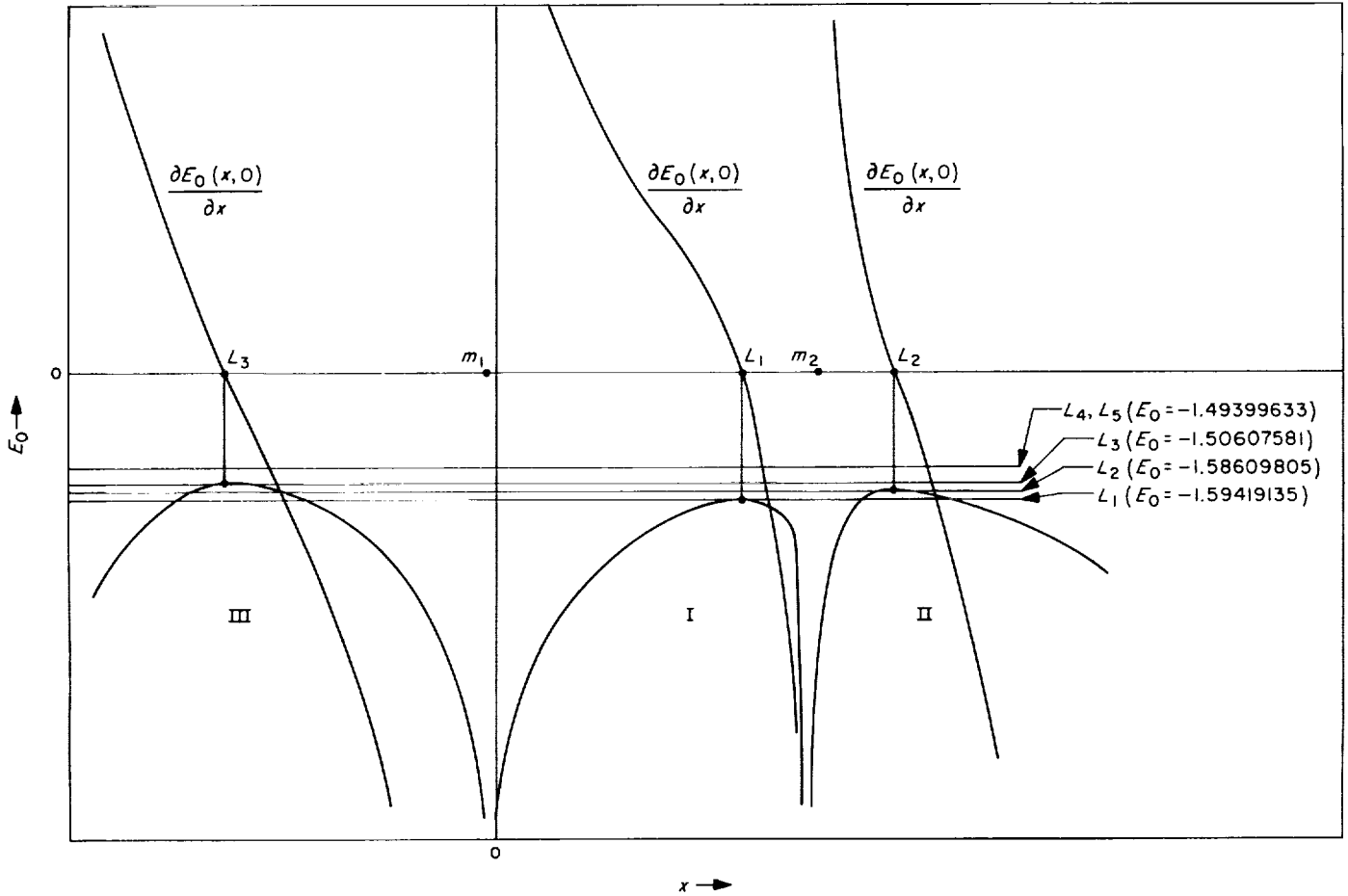

Fig. 3. Syzygial potential line and partial $\partial E_0(x, 0)/\partial x$

equipotential lines we have solved Eq. (51) for a given set of values of C . We can either take a series of values of r_2 and solve for r_1 or take a table of values for r_1 and then solve for r_2 . In both cases we obtain a third-degree equation, using Newton's iterative technique to solve the equation numerically. Let us take a fixed value for C and r_2 . Then we have the following equation for r_1 :

$$r_1^3 + ar_1 + 2 = 0 \quad (52)$$

with

$$a = \frac{\mu}{(1-\mu)} \left(r_2^2 + \frac{2}{r_2} \right) - \frac{C + \mu(1-\mu)}{(1-\mu)} \quad (53)$$

In the iterative technique with Newton's method, an approximation \bar{r}_1 for r_1 can be replaced by an improved value:

$$r_1 = \frac{2(\bar{r}_1^2 - 1)}{3\bar{r}_1^2 + a} \quad (54)$$

B. The Five Equilibrium Points

Lagrange has shown that there exist five equilibrium points in the restricted three-body problem. When a satellite is placed at any one of these points with a zero velocity (relative to the rotating system of axes) it remains there permanently. These points correspond also to singular points on the equipotential surface:

$$\begin{aligned} \frac{\partial E_0}{\partial y} &= x - (1-\mu) \frac{x-x_1}{r_1^3} - \mu \frac{x-x_2}{r_2^3} = 0 \\ \frac{\partial E_0}{\partial x} &= y - (1-\mu) \frac{y}{r_1^3} - \mu \frac{y}{r_2^3} = 0 \end{aligned} \quad (55)$$

When we solve these two equations for x and y , we arrive at the conclusion that there are five solutions, three of which are on the x -axis, the two remaining ones making equilateral triangles with m_1 and m_2 .

In the case where y is not zero, the equations are easily seen to have the solution $r_1 = r_2 = 1$. We have thus two

solutions, symmetric with respect to the x -axis. They are generally designated by the symbols L_4 and L_5 and have the coordinates

$$L_4\left(\frac{1}{2} - \mu, \frac{\sqrt{3}}{2}\right), \quad L_5\left(\frac{1}{2} - \mu, \frac{-\sqrt{3}}{2}\right) \quad (56)$$

In the second case, where $y = 0$, we have to solve the first equation in (55) for x . This reduces to a fifth-degree equation, which can be solved numerically. There are three real roots, corresponding to the points L_1, L_2, L_3 on the syzygial potential line represented in Fig. 3. (This is the section of the equipotential surface by the plane $y = 0$.)

Let us insert here the partial derivatives of E_0 , because these expressions will be needed in the study of the equilibrium points. The first partials are given in Eq. (55). The second partial derivatives are

$$\begin{aligned} \frac{\partial^2 E_0}{\partial x^2} &= -1 - \frac{3(1-\mu)(x-x_1)^2}{r_1^5} - \frac{3\mu(x-x_2)^2}{r_2^5} \\ &\quad + \frac{1-\mu}{r_1^3} + \frac{\mu}{r_2^3} \end{aligned} \quad (57)$$

$$\frac{\partial^2 E_0}{\partial x \partial y} = -\frac{3(1-\mu)(x-x_1)y}{r_1^5} - \frac{3\mu(x-x_2)y}{r_2^5}$$

$$\frac{\partial^2 E_0}{\partial y^2} = -1 - \frac{3(1-\mu)y^2}{r_1^5} - \frac{3\mu y^2}{r_2^5} + \frac{1-\mu}{r_1^3} + \frac{\mu}{r_2^3}$$

When $y = 0$, the first equation in (55) can be written in the form

$$\frac{\partial E_0(x, 0)}{\partial x} = -x + (1-\mu) \frac{(x-x_1)}{|x-x_1|^3} + \mu \frac{(x-x_2)}{|x-x_2|^3} = 0 \quad (58)$$

and then

$$\frac{\partial^2 E_0(x, 0)}{\partial x^2} = -1 - \frac{2(1-\mu)}{|x-x_1|^3} - \frac{2\mu}{|x-x_2|^3} < 0 \quad (59)$$

Equations (58) and (59) have a singularity $x = x_1$ or $x = x_2$. We have thus three regions of values for x :

$$x < x_1, \quad x_1 < x < x_2, \quad x_2 < x \quad (60)$$

In each region, the energy $E_0(x, 0)$ is always negative and becomes $-\infty$ at the limits of each of the three intervals (Fig. 3). The first derivative of E_0 , according

to Eq. (58), changes from $+\infty$ to $-\infty$ and always decreases in each of those intervals, the second derivative in Eq. (59) being negative. This is why in each of the three intervals we have one single real root for Eq. (55). The three roots correspond to a maximum of E_0 and are often defined in the order 3, 1, 2 from left to right. The abscissas verify the relations

$$-1 - \mu < x(L_3) < x_1 < x(L_1) < x_2 < x(L_2) < 2 - \mu \quad (61)$$

When μ tends to zero, $x(L_3)$ tends to -1 , and $x(L_1)$, $x(L_2)$ both tend to $+1$. The respective positions of L_1, L_2, L_3 for the earth-moon mass ratio are clearly shown in Fig. 3, together with the partial derivative in Eq. (58).

The five equilibrium points are important in the classification of orbits according to their energy E . The potential energy E_0 at the equilibrium points satisfies the following relations:

$$E_0(L_1) < E_0(L_2) < E_0(L_3) < E_0(L_4) = E_0(L_5) < 0 \quad (62)$$

Figure 2 shows the "singular" equipotential lines corresponding to the equilibrium points. These lines define in the plane four regions, which we have numbered 1 to 4. For different energies E of the satellite we have the following accessible regions:

$-\infty \leq E \leq E_0(L_1)$	Part of region 1
$E_0(L_1) \leq E \leq E_0(L_2)$	Part of region 1 + 2
$E_0(L_2) \leq E \leq E_0(L_3)$	Part of region 1 + 2 + 3
$E_0(L_3) \leq E \leq E_0(L_4)$	Part of region 1 + 2 + 3 + 4
$E_0(L_4) \leq E$	Total region 1 + 2 + 3 + 4

The following table gives the coordinates of the equilibrium points, together with their corresponding energy, for the earth-moon mass ratio $\mu = 0.012155099$:

	x	y	E_0
L_1	+0.836892919	0	-1.59419135
L_2	+1.155699520	0	-1.58609805
L_3	-1.005064520	0	-1.50607581
L_4	+0.487844901	+0.866025404	-1.49399633
L_5	+0.487844901	-0.866025404	-1.49399633

C. Variational Equations in the Neighborhood of the Equilibrium Points

To study the possible motions of the satellite in an infinitesimal neighborhood of the equilibrium points, we first define the variations ξ, η by

$$x = x_0 + \xi, \quad y = y_0 + \eta \quad (63)$$

where x_0, y_0 designate the coordinates of one of the five equilibrium points. By making the substitution in the equations of motion (9), we obtain two differential equations in ξ and η , called variational equations:

$$\begin{aligned} \xi'' - 2\eta' - \xi &= U_{x_0x_0}\xi + U_{x_0y_0}\eta \\ \eta'' + 2\xi' - \eta &= U_{x_0y_0}\xi + U_{y_0y_0}\eta \end{aligned} \quad (64)$$

The coefficients of the right-hand members of the variational equations are the partial derivatives, taken at (x_0, y_0) for

$$U = \frac{1-\mu}{r_1} + \frac{\mu}{r_2} \quad (65)$$

All the higher order derivatives can be neglected if ξ and η are supposed small.

We have in Eq. (64) two linear homogeneous differential equations with constant coefficients, so that the solution is of the form

$$\xi = Ae^{st}, \quad \eta = Be^{st} \quad (66)$$

where A and B are constants that are related by the homogeneous linear equations

$$\begin{aligned} A(s^2 - 1 - U_{x_0x_0}) - B(2s + U_{x_0y_0}) &= 0 \\ A(2s - U_{x_0y_0}) + B(s^2 - 1 - U_{y_0y_0}) &= 0 \end{aligned} \quad (67)$$

The system of equations in (67) is compatible in A and B for those values of s that satisfy the characteristic equation

$$\begin{aligned} s^4 + s^2(2 - U_{x_0x_0} - U_{y_0y_0}) - U_{x_0y_0}^2 \\ + (1 + U_{x_0x_0})(1 + U_{y_0y_0}) = 0 \end{aligned} \quad (68)$$

The roots of this equation are called characteristic exponents. These characteristic exponents play an important role in determining the form of the orbits in the vicinity

of the equilibrium points. We shall now study some properties of the characteristic exponents and the corresponding orbits.

D. Solutions in the Neighborhood of L_4 and L_5

We have seen in Eq. (55) that the coordinates of L_4 and L_5 are

$$x_0 = \frac{1}{2} - \mu, \quad y_0 = \pm \frac{\sqrt{3}}{2} \quad (69)$$

where the plus sign is for L_4 and the minus sign for L_5 . At these points, U and its partial derivatives have the values

$$\begin{aligned} U = 1, \quad U_{x_0} = \mu - \frac{1}{2}, \quad U_{y_0} = \pm \frac{\sqrt{3}}{2}, \\ U_{x_0x_0} = \frac{-1}{4}, \quad U_{x_0y_0} = \pm \frac{3\sqrt{3}}{4}(1 - 2\mu), \\ U_{y_0y_0} = \frac{5}{4} \end{aligned} \quad (70)$$

The characteristic equation (68) then becomes

$$s^4 + s^2 + \frac{27}{4}\mu(1 - \mu) = 0 \quad (71)$$

The character of the roots of this second-degree equation in s^2 depends on the sign of

$$\rho = 1 - 27\mu(1 - \mu) \quad (72)$$

which depends on the value of μ only. We have the three following possibilities for the values of ρ .

I. $\rho = 0$. This value of ρ corresponds to the critical mass ratio $\bar{\mu}$, so that

$$\bar{\mu}(1 - \bar{\mu}) = \frac{1}{27}, \quad \bar{\mu} = 0.038520896 \quad (73)$$

For this value of μ , the characteristic equation (71) has the four imaginary roots:

$$\frac{+i}{\sqrt{2}}, \quad \frac{-i}{\sqrt{2}}, \quad \frac{+i}{\sqrt{2}}, \quad \frac{-i}{\sqrt{2}} \quad (74)$$

Because of the multiple roots, the general solution of the variational equations (64) has the form

$$\begin{aligned}\xi &= (A_1 + A_2 t) e^{i\alpha t} + (B_1 + B_2 t) e^{-i\alpha t} \\ \eta &= (A_3 + A_4 t) e^{i\alpha t} + (B_3 + B_4 t) e^{-i\alpha t}\end{aligned}\quad (75)$$

where $\alpha = 1/\sqrt{2}$.

The four integration constants A_i may be supposed to be arbitrary, but the four constants B_i are then related to the A_i 's by homogeneous linear equations. The solution in Eq. (75) is complex, but the most general real solution is in the form

$$\begin{aligned}\xi &= A \cos(\alpha t + \phi) + A' t \cos(\alpha t + \phi') \\ \eta &= B \cos(\alpha t + \psi) + B' t \cos(\alpha t + \psi')\end{aligned}\quad (76)$$

Here the integration constants A, B, ϕ, ψ may be supposed arbitrary, but A', B', ϕ', ψ' are then related to the preceding constants.

2. $\rho > 0; 0 < \mu < \bar{\mu}$. In this case the characteristic equation (71) has two real negative roots for s^2 , and thus four imaginary roots for s :

$$s = \pm i\alpha, \quad s = \pm i\beta \quad (77)$$

where α and β are supposed real and positive.

The two motions that correspond to these roots are both of the sinusoidal type with periods $2\pi/\alpha$ and $2\pi/\beta$. The general solution is of the form

$$\begin{aligned}\xi &= A_1 e^{i\alpha t} + A_2 e^{-i\alpha t} + A_3 e^{i\beta t} + A_4 e^{-i\beta t} \\ \eta &= B_1 e^{i\alpha t} + B_2 e^{-i\alpha t} + B_3 e^{i\beta t} + B_4 e^{-i\beta t}\end{aligned}\quad (78)$$

where the B 's are related to the arbitrary A 's by relations similar to Eq. (67). However, the most general solution of the variational equations (78) is of the complex type, and the most general real solution may be written as

$$\begin{aligned}\xi &= A \cos(\alpha t + \phi) + B(\beta t + \psi) \\ \eta &= A |\gamma_1| \cos(\alpha t + \phi + X) + B |\gamma_3| \cos(\beta t + \psi - \epsilon)\end{aligned}\quad (79)$$

The arbitrary integration constants, which are all real here, are A, B, ϕ , and ψ . The constants $|\gamma_1|$ and X are the modulus and the argument of the complex number $\gamma_1 = B_1/A_1$, and $|\gamma_3|$ and ϵ are the corresponding quantities for $\gamma_3 = B_3/A_3$. We see that Eq. (78) represents the sum of two periodic motions, with different periods.

It is of interest to study separately each of these pure motions. For this purpose we take the solution corresponding to Eq. (78) with $B = 0$.

Eliminating the time t between the two equations in (79) gives us the following equation of an ellipse:

$$\xi^2 + \frac{\eta^2}{|\gamma_1|^2} - 2 \frac{\cos X}{|\gamma_1|} \xi \eta = A^2 \sin^2 X \quad (80)$$

This ellipse is completely inside the rectangle defined by

$$\xi = \pm A, \quad \eta = \pm A |\gamma_1| \quad (81)$$

where the integration constant A defines the dimension of the ellipse and the fixed constant γ_1 its shape.

3. $\rho < 0; \bar{\mu} < \mu < 1/2$. In this case, there is unstable asymptotic motion around L_4 . The characteristic equation (71) has two complex conjugated roots for s^2 and thus four complex roots of the form

$$+\alpha + i\beta, \quad +\alpha - i\beta, \quad -\alpha + i\beta, \quad -\alpha - i\beta \quad (82)$$

where α and β are both real and positive. These roots correspond to infinitesimal motions in the neighborhood of L_4 which are of the periodic type with period $2\pi/\beta$, but the amplitude is an exponential function of time related to α . The most general solution of the variational equations of motion (64) is, in the neighborhood of L_4 ,

$$\begin{aligned}\xi &= A_1 e^{s_1 t} + A_2 e^{s_2 t} + A_3 e^{s_3 t} + A_4 e^{s_4 t} \\ \eta &= B_1 e^{s_1 t} + B_2 e^{s_2 t} + B_3 e^{s_3 t} + B_4 e^{s_4 t}\end{aligned}\quad (83)$$

where the s_i are the four roots (82).

Here again the constants B are related to the arbitrary integration constants A by Eq. (67). The most general real solution which corresponds to the roots (82) is

$$\begin{aligned}\xi &= e^{\alpha t} (A \cos \beta t + B \sin \beta t) \\ &\quad + e^{-\alpha t} (C \cos \beta t + D \sin \beta t) \\ \eta &= e^{\alpha t} (A' \cos \beta t + B' \sin \beta t) \\ &\quad + e^{-\alpha t} (C' \cos \beta t + D' \sin \beta t)\end{aligned}\quad (84)$$

where the constants A', B', C', D' are also functions of A, B, C, D . If we take the particular solution of Eq. (84) corresponding to $C = D = 0$, we have asymptotic orbits going away from L_4 when the time t is increasing. Each

complete revolution is described in the time $T = 2\pi/\beta$, and the amplitude increases by the constant factor $e^{\alpha T}$ during this time. Taking $A = B = 0$, instead of C and D , we obtain similar solutions, but which have a decreasing amplitude.

E. Solutions in the Neighborhood of L_1 , L_2 , and L_3

We first consider the signs of the different coefficients of the characteristic equation (68) in the vicinity of the collinear equilibrium points. Let us use the following quantities at L_1 , L_2 , L_3 , where $y = 0$:

$$U_{x_0x_0} = 2A, \quad U_{y_0y_0} = -A, \quad U_{x_0y_0} = 0 \quad (85)$$

$$A = \frac{1-\mu}{|x-x_1|^3} + \frac{\mu}{|x-x_2|^3} \quad (86)$$

We shall first show that A is larger than $+1$ at each of the three collinear points, for all values of μ . This is done in the same way for all three points, and for this reason we only consider L_1 . At this point we have

$$r_1 + r_2 = 1, \quad \frac{\partial r_1}{\partial x} + \frac{\partial r_2}{\partial x} = 0 \quad (87)$$

together with Eq. (55). The first relation in (55) can be written

$$\frac{\partial E_0}{\partial x} = \frac{\partial E_0}{\partial r_1} \frac{\partial r_1}{\partial x} + \frac{\partial E_0}{\partial r_2} \frac{\partial r_2}{\partial x} = 0$$

or

$$\frac{\partial E_0}{\partial r_1} = -\frac{\partial E_0}{\partial r_2}$$

or

$$(1-\mu)\left(r_1 - \frac{1}{r_1^3}\right) = \mu\left(r_2 - \frac{1}{r_2^3}\right)$$

or

$$\mu\left(1 - \frac{1}{r_2^3}\right) = (1-\mu)\frac{r_1}{r_2}\left(1 - \frac{1}{r_1^3}\right) \quad (88)$$

Now the use of Eq. (88) allows us to rewrite the condition

$$1 - A = 1 - \frac{1-\mu}{r_1^3} - \frac{\mu}{r_2^3} \\ = (1-\mu)\left(1 - \frac{1}{r_1^3}\right) + \mu\left(1 - \frac{1}{r_2^3}\right) < 0 \quad (89)$$

in the form

$$-(1-\mu)\left(1 - \frac{1}{r_1^3}\right)\left(1 + \frac{r_1}{r_2}\right) < 0 \quad (90)$$

and this inequality is satisfied because all three factors following the minus sign are positive at L_1 . Having now established this fundamental inequality for A , Eq. (85) shows us that

$$1 + U_{x_0x_0} > 3, \quad 1 + U_{y_0y_0} < 0 \quad (91)$$

and these inequalities give us the necessary information concerning the roots of the characteristic equation (68): the zero-degree term being negative we always have two real roots in s^2 , with opposite signs,

$$s^2 = \alpha^2, \quad s^2 = -\beta^2 \quad (92)$$

Taking α and β positive, we thus have the four roots for s :

$$+\alpha, \quad -\alpha, \quad +i\beta, \quad -i\beta \quad (93)$$

This fundamental result holds as well for all values of the mass ratio μ at L_1 , L_2 , and L_3 .

Orbits of the exponential type correspond to the roots $\pm\alpha$, and periodic solutions with period $2\pi/\beta$ correspond to the roots $\pm i\beta$. We shall now study these solutions in more detail.

We designate by γ , $-\gamma$, $i\delta$, $-i\delta$ the values of the ratios B/A in Eq. (67) corresponding to the roots (93). The most general solution of the variational equations (64) can then be written in the form

$$\xi = A_1 e^{\alpha t} + A_2 e^{-\alpha t} + A_3 e^{i\beta t} + A_4 e^{-i\beta t} \\ \eta = A_1 \gamma e^{\alpha t} - A_2 \gamma e^{-\alpha t} + iA_3 \delta e^{i\beta t} - iA_4 \delta e^{-i\beta t} \quad (94)$$

The most general real solution may be written in the form

$$\begin{aligned}\xi &= A\cosh at + B\sinh at + C \cos \beta t + D \sin \beta t \\ \eta &= A\gamma\sinh at + B\gamma\cosh at - C\delta \sin \beta t + D\delta \cos \beta t\end{aligned}\quad (95)$$

where A , B , C , D are four arbitrary real integration constants. We shall now consider three particular forms of possible trajectories.

1. Periodic Orbits. If we suppose that in Eq. (95) A and B are zero, then we have the equations

$$\begin{aligned}\xi &= C \cos \beta t + D \sin \beta t \\ \eta &= -C\delta \sin \beta t + D\delta \cos \beta t\end{aligned}\quad (96)$$

which represent a periodic motion.

Without restricting the form of the motion we may simplify Eq. (96) by changing the time origin

$$\begin{aligned}\xi &= \xi_0 \cos \beta t \\ \eta &= -\xi_0\delta \sin \beta t\end{aligned}\quad (97)$$

We thus have a one-parameter family of ellipses crossing the ξ -axis at a 90-deg angle, and having the libration point L_1 , L_2 , or L_3 as the center. The motion on these ellipses is retrograde because the constant δ is positive.

2. Hyperbolic Orbits. We can have a hyperbolic motion in the vicinity of a collinear equilibrium point by choosing the values $C = D = 0$ in Eq. (95). If we also make a change of the time origin, this motion can then be represented by the equations

$$\begin{aligned}\xi &= \xi_0\cosh at \\ \eta &= \gamma\xi_0\sinh at\end{aligned}\quad (98)$$

and we thus have a one-parameter family of hyperbolas with center L_1 , L_2 , or L_3 , and crossing the ξ -axis at a right angle.

3. Asymptotic Orbits. We see that this type of motion is possible by choosing in Eq. (95) the particular values

of $C = D = 0$ and $B = \pm A$. We have then the equations of the motion

$$\begin{aligned}\xi &= \xi_0 e^{\pm at} \\ \eta &= \pm \gamma \xi_0 e^{\pm at}\end{aligned}\quad (99)$$

Thus we have a rectilinear trajectory which may be considered as a hyperbola degenerated in its asymptotes. If we choose the plus sign in Eq. (99), the satellite is asymptotically going away from L_1 , L_2 , or L_3 when the time t is increasing. If we choose the minus sign, the satellite is asymptotically coming in towards the equilibrium point. The equations of motion (99) show that we no longer have the one-parameter family, as in the previous cases 1 and 2. There are only a finite number of asymptotic orbits, because we can always choose the time origin so that ξ_0 takes the value $+1$ or -1 . For each libration point L_1 , L_2 , and L_3 , there are only four asymptotic orbits:

$$1 \left\{ \begin{array}{l} \xi = e^{at} \\ \eta = \gamma e^{at} \end{array} \right. \quad 2 \left\{ \begin{array}{l} \xi = -e^{at} \\ \eta = -\gamma e^{at} \end{array} \right. \quad 3 \left\{ \begin{array}{l} \xi = +e^{-at} \\ \eta = -\gamma e^{-at} \end{array} \right. \quad 4 \left\{ \begin{array}{l} \xi = -e^{-at} \\ \eta = \gamma e^{-at} \end{array} \right. \quad (100)$$

On the other hand, because of the symmetry of the restricted three-body problem with respect to the x -axis, only two of the four orbits are really fundamental: 3 and 4 are the symmetric images of 1 and 2; the asymptotic orbits 1 and 2 are outgoing, while 3 and 4 are incoming. It is also possible for some asymptotic orbits to become double asymptotic orbits, but only for particular values of the mass ratio μ .

IV. Periodic Orbits

A. Symmetric Periodic Orbits

The symmetry properties of the equations of motion in synodical barycentric coordinates are important because they lead to sufficient conditions for the existence of periodic orbits.

Let us rewrite here the equations of motion (9) in a form that is more appropriate to show the symmetry properties:

$$\begin{aligned}x'' &= +2y' + a(x, y^2)x + b(x, y^2) \\ y'' &= -2x' + c(x, y^2)y\end{aligned}\quad (101)$$

The functions a , b , c are symmetric with respect to y , but not with respect to x . They have the explicit form

$$a = c = 1 - \left[\frac{1 - \mu}{r_1^3} + \frac{\mu}{r_2^3} \right], \quad b = \mu(1 - \mu) \left[\frac{1}{r_2^3} - \frac{1}{r_1^3} \right] \quad (102)$$

and depend thus on x and y through r_1 and r_2 only. In general, there is symmetry with respect to y , but not x ; in the particular case where the masses are equal, there is a higher degree of symmetry. When $\mu = 1 - \mu = 1/2$, we have

$$r_1(-x) = r_2(x), \quad r_2(-x) = r_1(x) \quad (103)$$

and for this reason a and c are even functions of x , but b is an odd function of x :

$$a(x) = a(-x), \quad c(x) = c(-x), \quad b(x) = -b(-x) \quad (104)$$

For all mass ratios,

$$a(y) = a(-y), \quad b(y) = b(-y), \quad c(y) = c(-y) \quad (105)$$

As a result of these symmetry properties, for every solution defined by the four functions

$$x(t), \quad y(t), \quad x'(t), \quad y'(t) \quad (106)$$

there is another solution that is symmetric with respect to the x -axis:

$$x(-t), \quad -y(-t), \quad -x'(-t), \quad y'(-t) \quad (107)$$

In the case of equal masses, there are two more solutions, which are the images of the preceding ones with respect to the y -axis:

$$\begin{array}{cccc} -x(t), & -y(t), & -x'(t), & -y'(t), \\ -x(-t), & +y(-t), & +x'(-t), & -y'(-t) \end{array} \quad (108)$$

Direct substitution shows that the functions (106), (107), and (108) are solutions of the equations of motion (101). It could also easily be shown that these substitutions leave the Lagrangian invariant.

It is possible to take several special cases of initial conditions. When the four initial conditions have the form

$$(x_0, 0, 0, y'_0) \quad (109)$$

then we have an orbit that coincides with its symmetric image with respect to the x -axis, and this is true for all values of the mass ratio. When the four initial conditions have the form

$$(0, y_0, x'_0, 0) \quad (110)$$

we have an orbit that coincides with its y -axis image, but this is true only in the case of equal masses.

These degenerated symmetry cases can be used to find sufficient periodicity conditions. If at two different times the four functions (106) have values that are either of the form (109) or (110), then the orbit is a closed periodic orbit, which can be symmetric with respect to the x -axis alone, or the y -axis alone, or both of these axes. This gives the possibility of three classes of periodic orbits, according to their type of symmetry. Only the periodic orbits symmetric with respect to the x -axis exist for any mass ratio μ . The existence of three classes of symmetric periodic orbits, of course, does not exclude the existence of periodic orbits that have no symmetry at all.

All the periodic orbits computed in this study have a mass ratio that is different from $1/2$, and all are symmetric with respect to the x -axis only. They have two points where the functions in (106) are of the form (109), one of which is the initial point for the integration. All the orbits were obtained by starting on the x -axis, at a right angle, and trying to find a new orthogonal intersection with the same axis. The initial values $x(0)$ and $y'(0)$ are the two parameters that can be freely adjusted in order to find the new orthogonal crossing, the mass ratio being kept constant. We have not taken any restriction for the period. In general, when one parameter, for instance $x(0)$, is taken as a constant, there are a finite number of values for the other parameter, $y'(0)$, which produce symmetric periodic orbits. This number depends on the number of intersections of the x -axis, and may eventually be zero. However, if both parameters are

varied, we can generally find continuous families of symmetric periodic orbits, with periods varying in a continuous manner. In many cases it is also interesting to consider the initial energy constant or Jacobi constant as one of the initial parameters, for instance instead of the velocity component $y'(0)$. The energy constant has the advantage that it stays finite in cases where the velocity component $y'(0)$ becomes infinite.

B. The Search for Periodic Orbits

In the following discussion, we have attempted to classify a large number of periodic orbits in families. We define a family as being a set of symmetric periodic orbits for which the initial parameter $x(0)$, the (initial) Jacobi constant and the fundamental period (i.e., the smallest positive period) can be considered all three as continuous functions of one single parameter. The families have been identified by one or several letters, with or without subscripts. The letters and subscripts have no meaning except as labels.

At the beginning of this study, three different approaches were used to find periodic orbits: the two-body approximation, a systematic sweeping of complete areas of initial conditions x_0, y'_0 , and some known analytical solutions. In the final stages of the work, computer programs were prepared to generate automatically complete series of periodic orbits, and a concentrated effort was made to improve both the speed and the precision of these computer programs.

The two-body approach was quite fruitful because the small mass ratio μ of our problem is close to zero. If the mass ratio is zero, we know the solution because this is simply the two-body problem represented in a system of coordinates that is rotating with a constant angular velocity. In order to obtain initial conditions, we may use the initial conditions for the two-body problem and then apply a rotation. These initial conditions are a first approximation for periodic orbits in the restricted three-body problem with a small mass ratio. It was found that in some cases the periodic orbits corresponding to $\mu = 0$ do not exist when the earth-moon mass ratio is used, and that in other cases, periodic orbits exist that have no corresponding orbits in the two-body problem. This led us to explore systematically some areas of initial conditions x_0, y'_0 . The values of x_0 from -4.0 to $+4.0$ with steps of $+0.1$ were explored in the earlier stages of the work. Upper and lower limits for the values of y'_0 were determined in a different way. The so-called escape or parabolic velocities were taken as approximate limits. In

other words, the initial velocity y'_0 was taken such that the total energy (relative to the inertial axes) is negative. Using the synodical initial conditions $x_0, 0, 0, y'_0$, the inertial energy of the satellite may be written in the form

$$E = \frac{1}{2} (x_0 + y'_0)^2 - \left(\frac{m_1}{r_1} + \frac{m_2}{r_2} \right)$$

If E is restricted to be negative, the following limits for y'_0 are obtained:

$$-x_0 - \sqrt{2 \left(\frac{m_1}{r_1} + \frac{m_2}{r_2} \right)} \leq y'_0 \leq -x_0 + \sqrt{2 \left(\frac{m_1}{r_1} + \frac{m_2}{r_2} \right)}$$

However, better limits can be established numerically for the values of y'_0 for some of the families of periodic orbits described in the following pages. The limits are approximately as given in the following table, which distinguishes between three possibilities according to the position of x_0 with respect to the positions x_1 and x_2 of m_1 and m_2 .

$x_0 < x_1 = -\mu$	$x_1 < x_0 < x_2$	$(1 - \mu) = x_2 < x_0$
$y'_0 \text{ max} = \text{family F}$	$y'_0 \text{ max} = \text{family A}_1$	$y'_0 \text{ max} = \text{family E}_1$
$y'_0 \text{ min} = \text{family E}_1$	$y'_0 \text{ min} = \text{family C}$	$y'_0 \text{ min} = \text{family F}$

An exception to this table is the upper limit for y'_0 when x_0 is between x_2 and approximately 1.7 (for the earth-moon mass ratio). In this case the upper limit is partly the family I and partly some other families.

In computing orbits with initial conditions $x_0, 0, 0, y'_0$, we fixed the number of intersections with the x -axis (usually from 1 to 6), and studied the intersection angles α with this axis as a function of x_0 and y'_0 ; more precisely for each x_0 , we have considered α as a function of y'_0 . According to the symmetry properties described in Section IV-A, the values of 90 deg or 270 deg for α correspond to periodic orbits. The function $\alpha(x_0, y'_0)$ may also be thought of as defining a surface in a three-dimensional space. We studied the sections of this surface by the planes $\alpha = 90$ deg or $\alpha = 270$ deg. Figure 4 represents two vertical sections of this surface by the plane $x_0 = -1.6$ and $x_0 = -1.5$. All the intersections with the values $\alpha = 90$ deg or $\alpha = 270$ deg give one periodic orbit. When several periodic orbits had been

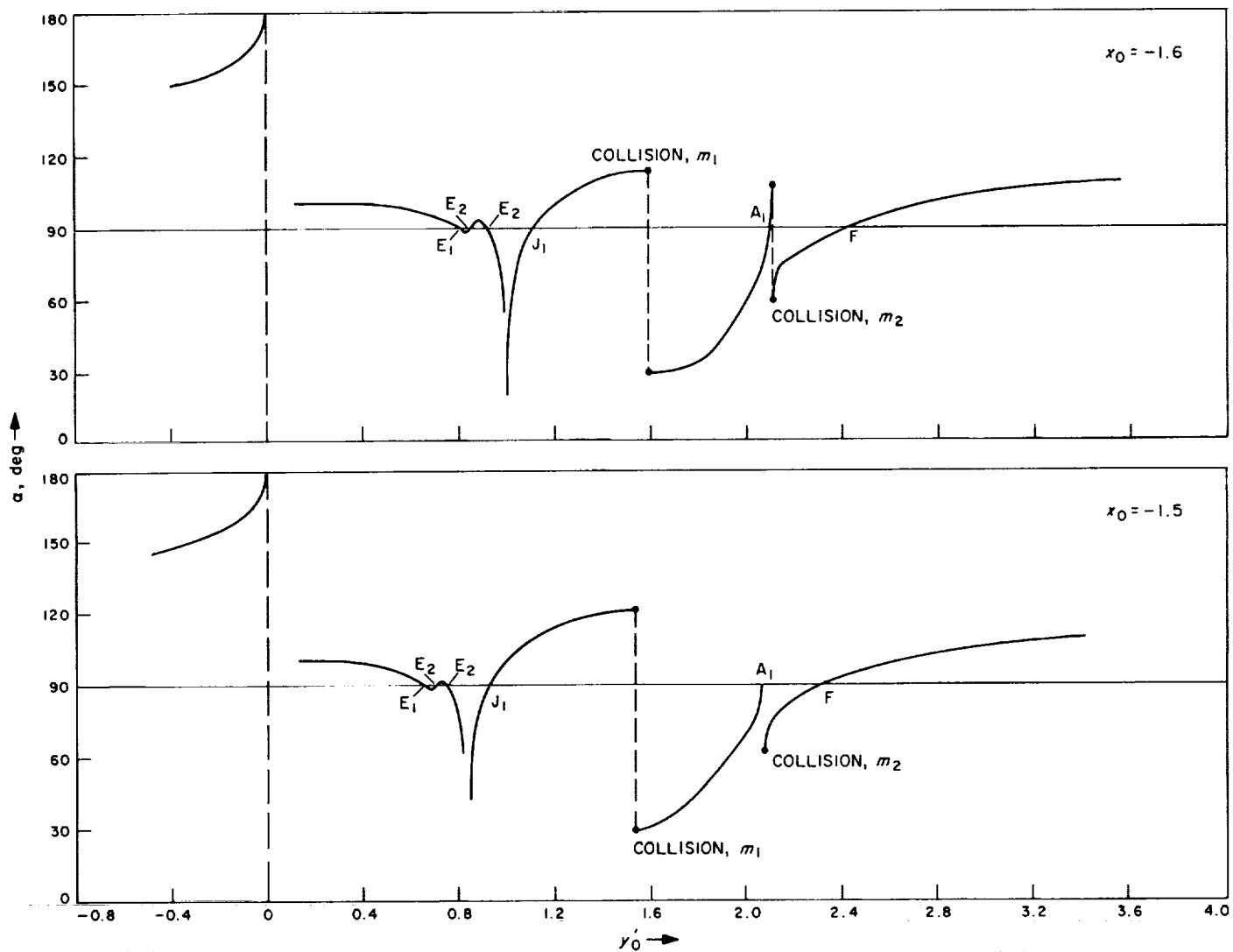

Fig. 4. Function $\alpha(y'_0)$ for $x_0 = -1.6$ and $x_0 = -1.5$

discovered in this way, graphs of y'_0 vs x_0 were constructed and used to discover new periodic orbits. Figures 5 and 6 give two examples of these graphs. The dots that appear on the lines correspond to some of the first computed periodic orbits. At the final stage of our work, computer programs were doing the search operations automatically. The programs had mainly the double function of improving the initial conditions of nearly-periodic orbits, and secondly of extending the families of periodic orbits by extrapolating them tangentially. Several dozens of families of periodic orbits have been discovered by these computer programs.

As a third approach in the search for periodic orbits of the restricted three-body problem, we have used the limiting cases of families that are known by analytical considerations. There are nine known situations where the existence of periodic orbits can be predicted analytically. Three cases correspond to the retrograde infinitesimal elliptic orbits around the collinear libration points L_1 , L_2 , and L_3 . We have described these solutions in Section III-E. The six other solutions are all of the circular type, and are justified by two-body considerations. In two solutions, the distance from the satellite to the main masses m_1 and m_2 is supposed to be large in comparison with the distance from m_1 to m_2 , so that the motion can be considered around the system $m_1 + m_2$, which may, in a first approximation, be considered as one single body. In the other four solutions we consider circular motion around one main body, m_1 or m_2 , and we neglect the other one. This approximation is valid if the radius of the circular motion is small enough in comparison with the distance of m_1 to m_2 . Taking the possible motions in both directions, direct and retrograde, we have six approximated solutions. These solutions can

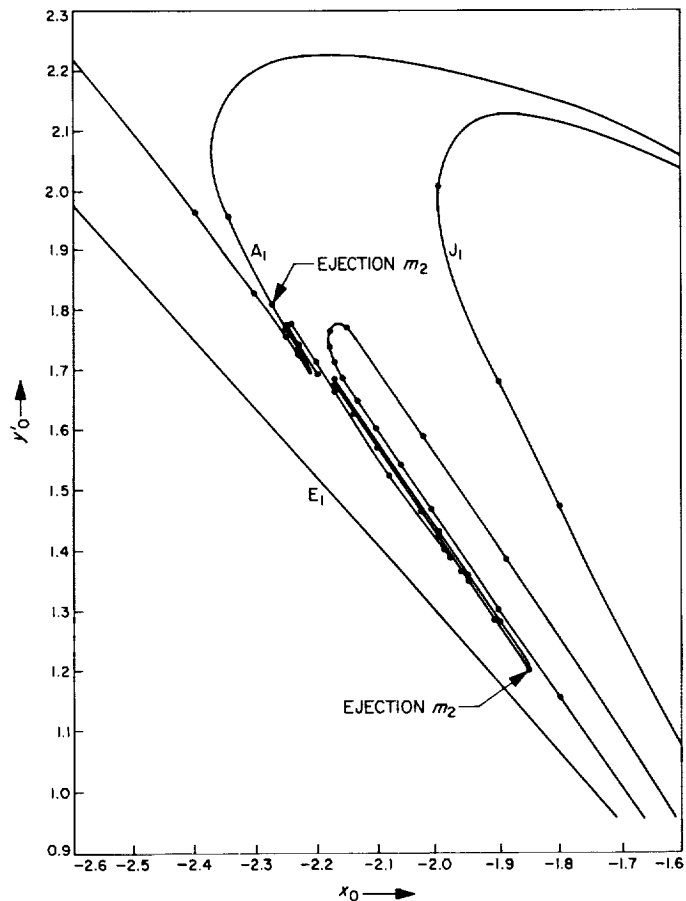

Fig. 5. Diagram (x_0, y'_0) for some families of periodic orbits

all be shown to generate families of periodic solutions in the restricted three-body problem. The approximate initial conditions that were used are as follows:

	Retrograde motion	Direct motion
Around m_1	$r_1, 0, 0, -\sqrt{\frac{1-\mu}{r_1}} - r_1$	$r_1, 0, 0, +\sqrt{\frac{1-\mu}{r_1}} - r_1$
Around m_2	$r_2, 0, 0, -\sqrt{\frac{\mu}{r_2}} - r_2$	$r_2, 0, 0, +\sqrt{\frac{\mu}{r_2}} - r_2$
Around $m_1 + m_2$	$r_1, 0, 0, -\sqrt{\frac{1}{r_1}} - r_1$	$r_1, 0, 0, +\sqrt{\frac{1}{r_1}} - r_1$

In the last velocity component of these initial conditions, the term with the square root gives the circular velocity in Keplerian motion. The last term comes from the rota-

tion of the coordinate system (with an angular velocity +1) and tends to make the motion more retrograde, because of its minus sign.

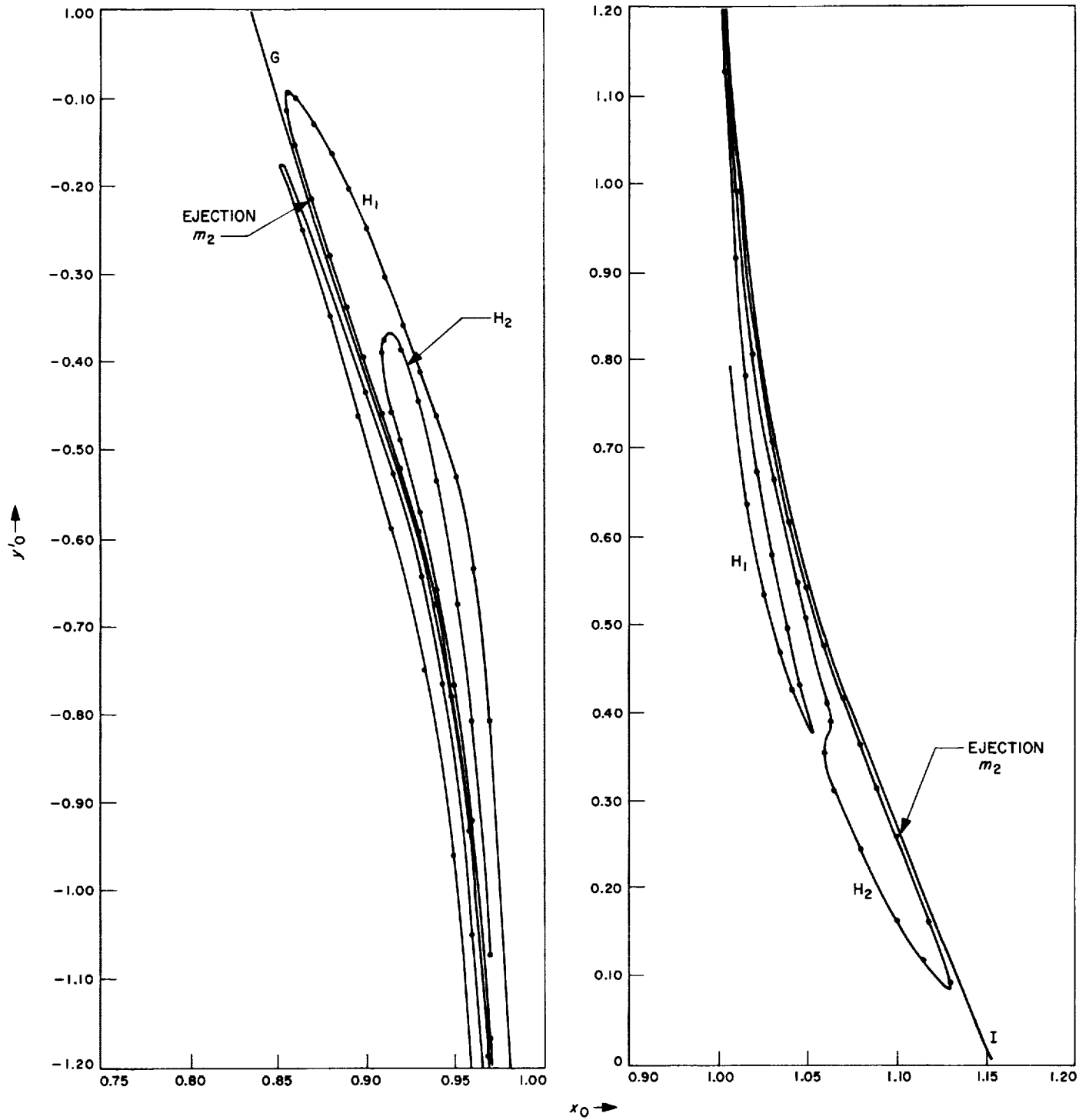

Fig. 6. Diagram (x_0, y_0) for some families of periodic orbits

C. Discussion of Results

In this report we have collected 1811 orbits, which form 10 families. A detailed description of the families of periodic orbits is given in Section V. These families all correspond to the nine solutions considered in Section IV-B. One supplementary family has been added because of its similarity with one of the nine families.

Of the several criteria considered for possible classifications of periodic orbits, most appeared to have some drawback.

The distinction between direct and retrograde orbits was considered as one possible criterion, but it was found that some families contain both direct and retrograde periodic orbits and there is a continuous transition between them. A classification of orbits according to the center which they include, such as m_1 , m_2 , L_1 , L_2 , or L_3 , also seemed to be unsatisfactory because of the complicated form and the numerous loops of some orbits.

However, it was possible to perfect the idea of the center of an orbit in such a way that it becomes clearly feasible to introduce six classes containing all the periodic orbits that are symmetric with respect to the x -axis. Each of the six classes contains several families of periodic orbits. The class and the center of a periodic orbit are defined in the following way. Every symmetric periodic orbit intersects the x -axis at two points, x_0 and x_1 , at a right angle. The center of the orbit (and the class) is defined by the relative positions of the four points m_1 , m_2 , x_0 , and x_1 on the x -axis. The six possible classes are listed in the following tabulation:

Class 1	x_0 x_1 m_1 m_2	Center: L_3
Class 2	x_0 m_1 x_1 m_2	Center: m_1
Class 3	x_0 m_1 m_2 x_1	Center: $m_1 + m_2$
Class 4	m_1 x_0 x_1 m_2	Center: L_1
Class 5	m_1 x_0 m_2 x_1	Center: m_2
Class 6	m_1 m_2 x_0 x_1	Center: L_2

The position of x_0 and x_1 with respect to m_1 and m_2 is of primary importance; the position with respect to L_1 , L_2 , or L_3 is secondary. The important feature about this classification is that a family always belongs completely to one single class. During the continuous evolution of a family, the relative position of x_0 and x_1 with respect

to m_1 and m_2 never changes, even when the evolution of the family encounters collision orbits. There is a special situation in which there are branch points between classes. However, this can only happen in exceptional cases where different families connect with each other at a "shrinkage point," in Wintner's terminology (Ref. 10). At these shrinkage points, the characteristic exponents have particular properties and the fundamental periods present discontinuities. We have considered that a shrinkage point is an end of a family when the period ceases to vary in a continuous way. A family of periodic orbits is, as previously defined, a set for which the initial abscissa x_0 on the x -axis, the energy constant, and the period vary in a continuous way. It is possible to have branch points in a continuous set of orbits, without having a discontinuity in the fundamental periods, and without having the phenomenon of collapsing or shrinking of several loops in a smaller number of loops. For these reasons, it is probably more fundamental to say that the periodic orbits in the restricted three-body problem form manifolds containing several segments along which there is a continuous evolution of the form of the periodic orbits, and that the different segments are interconnected through the branch points of the manifold (Ref. 11). It is then much less fundamental whether we define families within the manifold or not, or how we introduce the definition.

In the 10 families described in this report, there are three cases of connections of families at shrinkage points: the family A_1 contains three orbits that belong to three other families, namely, families G , J_1 , BD . Thus we have four families forming one single manifold and having three branch points. In the structure of the manifold illustrated in Fig. 7, the two branch points with G and J_1 are in a Y-form, while the branch point with BD is in an X-form.

All the orbits have been recomputed a large number of times by different programs and by different numerical integration methods. All the computer programs have had in common the features that they integrate with parabolic coordinates in the neighborhood of m_1 and m_2 (distance 0.1 in canonical units) and in rotating rectangular coordinates in all regions that are not close to m_1 and m_2 . In rectangular coordinates, a variable step-size was used for the integration, whenever the numerical integration method allowed a variable step-size.

The classical Runge-Kutta method (fourth-order) was used in the first integrations. Two single-precision programs were written, one using floating-point arithmetic,

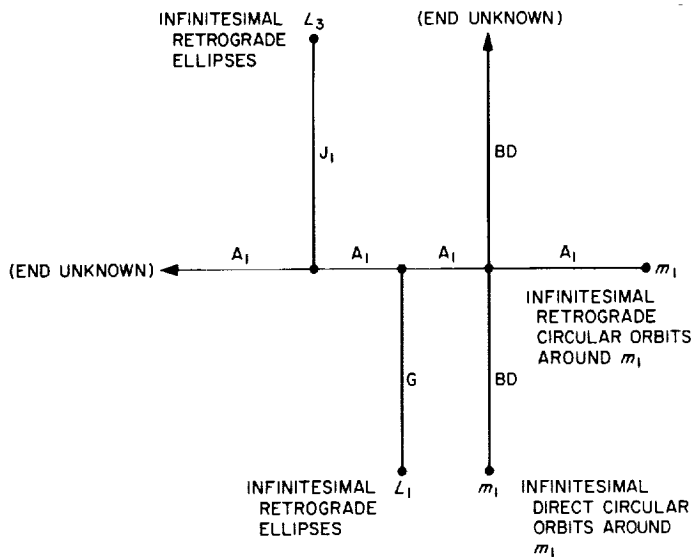

Fig. 7. Branchings between families A_1 , G , J_1 , BD

and the other fixed-point arithmetic. The next integrations were made with a program using the Runge-Kutta method in floating-point double-precision arithmetic. This program resulted in somewhat better precision, but was not entirely satisfactory. Two new programs were written in FORTRAN IV to integrate in double precision, one with the Adams-Moulton method, and the other with recurrent power series. After much testing, two programs were retained for the final computations: the Runge-Kutta double-precision program as a fast but inaccurate exploration program, and the recurrent power series program as an accurate but slower program. The recurrent power series program is in double precision, and it uses the recurrent power series in parabolic coordinates as well as in rectangular coordinates. The decision to perform most of the numerical integrations with the recurrent power series method has its origin in the extremely good results obtained with this method by other investigators of the restricted three-body problem; for instance, by E. Rabe (Ref. 12) and by A. Deprit and J. Price (Ref. 13). Recently, V. Szebehely has obtained explicit expressions, rather than recurrence relations, for the power series solution of the restricted three-body problem (Ref. 14). In the integration with rectangular coordinates the length of the integration step is $h\bar{r}_1\bar{r}_2$, where h is a given constant and \bar{r}_1 and \bar{r}_2 are the distances to m_1 and m_2 at the end of the preceding integration step.

As to the precision of the results, it can be stated in general that the listings in the tables of initial conditions given for each family of periodic orbits in Section V are correct up to seven or eight significant places. All the

results have been checked with the energy constant, and all integrations have been done in such a way that at the end of every orbit at least 12 places of the energy constant are conserved. In general, for 12 correct places in the energy constant, there are at least 9 correct places in the coordinates and velocity. Only a very small number of orbits in the listings are less accurate.

The stability index was computed to at least five correct places for the orbits that are not close to collision orbits. Two special-purpose programs were used for the computation of the stability index. The first program is a modification of a program published by A. Deprit and uses no regularization (Ref. 13); this is why the results with this program are not satisfactory for several near-collision orbits. For all these near-collision orbits we have used the method published by M. Henon (Ref. 15-18), applied with a regularized program. Better results were obtained with this program, although the results are only approximate because the partial derivatives are obtained with a linear approximation by taking differences between a nominal and a slightly perturbed orbit. On a few very unstable orbits, the large values obtained for the stability index are only an approximate determination. The main concern of this study was merely to determine which orbits are stable and which are unstable, rather than the precise determination of the characteristic exponents. Designating one of the non-trivial characteristic roots by λ , and the corresponding characteristic exponent by α , the four characteristic roots, which are the eigenvalues of the monodromy matrix $\mathbf{R}(\mathbf{T})$, are

$$+1, \quad +1, \quad \lambda = e^{\alpha T}, \quad \frac{1}{\lambda} = e^{-\alpha T}$$

In the program by A. Deprit (Ref. 13), the monodromy matrix $\mathbf{R}(\mathbf{T})$ is constructed by solving numerically the variational equations, and between the characteristic roots, the stability index k , and the trace of the monodromy matrix we have the relations

$$\text{trace}[\mathbf{R}(\mathbf{T})] = 1 + 1 + \lambda + \frac{1}{\lambda}$$

$$k = \lambda + \frac{1}{\lambda} = (e^{\alpha T} + e^{-\alpha T}) = 2 \cosh \alpha T$$

In the second program, using the method described by M. Henon (Ref. 15-18), we have two distinct ways of

determining the stability index

$$k = \left(\frac{\partial x}{\partial x_0} \right)_{t=T} = \left(\frac{\partial x'}{\partial x'_0} \right)_{t=T}$$

We have used both partial derivatives in order to check the result. The stability index has thus been computed in three different ways for all the orbits. The value published in the tables of initial conditions in Section V is the value from the Deprit program for most of the orbits; for the near-collision program, it is the value from the Henon method.

The stable orbits have a stability index k that is between -2 and $+2$, while for the unstable orbits the stability index is outside these limits. There is some special interest in the limiting situation $k = -2$ or $+2$ and also in some other particular values for k .

V. Classification of Families of Periodic Orbits

The periodic orbits computed in this study have been classified into nine families that have a known origin, with one supplementary family included that shows certain similarities to one of the other nine. Because of the tremendous number of existing periodic orbits, only the simpler forms were analyzed, and the investigation of a family was terminated when the forms of the orbits became too complicated. Thus, among the 10 families of periodic orbits described in this section, only three have a known origin and end; for six of the families, a natural termination has not been found; and in one family, neither the origin nor the end is known. From the large number of periodic orbits computed and analyzed for each family, it has been established with reasonable certainty that each is a continuous set, as far as the values of the initial abscissa, the Jacobi constant, and the half-period are concerned.

The initial conditions for each of the 10 families of periodic orbits are listed in separate tables under each family description. Following is a recapitulation of the system of differential equations for which the numbers in the tables are the initial conditions:

$$\begin{cases} \frac{d^2x}{dt^2} - 2 \frac{dy}{dt} - x = -m_1 \frac{x-x_1}{r_1^3} - m_2 \frac{x-x_2}{r_2^3} \\ \frac{d^2y}{dt^2} + 2 \frac{dx}{dt} - y = -m_1 \frac{y}{r_1^3} - m_2 \frac{y}{r_2^3} \end{cases}$$

where

$$\begin{aligned} x_1 &= -\mu, & x_2 &= 1-\mu \\ m_1 &= 1-\mu, & m_2 &= \mu \\ r_1^3 &= (x-x_1)^2 + y^2 \\ r_2^3 &= (x-x_2)^2 + y^2 \end{aligned}$$

The values given in the tables of initial conditions are defined by column headings, as follows:

(1) X0 and YDOT0

These two columns give the values x_0, y_0 , which form the initial conditions

$$(x_0, y_0 = 0, \dot{x}_0 = 0, \dot{y}_0)$$

at the beginning of the orbit.

(2) X1 and YDOT1

These two columns give values (x_1, \dot{y}_1) for the initial conditions at the end of a half revolution of the orbit (time = $T/2$). These numbers give thus a set of initial conditions:

$$(x_1, y_1 = 0, \dot{x}_1 = 0, \dot{y}_1)$$

(3) ENERGY

This number gives the energy constant E of the orbit corresponding to the energy integral or Jacobi integral

$$E = \frac{-C}{2} = \frac{1}{2}(\dot{x}^2 + \dot{y}^2) - \frac{1}{2}(x^2 + y^2) - \left(\frac{m_1}{r_1} + \frac{m_2}{r_2} \right)$$

where C is called the "Jacobi constant."

(4) T/2

This number gives the half-period of the orbit.

(5) MASS

This number gives the value of the mass ratio μ , which is the only variable parameter entering the differential equations. It can be seen that the mass ratio μ has changed slightly during the first stages of our work. These variations in μ being small, we have not attempted to make all orbits consistent in μ .

(6) INDEX

This number gives the stability index k of the orbit. It is related to the four characteristic roots

$$\left(+1, +1, \lambda, \frac{1}{\lambda} \right)$$

of the periodic orbit by the simple relation

$$k = \lambda + \frac{1}{\lambda}$$

Stability corresponds to the values of k , which are between -2 and $+2$.

(7) N

This number gives the number of crossings of the x -axis for a half orbit, excluding the initial point.

A. Family G of Periodic Orbits Around L_1

As previously stated, there are infinitesimal retrograde elliptic orbits around the collinear equilibrium points. We shall here give some numerical characteristics of the infinitesimal ellipses around L_1 , together with the continuation of the family of periodic orbits obtained by numerical integration.

The coordinates of the equilibrium point L_1 are

$$x = +0.836892919, \quad y = 0$$

and the value of the potential energy E_0 (given by Eq. 50) is at this point

$$E_0 = 1.59419137$$

At L_1 , the potential function U and the partial derivatives have the following values (for $\mu = 0.012155099$) according to Eq. (65):

$$\begin{aligned} U &= 1.24399649 \\ U_{xx} &= 10.29551567 \\ U_{yy} &= -5.14775783 \\ U_{xy} &= 0 \end{aligned}$$

so that the characteristic equation at L_1 is

$$s^4 - 3.14775777 s^2 - 46.85106249 = 0$$

The roots in s^2 and s are

$$s^2 = \alpha^2 = 8.59727958 \begin{cases} s_1 = +\alpha = +2.93211180 \\ s_2 = -\alpha = -2.93211180 \end{cases}$$

$$s^2 = -\beta^2 = -5.44952180 \begin{cases} s_3 = +i\beta = +i2.33442108 \\ s_4 = -i\beta = -i2.33442108 \end{cases}$$

These four roots correspond to the following values of the coefficients $\gamma = B/A$ of the linear equations (67):

$$\begin{aligned} \gamma_1 &= +\gamma = -0.46011819 \\ \gamma_2 &= -\gamma = +0.46011819 \\ \gamma_3 &= +i\delta = +i3.58655032 \\ \gamma_4 &= -i\delta = -i3.58655032 \end{aligned}$$

The period of the elliptic motion around L_1 is

$$T = \frac{2\pi}{\beta} = 2.69153896$$

and the ratio of the principal axes of the ellipse is

$$\delta = 3.58655032$$

the longest axis being perpendicular to the x -axis.

It is well known that the family of infinitesimal ellipses can be continued into a family of periodic orbits with finite dimensions. We have computed 84 periodic orbits of family G by numerical integration. The first 69 orbits are all simple, while orbits 70 to 84 have two loops.

Between orbits 69 and 70 there is a periodic collision orbit. At the end of the family occurs the phenomenon of the shrinking or coalescence of two loops into one, and a branching with family A_1 (see Fig. 7). Some typical graphs of the actual trajectories are given in Fig. 8. The energy diagram in Fig. 9, which represents the energy E of the orbits as a function of the initial abscissa x_0 , shows the minimum energy at L_1 and the maximum energy at the other end of the family, at the branching with family A_1 .

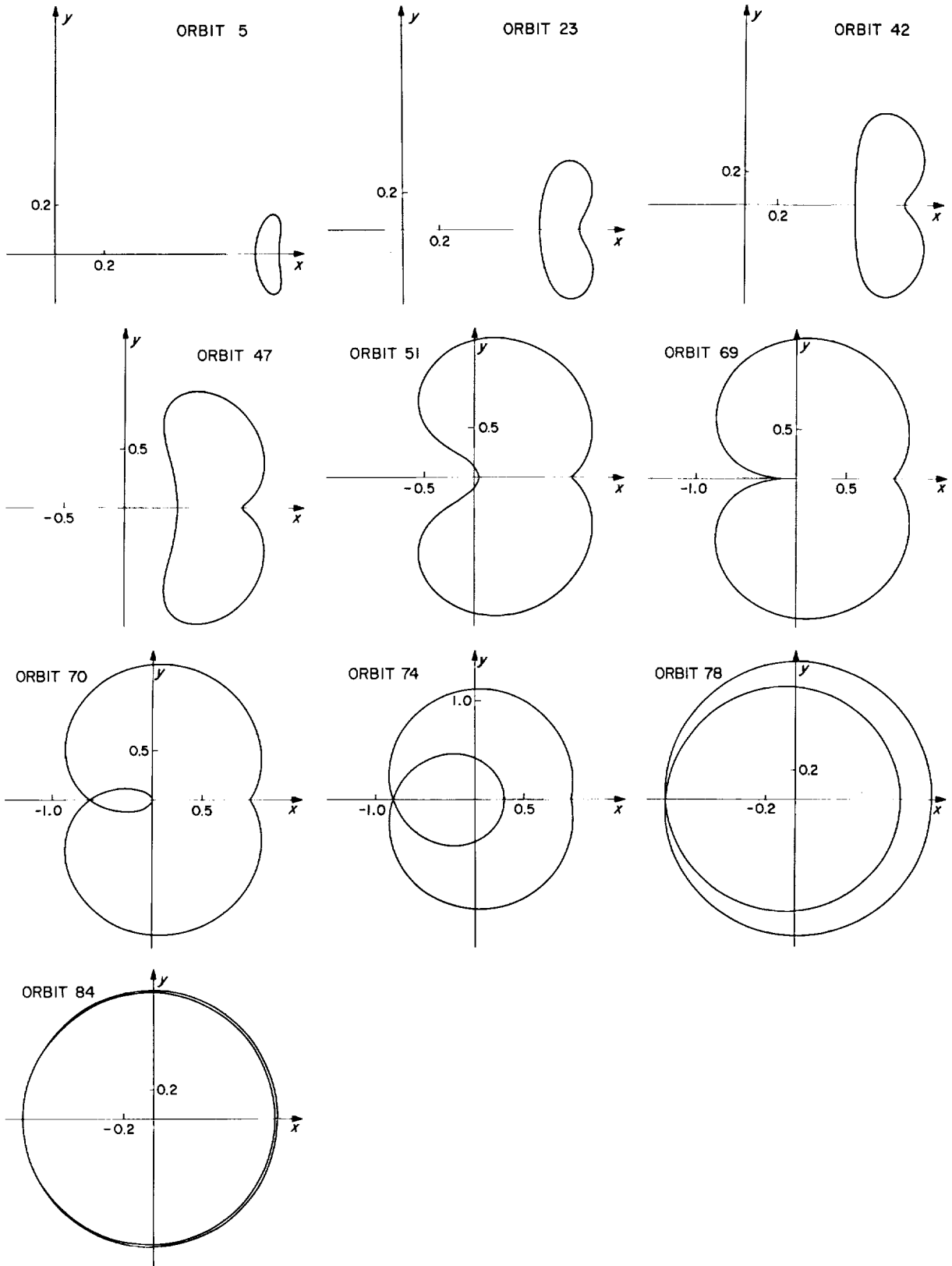

Fig. 8. Typical trajectories in family G of periodic orbits around L_1

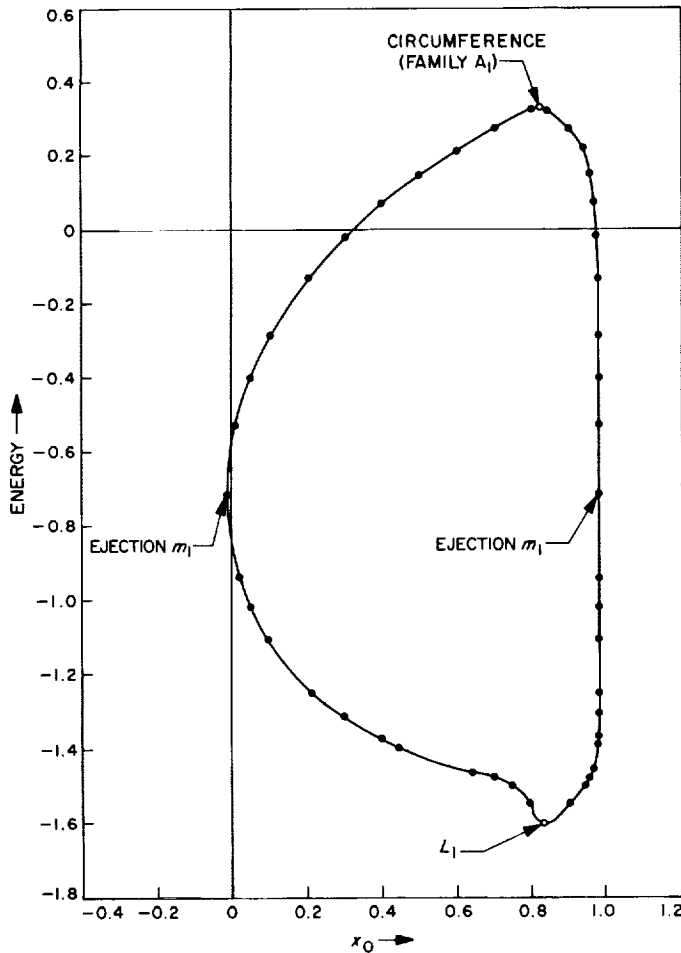

Fig. 9. Energy diagram of family G

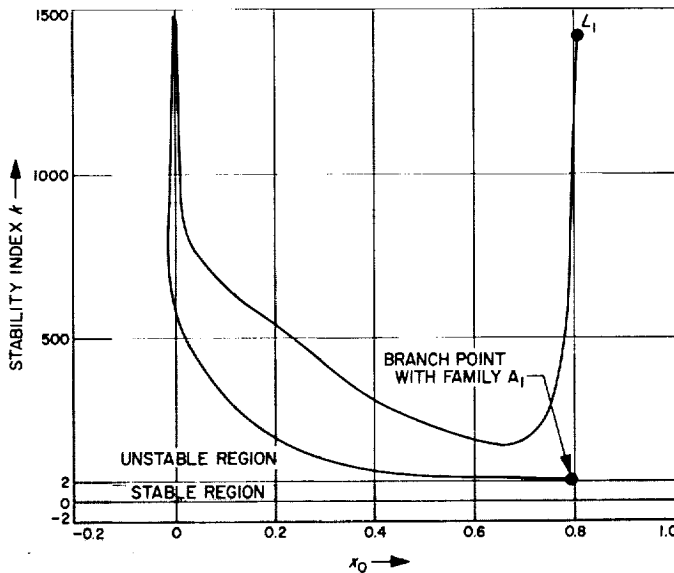

Fig. 10. Stability evolution of family G

The initial conditions for family G are listed in Table 1. All orbits in family G are unstable and have a positive stability index. At the end of the family, the stability index tends to +2, as shown in Fig. 10.

Our family G corresponds to "class" c of orbits around L_1 in Stromgren's problem with equal masses (Ref. 1). However, the evolution of Stromgren's class c is entirely different. A main difference is that his class c is symmetric with respect to both the x - and the y -axis.

B. Family I of Periodic Orbits Around L_2

The coordinates of the equilibrium point L_2 are

$$x = 1.115699521, \quad y = 0$$

and the potential energy E_0 at this point is

$$E_0 = -1.58609804$$

The values of the potential function U and its partial derivatives are

$$U = 0.91827735$$

$$U_{xx} = 6.38067486$$

$$U_{yy} = 3.19037430$$

$$U_{xy} = 0$$

The characteristic equation is thus

$$s^4 - 1.19033743 s^2 - 16.16616843 = 0$$

and its roots are

$$s^2 = \alpha^2 = 4.65969750 \begin{cases} s_1 = +\alpha = +2.1586332 \\ s_2 = -\alpha = -2.1586332 \end{cases}$$

$$s^2 = -\beta^2 = -3.46936007 \begin{cases} s_3 = +i\beta = +i1.8626218 \\ s_4 = -i\beta = -i1.8626218 \end{cases}$$

These roots correspond to the following values of the coefficients $\gamma = B/A$ of the linear equations (67):

$$\gamma_1 = +\gamma = -0.63025467$$

$$\gamma_2 = -\gamma = +0.63025467$$

$$\gamma_3 = +i\delta = +i2.9125705$$

$$\gamma_4 = -i\delta = -i2.9125705$$

The period of the periodic motion is

$$T = \frac{2\pi}{\beta} = 3.37330166$$

For the orbits in family I with finite dimensions, 127 orbits were computed. The initial conditions are given in Table 2 and a representative evolution of the form of the orbits is shown in Fig. 11. Because the orbits become rather complicated, it was not possible to determine the end of the family. There is a periodic collision orbit between orbits 70 and 71. The energy profile of family I is given in the diagram in Fig. 12, and as shown in Fig. 13, all the orbits are unstable with a positive stability index.

In Stromgren's problem with equal masses, the corresponding family is class a. However, the evolution is completely different, with his class a ending by a branching on another class (class f).

C. Family J_1 of Periodic Orbits Around L_3

The coordinates of the equilibrium point L_3 are

$$x = -1.005064527, \quad y = 0$$

with the value

$$E_0 = -1.50607583$$

for the potential energy at this point.

The potential function U of Eq. (65) and its partial derivatives have the values

$$U = 1.00099848$$

$$U_{xx} = 2.02139058$$

$$U_{yy} = -1.01069529$$

$$U_{xy} = 0$$

The characteristic equation is

$$s^4 + 0.98930473 s^2 - 0.03231459 = 0$$

and has the roots

$$s^2 = +\alpha^2 = 0.03165130 \begin{cases} s_1 = +\alpha = +0.17790813 \\ s_2 = -\alpha = -0.17790813 \end{cases}$$

$$s^2 = -\beta^2 = -1.02095603 \begin{cases} s_3 = +i\beta = +i1.01042369 \\ s_4 = -i\beta = -i1.01042369 \end{cases}$$

The corresponding values for the coefficients $\gamma = B/A$ of the homogeneous linear equations (67) are

$$\gamma_1 = +\gamma = -8.40248084$$

$$\gamma_2 = -\gamma = +8.40248084$$

$$\gamma_3 = +i\delta = +i2.000322545$$

$$\gamma_4 = -i\delta = -i2.000322545$$

The period of the elliptic motion around L_3 is

$$T = \frac{2\pi}{\beta} = 6.21836698$$

and the ratio of the principal axes of the ellipse is again δ .

We have studied by numerical integration the continuation of the infinitesimal ellipses into a family of finite periodic orbits. For family J, 134 periodic orbits were computed and classified. The evolution of this family has some similarity with family G around L_1 . Some typical trajectories in family J_1 around L_3 are shown in Fig. 14. Initial conditions for family J_1 are given in Table 3. Orbits 1 to 38 all have one loop and then pass through a periodic collision orbit, while all the following orbits have two loops. The family ends with a branching on the family A_1 (Fig. 7) when both loops coalesce into one single loop. As shown on the energy diagram in Fig. 15, the beginning of the family has the minimum energy, while at the other end, at the branch point with A_1 , it has the maximum energy.

Family J_1 appears somewhat more complicated than family G when one considers its stability evolution. The family contains both stable and unstable orbits as shown in Fig. 16, in which the stability index k is plotted as a function of the initial abscissa x_0 . At the beginning of the family the orbits are slightly unstable with decreasing index k . Orbits 20 to 41 traverse a stable region, and the stability index reaches a minimum value around orbit 62. The stability index then increases for the rest of the family up to the limit value $+2$, and all the last orbits (81 to 134) are stable.

Table 1. Initial conditions for family G of periodic orbits around L_1

	X0	YDOT0	X1	YDOT1	ENERGY	T/2	MASS	INDEX	N
1	.809028225	.281939566	.886475416	-.327596690	-1.558446501	1.508245825	.012155092	1338.90415	1
2	.805151527	.318141359	.895684194	-.380588019	-1.548719162	1.570796265	.012155092	1079.88874	1
3	.805151325	.318143093	.895684651	-.380590661	-1.548718672	1.570799692	.012155092	1079.87670	1
4	.805103565	.318553053	.895792855	-.381215482	-1.548602954	1.571611225	.012155092	1077.03149	1
5	.804225776	.325927304	.897753341	-.392558080	-1.546502023	1.586651369	.012155092	1026.30445	1
6	.800000036	.357334362	.906374462	-.443232280	-1.537189642	1.661109730	.012155092	821.89448	1
7	.792079908	.401610817	.918987637	-.522008864	-1.523443690	1.800720944	.012155092	576.14050	1
8	.787102339	.422989428	.925041752	-.563252847	-1.516809025	1.884953006	.012155092	478.98807	1
9	.787102183	.422990041	.925041923	-.563254058	-1.516808837	1.884955584	.012155092	478.98550	1
10	.787098638	.423004024	.925045831	-.563281671	-1.516804545	1.885014369	.012155092	478.92684	1
11	.786602629	.424945575	.925587457	-.567123584	-1.516209353	1.893223151	.012155092	470.84407	1
12	.781085049	.444803362	.930999861	-.607211769	-1.510239310	1.982256173	.012155092	395.26160	1
13	.773750641	.467580062	.936813977	-.654541766	-1.503754844	2.094355642	.012155092	324.01217	1
14	.773747983	.467587768	.936815856	-.654557935	-1.503752731	2.094395040	.012155092	323.99072	1
15	.773747862	.467588118	.936815941	-.654558669	-1.503752635	2.094396829	.012155092	323.98975	1
16	.772949882	.469886390	.937373466	-.659384048	-1.503124980	2.106184124	.012155092	317.67059	1
17	.758727924	.507149178	.945540644	-.737696774	-1.493731726	2.303944467	.012155092	234.86048	1
18	.754685024	.516874069	.947390204	-.757890982	-1.491529263	2.356183438	.012155092	218.58902	1
19	.754684154	.516876133	.947390584	-.757895248	-1.491528807	2.356194495	.012155092	218.58577	1
20	.754529665	.517242654	.947458018	-.758652574	-1.491447773	2.358157753	.012155092	218.00974	1
21	.748301845	.531765241	.950000308	-.788398583	-1.488348437	2.435341178	.012155092	197.18260	1
22	.741694398	.546758623	.952371110	-.818495402	-1.485364237	2.513184338	.012155092	179.34657	1
23	.741686591	.546776148	.952373738	-.818530181	-1.485360868	2.513273924	.012155092	179.32767	1
24	.741686578	.546776178	.952373742	-.818530238	-1.485360863	2.513274073	.012155092	179.32764	1
25	.741686326	.546776743	.952373827	-.818531360	-1.485360754	2.513276963	.012155092	179.32703	1
26	.740520857	.549388940	.952761921	-.823704234	-1.484861721	2.526589005	.012155092	176.55686	1
27	.736628817	.558058943	.953999388	-.840715354	-1.483246794	2.570160507	.012155092	168.00763	1
28	.711394112	.613372422	.960357758	-.943340772	-1.474173053	2.821722477	.012155092	131.52451	1
29	.704384204	.628730619	.961742743	-.970079831	-1.471941768	2.882787703	.012155092	125.41111	1
30	.700000053	.638373705	.962545791	-.986508801	-1.470587841	2.919180452	.012155092	122.20746	1
31	.696355205	.646418978	.963180090	-1.000012344	-1.469482686	2.948417424	.012155092	119.86338	1
32	.692966575	.653924998	.963744644	-1.012449966	-1.468469764	2.974790811	.012155092	117.92101	1
33	.690681027	.659003204	.964112536	-1.020779246	-1.467793633	2.992148607	.012155092	116.73067	1
34	.677892449	.687680552	.966000000	-1.066599852	-1.464093455	3.083148598	.012155092	111.62205	1
35	.669525301	.706713732	.967098060	-1.095958599	-1.461727149	3.137376844	.012155092	109.48699	1
36	.669426511	.706939836	.967111045	-1.096302681	-1.461699387	3.137993335	.012155092	109.46670	1
37	.668848921	.708262458	.967182657	-1.098313284	-1.461537145	3.141586899	.012155092	109.35026	1
38	.668848873	.708262568	.967182663	-1.098313451	-1.461537132	3.141587197	.012155092	109.35025	1
39	.668848782	.708262777	.967182674	-1.098313768	-1.461537106	3.141587763	.012155092	109.35024	1
40	.668848316	.708263844	.967182732	-1.098315389	-1.461536976	3.141590654	.012155092	109.35014	1
41	.668848153	.708264218	.967182753	-1.098315957	-1.461536930	3.141591667	.012155092	109.35011	1
42	.668847989	.708264592	.967182773	-1.098316525	-1.461536884	3.141592680	.012155092	109.35008	1
43	.668847975	.708264625	.967182775	-1.098316575	-1.461536880	3.141592770	.012155092	109.35008	1
44	.668847802	.708265021	.967182796	-1.098317177	-1.461536831	3.141593843	.012155092	109.35004	1
45	.668844070	.708273570	.967183261	-1.098330160	-1.461535783	3.141616999	.012155092	109.34930	1
46	.643257764	.768071307	.970000036	-1.185739016	-1.454408018	3.283429383	.012155092	107.38360	1
47	.443313100	1.344032402	.979999993	-1.810552087	-1.386229763	3.711632757	.012155092	199.04025	1
48	.299999927	1.959410538	.982327431	-2.177706530	-1.307623621	3.703834473	.012155092	347.34869	1
49	.217963994	2.485552288	.982999968	-2.341499255	-1.243312537	3.647460284	.012155092	463.54958	1
50	1.000000028	3.929778078	.983472008	-2.510170078	-1.104957490	3.506496764	.012155092	554.71093	1
51	.049999990	5.458017660	.983500009	-2.553773333	-1.012462194	3.413966777	.012155085	722.61829	1
52	.020000018	7.720369740	.983428249	-2.567464752	-.931951493	3.336607830	.012155085	759.12815	1
53	.002074573	11.711010270	.983305724	-2.566557530	-.859995593	3.269986422	.012155085	1402.03686	1
54	-.009178486	25.733347255	.983110192	-2.554619491	-.779980019	3.198496353	.012155085	721.84423	1
55	-.011633490	61.533125758	.982988856	-2.545130444	-.740031701	3.163756799	.012155085	698.53058	1

Table 1 (contd)

	X0	YDQTO	X1	YDOT1	ENERGY	T/2	MASS	INDEX	N
56	-.012105503	199.611717429	.982921719	-2.539588492	-.719988156	3.146554582	.012155085	683.74280	1
57	-.012145337	450.185435506	.982904344	-2.538132753	-.715001547	3.142298081	.012155085	674.41954	1
58	-.012145451	452.845872469	.982904262	-2.538125865	-.714978197	3.142278171	.012155085	674.37976	1
59	-.012148953	567.592782065	.982901453	-2.537889834	-.714179327	3.141597128	.012155085	669.67341	1
60	-.012148961	567.950935874	.982901446	-2.537889246	-.714177339	3.141595433	.012155085	669.51042	1
61	-.012148982	568.623749253	.982901423	-2.537888130	-.714173616	3.141592257	.012155092	669.56872	1
62	-.012148990	568.983197286	.982901416	-2.537887541	-.714171628	3.141590562	.012155092	669.34386	1
63	-.012148999	569.394549777	.982901408	-2.537886869	-.714169356	3.141588625	.012155092	669.60886	1
64	-.012149010	570.264125431	.982901401	-2.537885463	-.714164557	3.141584539	.012155085	669.41467	1
65	-.012149027	571.039359854	.982901386	-2.537884202	-.714160297	3.141580907	.012155085	669.45470	1
66	-.012149051	572.180170646	.982901364	-2.537882353	-.714154048	3.141575581	.012155085	669.57124	1
67	-.012149084	573.743150055	.982901334	-2.537879831	-.714145528	3.141568319	.012155085	669.32875	1
68	-.012149100	574.527829038	.982901319	-2.537878570	-.714141268	3.141564688	.012155085	669.29862	1
69	-.012149617	601.045380978	.982900835	-2.537837882	-.714003837	3.141447553	.012155085	668.09959	1
70	.010000025	-9.389476096	.981968896	-2.459830143	-.519025056	2.982134192	.012155085	455.99139	2
71	.050000016	-5.571040779	.980963868	-2.388768472	-.389186213	2.884144484	.012155085	360.07789	2
72	.100000028	-4.134287325	.979710495	-2.319385150	-.280369546	2.808653473	.012155092	249.04248	2
73	.200000028	-3.021814231	.976686299	-2.208739826	-.125986457	2.718606650	.012155092	121.69086	2
74	.300000161	-2.536145497	.972392918	-2.122031873	-.011249165	2.674750953	.012155092	58.36184	2
75	.399997278	-2.271238617	.965853829	-2.054757012	.081790833	2.663847624	.012155092	26.87912	2
76	.499999446	-2.116044001	.955280143	-2.005362278	.160103114	2.679059475	.012155092	11.85307	2
77	.599999679	-2.025252771	.937162622	-1.972469095	.225766963	2.712795197	.012155092	5.25104	2
78	.699999720	-1.975386294	.904463068	-1.954090994	.276726805	2.753218292	.012155092	2.73854	2
79	.800000168	-1.952374884	.842769277	-1.948969598	.304850325	2.780809580	.012155092	2.02371	2
80	.802020627	-1.952127553	.841042379	-1.949027503	.305063909	2.781032950	.012155098	2.01969	2
81	.804239392	-1.951865436	.839116977	-1.949100746	.305277315	2.781256350	.012155098	2.01569	2
82	.806738217	-1.951582154	.836911287	-1.949195678	.305490527	2.781479750	.012155098	2.01171	2
83	.809676890	-1.951265243	.834265518	-1.949324764	.305703546	2.781703150	.012155098	2.00776	2
84	.813471672	-1.950882153	.830763411	-1.949520551	.305916371	2.781926550	.012155098	2.00382	2

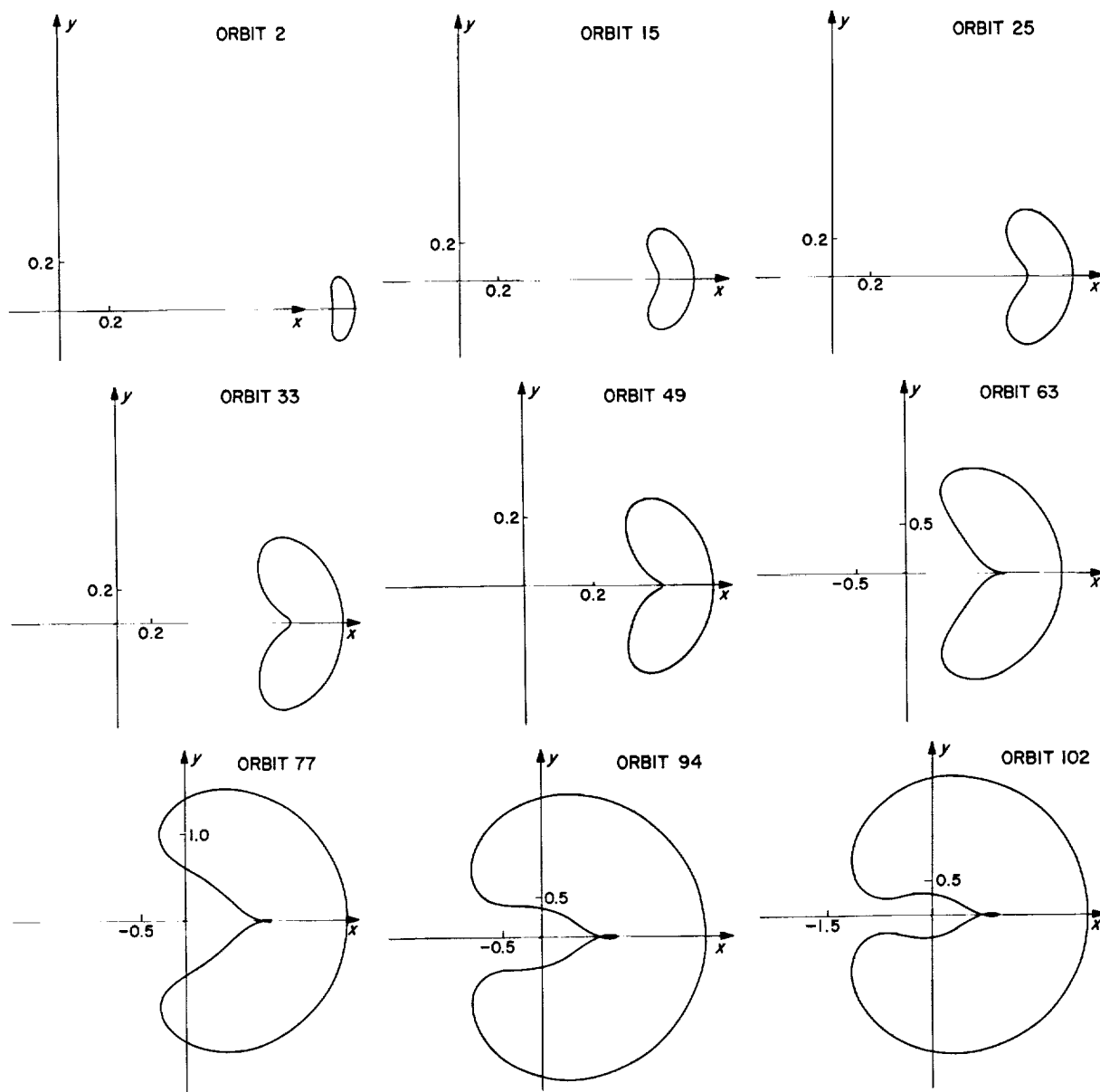

Fig. 11. Typical trajectories in family I of periodic orbits around L_2

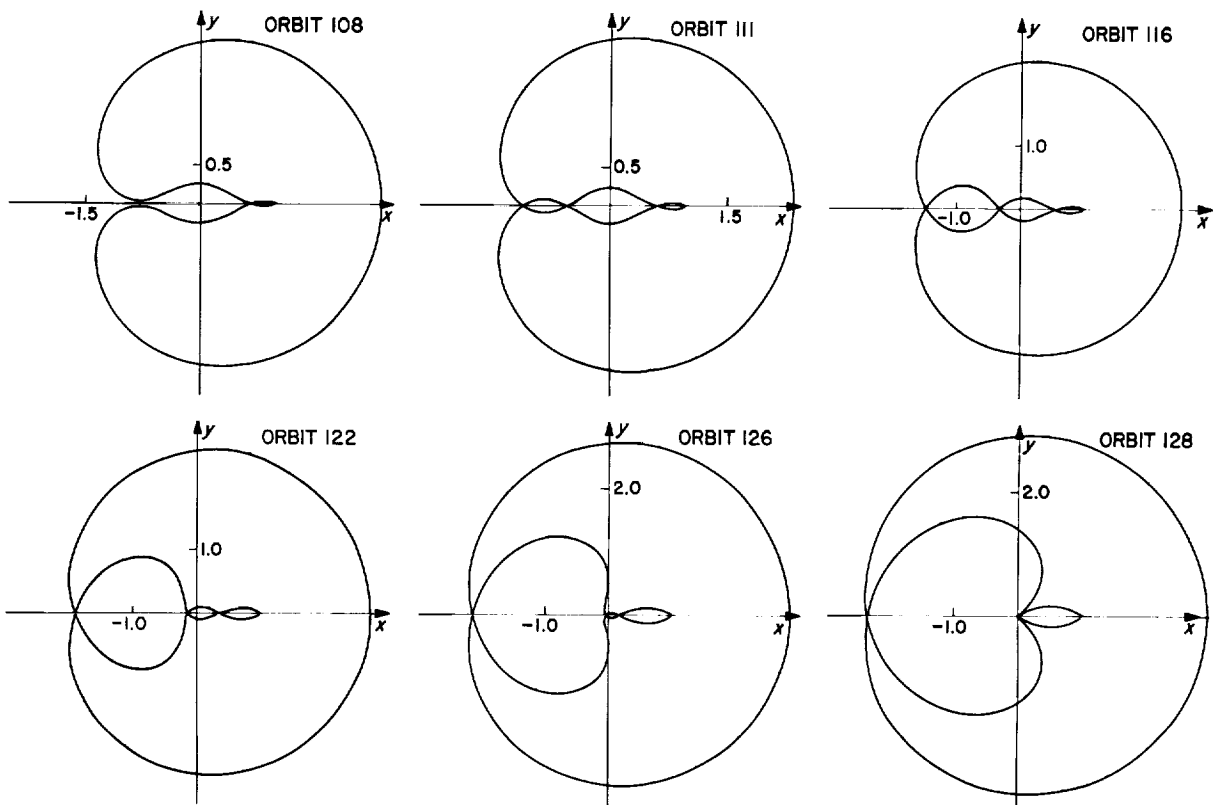

Fig. 11 (contd)

Table 2. Initial conditions for family I of periodic orbits around L_2

	X0	YDOTO	X1	YDOT1	ENERGY	T/2	MASS	INDEX	N
1	1.178499483	-.138556643	1.124999656	.154159569	-1.578251476	1.702793925	.012155092	1261.95372	1
2	1.189707571	-.225810122	1.100000998	.272957288	-1.564349888	1.739334895	.012155092	967.88861	1
3	1.199097269	-.311211446	1.071265746	.418833385	-1.543585746	1.822311281	.012155092	626.20579	1
4	1.199097669	-.311215006	1.071264472	.418840402	-1.543584740	1.822316452	.012155092	626.19181	1
5	1.199153569	-.311711652	1.071086710	.419820269	-1.543444226	1.823039695	.012155092	624.24285	1
6	1.199218069	-.312283786	1.070881807	.420951472	-1.543282093	1.823877542	.012155092	621.99973	1
7	1.199999969	-.319135066	1.068418295	.434702197	-1.541319095	1.834311693	.012155092	595.32347	1
8	1.203259368	-.345555487	1.058781612	.491670444	-1.533402622	1.882476865	.012155092	496.50144	1
9	1.203416956	-.346731904	1.058348938	.494369237	-1.533038428	1.884955584	.012155092	492.28193	1
10	1.203416963	-.346731953	1.058348920	.494369350	-1.533038413	1.884955688	.012155092	492.28176	1
11	1.203417067	-.346732733	1.058348633	.494371145	-1.533038171	1.884957342	.012155092	492.27896	1
12	1.203419868	-.346753546	1.058340976	.494419027	-1.533031720	1.885001480	.012155092	492.20447	1
13	1.206764967	-.369406088	1.049996764	.549543235	-1.525859715	1.939443021	.012155092	414.67666	1
14	1.208355267	-.378711965	1.046583791	.574107372	-1.522842755	1.965961694	.012155092	385.10603	1
15	1.216101065	-.414021839	1.034016730	.679467964	-1.511262036	2.093596636	.012155092	286.98426	1
16	1.216150794	-.414208034	1.033953090	.680070468	-1.511201246	2.094395249	.012155092	286.52984	1
17	1.216150965	-.414208673	1.033952872	.680081717	-1.511201038	2.094397991	.012155092	286.52828	1
18	1.219116664	-.424648971	1.030447748	.715387002	-1.507813372	2.141428529	.012155092	262.14333	1
19	1.219530564	-.426012282	1.029999955	.720145093	-1.507374693	2.147898286	.012155092	259.11830	1
20	1.233682561	-.463801060	1.018748015	.865673148	-1.495790434	2.356180279	.012155092	189.58567	1
21	1.233683581	-.463803355	1.018747409	.865682759	-1.495789774	2.356194465	.012155092	189.58226	1
22	1.233683609	-.463803417	1.018747393	.865683022	-1.495789756	2.356194853	.012155092	189.58216	1
23	1.233683761	-.463803760	1.018747302	.865684456	-1.495789658	2.356196969	.012155092	189.58165	1
24	1.234711361	-.466093763	1.018147413	.875322017	-1.495133896	2.370434939	.012155092	186.21647	1
25	1.245456459	-.487989366	1.012927141	.971703052	-1.489190758	2.513268440	.012155092	158.40188	1
26	1.245456878	-.487990162	1.012926968	.971706683	-1.489190553	2.513273804	.012155092	158.40101	1
27	1.245456899	-.487990201	1.012926959	.971706866	-1.489190543	2.513274073	.012155092	158.40096	1
28	1.245456927	-.487990254	1.012926948	.971707107	-1.489190530	2.513274430	.012155092	158.40091	1
29	1.245456959	-.487990316	1.012926935	.971707390	-1.489190514	2.513274847	.012155092	158.40084	1
30	1.246159359	-.489319324	1.012640008	.977789231	-1.488849375	2.522254466	.012155092	156.95094	1
31	1.253320158	-.502359568	1.010000098	1.038745848	-1.485621098	2.611526578	.012155092	144.02949	1
32	1.299999997	-.576269443	.999914805	1.422884069	-1.470737612	3.109155405	.012155092	104.79654	1
33	1.303519398	-.581492260	.999434548	1.452517622	-1.469847686	3.141592003	.012155098	103.61724	1
34	1.303519428	-.581492304	.999434544	1.452517876	-1.469847678	3.141592277	.012155098	103.61720	1
35	1.303519443	-.581492327	.999434542	1.452518002	-1.469847674	3.141592414	.012155098	103.61720	1
36	1.303519458	-.581492349	.999434540	1.452518129	-1.469847671	3.141592551	.012155098	103.61720	1
37	1.303519487	-.581492372	.999434534	1.452518495	-1.469847664	3.141593235	.012155092	103.61718	1
38	1.303519696	-.581492682	.999434506	1.452520262	-1.469847612	3.141595142	.012155092	103.61711	1
39	1.303519741	-.581492749	.999434500	1.452520643	-1.469847601	3.141595553	.012155092	103.61710	1
40	1.303519770	-.581492792	.999434496	1.452520888	-1.469847593	3.141595817	.012155092	103.61709	1
41	1.303519800	-.581492836	.999434493	1.452521141	-1.469847586	3.141596091	.012155092	103.61708	1
42	1.303519830	-.581492880	.999434489	1.452521395	-1.469847578	3.141596365	.012155092	103.61707	1
43	1.303519875	-.581492947	.999434483	1.452521775	-1.469847567	3.141596776	.012155092	103.61705	1
44	1.303519905	-.581492991	.999434479	1.452522029	-1.469847560	3.141597050	.012155092	103.61705	1
45	1.303519934	-.581493034	.999434475	1.452522274	-1.469847552	3.141597314	.012155092	103.61704	1
46	1.303519949	-.581493057	.999434473	1.452522401	-1.469847549	3.141597451	.012155092	103.61704	1
47	1.303683192	-.581734760	.999412792	1.453902646	-1.469806725	3.143086556	.012155092	103.56628	1
48	1.319999993	-.605702069	.997477509	1.594913707	-1.465896091	3.285287106	.012155092	100.06832	1
49	1.358780131	-.661860955	.994204414	1.964538804	-1.457443323	3.575807648	.012155092	101.40759	1
50	1.399999991	-.721208745	.991967106	2.439479330	-1.448950555	3.824217416	.012155092	113.32811	1
51	1.419425189	-.749165801	.991194903	2.705257199	-1.444961465	3.923866443	.012155092	121.85051	1
52	1.420065194	-.750086973	.991171868	2.714576199	-1.444829519	3.926984290	.012155092	122.15979	1
53	1.420066595	-.750088990	.991171818	2.714596641	-1.444829230	3.926991104	.012155092	122.16047	1

Table 2 (contd)

	X0	YDOT0	X1	YDOT1	ENERGY	T/2	MASS	INDEX	N
54	1.420066759	-.750089226	.991171812	2.714599034	-1.444829196	3.926991902	.012155092	122.16056	1
55	1.436012194	-.773041206	.990641562	2.959914076	-1.441525460	4.001531797	.012155092	130.42915	1
56	1.482472688	-.839913548	.989488452	3.857403870	-1.431639852	4.188761279	.012155092	160.43518	1
57	1.482479885	-.839923904	.989488310	3.857569437	-1.431638284	4.188787283	.012155092	160.44049	1
58	1.482480749	-.839925147	.989488293	3.857589314	-1.431638095	4.188790405	.012155092	160.44113	1
59	1.482480839	-.839925277	.989488291	3.857591385	-1.431638076	4.188790730	.012155092	160.44120	1
60	1.484291896	-.842531112	.989452980	3.899568409	-1.431242946	4.195308158	.012155092	161.78525	1
61	1.500000000	-.865127084	.989171608	4.291824258	-1.427780360	4.249713159	.012155092	173.99166	1
62	1.527747691	-.905008902	.988770468	5.135550443	-1.421497659	4.337386692	.012155092	197.99399	1
63	1.571709588	-.968071397	.988331206	7.079513373	-1.411065481	4.458006706	.012155092	242.71335	1
64	1.599999994	-1.008550650	.988144472	9.016376026	-1.404017077	4.526024790	.012155092	276.16285	1
65	1.693663090	-1.141870270	.987865285	34.541683139	-1.378638035	4.712379551	.012155092	417.24444	1
66	1.693667486	-1.141876501	.987865280	34.545587855	-1.378636766	4.712387189	.012155092	417.25208	1
67	1.693668589	-1.141878069	.987865273	34.546526481	-1.378636446	4.712389032	.012155098	417.25407	1
68	1.695875689	-1.145005836	.987863040	36.617204989	-1.377998562	4.716213147	.012155092	421.20961	1
69	1.711218700	-1.166731114	.987851332	61.511045142	-1.373511399	4.742210957	.012155092	449.59741	1
70	1.719999999	-1.179151093	.987847426	98.225828209	-1.370901334	4.756650280	.012155092	466.56109	1
71	1.759999990	-1.235596959	.987850654	-65.040637117	-1.358617603	4.818788631	.012155092	550.83408	2
72	1.779999986	-1.263741936	.987862566	-37.105705756	-1.352227505	4.847865560	.012155092	597.54681	2
73	1.799999997	-1.291836326	.987879650	-26.456809334	-1.345667528	4.875779626	.012155092	647.52774	2
74	1.800024092	-1.291870143	.987879673	-26.447957457	-1.345659521	4.875812598	.012155092	647.58956	2
75	1.820071399	-1.319981429	.987900960	-20.831899641	-1.338909969	4.902732183	.012155092	701.13956	2
76	1.840141490	-1.348076531	.987925568	-17.368693232	-1.331974934	4.928716997	.012155092	758.37933	2
77	1.860233486	-1.376155712	.987952773	-15.022505432	-1.324850572	4.953850030	.012155092	819.49552	2
78	1.880346999	-1.404220071	.987981963	-13.330031260	-1.317532771	4.978206965	.012155092	884.67929	2
79	1.899999991	-1.431600306	.988011882	-12.079836135	-1.310199334	5.001298826	.012155092	952.40949	2
80	1.900480792	-1.432269651	.988012628	-12.053029667	-1.310017625	5.001855526	.012155092	954.11790	2
81	1.920634091	-1.460305256	.988044339	-11.056400090	-1.302300959	5.024857962	.012155092	1028.00684	2
82	1.940805793	-1.488327336	.988076740	-10.257846687	-1.294378607	5.047270832	.012155092	1106.53924	2
83	1.960995197	-1.516336987	.988109537	-9.604354220	-1.286246129	5.069146475	.012155092	1189.91079	2
84	1.981200993	-1.544334542	.988142488	-9.060254440	-1.277899200	5.090532459	.012155092	1278.30905	2
85	2.000000000	-1.570353540	.988173087	-8.630607119	-1.269942749	5.110014472	.012155092	1365.17262	2
86	2.001422375	-1.572321102	.988175396	-8.600643753	-1.269333159	5.111473277	.012155092	1371.92893	2
87	2.021658182	-1.600297347	.988208099	-8.207622785	-1.260543352	5.132009852	.012155092	1470.95785	2
88	2.041907191	-1.628263930	.988240472	-7.867990832	-1.251525006	5.152180244	.012155092	1575.57797	2
89	2.062168181	-1.656221567	.988272412	-7.571797978	-1.242273196	5.172020039	.012155092	1685.96381	2
90	2.082440287	-1.684171519	.988303844	-7.311398020	-1.232782666	5.191562980	.012155092	1802.28999	2
91	2.099999994	-1.708365128	.988330601	-7.110216270	-1.224368848	5.208267891	.012155092	1907.92832	2
92	2.102722079	-1.712114324	.988334708	-7.080828005	-1.223048246	5.210840340	.012155092	1924.71460	2
93	2.123012185	-1.740050652	.988364964	-6.875362867	-1.213064560	5.229881764	.012155092	2053.38856	2
94	2.129563659	-1.749067619	.988374596	-6.813747469	-1.209787553	5.235982920	.012155092	2096.28272	2
95	2.129568905	-1.749078439	.988374603	-6.813698993	-1.209784919	5.235987796	.012155092	2096.32046	2
96	2.143309772	-1.767981971	.988394583	-6.691205695	-1.202825765	5.248715929	.012155092	2188.45253	2
97	2.149999976	-1.777185399	.988404201	-6.634646425	-1.199394842	5.254881677	.012155092	2234.38239	2
98	2.163613379	-1.795908942	.988423550	-6.525279443	-1.192326112	5.267369629	.012155092	2330.03165	2
99	2.183921695	-1.823832488	.988451858	-6.375058186	-1.181559552	5.285868694	.012155092	2478.23862	2
100	2.204233289	-1.851753431	.988479508	-6.238450497	-1.170519856	5.304237893	.012155092	2633.15744	2
101	2.224546999	-1.879673031	.988506511	-6.113707293	-1.159200384	5.322501435	.012155092	2794.86861	2
102	2.244861275	-1.907592085	.988532880	-5.999357804	-1.147594420	5.340682513	.012155092	2963.40684	2
103	2.265174896	-1.935511921	.988558634	-5.894152428	-1.135694754	5.358804082	.012155092	3138.82115	2
104	2.285486072	-1.963433173	.988583796	-5.797026479	-1.123494169	5.376888180	.012155092	3321.08837	2
105	2.305793792	-1.991357639	.988608394	-5.707061084	-1.110984614	5.394957247	.012155092	3510.19665	2
106	2.326095670	-2.019285333	.988632455	-5.623467297	-1.098158482	5.413032330	.012155092	3706.05670	2
107	2.327719390	-2.021519544	.988634358	-5.617034271	-1.097118548	5.414479131	.012155092	3722.01852	2
108	2.346390694	-2.047218274	.988656013	-5.545553328	-1.085006881	5.431135642	.012155092	3908.60630	2

Table 2 (contd)

	X0	YDOT0	X1	YDOT1	ENERGY	T/2	MASS	INDEX	N
109	2.359999955	-2.065959297	.988671556	-5.496167753	-1.075997912	5.443306001	.012155085	4048.13291	2
110	2.379999965	-2.093518100	.988694036	-5.427369058	-1.062473902	5.461253225	.012155085	4258.54810	4
111	2.399988711	-2.121085157	.988716117	-5.362689238	-1.048609187	5.479284138	.012155085	4475.00788	4
112	2.429946572	-2.162453893	.988748570	-5.272498464	-1.027151538	5.506534055	.012155085	4810.53820	4
113	2.459868461	-2.203848822	.988780335	-5.189436907	-1.004868837	5.534094167	.012155085	5158.18994	4
114	2.474813670	-2.224557581	.988796002	-5.150250640	-.993405952	5.548014352	.012155085	5336.17841	4
115	2.489747167	-2.245274780	.988811549	-5.112471192	-.981721718	5.562041168	.012155085	5516.71618	4
116	2.512123317	-2.276367984	.988834682	-5.058208272	-.963768045	5.583303861	.012155085	5791.84944	4
117	2.545626193	-2.323051936	.988869088	-4.981587812	-.935835670	5.615770511	.012155085	6212.78149	4
118	2.579043627	-2.369797153	.988903343	-4.909828811	-.906633550	5.649041042	.012155085	6640.94327	4
119	2.612360597	-2.416613970	.988937690	-4.842067046	-.876076002	5.683259071	.012155085	7072.76265	4
120	2.645559937	-2.463514322	.988972398	-4.777532714	-.844064271	5.718585382	.012155085	7504.04363	4
121	2.678621531	-2.510511815	.989007767	-4.715526139	-.810483523	5.755202666	.012155085	7929.97582	4
122	2.711521655	-2.557622419	.989044138	-4.655395236	-.775198475	5.793322209	.012155085	8344.79437	4
123	2.744231910	-2.604865168	.989081915	-4.596513997	-.738047591	5.833192829	.012155085	8741.85461	4
124	2.776717424	-2.652262670	.989121578	-4.538260317	-.698835440	5.875112921	.012155085	9113.33084	4
125	2.808934957	-2.699842804	.989163724	-4.479989044	-.657321094	5.919448553	.012155085	9449.97947	4
126	2.840829343	-2.747640074	.989209113	-4.420998518	-.613202091	5.966659294	.012155085	9740.70194	4
127	2.872328728	-2.795698610	.989258752	-4.360481923	-.566089413	6.017338848	.012155085	9971.91803	4

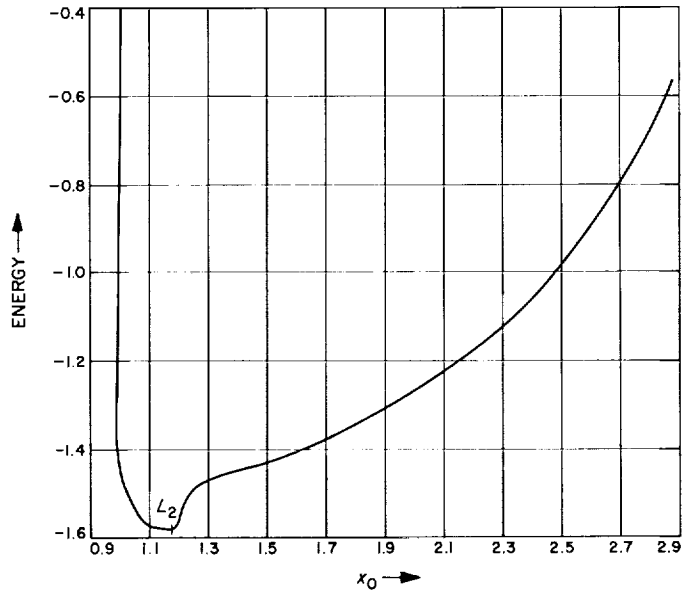

Fig. 12. Energy diagram of family I

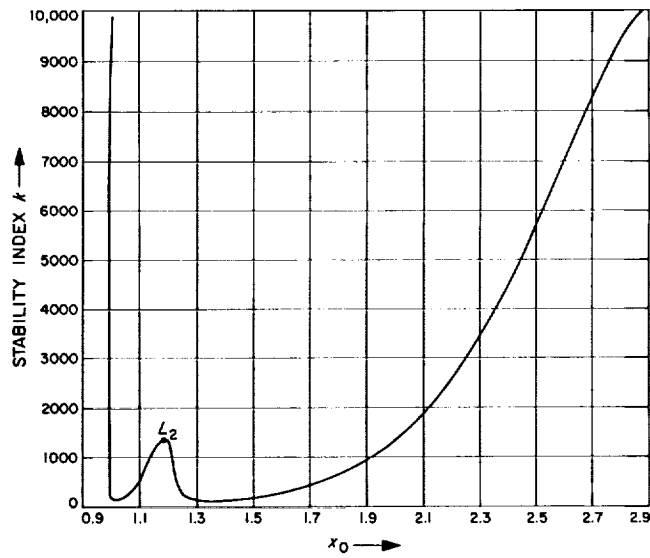

Fig. 13. Stability evolution of family I

Table 3. Initial conditions for family J_1 of periodic orbits around L_3

	X0	YDOT0	X1	YDOT1	ENERGY	T/2	MASS	INDEX	N
1	-1.009805506	.009571149	-1.000323331	-.009594077	-1.506063868	3.109183936	.012155085	3.35390	1
2	-1.010070783	.010106027	-1.000058037	-.010131593	-1.506062496	3.109183966	.012155092	3.35389	1
3	-1.099993784	.187758081	-.910053867	-.197021599	-1.501268788	3.109351634	.012155092	3.34411	1
4	-1.110018636	.207154441	-.900010944	-.218496346	-1.500196662	3.109389125	.012155092	3.34192	1
5	-1.110018636	.207154441	-.900010944	-.218496346	-1.500196662	3.109389125	.012155092	3.34192	1
6	-1.199995236	.378232982	-.809792187	-.418225717	-1.485651124	3.109897493	.012155092	3.31236	1
7	-1.209747797	.396487566	-.800004840	-.440722981	-1.483533587	3.109971463	.012155092	3.30807	1
8	-1.299998180	.563279297	-.709355787	-.658642887	-1.458722535	3.110837637	.012155092	3.25803	1
9	-1.309303946	.580287830	-.700001230	-.682247651	-1.455613734	3.110946118	.012155092	3.25179	1
10	-1.399998652	.744689937	-.608760196	-.926383708	-1.419591016	3.112203001	.012155092	3.17985	1
11	-1.408696713	.760353259	-.600003304	-.951348240	-1.415567459	3.112343430	.012155092	3.17185	1
12	-1.499999233	.924179947	-.508022915	-1.234948529	-1.366774165	3.114049016	.012155092	3.07525	1
13	-1.507956410	.938433145	-.500001935	-1.261870414	-1.361919944	3.114219098	.012155092	3.06566	1
14	-1.599999056	1.103631371	-.407180184	-1.609037760	-1.297824096	3.116476833	.012155092	2.93894	1
15	-1.607113994	1.116457266	-.400002699	-1.639233881	-1.292207857	3.116676032	.012155092	2.92779	1
16	-1.699999584	1.285553866	-.306298890	-2.100575496	-1.208467263	3.119685917	.012155092	2.75924	1
17	-1.799999995	1.474186406	-.205538045	-2.845789454	-1.090281139	3.124128907	.012155092	2.50623	1
18	-1.900000194	1.679723559	-.105407762	-4.401850025	-.921739672	3.131155877	.012155092	2.07714	1
19	-1.910000000	1.702191646	-.095488321	-4.683995869	-.900025091	3.132144469	.012155098	2.01165	1
20	-1.915000000	1.713640573	-.090540400	-4.843374173	-.888658848	3.132671039	.012155098	1.97680	1
21	-1.920000000	1.725250529	-.085601652	-5.017552829	-.876915917	3.133221870	.012155098	1.93931	1
22	-1.925000000	1.737037586	-.080673203	-5.209059396	-.864762719	3.133799435	.012155098	1.90004	1
23	-1.930000000	1.749020513	-.075756383	-5.421065656	-.852160104	3.134406623	.012155098	1.85791	1
24	-1.935000000	1.761221464	-.070852777	-5.657614081	-.839061962	3.135046842	.012155098	1.81341	1
25	-1.940000000	1.773666895	-.065964294	-5.923949409	-.825413331	3.135724159	.012155098	1.76504	1
26	-1.945000000	1.786388837	-.061093270	-6.227018025	-.811147812	3.136443492	.012155098	1.71311	1
27	-1.945403478	1.787428625	-.060701041	-6.253339189	-.809967416	3.136503546	.012155092	1.70969	1
28	-1.950000000	1.799426695	-.056242600	-6.576245290	-.796183892	3.137210877	.012155098	1.65653	1
29	-1.955000000	1.812829869	-.051415944	-6.984793323	-.780419607	3.138033856	.012155098	1.59444	1
30	-1.960000000	1.826661718	-.046618028	-7.471692869	-.763724485	3.138922069	.012155098	1.52603	1
31	-1.965000000	1.841005790	-.041855129	-8.065666765	-.745926875	3.139888161	.012155098	1.44973	1
32	-1.970000000	1.855976191	-.037135864	-8.812488403	-.726792914	3.140949305	.012155098	1.36619	1
33	-1.972795736	1.864677641	-.034520496	-9.323682606	-.715393536	3.141592710	.012155092	1.27941	1
34	-1.975000000	1.871735966	-.032472606	-9.790488214	-.705989256	3.142129869	.012155098	1.26765	1
35	-1.980000000	1.888532787	-.027884217	-11.147459117	-.683010825	3.143466564	.012155098	1.15391	1
36	-1.985000000	1.906777211	-.023402039	-13.205119687	-.657022557	3.145019677	.012155098	1.01602	1
37	-1.990000000	1.927249412	-.019085689	-16.847541728	-.626441885	3.146902522	.012155098	.83978	1
38	-1.995000000	1.951856159	-.015080766	-25.964301238	-.587412018	3.149388554	.012155098	.58904	1
39	-2.000000000	2.027074676	-.014909933	26.763845948	-.446494954	3.158947147	.012155098	-.57341	2
40	-1.995000000	2.055035740	-.022851506	13.563521218	-.380697303	3.163502956	.012155098	-1.32349	2
41	-1.990000000	2.068665749	-.029679163	10.586713555	-.343898042	3.165983980	.012155098	-1.83259	2
42	-1.985000000	2.078168242	-.036170038	9.036768445	-.315530602	3.167830030	.012155098	-2.28055	2
43	-1.980000000	2.085449951	-.042470200	8.038266329	-.291738120	3.169315346	.012155098	-2.69374	2
44	-1.975000000	2.091291093	-.048639636	7.323617449	-.270937802	3.170553904	.012155098	-3.09001	2
45	-1.970000000	2.096102334	-.054709987	6.778538286	-.252294227	3.171606560	.012155098	-3.47561	2
46	-1.965000000	2.100131518	-.060700357	6.344616626	-.235301838	3.172510538	.012155098	-3.85660	2
47	-1.960000000	2.103541921	-.066623320	5.988370324	-.219626694	3.173290688	.012155098	-4.23399	2
48	-1.955000000	2.106447917	-.072487672	5.689003883	-.205034260	3.173964656	.012155098	-4.61071	2
49	-1.950000000	2.108933368	-.078299856	5.432808729	-.191352132	3.174545572	.012155098	-4.98798	2
50	-1.945000000	2.111061965	-.084064767	5.210321891	-.178449039	3.175043582	.012155098	-5.36480	2
51	-1.940000000	2.112883466	-.089786241	5.014766460	-.166222187	3.175466772	.012155098	-5.74078	2
52	-1.935000000	2.114437641	-.095467371	4.841141096	-.154589216	3.175821762	.012155098	-6.11753	2
53	-1.930000000	2.115756886	-.101110708	4.685661241	-.143482881	3.176114102	.012155098	-6.51640	2
54	-1.925000000	2.116868021	-.106718409	4.545401771	-.132847397	3.176348538	.012155098	-6.87910	2
55	-1.920000000	2.117793549	-.112292332	4.418060358	-.122635853	3.176529208	.012155098	-7.24837	2

Table 3 (contd)

	X0	YDOTO	X1	YDOT1	ENERGY	T/2	MASS	INDEX	N
56	-1.915000000	2.118552576	-.117834115	4.301796108	-.112808347	3.176659773	.012155098	-7.62378	2
57	-1.910000000	2.119161483	-.123345220	4.195116642	-.103330596	3.176743522	.012155098	-7.99965	2
58	-1.905000000	2.119634445	-.128826978	4.096797310	-.094172888	3.176783443	.012155098	-8.37429	2
59	-1.899996465	2.119984029	-.134284448	4.005760467	-.085303102	3.176782249	.012155092	-8.74698	2
60	-1.827305105	2.115923746	-.211005918	3.168808659	.020504747	3.173429399	.012155092	-13.49737	2
61	-1.799999953	2.111724319	-.238891148	2.982631214	.052795945	3.171158730	.012155092	-14.74762	2
62	-1.699999655	2.090867121	-.338600055	2.547009370	.151070929	3.161382793	.012155092	-16.11169	2
63	-1.600000312	2.066174572	-.436498884	2.306272646	.227711967	3.151928156	.012155092	-13.54972	2
64	-1.462133077	2.031296921	-.570910505	2.119730331	.307923024	3.141609340	.012155092	-7.75418	2
65	-1.461948153	2.031251325	-.571090990	2.119551879	.308013496	3.141597836	.012155092	-7.74638	2
66	-1.461867170	2.031231358	-.571170030	2.119473778	.308053103	3.141592800	.012155092	-7.74296	2
67	-1.461865240	2.031230882	-.571171914	2.119471917	.308054047	3.141592680	.012155092	-7.74288	2
68	-1.451225459	2.028617209	-.581558253	2.109461550	.313186166	3.140941261	.012155092	-7.29726	2
69	-1.399999220	2.016345398	-.631623895	2.067653644	.335951312	3.138082921	.012155098	-5.25587	2
70	-1.387059904	2.013341930	-.644287639	2.058603115	.341204736	3.137431691	.012155098	-4.77304	2
71	-1.373534119	2.010250350	-.657533666	2.049728664	.346487013	3.136780461	.012155098	-4.28436	2
72	-1.359347313	2.007064181	-.671436497	2.041031730	.351800152	3.136129231	.012155098	-3.79017	2
73	-1.344408269	2.003776000	-.686087312	2.032514797	.357146222	3.135478001	.012155098	-3.29083	2
74	-1.328603268	2.000377190	-.701599787	2.024181622	.362527355	3.134826771	.012155098	-2.78670	2
75	-1.311787321	1.996857604	-.718118866	2.016037562	.367945758	3.134175541	.012155098	-2.27816	2
76	-1.310042252	1.996498339	-.719833990	2.015233342	.368490061	3.134110379	.012155098	-2.22705	2
77	-1.308286129	1.996137965	-.721560143	2.014431613	.369034411	3.134045259	.012155098	-2.17593	2
78	-1.306517604	1.995776236	-.723298653	2.013631865	.369579162	3.133980139	.012155098	-2.12477	2
79	-1.304736445	1.995413138	-.725049754	2.012834107	.370124315	3.133915019	.012155098	-2.07357	2
80	-1.302942408	1.995048658	-.726813687	2.012038349	.370669872	3.133849899	.012155098	-2.02233	2
81	-1.301135247	1.994682780	-.728590703	2.011244602	.371215837	3.133784779	.012155098	-1.97106	2
82	-1.299314702	1.994315489	-.730381056	2.010452874	.371762212	3.133719659	.012155098	-1.91974	2
83	-1.297480508	1.993946771	-.732185014	2.009663178	.372308999	3.133654539	.012155098	-1.86839	2
84	-1.295632392	1.993576609	-.734002851	2.008875523	.372856200	3.133589419	.012155098	-1.81700	2
85	-1.293770413	1.993205056	-.735834511	2.008090067	.373403716	3.133524311	.012155098	-1.76558	2
86	-1.274294764	1.989404559	-.755004443	2.000349422	.378903609	3.132873081	.012155098	-1.24936	2
87	-1.271152924	1.988806584	-.758098929	1.999179686	.379752222	3.132773057	.012155098	-1.16978	2
88	-1.267967534	1.988204746	-.761236869	1.998015499	.380601688	3.132673057	.012155098	-1.09014	2
89	-1.264736126	1.987598820	-.764420722	1.996856645	.381452219	3.132573057	.012155098	-1.01042	2
90	-1.261456863	1.986988718	-.767652321	1.995703194	.382303825	3.132473057	.012155098	-.93063	2
91	-1.258127785	1.986374351	-.770933627	1.994555220	.383156515	3.132373057	.012155098	-.85077	2
92	-1.254746792	1.985755623	-.774266741	1.993412801	.384010298	3.132273057	.012155098	-.77084	2
93	-1.251311633	1.985132433	-.777653913	1.992276021	.384865185	3.132173057	.012155098	-.69085	2
94	-1.247819886	1.984504677	-.781097564	1.991144968	.385721184	3.132073057	.012155098	-.61079	2
95	-1.244268945	1.983872242	-.784600302	1.990019737	.386578306	3.131973057	.012155098	-.53066	2
96	-1.240655992	1.983235012	-.788164943	1.988900427	.387436559	3.131873057	.012155098	-.45047	2
97	-1.236977980	1.982592863	-.791794533	1.987787147	.388295954	3.131773057	.012155098	-.37022	2
98	-1.233231600	1.981945662	-.795492381	1.986680011	.389156501	3.131673057	.012155098	-.28990	2
99	-1.229413253	1.981293269	-.799262087	1.985579142	.390018210	3.131573057	.012155098	-.20953	2
100	-1.225519007	1.980635536	-.803107583	1.984484673	.390881090	3.131473057	.012155098	-.12910	2
101	-1.221544557	1.979972303	-.807033172	1.983396746	.391745151	3.131373057	.012155098	-.04862	2
102	-1.217485170	1.979303399	-.811043587	1.982315515	.392610405	3.131273057	.012155098	.03191	2
103	-1.213335625	1.978628640	-.815144049	1.981241146	.393476860	3.131173057	.012155098	.11250	2
104	-1.209090140	1.977947828	-.819340341	1.980173821	.394344528	3.131073057	.012155098	.19314	2
105	-1.204742277	1.977260748	-.823638899	1.979113738	.395213418	3.130973057	.012155098	.27384	2
106	-1.200284841	1.976567168	-.828046919	1.978061112	.396083542	3.130873057	.012155098	.35458	2
107	-1.195709741	1.975866833	-.832572489	1.977016182	.396954909	3.130773057	.012155098	.43536	2
108	-1.191007832	1.975159462	-.837224757	1.975979209	.397827531	3.130673057	.012155098	.51619	2
109	-1.186168704	1.974444747	-.842014131	1.974950486	.398701418	3.130573057	.012155098	.59707	2
110	-1.181180427	1.973722346	-.846952541	1.973930338	.399576581	3.130473057	.012155098	.67799	2

Table 3 (contd)

	X0	YDOT0	X1	YDOT1	ENERGY	T/2	MASS	INDEX	N
111	-1.176029217	1.972991875	-.852053770	1.972919132	.400453030	3.130373057	.012155098	.75894	2
112	-1.170699006	1.972252900	-.857333887	1.971917283	.401330777	3.130273057	.012155098	.83994	2
113	-1.165170870	1.971504931	-.862811816	1.970925266	.402209833	3.130173057	.012155098	.92097	2
114	-1.159422260	1.970747400	-.868510102	1.969943630	.403090209	3.130073057	.012155098	1.00204	2
115	-1.153425952	1.969979648	-.874455973	1.968973016	.403971916	3.129973057	.012155098	1.08314	2
116	-1.147148553	1.969200898	-.880682820	1.968014187	.404854965	3.129873057	.012155098	1.16427	2
117	-1.140548344	1.968410214	-.887232360	1.967068059	.405739368	3.129773057	.012155098	1.24544	2
118	-1.133572042	1.967606449	-.894157879	1.966135762	.406625137	3.129673057	.012155098	1.32663	2
119	-1.126149725	1.966788161	-.901529295	1.965218721	.407512283	3.129573057	.012155098	1.40785	2
120	-1.118189964	1.965953831	-.909438061	1.964319167	.408400445	3.129473099	.012155098	1.48906	2
121	-1.113965773	1.965529586	-.913636700	1.963876367	.408845236	3.129423099	.012155098	1.52969	2
122	-1.109551575	1.965100219	-.918025316	1.963438862	.409290380	3.129373099	.012155098	1.57033	2
123	-1.104919832	1.964665240	-.922631449	1.963007139	.409735876	3.129323099	.012155098	1.61097	2
124	-1.100035589	1.964224040	-.927490051	1.962581805	.410181727	3.129273099	.012155098	1.65162	2
125	-1.094853342	1.963775848	-.932646629	1.962163629	.410627934	3.129223099	.012155098	1.69228	2
126	-1.089311943	1.963319653	-.938162329	1.961753620	.411074499	3.129173099	.012155098	1.73293	2
127	-1.083325837	1.962854078	-.944122705	1.961353151	.411521423	3.129123099	.012155098	1.77360	2
128	-1.076768751	1.962377147	-.950654034	1.960964197	.411968708	3.129073099	.012155098	1.81426	2
129	-1.066767158	1.961717759	-.960621223	1.960468880	.412565877	3.129006408	.012155098	1.86852	2
130	-1.056766433	1.961142880	-.970593454	1.960088950	.413060264	3.128951249	.012155098	1.91339	2
131	-1.046764971	1.960654993	-.980572334	1.959821082	.413451967	3.128907582	.012155098	1.94892	2
132	-1.036761154	1.960256716	-.990559482	1.959662124	.413740996	3.128875381	.012155098	1.97512	2
133	-1.027040728	1.959958287	-1.000269383	1.959609174	.413923382	3.128855078	.012155092	1.99164	2
134	-1.026746298	1.959950625	-1.000563589	1.959609090	.413927366	3.128854627	.012155098	1.99201	2

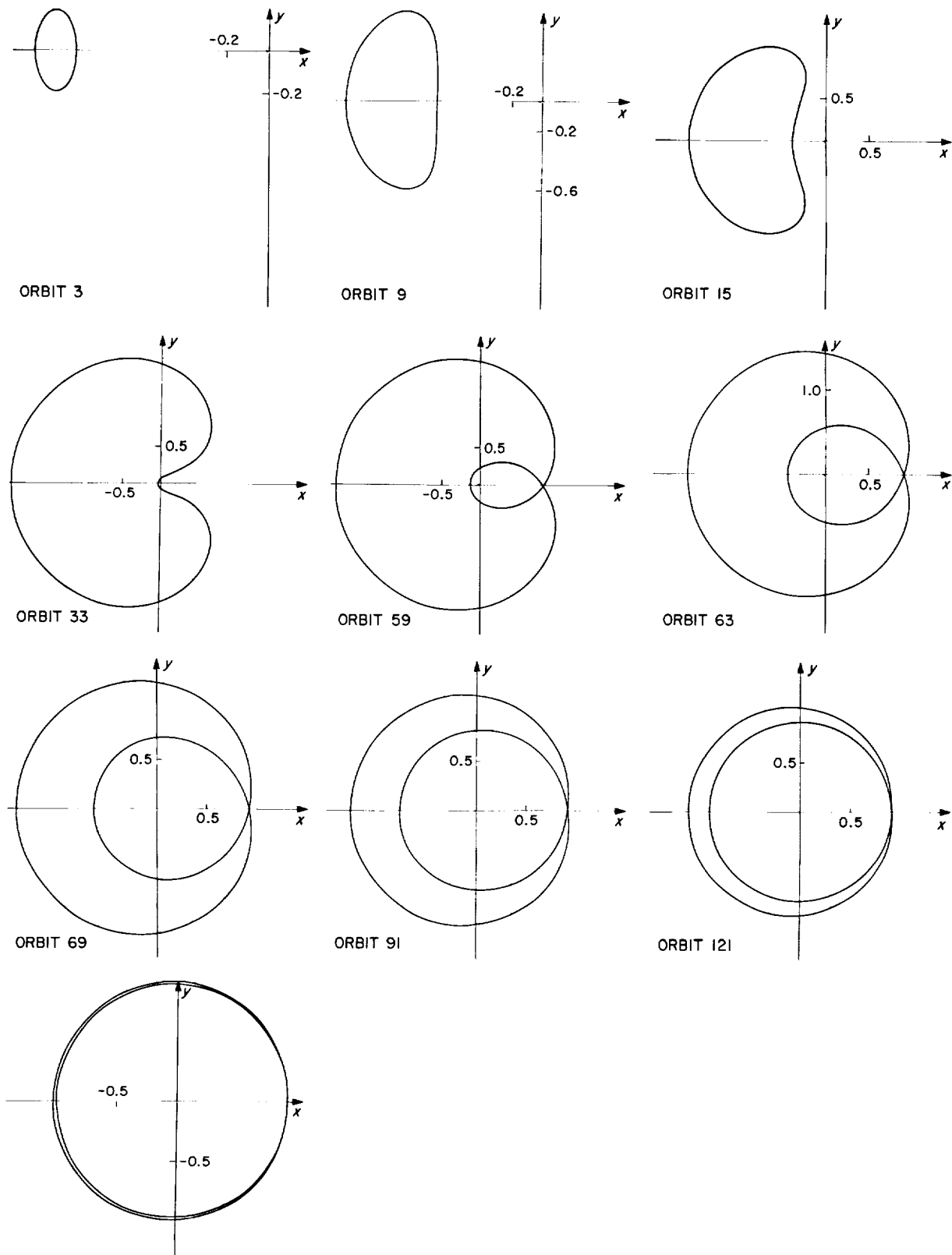

Fig. 14. Typical trajectories in family J_1 of periodic orbits around L_3

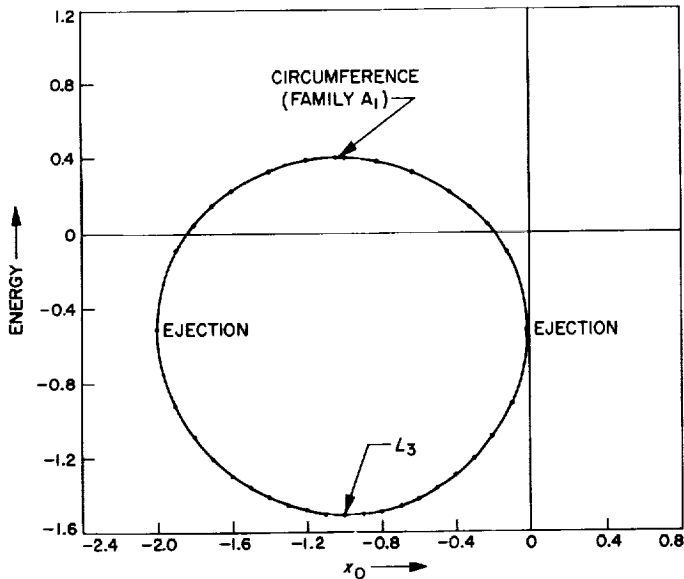

Fig. 15. Energy diagram of family J_1

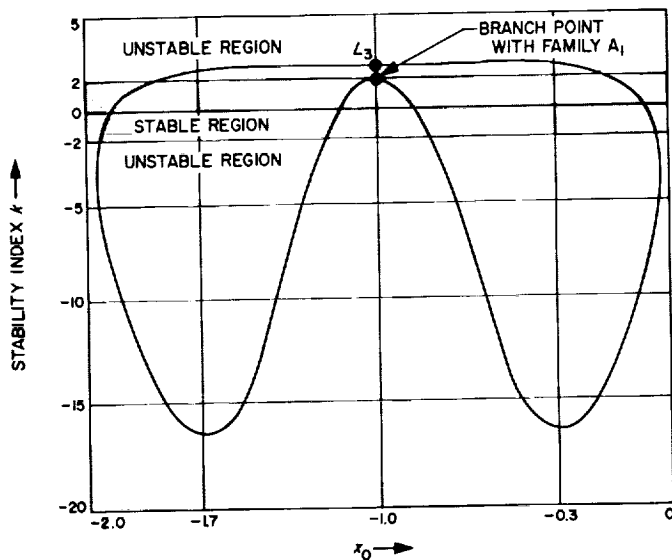

Fig. 16. Stability evolution of family J_1

Family J_1 has another remarkable feature in that we know exactly its limit when the mass ratio μ tends to zero. In fact, the family still exists when $\mu = 0$ and has an evolution that is similar to the case with $\mu \neq 0$. When $\mu = 0$, the existence of this family follows from the properties of the two-body problem relative to a rotating frame of axes. The libration point L_3 still exists when $\mu = 0$, and has the coordinates $(-1, 0)$. The family of orbits around this point corresponds to a family of Keplerian ellipses with semimajor axes and mean motion equal to $+1$, and with variable eccentricity. The period of all the orbits of this family is constant and equal to 2π .

At the end of the family, there is a limit orbit, which is circular and retrograde (with radius $+1$ and velocity $+2$). In the case $\mu = 0$ the diagram of the energy can still be drawn and we obtain a circle with center $(-1, -0.5)$ and with radius $+1$. Family J_1 of periodic orbits, which probably exists for all mass ratios from 0 to $1/2$, including the limits, is a good illustration of how the restricted three-body problem with small mass ratio is a perturbation of the two-body problem.

With respect to Stromgren's investigation (Ref. 1), our family J_1 corresponds to Stromgren's class a, and the evolution seems to be similar. Stromgren's class a is around L_2 , but in the case with equal masses, L_2 and L_3 have similar properties.

D. Family A_1 of Retrograde Periodic Orbits Around m_1

In this family of periodic orbits, which starts with retrograde infinitesimal orbits around the larger primary m_1 , 317 orbits have been classified. Although the end of the family has not yet been determined, it seems likely that the orbits become more and more complicated, with a larger number of loops.

The family begins with infinitesimal circular orbits with radius r_1 , which are retrograde in both the inertial and the rotating axes. The velocity is

$$\sqrt{\frac{1-\mu}{\mu_1}}$$

in the inertial axes, and

$$+r_1 + \sqrt{\frac{1-\mu}{\mu_1}}$$

in the rotating system of axes.

As the orbits become larger in the evolution of the family, the trajectory passes closer and closer to the smaller primary m_2 , and finally a periodic collision orbit takes place. The collision with m_2 transforms later into a loop around m_2 , and when this loop becomes larger and passes closer to m_1 , a collision with m_1 takes place. Following the periodic collision orbit, a few more periodic orbits having a new loop around m_1 were computed. Some typical trajectories in family A_1 are illustrated in Fig. 17, and the evolution of the family is shown in the energy diagram in Fig. 18. Initial conditions are given in Table 4.

In the problem with equal masses, Stromgren has also studied the retrograde periodic orbits around one of the primaries, which he has called class f of orbits. Our family A_1 and Stromgren's class f have many features in common.

Family A_1 is also remarkable for its stability evolution (Fig. 19). It contains several alternating zones of stability and instability, and also several branch points with other families. The family starts at the stability limit $k = 2$, with a series of stable orbits (1 to 61), then moves slightly into the negative unstable zone (orbits 62 to 74), and becomes stable again in orbits 75 to 97. The stability index continues to increase to a maximum of around 4000 (orbit 175) and then decreases to cross the stable zone again (between orbits 206 and 207), reaching a minimum of -70 (orbit 218). It then increases and reaches the stable zone again at orbit 225 and all the last orbits are stable. As we have said before, family A_1 has three connecting points with other families (Fig. 19).

- (1) In the neighborhood of orbit 28, there is in the first stable region of the family a periodic orbit with stability index $k_1 = -1$, which is a branch point with the family BD. This particular simple orbit unfolds in a "triple" orbit with a period that is three times the original period and with a stability index $k_3 = +2 (= k_1^2 - 3k_1)$. At this limiting orbit, there is a connection of four different "branches" of periodic orbits.
- (2) At the lower end ($k = -2$) of the same stability zone, in the neighborhood of orbit 61, there is another branch point with the end of family G. The simple orbit in family A_1 has the stability index $k_1 = -2$, and the unfolding orbit in family G has twice the simple period and the stability index $k_2 = +2 (= k_1^2 - 2)$. This is a connecting point for three branches of periodic orbits.
- (3) At the next change from instability to stability (orbit 75), the stability index is again $k_1 = -2$, which is a branch point with the end of family J. We have again the phenomenon of unfolding of a simple orbit in two loops, and the stability indices are related by $k_2 = +2 = k_1^2 - 2$. Three branches of periodic orbits connect at this point.

E. Family BD of Direct Periodic Orbits Around m_1

Family BD, for which the beginning is known, starts with infinitesimal direct circular periodic orbits around the larger primary m_1 . The orbits are direct in both the

rotating and the inertial axes, at least in the first orbits of the family, because we have followed it along 263 orbits without reaching a natural end of what seems to be a very complicated family.

The first orbits of the family have an approximately circular form with radius r_1 and velocity

$$\sqrt{\frac{1-\mu}{\mu_1}}$$

in the inertial axes, and

$$-r_1 - \sqrt{\frac{1-\mu}{\mu_1}}$$

in the rotating axes.

These orbits form the starting point of a complex evolution of orbits. Figure 20 illustrates a number of orbits so that the continuous evolution can be seen. The initial conditions for family BD are given in Table 5, and the energy diagram is shown in Fig. 21.

This family contains three periodic collision orbits, two of which are very near each other, close to orbit 70. The exact evolution is shown in the partial orbits in Fig. 22. These orbits belong to a sequence of periodic orbits that also exist for the value 0 of the mass ratio (the two-body problem, with respect to rotating axes). In the two-body problem the mean motion n is $2/1$, and the motion is direct in the inertial axes. The eccentricity is the variable parameter. These two collision orbits for the earth-moon mass ratio both tend to one single collision orbit when the mass ratio tends to zero. This limiting collision orbit has two collision cusps, one at the left and one at the right side, and corresponds to the eccentricity $+1$ in the two-body problem.

There is another collision orbit in this family, in the neighborhood of orbit 104. This orbit has a special property in the direction of collision. Generally, the periodic collision orbits in our families have only one single collision, which is along the syzygy axis either to the left or the right. The collision orbit in family BD has two collisions, which are not on the x -axis, but symmetric with respect to the x -axis. The direction of collision with m_1 makes an angle of about 110 deg (for the symmetric collision, 260 deg) with the x -axis. We have not included the exact initial conditions of this orbit in Table 5.

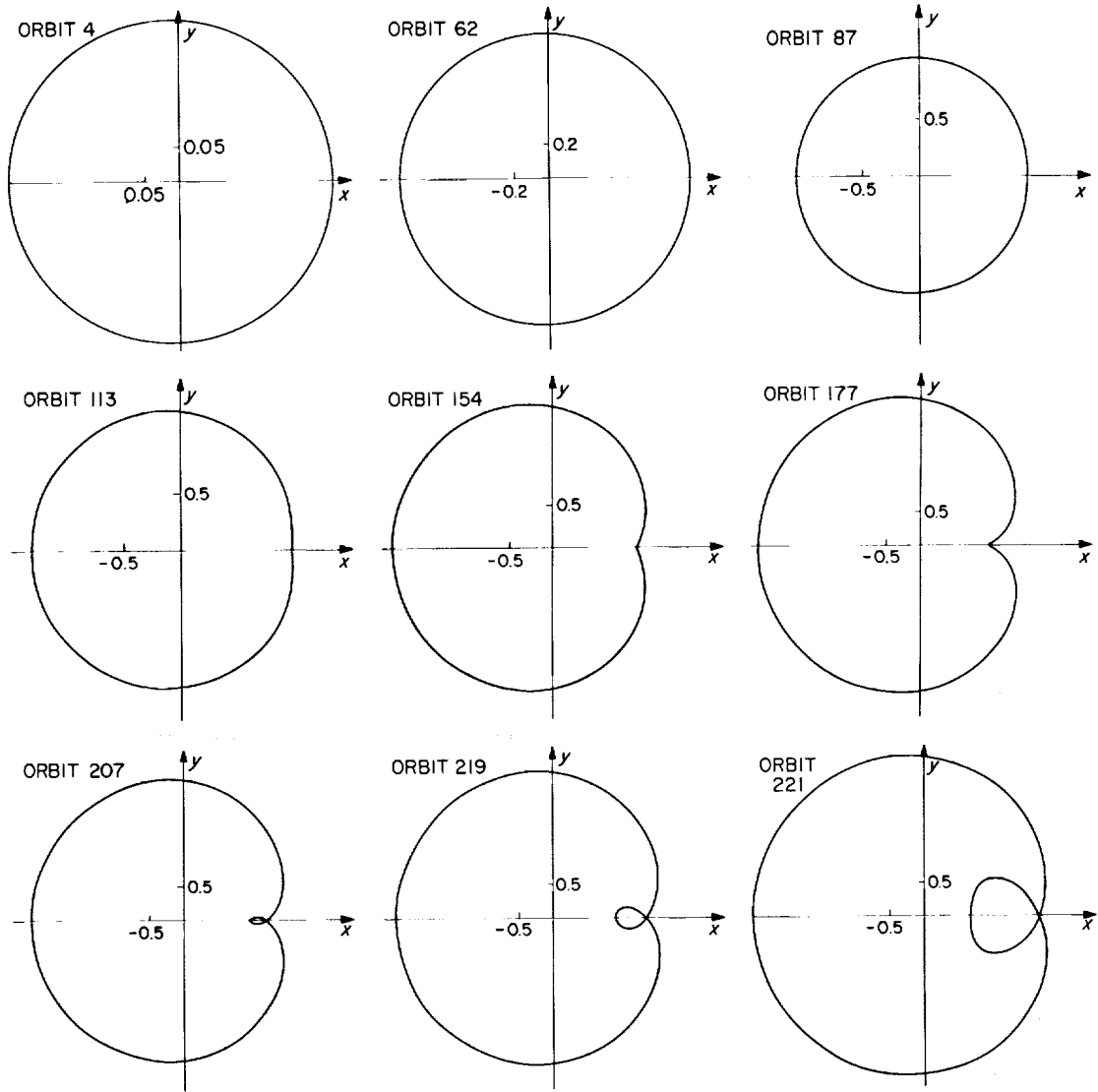

Fig. 17. Typical trajectories in family A_1 of retrograde periodic orbits around m_1

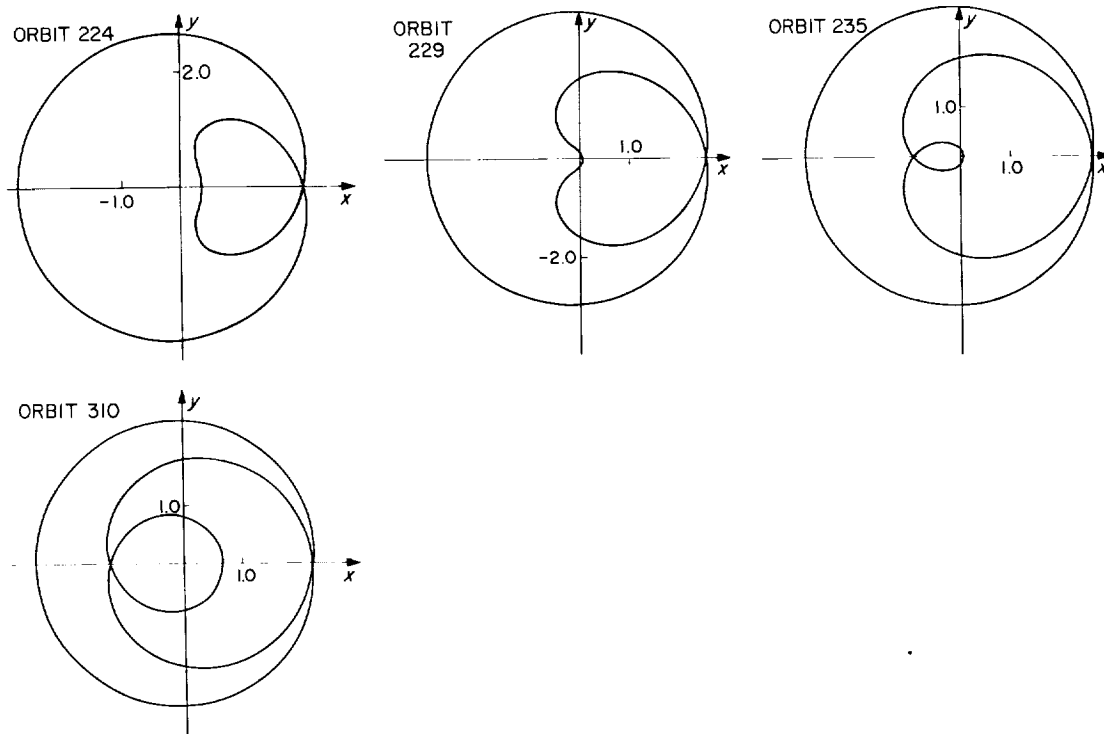

Fig. 17 (contd)

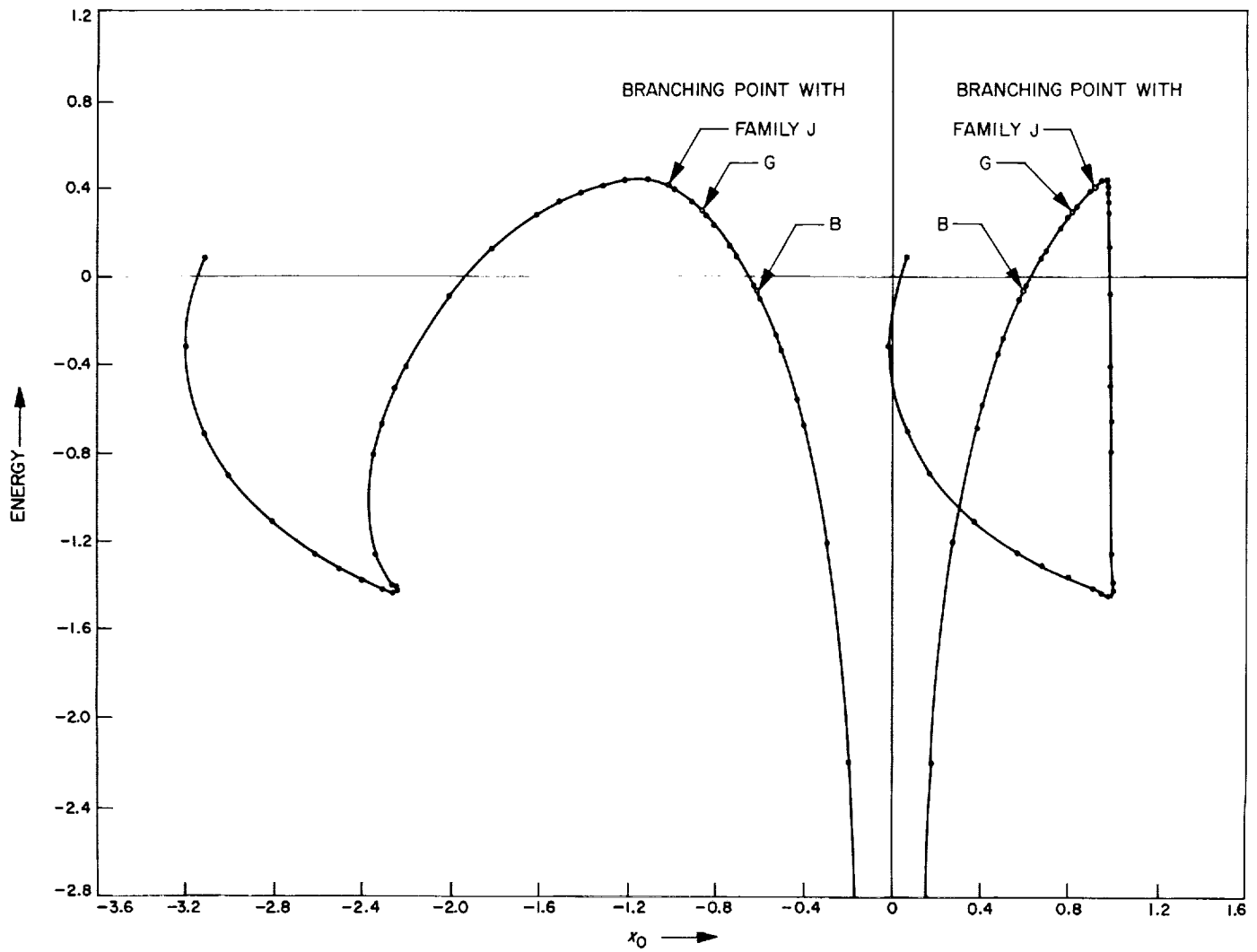

Fig. 18. Energy diagram of family A_1

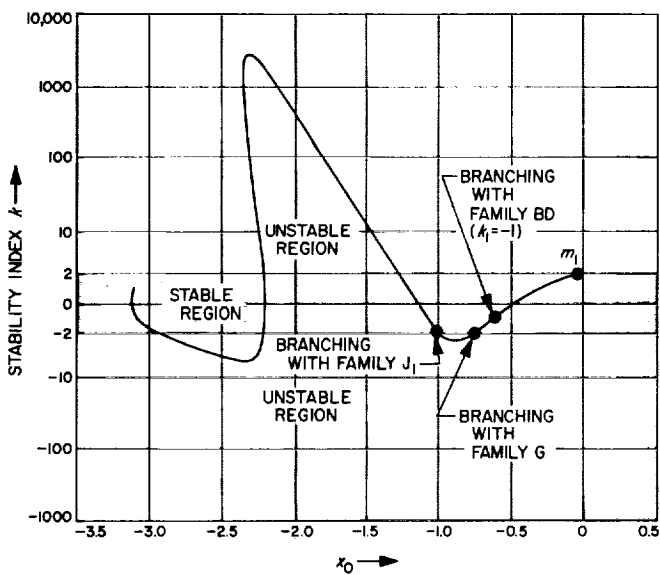

Fig. 19. Stability evolution of family A_1

Table 4. Initial conditions for family A₁ of retrograde periodic orbits around m₁

	X0	YDOT0	X1	YDOT1	ENERGY	T/2	MASS	INDEX	N
1	-.049999917	5.146901441	.025689490	-5.146934008	-12.870174333	.023099816	.012155092	1.99786	1
2	-.099999958	3.441231785	.075685200	-3.441406582	-5.340470052	.080193496	.012155092	1.97431	1
3	-.199999971	2.480989743	.175624862	-2.481784706	-2.211411154	.237824283	.012155092	1.77764	1
4	-.249452389	2.277501612	.224995203	-2.278769632	-1.610330220	.327243029	.012155085	1.58578	1
5	-.290031146	2.163174387	.265465130	-2.164915329	-1.266893131	.403410575	.012155085	1.38179	1
6	-.290031685	2.163173098	.265465667	-2.164914047	-1.266889185	.403411596	.012155085	1.38179	1
7	-.299999993	2.140189817	.275400167	-2.142058997	-1.196097329	.422357499	.012155092	1.32580	1
8	-.399999993	1.983336644	.374854063	-1.986776822	-.668956298	.613833918	.012155092	.66602	1
9	-.407597840	1.975499700	.382391397	-1.979082226	-.638552173	.628315492	.012155092	.61066	1
10	-.407599428	1.975498108	.382392973	-1.979080664	-.638545921	.628318517	.012155092	.61065	1
11	-.407611382	1.975486127	.382404829	-1.979068910	-.638498875	.628341279	.012155092	.61056	1
12	-.425362593	1.958842675	.400001697	-1.962772141	-.571210580	.662056095	.012155092	.47964	1
13	-.491358473	1.914063916	.465236396	-1.919474592	-.358544982	.785391360	.012155092	-.01523	1
14	-.491362163	1.914062054	.465240033	-1.919472821	-.358534469	.785398147	.012155092	-.01526	1
15	-.491470711	1.914007285	.465347047	-1.919420766	-.358225199	.785597830	.012155092	-.01607	1
16	-.499999992	1.909872337	.473752525	-1.915502181	-.334279348	.801251142	.012155092	-.07970	1
17	-.502700332	1.908631235	.476412285	-1.914330895	-.326841237	.806191451	.012155092	-.09979	1
18	-.526683292	1.898959424	.500003662	-1.905308516	-.263604170	.849727197	.012155092	-.27643	1
19	-.599999990	1.882212677	.571700273	-1.890935894	-.096744415	.978624723	.012155092	-.78590	1
20	-.629171292	1.879947425	.599998756	-1.889821131	-.039347280	1.027993335	.012155092	-.97092	1
21	-.629745436	1.879924194	.600554102	-1.889821984	-.038261320	1.028953470	.012155098	-.97445	1
22	-.630319852	1.879901744	.601109660	-1.889823684	-.037176441	1.029913620	.012155098	-.97797	1
23	-.630894538	1.879880071	.601665412	-1.889826231	-.036092668	1.030873770	.012155098	-.98148	1
24	-.631469495	1.879859173	.602221359	-1.889829625	-.035009996	1.031833920	.012155098	-.98500	1
25	-.632044722	1.879839049	.602777500	-1.889833864	-.033928425	1.032794070	.012155098	-.98851	1
26	-.632620220	1.879819699	.603333836	-1.889838948	-.032847951	1.033754220	.012155098	-.99201	1
27	-.633195990	1.879801121	.603890368	-1.889844877	-.031768572	1.034714370	.012155098	-.99552	1
28	-.633772033	1.879783314	.604447094	-1.889851650	-.030690285	1.035674520	.012155098	-.99902	1
29	-.634348348	1.879766279	.605004016	-1.889859266	-.029613088	1.036634670	.012155098	-1.00252	1
30	-.634924937	1.879750012	.605561133	-1.889867725	-.028536978	1.037594820	.012155098	-1.00601	1
31	-.635501800	1.879734515	.606118446	-1.889877026	-.027461953	1.038554970	.012155098	-1.00950	1
32	-.636078937	1.879719785	.606675954	-1.889887168	-.026388010	1.039515120	.012155098	-1.01299	1
33	-.636656350	1.879705823	.607233659	-1.889898152	-.025315146	1.040475270	.012155098	-1.01648	1
34	-.637234038	1.879692626	.607791560	-1.889909976	-.024243360	1.041435420	.012155098	-1.01996	1
35	-.637812002	1.879680194	.608349657	-1.889922640	-.023172649	1.042395570	.012155098	-1.02344	1
36	-.638390243	1.879668527	.608907950	-1.889936143	-.022103010	1.043355720	.012155098	-1.02692	1
37	-.638968761	1.879657623	.609466440	-1.889950485	-.021034441	1.044315870	.012155098	-1.03039	1
38	-.639547557	1.879647481	.610025127	-1.889965666	-.019966940	1.045276020	.012155098	-1.03386	1
39	-.640126632	1.879638101	.610584010	-1.889981684	-.018900504	1.046236170	.012155098	-1.03732	1
40	-.640705930	1.879629488	.611143053	-1.889998538	-.017835212	1.047196238	.012155092	-1.04079	1
41	-.640706749	1.879629476	.611143842	-1.889998563	-.017833708	1.047197594	.012155092	-1.04079	1
42	-.640911612	1.879626611	.611341519	-1.890004722	-.017457363	1.047536998	.012155092	-1.04201	1
43	-.699999992	1.882452050	.667920871	-1.895821793	.083466475	1.142977520	.012155092	-1.36792	1
44	-.734020087	1.886948643	.699998915	-1.902484189	.135373457	1.195666893	.012155092	-1.53036	1
45	-.774816152	1.894564972	.737789630	-1.913301654	.192361593	1.256631493	.012155092	-1.70059	1
46	-.774819967	1.894565783	.737793122	-1.913302803	.192366668	1.256637080	.012155092	-1.70060	1
47	-.775007723	1.894605727	.737964959	-1.913359346	.192616378	1.256912022	.012155092	-1.70133	1
48	-.792590370	1.898522440	.753956817	-1.918920001	.215505478	1.282429396	.012155085	-1.76651	1
49	-.792590557	1.898522483	.753956985	-1.918920062	.215505715	1.282429664	.012155085	-1.76651	1
50	-.799792834	1.900221944	.760446115	-1.921347996	.224601046	1.292750626	.012155085	-1.79182	1
51	-.799999989	1.900271585	.760632168	-1.921419109	.224860230	1.293046339	.012155092	-1.79254	1
52	-.844807787	1.911886113	.800000010	-1.938464512	.277788757	1.355517059	.012155092	-1.93202	1
53	-.847491430	1.912628861	.802293443	-1.939590225	.280759445	1.359163859	.012155098	-1.93940	1
54	-.850183003	1.913378149	.804585181	-1.940731207	.283716002	1.362810659	.012155098	-1.94669	1
55	-.852882584	1.914133857	.806874982	-1.941887619	.286658208	1.366457459	.012155098	-1.95389	1

Table 4 (contd)

	X0	YD0T0	X1	YD0T1	ENERGY	T/2	MASS	INDEX	N
56	-.855590250	1.914895869	.809162606	-1.943059626	.289585849	1.370104259	.012155098	-1.96100	1
57	-.858306077	1.915664063	.811447807	-1.944247398	.292498698	1.373751059	.012155098	-1.96801	1
58	-.861030142	1.916438316	.813730325	-1.945451110	.295396519	1.377397859	.012155098	-1.97493	1
59	-.863762523	1.917218498	.816009892	-1.946670944	.298279063	1.381044659	.012155098	-1.98175	1
60	-.866503300	1.918004475	.818286227	-1.947907085	.301146070	1.384691459	.012155098	-1.98848	1
61	-.869252552	1.918796108	.820559041	-1.949159728	.303997269	1.388338259	.012155098	-1.99510	1
62	-.872010360	1.919593254	.822828029	-1.950429071	.306832374	1.391985059	.012155098	-2.00162	1
63	-.874776808	1.920395764	.825092878	-1.951715320	.309651088	1.395631859	.012155098	-2.00803	1
64	-.877551976	1.921203486	.827353261	-1.953018687	.312453101	1.399278659	.012155098	-2.01433	1
65	-.880335950	1.922016260	.829608838	-1.954339388	.315238088	1.402925459	.012155098	-2.02052	1
66	-.883128814	1.922833923	.831859256	-1.955677649	.318005712	1.406572259	.012155098	-2.02660	1
67	-.885930653	1.923656304	.834104150	-1.957033701	.320755620	1.410219059	.012155098	-2.03255	1
68	-.888741552	1.924483229	.836343141	-1.958407781	.323487448	1.413865859	.012155098	-2.03839	1
69	-.891561599	1.925314516	.838575835	-1.959800132	.326200813	1.417512659	.012155098	-2.04409	1
70	-.894390880	1.926149979	.840801827	-1.961211006	.328895320	1.421159459	.012155098	-2.04967	1
71	-.897229482	1.926989426	.843020695	-1.962640658	.331570559	1.424806259	.012155098	-2.05510	1
72	-.899999985	1.927809707	.845172045	-1.964049734	.334154236	1.428353979	.012155092	-2.06026	1
73	-.900609978	1.951100574	.899999520	-2.011343145	.396402214	1.526665806	.012155092	-2.10467	1
74	-1.009245277	1.958593386	.915034189	-2.031228915	.411941868	1.559460997	.012155092	-2.02158	1
75	-1.018285035	1.960837843	.919243864	-2.037841191	.416104970	1.569614797	.012155098	-1.97415	1
76	-1.019329473	1.961093406	.919713785	-2.038615211	.416563347	1.570782273	.012155092	-1.96785	1
77	-1.019341877	1.961096436	.919719345	-2.038624416	.416568763	1.570796131	.012155092	-1.96777	1
78	-1.019341956	1.961096456	.919719381	-2.038624475	.416568797	1.570796220	.012155092	-1.96777	1
79	-1.019342037	1.961096475	.919719417	-2.038624535	.416568833	1.570796310	.012155092	-1.96777	1
80	-1.019342064	1.961096482	.919719429	-2.038624555	.416568844	1.570796340	.012155092	-1.96777	1
81	-1.027402828	1.963042774	.923232066	-2.044667195	.419949887	1.579768597	.012155098	-1.91275	1
82	-1.036595315	1.965207665	.926996362	-2.051703251	.423473737	1.589922397	.012155098	-1.83472	1
83	-1.0455858628	1.967333137	.930536968	-2.058943944	.426676295	1.600076197	.012155098	-1.73708	1
84	-1.055188463	1.969420864	.933856631	-2.066382294	.429559892	1.610229997	.012155098	-1.61647	1
85	-1.064580196	1.971473451	.936960414	-2.074009981	.432129201	1.620383797	.012155098	-1.46919	1
86	-1.074028992	1.973494268	.939855382	-2.081817630	.434390931	1.630537597	.012155098	-1.29120	1
87	-1.083529919	1.975487264	.942550227	-2.089795107	.436353461	1.640691397	.012155098	-1.07810	1
88	-1.093078052	1.977456783	.945054865	-2.097931824	.438026439	1.650845197	.012155098	-.82519	1
89	-1.102668558	1.979407377	.947380046	-2.106217012	.439420389	1.660998997	.012155098	-.52747	1
90	-1.112296766	1.981343646	.949536985	-2.114639971	.440546346	1.671152797	.012155098	-.17964	1
91	-1.114459981	1.981776235	.949998629	-2.116546107	.440763159	1.673429131	.012155092	-.09422	1
92	-1.121958223	1.983270103	.951537048	-2.123190259	.441415541	1.681306597	.012155098	.22386	1
93	-1.131648724	1.985191068	.953391493	-2.131857849	.442039135	1.691460397	.012155098	.68887	1
94	-1.141364330	1.987110586	.955111264	-2.140633236	.442428019	1.701614197	.012155098	1.22145	1
95	-1.151101383	1.989032381	.956706847	-2.149507506	.442592659	1.711767997	.012155098	1.82787	1
96	-1.152076137	1.989224819	.956859963	-2.150400049	.442597177	1.712783379	.012155098	1.89282	1
97	-1.153051066	1.989417317	.957011946	-2.151293487	.442599562	1.713798759	.012155098	1.95858	1
98	-1.154026169	1.989609877	.957162806	-2.152187815	.442599824	1.714814139	.012155098	2.02516	1
99	-1.155001442	1.989802504	.957312552	-2.153083025	.442597972	1.715829519	.012155098	2.09256	1
100	-1.155976884	1.989995200	.957461194	-2.153979109	.442594016	1.716844899	.012155098	2.16079	1
101	-1.156952489	1.990187968	.957608741	-2.154876060	.442587965	1.717860279	.012155098	2.22986	1
102	-1.157928256	1.990380811	.957755203	-2.155773869	.442579828	1.718875659	.012155098	2.29977	1
103	-1.158904181	1.990573732	.957900589	-2.156672529	.442569614	1.719891039	.012155098	2.37053	1
104	-1.159880261	1.990766735	.958044907	-2.157572033	.442557333	1.720906419	.012155098	2.44215	1
105	-1.160856492	1.990959821	.958188167	-2.158472371	.442542995	1.721921797	.012155098	2.51463	1
106	-1.170626532	1.992895902	.959564527	-2.167520181	.442288375	1.732075597	.012155098	3.28845	1
107	-1.180408626	1.994843258	.960844580	-2.176643913	.441837529	1.742229397	.012155098	4.15621	1
108	-1.190200127	1.996804160	.962036325	-2.185837150	.441198557	1.752383197	.012155098	5.12500	1
109	-1.199998602	1.998780546	.963147121	-2.195094048	.440378940	1.762536997	.012155098	6.20206	1
110	-1.199999969	1.998780831	.963147287	-2.195095345	.440378832	1.762538417	.012155092	6.20222	1

Table 4 (contd)

	X0	YDOTO	X1	YDOT1	ENERGY	T/2	MASS	INDEX	N
111	-1.299999978	2.020086801	.971148443	-2.292246475	.423009761	1.866209923	.012155092	25.20282	1
112	-1.314462083	2.023364076	.971953253	-2.306641683	.419281684	1.881266816	.012155092	29.47593	1
113	-1.318000235	2.024173636	.972140540	-2.310175476	.418326352	1.884954675	.012155092	30.59261	1
114	-1.318000521	2.024173702	.972140555	-2.310175761	.418326274	1.884954973	.012155092	30.59270	1
115	-1.318000778	2.024173761	.972140569	-2.310176018	.418326204	1.884955241	.012155092	30.59278	1
116	-1.318000978	2.024173807	.972140579	-2.310176219	.418326149	1.884955450	.012155092	30.59284	1
117	-1.318001078	2.024173830	.972140584	-2.310176318	.418326122	1.884955554	.012155092	30.59288	1
118	-1.318001579	2.024173945	.972140611	-2.310176819	.418325986	1.884956076	.012155092	30.59304	1
119	-1.318031779	2.024180868	.972142194	-2.310207002	.418317759	1.884987562	.012155092	30.60269	1
120	-1.399999987	2.043756406	.975647199	-2.393361489	.391596375	1.971022262	.012155092	65.63750	1
121	-1.407923494	2.045726923	.975918047	-2.401529895	.388558762	1.979412033	.012155098	70.08729	1
122	-1.499999967	2.069464635	.978474185	-2.498216625	.347512713	2.078161715	.012155092	139.19901	1
123	-1.514673777	2.073368679	.978801431	-2.513942454	.339994055	2.094146787	.012155092	153.60301	1
124	-1.514898952	2.073428802	.978806314	-2.514184496	.339876573	2.094392686	.012155092	153.83220	1
125	-1.514899580	2.073428970	.978806327	-2.514185171	.339876246	2.094393372	.012155092	153.83284	1
126	-1.514900153	2.073429123	.978806340	-2.514185786	.339875947	2.094393997	.012155092	153.83342	1
127	-1.514900644	2.073429254	.978806351	-2.514186315	.339875690	2.094394534	.012155092	153.83392	1
128	-1.514900971	2.073429341	.978806358	-2.514186666	.339875520	2.094394891	.012155092	153.83426	1
129	-1.514901108	2.073429378	.978806361	-2.514186813	.339875449	2.094395040	.012155092	153.83440	1
130	-1.514902064	2.073429633	.978806381	-2.514187840	.339874950	2.094396084	.012155092	153.83537	1
131	-1.599999994	2.096515653	.980398750	-2.607338638	.290862614	2.188787951	.012155092	260.06866	1
132	-1.740835696	2.135277968	.982251693	-2.770396710	.188552539	2.353264469	.012155092	542.84986	1
133	-1.743220836	2.135928220	.982277196	-2.773275258	.186577491	2.356162541	.012155092	549.02918	1
134	-1.743222490	2.135928671	.982277214	-2.773277256	.186576119	2.356164552	.012155092	549.03335	1
135	-1.743224144	2.135929122	.982277231	-2.773279253	.186574746	2.356166564	.012155092	549.03930	1
136	-1.743225813	2.135929577	.982277249	-2.773281269	.186573361	2.356168593	.012155092	549.04296	1
137	-1.743227497	2.135930035	.982277267	-2.773283303	.186571964	2.356170641	.012155092	549.04665	1
138	-1.743229181	2.135930494	.982277285	-2.773285337	.186570566	2.356172689	.012155092	549.05224	1
139	-1.743230894	2.135930961	.982277303	-2.773287406	.186569145	2.356174771	.012155092	549.05534	1
140	-1.743232623	2.135931432	.982277322	-2.773289494	.186567710	2.356176874	.012155092	549.06014	1
141	-1.743234381	2.135931912	.982277341	-2.773291618	.186566251	2.356179012	.012155092	549.06460	1
142	-1.743236184	2.135932403	.982277360	-2.773293795	.186564755	2.356181204	.012155092	549.06878	1
143	-1.743238047	2.135932911	.982277380	-2.773296046	.186563209	2.356183469	.012155092	549.07361	1
144	-1.743245140	2.135934844	.982277455	-2.773304613	.186557322	2.356192094	.012155092	549.09215	1
145	-1.743245587	2.135934965	.982277460	-2.773305153	.186556951	2.356192638	.012155092	549.09325	1
146	-1.743246585	2.135935233	.982277462	-2.773306350	.186556113	2.356193851	.012155098	549.09558	1
147	-1.743247092	2.135935371	.982277467	-2.773306962	.186555692	2.356194468	.012155098	549.09695	1
148	-1.743247256	2.135935416	.982277469	-2.773307160	.186555556	2.356194667	.012155098	549.09727	1
149	-1.795785189	2.150106775	.982801786	-2.837916613	.140851156	2.421202467	.012155092	698.80578	1
150	-1.795793191	2.150108906	.982801861	-2.837926640	.140843867	2.421212549	.012155092	698.83063	1
151	-1.796044886	2.150175955	.982804213	-2.838242049	.140614545	2.421529717	.012155092	699.61278	1
152	-1.799999997	2.151228307	.982840982	-2.843206201	.136997693	2.426521302	.012155092	711.98908	1
153	-1.862675294	2.167529776	.983380855	-2.924006102	.076228758	2.507698031	.012155092	930.24156	1
154	-1.866858989	2.168588168	.983414276	-2.929555597	.071932196	2.513268001	.012155092	946.35693	1
155	-1.866861582	2.168588823	.983414297	-2.929559043	.071929524	2.513271460	.012155092	946.36706	1
156	-1.866863072	2.168589199	.983414308	-2.929561023	.071927988	2.513273447	.012155092	946.37378	1
157	-1.866863251	2.168589244	.983414310	-2.929561261	.071927803	2.513273686	.012155092	946.37330	1
158	-1.866863504	2.168589308	.983414312	-2.929561598	.071927543	2.513274023	.012155092	946.37411	1
159	-1.866863564	2.168589323	.983414312	-2.929561677	.071927481	2.513274103	.012155092	946.37520	1
160	-1.866864786	2.168589632	.983414322	-2.929563301	.071926221	2.513275733	.012155092	946.37927	1
161	-2.000000000	2.199269609	.984344937	-3.119640443	-.082617419	2.703353916	.012155092	1571.02543	1
162	-2.199999988	2.222554850	.985441212	-3.500616088	-.405452945	3.072374871	.012155092	2936.88496	1
163	-2.227865189	2.221108474	.985584427	-3.574449203	-.464646846	3.140093794	.012155092	3157.05487	1
164	-2.228474796	2.221054044	.985587584	-3.576173574	-.466002700	3.141561383	.012155092	3161.87719	1
165	-2.228485793	2.221053052	.985587641	-3.576204729	-.466027185	3.141589515	.012155092	3161.96419	1

Table 4 (contd)

	X0	YDOTO	X1	YDOT1	ENERGY	T/2	MASS	INDEX	N
166	-2.228486538	2.221052985	.985587645	-3.576206840	-.466028844	3.141591421	.012155092	3161.97026	1
167	-2.228486866	2.221052956	.985587647	-3.576207769	-.466029574	3.141592260	.012155092	3161.97283	1
168	-2.228487074	2.221052937	.985587648	-3.576208358	-.466030038	3.141592792	.012155092	3161.97429	1
169	-2.228487104	2.221052934	.985587648	-3.576208443	-.466030104	3.141592869	.012155092	3161.97456	1
170	-2.228487134	2.221052931	.985587648	-3.576208529	-.466030171	3.141592946	.012155092	3161.97544	1
171	-2.228487164	2.221052929	.985587648	-3.576208613	-.466030238	3.141593022	.012155092	3161.97567	1
172	-2.228488296	2.221052827	.985587654	-3.576211821	-.466032758	3.141595918	.012155092	3161.98398	1
173	-2.239999980	2.219812882	.985647597	-3.609817052	-.492189335	3.171736193	.012155092	3252.84413	1
174	-2.299999982	2.204157875	.985981566	-3.833465182	-.651320634	3.360460589	.012155092	3695.23420	1
175	-2.339999974	2.175841400	.986265054	-4.091677797	-.798669861	3.548492663	.012155092	3873.83383	1
176	-2.358162880	2.147169195	.986459957	-4.324886326	-.900005884	3.689786604	.012155092	3822.73645	1
177	-2.368698150	2.087358718	.986774426	-4.854054328	-1.049645953	3.926994244	.012155092	3419.89391	1
178	-2.368698031	2.087345226	.986774490	-4.854188933	-1.049673854	3.927042780	.012155092	3419.77792	1
179	-2.368697882	2.087328467	.986774570	-4.854356144	-1.049708509	3.927103067	.012155092	3419.63345	1
180	-2.368696183	2.087146833	.986775435	-4.856169334	-1.050083901	3.927756299	.012155092	3418.06866	1
181	-2.368695974	2.087125566	.986775536	-4.856381751	-1.050127831	3.927832767	.012155092	3417.88535	1
182	-2.368695676	2.087095606	.986775678	-4.856681028	-1.050189708	3.927940481	.012155092	3417.62710	1
183	-2.367026597	2.061326209	.986895463	-5.133831476	-1.099987642	4.017968395	.012155092	3183.38184	1
184	-2.356866866	2.009100101	.987128294	-5.874270633	-1.184110834	4.188783107	.012155092	2663.53951	1
185	-2.356866568	2.009098969	.987128299	-5.874290395	-1.184112458	4.188786688	.012155092	2663.52814	1
186	-2.356866300	2.009097951	.987128303	-5.874308167	-1.184113920	4.188789908	.012155092	2663.51733	1
187	-2.356865585	2.009095237	.987128315	-5.874355581	-1.184117818	4.188798500	.012155092	2663.48960	1
188	-2.356863976	2.009089128	.987128342	-5.874462281	-1.184126590	4.188817832	.012155092	2663.42722	1
189	-2.356862098	2.009081998	.987128373	-5.874586819	-1.184136827	4.188840395	.012155092	2663.35394	1
190	-2.356854975	2.009054960	.987128492	-5.875059182	-1.184175648	4.188925960	.012155092	2663.07751	1
191	-2.356852174	2.009044330	.987128539	-5.875244932	-1.184190909	4.188959601	.012155092	2662.96867	1
192	-2.356818199	2.008915465	.987129105	-5.877498094	-1.184375865	4.189367375	.012155092	2661.64913	1
193	-2.354378194	2.000002171	.987168228	-6.040151406	-1.196936083	4.217448864	.012155092	2570.24720	1
194	-2.339999974	1.955926842	.987360483	-7.115427616	-1.252987855	4.353515715	.012155092	2119.17915	1
195	-2.287782639	1.837644910	.987810154	-26.452522050	-1.366313858	4.712381084	.012155092	1014.04729	1
196	-2.287782371	1.837644377	.987810155	-26.452989361	-1.366314276	4.712382730	.012155092	1014.04393	1
197	-2.287782043	1.837643725	.987810156	-26.453561301	-1.366314786	4.712384744	.012155092	1014.03818	1
198	-2.287781745	1.837643133	.987810158	-26.454080947	-1.366315250	4.712386574	.012155092	1014.03237	1
199	-2.287781566	1.837642777	.987810159	-26.454393107	-1.366315529	4.712387674	.012155092	1014.03012	1
200	-2.287781358	1.837642364	.987810160	-26.454755836	-1.366315853	4.712388951	.012155092	1014.02612	1
201	-2.287781328	1.837642304	.987810160	-26.454808164	-1.366315899	4.712389135	.012155092	1014.02647	1
202	-2.287780881	1.837641416	.987810162	-26.455587734	-1.366316595	4.712391880	.012155092	1014.01893	1
203	-2.287763983	1.837607827	.987810239	-26.485095032	-1.366342902	4.712495657	.012155092	1013.73892	1
204	-2.286511093	1.835122576	.987815781	-28.894391999	-1.368281755	4.720181772	.012155092	993.08308	1
205	-2.250000000	1.766101516	.987629422	10.627054646	-1.416873671	4.944274223	.012155092	463.17831	2
206	-2.229999989	1.729430772	.986156176	3.803516479	-1.440169549	5.091228551	.012155092	188.87478	2
207	-2.229999972	1.723968701	.977814978	1.573655490	-1.449600871	5.221879004	.012155092	-12.95929	2
208	-2.232942920	1.727770619	.975462005	1.420270414	-1.449012665	5.235987185	.012155092	-29.85131	2
209	-2.232942935	1.727770638	.975461994	1.420269801	-1.449012661	5.235987245	.012155092	-29.85138	2
210	-2.232942963	1.727770675	.975461972	1.420268585	-1.449012654	5.235987364	.012155092	-29.85151	2
211	-2.232942977	1.727770694	.975461961	1.420267973	-1.449012651	5.235987424	.012155092	-29.85158	2
212	-2.232943005	1.727770731	.975461939	1.420266757	-1.449012644	5.235987543	.012155092	-29.85171	2
213	-2.232943062	1.727770805	.975461895	1.420264326	-1.449012630	5.235987781	.012155092	-29.85198	2
214	-2.232943076	1.727770824	.975461884	1.420263714	-1.449012626	5.235987841	.012155092	-29.85205	2
215	-2.232945253	1.727773694	.975460197	1.420169966	-1.449012090	5.235997020	.012155092	-29.86233	2
216	-2.232976660	1.727815109	.975435860	1.418820030	-1.449004338	5.236129283	.012155092	-30.01037	2
217	-2.234154752	1.729377787	.974529710	1.371281382	-1.448697228	5.240897714	.012155092	-35.20562	2
218	-2.249999940	1.751254490	.962394210	1.011289438	-1.442984687	5.289797067	.012155092	-70.46986	2
219	-2.299999936	1.822548287	.914950655	.679994794	-1.419635380	5.441675245	.012155092	-66.54074	2
220	-2.399999926	1.962735951	.796585989	.679954382	-1.371118747	5.784669517	.012155092	-22.48629	2

Table 4 (contd)

	X0	YDOT0	X1	YDOT1	ENERGY	T/2	MASS	INDEX	N
221	-2.499999883	2.100046263	.683396608	.863963584	-1.320456084	5.999708830	.012155092	-9.50024	2
222	-2.577409778	2.206227409	.600002267	1.047621757	-1.276296696	6.095927595	.012155092	-5.78086	2
223	-2.599999877	2.237289652	.576066435	1.106743374	-1.262379986	6.116877853	.012155092	-5.11688	2
224	-2.799999904	2.515800435	.368657414	1.771274912	-1.112922781	6.227636754	.012155092	-2.38303	2
225	-2.999999894	2.809463582	.166535808	3.056067226	-.887126133	6.274526535	.012155092	-1.33895	2
226	-3.062284610	2.908968930	.104533652	3.924347083	-.784614383	6.283183872	.012155092	-1.02988	2
227	-3.062296160	2.908988085	.104522205	3.924563876	-.784592795	6.283185302	.012155092	-1.02982	2
228	-3.066386304	2.915792670	.100469446	4.003250345	-.776872040	6.283688067	.012155092	-1.00792	2
229	-3.100000045	2.973631640	.067271628	4.846856192	-.706645073	6.287563621	.012155092	-.81514	2
230	-3.100000000	3.230688886	.076216457	-4.750860672	.090787838	6.301696427	.012155098	.43983	3
231	-3.098000000	3.230287297	.078291908	-4.697598715	.095479713	6.301760536	.012155098	.41756	3
232	-3.096000000	3.229868747	.080366924	-4.646202473	.100112692	6.301824538	.012155098	.44944	3
233	-3.094000000	3.229433835	.082441526	-4.596568217	.104688740	6.301888450	.012155098	.46674	3
234	-3.092000000	3.228983131	.084515735	-4.548600139	.109209711	6.301952290	.012155098	.48971	3
235	-3.090000000	3.228517170	.086589572	-4.502209592	.113677358	6.302016072	.012155098	.51020	3
236	-3.088000000	3.228036462	.088663054	-4.457314410	.118093342	6.302079813	.012155098	.86925	3
237	-3.086000000	3.227541487	.090736200	-4.413838316	.122459238	6.302143527	.012155098	.87515	3
238	-3.084000000	3.227032701	.092809028	-4.371710386	.126776539	6.302207227	.012155098	.88187	3
239	-3.082000000	3.226510539	.094881553	-4.330864574	.131046665	6.302270926	.012155098	.88747	3
240	-3.080000000	3.225975412	.096953791	-4.291239292	.135270966	6.302334636	.012155098	.89356	3
241	-3.078000000	3.225427713	.099025757	-4.252777026	.139450727	6.302398370	.012155098	.89928	3
242	-3.076000000	3.224867816	.101097466	-4.215423999	.143587172	6.302462138	.012155098	.90517	3
243	-3.074000000	3.224296075	.103168930	-4.179129860	.147681471	6.302525951	.012155098	.91084	3
244	-3.072000000	3.223712832	.105240163	-4.143847412	.151734738	6.302589819	.012155098	.91633	3
245	-3.070000000	3.223118411	.107311178	-4.109532360	.155748038	6.302653752	.012155098	.92212	3
246	-3.068000000	3.222513121	.109381986	-4.076143084	.159722392	6.302717760	.012155098	.92726	3
247	-3.066000000	3.221897261	.111452599	-4.043640437	.163658774	6.302781851	.012155098	.93294	3
248	-3.064000000	3.221271113	.113523028	-4.011987559	.167558119	6.302846034	.012155098	.93808	3
249	-3.062000000	3.220634950	.115593284	-3.981149704	.171421321	6.302910317	.012155098	.94336	3
250	-3.060000000	3.219989032	.117663377	-3.951094092	.175249240	6.302974708	.012155098	.94847	3
251	-3.058000000	3.219333612	.119733318	-3.921789763	.179042700	6.303039216	.012155098	.95370	3
252	-3.056000000	3.218668927	.121803115	-3.893207452	.182802492	6.303103846	.012155098	.95856	3
253	-3.054000000	3.217995211	.123872778	-3.865319471	.186529378	6.303168608	.012155098	.96374	3
254	-3.052000000	3.217312684	.125942317	-3.838099598	.190224090	6.303233507	.012155098	.96837	3
255	-3.050000000	3.216621559	.128011739	-3.811522986	.193887331	6.303298551	.012155098	.97352	3
256	-3.048000000	3.215922044	.130081053	-3.785566061	.197519780	6.303363746	.012155098	.97819	3
257	-3.046000000	3.215214335	.132150268	-3.760206450	.201122090	6.303429098	.012155098	.98289	3
258	-3.044000000	3.214498622	.134219391	-3.735422894	.204694892	6.303494614	.012155098	.98746	3
259	-3.042000000	3.213775091	.136288430	-3.711195186	.208238791	6.303560299	.012155098	.99222	3
260	-3.040000000	3.213043918	.138357392	-3.687504098	.211754376	6.303626159	.012155098	.99674	3
261	-3.038000000	3.212305275	.140426286	-3.664331325	.215242211	6.303692201	.012155098	1.00117	3
262	-3.036000000	3.211559326	.142495117	-3.641659425	.218702844	6.303758430	.012155098	1.00641	3
263	-3.034000000	3.210806232	.144563892	-3.619471773	.222136802	6.303824851	.012155098	1.01027	3
264	-3.032000000	3.210046146	.146632620	-3.597752506	.225544597	6.303891469	.012155098	1.01463	3
265	-3.030000000	3.209279218	.148701305	-3.576486484	.228926722	6.303958290	.012155098	1.01859	3
266	-3.028000000	3.208505592	.150769955	-3.555659243	.232283657	6.304025319	.012155098	1.02266	3
267	-3.026000000	3.207725408	.152838575	-3.535256962	.235615864	6.304092561	.012155098	1.02707	3
268	-3.024000000	3.206938801	.154907172	-3.515266423	.238923791	6.304160020	.012155098	1.03117	3
269	-3.019000000	3.204945033	.160078601	-3.467009763	.247090207	6.304329653	.012155098	1.04132	3
270	-3.014000000	3.202913870	.165250012	-3.421065452	.255113995	6.304500749	.012155098	1.05125	3
271	-3.009000000	3.200847107	.170421489	-3.377268434	.263001127	6.304673380	.012155098	1.06096	3
272	-3.004000000	3.198746415	.175593114	-3.335469745	.270757151	6.304847614	.012155098	1.07019	3
273	-2.999000000	3.196613346	.180764964	-3.295534550	.278387238	6.305023516	.012155098	1.07935	3
274	-2.994000000	3.194449349	.185937114	-3.257340462	.285896213	6.305201151	.012155098	1.08831	3

Table 4 (contd)

	X0	YDOT0	X1	YDOT1	ENERGY	T/2	MASS	INDEX	N
275	-2.989000000	3.192255778	.191109636	-3.220776101	.293288589	6.305380583	.012155098	1.09693	3
276	-2.984000000	3.190033899	.196282600	-3.185739852	.300568593	6.305561873	.012155098	1.10538	3
277	-2.979000000	3.187784901	.201456073	-3.152138790	.307740193	6.305745083	.012155098	1.11376	3
278	-2.974000000	3.185509901	.206630121	-3.119887745	.314807117	6.305930275	.012155098	1.12164	3
279	-2.970000000	3.183671886	.210769817	-3.095006137	.320387656	6.306079895	.012155098	1.12793	3
280	-2.960000000	3.179010276	.221121056	-3.036124511	.334066761	6.306459863	.012155098	1.14305	3
281	-2.950000000	3.174259343	.231475541	-2.981583345	.347376305	6.306848673	.012155098	1.15764	3
282	-2.940000000	3.169425670	.241833749	-2.930937561	.360338347	6.307246811	.012155098	1.17141	3
283	-2.930000000	3.164515177	.252196148	-2.883803760	.372972742	6.307654773	.012155098	1.18464	3
284	-2.920000000	3.159533216	.262563202	-2.839849649	.385297445	6.308073065	.012155098	1.19734	3
285	-2.910000000	3.154484641	.272935374	-2.798785592	.397328759	6.308502211	.012155098	1.20888	3
286	-2.900000000	3.149373878	.283313129	-2.760357824	.409081548	6.308942754	.012155098	1.22104	3
287	-2.890000000	3.144204977	.293696941	-2.724342927	.420569409	6.309395260	.012155098	1.23196	3
288	-2.880000000	3.138981655	.304087291	-2.690543322	.431804832	6.309860322	.012155098	1.24254	3
289	-2.870000000	3.133707340	.314484675	-2.658783554	.442799317	6.310338562	.012155098	1.25270	3
290	-2.860000000	3.128385198	.324889605	-2.628907208	.453563495	6.310830638	.012155098	1.26235	3
291	-2.850000000	3.123018170	.335302609	-2.600774337	.464107217	6.311337243	.012155098	1.27204	3
292	-2.840000000	3.117608989	.345724243	-2.574259306	.474439640	6.311859115	.012155098	1.28053	3
293	-2.830000000	3.112160207	.356155083	-2.549248969	.484569299	6.312397037	.012155098	1.28901	3
294	-2.820000000	3.106674215	.366595739	-2.525641126	.494504170	6.312951845	.012155098	1.29710	3
295	-2.810000000	3.101153255	.377046852	-2.503343208	.504251729	6.313524430	.012155098	1.30499	3
296	-2.800000000	3.095599441	.387509103	-2.482271150	.513818997	6.314115748	.012155098	1.31226	3
297	-2.790000000	3.090014767	.397983214	-2.462348424	.523212590	6.314726825	.012155098	1.31902	3
298	-2.780000000	3.084401123	.408469953	-2.443505204	.532438756	6.315358762	.012155098	1.32605	3
299	-2.770000000	3.078760307	.418970145	-2.425677643	.541503413	6.316012747	.012155098	1.33244	3
300	-2.750000000	3.067403929	.440014479	-2.392840328	.559170407	6.317392097	.012155098	1.34429	3
301	-2.730000000	3.055958483	.461124122	-2.363423375	.576255480	6.318876475	.012155098	1.35486	3
302	-2.710000000	3.044435884	.482308325	-2.337076633	.592797106	6.320479587	.012155098	1.36384	3
303	-2.690000000	3.032847356	.503578046	-2.313501766	.608831104	6.322217794	.012155098	1.37227	3
304	-2.670000000	3.021203659	.524946418	-2.292443636	.624391366	6.324110822	.012155098	1.37908	3
305	-2.650000000	3.009515326	.546429391	-2.273683657	.639510579	6.326182743	.012155098	1.38438	3
306	-2.630000000	2.997792925	.568046615	-2.257034712	.654221018	6.328463316	.012155098	1.38865	3
307	-2.610000000	2.986047363	.589822691	-2.242337405	.668555455	6.330989899	.012155098	1.39106	3
308	-2.590000000	2.974429029	.611788990	-2.229457528	.682548332	6.333810223	.012155098	1.39175	3
309	-2.570000000	2.962534660	.633986385	-2.218284796	.696237351	6.336986565	.012155098	1.39044	3
310	-2.550000000	2.950795532	.656469523	-2.208733094	.709665826	6.340602256	.012155098	1.38650	3
311	-2.530000000	2.939091406	.679313814	-2.200742902	.722886408	6.344772339	.012155098	1.37978	3
312	-2.510000000	2.927446438	.702627572	-2.194287346	.735967419	6.349662047	.012155098	1.36900	3
313	-2.490000000	2.915894591	.726574762	-2.189385269	.749004625	6.355521411	.012155098	1.35277	3
314	-2.470000000	2.904488206	.751422255	-2.186130029	.762145579	6.362757064	.012155098	1.32861	3
315	-2.450000000	2.893318620	.777653754	-2.184760379	.775648280	6.372105121	.012155098	1.29164	3
316	-2.430000000	2.882579229	.806318627	-2.185878188	.790060930	6.385159813	.012155098	1.23082	3
317	-2.410000000	2.872880095	.840772620	-2.191528425	.807120750	6.407006861	.012155098	1.10725	3

Table 5. Initial conditions for family BD of direct periodic orbits around m_1

	X0	YDOT0	X1	YDOT1	ENERGY	T/2	MASS	INDEX	N
1	.049999973	3.924467379	-.074308770	-3.924556353	-8.206720872	.049755334	.012155092	1.99010	1
2	.099999992	2.855636051	-.124299007	-2.855930676	-4.749209588	.123380369	.012155092	1.93946	1
3	.200000007	1.945800172	-.224200137	-1.946904720	-2.798598379	.342518388	.012155092	1.54965	1
4	.287610535	1.516232604	-.311527903	-1.518529254	-2.204628699	.621456324	.012155092	.64846	1
5	.289444334	1.508891657	-.313352688	-1.511218009	-2.196270234	.628318413	.012155092	.62253	1
6	.289444363	1.508891538	-.313352717	-1.511217891	-2.196270099	.628318525	.012155092	.62253	1
7	.289446036	1.508884865	-.313354382	-1.511211244	-2.196262528	.628324806	.012155092	.62251	1
8	.289453104	1.508856669	-.313361415	-1.511183163	-2.196230537	.628351345	.012155092	.62241	1
9	.300000005	1.467598480	-.323853452	-1.470099139	-2.150345046	.668733745	.012155092	.46768	1
10	.325773196	1.373028438	-.349469420	-1.375975745	-2.052057986	.774322330	.012155092	.05165	1
11	.328338360	1.364056549	-.352017022	-1.367049652	-2.043224059	.785398117	.012155092	.00758	1
12	.328340376	1.364049526	-.352019024	-1.367042666	-2.043217178	.785406864	.012155092	.00754	1
13	.328353435	1.364004040	-.352031993	-1.366997414	-2.043172606	.785463526	.012155092	.00732	1
14	.376724705	1.207394957	-.400001139	-1.211263833	-1.902181311	1.016034185	.012155092	-.87839	1
15	.382402755	1.190404505	-.405622887	-1.194372734	-1.888336607	1.046084612	.012155092	-.98400	1
16	.382610560	1.189787684	-.405828596	-1.193759510	-1.887839124	1.047197550	.012155092	-.98784	1
17	.382611706	1.189784284	-.405829730	-1.193756129	-1.887836383	1.047203689	.012155092	-.98786	1
18	.400000007	1.139373942	-.423033904	-1.143632974	-1.848370421	1.143786549	.012155092	-1.30118	1
19	.416201816	1.094436595	-.439050103	-1.098925561	-1.815105441	1.240420996	.012155092	-1.56690	1
20	.418810999	1.087374402	-.441628342	-1.091895428	-1.810034580	1.256636976	.012155092	-1.60611	1
21	.418811018	1.087374351	-.441628361	-1.091895377	-1.810034545	1.256637095	.012155092	-1.60611	1
22	.418812637	1.087369985	-.441629960	-1.091891031	-1.810031421	1.256647213	.012155092	-1.60613	1
23	.418822827	1.087342498	-.441640029	-1.091863665	-1.810011765	1.256710916	.012155092	-1.60628	1
24	.461304668	.978837081	-.483610012	-.983511662	-1.736863806	1.551443933	.012155092	-2.00069	1
25	.463788658	.972865822	-.486066325	-.977515691	-1.733059949	1.570796191	.012155092	-2.00390	1
26	.463788672	.972865790	-.486066338	-.977515659	-1.733059929	1.570796295	.012155092	-2.00390	1
27	.463789847	.972862974	-.486067500	-.977512830	-1.733058140	1.570805519	.012155092	-2.00390	1
28	.463797737	.972844075	-.486075303	-.977493844	-1.733046128	1.570867433	.012155092	-2.00391	1
29	.477861907	.939843757	-.500000078	-.944232987	-1.712297240	1.686123236	.012155092	-1.96352	1
30	.499179759	.892716547	-.521221578	-.896109589	-1.682887212	1.884243085	.012155092	-1.66787	1
31	.499249894	.892568162	-.521291797	-.895956140	-1.682793306	1.884955405	.012155092	-1.66634	1
32	.499249912	.892568125	-.521291815	-.895956101	-1.682793282	1.884955584	.012155092	-1.66634	1
33	.499252140	.892563412	-.521294045	-.895951277	-1.682790299	1.884978220	.012155092	-1.66629	1
34	.500000009	.890984262	-.522043043	-.894317103	-1.681789706	1.892604097	.012155092	-1.64965	1
35	.502164050	.886447553	-.524212869	-.889611020	-1.678901344	1.914990066	.012155092	-1.59878	1
36	.504969059	.880643149	-.527031576	-.883562275	-1.675169416	1.944761380	.012155092	-1.52659	1
37	.516394920	.858060957	-.538614389	-.859602186	-1.659951404	2.077050566	.012155092	-1.15040	1
38	.517736890	.855546222	-.539989612	-.856871986	-1.658140286	2.094067751	.012155092	-1.09633	1
39	.517760532	.855502236	-.540013876	-.856824075	-1.658108288	2.094371020	.012155092	-1.09536	1
40	.517762394	.855498771	-.540015788	-.856820301	-1.658105766	2.094394921	.012155092	-1.09528	1
41	.517762406	.855498750	-.540015800	-.856820277	-1.658105751	2.094395070	.012155092	-1.09528	1
42	.520000011	.851388892	-.542318729	-.852316667	-1.655059637	2.123689919	.012155092	-.99965	1
43	.527691693	.838293314	-.550366201	-.837422198	-1.644138344	2.236011594	.012155092	-.60931	1
44	.533344905	.830414301	-.556519300	-.827438840	-1.635076410	2.338557272	.012155092	-.23302	1
45	.534152104	.829517923	-.557430160	-.826138218	-1.633623093	2.355832278	.012155092	-.16894	1
46	.534166004	.829503242	-.557445952	-.826116233	-1.633597511	2.356138437	.012155092	-.16781	1
47	.534168534	.829500573	-.557448827	-.826112233	-1.633592852	2.356194197	.012155092	-.16760	1
48	.534168548	.829500559	-.557448842	-.826112212	-1.633592827	2.356194495	.012155092	-.16760	1
49	.539139779	.828238084	-.563661934	-.820447583	-1.621298996	2.511385321	.012155092	.39823	1
50	.539167679	.828301120	-.563706657	-.820454785	-1.621172833	2.513055711	.012155092	.40411	1
51	.539171277	.828309491	-.563712457	-.820455850	-1.621156364	2.513273864	.012155092	.40487	1
52	.539171281	.828309499	-.563712463	-.820455851	-1.621156348	2.513274073	.012155092	.40487	1
53	.539171680	.828310432	-.563713107	-.820455971	-1.621154517	2.513298332	.012155092	.40496	1
54	.539172100	.828311414	-.563713785	-.820456098	-1.621152591	2.513323842	.012155092	.40505	1
55	.539205239	.828391423	-.563767623	-.820467524	-1.620998492	2.515366255	.012155092	.41223	1

Table 5 (contd)

	X0	YDOT0	X1	YDOT1	ENERGY	T/2	MASS	INDEX	N
56	.539389470	.828951660	-.564083013	-.820595671	-1.620046266	2.528031646	.012155092	.45652	1
57	.520000035	.920931469	-.550927475	-.894132778	-1.593433703	2.875285565	.012155092	1.41080	1
58	.500000042	.994149726	-.533483017	-.959797318	-1.584549240	2.955166160	.012155092	1.52790	1
59	.463562652	1.128337407	-.500000554	-1.083965814	-1.570592522	3.028513997	.012155092	1.59311	1
60	.400000079	1.381282852	-.438972693	-1.323499099	-1.543485367	3.085477053	.012155092	1.61572	1
61	.360479563	1.557228787	-.400000354	-1.491928303	-1.522841158	3.103702812	.012155092	1.61653	1
62	.300000077	1.867314491	-.339304777	-1.790216531	-1.483835283	3.120809524	.012155092	1.60885	1
63	.199999713	2.568290374	-.236826288	-2.466252006	-1.393616209	3.136156767	.012155092	1.56753	1
64	.192963837	2.632163529	-.229531000	-2.527847529	-1.385728662	3.136930047	.012155085	1.56267	1
65	.192955560	2.632240280	-.229522411	-2.527921539	-1.385719240	3.136930942	.012155085	1.56266	1
66	.192676991	2.634825445	-.229233355	-2.530414377	-1.385401952	3.136961042	.012155085	1.56246	1
67	.145805342	3.147345703	-.180364621	-3.024385562	-1.325921369	3.141592710	.012155092	1.51978	1
68	.145317848	3.153684482	-.179853933	-3.030491828	-1.325231557	3.141637443	.012155092	1.51922	1
69	.099999994	3.891969506	-.132157912	-3.741285422	-1.252824776	3.145670899	.012155092	1.45289	1
70	.039999999	5.972717128	-.068282043	-5.743962594	-1.117475569	3.151450502	.012155092	1.28109	1
71	.068674557	-4.862188744	-.100000110	4.657258355	-.416461010	3.155423232	.012155092	.57037	3
72	.165839352	-3.262536479	-.199999871	3.172613748	-.256329987	3.142709284	.012155092	1.22523	3
73	.174230445	-3.188792237	-.208475311	3.104115814	-.245928118	3.141739129	.012155092	1.27471	3
74	.175514352	-3.177969132	-.209770499	3.094060554	-.244371261	3.141592680	.012155092	1.28211	3
75	.175518014	-3.177938425	-.209774193	3.094032026	-.244366833	3.141592263	.012155092	1.28214	3
76	.265768692	-2.627720144	-.300000126	2.581563543	-.154066838	3.132522612	.012155092	1.68495	3
77	.366899646	-2.282963304	-.400000387	2.257772950	-.086996637	3.124534546	.012155092	1.90595	3
78	.468464341	-2.069543285	-.499999797	2.054799579	-.046985578	3.117607145	.012155092	1.98464	3
79	.570119581	-1.927411939	-.599999385	1.916988604	-.030685411	3.110519140	.012155092	1.99983	3
80	.605122973	-1.889861002	-.634471457	1.879762740	-.029383191	3.110519140	.012155098	1.99996	3
81	.605037847	-1.889859756	-.634383360	1.879765269	-.029547698	3.110078960	.012155098	1.99997	3
82	.604952726	-1.889858530	-.634295269	1.879767815	-.029712231	3.109638780	.012155098	1.99998	3
83	.604867609	-1.889857323	-.634207185	1.879770380	-.029876789	3.109198600	.012155098	1.99999	3
84	.604782497	-1.889856136	-.634119107	1.879772962	-.030041373	3.108758419	.012155098	1.99999	3
85	.604697389	-1.889854969	-.634031035	1.879775563	-.030205982	3.108318239	.012155098	1.99999	3
86	.609329484	-1.885039021	-.638585597	1.874967670	-.030559919	3.107437878	.012155098	2.00000	3
87	.614613689	-1.879746254	-.643787216	1.869666346	-.030810618	3.106997698	.012155098	2.00001	3
88	.619816326	-1.874625080	-.648908957	1.864523321	-.031120542	3.106557518	.012155098	2.00004	3
89	.624937118	-1.869669586	-.653950554	1.859533122	-.031487104	3.106117337	.012155098	2.00009	3
90	.629975953	-1.864873993	-.658911900	1.854690398	-.031907759	3.105677157	.012155098	2.00016	3
91	.634932870	-1.860232662	-.663793038	1.849989923	-.032380015	3.105236977	.012155098	2.00026	3
92	.639808049	-1.855740103	-.668594150	1.845426606	-.032901431	3.104796797	.012155098	2.00040	3
93	.644601801	-1.851390976	-.673315541	1.840995494	-.033469627	3.104356616	.012155098	2.00057	3
94	.649314553	-1.847180096	-.677957635	1.836691773	-.034082289	3.103916436	.012155098	2.00078	3
95	.653946839	-1.843102437	-.682520959	1.832510777	-.034737168	3.103476256	.012155098	2.00104	3
96	.658499293	-1.839153134	-.687006138	1.828447983	-.035432084	3.103036075	.012155098	2.00133	3
97	.662972633	-1.835327478	-.691413879	1.824499018	-.036164930	3.102595895	.012155098	2.00168	3
98	.667367658	-1.831620922	-.695744968	1.820659650	-.036933672	3.102155715	.012155098	2.00207	3
99	.671685419	-1.828028933	-.700000426	1.816925654	-.037736365	3.101715534	.012155092	2.00252	3
100	.772895801	-1.756053488	-.799999841	1.737219402	-.071690309	3.088116228	.012155092	2.04551	3
101	.852332940	-1.705262358	-.899998277	1.658593353	-.148605550	3.059810220	.012155092	2.36036	3
102	.970922291	-1.704250031	-.999999044	1.517432432	-.354814129	2.992979257	.012155092	9.08632	3
103	.965692323	-1.730853537	-1.049995468	1.401257190	-.527276479	2.990440964	.012155092	30.15533	3
104	.971889697	-1.730891718	-1.100013067	1.248135406	-.739979402	3.045271349	.012155092	75.30033	3
105	.973267697	-1.643897065	-1.127966523	1.066290786	-.958726380	3.134145625	.012155092	117.07587	3
106	.973266624	-1.643603967	-1.127988576	1.065903264	-.959146835	3.134326188	.012155092	117.10240	3
107	.973266415	-1.643547299	-1.127992818	1.065828408	-.959228029	3.134361055	.012155092	117.11196	3
108	.973265700	-1.643354450	-1.128007203	1.065573830	-.959504108	3.134479609	.012155092	117.14407	3
109	.973226286	-1.634372700	-1.128592957	1.053987561	-.971977853	3.139830604	.012155092	118.53322	3
110	.973210163	-1.631289610	-1.128758445	1.050124988	-.976096695	3.141594319	.012155092	118.94658	3

Table 5 (contd)

	X0	YDOTO	X1	YDOT1	ENERGY	T/2	MASS	INDEX	N
111	.973210156	-1.631288321	-1.128758510	1.050123385	-.976098400	3.141595049	.012155092	118.94671	3
112	.973209523	-1.631171956	-1.128764422	1.049978678	-.976252322	3.141660921	.012155092	118.96222	3
113	.973209441	-1.631156906	-1.128765185	1.049959967	-.976272223	3.141669437	.012155092	118.96437	3
114	.972232893	-1.534082224	-1.128001246	.947868016	-1.077999036	3.183689272	.012155092	123.30145	3
115	.970422116	-1.426782103	-1.120000507	.858634375	-1.156021849	3.211201548	.012155092	118.28572	3
116	.966095884	-1.256072376	-1.100001238	.738103486	-1.246498915	3.231541156	.012155092	104.86385	3
117	.952281734	-.957747254	-1.050000254	.544421885	-1.360840363	3.225384473	.012155092	90.16649	3
118	.934552348	-.748065828	-1.000000330	.394173394	-1.428428371	3.209237306	.012155092	103.27107	3
119	.915337539	-.590101213	-.950001580	.258125792	-1.477521457	3.214372425	.012155092	144.26225	3
120	.896730023	-.460829590	-.899999941	.125785786	-1.516159880	3.259828090	.012155092	216.12092	3
121	.880065150	-.347430267	-.849999533	-.008732389	-1.546856656	3.377418815	.012155092	319.26263	2
122	.867192221	-.248925665	-.800000943	-.151638782	-1.569157900	3.667959242	.012155092	410.16311	2
123	.866097866	-.238859321	-.793740973	-.170729205	-1.571158863	3.731358999	.012155098	402.15062	2
124	.865317194	-.231044951	-.788346723	-.187545935	-1.572683620	3.794758999	.012155098	381.97773	2
125	.864791251	-.225107504	-.783654902	-.202516225	-1.573834021	3.858158999	.012155098	348.48142	2
126	.864500889	-.221146676	-.779945068	-.214634591	-1.574607257	3.915028124	.012155092	306.44513	2
127	.864477336	-.220766657	-.779545895	-.215955815	-1.574682363	3.921558999	.012155098	300.88082	2
128	.864459229	-.220461557	-.779217922	-.217044134	-1.574742798	3.926990776	.012155092	296.13773	2
129	.864459224	-.220461473	-.779217831	-.217044437	-1.574742815	3.926992296	.012155092	296.13639	2
130	.864455502	-.220397275	-.779147853	-.217276968	-1.574755561	3.928158878	.012155092	295.10408	2
131	.864343753	-.217806469	-.775930552	-.228102096	-1.575281192	3.984958999	.012155098	239.11135	2
132	.864366412	-.216055810	-.772741636	-.239135584	-1.575669475	4.048358999	.012155098	164.17826	2
133	.864526529	-.215375194	-.769928015	-.249194499	-1.575876684	4.111758999	.012155098	78.48991	2
134	.864549532	-.215361310	-.769665291	-.250152614	-1.575888386	4.118108999	.012155098	69.45659	2
135	.864573708	-.215356865	-.769406303	-.251100642	-1.575898509	4.124448999	.012155098	60.37413	2
136	.864599080	-.215361725	-.769150604	-.252040186	-1.575907091	4.130788999	.012155098	51.23358	2
137	.864625633	-.215375787	-.768898161	-.252971334	-1.575914152	4.137128999	.012155098	42.04035	2
138	.864653356	-.215398947	-.768648943	-.253894169	-1.575919710	4.143468999	.012155098	32.80001	2
139	.864682235	-.215431104	-.768400920	-.254808775	-1.575923783	4.149808999	.012155098	23.51834	2
140	.864712259	-.215472160	-.768160063	-.255715230	-1.575926389	4.156148999	.012155098	14.20128	2
141	.864740972	-.215517859	-.767938722	-.256544608	-1.575927506	4.161999999	.012155098	5.57672	2
142	.864743415	-.215522015	-.767920343	-.256613614	-1.575927544	4.162488999	.012155098	4.85495	2
143	.864743971	-.215522965	-.767916174	-.256629271	-1.575927552	4.162599999	.012155098	4.69109	2
144	.864746980	-.215528150	-.767893654	-.256713863	-1.575927584	4.163199999	.012155098	3.80525	2
145	.864749998	-.215533413	-.767871162	-.256798384	-1.575927604	4.163799999	.012155098	2.91921	2
146	.864753027	-.215538753	-.767848698	-.256882833	-1.575927611	4.164399999	.012155098	2.03298	2
147	.864756065	-.215544171	-.767826261	-.256967210	-1.575927605	4.164999999	.012155098	1.14656	2
148	.864759114	-.215549667	-.767803853	-.257051516	-1.575927586	4.165599999	.012155098	.25996	2
149	.864762173	-.215555240	-.767781472	-.257135751	-1.575927555	4.166199999	.012155098	-.62681	2
150	.864765241	-.215560891	-.767759118	-.257219915	-1.575927510	4.166799999	.012155098	-1.51377	2
151	.864768320	-.215566619	-.767736793	-.257304007	-1.575927453	4.167399999	.012155098	-2.40089	2
152	.864775692	-.215580572	-.767683732	-.257504002	-1.575927267	4.168828999	.012155098	-4.51435	2
153	.864809024	-.215647622	-.767450568	-.258385082	-1.575925576	4.175158999	.012155098	-13.88533	2
154	.865201370	-.216772103	-.765279183	-.266789181	-1.575834148	4.238558999	.012155098	-107.10347	2
155	.865692774	-.218659056	-.763390487	-.274470037	-1.575617040	4.301958999	.012155098	-193.63111	2
156	.866273596	-.221227106	-.761766097	-.281476812	-1.575286551	4.365358999	.012155098	-264.57349	2
157	.866934949	-.224400954	-.760391242	-.287848207	-1.574853370	4.428758999	.012155098	-310.24796	2
158	.867164320	-.225543300	-.759998540	-.289775088	-1.574693161	4.449231266	.012155092	-317.98017	2
159	.867668451	-.228110062	-.759253684	-.293615358	-1.574327091	4.492158999	.012155098	-320.96145	2
160	.868466075	-.232287961	-.758342888	-.298804150	-1.573716566	4.555558999	.012155098	-287.90644	2
161	.869320094	-.236871992	-.757649396	-.303437010	-1.573030127	4.618958999	.012155098	-204.06041	2
162	.870223071	-.241803329	-.757164381	-.307534247	-1.572275718	4.682358999	.012155098	-64.96586	2
163	.870315785	-.242313418	-.757127017	-.307915255	-1.572196834	4.688698999	.012155098	-47.93728	2
164	.870408909	-.242826376	-.757091645	-.308291117	-1.572117355	4.695038999	.012155098	-30.34051	2
165	.870502438	-.243342150	-.757058255	-.308661851	-1.572037287	4.701378999	.012155098	-12.17640	2

Table 5 (contd)

	X0	YDOTO	X1	YDDT1	ENERGY	T/2	MASS	INDEX	N
166	.870596365	-.243860689	-.757026841	-.309027478	-1.571956638	4.707718999	.012155098	6.55386	2
167	.870690682	-.244381942	-.756997392	-.309388015	-1.571875414	4.714058999	.012155098	25.84874	2
168	.870785383	-.244905858	-.756969902	-.309743480	-1.571793625	4.720398999	.012155098	45.70636	2
169	.870880461	-.245432386	-.756944362	-.310093893	-1.571711276	4.726738999	.012155098	66.12450	2
170	.870975910	-.245961476	-.756920763	-.310439271	-1.571628375	4.733078999	.012155098	87.10059	2
171	.871071723	-.246493079	-.756899097	-.310779634	-1.571544930	4.739418999	.012155098	108.63172	2
172	.871167892	-.247027145	-.756879356	-.311114999	-1.571460946	4.745758999	.012155098	130.71464	2
173	.872147812	-.252492818	-.756786001	-.314197831	-1.570593096	4.809158999	.012155098	380.93708	2
174	.873156503	-.258154098	-.756876097	-.316801061	-1.569679111	4.872558999	.012155098	680.32964	2
175	.874188096	-.263969197	-.757141526	-.318942862	-1.568725564	4.939958999	.012155098	1020.53730	2
176	.875237213	-.269900781	-.757574322	-.320641197	-1.567738624	4.999358999	.012155098	1390.79799	2
177	.876298981	-.275915859	-.758166762	-.321913649	-1.566724030	5.062758999	.012155098	1778.67037	2
178	.877369032	-.281985593	-.758911466	-.322777163	-1.565687070	5.126158999	.012155098	2170.82874	2
179	.878443498	-.288085045	-.759801520	-.323247742	-1.564632575	5.189558999	.012155098	2553.84822	2
180	.879518987	-.294192879	-.760830596	-.323340096	-1.563564920	5.252958999	.012155098	2914.91912	2
181	.880592561	-.300291046	-.761993093	-.323067260	-1.562488028	5.316358999	.012155098	3242.44879	2
182	.881661705	-.306364470	-.763248282	-.322440154	-1.561405392	5.379758999	.012155098	3526.52819	2
183	.882724300	-.312400743	-.764700487	-.321467061	-1.560320087	5.443158999	.012155098	3759.53760	2
184	.883778594	-.318389854	-.766239296	-.320152995	-1.559234800	5.506558999	.012155098	3934.93851	2
185	.884823181	-.324323954	-.767899853	-.318498860	-1.558151840	5.569958999	.012155098	4050.14879	2
186	.885856984	-.330197180	-.769688324	-.316500330	-1.557073164	5.633358999	.012155098	4103.72437	2
187	.886879253	-.336005538	-.771593042	-.314146261	-1.556000382	5.696758999	.012155098	4096.67530	2
188	.887889576	-.341746902	-.773636116	-.311416402	-1.554934758	5.760158999	.012155098	4032.06853	2
189	.888887920	-.347421139	-.775823817	-.308277991	-1.553877188	5.823558999	.012155098	3914.91573	2
190	.889874713	-.353030478	-.778173795	-.304680587	-1.552828144	5.886958999	.012155098	3752.11743	2
191	.890851004	-.358580262	-.780712819	-.300548044	-1.551787559	5.950358999	.012155098	3552.54049	2
192	.891818746	-.364080402	-.783481230	-.295765862	-1.550754597	6.013758999	.012155098	3327.36109	2
193	.892781339	-.369548142	-.786540010	-.290161084	-1.549727202	6.077158999	.012155098	3090.92161	2
194	.893744614	-.375013339	-.789981843	-.283470804	-1.548701208	6.140558999	.012155098	2862.59298	2
195	.894718683	-.380528587	-.793947285	-.275296045	-1.547668589	6.203958999	.012155098	2670.61710	2
196	.895721221	-.386187879	-.798643406	-.265048181	-1.546614100	6.267358999	.012155098	2559.69490	2
197	.896782408	-.392156398	-.804347263	-.251937353	-1.545509655	6.330758999	.012155098	2604.47663	2
198	.897948854	-.398698849	-.811343070	-.235147058	-1.544308372	6.394158999	.012155098	2927.09990	2
199	.899276990	-.406152887	-.819738825	-.214349194	-1.542948092	6.457558999	.012155098	3700.76892	2
200	.900807909	-.414792429	-.829274249	-.190247643	-1.541376197	6.520958999	.012155098	5106.54533	2
201	.902542480	-.424674997	-.839394605	-.164377126	-1.539580082	6.584358999	.012155098	7251.14450	2
202	.904444558	-.435641710	-.849542257	-.138288137	-1.537589889	6.647758999	.012155098	10115.00278	2
203	.906462849	-.447434147	-.859339238	-.113034713	-1.535475159	6.711158999	.012155098	13564.96852	2
204	.908548083	-.459794212	-.868590289	-.089164701	-1.533234930	6.774558999	.012155098	17401.68813	2
205	.910659975	-.472507491	-.877221969	-.066888961	-1.530968318	6.837958999	.012155098	21407.74296	2
206	.912768166	-.485411155	-.885228797	-.046230848	-1.528692241	6.901358999	.012155098	25382.26756	2
207	.914850917	-.498387913	-.892639345	-.027119961	-1.526432213	6.964758999	.012155098	29160.16524	2
208	.916893300	-.511356558	-.899497250	-.009444390	-1.524206058	7.028158999	.012155098	32618.99959	2
209	.918885524	-.524263068	-.905851129	.006921669	-1.522025651	7.091558999	.012155098	35677.83001	3
210	.920821578	-.537073341	-.911749421	.022103890	-1.519898416	7.154958999	.012155098	38291.73260	3
211	.922698178	-.549767656	-.917237913	.036221092	-1.517828514	7.218358999	.012155098	40444.66475	3
212	.924513983	-.562336559	-.922358686	.049382410	-1.515817750	7.281758999	.012155098	42142.28893	3
213	.926269018	-.574777884	-.927149822	.061686494	-1.513866252	7.345158999	.012155098	43405.58654	3
214	.927964253	-.587094617	-.931645492	.073221742	-1.511972967	7.408558999	.012155098	44265.58423	3
215	.929601294	-.599293366	-.935876227	.084067011	-1.510136033	7.471958999	.012155098	44759.22454	3
216	.931182171	-.611383297	-.939869263	.094292534	-1.508353038	7.535358999	.012155098	44926.26801	3
217	.932709173	-.623375382	-.943648908	.103960869	-1.506621208	7.598758999	.012155098	44807.05855	3
218	.934184744	-.635281884	-.947236886	.113127821	-1.504937548	7.662158999	.012155098	44440.97673	3
219	.935611396	-.647116015	-.950652666	.121843287	-1.503298929	7.725558999	.012155098	43865.42209	3
220	.936991664	-.658891714	-.953913752	.130152016	-1.501702157	7.788958999	.012155098	43115.19035	3

Table 5 (contd)

	X0	YDOT0	X1	YDOT1	ENERGY	T/2	MASS	INDEX	N
221	.938328058	-.670623514	-.957035944	.138094291	-1.500144016	7.852358999	.012155098	42222.13833	3
222	.939623047	-.682326482	-.960033570	.145706523	-1.498621291	7.915758999	.012155098	41215.05275	3
223	.940879038	-.694016209	-.962919688	.153021775	-1.497130790	7.979158999	.012155098	40119.65972	3
224	.942098367	-.705708833	-.965706263	.160070225	-1.495669341	8.042558999	.012155098	38958.72769	3
225	.943283298	-.717421105	-.968404332	.166879570	-1.494233798	8.105958999	.012155098	37752.22974	3
226	.943832633	-.722975024	-.969653143	.170025740	-1.493562650	8.135958999	.012155098	37170.53497	3
227	.944374982	-.728539149	-.970885472	.173126690	-1.492896270	8.165958999	.012155098	36584.21270	3
228	.944910568	-.734115434	-.972102321	.176184899	-1.492234329	8.195958999	.012155098	35994.79874	3
229	.945439610	-.739705881	-.973304663	.179202772	-1.491576496	8.225958999	.012155098	35403.71978	3
230	.945962323	-.745312544	-.974493446	.182182643	-1.490922438	8.255958999	.012155098	34812.29856	3
231	.946478919	-.750937531	-.975669596	.185126782	-1.490271824	8.285958999	.012155098	34221.75901	3
232	.946989607	-.756583010	-.976834019	.188037402	-1.489624317	8.315958999	.012155098	33633.23130	3
233	.947494592	-.762251216	-.977987602	.190916663	-1.488979583	8.345958999	.012155098	33047.75676	3
234	.947994077	-.767944449	-.979131219	.193766678	-1.488337280	8.375958999	.012155098	32466.29270	3
235	.948488262	-.773665089	-.980265728	.196589520	-1.487697068	8.405958999	.012155098	31889.71708	3
236	.948977345	-.779415593	-.981391977	.199387224	-1.487058598	8.435958999	.012155098	31318.83305	3
237	.949461519	-.785198508	-.982510806	.202161796	-1.486421520	8.465958999	.012155098	30754.37338	3
238	.949940978	-.791016472	-.983623047	.204915217	-1.485785477	8.495958999	.012155098	30197.00460	3
239	.950415911	-.796872226	-.984729528	.207649445	-1.485150107	8.525958999	.012155098	29647.33121	3
240	.950886508	-.802768620	-.985831074	.210366423	-1.484515039	8.555958999	.012155098	29105.89952	3
241	.951352954	-.808708621	-.986928513	.213068086	-1.483879896	8.585958999	.012155098	28573.20150	3
242	.951815436	-.814695322	-.988022672	.215756362	-1.483244292	8.615958999	.012155098	28049.67838	3
243	.952274136	-.820731954	-.989114385	.218433179	-1.482607829	8.645958999	.012155098	27535.72415	3
244	.952729236	-.826821892	-.990204491	.221100473	-1.481970102	8.675958999	.012155098	27031.68896	3
245	.953180919	-.832968673	-.991293841	.223760187	-1.481330689	8.705958999	.012155098	26537.88227	3
246	.953629364	-.839176002	-.992383297	.226414286	-1.480689157	8.735958999	.012155098	26054.57600	3
247	.954060560	-.845246245	-.993438855	.228980065	-1.480065692	8.764999999	.012155098	25596.94563	3
248	.954503160	-.851584288	-.994531101	.231628941	-1.479418665	8.794999999	.012155098	25134.96775	3
249	.954943055	-.857995026	-.995626115	.234278191	-1.478768136	8.824999999	.012155098	24684.10458	3
250	.955380426	-.864482992	-.996724840	.236929908	-1.478113604	8.854999999	.012155098	24244.50713	3
251	.955815453	-.871052970	-.997828245	.239586239	-1.477454541	8.884999999	.012155098	23816.30252	3
252	.956248315	-.877710021	-.998937334	.242249391	-1.476790397	8.914999999	.012155098	23399.59641	3
253	.956679196	-.884459500	-1.000053147	.244921638	-1.476120594	8.944999999	.012155098	22994.47537	3
254	.957108276	-.891307088	-1.001176765	.247605335	-1.475444523	8.974999999	.012155098	22601.00917	3
255	.957535741	-.898258819	-1.002309318	.250302926	-1.474761542	9.004999999	.012155098	22219.25300	3
256	.957961777	-.905321111	-1.003451987	.253016955	-1.474070973	9.034999999	.012155098	21849.24964	3
257	.958386572	-.912500803	-1.004606015	.255750084	-1.473372095	9.064999999	.012155098	21491.03156	3
258	.958810317	-.919805197	-1.005772707	.258505102	-1.472664143	9.094999999	.012155098	21144.62303	3
259	.959233207	-.927242097	-1.006953448	.261284946	-1.471946302	9.124999999	.012155098	20810.04208	3
260	.959655440	-.934819867	-1.008149704	.264092715	-1.471217698	9.154999999	.012155098	20487.30260	3
261	.960077218	-.942547482	-1.009363035	.266931697	-1.470477398	9.184999999	.012155098	20176.41628	3
262	.960498748	-.950434598	-1.010595107	.269805385	-1.469724394	9.214999999	.012155098	19877.39464	3
263	.960920244	-.958491618	-1.011847706	.272717510	-1.468957604	9.244999999	.012155098	19590.25101	3

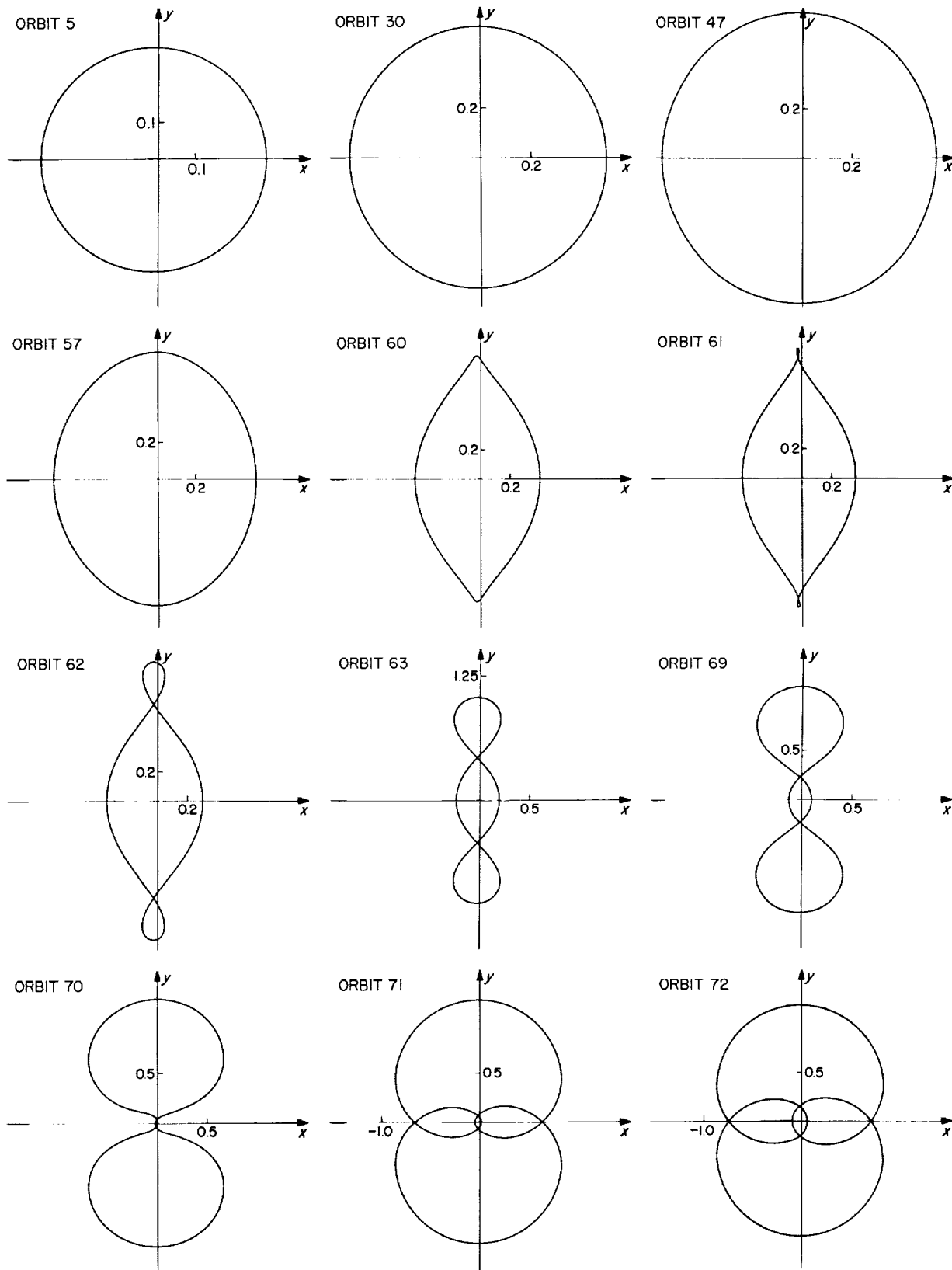

Fig. 20. Typical trajectories in family BD of direct periodic orbits around m_1

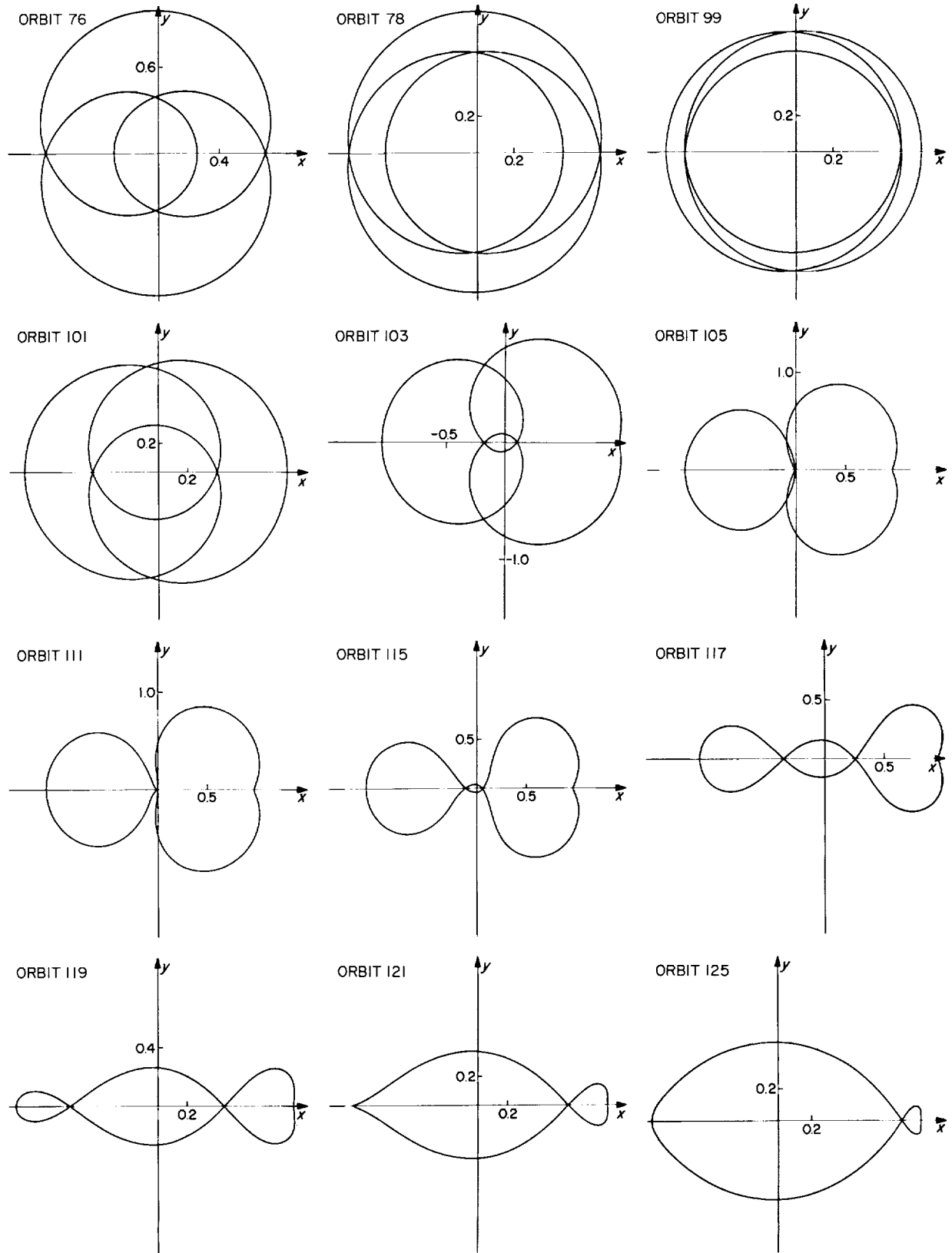

Fig. 20 (contd)

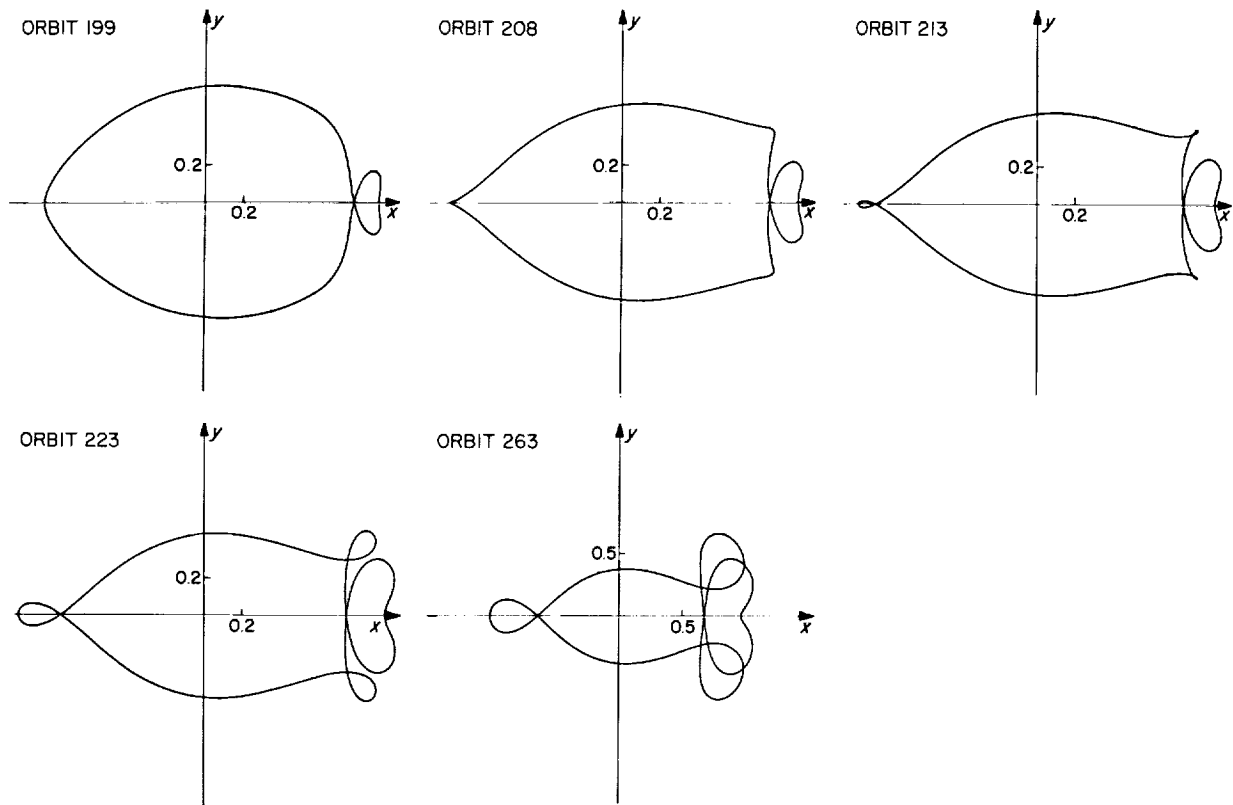

Fig. 20 (contd)

The approximate initial conditions are

$$(-1.123843, 0, 0, 1.116070)$$

or

$$(0.9732787, 0, 0, -1.677794)$$

with energy $E_0 = -0.9030628$.

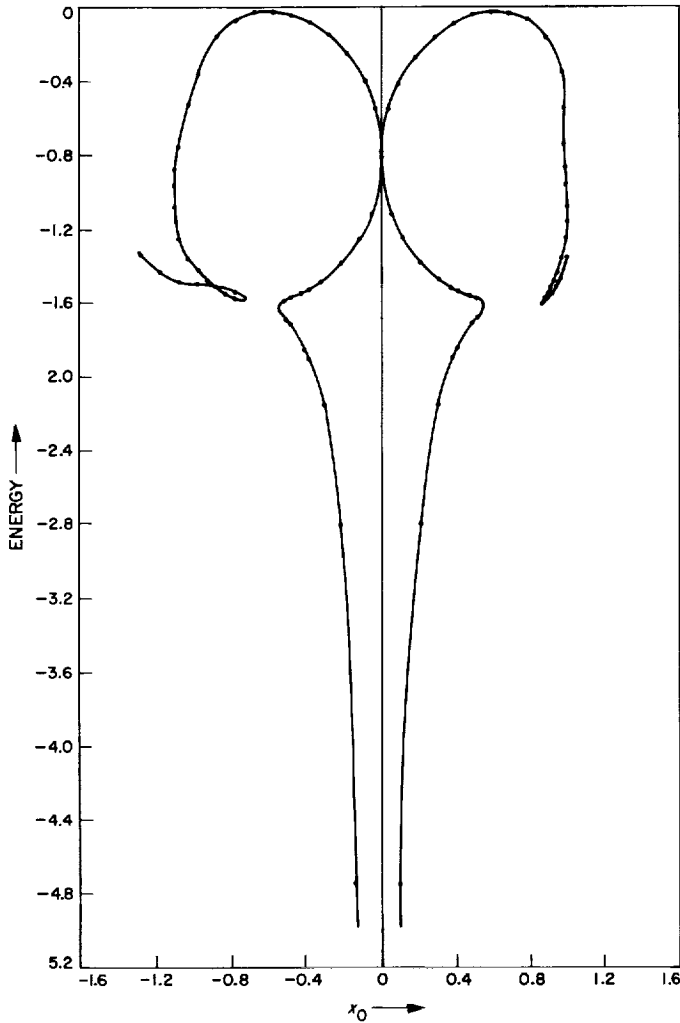

Fig. 21. Energy diagram of family BD

In Stromgren's problem with equal masses (Ref. 1), there is a class g of direct orbits around m_2 (m_1 and m_2 are identical in Stromgren's problem) However, the evolution is completely different from our family BD. Stromgren expressed the opinion that the end of class g was related to the libration points L_4 and L_5 , and this has more recently been stated to be correct by Bartlett (Refs. 19, 20).

The stability index has a rapid evolution throughout the family (Fig. 23). The family starts with stable orbits in the neighborhood of $k = 2$. The stability index then decreases and moves slightly into the instability region before it increases and returns to stable values again. It continues to increase for a large number of orbits before it goes up and down again through the stable regions. Close to orbit 85 we have the limit of a stability region, with $k = 2$. It is at this point that the branching with family A_1 , mentioned previously, occurs. In the neighborhood of orbits 148 and 166, family BD traverses the

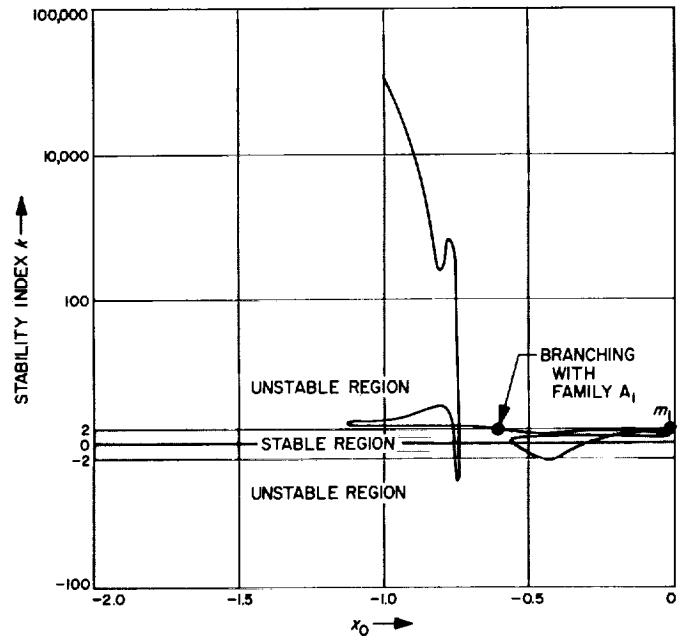

Fig. 23. Stability evolution of family BD

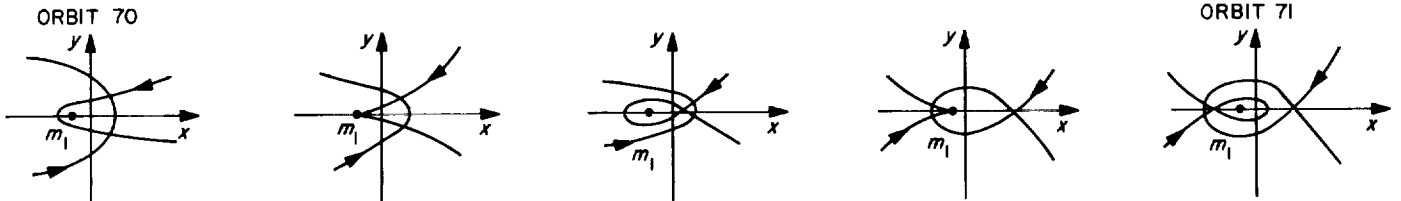

Fig. 22. Evolution of periodic collision orbits in family BD

stable region, but the evolution is very fast in this part of the family. All the last orbits of the family

in approximately a Keplerian motion around this point. The velocity is

$$+ \sqrt{\frac{I}{r_1}}$$

F. Family E₁ of Direct Periodic Orbits Around m₁ and m₂

This family of orbits starts with circular orbits with infinite radius around both masses m₁ and m₂ simultaneously. The direction of the motion is direct relative to inertial axes and retrograde relative to rotating axes. If the radius is sufficiently large we may suppose that the two primaries are joined at the barycenter, which results

with respect to the inertial axes, and

$$+ \sqrt{\frac{I}{r_1}} - r_1$$

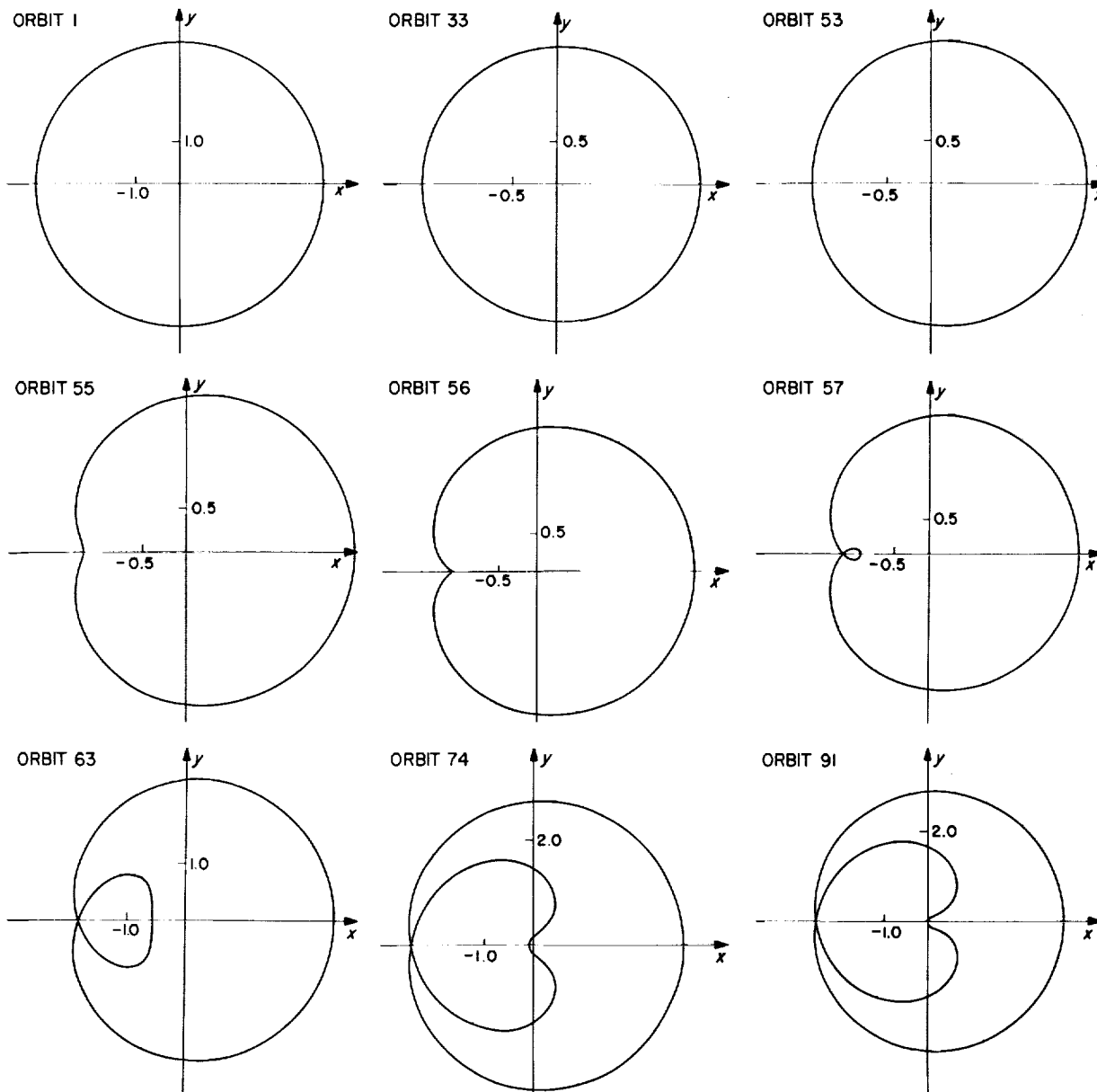

Fig. 24. Typical trajectories in family E₁ of direct periodic orbits around m₁ and m₂

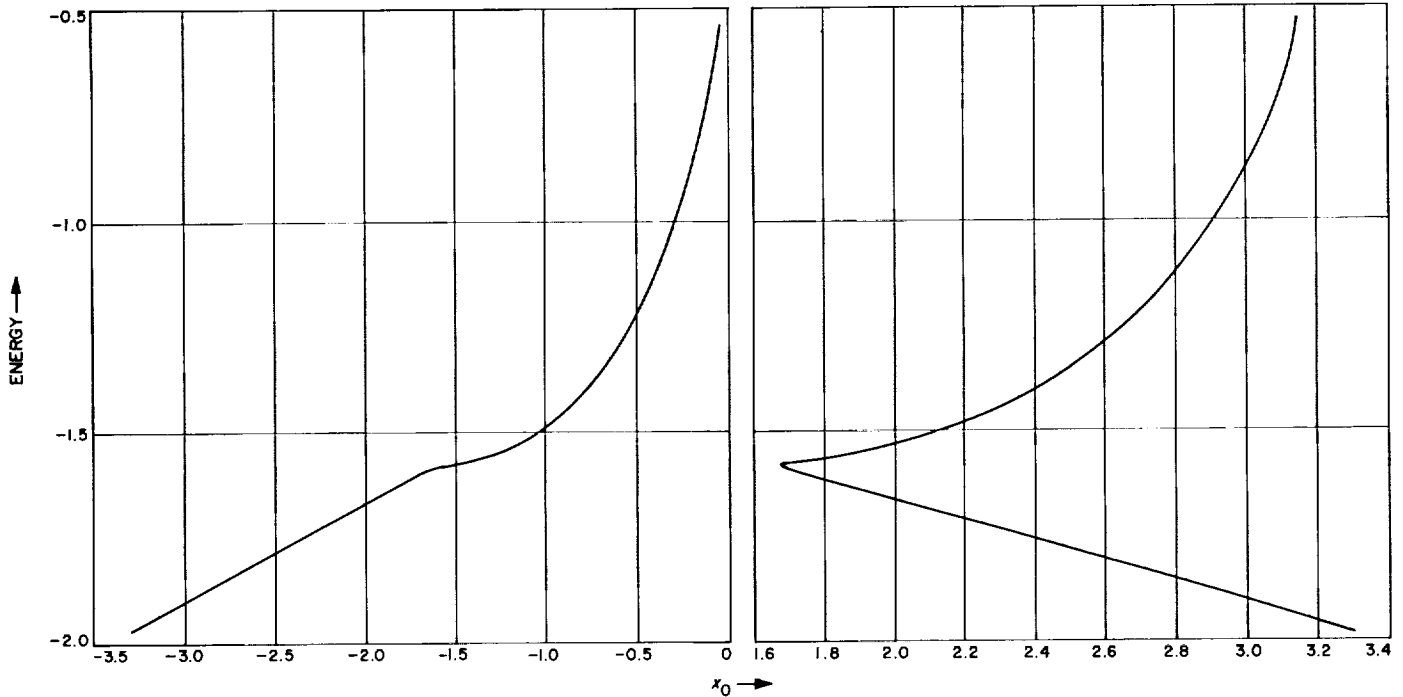

Fig. 25. Energy diagram of family E_1

with respect to the rotating axes. Thus, when the radius r_1 is large, the direct inertial motion gives a retrograde synodical motion.

Family E_1 starts with decreasing values of the radius r_1 . Up to 91 periodic orbits were computed in this family without reaching a natural end. As shown in Fig. 24, at some moment in the evolution a loop appears at one side of the orbits, and later this loop develops to a collision with m_1 . The initial conditions for family E_1 are listed in Table 6, and the energy diagram is given in Fig. 25.

This family corresponds to Stromgren's class 1, which begins in a similar way. However, Stromgren's class 1 ends in a natural way, with two of the double asymptotic orbits at L_4 and L_5 . Our family E_1 , of course, cannot end this way because the double asymptotic orbits do not exist for our mass ratio.

Family E_1 contains both stable and unstable orbits, as shown by the stability evolution in Fig. 26. First, there is a series of stable orbits with decreasing stability index. Then the stability index moves slightly into the unstable zone, just below -2 , before it turns up and goes through the complete stable zone again. The change in stability and instability with increasing stability index corresponds

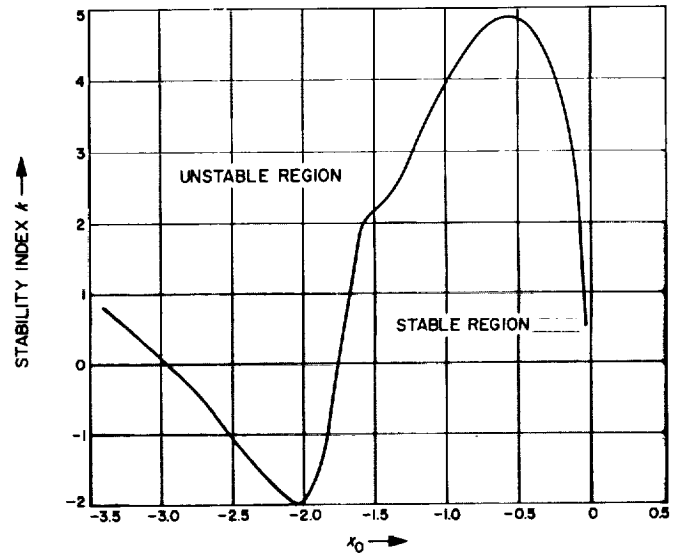

Fig. 26. Stability evolution of family E_1

to the change in the evolution of the form of the orbits. In particular, there is a change in direction in the motion of the right intersection point with the x -axis. The minimum value of x_0 seems to be close to 1.68. In the further evolution of the stability index, a maximum of about 5.0 is reached before it returns to the stable zone.

Table 6. Initial conditions for family E_1 of direct periodic orbits around m_1 and m_2

	X0	YDOT0	X1	YDOT1	ENERGY	T/2	MASS	INDEX	N
1	3.316000014	-2.766756370	-3.315814873	2.766463702	-1.972493117	3.765521257	.012155092	.63700	1
2	2.722111658	-2.116019641	-2.721465647	2.114997527	-1.834468456	4.042650162	.012155092	-.45301	1
3	2.672781539	-2.061145640	-2.672051290	2.059990272	-1.822855004	4.072549671	.012155092	-.57851	1
4	2.598866416	-1.978637968	-2.597982624	1.977239797	-1.805430744	4.128131210	.012155092	-.77662	1
5	2.598857127	-1.978627577	-2.597973313	1.977229372	-1.805428552	4.128138184	.012155092	-.77665	1
6	2.594594547	-1.973858639	-2.593700703	1.972444578	-1.804423058	4.131347715	.012155092	-.78842	1
7	2.502348136	-1.870350403	-2.501197719	1.868530873	-1.782652449	4.205582200	.012155085	-1.05057	1
8	2.501154081	-1.869006661	-2.499999776	1.867180988	-1.782370566	4.206607043	.012155085	-1.05404	1
9	2.501152555	-1.869004943	-2.499998245	1.867179263	-1.782370206	4.206608354	.012155085	-1.05405	1
10	2.501148531	-1.869000414	-2.499994208	1.867174713	-1.782369256	4.206611811	.012155085	-1.05406	1
11	2.433499447	-1.792699908	-2.432095099	1.790479392	-1.766399736	4.267657729	.012155098	-1.25235	1
12	2.372044766	-1.723084386	-2.370351397	1.720407841	-1.751899339	4.328703659	.012155098	-1.43213	1
13	2.315961389	-1.659290302	-2.313935616	1.656089741	-1.738679329	4.389749589	.012155098	-1.59077	1
14	2.264570020	-1.600603407	-2.262163631	1.596803415	-1.726582107	4.450795519	.012155098	-1.72595	1
15	2.217304972	-1.546427683	-2.214464432	1.541944674	-1.715474970	4.511841449	.012155098	-1.83571	1
16	2.173691358	-1.496261830	-2.170357238	1.491003194	-1.705245327	4.572887379	.012155098	-1.91846	1
17	2.133327629	-1.449681249	-2.129433962	1.443544394	-1.695796993	4.633933309	.012155098	-1.97302	1
18	2.095872066	-1.406324084	-2.091345600	1.399195324	-1.687047267	4.694979239	.012155098	-1.99861	1
19	2.073975342	-1.380918121	-2.069016130	1.373111776	-1.681940410	4.732836007	.012155085	-1.99975	1
20	2.061032204	-1.365880294	-2.055791549	1.357633577	-1.678924636	4.756025169	.012155098	-1.99488	1
21	2.028556501	-1.328083028	-2.022511141	1.318578466	-1.671366919	4.817071079	.012155092	-1.96189	1
22	1.939191826	-1.223620114	-1.929884031	1.209033023	-1.650623557	5.009964167	.012155092	-1.67344	1
23	1.883590478	-1.158353905	-1.870948493	1.138596055	-1.637719634	5.153425096	.012155085	-1.29774	1
24	1.799999999	-1.060175688	-1.778131924	1.026201884	-1.618101835	5.418831705	.012155092	-.35179	1
25	1.699999981	-.945729698	-1.638329921	.851270409	-1.591825629	5.905911683	.012155092	1.47508	1
26	1.685965991	-.932044270	-1.600040426	.801059749	-1.586026746	6.039367794	.012155092	1.82466	1
27	1.685125240	-.931399767	-1.596371935	.796165927	-1.585519275	6.051409539	.012155098	1.85084	1
28	1.684371533	-.930877298	-1.592648143	.791181764	-1.585013392	6.063451284	.012155098	1.87608	1
29	1.683710412	-.930484940	-1.588862648	.786097505	-1.584508773	6.075493028	.012155098	1.90036	1
30	1.683148137	-.930231798	-1.585008277	.780902199	-1.584005057	6.087534773	.012155098	1.92367	1
31	1.682691820	-.930128209	-1.581076943	.775583484	-1.583501832	6.099576517	.012155098	1.94601	1
32	1.682349583	-.930185963	-1.577059487	.770127332	-1.582998630	6.111618262	.012155098	1.96738	1
33	1.682130751	-.930418580	-1.572945466	.764517728	-1.582494909	6.123660007	.012155098	1.98778	1
34	1.682046088	-.930841654	-1.568722906	.758736276	-1.581990045	6.135701751	.012155098	2.00721	1
35	1.682108101	-.931473286	-1.564377977	.752761703	-1.581483301	6.147743496	.012155098	2.02567	1
36	1.682331425	-.932334638	-1.559894587	.746569216	-1.580973811	6.159785240	.012155098	2.04318	1
37	1.682733316	-.933450644	-1.555253854	.740129683	-1.580460534	6.171826985	.012155098	2.05976	1
38	1.683334309	-.934850951	-1.550433415	.733408554	-1.579942216	6.183868730	.012155098	2.07544	1
39	1.684159080	-.936571160	-1.545406509	.726364422	-1.579417319	6.195910474	.012155098	2.09025	1
40	1.685237629	-.938654519	-1.540140734	.718947080	-1.578883935	6.207952219	.012155098	2.10425	1
41	1.686606901	-.941154253	-1.534596330	.711094824	-1.578339658	6.219993963	.012155098	2.11752	1
42	1.688313095	-.944136871	-1.528723746	.702730641	-1.577781403	6.232035708	.012155098	2.13014	1
43	1.690415015	-.947686971	-1.522460111	.693756657	-1.577205128	6.244077453	.012155098	2.14227	1
44	1.692989108	-.951914452	-1.515723935	.684045800	-1.576605421	6.256119197	.012155098	2.15409	1
45	1.696137326	-.956965773	-1.508406847	.673428774	-1.575974821	6.268160942	.012155098	2.16588	1
46	1.699999976	-.963042334	-1.500360093	.661672759	-1.575302685	6.280202686	.012155092	2.17803	1
47	1.700162981	-.963296488	-1.500037942	.661200399	-1.575276184	6.280659436	.012155092	2.17851	1
48	1.700985469	-.964576469	-1.498430901	.658842104	-1.575144409	6.282909452	.012155092	2.18087	1
49	1.701062581	-.964696272	-1.498281766	.658623088	-1.575132216	6.283115863	.012155092	2.18109	1
50	1.701088586	-.964736667	-1.498231530	.658549306	-1.575128109	6.283185302	.012155092	2.18116	1
51	1.702544386	-.966992148	-1.495463700	.654479394	-1.574902877	6.286940693	.012155092	2.18520	1
52	1.772754957	-1.070542782	-1.400027702	.509255849	-1.567227517	6.353805303	.012155092	2.37296	1
53	1.799999807	-1.109688279	-1.369744134	.461558155	-1.564383756	6.359472870	.012155092	2.46328	1
54	1.866701338	-1.204590959	-1.300002625	.349286049	-1.556367067	6.360901772	.012155092	2.71484	1
55	1.966939614	-1.345699932	-1.200008959	.182548986	-1.540525978	6.351019620	.012155092	3.13029	1

Table 6 (contd)

	FAMILY XO	E1 YDOTO	OF PERIODIC X1	ORBITS	YDOT1	ENERGY	T/2	MASS	INDEX	N
56	2.069185586	-1.488463769	-1.100001138		.008329515	-1.518862577	6.337485551	.012155092	3.55439	1
57	2.171971530	-1.631226148	-1.000003569		-.174843461	-1.490829536	6.324042796	.012155092	3.94988	2
58	2.274747974	-1.773566003	-.899994734		-.369321171	-1.455873706	6.311800956	.012155092	4.29343	2
59	2.377234018	-1.915435486	-.799996146		-.578456948	-1.413352654	6.301076590	.012155092	4.56785	2
60	2.598795749	-2.223784151	-.582350966		-1.113211179	-1.290153791	6.283185302	.012155092	4.85841	2
61	2.598796667	-2.223785439	-.582350059		-1.113213734	-1.290153177	6.283185243	.012155092	4.85841	2
62	2.598857874	-2.223871268	-.582289618		-1.113384150	-1.290112217	6.283181309	.012155092	4.85842	2
63	2.600000142	-2.225473145	-.581161614		-1.116567536	-1.289347023	6.283107995	.012155092	4.85865	2
64	2.800000836	-2.509889167	-.382674705		-1.799989491	-1.128214776	6.273424565	.012155092	4.63959	2
65	3.000000403	-2.810882582	-.182505586		-3.144033157	-.883464421	6.271529435	.012155092	3.60700	2
66	3.073135029	-2.932013216	-.109306812		-4.344048857	-.749736610	6.274403273	.012155092	2.70082	2
67	3.075472326	-2.936093803	-.106976623		-4.402286501	-.744700612	6.274557002	.012155098	2.66044	2
68	3.077734423	-2.940060082	-.104722389		-4.460601595	-.739766428	6.274710791	.012155098	2.62036	2
69	3.079925065	-2.943917558	-.102540345		-4.519014595	-.734929799	6.274864580	.012155098	2.58057	2
70	3.082048412	-2.947672557	-.100426312		-4.577564098	-.730185221	6.275018369	.012155098	2.54104	2
71	3.084108236	-2.951330811	-.098376499		-4.636286179	-.725527702	6.275172158	.012155098	2.50175	2
72	3.086107968	-2.954897533	-.096387459		-4.695214756	-.720952704	6.275325947	.012155098	2.46267	2
73	3.088050741	-2.958377484	-.094456043		-4.754381906	-.716456083	6.275479736	.012155098	2.42380	2
74	3.089939426	-2.961775023	-.092579366		-4.813818124	-.712034045	6.275633525	.012155098	2.38511	2
75	3.091776659	-2.965094156	-.090754776		-4.873552554	-.707683102	6.275787314	.012155098	2.34659	2
76	3.093564873	-2.968338573	-.088979831		-4.933613181	-.703400042	6.275941102	.012155098	2.30822	2
77	3.095306313	-2.971511682	-.087252271		-4.994027003	-.699181898	6.276094891	.012155098	2.26999	2
78	3.097003058	-2.974616641	-.085570006		-5.054820178	-.695025920	6.276248680	.012155098	2.23189	2
79	3.098657042	-2.977656380	-.083931092		-5.116018154	-.690929558	6.276402469	.012155098	2.19390	2
80	3.100270062	-2.980633626	-.082333722		-5.177645786	-.686890436	6.276556258	.012155098	2.15602	2
81	3.101843793	-2.983550921	-.080776210		-5.239727438	-.682906342	6.276710047	.012155098	2.11823	2
82	3.103379802	-2.986410638	-.079256981		-5.302287075	-.678975207	6.276863836	.012155098	2.08053	2
83	3.104879554	-2.989215001	-.077774559		-5.365348343	-.675095095	6.277017625	.012155098	2.04291	2
84	3.106344426	-2.991966092	-.076327562		-5.428934649	-.671264193	6.277171414	.012155098	2.00535	2
85	3.107775707	-2.994665867	-.074914691		-5.493069230	-.667480794	6.277325203	.012155098	1.96785	2
86	3.109174597	-2.997316139	-.073534732		-5.557774465	-.663743338	6.277478992	.012155092	1.93041	2
87	3.145252387	-3.071359155	-.038482310		-8.600722348	-.548182707	6.283185302	.012155092	.54496	2
88	3.145263113	-3.071383568	-.038472143		-8.602412493	-.548140371	6.283187746	.012155092	.54552	2
89	3.145282464	-3.071427617	-.038453801		-8.605464070	-.548063974	6.283192157	.012155092	.54664	2
90	3.145348803	-3.071578682	-.038390926		-8.615948796	-.547801889	6.283207296	.012155092	.55011	2
91	3.147603117	-3.076762850	-.036260236		-8.994939264	-.538728929	6.283737837	.012155092	.50846	2

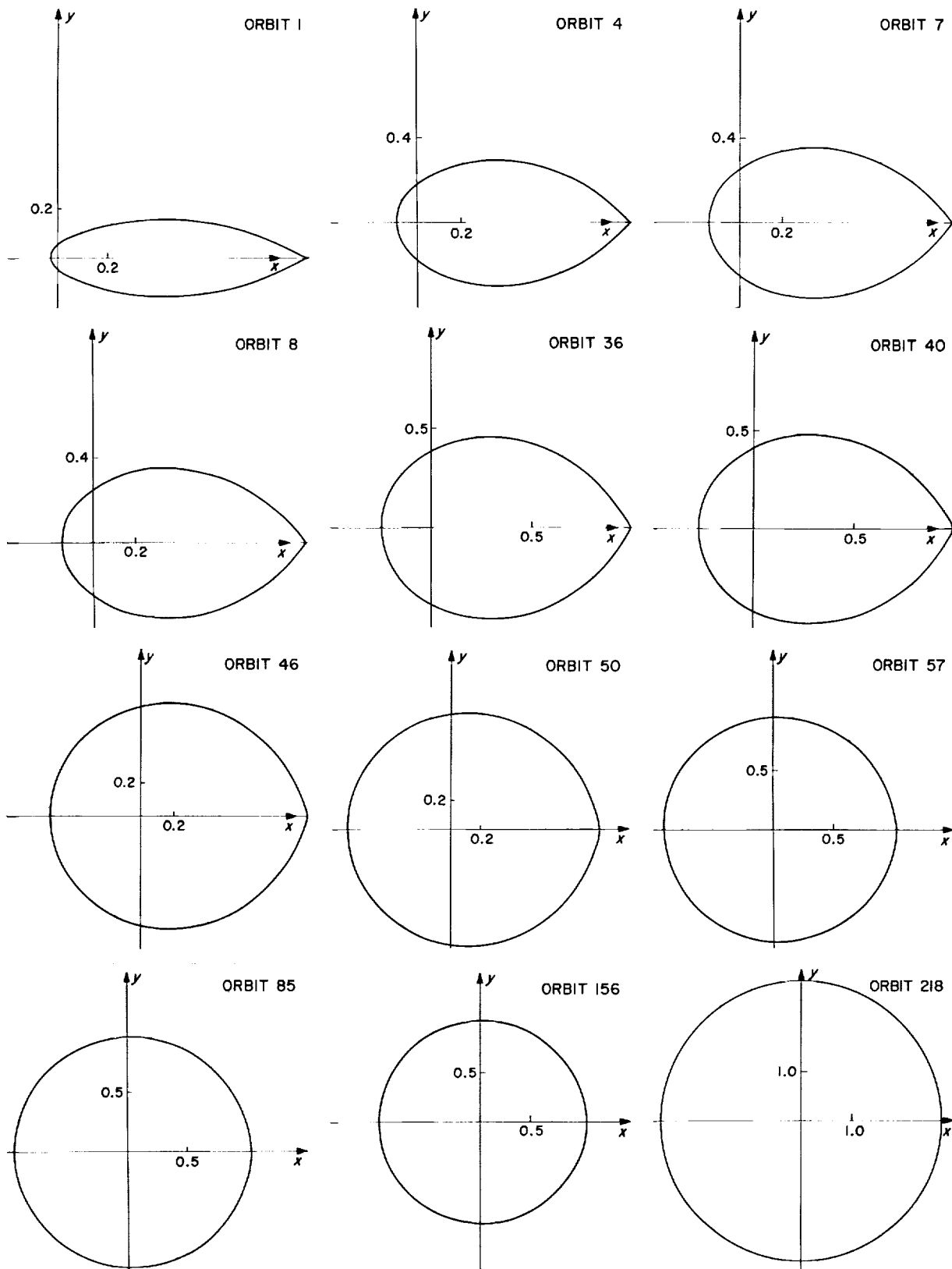

Fig. 27. Typical trajectories in family F of retrograde orbits around m_1 and m_2

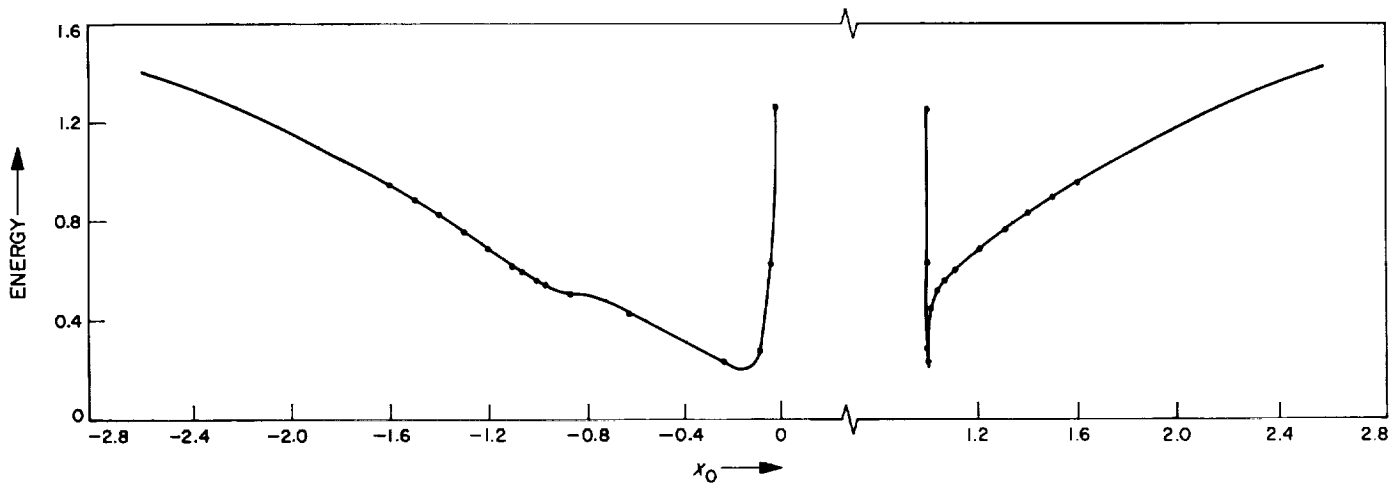

Fig. 28. Energy diagram of family F

G. Family F of Retrograde Orbits Around m_1 and m_2

This family corresponds to family E_1 studied in the preceding section, except that family F has circular orbits that are retrograde in both the fixed and the rotating axes. The velocity is approximately

$$-\sqrt{\frac{1}{r_1}}$$

in the fixed axes and

$$-\sqrt{\frac{1}{r_1} - r_1}$$

in the rotating axes (when r_1 is large). When the radius r_1 decreases, the orbits smoothly transform from the circular type to an ellipse-type orbit around m_1 and m_2 as illustrated in Fig. 27. At the limit of the family there is a rectilinear orbit between m_1 and m_2 , with infinite velocity and infinite energy. At this limit orbit with infinite velocity, the motion becomes rectilinear in both the rotating and the fixed axes, and the period tends to zero. At both ends of the family the energy tends to $+\infty$, both for the circular orbits with infinite radius and for the rectilinear limit orbit. In between is an orbit with minimum energy. The remarkable feature of this family is that all the orbits have a positive energy (relative to the rotating axes), as can be seen in the energy diagram in Fig. 28.

With respect to stability, as illustrated in Fig. 29, all the inside orbits are unstable. At the orbit that crosses

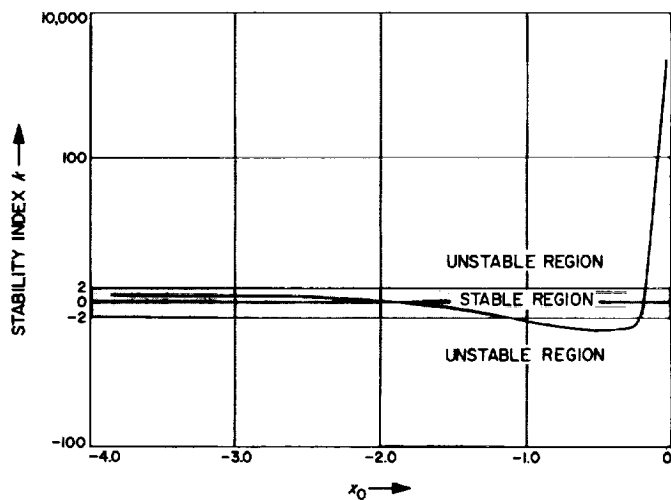

Fig. 29. Stability evolution of family F

the x -axis around the abscissa $x_0 = 1.0558$, there is a change to stability, and all the outside orbits are stable.

A total of 251 orbits were computed in family F, with initial conditions as given in Table 7, in which the inner orbits are listed first and the outer orbits last.

H. Family C of Retrograde Periodic Orbits Around m_2

Family C starts with infinitesimal circular retrograde orbits around m_2 . The word retrograde applies here for the inertial as well as the rotating coordinate system. The velocities in the inertial and rotating systems are

$$\sqrt{\frac{\mu}{r_2}} \quad \text{and} \quad \sqrt{\frac{\mu}{r_2} + r_2}$$

Table 7. Initial conditions for family F of retrograde periodic orbits around m_1 and m_2

	X0	YD0T0	X1	YD0T1	ENERGY	T/2	MASS	INDEX	N
1	.988193899	-8.667382311	-.029999312	10.642238346	1.256849114	.378057049	.012155092	4503.79807	1
2	.988615297	-5.980247608	-.050000186	7.313461361	.628072467	.447733624	.012155092	1357.36688	1
3	.989591137	-4.174350071	-.099995622	4.803775797	.276068138	.553320210	.012155092	257.05068	1
4	.989591196	-4.174291680	-.099998864	4.803687687	.276059574	.553325841	.012155092	257.02625	1
5	.990407944	-3.586276255	-.147521118	3.881141335	.212458154	.628315156	.012155092	51.58237	1
6	.990407974	-3.586260530	-.147522956	3.881115642	.212457267	.628317837	.012155092	51.57807	1
7	.990408085	-3.586202348	-.147529756	3.881020581	.212453985	.628327755	.012155092	51.56199	1
8	.990441866	-3.568693539	-.149603371	3.852378443	.211502920	.631343880	.012155092	46.78220	1
9	.990597679	-3.492740074	-.159267073	3.727321960	.208266860	.645197573	.012155098	27.04572	1
10	.990675586	-3.457489752	-.164157001	3.668846409	.207293658	.652090166	.012155098	18.44794	1
11	.990753492	-3.423890589	-.169083430	3.612861771	.206704873	.658961110	.012155098	10.59595	1
12	.990831399	-3.391832423	-.174044492	3.559227821	.206469899	.665810809	.012155098	3.42350	1
13	.990839189	-3.388707604	-.174542397	3.553988985	.206464756	.666494576	.012155098	2.74142	1
14	.990846980	-3.385596887	-.175040660	3.548771903	.206462840	.667178177	.012155098	2.06545	1
15	.990854771	-3.382500378	-.175539245	3.543576790	.206464124	.667861566	.012155098	1.39531	1
16	.990862561	-3.379417983	-.176038151	3.538403524	.206468583	.668544745	.012155098	.73148	1
17	.990870352	-3.376349610	-.176537375	3.533251988	.206476189	.669227712	.012155098	.07346	1
18	.990878143	-3.373295167	-.177036916	3.528122061	.206486917	.669910469	.012155098	-.57854	1
19	.990885933	-3.370254562	-.177536771	3.523013626	.206500740	.670593014	.012155098	-1.22450	1
20	.990893724	-3.367227704	-.178036939	3.517926567	.206517633	.671275347	.012155098	-1.86491	1
21	.990901515	-3.364214504	-.178537416	3.512860768	.206537571	.671957469	.012155098	-2.49923	1
22	.990909306	-3.361214796	-.179038215	3.507815985	.206560528	.672639397	.012155098	-3.12808	1
23	.990987212	-3.331945862	-.184062541	3.458508020	.206950698	.679446768	.012155098	-9.11214	1
24	.991065119	-3.303941450	-.189115324	3.411194858	.207616267	.686232598	.012155098	-14.57631	1
25	.991143026	-3.277124246	-.194194346	3.365775615	.208534832	.692996368	.012155098	-19.56338	1
26	.991220933	-3.251423086	-.199297323	3.322156713	.209685558	.699737388	.012155098	-24.11231	1
27	.991298839	-3.226772326	-.204421914	3.280251128	.211049040	.706454816	.012155098	-28.25846	1
28	.991376746	-3.203111306	-.209565732	3.239977720	.212607181	.713147681	.012155098	-32.03378	1
29	.991454653	-3.180383865	-.214726353	3.201260654	.214343083	.719814895	.012155098	-35.46754	1
30	.991532559	-3.158537920	-.219901322	3.164028889	.216240953	.726455279	.012155098	-38.32692	1
31	.991610466	-3.137525092	-.225088171	3.128215725	.218286022	.733067572	.012155098	-41.17944	1
32	.991688373	-3.117300375	-.230284420	3.093758406	.220464472	.739650452	.012155098	-42.25694	1
33	.991766279	-3.097821839	-.235487593	3.060597775	.222763369	.746202549	.012155098	-46.28816	1
34	.991844186	-3.079050369	-.240695222	3.028677957	.225170606	.752722459	.012155098	-48.36916	1
35	.991922093	-3.060949429	-.245904859	2.997946093	.227674855	.759208756	.012155098	-50.24079	1
36	.991999999	-3.043485945	-.251113745	2.968353953	.230265342	.765659596	.012155092	-51.91091	1
37	.992238536	-2.993644433	-.267036175	2.884331345	.238634231	.785179378	.012155092	-55.96651	1
38	.992241196	-2.993117448	-.267213332	2.883447254	.238730633	.785394969	.012155092	-56.00356	1
39	.992241226	-2.993111508	-.267215330	2.883437290	.238731720	.785397400	.012155092	-56.00396	1
40	.992380358	-2.966364949	-.276463476	2.838714049	.243847716	.796606355	.012155092	-57.71978	1
41	.996233098	-2.567135312	-.492411656	2.261198316	.370152026	1.041932366	.012155092	-43.89943	1
42	.996343486	-2.560785329	-.497213451	2.254344368	.372690160	1.047151745	.012155092	-43.16908	1
43	.996344343	-2.560736629	-.497250446	2.254292183	.372709640	1.047191930	.012155092	-43.16344	1
44	.996344432	-2.560731572	-.497254288	2.254286764	.372711663	1.047196103	.012155092	-43.16286	1
45	.996344455	-2.560730265	-.497255281	2.254285364	.372712186	1.047197181	.012155092	-43.16271	1
46	.997425802	-2.505727981	-.540643967	2.199111023	.394756631	1.094058188	.012155092	-36.52600	1
47	1.000000006	-2.411504377	-.622055567	2.122453488	.431695485	1.180765494	.012155092	-24.73237	1
48	1.002879103	-2.341787679	-.687697043	2.080100787	.457391734	1.249814092	.012155092	-16.67515	1
49	1.003215705	-2.335219969	-.694117411	2.076719725	.459723209	1.256537138	.012155092	-15.97783	1
50	1.003220797	-2.335122655	-.694212859	2.076670401	.459757639	1.256637051	.012155092	-15.96760	1
51	1.005934897	-2.290571313	-.738931712	2.056430458	.475189965	1.303354426	.012155092	-11.60634	1
52	1.019999972	-2.176967128	-.866617236	2.026068478	.514308080	1.436434372	.012155092	-3.99081	1
53	1.025974726	-2.154278157	-.897152916	2.024303872	.523801399	1.468417450	.012155085	-3.12754	1
54	1.028103309	-2.147949333	-.906369551	2.024193689	.526803283	1.478099077	.012155085	-2.92529	1
55	1.028131502	-2.147870512	-.906486875	2.024193575	.526842028	1.478222414	.012155085	-2.92288	1

Table 7 (contd)

	X0	YDOT0	X1	YDOT1	ENERGY	T/2	MASS	INDEX	N
56	1.029480981	-2.144238592	-.911968651	2.024224750	.528668593	1.483987912	.012155085	-2.81439	1
57	1.029482455	-2.144234771	-.911974499	2.024224822	.528670559	1.483994066	.012155085	-2.81428	1
58	1.029729726	-2.143598146	-.912951509	2.024237921	.528999587	1.485022216	.012155085	-2.79582	1
59	1.029761421	-2.143517168	-.913076148	2.024239757	.529041640	1.485153391	.012155085	-2.79349	1
60	1.030412715	-2.141883745	-.915608253	2.024285128	.529899889	1.487818911	.012155085	-2.74693	1
61	1.030414117	-2.141880291	-.915613645	2.024285241	.529901725	1.487824588	.012155085	-2.74683	1
62	1.030862091	-2.140789934	-.917323758	2.024324645	.530485699	1.489625483	.012155085	-2.71636	1
63	1.030895291	-2.140710171	-.917449503	2.024327821	.530528779	1.489757924	.012155085	-2.71415	1
64	1.031386704	-2.139546088	-.919295000	2.024378844	.531163310	1.491702049	.012155085	-2.68219	1
65	1.031388043	-2.139542956	-.919299993	2.024378993	.531165032	1.491707309	.012155085	-2.68211	1
66	1.031645447	-2.138945392	-.920408566	2.024408656	.531495109	1.492713689	.012155085	-2.66591	1
67	1.031679510	-2.138866929	-.920380882	2.024412728	.531538674	1.492846264	.012155085	-2.66380	1
68	1.032405718	-2.137227595	-.923031150	2.024507491	.532461233	1.495639845	.012155085	-2.62016	1
69	1.032407281	-2.137224135	-.923036789	2.024507711	.532463206	1.495645790	.012155085	-2.62007	1
70	1.033269763	-2.135357557	-.926107901	2.024639069	.533544062	1.498884662	.012155085	-2.57170	1
71	1.033306733	-2.135279428	-.926237754	2.024645134	.533590049	1.499021648	.012155085	-2.56971	1
72	1.033472492	-2.134930985	-.926818193	2.024672752	.533795899	1.499634012	.012155085	-2.56085	1
73	1.033474073	-2.134927676	-.926823715	2.024673019	.533797860	1.499639838	.012155085	-2.56076	1
74	1.034522705	-2.132792167	-.930430217	2.024863324	.535087710	1.503446176	.012155085	-2.50750	1
75	1.034561809	-2.132714768	-.930562578	2.024870922	.535135409	1.503585919	.012155085	-2.50560	1
76	1.034590328	-2.132658419	-.930659016	2.024876485	.535170178	1.503687738	.012155085	-2.50422	1
77	1.034591802	-2.132655509	-.930663998	2.024876773	.535171975	1.503692998	.012155085	-2.50415	1
78	1.035344209	-2.131198652	-.933179957	2.025030119	.536084017	1.506349980	.012155085	-2.46893	1
79	1.035365353	-2.131158525	-.933249885	2.025034606	.536109503	1.506423845	.012155085	-2.46797	1
80	1.035367959	-2.131153581	-.933258504	2.025035160	.536112645	1.506432949	.012155085	-2.46785	1
81	1.035384651	-2.131121938	-.933313676	2.025038710	.536132759	1.506491228	.012155085	-2.46710	1
82	1.036164595	-2.129673290	-.935863160	2.025211084	.537067369	1.509184941	.012155085	-2.43295	1
83	1.036166753	-2.129669361	-.935870139	2.025211579	.537069942	1.509192317	.012155085	-2.43286	1
84	1.036189492	-2.129627995	-.935943641	2.025216791	.537097038	1.509269996	.012155085	-2.43189	1
85	1.036230858	-2.129552868	-.936077235	2.025226300	.537146310	1.509411185	.012155085	-2.43015	1
86	1.036990493	-2.128201116	-.938504022	2.025406850	.538046318	1.511976539	.012155085	-2.39909	1
87	1.037844515	-2.126742573	-.941174141	2.025622684	.539047673	1.514800443	.012155085	-2.36638	1
88	1.037845914	-2.126740235	-.941178466	2.025623049	.539049305	1.514805018	.012155085	-2.36632	1
89	1.037938616	-2.126585695	-.941464704	2.025647261	.539157357	1.515107824	.012155085	-2.36291	1
90	1.037979103	-2.126518427	-.941589500	2.025657883	.539204510	1.515239849	.012155085	-2.36142	1
91	1.038726411	-2.125301218	-.943869762	2.025858931	.540070740	1.517652719	.012155085	-2.33486	1
92	1.038728126	-2.125298478	-.943874944	2.025859403	.540072718	1.517658203	.012155085	-2.33480	1
93	1.039272362	-2.124440529	-.945508462	2.026011599	.540698790	1.519387334	.012155085	-2.31642	1
94	1.039319104	-2.124367935	-.945647719	2.026024890	.540752379	1.519534766	.012155085	-2.31488	1
95	1.039635830	-2.123880486	-.946587101	2.026115837	.541114762	1.520529388	.012155085	-2.30458	1
96	1.039636874	-2.123878893	-.946590183	2.026116139	.541115954	1.520532652	.012155085	-2.30454	1
97	1.040196560	-2.123036274	-.948232328	2.026280573	.541753226	1.522271766	.012155085	-2.28695	1
98	1.040576078	-2.122478190	-.949333215	2.026394688	.542183172	1.523437946	.012155085	-2.27544	1
99	1.040577062	-2.122476756	-.949336056	2.026394986	.542184284	1.523440956	.012155085	-2.27542	1
100	1.040595421	-2.122450028	-.949389055	2.026400559	.542205039	1.523497104	.012155085	-2.27487	1
101	1.041097144	-2.121728991	-.950828502	2.026554684	.542770696	1.525022282	.012155085	-2.26019	1
102	1.041505586	-2.121155191	-.951987792	2.026682699	.543229046	1.526250898	.012155085	-2.24865	1
103	1.041546725	-2.121098042	-.952103946	2.026695717	.543275108	1.5263374011	.012155085	-2.24750	1
104	1.041548289	-2.121095871	-.952108360	2.026696212	.543276859	1.526378690	.012155085	-2.24746	1
105	1.042123004	-2.120309665	-.953719452	2.026880393	.543918384	1.528086572	.012155085	-2.23187	1
106	1.042549759	-2.119740231	-.954902121	2.027019880	.544392447	1.529340594	.012155085	-2.22072	1
107	1.042552654	-2.119736410	-.954910103	2.027020833	.544395656	1.529349058	.012155085	-2.22064	1
108	1.042954609	-2.119211069	-.956013590	2.027154280	.544840416	1.530519350	.012155085	-2.21046	1
109	1.043376670	-2.118670612	-.957161667	2.027296482	.545305652	1.531737163	.012155085	-2.20010	1

Table 7 (contd)

	X0	YDOT0	X1	YDOT1	ENERGY	T/2	MASS	INDEX	N
110	1.043586377	-2.118406256	-.957728136	2.027367911	.545536150	1.532338126	.012155085	-2.19507	1
111	1.043587450	-2.118404909	-.957731030	2.027368278	.545537329	1.532341196	.012155085	-2.19505	1
112	1.044348735	-2.117468046	-.959765783	2.027631772	.546370504	1.534500315	.012155085	-2.17743	1
113	1.044655954	-2.117099862	-.960577524	2.027739909	.5467705187	1.535361870	.012155085	-2.17059	1
114	1.044657026	-2.117098587	-.960580345	2.027740288	.546706353	1.535364865	.012155085	-2.17057	1
115	1.044804637	-2.116923676	-.960968475	2.027792605	.546866849	1.535776853	.012155085	-2.16734	1
116	1.045732950	-2.115852489	-.963382037	2.028126802	.547871725	1.538339346	.012155085	-2.14781	1
117	1.045733113	-2.115852305	-.963382458	2.028126862	.547871901	1.538339793	.012155085	-2.14780	1
118	1.045757838	-2.115824442	-.963446108	2.028135882	.547898562	1.538407384	.012155085	-2.14730	1
119	1.045760652	-2.115821274	-.963453349	2.028136909	.547901596	1.538415073	.012155085	-2.14724	1
120	1.046679494	-2.114809795	-.965796002	2.028476358	.548888702	1.540903225	.012155085	-2.12919	1
121	1.046683548	-2.114805434	-.965806242	2.028477873	.548893041	1.540914102	.012155085	-2.12912	1
122	1.046897556	-2.114576432	-.966345626	2.028558090	.549121940	1.541487112	.012155085	-2.12508	1
123	1.046898141	-2.114575809	-.966347098	2.028558310	.549122566	1.541488676	.012155085	-2.12507	1
124	1.047323790	-2.114127509	-.967413101	2.028719103	.549576740	1.542621269	.012155085	-2.11722	1
125	1.04755789	-2.113682093	-.968485934	2.028883952	.550036238	1.543761297	.012155085	-2.10950	1
126	1.047756583	-2.113681284	-.968487897	2.028884256	.550037081	1.543763383	.012155085	-2.10948	1
127	1.048071397	-2.113362668	-.969264045	2.029005415	.550371029	1.544588252	.012155085	-2.10400	1
128	1.048072828	-2.113361231	-.969267564	2.029005968	.550372546	1.544591992	.012155085	-2.10397	1
129	1.048626629	-2.112812733	-.970621553	2.029221151	.550958198	1.546031191	.012155085	-2.09462	1
130	1.049281122	-2.112183692	-.972203550	2.029478711	.551647454	1.547713085	.012155085	-2.08402	1
131	1.049599487	-2.111885045	-.972966132	2.029605230	.551981631	1.548523947	.012155085	-2.07903	1
132	1.049999969	-2.111516082	-.973919055	2.029765502	.552401010	1.549537315	.012155092	-2.07291	1
133	1.050525637	-2.111042778	-.975159438	2.029977704	.552949833	1.550856559	.012155085	-2.06513	1
134	1.050535338	-2.111034161	-.975182217	2.029981640	.552959944	1.550880789	.012155085	-2.06499	1
135	1.051488259	-2.110207800	-.977400835	2.030371519	.553950175	1.553240970	.012155085	-2.05159	1
136	1.051803868	-2.109942724	-.978127497	2.030502054	.554276873	1.554014130	.012155085	-2.04734	1
137	1.051805100	-2.109941697	-.978130325	2.030502565	.554278147	1.554017140	.012155085	-2.04732	1
138	1.052457910	-2.109406667	-.979620828	2.030774710	.554951947	1.555603220	.012155085	-2.03881	1
139	1.053119894	-2.108881887	-.981115487	2.031053534	.555632620	1.557193979	.012155085	-2.03055	1
140	1.053121085	-2.108880959	-.981118161	2.031054038	.555633843	1.557196825	.012155085	-2.03053	1
141	1.054435237	-2.107890280	-.984037060	2.031615668	.556977666	1.560304089	.012155085	-2.01517	1
142	1.054468448	-2.107866097	-.984110020	2.031629996	.557011504	1.560381769	.012155085	-2.01480	1
143	1.055848246	-2.106897222	-.987107459	2.032230847	.558412152	1.563573523	.012155085	-2.00006	1
144	1.055857928	-2.106890665	-.987128265	2.032235101	.558421947	1.563595681	.012155085	-1.99996	1
145	1.057262623	-2.105973835	-.990114264	2.032857505	.559837888	1.566776006	.012155085	-1.98625	1
146	1.057269221	-2.105969686	-.990128141	2.032860453	.559844516	1.566790788	.012155085	-1.98619	1
147	1.059080927	-2.104884169	-.993888068	2.033677884	.561656899	1.570796280	.012155092	-1.97023	1
148	1.059080955	-2.104884154	-.993888125	2.033677897	.561656927	1.570796340	.012155092	-1.97023	1
149	1.059283057	-2.104769492	-.994301510	2.033770047	.561858190	1.571236773	.012155092	-1.96856	1
150	1.060169036	-2.104281472	-.996099962	2.034176186	.562738410	1.573152988	.012155085	-1.96147	1
151	1.060181258	-2.104274904	-.996124618	2.034181813	.562750530	1.573179259	.012155085	-1.96138	1
152	1.062126955	-2.103284517	-.999997852	2.035085669	.564672099	1.577306508	.012155092	-1.94712	1
153	1.066329480	-2.101490842	-1.008040163	2.037087626	.568773824	1.585876717	.012155085	-1.92146	1
154	1.066332502	-2.101489710	-1.008045798	2.037089087	.568776751	1.585882722	.012155085	-1.92145	1
155	1.068134041	-2.100852033	-1.011370831	2.037965786	.570516622	1.589425622	.012155085	-1.91224	1
156	1.070416787	-2.100146292	-1.015488812	2.039090809	.572706819	1.593812614	.012155085	-1.90183	1
157	1.070417470	-2.100146097	-1.015490028	2.039091147	.572707471	1.593813910	.012155085	-1.90183	1
158	1.079462476	-2.098321246	-1.030907122	2.043680604	.581247589	1.610222458	.012155085	-1.87115	1
159	1.079463633	-2.098321100	-1.030909014	2.043681203	.581248668	1.610224469	.012155085	-1.87114	1
160	1.099999978	-2.098386951	-1.062068257	2.054661545	.600010492	1.643224924	.012155092	-1.83485	1
161	1.106458712	-2.099270896	-1.071095051	2.058231327	.605770172	1.652720555	.012155085	-1.82779	1
162	1.106460115	-2.099271123	-1.071096980	2.058232107	.605771417	1.652722581	.012155085	-1.82779	1
163	1.128439038	-2.104372700	-1.100000273	2.070684668	.624970456	1.682850017	.012155092	-1.80856	1
164	1.158197000	-2.114830577	-1.136185329	2.088136279	.650133422	1.719824298	.012155085	-1.78319	1

Table 7 (contd)

	X0	YDOTO	X1	YDOT1	ENERGY	T/2	MASS	INDEX	N
165	1.158197477	-2.114830769	-1.136185890	2.088136563	.650133818	1.719824864	.012155085	-1.78319	1
166	1.199999966	-2.133717367	-1.183818525	2.113554208	.684132210	1.766981660	.012155092	-1.73839	1
167	1.214679978	-2.141142253	-1.199999298	2.122696956	.695737945	1.782576202	.012155092	-1.71971	1
168	1.254917767	-2.163002620	-1.243429561	2.148274580	.726741060	1.823332130	.012155085	-1.66135	1
169	1.299999991	-2.189502868	-1.291010731	2.177757193	.760180560	1.866136967	.012155092	-1.58547	1
170	1.308602978	-2.194753011	-1.300000247	2.183475474	.766416804	1.874009489	.012155092	-1.56994	1
171	1.320726373	-2.202243579	-1.312629301	2.191581562	.775129684	1.884955599	.012155092	-1.54757	1
172	1.320726971	-2.202243951	-1.312629923	2.191581963	.775130112	1.884956135	.012155092	-1.54757	1
173	1.321320365	-2.202613245	-1.313246973	2.191980142	.775554347	1.885487570	.012155092	-1.54646	1
174	1.399999970	-2.253482088	-1.394368756	2.245879321	.830069196	1.952673285	.012155092	-1.38991	1
175	1.405500985	-2.257163647	-1.399999998	2.249725482	.833758614	1.957144632	.012155092	-1.37840	1
176	1.437391256	-2.278782649	-1.432569473	2.272208736	.854854240	1.982533707	.012155085	-1.31059	1
177	1.437391446	-2.278782779	-1.432569667	2.272208872	.854854364	1.982533856	.012155085	-1.31059	1
178	1.499999984	-2.322457311	-1.496214463	2.317222628	.894901201	2.029904186	.012155092	-1.17373	1
179	1.503732989	-2.325108002	-1.499999379	2.319941133	.897234823	2.032631039	.012155092	-1.16547	1
180	1.592343963	-2.389370028	-1.589607169	2.385520873	.950985351	2.094395070	.012155092	-.96821	1
181	1.592344589	-2.389370490	-1.589607801	2.385521343	.950985720	2.094395487	.012155092	-.96820	1
182	1.592681263	-2.389619206	-1.589947546	2.385774169	.951184221	2.094619810	.012155092	-.96746	1
183	1.599999953	-2.395033752	-1.597331910	2.391276662	.955489101	2.099477737	.012155092	-.95117	1
184	1.602643974	-2.396993551	-1.599999147	2.393267587	.957039565	2.101224123	.012155092	-.94529	1
185	1.613020300	-2.404703316	-1.610464074	2.401096316	.963100134	2.108033865	.012155085	-.92224	1
186	1.613020436	-2.404703417	-1.610464211	2.401096419	.963100213	2.108033954	.012155085	-.92224	1
187	1.697747262	-2.468696168	-1.695787718	2.465898135	1.011215233	2.161136000	.012155085	-.73618	1
188	1.699169233	-2.469784973	-1.697218073	2.466998410	1.012002862	2.161990791	.012155085	-.73310	1
189	1.784639567	-2.536036304	-1.783117807	2.533841499	1.058234142	2.211320518	.012155085	-.55154	1
190	1.784640105	-2.536036725	-1.783118347	2.533841923	1.058234426	2.211320816	.012155085	-.55154	1
191	1.953459852	-2.670943800	-1.952486047	2.669518063	1.143816988	2.298084824	.012155085	-.21824	1
192	1.953460415	-2.670944258	-1.952486611	2.669518522	1.143817262	2.298085092	.012155085	-.21824	1
193	2.001001321	-2.709762699	-2.000134956	2.708489916	1.166711985	2.320254712	.012155085	-.13127	1
194	2.003238703	-2.711597619	-2.002377019	2.710331518	1.167777538	2.321275591	.012155085	-.12725	1
195	2.082485312	-2.777028615	-2.081770837	2.775973472	1.204861275	2.356193929	.012155092	.01045	1
196	2.082486641	-2.777029719	-2.081772168	2.775974579	1.204861887	2.356194495	.012155092	.01045	1
197	2.082724390	-2.777227259	-2.082010309	2.776172684	1.204971278	2.356295734	.012155092	.01085	1
198	2.120184154	-2.808439644	-2.119528681	2.807469521	1.222073525	2.371995269	.012155085	.07288	1
199	2.264544186	-2.930239963	-2.264065615	2.929526531	1.285658767	2.428118735	.012155085	.29403	1
200	2.264695873	-2.930369120	-2.264217454	2.929655911	1.285723761	2.428174286	.012155085	.29425	1
201	2.285264480	-2.947904079	-2.284806189	2.947220260	1.294503500	2.435644298	.012155085	.32351	1
202	2.285264894	-2.947904432	-2.284806603	2.947220614	1.294503676	2.435644447	.012155085	.32351	1
203	2.325987479	-2.982743140	-2.325566053	2.982113255	1.311694581	2.450074970	.012155092	.37985	1
204	2.349485696	-3.002917742	-2.349083885	3.002316613	1.321501631	2.458191245	.012155092	.41142	1
205	2.449020589	-3.088920913	-2.448690417	3.088425161	1.362175427	2.490956335	.012155085	.53777	1
206	2.449021060	-3.088921322	-2.448690888	3.088425570	1.362175616	2.490956484	.012155085	.53777	1
207	2.467145619	-3.104672273	-2.466826752	3.104193204	1.369437520	2.496655076	.012155085	.55954	1
208	2.521483856	-3.152051337	-2.521196157	3.151618343	1.390955998	2.513273834	.012155092	.62263	1
209	2.521484654	-3.152052034	-2.521196956	3.151619041	1.390956311	2.513274073	.012155092	.62264	1
210	2.563592094	-3.188922364	-2.563326017	3.188521406	1.407379046	2.525689899	.012155085	.66935	1
211	2.611686650	-3.231193453	-2.611442894	3.230825632	1.425878603	2.539400636	.012155085	.72048	1
212	2.611687075	-3.231193828	-2.611443319	3.230826006	1.425878765	2.539400755	.012155085	.72048	1
213	2.659702223	-3.273555934	-2.659478516	3.273217935	1.444083678	2.552610814	.012155085	.76925	1
214	2.755508394	-3.358533669	-2.755319021	3.358246879	1.479660808	2.577628463	.012155085	.86018	1
215	2.773440292	-3.374502266	-2.773256614	3.374223988	1.486213812	2.582122653	.012155085	.87630	1
216	2.773440770	-3.374502692	-2.773257092	3.374224414	1.486213986	2.582122772	.012155085	.87630	1
217	2.813233854	-3.410007077	-2.813062087	3.409746618	1.500641393	2.591894030	.012155085	.91110	1
218	2.813750309	-3.410468477	-2.813578690	3.410208240	1.500827617	2.592019050	.012155085	.91155	1
219	2.851038371	-3.443821692	-2.850877062	3.443576897	1.514205157	2.600926815	.012155085	.94298	1

Table 7 (contd)

	X0	YDOTO	X1	YDOT1	ENERGY	T/2	MASS	INDEX	N
220	2.934419694	-3.518680232	-2.934278847	3.518466141	1.543649531	2.620029955	.012155085	1.00939	1
221	2.934420098	-3.518680596	-2.934279251	3.518466505	1.543649672	2.620030045	.012155085	1.00939	1
222	2.946316459	-3.529390882	-2.946178268	3.529180782	1.547799438	2.622667371	.012155085	1.01845	1
223	3.041364251	-3.615216197	-3.041245241	3.615034959	1.580516389	2.642992525	.012155085	1.08731	1
224	3.094734332	-3.663596859	-3.094624680	3.663429728	1.598558438	2.653851240	.012155085	1.12338	1
225	3.136199940	-3.701274989	-3.136096949	3.701117911	1.612419968	2.662028073	.012155085	1.15021	1
226	3.174647686	-3.736277983	-3.174550439	3.736129582	1.625154301	2.669414668	.012155085	1.17417	1
227	3.174670465	-3.736298740	-3.174573222	3.736150344	1.625161813	2.669418990	.012155085	1.17419	1
228	3.222744751	-3.780153566	-3.222654155	3.780015219	1.640928766	2.678400456	.012155092	1.20299	1
229	3.230840893	-3.787548467	-3.230751361	3.787411732	1.643567389	2.679885953	.012155085	1.20772	1
230	3.254472624	-3.809148459	-3.254386115	3.809016297	1.651242220	2.684178351	.012155085	1.22132	1
231	3.254473123	-3.809148916	-3.254386614	3.809016754	1.651242381	2.684178441	.012155085	1.22132	1
232	3.259999885	-3.814203729	-3.259914065	3.814072610	1.653031537	2.685173034	.012155092	1.22446	1
233	3.325301598	-3.874019152	-3.325223437	3.873899636	1.674009368	2.696665673	.012155085	1.26038	1
234	3.413249600	-3.954830284	-3.413180495	3.954724503	1.701805502	2.711422115	.012155085	1.30554	1
235	3.413706891	-3.955251194	-3.413637830	3.955145479	1.701948703	2.711496769	.012155085	1.30576	1
236	3.419595446	-3.960671919	-3.419526943	3.960567053	1.703791504	2.712456225	.012155085	1.30866	1
237	3.513733970	-4.047492833	-3.513673710	4.047400490	1.732954680	2.727337270	.012155085	1.35298	1
238	3.572309845	-4.101663054	-3.572254112	4.101577598	1.750827338	2.736180513	.012155085	1.37876	1
239	3.572504313	-4.101843078	-3.572448594	4.101757643	1.750886335	2.736209362	.012155085	1.37884	1
240	3.572505715	-4.101844376	-3.572449997	4.101758942	1.750886760	2.736209570	.012155085	1.37884	1
241	3.607728370	-4.134470160	-3.607675176	4.134388569	1.761536084	2.741380512	.012155085	1.39372	1
242	3.677702789	-4.199397272	-3.677654214	4.199322717	1.782482005	2.751341849	.012155085	1.42196	1
243	3.678135520	-4.199799241	-3.678086972	4.199724727	1.782610684	2.751402198	.012155085	1.42213	1
244	3.701598769	-4.221602659	-3.701551660	4.221530338	1.789572380	2.754651903	.012155085	1.43122	1
245	3.748025889	-4.264791726	-3.747981478	4.264723520	1.803259406	2.760954319	.012155085	1.44868	1
246	3.748470692	-4.265205799	-3.748426306	4.265137631	1.803389978	2.761013894	.012155085	1.44884	1
247	3.795193690	-4.308731147	-3.795151832	4.308666836	1.817047310	2.767188578	.012155085	1.46572	1
248	3.795322578	-4.308851296	-3.795280727	4.308786995	1.817084827	2.767205386	.012155085	1.46577	1
249	3.888905889	-4.396205210	-3.888868600	4.396147875	1.844101060	2.779093890	.012155085	1.49764	1
250	3.888942981	-4.396239877	-3.888905693	4.396182545	1.844111681	2.779098480	.012155085	1.49766	1
251	3.888944670	-4.396241456	-3.888907382	4.396184124	1.844112164	2.779098689	.012155085	1.49766	1

A total of 180 periodic orbits were computed for family C, the characteristic evolution of which is shown in Fig. 30. Initial conditions for this family are listed in Table 8.

Two periodic collision orbits were discovered in this family, but the natural end of the family has not yet been determined. While at the beginning of the family some orbits are very close to Keplerian circular, there are also some other orbits that have an important connection with the two-body problem. In the two-body problem, relative to rotating axes, there is an equilibrium point with coordinates $(+1, 0)$ and around this equilibrium point there is a family of retrograde periodic orbits. Some of the periodic orbits in family C are exactly of this type. In inertial axes, these two-body-problem orbits should be ellipses with semimajor axis $a = +1$, and variable eccentricity. These ellipses all have the same mean motion $n = +1$ and the same period $= 2\pi$. In the two-body problem the energy diagram should be a circle with center $(+1, -0.5)$ and radius $+1$. In the perturbed (three-body) problem, the energy diagram (Fig. 31) has a similar form.

Our family C corresponds with Stromgren's class f (Ref. 1) and the evolution seems to be identical. This would indicate that a similar family of periodic orbits probably exists for all mass ratios.

In family C, all the first circular-type orbits have been found stable (Fig. 32). The stability index starts at $+2$ and goes through some oscillations and even becomes slightly unstable below -2 , with a minimum at orbit 115 before it starts increasing and passes again through the stable zone, around orbits 122 to 132. The last orbits are all unstable.

I. Families H_1 and H_2 of Direct Orbits Around m_2

These two families of periodic orbits are very similar. A natural beginning is known for family H_1 , but not the end; for family H_2 , neither the beginning nor the end is known. However, both families belong to the same class (in the sense of the six classes discussed in Section IV-C).

Family H_2 also contains some orbits that are nearly the symmetric image of certain orbits of H_1 , with respect to a vertical axis through m_2 . It is likely that, if one were to continue family H_1 , or the two open ends of H_2 , some junction between H_1 and H_2 would be found.

The initial conditions for 162 period orbits of family H_1 are listed in Table 9; those for 202 orbits of family H_2 in Table 10. The first orbits of family H_1 are of the circular type around m_2 , with a direct motion, and a velocity that is a function of r_2 :

$$\sqrt{\frac{\mu}{r_2}} - r_2$$

The circular character of the orbits of family H_1 is soon destroyed when the radius r_2 increases, and then a complicated evolution of orbits begins, as can be seen in Fig. 33. Family H_2 (Fig. 34) has the most complicated forms of orbits at both ends of the family. In the middle of the family there are some orbits that are nearly circular and very similar to some of the first orbits of family H_1 . The energy diagrams for families H_1 and H_2 are given in Fig. 35.

Several of the orbits in families H_1 and H_2 have certain similarities to some of the periodic orbits computed by Sir G. H. Darwin (satellites A, B, and C, Ref. 3). Darwin used the mass ratio $\mu = 1/11$, but was mainly interested in the sun-Jupiter case. Darwin's satellites A correspond to the first orbits of our family H_1 , and his satellites B and C correspond to some of our orbits H_2 .

In Stromgren's work (Ref. 1), class g is the closest to our families H_1 and H_2 , although the evolutions seem to be entirely different.

As shown in Fig. 36, the first orbits of H_1 are all stable, with the family starting at the value 2 for the stability index. At the end of the family, there are two other zones of stable orbits. Family H_2 (Fig. 37) contains one large zone of stable orbits in the middle and is unstable otherwise.

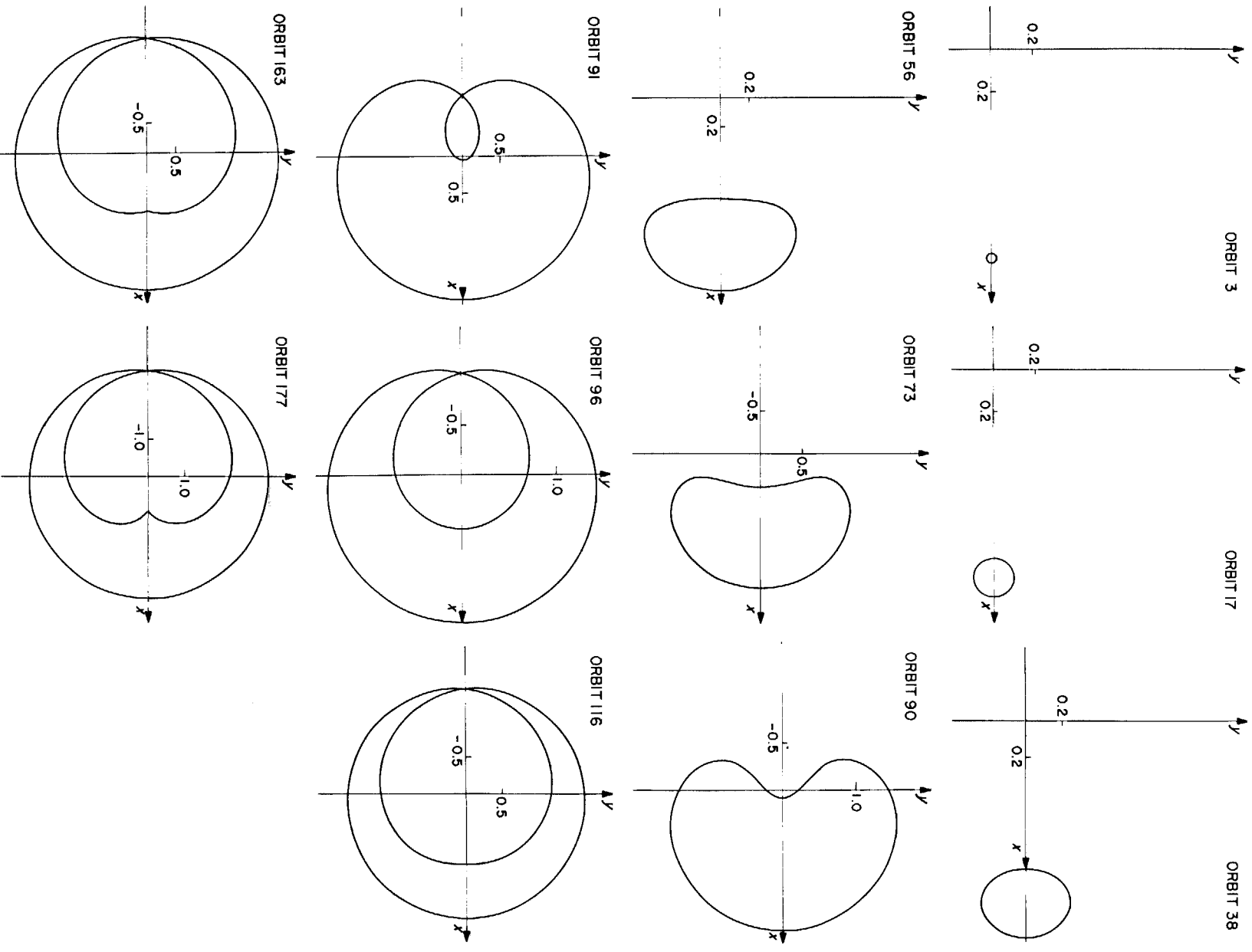

Fig. 30. Typical trajectories in family C of retrograde periodic orbits around m_2 .

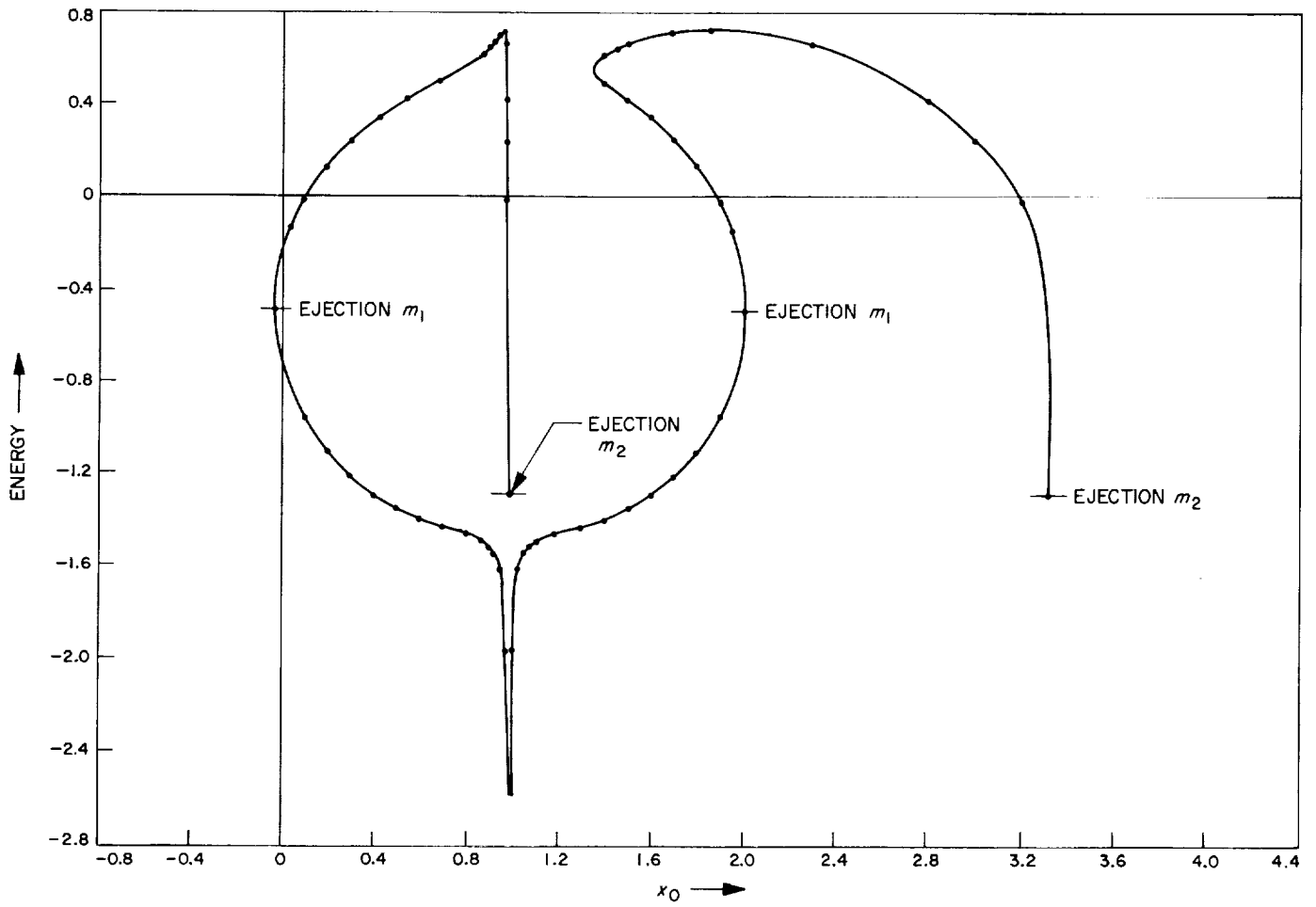

Fig. 31. Energy diagram of family C

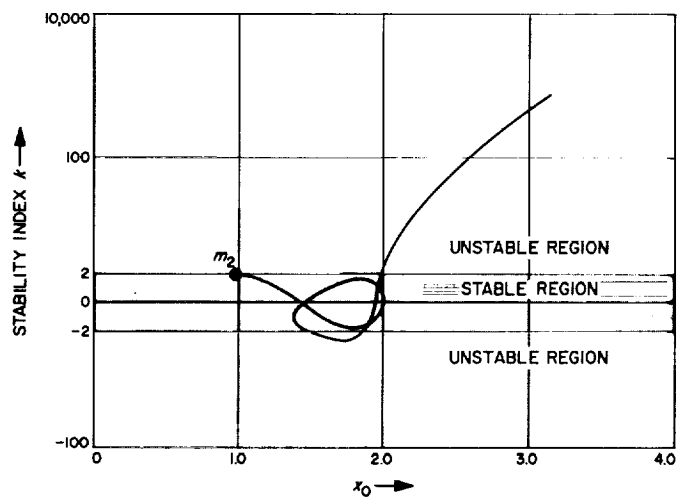

Fig. 32. Stability evolution of family C

Table 8. Initial conditions for family C of retrograde periodic orbits around m_2

	X0	YDOT0	X1	YDOT1	ENERGY	T/2	MASS	INDEX	N
1	.978449617	1.146938874	.997241495	-1.146781620	-2.111904711	.025742917	.012155092	1.99731	1
2	.975692710	1.012479561	1.000000242	-1.012221070	-1.963666080	.037730879	.012155092	1.99421	1
3	.964847496	.750905616	1.010869226	-.750052882	-1.723175072	.096562034	.012155092	1.96151	1
4	.950000010	.607345222	1.025824533	-.605313389	-1.614698003	.198372989	.012155092	1.83648	1
5	.936647849	.543860150	1.039384288	-.540553424	-1.569329125	.304219252	.012155092	1.62189	1
6	.936380887	.542923639	1.039656662	-.539590066	-1.568649462	.306443951	.012155092	1.61656	1
7	.926284815	.513991776	1.049996877	-.509614586	-1.547004751	.393208720	.012155092	1.38697	1
8	.920000014	.501077772	1.056473988	-.496027792	-1.536563636	.449541463	.012155092	1.21882	1
9	.917879899	.497415242	1.058666165	-.492134926	-1.533430686	.468901603	.012155092	1.15836	1
10	.917010833	.496004654	1.059565828	-.490629456	-1.532195962	.476886726	.012155092	1.13308	1
11	.911172433	.487772716	1.065625806	-.481753292	-1.524564032	.531232997	.012155092	.95672	1
12	.911172269	.487772513	1.065625977	-.481753071	-1.524563832	.531234539	.012155092	.95672	1
13	.901057987	.477858872	1.076190226	-.470695418	-1.513559375	.627997859	.012155092	.63150	1
14	.901024984	.477834273	1.076224834	-.470667025	-1.513527247	.628318517	.012155092	.63041	1
15	.901024914	.477834221	1.076224908	-.470666965	-1.513527179	.628319195	.012155092	.63041	1
16	.900000021	.477093007	1.077300074	-.469807742	-1.512540186	.638291790	.012155092	.59660	1
17	.897802234	.475647892	1.079608518	-.468108189	-1.510491311	.659771792	.012155092	.52383	1
18	.885281110	.470742311	1.092832678	-.461712740	-1.500315762	.784361235	.012155092	.11046	1
19	.885178301	.470723014	1.092941757	-.461680891	-1.500241274	.785398177	.012155092	.10712	1
20	.885178195	.470722994	1.092941870	-.461680858	-1.500241197	.785399250	.012155092	.10712	1
21	.885178105	.470722978	1.092941965	-.461680831	-1.500241132	.785400151	.012155092	.10712	1
22	.878540920	.470109914	1.100000374	-.460244483	-1.495690651	.852752416	.012155092	-.10414	1
23	.870000024	.470990288	1.109128752	-.460022705	-1.490487570	.940438046	.012155092	-.36025	1
24	.859712405	.474209396	1.120185744	-.461835564	-1.485000726	1.047141536	.012155092	-.63744	1
25	.859707585	.474211405	1.120190939	-.461836890	-1.484998325	1.047191723	.012155092	-.63756	1
26	.859707021	.474211640	1.120191547	-.461837046	-1.484998044	1.047197594	.012155092	-.63757	1
27	.859706930	.474211678	1.120191646	-.461837071	-1.484997999	1.047198548	.012155092	-.63757	1
28	.859589822	.474260623	1.120317868	-.461869436	-1.484939709	1.048417940	.012155092	-.64050	1
29	.839637097	.486117931	1.141920870	-.470669033	-1.476079001	1.256578489	.012155092	-1.06059	1
30	.839631467	.486122184	1.141926988	-.470672350	-1.476076756	1.256637110	.012155092	-1.06069	1
31	.839631411	.486122226	1.141927049	-.470672382	-1.476076734	1.256637691	.012155092	-1.06069	1
32	.839166949	.486474786	1.142431893	-.470947482	-1.475891942	1.261473580	.012155092	-1.06857	1
33	.818566314	.505122338	1.164880366	-.485798364	-1.468397401	1.473711207	.012155092	-1.33834	1
34	.818563639	.505125116	1.164883285	-.485800598	-1.468396502	1.473738356	.012155092	-1.33836	1
35	.808908902	.515703066	1.175424799	-.494317944	-1.465249599	1.570774375	.012155092	-1.41709	1
36	.808906694	.515705608	1.175427210	-.494319991	-1.465248899	1.570796325	.012155092	-1.41711	1
37	.808906645	.515705665	1.175427264	-.494320037	-1.465248883	1.570796817	.012155092	-1.41711	1
38	.808532627	.516136989	1.175835679	-.494667435	-1.465130500	1.574513226	.012155092	-1.41963	1
39	.800000037	.526391844	1.185151212	-.502918764	-1.462489379	1.658299087	.012155092	-1.46761	1
40	.786382336	.544314259	1.199999275	-.517263806	-1.458461589	1.787467613	.012155092	-1.51065	1
41	.775653442	.559680065	1.211666685	-.529449990	-1.455396811	1.884630202	.012155092	-1.52050	1
42	.775616666	.559734520	1.211706616	-.529492964	-1.455386418	1.884955629	.012155092	-1.52050	1
43	.775616599	.559734620	1.211706689	-.529493043	-1.455386399	1.884956225	.012155092	-1.52050	1
44	.773259430	.563249647	1.214265156	-.532263733	-1.454721519	1.905701800	.012155092	-1.52020	1
45	.750632774	.599341716	1.238710500	-.560316259	-1.448406365	2.092924564	.012155092	-1.47967	1
46	.750443630	.599660478	1.238913874	-.560560700	-1.448353687	2.094395011	.012155092	-1.47907	1
47	.750443622	.599660491	1.238913882	-.560560709	-1.448353685	2.094395070	.012155092	-1.47907	1
48	.750443595	.599660536	1.238913911	-.560560744	-1.448353677	2.094395279	.012155092	-1.47907	1
49	.745064263	.608838249	1.244690505	-.567573384	-1.446853536	2.135539799	.012155092	-1.46063	1
50	.712577455	.668566466	1.279251570	-.612035186	-1.437597673	2.356194525	.012155092	-1.29635	1
51	.712577101	.668567154	1.279251943	-.612035687	-1.437597570	2.356196671	.012155092	-1.29635	1
52	.709820309	.673953130	1.282158282	-.615947501	-1.436788369	2.372761487	.012155092	-1.27912	1
53	.700000054	.693515844	1.292477783	-.630025824	-1.433866221	2.429141282	.012155092	-1.21472	1
54	.692809357	.708203672	1.300001455	-.640464979	-1.431684030	2.467894851	.012155092	-1.16510	1
55	.683912893	.726787499	1.309272929	-.653517210	-1.428929958	2.513005256	.012155092	-1.10153	1

Table 8 (contd)

	X0	YDOT0	X1	YDOT1	ENERGY	T/2	MASS	INDEX	N
56	.683858008	.726903536	1.309330004	-.653598171	-1.428912772	2.513274102	.012155092	-1.10114	1
57	.683857758	.726904064	1.309330264	-.653598540	-1.428912694	2.513275324	.012155092	-1.10113	1
58	.680807574	.733379127	1.312499801	-.658105944	-1.427953748	2.528038054	.012155092	-1.07891	1
59	.674703563	.746491382	1.318829084	-.667171852	-1.426011360	2.556549589	.012155098	-1.03397	1
60	.668292784	.760481060	1.325457580	-.676755030	-1.423936711	2.585061079	.012155098	-.98628	1
61	.661539768	.775455690	1.332419872	-.686913194	-1.421711461	2.613572569	.012155098	-.93575	1
62	.654403155	.791542458	1.339756336	-.697713857	-1.419313806	2.642084059	.012155098	-.88230	1
63	.646834249	.808893346	1.347514563	-.709236776	-1.416717537	2.670595549	.012155098	-.82583	1
64	.638775203	.827691760	1.355751154	-.721576998	-1.413890825	2.699107039	.012155098	-.76624	1
65	.630156626	.848161489	1.364534095	-.734848906	-1.410794575	2.727618529	.012155098	-.70343	1
66	.620894359	.870579021	1.373945949	-.749191682	-1.407380149	2.756130019	.012155098	-.63727	1
67	.610885055	.895290838	1.384088251	-.764776807	-1.403586160	2.784641509	.012155098	-.56764	1
68	.600000062	.922738097	1.395087588	-.781818475	-1.399333883	2.813152998	.012155092	-.49438	1
69	.599996757	.922746522	1.395090923	-.781823664	-1.399332572	2.813161283	.012155092	-.49436	1
70	.595128768	.935215594	1.400000787	-.789474495	-1.397387256	2.825129508	.012155092	-.46249	1
71	.500000072	1.204366485	1.495216051	-.941985892	-1.353466667	2.986983388	.012155092	.04631	1
72	.495200172	1.219347213	1.499998969	-.949813772	-1.350928642	2.992453544	.012155092	.06670	1
73	.400000066	1.551958495	1.594795610	-1.107498580	-1.293169009	3.069890677	.012155092	.39633	1
74	.394775013	1.572527307	1.600000830	-1.116291390	-1.289552042	3.072845190	.012155092	.41115	1
75	.300000121	2.006527057	1.694573792	-1.278743442	-1.214191136	3.112162500	.012155092	.64380	1
76	.214561586	2.557224541	1.780173100	-1.431631509	-1.126216523	3.132261305	.012155085	.81919	1
77	.200000095	2.676924017	1.794800997	-1.458563481	-1.108704532	3.134761392	.012155092	.84778	1
78	.199659403	2.679849260	1.795143394	-1.459197418	-1.108284325	3.134817301	.012155085	.84845	1
79	.199648495	2.679943016	1.795154357	-1.459217718	-1.108270863	3.134819089	.012155085	.84847	1
80	.196227933	2.709652447	1.798592399	-1.465592610	-1.104024278	3.135374009	.012155085	.85517	1
81	.196217170	2.709746911	1.798603218	-1.465612697	-1.104010837	3.135375737	.012155085	.85519	1
82	.156957467	3.103864138	1.838116347	-1.540270840	-1.051306152	3.140988558	.012155092	.93224	1
83	.152587142	3.155175400	1.842521290	-1.548776121	-1.044934349	3.141535102	.012155092	.94089	1
84	.152312592	3.158459464	1.842798061	-1.549311918	-1.044530294	3.141568958	.012155092	.94143	1
85	.152119707	3.160771072	1.842992509	-1.549688449	-1.044246155	3.141592710	.012155092	.94181	1
86	.152108810	3.160901770	1.843003494	-1.549709723	-1.044230097	3.141594051	.012155092	.94184	1
87	.152098149	3.161029661	1.843014242	-1.549730538	-1.044214384	3.141595363	.012155092	.94186	1
88	.144635195	3.253383405	1.850539795	-1.564368755	-1.033044678	3.142493336	.012155092	.95670	1
89	.141193214	3.297995678	1.854012056	-1.571167367	-1.027774380	3.142894058	.012155092	.96358	1
90	.099999853	3.967049586	1.895645478	-1.655361079	-.957807886	3.147096514	.012155092	1.04842	1
91	.053953617	-5.442182357	1.949999267	-2.130164262	-.148531015	3.158798425	.012155092	1.63618	2
92	.106244942	-4.081426787	1.899996191	-2.145339852	-.033691373	3.160817056	.012155092	1.68744	2
93	.211205606	-3.028649592	1.799998280	-2.147485136	.125760167	3.165846913	.012155092	1.74880	2
94	.317784037	-2.570293959	1.700002389	-2.135219616	.240550219	3.173190354	.012155092	1.78497	2
95	.427751061	-2.319206740	1.600000019	-2.118110423	.330591568	3.184846579	.012155092	1.80569	2
96	.545332991	-2.169859851	1.500000281	-2.101442148	.406026466	3.205924242	.012155092	1.80901	2
97	.688666941	-2.082565463	1.400000476	-2.092966118	.481228349	3.258658319	.012155092	1.75490	2
98	.885679314	-2.102094356	1.400006401	-2.148015835	.597959093	3.501924573	.012155092	.70279	2
99	.915055882	-2.134193712	1.449996790	-2.181513184	.626343138	3.600280284	.012155092	-.34342	2
100	.931545378	-2.164632738	1.499996998	-2.212803797	.646250592	3.682498663	.012155092	-1.63592	2
101	.934498060	-2.171749177	1.511806602	-2.220102267	.650240506	3.700714259	.012155098	-1.97630	2
102	.937242737	-2.178991328	1.523838355	-2.227525349	.654084291	3.718929819	.012155098	-2.33519	2
103	.939796908	-2.186355886	1.536075979	-2.235069464	.657784104	3.737145379	.012155098	-2.71145	2
104	.942176468	-2.193839945	1.548504727	-2.242731098	.661341768	3.755360939	.012155098	-3.10348	2
105	.944395836	-2.201440942	1.561111268	-2.250506824	.664758809	3.773576499	.012155098	-3.50921	2
106	.946468101	-2.209156612	1.573883540	-2.258393308	.668036693	3.791792059	.012155098	-3.92604	2
107	.948405157	-2.216984944	1.586810614	-2.266387312	.671175853	3.810007619	.012155098	-4.35081	2
108	.950217811	-2.224924147	1.599882578	-2.274485692	.674177713	3.828223179	.012155098	-4.77968	2
109	.951915895	-2.232972620	1.613090430	-2.282685398	.677042708	3.846438739	.012155098	-5.20818	2
110	.953508403	-2.241128943	1.626425943	-2.290983455	.679771322	3.8646454302	.012155085	-5.63105	2

Table 8 (contd)

	X0	YDOT0	X1	YDOT1	ENERGY	T/2	MASS	INDEX	N
111	.953519766	-2.241189443	1.626524667	-2.291044961	.679790923	3.864788531	.012155085	-5.63413	2
112	.957227841	-2.262940769	1.661821223	-2.313109400	.686258956	3.912250160	.012155092	-6.66298	2
113	.958264421	-2.269840474	1.672931759	-2.320086496	.688080038	3.926990806	.012155092	-6.94561	2
114	.958264642	-2.269841989	1.672934192	-2.320088025	.688080426	3.926994025	.012155092	-6.94567	2
115	.958285034	-2.269981832	1.673158939	-2.320229320	.688116236	3.927291303	.012155092	-6.95113	2
116	.960000022	-2.282360917	1.692982943	-2.332717514	.691117712	3.953380345	.012155092	-7.38388	2
117	.970000017	-2.392683813	1.863268205	-2.441955298	.705072117	4.169323980	.012155092	-2.46281	2
118	.970038065	-2.393300106	1.864187355	-2.442553639	.705092959	4.170459339	.012155098	-2.36510	2
119	.970076013	-2.393916769	1.865106686	-2.443152183	.705113245	4.171594679	.012155098	-2.26626	2
120	.970113847	-2.394533805	1.866026224	-2.443750944	.705132967	4.172730019	.012155098	-2.16627	2
121	.970151568	-2.395151214	1.866945969	-2.444349922	.705152126	4.173865359	.012155098	-2.06514	2
122	.970189174	-2.395768997	1.867865919	-2.444949116	.705170721	4.175000699	.012155098	-1.96285	2
123	.970226669	-2.396387153	1.868786075	-2.445548527	.705188752	4.176136039	.012155098	-1.85940	2
124	.970264050	-2.397005683	1.869706435	-2.446148153	.705206219	4.177271379	.012155098	-1.75478	2
125	.970301320	-2.397624585	1.870627000	-2.446747994	.705223122	4.178406719	.012155098	-1.64898	2
126	.970338479	-2.398243860	1.871547768	-2.447348049	.705239459	4.179542059	.012155098	-1.54200	2
127	.970375541	-2.398863522	1.872468739	-2.447948321	.705255239	4.180677413	.012155092	-1.43382	2
128	.970637073	-2.403302149	1.879055526	-2.452243812	.705351479	4.188790142	.012155092	-.62547	2
129	.970637123	-2.403302998	1.879056784	-2.452244633	.705351495	4.188791691	.012155092	-.62531	2
130	.970639715	-2.403347575	1.879122845	-2.452287734	.705352313	4.188872992	.012155092	-.61689	2
131	.971261170	-2.414371579	1.895404139	-2.462922905	.705464974	4.208872999	.012155092	1.65712	2
132	.971321551	-2.415480312	1.897035552	-2.463989903	.705466501	4.210872999	.012155098	1.90761	2
133	.971381635	-2.416590203	1.898667539	-2.465057517	.705466260	4.212872999	.012155098	2.16247	2
134	.971441412	-2.417701245	1.900300106	-2.466125750	.705464243	4.214872999	.012155098	2.42176	2
135	.971500883	-2.418813438	1.901933250	-2.467194598	.705460448	4.216872999	.012155098	2.68551	2
136	.971560051	-2.419926780	1.903566970	-2.468264060	.705454874	4.218872999	.012155098	2.95377	2
137	.971618917	-2.421041273	1.905201261	-2.469334131	.705447519	4.220872999	.012155098	3.22659	2
138	.971677483	-2.422156915	1.906836122	-2.470404811	.705438382	4.222872999	.012155098	3.50402	2
139	.971735751	-2.423273706	1.908471549	-2.471476095	.705427461	4.224872999	.012155098	3.78611	2
140	.971793724	-2.424391646	1.910107539	-2.472547981	.705414755	4.226872999	.012155098	4.07289	2
141	.971851416	-2.425510741	1.911744080	-2.473620462	.705400270	4.228872999	.012155092	4.36442	2
142	.972412467	-2.436764712	1.928139805	-2.484377684	.705156775	4.248872999	.012155092	7.55161	2
143	.972946178	-2.448133152	1.944588517	-2.495191852	.704733029	4.268872999	.012155092	11.26837	2
144	.973454262	-2.459615739	1.961087474	-2.506060243	.704127548	4.288872999	.012155092	15.56744	2
145	.973938302	-2.471212156	1.977633981	-2.516980131	.703338823	4.308872999	.012155092	20.50475	2
146	.974399761	-2.482922098	1.994225376	-2.527948783	.702365333	4.328872999	.012155092	26.13947	2
147	.974839993	-2.494745267	2.010859024	-2.538963454	.701205539	4.348872999	.012155092	32.53393	2
148	.975260256	-2.506681368	2.027532306	-2.550021388	.699857896	4.368872999	.012155092	39.75386	2
149	.975661713	-2.518730110	2.044242611	-2.561119812	.698320857	4.388872999	.012155092	47.86827	2
150	.976045447	-2.530891207	2.060987332	-2.572255936	.696592873	4.408872999	.012155092	56.95006	2
151	.976412464	-2.543164369	2.077763857	-2.583426952	.694642398	4.428872999	.012155092	67.07357	2
152	.976763699	-2.555549312	2.094569566	-2.594630027	.692557898	4.448872999	.012155092	78.31941	2
153	.977100025	-2.568045747	2.111401826	-2.605862309	.690247850	4.468872999	.012155092	90.77020	2
154	.977422254	-2.580653383	2.128257986	-2.617120922	.687740748	4.488872999	.012155092	104.51050	2
155	.978027405	-2.605201094	2.162031289	-2.639705501	.682129462	4.528872999	.012155092	136.22025	2
156	.978311699	-2.619140576	2.178943011	-2.651025585	.679022385	4.568872999	.012155092	154.37797	2
157	.978846821	-2.645349291	2.212802821	-2.673706429	.672198370	4.588872999	.012155092	195.80113	2
158	.979098774	-2.658617910	2.229745304	-2.685061141	.668478746	4.608872999	.012155092	219.27045	2
159	.979574095	-2.685486789	2.263647003	-2.707877733	.660416414	4.648879899	.012155092	272.31157	2
160	.979798309	-2.699081783	2.280594553	-2.719149476	.656072686	4.668879899	.012155092	302.12058	2
161	.979999997	-2.711866244	2.296406394	-2.729748853	.651829381	4.687544025	.012155092	331.70267	2
162	.980163634	-2.722651628	2.309651708	-2.738626338	.648131917	4.703184063	.012155092	358.29989	2
163	.980257720	-2.729029316	2.317443661	-2.743847932	.645895454	4.712387833	.012155092	374.66357	2
164	.980257727	-2.729029795	2.317444246	-2.743848323	.645895284	4.712388524	.012155092	374.66408	2

Table 8 (contd)

	X0	YDOTO	X1	YDOT1	ENERGY	T/2	MASS	INDEX	N
165	.980258495	-2.729082401	2.317508393	-2.743891307	.645876683	4.712464304	.012155092	374.80083	2
166	.982717387	-2.962228486	2.582150158	-2.919994578	.541036024	5.029205246	.012155092	1347.03867	2
167	.982733056	-2.964304164	2.584331695	-2.921429094	.539920738	5.031874238	.012155092	1359.27551	2
168	.983613424	-3.101209843	2.721455646	-3.010636255	.460423485	5.203002348	.012155092	2313.49769	2
169	.983758487	-3.128457845	2.747155107	-3.027101108	.443326662	5.235980984	.012155092	2537.35173	2
170	.983758502	-3.128460747	2.747157816	-3.027102839	.443324821	5.235984478	.012155092	2537.37616	2
171	.983761430	-3.129027473	2.747686711	-3.027440685	.442965159	5.236666809	.012155092	2542.14714	2
172	.983999997	-3.177630100	2.792191614	-3.055713570	.411534229	5.294653306	.012155092	2968.22299	2
173	.984948099	-3.435498011	2.999992491	-3.182291378	.229517189	5.585982392	.012155092	5676.81060	2
174	.985695094	-3.770151228	3.199362549	-3.288853058	-.022773826	5.925476595	.012155092	9449.70008	2
175	.985862464	-3.874829141	3.246266849	-3.309889173	-.099989842	6.022486299	.012155092	10452.16248	2
176	.986225881	-4.167357453	3.343410652	-3.343278725	-.299991209	6.268632153	.012155092	12418.20815	2
177	.986244358	-4.185390469	3.347954525	-3.344306717	-.311348134	6.282567755	.012155092	12496.87714	2
178	.986244798	-4.185824461	3.348062036	-3.344330200	-.311619909	6.282901346	.012155092	12498.71150	2
179	.986245163	-4.186184640	3.348151196	-3.344349643	-.311845405	6.283178137	.012155092	12500.23201	2
180	.986249290	-4.190267444	3.349157735	-3.344567239	-.314397989	6.286311642	.012155092	12517.33447	2

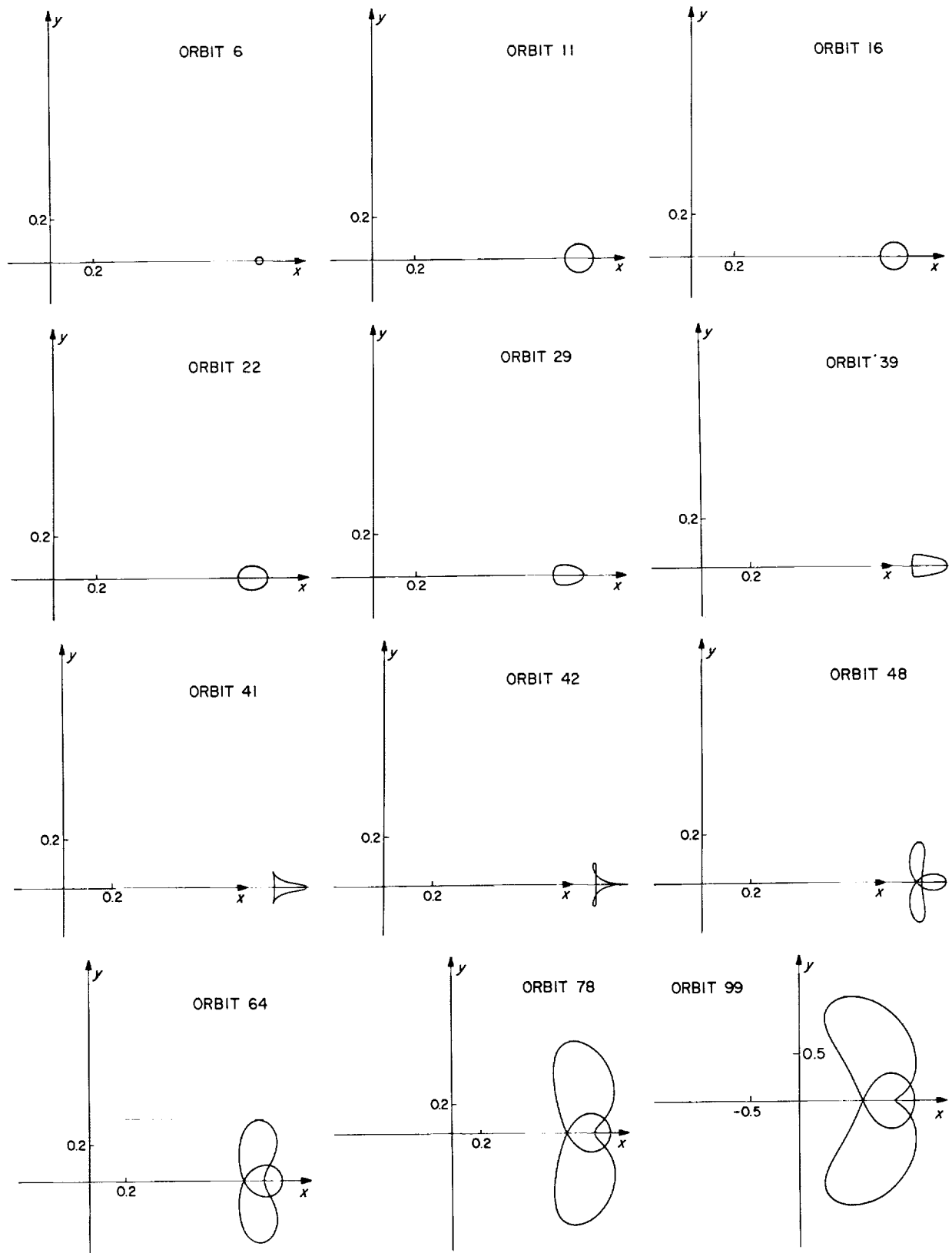

Fig. 33. Typical trajectories in family H_1 of direct periodic orbits around m_2

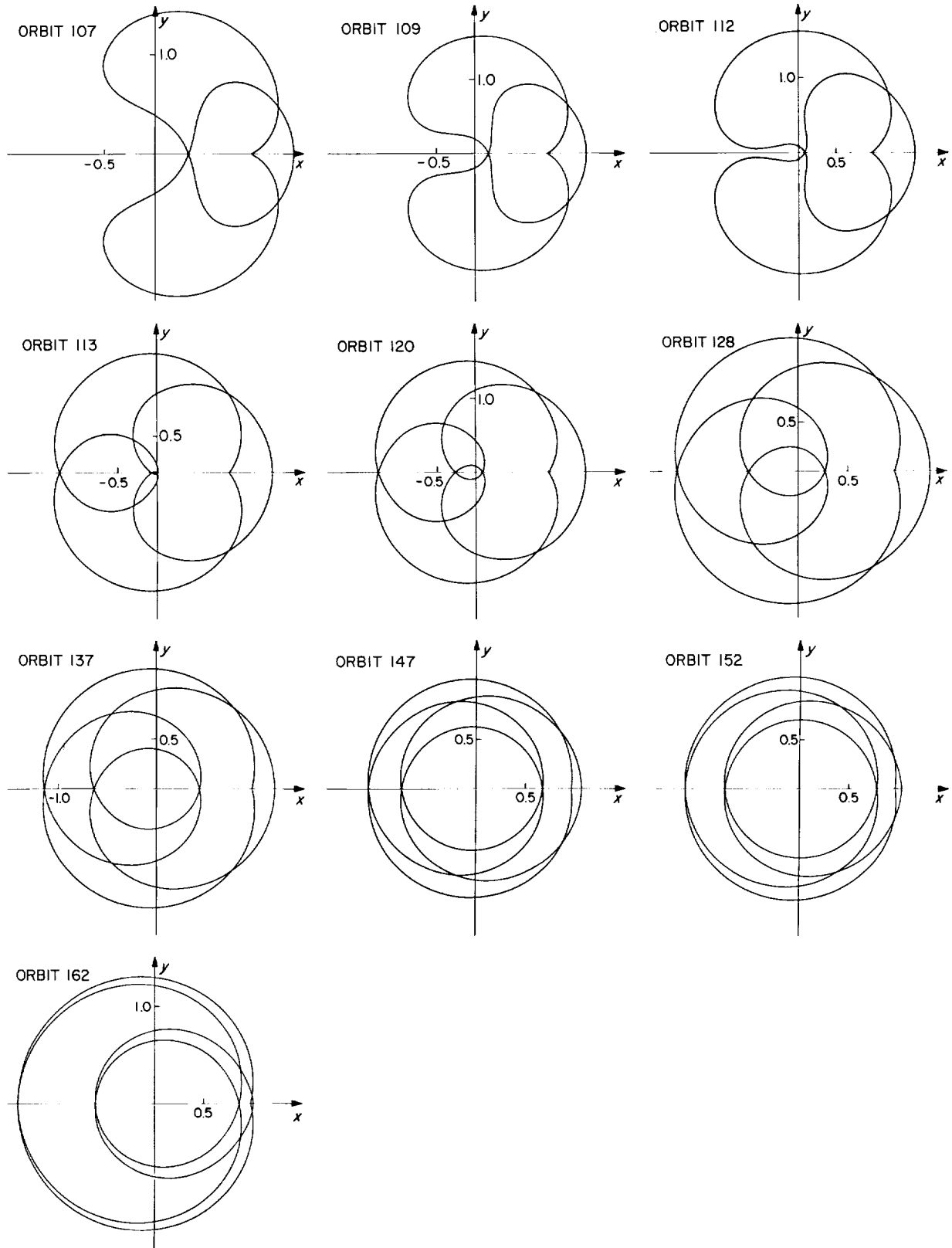

Fig. 33 (contd)

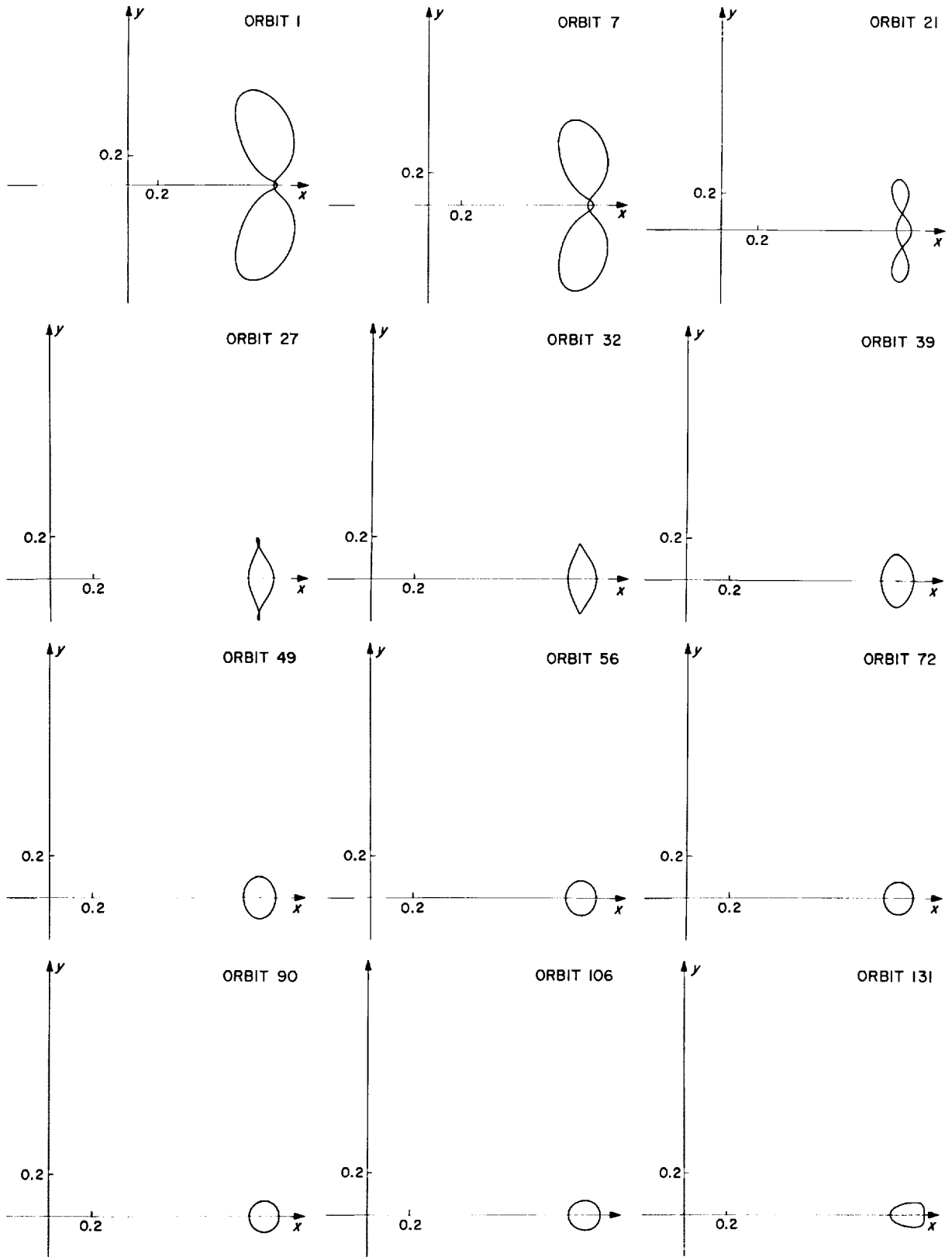

Fig. 34. Typical trajectories in family H_2 of direct periodic orbits around m_2

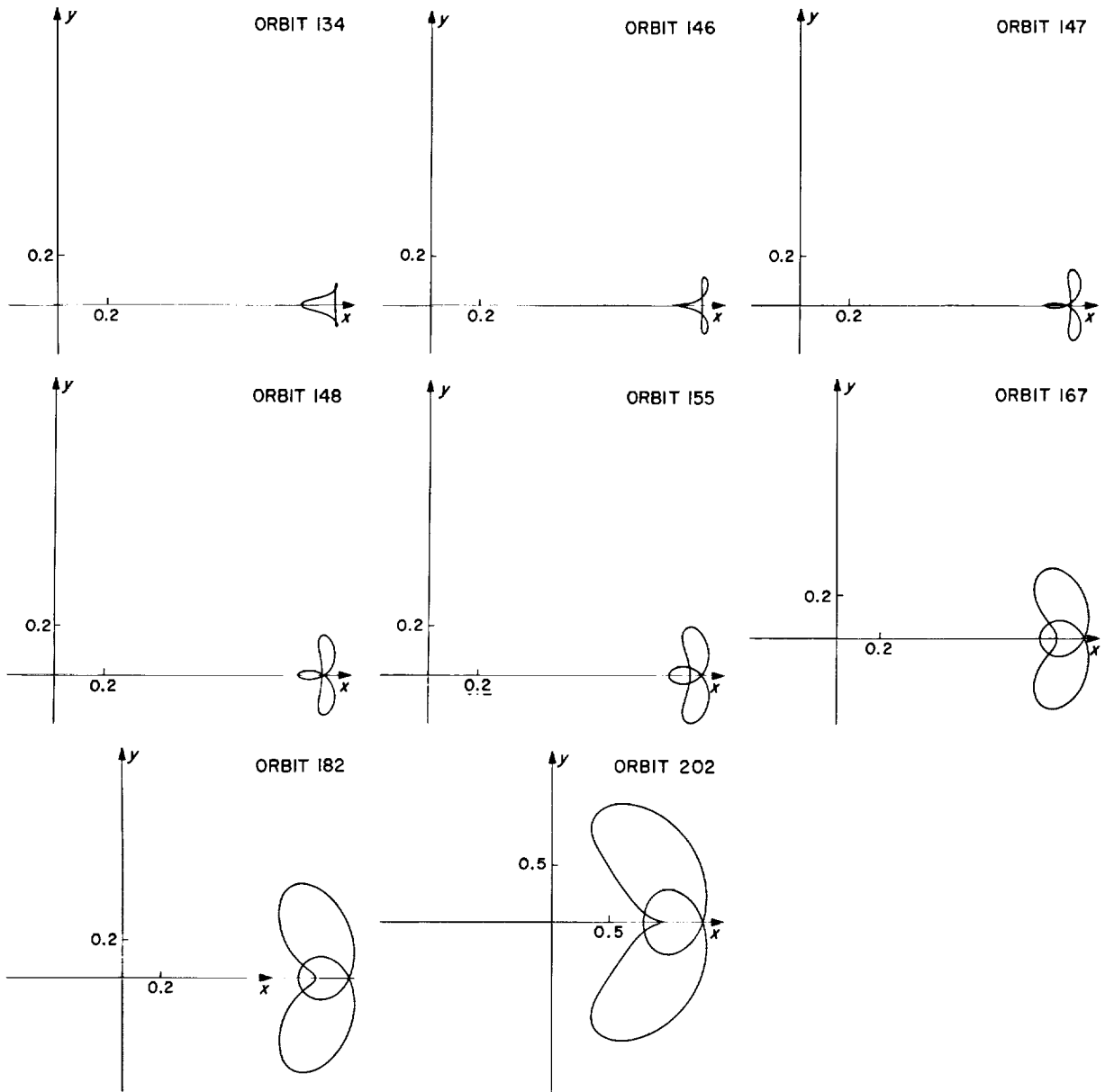

Fig. 34 (contd)

Table 9. Initial conditions for family H_1 of direct periodic orbits around m_2

	X0	YDOT0	X1	YDOT1	ENERGY	T/2	MASS	INDEX	N
1	.998187852	1.073877039	.977499976	-1.073669120	-2.074521989	.030271537	.012155092	1.99639	1
2	.999414436	1.013621108	.976272411	-1.013358550	-2.012859987	.035880505	.012155092	1.99494	1
3	.999579120	1.006245101	.976107572	-1.005974669	-2.005570059	.036658934	.012155092	1.99472	1
4	.999616731	1.004581882	.976069926	-1.004309633	-2.003934045	.036837540	.012155092	1.99467	1
5	.999627004	1.004128947	.976059643	-1.003856201	-2.003489016	.036886378	.012155092	1.99466	1
6	1.005676007	.808367091	.969999528	-.807706969	-1.831181899	.069449282	.012155092	1.98148	1
7	1.015613009	.635553562	.960000266	-.633734632	-1.712661984	.138426996	.012155092	1.93069	1
8	1.025418599	.535051266	.950004506	-.531028961	-1.658173863	.225757792	.012155092	1.83484	1
9	1.034899997	.468796201	.940000486	-.460318689	-1.627391029	.332662105	.012155092	1.70937	1
10	1.043247003	.427404453	.930000689	-.407058032	-1.608231727	.458781279	.012155092	1.65159	1
11	1.045540006	.431139152	.919994034	-.357250795	-1.598274545	.565423801	.012155092	1.82812	1
12	1.045800096	.435808255	.918984362	-.351606221	-1.597869038	.570992409	.012155092	1.84741	1
13	1.030579990	.496310283	.909999960	-.300276099	-1.596347166	.598478182	.012155092	1.91961	1
14	1.030395999	.580318307	.899990594	-.247702394	-1.595658678	.625523156	.012155092	1.85542	1
15	1.029856996	.586571426	.899291759	-.244280926	-1.595610136	.627855903	.012155092	1.84652	1
16	1.029752527	.587794615	.899155695	-.243618529	-1.595600612	.628318517	.012155092	1.84472	1
17	1.029751703	.587804268	.899154622	-.243613310	-1.595600536	.628322176	.012155092	1.84470	1
18	1.029751197	.587810204	.899153962	-.243610101	-1.595600490	.628324426	.012155092	1.84469	1
19	1.023079993	.674740671	.889997541	-.201774032	-1.594902918	.666558168	.012155092	1.67286	1
20	1.016520997	.783294718	.880000652	-.161874264	-1.594064747	.728180869	.012155092	1.35996	1
21	1.012750692	.861571580	.873858630	-.140149164	-1.593561854	.780456110	.012155092	1.09184	1
22	1.012445498	.868591197	.873353899	-.138457123	-1.593522019	.785398154	.012155092	1.06670	1
23	1.012445492	.868591325	.873353890	-.138457093	-1.593522019	.785398244	.012155092	1.06670	1
24	1.012445398	.868593518	.873353733	-.138456570	-1.593522006	.785399795	.012155092	1.06669	1
25	1.012441895	.868674756	.873347937	-.138437223	-1.593521550	.785457200	.012155092	1.06640	1
26	1.010420002	.918341534	.869999217	-.127581801	-1.593264554	.821356467	.012155092	.88333	1
27	1.003944993	1.130110527	.859999369	-.099837888	-1.592541083	.980431917	.012155092	-.34337	1
28	1.002355093	1.201166452	.858023041	-.095759368	-1.592367330	1.030538797	.012155092	-1.27079	1
29	1.001851335	1.226023616	.857463840	-.094790443	-1.592308415	1.047198060	.012155092	-1.71223	1
30	1.001851186	1.226031155	.857463680	-.094790181	-1.592308398	1.047203037	.012155092	-1.71238	1
31	1.001845792	1.226304173	.857457886	-.094780718	-1.592307752	1.047383234	.012155092	-1.71762	1
32	.998917192	1.401327487	.855000139	-.092845019	-1.591879848	1.149317077	.012155092	-7.17101	1
33	.997387283	1.521936584	.854334112	-.094715934	-1.591554345	1.203910495	.012155092	-13.58834	1
34	.996999741	1.557020717	.854239239	-.095542086	-1.591454896	1.217654757	.012155092	-15.83804	1
35	.995915212	1.667861231	.854138814	-.098662912	-1.591129917	1.255677131	.012155092	-23.88559	1
36	.995887525	1.670972275	.854139495	-.098758739	-1.591120607	1.256637346	.012155092	-24.12925	1
37	.995887532	1.670971413	.854139495	-.098758712	-1.591120609	1.256637081	.012155092	-24.12918	1
38	.995887443	1.670981512	.854139497	-.098759024	-1.591120579	1.256640189	.012155092	-24.12997	1
39	.995772347	1.684083740	.854144091	-.099166275	-1.591081277	1.260625552	.012155092	-25.16539	1
40	.995252207	1.746948914	.854200588	-.101188567	-1.590891018	1.278504282	.012155092	-30.31945	1
41	.993239798	2.068319074	.855000091	-.112073089	-1.589909747	1.345535161	.012155092	-59.18715	1
42	.989451997	3.860911874	.860000194	-.152709729	-1.585865006	1.470965558	.012155092	-177.92851	1
43	.989438497	-3.882110399	.880000137	-.280351170	-1.567867644	1.685120467	.012155092	-477.71993	2
44	.993094899	-2.113422371	.890000102	-.339042449	-1.557786830	1.789367836	.012155092	-549.01081	2
45	.997135125	-1.571381452	.897843303	-.384744941	-1.549646913	1.883035325	.012155092	-581.36972	2
46	.997221388	-1.563804250	.897993040	-.385621276	-1.549490288	1.884955338	.012155092	-581.83417	2
47	.997221515	-1.563793172	.897993260	-.385622564	-1.549490058	1.884958163	.012155092	-581.83485	2
48	.998409390	-1.469083268	.900000004	-.397394612	-1.547387794	1.911227319	.012155092	-587.58553	2
49	1.005183995	-1.131701699	.910000646	-.457333672	-1.536854193	2.059335860	.012155092	-605.37062	2
50	1.006624281	-1.085068548	.911895943	-.469051092	-1.534852722	2.091177369	.012155092	-607.12387	2
51	1.006769121	-1.080683621	.912083035	-.470215921	-1.534655124	2.094394913	.012155092	-607.27444	2
52	1.006769306	-1.080678040	.912083274	-.470217411	-1.534654871	2.094399035	.012155092	-607.27328	2
53	1.013335993	-.924399955	.920000578	-.521172905	-1.526293873	2.244308144	.012155092	-610.50970	2
54	1.017655706	-.852625859	.924717499	-.553516674	-1.521316337	2.348482579	.012155092	-610.05668	2
55	1.017966986	-.848108801	.925044963	-.555831419	-1.520970880	2.356194254	.012155092	-609.97122	2

Table 9 (contd)

	X0	YDOT0	X1	YDOT1	ENERGY	T/2	MASS	INDEX	N
56	1.017967001	-.848108585	.925044978	-.555831531	-1.520970864	2.356194627	.012155092	-609.97134	2
57	1.017968386	-.848088659	.925046432	-.555841827	-1.520969330	2.356229004	.012155092	-609.97118	2
58	1.022860005	-.786056275	.930000278	-.592174199	-1.515743287	2.481500577	.012155092	-607.87607	2
59	1.023903593	-.774689675	.931014038	-.599949568	-1.514673432	2.509293520	.012155092	-607.27066	2
60	1.024051696	-.773122514	.931156770	-.601054633	-1.514522778	2.513270263	.012155092	-607.18084	2
61	1.024051830	-.773121101	.931156899	-.601055633	-1.514522642	2.513273864	.012155092	-607.18104	2
62	1.024051837	-.773121019	.931156906	-.601055691	-1.514522634	2.513274073	.012155092	-605.87857	2
63	1.033800988	-.690141308	.940000185	-.675537808	-1.505160457	2.794866352	.012155092	-598.36531	2
64	1.043731392	-.634466889	.948085829	-.758194748	-1.496469358	3.130047529	.012155092	-587.46745	2
65	1.044045197	-.633046910	.948328668	-.760977558	-1.496204467	3.141579895	.012155092	-587.09208	2
66	1.044045285	-.633046513	.948328736	-.760978342	-1.496204392	3.141583144	.012155092	-587.09197	2
67	1.044046685	-.633040219	.948329818	-.760990784	-1.496203212	3.141634731	.012155092	-587.09030	2
68	1.046229988	-.623643080	.949999681	-.780713326	-1.494372709	3.223623036	.012155092	-584.47494	2
69	1.060360996	-.579675052	.960000602	-.928004091	-1.482844088	3.833036899	.012155092	-573.98431	2
70	1.062303990	-.575501614	.961256910	-.951548246	-1.481277209	3.926961306	.012155092	-575.30349	2
71	1.062304590	-.575500383	.961257293	-.951555642	-1.481276725	3.926990628	.012155092	-575.30423	2
72	1.062305301	-.575498926	.961257747	-.951564393	-1.481276152	3.927025317	.012155092	-575.30454	2
73	1.067569599	-.565998430	.964471100	-1.019388936	-1.477043087	4.188712751	.012155092	-583.70191	2
74	1.067571133	-.565996015	.964471990	-1.019409510	-1.477041859	4.188789763	.012155092	-583.70595	2
75	1.067571893	-.565994818	.964472431	-1.019419703	-1.477041250	4.188827918	.012155092	-583.70780	2
76	1.067682087	-.565821839	.964536303	-1.020898707	-1.476952994	4.194360151	.012155092	-583.98998	2
77	1.078408495	-.553030156	.969912158	-1.170875383	-1.468587858	4.710859360	.012155092	-633.50831	2
78	1.078440487	-.553001983	.969925478	-1.171325402	-1.468564871	4.712271679	.012155092	-633.71124	2
79	1.078440800	-.553001708	.969925608	-1.171329805	-1.468564638	4.712285491	.012155092	-633.71325	2
80	1.078440890	-.553001629	.969925646	-1.171331070	-1.468564571	4.712289463	.012155092	-633.71368	2
81	1.078441486	-.553001105	.969925894	-1.171339453	-1.468564126	4.712315764	.012155092	-633.71759	2
82	1.078441888	-.553000751	.969926061	-1.171345108	-1.468563826	4.712333503	.012155092	-633.72003	2
83	1.078442901	-.552999860	.969926483	-1.171359356	-1.468563069	4.712378204	.012155092	-633.72656	2
84	1.078443140	-.552999649	.969926582	-1.171362717	-1.468562891	4.712388751	.012155092	-633.72781	2
85	1.078443170	-.552999623	.969926595	-1.171363139	-1.468562869	4.712390074	.012155092	-633.72808	2
86	1.078443393	-.552999427	.969926687	-1.171366276	-1.468562702	4.712399915	.012155092	-633.72966	2
87	1.078617990	-.552846549	.969999084	-1.173820887	-1.468432496	4.720088423	.012155092	-634.84040	2
88	1.091033891	-.545001752	.974002040	-1.337328955	-1.459903364	5.179759509	.012155092	-718.59454	2
89	1.092945933	-.544228153	.974450432	-1.359987796	-1.458720346	5.235987671	.012155092	-730.33892	2
90	1.092947289	-.544227640	.974450738	-1.360003608	-1.458719519	5.236026343	.012155092	-730.34735	2
91	1.092948005	-.544227368	.974450899	-1.360011957	-1.458719082	5.236046761	.012155092	-730.35150	2
92	1.092948198	-.544227295	.974450943	-1.360014207	-1.458718964	5.236052265	.012155092	-730.35271	2
93	1.093164399	-.544146026	.974499409	-1.362530607	-1.458587258	5.242196619	.012155092	-731.63789	2
94	1.099999994	-.542183168	.975831661	-1.437473930	-1.454622103	5.416694869	.012155092	-767.17953	2
95	1.119999990	-.542254571	.978288860	-1.614427884	-1.444690931	5.775988611	.012155092	-814.94644	2
96	1.145793989	-.552462238	.979999946	-1.784040798	-1.433869182	6.072781102	.012155092	-799.24303	2
97	1.171365693	-.571092072	.981048011	-1.918482818	-1.423874794	6.282775833	.012155092	-754.59466	2
98	1.171419591	-.5711138788	.981049841	-1.918744675	-1.423853795	6.283161686	.012155092	-754.49188	2
99	1.171422392	-.5711141216	.981049936	-1.918758282	-1.423852703	6.283181732	.012155092	-754.48651	2
100	1.171422884	-.5711141643	.981049952	-1.918760672	-1.423852512	6.283185254	.012155092	-754.48525	2
101	1.172512993	-.572092691	.981086686	-1.924041797	-1.423427587	6.290945991	.012155092	-752.40236	2
102	1.179999992	-.578934096	.981326335	-1.959601177	-1.420495469	6.324129014	.012155092	-737.98313	2
103	1.219999999	-.623501381	.982341580	-2.135691057	-1.403901892	6.564028148	.012155092	-660.41504	2
104	1.250000000	-.664221440	.982917681	-2.259662843	-1.389686207	6.684828222	.012155092	-600.44194	2
105	1.279999986	-.709916483	.983389396	-2.379322705	-1.373308289	6.773516674	.012155092	-535.02911	2
106	1.349999994	-.831802327	.984182085	-2.634470087	-1.324073030	6.879180087	.012155092	-340.57264	2
107	1.399999991	-.929838561	.984540656	-2.784845432	-1.276721707	6.887574369	.012155092	-142.58507	2
108	1.449999988	-1.037095318	.984767439	-2.901760972	-1.215376375	6.853534365	.012155092	131.37103	2
109	1.500000000	-1.156650558	.984884765	-2.982934242	-1.133082539	6.781276687	.012155092	509.79904	2
110	1.544119596	-1.280806016	.984892981	-3.021568788	-1.028521229	6.678204936	.012155092	960.35406	2

Table 9 (contd)

	X0	YDOTO	X1	YDOT1	ENERGY	T/2	MASS	INDEX	N
111	1.549999997	-1.299842904	.984884788	-3.023781122	-1.010436848	6.660144982	.012155092	1031.00959	2
112	1.555666089	-1.319106609	.984873864	-3.025047318	-.991508901	6.641262576	.012155092	1102.00881	2
113	1.560307801	-1.666833700	.983857366	-2.844818001	-.477560986	6.156415602	.012155092	1554.55965	4
114	1.549999997	-1.683997901	.983706760	-2.819861293	-.437308170	6.120297299	.012155092	1478.79833	4
115	1.538163543	-1.700100970	.983539911	-2.793633130	-.397077562	6.084346649	.012155085	1393.25269	4
116	1.538163394	-1.700101120	.983539899	-2.793632856	-.397077150	6.084346284	.012155092	1393.25385	4
117	1.524900883	-1.715071882	.983356131	-2.766380126	-.357244746	6.048884070	.012155085	1300.14002	4
118	1.510396928	-1.728845524	.983155466	-2.738444461	-.318265671	6.014304789	.012155085	1202.44573	4
119	1.494851530	-1.741429279	.982937883	-2.710128067	-.280478174	5.980904505	.012155085	1103.12418	4
120	1.478457615	-1.752885519	.982703144	-2.681675462	-.244100607	5.948880679	.012155085	1004.54944	4
121	1.461388856	-1.763311355	.982450737	-2.653272836	-.209250708	5.918350461	.012155085	908.74098	4
122	1.443794742	-1.772821832	.982179834	-2.625055256	-.175970120	5.889372744	.012155085	817.09882	4
123	1.425795346	-1.781540452	.981889194	-2.597109069	-.144238671	5.861960935	.012155085	730.59303	4
124	1.407486424	-1.789589726	.981577174	-2.569487138	-.113999829	5.836105564	.012155085	649.80793	4
125	1.388944760	-1.797086604	.981241729	-2.542220625	-.085177651	5.811789553	.012155085	575.03704	4
126	1.370230362	-1.804141814	.980880345	-2.515323985	-.057683711	5.788995172	.012155085	506.35858	4
127	1.351392552	-1.810858997	.980490036	-2.488804511	-.031427145	5.767713981	.012155085	443.70432	4
128	1.332470506	-1.817336732	.980067228	-2.462663180	-.006314528	5.747948739	.012155085	386.89781	4
129	1.330070525	-1.818144605	.980011173	-2.459380431	-.003211966	5.745555197	.012155085	380.11070	4
130	1.313500106	-1.823668665	.979607768	-2.436904116	.017742564	5.729722016	.012155085	335.70011	4
131	1.302095175	-1.827440255	.979312159	-2.421617388	.031721978	5.719530101	.012155085	307.52628	4
132	1.294510782	-1.829947318	.979106703	-2.411530158	.040834036	5.713074427	.012155085	289.82097	4
133	1.275534227	-1.836264069	.978558326	-2.386554803	.063042960	5.698075032	.012155085	248.94898	4
134	1.256602317	-1.842712969	.977955975	-2.361999769	.084451438	5.684822002	.012155085	212.76038	4
135	1.237750620	-1.849393029	.977291969	-2.337900648	.105139750	5.673449769	.012155085	180.92358	4
136	1.219022214	-1.856410798	.976557627	-2.314313526	.125185917	5.664137039	.012155085	153.11258	4
137	1.200470537	-1.863883745	.975743393	-2.291321291	.144666891	5.657115342	.012155085	129.00654	4
138	1.182165816	-1.871942556	.974839401	-2.269045705	.163656344	5.652680029	.012155085	108.29561	4
139	1.164201260	-1.880732948	.973836645	-2.247660624	.182222764	5.651199815	.012155085	90.68351	4
140	1.156627536	-1.884767881	.973374510	-2.238815947	.190073828	5.651578958	.012155085	84.00616	4
141	1.146700844	-1.890414527	.972729338	-2.227408706	.200424547	5.653122058	.012155085	75.88577	4
142	1.129827768	-1.901152945	.971519171	-2.208619415	.218300286	5.658964640	.012155085	63.62936	4
143	1.113788828	-1.913100600	.970222001	-2.191719535	.235854038	5.669278667	.012155085	53.64713	4
144	1.098821416	-1.926366630	.968875851	-2.177215666	.253043335	5.684569555	.012155085	45.66433	4
145	1.085162714	-1.940975995	.967547513	-2.165641915	.269767962	5.705172794	.012155085	39.38637	4
146	1.072991848	-1.956846224	.966330896	-2.157464997	.285880717	5.731131465	.012155085	34.48102	4
147	1.062378392	-1.973798012	.965333928	-2.152998042	.301208676	5.762134450	.012155085	30.57420	4
148	1.053266600	-1.991602076	.964657247	-2.152371922	.315571382	5.797541329	.012155085	27.25318	4
149	1.045504332	-2.010034141	.964373535	-2.155571386	.328779126	5.836442251	.012155085	24.07196	4
150	1.038893983	-2.028909989	.964513498	-2.162488146	.340615942	5.877686464	.012155085	20.55740	4
151	1.033238187	-2.048094156	.965059239	-2.172939025	.350830895	5.919881087	.012155085	16.24521	4
152	1.028367966	-2.067491831	.965945476	-2.186637385	.359162644	5.961439490	.012155085	10.82281	4
153	1.024151579	-2.087042615	.967071891	-2.203160255	.365404735	6.000779832	.012155085	4.50857	4
154	1.020492256	-2.106705729	.968325944	-2.221955697	.369473562	6.036614638	.012155085	-1.16774	4
155	1.017316788	-2.126452238	.969608191	-2.242418201	.371438061	6.068201528	.012155085	-2.06500	4
156	1.014563769	-2.146262418	.970848215	-2.263992342	.371488258	6.095392680	.012155085	10.42765	4
157	1.012178332	-2.166113730	.972005852	-2.286230175	.369871221	6.118473602	.012155085	51.77060	4
158	1.010106832	-2.186012314	.973065851	-2.308842128	.366830975	6.137985726	.012155085	147.27594	4
159	1.008304417	-2.205931697	.974025433	-2.331607451	.362584461	6.154491334	.012155085	335.28084	4
160	1.006729484	-2.225868735	.974890447	-2.354406468	.357306314	6.168538966	.012155085	670.96854	4
161	1.005346596	-2.245821475	.975669685	-2.377168456	.351133222	6.180598593	.012155085	1230.16516	4
162	1.004128918	-2.265739141	.976370903	-2.399795322	.344189576	6.191031583	.012155085	2110.26585	4

Table 10. Initial conditions for family H₂ of direct periodic orbits around m₂

	X0	YDOTO	X1	YDOT1	ENERGY	T/2	MASS	INDEX	N
1	.994238697	1.949878642	.970000861	-1.167509444	-1.475888815	4.441199279	.012155092	4202.38300	1
2	.996178016	1.705512010	.967407274	-1.087201245	-1.480131254	4.189641564	.012155092	3751.12735	1
3	.996184945	1.704793189	.967398230	-1.086946875	-1.480145260	4.188793696	.012155092	3749.87456	1
4	.996184967	1.704790908	.967398201	-1.086946068	-1.480145305	4.188791004	.012155092	3749.87041	1
5	.997268096	1.602217024	.966001008	-1.049455596	-1.482258181	4.060375863	.012155092	3574.91875	1
6	.998469762	1.506984786	.964485957	-1.012419308	-1.484453266	3.926991882	.012155092	3417.47835	1
7	.998470105	1.506959883	.964485529	-1.012409328	-1.484453874	3.926955103	.012155092	3417.43739	1
8	.998471104	1.506887358	.964484284	-1.012380264	-1.484455644	3.926847987	.012155092	3417.31836	1
9	.998559609	1.500501532	.964374031	-1.009815906	-1.484612141	3.917382312	.012155092	3406.83965	1
10	1.002178982	1.291111081	.960000723	-.919685199	-1.490568473	3.567891813	.012155092	3050.89288	1
11	1.007471696	1.093020507	.953999426	-.822616137	-1.498293921	3.164373933	.012155092	2622.97464	1
12	1.007796898	1.083347897	.953643715	-.817558164	-1.498743990	3.142897950	.012155092	2597.63538	1
13	1.007816806	1.082762898	.953621985	-.817251273	-1.498771468	3.141594066	.012155092	2596.08577	1
14	1.007816821	1.082762457	.953621968	-.817251042	-1.498771489	3.141593084	.012155092	2596.07753	1
15	1.007817388	1.082745808	.953621350	-.817242306	-1.498772271	3.141555966	.012155092	2596.03701	1
16	1.008160293	1.072795355	.953247871	-.812004991	-1.499244256	3.119290481	.012155092	2569.37789	1
17	1.011199996	.993658987	.950001779	-.769175867	-1.503331157	2.936590644	.012155092	2335.91112	1
18	1.020175800	.822897466	.941016933	-.669382194	-1.514665539	2.513274983	.012155092	1689.89344	1
19	1.020175815	.822897234	.941016918	-.669382051	-1.514665557	2.513274384	.012155092	1689.89179	1
20	1.020175993	.822894475	.941016748	-.669380355	-1.514665774	2.513267282	.012155092	1689.87713	1
21	1.020296797	.821026632	.940901328	-.668231516	-1.514812830	2.508456642	.012155092	1681.77689	1
22	1.021245010	.806657967	.940000088	-.659351945	-1.515963131	2.471339344	.012155092	1617.34025	1
23	1.024374666	.762539607	.937083368	-.631623462	-1.519714265	2.356194734	.012155092	1418.27130	1
24	1.032612792	.664582160	.929806921	-.567580994	-1.529339688	2.094271122	.012155092	957.26446	1
25	1.035000001	.639774717	.927802699	-.550838866	-1.532085695	2.026345818	.012155092	841.01954	1
26	1.035035601	.639414261	.927773161	-.550594116	-1.532126563	2.025352864	.012155092	839.34478	1
27	1.040225301	.589389615	.923578743	-.516237288	-1.538075181	1.885456680	.012155092	613.51335	1
28	1.040244300	.589214637	.923563801	-.516115821	-1.538096973	1.884958713	.012155092	612.75296	1
29	1.040244413	.589213601	.923563713	-.516115102	-1.538097102	1.884955763	.012155092	612.74845	1
30	1.040244598	.589211894	.923563567	-.516113917	-1.538097315	1.884950905	.012155092	612.74104	1
31	1.044898989	.547750142	.919999490	-.487110925	-1.543463307	1.764578371	.012155092	440.83883	1
32	1.049999998	.504693398	.916338560	-.456629402	-1.549491273	1.632342054	.012155092	284.77988	1
33	1.051601798	.491468558	.915252468	-.447228570	-1.551447859	1.589464723	.012155092	242.59592	1
34	1.052273796	.485938576	.914807540	-.443297029	-1.552282544	1.571115523	.012155092	225.85187	1
35	1.052284793	.485848126	.914800315	-.443232730	-1.552296281	1.570813133	.012155092	225.58251	1
36	1.052285400	.485843135	.914799917	-.443229182	-1.552297039	1.570796444	.012155092	225.56765	1
37	1.061093998	.410086745	.909999814	-.390355169	-1.565241199	1.273155003	.012155092	55.54035	1
38	1.061320287	.407819424	.909930290	-.388855965	-1.565703474	1.261846392	.012155092	52.23440	1
39	1.061420886	.406795309	.909901610	-.388182480	-1.565914957	1.256654649	.012155092	50.77507	1
40	1.061421223	.406791864	.909901516	-.388180218	-1.565915671	1.256637095	.012155092	50.77019	1
41	1.063368988	.381987367	.909999660	-.373065366	-1.571840624	1.107093661	.012155092	21.68517	1
42	1.063598495	.375095620	.910523494	-.369718925	-1.574009958	1.051126345	.012155092	15.61320	1
43	1.063604027	.374664450	.910570398	-.369536640	-1.574161039	1.047228008	.012155092	15.25937	1
44	1.063604038	.374663473	.910570506	-.369536232	-1.574161384	1.047219112	.012155092	15.25858	1
45	1.063604049	.374662559	.910570608	-.369535850	-1.574161707	1.047210782	.012155092	15.25783	1
46	1.063604063	.374661280	.910570750	-.369535315	-1.574162159	1.047199129	.012155092	15.25678	1
47	1.063604065	.374661111	.910570769	-.369535245	-1.574162218	1.047197594	.012155092	15.25664	1
48	1.063604076	.374660131	.910570878	-.369534836	-1.574162564	1.047188668	.012155092	15.25584	1
49	1.063485991	.368222097	.911599019	-.367497555	-1.576779608	.980066023	.012155092	10.29739	1
50	1.061191986	.358403004	.917195842	-.376071777	-1.584898675	.788265048	.012155092	3.63687	1
51	1.061147192	.358298332	.917314274	-.376423769	-1.585028329	.785521238	.012155092	3.58921	1
52	1.061146985	.358297841	.917314826	-.376425424	-1.585028931	.785508527	.012155092	3.58899	1
53	1.061146285	.358296182	.917316695	-.376431023	-1.585030966	.785465537	.012155092	3.58825	1
54	1.061145207	.358293627	.917319572	-.376439647	-1.585034101	.785399361	.012155092	3.58711	1
55	1.061145188	.358293581	.917319624	-.376439802	-1.585034157	.785398169	.012155092	3.58709	1

Table 10 (contd)

	X0	YDOT0	X1	YDOT1	ENERGY	T/2	MASS	INDEX	N
56	1.060722790	.357050087	.918595920	-.380589261	-1.586354264	.758152700	.012155092	3.15811	1
57	1.060427985	.355209686	.919986696	-.385858291	-1.587627520	.733090504	.012155092	2.82517	1
58	1.060403784	.354889077	.920182852	-.386666127	-1.587792384	.729935968	.012155098	2.78683	1
59	1.060383859	.354539615	.920385113	-.387516036	-1.587958341	.726781438	.012155098	2.74920	1
60	1.060368820	.354157516	.920594052	-.388412332	-1.588125451	.723626909	.012155098	2.71225	1
61	1.060359375	.353738307	.920810359	-.389359983	-1.588293755	.720472379	.012155098	2.67594	1
62	1.060356358	.353276723	.921034847	-.390364840	-1.588463296	.717317849	.012155098	2.64025	1
63	1.060360757	.352766518	.921268481	-.391433873	-1.588634126	.714163320	.012155098	2.60512	1
64	1.060373764	.352200205	.921512423	-.392575459	-1.588806304	.711008790	.012155098	2.57051	1
65	1.060396827	.351568700	.921768082	-.393799801	-1.588979899	.707854261	.012155098	2.53638	1
66	1.060431729	.350860830	.922037199	-.395119496	-1.589154995	.704699731	.012155098	2.50266	1
67	1.060480710	.350062632	.922321955	-.396550357	-1.589331697	.701545202	.012155098	2.46927	1
68	1.060546630	.349156316	.922625136	-.398112632	-1.589510135	.698390672	.012155098	2.43612	1
69	1.060633233	.348118677	.922950391	-.399832869	-1.589690482	.695236142	.012155098	2.40310	1
70	1.060745564	.346918560	.923302637	-.401746920	-1.589872969	.692081613	.012155098	2.37003	1
71	1.060890684	.345512550	.923688752	-.403905058	-1.590057926	.688927083	.012155098	2.33670	1
72	1.061078968	.343837121	.924118847	-.406381348	-1.590245843	.685772554	.012155098	2.30279	1
73	1.061326736	.341792796	.924608829	-.409292612	-1.590437513	.682618024	.012155098	2.26777	1
74	1.061662383	.339207376	.925186372	-.412842661	-1.590634352	.679463494	.012155098	2.23072	1
75	1.062144215	.335729089	.925908316	-.417451326	-1.590839373	.676308965	.012155098	2.18972	1
76	1.065912078	.312247394	.930002868	-.446633567	-1.591346595	.671102106	.012155092	2.01984	1
77	1.066875334	.306776952	.930863931	-.453333303	-1.591351288	.672070880	.012155098	1.99039	1
78	1.068189875	.299531244	.931979169	-.462267959	-1.591320817	.674141760	.012155098	1.95303	1
79	1.069204189	.294091709	.932802485	-.469045058	-1.591275540	.676212641	.012155098	1.92551	1
80	1.070081920	.289480325	.933493446	-.474849535	-1.591224463	.678283521	.012155098	1.90219	1
81	1.070875868	.285380206	.934103532	-.480062719	-1.591170397	.680354402	.012155098	1.88129	1
82	1.071611170	.281639870	.934657245	-.484865677	-1.591114633	.682425282	.012155098	1.86199	1
83	1.072302160	.278172570	.935168554	-.489361395	-1.591057881	.684496162	.012155098	1.84383	1
84	1.072957946	.274922953	.935646335	-.493615131	-1.591000576	.686567043	.012155098	1.82652	1
85	1.073584753	.271853029	.936096651	-.497671362	-1.590943000	.688637923	.012155098	1.80987	1
86	1.074187064	.268935315	.936523869	-.501562036	-1.590885348	.690708803	.012155098	1.79374	1
87	1.074768242	.266149118	.936931263	-.505311042	-1.590827759	.692779684	.012155098	1.77804	1
88	1.075330889	.263478361	.937321365	-.508936809	-1.590770334	.694850564	.012155098	1.76268	1
89	1.075877067	.260910233	.937696182	-.512453921	-1.590713150	.696921445	.012155098	1.74763	1
90	1.076408451	.258434312	.938057343	-.515874164	-1.590656263	.698992325	.012155098	1.73282	1
91	1.076926419	.256041968	.938406189	-.519207229	-1.590599719	.701063205	.012155098	1.71822	1
92	1.077432127	.253725949	.938743842	-.522461208	-1.590543551	.703134086	.012155098	1.70381	1
93	1.077926554	.251480083	.939071255	-.525642944	-1.590487787	.705204966	.012155098	1.68955	1
94	1.078410541	.249299060	.939389242	-.528758290	-1.590432446	.707275847	.012155098	1.67543	1
95	1.078884814	.247178263	.939698509	-.531812299	-1.590377545	.709346727	.012155098	1.66143	1
96	1.079350003	.245113590	.939999691	-.534809319	-1.590323071	.711417614	.012155092	1.64754	1
97	1.092405902	.192741351	.947755273	-.620865517	-1.588682140	.785388417	.012155092	1.17643	1
98	1.092406288	.192739945	.947755487	-.620868154	-1.588682091	.785391076	.012155092	1.17641	1
99	1.092406690	.192738480	.947755709	-.620870903	-1.588682039	.785393848	.012155092	1.17640	1
100	1.092407288	.192736306	.947756039	-.620874981	-1.588681963	.785397961	.012155092	1.17637	1
101	1.092407316	.192736203	.947756055	-.620875172	-1.588681960	.785398154	.012155092	1.17637	1
102	1.092407599	.192735172	.947756212	-.620877108	-1.588681924	.785400106	.012155092	1.17636	1
103	1.092413800	.192712598	.947759640	-.620919453	-1.588681134	.785442813	.012155092	1.17609	1
104	1.092929886	.190840703	.948044278	-.624450879	-1.588615503	.789024643	.012155092	1.15377	1
105	1.096509083	.178227469	.949984726	-.649367009	-1.588165479	.815404475	.012155092	.99042	1
106	1.101083395	.163003311	.952394225	-.682558596	-1.587609371	.853400140	.012155092	.75920	1
107	1.103408289	.155632632	.953596891	-.700180294	-1.587337479	.874796628	.012155092	.63177	1
108	1.105475288	.149280731	.954658279	-.716382100	-1.587102798	.895155384	.012155092	.51273	1
109	1.109999785	.136026494	.956973987	-.754104060	-1.586614410	.944804563	.012155092	.23221	1

Table 10 (contd)

	X0	YDOTO	X1	YDOT1	ENERGY	T/2	MASS	INDEX	N
110	1.115802981	.120347283	.959999971	-.809229756	-1.586040772	1.021613627	.012155092	-.18015	1
111	1.117187582	.116839372	.960747630	-.824059200	-1.585912070	1.042808114	.012155092	-.29315	1
112	1.117463492	.116151950	.960898508	-.827117024	-1.585886745	1.047193333	.012155092	-.31674	1
113	1.117463750	.116151309	.960898650	-.827119901	-1.585886722	1.047197460	.012155092	-.31677	1
114	1.117466488	.116144508	.960900150	-.827150425	-1.585886471	1.047241255	.012155092	-.31700	1
115	1.124999992	.099254928	.965497009	-.932966289	-1.585208196	1.197203382	.012155092	-1.35130	1
116	1.125594577	.098137635	.965931986	-.944497229	-1.585151041	1.212800919	.012155092	-1.51455	1
117	1.125685072	.097971870	.965999881	-.946325418	-1.585142174	1.215251951	.012155092	-1.54187	1
118	1.125836081	.097698008	.966114241	-.949422821	-1.585127291	1.219390159	.012155098	-1.58910	1
119	1.125984829	.097431623	.966228293	-.952533861	-1.585112457	1.223528319	.012155098	-1.63777	1
120	1.126131344	.097172695	.966342042	-.955659190	-1.585097690	1.227666479	.012155098	-1.68793	1
121	1.126275637	.096921192	.966455502	-.958799308	-1.585082985	1.231804639	.012155098	-1.73965	1
122	1.126417718	.096677084	.966568685	-.961954726	-1.585068335	1.235942799	.012155098	-1.79299	1
123	1.126557598	.096440344	.966681607	-.965125964	-1.585053735	1.240080959	.012155098	-1.84801	1
124	1.126695287	.096210945	.966794280	-.968313553	-1.585039178	1.244219119	.012155098	-1.90478	1
125	1.126830792	.095988864	.966906717	-.971518034	-1.585024658	1.248357279	.012155098	-1.96337	1
126	1.126964123	.095774079	.967018932	-.974739959	-1.585010170	1.252495439	.012155098	-2.02385	1
127	1.127095272	.095566554	.967130948	-.977979784	-1.584995683	1.256633623	.012155092	-2.08628	1
128	1.127095370	.095566401	.967131033	-.977982230	-1.584995672	1.256636738	.012155092	-2.08633	1
129	1.127095382	.095566382	.967131043	-.977982533	-1.584995671	1.256637125	.012155092	-2.08634	1
130	1.127121975	.095524787	.967153955	-.978648273	-1.584992712	1.257484524	.012155092	-2.09937	1
131	1.129753981	.092715903	.970000224	-1.070321229	-1.584609933	1.363797410	.012155092	-4.67456	1
132	1.125000000	.137863215	.981907108	-1.970916695	-1.580630831	1.724527096	.012155092	-70.69575	1
133	1.124932393	.138228974	.981950440	-1.978552662	-1.580599640	1.725521335	.012155092	-71.18573	1
134	1.119999990	.163996944	.984469972	-2.645409553	-1.578263442	1.882545986	.012155092	-104.05051	1
135	1.105183497	.237328877	.987710355	-13.434522769	-1.570247928	1.884955534	.012155092	-175.98761	1
136	1.105183199	.237330334	.987710375	-13.435523424	-1.570247752	1.884957236	.012155092	-175.98862	1
137	1.105183154	.237330554	.987710378	-13.435674541	-1.570247726	1.884957493	.012155092	-175.98853	1
138	1.105183110	.237330769	.987710381	-13.435822305	-1.570247700	1.884957744	.012155092	-175.98882	1
139	1.105183080	.237330916	.987710383	-13.435923057	-1.570247682	1.884957916	.012155092	-175.98927	1
140	1.105182976	.237331424	.987710390	-13.436272334	-1.570247620	1.884958510	.012155092	-175.98950	1
141	1.105182797	.237332299	.987710402	-13.436873535	-1.570247514	1.884959532	.012155092	-175.99013	1
142	1.105182573	.237333395	.987710417	-13.437625953	-1.570247382	1.884960811	.012155092	-175.99118	1
143	1.105182320	.237334632	.987710434	-13.438475880	-1.570247232	1.884962256	.012155092	-175.99221	1
144	1.105182052	.237335942	.987710452	-13.439376312	-1.570247074	1.884963786	.012155092	-175.99307	1
145	1.105174690	.237371938	.987710946	-13.464157826	-1.570242719	1.885005826	.012155092	-176.02044	1
146	1.104758099	.239408852	.987737377	-15.029646891	-1.569995724	1.887379463	.012155092	-177.56722	1
147	1.089999989	.312218300	.986918310	5.105523052	-1.560581378	1.970178585	.012155092	-219.94512	2
148	1.079999998	.363413512	.984625531	2.719496204	-1.553554951	2.031893943	.012155092	-238.26607	2
149	1.071371391	.409886091	.981611314	1.938361397	-1.547133132	2.093575086	.012155092	-249.78331	2
150	1.071265578	.410473478	.981568512	1.931531169	-1.547052466	2.094395051	.012155092	-249.90731	2
151	1.071265563	.410473561	.981568506	1.931530204	-1.547052455	2.094395168	.012155092	-249.90714	2
152	1.071265385	.410474550	.981568434	1.931518754	-1.547052319	2.094396548	.012155092	-249.90708	2
153	1.071264595	.410478937	.981568114	1.931467938	-1.547051717	2.094402677	.012155092	-249.90802	2
154	1.069999993	.417536821	.981045646	1.853351956	-1.546084177	2.104338166	.012155092	-251.35686	2
155	1.059999987	.476252161	.976201605	1.401220339	-1.538213648	2.193121790	.012155092	-261.53481	2
156	1.049999997	.542007217	.970061220	1.122295510	-1.529963079	2.305716298	.012155092	-270.96056	2
157	1.047364503	.560951506	.968217139	1.065739503	-1.527724632	2.340639234	.012155092	-273.59147	2
158	1.046249896	.569211280	.967407768	1.043435893	-1.526769626	2.356194594	.012155092	-274.74666	2
159	1.046249598	.569213509	.967407549	1.043430050	-1.526769370	2.356198819	.012155092	-274.74648	2
160	1.046197593	.569602708	.967369352	1.042411332	-1.526724689	2.356936606	.012155092	-274.80090	2
161	1.039999995	.618733487	.962532843	.933406750	-1.521318792	2.453371376	.012155092	-281.84607	2
162	1.036666766	.647808578	.959688648	.883545627	-1.518340747	2.513266174	.012155092	-286.22060	2
163	1.036666349	.647812352	.959688281	.883539721	-1.518340371	2.513274071	.012155092	-286.22097	2
164	1.034999996	.663189436	.958199243	.860556663	-1.516831457	2.545700674	.012155092	-288.60573	2

Table 10 (contd)

	X0	YDOTO	X1	YDOT1	ENERGY	T/2	MASS	INDEX	N
165	1.029999986	.713391426	.953447579	.798402881	-1.512215305	2.654655318	.012155092	-296.71742	2
166	1.019999996	.839992066	.942520024	.699431400	-1.502491485	2.943211987	.012155092	-318.79659	2
167	1.015275204	.919133347	.936585055	.662349596	-1.497586820	3.127151281	.012155092	-333.06685	2
168	1.014943883	.925363157	.936147414	.659955500	-1.497233032	3.141593190	.012155092	-334.18936	2
169	1.014943401	.925372287	.936146776	.659952039	-1.497232517	3.141614348	.012155092	-334.19173	2
170	1.014941603	.925406384	.936144392	.659939115	-1.497230592	3.141693355	.012155092	-334.19731	2
171	1.009999990	1.032822555	.929235795	.627246768	-1.491759029	3.387306365	.012155092	-353.43275	2
172	1.004790291	1.189999135	.921000527	.598535337	-1.485447195	3.726379584	.012155092	-381.30245	2
173	1.002322659	1.291114601	.916609640	.586816250	-1.482154601	3.926991383	.012155092	-399.54410	2
174	1.002319038	1.291281043	.916602881	.586799864	-1.482149573	3.927309129	.012155092	-399.57411	2
175	1.000122085	1.405046044	.912279618	.577254109	-1.478964888	4.134659181	.012155092	-420.84437	2
176	1.000000000	1.412234261	.912024185	.576745239	-1.478778952	4.147100359	.012155092	-422.22002	2
177	.999599189	1.436597408	.911172024	.575088935	-1.478160758	4.188688052	.012155092	-426.91142	2
178	.999598213	1.436658216	.911169923	.575084928	-1.478159238	4.188790735	.012155092	-426.92325	2
179	.999598205	1.436658714	.911169905	.575084895	-1.478159225	4.188791577	.012155092	-426.92328	2
180	.999598049	1.436668434	.911169570	.575084255	-1.478158982	4.188807990	.012155092	-426.92516	2
181	.999597706	1.436689806	.911168831	.575082847	-1.478158448	4.188844078	.012155092	-426.92928	2
182	.999590464	1.437141268	.911153233	.575053118	-1.478147164	4.189606240	.012155092	-427.01664	2
183	.999508001	1.442310922	.910975108	.574715089	-1.478018387	4.198311948	.012155092	-428.01803	2
184	.992284313	2.345680711	.886488496	.546691863	-1.462681422	5.231335272	.012155098	-606.51057	2
185	.992260955	2.351878690	.886341132	.546602884	-1.462605621	5.235988821	.012155098	-607.55695	2
186	.991394095	2.623366866	.880000657	.543429206	-1.459508738	5.419987192	.012155092	-648.92364	2
187	.989795096	3.537563759	.859997496	.540660197	-1.451367589	5.849984210	.012155092	-727.43847	2
188	.989016339	4.562294649	.839999096	.546769535	-1.444768027	6.153343371	.012155092	-745.23936	2
189	.988768816	5.136170433	.829994282	.552546054	-1.441799833	6.279813484	.012155092	-742.06109	2
190	.988763787	5.150183289	.829760908	.552700208	-1.441732444	6.282620113	.012155092	-741.93323	2
191	.988763414	5.151227201	.829743543	.552711712	-1.441727432	6.282828711	.012155092	-741.92408	2
192	.988763258	5.151663986	.829736279	.552716527	-1.441725336	6.282915971	.012155092	-741.91961	2
193	.988763146	5.151977643	.829731062	.552719984	-1.441723830	6.282978626	.012155092	-741.91718	2
194	.988762937	5.152563104	.829721326	.552726439	-1.441721021	6.283095558	.012155092	-741.91135	2
195	.988762900	5.152666771	.829719602	.552727582	-1.441720524	6.283116261	.012155092	-741.91083	2
196	.988762848	5.152812476	.829717179	.552729188	-1.441719824	6.283145358	.012155092	-741.90905	2
197	.988762766	5.153042266	.829713358	.552731722	-1.441718722	6.283191244	.012155092	-741.90693	2
198	.988762349	5.154211311	.829693920	.552744614	-1.441713114	6.283424636	.012155092	-741.89616	2
199	.988762170	5.154713376	.829685574	.552750152	-1.441710706	6.283524844	.012155092	-741.89154	2
200	.988607600	5.652146306	.821741625	.558503901	-1.439457284	6.375721323	.012155092	-736.56565	2
201	.988577254	5.767884649	.819985545	.559902182	-1.438968207	6.395315159	.012155092	-735.19641	2
202	.988303997	7.282679939	.799993915	.578779150	-1.433543075	6.602420308	.012155092	-717.72070	2

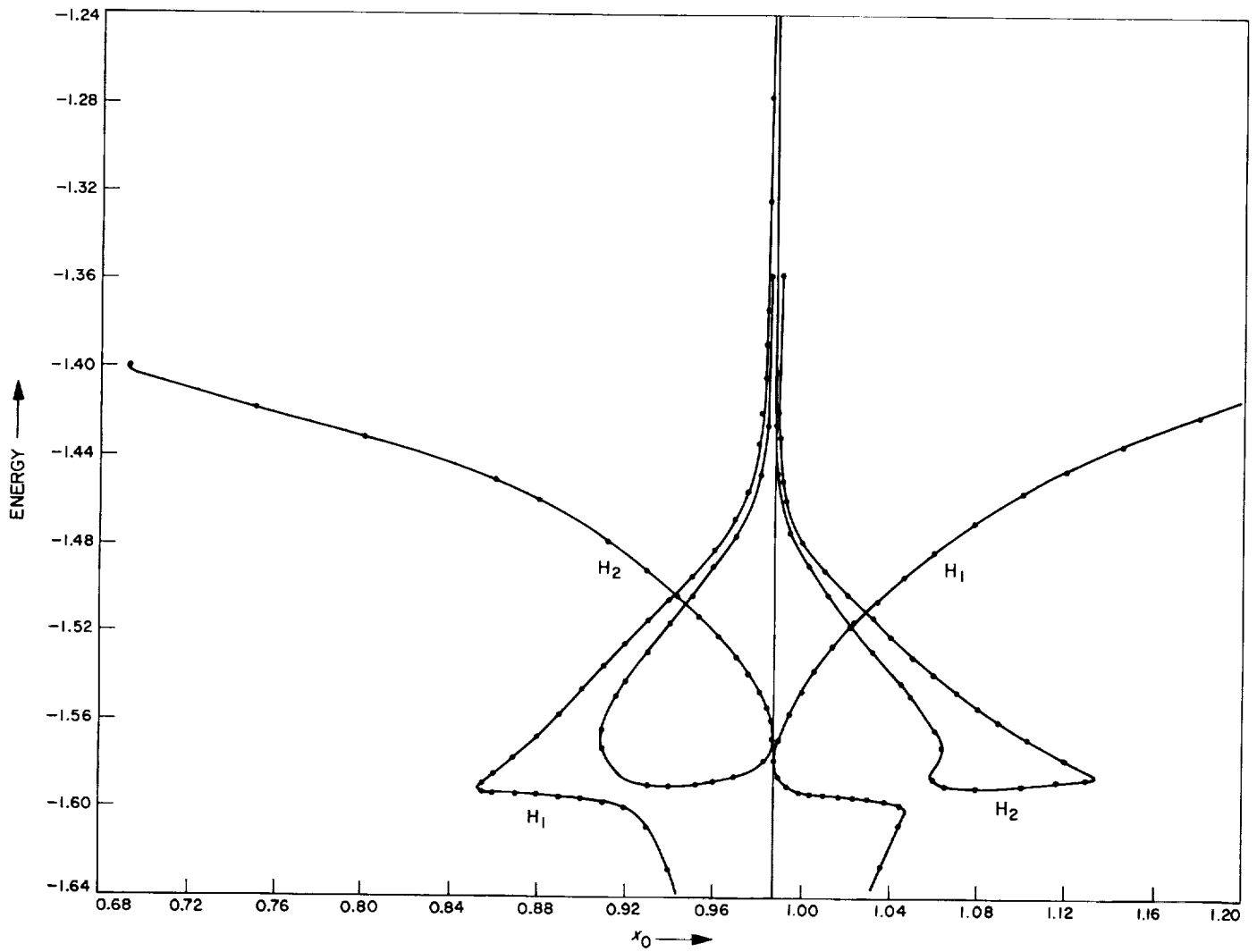

Fig. 35. Energy diagrams of families H_1 and H_2

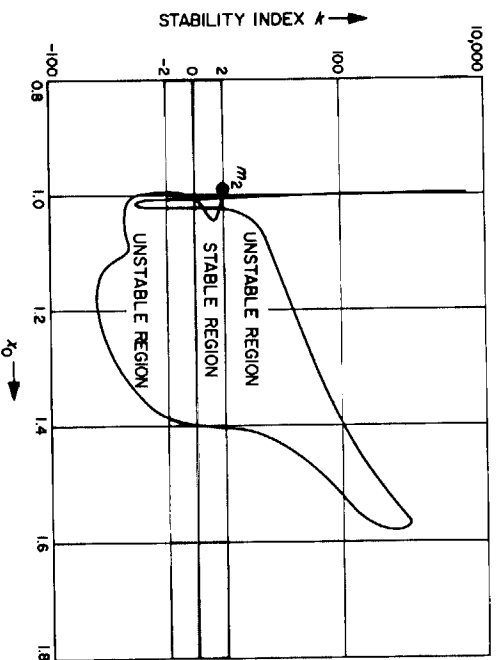

Fig. 36. Stability evolution of family H_1 .

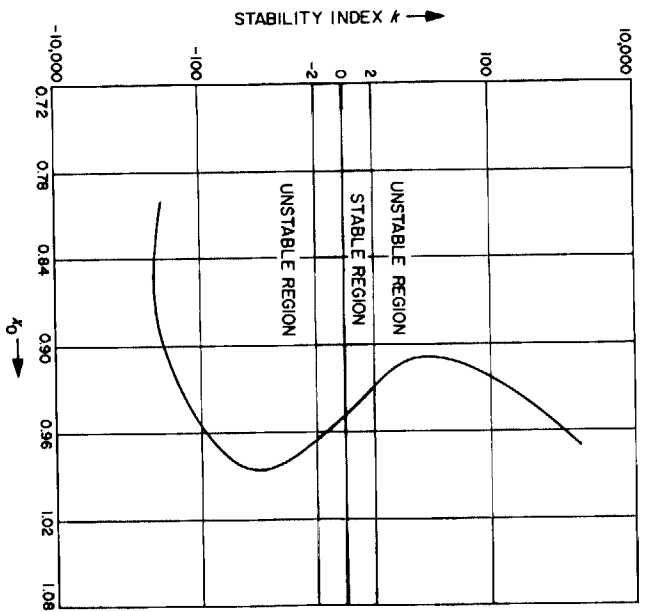

Fig. 37. Stability evolution of family H_2 .

References

1. Stromgren, E., "Connaissance Actuelle des Orbites dans le Problème des Trois Corps," *Publications and Minor Communications of Copenhagen Observatory*, Publication 100. Copenhagen University, Astronomical Observatory, Denmark, 1935.
2. Moulton, F. R., "Periodic Orbits," *Carnegie Institute of Washington Publications*, No. 161, 1920.
3. Darwin, G. H., "Periodic Orbits," *Scientific Papers*, Vol. 4, Cambridge University Press, Cambridge, Mass., 1911.
4. Poincaré, H., *Les Méthodes Nouvelles de la Mécanique Céleste*, Vol. 1. Gauthier-Villars, Paris, France, 1899. Also available from Dover Publications (Vols. 1-3), N. Y. 1957.
5. Wintner, A., *The Analytical Foundations of Celestial Mechanics*. Princeton University Press, Princeton, N. J., 1941.
6. Barrar, R. B., "Existence of Periodic Orbits of the Second Kind in the Restricted Problem of Three Bodies," *Astron. J.*, Vol. 70, pp. 3-4, Feb. 1965.
7. Arenstorf, R. F., "Periodic Solutions of the Restricted Three-Body Problem Representing Analytic Continuations of Keplerian Elliptic Motions," *Am. J. Math.*, Vol. 85, No. 1, pp. 27-35, Jan. 1963.
8. Steffensen, J. F., "On the Restricted Problem of Three Bodies," *Mat. Fys. Medd. Dan. Vidensk. Selsk.*, Vol. 30, No. 18, 17 pages, 1956.
9. Broucke, R. A., *Recherches d'Orbites Periodiques dans le Problème Restreint Plan (Système Terre-Lune)*, Doctoral Dissertation. University of Louvain, Belgium, February 1963.
10. Wintner, A., "Upon the Characteristic Exponents in the Stromgrenian Groups of Periodic Orbits," *Publications and Minor Communications of Copenhagen Observatory*, Publication 78, Note 2. Copenhagen University, Astronomical Observatory, Denmark, 1931. Also in *Am. J. Math.*, Vol. 53, No. 3, pp. 611-616, 1931.
11. Deprit, A., and Henrard, J., "Natural Families of Periodic Orbits," *Astron. J.*, Vol. 72, No. 2, pp. 158-172, Mar. 1967.
12. Rabe, E., "Periodic Librations About the Triangular Solutions of the Restricted Earth-Moon Problem and Their Orbital Stabilities," *Astron. J.*, Vol. 67, No. 10, pp. 732-739, Dec. 1962.
13. Deprit, A., and Price, J. F., "The Computation of Characteristic Exponents in the Planar Restricted Problem of Three Bodies," *Astron. J.*, Vol. 70, No. 10, pp. 836-846, Dec. 1965.
14. Szebehely, V., "Solution of the Restricted Problem of Three Bodies by Power Series," *Astron. J.*, Vol. 71, No. 10, pp. 968-975, Dec. 1966.
15. Henon, M., "Exploration Numérique du Problème des Trois Corps, (I) Masses Egales, Orbites Périodiques," *Ann. Astrophys.*, Vol. 28, No. 3, pp. 499-511, 1965.

References (contd)

16. Henon, M., "Exploration Numérique du Problème des Trois Corps, (II) Masses Inegales, Orbites Périodiques," *Ann. Astrophys.*, Vol. 28, No. 6, pp. 992-1007, 1965.
17. Henon, M., "Exploration Numérique du Problème des Trois Corps, (III) Masses Egales, Orbites Non Périodiques," *Bull. Astron.*, Vol. 1, No. 1, pp. 57-80, 1966.
18. Henon, M., "Exploration Numérique du Problème des Trois Corps, (IV) Masses Egales, Orbites Non Périodiques," *Bull. Astron.*, Vol. 1, No. 2, pp. 49-66, 1966.
19. Bartlett, J. H., "The Restricted Problem of Three Bodies (1)," *Kong. Dan. Vidensk. Selsk., Mat.-Fys. Skr.*, Vol. 2, No. 7, 1964.
20. Bartlett, J. H., and Wagner, C. A., "The Restricted Problem of Three Bodies (II)," *Kong. Dan. Vidensk. Selsk., Mat.-Fys. Skr.*, Vol. 3, No. 1, 1965.