



**N6912289**

---

---

# **APOLLO LUNAR SURFACE DRILL (ALSD) FINAL REPORT**

**MARTIN CO.  
BALTIMORE, MD**

**01 NOV 1968**

---

NASA CR 92412

N6912289



FINAL REPORT  
FOR  
APOLLO LUNAR SURFACE DRILL (ALSD)

DPR-6-1

MARTIN MARIETTA ENGINEERING REPORT NO. ER 14778

NOVEMBER 1, 1968

CONTRACT NO. NAS9-6587

Approved by NASA per paragraph 1.1  
of Exhibit C of Contract NAS9-6587

MARTIN MARIETTA CORPORATION  
P. O. BOX 988  
BALTIMORE, MARYLAND 21203

## GENERAL DISCLAIMER

This document may have problems that one or more of the following disclaimer statements refer to:

- This document has been reproduced from the best copy furnished by the sponsoring agency. It is being released in the interest of making available as much information as possible.
- This document may contain data which exceeds the sheet parameters. It was furnished in this condition by the sponsoring agency and is the best copy available.
- This document may contain tone-on-tone or color graphs, charts and/or pictures which have been reproduced in black and white.
- The document is paginated as submitted by the original source.
- Portions of this document are not fully legible due to the historical nature of some of the material. However, it is the best reproduction available from the original submission.

ER 14778

FINAL REPORT  
FOR  
APOLLO LUNAR SURFACE DRILL (ALSD)

Prepared by: D. S. Crouch  
D. S. Crouch  
ALSD Program Manager  
Martin Marietta Corporation  
(Denver Division)

9 October 1968  
Date

Approved by: G. W. Smith  
G. W. Smith, Manager  
Systems Research Department  
Martin Marietta Corporation  
(Denver Division)

10 October 1968  
Date



ER 14778

FOREWORD

This document is prepared and submitted in accordance with the requirements of Contract NAS9-6587, Article XI.B of the contract schedule.

This document presents a summary of the Apollo Lunar Surface Drill Program, including the evolution of the final design configuration, results of the development and qualification tests which influenced design changes, and recommendations for future improvements to the drill system. Detail design drawings, thermal analyses, informal development test reports, formal test procedures, and formal qualification test reports which are referenced herein have been previously forwarded to NASA in accordance with applicable program schedules, and are not included with this report.

## TABLE OF CONTENTS

	<u>Page No.</u>
Foreword. . . . .	ii
Table of Contents . . . . .	iii
List of Illustrations . . . . .	v
List of Tables. . . . .	vii
Glossary of Terms . . . . .	viii
 I. SUMMARY	
1.0 General Program Information. . . . .	I-1
2.0 General System Requirements. . . . .	I-2
3.0 General System Description . . . . .	I-3
 II. ALSD CONFIGURATION DEVELOPMENT	
1.0 Phase C Design Approach. . . . .	II-1
2.0 Phase D Baseline Mockup. . . . .	II-9
3.0 Development Model. . . . .	II-13
4.0 Development Model (First Modification) . . . . .	II-22
5.0 Development Model (Second Modification). . . . .	II-26
6.0 Final ALSD Configuration . . . . .	II-31
 III. DEVELOPMENT TEST PROGRAM	
1.0 Introduction . . . . .	III-1
2.0 Core Bit Optimization. . . . .	III-2
3.0 Core Bit Extension Tube Optimization . . . . .	III-11
4.0 Hole Casing Sleeve Optimization. . . . .	III-15
5.0 Power Head Electromagnetic Interference. . . . .	III-25
6.0 Power Head High Temperature Operating Charac- teristics. . . . .	III-27
7.0 Power Head Pressurization System Operation in a Vacuum . . . . .	III-33
8.0 Power Head Magnetic Field Radiation Measurements	III-35
9.0 Battery Performance Characteristics. . . . .	III-36
10.0 Drill String Operational Temperature Rise. . . . .	III-43
11.0 Power Head Vacuum Rock Drilling Test . . . . .	III-46
12.0 Three-Meter Drilling Tests . . . . .	III-49
13.0 Spacesuited Subject Operability. . . . .	III-55
14.0 Battery Pre-Qualification Tests. . . . .	III-61

TABLE OF CONTENTS CONTINUED---

	<u>Page No.</u>
IV. QUALIFICATION TEST PROGRAM	
1.0 Introduction . . . . .	IV-1
2.0 Sinusoidal and Random Vibration . . . . .	IV-2
3.0 Acceleration . . . . .	IV-6
4.0 Shock . . . . .	IV-8
5.0 Electromagnetic Interference . . . . .	IV-10
6.0 Thermal Vacuum . . . . .	IV-12
7.0 Auxiliary Power Head Vacuum Test . . . . .	IV-19
8.0 Auxiliary Power Head Thermal Vacuum Test . . . . .	IV-20
9.0 Battery Electrolyte Leakage Elimination . . . . .	IV-22
10.0 Drilling and Casing . . . . .	IV-23
V. CONCLUSIONS AND RECOMMENDATIONS	
1.0 Conclusions . . . . .	V-1
2.0 Recommendations . . . . .	V-4
APPENDIX A - REFERENCES . . . . .	A-1

## LIST OF ILLUSTRATIONS

<u>Figure No.</u>		<u>Page No.</u>
I-1	ALSD Assembly, Stowage and Lunar Operation Sequence. . . . .	I-4
I-2	ALSD Shipping Container . . . . .	I-5
I-3	ALSD/ALSEP Spacecraft Stowage Mode. . . . .	I-6
I-4	ALSD Lunar Surface Deployed Mode. . . . .	I-7
I-5	ALSD Pressurization Unit. . . . .	I-9
I-6	ALSD Battery Charging Unit. . . . .	I-10
II-1	ALSD Phase C Mockup . . . . .	II-2
II-2	ALSD Phase C Mockup Transport Mode. . . . .	II-3
II-3	ALSD Phase C Mockup Operational Mode. . . . .	II-4
II-4	ALSD Stowage Mode (Mockup). . . . .	II-10
II-5	ALSD Accessory Group Subsystem Components (Mockup). . . . .	II-11
II-6	ALSD Operational Configuration (Mockup) . . . . .	II-12
II-7	Development Model ALSD with Carrying Case . . . . .	II-14
II-8	Development Model Power Head and Battery Assembly . . . . .	II-15
II-9	Development Model Treadle Assembly. . . . .	II-16
II-10	Miscellaneous Development Model Components. . . . .	II-17
II-11	Development Model ALSD - Operational Mode . . . . .	II-18
II-12	Development Model ALSD (First Modification Components) . . . . .	II-23
II-13	Development Model ALSD (First Modification Operational Mode) . . . . .	II-24
II-14	Development Model ALSD (Second Modification Components) . . . . .	II-27
II-15	Development Model ALSD (Second Modification Operational Mode) . . . . .	II-28
III-1	Volume - Energy Relation for 60° and 90° Wedge Bits in Drop Tests on NASA Standard Basalt Sample. . . . .	III-3
III-2	Core Bit and Extension Tube Optimization Tests. . . . .	III-5
III-3	Typical Core Bit Test Specimens . . . . .	III-6
III-4	ALSD Performance Characteristics in NASA Standard High Density Basalt . . . . .	III-8
III-5	ALSD Performance Characteristics in NASA Standard 43% Vesicular Basalt. . . . .	III-9
III-6	Typical Core Bit Extension Tube Test Specimens. . . . .	III-14
III-7	Internal Split Tube Casing Tests. . . . .	III-16
III-8	Concurrent Drilling/Casing Tests. . . . .	III-17
III-9	Hole Casing Tip Configurations. . . . .	III-19
III-10	Final ALSD Casing and Adapter Configuration . . . . .	III-23

## LIST OF ILLUSTRATIONS CONTINUED---

<u>Figure No.</u>		<u>Page No.</u>
III-11	Casing-to-Power Head Adapter Configurations. . . .	III-24
III-12	Class I Radiated EMI of ALSD Power Head (EMI Model) . . . . .	III-26
III-13	ALSD Motor Temperature Test Schematic. . . . .	III-28
III-14	ALSD Motor Characteristics at 70°F Ambient Temperature . . . . .	III-29
III-15	ALSD Motor Characteristics at 310°F Ambient Temperature. . . . .	III-30
III-16	Percussor Spring Test Fixture. . . . .	III-32
III-17	Power Head Seals Vacuum Test Setup . . . . .	III-34
III-18	Battery/Power Head Low Temperature Test Setup. . .	III-40
III-19	Battery Low Temperature Test Schematic. . . . .	III-41
III-20	ALSD Drill String Temperature Rise Test. . . . .	III-44
III-21	ALSD Vacuum Drilling Test Equipment. . . . .	III-47
III-22	Vacuum Chamber Installation of ALSD Power Head . .	III-48
III-23	Three-Meter Vesicular Basalt Drilling Test . . . .	III-50
III-24	3-Meter Conglomerate and Pumice Model Construction	III-51
III-25	ALSD Field Tests - Shoshone, California. . . . .	III-53
III-26	ALSD Assembly - Surface Level. . . . .	III-58
III-27	ALSD Assembly with ALHT Carrier. . . . .	III-59
III-28	ALSD Drilling Under Simulation 1/6-G Conditions. .	III-60
IV-1	ALSD Vibration Test Setup. . . . .	IV-3
IV-2	ALSD Acceleration Test Setup . . . . .	IV-7
IV-3	ALSD Shock Test Setup. . . . .	IV-9
IV-4	ALSD Electromagnetic Interference Test Setup . . .	IV-11
IV-5	ALSD Thermal-Vacuum Test Control Panel . . . . .	IV-13
IV-6	ALSD Thermal-Vacuum Test Equipment . . . . .	IV-14
IV-7	ALSD/SEQ Simulator . . . . .	IV-15
IV-8	ALSD Operational Mode on Lunar Surface Simulator .	IV-16
IV-9	Summary of Power Head Thermal-Vacuum Test. . . . .	IV-21
IV-10	ALSD Transport Mode. . . . .	IV-27
IV-11	ALSD First Hole Deployment . . . . .	IV-28
IV-12	ALSD Casing Operation. . . . .	IV-29
IV-13	ALSD Drill String Withdrawal . . . . .	IV-30
IV-14	ALSD Drill String Decoupling . . . . .	IV-31

ER 14778

LIST OF TABLES

<u>Table No.</u>		<u>Page No.</u>
II-1	ALSD Subsystem Part Numbers. . . . .	II-32, 33
III-1	Typical 3, 4, & 5 Carbide Tip Penetration Rate Tests. . . . .	III-4
IV-1	Consolidated Rock Model Drilling Test Results. . .	IV-25

GLOSSARY OF TERMS

ALHT. . . . .	Apollo Lunar Hand Tools
ALSD. . . . .	Apollo Lunar Surface Drill
ALSEP . . . . .	Apollo Lunar Surface Experiments Package
ALSRC . . . . .	Apollo Lunar Sample Return Container
ECS . . . . .	Environmental Control System
GFE . . . . .	Government Furnished Equipment
GSE . . . . .	Ground Support Equipment
HFE . . . . .	Heat Flow Experiment
KSC . . . . .	Kennedy Space Center
LM. . . . .	Lunar Module
MMC . . . . .	Martin Marietta Corporation
SEQ . . . . .	Scientific Equipment Bay

I. SUMMARY

1.0 GENERAL PROGRAM INFORMATION

The Martin Marietta Corporation has completed a two-phase program for the design, development, fabrication, and test of flight model Apollo Lunar Surface Drill (ALSD) systems to be used by early Apollo astronauts for the emplacement of lunar subsurface Heat Flow Experiment probes. Tasks performed under these programs, designated as Phase C and Phase D, are briefly described below.

The ALSD Phase C Program consisted of the following major tasks: 1) Generation of design concepts supported by performance of preliminary development tests, 2) Preparation of top-level drawings and fabrication of a representative mock-up, and 3) Preparation of detail engineering, manufacturing, quality assurance, reliability, test, and program management plans required for the performance of the subsequent Phase D Program.

The Phase D Program consisted predominantly of the fabrication of development, training, qualification test, and flight unit ALSD's. The magnitude of development testing required to finalize the design was considerably greater than originally anticipated, primarily due to unexpected problems with the original subsurface hole encasement design approach. Significant design changes beyond the Phase C design baseline were also incorporated as a result of the following: 1) Reallocation (reduction) in the available stowage volume for the ALSD aboard the spacecraft, 2) Redefinition of the lunar surface model simulation resulting from updated Lunar Orbiter and Surveyor information, 3) Refinement of environmental design criteria, 4) Data from spacesuited operability tests and, 5) Astronaut change requests.



## 2.0 GENERAL SYSTEM REQUIREMENTS

The ALSD general design requirements included the following major items: 1) Lightweight, transportable, and operable by a single astronaut on the lunar surface, 2) Powered from a self-contained power source (battery), 3) Capable of drilling and casing two, 3-meter holes in the lunar subsurface within 66.4 minutes, 4) Capable of retaining the lunar subsurface core specimens from the second hole for return to earth for subsequent analysis, 5) Capable of withstanding the vibration, shock, acceleration, and temperature environments of the Saturn spacecraft during transit from earth to the moon, and, 6) Capable of operating in the reduced gravity, vacuum environment of the lunar surface at any sun angle between 7 and 45° above the horizon.

The lunar surface simulation models required for design guidelines were revised during the program resulting from updated Lunar Orbiter and Surveyor spacecraft data. Original drilling requirements for the ALSD included the following alternate models:

- 1) Two, 3-meter holes in 50% porosity basalt, and
- 2) Two, 1.2 meter holes in unsorted, uncohesive conglomerate containing a maximum of 0.5 meter of dense basalt.

The updated lunar surface information obtained later in the program resulted in the following alternate simulation models:

- 1) Two, 3-meter holes in unsorted, uncohesive conglomerate inclusive of a maximum of 0.5 meter of 43% porosity basalt chunks, and
- 2) Two, 3-meter holes in unsorted, uncohesive conglomerate inclusive of a 0.75 meter block (maximum) of 43% porosity basalt, and
- 3) Two, 3-meter holes in unsorted, uncohesive conglomerate inclusive of a 0.15 meter block (maximum) of dense basalt.

A brief description of the final ALSD configuration which meets the design requirements is described in the following paragraphs; the design evolution leading to the final design approach is presented in Section II of this report.

## 3.0 GENERAL SYSTEM DESCRIPTION

The ALSD is designed as a totally integrated system which interfaces with the ALSEP pallet located in the LM-SEQ during transit from earth to the moon's surface. The drill, with its various subsystems, can be removed as a single package from the ALSEP pallet and transported by the astronaut to the selected drilling site for subsequent assembly and operation. The core bit and extension tubes, which are transported from earth to the moon in the ALSRC, are integrated with the ALSD package in the vicinity of the LM or at the drilling site. After assembly at the drilling site, the ALSD is used by the astronaut to drill two, 3-meter holes in the lunar subsurface for emplacement of the HFE probes.

A brief description of the ALSD subsystems (Figs. I-1 through I-4) required to perform the lunar surface drilling mission includes the following:

- 1) Battery-Provides the total electrical power required to perform a two-hole lunar surface drilling mission,
- 2) Battery Thermal Shroud-Provides battery protection from low temperature during lunar surface operations at a low sun angle,
- 3) Power Head-Contains the electric-motor, percussion and rotation systems required for powering the drill bit,
- 4) Power Head Thermal Guard-Prevents the astronaut from accidentally contacting areas of the power head which may exceed +250°F during drilling operations,
- 5) Handle and Switch Actuator Assembly-Provides the astronaut with a means of manual restraint and motor control of the drill,
- 6) Core Bit-Provides the cutting capability required for rock penetration,
- 7) Extension Tubes-Transmit the rotary-percussive energy from the power head to the core bit, provides a means for core collection, and mechanically conveys rock cuttings from the core bit/rock interface to the surface,
- 8) Extension Tube Caps-Preclude loss of core material from the extension tubes during storage in the ALSRC,

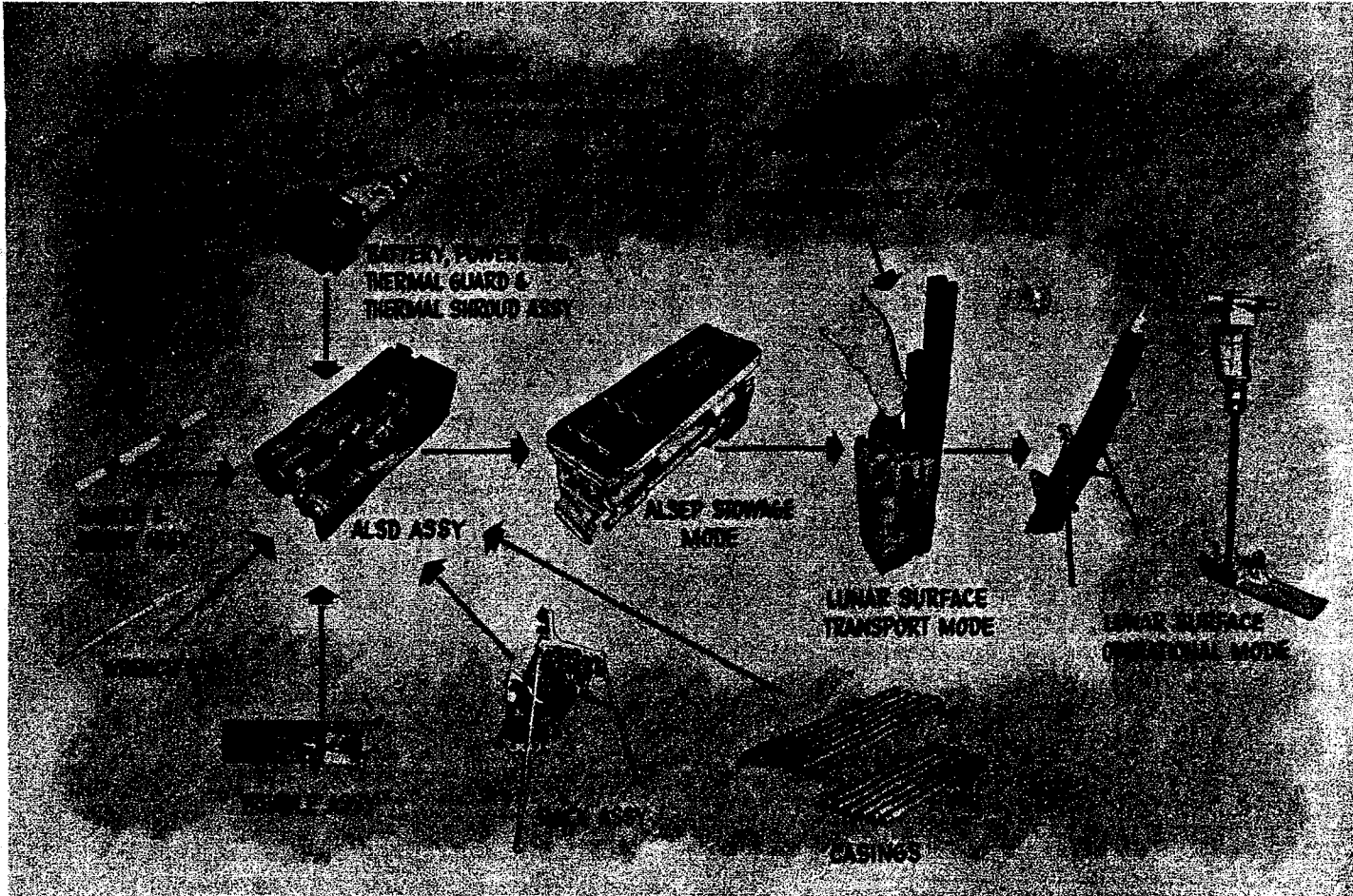
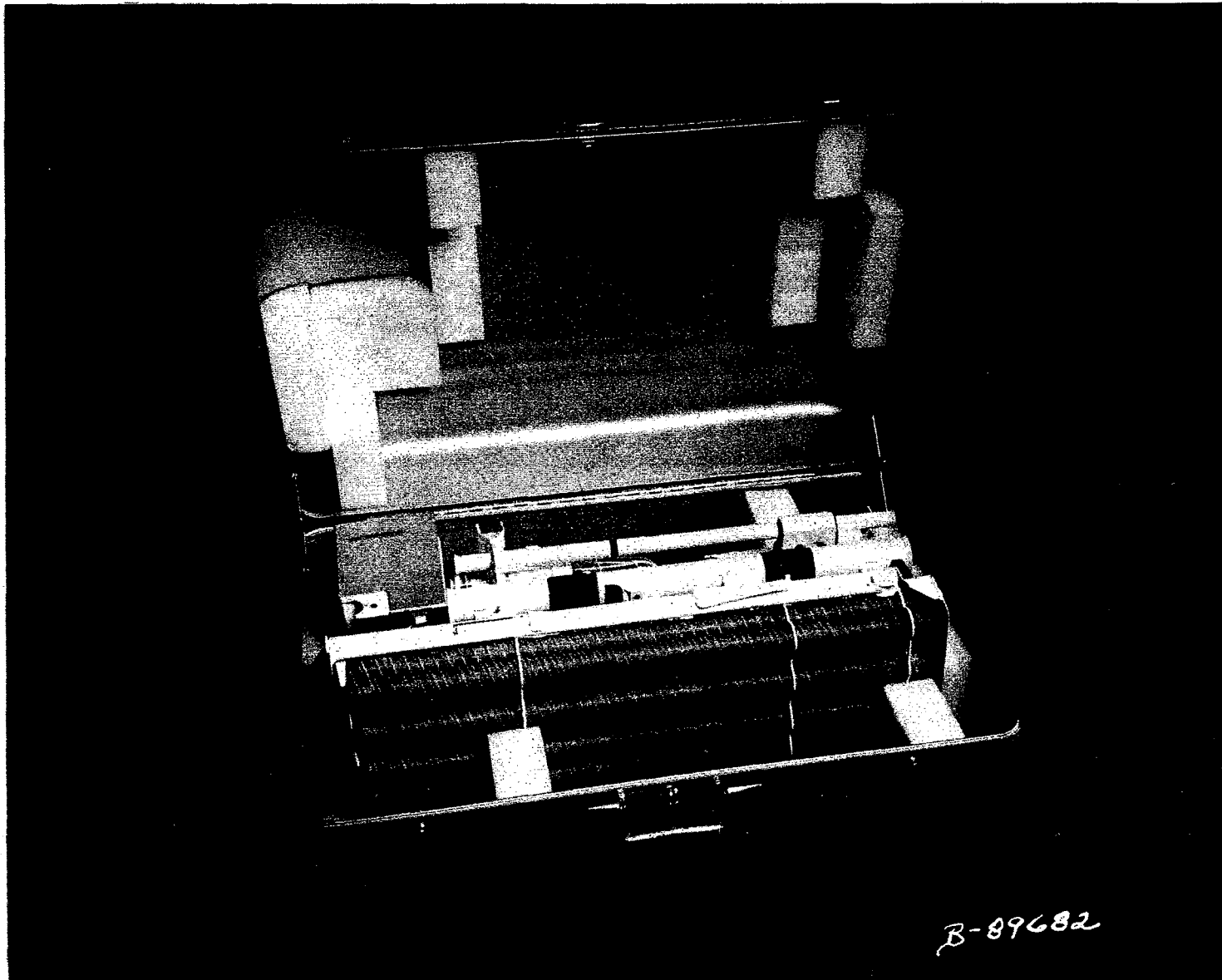

Figure I-1 ALSD Assembly, Stowage and Lunar Operating Sequence

I-5



ER 14778

Figure I-2 ALSD Shipping Container

I-6

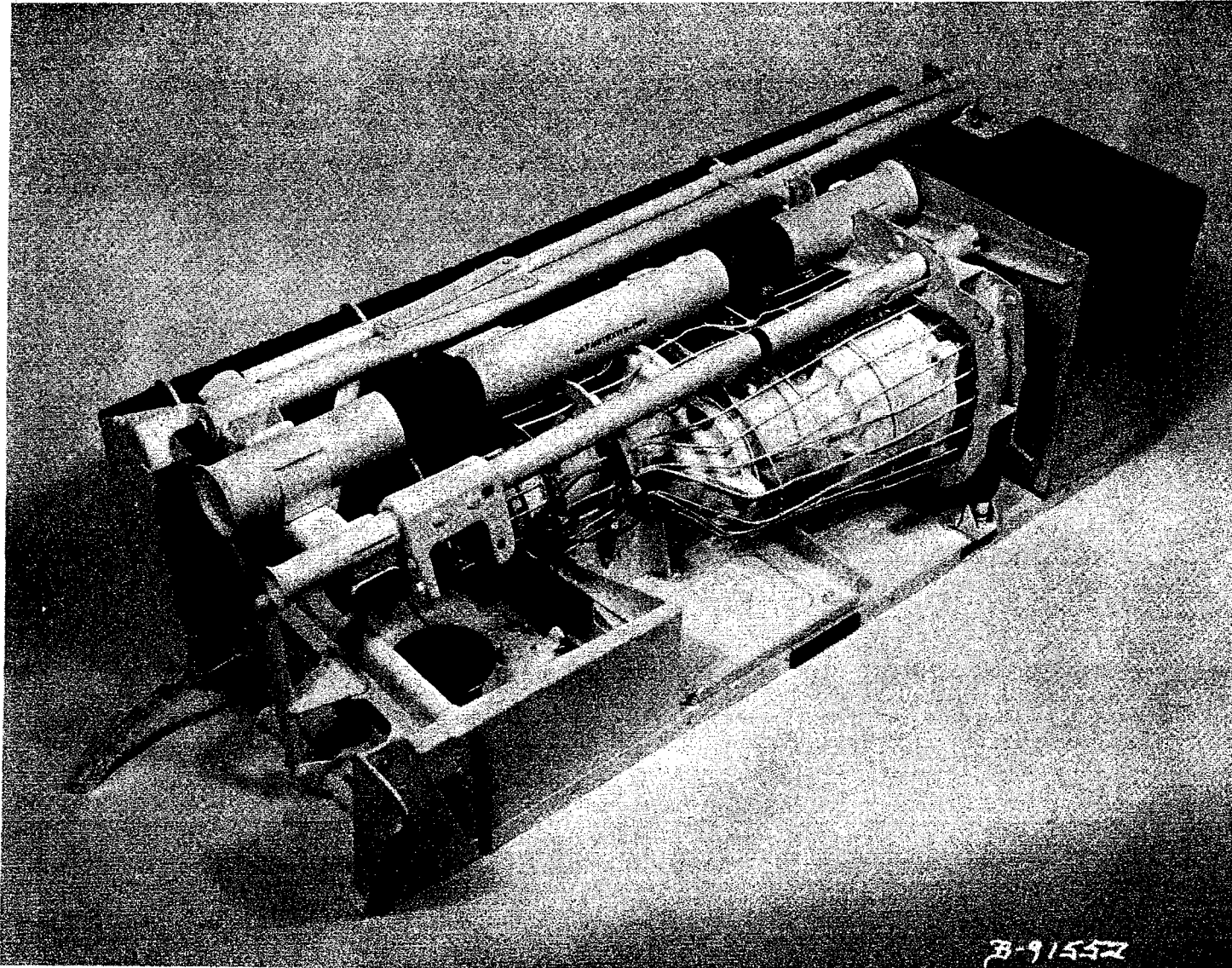

ER 14778

Figure I-3 ALSD/ALSEP Spacecraft Stowage Mode

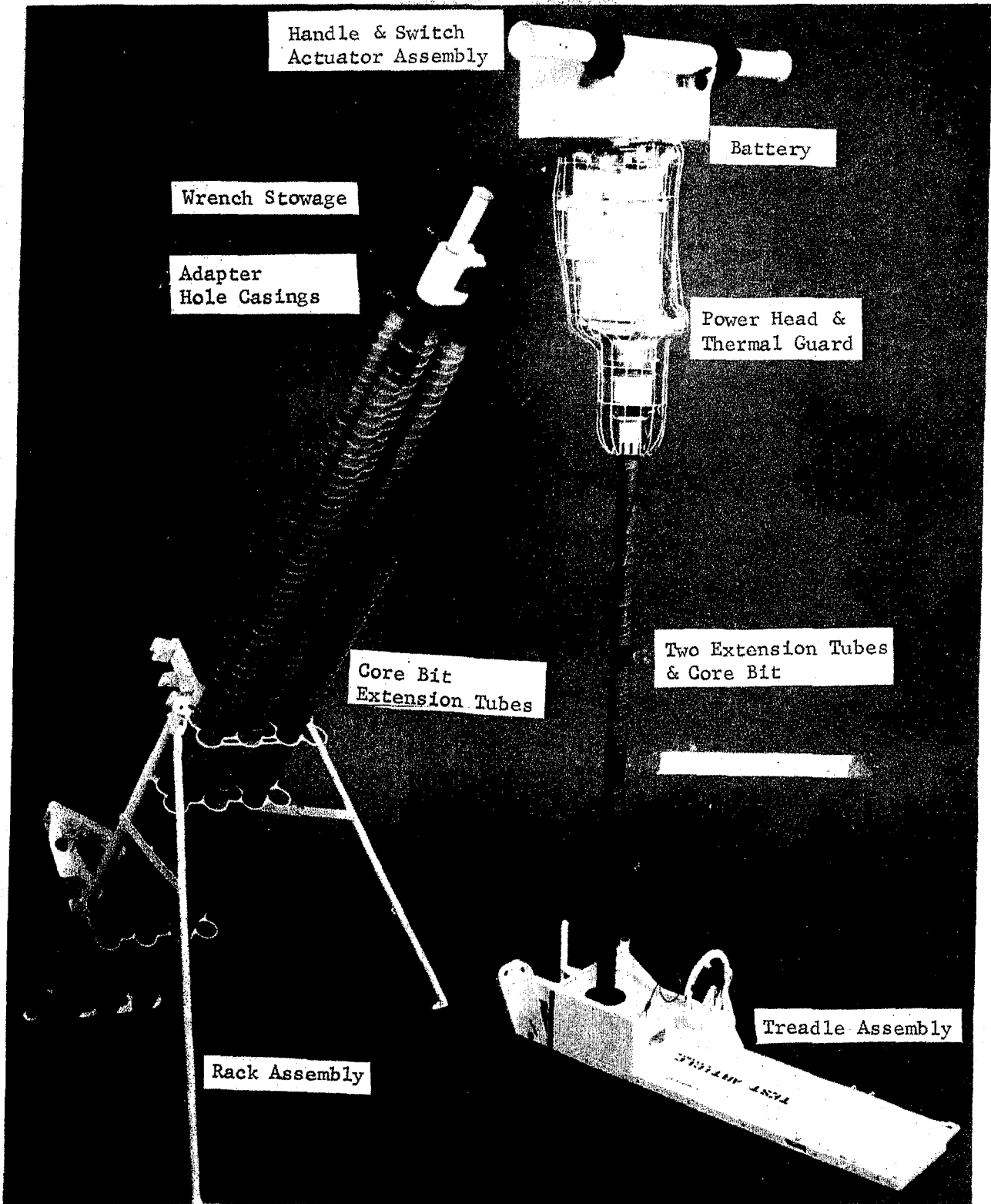

Figure I-4 ALSD Lunar Surface Deployed Mode

ER 14778

- 9) Hole Casings-Provides a means of displacing lunar cave-in material from a pre-drilled subsurface hole and restrain the walls of the hole if required in unconsolidated material,
- 10) Hole Casing Adapter-Couples hole casings to power head output spindle during emplacement,
- 11) Wrench-Provides a means for decoupling extension tubes,
- 12) Rack Assembly-Provides outbound mission stowage restraint for hole casings, wrench, and handle assembly, and provides temporary vertical stowage of hole casings, extension tubes, and wrench during lunar drilling operations,
- 13) Treadle Assembly-Provides structural restraint for the entire ALSD system during outbound mission stowage, and houses the drill string lock used in conjunction with the wrench for extension tube decoupling operations.

Major items of GSE (Figs. I-5 and I-6) required to support the ALSD during earth preparations include the following:

- 1) Shipping Container-Provides a convenient means for shipping or hand-carrying the ALSD Assembly,
- 2) Pressurization Unit-Provides capability for sequentially pressurizing the battery and power head for verification of relief valve operation and seal integrity,
- 3) Battery Charging Unit-Provides capability for recharging of battery if required,
- 4) Battery Activation Kit-Contains electrolyte for individually activating the sixteen battery cells.

A detailed description of the ALSD subsystems and GSE, operating procedures, and maintenance instructions, are provided in Reference 2.

I-9

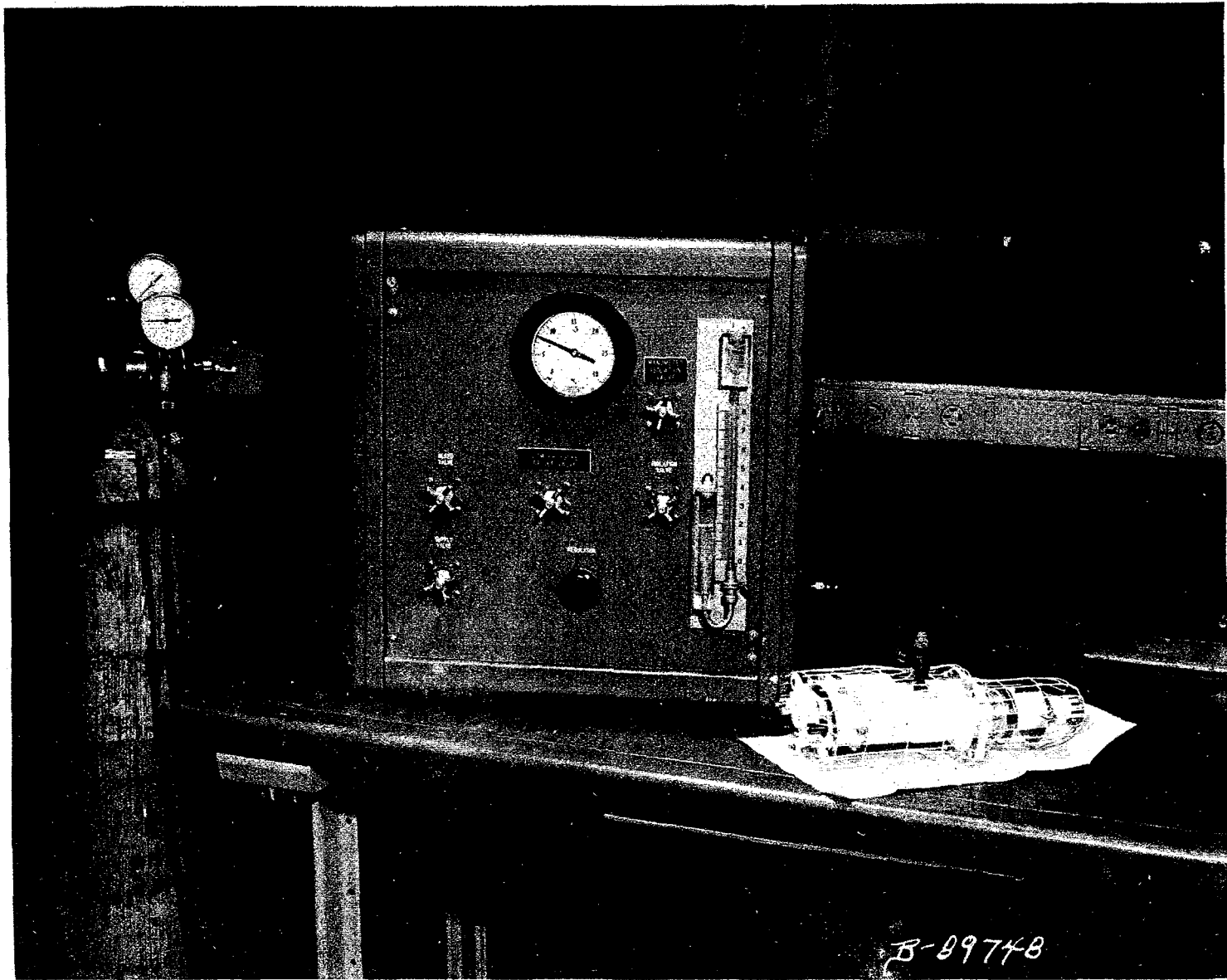

ER 14778

Figure 1-5 ALSD Pressurization Unit



I-10



ER 14778

Figure I-6 ALSD Battery Charging Unit

## II. ALSD CONFIGURATION DEVELOPMENT

## 1.0 PHASE C DESIGN APPROACH

1.1 Design Concept - The Phase C study and development program (1) resulted in the ALSD design concept illustrated in Figures II-1, 2, and 3. This model, weighing approximately 22 pounds and occupying a stowage volume of 22 x 19 x 8.8 inches, was designed to meet the original contractual requirements. A brief description of the components and design parameters are delineated in the following paragraphs.

1.2 Core Bit - The initial contract requirements of 1.125 inch maximum lunar subsurface hole diameter and 0.750 inch minimum core diameter dictated the major design parameters for the core bit. An outside diameter of 1.032 inches (cutting tip O. D.) was selected to allow for drill string eccentricity, and the possible drilling of oversize holes in low density lunar surface materials. The selected 0.752 inch inside diameter (cutting tip I. D.) resulted in a cutting tip kerf of 0.140 inches. A cutting tip-to-body clearance (both I. D. and O. D.) of 0.30 inches resulted in a basic wall thickness of 0.080 for both the core bit body and core bit extension tubes.

Minor changes to the core bit geometry, and results of the cutting tip optimization program are described in Section III of this report.

1.3 Core Bit Extension Tubes - The six (6) extension tubes initially selected for the ALSD were to be fabricated from magnesium with 440 - series stainless steel caps for increased strength of the coupling joints. A proprietary process by an outside vendor for fusing the dissimilar magnesium and stainless steel initially appeared promising, but schedule difficulties precluded use of the process. However, a subsequent percussive energy strain wave transmission efficiency analysis indicated that the final material selection (6 Al - 4V titanium) will outperform the initial material selection.

Regardless of material selection, the tubes were designed to provide an extension of the helical flute, rock cuttings transport system from the core bit cutting tips to the lunar surface. The initial design consisted of four, 1-inch lead flutes, 0.030 inches in depth, commencing at the four carbide cutting-tips of the core bit, and running continuously along the six tubes when assembled to form the drill string. Alignment of the external flutes of adjacent tubes was controlled by the double coupling threads which were machined coincident with two of the four flutes.

II-2

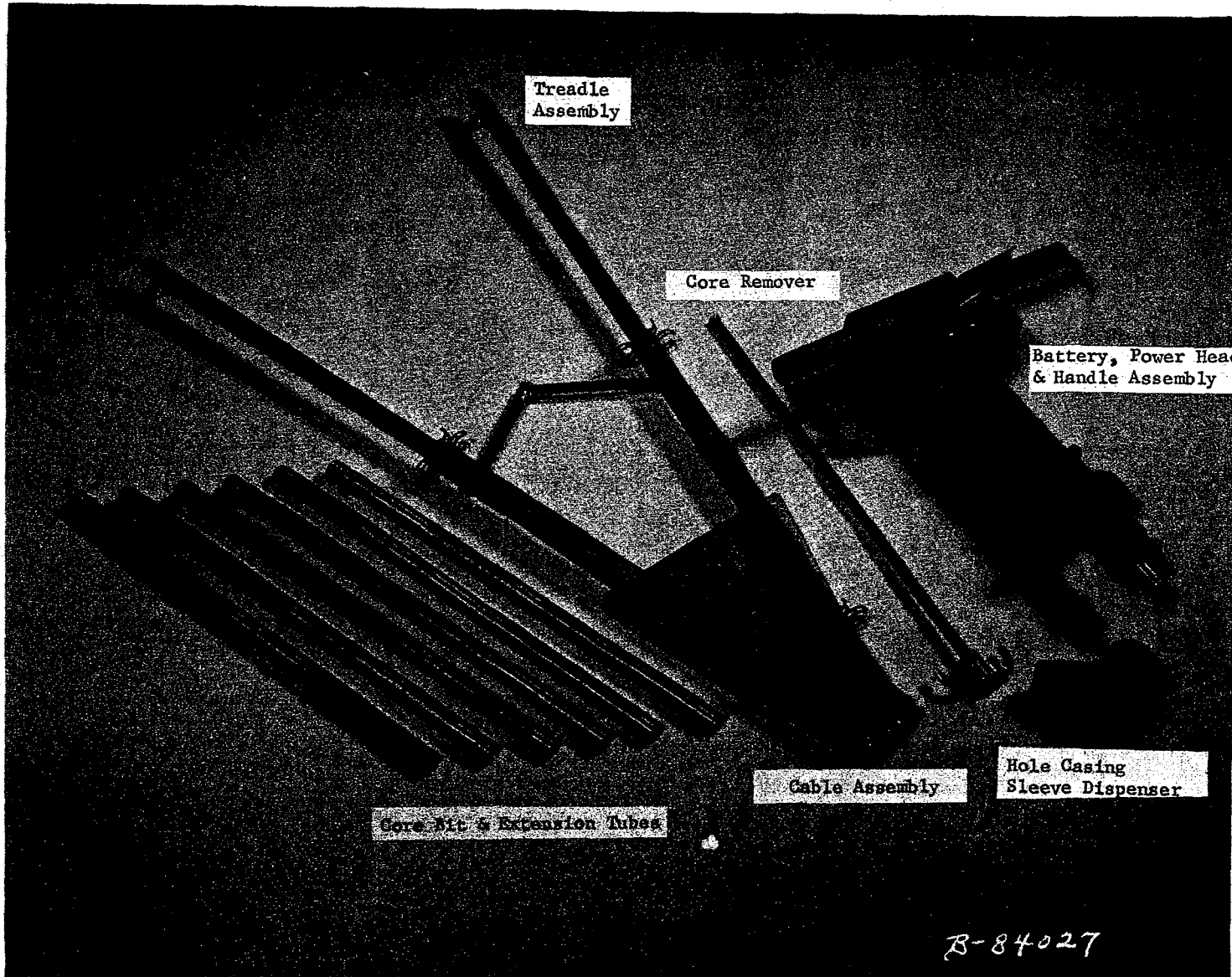

ER 14778

Figure II-1 ALSD Phase "C" Mockup



Figure II-2 ALSD Phase "C" Mockup Transport Mode

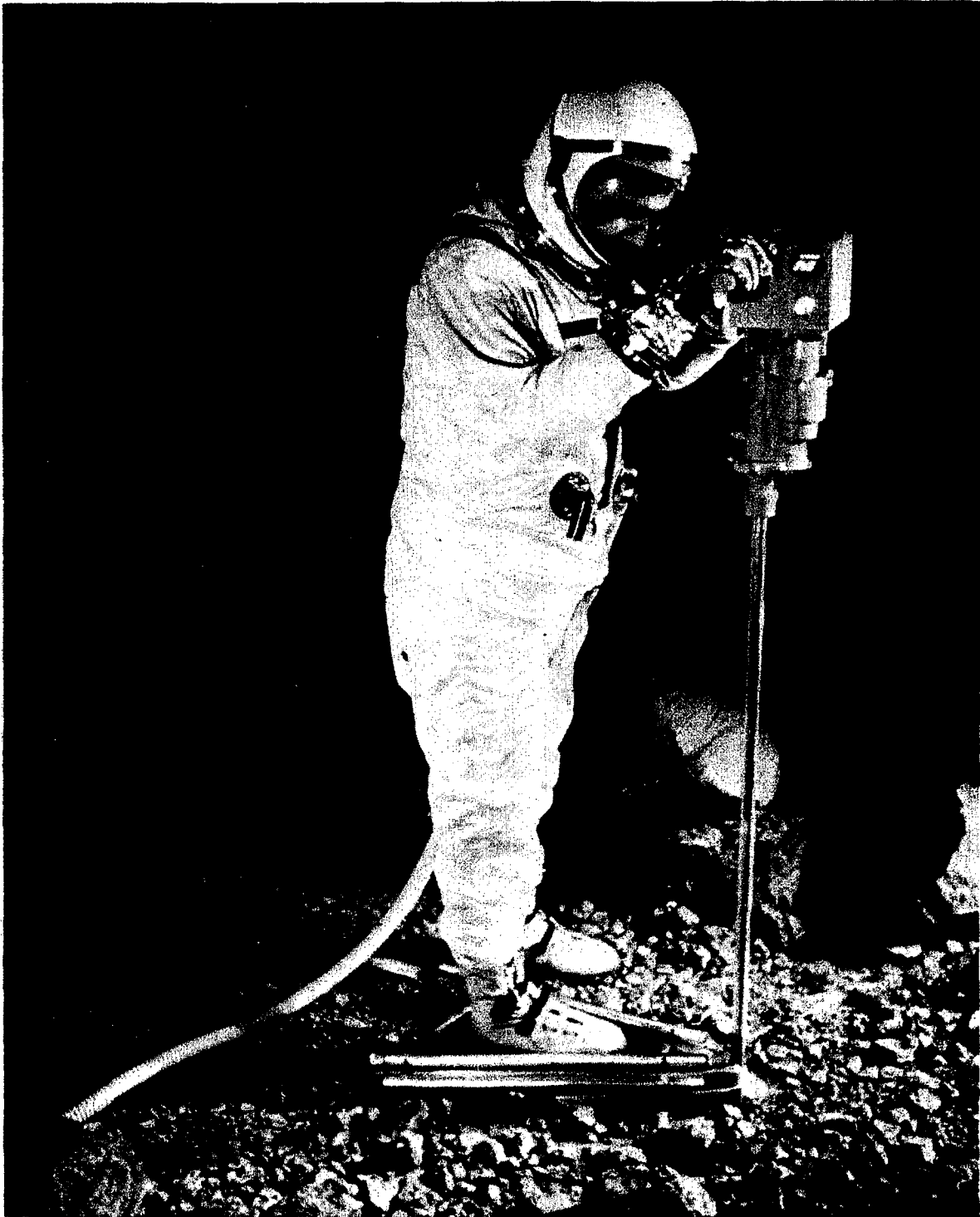

Figure II-3 ALSD Phase "C" Mockup Operational Mode

ER 14778

The assembled drill string was designed for a continuous O. D. and I. D. of 0.972 and 0.812 inches, respectively, throughout its length.

Minor changes to the extension tube geometry, and results of the development test program are described in Section III of this report.

1.4 Power Head - The initial operating parameters for the power head were established as a result of development drilling tests conducted during the Phase C program as reported in Reference 1. These tests were conducted using NASA furnished rock "standards" consisting of high density basalt, scoria, and pumice. An engineering model drill mechanism was fabricated which was capable of parameter variation -- rpm, blows per bit revolution, blows per minute, percussive blow energy, and percussive hammer mass. This device was used to establish relative rock sample drillability, penetration rates, and power consumption data per unit volume of rock drilled. As a result of these tests, the following initial operating parameters were established.

#### Motor Characteristics

- 1) Nominal Operating Voltage: 24 VDC
- 2) Nominal Operating Current: 19 Amperes d.c.
- 3) Nominal Operating Speed: 8,000 rpm
- 4) Nominal Operating Motor Torque: 3.3 in.-lbs.
- 5) Efficiency: 65-70%

#### Percussion System

- 1) Cam: Single lobe, 0.5-inch max. deflection, 15\* rise angle
- 2) Spring: 240 lbs./inch
- 3) Ram Weight: 0.66 lbs.
- 4) Energy Per Blow: 30 in.-lbs.

#### Power Train System

- 1) Motor-to-Rotary Drive Ratio: 39.6
- 2) Nominal Core Bit Speed: 200 RPM

- 3) Motor-to-Cam Ratio: 3.56
- 4) Nominal Percussion Rate: 2,250 BPM
- 5) Blows Per Bit Revolution: 11.25

The power head was designed as a totally integrated unit, with the motor, percussion system, and power train compactly enclosed within a pressurizable magnesium housing. Minor changes to the power head operating parameters, and results of the development test program are described in Section III of this report.

1.5 Battery - A silver-zinc battery was selected for the ALSD since this system represented the maximum power-to-weight ratio available in the required power range. Additionally, reliability of a similar battery system, manufactured by the same battery contractor for the astronaut personnel life support system, also influenced the ALSD power source selection.

The total power requirement established for the ALSD battery was based upon the Phase C test program described in Reference 1. At that time the maximum power was required in the lunar surface simulation model consisting of two, 3-meter holes in 50% porosity basalt. Although a 3-meter vesicular basalt "standard" model was not available for the Phase C program, previous tests performed by MMC using small rock samples indicated a normalized power requirement of 3 watt-hrs./in.<sup>3</sup> of drilled material. For the bit described in paragraph 1.2 having a kerf cutting area of 0.392 in.<sup>2</sup>, the total volume of drilled material required for two holes is approximately 94 in.<sup>3</sup>, and the total power requirement was calculated to be 282 watt-hours. Therefore, the total battery power capacity was established at 300 watt-hours. Although the lunar surface simulation model was subsequently modified resulting from updated Lunar Orbiter and Surveyor data, the initially established power capacity was sufficient to perform the two-hole drilling mission.

The basic operating parameters for the ALSD battery did not change throughout the program although the qualification test program did result in significant structural modifications as described in Section III of this report. Basically, the 300 watt-hour capacity was attained by the use of sixteen, 12.5 ampere-hour, silver-zinc cells housed in a pressurizable magnesium case. The battery case was designed for direct mechanical and electrical interface with the power head; electrical control was accomplished by an internally installed microswitch which interfaced with the ALSD handle assembly control lever through a pressure-tight rubber boot.

1.6 Treadle Assembly - The ALSD treadle assembly was designed to perform three basic functions: 1) Maintain structural restraint of all ALSD components during the spacecraft stowage and lunar transport modes, 2) Provide a locking mechanism for restraining the drill string during decoupling operations in conjunction with the wrench, and 3) Provide a platform during drilling operations to permit the astronaut to apply foot pressure to the power head (via the cable assembly) which, in turn, increased the drilling efficiency due to the increased core bit/rock interface pressure.

The third basic function of the treadle assembly was incorporated as a result of the Reference 1 tests, which indicated that the astronaut's capability for applying axial forces (15-25 pounds) to the ALSD for a time period sufficient to efficiently drill 3 meters of vesicular basalt was extremely doubtful. Utilization of the treadle in the open loop mode (as indicated in Fig. II-3), or in the closed loop mode (in conjunction with a forward treadle pivot anchored to the lunar surface) permitted the operator to apply approximately 30 or 60 pounds respectively to the power head under 1/6-G conditions by applying foot pressure to the treadle in lieu of arm pressure.

1.7 Cable Assembly - During normal drilling operations the cable assembly was attached between the front of the treadle and the power head. The reel assembly housing contained two negator (constant force) springs, one of which automatically extended/retracted the cable on its reel in accordance with demand, and the other which limited the maximum force to 60 pounds which could be applied to the cable assembly via the foot treadle. During both the open loop and closed loop modes of ALSD operation, the operator was required to "pump" the treadle assembly as the drill string penetrated into the subsurface in order to wind up the cable and maintain a continuous force on the power head.

1.8 Core Remover - The core remover was designed to perform two functions - to serve as a spanner wrench for decoupling extension tubes in conjunction with the treadle lock, and to provide a means for the operator to dislodge rock core segments from the extension tubes after drilling.

1.9 Vertical Indicator - The vertical indicator (Figures II-5, 8) was designed to be attached to either the power head handle or the emplaced drill string, and was used to provide a gross indication of the drill string emplacement angle. The device consisted essentially of a concave dish inscribed with concentric circles calibrated in angular degrees from the center to its outer periphery. A hollow ball filled with a high viscosity liquid to induce damping was employed as the angular indicator. A transparent cover attached to the top of the concave dish restrained the ball without loss of visibility.



1.10 Hole Casing Sleeve - The initial casing concept consisted of the use of a thin-wall (.004 in.), slotted tube which was capable of storage on a reel within the dispenser illustrated in Figure II-1. After emplacement of the drill string, the casing was reeled from the dispenser, inserted over the drill string, and forced down into the subsurface to restrain the hole walls during the period between removal of the drill string and emplacement of the HFE probe. After emplacement of the probe, the slotted, thin-wall sleeve was removed from around the electronics cable and reeled into the dispenser in preparation for the second hole encasement.

Although this casing technique could be performed with some success in pumice, and to a limited depth in conglomerate overburden, it was subsequently replaced with the power-driven fiberglass casings described in Section III of this report.

## 2.0 PHASE D BASELINE MOCKUP

2.1 Design Concept - During the early part of the Phase D program, a major repackaging of the ALSD concept described in paragraph 1.0 was required due to a reduction in ALSEP-allocated volume from the original 22 x 19 x 8.8 inches to 22 x 9.6 x 7 inches. The modified packaging concept is illustrated in Figure II-4. The ALSD components illustrated in Figures II-5 and II-6 are similar to those described in paragraph 1.0 except for the following changes:

- 1) The tubular treadle illustrated in Figure II-1 was replaced with a laminated honeycomb board to provide a more rigid restraint for the various ALSD components during the launch, boost, and landing phases of the lunar mission,
- 2) The core bit extension tubes were mounted in a rack which pivoted to a vertical position during ALSD operation to improve their accessibility to the operator,
- 3) A drill guide and debris deflector were added to preclude the possibility of subsurface, gas-ejected particles from impinging upon the astronaut during drilling operations,
- 4) A cuttings collector box was added to preclude thermal disturbances in the immediate area of the bore hole resulting from cuttings being distributed on the surface,
- 5) The reduced volume allocation for the ALSD necessitated separation of the operating handle assembly from the battery in the stowage mode.

2.1 Mockup Fabrication - A total of three mockups similar to that illustrated in Figures II-4, 5, and 6 were fabricated during the early portion of the Phase D program. These simulators were designed to provide a representation of the structural, mass, and thermal/mechanical properties of the flight model ALSD.

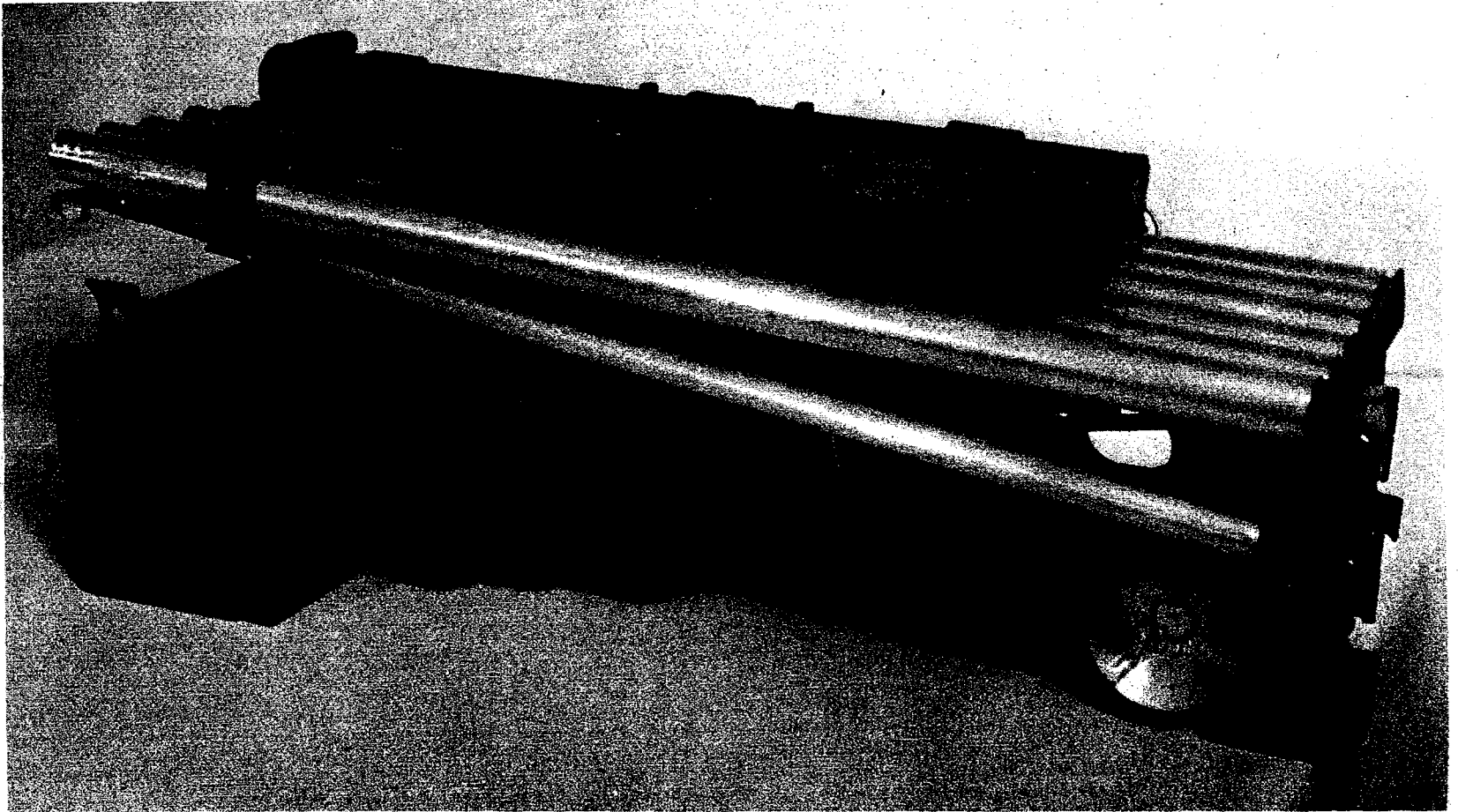

Figure II-4 ALSD Stowage Mode (Mockup)

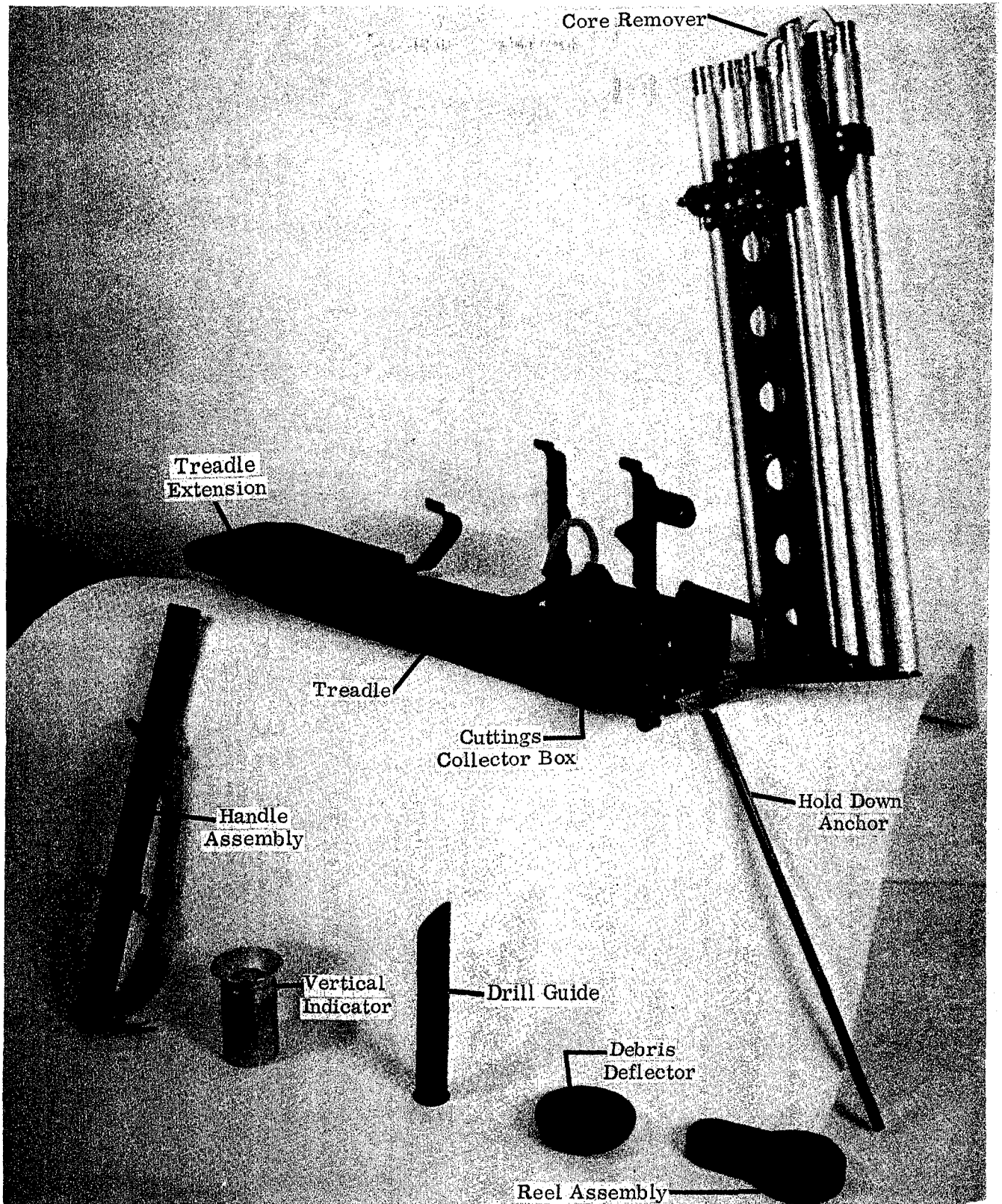

Figure II-5 ALSA Accessory Group Subsystem Components (Mockup)



Figure II-6 ALSD Operational Configuration (Mockup)

### 3.0 DEVELOPMENT MODEL

3.1 Design Concept - The first operational ALSD model is illustrated in Figures II-7 through II-11. The unit included functional subsystems similar to those previously described, and the assembly was packaged to stow within the reduced ALSEP volume allocation. A brief description of the ALSD subsystems is delineated in the following paragraphs.

3.2 Carrying Case (Fig. II-7) - A commercial aluminum carrying case was modified by the incorporation of molded styrofoam designed to form-fit the ALSD assembly. The carrying case was designed to preclude damage to the ALSD assembly during storage or transport on earth.

3.3 Power Head (Fig. II-8) - The final operating parameters selected for the power head were modified somewhat as compared to those previously described in paragraph 1.4. These changes included an increase in the output rpm and percussive energy to increase the drilling efficiency in high density basalt as indicated below:

#### Motor Characteristics

- 1) Operating Voltage:  $23 \pm 1$  VDC
- 2) Nominal Operating Current: 18.75 Amperes d.c.
- 3) Nominal Operating Speed: 9300 rpm
- 4) Efficiency: 70%

#### Percussion System

- 1) Cam: Single lobe, 0.5 inch max deflection,  $14^\circ$  rise angle
- 2) Spring: 240 lbs./in.
- 3) Ram Weight: 0.661 pounds
- 4) Energy Per Blow: 39 in.-lbs.

#### Power Train System

- 1) Motor-to-Rotary Drive Ratio: 33.1
- 2) Nominal Core Bit Speed: 280 rpm
- 3) Motor-to-Cam Ratio: 4.1

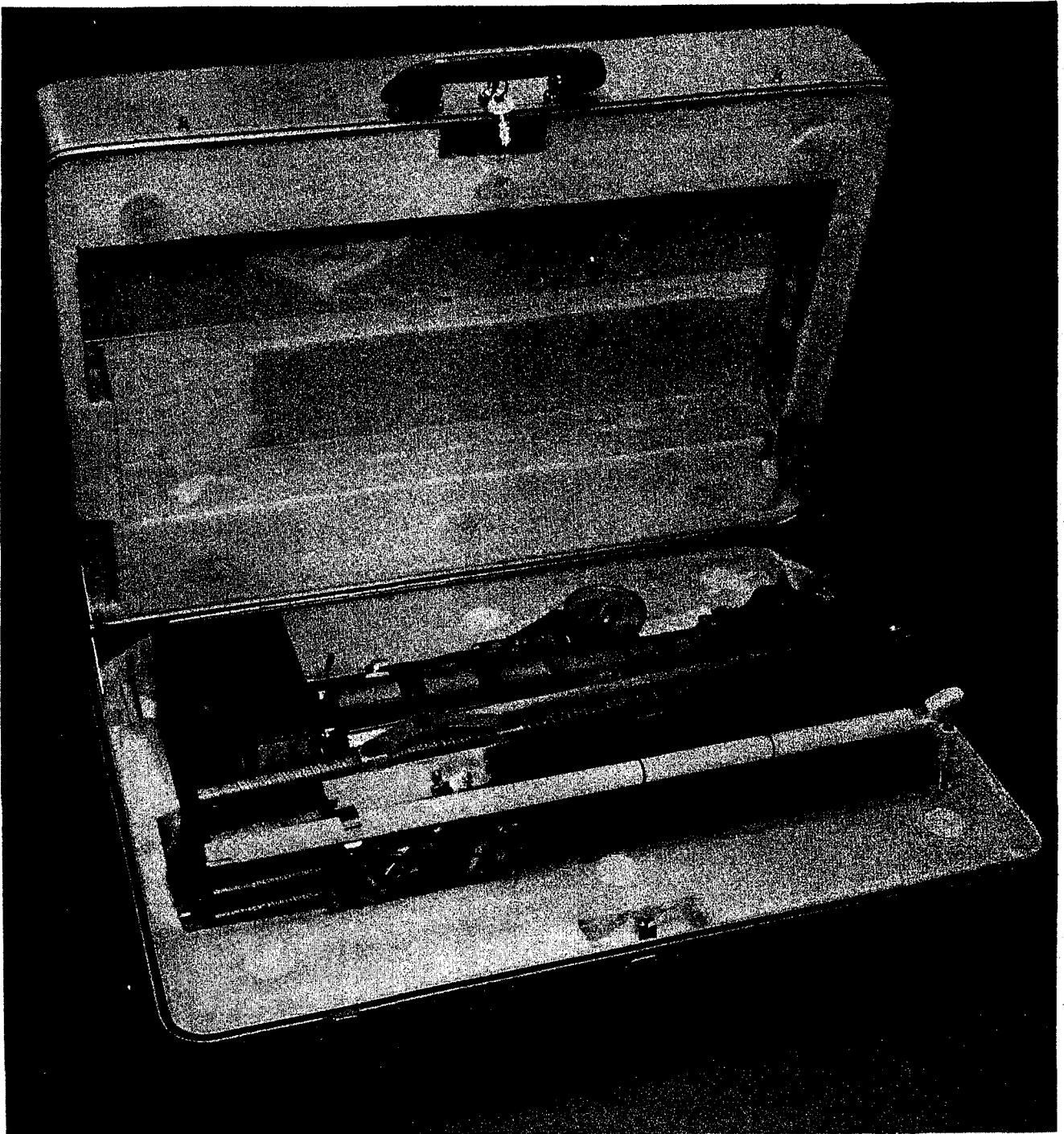

Figure II-7 Development Model ALSD With Carrying Case.



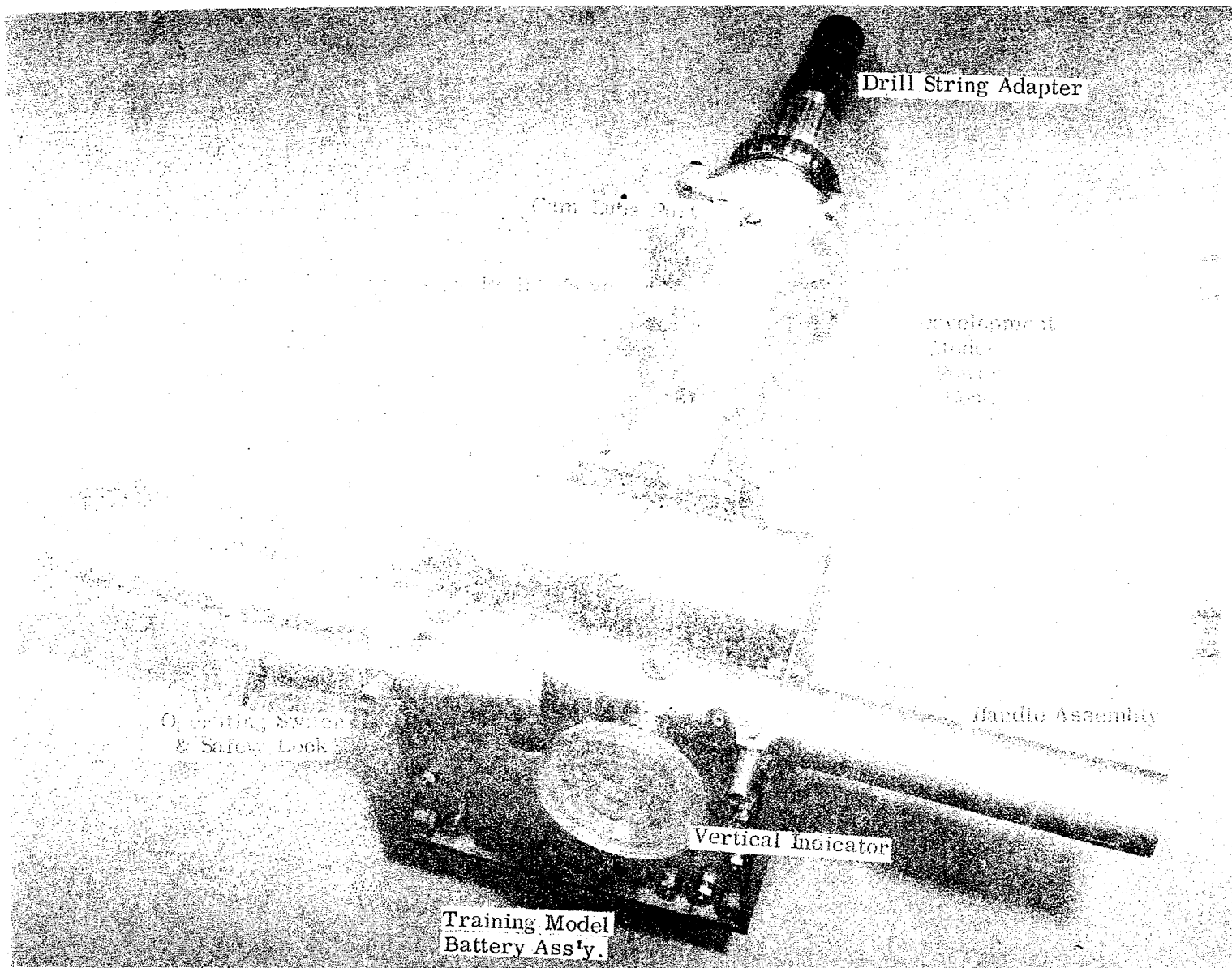

Figure II-8 Development Model Power Head and Battery Assembly.



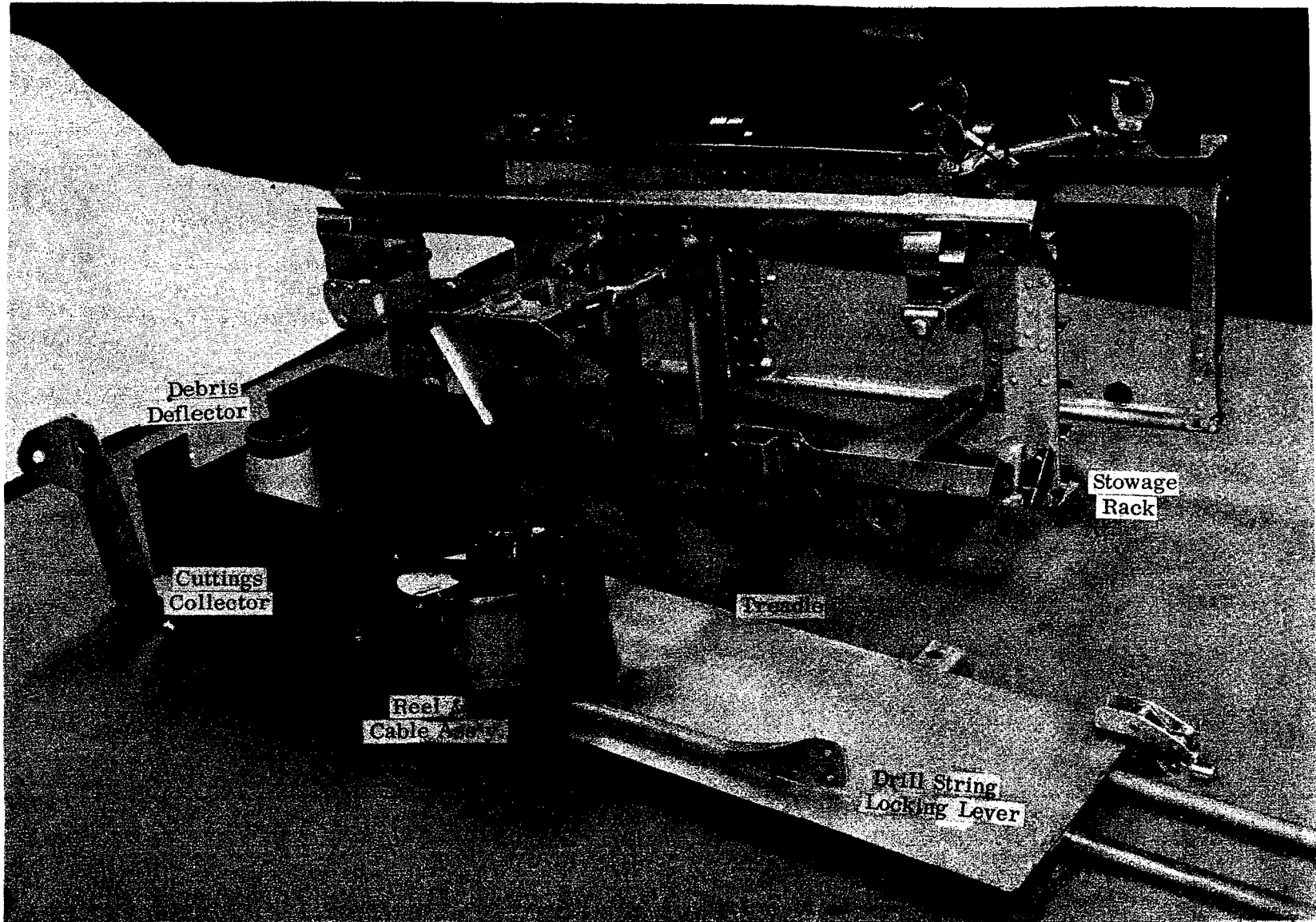

Figure II-9 Development Model Treadle Assembly.

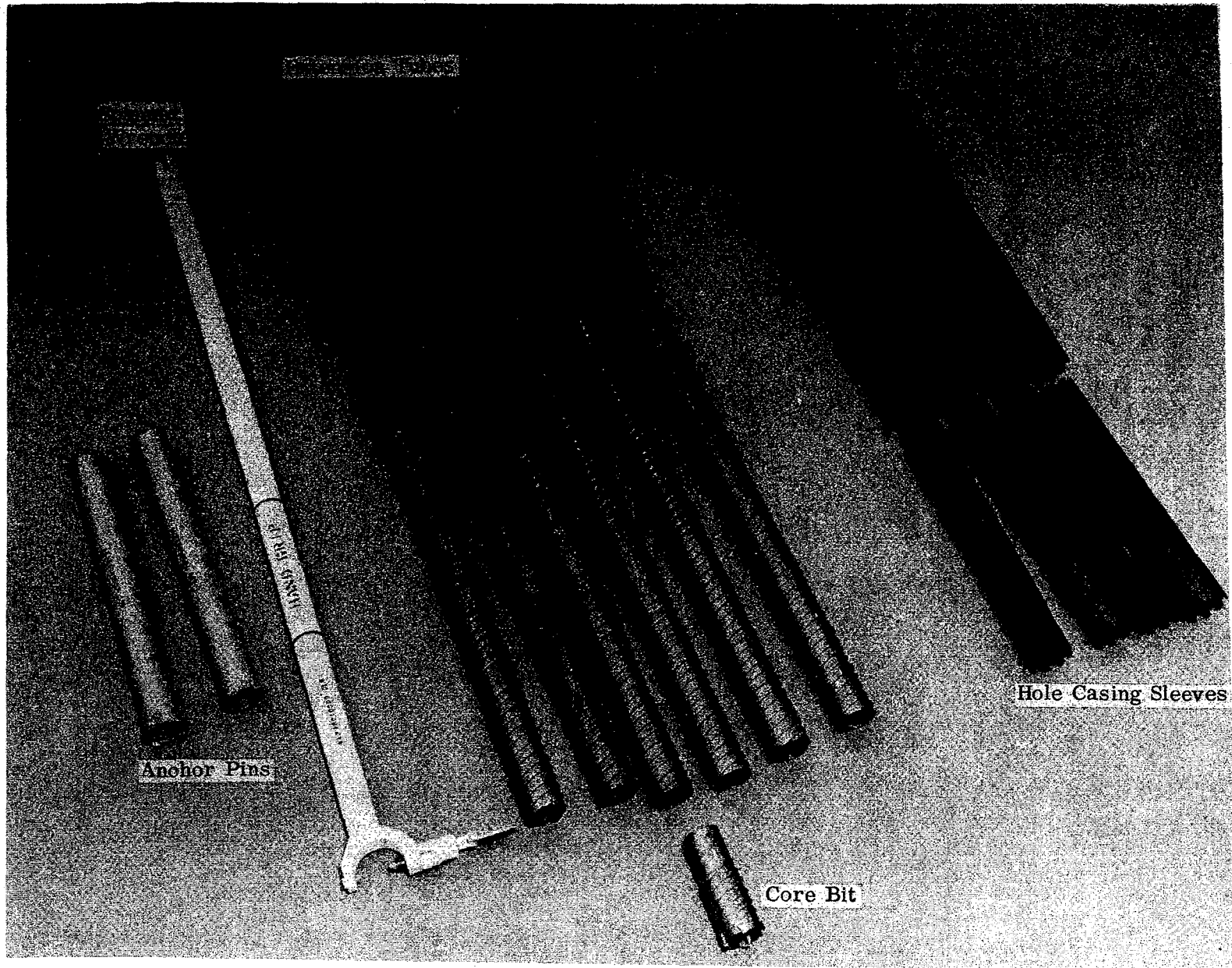

figure 11-10 Miscellaneous Development Model Components.

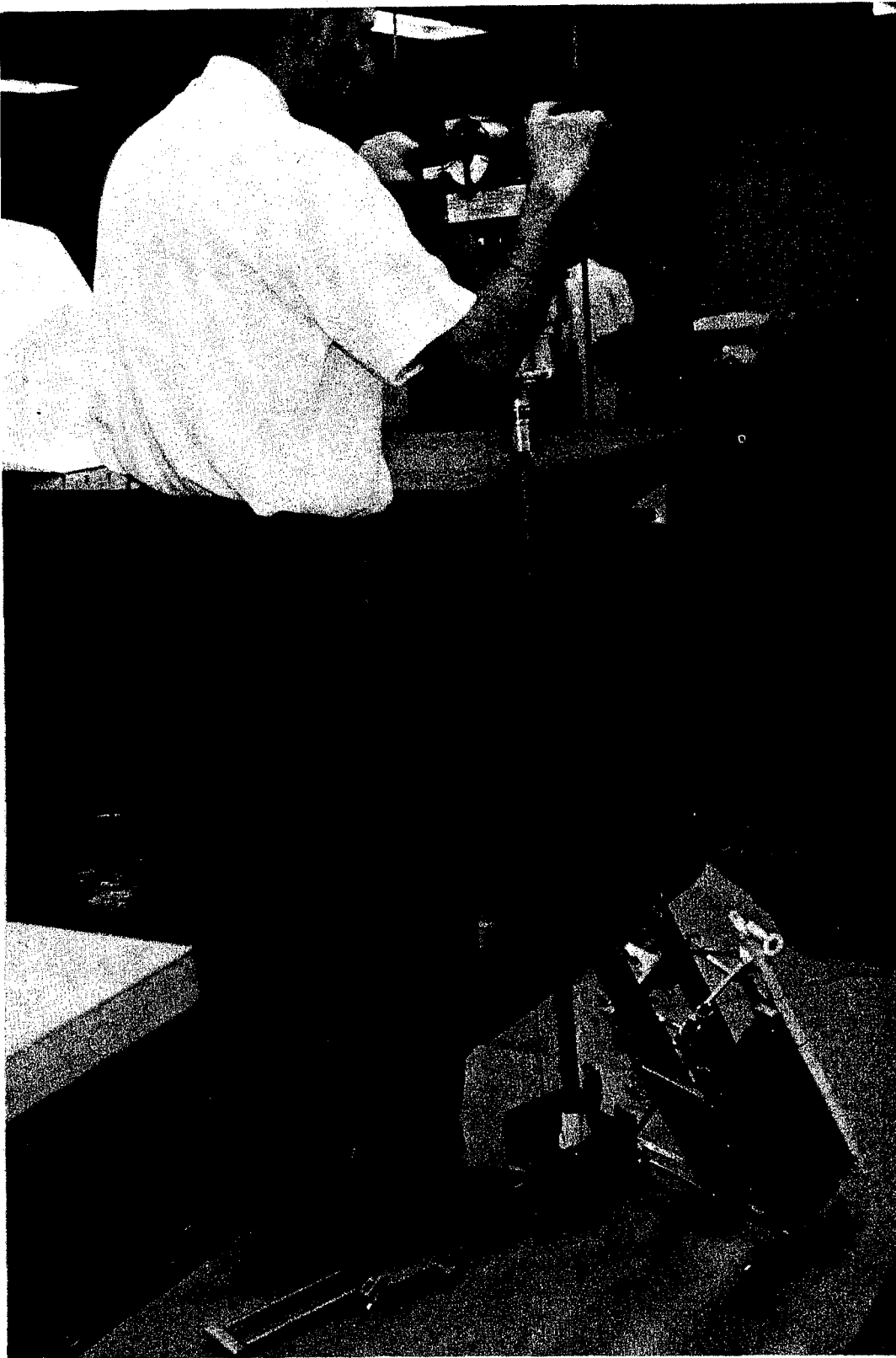

Figure II-11 Development Model ALSD - Operational Mode

- 4) Nominal Percussion Rate: 2270 BPM
- 5) Blows Per Bit Revolution: 8.1

In order to reduce procurement time, the power head castings for the development model ALSD were fabricated from sand cast aluminum rather than the investment magnesium castings used for the flight units.

3.4 Battery (Fig. II-8) - The silver-zinc battery employed with the development model ALSD consisted of secondary-type cells housed in a steel case. The secondary cells were used in lieu of the primary flight cells for their greater recharge and operating life characteristics. A steel case was used in lieu of the flight-type magnesium case to prolong the structural life of the battery. The 120 watt-hour power capacity of this battery was attained by use of sixteen, 5 ampere-hour silver-zinc cells.

3.5 Handle Assembly (Fig. II-8) - The tubular handle assembly consisted of two pivoted battery locking pins, an operating switch with safety lock, and a mounting post for the vertical indicator. Engagement of the pivoted locking pins into the battery case receptacles required use of the spanner wrench to apply the required locking forces.

3.6 Vertical Indicator (Fig. II-8) - The operation of the development model vertical indicator was identical to that described for the mockup in paragraph 1.9.

3.7 Treadle Assembly (Fig. II-9) - The treadle assembly included the honeycomb treadle board, cuttings collector box, debris deflector, and foot operated drill string lock. A tubular extension was added to the basic treadle board which, when extended, increased its moment arm when used in conjunction with the reel and cable assembly. This permitted the operator to apply greater axial forces to the power head and drill string via the reel cable.

3.8 Reel and Cable Assembly (Fig. II-9) - The operation of the development model reel and cable assembly was identical to that described for the mockup in paragraph 1.7, except a pointer indicator was added to provide a visual indication of the "loaded" or "unloaded" condition of the restraint system in the closed loop mode of operation. When the pointer on the front of the assembly indicated an "unloaded" condition during penetration of the drill, the operator was required to "pump" the treadle in order to reset the springs and cable for the reapplication of foot pressure to the power head via the cable.

3.9 Core Bit and Extension Tubes (Fig. II-10) - The configuration of the core bit and extension tubes is similar to that described in paragraph 1.2 and 1.3, except two small tool holes were incorporated near the male coupling joint of each section to permit engagement of the spanner wrench during decoupling operations. The development model extension tubes were fabricated from hi-tuff steel which was subsequently changed to titanium.

3.10 Spanner Wrench (Fig. II-10) - This device was used to perform the same functions as described for the core remover in paragraph 1.8. In addition, the tool was used for attachment of the handle assembly to the battery case, and for disengagement of the various latching devices used to restrain the battery/power head assembly and rack assembly in the stowage mode configuration.

3.11 Anchor Pins (Fig. II-10) - The development model anchor pins were used to restrain the front end of the treadle assembly to the drilling surface during the closed loop mode of drilling in consolidated rock. The anchor pins were attached to the treadle by a pin-and-yoke arrangement. This mode of operation permitted the operator to apply a force of 60 pounds to the power head, as controlled by the reel and cable assembly negator spring. This force, gained through the mechanical advantage of the restraint system, permitted power head axial loadings in excess of operator lunar weight.

Use of the anchor pins (one for each 3-meter hole) required the operator to pre-drill a one or two inch deep hole into the consolidated rock near the proposed 3-meter drilling site. After drilling of the shallow hole, the anchor pin (assembled to the treadle) was inserted into the hole where it resisted an upward force by four pivoted, serrated pawls which latched against the walls of the hole.

3.12 Hole Casing Sleeves (Fig. II-10) - The hole casing technique previously described in paragraph 1.10 was replaced by use of thin-wall (0.012 inches) fiberglass tubes on the first ALSD development model. The serrated tubes were interlocked, placed concentrically around the extension tubes, and driven concurrently with the drill string during the drilling operation. The casing string was held rigid (non rotating with respect to the drill string) by a matching serrated cap which was clamped to the lower portion of the power head.

This casing technique, which proved to be unreliable and impractical beyond a depth of 15-20 inches in conglomerate overburden, was abandoned when the new requirement of casing to a full 3-meter depth was incorporated.

3.13 Stowage Rack (Fig. II-9, 11) - The stowage rack, pivot-mounted to the treadle assembly on the first ALSD development model, provided restraint for the core bit extension tubes, hole casing sleeves, spanner wrench, handle assembly, and all miscellaneous components for both the transport and operational modes.

3.14 Development Model Fabrication - Two development-type ALSD's were fabricated - one was retained by the Contractor for the performance of numerous development tests and the other model, designated EMI Test Model to be used for electrical interference testing, was delivered to NASA. The latter model was subsequently designated as a Development/Training Unit and was used accordingly by NASA for the performance of 1-G and KC-135 1/6-G tests.

## 4.0 DEVELOPMENT MODEL (FIRST MODIFICATION)

4.1 Design Concept - As a result of spacesuit operability evaluations and casing technique development tests, several modifications were incorporated into the ALSD development model as illustrated in Figures II-12 and II-13. These modifications included the following items:

- 1) The rack assembly was redesigned for detachment from the treadle by the operator during ALSD deployment operations. Spacesuit operability tests indicated that system stability and accessibility of the accessory components would be improved if the rack assembly were erected on the surface two or three feet away from the treadle.
- 2) A reel and cable assembly support post capable of pivoting to an upright position was added to the treadle assembly. This device was required to provide a convenient temporary stowage point for the reel and cable assembly during extension tube addition operations. This function was previously accomplished by the rack assembly with the configuration illustrated in Figure II-11.
- 3) The handle assembly-to-battery case locking pin located under the operating switch was changed from a pivoted to a fixed pin thus eliminating one locking operation with the spanner wrench.
- 4) The concurrently-driven hole casing sleeves illustrated in Figure II-10 were replaced with the heavier, power-driven casings illustrated in Figure II-12. This casing technique required that the 3-meter subsurface hole be predrilled with the core bit and metal drill string, followed by power driving of the closed-end fiberglass casings. A more extensive discussion of the evolution leading to the final casing technique selected for the ALSD is presented in Section III of this report.
- 5) The quadruple flute, one-inch lead hi-tuff steel extension tubes illustrated in Figure II-10 were replaced with double flute, one-inch lead titanium (6 Al - 4V) tubes. A description of other extension tube materials tested for this program is presented in Section III of this report.

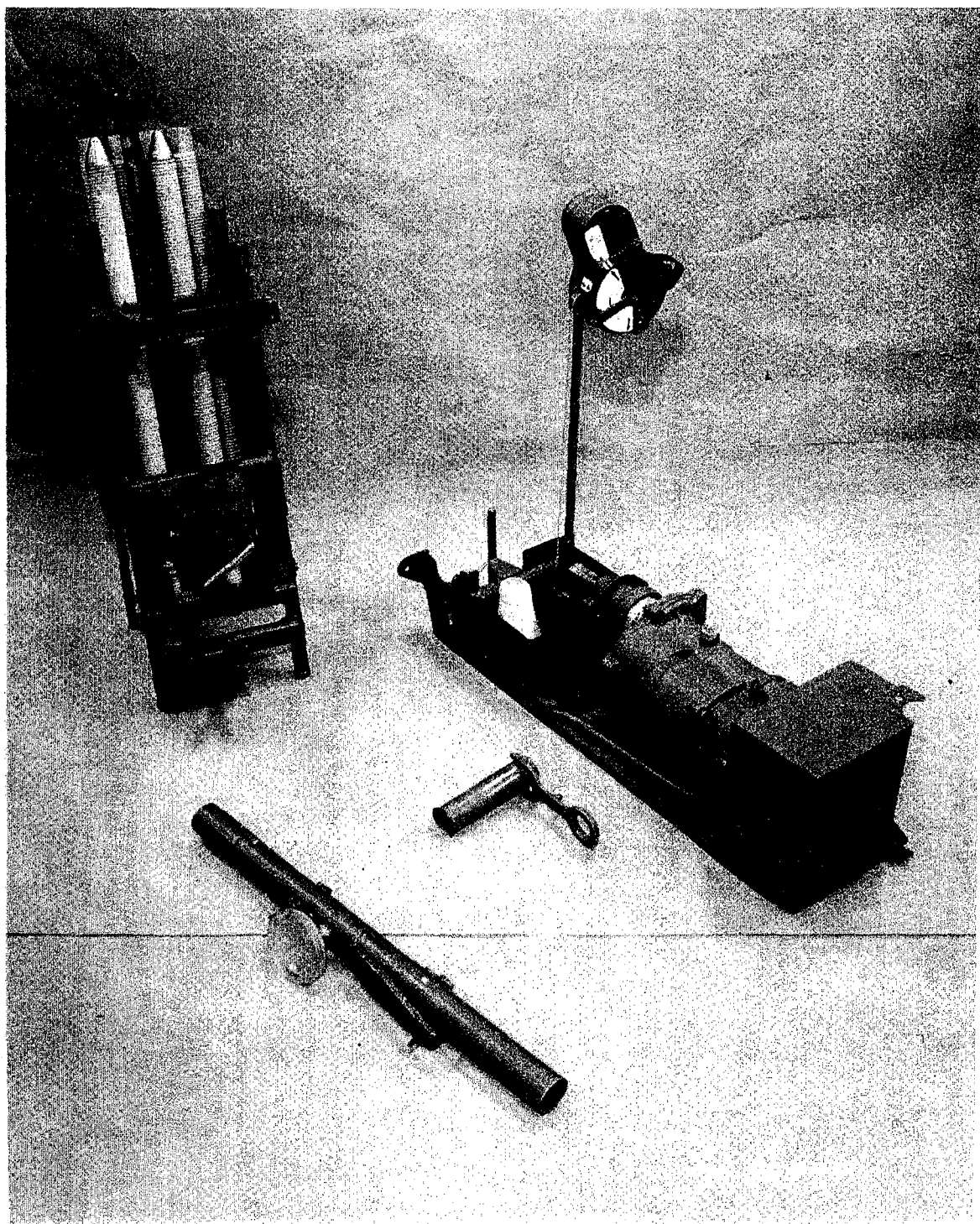

Figure II-12 Development Model ALSD (First Modification Components)



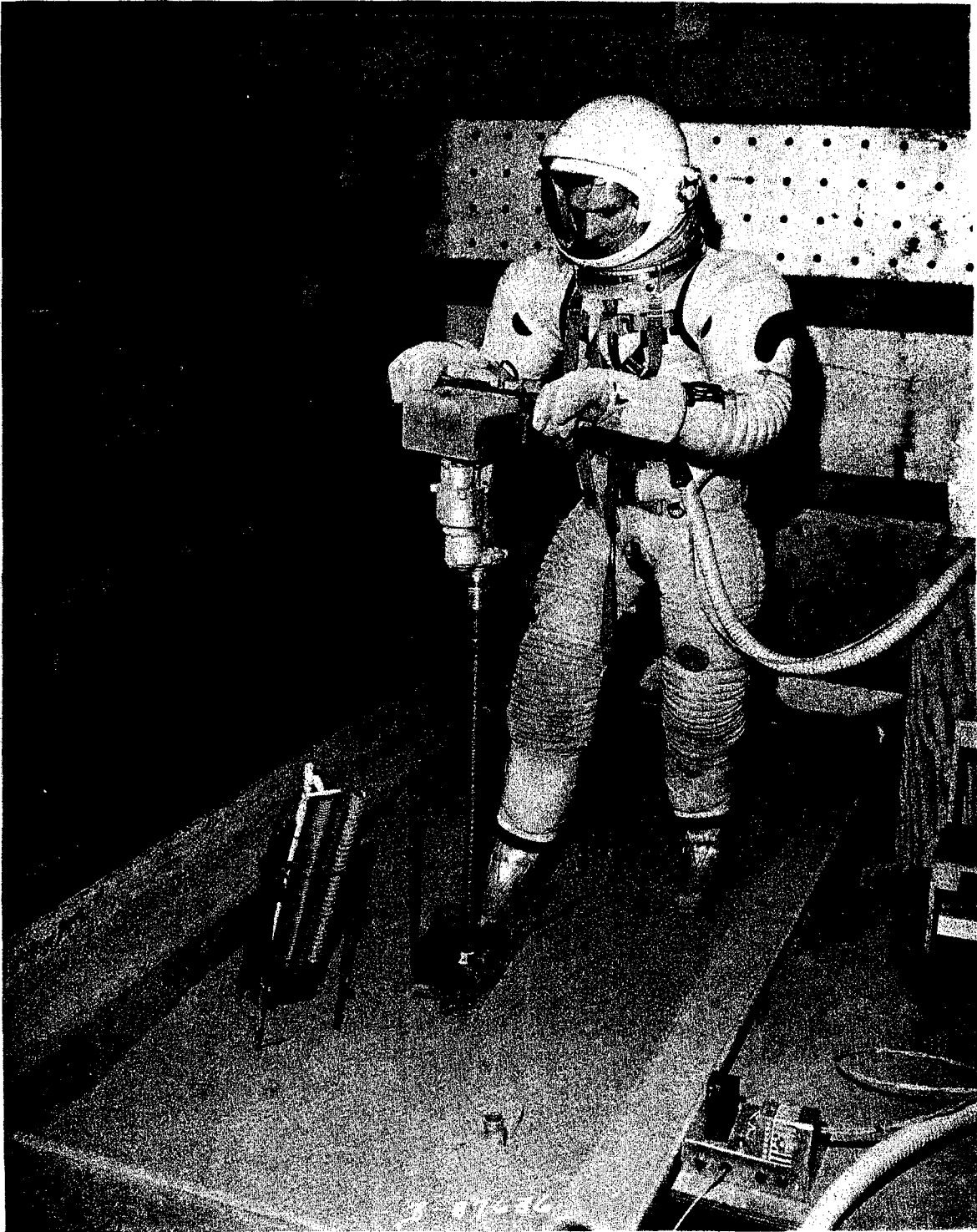

Figure II-13 Development Model ALSD (First Modification Operational Mode)

- 6) The four serrated locking pawls employed on the anchor pins described in paragraph 3.11 were replaced with a silicon rubber sleeve (approx. 0.8 in. long x 1.050 in. diameter) located at the bottom of the pin. The rubber sleeve was restrained by a metal ring around its lower edge in a manner which allowed axial stretching (and decreasing diameter) of the rubber sleeve when the anchor pin was forced into a shallow, predrilled 1.032 inch diameter hole. When an upward force was applied to the emplaced anchor pin, the lower metal ring restrained axial stretching of the rubber sleeve causing it to expand radially thus applying a side force on the hole wall which reacted against the upward force applied by the treadle assembly. Operation of this design was found to be more effective than the previous design.

4.2 Development Model Fabrication (First Modification) - The ALSD modifications previously described were incorporated into the NASA development/training unit and the MMC development model.

## 5.0 DEVELOPMENT MODEL (SECOND MODIFICATION)

5.1 Design Concept - The second modification to the development model ALSD involved major changes to nearly every component in the system. These changes resulted from: 1) A redefinition of the lunar surface model based upon updated Lunar Orbiter and Surveyor data, 2) Spacesuited operability and drilling development tests, and 3) Redefinition of operating environment extremes. These modifications, illustrated in Figures II-14 and II-15, included the following items:

- 1) The quantity of fiberglass hole casings furnished with each ALSD was increased from six to twelve, and the length of each casing section was increased from approximately 18 to 22 inches. This provided the capability for encasing each hole to the full 3-meter depth.
- 2) The quantity of core bit extension tubes was increased from six to eight, and the length of each reduced from approximately 22 to 17 inches. This change permitted the drill string to be stowed outbound and inbound in the ALSRC; thus providing the necessary storage volume in the ALSD rack for stowing of the increased quantity of hole casings. This change also provided the capability of returning relatively undisturbed lunar subsurface core specimens from the second drill hole directly to earth in the ALSRC.
- 3) The reel and cable assembly and anchor pins were eliminated to improve the overall operability of the system. Although dense rock drilling can be performed more efficiently with the higher axial core bit pressures made possible by the restraint system components, the reassessment of upper lunar surface characteristics indicated that consolidated rock will not comprise a significant portion of the three meter drilling requirements. If subsurface blocks of consolidated rock are encountered, the ALSD operated at a normal astronaut-applied axial bit force (approx. 15 to 20 pounds) will be sufficient to penetrate at a rate of 50 to 75 percent of that attainable with the restraint system.
- 4) A power head thermal guard was designed to preclude the spacesuited astronaut from touching surfaces which may exceed +250°F under worst-case conditions (maximum non-operating temperatures in the LM during outbound flight, maximum sun angle, and maximum power requirement drilling model) while operating on the moon's surface.

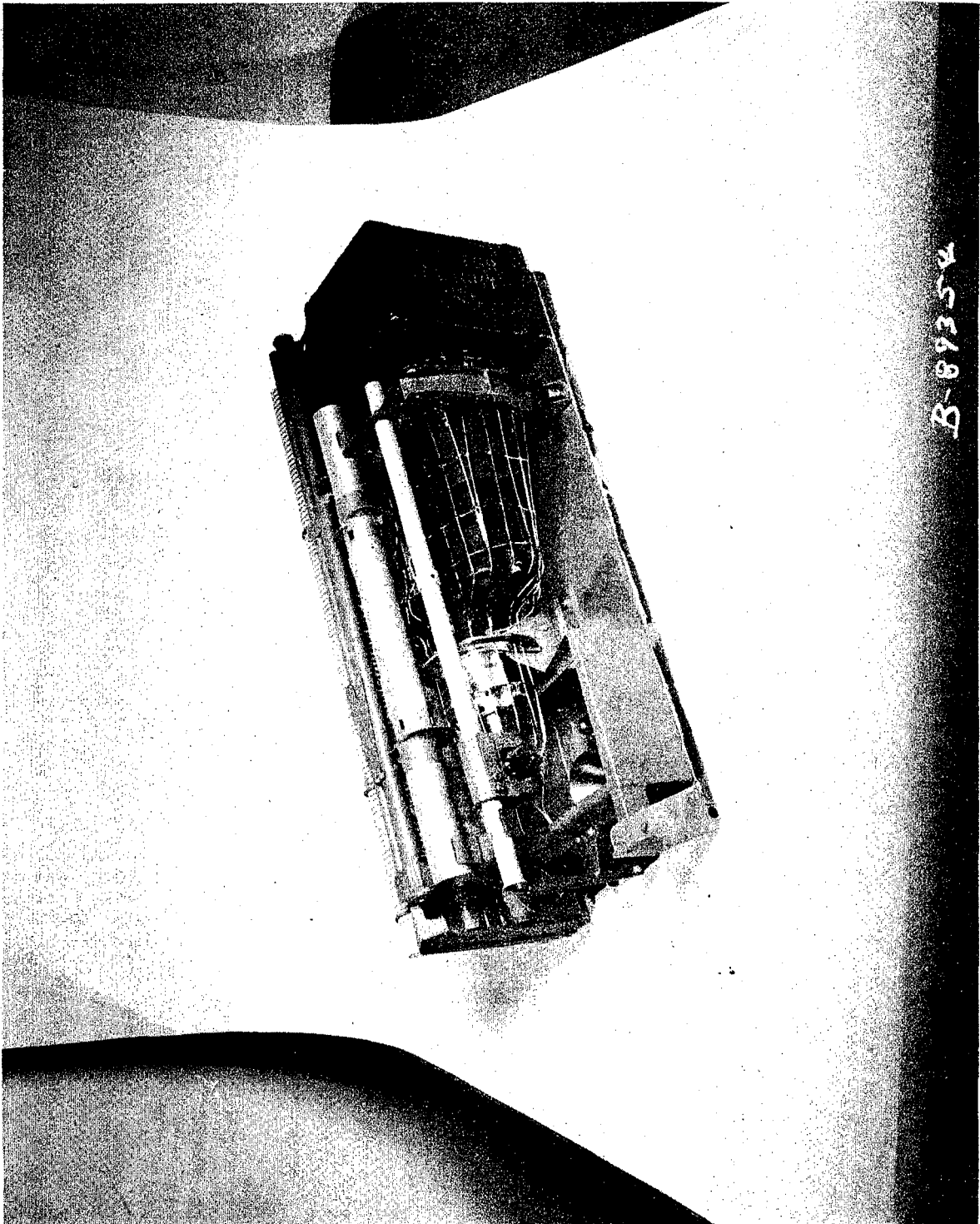

Figure II-14 Development Model ALSD (Second Modification Components)

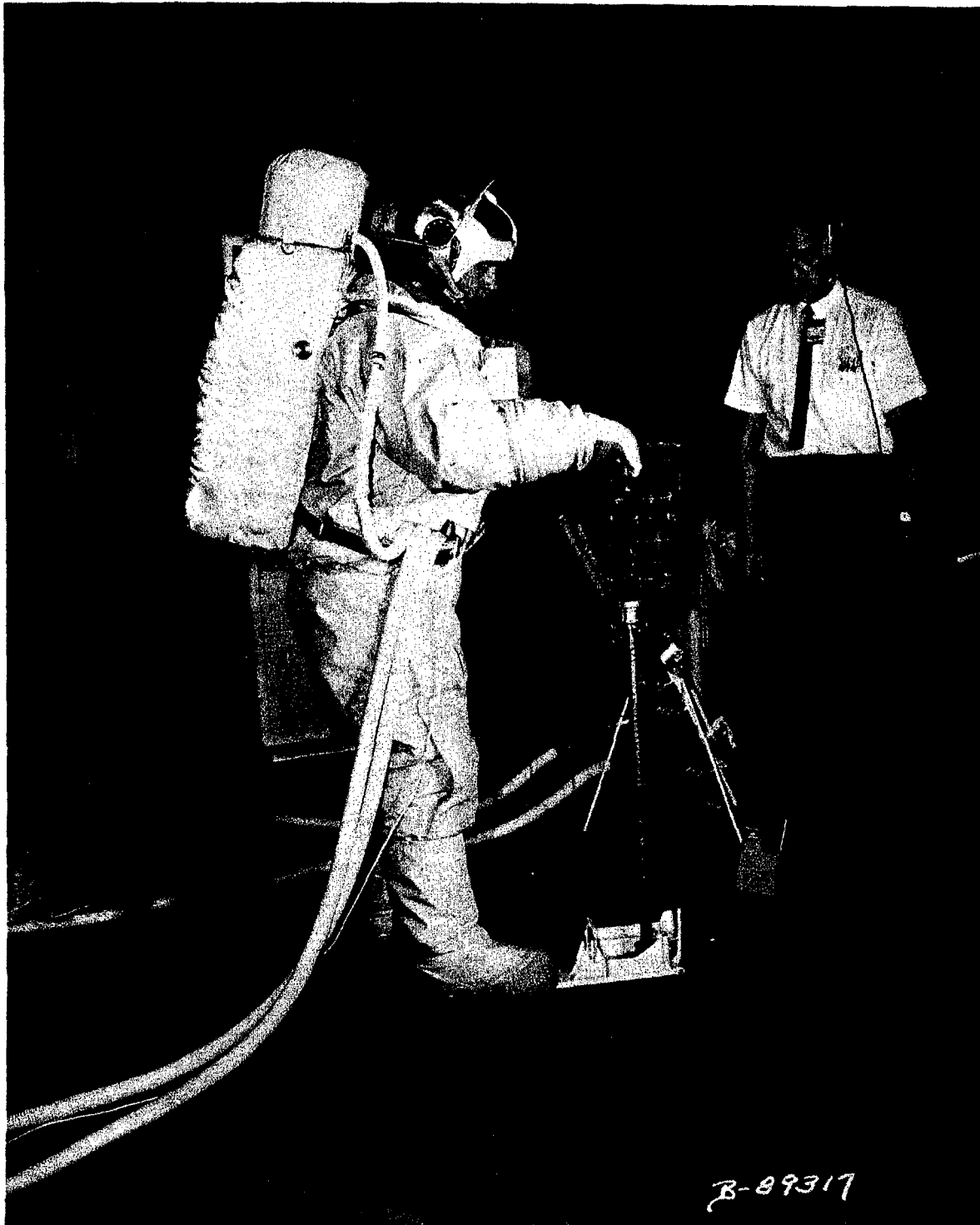

Figure II-15 Development Model ALSD (Second Modification Operational Mode)

- 5) The handle assembly operating switch was changed from the single pivoted lever illustrated in Figures II-12 and II-13 to the double actuating, concentric sleeve switches illustrated in Figure II-14. Both sleeve switches must be depressed towards the center of the handle in order to operate the drill. This concept resulted in improved fail-safe characteristics, and the symmetrical shape of the switch sleeves provided a constant profile to the operator regardless of operating height, thus improving ALSD operability.

The handle-to-battery case pivoted locking pin was changed to a spring-loaded latch thus eliminating the need for the wrench to provide the required locking torque. Flared fittings were later incorporated on each end of the handle assembly to improve the operator's grip, as requested by NASA astronaut.

- 6) The spanner configuration of the wrench head was changed to opposing "fixed" and "pivoted" serrated jaws. This modification permitted the wrench to grip the core bit extension tubes at any location on the double flute system. The previous wrench configuration required alignment of the spanner "fixed" and "spring-loaded" pins with the mating extension tube tool holes which was somewhat difficult for a spacesuited subject to perform. Flared ends to the wrench handle were later incorporated for improved gripping, as requested by NASA astronaut.
- 7) The foot-operated drill string locking mechanism integrated with the treadle assembly was replaced with a semi-automatic, serrated locking pawl. This device automatically locked the drill string in response to a counterclockwise rotation, and unlocked the drill string in response to a clockwise rotation. A concentric cone was added to the treadle to aid the operator in guiding the drill string through the treadle lock.
- 8) The wrench-operated dzus-type fasteners for attaching the battery/power head and rack assemblies to the treadle, and the casing restraint bracket to the rack were replaced with hand-operated camloc fasteners, thus reducing the overall ALSD deployment time.
- 9) A battery shroud was added to the system to stabilize the internal temperature of the battery during non-

ER 14778

operating storage of the ALSD on the lunar surface with sun angles less than 22° above the horizon. During operation of the ALSD the shroud is removed by the astronaut by use of the quick release lanyard.

5.2 Development Model Fabrication (Second Modification) - The ALSD modifications previously described were incorporated into the MMC development model. A similar model, designated Training Unit No. 1, was fabricated and delivered to NASA. Two Qualification Units were fabricated for the MMC test program described in Section IV of this report.

## 6.0 FINAL ALSD CONFIGURATION

6.1 Design Concept - The final ALSD flight configuration is similar to that described for the second modification of the development model, except for minor changes resulting from the Qualification Test Program. These changes, described in Section IV of this report, included the treadle assembly locking pawl, treadle assembly power head restraint structure, hole casing tip, casing adapter, and power head guard.

Figures I-1 through I-4 illustrate the final configuration of the ALSD, and Figures I-5 and I-6 illustrate the GSE. A more comprehensive description of the overall system, including thermal control parameters, operating procedures, and maintenance instructions are presented in Reference 2. A listing of final configuration drawings is tabulated in Table II-1.

6.2 Final Configuration Fabrication - Three flight units and a similar training unit were fabricated in accordance with the drawings delineated in Table II-1. The drawings listed in Table II-1 also document the configuration of the qualification units and the first training unit. Throughout design development, configuration records and formal engineering drawings were maintained on qualification, training, and flight units.



Table II-1 ALSD Subsystem Part Numbers

Nomenclature	Effectivity	Part Identification		
		Part Number	Qty/Unit	Mfg.
Container for ALSD	Fl., Tr. 1, 2	467A8050003-009	1	MMC
ALSD-Flight Unit	Fl.	467A8050000-029	1	MMC
ALSD-Training Unit	Tr. 1	-019	1	MMC
ALSD-Training Unit	Tr. 2	-079	1	MMC
Battery, ALSD Flight Cells	Fl.	PS9403000014-003	1	MMC
Silvercel Fill. Kit	Fl.	PM 5 Special	16	YEC
Battery, ALSD Train. Cells	Tr. 1, 2	11310	1	YEC
Silvercel Fill. Kit	Tr. 1, 2	PS9403000014-001	1	MMC
	Tr. 1, 2	HR 5 Special	16	YEC
	Tr. 1, 2	11294	1	YEC
Thermal Shroud	Fl.	467A8050029-009	1	MMC
	Tr. 1, 2	-049	1	MMC
Power Head, Flight	Fl.	PS955000002-007	1	MMC
Power Head, Train.	Tr. 1, 2	-005	1	MMC
Thermal Guard	Fl., Tr. 2	467A8050030-089	1	MMC
	Tr. 1	-009	1	MMC
Insulation (Thermal)	Fl., Tr.1, 2	467A8040000-001	25	MMC
Retainer	Fl., Tr.1, 2	467A8040000-023	1	MMC
Shield, Connector	Fl., Tr.1, 2	12062-94	1	B/D
Handle & Sw. Actuator	Fl., Tr. 2	467A8050013-099	1	MMC
	Tr. 1	-009	1	MMC

Notes: MMC = Martin Marietta Corporation  
 B/D = Black & Decker Mfg. Co.  
 YEC = Yardney Electric Corporation

Fl. = All Flight Units  
 Tr. 1 = Training Unit S/N 001, etc.

Table II-1 ALSD Subsystem Part Numbers (Cont.)

Nomenclature	Effectivity	Part Identification		
		Part Number	Qty/Unit	Mfg.
Wrench, Drill String	Fl., Tr. 2	467A8050014-039	1	MMC
	Tr. 1	-009	1	MMC
Hole Casing String	Fl., Tr. 2	467A8050003-019	8	MMC
		-029	1	MMC
		-039	1	MMC
		-079	2	MMC
	Tr. 1	467A8050003-019	8	MMC
		-029	1	MMC
		-039	1	MMC
		-049	2	MMC
Adapter, ALSD	Fl., Tr. 2	467A8050036-009	1	MMC
	Tr. 1	467A8050025-019	1	MMC
Rack Assembly	Fl., Tr. 2	467A8050028-029	1	MMC
	Tr. 1	-009	1	MMC
Treadle Assembly	Fl., Tr. 2	467A8050001-039	1	MMC
	Tr. 1	-009	1	MMC
Lock Pin Ass'y. (with attached camloc)	Fl., Tr. 2	467A8050015-069	1	MMC
	Tr. 1	-059	1	MMC
Lock Pin Ass'y.	Fl., Tr. 1, 2	467A8050009-029	2	MMC
Kit Accessory Details	Fl., Tr. 1, 2	467A8050000-059	1	MMC
Extension Tube	Fl., Tr. 1, 2	PS600100022-001	7	MMC
Extension Tube	Fl., Tr. 1, 2	PS600100022-003	1	MMC
Drill Bit	Fl., Tr. 2	467A8050000-011	1	MMC
Drill Bit	Tr. 1	PS600100023-007	1	MMC
Rack, Sample Cap	Fl., Tr. 1, 2	467A8050027-009	1	MMC
Rack, Sample Cap	Fl., Tr. 1, 2	467A8050027-019	1	MMC

## III. DEVELOPMENT TEST PROGRAM

## 1.0 INTRODUCTION

An extensive development test program was performed concurrently with the design of the ALSD. These tests served as a basis for validation of the design concepts and components integrated into the ALSD development model and its various modifications prior to the performance of the formal qualification test program. The major design areas encompassed by these tests included the following:

- 1) Core bit optimization in conjunction with the development model power head,
- 2) Core bit extension tube optimization,
- 3) Hole casing sleeve optimization,
- 4) Power head electromagnetic interference,
- 5) Power head high temperature operating characteristics,
- 6) Power head pressurization system operation in vacuum,
- 7) Power head magnetic field radiation measurements,
- 8) Battery performance characteristics,
- 9) Drill string operational temperature rise,
- 10) Power head vacuum rock drilling,
- 11) Three meter drilling,
- 12) Spacesuited subject operability.

A brief description of these major test areas is presented in the following paragraphs. Numerous other tests were performed, some of which are referenced at the end of this report; and others, which were not formally documented, were conducted during the performance of this program. Those tests, which did not significantly influence the design of the ALSD, are not included in this report.

## 2.0 CORE BIT OPTIMIZATION

2.1 Scope - Major factors involved in the design of the lunar drilling system included: 1) total energy required to drill the hole(s), 2) desired penetration rates, 3) maximum allowable system weight/size, and, 4) system efficiency. The objective of these tests was to develop a core bit with a cutting tip geometry and material which would drill reliably (minimum degradation) and efficiently (maximum penetration rate with minimum power consumption) when powered by a light-weight, low energy power head. These characteristics were required for all lunar material simulants such as dense basalt, vesicular basalt, scoria, pumice, and conglomerates.

Optimization of the core bit was primarily accomplished using the dense basalt as a standard because of its tougher drillability characteristics and its homogeneity, which was conducive to the performance of repeatable tests. Subsequent tests indicated that the vesicular basalts, although easier to drill, can often result in greater degradation of the core bit than the dense basalt. This factor had to be taken under consideration during design finalization.

2.2 Dense Basalt "Standard" Characteristics - The NASA furnished dense basalt standard, which represented the maximum drilling energy requirement of the lunar material simulants, was subjected to a series of tests(15) to determine its characteristics. The uniaxial, ultimate, compressive strength of the sample was measured at 21,732 psi (average) and the average shore hardness was 41.6 with a standard deviation of  $\pm 23$ . Drop tests were conducted in accordance with standard procedures using 60° and 90° wedge bits in the energy range of 2 to 20 foot pounds as shown Figure III-1. Using the data for the 90° bit, it was calculated that the ALSD operating at a percussive blow rate of 2250 bpm would require a bit delivered energy of 27.6 inch-pounds per blow to maintain a 2 inch/minute penetration rate. Assuming a power head output energy of 30 inch-pounds, a cuttings scavenging loss of 20% and a 10% energy loss per extension tube, the following empirical ALSD penetration rates were calculated:

<u>Number of Extension with Bit</u>	<u>Penetration Rate (In./Min.)</u>
1	1.26
2	1.09
3	0.93
4	0.81

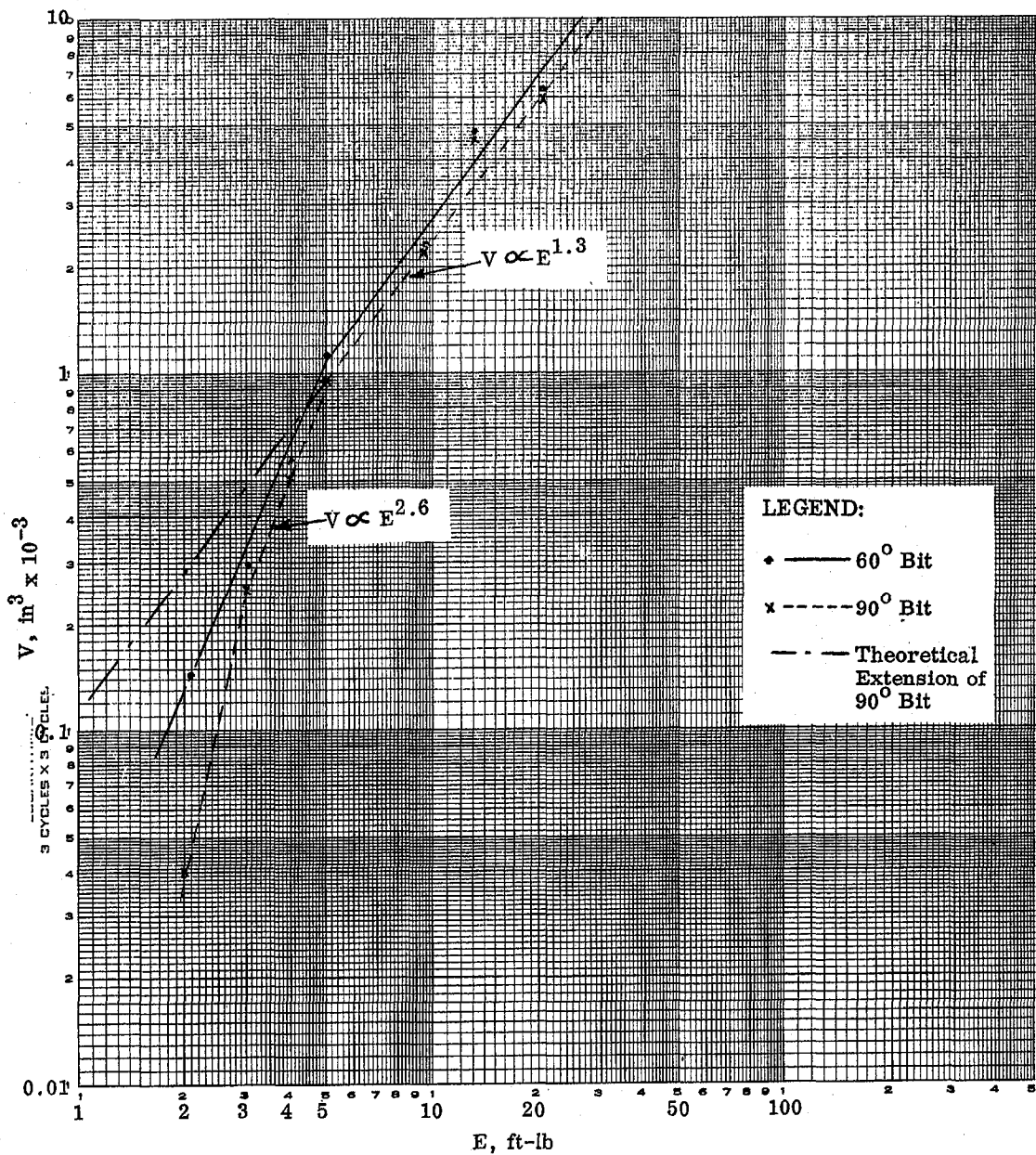

Figure III-1 Volume-Energy Relation for 60° and 90° Wedge Bits in Drop Tests on NASA Standard Basalt Sample.

These predictions did not take into account the benefit derived from optimization of blow indexing, which, at the time of initial power head design, was believed by most researchers to be of little or no benefit.

2.3 Core Bit Test Summary - Throughout the performance of this program, approximately 100 development bits were tested. In general, the bits were designed and fabricated in groups of 6 to 15 each, tested, and the results of the tests and redesign recommendations forwarded to the core bit contractor for incorporation in subsequent test groups. Major design variations included tip geometry and tip material (tungsten carbide) chemistry. Minor variations in tip brazing techniques and core bit body geometry were also studied prior to selection of the final design.

Most of the optimization tests (16-21) were conducted using the equipment illustrated in Figure III-2. With this arrangement it was possible to accurately control the axial bit force and power head input voltage while monitoring rpm, penetration rate and power consumption of the system.

Typical bit configurations tested included those illustrated in Figure III-3, where 3, 4, and 5 tips per bit of a single geometry and tungsten carbide chemistry were tested to investigate the effects of index variations. The advantage of indexing was clearly demonstrated during these particular tests by the typical results delineated in Table III-1 for three rock materials:

Table III-1. Typical 3, 4, & 5 Carbide Tip Penetration Rate Tests

Rock Material	No. of Tips	Voltage (VDC)	Current (Amps.)	Rate (In./Min.)	Power Watt-Hr./In. <sup>3</sup>
Dense Basalt	3	23.0	22.0	2.6	8.4
Dense Basalt	4	↑ ↓	19.5	1.1	17.5
Dense Basalt	5		22.0	2.3	9.3
Vesic. Basalt	3		23.0	8.5	2.6
Vesic. Basalt	4		21.0	4.3	4.7
Vesic. Basalt	5		21.5	7.3	2.9
Scoria	3	↓	23.0	10.2	2.2
Scoria	4		22.0	5.7	3.8
Scoria	5		23.0	24.0	14.2

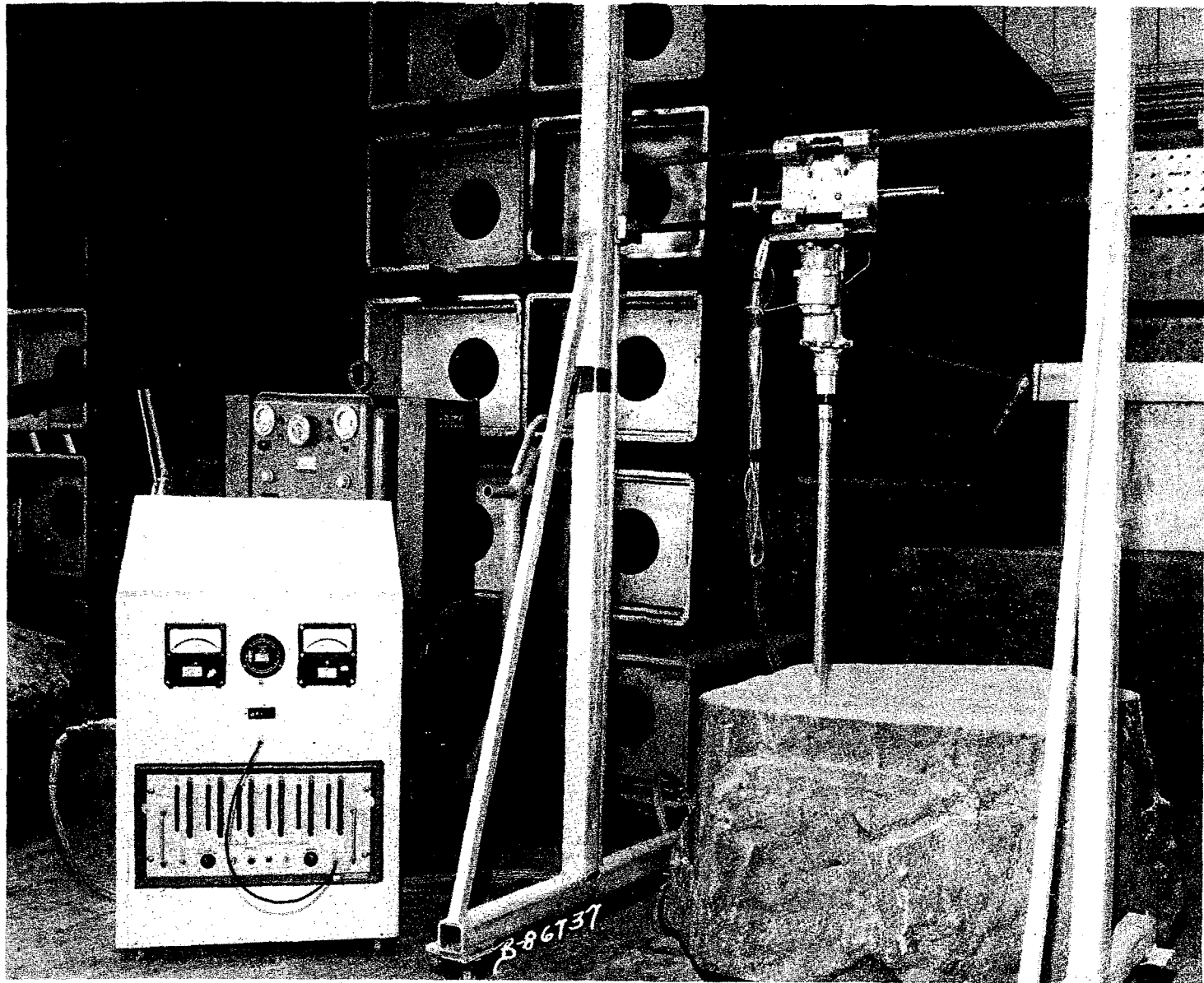

Figure III-2 Core Bit and Extension Tube Optimization Tests

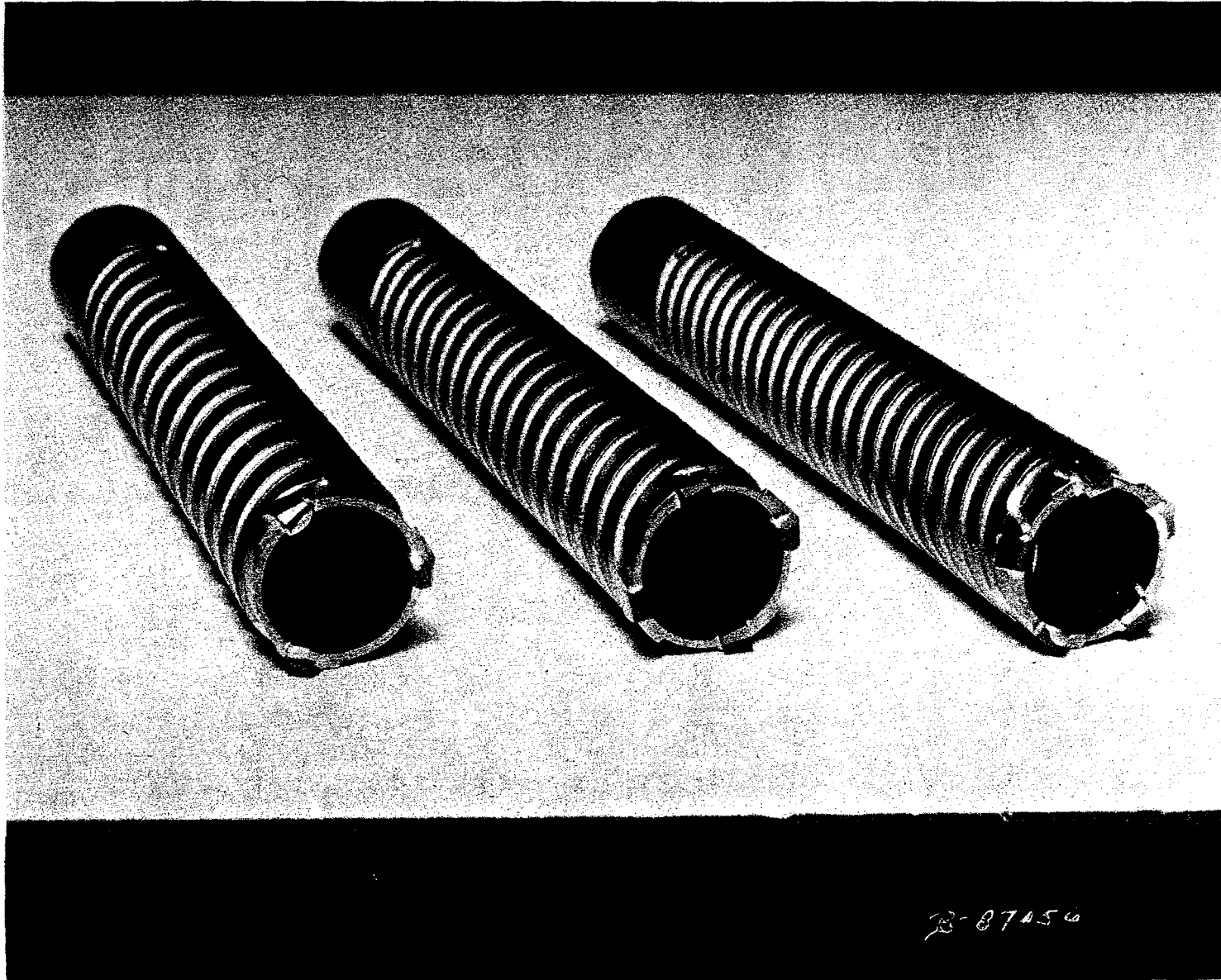

Figure III-3 Typical Core Bit Test Specimens



- Notes: 1) All tests conducted with the 6-inch bits coupled directly to the power head adapter.
- 2) All tests conducted with an axial bit force of 55 pounds.

These tests clearly demonstrated that the 3 and 5 carbide tip bits outperformed the 4-tip version due to improved indexing. At this point in the ALSD development program, a decision was made to replace the original 4-tip design bits with the 5-tip configuration. Although the 3-tip design indicated slightly superior performance, the bit tended to "chatter" excessively during operation and it was anticipated that rapid degradation of the tips would occur.

Another factor demonstrated during the performance of the core bit test program was the importance of optimum axial bit force to obtain maximum penetration rate at a minimum power consumption. Figures III-4 and III-5 illustrate the relative penetration rates and power consumption of the 5-carbide bit previously described with varying axial bit force in dense and vesicular basalt. Although this bit does not represent the final selected design configuration, the data does clearly illustrate the significance of optimum axial bit force in dense basalt. Bit force is not as critical in softer rocks such as scoria or vesicular basalt, shown in Figure III-5, because of the lower energy threshold required for predictable fracturing.

One technique for predicting minimum bit force required for efficient transfer of percussive energy from the drill string and bit to the rock follows:

$$P_{\text{MIN}} = \frac{2(1 + \gamma)FW\nu}{g}$$

f = blow frequency (blows/sec)

W = percussor ram weight (pounds)

$\nu$  = percussor velocity (feet/sec)

g = gravitational acceleration (32.2 ft./sec.<sup>2</sup>)

$\gamma$  = coefficient of restitution between the percussor ram and drill string (assumed to be 0.33)

Using the design parameters of the ALSD,  $P_{\text{MIN}}$  was calculated to be 37 pounds.

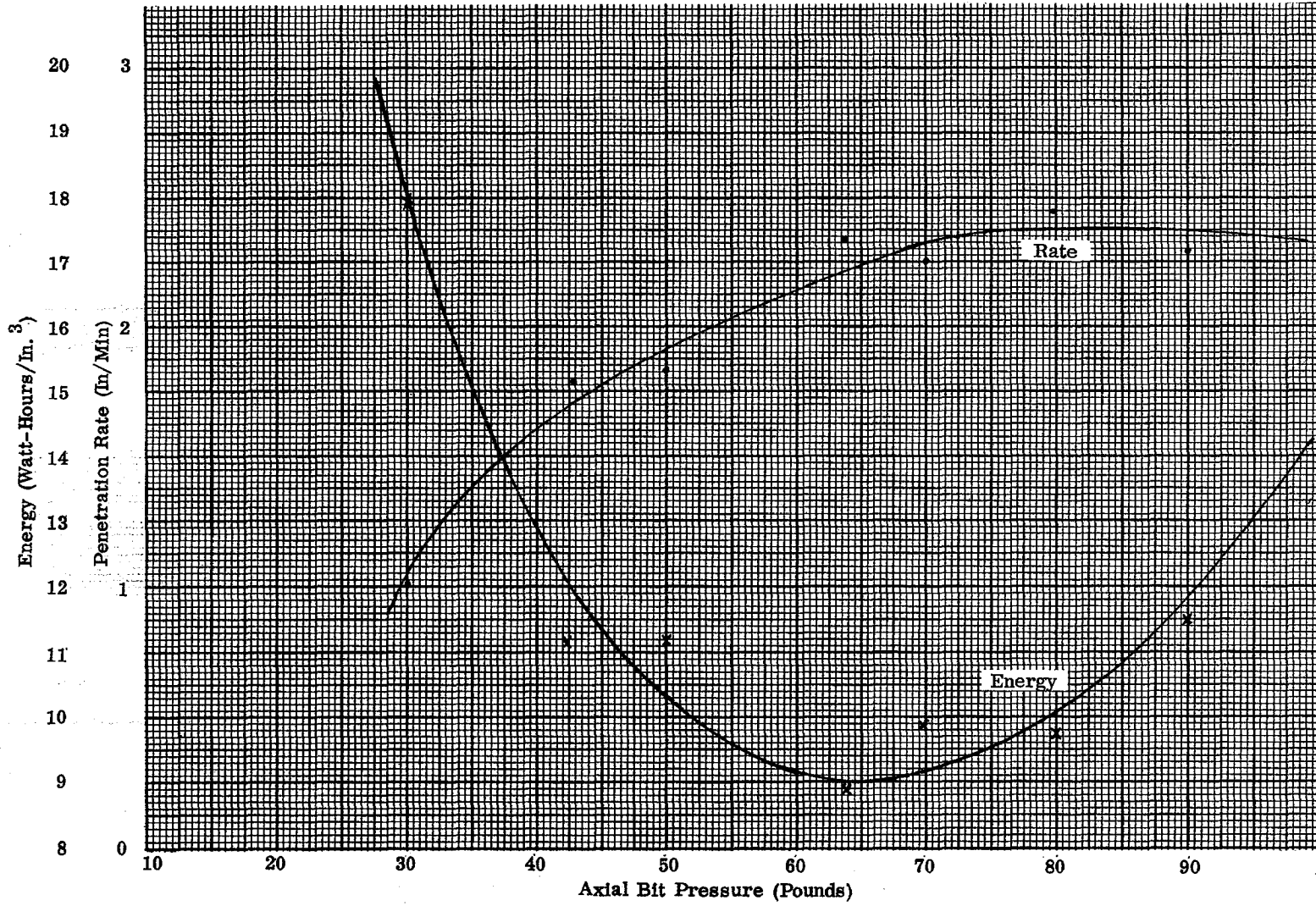

Figure III-4 ALSD Performance Characteristics in NASA Standard High Density Basalt

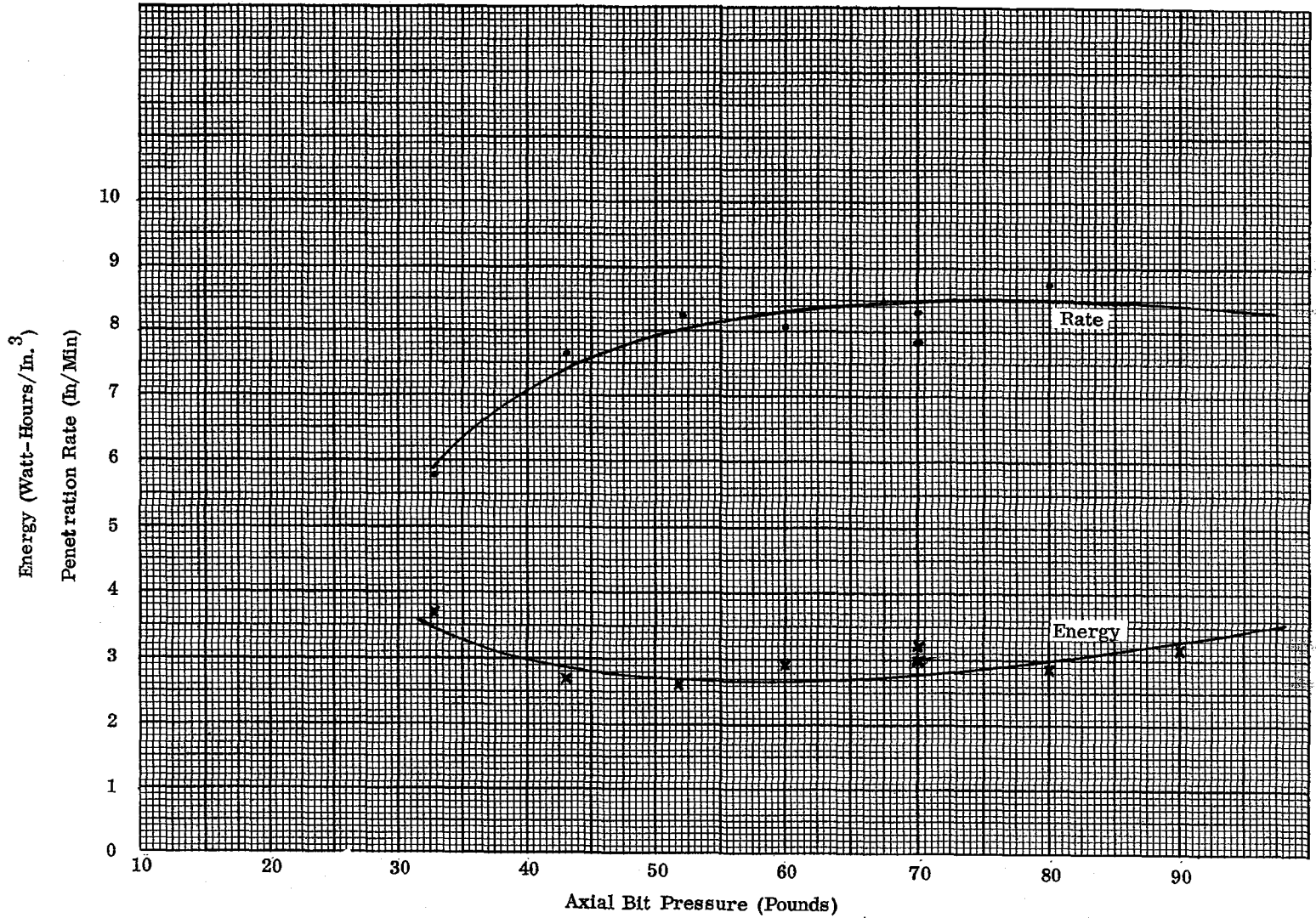

Figure III-5 ALSD Performance Characteristics in NASA Standard 43% Vesicular Basalt

The original design of the ALSD included use of the anchor pin, reel and cable assembly, and treadle, previously illustrated in Figure II-13, for providing a means for the operator to apply the required axial force to the core bit. Subsequently, redefinition of the lunar surface model reduced the quantity of anticipated dense basalt thus eliminating the requirement for the restraint system. The final drilling tests indicated that a spacesuited subject operating under 1/6-G conditions can drill the NASA standard dense and vesicular basalt rocks (located at a depth of 1.5-2.0 meters below the overburden surface) at penetration rates of 1 and 5 inches per minute respectively.

2.4 Final Core Bit Selection - The core bit test program indicated that a compromise design was mandatory in order to meet the ALSD drilling requirements in all lunar simulant materials. The harder tungsten carbides (91.3 RA) possess good wear characteristics in dense basalt, but tend to fracture if operated under light loads. Tip geometries which perform at high penetration rates and low power consumption tend to degrade rapidly. The final basic configuration selected is detailed in MMC drawing PS600100023-011. A minor modification was incorporated, as shown on MMC Drawing 467A8050000-011, to ensure that a uniformly round hole was drilled in consolidated materials. The selected carbide material (89.3 RA) consists of 87% WC and 13% Cobalt.

## 3.0 CORE BIT EXTENSION TUBE OPTIMIZATION

3.1 Scope - The ALSD drill string (assembled core bit extension tubes) is as important as the core bit in regards to system drilling efficiency. There is little advantage to be gained by having a highly efficient cutting bit if the percussive energy generated by the power head is lost by inefficient transmission of strain wave energy in the drill string. However, the drill string energy transmission efficiency must be "traded off" against its weight, since this subsystem represents a significant portion of the overall system weight. As an example, an ALSD drill string fabricated from magnesium or beryllium would weigh approximately 1.4 pounds as compared to steel at 5.9 pounds. The lighter drill string, of course, is of no value if it will not transmit sufficient energy to drill dense basalt at a reasonable penetration rate.

An analysis was performed for the ALSD system using the classical techniques for determining drill string stress waveforms, peak forces, and total wave energy under ideal conditions. A summary follows:

The stress developed in the drill string is given by:

$$\sigma_i = \sigma_1 \left[ 1 - 2P \left\{ \frac{1 - S^{(i-S)}}{1 - S} \right\} \right] \quad i = 1, 2, 3 \dots n$$

where n is largest integer  $\leq \frac{L_D}{C_D} \cdot \frac{C_H}{L_H}$

$$S = \frac{1 - T}{1 + T}, \quad P = \frac{T}{1 + T}, \quad \& \quad T = \left( \frac{A_D}{A_H} \cdot \frac{C_H}{E_H} \cdot \frac{E_D}{C_D} \right)$$

where: A = cross sectional area of drill or percussor

C = wave velocity of drill or percussor

E = modulus of elasticity of drill or percussor

Calculations and graphic analyses indicated the following results for various drill string materials:

<u>Material</u>	<u>Peak Stress</u> (lb./in. <sup>2</sup> )	<u>Peak Force</u> (Pounds)	<u>Wave Energy</u> (% of Impact Energy)
Steel	22,500	4,600	100
Titanium	13,300	2,700	97
Lockalloy	12,200	2,500	97
Aluminum	9,000	1,800	97
Magnesium	6,100	1,200	88

Calculations were also made to determine the energy transfer efficiency between the various material drill strings and the dense basalt. Using the rate of decay of the incident percussive waveform and the slope of the force-penetration characteristics of the bit-rock combination, the following ratio indicator is attained:

$$\pi = \frac{\beta}{K}$$

$$\text{where: } \beta = \frac{A_D^2 E_D \rho_D}{W}$$

W = percussor ram weight

$\rho_D$  = drill string material density

K =  $14 \times 10^4$  lb./in. (determined from Fig. III-1)

The following values of  $\pi$  were calculated, from which energy transfer efficiency can be analytically determined:

<u>Material</u>	<u><math>\pi</math></u>	<u>Energy Transfer</u> <u>Efficiency</u>
Steel	7.1	35%
Titanium	2.1	50%
Lockalloy	1.8	50%
Aluminum	0.8	50%
Magnesium	0.3	38%

The analytical results summarized above were calculated to serve as a means for predicting performance of the various drill string materials.

3.2 Test Results Summary - The drill string types tested during this program are illustrated in Figure III-6. Steel, titanium, aluminum, and magnesium materials were used in combination with double and quadruple flute cuttings transport systems. Numerous drilling tests were performed, predominately in the dense basalt standard. The average relative penetration rates attained using a normalized base follow:

Steel	1
Titanium	0.6
Aluminum	0.28
Magnesium	0.15

The actual penetration rates varied depending upon the type of bit and number of extensions employed, but the relative values for the various materials remained approximately constant. These test results generally agreed with the predictions which were made from the peak stress and energy transfer calculations. The energy transmitted by the aluminum and magnesium drill strings was in the gray region between "above" and "below" the energy threshold required for initiating rock fracturing. In softer rocks (vesicular basalt, scoria, etc.) with lower energy thresholds, the relative difference between aluminum and magnesium, and the other metals was not as great as for the dense basalt.

The aluminum and magnesium was ultimately deleted as candidates for the ALSD because of the possibility that a block of dense basalt may be encountered below the lunar surface at a depth great enough such that the fully assembled drill string could not penetrate due to excessive energy losses. The heavier titanium was selected for the ALSD drill string. The double-flute cuttings transport system was selected because of its greater capacity which could be required if the rapid penetration rates (10-15 in./min.) of scoriaceous-type materials are encountered on the lunar surface.

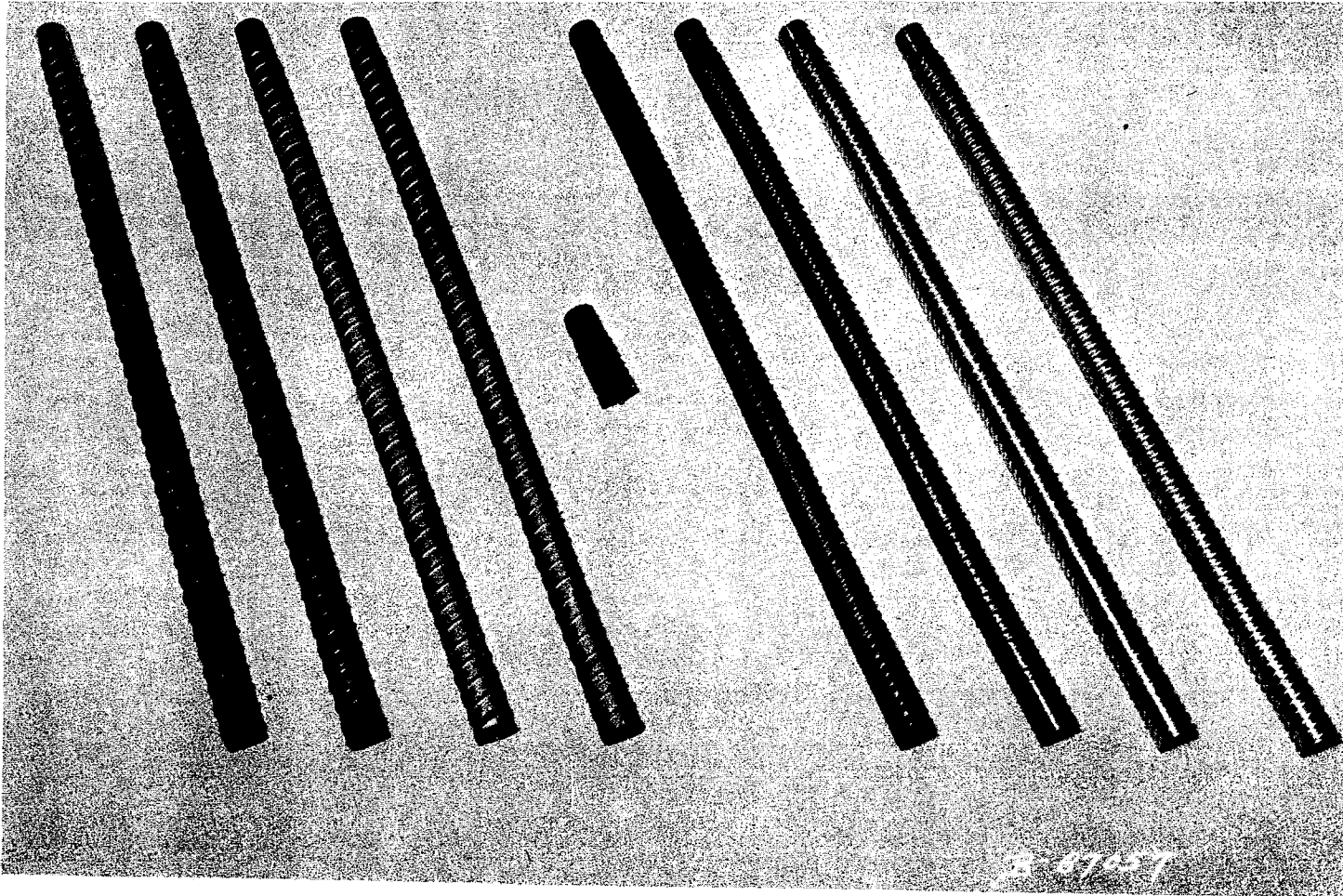

Figure III-6 Typical Core Bit Extension Tube Test Specimens



#### 4.0 HOLE CASING SLEEVE OPTIMIZATION

4.1 Scope - One of the major problems encountered during performance of the ALSD program was development of the hole casing sleeves. This subsystem is used to prevent the collapse of the 3-meter subsurface hole against critical elements of the emplaced HFE probe. Two major constraints of the HFE which contributed to the hole casing sleeve development problem included: 1) The casing sleeve, if permanently emplaced with the HFE probe, was required to be fabricated from a non-metallic material (metallic casings could be used if removed from the hole after probe emplacement), and 2) The HFE probe signal cable could not be decoupled from the probe or its control box. This prevented removal of any tubular casing sleeve if temporarily emplaced in the subsurface hole to restrain the cave-in during probe emplacement.

The development tests (24-38) performed which resulted in the final design selection are summarized below.

4.2 Test Results Summary - The initial hole casing approach proposed during the Phase C program shown in Figure II-1, consisting of the manual insertion of an axially split, thin-wall sleeve around the emplaced drill string, was abandoned early in the development program. This approach was abandoned because of the difficulty encountered in forcing the sleeve to depths greater than 1-2 feet into unconsolidated material which had collapsed around the drill string after its emplacement. Tests were also conducted to determine the feasibility of emplacing the split casing concurrently with the drilling operation. This approach was also abandoned because of the tendency of the split tubing to wind around the rotating drill string.

One modification of the initial split tubing approach which appeared to have merit is illustrated in Figure III-7. This approach consisted of installing the spring-loaded split tubing against the inner walls of the drill string segments prior to drilling the hole. Upon completion of drilling, the inner split tubing was withdrawn from the emplaced drill string, emptied of core material, and replaced within the drill string. The drill string was subsequently manually withdrawn, leaving the split tube casing emplaced in the subsurface hole. The HFE probe was then inserted into the hole, and the split tubing was withdrawn from around the probe and its cable. Although this technique was found to be technically feasible during test, the spacesuited subject operational problems were considered to be excessive.

Numerous tests were performed using the concurrent casing technique illustrated in Figure III-8. This technique consisted of

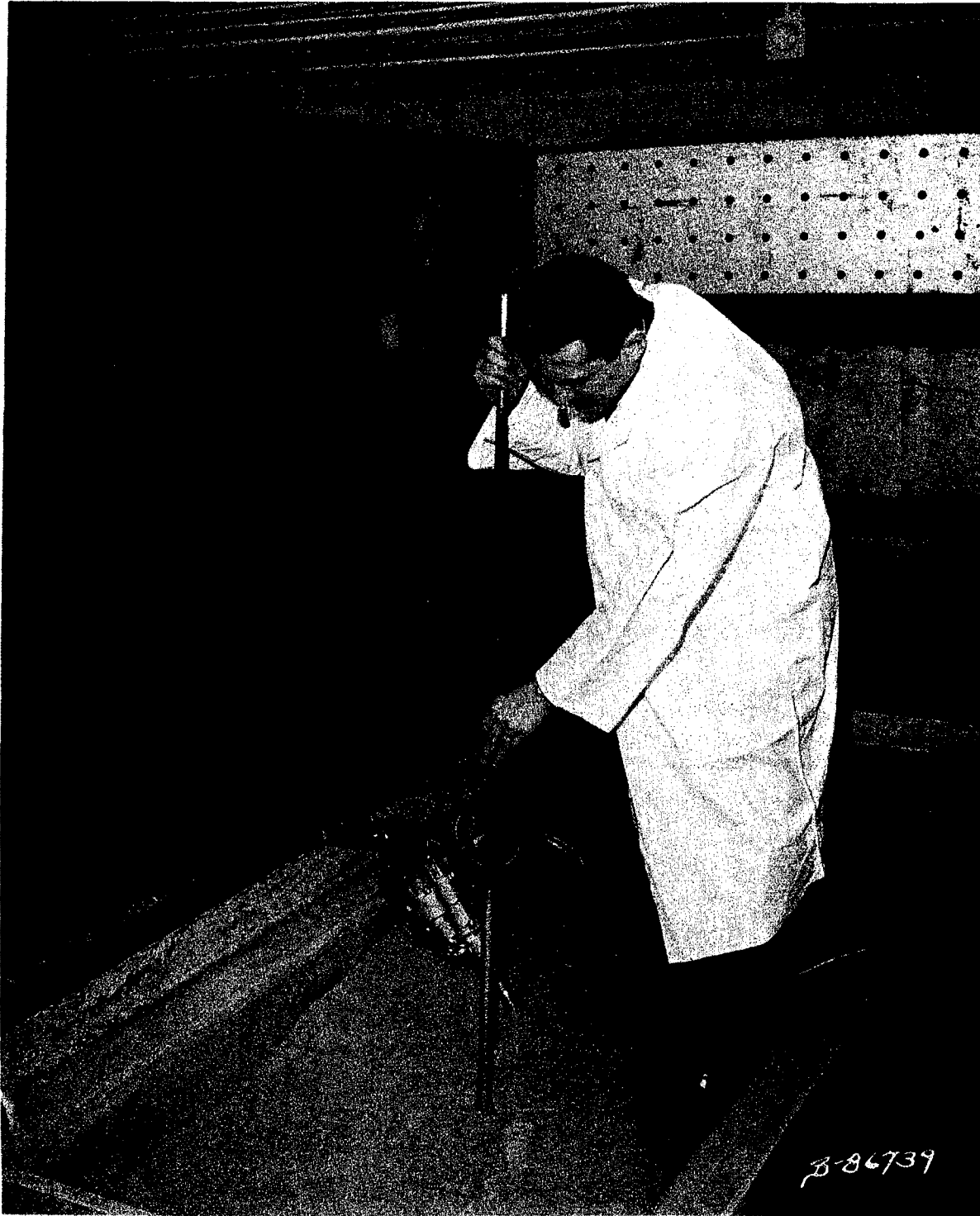

Figure III-7 Internal Split Tube Casing Tests

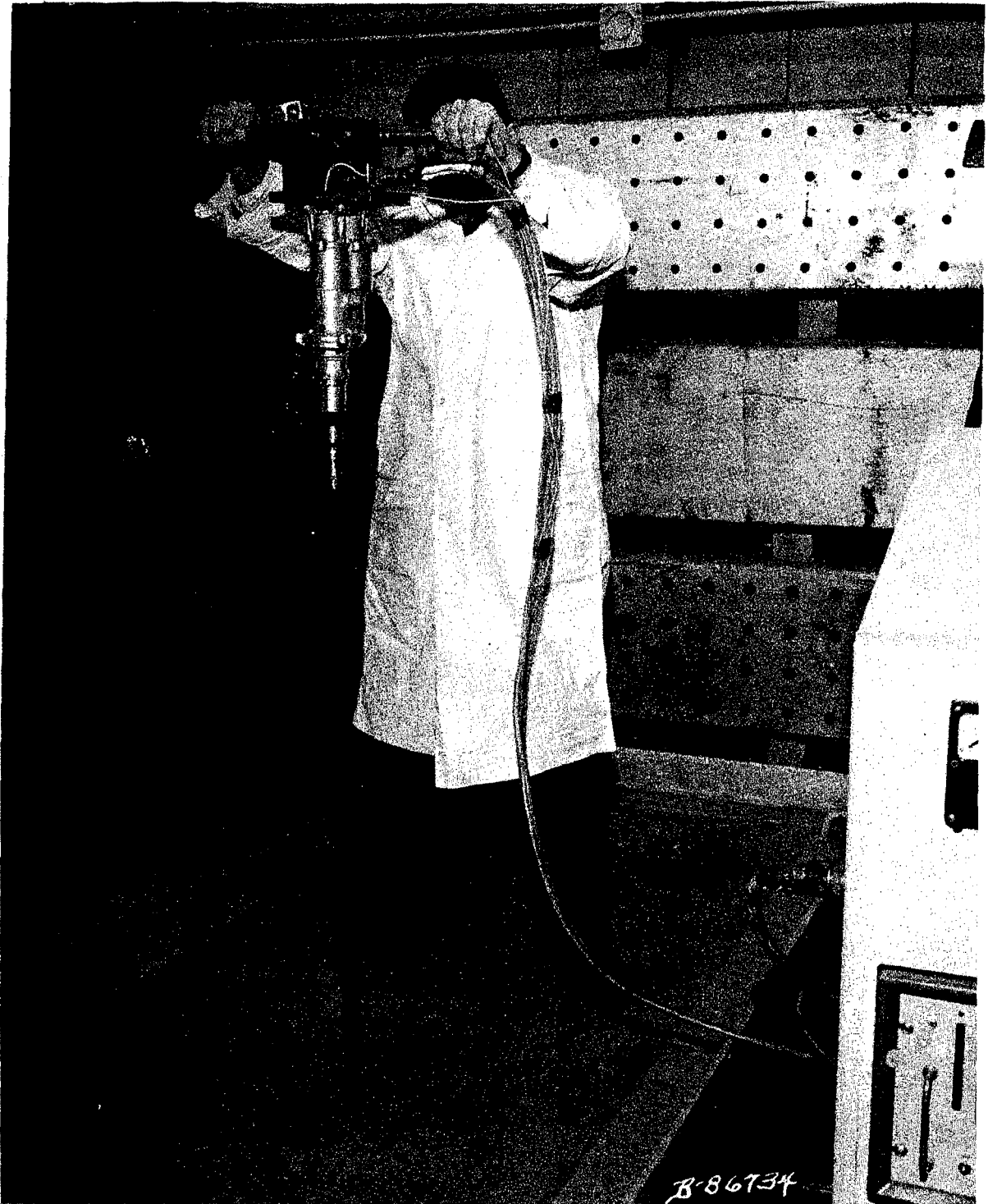

Figure III-8 Concurrent Drilling/Casing Tests

assembling the serrated fiberglass tube sections, depicted in Figure II-10, around the drill string, and drilling with the complete assembly to the required depth. This approach was tested, both with the casing rotating, and non-rotating, with respect to the inner drill string. The concurrent drilling/casing technique was subsequently abandoned because of the excessive torques developed, both between the drill string and casing, and between the casing and walls of the subsurface hole. These torques, in addition to causing failure of the relatively thin-wall fiberglass tubes, were in excess of the spacesuited subject's restraint capability under a 1/6-G operating mode. A secondary reason for eliminating this casing technique is that the carbide bit tips will not "over-drill" the hole in consolidated rock with sufficient clearance to allow a thin-wall casing (4-5 mils, or greater) to pass through the hole simultaneously with the bit.

The final hole casing technique which was extensively pursued during this program involved the following, two-step operation: 1) The 3-meter subsurface hole was initially drilled with the drill string and bit, and subsequently withdrawn with the encapsulated conglomerate and consolidated rock (if any) core samples, leaving a subsurface hole which had partially or completely collapsed with relatively low density unconsolidated material, 2) The subsurface hole was subsequently encased by sequentially power-driving fluted, closed-end fiberglass casing sections which, after emplacement, restrained the walls of the hole and provided a "receptacle" for insertion of the HFE probe.

The final hole casing technique selected for incorporation into the ALSD system still required extensive development, predominately in the area of the penetrating tip configuration and the design of the quick-release, casing-to-power head adapter. Design of a casing tip to penetrate unconsolidated material presented no problem, but a design to penetrate a pre-drilled hole in a subsurface block of consolidated rock presented numerous problems. The pre-drilled hole normally back-filled with conglomerate materials during retraction of the drill string. These problems were predominately related to the constraints of the HFE, which dictated the maximum diameter of the core bit (1.032 inches) and minimum inside casing diameter (0.875 inches). In order to ensure sufficient strength of the fiberglass casing sections, a one-inch outside diameter was required resulting in a basic material wall thickness of 0.125 inches. The strength of the basic fiberglass tubes was degraded somewhat by the machined 0.022 inch-deep cuttings transport helical flutes and the male/female tapered coupling joints.

Figure III-9 illustrates 11 of the approximately 25 development casing tip configurations which were tested during the program. The design

III-19

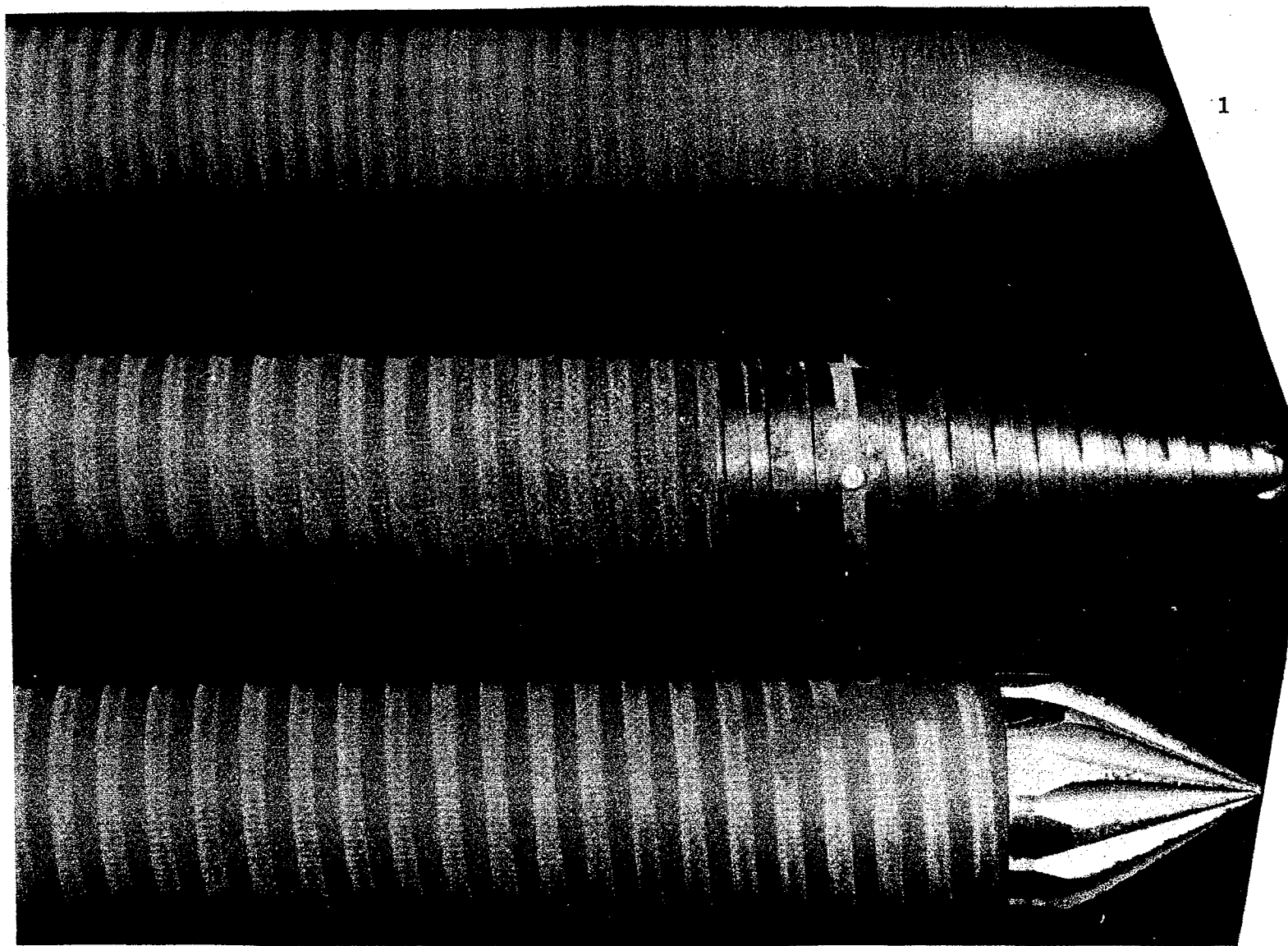

1

2

3

ER 14778

Figure III-9 Hole Casing Tip Configurations (Sheet 1 of 3)

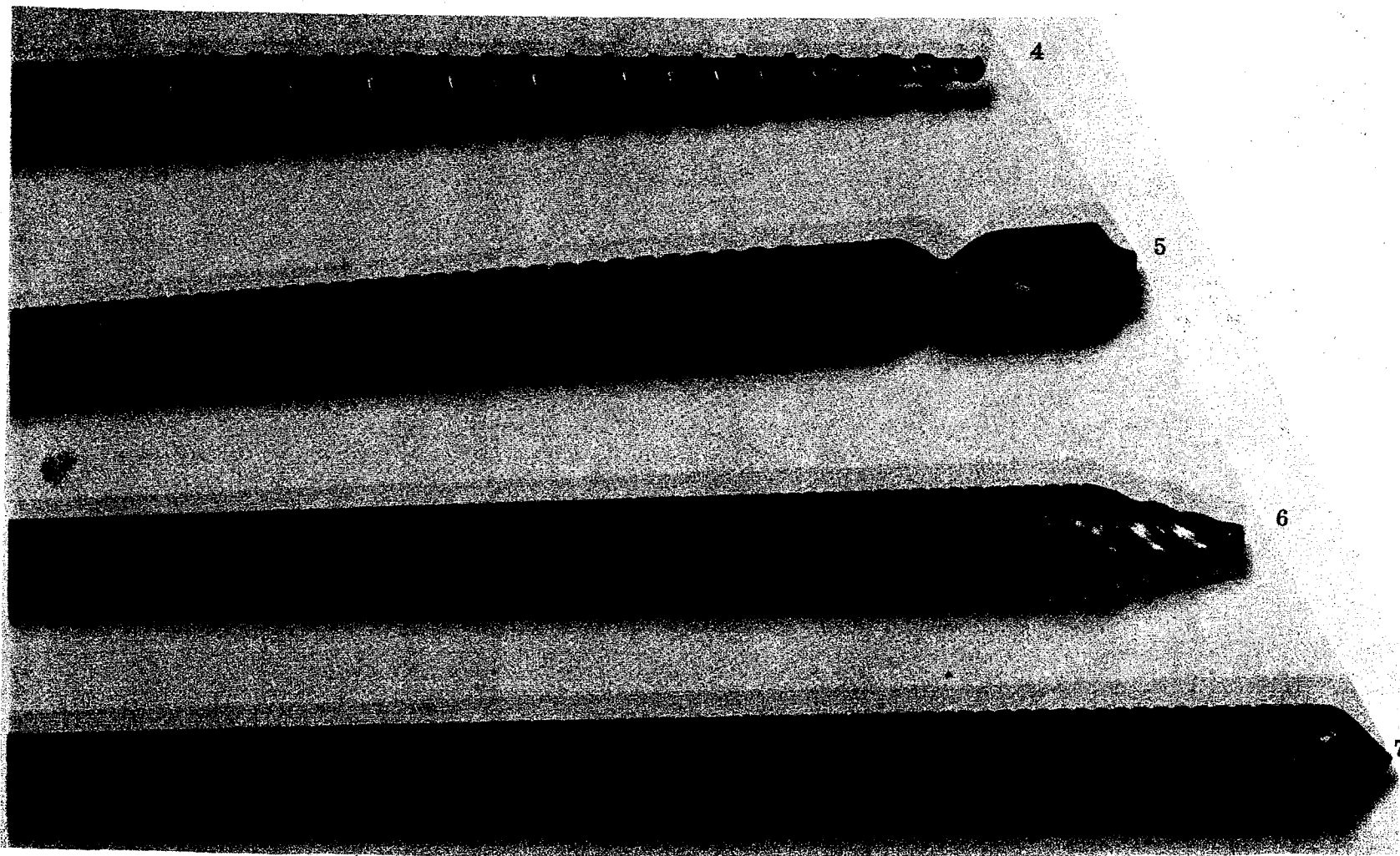
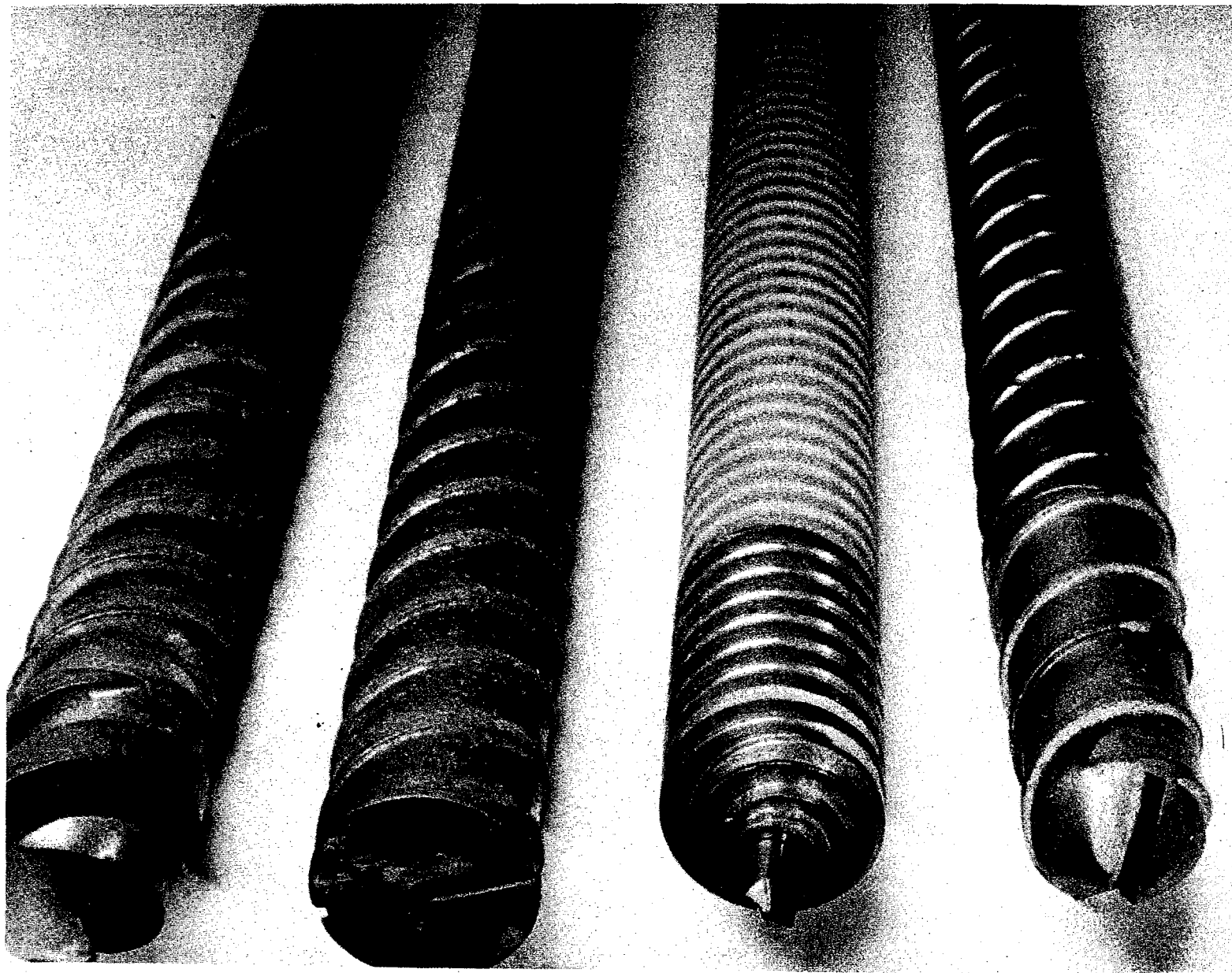

Figure III-9 Hole Casing Tip Configurations (Sheet 2 of 3)



8

9

10

11

Figure III-9 Hole Casing Tip Configurations (Sheet 3 of 3)

requirements of the tip which evolved during the test program included: 1) Capable of cutting and penetrating through unconsolidated material which has caved into the pre-drilled hole in a subsurface rock (this material tends to compact into a rock-hard consistency when restrained by the consolidated rock hole walls), 2) Capable of fracturing and grinding material which is initially too large to pass between the casing flute grooves and the hole walls, 3) Capable of metering and transporting the cuttings at a rate consistent with a 5-6 inch per minute casing penetration rate -- a fast penetration rate results in overloading the cuttings transport system and subsequent jamming of the casing string; a slow rate results in excessive abrasion of the fiberglass material, destruction of the flute transport system and subsequent jamming of the casing string.

The final ALSD casing configuration is illustrated in Figure III-10. During testing of the hole casing design, small, stainless steel support bands epoxyed concentrically with each female taper joint were incorporated to increase the hoop strength of the casing string; and the addition of a copper-nickel cladding for a length of 1.6 inches above the tip was incorporated to preclude severe abrasion at the tip/casing transition.

Design of the casing-to-power head adapter also required a considerable development test (39) effort during performance of the ALSD program. The major design requirements of the adapter included: 1) The capability to transmit torques to 20 foot-pounds through the friction taper mate with the casing sections, and 2) Capable of quick release from the casing taper after emplacement. Figure III-11 illustrates several of the designs which were tested in an effort to attain the design requirements. The final adapter design, illustrated in Figure III-11, operates through the interaction of matched tapers. The inner collet and outer shell with the matched tapers in full engagement grip the hole casing. The use of a key block, driven by the ALSD power head, provides the means to separate the matched tapers and thereby release the grip on the hole casing. Detailed operating instructions and operational techniques are presented in the Familiarization/Support Manual. (2)



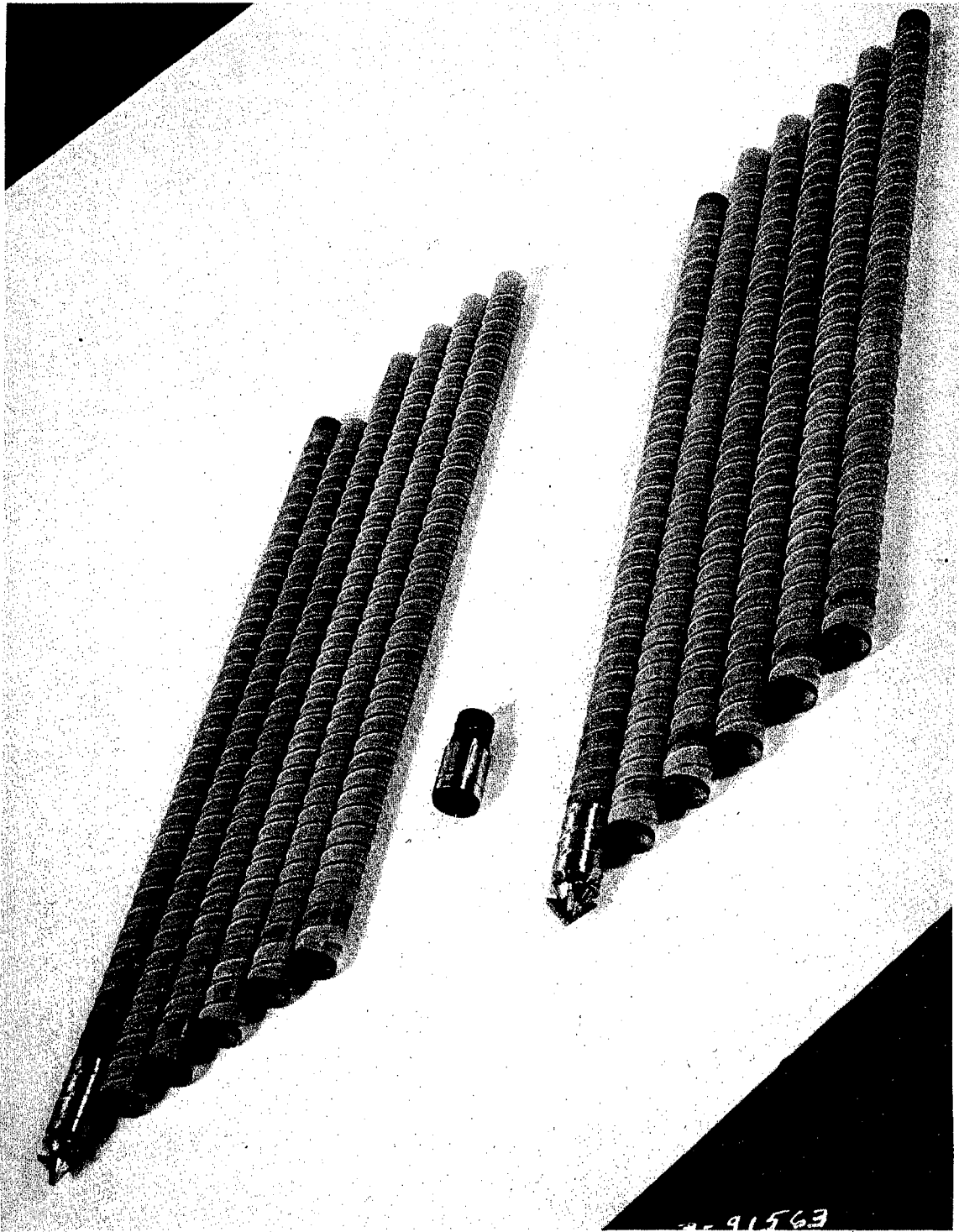

Figure III-10 Final ALSD Casing and Adapter Configuration

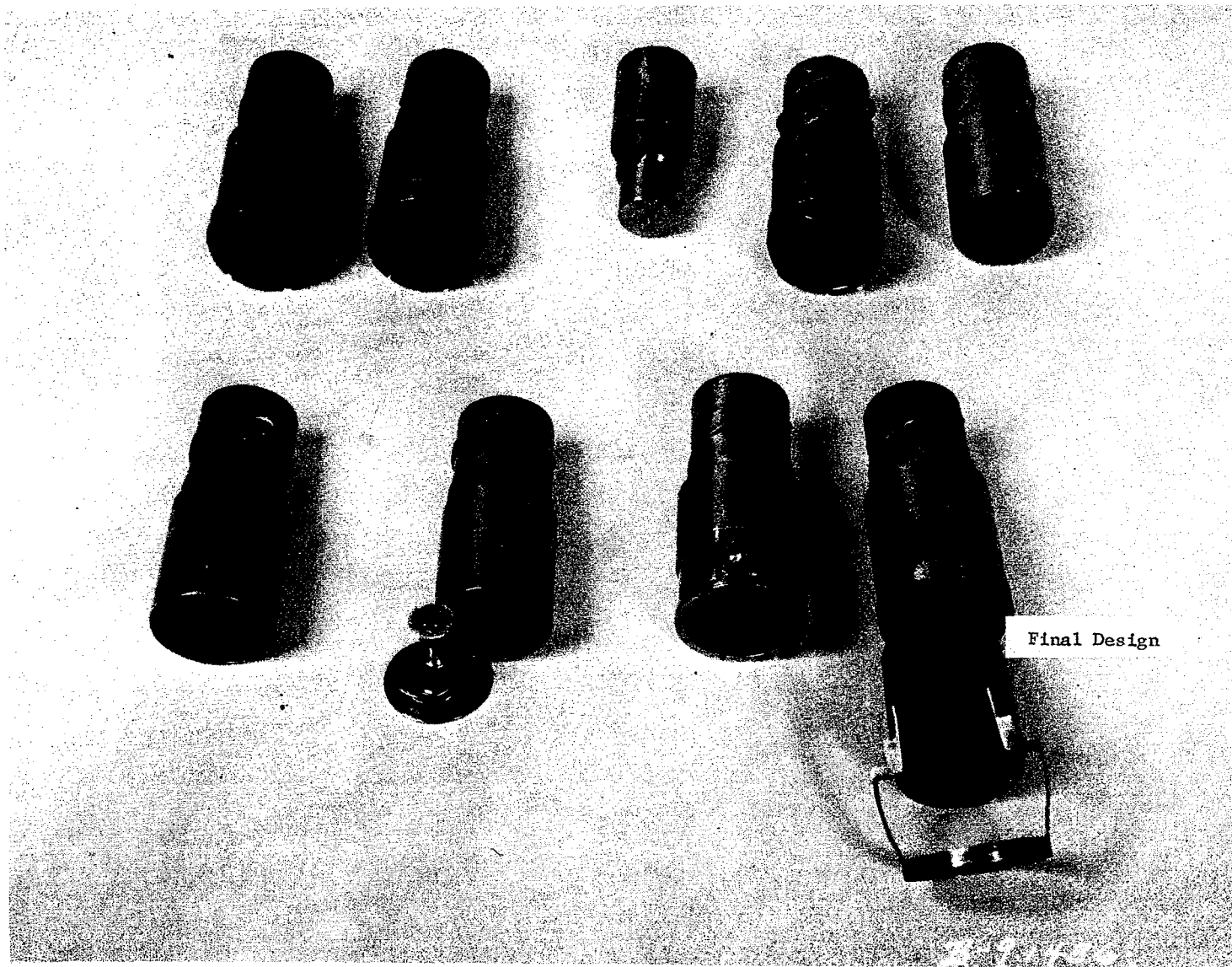

Figure III-11 Casing-to-Power Head Adapter Configurations

## 5.0 POWER HEAD ELECTROMAGNETIC INTERFERENCE

5.1 Scope - A primary concern during initial design of the ALSD power head was that the dc, mechanically commutated motor would exceed the electromagnetic radiation limits of MIL-I-26600, Class I, as amended by NASA document MSC-ASPO-EMI-10A. Since problems of this nature are difficult to correct on dc motors, a series of EMI tests were scheduled early in the program for the Powered Lunar Geologist Tool (a drill similar to the ALSD developed on a previous program) and the EMI Test Model ALSD in order to identify and correct any apparent problems prior to fabrication and test of the flight units. The development tests (41) (42) are summarized below.

5.2 Test Results Summary - The tests performed on the Powered Lunar Geologist Tool (PLGT) revealed that all the requirements of MIL-I-26600 were met for radiated EMI. Conducted EMI and EMI susceptibility were not required for the ALSD.

The initial tests conducted with the EMI Test Model-ALSD resulted in several out-of-tolerance measurements. The differences between the PLGT and EMI Test Model were attributed to the heavier physical construction of the former unit which tended to contain the electromagnetic radiation in a more efficient manner. As a result of these tests, the following modifications were incorporated into the ALSD system:

- 1) Mu-metal shielding was installed inside the power head castings in the area of the motor commutator,
- 2) A mu-metal shield was installed around the external connector pair which is the electrical interface between the battery and the power head,
- 3) Spring-loaded, molybdenum buttons were installed in the forward power head housing to conduct the static electricity generated by the rotating output spindle to the case of the unit.

Subsequent testing revealed that the EMI Test Model-ALSD met the MIL-I-26600 requirements as illustrated in Figure III-12.

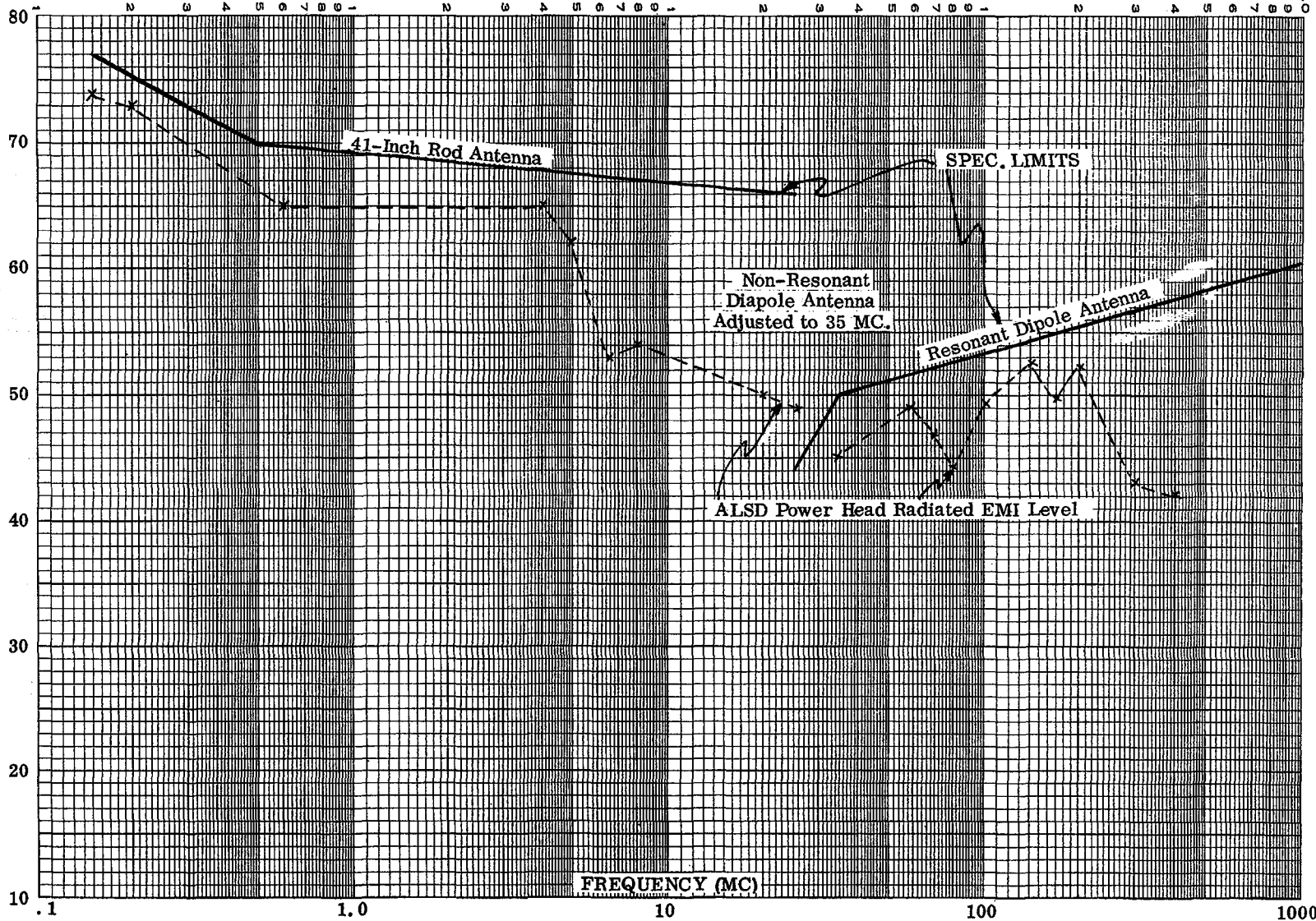

Figure III-12 Class I Radiated EMI of ALS D Power Head (EMI Model)

## 6.0 POWER HEAD HIGH TEMPERATURE OPERATING CHARACTERISTICS

6.1 Scope - Preliminary thermal analyses (1) performed during the Phase C program indicated that the power head housing and permanent magnet may experience temperatures in the vicinity of 335°F at the end of a drilling mission under worst-case conditions. These conditions included maximum temperature during transit to the lunar surface, and a maximum sun angle above the horizon while performing a worst-case drilling mission (max. power requirement) on the lunar surface. (Subsequent Phase D thermal-vacuum tests under modified worst-case operating conditions revealed average power head housing temperatures of approximately 325°F.)

The ALSD power head was designed with the latest state-of-the-art insulations and materials available to withstand the maximum anticipated operating temperatures using a passive thermal control system. The Genox R6-C permanent magnet material was selected for its optimum low and high temperature operating characteristics. A test (46) was performed on a bare ALSD motor to determine its operating conditions under ambient and elevated temperatures as summarized below. A similar test (72) was performed on the power head percussor spring to ensure its reliability at elevated temperature.

6.2 Test Results Summary - As diagramed in Figure III-13, the ALSD motor was mounted in a temperature chamber, with provisions for measuring input power and controlling the output mechanical load. Operating characteristics at ambient (70°F) and elevated (310°F) temperatures were measured as graphically illustrated in Figures III-14 and III-15. The motor characteristics at the approximate operating point included:

	<u>@70°F</u>	<u>@310°F</u>
Input Voltage (VDC)	23.2	23.2
Input Current (Amps DC)	16.5	20.0
Output Speed (RPM)	8100	9000
Output Torque (Oz.-In.)	50	50
Efficiency %	80	69

Other component temperatures measured during the elevated test included the following:

Magnet Temperature	=	350°F
Commutator Bearing Block	=	340°F
Front Bearing Block	=	350°F
Brush Holder	=	530°F

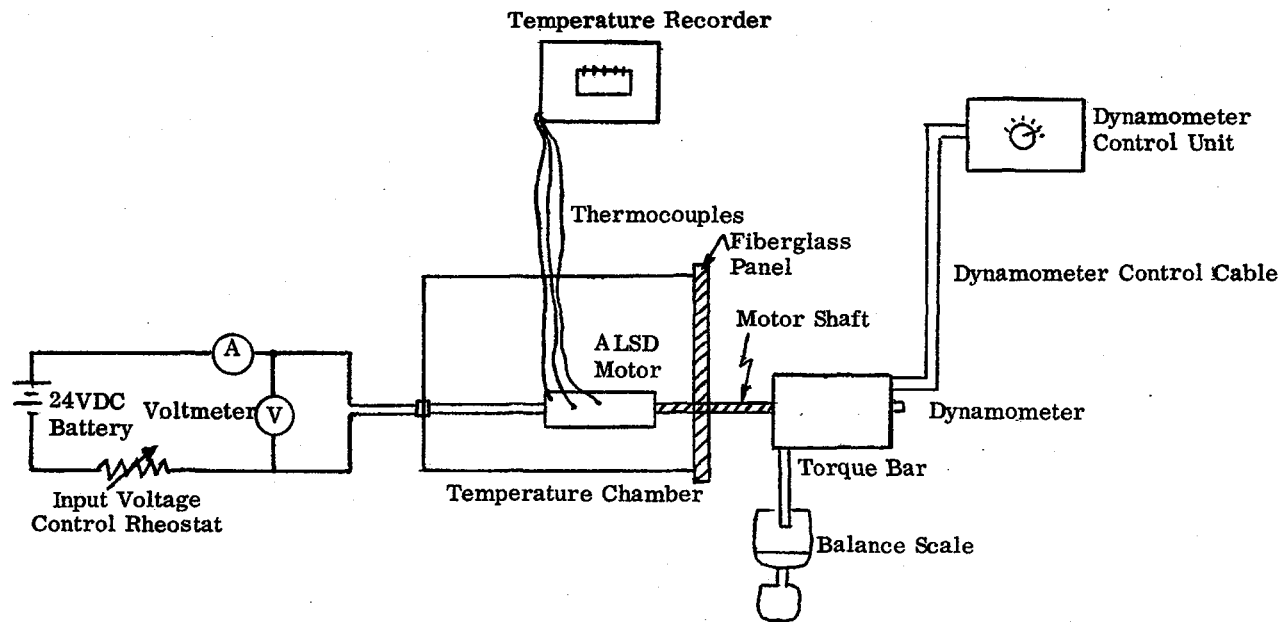

Figure III-13 ALSD Motor Temperature Test Schematic

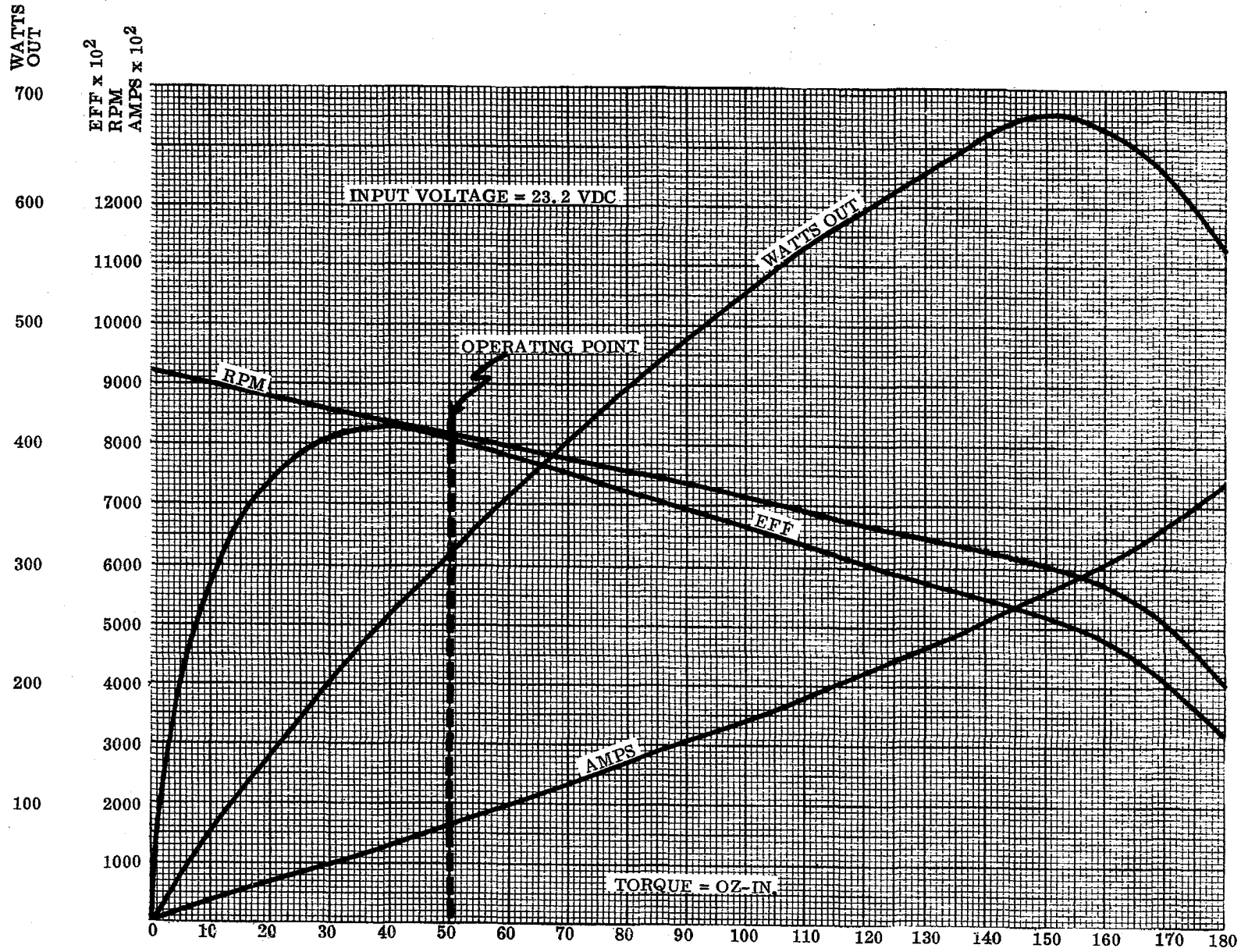

Figure III-14 ALSD Motor Characteristics at 70°F Ambient Temperature

III-30

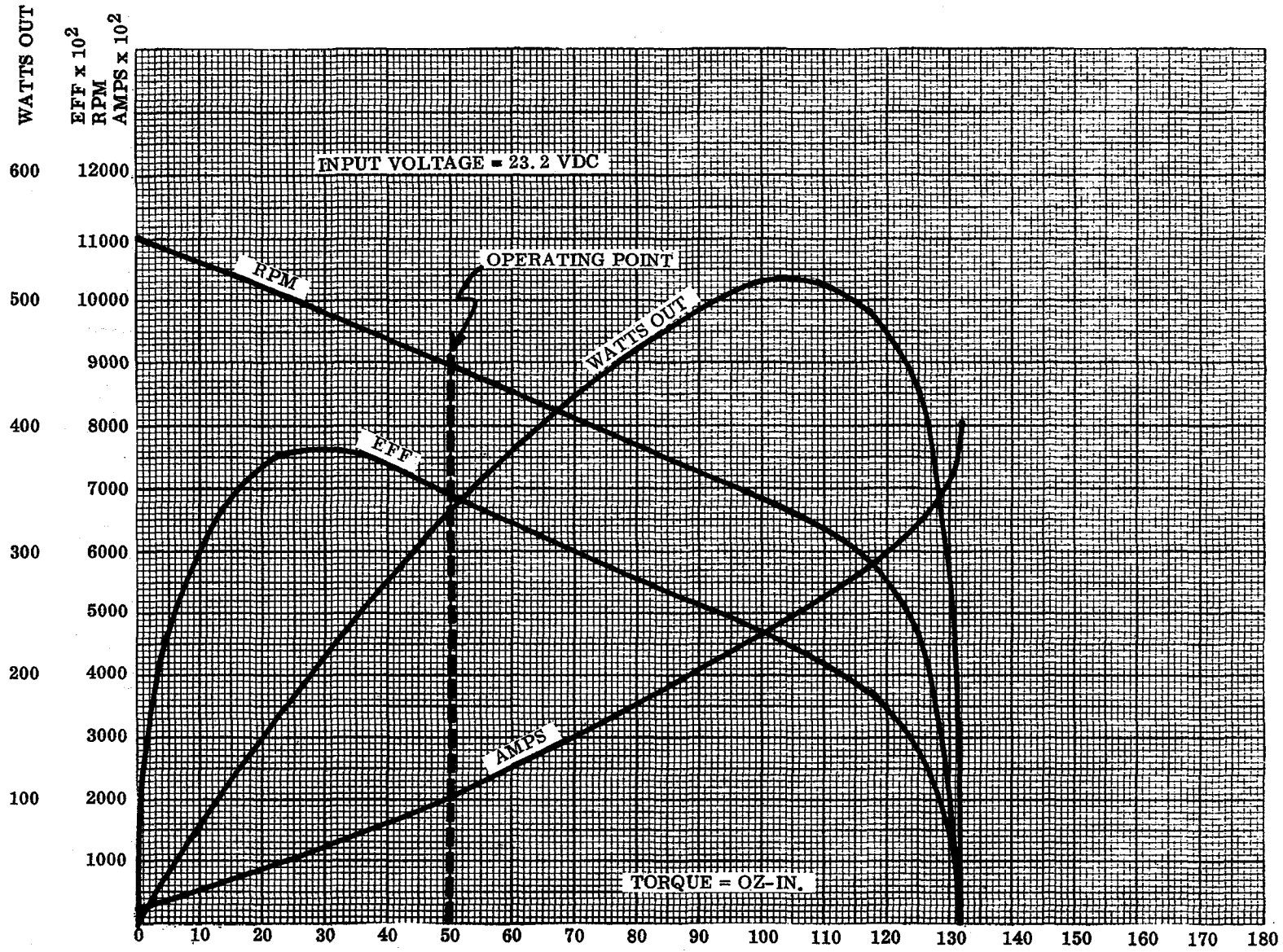

Figure III-15 ALSD Motor Characteristics at 310°F Ambient Temperature

ER 14778



ER 14778

The test indicated that the ALSD motor design will perform satisfactorily under worst-case temperature conditions anticipated on the lunar surface.

A high temperature operating test was also performed on two candidate material percussor springs to determine their respective energy constant degradation and fatigue life. A special fixture, as shown in Figure III-16, was designed and fabricated for sequentially mounting and preloading the springs in the high temperature chamber with provisions for cycling at approximately the same rate (1790 CPM) and compression (0.5 in.) as encountered during normal operation in the power head.

Two samples of each candidate material (17-7 PH Stainless and Vascojet 1000) were sequentially subjected to one million operating cycles at an ambient temperature of 400°F with no visible degradation of the four springs. Subsequently, two of the four springs were subjected to an additional one million cycles at 400°F with no visible degradation of the two candidate materials. Since the maximum cyclic life span of a flight unit percussor including both test and lunar surface operation will not exceed 125,000 cycles, these tests represent the spring cycling to 16 times the normal operational spring life for flight units. No failures of percussor springs occurred during the full extent of development testing.

The final test performed on the two candidate material springs consisted of measurement of energy degradation resulting from the high temperature environment as tabulated below:

	<u>@70°F</u>	<u>@400°F</u>
17-7 PH Stainless	233 lb./in.	220 lb./in.
Vascojet 1000	260 lb./in.	220 lb./in.

The 17-7 PH spring was selected for use in the power head percussor since it exhibited a more consistent spring constant over the entire anticipated temperature operating range.

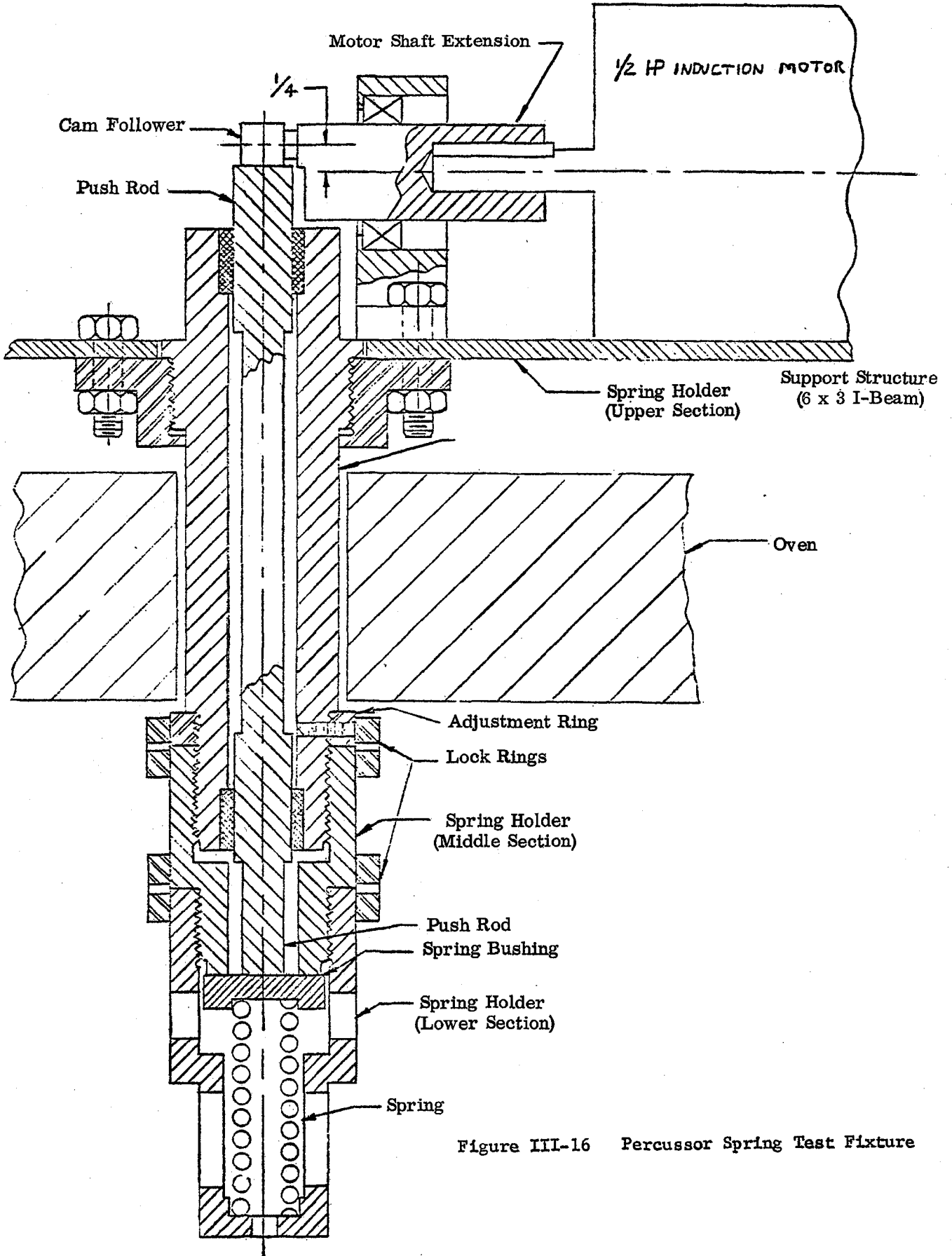

Figure III-16 Percussor Spring Test Fixture

## 7.0 POWER HEAD PRESSURIZATION SYSTEM OPERATION IN A VACUUM

7.1 Scope - A major design area which received considerable attention during the initial ALSD development test program included the power head pressurization seals. This system, which consists of two rotary dynamic, one linear bellows dynamic, and eight static seals, was required to maintain the internal pressure during operation of the power head. Proper performance of the dynamic seals in a vacuum was of particular concern since no previous space application requirements existed for combined rotary and linear motion sealing comparable to the rotary-percussive action of the power head spindle. A vacuum test (55) of the power head was scheduled early in the program to identify and correct any problems with the seal system.

7.2 Test Results Summary - The power head was installed in a Varian vacuum chamber as illustrated in Figure III-17. A test fixture was designed incorporating a rotary-thrust bearing and threaded loading rods which permitted application of a nominal drilling-load (approx. 40 axial pounds as defined at that time) to the power head output spindle. Instrumentation was provided for the measurement of input power (supplied by an external power source) and power head pressure. Power head temperature measurements were also recorded although they were not pertinent to the test because of the absence of space and solar simulation.

The power head was operated in the vacuum chamber at environmental pressures in the range of  $10^{-3}$  mm Hg at a typical duty cycle of 5 minutes on, 1 minute off for a total power-on time of 40 minutes. The pressure relief valve, adjusted for an operating pressure of  $25 \pm 1$  psi, did not appear to "crack" during the test because the absolute power head pressure rise from 15 (ambient) to 20 psia did not exceed the lower actuation pressure. Theoretically, the pressure should have increased to approximately 23 psia based upon the measured temperature rise which indicated that there was some minor leakage during the test.

An operational rock drilling test (54) was performed concurrently with pressurization measurements. During the test, the power head seals maintained pressurization for a non-operating period of approximately 41 hours, and for an operating (rock drilling with an axial bit thrust of 60 pounds) period of 51.2 minutes.

As a result of the two tests summarized above, the ALSD power head seals system was deemed satisfactory for incorporation into the flight unit power heads.

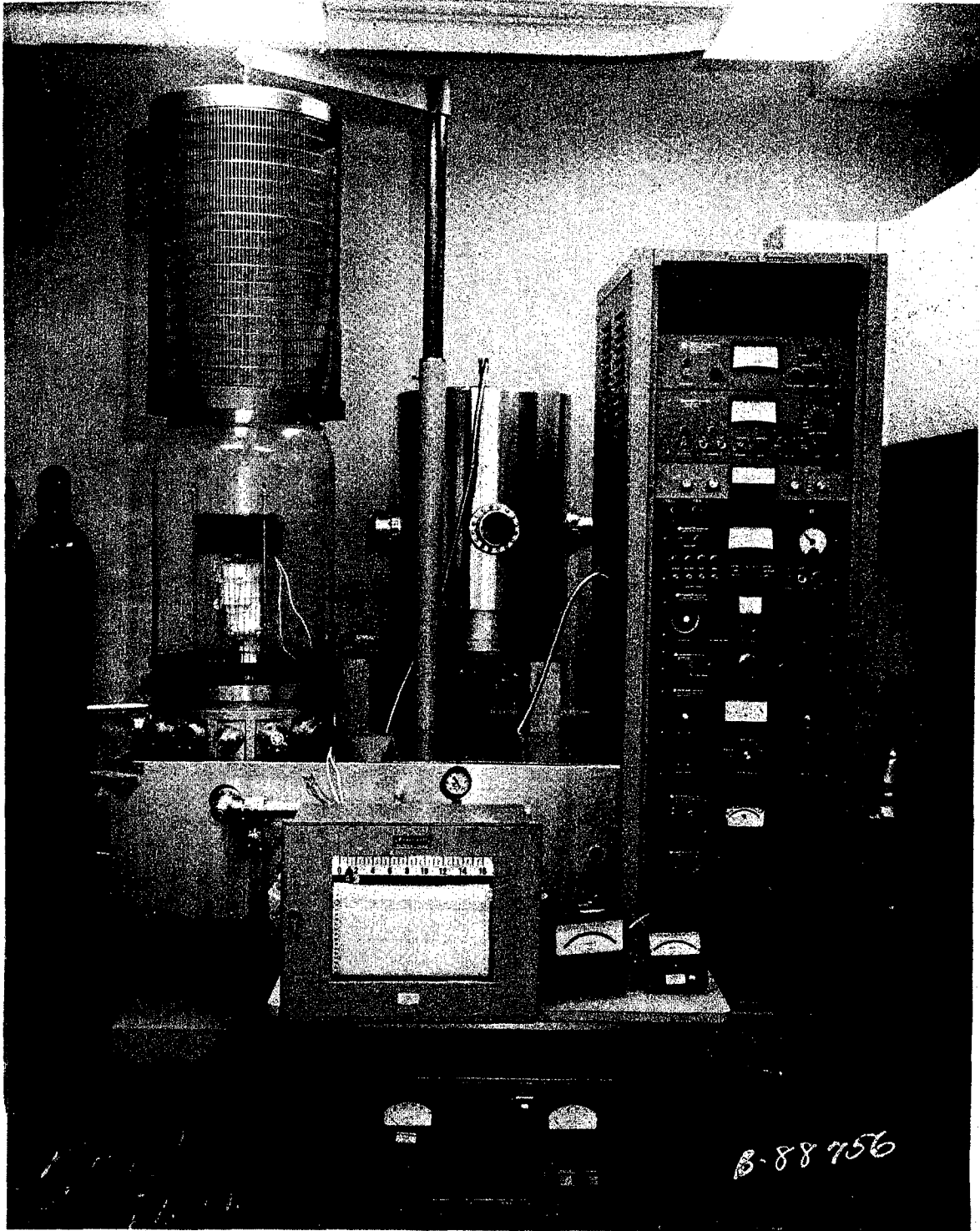

Figure III-17 Power Head Seals Vacuum Test Setup

## 8.0 POWER HEAD MAGNETIC FIELD RADIATION MEASUREMENTS

8.1 Scope - A design constraint was introduced into the ALSD program which limited the allowable magnetic field intensity generated by the power head (or any subsystem) to a maximum of 10 gammas for frequencies less than 30 Hz at distances greater than ten feet. The constraint was introduced to eliminate any possible magnetic damage to the lunar surface magnetometer experiment. This requirement was later rescinded, and replaced with the design goal that the magnetic field generated by the power head could not exceed 0.25 gauss at distances of 6 inches or more from the ALSD envelope in the ALSEP stowage mode. A test (71) was conducted to map the magnetic field generated by the power head as summarized below.

8.2 Test Results Summary - Magnetic field intensity measurements were performed on the EMI Test Model power head using the Gulf flux-gate magnetometer III. Measurements were made at distances of 0.5, 1, 2, 3, 5, and 10 feet from the magnetometer sensor while rotating the power head about its longitudinal and transverse axes. Other measurements were taken by holding the ALSD in a fixed orientation and moving it towards the established measurement intervals. Maximum magnetic field measurements were recorded at each location.

At the 10 foot distance from the power head, the average maximum magnetic field measurements using the four measuring modes was 6.1 gamma. The maximum recorded value from all measurements at a distance of ten feet was 10.05 gamma.

The maximum 0.25 gauss design goal at a distance of 6 inches from the ALSD envelope is equivalent, at the nearest point, to approximately 9 inches from the center of the power head permanent magnets. Using the inverse cube relationship for diminution of the magnetic field, the maximum calculated field (1 foot measurement as a reference) was 0.2 gauss. This maximum field intensity is in the direction of the ALSEP pallet. The field intensity in any other direction (6 inches from the battery top, transport handle side, etc.) would be less than the 0.2 gauss. These measurements do not take into consideration the shielding which may result from the various ALSD components in their stowed configurations.

## 9.0 BATTERY PERFORMANCE CHARACTERISTICS

9.1 Scope - Numerous development tests (57-67) were performed to verify the electrical performance of the ALSD training and flight batteries. The training battery was designed with secondary-type, silver-zinc cells which exhibit longer activated life and multiple recharge capability characteristics at the trade-off of reduced capacity per discharge. The training cell tests were performed to verify that the required operating time (16 minutes) and power output level (450 watts) were obtained at ambient temperature conditions.

The flight battery tests were more extensive, and included low and elevated temperature performance characteristics in addition to verification of the ambient requirements. The tests also encompassed verification of high current discharge capabilities, which became a requirement when the depth of the conglomerate lunar surface simulation model was increased from 1.2 to 3 meters. This drilling model may intermittently demand peak currents of 30 to 50 amperes, which is in excess of the nominal 18.75 ampere design parameter.

9.2 Training Cell Test Results Summary - The initial training cell design, designated HR5DC-12X, contained the following elements within a Bakelite C-11 case:

Electrodes per cell:	12(+)/13(-)
Silver per cell:	19.6 grams
Zinc per cell:	15.2 grams
Active area per cell:	70.1 in. <sup>2</sup>
*Separators:	1T VN2.5/4C-19

\*Note: 1VN2.5 Interseparator: vitanyzed nylon fabric  
C-19 Main separator: regenerated cellophane with contractor patented treatment

A discharge test of 5 cells at an 18.75 ampere rate indicated that the terminal voltage decreased below the minimum acceptable level of 1.41 VDC in the range of 12-14 minutes after initiation of discharge. Performance during four subsequent discharge cycles showed no improvement.

The training cell was subsequently redesigned (designated HR5DC-12x1) with the following major elements:

ER 14778

Electrodes per cell:	10(+)/11(-)
Silver per cell:	20.4 grams
Zinc per cell:	16.3 grams
Active area per cell:	58.5 in. <sup>2</sup>
Separators:	1T VN2.5/4C-19

A discharge test of 4 cells at an 18.75 ampere rate indicated that the terminal voltage decreased below the minimum acceptable level of 1.41 VDC in the range of 18-20 minutes after initiation of discharge which exceeded the required 16 minutes. Subsequent charge/discharge cycles indicated that 18 minutes of operating time was exceeded up to at least the tenth cycle. Tests of those cells were discontinued at that time.

A second series of 4 cells were tested to optimize the quantity of KOH electrolyte. Two of the four cells were activated with 20 cc of KOH; the remaining cells were activated with 21 cc. Marginal operating times for the lower electrolyte quantity cells were recorded during the 3rd, 4th and 5th discharge cycles. The quantity of electrolyte in the marginal cells was increased, and a minimum of 18 minutes operating time was recorded for the subsequent 6th through 11th discharge cycles.

In summary, the operating characteristics of the training unit silver-zinc cells include:

Open Circuit Voltage:	1.85 ± 0.03 VDC
Operating Voltage:	1.46 ± 0.05 VDC @ 18.75 Amperes
Capacity:	5-5.7 Ampere-hours

9.3 Flight Cell Test Results Summary (Ambient and Elevated Temperature) - The flight cell design, designated PM5(13)-2, contained the following elements within a Bakelite C-11 case:

Electrodes per cell:	8(+)/9(-)
Silver per cell:	45.2 grams
Zinc per cell:	31.0 grams
Active area per cell:	50.4 in. <sup>2</sup>
Separators:	1T VN2.5/2C-19

The cell case material was subsequently changed from C-11 to the higher operating temperature Cycolac X-27 for the final flight units.

A group of 4 cells was selected from the first production lot and subjected to a discharge test at room ambient temperature immediately after activation. The four cells delivered 18.75 amperes for a period exceeding 40 minutes thus meeting the specification requirements.

A second group of 4 cells was activated and subjected to the ALSD pre-discharge temperature environment consisting of nine days at 90°F and six days at 100°F. The cells were subsequently discharged in a 100°F environment at the 18.75 ampere rate to an end voltage of 1.375 VDC. The discharge time for the 4 cells ranged from 42 to 45.5 minutes thus surpassing the specification requirement.

In summary, the operating characteristics of the flight unit silver-zinc cells include:

Open Circuit Voltage:	1.85 ± 0.03 VDC
Operating Voltage:	1.44 ± 0.06 VDC @ 18.75 amperes
Capacity:	12.5-14.2 ampere-hours

9.4 Flight Battery Test Results Summary (Ambient & Elevated Temperature -  
Four complete battery assemblies (16 cells/assembly) were subjected to electrical discharge tests. Two of the batteries were activated and stored at room ambient temperature for 15 days prior to discharge; the remaining two batteries were subjected to an activated storage environment of nine days at 90°F and six days at 100°F followed by a 100°F environment discharge. The room ambient temperature batteries provided capacity outputs of 13.9 and 14.2 ampere-hours; the elevated temperature discharge batteries provided outputs of 14.4 and 14.6 ampere-hours. Silver-zinc cells characteristically develop a higher capacity output at elevated temperatures as compared to room temperature.

In summary, the operating characteristics of the flight unit battery assembly include:

Open Circuit Voltage:	29.6 ± 0.5 VDC
Operating Voltage:	23.0 ± 1.0 VDC @ 18.75 amperes
Capacity:	12.5-14.2 ampere-hours
Power Density:	41-45 watt-hours/lb.

9.5 Flight Battery Low Temperature Test Summary - A series of tests was performed to determine the operating characteristics of the flight



battery when subjected to ambient environments of 0, 20, 30, and 40°F. The final ALSD thermal analysis indicated that the battery would experience a minimum initial temperature of 21°F under worst-case (minimum SEB temperature and 7° lunar sun angle) operating conditions with the shroud installed. With the shroud removed, a minimum temperature of -35°F could be experienced by the battery. The purposes of these tests were to determine the temperature at which the battery terminal voltage would decrease below the minimum required for starting the power head, and to determine the battery output power degradation resulting from the low temperature environment.

Figures III-18 and III-19 illustrate the test equipment used for these tests. The switching arrangement permitted the battery output to be connected either to the power head for determination of sufficient starting voltage or to the external load bank for measurement of power output. The battery was discharged at the nominal 18.75 ampere rate for each tests. Power output for each temperature interval is indicated below:

<u>Temperature</u>	<u>Power Output During 40-Min. Discharge</u>
70°F	300 watt-hours (design requirement)
40°F	284 watt-hours
30°F	282 watt-hours
20°F	276 watt-hours
0°F	268 watt-hours

The minimum stabilized temperature at which the battery/power head combination would operate was -10°F. Operation of the unit at lower temperatures (-20 to -30°F) may be possible, but considerable energy would be expended in heating-up the battery (resulting from the short circuit effect of the stalled power head motor) until the terminal voltage increased sufficiently to start the power head.

The decrease in battery power capacity at temperatures down to 20°F is not considered excessive in view of the power requirements for the modified lunar surface simulation models.

9.6 Off-Limit Flight Battery Electrical Characteristics - Several tests were conducted to determine characteristics of the flight battery which were beyond specification requirements. The first tests consisted of evaluating the effects of battery recharge and increased activated stand time. Two batteries (used in the previous low temperature tests)

III-40

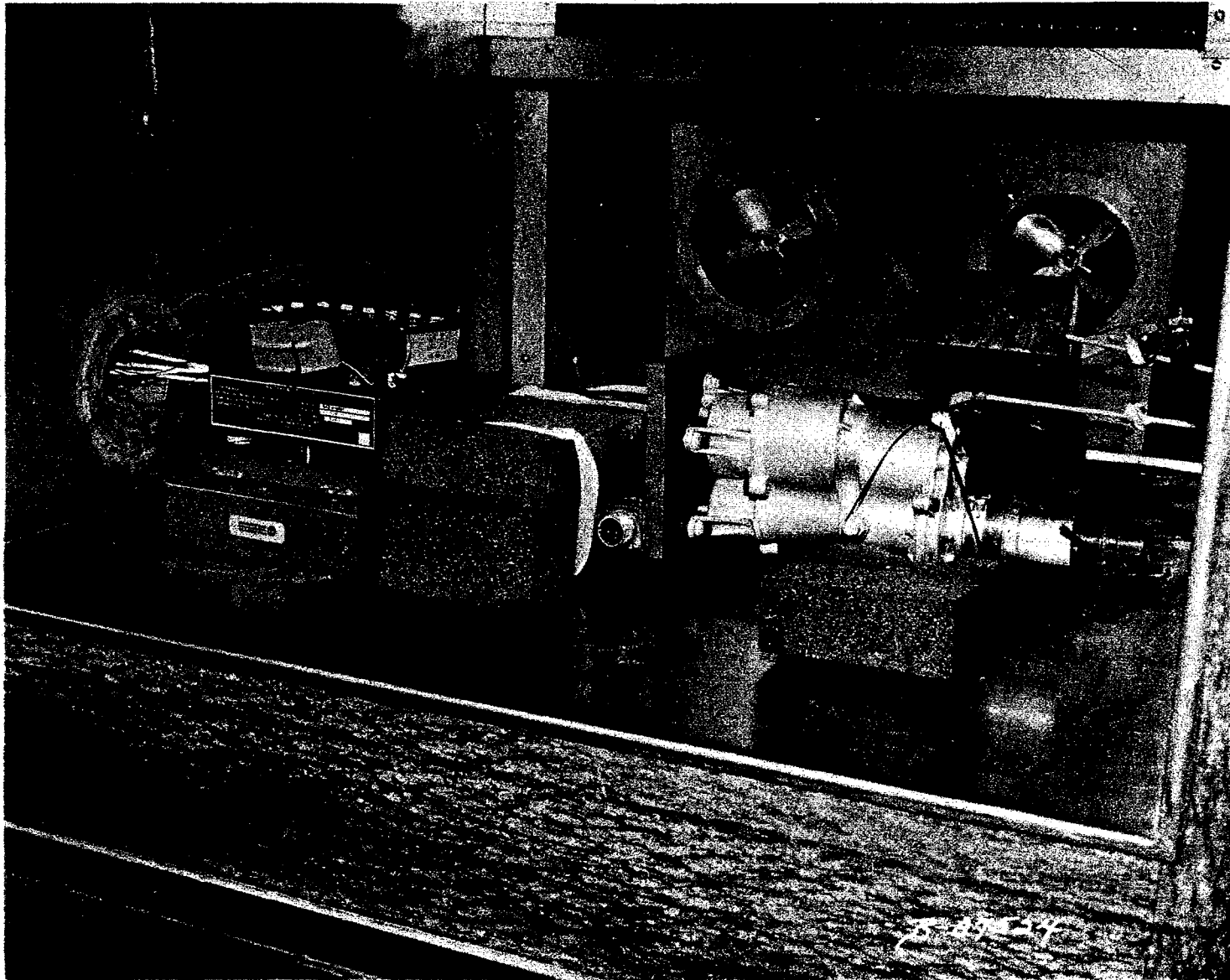

ER 14778

Figure III-18 Battery/Power Head Low Temperature Test Setup

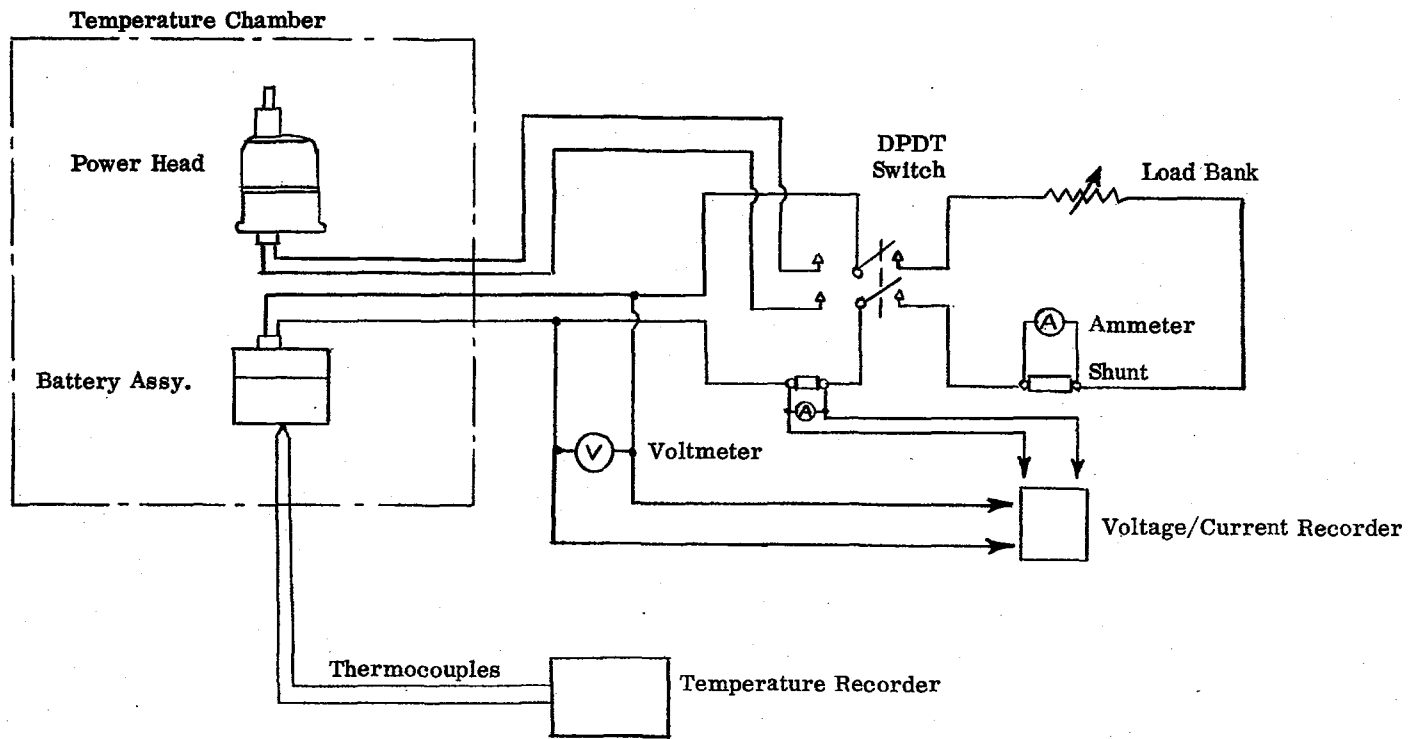

Figure III-19 Battery Low Temperature Test Schematic

ER 14778

with the operating histories delineated below were subjected to a standard discharge at room ambient temperature.

	<u>Battery #1</u>	<u>Battery #2</u>
Total Activated Stand Time	36 days	34 days
Total Number of Previous Discharge Cycles	3 days	2 days
Elapsed Time Since Last Charge	13 days	13 days

The batteries delivered total capacities of 14.0 and 14.6 ampere-hours respectively, exceeding design requirements.

A battery assembly high current test was performed to determine operating characteristics if intermittent, high power delivery is demanded when drilling in the 3-meter lunar surface simulation models. A 60-ampere, 2 minutes on, 2 minutes off discharge duty cycle was used for the test. The operating voltage during this test decreased from the nominal  $23 \pm 1$ VDC to approximately  $22 \pm 0.3$ VDC throughout most of the test, and the delivered power was measured at 306 watts. Operation of the power head under the reduced voltage condition would not adversely affect the drilling mission.

## 10.0 DRILL STRING OPERATIONAL TEMPERATURE RISE

10.1 Scope - As described in paragraph 3.0, the ALSD rock fracturing energy is generated in the power head, and transmitted in the form of strain wave percussive energy through the titanium drill string extension tubes to the core bit tungsten carbide cutting tips. A portion of this transmitted energy is converted into heat as it passes through the titanium material and the extension tube coupling joints. A significant portion of the total energy loss is converted into heat at the coupling joints through frictional movement of the mating surfaces. The design of the joint (double, one-inch lead acme-type thread) was necessarily a compromise between joint efficiency (minimum energy loss) and the limited capability of a spacesuited subject to decouple the extension tubes.

A series of tests (48, 50) was performed to determine the maximum temperature rise which may be experienced on the drill string resulting from percussive drilling in a vacuum environment.

10.2 Test Results Summary - A titanium drill string was instrumented with eight thermocouples along the first two extension tubes below the power head, which is the highest temperature-rise area of the drill string. The drill string was insulated internally and externally with fiberglass to minimize heat loss, and installed in the drilling test fixture, as shown in Figure III-20. Drill string temperatures were recorded immediately after each drilling run which was conducted at a duty cycle of 5 minutes on, 2 minutes off. Temperature rise data was accumulated for dense basalt, vesicular basalt, and unsorted conglomerate drilling models. Using this data, temperature-rise predictions were made for the 3-meter lunar surface simulation models consisting of the various combinations of materials delineated below:

<u>Lunar Surface Simulation Model</u>	<u>Drilling Time</u>	<u>Max. Temp. Rise</u>
3 meters conglomerate inclusive of 0.15 meter dense basalt block	1 minute in conglomerate, 6 minutes in dense basalt	72°F
3 meters conglomerate inclusive of 0.75 meter vesicular basalt block	1 minute in conglomerate, 5 minutes in vesicular basalt	65°F
3 meters conglomerate	2 minutes in conglomerate	14°F



Figure III-20 ALS D Drill String Temperature Rise Test

ER 14778

The concern for drill string temperature rise is based upon the 250°F maximum equipment temperature which can be comfortably handled by the astronaut. Preliminary data furnished by the ALSRC contractor indicated that the drill string extension tubes may attain a maximum temperature of 150°F prior to removal from the ALSRC. Therefore, any additional temperature rise resulting from drilling should be minimized. The lunar surface drill string cooling characteristics (4) resulting from the grit blast passive thermal control finish, in consideration of the maximum operational temperature rise indicated by this test series, revealed that the maximum 250°F temperature limitation will not be exceeded.

## 11.0 POWER HEAD VACUUM ROCK DRILLING TEST

11.1 Scope - All of the previously described ALSD drilling tests were conducted under room ambient conditions. A preliminary test (56) was conducted to provide a cursory investigation of the effects of core drilling a vesicular basalt specimen with the ALSD power head in a near vacuum environment. Although it was known in advance that the  $10^{-11}$  torr range chamber (clean, dry, and empty) would increase in pressure by several orders of magnitude during a drilling operation, it was anticipated that the following parameters could be compared with room ambient results: 1) Relative drilling penetration rate, 2) Relative drilling torque requirements, and 3) Rock cuttings particle behavior.

11.2 Test Results Summary - The power head, restraint carriage, and vesicular basalt specimen were installed in a NASA-MSFC Varian chamber as illustrated in Figures III-21 and III-22. A solenoid actuator was installed to drive a thermocouple against the core bit after completion of drilling, but mechanical and electrical difficulties precluded the accumulation of reliable data. High speed movies were taken through the chamber viewing ports as an aid in studying the rock cuttings trajectories during the drilling operation. The outgassing load of the equipment resulted in a chamber operating pressure range of  $10^{-6}$  -  $10^{-7}$  torr during the drilling runs. The following conclusions were made from these tests:

- 1) The relative drill bit penetration rates were approximately the same during the control ambient and vacuum drilling tests,
- 2) The drilling torque (as related to input power) was approximately the same for the ambient and vacuum drilling tests,
- 3) The rock cuttings particles exited from the drill hole at slightly higher velocities than during the ambient control test. Maximum observed vertical travel of the drill hole ejected particles was approximately eight inches; most of the cuttings traveled less than four inches. The slightly higher velocity and travel of the cuttings particles during the vacuum test are attributed to release of entrapped moisture in the vesicular basalt and absence of significant aerodynamic damping of ejected particles. This particular test substantiated a previous decision to remove the debris deflector (drill string boot) from the ALSD system.



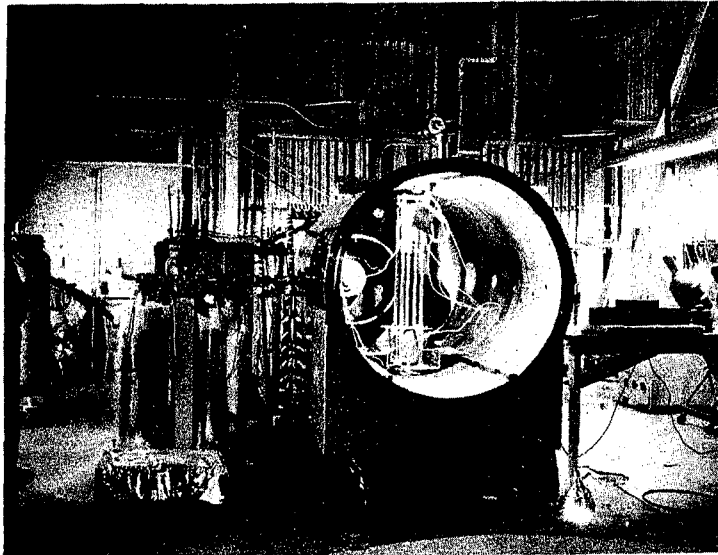

(A) Varian Vacuum Chamber (NASA-MSFC)

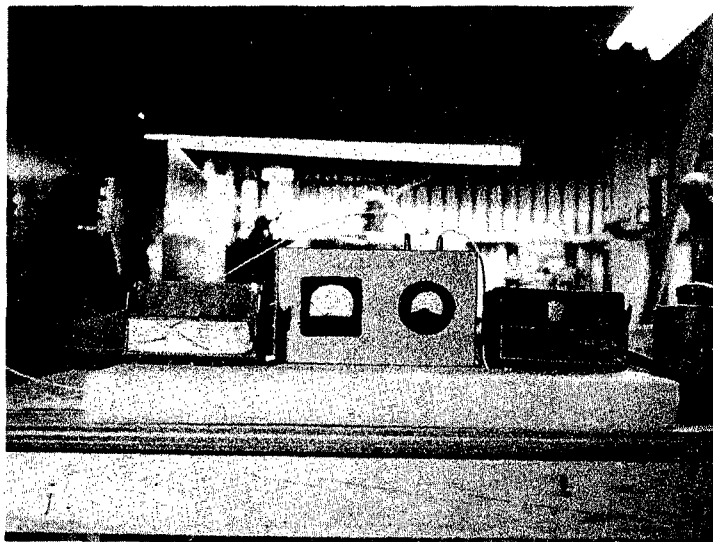

(B) Power Head and Thermocouple Actuator Control Equipment

Figure III-21 ALSD Vacuum Drilling Test Equipment.

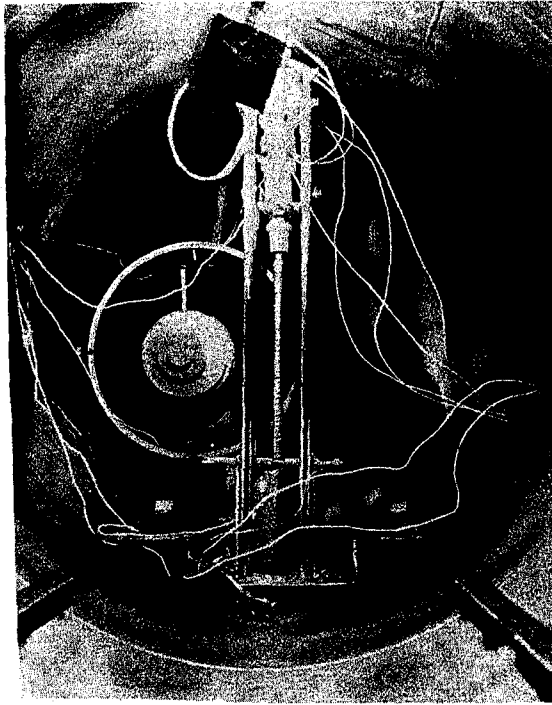

(A) Power Head Installation

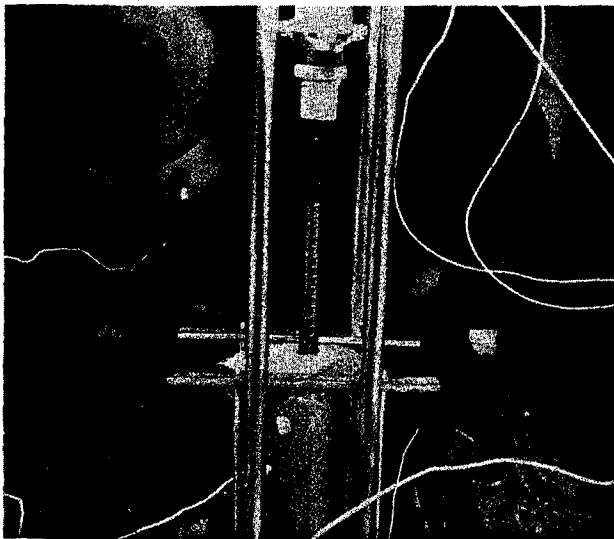

(B) Vesicular Basalt Drilling Specimen

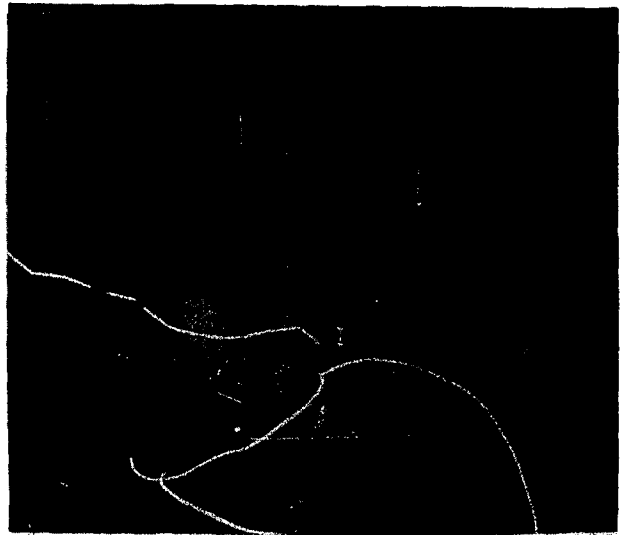

(C) Bit Temperature Thermocouple Act.

Figure III-22 Vacuum Chamber Installation of ALS D Power Head.

## 12.0 THREE METER DRILLING TESTS

12.1 Scope - A continuing series of 3-meter drilling tests was performed throughout the duration of the program. These tests were performed to accumulate a variety of engineering data including: 1) Reliability and efficiency of the core bit/drill string system, 2) Power requirements, 3) Axial thrust and torque restraint requirements, 4) Core collection and retention capability, and, 5) Casing reliability.

12.2 Test Results Summary - Consolidated Rock Drilling - The initial 3-meter drilling tests were performed in consolidated rock models as contractually established early in the program. These tests were conducted in vesicular basalt, pumice, and scoria in a manner similar to that illustrated in Figure III-23. The following summarizes the results of these tests:

- 1) The 43% porosity basalt could be drilled to a depth of three meters at an axial bit thrust commensurate with the capability of an astronaut working on the lunar surface (12-18 pounds) at an average rate of 3-8 inches per minute. The relatively wide range of penetration rates is attributed to the wide range of drillability characteristics of the vesicular basalt specimens. A 95% core collection could be attained without the use of a core retainer. The 3-meter core varied in quality, with core lengths varying from chip-size to a maximum of 16 inches, with an average of approximately 3-4 inches.
- 2) The pumice could be drilled to a depth of three meters at an average rate of 120-140 inches per minute, with an axial bit thrust of 2-6 pounds. Core accumulation in this relatively low-strength, low-density material generally averaged 50-60% of the total depth drilled. This relatively low core recovery is due to the fact that the compressive strength of the pumice is too low to overcome the frictional forces of the core within the extension tubes during penetration of the drill string.
- 3) The scoria could be drilled to a depth of 3 meters at penetration rates of 6-12 inches per minute with axial bit thrusts of 12-18 pounds. A 95% core collection could be attained without the use of a core retainer. Core lengths varied from chip-size to a maximum of 4-5 inches.

12.3 Test Results Summary - Conglomerate Model Drilling - Revision of the consolidated rock models to those illustrated in Figure III-24 presented a new set of problems which required study. In general, less drilling power

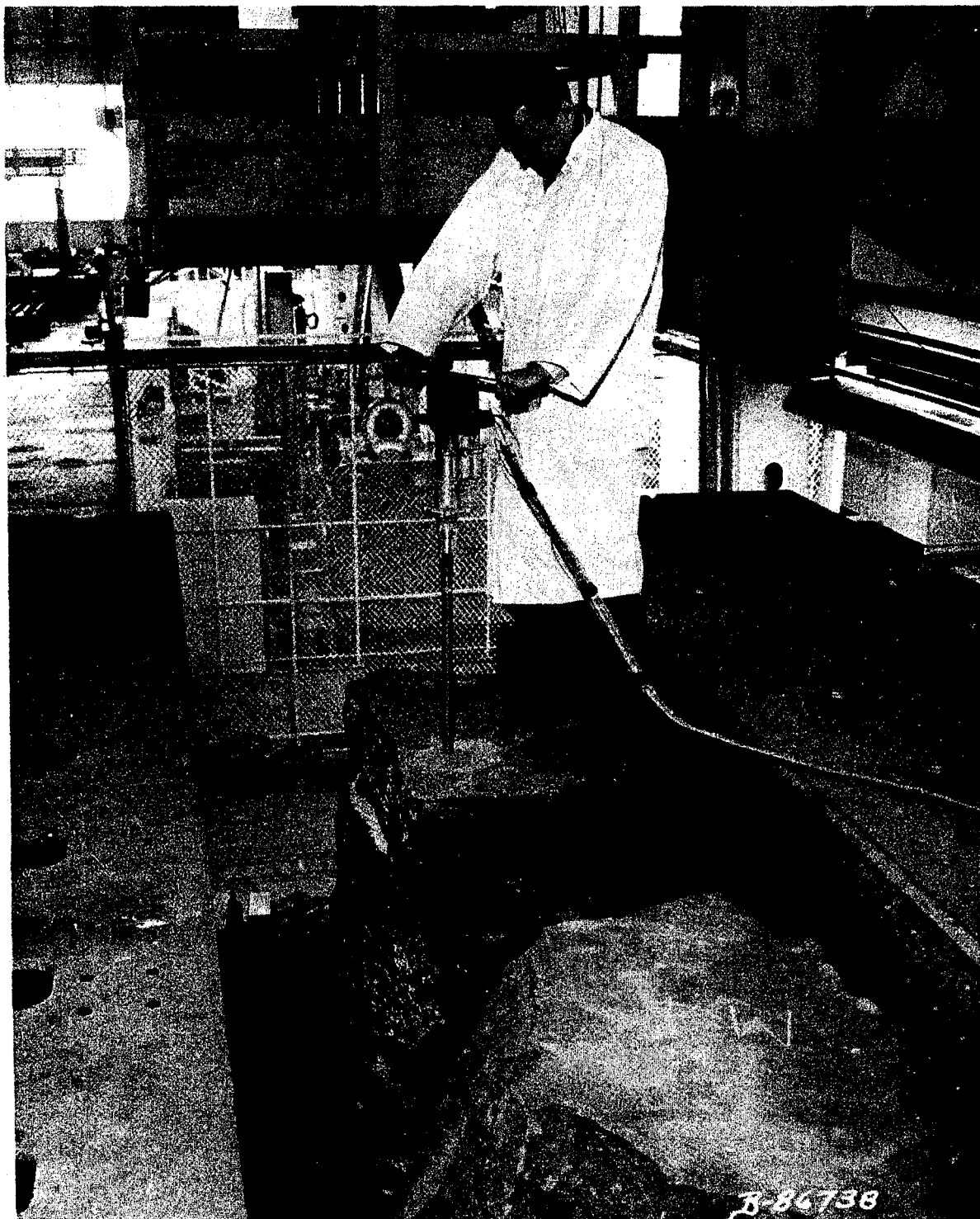

Figure III-23 Three-Meter Vesicular Basalt Drilling Test

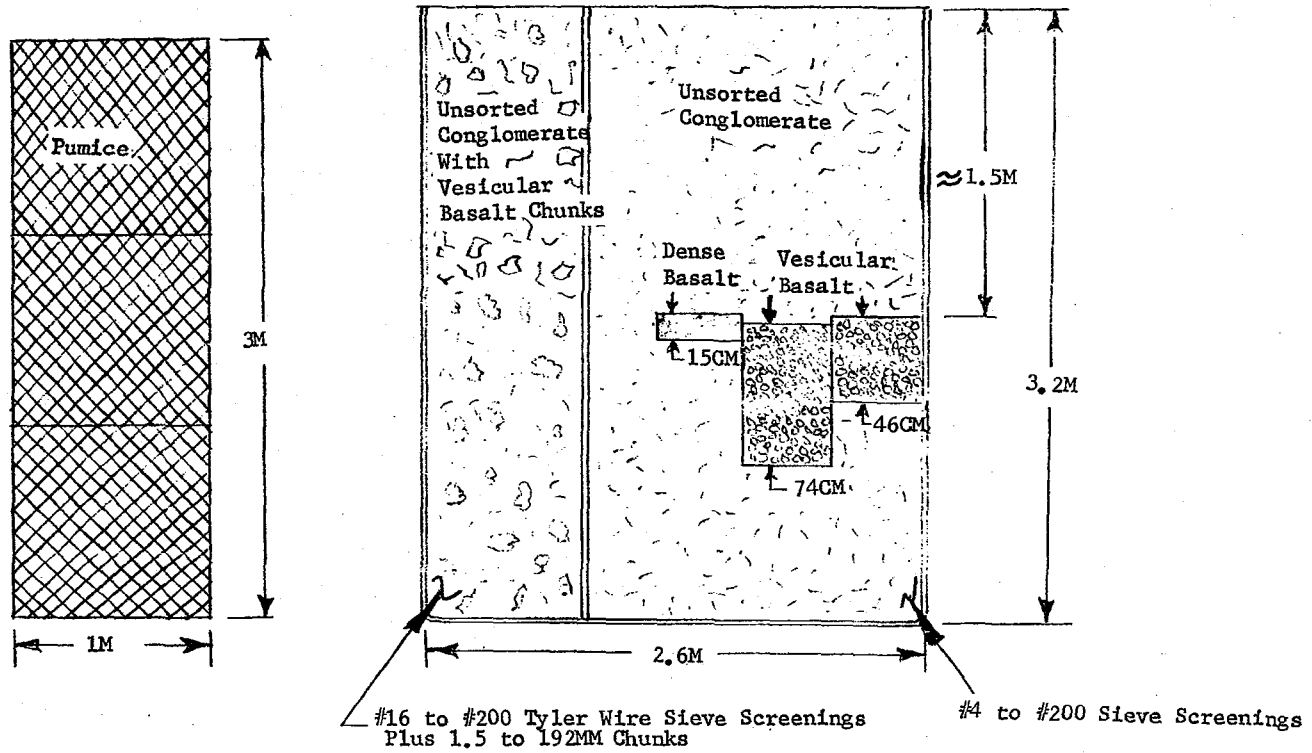

Figure III-24 3-Meter Conglomerate and Pumice Model Construction

capacity was required for each 3-meter hole, but this savings was partially negated by the increase required for power-driving the casings. Drilling torques were somewhat higher for the conglomerates than for the consolidated rock models, but penetration rates were also higher and the axial bit thrust requirements were lower, thus tending to reduce the astronaut work load for each 3-meter hole. The following summarizes the results of these tests:

- 1) The conglomerate with vesicular basalt chunks drilled at a penetration rate of approximately 120 inches per minute except when the vesicular basalt chunks were encountered, at which time the rate slowed to 3-5 inches per minute with a 12-18 pound axial bit thrust. Average drilling torques in the model were 3-10 foot-pounds, with peaks to 20 foot-pounds. Total power required to drill and case each hole varied from 1-2 ampere-hours. Core recovery varied from 40-50% of the linear depth of the hole.
- 2) The conglomerate with vesicular basalt block (0.75 meter) drilled at a penetration rate of approximately 120 inches per minute except when the vesicular basalt block was encountered, at which time the rate slowed to 5-8 inches per minute. Average drilling torques in the model were 3-5 foot-pounds, with peaks to 10 foot-pounds. Total power required to drill and case each hole varied from 4-6 ampere-hours. Core recovery varied from 40-60%.
- 3) The conglomerate with dense basalt block (0.15 meters) drilled at a penetration rate of approximately 120 inches per minute except when the dense basalt block was encountered, at which time the rate slowed to 1 inch per minute. Average drilling torques in the model were 3-6 foot-pounds, with peaks to 11 foot-pounds. Total power required to drill and case each hole varied from 3-5 ampere-hours. Core recovery varied from 40-50%.

12.4 Test Results Summary - Field Tests - Two series of field tests (24) were conducted to acquire drilling experience in possible lunar surface simulation models of unknown subsurface characteristics. These tests were performed in the Shoshone, Death Valley, and Bakersfield areas of California.

The Shoshone sites, as illustrated in Figure III-25, provided drilling experience in both cobblestone-size, and fine clay-size materials. The ALSD was capable of drilling to the full 3-meter depth in these materials



Figure III-25 ALSD Field Tests-Shoshone, California

with penetration rates varying from 11 to 30 inches per minute. The core recovery in these field models was significantly higher than in the MMC models illustrated in Figure III-24, and ranged from approximately 90 to 100%. The Death Valley drilling model was similar to the MMC conglomerate model, and the core recovery averaged approximately 55% of the linear hole depth.

The major problem encountered during the Shoshone and Death Valley tests was with the hole casing tip, which, at that time, had not been perfected. The casing tip used during those tests was similar to configuration number 1 of Figure III-9, which did not have the subsurface penetration capability of the final configuration illustrated in Figure III-10. The final casing tip configuration used during the Bakersfield test presented no subsurface penetration problem.

An additional problem, caused by excessive moisture content at the lower hole depths, resulted in excessive casing string torques which caused a jamming of the power head. This was considered as an "earth drilling" problem which should not be encountered on the lunar surface.



## 13.0 SPACESUITED SUBJECT OPERABILITY

13.1 Scope - The man/machine interface problems received a major consideration during design of the ALSD system. In addition to Contractor-conducted operability tests, many comments, originating from NASA Flight Crew Operations Office testing including 1/6-G trajectory KC-135 tests, were evaluated and mutually resolved through hardware and procedural changes. The final design approach necessarily resulted from trade-offs between space-suited subject operability considerations and the practical limitations of weight and volume allocations for the ALSD system aboard the LM spacecraft.

Throughout the performance of the ALSD development test program concurrent evaluations of man/machine interface problems were conducted. These evaluations often resulted in equipment modifications, operating procedural changes, or a combination of both.

13.2 Test Results Summary - A delineation of ALSD operability problem areas and subsequent equipment modifications incorporated to correct the problem area is presented below:

<u>Spacesuited Subject Operability Problem</u>	<u>Corrective Action</u>
1) ALSD package in stowed configuration difficult to transport	Added carrying handle (Ref. Fig. I-1)
2) Eight core bit extension tubes (transported to the lunar surface in the ALSRC) difficult to transport from LM to drill site	Added capability for double stacking the hole casings in the ALSD rack to provide stowage space for extension tubes during lunar transport (Ref. Fig. I-1, I-4)
3) Dzus-type fasteners time consuming to manipulate with wrench during assembly of the ALSD from stowage mode to operating mode.	Incorporated hand-operated cam-locs and lanyard actuated pull pins to replace Dzus-type fasteners (Ref. Fig. I-3)
4) Power head housing may exceed + 250°F, resulting in astronaut discomfort if accidentally contacted for a significant period of time	Protective thermal guard incorporated (Ref. Fig. I-3, I-4)
5) Power head/battery assembly difficult to retrieve from surface	Pickup lanyard incorporated (Ref. Fig. I-4)

- |     |   |  |
|-----|---|--|
| 6)  | Difficult to detect rotation of power head output spindle   | Alternate black and white vertical stripes incorporated on spindle (Ref. Fig. I-4)   |
| 7)  | Handle and switch actuator assembly power control lever difficult to actuate at all ALSD operating heights; power control lever safety switch not positive under all operating conditions | Incorporated dual actuating switch collars (Ref. Fig. I-4) which provide constant profile at all operating heights; design includes positive fail-safe operation |
| 8)  | Attachment of handle and switch actuator assembly to battery time consuming with wrench-operated locking pin  | Incorporated spring-loaded, self-locking pin   |
| 9)  | Spacesuited subject tends to drop power head/battery assembly when grasping handle with one hand  | Incorporated flares on both ends of handle and switch actuator assembly to provide a more positive hand grip (Ref. Fig. I-4)                                     |
| 10) | ALSD restraint system (2 anchor pins, reel and cable assembly with support post) difficult and time consuming to operate by a spacesuited subject   | Restraint system deleted with little degradation of drilling efficiency in the updated lunar surface simulation models   |
| 11) | Foot-actuated, drill string lock on treadle difficult to operate  | Incorporated a semi-automatic lock requiring no foot operations  |
| 12) | Treadle difficult to retrieve from the surface  | Incorporated retrieval lanyard (Ref. Fig. I-4)   |
| 13) | Rack assembly stability marginal  | Incorporated tripod configuration to improve stability (Ref. Fig. I-4)   |
| 14) | Deployment of rack assembly legs time consuming   | Incorporated spring-loaded, automatically deployable legs  |
| 15) | Core bit extension tubes and hole casing sections removal from rack assembly difficult due to flute hang-up in bulkhead stowage holes   | Incorporated chamfers on the lower side of all bulkhead holes  |

- |   |  |
|---|--|
| 16) Spanner-type wrench assembly difficult to engage with mating extension tube holes | Incorporated self-locking jaws which will engage the extension tubes at any location (Ref. Fig. I-3) |
| 17) Spacesuited subject tends to drop wrench  | Incorporated flare on wrench handle to provide a more positive hand grip (Ref. Fig. I-3)             |
| 18) Detection of drill joints was difficult in spacesuit                              | Color coding bands were incorporated at extension tube joints  |

As a result of these and other changes to the ALSD, the total number of components requiring handling by the spacesuited subject has been reduced by eleven items with a corresponding decrease in operational complexity. These items included: 1) Reel and cable assembly, 2) Reel and cable assembly support post, 3) Debris deflector, 4) Treadle extension, 5) Hole casing-to-power head restraining lock, 6) Vertical indicator, 7) Two rack support members, 8) Two anchor pins, and 9) The drill string guide.

One of the major operational problems encountered early in the development test program was deployment of the relatively small and compact ALSD package into its operational mode. Although surface level assembly can be accomplished as illustrated in Figure III-26, use of a work platform such as the ALMT carrier illustrated in Figure III-27 is preferable. The latter technique has been incorporated in the final ALSD lunar surface operating procedures.

Another possible problem area which has been identified during NASA KC-135 1/6-G tests is the difficulty in casing to the minimum allowable handle height of 24 inches as illustrated in Figure III-28. This difficulty can be alleviated somewhat by placing one leg behind the other so as to reduce the total force required for bending the spacesuit.

Detailed operating procedures (2) were developed for the ALSD throughout the development test program and minor changes were incorporated during the performance of the qualification test program. In addition, contingency instructions were developed as a guide for the ALSD astronaut-operator in the event that a problem should develop; i.e., accidental dropping of a hole casing section, difficulty in disengaging the power head from the drill string, etc.

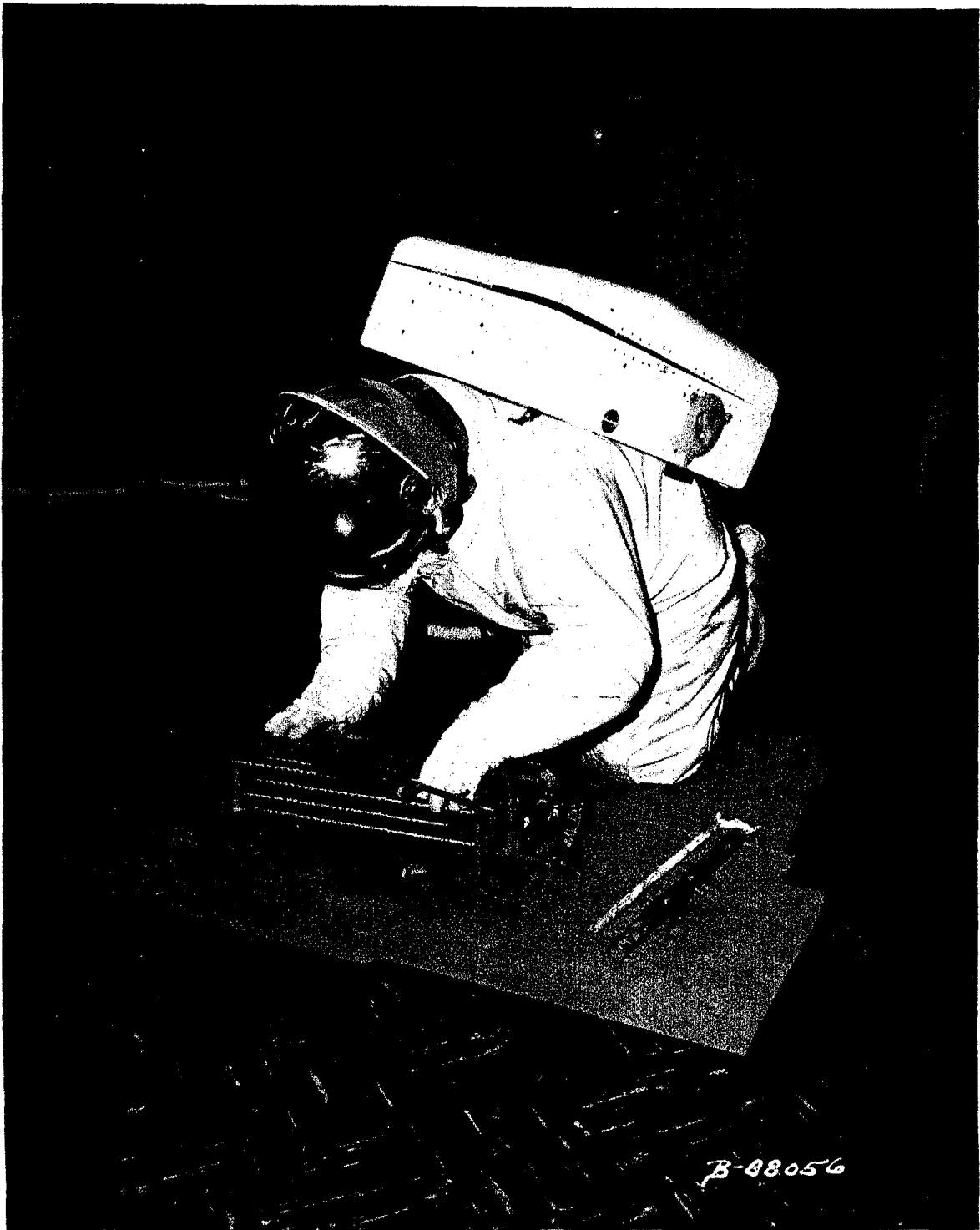

Figure III-26 ALSD Assembly-Surface Level



Figure III-27 ALSD Assembly with ALHT Carrier

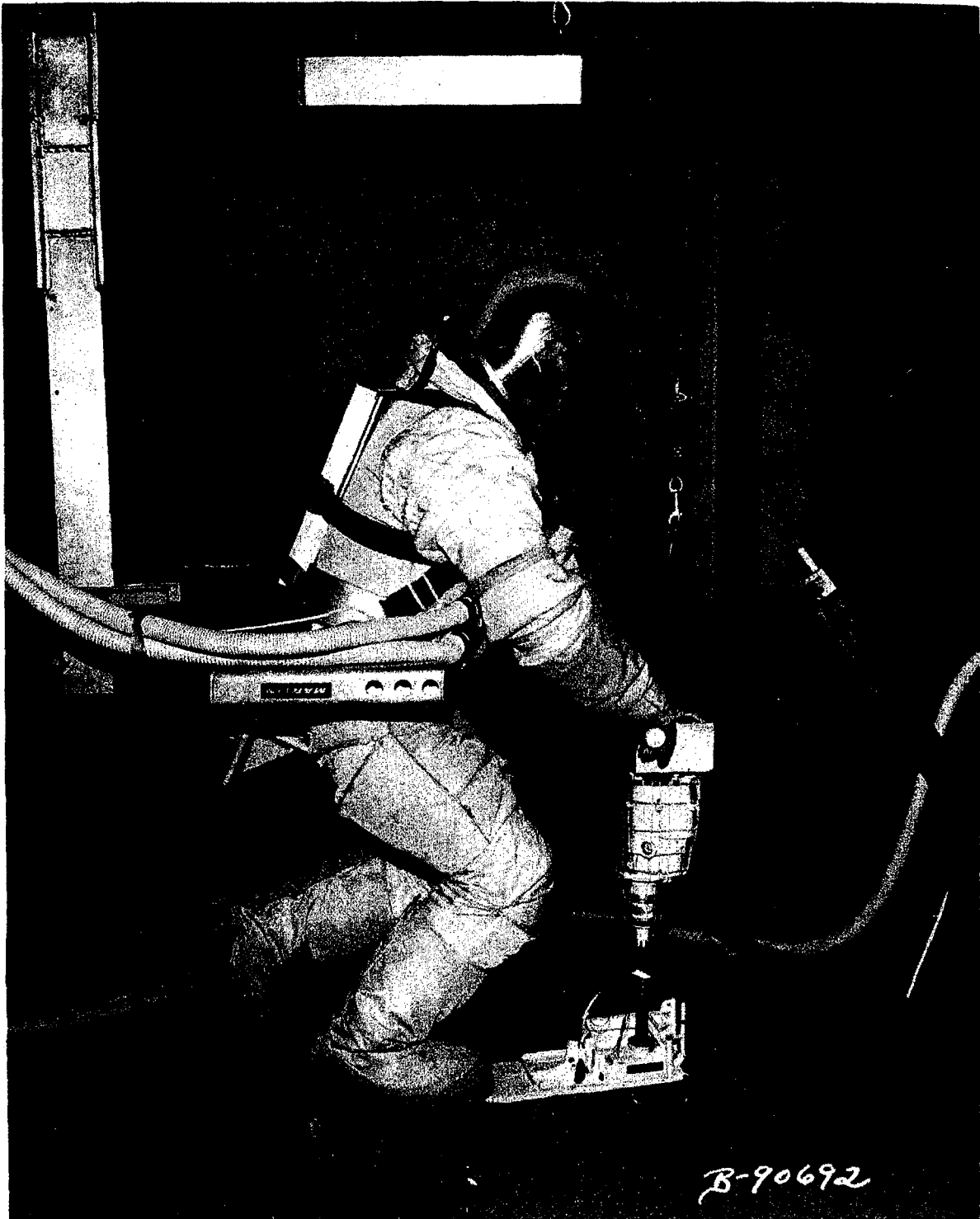

Figure III-28 ALSD Drilling under Simulated 1/6-G Conditions

## 14.0 BATTERY PRE-QUALIFICATION TESTS

14.1 Scope - A series of tests (13) was performed by the battery contractor to verify that the flight battery subsystem was capable of performing properly after subjection to specified mechanical and thermal environments. These tests were conducted prior to integration of the battery into the ALSD for the final system-level qualification tests described in Section IV of this report.

Several problems were encountered during these tests which required modifications to both the battery cells and battery case before completion of the program. A total of ten batteries were utilized during this program as summarized below.

14.2 Temperature Test Results Summary - The initial group of temperature-test batteries (2 units) was subjected to the following environmental profile:

<u>Time</u>	<u>Temperature</u>	<u>Activity</u>
9 days	90°F	Activated stand
6 days	100°F	Activated stand
40 min.	100°F	Discharge at normal 18.75 amp rate

During the elevated temperature discharge test both batteries delivered a total power output in excess of that required by specification. However, the high temperatures experienced by the inner most silver-zinc cells were above the softening temperature of the case material (Bakelite C-11). Several cell top-to-cell case leaks developed resulting in a significant expulsion of electrolyte from the cells into the voids of the battery case. Although this electrolyte leakage did not affect the battery performance, its presence was considered undesirable. A new cell case material (Cyclocac X-27) with a softening temperature of 225°F was employed for all subsequent flight batteries.

The final temperature test in this series was performed on a battery which had previously been subjected to the mechanical (vibration, shock, acceleration) environmental tests. This battery, with Cyclocac X-27 cell cases, was subjected to an ambient temperature of 100°F for five days, and subsequently discharged at that temperature. Structural integrity of the cell cases was not degraded during this test, although the internal battery temperature reached approximately 190°F. The battery assembly delivered a total power output in excess of that required by specification.

14.3 Vibration Test Results Summary - The initial vibration environmental test levels required for the ALSD batteries consisted of the following:

<u>Sinusoidal Vibration Frequency</u>	<u>Level</u>
5-22 cps	0.4 inch double amplitude
22-100 cps	10g constant

Two increasing/decreasing frequency sweeps at a rate of 1 octave/min. in each of three perpendicular axes.

<u>Random Vibration Frequency</u>	<u>Power Spectral Density (<math>g^2/cps</math>)</u>
10-50 cps	6 db/octave increase
50-1000 cps	1.0
1000-2000 cps	12 db/octave decrease

12.5 minutes in each of three perpendicular axes.

The vibration levels indicated above were subsequently revised to those tabulated in Section IV, paragraph 2.0.

A total of eight batteries were tested during this series. As a result of several failures (predominately weld cracks and internal cell wiring breakages) the following major modifications were sequentially incorporated into the ALSD flight battery:

- 1) The cell interconnect wires between the internal plates and cell terminals were potted to preclude breakage.
- 2) The cells within the battery case were cemented together concurrently with their installation to preclude individual movement when subjected to vibration or shock environments.
- 3) The resultant cell block from item (2) was restrained from movement by use of potting plugs molded into each of the four corners of the battery below the lid mounting flange.
- 4) The battery case bottom was increased in thickness and an external stiffener was added to increase structural rigidity.
- 5) The battery case weld joints were redesigned for improved structural integrity.



After incorporation of all modifications, the final pre-qualification test battery successfully passed the vibration tests with no degradation of pressure or structural integrity. New batteries consisting of the final modifications were subsequently employed for the ALS system level qualification test program described in Section IV.

14.4 Shock Test Results Summary - The shock environmental test levels required for the battery assemblies consisted of four, 50g sawtooth shock pulses of 11 milliseconds duration, applied in both directions of three mutually perpendicular axes.

There were no significant problems encountered during the shock tests performed on the various battery assemblies. The final configuration battery which successfully passed the vibration test also passed the shock test without difficulty.

14.5 Acceleration Test Results Summary - The initial acceleration environment requirement for the battery consisted of the application of 6 g's in both directions of three mutually perpendicular axes for a duration of 280 seconds for each test. This acceleration level was subsequently increased to 14 g's, and the exposure time reduced to 60 seconds.

The initial 6-g tests presented no problems for the battery, but the subsequent 14-g tests resulted in trace quantities of electrolyte leakage through the cell vent valves. Although this minor leakage did not affect battery electrical performance or structural integrity, electrolyte trap assemblies consisting of cellulosic sponges were designed and incorporated to encapsulate each of the 16 cell vent valves so that any leakage electrolyte would be contained within the sponges.

Subsequent to the acceleration tests conducted during this series, an additional modification was incorporated to eliminate electrolyte leakage. This modification, consisting of a reduction of electrolyte quantity in each cell, is described in Section IV, paragraph 9.0.

#### IV. QUALIFICATION TEST PROGRAM

##### 1.0 INTRODUCTION

A qualification test program was performed on the ALSD to prove its capability of withstanding the specified major translunar and lunar surface environments with the system in a non-operating mode. Subsequently, the system was tested for its capability of operating in the thermal-vacuum environment of the lunar surface followed by an operational drilling test by a spacesuited subject in each of the three lunar surface simulation models.

The details of the qualification test program are presented in References 5 through 14. A summary of these tests and corrective actions taken are reported in the following paragraphs.

## 2.0 SINUSOIDAL AND RANDOM VIBRATION

2.1 Test Requirements - The sinusoidal vibration test (5) consisted of subjecting the ALSD assembly (stowage mode) to one sweep with increasing (5 to 100 cps) and decreasing (100 to 5 cps) frequency at a rate of 1 octave per minute in each axis at the following levels:

<u>Axis</u>	<u>Frequency</u>	<u>Level</u>
X <sub>L</sub>	5- 19 cps	0.325 inch double amplitude
	19-100 cps	6.0 ± 0.5 g's 0 to peak
Y <sub>L</sub>	5- 17 cps	0.325 inch double amplitude
	17-100 cps	5.0 ± 0.5 g's 0 to peak
Z <sub>L</sub>	Same as Y <sub>L</sub>	Same as Y <sub>L</sub>

Note: Standard LM axes system used for application of vibration, shock, and acceleration environments are X<sub>L</sub>, Y<sub>L</sub>, Z<sub>L</sub>.

The random vibration test consisted of subjecting the ALSD assembly (stowage mode) to a minimum of 5 minutes of random vibration in each of the X<sub>L</sub>, Y<sub>L</sub> and Z<sub>L</sub> axes with the following spectral levels:

<u>Frequency</u>	<u>Power Spectral Density (g<sup>2</sup>/cps)</u>
23- 58 cps	0.167
58-102 cps	5.5 db/octave increase
102-150 cps	0.45
150-2000 cps	6 db/octave decrease

10.2 ± 1 G<sub>rms</sub> overall

The ALSD vibration test setup is shown in Figure IV-1. A test fixture was fabricated which duplicated the LM-ALSEP restraint points for the ALSD. Both the power head and battery assembly were pressurized

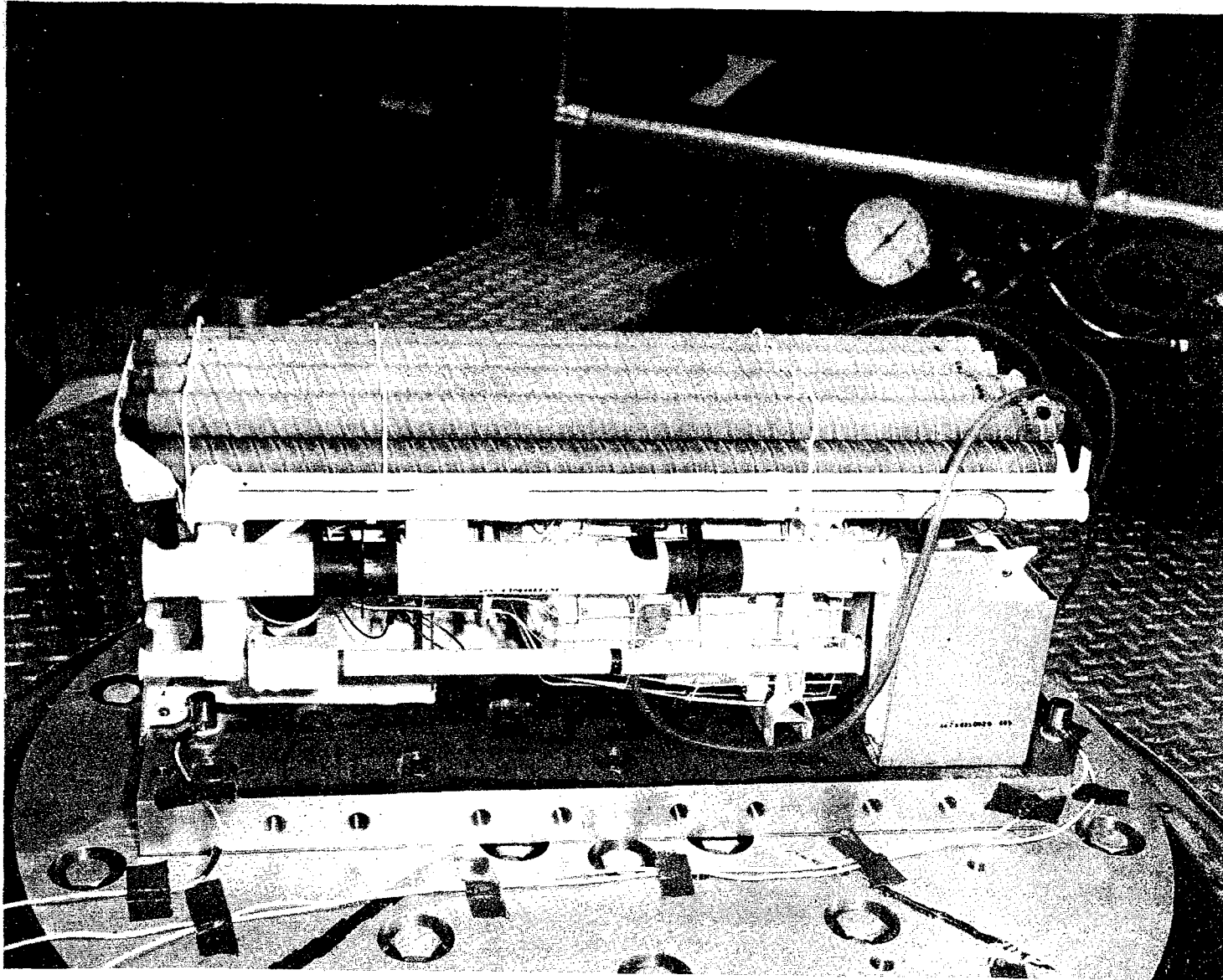

Figure IV-1 ALSD Vibration Test Setup

during the tests. Satisfactory performance of the ALSD was predicated upon visual inspections, satisfactory deployment, pressure integrity, and power head operation. A final test, consisting of measurement of total battery capacity, was performed after completion of all mechanical environmental tests.

2.2 Test Results Summary - As a result of minor failures encountered during the vibration tests, the following modifications were incorporated in the ALSD:

- 1) The wrench, and handle and switch actuator assembly stowage clips located on the rack assembly were redesigned with a higher spring constant to preclude loosening of the tools during vibration,
- 2) The lanyard pull pin which restrains the rack assembly leg to the treadle was lengthened to preclude disengagement during vibration,
- 3) The hollow, rack-to-treadle support tube was redesigned as an integral, solid element to preclude shearing,
- 4) The drill string lock spring located on the treadle was redesigned for a longer fatigue life,
- 5) The power head support bracket mounted on the treadle was redesigned for improved structural integrity, and its base was increased in width to distribute the power head loading over a wider area of the honeycomb treadle,
- 6) The rubber pad on the hole casing cover assembly was removed to eliminate degradation by the hole casing sections,
- 7) The longitudinal power head guard tubes were recessed into slots on the supporting bulkheads to increase the welding area.

Another problem was identified during the vibration test series which was not directly related to the externally applied vibration environment. This problem was caused by excessive, self-induced vibration of the power head during stowage mode functional checkout, and resulted in loss of nitrogen through the pressure relief valve due to "chattering" of the valve poppet. This problem was not identified during previous tests (Ref. Para. III.7.0) because the ALSD was operated in a normal drilling

ER 14778

mode with an axial force on the output spindle. In this condition, the power head delivers a significant portion of its mechanical energy to the drilling surface, and the residual energy within the power head is insufficient to cause the relief valve poppet to "chatter". This problem, and its resolution is presented below, in paragraphs 7.0 and 8.0.

Other than the problem described above, the equipment modifications to the ALSD permitted successful completion of the sinusoidal and random vibration tests. All modifications were tested through the complete spectra of paragraph 2.1, above.

3.0 ACCELERATION

3.1 Test Requirements - The acceleration test (5) consisted of subjecting the ALSD assembly (stowage mode) to a steady state acceleration in each direction of the  $X_L$ ,  $Y_L$ ,  $Z_L$  axes. The acceleration was applied for a minimum of 1 minute at a  $14 \pm 1g$  level.

The ALSD acceleration test setup is shown in Figure IV-2. Satisfactory performance of the ALSD was predicated upon visual inspections, satisfactory deployment, pressure integrity, and power head operation.

3.2 Test Results Summary - The ALSD successfully passed the acceleration tests with no equipment malfunctions.

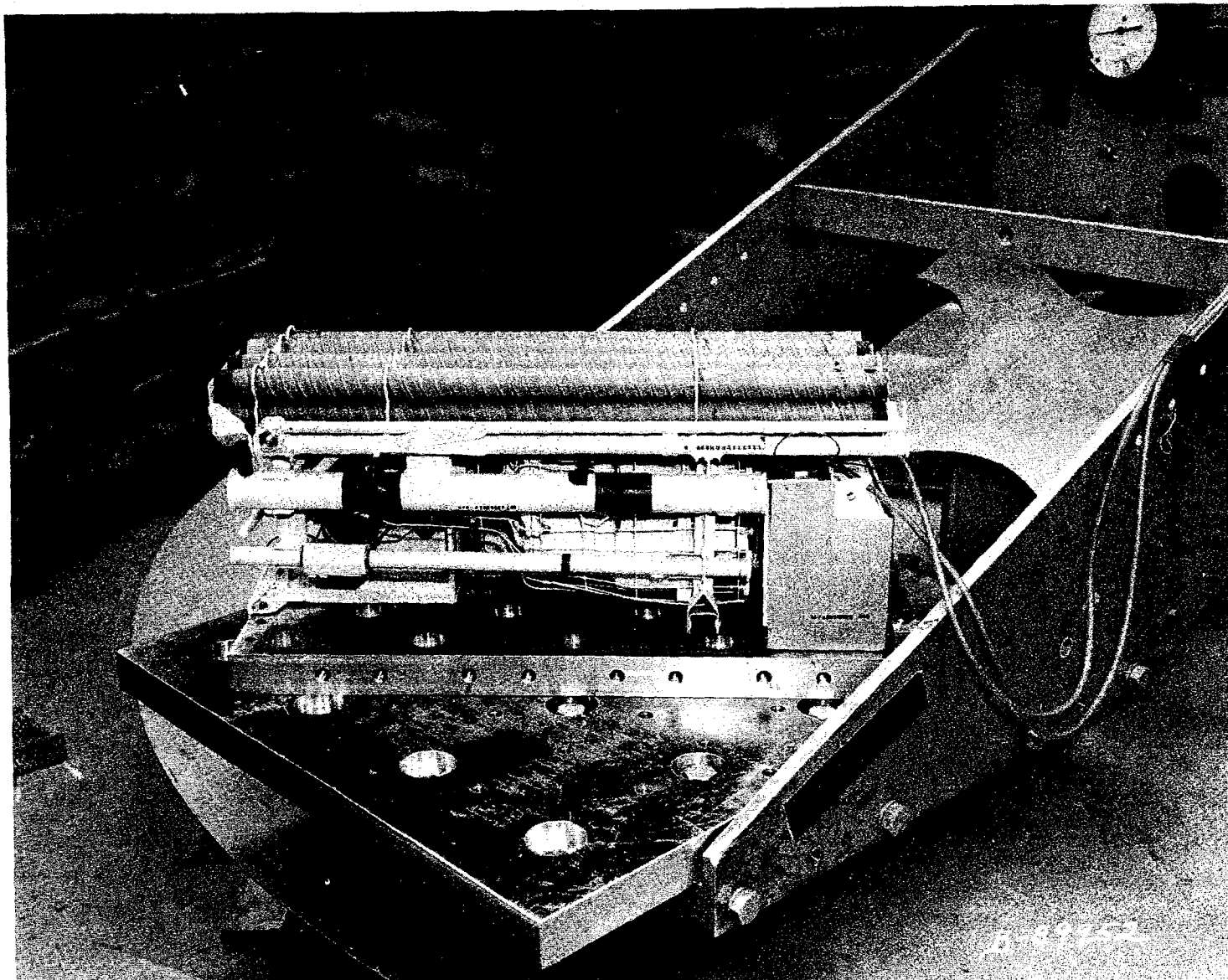

Figure IV-2 ALSD Acceleration Test Setup



4.0 SHOCK

4.1 Test Requirements - The shock test (5) consisted of subjecting the ALSD assembly (stowage mode) to one saw-tooth shock pulse in each direction of the  $X_L$ ,  $Y_L$ ,  $Z_L$  axes. The shock pulse had a minimum amplitude of 19 G's and time duration of 11 milliseconds.

The ALSD shock test setup is shown in Figure IV-3. Satisfactory performance of the ALSD was predicated upon visual inspections, satisfactory deployment, pressure integrity, and power head operation.

A final two-step test was performed on the battery assembly to assure that it completely met design requirements after subjection to the vibration, acceleration, and shock tests. These tests consisted of:

- 1) A room ambient discharge test to verify total output capacity, and
- 2) Recharge of the battery followed by the drilling of two, 3-meter holes in conglomerate with a 0.75 meter block of vesicular basalt, and two, 3-meter holes in pure conglomerate to simulate the casing operation power requirement.

4.2 Test Results Summary - The ALSD successfully passed the shock tests with no equipment malfunctions.

The battery was discharged at an 18.75 ampere rate to an end voltage of 21.0 VDC during a period of 40.15 minutes. This battery, which had been activated for 24 days and partially discharged during functional operation of the power head surpassed the specification requirements.

The battery was subsequently recharged and used to drill the required four, 3-meter holes in the lunar surface simulation models, thus meeting the required specifications.

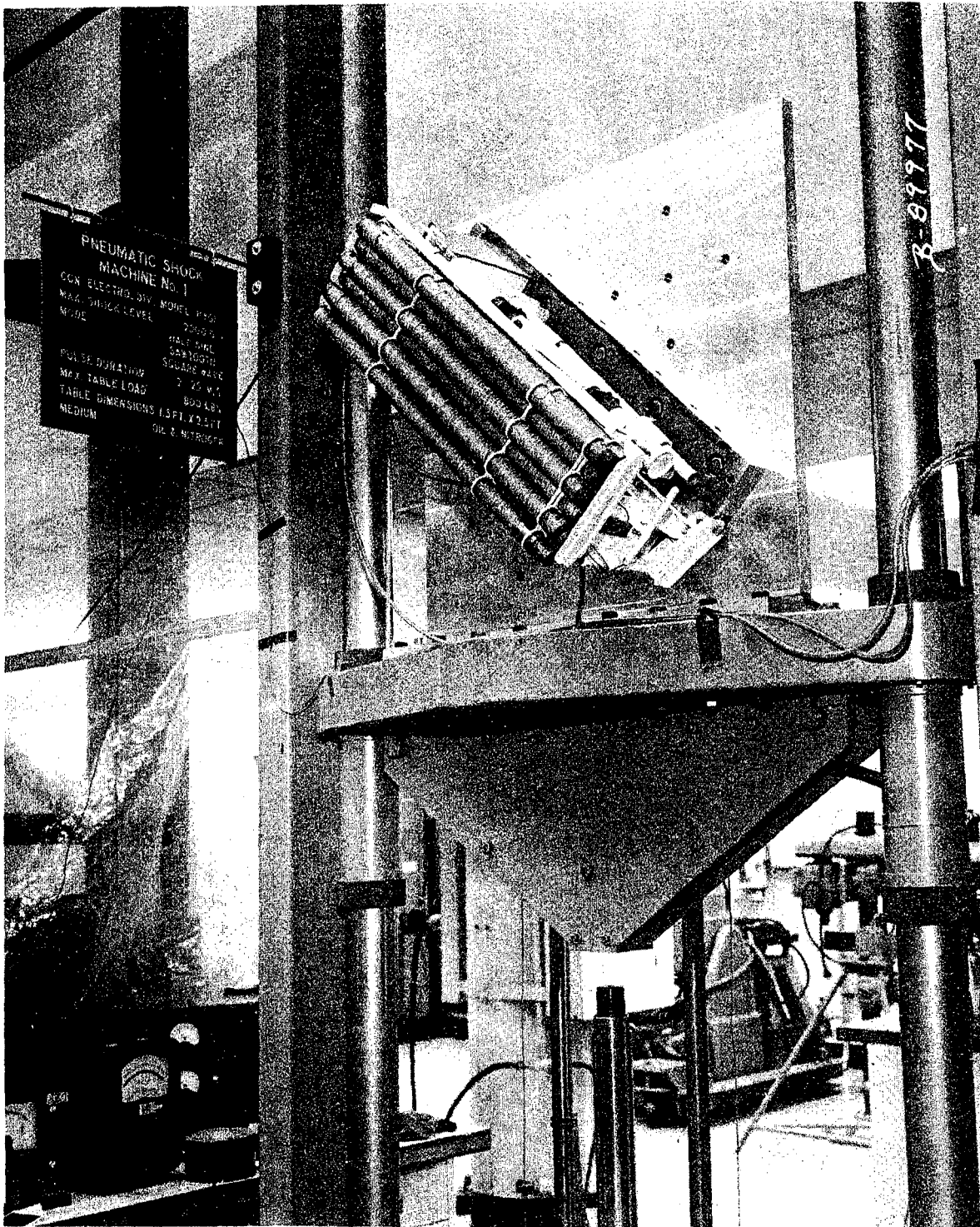

Figure IV-3 ALSD Shock Test Setup

5.0 ELECTROMAGNETIC INTERFERENCE

5.1 Test Requirements - The EMI test (7) consisted of measuring the radiated output of the ALSD power head in accordance with the Class I ungrounded requirements of MIL-I-26600. Conducted and susceptibility EMI tests were not required. Figure IV-4 shows the equipment setup used for these tests.

5.2 Test Results Summary - The initial series of radiated interference measurements resulted in above tolerance readings at several frequencies. Investigation of the problem revealed that the major cause was a high resistance path between the power head output spindle and the housing through the spring-loaded, EMI button system. The spring-loaded button rides against the rotating spindle and conducts mechanically generated electricity to the tool housing. The high resistance problem was corrected by: 1) Increasing the suppression button spring pressure, 2) Increasing the contact area and tightness of the fit of the spring in its housing seat, and 3) Changing the suppression button material from molybdenum to copper.

Incorporation of the above listed changes resulted in the power head successfully passing the EMI specification requirements.

IV-11

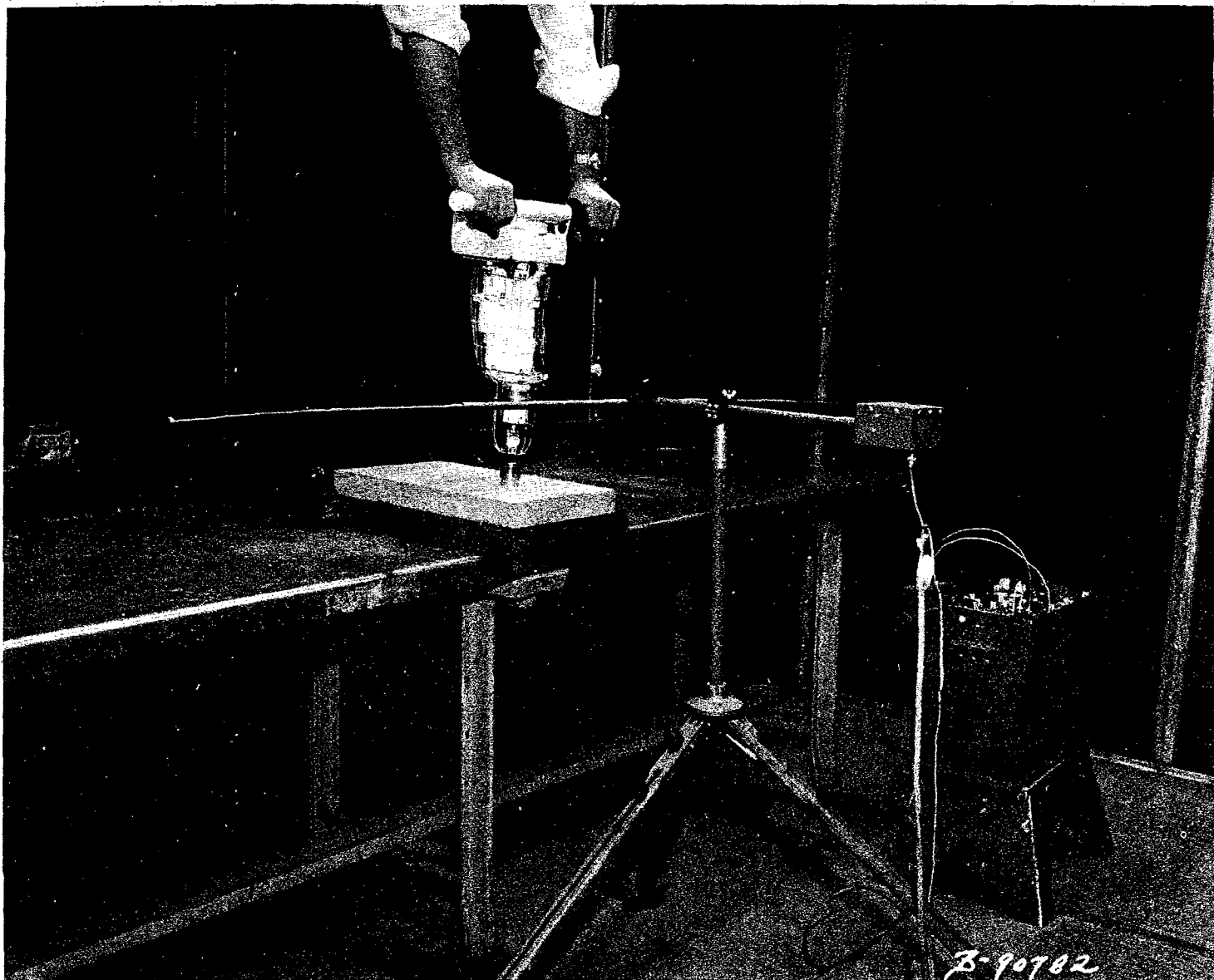

ER 14778

Figure IV-4 ALSD Electromagnetic Interference Test Setup

## 6.0 THERMAL VACUUM

6.1 Test Requirements - The ALSD thermal vacuum test (6) was conducted in several phases to simulate low and high temperature conditions during both transit to the moon's surface and during operation on the surface after landing of the LM spacecraft. A brief description of these test phases follows:

<u>Test</u>	<u>Thermal-Vacuum Condition</u>	<u>Time (hrs.)</u>
1) Transit (High Temp.)	SEQ Simulator @ 100°F & $1 \times 10^{-4}$ mm Hg	20
1A) Touchdown (High Temp.)	SEQ Simulator @ 160°F & $1 \times 10^{-4}$ mm Hg	15
2) Transit (Low Temp.)	SEQ Simulator @ 30°F & $1 \times 10^{-4}$ mm Hg	20
2A) Touchdown (Low Temp.)	SEQ Simulator @ 20°F & $1 \times 10^{-4}$ mm Hg	15
3) Lunar Surface (Low Temp.)	Solar Simulator @ 47°, lunar surface simulator @ -47°F, & $1 \times 10^{-5}$ mm Hg	10
4) Lunar Surface (High Temp.)	Solar Simulator @ 45°, lunar surface simulator @ 188°F, & $1 \times 10^{-5}$ mm Hg	10
4A) Lunar Surface (Low Temp. Operational)	Adjust chamber walls for min. battery temp. from test (3) & $1 \times 10^{-5}$ mm Hg	3
4B) Lunar Surface (High Temp. Operational)	Solar Simulator @ 45°, lunar surface simulator @ 188°F, & $1 \times 10^{-5}$ mm Hg	≈ 2

The thermal vacuum test control panel and miscellaneous equipment is shown in Figures IV-5 and IV-6. Figure IV-7 illustrates the ALSD mounted in the SEQ simulator (top removed) for the translunar portion of the test simulation. The simulator possessed an emissivity equivalent to the spacecraft SEQ, and its wall temperature could be controlled over the required temperature range of 20 to 160°F by a combination of heat exchange to the chamber cold wall and an integral strip heater system.

The lunar surface simulator shown in Figure IV-8 was designed using accepted techniques for simulating the infinite plane of the lunar



Figure IV-5 ALSD Thermal-Vacuum Test Control Panel

IV-14

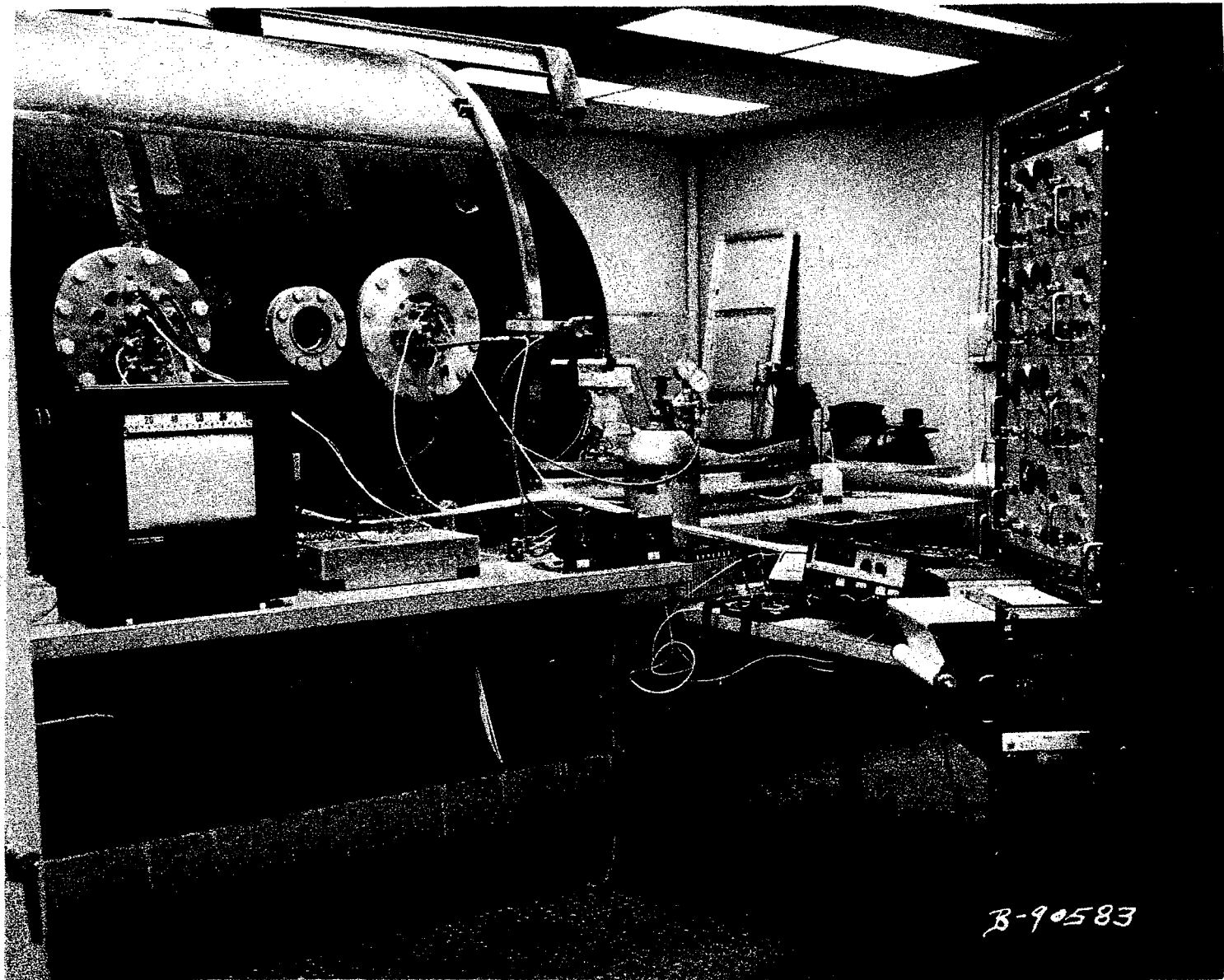

ER 14778

B-90583

Figure IV-6 ALSD Thermal-Vacuum Test Equipment

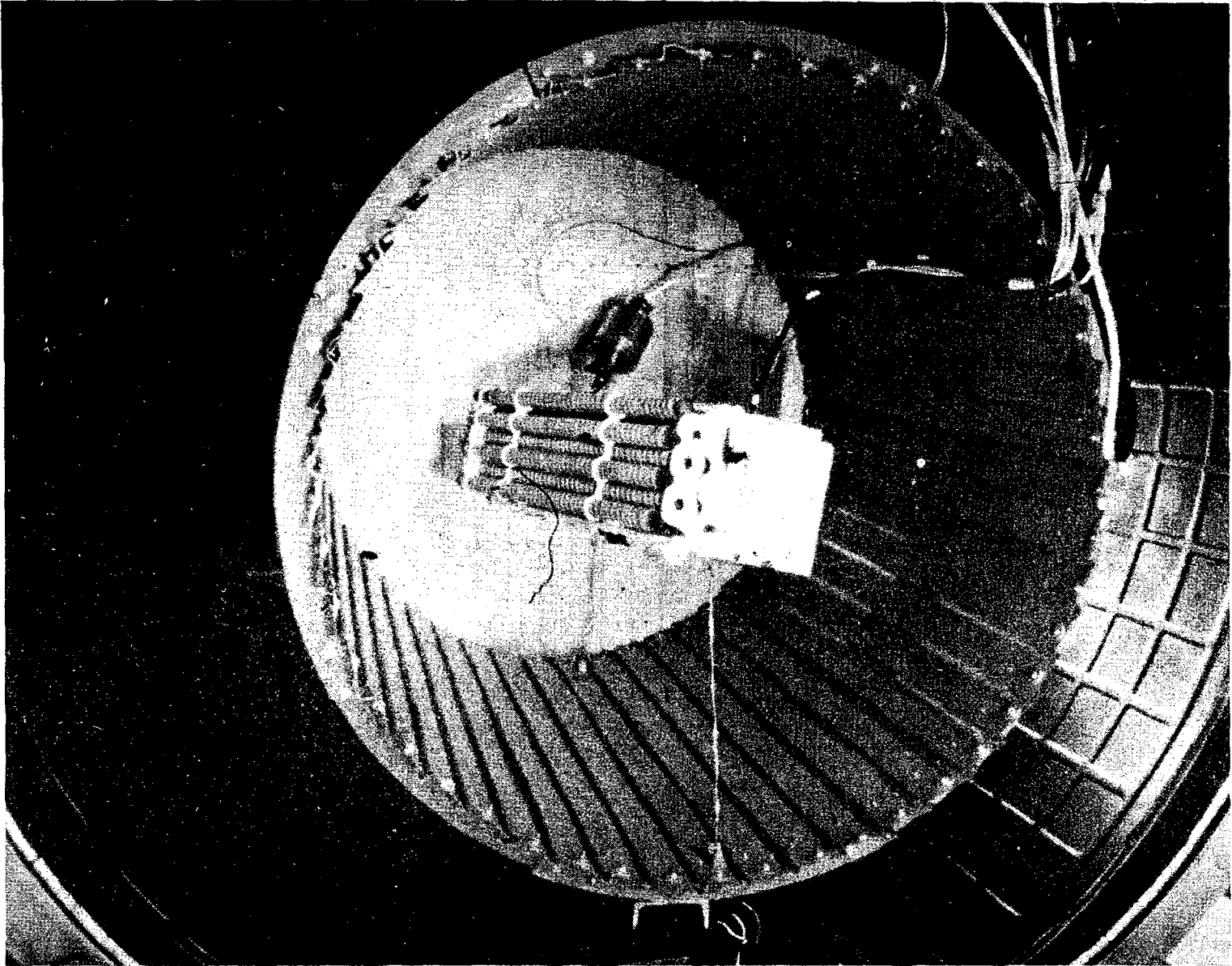

Figure IV-7 ALSD/SEQ Simulator



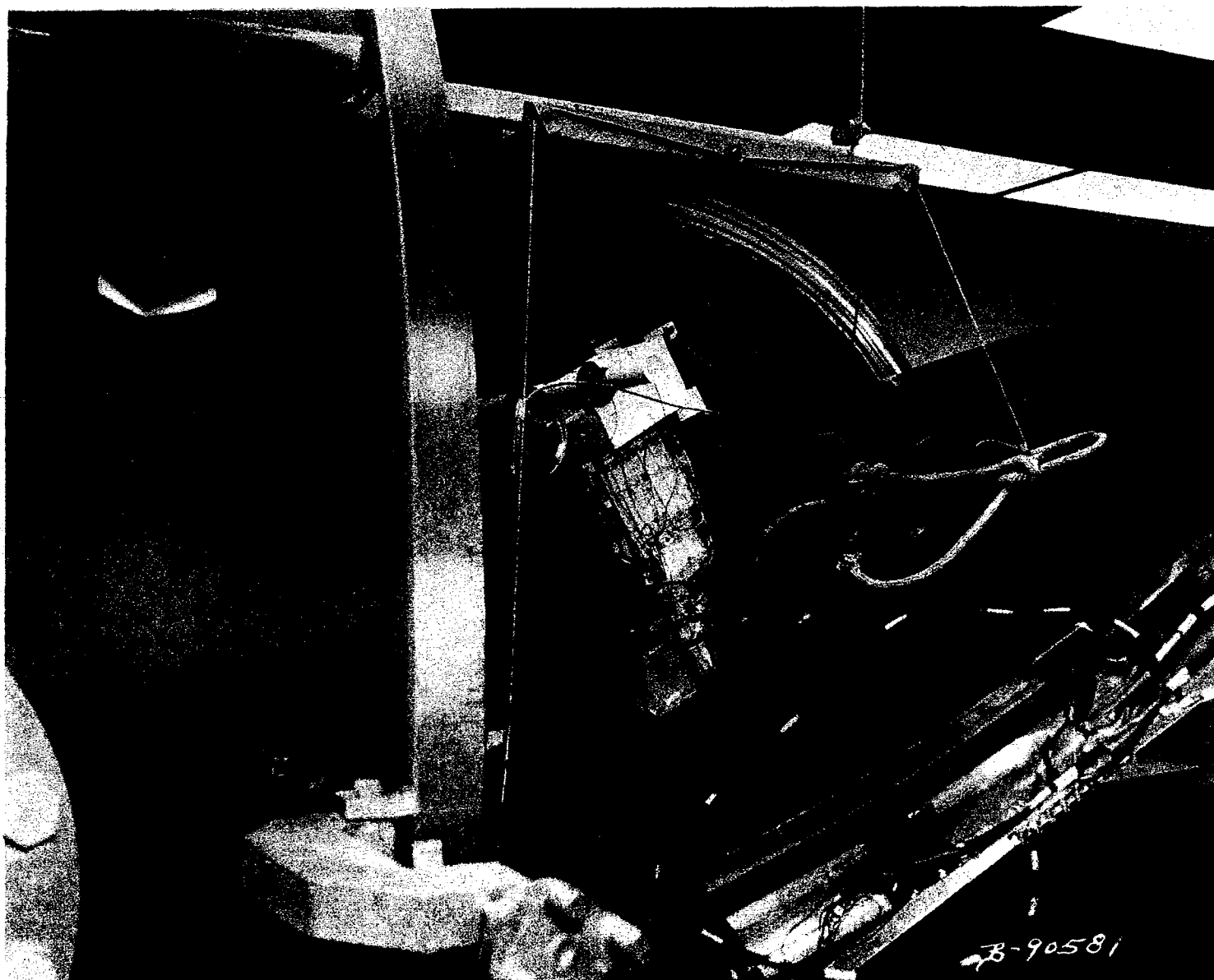

Figure IV-8 ALSD Operational Mode on Lunar Surface Simulator

surface with a finite-size, rimmed plate. Temperature control of the simulator could be varied over the required range of  $-47$  to  $+188^{\circ}\text{F}$  by means of strip heaters and heat exchange with the chamber cold walls in a manner similar to that described for the SEQ simulator. In the non-operating test modes the ALSD was oriented with the battery and handle against the lunar surface simulator, and the entire assembly was positioned at  $\angle 7^{\circ}$  or  $\angle 45^{\circ}$  relative to the solar simulation light source to simulate the minimum and maximum lunar sun angles. In the operating test mode the ALSD was oriented as shown in Figure IV-8. A load simulator consisting of a spring-loaded thrust bearing was incorporated on the bottom side of the lunar simulator to simulate a typical drilling load.

Tests 1, 1A, 2, and 2A consisted primarily of temperature measurements of the battery (internal and external), operating handle, thermal guard, and power head housing. Internal battery and power head pressure levels were also monitored to assure seal integrity in the vacuum environment. Tests 3 and 4 were performed to determine minimum and maximum temperatures experienced by the non-operating system resulting from low and high sun angles on the lunar surface. Test 4A was conducted to verify that the battery/power head assembly would start under the minimum low temperature condition, and test 4B verified that the system would operate for a typical 40 minute drilling mission under maximum temperature conditions.

The major criteria for success during this test were: 1) The ALSD power head and battery would operate under minimum temperature conditions, 2) The power head and battery would operate for the complete simulated lunar drilling mission under maximum temperature conditions thus proving the capability of the passive ECS systems, and 3) The power head thermal guard and handle would not exceed  $+250^{\circ}\text{F}$ .

The pressure relief valve poppet chattering problem described in paragraph 2.2 was corrected during this test by the use of a threaded, locking cap mounted concentrically with the valve body. During the transit to lunar surface portion of the test, the locking cap remained in the unlocked position, thus permitting normal operation of the valve. During the lunar surface operation phase the cap was locked against the poppet which precluded chattering, resulting from power head operation. In this mode of operation the internal pressure would rise proportional to the internal power head temperature.

6.2 Test Results Summary - The ALSD was subjected to the 8-phase test outlined in paragraph 6.1. The power head/battery assembly operated without difficulty during the low temperature and high temperature simulated lunar environment tests. However, three significant problem areas occurred

which required subsequent correction and retest:

- 1) The power head thermal guard experienced a maximum temperature of 263.7°F (250°F max. allowable) near the end of the simulated, 2-hole lunar drilling mission under the maximum initial temperature and sun angle conditions.
- 2) The power head dynamic bellows seal failed after approximately 4 minutes of operation during the simulated lunar drilling mission, thus resulting in loss of all appreciable internal pressure. However, the power head continued to operate throughout the remaining 36 minutes of power-on time in spite of the loss of pressurization. Failure of the dynamic seal was later attributed to improper installation.
- 3) Inspection of the battery indicated a minor expulsion of electrolyte from some of the cells which resulted in the creation of a high resistance voltage path to the magnesium case. The battery delivered the required total power capacity in spite of this anomaly.

In view of the problems described above, the following equipment modifications and additional test planning were pursued:

- 1) Additional thermal insulating washers were incorporated between the power head guard and the mounting bulkheads to reduce heat conduction in an effort to reduce the maximum temperature below 250°F.
- 2) A series of tests was planned to investigate the possible elimination of the relief valve locking cap and to verify the effectiveness of the thermal guard modification.
- 3) A series of tests was planned to investigate the possible reduction of electrolyte quantity in each battery cell as a means of eliminating electrolyte expulsion during elevated temperature operation.

7.0 AUXILIARY POWER HEAD VACUUM TEST

7.1 Test Requirements - This test (9) was conducted to determine the minimum pressure level which would be experienced by the power head resulting from "unloaded" spindle operation in a vacuum environment without the locking cap. The vacuum test setup was similar to that shown in Figure III-17, except the power head was mounted with the spindle pointing upward without the drilling load simulator. The pressure relief valve was adjusted for a cracking pressure of  $15 \pm 1$  psi, and the power head was operated in the vacuum range of  $1 \times 10^{-3}$  to  $5 \times 10^{-2}$  mm Hg at a duty cycle of 15 seconds on, 45 seconds off.

7.2 Test Results Summary - The power head rapidly lost pressure from its starting point of 27.8 in. Hg during the first 1-2 minutes of power on time as a result of relief valve poppet "chattering". Subsequently, the rate of decline decreased, and the test was terminated after a total elapsed time of 55 minutes. The end-of-test power head internal pressure was 1.1 in. Hg.

The information attained from this test was used to establish the initial power head pressure for performance of the subsequent thermal-vacuum test.

## 8.0 AUXILIARY POWER HEAD THERMAL VACUUM TEST

8.1 Test Requirements - This test (11) was performed to determine if the power head would operate satisfactorily at the reduced internal pressurization level determined from the previous test. The major advantage to be gained from successful operation was that the astronaut task of closing a power head relief valve locking cap on the lunar surface would be eliminated. A secondary purpose of this test was to assure that the additional thermal insulation washers would be sufficient to preclude the power head thermal guard temperature from exceeding the allowable 250°F.

The test was performed similar to Test 4B, described in paragraph 6.1. The solar simulator was used to establish the initial power head starting temperature of 154°F, which was the maximum experienced by the control thermocouple during the previous Test 4. Internal power head pressure was initially set to approximately 1 in. Hg. by means of an external bleed valve; the pressure relief valve spring was previously adjusted for a normal cracking pressure of 15 ± 1 psi. Since this test involved only the power head, power was supplied from an external source in lieu of the ALSD battery used in the previous thermal vacuum test.

After establishing the initial power head temperature and internal pressure, the operational test was performed in a manner identical to that described by Test 4B of paragraph 6.1.

8.2 Test Results Summary - A summary of the test results is shown in Figure IV-9. The power head pressure, initially adjusted for approximately 1 in. Hg. prior to start of the operational test, increased linearly to approximately 11 in. Hg. at the end of the 66 minute test. This pressure increase was attributed to the combination of unavoidable traces of moisture and lubricant vapors within the power head. The maximum temperature experienced by the thermal guard during this test was 234.5°F, which was well below the maximum allowable 250°F.

As a result of the tests described in paragraphs 6.0, 7.0 and 8.0, the ALSD power head was proven capable of meeting the thermal-vacuum requirements of transit and lunar surface operation.

IV-21/

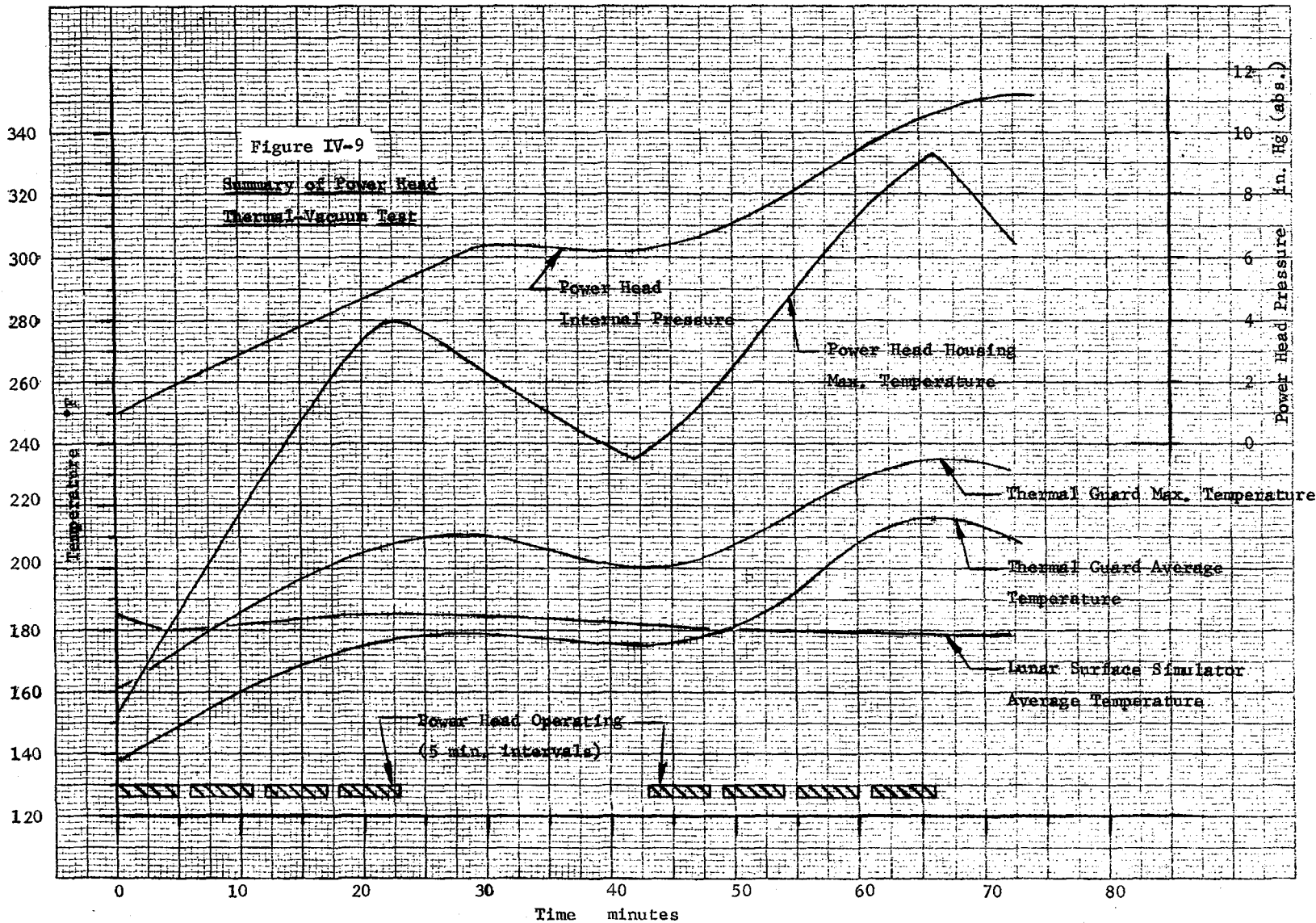

ER 14778

## 9.0 BATTERY ELECTROLYTE LEAKAGE ELIMINATION

9.1 Test Requirements - This test (14) consisted of two phases: 1) Phase I was conducted to determine the minimum quantity of electrolyte which could be used in the ALSD flight battery cells without degradation of electrical performance characteristics, and 2) Phase II consisted of a modified requalification test to verify that battery cell electrolyte expulsion would not occur during elevated temperature operation in a vacuum environment.

After determining that 17 cc's of electrolyte should be employed in each silver-zinc cell, the flight-type battery was subjected to the following tests:

- 1) Acceleration - The battery was accelerated in the direction of the cell vent valves at a level of  $14 \pm 1g$  for 60 seconds.
- 2) Thermal Vacuum Storage - The battery was subjected to a non-operating storage test at an ambient temperature of 100°F for four days followed by a 4-hour near vacuum exposure at 0.2 psia.
- 3) Thermal Vacuum Discharge - The battery temperature was adjusted to 100°F and subsequently discharged in a near vacuum environment at an 18.75 ampere rate with a duty cycle of 5 minutes on and 1 minute off.

The criteria for success of the three tests was that there be no evidence of significant electrolyte expulsion and that no measurable electrical potential exist on the battery case.

9.2 Test Results Summary - Visual inspection and electrical measurements of the battery following each of the tests revealed that no electrolyte was expelled. The final thermal vacuum discharge of the battery, which had been activated for 15 days, resulted in a 14.0 ampere-hour output capacity. This output was approximately 8% greater than specification requirements.

As a result of these tests, the ALSD was proven capable of meeting the transit and lunar surface thermal-vacuum environments.

## 10.0 DRILLING AND CASING

10.1 Test Requirements - The ALSD drilling and casing tests (8) consisted of two general categories: 1) Verify the ALSD drilling penetration rate and coring capability in four (4) consolidated rock models, and 2) Verify that a spacesuited subject can physically drill and case 3-meter holes in the various lunar surface simulation models. Specific requirements of the tests included the following:

- 1) Demonstrate that the ALSD is capable of drilling each of the following rock specimens with a single core bit at the required penetration rates and percentage of core recovery:

<u>Rock Specimen</u>	<u>Specimen Temperature</u>	<u>Accumulated Drilling Depth</u>	<u>Penetration Rate</u>	<u>Core Recovery</u>
43% Porosity Basalt	Room	100 in.	4 in./Min.	95%
43% Porosity Basalt	-58°F	20 in.	4 in./Min.	95%
Pumice	Room	240 in.	60 in./Min.	54%
Dense Basalt	Room	20 in.	0.8 in./Min.	95%

- 2) Verify that a spacesuited subject can physically drill and case two, 3-meter holes in each of three lunar surface models in a maximum of 66.4 minutes for each model.
- 3) Verify that a spacesuited subject can provide the torque and thrust requirements necessary for drilling under a 1/6-G gravitational environment.
- 4) Verify that the ALSD equipment, inclusive of the self-contained battery power source, is capable of drilling and casing two 3-meter holes in each of the three lunar surface simulation models.
- 5) Verify that the ALSD is capable of recovering core material equivalent to at least 40 percent of the linear drilled depth from the second 3-meter hole in each of the three lunar surface simulation models, and that the largest piece of consolidated core will be at least one inch in length.



- 6) Verify that the emplaced casing in each of the lunar surface simulation models is within  $\pm 15$  degrees of the local vertical, and is of sufficient straightness so that a 22-inch probe, 0.75-inch minimum diameter, will pass freely to the bottom of the hole.

10.2 Test Results Summary (Shirtsleeve Subject) - A tabulation of the consolidated rock model drilling test results is presented in Table IV-1. These models were drilled by a shirtsleeved operator, using the weight of the drill to provide the axial thrust. Drilling rate in the vesicular basalt at room temperature (7.2 in./min.) as compared to the low rock temperature test (4.7 in./min.) is attributed to the variation of sample drillability and not to the low temperature effects. An ambient room temperature test of the same specimen used for the low temperature test resulted in approximately the same penetration rate.

The vesicular basalt calculated core recovery of 106% is attributed to the presence of voids in the drill string between fragmented core sections. It is estimated that the true recovery was approximately 96-98%, based upon the quantity of material remaining in the hole after drill string withdrawal.

In general, the major drilling requirements (penetration rates, core recovery, length of consolidated core sections) were surpassed during the tests. The new bit which was employed for each of the four tests survived the drilling environment, and was still operating at the conclusion of each test with deterioration varying from nil in the pumice model to moderate in the vesicular basalt models.

10.3 Test Results Summary (Spacesuited Subject) - The initial space-suited subject tests were performed using the test setup shown in Figure III-28. During these tests both the subject and drill were counterbalanced to 1/6-G during the actual drilling portions of the simulated mission to assure that the subject could provide the necessary torque and axial restraints to the ALSD. Subsequent tests were performed without the 1/6-G simulators to attain better task time data without the interruptions of coupling/decoupling the simulators.

The 3-meter drilling and casing requirements for each of the three lunar surface simulation models included the following major tasks:

Table IV-1

## Consolidated Rock Model Drilling Test Results

Parameter	Ves. Basalt (Ambient)		Ves. Basalt (Low Temp)		Dense Basalt		Pumice	
	Req't.	Actual	Req't.	Actual	Req't.	Actual	Req't.	Actual
Total Drilling Depth (In.)	100	108.6 <sup>(1)</sup>	20	27.9 <sup>(2)</sup>	20	20.4 <sup>(3)</sup>	240	243.5 <sup>(4)</sup>
Total Core Recovery (In.)	N/A	115.2	N/A	26.9	N/A	20.2	N/A	138.8
Total Drilling Time (Min.)	N/A	15.2	N/A	5.95	N/A	14.1	N/A	1.7
Calc. Drilling Rate (In./Min.)	4.0	7.2	4.0	4.7	0.8	1.4	60	142
Calc. Core Recovery (%)	95	106	95	96.4	95	99	54	57
Length of Longest Core (In.)	1.0	1.9	1.0	1.75	1.0	8.0	1.0	1.9
Rock Temperature (°F)	Room	Room	-58±5	-56	Room	Room	Room	Room

- Notes:
- (1) Sequentially drilled 8 holes, 12-14 inches per hole, in a 15-inch slab of vesicular basalt.
  - (2) Sequentially drilled 3 holes, 8-10 inches per hole, in a 12-inch slab of vesicular basalt placed in a low temperature chamber.
  - (3) Drilled a single hole in a 21-inch slab of dense basalt.
  - (4) Sequentially drilled two, 10-foot holes in pumice model.

<u>Major Task</u>	<u>Description</u>
1) Post Landing Preparation	Simulate removal of ALSD from ALSEP. Stack hole casings and drill strings (simulated retrieval from ALSRC) in ALSD rack. Stow caps and stowage racks (simulated retrieval from ALSRC) on ALHT.
2) Deployment (First Hole Site)	Disassembly of ALSD from stowage mode, attach operation handle, erect rack, emplace treadle, prepare to drill first hole.
3) First Hole Drilling	Drill and sequentially add extension tubes.
4) First Hole Withdrawal	Perform preparatory tasks for casing hole, withdraw drill string from hole.
5) First Hole Encasement	Sequentially power drive hole casings, decouple and stow extension tubes.
6) Second Hole Drilling	Discard first hole core, drill and sequentially add extension tubes.
7) Second Hole Withdrawal	Perform preparatory tasks for casing hole, withdraw drill string from hole.
8) Second Hole Encasement	Sequentially power drive hole casings; decouple, cap and stow individual extension tubes with second hole core.

Note: See References 2 and 8 for detail delineation of major tasks.

A portion of these tasks are shown in Figures IV-10 through IV-14. Task items 2 through 8 had to be accomplished within 66.4 minutes for each of the three lunar surface simulation models.

During performance of the spacesuited subject drilling and casing tests several problems occurred which required equipment and/or procedural modifications. The major equipment modifications included the following:

- 1) The power head thermal guard was redesigned with softer grade stainless steel tubing to preclude fatigue failure resulting from drilling vibrations,

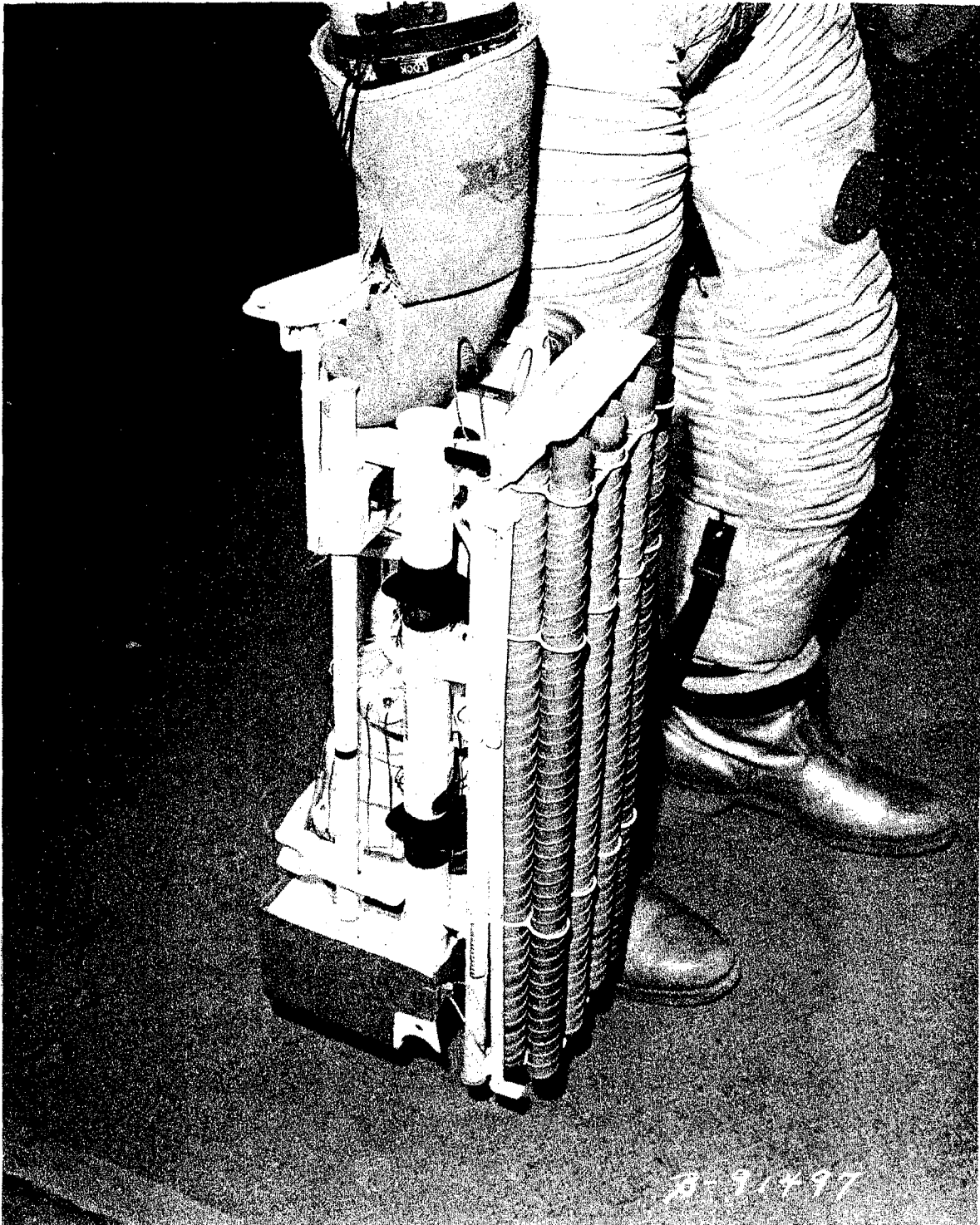

Figure IV-10 ALSD Transport Mode

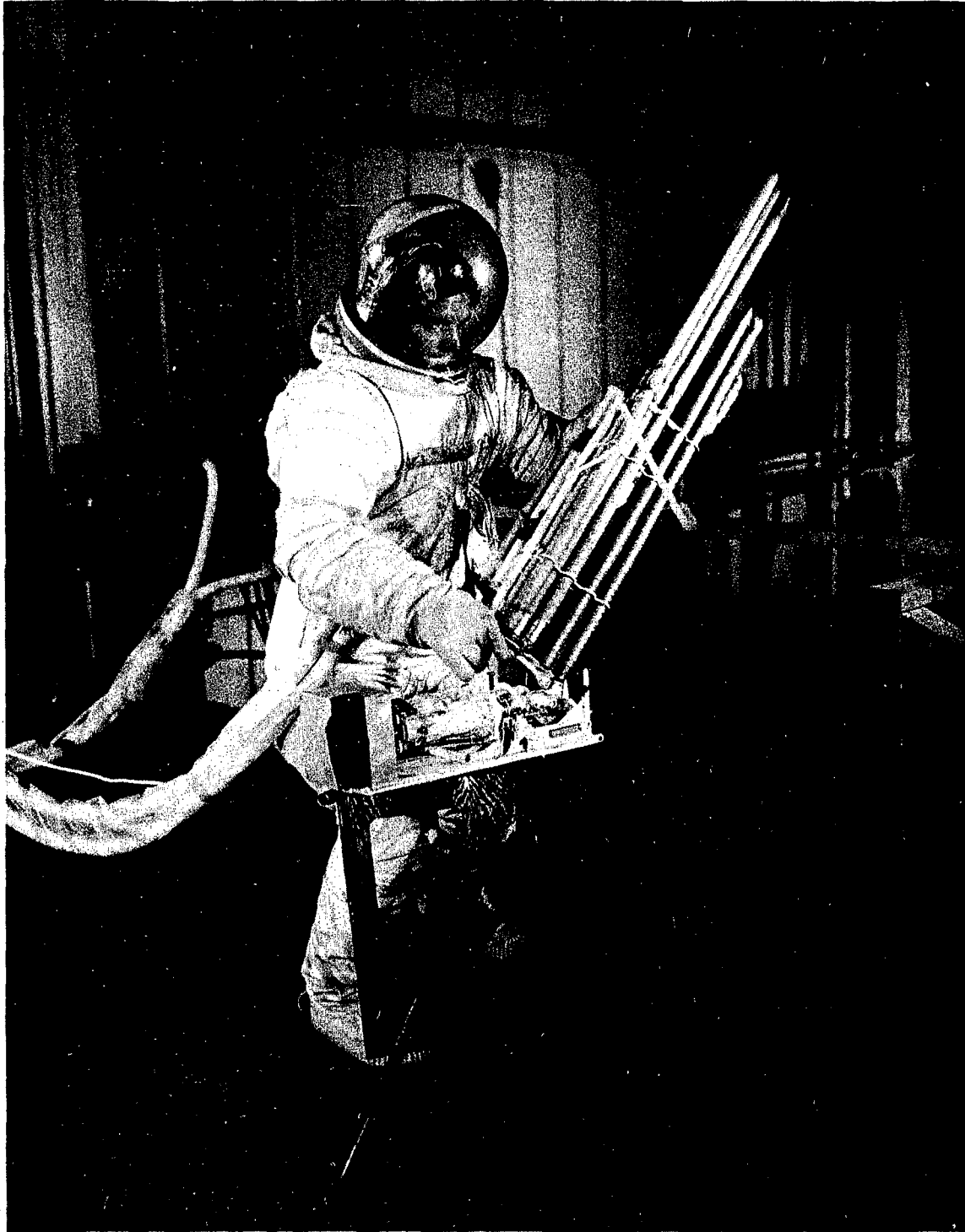

Figure IV-11 ALSD First Hole Deployment

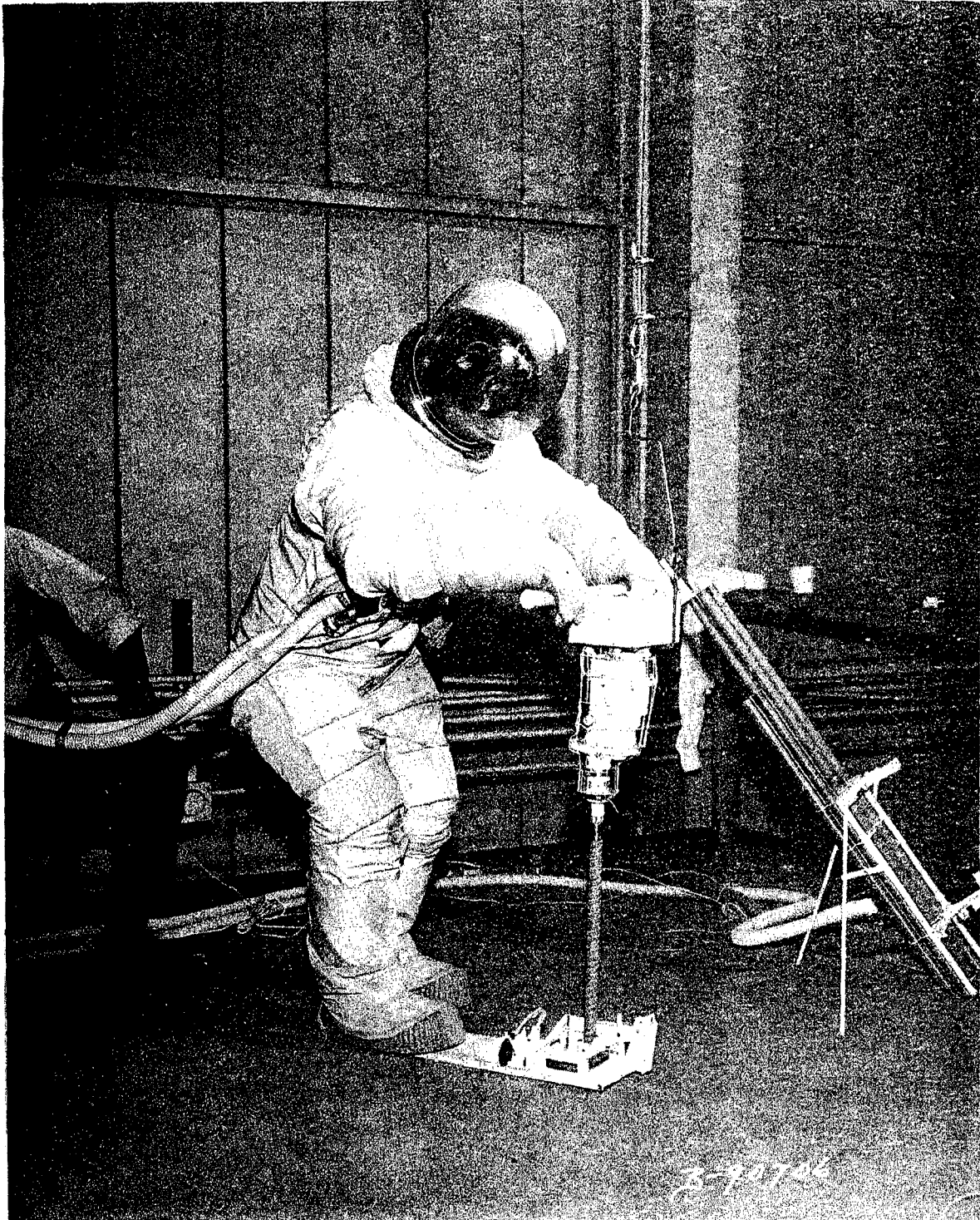

Figure IV-12 ALSD Casing Operation

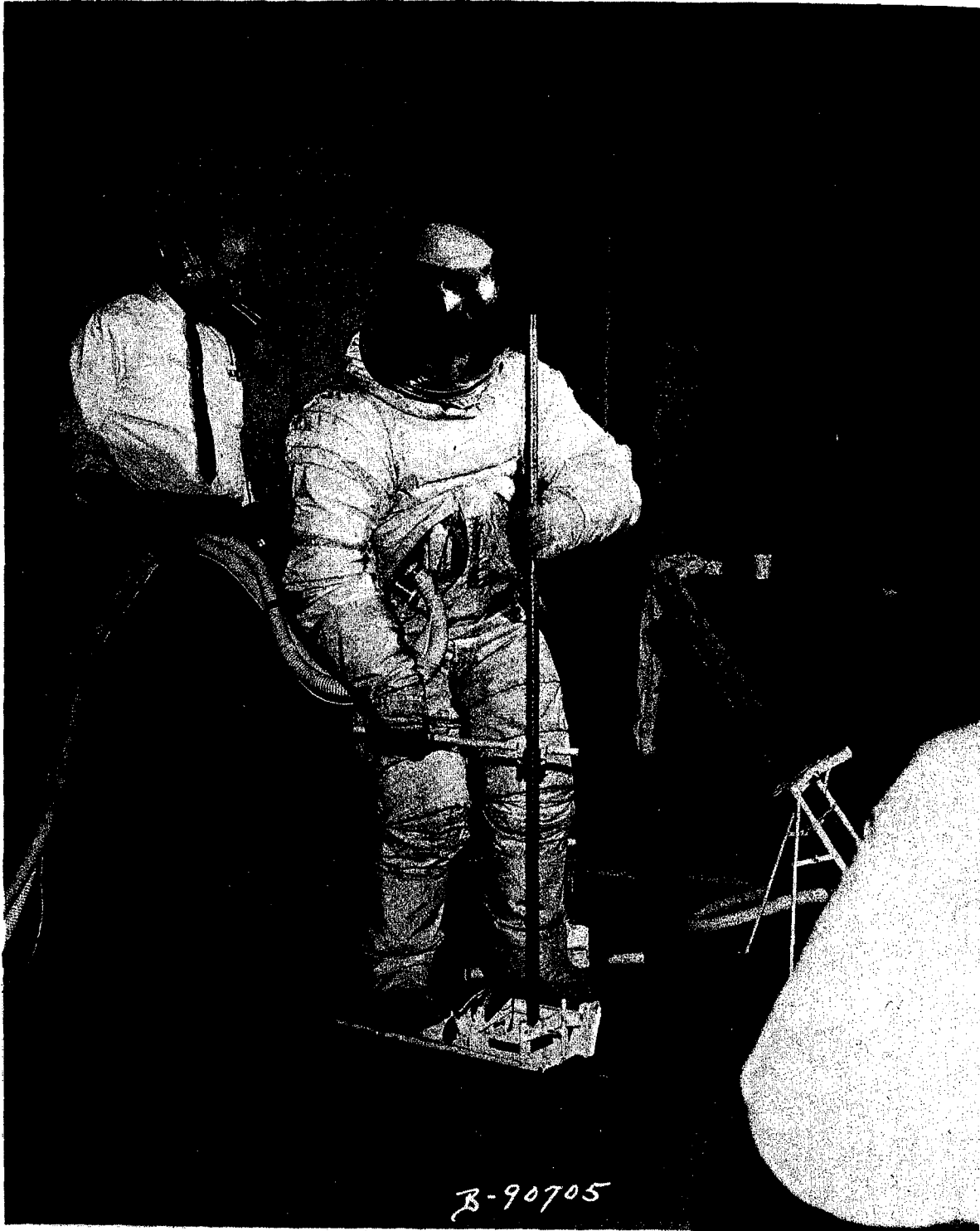

Figure IV-13 ALSD Drill String Withdrawal



Figure IV-14 ALSD Drill String Decoupling



- 2) The handle-to-battery fixed locking pin was redesigned as a solid machined fitting (in lieu of welded assembly) to reduce the possibility of failures resulting from droppage of the battery/power head/handle assembly.
- 3) The drill string treadle lock mechanical spring was replaced with a molded, silicon rubber boot to preclude temporary jamming caused by rock cuttings entering the lock cavity.
- 4) The casing tip was redesigned to the configuration illustrated in Figure III-10 to improve the reliability of penetration through back-filled, predrilled holes in consolidated rock.
- 5) The casing-to-power head adapter was redesigned to the configuration illustrated in Figure III-10 to attain optimum torque transmission and quick release characteristics.

The major procedural change developed during the qualification test program was the decoupling of the drill string after its withdrawal from the hole using the wrench and treadle lock as illustrated in Figure IV-14. This technique was preferred over the previous procedure of decoupling sequentially while withdrawing the drill string because: 1) The subsurface hole disturbance was minimized, thus increasing hole recovery for the casing operation, and 2) The task of decoupling extension tubes was more difficult at the relatively low levels required concurrent with withdrawal compared to the Figure IV-14 technique.

A tabulation of the final spacesuited subject test results for the three lunar surface simulation models is presented below:

<u>Parameter</u>	<u>Requirement</u>	<u>Congl. + V.B. Chunks</u>	<u>Congl. + V.B. Block</u>	<u>Congl. + D.B. Block</u>
Mission Time (Tasks 2-8)	66.4 Min.	46.1 Min.	59.4 Min.	57.1 Min.
First Hole Verti- cality	< 15°	2.5°	2°	< 5°
First Hole Straightness	Accept.	Accept.	Accept.	Accept.
Second Hole Verti- cality	< 15°	2°	1°	0°
Second Hole Straightness	Accept.	Accept.	Accept.	Accept.
Second Hole Core Recovery	40% Min.	40.1%	50.8%	32%

ER 14778

Because of the casing problems experienced prior to design finalization, a series of casing tests was performed to demonstrate reliability of the final configuration. This test series involved encasement of nine holes -- three holes in each of the three lunar surface simulation models by a spacesuited subject. These tests were all successful with the exception that the casing tip sheared during the encasement of one hole (conglomerate with vesicular basalt block) resulting in the reduced useable hole depth of 2.6 meters. This particular problem was attributed to a chunk of rock which had separated from the parent rock as a result of weakening from the numerous holes which had been previously drilled.

In summary, the drilling and casing qualification test program which resulted in several procedural and equipment modifications, demonstrated that the final ALSD configuration is capable of performing the two-hole drilling mission on the lunar surface.

## V. CONCLUSIONS AND RECOMMENDATIONS

## 1.0 CONCLUSIONS

The primary conclusion of this report and of the ALSD Program is that a hand-operated lunar drill has been designed, fabricated, and qualified for the purpose of drilling two, 3-meter holes in the lunar subsurface for the emplacement of HFE probes. Other subsidiary conclusions which have evolved from the design and test phases of the drill system are presented in the following paragraphs.

1.1 Drill Operability - As evidenced by the results of the ALSD Qualification Test Program, a single, spacesuited subject can perform the necessary operations (2) for drilling and casing two, 3-meter holes in the lunar surface in less than the allotted time of 66.4 minutes. Actual mission time depends, in part, upon the drilling characteristics of the subsurface material. Of equal importance in ensuring successful accomplishment of the drilling mission in a minimum time period is the adequacy of the astronaut training program. Specific recommendations for accomplishing this objective are presented in paragraph 2.1.

1.2 Design Technology - Development of the ALSD drilling system required unique applications of a multitude of design technologies in order to attain the desired results. Some of the major ALSD subsystems which incorporated technologies originally developed for other applications include the following:

- 1) Application of metallic cladding (copper and nickel) to the hole casing fiberglass substrate to improve the abrasion resistance characteristics of the base material,
- 2) Employment of eccentric cam characteristics for the development of the semi-automatic drill string locking device,
- 3) Application of state-of-the-art gear and bearing systems combined with unique packaging techniques to minimize weight and power inefficiencies in the power head,
- 4) Application of magnetic saturable reactance techniques for minimizing flux density (and motor speed) variation with temperature over the power head operating temperature range,
- 5) Employment of independent rotary dynamic and linear bellows dynamic seals in the power head to provide seal-

ing of the output spindle, which requires two-dimensional (axial and rotary) freedom for its operation,

- 6) Development of a high discharge rate, high power-to-weight ratio (40-45 watt-hours/pound) battery system inclusive of an internally mounted power control switch to minimize system complexity,
- 7) Development of a minimum tube thickness drill string capable of optimum percussive energy transmission consistent with the storage requirements (number of extension tubes) and astronaut decoupling capabilities in the lunar environment,
- 8) Employment of drill string dry cuttings transport system consisting of an external helical flute capable of operation to subsurface depths exceeding three meters,
- 9) Application of optimum core bit indexing principles to improve the consolidated rock drilling power efficiency.

1.3 Materials and Processes - Development of the ALSD drilling system also required utilization of state-of-the-art materials and processes in order to meet the weight and operating environment requirements as delineated below:

- 1) Investment-cast magnesium housings were used for the power head to minimize weight and maximize thermal conductance for the passive ECS,
- 2) The superior strength-to-weight characteristics of titanium were employed in the power head shock absorber system, casing adapter and tip, and core bit extension tubes,
- 3) Magnesium sheet was used for construction of the battery outer cases to minimize weight and maximize thermal conductance for the passive ECS,
- 4) Passive ECS finishes with appropriate absorptivity and emissivity characteristics were used on the power head, thermal guard, battery case and battery shroud to eliminate the weight penalties of active thermal control systems,
- 5) Recently developed fluorinated-teflon lubricants (oil and grease) were employed in the sealed power head to accommodate

the high temperature-high loading requirements. Solid film lubricants were employed for lightly-loaded moving parts of the ALSD exposed to the near vacuum environment,

- 6) A recently developed, teflon-impregnated anodize finish was used on the extension tube coupling joints to meet the rigid contamination control requirements of the ALSRC.

Other new manufacturing processes were considered for use on the ALSD system such as electrophoretic deposition of carbide coatings for the drill bits, but were subsequently rejected due to schedule requirements. Utilization of some of these processes are described under recommendations for future improvements of the ALSD system.

## 2.0 RECOMMENDATIONS

The recommendations described below may be categorized as follows: 1) Operability and training recommendations, 2) Design changes to the ALSD requiring minimal re-qualification, 3) Product improvements requiring more significant evaluation and test, and, 4) Advanced lunar drilling systems.

### 2.1 Operability and Training -

- 1) A permanent instructor(s) should be selected for the ALSD portion of the ALSEP astronaut training program. This instructor should possess a reasonable technical understanding of the ALSD subsystems, and should have performed several simulated drilling and casing missions (both shirtsleeve and spacesuited) using the detailed operating procedures provided in Reference 2. In this manner, the experienced instructor can more efficiently provide the candidate astronauts with the required training within the limited time allocated for ALSEP training. Use of the ALSD operational film provided by the contractor in conjunction with film coverage during the astronaut performance sessions will also serve as invaluable aids for training critiques. The operating procedures (2) have been developed through the performance of numerous simulated drilling missions, and any major deviations should be carefully evaluated prior to their incorporation.
- 2) Man/machine interface evaluation tests should be continued with the ALSD using both KC-135 and neutral buoyancy 1/6-G simulation techniques. As additional modifications are incorporated into the spacesuits, requirements for accompanying ALSD modifications may become apparent, especially in the areas of minimum and maximum reach heights.

### 2.2 Minimal Design Changes -

- 1) Investigate the possibility of deleting the thermal guard predicated upon updated information regarding maximum SEQ temperature profiles, lunar sun angle extremes during ALSD operation, probable lunar surface drilling characteristics as related to ALSD power requirements, and temperature capabilities of the spacesuit outer thermal garments. Elimination of the thermal guard would result in a weight reduction of approximately 0.5 pounds, and improved operability of the system.

- 2) Investigate the possibility of increasing the length of the ALSD wrench handle as a means of increasing the minimum reach height required of the astronaut during pick-up of the rack and treadle assemblies from the surface during lunar operations.
- 3) Conduct tests to determine the maximum allowable pre-flight battery activation time (beyond the current 11-day restriction) to provide additional flexibility during the KSC operations.
- 4) Conduct tests to determine improvements (faster penetration rates) realized when casing through back-filled holes in consolidated rock which have been predrilled with oversized core bits (1.125 inches). Power requirements must also be determined for the larger diameter core bits to ensure that the battery capacity is not exceeded.
- 5) Incorporate a power head modification consisting of the addition of a shock-absorbing sleeve mounted concentrically to the cam follower. This will reduce shock loading of the power train system encountered during high torque drilling or casing situations which will prolong component life.

2,3

Product Improvements -

- 1) Conduct studies and tests to determine an optimum configuration boron-filament casing with drill bit to replace the existing fiberglass casings. The major advantage of the boron material is that a simultaneous drilling and casing operation can be performed in lieu of the separate operations currently required, thus substantially reducing the astronaut task time and work load. Preliminary development tests have been performed with boron filament tubes which have demonstrated feasibility of this approach.
- 2) Conduct studies and tests to determine the feasibility of utilizing electrophoretically deposited carbide coated bit tips with a metal substrate in lieu of the current solid tungsten carbide tips. Although the existing bits have performed satisfactorily in the dense and vesicular basalt rock standards, other igneous rocks such as extremely dense basalt, obsidian, and abrasive vesicular basalts can result in more rapid deterioration of tungsten carbide through

the processes of abrasion, fractures, or braze failures. Utilization of the coated tips would theoretically provide the high strength characteristics of steel combined with the hardness characteristics of carbide.

- 3) Conduct studies and tests to determine the feasibility of using the ALSD as an alternate lunar surface experiment (in addition to HFE probe emplacement) for obtaining a large array of core specimens. With relatively few modifications (primarily deletion of components) the ALSD system could be converted to a shallow hole (40-80 cm.) sampling device which would not impose a large work load on the astronaut operator.
- 4) Conduct studies and tests to determine areas where the ALSD weight can be reduced. Primary areas of investigation include substitution of Lockalloy for titanium in the drill string which would save approximately 1.5 pounds, and use of a machined magnesium treadle in lieu of the current honeycomb assembly with welded components, which would save approximately 0.5 pounds.
- 5) Fabricate a lunar surface simulation model using updated Surveyor and Lunar Orbiter information. The model specifications should be agreed upon by the scientific community including NASA, U. S. Geological Survey (Astrogeology Branch), principal investigators, etc. The model should provide a minimum of 4 variations of drilling characteristics, and should occupy an area of approximately 9 square meters with a depth of 5 meters. A working area of approximately 36 square meters at the top should be provided in order to adequately accommodate spacesuited subject training and related equipment. The model could be used jointly by the drill contractor, NASA astronaut training, and other contractors and principal investigators engaged in lunar surface experiment work for NASA.

2.4 Advanced Lunar Drilling Systems - In addition to the specific recommendations submitted in support of the ALSD, consideration should be given to immediate continued development of drilling techniques and equipment which will ultimately be required for larger lunar drilling devices. The ALSD represents a significant beginning for such devices, but considerable development work is required before practical deep drilling devices can be fabricated for use on the moon. The differences between present-day earth drilling rigs and comparable lunar drilling devices is analogous to the differences between a jet plane and a spacecraft capable of landing on the moon's surface.



The importance of planetary drilling systems cannot be over-emphasized because of the numerous geological and geophysical experiments which require subsurface holes. A partial listing of potential experimental measurements includes the following:

- |                            |                         |
|----------------------------|-------------------------|
| 1) Subsurface temperature  | 7) Acoustic velocity    |
| 2) Thermal diffusivity     | 8) Mass spectrometer    |
| 3) Magnetic susceptibility | 9) Neutron-gamma        |
| 4) Electrical conductivity | 10) TV Probes           |
| 5) Natural gamma           | 11) Geological sampling |
| 6) Bulk Density            | 12) Biological sampling |

Throughout the performance of the ALSD program, various drilling techniques and mechanism concepts have been suggested and discarded for use on the ALSD system, but which could be developed on an engineering model basis now for future implementation in planetary drilling devices. These developments should be pursued immediately in order to meet the future drilling requirements.

APPENDIX A - REFERENCES

1. Martin Marietta Report No. ER 14349P(DPR-3), Phase C Final Report/Phase D Technical Proposal for Apollo Lunar Surface Drill, dated August 18, 1966.
2. Martin Marietta Report No. ER 14756(DSM-1 & DSM-2), Familiarization and Support Manual for Apollo Lunar Surface Drill, dated July 15, 1968.
3. Martin Marietta Plan No. DPL-1-1-2, Qualification Test Plan for Apollo Lunar Surface Drill, dated 30 September 1966 and revised 10 September 1967.
4. Martin Marietta Report No. ER 14682(DER-1-15), Apollo Lunar Surface Drill Theoretical Thermal Analysis Report, dated November 1967.
5. Martin Marietta Report No. DQR-3-1, Apollo Lunar Surface Drill Qualification Test Report (Mechanical), dated January 12, 1968.
6. Martin Marietta Report No. DQR-3-2, Apollo Lunar Surface Drill Qualification Test Report (Thermal Vacuum), dated March 20, 1968.
7. Martin Marietta Report No. DQR-3-3, Apollo Lunar Surface Drill Qualification Test Report (Electromagnetic Interference), dated March 15, 1968.
8. Martin Marietta Report No. DQR-3-4, Apollo Lunar Surface Drill Qualification Test Report (Drilling and Casing), dated May 28, 1968.
9. Martin Marietta Report No. DQR-8-1, Apollo Lunar Surface Drill Auxiliary Qualification Test Report (Power Head Vacuum Test), dated March 18, 1968.
10. Martin Marietta Report No. DQR-8-2, Apollo Lunar Surface Drill Auxiliary Test Report (Power Head Thermal Vacuum Tests), dated March 29, 1968.
11. Martin Marietta Report No. DQR-8-3, Apollo Lunar Surface Drill Qualification Data Verification and Test Report (Mechanical), dated April 12, 1968.
12. Martin Marietta Report No. DQR-8-5, Apollo Lunar Surface Drill Design Verification Test Report (Hold-down Attachment), dated 6 September 1968.

13. Yardney Electric Corporation Report No. 988-68, Qualification Testing of the PS 940300014-003 Apollo Lunar Surface Drill Battery, dated January 1968.
14. Yardney Electric Corporation Report No. 1069-68, Investigation and Requalification Test Report for ALSD Battery Electrolyte Leakage Elimination Tests, dated July 1968.

Informal Development Test Reports

15. DQR-2-1-001, Core Bit Optimization Tests - Determination of NASA Standard Sample High Density Basalt Properties, dated 17 February 1967.
16. DQR-2-1-002, Core Bit Optimization Tests - Preliminary ALSD Drill Rate Verification, dated 12-15 January 1967.
17. DQR-2-1-003, Core Bit Optimization Tests - Summary of 4-Carbide Bit Penetration Rate Tests, dated 25 January - 12 March 1967.
18. DQR-2-1-004, Core Bit Optimization Tests - Evaluation of Three, Four and Five Carbide Tipped Bits, dated 16-20 March 1967.
19. DQR-2-1-005, Core Bit Optimization Tests - Verification of ALSD Axial Bit Pressure Requirements, dated 30 March - 4 April 1967.
20. DQR-2-1-006, Core Bit Optimization Tests - Evaluation of Carbide Geometries and Hardness, dated 28 April - 31 May 1967.
21. DQR-2-1-007, Core Bit Optimization Tests - Evaluation of Carbide Geometries and Hardness, dated 17 June 1967.
22. DQR-2-2-001, 3-Meter Conglomerate and Pumice Model Drilling - Penetration Rates and Core Recovery Tests, dated 7-21 August 1967.
23. DQR-2-2-002, Special Pumice Core Recovery Tests, dated 19 September - 16 October 1967.
24. DQR-2-2-003, ALSD Field Drilling Tests, dated 15-21 October 1967.
25. DQR-2-3-001, Hole Casing Sleeve Tests (Bore Hole Geometry with 5-Carbide Bit), dated 6 October 1966.
26. DQR-2-3-002, Hole Casing Sleeve Tests (Bore Hole Geometry with 4-Carbide Bit), dated 7 October 1966.

27. DQR-2-3-003, Hole Casing Sleeve Tests (Split Tube Casing within Drill String), dated 10 October 1966.
28. DQR-2-3-004, Hole Casing Sleeve Tests (Split Tube within Drill String), dated 11 October 1966.
29. DQR-2-3-005, Hole Casing Sleeve Tests (Conglomerate Model Hole Recovery), dated 10 February 1967.
30. DQR-2-3-006, Hole Casing Sleeve Test (External Fiberglas), dated 11 February 1967.
31. DQR-2-3-007, Hole Casing Sleeve Test (External Metallic), dated 13 February 1967.
32. DQR-2-3-008, Hole Casing Sleeve Test (Torque Restraint Measurement), dated 17 February 1967.
33. DQR-2-3-009, Hole Casing Sleeve Test (Internal Drill String Split Tube), dated 18 February 1967.
34. DQR-2-3-010, Hole Casing Sleeve Test (Power Driven Sleeve), dated 23 February 1967.
35. DQR-2-3-011, Hole Casing Sleeve Test (Perforated Metallic Sleeve), dated 24 February 1967.
36. DQR-2-3-012, Hole Casing Sleeve Test (Powered, Fluted Fiberglas), dated 1 May - 29 June 1967.
37. DQR-2-3-013, Hole Casing Tip Optimization Tests, dated 15 September - 30 October 1967.
38. DQR-2-3-014, Hole Casing Tip Development, dated February-April 1968.
39. DQR-2-3-015, Hole Casing Adapter Development, dated April-May 1968.
40. DQR-2-3-016, Hold-Down Attachment Development Tests, dated 5-22 August 1968.
41. DQR-2-4-001, Electromagnetic Interference Test (PLGT), dated 1-14 November 1966.
42. DQR-2-4-002, Electromagnetic Interference Test (EMI Model Power Head), dated 25-27 January 1967.

43. DQR-2-5-001, Human Factors Exploratory Tests, dated 31 May 1967.
44. DQR-2-5-002, ALSD Human Factors Torque/Thrust Capability Test, dated 13-14 June 1967.
45. DQR-2-5-003, ALSD/EMU Operability Tests (A5L Spacesuit), dated 1-2 June 1967.
46. DQR-2-6-001, ALSD Power Head High Temperature Test, dated 20-30 December 1966.
47. DQR-2-6-002, ALSD Power Head Temperature Distribution at 1 ATM, dated 7 March 1967.
48. DQR-2-6-003, Drill String Temperature Test (Preliminary), dated 23-24 March 1967.
49. DQR-2-6-004, Low Temperature Battery Performance Tests, dated 17-20 April 1967.
50. DQR-2-6-005, Drill String Temperature Test (Final), dated 4-11 May 1967.
51. DQR-2-7-001, ALSD Drilling Tests (Preliminary), dated 13-15 January 1967.
52. DQR-2-7-002, ALSD Drilling Tests - Deep Hole Scoria, dated 5 April 1967.
53. DQR-2-7-003, ALSD Power Head and Treadle Lock Reliability Test, dated 10-11 October 1967.
54. DQR-2-12-001, ALSD Power Head Seal Test, dated 12-15 January 1967.
55. DQR-2-12-002, ALSD Power Head Seal Performance in Vacuum, dated 25 July - 1 August 1967.
56. DQR-2-12-003, ALSD Power Head Vacuum Rock Drilling Test, dated 17-19 December 1967.
57. DQR-2-13-001, Battery Cell Electrical Characteristics (Flight), dated 26 October - 7 November 1966.
58. DQR-2-13-002, Battery Cell Electrical Characteristics (Training), dated 27 October - 7 November 1966.

59. DQR-2-13-003, Battery Cell Electrical Characteristics (Training), dated 21-30 November 1966.
60. DQR-2-13-004, Battery Cell Electrical Characteristics (Training), dated 15-30 December 1966.
61. DQR-2-13-005, Battery Assembly Electrical Characteristics (Flight), dated 28 March 1967.
62. DQR-2-13-006, Battery Assembly High Temperature Electrical Characteristics (Flight), dated 31 March - 3 April 1967.
63. DQR-2-13-007, Battery Assembly Off-Limit Electrical Characteristics (Flight), dated 16-17 May 1967.
64. DQR-2-13-008, Battery Assembly High Current Test (Flight), dated 14 June 1967.
65. DQR-2-14-001, Electrical Switch Low Pressure Performance Verification, dated 5-9 December 1966.
66. DQR-2-14-002, Electrical Connector Performance Tests, dated 6 April 1967.
67. DQR-2-14-003, Battery Assembly Switch High Current Test, dated 15 June 1967.
68. DQR-2-15-001, Determination of Rock Cutting Packing Factor, dated 30 January 1967.
69. DQR-2-15-002, Evaluation of Cuttings Collection Requirement, dated 6 April 1967.
70. DQR-2-16-001, ALSD Start-Cycle Power Losses, dated 6 February 1967.
71. DQR-2-17-001, Magnetic Field Measurements Tests, ALSD, dated February 1967.
72. DQR-2-18-001, Power Head Percussion Spring High Temperature Cycle Life Test, dated 16 March 1967.
73. DQR-2-19-001, Evaluation of ALSD Treadle Open Loop System, dated 1 April 1967.
74. DQR-2-19-002, Evaluation of Drill String Anchor System, dated 14 April 1967.

ER 14778

75. DQR-2-19-003, Evaluation of Universal Anchor, dated 31 May 1967.
76. DQR-2-19-004, Evaluation of Partially Fluted Drill String, dated 23 June 1967.
77. DQR-2-19-005, Determination of Open Loop Drilling Parameters, dated 1 May - 29 June 1967.
78. DQR-2-19-006, Vertical Indicator Response Tests, dated 22 September 1967.
79. DQR-2-19-007, ALSD Drill String Treadle Lock Accidental Disengagement Test, dated 20 October 1967.