

2-P  
TMX

DATA MANAGEMENT COPY #4

CR-119857  
DMS-DR-1067  
FEBRUARY 1971



—SPACE SHUTTLE—

LONGITUDINAL AND LATERAL  
DIRECTIONAL STABILITY  
CHARACTERISTICS OF THE MDAC  
HIGH CROSS RANGE DELTA WING  
ORBITER

By

P. J. Seeny

D. Field

D. Heinemann

FACILITY FORM 602	N71-35109	(THRU)
	(ACCESSION NUMBER)	63
	416	(CODE)
	CR-119857	31
(PAGES)	(CATEGORY)	
(NASA CR OR TMX OR AD NUMBER)		

MCDONNELL-DOUGLAS

LOW SPEED

WIND TUNNEL TEST RESULTS  
DATA REPORT

SADSAC SPACE SHUTTLE  
AEROTHERMODYNAMIC  
DATA MANAGEMENT SYSTEM

CONTRACT NAS8-4016  
AMENDMENT 130  
DRL 184-58  
MARSHALL SPACE FLIGHT CENTER



Reproduced by  
NATIONAL TECHNICAL  
INFORMATION SERVICE  
U.S. Department of Commerce  
Springfield, VA 22151

DMS-DR-1067  
February, 1971

SADSAC/SPACE SHUTTLE  
WIND TUNNEL TEST DATA REPORT

CONFIGURATION: MDAC STS ORBITER (02), HIGH CROSS RANGE; 4% SCALE

TEST PURPOSE: Obtain Longitudinal and Lateral-Directional Stability Characteristics on the High Cross Range Delta Wing Orbiter to Substantiate the Configuration That Has Evolved During the Phase B Shuttle development period.

TEST FACILITY: MDC MCAIR Low Speed Wind Tunnel

TESTING AGENCY: MDAC-ED

TEST NO. & DATE: LSWT 248; 5 February through 11 February 1971

TEST CONDUCTOR(S): P. J. Seeney, D. Field, D. Heinemann  
Phone No. 314-232-7547

DATA MANAGEMENT SERVICES

LIAISON: John E. Vaughan DATA OPERATIONS: W.R. Morgan  
205-895-1560

RELEASE APPROVAL: W.R. Morgan for  
N. D. Kemp, Supervisor  
Aero Thermo Data Group

This report has been prepared by Chrysler Corporation Space Division under a Data Management Contract to the NASA. Chrysler assumes no responsibility for the data presented herein other than its display characteristics.

## TABLE OF CONTENTS

	<u>PAGE NUMBER</u>
LIST OF FIGURES	iii
LIST OF TABLES	v
ABSTRACT	1
AXIS SYSTEM AND NOMENCLATURE SUMMARY	2
FACILITY DESCRIPTION	4
TEST CONDITIONS	5
DATA REDUCTION	7
CONFIGURATIONS INVESTIGATED	8
DATA SET COLLATION SHEETS	10
MODEL SKETCHES AND COMPONENT DESCRIPTION	13
MODEL PHOTOGRAPHS	34
TEST NOMENCLATURE	42
TABULATED DATA LISTING	51
DATA DISPLAY INDEX	52
PLOTTED DATA	78

## LIST OF FIGURES

<u>FIGURE</u>	<u>TITLE</u>	<u>PAGE NUMBER</u>
1	Axis System showing direction and sense of force and moment coefficients, angle of attack and sideslip angle.	2
2	Model Installation (Upright)	13
3	Model Installation (Inverted)	14
4	4% Scale Delta Wing Orbiter	15
5	General Assembly	16
6	HCR Orbiter - Body Alone Definition	18
7	Body Flap	20
8	Aft Body Speed Brake	21
9	Wing ( $W_{11}$ ), Elevon ( $EN_6$ ) and Body Flap ( $FB_2$ )	23
10	Vertical Tail ( $V_6$ )	25
11	Base Area and Simulated Rocket Details	28
12	Base Pressure Orifice Location	29
13	Engine Nacelle - 4% Delta Wing Series III LSWT	30
14	Engine Nacelle - 4% Delta Wing Series III LSWT	31
15	4% Delta Wing Orbiter - Series III LSWT Main Landing Gear	32
16	4% Delta Wing Orbiter - Series III LSWT Nose Landing Gear	33

LIST OF FIGURES (continued)

<u>FIGURES</u>	<u>TITLE</u>	<u>PAGE NUMBER</u>
17	Front and rear view of the model installed in the MCAIR Low Speed Wind Tunnel	34
18	View of Model Aft End Showing Simulated Rocket Engines and View of Model Showing Body Flap and Speed Brakes	35
19	Front and Rear View of the Model with Cruise Engine Pods and Front and Rear View of Model with Cruise Engine Pods and Landing Gear.	36
20	Tuft Study Showing Wing Upper Surface Vortex Path at $B = 0^\circ$	37
21	Tuft Study Showing Wing Upper Surface Vortex Path at $B = -3^\circ$	38
22	Tuft Study Showing Wing Upper Surface Vortex Path at $B = +3^\circ$	39
23	Tuft Study Showing Wing Upper Surface Vortex Path at $B = 0^\circ$	40
24	Tuft Study Showing Wing Upper Surface Vortex Path at $B = -3^\circ$	41

LIST OF TABLES

<u>TABLE</u>		<u>PAGE NUMBER</u>
I	Test Conditions	6
II	Control Deflection Terminology	9
III	Data Set Collation Sheets	10
IV	Model Component - Body B <sub>5</sub>	17
V	Model Component - Body Flap FB <sub>2</sub>	19
VI	Model Component - Wing W <sub>11</sub>	22
VII	Model Component - Elevon (Wing W <sub>11</sub> )	24
VIII	Model Component - Vertical Tail (V <sub>6</sub> )	26
IX	Model Component - Rudder (Vertical V <sub>6</sub> )	27

## ABSTRACT

The purpose of this test is to substantiate the high crossrange delta wing orbiter configuration that has evolved during the Phase B Shuttle Development program, by providing experimental verification of the estimated aerodynamic stability and control characteristics. The test article is a 4% scale model of the orbiter as specified on drawing 255BJ00050 Revision B. The test was performed in the MCAIR Low Speed Wind Tunnel between 5 and 11 February 1971. Test variables included configuration buildup, rudder deflections, elevon/aileron deflections, cruise and landing configuration, with and without simulated engine pods. Nominal test conditions are Mach no. 0.26, dynamic pressure of 100 psf, and Reynolds no. of 1.6 million per foot.

Notes:

1. Positive directions of force coefficients, moment coefficients, and angles are indicated by arrows.
2. For clarity, origins of wind and stability axes have been displaced from the center of gravity.

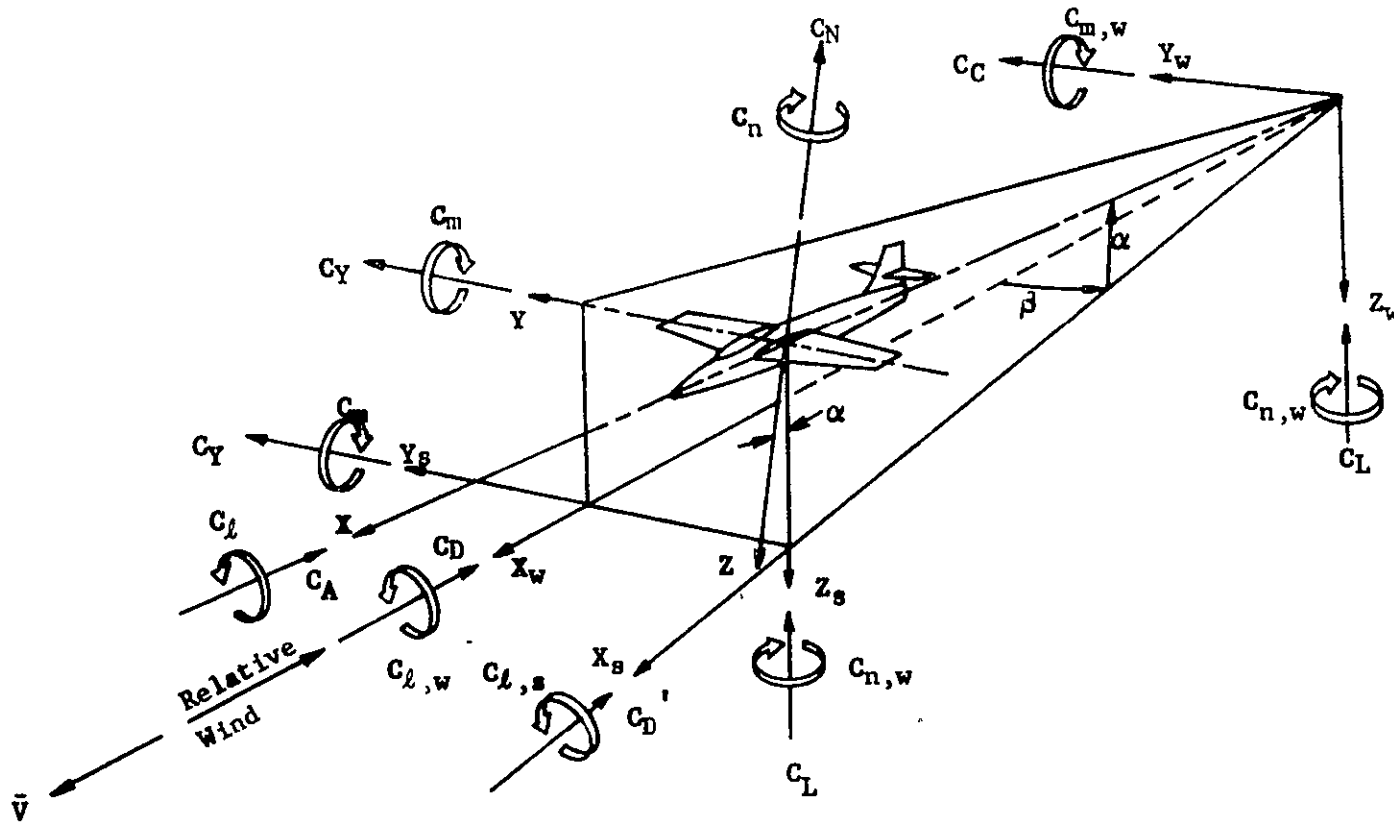

Figure 1. Axis systems, showing direction and sense of force and moment coefficients, angle of attack, and sideslip angle



COEFFICIENT	COEFFICIENT NAME	SADSAC NOMENCLATURE		
		BODY AXIS	STABILITY AXIS	WIND AXIS
$C_A$	Total Axial Force	CA	-	-
$C_{AB}$	Base Axial Force	CAB	--	-
$C_{AF}$	Forebody Axial Force	CAF	-	-
$C_D$	Total Drag Force	-	CD	CDTOTL
$C_{DB}$	Base Drag Force	-	CDB	CDBASE
$C_{DF}$	Forebody Drag Force	-	CDF	CDFORE
$C_L$	Lift Force	-	CL	CL
$C_N$	Normal Force	CN	-	-
$C_Y$	Side Force	CY	CY	CC
$C$	Rolling Moment	CBL	CSL	CWL
$C_m$	Pitching Moment	CLM	CLM	CPM
$C_n$	Yawing Moment	CYN	CLN	CLN
L/D	Lift-To-Drag Force Ratio	-	L/D	CL/CD
L/D	Lift-To-Forebody Drag Force Ratio	-	L/DF	CL/CDF
N/A	Normal-To-Axial Force Ratio	N/A	-	-
N/A	Normal-To-Forebody Axial Force Ratio	CN/CAF	-	-

SUMMARY OF SADSAC NOMENCLATURE - AERODYNAMIC FORCE AND MOMENT COEFFICIENTS

The MCAIR Low Speed Wind Tunnel (LSWT) is a closed circuit, single return, continuous flow, atmospheric tunnel. The test section is 8.5 x 12 x 18 feet. This test uses the LSWT external pyramidal balance with a dual strut model mount.

## TEST CONDITIONS

Table I lists the conditions that prevailed during the test and gives some estimate of the data accuracy.

The model was strut mounted in the tunnel utilizing a two point connection to an external pyramidal type balance. Tests were conducted with the model both upright and inverted. Figures 2 and 3 show these installations. An image support system shown in the figures was installed only during tare and interference runs which data are not included in this report. Model base pressure was measured at (15) locations on the body base as shown in Figure 12.

Several runs were made with tufts applied to the model to aid in visualizing the flow. Many polaroid pictures were taken to record the phenomena. Only a few representative ones are shown in Figure 20 through 24. Force data were recorded during these tufting runs but are not included herein.



## DATA REDUCTION

Six components of force and moment are measured with the external galance and reduced to coefficients for both body axes and stability axes systems. Base pressure is measured at 15 placed on the base and reduced to pressure coefficients. The data reduction constants (model scale) are:

$$\text{Ref Area} = S_w = 8.869 \text{ sq. ft, } W_{11}$$

$$\text{Ref Length} = \bar{c} = 29.57 \text{ inches, } W_{11}$$

$$\text{Ref Length} = b = 51.6 \text{ inches, } W_{11}$$

Base Area = .725 sq. ft.

Reference Moment Center at F.S. 59.32 and W.L. 11.60

The data are corrected for tunnel walls, and strut tare and interference. No base drag corrections are applied; however, base pressure coefficients are averaged and corrected by the ratio of base area to reference area to produce a pseudo-base drag coefficient. This drag is not a precise value since no area weighting or integration procedure is used with the irregular base shape. It is included only as an indicator of the effects of test variables on base drag. These base drag values are presented whereas the individual pressure coefficient data are unavailable.

All data calculations and axis system conversion data presented are made using measured uncorrected drag coefficient (CD).

Examples:

- (1) L/D is calculated using CD
- (2) CN and CA were obtained through axis system conversion using CL and CD

CONFIGURATIONS INVESTIGATED

(Ref. Configuration Dwg. 255BJ00050 Rev. B)

Component Combinations Tested

B5	B5W11P
B5W11	B5W11SB2
B5W11G	B5W11V6
B5W11GP	

Component Descriptions

		Model Dwg. No.
B5	Fuselage	STS-03304
W11	Wing	STS-03305, 7, 8, 9, 14
V6	Vertical Tail	STS-03306
P	Simulated Engine Pods	STS-03310
G	Landing Gear (G3 Nose, G4 Main)	STS-03311
SB2	Speed Brake	STS-03312
FB2	Body Flap	STS-03313

(General Assy. STS-03315)

NOTE: SB2 speed brake can be located at three vertical positions on the fuselage side as shown on the sketch and identified as follows:

<u>Position</u>	<u>Description</u>
1	Upper Location
3	Mid Location
4	Lower Location
2	Mid Location with 0.5 inch gap (model scale) between speed brake and fuselage at speed brake hinge line.

TABLE II

CONTROL DEFLECTION TERMINOLOGY

MODEL CONTROL SETTING TESTED*		REFERENCE CALLOUT	
LEFT WING ELEVON	RIGHT WING ELEVON	ELEVATOR (ELEVTR)	AILERON (AILRØN)
0	0	0	0
-5	-5	-5	0
-10	-10	-10	0
-15	-15	-15	0
10	-10	0	10
0	-20	-10	10
10	-30	-10	20

\* See Figure For Control Deflection Sign Convention.

Table II reflects the model control deflections tested and their corresponding reference callout.





TEST MDAC-LSWT-248 DATA SET COLLATION SHEET

PRETEST  
 POSTTEST

DATA SET IDENTIFIER	CONFIGURATION	SCHD.		PARAMETERS/VALUES					MACH NUMBERS (OR ALTERNATE INDEPENDENT VARIABLE)															
		$\alpha$	$\beta$	$\delta_e$	$\delta_a$	$\delta_R$	$\delta_{SB}$	$\delta_{RF}$	SBPOS															
RCPO 28	B5	A	0	-	-	-	0	0	-															
29	↓	A	-3	-	-	-	0	0	-															
25	B5W11	A	0	0	0	-	0	0	-															
26	↓	A	-3	0	0	-	0	0	-															
49	↓	A	0	-10	0	-	0	15	-															
48	↓	A	0	-10	0	-	0	30	-															
44	B5W11SB2	A	0	-10	0	-	30	0	1															
41	↓	A	0	-10	0	-	30	15	2															
40	↓	A	0	-10	0	-	30	15	3															
39	↓	A	0	-10	0	-	30	15	3															
42	↓	A	-3	-10	0	-	30	15	3															
50	↓	A	0	0	0	-	30	15	3															
45	↓	A	0	-10	0	-	60	0	3															
46	↓	A	0	-10	0	-	60	30	3															
52	B5W11G	A	0	0	0	-	0	0	-															
53	↓	A	0	-10	0	-	0	0	-															
54	↓	A	-3	-10	0	-	0	0	-															
RCPO 02	B5W11 V6	A	0	0	0	0	0	0	-															
10	↓	A	0	0	0	0	0	0	-															
11	↓	A	-3	0	0	0	0	0	-															

1            7            13            19            25            31            37            43            49            55            61            67            75 76

BETA    iCL    iCD    iCLM    iCY    iCLN    iCSL    iCDB    \_\_\_\_\_ |IDPVAR(1)| IDPVAR(2)| NDV

COEFFICIENTS:

$\alpha$  or  $\beta$   
 SCHEDULES

A)  $-6^\circ \rightarrow 18^\circ, \Delta 2^\circ + 7^\circ, 9^\circ, 11^\circ$   
 B)  $-5^\circ \rightarrow 10^\circ, \Delta 1^\circ$



NOTES: All dimensions are model scale in inches  
 Reference: McDonnell DWG No. STS-03315

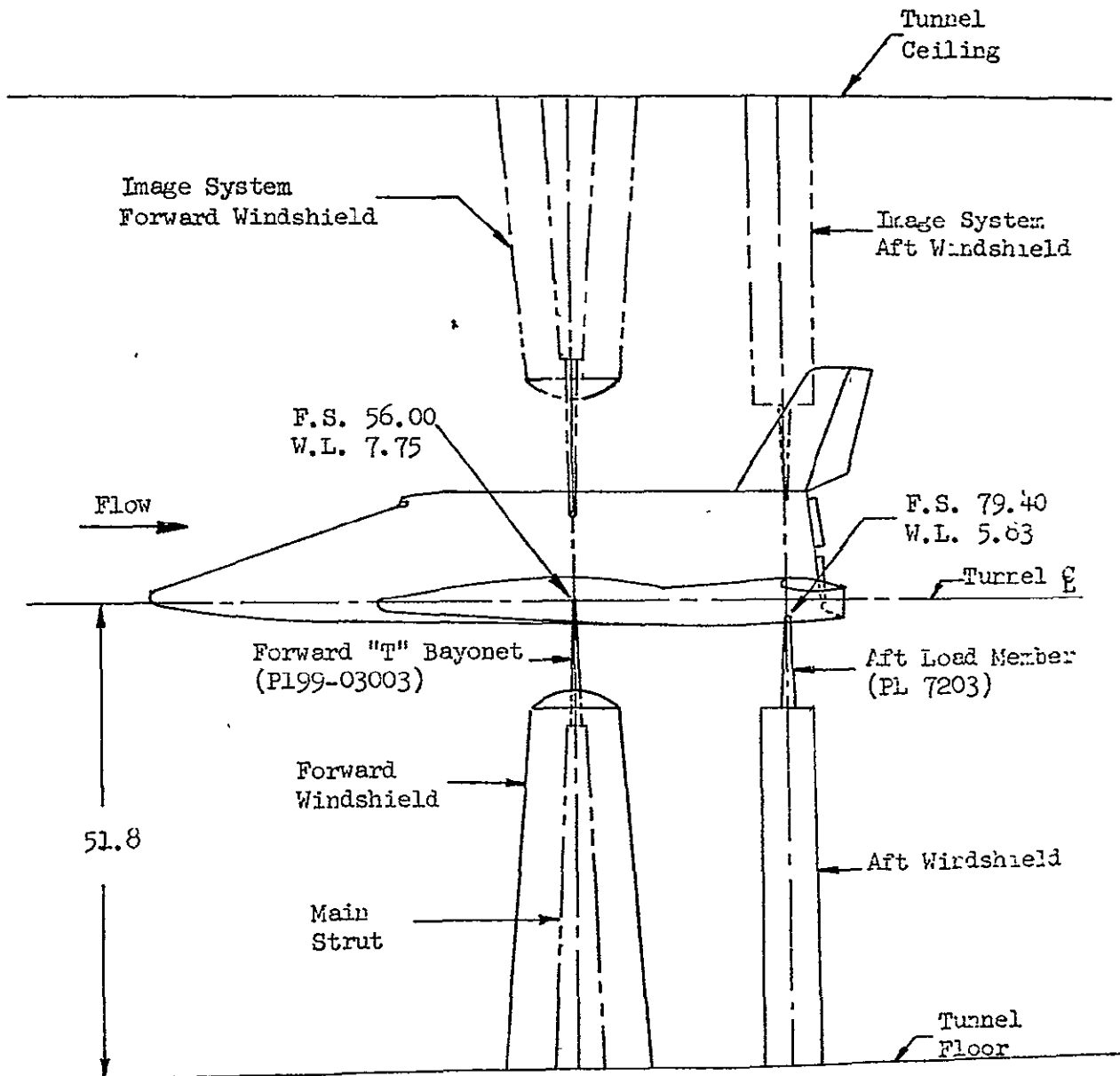

FIGURE 2. - MODEL INSTALLATION (UPRIGHT)

NOTES:

All Dimensions are model scale in inches.  
 Reference: McDonnell DWG No. SPS-03315

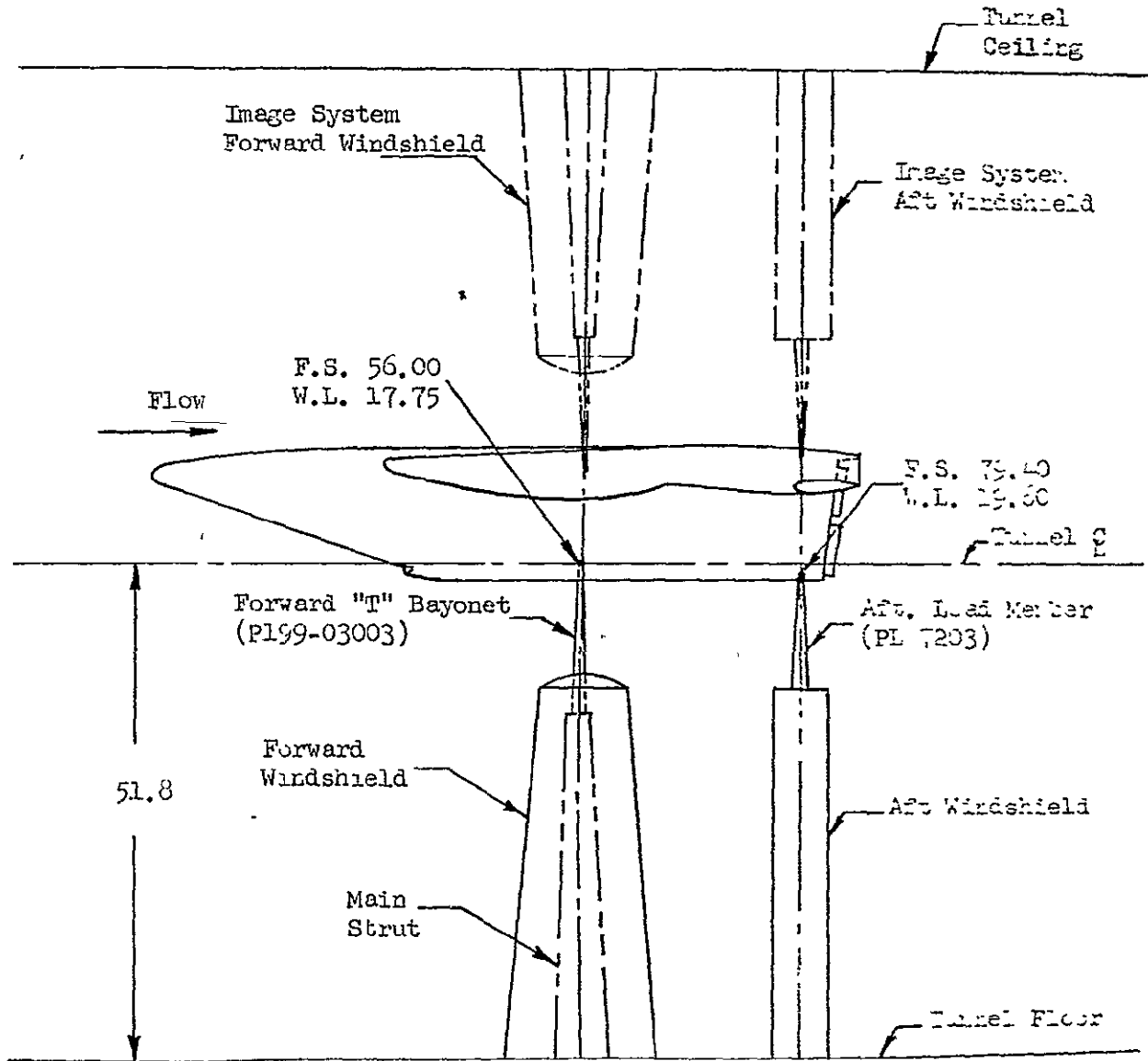

FIGURE 3. - MODEL INSTALLATION (INVERTED)

4% SCALE DELTA WING ORBITER  
SERIES III LSWT

ALL DIMENSIONS ARE MODEL SCALE.  
 REF. DWG. STS-03304 TO 03313

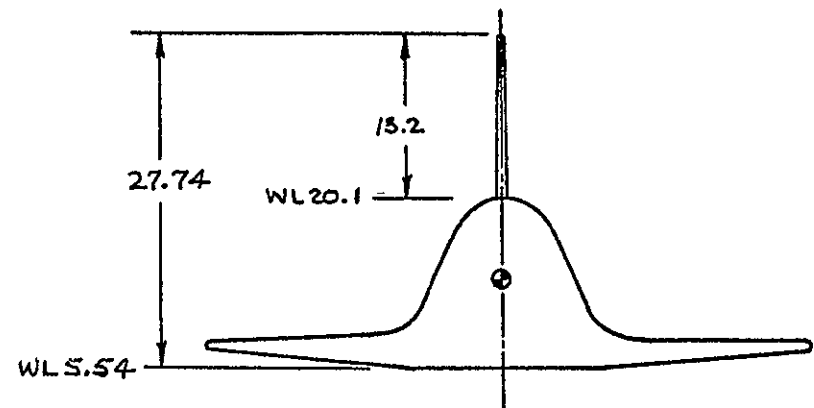
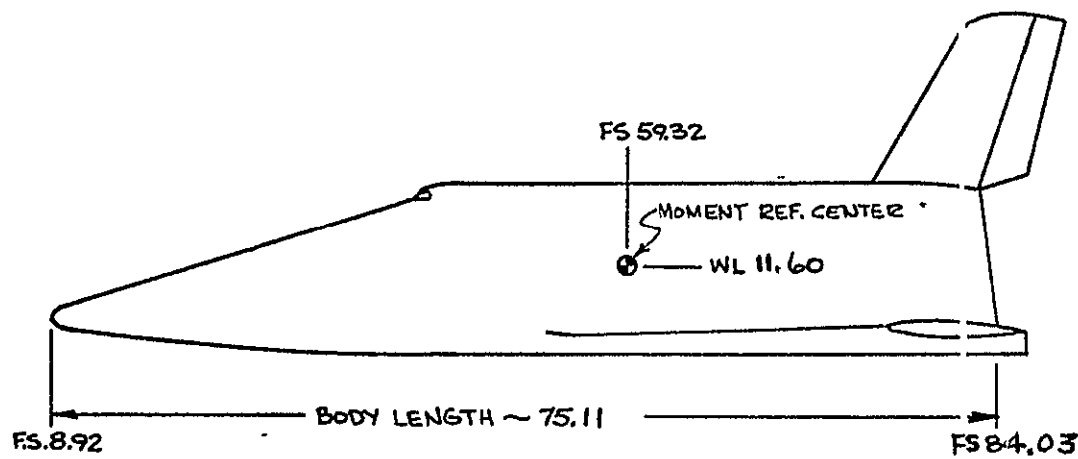
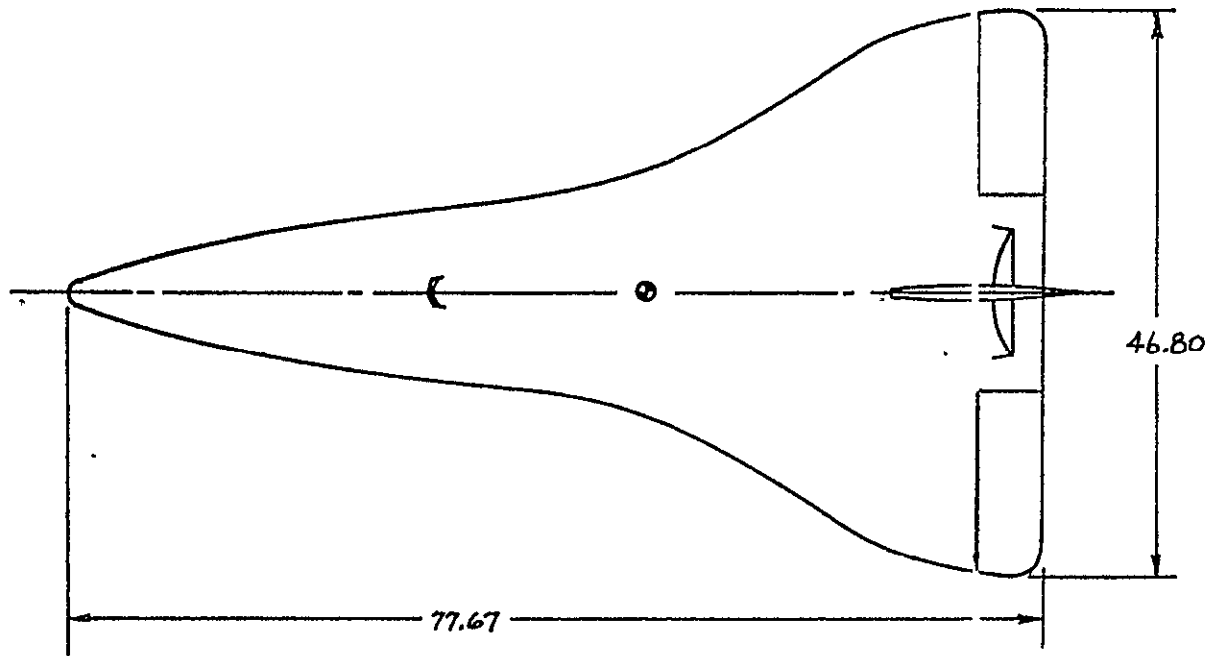

FIGURE 4.

NOTE: All dimensions are model scale  
in inches.  
Reference: McDonnell DWG No. STS

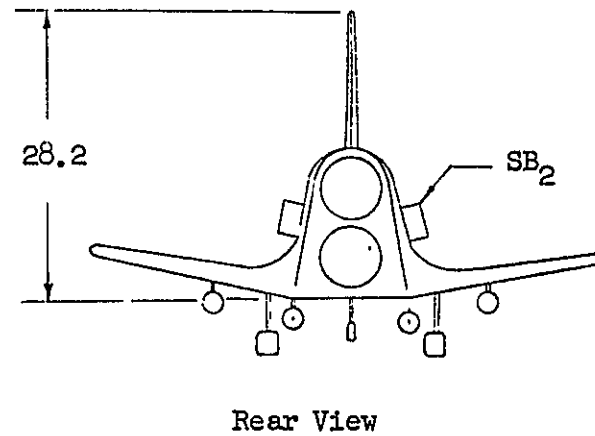
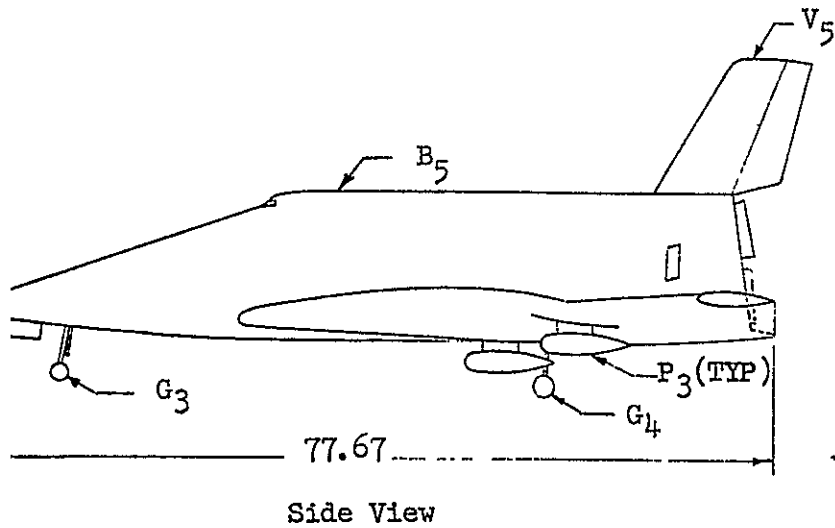
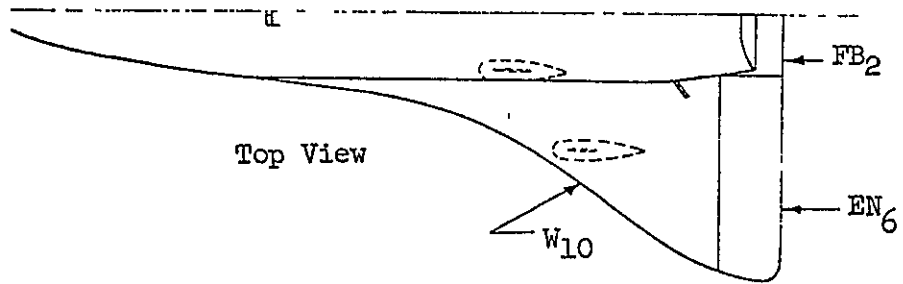

FIGURE 5. - GENERAL ASSEMBLY (B<sub>5</sub> EN<sub>6</sub> FB<sub>2</sub> G<sub>3</sub> G<sub>4</sub> P<sub>3</sub> V<sub>5</sub> W<sub>10</sub>)

TABLE IV

MODEL COMPONENT      BODY B<sub>5</sub>

---

GENERAL DESCRIPTION

---

REF. DESIGN DWG. 255BJ00050 REV. B

---

MODEL LINES DWG. 255BT00052 REV. A

---

DRAWING NUMBER      MODEL FUSELAGE ASSEMBLY STS-03304

DIMENSIONS	<u>FULL SCALE</u>	<u>MODEL SCALE</u> 4.0000PCT
LENGTH	156.4000	6.25600
MAX. WIDTH	27.1000	1.08400
MAX. DEPTH	30.3000	1.21200
FINENESS RATIO		
AREA		
MAX. CROSS-SECTIONAL	627.4000	1.00384
PLANFORM	3790.0000	6.06400
WETTED	12520.0000	20.03200
BASE	447.0000	0.71520

NOTE--ALL UNITS ARE FT OR SQ.FT  
 THIS DATA INCLUDES BOTH SIDES OF THE VEHICLE

J.E. Williams  
1-4-71

# HCR ORBITER - BODY ALONE DEFINITION

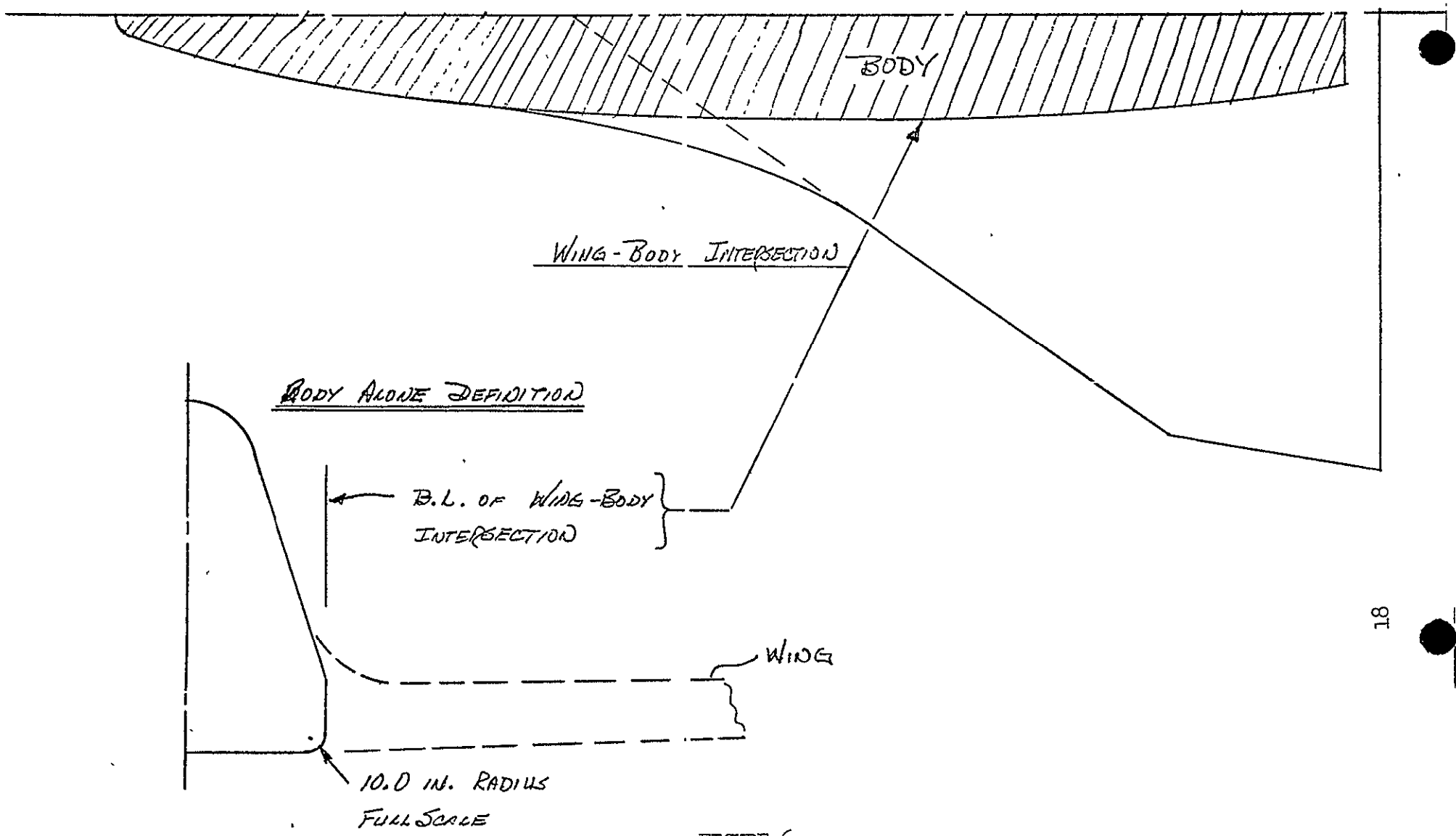

FIGURE 6.



TABLE V

MODEL COMPONENT: BODY FLAP FB2

GENERAL DESCRIPTION: ALL DATA GIVEN FOR TWO SURFACES

MODEL LINES DWG. 255BT00052 REV. A

DRAWING NUMBER: BODY FLAP DRAWING STS-03313

<u>DIMENSIONS:</u>	<u>FULL-SCALE</u>	<u>MODEL SCALE</u>
Area	<u>140.88</u>	<u>4.0000 PCT .2254</u>
Span (equivalent)	<u>23.808</u>	<u>.9523</u>
Inb'd equivalent chord	<u>5.333</u>	<u>.2133</u>
Outb'd equivalent chord	<u>12.8000</u>	<u>.5120</u>
Ratio movable surface chord/ total surface chord		
At Inb'd equiv. chord	<u>          </u>	<u>          </u>
At Outb'd equiv. chord	<u>          </u>	<u>          </u>
Sweep Back Angles, degrees		
Leading Edge	<u>0.0</u>	<u>0.0</u>
Tailing Edge	<u>0.0</u>	<u>0.0</u>
Hingeline	<u>0.0</u>	<u>0.0</u>
Area Moment (Normal to hinge line)	<u>          </u>	<u>          </u>

NOTE: ALL UNITS ARE FT, SQ. FT, OR DEGREES  
THIS DATA INCLUDES BOTH SIDES OF THE VEHICLE

# BODY FLAP CONFIGURATION FOR 4% SCALE DELTA WING SER. III

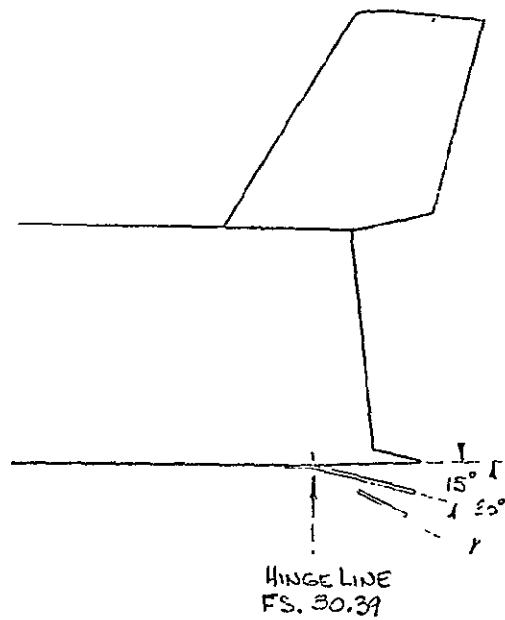
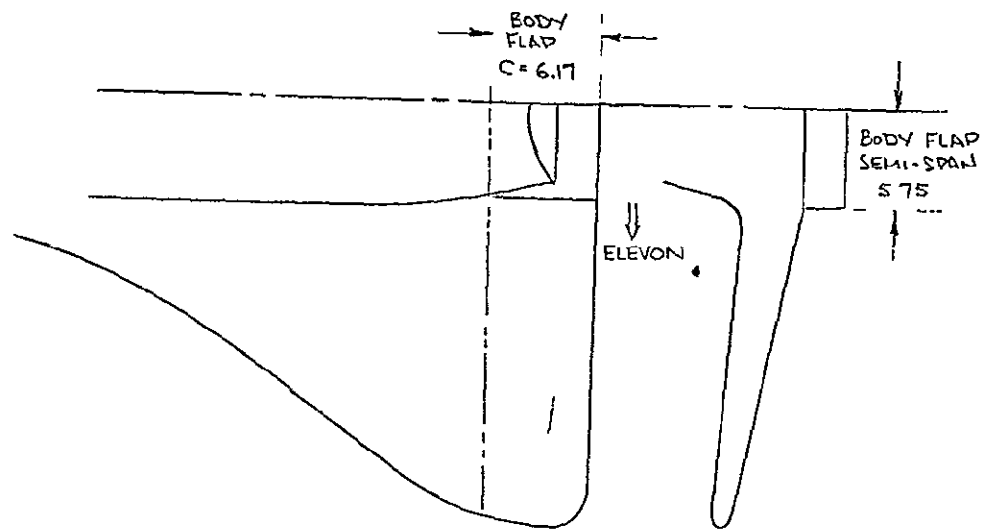

FIGURE 7.

V. Seaney  
7 Jan 71

AFT BODY SPEED BRAKE. ~ 4% DELTA WING SERIES III LSWT

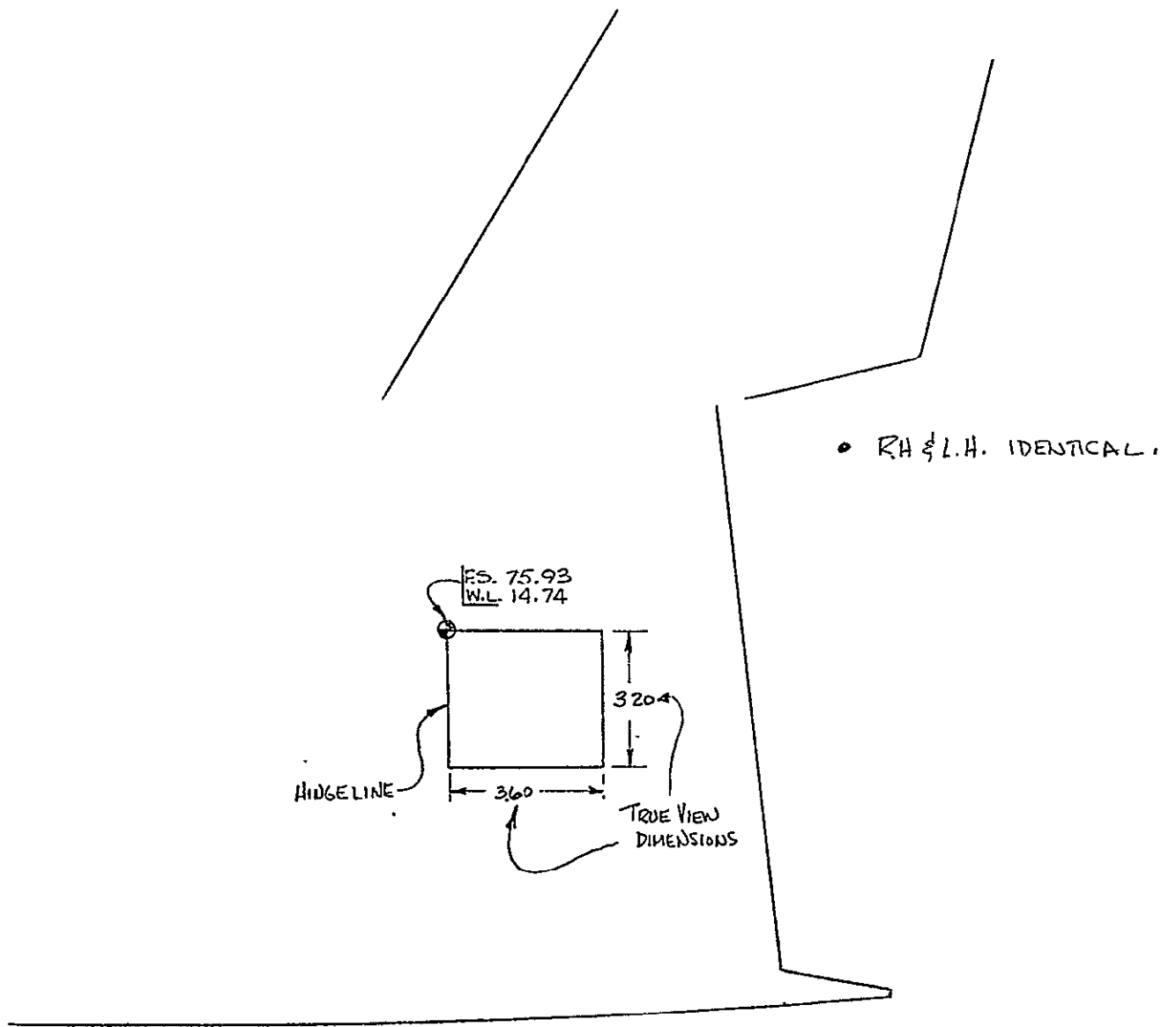

FIGURE 8.

TABLE VI

MODEL COMPONENT

WING W<sub>11</sub>

GENERAL DESCRIPTION

SAME AS W<sub>10</sub> WITH SPAN INCREASED 10 FT.

MODEL LINES DWG. 255BT00052 REV. A

DRAWING NUMBER

MODEL WING ASSEMBLY STS-03305

DIMENSIONS

FULL SCALEMODEL SCALE

4.0000PCT

## TOTAL DATA

## AREA

PLANFORM

5543.1000

8.86900

WETTED

SPAN (EQUIVALENT)

107.5000

4.30000

ASPECT RATIO

2.0400

2.04000

RATE OF TAPER

TAPER RATIO

0.1580

0.15800

DIHEDRAL ANGLE, DEGREES

10.0000

10.00000

INCIDENCE ANGLE, DEGREES

2.0000

2.00000

AERODYNAMIC TWIST, DEGREES

0.0

0.0

TOE-IN ANGLE DEGREES

0.0

0.0

CANT ANGLE DEGREES

0.0

0.0

SWEEP BACK ANGLES, DEGREES

LEADING EDGE

55.0000

55.00000

TRAILING EDGE

0.0

0.0

0.25 ELEMENT LINE

## CHORDS

ROOT (WING STATION 0.0)

90.4300

3.61720

TIP (EQUIVALENT)

14.2900

0.57200

MAC

61.6000

2.46000

B.L. OF .25 MAC

20.2000

0.80800

FUS. STA. OF .25 MAC

134.2000

5.36800

W.P. OF .25 MAC

AIRFOIL SECTION NACA

ROOT BL 162

0010-64

0010-64

TIP BL 540

0012-64

0012-64

## EXPOSED DATA

## AREA

3360.4000

5.37700

SPAN (EQUIVALENT)

80.5000

3.22000

ASPECT RATIO

1.8700

1.87000

TAPER RATIO

0.1780

0.17800

## CHORDS

ROOT

71.2500

2.85000

TIP

14.2900

0.57200

MAC

49.4000

1.97600

B.L. OF .25 MAC

28.7000

1.14800

FUS. STA. OF .25 MAC

143.2000

5.72800

W.P. OF .25 MAC

NOTE--ALL UNITS ARE FT, SQ. FT, OR DEGREES

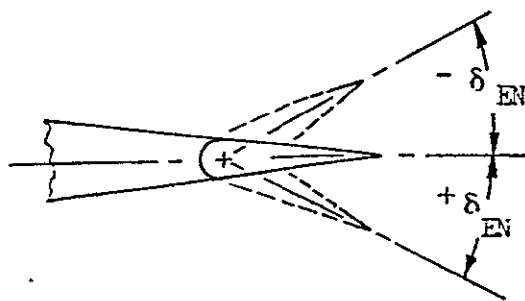
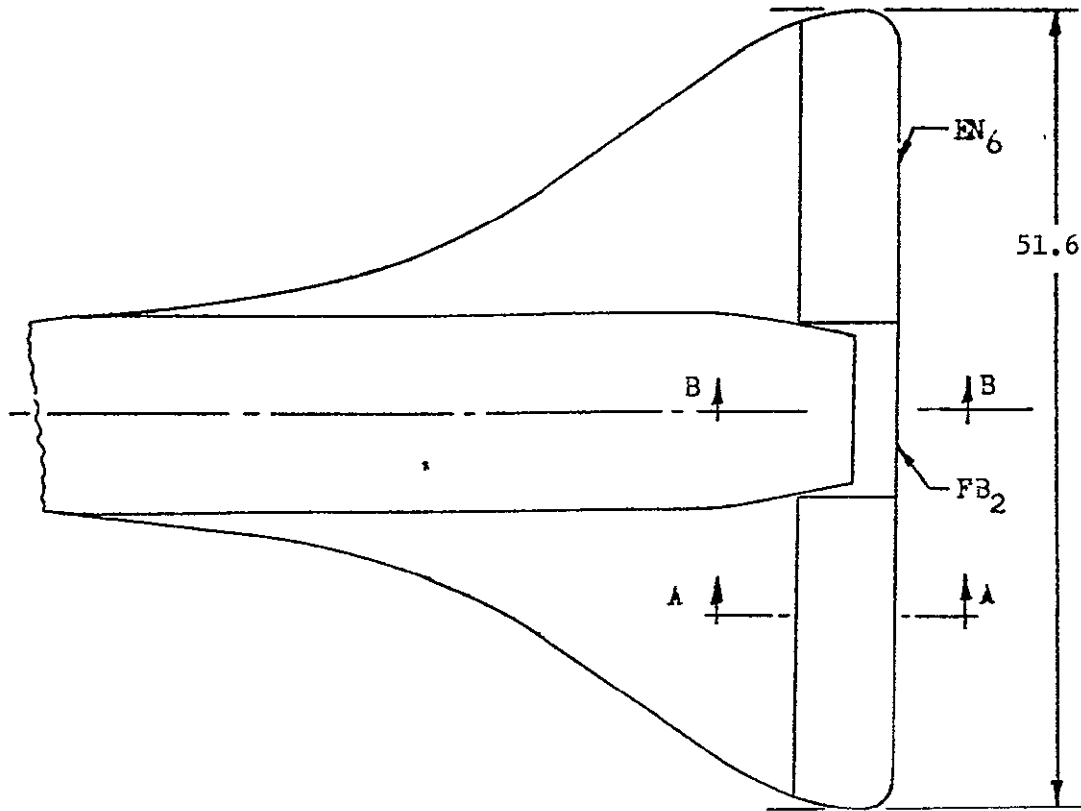

Section A-A

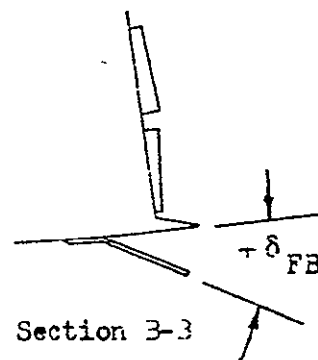

Section B-B

Note: All dimensions are model scale in inches.

Reference: McDonnell Dwg. Nos. STS-03305 and STS-03308

FIGURE 9.- WING (W<sub>11</sub>), ELEVONS (EN<sub>6</sub>), AND BODY FLAP (FB<sub>2</sub>)

TABLE VII

MODEL COMPONENT

ELEVON (WING W<sub>11</sub>)

GENERAL DESCRIPTION

ALL DATA GIVEN FOR TWO SURFACES

REF. DESIGN DWG. 255BJ00050 REV. B

DRAWING NUMBER

MODEL WING ASSEMBLY STS-03305

DIMENSIONS

FULL SCALEMODEL SCALE

4.0000PCT

AREA	1071.2000	1.71392
SPAN (EQUIVALENT)	83.6900	3.34760
INBD EQUIVALENT CHORD	12.8000	0.51200
OUTBD EQUIVALENT CHORD	12.8000	0.51200
RATIO MOVABLE SURFACE CHORD/ TOTAL SURFACE CHORD AT INBD EQUIV. CHORD	VARIABLE	
AT OUTBD EQUIV. CHORD		
SWEEP BACK ANGLES, DEGREES LEADING EDGE	0.0	0.0
TRAILING EDGE	0.0	0.0
HINGELINE	0.0	0.0
AREA MOMENT (NORMAL TO H.L.)		

NOTE--ALL UNITS ARE FT, SQ. FT, OR DEGREES  
THIS DATA INCLUDES BOTH SIDES OF THE VEHICLE

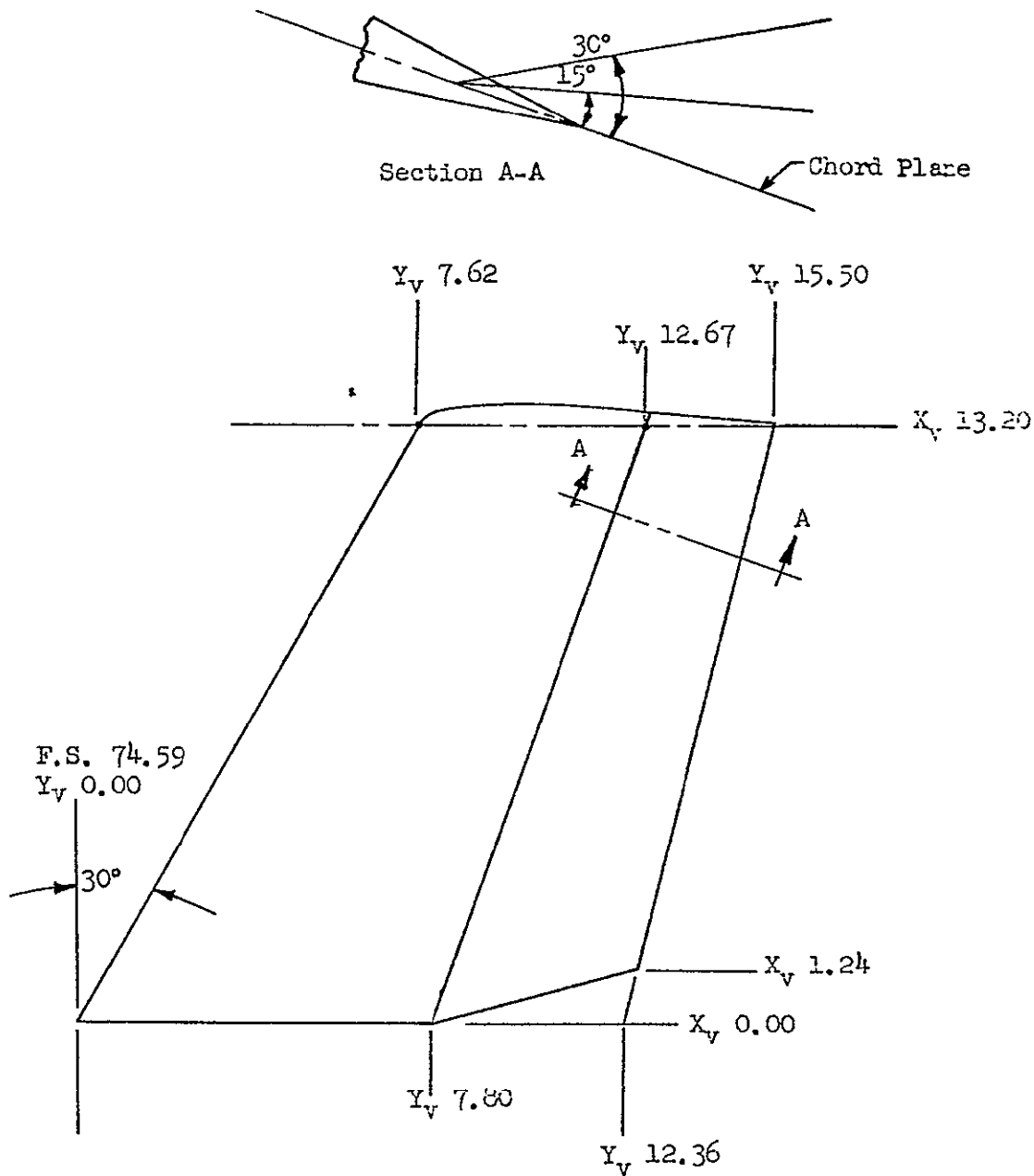

NOTES:

All dimensions are model scale in inches,  
Reference: McDonnell DWG No. STS -03306

FIGURE 10.- VERTICAL TAIL (V<sub>6</sub>)

TABLE VIII

MODEL COMPONENT

VERTICAL TAIL V<sub>6</sub>

GENERAL DESCRIPTION

REF. DESIGN DWG. 255BJ00050 REV. B

MODEL LINES DWG. 255BT00052 REV. A

DRAWING NUMBER

MODEL VERTICAL ASSEMBLY STS-03306

DIMENSIONS

FULL SCALEMODEL SCALE

4.0000PCT

## TOTAL DATA

## AREA

PLANFORM

580.0000

0.92800

WETTED

SPAN (EQUIVALENT)

27.5000

1.10000

ASPECT RATIO

1.3000

1.30000

RATE OF TAPER

TAPER RATIO

0.6380

0.63800

DIHEDRAL ANGLE, DEGREES

0.0

0.0

INCIDENCE ANGLE, DEGREES

0.0

0.0

AERODYNAMIC TWIST, DEGREES

0.0

0.0

TOE-IN ANGLE DEGREES

0.0

0.0

CANT ANGLE DEGREES

0.0

0.0

SWEEP BACK ANGLES, DEGREES

LEADING EDGE

30.0000

30.00000

TRAILING EDGE

13.3800

13.38000

0.25 ELEMENT LINE

## CHORDS

ROOT (WING STATION 0.0)

25.7500

1.03000

TIP (EQUIVALENT)

16.4200

0.65680

MAC

21.4300

0.85720

B.L. OF .25 MAC

FUS. STA. OF .25 MAC

W.P. OF .25 MAC

AIRFOIL SECTION NACA

ROOT

0009-64

0009-64

TIP

0009-64

0009-64

## EXPOSED DATA

## AREA

580.0000

0.92800

SPAN (EQUIVALENT)

27.5000

1.10000

ASPECT RATIO

1.3000

1.30000

TAPER RATIO

0.6380

0.63800

## CHORDS

ROOT

25.7500

1.03000

TIP

16.4200

0.65680

MAC

21.4300

0.85720

B.L. OF .25 MAC

FUS. STA. OF .25 MAC

W.P. OF .25 MAC

NOTE--ALL UNITS ARE FT, SQ. FT, OR DEGREES



TABLE IX

MODEL COMPONENT

RUDDER (VERTICAL  $V_6$ )

## GENERAL DESCRIPTION

REF. DESIGN DWG. 255BJ00050 REV. B

MODEL LINES DWG. 255BT00052 REV. A

DRAWING NUMBER

MODEL VERTICAL ASSEMBLY STS-03306

## DIMENSIONS

FULL SCALEMODEL SCALE  
4.0000PCT

AREA	213.9000	0.34224
SPAN (EQUIVALENT)	27.5000	1.10000
INBD EQUIVALENT CHORD	9.5000	0.38000
OUTBD EQUIVALENT CHORD	6.1000	0.24400
RATIO MOVABLE SURFACE CHORD/ TOTAL SURFACE CHORD		
AT INPD EQUIV. CHORD	0.3690	0.36900
AT OUTBD EQUIV. CHORD	0.3690	0.36900
SWEEP BACK ANGLES, DEGREES		
LEADING EDGE	30.0000	30.00000
TRAILING EDGE	13.3800	13.38000
HINGELINE	19.9500	19.95000
AREA MOMENT (NORMAL TO H.L.)		

NOTE--ALL UNITS ARE FT, SQ. FT, OR DEGREES  
THIS DATA APPLIES TO ONLY ONE SIDE

BASE AREA AND SIMULATED ROCKET DETAILS

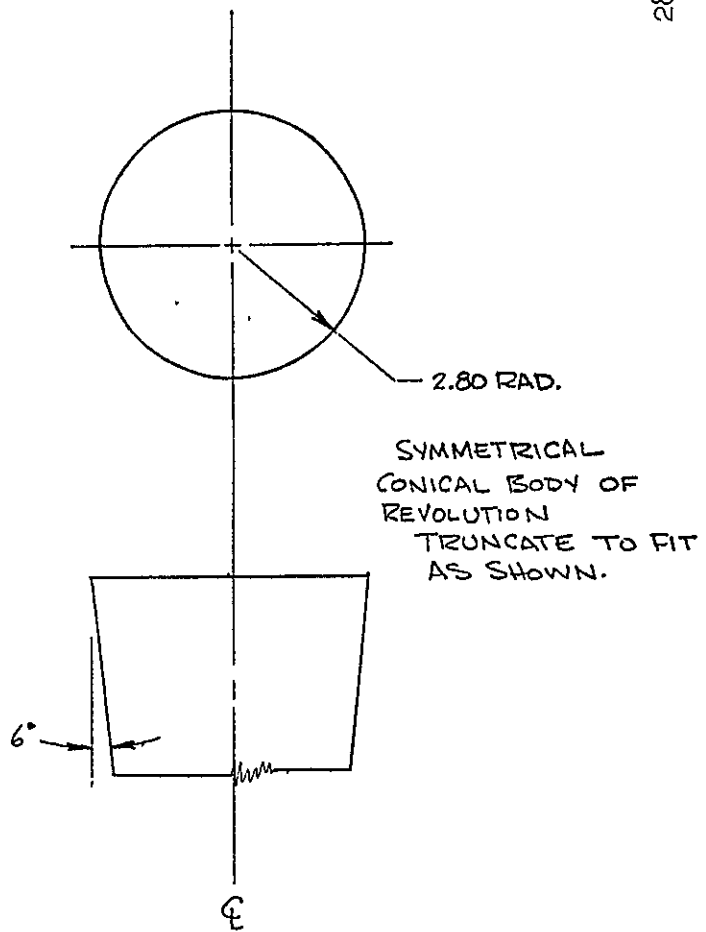
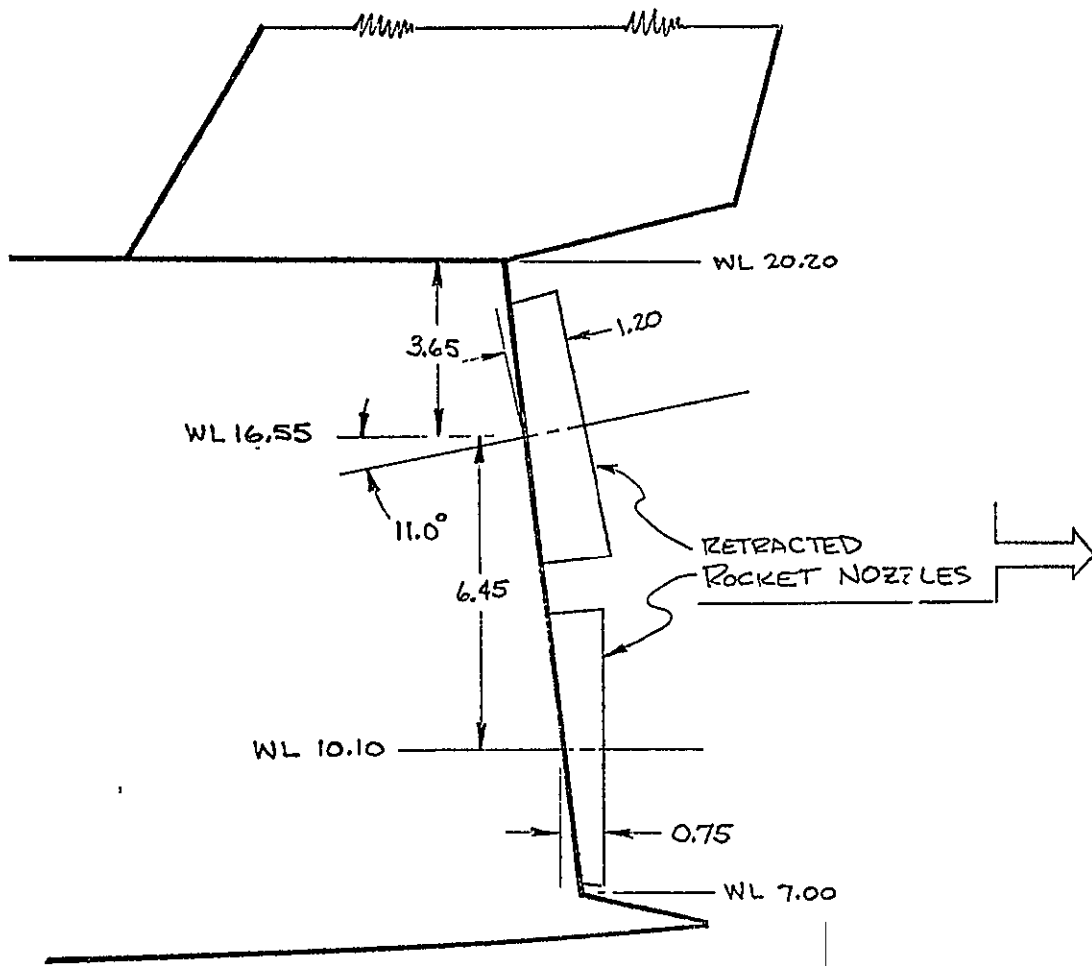
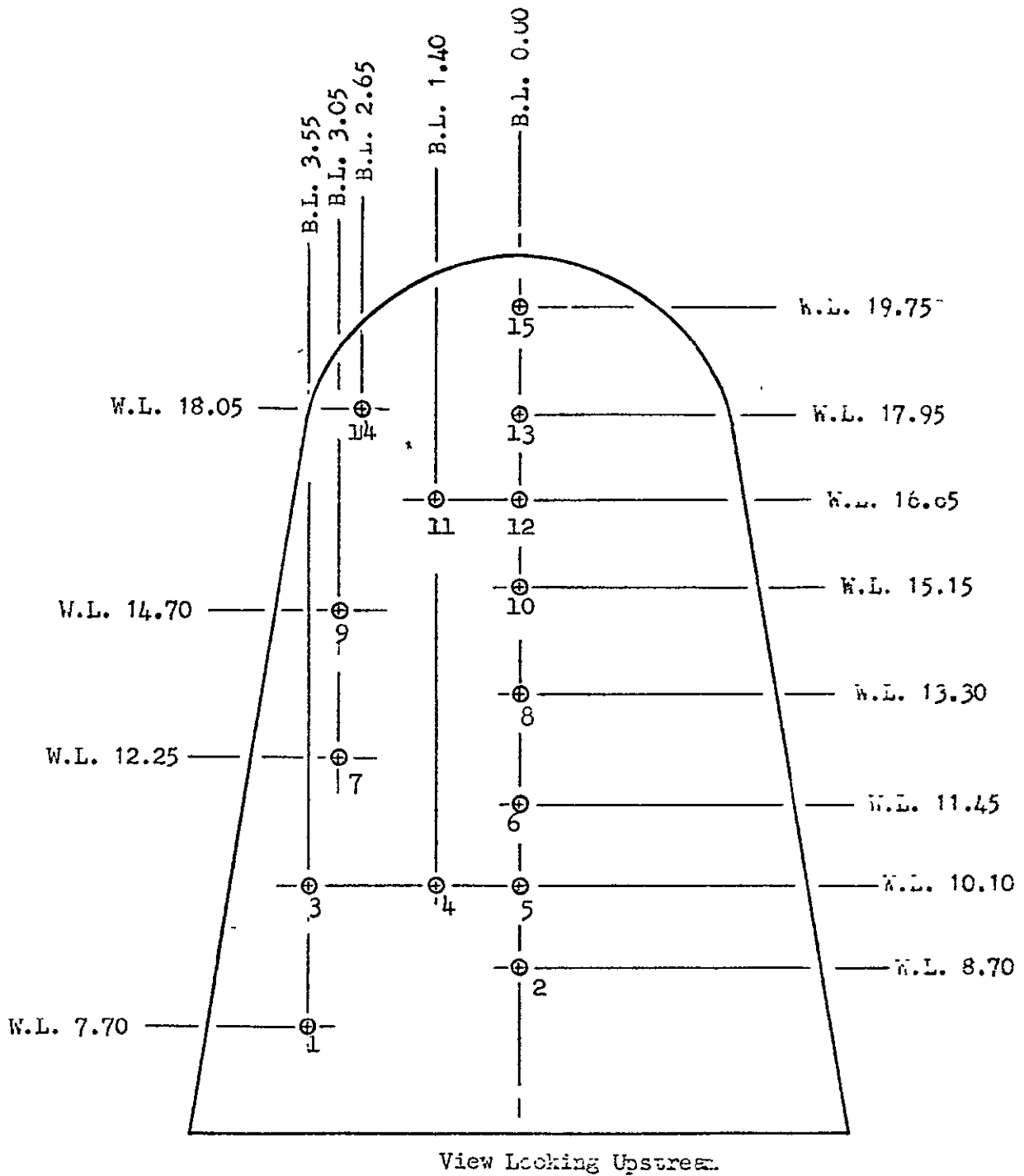

FIGURE 11.



NOTES:

All dimensions are model scale in inches.

Reference: McDonnell DWG No. STS-03315

FIGURE 12. - BASE PRESSURE ORIFICE LOCATIONS

*P. Scenery*  
8 Jan 71

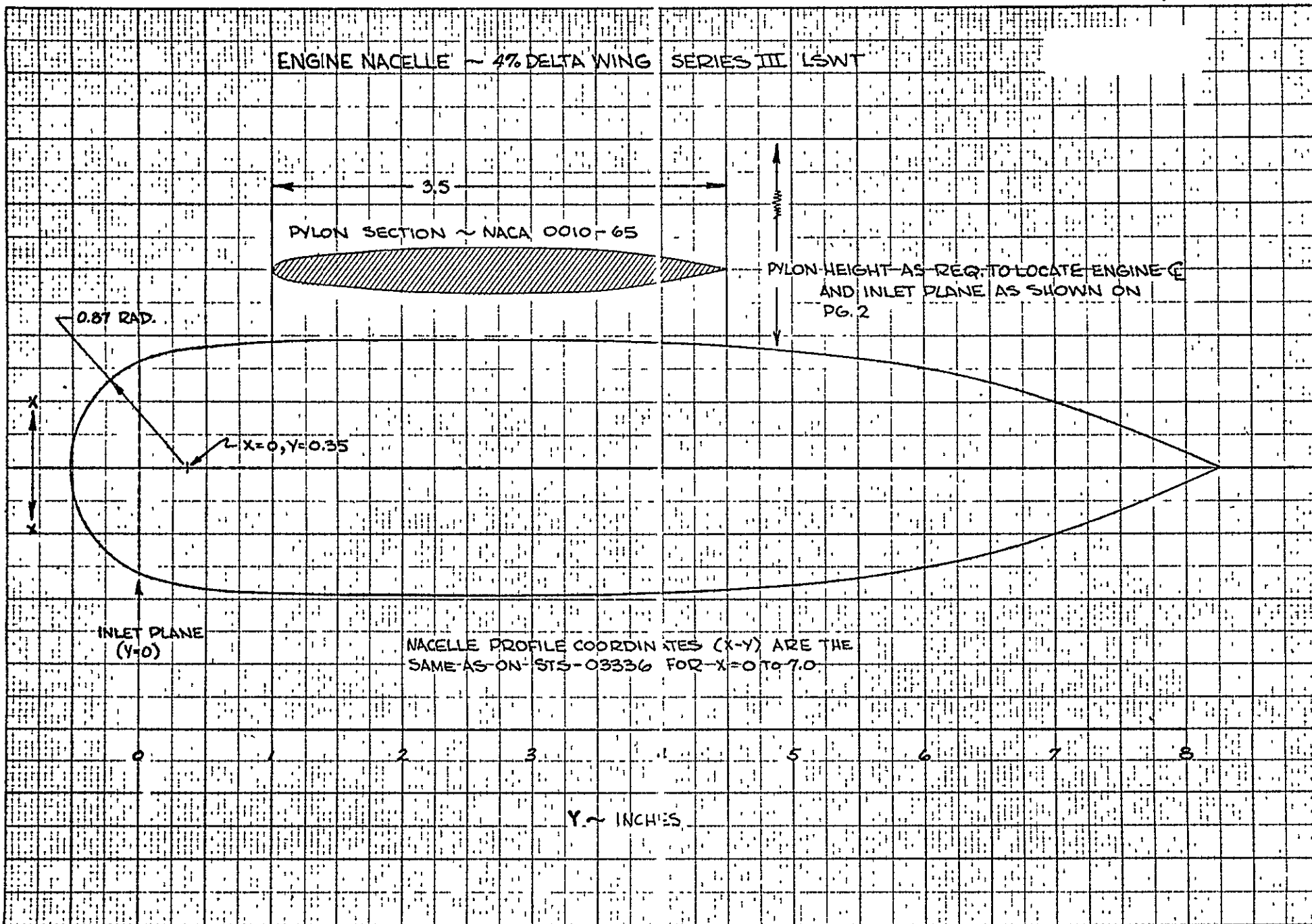
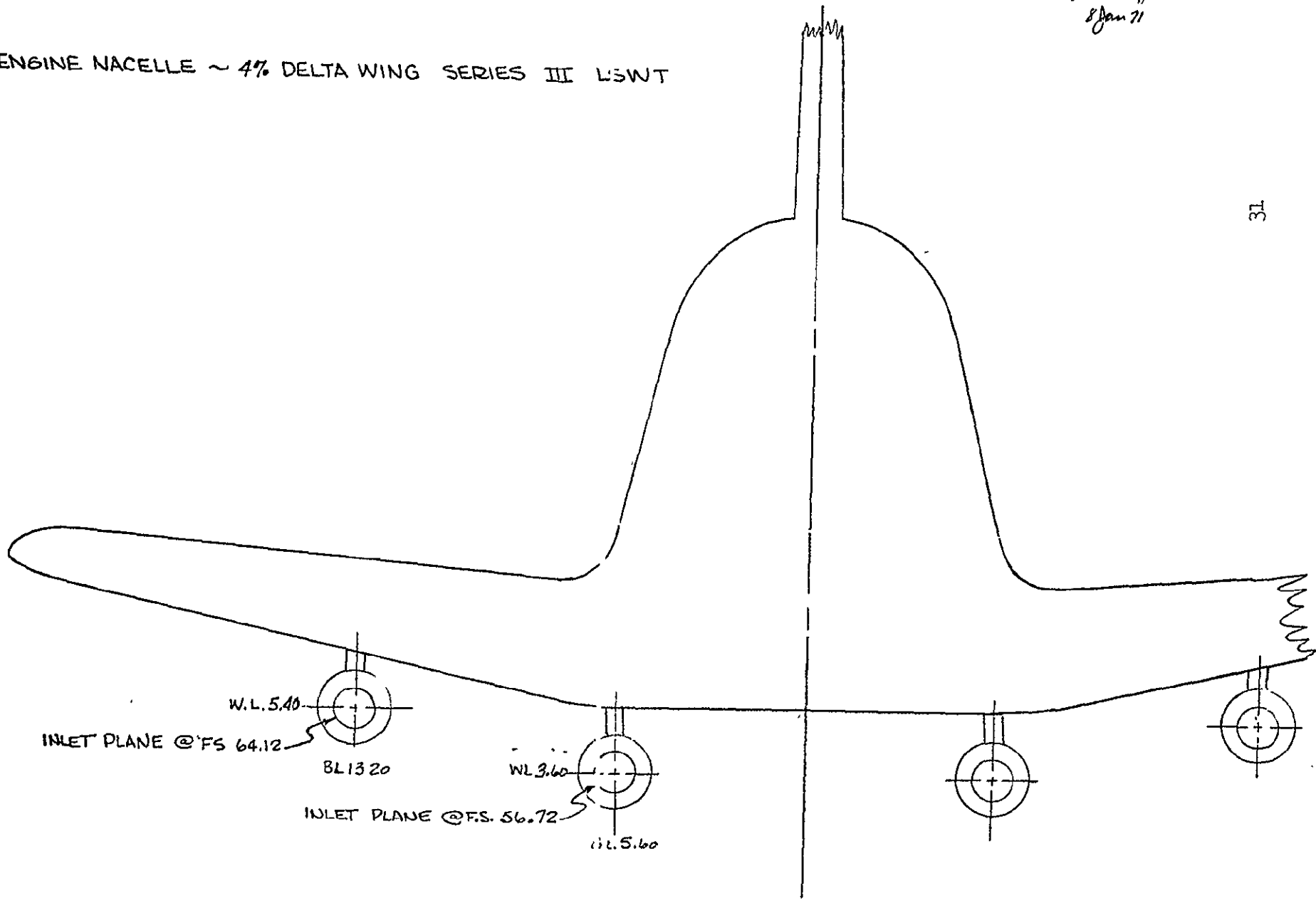

FIGURE 13.

P. Keener  
8 Jan 71

ENGINE NACELLE ~ 4% DELTA WING SERIES III LSWT



31

FIGURE 14.

47. DELTA WING ORBITER 2 ~ SERIES III LSWT  
MAIN LANDING GEAR

P. SEENEY 12-28-70

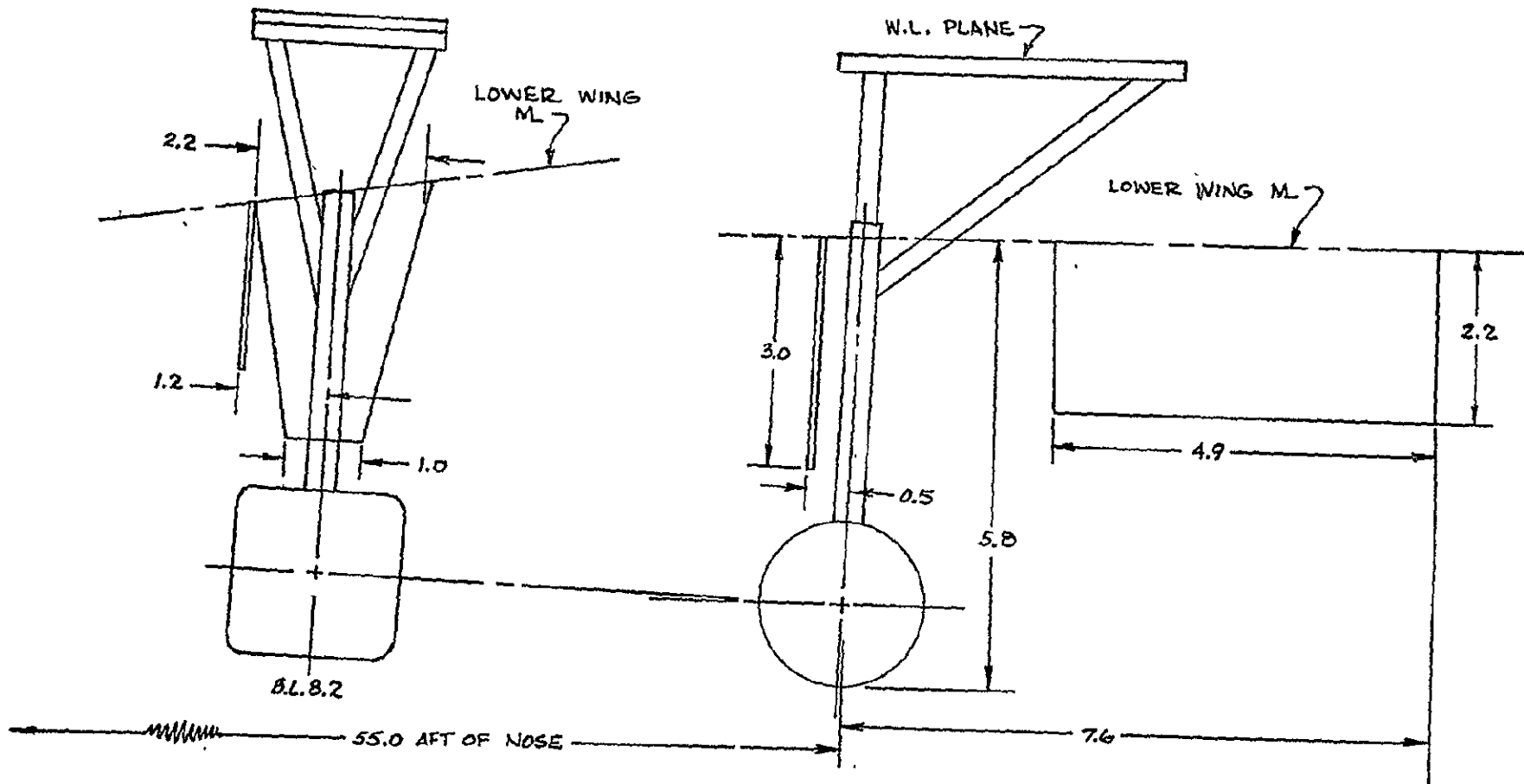

32

FIGURE 15.

# 47% DELTA WING ORBITER ~ SERIES III LSWT NOSE LANDING GEAR

P. SEENEY 12-23-70

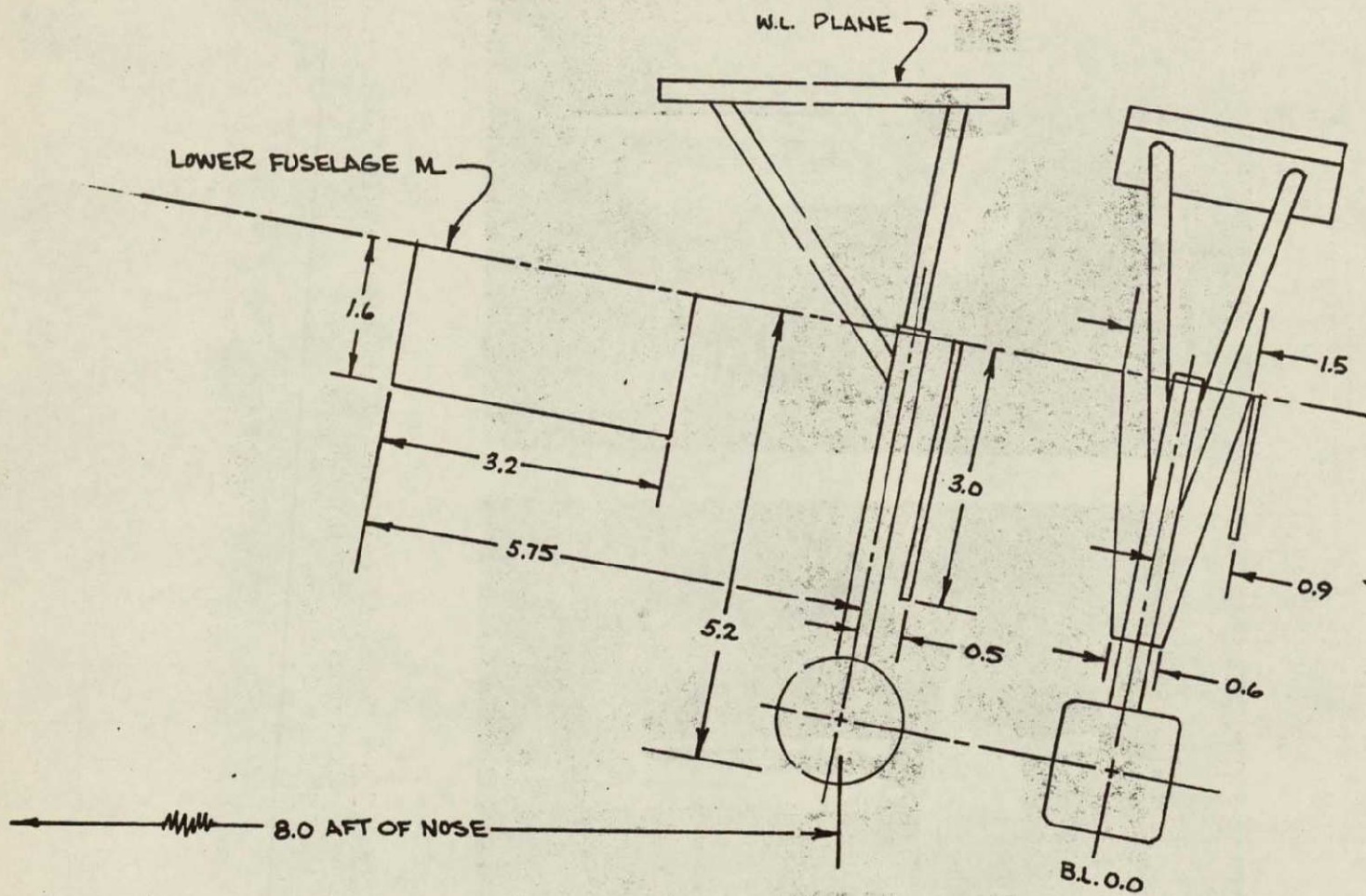

33

FIGURE 16.



MCAIR LSWT Test 248 - Front and rear view of the model installed in the  
MCAIR Low Speed Wind Tunnel. Config. B<sub>5</sub>W<sub>11</sub>V<sub>6</sub>  
 $\delta e = -5^\circ$ ,  $\delta a = 0^\circ$   $\delta R = 0^\circ$   $\delta SB = 0^\circ$   
 $\delta BF = 0^\circ$

FIGURE 17.



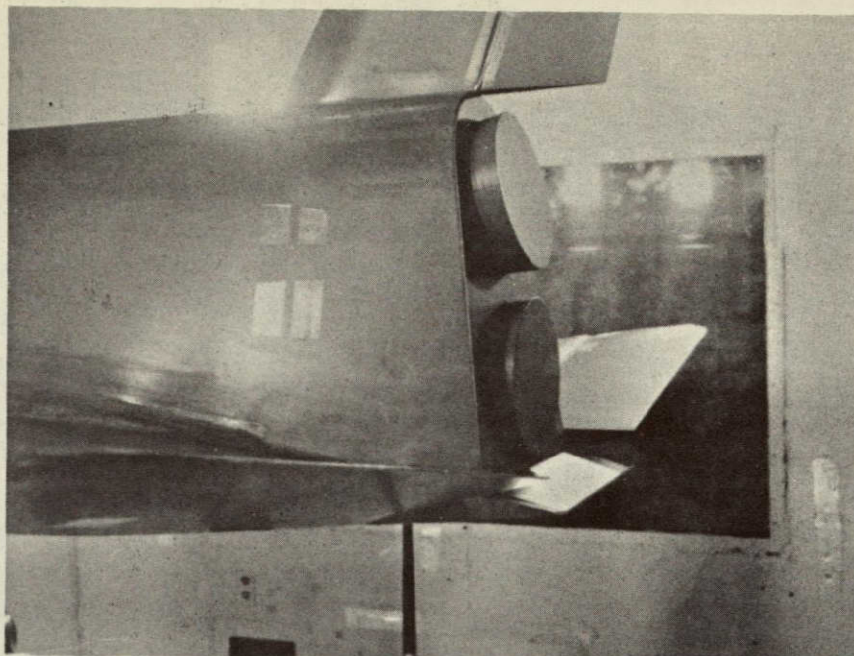

Config. B<sub>5</sub>W<sub>11</sub>V<sub>6</sub>  $\delta e = -10^\circ$   $\delta a = \delta R = \delta SB = \delta BF = 0^\circ$   
 View of Model aft end showing simulated rocket nozzles.

NOT REPRODUCIBLE

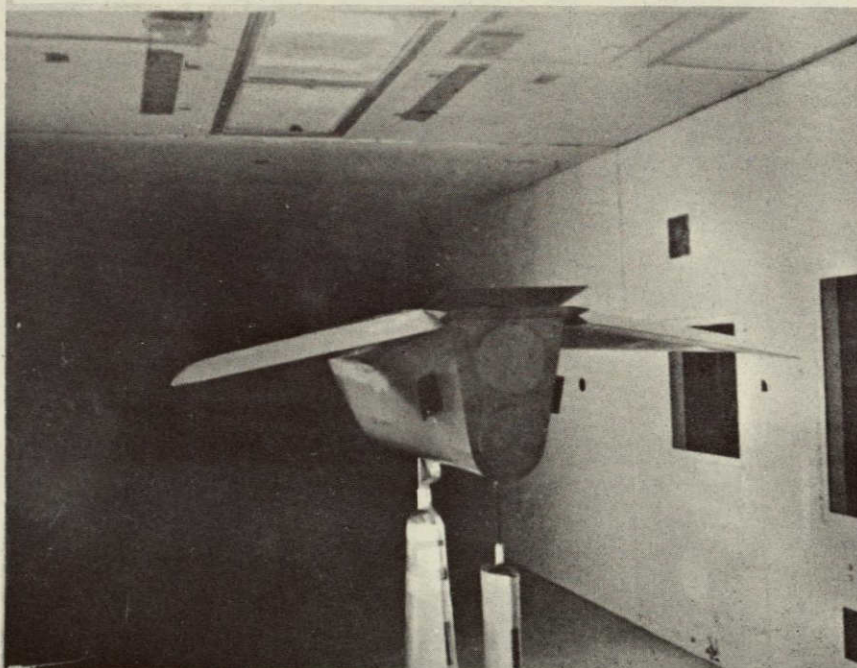

Config. B<sub>5</sub>W<sub>11</sub> SB2  $\delta e = -10^\circ$   $\delta a = 0^\circ$   $\delta SB = 30^\circ$   $\delta BF = 15^\circ$   
 View of model showing body flap and speed brakes

FIGURE 18.

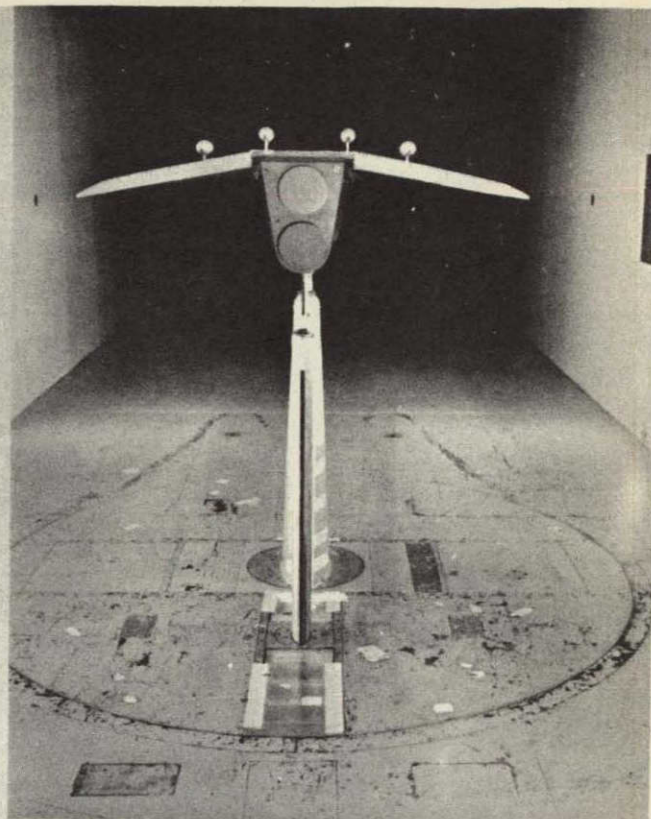
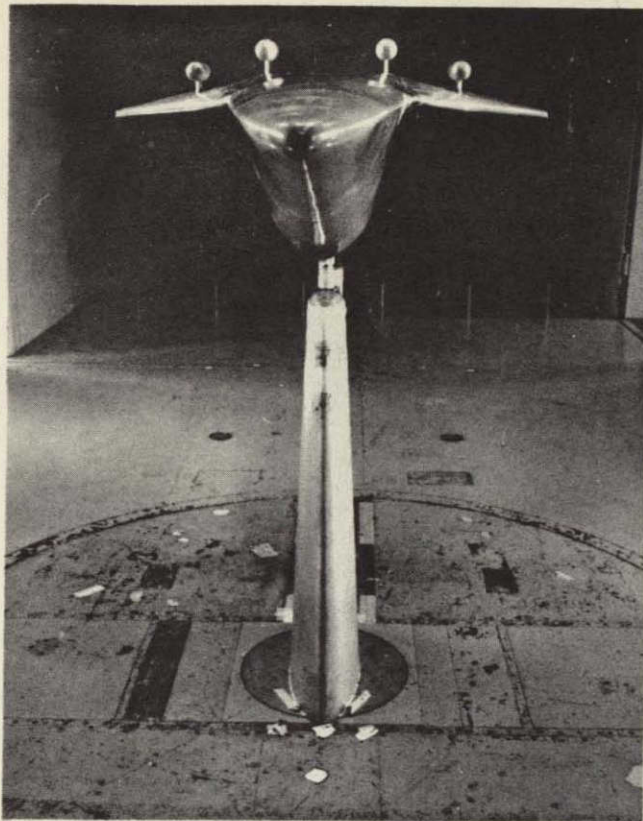

Front and Rear View of the Model with Cruise Engine Pods.  
 Config: B<sub>5</sub>W<sub>11</sub>P  $\delta_e = -10^\circ$   $\delta_a = \delta_{SB} = \delta_{BF} = 0^\circ$

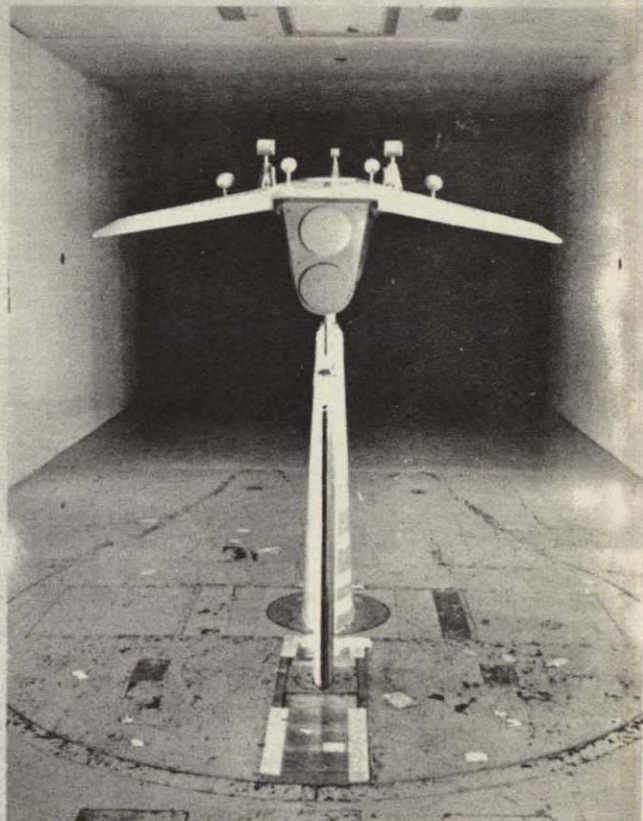
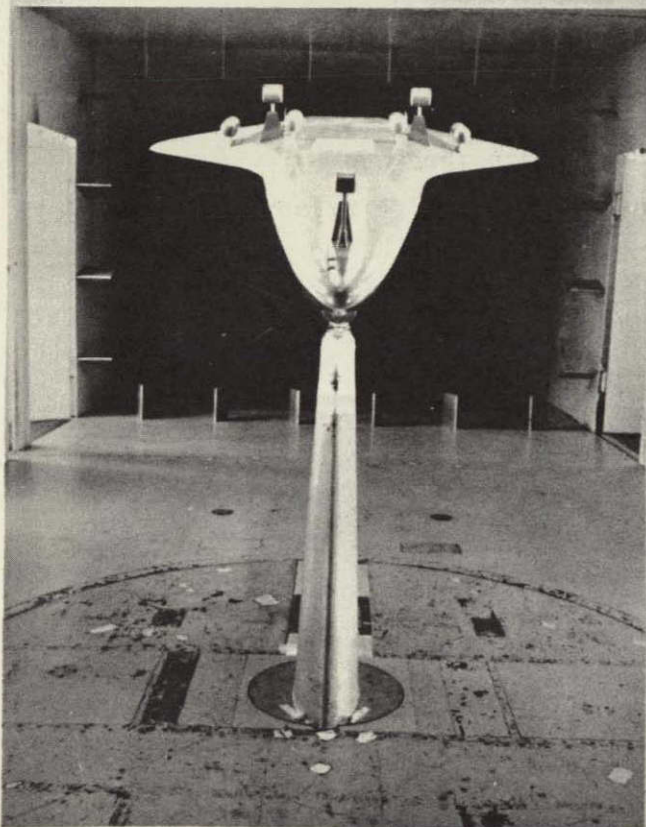

Front and Rear View of Model with Cruise Engine Pods and Landing Gear.  
 Config. B<sub>5</sub>W<sub>11</sub>GP  $\delta_e = -10^\circ$   $\delta_a = \delta_{SB} = \delta_{BF} = 0^\circ$

FIGURE 19. MCAIR LSWT TEST 248

NOT REPRODUCIBLE

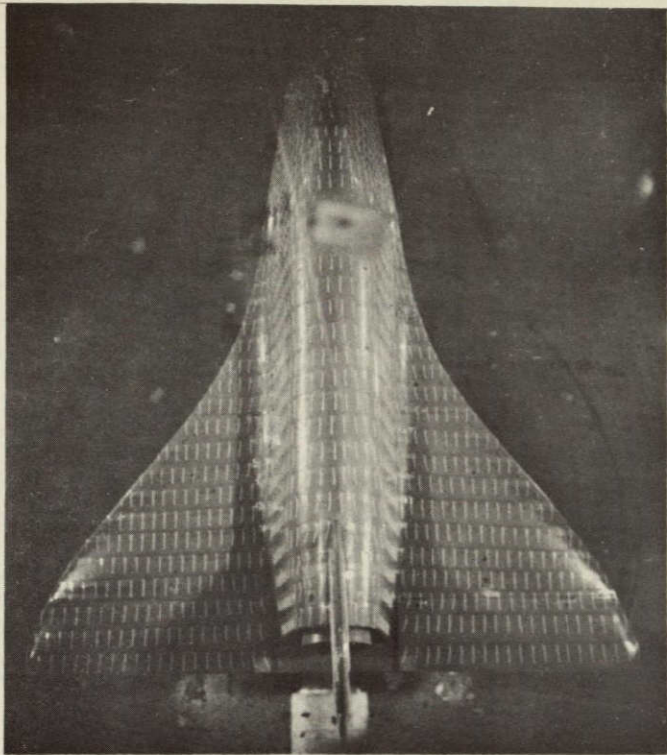

$\alpha = 6^\circ$

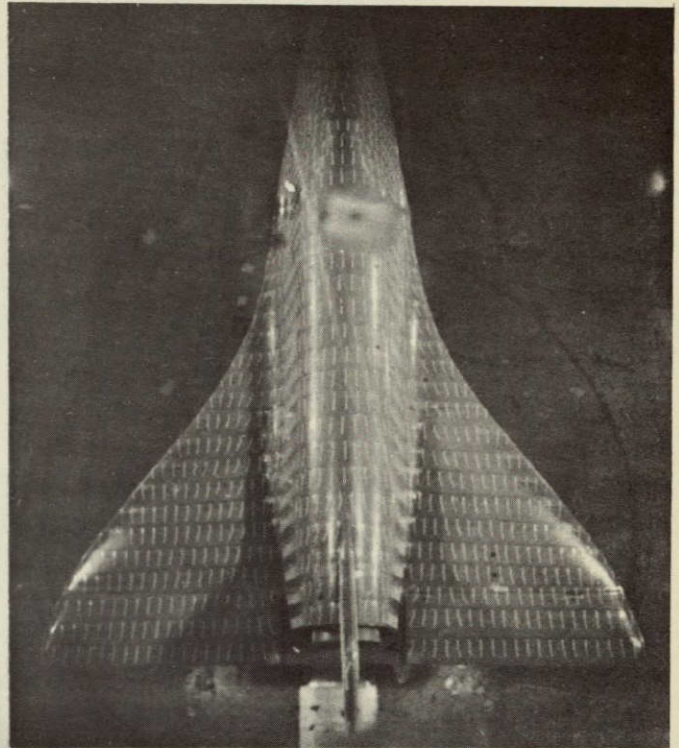

$\alpha = 8^\circ$

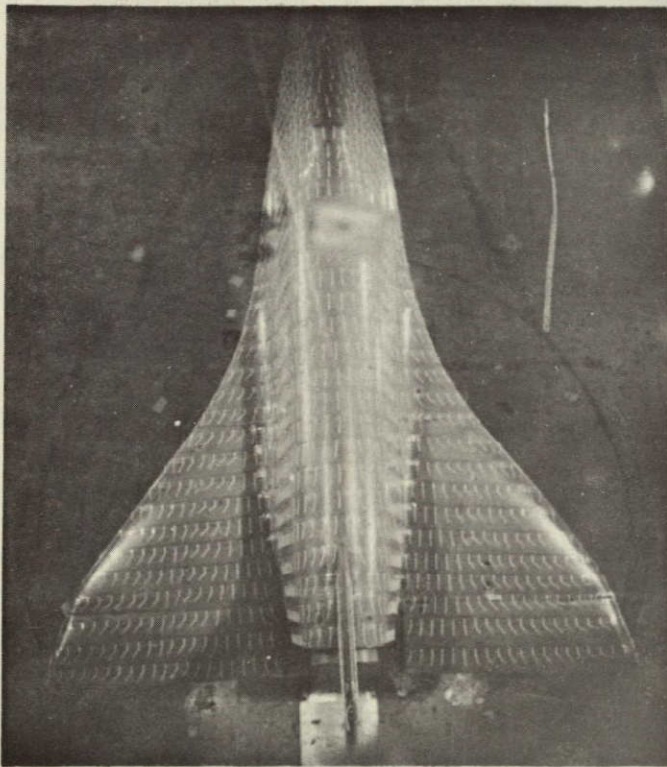

$\alpha = 12^\circ$

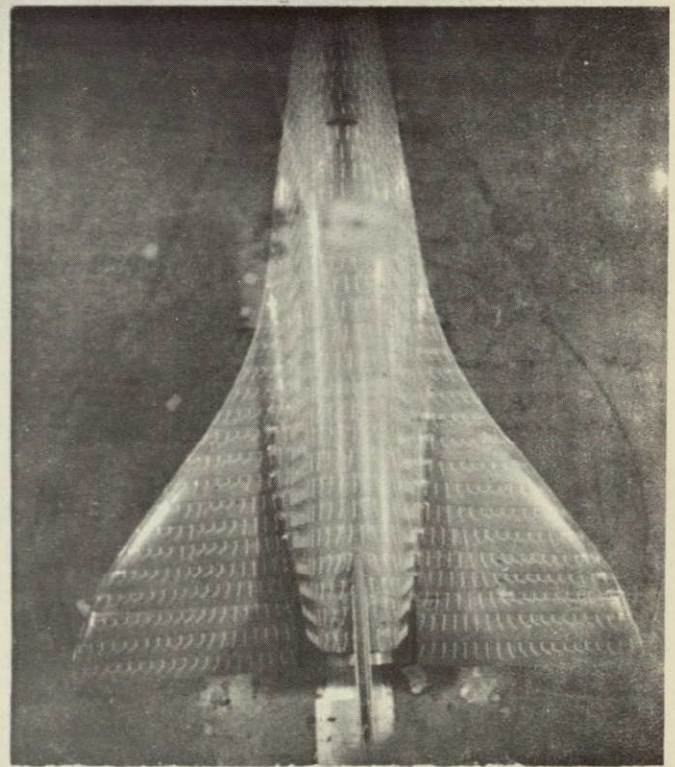

$\alpha = 16^\circ$

MCAIR LSWT TEST 248 - Tuft study showing wing upper surface vortex path at  $\beta = 0^\circ$  (vortex path symmetrical on left and right wings). Run 59. Config B<sub>5</sub>W<sub>11</sub>V<sub>6</sub>  
 $\delta e = -10^\circ, \delta a = \delta R = \delta SB = \delta BF = 0^\circ$

FIGURE 20.

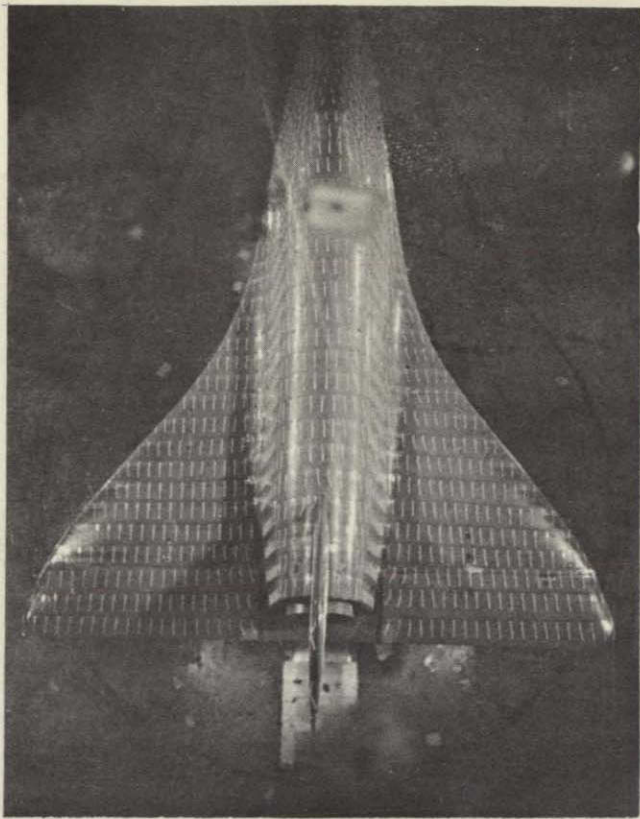

$\alpha = 6^\circ$

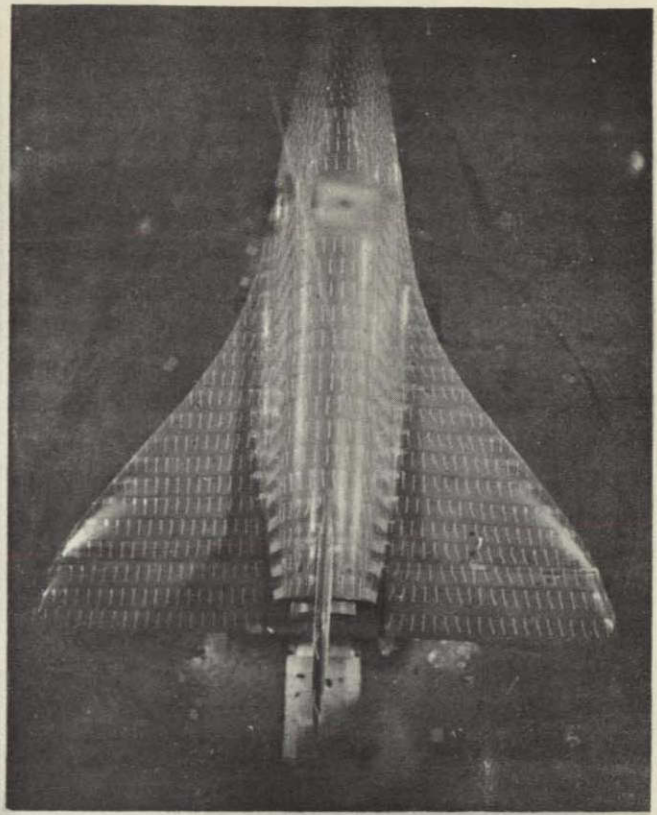

$\alpha = 8^\circ$

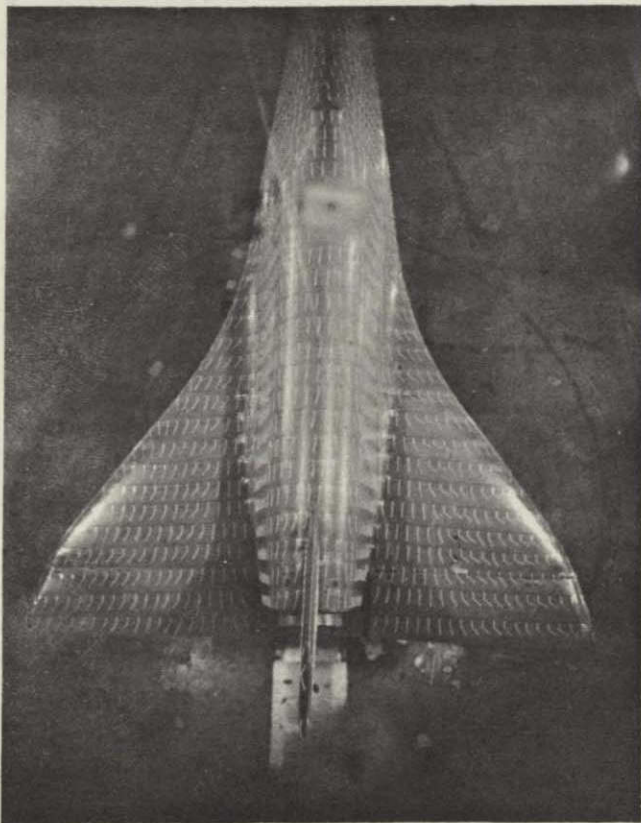

$\alpha = 12^\circ$

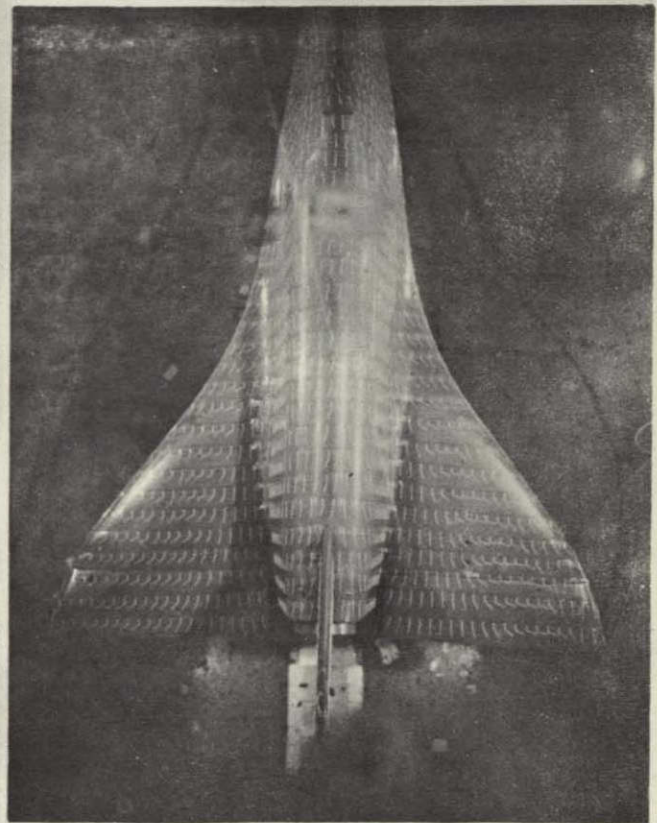

$\alpha = 16^\circ$

MCAIR LSWT TEST 248 - Tuft study showing wing upper surface vortex path at  $\beta = -3^\circ$   
 (vortex appears stronger on right wing). Run 60. Config B<sub>5</sub>W<sub>11</sub>V<sub>6</sub>  
 $\delta e = -10^\circ$ ,  $\delta a = \delta R = \delta SB = \delta BF = 0^\circ$

FIGURE 21.

NOT REPRODUCIBLE

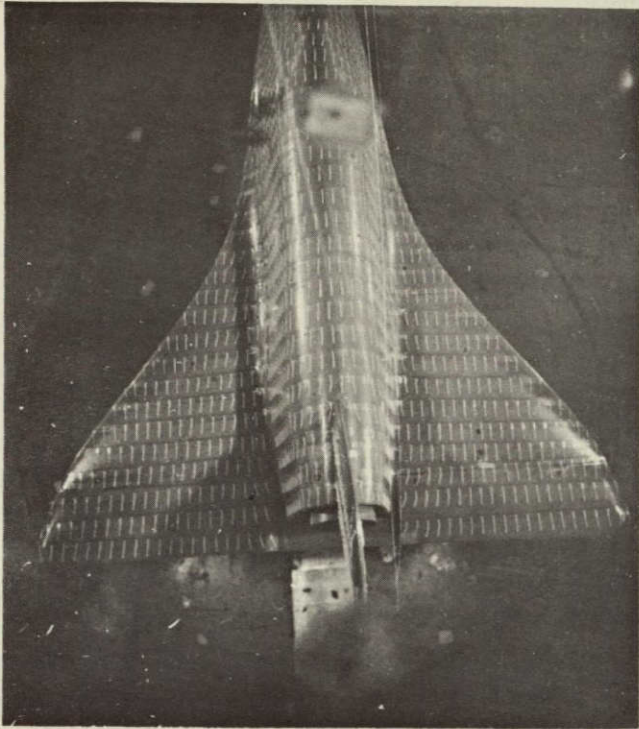

$\alpha = 6^\circ$

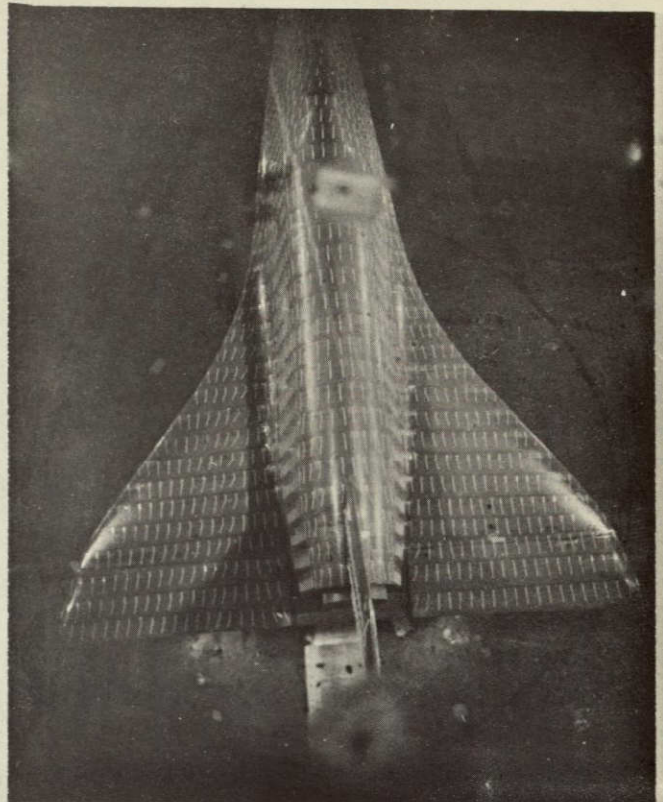

$\alpha = 8^\circ$

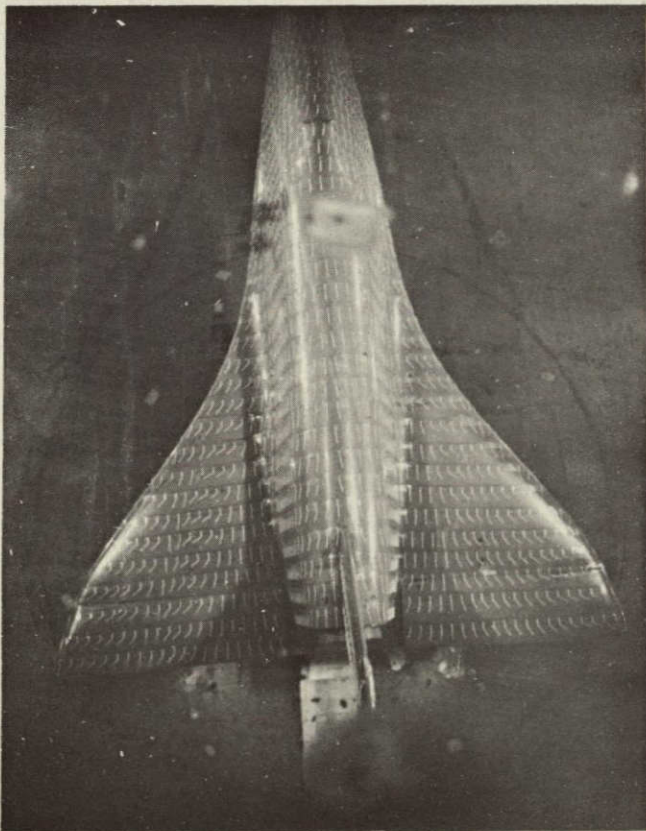

$\alpha = 12^\circ$

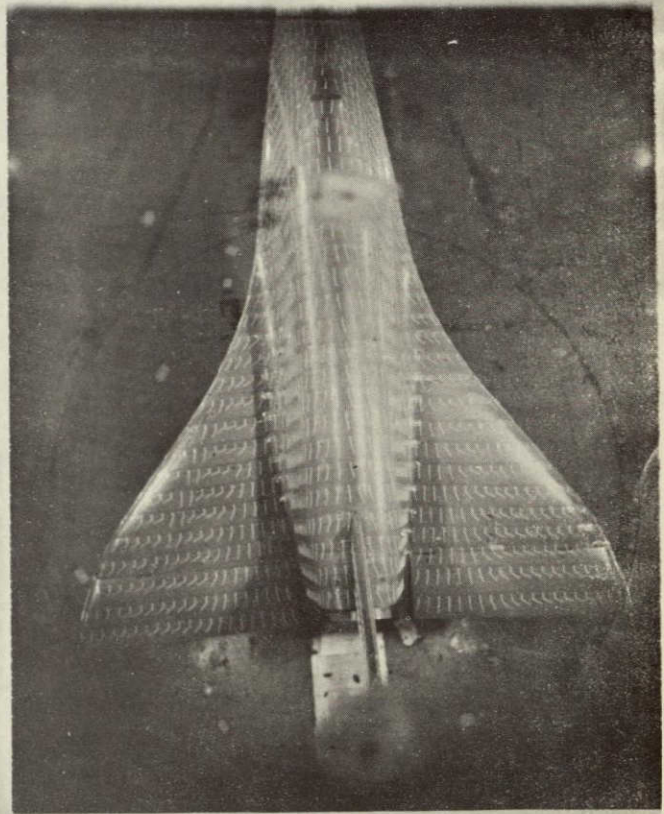

$\alpha = 16^\circ$

MCAIR LSWT Test 248 - Tuft study showing wing upper surface vortex path at  $\beta = +3^\circ$   
(Vortex appears stronger on left wing). Run 61. Config.  $B_5W_{11}V_6$   
 $\delta e = -10^\circ$ ,  $\delta a = \delta R = \delta SB = \delta BF = 0^\circ$

FIGURE 22.

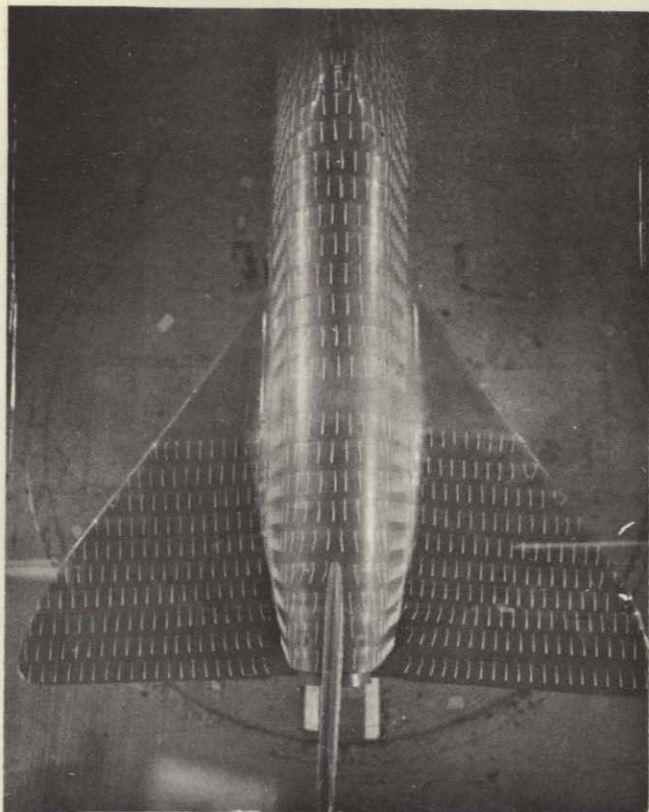

$\alpha = 6^\circ$

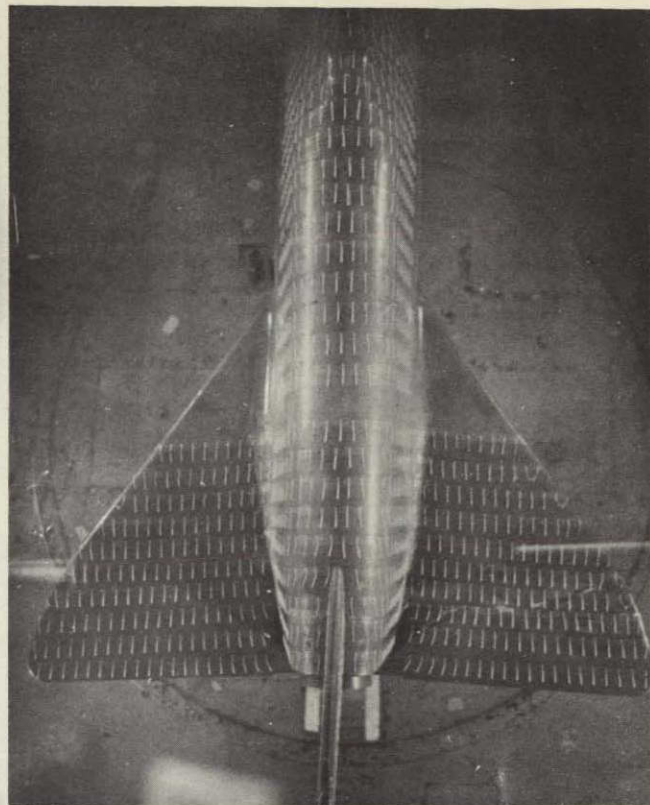

$\alpha = 8^\circ$

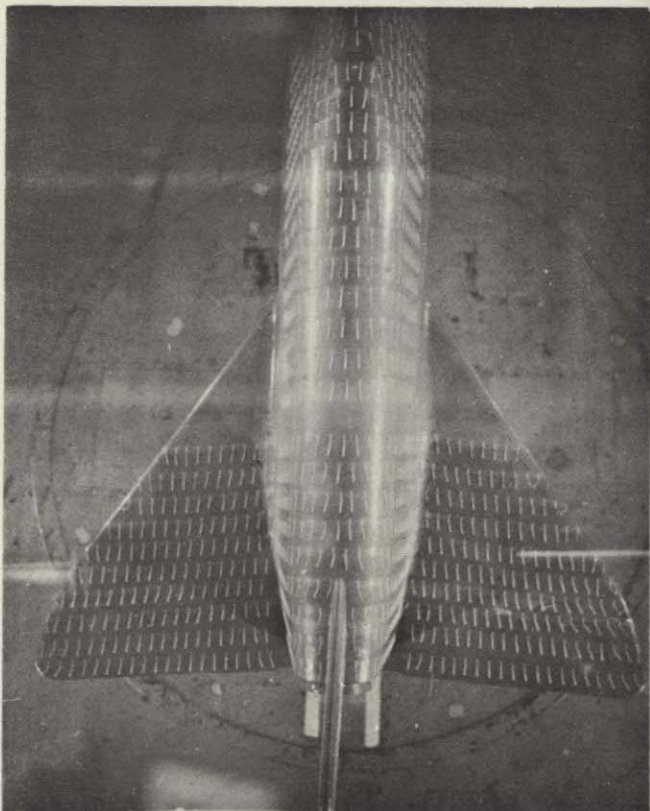

$\alpha = 12^\circ$

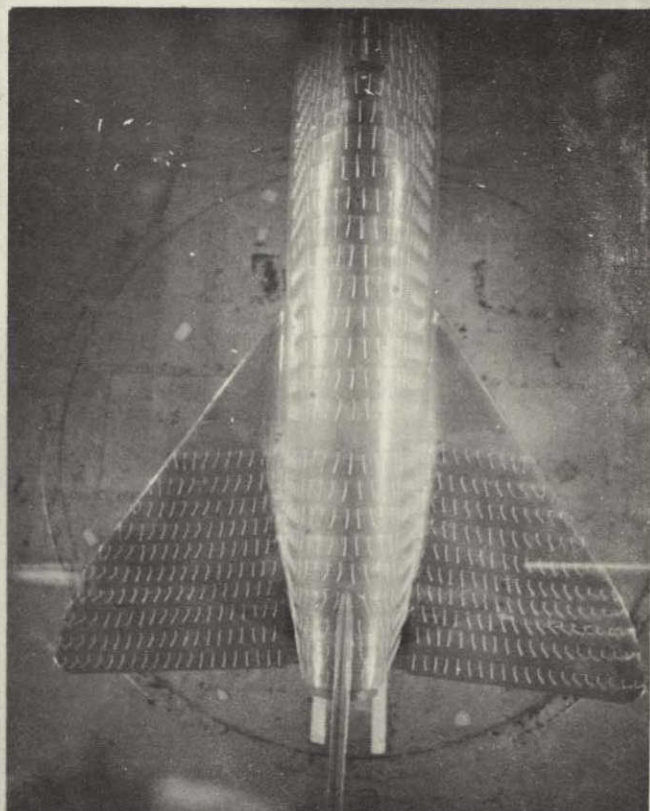

$\alpha = 16^\circ$

MCAIR LSWT TEST 248 - Tuft Study showing wing upper surface vortex path at  $\beta = 0^\circ$   
 (vortex path symmetrical on left and right wings). W11 wing with strakes removed.  
 Config: B<sub>5</sub>W<sub>12</sub>V<sub>6</sub>  $\delta e = -10^\circ$ ,  $\delta a = \delta R = \delta SB = \delta BF = 0^\circ$  RUN 66

FIGURE 23.

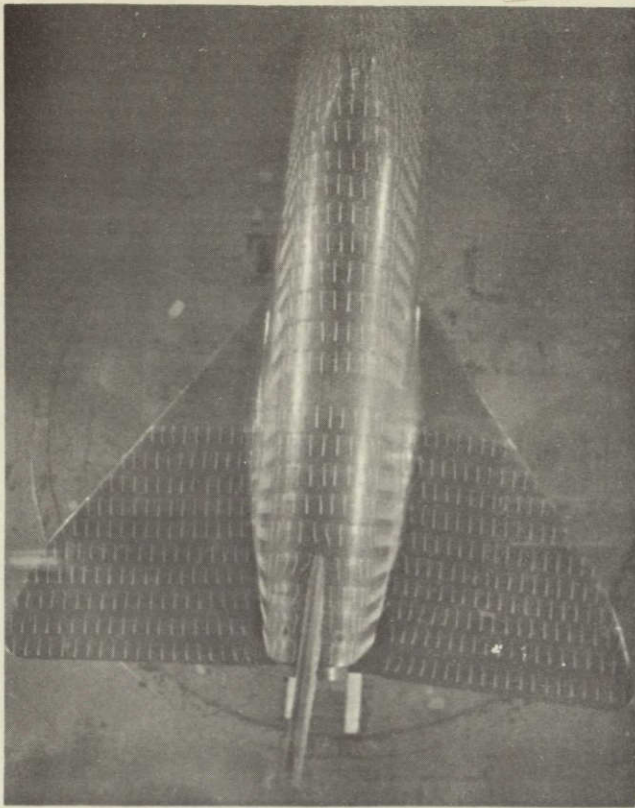

$\alpha = 6^\circ$

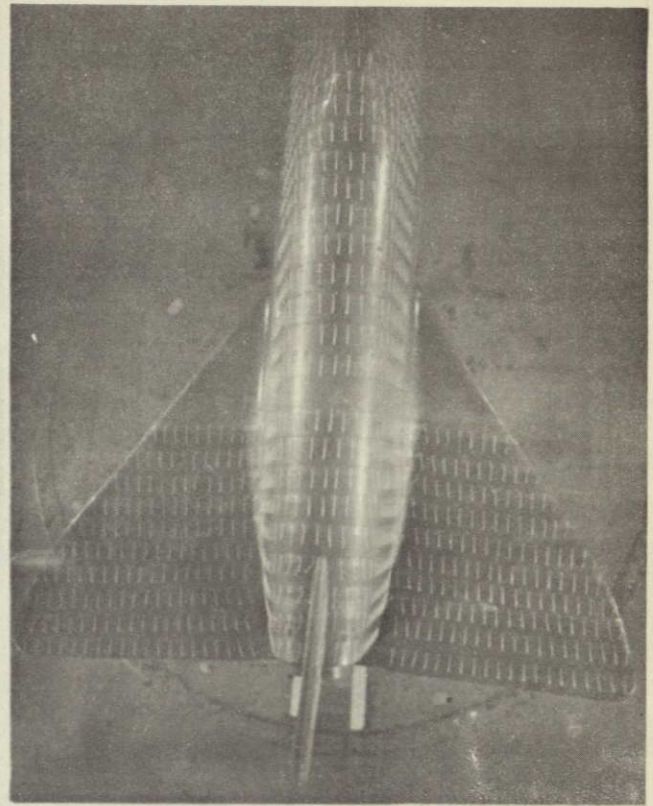

$\alpha = 8^\circ$

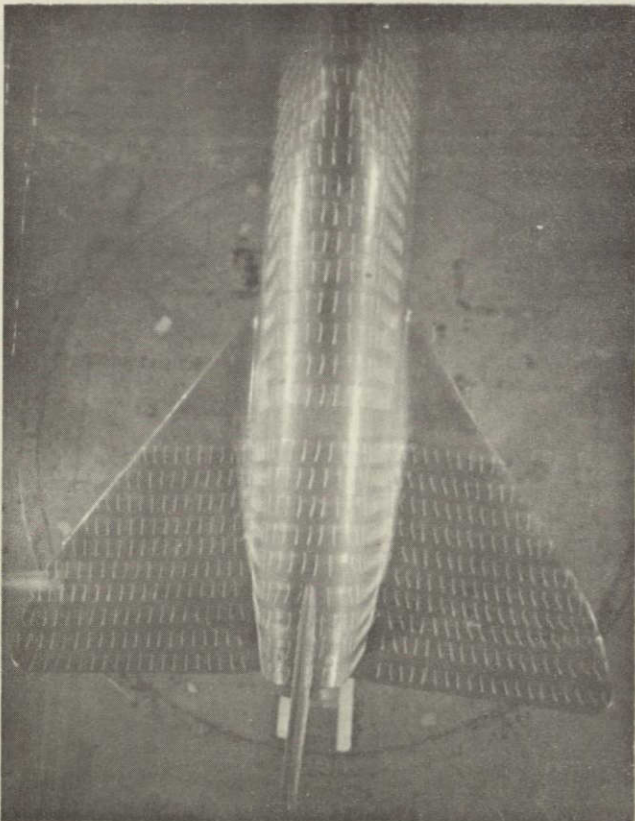

$\alpha = 12^\circ$

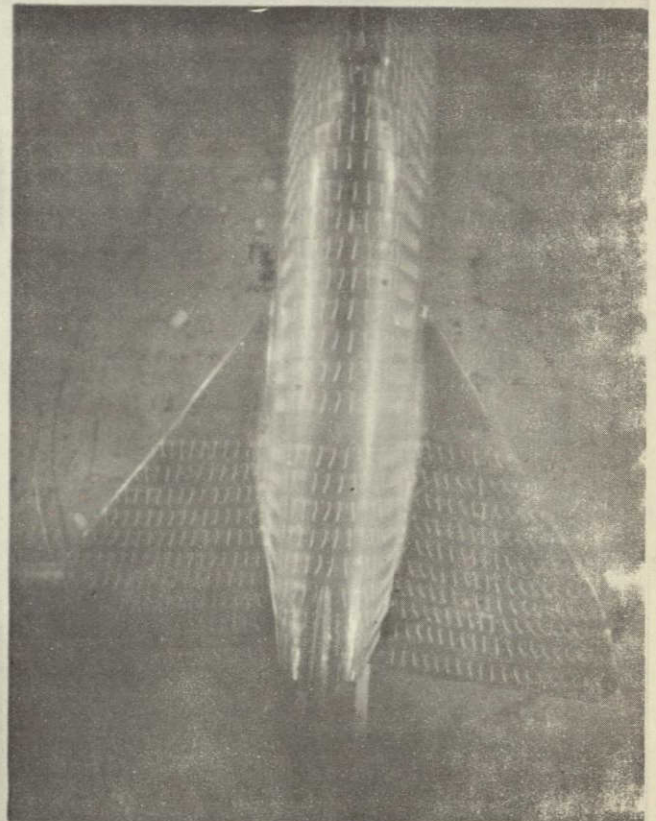

$\alpha = 16^\circ$

MCAIR LSWT TEST 248 - Tuft study showing wing upper surface vortex path at  $\beta = -3^\circ$  (vortex strength appears reduced on right wing compared to W11 wing with strakes). W11 wing with strakes removed. Run 64. Config. B<sub>5</sub>W<sub>12</sub>V<sub>6</sub>,  $\delta e = -10^\circ$ ,  $\delta a = \delta R = \delta SB = \delta BF = 0^\circ$

FIGURE 24.

## NOMENCLATURE

<u>SYMBOL</u>	<u>SADSAC SYMBOL</u>	<u>DEFINITION</u>
$A_b$		base area; $m^2$ , $ft^2$ , $in^2$
a		speed of sound; m/sec, ft/sec
AR	ASPECT	aspect ratio, $b^2/S$
b	REFB	wing span or reference span; m, ft, in
c		wing chord; m, ft, in
$\bar{c}$		wing mean aerodynamic chord or reference chord; m, ft, in (see $l_{ref}$ or refl)
c.g.		center of gravity
C.P.		center of pressure
$C_A$	CA	axial force coefficient, $F_A/qS_{ref}$
$C_{A_b}$	CAB	See pg. 50. Symbols used in MDAC-LSWT 240 which do not appear in the standard SADSAC Nomenclature
$C_{A_f}$	CAF	forebody axial force coefficient, $C_A - C_{A_b}$
$C_D$	CDTOTL	drag force coefficient in the wind axis system, $F_D/q S_{ref}$



NOMENCLATURE (continued)

<u>SYMBOL</u>	<u>SADSAC SYMBOL</u>	<u>DEFINITION</u>
$C'_D$	CD	drag force coefficient in the stability axis system, $F'_D/q S_{ref}$
$C_L$	CL	lift force coefficient (stability or wind axis) $F_L/q S_{ref}$
$C_l$	CBL	rolling moment coefficient in body axis system, $M_x/q S_{ref} b$
$C_{l,s}$	CSL	rolling moment coefficient in the stability axis system, $M_{x,s}/q S_{ref} b$
$C_{l,w}$	CWL	rolling moment coefficient in the wind axis system, $M_{x,w}/q S_{ref} b$
$C_m$	CLM	pitching moment coefficient in the body axis system, $M_y/q S_{ref} l_{ref}$
$C_{m,s}$	CLM	pitching moment coefficient in the stability axis system, $C_{m,s} = C_m$
$C_{m,w}$	CPM	pitching moment coefficient in the wind axis system, $M_{y,w}/q S_{ref} l_{ref}$
$C_N$	CN	normal force coefficient in the body axis system, $F_N/q S_{ref}$

NOMENCLATURE ( continued)

<u>SYMBOL</u>	<u>SADSAC SYMBOL</u>	<u>DEFINITION</u>
$C_n$	CYN	yawing moment coefficient in the body axis system, $M_z/q S_{ref} b$
$C_{n,s}$	CLN	yawing moment coefficient in the stability axis system, $C_{n,s} = C_n$
$C_{n,w}$	CLN	yawing moment coefficient in the wind axis system, $M_{z,w}/q S_{ref} b$
$C_p$	CP	pressure coefficient, $(p-p_\infty)/q$
$C_y$	CY	side force coefficient (body or stability axis system), $F_y/q S_{ref}$
$C_c$	CC	side force coefficient (wind axis system), $F_y/q S_{ref}$
$F_A$		axial force; N, lb
$F_D$		drag force in wind axis system; N, lb
$F'_D$		drag force in the stability axis system; N, lb
$F_L$		lift force (stability or wind axis system); N, lb
$F_N$		normal force; N, lb

NOMENCLATURE (continued)

<u>SYMBOL</u>	<u>SADSAC SYMBOL</u>	<u>DEFINITION</u>
$F_Y$		side force; N, lb
	N/A	normal to axial force ratio
$l_{ref}$	REFL	reference length; m, ft, in (see $\bar{c}$ )
L/D	L/D	lift-to-drag ratio, $C_L/C_D$ (stability axis system)
L/D	CL/CD	lift-to-drag ratio, $\dot{C}_L/C_D$ (wind axis system)
M	MACH	Mach number
MRP	MRP	abbreviation for moment reference point
	XMRP	abbreviation for moment reference point on x-axis
	YMRP	abbreviation for moment reference point on y-axis
	ZMRP	abbreviation for moment reference point on z-axis
$M_x$		rolling moment in the body axis system; N-m, ft-lb
$M_{x,s}$		rolling moment in the stability axis system; N-m, ft-lb

NOMENCLATURE (continued)

<u>SYMBOL</u>	<u>SADSAC SYMBOL</u>	<u>DEFINITION</u>
$M_{x,w}$		rolling moment in the wind axis system; N-m, ft-lb
$M_y$		pitching moment in the body (or stability) axis system; N-m, ft-lb
$M_{y,w}$		pitching moment in the wind axis system; N-m, ft-lb
$M_z$		yawing moment in the body axis system; N-m, ft-lb
$M_{z,w}$		yawing moment in the wind axis system; N-m, ft-lb
p		static pressure; N/m <sup>2</sup> ; psi
P		total pressure; N/m <sup>2</sup> ; psi
q	Q(PSI) Q(PSF)	dynamic pressure; N/m <sup>2</sup> , psi, psf
RN/L	RN/L	Reynold's number per unit length; million/ft.
S		wing area; m <sup>2</sup> , ft <sup>2</sup>
S <sub>ref</sub>	REFS	reference area; m <sup>2</sup> , ft <sup>2</sup>
T		temperature; °K, °C, °R, °F
V		speed of vehicle relative to surrounding atmosphere; m/sec, ft/sec

NOMENCLATURE (continued)

<u>SYMBOL</u>	<u>SADSAC SYMBOL</u>	<u>DEFINITION</u>
$i_T$		tail incidence positive when trailing edge down, deg
$\bar{V}$		velocity of vehicle relative to surrounding atmosphere; m/sec, ft/sec
$\alpha$	ALPHA	angle of attack, angle between the projection of the wind $X_w$ -axis on the body X, Z-plane and the body X-axis; deg
$\beta$	BETA	sideslip angle, angle between the wind $X_w$ -axis and the projection of this axis on the body X-Z-plane; deg
$\gamma$		ratio of specific heats
$\Gamma$	DIHDRL	wing dihedral angle; deg
$\delta$		control surface deflection angle; deg
		positive deflections are:
	AILRON	aileron - left aileron trailing edge down
	ELEVTR	elevator - trailing edge down
	RUDDER	rudder - trailing edge to the left
	FLAP	flap - trailing edge down
	TAB	tab - trailing edge down with respect to control surface
$\rho$		air density; $K_g/m^3$ , slugs/ft <sup>3</sup>

NOMENCLATURE (continued)

<u>SYMBOL</u>	<u>SADSAC SYMBOL</u>	<u>DEFINITION</u>
$\theta$		pitch angle, angle of rotation about the body Y-axis, positive when the positive Z-axis is rotated toward the positive X-axis; deg
$\phi$	PHI	roll angle, angle of rotation about the body X-axis, positive when the positive Y-axis is rotated toward the positive Z-axis; deg
$\psi$	PSI	yaw angle, angle of rotation about the body Z-axis, positive when the positive X-axis is rotated toward the positive Y-axis; deg

## NOMENCLATURE (continued)

<u>SUBSCRIPTS</u>	<u>DEFINITION</u>
a	aileron
b	base
c	canard
e	elevator or elevon
f	flap
r	rudder or ruddervator
s	stability axis system
t	tail, or total conditions
w	wind axis system
ref	reference conditions
$\infty$	freestream condition

NOMENCLATURE (continued)

<u>SYMBOL</u>	<u>SADSAC SYMBOL</u>	<u>DEFINATION</u>
$C_{A_B}$	CAB	base pressure coefficient, $[(p_b - p)/q] (A_b/S_{REF})$
	BFLAP	body flap, deg., positive deflection trailing edge down
	SPBRK	speed brake, deg.
	SLOPE	a parameter name used to indicate that different angle of attack ranges were utilized in determining cross-derivative slopes



## TABULATED DATA LISTING

A tabulated data listing, consisting of all aero data sets, both original and those created in arriving at the plotted material to be presented subsequently, is available as an addendum to this report. The tabular listing is made up in two sections:

- (a) a brief summary list of all data sets containing the identifier, the descriptor, and the resident dependent variables.
- (b) the full list of all data sets containing all resident or selected aerodynamic coefficients of the data sets as well as the above mentioned information.

The listing is currently sent on limited distribution to the following organizations:

NASA AMES	Mr. John Axelson
NASA LaRC	Mr. David Stone
NASA MSC	Mr. Ray Nelson
NASA MSFC	Mr. Jim Weaver
MDAC (East)	Mr. John Hrenak

If copies of this listing are desired, please contact the above or the cognizant SADSAC personnel who, for this data, is:

W. R. Morgan  
Department 2780  
Chrysler Corporation Space Division  
New Orleans, La. 70129

(504) 255-2304

DATA PLOT INDEX

DATA REPEATABILITY

DEPENDENT VARIABLE VS INDEPENDENT VARIABLE

--- DATASETS PLOTTED: ---

CCP002 CCP010

DEPENDENT VARIABLE	INDEPENDENT VARIABLE	PLOT PAGE BEGINNING / ENDING	
CLM	ALPHA	1	1
CL	ALPHA	2	2
CD	ALPHA	3	3
CDB	ALPHA	4	4
L/D	ALPHA	5	5

--- DATASETS PLOTTED: ---

BCP002 BCP010

DEPENDENT VARIABLE	INDEPENDENT VARIABLE	PLOT PAGE BEGINNING / ENDING	
CN	ALPHA	6	6
CA	ALPHA	7	7

--- DATASETS PLOTTED: ---

CCP002 CCP010

DEPENDENT VARIABLE	DEPENDENT VARIABLE	PLOT PAGE BEGINNING / ENDING	
CL	CLM	8	8
CL	CD	9	9
CD	CLSQR	10	10

--- DATASETS PLOTTED: ---

BCP002 BCP010

DEPENDENT VARIABLE	DEPENDENT VARIABLE	PLOT PAGE BEGINNING / ENDING	
CN	CLM	11	11

DATA PLOT INDEX

COMPONENT BUILD-UP BASIC CONFIGURATION

DEPENDENT VARIABLE VS INDEPENDENT VARIABLE

DATASETS PLOTTED:

CCP028 CCP025 CCP002

DEPENDENT VARIABLE	INDEPENDENT VARIABLE	PLOT PAGE BEGINNING / ENDING	
CLM	ALPHA	12	12
CL	ALPHA	13	13
CD	ALPHA	14	14
CDB	ALPHA	15	15
L/D	ALPHA	16	16
CY	ALPHA	17	17
CYN	ALPHA	18	18
CBL	ALPHA	19	19

DATASETS PLOTTED:

RCP028 RCP025 RCP002

DEPENDENT VARIABLE	INDEPENDENT VARIABLE	PLOT PAGE BEGINNING / ENDING	
CLN	ALPHA	20	20
CSL	ALPHA	21	21

DATASETS PLOTTED:

BCP028 BCP025 BCP002

DEPENDENT VARIABLE	INDEPENDENT VARIABLE	PLOT PAGE BEGINNING / ENDING	
CN	ALPHA	22	22
CA	ALPHA	23	23

DATASETS PLOTTED:

CCP028 CCP025 CCP002

DEPENDENT VARIABLE	DEPENDENT VARIABLE	PLOT PAGE BEGINNING / ENDING	
CL	CLM	24	24
CL	CD	25	25
CD	CLSQR	26	26

DATASETS PLOTTED:

BCP028 BCP025 BCP002

DEPENDENT VARIABLE	DEPENDENT VARIABLE	PLOT PAGE BEGINNING / ENDING	
CN	CLM	27	27

DATA PLOT INDEX

COMPONENT BUILD-UP BASIC CONFIGURATION

DEPENDENT VARIABLE VS INDEPENDENT VARIABLE

DATASETS PLOTTED:

DCPD29 DCPD26 DCPD11

DEPENDENT VARIABLE	INDEPENDENT VARIABLE	PLOT PAGE BEGINNING / ENDING	
CYBETA	ALPHA	28	28
DCYNDB	ALPHA	29	29
DCBLDB	ALPHA	30	30

DATASETS PLOTTED:

ECPD29 ECPD26 ECPD11

DEPENDENT VARIABLE	INDEPENDENT VARIABLE	PLOT PAGE BEGINNING / ENDING	
DCLNDB	ALPHA	31	31
DCSLDB	ALPHA	32	32

DATASETS PLOTTED:

BCPD14 BCPD15 BCPD16

DEPENDENT VARIABLE	INDEPENDENT VARIABLE	PLOT PAGE BEGINNING / ENDING	
CY	BETA	33	33
CYN	BETA	34	34
CBL	BETA	35	35

DATASETS PLOTTED:

RCPD14 RCPD15 RCPD16

DEPENDENT VARIABLE	INDEPENDENT VARIABLE	PLOT PAGE BEGINNING / ENDING	
CLN	BETA	36	36
CSL	BETA	37	37

DATASETS PLOTTED:

CCPD02 CCPD06 CCPD12 CCPD08

DEPENDENT VARIABLE	INDEPENDENT VARIABLE	PLOT PAGE BEGINNING / ENDING	
CLM	ALPHA	38	38
CL	ALPHA	39	39
CD	ALPHA	40	40

DATA PLOT INDEX

LONGITUDINAL CONTROL POWER BASIC CONFIGURATION

DEPENDENT VARIABLE VS INDEPENDENT VARIABLE

DATASETS PLOTTED:

CCP002 CCP006 CCP012 CCP008

DEPENDENT VARIABLE	INDEPENDENT VARIABLE	PLOT PAGE BEGINNING / ENDING	
CDB	ALPHA	41	41
L/D	ALPHA	42	42
CY	ALPHA	43	43
CYN	ALPHA	44	44
CBL	ALPHA	45	45

DATASETS PLOTTED:

RCP002 RCP006 RCP012 RCP008

DEPENDENT VARIABLE	INDEPENDENT VARIABLE	PLOT PAGE BEGINNING / ENDING	
CLN	ALPHA	46	46
CSL	ALPHA	47	47

DATASETS PLOTTED:

BCP002 BCP006 BCP012 BCP008

DEPENDENT VARIABLE	INDEPENDENT VARIABLE	PLOT PAGE BEGINNING / ENDING	
CN	ALPHA	48	48
CA	ALPHA	49	49

DEPENDENT VARIABLE VS DEPENDENT VARIABLE

DATASETS PLOTTED:

CCP002 CCP006 CCP012 CCP008

DEPENDENT VARIABLE	DEPENDENT VARIABLE	PLOT PAGE BEGINNING / ENDING	
CL	CLM	50	50
CL	CD	51	51
CD	CLSQR	52	52

DATASETS PLOTTED:

BCP002 BCP006 BCP012 BCP008

DEPENDENT VARIABLE	DEPENDENT VARIABLE	PLOT PAGE BEGINNING / ENDING	
CN	CLM	53	53

DATA PLOT INDEX

LONGITUDINAL CONTROL POWER BASIC CONFIGURATION

DEPENDENT VARIABLE VS PARAMETRIC VARIABLE

DATASETS PLOTTED:

NCPO02    NCPO06    NCP012    NCP008

DEPENDENT VARIABLE	PARAMETRIC VARIABLE	PLOT PAGE BEGINNING / ENDING	
--------------------	---------------------	------------------------------	--

CD	ELEVTR	54	66
----	--------	----	----

DEPENDENT VARIABLE VS INDEPENDENT VARIABLE

DATASETS PLOTTED:

XCP006    XCP012    XCP008

DEPENDENT VARIABLE	INDEPENDENT VARIABLE	PLOT PAGE BEGINNING / ENDING	
--------------------	----------------------	------------------------------	--

DCLMDE	ALPHA	67	67
DCL/DE	ALPHA	68	68
DCD/DE	ALPHA	69	69

DATASETS PLOTTED:

CCP011    CCP007    CCP013    CCP009

DEPENDENT VARIABLE	INDEPENDENT VARIABLE	PLOT PAGE BEGINNING / ENDING	
--------------------	----------------------	------------------------------	--

CLM	ALPHA	70	70
CL	ALPHA	71	71
CD	ALPHA	72	72
CDB	ALPHA	73	73
L/D	ALPHA	74	74
CY	ALPHA	75	75
CYN	ALPHA	76	76
CBL	ALPHA	77	77

DATASETS PLOTTED:

RCPO11    RCP007    RCP013    RCP009

DEPENDENT VARIABLE	INDEPENDENT VARIABLE	PLOT PAGE BEGINNING / ENDING	
--------------------	----------------------	------------------------------	--

CLN	ALPHA	78	78
CSL	ALPHA	79	79

DATA PLOT INDEX

LONGITUDINAL CONTROL POWER BASIC CONFIGURATION

DATASETS PLOTTED:

BCP011 BCP007 BCP013 BCP009

DEPENDENT VARIABLE	INDEPENDENT VARIABLE	PLOT PAGE BEGINNING / ENDING	
CN	ALPHA	80	80
CA	ALPHA	81	81

DEPENDENT VARIABLE VS DEPENDENT VARIABLE

DATASETS PLOTTED:

CCP011 CCP007 CCP013 CCP009

DEPENDENT VARIABLE	DEPENDENT VARIABLE	PLOT PAGE BEGINNING / ENDING	
CL	CLM	82	82
CL	CD	83	83
CD	CLSQR	84	84

DATASETS PLOTTED:

BCP011 BCP007 BCP013 BCP009

DEPENDENT VARIABLE	DEPENDENT VARIABLE	PLOT PAGE BEGINNING / ENDING	
CN	CLM	85	85

DEPENDENT VARIABLE VS PARAMETRIC VARIABLE

DATASETS PLOTTED:

NCP011 NCP007 NCP013 NCP009

DEPENDENT VARIABLE	PARAMETRIC VARIABLE	PLOT PAGE BEGINNING / ENDING	
CD	ELEVTR	86	98

DATA PLOT INDEX

LONGITUDINAL CONTROL POWER BASIC CONFIGURATION

DEPENDENT VARIABLE VS INDEPENDENT VARIABLE

DATASETS PLOTTED:

XCPO07    XCP013    XCP009

DEPENDENT VARIABLE	INDEPENDENT VARIABLE	PLOT PAGE BEGINNING / ENDING	
DCLMDE	ALPHA	99	99
DCL/DE	ALPHA	100	100
DCD/DE	ALPHA	101	101

DATASETS PLOTTED:

DCPO11    DCP007    DCP013    DCP009

DEPENDENT VARIABLE	INDEPENDENT VARIABLE	PLOT PAGE BEGINNING / ENDING	
CYBETA	ALPHA	102	102
DCYNDB	ALPHA	103	103
DCBLDB	ALPHA	104	104

DATASETS PLOTTED:

ECPO11    ECP007    ECP013    ECP009

DEPENDENT VARIABLE	INDEPENDENT VARIABLE	PLOT PAGE BEGINNING / ENDING	
DCLNDB	ALPHA	105	105
DCSLDB	ALPHA	106	106

DATASETS PLOTTED:

CCPU21    CCP003

DEPENDENT VARIABLE	INDEPENDENT VARIABLE	PLOT PAGE BEGINNING / ENDING	
CLM	ALPHA	107	107
CL	ALPHA	108	108
CD	ALPHA	109	109
CDB	ALPHA	110	110
L/D	ALPHA	111	111

DATASETS PLOTTED:

BCPO21    BCP003

DEPENDENT VARIABLE	INDEPENDENT VARIABLE	PLOT PAGE BEGINNING / ENDING	
.CN	ALPHA	112	112



DATA PLOT INDEX

LONGITUDINAL CONTROL POWER BASIC CONFIGURATION

DEPENDENT VARIABLE VS INDEPENDENT VARIABLE

DATASETS PLOTTED:  
BCP021 BCP003

DEPENDENT VARIABLE	INDEPENDENT VARIABLE	PLOT PAGE BEGINNING / ENDING	
CA	ALPHA	113	113

DEPENDENT VARIABLE VS DEPENDENT VARIABLE

DATASETS PLOTTED:  
CCP021 CCP003

DEPENDENT VARIABLE	DEPENDENT VARIABLE	PLOT PAGE BEGINNING / ENDING	
CL	CLM	114	114
CL	CD	115	115
CD	CLSQR	116	116

DATASETS PLOTTED:  
BCP021 BCP003

DEPENDENT VARIABLE	DEPENDENT VARIABLE	PLOT PAGE BEGINNING / ENDING	
CN	CLM	117	117

DEPENDENT VARIABLE VS INDEPENDENT VARIABLE

DATASETS PLOTTED	DEPENDENT VARIABLE	INDEPENDENT VARIABLE	PLOT PAGE BEGINNING / ENDING	
XCPE03	DCLMDE	ALPHA	118	118
XCPE03	DCL/DE	ALPHA	119	119
XCPE03	DCD/DE	ALPHA	120	120

DATA PLOT INDEX

LONGITUDINAL CONTROL POWER LAUNDING GEAR EXTENDED

DEPENDENT VARIABLE VS INDEPENDENT VARIABLE

DATASETS PLOTTED:

CCP052 CCP053

DEPENDENT VARIABLE	INDEPENDENT VARIABLE	PLOT PAGE BEGINNING / ENDING	
CLM	ALPHA	121	121
CL	ALPHA	122	122
CD	ALPHA	123	123
CDB	ALPHA	124	124
L/D	ALPHA	125	125

DATASETS PLOTTED:

BCP052 BCP053

DEPENDENT VARIABLE	INDEPENDENT VARIABLE	PLOT PAGE BEGINNING / ENDING	
CN	ALPHA	126	126
CA	ALPHA	127	127

DEPENDENT VARIABLE VS DEPENDENT VARIABLE

DATASETS PLOTTED:

CCP052 CCP053

DEPENDENT VARIABLE	DEPENDENT VARIABLE	PLOT PAGE BEGINNING / ENDING	
CL	CLM	128	128
CL	CD	129	129
CD	CLSQR	130	130

DATASETS PLOTTED:

BCP052 BCP053

DEPENDENT VARIABLE	DEPENDENT VARIABLE	PLOT PAGE BEGINNING / ENDING	
CN	CLM	131	131

DATA PLOT INDEX

LONGITUDINAL CONTROL POWER LANDING GEAR EXTENDED

DEPENDENT VARIABLE VS INDEPENDENT VARIABLE

DATASETS PLOTTED	DEPENDENT VARIABLE	INDEPENDENT VARIABLE	PLOT PAGE BEGINNING / ENDING	
XCPO53	DCLMDE	ALPHA	132	132
XCPO53	DCL/DE	ALPHA	133	133
XCPO53	DCD/DE	ALPHA	134	134

DEPENDENT VARIABLE VS INDEPENDENT VARIABLE

DATASETS PLOTTED:

CCPO50 CCPO39

DEPENDENT VARIABLE	INDEPENDENT VARIABLE	PLOT PAGE BEGINNING / ENDING	
CLM	ALPHA	135	135
CL	ALPHA	136	136
CD	ALPHA	137	137
CDB	ALPHA	138	138
L/D	ALPHA	139	139

DATASETS PLOTTED:

BCPO50 BCPO39

DEPENDENT VARIABLE	INDEPENDENT VARIABLE	PLOT PAGE BEGINNING / ENDING	
CN	ALPHA	140	140
CA	ALPHA	141	141

DEPENDENT VARIABLE VS DEPENDENT VARIABLE

DATASETS PLOTTED:

CCPO50 CCPO39

DEPENDENT VARIABLE	DEPENDENT VARIABLE	PLOT PAGE BEGINNING / ENDING	
CL	CLM	142	142
CL	CD	143	143
CD	CLSQR	144	144

DATA PLOT INDEX

LONGITUDINAL CONTROL POWER SPEED BRAKES EXTENDED

DATASETS PLOTTED:

BCP050      BCP039

DEPENDENT VARIABLE	DEPENDENT VARIABLE	PLOT PAGE BEGINNING / ENDING	
CN	CLM	145	145

DEPENDENT VARIABLE VS INDEPENDENT VARIABLE

DATASETS PLOTTED	DEPENDENT VARIABLE	INDEPENDENT VARIABLE	PLOT PAGE BEGINNING / ENDING	
XCP039	DCL/DE	ALPHA	146	146
XCP039	DCL/DE	ALPHA	147	147
XCP039	DCD/DE	ALPHA	148	148

EFFECT OF LANDING GEAR ON LATERAL-DIRECTIONAL STABILITY

DEPENDENT VARIABLE VS INDEPENDENT VARIABLE

DATASETS PLOTTED:

BCP053      BCP054

DEPENDENT VARIABLE	INDEPENDENT VARIABLE	PLOT PAGE BEGINNING / ENDING	
CY	ALPHA	149	149
CYN	ALPHA	150	150
CBL	ALPHA	151	151

DATASETS PLOTTED:

RCP053      RCP054

DEPENDENT VARIABLE	INDEPENDENT VARIABLE	PLOT PAGE BEGINNING / ENDING	
CLH	ALPHA	152	152
CSL	ALPHA	153	153

DATA PLOT INDEX

EFFECT OF LANDING GEAR ON LATERAL-DIRECTIONAL STABILITY

DEPENDENT VARIABLE VS INDEPENDENT VARIABLE

DATASETS PLOTTED	DEPENDENT VARIABLE	INDEPENDENT VARIABLE	PLOT PAGE BEGINNING / ENDING	
DCP054	CYBETA	ALPHA	154	154
DCP054	DCYNDB	ALPHA	155	155
DCP054	DCBLDB	ALPHA	156	156
ECP054	DCLNDB	ALPHA	157	157
ECP054	DCSLDB	ALPHA	158	158

LATERAL CONTROL POWER BASIC CONFIGURATION

DEPENDENT VARIABLE VS INDEPENDENT VARIABLE

DATASETS PLOTTED:

CCP012 CCP003 CCP022

DEPENDENT VARIABLE	INDEPENDENT VARIABLE	PLOT PAGE BEGINNING / ENDING	
CLM	ALPHA	159	159
CL	ALPHA	160	160
CD	ALPHA	161	161
CDB	ALPHA	162	162
L/D	ALPHA	163	163

DATASETS PLOTTED:

CCP012 CCP003 CCP022

DEPENDENT VARIABLE	INDEPENDENT VARIABLE	PLOT PAGE BEGINNING / ENDING	
CY	ALPHA	164	164
CYN	ALPHA	165	165
CBL	ALPHA	166	166

DATASETS PLOTTED:

RCP012 RCP003 RCP022

DEPENDENT VARIABLE	INDEPENDENT VARIABLE	PLOT PAGE BEGINNING / ENDING	
CLN	ALPHA	167	167
CSL	ALPHA	168	168

DATA PLOT INDEX

LATERAL CONTROL POWER BASIC CONFIGURATION

DATASETS PLOTTED:

BCP012 BCP003 BCP022

DEPENDENT VARIABLE	INDEPENDENT VARIABLE	PLOT PAGE BEGINNING / ENDING	
CN	ALPHA	169	169
CA	ALPHA	170	170

DEPENDENT VARIABLE VS DEPENDENT VARIABLE

DATASETS PLOTTED:

CCP012 CCP003 CCP022

DEPENDENT VARIABLE	DEPENDENT VARIABLE	PLOT PAGE BEGINNING / ENDING	
CL	CLM	171	171
CL	CD	172	172
CD	CLSQR	173	173

DATASETS PLOTTED:

BCP012 BCP003 BCP022

DEPENDENT VARIABLE	DEPENDENT VARIABLE	PLOT PAGE BEGINNING / ENDING	
CN	CLM	174	174

DEPENDENT VARIABLE VS PARAMETRIC VARIABLE

DATASETS PLOTTED:

NCP012 NCP003 NCP022

DEPENDENT VARIABLE	PARAMETRIC VARIABLE	PLOT PAGE BEGINNING / ENDING	
CD	AILRON	175	187

DATA PLOT INDEX

LATERAL CONTROL POWER BASIC CONFIGURATION

DEPENDENT VARIABLE VS INDEPENDENT VARIABLE

DATASETS PLOTTED:

CCP002 CCP021

DEPENDENT VARIABLE	INDEPENDENT VARIABLE	PLOT PAGE BEGINNING / ENDING	
CLM	ALPHA	188	188
CL	ALPHA	189	189
CD	ALPHA	190	190
CDB	ALPHA	191	191
L/D	ALPHA	192	192

DATASETS PLOTTED:

CCP002 CCP021

DEPENDENT VARIABLE	INDEPENDENT VARIABLE	PLOT PAGE BEGINNING / ENDING	
CY	ALPHA	193	193
CYN	ALPHA	194	194
CBL	ALPHA	195	195

DATASETS PLOTTED:

RCP002 RCP021

DEPENDENT VARIABLE	INDEPENDENT VARIABLE	PLOT PAGE BEGINNING / ENDING	
CLN	ALPHA	196	196
CSL	ALPHA	197	197

DATASETS PLOTTED:

BCP002 BCP021

DEPENDENT VARIABLE	INDEPENDENT VARIABLE	PLOT PAGE BEGINNING / ENDING	
CN	ALPHA	198	198
CA	ALPHA	199	199

DATA PLOT INDEX

LATERAL CONTROL POWER BASIC CONFIGURATION

DEPENDENT VARIABLE VS DEPENDENT VARIABLE

DATASETS PLOTTED:

CCP002 CCP021

DEPENDENT VARIABLE	DEPENDENT VARIABLE	PLOT PAGE BEGINNING / ENDING	
CL	CLM	200	200
CL	CD	201	201
CD	CLSQR	202	202

DATASETS PLOTTED:

BCP002 BCP021

DEPENDENT VARIABLE	DEPENDENT VARIABLE	PLOT PAGE BEGINNING / ENDING	
CN	CLM	203	203

DEPENDENT VARIABLE VS INDEPENDENT VARIABLE

DATASETS PLOTTED	DEPENDENT VARIABLE	INDEPENDENT VARIABLE	PLOT PAGE BEGINNING / ENDING	
XCPO21	DCY/DA	ALPHA	204	204
XCPO21	DCYNDA	ALPHA	205	205
XCPO21	DCBLDA	ALPHA	206	206

DEPENDENT VARIABLE VS INDEPENDENT VARIABLE

DATASETS PLOTTED:

XCPO03 XCPO22

DEPENDENT VARIABLE	INDEPENDENT VARIABLE	PLOT PAGE BEGINNING / ENDING	
DCY/DA	ALPHA	207	207
DCYNDA	ALPHA	208	208
DCBLDA	ALPHA	209	209



DATA PLOT INDEX

LATERAL CONTROL POWER BASIC CONFIGURATION

DATASETS PLOTTED:

CCP013 CCP004 CCP023

DEPENDENT VARIABLE	INDEPENDENT VARIABLE	PLOT PAGE BEGINNING / ENDING	
CLM	ALPHA	210	210
CL	ALPHA	211	211
CD	ALPHA	212	212
CDB	ALPHA	213	213
L/D	ALPHA	214	214

DATASETS PLOTTED:

CCP013 CCP004 CCP023

DEPENDENT VARIABLE	INDEPENDENT VARIABLE	PLOT PAGE BEGINNING / ENDING	
CY	ALPHA	215	215
CYN	ALPHA	216	216
CBL	ALPHA	217	217

DATASETS PLOTTED:

RCP013 RCP004 RCP023

DEPENDENT VARIABLE	INDEPENDENT VARIABLE	PLOT PAGE BEGINNING / ENDING	
CLN	ALPHA	218	218
CSL	ALPHA	219	219

DATASETS PLOTTED:

BCP013 BCP004 BCP023

DEPENDENT VARIABLE	INDEPENDENT VARIABLE	PLOT PAGE BEGINNING / ENDING	
CN	ALPHA	220	220

DEPENDENT VARIABLE VS INDEPENDENT VARIABLE

DATASETS PLOTTED:

BCP013 BCP004 BCP023

DEPENDENT VARIABLE	INDEPENDENT VARIABLE	PLOT PAGE BEGINNING / ENDING	
CA	ALPHA	221	221

DATA PLOT INDEX

LATERAL CONTROL POWER BASIC CONFIGURATION

DEPENDENT VARIABLE VS DEPENDENT VARIABLE

DATASETS PLOTTED:

CCP013 CCP004 CCP023

DEPENDENT VARIABLE	DEPENDENT VARIABLE	PLOT PAGE BEGINNING / ENDING	
CL	CLM	222	222
CL	CD	223	223
CD	CLSQR	224	224

DATASETS PLOTTED:

BCP013 BCP004 BCP023

DEPENDENT VARIABLE	DEPENDENT VARIABLE	PLOT PAGE BEGINNING / ENDING	
CN	CLM	225	225

DEPENDENT VARIABLE VS INDEPENDENT VARIABLE

DATASETS PLOTTED:

XCP004 XCP023

DEPENDENT VARIABLE	INDEPENDENT VARIABLE	PLOT PAGE BEGINNING / ENDING	
DCY/DA	ALPHA	226	226
DCYNDA	ALPHA	227	227
DCBLDA	ALPHA	228	228

DATASETS PLOTTED:

CCP004 CCP003 CCP005

DEPENDENT VARIABLE	INDEPENDENT VARIABLE	PLOT PAGE BEGINNING / ENDING	
CLM	ALPHA	229	229
CL	ALPHA	230	230
CD	ALPHA	231	231
CDB	ALPHA	232	232
L/D	ALPHA	233	233

DATA PLOT INDEX

LATERAL CONTROL POWER BASIC CONFIGURATION

DATASETS PLOTTED:

CCP004 CCP003 CCP005

DEPENDENT VARIABLE	INDEPENDENT VARIABLE	PLOT PAGE BEGINNING / ENDING	
CY	ALPHA	234	234
CYN	ALPHA	235	235
CBL	ALPHA	236	236

DATASETS PLOTTED:

RCP004 RCP003 RCP005

DEPENDENT VARIABLE	INDEPENDENT VARIABLE	PLOT PAGE BEGINNING / ENDING	
CLN	ALPHA	237	237
CSL	ALPHA	238	238

DATASETS PLOTTED:

BCP004 BCP003 BCP005

DEPENDENT VARIABLE	INDEPENDENT VARIABLE	PLOT PAGE BEGINNING / ENDING	
CN	ALPHA	239	239
CA	ALPHA	240	240

DEPENDENT VARIABLE VS DEPENDENT VARIABLE

DATASETS PLOTTED:

CCP004 CCP003 CCP005

DEPENDENT VARIABLE	DEPENDENT VARIABLE	PLOT PAGE BEGINNING / ENDING	
CL	CLM	241	241
CL	CD	242	242
CD	CLSQR	243	243

DATASETS PLOTTED:

BCP004 BCP003 BCP005

DEPENDENT VARIABLE	DEPENDENT VARIABLE	PLOT PAGE BEGINNING / ENDING	
CN	CLM	244	244

DATA PLOT INDEX

LATERAL CONTROL POWER BASIC CONFIGURATION

DEPENDENT VARIABLE VS INDEPENDENT VARIABLE

DATASETS PLOTTED:

GCPO04 GCPO05

DEPENDENT VARIABLE	INDEPENDENT VARIABLE	PLOT PAGE BEGINNING / ENDING	
CYBETA	ALPHA	245	245
DCYNDB	ALPHA	246	246
DCBLDB	ALPHA	247	247

DATASETS PLOTTED:

HCP004 HCP005

DEPENDENT VARIABLE	INDEPENDENT VARIABLE	PLOT PAGE BEGINNING / ENDING	
DCLNDB	ALPHA	248	248
DCSLDB	ALPHA	249	249

DATASETS PLOTTED:

CCP012 CCP018 CCP020

DEPENDENT VARIABLE	INDEPENDENT VARIABLE	PLOT PAGE BEGINNING / ENDING	
CY	ALPHA	250	250
CYN	ALPHA	251	251
CBL	ALPHA	252	252
L/D	ALPHA	253	253
CDB	ALPHA	254	254

DATASETS PLOTTED:

XCPO18 XCPO20

DEPENDENT VARIABLE	INDEPENDENT VARIABLE	PLOT PAGE BEGINNING / ENDING	
DCY/DR	ALPHA	255	255
DCYNDR	ALPHA	256	256
DCBLDR	ALPHA	257	257

DATASETS PLOTTED:

CCP018 CCP017 CCP019

DEPENDENT VARIABLE	INDEPENDENT VARIABLE	PLOT PAGE BEGINNING / ENDING	
CY	ALPHA	258	258

DATA PLOT INDEX

DIRECTIONAL CONTROL POWER BASIC CONFIGURATION

DEPENDENT VARIABLE VS INDEPENDENT VARIABLE

DATASETS PLOTTED:

CCP018 CCP017 CCP019

DEPENDENT VARIABLE	INDEPENDENT VARIABLE	PLOT PAGE BEGINNING / ENDING	
CYN	ALPHA	259	259
CBL	ALPHA	260	260
L/D	ALPHA	261	261
CDB	ALPHA	262	262

DATASETS PLOTTED:

XCP018 XCP019

DEPENDENT VARIABLE	INDEPENDENT VARIABLE	PLOT PAGE BEGINNING / ENDING	
DCY/DR	ALPHA	263	263
DCYNDR	ALPHA	264	264
DCBLDR	ALPHA	265	265

DATASETS PLOTTED:

GCP019 GCP017

DEPENDENT VARIABLE	INDEPENDENT VARIABLE	PLOT PAGE BEGINNING / ENDING	
CYBETA	ALPHA	266	266
DCYNDB	ALPHA	267	267
DCBLDB	ALPHA	268	268

DATASETS PLOTTED:

HCP019 HCP017

DEPENDENT VARIABLE	INDEPENDENT VARIABLE	PLOT PAGE BEGINNING / ENDING	
DCLNDB	ALPHA	269	269
DCSLDB	ALPHA	270	270

DATASETS PLOTTED:

CCP012 CCP053 CCP058 CCP056

DEPENDENT VARIABLE	INDEPENDENT VARIABLE	PLOT PAGE BEGINNING / ENDING	
CLM	ALPHA	271	271

DATA PLOT INDEX

ENGINE POD AND LANDING GEAR EFFECTS ON LONGITUDINAL CHARACTERISTICS

DEPENDENT VARIABLE VS INDEPENDENT VARIABLE

DATASETS PLOTTED:

CCP012 CCP053 CCP058 CCP056

DEPENDENT VARIABLE	INDEPENDENT VARIABLE	PLOT PAGE BEGINNING / ENDING	
--------------------	----------------------	------------------------------	--

CL	ALPHA	272	272
CD	ALPHA	273	273
CDB	ALPHA	274	274
L/D	ALPHA	275	275

DATASETS PLOTTED:

BCP012 BCP053 BCP058 BCP056

DEPENDENT VARIABLE	INDEPENDENT VARIABLE	PLOT PAGE BEGINNING / ENDING	
--------------------	----------------------	------------------------------	--

CN	ALPHA	276	276
CA	ALPHA	277	277

DEPENDENT VARIABLE VS DEPENDENT VARIABLE

DATASETS PLOTTED:

CCP012 CCP053 CCP058 CCP056

DEPENDENT VARIABLE	DEPENDENT VARIABLE	PLOT PAGE BEGINNING / ENDING	
--------------------	--------------------	------------------------------	--

CL	CLM	278	278
CL	CD	279	279
CD	CLSQR	280	280

DATASETS PLOTTED:

BCP012 BCP053 BCP058 BCP056

DEPENDENT VARIABLE	DEPENDENT VARIABLE	PLOT PAGE BEGINNING / ENDING	
--------------------	--------------------	------------------------------	--

CN	CLM	281	281
----	-----	-----	-----

DATA PLOT INDEX

EFFECT OF SPEED BRAKE VERTICAL POSITION AND SIMULATED SLOT (BETA=0)

DEPENDENT VARIABLE VS INDEPENDENT VARIABLE

DATASETS PLOTTED:

CCP039 CCP040 CCP041

DEPENDENT VARIABLE	INDEPENDENT VARIABLE	PLOT PAGE BEGINNING / ENDING	
CLM	ALPHA	282	282
CL	ALPHA	283	283
CD	ALPHA	284	284
CDB	ALPHA	285	285
L/D	ALPHA	286	286

DATASETS PLOTTED:

BCP039 BCP040 BCP041

DEPENDENT VARIABLE	INDEPENDENT VARIABLE	PLOT PAGE BEGINNING / ENDING	
CN	ALPHA	287	287
CA	ALPHA	288	288

DEPENDENT VARIABLE VS DEPENDENT VARIABLE

DATASETS PLOTTED:

CCP039 CCP040 CCP041

DEPENDENT VARIABLE	DEPENDENT VARIABLE	PLOT PAGE BEGINNING / ENDING	
CL	CLM	289	289
CL	CD	290	290
CD	CLSQR	291	291

DATASETS PLOTTED:

BCP039 BCP040 BCP041

DEPENDENT VARIABLE	DEPENDENT VARIABLE	PLOT PAGE BEGINNING / ENDING	
CN	CLM	292	292

DATA PLOT INDEX

SPEEDBRAKE EFFECTIVENESS BODY FLAP DEFLECTION= 0 DEGREES (BETA=0)

DEPENDENT VARIABLE VS INDEPENDENT VARIABLE

DATASETS PLOTTED:

CCP012 CCP044 CCP045

DEPENDENT VARIABLE	INDEPENDENT VARIABLE	PLOT PAGE BEGINNING / ENDING	
CLM	ALPHA	293	293
CL	ALPHA	294	294
CD	ALPHA	295	295
CDB	ALPHA	296	296
L/D	ALPHA	297	297

DATASETS PLOTTED:

BCP012 BCP044 BCP045

DEPENDENT VARIABLE	INDEPENDENT VARIABLE	PLOT PAGE BEGINNING / ENDING	
CN	ALPHA	298	298
CA	ALPHA	299	299

DEPENDENT VARIABLE VS DEPENDENT VARIABLE

DATASETS PLOTTED:

CCP012 CCP044 CCP045

DEPENDENT VARIABLE	DEPENDENT VARIABLE	PLOT PAGE BEGINNING / ENDING	
CL	CLM	300	300
CL	CD	301	301
CD	CLSQR	302	302

DATASETS PLOTTED:

BCP012 BCP044 BCP045

DEPENDENT VARIABLE	DEPENDENT VARIABLE	PLOT PAGE BEGINNING / ENDING	
CN	CLM	303	303



DATA PLOT INDEX

SPEEDBRAKE EFFECTIVENESS BODY FLAP DEFLECTION= 15 DEGREES (BETA=0)

DEPENDENT VARIABLE VS INDEPENDENT VARIABLE

DATASETS PLOTTED:

CCP049 CCP039

DEPENDENT VARIABLE	INDEPENDENT VARIABLE	PLOT PAGE BEGINNING / ENDING	
CLM	ALPHA	304	304
CL	ALPHA	305	305
CD	ALPHA	306	306
CDB	ALPHA	307	307
L/D	ALPHA	308	308

DATASETS PLOTTED:

BCP049 BCP039

DEPENDENT VARIABLE	INDEPENDENT VARIABLE	PLOT PAGE BEGINNING / ENDING	
CN	ALPHA	309	309
CA	ALPHA	310	310

DEPENDENT VARIABLE VS DEPENDENT VARIABLE

DATASETS PLOTTED:

CCP049 CCP039

DEPENDENT VARIABLE	DEPENDENT VARIABLE	PLOT PAGE BEGINNING / ENDING	
CL	CLM	311	311
CL	CD	312	312
CD	CLSQR	313	313

DATASETS PLOTTED:

BCP049 BCP039

DEPENDENT VARIABLE	DEPENDENT VARIABLE	PLOT PAGE BEGINNING / ENDING	
CN	CLM	314	314

DATA PLOT INDEX

SPEEDBRAKE EFFECTIVENESS=BODY FLAP DEFLECTION=30 DEGREES (BETA=0)

DEPENDENT VARIABLE VS INDEPENDENT VARIABLE

DATASETS PLOTTED:

CCP048 CCP046

DEPENDENT VARIABLE	INDEPENDENT VARIABLE	PLOT PAGE BEGINNING / ENDING	
CLM	ALPHA	315	315
CL	ALPHA	316	316
CD	ALPHA	317	317
CDB	ALPHA	318	318
L/D	ALPHA	319	319

DATASETS PLOTTED:

BCP048 BCP046

DEPENDENT VARIABLE	INDEPENDENT VARIABLE	PLOT PAGE BEGINNING / ENDING	
CN	ALPHA	320	320
CA	ALPHA	321	321

DEPENDENT VARIABLE VS DEPENDENT VARIABLE

DATASETS PLOTTED:

CCP048 CCP046

DEPENDENT VARIABLE	DEPENDENT VARIABLE	PLOT PAGE BEGINNING / ENDING	
CL	CLM	322	322
CL	CD	323	323
CD	CLSQR	324	324

DATASETS PLOTTED:

BCP048 BCP046

DEPENDENT VARIABLE	DEPENDENT VARIABLE	PLOT PAGE BEGINNING / ENDING	
CN	CLM	325	325

DATA PLOT INDEX

LONGITUDINAL CONTROL POWER SPEED BRAKES EXTENDED

DEPENDENT VARIABLE VS INDEPENDENT VARIABLE

DATASETS PLOTTED:

CCP039 CCP042

DEPENDENT VARIABLE	INDEPENDENT VARIABLE	PLOT PAGE BEGINNING / ENDING	
CY	ALPHA	326	326
CYN	ALPHA	327	327
CBL	ALPHA	328	328
L/D	ALPHA	329	329
CDB	ALPHA	330	330

DEPENDENT VARIABLE VS INDEPENDENT VARIABLE, (FSALFA)

DATASETS PLOTTED	DEPENDENT VARIABLE	INDEPENDENT VARIABLE	PLOT PAGE BEGINNING / ENDING	
DCP042	CYBETA	ALPHA	331	331
DCP042	DCYNDB	ALPHA	332	332
DCP042	DCBLDB	ALPHA	333	333
ECP042	DCLNDB	ALPHA	334	334
ECP042	DCSLDB	ALPHA	335	335

PLOTTED DATA

# DATA REPEATABILITY

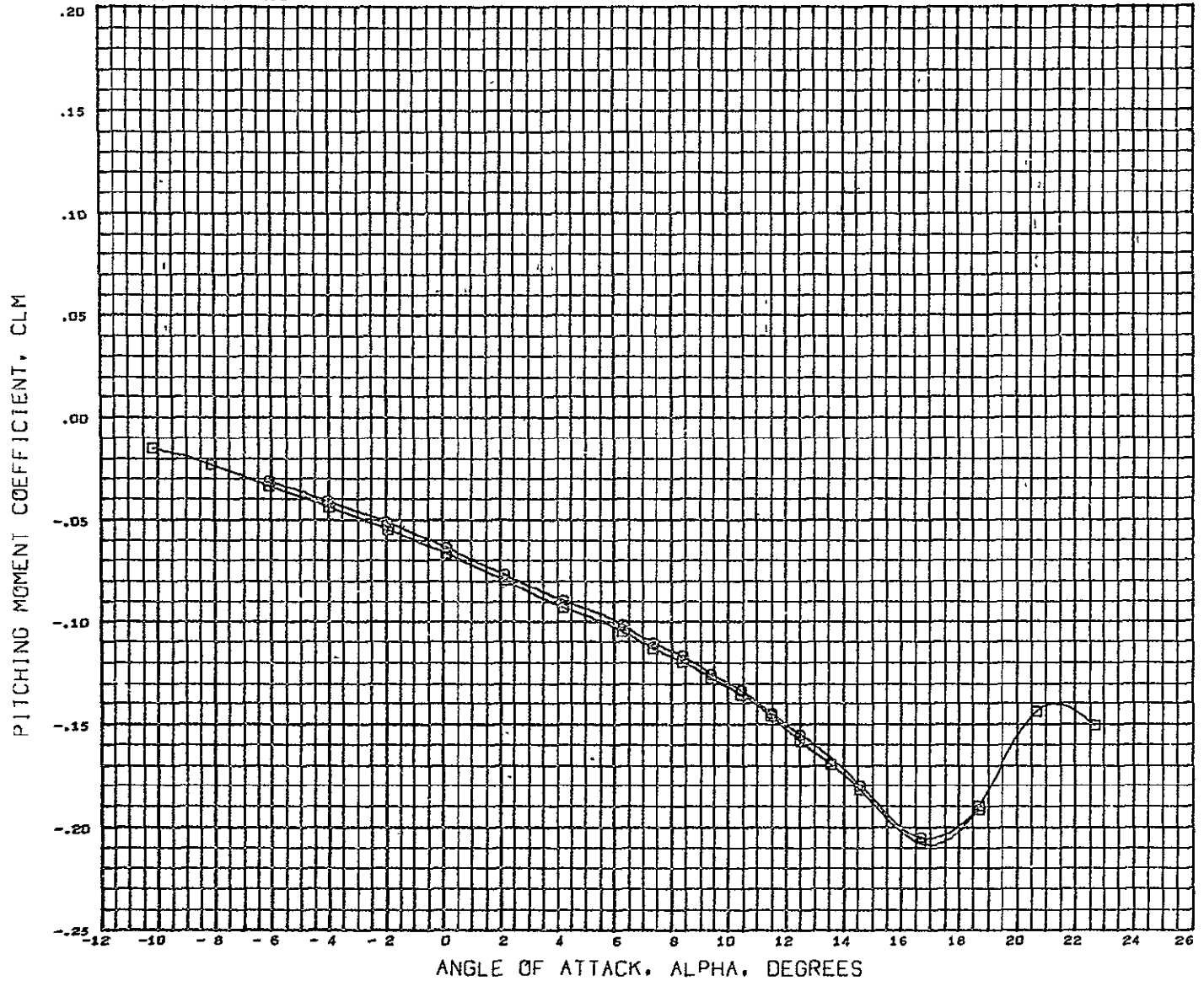

DATA SET SYMBOL    CONFIGURATION DESCRIPTION

(CCP002)    ○    LSWT 248 MDAC 4.0 FC 02 HCR ORB

(CCP010)    □    LSWT 248 MDAC 4.0 FC 02 HCR ORB

B5W11V6            BETA    ELEVTR    AILRON

0.000    0.000    0.000

0.000    0.000    0.000

REFERENCE INFORMATION

REFS            6.8690    SQ.FT

REFL            29.5700    IN.

REFB            51.6000    IN.

YMRP            59.3200    IN.

ZMRP            0.0000    IN.

SCALE            11.6000    IN.

SCALE            4.0000    PERCENT

MACH            0.250

# DATA REPEATABILITY

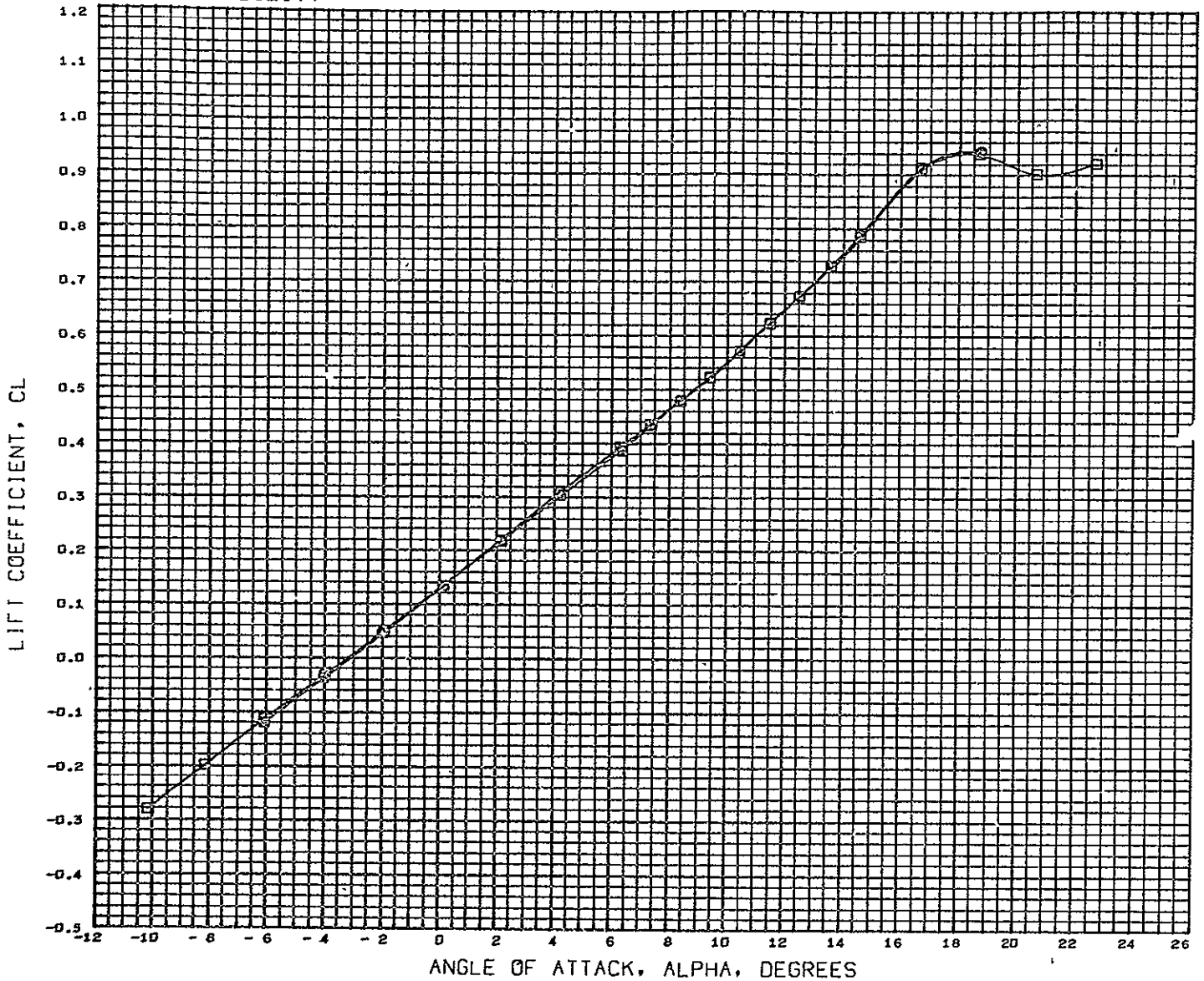

DATA SET SYMBOL	CONFIGURATION DESCRIPTION	BETA	ELEVTR	AILRON
(CCFD02)	LSWT 248 HDAC 4.0 FC 02 HCR ORB	0.000	0.000	0.000
(CCFD10)	LSWT 248 HDAC 4.0 FC 02 HCR ORB	0.000	0.000	0.000

REFERENCE INFORMATION	
REFS	8 8690 SQ.FT
REFL	29.5700 IN.
REFB	51.6000 IN.
XMRP	59 3200 IN
YMRP	0.0000 IN.
ZMRP	11 6000 IN.
SCALE	4.0000 PERCNT

MACH 0.250

# DATA REPEATABILITY

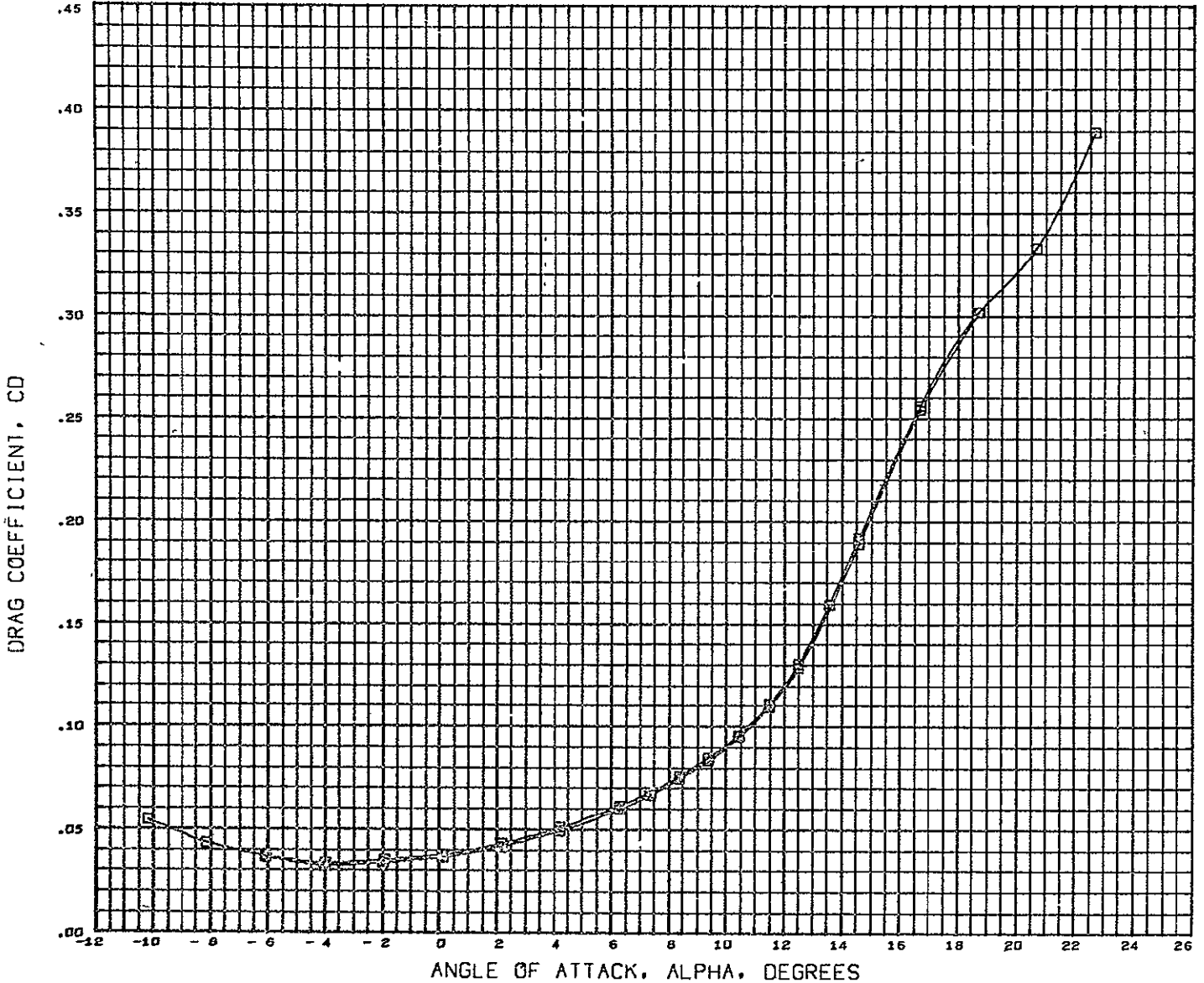

DATA SET SYMBOL	CONFIGURATION DESCRIPTION	BETA	ELEVTR	AILRON	REFERENCE INFORMATION	
(CCF002)	LSWT 248 HDAC 4.0 FC 02 HCR ORB	0.000	0.000	0.000	REFS	8.8690 SQ.FT
(CCP010)	LSWT 248 HDAC 4.0 FC 02 HCR ORB	0.000	0.000	0.000	REFL	29.5700 IN.
					REFB	51.6000 IN.
					XMRP	59.3200 IN.
					YMRP	0.0000 IN.
					ZMRP	11.6000 IN.
					SCALE	4.0000 PERCNT

MACH 0.250

# DATA REPEATABILITY

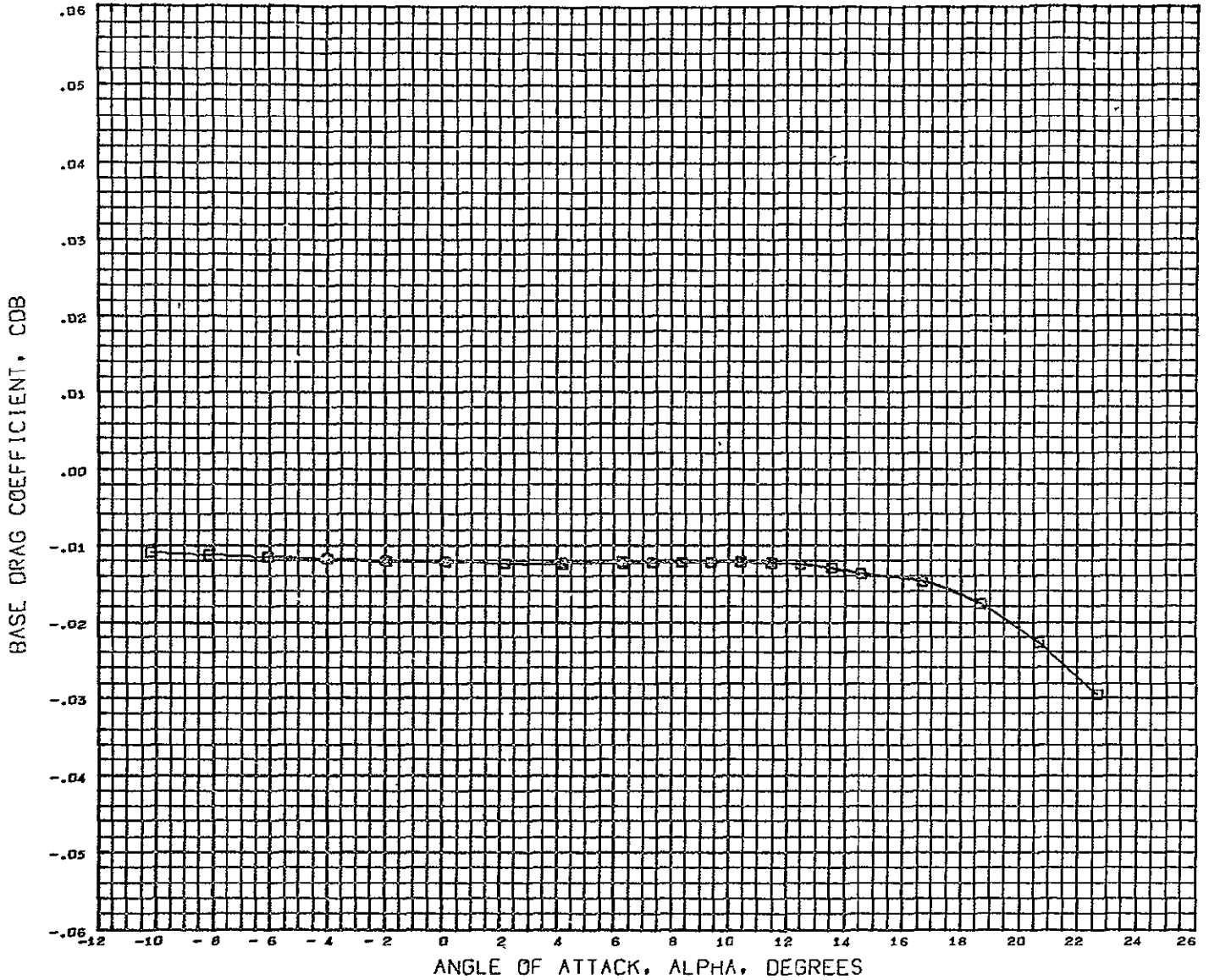

DATA SET SYMBOL	CONFIGURATION DESCRIPTION	BETA	ELEVTR	AILRON	REFERENCE INFORMATION
(CCF002)	LSWT 248 HDAC 4.0 FC 02 HCR ORB	0.000	0.000	0.000	REFS 8.8690 SQ.FT.
(CCF010)	LSWT 248 HDAC 4.0 FC 02 HCR ORB	0.000	0.000	0.000	REFL 29.5700 IN.
					REFB 51.6000 IN.
					XMRP 59.3200 IN.
					YMRP 0.0000 IN.
					ZMRP 11.6000 IN.
					SCALE 4.0000 PERCNT

MACH 0.250



# DATA REPEATABILITY

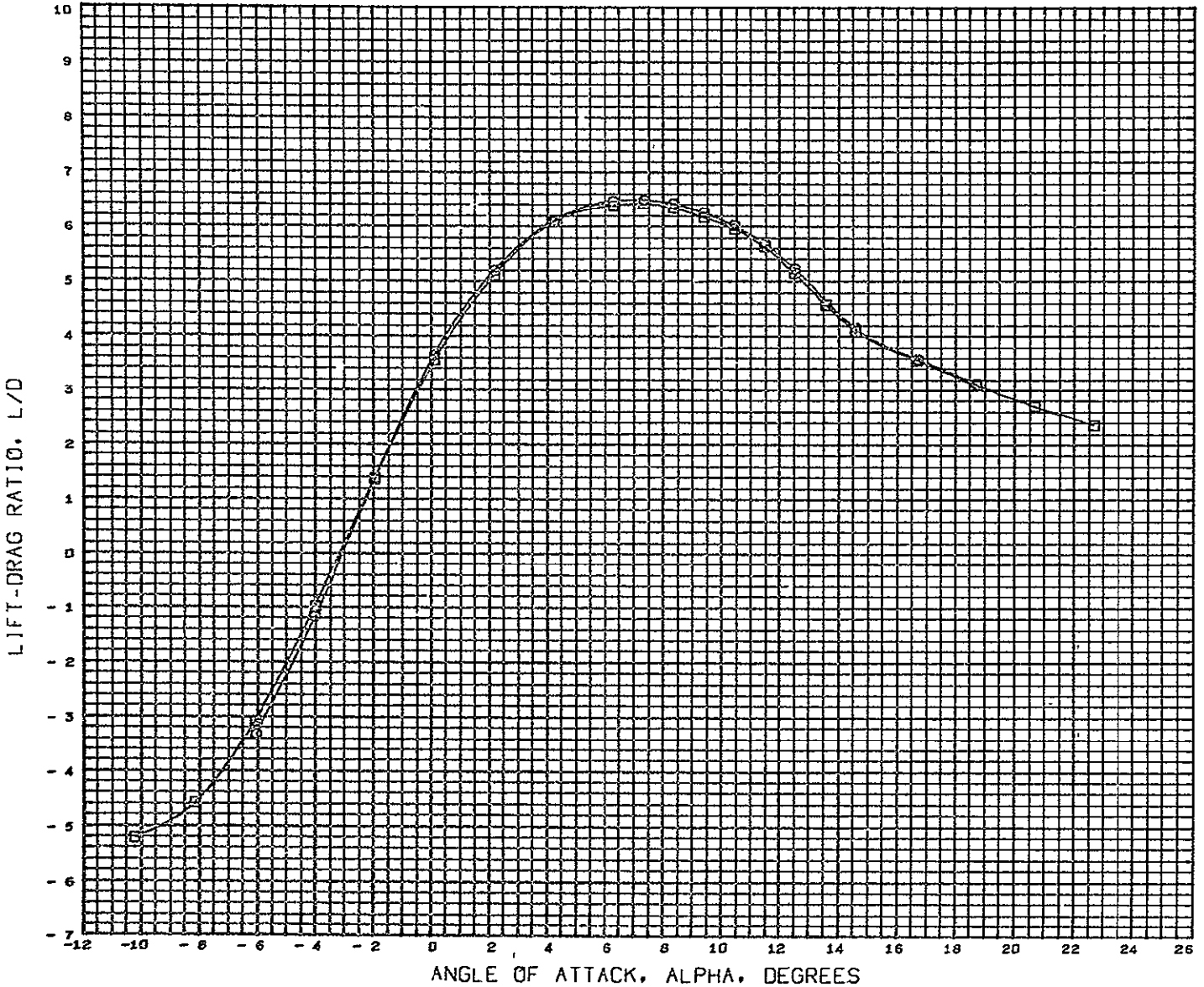

DATA SET SYMBOL	CONFIGURATION DESCRIPTION	BETA	ELEVTR	AILRON	REFERENCE INFORMATION
(CCPB02)	LSWT 248 HDAC 4.0 PC O2 HCR ORB	0.000	0.000	0.000	REFS 8.8690 SQ.FT
(CCPB10)	LSWT 248 HDAC 4.0 PC O2 HCR ORB	0.000	0.000	0.000	REFL 29.5700 IN.
					REFB 51.6000 IN
					XMRP 59.3200 IN
					YMRP 0.0000 IN
					ZMRP 11.6000 IN.
					SCALE 4.0000 PERCENT

MACH 0.250

# DATA REPEATABILITY

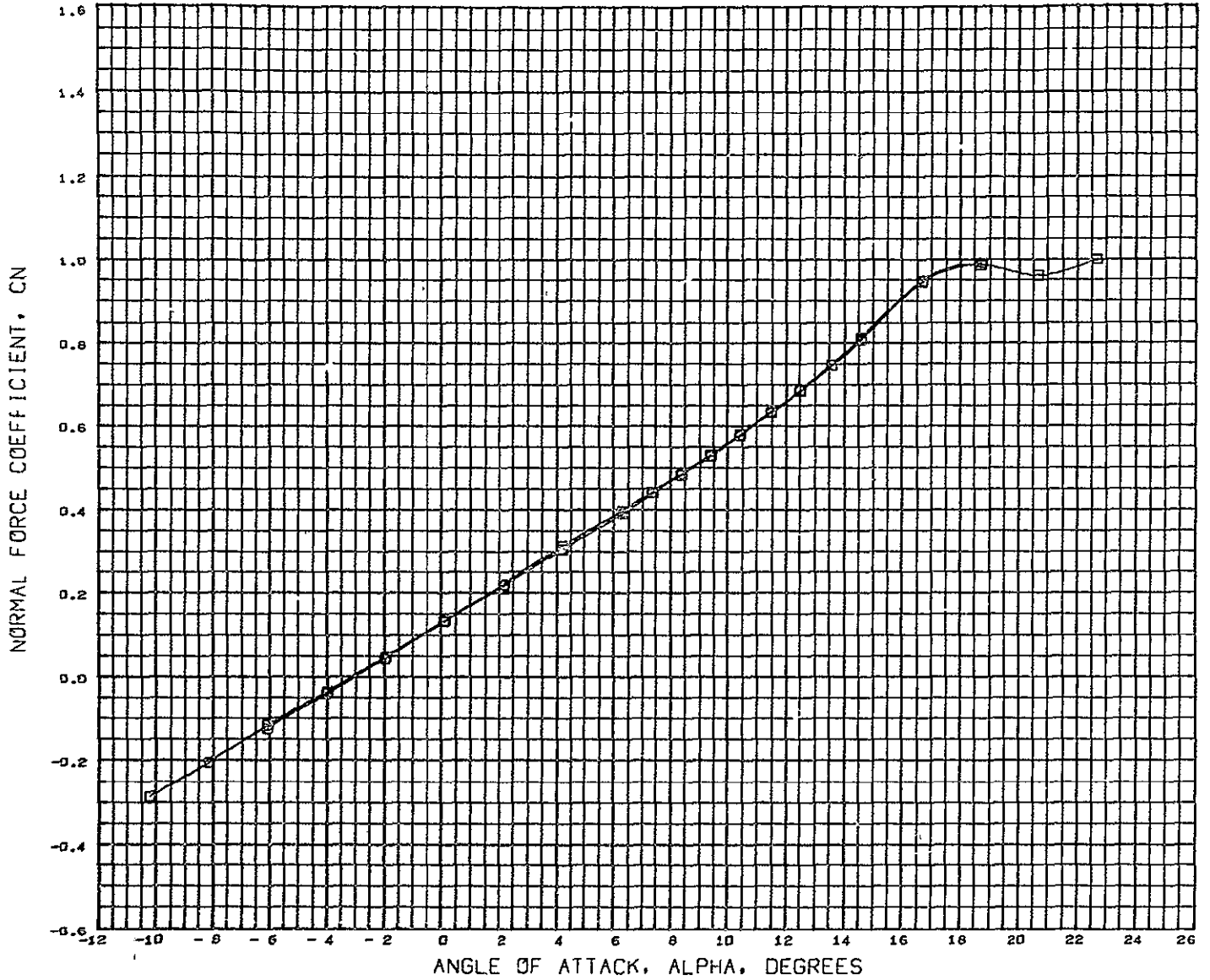

DATA SET SYMBOL	CONFIGURATION DESCRIPTION	BETA	ELEVTR	AILRON
(BCP002)	LSWT 248 ACAC 4.0 PC 02 HCR ORB	0.000	0.000	0.000
(BCP010)	LSWT 248 NDAC 4.0 PC 02 HCR ORB	0.000	0.000	0.000

REFERENCE INFORMATION	
REFS	8.8690 SQ FT.
REFL	29.5700 IN.
REFB	51.6000 IN.
XMRP	59.3200 IN.
YMRP	0.0000 IN.
ZMRP	11.6000 IN.
SCALE	4.0000 PERCENT

HACH 0.250

# DATA REPEATABILITY

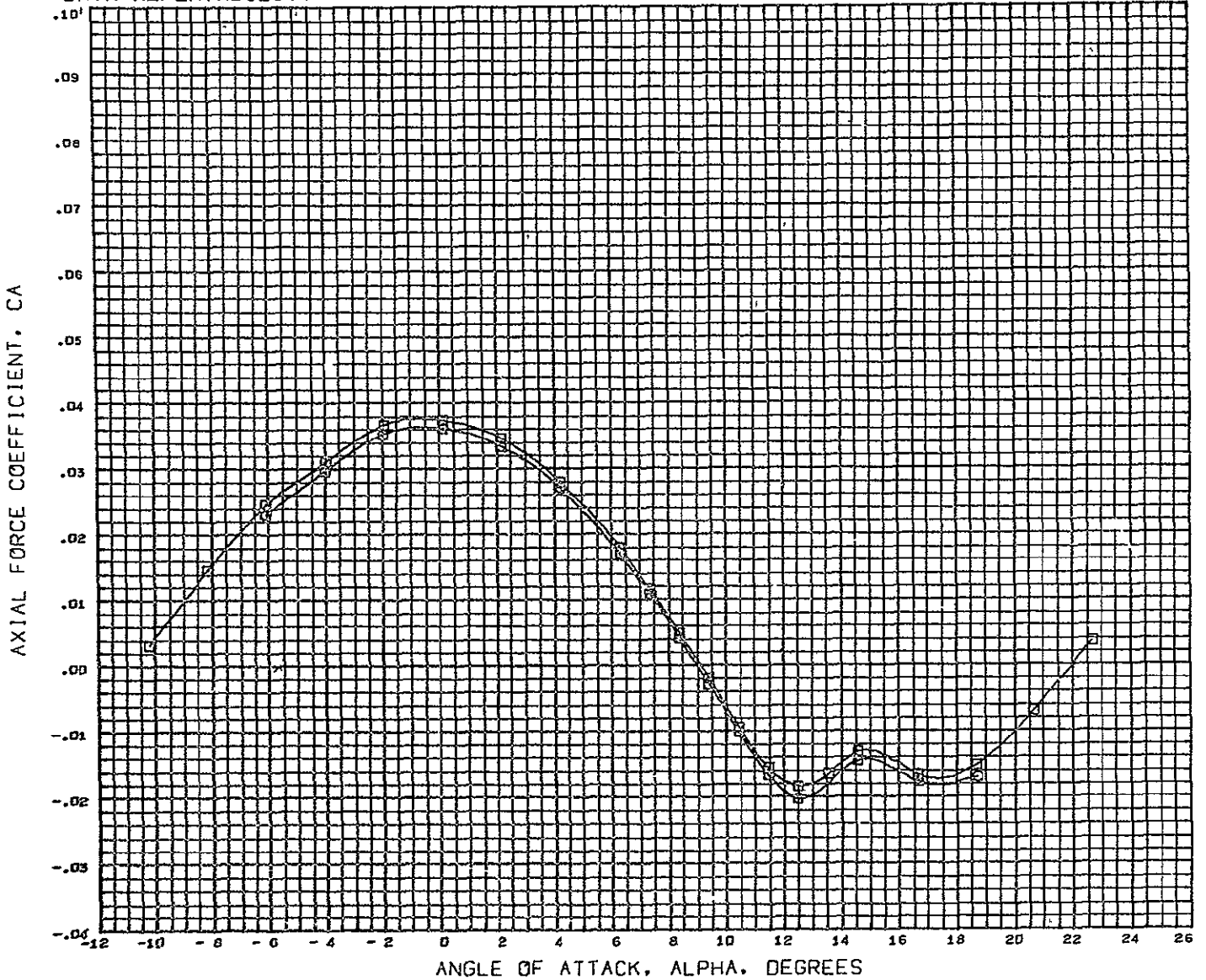

DATA SET SYMBOL	CONFIGURATION DESCRIPTION	BETA	ELEVTR	AILRON
(BCF002)	LSWT 248 MDAC 4.0 PC O2 HCR ORB	0.000	0.000	0.000
(BCF010)	LSWT 248 MDAC 4.0 PC O2 HCR ORB	0.000	0.000	0.000

REFERENCE INFORMATION		
REFS	8.8690	SQ.FT.
REFL	29.5700	IN.
REFB	51.6000	IN.
XMRP	59.3200	IN.
YMRP	0.0000	IN.
ZMRP	11.6000	IN.
SCALE	4.0000	PERCENT

HACH 0.250

# DATA REPEATABILITY

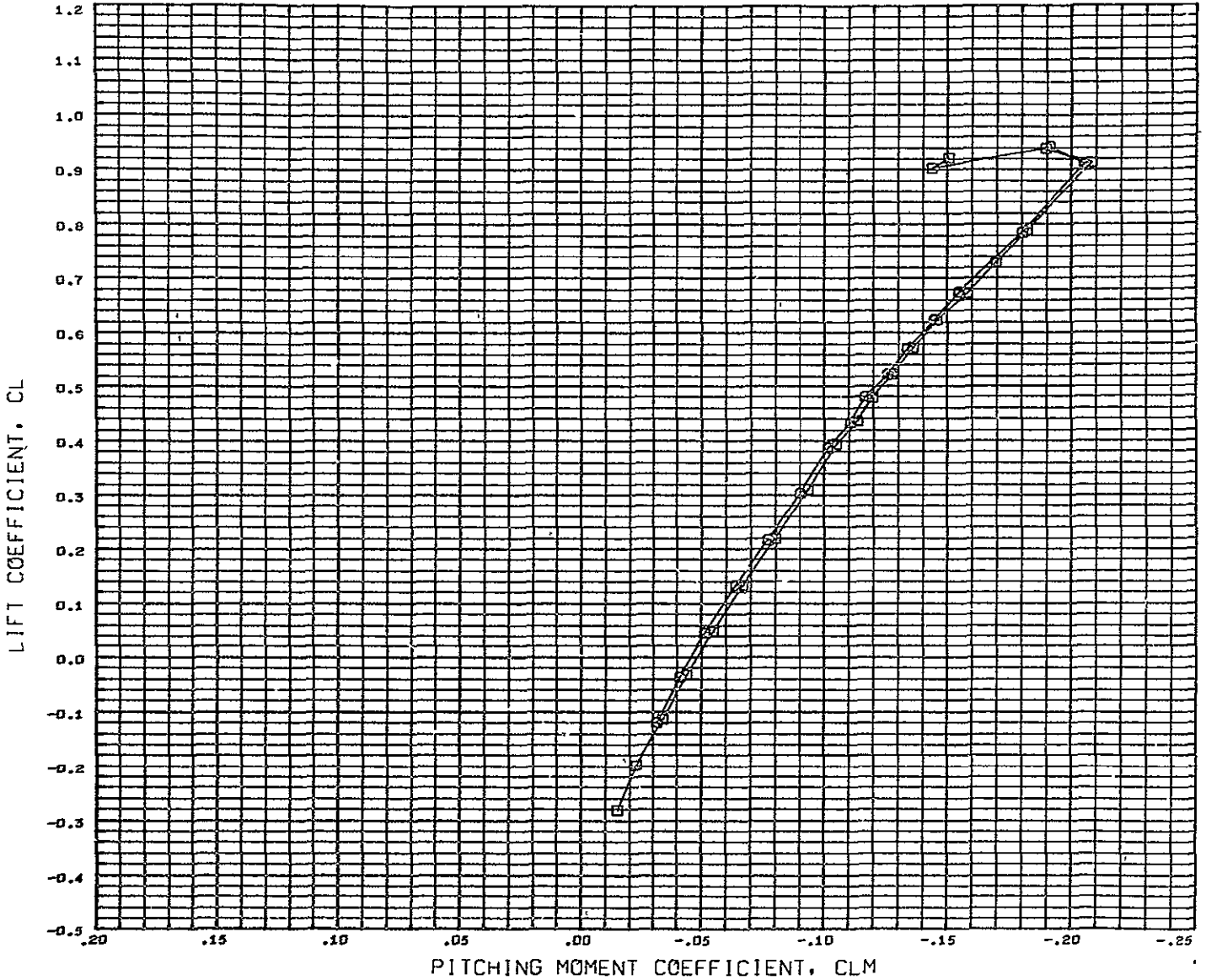

DATA SET SYMBOL	CONFIGURATION DESCRIPTION	BETA	ELEVTR	AILRON	REFERENCE INFORMATION	
(CCFD02)	LSWT 248 MDAC 4.0 FC 02 HCR ORB 85W11V6	0.000	0.000	0.000	REFS	8.8690 SQ.FT.
(CCFD10)	LSWT 248 MDAC 4.0 FC 02 HCR ORB 85W11V6	0.000	0.000	0.000	REFL	29.5700 IN
					REFB	51.6000 IN
					XMRP	59.3200 IN
					YMRP	0.0000 IN.
					ZMRP	11.6000 IN.
					SCALE	4.0000 PERCNT

MACH 0.250

# DATA REPEATABILITY

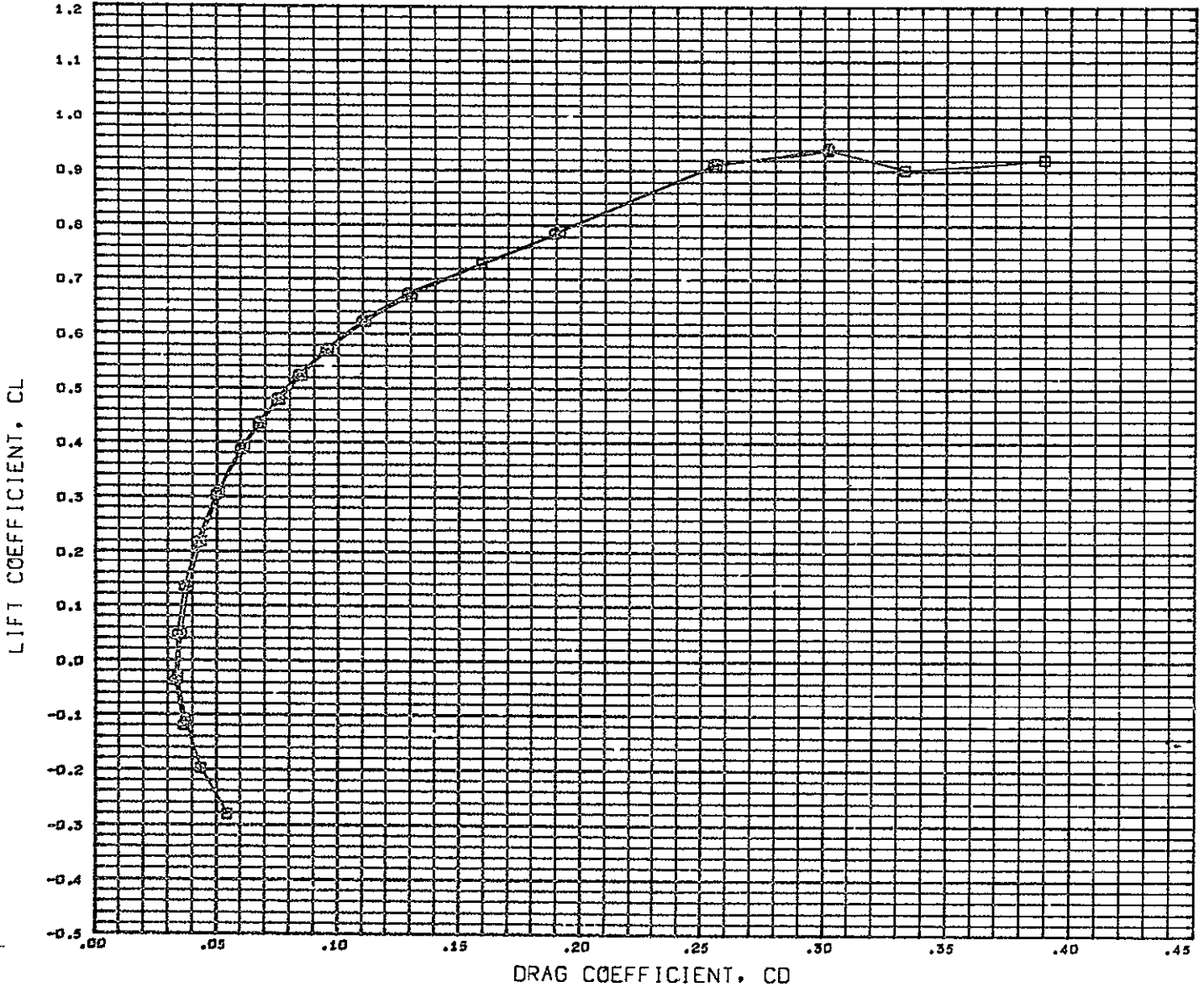

DATA SET SYMBOL	CONFIGURATION DESCRIPTION	BETA	ELEVTR	AILRON
(CCP002)	LSWT 248 HDAC 4.0 PC 02 HCR ORB	0.000	0.000	0.000
(CCP010)	LSWT 248 HDAC 4.0 PC 07 HCR ORB	0.000	0.000	0.000

REFERENCE INFORMATION		
REFS	8.8690	SQ FT.
REFL	29.5700	IN.
REFB	51.6000	IN.
XMRP	59.3200	IN.
YMRP	0.0000	IN.
ZMRP	11.6000	IN.
SCALE	4.0000	PERCENT

HACH 0.250

# DATA REPEATABILITY

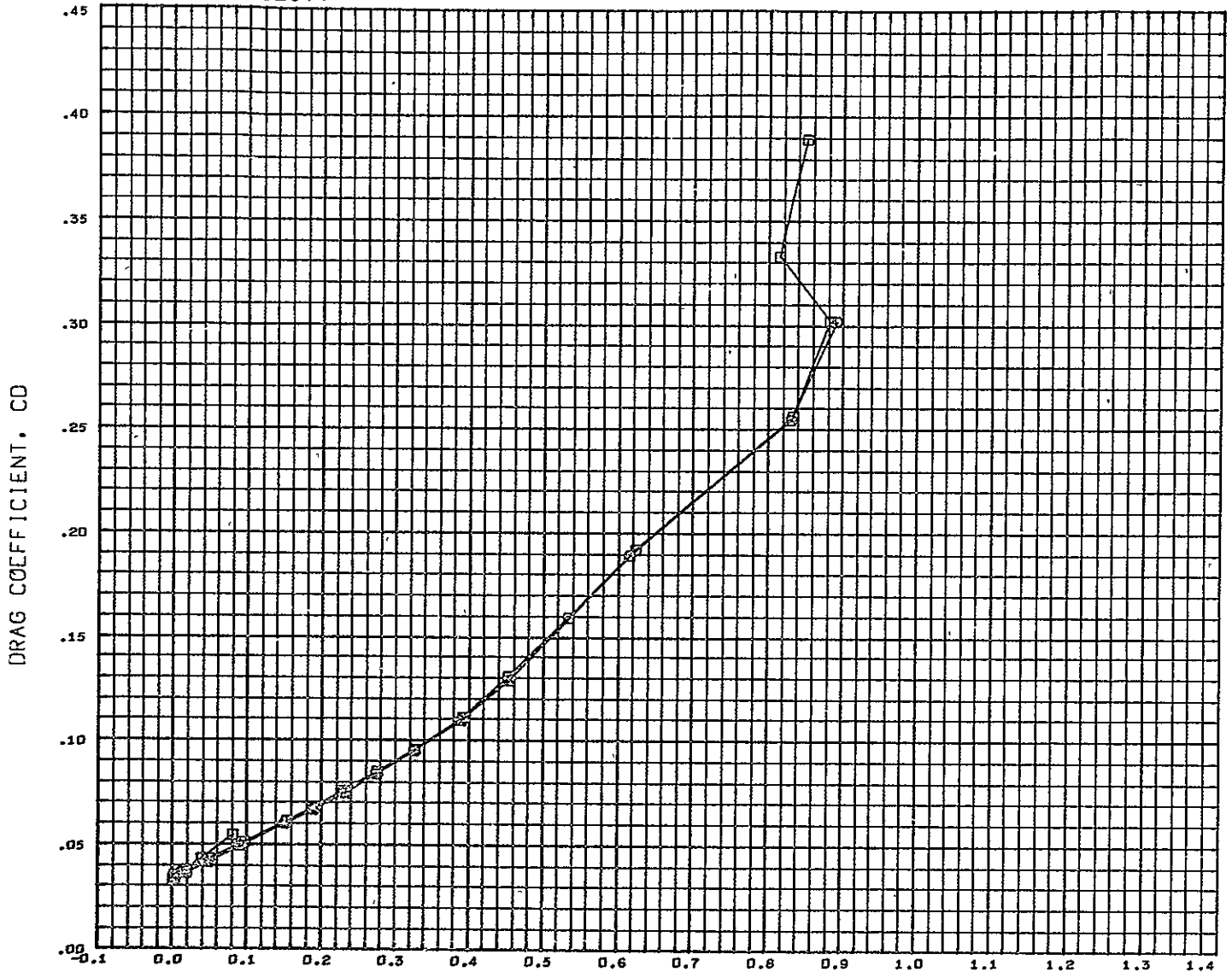

LIFT COEFFICIENT SQUARED, CLSQ

DATA SET SYMBOL	CONFIGURATION DESCRIPTION	BETA	ELEVTR	AILRON	REFERENCE INFORMATION
(CCFD02)	LSWT 248 MDAC 4.0 PC O2 HCR ORB	0.000	0.000	0.000	REFS 8.8690 SQ.FT
(CCFD10)	LSWT 248 MDAC 4.0 PC O2 HCR ORB	0.000	0.000	0.000	REFL 29.5700 IN
					REFB 51.6000 IN
					XMRP 59.3200 IN
					YMRP 0.0000 IN
					ZMRP 11.6000 IN
					SCALE 4.0000 PERCENT

HACH 0.250

# DATA REPEATABILITY

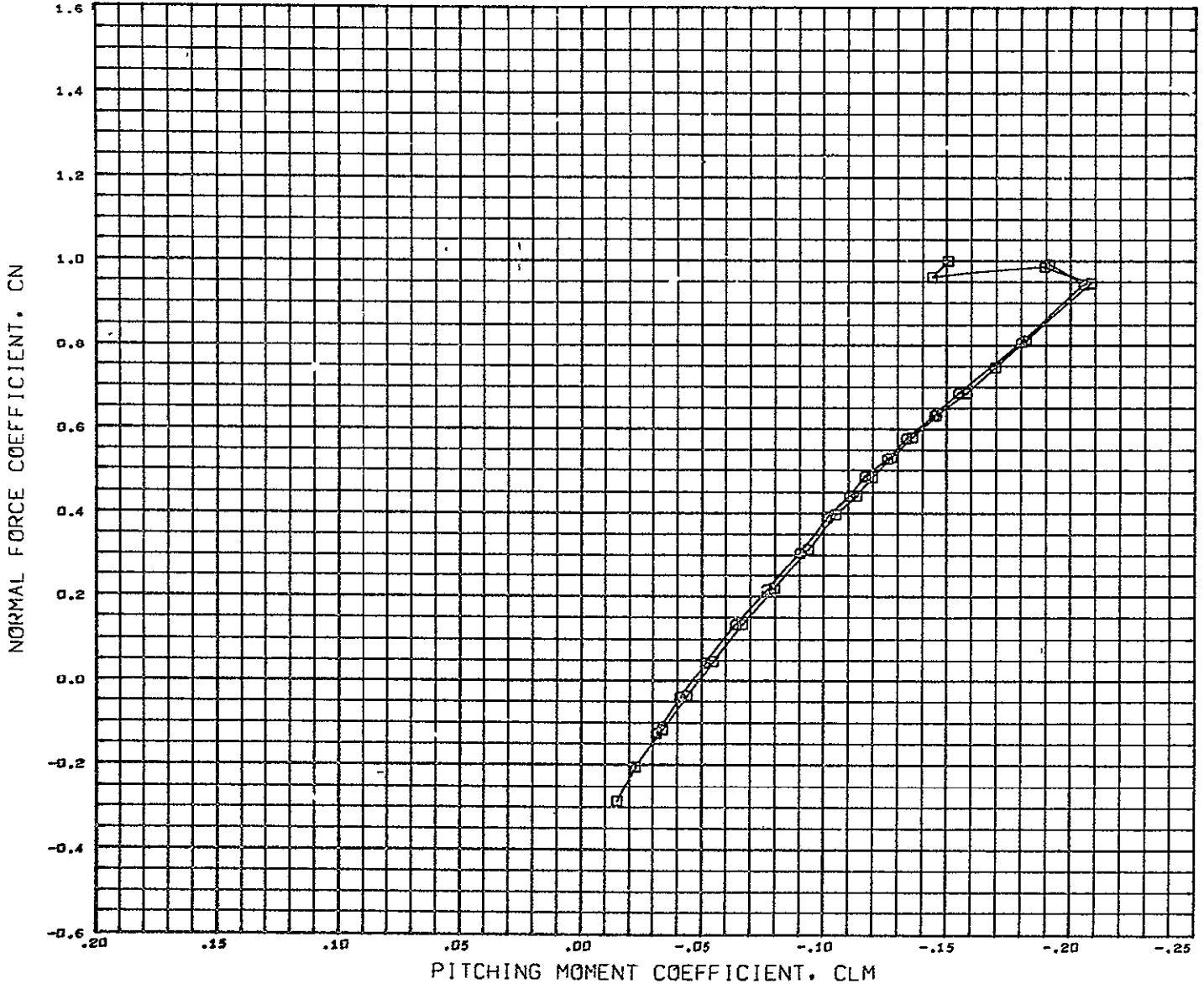

DATA SET SYMBOL    CONFIGURATION DESCRIPTION  
 (BCPD02)    □    LSWT 248 MDAC 4.0 PC O2 HCR ORB  
 (BCPD10)    □    LSWT 248 MDAC 4.0 PC O2 HCR ORB

B5W11V6  
 B5W11V6

BETA    ELEVTR    AILRON  
 0.000    0.000    0.000  
 0.000    0.000    0.000

REFERENCE INFORMATION  
 REFS    8.8690    SQ FT.  
 REFL    29.5700    IN.  
 REFB    51.6000    IN.  
 XMRP    59.3200    IN.  
 YMRP    0.0000    IN.  
 ZMRP    11.6000    IN.  
 SCALE    4.0000    PERCNT

MACH    0.250

COMPONENT BUILD-UP BASIC CONFIGURATION

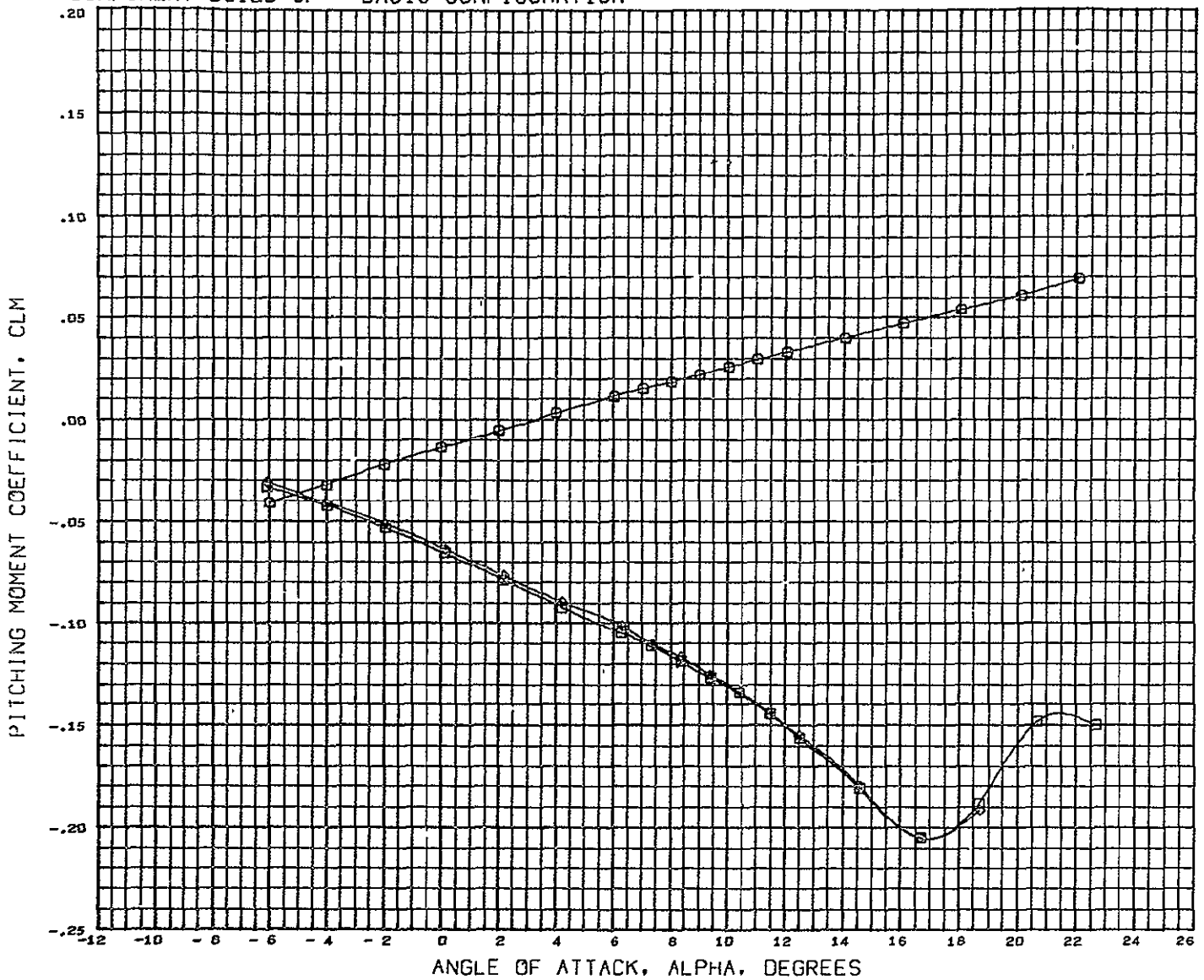

DATA SET SYMBOL	CONFIGURATION DESCRIPTION	BETA	ELEVTR	AILRON	REFERENCE INFORMATION
(CCPD28)	LSWT 248 MDAC 4.0 FC O2 HCR ORB B5	0.000			REFS 8.8690 SQ.FT.
(CCPD25)	LSWT 248 MDAC 4.0 FC O2 HCR ORB B5W11	0.000	0.000	0.000	REFL 29.5700 IN.
(CCPD02)	LSWT 248 MDAC 4.0 FC O2 HCR ORB B5W11V6	0.000	0.000	0.000	REFB 51.6000 IN.
					XMRP 59.3200 IN.
					YMRP 0.0000 IN.
					ZMRP 11.6000 IN.
					SCALE 4.0000 PERCENT

MACH 0.250



COMPONENT BUILD-UP BASIC CONFIGURATION

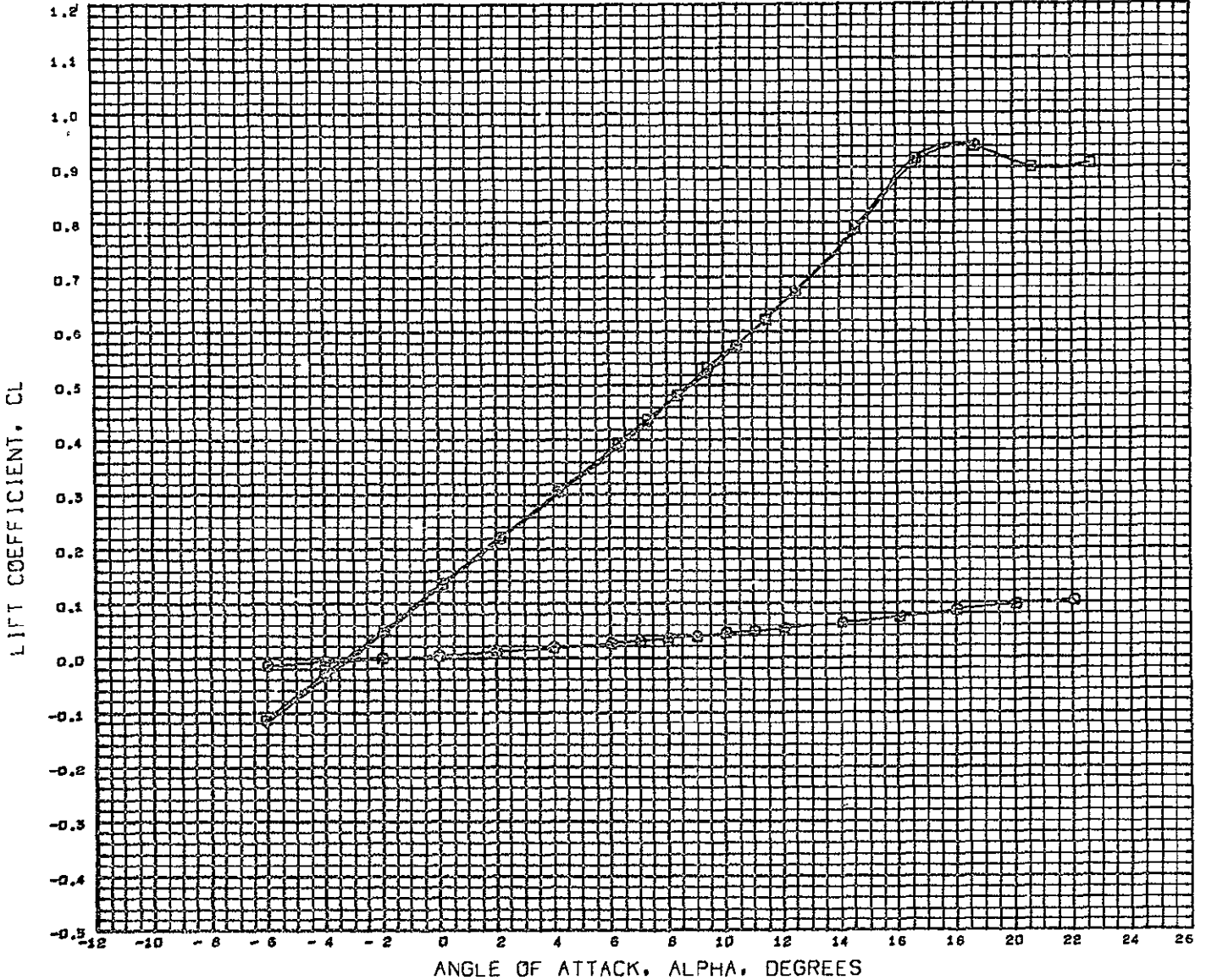

DATA SET SYMBOL	CONFIGURATION DESCRIPTION	BETA	ELEVTR	AILRON	REFERENCE INFORMATION
(CCP020)	LSWT 248 MDAC 4.0 FC 02 HCR ORB	0.000			REFS 8.8690 SQ.FT.
(CCP025)	LSWT 248 MDAC 4.0 FC 02 HCR ORB	0.000	0.000	0.000	REFL 29.5700 IN.
(CCP002)	LSWT 248 MDAC 4.0 FC 02 HCR ORB	0.000	0.000	0.000	REFB 51.6000 IN.
					YHRP 59.3200 IN.
					YHRP 0.0000 IN.
					ZHRP 11.6000 IN.
					SCALE 4.0000 PERCENT

MACH 0.250

# COMPONENT BUILD-UP BASIC CONFIGURATION

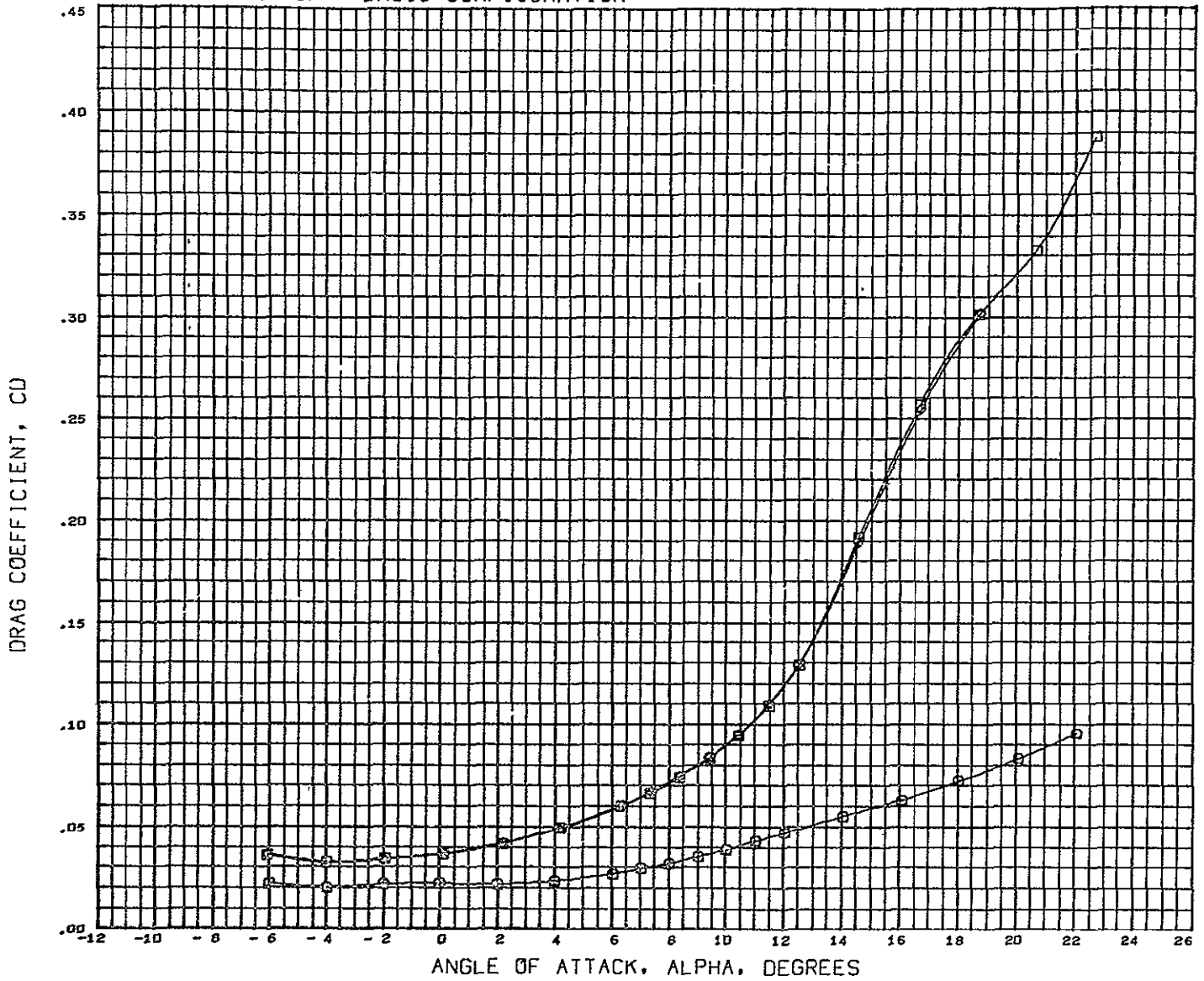

DATA SET	SYMBOL	CONFIGURATION DESCRIPTION	BETA	ELEVTR	AILRON	REFERENCE INFORMATION
(CCF020)	□	LSWT 248 NDAC 4.0 FC O2 HCR ORB	0.000			REFS 8.8690 SQ.FT
(CCF025)	○	LSWT 248 NDAC 4.0 FC O2 HCR ORB	0.000	0.000	0.000	REFL 29.5700 IN.
(CCF022)	△	LSWT 248 NDAC 4.0 FC O2 HCR ORB	0.000	0.000	0.000	REFB 51.6000 IN.
						XMRP 59.3200 IN.
						YMRP 0.0000 IN.
						ZMRP 11.6000 IN.
						SCALE 4.0000 PERCNT

MACH 0.250

COMPONENT BUILD-UP BASIC CONFIGURATION

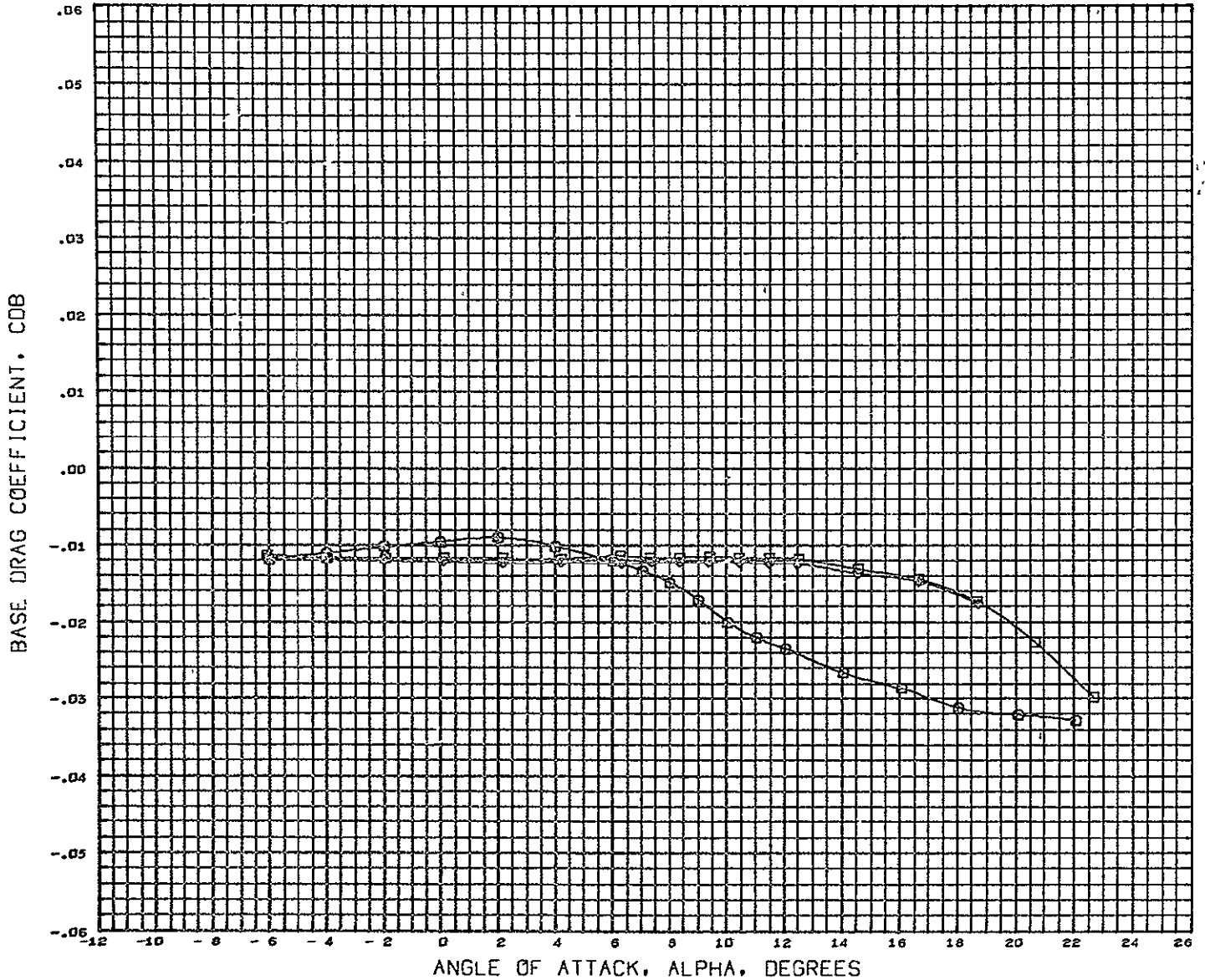

DATA SET SYMBOL	CONFIGURATION DESCRIPTION	BETA	ELEVTR	AILRON	REFERENCE INFORMATION
(CCPD28)	LSWT 248 MDAC 4.0 PC O2 HCR ORB 85	0.000			REFS 8.8690 SQ.FT
(CCPD25)	LSWT 248 MDAC 4.0 PC O2 HCR ORB 85W11	0.000	0.000	0.000	REFL 29.5700 IN.
(CCPD02)	LSWT 248 MDAC 4.0 PC O2 HCR ORB 85W11V6	0.000	0.000	0.000	REFB 51.6000 IN.
					XMRP 59.3200 IN.
					YMRP 0.0000 IN.
					ZMRP 11.6000 IN.
					SCALE 4.0000 PERCNT

MACH 0.250

COMPONENT BUILD-UP BASIC CONFIGURATION

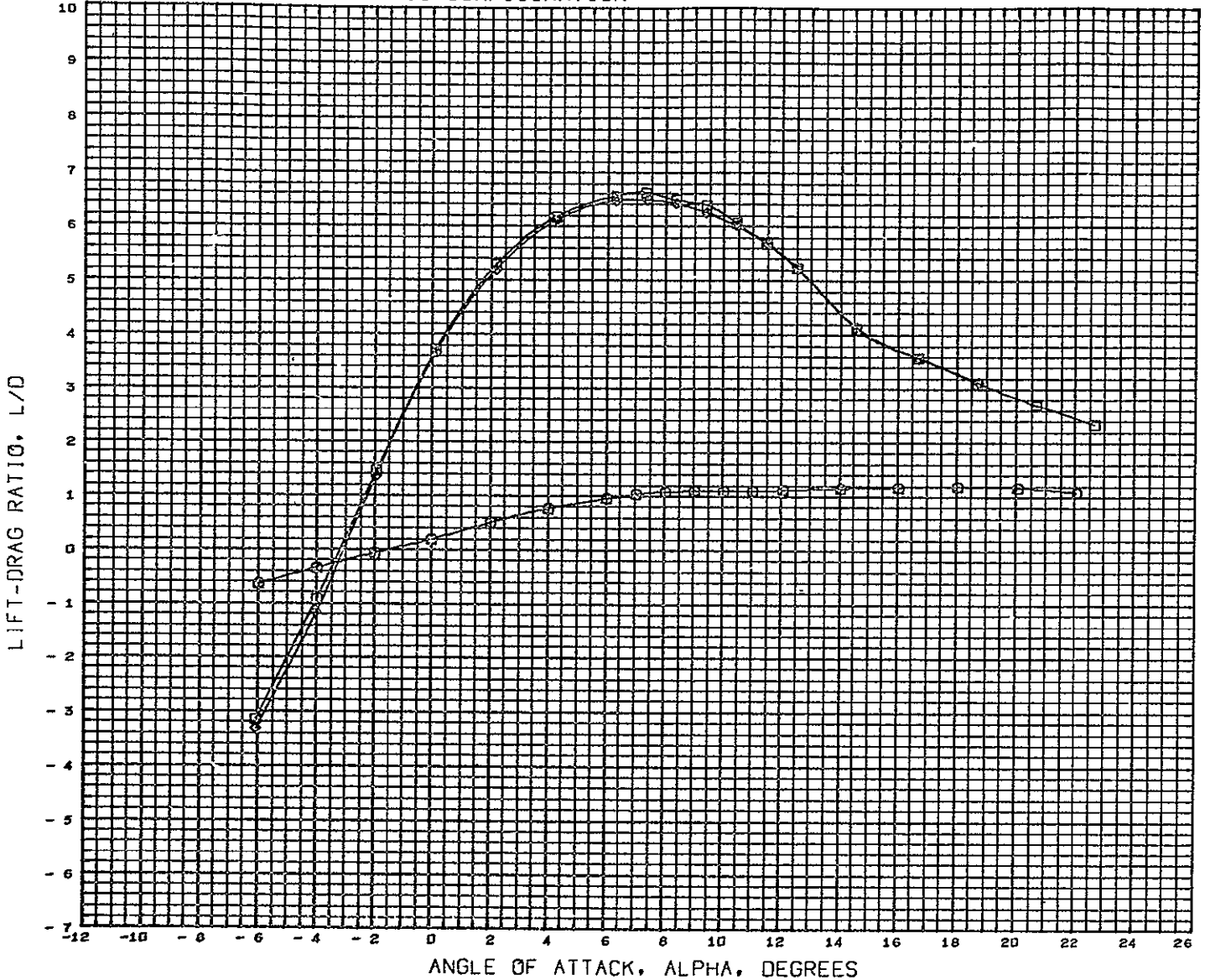

DATA SET SYMBOL	CONFIGURATION DESCRIPTION	BETA	ELEVTR	AILRON	REFERENCE INFORMATION
(CCP028)	LSWT 248 HDAC 4.0 FC 02 HCR ORB B5	0.000			REFS 8.8690 SQ.FT.
(CCP025)	LSWT 248 HDAC 4.0 FC 02 HCR ORB B5W11	0.000	0.000	0.000	REFL 29.5700 IN.
(CCP002)	LSWT 248 HDAC 4.0 FC 02 HCR ORB B5W11V6	0.000	0.000	0.000	REFB 51.6000 IN.
					XMRP 59.3200 IN.
					YMRP 0.0000 IN.
					ZMRP 11.6000 IN.
					SCALE 4.0000 PERCNT

MACH 0.250

# COMPONENT BUILD-UP BASIC CONFIGURATION

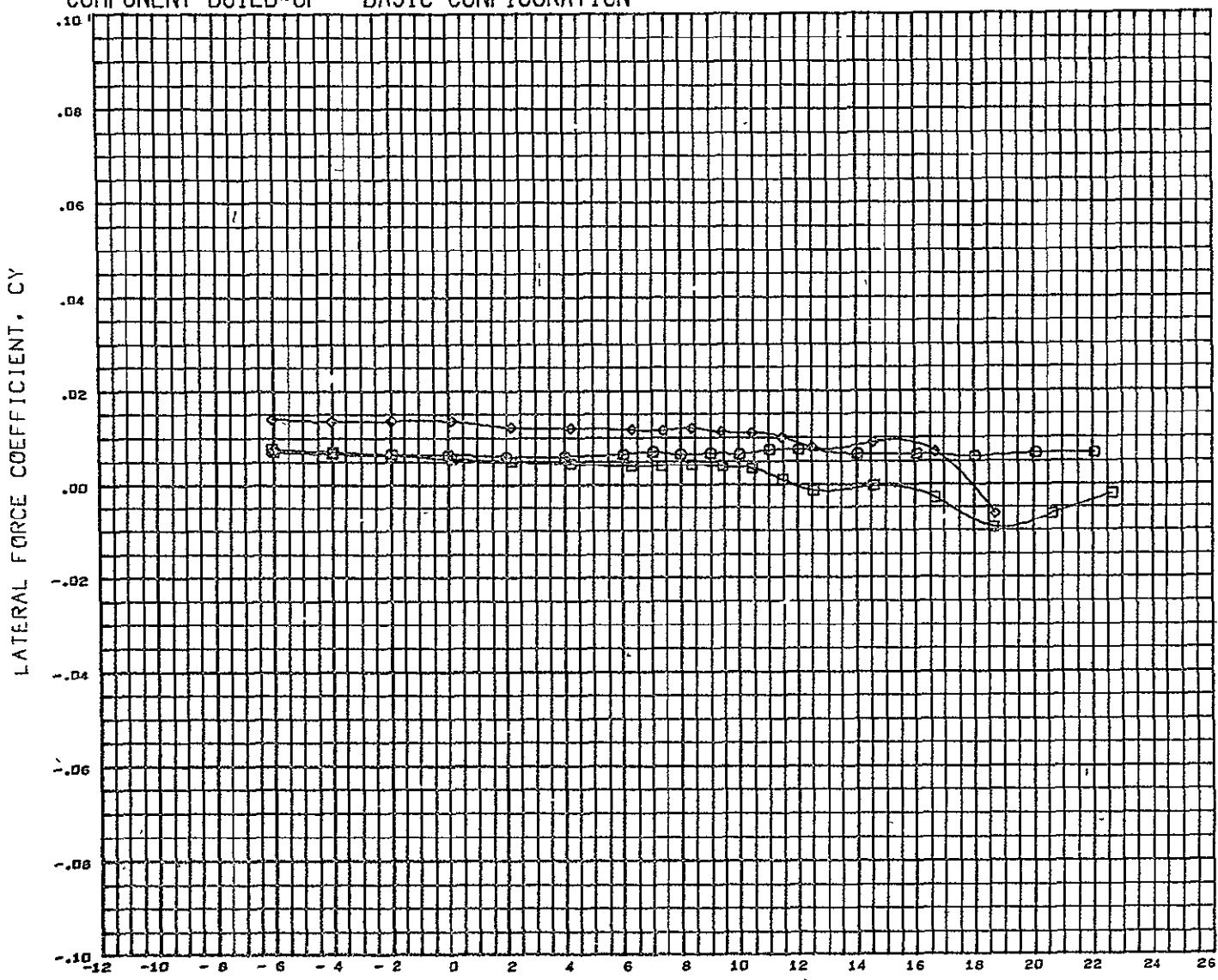

DATA SET SYMBOL	CONFIGURATION DESCRIPTION	BETA	ELEVTR	AILRON	REFERENCE INFORMATION
(CCPD28) ○	LSWT 248 MDAC 4.0 FC O2 HCR ORB 85	0.000			REFS 8.8690 SQ.FT.
(CCPD25) □	LSWT 248 MDAC 4.0 FC O2 HCR ORB 85W11	0.000	0.000	0.000	REFL 29.5700 IN.
(CCPD22) ◇	LSWT 248 MDAC 4.0 FC O2 HCR ORB 85W11V6	0.000	0.000	0.000	REFB 51.6000 IN.
					YHRF 59.3200 IN.
					YHRF 0.0000 IN.
					ZHRP 11.6000 IN.
					SCALE 4.0000 PERCNT

MACH 0.250

COMPONENT BUILD-UP BASIC CONFIGURATION

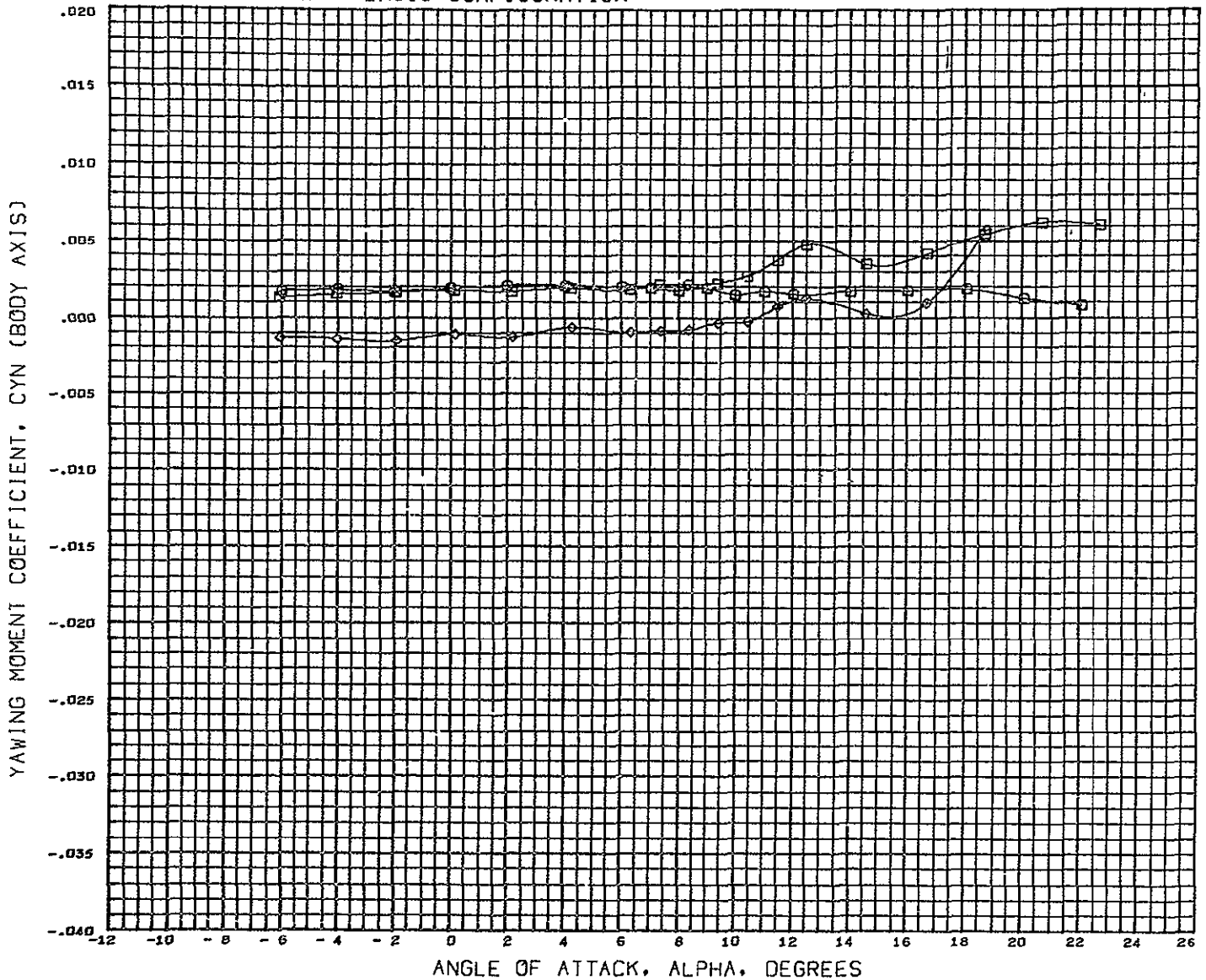

DATA SET SYMBOL	CONFIGURATION DESCRIPTION	BETA	ELEVTR	AILRON	REFERENCE INFORMATION
(CCP028)	□ LSWT 248 MDAC 4.0 FC 02 HCR ORB	0.007			REFS 8.8690 SQ FT.
(CCP025)	□ LSWT 248 MDAC 4.0 FC 02 HCR ORB	0.000	0.000	0.000	REFL 29.5700 IN.
(CCP002)	◇ LSWT 248 MDAC 4.0 FC 02 HCR ORB	0.000	0.000	0.000	REFB 51.6000 IN.
					XMRP 59.3200 IN.
					YMRP 0.0000 IN.
					ZMRP 11.6000 IN.
					SCALE 4.0000 PERCENT

HACH 0.250

COMPONENT BUILD-UP BASIC CONFIGURATION

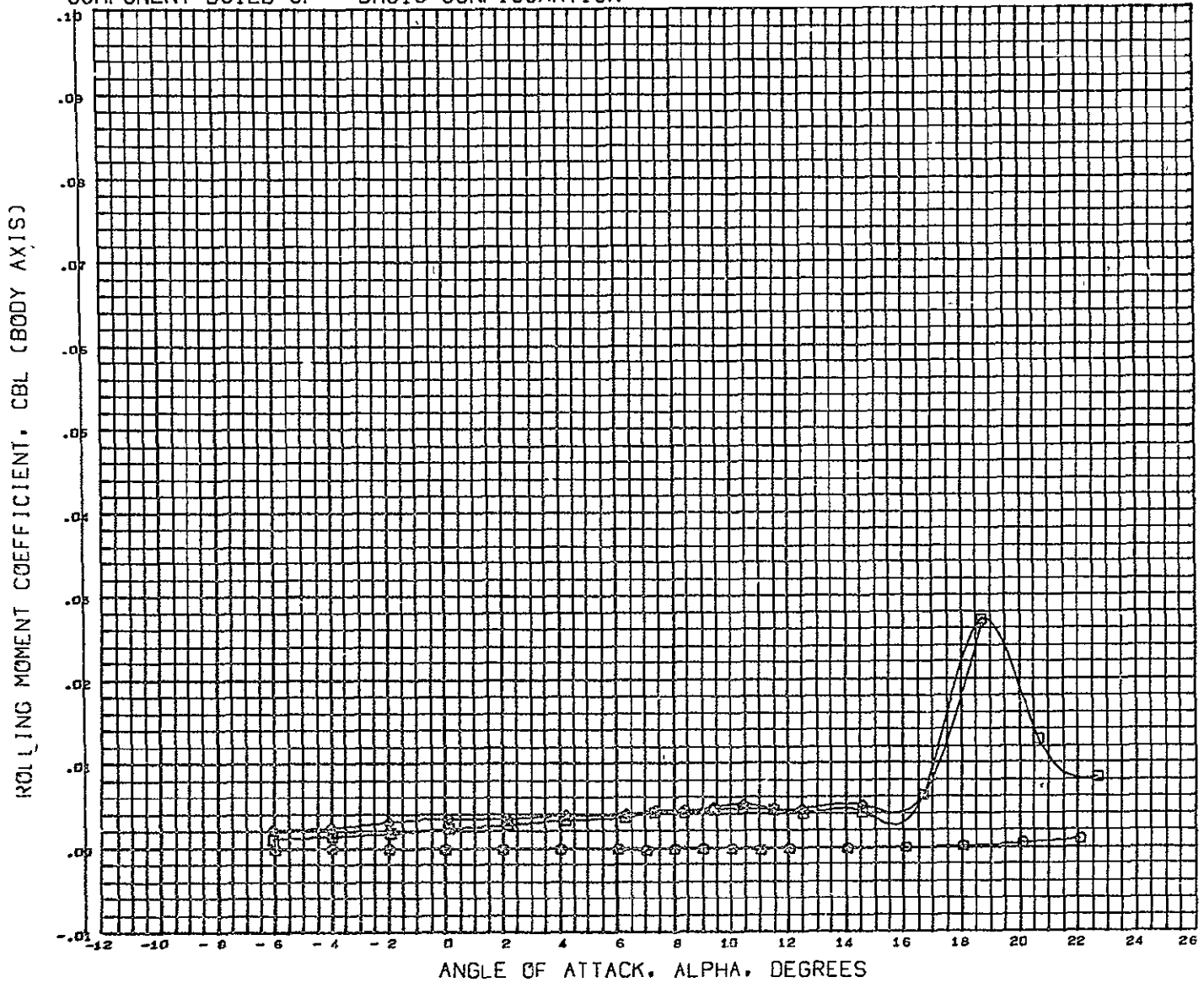

DATA SET SYMBOL	CONFIGURATION DESCRIPTION
(CCFD28)	□ LSWT 248 MDAC 4.0 PC O2 HCR ORB
(CCFD25)	□ LSWT 248 MDAC 4.0 PC O2 HCR ORB
(CCFD02)	◇ LSWT 248 MDAC 4.0 PC O2 HCR ORB

BETA	ELEVTR	AJLRON
0.000	0.000	0.000
0.000	0.000	0.000
0.000	0.000	0.000

REFERENCE INFORMATION		
REFS	8 8690	SQ FT
REFL	29.5700	IN
REFB	51.6000	IN
XMRP	59.3200	IN
YMRP	0.0000	IN
ZMRP	11.6000	IN.
SCALE	4 0000	PERCENT

MACH 0.250

# COMPONENT BUILD-UP BASIC CONFIGURATION

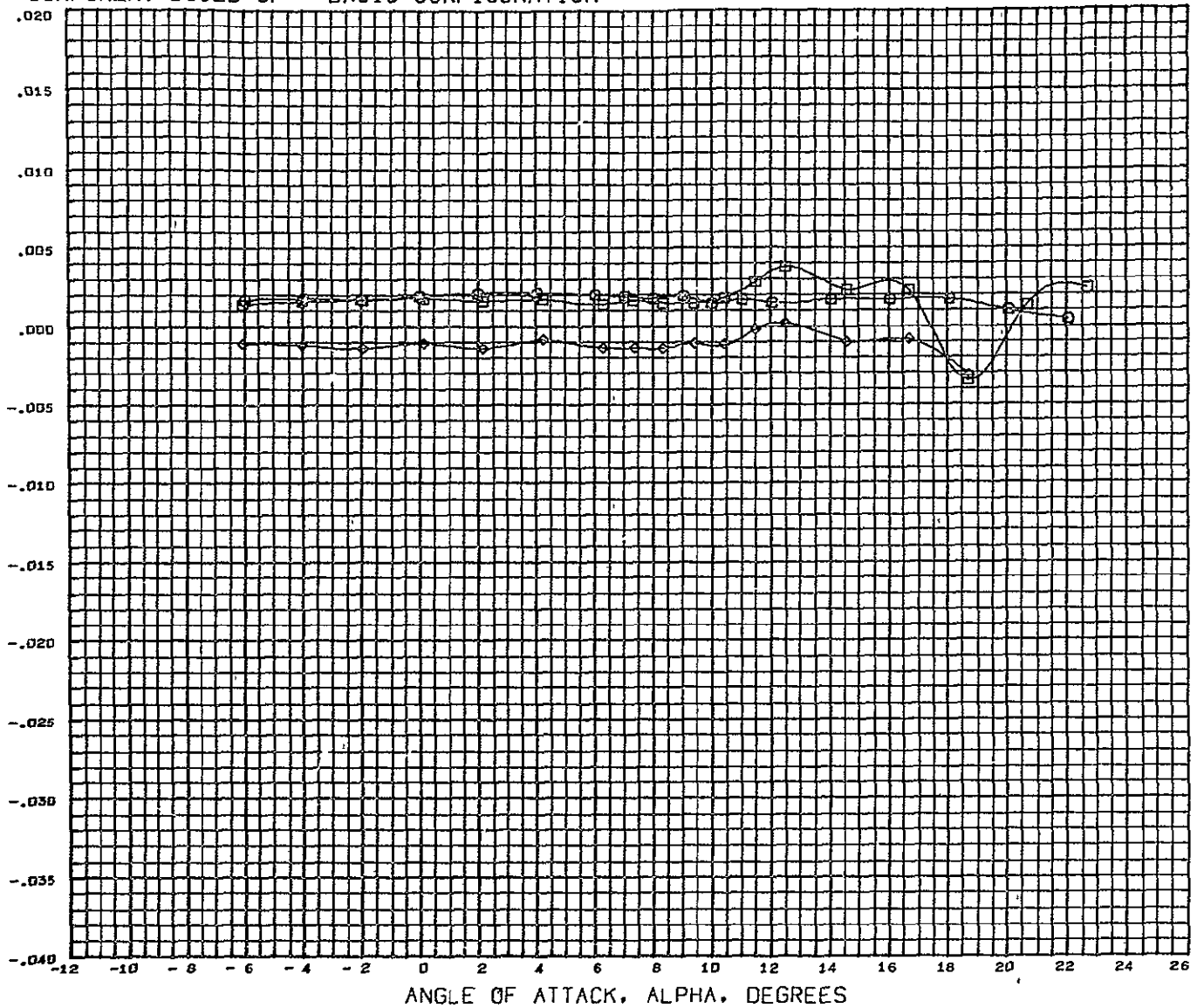

DATA SET SYMBOL	CONFIGURATION DESCRIPTION	BETA	ELEVTR	AILRON	REFERENCE INFORMATION
RCP020)	LSWT 248 MDAC 4.0 FC O2 HCR ORB	85	0.000		REFS 8.8690 SQ.FT.
RCP025)	LSWT 248 MDAC 4.0 FC O2 HCR ORB	85W11	0.000	0.000	REFL 29.5700 IN.
RCP002)	LSWT 248 MDAC 4.0 FC O2 HCR ORB	85W11V6	0.000	0.000	REFB 51.6000 IN.
					XMRP 59.3200 IN.
					YMRP 0.0000 IN.
					ZMRP 11.6000 IN.
					SCALE 4.0000 PERCNT

HACH 0.250



COMPONENT BUILD-UP BASIC CONFIGURATION

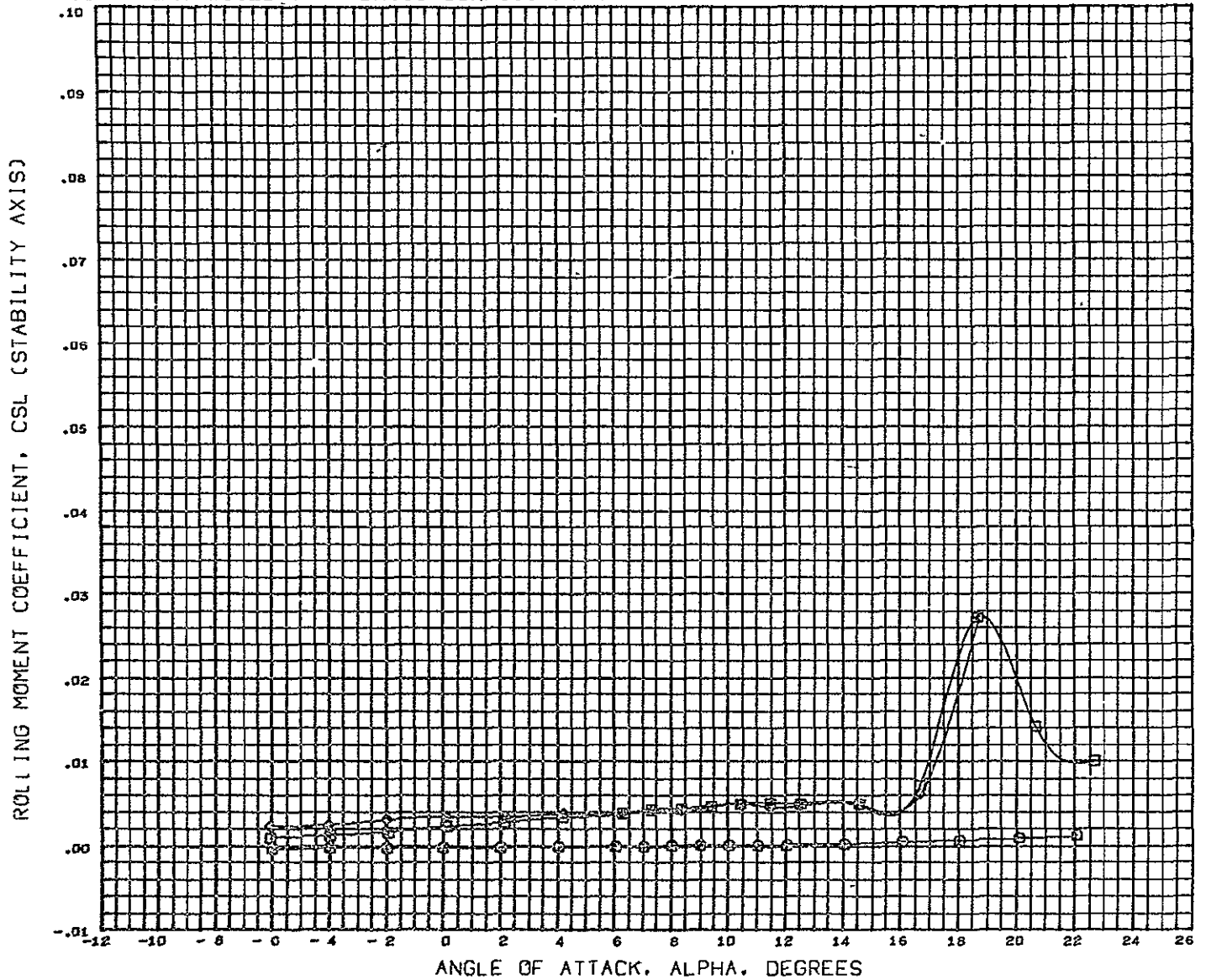

DATA SET SYMBOL	CONFIGURATION DESCRIPTION	BETA	ELEVTR	AILRON	REFERENCE INFORMATION
(RCP028)	LSWT 248 MDAC 4.0 PC 02 HCR ORB	B5	0.000	0.000	REFS 8.8690 SQ.FT.
(RCP025)	LSWT 248 MDAC 4.0 PC 02 HCR ORB	B5W11	0.000	0.000	REFL 29.5700 IN.
(RCP002)	LSWT 248 MDAC 4.0 PC 02 HCR ORB	B5W11V6	0.000	0.000	REFB 51.6000 IN.
					XMRP 59.3200 IN.
					YMRP 0.0000 IN.
					ZMRP 11.6000 IN.
					SCALE 4.0000 PERCNT

MACH 0.250

COMPONENT BUILD-UP BASIC CONFIGURATION

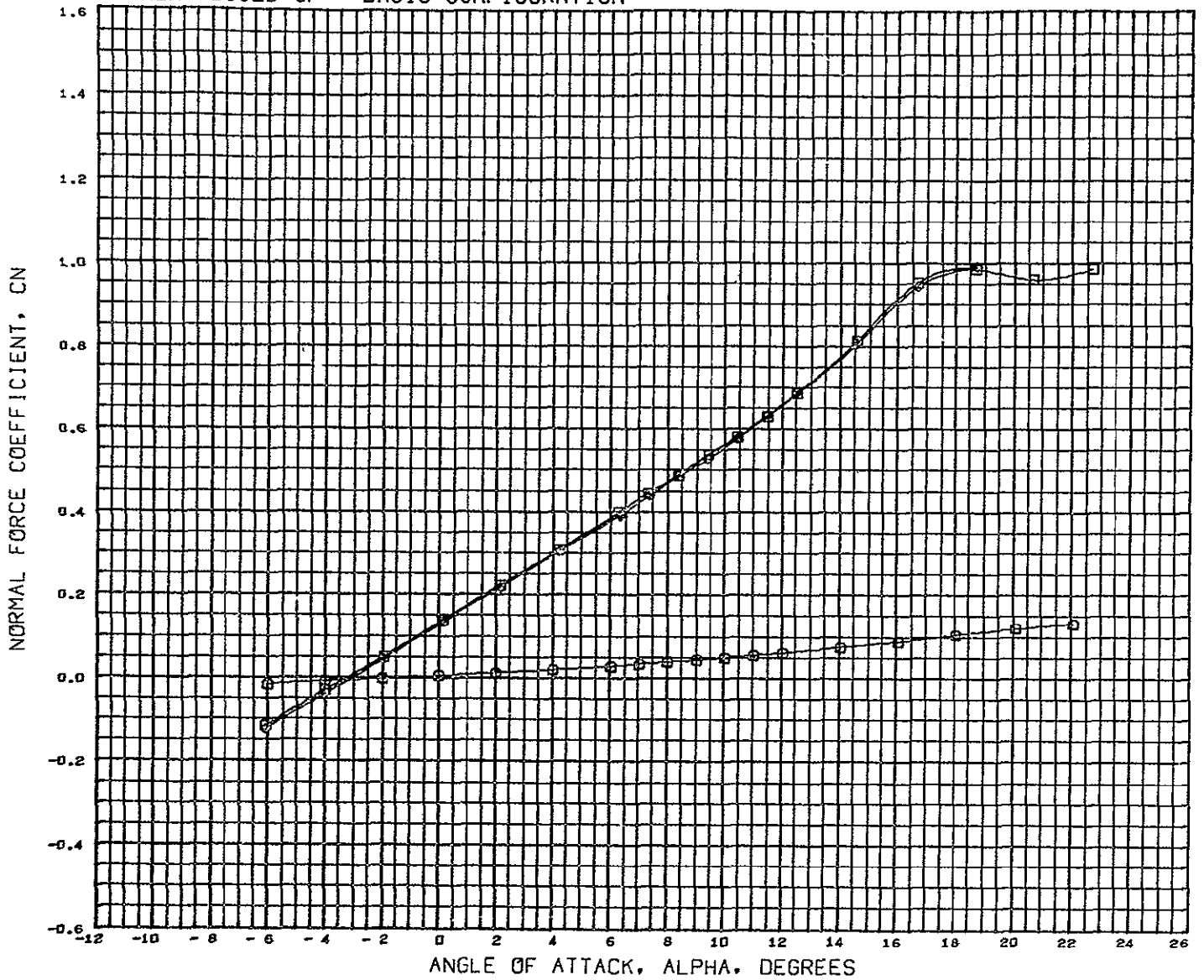

DATA SET SYMBOL	CONFIGURATION DESCRIPTION	BETA	ELEVTR	AILRON	REFERENCE INFORMATION
(BCF028)	○ LSWT 248 MDAC 4.0 FC O2 HCR ORB	0.000	0.000	0.000	REFS 8.8690 SQ FT.
(BCF025)	□ LSWT 248 MDAC 4.0 FC O2 HCR ORB	0.000	0.000	0.000	REFL 29.5700 IN.
(BCF022)	◇ LSWT 248 MDAC 4.0 FC O2 HCR ORB	0.000	0.000	0.000	REFB 51.6000 IN.
					XHRP 59.3200 IN.
					YHRP 0.0000 IN.
					ZHRP 11.6000 IN.
					SCALE 4.0000 PERCNT

MACH 0.250

COMPONENT BUILD-UP BASIC CONFIGURATION

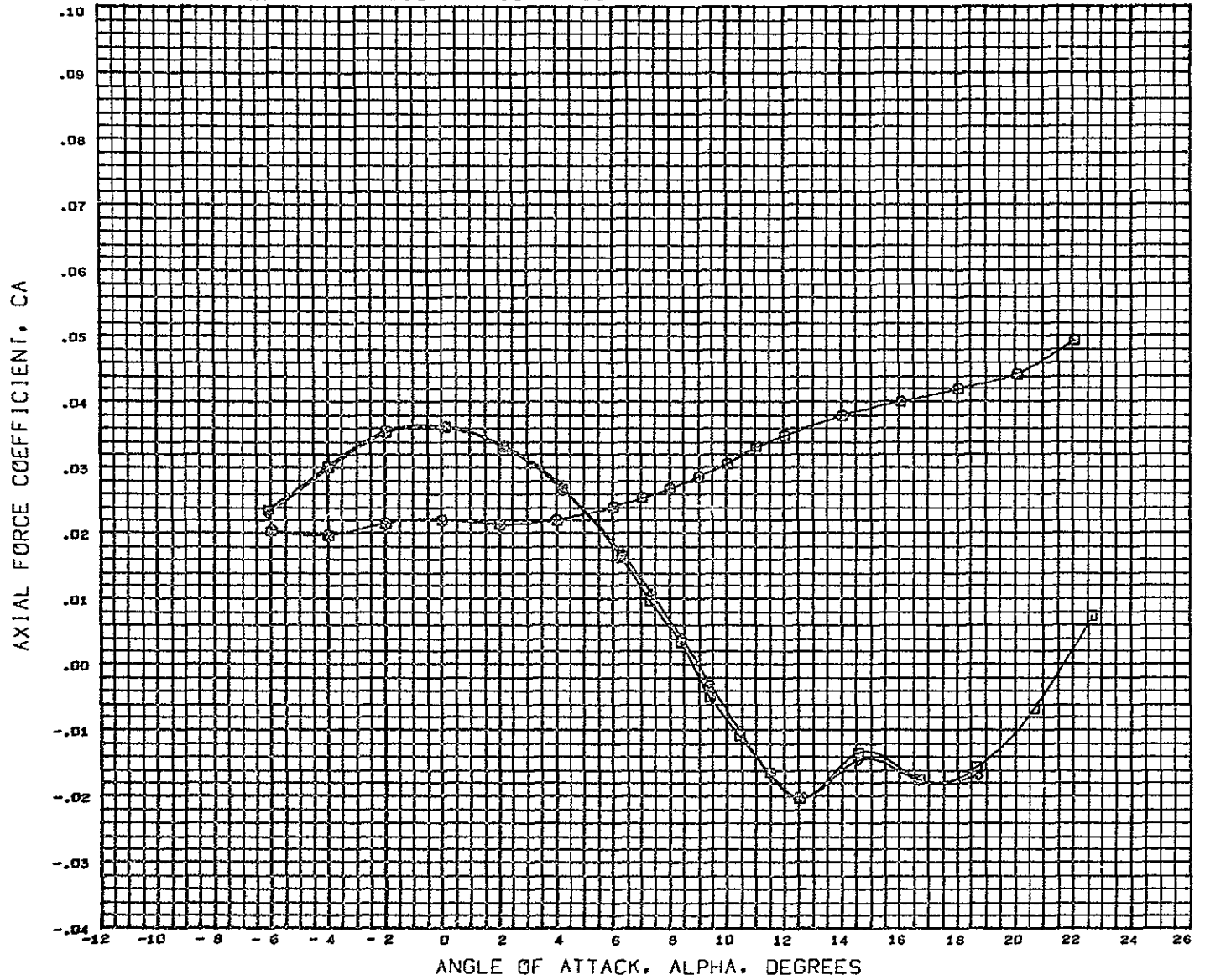

DATA SET SYMBOL	CONFIGURATION DESCRIPTION	BETA	ELEVTR	AILRON	REFERENCE INFORMATION
(BCF020)	LSWT 248 MDAC 4.0 FC 02 HCR ORB	0.000	0.000	0.000	REFS 8.8690 SQ FT.
(BCF025)	LSWT 248 MDAC 4.0 FC 02 HCR ORB	0.000	0.000	0.000	REFL 29.5700 IN.
(BCF002)	LSWT 248 MDAC 4.0 FC 02 HCR ORB	0.000	0.000	0.000	REFB 51.6000 IN.
					XMRP 59.3200 IN.
					YMRP 0.0000 IN.
					ZMRP 11.6000 IN.
					SCALE 4.0000 PERCENT

MACH 0.250,

COMPONENT BUILD-UP BASIC CONFIGURATION

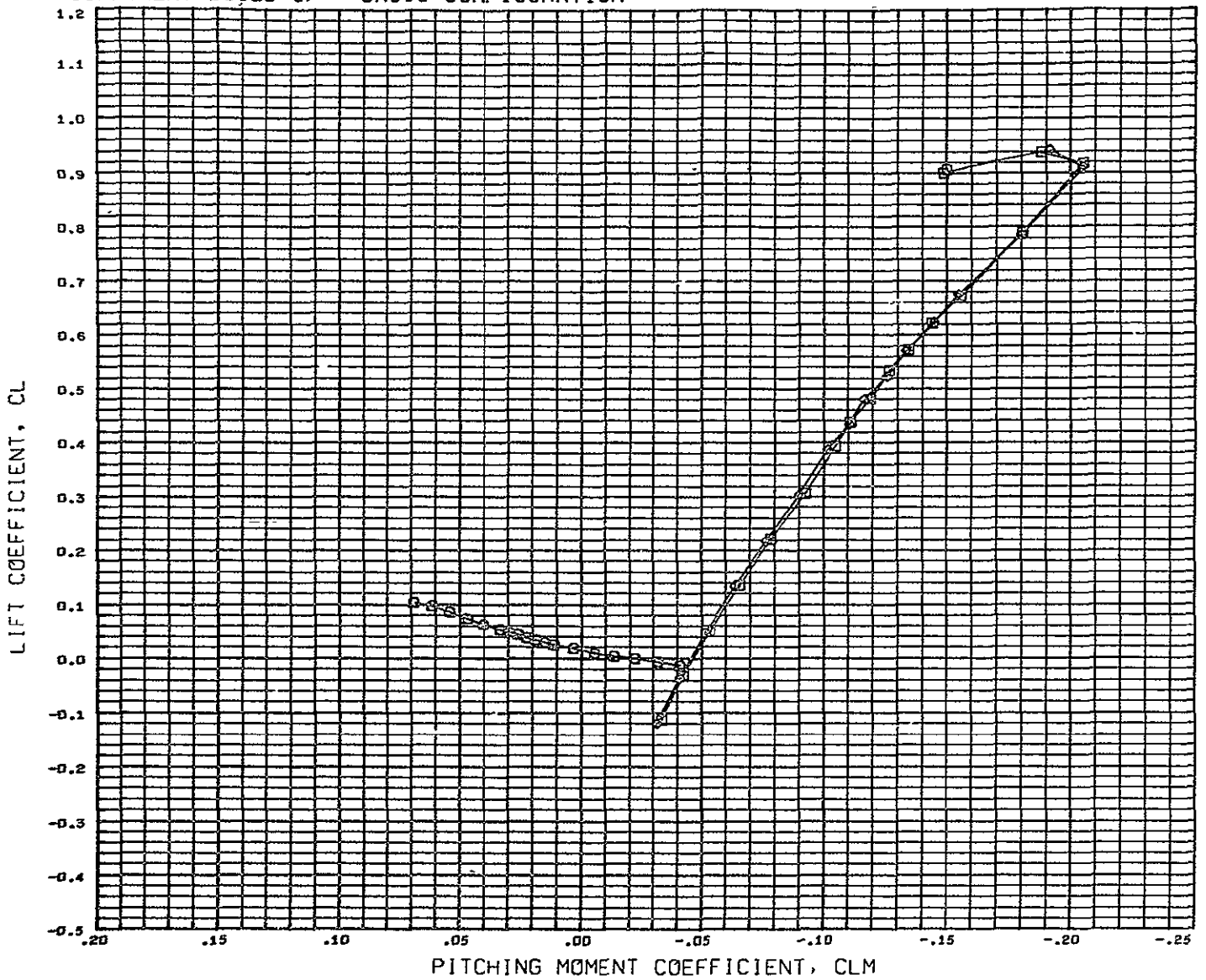

DATA SET SYMBOL	CONFIGURATION DESCRIPTION	BETA	ELEVTR	AILRON	REFERENCE INFORMATION
(CCP028)	LSWT 248 MDAC 4.0 FC 02 HCR ORB B5	0.000			REFS 8 8690 SQ.FT.
(CCP025)	LSWT 248 MDAC 4.0 FC 02 HCR ORB B5W11	0.000	0.000	0.000	REFL 29.5700 IN
(CCP002)	LSWT 248 MDAC 4.0 FC 02 HCR ORB B5W11V6	0.000	0.000	0.000	REFB 51.6000 IN.
					XHRF 59.3200 IN.
					YHRP 0.0000 IN.
					ZHRP 11.6000 IN
					SCALE 4.0000 PERCNT

MACH 0.250

COMPONENT BUILD-UP BASIC CONFIGURATION

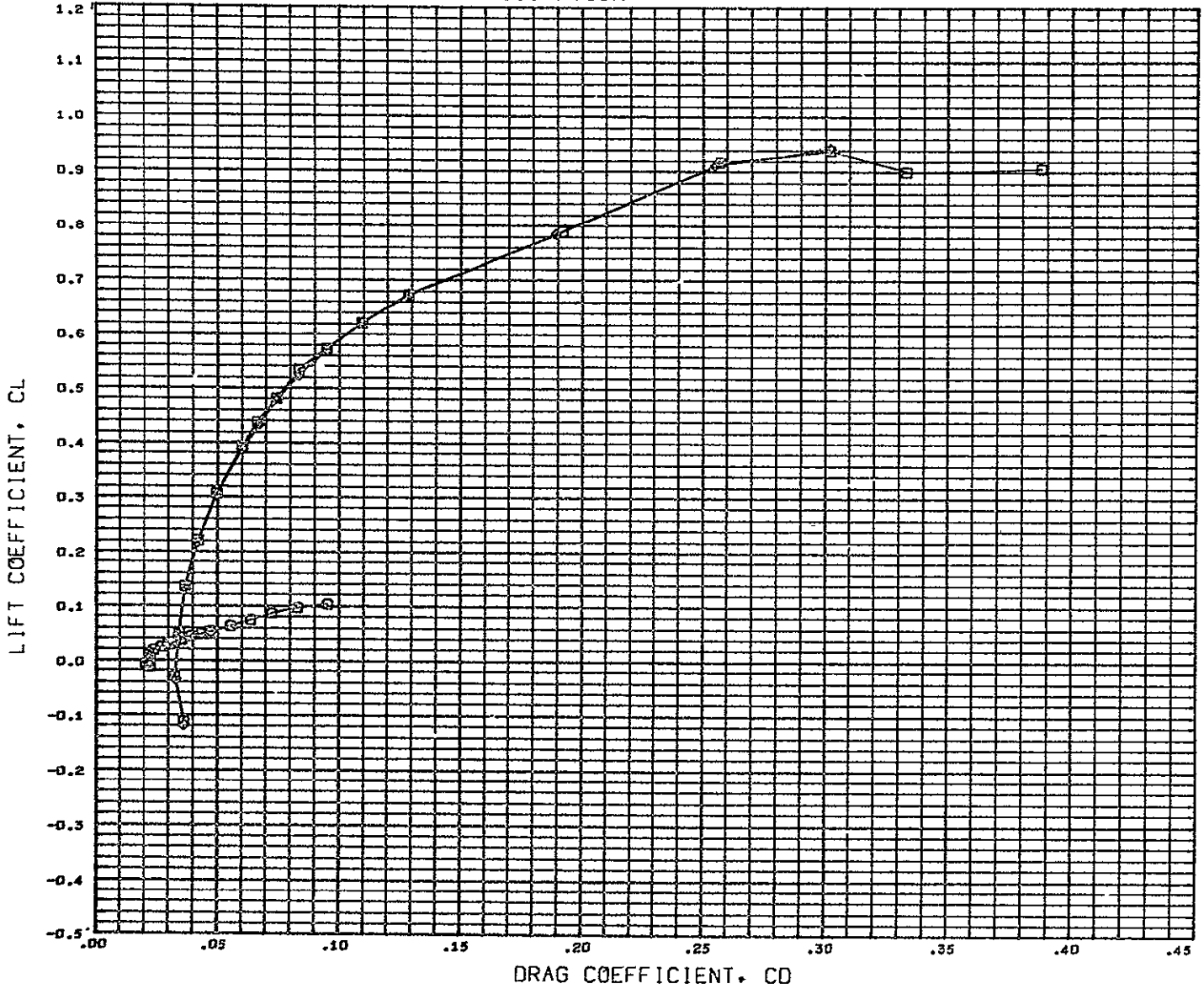

DATA SET SYMBOL	CONFIGURATION DESCRIPTION	BETA	ELEVTR	AILRON
(CCF028)	LSWT 248 MDAC 4.0 FC 02 HCR ORB	B5	0.000	0.000
(CCF025)	LSWT 248 MDAC 4.0 FC 02 HCR ORB	B5W11	0.000	0.000
(CCF002)	LSWT 248 MDAC 4.0 FC 02 HCR ORB	B5W11V6	0.000	0.000

REFERENCE INFORMATION		
REFS	8.8690	SQ FT.
REFL	29.5700	IN.
REFB	51.6000	IN.
XMRP	59.3200	IN.
YMRP	0.0000	IN.
ZMRP	11.6000	IN.
SCALE	4.0000	PERCENT

MACH 0.250

COMPONENT BUILD-UP BASIC CONFIGURATION

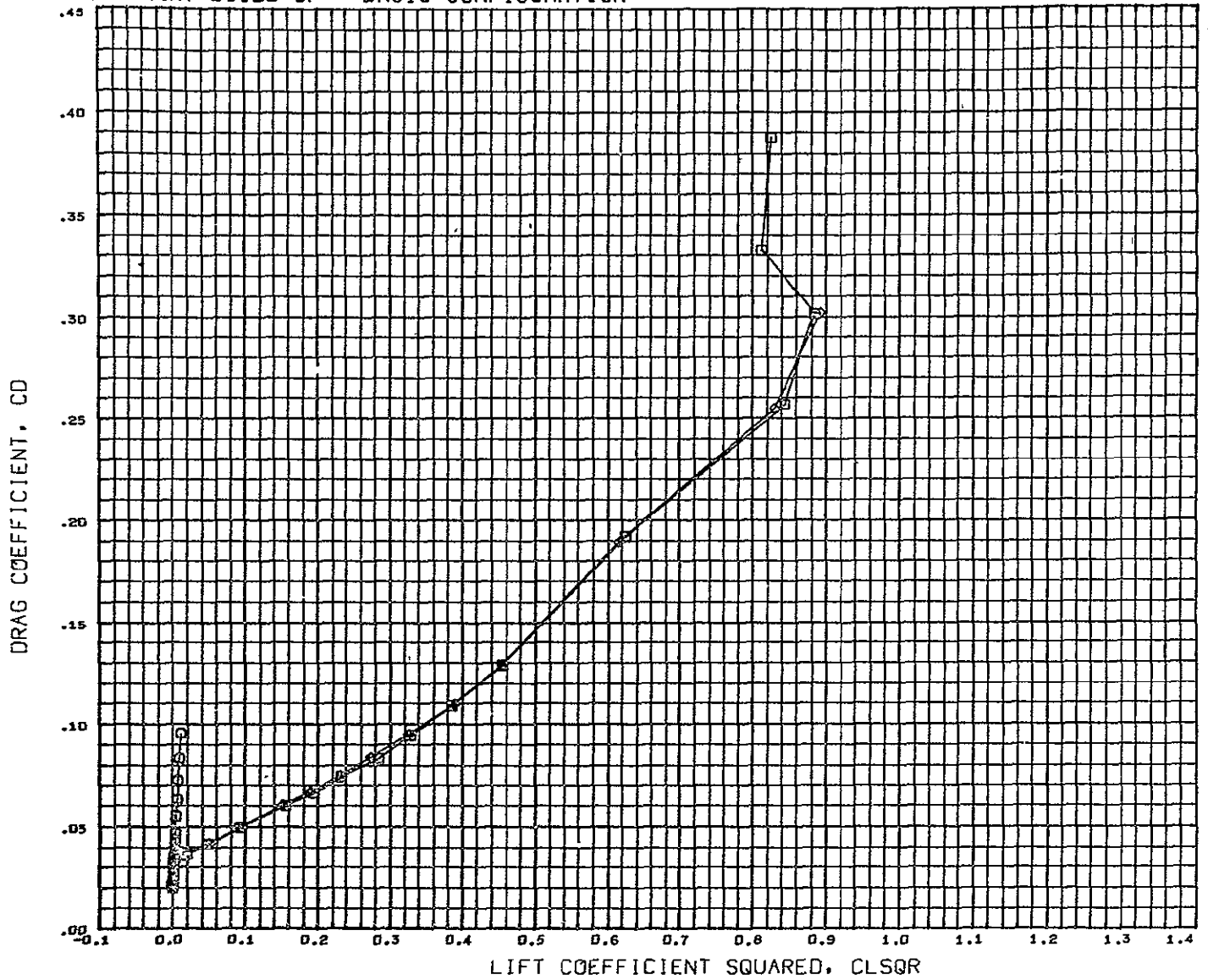

DATA SET SYMBOL	CONFIGURATION DESCRIPTION	BETA	ELEVTR	AILRON	REFERENCE INFORMATION
(CCF028)	LSWT 248 HDAC 4.0 FC O2 HCR ORB	85	0.000	0.000	REFS 8.8690 SQ.FT.
(CCF025)	LSWT 248 HDAC 4.0 FC O2 HCR ORB	85W11	0.000	0.000	REFL 29.5700 IN.
(CCF002)	LSWT 248 HDAC 4.0 FC O2 HCR ORB	85W11V6	0.000	0.000	REFB 51.6000 IN.
					XMRP 59.3200 IN.
					YMRF 0.0000 IN.
					ZMRP 11.6000 "
					SCALE 4.0000 " RCNT

MACH 0.250

COMPONENT BUILD-UP BASIC CONFIGURATION

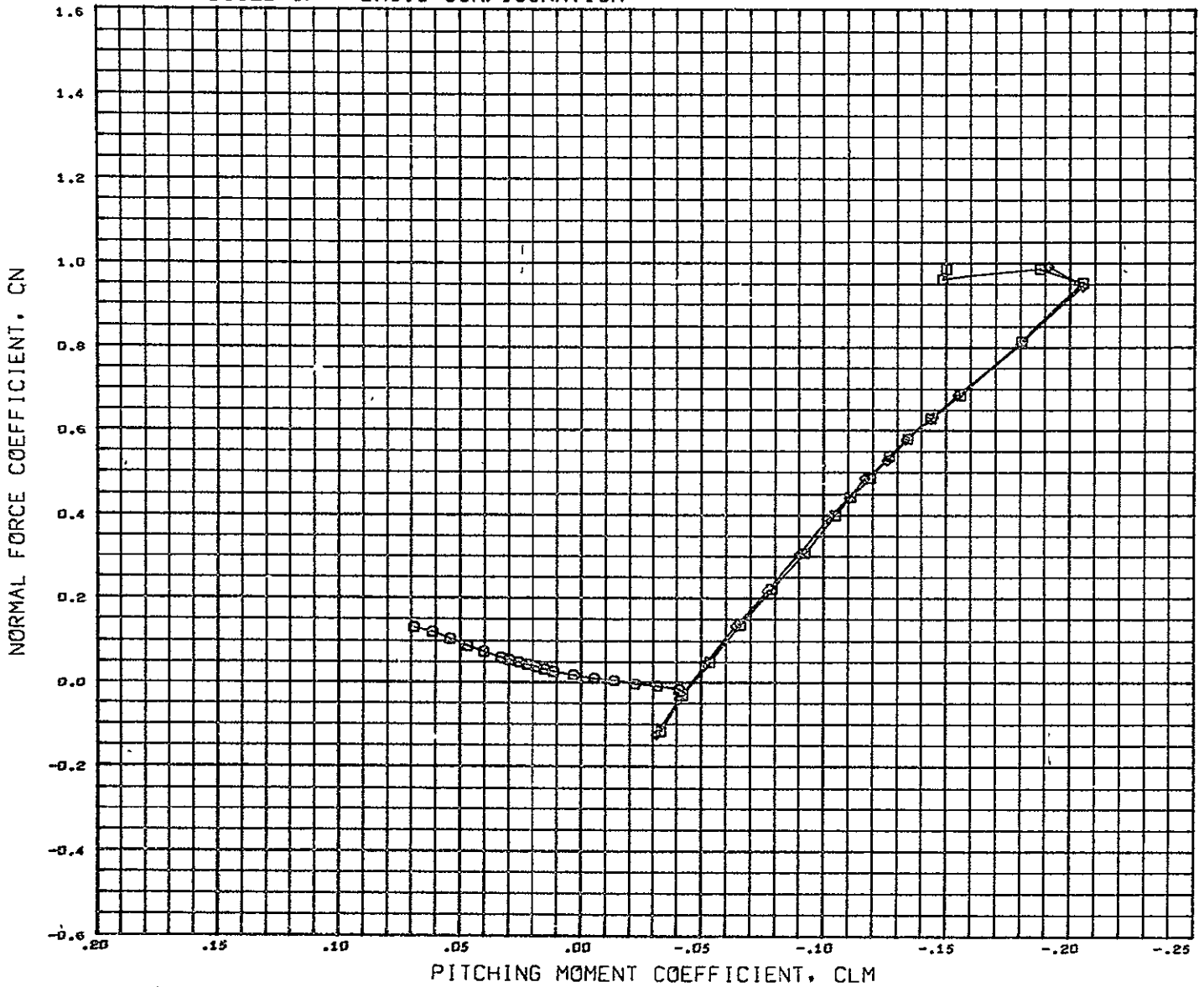

DATA SET SYMBOL	CONFIGURATION DESCRIPTION	BETA	ELEVTR	AILRON	REFERENCE INFORMATION
(BCP020)	LSWT 248 HDAC 4.0 FC O2 HCR ORB B5	0.007			REFS 8.8690 SQ.FT.
(BCP025)	LSWT 248 HDAC 4.0 FC O2 HCR ORB B5W11	0.000	0.000	0.000	REFL 29.5700 IN.
(BCP002)	LSWT 248 HDAC 4.0 FC O2 HCR ORB B5W11V6	0.000	0.000	0.000	REFB 51.6000 IN.
					XMRP 59.3200 IN.
					YMRP 0.0000 IN.
					ZMRP 11.6000 IN.
					SCALE 4.0000 PERCENT

MACH 0.250

COMPONENT BUILD-UP BASIC CONFIGURATION

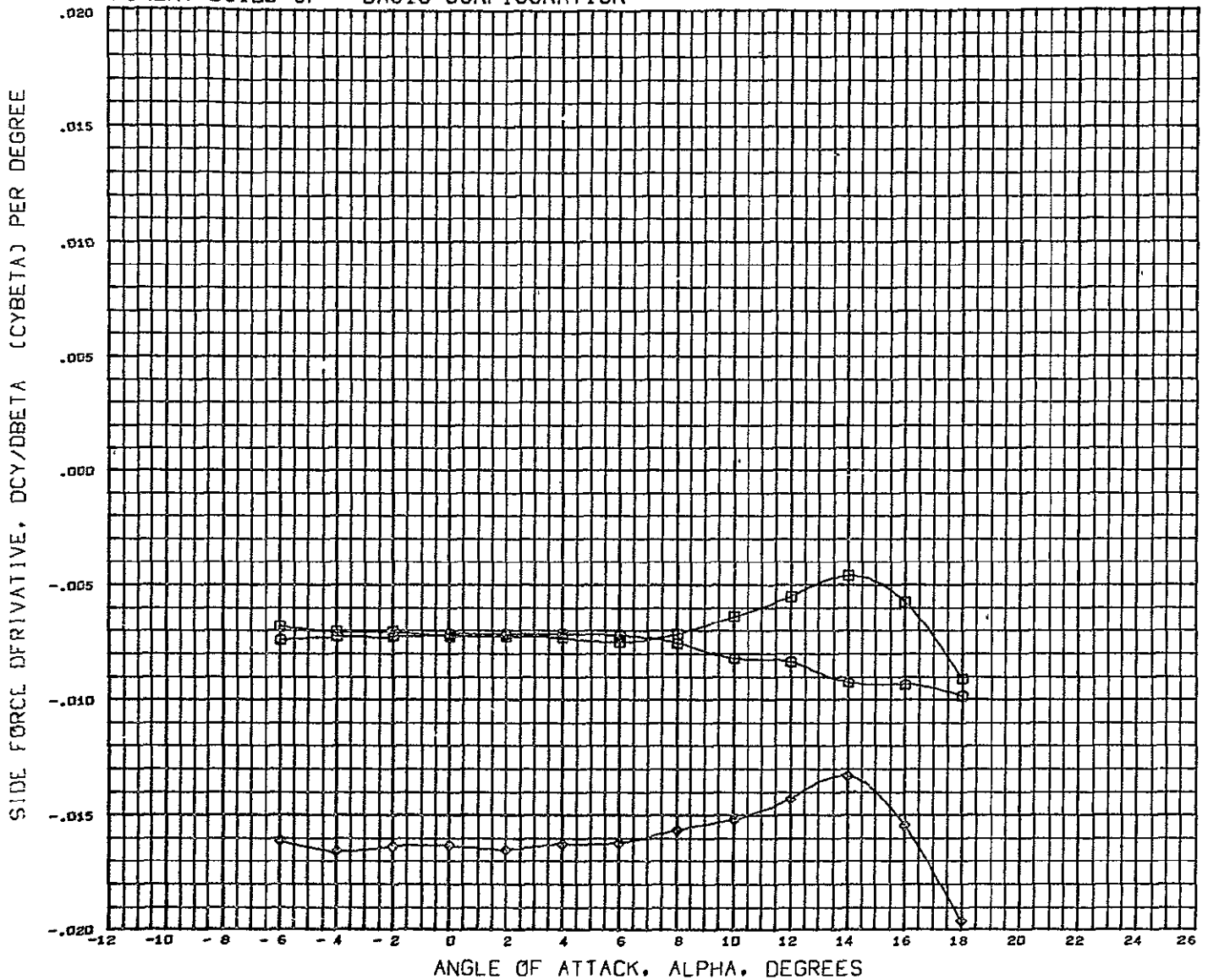

DATA SET SYMBOL	CONFIGURATION DESCRIPTION	ELEVTR	AILRON	REFERENCE INFORMATION
(DCFD29)	□ LSWT 248 MDAC 4.0 PC 02 HCR ORB B5			REFS 8.8690 SQ.FT
(DCFD26)	□ LSWT 248 MDAC 4.0 PC 02 HCR ORB B5W11	0.000	0.000	REFL 29.5700 IN.
(DCFD11)	◇ LSWT 248 MDAC 4.0 PC 02 HCR ORB B5W11V6	0.000	0.000	REFD 51.6000 IN.
				XMRP 59.3200 IN.
				YMRP 0.0000 IN.
				ZMRP 11.6000 IN.
				SCALE 4.0000 PERCNT

MACH 0.260



COMPONENT BUILD-UP BASIC CONFIGURATION

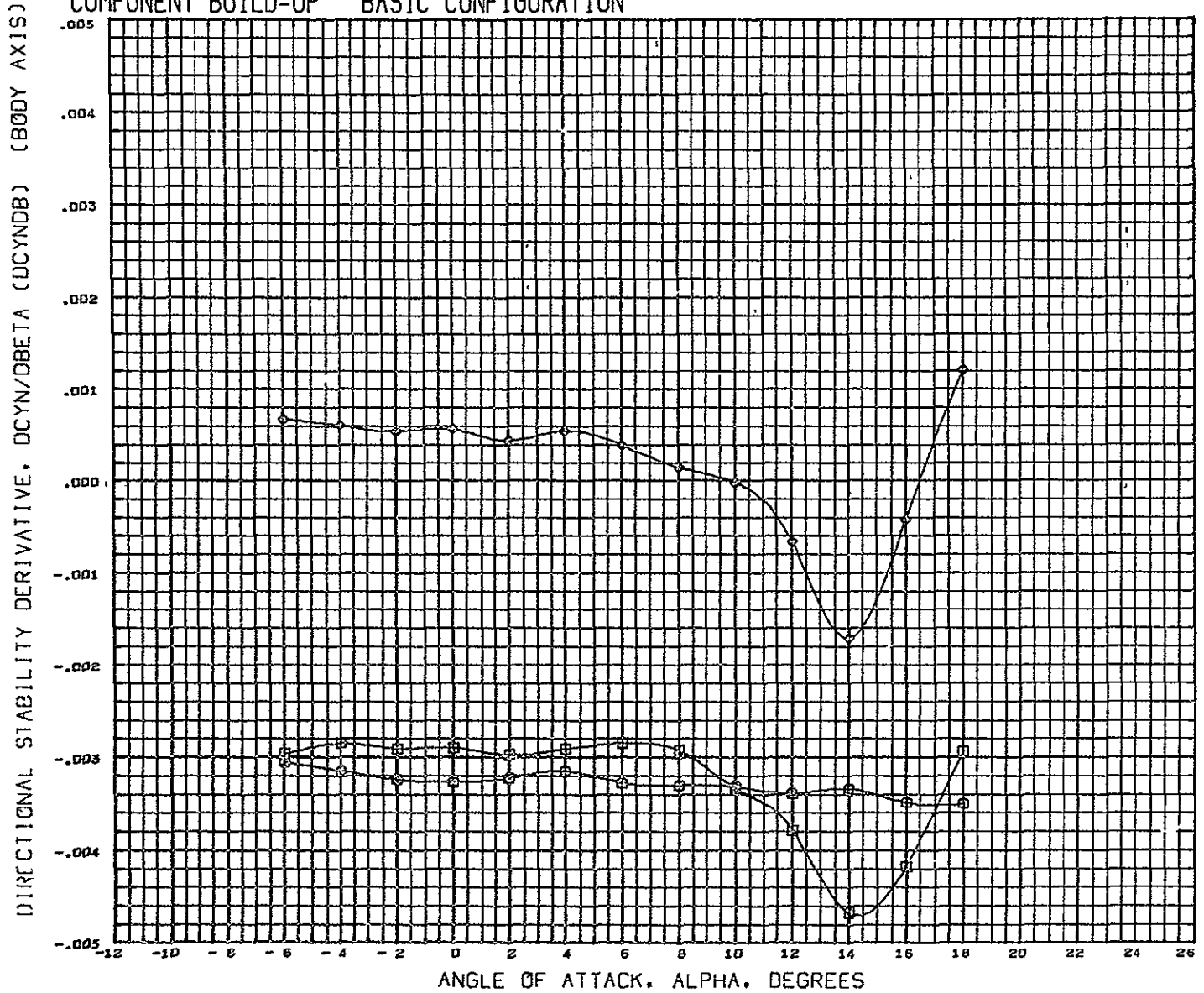

DATA SET SYMBOL	CONFIGURATION DESCRIPTION	ELEVTR	AILRON	REFERENCE INFORMATION
(CCP029)	□ LSWT 248 MDAC 4.0 FC 02 HCR ORB B5	0.000	0.000	REFS 8.8690 SQ.FT
(DCP026)	□ LSWT 248 MDAC 4.0 FC 02 HCR ORB B5W11	0.000	0.000	REFL 29.5700 IN.
(DCP011)	○ LSWT 248 MDAC 4.0 FC 02 HCR ORB B5W11V6	0.000	0.000	REFB 51.6000 IN.
				XMRP 59.3200 IN.
				YMRP 0.0000 IN.
				ZMRP 11.6000 IN.
				SCALE 4.0000 PERCENT

MACH 0.260

COMPONENT BUILD-UP BASIC CONFIGURATION

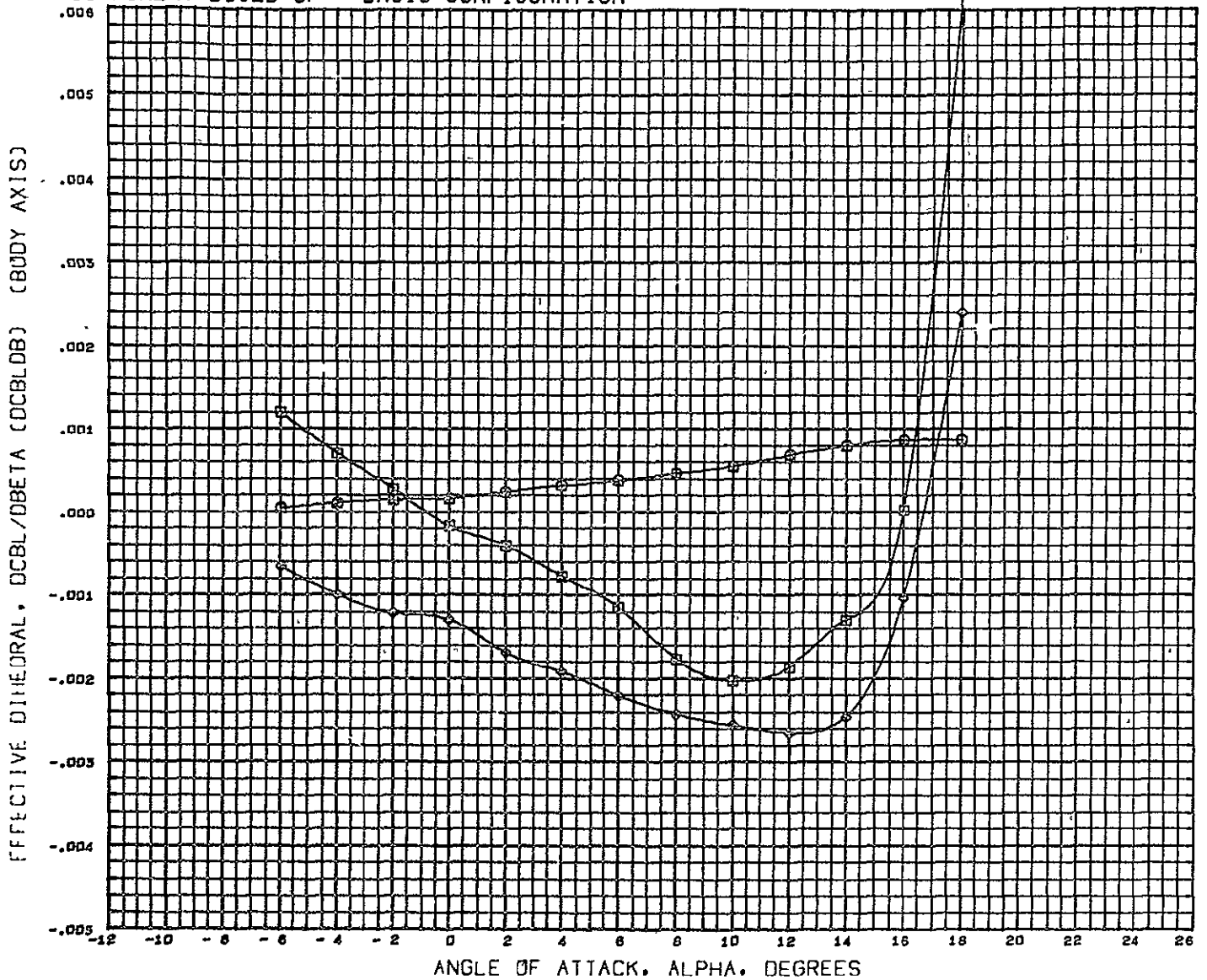

DATA SET SYMBOL	CONFIGURATION DESCRIPTION	ELEVTR	AILRON	REFERENCE INFORMATION
(DCP029)	□ LSWT 248 MDAC 4.0 PC 02 HCR ORB B5			REFS 8.8690 SQ.FT.
(DCP026)	○ LSWT 248 MDAC 4.0 PC 02 HCR ORB B5W11	0.000	0.000	REFL 29.5700 IN.
(DCP011)	◇ LSWT 248 MDAC 4.0 PC 02 HCR ORB B5W11V6	0.000	0.000	REFB 51.6000 IN.
				XMRP 59.3200 IN.
				YMRP 0.0000 IN.
				ZMRP 11.6000 IN.
				SCALE 4.0000 PERCENT

MACH 0.260

COMPONENT BUILD-UP BASIC CONFIGURATION

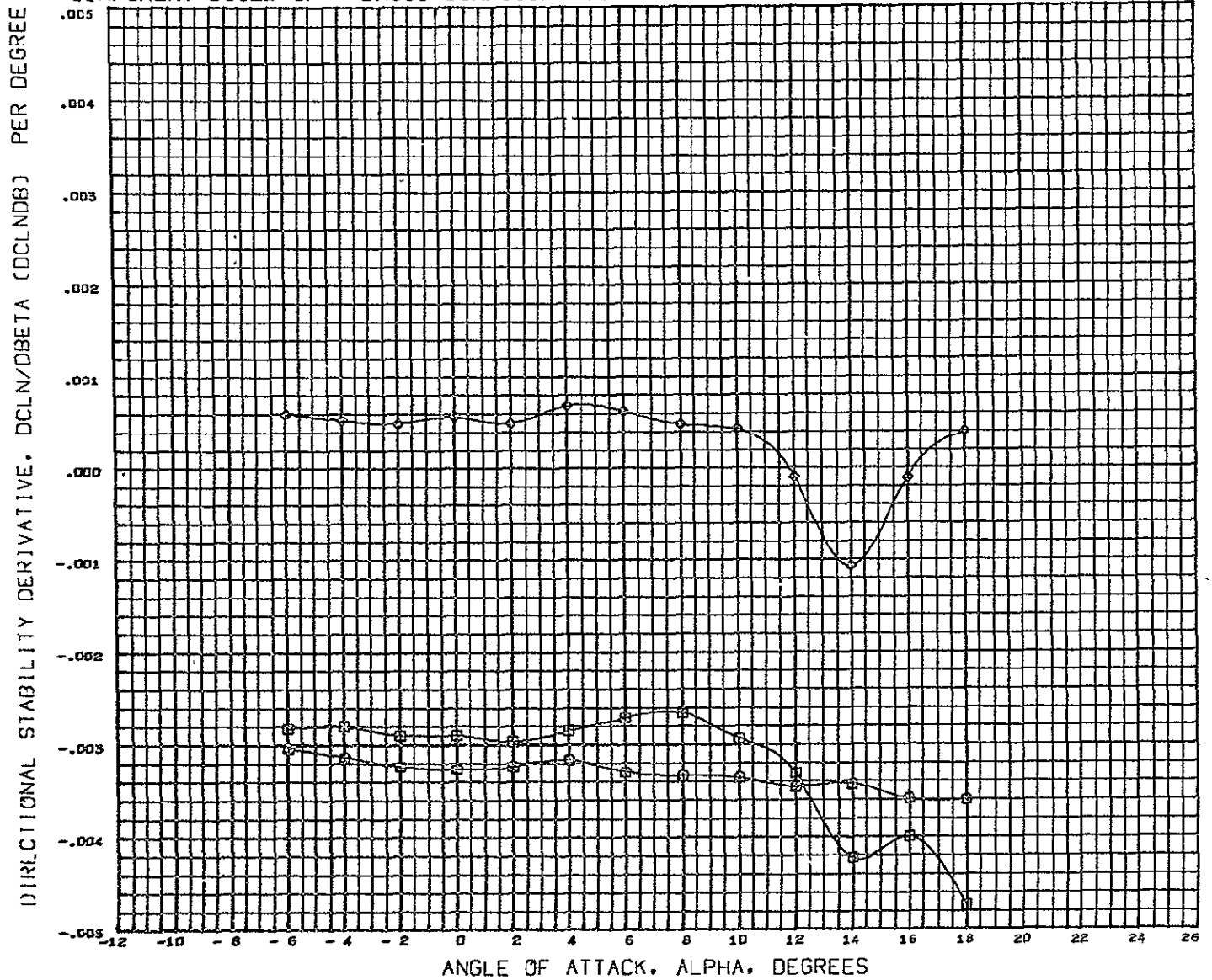

DATA SET SYMBOL	CONFIGURATION DESCRIPTION	ELEVTR	AILRON	REFERENCE INFORMATION	
(ECF029)	□ LSWT 248 MDAC 4.0 FC 02 HCR ORB B5	0.000	0.000	REFS	8.8690 SQ.FT.
(ECF026)	□ LSWT 248 MDAC 4.0 FC 02 HCR ORB B5W11	0.000	0.000	REFL	29.5700 IN.
(ECF011)	○ LSWT 248 MDAC 4.0 FC 02 HCR ORB B5W11V6	0.000	0.000	REFB	51.6000 IN.
				XMRP	59.3200 IN.
				YHRP	0.0000 IN.
				ZHRP	11.6000 IN.
				SCALE	4.0000 PERCENT

MACH 0.260

COMPONENT BUILD-UP BASIC CONFIGURATION

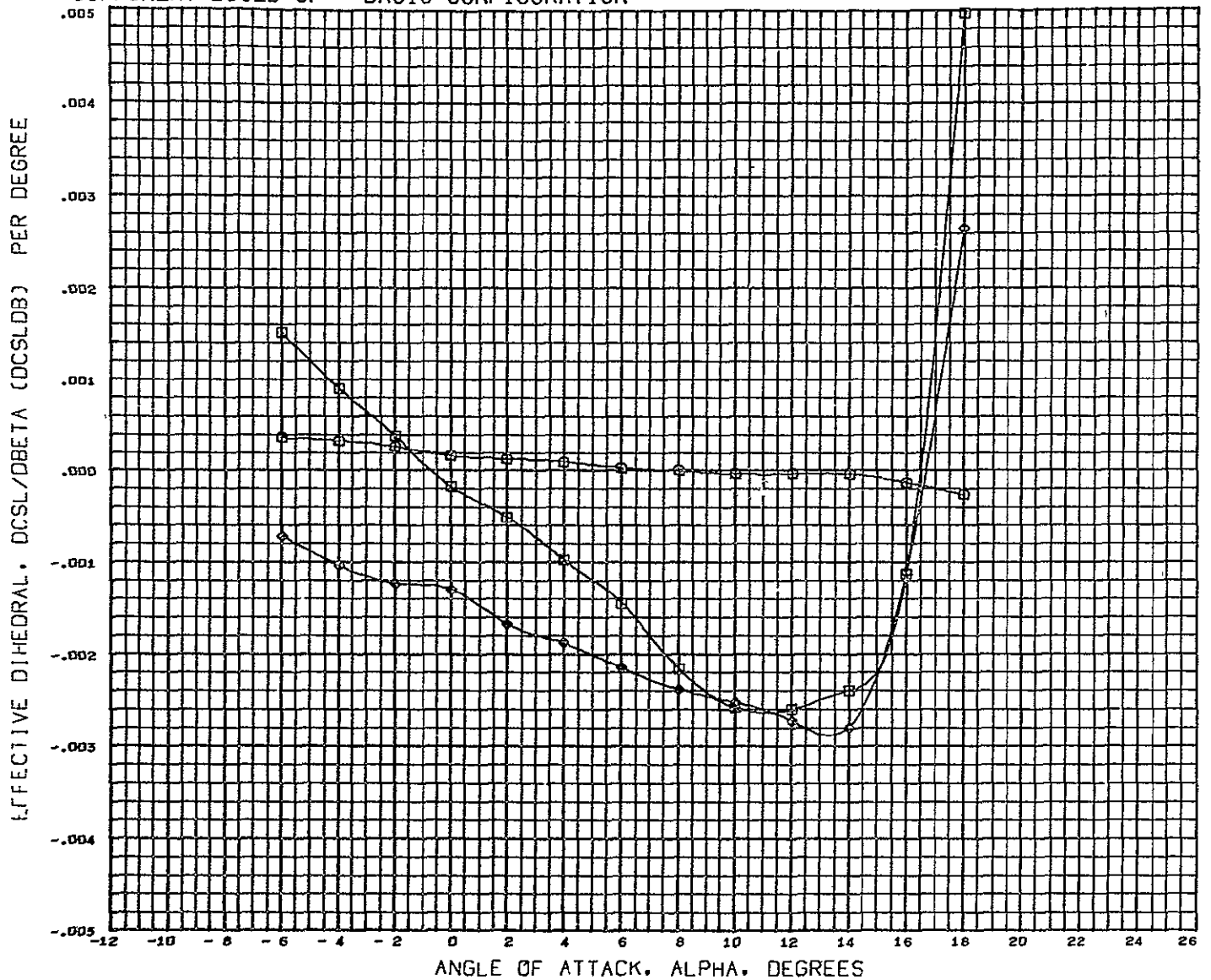

DATA SET SYMBOL	CONFIGURATION DESCRIPTION	ELEVTR	AILRON	REFERENCE INFORMATION
(ECP029)	○ LSWT 248 HDAC 4.0 FC 02 HCR ORB 85			REFS 8.8690 SQ FT.
(ECP026)	□ LSWT 248 HDAC 4.0 FC 02 HCR ORB 85W11	0.000	0.000	REFL 29.5700 IN.
(ECP011)	◇ LSWT 248 HDAC 4.0 FC 02 HCR ORB 85W11V6	0.000	0.000	REFB 51.6000 IN.
				XMRP 59.3200 IN.
				YMRP 0.0000 IN.
				ZMRP 11.6000 IN.
				SCALE 4.0000 PERCENT

MACH 0.260

YAW LINEARITY TEST BASIC CONFIGURATION

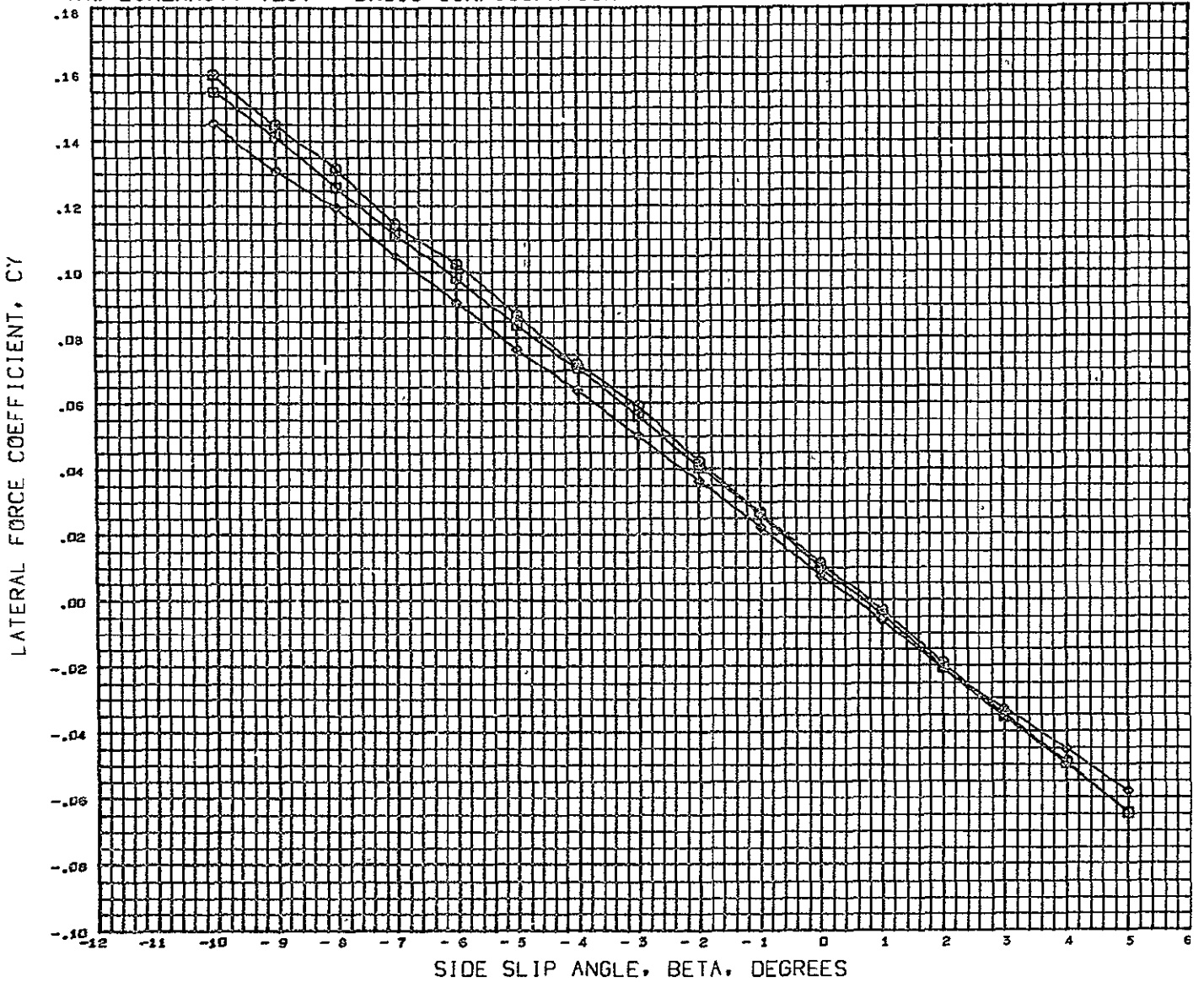

DATA SET SYMBOL	CONFIGURATION DESCRIPTION	ALPHA	ELEVTR	AILRON
(BCPD14) □	LSWT 248 HDAC 4.0 FC O2 HCR ORB B5W11V6	4.000 - 10.000	0.000	
(BCPD15) □	LSWT 248 HDAC 4.0 FC O2 HCR ORB B5W11V6	8.000 - 10.000	0.000	
(BCPD16) ◇	LSWT 248 HDAC 4.0 FC O2 HCR ORB B5W11V6	12.000 - 10.000	0.000	

REFERENCE INFORMATION	
REFS	8.0690 SQ.-FT.
REFL	29.5700 IN
REFB	51.6000 IN
XMRP	59.3200 IN
YMRP	0.0000 IN.
ZMRP	11.6000 IN.
SCALE	4.0000 PERCENT

MACH 0.250



# YAW LINEARITY TEST BASIC CONFIGURATION

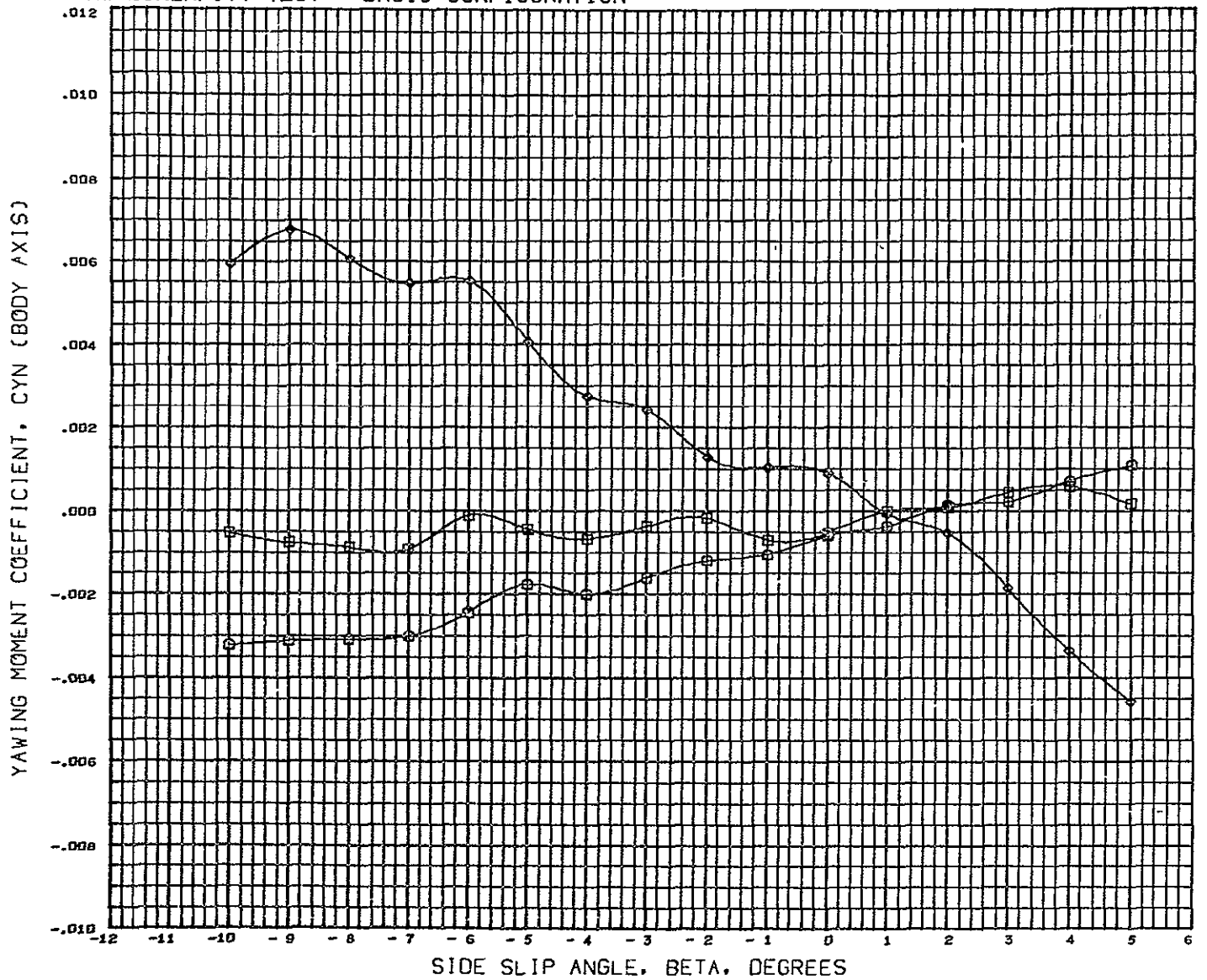

DATA SET SYMBOL	CONFIGURATION DESCRIPTION	ALPHA	ELEVTR	AILRON	REFERENCE INFORMATION
{BCPD14}	□ LSWT 248 MDAC 4.0 FC 02 HCR ORB B5W11V6	4.000 - 10.000	0.000	0.000	REFS 8.8690 SQ FT.
{BCPD15}	□ LSWT 248 MDAC 4.0 FC 02 HCR ORB B5W11V6	8.000 - 10.000	0.000	0.000	REFL 29.5700 IN.
{BCPD16}	◇ LSWT 248 MDAC 4.0 FC 02 HCR ORB B5W11V6	12.000 - 10.000	0.000	0.000	REFB 51.6000 IN.
					XMRP 59.3200 IN.
					YMRF 0.0000 IN.
					ZMRF 11.6000 IN.
					SCALE 4.0000 PERCNT

MACH 0.250

# YAW LINEARITY TEST BASIC CONFIGURATION

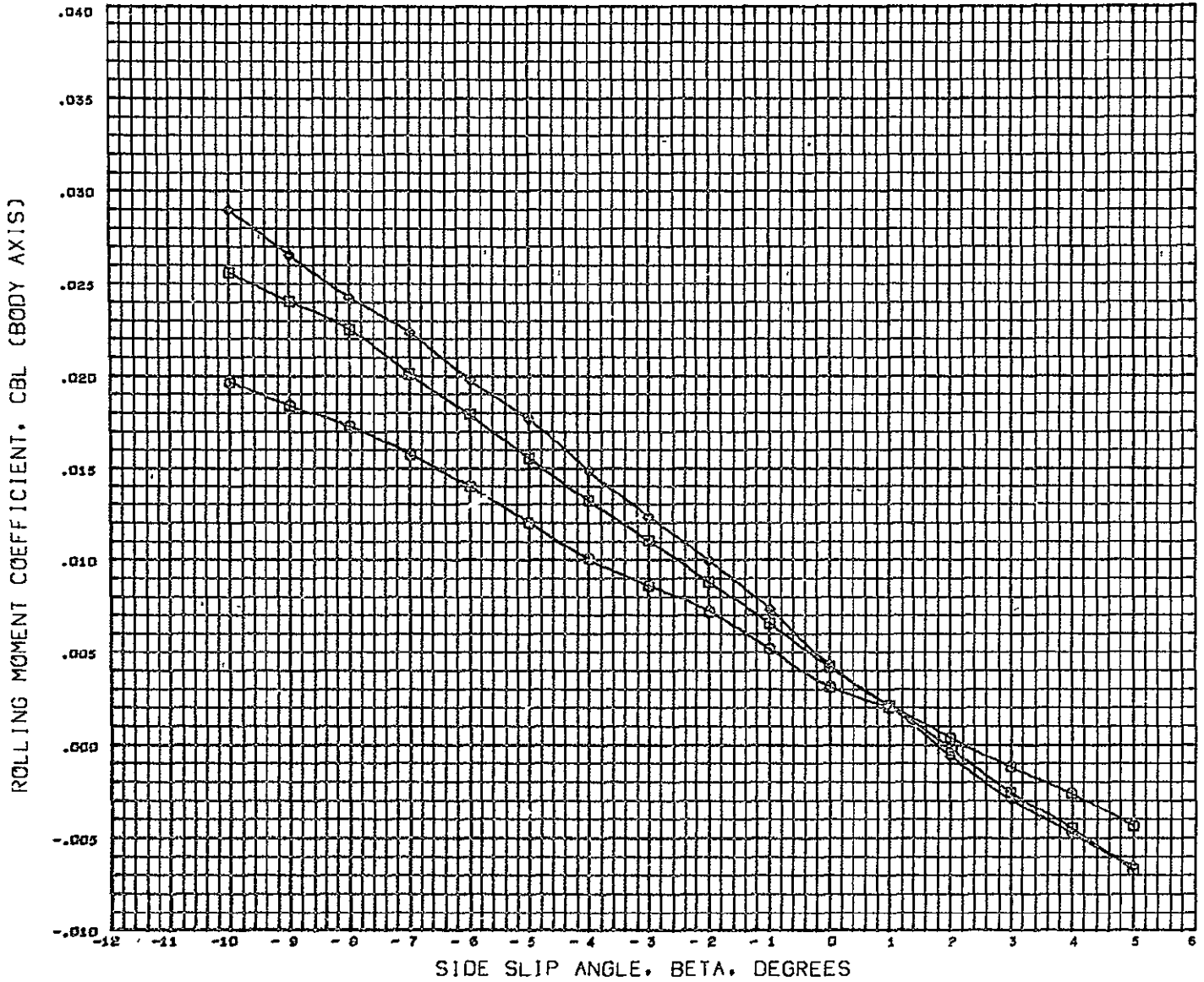

DATA SET SYMBOL	CONFIGURATION DESCRIPTION	ALPHA	ELEVTR	AILRON
(BCF014)	□ LSWT 248 MDAC 4.0 PC O2 HCR ORB	85W11V6	4.000 - 10.000	0.000
(BCF015)	◇ LSWT 248 MDAC 4.0 PC O2 HCR ORB	85W11V6	8.000 - 10.000	0.000
(BCF016)	○ LSWT 248 MDAC 4.0 PC O2 HCR ORB	85W11V6	12.000 - 10.000	0.000

REFERENCE INFORMATION		
REFS	8.8690	SQ.FT.
REFL	29.5700	IN.
REFB	51.6000	IN.
XMRP	59.3200	IN.
YMRP	0.0000	IN.
ZMRP	11.6000	IN.
SCALE	4.0000	PERCENT

MACH 0.250

# YAW LINEARITY TEST BASIC CONFIGURATION

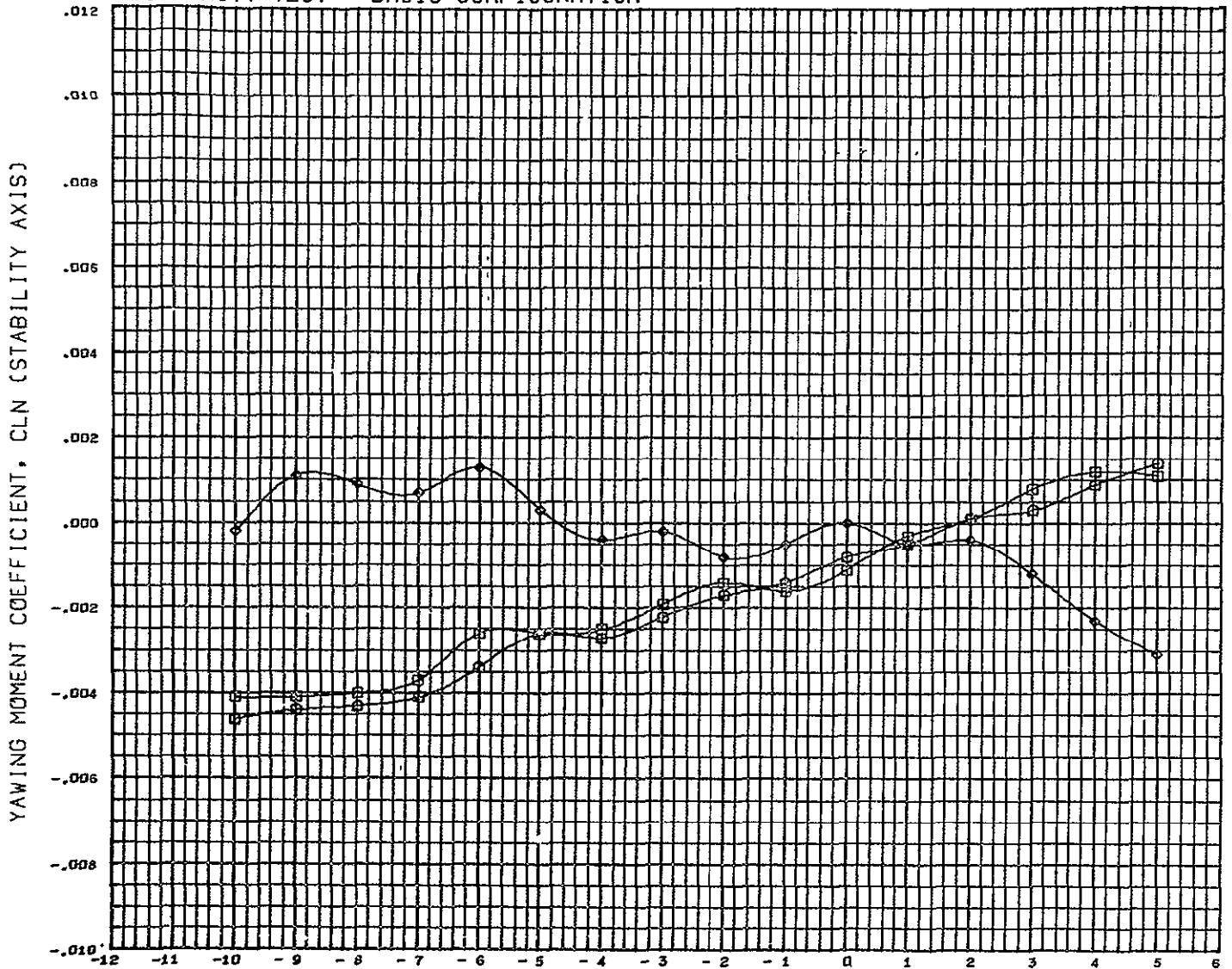

SIDE SLIP ANGLE, BETA, DEGREES

DATA SET SYMBOL	CONFIGURATION DESCRIPTION	ALPHA	ELEVTR	AILRON
(RCFD14)	□ LSWT 248 MDAC 4.0 FC 02 HCR ORB B5W11V6	4.000 - 10.000	0.000	
(RCFD15)	□ LSWT 248 MDAC 4.0 FC 02 HCR ORB B5W11V6	8.000 - 10.000	0.000	
(RCFD16)	◇ LSWT 248 MDAC 4.0 FC 02 HCR ORB B5W11V6	12.000 - 10.000	0.000	

REFERENCE INFORMATION		
REFS	8.8690	SQ.FT
REFL	29.5700	IN.
REFE	51.6000	IN.
XMRP	59.3200	IN.
YMRP	0.0000	IN.
ZMRP	11.6000	IN.
SCALE	4.0000	PERCNT

MACH 0.250



# YAW LINEARITY TEST BASIC CONFIGURATION

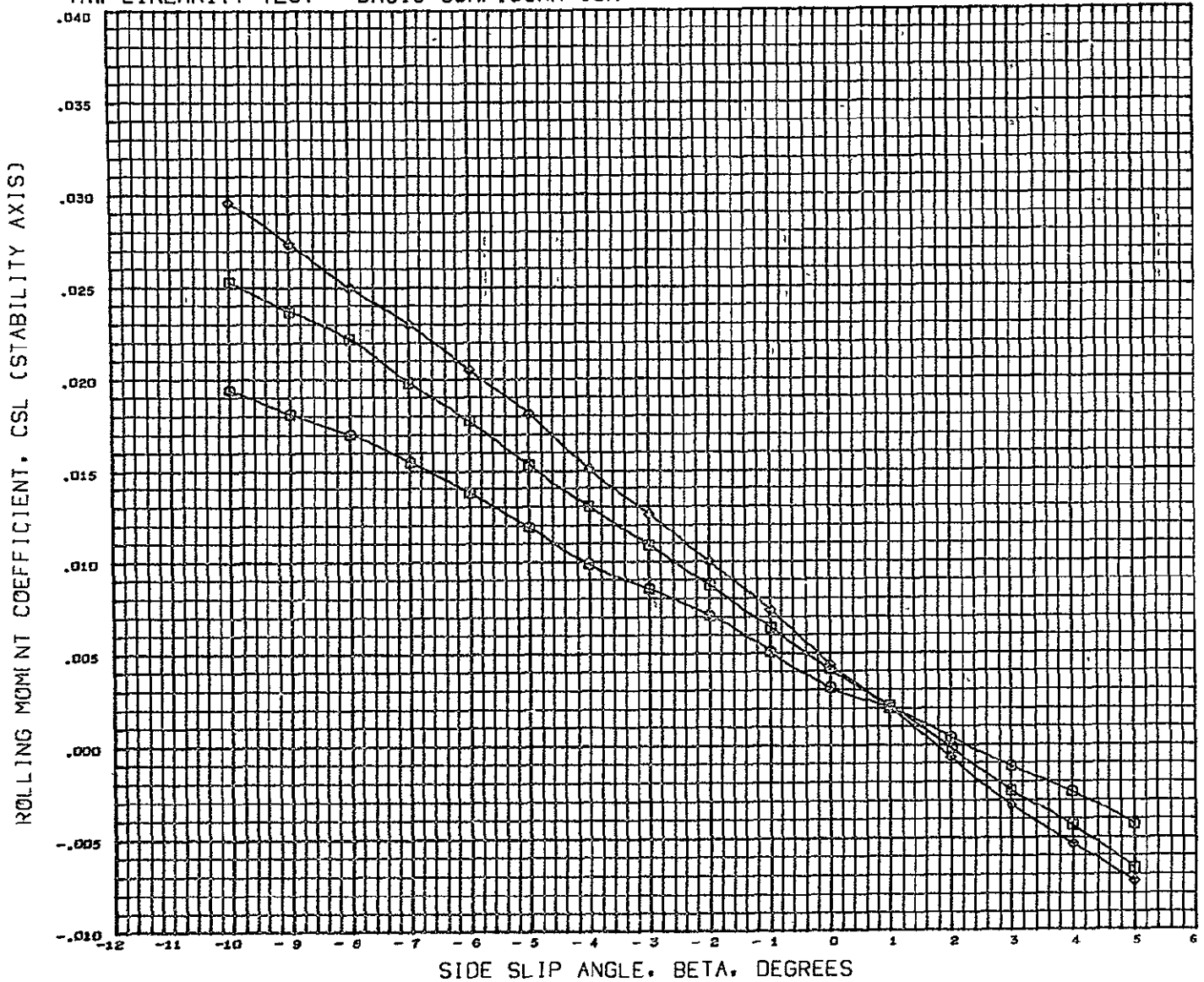

DATA SET SYMBOL	CONFIGURATION DESCRIPTION	ALPHA	ELEVTR	AILRON
(RCPD14)	LSWT 248 MDAC 4.0 FC 02 HCR ORB	4.000 - 10.000	0.000	0.000
(RCPD15)	LSWT 248 MDAC 4.0 FC 02 HCR ORB	8.000 - 10.000	0.000	0.000
(RCPD16)	LSWT 248 MDAC 4.0 FC 02 HCR ORB	12.000 - 10.000	0.000	0.000

REFERENCE INFORMATION		
REFS	8.8690	SQ.FT.
REFL	29.5700	IN.
REFB	51.6000	IN.
XMRP	59.3200	IN.
YMRP	0.0000	IN.
ZMRP	11.6000	IN.
SCALE	4.0000	PERCENT

MACH 0.250

# LONGITUDINAL CONTROL POWER BASIC CONFIGURATION

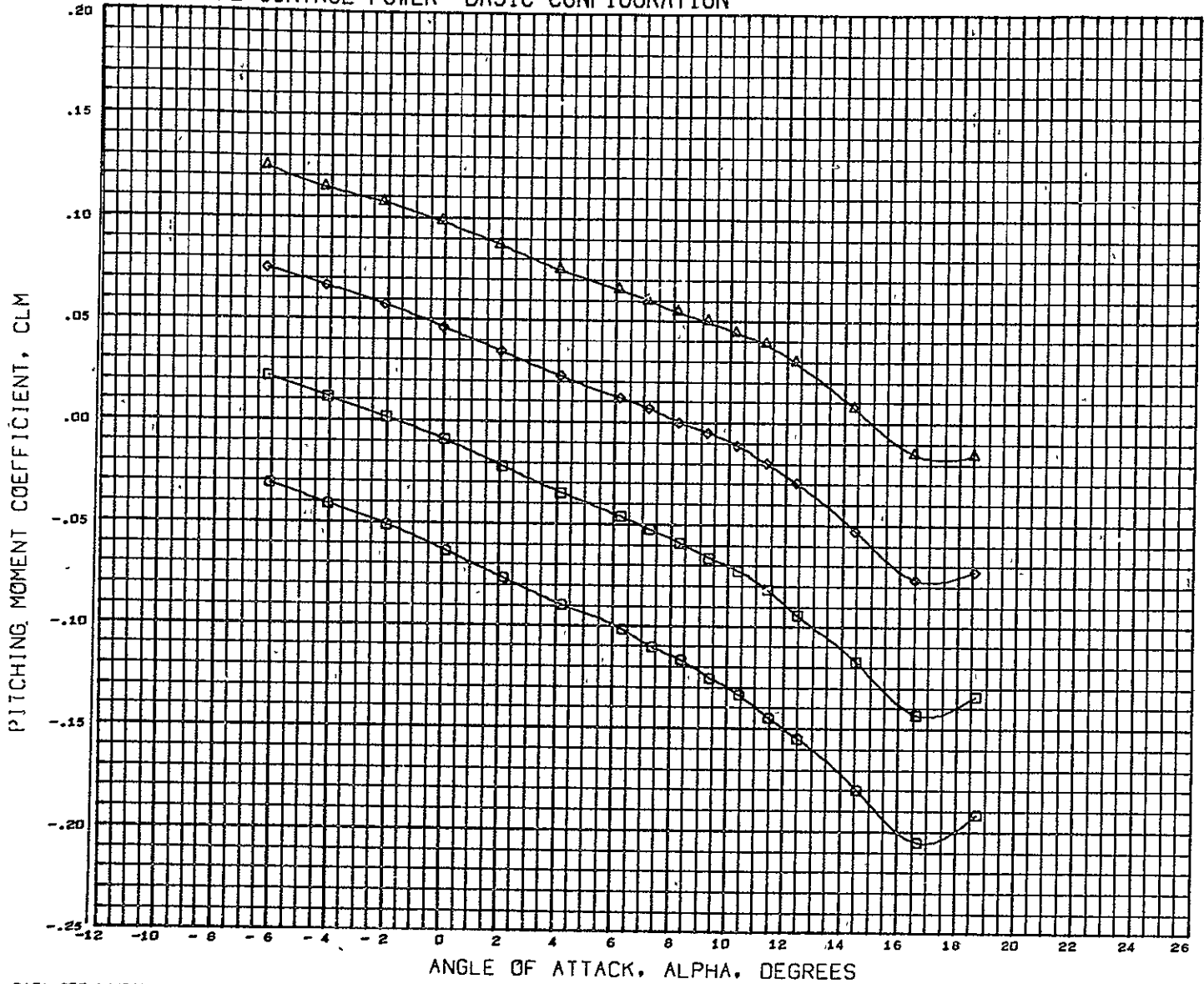

DATA SET SYMBOL	CONFIGURATION DESCRIPTION	BETA	ELEVTR	AILRON	REFERENCE INFORMATION
(CCF002)	LSWT 248 MDAC 4.0 FC 02 HCR ORB	B5W11V6	0.000	0.000	REFS 8.8690 SQ FT.
(CCF006)	LSWT 248 MDAC 4.0 FC 02 HCR ORB	B5W11V6	0.000 - 5.000	0.000	REFL 29.5700 IN.
(CCF012)	LSWT 248 MDAC 4.0 FC 02 HCR ORB	B5W11V6	0.000 - 10.000	0.000	REFB 51.6000 IN.
(CCF008)	LSWT 248 MDAC 4.0 FC 02 HCR ORB	B5W11V6	0.000 - 15.000	0.000	XMRP 59.3200 IN.
					YMRP 0.0000 IN.
					ZMRP 11.6000 IN.
					SCALE 4.0000 PERCENT

MACH 0.250

# LONGITUDINAL CONTROL POWER BASIC CONFIGURATION

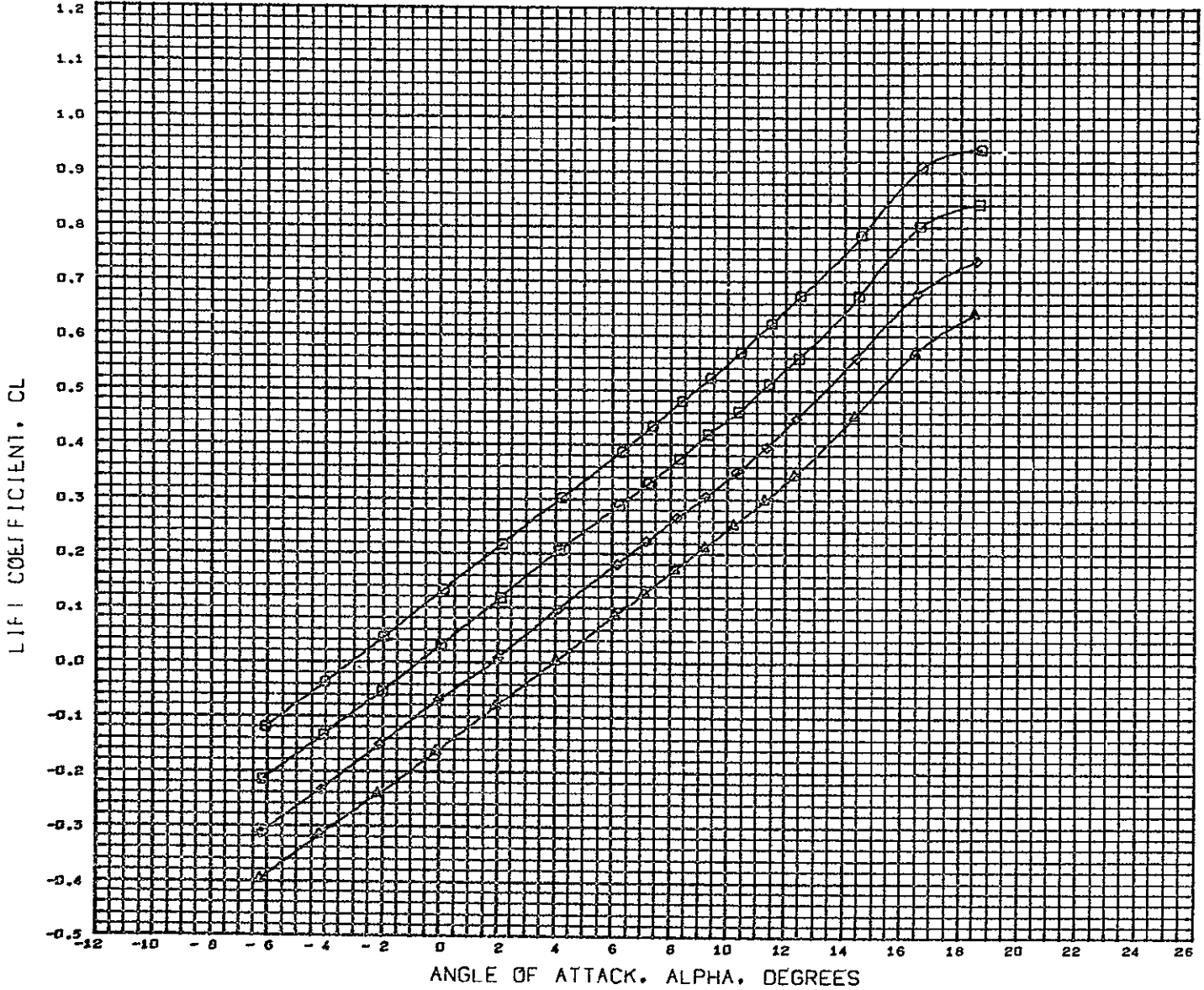

DATA SET SYMBOL	CONFIGURATION DESCRIPTION	BETA	ELEVTR	AILRON	REFERENCE INFORMATION
(CCP002)	LSWT 248 HDAC 4.0 FC O2 HCR ORB	B5W11V6	0.000	0.000	REFS 8.8690 SQ.FT.
(CCP006)	LSWT 248 HDAC 4.0 FC O2 HCR ORB	B5W11V6	0.000 - 5.000	0.000	REFL 29.5700 IN.
(CCP012)	LSWT 248 HDAC 4.0 FC O2 HCR ORB	B5W11V6	0.000 - 10.000	0.000	REFB 51.6000 IN.
(CCP008)	LSWT 248 HDAC 4.0 FC O2 HCR ORB	B5W11V6	0.000 - 15.000	0.000	XMRP 59.3200 IN.
					YMRP 0.0000 IN.
					ZMRP 11.6000 IN.
					SCALE 4.0000 PERCENT

MACH 0.250

# LONGITUDINAL CONTROL POWER BASIC CONFIGURATION

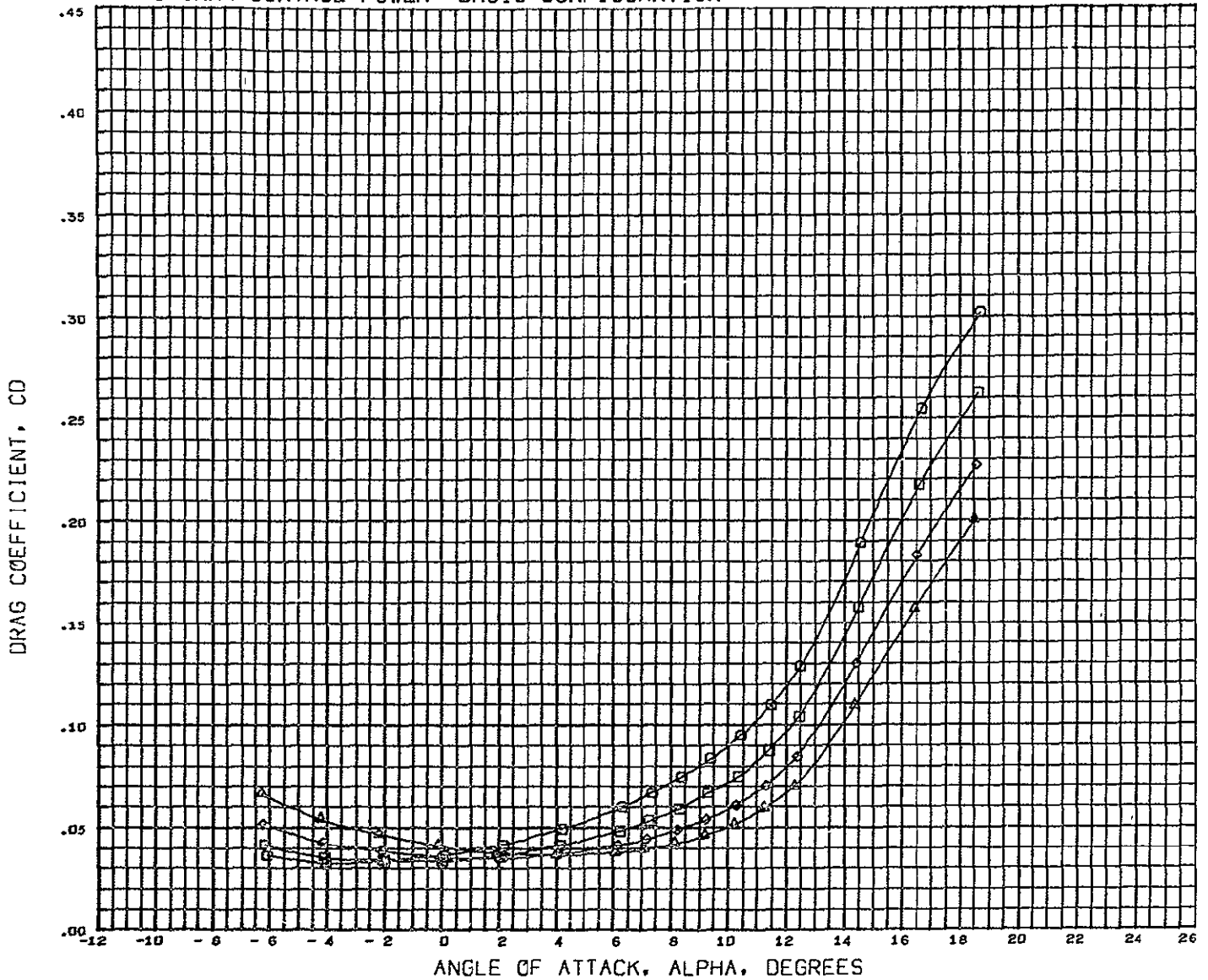

DATA SET SYMBOL	CONFIGURATION DESCRIPTION	BETA	ELEVTR	AILRON	REFERENCE INFORMATION	
(CCF002)	LSWT 248 MDAC 4.0 FC 02 HCR ORB	B5W11V6	0.000	0.000	0.000	REFS 8.8690 SQ. FT.
(CCF006)	LSWT 248 MDAC 4.0 FC 02 HCR ORB	B5W11V6	0.000 - 5.000	0.000		REFL 29.5700 IN.
(CCF012)	LSWT 248 MDAC 4.0 FC 02 HCR ORB	B5W11V6	0.000 - 10.000	0.000		REFB 51.6000 IN.
(CCF008)	LSWT 248 MDAC 4.0 FC 02 HCR ORB	B5W11V6	0.000 - 15.000	0.000		XMRP 59.3200 IN.
						YMRP 0.0000 IN.
						ZMRP 11.6000 IN.
						SCALE 4.0000 PERCENT

MACH 0.250

# LONGITUDINAL CONTROL POWER BASIC CONFIGURATION

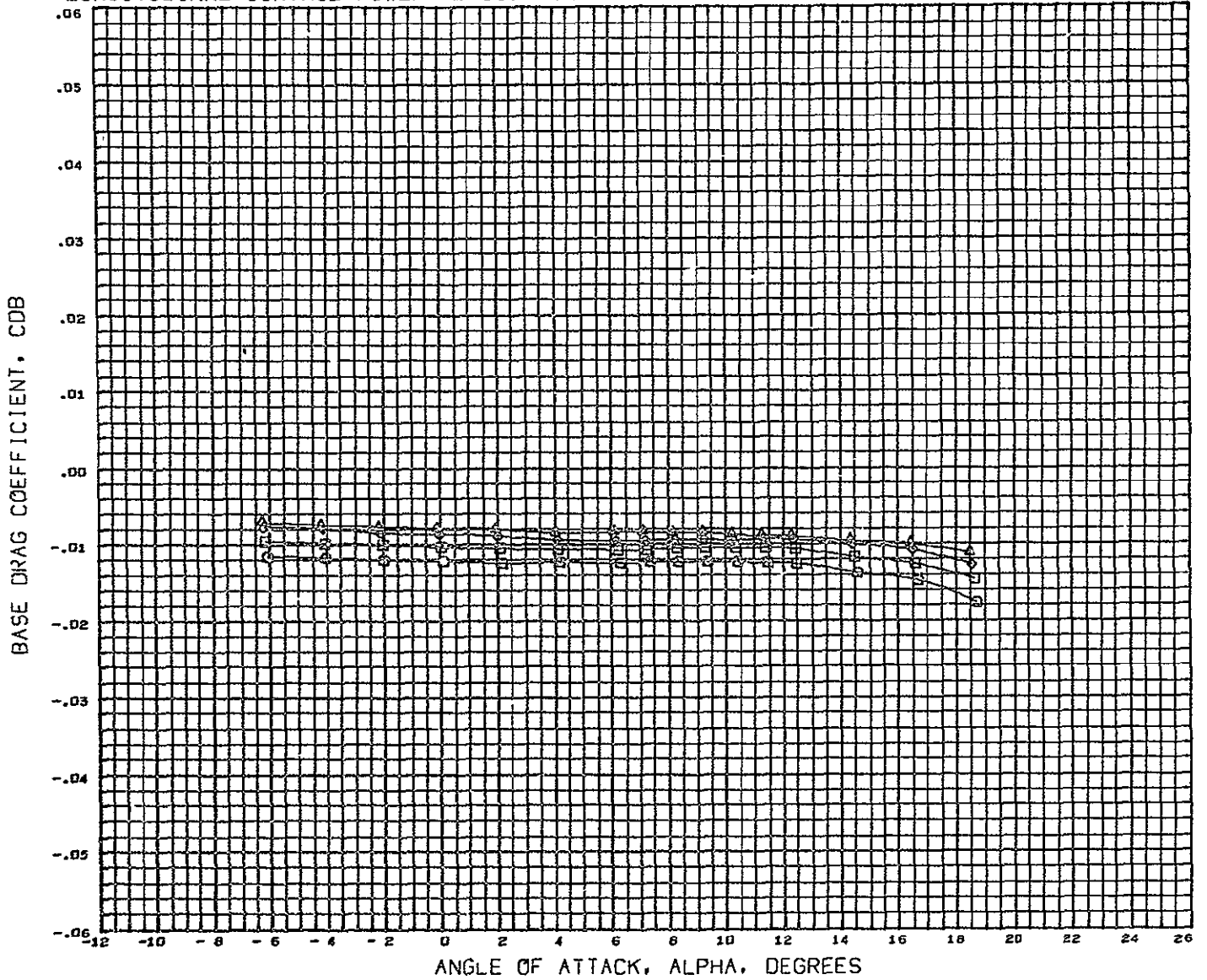

DATA SET SYMBOL	CONFIGURATION DESCRIPTION	BETA	ELEVTR	AILRON	REFERENCE INFORMATION
(CCP002)	LSWT 248 HDAC 4.0 FC 02 HCR ORB B5W11V6	0.000	0.000	0.000	REFS 8.8690 SQ.FT.
(CCP006)	LSWT 248 HDAC 4.0 FC 02 HCR ORB B5W11V6	0.000 - 5.000	0.000	0.000	REFL 29.5700 IN.
(CCP012)	LSWT 248 HDAC 4.0 FC 02 HCR ORB B5W11V6	0.000 - 10.000	0.000	0.000	REFB 51.6000 IN.
(CCP008)	LSWT 248 HDAC 4.0 FC 02 HCR ORB B5W11V6	0.000 - 15.000	0.000	0.000	XMRP 59.3200 IN.
					YMRP 0.0000 IN.
					ZMRP 11.6000 IN.
					SCALE 4.0000 PERCENT

MACH 0.250

# LONGITUDINAL CONTROL POWER BASIC CONFIGURATION

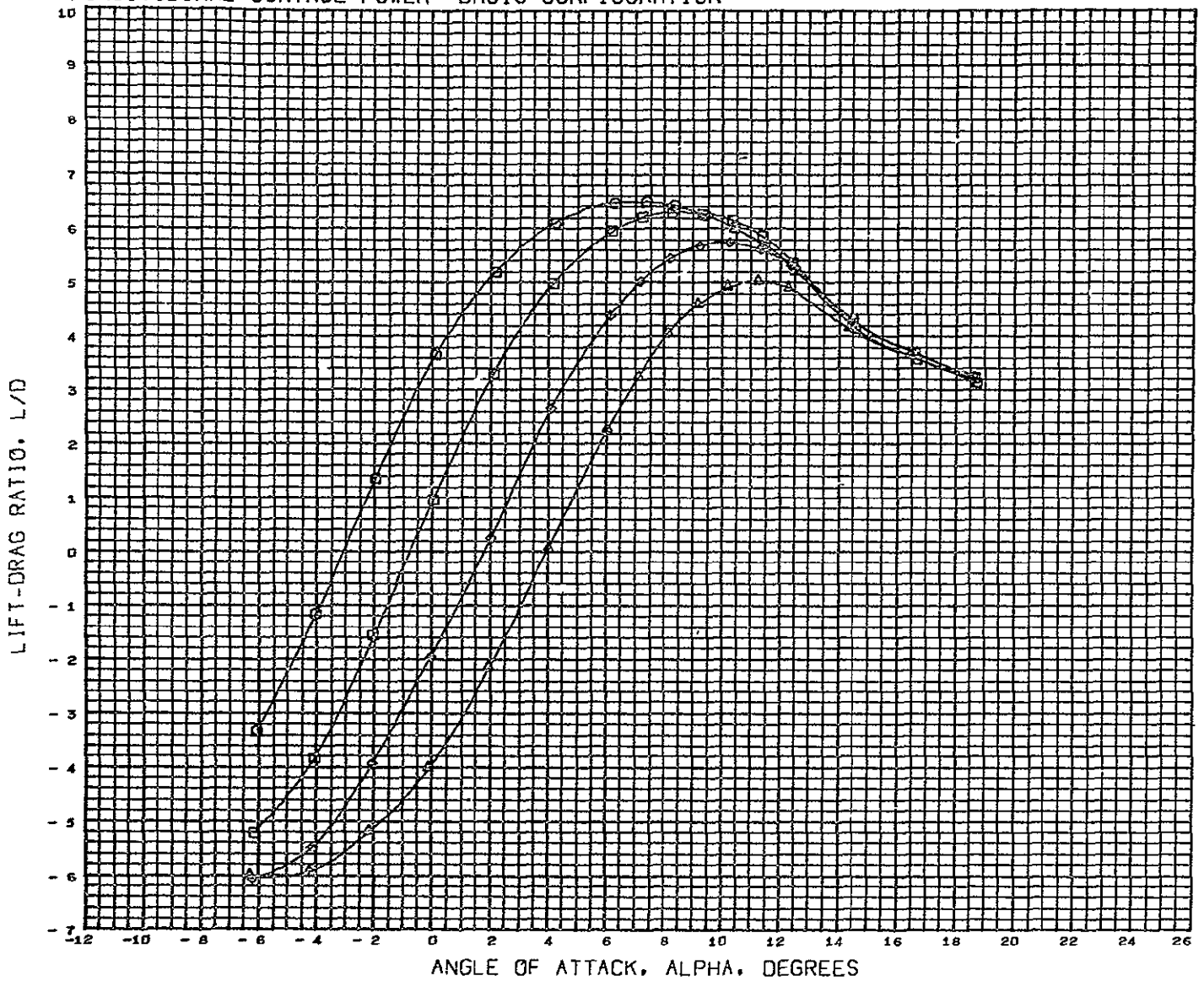

DATA SET SYMBOL	CONFIGURATION DESCRIPTION	BETA	ELEVTR	AILRON	REFERENCE INFORMATION	
(CCFD02)	LSWT 248 MDAC 4.0 FC 02 HCR ORB	B5W11V6	0.000	0.000	0.000	REFS 8.8690 SQ.FT.
(CCFD06)	LSWT 248 MDAC 4.0 FC 02 HCR ORB	B5W11V6	0.000 - 5.000	0.000		REFL 29.5700 IN.
(CCFD12)	LSWT 248 MDAC 4.0 FC 02 HCR ORB	B5W11V6	0.000 - 10.000	0.000		REFB 51.6000 IN.
(CCFD08)	LSWT 248 MDAC 4.0 FC 02 HCR ORB	B5W11V6	0.000 - 15.000	0.000		XMRP 59.3200 IN.
						YMRP 0.0000 IN.
						ZMRP 11.6000 IN.
						SCALE 4.0000 PERCENT

MACH 0.250

# LONGITUDINAL CONTROL POWER BASIC CONFIGURATION

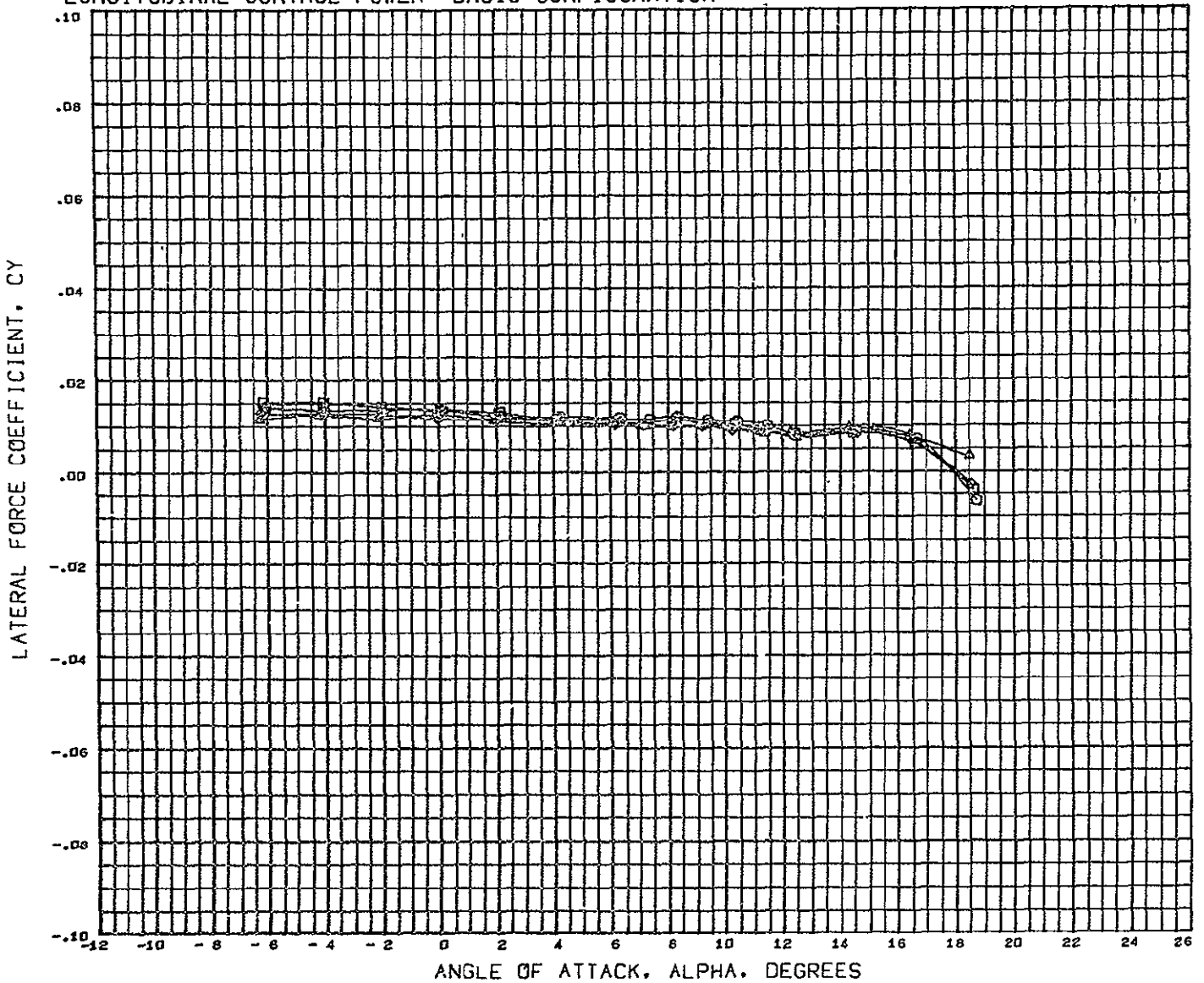

DATA SET SYMBOL	CONFIGURATION DESCRIPTION	BETA	ELEVTR	AILRON	REFERENCE INFORMATION
(CCF002)	LSWT 248 MDAC 4.0 FC 02 HCR ORB B5W11V6	0.000	0.000	0.000	REFS 8 8690 SQ.FT.
(CCF006)	LSWT 248 MDAC 4.0 FC 02 HCR ORB B5W11V6	0.000 - 5.000	0.000	0.000	REFL 29.5700 IN.
(CCF012)	LSWT 248 MDAC 4.0 FC 02 HCR ORB B5W11V6	0.000 - 10.000	0.000	0.000	REFB 51.6000 IN.
(CCF008)	LSWT 248 MDAC 4.0 FC 02 HCR ORB B5W11V6	0.000 - 15.000	0.000	0.000	XMRF 59.3200 IN.
					YMRF 0.0000 IN.
					ZMRF 11.6000 IN.
					SCALE 4.0000 PERCENT

MACH 0.250

# LONGITUDINAL CONTROL POWER BASIC CONFIGURATION

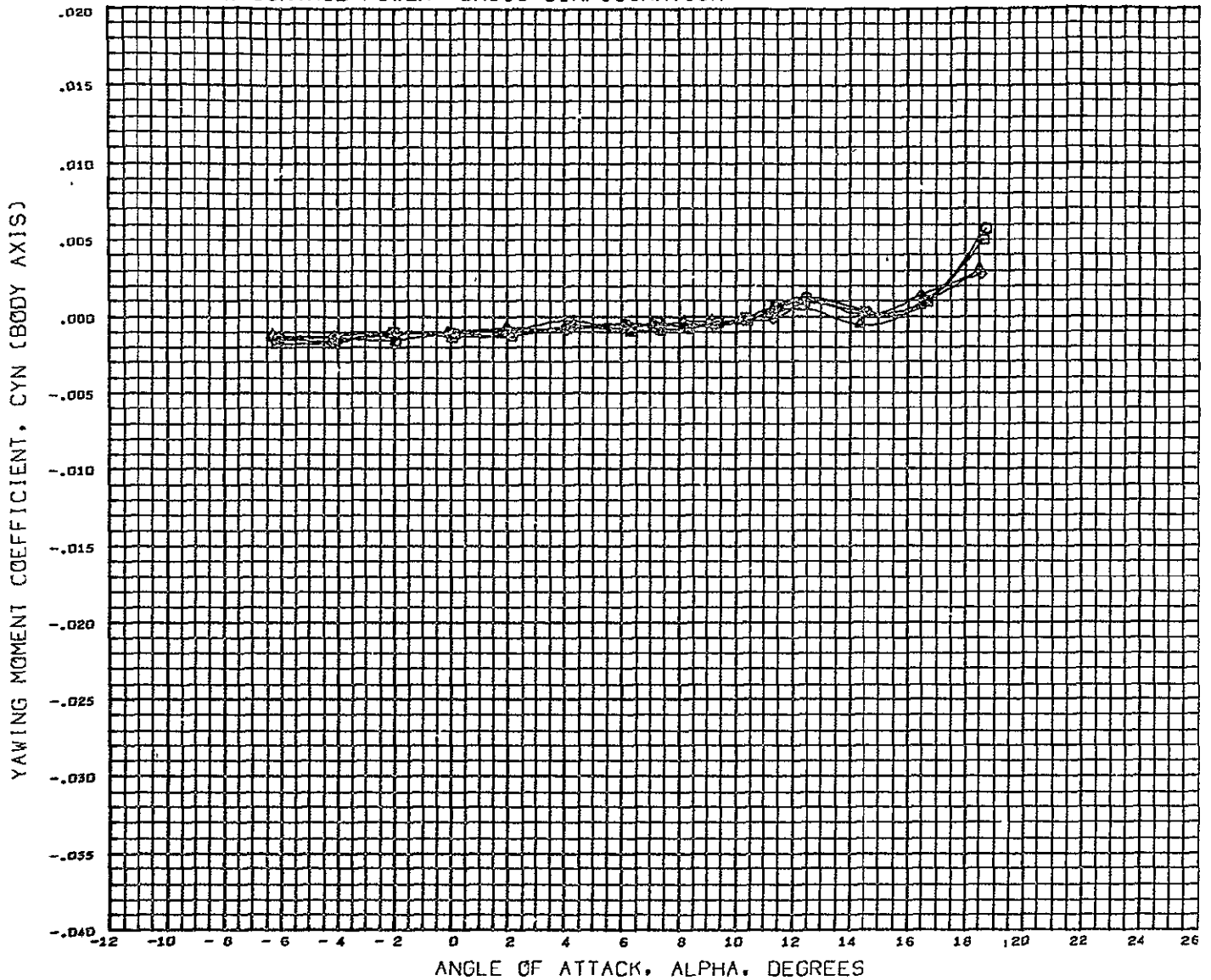

DATA SET SYMBOL	CONFIGURATION DESCRIPTION	BETA	ELEVTR	AILRON	REFERENCE INFORMATION
(CCP002)	LSWT 248 NDAC 4.0 FC 02 HCR ORB	0.000	0.000	0.000	REFS 8.8690 SQ FT.
(CCP006)	LSWT 248 NDAC 4.0 FC 02 HCR ORB	0.000 - 5.000	0.000	0.000	REFL 29.5700 IN.
(CCP012)	LSWT 248 NDAC 4.0 FC 02 HCR ORB	0.000 - 10.000	0.000	0.000	REFB 51.6000 IN.
(CCP008)	LSWT 248 NDAC 4.0 FC 02 HCR ORB	0.000 - 15.000	0.000	0.000	XMRP 59.3200 IN.
					YMRP 0.0000 IN.
					ZMRP 11.6000 IN.
					SCALE 4.0000 PERCENT

MACH 0.250



# LONGITUDINAL CONTROL POWER BASIC CONFIGURATION

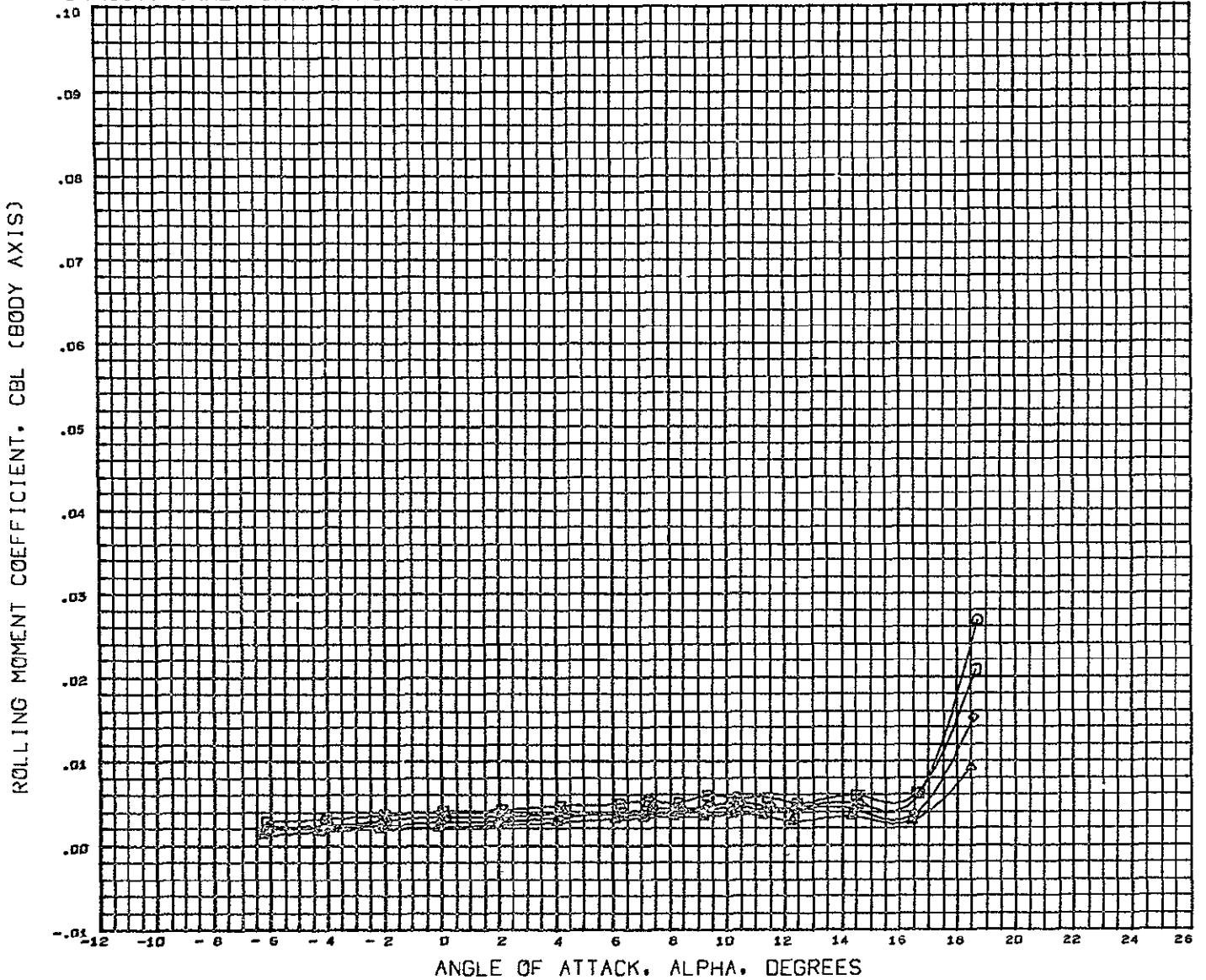

DATA SET SYMBOL	CONFIGURATION DESCRIPTION	BETA	ELEVTR	AILRON	REFERENCE INFORMATION
(CCF002)	○ LSWT 248 NDAC 4.0 FC 02 HCR ORB B5W11V6	0.000	0.000	0.000	REFS 8.8690 SQ.FT.
(CCF006)	□ LSWT 248 NDAC 4.0 FC 02 HCR ORB B5W11V6	0.000 - 5.000	0.000	0.000	REFL 29.5700 IN.
(CCF012)	◇ LSWT 248 NDAC 4.0 FC 02 HCR ORB B5W11V6	0.000 - 10.000	0.000	0.000	REFB 51.6000 IN.
(CCF008)	△ LSWT 248 NDAC 4.0 FC 02 HCR ORB B5W11V6	0.000 - 15.000	0.000	0.000	XMRP 59.3200 IN.
					YMRP 0.0000 IN.
					ZMRP 11.6000 IN.
					SCALE 4.0000 PERCENT

MACH 0.250

# LONGITUDINAL CONTROL POWER BASIC CONFIGURATION

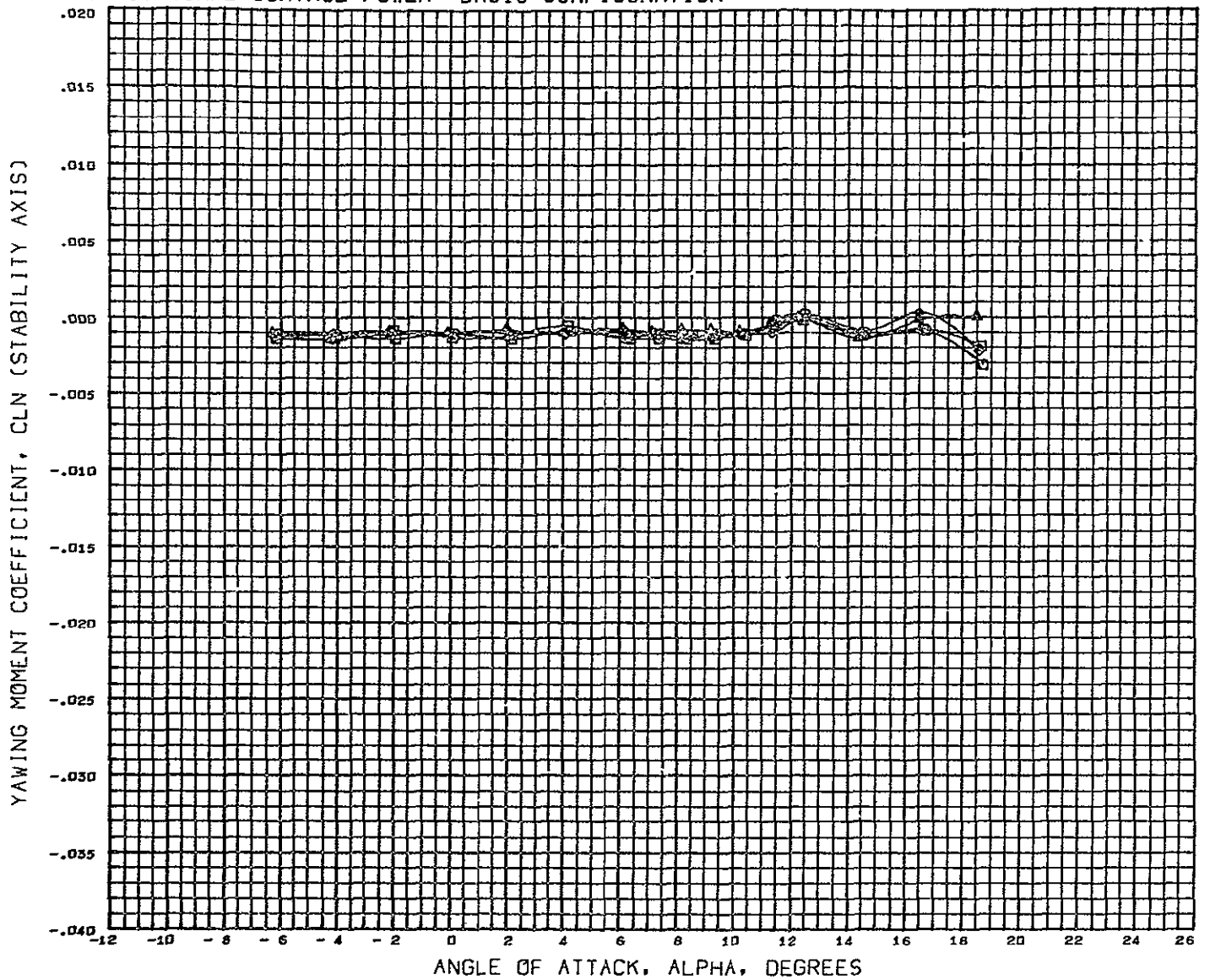

DATA SET SYMBOL	CONFIGURATION DESCRIPTION	BETA	ELEVTR	AILRON	REFERENCE INFORMATION
(RCP002)	LSWT 248 MDAC 4.0 FC 02 HCR ORB B5W11V6	0.000	0.000	0.000	REFS 8.8690 SQ.FT.
(RCP006)	LSWT 248 MDAC 4.0 FC 02 HCR ORB B5W11V6	0.000 - 5.000	0.000	0.000	REFL 29.5700 IN.
(RCP012)	LSWT 248 MDAC 4.0 FC 02 HCR ORB B5W11V6	0.000 - 10.000	0.000	0.000	REFB 51.6000 IN.
(RCP008)	LSWT 248 MDAC 4.0 FC 02 HCR ORB B5W11V6	0.000 - 15.000	0.000	0.000	XMRP 59.3200 IN.
					YMRP 0.0000 IN.
					ZMRP 11.6000 IN.
					SCALE 4.0000 PERCNT

MACH 0.250

LONGITUDINAL CONTROL POWER BASIC CONFIGURATION

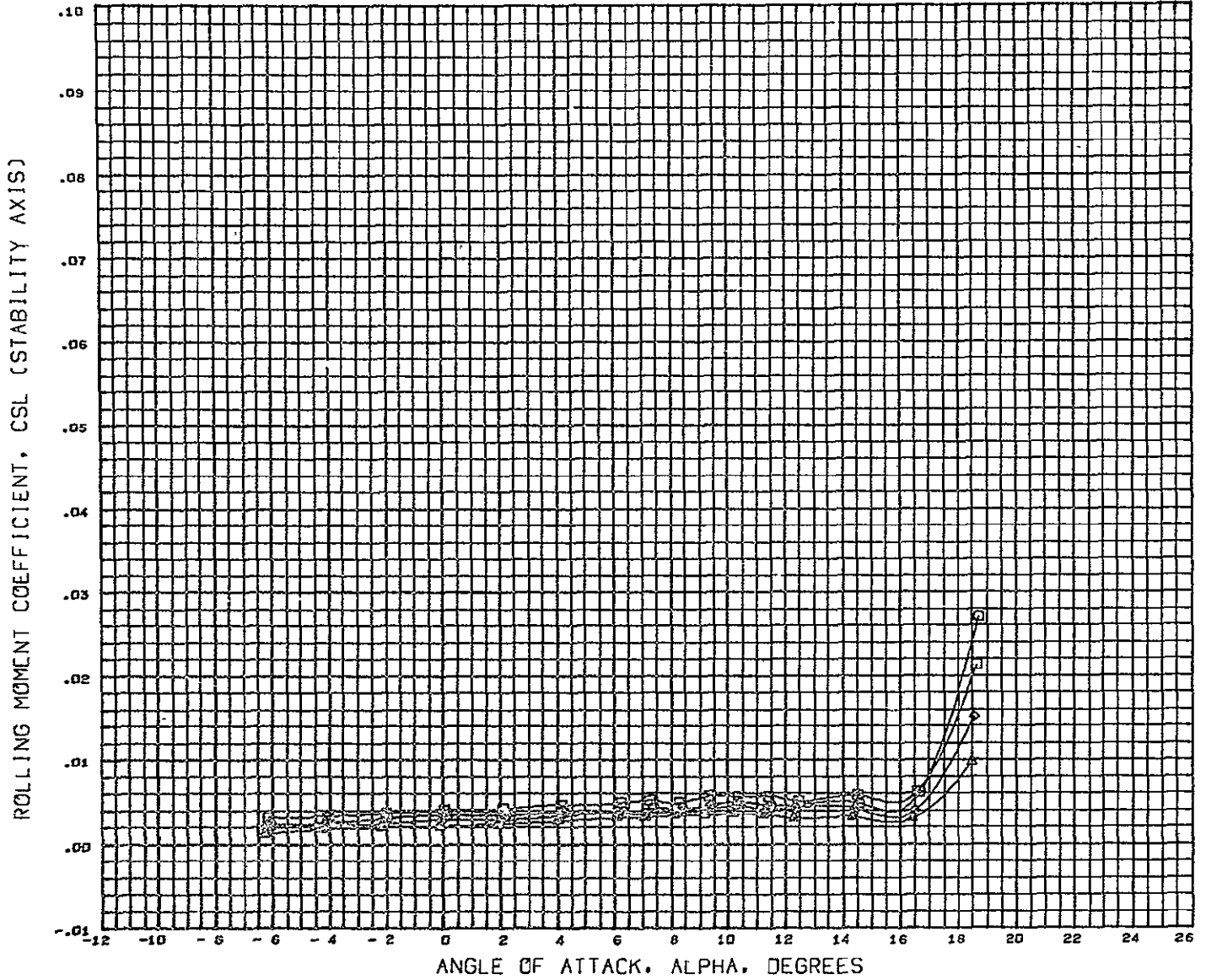

DATA SET SYMBOL	CONFIGURATION DESCRIPTION	BETA	ELEVTR	AILRON	REFERENCE INFORMATION
(RCFD02)	□ LSWT 248 HDAC 4.0 FC 02 HCR ORB B5W11V6	0.000	0.000	0.000	REFS 8.8690 SQ.FT
(RCFD06)	◻ LSWT 248 HDAC 4.0 FC 02 HCR ORB B5W11V6	0.000 - 5.000	0.000	0.000	REFL 29.5700 IN.
(RCFD12)	◊ LSWT 248 HDAC 4.0 FC 02 HCR ORB B5W11V6	0.000 - 10.000	0.000	0.000	REFB 51.6000 IN.
(RCFD08)	△ LSWT 248 HDAC 4.0 FC 02 HCR ORB B5W11V6	0.000 - 15.000	0.000	0.000	XMRP 59.3200 IN.
					YMRP 0.0000 IN.
					ZMRP 11.6000 IN.
					SCALE 4.0000 PERCENT

MACH 0.250

# LONGITUDINAL CONTROL POWER BASIC CONFIGURATION

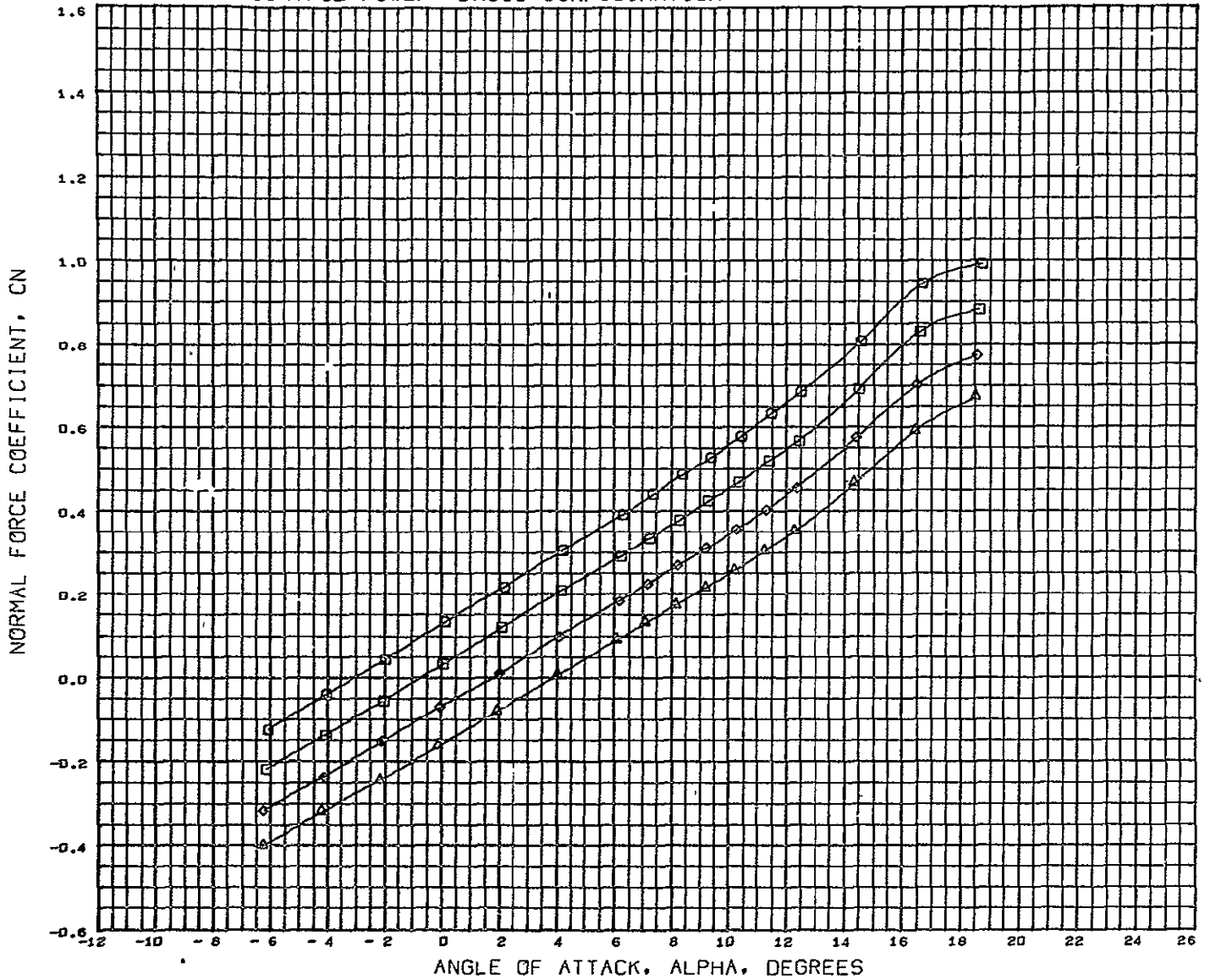

DATA SET SYMBOL	CONFIGURATION DESCRIPTION	BETA	ELEVTR	AILRON	REFERENCE INFORMATION	
(BCFD02)	LSWT 248 MDAC 4.0 FC 02 HCR ORB	B5W11V6	0.000	0.000	0.000	REFS 8.8690 SQ.FT.
(BCFD06)	LSWT 248 MDAC 4.0 FC 02 HCR ORB	B5W11V6	0.000 - 5.000	0.000		REFL 29.5700 IN.
(BCFD12)	LSWT 248 MDAC 4.0 FC 02 HCR ORB	B5W11V6	0.000 - 10.000	0.000		REFB 51.6000 IN.
(BCFD08)	LSWT 248 MDAC 4.0 FC 02 HCR ORB	B5W11V6	0.000 - 15.000	0.600		XMRP 59.3200 IN.
						YMRP 0.0000 IN.
						ZMRP 11.6000 IN.
						SCALE 4.0000 PERCENT

HACH 0.250

# LONGITUDINAL CONTROL POWER BASIC CONFIGURATION

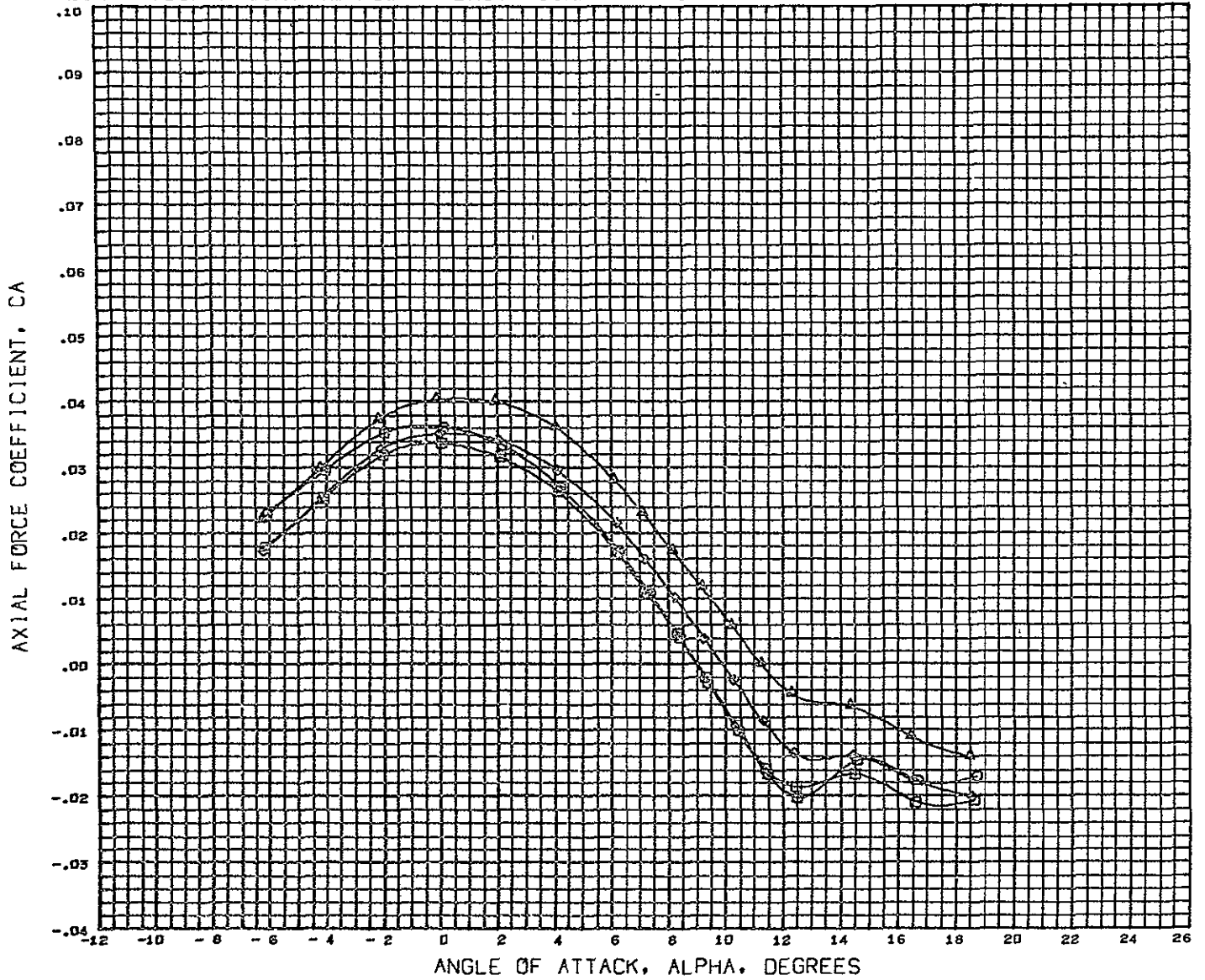

DATA SET SYMBOL	CONFIGURATION DESCRIPTION	BETA	ELEVTR	AILRON	REFERENCE INFORMATION	
(BCFD02)	□ LSWT 248 HDAC 4.0 PC 02 HCR ORB	85W11V6	0.000	0.000	0.000	REFS 8.8690 SQ.FT
(BCFD06)	□ LSWT 248 HDAC 4.0 PC 02 HCR ORB	85W11V6	0.000 - 5.000	0.000		REFL 29.5700 IN.
(BCFD12)	○ LSWT 248 HDAC 4.0 PC 02 HCR ORB	85W11V6	0.000 - 10.000	0.000		REFB 51.6000 IN.
(BCFD08)	△ LSWT 248 HDAC 4.0 PC 02 HCR ORB	85W11V6	0.000 - 15.000	0.000		XMRP 59.3200 IN.
						YMRP 0.0000 IN.
						ZMRP 11.6000 IN.
						SCALE 4.0000 PERCNT

HACH 0.250

# LONGITUDINAL CONTROL POWER BASIC CONFIGURATION

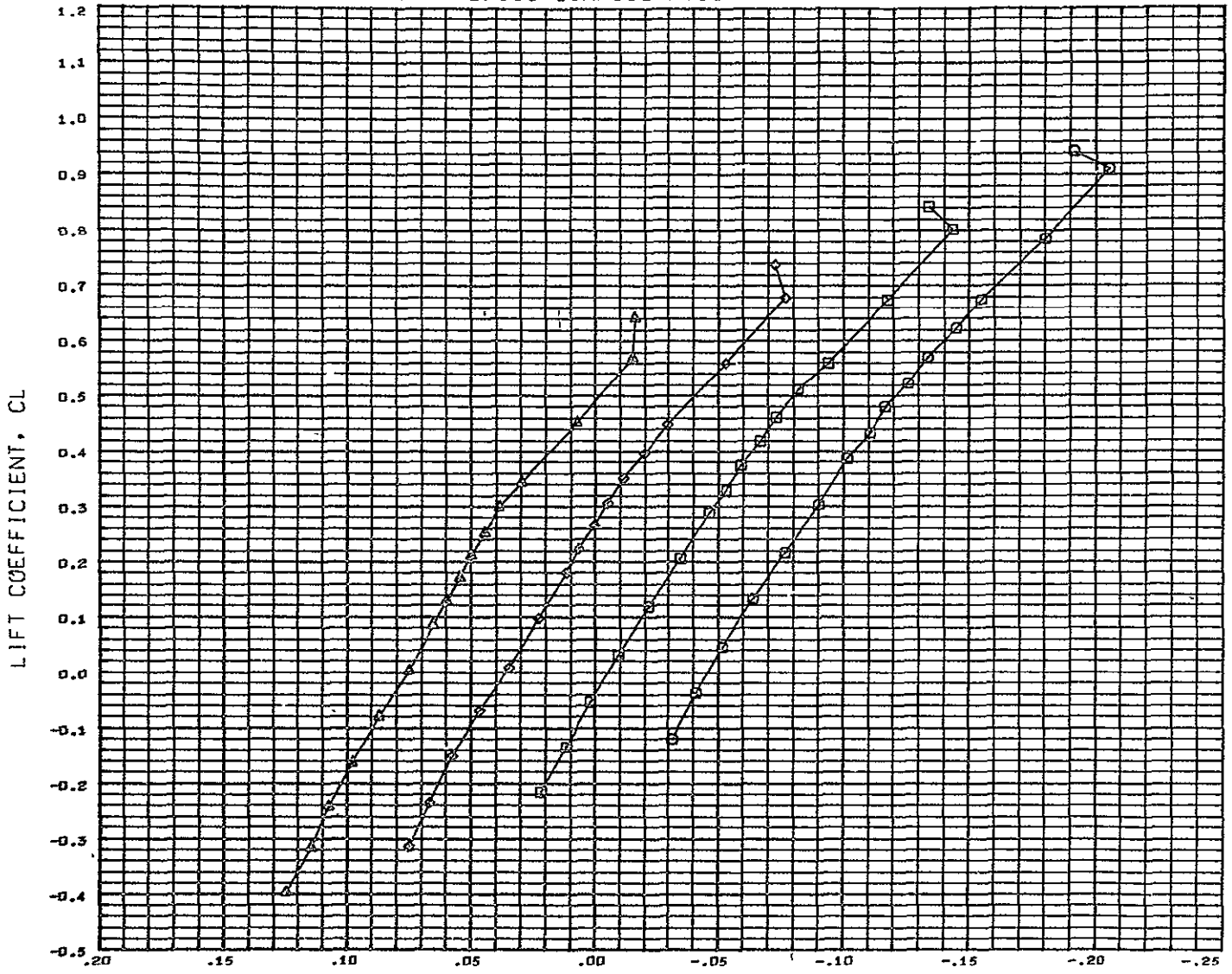

PITCHING MOMENT COEFFICIENT, CLM

DATA SET SYMBOL	CONFIGURATION DESCRIPTION	BETA	ELEVTR	AILRON	REFERENCE INFORMATION
(CCP002)	○ LSWT 248 MDAC 4.0 PC O2 HCR ORB 85W11V6	0.000	0.000	0.000	REFS 8.8690 SQ.FT
(CCP006)	□ LSWT 248 MDAC 4.0 PC O2 HCR ORB 85W11V6	0.000 - 5.000	0.000	0.000	REFL 29.5700 IN.
(CCP012)	◇ LSWT 248 MDAC 4.0 PC O2 HCR ORB 85W11V6	0.000 - 10.000	0.000	0.000	REFB 51.6000 IN.
(CCP008)	△ LSWT 248 MDAC 4.0 PC O2 HCR ORB 85W11V6	0.000 - 15.000	0.000	0.000	XMRP 59.3200 IN.
					YMRP 0.0000 IN.
					ZMRP 11.6000 IN.
					SCALE 4.0000 PERCENT

HACH 0.250

# LONGITUDINAL CONTROL POWER BASIC CONFIGURATION

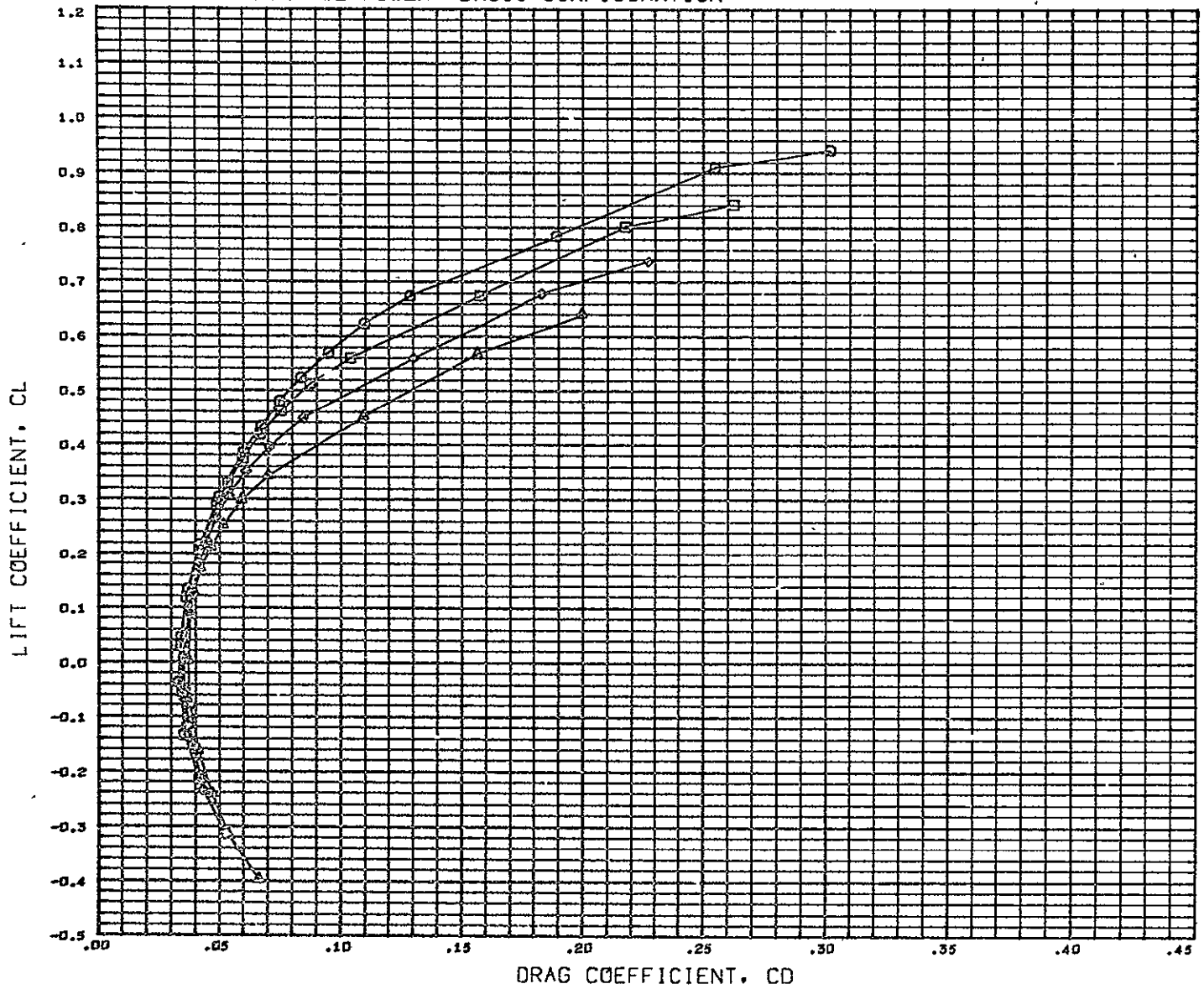

DATA SET SYMBOL	SYMBOL	CONFIGURATION DESCRIPTION	BETA	ELEVTR	AILRON	REFERENCE INFORMATION	
(CCFD02)	□	LSWT 248 MDAC 4.0 PC 02 HCR ORB	B5W11V6	0.000	0.000	0.000	REFS 8.8690 SQ.FT
(CCFD06)	◇	LSWT 248 MDAC 4.0 PC 02 HCR ORB	B5W11V6	0.000 - 5.000	0.000		REFL 29.5700 IN.
(CCFD12)	○	LSWT 248 MDAC 4.0 PC 02 HCR ORB	B5W11V6	0.000 - 10.000	0.000		REFB 51.6000 IN.
(CCFD08)	△	LSWT 248 MDAC 4.0 PC 02 HCR ORB	B5W11V6	0.000 - 15.000	0.000		XNRF 59.3200 IN.
							YNRF 0.0000 IN.
							ZNRF 11.6000 IN.
							SCALE 4 0000 PERCNT

MACH 0.250

# LONGITUDINAL CONTROL POWER BASIC CONFIGURATION

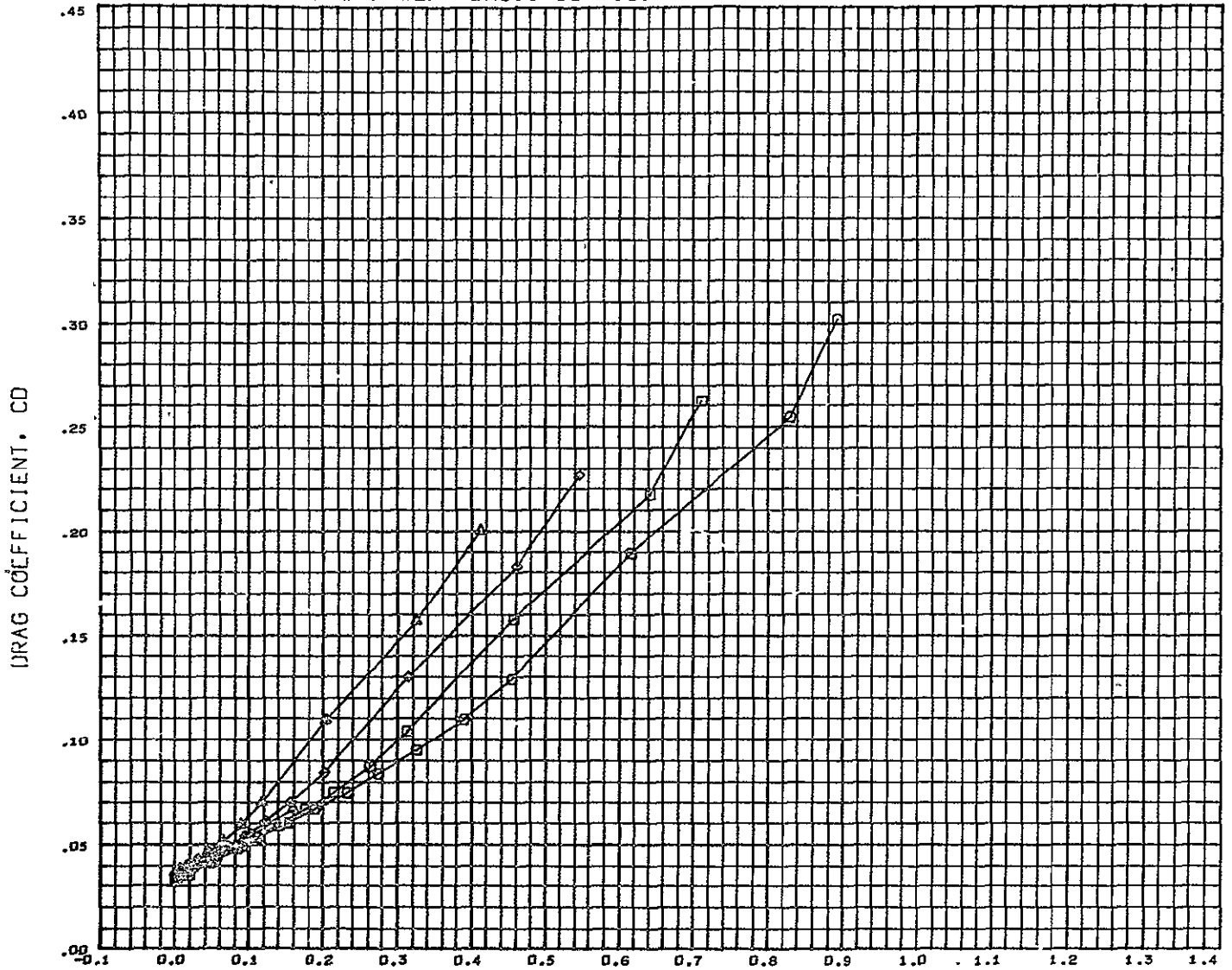

LIFT COEFFICIENT SQUARED, CLSQR

DATA SET SYMBOL	CONFIGURATION DESCRIPTION	BETA	ELEVTR	AILRON	REFERENCE INFORMATION	
(CCF002)	□ LSWT 248 HDAC 4.0 FC 02 HCR ORB	85W11V6	0.000	0.000	0.000	REFS 8 8690 SQ.FT
(CCF006)	□ LSWT 248 HDAC 4.0 FC 02 HCR ORB	85W11V6	0.000 - 5.000	0.000		REFL 29.5700 IN.
(CCF012)	◇ LSWT 248 HDAC 4.0 FC 02 HCR ORB	85W11V6	0.000 - 10.000	0.000		REFB 51.6000 IN.
(CCF008)	△ LSWT 248 HDAC 4.0 FC 02 HCR ORB	85W11V6	0.000 - 15.000	0.000		XNRP 69.3200 IN.
						YNRP 0.0000 IN.
						ZNRP 11.6000 IN.
						SCALE 4.0000 PERCENT

MACH 0.250



# LONGITUDINAL CONTROL POWER BASIC CONFIGURATION

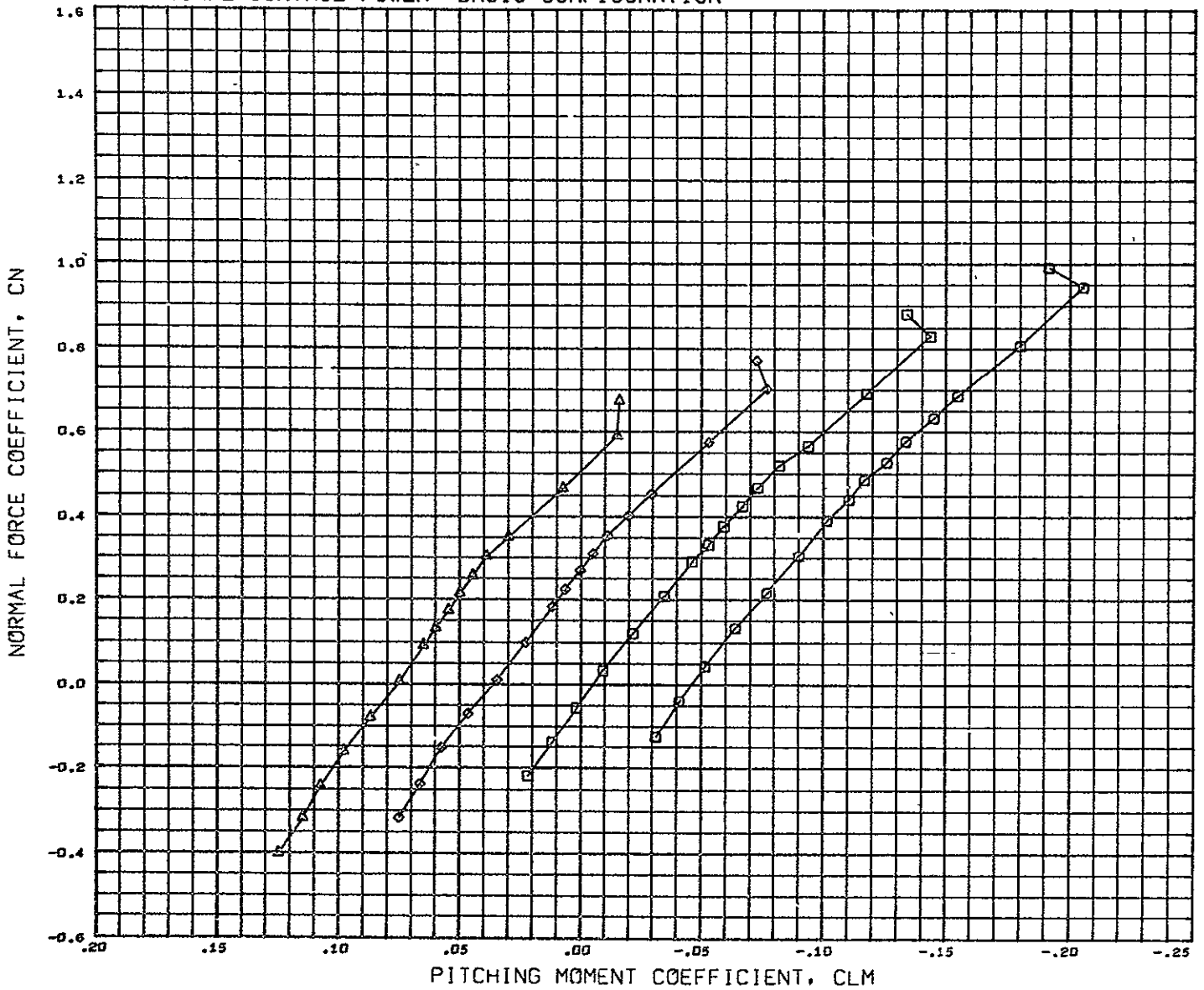

DATA SET SYMBOL	CONFIGURATION DESCRIPTION	BETA	ELEVTR	AILRON	REFERENCE INFORMATION
(BCF002)	○ LSWT 248 MDAC 4.0 FC 02 HCR ORB B5W11V6	0.000	0.000	0.000	REFS 8.8690 50.FT.
(BCF006)	□ LSWT 248 MDAC 4.0 FC 02 HCR ORB B5W11V6	0.000 - 5.000	0.000	0.000	REFL 29.5700 IN.
(BCF012)	◇ LSWT 248 MDAC 4.0 FC 02 HCR ORB B5W11V6	0.000 - 10.000	0.000	0.000	REFB 51.6000 IN.
(BCF008)	△ LSWT 248 MDAC 4.0 FC 02 HCR ORB B5W11V6	0.000 - 15.000	0.000	0.000	XHRP 59.3200 IN.
					YMRP 0.0000 IN.
					ZMRP 11.6000 IN.
					SCALE 4.0000 PERCNT

HACH 0.250

LONGITUDINAL CONTROL POWER BASIC CONFIGURATION

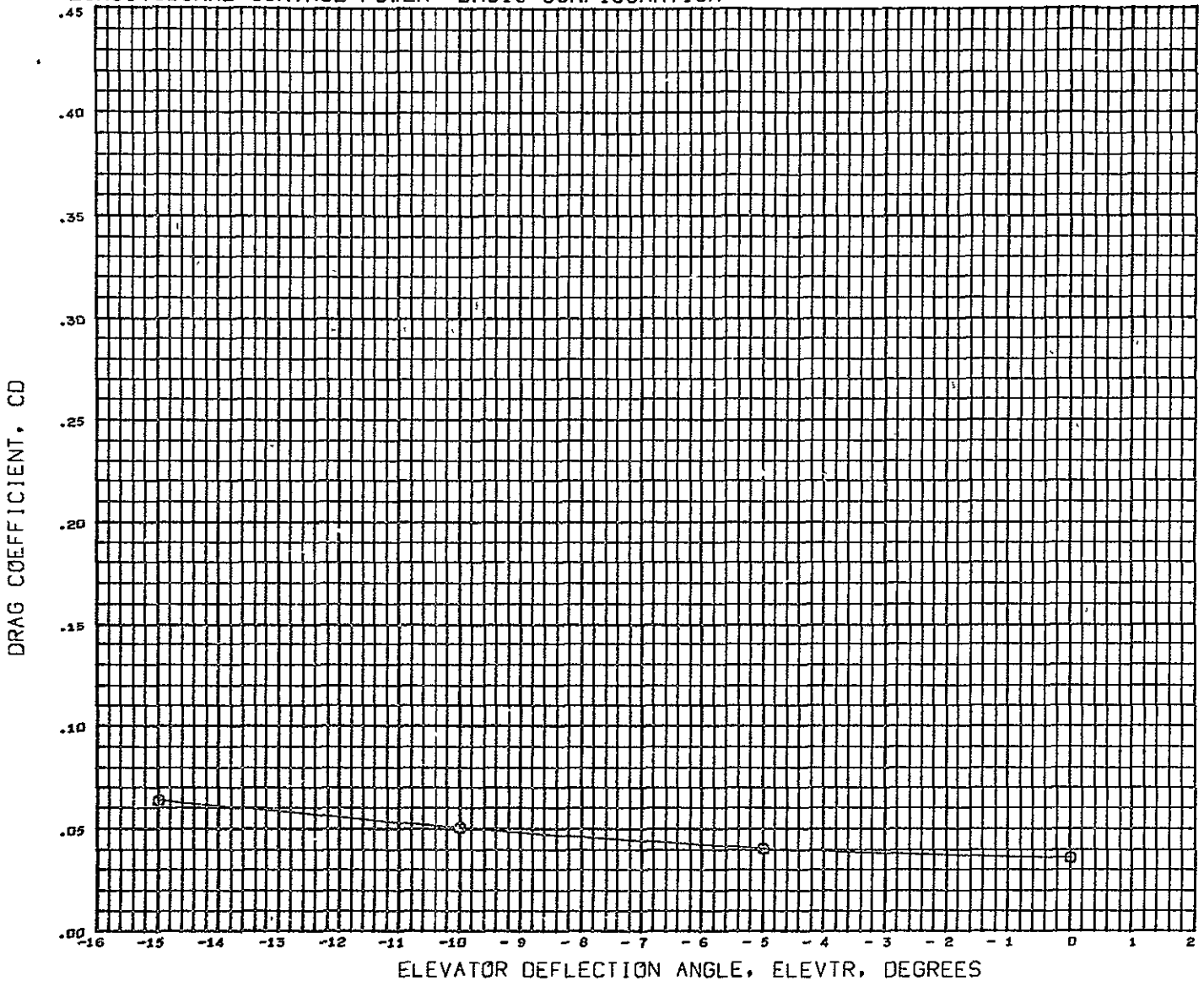

ELEVATOR DEFLECTION ANGLE, ELEVTR, DEGREES

SYMBOL	ALPHA	PARAMETRIC VALUES				DATA SOURCE				REFERENCE INFORMATION		
○	- 6.000	MACH	0.260	BETA	0.000	DATASET	ELEVTR	DATASET	ELEVTR	REFS	8.8590	SQ.FT.
		AILRON	0.000	SFBRK	0.000	NCP002	0.000	NCP006	- 5.000	REFL	29.5700	IN.
		BFLAF	0.000	RUDDER	0.000	NCP012	- 10.000	NCP008	- 15.000	REFB	51.6000	IN.
										XMRP	59.3200	IN.
										YMRF	0.0000	IN.
										ZMRP	11.6000	IN.
										SCALE	4.0000	PERCENT

DATA HIST. CODE M#EV#EI

# LONGITUDINAL CONTROL POWER BASIC CONFIGURATION

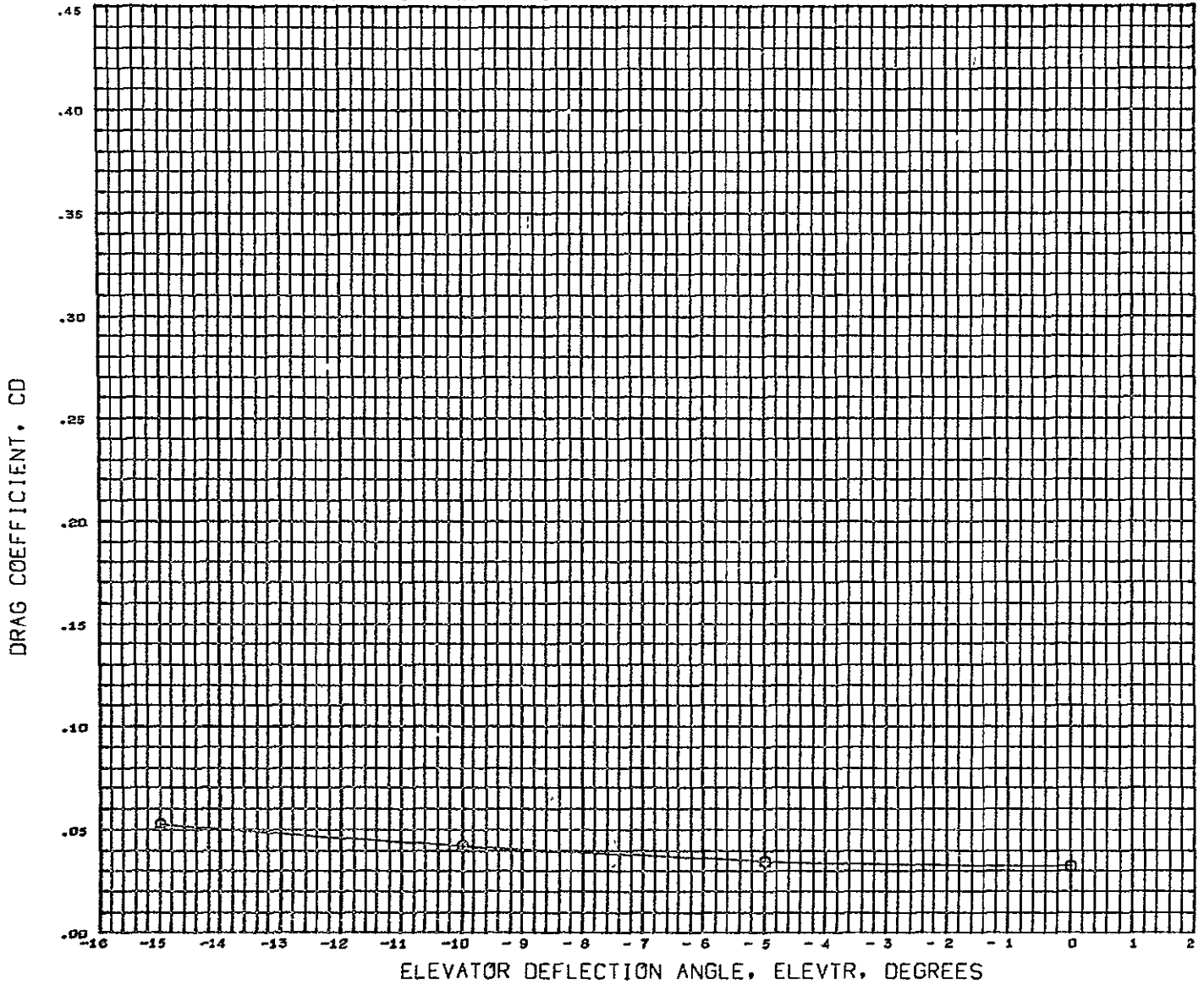

SYMBOL	ALPHA	PARAMETRIC VALUES				DATA SOURCE				REFERENCE INFORMATION		
○	- 4.000	<u>MACH</u>	0.260	BETA	0.000	DATASET	ELEVTR	DATASET	ELEVTR	REFS	8 8690	SQ.FT
		AIRON	0.000	SPBRK	0.000	NCP002	0.000	NCP006	- 5.000	REFL	29.5700	IN.
		BFLAP	0.000	RUDDER	0.000	NCP012	- 10.000	NCP008	- 15.000	REFB	51.6000	IN.
										XMRP	59.3200	IN.
										YMRP	0.0000	IN.
										ZMRP	11.6000	IN.
										SCALE	4.0000	PERCNT

DATA HIST. CODE M#EV#EI

# LONGITUDINAL CONTROL POWER BASIC CONFIGURATION

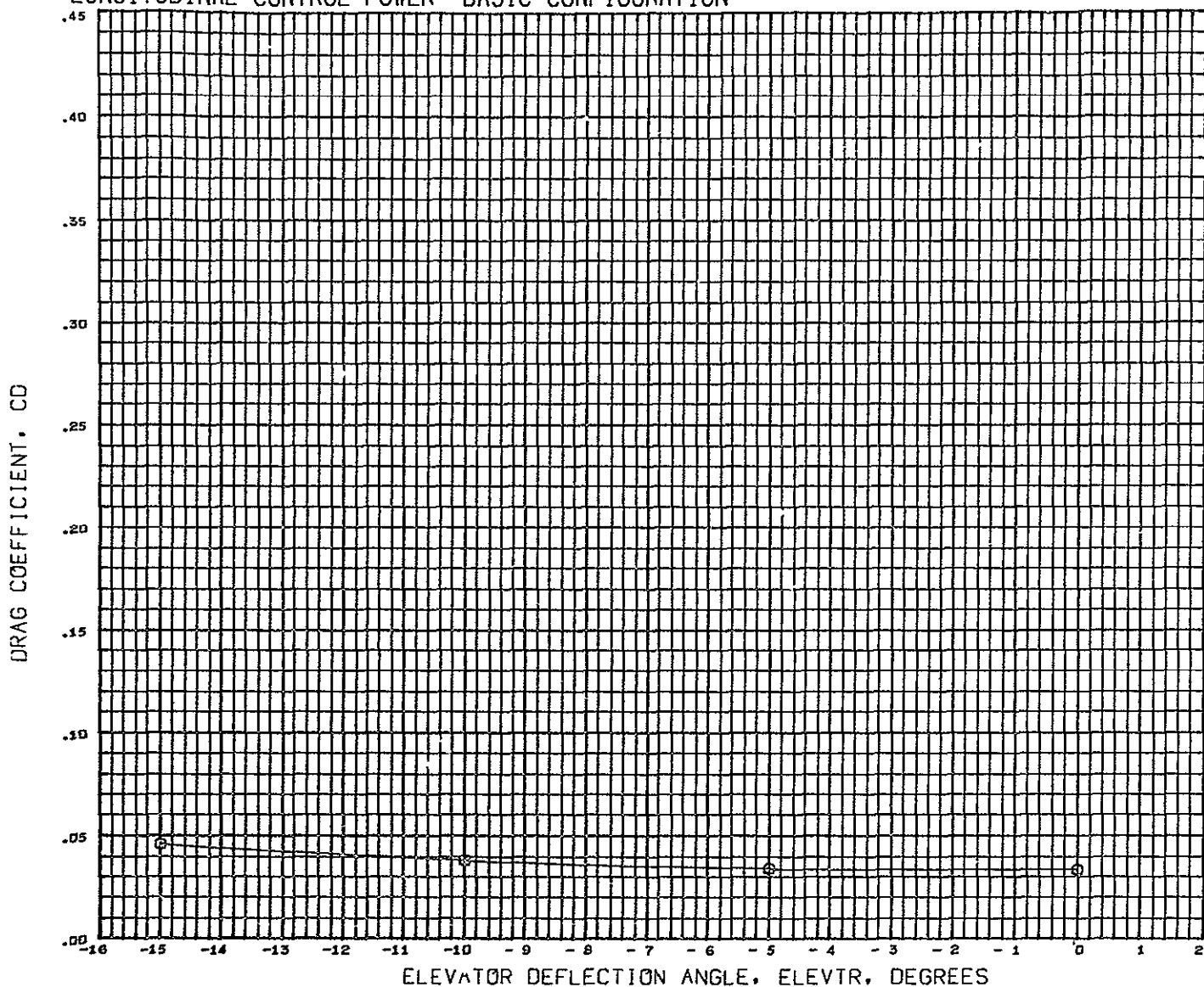

SYMBOL	ALPHA	PARAMETRIC VALUES				DATA SOURCE				REFERENCE INFORMATION		
Q	- 2.000	<u>MACH</u>	0.260	BETA	0.000	DATASET	ELEVTR	DATASET	ELEVTR	REFS	8.8690	SQ.FT.
		AIRON	0.000	CFBK	0.000	NCP002	0.000	NCP006	- 5.000	REFL	29.5700	IN.
		BFLAP	0.000	RUDDER	0.000	NCP012	- 10.000	NCP008	- 15.000	REFB	51.6000	IN.
										XMRP	59.3200	IN.
										YMRP	0.0000	IN.
										ZMRP	11.6000	IN.
										SCALE	4.0000	PERCENT

DATA HIST. CODE M#EV#EI

LSW 248 MDAC 4.0 PC 02 HCR ORB

BSW11V6

(NCP002) 26 FEB 71

PAGE

56

# LONGITUDINAL CONTROL POWER BASIC CONFIGURATION

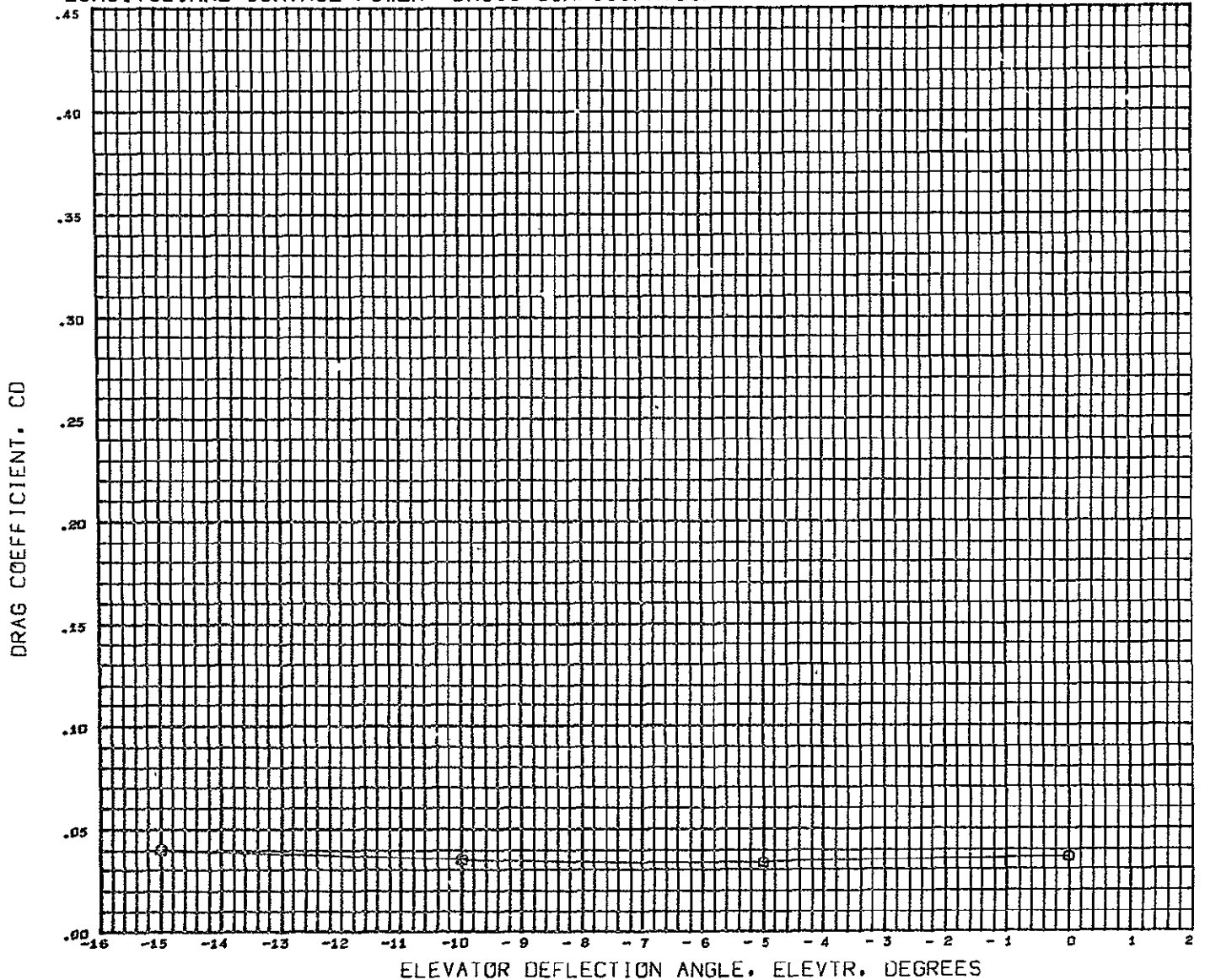

SYMBOL	ALFMA	PARAMETRIC VALUES				DATA SOURCE				REFERENCE INFORMATION					
		HACH	BETA	SPBRK	RUDDER	DATA SET	ELEVTR	DATA SET	ELEVTR	REFS	IN.	PERCENT			
○	0.000	0.260	0.000	0.000	0.000		NCP006	- 5.000	8.8690	29.5700	51.6000	59.3200	0.0000	11.6000	4.0000
		0.000	0.000	0.000	0.000	NCP002	0.000	NCP008	- 15.000						
		0.000	0.000	0.000	0.000	NCP012	- 10.000								

DATA HIST. CODE H#EV#EI

LONGITUDINAL CONTROL POWER BASIC CONFIGURATION

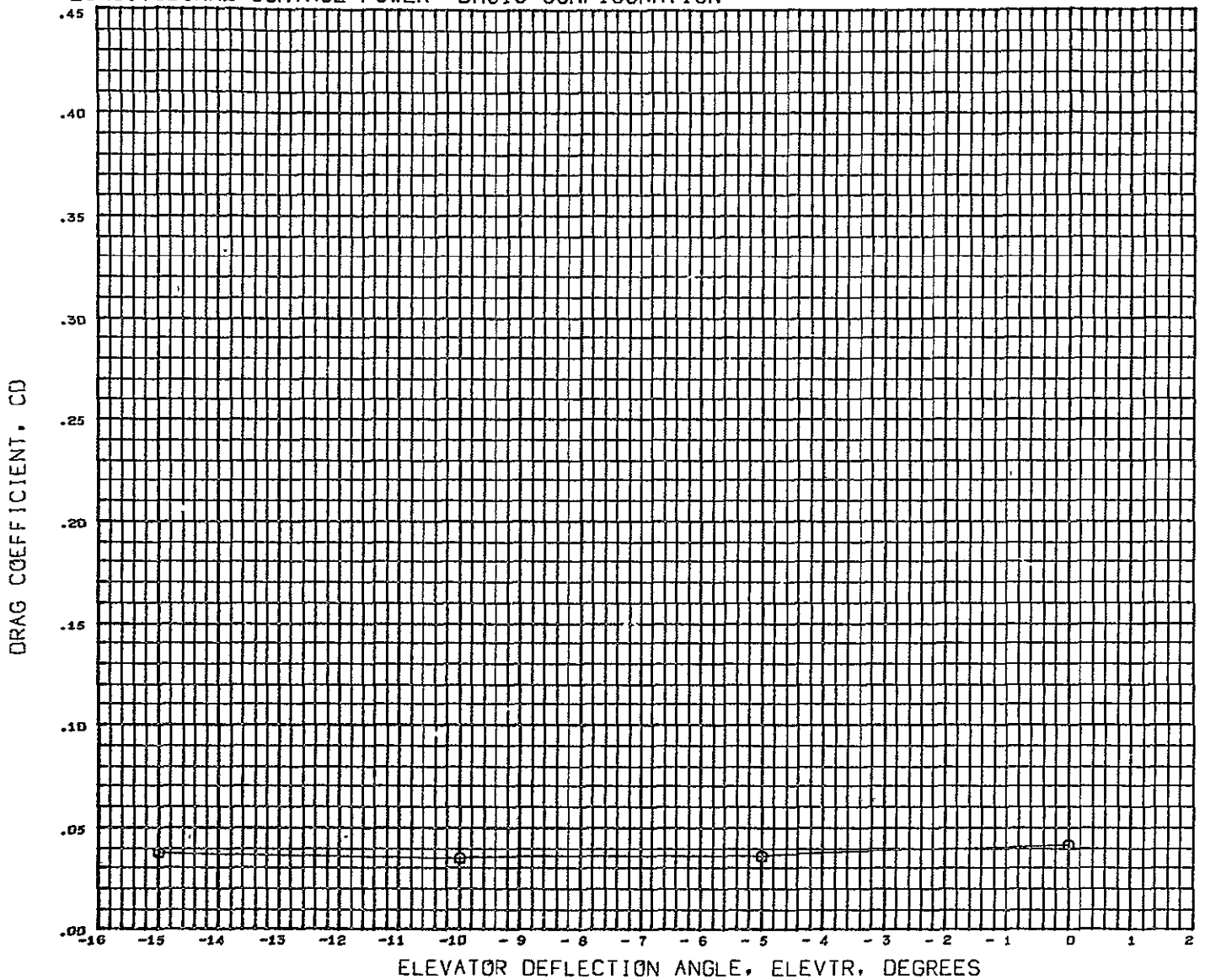

SYMBOL	ALPHA	PARAMETRIC VALUES				DATA SOURCE				REFERENCE INFORMATION		
		MACH	BETA	SPBRK	RUDDER	DATASET	ELEVTR	DATASET	ELEVTR	REFS	IN.	SQ.FT.
Q	2.000	0.260	0.000	0.000	0.000	NCP002	0.000	NCP006	- 5.000	8.8690	29.5700	IN.
		0.000	0.000	0.000	0.000	NCPD12	- 10.000	NCP008	- 15.000	51.6000	59.3200	IN.
		0.000	0.000	0.000	0.000					0.0000	11.6000	IN.
										11.6000	4.0000	PERCENT

DATA HIST. CODE M#EV#EI

\_SWT 248 MDAC 4.0 PC 02 HCR 0RB

BSW11V6

(NCP002)

26 FEB 71

PAGE

58

LONGITUDINAL CONTROL POWER BASIC CONFIGURATION

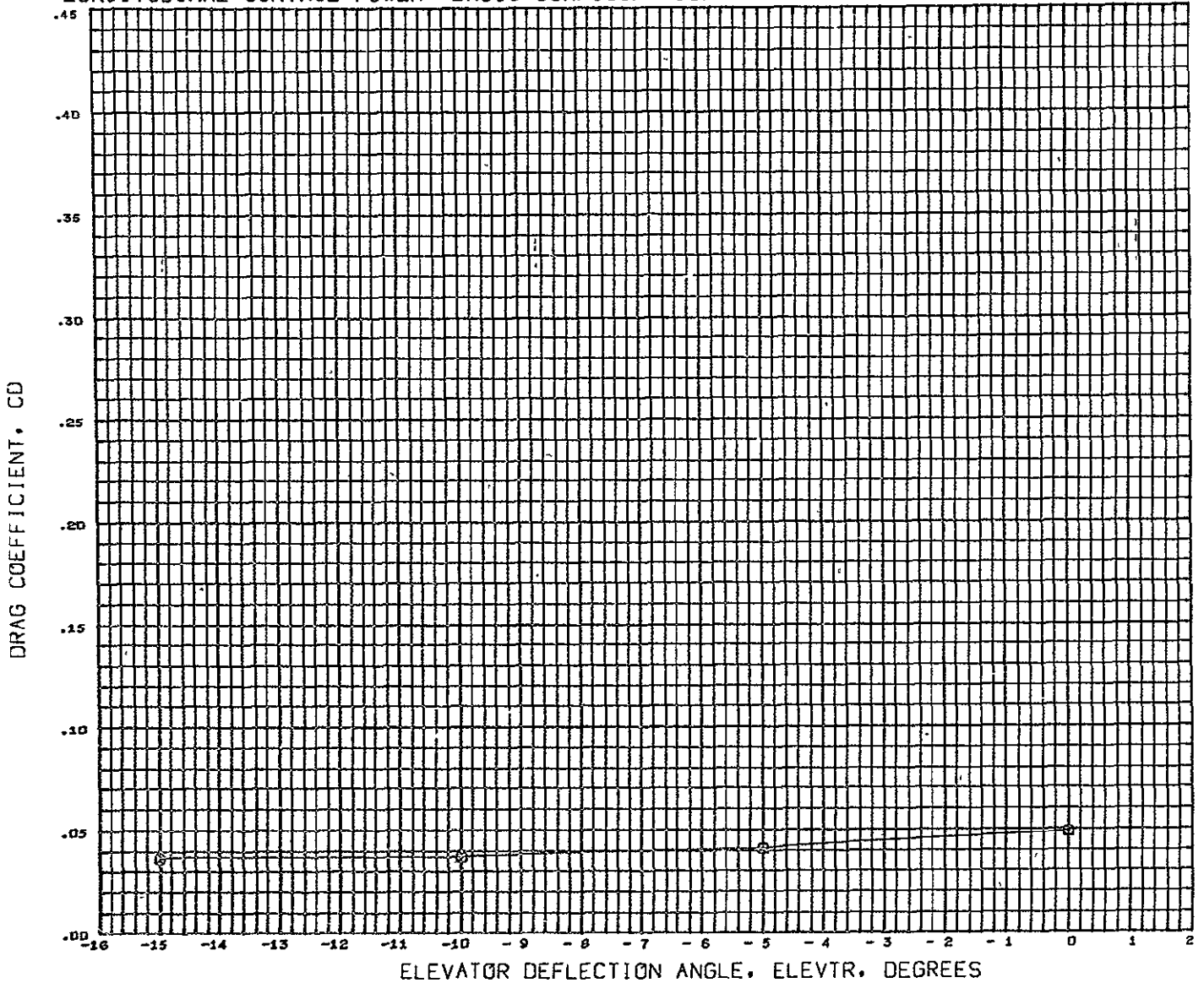

SYMBOL	ALPHA	PARAMETRIC VALUES				DATA SOURCE			REFERENCE INFORMATION		
		MACH	BETA	DATASET	ELEVTR	DATASET	ELEVTR	REFS	SQ FT.		
○	4.000	0.260	0.000	NCP002	0.000	NCP006	- 5.000	REFL	8.8690	IN.	
		0.000	0.000	NCP012	- 10.000	NCP008	- 15.000	REFB	29.5700	IN.	
		0.000	0.000					XMRP	51.6000	IN.	
								YMRP	59.3200	IN.	
								ZMRP	0.0000	IN.	
								SCALE	11.6000	IN.	
									4.0000	PERCNT	

DATA MIST. CODE M#EV#EI

# LONGITUDINAL CONTROL POWER BASIC CONFIGURATION

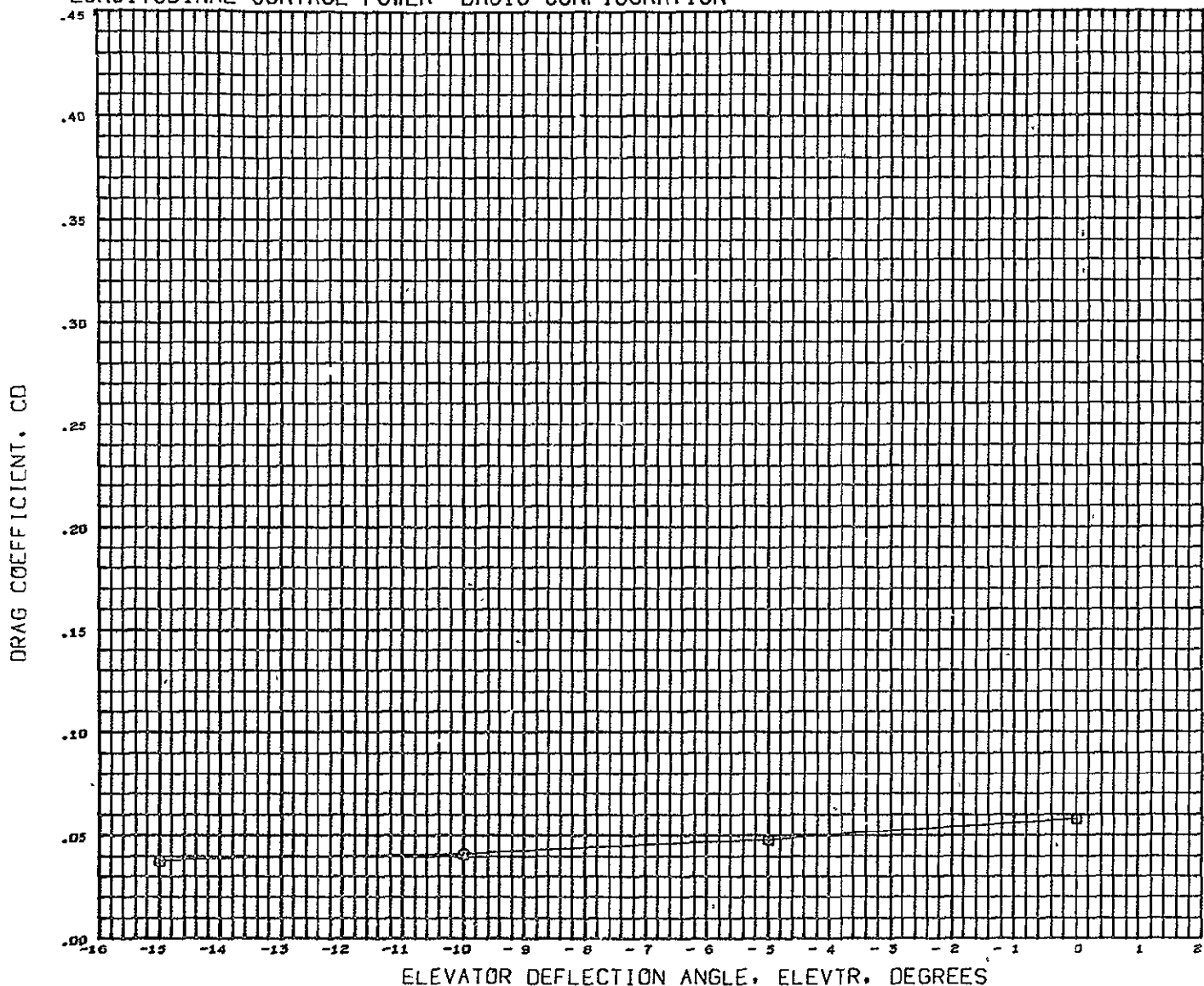

SYMBOL	ALPHA	PARAMETRIC VALUES				DATA SOURCE				REFERENCE INFORMATION		
		MACH	BETA	SPBRK	RUDDER	DATASET	ELEVTR	DATASET	ELEVTR	REFS	REFL	SQ.FT.
○	6.000	0.260	0.000	0.000	0.000	NCP002	0.000	NCP006	- 5.000	8.8690	29.5700	IN.
		0.000	0.000	0.000	0.000	NCP012	- 10.000	NCP008	- 15.000	51.6000	59.3200	IN.
										0.0000	11.6000	IN.
										SCALE	4.0000	PERCENT

DATA HIST. CODE H#EV#EI



LONGITUDINAL CONTROL POWER BASIC CONFIGURATION

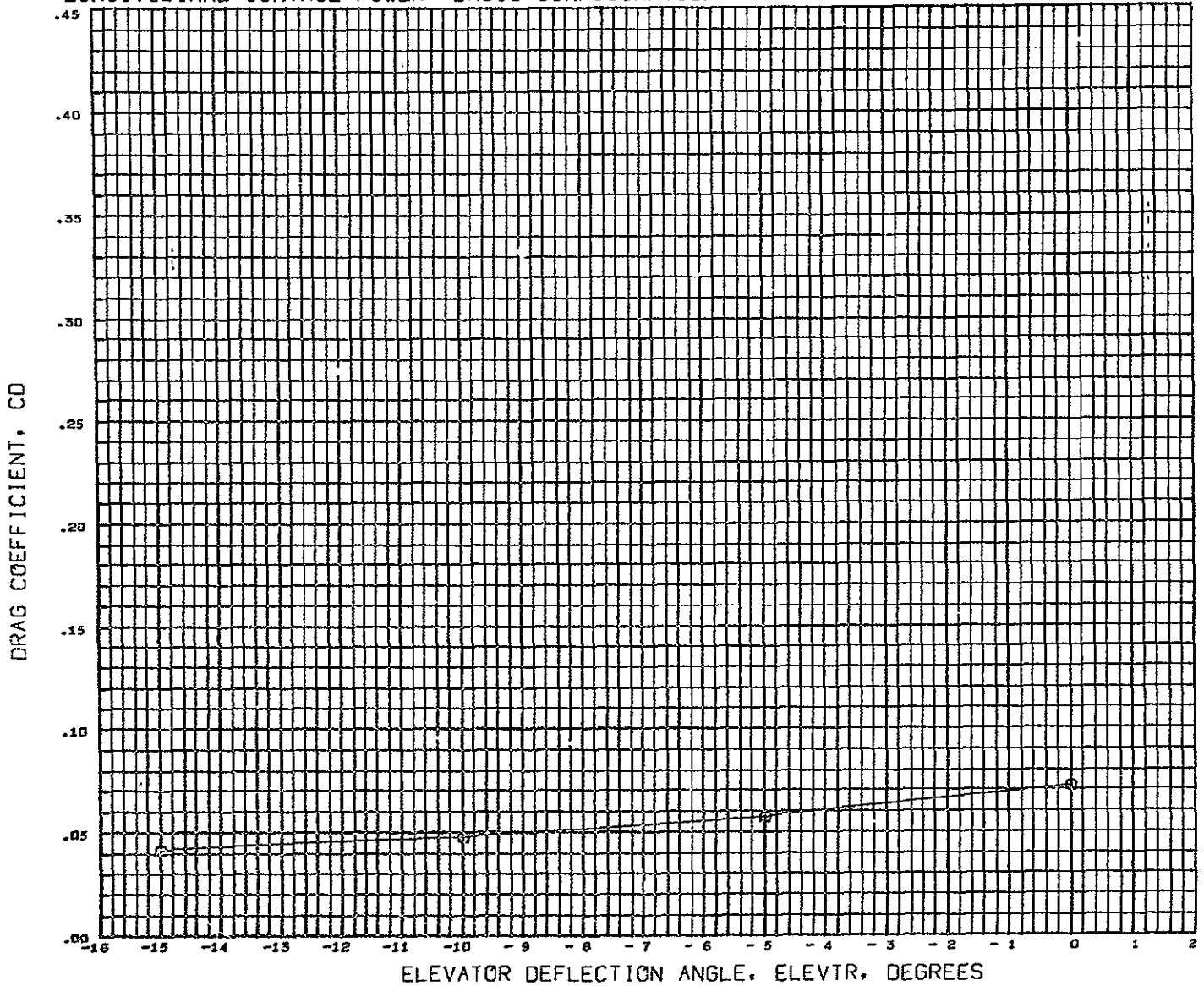

SYMBOL	ALPHA	PARAMETRIC VALUES				DATA SOURCE				REFERENCE INFORMATION		
		MACH	BETA	SFBRK	RUDDER	DATASET	ELEVTR	DATASET	ELEVTR	REFS		SQ.FT
○	0.000	0.260	0.000	0.000	0.000	NCP002	0.000	NCP006	- 5.000	8.0690		
		0.000	0.000	0.000	0.000	NCP012	- 10.000	NCP008	- 15.000	29.5700		IN.
		0.000	0.000	0.000	0.000					51.6000		IN.
										59.3200		IN.
										0.0000		IN.
										11.6000		IN.
										4.0000		PERCENT

DATA HIST. CODE H#EV#EI

# LONGITUDINAL CONTROL POWER BASIC CONFIGURATION

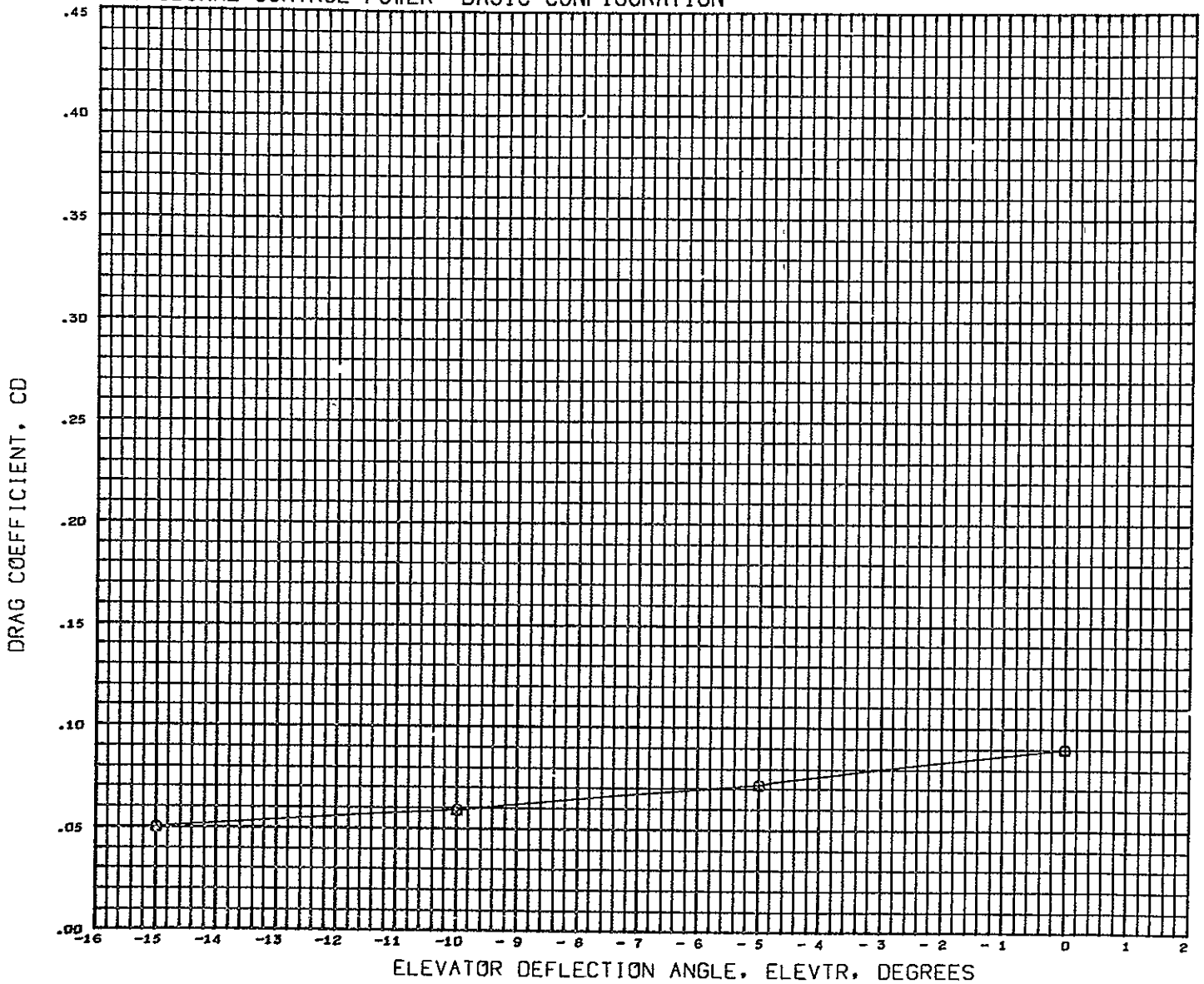

SYMBOL	ALPHA	MACH	PARAMETRIC VALUES				DATA SOURCE				REFERENCE INFORMATION		
Q	10.000		0.260	BETA	0.000	DATA SET	ELEVTR	DATA SET	ELEVTR	REFS	8.8690	SQ.FT.	
			0.000	SPBRK	0.000	NCP002	0.000	NCP006	- 5.000	REFL	29.5700	IN.	
			0.000	RUDDER	0.000	NCP012	- 10.000	NCP008	- 15.000	REFB	51.6000	IN.	
										XMRP	59.3200	IN.	
										YMRP	0.0000	IN.	
										ZMRP	11.6000	IN.	
										SCALE	4.0000	PERCENT	

DATA HIST. CODE H#EV#EI

# LONGITUDINAL CONTROL POWER BASIC CONFIGURATION

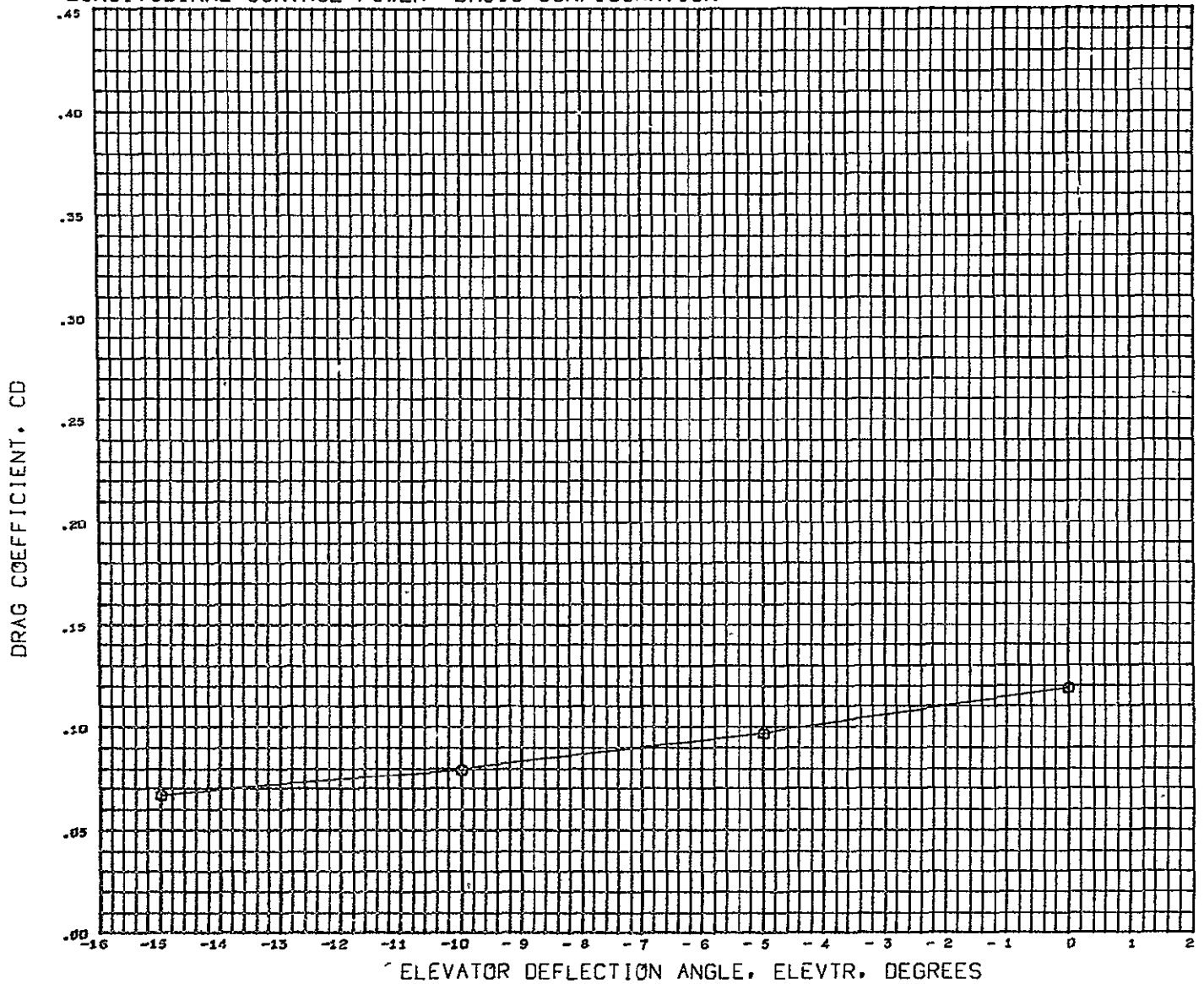

SYMBOL	ALPHA	PARAMETRIC VALUES				DATA SOURCE				REFERENCE INFORMATION		
○	12.000	<u>NACH</u>	0.260	BETA	0.000	DATASET	ELEVTR	DATASET	ELEVTR	REFS	8.8690	SQ.FT.
		AILRON	0.000	SPBRK	0.000	NCP002	0.000	NCP006	- 5.000	REFL	29.5700	IN.
		BFLAP	0.000	RUDDER	0.000	NCP012	- 10.000	NCP008	- 15.000	REFB	51.6000	IN.
										XMRP	59.3200	IN.
										YMRP	0.0000	IN.
										ZMRP	11.6000	IN.
										SCALE	4.0000	PERCNT

DATA HIST. CODE M#EV#EI

# LONGITUDINAL CONTROL POWER BASIC CONFIGURATION

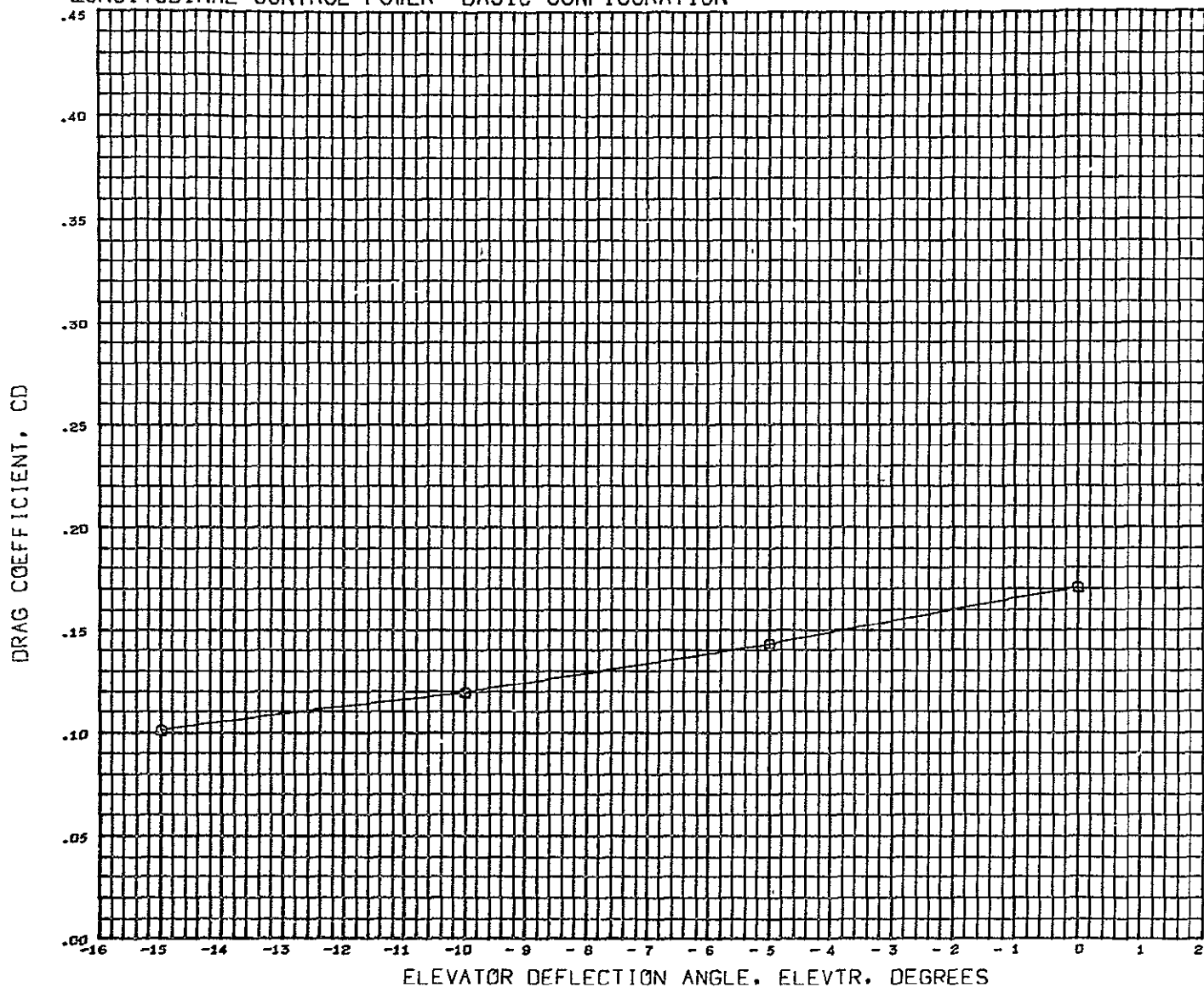

SYMBOL	ALPHA	PARAMETRIC VALUES				DATA SOURCE				REFERENCE INFORMATION		
		MACH	BETA	SPBRK	RUDDER	DATASET	ELEVTR	DATASET	ELEVTR	REFS	IN.	PERCENT
Q	14.000	0.260	0.000	0.000	0.000	NCP002	0.000	NCP006	- 5.000	8.8690	29.5700	51.6000
		0.000	0.000	0.000	0.000	NCP012	- 10.000	NCP008	- 15.000	59.3200	0.0000	11.6000
										4.0000		

DATA HIST. CODE H#EV#EI

# LONGITUDINAL CONTROL POWER BASIC CONFIGURATION

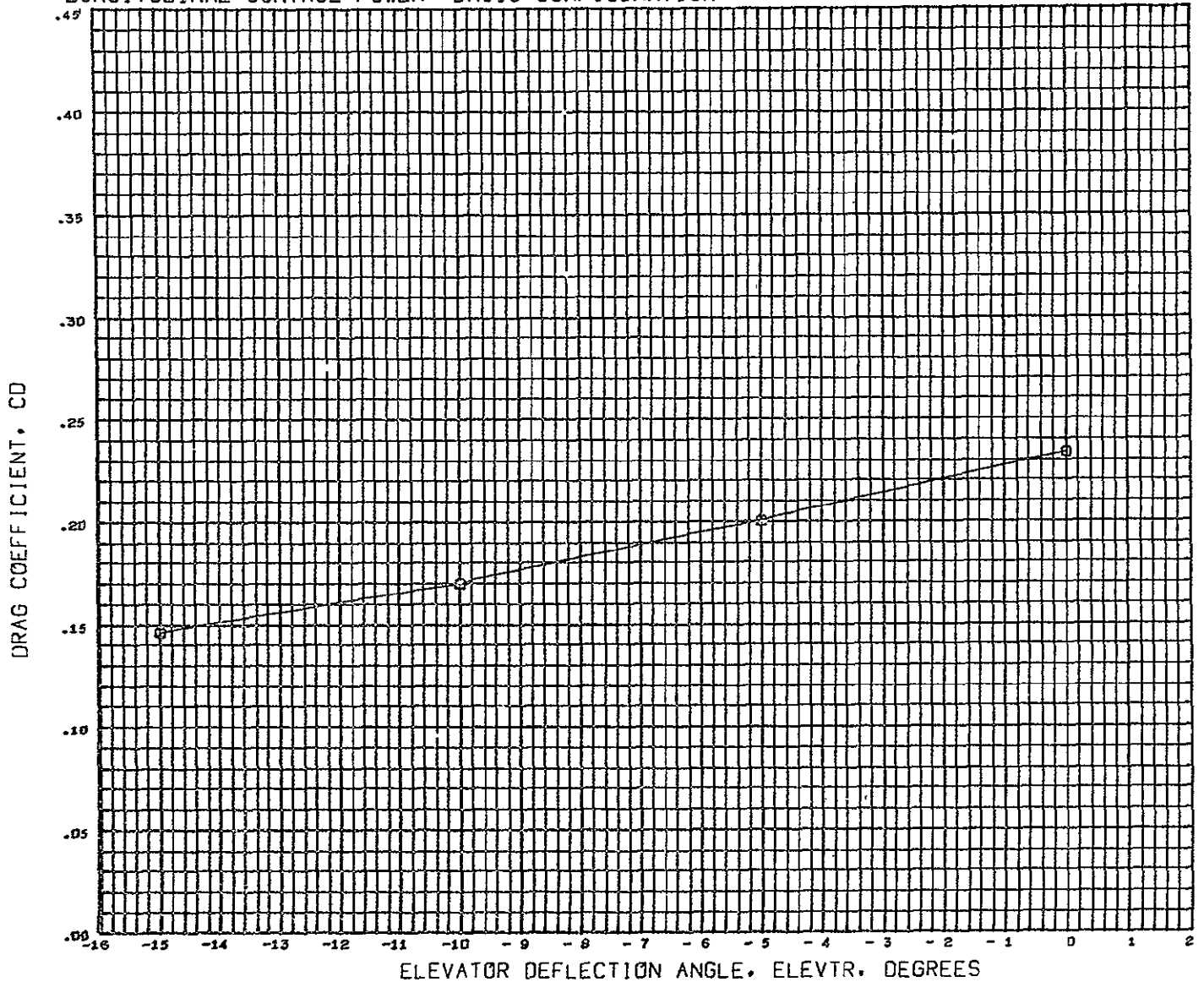

SYMBOL	ALPHA	PARAMETRIC VALUES				DATA SOURCE			REFERENCE INFORMATION			
		MACH	BETA	SPBRK	RUDDER	DATASET	ELEVTR	DATASET	ELEVTR	REFS	SQ FT.	
○	16.000	0.260	0.000	0.000	0.000	NCP002	0.000	NCP006	- 5.000	REFL	29.5700	IN.
		0.000	0.000	0.000	0.000	NCP012	- 10.000	NCP008	- 15.000	REFB	51.6000	IN.
		0.000								XMRP	59.3200	IN.
										YMRP	0.0000	IN.
										ZMRP	11.6000	IN.
										SCALE	4.0000	PERCNT

DATA HIST. CODE M#EV#EI

# LONGITUDINAL CONTROL POWER BASIC CONFIGURATION

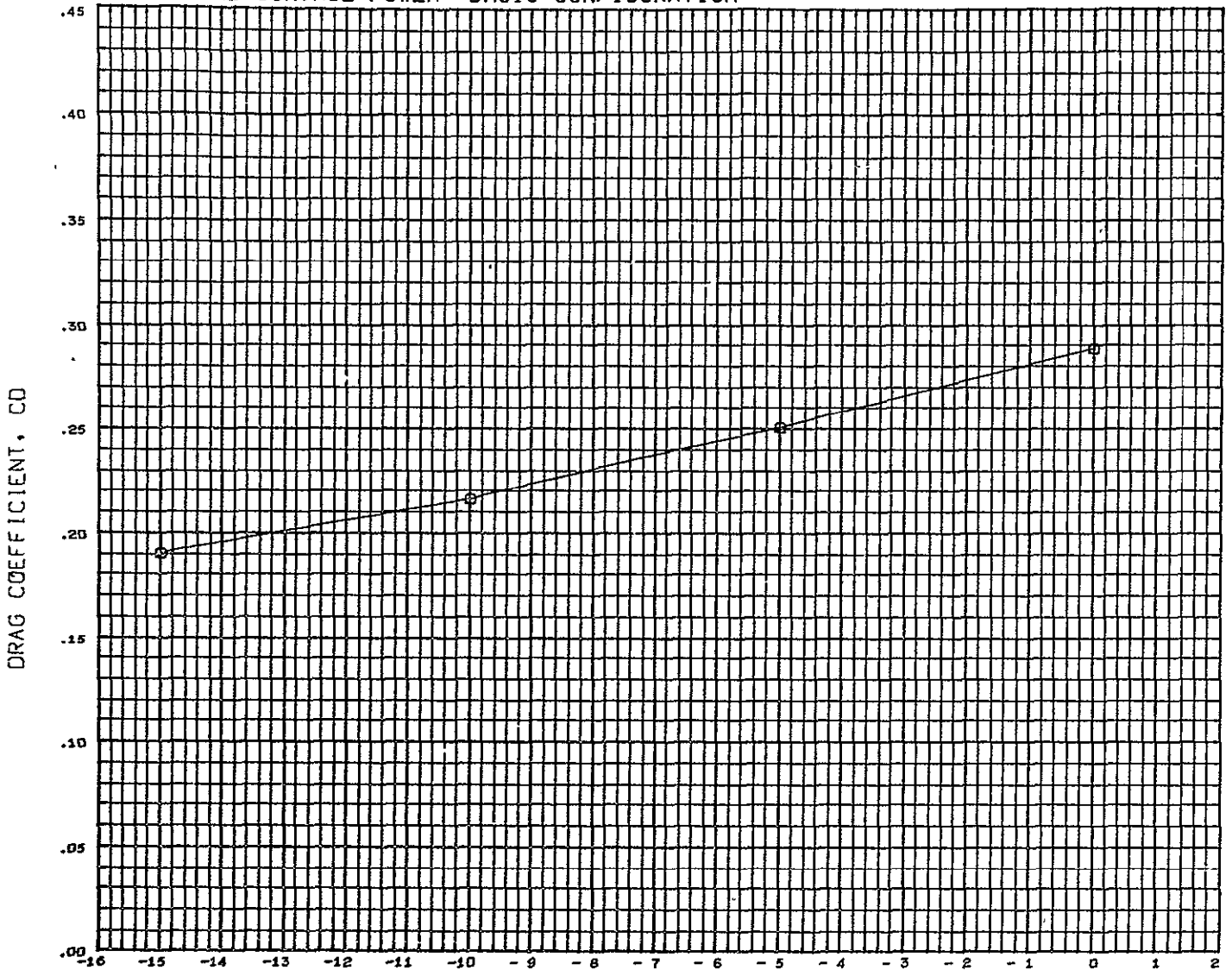

ELEVATOR DEFLECTION ANGLE, ELEVTR, DEGREES

SYMBOL	ALPHA	PARAMETRIC VALUES				DATA SOURCE				REFERENCE INFORMATION		
□	18.000	MACH	0.260	BETA	0.000	DATASET	ELEVTR	DATASET	ELEVTR	REFS	8.8690	SQ FT
		AILRON	0.000	SFBRK	0.000	NCP002	0.000	NCP006	- 5.000	REFL	29.5700	IN.
		BFLAP	0.000	RUDDER	0.000	NCP012	- 10.000	NCP008	- 15.000	REFB	51.6000	IN.
										XNRP	59.3200	IN.
										YNRP	0.0000	IN.
										ZMRP	11.6000	IN.
										SCALE	4 0000	PERCNT

DATA HIST. CODE M#EV#EI

\_SW 248 MDAC 4.0 PC 02 HCR ORB

BSW11V6

(NCP002)

26 FEB 71

PAGE

66

# LONGITUDINAL CONTROL POWER BASIC CONFIGURATION

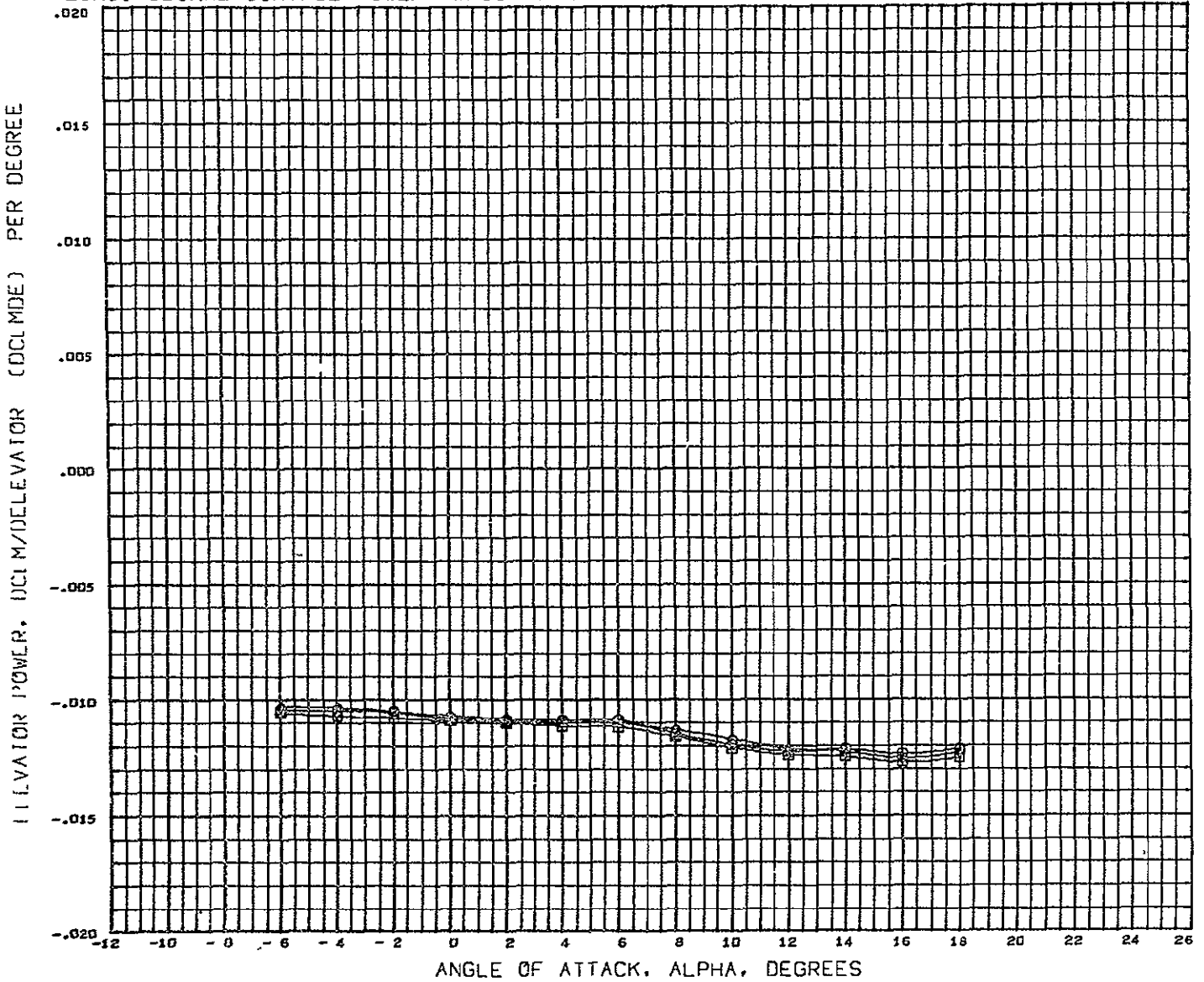

DATA SET SYMBOL	CONFIGURATION DESCRIPTION	SLOPE	BETA	AILRON	REFERENCE INFORMATION	
(XCF006)	LSWT 248 MDAC 4.0 FC 02 HCP ORB B5W11V6	1.000	0.000	0.000	REFS	8.8690 SQ.FT
(XCF012)	LSWT 248 MDAC 4.0 FC 02 HCR ORB B5W11V6	2.000	0.000	0.000	REFL	29.5700 IN
(XCF008)	LSWT 248 MDAC 4.0 FC 02 HCR ORB B5W11V6	3.000	0.000	0.000	REFB	51.6000 IN
					XMRP	59.3200 IN.
					YMRP	0.0000 IN.
					ZMRP	11.6000 IN
					SCALE	4.0000 PERCNT

MACH 0.260

# LONGITUDINAL CONTROL POWER BASIC CONFIGURATION

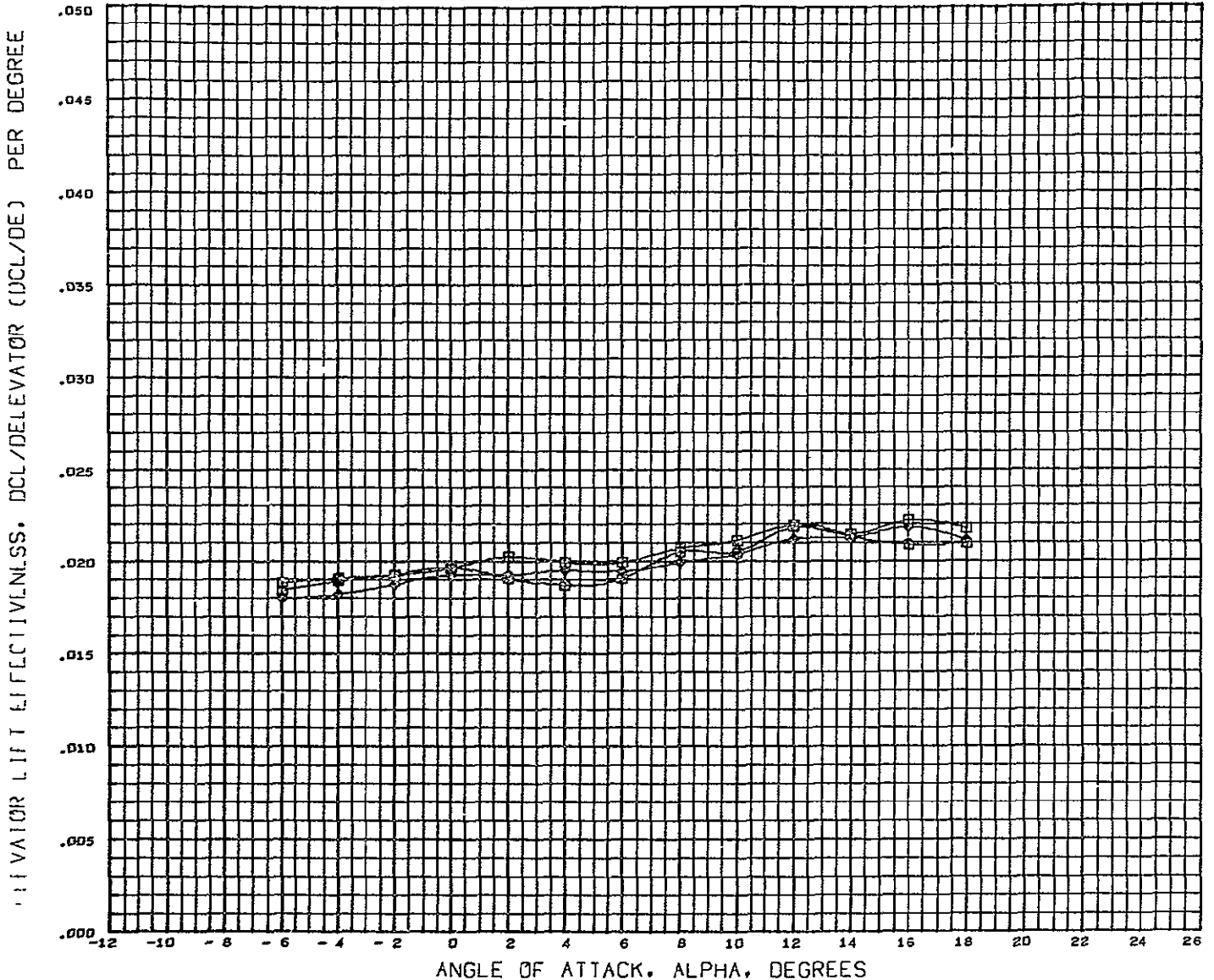

DATA SET SYMBOL	CONFIGURATION DESCRIPTION	SLOPE	BETA	AIRCIN	REFERENCE INFORMATION
(XCF006)	LSWT 248 HDAC 4.0 FC O2 HCR ORB B5W11V6	1.000	0.000	0.000	REFS 8.8690 SQ.FT
(XCF012)	LSWT 248 HDAC 4.0 FC O2 HCR ORB B5W11V6	2.000	0.000	0.000	REFL 29.5700 IN.
(XCF008)	LSWT 248 HDAC 4.0 FC O2 HCR ORB B5W11V6	3.000	0.000	0.000	REFB 51.6000 IN.
					XMRP 59.3200 IN.
					YMRP 0.0000 IN.
					ZMRP 11.6000 IN.
					SCALE 4.0000 PERCENT

MACH 0.260



# LONGITUDINAL CONTROL POWER BASIC CONFIGURATION

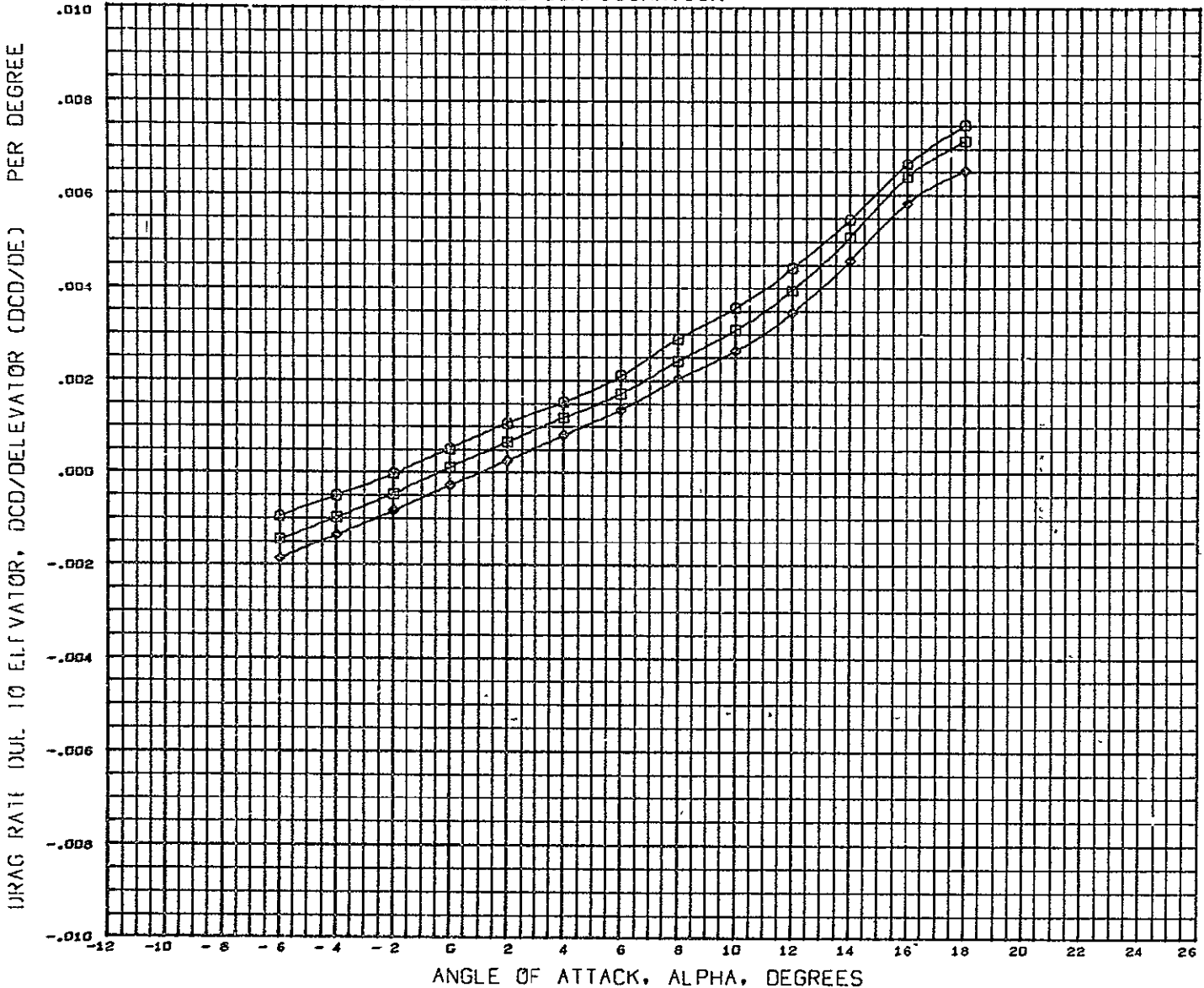

DATA SET SYMBOL	CONFIGURATION DESCRIPTION	SLOPE	BETA	AILRON	REFERENCE INFORMATION
(XCP006)	LSWT 248 HDAC 4.0 FC 02 HCR ORB B5W11V6	1.000	0.000	0.000	REFS 8.8690 SQ.FT.
(XCP012)	LSWT 248 HDAC 4.0 FC 02 HCR ORB B5W11V6	2.000	0.000	0.000	REFL 29.5700 IN.
(XCP008)	LSWT 248 HDAC 4.0 FC 02 HCR ORB B5W11V6	3.000	0.000	0.000	REFB 51.6000 IN.
					XMRP 59.3200 IN.
					YMRP 0.0000 IN.
					ZMRP 11.6000 IN.
					SCALE 4.0000 PERCENT

MACH 0.260

# LONGITUDINAL CONTROL POWER BASIC CONFIGURATION

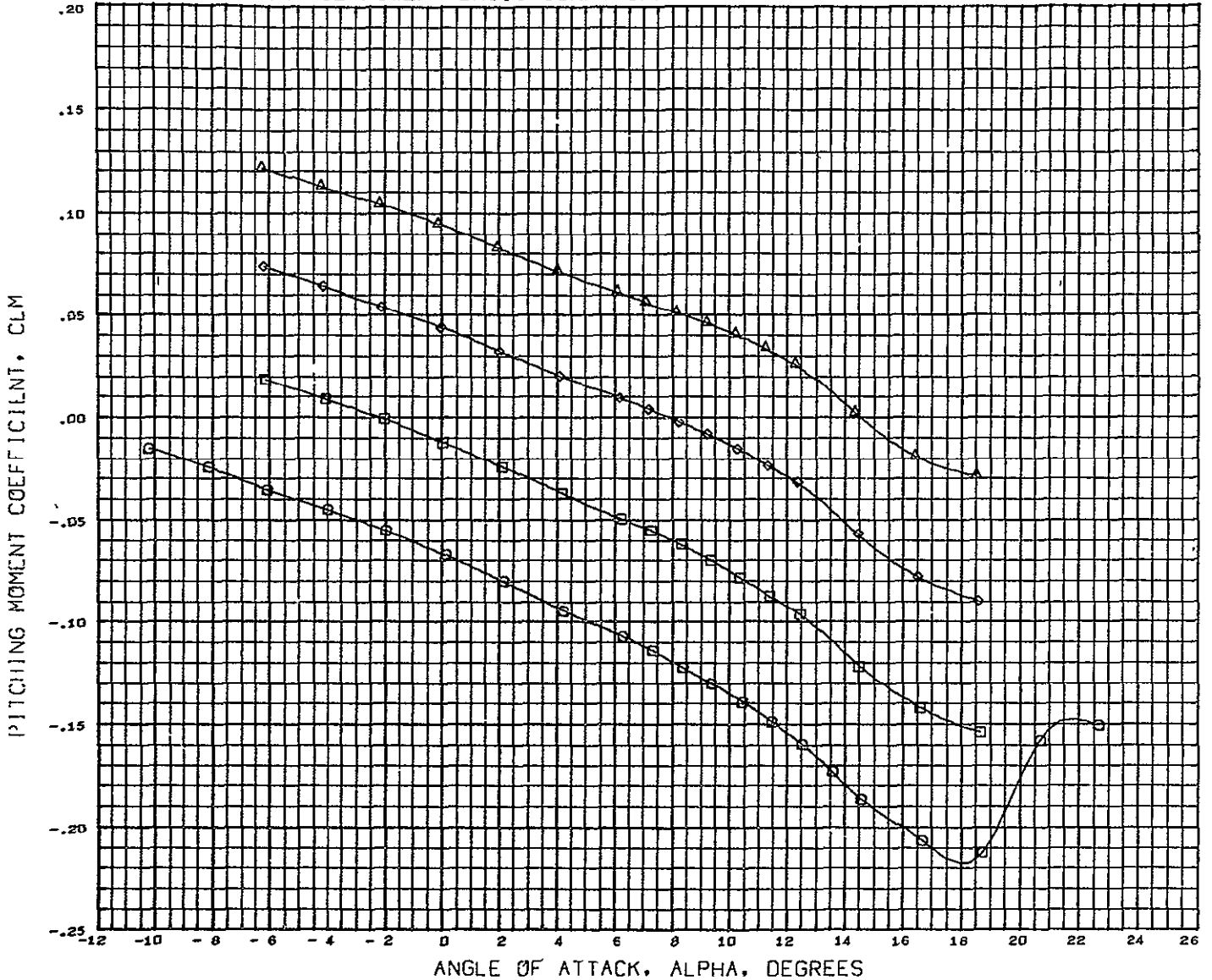

DATA SET SYMBOL	CONFIGURATION DESCRIPTION	BETA	ELEVTR	AILRON	REFERENCE INFORMATION	
(CCF011)	LSWT 248 HDAC 4.0 FC 02 HCR ORB	85W11V6	- 3.000	0.000	0.000	REFS 8.8690 SQ FT.
(CCF007)	LSWT 248 HDAC 4.0 FC 02 HCR ORB	85W11V6	- 3.000	- 5.000	0.000	REFL 29.5700 IN.
(CCF013)	LSWT 248 HDAC 4.0 FC 02 HCR ORB	85W11V6	- 3.000	- 10.000	0.000	REFB 51.6000 IN.
(CCF009)	LSWT 248 HDAC 4.0 FC 02 HCR ORB	85W11V6	- 3.000	- 15.000	0.000	XMRP 59.3200 IN.
						YMRP 0.0000 IN.
						ZMRP 11.6000 IN.
						SCALE 4.0000 PERCNT

MACH 0 250

# LONGITUDINAL CONTROL POWER BASIC CONFIGURATION

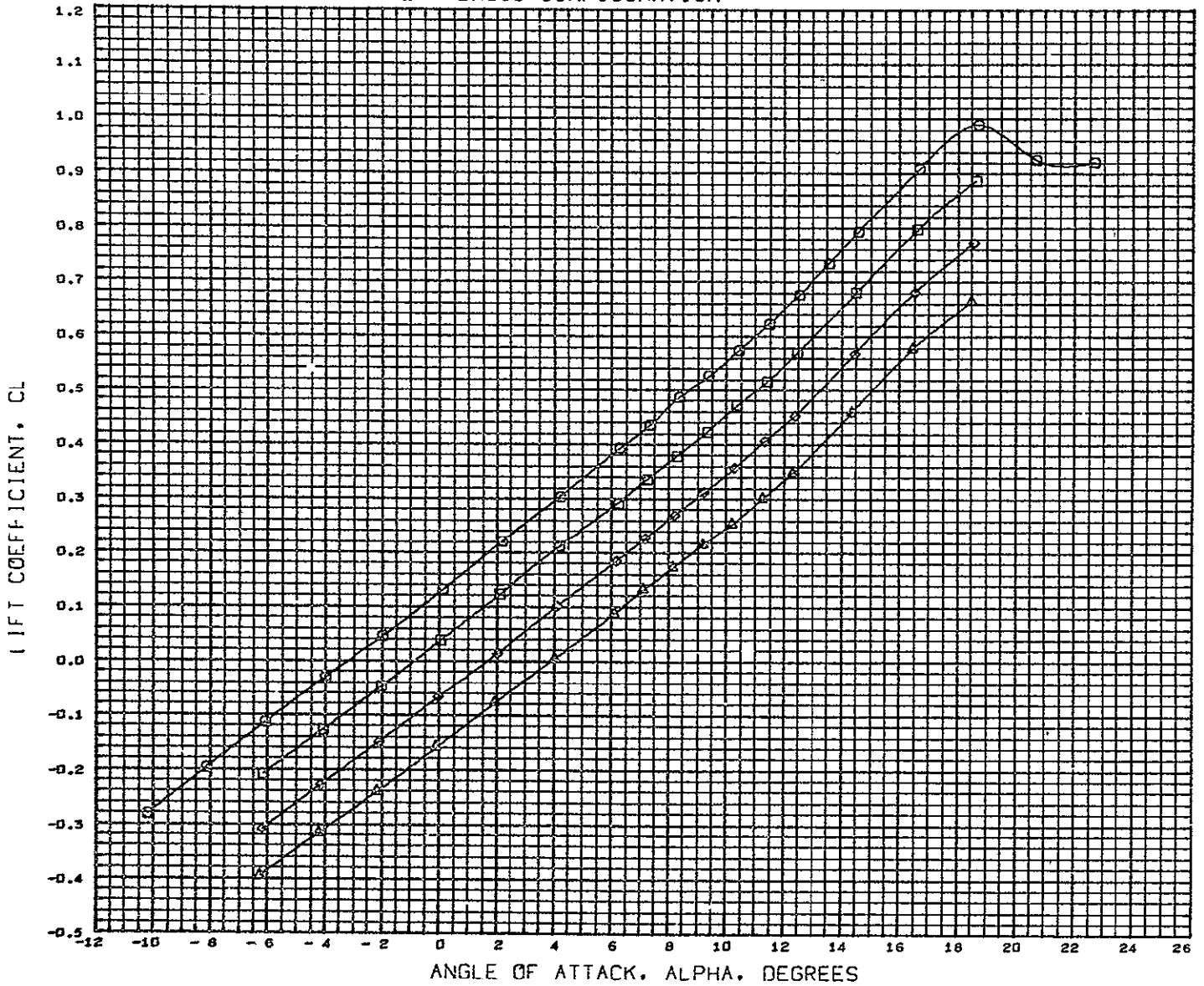

DATA SET SYMBOL	CONFIGURATION DESCRIPTION	BETA	ELEVTR	AILRON	REFERENCE INFORMATION
(CCF011)	LSWT 248 HDAC 4.0 FC 02 HCR ORB B5W11V6	- 3.000	0.000	0.000	REFS 8.8690 SQ FT
(CCF007)	LSWT 248 HDAC 4.0 FC 02 HCR ORB B5W11V6	- 3.000 - 5.000	0.000	0.000	REFL 29.5700 IN.
(CCF013)	LSWT 248 HDAC 4.0 FC 02 HCR ORB B5W11V6	- 3.000 - 10.000	0.000	0.000	REFB 51.6000 IN.
(CCF009)	LSWT 248 HDAC 4.0 FC 02 HCP ORB B5W11V6	- 3.000 - 15.000	0.000	0.000	XMRP 59.3200 IN.
					YMRP 0.0000 IN.
					ZMRP 11.6000 IN.
					SCALE 4.0000 PERCENT

HACH 0.250

# LONGITUDINAL CONTROL POWER BASIC CONFIGURATION

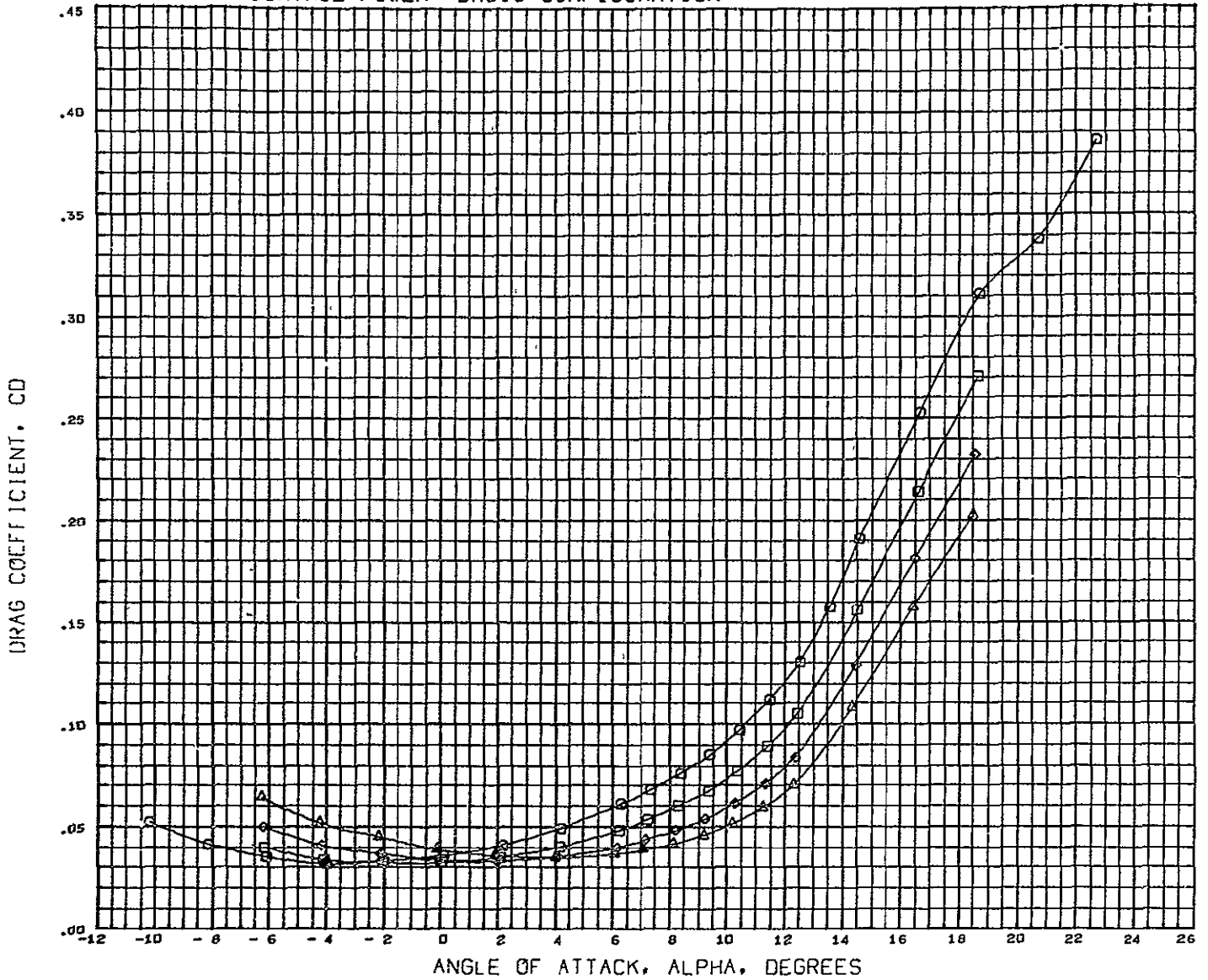

DATA SET	SYMBOL	CONFIGURATION DESCRIPTION	BETA	ELEVTR	AILRON	REFERENCE INFORMATION	
(CCFD11)	○	LSWT 248 MDAC 4.0 FC 02 HCR ORB	B5W11V6	- 3.000	0.000	0.000	REFS 8.8690 SQ.FT.
(CCFD07)	□	LSWT 248 MDAC 4.0 FC 02 HCR ORB	B5W11V6	- 3.000 - 5.000	0.000	0.000	REFL 29.5700 IN.
(CCFD13)	◇	LSWT 248 MDAC 4.0 FC 02 HCR ORB	B5W11V6	- 3.000 - 10.000	0.000	0.000	REFB 51.6000 IN.
(CCFD09)	△	LSWT 248 MDAC 4.0 FC 02 HCR ORB	B5W11V6	- 3.000 - 15.000	0.000	0.000	XMRP 59.3200 IN.
							YMRP 0.0000 IN.
							ZMRP 11.6000 IN.
							SCALE 4.0000 PERCENT

MACH 0.250

# LONGITUDINAL CONTROL POWER BASIC CONFIGURATION

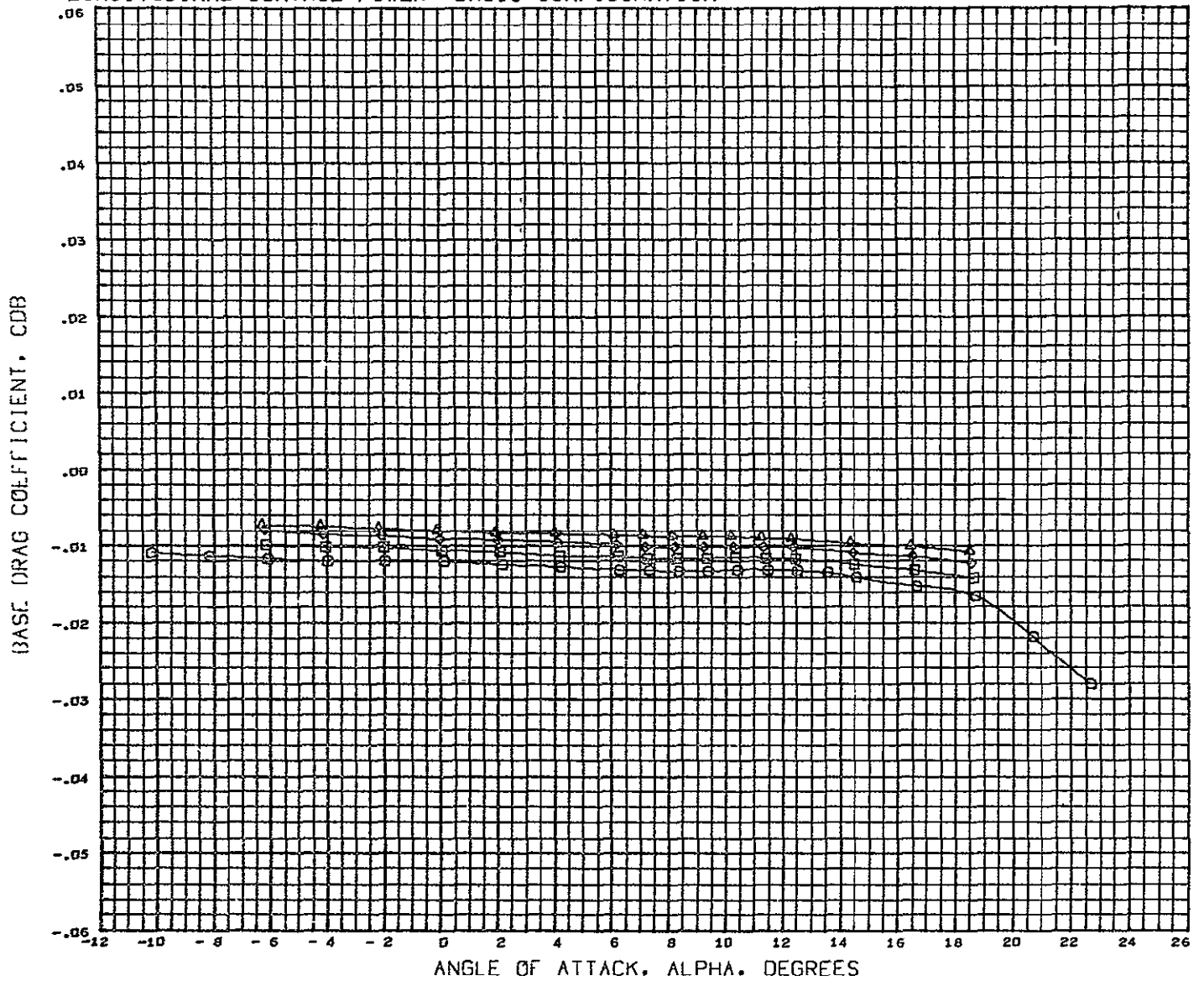

DATA SET SYMBOL	CONFIGURATION DESCRIPTION	BETA	ELEVTR	AILRON	REFERENCE INFORMATION
(CCP011)	LSWT 248 HDAC 4.0 FC 02 HCR ORB B5W11V6	- 3.007	0.000	0.000	REFS 8 8690 SQ.FT
(CCP007)	LSWT 248 HDAC 4.0 FC 02 HCR ORB B5W11V6	- 3.000	- 5.000	0.000	REFL 29.5700 IN.
(CCP013)	LSWT 248 HDAC 4.0 FC 02 HCR ORB B5W11V6	- 3.000	- 10.000	0.000	REFB 51.6000 IN.
(CCP009)	LSWT 248 HDAC 4.0 FC 02 HCR ORB B5W11V6	- 3.000	- 15.000	0.000	XMRP 59.3200 IN.
					YMRP 0.0000 IN.
					ZMRP 11.6000 IN.
					SCALE 4.0000 PERCENT

MACH 0.250

# LONGITUDINAL CONTROL POWER BASIC CONFIGURATION

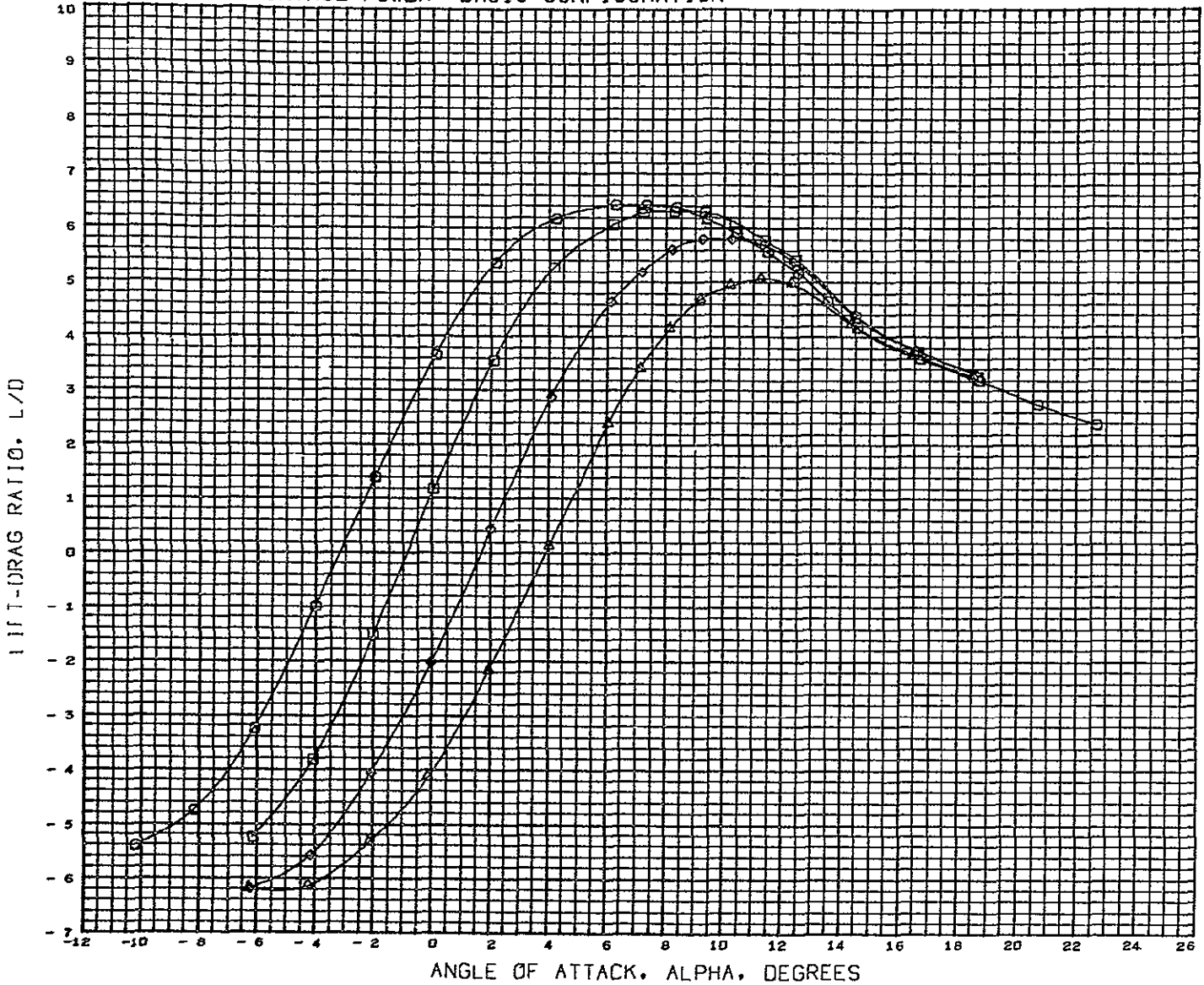

DATA SET SYMBOL	CONFIGURATION DESCRIPTION	BETA	ELEVTR	AILRON	REFERENCE INFORMATION	
(CCP011)	LSWT 248 MDAC 4.0 FC 02 HCR ORB	B5W11V6	- 3.000	0.000	0.000	REFS 8.8690 SQ.FT
(CCP007)	LSWT 248 MDAC 4.0 FC 02 HCR ORB	B5W11V6	- 3.000	- 5.000	0.000	REFL 29.5700 IN
(CCP013)	LSWT 248 MDAC 4.0 FC 02 HCR ORB	B5W11V6	- 3.000	- 10.000	0.000	REFB 51.6000 IN
(CCP009)	LSWT 248 MDAC 4.0 FC 02 HCR ORB	B5W11V6	- 3.000	- 15.000	0.000	XMRP 59.3200 IN
						YMRP 0.0000 IN
						ZMRP 11.6000 IN
						SCALE 4.0000 PERCNT

HACH 0.250

# LONGITUDINAL CONTROL POWER BASIC CONFIGURATION

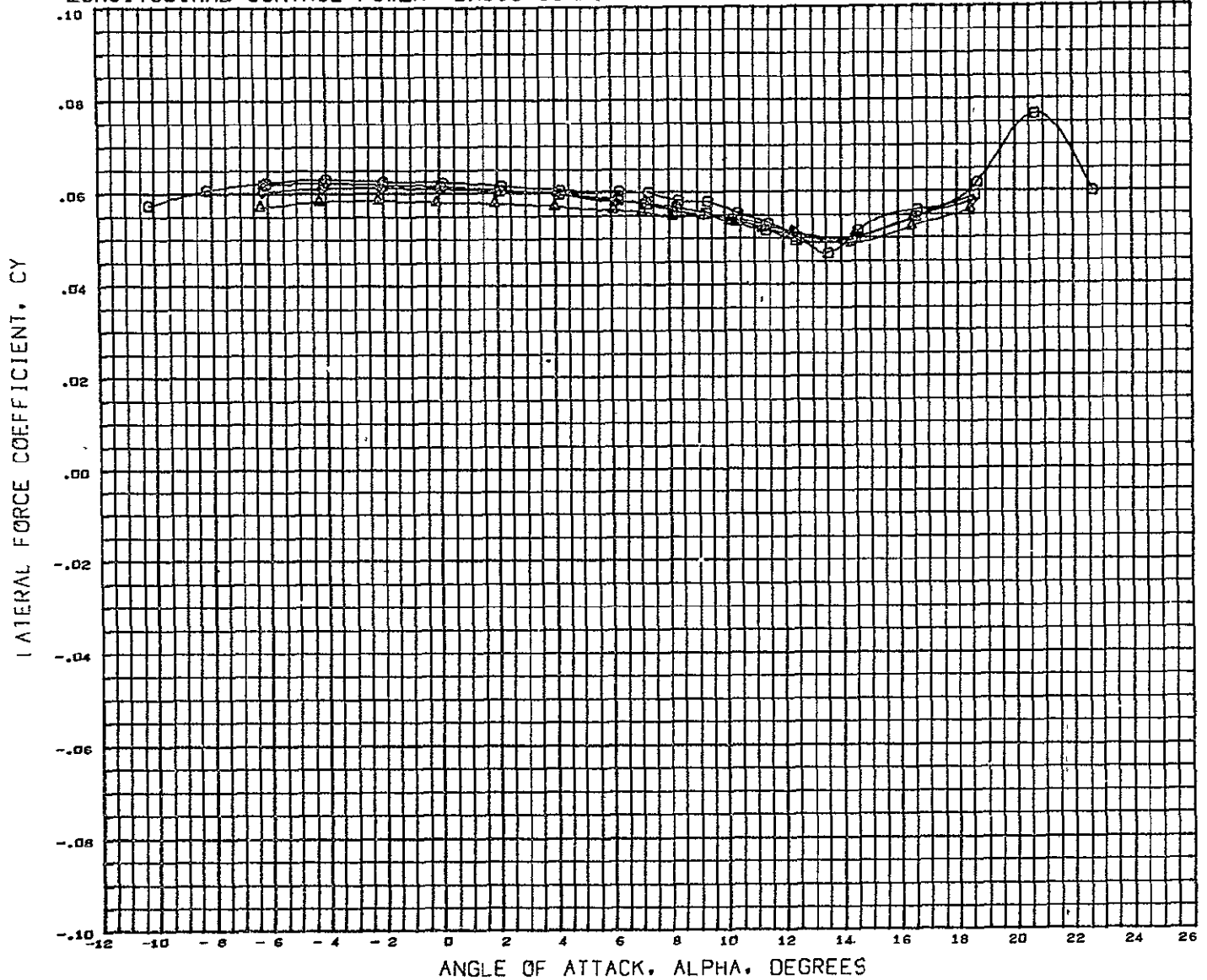

DATA SET SYMBOL	CONFIGURATION DESCRIPTION	BETA	ELEVTR	AILRON	REFERENCE INFORMATION	
(CCF011)	□ LSWT 248 MDAC 4.0 FC 02 HCR ORB	85W11V6	- 3.000	0.000	0.000	REFS 8.8690 SQ.FT
(CCF007)	○ LSWT 248 MDAC 4.0 FC 02 HCR ORB	85W11V6	- 3.000 - 5.000	0.000	0.000	REFL 29.5700 IN.
(CCF013)	◇ LSWT 248 MDAC 4.0 FC 02 HCR ORB	85W11V6	- 3.000 - 10.000	0.000	0.000	REFB 51.6000 IN.
(CCF009)	△ LSWT 248 MDAC 4.0 FC 02 HCR ORB	85W11V6	- 3.000 - 15.000	0.000	0.000	XMRP 59.3200 IN.
						YMRP 0.0000 IN.
						ZMRP 11.6000 IN.
						SCALE 4.0000 PERCNT

MACH 0.250

# LONGITUDINAL CONTROL POWER BASIC CONFIGURATION

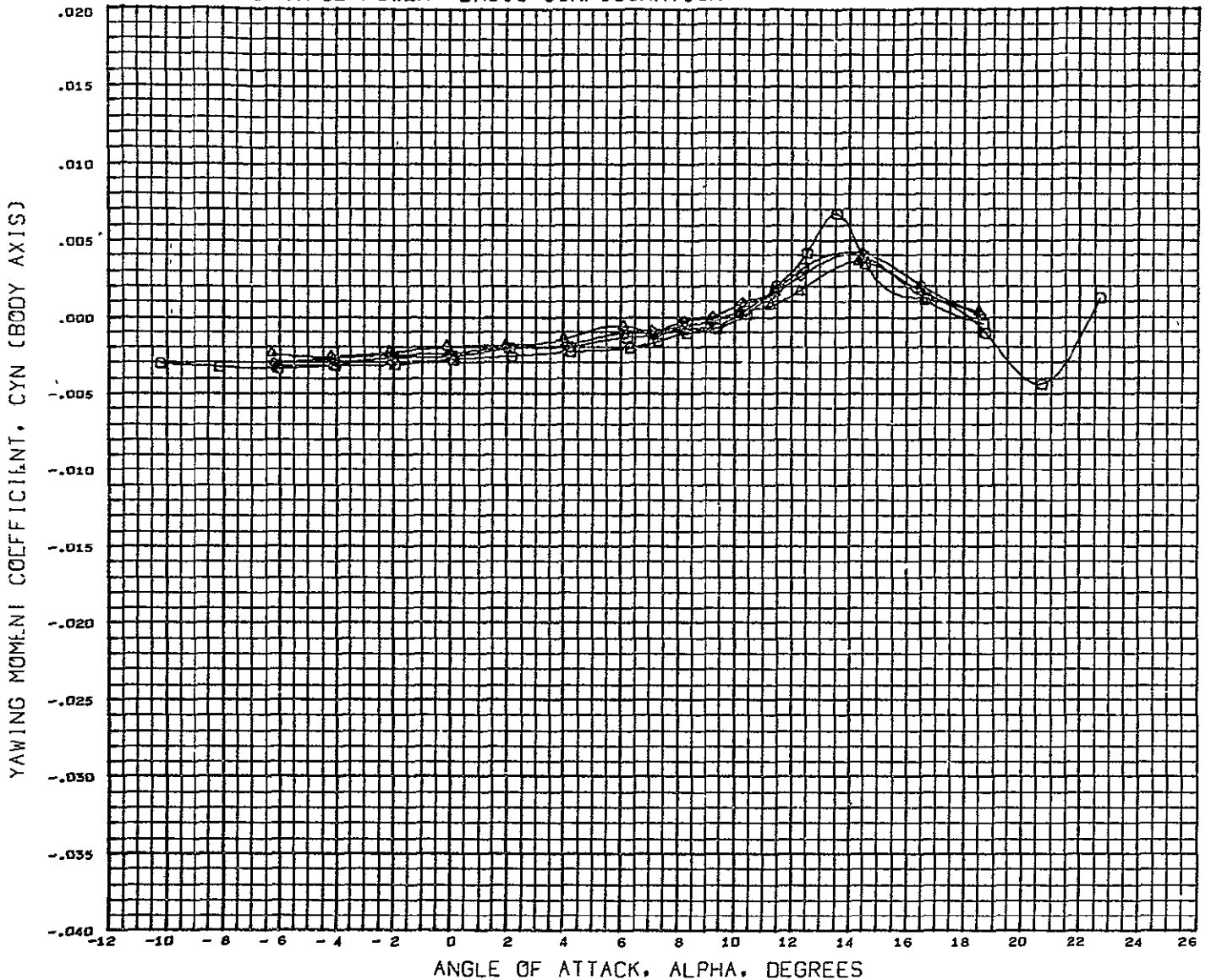

DATA SET SYMBOL	CONFIGURATION DESCRIPTION	BETA	ELEVTR	AILRON	REFERENCE INFORMATION	
(CCF011)	LSWT 248 HDAC 4.0 FC O2 HCR ORB	85W11V6	- 3.000	0.000	0.000	REFS 8.8690 SQ FT.
(CCF007)	LSWT 248 HDAC 4.0 FC O2 HCR ORB	85W11V6	- 3.000	- 5.000	0.000	REFL 29.5700 IN.
(CCF013)	LSWT 248 HDAC 4.0 FC O2 HCR ORB	85W11V6	- 3.000	- 10.000	0.000	REFB 51.6000 IN.
(CCF009)	LSWT 248 HDAC 4.0 FC O2 HCR ORB	85W11V6	- 3.000	- 15.000	0.000	XMRP 59.3200 IN.
						YMRP 0.0000 IN.
						ZMRP 11.6000 IN.
						SCALE 4.0000 PERCENT

HACH 0.250



# LONGITUDINAL CONTROL POWER BASIC CONFIGURATION

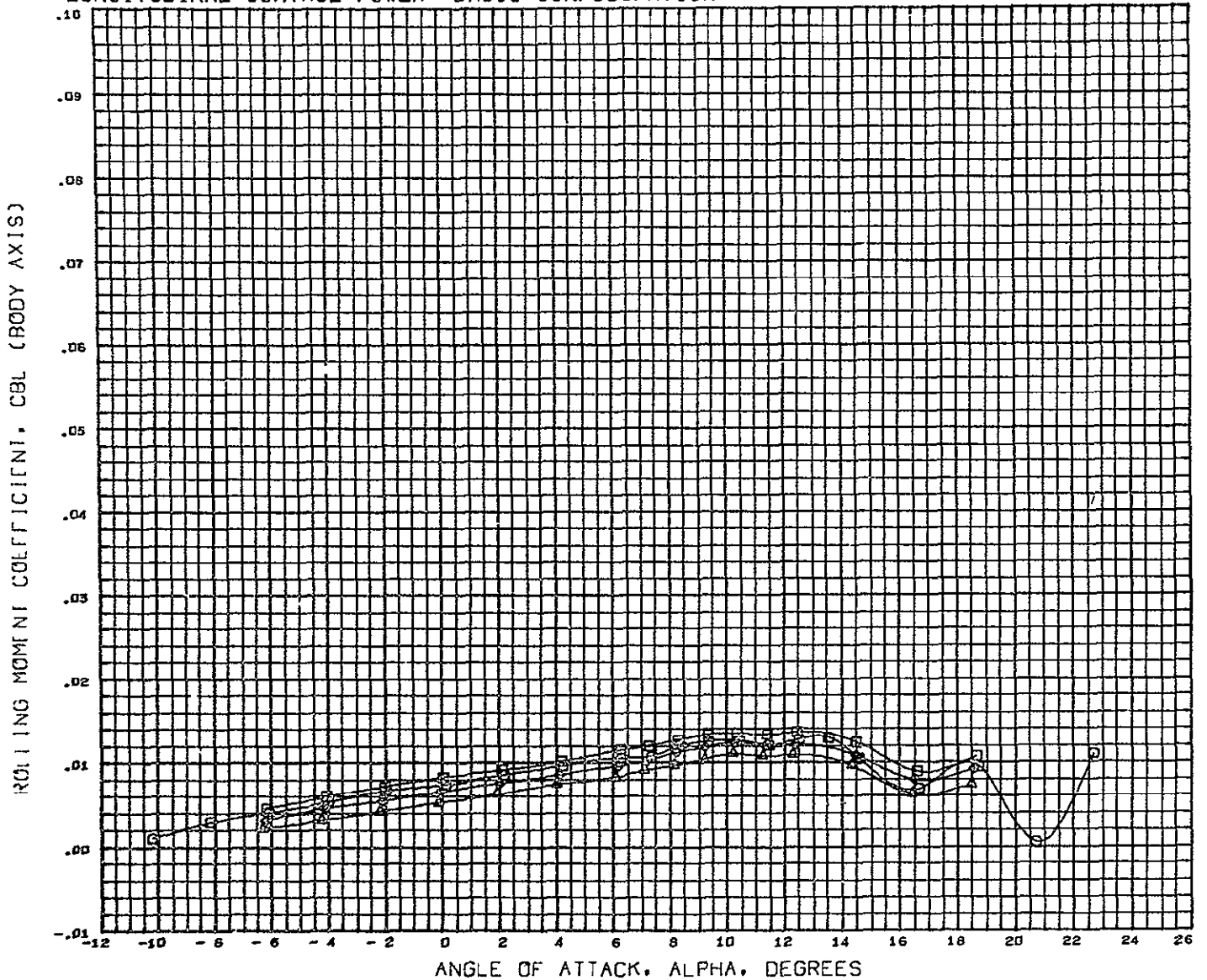

DATA SET SYMBOL	CONFIGURATION DESCRIPTION	BETA	ELEVTR	AILRON	REFERENCE INFORMATION	
(CCF011)	LSWT 248 MDAC 4.0 FC 02 HCR ORB	B5W11V6	- 3.000	0.000	0.000	REFS 8.8690 SQ.FT
(CCF007)	LSWT 248 MDAC 4.0 FC 02 HCR ORB	B5W11V6	- 3.000	- 5.000	0.000	REFL 29.5700 IN.
(CCF013)	LSWT 248 MDAC 4.0 FC 02 HCR ORB	B5W11V6	- 3.000	- 10.000	0.000	REFB 51.6000 IN.
(CCF009)	LSWT 248 MDAC 4.0 FC 02 HCR ORB	B5W11V6	- 3.000	- 15.000	0.000	XMRP 59.3200 IN.
						YMRP 0.0000 IN.
						ZMRP 11.6000 IN.
						SCALE 4 0000 PERCNT

MACH 0.250

# LONGITUDINAL CONTROL POWER BASIC CONFIGURATION

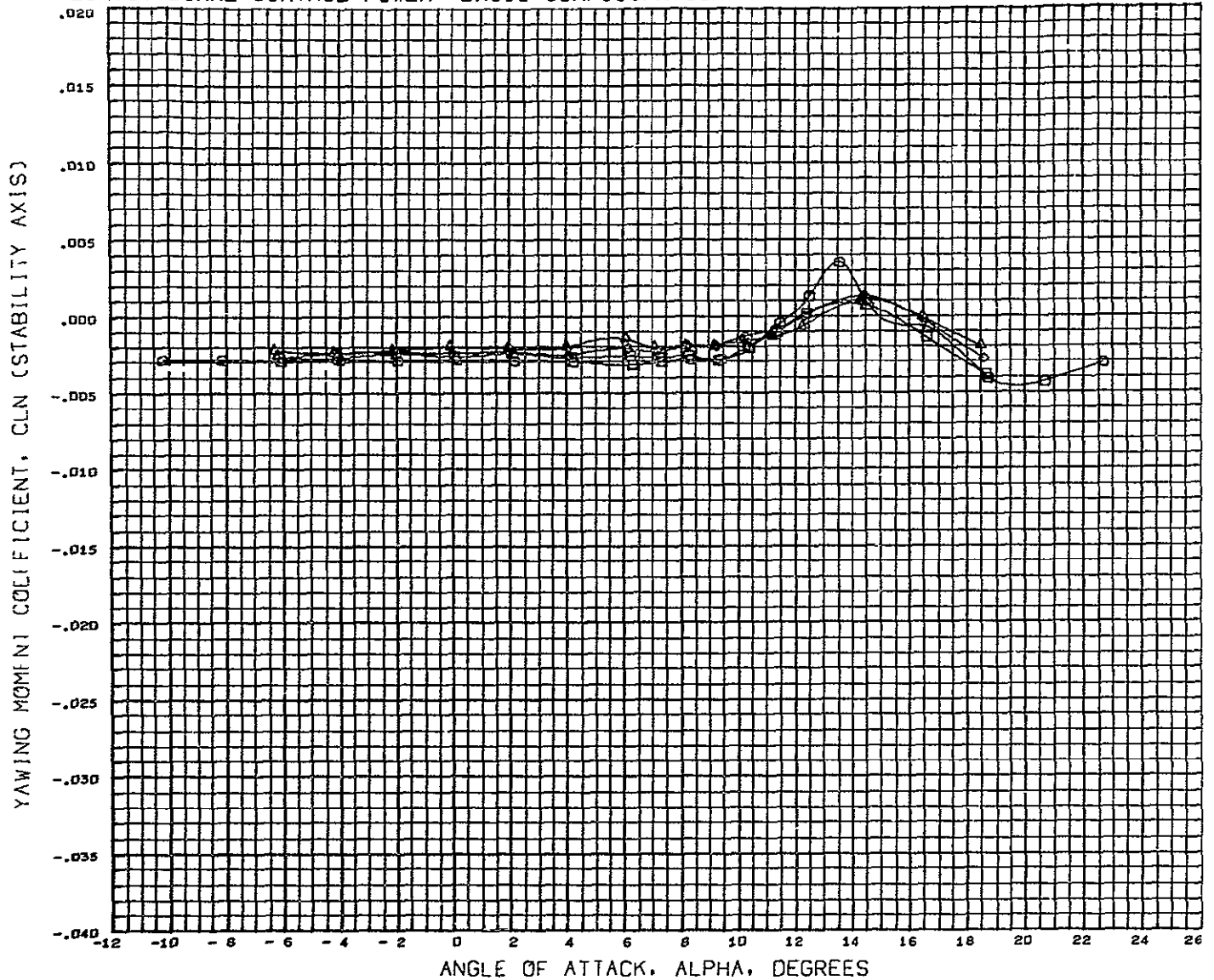

DATA SET SYMBOL	CONFIGURATION DESCRIPTION	BETA	ELEVTR	AILRON	REFERENCE INFORMATION
(RCPD11)	LSWT 248 HDAC 4.0 FC O2 HCR ORB	3.000	0.000	0.000	REFS 0.8690 SQ.FT.
(RCPD07)	LSWT 248 HDAC 4.0 FC O2 HCR ORB	3.000 - 5.000	0.000	0.000	REFL 29.5700 IN.
(RCPD13)	LSWT 248 HDAC 4.0 FC O2 HCR ORB	3.000 - 10.000	0.000	0.000	REFB 51.6000 IN.
(RCPD09)	LSWT 248 HDAC 4.0 FC O2 HCR ORB	3.000 - 15.000	0.000	0.000	XMRP 59.3200 IN.
					YMRP 0.0000 IN.
					ZMRP 11.6000 IN.
					SCALE 4.0000 PERCNT

MACH 0.250

# LONGITUDINAL CONTROL POWER BASIC CONFIGURATION

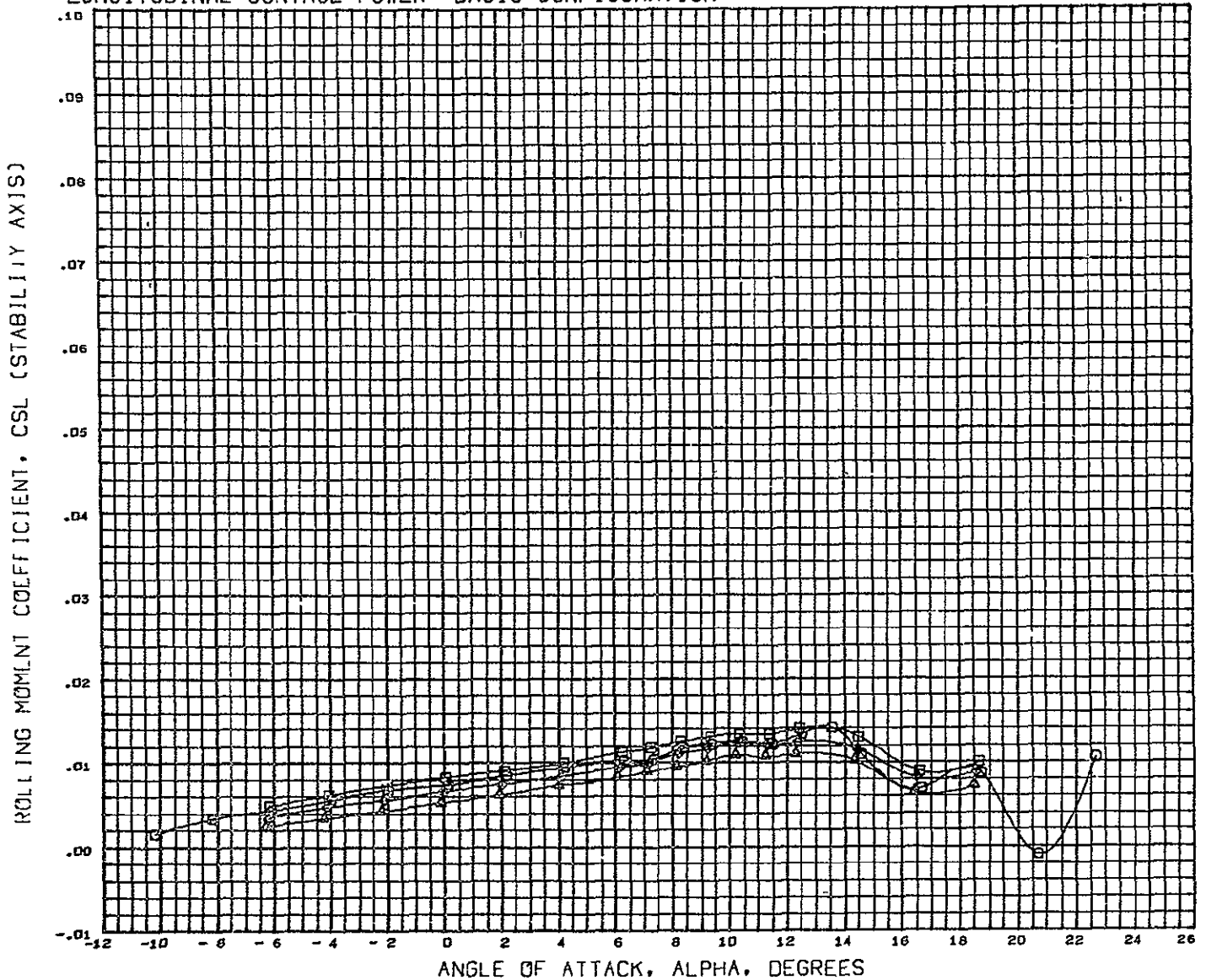

DATA SET SYMBOL	CONFIGURATION DESCRIPTION	BETA	ELEVTR	AILRON	REFERENCE INFORMATION
(RCPD11)	□ LSW 248 MDAC 4.0 FC 02 HCR ORB B5W11V6	- 3.000	0.000	0.000	REFS 8.8690 SQ.FT.
(RCPD07)	□ LSW 248 MDAC 4.0 FC 02 HCR ORB B5W11V6	- 3.000	- 5.000	0.000	REFL 29.5700 IN.
(RCPD13)	◇ LSWT 248 MDAC 4.0 FC 02 HCR ORB B5W11V6	- 3.000	- 10.000	0.000	REFB 51.6000 IN.
(RCPD09)	△ LSWT 248 MDAC 4.0 FC 02 HCR ORB B5W11V6	- 3.000	- 15.000	0.000	XMRP 59.3200 IN.
					YMRP 0.0000 IN.
					ZMRP 11.6000 IN.
					SCALE 4.0000 PERCNT

MACH 0.250

# LONGITUDINAL CONTROL POWER BASIC CONFIGURATION

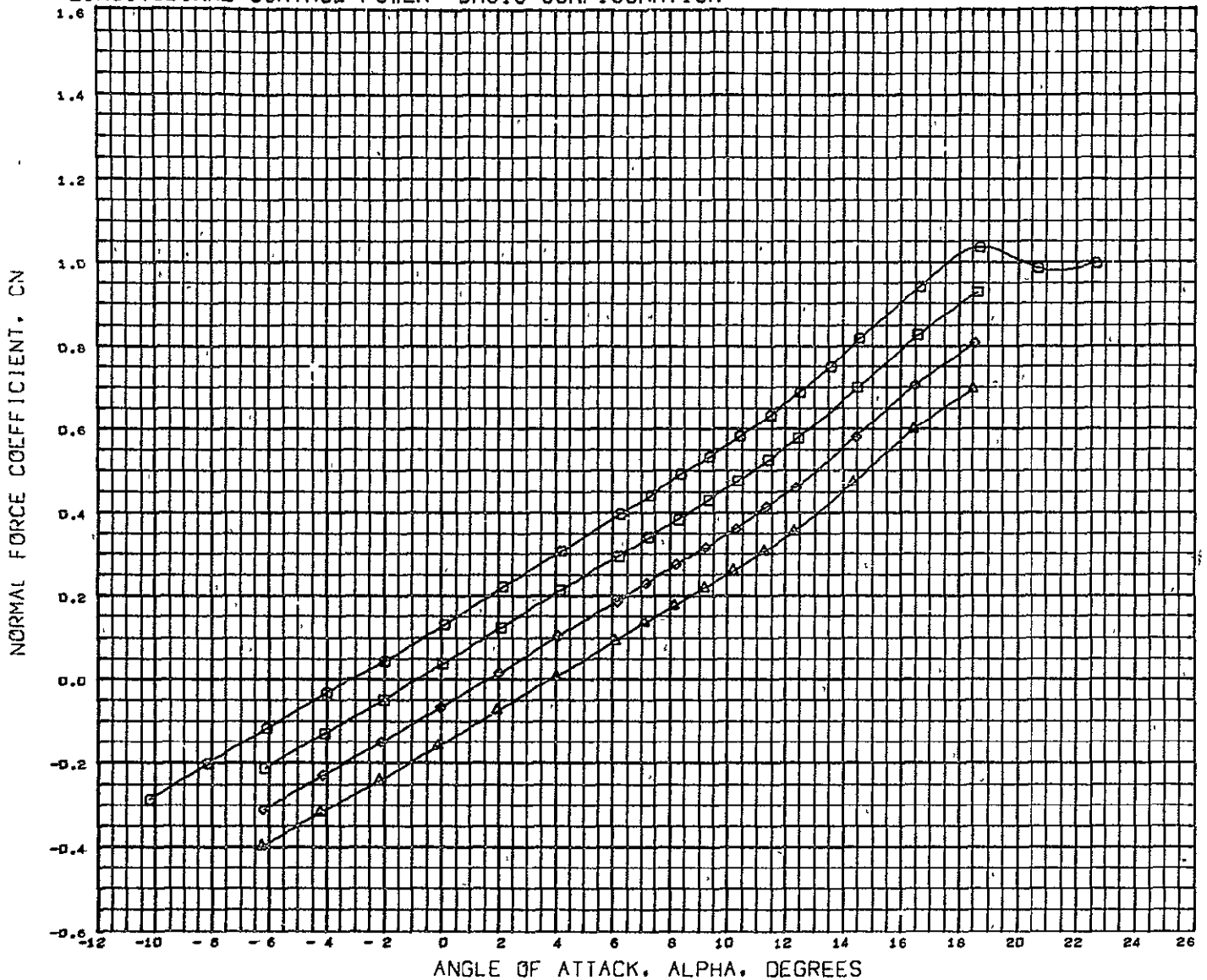

DATA SET SYMBOL	CONFIGURATION DESCRIPTION	BETA	ELEVTR	AILRON	REFERENCE INFORMATION		
(BCF011)	LSWT 248 MDAC 4.0 FC 02 HCR ORB	85W11V6	- 3.000	0.000	0.000	REFS	8.8690 SQ.FT.
(BCF007)	LSWT 248 MDAC 4.0 FC 02 HCR ORB	85W11V6	- 3.000	- 5.000	0.000	REFL	29.5700 IN.
(BCF013)	LSWT 248 MDAC 4.0 FC 02 HCR ORB	85W11V6	- 3.000	- 10.000	0.000	REFB	51.6000 IN.
(BCF009)	LSWT 248 MDAC 4.0 FC 02 HCR ORB	85W11V6	- 3.000	- 15.000	0.000	XMRP	59.3200 IN.
						YMRP	0.0000 IN.
						ZMRP	11.6000 IN.
						SCALE	4.0000 PERCENT

MACH 0.250

# LONGITUDINAL CONTROL POWER BASIC CONFIGURATION

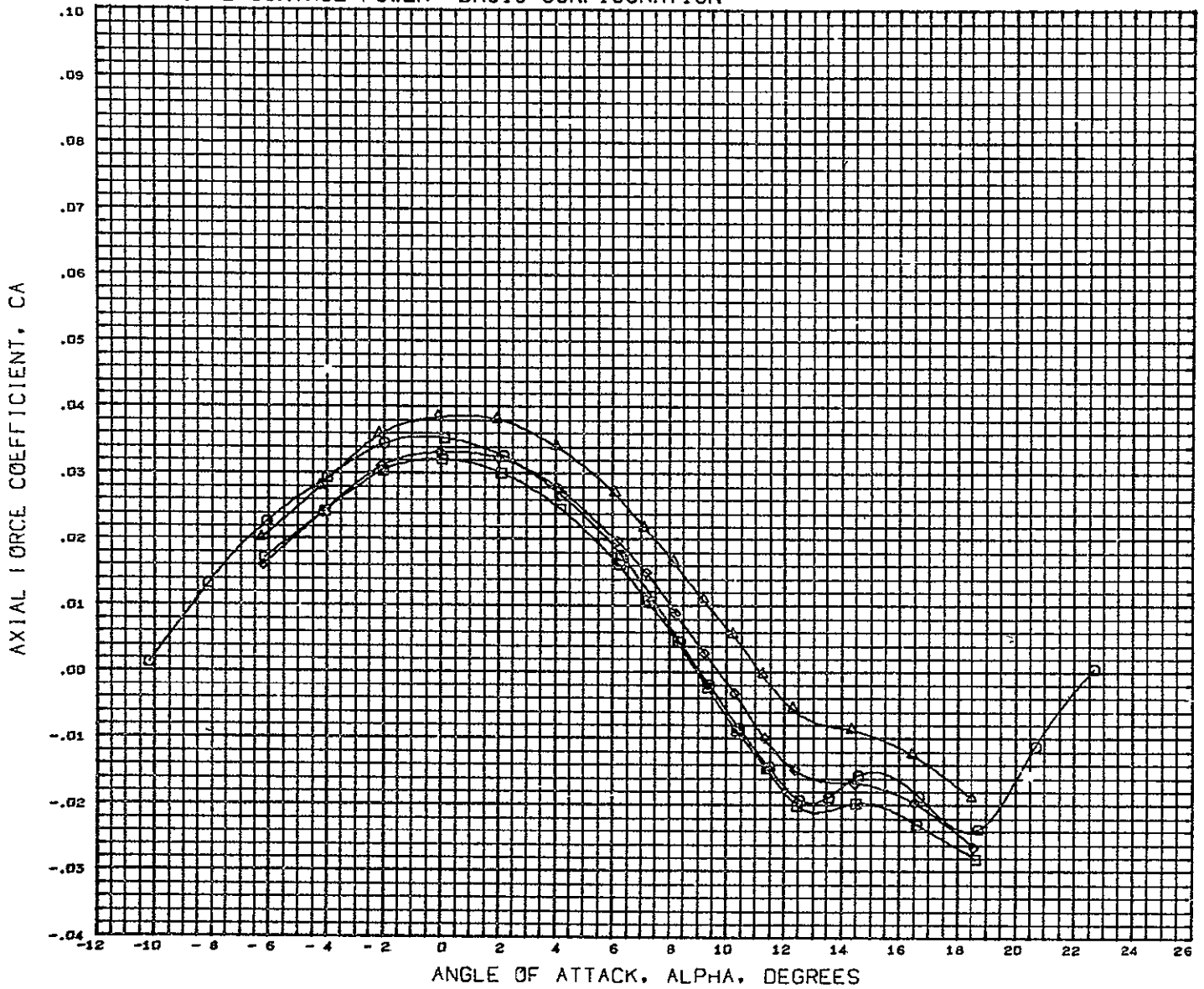

DATA SET SYMBOL	CONFIGURATION DESCRIPTION	BETA	ELEVTR	AILRON	REFERENCE INFORMATION
(BCPD11)	LSWT 248 HDAC 4.0 FC O2 HCR ORB	3.000	0.000	0.000	REFS 8.8690 SQ.FT.
(BCPD07)	LSWT 248 HDAC 4.0 FC O2 HCR ORB	3.000	5.000	0.000	REFL 29.5700 IN.
(BCPD13)	LSWT 248 HDAC 4.0 FC O2 HCR ORB	3.000	10.000	0.000	REFB 51.6000 IN.
(DCPD09)	LSWT 248 HDAC 4.0 FC O2 HCR ORB	3.000	15.000	0.000	XMRP 59.3200 IN.
					YMRP 0.0000 IN.
					ZMRP 11.6000 IN.
					SCALE 4.0000 PERCENT

MACH 0.250

# LONGITUDINAL CONTROL POWER BASIC CONFIGURATION

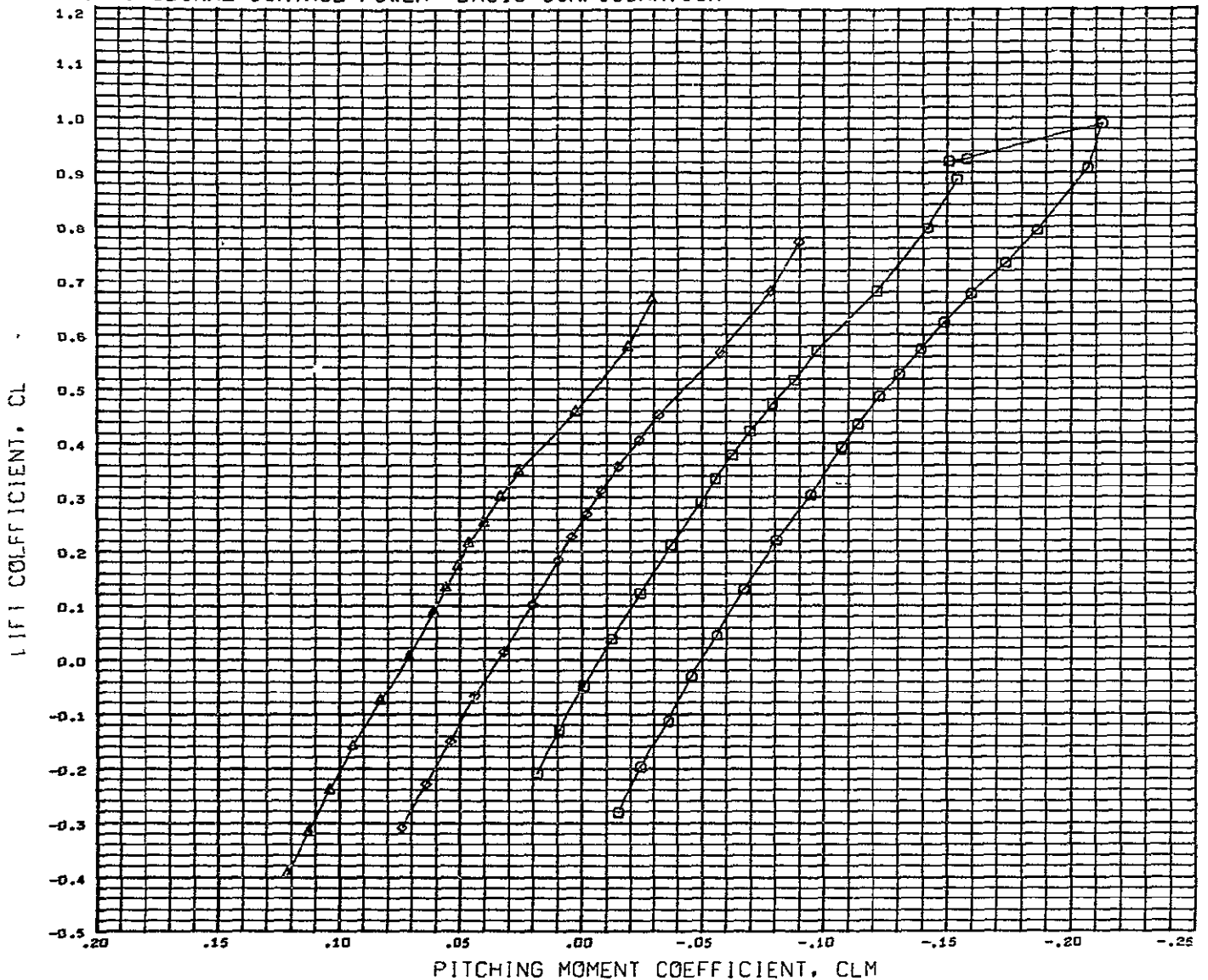

DATA SET SYMBOL	CONFIGURATION DESCRIPTION	BETA	ELEVTR	AILRON	REFERENCE INFORMATION
(CCF011)	LSWT 248 MDAC 4.0 FC 02 HCR ORB B5W11V6	- 3.000	0.000	0.000	REFS 8.8690 SQ.FT
(CCF007)	LSWT 248 MDAC 4.0 FC 02 HCR ORB B5W11V6	- 3.000 - 5.000	0.000	0.000	REFL 29.5700 IN.
(CCF013)	LSWT 248 MDAC 4.0 FC 02 HCR ORB B5W11V6	- 3.000 - 10.000	0.000	0.000	REFB 51.6000 IN.
(CCF009)	LSWT 248 MDAC 4.0 FC 02 HCR ORB B5W11V6	- 3.000 - 15.000	0.000	0.000	XMRP 59.3200 IN.
					YMRF 0.0000 IN.
					ZMRF 11.6000 IN.
					SCALE 4.0000 PERCNT

MACH 0.250

# LONGITUDINAL CONTROL POWER BASIC CONFIGURATION

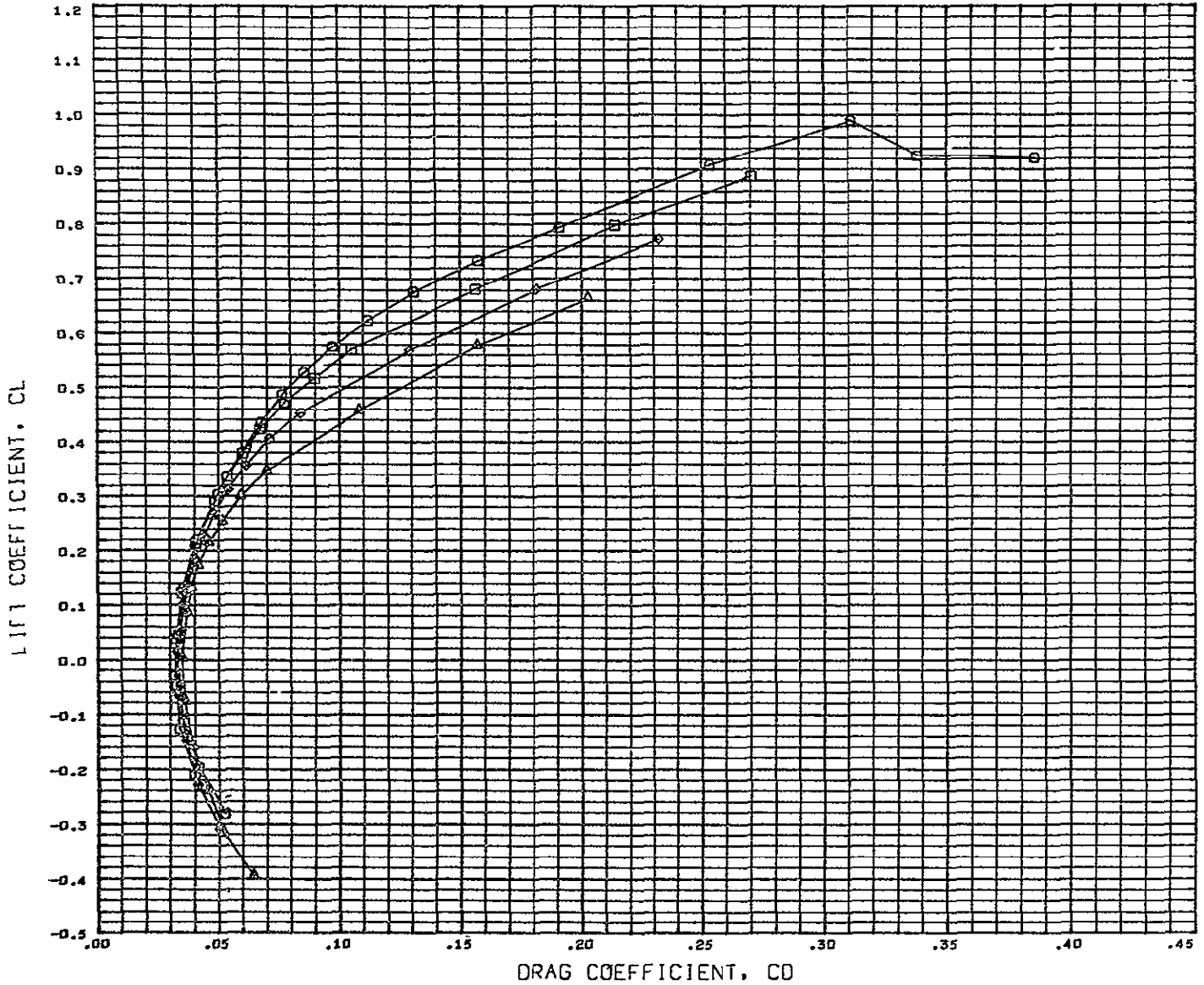

DATA SET SYMBOL	CONFIGURATION DESCRIPTION	BETA	ELEVTR	AILRON	REFERENCE INFORMATION	
(CCF011)	□ LSWT 248 MDAC 4.0 FC 02 HCR ORB	B5W11V6	- 3,000	0.000	0.000	REFS 8.8690 SQ.FT
(CCF007)	□ LSWT 248 MDAC 4.0 FC 02 HCR ORB	B5W11V6	- 3,000 - 5,000	0.000	0.000	REFL 29.5700 IN.
(CCF013)	○ LSWT 248 MDAC 4.0 FC 02 HCR ORB	B5W11V6	- 3,000 - 10,000	0.000	0.000	REFB 51.6000 IN.
(CCF009)	△ LSWT 248 MDAC 4.0 FC 02 HCR ORB	B5W11V6	- 3,000 - 15,000	0.000	0.000	XMRP 59.3200 IN.
						YMRP 0.0000 IN.
						ZMRP 11.6000 IN.
						SCALE 4.0000 PERCENT

MACH 0.250

# LONGITUDINAL CONTROL POWER BASIC CONFIGURATION

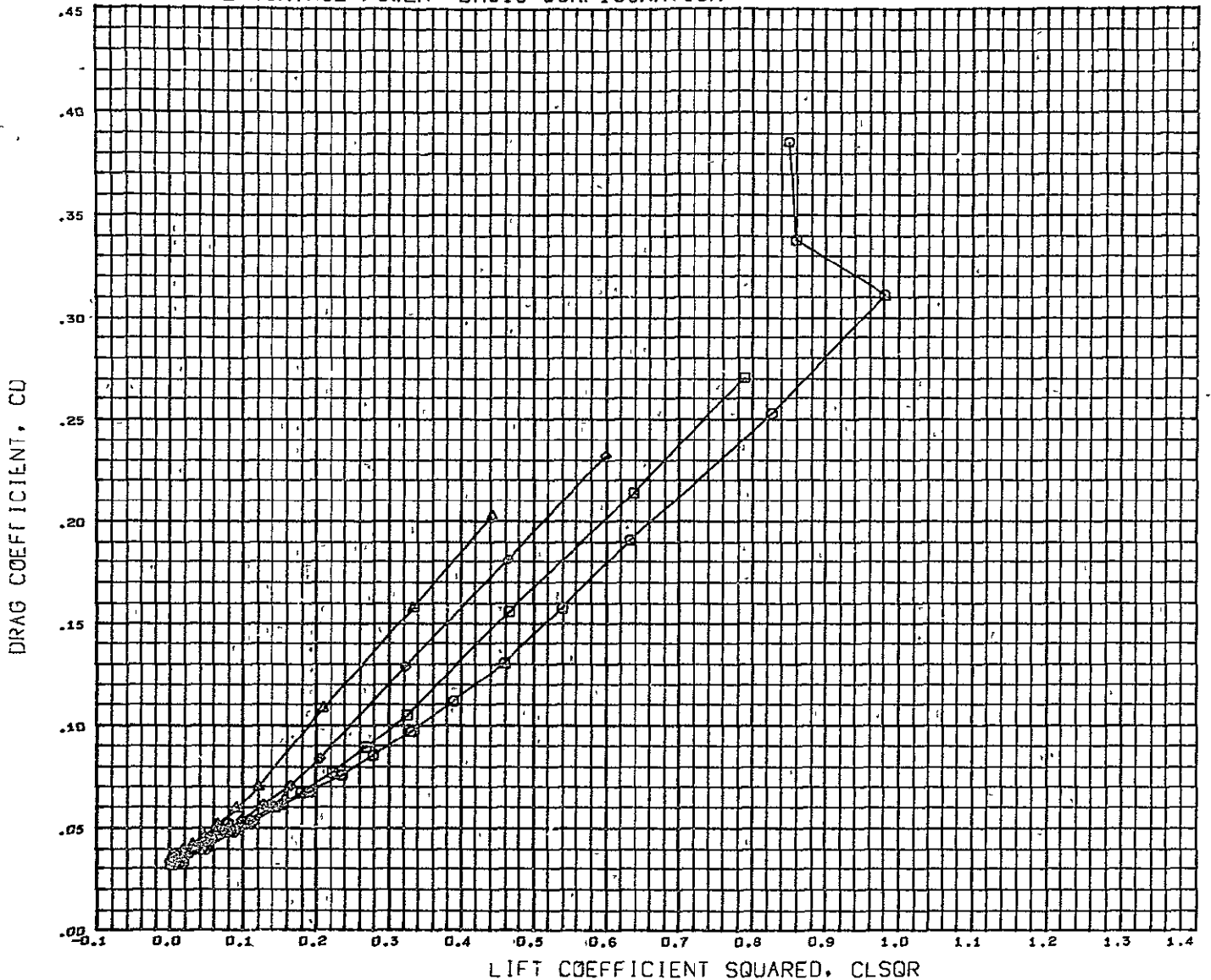

DATA SET	SYMBOL	CONFIGURATION DESCRIPTION	BETA	ELEVTR	AILRON	REFERENCE INFORMATION	
(CCFD11)	□	LSWT 248 MDAC 4.0 FC O2 HCR ORB	B5W11V6	- 3.000	0.000	0.000	REFS 8.8690 SQ.FT
(CCFD07)	◇	LSWT 248 MDAC 4.0 FC O2 HCR ORB	B5W11V6	- 3.000	- 5.000	0.000	REFL 29.5700 IN
(CCFD13)	○	LSWT 248 MDAC 4.0 FC O2 HCR ORB	B5W11V6	- 3.000	- 10.000	0.000	REFB 51.6000 IN
(CCFD09)	△	LSWT 248 MDAC 4.0 FC O2 HCR ORB	B5W11V6	- 3.000	- 15.000	0.000	XMRP 59.3200 IN.
							YMRP 0.0000 IN.
							ZMRP 11.6000 IN
							SCALE 4.0000 PERCENT
HACH		0.250					



# LONGITUDINAL CONTROL POWER BASIC CONFIGURATION

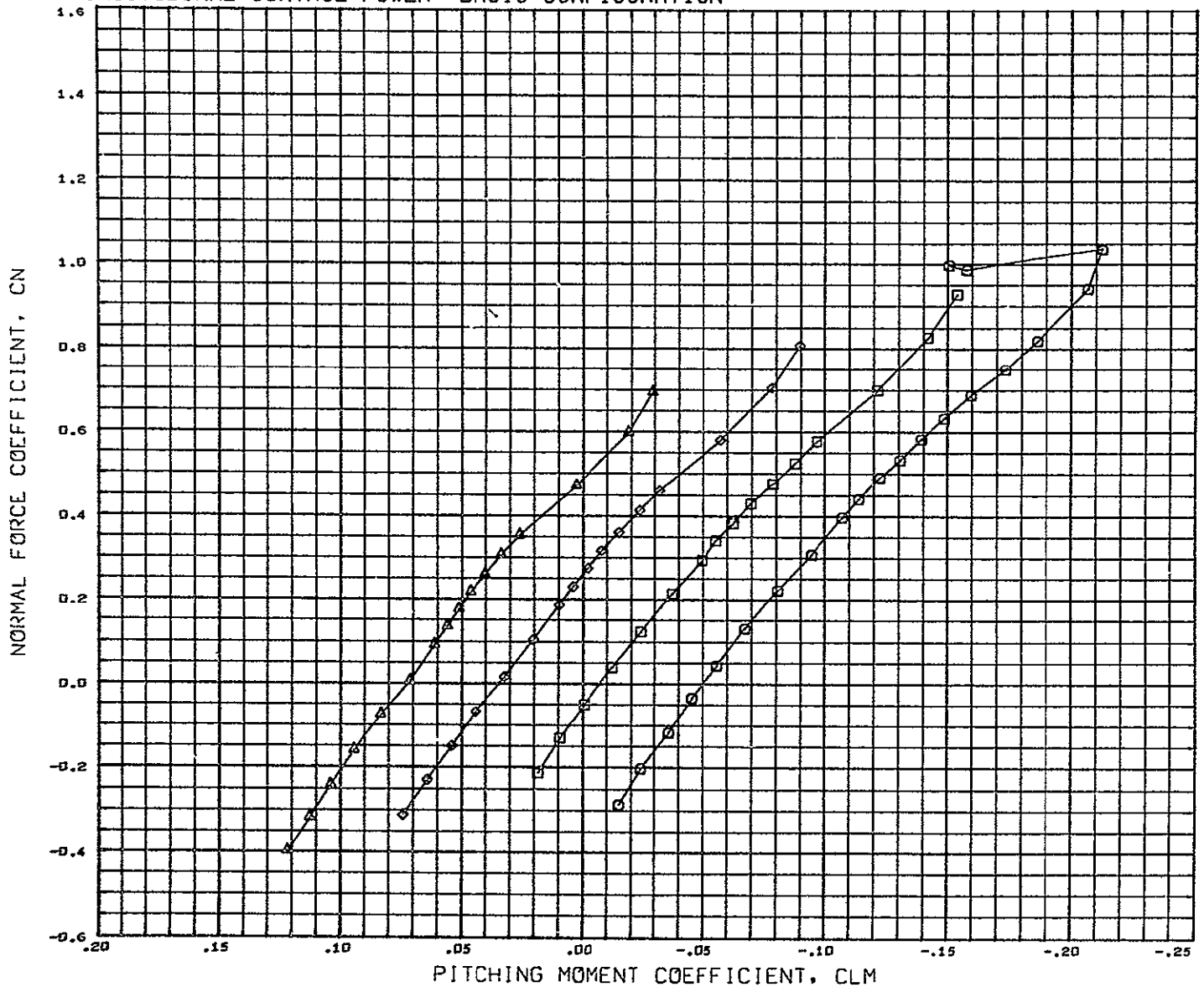

DATA SET SYMBOL	CONFIGURATION DESCRIPTION	BETA	ELEVTR	AIRTON	REFERENCE INFORMATION	
(BCFD11)	LSWT 248 MDAC 4.0 FC O2 HCR ORB	B5W11V6	- 3.000	0.000	0.000	REFS 8.8690 SQ.FT
(BCFD07)	LSWT 248 MDAC 4.0 FC O2 HCR ORB	B5W11V6	- 3.000	- 5.000	0.000	REFL 29.5700 IN.
(BCFD13)	LSWT 248 MDAC 4.0 FC O2 HCR ORB	B5W11V6	- 3.000	- 10.000	0.000	REFB 51.6000 IN.
(BCFD09)	LSWT 248 MDAC 4.0 FC O2 HCR ORB	B5W11V6	- 3.000	- 15.000	0.000	XMRP 59.3200 IN.
						YMRP 0.0000 IN.
						ZMRP 11.6000 IN.
						SCALE 4.0000 PERCNT

MACH 0.250

# LONGITUDINAL CONTROL POWER BASIC CONFIGURATION

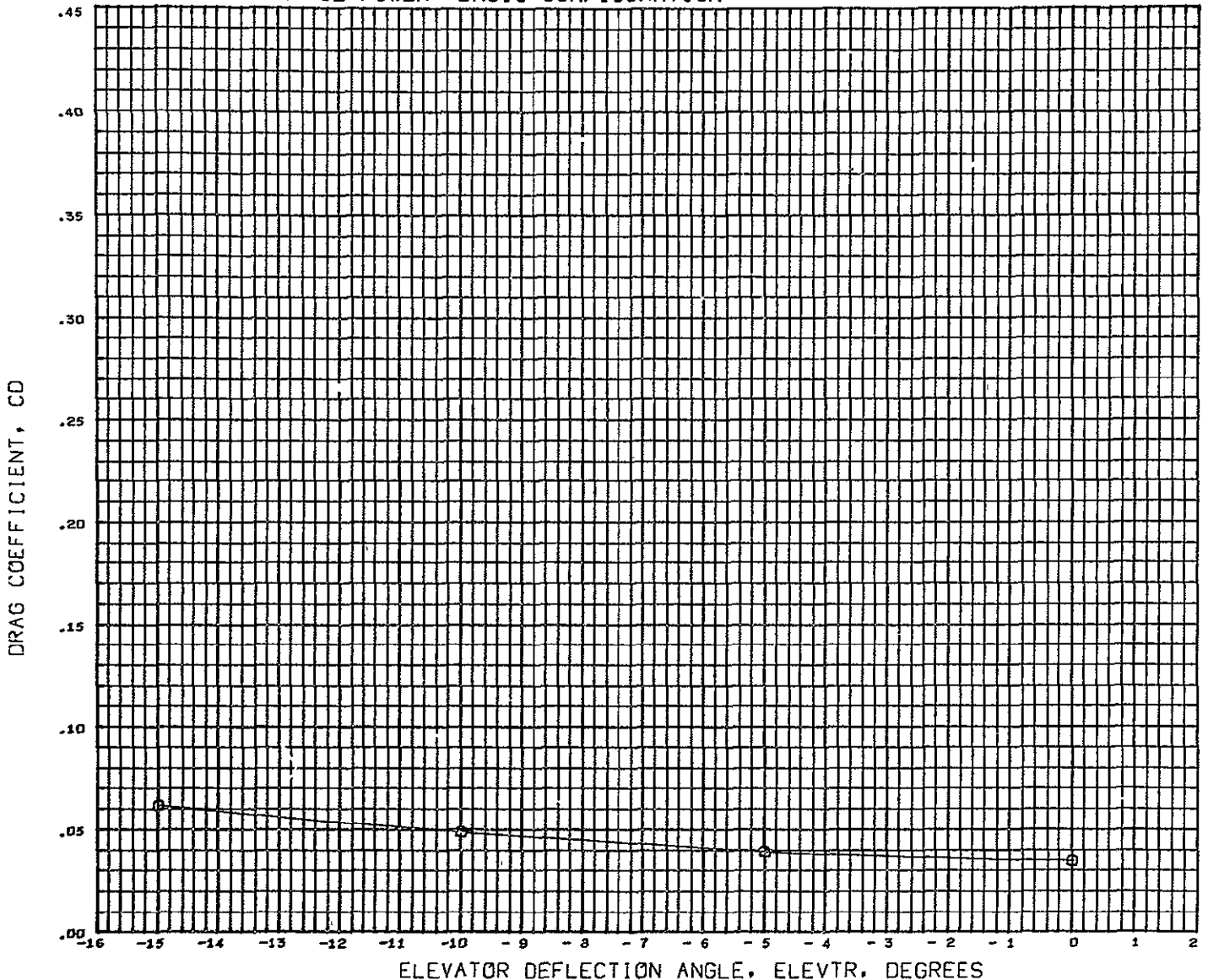

SYMBOL	ALPHA	PARAMETRIC VALUES				DATA SOURCE			REFERENCE INFORMATION		
□	6.000	MACH	0.260	BETA	- 3.000	DATASET	ELEVTR	REFS	8.8690	SQ.FT.	
		AILRON	0.000	SPBRK	0.000	NCP011	0.000	REFL	29.5700	IN.	
		BFLAP	0.000	RUDDER	0.000	NCP013	- 10.000	REFB	51.6000	IN.	
								XHRF	59.3200	IN.	
								YHRF	0.0000	IN.	
								ZHRF	11.6000	IN.	
								SCALE	4.0000	PERCNT	

DATA HIST. CODE M#EV#EI

LSW 248 MDAC 4.0 PC 02 HCR 0RB

B5W11V6

(NCP011) 26 FEB 71

PAGE

86

# LONGITUDINAL CONTROL POWER BASIC CONFIGURATION

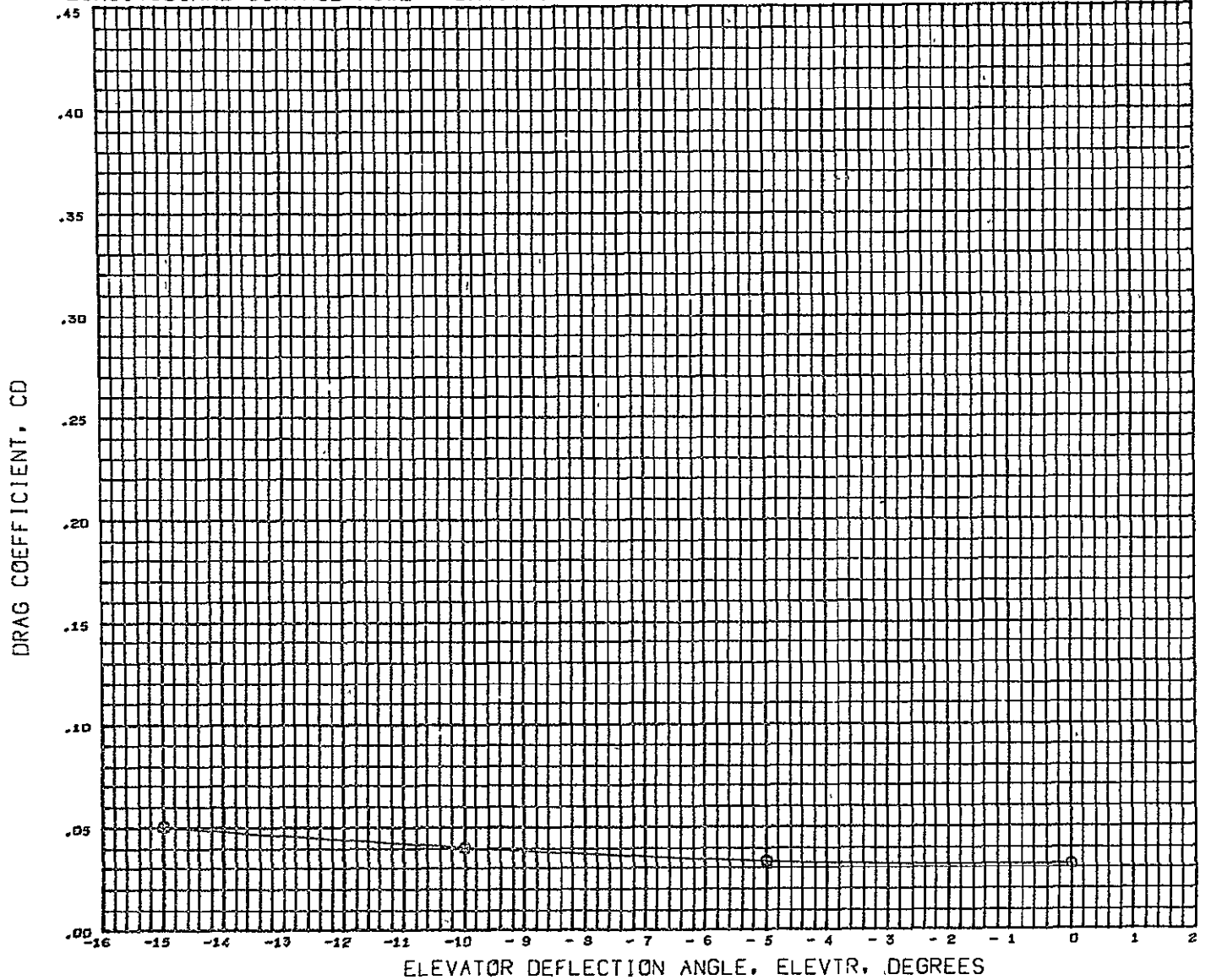

SYMBOL	ALPHA	PARAMETRIC VALUES				DATA SOURCE				REFERENCE INFORMATION		
○	- 4.000	MACH	0.260	BETA	- 3.000	DATASET	ELEVTR	DATASET	ELEVTR	REFS	8.8690	SQ FT
		AILRON	0.000	SPBRK	0.000	NCP011	0.000	NCP007	- 5.000	REFL	29.5700	IN.
		BFLAF	0.000	RUDDER	0.000	NCP013	- 10.000	NCP009	- 15.000	REFB	51.6000	IN.
										XMRP	59.3200	IN.
										YMRP	0.0000	IN.
										ZMRP	11.6000	IN.
										SCALE	4.0000	PERCENT

DATA HIST. CODE M#EV#EI

# LONGITUDINAL CONTROL POWER BASIC CONFIGURATION

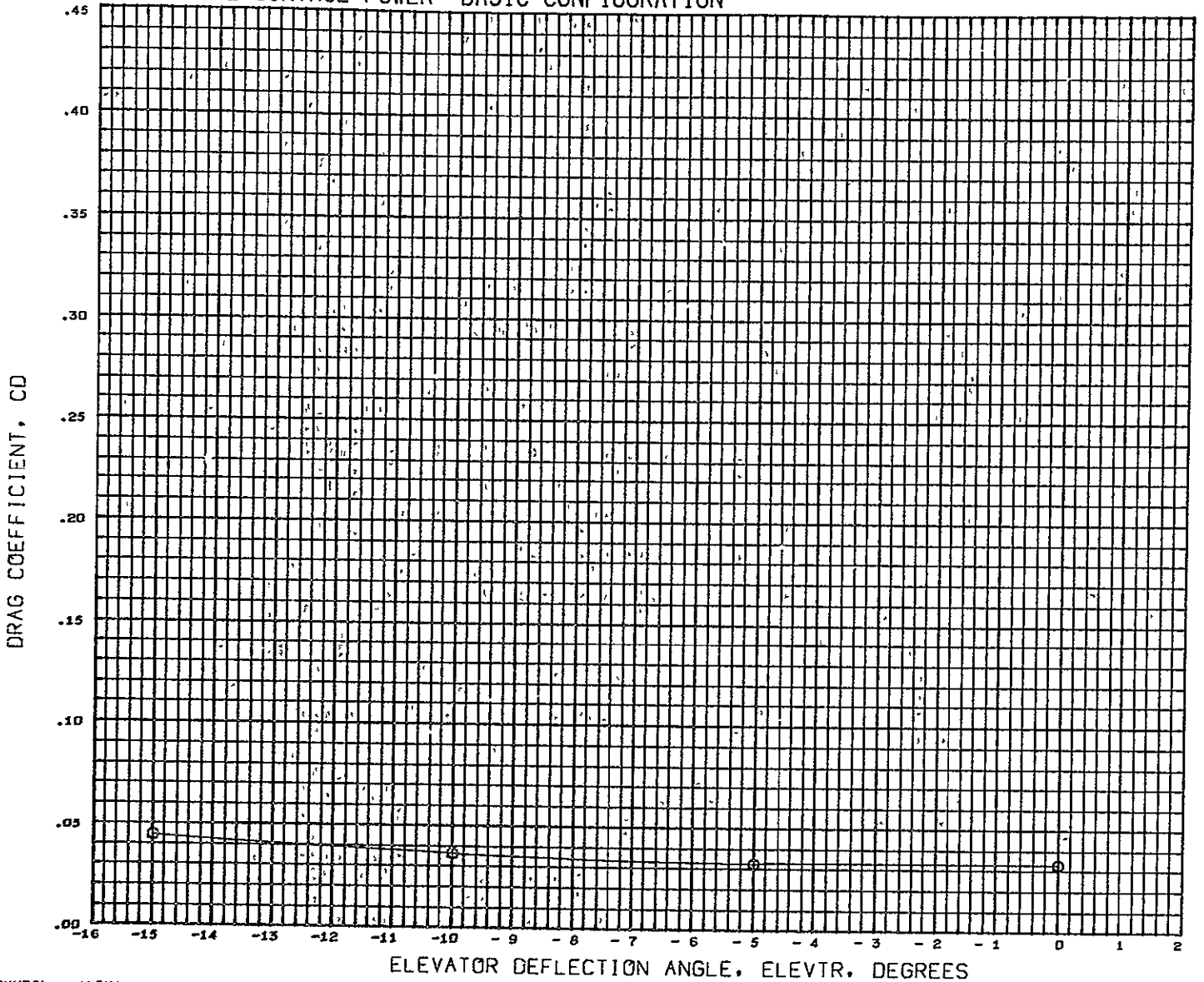

SYMBOL	ALPHA	PARAMETRIC VALUES		DATA SOURCE		REFERENCE INFORMATION				
○	- 2.000	MACH	0.260	BETA	- 3.000	DATA SET	ELEVTR	REFS	8.8690	SQ FT.
		AILRON	0.000	SPBRK	0.000	NCP011	0.000	REFL	29.5700	IN.
		BFLAP	0.000	RUDDER	0.000	NCP013	- 10.000	REFB	51.6000	IN.
								XMRP	59.3200	IN.
								YMRP	0.0000	IN.
								ZMRP	11.6000	IN.
								SCALE	4.0000	PERCNT

DATA HIST. CODE M#EV#EI

\_SWT 248 MDAC 4.0 PC 02 HCR ORB

BSW11V6

(NCP011) 26 FEB 71

PAGE

88

LONGITUDINAL CONTROL POWER BASIC CONFIGURATION

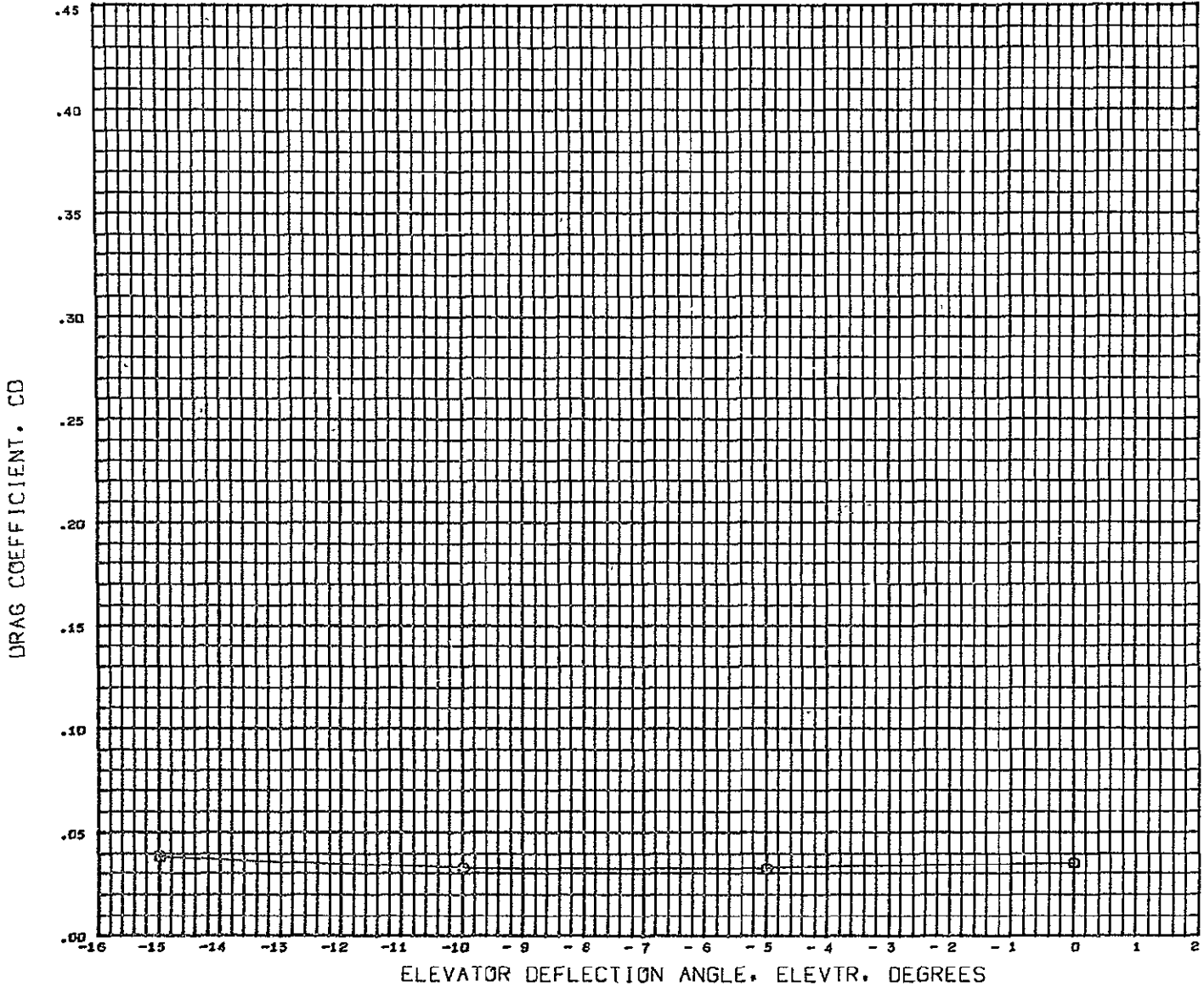

SYMBOL	ALPHA	PARAMETRIC VALUES				DATA SOURCE				REFERENCE INFORMATION		
○	0.000	MACH	0.260	BETA	- 3.000	DATASET	ELEVTR	DATASET	ELEVTR	REFS	8.8690	SQ.FT.
		AIRLON	0.000	SPBRK	0.000	NCP011	0.000	NCP007	- 5.000	REFL	29.5700	IN.
		BFLAP	0.000	RUDDER	0.000	NCP013	- 10.000	NCP009	- 15.000	REFB	1.6000	IN.
										XMRP	59.3200	IN.
										YMRP	0.0000	IN.
										ZMRP	11.6000	IN.
										SCALE	4.0000	PERCENT

DATA HIST. CODE M#EV#EI

# LONGITUDINAL CONTROL POWER BASIC CONFIGURATION

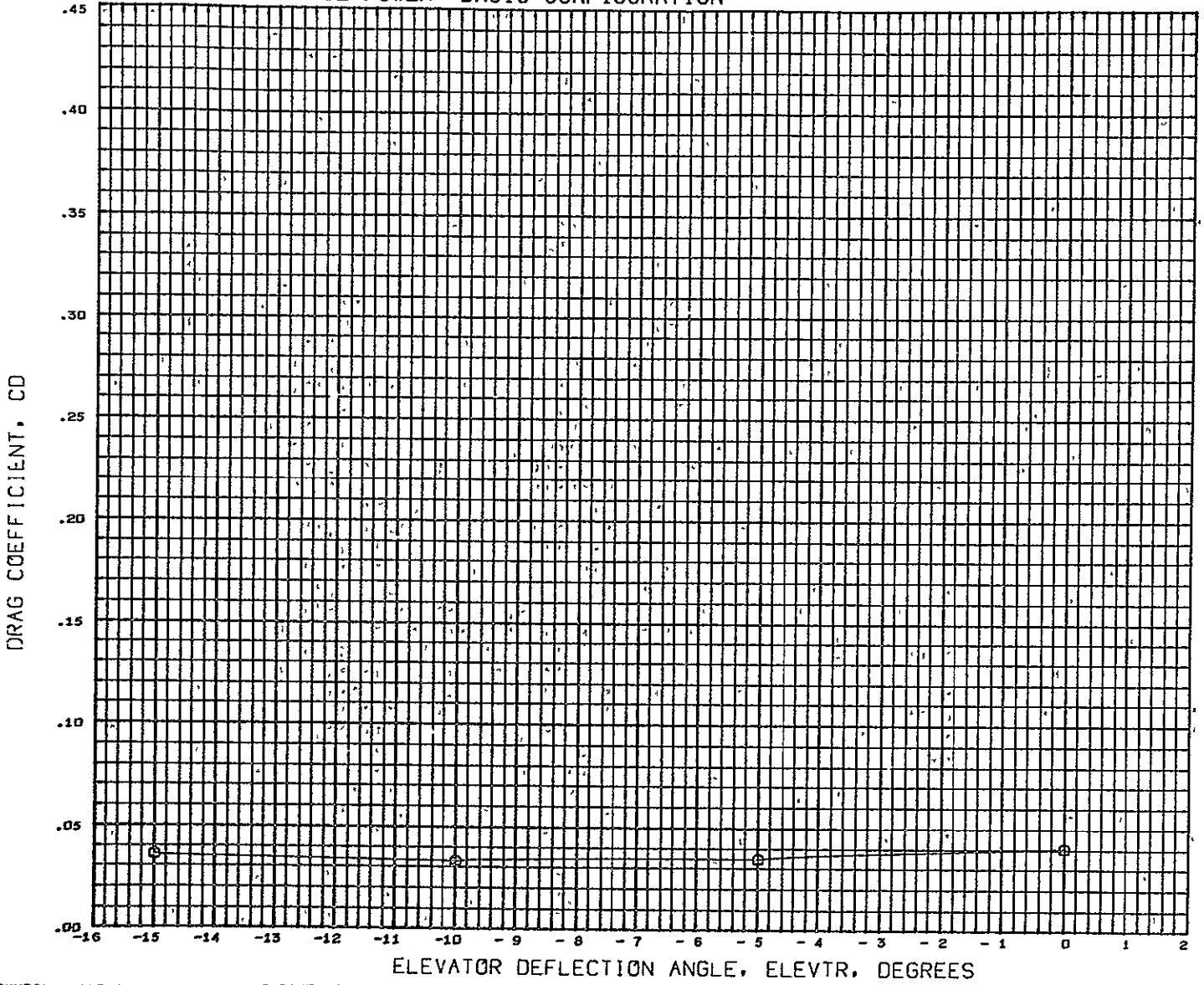

SYMBOL	ALPHA	PARAMETRIC VALUES				DATA SOURCE				REFERENCE INFORMATION		
O	2.000	<u>MACH</u>	0.260	BETA	- 3.000	DATASET	ELEVTR	DATASET	ELEVTR	REFS	8.8690	SQ.FT.
		AILRON	0.000	SPBRK	0.000	NCF011	0.000	NCF007	- 5.000	REFL	29.5700	IN.
		BFLAP	0.000	RUDDER	0.000	NCF013	- 10.000	NCF009	- 15.000	REFB	51.6000	IN.
										XMRP	59.3200	IN.
										YMRP	0.0000	IN.
										ZMRP	11.6000	IN.
										SCALE	4.0000	PERCNT

DATA HIST. CODE M#EV#EI

LONGITUDINAL CONTROL POWER BASIC CONFIGURATION

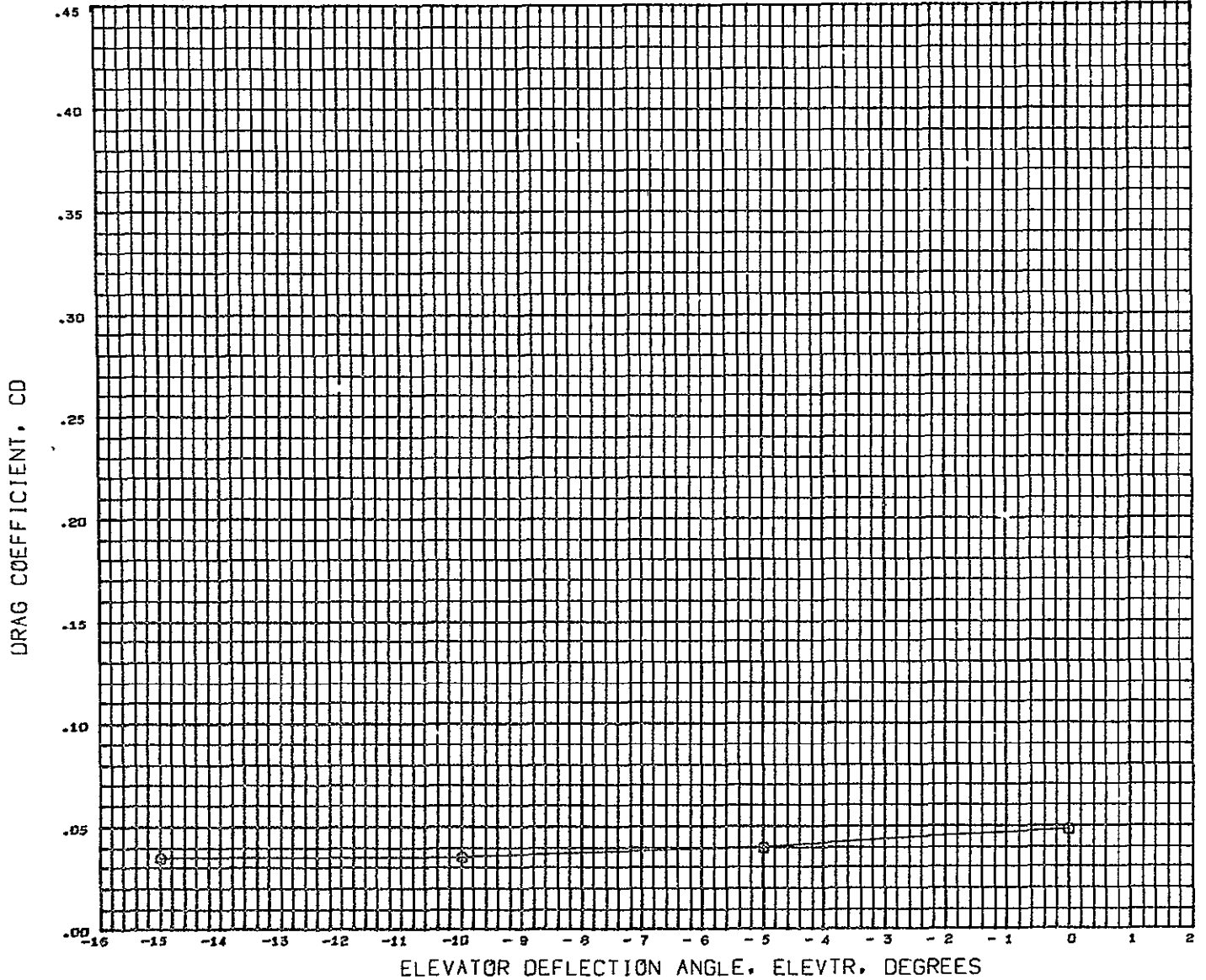

SYMBOL	ALPHA	PARAMETRIC VALUES				DATA SOURCE			REFERENCE INFORMATION			
○	4.000	MACH	0.260	BETA	- 3.000	DATASET	ELEVTR	DATASET	ELEVTR	REFS	8.8690	SQ FT.
		AILRON	0.000	SPBRK	0.000	NCP011	0.000	NCP007	- 5.000	REFL	29.5700	IN.
		BFLAF	0.000	RUDDER	0.000	NCP013	- 10.000	NCP009	- 15.000	REFB	51.6000	IN.
										XMRP	59.3200	IN.
										YMRP	0.0000	IN.
										ZMRP	11.6000	IN.
										SCALE	4.0000	PERCNT

DATA HIST. CODE M#EV#EI

# LONGITUDINAL CONTROL POWER BASIC CONFIGURATION

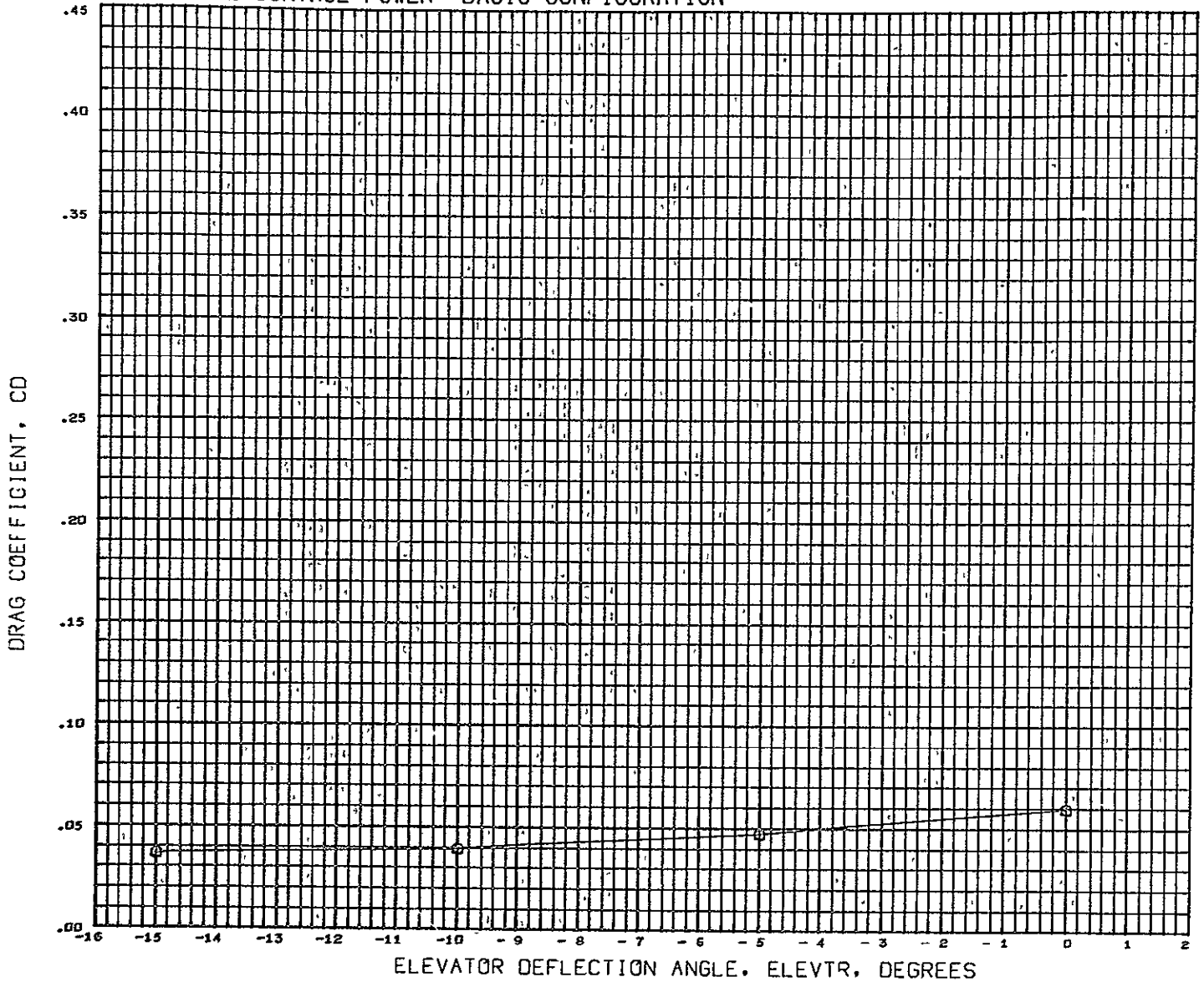

SYMBOL	ALPHA	PARAMETRIC VALUES				DATA SOURCE				REFERENCE INFORMATION		
○	6.000	MACH	0.260	BETA	- 3.000	DATASET	ELEVTR	DATASET	ELEVTR	REFS	8.8690	SQ.FT.
		AILRON	0.000	SPBRK	0.000	NCP011	0.000	NCP007	- 5.000	REFL	29.5700	IN.
		BFLAF	0.000	RUDDER	0.000	NCP013	- 10.000	NCP009	- 15.000	REFB	51.6000	IN.
										XMRP	59.3200	IN.
										YMRP	0.0000	IN.
										ZMRP	11.6000	IN.
										SCALE	4.0000	PERCNT

DATA HIST. CODE M#EV#EI



LONGITUDINAL CONTROL POWER BASIC CONFIGURATION

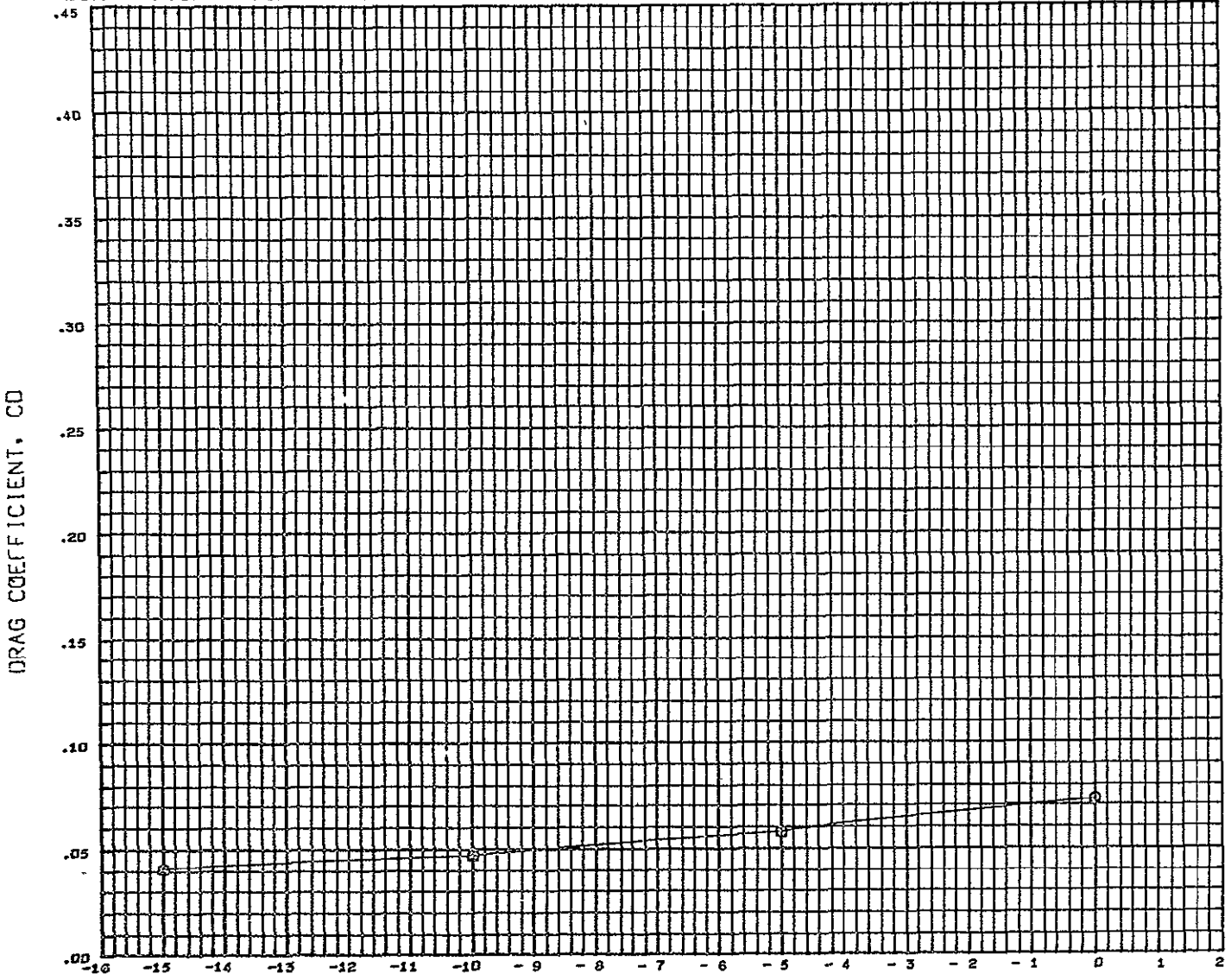

ELEVATOR DEFLECTION ANGLE, ELEVTR, DEGREES

SYMBOL	ALPHA	PARAMETRIC VALUES				DATA SOURCE				REFERENCE INFORMATION		
		MACH	BETA	SPURK	RUDDER	DATASET	ELEVTR	DATASET	ELEVTR	REFS	REFL	SQ.FT.
□	8.000	0.260	- 3.000	0.000	0.000	NCP011	0.000	NCP007	- 5.000	8.8690	29.5700	IN.
		0.000	0.000	0.000	0.000	NCP013	- 10.000	NCP009	- 15.000	51.6000	59.3200	IN.
		0.000	0.000	0.000	0.000					0.0000	11.6000	IN.
											4.0000	PERCNT

DATA HIST. CODE M#EV#EI



# LONGITUDINAL CONTROL POWER BASIC CONFIGURATION

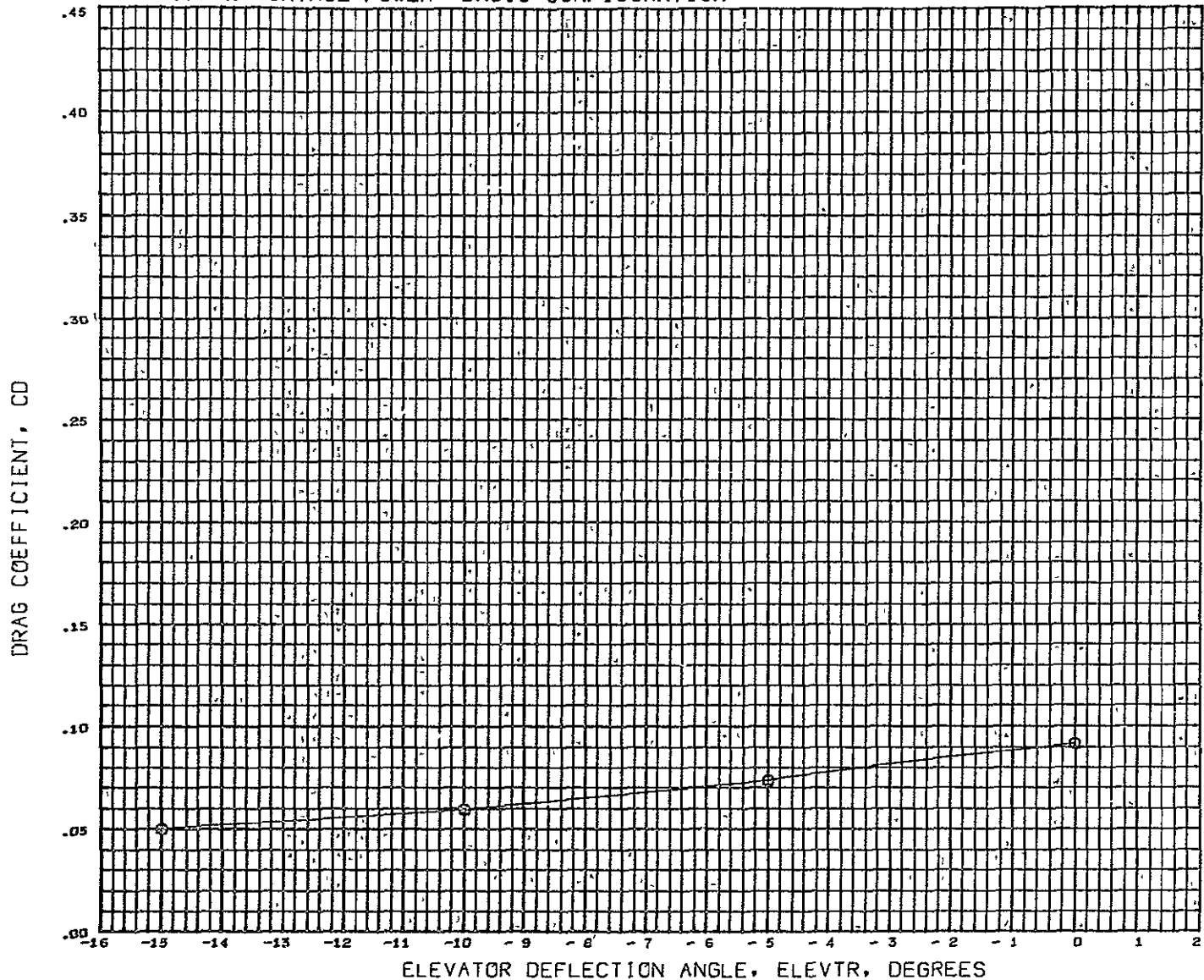

SYMBOL	ALPHA	PARAMETRIC VALUES				DATA SOURCE				REFERENCE INFORMATION		
○	10.000	<u>MACH</u>	0.260	BETA	- 3.000	DATASET	ELEVTR	DATASET	ELEVTR	REFS	8.8690	SQ.FT.
		AILRON	0.000	SPBRK	0.000	NCP011	0.000	NCP007	- 5.000	REFL	29.5700	IN.
		BFLAP	0.000	RUDDER	0.000	NCP013	- 10.000	NCP009	- 15.000	REFB	51.6000	IN.
										XMRP	59.3200	IN.
										YMRP	0.0000	IN.
										ZMRP	11.6000	IN.
										SCALE	4.0000	PERCNT

DATA HIST. CODE H#EV#EI

# LONGITUDINAL CONTROL POWER BASIC CONFIGURATION

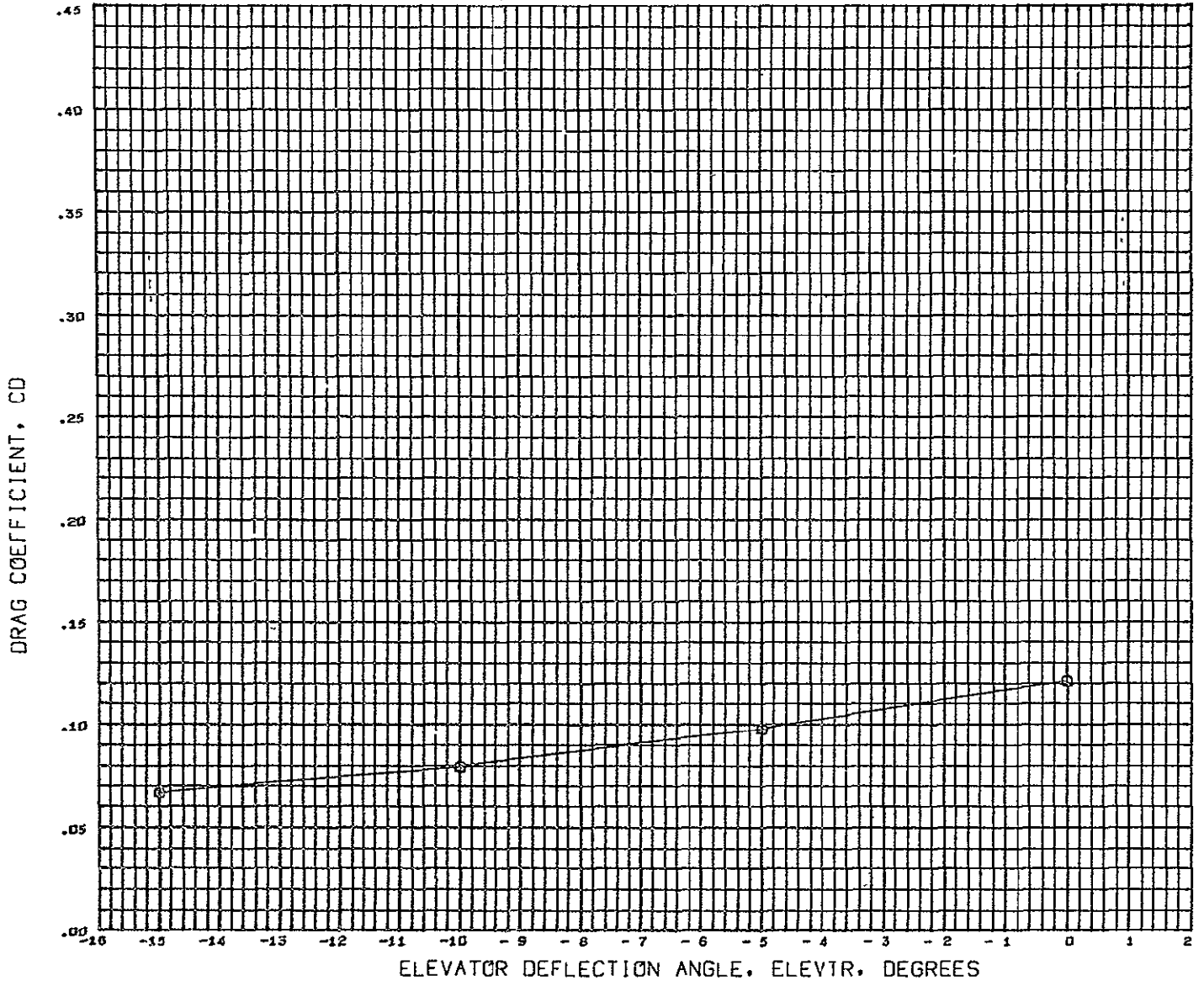

SYMBOL	ALPHA	PARAMETRIC VALUES				DATA SOURCE				REFERENCE INFORMATION		
○	12.000	MACH	0.260	BETA	- 3.000	DATASET	ELEVTR	DATASET	ELEVTR	REFS	0.8690	SQ FT
		AILRON	0.000	SPBRK	0.000	NCP011	0.000	NCP007	- 5.000	REFL	29.5700	IN.
		BFLAP	0.000	RUDDER	0.000	NCP013	- 10.000	NCP009	- 15.000	REFB	51.6000	IN.
										XMRP	59.3200	IN.
										YMRP	0.0000	IN.
										ZMRP	11.6000	IN.
										SCALE	4.0000	PERCNT
		DATA HIST. CODE	M#EV#EI									

# LONGITUDINAL CONTROL POWER BASIC CONFIGURATION

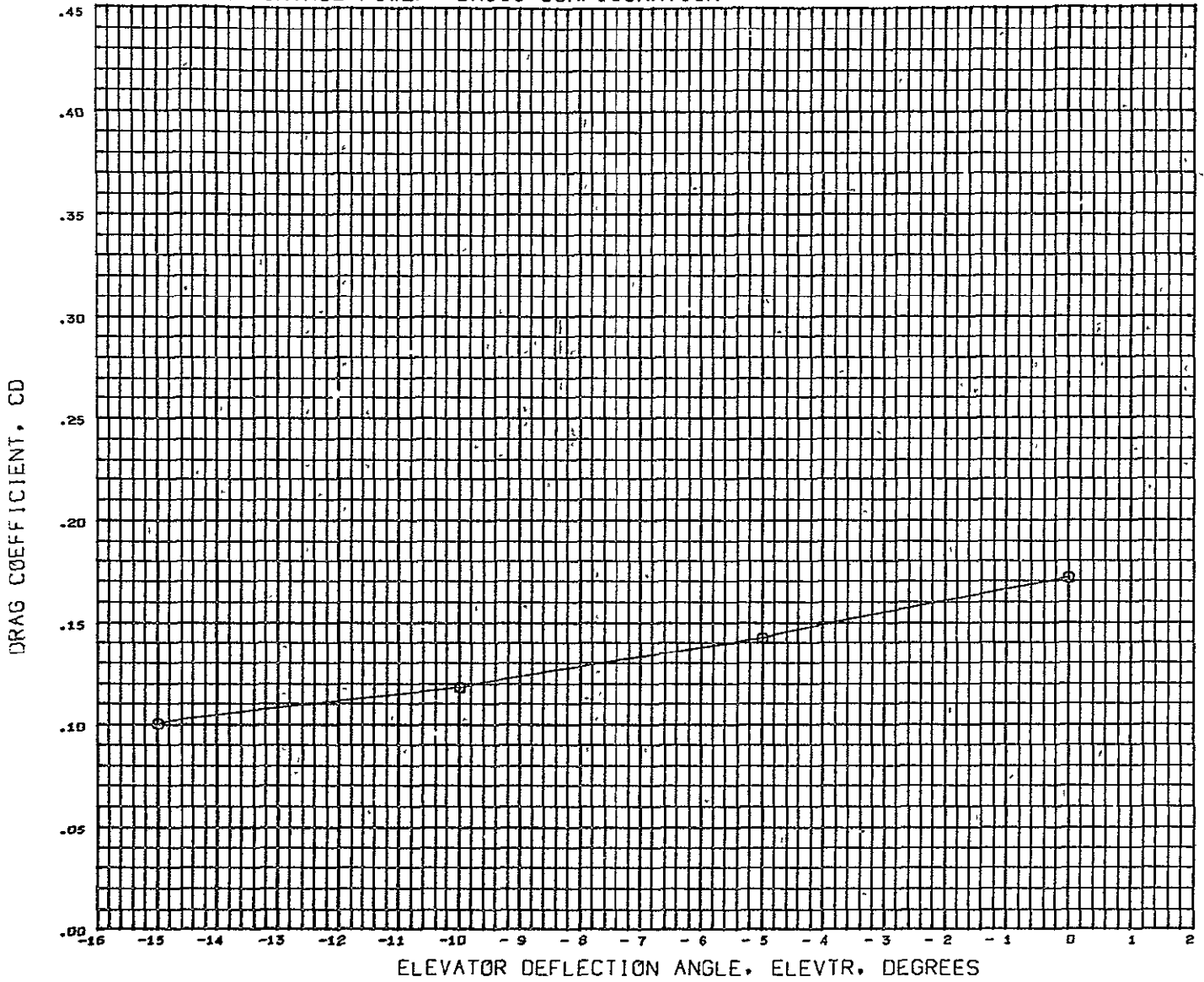

SYMBOL	ALPHA	PARAMETRIC VALUES				DATA SOURCE				REFERENCE INFORMATION		
		MACH	BETA	SPRKR	RUDDER	DATASET	ELEVTR	DATASET	ELEVTR	REFS	IN.	PERCENT
○	1.000	0.260	- 3.000	0.000	0.000	NCP011	0.000	NCF007	- 5.000	8.8690	29.5700	51.6000
		0.000	0.000	0.000	0.000	NCP013	- 10.000	NCF009	- 15.000	59.3200	0.0000	11.6000
										SCALE	4.0000	

DATA HIST. CODE M#EV\*EI

# LONGITUDINAL CONTROL POWER BASIC CONFIGURATION

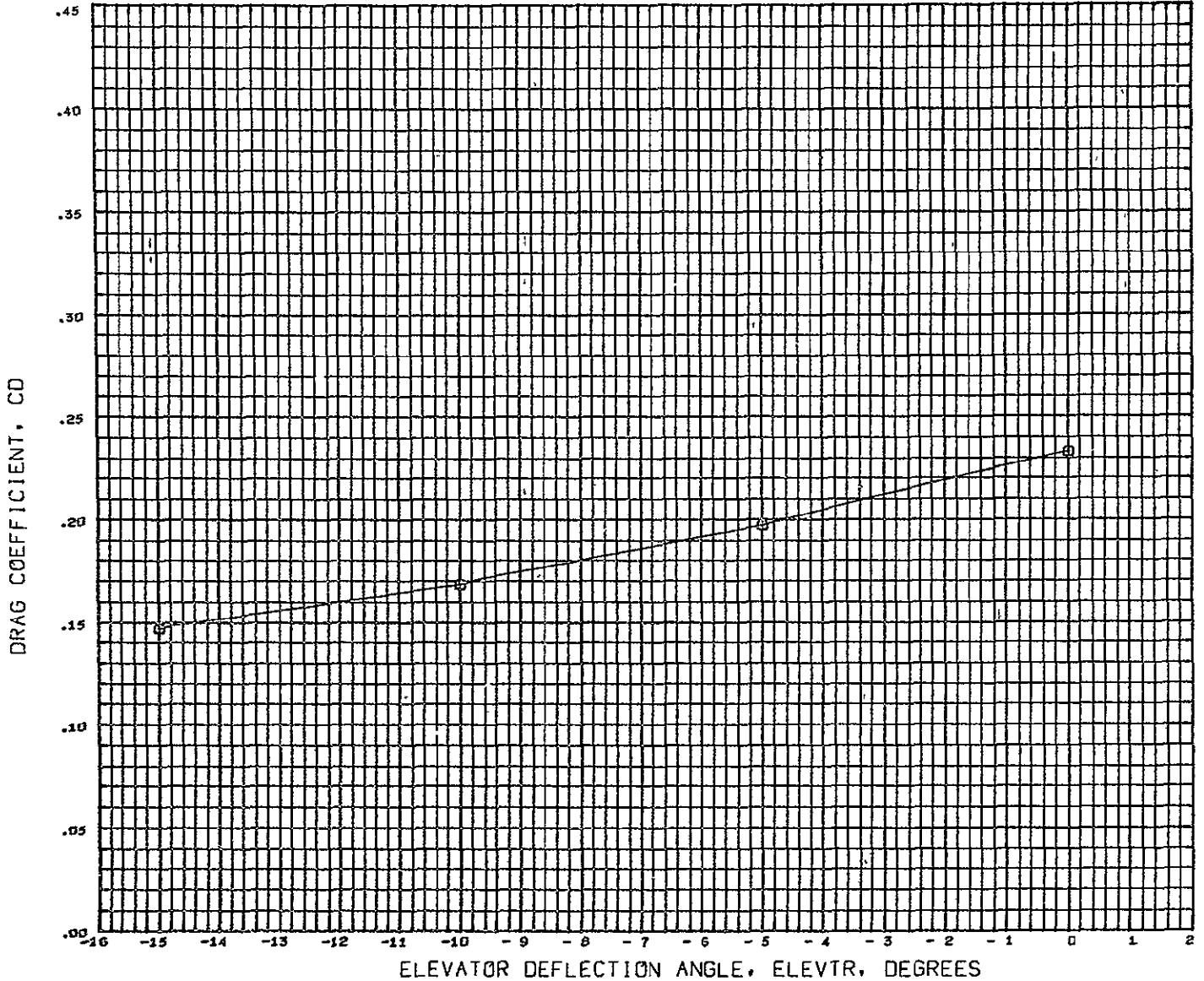

SYMBOL	ALPHA	PARAMETRIC VALUES				DATA SOURCE				REFERENCE INFORMATION		
○	16.000	<u>MACH</u>	0.260	BETA	- 3.000	DATASET	ELEVTR	DATASET	ELEVTR	REFS	8.8690	SQ FT.
		AILERON	0.000	SPBRK	0.000	NCP011	0.000	NCP007	- 5.000	REFL	29.5700	IN.
		BFLAP	0.000	RUDDER	0.000	NCP013	- 10.000	NCP009	- 15.000	REFB	51.6000	IN.
										XMRP	59.3200	IN.
										YMRP	0.0000	IN.
										ZMRP	11.6000	IN.
										SCALE	4.0000	PERCENT

DATA HIST. CODE H#EV#E1

# LONGITUDINAL CONTROL POWER BASIC CONFIGURATION

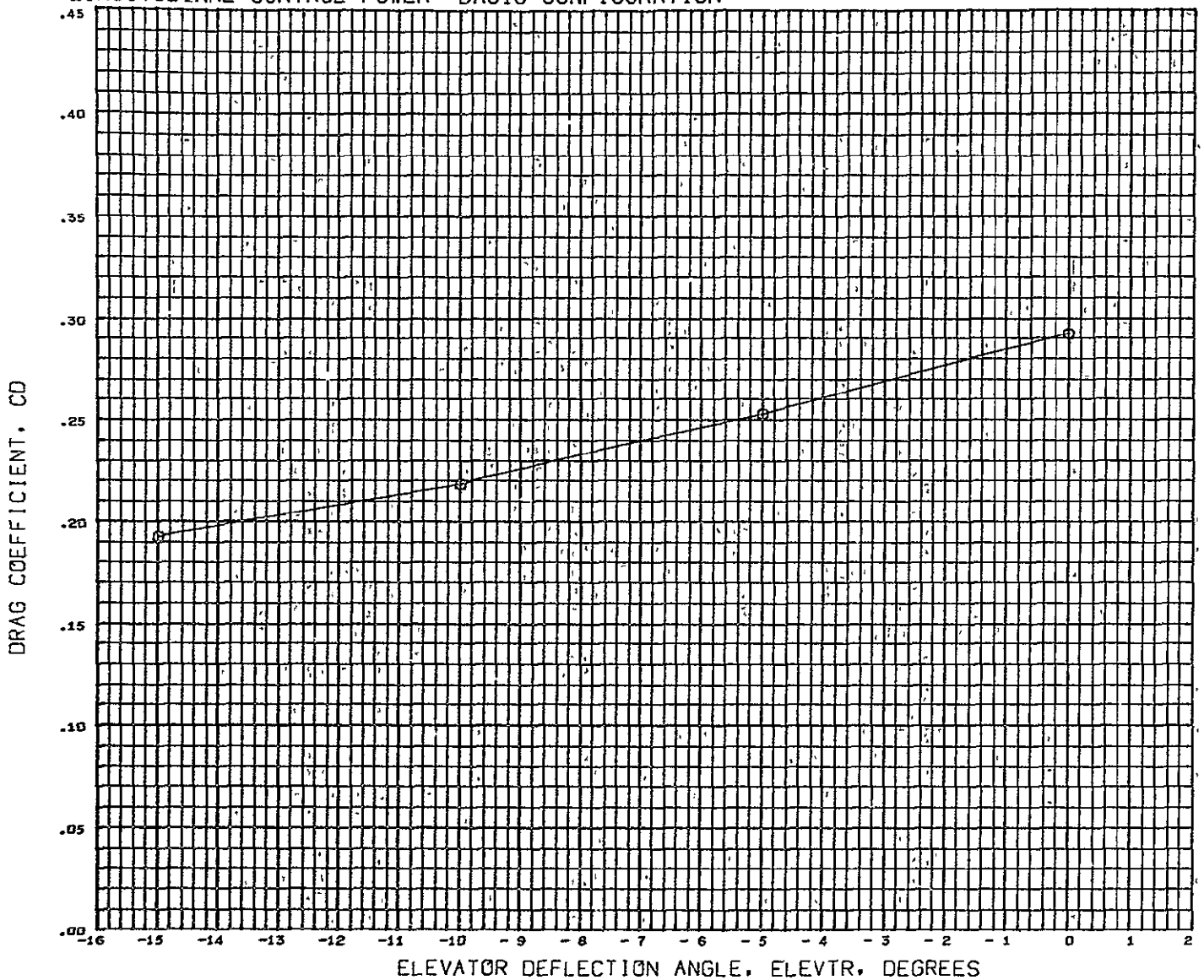

SYMBOL	ALPHA	PARAMETRIC VALUES				DATA SOURCE				REFERENCE INFORMATION		
○	10.000	MACH	0.260	BETA	- 3.000	DATASET	ELEVTR	DATASET	ELEVTR	REFS	8.8690	SQ FT.
		AILRON	0.000	SPBRK	0.000	NCP011	0.000	NCP007	- 5.000	REFL	29.5700	IN.
		BFLAP	0.000	RUDDER	0.000	NCP013	- 10.000	NCP009	- 15.000	REFB	51.6000	IN.
										XHRP	59.3200	IN.
										YHRP	0.0000	IN.
										ZHRP	11.6000	IN.
										SCALE	4.0000	PERCENT

DATA HIST. CODE H#EV#EI

# LONGITUDINAL CONTROL POWER BASIC CONFIGURATION

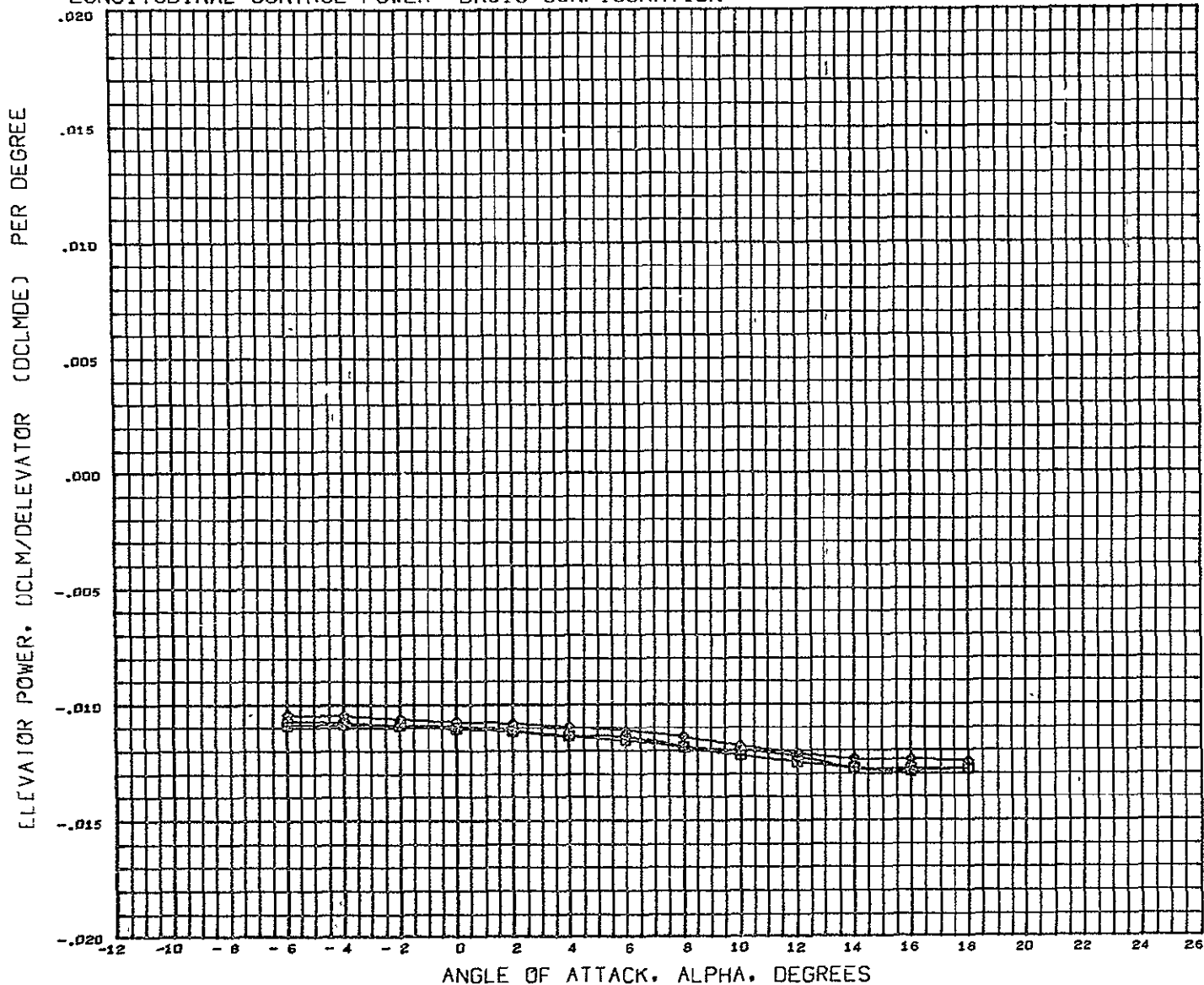

DATA SET SYMBOL	CONFIGURATION DESCRIPTION	SLOPE	BETA	AILRON
(XCF007)	LSWT 248 MDAC 4.0 FC O2 HCR ORB B5W11V6	1.000 -	3.000	0.000
(XCF013)	LSWT 248 MDAC 4.0 FC O2 HCR ORB B5W11V6	2.000 -	3.000	0.000
(XCF009)	LSWT 248 MDAC 4.0 FC O2 HCR ORB B5W11V6	3.000 -	3.000	0.000

REFERENCE INFORMATION		
REFS	8.8590	SQ.FT
REFL	29.5700	IN.
REFB	51.6000	IN
XMRP	59.3200	IN
YMRP	0.0000	IN
ZMRP	11.6000	IN.
SCALE	4.0000	PERCENT

MACH 0.260

# LONGITUDINAL CONTROL POWER BASIC CONFIGURATION

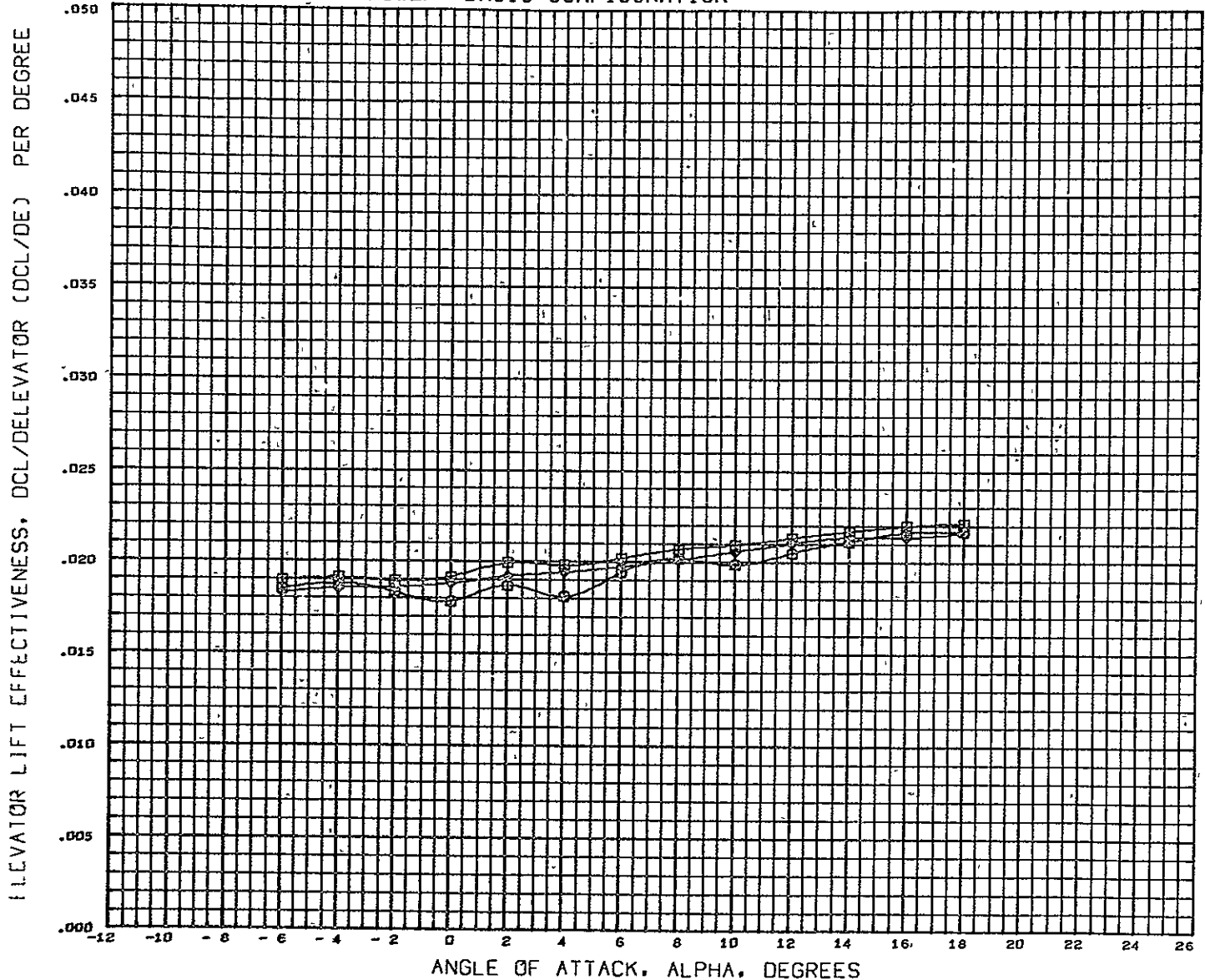

DATA SET SYMBOL	CONFIGURATION DESCRIPTION	SLOPE	BETA	AILRON	REFERENCE INFORMATION
(XCF007)	LSWT 248 HDAC 4.0 FC O2 HCR ORB B5W11V6	1,000 - 3,000	0,000	0,000	REFS 8.8690 SQ.FT.
(XCF013)	LSWT 248 HDAC 4.0 FC O2 HCR ORB B5W11V6	2,000 - 3,000	0,000	0,000	REFL 29.5700 IN.
(XCF009)	LSWT 248 HDAC 4.0 FC O2 HCR ORB B5W11V6	3,000 - 3,000	0,000	0,000	REFB 51.6000 IN.
					XMRP 59.3200 IN.
					YMRP 0.0000 IN.
					ZMRP 11.6000 IN.
					SCALE 4.0000 PERCENT

MACH 0.260



# LONGITUDINAL CONTROL POWER BASIC CONFIGURATION

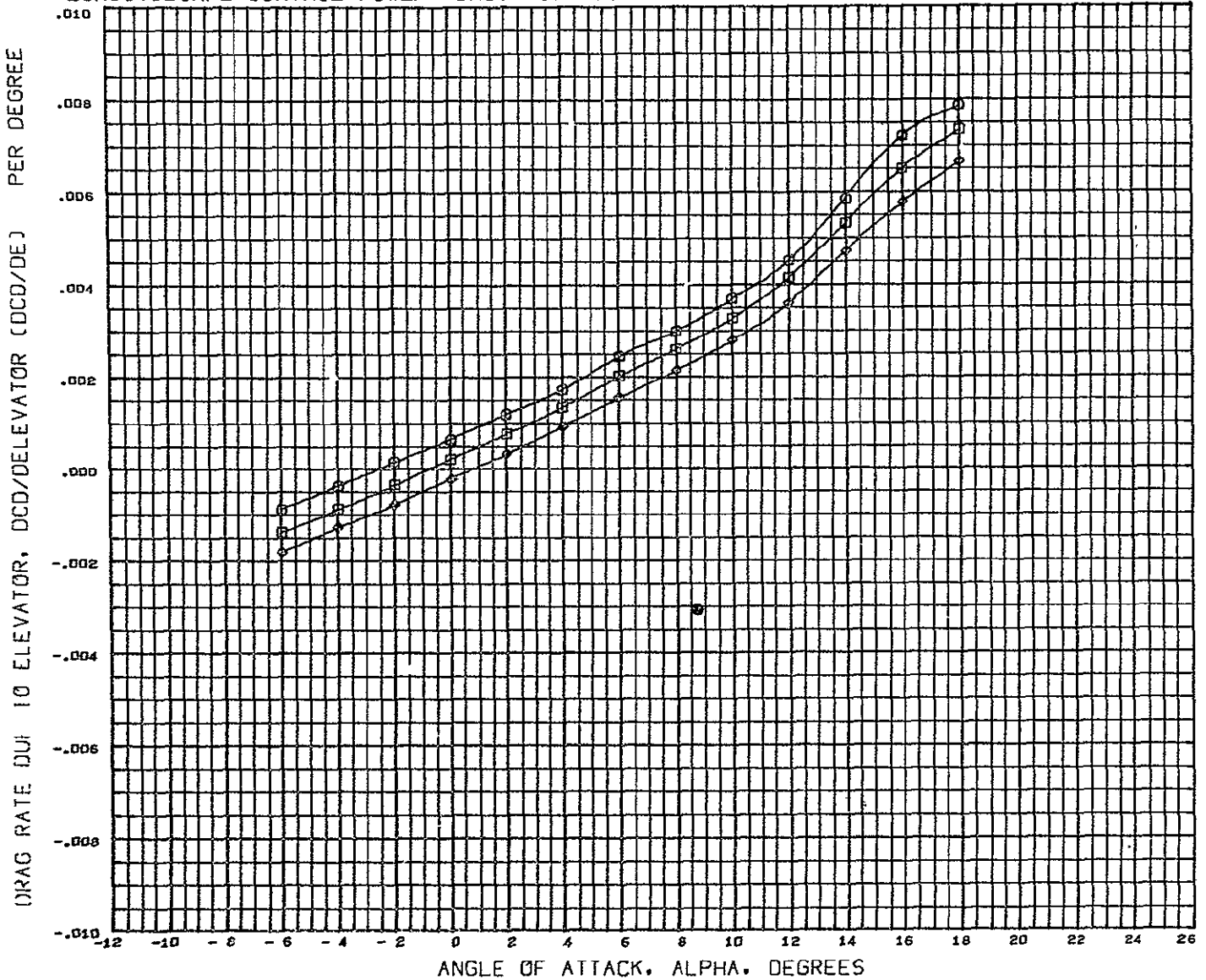

DATA SET SYMBOL	CONFIGURATION DESCRIPTION	SLOPE	BETA	AILRON	REFERENCE INFORMATION
(XCF007)	LSWT 248 MDAC 4.0 FC 02 HCR ORB B5W11V6	1.000 - 3.000	0.000	0.000	REFS 8.8690 SQ.FT.
(XCF013)	LSWT 248 MDAC 4.0 FC 02 HCR ORB B5W11V6	2.000 - 3.000	0.000	0.000	REFL 29.5700 IN.
(XCF009)	LSWT 248 MDAC 4.0 FC 02 HCR ORB B5W11V6	3.000 - 3.000	0.000	0.000	REFB 51.6000 IN.
					XMRP 59.3200 IN.
					YMRP 0.0000 IN.
					ZMRP 11.6000 IN.
					SCALE 4.0000 PERCNT

MACH 0.260

# LONGITUDINAL CONTROL POWER BASIC CONFIGURATION

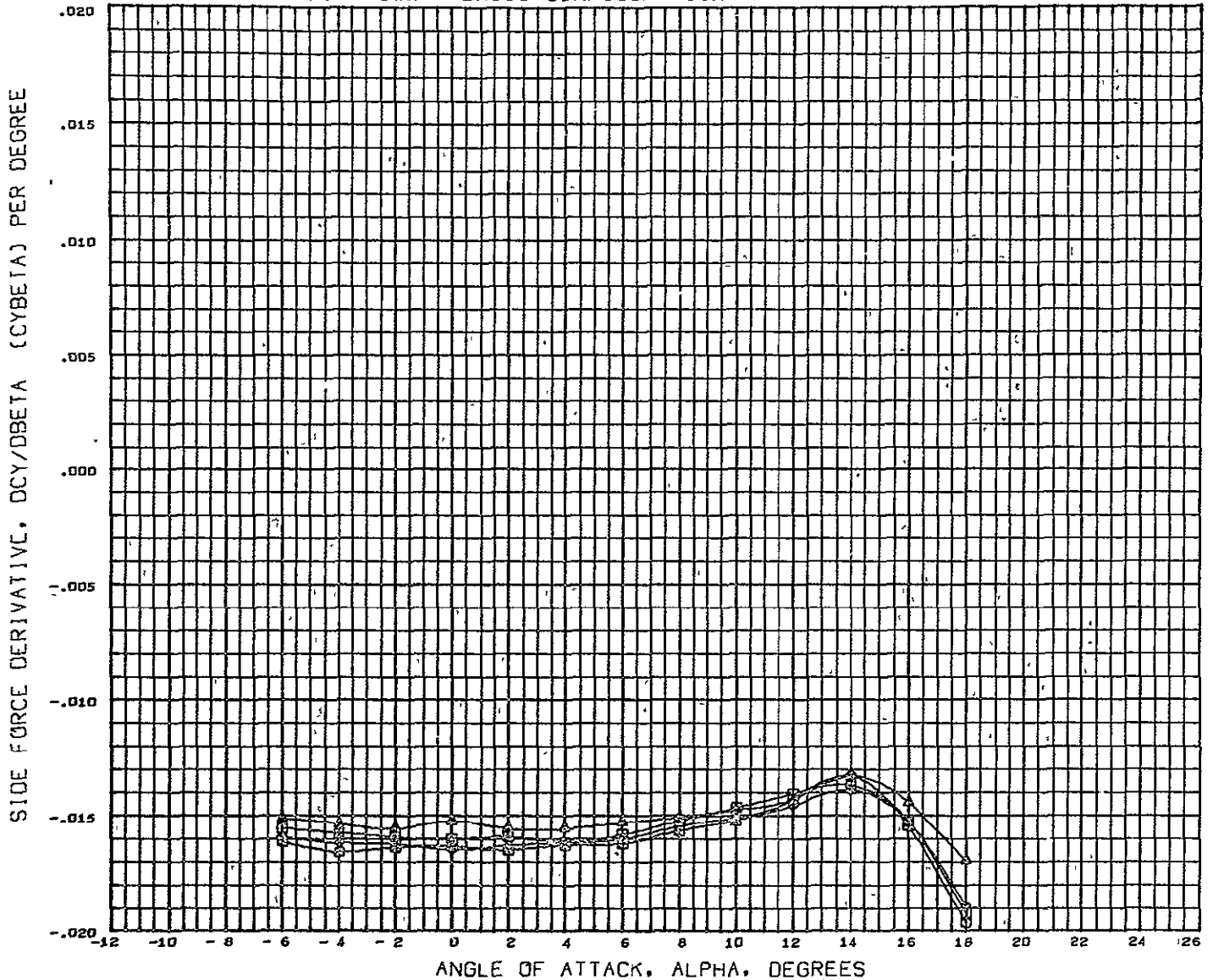

ANGLE OF ATTACK, ALPHA, DEGREES

DATA SET SYMBOL	CONFIGURATION DESCRIPTION	ELEVTR	AILRON	REFERENCE INFORMATION
(DCPD11)	LSWT 248 MDAC 4.0 FC 02 HCR ORB B5W11V6	0.000	0.000	REFS 8.8690 SQ.FT
(DCPD07)	LSWT 248 MDAC 4.0 FC 02 HCR ORB B5W11V6	- 5.000	0.000	REFL 29.5700 IN.
(DCPD13)	LSWT 248 MDAC 4.0 FC 02 HCR ORB B5W11V6	- 10.000	0.000	REFB 51.6000 IN.
(DCPD09)	LSWT 248 MDAC 4.0 FC 02 HCR ORB B5W11V6	- 15.000	0.000	XMRP 59.3200 IN.
				YMRP 0.0000 IN.
				ZMRP 11.6000 IN.
				SCALE 4.0000 PERCNT

AACH 0.265

# LONGITUDINAL CONTROL POWER BASIC CONFIGURATION

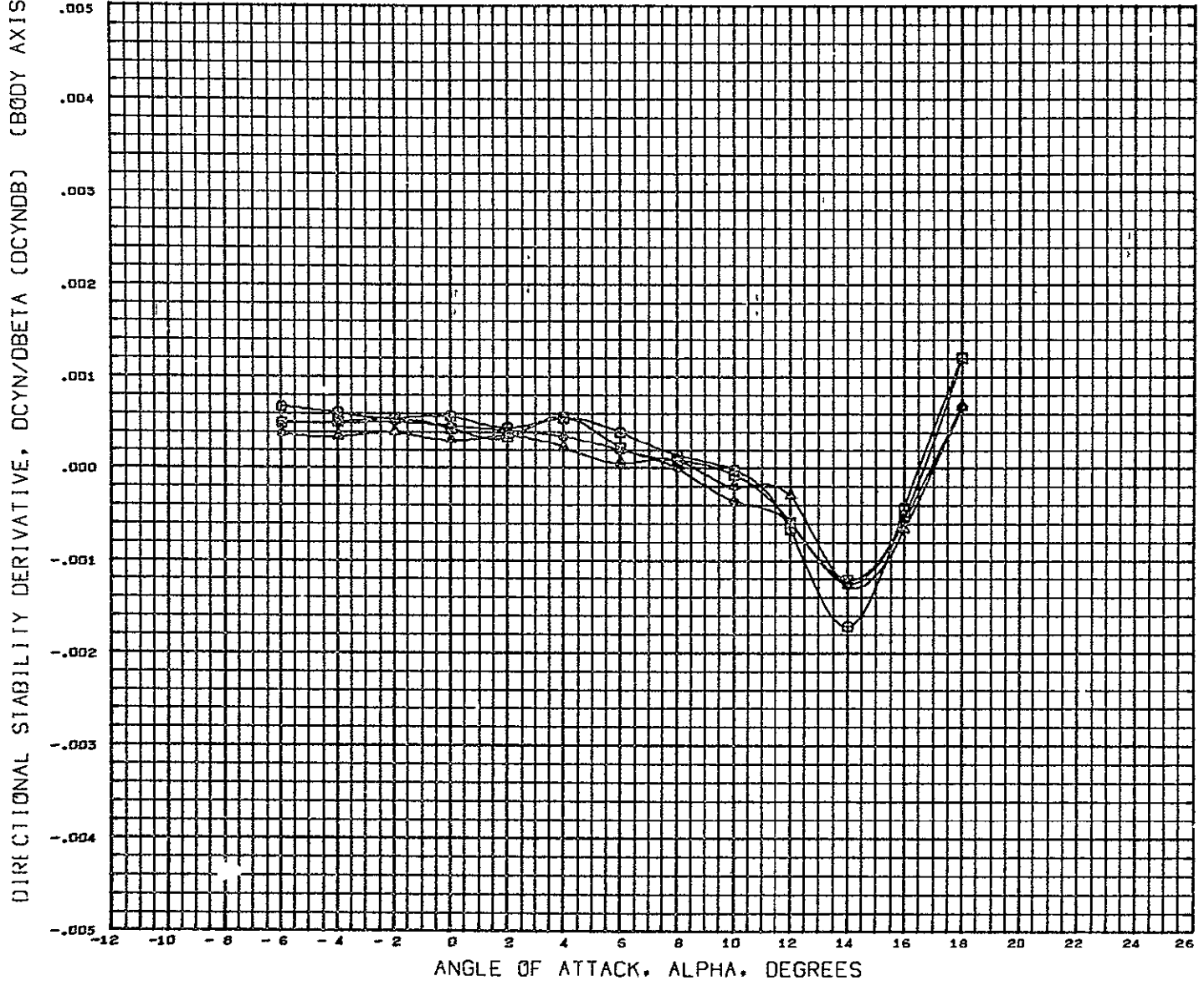

DATA SET SYMBOL	CONFIGURATION DESCRIPTION	ELEVTR	AILRON	REFERENCE INFORMATION
(DCFD11)	LSWT 248 MDAC 4.0 FC O2 HCR ORB B5W11V6	0.000	0.000	REFS 8.8690 SQ.FT.
(DCFD07)	LSWT 248 MDAC 4.0 FC O2 HCR ORB B5W11V6	- 5.000	0.000	REFL 29.5700 IN.
(DCFD13)	LSWT 248 MDAC 4.0 FC O2 HCR ORB B5W11V6	- 10.000	0.000	REFB 51.6000 IN.
(DCFD99)	LSWT 248 MDAC 4.0 FC O2 HCR ORB B5W11V6	- 15.000	0.000	XMRP 59.3200 IN.
				YMRF 0.0000 IN.
				ZHRP 11.6000 IN.
				SCALE 4.0000 PERCNT

HACH 0.260

# LONGITUDINAL CONTROL POWER BASIC CONFIGURATION

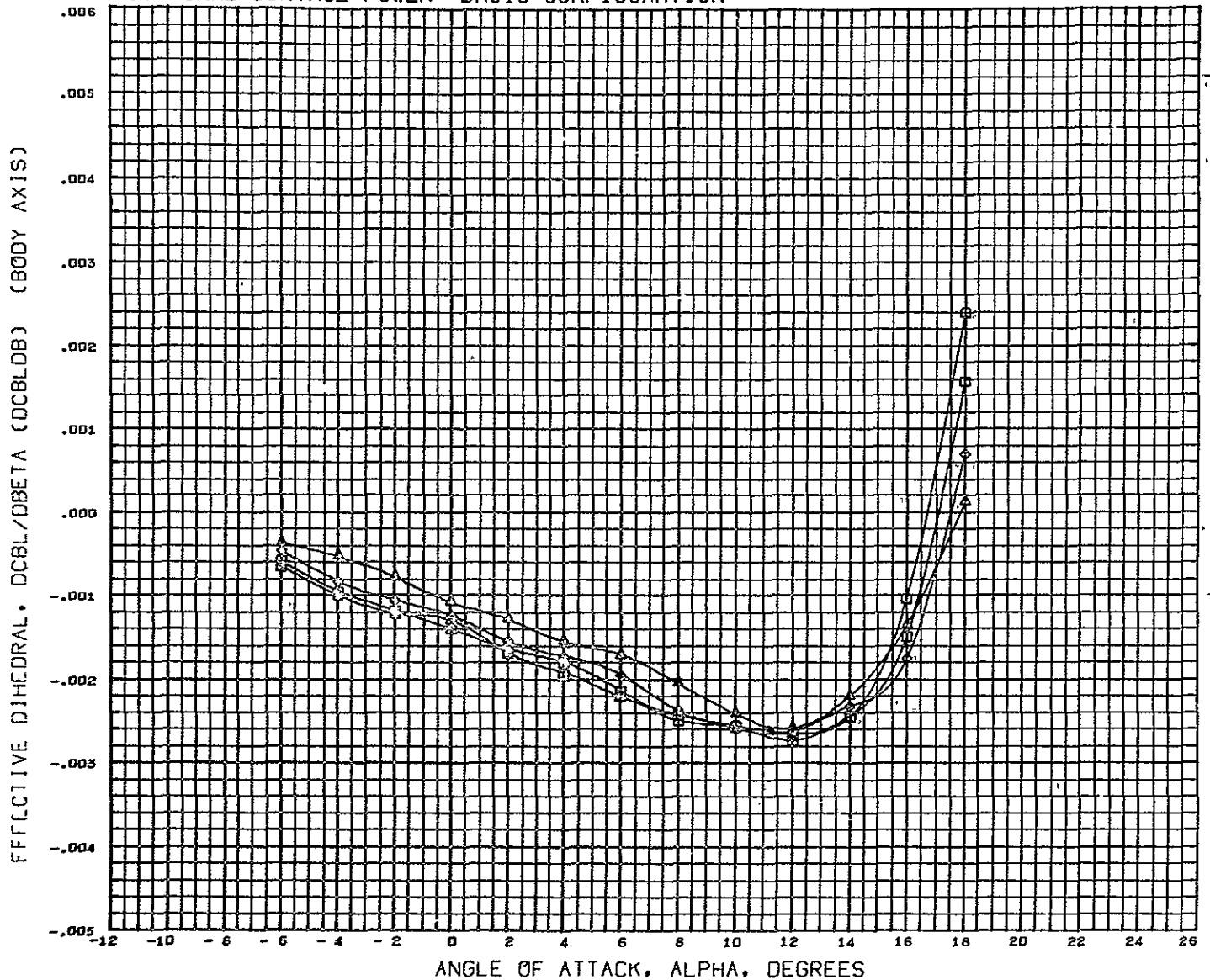

DATA SET SYMBOL	CONFIGURATION DESCRIPTION	ELEVTR	AILRON	REFERENCE INFORMATION	
(DCFD11)	LSWT 248 HDAC 4.0 FC 02 HCR ORB B5W11V6	0.000	0.000	REF3	8.8690 39.F.T
(DCFD07)	LSWT 248 HDAC 4.0 FC 02 HCR ORB B5W11V6	- 5.000	0.000	REFL	29.5700 IN.
(DCFD13)	LSWT 248 HDAC 4.0 FC 02 HCR ORB B5W11V6	- 10.000	0.000	REFB	51.6000 IN.
(DCFD09)	LSWT 248 HDAC 4.0 FC 02 HCR ORB B5W11V6	- 15.000	0.000	XMRP	59.3200 IN.
				YMRF	0.0000 IN.
				ZMRF	11.6000 IN.
				SCALE	4.0000 PERCNT

MACH 0.260

LONGITUDINAL CONTROL POWER BASIC CONFIGURATION

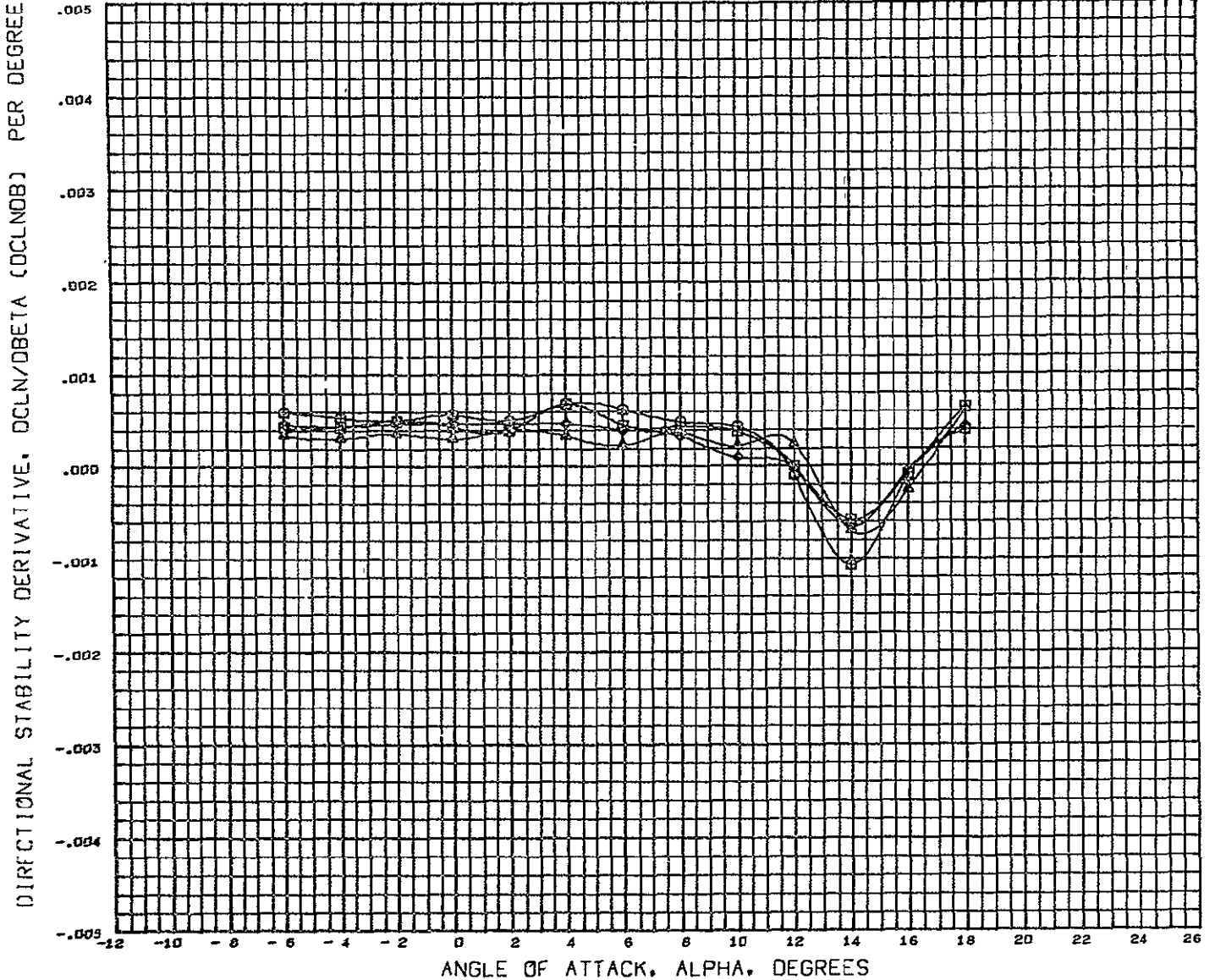

DATA SET SYMBOL	CONFIGURATION DESCRIPTION	ELEVTR	AILRON
(ECP011)	LSWT 248 MDAC 4.0 PC O2 HCR ORB B5W11V6	0.000	0.000
(ECP007)	LSWT 248 MDAC 4.0 PC O2 HCR ORB B5W11V6	- 5.000	0.000
(ECP013)	LSWT 248 MDAC 4.0 PC O2 HCR ORB B5W11V6	- 10.000	0.000
(ECP009)	LSWT 248 MDAC 4.0 PC O2 HCR ORB B5W11V6	- 15.000	0.000

REFERENCE INFORMATION		
REFS	8.8690	SQ FT.
REFL	29.5700	IN.
REFB	51.6000	IN.
XMRP	59.3200	IN.
YMRP	0.0000	IN.
ZMRP	11.6000	IN.
SCALE	4.0000	PERCENT

HACH 0.260

# LONGITUDINAL CONTROL POWER BASIC CONFIGURATION

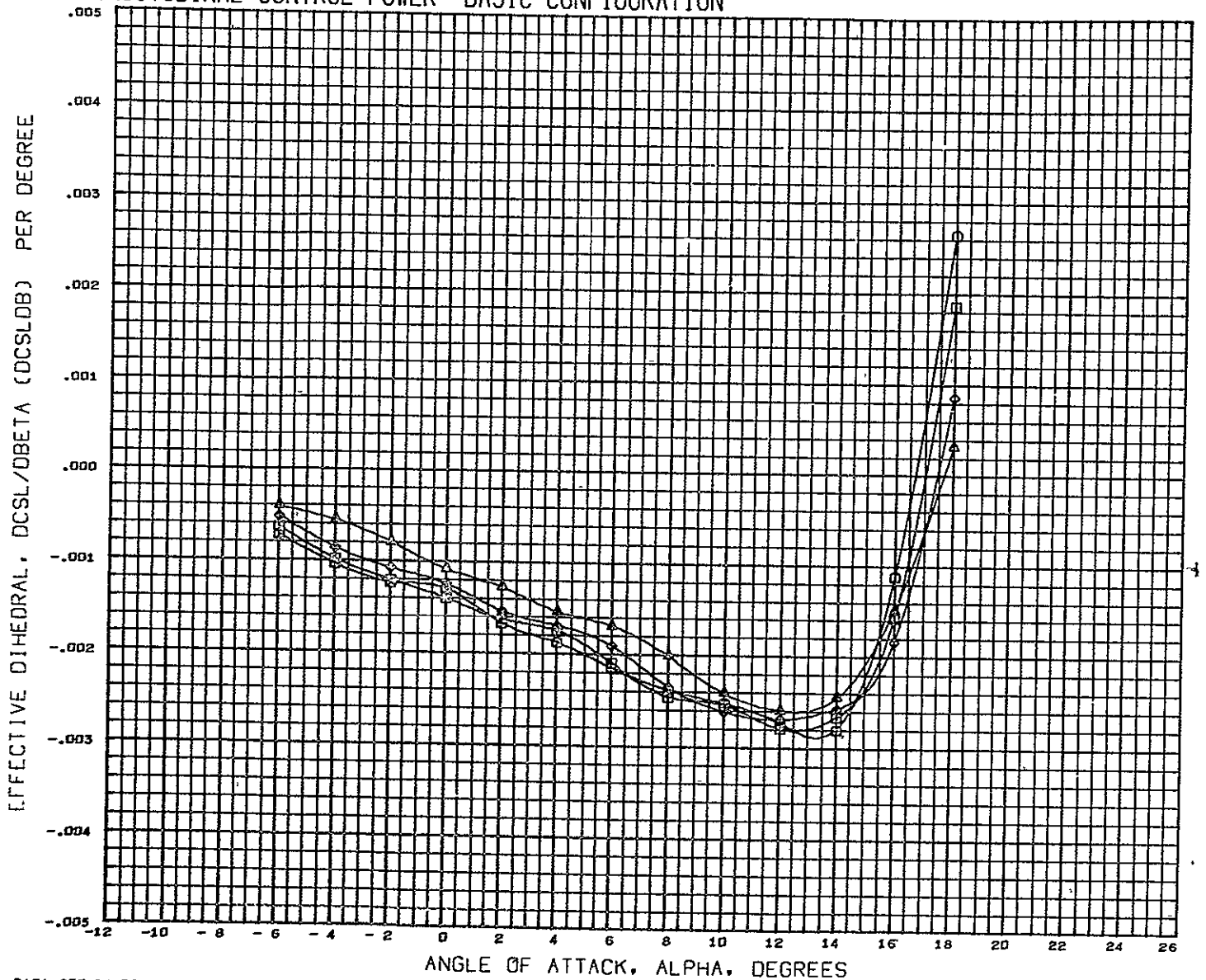

DATA SET SYMBCL	CONFIGURATION DESCRIPTION	ELEVTR	AILRON
(ECP011)	LSWT 248 MDAC 4.0 FC 02 HCR ORB 85W11V6	0.000	0.000
(ECP007)	LSWT 248 MDAC 4.0 FC 02 HCR ORB 85W11V6	- 5.000	0.000
(ECP013)	LSWT 248 MDAC 4.0 FC 02 HCR ORB 85W11V6	- 10.000	0.000
(ECP009)	LSWT 248 MDAC 4.0 FC 02 HCR ORB 85W11V6	- 15.000	0.000

REFERENCE INFORMATION		
REFS	8.8690	SQ FT.
REFL	29.5700	IN.
REFB	51.6000	IN.
XMRP	59.3200	IN.
YMRF	0.0000	IN.
ZMRP	11.6000	IN.
SCALE	4.0000	PERCNT

MACH 0.260

# LONGITUDINAL CONTROL POWER BASIC CONFIGURATION

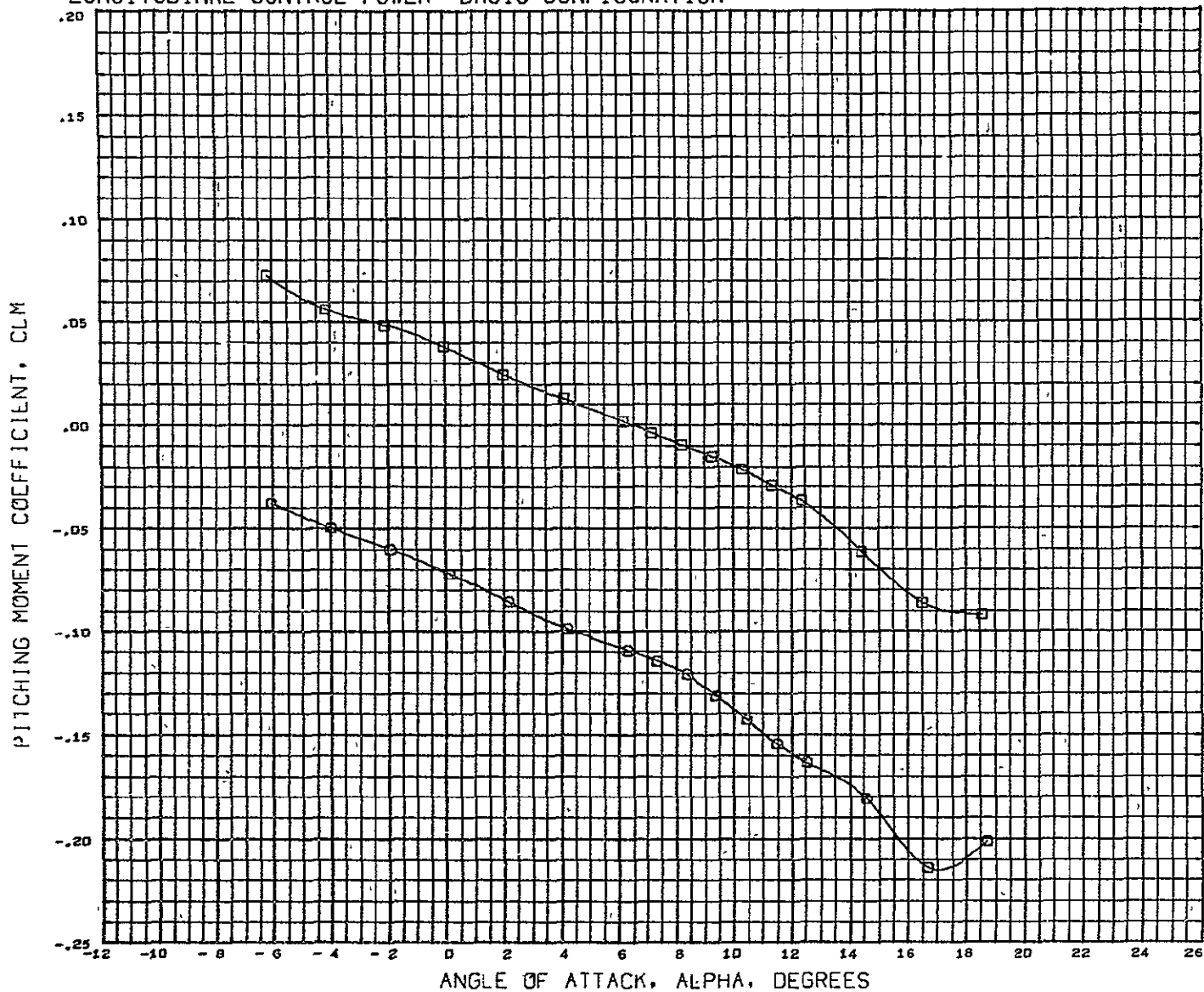

DATA SET SYMBOL	CONFIGURATION DESCRIPTION	BETA	ELEVTR	AILRON	REFERENCE INFORMATION
(CCF021)	LSWT 248 HDAC 4.0 FC O2 HCR ORB B5W11V6	0.000	0.000	10.000	REFS 8.8690 SQ FT.
(CCF003)	LSWT 248 HDAC 4.0 FC O2 HCR ORB B5W11V6	0.000 - 10.000		10.000	REFL 29.5700 IN.
					REFB 51.6000 IN.
					YMRF 59.3200 IN.
					YMRF 0.0000 IN.
					ZMRF 11.6000 IN.
					SCALE 4.0000 PERCNT

MACH 0.250

# LONGITUDINAL CONTROL POWER BASIC CONFIGURATION

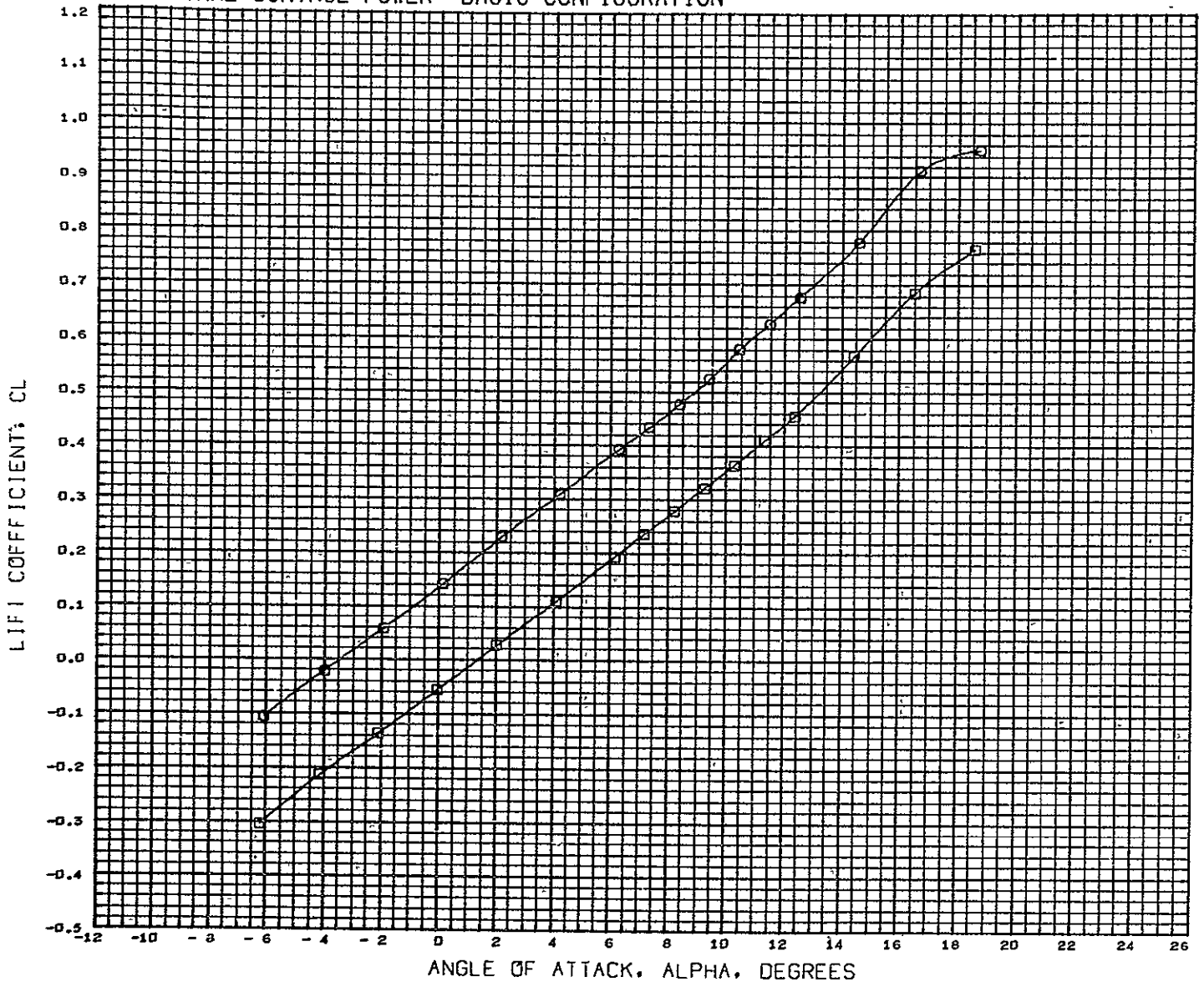

DATA SET SYMBOL	CONFIGURATION DESCRIPTION	BETA	ELEVTR	AILRON	REFERENCE INFORMATION
(CCF021)	LSWT 248 MCAC 4.0 FC 02 HCR ORB	0.000	0.000	10.000	REFS 8.8690 SQ FT.
(CCF003)	LSWT 248 MCAC 4.0 FC 02 HCR ORB	0.000 - 10.000		10.000	REFL 29.5700 IN.
					REFB 51.6000 IN.
					XMRP 59.3200 IN.
					YMRP 0.0000 IN.
					ZMRP 11.6000 IN.
					SCALE 4.0000 PERCENT

MACH 0.250



# LONGITUDINAL CONTROL POWER BASIC CONFIGURATION

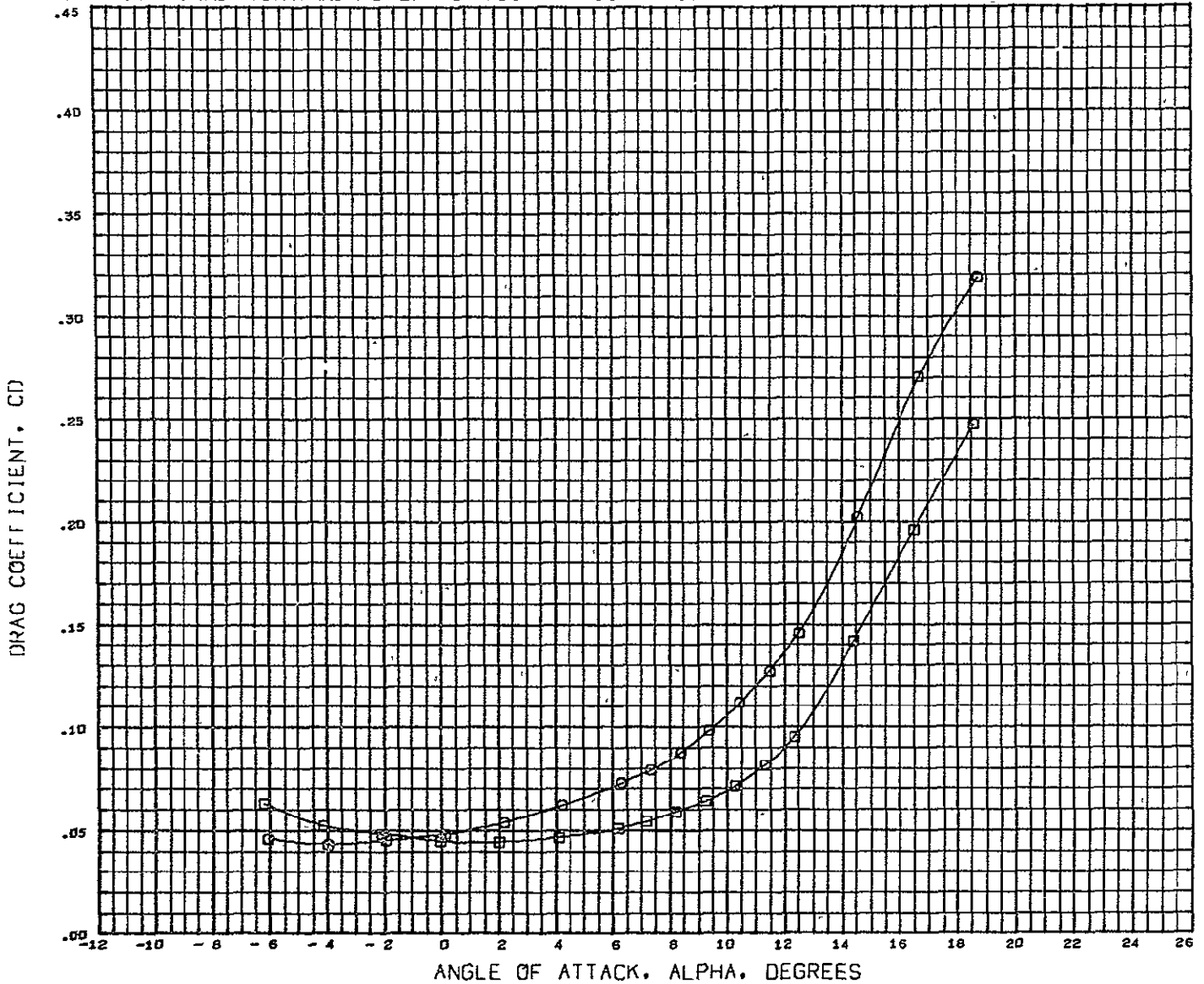

DATA SET SYMBOL	CONFIGURATION DESCRIPTION	BETA	ELEVTR	AILRON	REFERENCE INFORMATION	
(CCF021)	LSWT 248 MDAC 4.0 FC 02 HCR ORB	85W11V6	0.000	0.000	10.000	REFS 8.8690 SQ.FY.
(CCF003)	LSWT 248 MDAC 4.0 FC 02 HCR ORB	85W11V6	0.000	- 10.000	10.000	REFL 29.5700 IN.
						REFB 51.6000 IN.
						XMRP 59.3200 IN.
						YMRF 0.0000 IN.
						ZMRP 11.6000 IN.
						SCALE 4.0000 PERCNT

MACH 0.250

# LONGITUDINAL CONTROL POWER BASIC CONFIGURATION

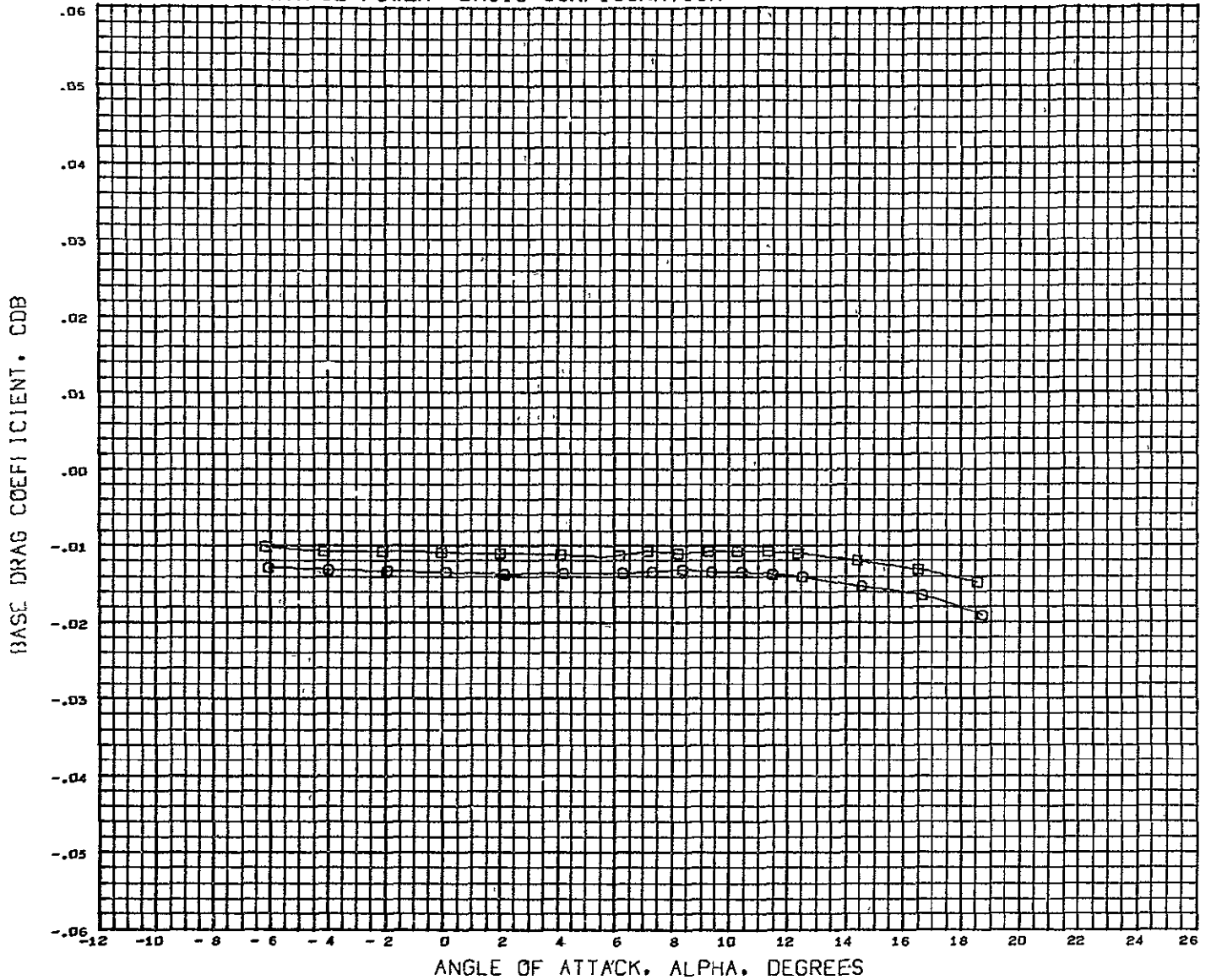

DATA SET SYMBOL	CONFIGURATION DESCRIPTION	BETA	ELEVTR	AILRON
(CCP021)	LSWT 248 MDAC 4.0 FC 02 HCR ORB 85W11V6	0.000	0.000	10.000
(CCP003)	LSWT 248 MDAC 4.0 FC 02 HCR ORB 85W11V6	0.000 - 10.000		10.000

REFERENCE INFORMATION		
REFS	8.8690	sq.FT
REFL	29.5700	IN.
REFB	51.6000	IN.
YMRP	59.3200	IN.
ZMRP	0.0000	IN.
ZMRP	11.6000	IN.
SCALE	4.0000	PERCNT

MACH 0.250

# LONGITUDINAL CONTROL POWER BASIC CONFIGURATION

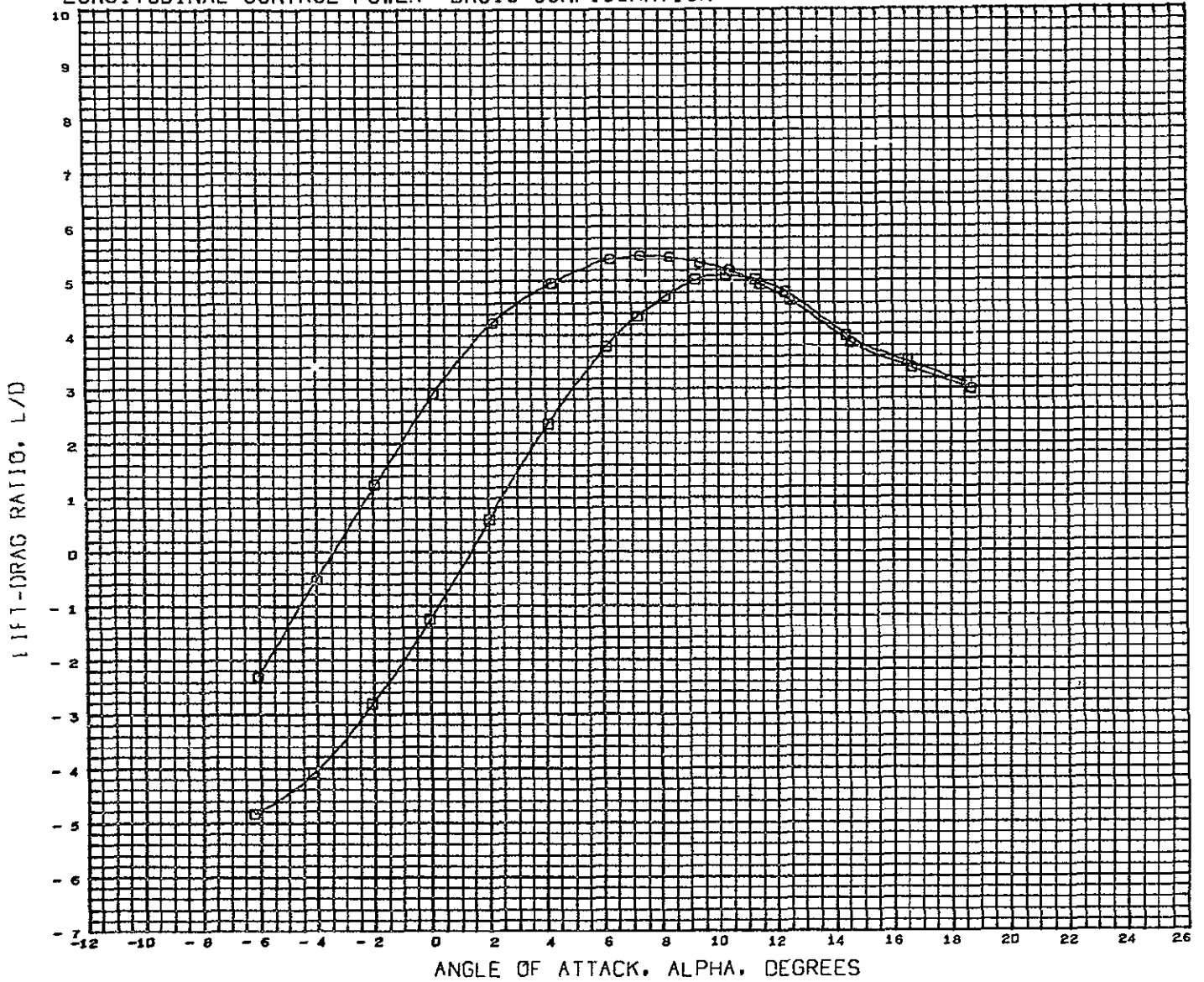

DATA SET SYMBOL	CONFIGURATION DESCRIPTION
(CCPD21)	○ LSWT 248 MDAC 4.0 PC 02 HCR ORB
(CCPD03)	□ LSWT 248 MDAC 4.0 PC 02 HCR ORB

BETA	ELEVTR	ATLON
0.000	0.000	10.000
0.000 - 10.000		10.000

REFERENCE INFORMATION		
REFS	8.8690	SQ.FT.
REFL	29.5700	IN
REFB	51.6000	IN
XMRP	59.3200	IN.
YMRP	0.0000	IN.
ZMRP	11.6000	IN
SCALE	4.0000	PERCENT

MACH 0.250

LONGITUDINAL CONTROL POWER BASIC CONFIGURATION

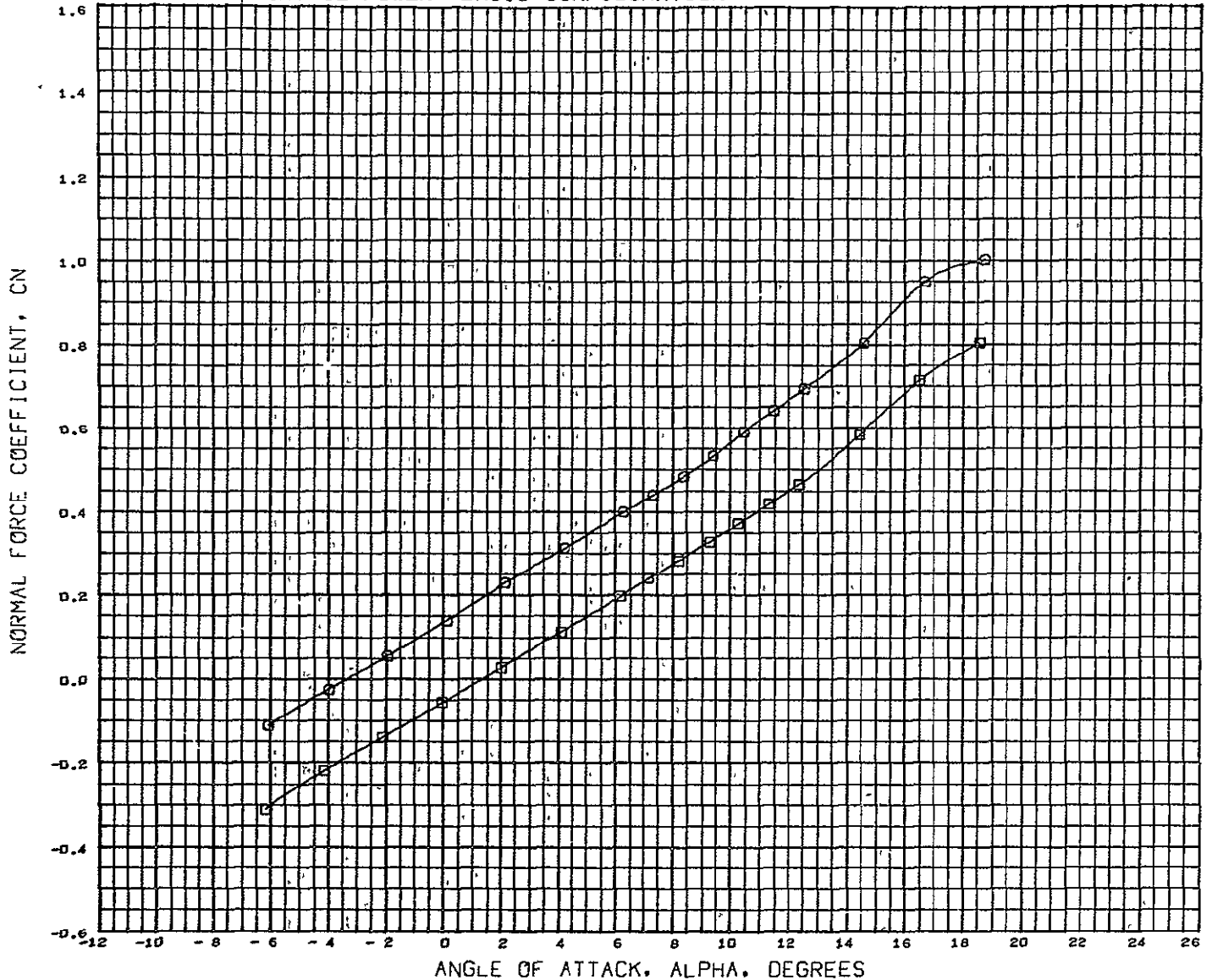

DATA SET SYMBOL	CONFIGURATION DESCRIPTION	BETA	ELEVTR	AILRON	REFERENCE INFORMATION
(BCP021)	LSWT 248 MDAC 4.0 FC 02 HCR ORB	0.000	0.000	10.000	REFS 8.8690 SQ FT
(BCP003)	LSWT 248 MDAC 4.0 FC 02 HCR ORB	0.000 - 10.000		10.000	REFL 29.5700 IN.
					REFB 51.6000 IN.
					XMRP 59.3200 IN.
					YMRP 0.0000 IN.
					ZMRP 11.6000 IN.
					SCALE 4.0000 PERCENT

MACH 0.250

# LONGITUDINAL CONTROL POWER BASIC CONFIGURATION

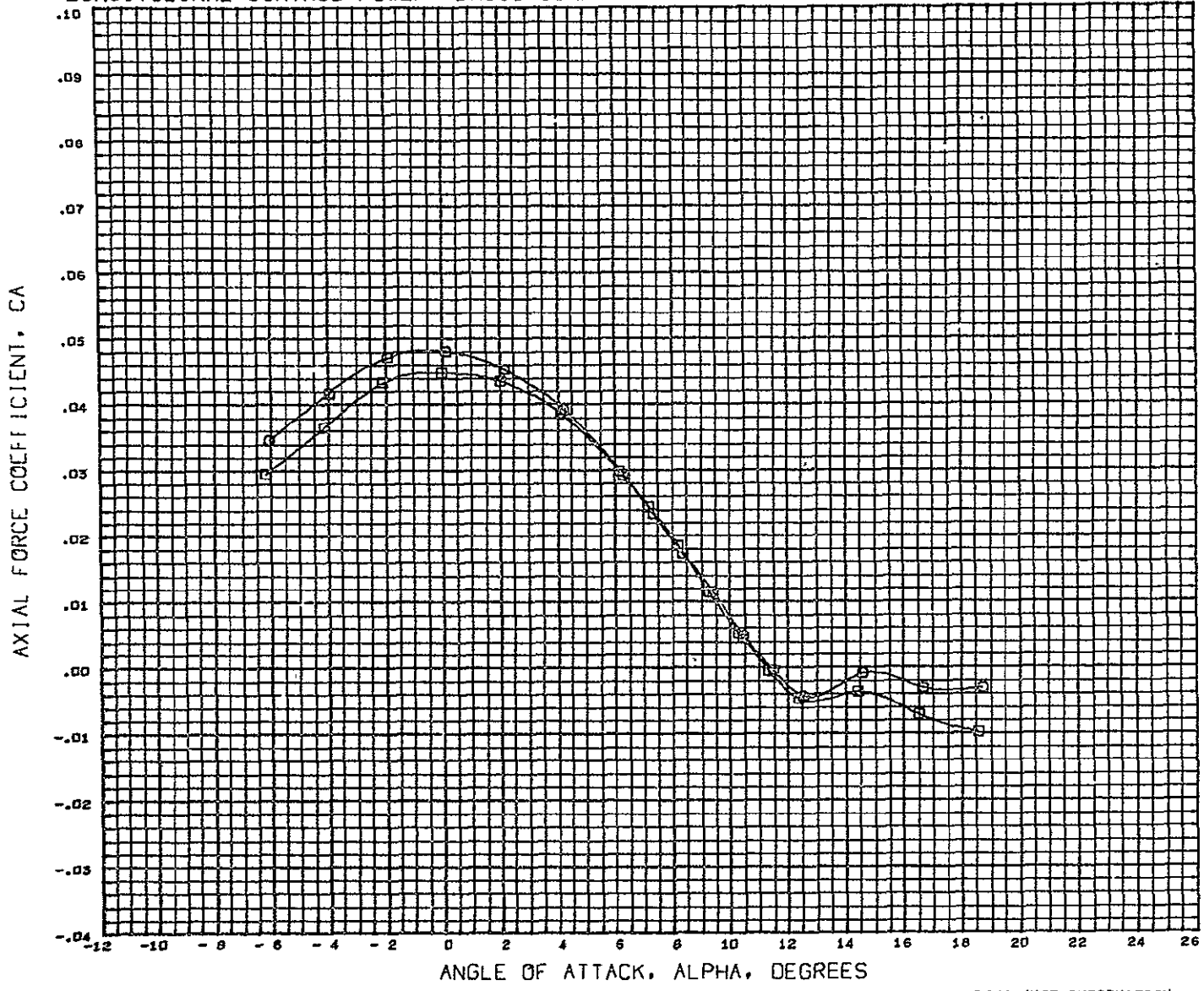

DATA SET SYMBOL	CONFIGURATION DESCRIPTION
(BCF021)	LSWT 248 MDAC 4.0 FC O2 HCR ORB
(BCF003)	LSWT 248 MDAC 4.0 FC O2 HCR ORB

BETA	ELEVTR	AILRON
0.000	0.000	10.000
0.000 -	10.000	10.000

REFERENCE INFORMATION		
REFS	8.8690	SQ.FT.
REFL	29.5700	IN.
REFB	51.6000	IN.
XMRP	59.3200	IN.
YMRP	0.0000	IN.
ZMRP	11.6000	IN.
SCALE	4.0000	PERCENT

MACH 0.250

# LONGITUDINAL CONTROL POWER BASIC CONFIGURATION

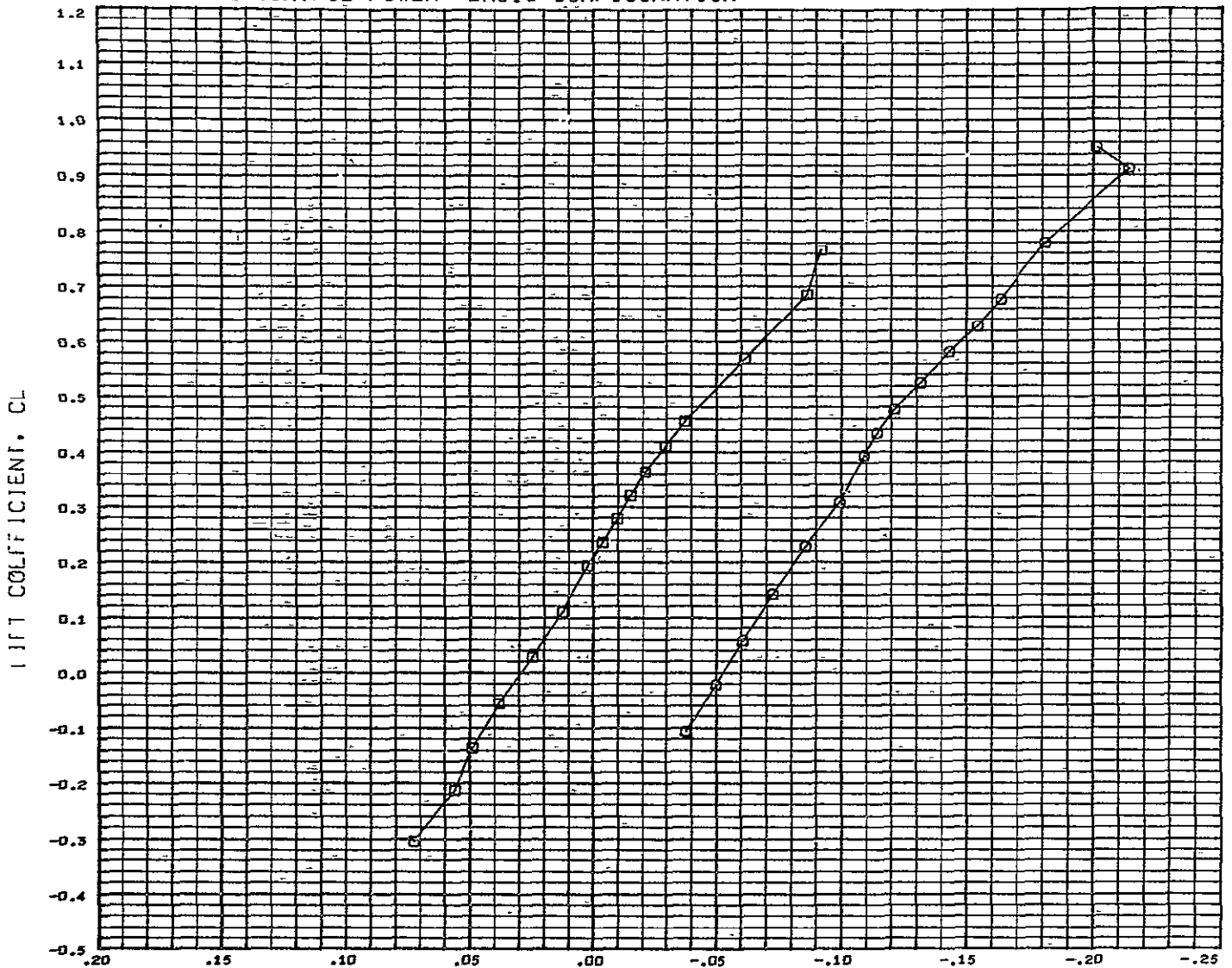

## PITCHING MOMENT COEFFICIENT, CLM

DATA SET SYMBOL	CONFIGURATION DESCRIPTION	BETA	ELEVTR	AILRON	REFERENCE INFORMATION
(CCP021)	LSWT 248 MDAC 4.0 FC 02 HCR ORB	0.000	0.000	10.000	REFS 8.8690 SQ.FT.
(CCP003)	LSWT 248 MDAC 4.0 FC 02 HCR ORB	0.000	-10.000	10.000	REFL 29.5700 IN.
					REFB 51.6000 IN.
					XMRP 59.3200 IN.
					YMRP 0.0000 IN.
					ZMRP 11.6000 IN.
					SCALE 4.0000 PERCENT

MACH 0.250

# LONGITUDINAL CONTROL POWER BASIC CONFIGURATION

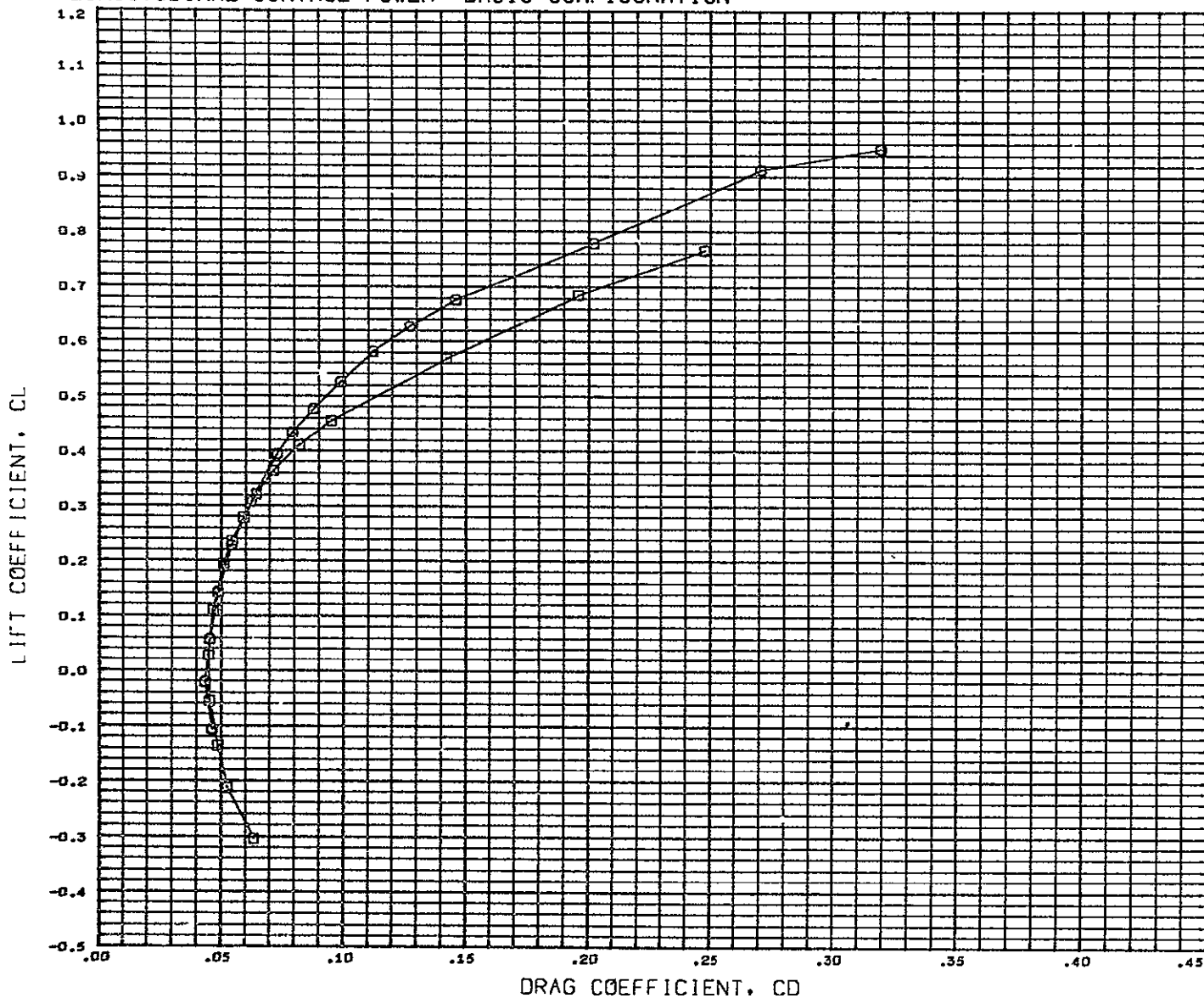

DATA SET SYMBOL    CONFIGURATION DESCRIPTION  
 (CCP021)    □    LSWT 248 HDAC 4.0 FC 02 HCR ORB  
 (CCP053)    □    LSWT 248 HDAC 4.0 FC 02 HCR ORB

BETA    ELEVTR    AILRON  
 0.000    0.000    10.000  
 0.000 - 10.000    10.000

REFERENCE INFORMATION  
 REFS    8.8690    SQ.FT.  
 REFL    29.5700    IN.  
 REFB    51.6000    IN.  
 XMRP    59.3200    IN.  
 YMRP    0.0000    IN.  
 ZMRP    11.6000    IN.  
 SCALE    4.0000    PERCENT

MACH    0.250

# LONGITUDINAL CONTROL POWER BASIC CONFIGURATION

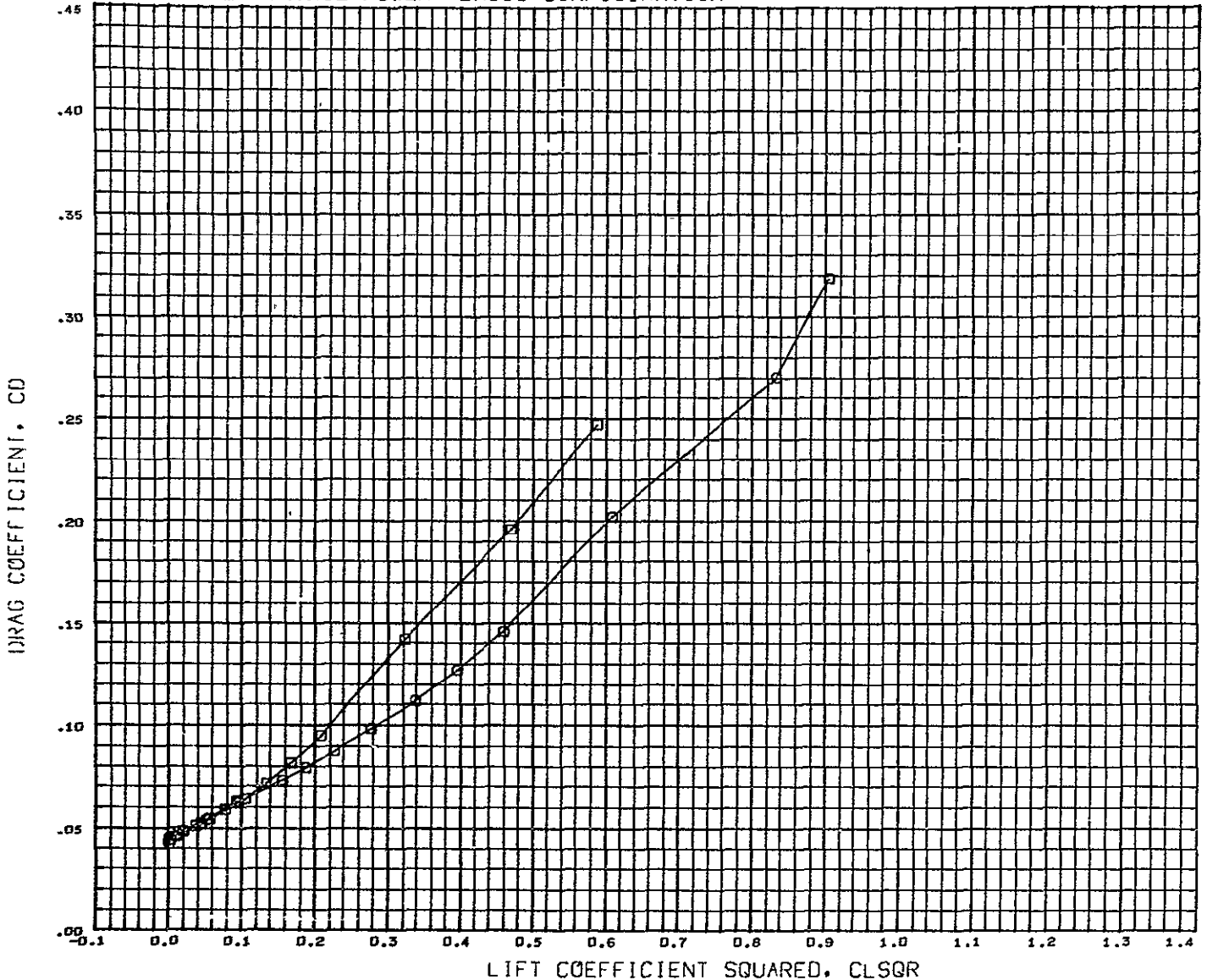

DATA SET SYMBOL	CONFIGURATION DESCRIPTION	BETA	ELEVTR	AILRON	REFERENCE INFORMATION
(CCF021)	LSWT 248 NDAC 4.0 FC 02 HCR ORB	0.003	0.000	10.000	REFS 8.8690 SQ.FT.
(CCF003)	LSWT 248 NDAC 4.0 FC 02 HCR ORB	0.000 - 10.000		10.000	REFL 29.5700 IN.
					REFB 51.6000 IN.
					XMRP 59.3200 IN.
					YMRP 0.0000 IN.
					ZMRP 11.6000 IN.
					SCALE 4.0000 PERCNT

MACH 0.250



# LONGITUDINAL CONTROL POWER BASIC CONFIGURATION

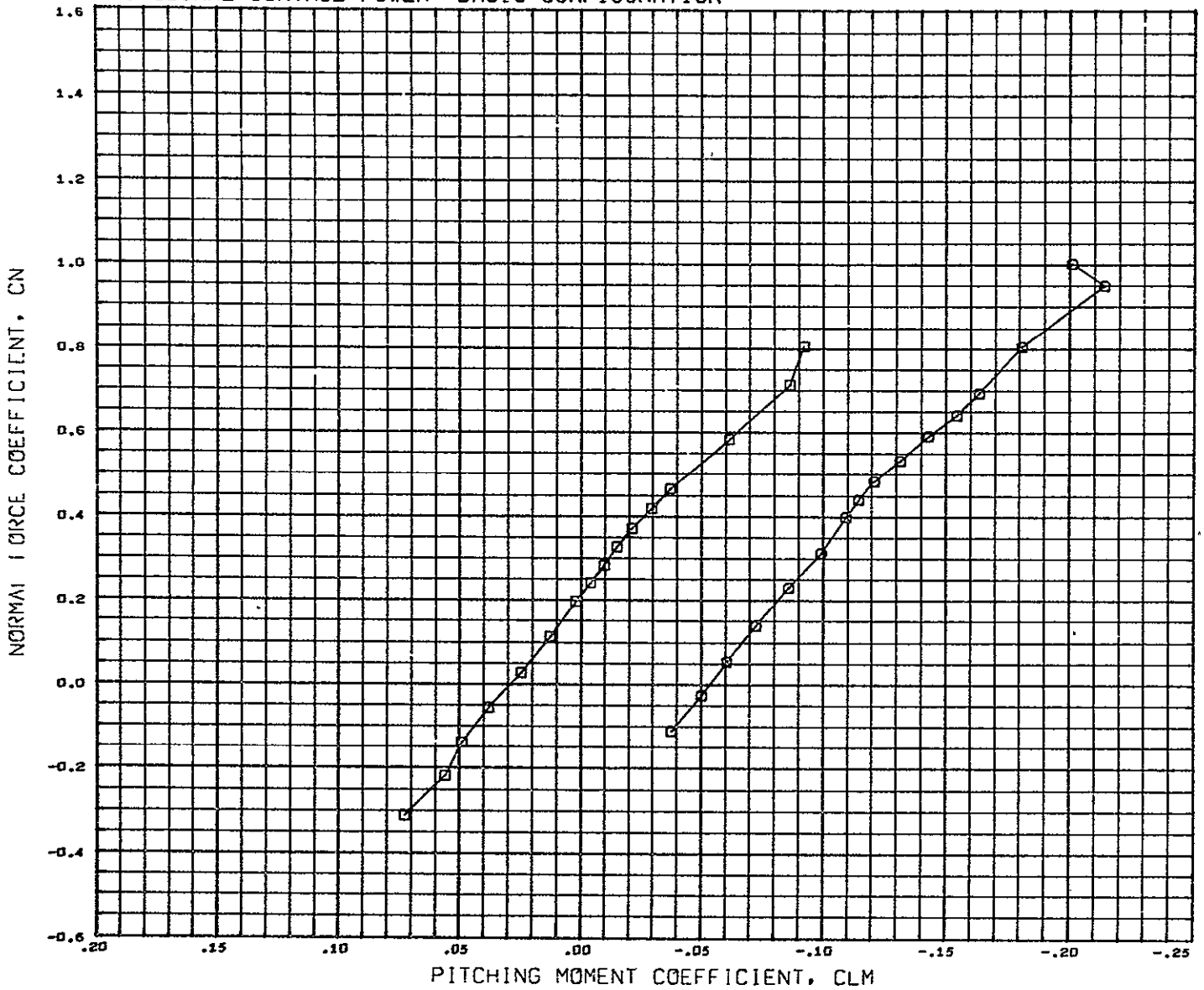

DATA SET SYMBOL	CONFIGURATION DESCRIPTION	BETA	ELEVTR	AILRON	REFERENCE INFORMATION
(BCF021)	LSWT 248 HDAC 4.0 FC O2 HCR ORB	0.000	0.000	10.000	REFS 8 8690 SQ.FT
(BCF003)	LSWT 248 HDAC 4.0 FC O2 HCR ORB	0.000	- 10.000	10.000	REFL 29.5700 IN.
					REFB 51.6000 IN.
					XMRP 59.3200 IN.
					YMRP 0.0000 IN.
					ZMRP 11.6000 IN.
					SCALE 4.0000 PERCENT

MACH 0.250

# LONGITUDINAL CONTROL POWER BASIC CONFIGURATION

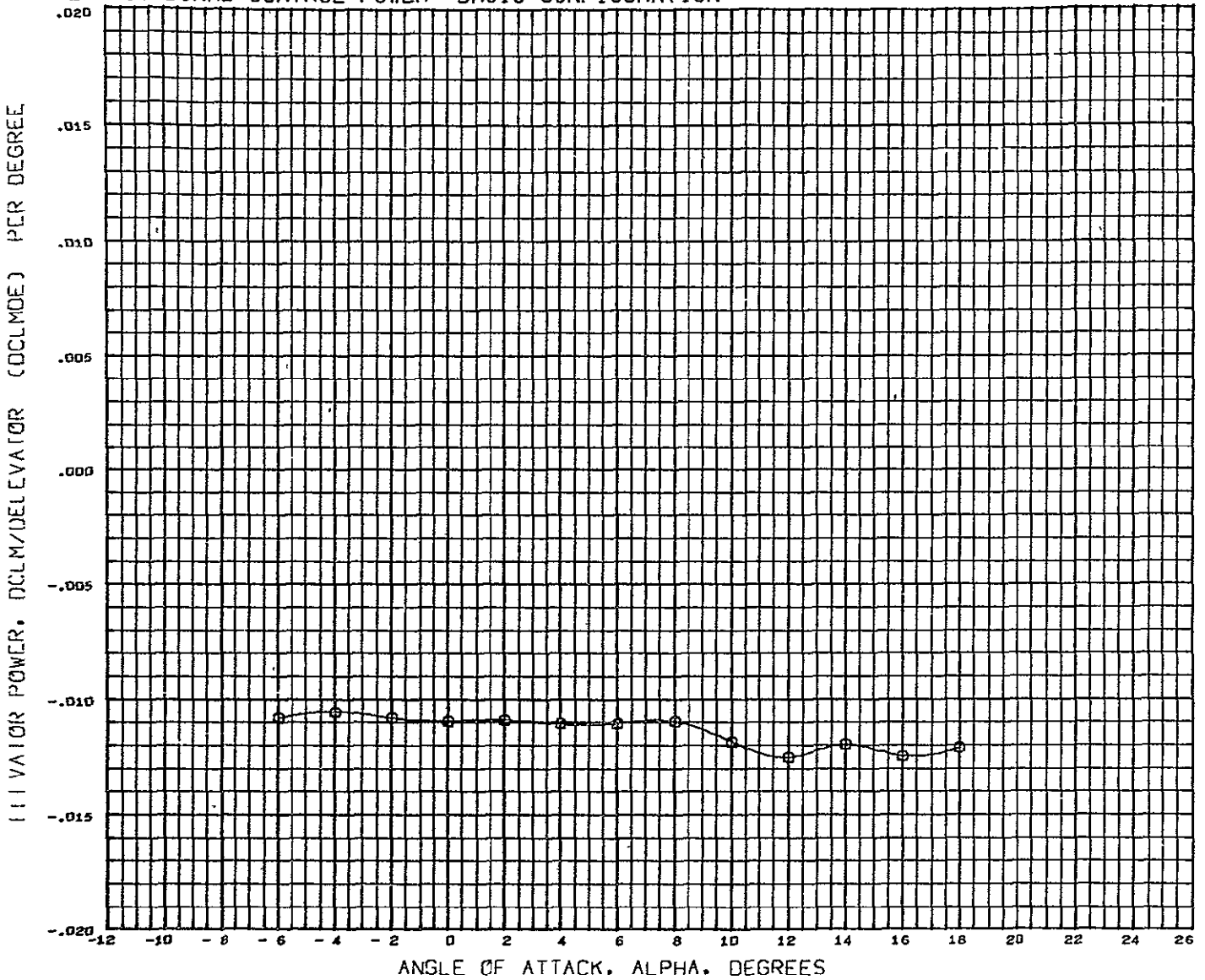

SYMBOL	MACH	PARAMETRIC VALUES			
○	0.260	BETA	0.000	ELEVTR	- 10.000
		AILRON	10.000	SPBRK	0.000
		BFLAF	0.000	RUDDER	0.000

REFERENCE INFORMATION		
REFS	8.8690	SQ.FT.
REFL	29.5700	IN.
REFB	51.6000	IN.
XMRP	59.3200	IN.
YMRP	0.0000	IN.
ZMRP	11.6000	IN.
SCALE	4.0000	PERCENT

DATA HIST. CODE #P

SW 248 YJAC 4.0 PC 02 HCR 0RB

B5W11V6

(XCPE03) 26 FEB 71

PAGE 118

LONGITUDINAL CONTROL POWER BASIC CONFIGURATION

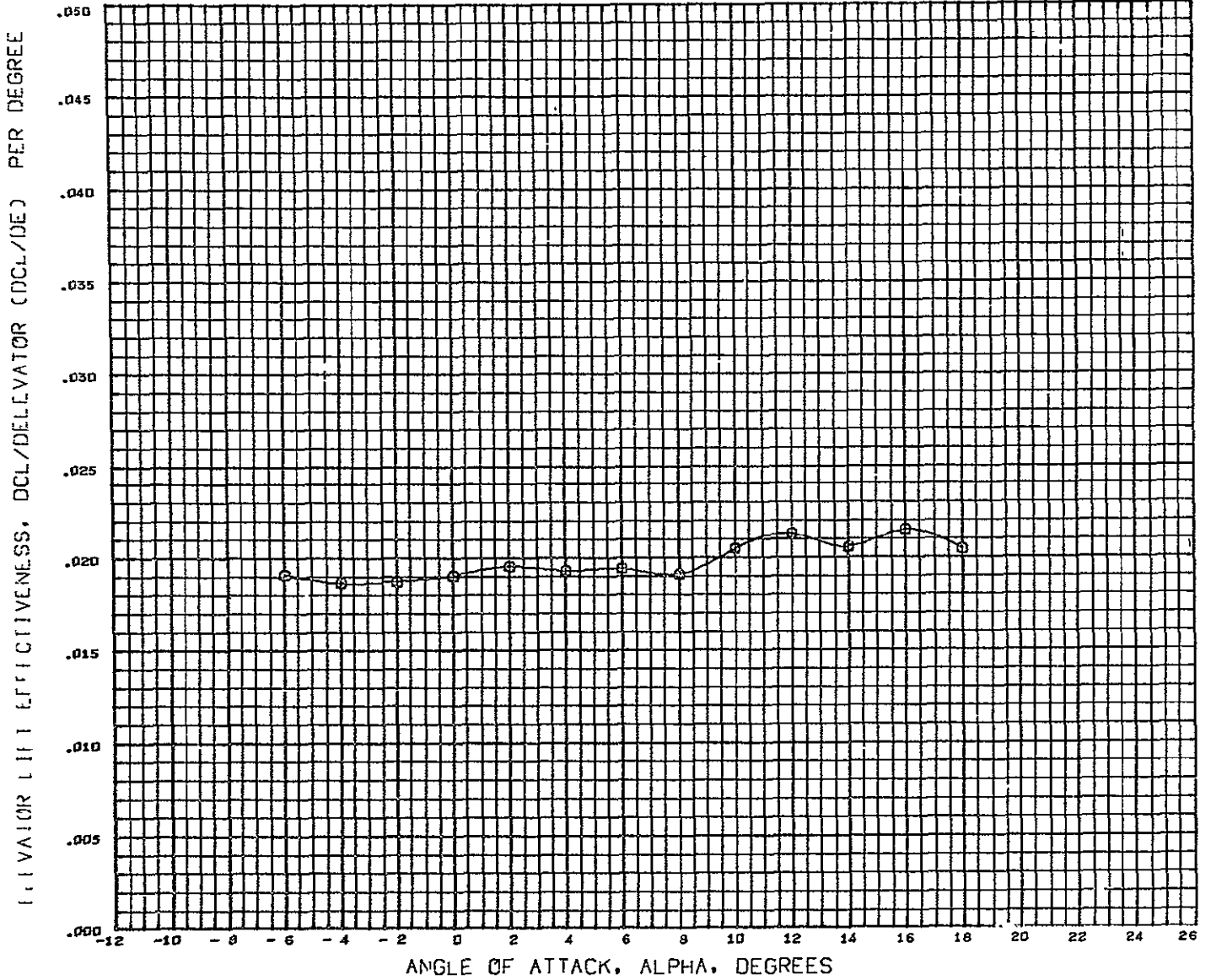

SYMBOL	MACH	PARAMETRIC VALUES			
0	0.250	BETA	0.000	ELEVTR	-10.000
		AILRON	10.000	SPBRK	0.000
		BFLAF	0.000	RUDDER	0.000

REFERENCE INFORMATION		
REFS	8.8690	SQ.FT.
REFL	29.5700	IN.
REFB	51.6000	IN.
XMRP	59.3200	IN.
YMRP	0.0000	IN.
ZMRP	11.6000	IN.
SCALE	4.0000	PERCENT

DATA HIST. CODE #F

LONGITUDINAL CONTROL POWER BASIC CONFIGURATION

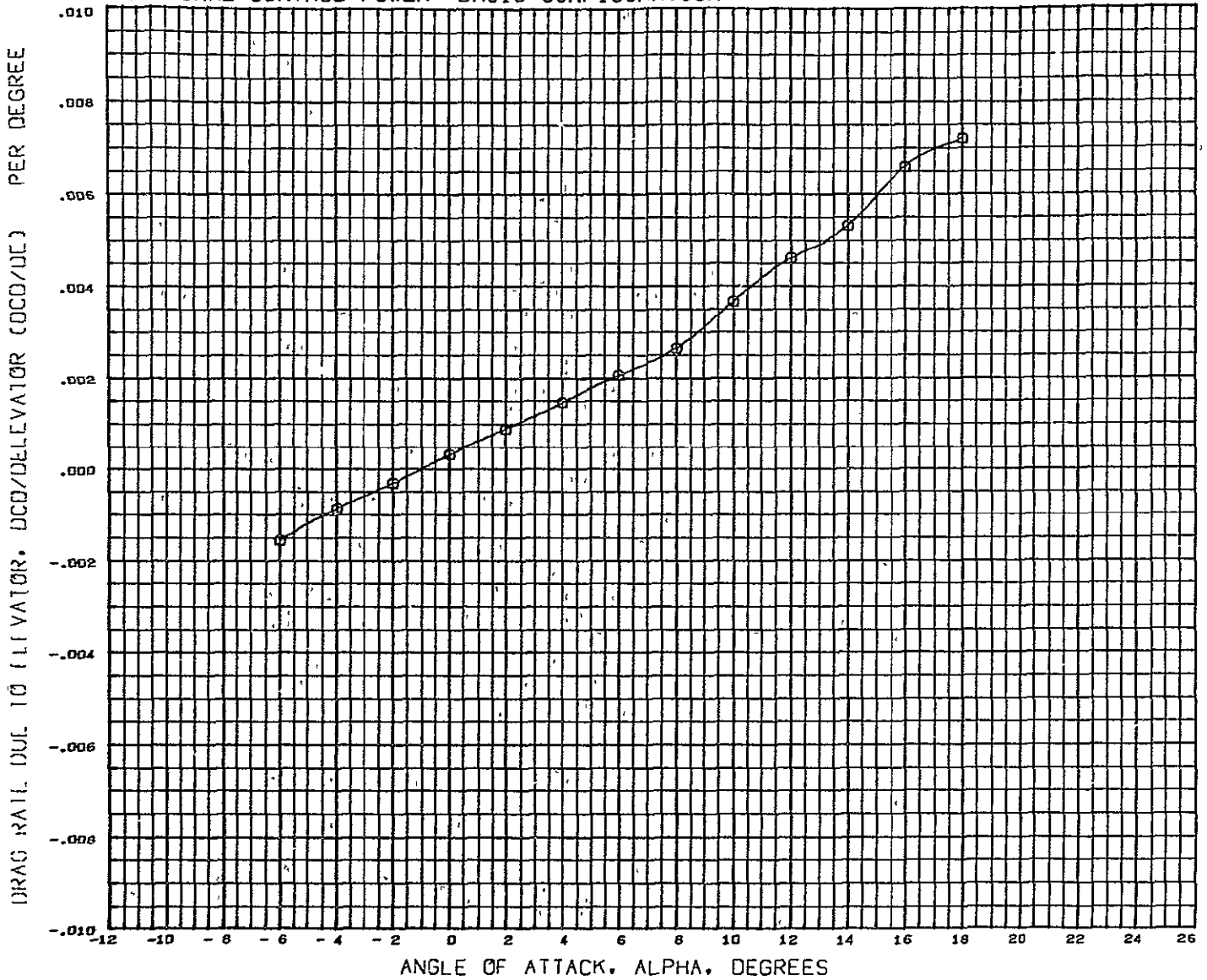

SYMBOL	HACH	PARAMETRIC VALUES			
Q	0.260	BETA	0.000	ELEVTR	- 10.000
		AILRON	10.000	SPBRK	0.000
		BFLAF	0.000	RUDDER	0.000

REFERENCE INFORMATION		
REFS	8.8690	SQ.FT
REFL	29.5700	IN.
REFB	51.6000	IN.
XMRP	59.3200	IN.
YMRP	0.0000	IN.
ZMRP	11.6000	IN.
SCALE	4.0000	PERCENT

DATA HIST. CODE \*F

LSN 248 MDAC 4.0 PC 02 HCR 0RB

BSW11V6

(XCPE03) 26 FEB 71

PAGE 120

# LONGITUDINAL CONTROL POWER LANDING GEAR EXTENDED

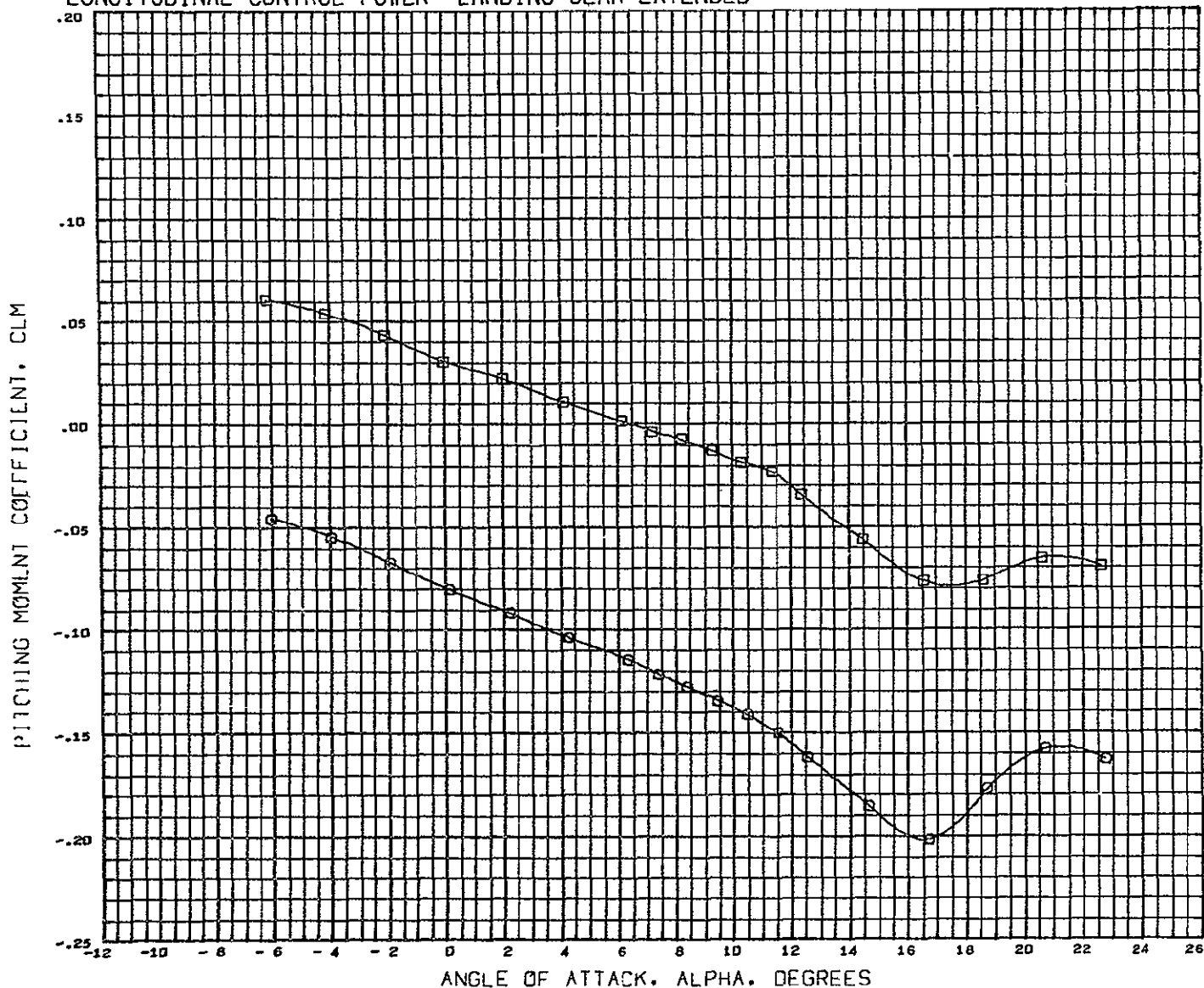

DATA SET SYMBOL	CONFIGURATION DESCRIPTION	BETA	ELEVTR	AILRON	REFERENCE INFORMATION
(CCP052)	LSWT 248 HDAC 4.0 PC 02 HCR ORB B5W116	0.000	0.000	0.000	REFS 8.8690 SQ.FT.
(CCP053)	LSWT 248 HDAC 4.0 PC 02 HCR ORB B5W116	0.000 - 10.000		0.000	REFL 29.5700 IN.
					REFB 51.6000 IN.
					XMRP 59.3200 IN.
					YMRP 0.0000 IN.
					ZMRP 11.6000 IN.
					SCALE 4.0000 PERCNT

MACH 0.250

# LONGITUDINAL CONTROL POWER LANDING GEAR EXTENDED

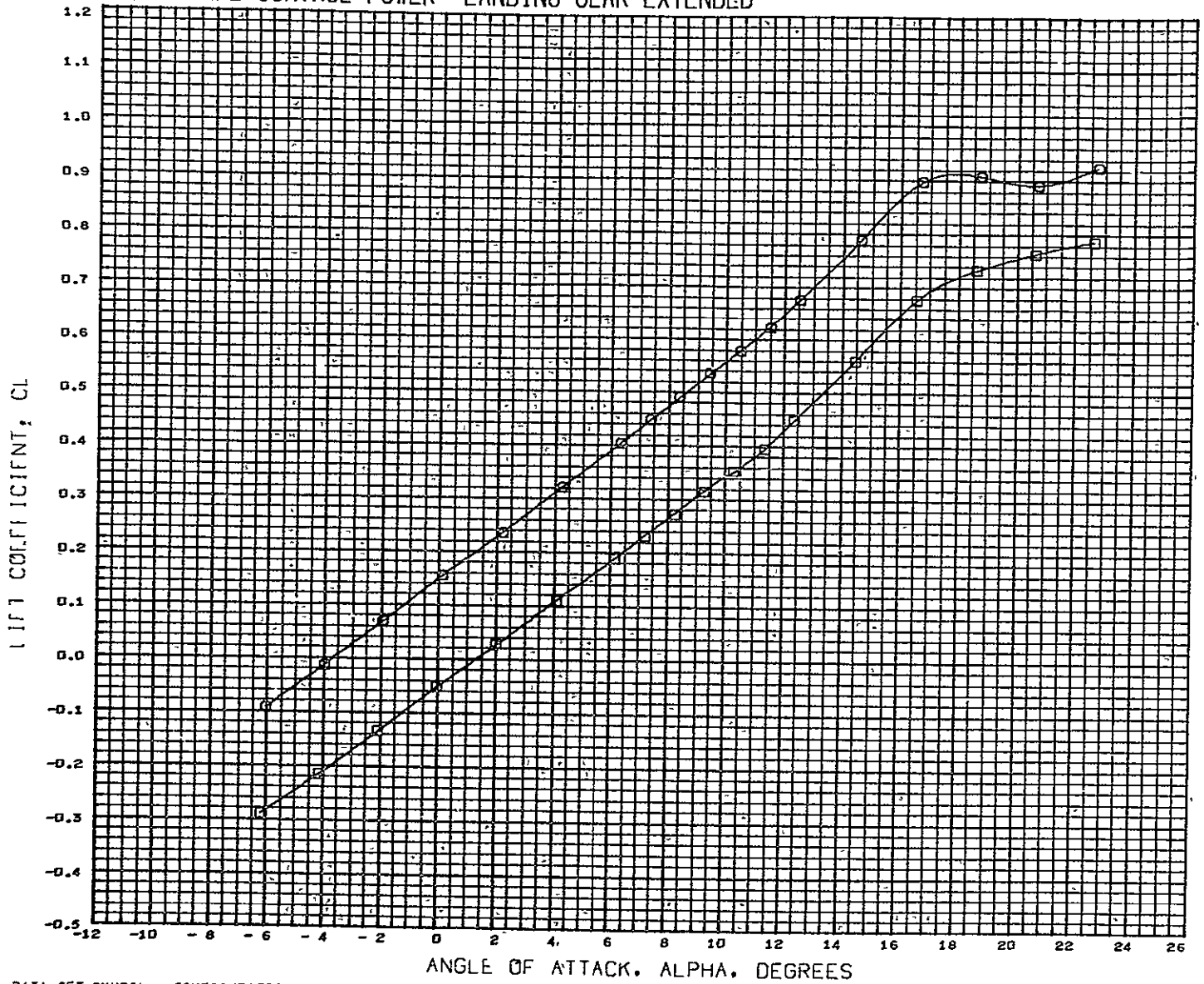

DATA SET SYMBOL	CONFIGURATION DESCRIPTION	BETA	ELEVTR	AILRON	REFERENCE INFORMATION
(CCF052)	LSWT 248 MDAC 4.0 FC O2 HCR ORB 85W11G	0.000	0.000	0.000	REFS 8.8690 SQ.FT.
(CCF053)	LSWT 248 MDAC 4.0 FC O2 HCR ORB 85W11G	0.000 - 10.000	0.000	0.000	REFL 29.5700 IN.
					REFB 51.6000 IN.
					XMRF 59.3200 IN.
					YMRF 0.0000 IN.
					ZMRF 11.6000 IN.
					SCALE 4.0000 PERCNT

MACH 0.250

LONGITUDINAL CONTROL POWER LANDING GEAR EXTENDED

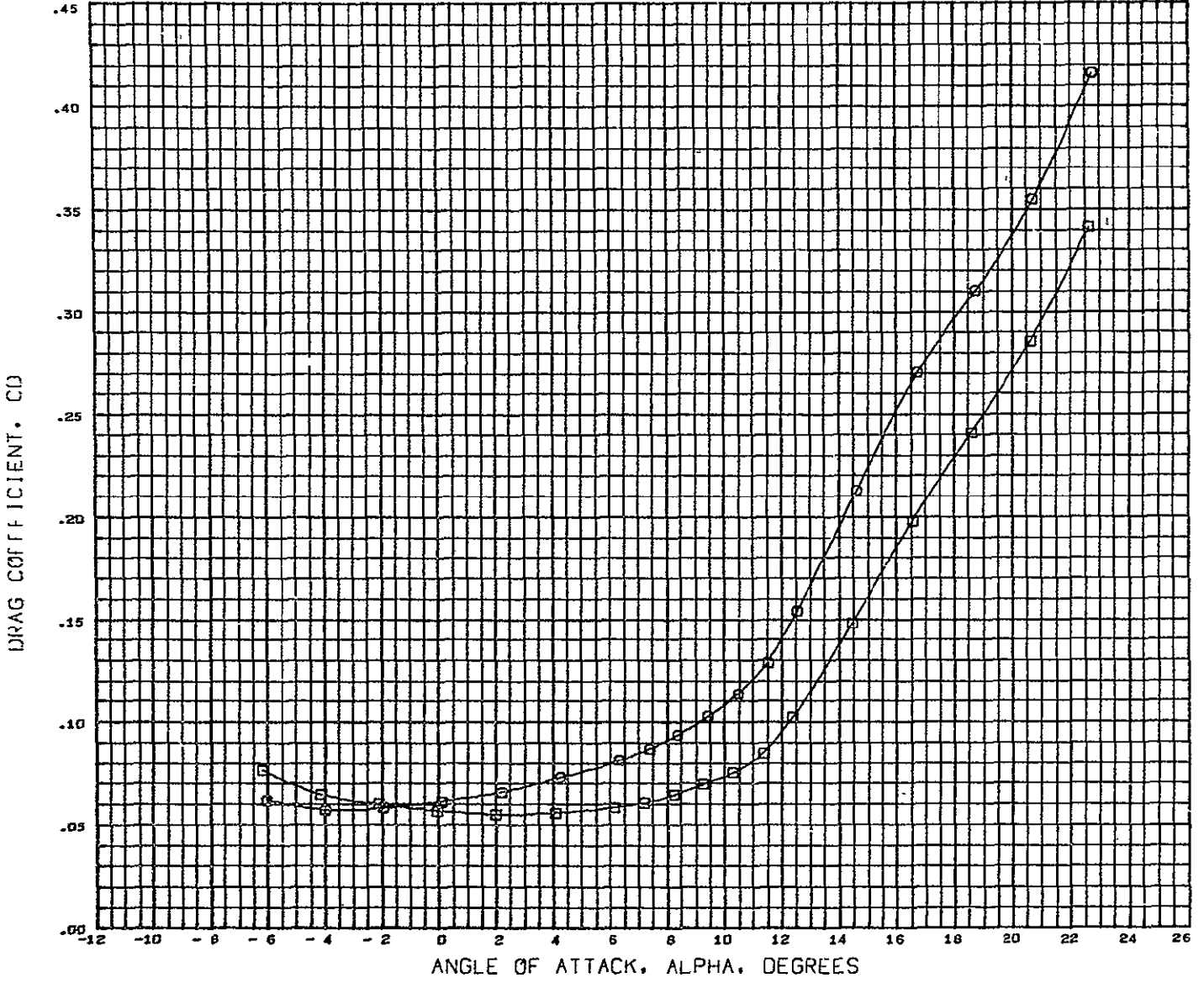

DATA SET SYMBOL	CONFIGURATION DESCRIPTION	BETA	ELEVTR	AILRON	REFERENCE INFORMATION
(CCF052)	LSWT 248 HDAC 4.0 FC 02 HCR ORB 85W11G	0.000	0.000	0.000	REFS 8.6690 SQ.FT.
(CCF053)	LSWT 248 HDAC 4.0 FC 02 HCR ORB 85W11G	0.000 - 10.000		0.000	REFL 29.5700 IN.
					REFB 51.6000 IN.
					XMRP 59.3200 IN.
					YMRP 0.0000 IN.
					ZMRP 11.6000 IN.
					SCALE 4.0000 PERCENT

MACH 0.250

# LONGITUDINAL CONTROL POWER LANDING GEAR EXTENDED

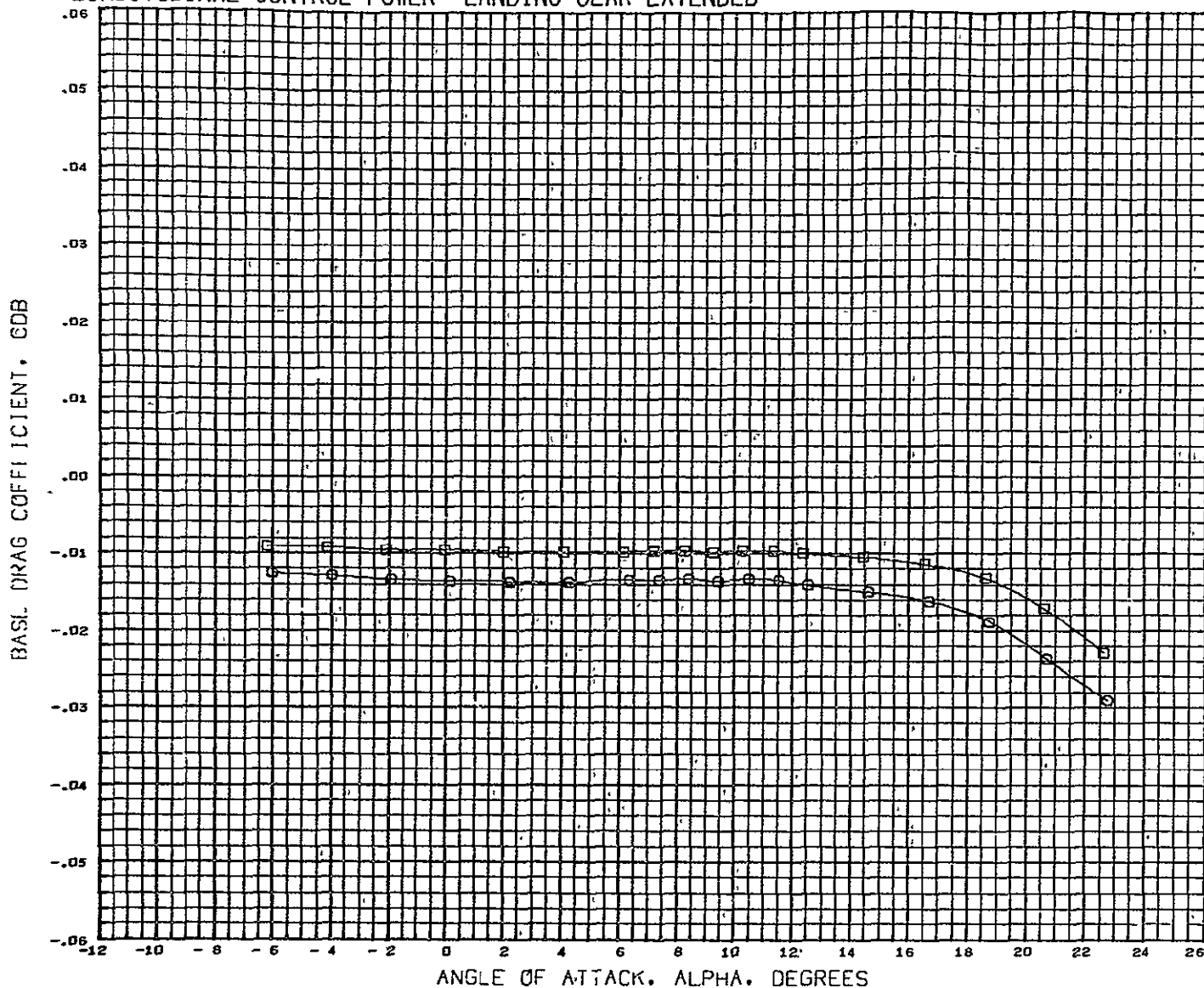

DATA SET SYMBOL	CONFIGURATION DESCRIPTION	BETA	ELEVTR	AILRON	REFERENCE INFORMATION
(CCF052)	□ LSWT 248 MDAC 4.0 FC 02 HCR ORB B5W11G	0.000	0.000	0.000	REFS 8.0690 SQ FT
(CCR053)	○ LSWT 248 MDAC 4.0 FC 02 HCR ORB B5W11G	0.000 - 10.000		0.000	REFL 29.5700 IN.
					REFB 51.6000 IN.
					XMRP 59.3200 IN.
					YMRP 0.0000 IN.
					ZMRP 11.6000 IN.
					SCALE 4 0000 PERCNT

MACH 0.250



LONGITUDINAL CONTROL POWER LANDING GEAR EXTENDED

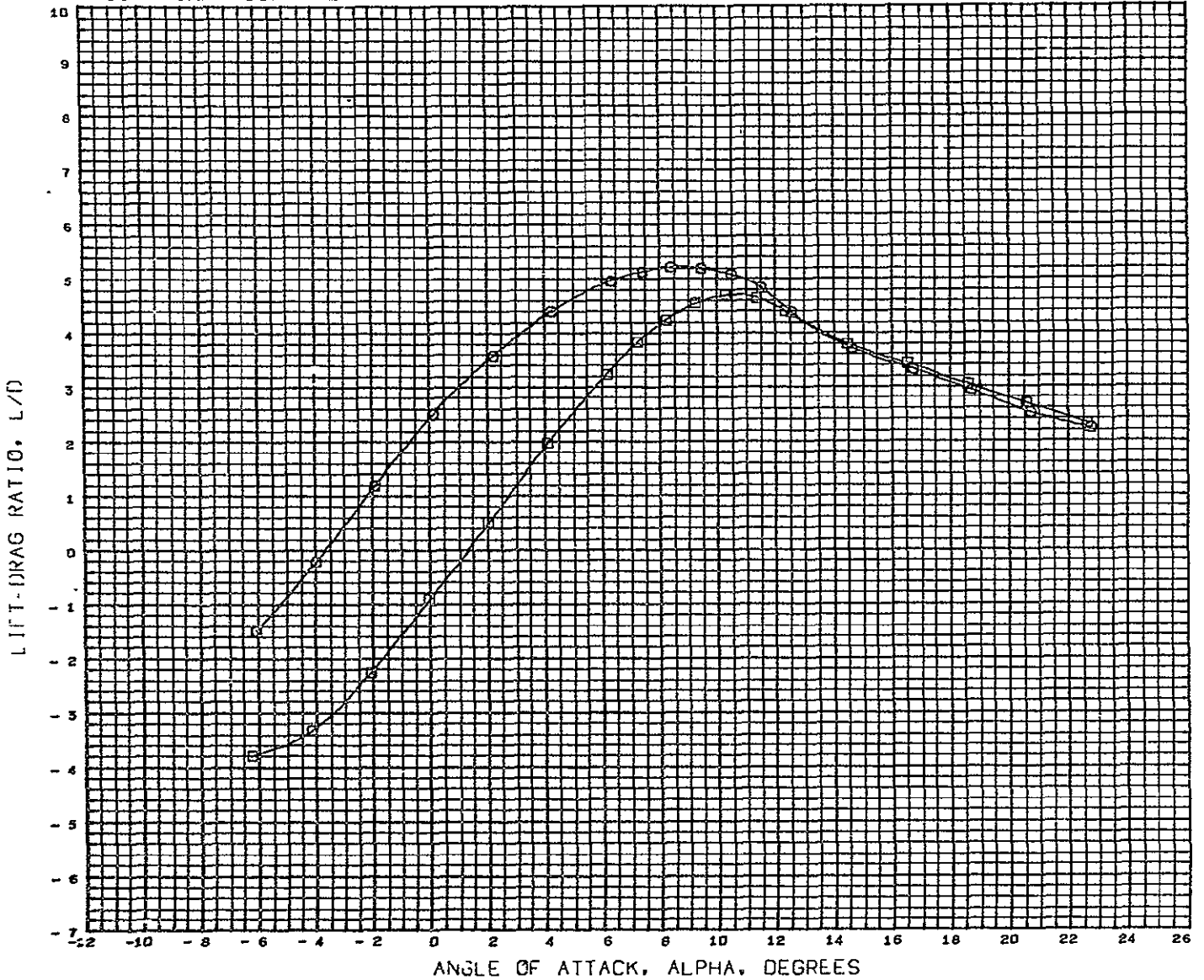

DATA SET SYMBOL	CONFIGURATION DESCRIPTION	BETA	ELEVTR	AILRON	REFERENCE INFORMATION
(CCP052)	LSWT 248 MDAC 4.0 FC 02 HCR ORB BSW11G	0.000	0.000	0.000	REFS 8.8690 SQ.FT
(CCP053)	LSWT 248 MDAC 4.0 FC 02 HCR ORB BSW11G	0.000	-10.000	0.000	REFL 29.5700 IN.
					REFB 51.6000 IN.
					XMRP 59.3200 IN.
					YMRP 0.0000 IN.
					ZMRP 11.6000 IN.
					SCALE 4.0000 PERCENT

MACH 0.250

# LONGITUDINAL CONTROL POWER LANDING GEAR EXTENDED

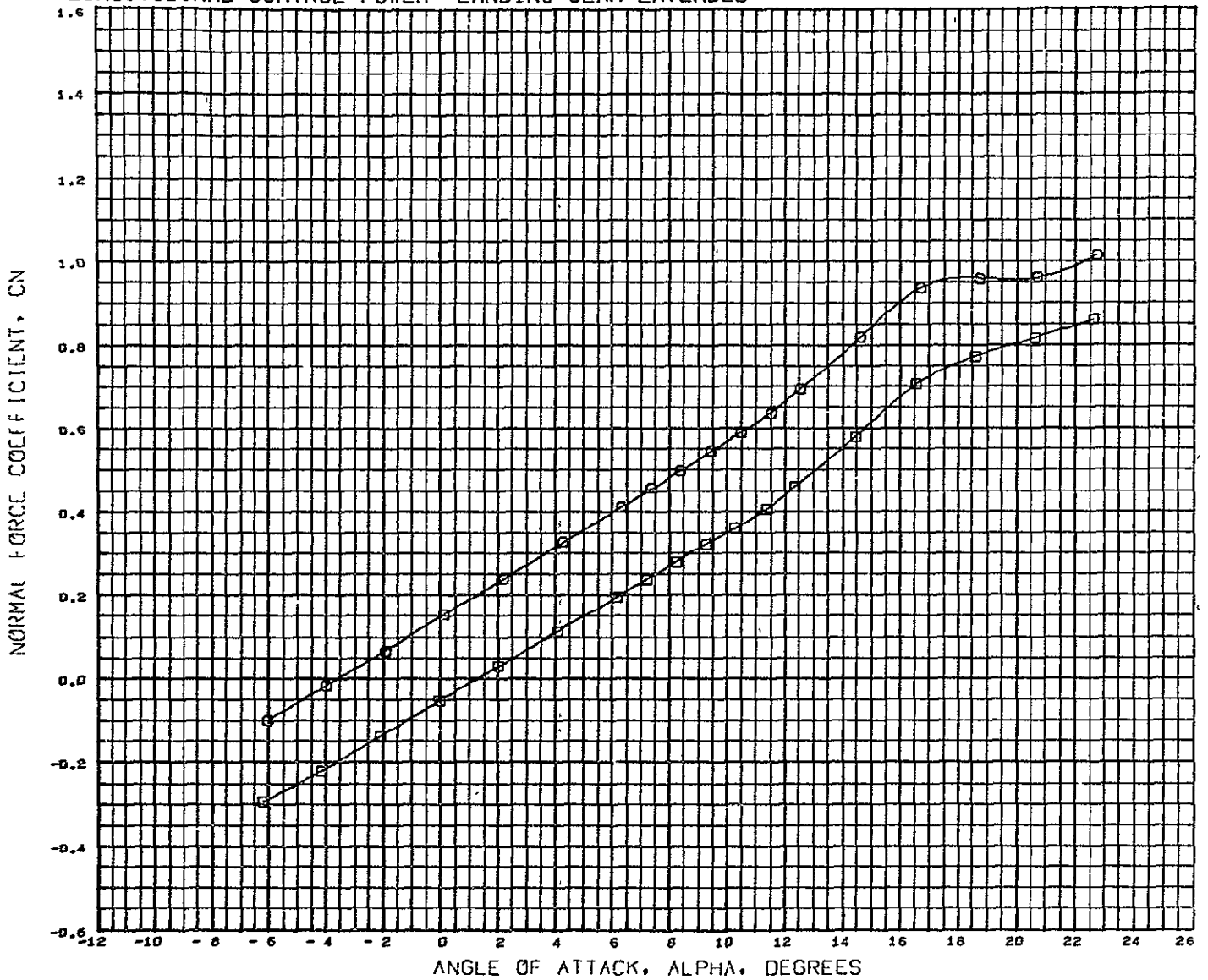

DATA SET SYMBOL	CONFIGURATION DESCRIPTION	BETA	ELEVTR	AILRON	REFERENCE INFORMATION	
(BCFD52)	○ LSWT 248 MDAC 4.0 FC 02 HCR ORB 85W11G	0.000	0.000	0.000	REFS	8.8690 SQ FT.
(BCFD53)	□ LSWT 248 MDAC 4.0 FC 02 HCR ORB 85W11G	0.000 - 10.000		0.000	REFL	29.5700 IN.
					REFB	51.6000 IN.
					XMRP	59.3200 IN.
					YMRP	0.0000 IN.
					ZMRP	11.6000 IN.
					SCALE	4.0000 PERCNT

HACH 0.250

# LONGITUDINAL CONTROL POWER LANDING GEAR EXTENDED

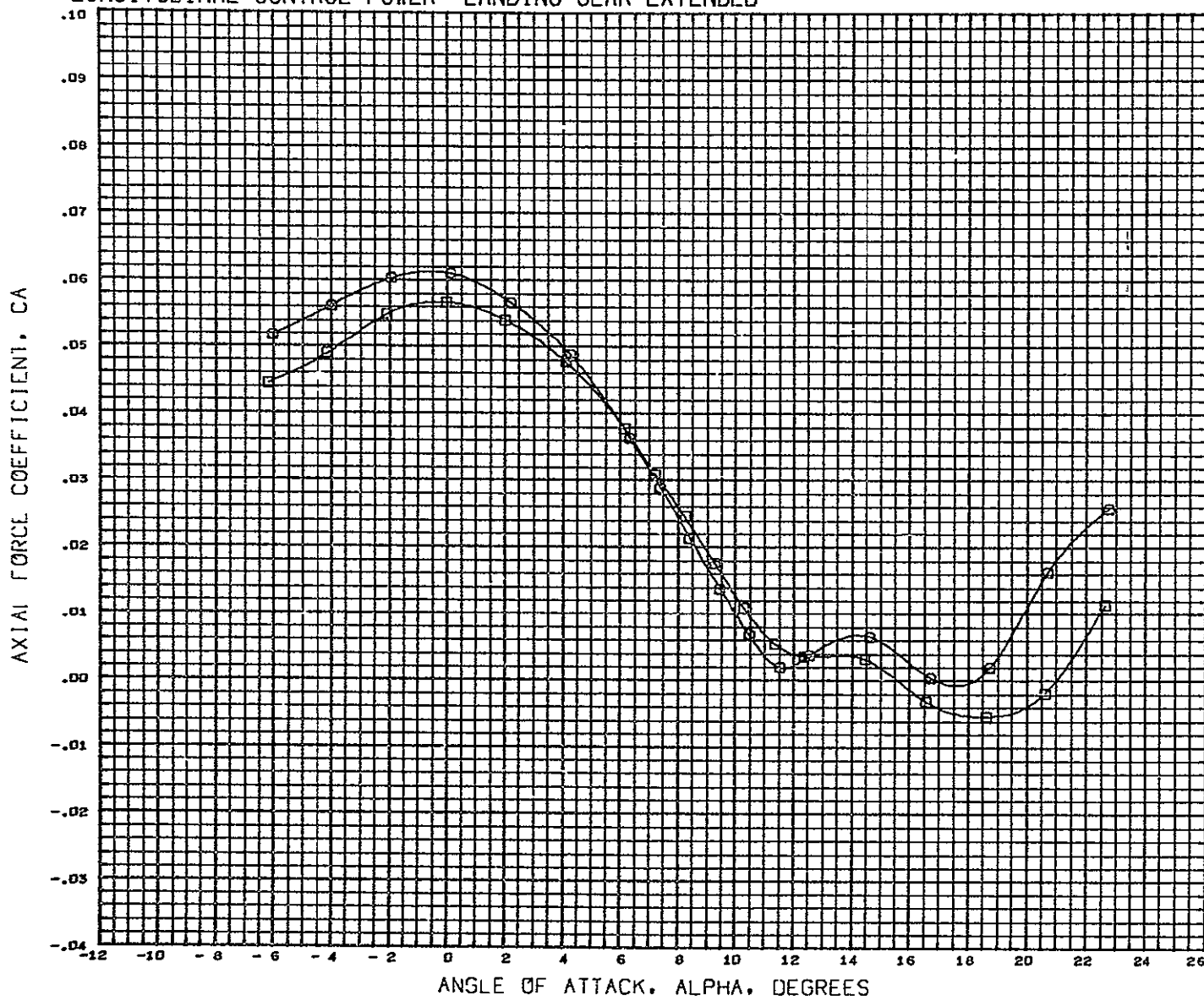

DATA SET SYMBOL	CONFIGURATION DESCRIPTION	BETA	ELEVTR	AILRON	REFERENCE INFORMATION
(BCF052)	LSWT 248 MDAC 4.0 PC O2 HCR ORB B5W11G	0.000	0.000	0.000	REFS 8 8690 SQ.FT.
(BCF053)	LSWT 248 MDAC 4.0 PC O2 HCR ORB B5W11G	0.000 - 10.000		0.000	REFL 29.5700 IN.
					REFB 51.6000 IN.
					XMRP 59.3200 IN.
					YMRP 0.0000 IN.
					ZMRP 11.6000 IN.
					SCALE 4.0000 PERCENT

HACH 0.250

LONGITUDINAL CONTROL POWER LANDING GEAR EXTENDED

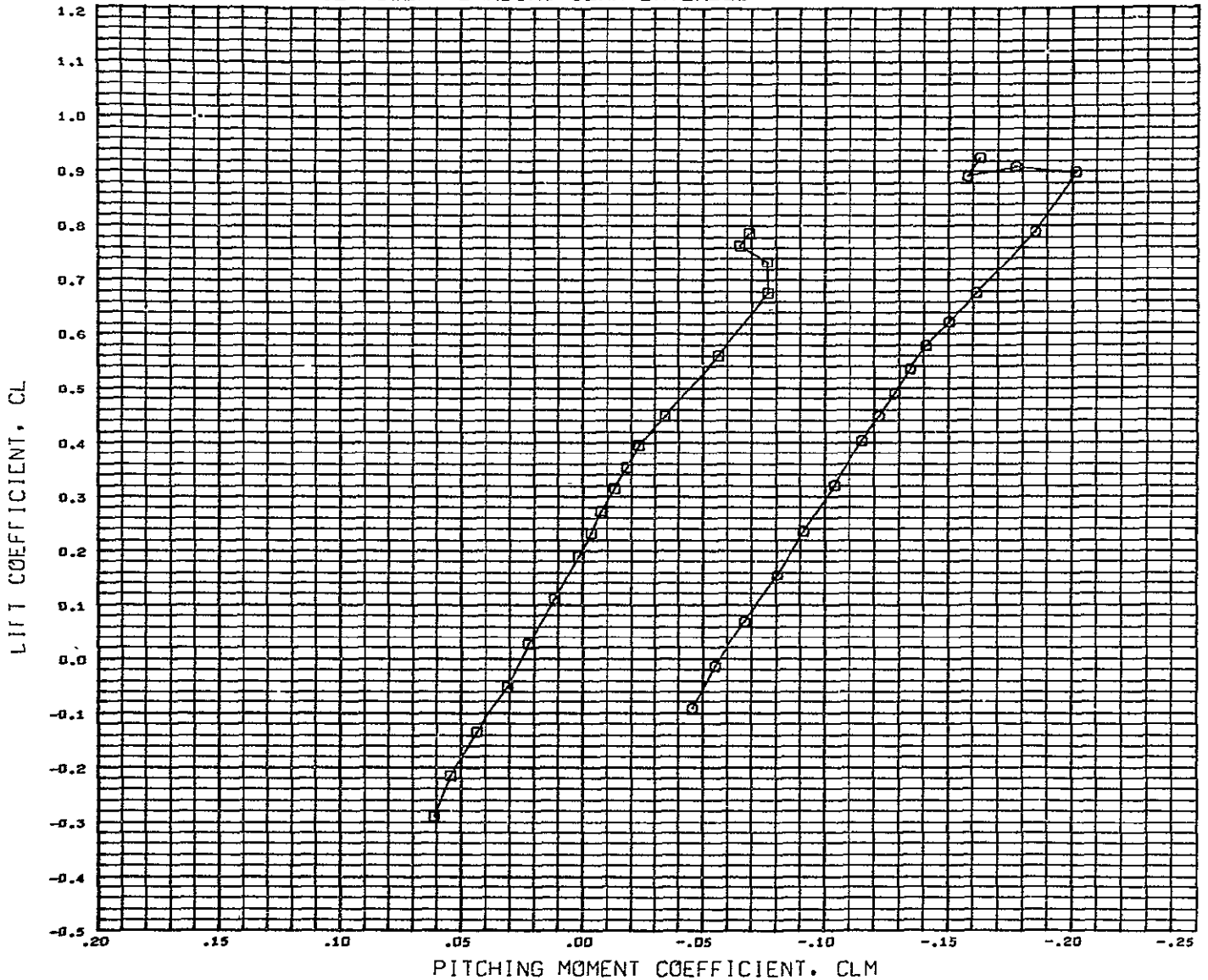

DATA SET SYMBOL	CONFIGURATION DESCRIPTION	BETA	ELEVTR	AILRON	REFERENCE INFORMATION
(CCPD52)	LSWT 248 MDAC 4.0 FC O2 HCR ORB 85W116	0.000	0.000	0.000	REFS 8 8690 SQ.FT
(CCPD53)	LSWT 248 MDAC 4.0 FC O2 HCR ORB 85W116	0.000 - 10.000		0.000	REFL 29.5700 IN.
					REFB 51.6000 IN.
					XMRP 59.3200 IN.
					YMRP 0.0000 IN.
					ZMRP 11.6000 IN.
					SCALE 4.0000 PERCNT

MACH 0.250

LONGITUDINAL CONTROL POWER LANDING GEAR EXTENDED

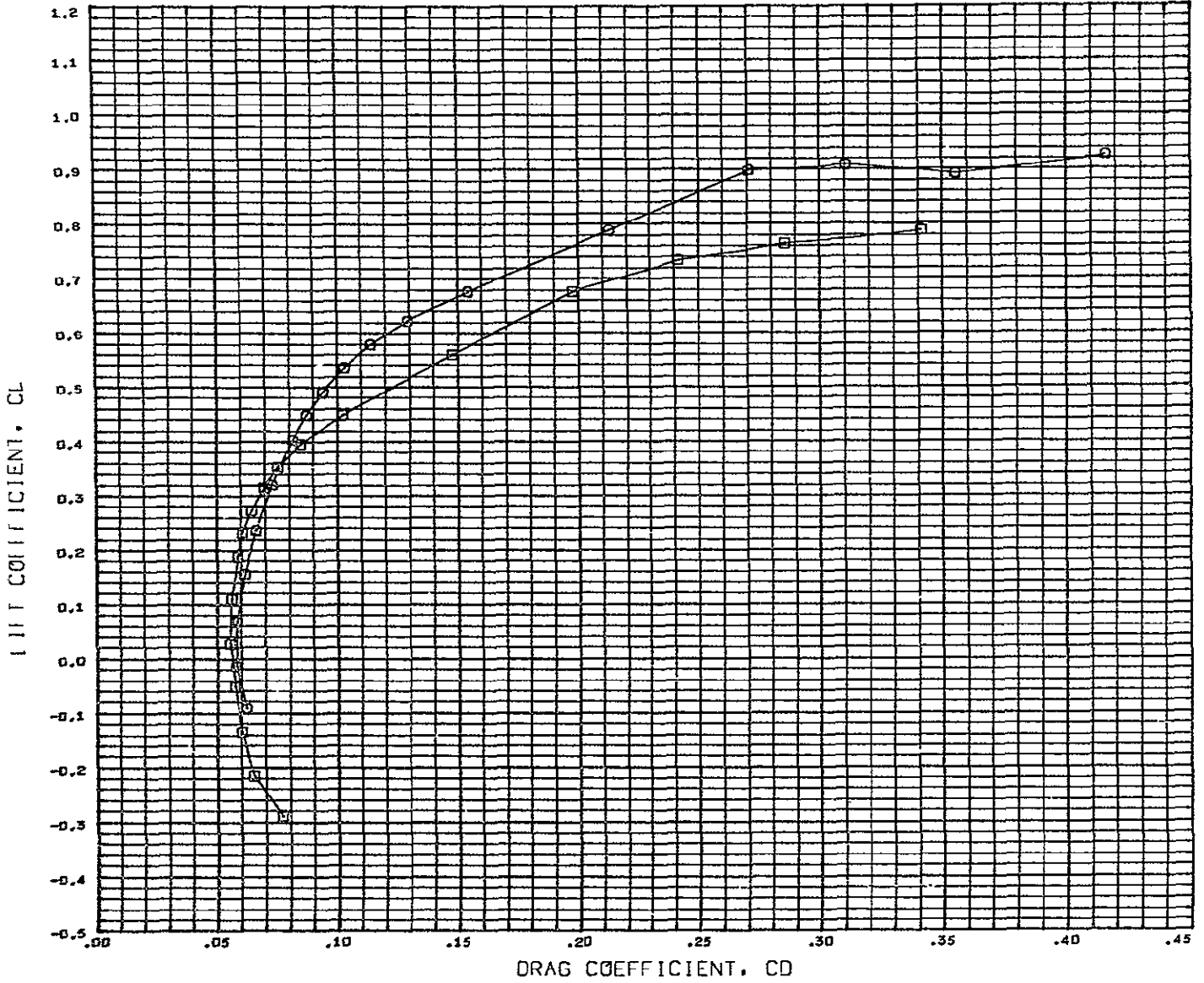

DATA SET SYMBOL	CONFIGURATION DESCRIPTION
(CCF052)	LSWT 248 HDAC 4.0 FC 02 HCR ORB
(CCF053)	LSWT 248 HDAC 4.0 FC 02 HCR ORB

DRAG COEFFICIENT, CD

BETA	ELEVTR	AILRON
0.000	0.000	0.000
0.000 - 10.000		0.000

REFERENCE INFORMATION		
REFS	8.8690	SQ.FT
REFL	29.5700	IN.
REFB	51.6000	IN.
XMRP	59.3200	IN.
YMRP	0.0000	IN.
ZMRP	11.6000	IN.
SCALE	4.0000	PERCNT

MACH 0.250

# LONGITUDINAL CONTROL POWER LANDING GEAR EXTENDED

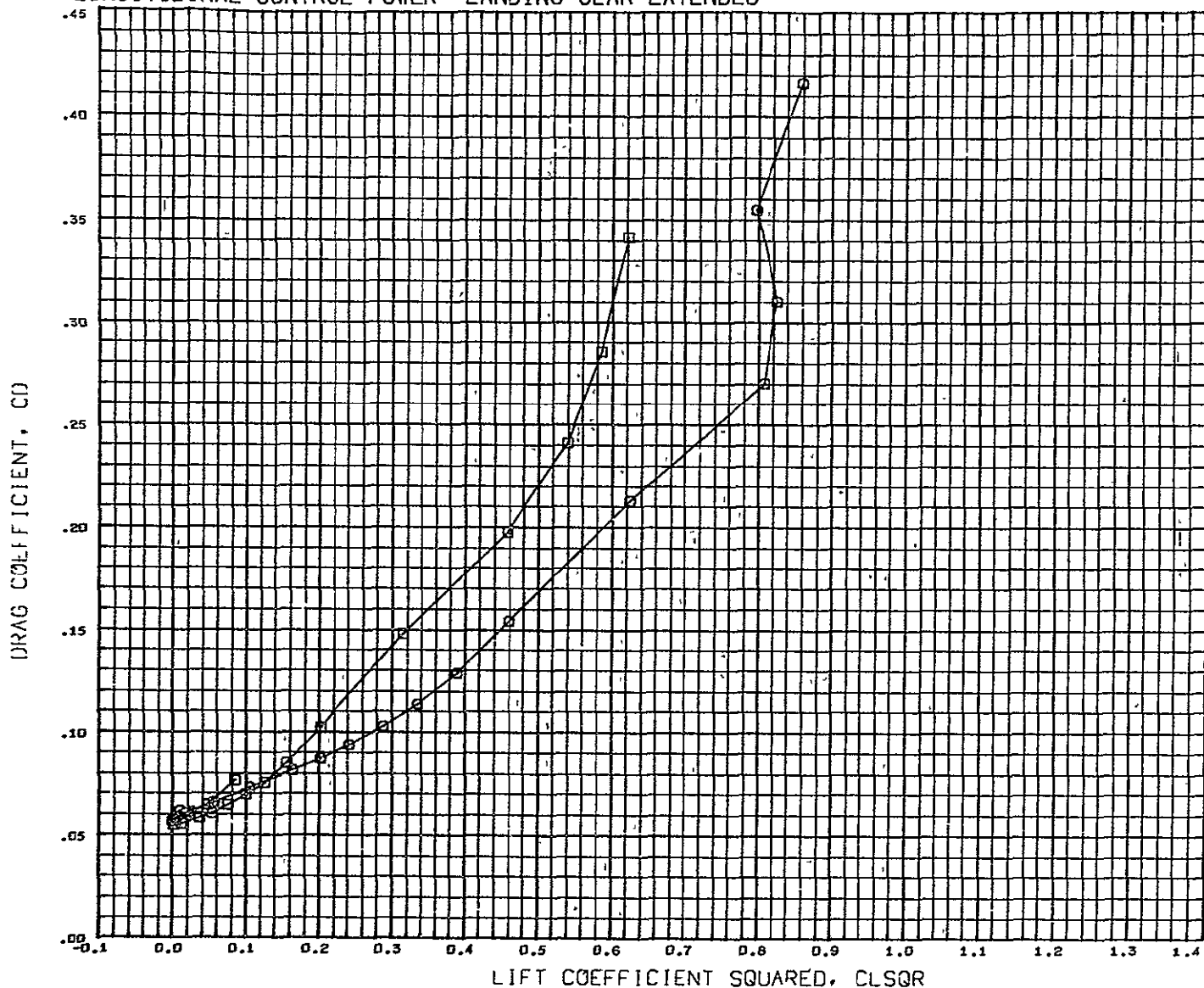

DATA SET SYMBOL	CONFIGURATION DESCRIPTION	BETA	ELEVTR	AILRON	REFERENCE INFORMATION
(CCF052)	□ LSWT 248 HDAC 4.0 FC 02 HCR ORB	0 000	0,000	0,000	REFS 8.8690 SQ.FT
(CCF053)	○ LSWT 248 HDAC 4.0 FC 02 HCR ORB	0.000 - 10,000		0 000	REFL 29.5700 IN.
					REFB 51.6000 IN.
					XMRP 59.3200 IN.
					YMRP 0.0000 IN.
					ZMRP 11.6000 IN.
					SCALE 4.0000 PERCENT

MACH 0.250

# LONGITUDINAL CONTROL POWER LANDING GEAR EXTENDED

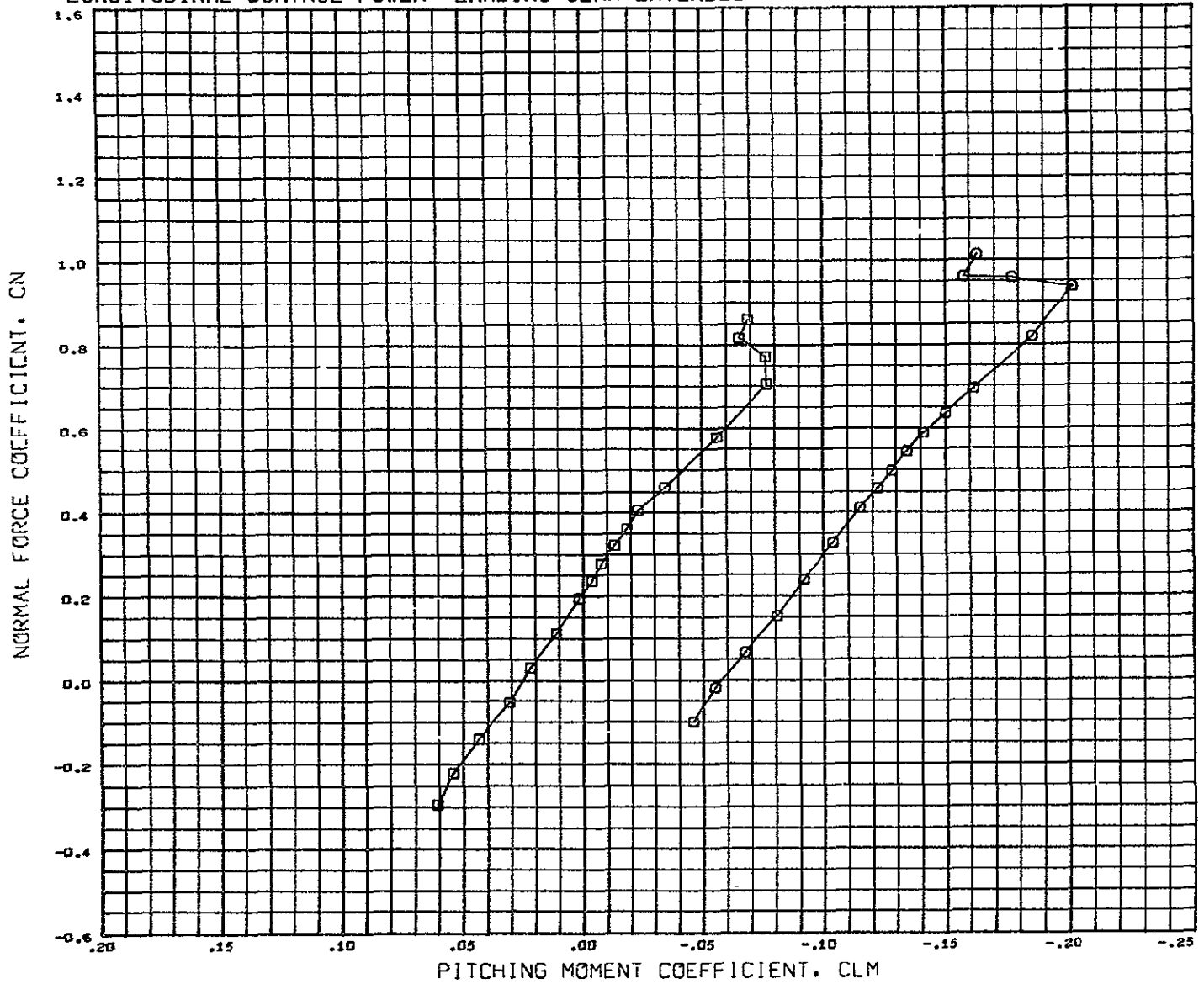

DATA SET SYMBOL	CONFIGURATION DESCRIPTION
(BCPD52)	LSWT 248 HDAC 4.0 PC OZ HCR ORB B5W11G
(BCPD53)	LSWT 248 HDAC 4.0 PC OZ HCR ORB B5W11G

BETA	ELEVTR	AILRON
0.000	0.000	0.000
0.000 - 10.000		0.000

REFERENCE INFORMATION		
REFS	8.8690	SQ FT.
REFL	29.5700	IN.
REFB	51.6000	IN.
XMRP	59.3200	IN.
YMRP	0.0000	IN.
ZMRP	11.6000	IN.
SCALE	4.0000	PERCENT

MACH 0.250

# LONGITUDINAL CONTROL POWER LANDING GEAR EXTENDED

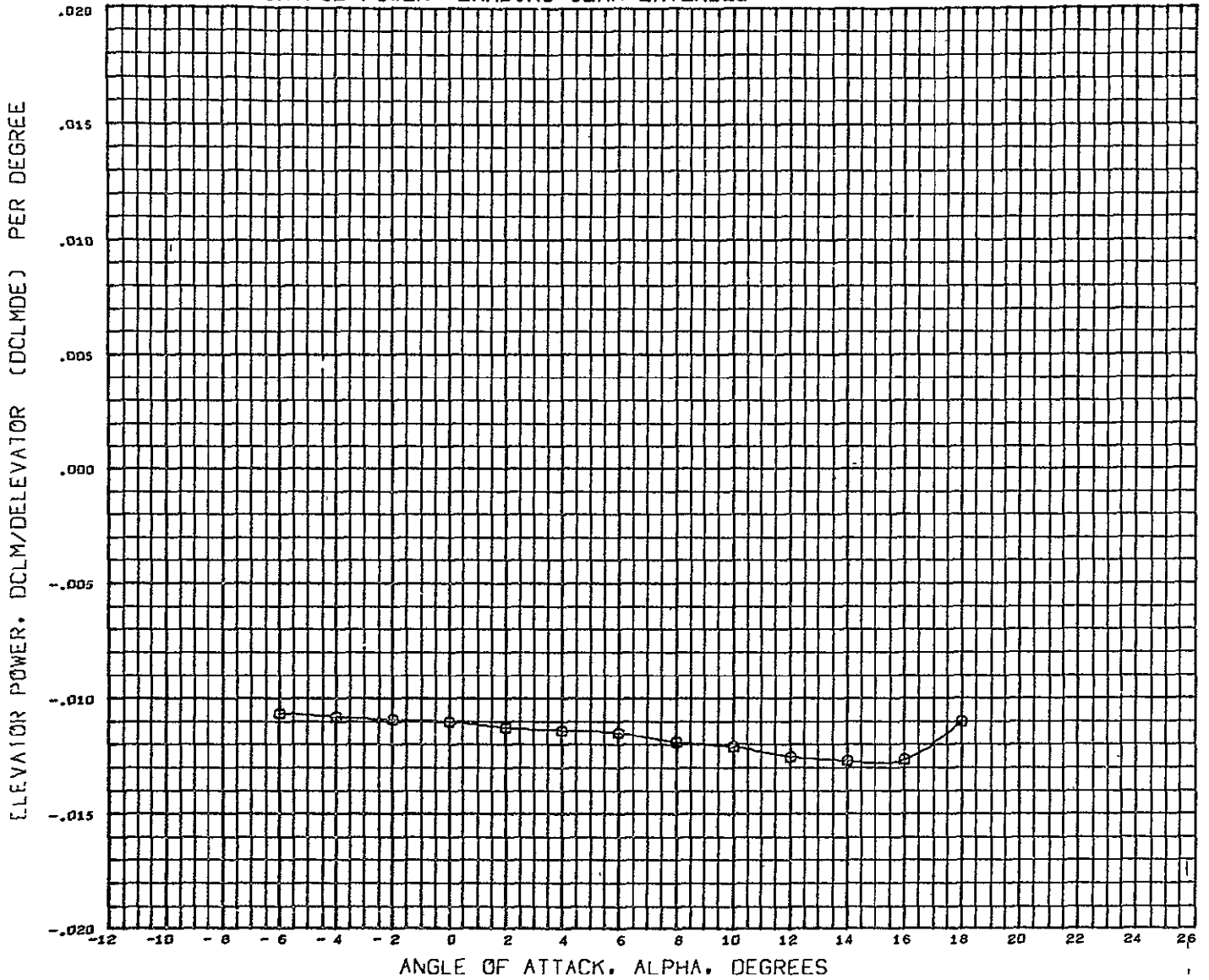

SYMBOL	MACH	PARAMETRIC VALUES				REFERENCE INFORMATION		
Q	0.260	BETA	0.000	ELEVTR	-10.000	REFS	8 8690	SO.FT.
		AILRON	0.000	SFBRK	0.000	REFL	29 5700	IN.
		BFLAP	0.000			REFB	51.6000	IN.
						XMRP	59 3200	IN.
						YMRP	0.0000	IN.
						ZMRP	11.6000	IN.
						SCALE	4.0000	PERCNT

DATA HIST. CODE #F



LONGITUDINAL CONTROL POWER LANDING GEAR EXTENDED

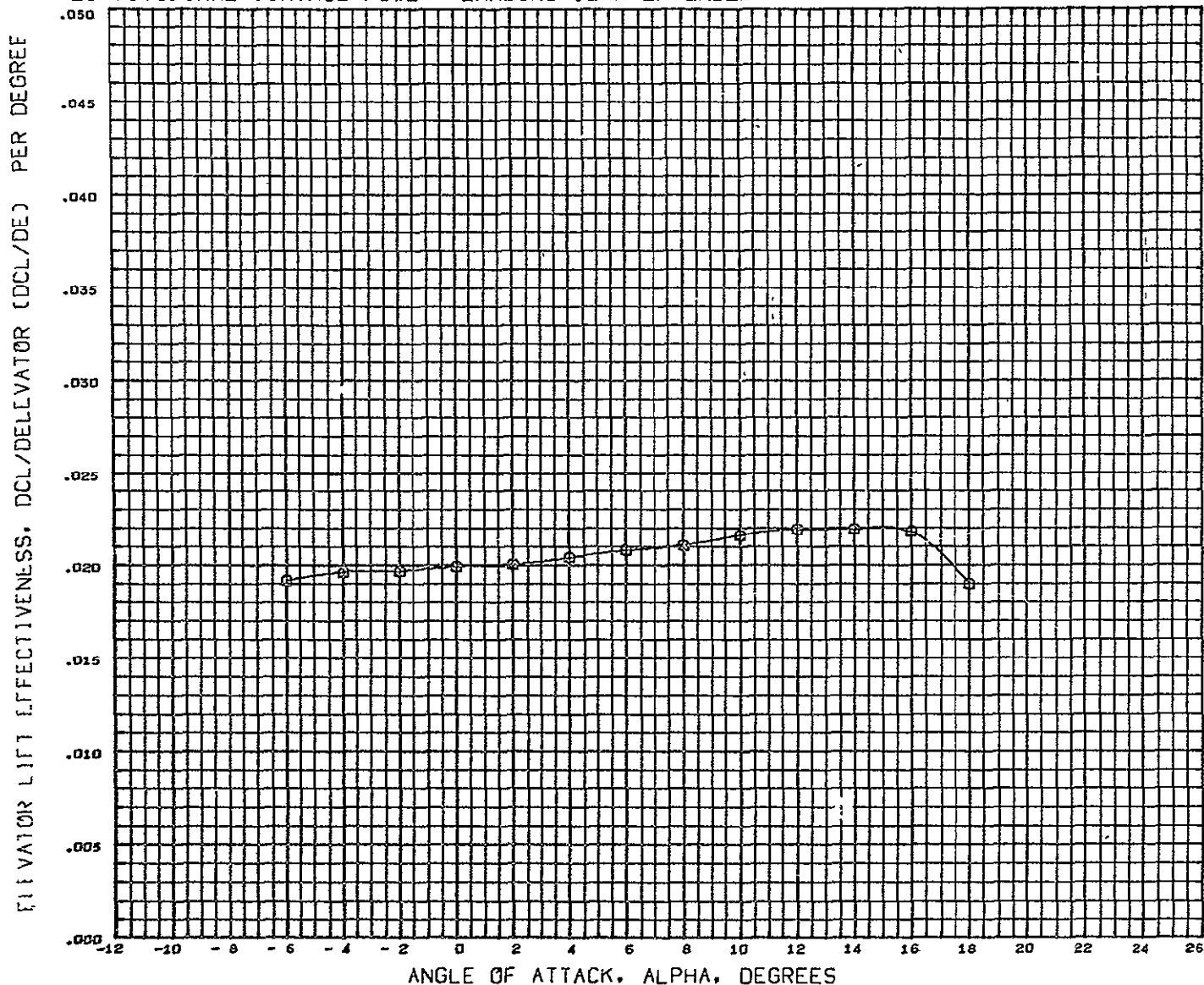

SYMBOL	MACH	PARAMETRIC VALUES			
Q	0.260	BETA	0.000	ELEVTR	- 10.000
		AILRON	0.000	SPBRK	0.000
		BFLAP	0.000		

REFERENCE INFORMATION		
REFS	8.8690	SG.FT
REFL	29.5700	IN.
REFB	51.6000	IN.
XMRP	59.3200	IN.
YMRP	0.0000	IN.
ZMRP	11.6000	IN.
SCALE	4.0000	PERCNT

DATA HIST. CODE #P

LONGITUDINAL CONTROL POWER LANDING GEAR EXTENDED

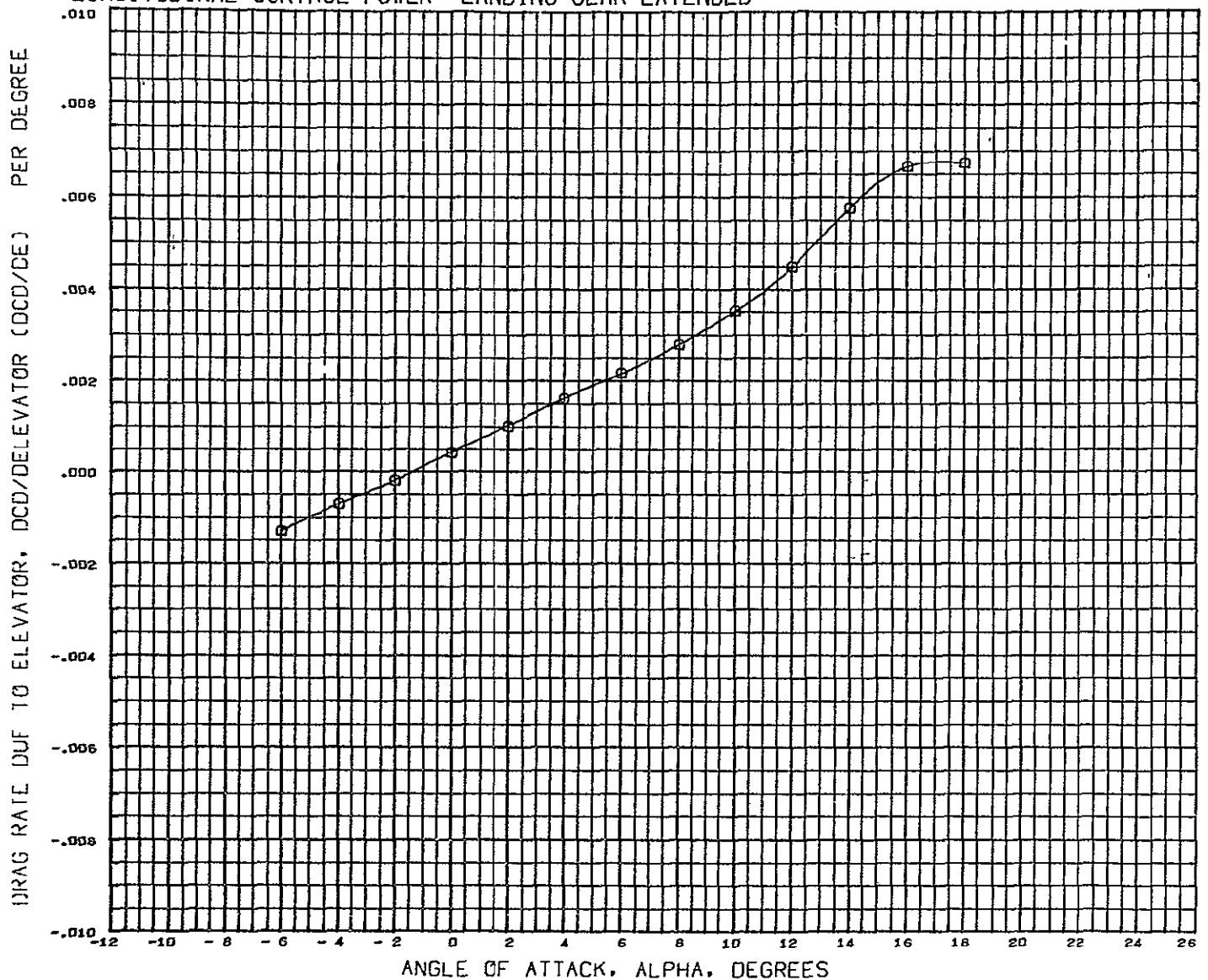

SYMBOL	MACH	PARAMETRIC VALUES				REFERENCE INFORMATION		
□	0.260	BETA	0.000	ELEVTR	- 10.000	REFS	8.8690	SG.FT
		AILERON	0.000	SPBRK	0.000	REFL	29.5700	IN
		DFLAP	0.000			REFB	51.6000	IN
						XMRP	59.3200	IN.
						YMRP	0.0000	IN
						ZMRP	11.6000	IN.
						SCALE	4.0000	PERCENT
		DATA HIST. CODE	#P					

# LONGITUDINAL CONTROL POWER SPEED BRAKES EXTENDED

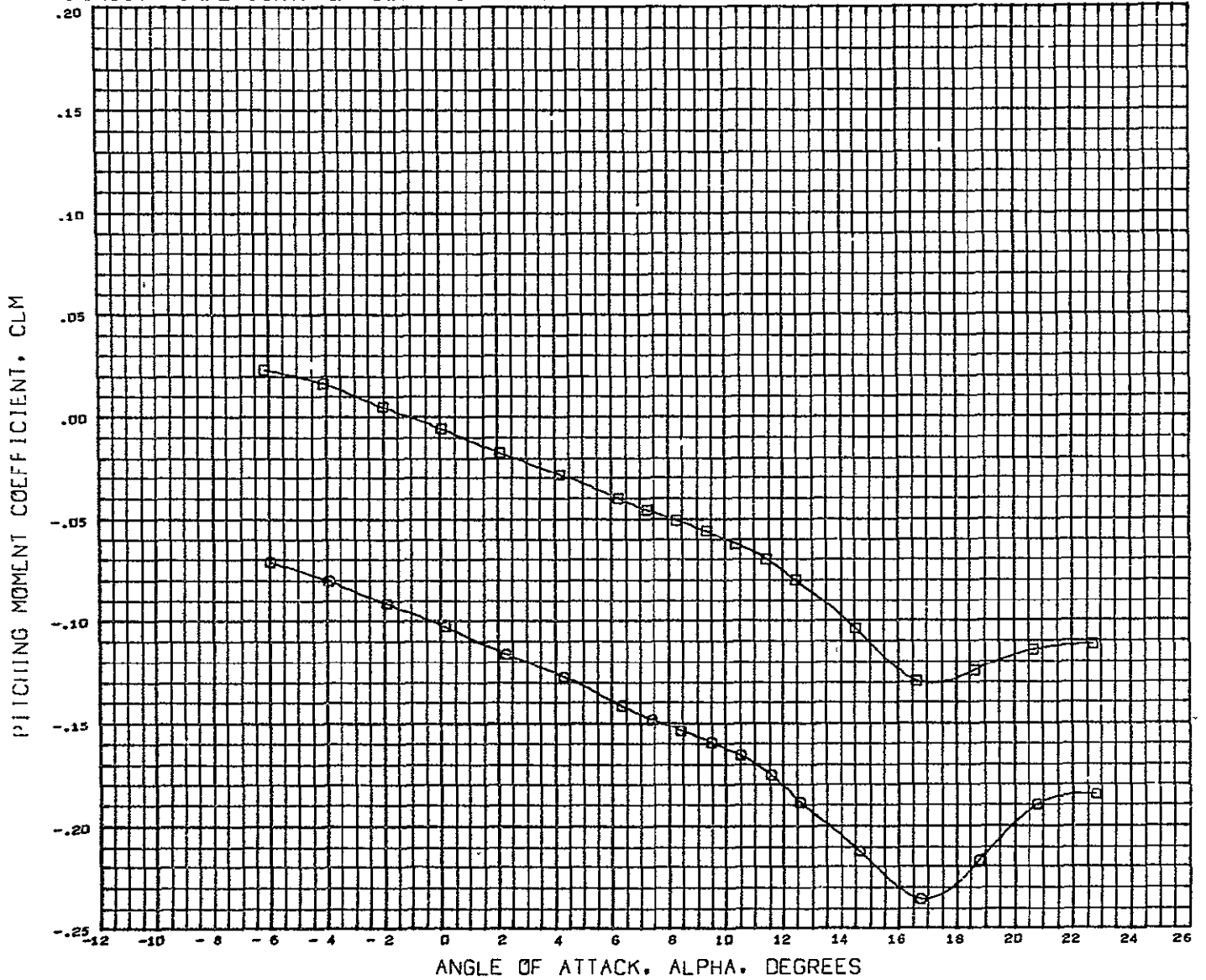

DATA SET SYMBOL	CONFIGURATION DESCRIPTION	BETA	ELEVTR	AILRON	SBPOS	REFERENCE INFORMATION
(CCP050)	LSWT 248 MDAC 4.0 FC O2 HCR ORB 85W11SB2	0.070	0.000	0.000	3.000	REFS 8.8690 SQ FT
(CCP039)	LSWT 248 MDAC 4.0 FC O2 HCR ORB 85W11SB2	0.000 - 10.000		0.000	3.000	REFL 29 5700 IN. REFB 51 6000 IN. XMRP 59 3200 IN. YMRP 0.0000 IN. ZMRP 11.6000 IN. SCALE 4.0000 PERCNT

MACH 0.250

# LONGITUDINAL CONTROL POWER SPEED BRAKES EXTENDED

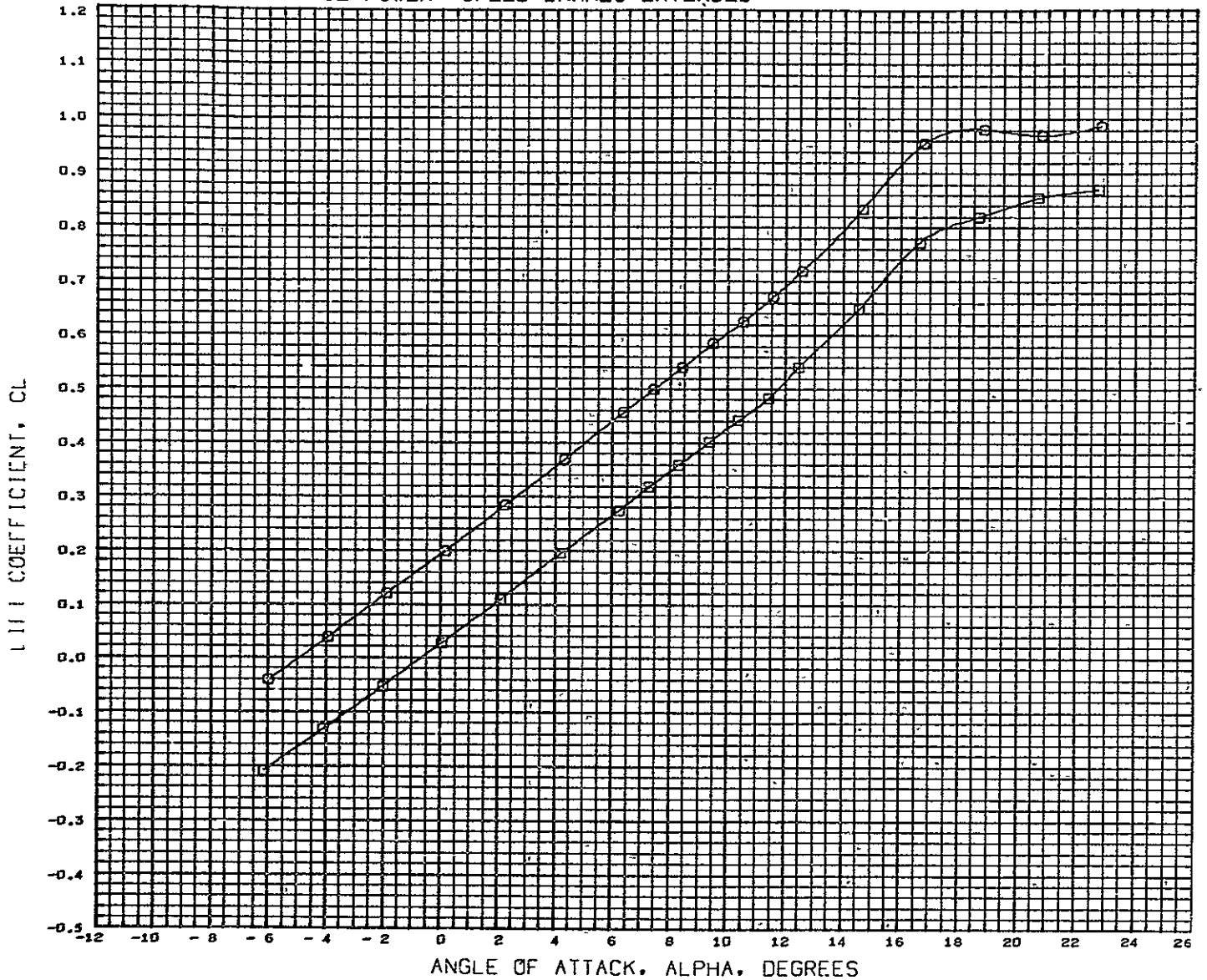

DATA SET SYMBOL	CONFIGURATION DESCRIPTION	BETA	ELEVTR	AILRON	SBPOS	REFERENCE INFORMATION
(CCFD39)	LSWT 248 MDAC 4.0 FC 02 HCR ORB	0.000	0.000	0.000	3.000	REFS 8.8690 SQ.FT
(CCFD39)	LSWT 248 MDAC 4.0 FC 02 HCR ORB	0.000 - 10.000		0.000	3.000	REFL 29.5700 IN.
						REFB 51.6000 IN.
						XMRP 59.3200 IN.
						YMRP 0.0000 IN.
						ZMRP 11.6000 IN.
						SCALE 4.0000 PERCENT

MACH 0.250

# LONGITUDINAL CONTROL POWER SPEED BRAKES EXTENDED

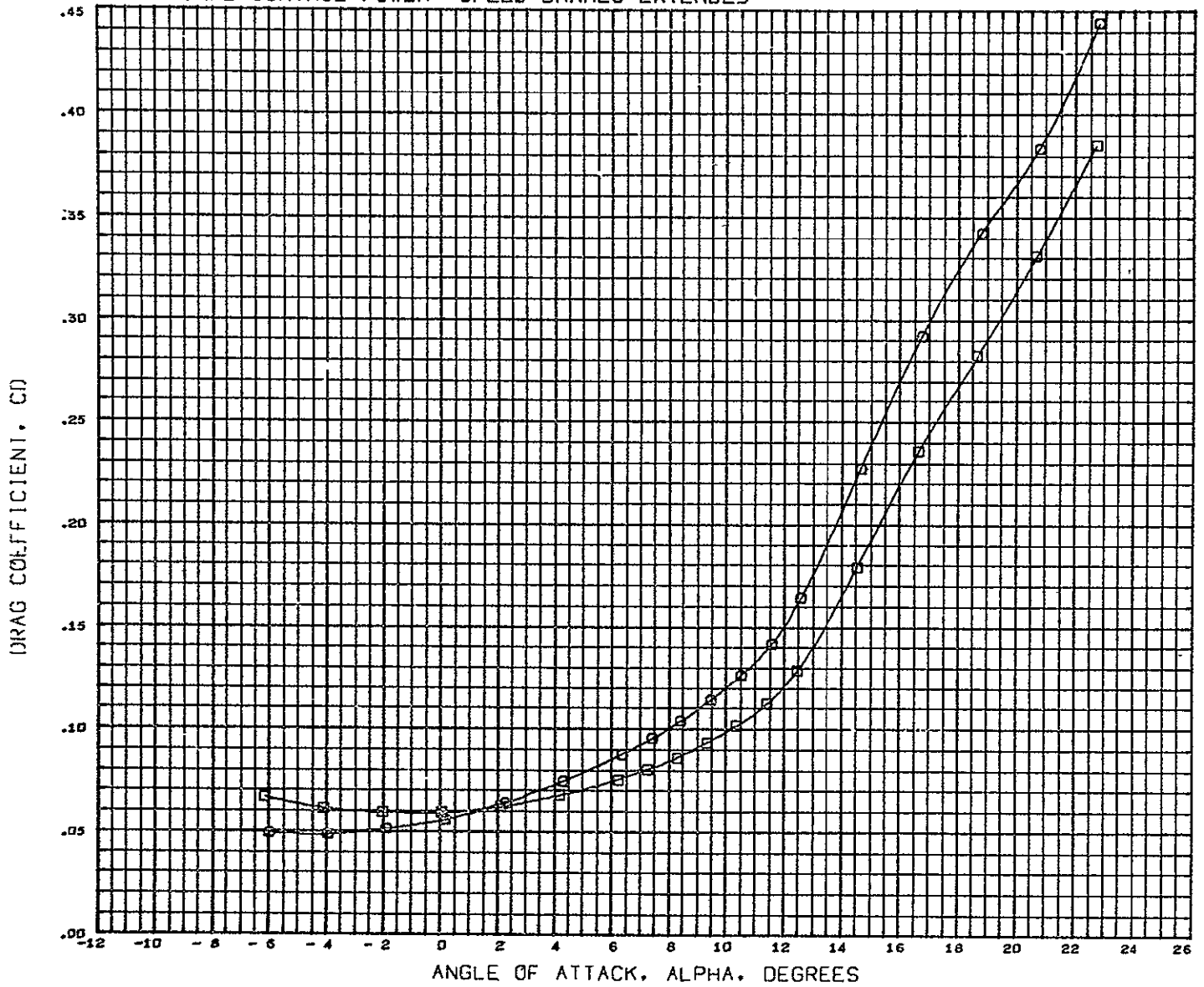

DATA SET SYMBOL	CONFIGURATION DESCRIPTION	BETA	ELEVTR	AILRON	SBPOS	REFERENCE INFORMATION
(CCF030)	LSWT 248 HDAC 4.0 FC 02 HCR ORB	0.000	0.000	0.000	3.000	REFS 8.8690 SQ.FT.
(CCF039)	LSWT 248 HDAC 4.0 FC 02 HCR ORB	0.000 - 10.000		0.000	3.000	REFL 29.5700 IN.
						REFB 51.6000 IN.
						XMRF 59.3200 IN.
						YMRF 0.0000 IN.
						ZMRF 11.6000 IN.
						SCALE 4.0000 PERCNT

MACH 0.250

LONGITUDINAL, CONTROL POWER SPEED BRAKES EXTENDED

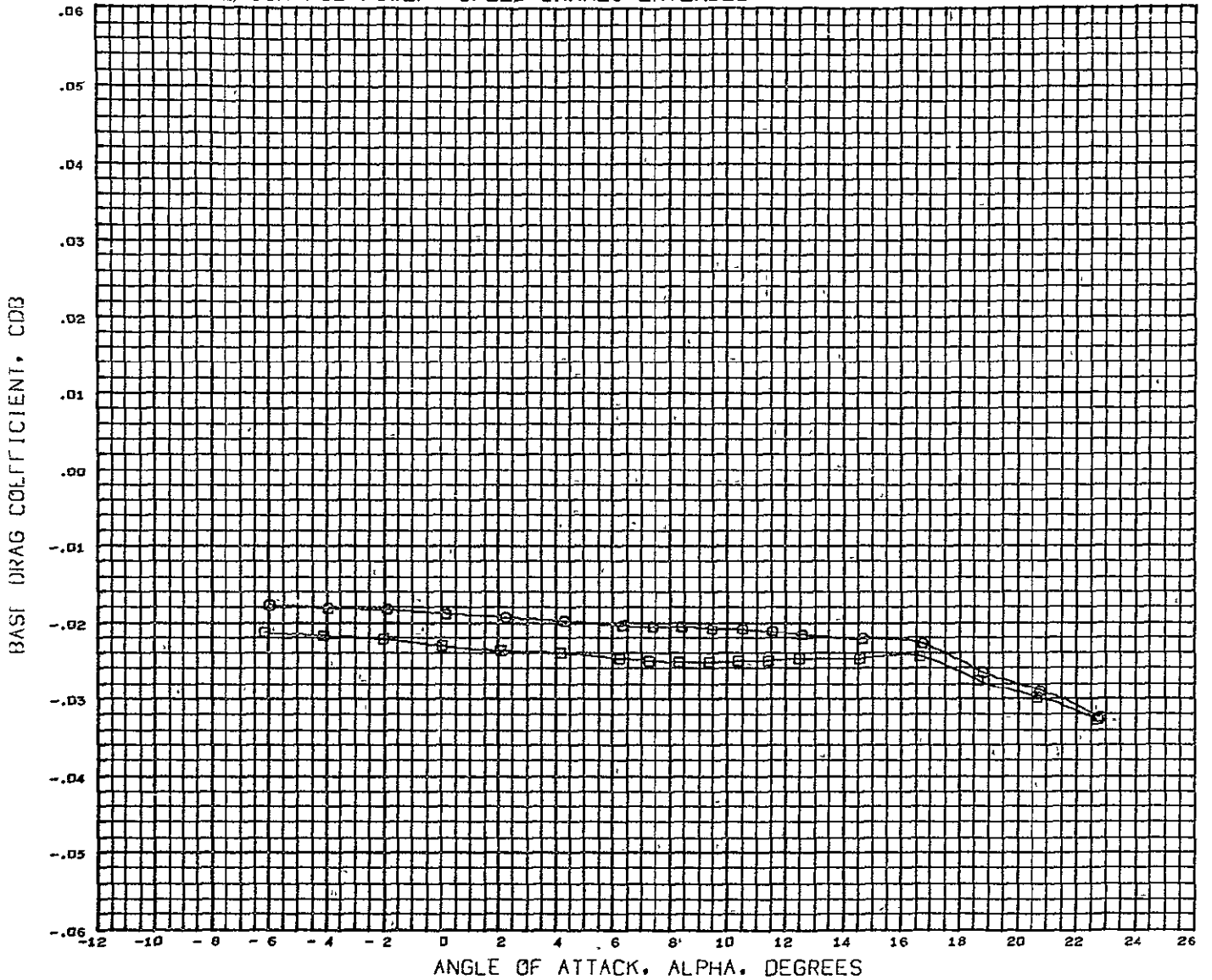

DATA SET SYMBOL	CONFIGURATION DESCRIPTION	BETA	ELEVTR	AILRON	SBPOS	REFERENCE INFORMATION
(CCP050)	LSWT 248 HDAC 4.0 FC O2 HCR ORB B5W11SB2	0.000	0.000	0.000	3.000	REFS 8.8690 SQ.FT.
(CCP039)	LSWT 248 HDAC 4.0 FC O2 HCR ORB B5W11SB2	0.000 - 10.000		0.000	3.000	REFL 29.5700 IN.
						REFB 51.6000 IN.
						XMRF 59.3200 IN.
						YMRF 0.0000 IN.
						ZMRF 11.6000 IN.
						SCALE 4.0000 PERCNT

HACH 0.250

LONGITUDINAL CONTROL POWER SPEED BRAKES EXTENDED

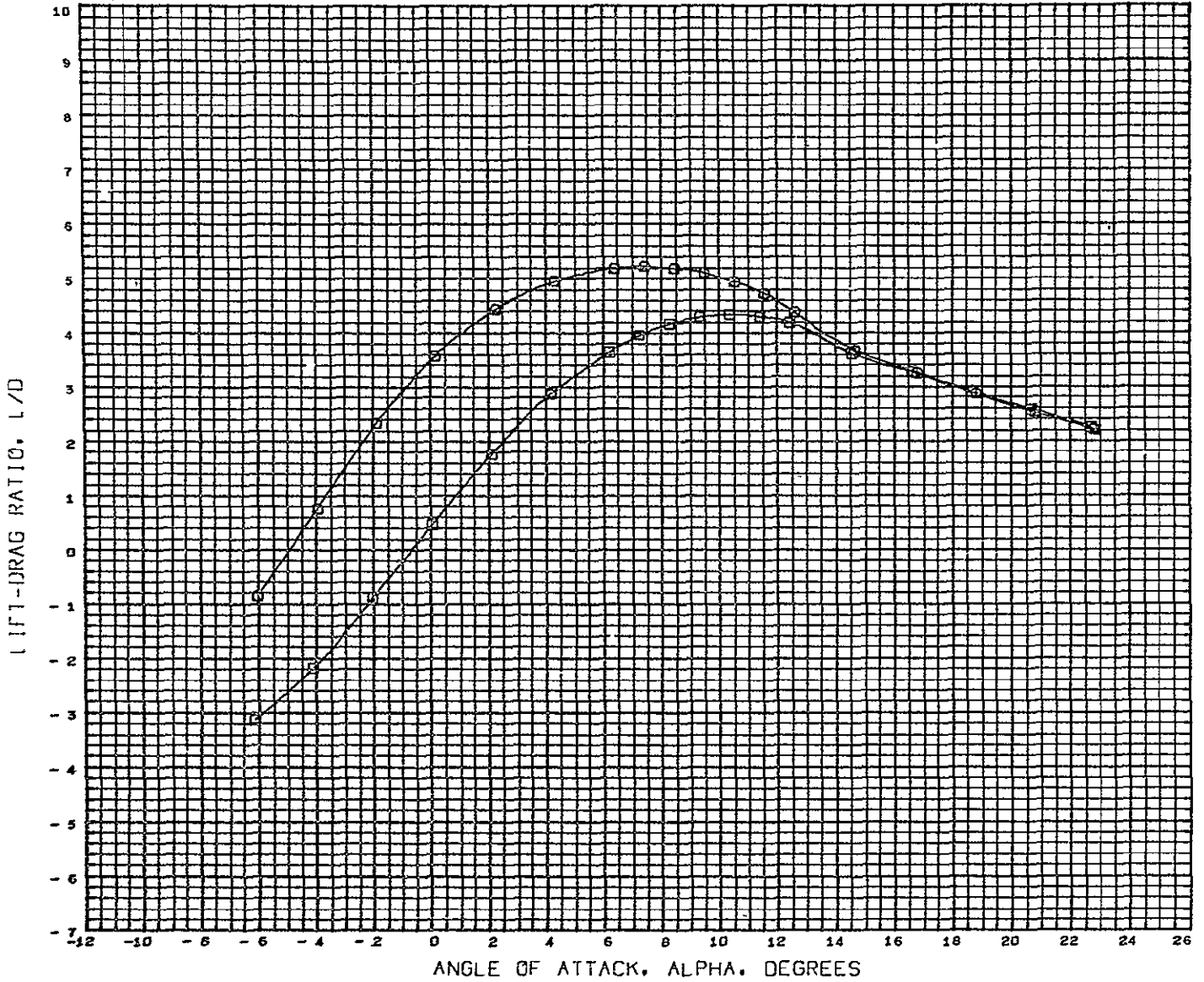

DATA SET SYMBOL	CONFIGURATION DESCRIPTION	BETA	ELEVTR	AILRON	SBPOS	REFERENCE INFORMATION
(CCFD50)	LSWT 248 MDAC 4.0 PC 02 HCR ORB	0.000	0.000	0.000	3.000	REFS 8.8690 SQ.FT
(CCFD59)	LSWT 248 MDAC 4.0 PC 02 HCR ORB	0.000 - 10.000		0.000	3.000	REFL 29.5700 IN.
						REFB 51.6000 IN.
						XMRP 59.3200 IN.
						YMRP 0.0000 IN.
						ZMRP 11.6000 IN.
						SCALE 4.0000 PERCNT

MACH 0.250

# LONGITUDINAL CONTROL POWER SPEED BRAKES EXTENDED

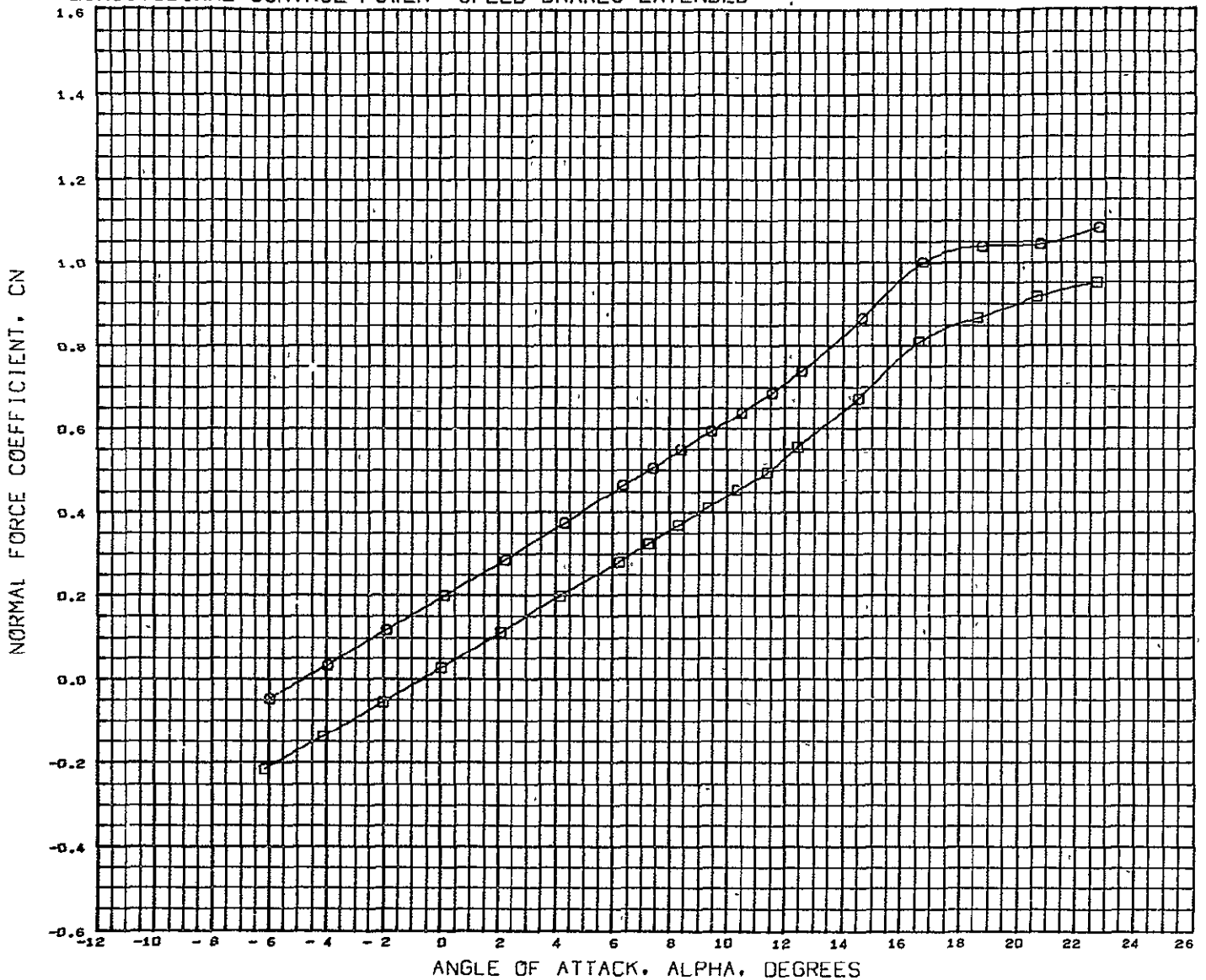

DATA SET SYMBOL	CONFIGURATION DESCRIPTION	BETA	ELEVTR	AILRON	SBPOS	REFERENCE INFORMATION
(BCF050)	LSWT 248 MDAC 4.0 FC 02 HCR ORB BSW11SB2	0.000	0.000	0.000	3.000	REFS -8 8690 SQ.FT
(BCF039)	LSWT 248 MDAC 4.0 FC 02 HCR ORB BSW11SB1	0.000 - 10.000	0.000	0.000	3.000	REFL 29.5700 IN.
						REFD 51.6000 IN.
						XMRP 59.3200 IN.
						YMRP 0.0000 IN.
						ZMRP 11.6000 IN.
						SCALE 4.0000 PERCENT

MACH 0.250



LONGITUDINAL CONTROL POWER SPEED BRAKES EXTENDED

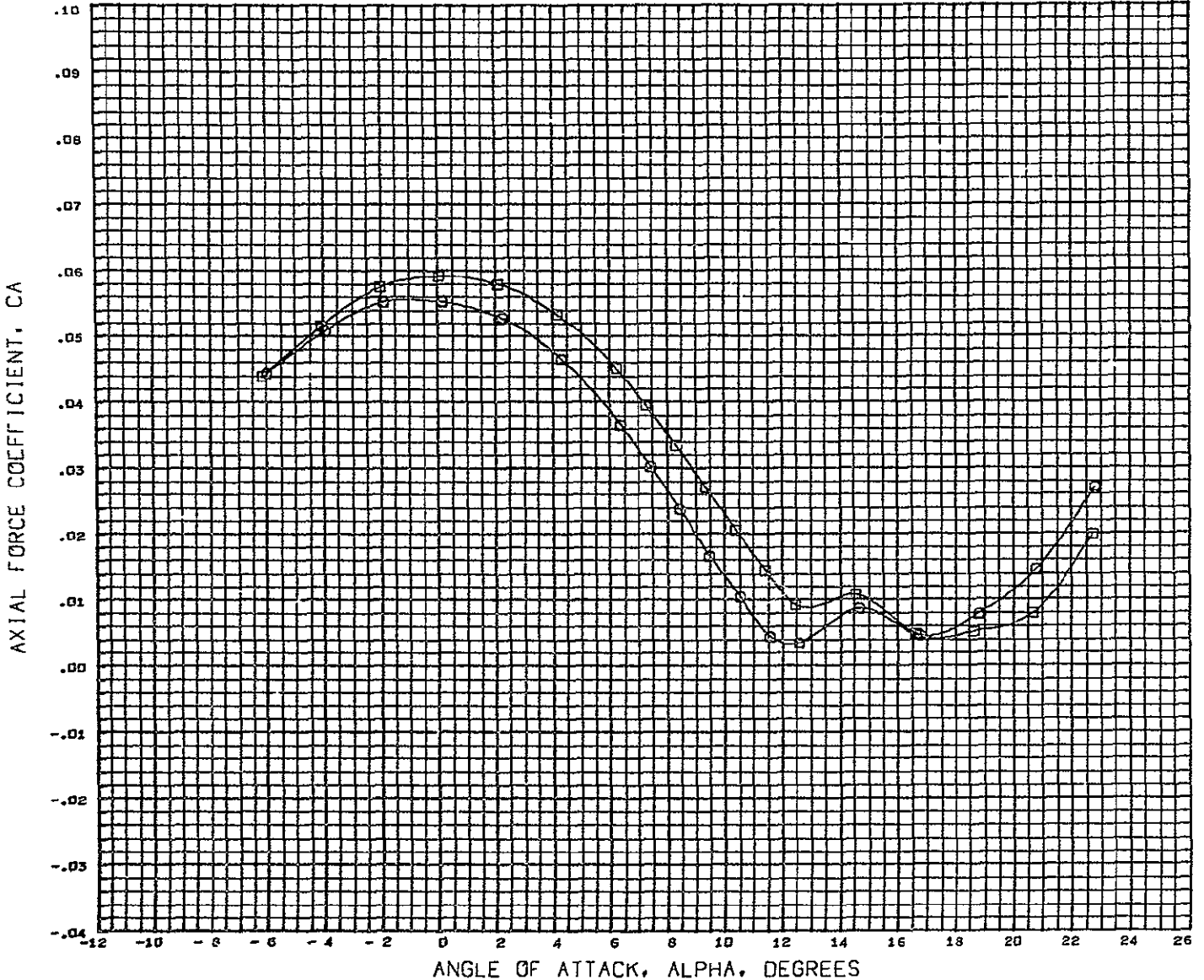

DATA SET SYMBOL	CONFIGURATION DESCRIPTION	BETA	ELEVTR	AILRON	SBPOS	REFERENCE INFORMATION
(BCFD59)	LSWT 248 MDAC 4.0 FC 02 HCR ORB B5W11SB2	0.000	0.000	0.000	3.000	REFS 8 8690 SQ.FT
(BCFD39)	LSWT 248 MDAC 4.0 FC 02 HCR ORB B5W11SB2	0.000 - 10.000		0.000	3.000	REFL 29.5700 IN. REFB 51.6000 IN. XMRP 59.3200 IN. YMRP 0.0000 IN. ZMRP 11.6000 IN. SCALE 4 0000 PERCNT

MACH 0.250

LONGITUDINAL CONTROL POWER SPEED BRAKES EXTENDED

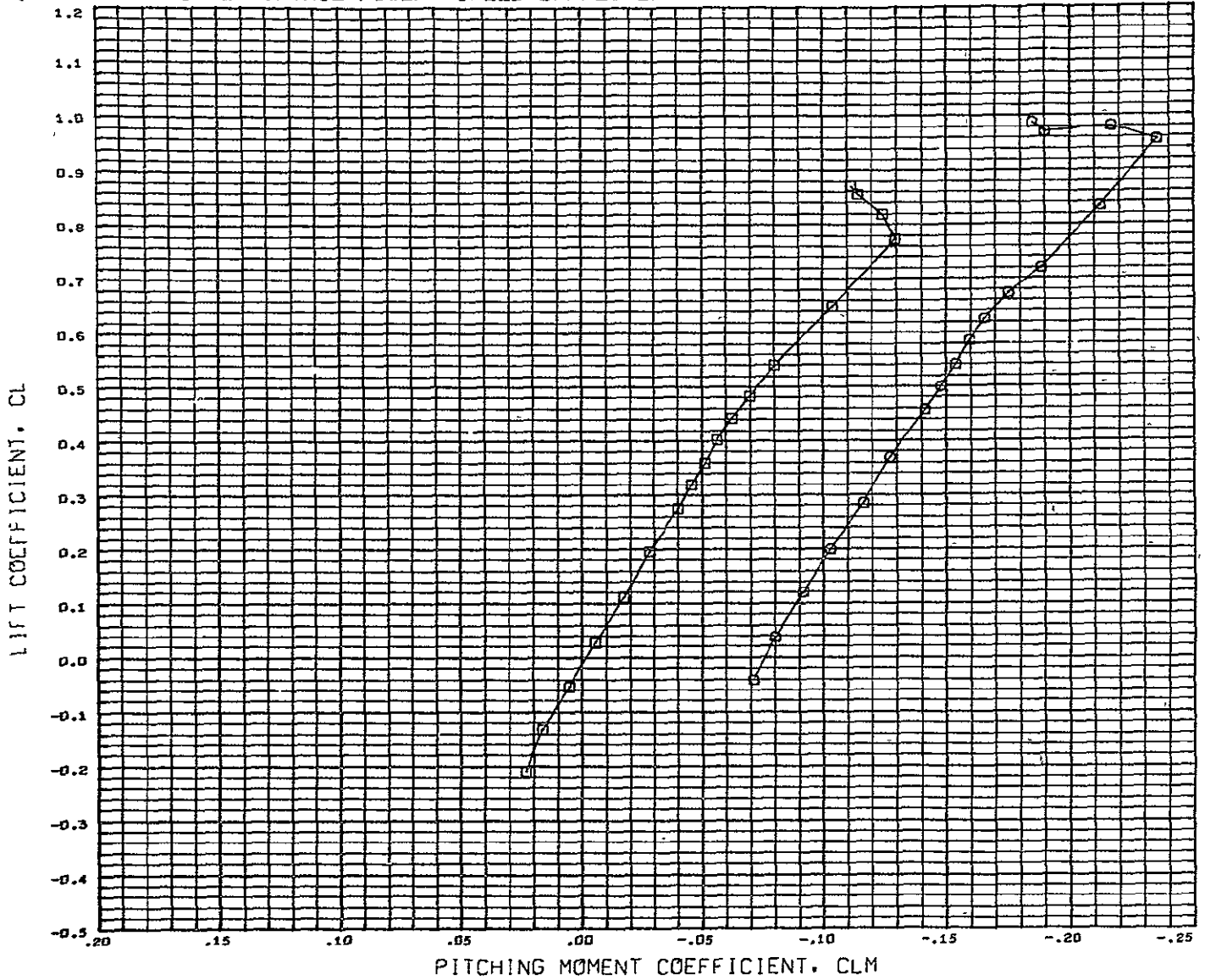

DATA SET SYMBOL	CONFIGURATION DESCRIPTION	BETA	ELEVTR	AILRON	SBPOS	REFERENCE INFORMATION
(CCPD59)	LSWT 248 MDAC 4.0 PC 02 HCR ORB B5W11SB2	0.000	0.000	0.000	3.000	REFS 8 8690 SQ FT.
(CCPD39)	LSWT 248 MDAC 4.0 PC 02 HCR ORB B5W11SB2	0.000 - 10.000		0.000	3.000	REFL 29.5700 IN.
						REFB 51.6000 IN.
						XMRP 99.3200 IN.
						YMRP 0.0000 IN.
						ZMRP 11.6000 IN.
						SCALE 4 0000 PERCENT

MACH 0.250

# LONGITUDINAL CONTROL POWER SPEED BRAKES EXTENDED

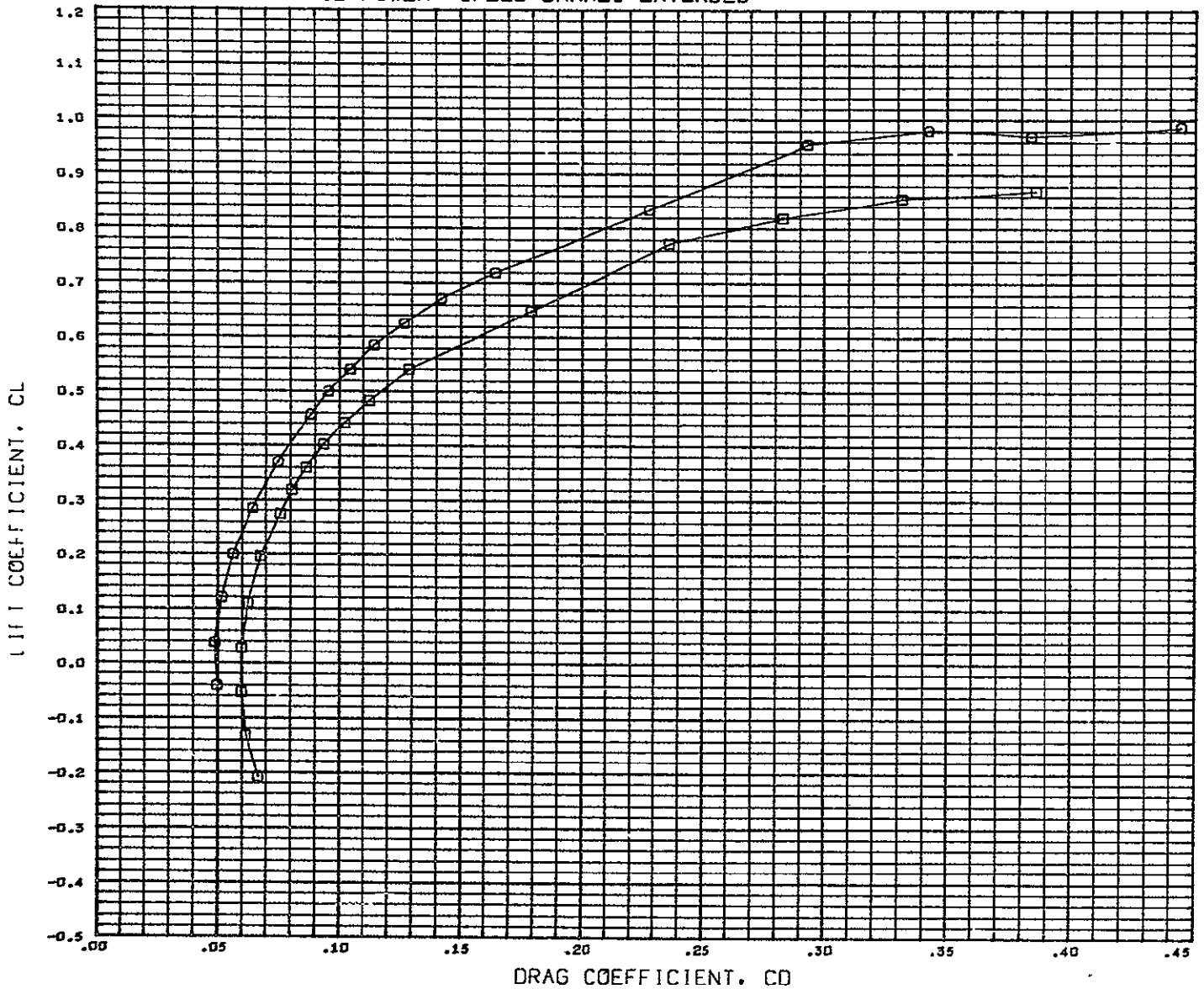

DATA SET SYMBOL	CONFIGURATION DESCRIPTION	BETA	ELEVTR	AILRON	SBPOS	REFERENCE INFORMATION
(CCPD50)	LSWT 248 MDAC 4.0 FC 02 HCR ORB	0.000	0.000	0.000	3.000	REFS 8.8690 SQ.FT.
(CCPD59)	LSWT 248 MDAC 4.0 FC 02 HCR ORB	0.000 - 10.000		0.000	3.000	REFL 29.5700 IN.
						REFB 51.6000 IN.
						XMRP 59.3200 IN.
						YMRP 0.0000 IN.
						ZMRP 11.6000 IN.
						SCALE 4.0000 PERCENT

MACH 0.250

LONGITUDINAL CONTROL POWER SPEED BRAKES EXTENDED.

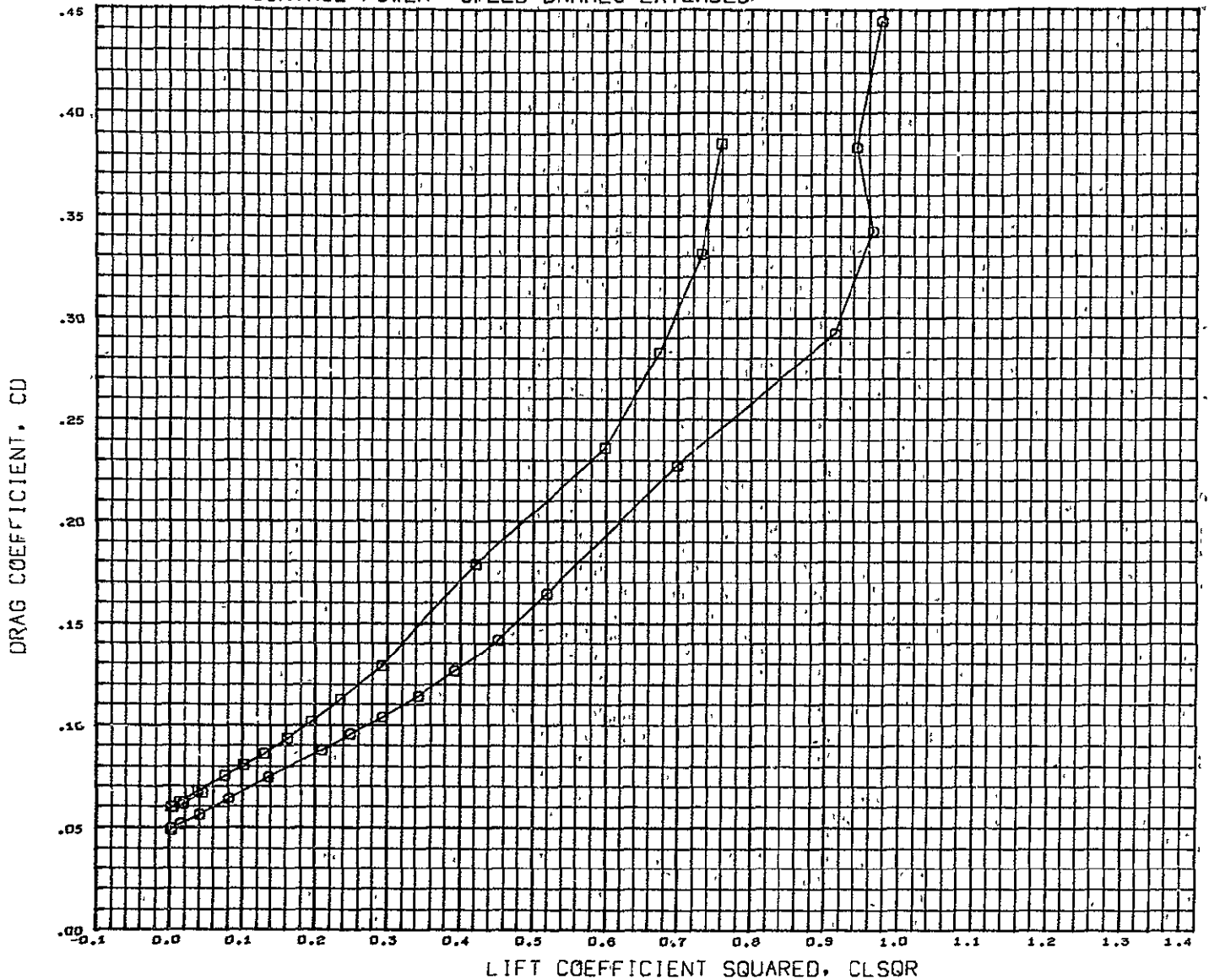

DATA SET SYMBOL	CONFIGURATION DESCRIPTION	BETA	ELEVTR	AILRON	SBPOS	REFERENCE INFORMATION	
(CCF050)	LSWT 248 HDAC 4.0 FC 02 HCR ORB	0.000	0.000	0.000	3.000	REFS	8 8690 SQ.FT
(CCF039)	LSWT 248 HDAC 4.0 FC 02 HCR ORB	0.000 - 10.000		0.000	3.000	REFL	29.5700 IN.
						REFB	51.6000 IN.
						XMRP	59.3200 IN.
						YMRP	0.0000 IN.
						ZMRP	11.6000 IN.
						SCALE	4.0000 PERCENT

MACH 0.250

LONGITUDINAL CONTROL POWER SPEED BRAKES EXTENDED

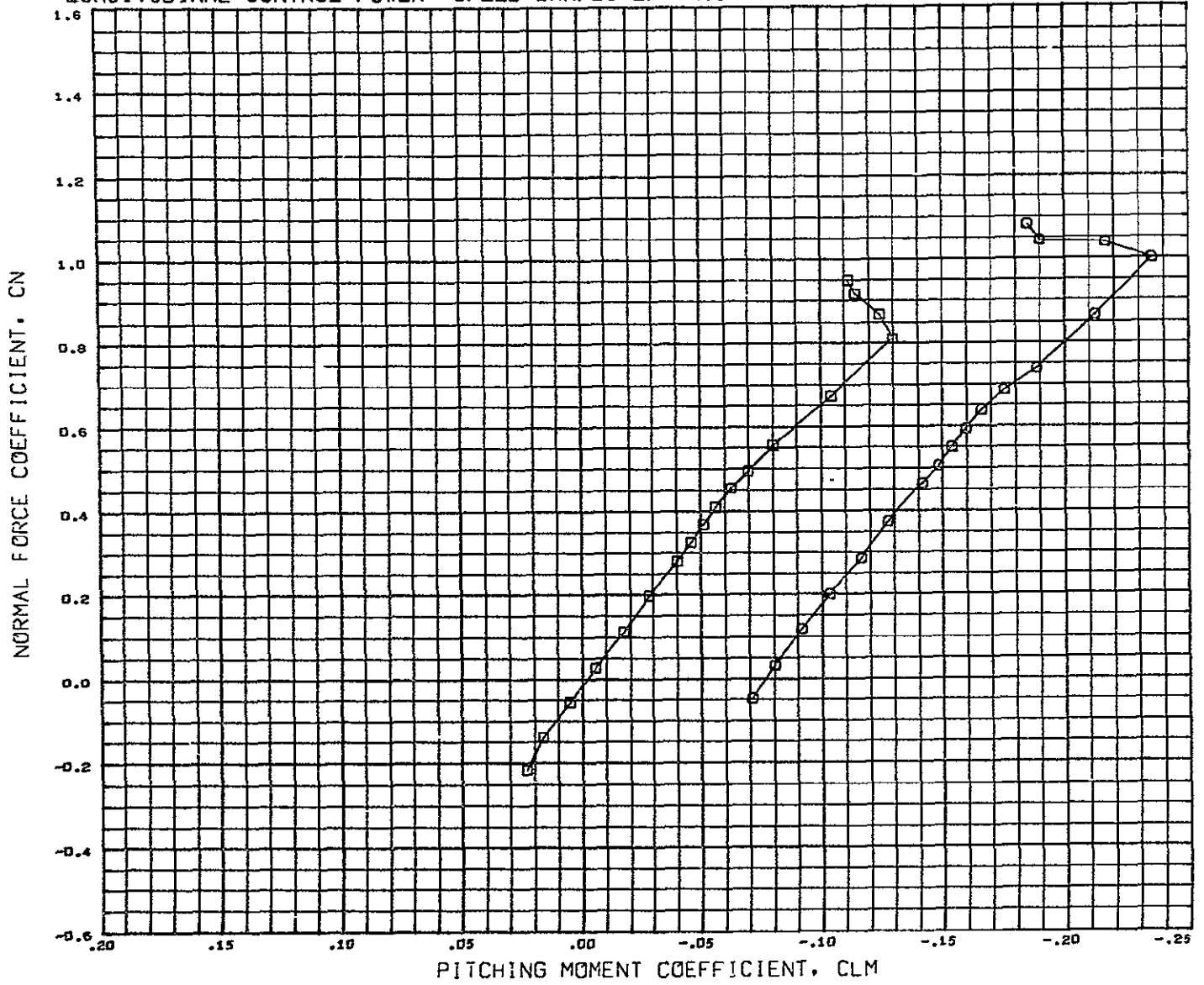

DATA SET SYMBOL	CONFIGURATION DESCRIPTION	BETA	ELEVTR	AILRON	SBPOS	REFERENCE INFORMATION	
(BCF050)	LSWT 248 HDAC 4.0 PC O2 HCR ORB	85W11SB2	0.000	0.000	0.000	3.000	REFS 8.8690 SQ.FT.
(BCF039)	LSWT 248 HDAC 4.0 PC O2 HCR ORB	85W11SB2	0.000	-10.000	0.000	3.000	REFL 29.5700 IN.
							REFB 51.6000 IN.
							XMRP 59.3200 IN.
							YMRP 0.0000 IN.
							ZMRP 11.6000 IN.
							SCALE 4.0000 PERCENT

MACH 0.250

# LONGITUDINAL CONTROL POWER SPEED BRAKES EXTENDED

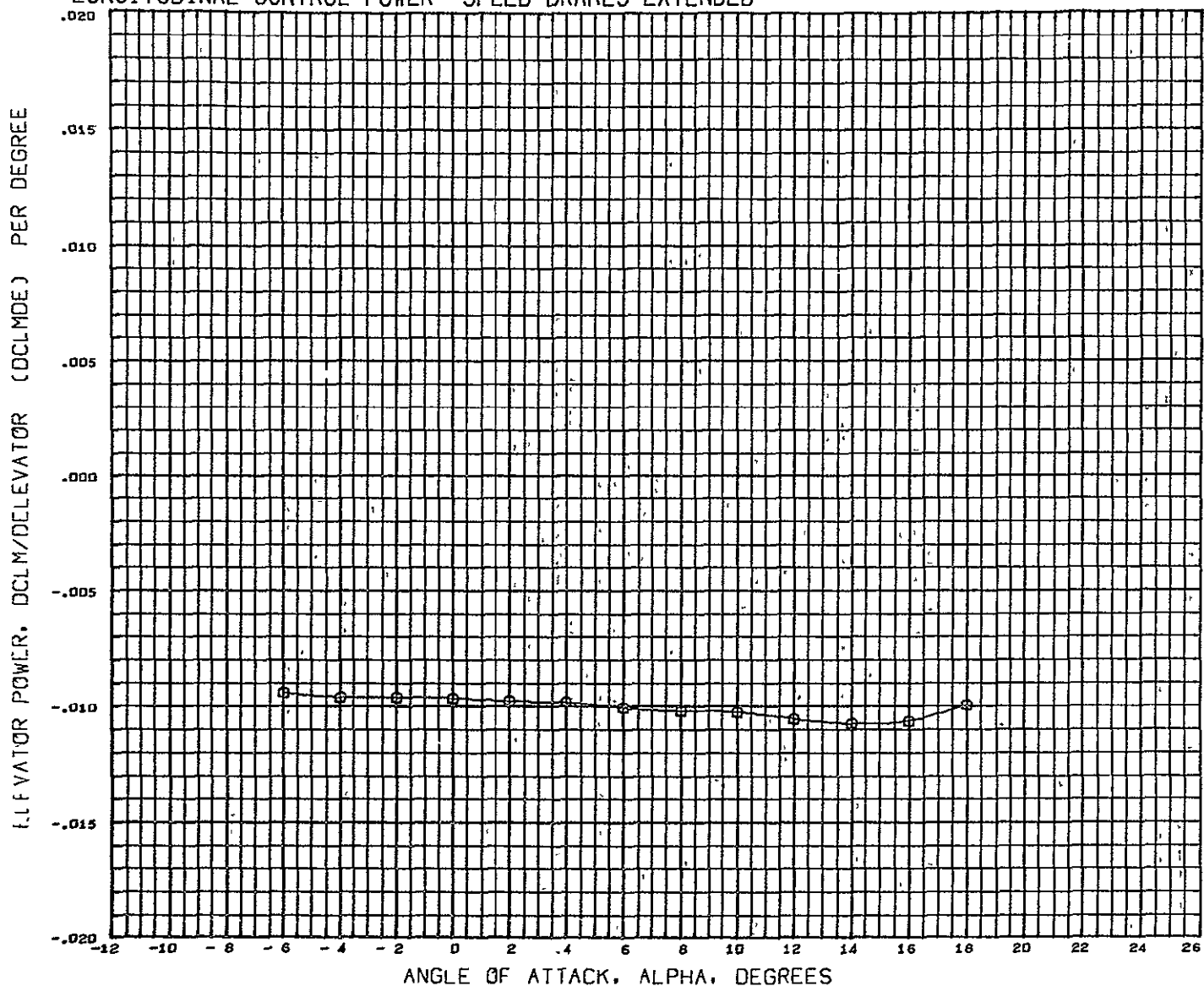

SYMBOL	MACH	PARAMETRIC VALUES			
0	0.260	BETA	0.000	ELEVTR	- 10.000
		AILRON	0.000	SPBRK	30.000
		BFLAF	15.000	SBFOS	3.000

REFERENCE INFORMATION		
REFS	8.8690	SQ.FT.
REFL	29.5700	IN.
REFB	51.6000	IN.
XMRP	59.3200	IN.
YMRP	0.0000	IN.
ZMRP	11.6000	IN.
SCALE	4.0000	PERCNT

DATA HIST. CODE #F

LONGITUDINAL CONTROL POWER SPEED BRAKES EXTENDED

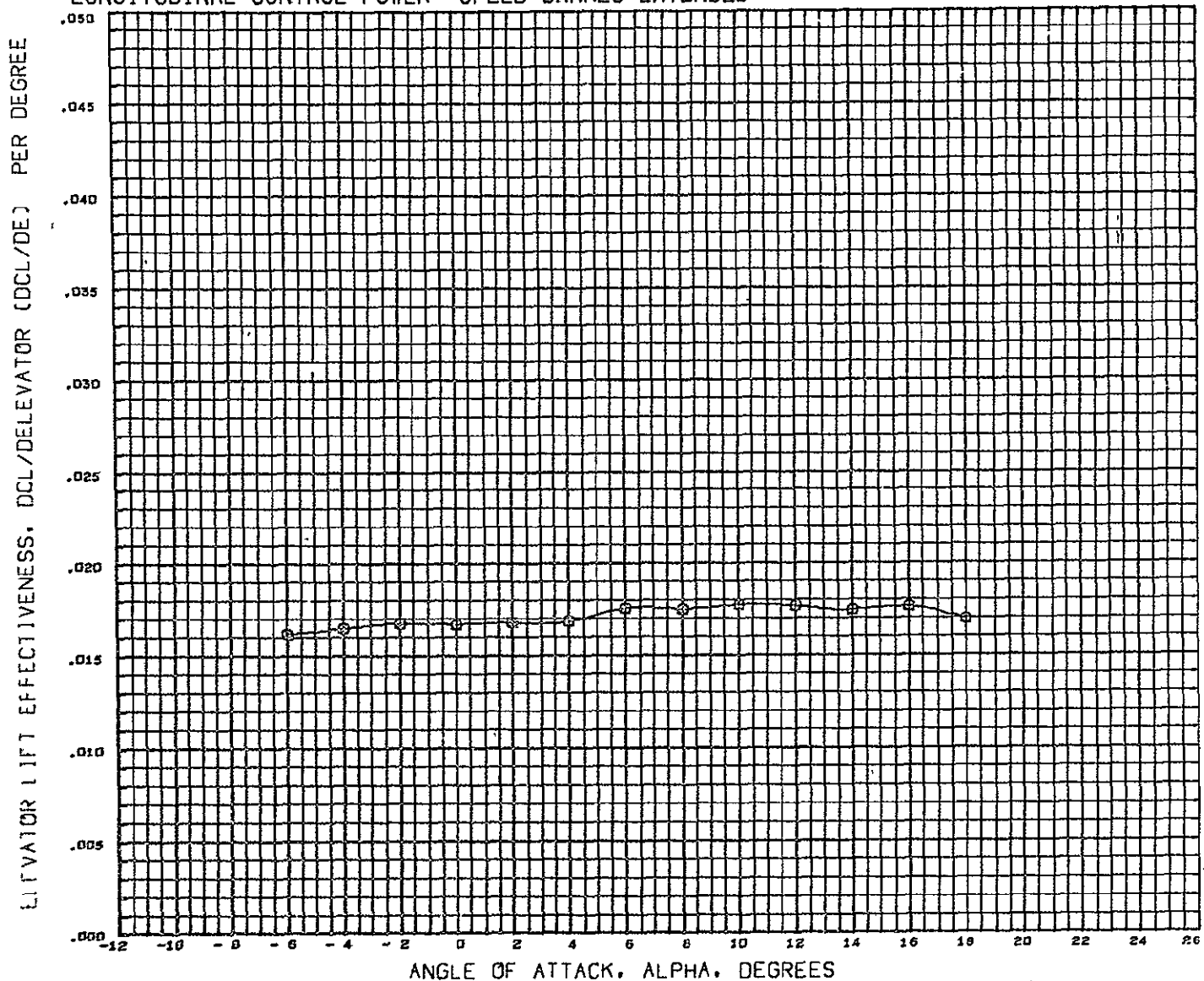

SYMBOL	MACH	PARAMETRIC VALUES			
Q	0.260	BETA	0.000	ELEVTR	- 10.000
		AILRON	0.000	SPBRK	30.000
		BFLAP	15.000	SBPOS	3.000

REFERENCE INFORMATION		
REFS	8.8890	Sq.FT
REFL	29.9700	IN.
REFB	51.6000	IN.
XMRP	59.3200	IN.
YMRP	0.0000	IN.
ZMRP	11.6000	IN.
SCALE	4.0000	PERCENT

DATA HIST. CODE #P

LONGITUDINAL CONTROL POWER SPEED BRAKES EXTENDED

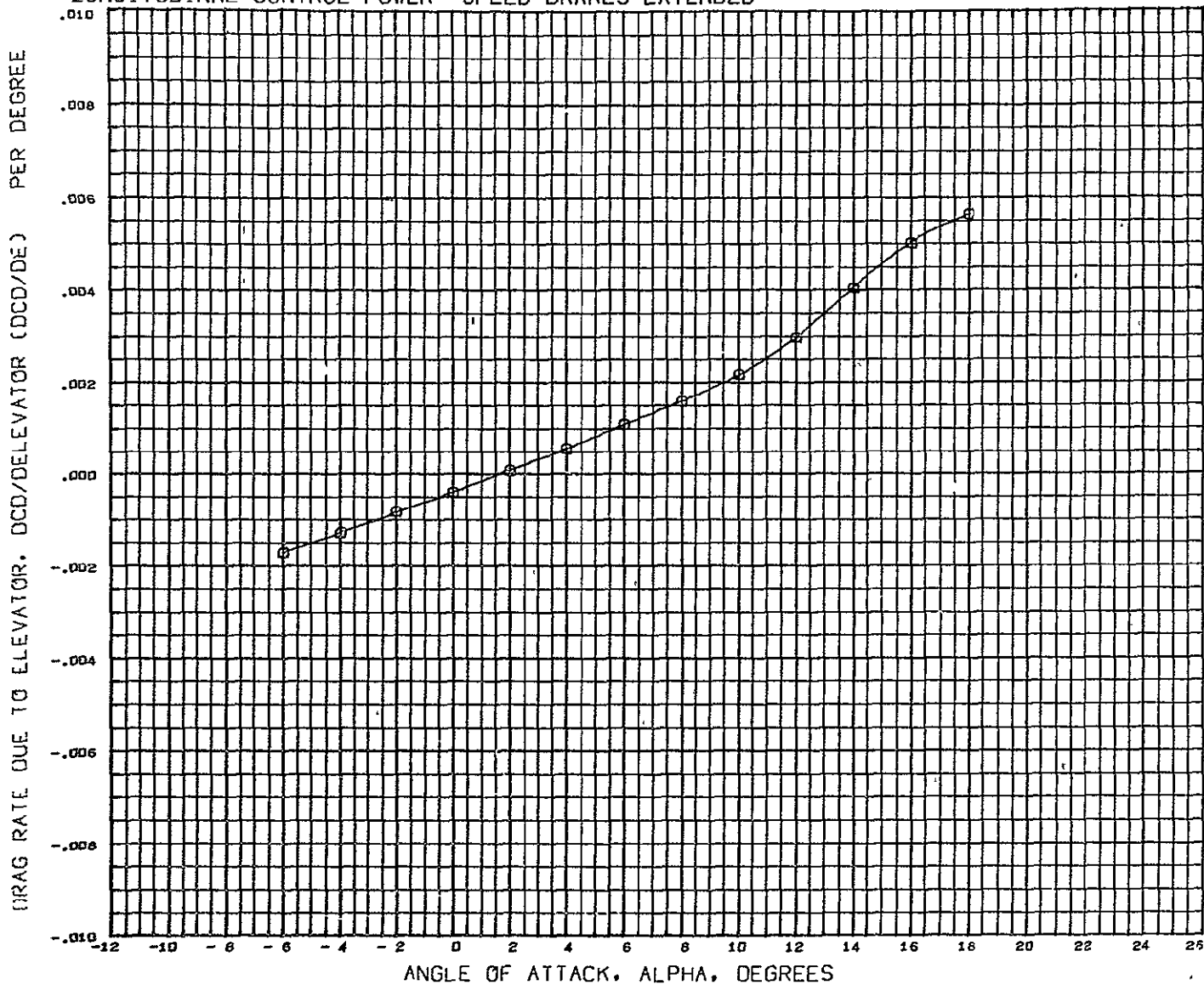

SYMBOL	HACH	PARAMETRIC VALUES				REFERENCE INFORMATION		
0	0.260	BETA	0.000	ELEVTR	- 10.000	REFS	8.8690	SQ FT.
		AILRON	0.000	SFBRK	30.000	REFL	29.5700	IN.
		BFLAF	15.000	SBPOS	3.000	REFB	51.6000	IN.
						XMRP	59.3200	IN.
						YMRP	0.0000	IN.
						ZMRP	11.6000	IN.
						SCALE	4.0000	PERCNT

DATA HIST. CODE #P



# EFFECT OF LANDING GEAR ON LATERAL-DIRECTIONAL STABILITY

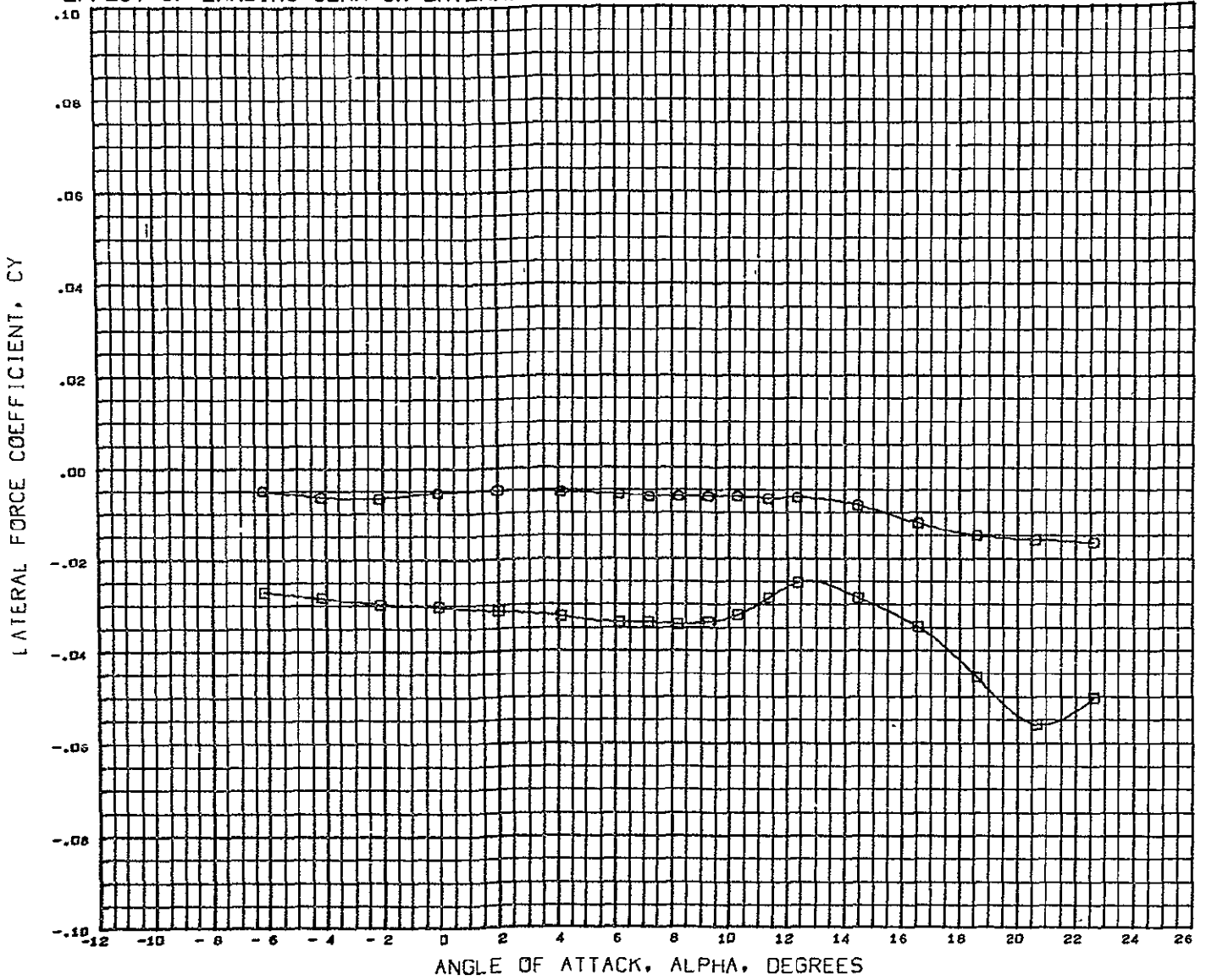

DATA SET SYMBOL	CONFIGURATION DESCRIPTION	BETA	ELEVTR	AILRON	REFERENCE INFORMATION
(BCPD53)	○ LSWT 248 MDAC 4.0 FC 02 HCR ORB B5W116	0.000 - 10.000	0.000	0.000	REFS 8.8690 SQ FT.
(BCPD54)	□ LSWT 248 MDAC 4.0 FC 02 HCR ORB B5W116	3.000 - 10.000	0.000	0.000	REFL 29.5700 IN.
					REFB 51.6000 IN.
					XMRP 59.3200 IN.
					YMRP 0.0000 IN.
					ZMRP 11.6000 IN.
					SCALE 4.0000 PERCNT

MACH 0.250

# EFFECT OF LANDING GEAR ON LATERAL-DIRECTIONAL STABILITY

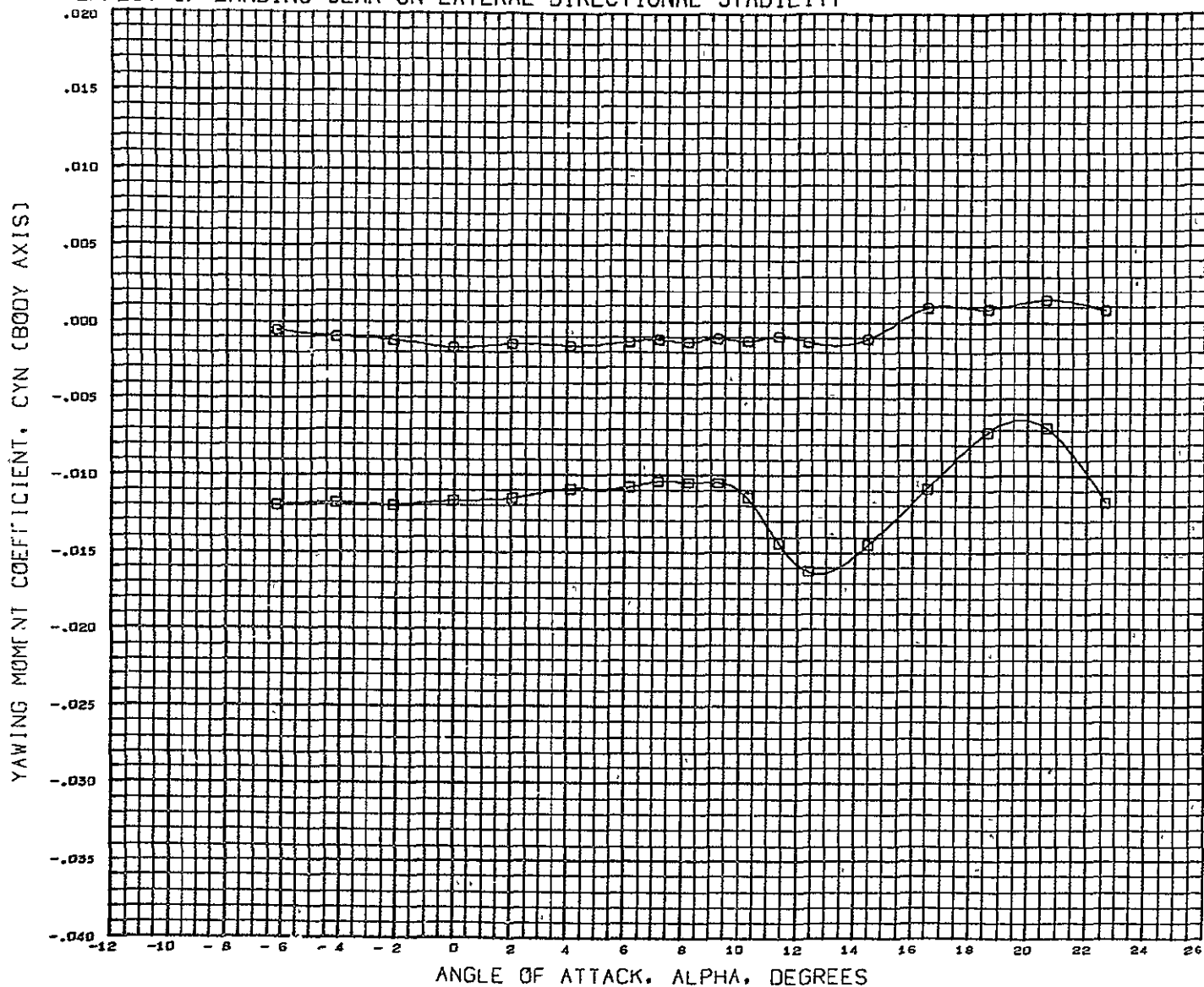

DATA SET SYMBOL	CONFIGURATION DESCRIPTION	BETA	ELEVTR	AILRON	REFERENCE INFORMATION
(BCPD53)	LSWT 248 MDAC 4.0 PC 02 HCR ORB B5W11G	0.000 - 10.000	0.000	0.000	REFS 8.8690 SQ.FT.
(BCPD54)	LSWT 248 MDAC 4.0 PC 02 HCR ORB B5W11G	3.000 - 10.000	0.000	0.000	REFL 29.5700 IN
					REFB 51.6000 IN
					XMRP 59.3200 IN.
					YMRP 0.0000 IN.
					ZMRP 11.6000 IN.
					SCALE 4.0000 PERCNT

MACH 0.250

# EFFECT OF LANDING GEAR ON LATERAL-DIRECTIONAL STABILITY

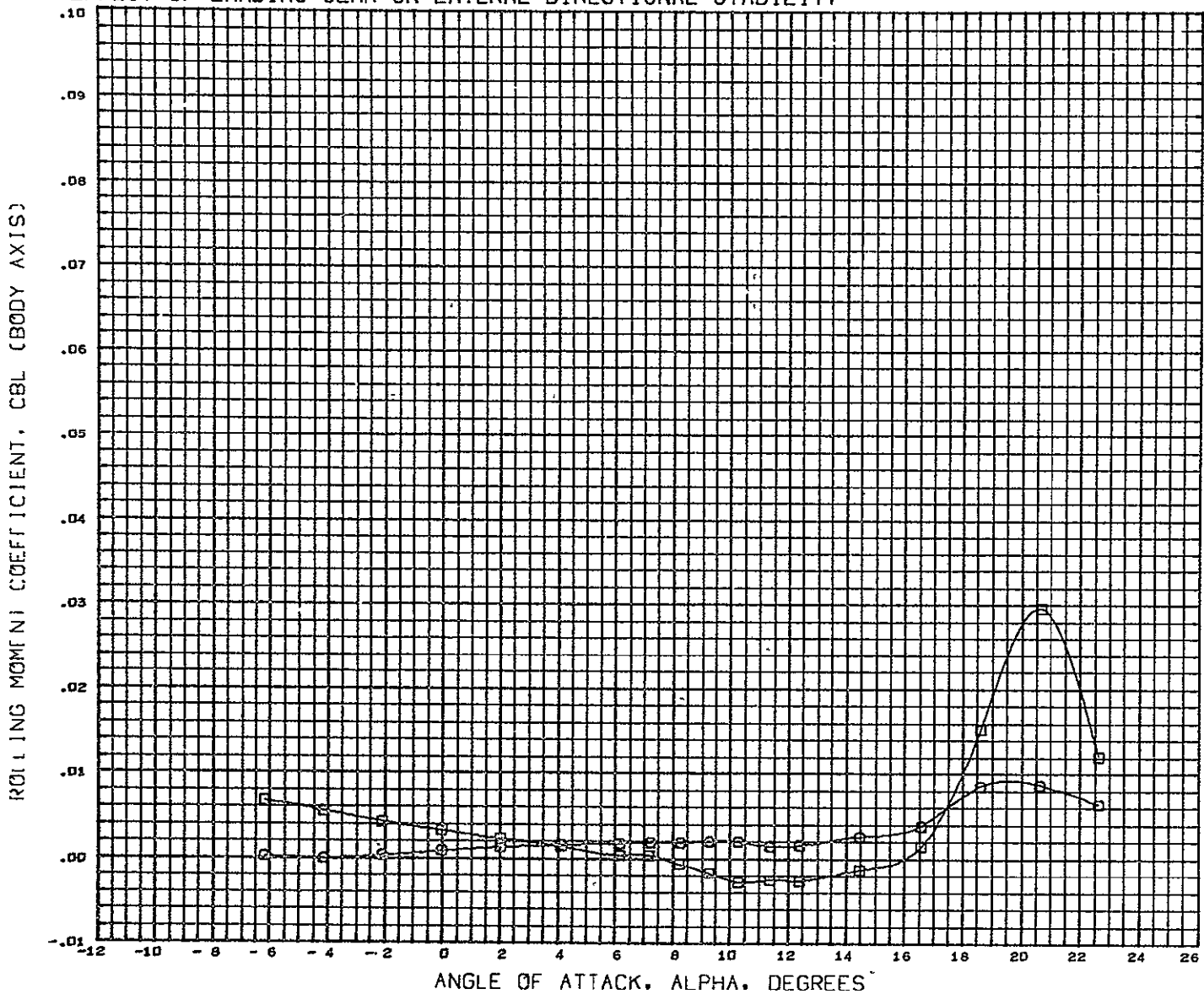

DATA SET SYMBOL CONFIGURATION DESCRIPTION

(BCP553) ○ LSWT 248 MDAC 4.0 FC 02 HCR ORB B5W11G

(BCP554) □ LSWT 248 MDAC 4.0 FC 02 HCR ORB B5W11G

BETA ELEVTR AILRON  
 0.000 - 10.000 0.000  
 3.000 - 10.000 0.000

REFERENCE INFORMATION

REFS 8.8690 SQ FT.  
 REFL 29.5700 IN.  
 REFB 51.6000 IN.  
 XMRP 59.3200 IN.  
 YMRP 0.0000 IN.  
 ZMRP 11.6000 IN.  
 SCALE 4.0000 PERCNT

MACH 0.250



# EFFECT OF LANDING GEAR ON LATERAL-DIRECTIONAL STABILITY

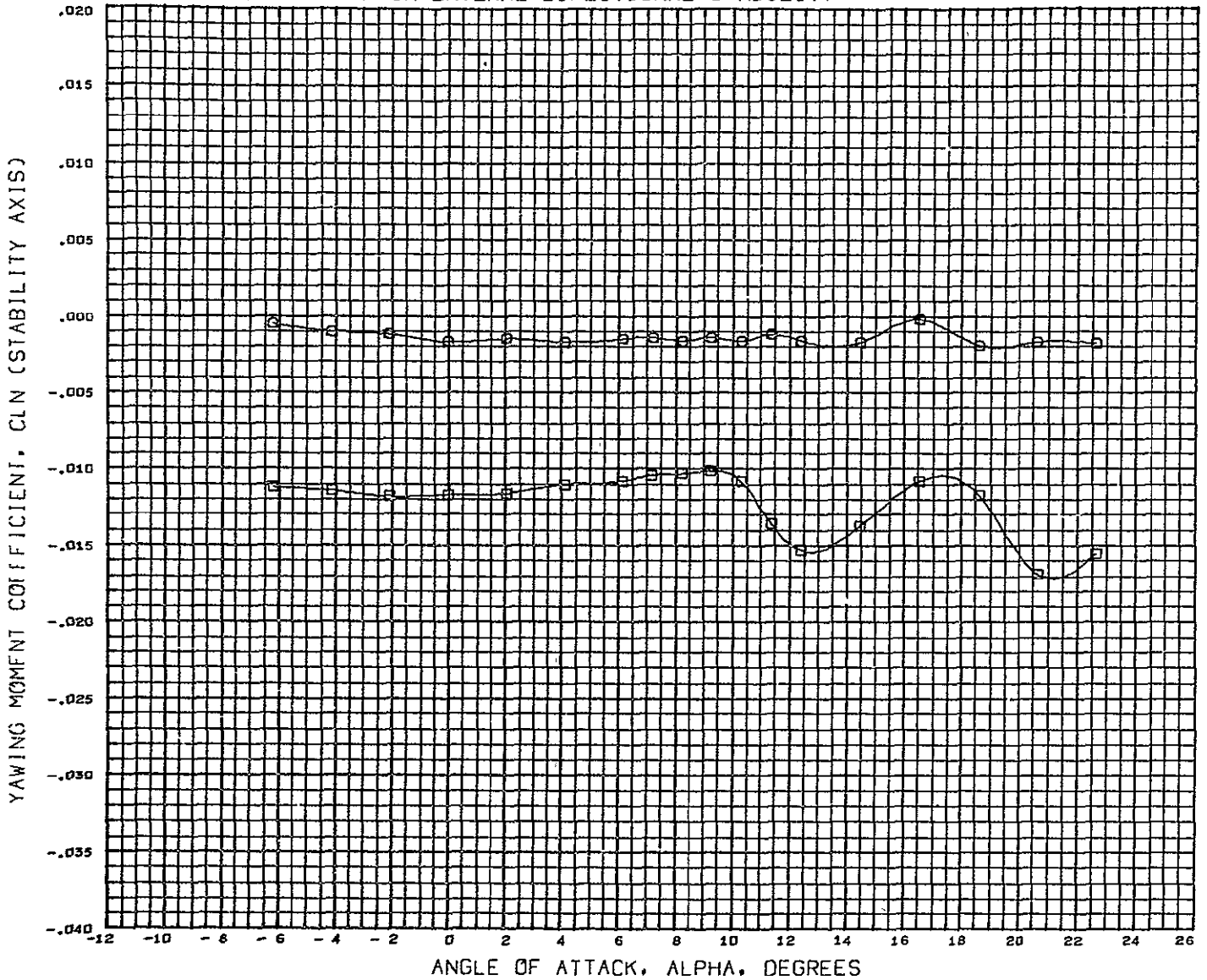

DATA SET SYMBOL	CONFIGURATION DESCRIPTION	BETA	ELEVTR	AILRON	REFERENCE INFORMATION
(PCP053)	□ LSWT 248 MDAC 4.0 FC 02 HCR ORB B5W11G	0.000 - 10.000	0.000	0.000	REFS 8 8690 SQ.FT.
(PCP054)	□ LSWT 248 MDAC 4.0 FC 02 HCR ORB B5W11G	3.000 - 10.000	0.000	0.000	PEFL 29.5700 IN.
					REFB 51.6000 IN.
					XMRP 59.3200 IN.
					YMRP 0.0000 IN.
					ZMRP 11 6000 IN.
					SCALE 4 0000 PERCENT

MACH 0.250

# EFFECT OF LANDING GEAR ON LATERAL-DIRECTIONAL STABILITY

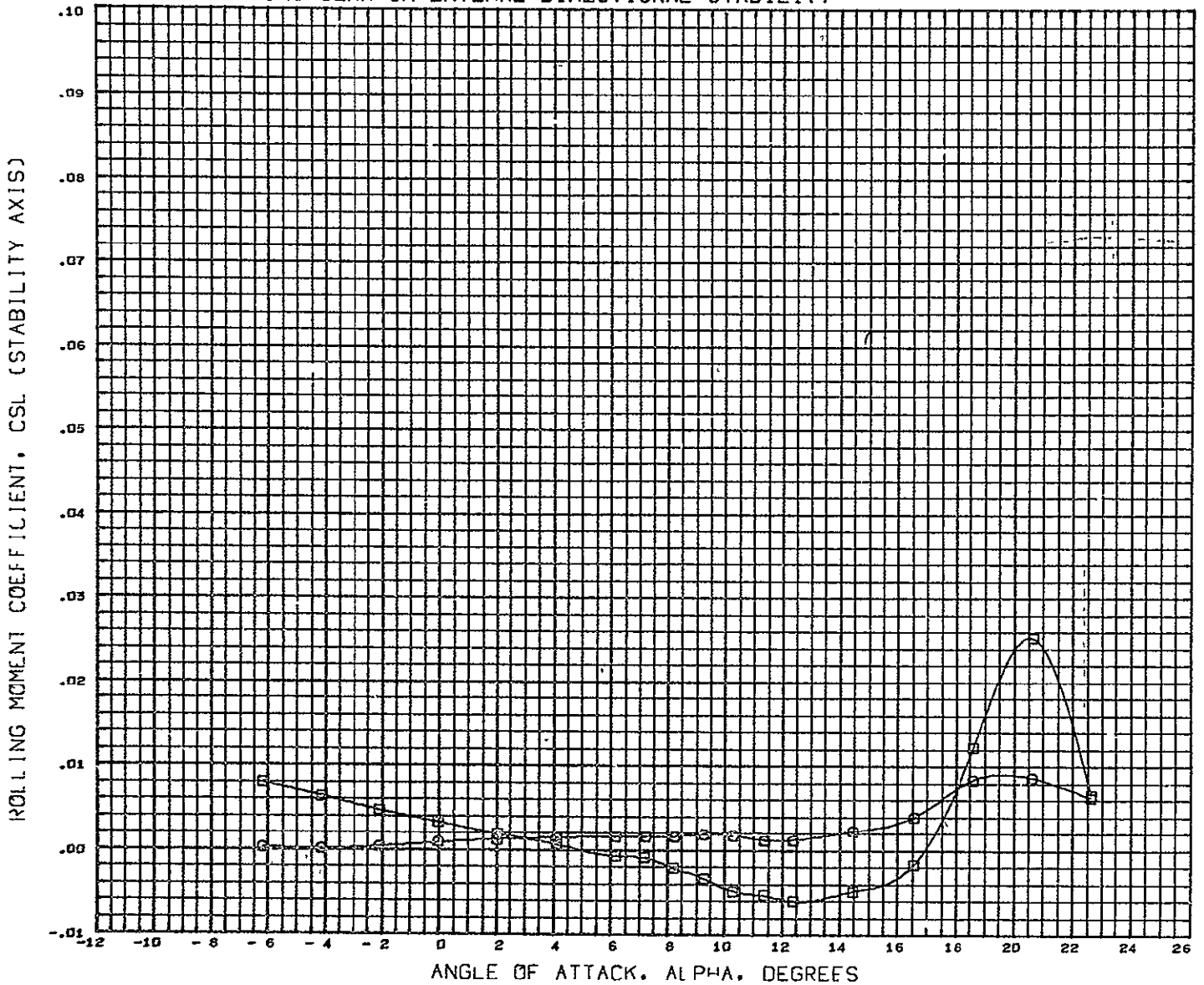

DATA SET SYMBOL	CONFIGURATION DESCRIPTION	BETA	ELEVTR	AILRON	REFERENCE INFORMATION	
(RCP053)	○ LSWT 248 MDAC 4.0 FC 02 HCR ORB	0.000 - 10.000	0.000	0.000	REFS	8.8690 SQ.FT
(RCP054)	□ LSWT 248 MDAC 4.0 FC 02 HCR ORB	3.000 - 10.000	0.000	0.000	REFL	29.5700 IN
					REFB	51.6000 IN
					XMRP	59.3200 IN
					YMRP	0.0000 IN
					ZMRP	11.6000 IN
					SCALE	4.0000 PERCNT

MACH 0.250

5

# EFFECT OF LANDING GEAR ON LATERAL-DIRECTIONAL STABILITY

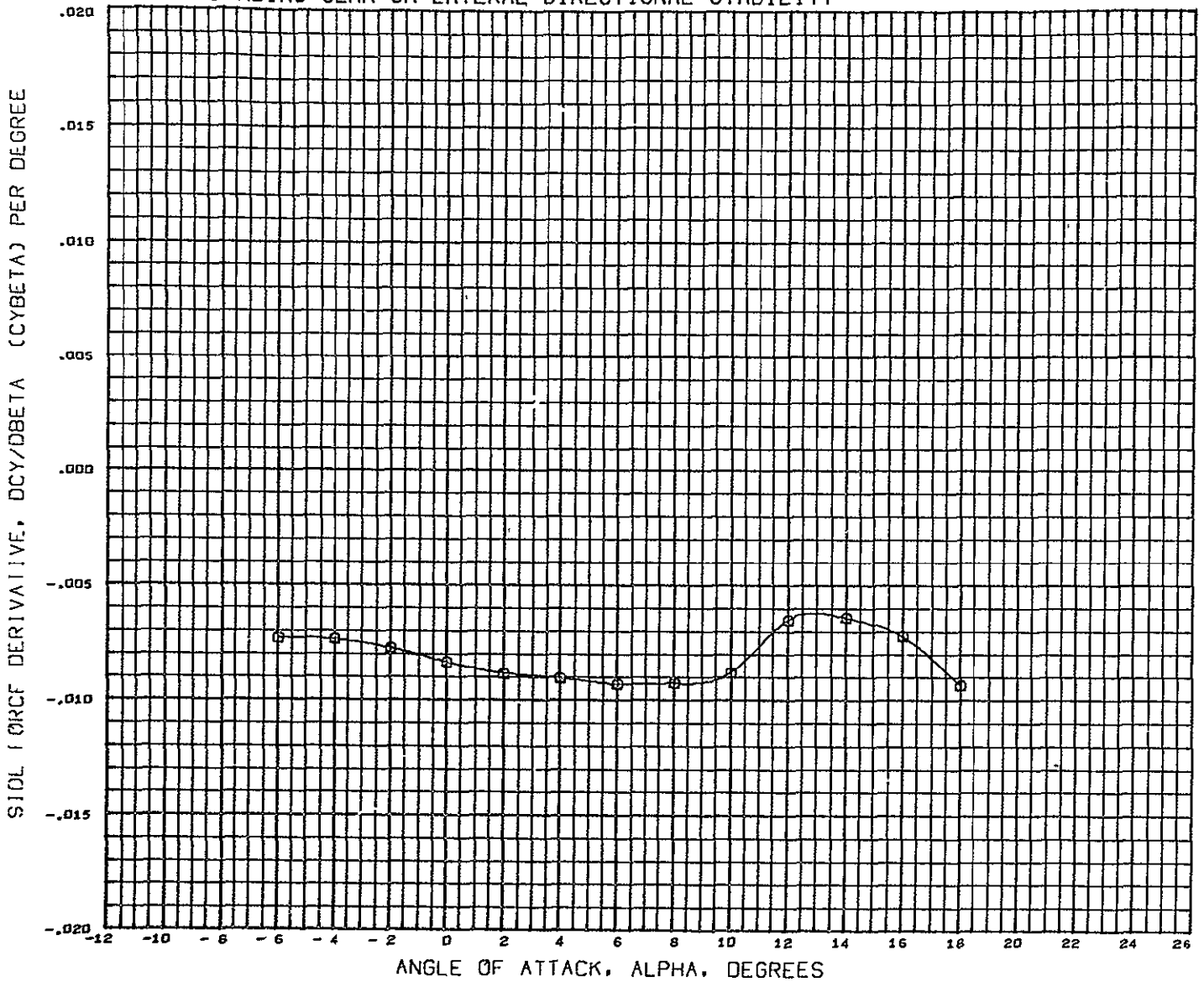

SYMBOL MACH PARAMETRIC VALUES  
 O 0.260 ELEVTR - 10.000 AILRON 0.000  
 SFBRK 0.000 BFLAP 0.000

REFERENCE INFORMATION  
 REFS 8.8690 SQ.FT.  
 REFL 29.5700 IN.  
 REFB 51.6000 IN.  
 XMRP 59.3200 IN.  
 YMRP 0.0000 IN.  
 ZMRP 11.6000 IN.  
 SCALE 4.0000 PERCENT

DATA HIST. CODE M#EV#EI#CV

LSW 248 MDAC 4.0 PC 02 HCR 0RB

B5W11G

(DCP054) 26 FEB 71

PAGE 154

EFFECT OF LANDING GEAR ON LATERAL-DIRECTIONAL STABILITY

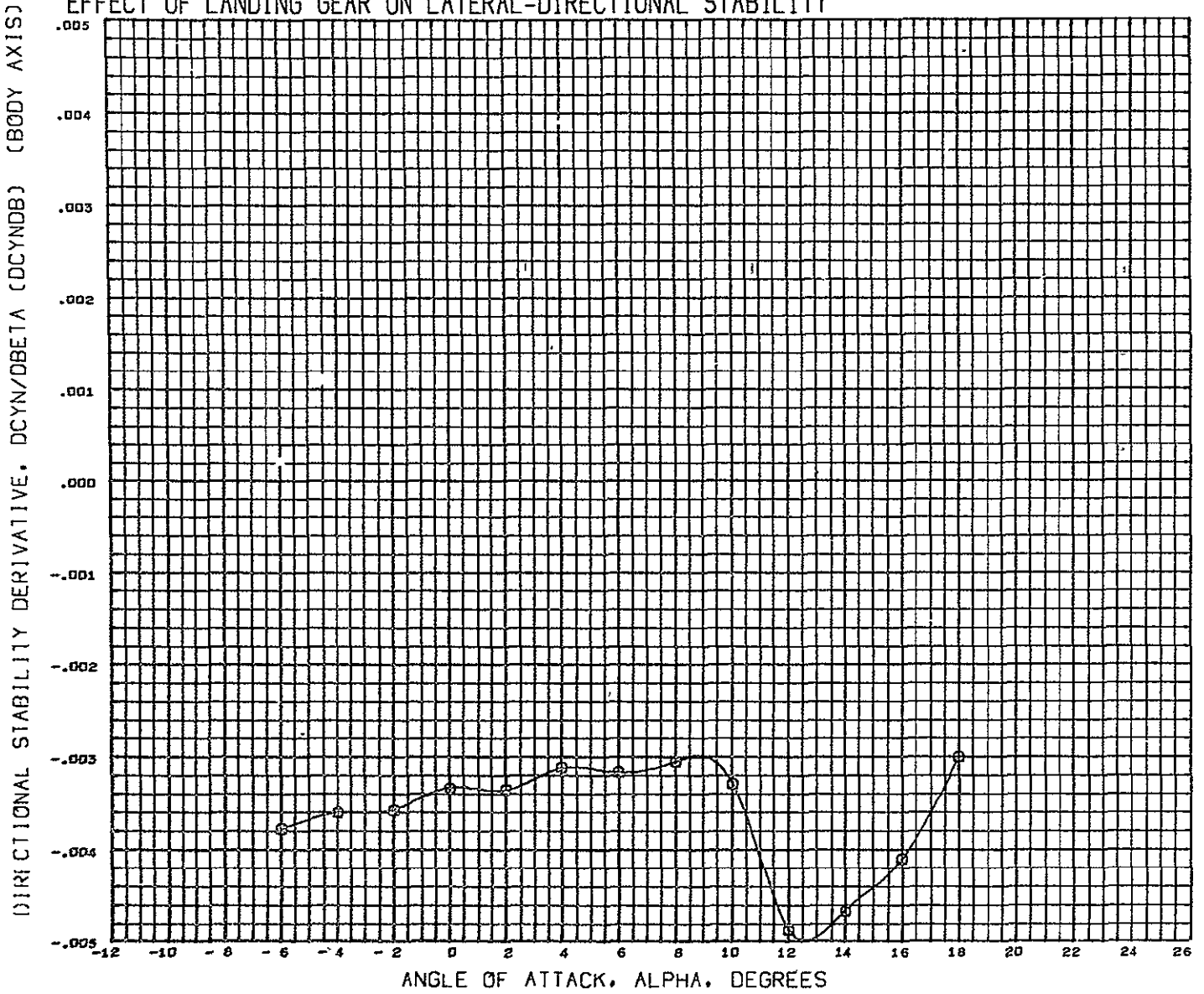

SYMBOL	MACH	PARAMETRIC VALUES			
0	0.260	ELEVTR	-10.000	AILRON	0.000
		SFBPK	0.000	BFLAP	0.000

REFERENCE INFORMATION		
REFS	8.8690	SQ FT.
REFL	29.5700	IN.
REFB	51.6000	IN.
XMRP	59.3200	IN.
YMRP	0.0000	IN.
ZMRP	11.6000	IN.
SCALE	4.0000	PERCENT

DATA HIST. CODE M#EV#E1#CV

# EFFECT OF LANDING GEAR ON LATERAL-DIRECTIONAL STABILITY

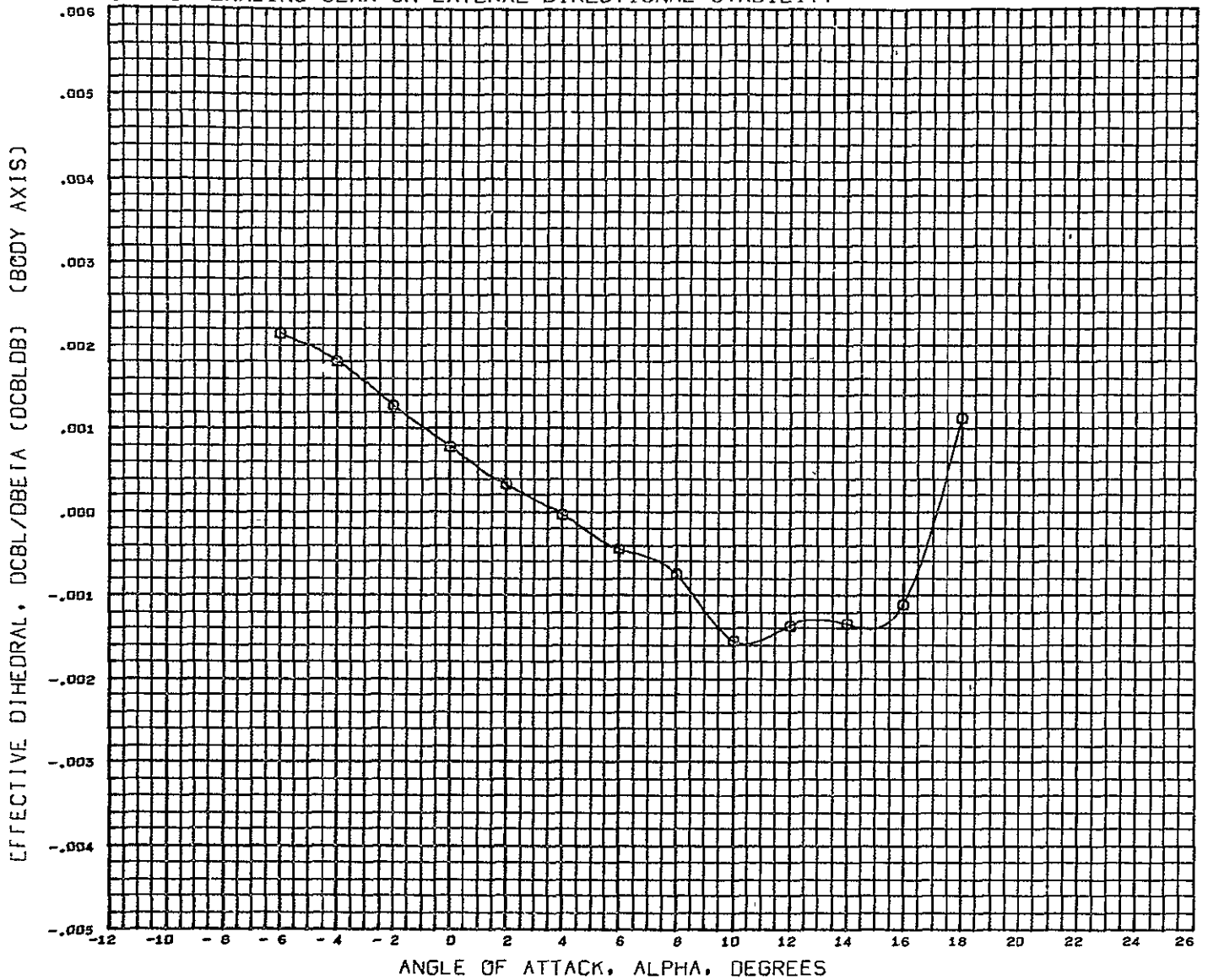

SYMBOL		MACH	PARAMETRIC VALUES			REFERENCE INFORMATION			
○		0.260	ELEVTR	-10.000	AILRON	0.000	REFS	8.8690	SQ FT
			SPBRK	0.000	BFLAP	0.000	REFL	29.5700	IN.
							REFB	51.6000	IN.
							XMRP	59.3200	IN.
							YMRP	0.0000	IN.
							ZMRP	11.6000	IN.
							SCALE	4.0000	PERCNT

DATA HIST. CODE M#EV#EI#CV



# EFFECT OF LANDING GEAR ON LATERAL-DIRECTIONAL STABILITY

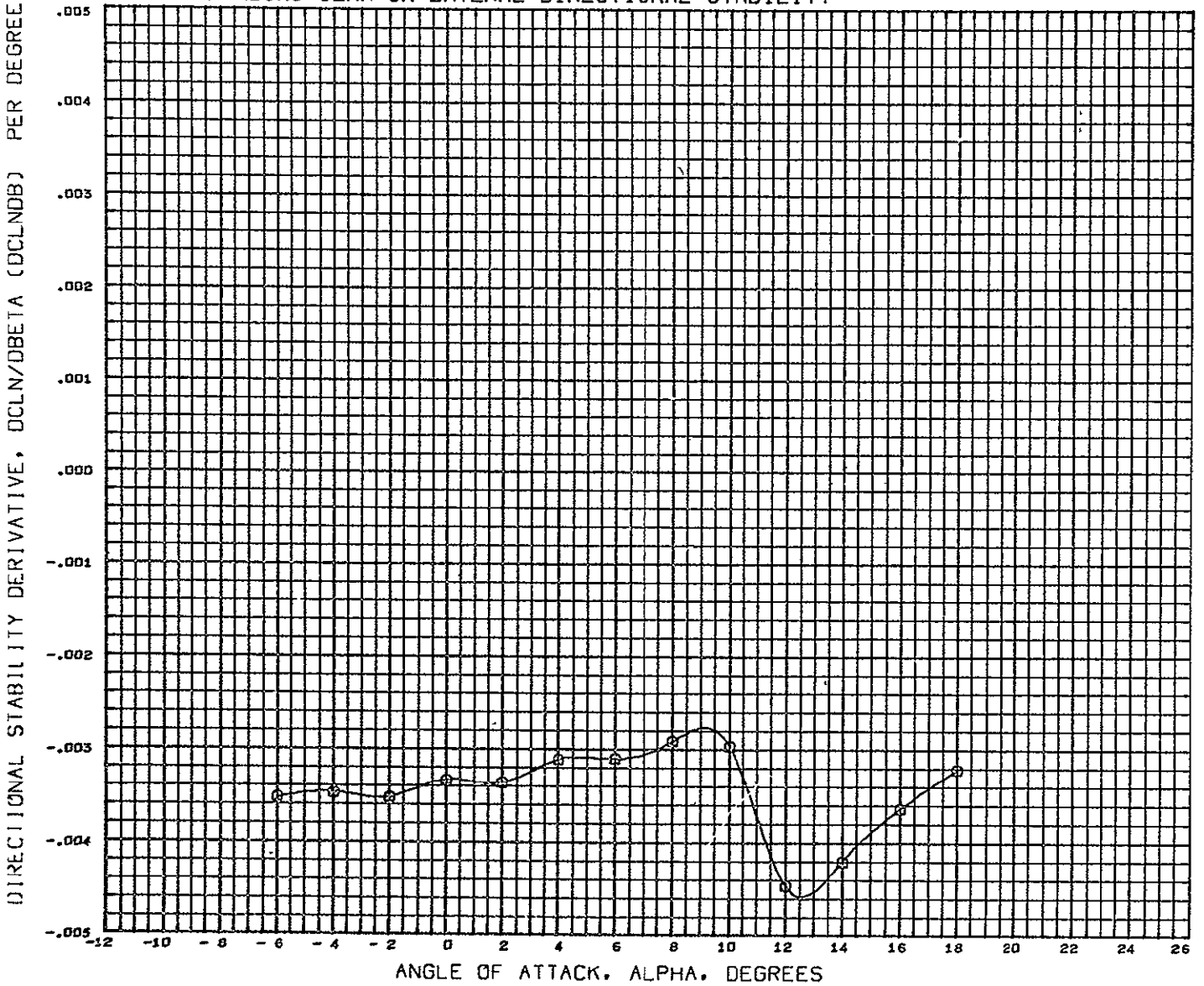

SYMBOL	MACH	PARAMETRIC VALUES			
○	0.26J	ELEVTR	- 10.000	AILRON	0.000
		SPBRK	0.000	BFLAP	0.000

REFERENCE INFORMATION		
REFS	8.8690	SQ.FT
REFL	29.5700	IN.
REFB	51.6000	IN.
XMRP	59.3200	IN.
YMRP	0.0000	IN.
ZMRP	11.6000	IN.
SCALE	4.0000	PERCENT

DATA HIST. CODE H#EVI#CV

EFFECT OF LANDING GEAR ON LATERAL-DIRECTIONAL STABILITY

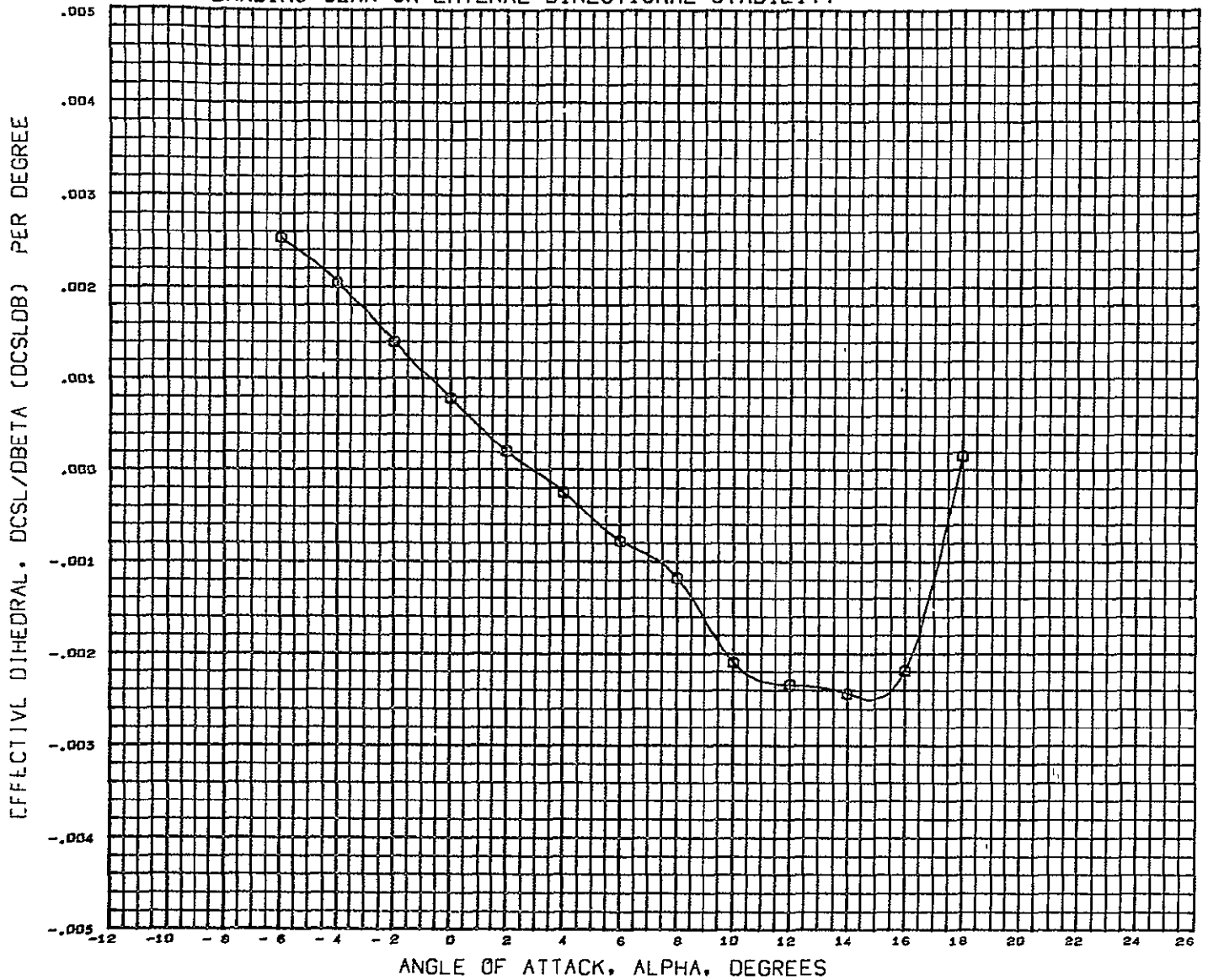

SYMBOL MACH PARAMETRIC VALUES  
 ○ 0.260 ELEVTR -10.000 AILRON 0.000  
 SPBRK 0.000 BFLAP 0.000

REFERENCE INFORMATION  
 REFS 8.8690 SQ. FT.  
 REFL 29.5700 IN.  
 REFB 51.6000 IN.  
 XMRP 59.3200 IN.  
 YMRP 0.0000 IN.  
 ZMRP 11.6000 IN.  
 SCALE 4.0000 PERCENT

DATA HIST. CODE M#EVI#CV

# LATERAL CONTROL POWER BASIC CONFIGURATION

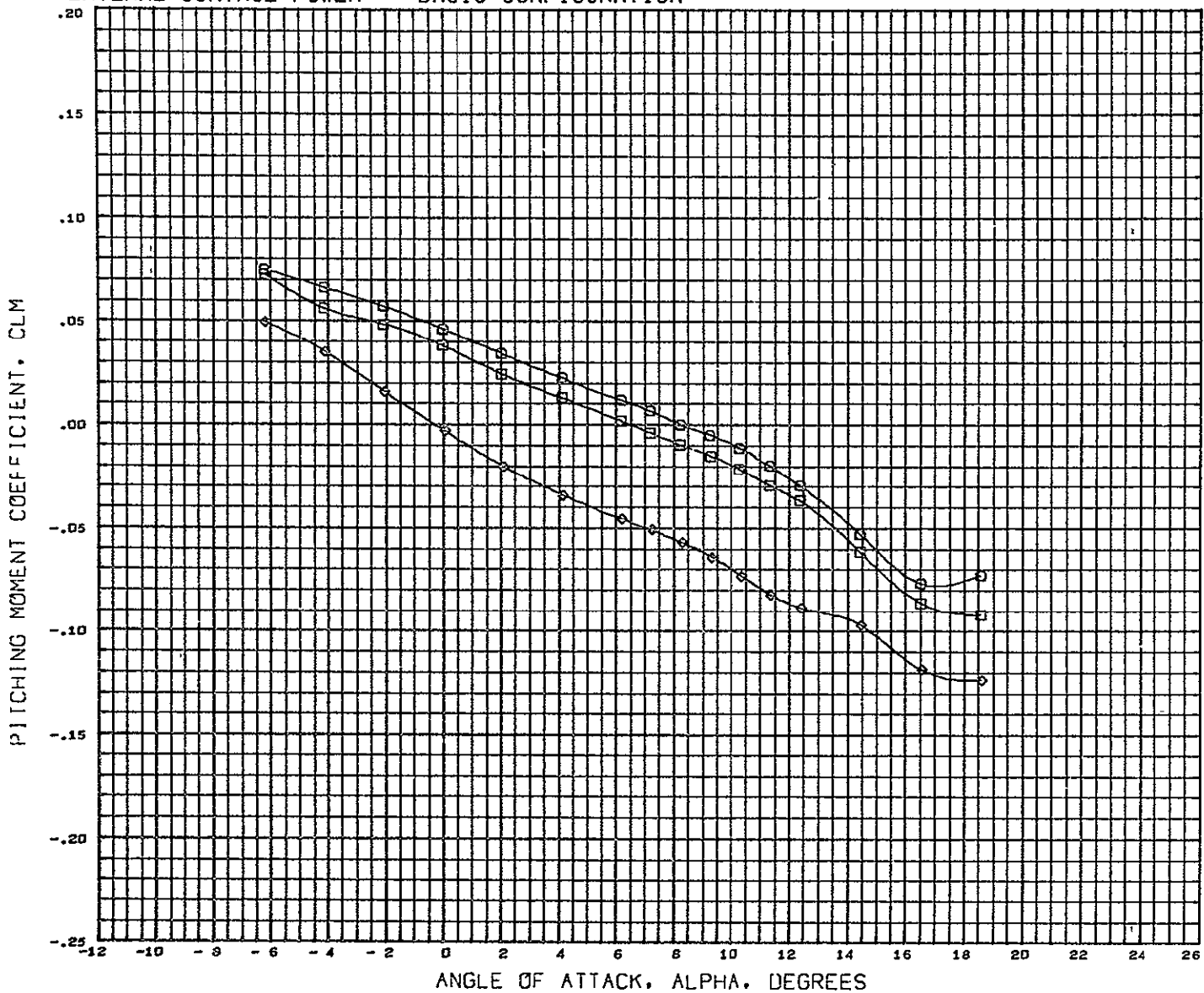

DATA SET SYMBOL	CONFIGURATION DESCRIPTION	BETA	ELEVTR	AILRON	REFERENCE INFORMATION
(CCPD12)	LSWT 248 MDAC 4.0 FC 02 HCR ORB B5W11V6	0.000 - 10.000	0.000		REFS 8 8690 SQ FT.
(CCPD03)	LSWT 248 MDAC 4.0 FC 02 HCR ORB B5W11V6	0.000 - 10.000	10.000		REFL 29.5700 IN.
(CCPD22)	LSWT 248 MDAC 4.0 FC 02 HCR ORB B5W11V6	0.000 - 10.000	20.000		REFB 51.6000 IN.
					XMRP 59 3200 IN.
					YMRP 0.0000 IN.
					ZMRP 11.6000 IN.
					SCALE 4.0000 PERCNT

HACH 0.250

# LATERAL CONTROL POWER BASIC CONFIGURATION

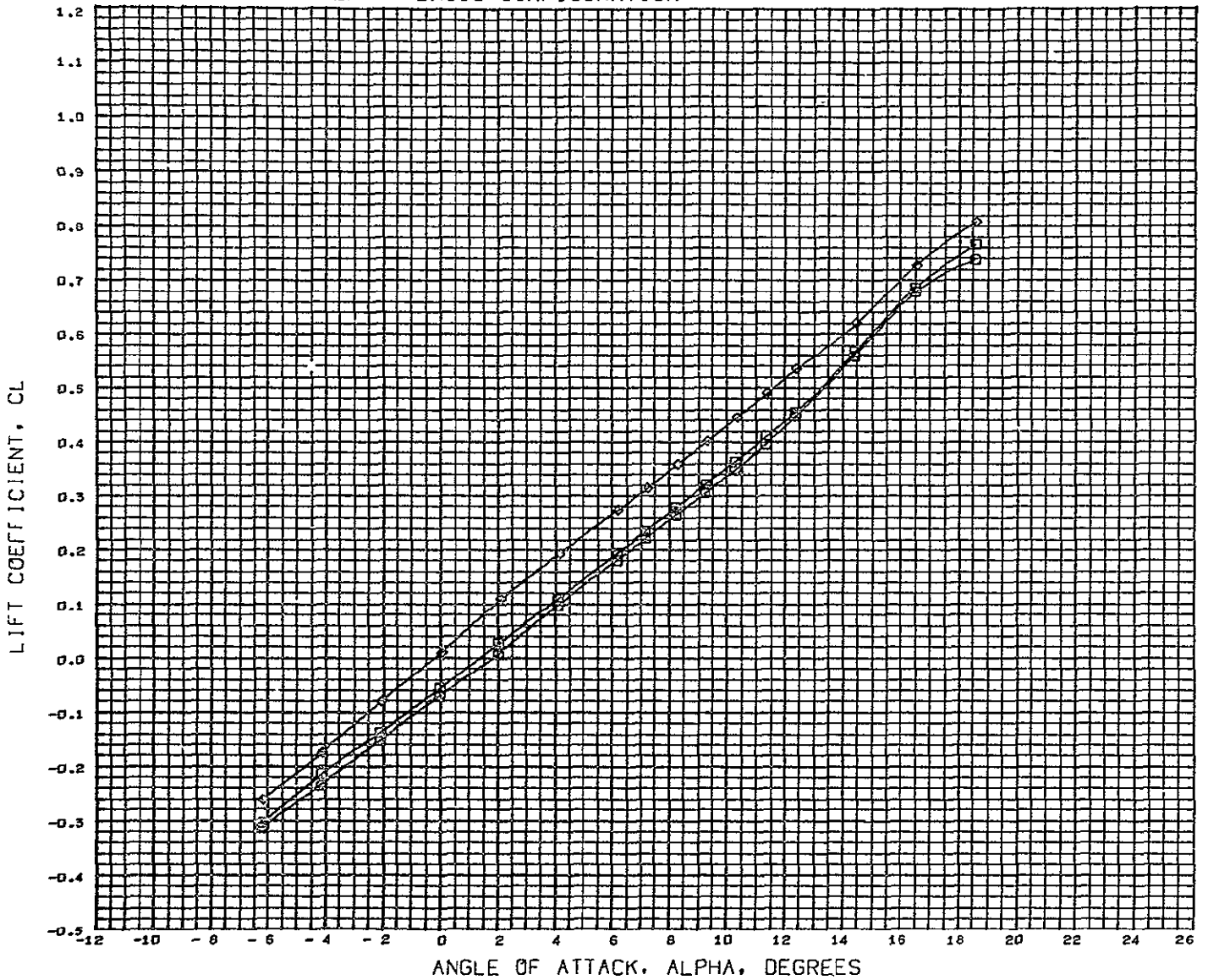

DATA SET SYMBOL - CONFIGURATION DESCRIPTION

(CCFD12)	○	LSWT 248 MDAC 4.0 FC O2 HCR ORB	B5W11V6
(CCFD03)	□	LSWT 248 MDAC 4.0 FC O2 HCR ORB	B5W11V6
(CCFD22)	◇	LSWT 248 MDAC 4.0 FC O2 HCR ORB	B5W11V6

BETA ELEVTR AILRON

0.000 - 10.000	0.000	
0.000 - 10.000	10.000	
0.000 - 10.000	20.000	

REFERENCE INFORMATION

REFS	8 8690	SG.FT.
REFL	29 5700	IN.
REFB	51.6000	IN.
XNRF	59.3200	IN.
YNRF	0 0000	IN.
ZNRF	11.6000	IN.
SCALE	4.0000	PERCNT

MACH 0.250

# LATERAL CONTROL POWER BASIC CONFIGURATION

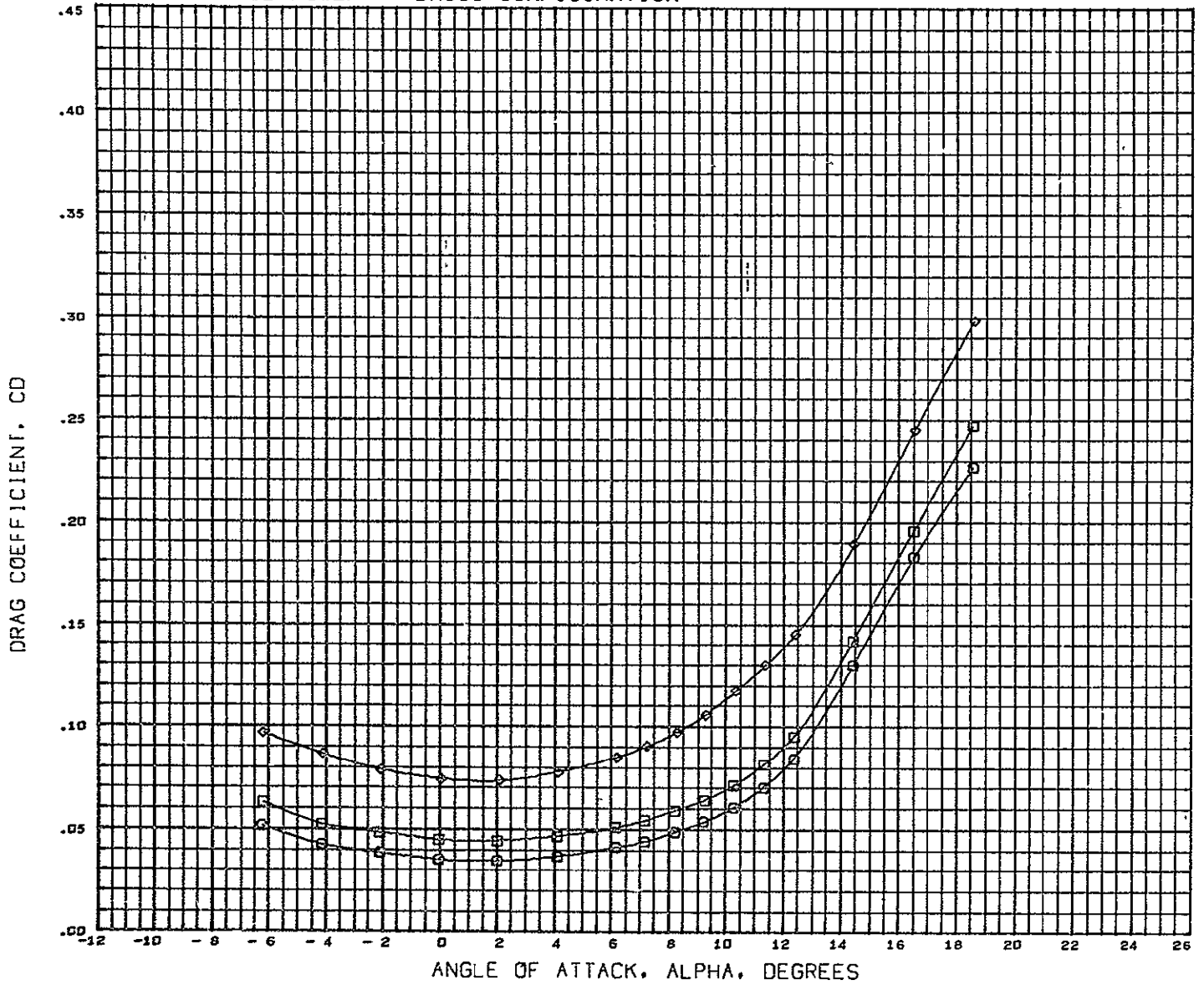

DATA SET SYMBOL	CONFIGURATION DESCRIPTION	BETA	ELEVTR	AILRON	REFERENCE INFORMATION
(CCP012)	LSWT 248 MDAC 4.0 PC 02 HCR ORB 85W11V6	0.000 - 10.000	0.000	0.000	REFS 8.8690 SQ.FT.
(CCP003)	LSWT 248 MDAC 4.0 PC 02 HCR ORB 85W11V6	0.000 - 10.000	10.000	0.000	REFL 29.5700 IN.
(CCP022)	LSWT 248 MDAC 4.0 PC 02 HCR ORB 85W11V6	0.000 - 10.000	20.000	0.000	REFB 51.6000 IN.
					XMRP 59.3200 IN.
					YMRP 0.0000 IN.
					ZMRP 11.6000 IN.
					SCALE 4.0000 PERCNT

MACH 0.250

LATERAL CONTROL POWER BASIC CONFIGURATION

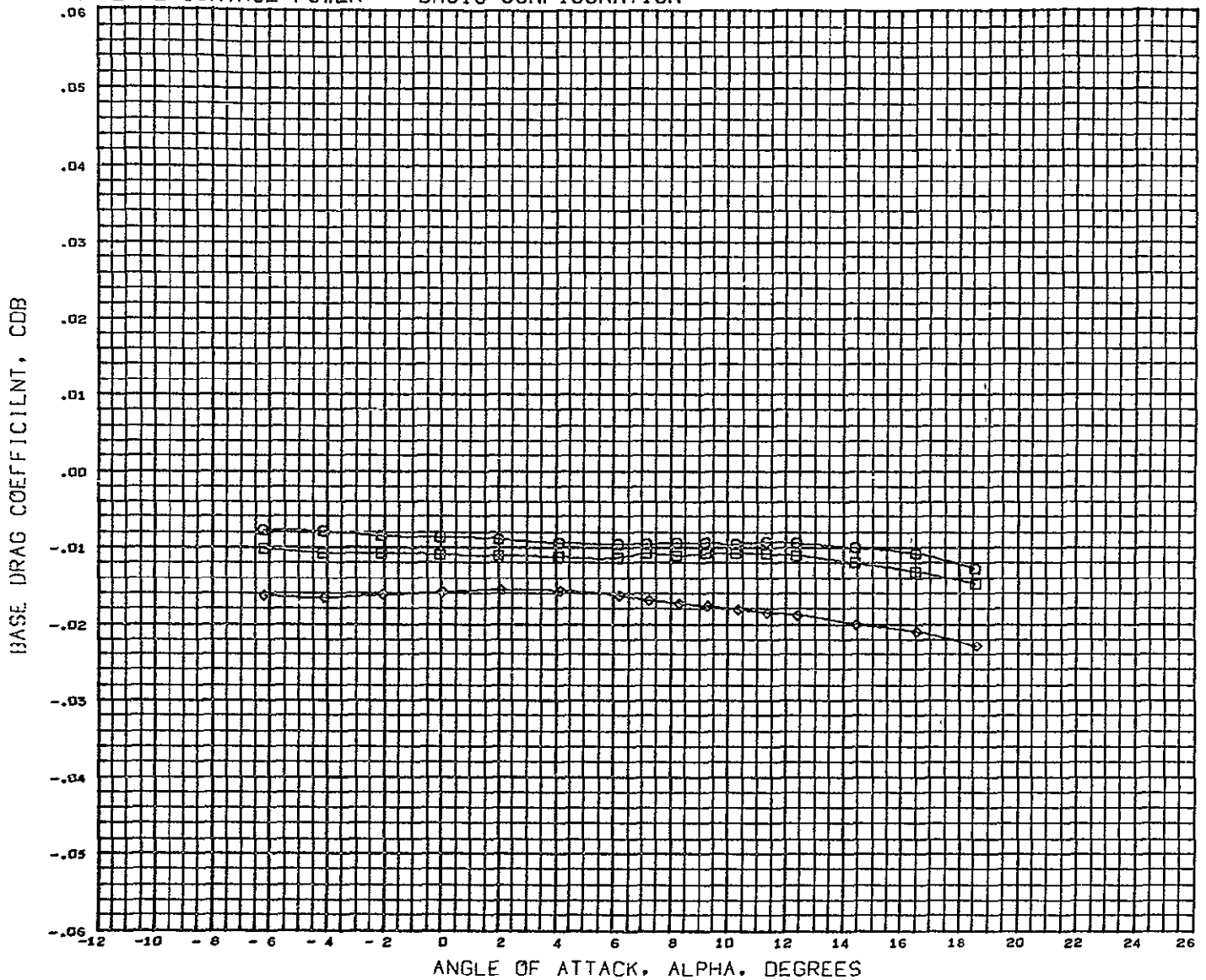

DATA SET SYMBOL	CONFIGURATION DESCRIPTION	BETA	ELEVTR	AILRON	REFERENCE INFORMATION
(CCF012)	LSWT 248 MDAC 4.0 FC 02 HCR ORB	0.000 - 10.000	0.000		REFS 8.8690 SQ.FT
(CCF003)	LSWT 248 MDAC 4.0 FC 02 HCR ORB	0.000 - 10.000	10.000		REFL 29.5700 IN.
(CCF022)	LSWT 248 MDAC 4.0 FC 02 HCR ORB	0.000 - 10.000	20.000		REFB 51.6000 IN.
					XNRP 59.3200 IN.
					YNRP 0.0000 IN.
					ZNRP 11.6000 IN.
					SCALE 4.0000 PERCENT

HACH 0.250

# LATERAL CONTROL POWER BASIC CONFIGURATION

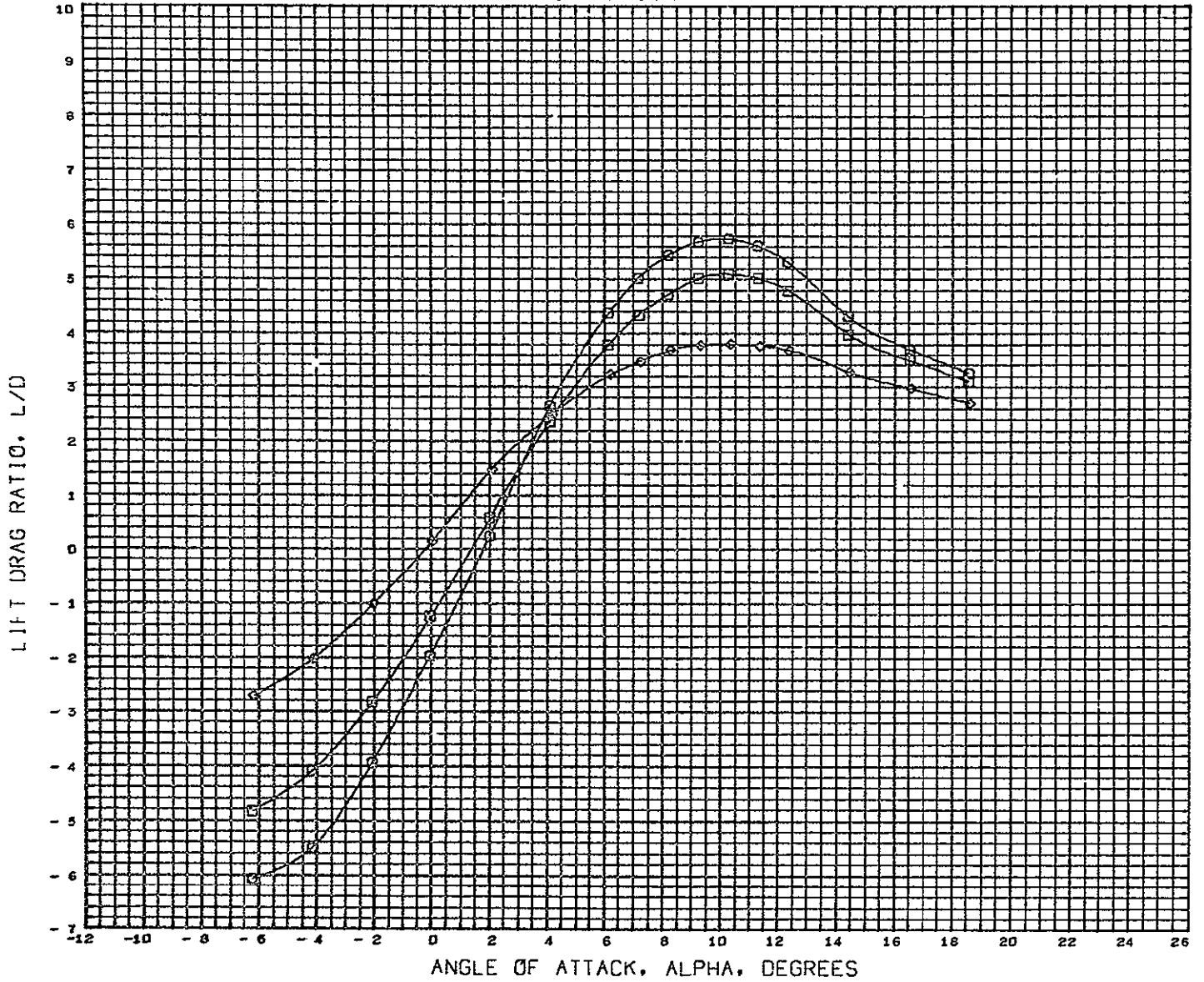

DATA SET SYMBOL	CONFIGURATION DESCRIPTION	BETA	ELEVTR	AILRON	REFERENCE INFORMATION	
(CCFD12)	LSWT 248 MDAC 4.0 FC O2 HCR ORB B5W11V6	0.000 - 10.000	0.000	0.000	REFS	8.8690 SQ.FT
(CCFD03)	LSWT 248 MDAC 4.0 FC O2 HCR ORB B5W11V6	0.000 - 10.000	10.000	10.000	REFL	29.5700 IN.
(CCFD22)	LSWT 248 MDAC 4.0 FC O2 HCR ORB B5W11V6	0.000 - 10.000	20.000	20.000	REFB	51.6000 IN.
					XMRP	59.3200 IN.
					YMRP	0.0000 IN.
					ZMRP	11.6000 IN.
					SCALE	4.0000 PERCENT

HACH 0.250

# LATERAL CONTROL POWER BASIC CONFIGURATION

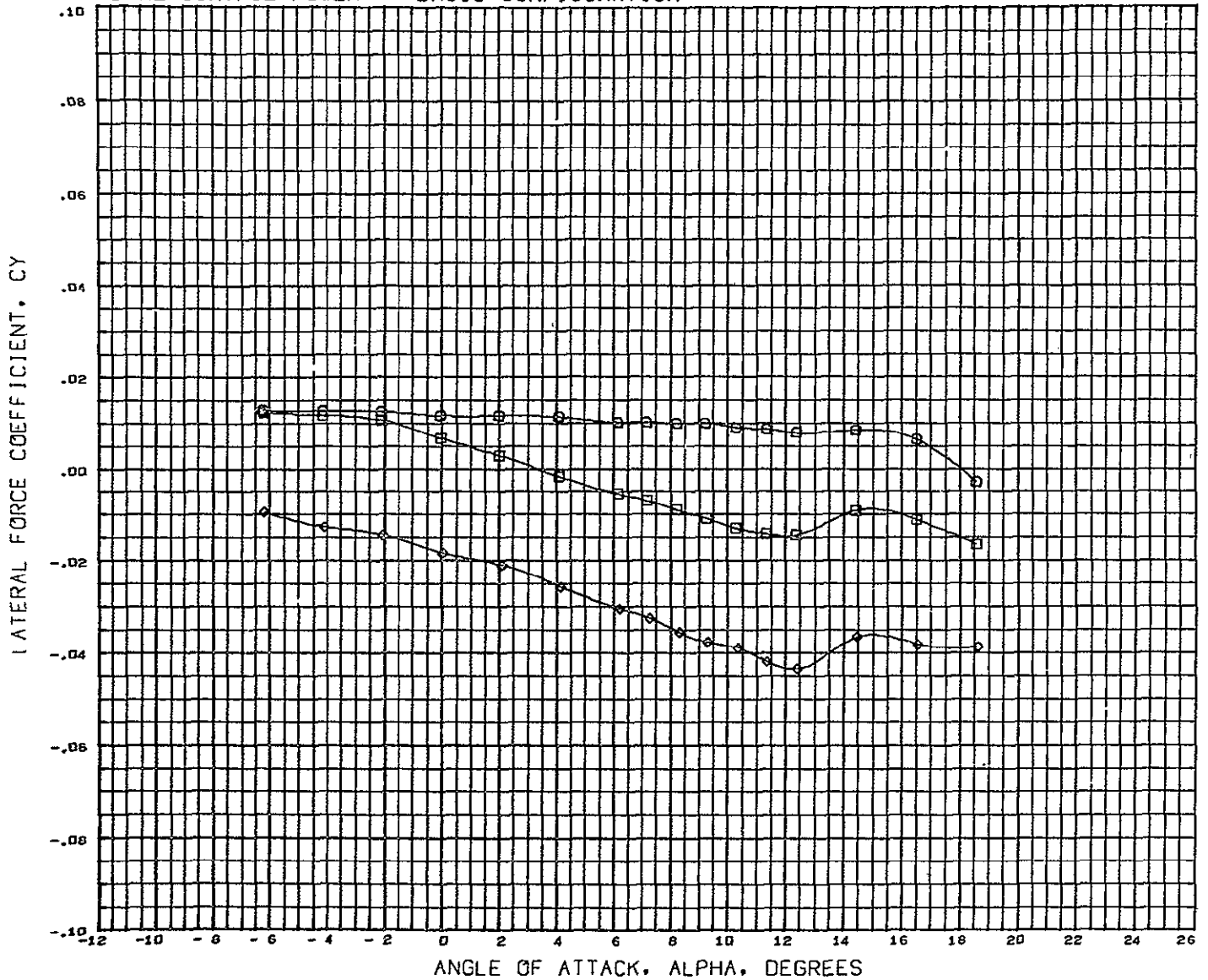

DATA SET SYMBOL	CONFIGURATION DESCRIPTION	BETA	ELEVTR	AILRON
(CCP012)	LSWT 248 HDAC 4.0 FC 02 HCR ORB	B5W11V6	0.000 - 10.000	0.000
(CCP003)	LSWT 248 HDAC 4.0 FC 02 HCR ORB	B5W11V6	0.000 - 10.000	10.000
(CCP022)	LSWT 248 HDAC 4.0 FC 02 HCR ORB	B5W11V6	0.000 - 10.000	20.000

REFERENCE INFORMATION		
REFS	8.8690	SQ.FT.
REFL	29.5700	IN.
REFB	51.6000	IN.
XMRP	59.3200	IN.
YMRP	0.0000	IN.
ZMRP	11.6000	IN.
SCALE	4.0000	PERCENT

MACH 0.250



# LATERAL CONTROL POWER BASIC CONFIGURATION

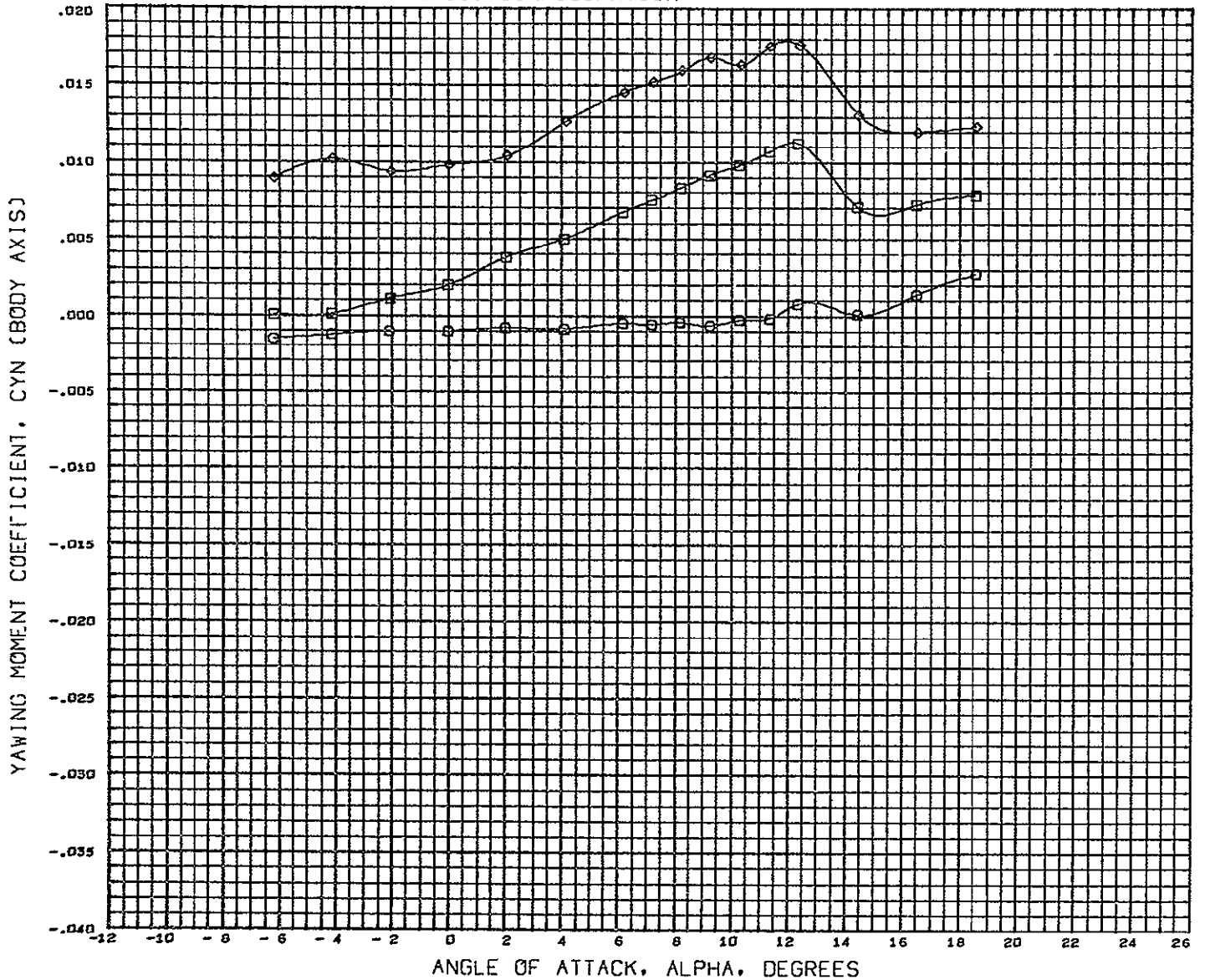

DATA SET SYMBOL	CONFIGURATION DESCRIPTION	BETA	ELEVTR	AILRON	REFERENCE INFORMATION
(CCFD12)	LSWT 248 HDAC 4.D FC O2 HCR ORB 85W11V6	0.000 - 10.000	0.000	0.000	REFS 8 8690 SQ.FT.
(CCFD03)	LSWT 248 HDAC 4.D FC O2 HCR ORB 85W11V6	0.000 - 10.000	10.000	0.000	REFL 29 5700 IN.
(CCFD22)	LSWT 248 HDAC 4.D FC O2 HCR ORB 85W11V6	0.000 - 10.000	20.000	0.000	REFB 51.6000 IN.
					XMRP 59.3200 IN.
					YMRP 0.0000 IN.
					ZMRP 11.6000 IN.
					SCALE 4.0000 PERCENT

HACH 0.250

# LATERAL CONTROL POWER BASIC CONFIGURATION

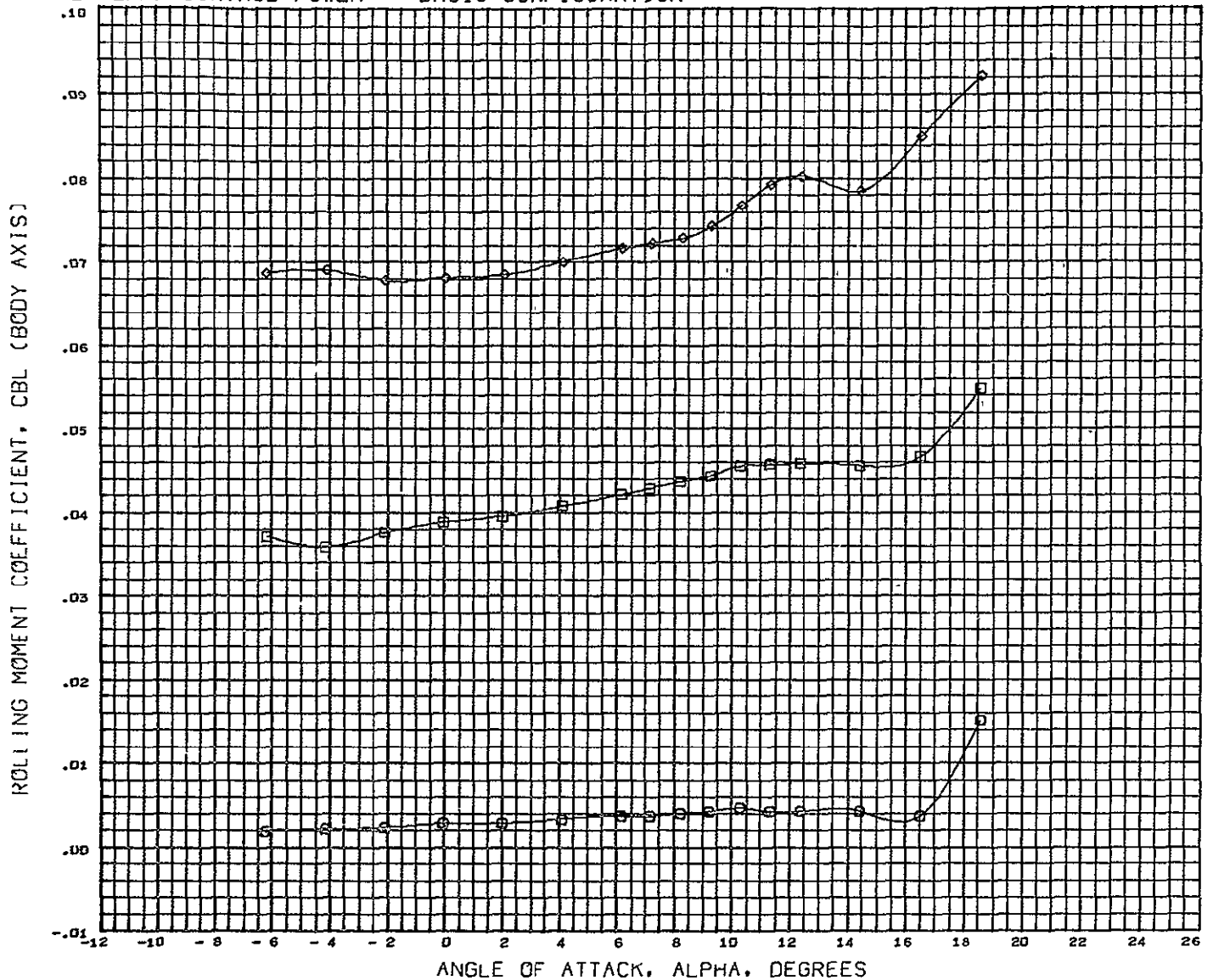

DATA SET SYMBOL	CONFIGURATION DESCRIPTION
(CCFD12)	LSWT 248 MDAC 4.0 FC O2 HCR ORB B5W11V6
(CCFD03)	LSWT 248 MDAC 4.0 FC O2 HCR ORB B5W11V6
(CCFD22)	LSWT 248 MDAC 4.0 FC O2 HCR ORB B5W11V6

BETA	ELEVTR	AILRON
0.000 - 10.000	0.000	
0.000 - 10.000	10.000	
0.000 - 10.000	20.000	

REFERENCE INFORMATION		
REFS	8 8690	SQ.FT
REFL	29.5700	IN.
REFB	51.6000	IN.
XHRF	59.3200	IN.
YHRF	0.0000	IN.
ZHRF	11.6000	IN.
SCALE	4 0000	PERCNT

MACH 0.250

# LATERAL CONTROL POWER BASIC CONFIGURATION

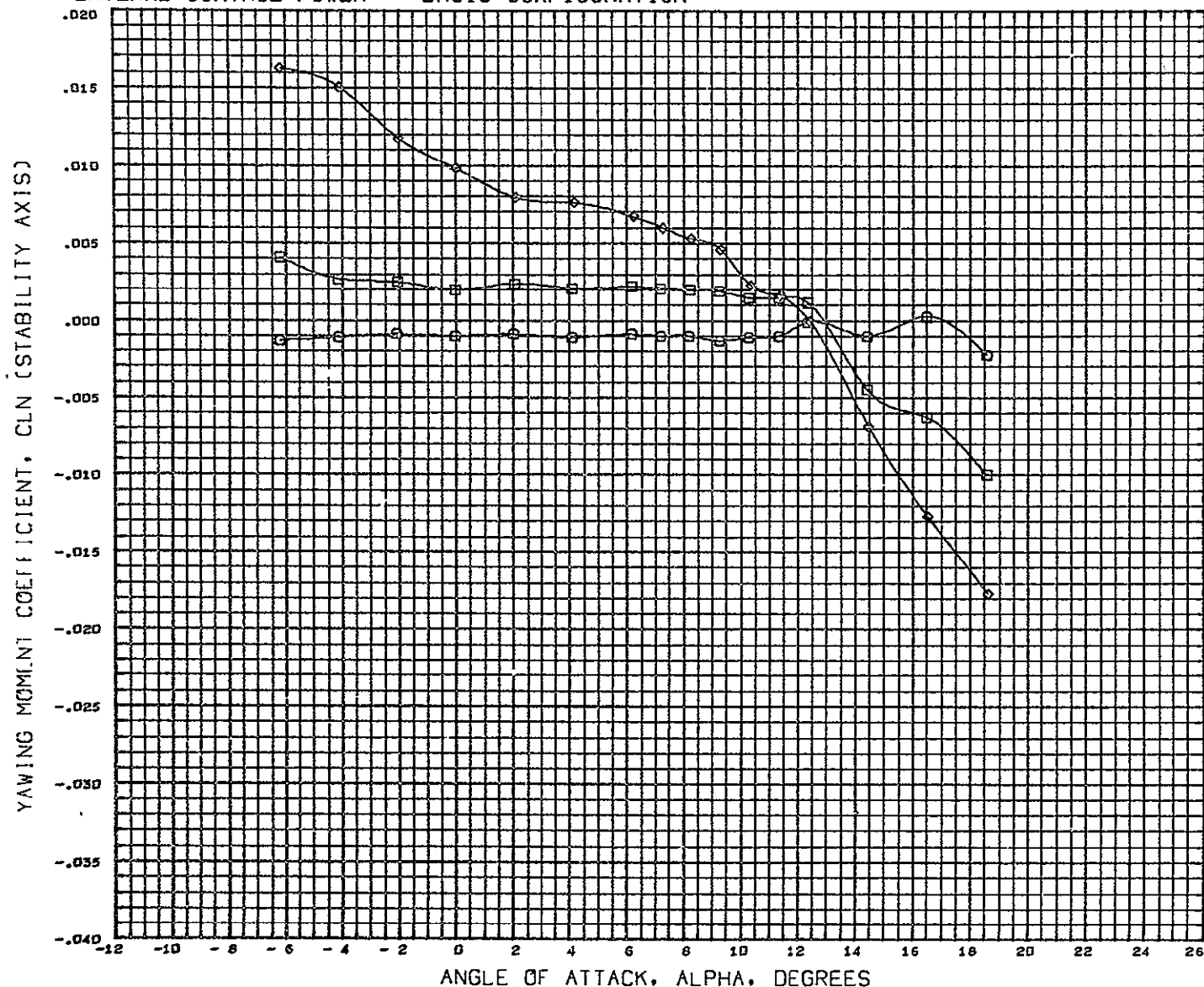

DATA SET SYMBOL	CONFIGURATION DESCRIPTION	BETA	ELEVTR	AILRON	REFERENCE INFORMATION
(RCP012)	LSWT 248 HDAC 4.0 FC 02 HCR ORB B5W11V6	0.000 - 10.000	0.000		REFS 8.8690 SQ FT
(RCP003)	LSWT 248 HDAC 4.0 FC 02 HCR ORB B5W11V6	0.000 - 10.000	10.000		REFL 29.5700 IN.
(RCP022)	LSWT 248 HDAC 4.0 FC 02 HCR ORB B5W11V6	0.000 - 10.000	20.000		REFB 51.6000 IN.
					XMRP 59.3200 IN.
					YMRP 0.0000 IN.
					ZMRP 11.6000 IN.
					SCALE 4.0000 PERCENT

HACH 0.250

# LATERAL CONTROL POWER BASIC CONFIGURATION

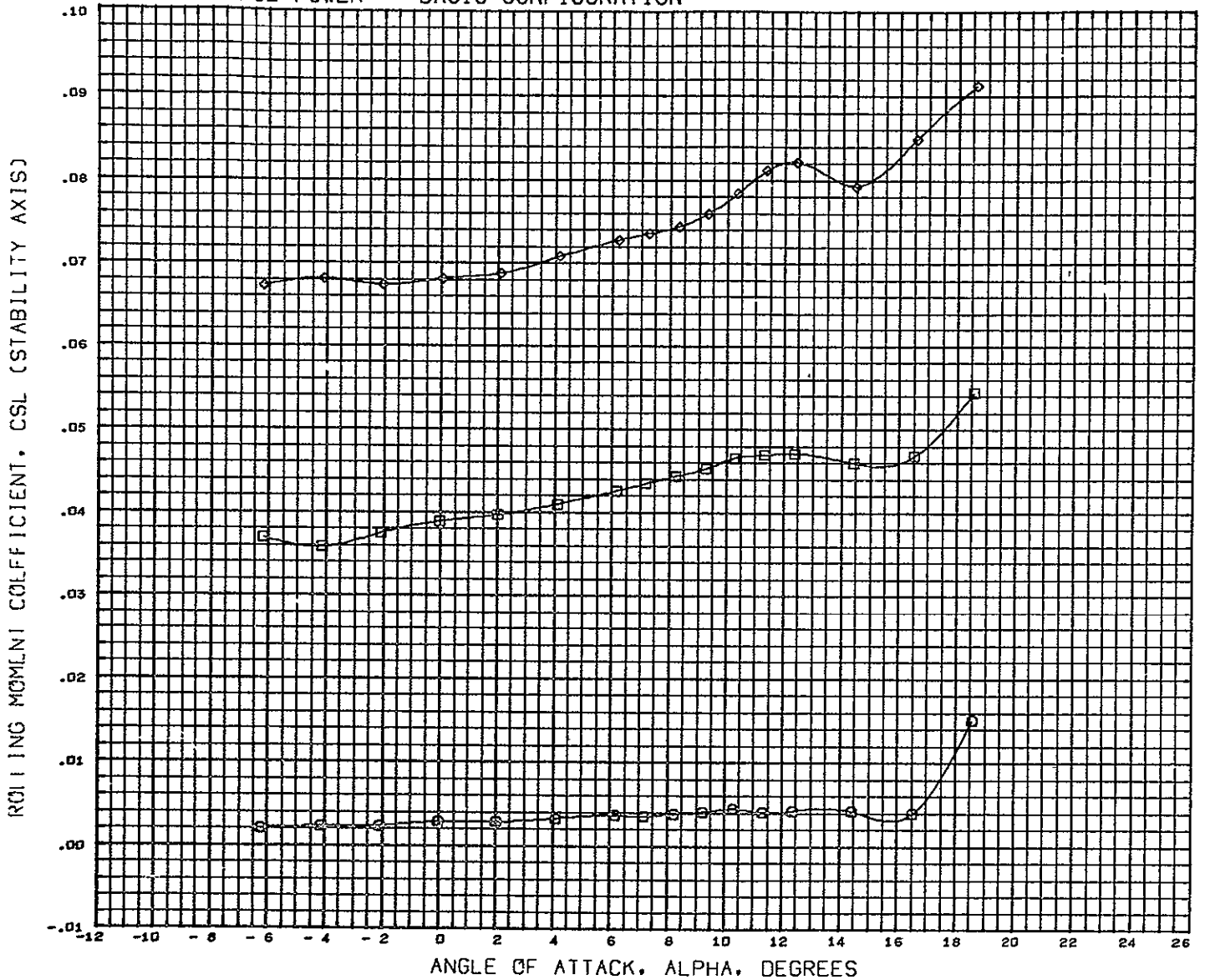

DATA SET SYMBOL	CONFIGURATION DESCRIPTION	BETA	ELEVTR	AILRON	REFERENCE INFORMATION
(RCP012)	LSWT 248 MDAC 4.0 FC 02 HCR ORB B5W11V6	0.000 - 10.000	0.000		REFS 8.8690 SQ.FT
(RCP003)	LSWT 248 MDAC 4.0 FC 02 HCR ORB B5W11V6	0.000 - 10.000	10.000		REFL 29.5700 IN
(RCP022)	LSWT 248 MDAC 4.0 FC 02 HCR ORB B5W11V6	0.000 - 10.000	20.000		REFB 51.6000 IN
					YMRP 59.3200 IN
					YMRP 0.0000 IN
					ZMRP 11.6000 IN.
					SCALE 4.0000 PERCNT

MACH 0.250

# LATERAL CONTROL POWER BASIC CONFIGURATION

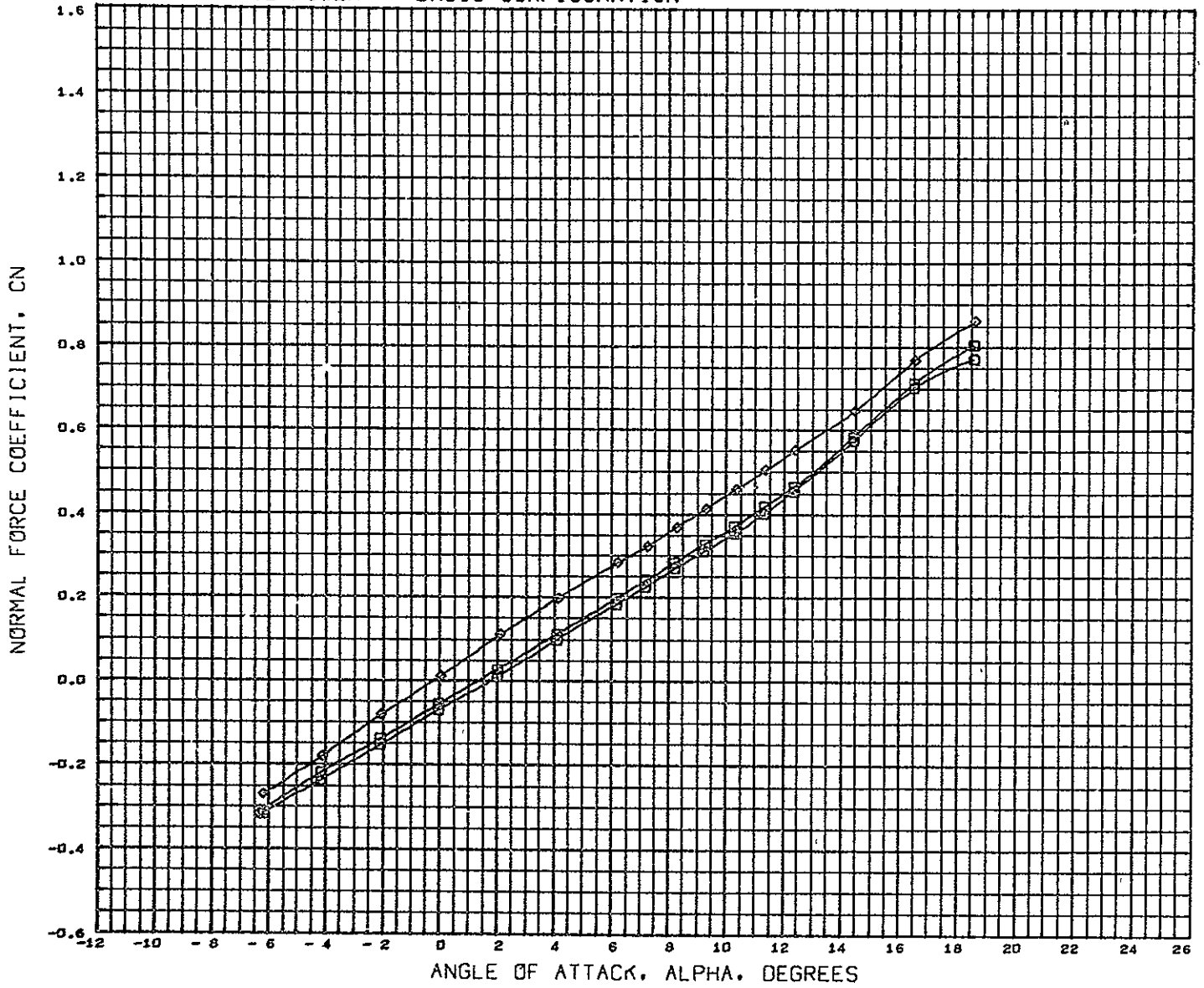

DATA SET SYMBOL	CONFIGURATION DESCRIPTION	BETA	ELEVTR	AILRON	REFERENCE INFORMATION
(BCF012)	LSWT 248 MDAC 4.0 FC O2 HCR ORB BSW11V6	0.000 - 10.000	0.000	0.000	REFS 8 8690 SQ.FT
(BCF003)	LSWT 248 MDAC 4.0 FC O2 HCR ORB BSW11V6	0.000 - 10.000	10.000	0.000	REFL 29 5700 IN.
(BCF022)	LSWT 248 MDAC 4.0 FC O2 HCR ORB BSW11V6	0.000 - 10.000	20.000	0.000	REFB 51.6000 IN.
					XMRP 59.3200 IN.
					YMRP 0.0000 IN.
					ZMRP 11.6000 IN.
					SCALE 4.0000 PERCNT

MACH 0.250

# LATERAL CONTROL POWER BASIC CONFIGURATION

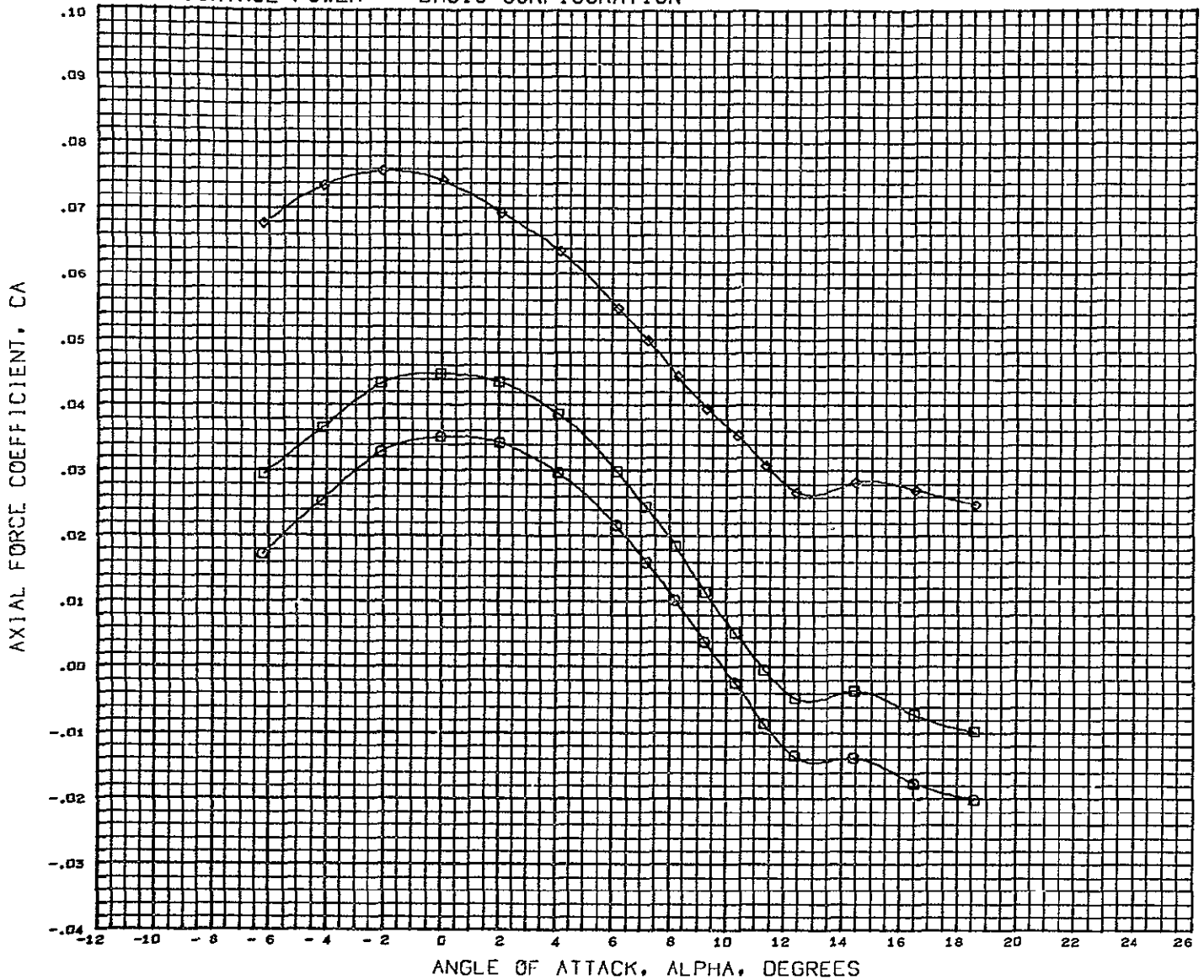

DATA SET SYMBOL	CONFIGURATION DESCRIPTION	BETA	ELEVTR	AILRON	REFERENCE INFORMATION
(BCFD12) ○	LSWT 248 HDAC 4.0 FC O2 HCR ORB B5M11V6	0.000 - 10.000	0.000		REFS 8.8690 SQ FT.
(BCFD03) □	LSWT 248 HDAC 4.0 FC O2 HCR ORB B5M11V6	0.000 - 10.000	10.000		REFL 29.5700 IN.
(BCFD22) ◇	LSWT 248 HDAC 4.0 FC O2 HCR ORB B5M11V6	0.000 - 10.000	20.000		REFB 51.6000 IN.
					XMRP 59.3200 IN.
					YMRP 0.0000 IN.
					ZMRP 11.6000 IN.
					SCALE 4.0000 PERCENT

MACH 0.250

# LATERAL CONTROL POWER BASIC CONFIGURATION

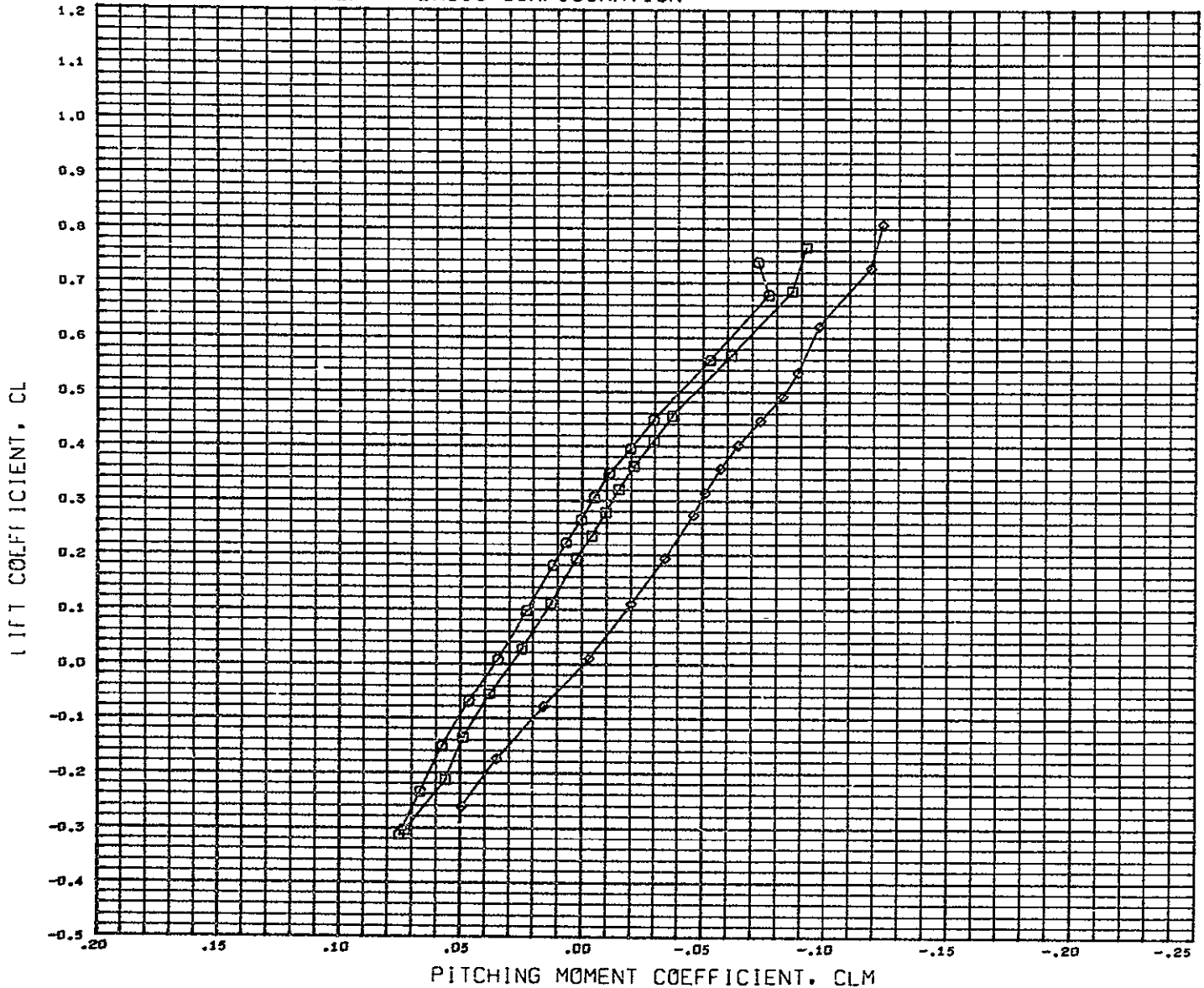

DATA SET	SYMBOL	CONFIGURATION DESCRIPTION	BETA	ELEVTR	AILRON	REFERENCE INFORMATION	
{CCP612}	○	LSWT 248 MDAC 4.0 FC 02 HCR ORB	B5W11V6	0.000 - 10.000	0.000	REFS	8.8690 SQ.FT.
{CCP003}	□	LSWT 248 MDAC 4.0 FC 02 HCR ORB	B5W11V6	0.000 - 10.000	10.000	REFL	29.5700 IN.
{CCP022}	△	LSWT 248 MDAC 4.0 FC 02 HCR ORB	B5W11V6	0.000 - 10.000	20.000	REFB	51.6000 IN.
						XMRP	59.3200 IN.
						YMRP	0.0000 IN.
						ZMRP	11.6000 IN.
						SCALE	4.0000 PERCENT

MACH 0.250

# LATERAL CONTROL POWER BASIC CONFIGURATION

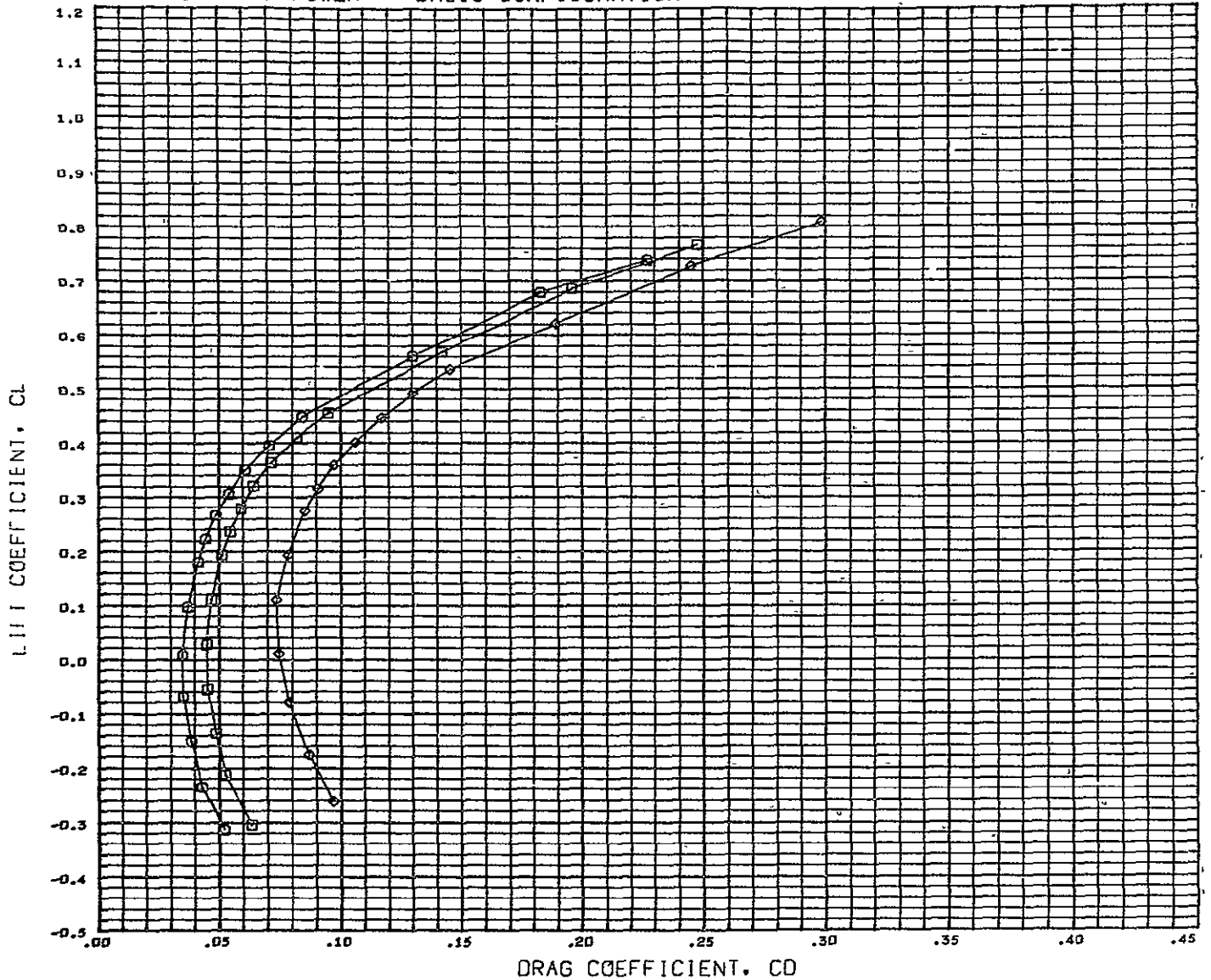

DATA SET SYMBOL	CONFIGURATION DESCRIPTION	BETA	ELEVTR	AILRON
(CCP012)	LSWT 248 MDAC 4.0 FC Q2 HCR ORB	85W11V6	0.000 - 10.000	0.000
(CCP003)	LSWT 248 MDAC 4.0 FC Q2 HCR ORB	85W11V6	0.000 - 10.000	10.000
(CCP022)	LSWT 248 MDAC 4.0 FC Q2 HCR ORB	85W11V6	0.000 - 10.000	20.000

REFERENCE INFORMATION		
REFS	8.8690	SQ.FT
REFL	29.5700	IN.
REFB	51.6000	IN.
XHRF	59.3200	IN.
YHRF	0.0000	IN.
ZHRF	11.6000	IN.
SCALE	4.0000	PERCNT

MACH 0.250



MACH 0.250

REFERENCE INFORMATION

REFS	29.5700	IN
REFL	51.6000	IN
REFB	59.3200	IN
XMRP	0.0000	IN
ZMRP	11.6000	IN
SCALE	4 0000	PERCENT

DATA SET SYMBOL	CONFIGURATION DESCRIPTION	BETA	ELEVTR	AIRLON
(CCF012)	LSMT 248 HDAC 4.0 FC 02 HCR ORB	0.007 - 10.000	0.000	0.000
(CCF003)	LSMT 248 HDAC 4.0 FC 02 HCR ORB	0.000 - 10.000	10.000	0.000
(CCF022)	LSMT 248 HDAC 4.0 FC 02 HCR ORB	0.000 - 10.000	20.000	0.000
(CCF012)	LSMT 248 HDAC 4.0 FC 02 HCR ORB	0.007 - 10.000	0.000	0.000
(CCF003)	LSMT 248 HDAC 4.0 FC 02 HCR ORB	0.000 - 10.000	10.000	0.000
(CCF022)	LSMT 248 HDAC 4.0 FC 02 HCR ORB	0.000 - 10.000	20.000	0.000

LIFT COEFFICIENT SQUARED, CLSQ

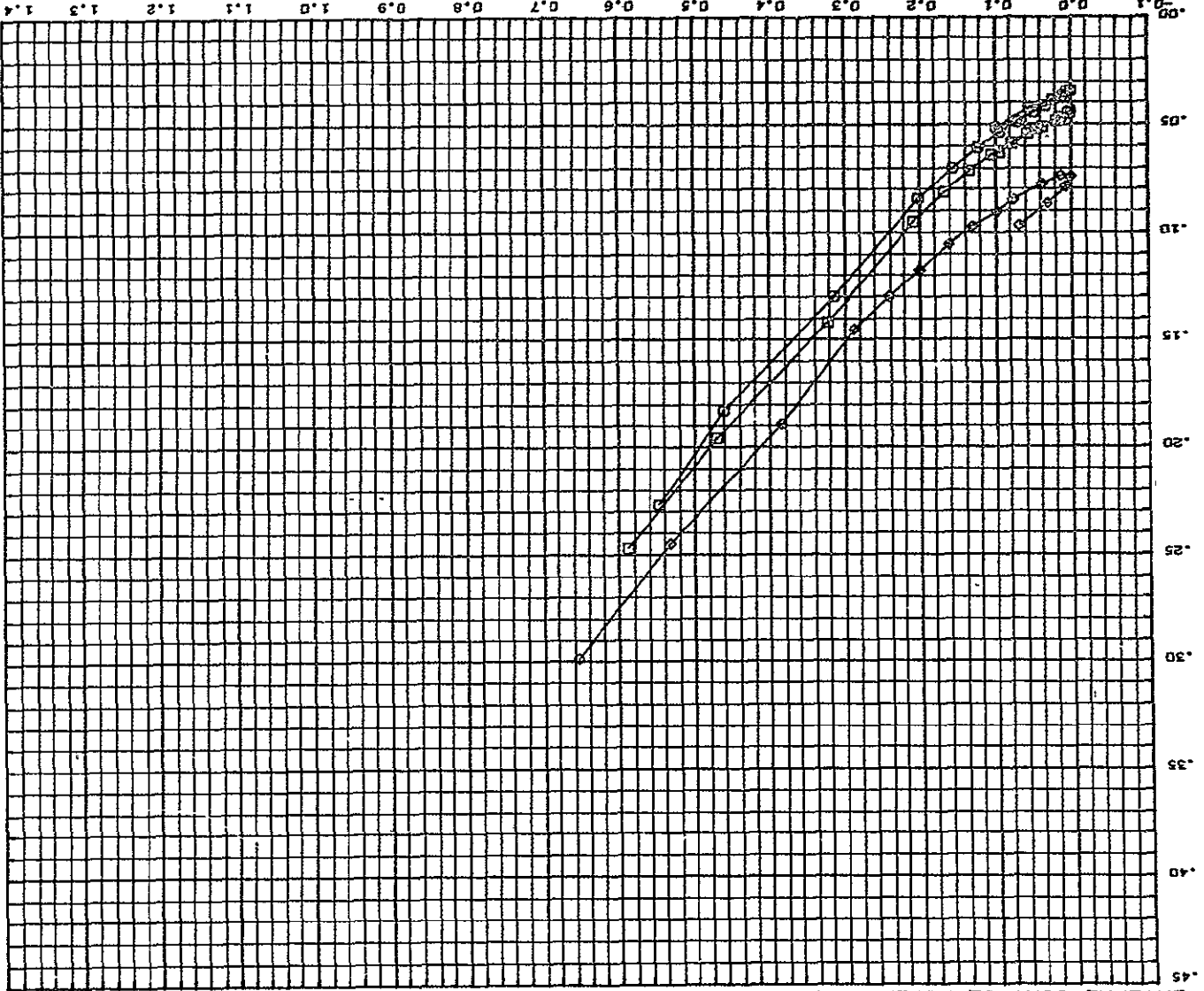

LATERAL CONTROL POWER BASIC CONFIGURATION

DRAG COEFFICIENT, CD

# LATERAL CONTROL POWER BASIC CONFIGURATION

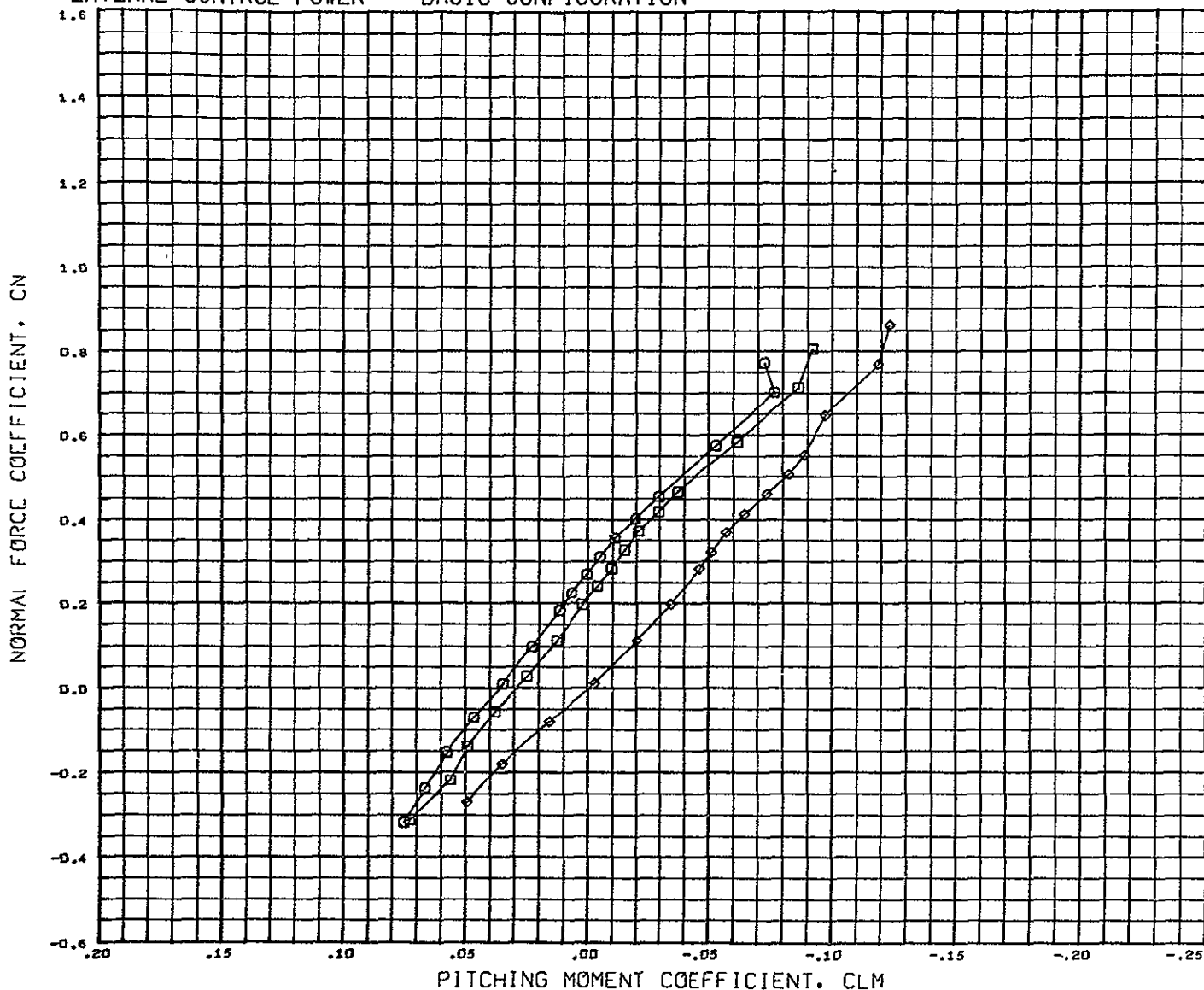

DATA SET SYMBOL	CONFIGURATION DESCRIPTION	BETA	ELEVTR	AILRON	REFERENCE INFORMATION
(BCF012)	LSWT 248 HDAC 4.0 FC 02 HCR ORB	B5W11V6	0.000 - 10.000	0.000	REFS 9.8690 SQ.FT
(BCF003)	LSWT 248 HDAC 4.0 FC 02 HCR ORB	B5W11V6	0.000 - 10.000	10.000	REFL 29.5700 IN.
(BCF022)	LSWT 248 HDAC 4.0 FC 02 HCR ORB	B5W11V6	0.000 - 10.000	20.000	REFB 51.6000 IN.
					XMRP 59.3200 IN.
					YMRP 0.0000 IN.
					ZMRP 11.6000 IN.
					SCALE 4.0000 PERCNT

PACH 0.250

# LATERAL CONTROL POWER BASIC CONFIGURATION

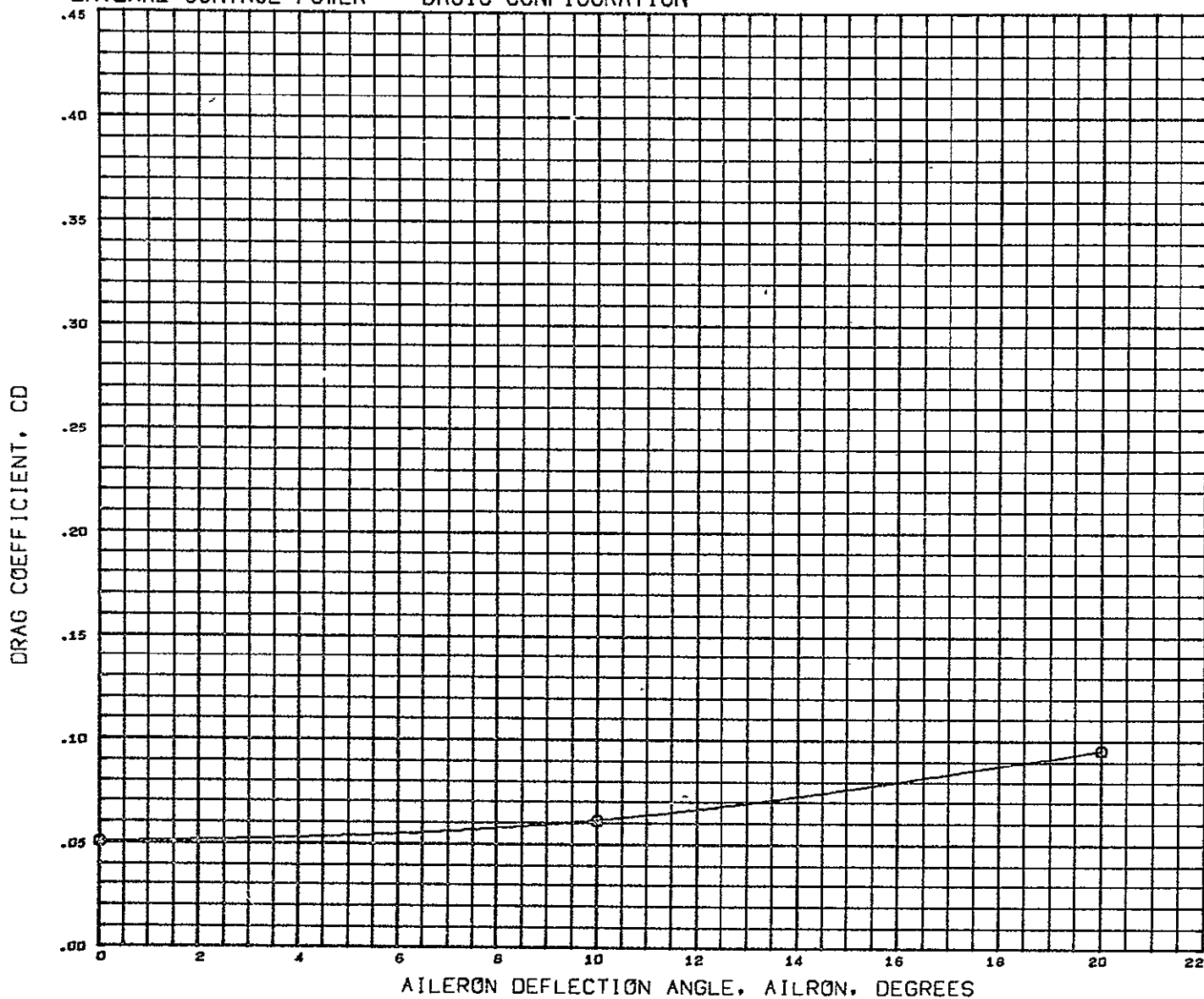

SYMBOL	ALPHA	PARAMETRIC VALUES				DATA SOURCE			REFERENCE INFORMATION			
□	- 6.000	MACH	0.260	BETA	0.000	DATASET	AILRON	DATASET	AILRON	REFS	8.8690	SQ.FT.
		ELEVTR	- 10.000	SPBRK	0.000	NCP012	0.000	NCP003	10.000	REFL	29.5700	IN.
		BFLAP	0.000	RUDDER	0.000	NCP022	20.000			REFB	51.6000	IN.
										XMRP	59.3200	IN.
										YMRP	0.0000	IN.
										ZMRP	11.6000	IN.
										SCALE	4.0000	PERCNT

DATA HIST. CODE M#EV#E1

LATERAL CONTROL POWER BASIC CONFIGURATION

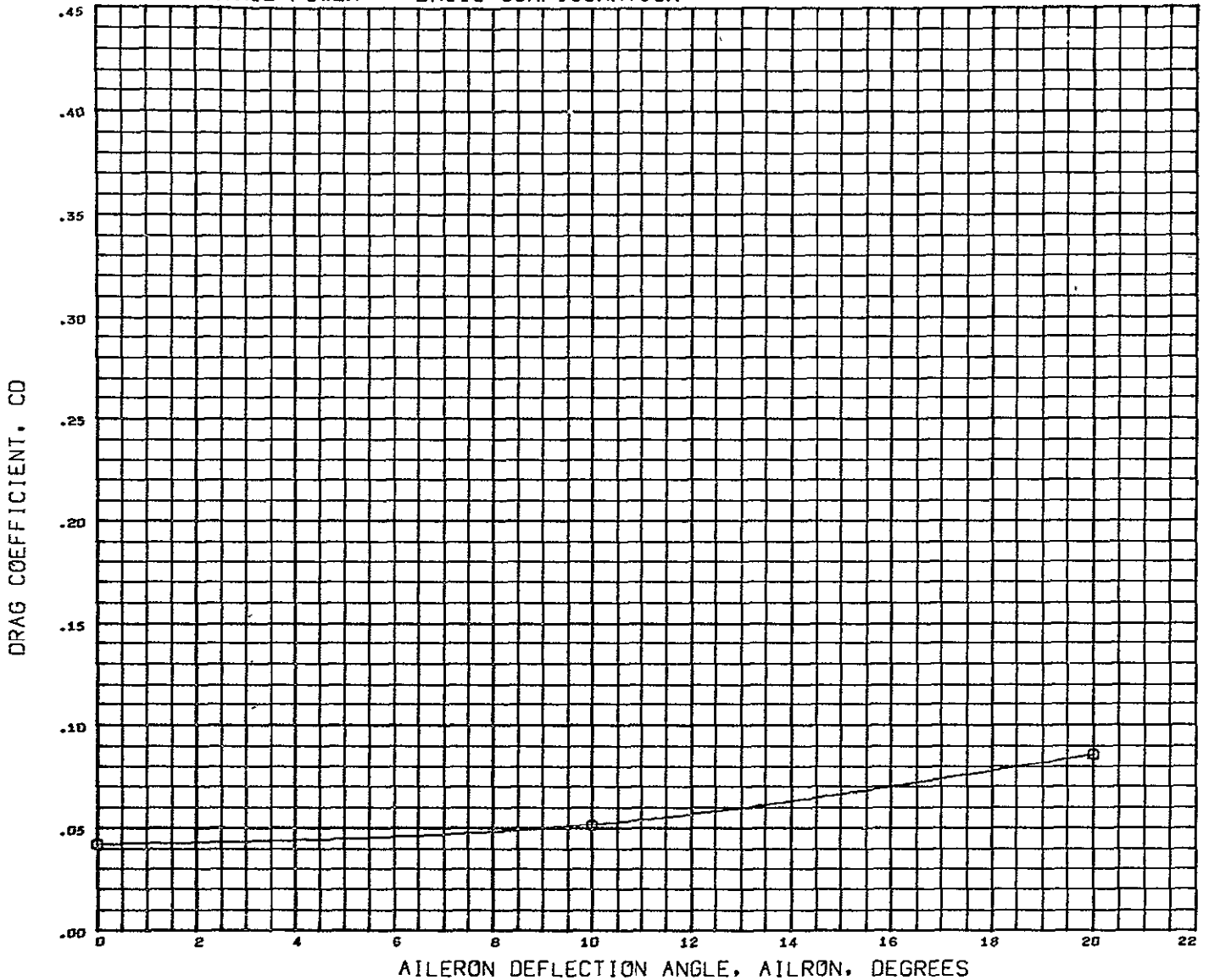

SYMBOL	ALPHA	PARAMETRIC VALUES				DATA SOURCE			REFERENCE INFORMATION				
○	4.000	MACH	0.260	BETA	0.000	DATASET	AILRON	0.000	DATASET	AILRON	REFS	8.8690	Sq.FT.
		ELEVTR	-10.000	SPBRK	0.000	NCP012	0.000	NCP003	10.000	REFL	29.5700	IN.	
		BFLAP	0.000	RUDDER	0.000	NCP022	20.000			REFB	51.6000	IN.	
										YHRP	59.3200	IN.	
										ZHRP	0.0000	IN.	
										ZHRP	11.6000	IN.	
										SCALE	4.0000	PERCNT	

DATA HIST. CODE H#EV#EI

LATERAL CONTROL POWER BASIC CONFIGURATION

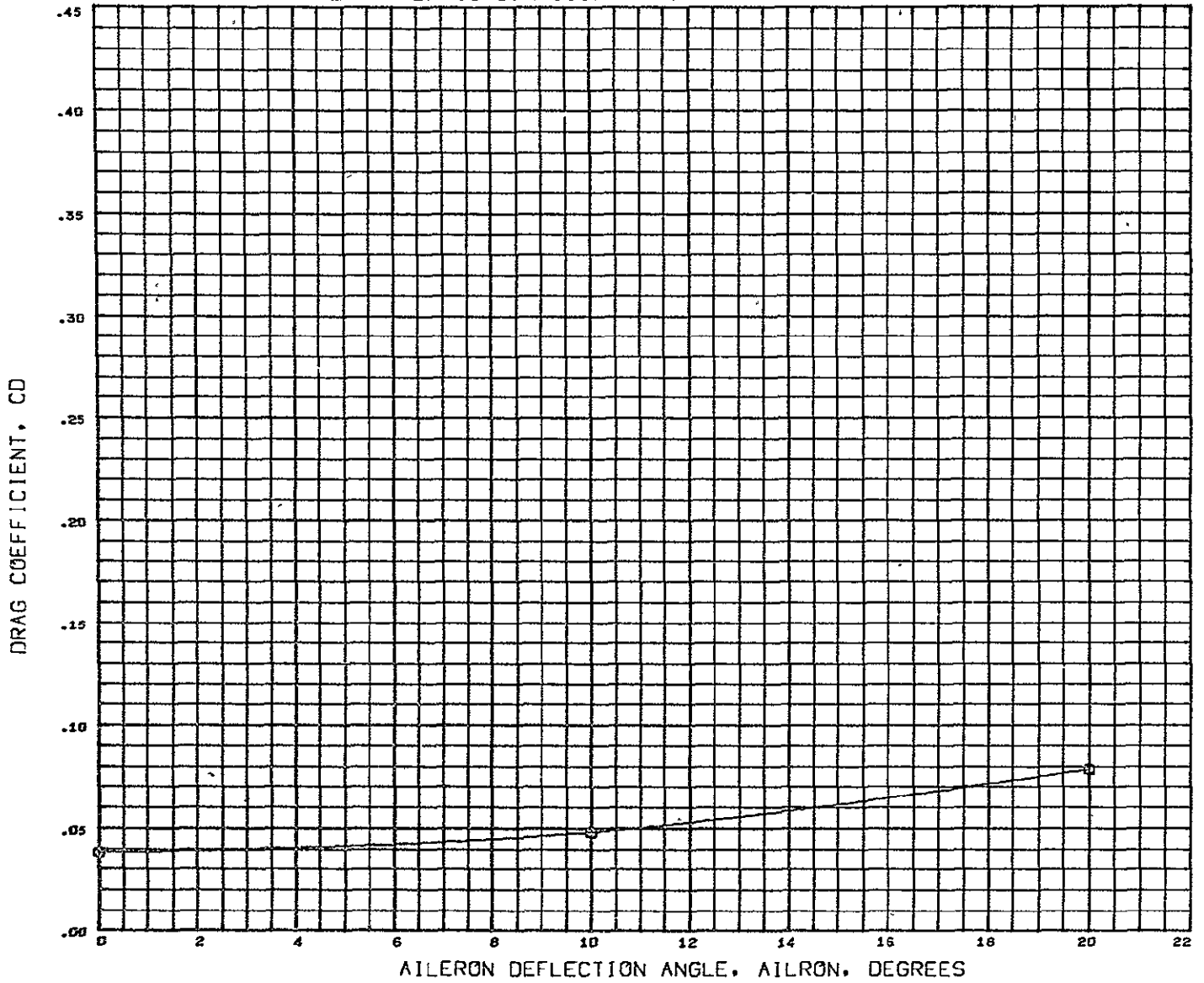

SYMBOL	ALPHA	PARAMETRIC VALUES				DATA SOURCE				REFERENCE INFORMATION		
□	- 2.000	MACH	0.260	BETA	0.000	DATASET	AILRON	DATASET	AILRON	REFS	8.8690	SQ.FT
		ELEVTR	- 10.000	SPBRK	0.000	NCP012	0.000	NCF003	10.000	REFL	29.5700	IN.
		BFLAP	0.000	RUDDER	0.000	NCF022	20.000			REFB	51.6000	IN.
										XMRP	59.3200	IN.
										YMRP	0.0000	IN.
										ZMRP	11.6000	IN.
										SCALE	4.0000	PERCNT

DATA HIST. CODE H#EV#E1

LATERAL CONTROL POWER BASIC CONFIGURATION

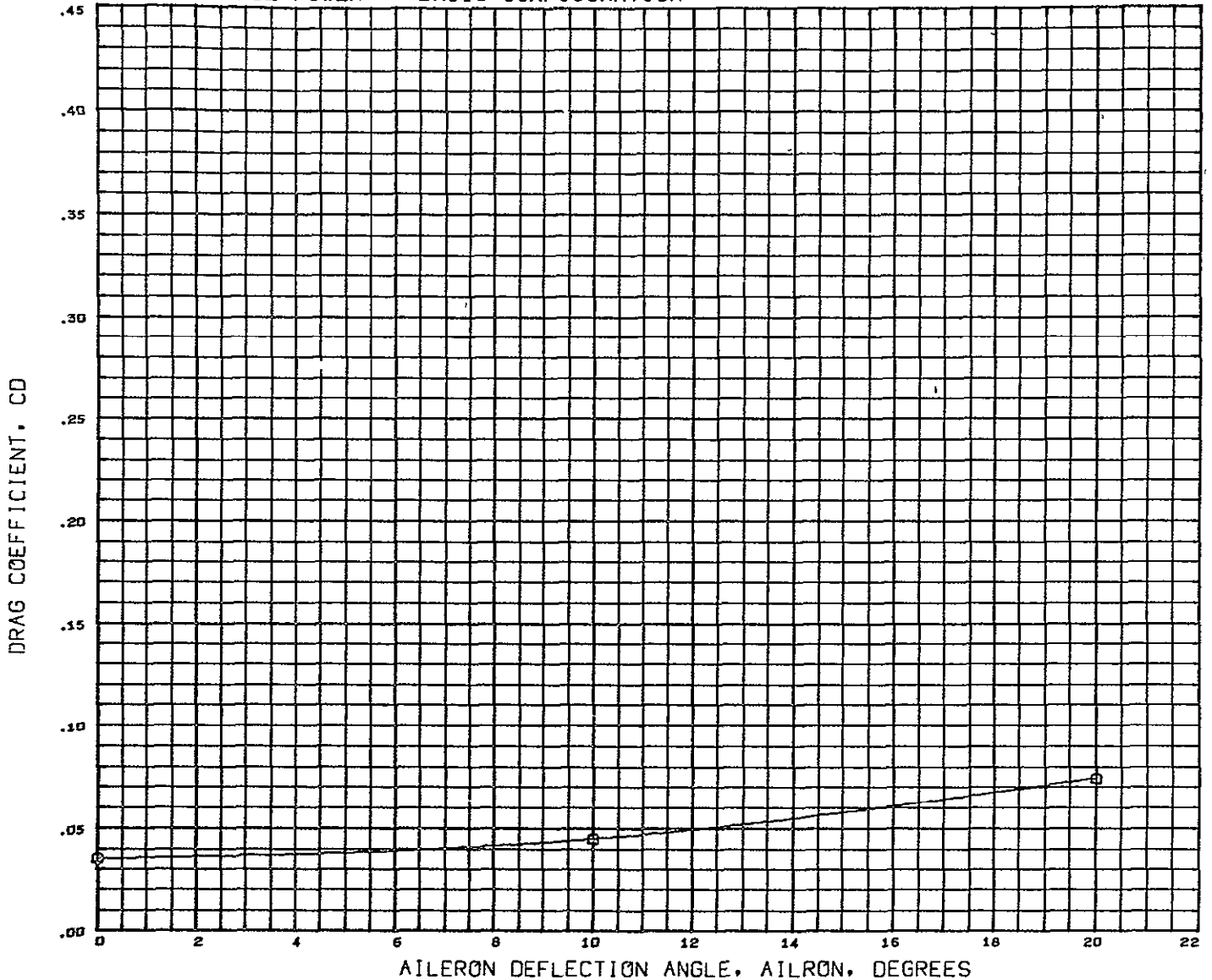

SYMBOL	ALPHA	PARAMETRIC VALUES				DATA SOURCE			REFERENCE INFORMATION		
□	0.000	MACH	0.260	BETA	0.000	DATASET	AILRON	REFS	8.8690	SQ.FT.	
		ELEVTR	-10.000	SPBRK	0.000	NCP012	0.000	REFL	29.5700	IN.	
		BFLAP	0.000	RUDDER	0.000	NCP022	20.000	REFB	51.6000	IN.	
								XMRP	59.3200	IN.	
								YMRP	0.0000	IN.	
								ZMRP	11.6000	IN.	
								SCALE	4.0000	PERCENT	

DATA HIST. CODE H#EV#EI

LATERAL CONTROL POWER BASIC CONFIGURATION

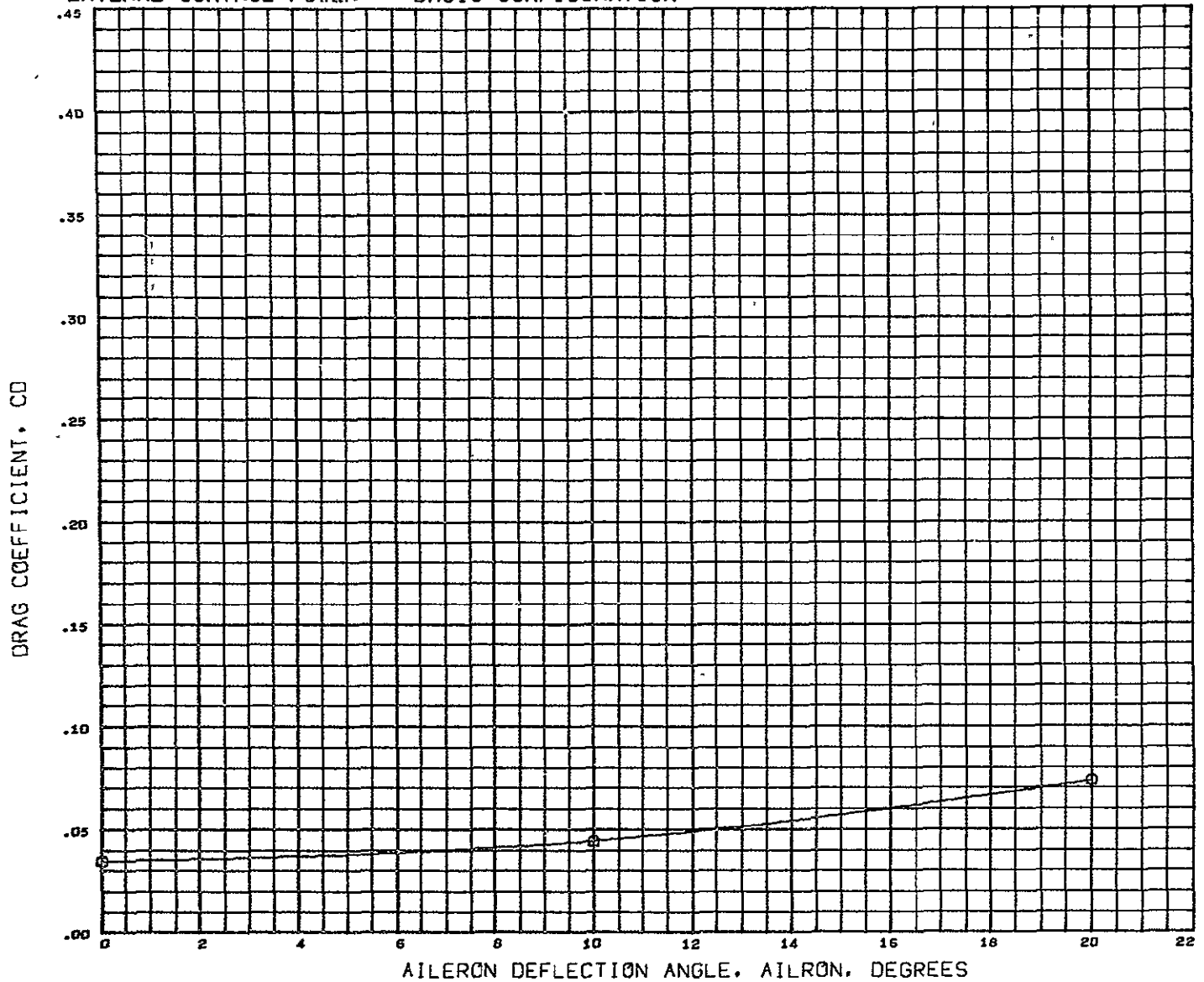

SYMBOL	ALPHA	PARAMETRIC VALUES				DATA SOURCE			REFERENCE INFORMATION			
○	2.000	MACH	0.260	BETA	0.000	DATASET	AILRON	DATASET	AILRON	REFS	8.8690	SQ.FT.
		ELEVTR	-10.000	SPBRK	0.000	NCP012	0.000	NCP003	10.000	REFL	29.5700	IN.
		BFLAP	0.000	RUDDER	0.000	NCP022	20.000			REFB	51.6000	IN.
										XMRP	59.3200	IN.
										YMRP	0.0000	IN.
										ZMRP	11.6000	IN.
										SCALE	4.0000	PERCNT

DATA HIST. CODE H#EV#E1

LATERAL CONTROL POWER BASIC CONFIGURATION

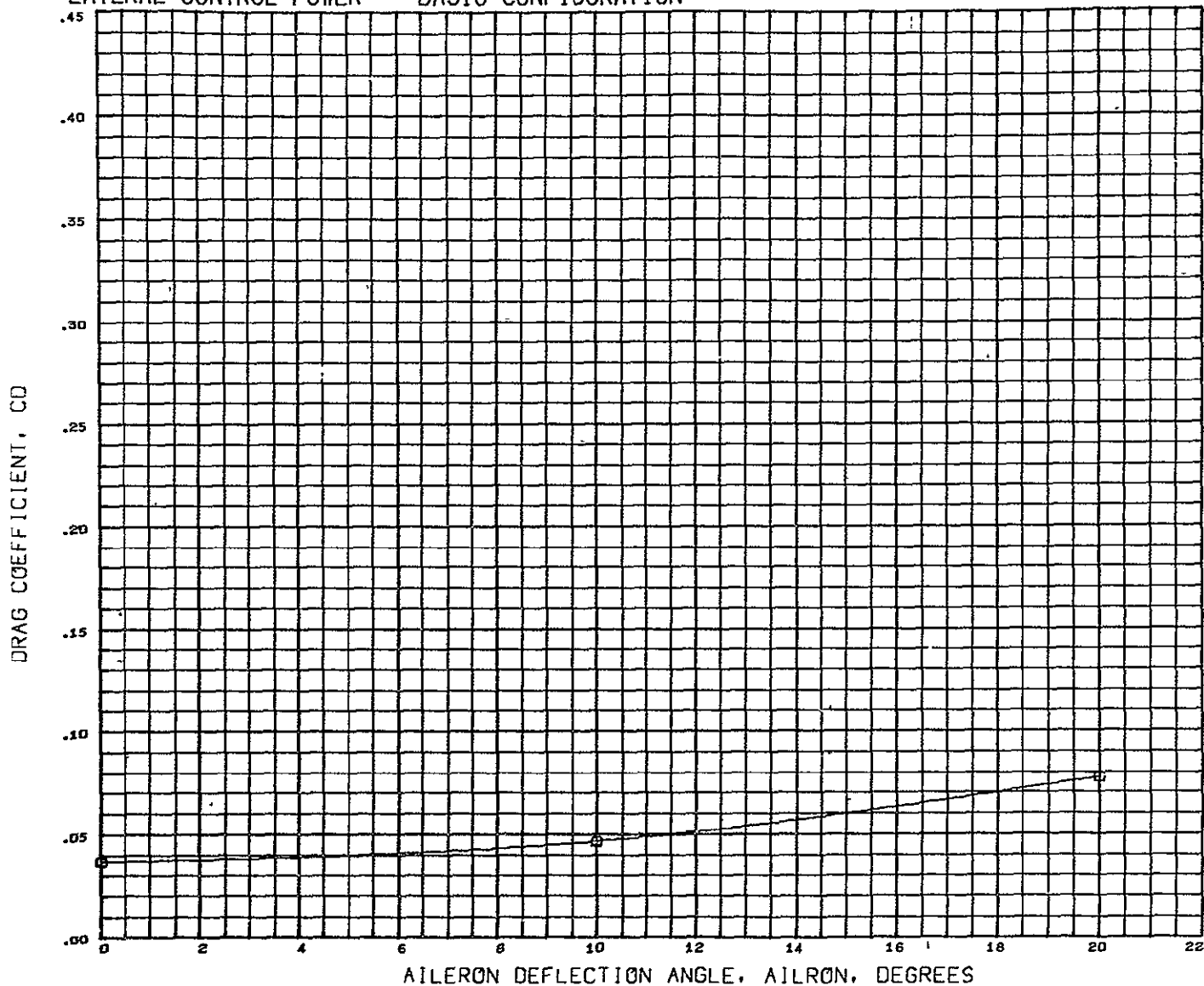

SYMBOL	ALPHA	PARAMETRIC VALUES				DATA SOURCE			REFERENCE INFORMATION			
C	4.000	MACH	0.260	BETA	0.000	DATASET	AILRON	DATASET	AILRON	REFS	8.8690	SQ FT.
		ELEVTR	-10.000	SPBRK	0.000	NCP012	0.000	NCP003	10.000	REFL	29.5700	IN.
		8FLAP	0.000	RUDDER	0.000	NCP022	20.000			REFB	51.6000	IN.
										XMRP	59.3200	IN.
										YMRP	0.0000	IN.
										ZMRP	11.6000	IN.
										SCALE	4.0000	PERCENT

DATA HIST. CODE M#EV#EI



LATERAL CONTROL POWER BASIC CONFIGURATION

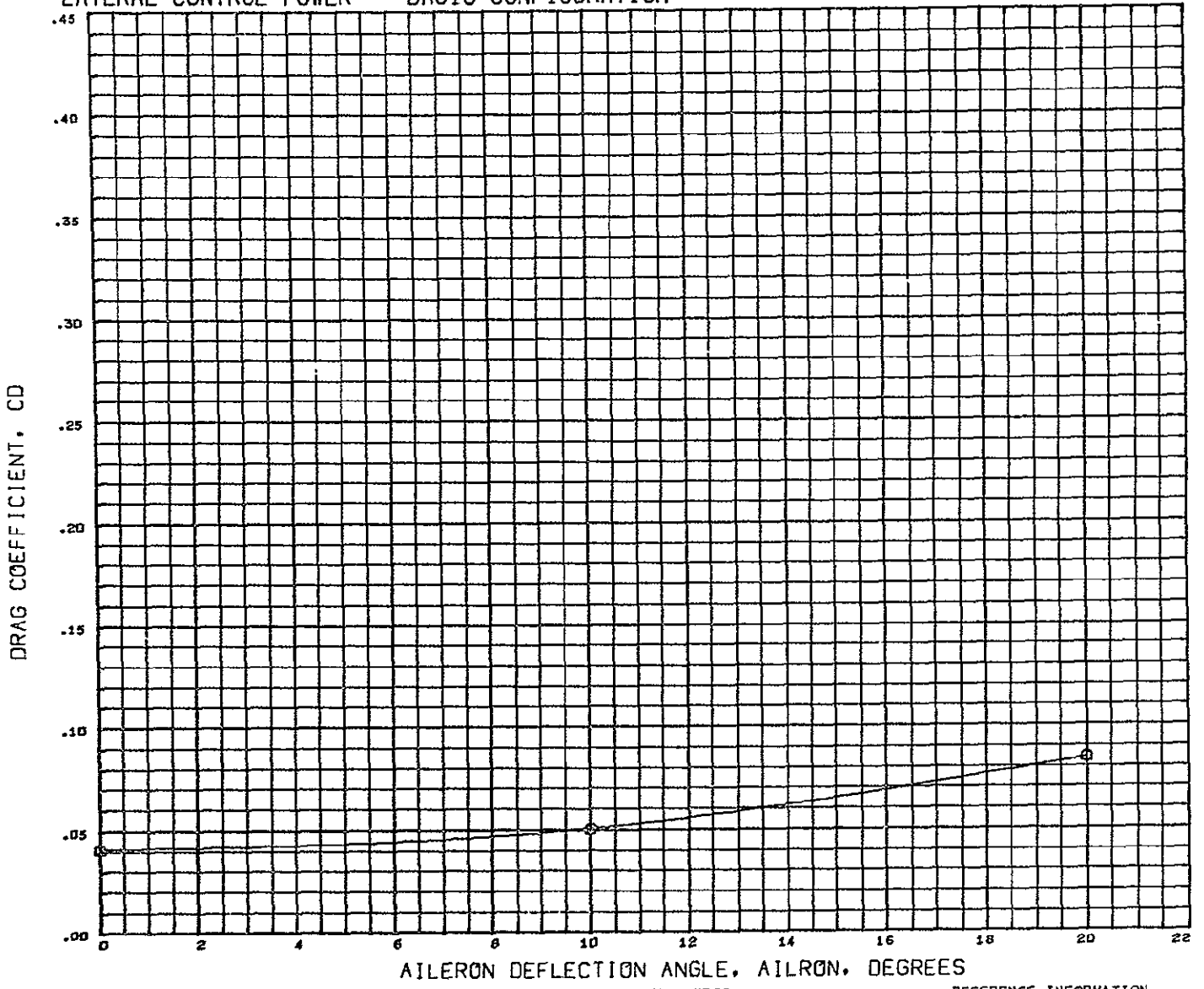

SYMBOL	ALPHA	PARAMETRIC VALUES				DATA SOURCE			REFERENCE INFORMATION		
		MACH	BETA	SPBRK	RUDDER	AILRON	AILRON	REFS	SCALE	PERCENT	
0	6.000	0.260	0.000	0.000	0.000	AILRON	8 8690	4.0000	SQ FT.		
		ELEVTR - 10.000	0.000	0.000	0.000	NCP012	29.5700		IN.		
		BFLAP 0.000	0.000	0.000	0.000	NCP022	51.6000		IN.		
							59.3200		IN.		
							0.0000		IN.		
							11.6000		IN.		
									PERCENT		

DATA HIST. CODE M#EV#EI

LATERAL CONTROL POWER BASIC CONFIGURATION

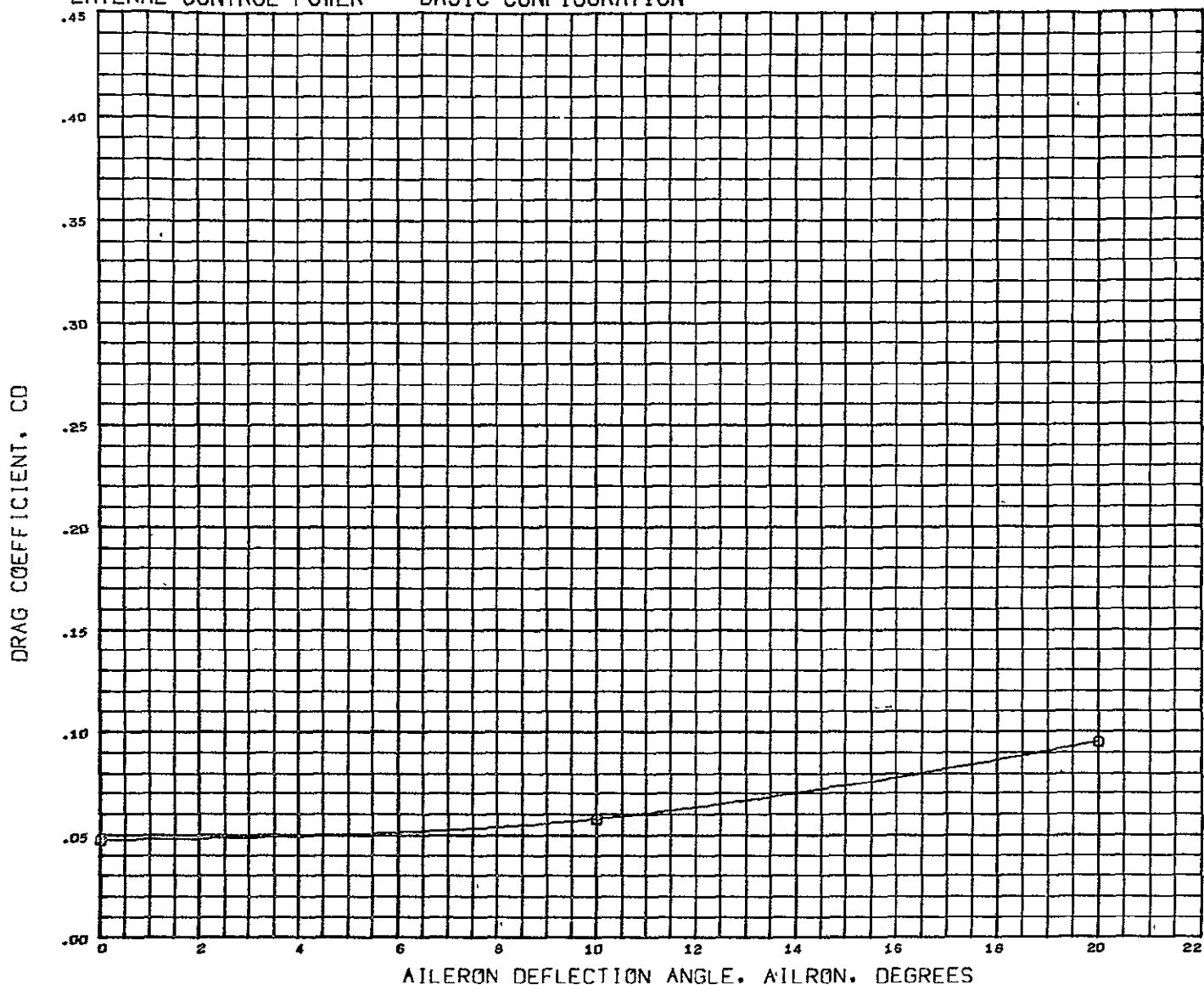

SYMBOL	ALPHA	PARAMETRIC VALUES				DATA SOURCE			REFERENCE INFORMATION			
○	8.000	MACH	0.260	BETA	0.000	DATASET	AILRON	DATASET	AILRON	REFS	8.8690	SQ.FT.
		ELEVTR	- 10.000	SPBRK	0.000	NCP012	0.000	NCP003	10.000	REFL	29.5700	IN.
		BFLAF	0.000	RUDDER	0.000	NCP022	20.000			REFB	51.6000	IN.
										XMRP	59.3200	IN.
										YMRP	0.0000	IN.
										ZMRP	11.6000	IN.
										SCALE	4.0000	PERCNT

DATA MIST. CODE M#EV#EI

LATERAL CONTROL POWER BASIC CONFIGURATION

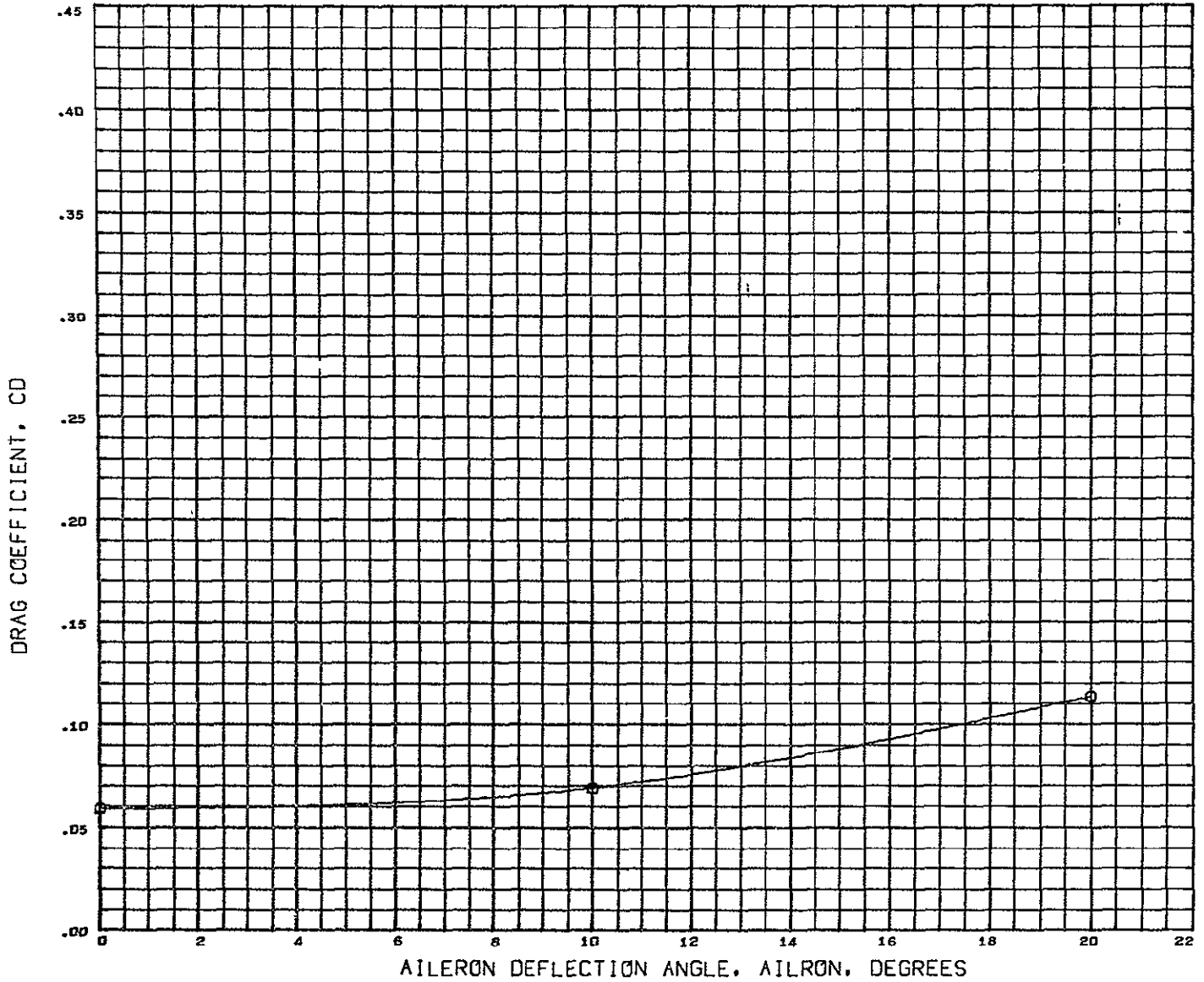

SYMBOL	ALPHA	PARAMETRIC VALUES				DATA SOURCE			REFERENCE INFORMATION			
C	10.000	MACH	0.260	BETA	0.000	DATASET	AILRON	DATASET	AILRON	REFS	8.8690	SQ.FT.
		ELEVTR	- 10.000	SPBRK	0.000	NCP012	0.000	NCP003	10.000	REFL	29.5700	IN.
		BFLAP	0.000	RUDDER	0.000	NCP022	20.000			REFB	51.6000	IN.
										XMRP	59.3200	IN.
										YMRP	0.0000	IN.
										ZMRP	11.6000	IN.
										SCALE	4.0000	PERCNT

DATA HIST. CODE H#EV#E1

LATERAL CONTROL POWER BASIC CONFIGURATION

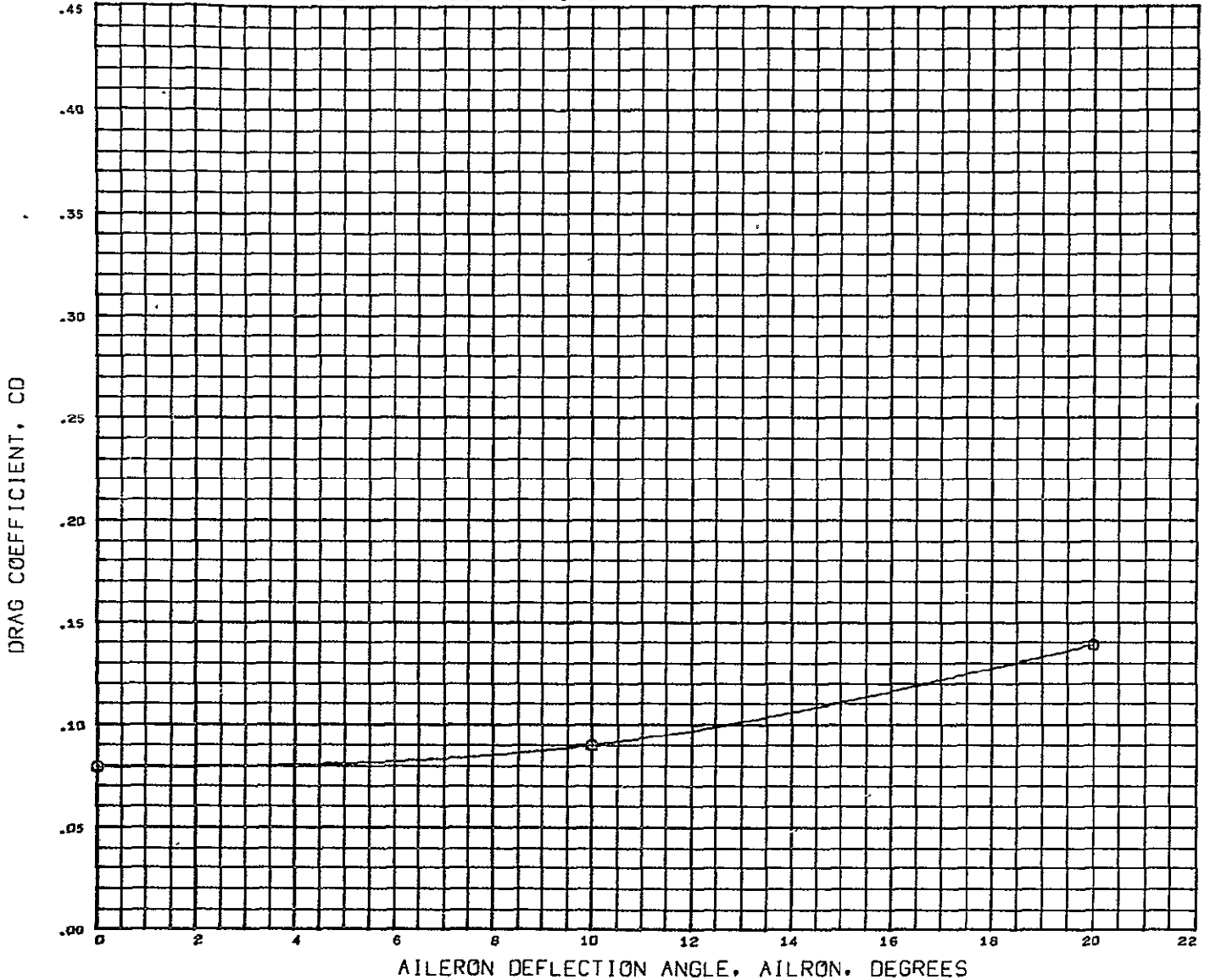

AILERON DEFLECTION ANGLE, AILRON, DEGREES

SYMBOL	ALPHA	PARAMETRIC VALUES				DATA SOURCE			REFERENCE INFORMATION			
□	12.000	MACH	0.260	BETA	0.000	DATASET	AILRON	DATASET	AILRON	REFS	8.8690	SQ.FT.
		ELEVTR	- 10.000	SPBRK	0.000	NCP012	0.000	NCP003	10.000	REFL	29.5700	IN.
		BFLAP	0.000	RUDDER	0.000	NCP022	20.000			REFB	51.6000	IN.
										YMRP	59.3200	IN.
										ZMRP	0.0000	IN.
										ZHRP	11.6000	IN.
										SCALE	4.0000	PERCENT

DATA HIST. CODE M#EV#EI

LSWT 248 MDAC 4.0 PC 02 HCR 0RB

B5W11V6

(NCP012) 26 FEB 71

PAGE 184

LATERAL CONTROL POWER BASIC CONFIGURATION

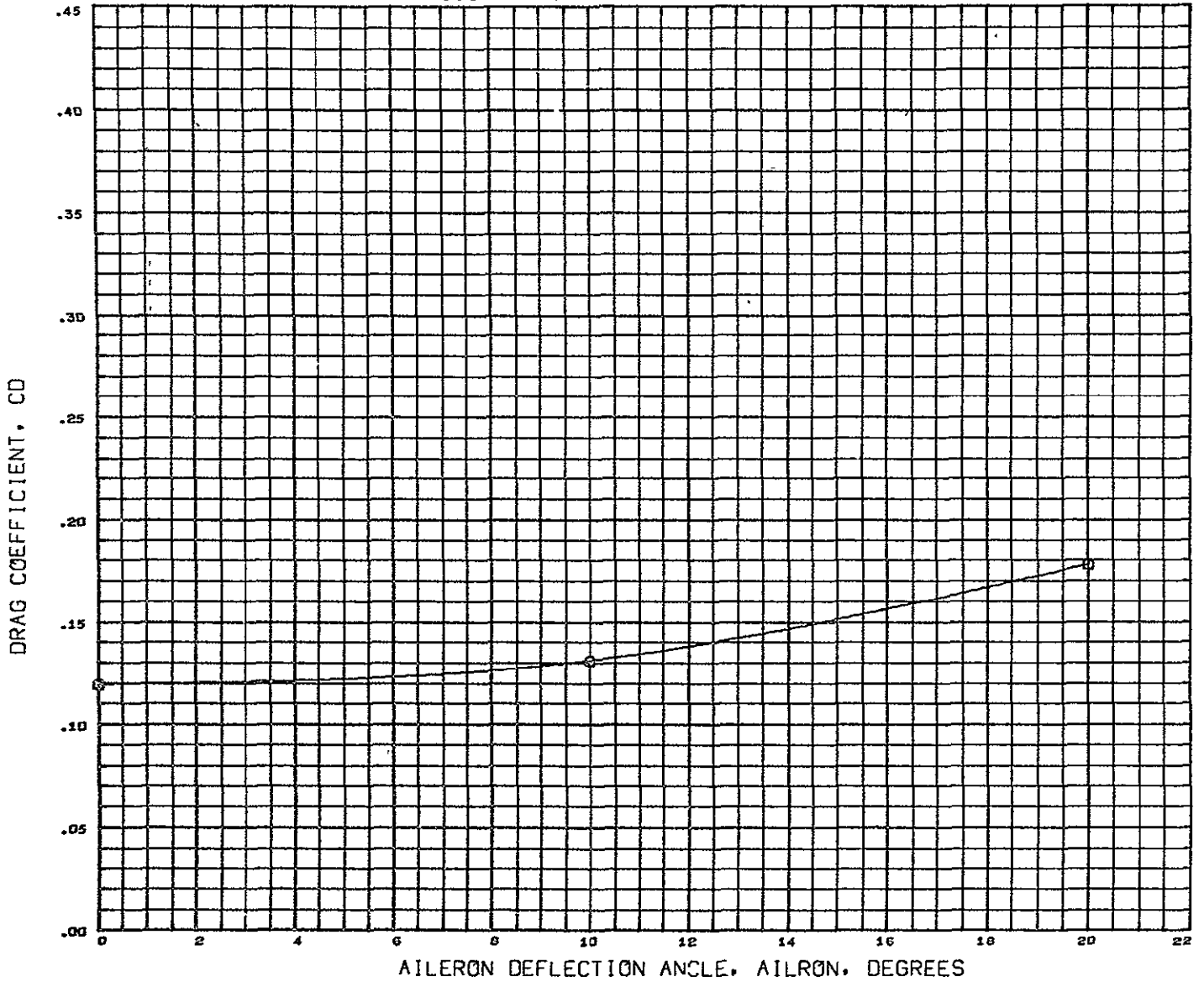

SYMBOL	ALPHA	PARAMETRIC VALUES				DATA SOURCE			REFERENCE INFORMATION			
0	14.000	MACH	0.260	BETA	0.000	DATASET	AILRON	DATASET	AILRON	REFS	0.6690	SQ.FT
		ELEVTR	- 10.000	SPBRK	0.000	NCP012	0.000	NCP003	10.000	REFL	29.5700	IN.
		BFLAP	0.000	RUDDER	0.000	NCP022	20.000			REFB	51.6000	IN.
										XMRP	59.3200	IN.
										YHRP	0.0000	IN.
										ZHRP	11.6000	IN.
										SCALE	4.0000	PERCNT

DATA HIST. CODE M#EV#EI

LATERAL CONTROL POWER BASIC CONFIGURATION

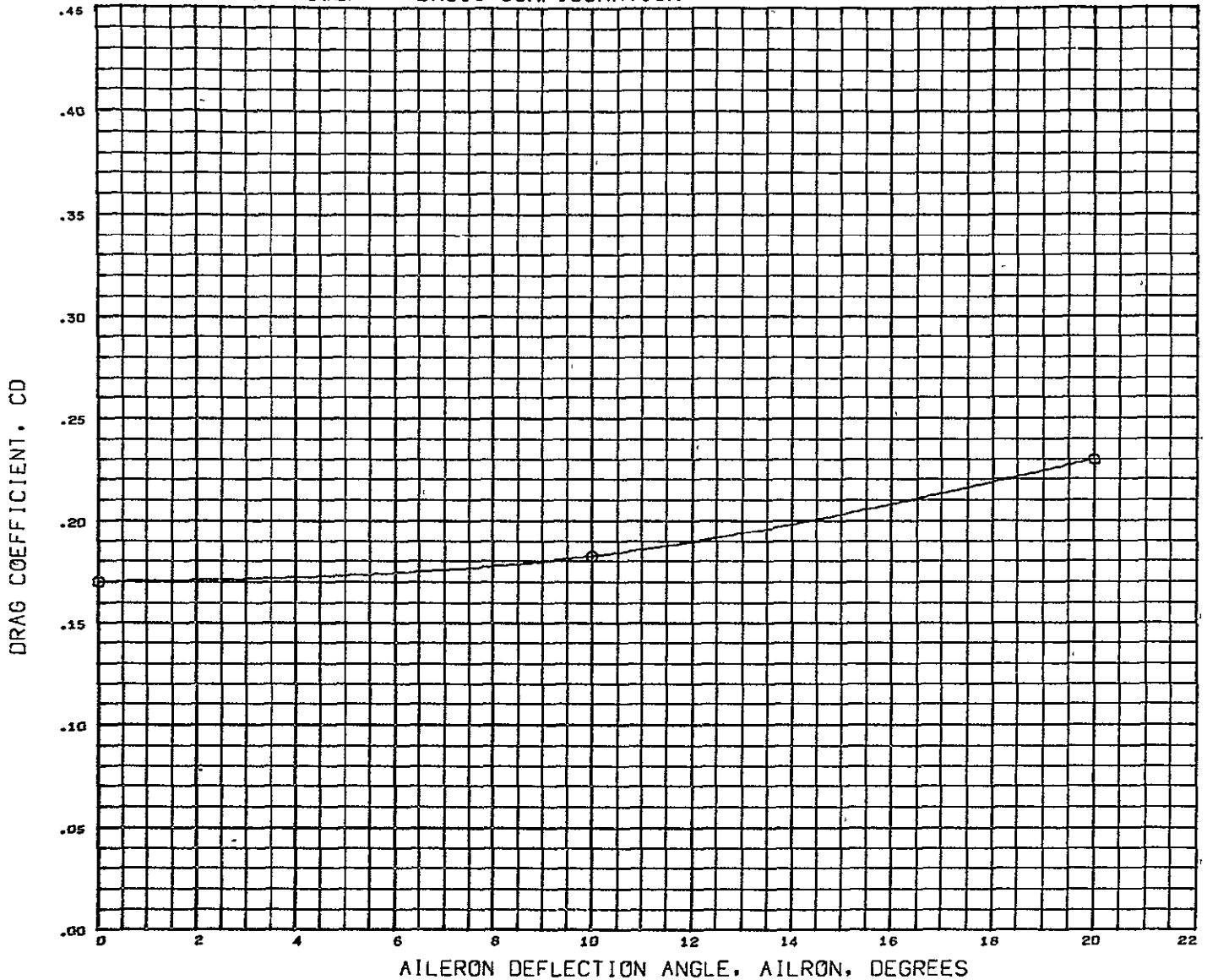

SYMBOL	ALPHA	PARAMETRIC VALUES				DATA SOURCE			REFERENCE INFORMATION			
○	16.000	MACH	0.260	BETA	0.000	DATASET	AILRON	DATASET	AILRON	REFS	8.8690	SQ.FT.
		ELEVTR	- 10.000	SPBRK	0.000	NCP012	0.000	NCP003	10.000	REFL	29.5700	IN.
		BFLAP	0.000	RUDDER	0.000	NCP022	20.000			REFB	51.6000	IN.
										XMRP	59.3200	IN.
										YMRP	0.0000	IN.
										ZMRP	11.6000	IN.
										SCALE	4.0000	PERCNT

DATA HIST. CODE H#EV#EI

LATERAL CONTROL POWER BASIC CONFIGURATION

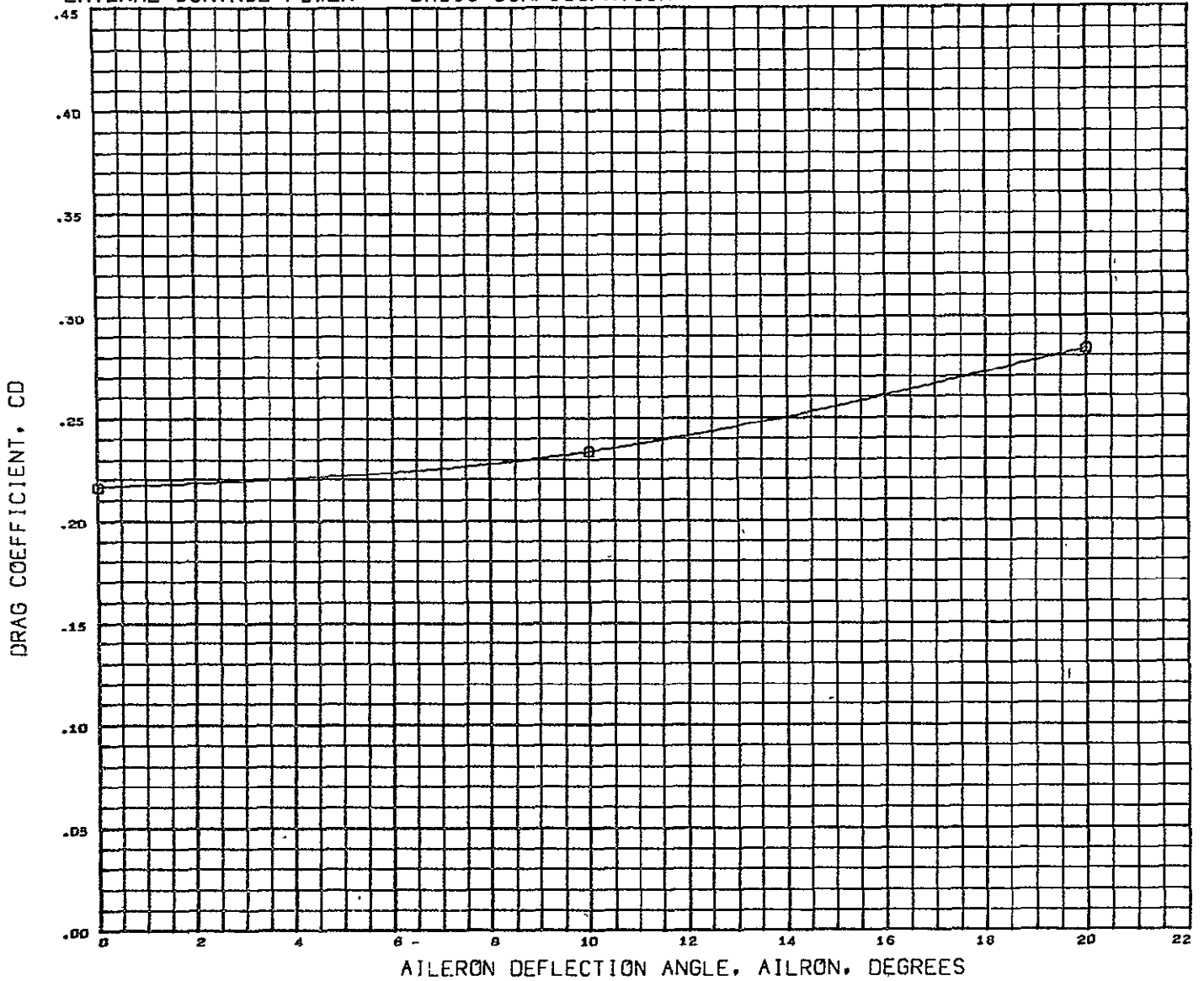

SYMBOL	ALPHA	PARAMETRIC VALUES				DATA SOURCE			REFERENCE INFORMATION		
		MACH	BETA	DATASET	AILRON	REFS	SQ.FT.				
Q	18.000	0.260	0.000	NCP012	0.000	29.5700	IN.				
		ELEVTR - 10.000	SFBRK 0.000	NCP003	10.000	51.6000	IN.				
		BFLAP 0.000	RUDDER 0.000	NCP022	20.000	59.3200	IN.				
						0.0000	IN.				
						11.6000	IN.				
						4.0000	PERCNT				

DATA HIST. CODE H#EV#EI

LATERAL CONTROL POWER BASIC CONFIGURATION

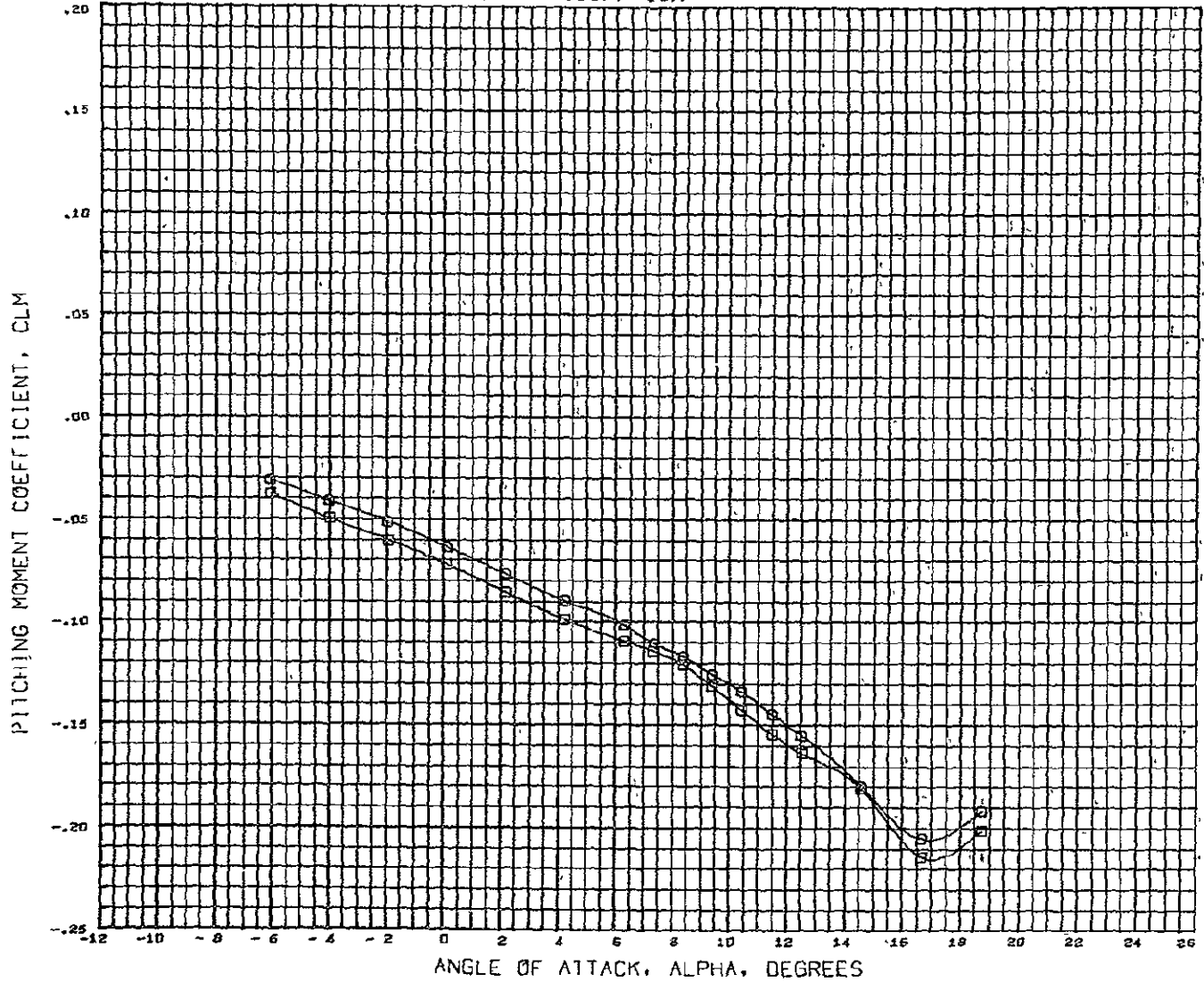

DATA SET SYMBOL	CONFIGURATION DESCRIPTION
(CCF002)	LSWT 248 MDAC 4.0 FC 02 HCR ORB
(CCF021)	LSWT 248 MDAC 4.0 FC 02 HCR ORB

BETA	ELEVTR	AILRON
0.000	0.000	0.000
0.000	0.000	10.000

REFERENCE INFORMATION	
REFS	8.8690 SQ FT.
REFL	29.5700 IN.
REFB	51.6000 IN.
XHRF	59.3200 IN.
YHRF	0.0000 IN.
ZHRF	11.6000 IN.
SCALE	4.0000 PERCENT

MACH 0.250



# LATERAL CONTROL POWER BASIC CONFIGURATION

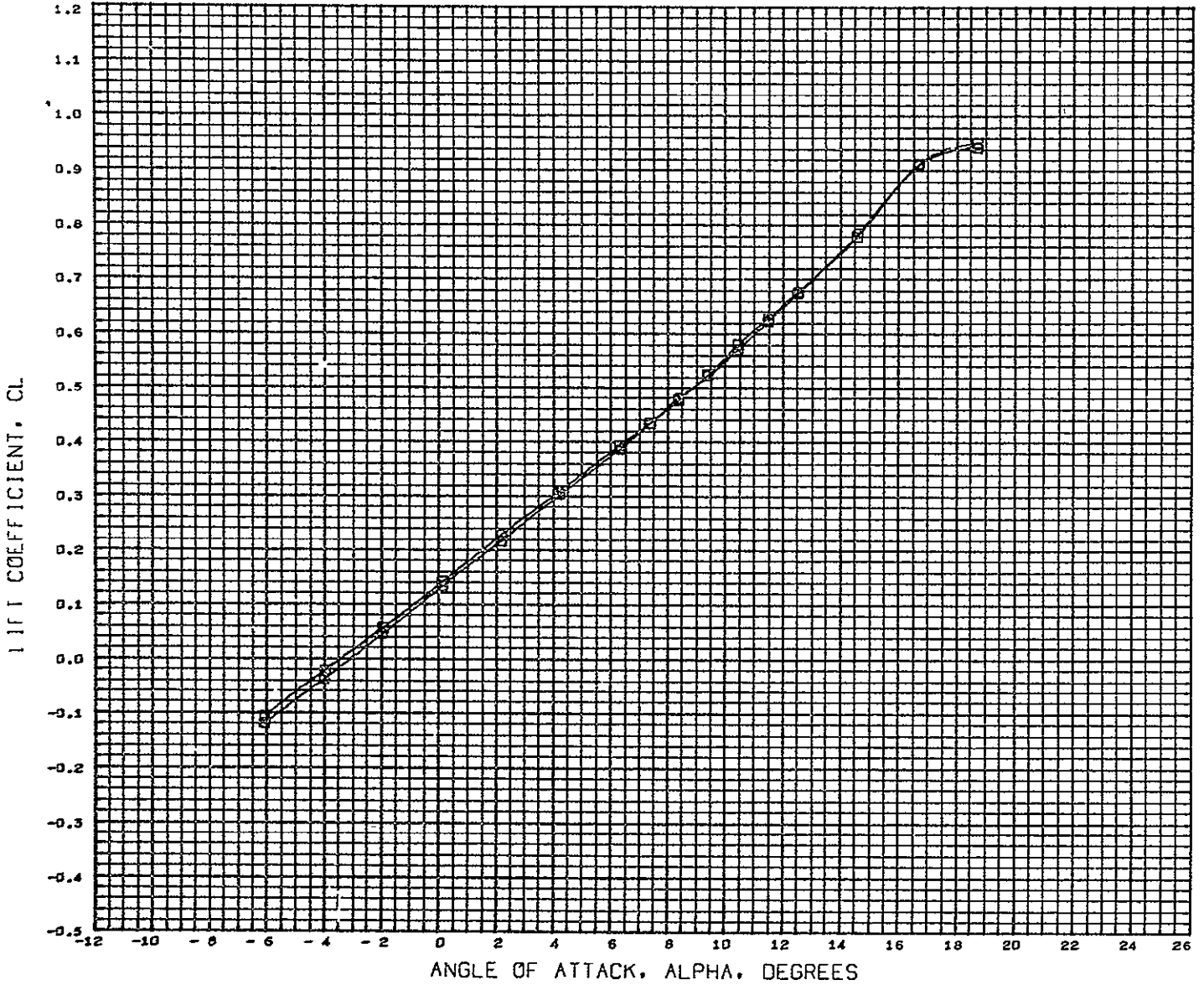

DATA SET SYMBOL	CONFIGURATION DESCRIPTION	BETA	ELEVTR	AILRON	REFERENCE INFORMATION
(CCPD02)	LSWT 248 MDAC 4.0 FC 02 HCR ORB	0.007	0.000	0.000	REFS 8.8690 SQ FT.
(CCPD21)	LSWT 248 MDAC 4.0 FC 02 HCR ORB	0.000	0.000	10.000	REFL 29.5700 IN.
					REFB 51.6000 IN.
					XMRP 59.3200 IN.
					YMRP 0.0000 IN.
					ZMRP 11.6000 IN.
					SCALE 4.0000 PERCNT

MACH 0.250

LATERAL CONTROL POWER BASIC CONFIGURATION

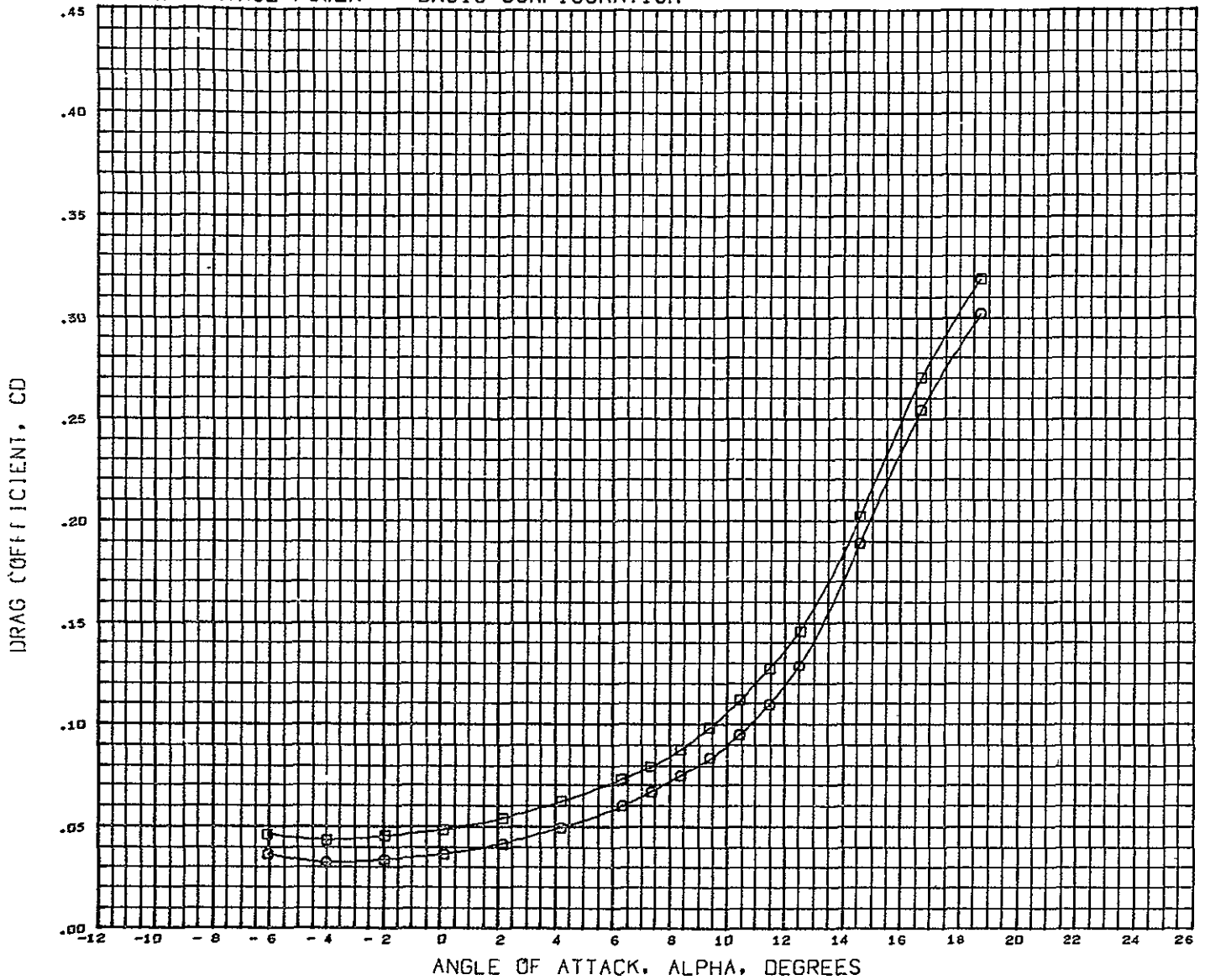

DATA SET SYMBOL	CONFIGURATION DESCRIPTION	BETA	ELEVTR	AILRON
(CCFD02)	LSWT 248 MDAC 4.0 PC 02 HCR ORB B5W11V6	0.000	0.000	0.000
(CCFD21)	LSWT 248 MDAC 4.0 PC 02 HCR ORB B5W11V6	0.000	0.000	10.000

REFERENCE INFORMATION		
REFS	8.8690	SQ.FT.
REFL	29.5700	IN.
REFB	51.6000	IN.
XMRP	59.3200	IN.
YMRP	0.0000	IN.
ZMRP	11.6000	IN.
SCALE	4.0000	PERCENT

MACH 0.250

LATERAL CONTROL POWER BASIC CONFIGURATION

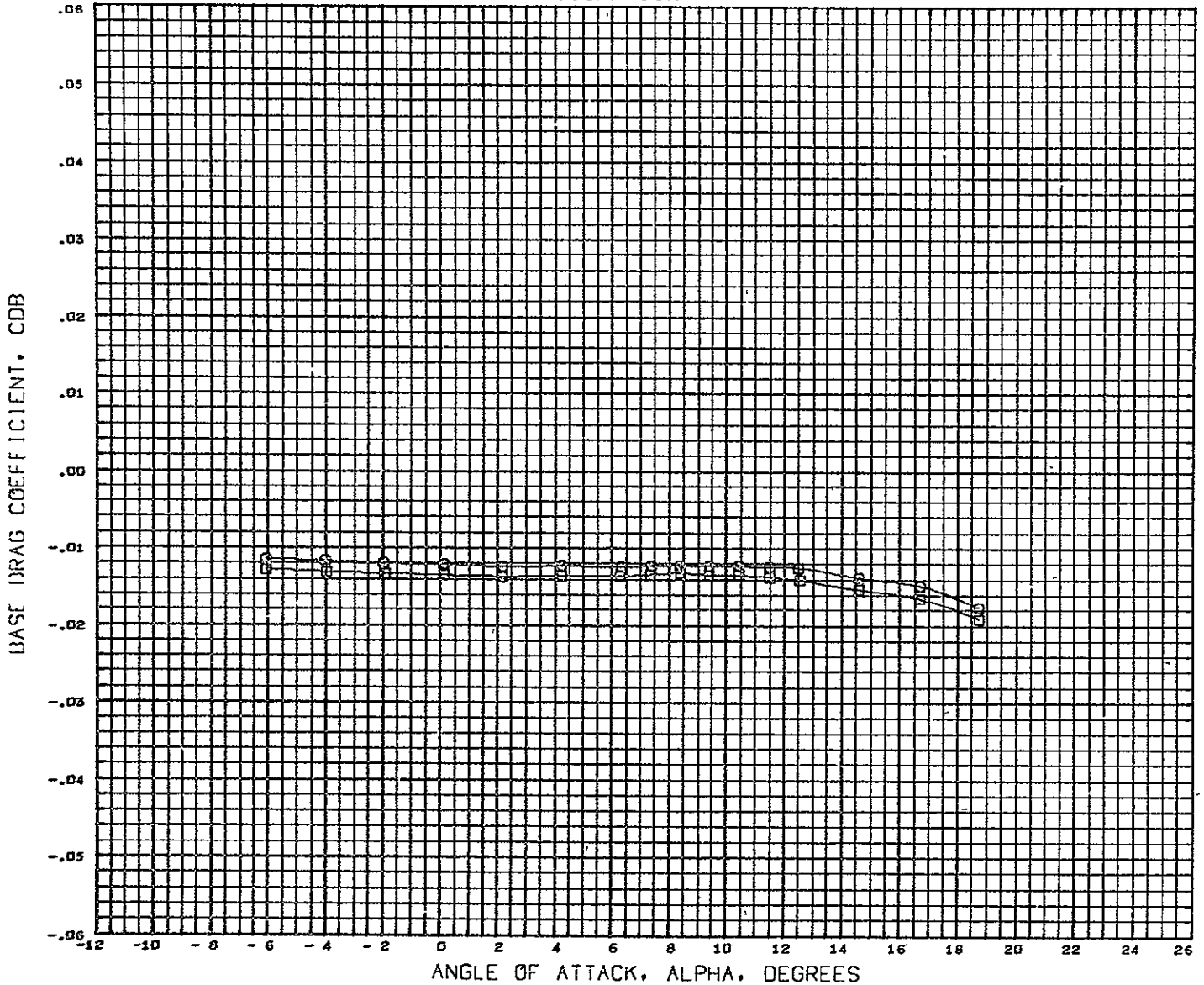

DATA SET SYMBOL	CONFIGURATION DESCRIPTION	BETA	ELEVTR	AILRON	REFERENCE INFORMATION
(CCP002)	LSWT 248 HDAC 4.0 FC 02 HCR ORB	0.000	0.000	0.000	REFS 8.8690 SQ FT.
(CCP021)	LSWT 248 HDAC 4.0 FC 02 HCR ORB	0.000	0.000	10.000	REFL 29.5700 IN.
					REFB 51.6000 IN.
					XMRP 59.3200 IN.
					YMRP 0.0000 IN.
					ZMRP 11.6000 IN.
					SCALE 4.0000 PERCNT

MACH 0.250

# LATERAL CONTROL POWER BASIC CONFIGURATION

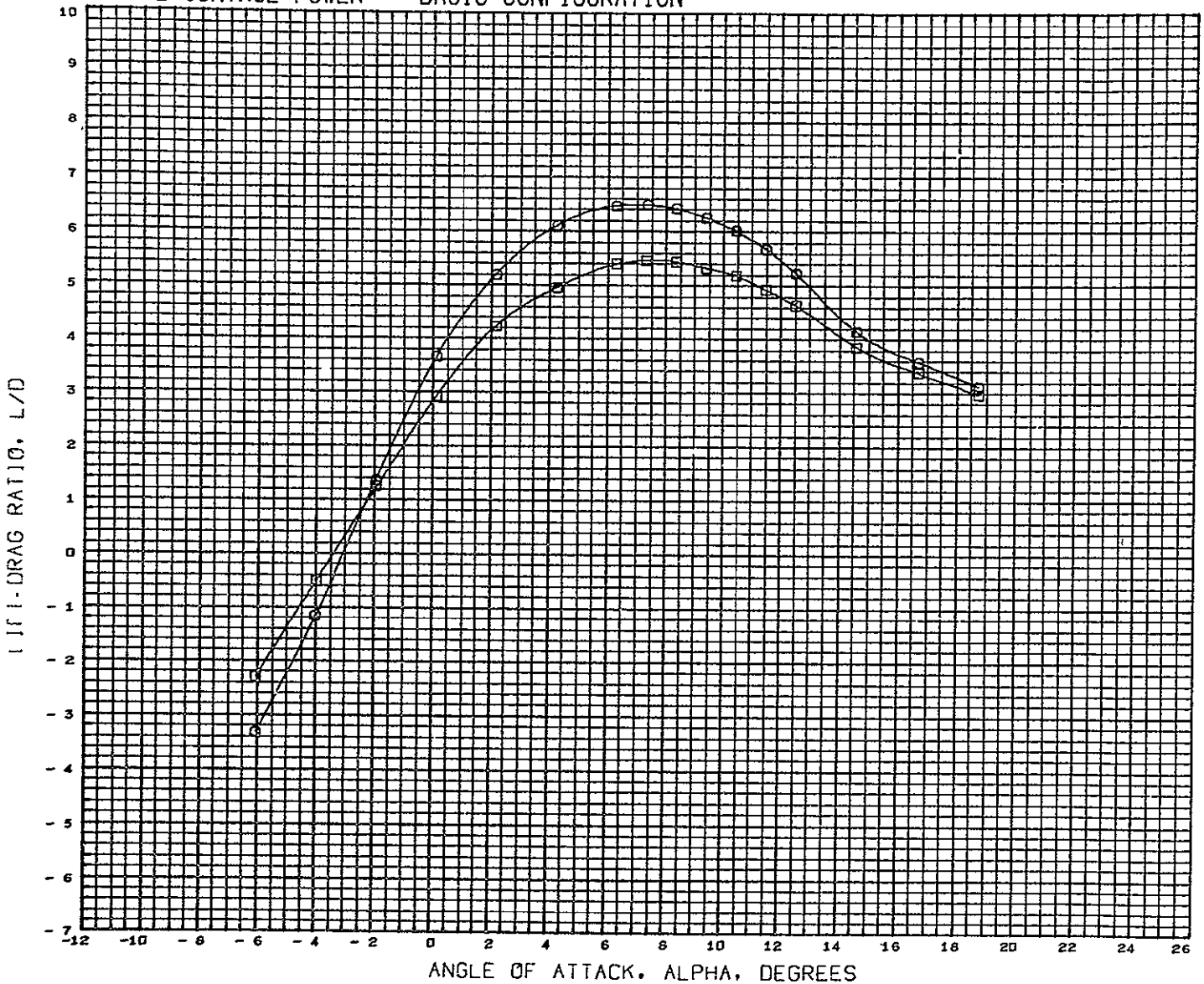

DATA SET SYMBOL	CONFIGURATION DESCRIPTION	BETA	ELEVTR	AILRON	REFERENCE INFORMATION
(CCP002)	LSWT 248 MDAC 4.0 PC 02 HCR ORB B5W11V6	0.000	0.000	0.000	REFS 8.8690 SQ FT
(CCP021)	LSWT 248 MDAC 4.0 PC 02 HCR ORB B5W11V6	0.000	0.000	10.000	REFL 29.5700 IN.
					REFB 51.6000 IN.
					XMRP 59.3200 IN.
					YMRP 0.0000 IN.
					ZMRP 11.6000 IN.
					SCALE 4.0000 PERCNT

MACH 0.250

# LATERAL CONTROL POWER BASIC CONFIGURATION

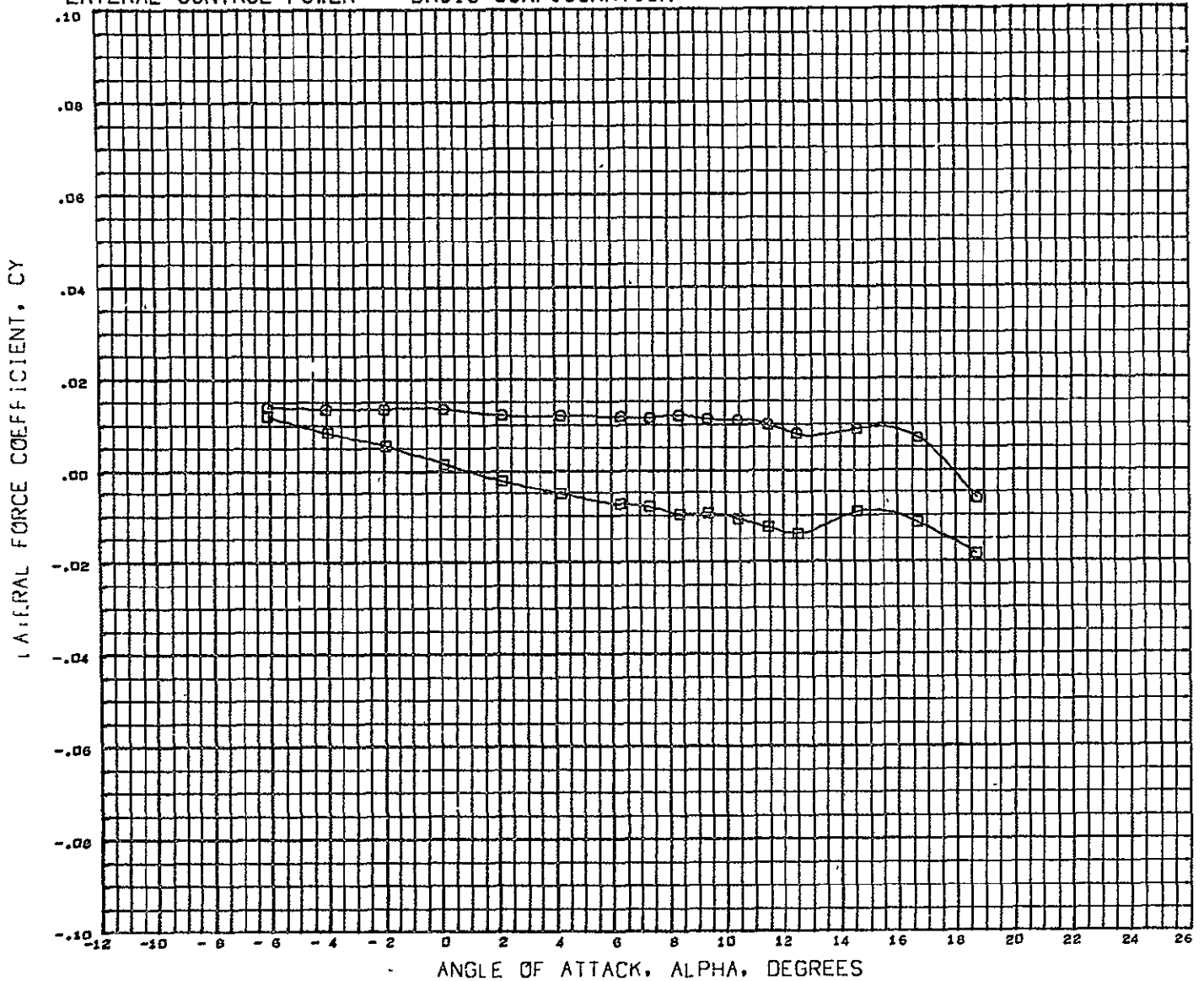

DATA SET SYMBOL	CONFIGURATION DESCRIPTION	BETA	ELEVTR	AILRON	REFERENCE INFORMATION
(CCP002)	LSWT 248 HDAC 4.0 FC 02 HCR ORB B5W11V6	0.070	0.000	0.000	REFS 8.8690 SQ.FT.
(CCP021)	LSWT 248 HDAC 4.0 FC 02 HCR ORB B5W11V6	0.000	0.000	10.000	REFL 29.5700 IN
					REFB 51.6000 IN
					XMRP 59.3200 IN.
					YMRP 0.0000 IN.
					ZMRP 11.6000 IN.
					SCALE 4.0000 PERCENT

MACH 0.250

# LATERAL CONTROL POWER BASIC CONFIGURATION

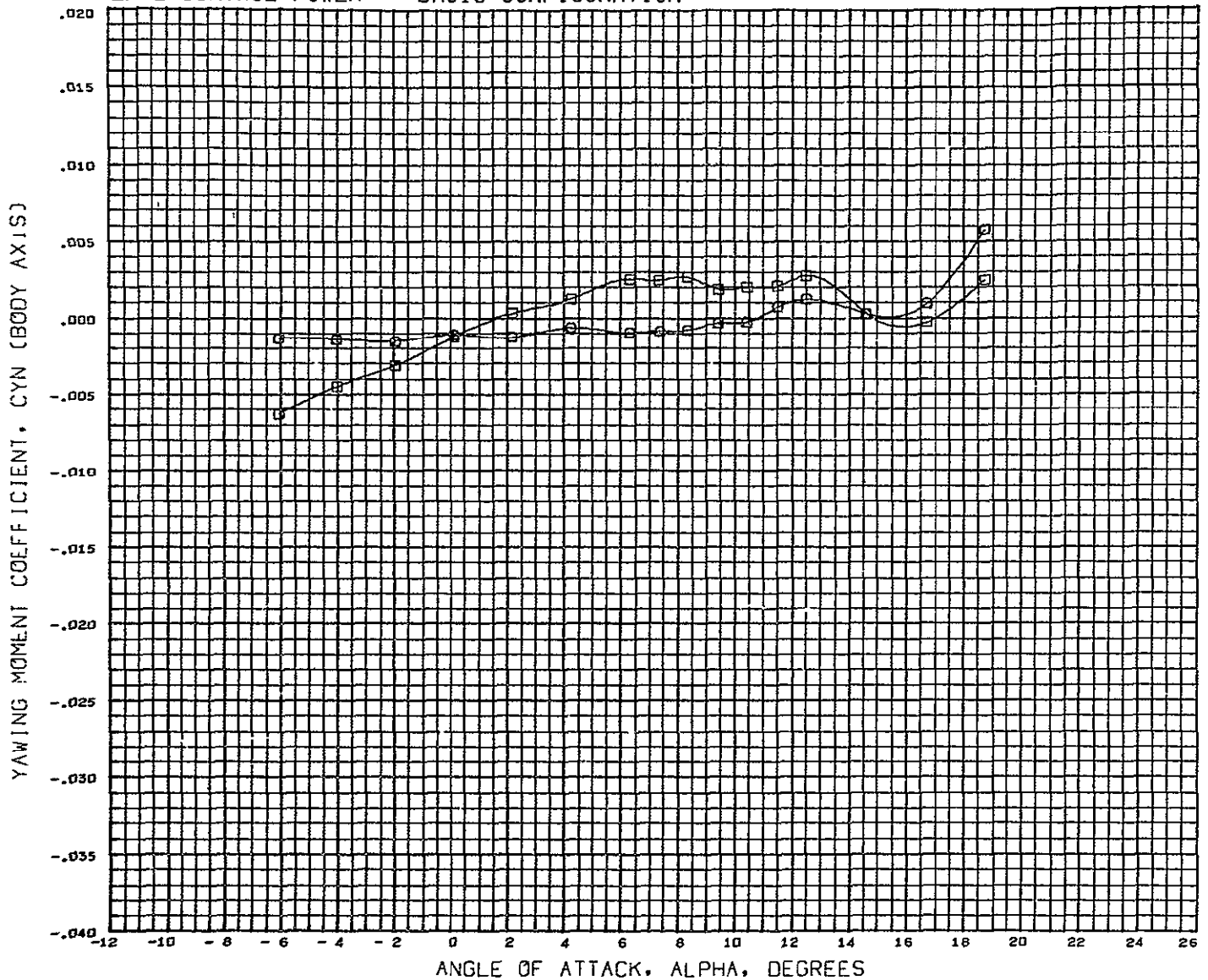

DATA SET SYMBOL	CONFIGURATION DESCRIPTION	BETA	ELEVTR	AILRON
(CCF002)	LSWT 248 MDAC 4.0 FC 02 HCR ORB	0.070	0.000	0.000
(CCF021)	LSWT 248 MDAC 4.0 FC 02 HCR ORB	0.000	0.000	10.000

REFERENCE INFORMATION		
REFS	8.8690	SQ.FT.
REFL	29.5700	IN.
REFB	51.6000	IN.
YMRP	59.3200	IN.
ZMRP	0.0000	IN.
ZMRP	11.6000	IN.
SCALE	4.0000	PERCENT

MACH 0.250

# LATERAL CONTROL POWER BASIC CONFIGURATION

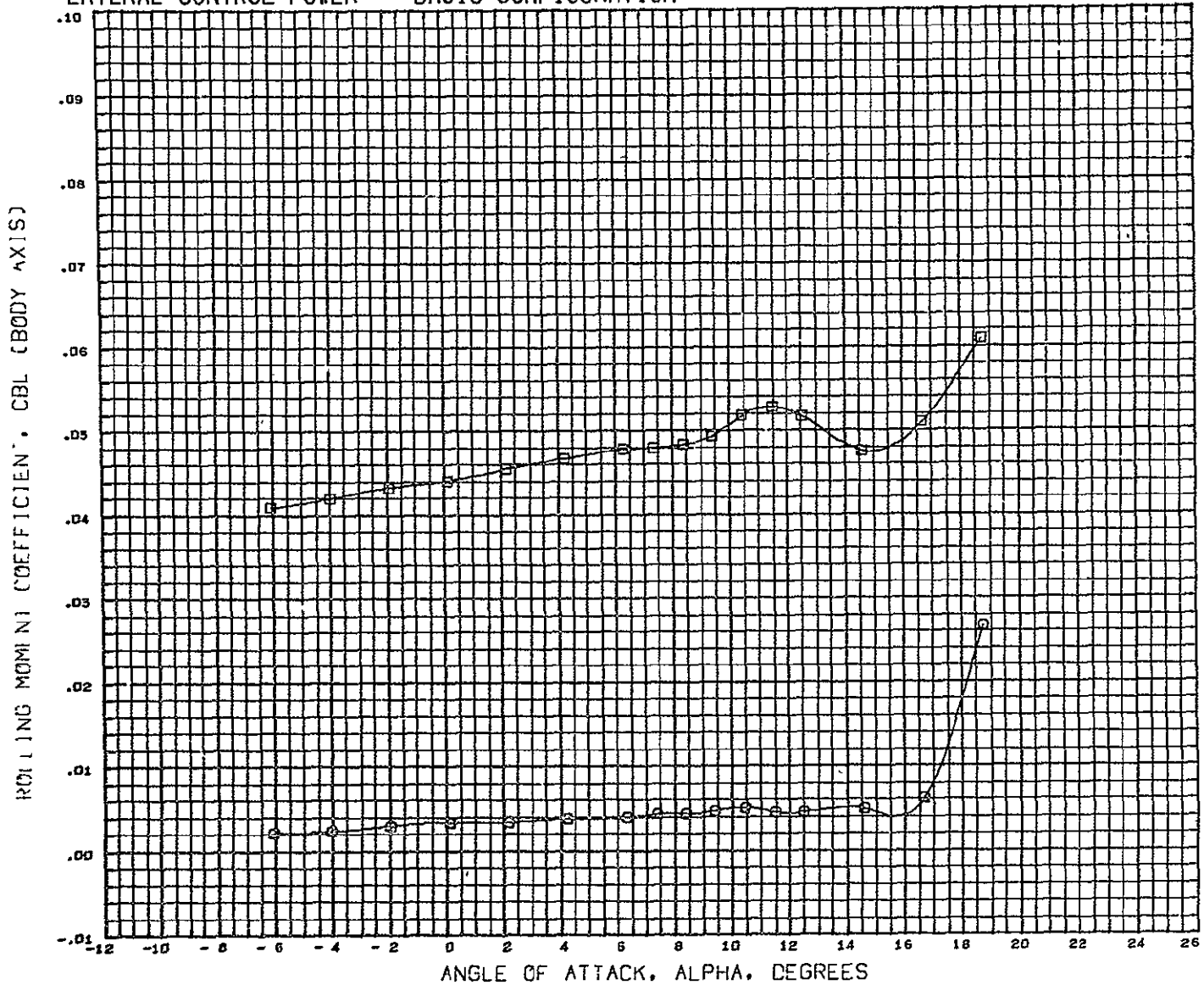

DATA SET SYMBOL	CONFIGURATION DESCRIPTION	BETA	ELEVTR	AILRON	REFERENCE INFORMATION
(CCP002)	□ LSWT 248 HDAC 4.0 FC 02 HCR ORB 85W11V6	0.000	0.000	0.000	REFS 8.8690 SQ FT.
(CCP021)	○ LSWT 248 HDAC 4.0 FC 02 HCR ORB 85W11V6	0.000	0.000	10.000	REFL 29.5700 IN.
					REFB 51.6000 IN.
					XMRP 59.3200 IN.
					YMRP 0.0000 IN.
					ZMRP 11.6000 IN.
					SCALE 4.0000 PERCENT

HACH 0.250

# LATERAL CONTROL POWER BASIC CONFIGURATION

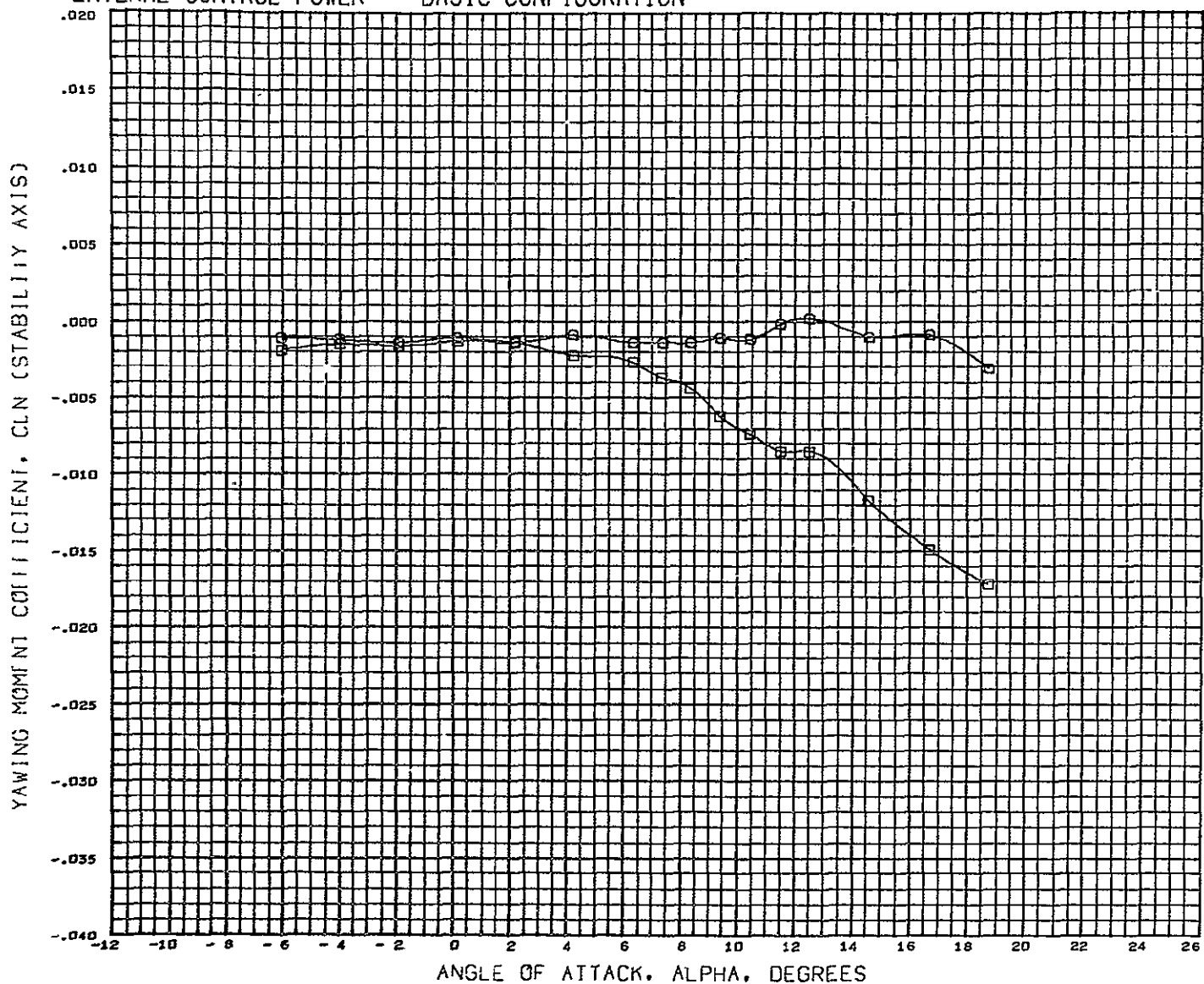

DATA SET SYMBOL	CONFIGURATION DESCRIPTION	BETA	ELEVTR	AILRON
(RCF02)	LSWT 248 MDAC 4.0 FC 02 HCR ORB B5W11V6	0.000	0.000	0.000
(RCF021)	LSWT 248 MDAC 4.0 FC 02 HCR ORB B5W11V6	0.000	0.000	10.000

REFERENCE INFORMATION		
REFS	8.8690	sq.ft.
REFL	29.5700	in.
REFB	51.6000	in.
XMRP	59.3200	in.
YMRP	0.0000	in.
ZMRP	11.6000	in.
SCALE	4.0000	PERCNT

MACH 0.250



# LATERAL CONTROL POWER BASIC CONFIGURATION

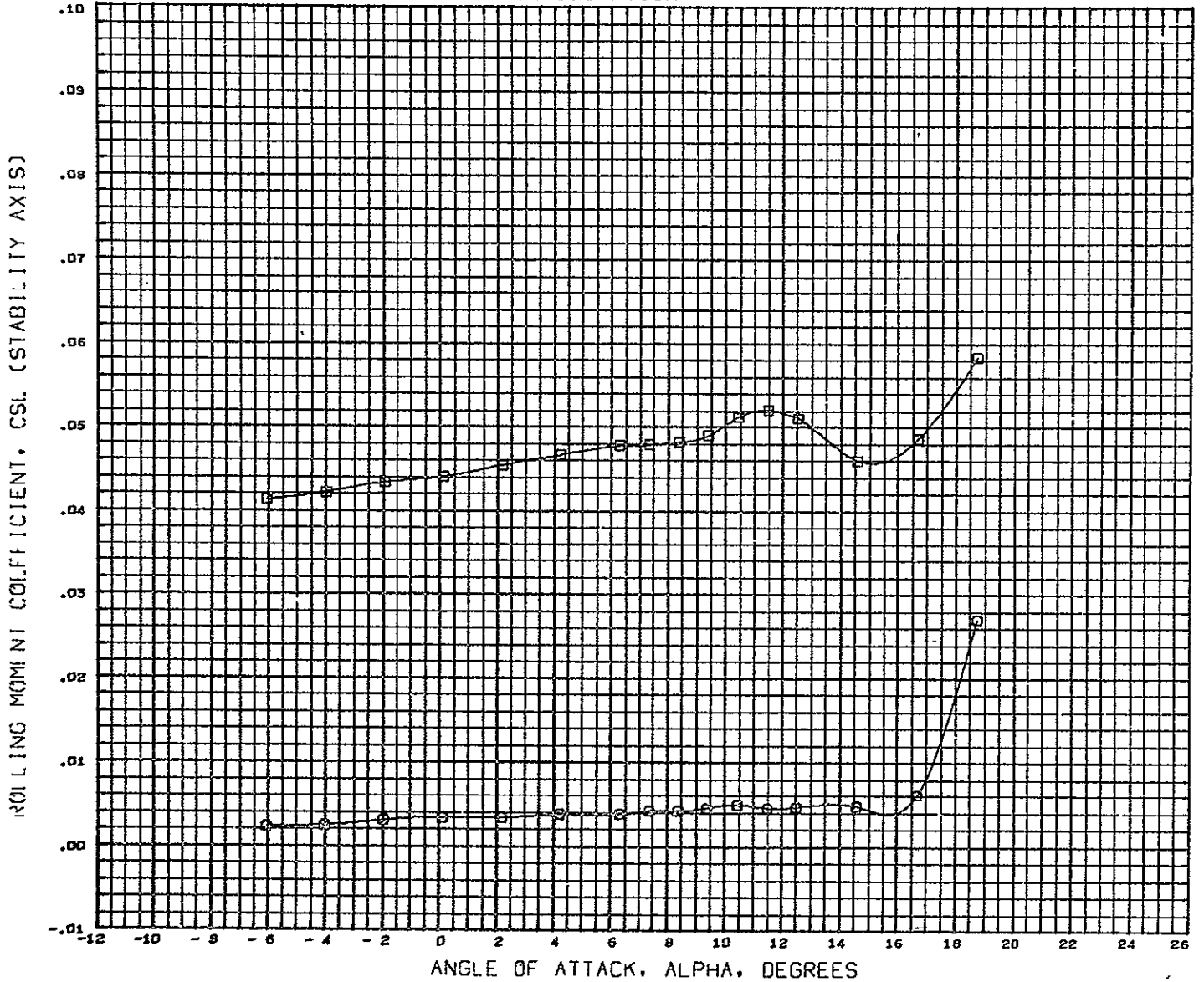

DATA SET SYMBOL	CONFIGURATION DESCRIPTION	BETA	ELEVTR	AILRON	REFERENCE INFORMATION
(RCFD02)	LSWT 248 HDAC 4.0 FC 02 HCR ORB B5W11V6	0.000	0.000	0.000	REFS 8 8690 SQ.FT.
(RCFD21)	LSWT 248 HDAC 4.0 FC 02 HCR ORB B5W11V6	0.000	0.000	10.000	REFL 29.5700 IN.
					REFB 51.6000 IN.
					XMRP 59.3200 IN.
					YMRP 0.0000 IN.
					ZMRP 11.6000 IN.
					SCALE 4.0000 PERCENT

MACH 0.250

# LATERAL CONTROL POWER BASIC CONFIGURATION

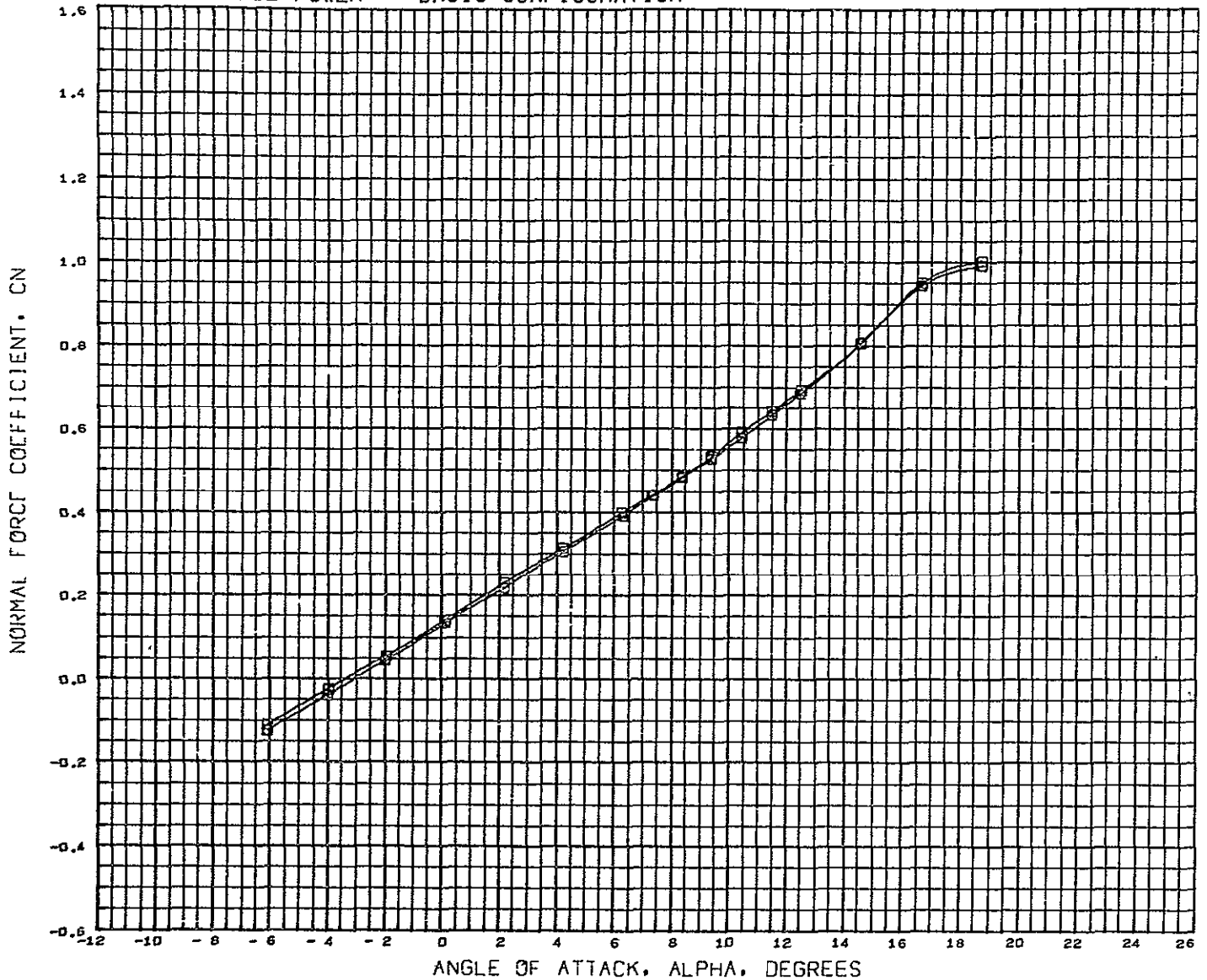

DATA SET SYMBOL	CONFIGURATION DESCRIPTION	BETA	ELEVTR	AILRON	REFERENCE INFORMATION
(BCF02)	LSWT 248 HDAC 4.0 FC 02 HCR ORB B5W11V6	0.000	0.000	0.000	REFS 8 8690 SQ.FT
(BCF02)	LSWT 248 HDAC 4.0 FC 02 HCR ORB B5W11V6	0.000	0.000	10.000	REFL 29.5700 IN.
					REFB 51.6000 IN.
					XMRP 59 3200 IN.
					YMRP 0.0000 IN.
					ZMRP 11.6000 IN.
					SCALE 4.0000 PERCNT

HACH 0.250

# LATERAL CONTROL POWER BASIC CONFIGURATION

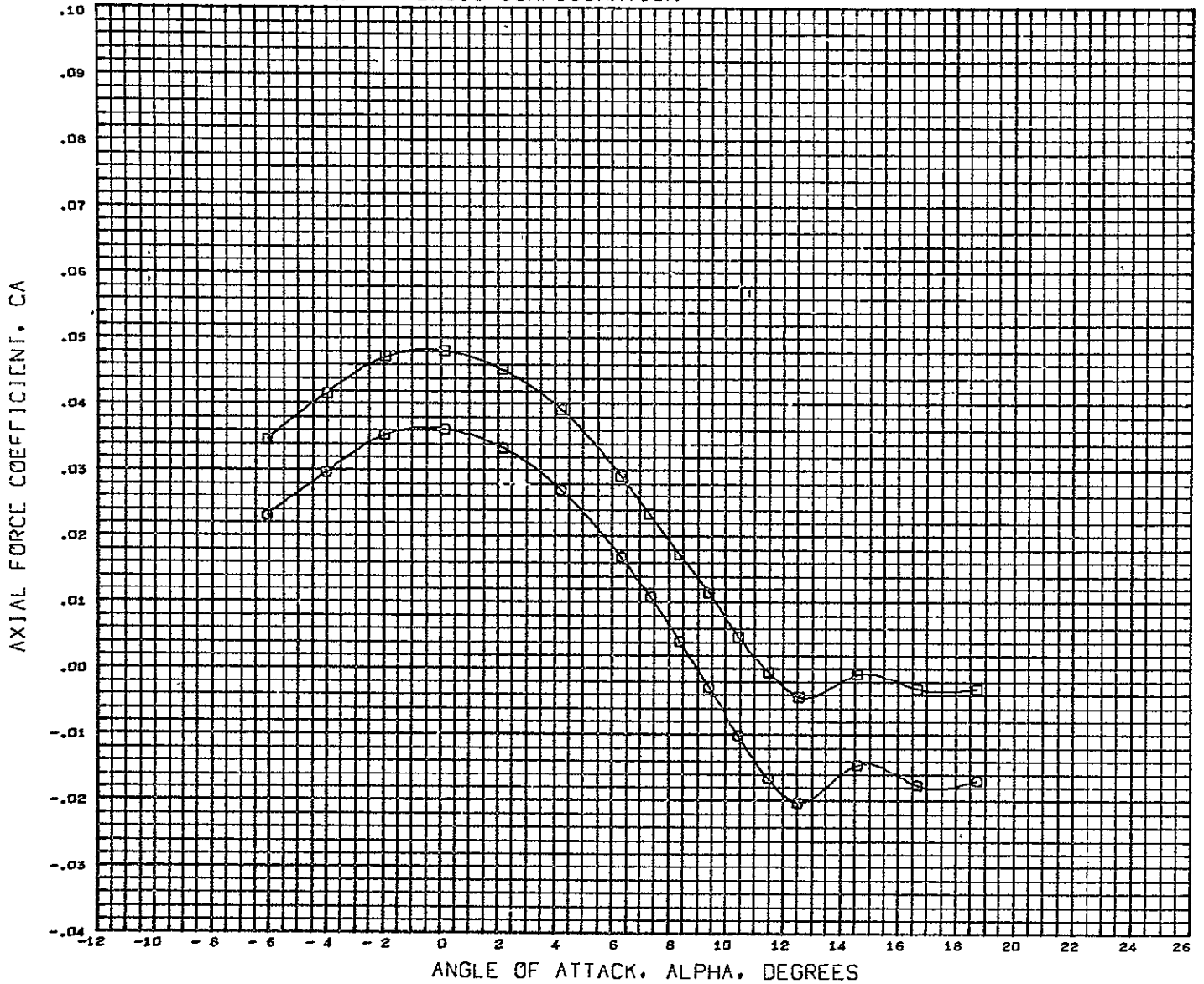

DATA SET SYMBOL	CONFIGURATION DESCRIPTION	BETA	ELEVTR	AILRON	REFERENCE INFORMATION
(8CF002)	LSWT 248 MDAC 4.0 FC 02 HCR ORB	0.000	0.000	0.000	REFS 8.8690 SQ FT
(8CF021)	LSWT 248 MDAC 4.0 FC 02 HCR ORB	0.000	0.000	10.000	REFL 29.5700 IN.
					REFS 51.6000 IN.
					XMRP 59.3200 IN.
					YMRP 0.0000 IN.
					ZMRP 11.6000 IN.
					SCALE 4.0000 PERCENT

HACH 0.250

LATERAL CONTROL POWER BASIC CONFIGURATION

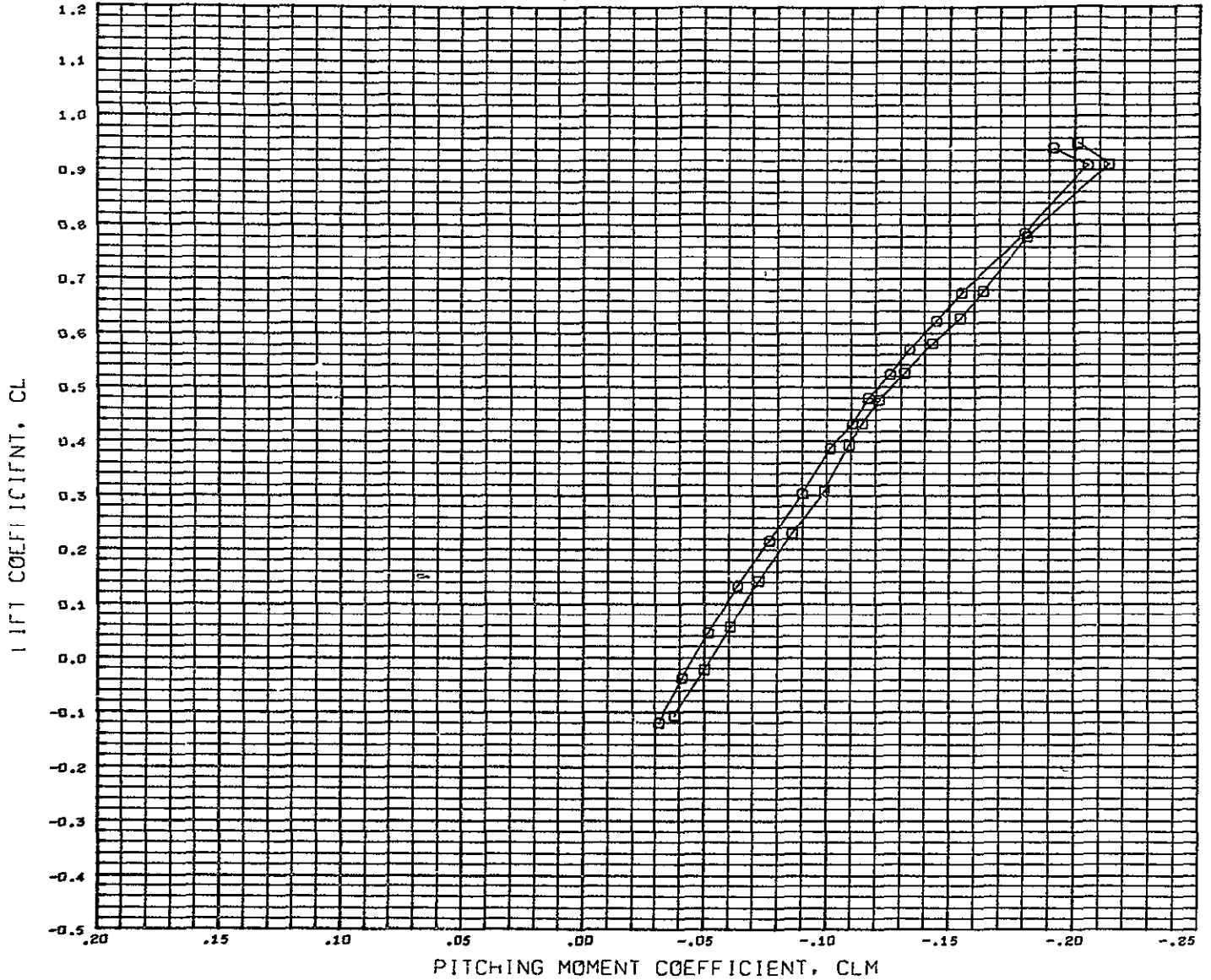

DATA SET SYMBOL	CONFIGURATION DESCRIPTION	BETA	ELEVTR	AILRON	REFERENCE INFORMATION
(CCF002)	LSWT 248 MDAC 4.0 PC 02 HCR ORB B5W11V6	0.000	0.000	0.000	REFS 8 8690 SQ.FT.
(CCF021)	LSWT 248 MDAC 4.0 PC 02 HCR ORB B5W11V6	0.000	0.000	10.000	REFL 29.5700 IN.
					REFB 51.6000 IN.
					XMRP 59.3200 IN.
					YMRF 0.0000 IN.
					ZMRP 11.6000 IN.
					SCALE 4.0000 PERCENT

MACH 0.250

# LATERAL CONTROL POWER BASIC CONFIGURATION

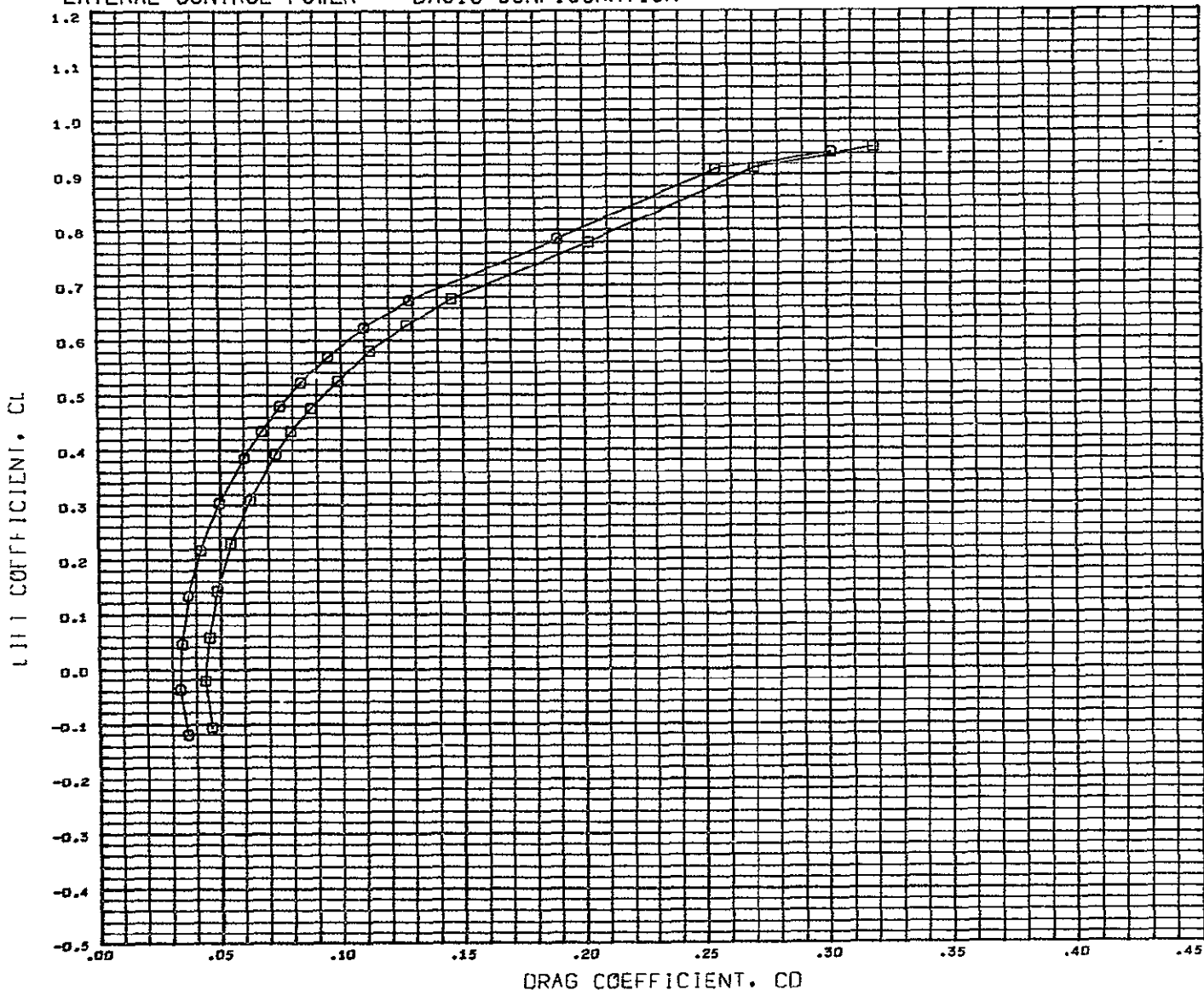

DATA SET SYMBOL	CONFIGURATION DESCRIPTION	B5W11V6	BETA	ELEVTR	AILRON
(CCFD02)	LSMT 248 HDAC 4.0 FC 02 HCR ORB	B5W11V6	0.000	0.000	0.000
(CCFD21)	LSMT 248 HDAC 4.0 FC 02 HCR ORB	B5W11V6	0.000	0.000	10.000

REFERENCE INFORMATION	
REFS	8.8690 SQ.FT
REFL	29.5700 IN.
REFB	51.6000 IN.
XMRP	59.3200 IN.
YMRP	0.0000 IN.
ZMRP	11.6000 IN.
SCALE	4.0000 PERCNT

HACH 0.250

# LATERAL CONTROL POWER BASIC CONFIGURATION

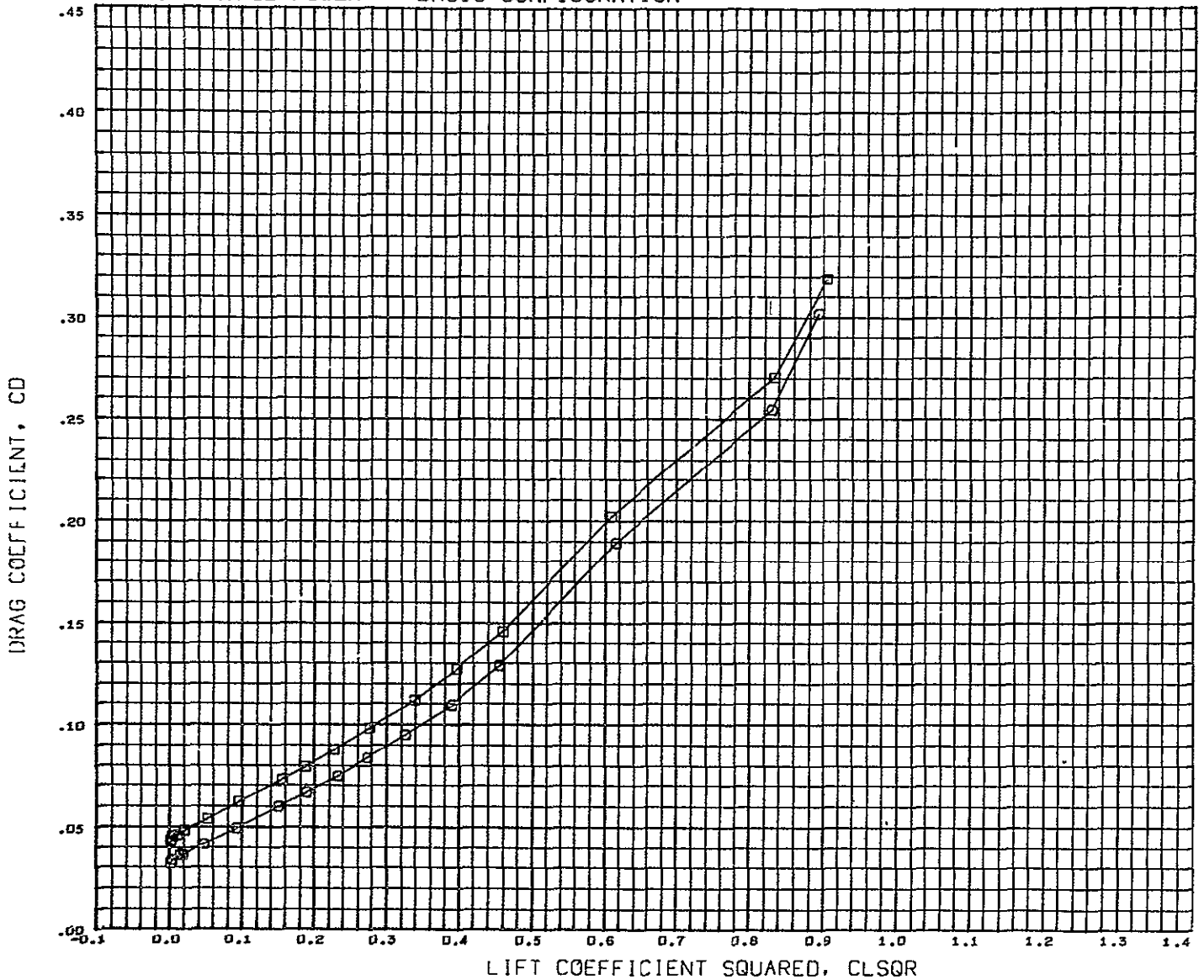

DATA SET SYMBOL	CONFIGURATION DESCRIPTION	BETA	ELEVTR	AILRON	REFERENCE INFORMATION
(CCFD02)	LSWT 248 MCAC 4.0 FC O2 HCR ORB	0.000	0.000	0.000	REFS 8.8690 SQ.FT.
(CCFD21)	LSWT 248 MCAC 4.0 FC O2 HCR ORB	0.000	0.000	10.000	REFL 29.5700 IN.
					REFB 51.6000 IN.
					XMRP 59.3200 IN.
					YMRP 0.0000 IN.
					ZMRP 11.6000 IN.
					SCALE 4.0000 PERCNT

MACH 0.250

# LATERAL CONTROL POWER BASIC CONFIGURATION

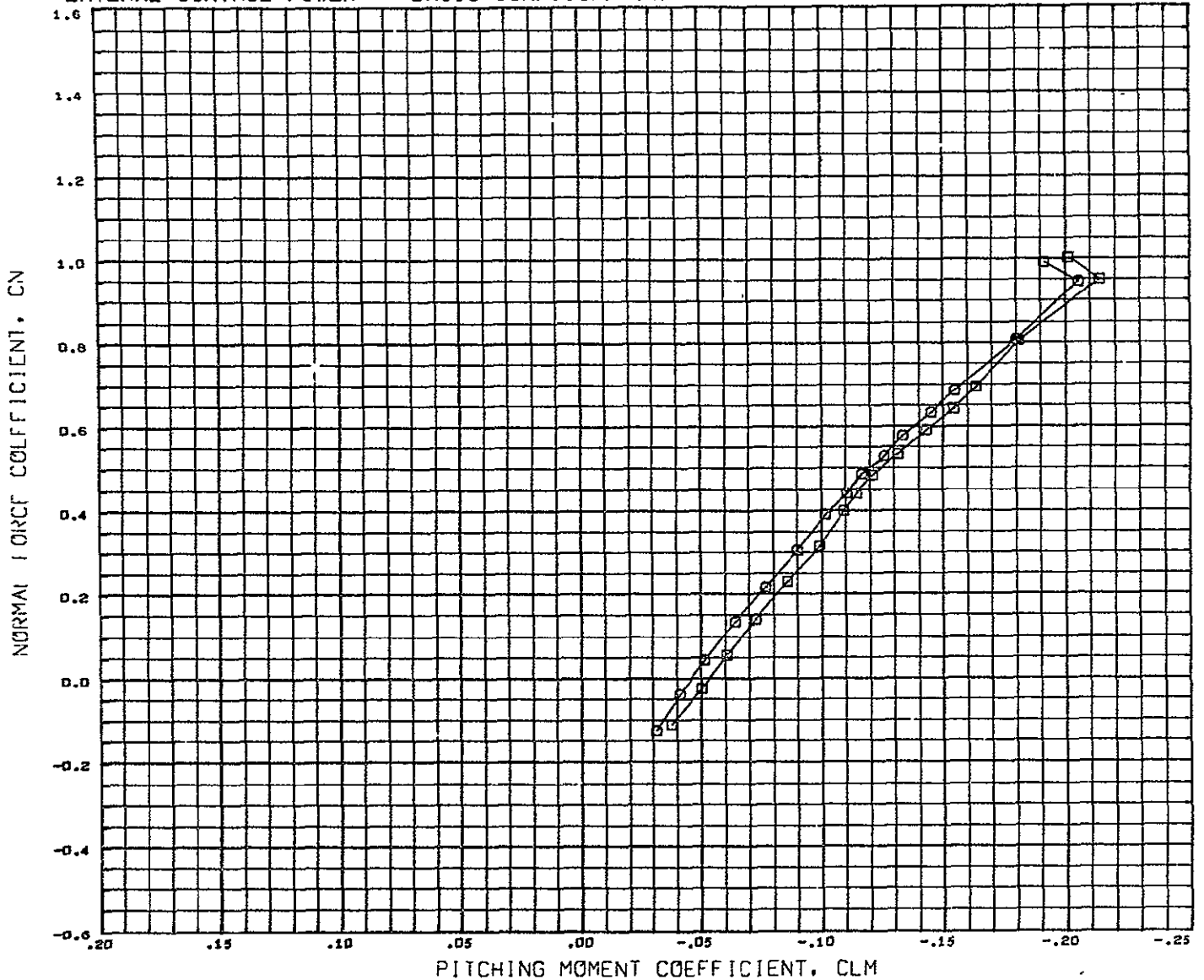

DATA SET SYMBOL	CONFIGURATION DESCRIPTION	BETA	ELEVTR	AILRON	REFERENCE INFORMATION
{BCF002}	LSWT 248 MDAC 4.0 FC 02 HCR ORB B5W11V6	0.000	0.000	0.000	REFS 8.8690 SQ FT.
{BCF021}	LSWT 248 MDAC 4.0 FC 02 HCR ORB B5W11V6	0.000	0.000	10.000	REFL 29.5700 IN.
					REFB 51.6000 IN.
					XMRP 59.3200 IN.
					YMRP 0.0000 IN.
					ZMRP 11.6000 IN.
					SCALE 4 0000 PERCENT

MACH 0.250

LATERAL CONTROL POWER BASIC CONFIGURATION

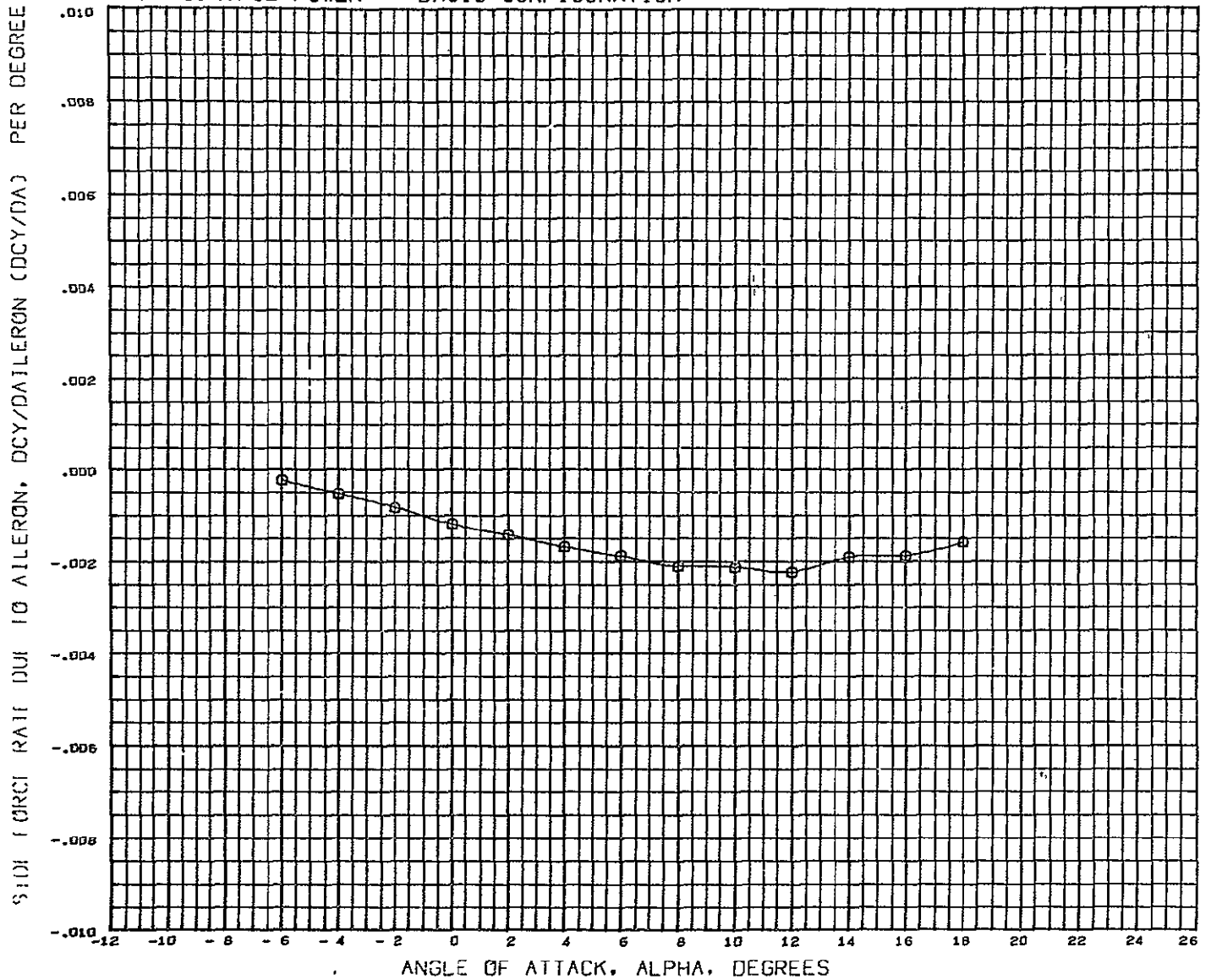

SYMBOL	MACH	PARAMETRIC VALUES				REFERENCE INFORMATION		
○	0.260	BETA	0.000	ELEVTR	0.000	REFS	8.8690	SQ.FT.
		AILRON	10.000	SPBRK	0.000	REFL	29.5700	IN.
		BFLAP	0.000	RUDDEF	0.000	REFB	51.6000	IN.
						XMRP	59.3200	IN.
						YMRP	0.0000	IN.
						ZMRP	11.6000	IN.
						SCALE	4.0000	PERCENT

DATA HIST. CODE #P



LATERAL CONTROL POWER BASIC CONFIGURATION

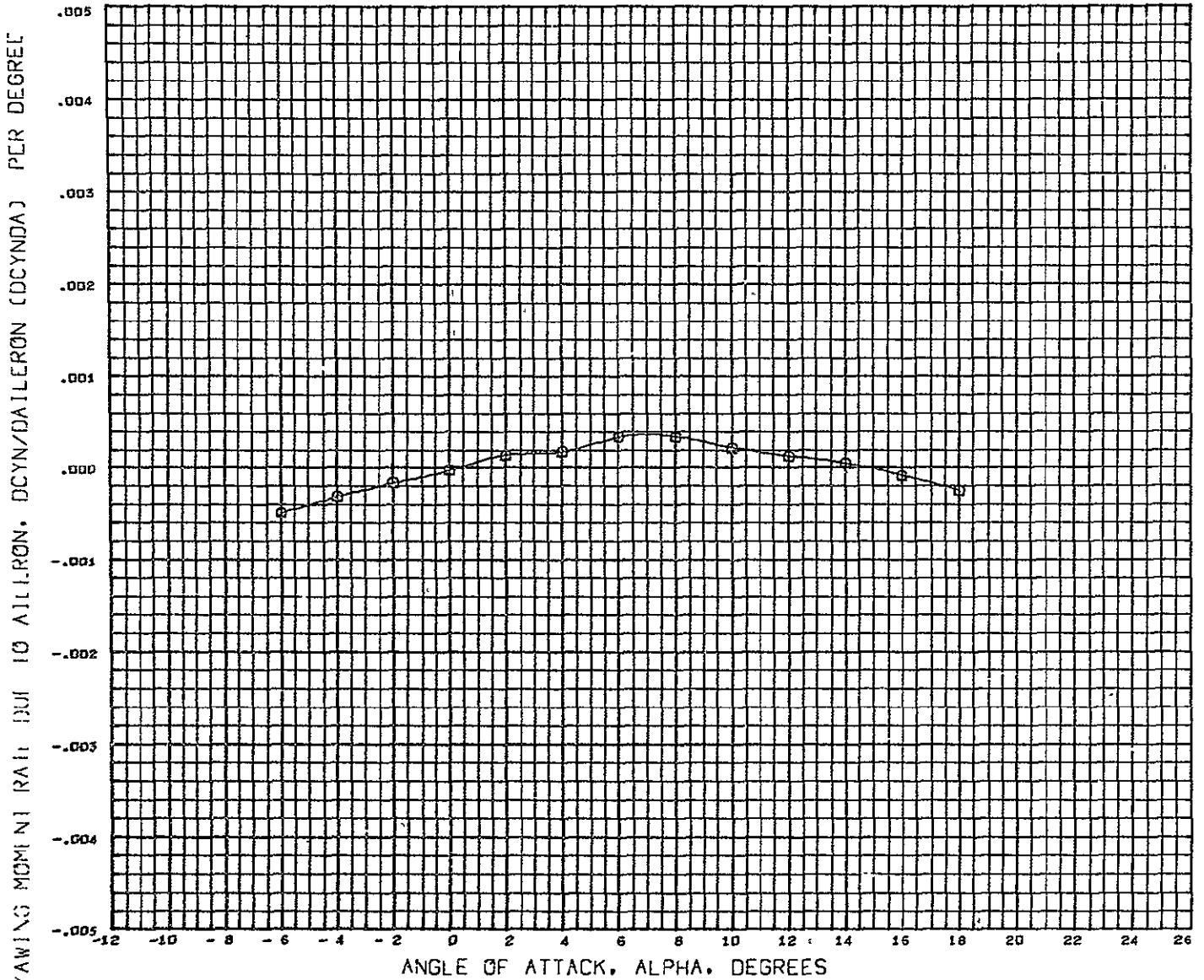

SYMBOL	MACH	PARAMETRIC VALUES				REFERENCE INFORMATION		
0	0.260	BETA	0.000	ELEVTR	0.000	REFS	8.8690	SQ.FT.
		AILRON	10.000	SFBRK	0.000	REFL	29.5700	IN.
		BFLAF	0.000	RUDDER	0.000	REFB	51.6000	IN.
						XMRP	59.3200	IN.
						YMRP	0.0000	IN.
						ZMRP	11.6000	IN.
						SCALE	4.0000	PERCENT
DATA HIST. CODE		0P						

# LATERAL CONTROL POWER BASIC CONFIGURATION

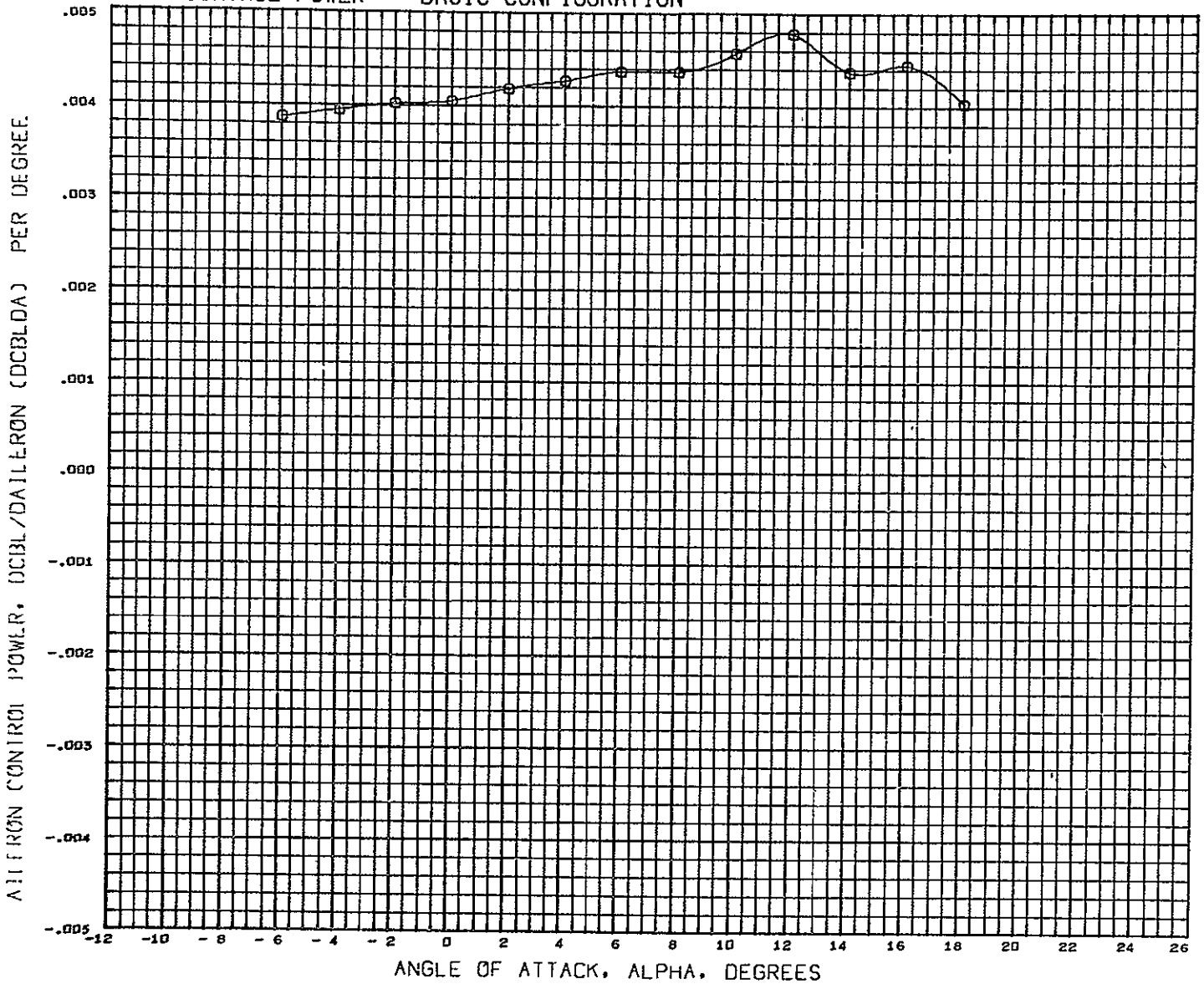

SYMBOL	MACH	PARAMETRIC VALUES				REFERENCE INFORMATION		
0	0.260	BETA	0.000	ELEVTR	0.000	REFS	8.8690	SQ.FT.
		AILRON	10.000	SPBRK	0.000	REFL	29.5700	IN.
		BFLAP	0.000	RUDDER	0.000	REFB	51.6000	IN.
						XMRP	59.3200	IN.
						YMRP	0.0000	IN.
						ZMRP	11.6000	IN.
						SCALE	4.0000	PERCNT

DATA HIST. CODE #P

LATERAL CONTROL POWER BASIC CONFIGURATION

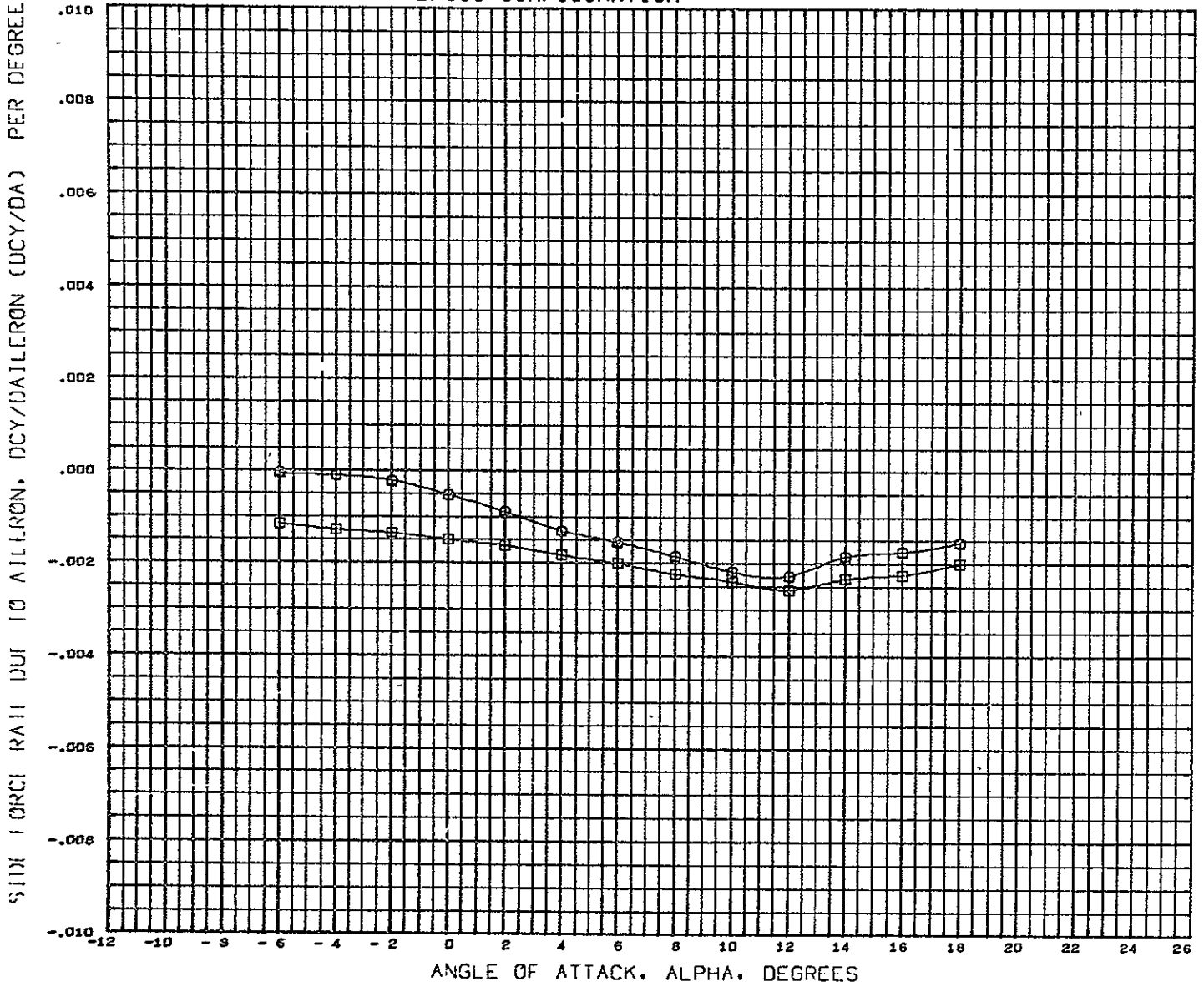

DATA SET SYMBOL	CONFIGURATION DESCRIPTION	SLOPE	ELEVTR	AILRON	REFERENCE INFORMATION
(XCF003)	LSWT 248 MDAC 4.0 FC 02 HCR ORB B5W11V6	1.000	10.000	10.000	REFS 8.8690 SQ.FT
(XCF022)	LSWT 248 MDAC 4.0 FC 02 HCR ORB B5W11V6	2.000	10.000	20.000	REFL 29.5700 IN.
					REFB 51.6000 IN.
					XMRP 59.3200 IN.
					YMRF 0.0000 IN.
					ZMRF 11.6000 IN.
					SCALE 4.0000 PERCNT

MACH 0.260

LATERAL CONTROL POWER BASIC CONFIGURATION

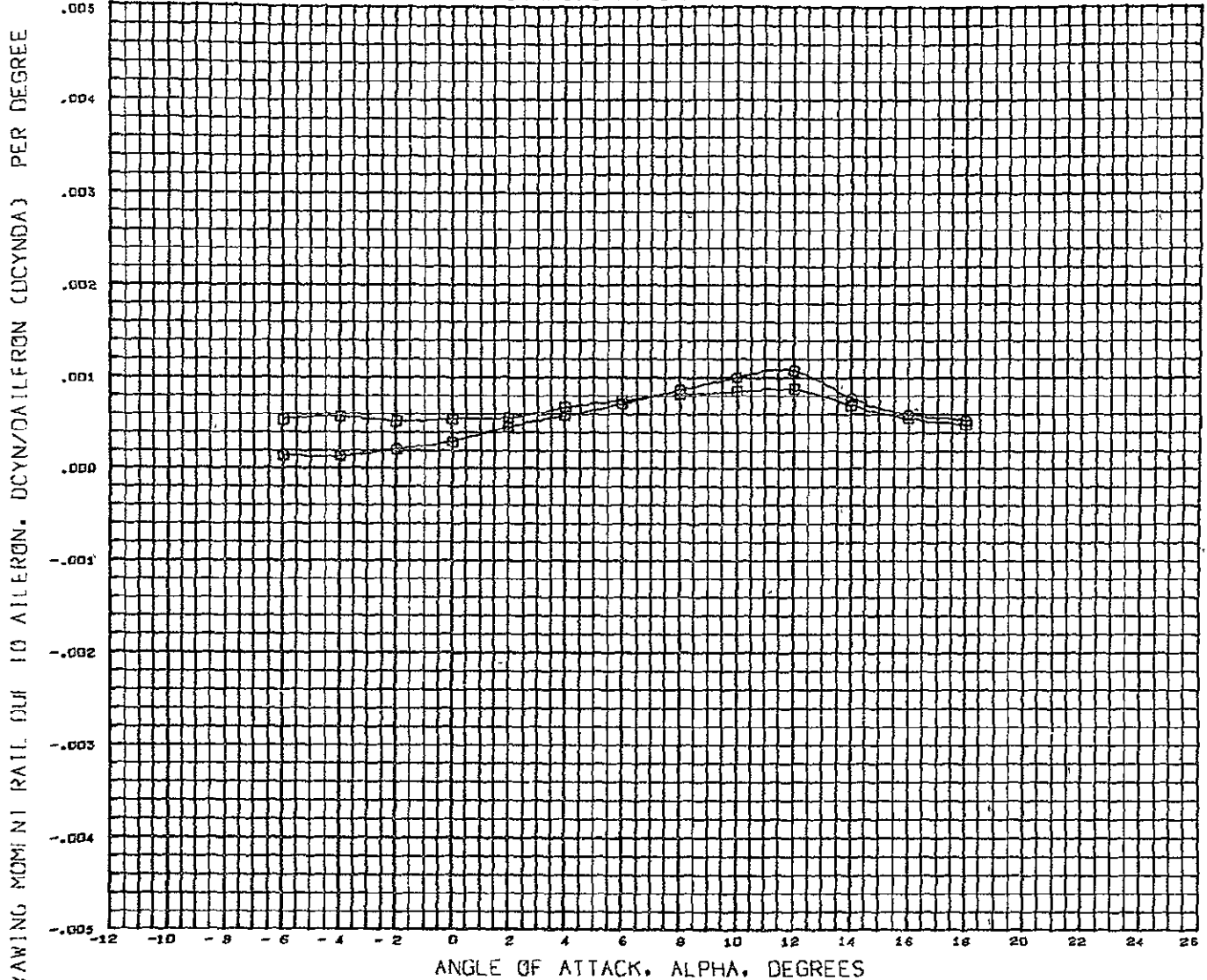

DATA SET SYMBOL CONFIGURATION DESCRIPTION

(XCP003) □ LSMT 248 MDAC 4.0 FC 02 HCR ORB 85W11V6

(XCP022) □ LSMT 248 MDAC 4.0 FC 02 HCR ORB 85W11V6

SLOPE ELEVTR AILRON  
 1.000 - 10.000 10.000  
 2.000 - 10.000 20.000

REFERENCE INFORMATION  
 REFS 8.8690 SQ.FT  
 REFL 29.5700 IN.  
 REFB 51.6000 IN.  
 XMRF 59.3200 IN.  
 YMRF 0.0000 IN.  
 ZMRF 11.6000 IN.  
 SCALE 4.0000 PERCNT

MACH 0.260

# LATERAL CONTROL POWER BASIC CONFIGURATION

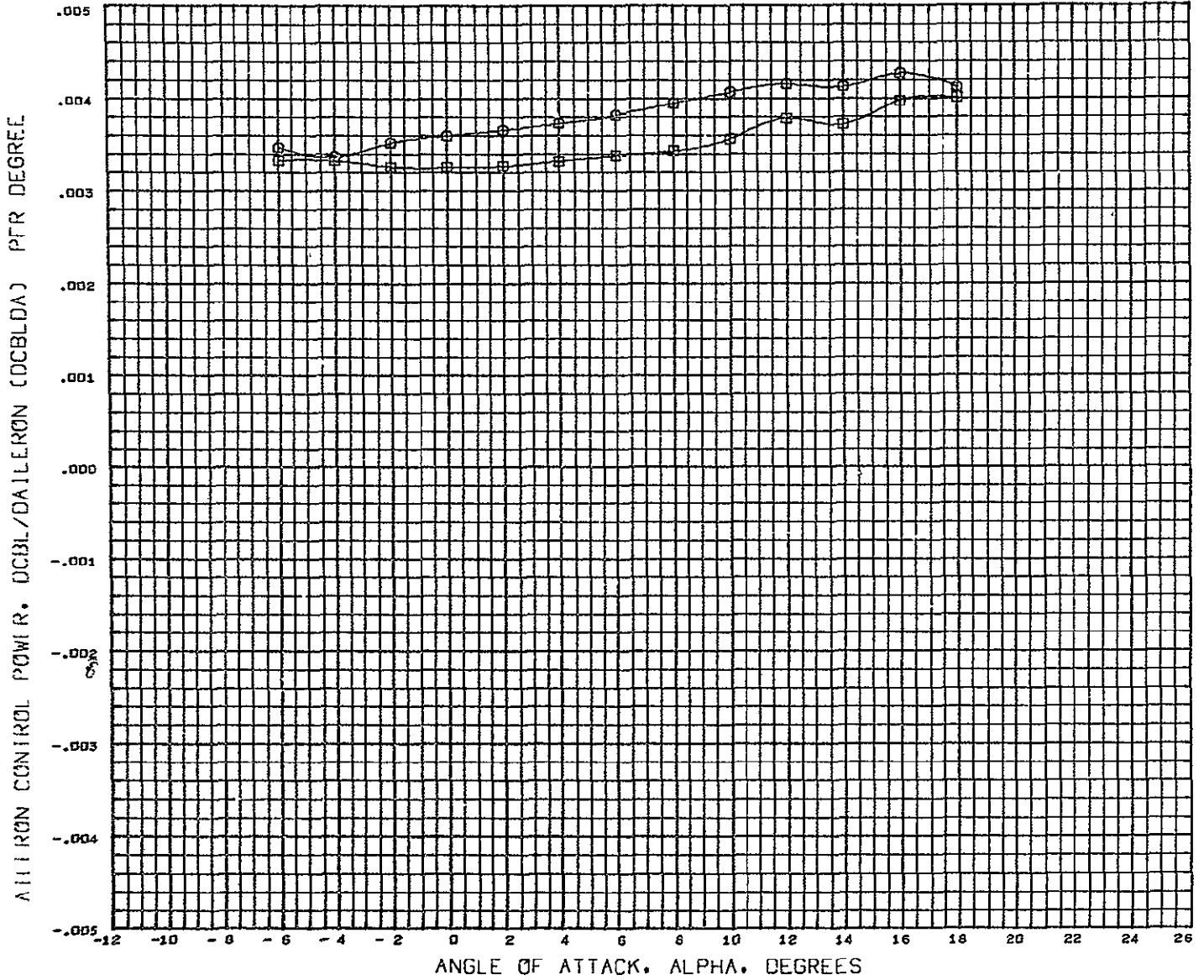

DATA SET SYMBOL	CONFIGURATION DESCRIPTION	SLOPE	ELEVTR	AILRON	REFERENCE INFORMATION
(XCP003)	LSWT 248 MDAC 4.0 FC 02 HCR ORB B5W11V6	1.000	10,000	10,000	REFS 8 8690 SQ.FT
(XCP022)	LSWT 248 MDAC 4.0 FC 02 HCR ORB B5W11V6	2.000	10,000	20,000	REFL 29 5700 IN.
					REFB 51 6000 IN.
					XMRP 59.3200 IN.
					YMRP 0.0000 IN.
					ZMRP 11.6000 IN.
					SCALE 4.0000 PERCENT

MACH 0.260

# LATERAL CONTROL POWER BASIC CONFIGURATION

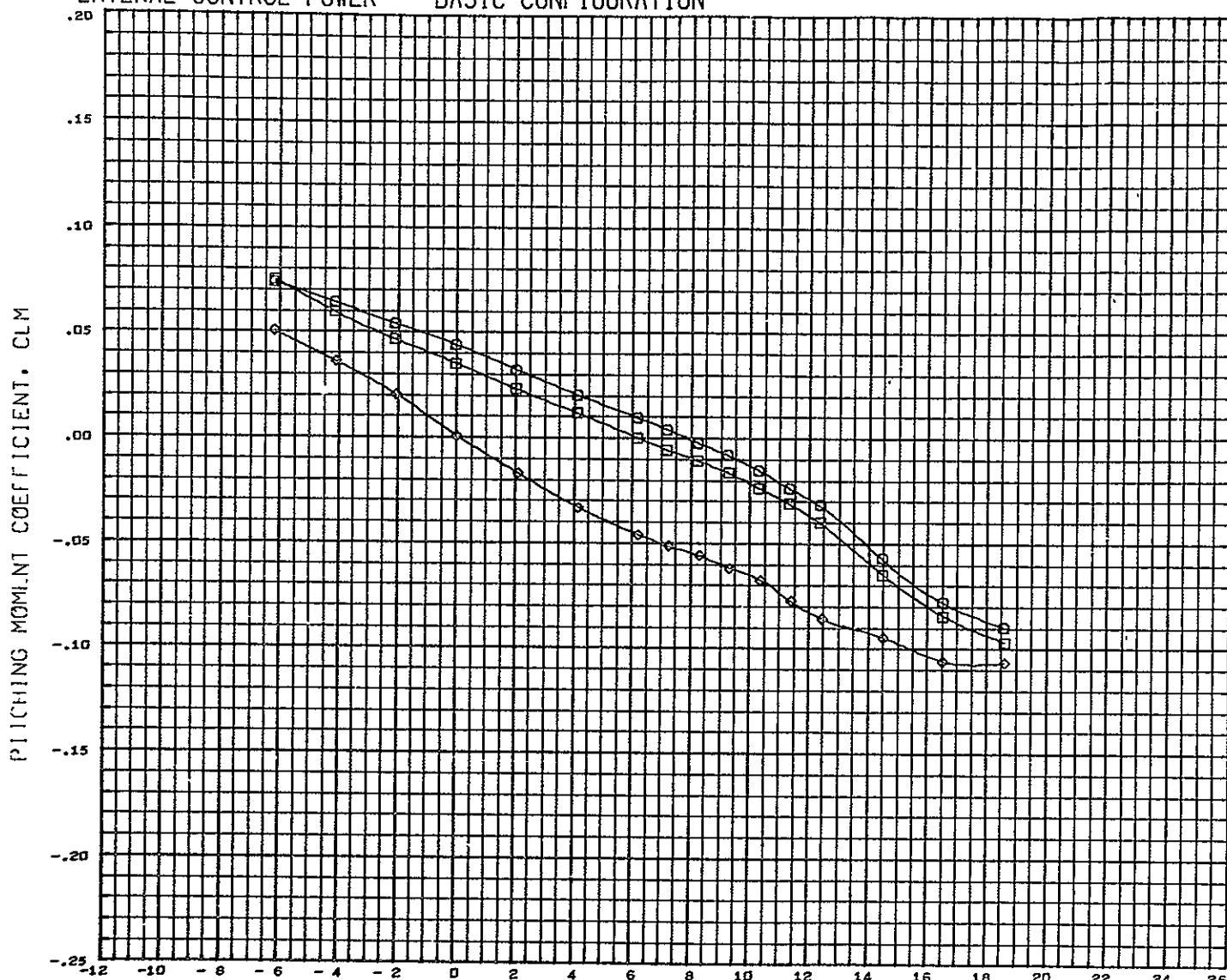

DATA SET SYMBOL	CONFIGURATION DESCRIPTION	BETA	ELEVTR	AILRON	REFERENCE INFORMATION
(CCF013)	LSWT 248 MDAC 4.0 FC 02 HCR ORB	85W11V6	- 3.000 - 10.000	0.000	REFS 8 8690 SQ FT
(CCF004)	LSWT 248 MDAC 4.0 FC 02 HCR ORB	85W11V6	- 3.000 - 10.000	10.000	REFL 29.5700 IN.
(CCF023)	LSWT 248 MDAC 4.0 FC 02 HCR ORB	85W11V6	- 3.000 - 10.000	20.000	REFB 51.6000 IN.
					XMRP 59.3200 IN.
					YMRP 0.0000 IN.
					ZMRP 11.6000 IN.
					SCALE 4.0000 PERCNT

HACH 0.250

# LATERAL CONTROL POWER BASIC CONFIGURATION

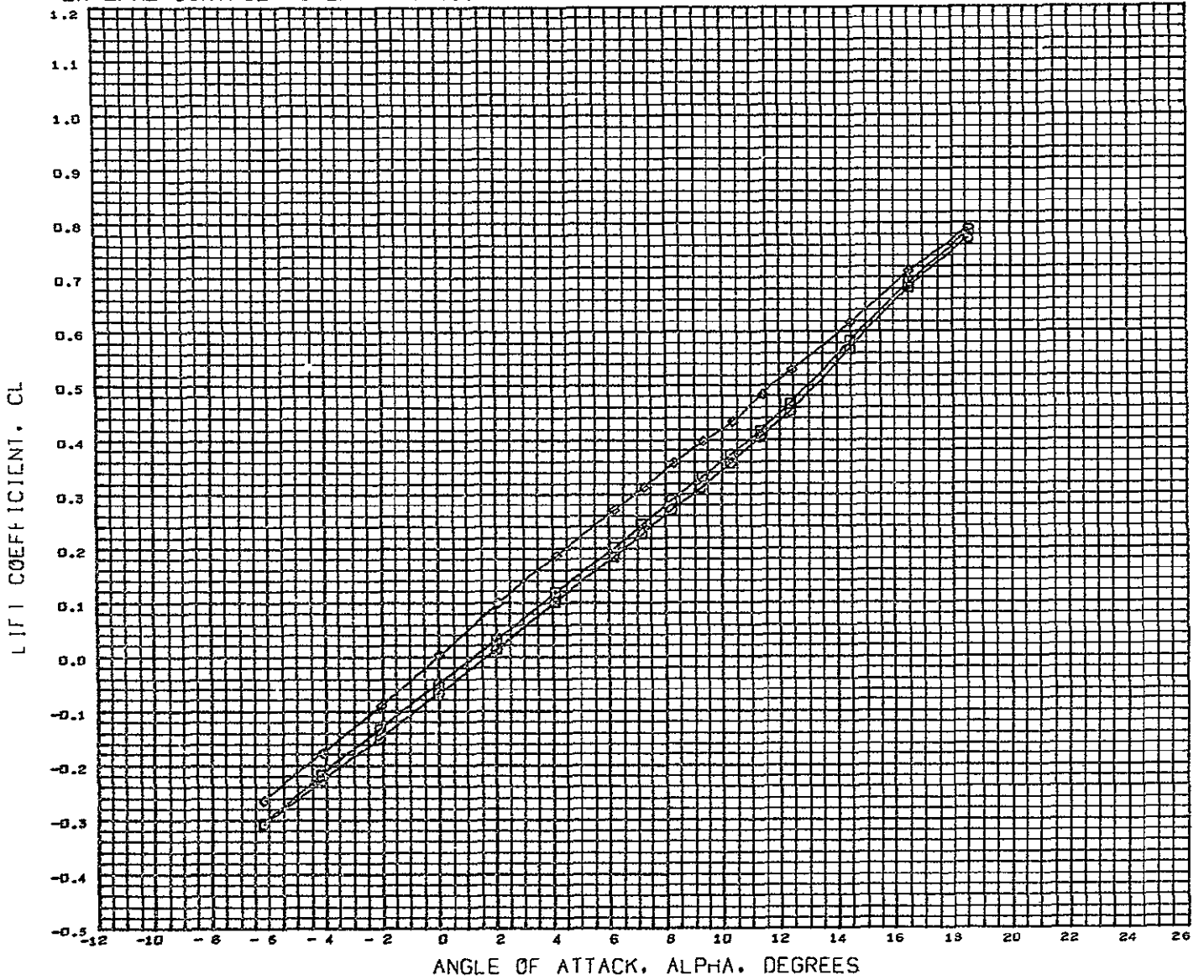

DATA SET SYMBOL	CONFIGURATION DESCRIPTION	BETA	ELEVTR	AILRON	REFERENCE INFORMATION
(CCF013)	LSWT 248 MDAC 4.0 FC O2 HCR ORB B5W11V6	- 3.000 - 10.000	0.000		REFS 8.8690 SQ.FT.
(CCF004)	LSWT 248 MDAC 4.0 FC O2 HCR ORB B5W11V6	- 3.000 - 10.000	10.000		REFL 29.5700 IN.
(CCF023)	LSWT 248 MDAC 4.0 FC O2 HCR ORB B5W11V6	- 3.000 - 10.000	20.000		REFB 51.6000 IN.
					XMRP 59.3200 IN.
					YMRP 0.0000 IN.
					ZMRP 11.6000 IN.
					SCALE 4.0000 PERCENT

MACH 0.250



LATERAL CONTROL POWER BASIC CONFIGURATION

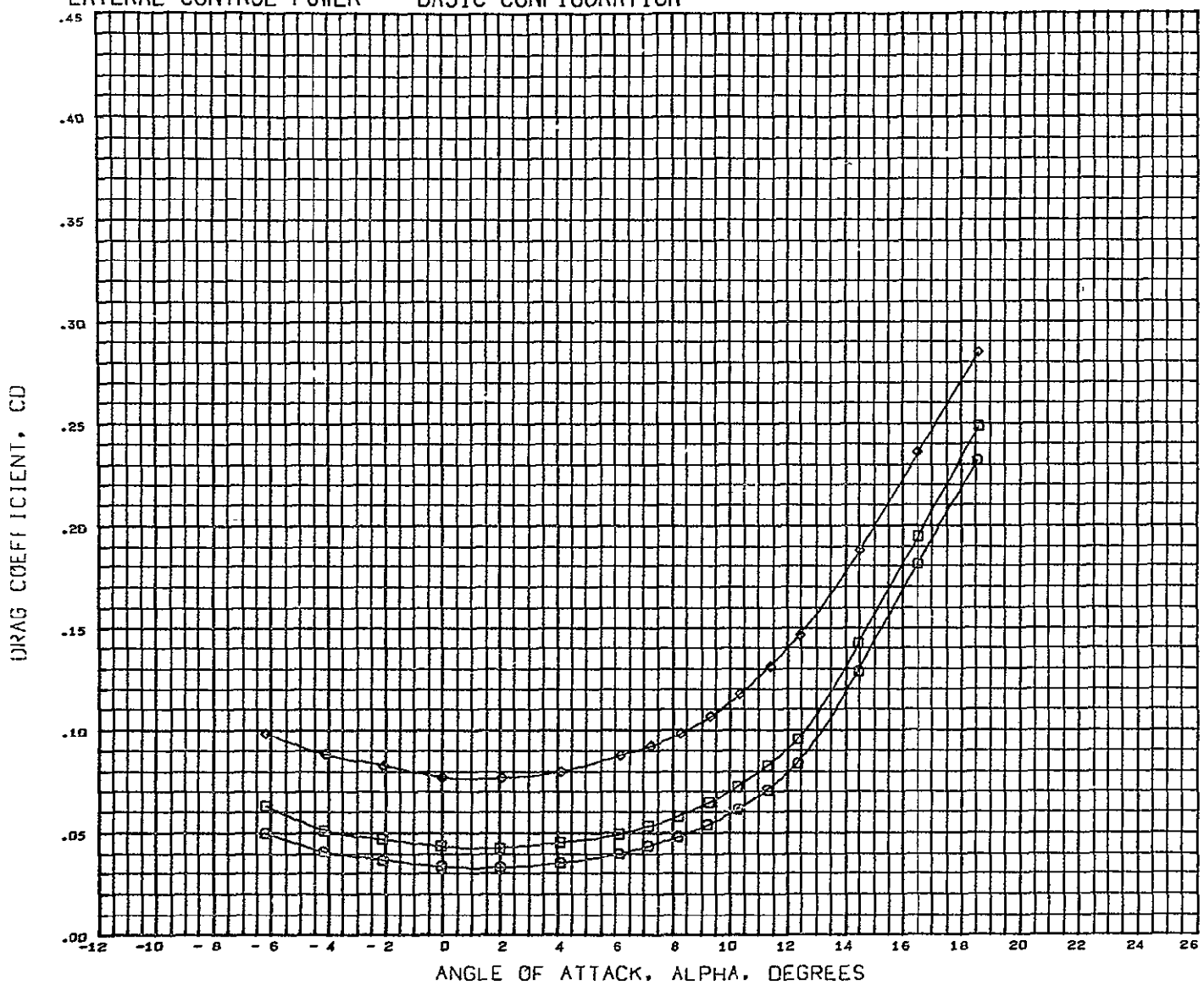

DATA SET SYMBOL	CONFIGURATION DESCRIPTION	BETA	ELEVTR	AILRON	REFERENCE INFORMATION
(CCPD13)	LSWT 248 MDAC 4.0 FC 02 HCR ORB B5W11V6	- 3.000	- 10.000	0.000	REFS 8.8690 SQ.FT
(CCPD04)	LSWT 248 MDAC 4.0 FC 02 HCR ORB B5W11V6	- 3.000	- 10.000	10.000	REFL 29.5700 IN
(CCPD23)	LSWT 248 MDAC 4.0 FC 02 HCR ORB B5W11V6	- 3.000	- 10.000	20.000	REFB 51.6000 IN
					XMRP 59.3200 IN
					YMRP 0.0000 IN
					ZMRP 11.6000 IN
					SCALE 4.0000 PERCNT

MACH 0.250



# LATERAL CONTROL POWER BASIC CONFIGURATION

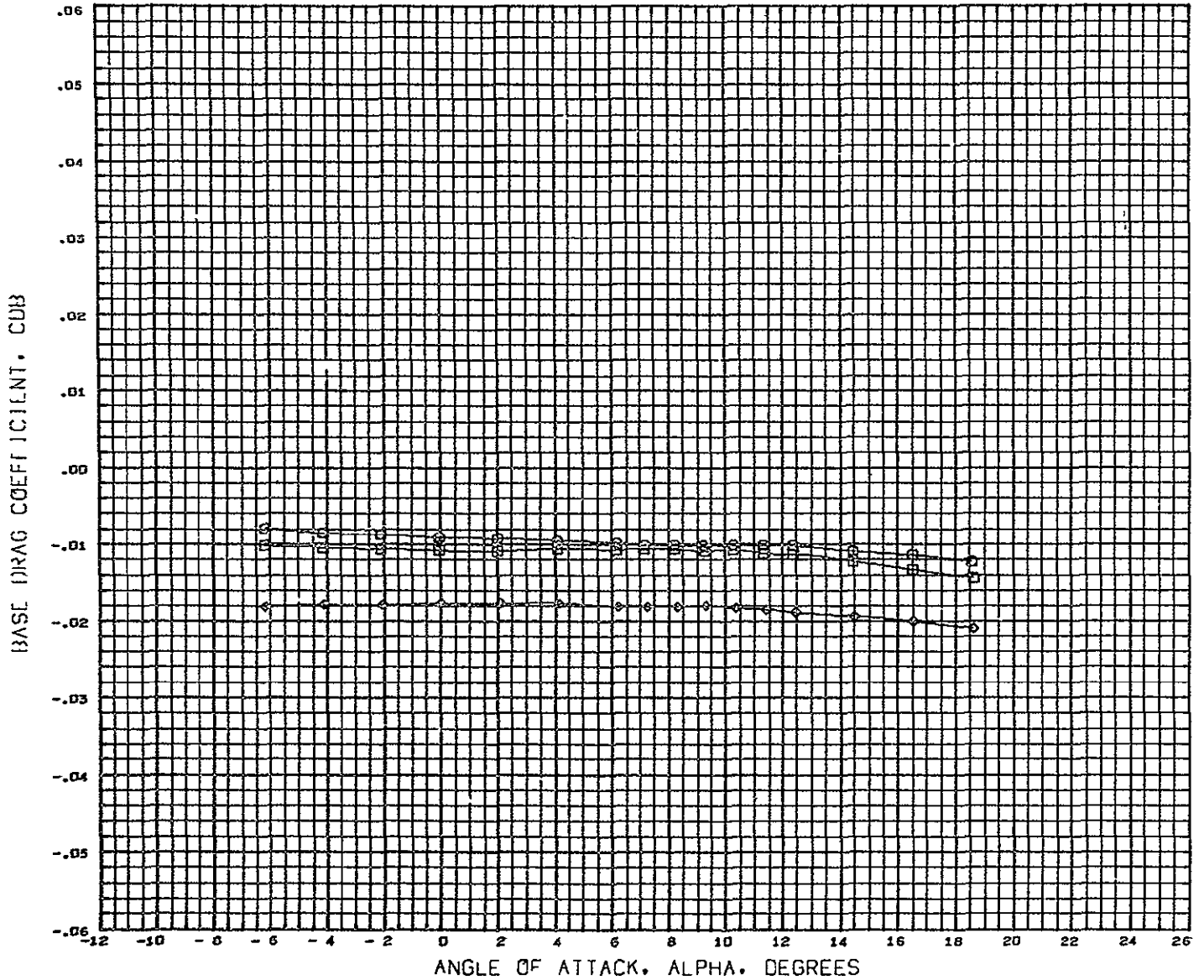

DATA SET SYMBOL	CONFIGURATION DESCRIPTION	BETA	ELEVTR	AILRON	REFERENCE INFORMATION
(CCPD13)	LSWT 248 MDAC 4.0 PC O2 HCR ORB	B5W11V6	- 3.000 - 10.000	0.000	REFS 8.8690 SQ.FT.
(CCPD2)	LSWT 248 MDAC 4.0 PC O2 HCR ORB	B5W11V6	- 3.000 - 10.000	10.000	REFL 29.5700 IN.
(CCPD23)	LSWT 248 MDAC 4.0 PC O2 HCR ORB	B5W11V6	- 3.000 - 10.000	20.000	REFB 51.6000 IN.
					XMRP 39.3200 IN.
					YMRP 0.0000 IN.
					ZMRP 11.6000 IN.
					SCALE 4.0000 PERCENT

MACH 0.250

# LATERAL CONTROL POWER BASIC CONFIGURATION

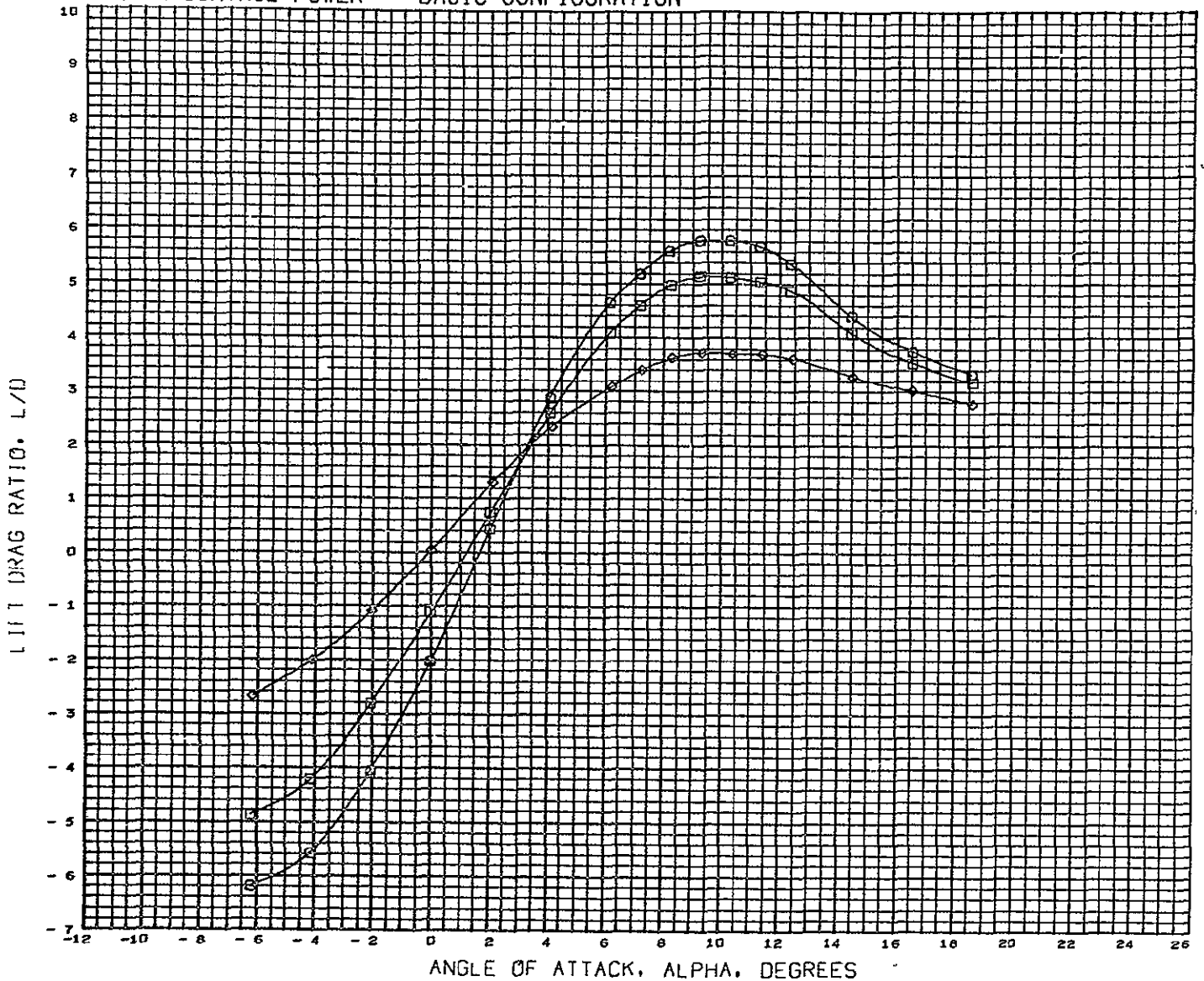

DATA SET SYMBOL	CONFIGURATION DESCRIPTION	BETA	ELEVTR	AILRON	REFERENCE INFORMATION
(CCF013)	LSWT 248 MDAC 4.0 PC 02 HCR ORB B5W11V6	- 3.000 - 10.000	0.000		REFS 8.8690 SQ.FT.
(CCF004)	LSWT 248 MDAC 4.0 PC 02 HCR ORB B5W11V6	- 3.000 - 10.000	10.000		REFL 29.5700 IN.
(CCF023)	LSWT 248 MDAC 4.0 PC 02 HCR ORB B5W11V6	- 3.000 - 10.000	20.000		REFB 51.6000 IN.
					XMRP 59.3200 IN.
					YMRF 0.0000 IN.
					ZMRP 11.6000 IN.
					SCALE 4.0000 PERCENT

MACH 0.250

# LATERAL CONTROL POWER BASIC CONFIGURATION

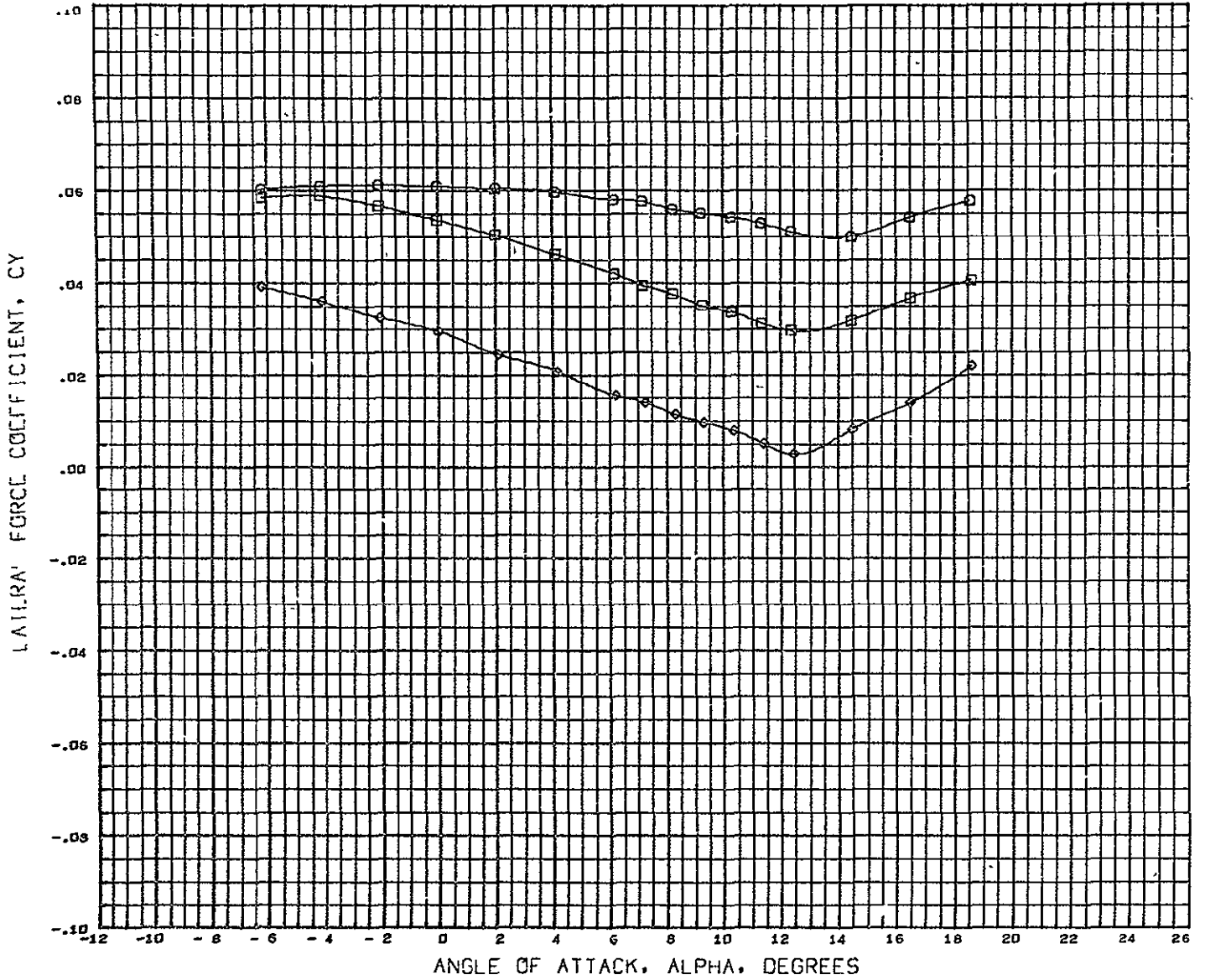

DATA SET SYMBOL	CONFIGURATION DESCRIPTION	BETA	ELEVTR	AILRON	REFERENCE INFORMATION
(CCF013)	LSWT 248 MDAC 4.0 PC O2 HCR ORB	85W11V6	- 3.000 - 10.000	0.000	REFS 8.8690 SQ.FT
(CCF004)	LSWT 248 MDAC 4.0 PC O2 HCR ORB	85W11V6	- 3.000 - 10.000	10.000	REFL 29.5700 IN
(CCF023)	LSWT 248 MDAC 4.0 PC O2 HCR ORB	85W11V6	- 3.000 - 10.000	20.000	REFB 51.6000 IN.
					XMRP 59.3200 IN.
					YMRP 0.0000 IN.
					ZMRP 11.6000 IN.
					SCALE 4.0000 PERCNT

MACH 0.250

# LATERAL CONTROL POWER BASIC CONFIGURATION

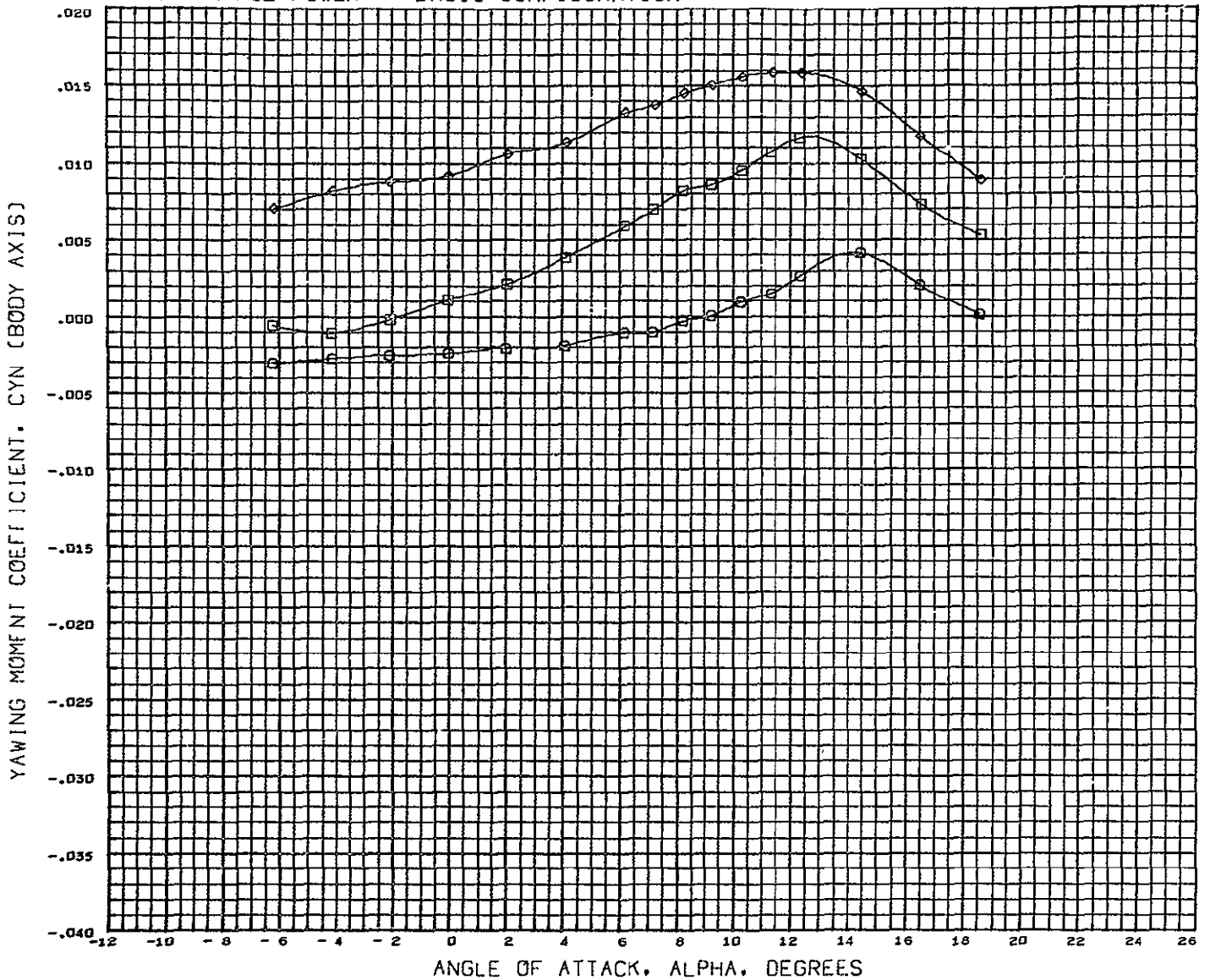

DATA SET SYMBOL	CONFIGURATION DESCRIPTION	BETA	ELEVTR	AILRON	REFERENCE INFORMATION
(CCP013)	LSWT 248 HDAC 4.0 FC 02 HCR ORB 65W11V6	- 3.000	- 10.000	0.000	REFS 8 8690 SQ FT
(CCP004)	LSWT 248 HDAC 4.0 FC 02 HCR ORB 65W11V6	- 3.000	- 10.000	10.000	REFL 29 5700 IN.
(CCP023)	LSWT 248 HDAC 4.0 FC 02 HCR ORB 65W11V6	- 3.000	- 10.000	20.000	REFB 51 6000 IN.
					XMRP 59.3200 IN.
					YMRP 0.0000 IN.
					ZMRP 11 6000 IN.
					SCALE 4 0000 PERCNT

MACH 0.250

# LATERAL CONTROL POWER BASIC CONFIGURATION

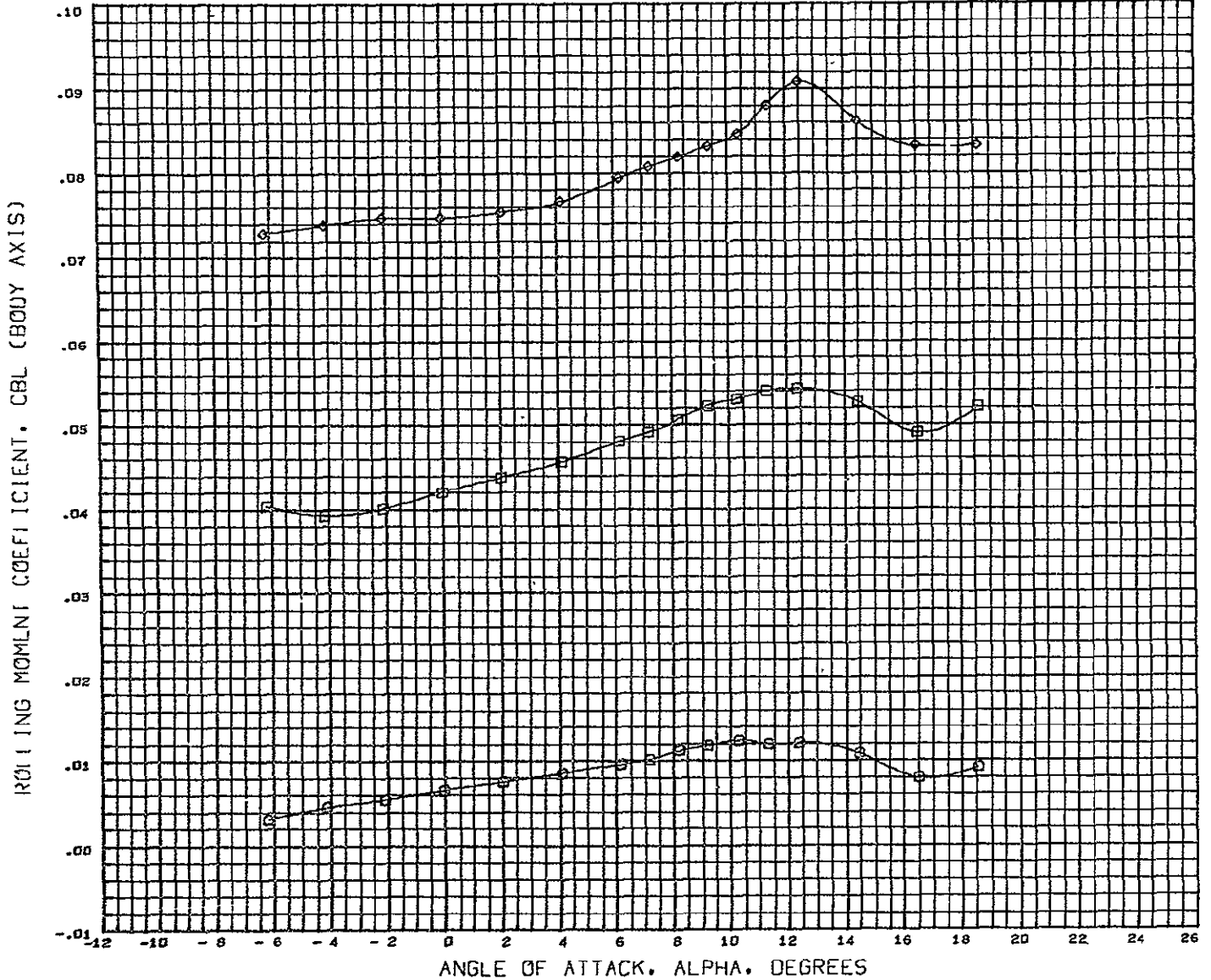

DATA SET SYMBOL	CONFIGURATION DESCRIPTION	BETA	ELEVTR	AILRON	REFERENCE INFORMATION
(CCFD13)	LSWT 248 MDAC 4.0 FC 02 HCR ORB B5W11V6	- 3.000 - 10.000	0.000		REFS 8.8690 SQ.FT.
(CCFD04)	LSWT 248 MDAC 4.0 FC 02 HCR ORB B5W11V6	- 3.000 - 10.000	10.000		REFL 29.5700 IN.
(CCFD23)	LSWT 248 MDAC 4.0 FC 02 HCR ORB B5W11V6	- 3.000 - 10.000	20.000		REFB 51.6000 IN.
					XMRP 59.3200 IN.
					YMRP 0.0000 IN.
					ZMRP 11.6000 IN.
					SCALE 4.0000 PERCNT

MACH 0.250

# LATERAL CONTROL POWER BASIC CONFIGURATION

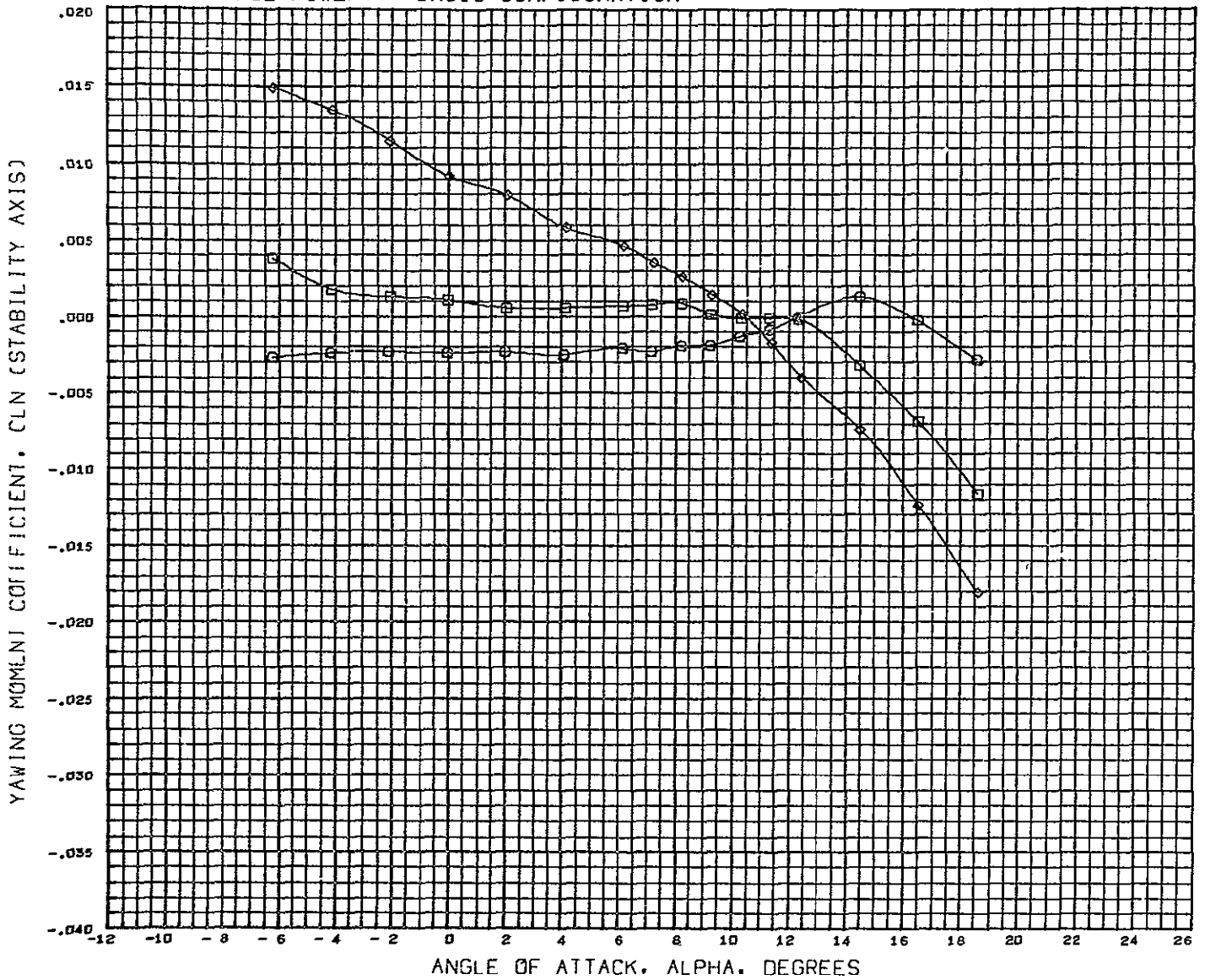

DATA SET SYMBOL	CONFIGURATION DESCRIPTION	BETA	ELEVTR	AILRON	REFERENCE INFORMATION
(RCP013)	LSWT 248 MDAC 4.0 FC 02 HCR ORB 85W11V6	- 3.000	- 10.000	0.000	REFS 8.8690 SQ FT.
(RCP004)	LSWT 248 MDAC 4.0 FC 02 HCR ORB 85W11V6	- 3.000	- 10.000	10.000	REFL 29.5700 IN.
(RCP023)	LSWT 248 MDAC 4.0 FC 02 HCR ORB 85W11V6	- 3.000	- 10.000	20.000	REFB 51.6000 IN.
					XMRP 59.3200 IN.
					YMRP 0.0000 IN.
					ZMRP 11.6000 IN.
					SCALE 4.0000 PERCENT

MACH 0.250

# LATERAL CONTROL POWER BASIC CONFIGURATION

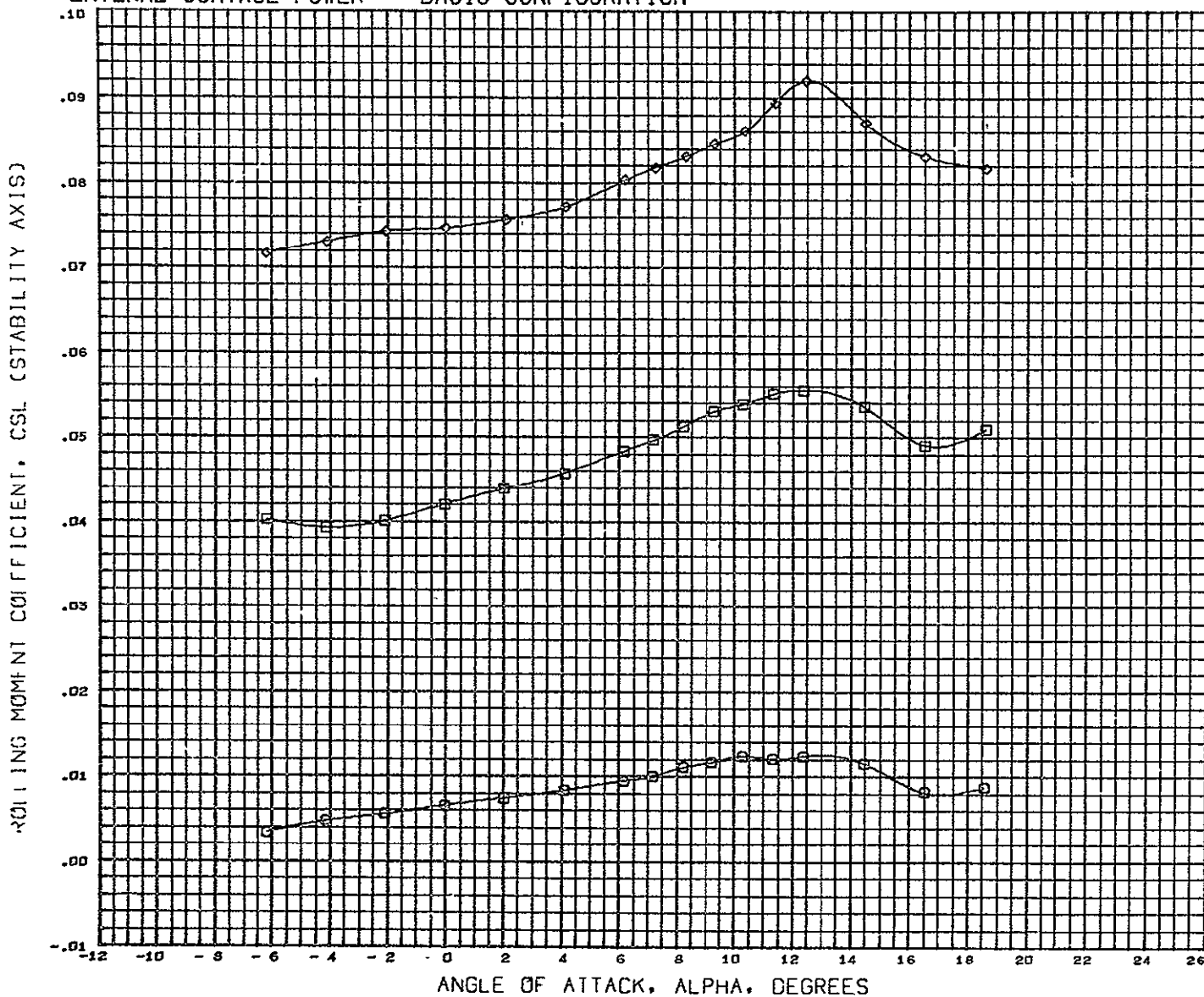

DATA SET SYMBOL	CONFIGURATION DESCRIPTION	BETA	ELEVTR	AILRON	REFERENCE INFORMATION
(RCF013)	LSWT 248 MDAC 4.0 FC 02 HCR ORB B5W11V6	- 3.000 - 10.000	0.000		REFS 8.8690 SQ.FT.
(RCF004)	LSWT 248 MDAC 4.0 FC 02 HCR ORB B5W11V6	- 3.000 - 10.000	10.000		REFL 29.5700 IN.
(RCF023)	LSWT 248 MDAC 4.0 FC 02 HCR ORB B5W11V6	- 3.000 - 10.000	20.000		REFB 51.6000 IN.
					XMRP 59.3200 IN.
					YMRP 0.0000 IN.
					ZMRP 11.6000 IN.
					SCALE 4.0000 PERCNT

MACH 0.250

# LATERAL CONTROL POWER BASIC CONFIGURATION

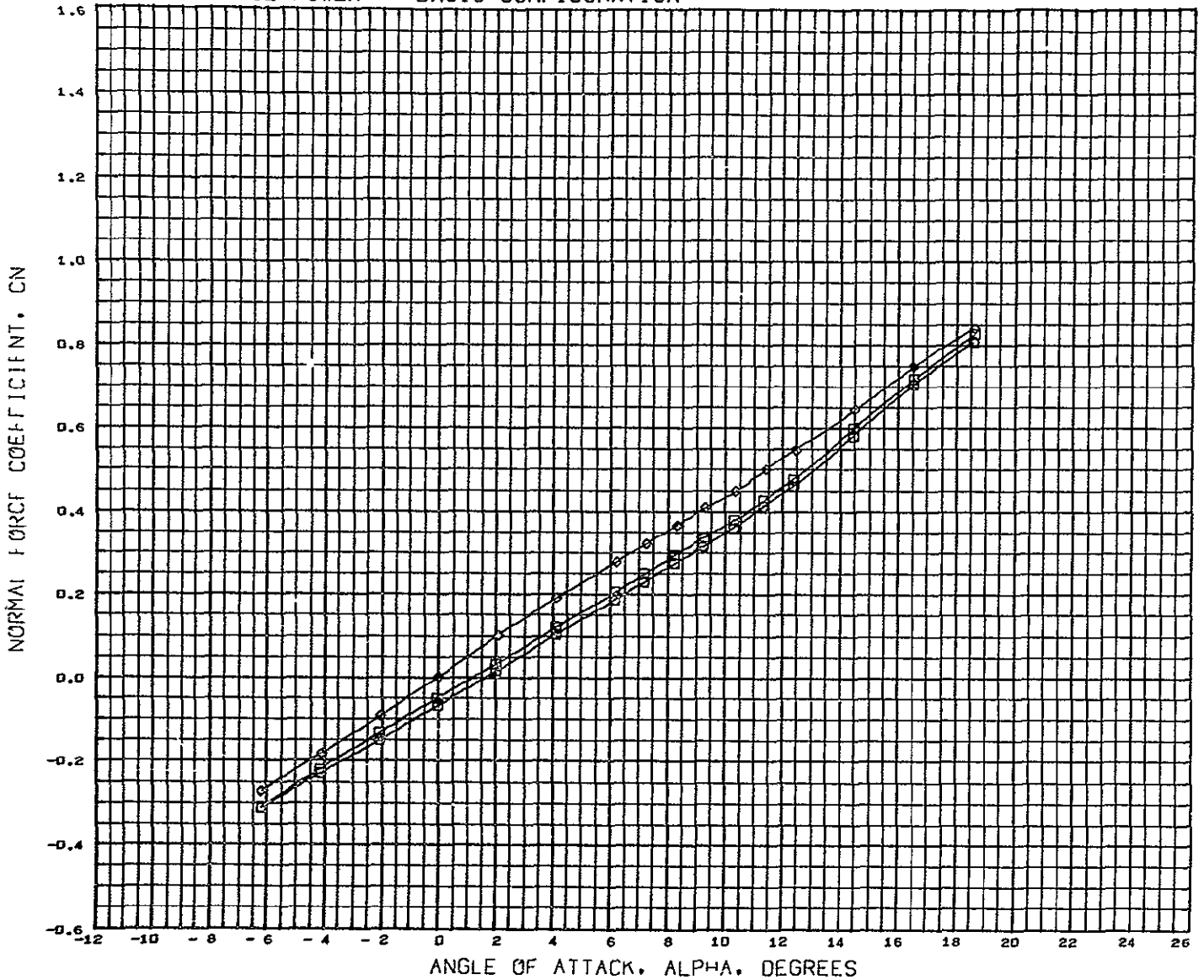

DATA SET SYMBOL	CONFIGURATION DESCRIPTION	BETA	ELEVTR	AILRON	REFERENCE INFORMATION
(BCPD13)	□ LSWT 248 MDAC 4.0 FC O2 HCR ORB B5W11V6	- 3.000 - 10.000	0.000		REFS 8.6690 SQ.FT
(BCPD04)	□ LSWT 248 MDAC 4.0 FC O2 HCR ORB B5W11V6	- 3.000 - 10.000	10.000		REFL 29.5700 IN.
(BCPD23)	◇ LSWT 248 MDAC 4.0 FC O2 HCR ORB B5W11V6	- 3.000 - 10.000	20.000		REFB 51.6000 IN.
					XMRP 59.3200 IN.
					YMRP 0.0000 IN.
					ZMRP 11.6000 IN.
					SCALE 4.0000 PERCENT

MACH 0.250



# LATERAL CONTROL POWER BASIC CONFIGURATION

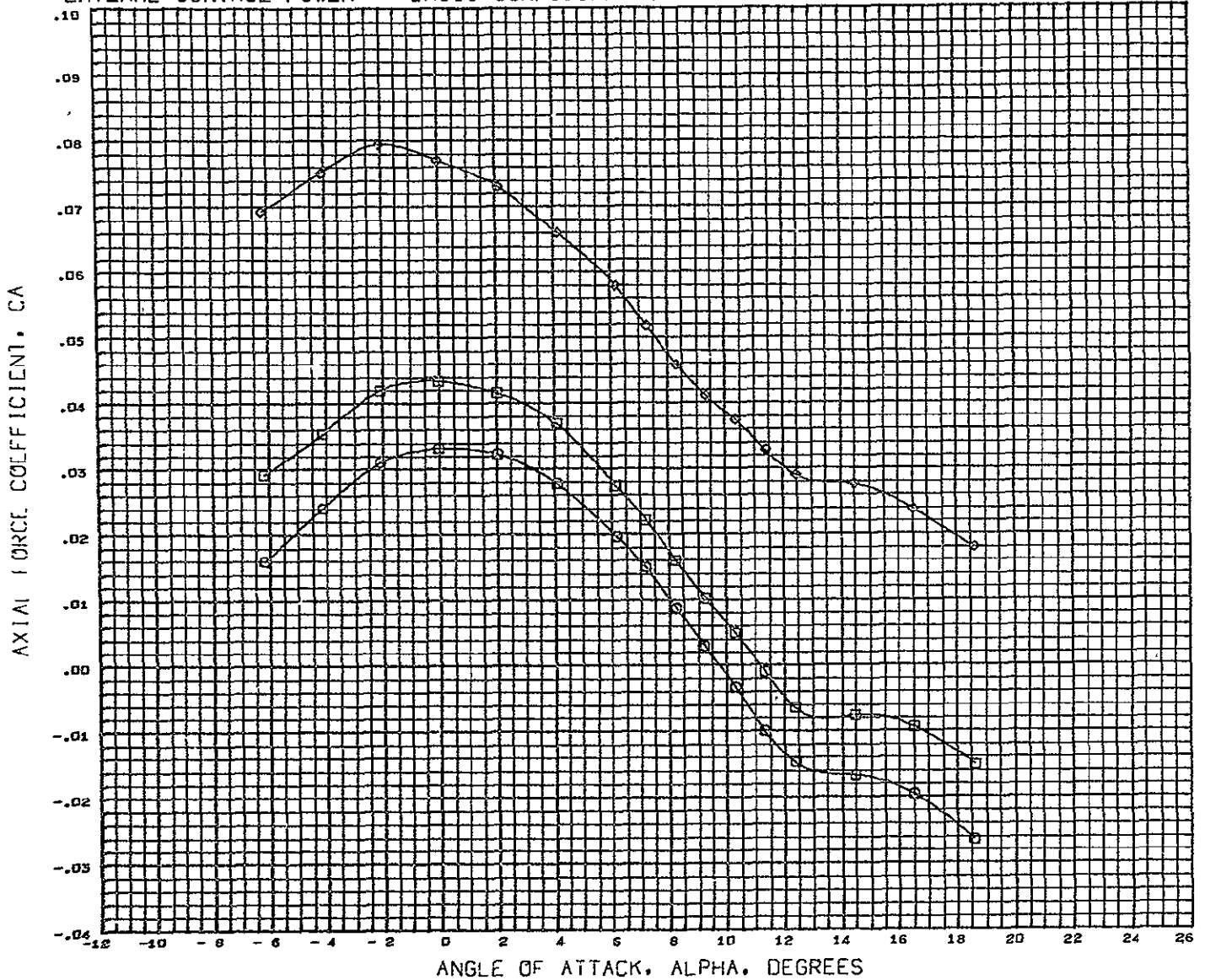

DATA SET SYMBOL	CONFIGURATION DESCRIPTION	BETA	ELEVTR	AILRON	REFERENCE INFORMATION
(BCF013)	□ LSWT 248 HDAC 4.0 FC 02 HCR ORB B5W11V6	- 3.000	- 10.000	0.000	REFS 8 8690 SQ.FT
(BCF004)	○ LSWT 248 HDAC 4.0 FC 02 HCR ORB B5W11V6	- 3.000	- 10.000	10.000	REFL 29.5700 IN.
(BCF023)	◇ LSWT 248 HDAC 4.0 FC 02 HCR ORB B5W11V6	- 3.000	- 10.000	20.000	REFB 51.6000 IN.
					XMRP 59.3200 IN.
					YMRP 0.0000 IN.
					ZMRP 11.6000 IN.
					SCALE 4.0000 PERCNT

MACH 0.250

# LATERAL CONTROL POWER BASIC CONFIGURATION

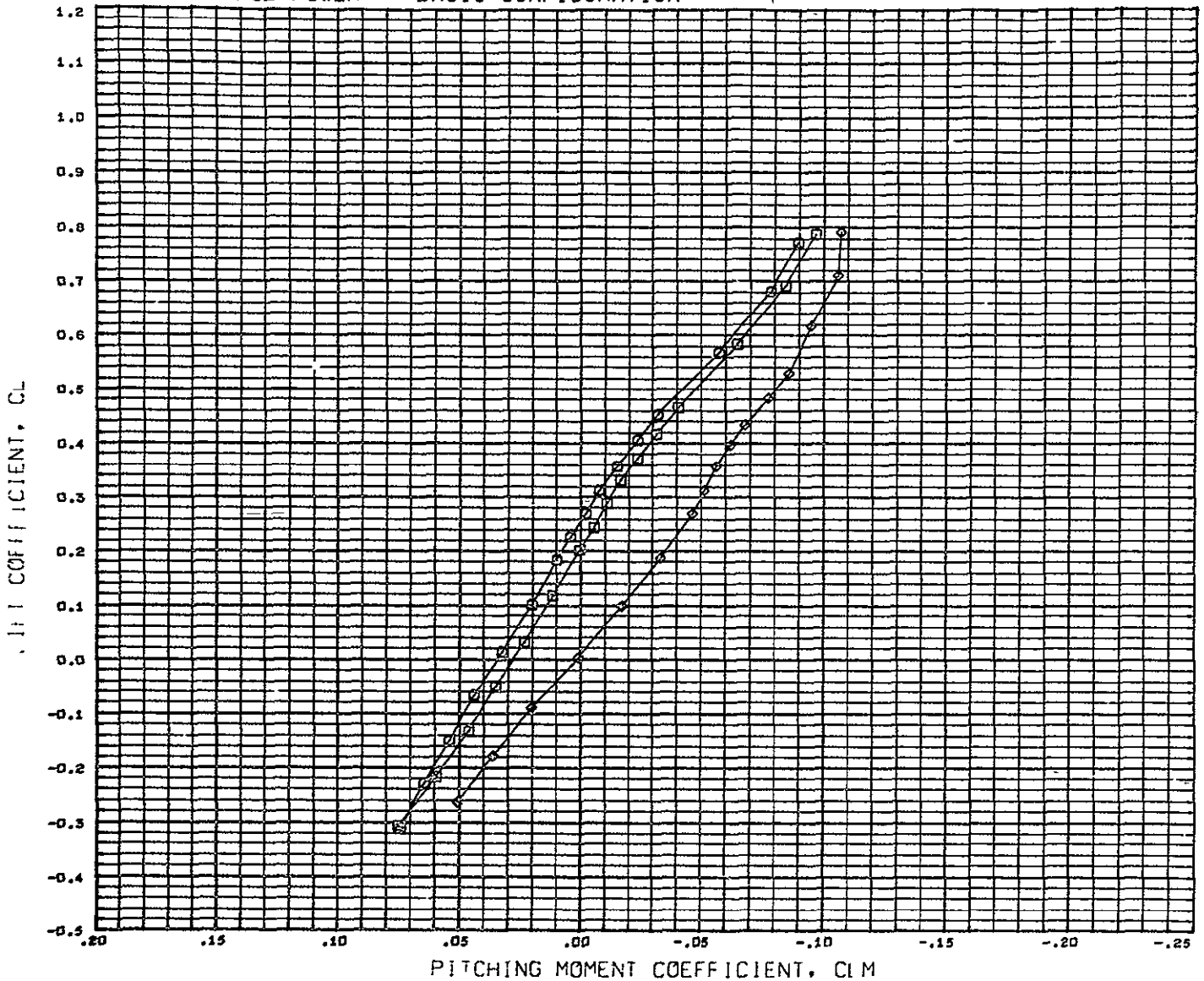

DATA SET SYMBOL	CONFIGURATION DESCRIPTION	BETA	ELEVTR	AILRON	REFERENCE INFORMATION
(CCP013)	□ LSWT 248 MDAC 4.0 FC 02 HCR ORB	B5W11V6	- 3.000 - 10.000	0.000	REFS 8.8690 SQ FT.
(CCP004)	○ LSWT 248 MDAC 4.0 FC 02 HCR ORB	B5W11V6	- 3.000 - 10.000	10.000	REFL 29.5700 IN.
(CCP023)	◇ LSWT 248 MDAC 4.0 FC 02 HCR ORB	B5W11V6	- 3.000 - 10.000	20.000	REFB 51.6000 IN.
					XMRP 59.3200 IN.
					YMRP 0.0000 IN.
					ZMRP 11.6000 IN.
					SCALE 4.0000 PERCENT

MACH 0.250

# LATERAL CONTROL POWER BASIC CONFIGURATION

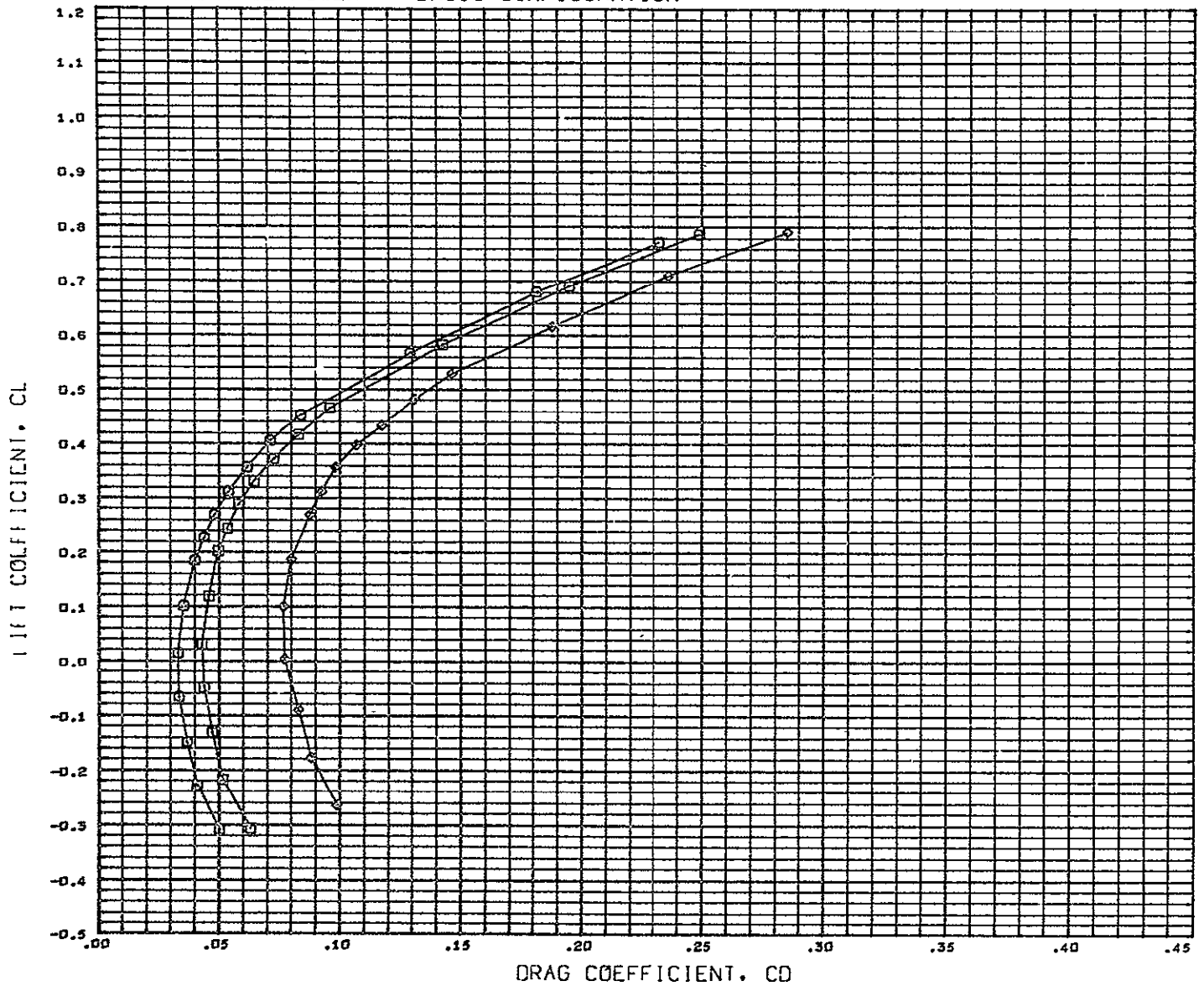

DATA SET SYMBOL	CONFIGURATION DESCRIPTION	BETA	ELEVTR	AILRON
(CCP013)	LSWT 248 HDAC 4.0 FC 02 HCR ORB	B5W11V6	- 3.007 - 10.000	0.000
(CCP004)	LSWT 248 HDAC 4.0 FC 02 HCR ORB	B5W11V6	- 3.000 - 10.000	10.000
(CCP023)	LSWT 248 HDAC 4.0 FC 02 HCR ORB	B5W11V6	- 3.000 - 10.000	20.000

REFERENCE INFORMATION		
REFS	8 8690	SQ. FT.
REFL	29 5700	IN.
REFB	51 6000	IN.
XMRP	59.3200	IN.
YMRP	0.0000	IN.
ZMRP	11.6000	IN.
SCALE	4.0000	PERCENT

MACH 0.250

# LATERAL CONTROL POWER BASIC CONFIGURATION

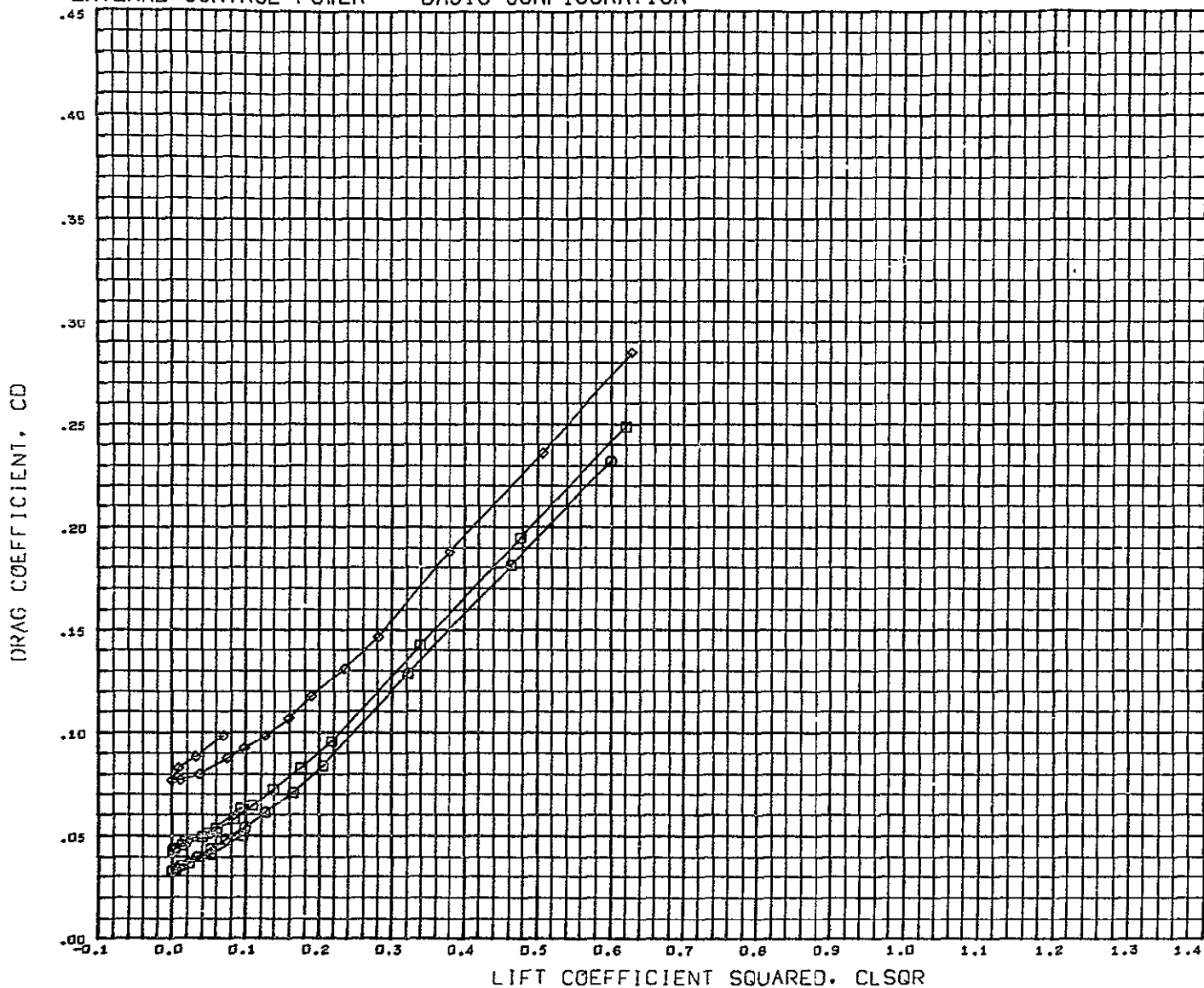

DATA SET SYMBOL	CONFIGURATION DESCRIPTION	BETA	ELEVTR	AILRON	REFERENCE INFORMATION
(CCP013)	LSWT 248 MDAC 4.0 FC O2 HCR ORB	B5W11V6	- 3.000 - 10.000	0.000	REFS 8.8690 SQ FT.
(CCP004)	LSWT 248 MDAC 4.0 FC O2 HCR ORB	B5W11V6	- 3.000 - 10.000	10.000	REFL 29.5700 IN.
(CCP023)	LSWT 248 MDAC 4.0 FC O2 HCR ORB	B5W11V6	- 3.000 - 10.000	20.000	REFB 51.6000 IN.
					XMRP 59.3200 IN.
					YMRP 0.0000 IN.
					ZMRP 11.6000 IN.
					SCALE 4.0000 PERCENT

MACH 0.250

# LATERAL CONTROL POWER BASIC CONFIGURATION

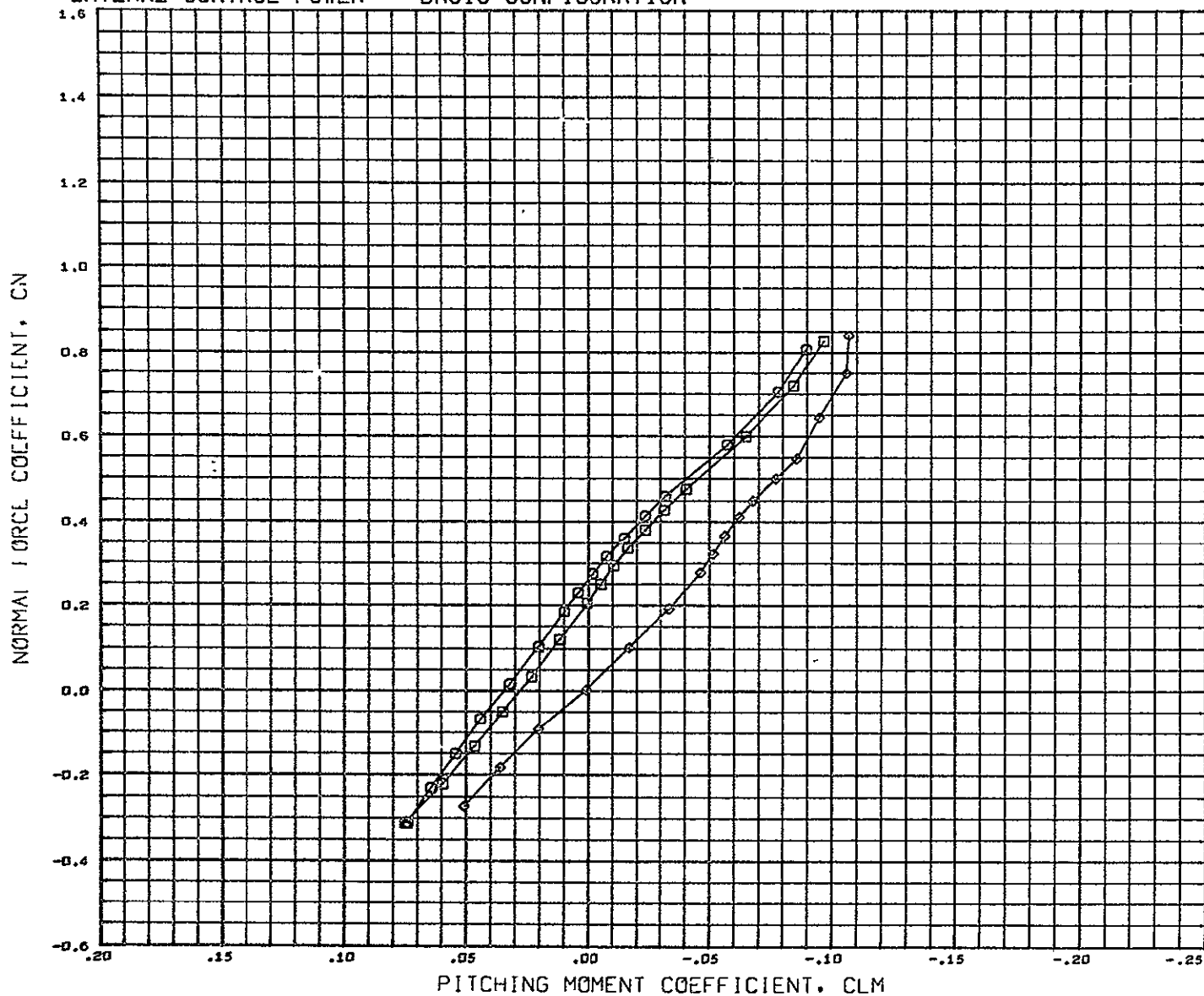

DATA SET SYMBOL	CONFIGURATION DESCRIPTION	BETA	ELEVTR	AILRON	REFERENCE INFORMATION
(BCF013)	LSWT 248 MDAC 4.0 FC 02 HCR ORB B5W11V6	- 3.000	- 10.000	0.000	REFS 8 8690 SQ FT
(BCF004)	LSWT 248 MDAC 4.0 FC 02 HCR ORB B5W11V6	- 3.000	- 10.000	10.000	REFL 29.5700 IN
(BCF023)	LSWT 248 MDAC 4.5 FC 02 HCR ORB B5W11V6	- 3.000	- 10.000	20.000	REFB 51.6000 IN
					XMRP 59.3200 IN
					YMRP 0.0000 IN
					ZMRP 11.6000 IN.
					SCALE 4.0000 PERCENT

HACH 0.250

LATERAL CONTROL POWER BASIC CONFIGURATION

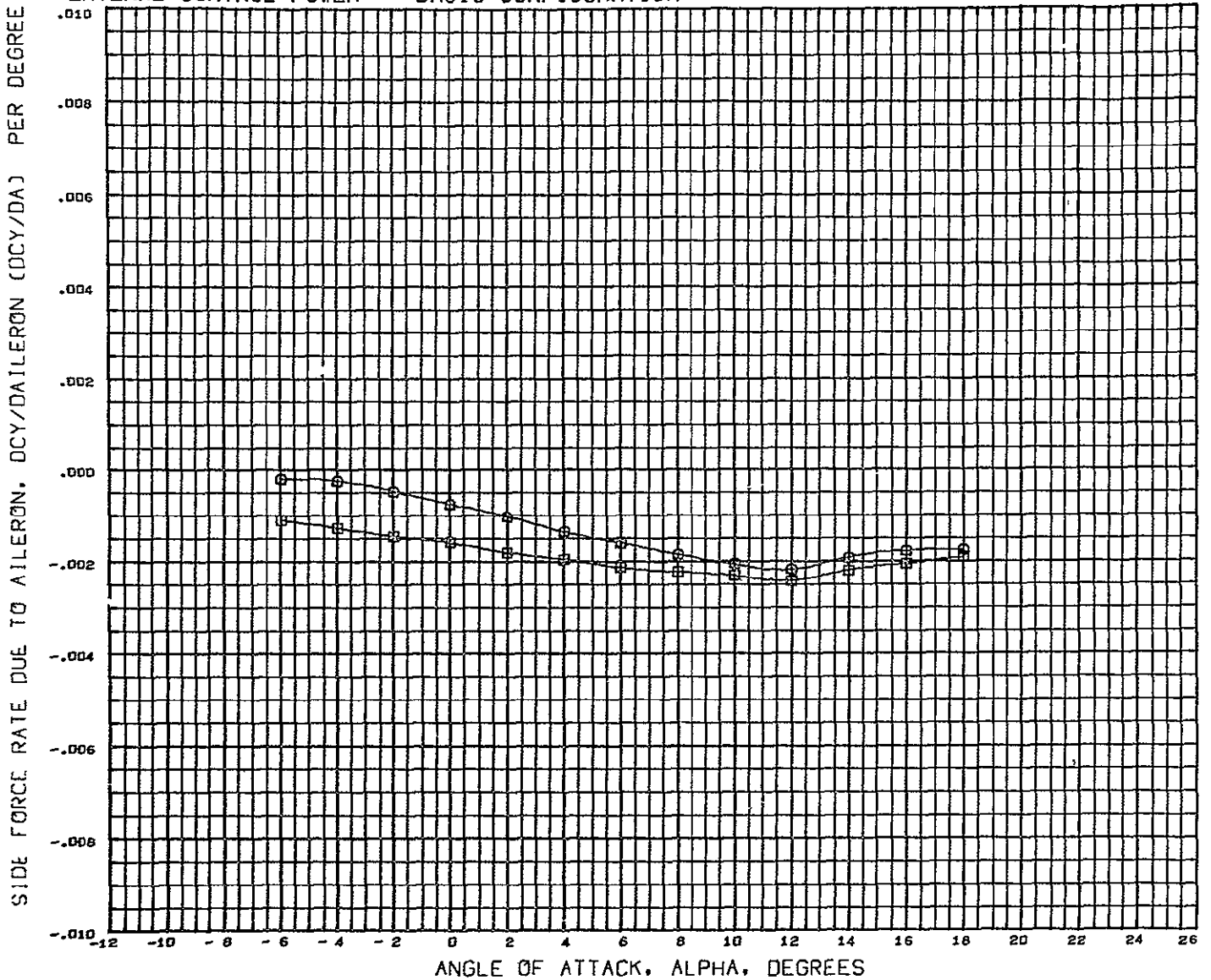

DATA SET SYMBOL	CONFIGURATION DESCRIPTION	SLOPE	BETA	ELEVTR
(XCP004)	LSWT 248 MDAC 4.0 PC O2 HCR ORB B5W11V6	1.000	3.000	10.000
(XCP023)	LSWT 248 MDAC 4.0 PC O2 HCR ORB B5W11V6	2.000	3.000	10.000

REFERENCE INFORMATION		
REFS	8	0690 SQ.FT.
REFL	29.5700	IN.
REFB	51.6000	IN.
XMRP	59.3200	IN.
YMRP	0.0000	IN.
ZMRP	11.6000	IN.
SCALE	4.0000	PERCENT

MACH 0.260

# LATERAL CONTROL POWER BASIC CONFIGURATION

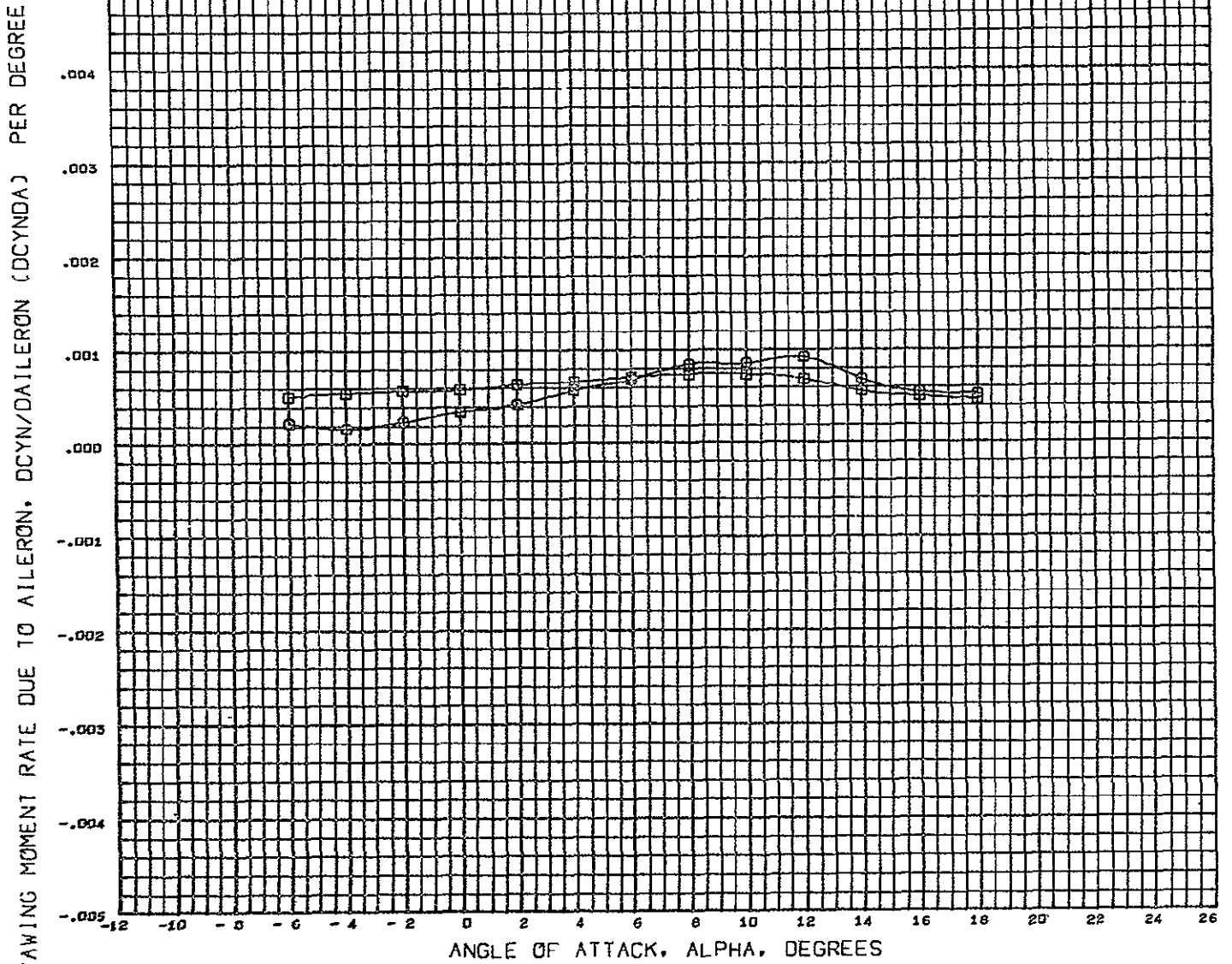

DATA SET SYMBOL	CONFIGURATION DESCRIPTION	B5W11V6
(XCF004)	LSWT 249 HDAC 4.0 PC 02 HCR ORB	B5W11V6
(XCF023)	LSWT 248 HDAC 4.0 PC 02 HCR ORB	B5W11V6

SLOPE	BETA	ELEVTR
1.000 -	3.000 -	10.000
2.000 -	3.000 -	10.000

REFERENCE INFORMATION		
REFS	8,8690	SQ.FT.
REFL	29,5700	IN.
REFB	51,6000	IN.
XMRP	59,3200	IN.
YMRP	0,0000	IN.
ZMRP	11,6000	IN.
SCALE	4,0000	PERCENT

MACH 0.260

# LATERAL CONTROL POWER BASIC CONFIGURATION

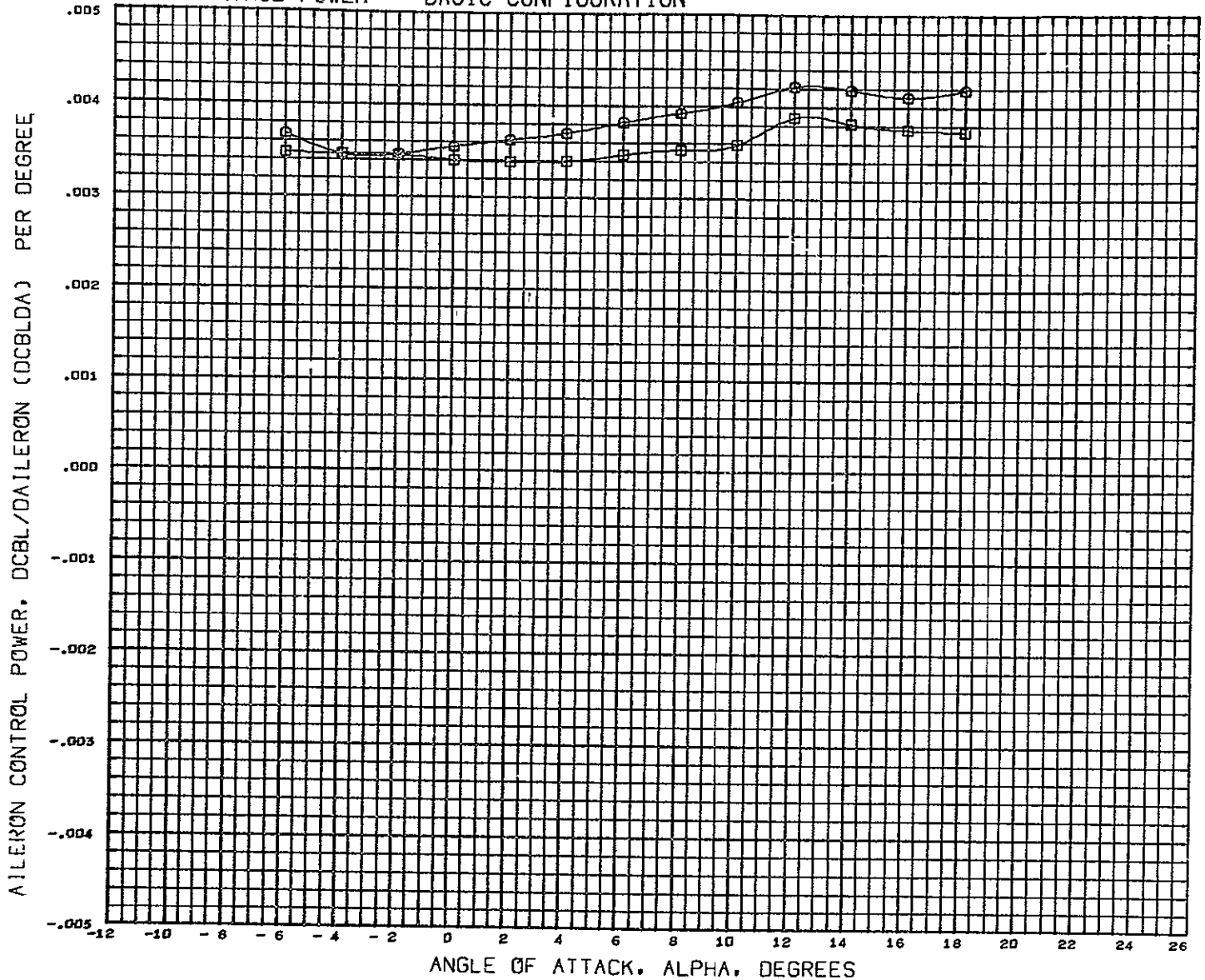

DATA SET SYMBOL	CONFIGURATION DESCRIPTION	SLOPE	BETA	ELEVTR	REFERENCE INFORMATION
(XCF004)	□ LSWT 248 MDAC 4.0 FC 02 HCR ORB 85W11V6	1.000	3.000	10.000	REFS 8.8690 SQ FT.
(XCF023)	□ LSWT 248 MDAC 4.0 FC 02 HCR ORB 85W11V6	2.000	3.000	10.000	REFL 29.5700 IN.
					REFB 51.6000 IN.
					XMRP 59.3200 IN.
					YMRP 0.0000 IN.
					ZMRP 11.6000 IN.
					SCALE 4.0000 PERCNT

MACH 0.260



# LATERAL CONTROL POWER BASIC CONFIGURATION

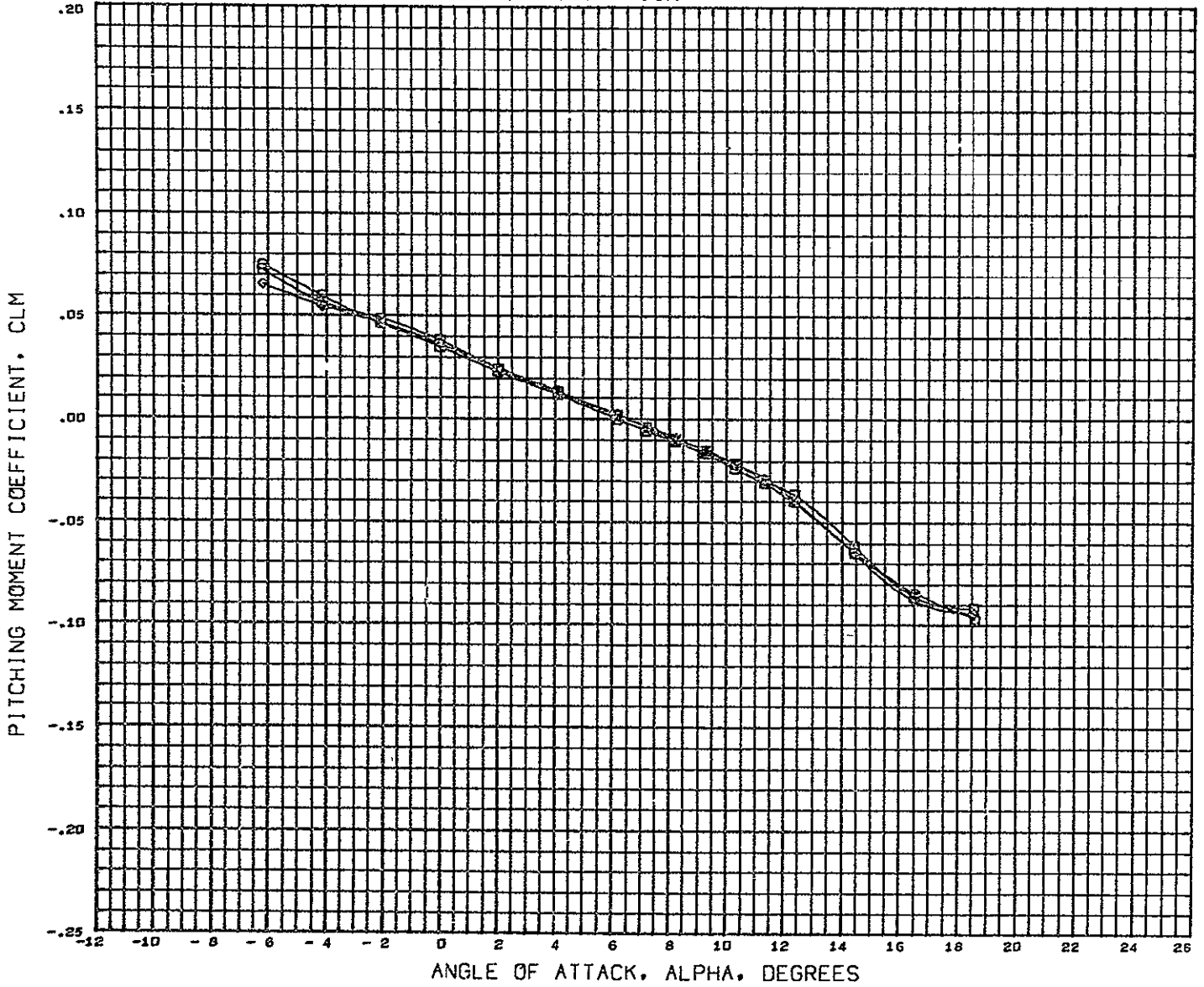

DATA SET SYMBOL	CONFIGURATION DESCRIPTION	BETA	ELEVTR	AILRON	REFERENCE INFORMATION
(CCF004)	LSWT 248 MDAC 4.0 PC 02 HCR ORB	B5W11V6	3.000 - 10.000	10.000	REFS 8.8690 SQ.FT
(CCF003)	LSWT 248 MDAC 4.0 PC 02 HCR ORB	B5W11V6	0.000 - 10.000	10.000	REFL 29.5700 IN.
(CCF005)	LSWT 248 MDAC 4.0 PC 02 HCR ORB	B5W11V6	3.000 - 10.000	10.000	REFB 51.6000 IN.
					XMRP 59.3200 IN.
					YMRP 0.0000 IN.
					ZMRP 11.6000 IN.
					SCALE 4.0000 PERCNT

MACH 0.250

LATERAL CONTROL POWER BASIC CONFIGURATION

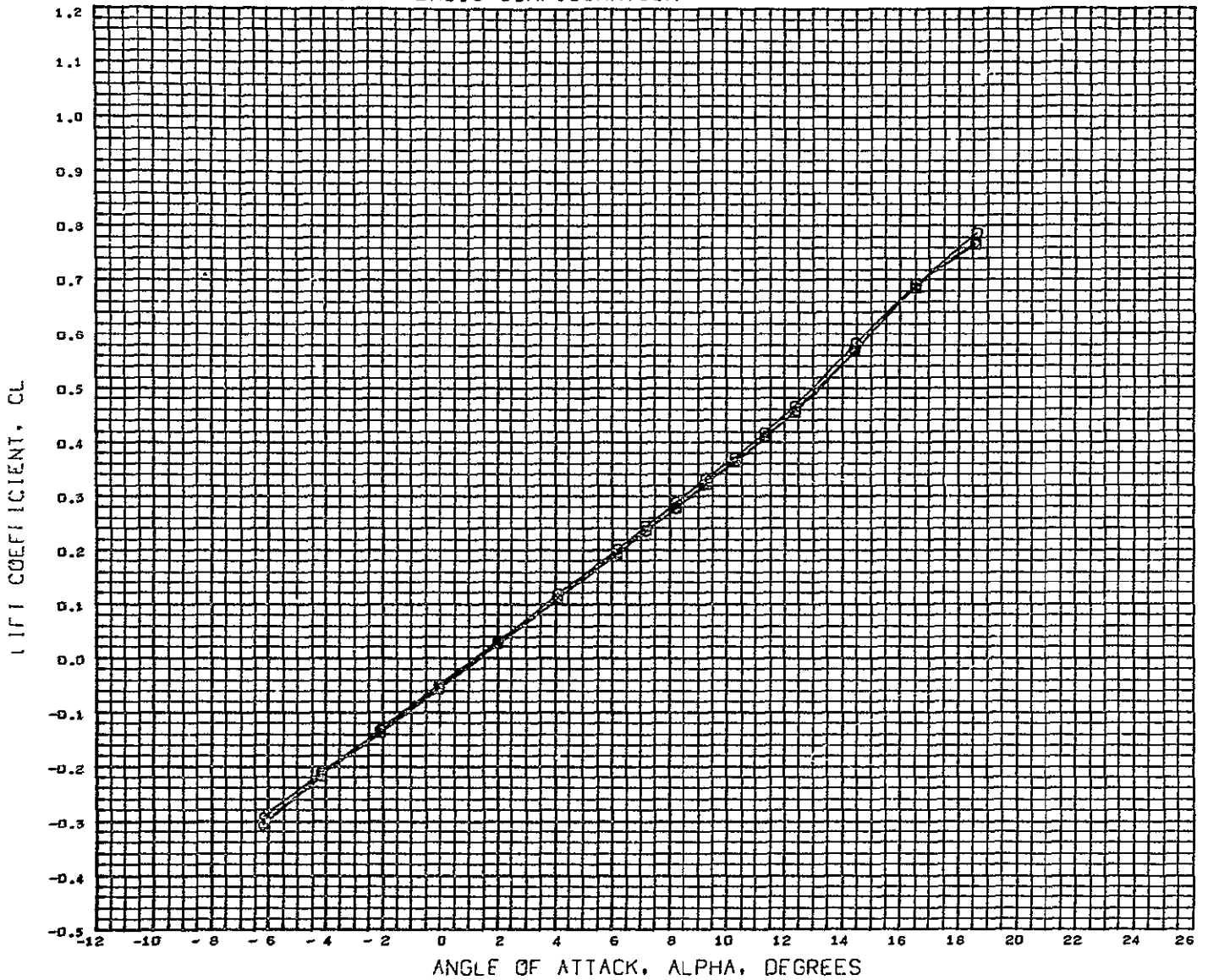

DATA SET SYMBOL	CONFIGURATION DESCRIPTION	BETA	ELEVTR	AILRON
(CCP004)	LSWT 248 MDAC 4.0 FC 02 HCR ORB	35W11V6	- 3.000 - 10.000	10.000
(CCP003)	LSWT 248 MDAC 4.0 FC 02 HCR ORB	B5W11V6	0.000 - 10.000	10.000
(CCP005)	LSWT 248 MDAC 4.0 FC 02 HCR ORB	B5W11V6	3.000 - 10.000	10.000

REFERENCE INFORMATION	
REFS	8.8690 SQ.FT.
REFL	29.5700 IN.
REFB	51.6000 IN.
XMRP	59.3200 IN.
YMRP	0.0000 IN.
ZMRP	11.6000 IN.
SCALE	4.0000 PERCNT

MACH 0.250

# LATERAL CONTROL POWER BASIC CONFIGURATION

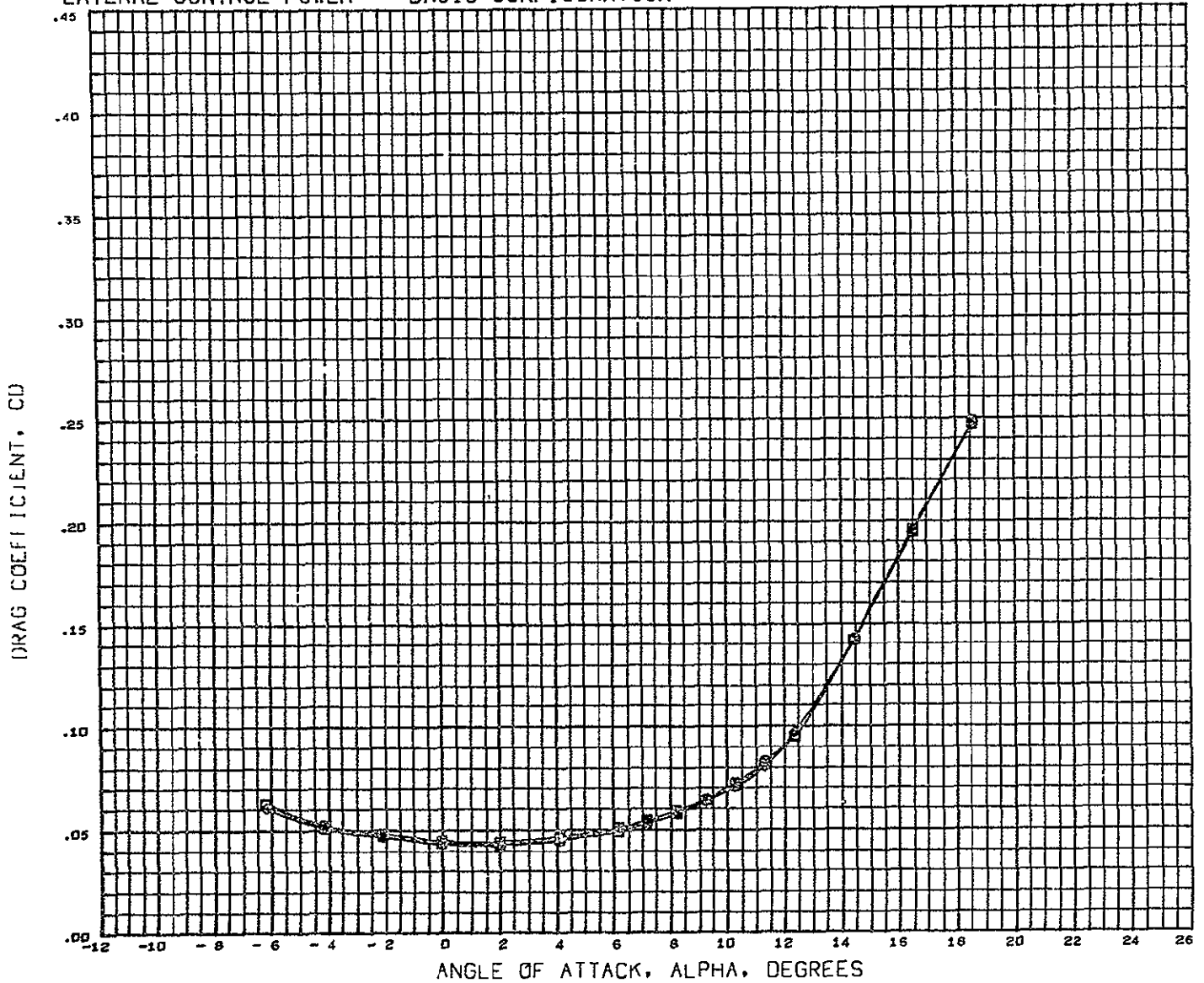

DATA SET SYMBOL	CONFIGURATION DESCRIPTION	BETA	ELEVTR	AILRON	REFERENCE INFORMATION
(CCP004)	LSWT 248 MDAC 4.0 FC O2 HCR ORB	85W11V6	- 3.000 - 10.000	10.000	REFS 8.6690 SQ.FT.
(CCP003)	LSWT 248 MDAC 4.0 FC O2 HCR ORB	85W11V6	0.000 - 10.000	10.000	REFL 29.5700 IN.
(CCP005)	LSWT 248 MDAC 4.0 FC O2 HCR ORB	85W11V6	3.000 - 10.000	10.000	REFB 51.6000 IN.
					XMRP 59.3200 IN.
					YMRP 0.0000 IN.
					ZMRP 11.6000 IN.
					SCALE 4.0000 PERCENT

MACH 0.250

LATERAL CONTROL POWER BASIC CONFIGURATION

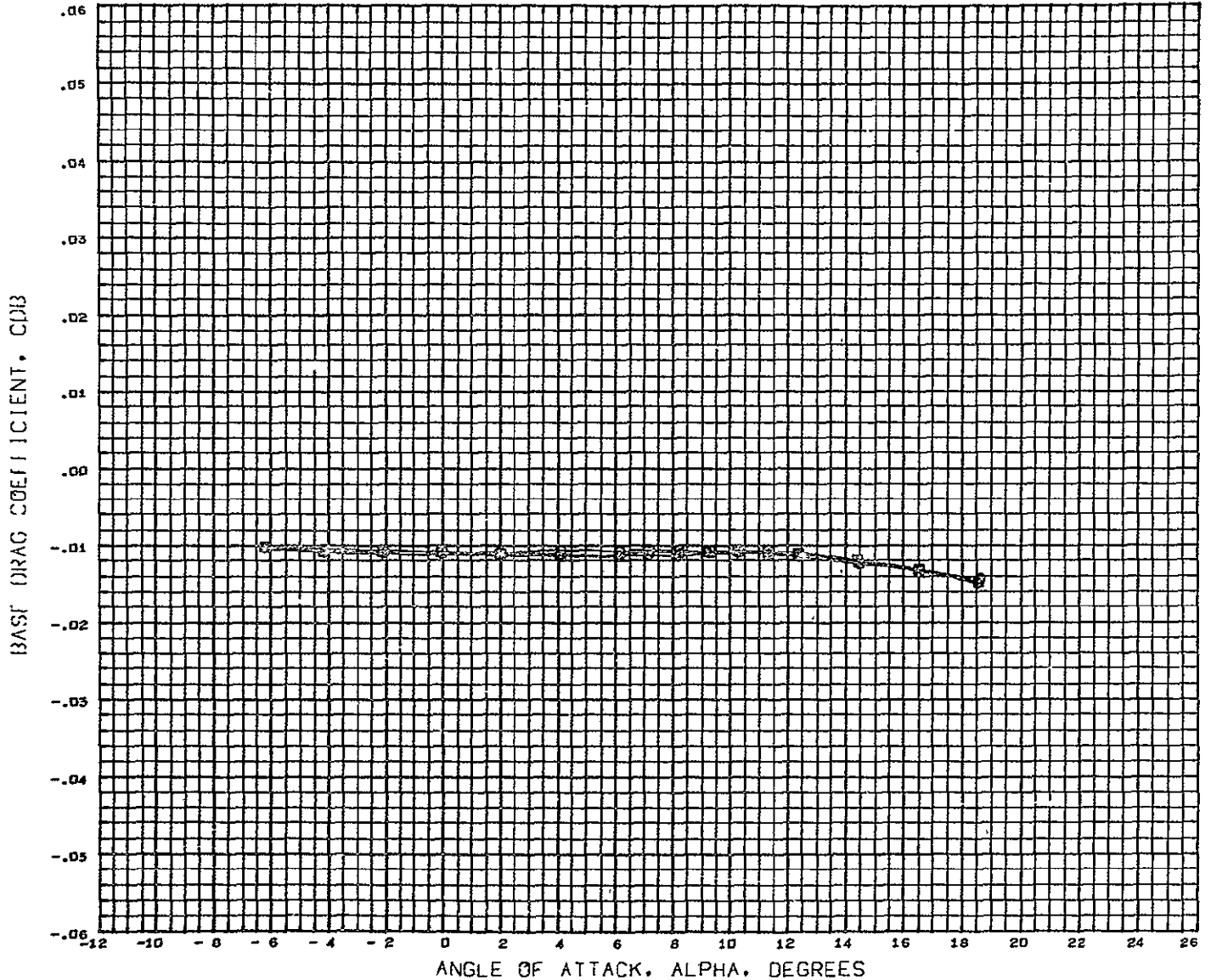

DATA SET SYMBCL	CONFIGURATION DESCRIPTION	BETA	ELEVTR	AILRON	REFERENCE INFORMATION
(CLP004)	LSWT 248 MDAC 4.0 FC 02 HCR ORB B5W11V6	- 3.000	- 10.000	10.000	REFS 8.8690 SQ FT.
(CCF003)	LSWT 248 MDAC 4.0 FC 02 HCR ORB B5W11V6	0.000	- 10.000	10.000	REFL 29.5700 IN.
(CCF005)	LSWT 248 MDAC 4.0 FC 02 HCR ORB B5W11V6	3.000	- 10.000	10.000	REFS 51.6000 IN.
					XMRP 59.3200 IN.
					YMRP 0.0000 IN.
					ZMRP 11.6000 IN.
					SCALE 4.0000 PERCNT

MACH 0.250

# LATERAL CONTROL POWER BASIC CONFIGURATION

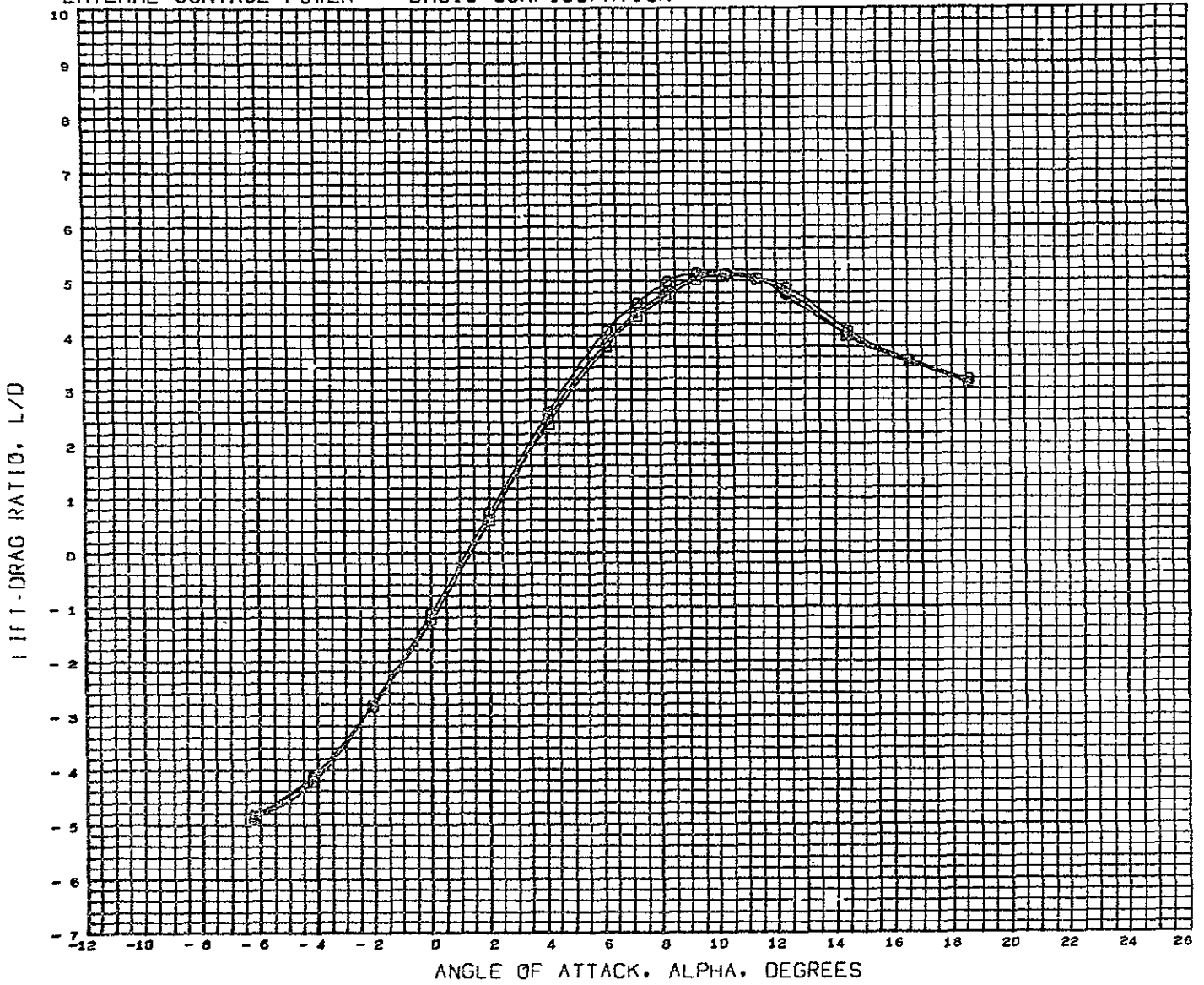

DATA SET SYMBOL	CONFIGURATION DESCRIPTION	BETA	ELEVTR	AILRON	REFERENCE INFORMATION
(CCF004)	□ LSWT 248 HDAC 4.0 FC 02 HCR ORB	85W11V6	- 3.000 - 10.000	10.000	REFS 8.8690 SQ FT.
(CCF003)	□ LSWT 248 HDAC 4.0 FC 02 HCR ORB	85W11V6	0.000 - 10.000	10.000	REFL 29.5700 IN.
(CCF005)	◇ LSWT 248 HDAC 4.0 FC 02 HCR ORB	85W11V6	3.000 - 10.000	10.000	REFB 51.6000 IN.
					XMRP 59.3200 IN.
					YMRP 0.0000 IN.
					ZMRP 11.6000 IN.
					SCALE 4.0000 PERCENT

MACH 0.250

# LATERAL CONTROL POWER BASIC CONFIGURATION

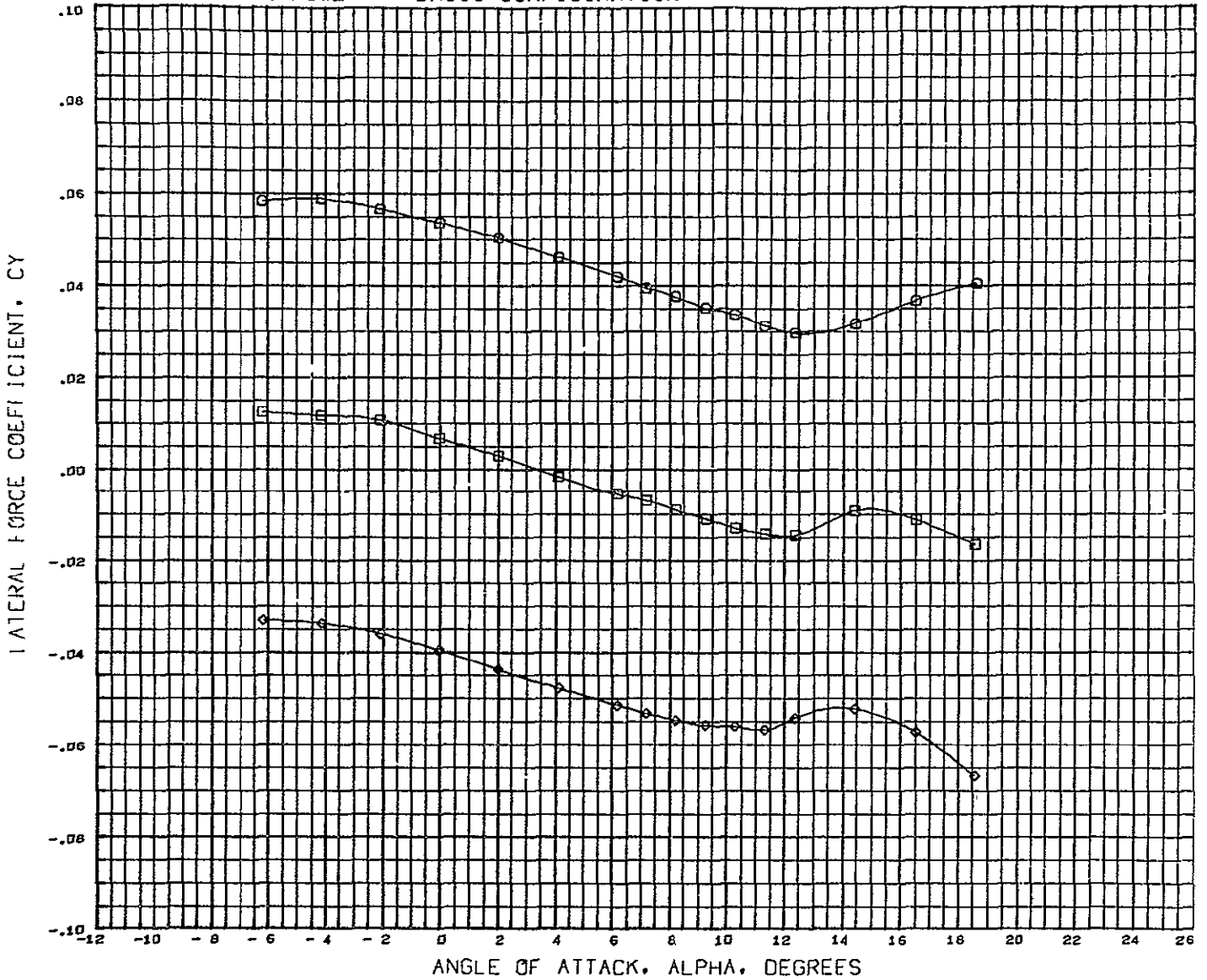

DATA SET	SYMBOL	CONFIGURATION DESCRIPTION	BETA	ELEVTR	AILRON	REFERENCE INFORMATION
CCF004	○	LSWT 248 MDAC 4.0 FC 02 HCR ORB	B5W11V6	- 3.000 - 10.000	10.000	REFS 8.8690 SQ.FT.
CCF003	□	LSWT 248 MDAC 4.0 FC 02 HCR ORB	B5W11V6	0.000 - 10.000	10.000	REFL 29.5700 IN.
CCF005	◇	LSWT 248 MDAC 4.0 FC 02 HCR ORB	B5W11V6	3.000 - 10.000	10.000	REFB 51.6000 IN.
						XMPF 59.3200 IN.
						YMRP 0.0000 IN.
						ZMRP 11.6000 IN.
						SCALE 4.0000 PERCNT

HACH 0.250

# LATERAL CONTROL POWER BASIC CONFIGURATION

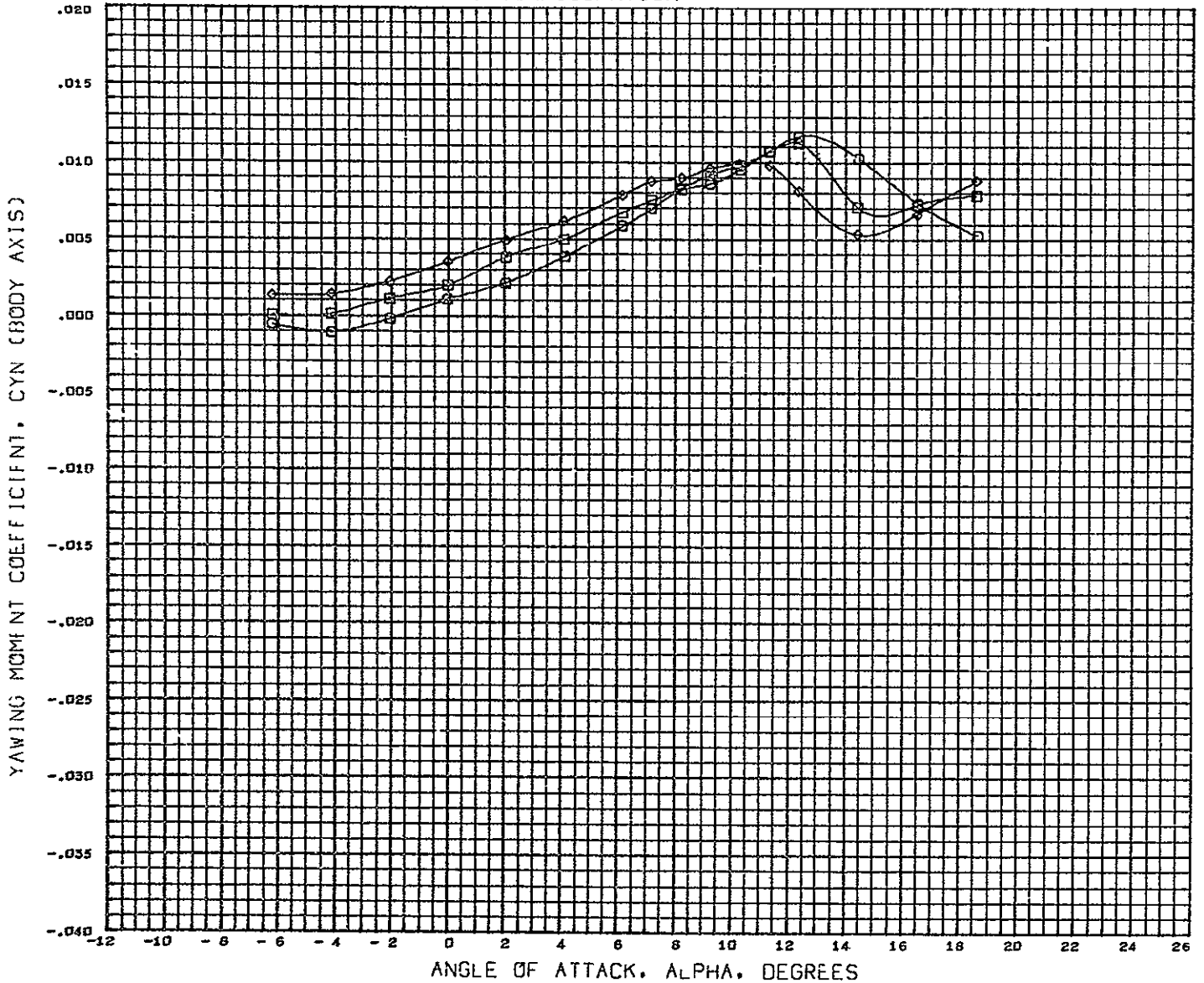

DATA SET SYMBOL	CONFIGURATION DESCRIPTION	BETA	ELEVTR	AILRON	REFERENCE INFORMATION
(CCF004)	LSWT 248 HDAC 4.0 PC 02 HCR ORB B5W11V6	-	3.000 - 10.000	10.000	REFS 8.8690 SQ.FT.
(CCF003)	LSWT 248 HDAC 4.0 PC 02 HCR ORB B5W11V6	0.000 - 10.000		10.000	REFL 29.5700 IN.
(CCF005)	LSWT 248 HDAC 4.0 PC 02 HCR ORB B5W11V6	3.000 - 10.000		10.000	REFB 51.6000 IN.
					XMRP 59.3200 IN.
					YMRP 0.0000 IN.
					ZMRP 11.6000 IN.
					SCALE 4.0000 PERCENT

MACH 0.250

# LATERAL CONTROL POWER BASIC CONFIGURATION

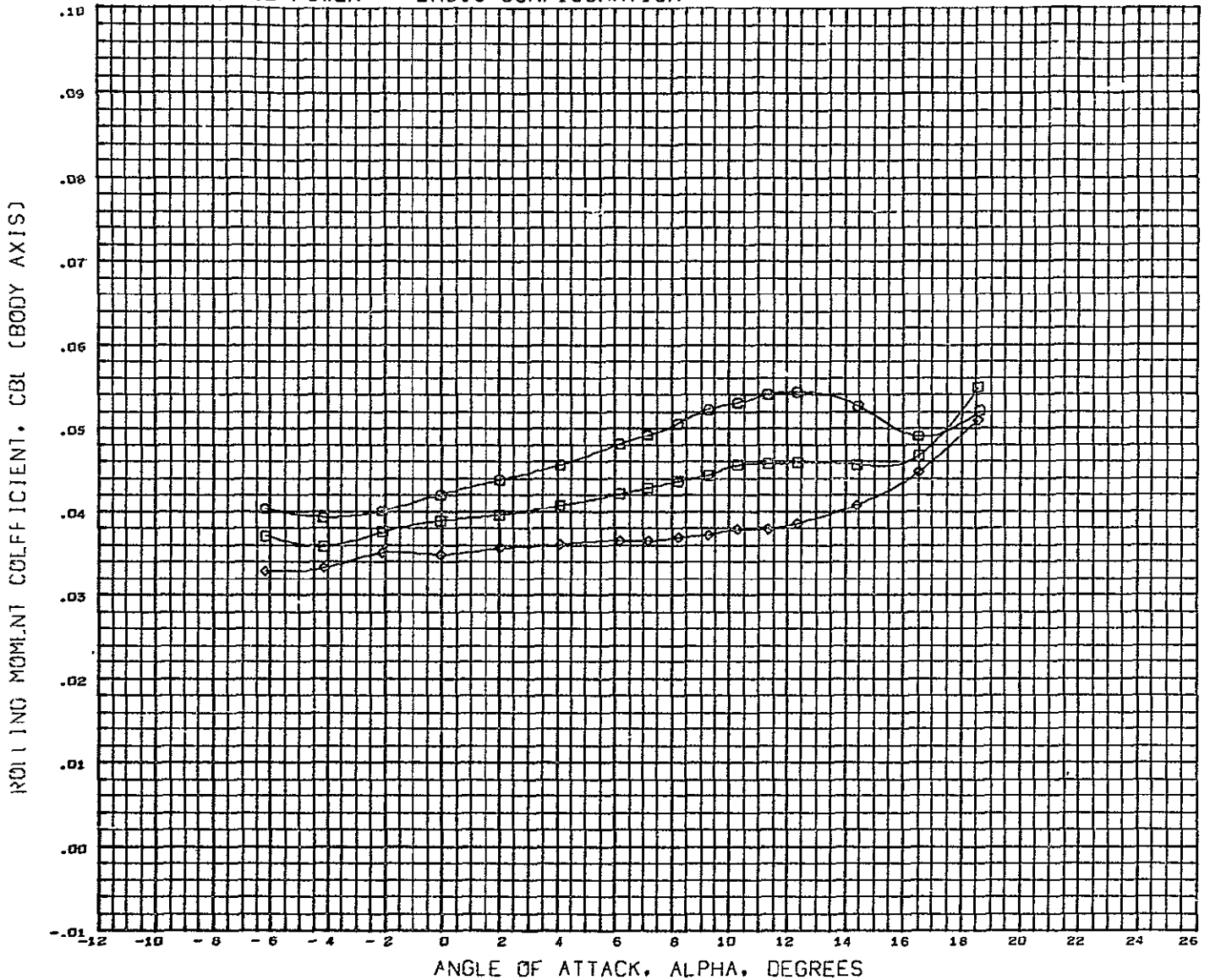

DATA SET SYMBOL	CONFIGURATION DESCRIPTION	BETA	ELEVTR	AILRON	REFERENCE INFORMATION
(CCP004)	LSWT 248 HDAC 4.0 FC 02 HCR ORB	85W11V6	- 3.000 - 10.000	10.000	REFS 8 8690 SQ.FT
(CCP003)	LSWT 248 HDAC 4.0 FC 02 HCR ORB	85W11V6	0.000 - 10.000	10.000	REFL 29.5700 IN.
(CCP005)	LSWT 248 HDAC 4.0 FC 02 HCR ORB	85W11V6	3.000 - 10.000	10.000	REFB 51.6000 IN.
					XMRP 59.3200 IN.
					YMRP 0.0000 IN.
					ZMRP 11.6000 IN.
					SCALE 4.0000 PERCENT

MACH 0.250



LATERAL CONTROL POWER BASIC CONFIGURATION

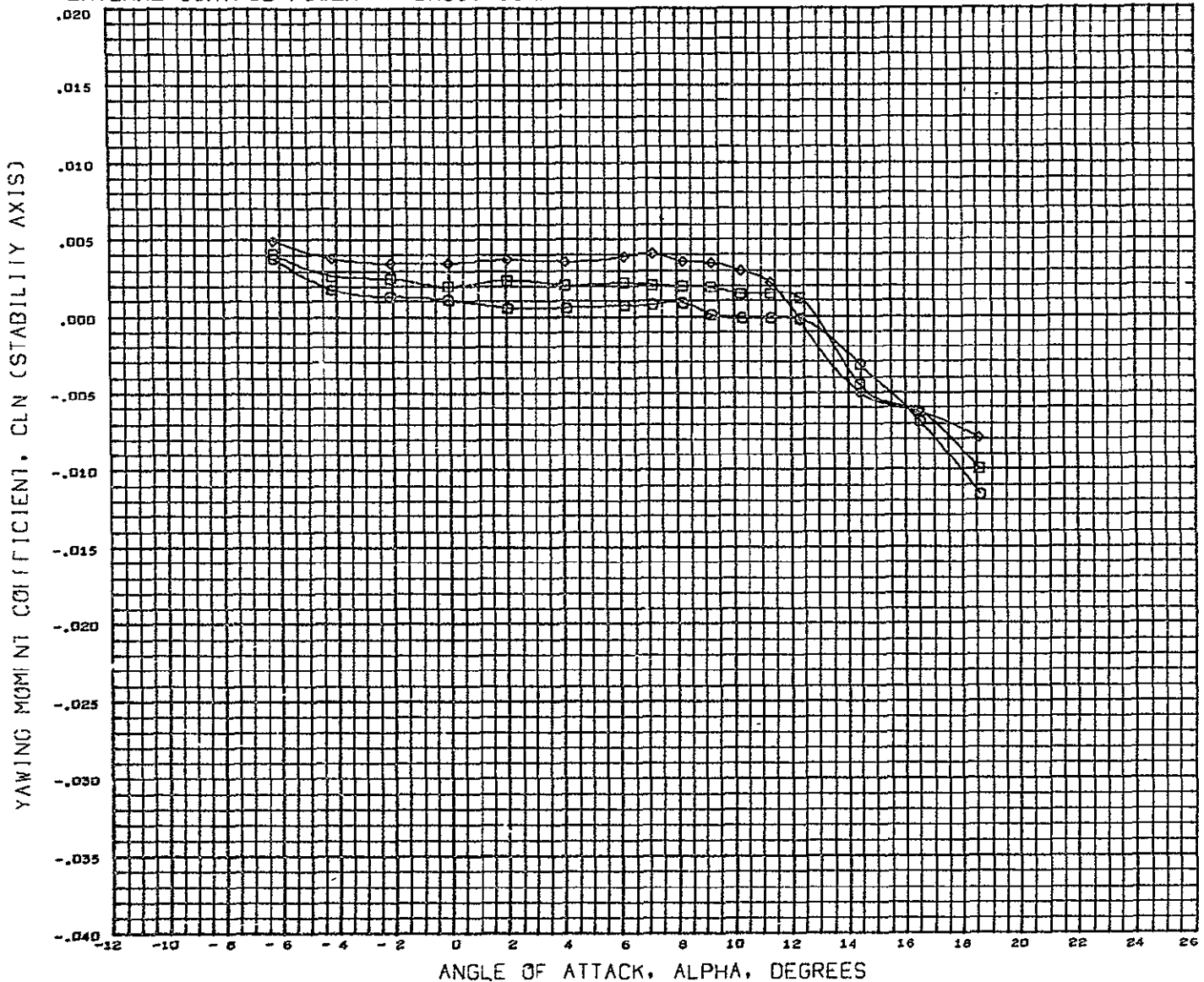

DATA SET SYMBOL	CONFIGURATION DESCRIPTION	BETA	ELEVTR	AILRON
(RCP004)	LSWT 248 MDAC 4.0 FC O2 HCR ORB	85W11V6	- 3.000 - 10.000	10.000
(RCP003)	LSWT 248 MDAC 4.0 FC O2 HCR ORB	85W11V6	0.000 - 10.000	10.000
(RCP005)	LSWT 248 MDAC 4.0 FC O2 HCR ORB	85W11V6	3.000 - 10.000	10.000

REFERENCE INFORMATION		
REFS	8 8690	SQ.FT.
REFL	29.5700	IN.
REFB	51.6000	IN.
XMRF	59.3200	IN.
YMRF	0.0000	IN.
ZMRF	11.6000	IN.
SCALE	4.0000	PERCNT

MACH 0.250

# LATERAL CONTROL POWER BASIC CONFIGURATION

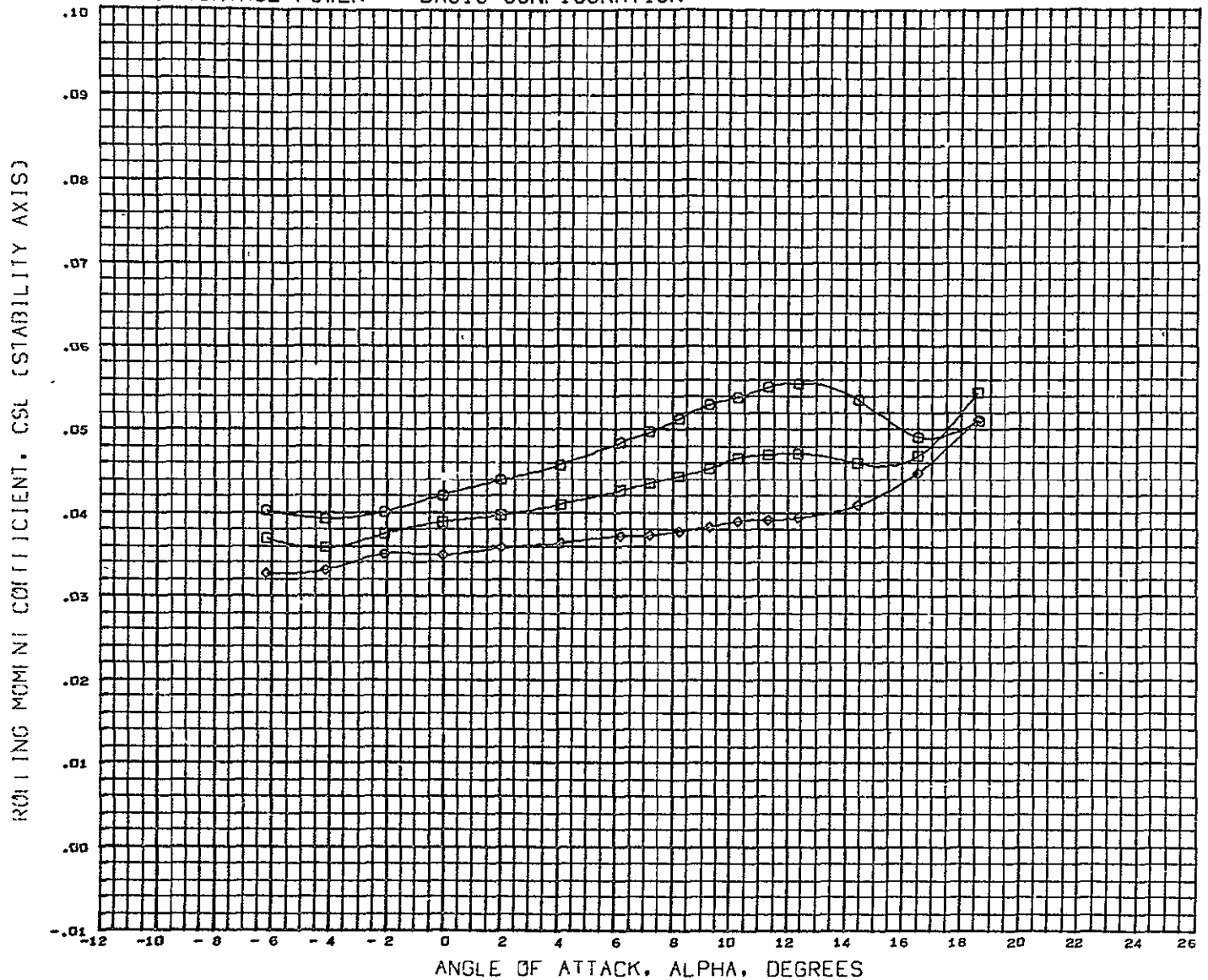

DATA SET SYMBOL	CONFIGURATION DESCRIPTION	BETA	ELEVTR	AILRON	REFERENCE INFORMATION
(RCP004)	LSWT 248 MDAC 4.0 FC 02 HCR ORB	85W11V6	- 3.000 - 10.000	10.000	REFS 8 8690 SQ.FT
(RCP003)	LSWT 248 MDAC 4.0 FC 02 HCR ORB	85W11V6	0.000 - 10.000	10.000	REFL 29.5700 IN
(RCP005)	LSWT 248 MDAC 4.0 FC 02 HCR ORB	85W11V6	3.000 - 10.000	10.000	REFB 51.6000 IN
					XMRP 59.3200 IN.
					YMRP 0.0000 IN.
					ZMRP 11.6000 IN
					SCALE 4.0000 PERCNT

PACH 0.250

# LATERAL CONTROL POWER BASIC CONFIGURATION

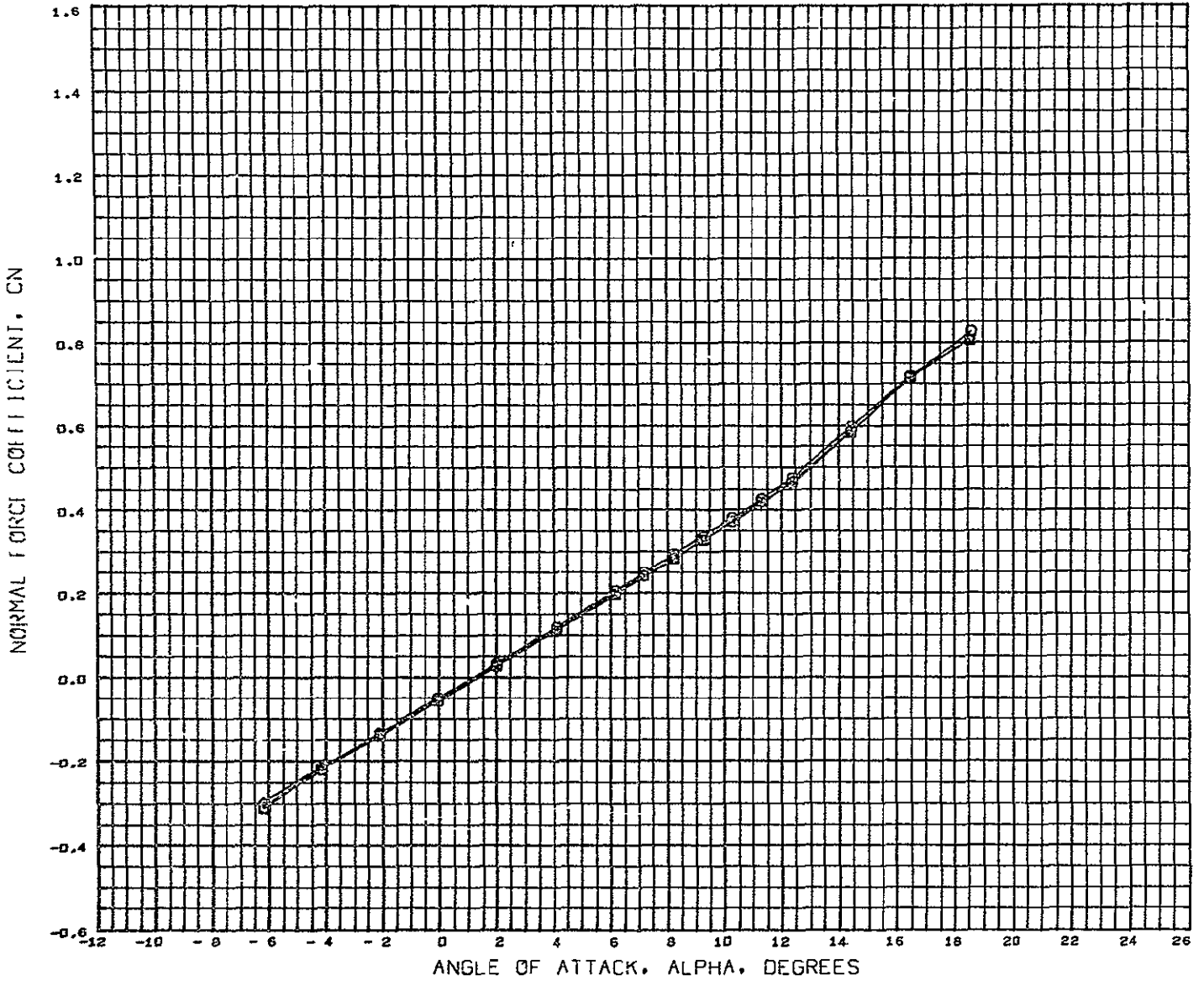

DATA SET SYMBOL	CONFIGURATION DESCRIPTION	BETA	ELEVTR	AILRON	REFERENCE INFORMATION
(BCF004)	LSWT 248 MDAC 4.0 FC 02 HCR ORB	85W11VG	- 3.000 - 10.000	10.000	REFS 8.8690 SQ FT.
(BCF003)	LSWT 248 MDAC 4.0 FC 02 HCR ORB	85W11VG	0.000 - 10.000	10.000	REFL 29.5700 IN.
(BCF005)	LSWT 248 MDAC 4.0 FC 02 HCR ORB	85W11VG	3.000 - 10.000	10.000	REFB 51.6000 IN.
					XMRP 59.3200 IN.
					YMRP 0.0000 IN.
					ZMRP 11.6000 IN.
					SCALE 4.0000 PERCENT

MACH 0.250

LATERAL CONTROL POWER BASIC CONFIGURATION

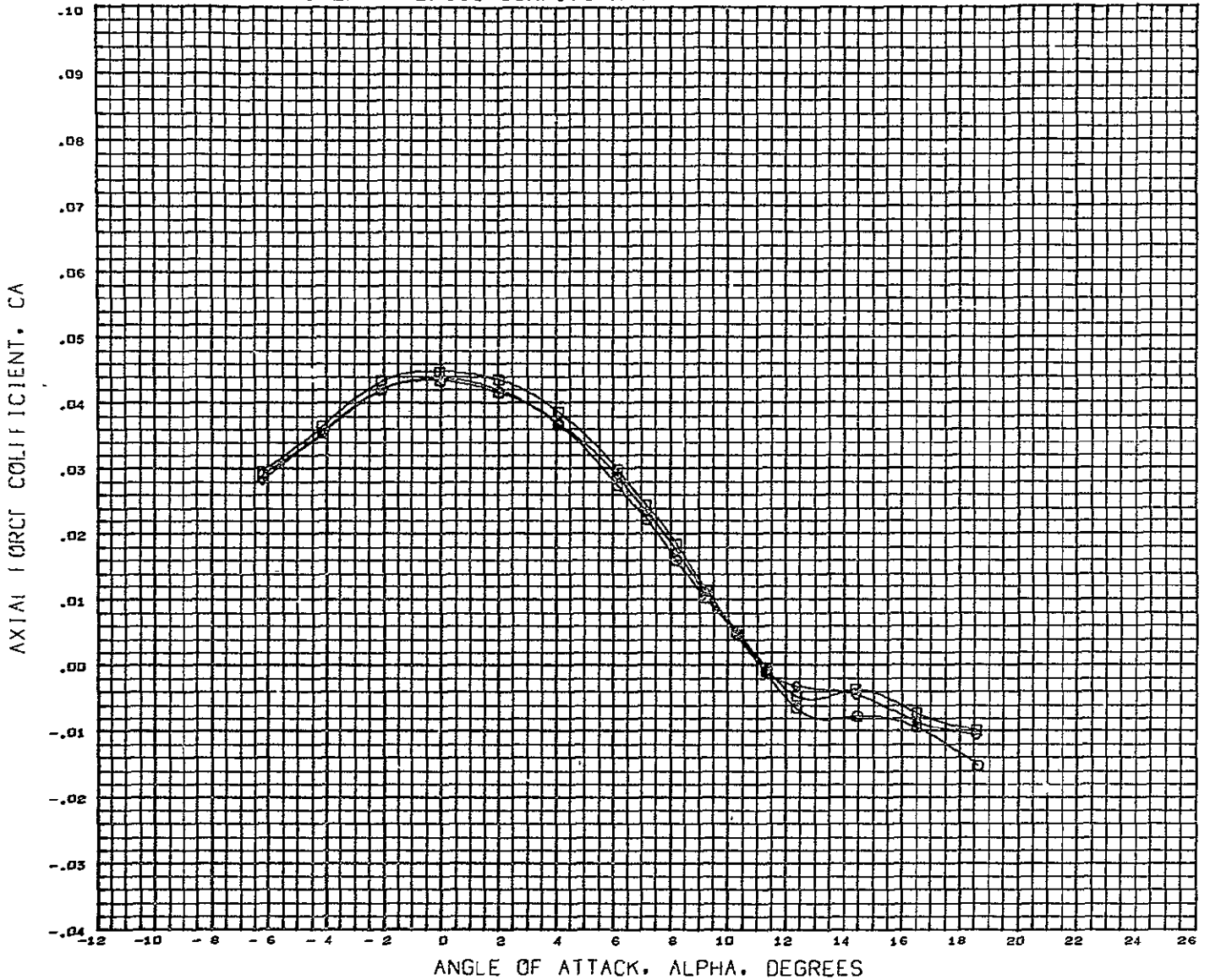

DATA SET SYMBOL	CONFIGURATION DESCRIPTION	BETA	ELEVTR	AILRON	REFERENCE INFORMATION
(BCF004)	LSWT 248 MDAC 4.0 FC 02 HCR ORB 85W11V6	- 3.000 - 10.000	10.000		REFS 8.8690 SQ FT.
(BCF003)	LSWT 248 MDAC 4.0 FC 02 HCR ORB 85W11V6	0.000 - 10.000	10.000		REFL 29.5700 IN.
(BCF005)	LSWT 248 MDAC 4.0 FC 02 HCR ORB 85W11V6	3.000 - 10.000	10.000		REFB 51.6000 IN.
					XMRP 59.3200 IN.
					YMRP 0.0000 IN.
					ZMRP 11.6000 IN.
					SCALE 4.0000 PERCENT

HACH 0.250

# LATERAL CONTROL POWER BASIC CONFIGURATION

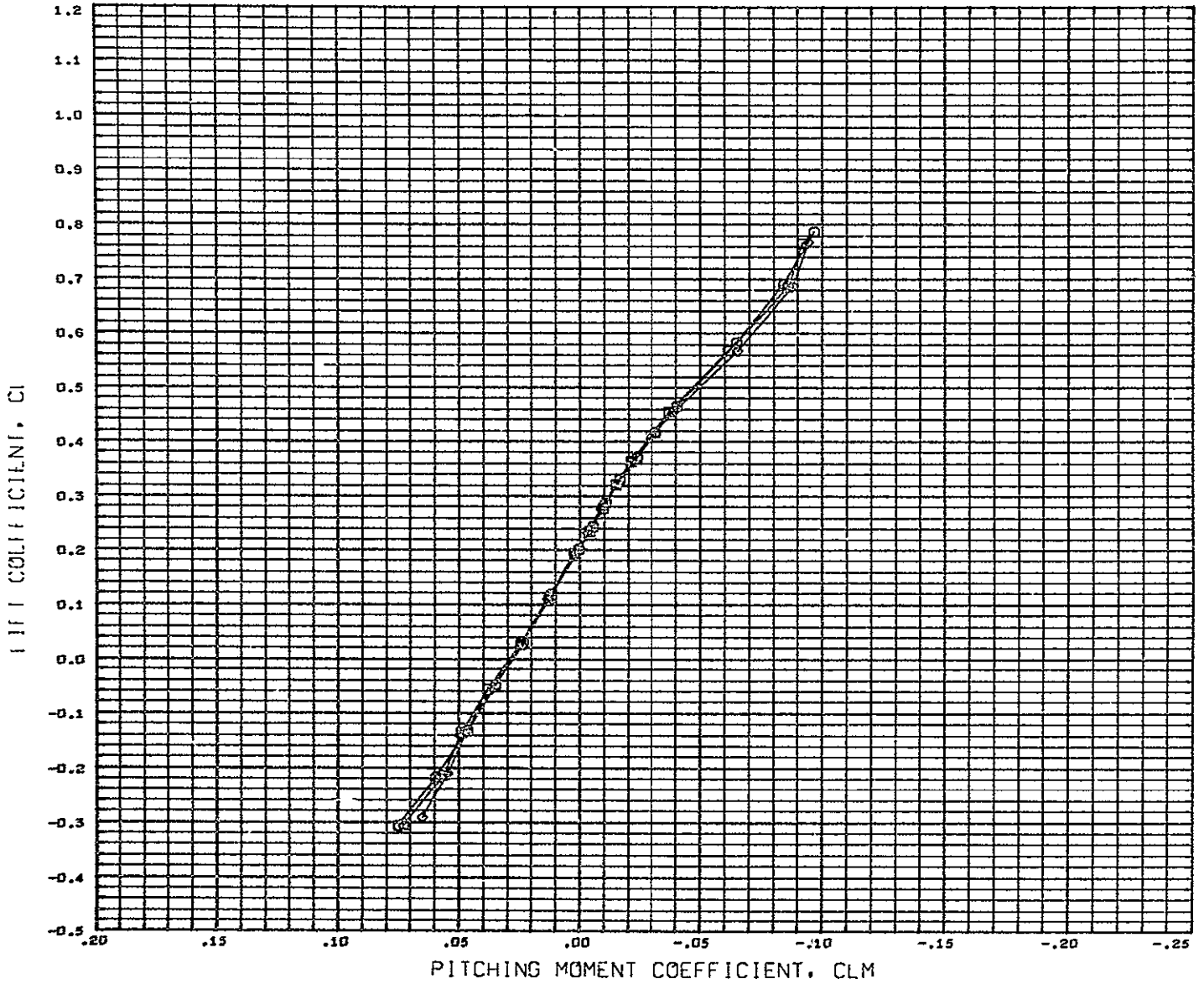

DATA SET SYMBOL	CONFIGURATION DESCRIPTION	BETA	ELEVTR	AILRON	REFERENCE INFORMATION
(CCP004)	LSWT 248 MDAC 4.0 FC 02 HCR ORB	B5W11V6	- 3.000 - 10.000	10.000	REFS 8.8690 SQ.FT
(CCP003)	LSWT 248 MDAC 4.0 FC 02 HCR ORB	B5W11V6	0.000 - 10.000	10.000	REFL 29.5700 IN.
(CCP005)	LSWT 248 MDAC 4.0 FC 02 HCR ORB	B5W11V6	3.000 - 10.000	10.000	REFB 51.6000 IN.
					XMRP 59.3200 IN.
					YMRP 0.0000 IN.
					ZMRP 11.6000 IN.
					SCALE 4.0000 PERCENT

MACH 0.250

LATERAL CONTROL POWER BASIC CONFIGURATION

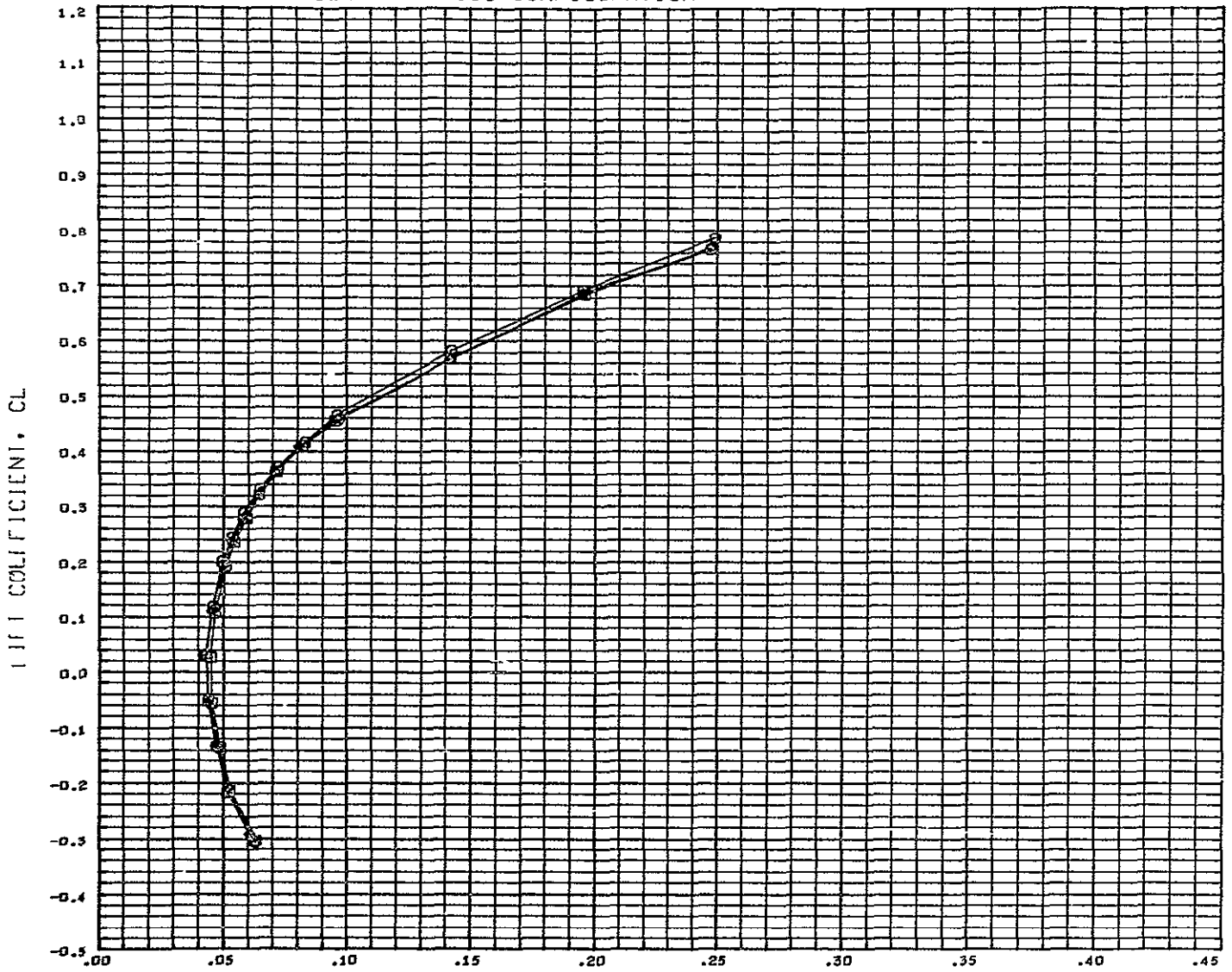

DATA SET SYMBOL	CONFIGURATION DESCRIPTION	BETA	ELEVTR	AILRON
(CCFDD4)	LSWT 248 HDAC 4.0 FC 02 HCR ORB	3.000	10.000	10.000
(CCFDD3)	LSWT 248 HDAC 4.0 FC 02 HCR ORB	0.000	10.000	10.000
(CCFDD5)	LSWT 248 HDAC 4.0 FC 02 HCR ORB	3.000	10.000	10.000

REFERENCE INFORMATION		
REFS	8	8690 SQ.FT
REFL	29.5700	IN.
REFB	51.6000	IN.
XMRP	59.3200	IN.
YMRP	0.0000	IN.
ZMRP	11.6000	IN.
SCALE	4.0000	PERCENT

MACH 0.250

# LATERAL CONTROL POWER BASIC CONFIGURATION

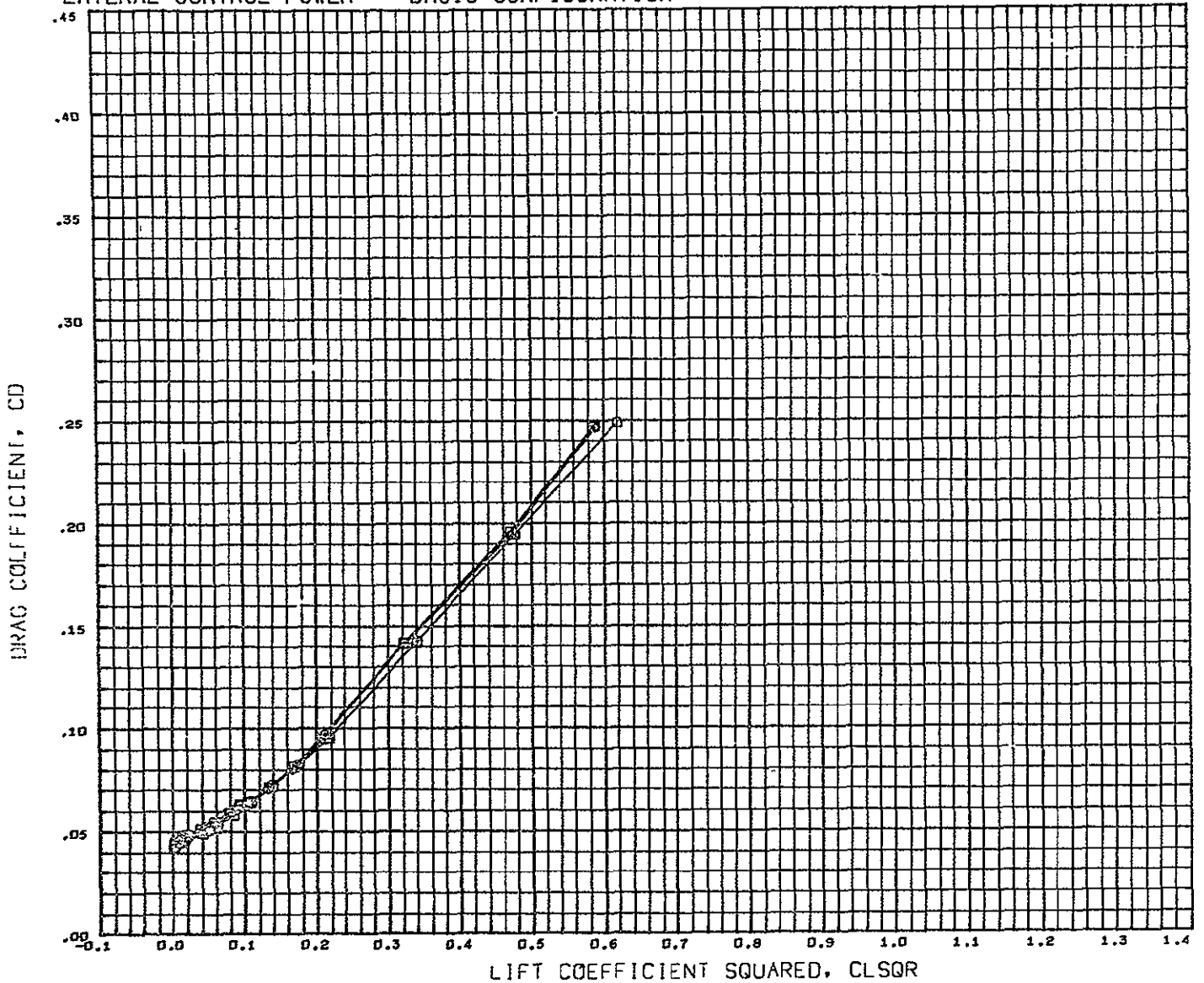

DATA SET SYMBOL	CONFIGURATION DESCRIPTION	BETA	ELEVTR	AILRON	REFERENCE INFORMATION
(CCP004)	LSWT 248 HDAC 4.0 FC 02 HCR ORB	85W11V6	3.000 - 10.000	10.000	REFS 8 8690 SQ FT.
(CCP003)	LSWT 248 HDAC 4.0 FC 02 HCR ORB	85W11V6	0.000 - 10.000	10.000	REFL 29.5700 IN.
(CCP005)	LSWT 248 HDAC 4.0 FC 02 HCR ORB	85W11V6	3.000 - 10.000	10.000	REFB 51.6000 IN.
					XHRP 59.3200 IN.
					YMRP 0.0000 IN.
					ZMRP 11.6000 IN.
					SCALE 4.0000 PERCENT

MACH 0.250

LATERAL CONTROL POWER BASIC CONFIGURATION

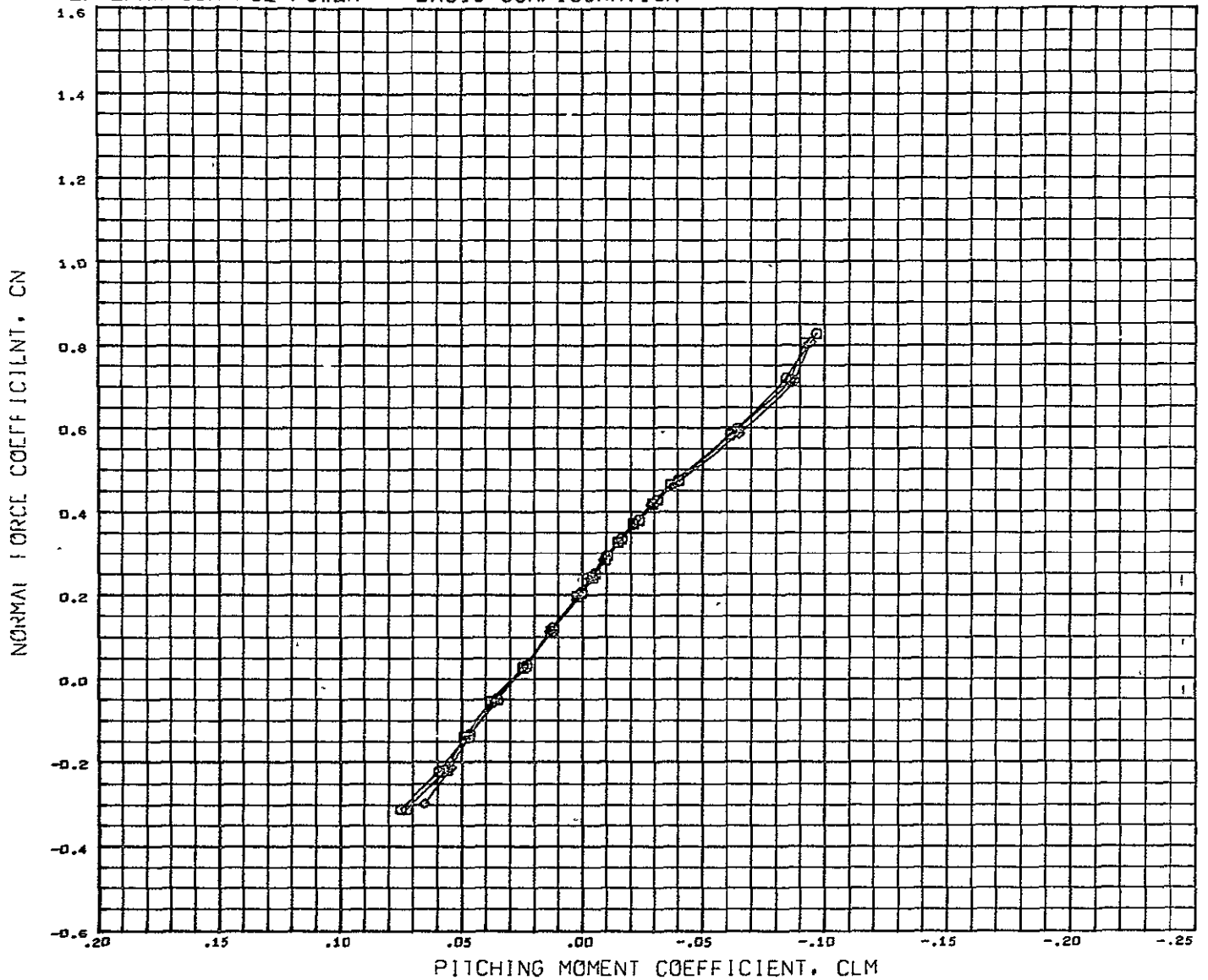

DATA SET SYMBOL	CONFIGURATION DESCRIPTION	BETA	ELEVTR	AILRON	REFERENCE INFORMATION
(BCFDD4)	LSWT 248 MDAC 4.0 FC 02 HCR ORB	B5W11V6	- 3.000 - 10.000	10.000	REFS 8.8690 SQ.FT.
(BCFDD3)	LSWT 248 MDAC 4.0 FC 02 HCR ORB	B5W11V6	0.000 - 10.000	10.000	REFL 29.5700 IN.
(BCFDD5)	LSWT 248 MDAC 4.0 FC 02 HCR ORB	B5W11V6	3.000 - 10.000	10.000	REFB 51.6000 IN.
					XMRP 59.3200 IN.
					YMRP 0.0000 IN.
					ZMRP 11.6000 IN.
					SCALE 4.0000 PERCENT

MACH 0.250



# LATERAL CONTROL POWER BASIC CONFIGURATION

SIDE FORCE DERIVATIVE, DCY/D BETA (CYBL/IA) PER DEGREE

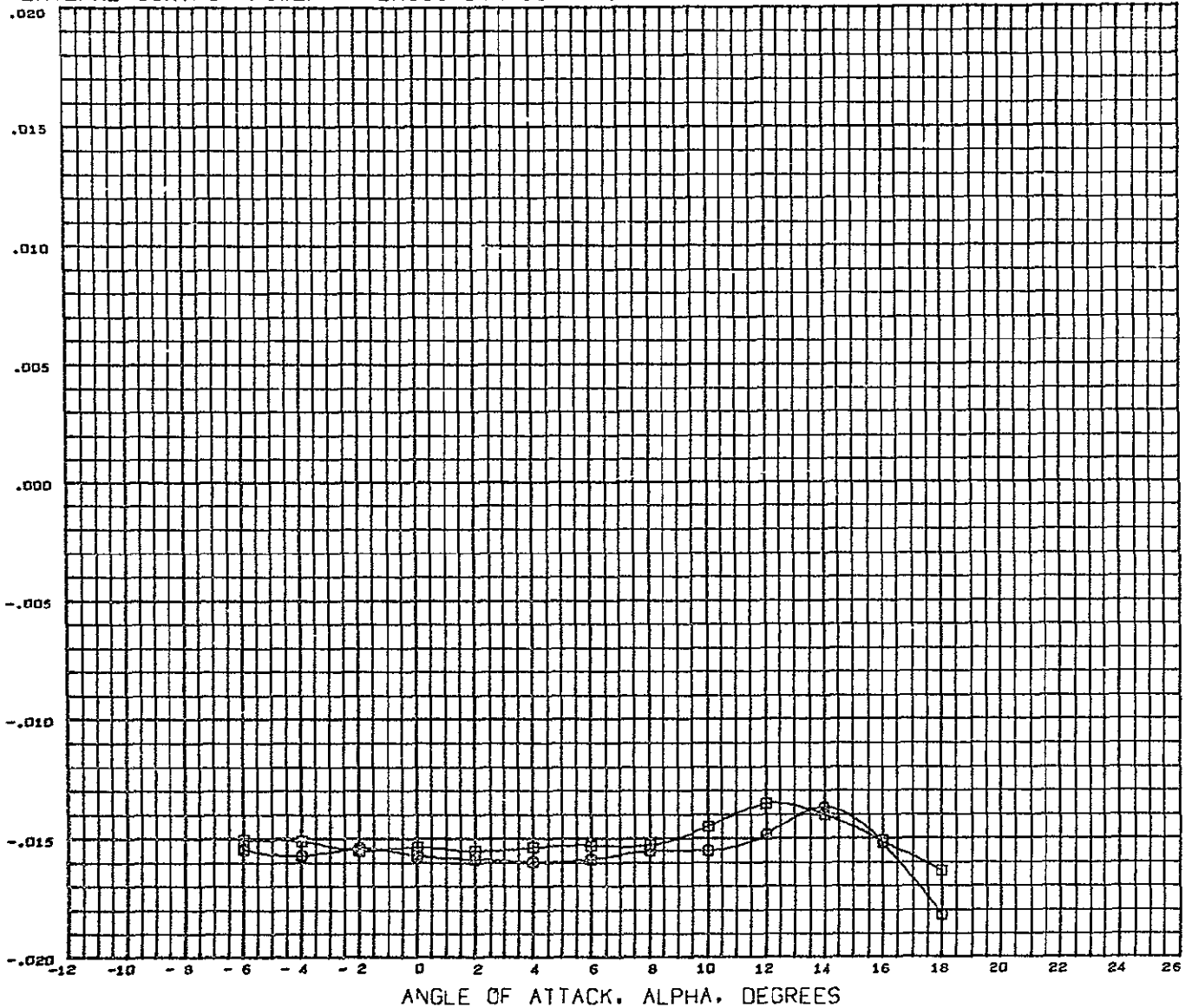

DATA SET	SYMBOL	CONFIGURATION DESCRIPTION	SLOPE	ELEVTR	AILRON	REFERENCE INFORMATION
(GCP004)	110	LSWT 248 HDAC 4.0 FC 02 HCR ORB B5W11V6	1.000	- 10.000	10.000	REFS 8.8690 SQ.FT
(GCP005)	110	LSWT 248 HDAC 4.0 FC 02 HCR ORB B5W11V6	2.000	- 10.000	10.000	REFL 29.5700 IN.
						REFB 51.6000 IN.
						XMRP 59.3200 IN.
						YMRP 0.0000 IN.
						ZMRP 11.6000 IN.
						SCALE 4.0000 PERCENT

MACH 0.260

LATERAL CONTROL POWER BASIC CONFIGURATION

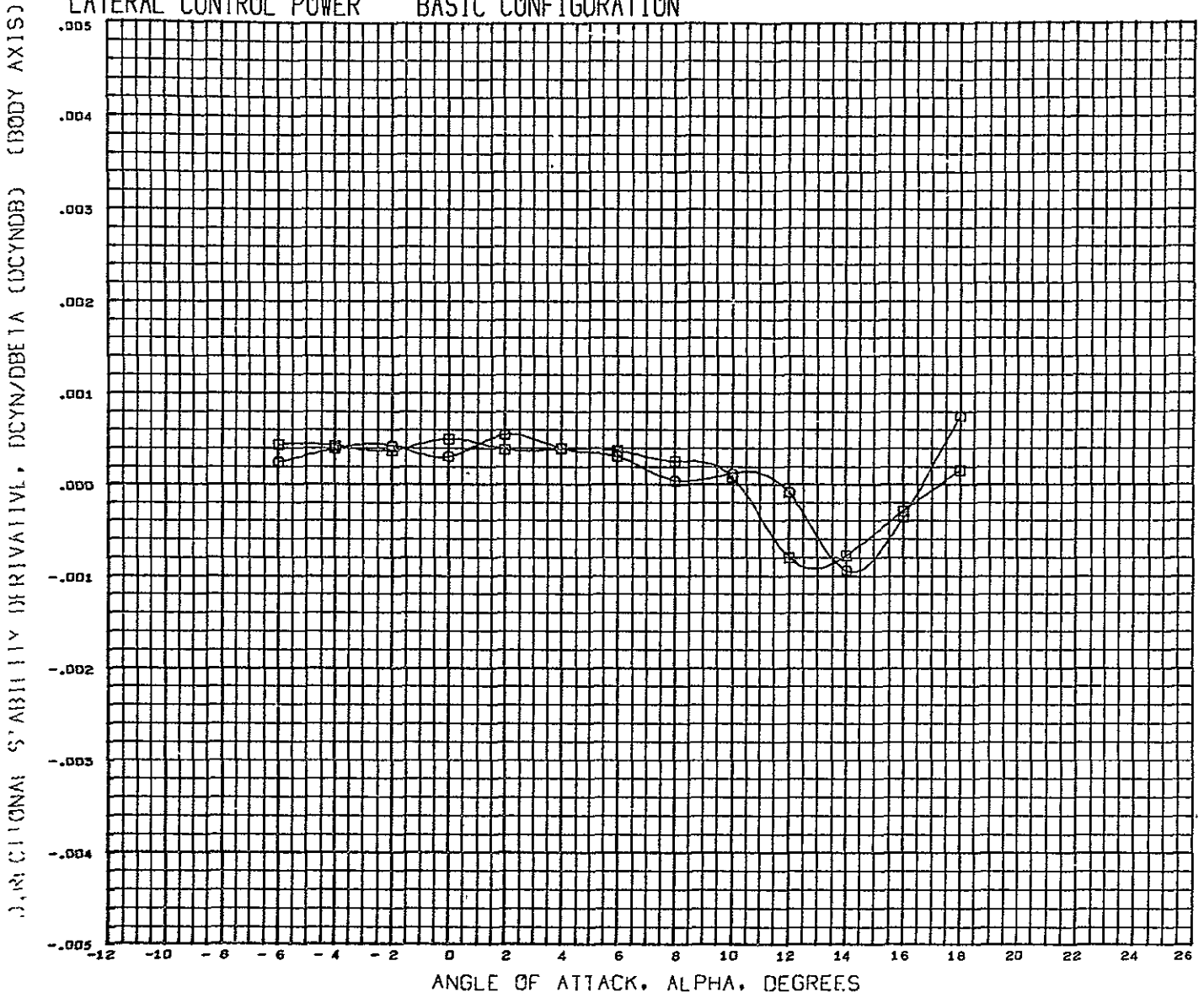

DATA SET SYMBOL	CONFIGURATION DESCRIPTION	SLOPE	ELEVTR	AILRON	REFERENCE INFORMATION
(GCP004)	LSWT 248 HDAC 4.0 FC 02 HCR ORB B5W11V6	1.000 - 10.000	10.000		REFS 8.8690 SQ FT
(GCP005)	LSWT 248 HDAC 4.0 FC 02 HCR ORB B5W11V6	2.000 - 10.000	10.000		REFL 29.5700 IN.
					REFB 51.6000 IN.
					XMRP 59.3200 IN.
					YMRP 0.0000 IN.
					ZMRP 11.6000 IN.
					SCALE 4.0000 PERCNT

MACH 0.260

# LATERAL CONTROL POWER BASIC CONFIGURATION

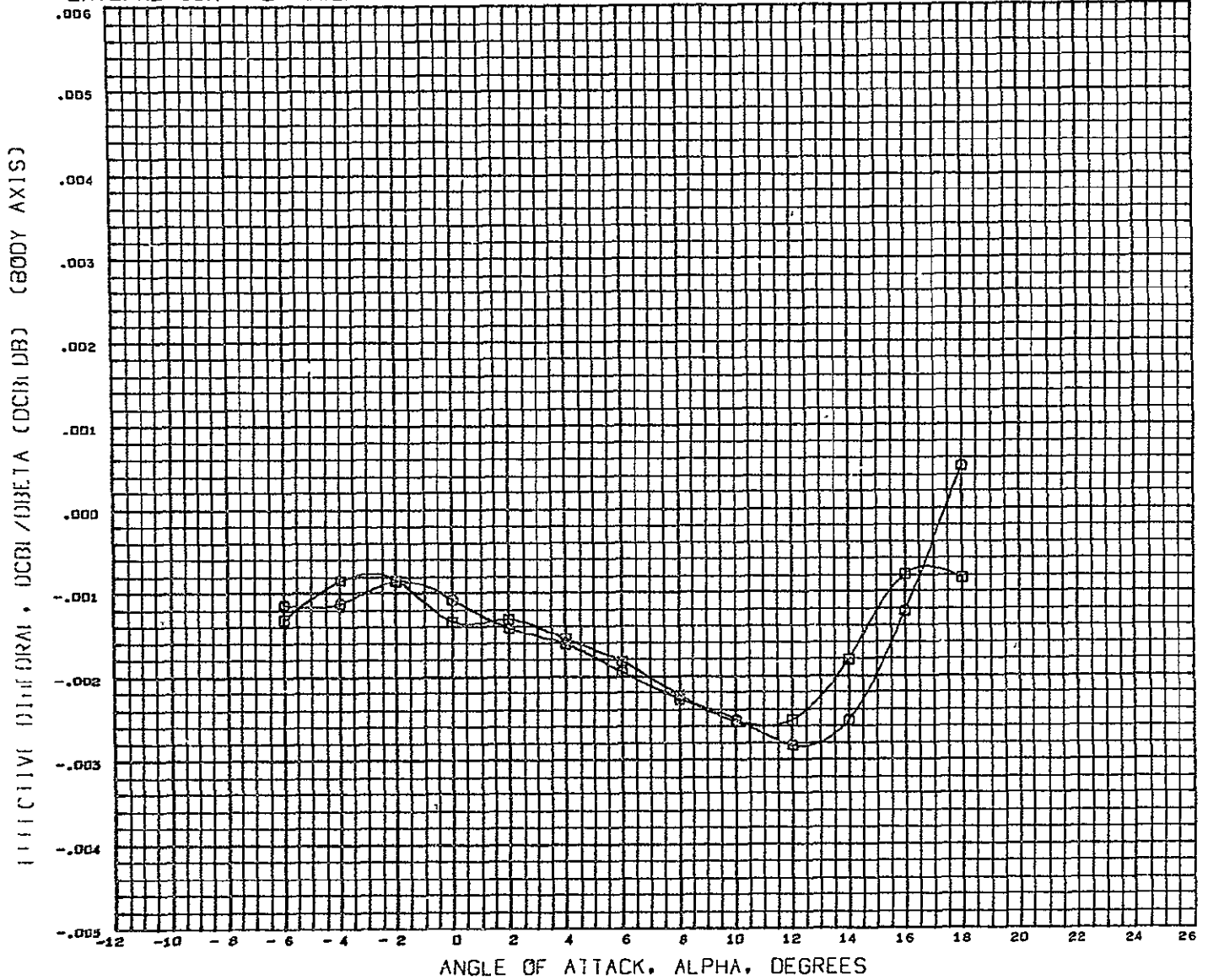

DATA SET SYMBOL	CONFIGURATION DESCRIPTION	SLOPE	ELEVTR	AILRON	REFERENCE INFORMATION
(GCP004)	LSWT 248 MDAC 4.0 FC 02 HCR ORB 85W11V6	1.000	-10.000	10.000	REFS 8.8690 SQ FT.
(GCP005)	LSWT 248 MDAC 4.0 FC 02 HCR ORB 85W11V6	2.000	-10.000	10.000	REFL 29.6700 IN.
					REFB 51.6000 IN.
					XMRP 59.3200 IN.
					YMRP 0.0000 IN.
					ZMRP 11.6000 IN.
					SCALE 4.0000 PERCENT

MACH 0.260

# LATERAL CONTROL POWER BASIC CONFIGURATION

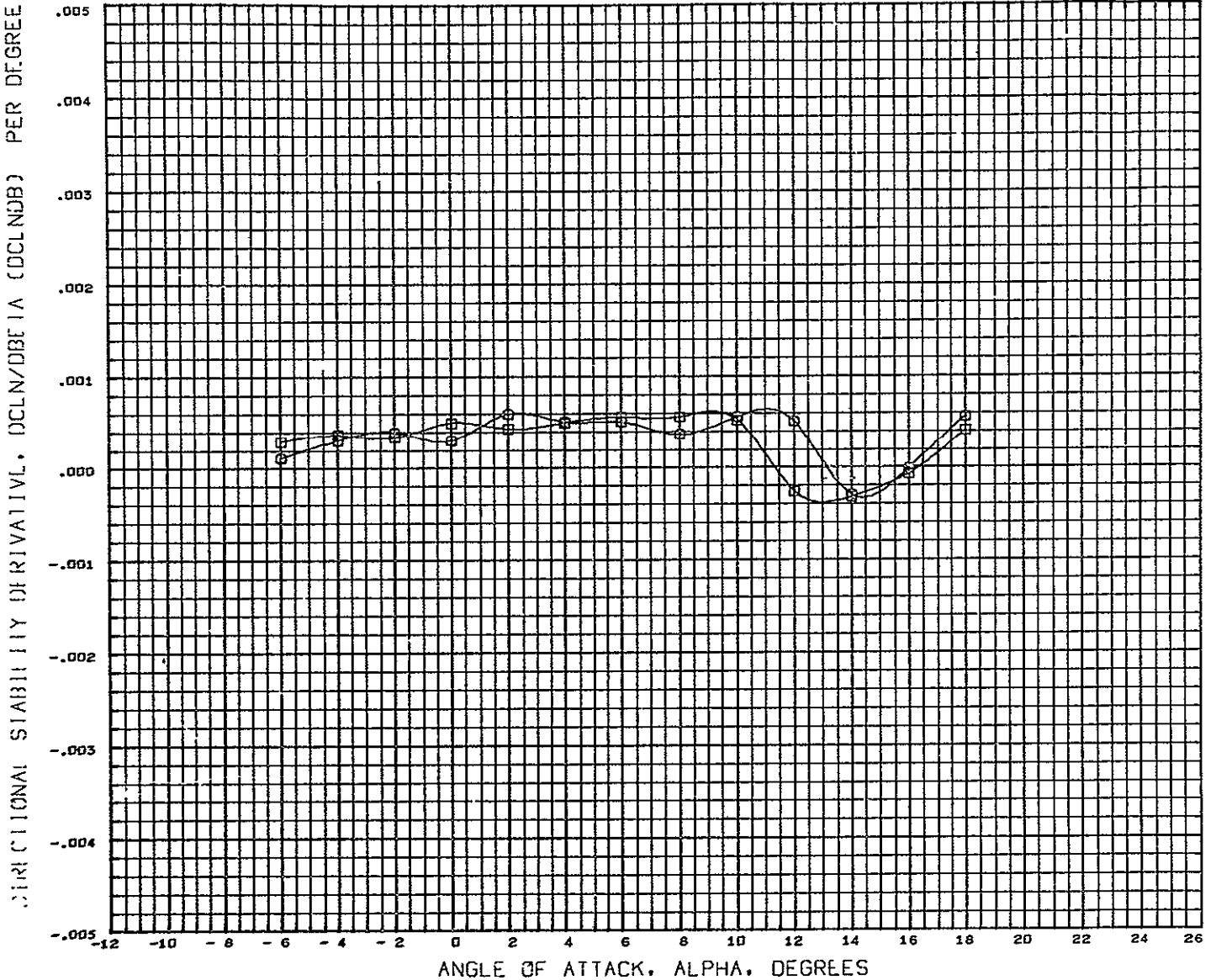

DATA SET SYMBOL	CONFIGURATION DESCRIPTION	SLOPE	ELEVTR	AILRON
(HCP004)	LSWT 248 MDAC 4.0 FC 02 HCR ORB 85W11V6	1.000	10.000	10.000
(HCP005)	LSWT 248 MDAC 4.0 FC 02 HCR ORB 85W11V6	2.000	10.000	10.000

REFERENCE INFORMATION		
REFS	8.8690	50 FT.
REFL	29.5700	IN
REFB	51.6000	IN
XMRP	59.3200	IN
YMRP	0.0000	IN
ZMRP	11.6000	IN
SCALE	4.0000	PERCENT

MACH 0.260

LATERAL CONTROL POWER BASIC CONFIGURATION

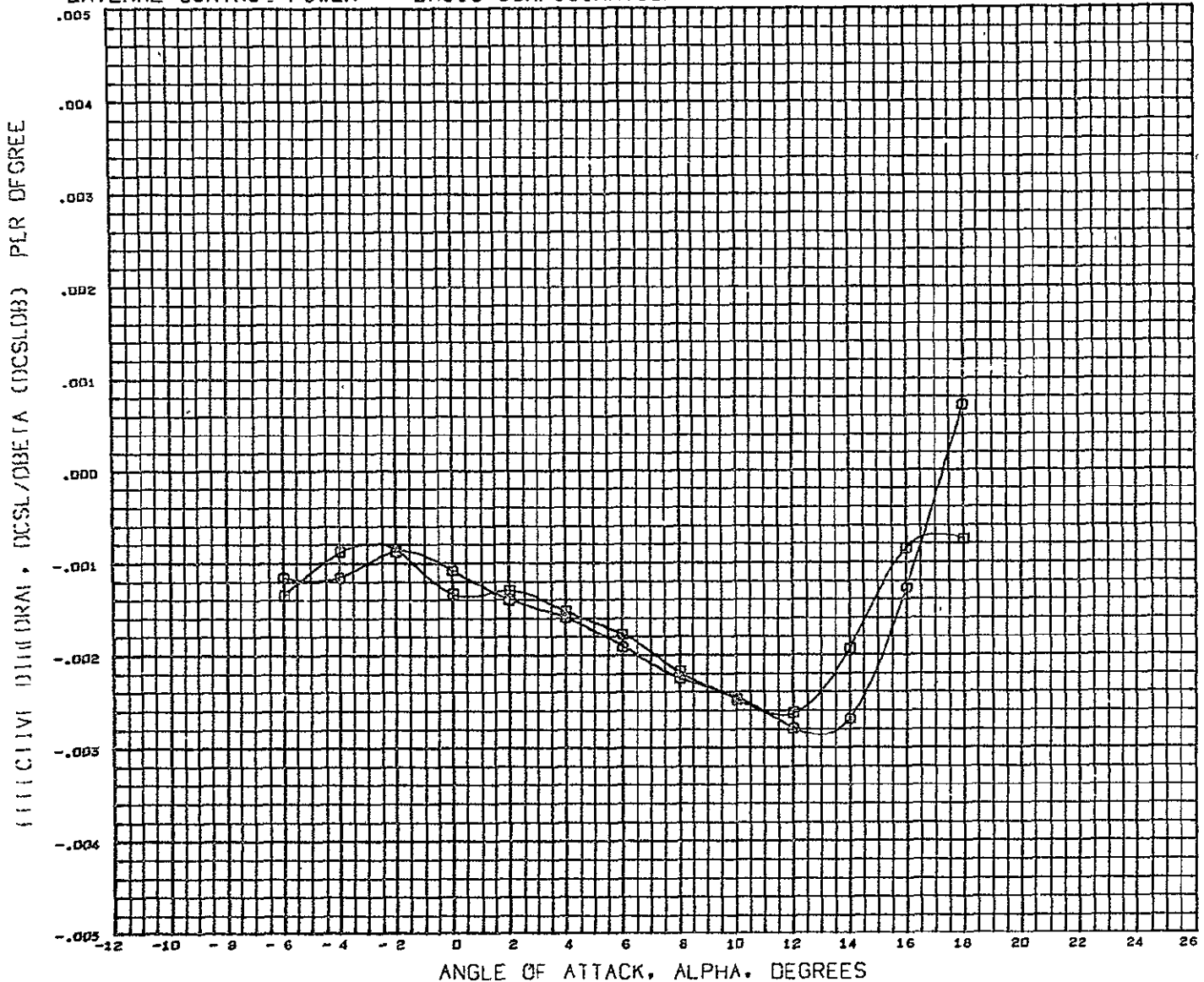

DATA SET SYMBOL	CONFIGURATION DESCRIPTION	SLOPE	ELEVTR	AILRON	REFERENCE INFORMATION
(HCF004)	LSWT 248 HDAC 4.0 FC 02 HCR ORB 05W11V6	1.000	-10.000	10.000	REFS 8.8690 SQ.FT.
(HCF005)	LSWT 248 HDAC 4.0 FC 02 HCR ORB 05W11V6	2.000	-10.000	10.000	REFL 29.5700 IN.
					REFB 51.6000 IN.
					XMRP 59.3200 IN.
					YMRP 0.0000 IN.
					ZMRP 11.6000 IN.
					SCALE 4.0000 PERCENT

MACH 0.260

# DIRECTIONAL CONTROL POWER BASIC CONFIGURATION

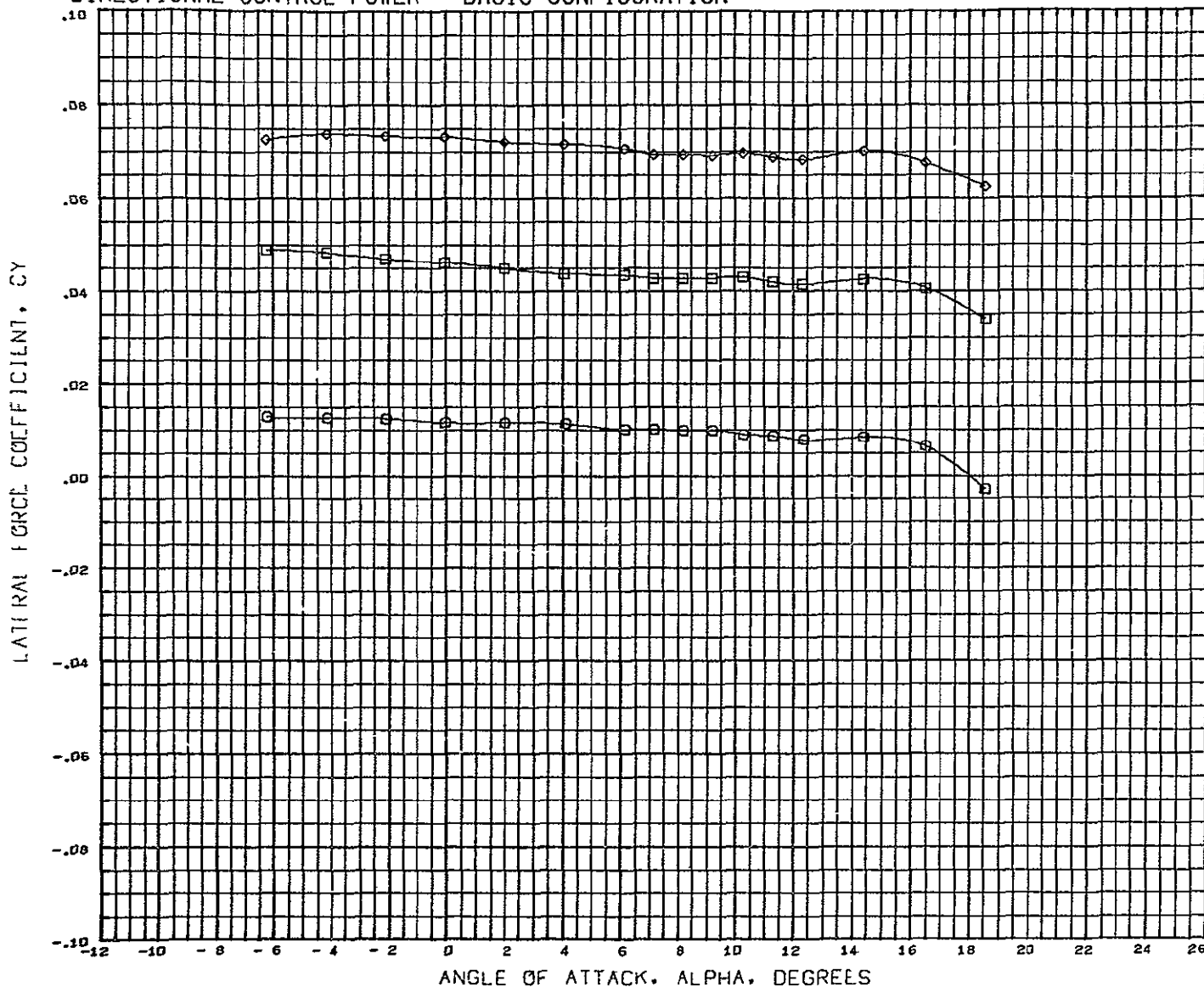

DATA SET SYMBOL	SYMBOL	CONFIGURATION DESCRIPTION	BETA	ELEVTR	AILRON	RUDDER	REFERENCE INFORMATION
(CCFD12)	◇	LSWT 248 MDAC 4.0 FC 02 HCR ORB BSW11V6	0.000 - 10.000	0.000	0.000	0.000	REFS 8.8690 SQ FT.
(CCFD18)	□	LSWT 248 MDAC 4.0 FC 02 HCR ORB B5W11V6	0.000 - 10.000	0.000	0.000	15.000	REFL 29.5700 IN.
(CCFD20)	○	LSWT 248 MDAC 4.0 FC 02 HCR ORB B5W11V6	0.000 - 10.000	0.000	0.000	30.000	REFB 51.6000 IN. XMRP 59.3200 IN. YMRP 0.0000 IN. ZMRP 11.6000 IN. SCALE 4.0000 PERCENT

MACH 0.250

# DIRECTIONAL CONTROL POWER BASIC CONFIGURATION

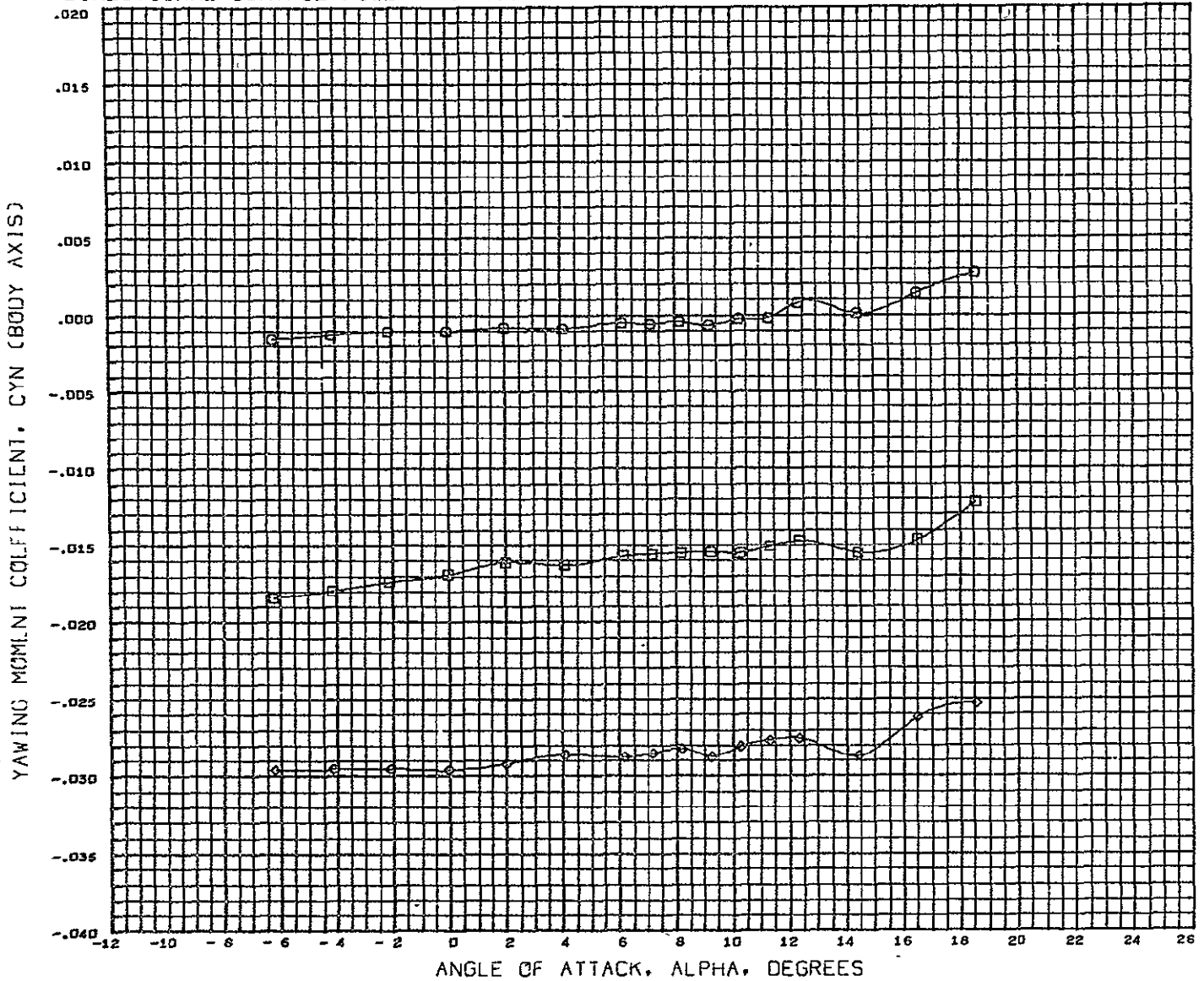

DATA SET SYMBOL	CONFIGURATION DESCRIPTION	BETA	ELEVTR	AILRON	RUDDER	REFERENCE INFORMATION
(CCP012)	LSWT 248 MCAC 4.0 FC 02 HCR ORB 85W11V6	0.000 - 10.000	0.000	0.000	0.000	REFS 8 8690 SQ.FT.
(CCP018)	LSWT 248 MCAC 4.0 FC 02 HCR ORB 85W11V6	0.000 - 10.000	0.000	0.000	15.000	REFL 29.5700 IN.
(CCP020)	LSWT 248 MCAC 4.0 FC 02 HCR ORB 85W11V6	0.000 - 10.000	0.000	0.000	30.000	REFB 51.6000 IN.
						XMRP 59.3200 IN.
						YMRP 0.0000 IN.
						ZMRP 11.6000 IN.
						SCALE 4.0000 PERCENT

MACH 0.250

# DIRECTIONAL CONTROL POWER BASIC CONFIGURATION

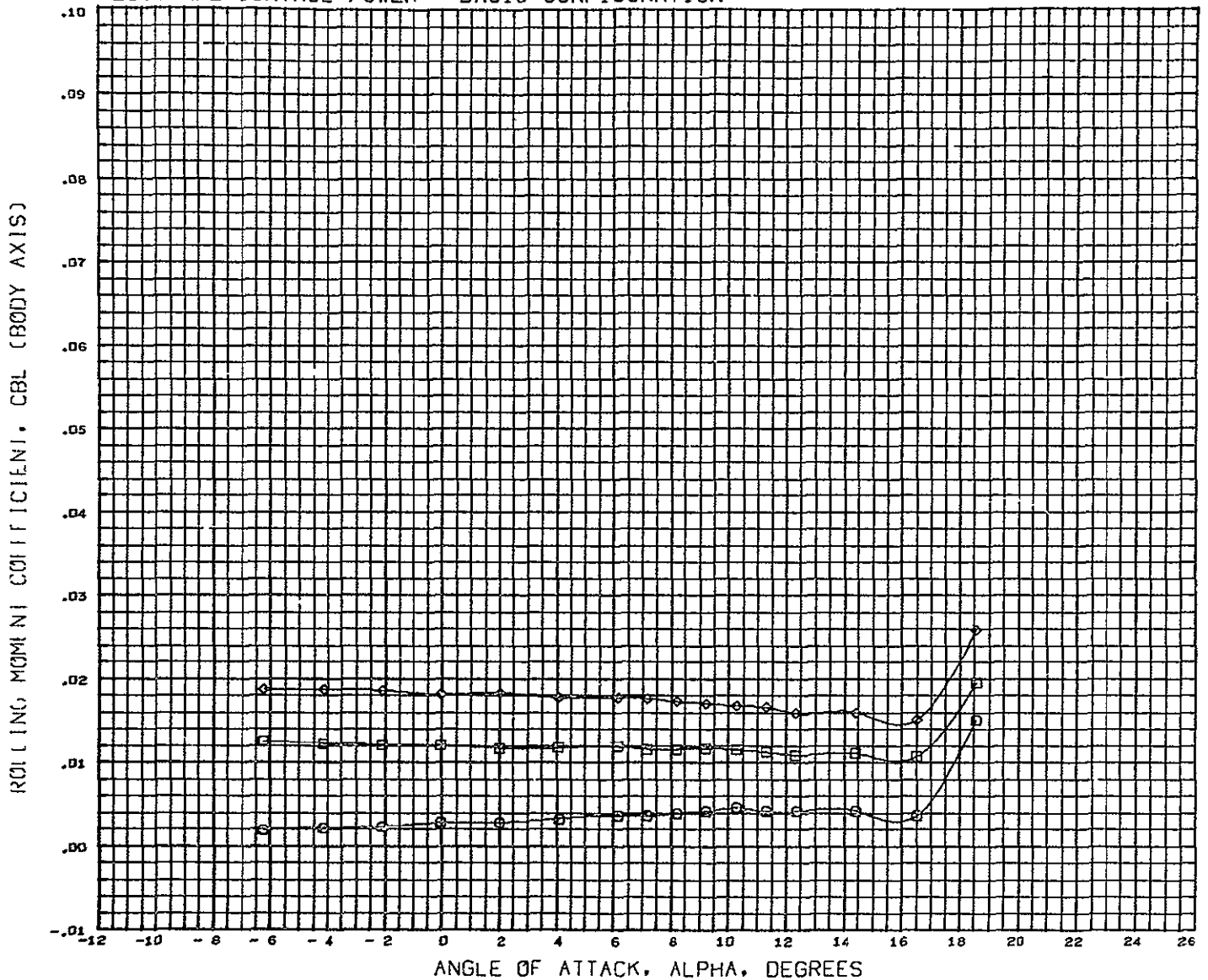

DATA SET SYMBOL	CONFIGURATION DESCRIPTION	BETA	ELEVTR	AILRON	RUDDER	REFERENCE INFORMATION
(CCP012)	LSWT 248 MDAC 4.0 FC O2 HCR ORB B5W11V6	0.000 - 10.000	0.000	0.000	0.000	REFS 8.8690 SQ.FT
(CCP018)	LSWT 248 MDAC 4.0 FC O2 HCR ORB B5W11V6	0.000 - 10.000	0.000	15.000	0.000	REFL 29.5700 IN.
(CCP020)	LSWT 248 MDAC 4.0 FC O2 HCR ORB B5W11V6	0.000 - 10.000	0.000	0.000	30.000	REFB 51.6000 IN.
						XMRP 59.3200 IN.
						YMRP 0.0000 IN.
						ZMRP 11.6000 IN.
						SCALE 4.0000 PERCENT

MACH 0.250



# DIRECTIONAL CONTROL POWER BASIC CONFIGURATION

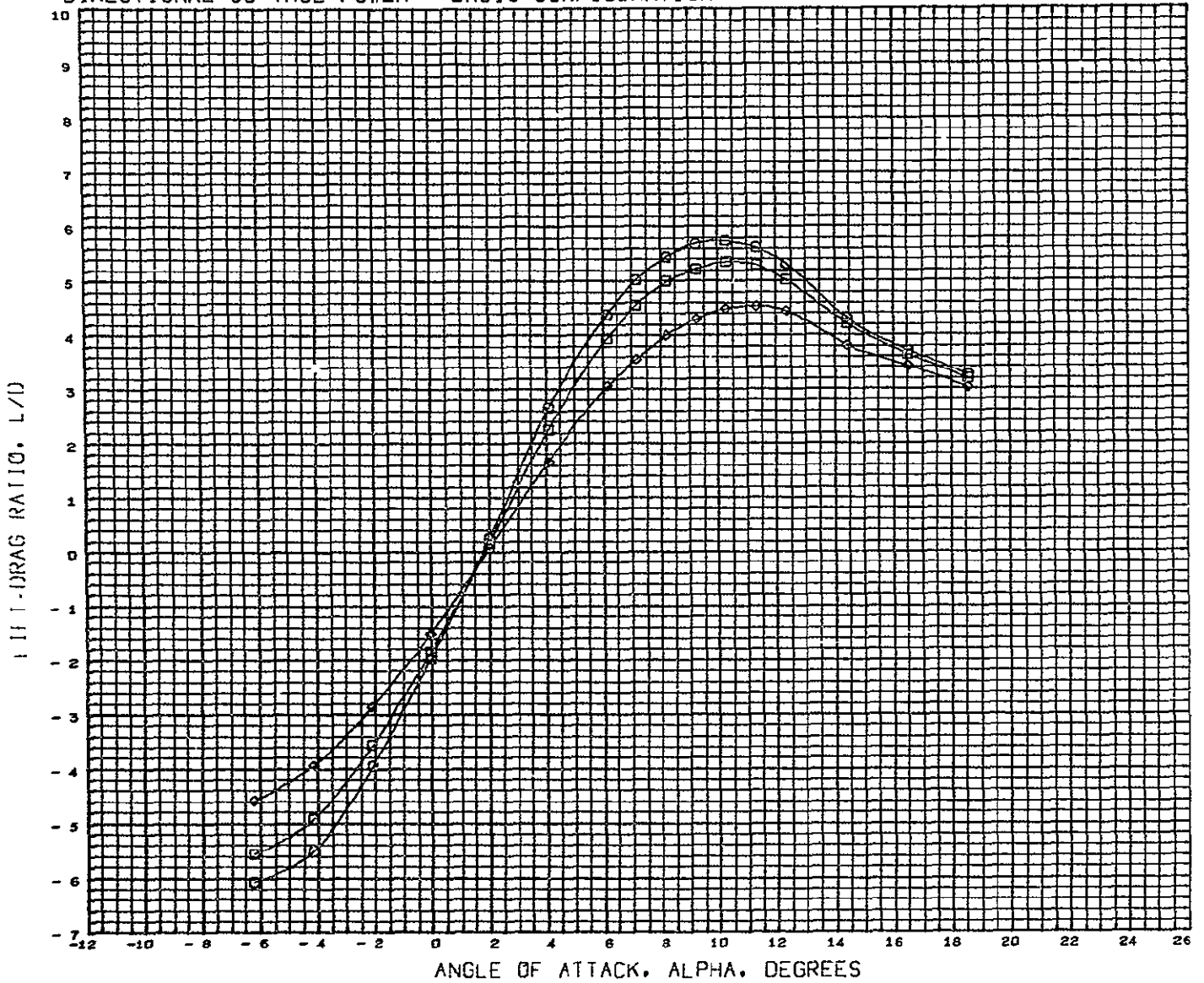

DATA SET SYMBOL	CONFIGURATION DESCRIPTION	BETA	ELEVTR	AILRON	RUDDER	REFERENCE INFORMATION
(CCFD12)	○ LSWT 248 MDAC 4.0 PC O2 HCR ORB 85W11V6	0.000 - 10.000	0.000	0.000	0.000	REFS 8.8690 SQ FT.
(CCFD18)	□ LSWT 248 MDAC 4.0 PC O2 HCR ORB 85W11V6	0.000 - 10.000	0.000	0.000	15.000	REFL 29.5700 IN.
(CCFD20)	◇ LSWT 248 MDAC 4.0 PC O2 HCR ORB 85W11V6	0.000 - 10.000	0.000	0.000	30.000	REFB 51.6000 IN.
						XMRP 59.3200 IN.
						YMRP 0.0000 IN.
						ZMRP 11.6000 IN.
						SCALE 4.0000 PERCENT

MACH 0.250

# DIRECTIONAL CONTROL POWER BASIC CONFIGURATION

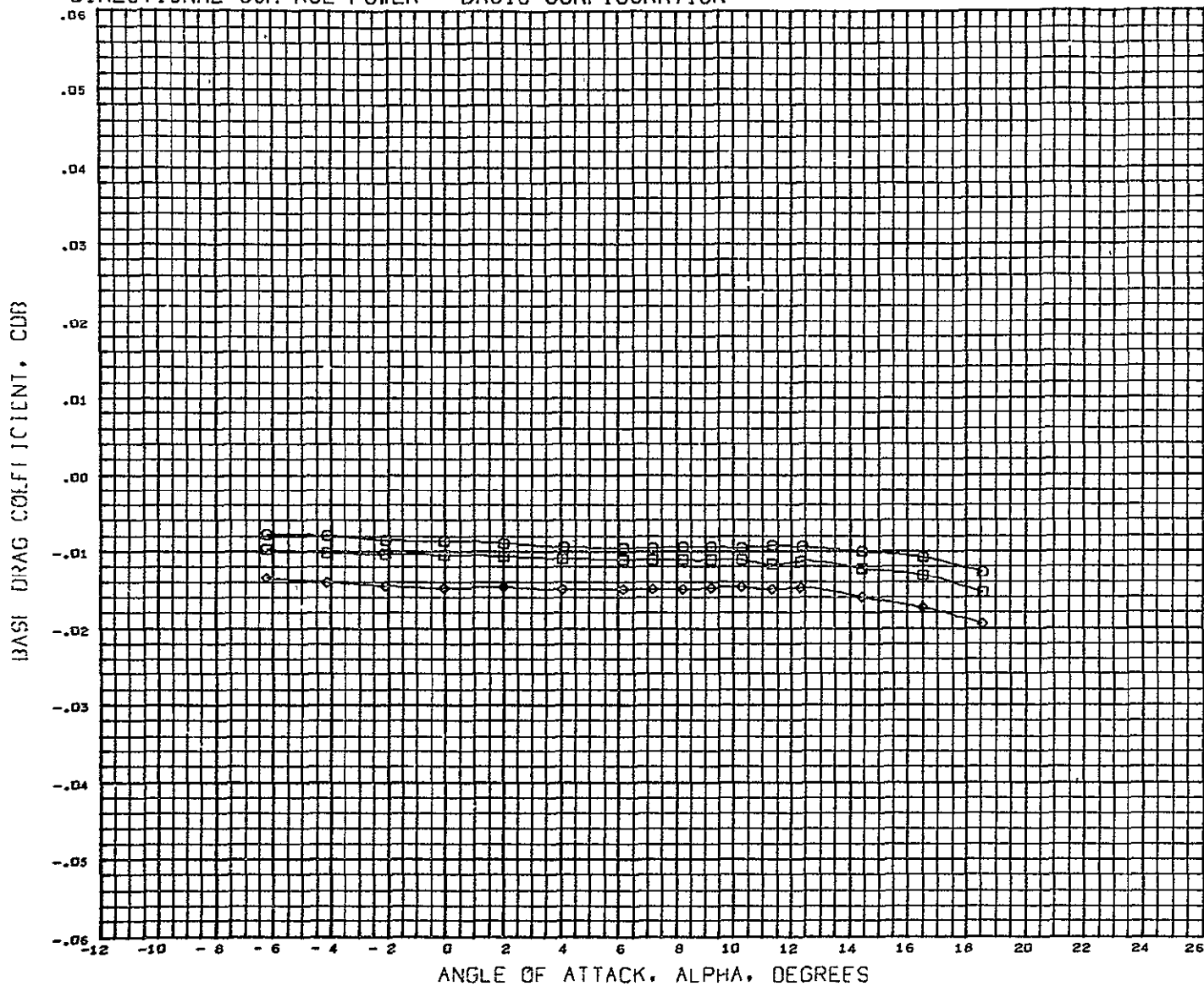

DATA SET SYMBOL	CONFIGURATION DESCRIPTION	BETA	ELEVTR	AILRON	RUDDER	REFERENCE INFORMATION
(CCFD12)	LSWT 248 MDAC 4.0 FC O2 HCR ORB B5W11V6	0.000 - 10.000	0.000	0.000	0.000	REFS 8.8690 SQ FT.
(CCFD18)	LSWT 248 MDAC 4.0 FC O2 HCR ORB B5W11V6	0.000 - 10.000	0.000	15.000	0.000	REFL 29.5700 IN.
(CCFD20)	LSWT 248 MDAC 4.0 FC O2 HCR ORB B5W11V6	0.000 - 10.000	0.000	0.000	30.000	REFB 51.6000 IN.
						XNRP 59.3200 IN.
						YNRP 0.0000 IN.
						ZNRP 11.6000 IN.
						SCALE 4.0000 PERCENT

MACH 0.250

# DIRECTIONAL CONTROL POWER BASIC CONFIGURATION

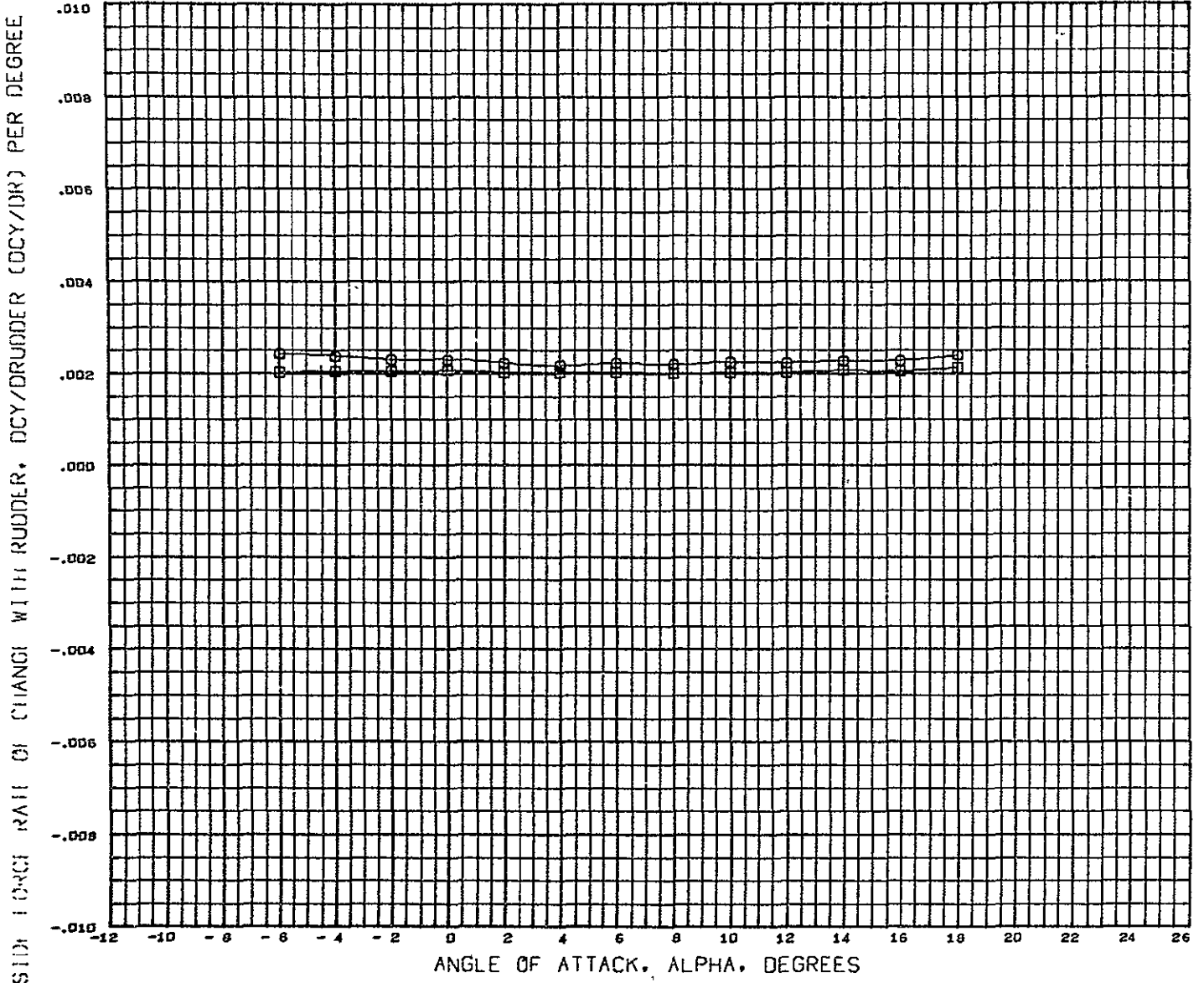

DATA SET SYMBOL	CONFIGURATION DESCRIPTION	SLOPE	BETA	ELEVTR	AILRON	REFERENCE INFORMATION
(XCP018)	LSWT 248 HDAC 4.0 PC O2 HCR ORB B5W1V6	1.000	0.000 - 10.000	0.000	0.000	REFS 8.8690 SQ.FT.
(XCP020)	LSWT 248 HDAC 4.0 PC O2 HCR ORB B5W1V6	2.000	0.000 - 10.000	0.000	0.000	REFL 29.5700 IN.
						REFB 51.6000 IN.
						XMRP 59.3200 IN.
						YMRP 0.0000 IN.
						ZMRP 11.6000 IN.
						SCALE 4.0000 PERCENT

MACH 0.260

# DIRECTIONAL CONTROL POWER BASIC CONFIGURATION

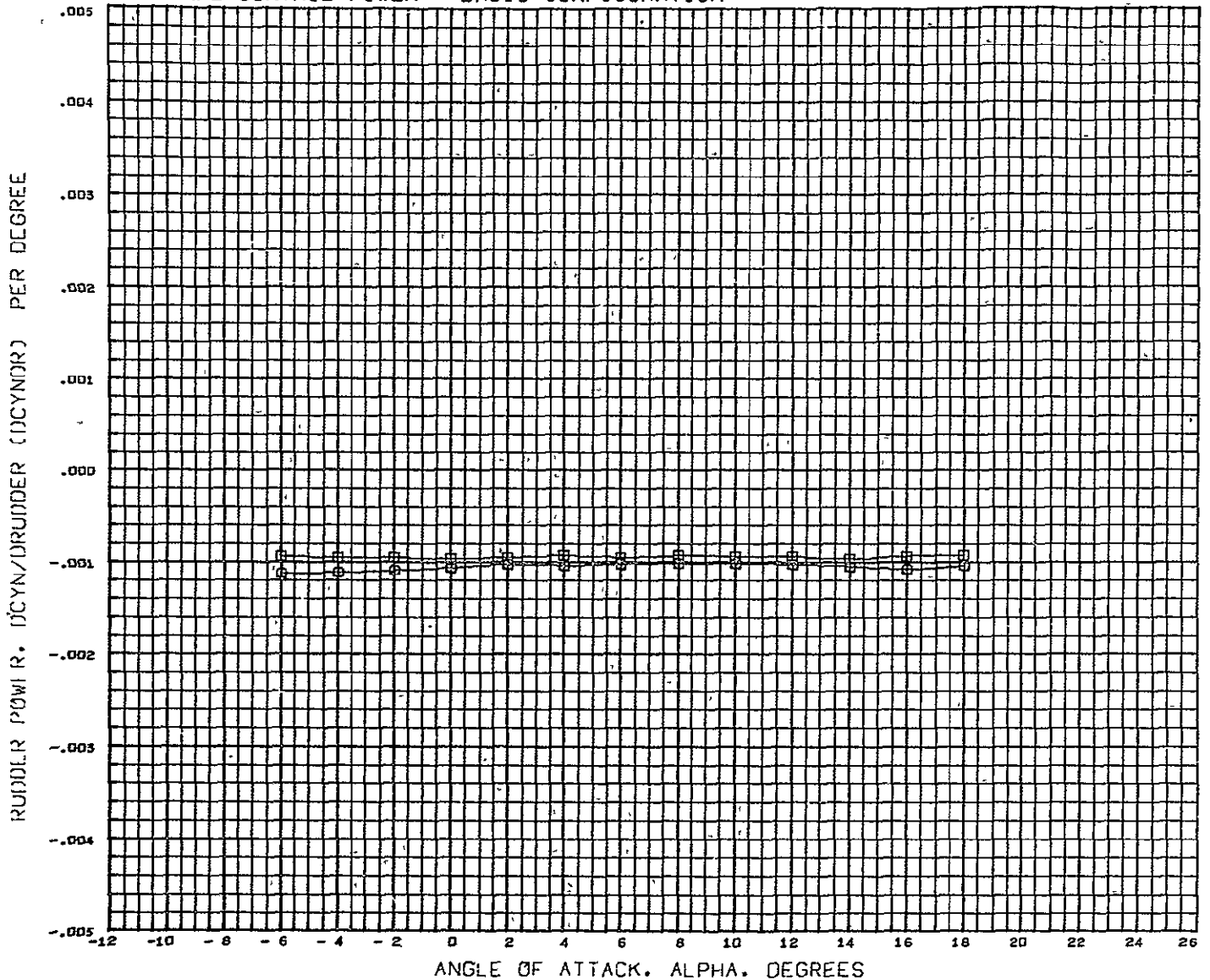

DATA SET SYMBOL	CONFIGURATION DESCRIPTION	SLOPE	BETA	ELEVTR	AILRON	REFERENCE INFORMATION
(XCF018)	LSWT 248 MDAC 4.0 PC 02 HCR ORB 05W11V6	1.000	0.000 - 10.000	0.000	0.000	REFS 8.8690 SQ.FT.
(XCF020)	LSWT 248 MDAC 4.0 PC 02 HCR ORB 05W11V6	2.000	0.000 - 10.000	0.000	0.000	REFL 29.5700 IN.
						REFB 51.6000 IN.
						XMRP 59.3200 IN.
						YMRP 0.0000 IN.
						ZMRP 11.6000 IN.
						SCALE 4.0000 PERCENT

HACH 0.260

# DIRECTIONAL CONTROL POWER BASIC CONFIGURATION

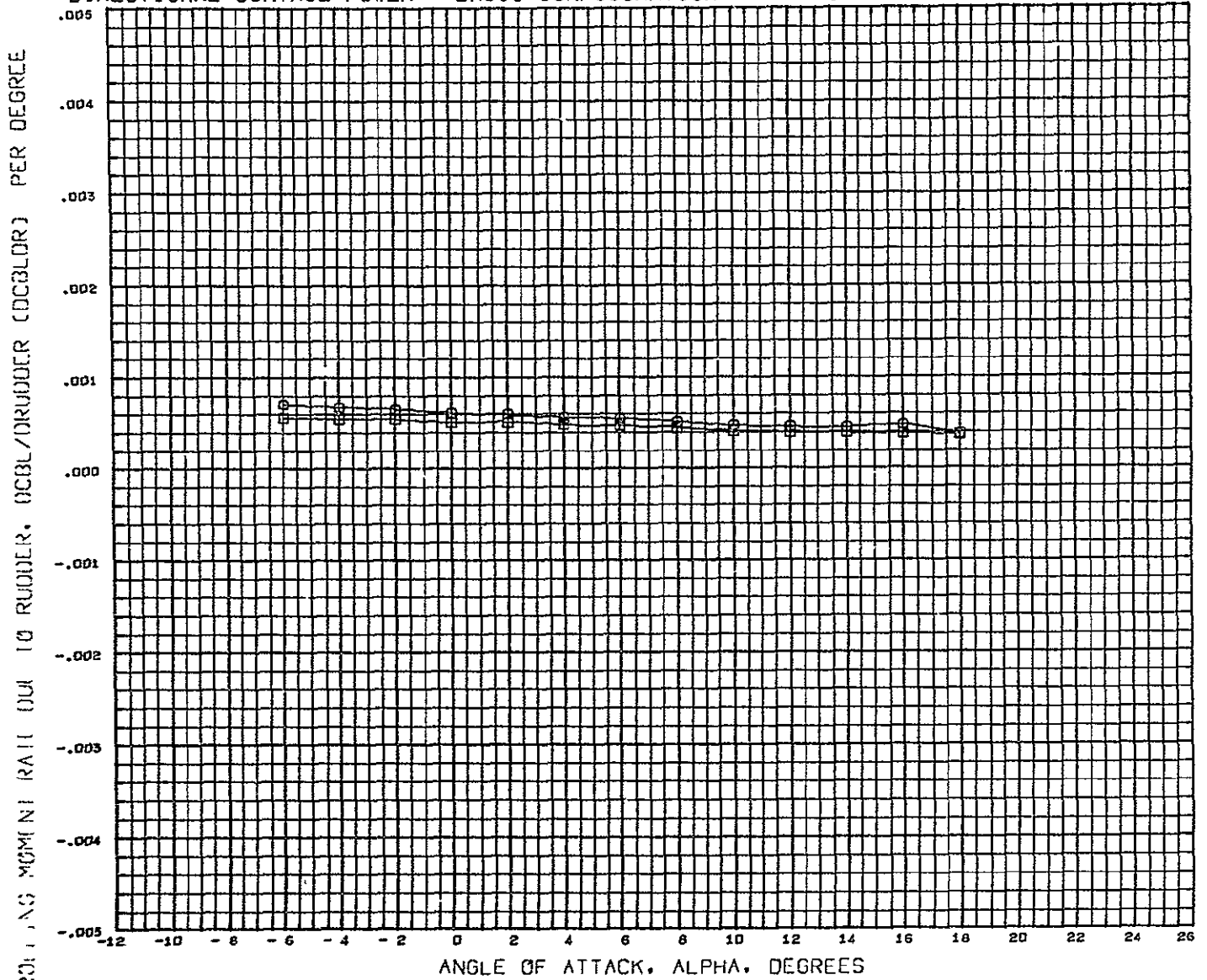

DATA SET SYMBOL	CONFIGURATION DESCRIPTION	SLOPE	BETA	ELEVTR	AILRON	REFERENCE INFORMATION
(XCFD18)	LSWT 248 HDAC 4.0 FC 02 HCR ORB B5W11V6	1,000	0.000 - 10.000	0.000	0.000	REFS 8.8690 SQ.FT.
(XCFD20)	LSWT 248 HDAC 4.0 FC 02 HCR ORB B5W11V6	2,000	0.000 - 10.000	0.000	0.000	REFL 29.5700 IN
						REFB 51.6000 IN
						XMRP 59.3200 IN.
						YMRP 0.0000 IN.
						ZMRP 11.6000 IN.
						SCALE 4.0000 PERCENT

HACH 0.260

# DIRECTIONAL CONTROL POWER BASIC CONFIGURATION

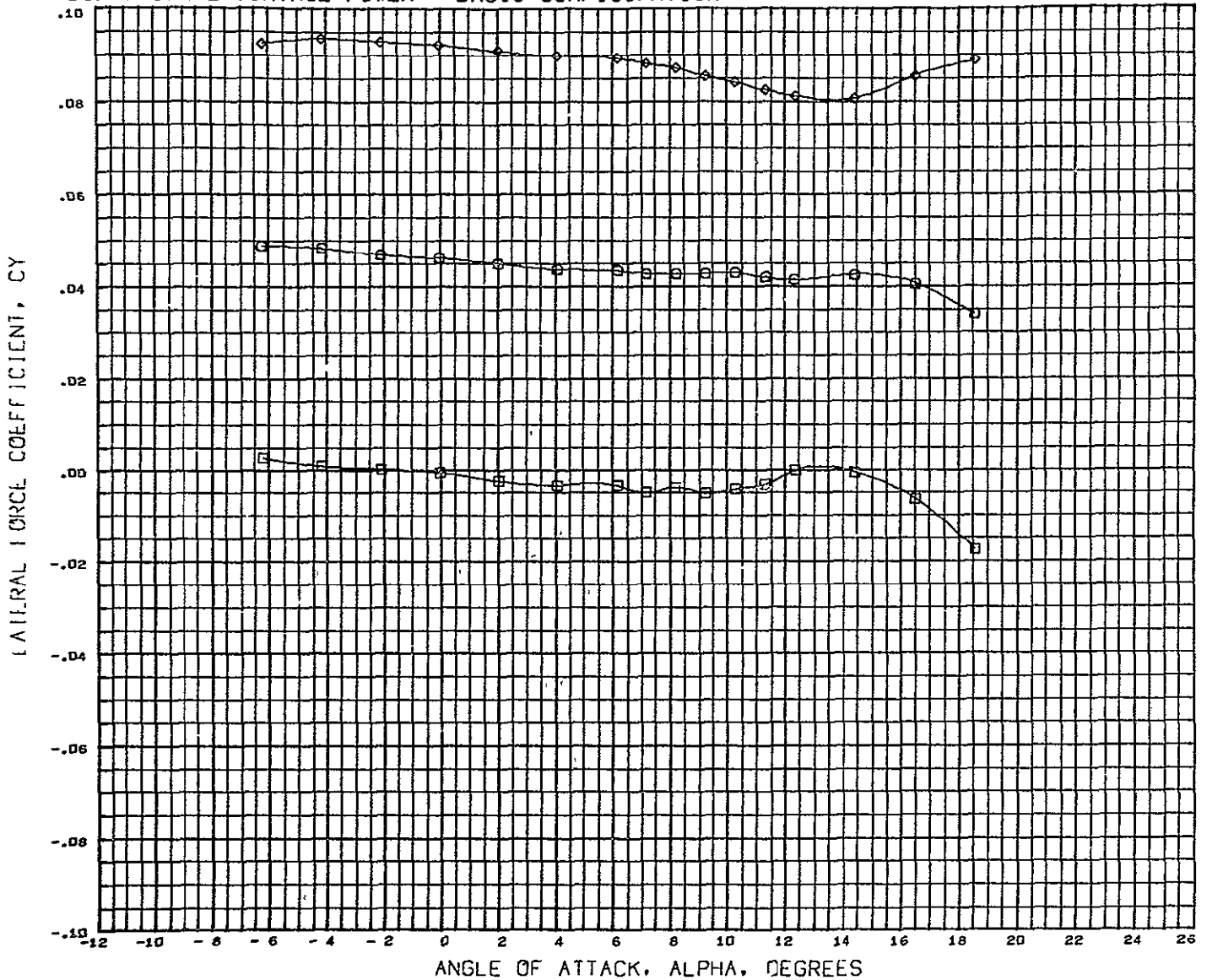

DATA SET SYMBOL	CONFIGURATION DESCRIPTION	BETA	ELEVTR	AILRON	RUDDER	REFERENCE INFORMATION
(CCFD18)	LSWT 248 MDAC 4.0 FC O2 HCR ORB B5W11V6	0.000 - 10.000	0.000	0.000	15.000	REFS 8.8690 SQ FT.
(CCFD17)	LSWT 248 MDAC 4.0 FC O2 HCR ORB B5W11V6	3.000 - 10.000	0.000	0.000	15.000	REFL 29.5700 IN.
(CCFD19)	LSWT 248 MDAC 4.0 FC O2 HCR ORB B5W11V6	- 3.000 - 10.000	0.000	0.000	15.000	REFB 51.6000 IN. XMRP 59.3200 IN. YMRP 0.0000 IN. ZMRP 11.6000 IN. SCALE 4.0000 PERCNT

MACH 0.250

# DIRECTIONAL CONTROL POWER BASIC CONFIGURATION

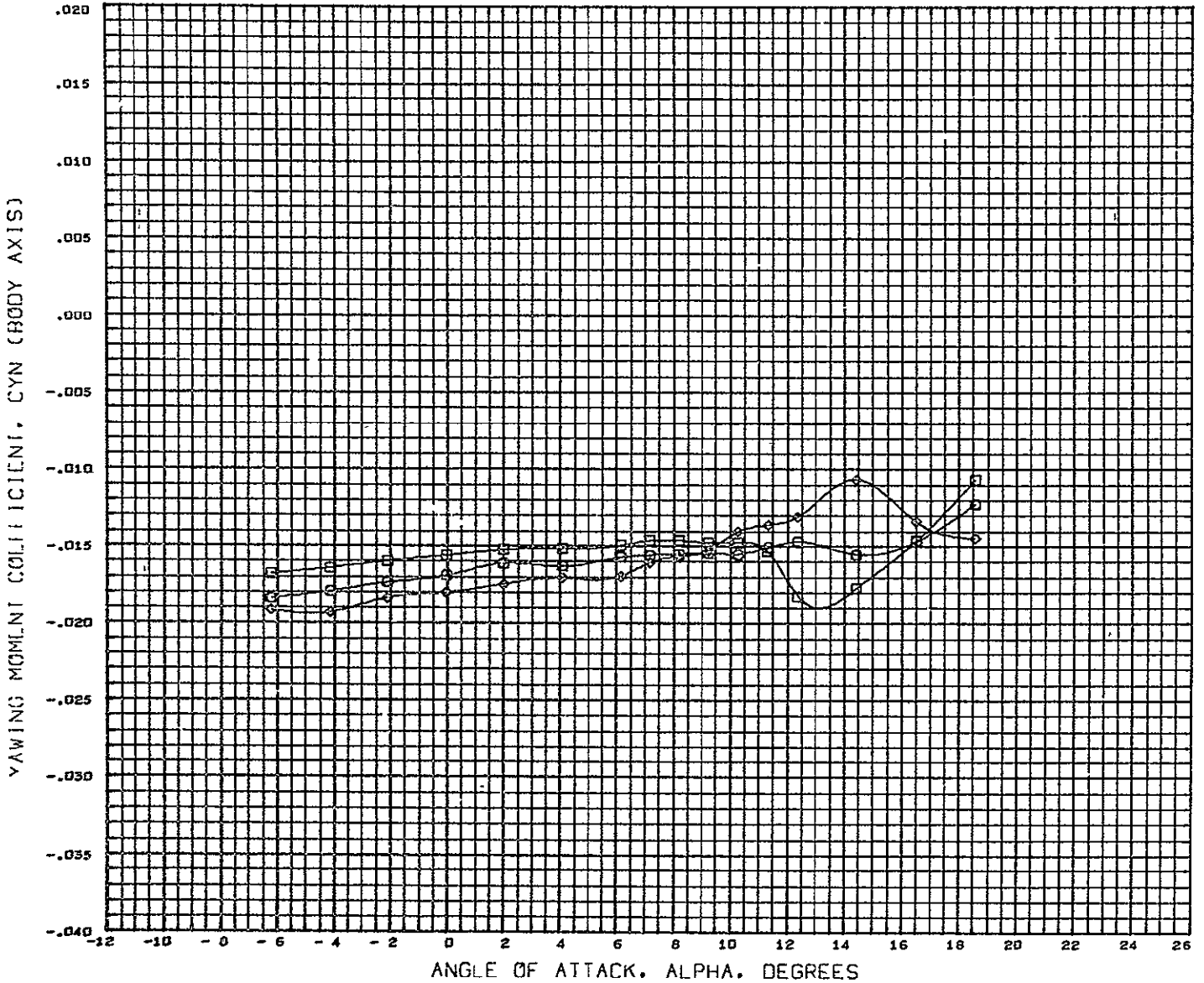

DATA SET SYMBOL	CONFIGURATION DESCRIPTION	BETA	ELEVTR	AILRON	RUDDER	REFERENCE INFORMATION
(CCPD18)	□ LSWT 248 HDAC 4.0 FC O2 HCR ORB B5W11V6	0.000 - 10.000	0.000	15.000	REFS	8 8690 SQ.FT
(CCPD17)	— LSWT 248 HDAC 4.0 FC O2 HCR ORB B5W11V6	3.000 - 10.000	0.000	15.000	REFL	29 5700 IN.
(CCPD19)	○ LSWT 248 HDAC 4.0 FC O2 HCR ORB B5W11V6	- 3.000 - 10.000	0.000	15.000	REFB	51 6000 IN.
					XMRP	59 3200 IN.
					YMRP	0 0000 IN.
					ZMRP	11 6000 IN.
					SCALE	4 0000 PERCNT

MACH 0.250

# DIRECTIONAL CONTROL POWER BASIC CONFIGURATION

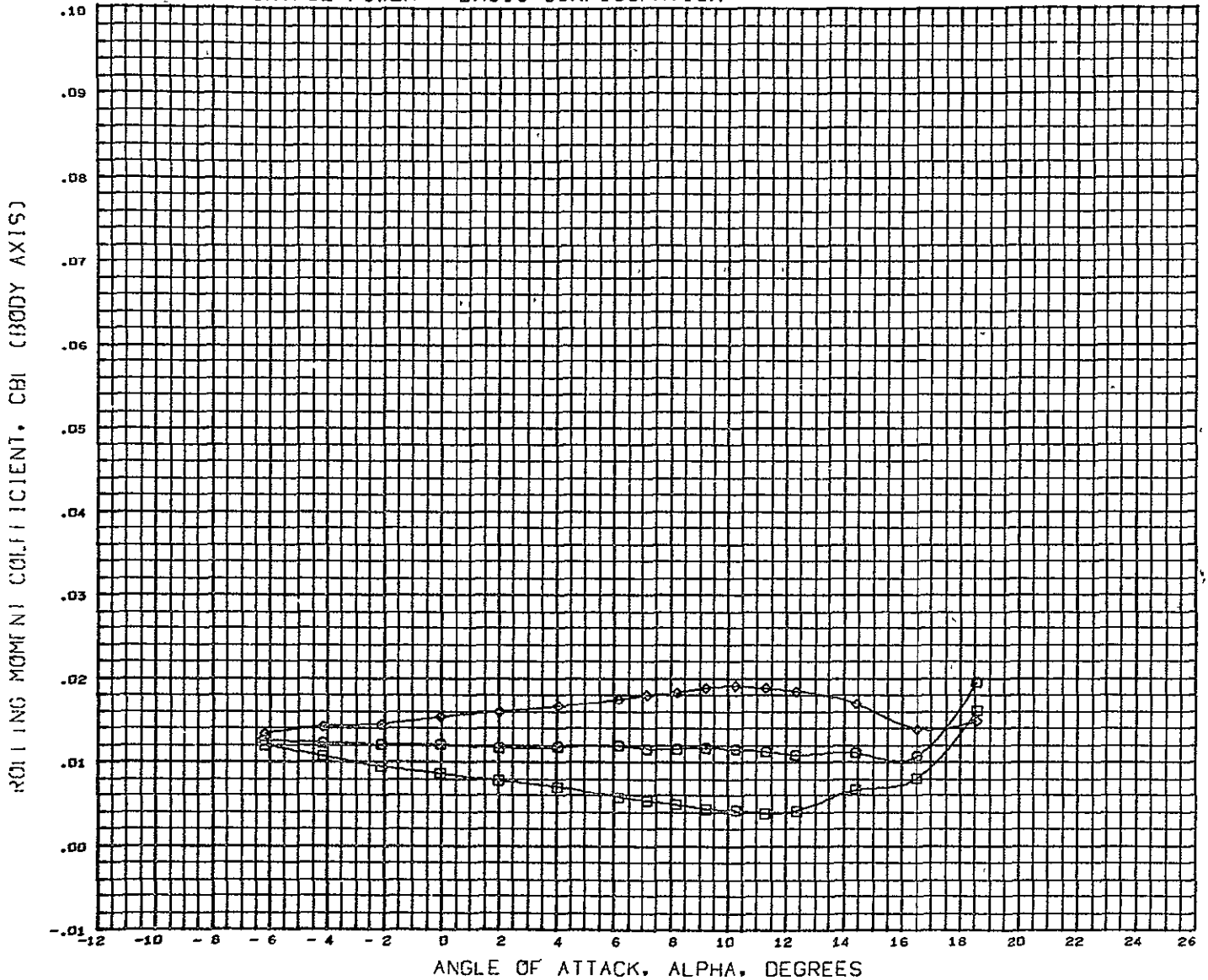

DATA SET SYMBOL	CONFIGURATION DESCRIPTION	BETA	ELEVTR	AILRON	RUDDER	REFERENCE INFORMATION
(CCFD18)	LSWT 248 MDAC 4.0 FC 02 HCR ORB 85W11V6	0.000 - 10.000	0.000	15.000	REFS	8 8690 SQ.FT
(CCFD17)	LSWT 248 MDAC 4.0 FC 02 HCR ORB 85W11V6	3.000 - 10.000	0.000	15.000	REFL	29 5700 IN.
(CCFD19)	LSWT 248 MDAC 4.0 FC 02 HCR ORB 85W11V6	- 3.000 - 10.000	0.000	15.000	REFB	51.6000 IN.
					XNRF	59.3200 IN.
					YNRF	0.0000 IN.
					ZNRF	11.6000 IN.
					SCALE	4.0000 PERCNT

MACH 0.250



# DIRECTIONAL CONTROL POWER BASIC CONFIGURATION

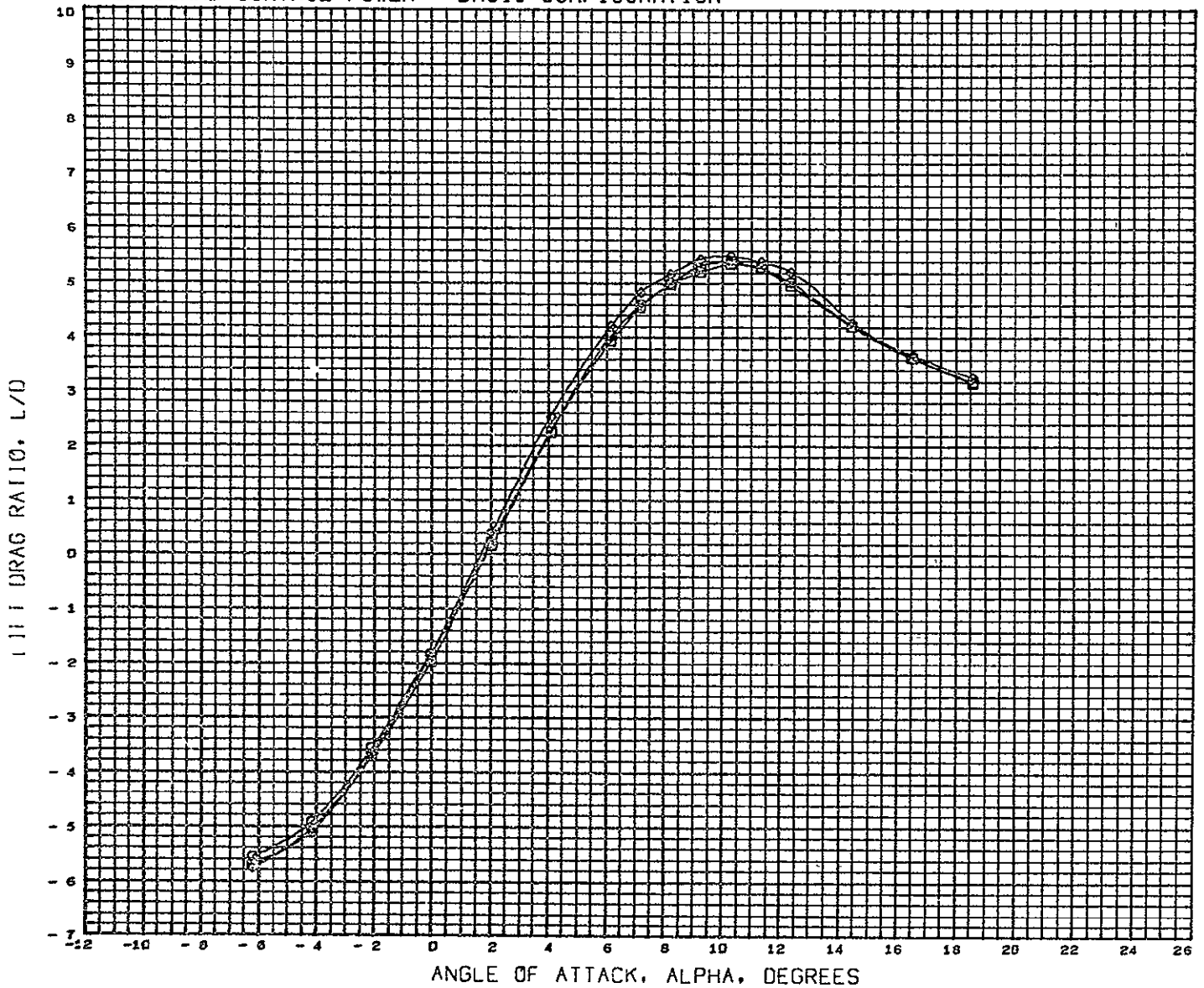

DATA SET SYMBOL	CONFIGURATION DESCRIPTION	BETA	ELEVTR	AILRON	RUDDER	REFERENCE INFORMATION
(CCFD10)	LSWT 248 MDAC 4.0 FC O2 HCR ORB 85W11V6	0.000 - 10.000	0.000	15.000	REFS	8.8690 SQ.FT.
(CCFD17)	LSWT 248 MDAC 4.0 FC O2 HCR ORB 85W11V6	3.000 - 10.000	0.000	15.000	REFB	29.5700 IN.
(CCFD19)	LSWT 248 MDAC 4.0 FC O2 HCR ORB 85W11V6	- 3.000 - 10.000	0.000	15.000	REFB	51.6000 IN.
					XMRP	59.3200 IN.
					YMRP	0.0000 IN.
					ZMRP	11.6000 IN.
					SCALE	4.0000 PERCENT

MACH 0.250

# DIRECTIONAL CONTROL POWER BASIC CONFIGURATION

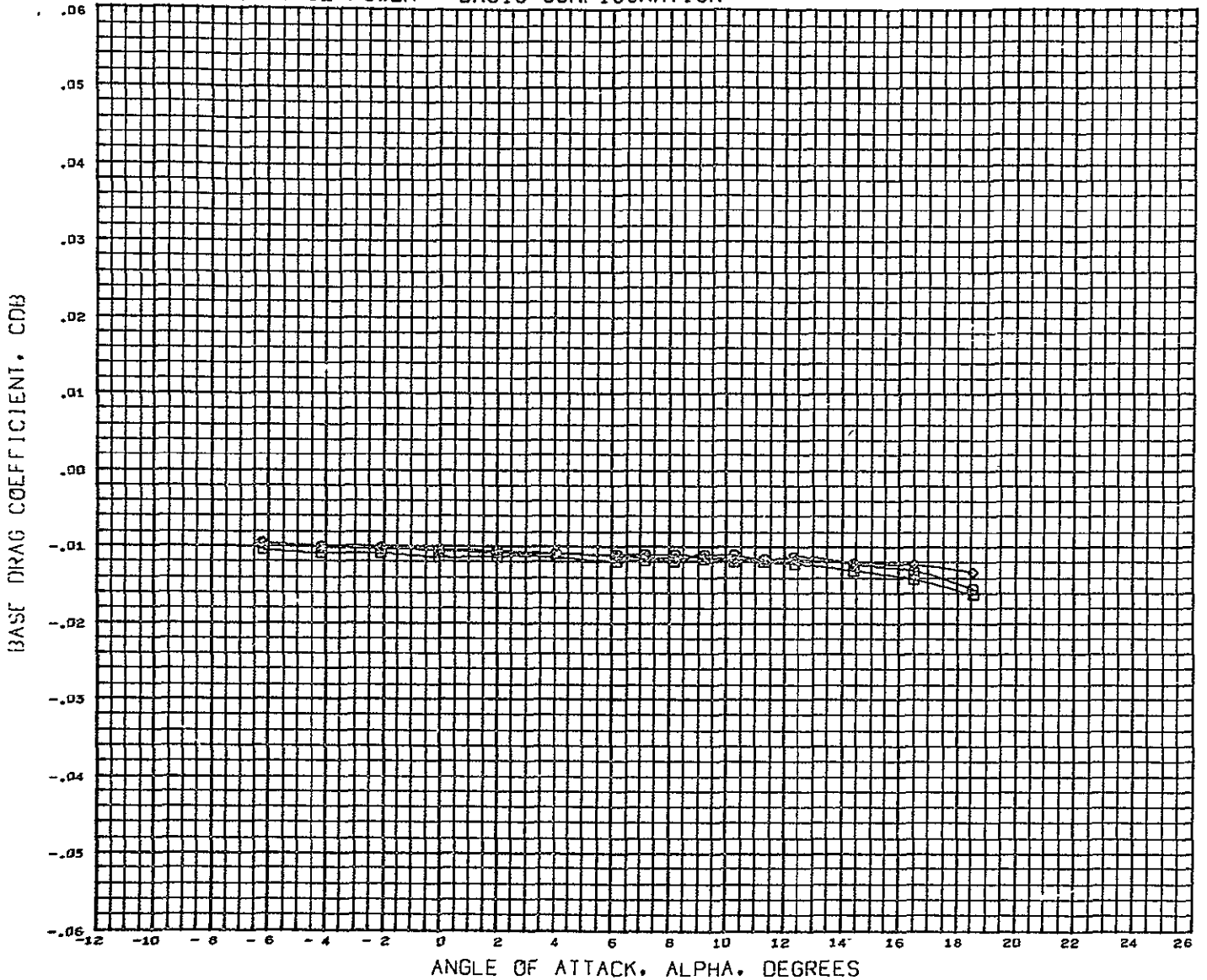

DATA SET SYMBOL	CONFIGURATION DESCRIPTION	BETA	ELEVTR	AILRON	RUDDER	REFERENCE INFORMATION
(CCPD18)	LSWT 248 MDAC 4.0 FC O2 HCR ORB B5W11V6	0.000 - 10.000	0.000	0.000	15.000	REFS 8 8690 SQ.FT.
(CCPD17)	LSWT 248 MDAC 4.0 FC O2 HCR ORB B5W11V6	3.000 - 10.000	0.000	0.000	15.000	REFL 29.5700 IN.
(CCPD19)	LSWT 248 MDAC 4.0 FC O2 HCR ORB B5W11V6	3.000 - 10.000	0.000	0.000	15.000	REFB 51.6000 IN.
						XNRP 59.3200 IN.
						YNRP 0.0000 IN.
						ZNRP 11.6000 IN.
						SCALE 4.0000 PERCENT

MACH 0.250

DIRECTIONAL CONTROL POWER BASIC CONFIGURATION

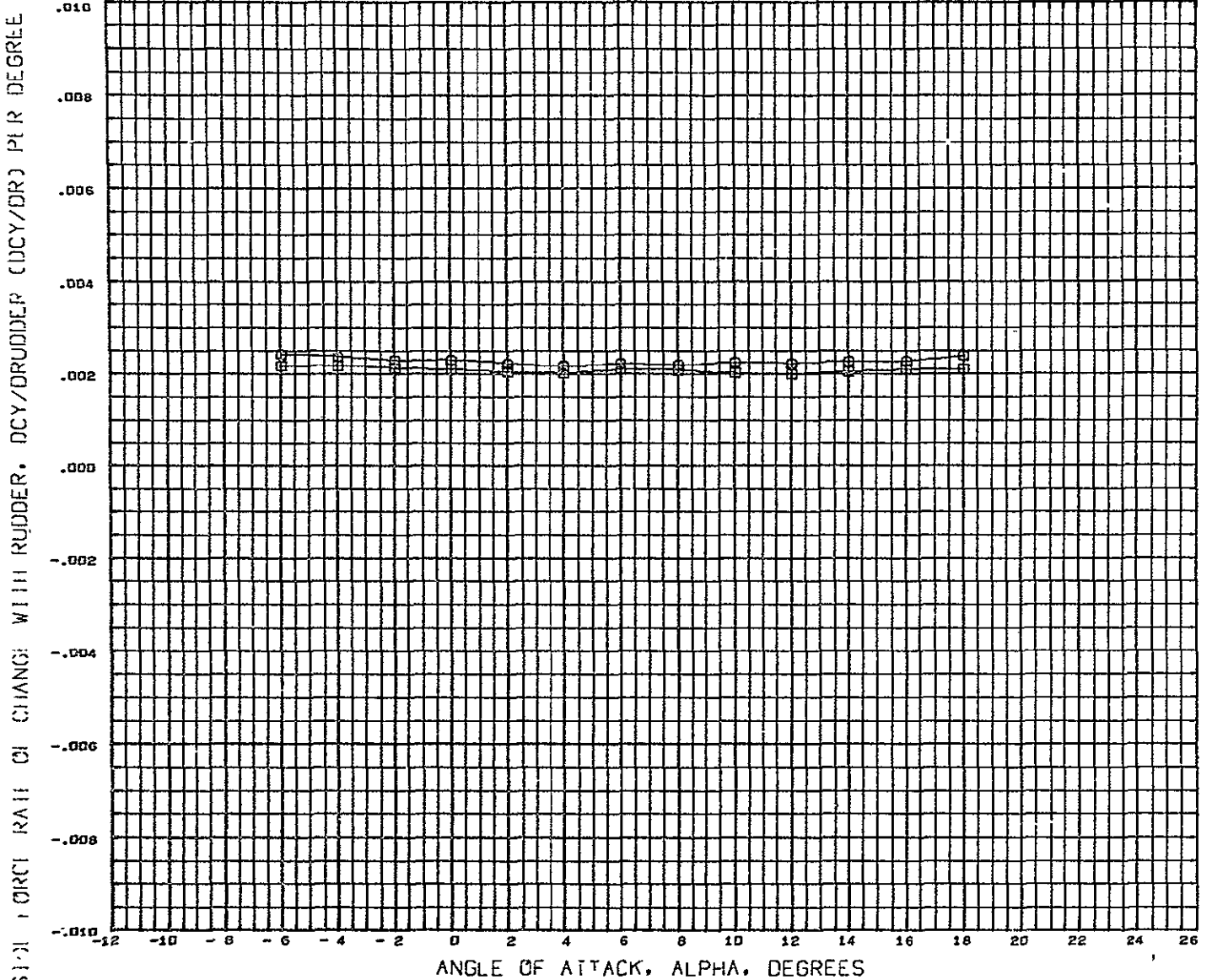

DATA SET SYMBOL	CONFIGURATION DESCRIPTION	BETA	ELEVTR	AILRON	REFERENCE INFORMATION
(XCPD18)	LSWT 248 HDAC 4.0 FC O2 HCR ORB B5W11V6	0.000 - 10.000	0.000	0.000	REFS 8.8690 SQ.FT
(XCPD19)	LSWT 248 HDAC 4.0 FC O2 HCR ORB B5W11V6	- 3.000 - 10.000	0.000	0.000	REFL 29.5700 IN.
					REFB 51.6000 IN.
					XHRF 59.3200 IN.
					YHRF 0.0000 IN.
					ZHRF 11.6000 IN.
					SCALE 4.0000 PERCNT

MACH 0.260

# DIRECTIONAL CONTROL POWER BASIC CONFIGURATION

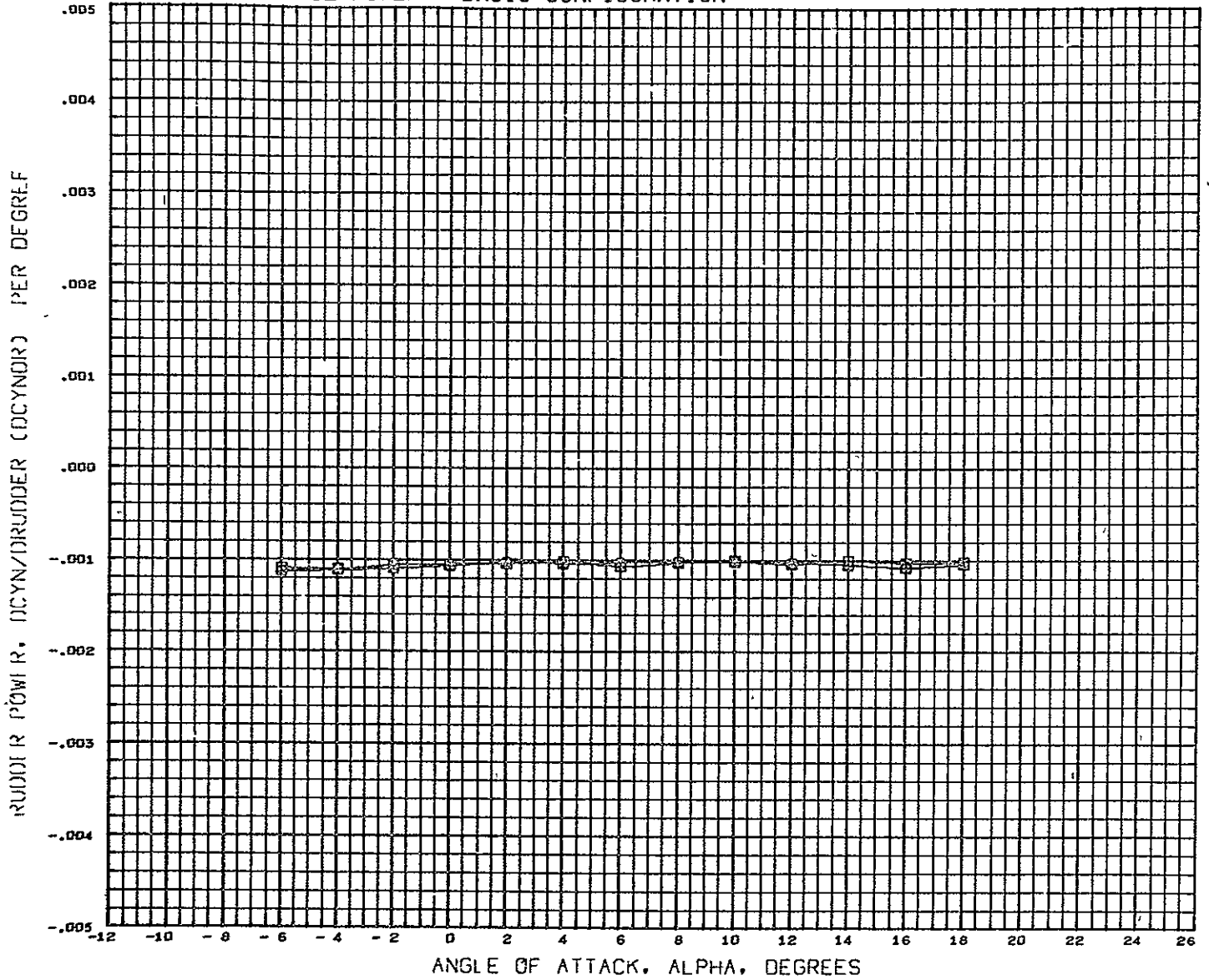

DATA SET SYMBOL	CONFIGURATION DESCRIPTION	BETA	ELEVTR	AILRON	REFERENCE INFORMATION
(XCF018)	LSWT 248 HDAC 4.0 FC 02 HCR ORB	BSW11V6	0.000 - 10.000	0.000	REFS 8.8690 SQ FT.
(XCF019)	LSWT 248 HDAC 4.0 FC 02 HCR ORB	BSW11V6	- 3.000 - 10.000	0.000	REFL 29.5700 IN.
					REFB 51.6000 IN.
					XMRP 59.3200 IN.
					YMRP 0.0000 IN.
					ZMRP 11.6000 IN.
					SCALE 4.0000 PERCNT

MACH 0.260

# DIRECTIONAL CONTROL POWER BASIC CONFIGURATION

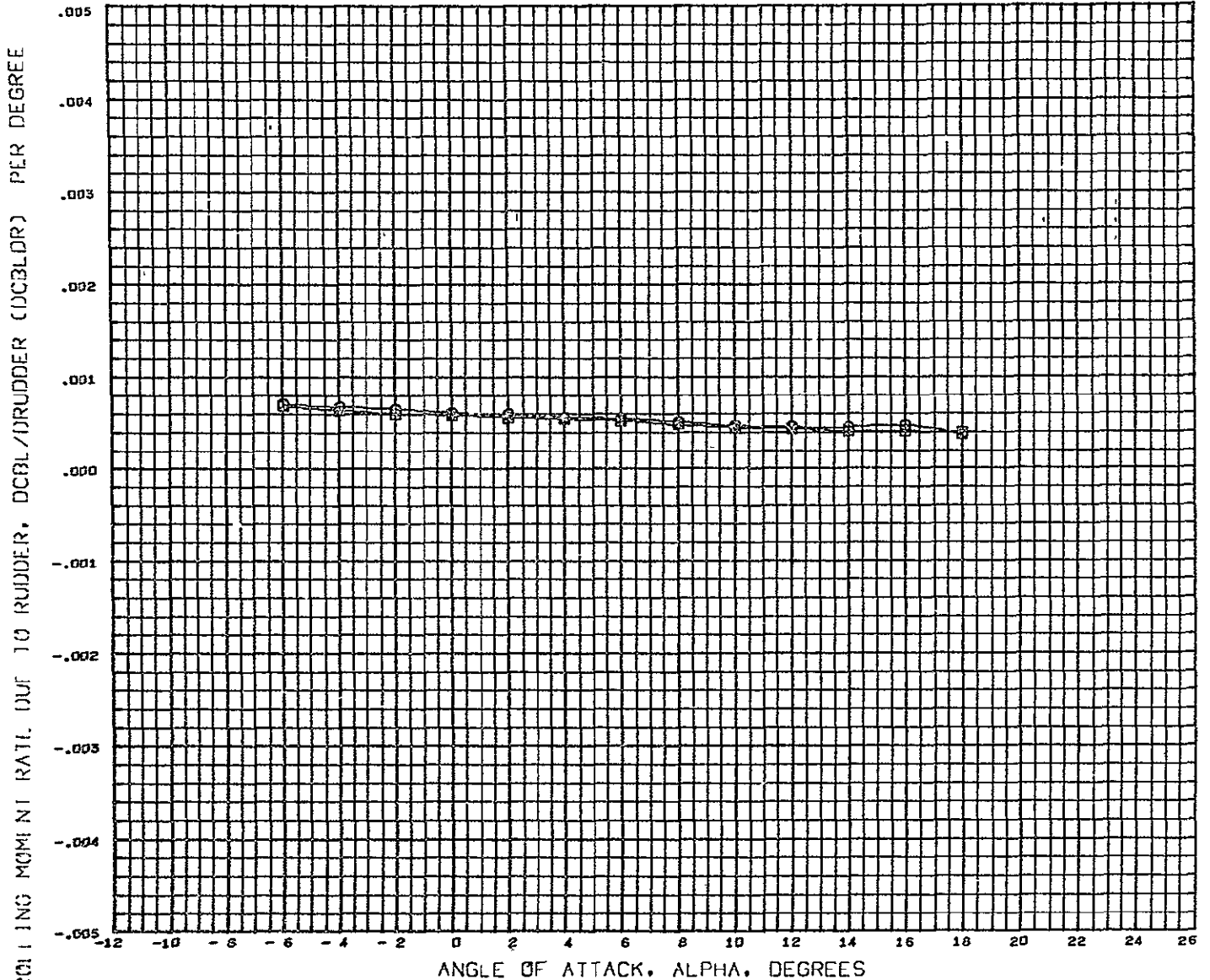

DATA SET SYMBOL	CONFIGURATION DESCRIPTION	BETA	ELEVTR	AILRON	REFERENCE INFORMATION
(XCF016)	LSWT 248 HDAC 4.0 FC 02 HCR ORB 85W11V6	0.000 - 10.000	0.000	0.000	REFS 8.8690 SQ.FT
(XCF019)	LSWT 248 HDAC 4.0 FC 02 HCR ORB 85W11V6	- 3.000 - 10.000	0.000	0.000	REFL 29.5700 IN.
					REFB 51.6000 IN.
					XMRP 59.3200 IN.
					YMRP 0.0000 IN.
					ZMRP 11.6000 IN.
					SCALE 4.0000 PERCNT

MACH 0.260

# DIRECTIONAL CONTROL POWER BASIC CONFIGURATION

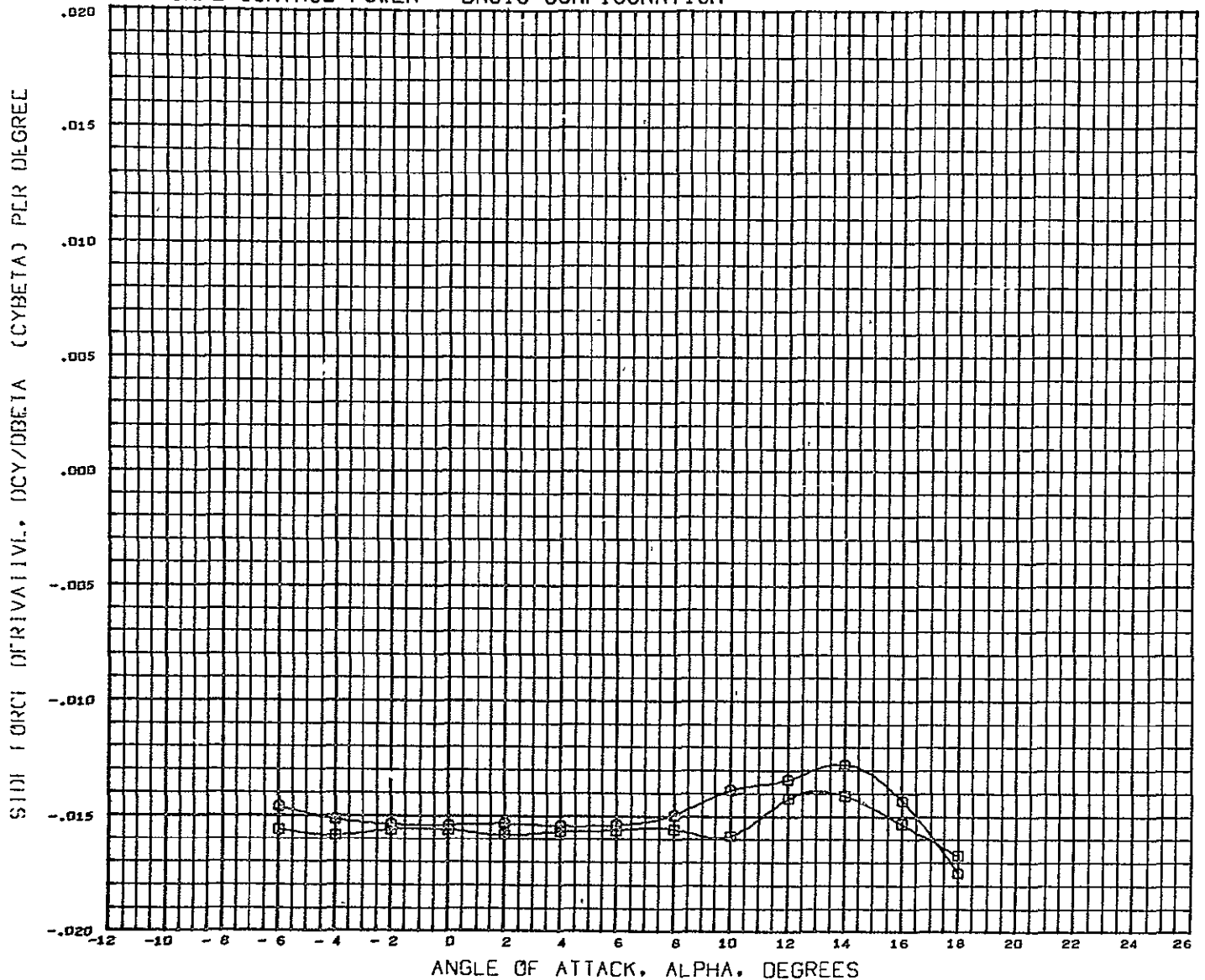

DATA-SET SYMBOL	CONFIGURATION DESCRIPTION	SLOPE	ELEVTR	AILRON	REFERENCE INFORMATION
(GCFD19)	LSWT 248 MDAC 4.0 PC O2 HCR ORB B5W11V6	1.000 - 10.000	0.000		REFS 6.8690 SQ.FT.
(GCFD17)	LSWT 248 MDAC 4.0 PC O2 HCR ORB B5W11V6	2.000 - 10.000	0.000		REFL 29.5700 IN.
					REFB 51.6000 IN.
					XMRP 59.3200 IN.
					YMRP 0.0000 IN.
					ZMRP 11.6000 IN.
					SCALE 4.0000 PERCENT

MACH 0.260

DIRECTIONAL STABILITY DERIVATIVE, DCYN/DBETA (LCYNUDB) (BODY AXIS)

DIRECTIONAL CONTROL POWER BASIC CONFIGURATION

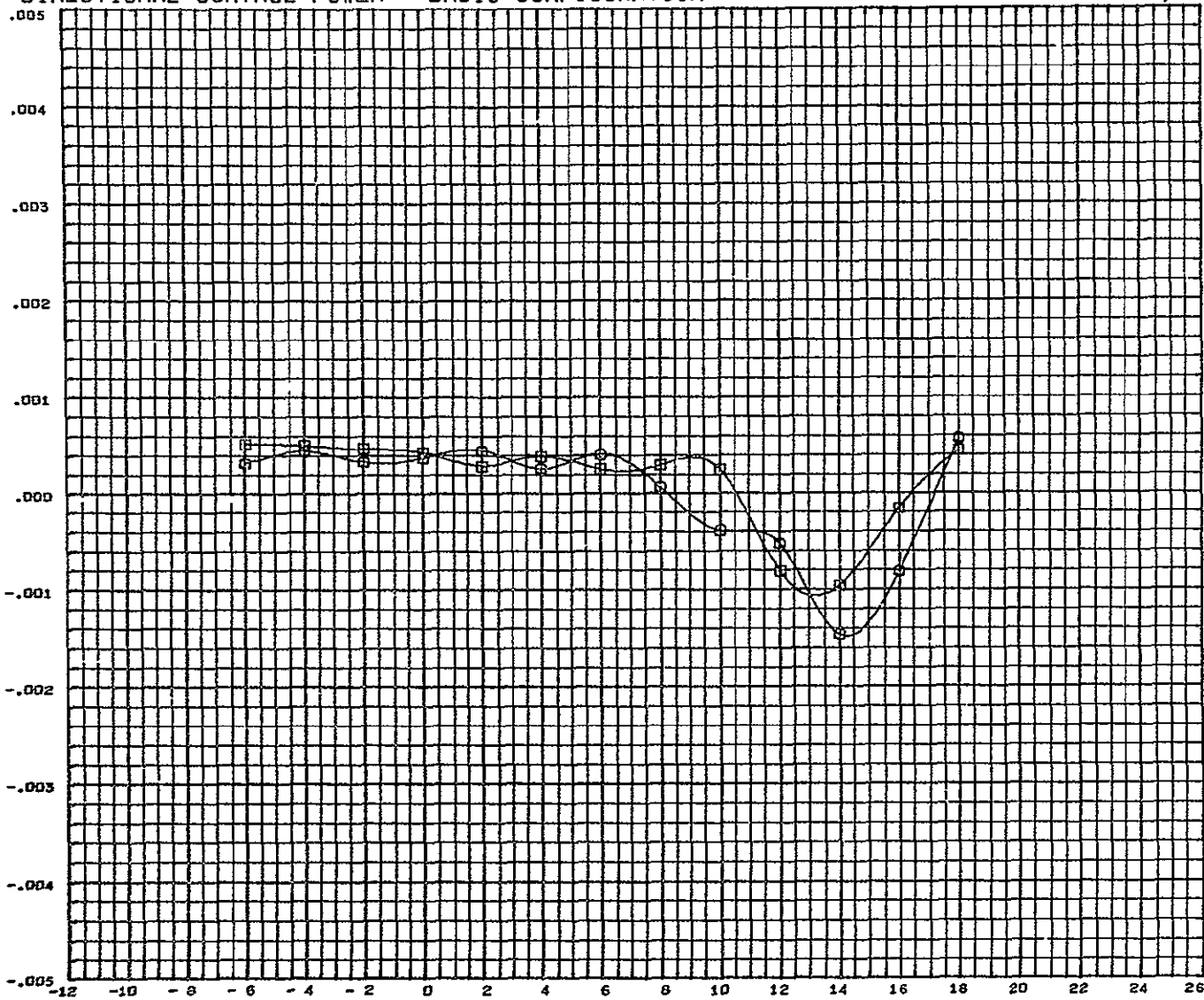

ANGLE OF ATTACK, ALPHA, DEGREES

DATA SET SYMBOL	CONFIGURATION DESCRIPTION	B5W11V6
(GCFD19)	LSWT 248 MDAC 4.0 PC O2 HCR ORB	B5W11V6
(GCFD17)	LSWT 248 MDAC 4.0 PC O2 HCR ORB	B5W11V6

SLOPE	ELEVTR	AILRON
1.000	- 10.000	0.000
2.000	- 10.000	0.000

REFERENCE INFORMATION		
REFS	8 8690	SQ.FT.
REFL	29.5700	IN.
REFB	51.6000	IN.
XMRP	59.3200	IN.
YMRP	0.0000	IN.
ZMRP	11.6000	IN.
SCALE	4.0000	PERCNT

MACH 0.260

# DIRECTIONAL CONTROL POWER BASIC CONFIGURATION

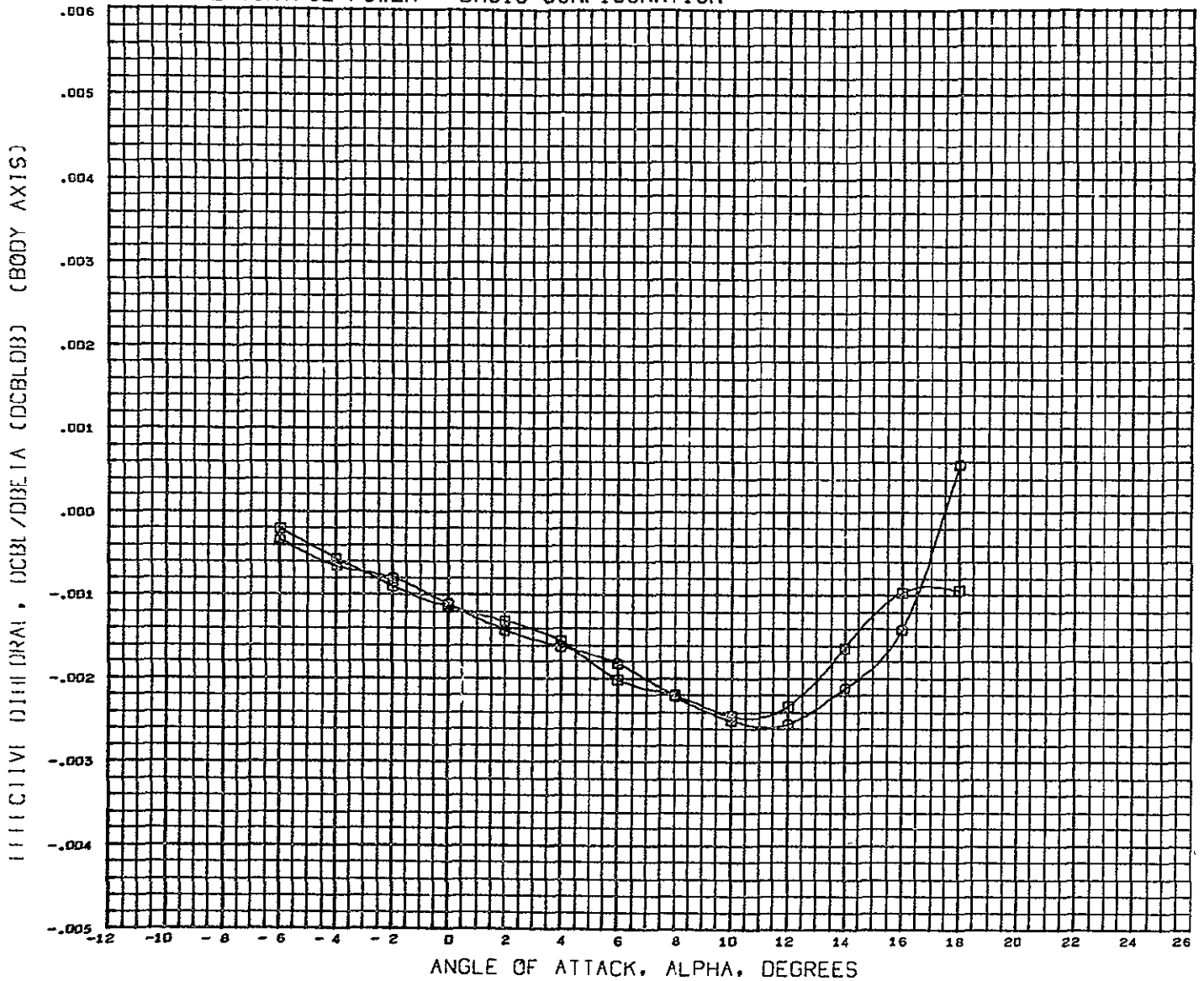

DATA SET SYMBOL		CONFIGURATION DESCRIPTION	SLOPE	ELEVTR	AILRON	REFERENCE INFORMATION	
(GCPD19)	Q	LSWT 248 MDAC 4.0 FC O2 HCR ORB B5W11V6	1.000	-10.000	0.000	REFS	8.8690 SQ.FT.
(GCPD17)	U	LSWT 248 MDAC 4.0 FC O2 HCR ORB B5W11V6	2.000	-10.000	0.000	REFL	29.5700 IN.
						REFB	51.6000 IN.
						XNRF	59.3200 IN.
						YNRF	0.0000 IN.
						ZNRF	11.6000 IN.
						SCALE	4.0000 PERCNT

HACH 0.260



# DIRECTIONAL CONTROL POWER BASIC CONFIGURATION

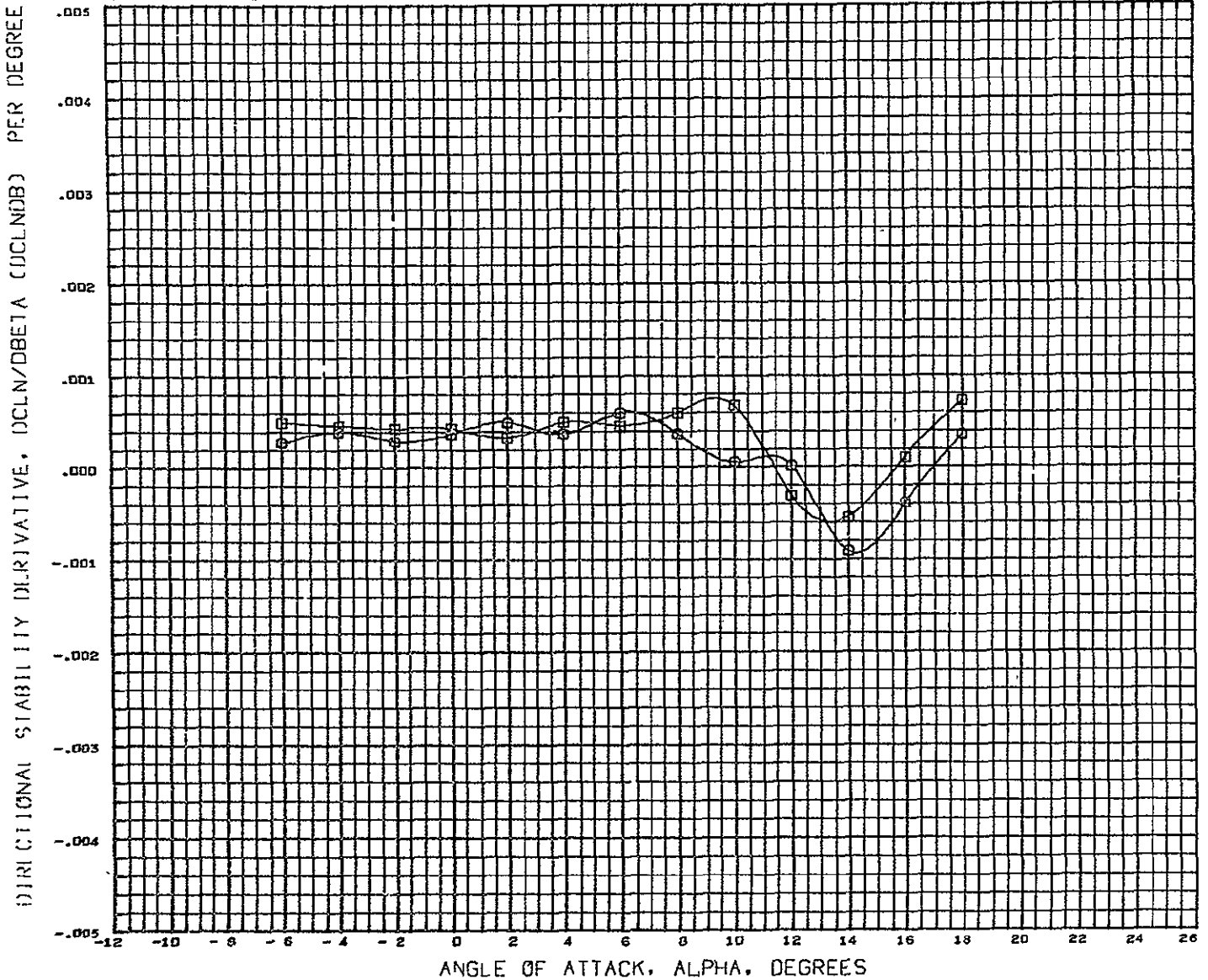

DATA SET SYMBOL	CONFIGURATION DESCRIPTION	BETA	ELEVTR	AILRON	REFERENCE INFORMATION
(HCFD19)	LSWT 248 MDAC 4.0 FC O2 HCR ORB B5W11V6	- 10.000	0.000		REFS 8.8690 SQ.FT.
(HCFD17)	LSWT 248 MDAC 4.0 FC O2 HCR ORB B5W11V6	- 10.000	0.000		REFL 29.5700 IN.
					REFB 51.6000 IN.
					XMRP 59.3200 IN.
					YMRP 0.0000 IN.
					ZMRP 11.6000 IN.
					SCALE 4.0000 PERCENT

HACH 0.260

9

DIRECTIONAL CONTROL POWER BASIC CONFIGURATION

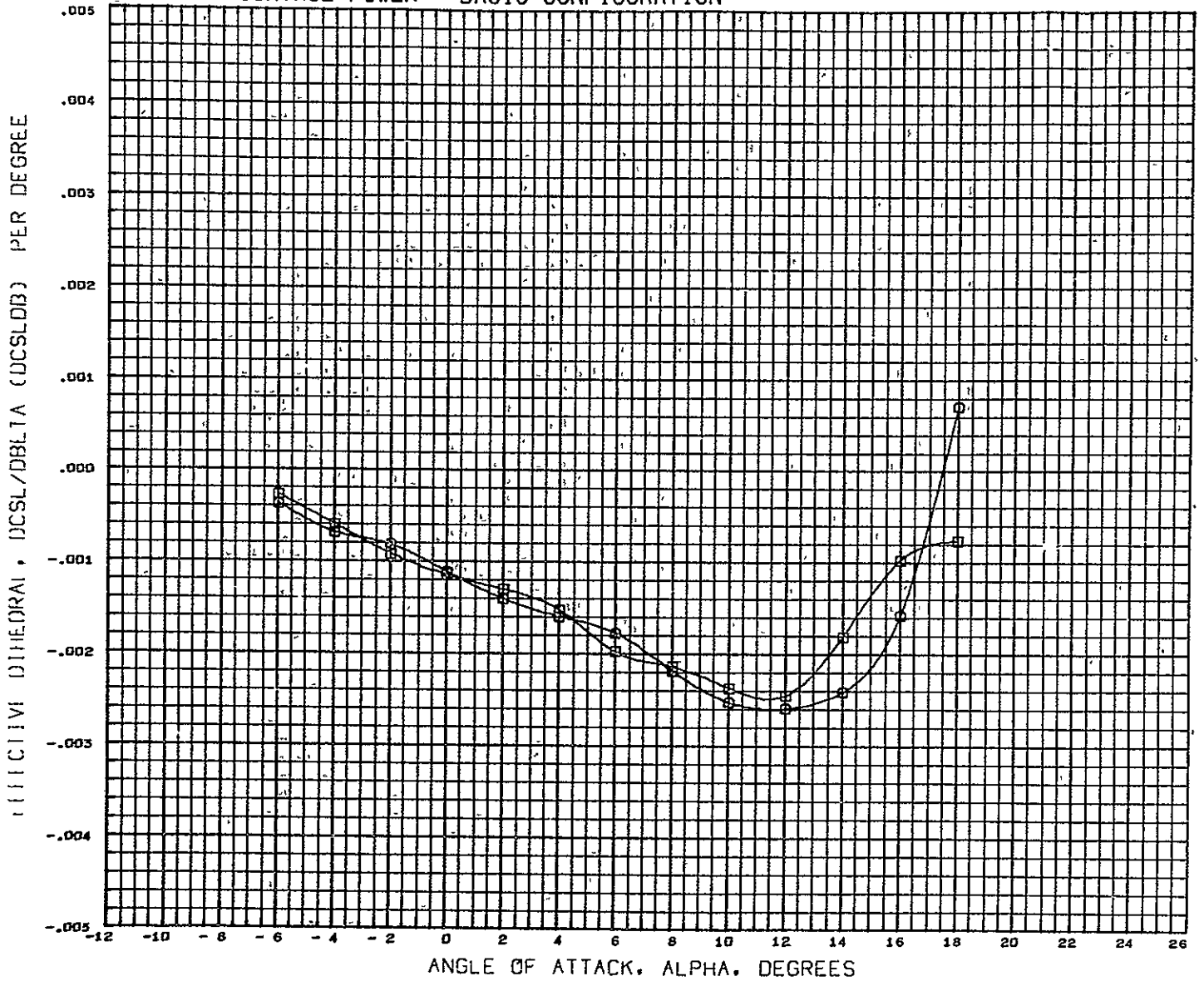

DATA SET SYMBOL	CONFIGURATION DESCRIPTION	BETA	ELEVTR	AILRON	REFERENCE INFORMATION
(HCF019)	LSWT 248 MDAC 4.0 FC 02 HCR ORB B5W11V6	- 10.000	0.000	0.000	REFS 8.8690 SQ.FT.
(HCF017)	LSWT 248 MDAC 4.0 FC 02 HCR ORB B5W11V6	- 10.000	0.000	0.000	REFL 29.5700 IN.
					REFB 51.6000 IN.
					XMRP 59.3200 IN.
					YMRP 0.0000 IN.
					ZMRP 11.6000 IN.
					SCALE 4.0000 PERCNT

HACH 0.260

# ENGINE POD AND LANDING GEAR EFFECTS ON LONGITUDINAL CHARACTERISTICS

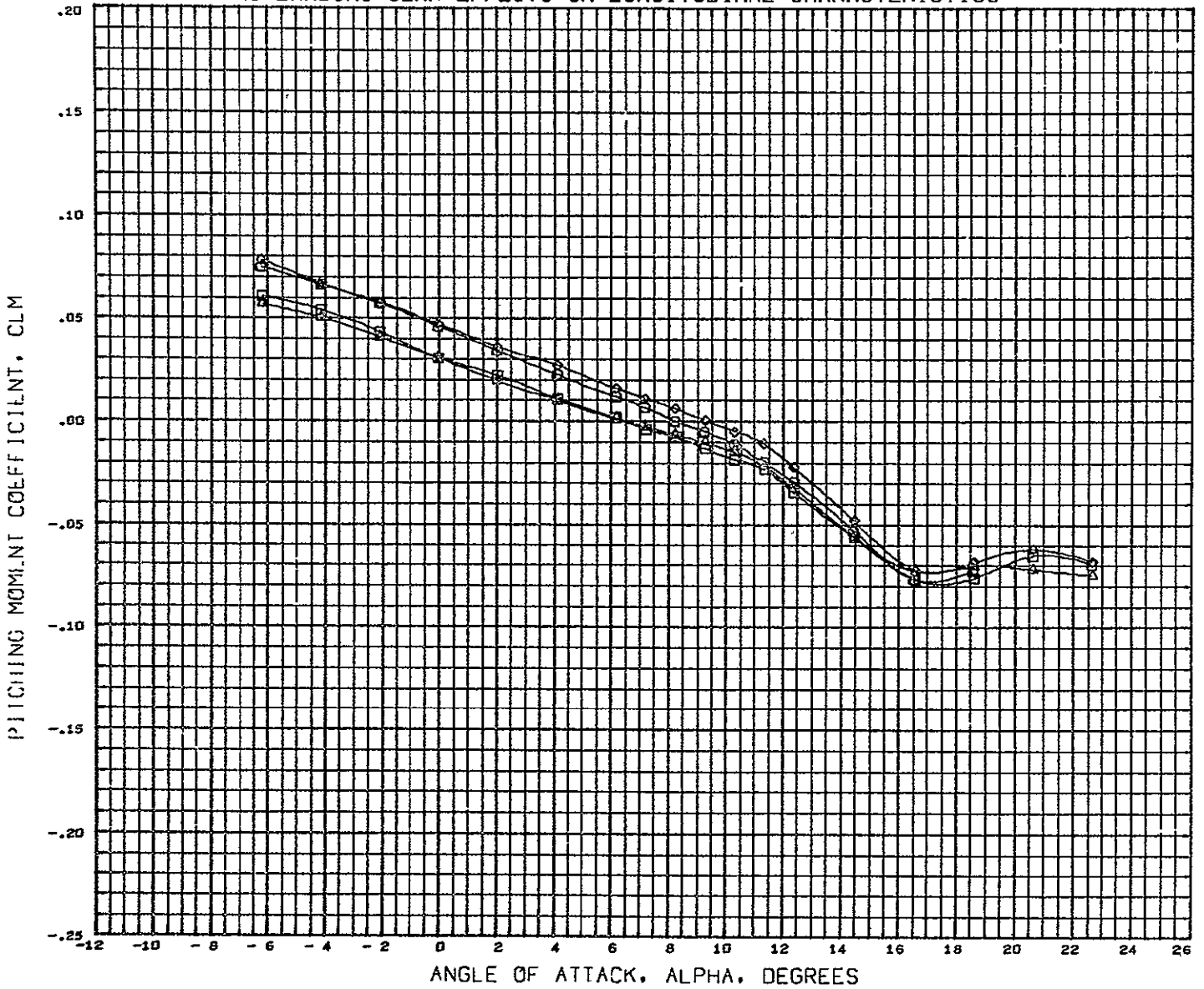

DATA SET SYMBOL	CONFIGURATION DESCRIPTION	BETA	ELEVTR	AILRON	REFERENCE INFORMATION
(CCPD12)	LSWT 248 MDAC 4.0 FC O2 HCR ORB B5W11V6	0.000 - 10.000	0.000	0.000	REFS 8.8690 SQ FT.
(CCPD53)	LSWT 248 MDAC 4.0 FC O2 HCR ORB B5W11G	0.000 - 10.000	0.000	0.000	REFL 29.5700 IN.
(CCPD58)	LSWT 248 MDAC 4.0 FC O2 HCR ORB B5W11F	0.000 - 10.000	0.000	0.000	REFB 51.6000 IN.
(CCPD56)	LSWT 248 MDAC 4.0 FC O2 HCR ORB B5W11PG	0.000 - 10.000	0.000	0.000	XMRP 59.3200 IN.
					YMRP 0.0000 IN.
					ZMRP 11.6000 IN.
					SCALE 4.0000 PERCNT

MACH 0.250

7

# ENGINE POD AND LANDING GEAR EFFECTS ON LONGITUDINAL CHARACTERISTICS

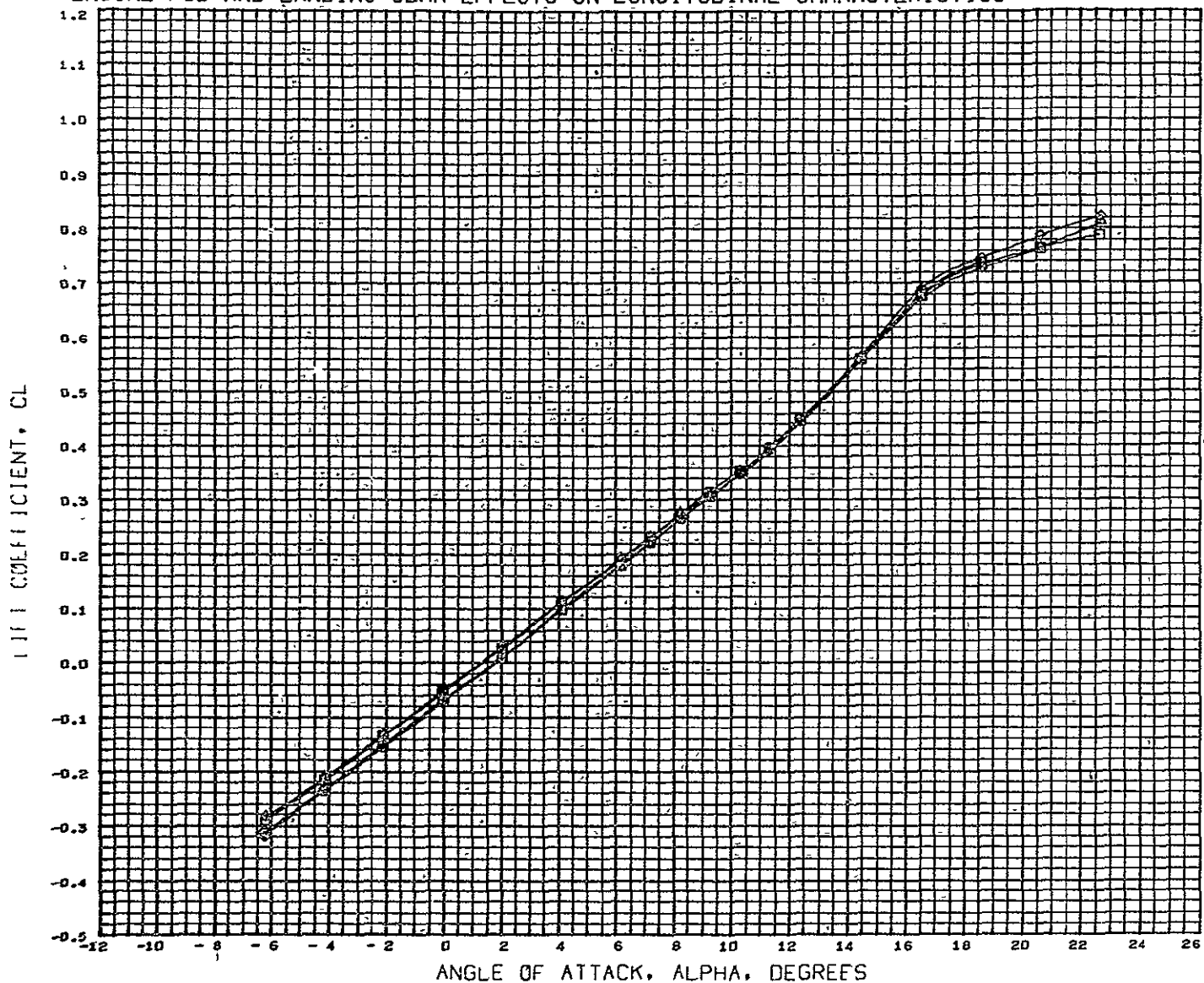

DATA SET SYMBOL	CONFIGURATION DESCRIPTION	BETA	ELEVTR	AILRON	REFERENCE INFORMATION
(CCF012)	LSWT 248 MDAC 4.0 FC 02 HCR ORB 85W11V6	0.000 - 10.000	0.000	0.000	REFS 8.8690 SQ.FT.
(CCF053)	LSWT 248 MDAC 4.0 FC 02 HCR ORB 85W11G	0.000 - 10.000	0.000	0.000	REFL 29.5700 IN.
(CCF058)	LSWT 248 MDAC 4.0 FC 02 HCR ORB 85W11F	0.000 - 10.000	0.000	0.000	REFB 51.6000 IN.
(CCF056)	LSWT 248 MDAC 4.0 FC 02 HCR ORB 85W11FG	0.000 - 10.000	0.000	0.000	XMRP 59.3200 IN.
					YMRP 0.0000 IN.
					ZMRP 11.6000 IN.
					SCALE 4.0000 PERCENT

MACH 0.250

# ENGINE POD AND LANDING GEAR EFFECTS ON LONGITUDINAL CHARACTERISTICS

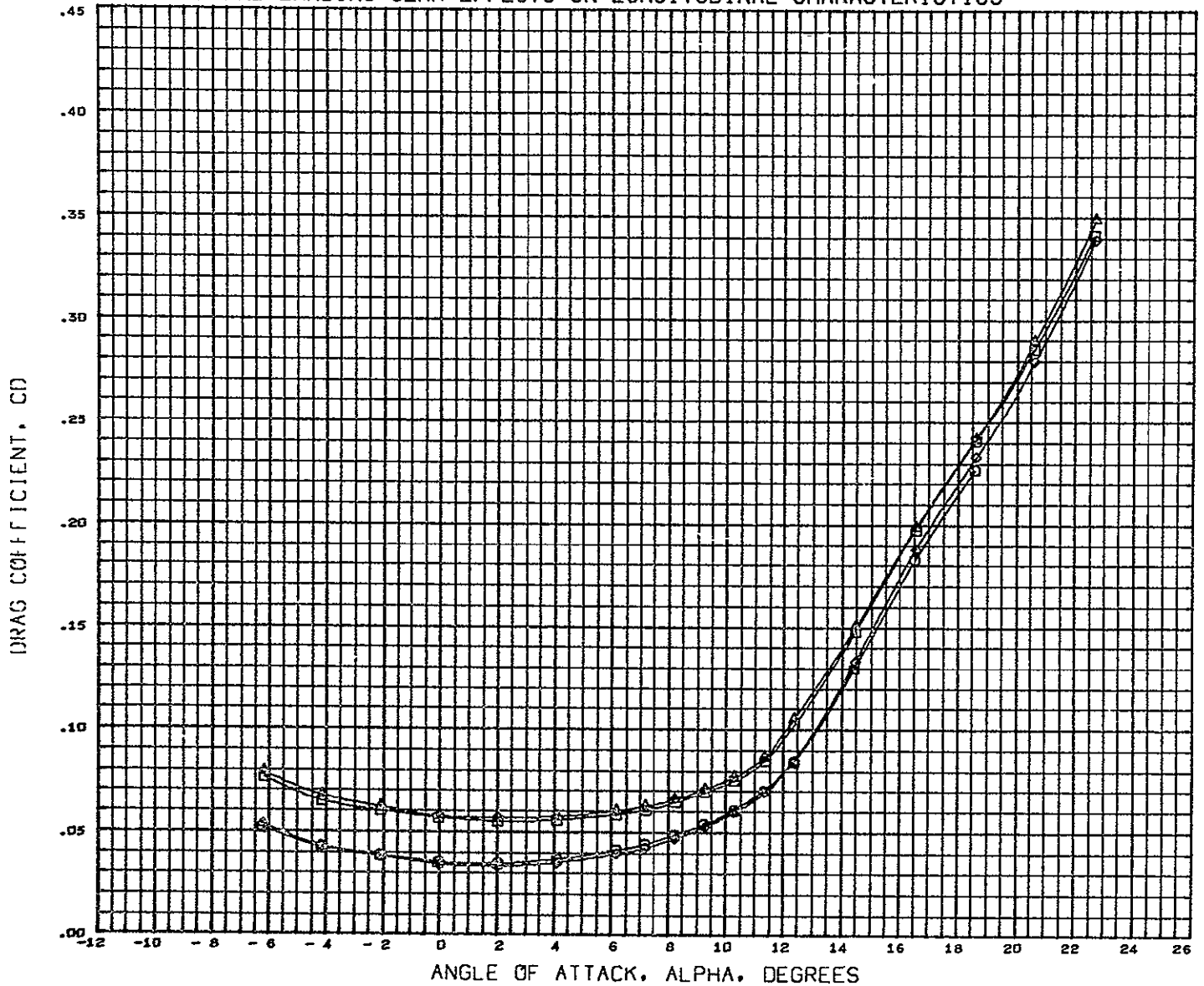

DATA SET SYMBOL	CONFIGURATION DESCRIPTION	BETA	ELEVTR	AILRON	REFERENCE INFORMATION
(CCPD12)	LSWT 248 MDAC 4.0 FC O2 HCR ORB B5W11V6	0.000	- 10.000	0.000	REFS 8.8690 SQ.FT.
(CCPD53)	LSWT 248 MDAC 4.0 FC O2 HCR ORB B5W11G	0.000	- 10.000	0.000	REFL 29.5700 IN.
(CCPD58)	LSWT 248 MDAC 4.0 FC O2 HCR ORB B5W11F	0.000	- 10.000	0.000	REFB 51.6000 IN.
(CCPD56)	LSWT 248 MDAC 4.0 FC O2 HCR ORB B5W11PG	0.000	- 10.000	0.000	XMRP 59.3200 IN.
					YMRP 0.0000 IN.
					ZMRP 11.6000 IN.
					SCALE 4.0000 PERCNT

MACH 0.250

# ENGINE POD AND LANDING GEAR EFFECTS ON LONGITUDINAL CHARACTERISTICS

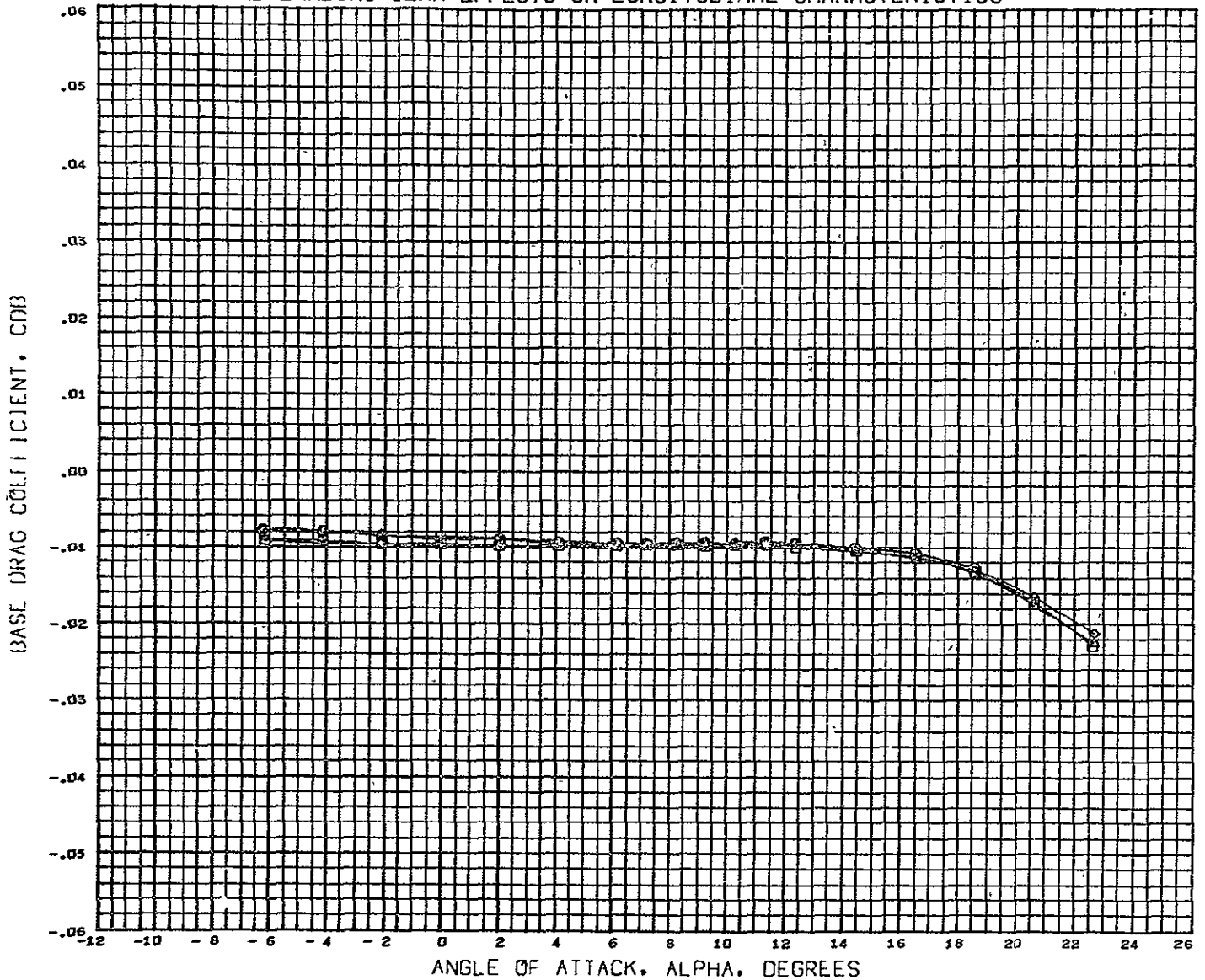

DATA SET SYMBOL	CONFIGURATION DESCRIPTION	BETA	ELEVTR	AILRON	REFERENCE INFORMATION
(CCP012)	LSWT 248 MDAC 4.0 FC O2 HCR ORB B5W11V6	0.000 - 10.000	0.000	0.000	REFS 8.8690 SQ FT.
(CCP053)	LSWT 248 MDAC 4.0 FC O2 HCR ORB B5W11G	0.000 - 10.000	0.000	0.000	REFL 29.5700 IN.
(CCP058)	LSWT 248 MDAC 4.0 FC O2 HCR ORB B5W11F	0.000 - 10.000	0.000	0.000	REFB 51.6000 IN.
(CCP056)	LSWT 248 MDAC 4.0 FC O2 HCR ORB B5W11G	0.000 - 10.000	0.000	0.000	XMRP 59.3200 IN.
					ZMRP 0.0000 IN.
					ZMRP 11.6000 IN.
					SCALE 4.0000 PERCENT

MACH 0.250

# ENGINE POD AND LANDING GEAR EFFECTS ON LONGITUDINAL CHARACTERISTICS

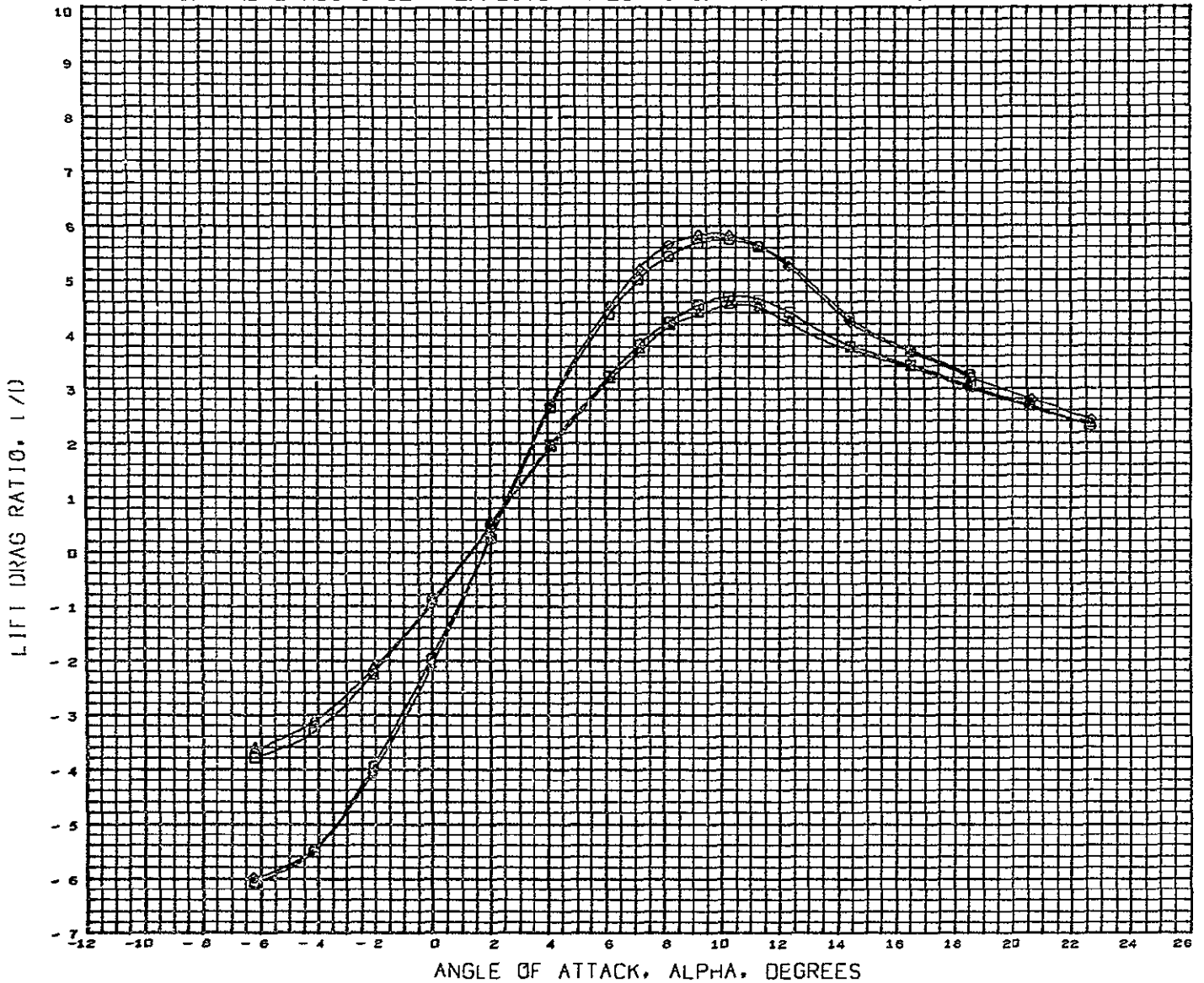

DATA SET SYMBOL	CONFIGURATION DESCRIPTION	BETA	ELEVTR	AILRON	REFERENCE INFORMATION
(CCP012)	□ LSWT 248 MDAC 4.0 FC O2 HCR ORB B5W11V6	0.000 - 10.000	0.000	0.000	REFS 8.8690 SQ FT
(CCP053)	○ LSWT 248 MDAC 4.0 FC O2 HCR ORB B5W11G	0.000 - 10.000	0.000	0.000	REFL 29.5700 IN.
(CCP058)	◇ LSWT 248 MDAC 4.0 FC O2 HCR ORB B5W11F	0.000 - 10.000	0.000	0.000	REFB 51.6000 IN.
(CCP056)	△ LSWT 248 MDAC 4.0 FC O2 HCR ORB B5W11FG	0.000 - 10.000	0.000	0.000	XMRP 59.3200 IN.
					YMRP 0.0000 IN.
					ZMRP 11.6000 IN.
					SCALE 4.0000 PERCENT

MACH 0.250

# ENGINE POD AND LANDING GEAR EFFECTS ON LONGITUDINAL CHARACTERISTICS

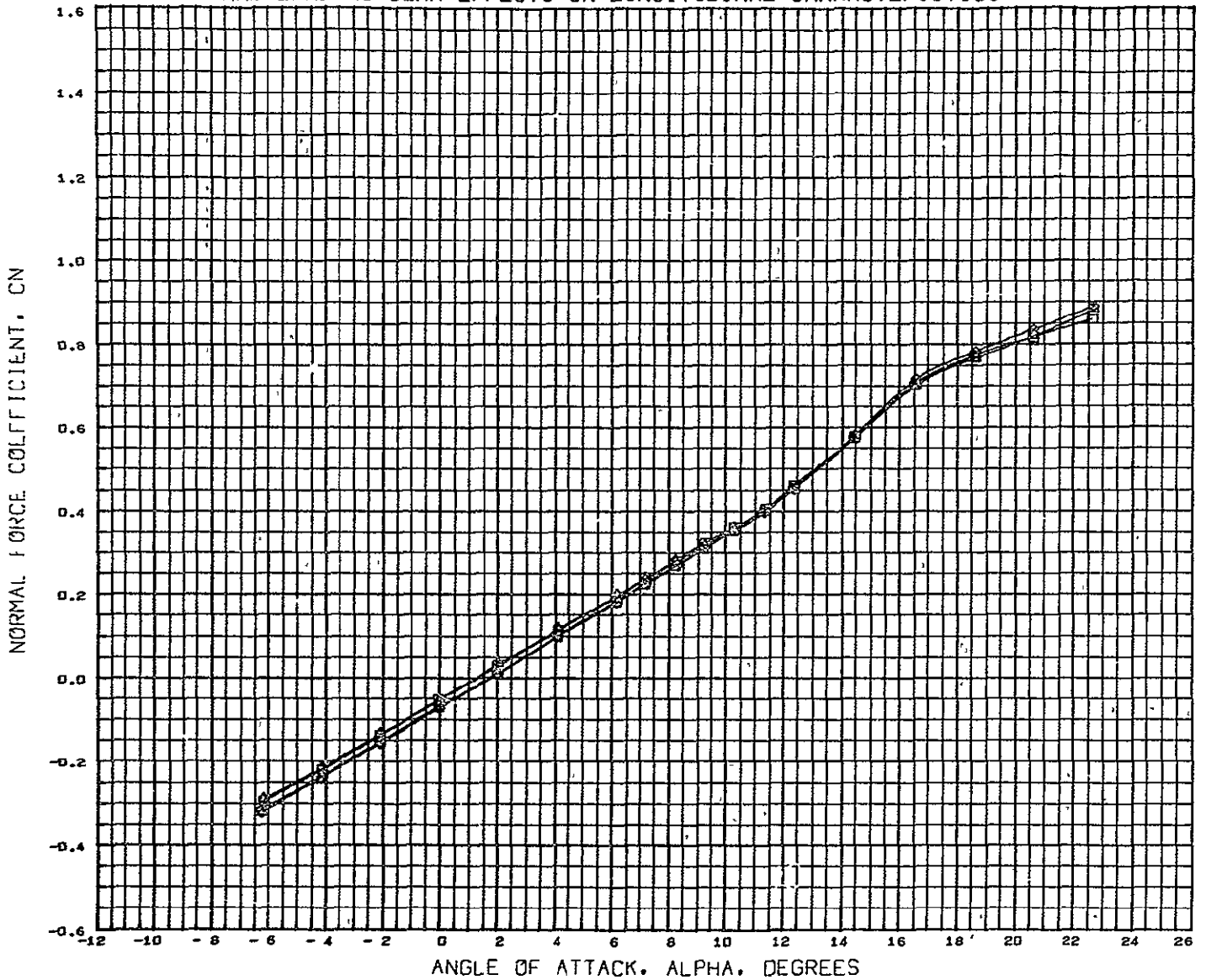

DATA SET SYMBOL	CONFIGURATION DESCRIPTION	BETA	ELEVTR	AILRON	REFERENCE INFORMATION
(BCFD12)	LSWT 248 MDAC 4.0 FC O2 HCR ORB B5W11V6	0.000 - 10.000	0.000	0.000	REFS 8.8690 SQ FT.
(BCFD53)	LSWT 248 MDAC 4.0 FC O2 HCR ORB B5W11G	0.000 - 10.000	0.000	0.000	REFL 29.5700 IN.
(BCFD58)	LSWT 248 MDAC 4.0 FC O2 HCR ORB B5W11F	0.000 - 10.000	0.000	0.000	REFB 51.6000 IN.
(BCFD56)	LSWT 248 MDAC 4.0 FC O2 HCR ORB B5W11FG	0.000 - 10.000	0.000	0.000	XMRP 59.3200 IN.
					YMRP 0.0000 IN.
					ZMRP 11.6000 IN.
					SCALE 4.0000 PERCNT

MACH 0.250



# ENGINE POD AND LANDING GEAR EFFECTS ON LONGITUDINAL CHARACTERISTICS

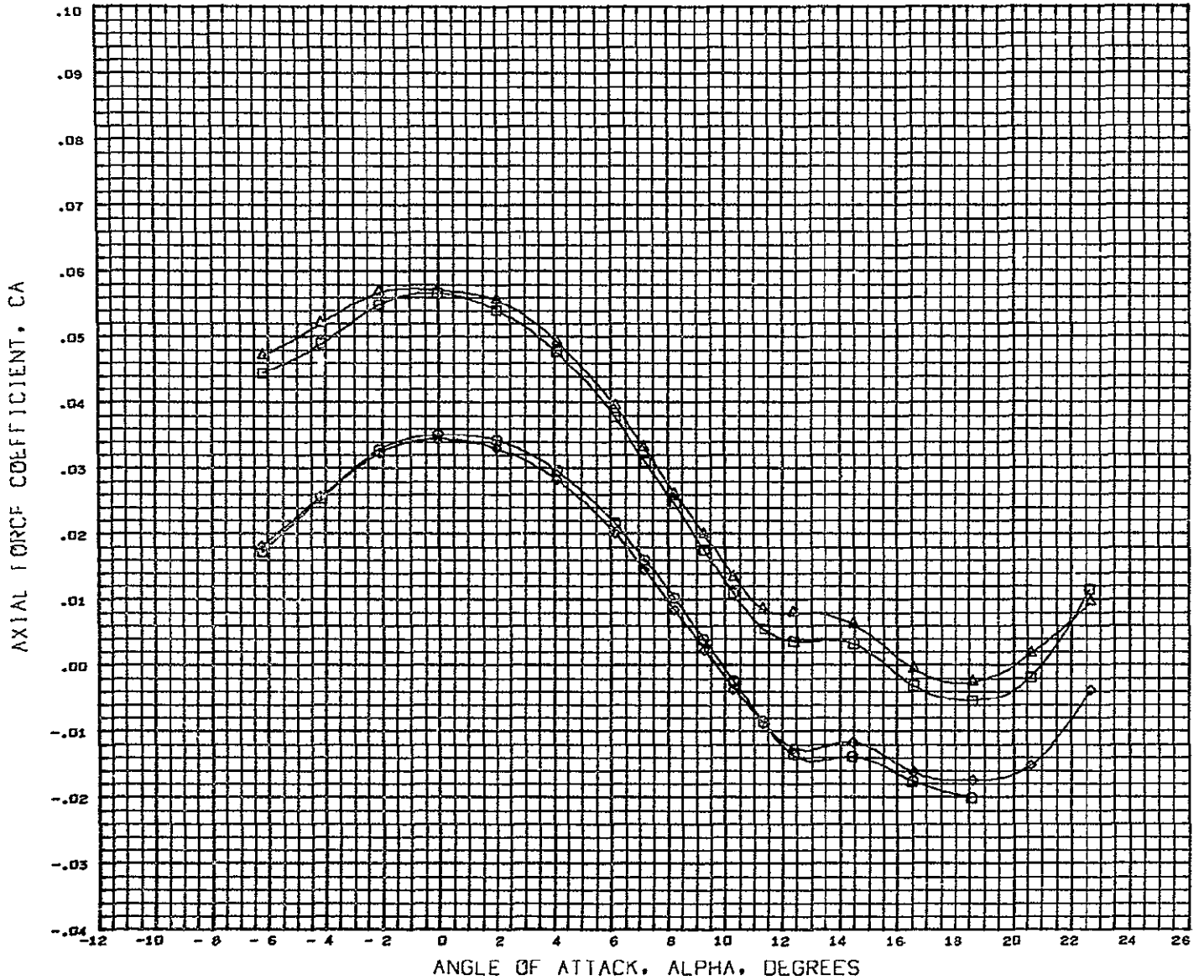

DATA SET SYMBOL	CONFIGURATION DESCRIPTION	BETA	ELEVTR	AILRON	REFERENCE INFORMATION
(BCF012)	LSWT 248 MDAC 4.0 FC O2 HCR ORB 85W11V6	0.000 - 10.000	0.000	0.000	REFS 8.8690 SQ.FT.
(BCF053)	LSWT 248 MDAC 4.0 FC O2 HCR ORB 85W11C	0.000 - 10.000	0.000	0.000	REFL 29.5700 IN.
(BCF058)	LSWT 248 MDAC 4.0 FC O2 HCR ORB 85W11F	0.000 - 10.000	0.000	0.000	REFB 51.6000 IN.
(BCF056)	LSWT 248 MDAC 4.0 FC C2 HCR ORB 85W11FG	0.000 - 10.000	0.000	0.000	XMRP 59.3200 IN.
					YMRP 0.0000 IN.
					ZMRP 11.6000 IN.
					SCALE 4.0000 PERCENT

MACH 0.250

# ENGINE POD AND LANDING GEAR EFFECTS ON LONGITUDINAL CHARACTERISTICS

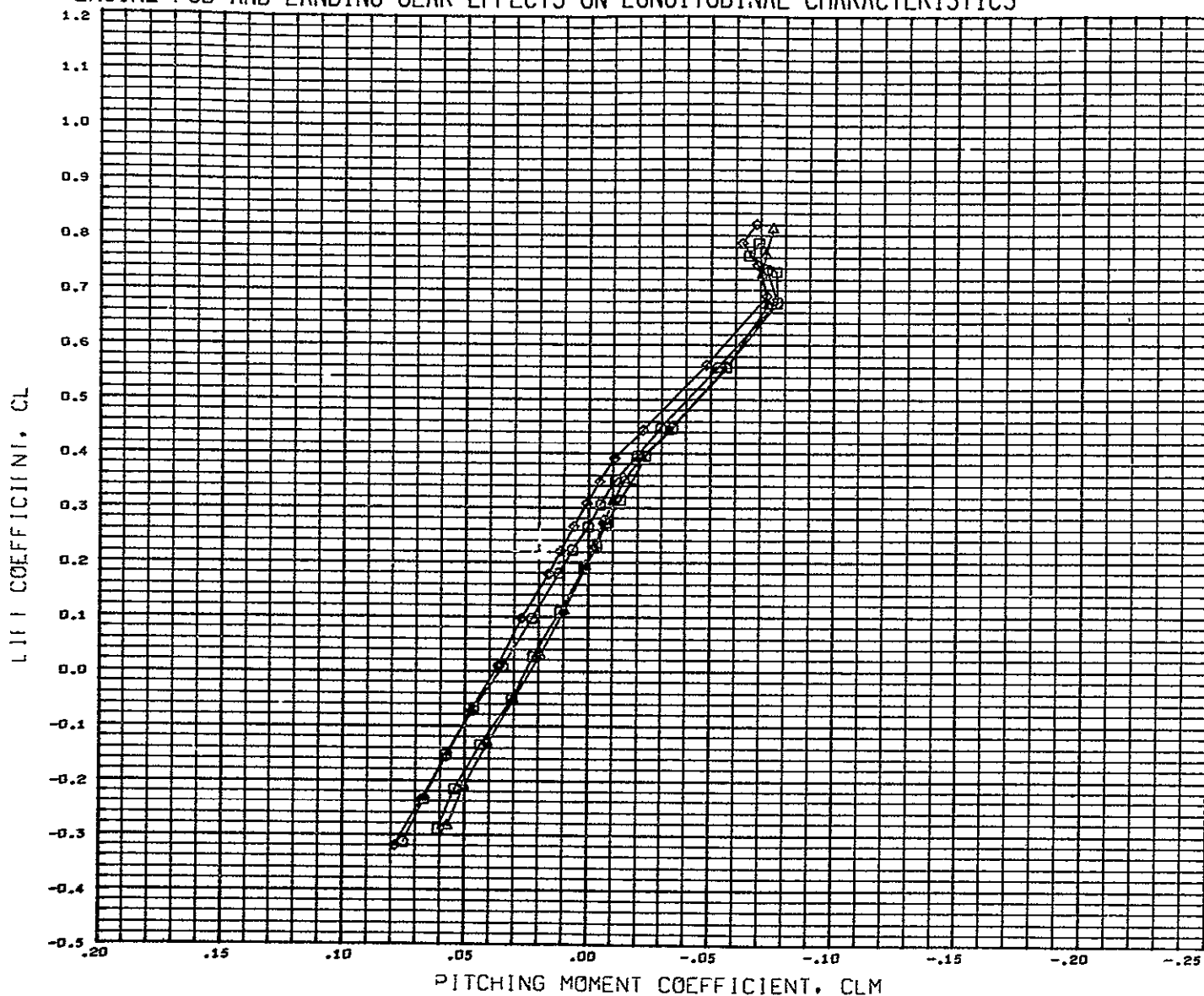

DATA SET SYMBOL	CONFIGURATION DESCRIPTION	BETA	ELEVTR	AILRON	REFERENCE INFORMATION
(CCPD12)	□ LSWT 248 HDAC 4.0 FC O2 HCR ORB B5W11V6	0.000 - 10.000	0.000	0.000	REFS 8 8690 SQ FT.
(CCPD53)	○ LSWT 248 HDAC 4.0 FC O2 HCR ORB B5W11G	0.000 - 10.000	0.000	0.000	REFL 29.5700 IN.
(CCPD56)	◇ LSWT 248 HDAC 4.0 FC O2 HCR ORB B5W11F	0.000 - 10.000	0.000	0.000	REFB 51.6000 IN.
(CCPD56)	△ LSWT 248 HDAC 4.0 FC O2 HCR ORB B5W11PG	0.000 - 10.000	0.000	0.000	XMRP 59.3200 IN.
					YMRP 0.0000 IN.
					ZMRP 11.6000 IN.
					SCALE 4 0000 PERCNT

MACH 0.250

# ENGINE POD AND LANDING GEAR EFFECTS ON LONGITUDINAL CHARACTERISTICS

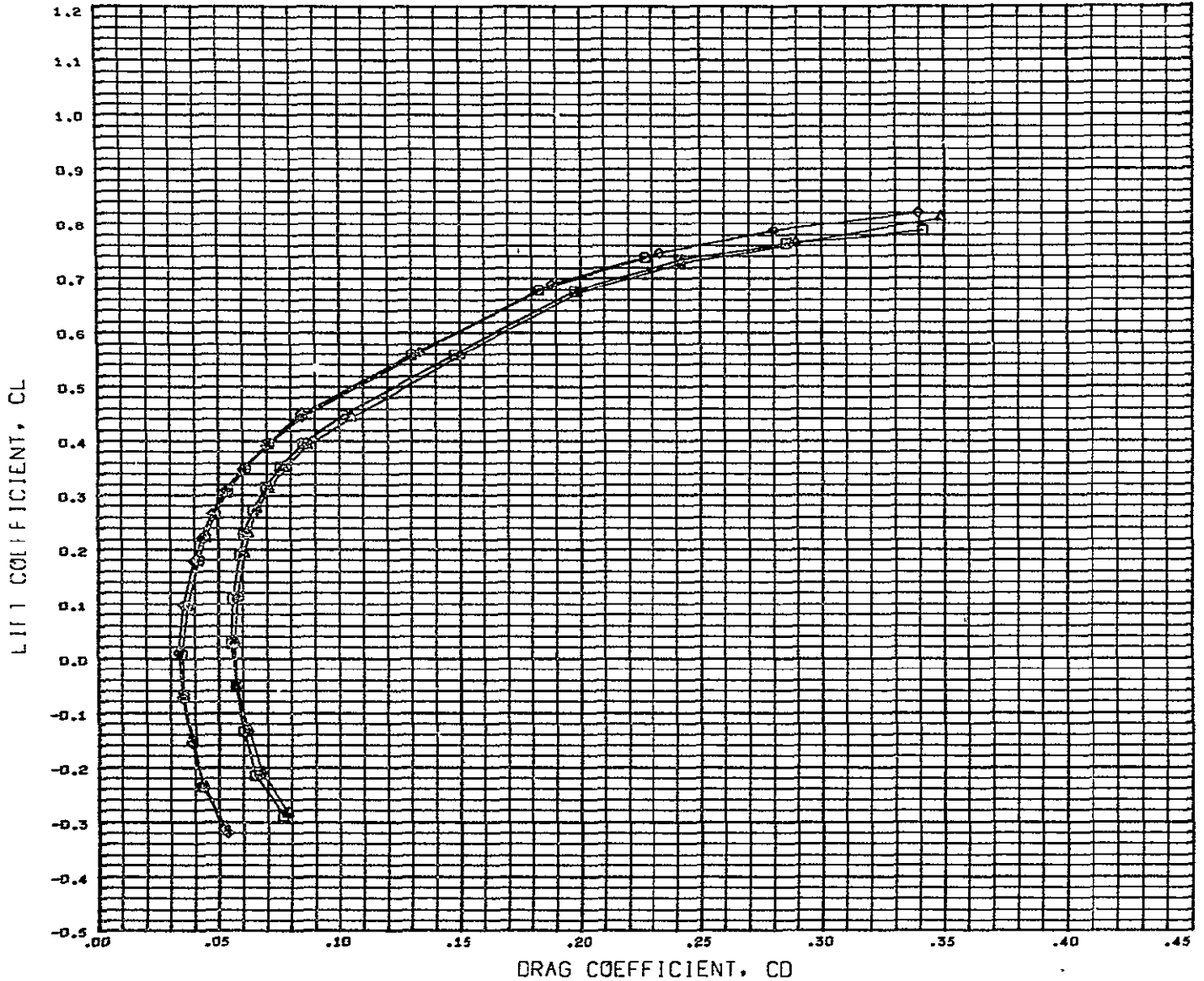

DATA SET SYMBOL	CONFIGURATION DESCRIPTION	BETA	ELEVTR	AILRON	REFERENCE INFORMATION
(CCP012)	LSWT 248 MDAC 4.D FC O2 HCR ORB	B5W11V6	0.000 - 10.000	0.000	REFS 8.8690 SQ.FT.
(CCP053)	LSWT 248 MDAC 4.D FC O2 HCR ORB	B5W11C	0.000 - 10.000	0.000	REFL 29.5700 IN.
(CCP058)	LSWT 248 MDAC 4.D FC O2 HCR ORB	B5W11F	0.000 - 10.000	0.000	REFB 59.3200 IN.
(CCP056)	LSWT 248 MDAC 4.D FC O2 HCR ORB	B5W11FG	0.000 - 10.000	0.000	XMRP 0.0000 IN.
					YMRP 11.6000 IN.
					ZMRP 4.0000 PERCNT
					SCALE 4.0000 PERCNT

HACH 0.25D

# ENGINE POD AND LANDING GEAR EFFECTS ON LONGITUDINAL CHARACTERISTICS

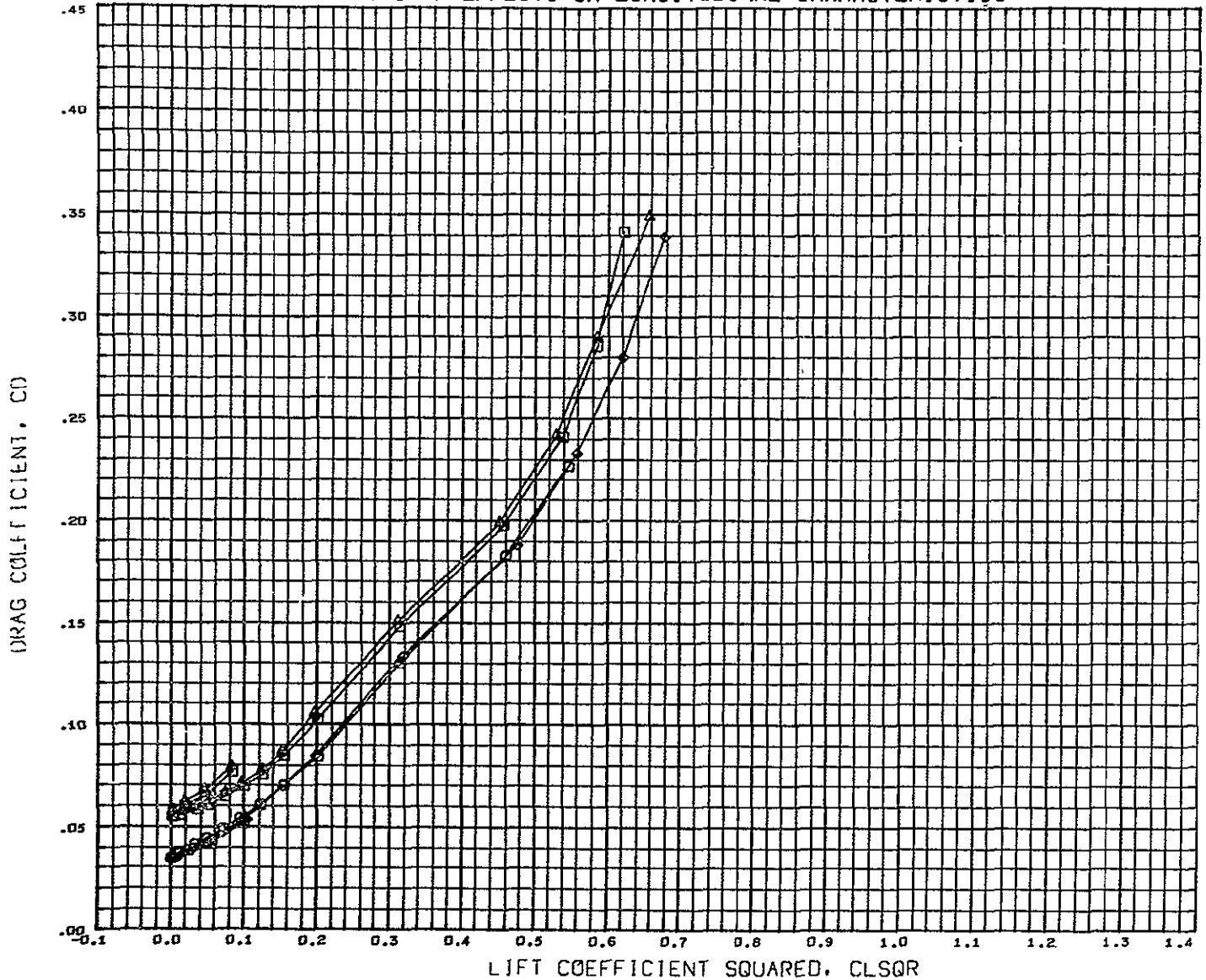

DATA SET SYMBOL	CONFIGURATION DESCRIPTION	BETA	ELEVTR	AILRON	REFEPENCE INFORMATION
(CCF012)	LSWT 248 MDAC 4.0 FC Q2 HCR ORB	B5W11V6	0.00L - 10.000	0.000	REFS 8.8690 SQ FT.
(CCF053)	LSWT 248 MDAC 4.0 FC Q2 HCR ORB	B5W11G	0.000 - 10.000	0.000	REFL 29.5700 IN.
(CCF058)	LSWT 248 MDAC 4.0 FC Q2 HCR ORB	B5W11F	0.000 - 10.000	0.000	REFB 51.6000 IN.
(CCF056)	LSWT 248 MDAC 4.0 FC Q2 HCR ORB	B5W11Pg	0.000 - 10.000	0.000	XMRP 59.3200 IN.
					YMRP 0.0000 IN.
					ZMRP 11.6000 IN.
					SCALE 4.0000 PERCENT

MACH 0.250

# ENGINE POD AND LANDING GEAR EFFECTS ON LONGITUDINAL CHARACTERISTICS

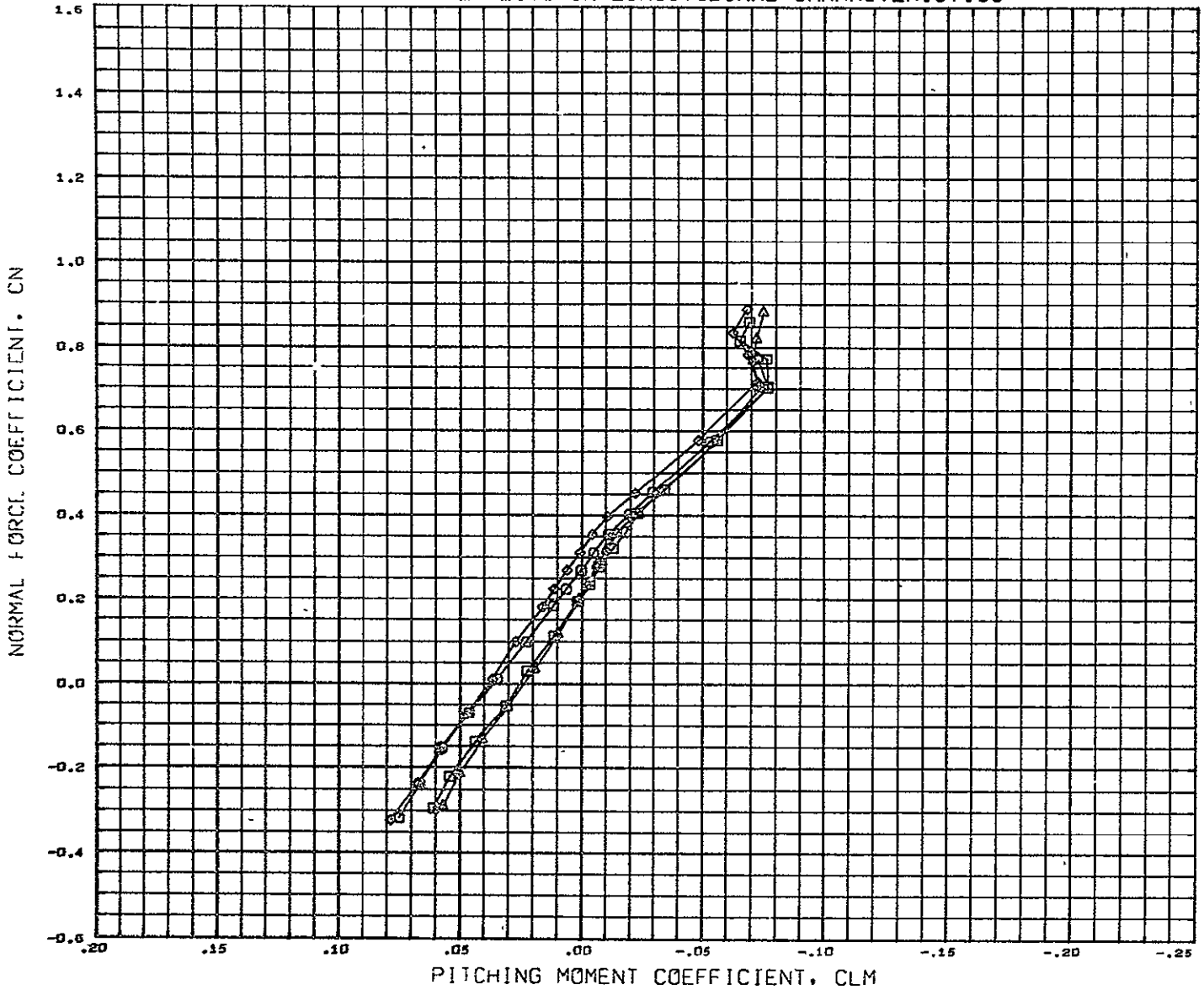

DATA SET SYMBOL	CONFIGURATION DESCRIPTION	BETA:	ELEVTR	AILRON	REFERENCE INFORMATION
(BCF012)	□ LSWT 248 HDAC 4.0 FC 02 HCR ORB B5W11V6	0.000 - 10.000	0.000	0.000	REFS 8.8698 SQ.FT.
(BCF053)	□ LSWT 248 HDAC 4.0 FC 02 HCR ORB B5W11G	0.000 - 10.000	0.000	0.000	REFL 29.5700 IN.
(BCF058)	◇ LSWT 248 HDAC 4.0 FC 02 HCR ORB B5W11F	0.000 - 10.000	0.000	0.000	REFB 51.6000 IN.
(BCF056)	△ LSWT 248 HDAC 4.0 FC 02 HCR ORB B5W11PG	0.000 - 10.000	0.000	0.000	XHRP 59.3200 IN.
					YHRF 0.0000 IN.
					ZHRF 11.6000 IN.
					SCALE 4.0000 PERCENT

MACH 0.250

EFFECT OF SPEED BRAKE VERTICAL POSITION AND SIMULATED SLOT (BETA=0)

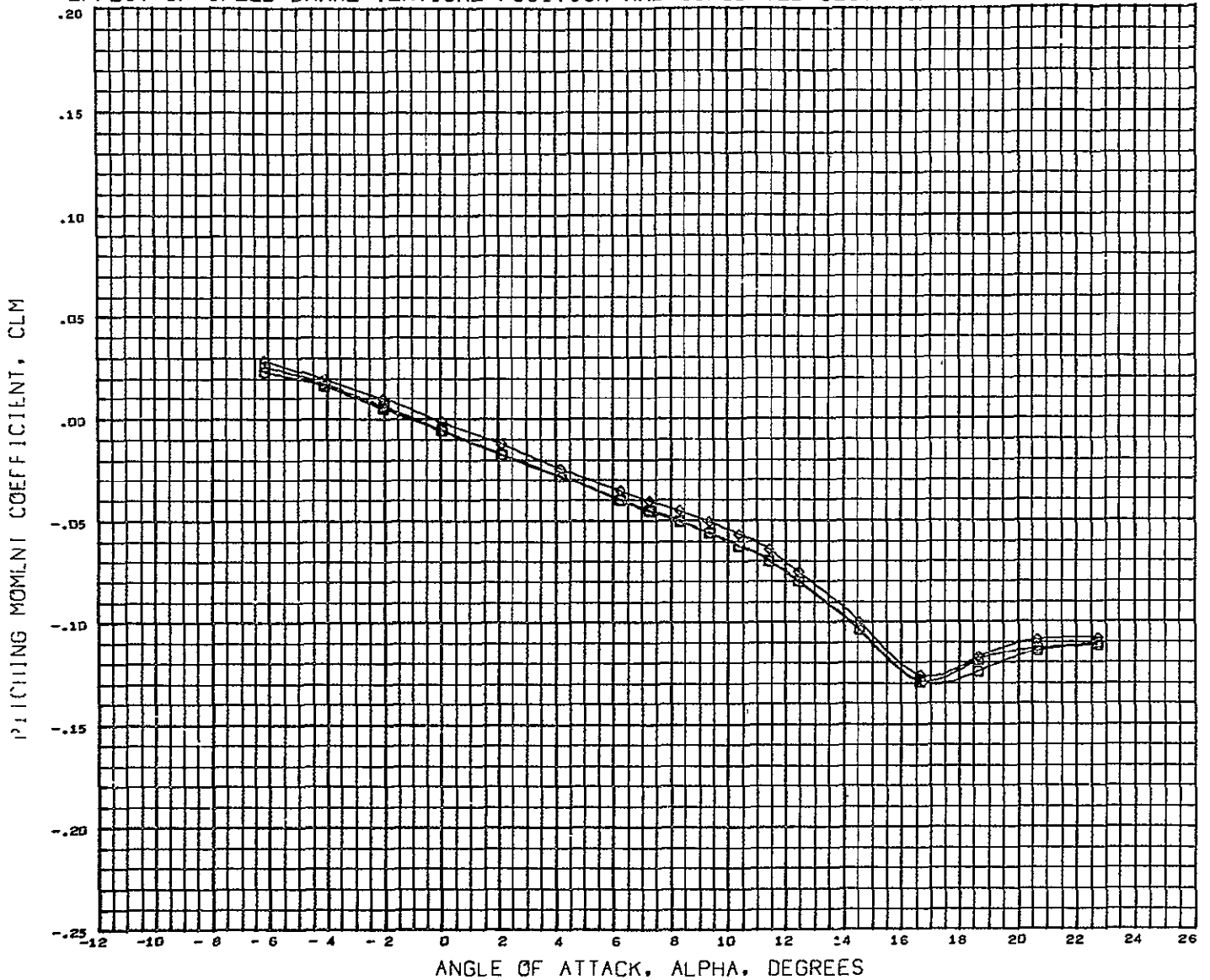

DATA SET SYMBOL	CONFIGURATION DESCRIPTION	ELEVTR	SBPOS	SPBRK	BFLAP	REFERENCE INFORMATION
(CCFG39)	LSWT 248 MDAC 4.0 FC 02 HCR ORB B5W11SB2	- 10.000	3.000	30.000	15.000	REFS 8.8690 SQ FT.
(CCFD40)	LSWT 248 MDAC 4.0 FC 02 HCR ORB B5W11SB2	- 10.000	1.000	30.000	15.000	REFL 29.5700 IN.
(CCFD41)	LSWT 248 MDAC 4.0 FC 02 HCR ORB B5W11SB2	- 10.000	2.000	30.000	15.000	REFB 51.6000 IN.
						XMRP 59.3200 IN.
						YMRP 0.0000 IN.
						ZMRP 11.6000 IN.
						SCALE 4.0000 PERCENT

HACH 0.250

# EFFECT OF SPEED BRAKE VERTICAL POSITION AND SIMULATED SLOT (BETA=0)

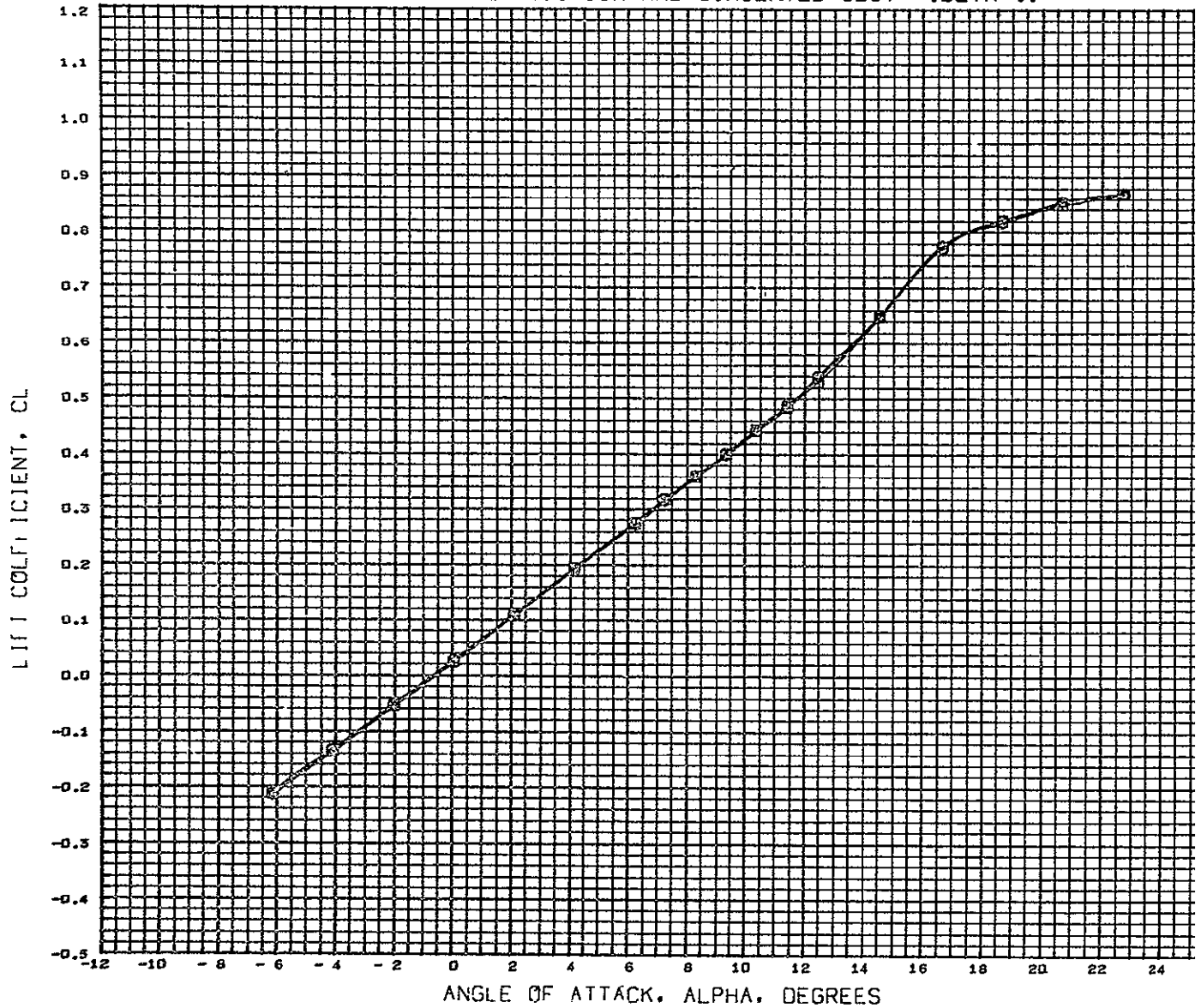

DATA SET SYMBOL	CONFIGURATION DESCRIPTION	ELEVTR	SBPOS	SPBRK	BFLAP	REFERENCE INFORMATION
(CCF039)	LSWT 248 MDAC 4.0 FC 02 HCR ORB B5W11SB2	- 10.000	3.000	30.000	15.000	REFS 8.8690 SQ.F
(CCF040)	LSWT 248 MDAC 4.0 FC 02 HCR ORB B5W11SB2	- 10.000	1.000	30.000	15.000	REFL 29.5700 IN.
(CCF041)	LSWT 248 MDAC 4.0 FC 02 HCR ORB B5W11SB2	- 10.000	2.000	30.000	15.000	REFB 51.6000 IN.
						XMRP 59.3200 IN.
						YMRP 0.0000 IN.
						ZMRP 11.6000 IN.
						SCALE 4.0000 PERC

MACH 0.250

EFFECT OF SPEED BRAKE VERTICAL POSITION AND SIMULATED SLOT (BETA=0)

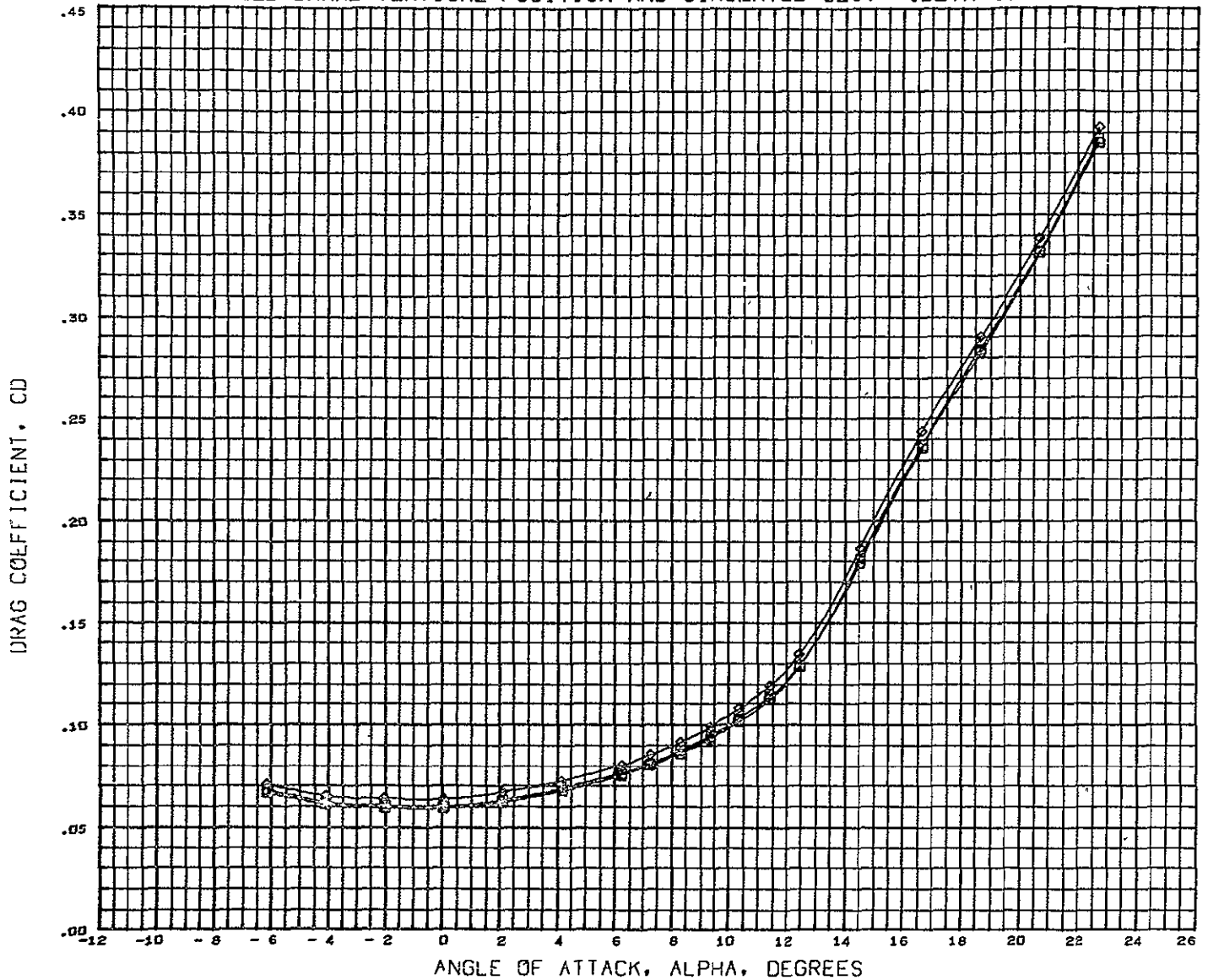

DATA SET SYMBOL	CONFIGURATION DESCRIPTION	ELEVTR	SBPOS	SPBRK	BFLAP	REFERENCE INFORMATION
(CCFD39)	LSWT 248 MDAC 4.0 FC 02 HCR ORB 85W11SB2	- 10.000	3.000	30.000	15.000	REFS 8 8690 SQ FT
(CCFD40)	LSWT 248 MDAC 4.0 FC 02 HCR ORB 85W11SB2	- 10.000	1.000	30.000	15.000	REFL 29 5700 IN.
(CCFD41)	LSWT 248 MDAC 4.0 FC 02 HCR ORB 85W11SB2	- 10.000	2.000	30.000	15.000	REFB 51.6000 IN. XMRP 59.3200 IN. YMRP 0.0000 IN. ZMRP 11.6000 IN. SCALE 4.0000 PERCENT

MACH 0.250



EFFECT OF SPEED BRAKE VERTICAL POSITION AND SIMULATED SLOT (BETA=0)

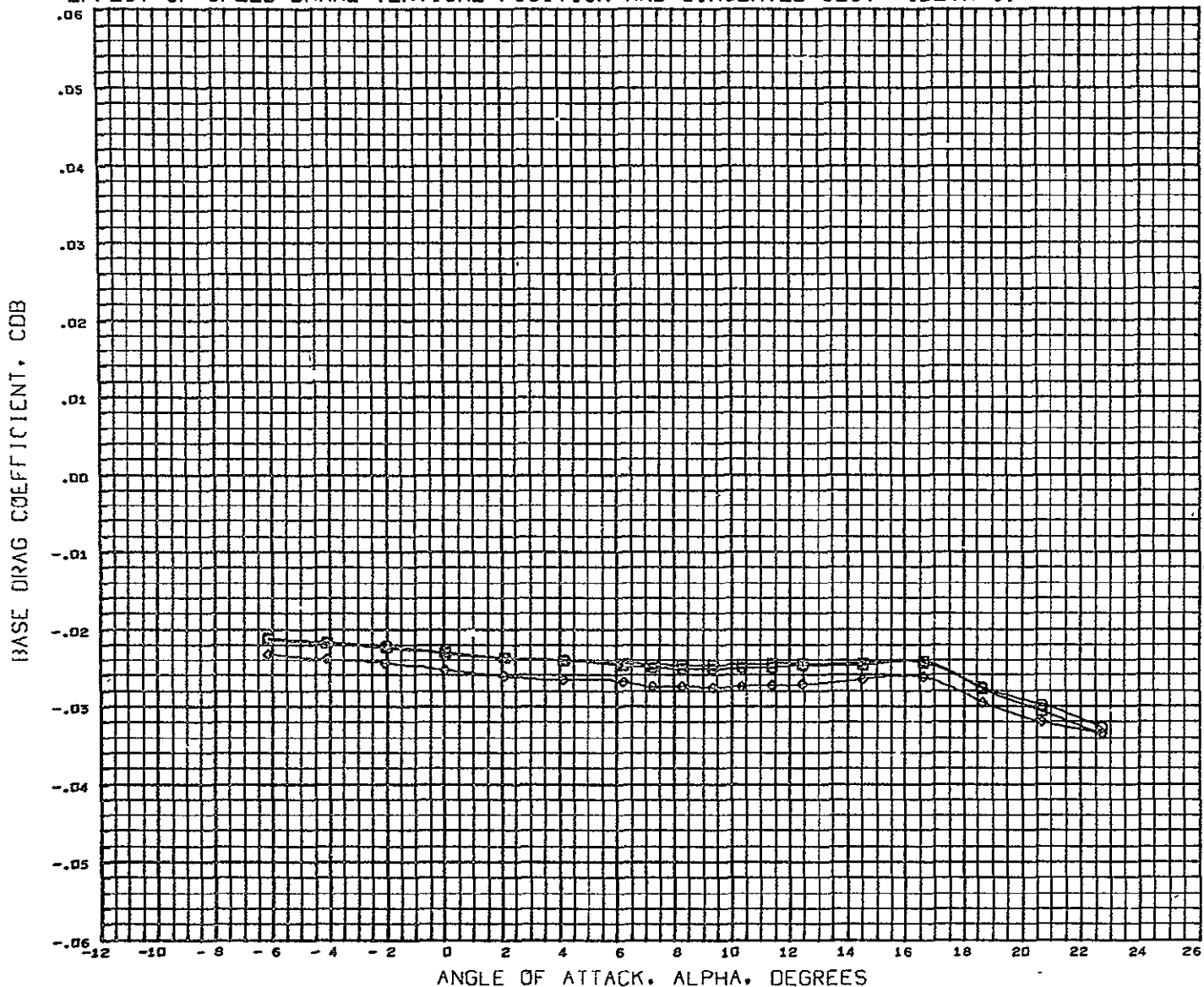

DATA SET SYMBOL	CONFIGURATION DESCRIPTION	ELEVTR	SBFOS	SPBRK	BFLAP	REFERENCE INFORMATION
(CCP039)	LSWT 248 MDAC 4.0 FC 02 HCR ORB B5W11SB2	-10.000	3.000	30.000	15.000	REFS 8.8690 SQ.FT.
(CCP040)	LSWT 248 MDAC 4.0 FC 02 HCR ORB B5W11SB2	-10.000	1.000	30.000	15.000	REFL 29.5700 IN.
(CCP041)	LSWT 248 MDAC 4.0 FC 02 HCR ORB B5W11SB2	-10.000	2.000	30.000	15.000	REFB 51.6000 IN.
						XMRP 59.3200 IN.
						YMRP 0.0000 IN.
						ZMRP 11.6000 IN.
						SCALE 4.0000 PERCNT

MACH 0.250

EFFECT OF SPEED BRAKE VERTICAL POSITION AND SIMULATED SLOT (BETA=0)

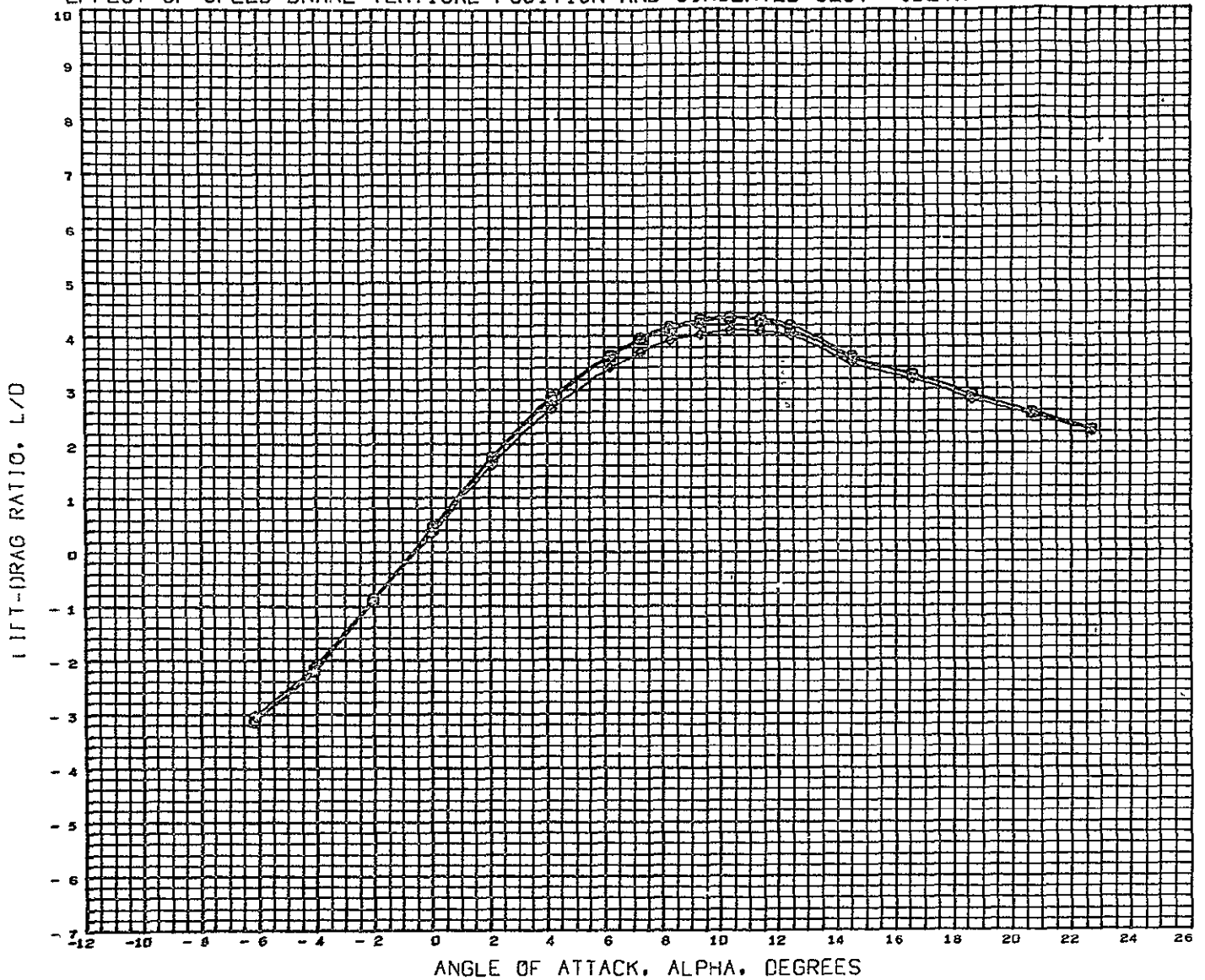

DATA SET SYMBOL	CONFIGURATION DESCRIPTION	ELEVTR	SBPOS	SPBRK	BFLAP	REFERENCE INFORMATION
(CCP039)	□ LSWT 248 MDAC 4.0 FC 02 HCR ORB B5W11SB2	- 10,000	3,000	30,000	15,000	REFS 8.8690 SQ.FT
(CCP040)	○ LSWT 248 MDAC 4.0 FC 02 HCR ORB B5W11SB2	- 10,000	1,000	30,000	15,000	REFL 29.5700 IN.
(CCP041)	◇ LSWT 248 MDAC 4.0 FC 02 HCR ORB B5W11SB2	- 10,000	2,000	30,000	15,000	REFB 51.6000 IN.
						XMRP 59.3200 IN.
						YMRP 0.0000 IN.
						ZMRP 11.6000 IN.
						SCALE 4.0000 PERCNT

MACH 0.259

EFFECT OF SPEED BRAKE VERTICAL POSITION AND SIMULATED SLOT (BETA=0)

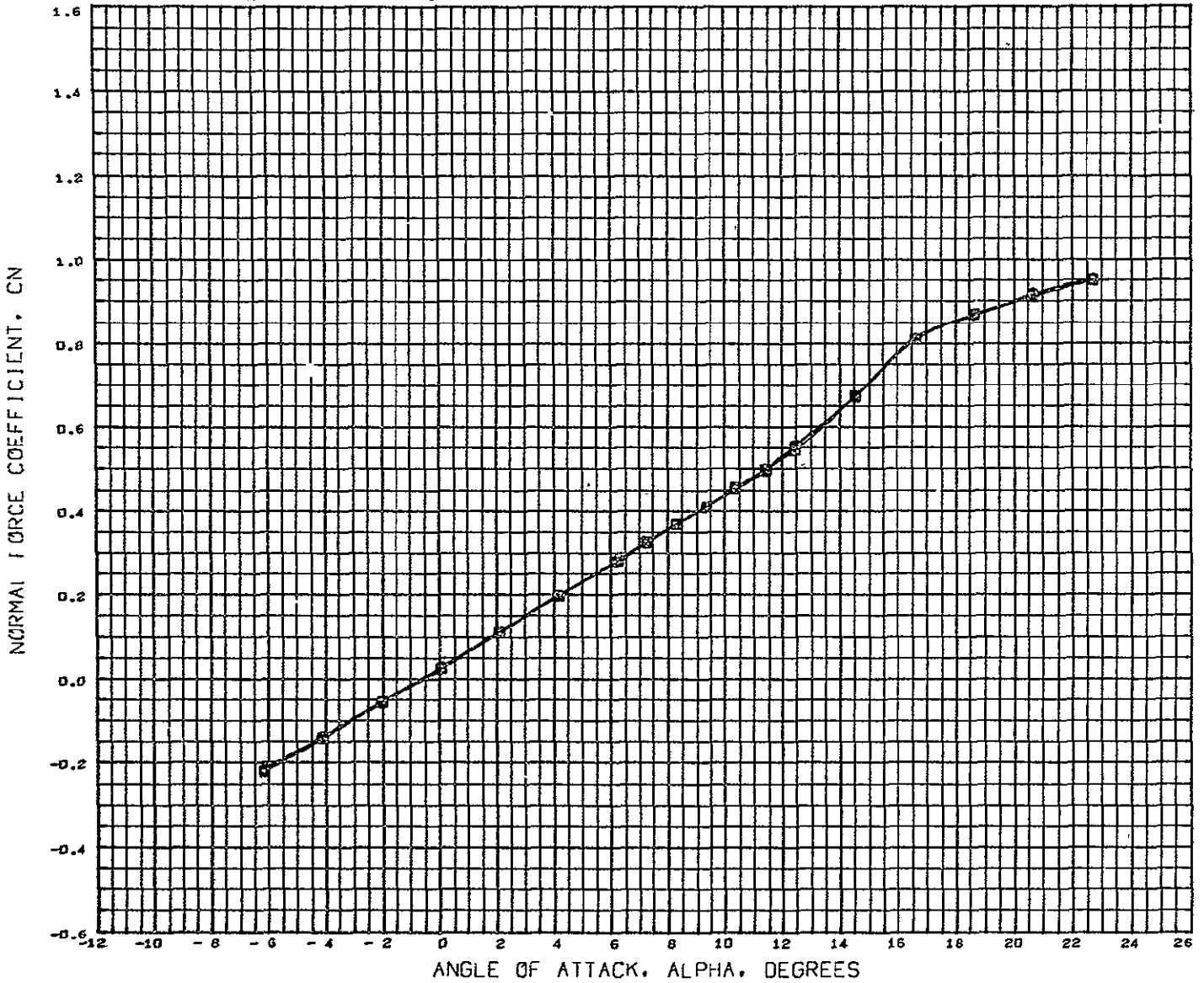

DATA SET	SYMBOL	CONFIGURATION DESCRIPTION	ELEVTR	SBPOS	SPBRK	BFLAP	REFERENCE INFORMATION
(BCPD39)	□	LSWT 248 MDAC 4.0 FC 02 HCR ORB B5W11SB2	- 10.000	3.000	30.000	15.000	REFS 8.8690 SQ.FT.
(BCPD40)	□	LSWT 248 MDAC 4.0 FC 02 HCR ORB B5W11SB2	- 10.000	1.000	30.000	15.000	REFL 29.5700 IN.
(BCPD41)	◇	LSWT 248 MDAC 4.0 FC 02 HCR ORB B5W11SB2	- 10.000	2.000	30.000	15.000	REFB 51.6000 IN.
							XMRP 59.3200 IN.
							YNRP 0.0000 IN.
							ZMRP 11.6000 IN.
							SCALE 4.0000 PERCENT

MACH 0.250

EFFECT OF SPEED BRAKE VERTICAL POSITION AND SIMULATED SLOT (BETA=0)

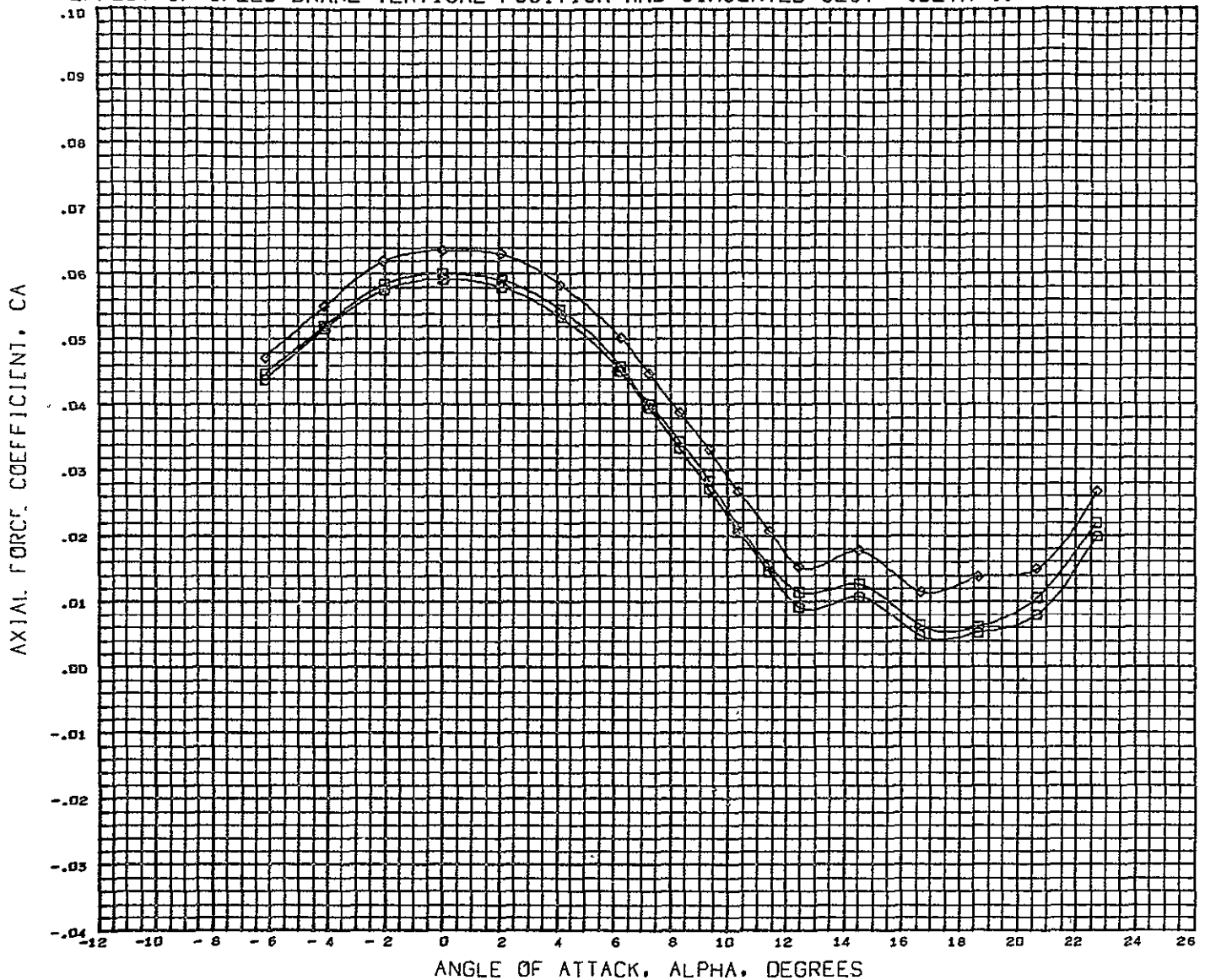

DATA SET SYMBOL	CONFIGURATION DESCRIPTION	ELEVTR	SBFOS	SPBRK	BFLAP	REFERENCE INFORMATION
(BCPD39)	LSWT 248 MDAC 4.0 FC 02 HCR ORB B5W11SB2	-10.000	3.000	30.000	15.000	REFS 8 8690 SQ FT.
(BCPD40)	LSWT 248 MDAC 4.0 FC 02 HCR ORB B5W11SB2	-10.000	1.000	30.000	15.000	REFL 29.5700 IN.
(BCPD41)	LSWT 248 MDAC 4.0 FC 02 HCR ORB B5W11SB2	-10.000	2.000	30.000	15.000	REFB 51.6000 IN.
						XMRP 59.3200 IN.
						YMRP 0.0000 IN.
						ZMRP 11.6000 IN.
						SCALE 4.0000 PERCNT

MACH 0.250

# EFFECT OF SPEED BRAKE VERTICAL POSITION AND SIMULATED SLOT (BETA=0)

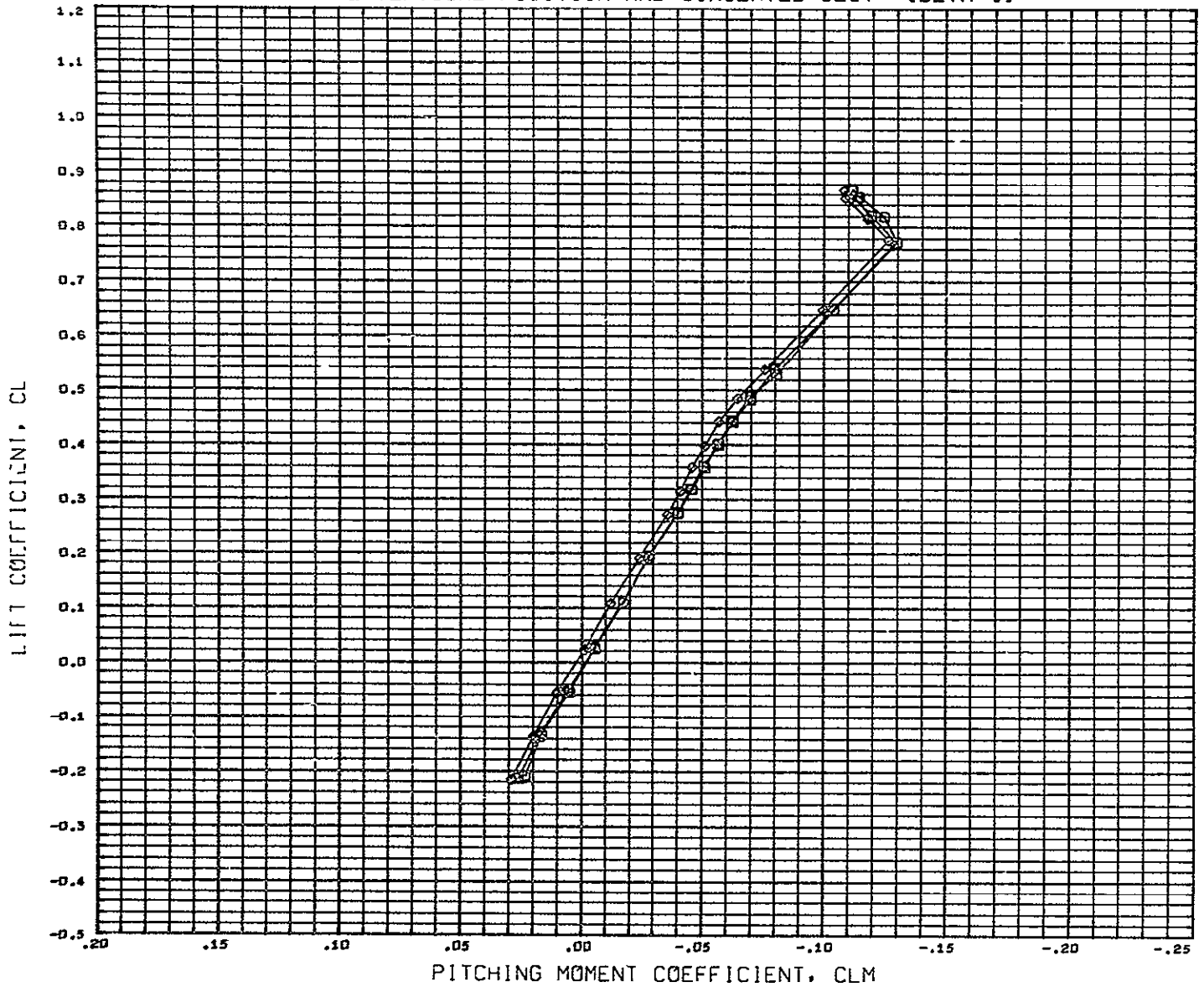

DATA SET SYMBOL	CONFIGURATION DESCRIPTION	ELEVTR	SBPOS	SPBRK	BFLAP	REFERENCE INFORMATION
(CCFD39)	□ LSWT 248 MDAC 4.0 FC 02 HCR ORB B5W11SB2	- 10.000	3.000	30.000	15.000	REFS 8.8690 SQ.FT
(CCFD40)	○ LSWT 248 MDAC 4.0 FC 02 HCR ORB B5W11SB2	- 10.000	1.000	30.000	15.000	REFL 29.5700 IN.
(CCFD41)	◇ LSWT 248 MDAC 4.0 FC 02 HCR ORB B5W11SB2	- 10.000	2.000	30.000	15.000	REFB 51.6000 IN.
						XMRP 59.3200 IN.
						YMRP 0.0000 IN.
						ZMRP 11.6000 IN.
						SCALE 4.0000 PERCNT

MACH 0.250

EFFECT OF SPEED BRAKE VERTICAL POSITION AND SIMULATED SLOT (BETA=0)

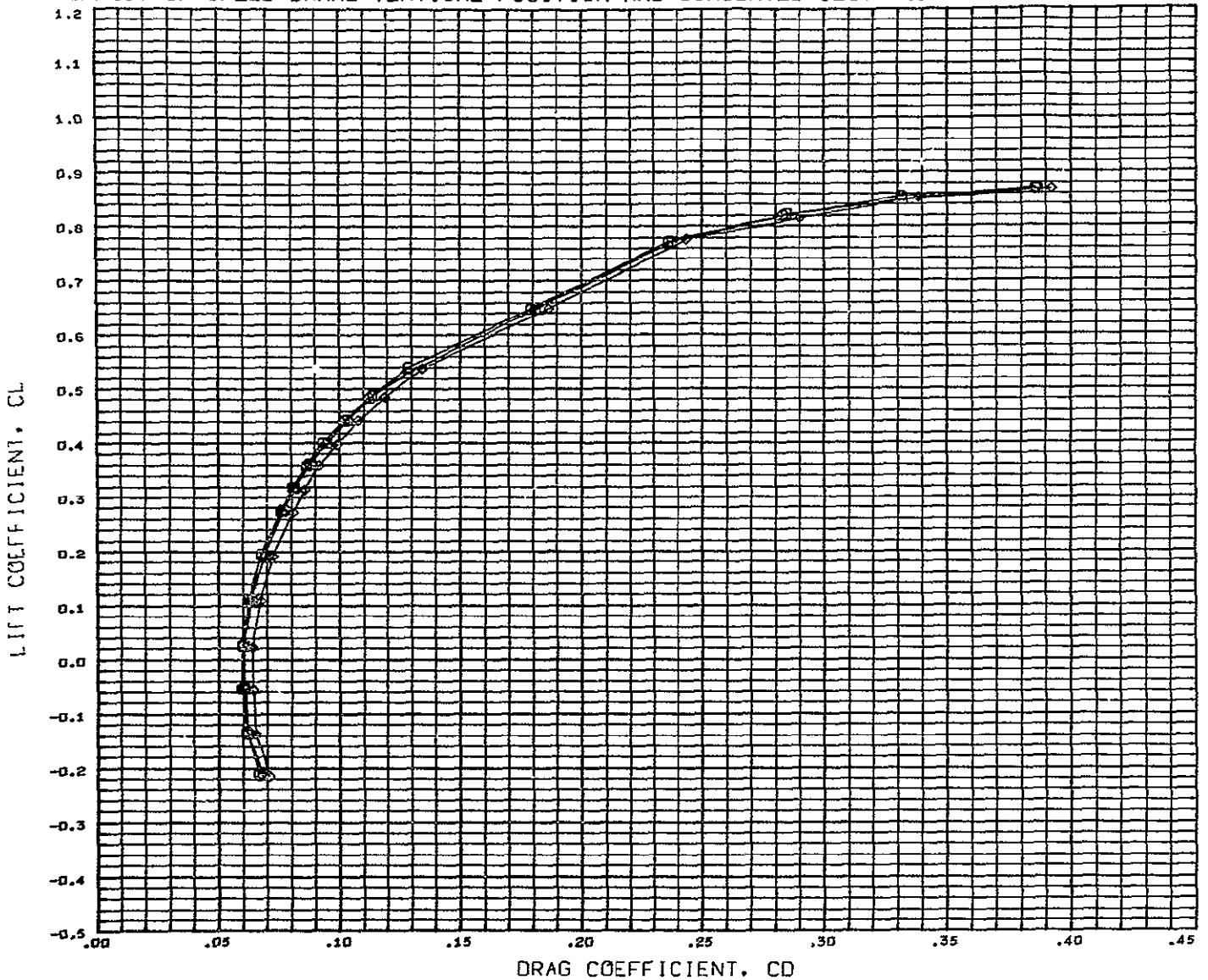

DATA SET SYMBOL	SYMBOL	CONFIGURATION DESCRIPTION	ELEVTR	SBPOS	SFBRK	BFLAP	REFERENCE INFORMATION	
(CCP039)	□	LSWT 248 HDAC 4.0 FC 02 HCR ORB	B5W115B2	- 10.000	3 000	30.000	15.000	REFS 8.8690 SQ.FT.
(CCP040)	□	LSWT 248 HDAC 4.0 FC 02 HCR ORB	B5W115B2	- 10.000	1.000	30.000	15.000	REFL 29.5700 IN.
(CCP041)	□	LSWT 248 HDAC 4.0 FC 02 HCR ORB	B5W115B2	- 10.000	2.000	30.000	15.000	REFB 51.6000 IN.
								XMRP 59.3200 IN.
								YMRP 0.0000 IN.
								ZMRP 11.6000 IN.
								SCALE 4.0000 PERCENT

KACH 0.250

EFFECT OF SPEED BRAKE VERTICAL POSITION AND SIMULATED SLOT (BETA=0)

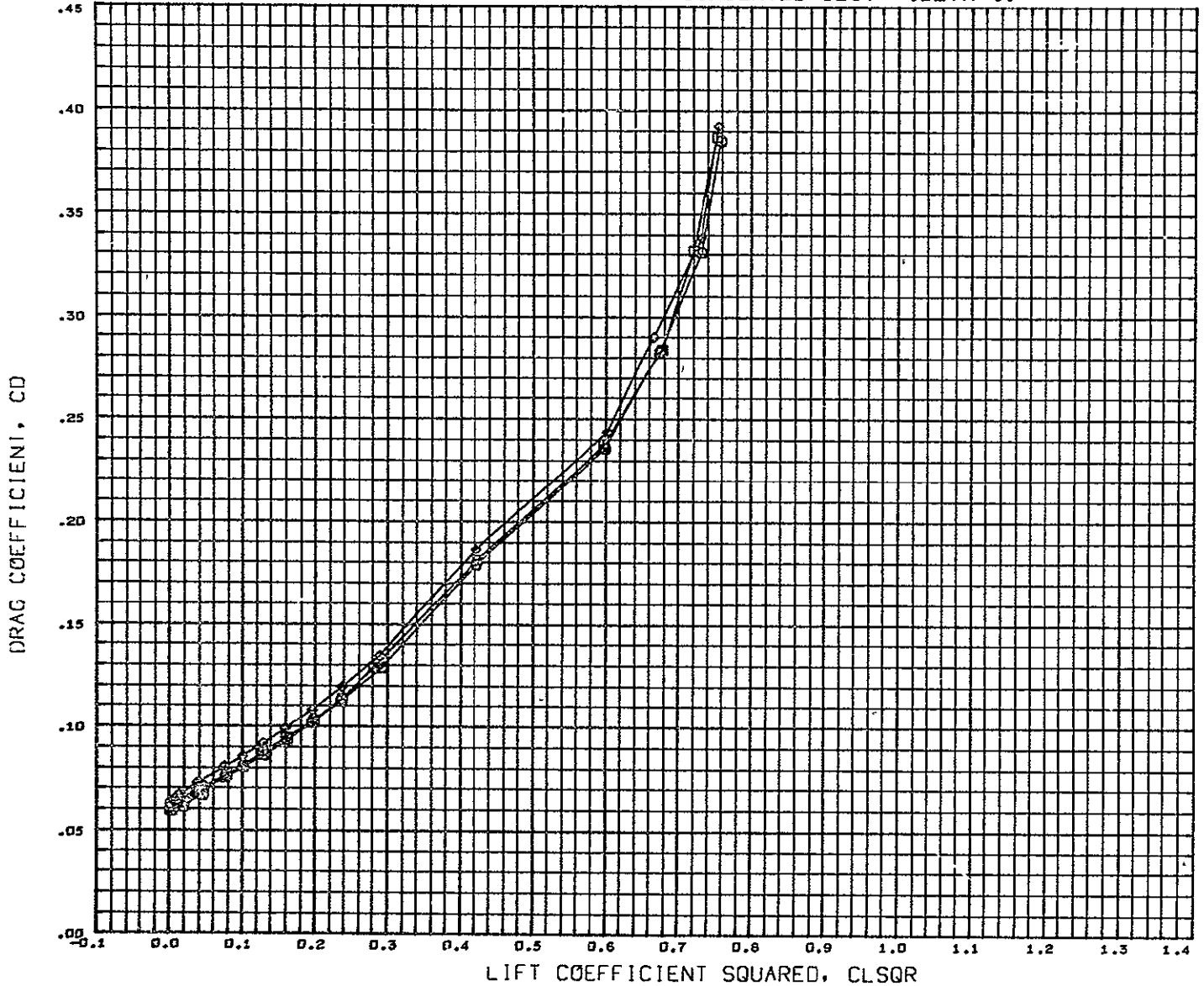

DATA SET SYMBOL	CONFIGURATION DESCRIPTION	ELEVTR	SBPOS	SPBRK	BFLAP	REFERENCE INFORMATION
(CCFD39)	□ LSMT 248 MDAC 4.0 FC O2 HCR ORB B5W11SB2	- 10.00J	3.000	30.000	15.000	REFS 8.8690 SQ FT.
(CCFD40)	◇ LSMT 248 MDAC 4.0 FC O2 HCR ORB B5W11SB2	- 10.000	1.000	30.000	15.000	REFL 29.5700 IN.
(CCFD41)	○ LSMT 248 MDAC 4.0 FC O2 HCR ORB B5W11SB2	- 10.000	2.000	30.000	15.000	REFB 51.6000 IN.
						XMRP 59.3200 IN.
						YMRP 0.0000 IN.
						ZMRP 11.6000 IN.
						SCALE 4.0000 PERCENT

MACH 0.250

EFFECT OF SPEED BRAKE VERTICAL POSITION AND SIMULATED SLOT (BETA=0)

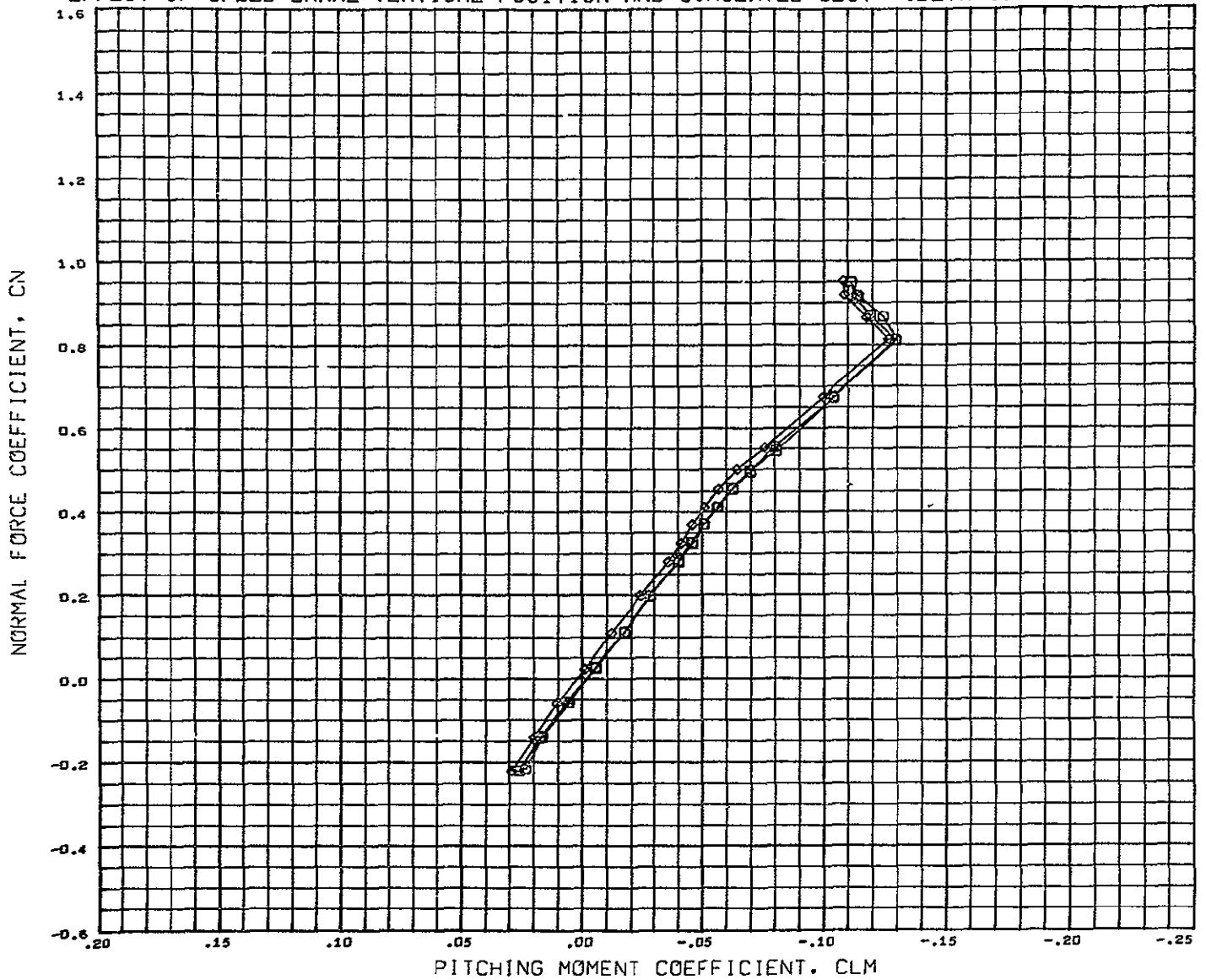

DATA SET	SYMBOL	CONFIGURATION DESCRIPTION	ELEVTR	SBPOS	SPBRK	BFLAP	REFERENCE INFORMATION	
(BCF039)	□	LSWT 248 MDAC 4.0 FC 02 HCR ORB	85W11SB2	- 10.000	3.000	30.000	15.000	REFS 8.8690 SQ FT.
(BCF040)	○	LSWT 248 MDAC 4.0 FC 02 HCR ORB	85W11SB2	- 10.000	1.000	30.000	15.000	REFL 29.5700 IN.
(BCF041)	◇	LSWT 246 MDAC 4.0 FC 02 HCR ORB	85W11SB2	- 10.000	2.000	30.000	15.000	REFB 51.6000 IN.
								XMRP 59.3200 IN.
								YMRP 0.0000 IN.
								ZMRP 11.6000 IN.
								SCALE 4.0000 PERCENT

MACH 0.250



SPEEDBRAKE EFFECTIVENESS BODY FLAP DEFLECTION= 0 DEGREES (BETA=0)

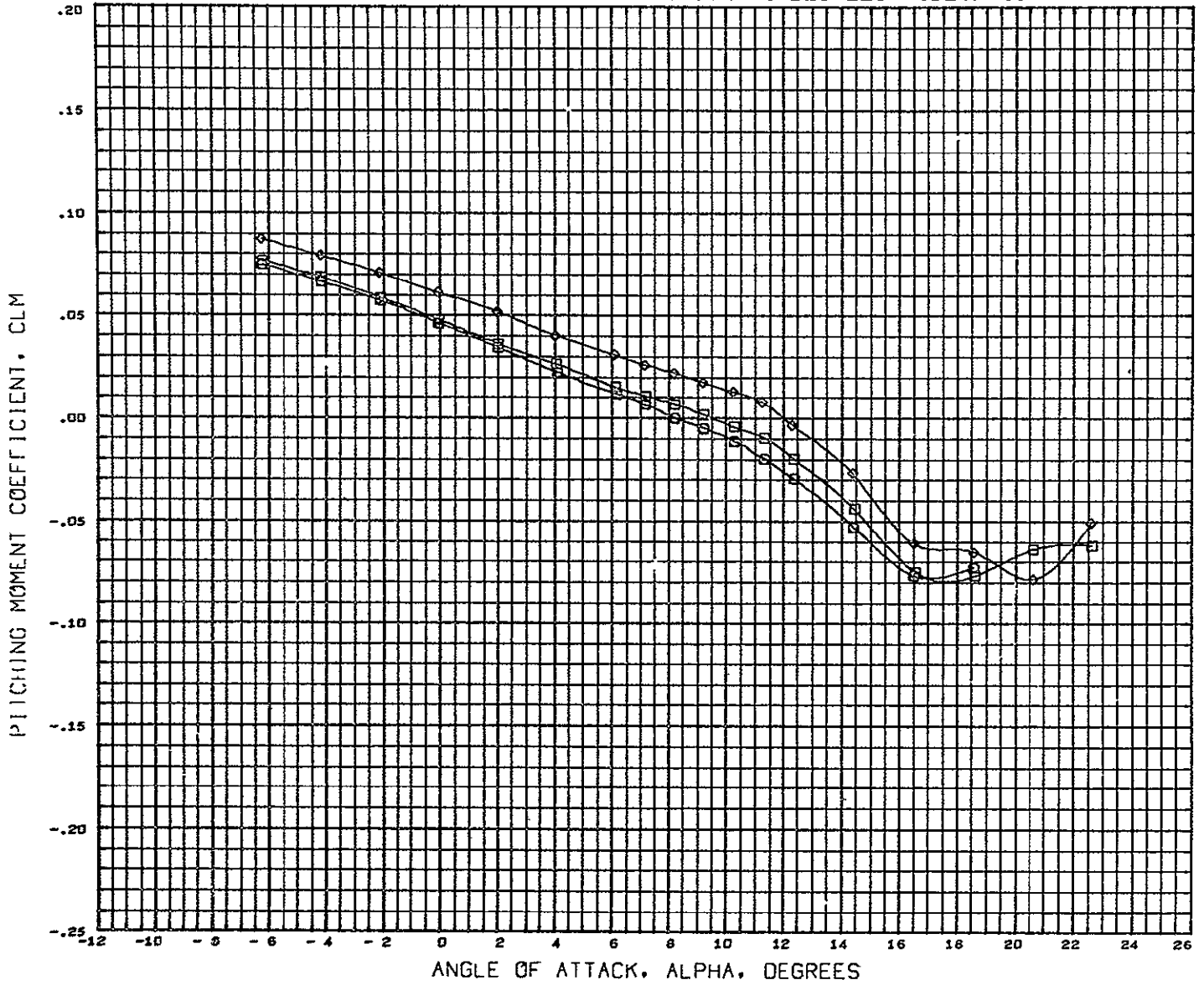

DATA SET SYMBOL	CONFIGURATION DESCRIPTION	ELEVTR	SBPOS	SPBRK	BFLAP	REFERENCE INFORMATION
(CCP012)	LSWT 248 HDAC 4.0 FC 02 HCR ORB B5W11V6	-10.000	0.000	0.000	0.000	REFS 8 8690 SQ.FT.
(CCP044)	LSWT 248 HDAC 4.0 FC 02 HCR ORB B5W11SB2	-10.000	3.000	30.000	0.000	REFL 29 5700 IN.
(CCP045)	LSWT 248 HDAC 4.0 FC 02 HCR ORB B5W11SB2	-10.000	3.000	60.000	0.000	REFB 51.6000 IN. XMRP 59.3200 IN. YMRP 0.0000 IN. ZMRP 11.6000 IN. SCALE 4.0000 PERCNT

MACH 0.250

SPEEDBRAKE EFFECTIVENESS BODY FLAP DEFLECTION= 0 DEGREES (BETA=0)

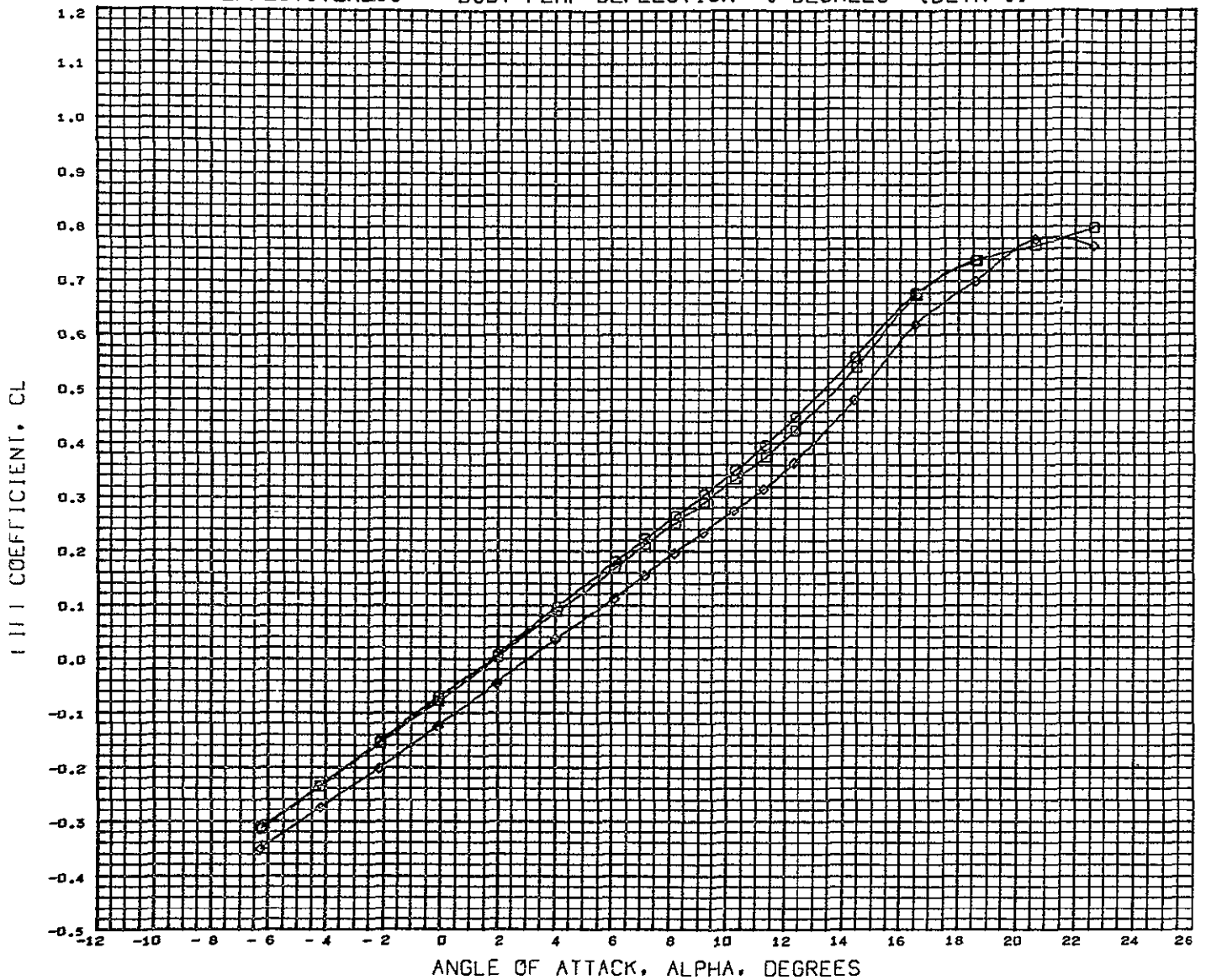

DATA SET SYMBOL	CONFIGURATION DESCRIPTION	ELEVTR	SBPOS	SPBRK	BFLAP	REFERENCE INFORMATION
(CCP012)	LSWT 248 MDAC 4.0 FC 02 HCR ORB B5W11V6	- 10.000		0.000	0.000	REFS 8.8690 SQ.FT
(CCP044)	LSWT 248 MDAC 4.0 FC 02 HCR ORB B5W11SB2	- 10.000	3.000	30.000	0.000	REFL 29.5700 IN.
(CCP045)	LSWT 248 MDAC 4.0 FC 02 HCR ORB B5W11SB2	- 10.000	3.000	60.000	0.000	REFB 51.6000 IN.
						XMRP 59.3200 IN.
						YMRP 0.0000 IN.
						ZMRP 11.6000 IN.
						SCALE 4.0000 PERCNT

MACH 0.250

SPEEDBRAKE EFFECTIVENESS BODY FLAP DEFLECTION= 0 DEGREES (BETA=0)

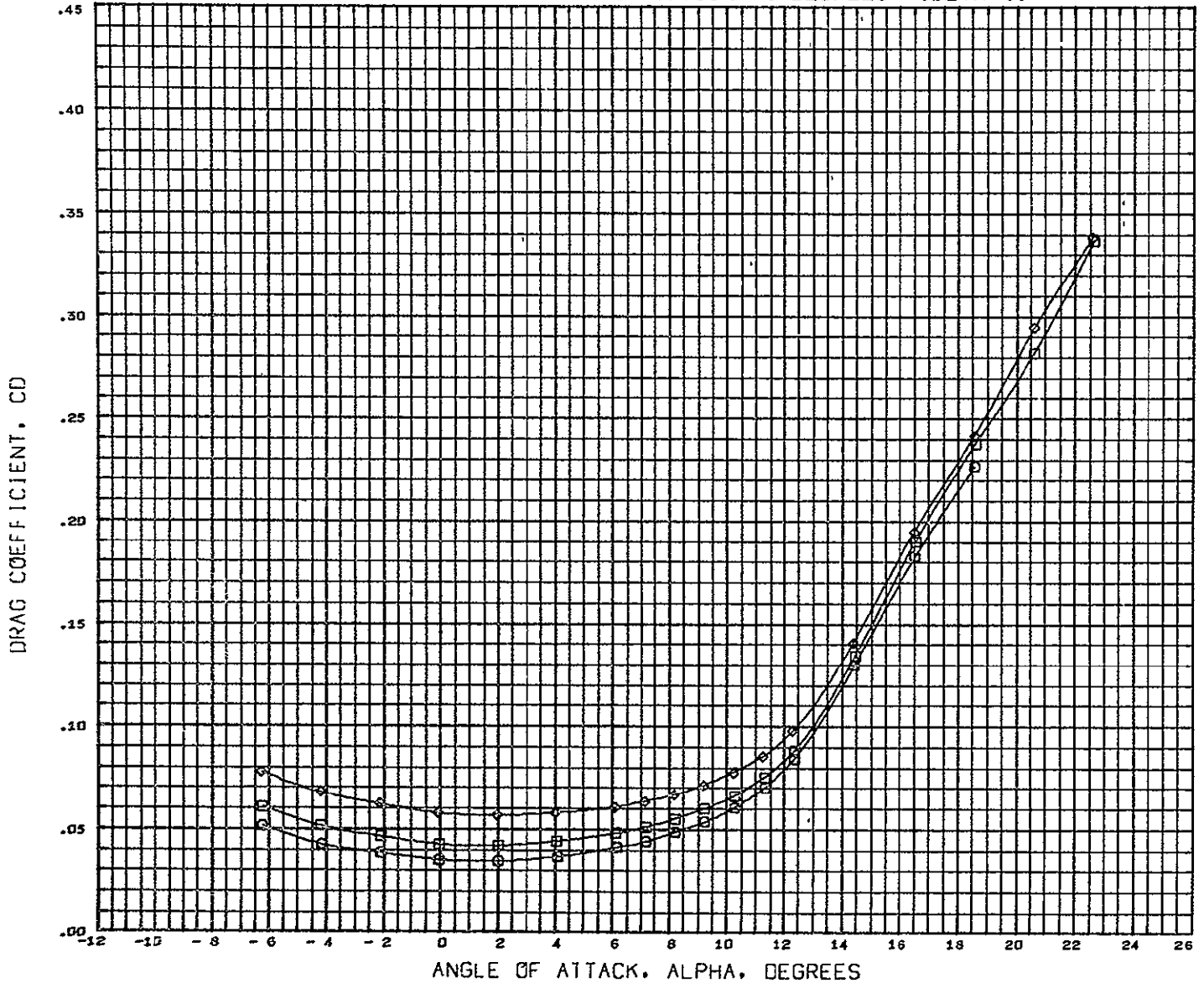

DATA SET SYMBOL	CONFIGURATION DESCRIPTION	ELEVTR	SBFOS	SPBRK	BFLAP	REFERENCE INFORMATION
(CCF012) □	LSWT 248 MDAC 4.0 FC 02 HCR ORB B5W11V6	- 10.000		0.000	0.000	REFS 8.8690 SQ.FT.
(CCF044) □	LSWT 248 MDAC 4.0 FC 02 HCR ORB B5W11SB2	- 10.000	3.000	30.000	0.000	REFL 29.5700 IN.
(CCF045) ◇	LSWT 248 MDAC 4.0 FC 02 HCR ORB B5W11SB2	- 10.000	3.000	60.000	0.000	REFB 51.6000 IN. XMRP 59.3200 IN. YMRP 0.0000 IN. ZMRP 11.6000 IN. SCALE 4.0000 PERCNT

MACH 0.250

SPEEDBRAKE EFFECTIVENESS BODY FLAP DEFLECTION= 0 DEGREES (BETA=0)

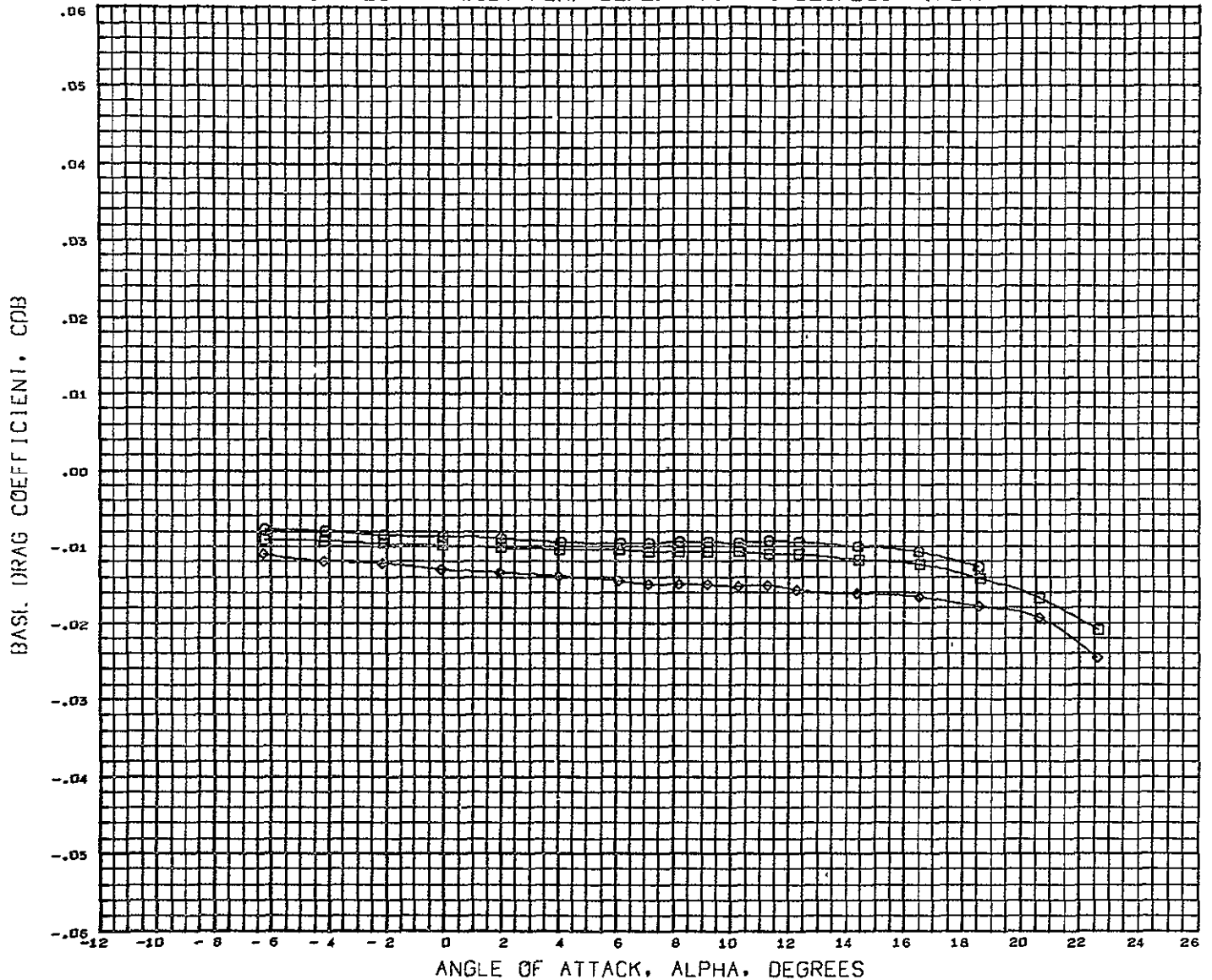

DATA SET SYMBOL	CONFIGURATION DESCRIPTION	ELEVTR	SBPOS	SPBRK	DFLAP	REFERENCE INFORMATION
(CCFD12)	LSWT 248 MDAC 4.0 FC 02 HCR ORB B5W11V6	- 10.000		0.000	0.000	REFS 8.8690 SQ.FT
(CCFD44)	LSWT 248 MDAC 4.0 FC 02 HCR ORB B5W11SB2	- 10.000	3.000	30.000	0.000	REFL 29.5700 IN.
(CCFD45)	LSWT 248 MDAC 4.0 FC 02 HCR ORB B5W11SB2	- 10.000	3.000	60.000	0.000	REFB 51.6000 IN.
						XHRF 59.3200 IN.
						YHRF 0.0000 IN.
						ZHRF 11.6000 IN.
						SCALE 4.0000 PERCNT

MACH 0.250

SPEEDBRAKE EFFECTIVENESS BODY FLAP DEFLECTION= 0 DEGREES (BETA=0)

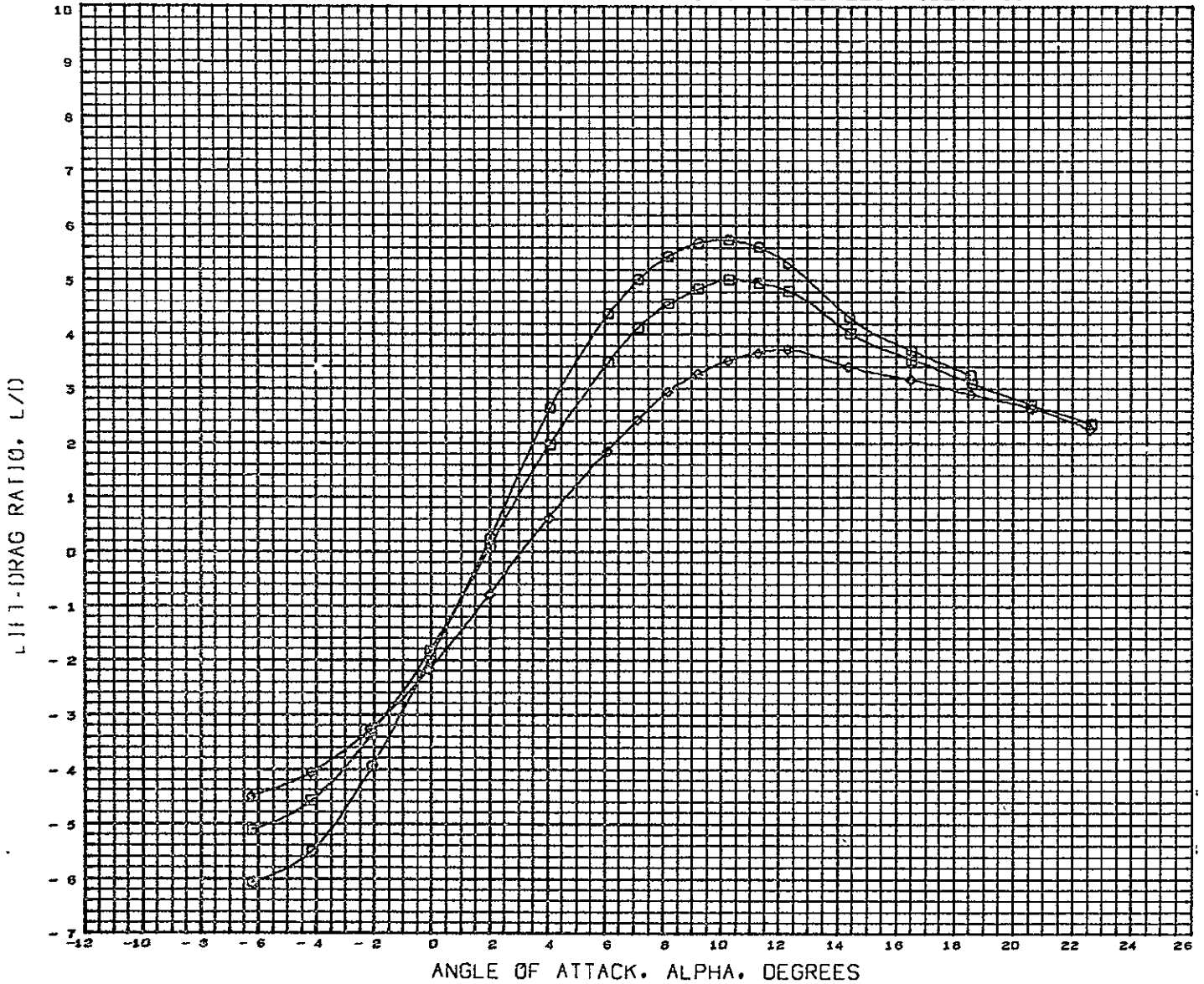

DATA SET SYMBOL	CONFIGURATION DESCRIPTION	ELEVTR	SBFOS	SPBRK	BFLAP	REFERENCE INFORMATION
(CCP012)	LSWT 248 NDAC 4.0 FC 02 HCR ORB B5W11V6	- 10,000		0,000	0,000	REFS 8.8690 SQ.FT.
(CCP042)	LSWT 248 NDAC 4.0 FC 02 HCR ORB B5W11SB2	- 10,000	3,000	30,000	0,000	REFL 29.5700 IN
(CCP045)	LSWT 248 NDAC 4.0 FC 02 HCR ORB B5W11SB2	- 10,000	3,000	60,000	0,000	REFB 51.6000 IN
						XMRP 59.3200 IN
						YMRP 0.0000 IN.
						ZMRP 11.6000 IN.
						SCALE 4.0000 PERCNT

MACH 0.250

SPEEDBRAKE EFFECTIVENESS BODY FLAP DEFLECTION= 0 DEGREES (BETA=0)

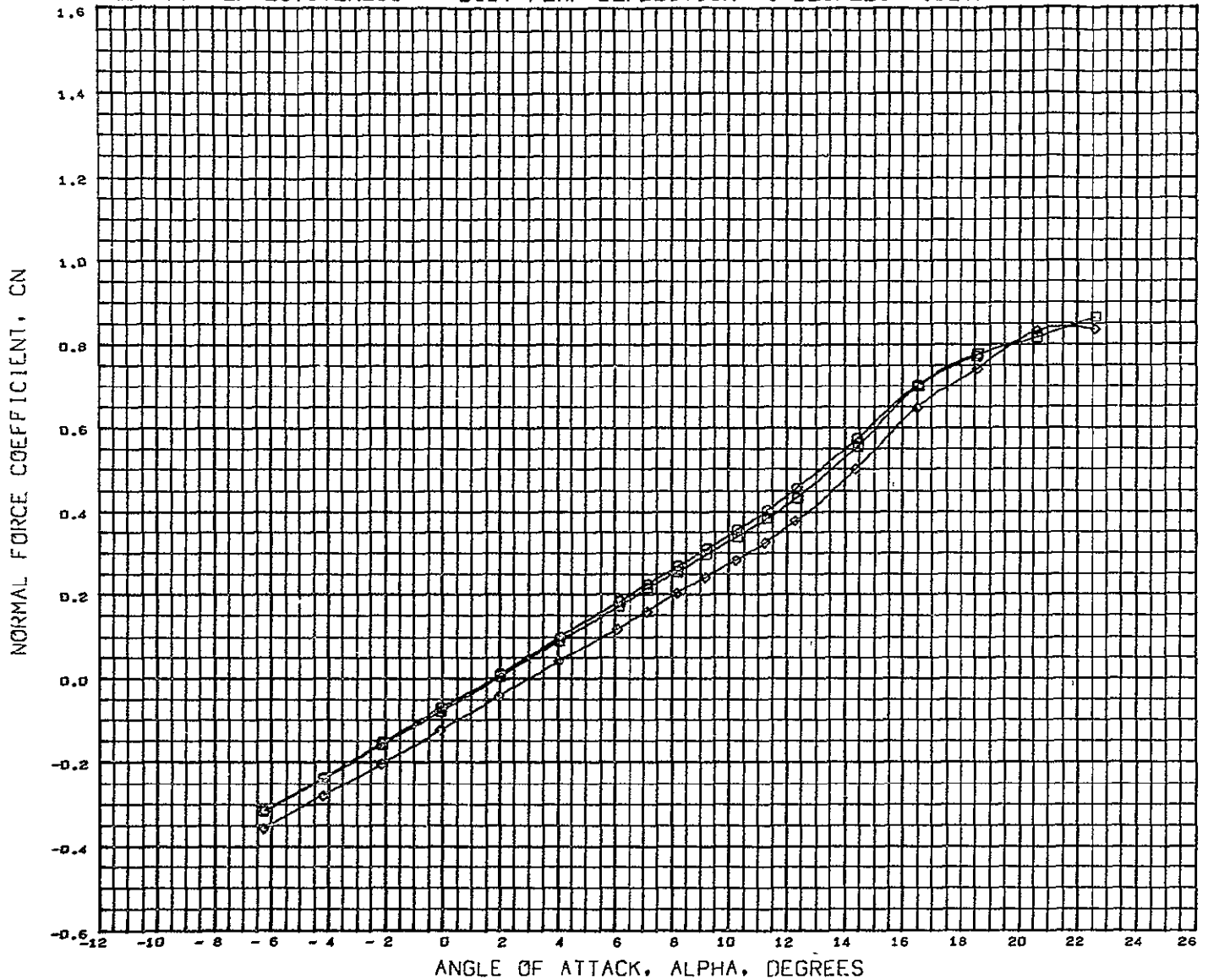

DATA SET SYMBOL	SYMBOL	CONFIGURATION DESCRIPTION	ELEVTR	SBPOS	SPBRK	BFLAP	REFERENCE INFORMATION
(8CFD12)	○	LSWT 248 HDAC 4.0 PC 02 HCR ORB B5W11V6	- 10.000		0.000	0.000	REFS 8 8690 SQ.FT
(8CFD44)	□	LSWT 248 HDAC 4.0 PC 02 HCR ORB B5W11SB2	- 10.000	3.000	30.000	0.000	REFL 29.5700 IN.
(8CFD45)	△	LSWT 248 HDAC 4.0 PC 02 HCR ORB B5W11SB2	- 10.000	3.000	60.000	0.000	REFB 51.6000 IN. XMRP 59.3200 IN. YMRP 0.0000 IN. ZMRP 11.6000 IN. SCALE 4.0000 IN PERCNT

MACH 0.250

SPEEDBRAKE EFFECTIVENESS BODY FLAP DEFLECTION= 0 DEGREES (BETA=0)

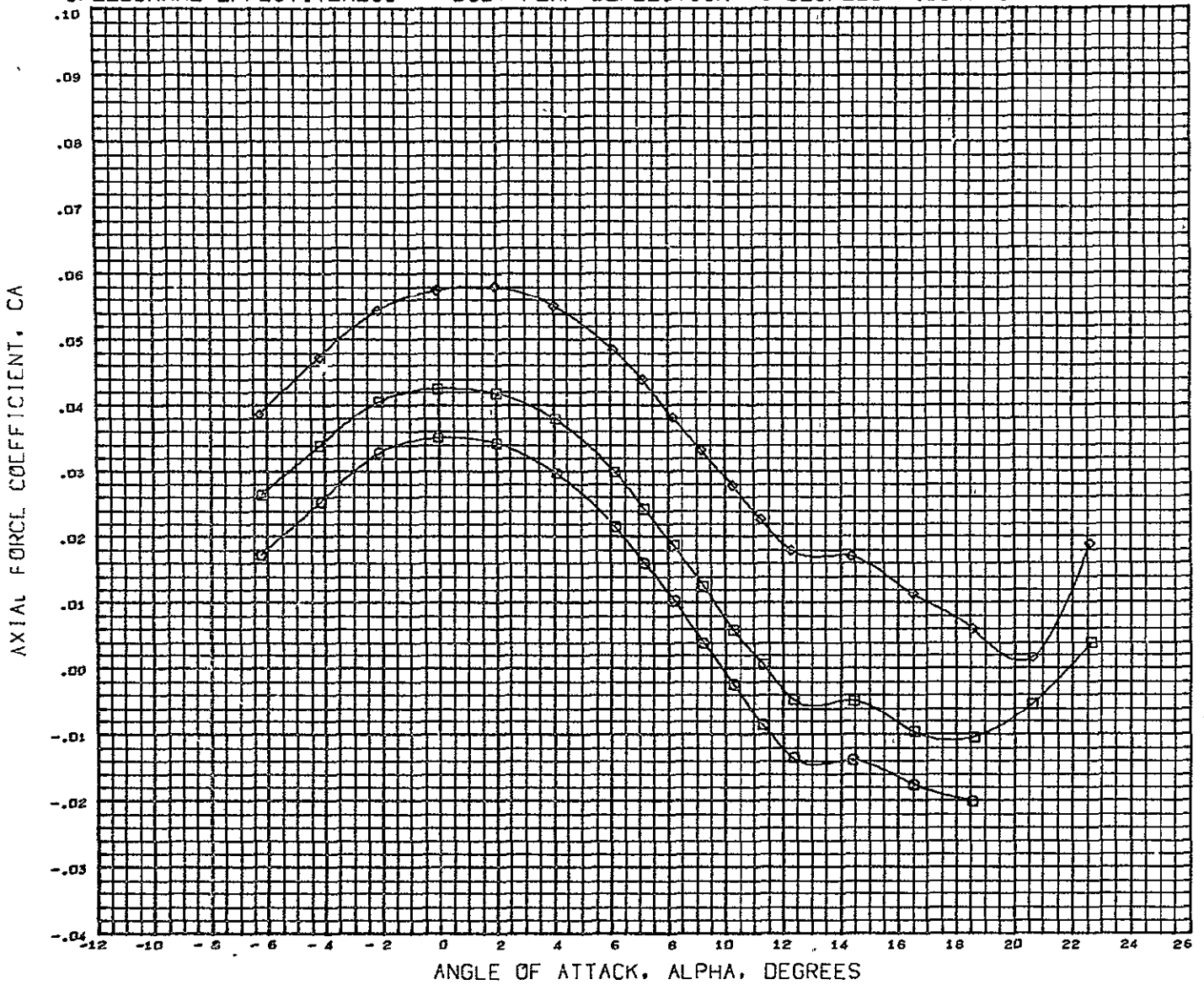

DATA SET SYMBOL	SYMBOL	CONFIGURATION DESCRIPTION	ELEVTR	SBPOS	SPBRK	BFLAP	REFERENCE INFORMATION
(BCF012)	□	LSWT 248 MDAC 4.0 FC O2 HCR ORB B5W11V6	- 10.000		0.000	0.000	REFS 8.8690 SQ.FT.
(BCF044)	○	LSWT 248 MDAC 4.0 FC O2 HCR ORB B5W11SB2	- 10.000	3.000	30.000	0.000	REFL 29.5700 IN.
(BCF045)	◇	LSWT 248 MDAC 4.0 FC O2 HCR ORB B5W11SB2	- 10.000	3.000	60.000	0.000	REF6 51.6000 IN.
							XMRP 59.3200 IN.
							YMRP 0.0000 IN.
							ZMRP 11.6000 IN.
							SCALE 4.0000 PERCENT

HACH 0.250

SPEEDBRAKE EFFECTIVENESS BODY FLAP DEFLECTION= 0 DEGREES (BETA=0)

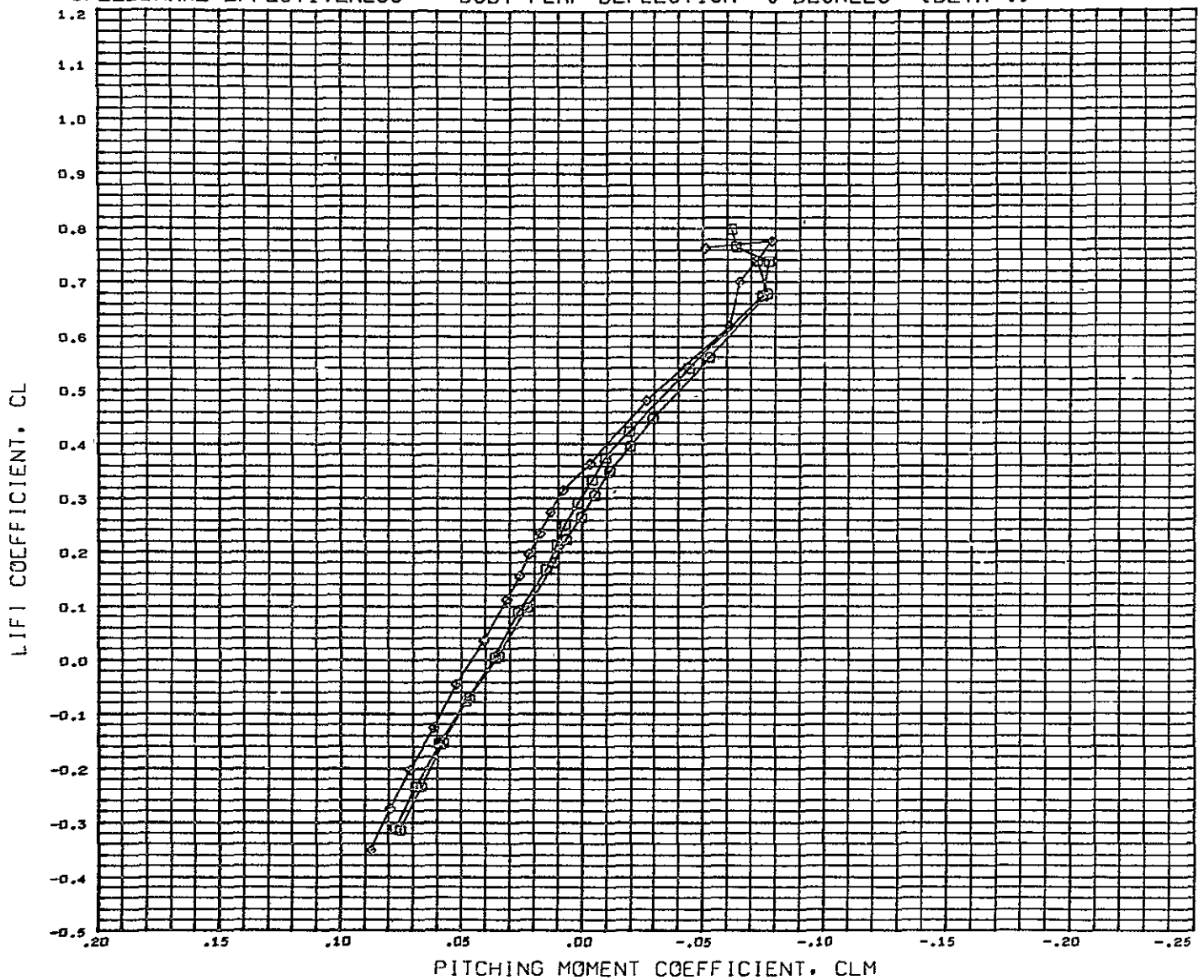

DATA SET SYMBOL	CONFIGURATION DESCRIPTION	ELEVTR	SBPOS	SFBRK	BFLAP	REFERENCE INFORMATION
(CCPD12)	□ LSWT 248 HDAC 4.0 FC 02 HCR ORB B5W11V6	- 10.000		0.000	0.000	REFS 8.8690 SQ FT.
(CCPD44)	□ LSWT 248 HDAC 4.0 FC 02 HCR ORB B5W11S82	- 10.000	3.000	30.000	0.000	REFL 29.5700 IN.
(CCPD45)	◇ LSWT 248 HDAC 4.0 FC 02 HCR ORB B5W11S82	- 10.000	3.000	60.000	0.000	REFB 51.6000 IN. XMRP 59.3200 IN. YMRP 0.0000 IN. ZMRP 11.6000 IN. SCALE 4.0000 PERCNT

MACH 0.250



SPEEDBRAKE EFFECTIVENESS BODY FLAP DEFLECTION= 0 DEGREES (BETA=0)

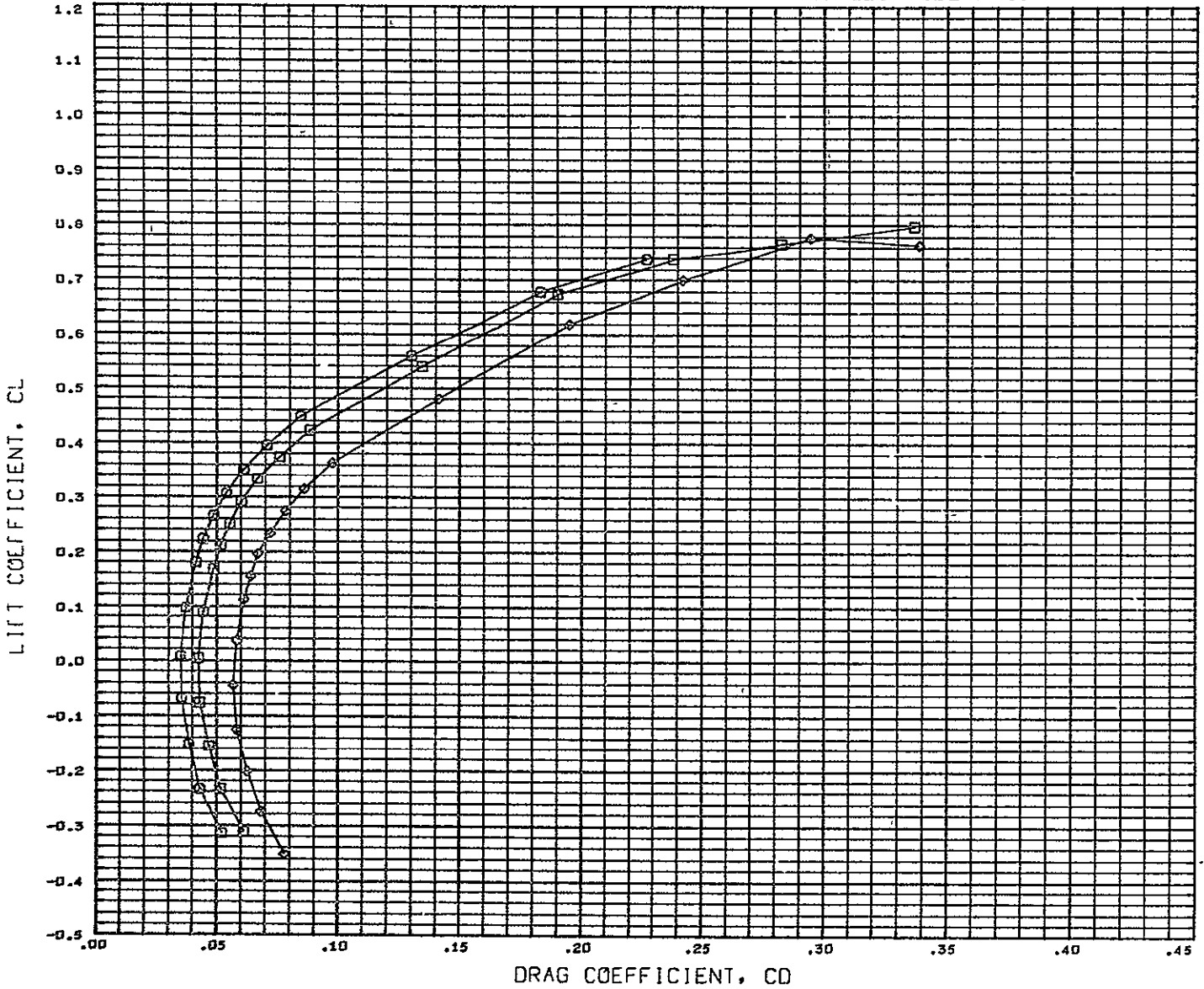

DATA SET SYMBOL	CONFIGURATION DESCRIPTION	ELEVTR	SBPOS	SPBRK	BFLAP	REFERENCE INFORMATION
(CCPD12)	LSWT 248 HDAC 4.0 FC O2 HCR ORB	B5W11V6	- 10.000	0.000	0.000	REFS 8.8690 sq FT
(CCPD44)	LSWT 248 HDAC 4.0 FC O2 HCR ORB	B5W11SB2	- 10.000	3.000	0.000	REFL 29.5700 IN.
(CCPD45)	LSWT 248 HDAC 4.0 FC O2 HCR ORB	B5W11SB2	- 10.000	3.000	60.000	REFB 51.6000 IN.
						XMRP 59.3200 IN.
						YMRP 0.0000 IN.
						ZMRP 11.6000 IN.
						SCALE 4.0000 PERCENT

MACH 0.250

SPEEDBRAKE EFFECTIVENESS BODY FLAP DEFLECTION= 0 DEGREES (BETA=0)

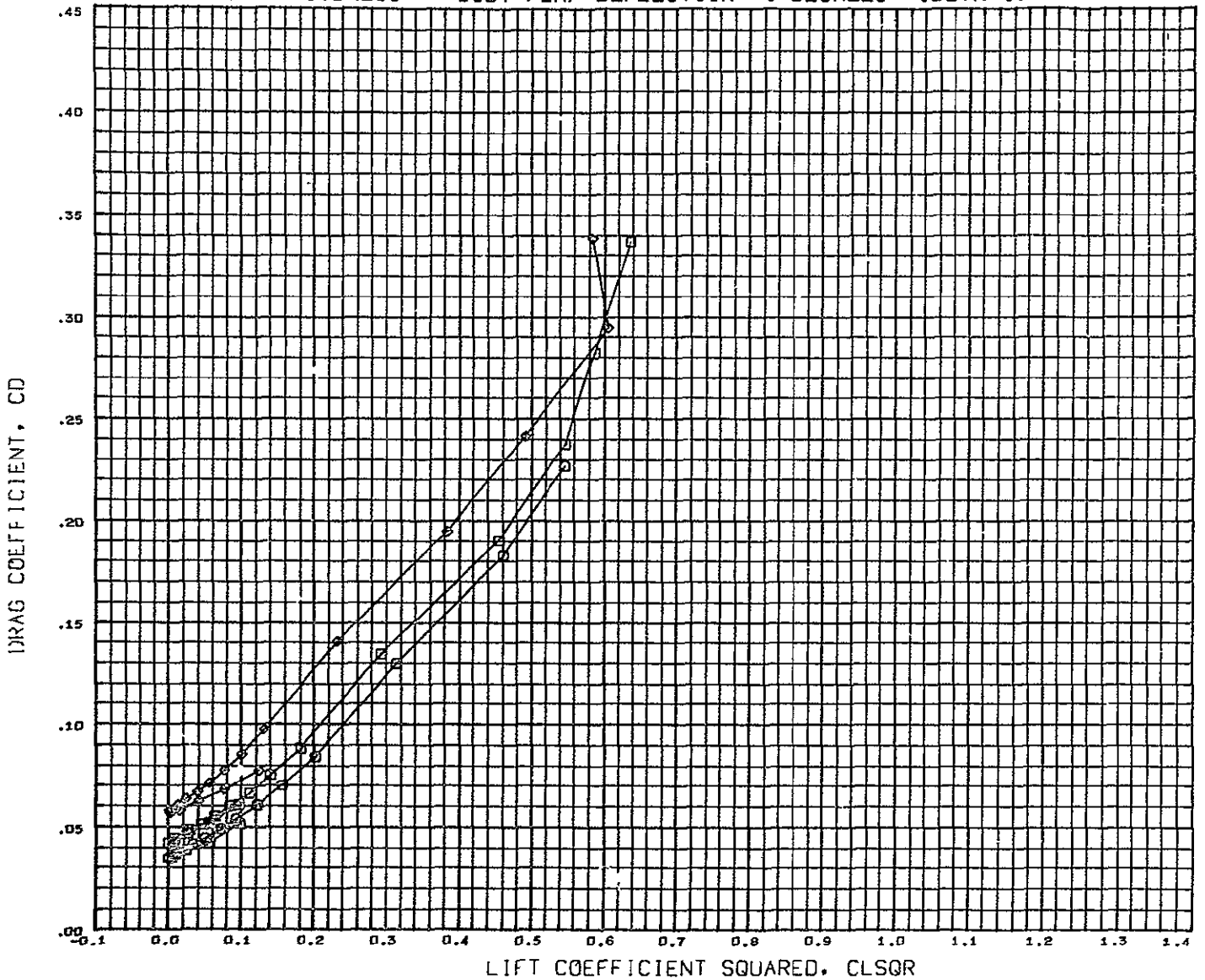

DATA SET SYMBOL	CONFIGURATION DESCRIPTION	ELEVTR	SBFOS	SPBRK	BFLAP	REFERENCE INFORMATION
(CCFB12)	LSWT 248 HDAC 4.0 FC 02 HCR ORB B5W11V6	- 10.000		0.000	0.000	REFS 8.8690 SQ FT
(CCFB44)	LSWT 248 HDAC 4.0 FC 02 HCR ORB B5W11S02	- 10.000	3.000	30.000	0.000	REFL 29.5700 IN.
(CCFB45)	LSWT 248 HDAC 4.0 FC 02 HCR ORB B5W11S02	- 10.000	3.000	60.000	0.000	REFB 51.6000 IN.
						XMRP 59.3200 IN.
						YMRP 0.0000 IN.
						ZMRP 11.6000 IN.
						SCALE 4.0000 PERCENT

MACH 0.250

SPEEDBRAKE EFFECTIVENESS BODY FLAP DEFLECTION= 0 DEGREES (BETA=0)

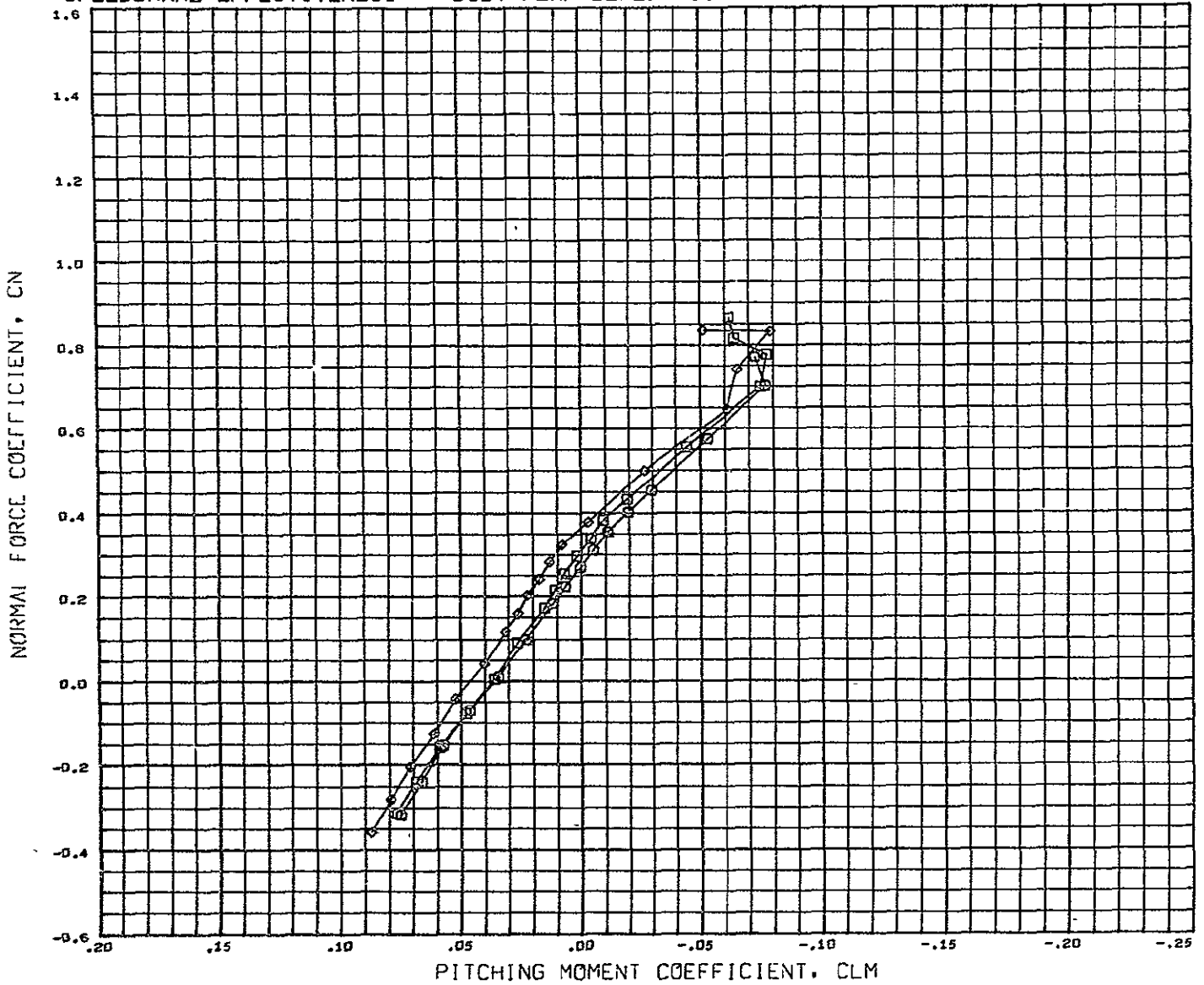

DATA SET SYMBOL	CONFIGURATION DESCRIPTION	ELEVTR	SBPOS	SPBRK	BFLAP	REFERENCE INFORMATION
(BCF012)	LSWT 248 MDAC 4.0 FC O2 HCR ORB 85W11V6	- 10.00J		0.000	0.000	REFS 8.8690 SQ.FT.
(BCF044)	LSWT 248 MDAC 4.0 FC O2 HCR ORB 85W11SB2	- 10.000	3.000	30.000	0.000	REFL 29.5700 IN.
(BCF045)	LSWT 248 MDAC 4.0 FC O2 HCR ORB 85W11SB2	- 10.000	3.000	60.000	0.000	REFB 51.8000 IN. XMRP 59.3200 IN. YMRP 0.0000 IN. ZMRP 11.6000 IN. SCALE 4.0000 PERCNT

MACH 0.250

SPEEDBRAKE EFFECTIVENESS BODY FLAP DEFLECTION= 15 DEGREES (BETA=0)

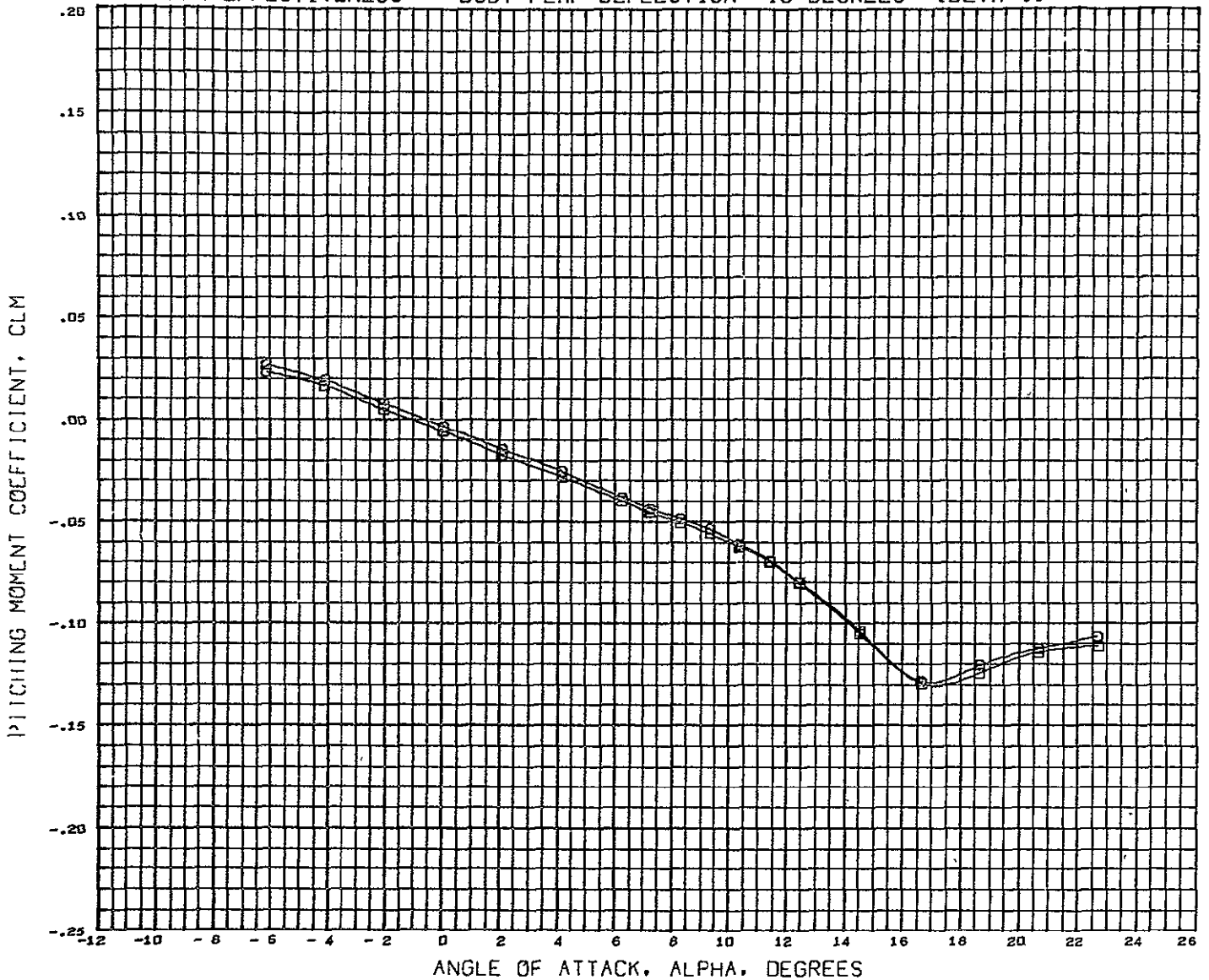

DATA SET SYMBOL	CONFIGURATION DESCRIPTION	ELEVTR	SBPOS	SPBRK	BFLAP	REFERENCE INFORMATION
(CCP049)	LSWT 248 MDAC 4.0 PC 02 HCR ORB B5W11	- 10.000		0.000	15.000	REFS 8.8690 SQ FT
(CCP039)	LSWT 248 MDAC 4.0 PC 02 HCR ORB B5W11SB2	- 10.000	3.000	30.000	15.000	REFL 29.5700 IN.
						REFB 51.6000 IN.
						XMRP 59.3200 IN.
						YMRP 0.0000 IN.
						ZMRP 11.6000 IN.
						SCALE 4.0000 PERCENT

MACH 0.250

SPEEDBRAKE EFFECTIVENESS BODY FLAP DEFLECTION= 15 DEGREES (BETA=0)

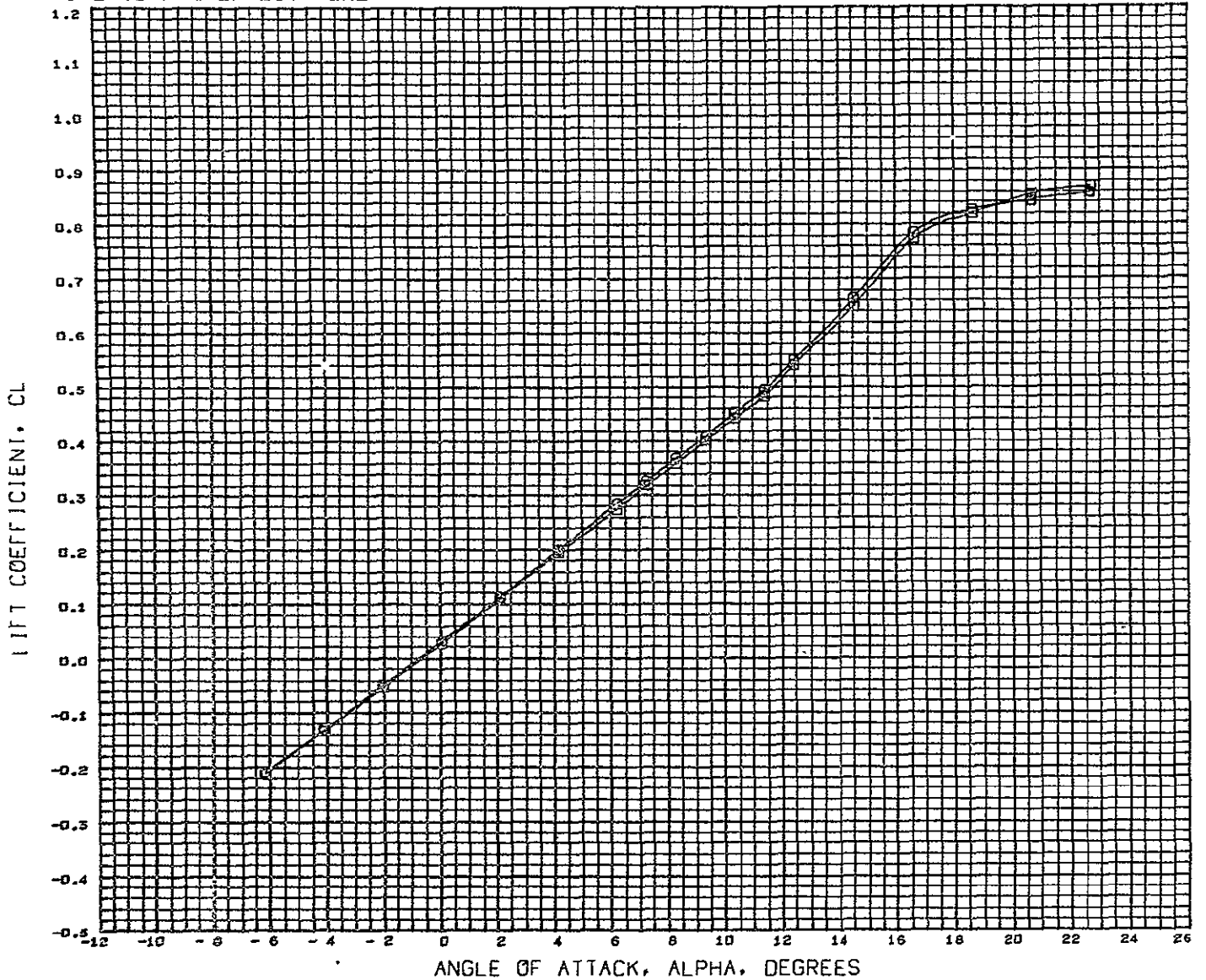

DATA SET SYMBOL	CONFIGURATION DESCRIPTION	ELEVTR	SBPOS	SBPRK	BFLAP	REFERENCE INFORMATION
(CCFD29)	LSWT 248 MDAC 4.0 FC 02 HCR ORB 85W11	- 10.000		0.000	15.000	REFS 8.8690 SQ.FT.
(CCFD39)	LSWT 248 MDAC 4.0 FC 02 HCR ORB 85W11SB2	- 10.000	3.000	30.000	15.000	REFL 29.5700 IN.
						REFB 51.5000 IN.
						XMRP 59.3200 IN.
						YMRP 0.0000 IN.
						ZMRP 11.6000 IN.
						SCALE 4.0000 PERCENT

MACH 0.250

SPEEDBRAKE EFFECTIVENESS BODY FLAP DEFLECTION= 15 DEGREES (BETA=0)

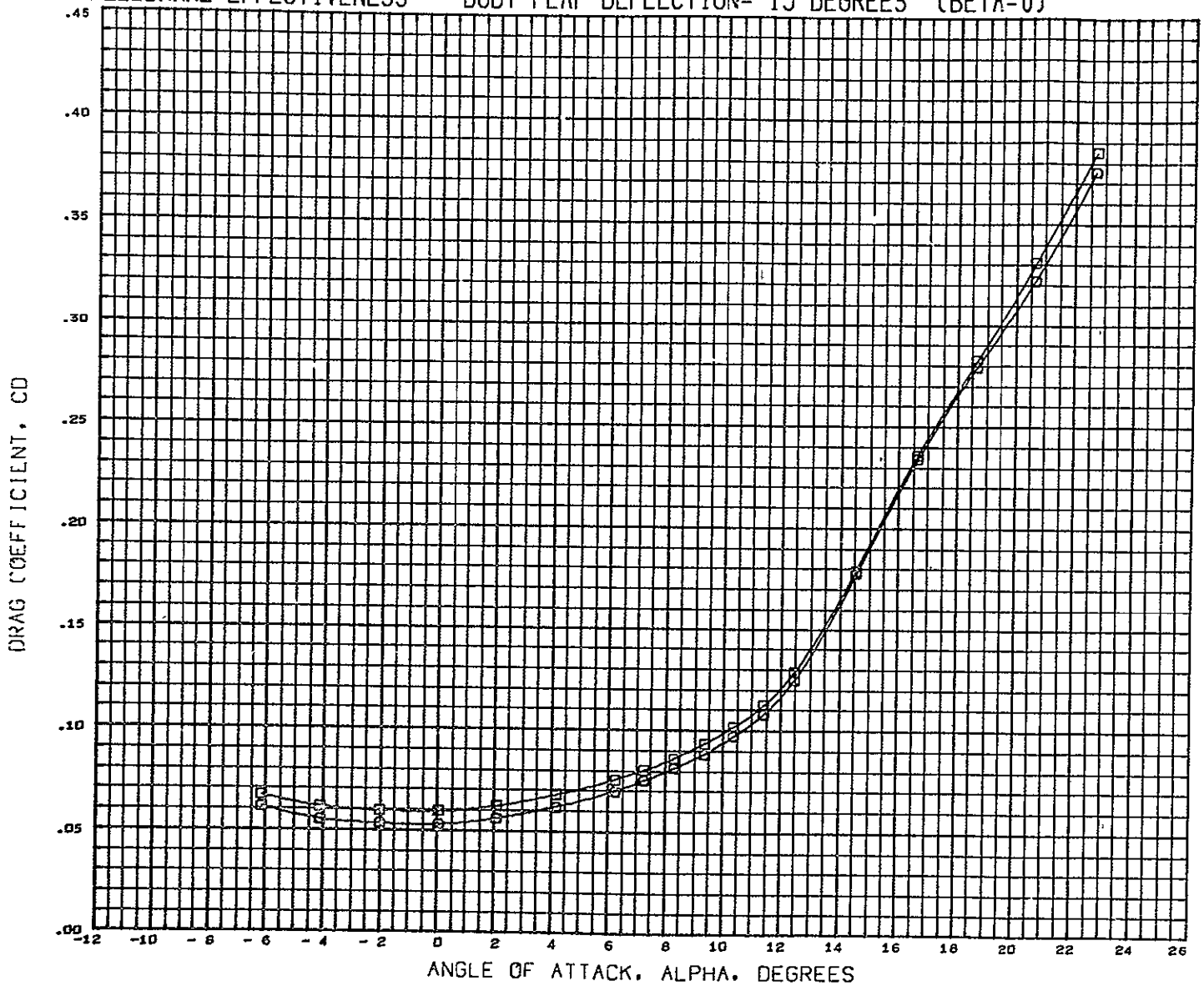

DATA SET SYMBOL	CONFIGURATION DESCRIPTION	ELEVTR	SBPOS	SPBRK	BFLAP	REFERENCE INFORMATION
(CCFD49)	LSWT 248 MDAC 4.0 FC 02 HCR ORB B5W11	- 10.000		0.000	15.000	REFS 8 8690 SQ FT.
(CCFD39)	LSWT 248 MDAC 4.0 FC 02 HCR ORB B5W11SB2	- 10.000	3.000	30.000	15.000	REFL 29.5700 IN.
						REFB 51.6000 IN.
						XMRP 59.3200 IN.
						YMRP 0.0000 IN.
						ZMRP 11.6000 IN.
						SCALE 4.0000 PERCNT

MACH 0.250

SPEEDBRAKE EFFECTIVENESS BODY FLAP DEFLECTION= 15 DEGREES (BETA=0)

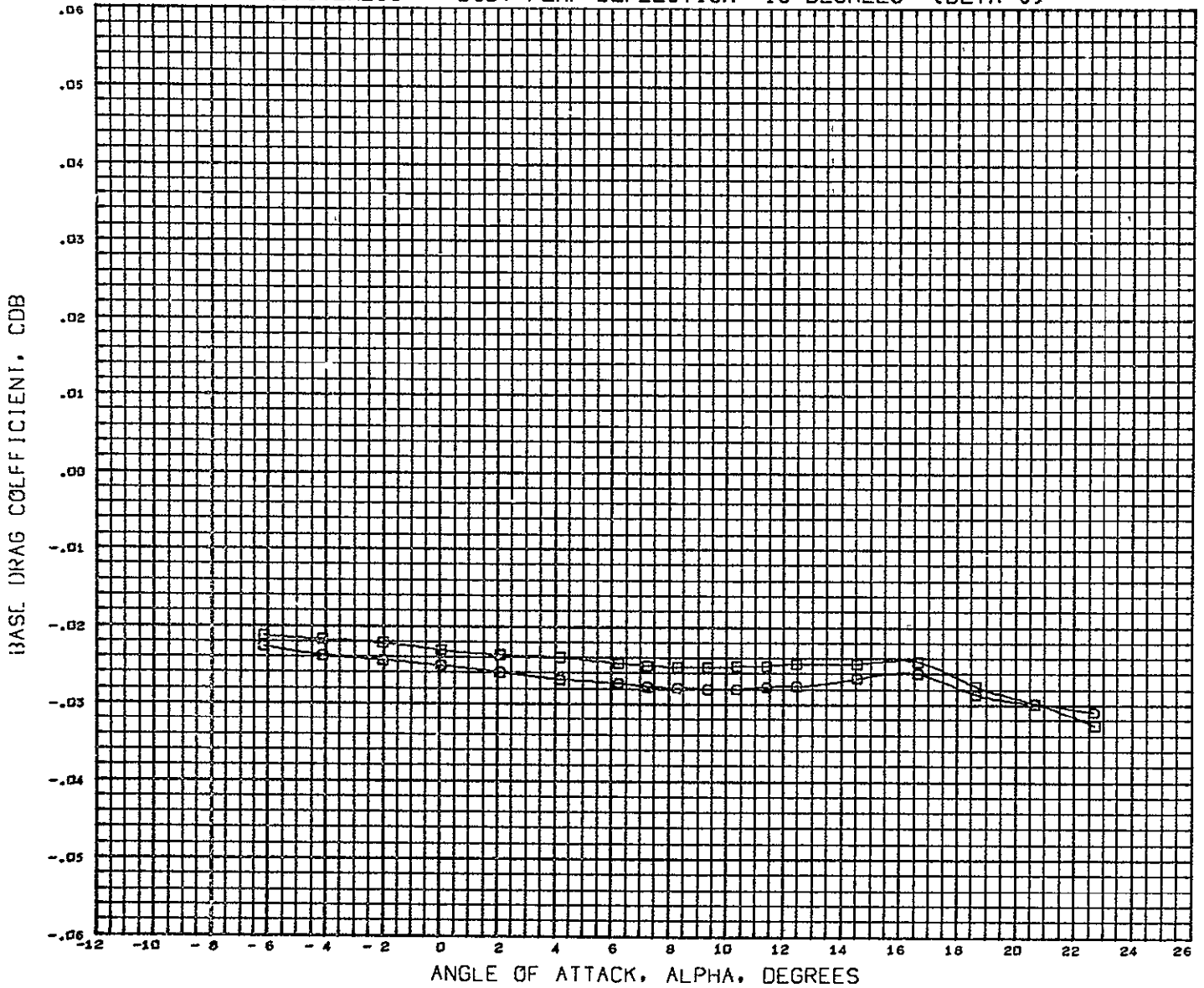

DATA SET	SYMBOL	CONFIGURATION DESCRIPTION	ELEVTR	SBPOS	SPBRK	BFLAF	REFERENCE INFORMATION
(CCP049)	○	LSWT 248 MDAC 4.0 PC 02 HCR ORB B5W11	- 10.000	0.000	0.000	15.000	REFS 8.8690 SQ.FT.
(CCP039)	□	LSWT 248 MDAC 4.0 PC 02 HCR ORB B5W11SB2	- 10.000	3.000	30.000	15.000	REFL 29.5700 IN.
							REFB 51.6000 IN.
							XMRP 59.3200 IN.
							YMRP 0.0000 IN.
							ZMRP 11.6000 IN.
							SCALE 4.0000 PERCNT

MACH 0.250

SPEEDBRAKE EFFECTIVENESS BODY FLAP DEFLECTION= 15 DEGREES (BETA=0)

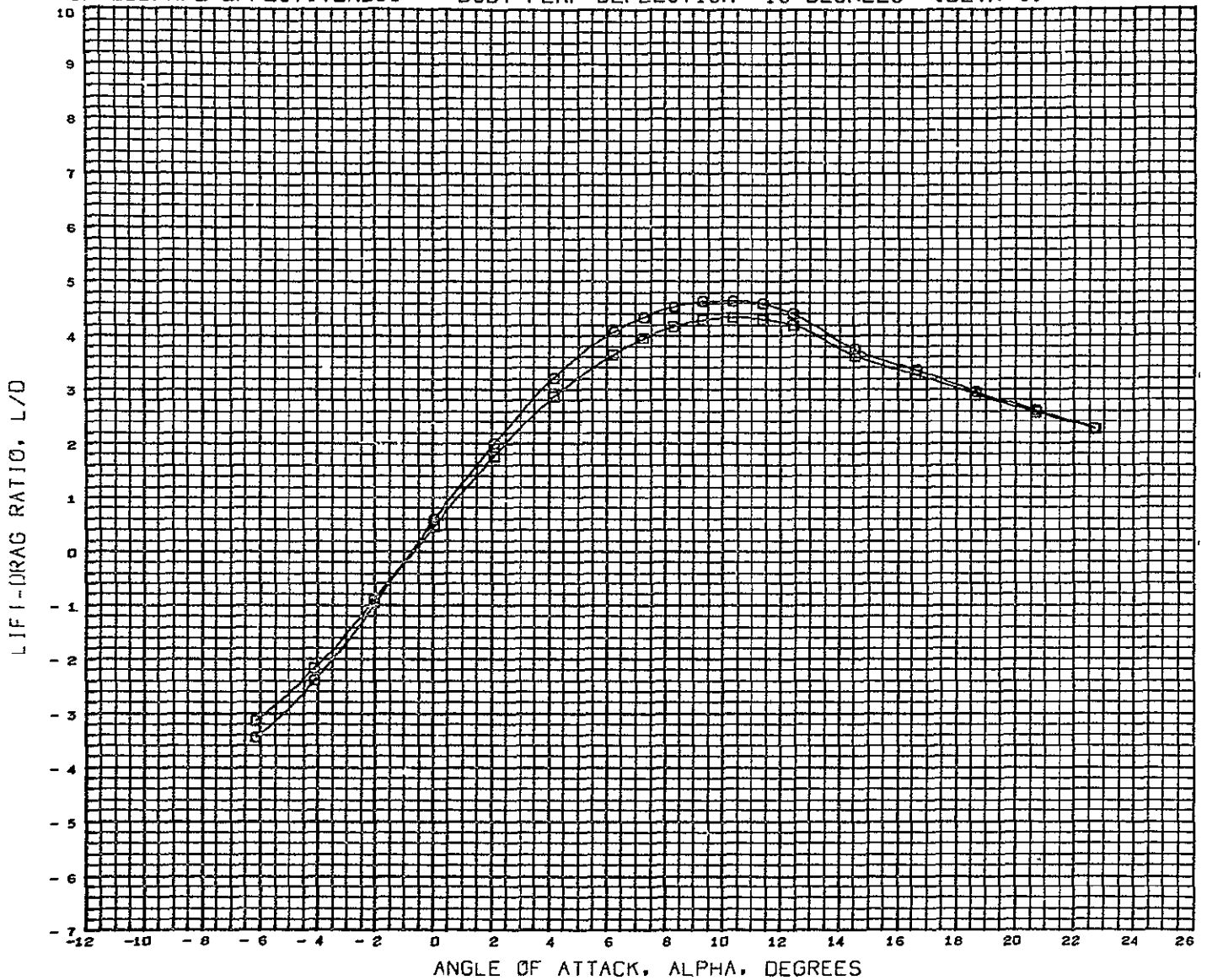

DATA SET SYMBOL	CONFIGURATION DESCRIPTION	ELEVTR	SBPOS	SPBRK	BFLAP	REFERENCE INFORMATION
(CCF049)	LSWT 248 MDAC 4.0 PC O2 HCR ORB	B5W11	- 10,000	0,000	15,000	REFS 8.8690 SQ.FT.
(CCF039)	LSWT 248 MDAC 4.0 PC O2 HCR ORB	B5W1SB2	- 10,000	3,000	30,000	REFL 29.5700 IN.
						REFB 51.6000 IN.
						XMRP 59.3200 IN.
						YMRP 0.0000 IN.
						ZMRP 11.6000 IN.
						SCALE 4.0000 PERCENT

MACH 0.250



SPEEDBRAKE EFFECTIVENESS BODY FLAP DEFLECTION= 15 DEGREES (BETA=0)

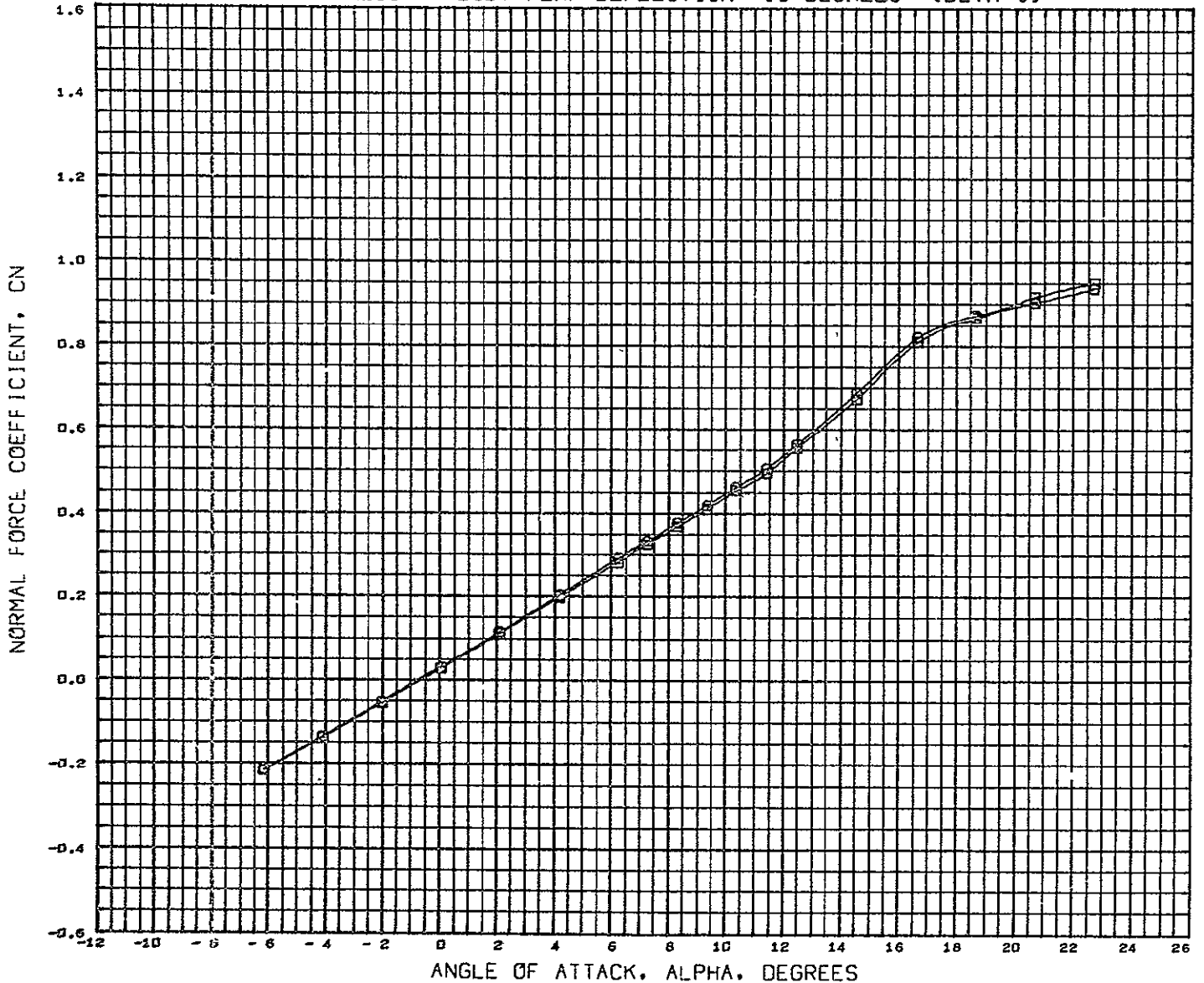

DATA SET SYMBOL	CONFIGURATION DESCRIPTION	ELEVTR	SBPOS	SPBRK	BFLAP	REFERENCE INFORMATION
(BCF049)	LSWT 248 MDAC 4.0 FC 02 HCR ORB B5W11	- 10.000'		0.000	15.000	REFS 8 8690 SQ.FT.
(BCF039)	LSWT 248 MDAC 4.0 FC 02 HCR ORB B5W11SB2	- 10.000'	3.000	30.000	15.000	REFL 29.5700 IN.
						REFB 51.6000 IN.
						XMRP 59.3200 IN.
						YMRP 0.0000 IN.
						ZMRP 11.6000 IN.
						SCALE 4.0000 PERCNT

MACH 0.250

SPEEDBRAKE EFFECTIVENESS BODY FLAP DEFLECTION= 15 DEGREES (BETA=0)

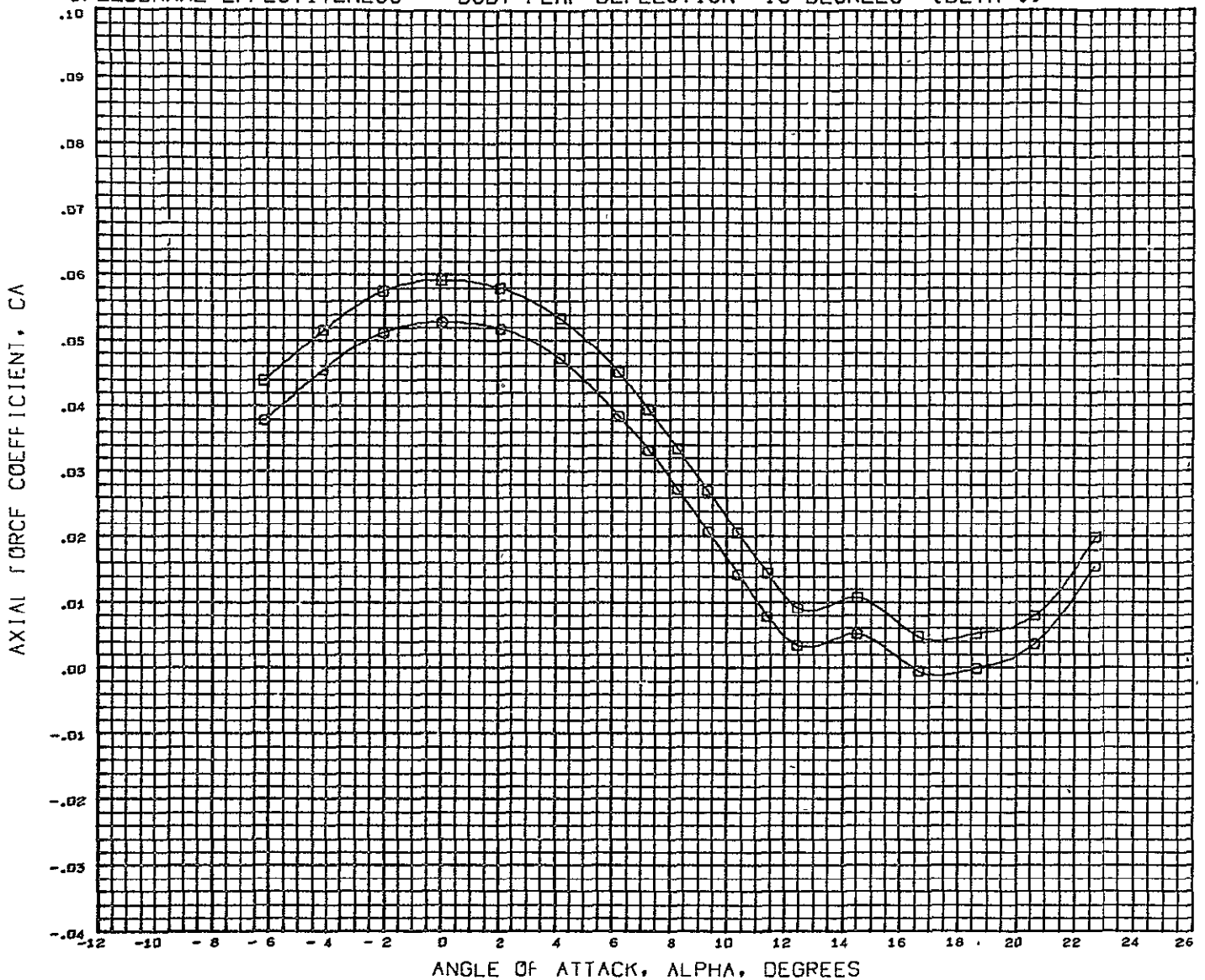

DATA SET SYMBOL	CONFIGURATION DESCRIPTION	ELEVTR	SBPOS	SPBRK	BFLAP	REFERENCE INFORMATION
(BCF049)	LSWT 248 MDAC 4.0 FC 02 HCR ORB B5W11	- 10.000		0.000	15.000	REFS 8.8690 SQ.FT.
(BCF039)	LSWT 248 MDAC 4.0 FC 02 HCR ORB B5W11SB2	- 10.000	3.000	30.000	15.000	REFL 29.5700 IN.
						REFB 51.6000 IN.
						XMRP 59.3200 IN.
						YMRP 0.0000 IN.
						ZMRP 11.6000 IN.
						SCALE 4.0000 PERCNT

HACH 0.250

SPEEDBRAKE EFFECTIVENESS BODY FLAP DEFLECTION= 15 DEGREES (BETA=0)



DATA SET	SYMBOL	CONFIGURATION DESCRIPTION	ELEVTR	SBPOS	SPBRK	BFLAP	REFERENCE INFORMATION
(CCPD49)	○	LSWT 248 MDAC 4.0 FC 02 HCR ORB	- 10.000		0.000	15.000	REFS 8.8690 SQ.FT.
(CCPD39)	□	LSWT 248 MDAC 4.0 FC 02 HCR ORB	- 10.000	3.000	30.000	15.000	REFL 29.5700 IN.
							REFB 51.6000 IN.
							XMRP 59.3200 IN.
							YMRP 0.0000 IN.
							ZMRP 11.6000 IN.
							SCALE 4.0000 PERCENT

MACH 0.250

SPEEDBRAKE EFFECTIVENESS BODY FLAP DEFLECTION= 15 DEGREES (BETA=0)

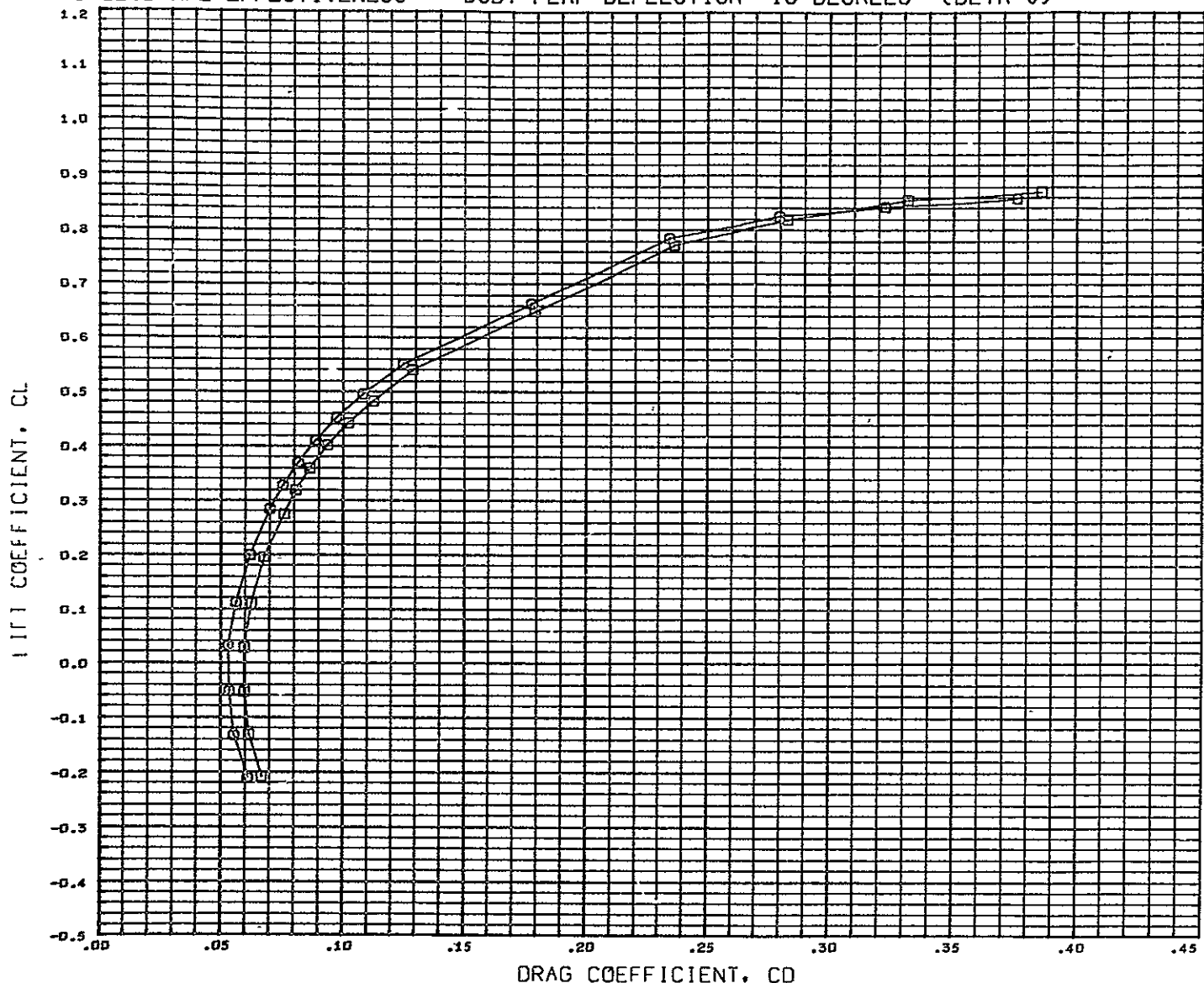

DATA SET SYMBOL	CONFIGURATION DESCRIPTION	ELEVTR	SBPOS	SPBRK	BFLAP	REFERENCE INFORMATION
(CCPD49)	LSWT 248 HDAC 4.0 FC O2 HCR ORB	B5W11	- 10.000	0.000	15.000	REFS 8.8690 SQ.FT
(CCPD39)	LSWT 248 HDAC 4.0 FC O2 HCR ORB	B5W11SB2	- 10.000	3.000	30.000	REFL 29.5700 IN.
						REFB 51.6000 IN.
						XMRF 59.3200 IN.
						YMRF 0.0000 IN.
						ZMRP 11.6000 IN.
						SCALE 4.0000 PERCNT

MACH 0.250

SPEEDBRAKE EFFECTIVENESS BODY FLAP DEFLECTION= 15 DEGREES (BETA=0)

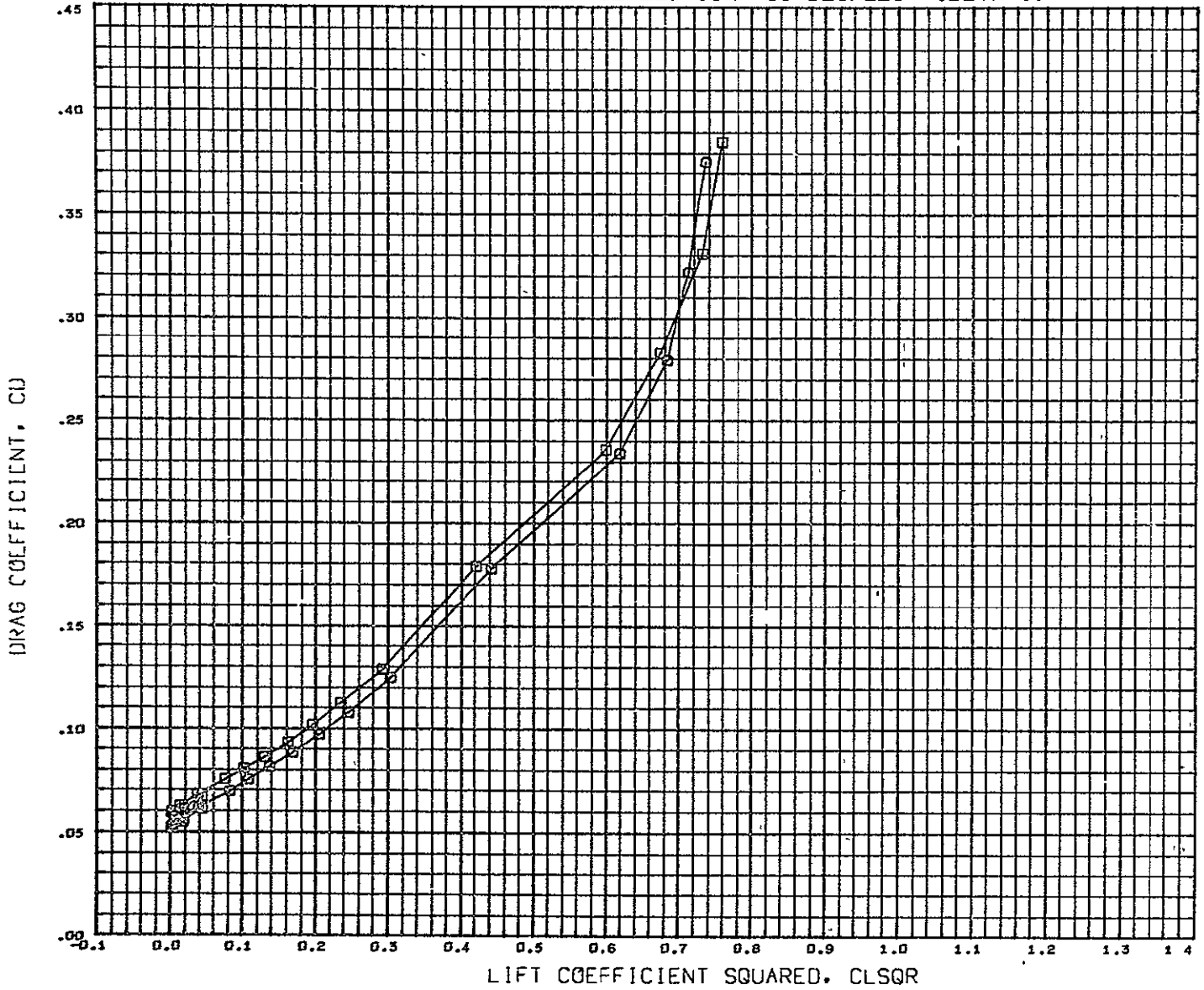

DATA SET SYMBOL	CONFIGURATION DESCRIPTION	ELEVTR	SBPOS	SPBRK	BFLAP	REFERENCE INFORMATION
(CCP049)	LSWT 248 MDAC 4.0 FC 02 HCR ORB	B5W11	- 10.000	0.000	15.000	REFS 8 8690 SQ.FT.
(CCP039)	LSWT 248 MDAC 4.0 FC 02 HCR ORB	B5W11SB2	- 10.000	3 000	15.000	REFL 29.5700 IN.
						REFB 51.6000 IN.
						XMRP 59.3200 IN.
						YMNP 0.0000 IN.
						ZMRP 11.6000 IN.
						SCALE 4.0000 PERCNT

MACH 0.250

SPEEDBRAKE EFFECTIVENESS BODY FLAP DEFLECTION= 15 DEGREES (BETA=0)

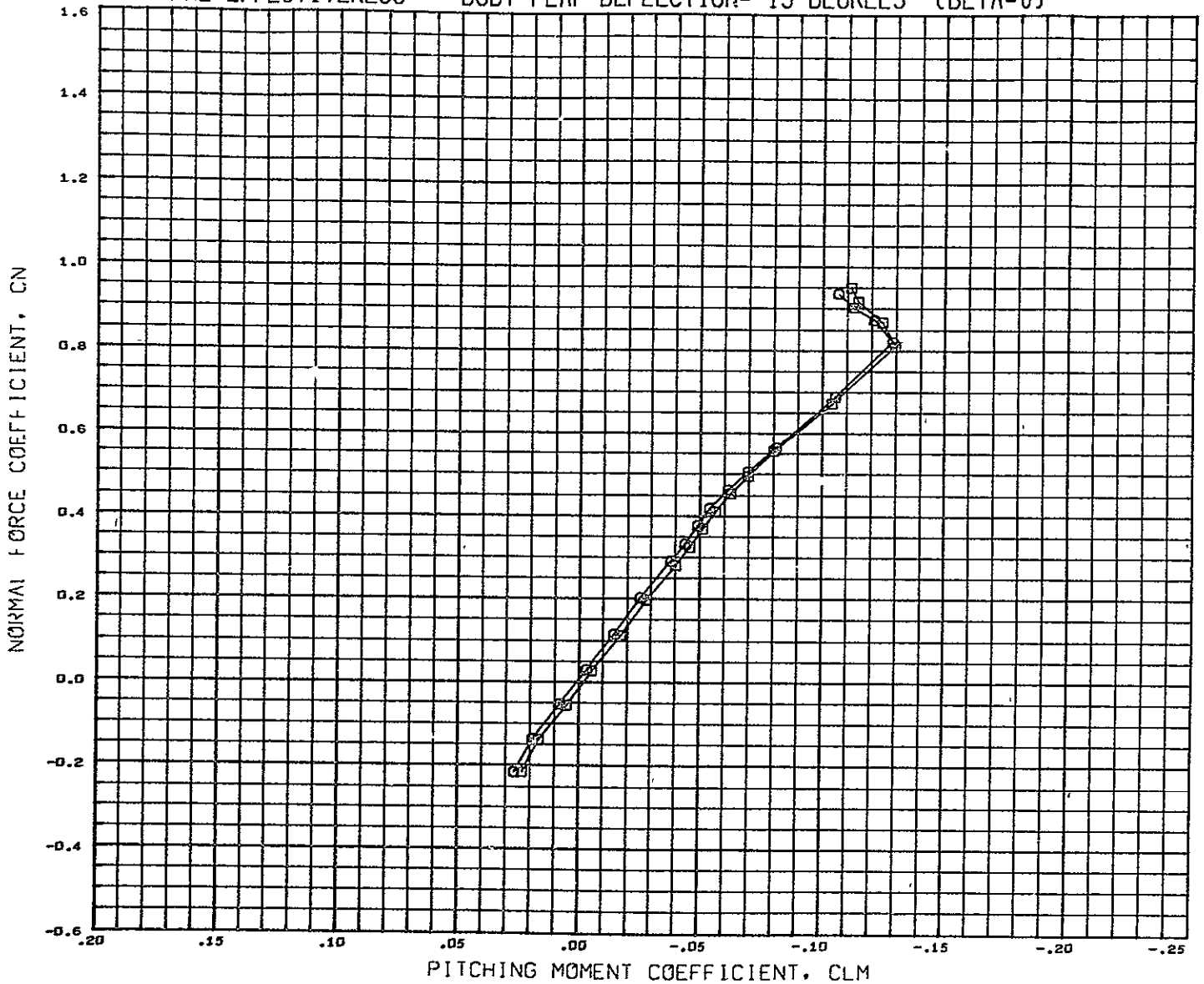

DATA SET SYMBOL	CONFIGURATION DESCRIPTION	ELEVTR	SBPOS	SPBRK	BFLAP	REFERENCE INFORMATION
(BCFD49)	LSWT 248 MDAC 4.0 FC 02 HCR ORB	85W11	- 10.000	0.000	15.000	REFS 8 8690 SQ.FT.
(BCFD39)	LSWT 248 MDAC 4.0 FC 02 HCR ORB	85W11SB2	- 10.000	3.000	15.000	REFL 29.5700 IN.
						REFB 51.6000 IN.
						XMRP 59.3200 IN.
						YMRP 0 0000 IN.
						ZMRP 11 6000 IN.
						SCALE 4.0000 PERCENT

MACH 0.250

SPEEDBRAKE EFFECTIVENESS--BODY FLAP DEFLECTION=30 DEGREES (BETA=0)

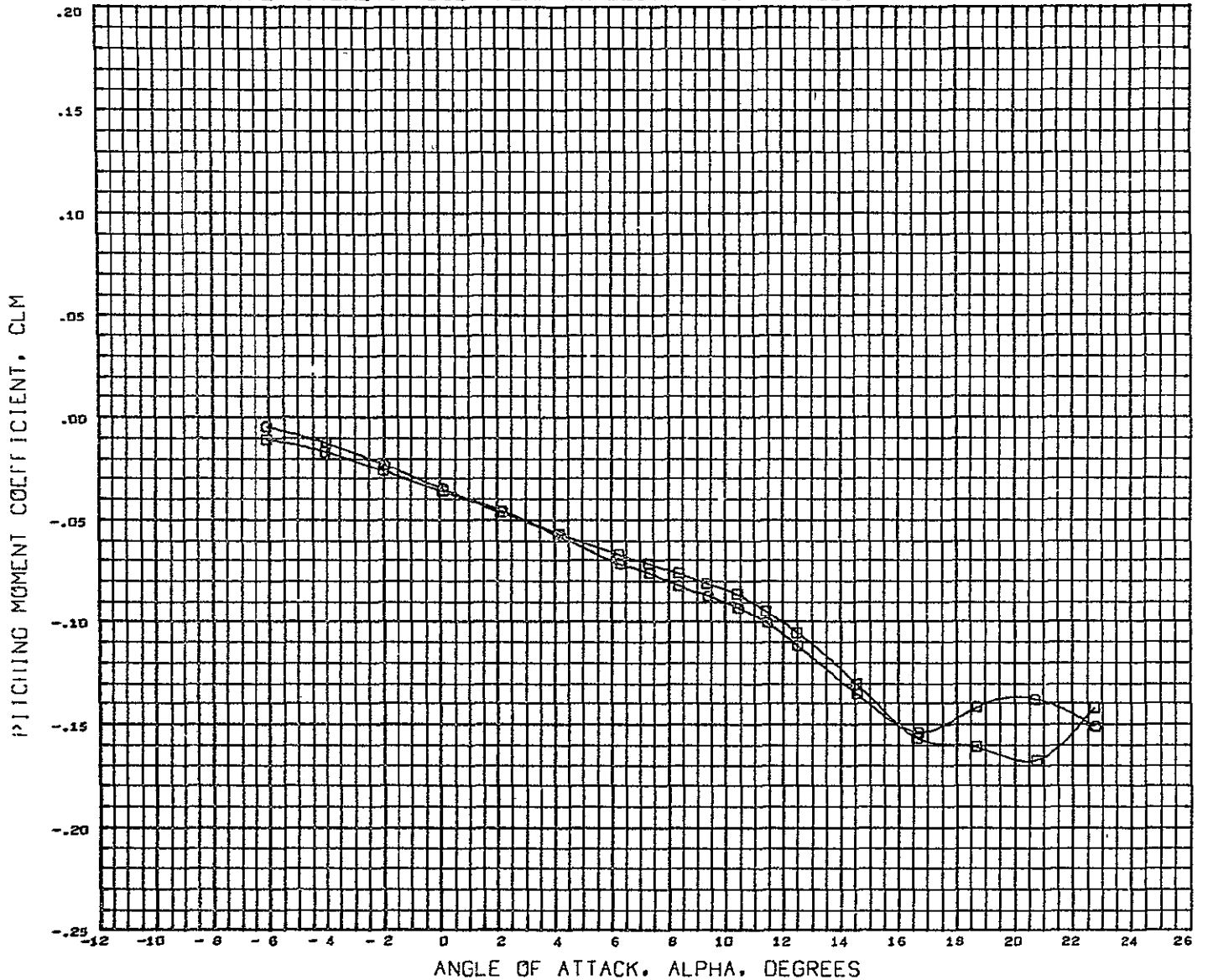

DATA SET SYMBOL	CONFIGURATION DESCRIPTION	ELEVTR	SBFOS	SPBRK	BFLAP	REFERENCE INFORMATION
(CCF048)	LSWT 248 HDAC 4.0 FC 02 HCR ORB B5W11	-10.000		0.000	30.000	REFS 8.8690 SQ.FT.
(CCF046)	LSWT 248 HDAC 4.0 FC 02 HCR ORB B5W11SB2	-10.000	3.000	60.000	30.000	REFL 29.5700 IN.
						REFB 51.6000 IN.
						XMRP 59.3200 IN.
						YMRP 0.0000 IN.
						ZMRP 11.6000 IN.
						SCALE 4.0000 PERCNT

MACH 0.250

SPEEDBRAKE EFFECTIVENESS--BODY FLAP DEFLECTION=30 DEGREES (BETA=0)

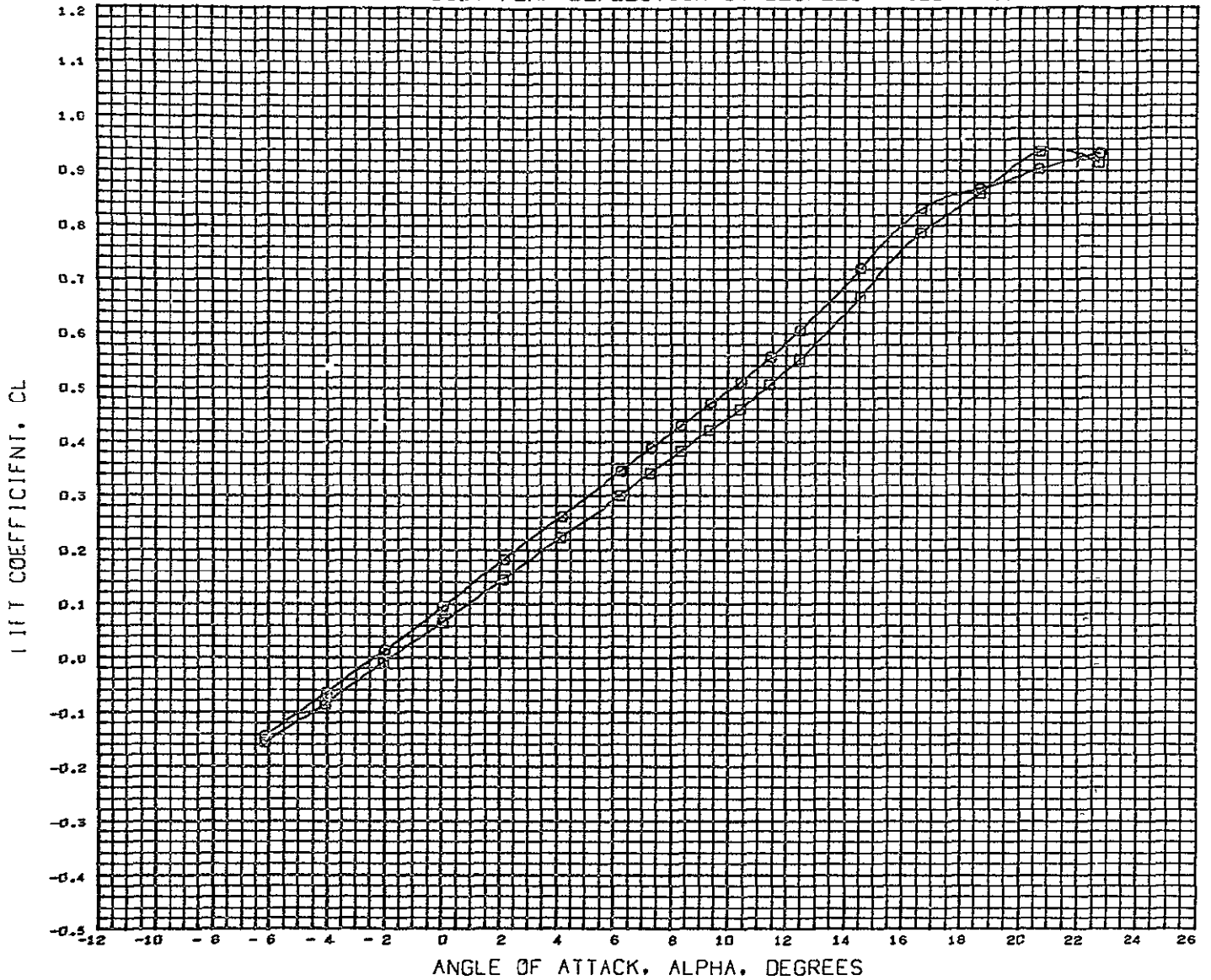

DATA SET SYMBOL	CONFIGURATION DESCRIPTION	ELEVTR	SBFOS	SPBRK	BFLAP	REFERENCE INFORMATION
(CCFD48)	LSWT 248 MDAC 4.0 FC 02 HCR ORB	85W11	- 10.000	0.000	30.000	REFS 8.8690 SQ.FT.
(CCFD46)	LSWT 248 MDAC 4.0 FC 02 HCR ORB	85W11SB2	- 10.000	3.000	60.000	REFL 29.5700 IN.
						REFB 51.6000 IN.
						XMRP 59.3200 IN.
						YMRP 0.0000 IN.
						ZMRP 11.6000 IN.
						SCALE 4.0000 PERCENT

MACH 0.250



SPEEDBRAKE EFFECTIVENESS--BODY FLAP DEFLECTION=30 DEGREES (BETA=0)

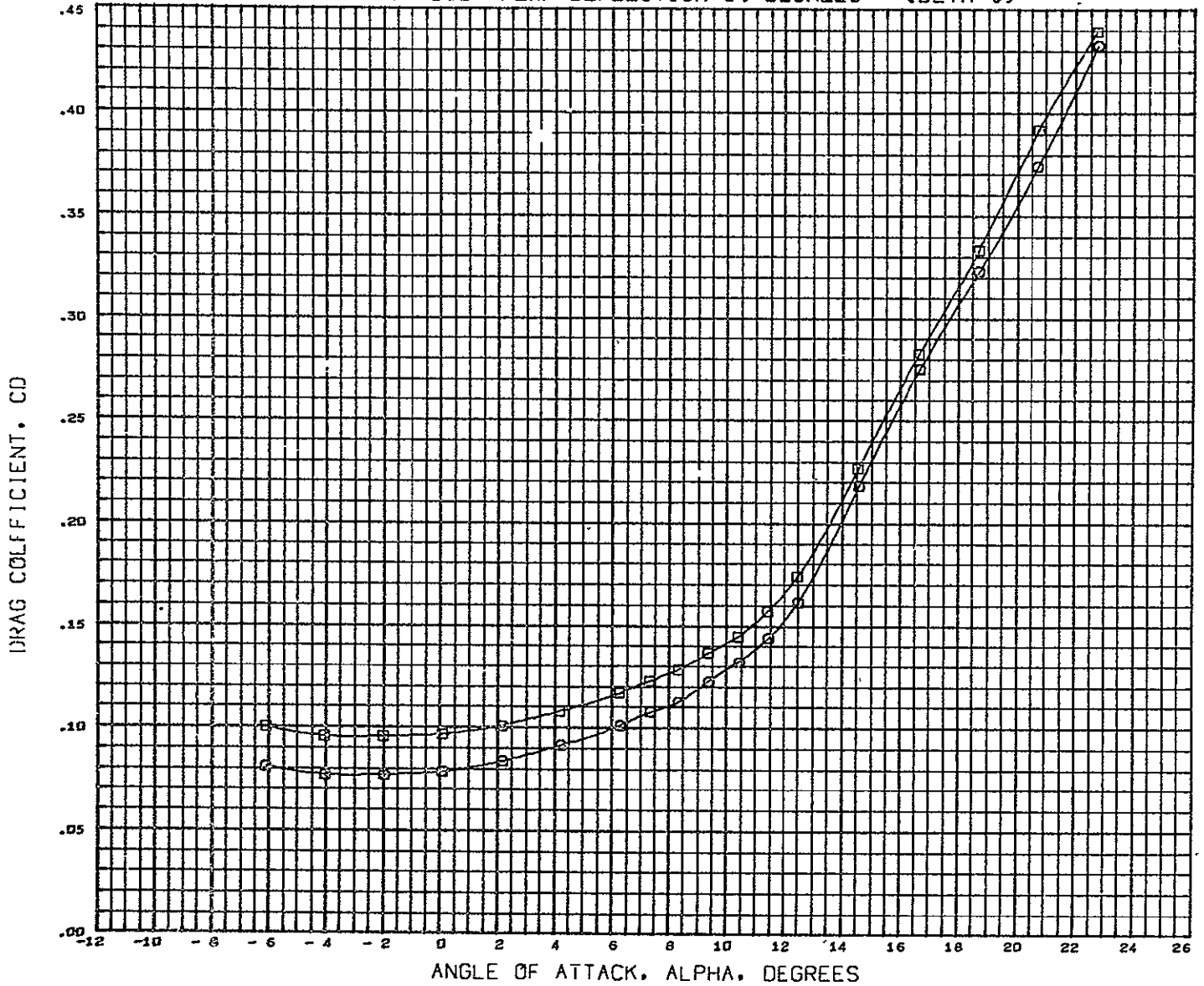

DATA SET SYMBOL	CONFIGURATION DESCRIPTION	ELEVTR	SBPOS	SPBRK	BFLAP	REFERENCE INFORMATION
(CCFD48)	LSWT 248 MDAC 4.0 FC 02 HCR ORB B5W11	- 10.000		0.000	30.000	REFS 8.8690 SQ.FT.
(CCFD46)	LSWT 248 MDAC 4.0 FC 02 HCR ORB B5W11SB2	- 10.000	3.000	60.000	30.000	REFL 29.5700 IN.
						REFB 51.6000 IN.
						XMRP 59.3200 IN.
						YMRP 0.0000 IN.
						ZMRP 11.6000 IN.
						SCALE 4.0000 PERCNT

MACH 0.250

SPEEDBRAKE EFFECTIVENESS--BODY FLAP DEFLECTION=30 DEGREES (BETA=0)

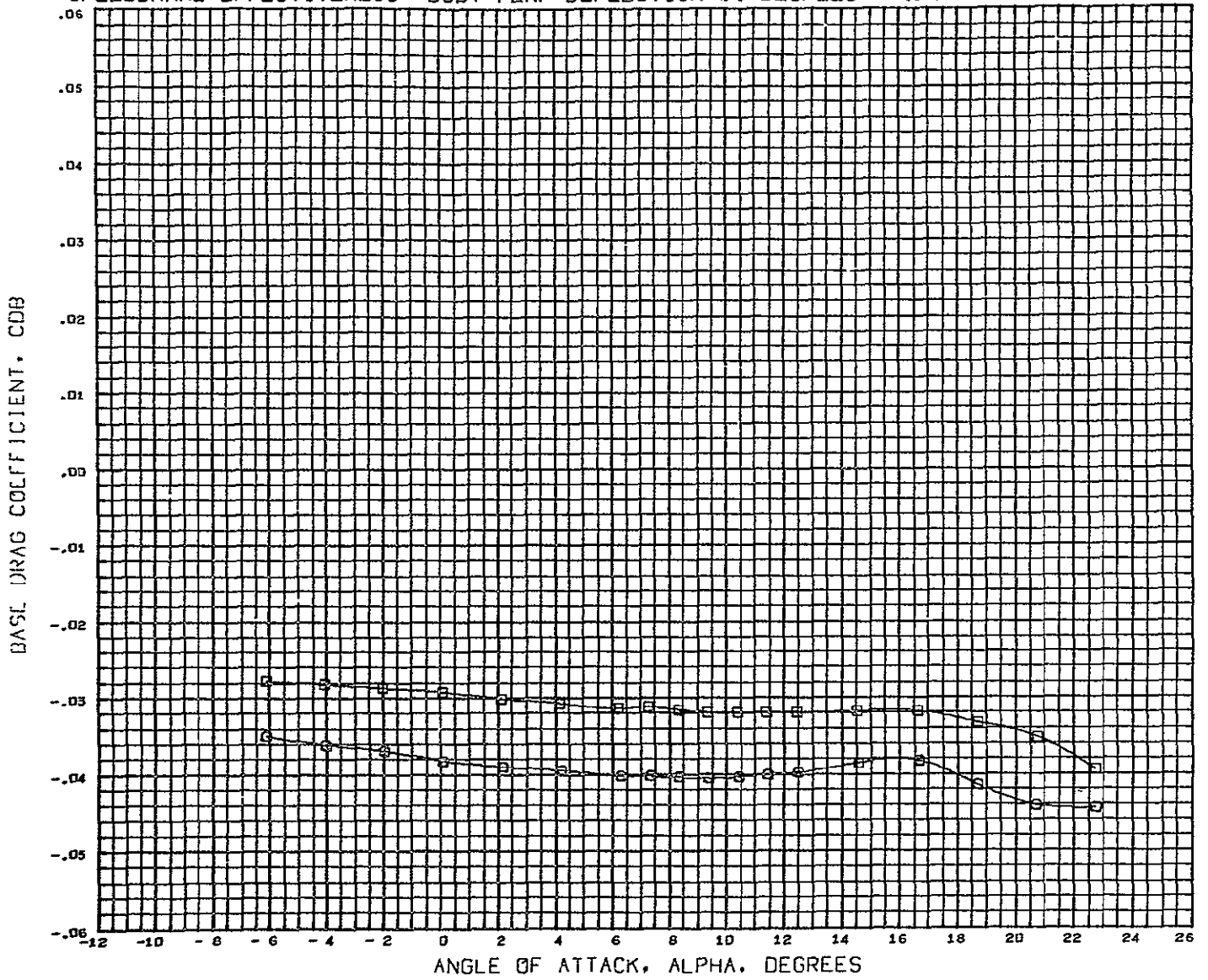

DATA SET SYMBOL	CONFIGURATION DESCRIPTION	ELEVTR	SBPOS	SPBRK	BFLAP	REFERENCE INFORMATION
(CCFD48)	LSWT 248 MDAC 4.0 FC 02 HCR ORB B5W11	- 10.000		0.000	30.000	REFS 8.8690 SQ.FT
(CCFD46)	LSWT 248 MDAC 4.0 FC 02 HCR ORB B5W11SB2	- 10.000	3.000	60.000	30.000	REFL 29.5700 IN.
						REFB 51.6000 IN.
						XMRP 59.3200 IN.
						YMRP 0.0000 IN.
						ZMRP 11.6000 IN.
						SCALE 4.0000 PERCNT

MACH 0.250

SPEEDBRAKE EFFECTIVENESS--BODY FLAP DEFLECTION=30 DEGREES (BETA=0)

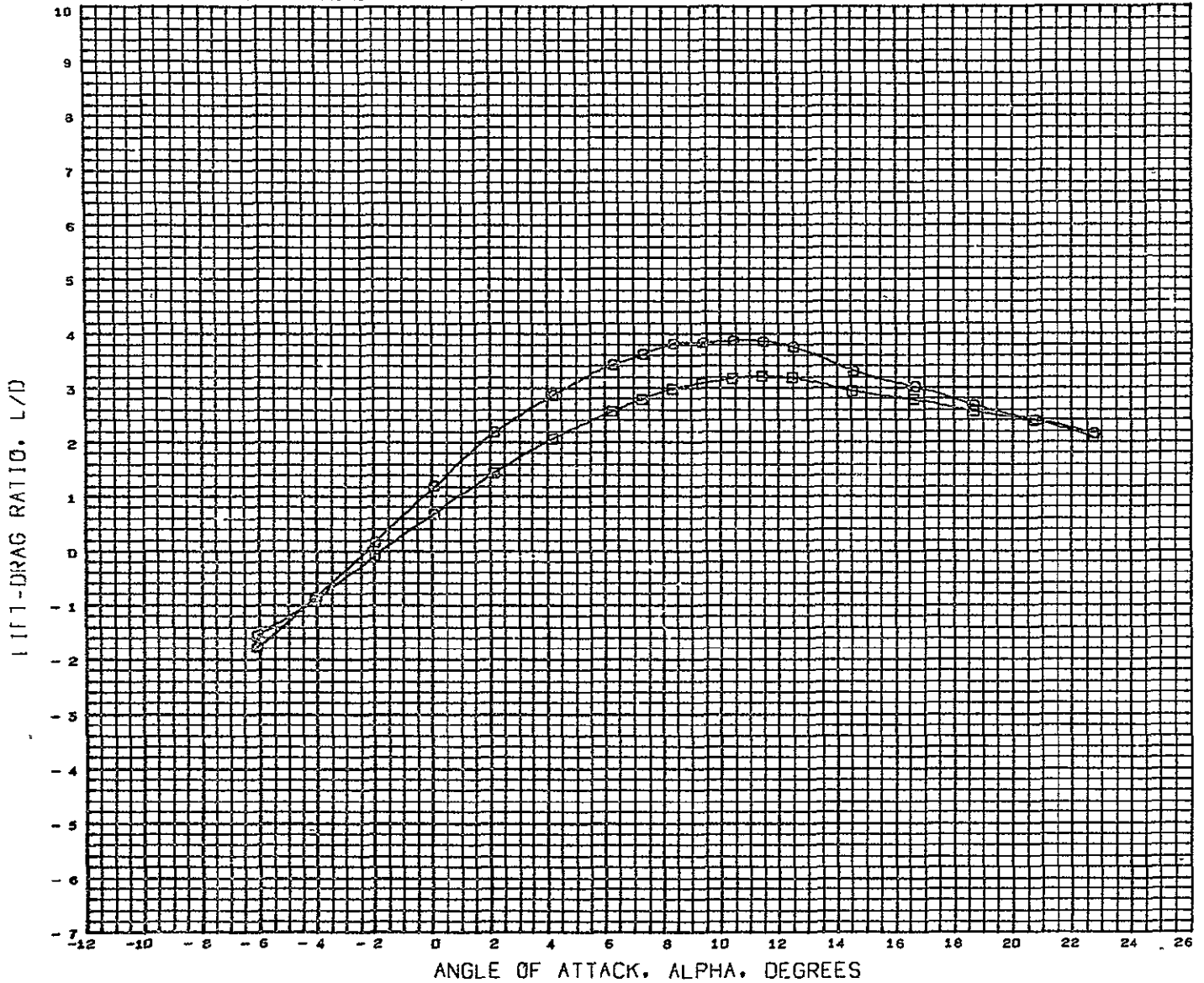

DATA SET SYMBOL	CONFIGURATION DESCRIPTION	ELEVTR	SBPOS	SPBRK	BFLAP	REFERENCE INFORMATION
(CCP046)	LSWT 248 MDAC 4.0 PC O2 HCR ORB	B5W11	- 10.000	0 000	30.000	REFS 8 8690 SQ.FT
(CCP046)	LSWT 248 MDAC 4.0 PC O2 HCR ORB	B5W11SB2	- 10.000	3 000	30.000	REFL 29 5700 IN.
						REFB 51.6000 IN.
						XMRP 59.3200 IN.
						YMRP 0.0000 IN.
						ZMRP 11.6000 IN.
						SCALE 4.0000 PERCNT

MACH 0.250

SPEEDBRAKE EFFECTIVENESS--BODY FLAP DEFLECTION=30 DEGREES (BETA=0)

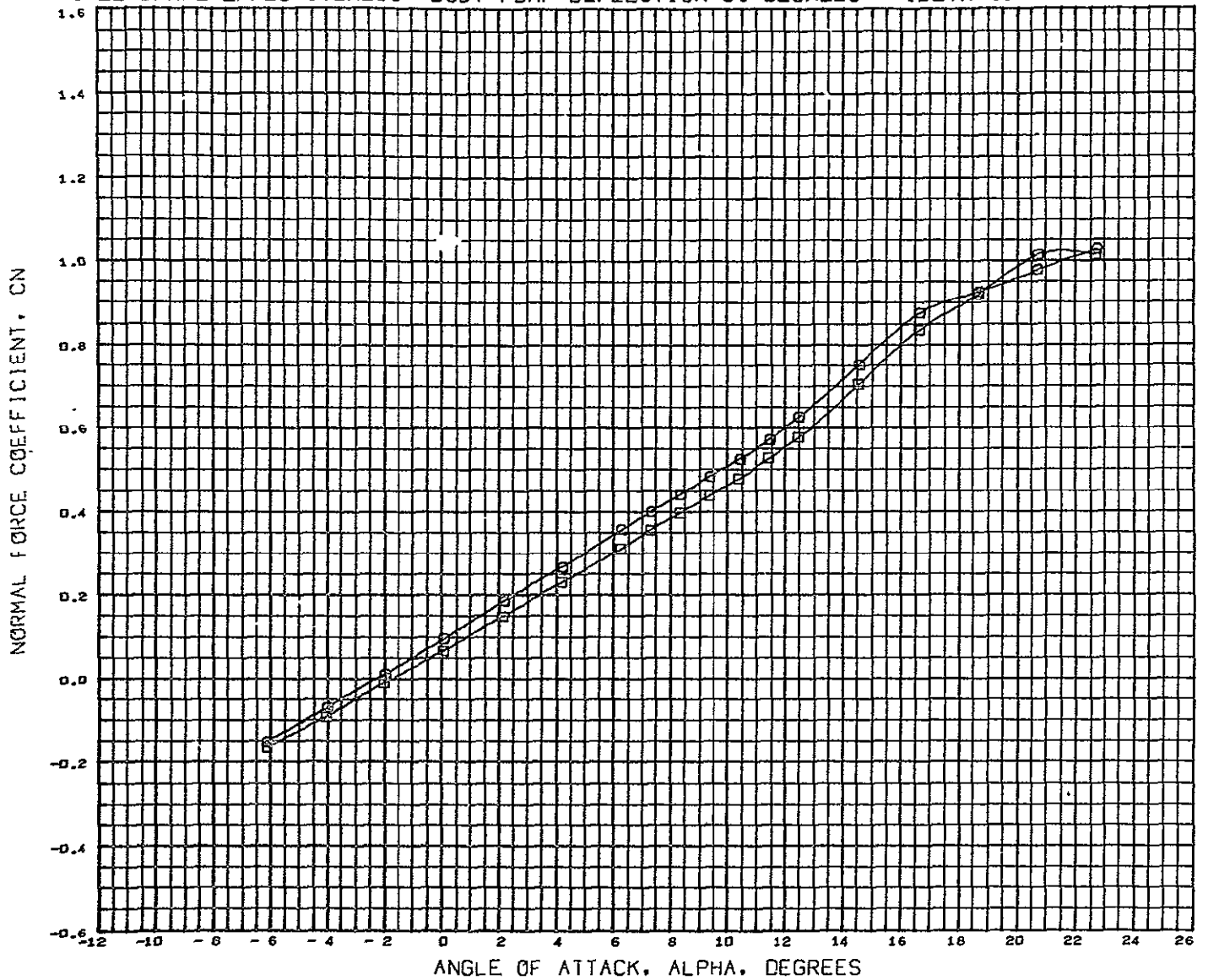

DATA SET SYMBOL	CONFIGURATION DESCRIPTION	ELEVTR	SBPOS	SPBRK	BFLAP	REFERENCE INFORMATION
(BCFD48)	LSWT 248 MDAC 4.0 FC 02 HCR ORB B5W11	- 10.000		0.000	30.000	REFS 8.8690 SQ.FT
(BCFD46)	LSWT 248 MDAC 4.0 FC 02 HCR ORB B5W11SB2	- 10.000	3 000	60.000	30 000	REFL 29.5700 IN.
						REFB 51.6000 IN.
						XMRP 59.3200 IN.
						YMRP 0.0000 IN.
						ZMRP 11.6000 IN.
						SCALE 4.0000 PERCNT

MACH 0.250

SPEEDBRAKE EFFECTIVENESS--BODY FLAP DEFLECTION=30 DEGREES (BETA=0)

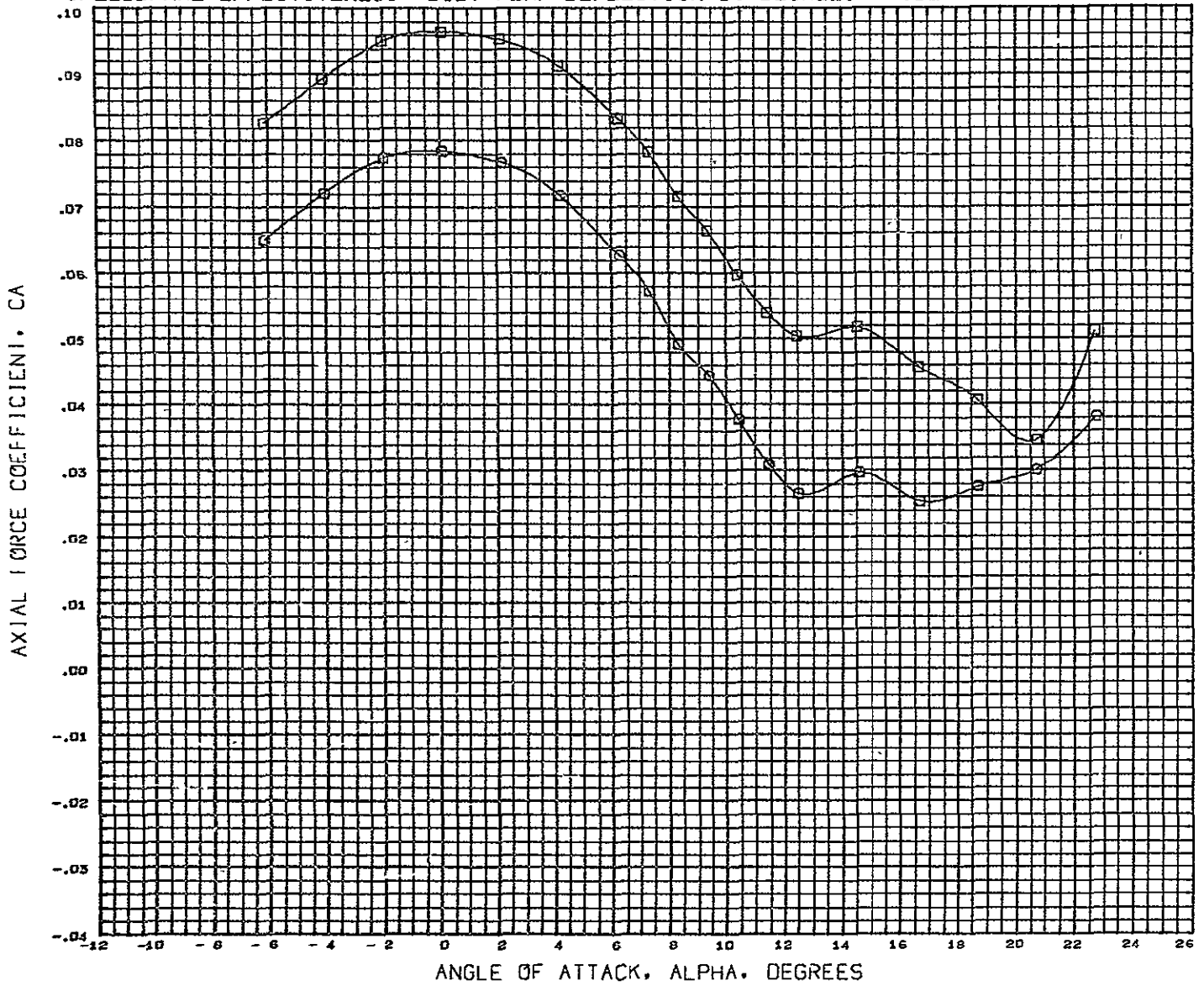

DATA SET SYMBOL	CONFIGURATION DESCRIPTION	ELEVTR	SBPOS	SPBRK	BFLAP	REFERENCE INFORMATION
(BCFD48)	LSWT 248 MDAC 4.0 FC 02 HCR ORB	85W11	- 10.000	0.000	30.000	REFS 8.8690 SQ.FT.
(BCFD46)	LSWT 248 MDAC 4.0 FC 02 HCR ORB	85W11SB2	- 10.000	3.000	30.000	REFL 29.5700 IN.
						REFB 51.6000 IN.
						XMRP 59.3200 IN.
						YMRF 0.0000 IN.
						ZMRF 11.6000 IN.
						SCALE 4.0000 PERCENT

MACH 0.250

SPEEDBRAKE EFFECTIVENESS--BODY FLAP DEFLECTION=30 DEGREES (BETA=0)

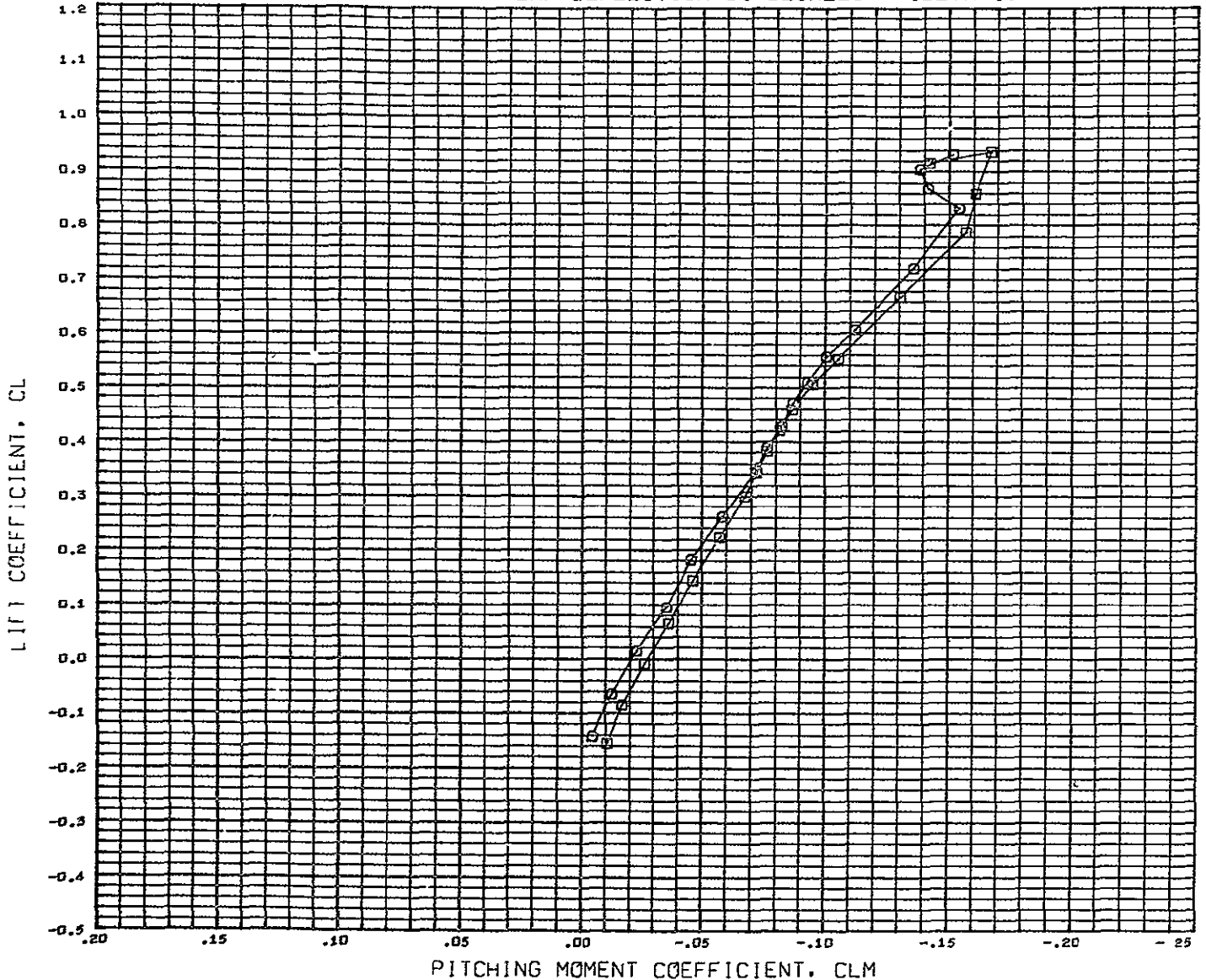

DATA SET SYMBOL	CONFIGURATION DESCRIPTION	ELEVTR	SBPOS	SFBRK	BFLAP	REFERENCE INFORMATION
(CCFB48)	LSMT 248 MDAC 4.0 FC 02 HCR ORB	- 10.000		0.000	30.000	REFS 8.8690 SQ FT.
(CCFB46)	LSMT 248 MDAC 4.0 FC 02 HCR ORB	- 10.000	3.000	60.000	30.000	REFL 29.5700 IN.
						REFB 51.6000 IN.
						XMRP 59.3200 IN.
						YMRP 0.0000 IN.
						ZMRP 11.6000 IN.
						SCALE 4.0000 PERCNT

MACH 0.250

SPEEDBRAKE EFFECTIVENESS--BODY FLAP DEFLECTION=30 DEGREES (BETA=0)

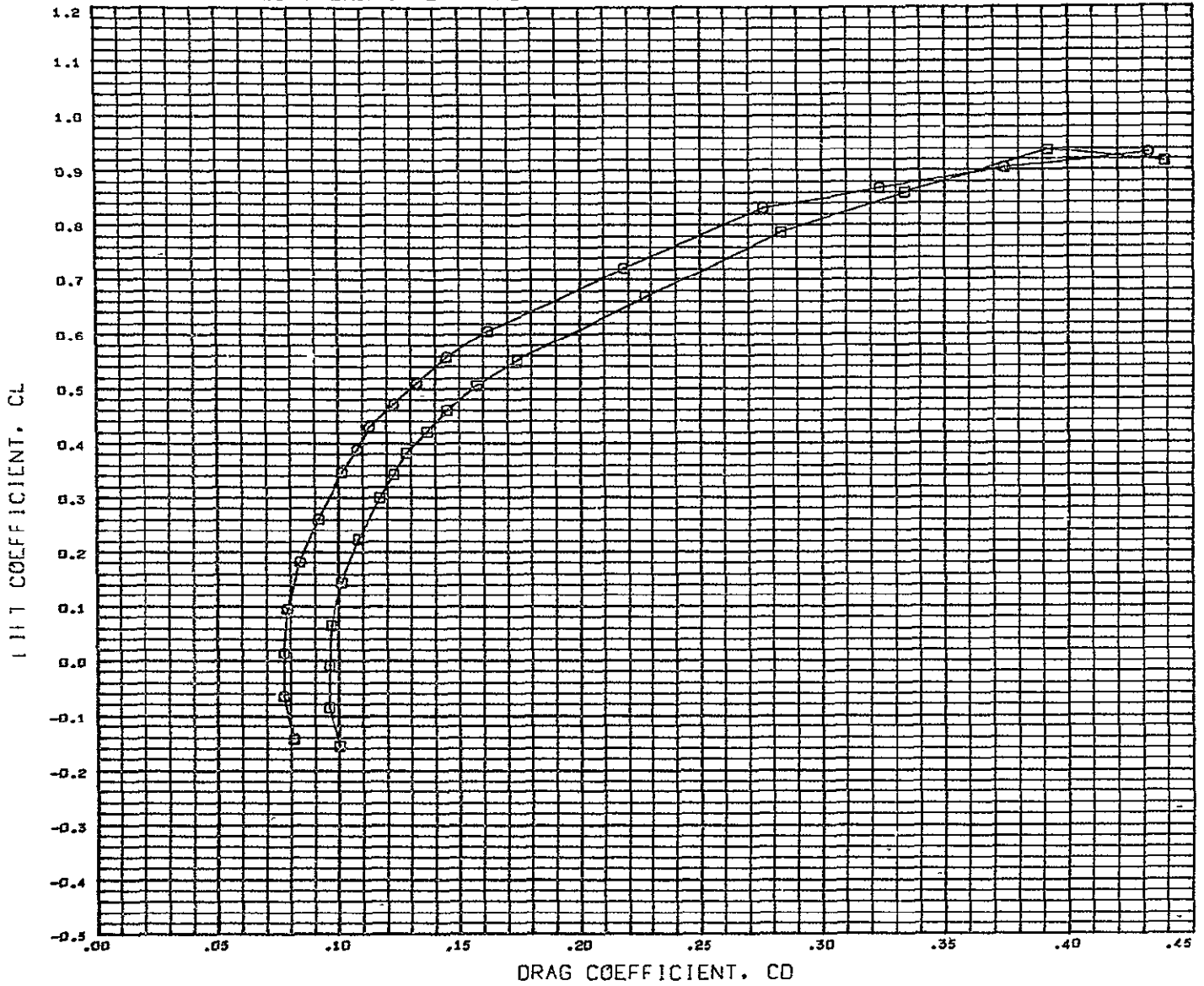

DATA SET SYMBOL	CONFIGURATION DESCRIPTION	ELEVTR	SBPOS	SPBRK	*BFLAP	REFERENCE INFORMATION
(CCFD48)	LSWT 248 MDAC 4.0 FC O2 HCR ORB	- 10.000		0.000	30.000	REFS 8.8690 SQ.FT.
(CCFD46)	LSWT 248 MDAC 4.0 FC O2 HCR ORB	- 10.000	3.000	60.000	30.000	REFL 29.5700 IN.
						REFB 51.6000 IN.
						XMRP 59.3200 IN.
						YMRP 0.0000 IN.
						ZMRP 11.6000 IN.
						SCALE 4.0000 PERCENT

MACH 0.250

SPEEDBRAKE EFFECTIVENESS--BODY FLAP DEFLECTION=30 DEGREES (BETA=0)

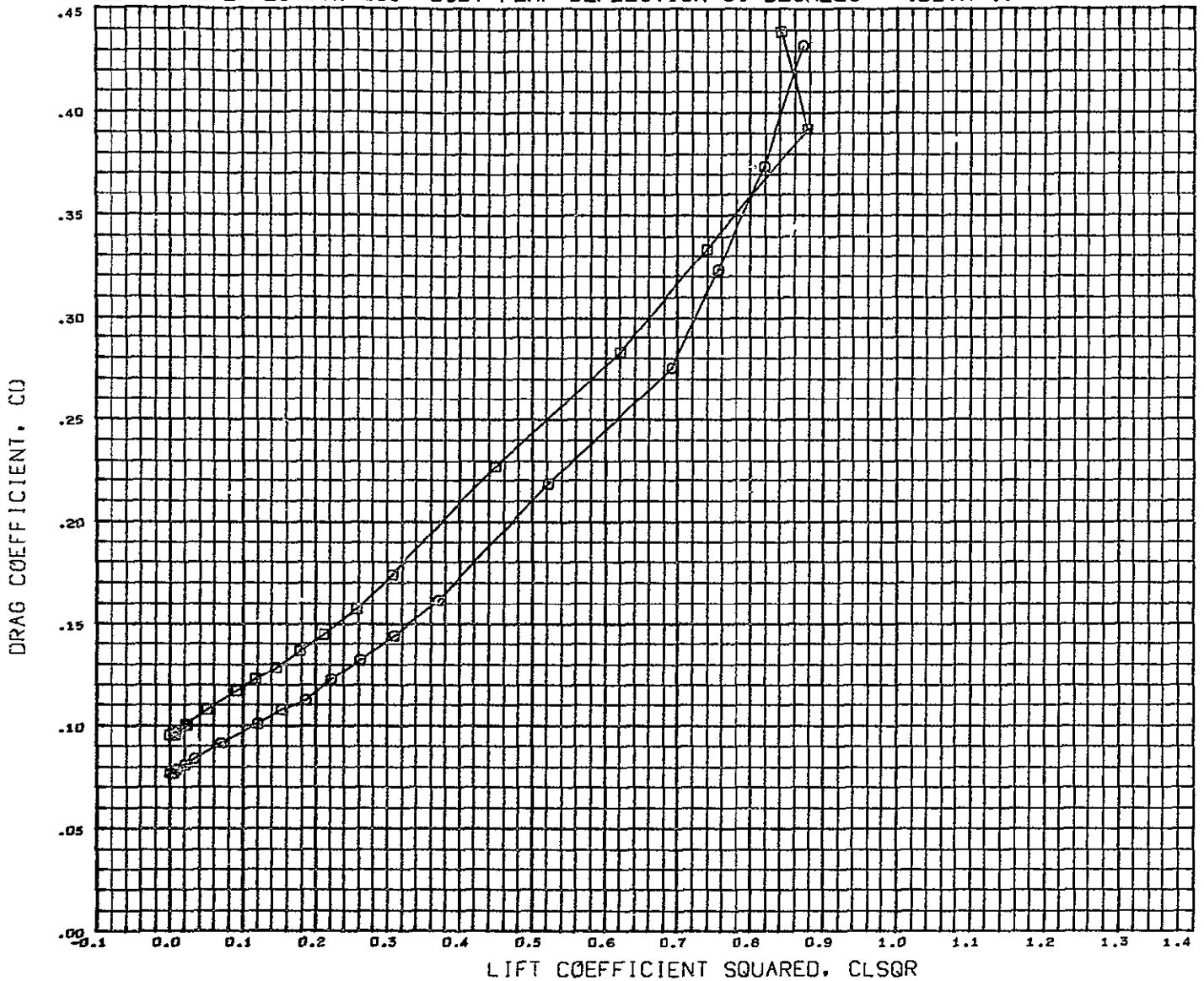

DATA SET SYMBOL	CONFIGURATION DESCRIPTION	ELEVTR	SBPOS	SFBRK	BFLAP	REFERENCE INFORMATION
(CCP048)	□ LSWT 248 HDAC 4.0 PC 02 HCR ORB	- 10.000		0.000	30.000	REFS 8.8690 SQ.FT.
(CCP046)	□ LSWT 248 HDAC 4.0 PC 02 HCR ORB	- 10.000	3.000	60.000	30.000	REFL 29.5700 IN.
						REFB 51.6000 IN.
						XMRP 59.3200 IN.
						YMRP 0.0000 IN.
						ZMRP 11.6000 IN.
						SCALE 4.0000 PERCENT

MACH 0.250



SPEEDBRAKE EFFECTIVENESS--BODY FLAP DEFLECTION=30 DEGREES (BETA=0)

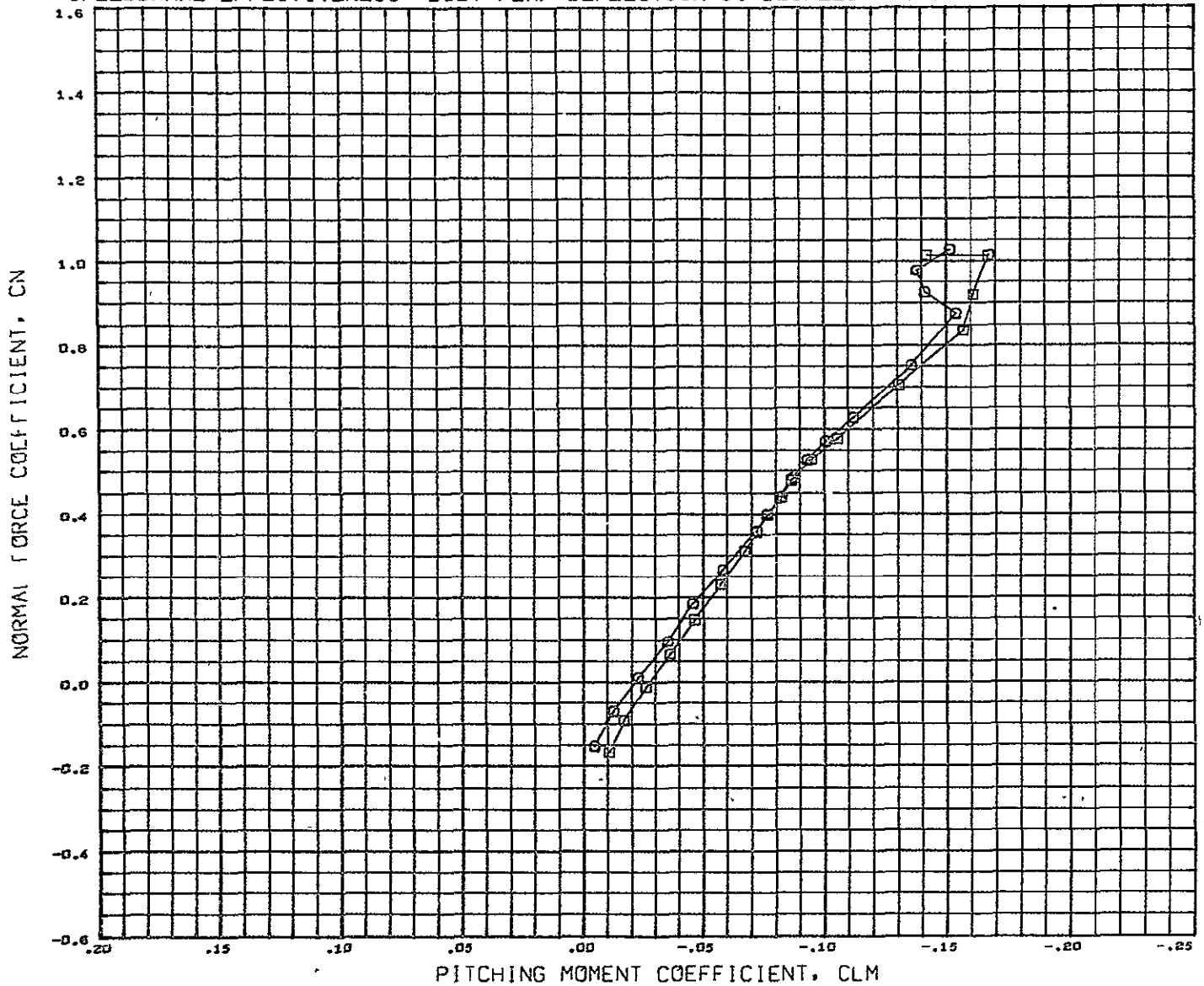

DATA SET SYMBOL	CONFIGURATION DESCRIPTION		ELEVTR	SBPOS	SPBRK	BFLAP	REFERENCE INFORMATION
(BCPD48)	LSWT 248 MDAC 4.0 FC O2 HCR ORB	B5W11	- 10.000		0.000	30.000	REFS 8.8690 SQ.FT.
(BCPD46)	LSWT 248 MDAC 4.0 FC O2 HCR ORB	B5W11SB2	- 10.000	3.000	60.000	30.000	REFL 29.5700 IN.
							REFB 51.6000 IN.
							X.RP 59.3200 IN.
							YMRP 0.0000 IN.
							ZMRP 11.6000 IN.
							SCALE 4.0000 PERCENT

MACH 0.250

# LONGITUDINAL CONTROL POWER SPEED BRAKES EXTENDED

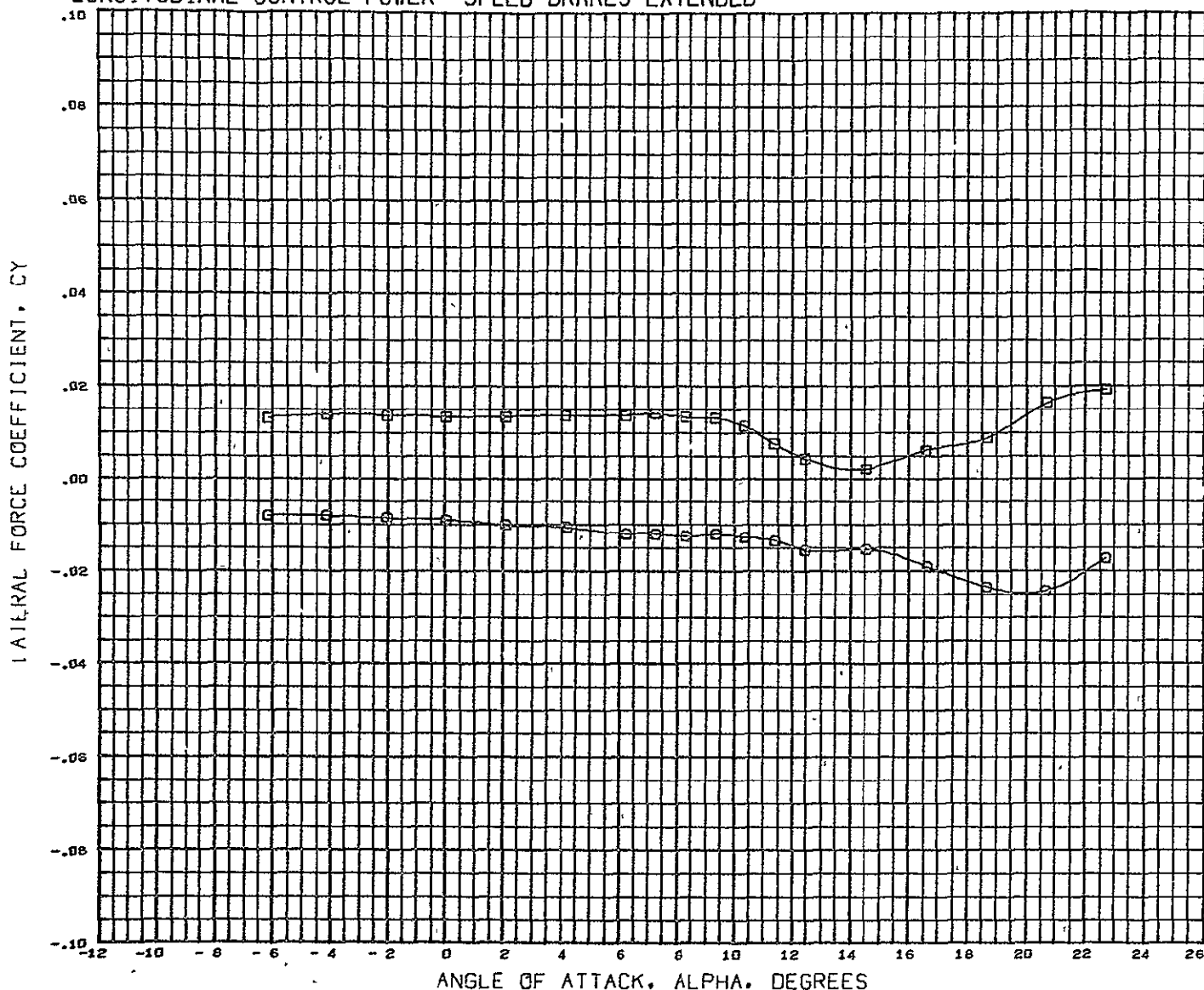

DATA SET SYMBOL	CONFIGURATION DESCRIPTION	BETA	ELEVTR	SPBRK	ØFLAP	REFERENCE INFORMATION
(CCPD39)	□ LSWT 248 MDAC 4.0 FC 02 HCR ORB B5W11SB2	0.000 - 10.000	30.000	15.000	REFS	8.8690 SQ.FT
(CCPD42)	□ LSWT 248 MDAC 4.0 FC 02 HCR ORB B5W11SB2	- 3.000 - 10.000	30.000	15.000	REFL	29.5700 IN.
					REFB	51.6000 IN.
					XMRP	59.3200 IN.
					YMRP	0.0000 IN.
					ZMRP	11.6000 IN.
					SCALE	4.0000 PERCNT

MACH 0.250

# LONGITUDINAL CONTROL POWER SPEED BRAKES EXTENDED

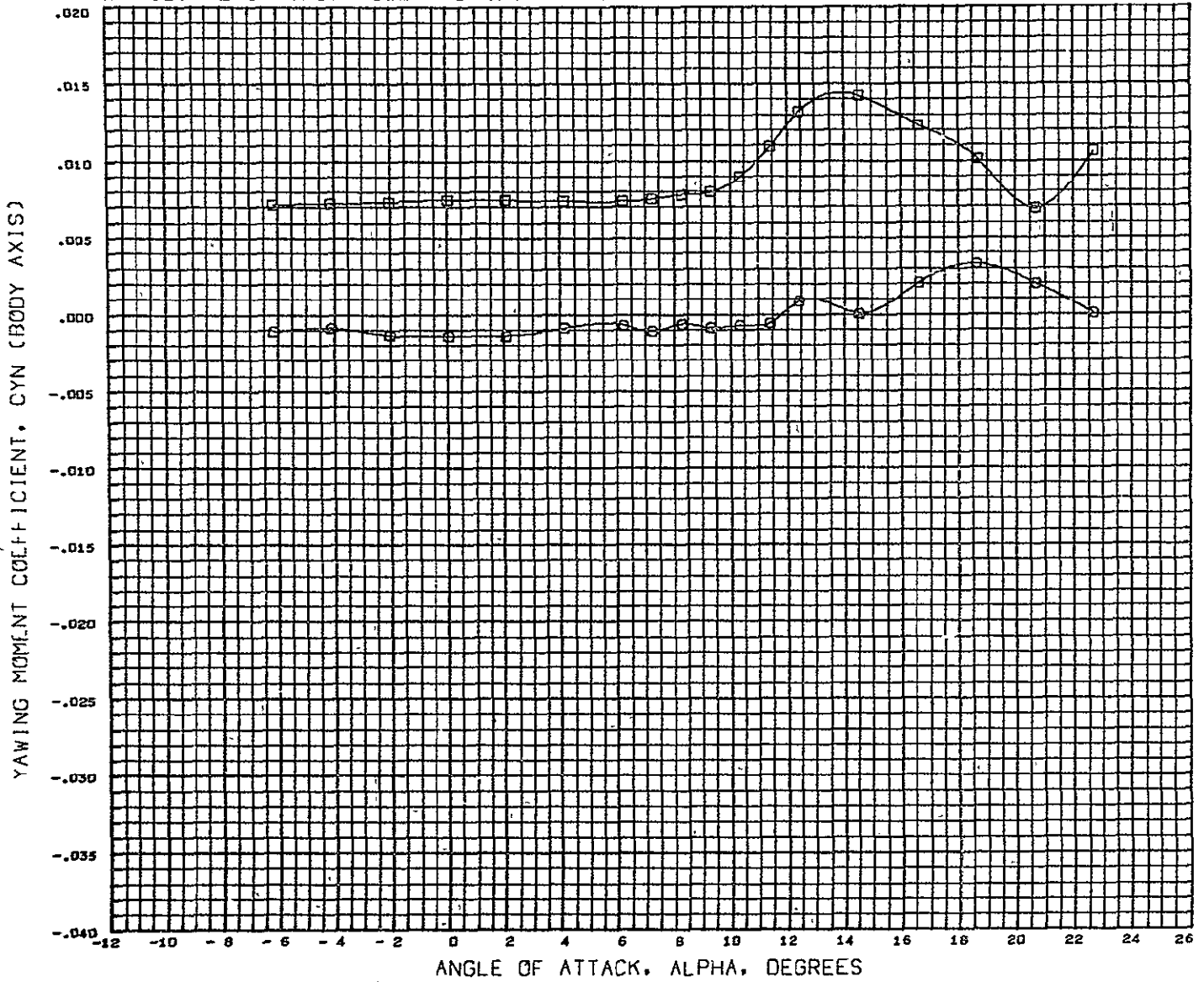

DATA SET SYMBOL	CONFIGURATION DESCRIPTION	BETA	ELEVTR	SPBRK	BFLAP	REFERENCE INFORMATION
(CCFD39)	LSWT 248 MDAC 4.0 PC 02 HCR ORB	85W11382	0.000 - 10.000	30.000	15.000	REFS 8.8600 SQ.FT.
(CCFD42)	LSWT 248 MDAC 4.0 PC 02 HCR ORB	85W11382	3.000 - 10.000	30.000	15.000	REFL 29.5700 IN.
						REFB 51.6000 IN.
						XMRP 59.3200 IN.
						YMRP 0.0000 IN.
						ZMRP 11.6000 IN.
						SCALE 4.0000 PERCENT

MACH 0.250

LONGITUDINAL CONTROL POWER SPEED BRAKES EXTENDED

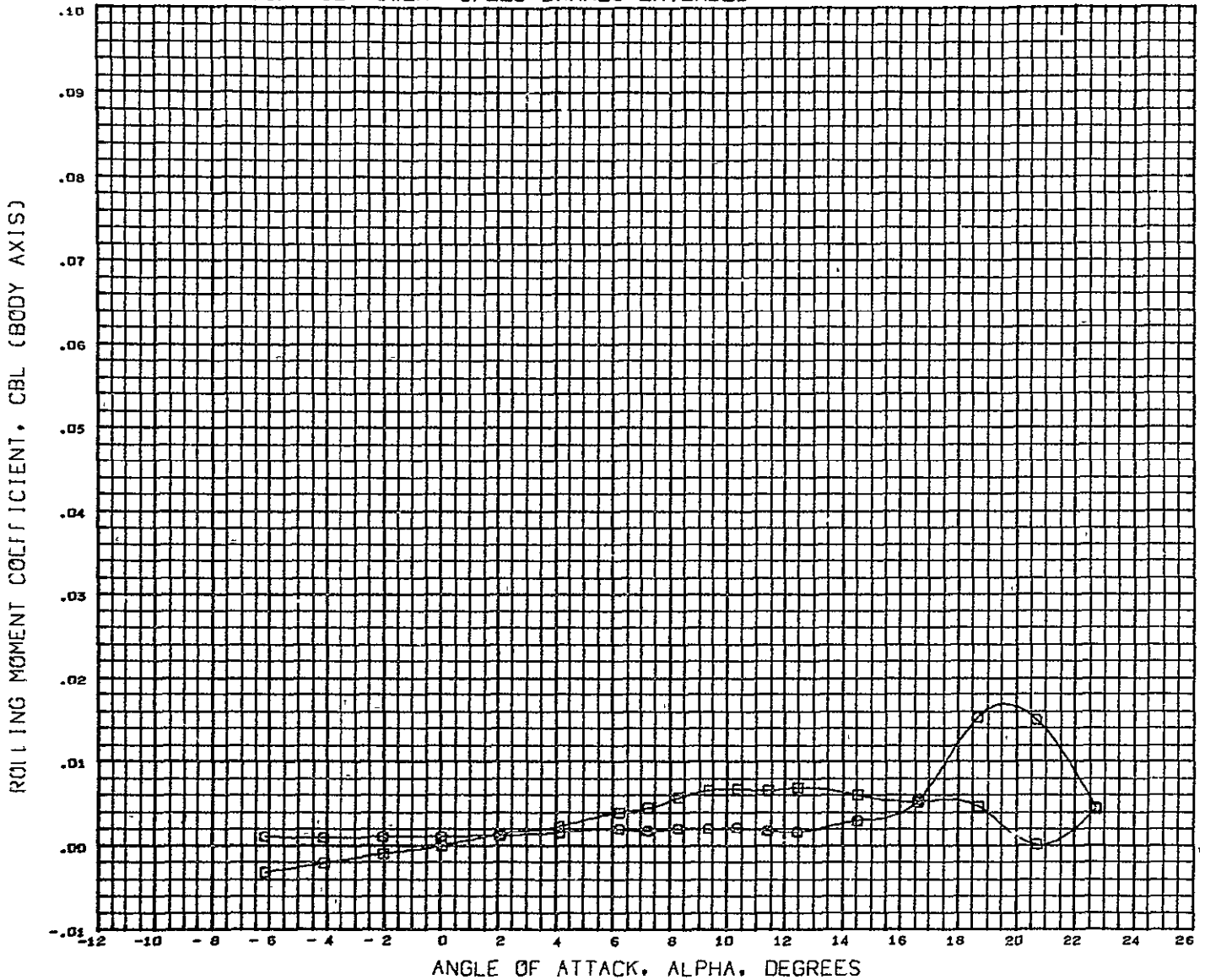

DATA SET	SYMBOL	CONFIGURATION DESCRIPTION	BETA	ELEVTR	SPBRK	BFLAP	REFERENCE INFORMATION
(CCF039)	○	LSWT 248 MDAC 4.0 PC 02 HCR ORB	0.000 - 10.000	30.000	15.000	REFS	8.8690 SQ.FT.
(CCF042)	□	LSWT 248 MDAC 4.0 PC 02 HCR ORB	- 3.000 - 10.000	30.000	15.000	REFL	29.5700 IN.
						REFB	51.6000 IN.
						YMRP	59.3200 IN.
						ZMRP	0.0000 IN.
						ZMRP	11.6000 IN.
						SCALE	4.0000 PERCENT

MACH 0.250

LONGITUDINAL CONTROL POWER SPEED BRAKES EXTENDED

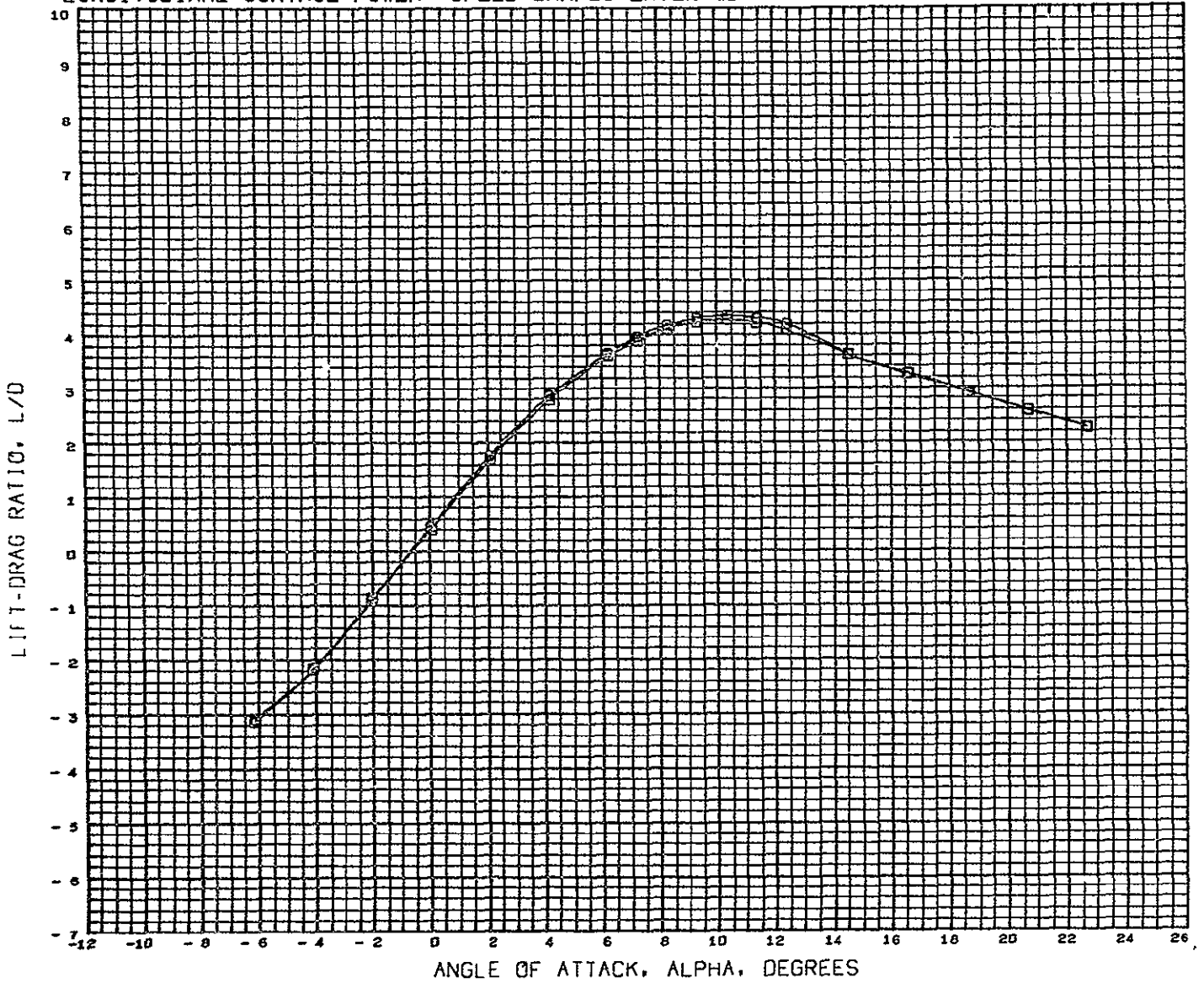

DATA SET SYMBOL	CONFIGURATION DESCRIPTION	BETA	ELEVTR	SFBRK	BFLAP	REFERENCE INFORMATION
(CCP039)	LSWT 248 HDAC 4.0 FC 02 HCR ORB	85W116B2	0.000 - 10.000	30.000	15.000	REFS 8.8690 SQ.FT.
(CCP042)	LSWT 248 HDAC 4.0 FC 02 HCR ORB	85W116B2	- 3.000 - 10.000	30.000	15.000	REFL 29.5700 IN.
						REFB 51.6000 IN.
						XMRP 59.3200 IN.
						YMRP 0.0000 IN.
						ZMRP 11.6000 IN.
						SCALE 4.0000 PERCENT

MACH 0.250



D

LONGITUDINAL CONTROL POWER SPEED BRAKES EXTENDED

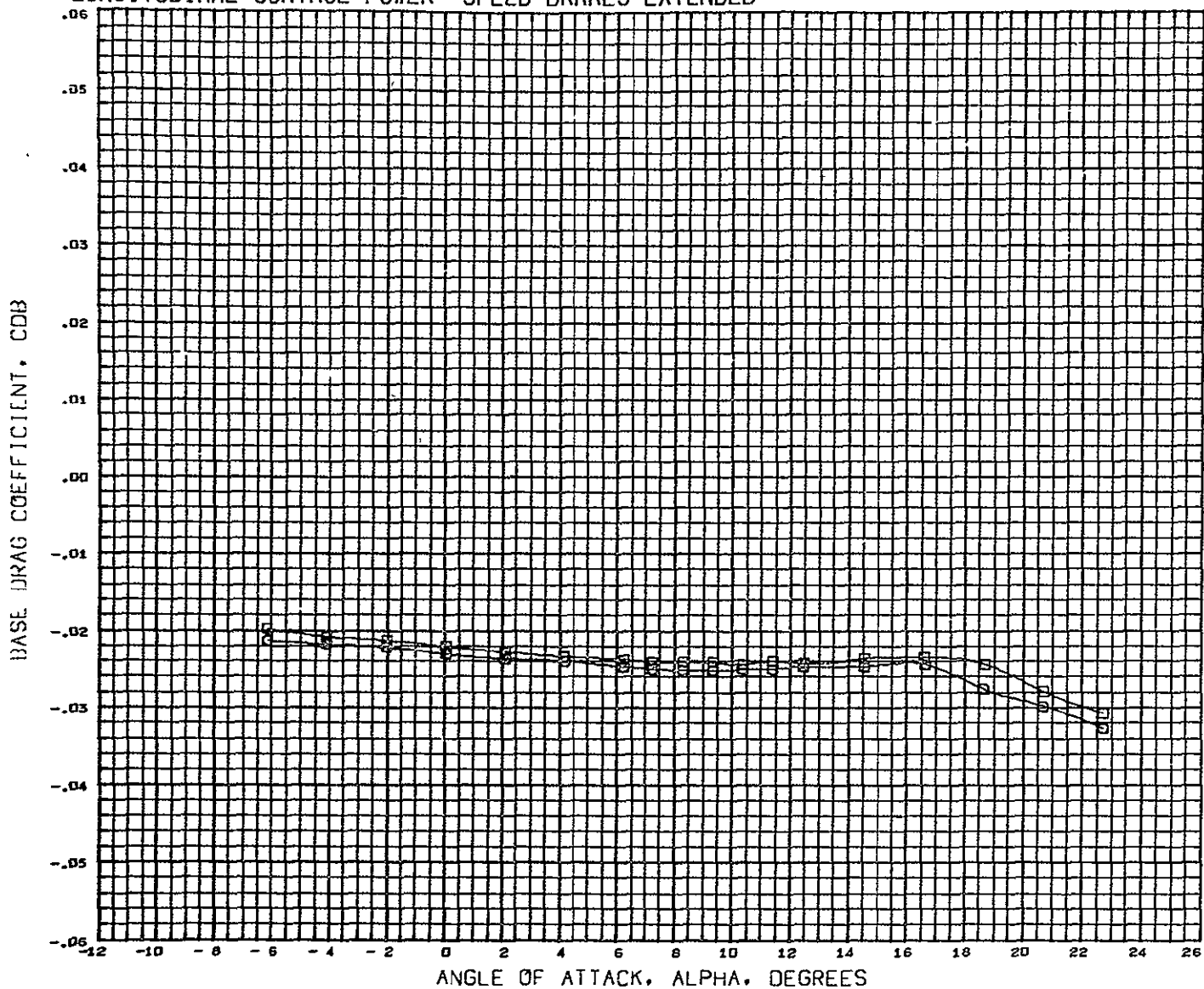

DATA SET SYMBOL	CONFIGURATION DESCRIPTION	BETA	ELEVTR	SPBRK	BFLAP	REFERENCE INFORMATION
(CCPD39)	LSWT 248 HDAC 4.0 FC O2 HCR ORB B5W11SB2	0.000 - 10.000	30.000	15.000	REFS	8 8690 SQ FT.
(CCPD42)	LSWT 248 HDAC 4.0 FC O2 HCR ORB B5W11SB2	- 3.000 - 10.000	30.000	15.000	REFL	29.5700 IN.
					REFB	51.6000 IN.
					XMRP	59.3200 IN.
					ZMRP	0.0000 IN.
					ZMRP	11.6000 IN.
					SCALE	4.0000 PERCENT

MACH 0.250

LONGITUDINAL CONTROL POWER SPEED BRAKES EXTENDED

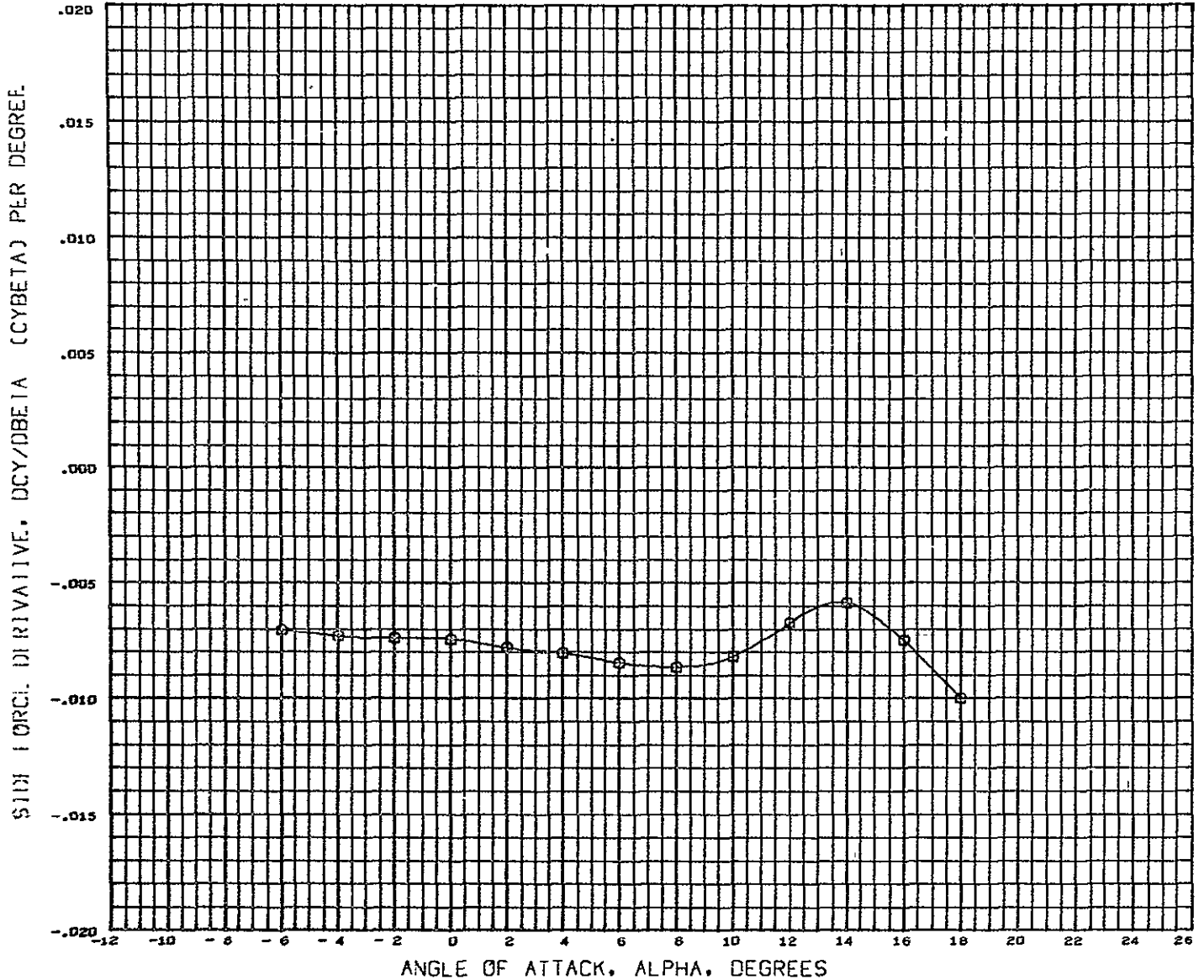

SYMBOL		MACH		PARAMETRIC VALUES				REFERENCE INFORMATION		
0	0.260	ELEVTR	-10.000	AILRON	0.000	REFS	8.8690	SQ.FT.		
		SPBRK	30.000	BFLAP	15.000	REFL	29.5700	IN.		
		SBPOS	3.000			REFB	51.6000	IN.		
						XMRP	59.3200	IN.		
						YMRP	0.0000	IN.		
						ZMRP	11.6000	IN.		
						SCALE	4.0000	PERCENT		

DATA HIST. CODE M#EV#EI#CV

LONGITUDINAL CONTROL POWER SPEED BRAKES EXTENDED

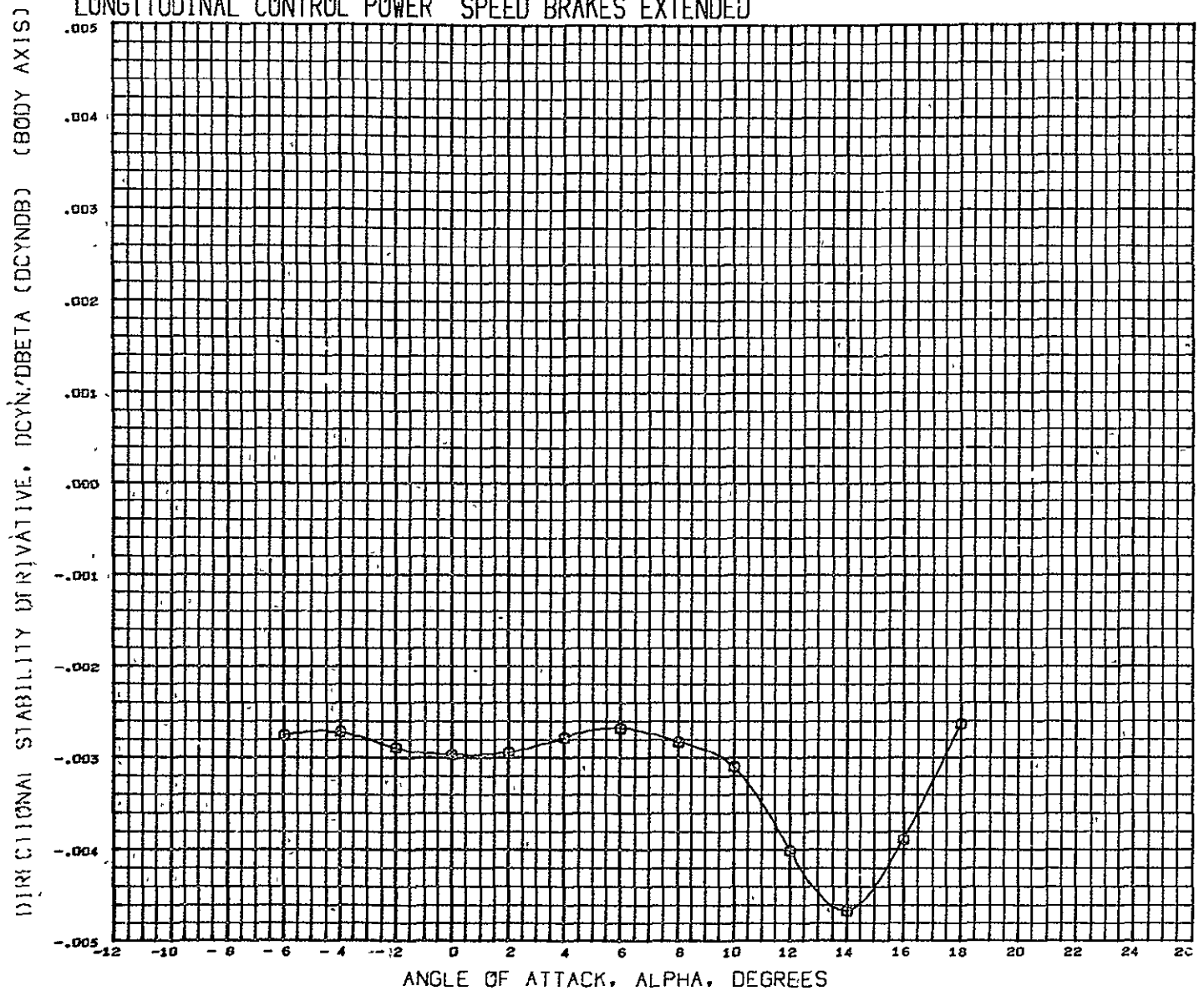

SYMBOL	MACH	PARAMETRIC VALUES			
0	0.260	ELEVTR	-10.000	AILRON	0.000
		SPBRK	30.000	BFLAP	15.000
		SBPOS	3.000		

REFERENCE INFORMATION		
REFS	8.8690	SQ.FT.
REFL	29.5700	IN.
REFB	51.6000	IN.
XMRP	59.3200	IN.
YMRP	0.0000	IN.
ZMRP	11.6000	IN.
SCALE	4.0000	PERCNT

DATA HIST. CODE M#EV#EI#CV



# LONGITUDINAL CONTROL POWER SPEED BRAKES EXTENDED

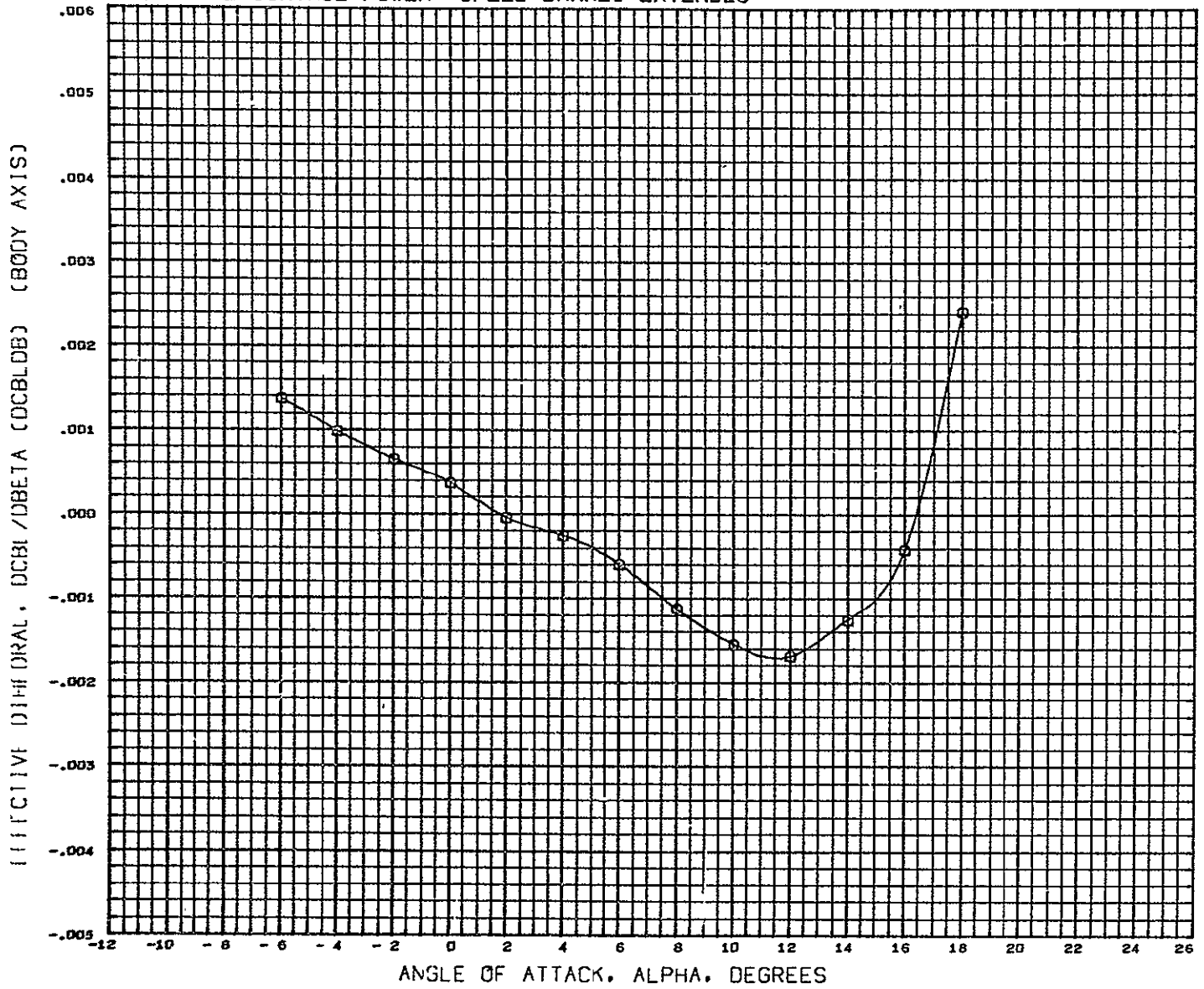

SYMBOL	HACH	PARAMETRIC VALUES				REFERENCE INFORMATION		
□	0.260	ELEVTR	-10.000	AILRON	0.000	REFS	0.8690	SQ.FT.
		SFBRK	30.000	BFLAP	15.000	REFL	29.5700	IN.
		SBFOS	3.000			REFB	51.6000	IN.
						XMRP	59.3200	IN.
						YMRP	0.0000	IN.
						ZMRP	11.6000	IN.
						SCALE	4.0000	PERCNT

DATA HIST. CODE H\*EV\*EI\*CV

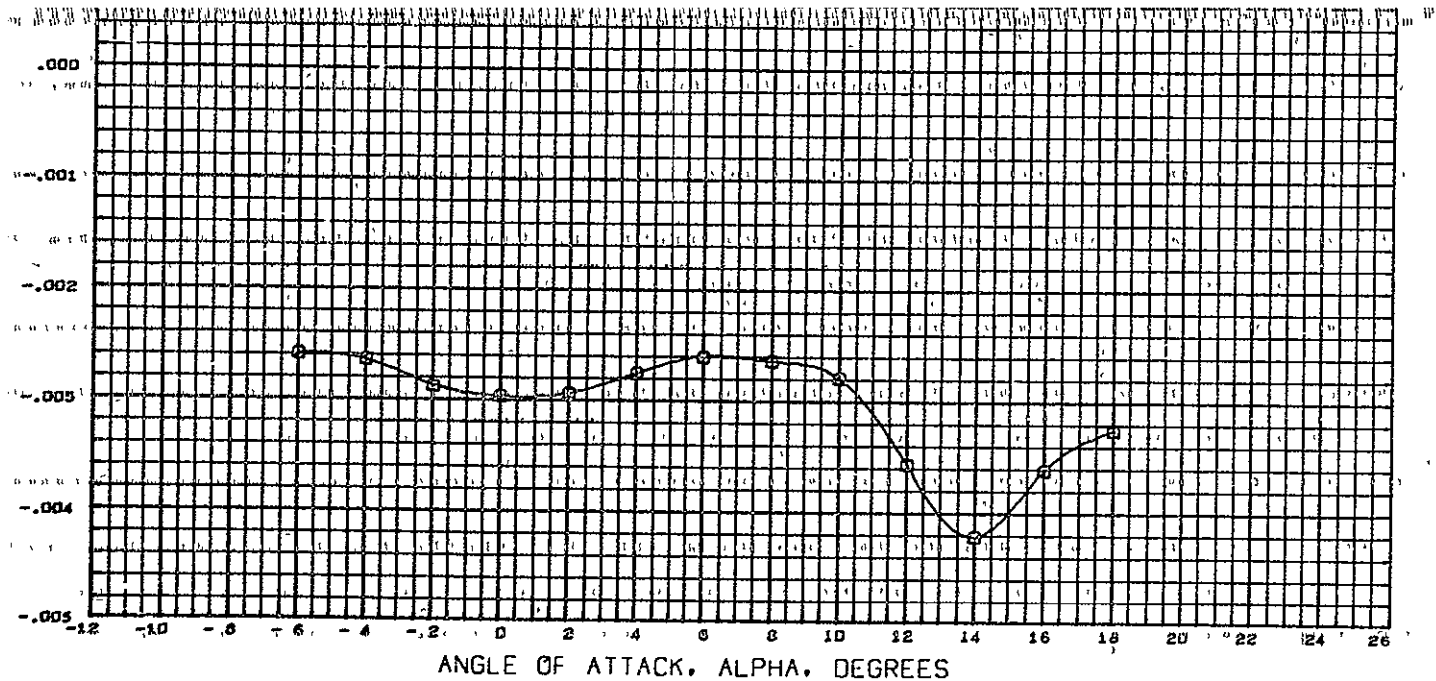

SYMBOL	MACH	PARAMETRIC VALUES				REFERENCE INFORMATION		
○	0.260	ELEVTR	-10.000	AILRON	0.000	REFS	8.8690	SQ.FT
		SPBRK	30.000	BFLAP	15.000	REFL	29.5700	IN
		SBPOS	3.000			REFB	51.6000	IN
						XMRP	59.3200	IN.
						YMRP	0.0000	IN.
						ZMRP	11.6000	IN.
						SCALE	4.0000	PERCENT

DATA HIST. CODE M#EVI#CV

LONGITUDINAL CONTROL POWER SPEED BRAKES EXTENDED

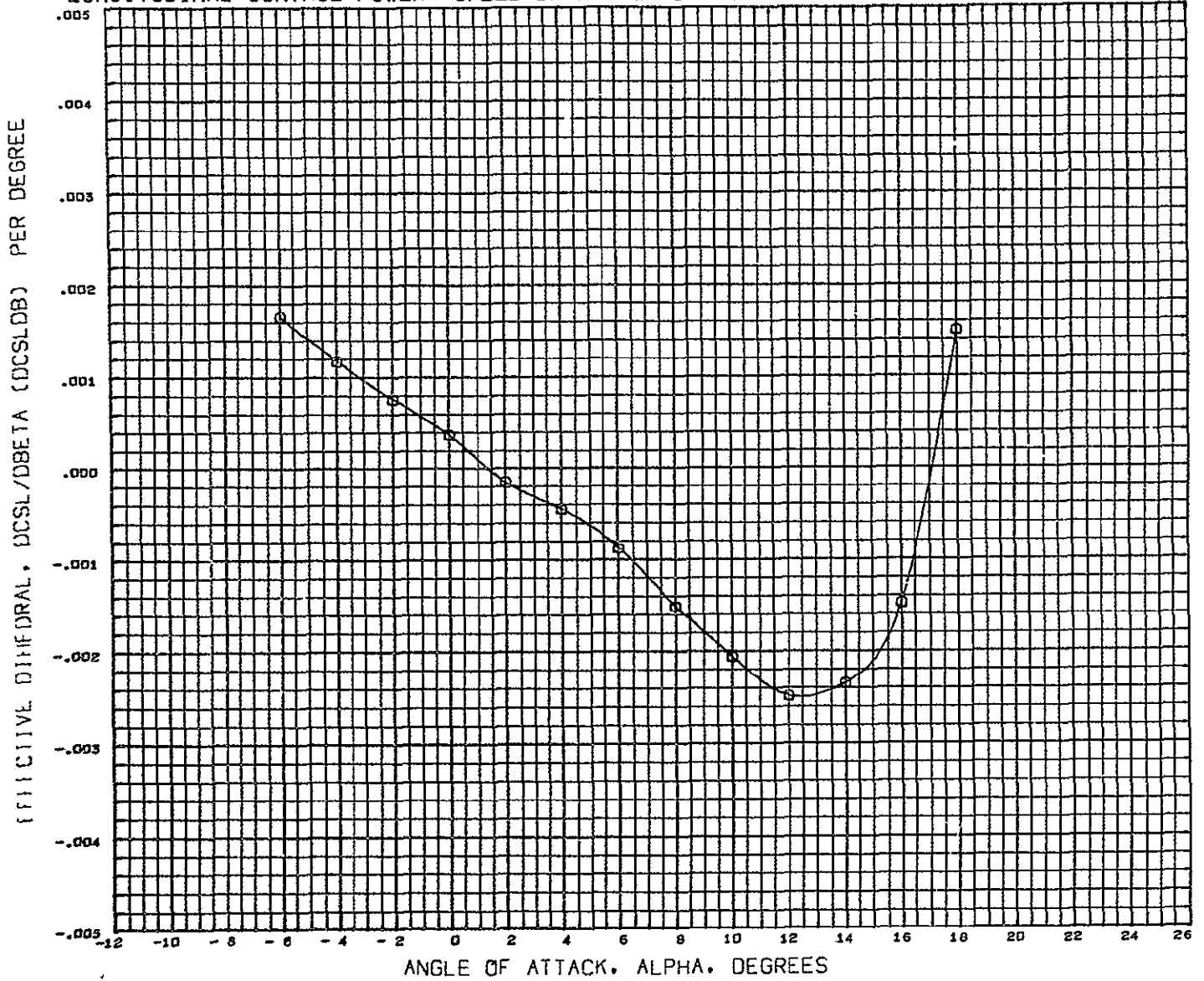

SYMBOL	MACH	PARAMETRIC VALUES			
○	0.260	ELEVTR	-10.000	AILRON	0.000
		SPERK	30.000	BFLAF	15.000
		SBPOS	3.000		

REFERENCE INFORMATION		
REFS	8.8690	SQ.FT.
REFL	29.5700	IN.
REFB	51.6000	IN.
XNRF	59.3200	IN.
YNRF	0.0000	IN.
ZNRF	11.6000	IN.
SCALE	4.0000	PERCNT

DATA HIST. CODE M#EVI#CV