

JULY 1971  
CR 119973

—SPACE SHUTTLE—



# INVESTIGATION OF THE McDONNELL- DOUGLAS ORBITER AND BOOSTER SHUTTLE MODELS IN PROXIMITY AT MACH NUMBERS 2.0 TO 6.0

## VOLUME I MACH NUMBER 5 BOOSTER PROXIMITY DATA

by

- L. L. Trimmer, AEDC
- D. A. Love, LMSC/HREC
- J. P. Decker, LaRC
- K. L. Blackwell, MSFC
- R. H. Burt, AEDC
- J. M. Rampy, LMSC/HREC

AEDC - VKF TUNNEL A

### ARNOLD ENGINEERING DEVELOPMENT CENTER

FACILITY FORM 602

471-38659  
(ACCESSION NUMBER)

426  
(PAGES)

CR-119973  
(NASA CR OR TMX OR AD NUMBER)

(THRU)

63

(CODE)

31  
(CATEGORY)

SADSAC SPACE SHUTTLE  
AEROTHERMODYNAMIC  
DATA MANAGEMENT SYSTEM

CONTRACT NAS8-4016  
MARSHALL SPACE FLIGHT CENTER



JULY, 1971

SADSAC/SPACE SHUTTLE  
WIND TUNNEL TEST DATA REPORT

CONFIGURATION: McDonnell-Douglas Orbiter and Booster Shuttle Models; 0.00556  
Scale

TEST PURPOSE: Experimental Aerodynamic Investigation of Space Shuttle Booster  
and Orbiter Vehicles in Close Proximity at Mach Numbers of 2.0  
to 5.0

TEST FACILITY: AEDC-VKF Tunnel A

TESTING AGENCY: LARC/MSFC

TEST NO. & DATE: AEDC VA 1163; 21 through 27 April 1971

SADSAC COORDINATORS: L. L. Trimmer            AEDC  
D. A. Love                                    IMSC/HREC

PROJECT ENGINEERS: J. P. Decker                            LARC  
K. L. Blackwell                           MSFC  
R. H. Burt                                    AEDC  
J. M. Reepy                                   IMSC/HREC

DATA MANAGEMENT SERVICES

LIAISON: *G. G. McDonald* DATA OPERATIONS: *J. L. Glynn*

RELEASE APPROVAL: *J. L. Glynn*  
FOR M. D. Kemp, Supervisor  
Aero Thermo Data Group

CONTRACT NAS8-4016

AMENDMENT 151

DRL 184 - 58

This report has been prepared by Chrysler Corporation Space Division under a Data Management Contract to the NASA. Chrysler assumes no responsibility for the data presented herein other than its display characteristics.

SADSAC COORDINATORS:

Mr. L. L. Trimmer  
VKF - SH  
AEDC  
Arnold Air Force Station,  
Tennessee 37389

Phone: (615)455-2671 Ext. 7377

Mr. D. A. Love  
Lockheed Missile & Space Company  
Huntsville Research Engineering Center  
4800 Bradford Blvd.  
Huntsville, Alabama 35805

Phone: (205) 837-1800 Ext. 378

PROJECT ENGINEERS:

Mr. J. P. Decker  
Langley Research Center  
Langley Station  
Hampton, Virginia 23365

Phone: (703) 827-3911

Mr. K. L. Blackwell  
Marshall Spaceflight Center  
Mail Stop S&E - AERO - AAE  
Huntsville, Alabama 35801

Phone: (205) 453-2517

Mr. R. H. Burt  
AEDC  
Arnold Air Force Station,  
Tennessee 37389

Phone: (615) 455-2671 Ext. 7533

Mr. J. M. Rampy  
Lockheed Missile & Space Company  
Huntsville Research Engineering Center  
4800 Bradford Blvd.  
Huntsville, Alabama 35805

Phone: (205) 837-1800 Ext. 335

SADSAC LIAISON:

Mr. G. G. McDonald  
Chrysler Corporation Space Division  
102 Wynn Drive  
Huntsville, Alabama 35805

Phone: (205) 895-1341

SADSAC OPERATIONS:

Mr. J. L. Glynn  
Chrysler Corporation Space Division  
P. O. Box 29200  
New Orleans, Louisiana 70129

Phone: (504) 255-2304

## ABSTRACT

This report presents aerodynamic data obtained from a joint Langley Research Center (LaRC)/Marshall Space Flight Center (MSFC) Space Shuttle abort stage separation wind tunnel test. The .00556 scale models of the McDonnell-Douglas orbiter and booster configurations were tested in close proximity using dual balances in Tunnel A of the Von Karman Facility (VKF), Arnold Engineering Development Center (AEDC) during the time period of April 21 to April 27, 1971. Data were obtained for both booster and orbiter over an angle of attack range from  $-10^{\circ}$  to  $10^{\circ}$  for zero degree sideslip angle. The models were tested at several relative incidence angles and separation distances and power conditions. Plug nozzles utilizing air were used to simulate booster and orbiter plumes at various altitudes along a nominal ascent trajectory. Powered conditions were 100, 50, 25 and 0 percent of full power for the orbiter and 100, 50 and 0 percent of full power for the booster. Pitch control effectiveness data were obtained for both booster and orbiter with power on and off. In addition, launch vehicle data with and without booster power were obtained utilizing a single balance in the booster model. Data were also obtained with the booster canard off in close proximity and for the launch configuration.

Plotted data for this test will be published under one data report number (DMS-DR-1108) with seven volumes as described below:

<u>Volume</u>	<u>Description</u>
I	Mach Number 5 Booster Proximity Data
II	Mach Number 5 Orbiter Proximity Data
III	Mach Number 3 Booster Proximity Data
IV	Mach Number 3 Orbiter Proximity Data
V	Mach Number 2 Booster Proximity Data
VI	Mach Number 2 Orbiter Proximity Data
VII	Interference Free Data for Orbiter and Booster, Launch Vehicle Data, and Proximity Data for Mach Numbers 4 and 6

A report containing Schlieren photographs will be published by AEDC. Schlieren photographs were taken at  $-10$ ,  $0$ , and  $10$  degrees angles of attack for each pitch polar.

THIS PAGE INTENTIONALLY LEFT BLANK

TABLE OF CONTENTS

	<u>PAGE NUMBER</u>
ABSTRACT .....	
LIST OF FIGURES AND TABLES .....	2
SUMMARY .....	3
NOMENCLATURE SUMMARY .....	4
CONFIGURATIONS INVESTIGATED .....	5
NOZZLE CALIBRATIONS .....	6
TEST PROCEDURE .....	8
DATASET COLLATIONS .....	10
TEST FACILITY DESCRIPTION .....	63
TEST CONDITIONS .....	64
DATA REDUCTION .....	70
SUMMARY DATA PLOT INDEX .....	74
FIGURES .....	75
MODEL COMPONENT DESCRIPTION SHEETS .....	87
NOMENCLATURE .....	96
ADDITIONS AND CHANGES TO NOMENCLATURE .....	101
REFERENCES .....	103
TABULATED DISPLAY LISTING .....	104
PLOTTED DATA .....	105

## LIST OF FIGURES AND TABLES

Figure	Title	Page
1	Axis Systems . . . . .	76
2	Separation Nomenclature and Moment Reference Points . . . . .	77
3	General Arrangement of Models in Tunnel . . . . .	78
4	Modifications to Orbiter Model . . . . .	79
5	Modifications to Booster Model . . . . .	80
6	Photograph of Booster and Orbiter Sting-Nozzle Hardware . . . . .	81
7	Photograph of Booster Nozzle Hardware . . . . .	82
8	Photograph of Orbiter Nozzle Hardware . . . . .	83
9	Photograph of MDAC Booster and Orbiter Models . . . . .	84
10	Photograph of Side View of Models and Separation Hardware . . . . .	85
11	Photograph of Top View of Models and Associated Separation Hardware . . . . .	86
Table	Title	Page
I	SADSAC Nomenclature of Aerodynamic Coefficients. . . . .	4

## SUMMARY

This report presents aerodynamic data obtained from a joint Langley Research Center (LaRC)/Marshall Space Flight Center (MSFC) Space Shuttle abort stage separation wind tunnel test. The .00556 scale models of the McDonnell-Douglas orbiter and booster configurations were tested in close proximity using dual balances in Tunnel A of the Von Karman Facility (VKF), Arnold Engineering Development Center (AEDC) during the time period of April 21 to April 27, 1971. Data were obtained for both booster and orbiter over an angle of attack range from  $-10^{\circ}$  to  $10^{\circ}$  for zero degree sideslip angle. The models were tested at several relative incidence angles and separation distances and power conditions. Plug nozzles utilizing air were used to simulate booster and orbiter plumes at various altitudes along a nominal ascent trajectory. Powered conditions were 100, 50, 25 and 0 percent of full power for the orbiter and 100, 50 and 0 percent of full power for the booster. Pitch control effectiveness data were obtained for both booster and orbiter with power on and off. In addition, launch vehicle data with and without booster power were obtained utilizing a single balance in the booster model. Data were also obtained with the booster canard off in close proximity and for the launch configuration.

Plotted data for this test will be published under one data report number (DMS-DR-1108) with seven volumes as described below:

<u>Volume</u>	<u>Description</u>
I	Mach Number 5 Booster Proximity Data
II	Mach Number 5 Orbiter Proximity Data
III	Mach Number 3 Booster Proximity Data
IV	Mach Number 3 Orbiter Proximity Data
V	Mach Number 2 Booster Proximity Data
VI	Mach Number 2 Orbiter Proximity Data
VII	Interference Free Data for Orbiter and Booster, Launch Vehicle Data, and Proximity Data for Mach Numbers 4 and 6.

A report containing Schlieren photographs will be published by AEDC. Schlieren photographs were taken at  $-10^{\circ}$ ,  $0^{\circ}$ , and  $10^{\circ}$  degrees angles of attack for each pitch polar.



TABLE I. SADSAC NOMENCLATURE OF AERODYNAMIC COEFFICIENTS

COEFFICIENT	COEFFICIENT NAME	SADSAC NOMENCLATURE		
		BODY AXIS	STABILITY AXIS	WIND AXIS
$C_A$	Total Axial Force	CA	-	-
$C_{AB}$	Base Axial Force	CAB	--	-
$C_{AF}$	Forebody Axial Force	CAF	-	-
$C_D$	Total Drag Force	-	CD	CDTOTL
$C_{DB}$	Base Drag Force	-	CDB	CDBASE
$C_{DF}$	Forebody Drag Force	-	CDF	CDFORE
$C_L$	Lift Force	-	CL	CL
$C_N$	Normal Force	CN	-	-
$C_Y$	Side Force	CY	CY	CC
$C_l$	Rolling Moment	CBL	CSL	CWL
$C_m$	Pitching Moment	CLM	CLM	CPM
$C_n$	Yawing Moment	CYN	CLN	CLN
L/D	Lift-To-Drag Force Ratio	-	L/D	CL/CD
L/D	Lift-To-Forebody Drag Force Ratio	-	L/DF	CL/CDF
N/A	Normal-To-Axial Force Ratio	N/A	-	-
N/A	Normal-To-Forebody Axial Force Ratio	CN/CAF	-	-

## CONFIGURATIONS INVESTIGATED

The two configurations tested were the MDAC orbiter and booster, figures 4 and 5 respectively. The orbiter is basically the configuration illustrated on MDAC drawing number 255BJ0050. Modifications made on the orbiter to allow for installation of the nozzle assembly is shown in figure 4.

The booster configuration is basically the configuration designated 19A by MDAC (drawing number 256-19-0001). The body, wing, and canard of the booster model are that of configuration 19A except that the body does not have a base flare or boattail, figure 5. The vertical tails are those which were designed for the configuration designated 17 (drawing number 256-17-001).

Both the orbiter and booster models had moveable elevons with deflection angles of  $0^\circ$ ,  $\pm 10^\circ$ , and  $\pm 20^\circ$ . Geometric characteristics are shown on the following pages. Figures 4, 5, and 6 are photographs showing both models and models with associated separation hardware. Figures 5 and 6 also show the trip strip installation. For Mach 5 a grit size of #26 was utilized. However, at the beginning of the test a grit sizing study was performed which showed a slight effect on  $C_A$  only.

## NOZZLE CALIBRATION

Two plug nozzle systems were designed and fabricated to simulate the rocket exhaust plume emitting from the booster and orbiter main propulsion systems during staging. Each nozzle was designed based on the gasdynamic simulation parameters established in Ref. 1. A variable area ratio capability was incorporated into both nozzle systems to permit the proper gasdynamic simulation of the full scale rocket exhaust plume at the various trajectory conditions of interest. Photographs of the nozzle hardware are shown in figures 6, 7 and 8.

### Nozzle Calibration Test Objectives

The objectives of the nozzle calibration test were:

- o Establish, experimentally, nozzle performance characteristics for the range of area ratio settings to be used with the booster and orbiter nozzles, respectively.
- o Establish the degree of plume simulation obtained with the booster and orbiter nozzles, respectively.
- o Establish a curve (based on experimental results) of nozzle exit conditions as a function of nozzle area ratio setting.

### Nozzle Calibration

Calibration testing of the booster and orbiter plug nozzles was accomplished in Tunnel C of the Arnold Engineering Development Center's Von Karman Gas Dynamics Facility. The nozzles were tested individually at a series of area ratio settings. Nozzle operating conditions (chamber pressure,  $P_{Oj}$ , and chamber

temperature,  $T_{oj}$ ) were maintained in a range compatible with the abort staging test conditions. A quiescent low pressure,  $P_b$ , condition was maintained in the test cell. Data recorded at each area ratio setting included: optical data to determine plume shapes; static pressure measurements on the sting surface at the nozzle exit; nozzle mass flow measurements; and pitot pressure surveys in the plume at several locations downstream of the nozzle exit plane. The various test parameters sampled at each setting were correlated during the data evaluation to establish actual nozzle performance characteristics.

In a parallel effort, analytical solutions of the nozzle flow field and associated plume were generated for various area ratio settings of the booster and orbiter models. A method of characteristics solution employing real gas thermodynamic data for air was utilized in the calculations. Analytical results for each area ratio setting included: plume shape; static pressure distribution along sting surface; and plots of constant Mach number and constant pitot pressure contours in the plume flow field. These results formed a baseline for evaluating the experimentally measured performance of the plug nozzles.

A detailed evaluation of the calibration test results has been prepared and presented in Reference 2. Included in this reference are curves relating experimentally measured nozzle performance to nozzle area ratio settings for both booster and orbiter. These curves were utilized to set the correct nozzle area ratio for exhaust plume gasdynamic simulations during the test.

## TEST PROCEDURE

Abort staging was simulated by movement of the orbiter model through a matrix of points in the booster model flow field. Vertical and axial translation of the orbiter model was provided by an electrically driven remotely controlled positioning mechanism. The general arrangement of the models in the tunnel is shown in figure 3. The orbiter positioning mechanism and the booster model support were attached to the wind tunnel angle of attack system which provided  $\pm 10$ -degree angle of attack variation for the booster-orbiter combination. Incidence angle variation was provided by manual adjustment of the orbiter sting.

The orbiter positioning mechanism provided axial translation of approximately 17 inches and vertical translation of approximately 15 inches with respect to the booster. An automatic control system allowed a series of positions to be programmed prior to a test run. The control system had provisions for 25 different x-positions and 25 different z-positions. For these tests, however, only 9 x-positions and 8 z positions were utilized. All x and z positions except the first and last could be switched in or out of the matrix as desired.

The automatic positioning mechanism was slaved to the angle of attack mechanism so that as a pitch sweep was completed the positioning mechanism

was released to advance to the next matrix point and as the point was reached the angle of attack mechanism was released for a pitch sweep. The entire matrix was covered in this manner and about 30 seconds were required for each pitch sweep in the matrix.

Plume simulation was provided by a single torodial nozzle in each model. The nozzles were designed with variable area ratio capability to permit proper simulation of the full-scale rocket plume at the various trajectory conditions of interest. Pretest calibration of the nozzles was used to correlate area ratio settings with measured plume shapes, nozzle mass flow, and nozzle exit static pressure. Air heated to approximately 100°F was supplied to the nozzles, and separate controls for the booster and orbiter supplies were provided.

TEST VA 1163 DATA SET COLLATION SHEET

10

PRETEST  
 POSTTEST

DATA SET IDENTIFIER	CONFIGURATION	SCHD.		PARAMETERS/VALUES							No. of Runs	DELTA Z/R							
		α	β	PWR	PWR	ΔX/R	α <sub>2</sub>	M <sub>00</sub>	δ <sub>02</sub>	δ <sub>00</sub>		.119	.151	.182	.228	.352	.599	908	100
RT8001	MDAC BOOSTER	A	0	0.0	0.0	-.391	0.0	5.0	0.0	0.0	8	301	318	319	338	339	354	355	355
	002					-.143					8	302	317	320	337	340	353	356	
	003					-.019					8	303	316	321	336	341	352	357	
	004					.043					6	304	315	322	335	342			
	005					.105					8	305	314	323	333	343	351	358	
	006					.167					6	306	313	324	332	344			
	007					.228					8	307	312	325	331	345	350	359	
	008					.351					8	308	311	326	330	346	349	360	
	009					.522					8	309	310	327	328	347	348	361	Y
	010					-.391	5.1				6	601	618	619	636	637		637	
	011					-.143					6	602	619	620	635	638			
	012					-.019					5	603	616	621	634				
	013					.043					5	604	615	622	633				
	014					.105					6	605	614	623	632	639			
	015					.167					5	606	613	624	631				
	016					.228					5	607	612	625	630				
	017					.351					5	608	611	626	629				
	018					.522					6	609	610	627	628	640			Y

1            7            13            19            25            31            37            43            49            55            61            67            7576

ALPHA QCLM    ICH    ICA    ICBL    CY    CYN    DELTA Z    7

COEFFICIENTS:    A = -10° to +10° ONE DATA POINT PER DEGREE    IDPVAR(1) IDPVAR(2) NDV

α or β

SCHEDULES

TEST VA 1163 DATA SET COLLATION SHEET

1

PRETEST  
 POSTTEST

DATA SET IDENTIFIER	CONFIGURATION	SCHED.		PARAMETERS/VALUES							No. of Runs	DELTA Z/°B								
		α	β	PWR	PWR	AX/L	α <sub>i</sub>	M <sub>0</sub>	δ <sub>0g</sub>	δ <sub>0g</sub>		.119	.151	.182	.222	.352	.599	.908	10.0	
RTB 019	MDAC BOOSTER	A	0	0.0	0.0	-.391	10.1	5.0	0.0	0.0	5				1101	1118	1119	1131		1131
020						-.143					5				1102	1117	1120	1130		
021						-.219					4				1103	1116	1121			
022						.043					4				1104	1115	1122			
023						.105					5				1105	1114	1123	1129		
024						.167					4				1106	1113	1124			
025						.228					4				1107	1112	1125			
026						.351					4				1108	1111	1126			
027						.501					5				1109	1110	1127	1121		↓
028						-.391	-4.9				7	741	701	718	719	736	737			737
029						-.143					7	743	702	717	720	735	738			
030						-.019					6	744	703	716	721	734				
031						.043					6	745	704	715	722	733				
032						.105					7	746	705	714	723	732	739			
033						.167					6	747	706	713	724	731				
034						.228					6	748	707	712	725	730				
035						.351					6	749	708	711	726	729				
↓ 036						.522					7	750	709	710	727	728	740			↓

1      7      13      19      25      31      37      43      49      55      61      67      75 76

ALPHA    CLM    ICN    ICR    ICBL    CY    CYN    DELTA Z    7

COEFFICIENTS: \_\_\_\_\_ IDPVAR(1) IDPVAR(2) NDV

α or β      A = -10° to +10° ONE DATA POINT PER DEGREE

SCHEDULES \_\_\_\_\_



PRETEST

POSTTEST

DATA SET IDENTIFIER	CONFIGURATION	SCHD.		PARAMETERS/VALUES						No. of Runs	DELTA Z/LB								
		a	B	PWR	PWR	AX/LA	$\alpha_i$	M <sub>0</sub>	$\delta_{02}$		$\delta_{00}$	.119	.151	.182	.228	.352	.599	.908	10.0
RT8 037	MDAC BOOSTER	A	0	50.	100.	.391	0.0	5.0	0.0	0.0	8	401	418	419	436	437	453	454	454
038						.143					8	402	417	420	435	438	452	455	
039						.019					8	403	416	421	434	439	451	456	
040						.043					6	404	415	422	433	440			
041						.105					8	405	414	423	432	441	450	457	
042						.167					6	406	413	424	431	442			
043						.228					8	407	412	425	430	443	449	458	
044						.351					8	408	411	426	429	444	447	459	
045						.522	Y				8	409	410	427	42	445	446	460	Y
046						.391	5.1				6	501	518	519	536	537		537	
047						.143					6	502	517	520	535	538			
048						.019					5	503	516	521	534				
049						.043					5	504	515	522	533				
050						.105					6	505	514	523	532	539			
051						.167					5	506	513	524	531				
052						.228					5	507	512	525	530				
053						.351					5	508	511	526	529				
054						.522	Y	Y	Y	Y	6	509	510	527	528	540			Y

1 7 13 19 25 31 37 43 49 55 61 67 75 76

ALPHA QCLM ICN ICB ICBL CY CYN DELTA 7

COEFFICIENTS:

a or B

SCHEDULES

A = -10° to +10° ONE DATA POINT PER DEGREE → |IDPVAR(1)| IDPVAR(2) |NDV

TEST VA 1163 DATA SET COLLATION SHEET

13

PRETEST  
 POSTTEST

DATA SET IDENTIFIER	CONFIGURATION	SCHED.		PARAMETERS/VALUES							No. of Runs	DELTA Z/2B								
		A	B	PWR	PWR	AL	A	M	SEP	60		.119	.151	.182	.228	.352	.599	.908	10.0	
RT8055	MDAC BOOSTER	A	D	50	100	-391	10.1	5.0	0.0	0.0	5				1001	1019	1020	1032		1032
056						-143					5				1002	1018	1021	1031		
057						-019					4				1003	1017	1022			
058						.043					4				1004	1016	1023			
059						.105					5				1005	1015	1024	1030		
060						.167					4				1006	1014	1025			
061						.228					4				1007	1022	1026			
062						.351					4				1008	1011	1027			
063						.501	∇				5				1009	1010	1028	1029		∇
064						-391	-5.0				7	801	818	819	837	838	850			850
065						-143					7	802	817	820	836	839	849			
066						-019					6	803	816	821	835	840				
067						.043					6	804	815	822	834	841				
068						.105					7	805	814	823	833	842	848			
069						.167					6	806	813	824	832	843				
070						.228					6	807	812	825	831	844				
071						.351					6	808	811	827	830	845				
∇ 073						.528	∇	∇	∇	∇	7	809	810	828	829	846	847			∇

1 7 13 19 25 31 37 43 49 55 61 67 75 76

ALPHA C L M I C N I C A I C B L I C Y I C N DELTA

COEFFICIENTS: \_\_\_\_\_ IDPVAR(1) IDPVAR(2) NDV

α or β A = -10° TO +10° ONE DATA POINT PER DEGREE

SCHEDULES \_\_\_\_\_

PRETEST

POSTTEST

DATA SET IDENTIFIER	CONFIGURATION	SCHD.		PARAMETERS/VALUES						No. of Runs	DELTA Z/LB								
		A	B	PWR	PWR	AX/10	α	M <sub>00</sub>	δ <sub>eg</sub>		δ <sub>eo</sub>	.119	.151	.182	.228	.352	.599	.908	10.0
RT8 073	MDAC BOOSTER	A	0	50	100	-391	-10.1	5.0	0.0	0.0	5			1201	1218	1219	1231		1251
074						-143					5			1202	1217	1220	1230		
075						-019					4			1203	1216	1221			
076						.043					4			1204	1215	1222			
077						.105					5			1205	1214	1223	1229		
078						.167					4			1206	1213	1224			
079						.228					4			1207	1212	1225			
080						.351					4			1208	1211	1226			
081				Y	Y	.522	Y				5			1209	1210	1227	1228		Y
082						0.0	0.0	-391	0.0		4	201	208	209	216				
083						-143					4	202	207	210	215				
084						.105					4	203	206	211	214				
085				Y	Y	.522	Y	Y	Y	Y	4	204	205	212	213				

1            7            13            19            25            31            37            43            49            55            61            67            7576

ALPHA DELTA LM    ICN    ICA    ICBL    ICY    CYN    DELTA    7

COEFFICIENTS:    A = -10° to +10° ONE DATA POINT PER DEGREE    IDPVAR(1) IDPVAR(2) NDV

α or β

SCHEDULES

TEST VA 1163 DATA SET COLLATION SHEET

PRETEST  
 POSTTEST

DATA SET IDENTIFIER	CONFIGURATION	SCHD.		PARAMETERS/VALUES						No. of Runs	DELTA Z/R												
		$\alpha$	$\beta$	PWR	PWR	AX/R	$\alpha$	M <sub>0</sub>	$\delta_{01}$		$\delta_{02}$	.119	.151	.182	.222	.352	.599	.902	10.				
RT8 086	MDAC BOOSTER	A	D	100	100	-.391	0.0	5.0	0.0	0.0	6	1301	1314	1315	1322	1329							133
087						-.143					6	1302	1313	1316	1327	1330							
088						-.217					5	1303	1312	1317	1326								
089						.105					6	1304	1311	1318	1325	1331							
090						.167					5	1305	1310	1319	1324								
091						.351					6	1306	1309	1320	1323	1332							
092						.522	Y				6	1307	1308	1321	1322	1333							Y
093						-.391	5.0				5		1501	1514	1515	1526							152
094						-.143					5		1502	1513	1516	1525							
095						-.019					4		1503	1512	1517								
096						.105					5		1504	1511	1518	1524							
097						.167					4		1505	1510	1519								
098						.351					5		1506	1509	1520	1523							
099						.522	Y	Y	Y	Y	5		1507	1508	1521	1522							Y

1            7            13            19            25            31            37            43            49            55            61            67            75

A.L.P.H.A.D.E.L.T.A. I.C.H. I.C.A. I.C.B.L. I.C.Y. E.Y.N. DELT.A.

COEFFICIENTS: \_\_\_\_\_

$\alpha$  or  $\beta$  \_\_\_\_\_ A = -10° TO +10° ONE DATA POINT PER DEGREE

SCHEDULES \_\_\_\_\_

\_\_\_\_\_ IDPVAR(1) IDPVAR(2) ND

PRETEST  
 POSTTEST

DATA SET IDENTIFIER	CONFIGURATION	SCHED.		PARAMETERS/VALUES							No. of Runs	DELTA Z/LP							
		a	B	PWR	PWR	AX/LP	α	M <sub>∞</sub>	SER	δ <sub>∞</sub>		.119	.151	.182	.228	.352	.599	.90P	10.0
RT8 100	NDAC BOOSTER	A	0	0.0	100.	-.391	0.0	5.0	0.0	0.0	5	1401	1414	1415	1428				3.55
101						-.143					5	1402	1413	1416	1427				
102						-.019					5	1403	1412	1417	1426				
103						.105					5	1404	1411	1418	1425				
104						.167					5	1405	1410	1419	1424				
105						.351					5	1406	1409	1420	1423				
106						.522					5	1407	1408	1421	1422				
107						50.	50.	-.391			6	1801	1814	1815	1828	1829			18.51
108						-.143					6	1802	1813	1816	1827	1830			
109						-.019					5	1803	1812	1817	1826				
110						.105					6	1804	1811	1818	1825	1831			
111						.167					5	1805	1810	1819	1824				
112						.351					6	1806	1809	1820	1823	1832			
113						.522					6	1807	1808	1821	1822	1833			

1                    7                    13                    19                    25                    31                    37                    43                    49                    55                    61                    67                    7576

ALPHA C.L.M. ICN ICB ICBL ICY CYN DELTA Z 7

COEFFICIENTS: A = -10° to +10° ONE DATA POINT PER DEGREE IDPVAR(1) IDPVAR(2) NDV

α or β \_\_\_\_\_  
 SCHEDULES \_\_\_\_\_

TEST VA 1163 DATA SET COLLATION SHEET

17

PRETEST  
 POSTTEST

DATA SET IDENTIFIER	CONFIGURATION	SCHD.		PARAMETERS/VALUES						No. of Runs	DELTA Z/R <sub>B</sub>								
		α	β	PWR	PWR	AX/R	α	M <sub>00</sub>	δ <sub>02</sub>		δ <sub>03</sub>	.118	.151	.182	.228	.352	.579	.908	10.0
RT8 114	MIDNC BOOSTER	A	0	50.	50.	-.391	5.0	5.0	0.0	0.0	5		1601	1614	1615	1626			1629
115						-.143					5		1602	1613	1616	1625			
116						-.019					4		1603	1612	1617				
117						.105					5		1604	1611	1618	1624			
118						.167					4		1605	1610	1619				
119						.351					5		1606	1609	1620	1623			
120				↓	↓	.522					5		1607	1608	1621	1622			
121				50.	25.	-.391					3		1701	1714					
122						-.143							1702	1713					
123						-.019							1703	1712					
124						.105							1704	1711					
125						.167							1705	1710					
126						.351							1706	1709					
127				↓	↓	.522	↓	↓	↓	↓	↓		1707	1708					↓

1                    7                    13                    19                    25                    31                    37                    43                    49                    55                    61                    67                    75 76

ALPHA    CLM    ICA    ICB    ICL    CY    CYN    DELTA    7

COEFFICIENTS: AE -10° to +10° ONE DATA POINT PER DEGREE → IDPVAR(1) IDPVAR(2) NDV

α or β

SCHEDULES

PRETEST  
 POSTTEST

DATA SET IDENTIFIER	CONFIGURATION	SCHED.		PARAMETERS/VALUES							No. of Runs	DELTA Z/ΔB						
		α	β	PWR	PWR	ΔX/Δ	α	M <sub>00</sub>	δ <sub>αβ</sub>	δ <sub>α0</sub>		.119	.151	.182	.228	.352	.599	.908
RTR 128	MDAC BOOSTER	A	0	0.0	0.0	-.391	0.0	5.0	20.	-20.	6	1901	1914	1915	1928	1929		1924
129						-.143					6	1902	1913	1916	1927	1930		
130						-.019					5	1903	1912	1917	1926			
131						-.105					6	1904	1911	1918	1925	1931		
132						-.167					5	1905	1910	1919	1924			
133						-.351					6	1906	1909	1920	1923	1932		
134				↓	↓	-.522					6	1907	1908	1921	1922	1933		↓
135						100. 100. -391					3	2001	2014	2015				
136						-.143					3	2002	2013	2016				
137						-.09					3	2003	2012	2017				
138						-.105					2	2004	2011					
139						-.167					2	2005	2010					
140						-.351					2	2006	2008					
141				↓	↓	-.522	↓	↓	↓	↓	2	2007	2008					

1                    7                    13                    19                    25                    31                    37                    43                    49                    55                    61                    67                    7576

ALPHA CLM    ICN    ICA    ICBL    CY    CYN    DELTA Z    7

COEFFICIENTS:    A = -10° TO +10° ONE DATA POINT PER DEGREE    IDPVAR(1) IDPVAR(2) NDV

α or β

SCHEDULES

TEST VA 1163 DATA SET COLLATION SHEET

PRETEST  
 POSTTEST

DATA SET IDENTIFIER	CONFIGURATION	SCHD.		PARAMETERS/VALUES							No. of Runs	DELTA Z/ΔR							
		α	β	PWR	PWR	AX/A <sub>0</sub>	α <sub>i</sub>	M <sub>0</sub>	δ <sub>α</sub>	δ <sub>β</sub>			.119	.151	.182	.228	.352	.599	.908
RT8142	MDAC DRIVER	A	0	0.0	0.0	-.391	0.0	5.0	0.0	0.0	8	301	318	319	338	339	354	355	361
143						-.143					8	302	317	320	337	340	353	356	
144						-.019					8	303	316	321	336	341	352	357	
145						.043					6	304	315	322	335	342			
146						.105					8	305	314	323	333	343	351	358	
147						.167					6	306	313	324	332	344			
148						.228					8	307	312	325	331	345	350	359	
149						.351					8	308	311	326	330	346	349	360	
150						.522	Y				8	309	310	327	328	347	348	361	Y
151						-.391	5.1				6	601	618	619	636	637		640	
152						-.143					6	602	617	620	635	638			
153						-.019					5	603	616	621	634				
154						.043					5	604	615	622	633				
155						.105					6	605	614	623	632	639			
156						.167					5	606	617	624	631				
157						.228					5	607	612	625	630				
158						.351					5	608	611	626	629				
159						.522	Y				6	609	610	627	628	640			Y

1      7      13      19      25      31      37      43      49      55      61      67      7576

ALPHA DELTA M    I.C.N.    I.C.A.    I.C.B.L.    I.C.Y.    C.Y.N.    I.DELTA    7

COEFFICIENTS:    \_\_\_\_\_    ⇒ IDPVAR(1) | IDPVAR(2) | NDV

α or β            \_\_\_\_\_    A = -10° to +10° ONE DATA POINT PER DEGREE

SCHEDULES        \_\_\_\_\_



TEST VA 1163 DATA SET COLLATION SHEET

PRETEST  
 POSTTEST

DATA SET IDENTIFIER	CONFIGURATION	SCHD.		PARAMETERS/VALUES						No. of Runs	DELTA Z/ΔB									
		α	β	PWR	PWR	AX/L	α	M <sub>0</sub>	δ <sub>α</sub>		δ <sub>β</sub>	.119	.151	.182	.222	.352	.599	.908	10.0	
RT8160	MDHC CRITTER	A	0	0.0	0.0	-.391	10.1	5.0	0.0	0.0	5				1101	1118	1119	1131		1128
161						-.143					5				1102	1117	1120	1130		
162						-.019					4				1103	1116	1121			
163						.043					4				1104	1115	1122			
164						.105					5				1105	1114	1125	1129		
165						.167					4				1106	1113	1124			
166						.228					4				1107	1112	1125			
167						.351					4				1108	1111	1126			
168						.501					5				1109	1110	1127	1121		Y
169						-.391	-4.9				7	741	701	718	719	736	737			740
170						-.143					7	743	702	717	720	735	738			
171						-.019					6	744	703	716	721	734				
172						.043					6	745	704	715	722	733				
173						.105					7	746	705	714	723	732	739			
174						.167					6	747	706	713	724	731				
175						.228					6	748	707	712	725	730				
176						.351					6	749	708	711	726	729				
177						.522					7	750	709	710	727	728	740			Y

1      7      13      19      25      31      37      43      49      55      61      67      7576

ALPHA, Q, CLM, ICN, ICA, ICBL, CY, CYN, DELTA, IDPVAR(1), IDPVAR(2), NDV

COEFFICIENTS: A = -10° TO +10° ONE DATA POINT PER DEGREE

α or β \_\_\_\_\_  
 SCHEDULES \_\_\_\_\_

TEST VA 1163 DATA SET COLLATION SHEET

PRETEST

POSTTEST

DATA SET IDENTIFIER	CONFIGURATION	SCHD.		PARAMETERS/VALUES						No. of Runs	DELTA Z/°R								
		α	β	PWR	PWR	AX/LA	α <sub>i</sub>	M <sub>00</sub>	δ <sub>00</sub>		δ <sub>00</sub>	.119	.151	.182	.228	.352	.599	.908	10.0
RTR 178	MIDAC ORRIFER	A	0	50.	100.	.391	0.0	5.0	0.0	0.0	8	401	412	419	436	437	453	454	465
179						.143					8	402	417	420	435	438	452	455	
180						.019					8	403	416	421	434	439	451	456	
181						.043					6	404	415	422	433	440			
182						.105					8	405	414	423	432	441	450	457	
183						.167					6	406	413	424	431	442			
184						.228					8	407	412	425	430	443	449	458	
185						.351					8	408	411	426	429	444	447	459	
186						.522	Y				8	409	410	427	428	445	446	460	Y
187						.391	5.1				6	501	518	519	536	537		540	
188						.143					6	502	517	520	535	538			
189						.019					5	503	516	521	534				
190						.043					5	504	515	522	533				
191						.105					6	505	514	523	532	539			
192						.167					5	506	513	524	531				
193						.228					5	507	512	525	530				
194						.351					5	508	511	526	529				
195						.522	Y	Y	Y	Y	6	509	510	527	528	540			Y

1      7      13      19      25      31      37      43      49      55      61      67      75 76

ALPHA QCLM    ICM    ICA    ICBL    CY    SYN    DELTAR    7

COEFFICIENTS:    A = -10° + 0 + 10° ONE DATA POINT PER DEGREE    IDPVAR(1) IDPVAR(2) NDV

α or β

SCHEDULES

PRETEST

POSTTEST

DATA SET IDENTIFIER	CONFIGURATION	SCHD.		PARAMETERS/VALUES							No. of Runs	DELTA Z/10 <sup>8</sup>						
		α	β	PWR	PWR	AX/L	α <sub>z</sub>	M <sub>00</sub>	δ <sub>01</sub>	δ <sub>02</sub>		.119	.151	.182	.228	.352	.579	.907
BT8 196	M-DAC FUTURE	A	0	50	100	-.391	10.1	5.0	0.0	0.0	5			1001	1019	1020	1032	1029
197						-.143					5			1002	1018	1021	1031	
198						-.019					4			1003	1017	1022		
199						.043					4			1004	1016	1023		
200						.105					5			1005	1015	1024	1030	
201						.167					4			1006	1014	1025		
202						.228					4			1007	1012	1026		
203						.351					4			1008	1011	1027		
204						501	↓				5			1009	1010	1028	1029	↓
205						-.391	-5.0				7	801	818	819	837	838	850	847
206						-.143					7	802	817	820	836	839	849	
207						-.019					6	803	816	821	835	840		
208						.043					6	804	815	822	834	841		
209						.105					7	805	814	823	833	842	848	
210						.167					6	806	813	824	832	843		
211						.228					6	807	812	825	831	844		
212						.351					6	808	811	827	830	845		
↓ 213	↓	↓	↓	↓	↓	.528	↓	↓	↓	↓	7	809	810	828	829	846	847	↓

1            7            13            19            25            31            37            43            49            55            61            67            75 76

ALPHA CLM    ICN    ICA    ICBL    ICY    ICYN    DELTA    7

COEFFICIENTS:

A = -10° TO +10° ONE DATA POINT PER DEGREE

→ IDPVAR(1) IDPVAR(2) NDV

α or β

SCHEDULES

TEST VA 1163 DATA SET COLLATION SHEET

23

PRETEST  
 POSTTEST

DATA SET IDENTIFIER	CONFIGURATION	SCHD.		PARAMETERS/VALUES							No. of Runs	DELTA Z/LR										
		α	β	PWR	PWR	Δ/LR	α	M <sub>0</sub>	δ <sub>0</sub>	δ <sub>0</sub>		.119	.151	.182	.222	.352	.599	.908	100			
RTR 214	MBAC ORBITER	A	0	58.	100.	-.391	-10.1	5.0	0.0	0.0	5							1201	1218	1219	1231	1238
215						-.143					5							1202	1217	1220	1230	
216						-.019					4							1203	1216	1221		
217						.043					4							1204	1215	1222		
218						.105					5							1205	1214	1223	1229	
219						.167					4							1206	1213	1224		
220						.228					4							1207	1212	1225		
221						.351					4							1208	1211	1226		
222				Y	Y	.522	Y				5							1209	1210	1227	1228	Y
223					0.0	0.0	-.391	0.0			4	201	208	209	216							
224						-.143					4	202	207	210	215							
225						.105					4	203	206	211	214							
226				Y	Y	.522	Y	Y	Y	Y	4	204	205	212	213							

1                  7                  13                  19                  25                  31                  37                  43                  49                  55                  61                  67                  7576

ALPHA Δ CLM ICH ICA ICB L CY CYN DELTA Δ  
 COEFFICIENTS: \_\_\_\_\_ IDPVAR(1) IDPVAR(2) NDV  
 α or β \_\_\_\_\_ A = -10° TO +10° ONE DATA POINT PER DEGREE  
 SCHEDULES \_\_\_\_\_

PRETEST  
 POSTTEST

DATA SET IDENTIFIER	CONFIGURATION	SCHD.		PARAMETERS/VALUES							No. of Runs	DELTA Z/Δ <sub>B</sub>							
		α	β	PWR	PWR	AX/Δ <sub>B</sub>	α <sub>i</sub>	M <sub>0</sub>	δ <sub>0B</sub>	δ <sub>0D</sub>		119	151	182	227	352	599	908	1000
RT8 227	NDIC CENTER	A	D	100	100	-391	0.0	5.0	2.0	0.0	6	1301	1314	1315	1328	1329			1301
228						-143					6	1308	1313	1316	1327	1330			
229						-019					5	1303	1312	1317	1326				
230						.105					6	1304	1311	1318	1325	1331			
231						.167					5	1305	1310	1319	1324				
232						.351					6	1306	1309	1320	1323	1332			
233						.522					6	1307	1308	1321	1322	1333			
234						-391	5.0				5		1501	1514	1515	1526			1527
235						-143					5		1502	1513	1516	1525			
236						-019					4		1503	1512	1517				
237						.105					5		1504	1511	1518	1524			
238						.167					4		1505	1510	1519				
239						.351					5		1506	1509	1520	1523			
240						.522					5		1507	1508	1521	1522			

1                    7                    13                    19                    25                    31                    37                    43                    49                    55                    61                    67                    75 76

ALPHA Δ C L M    I C M    I C A    I C B L    C Y    C Y N    DELTA Z

COEFFICIENTS:    A = -10° TO +10° ONE DATA POINT PER DEGREE    IDPVAR(1) IDPVAR(2) NOV

α or β

SCHEDULES

TEST VA 1163 DATA SET COLLATION SHEET

25

PRETEST  
 POSTTEST

DATA SET IDENTIFIER	CONFIGURATION	SCHD.		PARAMETERS/VALUES							No. of Runs	DELTA Z/δR							
		α	β	PWR	PWR	ΔX/ΔR	α	M <sub>0</sub>	δe <sub>z</sub>	δe <sub>ρ</sub>		.119	.157	.182	.228	.352	.599	190P	100
RT8 241	ODAC PRINTER	A	0	0.0	100.	-.391	0.0	5.0	0.0	0.0	5	1401	1414	1415	1428				460
242						-.443					5	1402	1413	1416	1427				
243						-.019					5	1403	1412	1417	1426				
244						.105					5	1404	1411	1418	1425				
245						.167					5	1405	1410	1419	1424				
246						.351					5	1406	1409	1420	1423				
247						.522					5	1407	1408	1421	1422				
248						50.	50.	-.391			6	1801	1814	1815	1828	1829			1834
249						-.443					6	1802	1813	1816	1827	1830			
250						-.019					5	1803	1812	1817	1826				
251						.105					6	1804	1811	1818	1825	1831			
252						.167					5	1805	1810	1819	1821				
253						.351					6	1806	1809	1820	1823	1832			
254						.522					6	1807	1808	1821	1822	1833			

1            7            13            19            25            31            37            43            49            55            61            67            7576

ALPHA ΔCLM    ICN    ICA    ICBL    ICY    ICYN    DELTA Δ    11

COEFFICIENTS: \_\_\_\_\_ IDPVAR(1) IDPVAR(2) NDV

α or β            A = -10° to +10° ONE DATA POINT PER DEGREE

SCHEDULES \_\_\_\_\_

PRETEST

POSTTEST

DATA SET IDENTIFIER	CONFIGURATION	SCHD.		PARAMETERS/VALUES							No. of Runs	DELTA Z/Δ <sub>Z</sub>							
		α	β	PWR	PWR	AX/L <sub>A</sub>	A <sub>Z</sub>	M <sub>0</sub>	δ <sub>0</sub>	δ <sub>0</sub>		119	151	183	225	357	579	908	10.0
RT8255	MDAC ORBITER	A	0	50.	50.	-391	5.0	5.0	0.0	0.0	5	1601	1614	1615	1626			1627	
256						-143					5	1602	1613	1616	1625				
257						-019					4	1603	1612	1617					
258						.105					5	1604	1611	1618	1624				
259						.167					4	1605	1610	1619					
260						.351					5	1606	1609	1620	1623				
261				↓	↓	.522					5	1607	1608	1621	1622			↓	
262						50. 25. -391					2	1701	1714						
263						-143						1702	1713						
264						-019						1703	1712						
265						.105						1704	1711						
266						.167						1705	1710						
267						.351						1706	1709						
268				↓	↓	.522	↓	↓	↓	↓		1707	1708						

1	7	13	19	25	31	37	43	49	55	61	67	7576
ALPHA	CLM	ICK	ICR	ICBL	ICY	CYN					DELTA	7

COEFFICIENTS: A = -10° to +10° ONE DATA POINT PER DEGREE → IDPVAR(1) | IDPVAR(2) | NDV

α or β \_\_\_\_\_

SCHEDULES \_\_\_\_\_

TEST VA 1163 DATA SET COLLATION SHEET

PRETEST  
 POSTTEST

DATA SET IDENTIFIER	CONFIGURATION	SCHD.		PARAMETERS/VALUES							No. of Runs	DELTA Z/δ <sub>R</sub>										
		α	β	PWR	PWR	ΔX/δ	α <sub>2</sub>	M <sub>∞</sub>	δ <sub>α</sub>	δ <sub>β</sub>		.119	.151	.182	.228	.352	.599	.908	10 c			
RTB 269	MDAC ORBITER	A	0	0.0	0.0	.391	0.0	5.0	2.0	-20.	6	1901	1914	1915	1928	1929						1931
270						.143					6	1902	1913	1916	1927	1930						
271						.019					5	1903	1912	1917	1926							
272						.105					6	1904	1911	1918	1925	1931						
273						.167					5	1905	1910	1919	1924							
274						.351					6	1906	1909	1920	1923	1932						
275				↓	↓	.522					6	1907	1908	1921	1922	1935						↓
276				100.	100.	.391					3	2001	2014	2015								
277						.143					3	2002	2013	2016								
278						.089					3	2003	2012	2017								
279						.105					2	2004	2011									
280						.167					2	2005	2010									
281						.351					2	2006	2009									
282				↓	↓	.522	↓	↓	↓	↓	2	2007	2008									

1            7            13            19            25            31            37            43            49            55            61            67            75

ALPHA CLM    ICM    ICB    ICBL    SY    CYN    DELTA Z

COEFFICIENTS: \_\_\_\_\_ [IDPVAR(1)] [IDPVAR(2)] [NDV]

α or β            A = -10° TO +10° ONE DATA POINT PER DEGREE

SCHEDULES \_\_\_\_\_



TEST VA 1163 DATA SET COLLATION SHEET

28

PRETEST  
 POSTTEST

DATA SET IDENTIFIER	CONFIGURATION	SCHD.		PARAMETERS/VALUES						No. of Runs	DELTA Z/LR									
		a	B	PWR	PWR	AX/LR	α	M <sub>0</sub>	60P		60D	.113	.119	.151	.182	.228	.352	.599	.908	1.00
RTR 283	MDAC BOOSTER	A	0	0.0	0.0	-.391	0.0	2.0	0.0	0.0	9	4201	3301	3318	3319	3336	3337	3352	3353	3353
284						-.143					9	4202	3302	3317	3320	3335	3338	3351	3354	
285						-.019					8	4203	3303	3316	3321	3334	3339	3350		
286						.043					7	4204	3304	3315	3322	3333	3340			
287						.105					9	4205	3305	3314	3323	3332	3341	3349	3355	
288						.167					7	4206	3306	3313	3324	3331	3342			
289						.228					8	4207	3307	3312	3325	3330	3343	3348		
290						.351					8	4208	3308	3311	3326	3329	3344	3347		
291						.501	Y				9	4209	3309	3310	3327	3328	3345	3346	3356	Y
292						-.391	5.0				7			3501	3518	3519	3526			3353
293						-.143					7			3502	3517	3520	3525	3538		
294						-.019					6			3503	3516	3521	3534			
295						.043					5			3504	3515	3522	3537			
296						.105					7			3505	3514	3523	3532			
297						.167					5			3506	3513	3524	3531			
298						.228					6			3507	3512	3525	3530			
299						.351					6			3508	3511	3526	3529			
300						.522	Y	Y	Y	Y	7			3509	3510	3517	3528	3543	3544	Y

1            7            13            19            25            31            37            43            49            55            61            67            7576

ALPHA C L M    ICN    ICA    ICBL    ICY    ICYN    DELTA Z    7

COEFFICIENTS:    A = -10° TO +10° ONE DATA POINT PER DEGREE    IDPVAR(1) IDPVAR(2) NDV

α or β  
 SCHEDULES

TEST VA 1163 DATA SET COLLATION SHEET

2

PRETEST  
 POSTTEST

DATA SET IDENTIFIER	CONFIGURATION	SCHED.		PARAMETERS/VALUES						No. of Runs	DELTA Z/°R									
		a	B	PWR	PWR	ΔX/Δ	α	M <sub>0</sub>	δ <sub>0</sub>		δ <sub>0</sub>	.119	.151	.182	.228	.352	.599	.908	10.0	
ATA 301	MDAC BOOSTER	A	0	0.0	0.0	-391	10.0	2.0	0.0	0.0	6				3801	3818	3819	3834	3835	3835
302						-113					6				3802	3817	3820	3833	3836	
303						-019					5				3803	3816	3821	3832		
304						.043					4				3804	3815	3822			
305						.105					6				3805	3814	3823	3831	3837	
306						.167					4				3806	3813	3824			
307						.228					5				3807	3812	3825	3830		
308						.351					5				3808	3811	3826	3829		
309						.501					6				3809	3810	3827	3828	3837	Y
310						.391	-5.0				8	3701	3718	3719	3736	3737	3752	3753	3755	
311						-.413					8	3702	3717	3720	3735	3738	3751	3754		
312						-.019					7	3703	3716	3721	3734	3739	3750			
313						.043					6	3704	3715	3722	3733	3740				
314						.105					8	3705	3714	3723	3732	3741	3749	3755		
315						.167					6	3706	3713	3724	3731	3742				
316						.228					7	3707	3712	3725	3730	3743	3748			
317						.351					7	3708	3711	3726	3729	3744	3747			
318						.502					8	3709	3710	3727	3728	3745	3746	3756	Y	

ALPHA CLM VCN ICA ICB CY SYN DELTA Z  
 → IDPVAR(1) IDPVAR(2) NDV

COEFFICIENTS: A = -10° TO +10° ONE DATA POINT PER DEGREE  
 a or B  
 SCHEDULES

TEST VA 1163 DATA SET COLLATION SHEET

PRETEST  
 POSTTEST

DATA SET IDENTIFIER	CONFIGURATION	SCHED.		PARAMETERS/VALUES							No. of Runs	DELTA Z/R							
		$\alpha$	$\beta$	PWR	PWR	AX/A	$\alpha_i$	$M_0$	$\delta_{01}$	$\delta_{02}$		.119	.151	.182	.228	.352	.599	908	100
RT8319	MDAC BY LSTER	A	0	50.0	100.0	-.391	0.0	2.0	0.0	0.0	7	3401	3418	3419	3436	3439	3452		3457
320						-.142					8	3402	3417	3420	3435	3438	3451	3454	
321						-.019					7	3403	3416	3421	3434	3437	3450		
322						.043					6	3404	3415	3422	3433	3440			
323						.125					8	3405	3414	3423	3432	3441	3449	3455	
324						.167					6	3406	3413	3424	3431	3442			
325						.228					7	3407	3412	3425	3430	3443	3448		
326						.351					7	3408	3411	3426	3429	3444	3447		
327						.522					8	3409	3410	3427	3428	3445	3446	3456	✓
328						-.391	5.0				7		3601	3618	3619	3626	3637	3647	3647
329						-.143					7		3602	3617	3620	3635	3638	3648	
330						-.019					6		3603	3616	3621	3634	3639		
331						.043					5		3604	3615	3622	3633			
332						.105					7		3605	3614	3623	3632	3640	3645	
333						.167					5		3606	3613	3624	3631			
334						.228					6		3607	3612	3625	3630	3641		
335						.351					6		3608	3611	3626	3629	3642		
336						.522					7		3609	3610	3627	3628	3643	3644	✓

1            7            13            19            25            31            37            43            49            55            61            67            75 76

ALPHA @ CLM    ICN    ICR    ICBL    KY    ICYN    DELTA    7

COEFFICIENTS:    A = -10° to 110° ONE DATA POINT PER DEGREE    IDPVAR(1) IDPVAR(2) IDV

$\alpha$  or  $\beta$  \_\_\_\_\_  
 SCHEDULES \_\_\_\_\_

TEST VA 1163 DATA SET COLLATION SHEET

31

PRETEST

POSTTEST

DATA SET IDENTIFIER	CONFIGURATION	SCHED.		PARAMETERS/VALUES							No. of Runs	DELTA Z/R							
		$\alpha$	$\beta$	PWR	PWR	AX/L	$\alpha$	M <sub>0</sub>	$\delta_{eq}$	$\delta_{eq}$		.119	.151	.182	.228	.352	.599	.908	10.0
RTB 337	MDAC BOOSTER	A	0	500	1000	.391	10.0	2.0	0.0	0.0	6			4001	4018	4019	4034	4035	4035
338						-.143					6			4002	4017	4020	4033	4036	
339						-.019					5			4003	4016	4021	4032		
340						.043					4			4004	4015	4022			
341						.105					6			4005	4014	4023	4031	4037	
342						.167					4			4006	4013	4024			
343						.228					5			4007	4012	4025	4030		
344						.351					5			4008	4011	4026	4029		
345				Y	Y	.501	Y				6			4009	4010	4027	4028	4038	Y
346						0.0	0.0	-.391	0.0		8	3901	3918	3919	3936	3937	3952	3953	3953
347						-.143					8	3902	3917	3920	3935	3938	3951	3954	
348						-.019					7	3903	3916	3921	3934	3939	3950		
349						.043					6	3904	3915	3922	3933	3940			
350						.105					8	3905	3914	3923	3932	3941	3949	3955	
351						.167					6	3906	3913	3924	3931	3942			
352						.228					7	3907	3912	3925	3930	3943	3948		
353						.351					7	3908	3911	3926	3929	3944	3947		
354				Y	Y	.522	Y	Y	Y	Y	8	3909	3910	3927	3928	3945	3946	3956	Y

1 7 13 19 25 31 37 43 49 55 61 67 75 76  
 A.L.P.H.A.B.I.C.L.M. I.C.H. I.C.A. I.C.B.L. I.C.Y. I.C.Y.N. I.D.E.L.T.A.B. 7

COEFFICIENTS: A = -10° to +10° ONE DATA POINT PER DEGREE

$\alpha$  or  $\beta$   
 SCHEDULES

[IDPVAR(1)] [IDPVAR(2)] [NDV]

PRETEST  
 POSTTEST

DATA SET IDENTIFIER	CONFIGURATION	SCHED.		PARAMETERS/VALUES						No. of Runs	DELTA Z/2B								
		α	β	PWR	PWR	AX/10	α	M <sub>0</sub>	δ <sub>05</sub>		δ <sub>00</sub>	.119	.151	.182	.228	.352	.599	.908	10.0
RTB 355	MDAC BOOSTER	A	0	0.0	0.0	-391	0.0	2.0	20.0	-20.0	8	4401	4414	4415	4419	4430	4441	4442	4443
356						-143					8	4402	4413	4416	4420	4431	4440	4443	
357						-019					6	4403	4412	4417	4437		4439		
358						.105					8	4404	4411	4418	4426	4432	4438	4444	
359						.167					5	4405	4410	4419	4424				
360						.351					7	4406	4409	4420	4423	4433	4436		
361						522					8	4407	4408	4421	4422	4434	4435	4445	↓
362						50.0	1000	-391			8	4501	4518	4519	4537	4538	4553	4554	4555
363						-143					8	4502	4517	4520	4536	4539	4552	4555	
364						-019					7	4503	4516	4521	4535	4540	4551		
365						.043					6	4504	4515	4522	4534	4541			
366						.105					8	4505	4514	4523	4533	4542	4550	4556	
367						.167					10	4506	4513	4524	4532	4543			
368						.228					7	4507	4512	4525	4530	4544	4549		
369						.351					7	4508	4511	4526	4529	4545	4548		
370						522					8	4509	4510	4527	4528	4546	4547	4557	↓

1            7            13            19            25            31            37            43            49            55            61            67            7576

ALPHA C L M    ICN    ICA    ICBL    IY    IYN    DELTA Z    7

COEFFICIENTS:    A = -10° to +10° ONE DATA POINT PER DEGREE    IDPVAR(1) IDPVAR(2) INDV

α or β  
 SCHEDULES

TEST VA 1163 DATA SET COLLATION SHEET

PRETEST  
 POSTTEST

DATA SET IDENTIFIER	CONFIGURATION	SCHD.		PARAMETERS/VALUES								No. of Runs	DELTA Z/2R						
		$\alpha$	$\beta$	PWR	PWR	AX/10	$\alpha_i$	M <sub>0</sub>	$\delta_{EP}$	$\delta_{EP}$	119								
RTB 371	RTAC BOOSTER	A	0	0.0	0.0	-.391	0.0	2.0	0.0	0.0	1	4201							
372						-.43						4202							
373						-.019						4203							
374						.043						4204							
375						.105						4205							
376						.167						4206							
377						.228						4207							
378						.351						4208							
379						.501						4209							
380					1000	-.391						4101							
381						-.43						4102							
382						-.019						4103							
383						.043						4104							
384						.105						4105							
385						.167						4106							
386						.228						4107							
387						.351						4108							
388						.501						4109							

1      7      13      19      25      31      37      43      49      55      61      67      75 76

ALPHA CLM    ICN    IC.R    IC.BL    ICY    CYN    DELTA Z

COEFFICIENTS:    IDPVAR(1) IDPVAR(2) IDV

$\alpha$  or  $\beta$      $A = -10^\circ$  to  $+10^\circ$  ONE DATA POINT PER DEGREE

SCHEDULES

TEST VA 1163 DATA SET COLLATION SHEET

PRETEST  
 POSTTEST

DATA SET IDENTIFIER	CONFIGURATION	SCHD.		PARAMETERS/VALUES							No. of Runs	DELTA Z/ $\epsilon_B$							
		$\alpha$	$\beta$	PWR	PWR	AX/L	$\alpha_i$	M <sub>0</sub>	$\delta_{ep}$	$\delta_{op}$		.119							
ATB 389	MDPC BOOSTER	A	0	0.0	0.0	-391	0.0	2.0	20.0	-20.0	1	4801							
390						-143						4802							
391						-019						4803							
392						.043						4804							
393						.105						4805							
394						.167						4806							
395						.228						4807							
396						.351						4808							
397						.522						4809							
398						100.0						4901							
399						-143						4902							
400						-019						4903							
401						.043						4904							
402						.105						4905							
403						.167						4906							
404						.228						4907							
405						.351						4908							
406						.522						4909							

1            7            13            19            25            31            37            43            49            55            61            67            75 76

ALPHA CLM    ICN    ICA    ICBL    CY    SYN    DELTA    7

COEFFICIENTS:    IDPVAR(1) IDPVAR(2) NDV  
 A = -10° TO +10° ONE DATA POINT PER DEGREE  
 a or b  
 SCHEDULES

TEST VA 1163 DATA SET COLLATION SHEET

35

PRETEST  
 POSTTEST

DATA SET IDENTIFIER	CONFIGURATION	SCHD.		PARAMETERS/VALUES							No. of Runs	DELTA Z/R									
		A	B	PWR	PWR	AX/L	A	M <sub>0</sub>	δ <sub>α</sub>	δ <sub>β</sub>		.113	.119	.151	.182	.228	.352	.599	.908	1.00	
RTR 407	MDAC BOOSTER	A	0	0.0	0.0	0.0	-391	5.0	3.0	0.0	0.0	9	3101	2201	2218	2219	2236	2237	2252	2253	2259
408							-143					9	3102	2202	2219	2220	2235	2237	2251	2254	
409							-019					8	3103	2203	2216	2221	2234	2239	2250		
410							043					7	3104	2204	2215	2222	2233	2240			
411							105					9	3105	2205	2214	2223	2232	2241	2249	2255	
412							167					7	3106	2206	2218	2224	2231	2242			
413							228					8	3107	2207	2212	2225	2230	2243	2248		
414							351					8	3108	2208	2211	2220	2229	2244	2247		
415							501	Y				9	3109	2209	2210	2227	2228	2215	2246	2256	Y
416							-391	5.0				8			2401	2418	2419	2436	2439	2447	2447
417							-143					8			2402	2417	2420	2435	2438	2446	
418							-019					7			2403	2416	2421	2434	2439		
419							043					6			2404	2415	2422	2433			
420							105					8			2405	2414	2423	2432	2440	2445	
421							167					6			2406	2413	2424	2431			
422							228					7			2407	2412	2425	2430	2441		
423							351					7			2408	2411	2426	2429	2442		
424							532	Y	Y	Y	Y	8			2409	2410	2427	2428	2443	2444	Y

ALPHA 0.0 CL 7 16 H 16 A 16 B L 16 X 16 Y N DELTA 7  
 COEFFICIENTS: A = -10° TO +10° ONE DATA POINT PER DEGREE  
 SCHEDULES



PRETEST  
 POSTTEST

DATA SET IDENTIFIER	CONFIGURATION	SCHED.		PARAMETERS/VALUES						No. of Runs	DELTA Z / $\lambda_R$									
		A	B	PWR	PWR	AX/A	$\alpha_i$	$m_0$	$\delta_{0A}$		$\delta_{0D}$	.119	.151	.182	.228	.352	.599	.908	10.0	
RTB 425	MDAC BOOSTER	A	0	0.0	0.0	.391	10.0	3.0	0.0	0.0	6				2901	2918	2919	2934	2935	2935
426						.143					6				2902	2917	2920	2933	2936	
427						.019					5				2903	2916	2921	2932		
428						.043					4				2904	2915	2922			
429						.105					6				2905	2914	2923	2931	2937	
430						.167					4				2906	2913	2924			
431						.228					5				2907	2912	2925	2930		
432						.351					5				2908	2911	2926	2929		
433						.501	Y				6				2909	2910	2927	2928	2932	Y
434						.391	-5.0				8	2601	2618	2619	2636	2637	2652	2653	2655	
435						.143					8	2602	2617	2620	2635	2638	2651	2654		
436						.019					7	2603	2616	2621	2634	2639	2650			
437						.043					6	2604	2615	2622	2633	2640				
438						.105					8	2605	2614	2623	2632	2641	2649	2655		
439						.167					6	2606	2613	2624	2631	2642				
440						.328					7	2607	2612	2625	2630	2643	2648			
441						.351					7	2608	2611	2626	2629	2644	2647			
442						.522	Y	Y	Y	Y	8	2609	2610	2627	2628	2645	2646	2656	Y	

1            7            13            19            25            31            37            43            49            55            61            67            7576

ALPHA  CLM  ICM  ICA  ICBL  IY  ICYN  DELTA Z  7

COEFFICIENTS:  IDPVAR(1)  IDPVAR(2)  NDV

A = -10° to +10° ONE DATA POINT PER DEGREE

A OR B

SCHEDULES

TEST VA 1163 DATA SET COLLATION SHEET

PRETEST  
 POSTTEST

DATA SET IDENTIFIER	CONFIGURATION	SCHD.		PARAMETERS/VALUES						No. of Runs	DELTA Z/L <sub>R</sub>									
		α	β	PWR	PWR AX/L <sub>R</sub>	α <sub>2</sub>	M <sub>0</sub>	δ <sub>ep</sub>	δ <sub>ep</sub>		.113	.119	.151	.183	.225	.352	.599	.908	10.0	
RTR 1143	INDAC BOOSTER	A	0	50.0	1000	.391	0.0	3.0	0.0	0.0	8	3001	2301	2318	2319	2336	2337	2352	2353	2353
444						-.143					7	3002	2302	2317	2320	2335		2351	2354	
445						-.019					7	3003	2303	2316	2321	2334	2339	2350		
446						.043					6	3004	2304	2315	2322	2333	2340			
447						.105					8	3005	2305	2314	2323	2332	2341	2349	2355	
448						.167					6	3006	2306	2313	2324	2331	2342			
449						.228					7	3007	2307	2312	2325	2330	2343	2348		
450						.351					7	3008	2308	2311	2326	2329	2344	2347		
451						.501	Y				8	3009	2309	2310	2327	2328	2345	2346	2356	Y
452						-.391	5.0				7			2501	2518	2519	2536	2537	2547	2547
453						-.143					7			2502	2517	2520	2535	2538	2546	
454						-.019					6			2503	2516	2521	2534	2539		
455						.043					5			2504	2515	2522	2533			
456						.105					7			2505	2514	2523	2532	2540	2545	
457						.167					5			2506	2513	2524	2531			
458						.228					6			2507	2512	2525	2530	2541		
459						.351					6			2508	2511	2526	2529	2542		
460						.528	Y	Y	Y	Y	7			2509	2510	2527	2528	2543	2544	Y

1      7      13      19      25      31      37      43      49      55      61      67      75 76

ALPHA   CLM   VCH   VCA   VCB   CY   CYN   DELTA   7

COEFFICIENTS: \_\_\_\_\_ IDPVAR(1) | IDPVAR(2) | NDV

α or β      A = -10° TO +10° ONE DATA POINT PER DEGREE

SCHEDULES \_\_\_\_\_

TEST VA 1163 DATA SET COLLATION SHEET

PRETEST  
 POSTTEST

DATA SET IDENTIFIER	CONFIGURATION	SCHD.		PARAMETERS/VALUES							No. of RUNS	DELTA Z/1R							
		A	B	PWR	PWR	AX/A	A	M <sub>0</sub>	δ <sub>0</sub>	δ <sub>0</sub>		.119	.151	.182	.227	.352	.599	.908	10.0
RT8461	MDAC BOOSTER	A	D	50.0	100.0	3.391	10.0	3.0	0.0	0.0	6			2801	2818	2819	2834	2835	2835
462						-143					6			2802	2817	2820	2833	2836	
463						-019					5			2803	2816	2821	2832		
464						.043					4			2804	2815	2822			
465						.105					6			2805	2814	2823	2831	2837	
466						.167					4			2806	2813	2824			
467						.228					5			2807	2812	2825	2830		
468						.351					5			2808	2811	2826	2829		
469						.501					6			2809	2810	2827	2828	2838	
470						.391	5.0				8	2701	2718	2719	2726	2737	2752	2753	2753
471						-143					8	2702	2717	2720	2735	2738	2751	2754	
472						-019					7	2703	2716	2721	2734	2739	2750		
473						.043					6	2704	2715	2723	2733	2740			
474						.105					8	2705	2714	2723	2732	2741	2749	2755	
475						.167					6	2706	2713	2724	2731	2742			
476						.228					7	2707	2712	2725	2730	2743	2748		
477						.351					7	2708	2711	2726	2729	2744	2747		
478						.501					8	2709	2710	2727	2732	2745	2746	2752	

1      7      13      19      25      31      37      43      49      55      61      67      7576

ALPHA CLM    ICN    ICA    ICAL    IGY    IGM    DELTA    7

COEFFICIENTS: \_\_\_\_\_ [IDPVAR(1)] IDPVAR(2) INDV

A = -10° TO +10° ONE DATA POINT PER DEGREE

a or B \_\_\_\_\_

SCHEDULES \_\_\_\_\_

TEST VA 1163 DATA SET COLLATION SHEET

PRETEST  
 POSTTEST

DATA SET IDENTIFIER	CONFIGURATION	SCHD.		PARAMETERS/VALUES						No. of Runs	DELTA Z/4R										
		α	β	PWR	PWR	AX/4R	α <sub>i</sub>	M <sub>00</sub>	SEP		SEP	.119	.151	.182	.222	.352	.599	.908	10.0		
RTB 479	MDAC BOOSTER (NO CAMER)	A	0	50.0	100.0	-.391	0.0	3.0	0.0	0.0	4	3201	3218	3219							3223
480						-.443					4	3202	3217	3220							
481						-.019					3	3203	3216								
482						.043					3	3204	3215								
483						.105					4	3205	3214	3221							
484						.167					3	3206	3213								
485						.228					3	3207	3212								
486						.351					3	3208	3211								
487						.522					4	3209	3210	3222							
488	MDAC BOOSTER (DAMP=STAIN)					-.391					8	5201	5218	5219	5236	5237	5252	5253	5255		
489						-.143					8	5202	5217	5220	5235	5238	5251	5254			
490						-.019					7	5203	5216	5221	5234	5239	5250				
491						.043					6	5204		5222	5233	5240					
492						.105					8	5205	5214	5223	5232	5241	5249	5255			
493						.167					6	5206	5213	5224	5231	5242					
494						.228					7	5207	5212	5225	5230	5243	5248				
495						.351					7	5208	5211	5226	5229	5244	5247				
496						.522					8	5209	5210	5227	5228	5245	5246	5256			

1            7            13            19            25            31            37            43            49            55            61            67            7576

ALPHA O.C.L.M.    I.C.H.    I.C.R.    I.C.B.L.    I.C.Y.    I.C.Y.N.    I.D.E.L.T.A.    7

COEFFICIENTS:    \_\_\_\_\_    I.D.P.V.A.R.(1) | I.D.P.V.A.R.(2) | I.D.V.

α or β            \_\_\_\_\_

SCHEDULES        \_\_\_\_\_

\_\_\_\_\_

TEST VA 1163 DATA SET COLLATION SHEET

PRETEST  
 POSTTEST

DATA SET IDENTIFIER	CONFIGURATION	SCHD.		PARAMETERS/VALUES							No. of Runs	DELTA Z/l <sub>R</sub>						
		α	β	PWR	PWR	AX/l <sub>R</sub>	α <sub>i</sub>	M <sub>∞</sub>	δ <sub>01</sub>	δ <sub>02</sub>		-113						
RTB 497	MDAC BOSTER	A	D	100.0	0.0	-.391	0.0	3.0	0.0	0.0	1	5001						
498						-.143						5002						
499						-.019						5003						
500						.043						5004						
501						.105						5005						
502						.167						5006						
503						.228						5007						
504						.351						5008						
505						↓ ↓ .522						5009						
506						0.0 0.0 -.391						5101						
507						-.143						5102						
508						-.019						5103						
509						.043						5104						
510						.105						5105						
511						.167						5106						
512						.228						5107						
513						.351						5108						
514						↓ ↓ .522						5109						

1 7 13 19 25 31 37 43 49 55 61 67 7576  
 ALPHA, DELTA, ICN, ICA, ICBL, ICY, GYN, DELTA Z  
 IDPVAR(1) IDPVAR(2) NDV

COEFFICIENTS: A = -10° to +10° ONE DATA POINT PER DEGREE  
 α or β  
 SCHEDULES

TEST VA 1163 DATA SET COLLATION SHEET

41

PRETEST  
 POSTTEST

DATA SET IDENTIFIER	CONFIGURATION	SCHD.		PARAMETERS/VALUES							No. of Runs	DELTA Z/LB							
		α	β	PWR	PWR AX/A	α <sub>0</sub>	M <sub>0</sub>	δ <sub>0α</sub>	δ <sub>0β</sub>	.119		.151	.187	.228	.352	.579	.908	10.0	
RTA 515	WZAC REOSTER	A	0	50.0	100.0	.391	0.0	4.0	0.0	0.0	7	5301	5310	5319	5336	5337	5352	5352	
516						-.143					7	5302	5317	5320	5335	5338	5351		
519						-.019					7	5303	5316	5321	5334	5339	5350		
518						.103					6	5304	5315	5322	5333	5340			
519						-.105					7	5305	5314	5323	5332	5341	5348		
520						.167					6	5306	5313	5324	5331	5342			
521						-.228					7	5307	5312	5325	5330	5343	5348		
522						.351					7	5308	5311	5326	5329	5344	5347		
523						.522					7	5309	5310	5327	5328	5345	5346	Y	
524						-.391	6.0				6	5401	5410	5419	5430	5437		5437	
525						-.143						5402	5417	5420	5435	5438			
526						-.019						5403	5416	5421	5434	5439			
527						.043						5404	5415	5422	5433	5440			
528						.105						5405	5414	5423	5432	5441			
529						.167						5406	5413	5404	5431	5442			
530						-.228						5407	5412	5425	5430	5443			
531						.351						5408	5411	5426	5429	5444			
532						.522						5409	5410	5427	5428	5445		Y	

1 7 13 19 25 31 37 43 49 55 61 67 7576  
 ALPHA C L M I C H I C A I C B L C Y C X N DELTA 2  
 COEFFICIENTS: IDPVAR(1) IDPVAR(2) NDV

A = -10° TO +10° ONE DATA POINT PER DEGREE

α or β  
SCHEDULES

PRETEST  
 POSTTEST

DATA SET IDENTIFIER	CONFIGURATION	SCHD.		PARAMETERS/VALUES						No. of Runs	DELTA Z/ $k_B$			
		$\alpha$	$\beta$	PWR	PWR	$\Delta X/\lambda$	$\alpha_i$	$M_{\alpha}$	$\delta_{\alpha}$		$\delta_{\beta}$			
RT8533	MORE BANDS (NO. CANNED)	A	0	50.0	1000	-.891	0.0	6.0	0.0	0.0	3	.119	.151	10.0
534						-.143						5501	5518	5519
535						-.019						5502	5517	
536						.043						5503	5516	
537						.105						5504	5515	
538						.167						5505	5514	
539						.228						5506	5513	
540						.351						5507	5512	
541						.528						5508	5511	
												5509	5510	

1            7            13            19            25            31            37            43            49            55            61            67            75 76

ALPHA  $\alpha$  C L M    I C N    I C A    I C B L    I C Y    I C Y N    DELTA  $\beta$

COEFFICIENTS:

$\alpha$  or  $\beta$

SCHEDULES

A = -10° to +10° ONE DATA POINT PER DEGREE

→ IDPVAR(1) IDPVAR(2) NDV

TEST VA 1163 DATA SET COLLATION SHEET

PRETEST  
 POSTTEST

DATA SET IDENTIFIER	CONFIGURATION	SCHD.		PARAMETERS/VALUES							No. of Runs	DELTA Z/°R									
		α	β	PWR	PWR AX/°	α <sub>1</sub>	M <sub>0</sub>	δ <sub>01</sub>	δ <sub>02</sub>	.113		.119	.151	.182	.228	.552	.599	.908	100		
RTR 542	NDAC DRIVER	A	0	0.0	0.0	.391	0.0	2.0	0.0	0.0	9	4201	3301	3318	3319	3336	3337	3352	3353	3354	
543						.143					9	4202	3302	3317	3320	3335	3338	3351	3354		
544						.019					8	4203	3303	3316	3321	3334	3339	3350			
545						.043					7	4204	3304	3315	3322	3333	3340				
546						.105					9	4205	3305	3314	3323	3332	3341	3349	3355		
547						.167					7	4206	3306	3313	3324	3331	3342				
548						.228					8	4207	3307	3312	3325	3330	3343	3348			
549						.351					8	4208	3308	3311	3326	3329	3344	3347			
550						.501	Y				9	4209	3309	3310	3327	3328	3345	3346	3356	Y	
551						.391	5.0				7		3501	3518	3519	3530				3544	
552						.143					7		3502	3517	3520	3535	3538				
553						.019					6		3503	3516	3521	3534					
554						.043					5		3504	3515	3522	3533					
555						.105					7		3505	3514	3523	3532					
556						.167					5		3506	3513	3524	3531					
557						.228					6		3507	3512	3525	3530					
558						.351					6		3508	3511	3526	3529					
559						.522	Y	Y	Y	Y	7		3509	3510	3527	3528	3543	3544	Y		

1            7            13            19            25            31            37            43            49            55            61            67            7576

ALPHA C L M    I C H    I C A    I C B L    I C Y    I C Y N    DELTA R    7

COEFFICIENTS:    A = -10° TO +10° ONE DATA POINT PER DEGREE    IDPVAR(1) IDPVAR(2) NDV

α or β

SCHEDULES



TEST VA 1163 DATA SET COLLATION SHEET

PRETEST  
 POSTTEST

DATA SET IDENTIFIER	CONFIGURATION	SCHED.		PARAMETERS/VALUES						No. of Runs	DELTA Z/L <sub>B</sub>									
		α	β	PWR	PWR	ΔX/L <sub>B</sub>	α <sub>i</sub>	M <sub>∞</sub>	δ <sub>∞</sub>		δ <sub>∞</sub>		.119	.151	.182	.228	.352	.579	.908	10.0
RT8560	MDAC ORBITER	A	0	0.0	0.0	-.391	10.0	2.0	0.0	0.0	6				3801	3818	3819	3834	3835	3835
561						-.143					6				3802	3817	3820	3833	3836	
562						-.019					5				3803	3816	3821	3832		
563						.043					4				3804	3815	3822			
564						.105					6				3805	3814	3823	3831	3837	
565						.167					4				3806	3813	3824			
566						.228					5				3807	3812	3825	3830		
567						.351					5				3808	3811	3826	3829		
568						.501					6				3809	3810	3827	3828	3832	Y
569						-.391	-5.0				8	3701	3718	3719	3736	3737	3752	3753	3756	
570						-.143					8	3702	3717	3720	3735	3738	3751	3754		
571						-.019					7	3703	3716	3721	3724	3739	3750			
572						.043					6	3704	3715	3722	3733	3740				
573						.105					8	3705	3714	3723	3732	3741	3749	3755		
574						.167					6	3706	3713	3724	3731	3742				
575						.228					7	3707	3712	3725	3730	3743	3748			
576						.351					7	3708	3711	3726	3729	3744	3747			
577						.501					8	3709	3710	3727	3728	3745	3746	3756	Y	

1                    7                    13                    19                    25                    31                    37                    43                    49                    55                    61                    67                    7576

ALPHA: ICLM    ICH    ICA    ICBL    CY    CYN    DELTAZ    7

COEFFICIENTS:    A = -10° TO +10° ONE DATA POINT PER DEGREE    IDPVAR(1) IDPVAR(2) NDV

α or β  
 SCHEDULES

TEST VA 1163 DATA SET COLLATION SHEET

PRETEST  
 POSTTEST

DATA SET IDENTIFIER	CONFIGURATION	SCHED.		PARAMETERS/VALUES						No. of Runs	DELTA Z/R								
		a	B	PWR	PWR	AX/PA	α	M <sub>0</sub>	δ <sub>0</sub>		β <sub>0</sub>	.119	.151	.182	.228	.352	.599	.908	1.00
RTB578	MDAC ORBITER	A	0	50.0	100.0	-.391	0.0	2.0	0.0	0.0	7	3401	3418	3419	3436	3437	3452		3456
						-.143					8	3402	3417	3420	3435	3438	3451	3454	
579						-.019					7	3403	3416	3421	3434	3437	3450		
580						.043					6	3404	3415	3422	3433	3440			
581						.105					8	3405	3414	3423	3432	3441	3449	3455	
582						.167					6	3406	3413	3424	3431	3442			
583						.228					7	3407	3412	3425	3430	3443	3448		
584						.351					7	3408	3411	3426	3429	3444	3447		
585						.522					8	3409	3410	3427	3428	3445	3446	3450	↓
586						-.391	5.0				7		3601	3618	3619	3636	3637	3647	3644
587						-.143					7		3602	3617	3620	3635	3638	3646	
588						-.019					6		3603	3616	3621	3634	3639		
589						.043					5		3604	3615	3622	3633			
590						.105					7		3605	3614	3623	3632	3640	3645	
591						.167					5		3606	3612	3624	3631			
592						.228					6		3607	3613	3625	3630	3641		
593						.351					6		3608	3611	3626	3629	3642		
594						.522					7		3609	3610	3627	3628	3643	3644	↓
595																			

ALPHA: C, L, M, N, CA, CB, C, CN, DELTA: [IDPVAR(1)] [IDPVAR(2)] INDV

COEFFICIENTS: A = -10° TO 110° ONE DATA POINT PER DEGREE  
 a or B  
 SCHEDULES

PRETEST  
 POSTTEST

DATA SET IDENTIFIER	CONFIGURATION	SCHD.		PARAMETERS/VALUES						No. of Runs	DELTA Z/°R								
		α	β	PWR	PWR	ΔX/ΔY	α <sub>i</sub>	M <sub>00</sub>	δ <sub>01</sub>		δ <sub>02</sub>	.119	.151	.182	.220	.352	.599	.908	10.0
RTB596	MIDAC OPERATOR	A	0	50.0	100.0	-.391	10.0	2.0	0.0	0.0	6			4001	4018	4019	4034	4035	4038
597						-.143					6			4002	4017	4020	4033	4036	
598						-.019					5			4003	4016	4021	4032		
599						.043					4			4004	4015	4022			
600						.105					6			4005	4014	4023	4031	4037	
601						.167					4			4006	4013	4024			
602						.228					5			4007	4012	4025	4030		
603						.351					5			4008	4011	4026	4029		
604				Y	Y	.501	Y				6			4009	4010	4027	4028	4038	Y
605				0.0	0.0	-.391	0.0				8	3901	3918	3919	3936	3937	3952	3953	3956
606						-.143					8	3902	3917	3920	3935	3938	3951	3954	
607						-.019					7	3903	3916	3921	3934	3939	3950		
608						.043					6	3904	3915	3922	3933	3940			
609						.105					8	3905	3914	3923	3932	3941	3949	3955	
610						.167					6	3906	3913	3924	3931	3942			
611						.228					7	3907	3912	3925	3930	3943	3948		
612						.351					7	3908	3911	3926	3929	3944	3947		
613				Y	Y	.525	Y	Y	Y	Y	8	3909	3910	3927	3928	3945	3946	3956	Y

1            7            13            19            25            31            37            43            49            55            61            67            75 76

ALPHA CLM    ICN    ICA    ICAL    CY    CYN    DELTAZ    7

COEFFICIENTS:    IDPVAR(1) IDPVAR(2) NDV  
 α or β    A = -10° to +10° ONE DATA POINT PER DEGREE  
 SCHEDULES

TEST VA 1163 DATA SET COLLATION SHEET

PRETEST  
 POSTTEST

DATA SET IDENTIFIER	CONFIGURATION	SCHD.		PARAMETERS/VALUES								No. of Runs	DELTA Z/°R							
		a	B	PWR	PWR	AK/°	α	M <sub>00</sub>	δ <sub>01</sub>	δ <sub>00</sub>	.119		.151	.182	.228	.352	.599	.908	10.0	
RTB 614	DIPAC MASTER	A	0	0.0	0.0	-391	0.0	2.0	20.0	-20.0	8	4401	4414	4415	4459	4430	4441	4442	4415	
615						-143					8	4402	4413	4416	4428	4431	4440	4473		
616						-019					6	4403	4412	4417	4437		4439			
617						.105					8	4404	4411	4418	4426	4432	4438	4444		
618						.167					5	4405	4410	4419	4424					
619						.351					7	4406	4409	4420	4423	4433	4436			
620				Y	Y	522					8	4407	4408	4421	4422	4434	4435	4445	Y	
621				50.0	100.0	-391					8	4501	4518	4519	4537	4538	4533	4534	4551	
622						-143					8	4502	4517	4520	4536	4539	4552	4535		
623						-019					7	4503	4516	4521	4535	4540	4551			
624						.043					6	4504	4515	4522	4534	4541				
625						.105					8	4505	4514	4523	4523	4542	4550	4536		
626						.167					10	4506	4513	4524	4522	4543				
627						.228					7	4507	4512	4525	4530	4544	4549			
628						.351					7	4508	4511	4526	4539	4545	4548			
629				Y	Y	522	Y	Y	Y	Y	8	4509	4510	4527	4538	4546	4547	4557	Y	

1            7            13            19            25            31            37            43            49            55            61            67            75 76

ALPHA C L M    I C N    K A    I C B L    I C Y    I C Y N    DELTA R    7

COEFFICIENTS: \_\_\_\_\_ IDPVAR(1) IDPVAR(2) IDV

a or B    A = -10° TO +10° ONE DATA POINT PER DEGREE

SCHEDULES

TEST VA 1163 DATA SET COLLATION SHEET

PRETEST  
 POSTTEST

DATA SET IDENTIFIER	CONFIGURATION	SCHD.		PARAMETERS/VALUES							No. of Runs	DELTA Z/LR							
		$\alpha$	$\beta$	PWR	PWR	$\Delta X/LR$	$\alpha_i$	$M_{\infty}$	$\delta_{\infty}$	$\delta_{\infty}$									
RTB 630	MDAC ARRETER	A	0	0.0	0.0	-.391	0.0	2.0	0.0	0.0	1	4119							
631						-.143						4201							
632						-.019						4202							
633						.043						4203							
634						.105						4204							
635						.167						4205							
636						.228						4206							
637						.351						4207							
638						.501						4208							
639					1000	-.391						4209							
640						-.143						4101							
641						-.019						4102							
642						.043						4103							
643						.105						4104							
644						.167						4105							
645						.228						4106							
646						.351						4107							
647						.501						4108							
												4109							

1                    7                    13                    19                    25                    31                    37                    43                    49                    55                    61                    67                    75 76

ALPHA CLM    ICN    ICA    ICB    ICY    CYN    DELTA    7

COEFFICIENTS: \_\_\_\_\_ IDPVAR(1) IDPVAR(2) IDV  
 $\alpha$  or  $\beta$     A = -10° TO +10° ONE DATA POINT PER DEGREE  
 SCHEDULES \_\_\_\_\_

TEST VA 1163 DATA SET COLLATION SHEET

PRETEST  
 POSTTEST

DATA SET IDENTIFIER	CONFIGURATION	SCHED.		PARAMETERS/VALUES							No. of Runs	DELTA Z/LB				
		a	B	PWR	PWR AX/A	R	M <sub>0</sub>	Seg	Seg							
ATA 647	AIDAC EXETER	A	0	0.0	0.0	-391	0.0	2.0	20.0	-20.0	1	.119				
648						-143						4801				
649						-099						4802				
650						.043						4803				
651						.105						4804				
652						.167						4805				
653						.228						4806				
654						.351						4807				
655						.522						4808				
656						1000						4809				
657						-391						4901				
658						-143						4902				
659						-099						4903				
660						.043						4904				
661						.105						4905				
662						.167						4906				
663						.228						4907				
664						.351						4908				
665						.522						4909				

1      7      13      19      25      31      37      43      49      55      61      67      7576

ALPHA CLM    VCN    ICA    IGBL    CY    SYN    DELTA Z    7

COEFFICIENTS:    IDFVAR(1) | IDFVAR(2) | NDV

α or β    A = -10° to +10° ONE DATA POINT PER DEGREE

SCHEDULES

TEST VA 1163 DATA SET COLLATION SHEET

PRETEST  
 POSTTEST

DATA SET IDENTIFIER	CONFIGURATION	SCHD.		PARAMETERS/VALUES						No. of Runs	DELTA Z/R									
		$\alpha$	$\beta$	PWR	PWR	$\Delta X/\Delta Y$	$\alpha_z$	$M_{10}$	$\delta_{0A}$		$\delta_{0D}$	.113	.119	.151	.182	.228	.352	.599	.908	10.0
RT8 666	MDAC PRETEST	A	0	0.0	0.0	-.391	0.0	3.0	0.0	0.0	9	3101	3201	3218	3219	3236	3237	3252	3253	3255
667						-.143					9	3102	3202	3217	3230	3235	3238	3251	3254	
668						-.019					8	3103	3203	3216	3221	3234	3239	3250		
669						.043					7	3104	3204	3215	3222	3233	3240			
670						.105					9	3105	3205	3214	3223	3232	3241	3249	3255	
671						.167					7	3106	3206	3218	3224	3231	3242			
672						.228					8	3107	3207	3212	3215	3230	3243	3248		
673						.351					8	3108	3208	3211	3224	3229	3244	3247		
674						.501	Y				9	3109	3209	3210	3227	3228	3245	3246	3256	Y
675						-.391	5.0				8			2401	2418	2419	2436	2439	2447	3.54
676						-.143					8			2402	2417	2420	2435	2438	2446	
677						-.019					7			2403	2416	2421	2434	2439		
678						.043					6			2404	2415	2422	2433			
679						.105					8			2405	2414	2423	2432	2440	2445	
680						.167					6			2406	2413	2424	2431			
681						.228					7			2407	2412	2425	2450	2441		
682						.351					7			2408	2411	2426	2429	2442		
683						.502	Y	Y	Y	Y	8			2409	2410	2427	2428	2443	2444	Y

1            7            13            19            25            31            37            43            49            55            61            67            75 76

ALPHA    CLM    ICN    ICA    ICBL    CY    CYN    DELTAZ    7

COEFFICIENTS:    A = -10° to +10° ONE DATA POINT PER DEGREE    IDPVAR(1) IDPVAR(2) NDV

$\alpha$  or  $\beta$  \_\_\_\_\_  
 SCHEDULES \_\_\_\_\_

TEST VA 1163 DATA SET COLLATION SHEET

PRETEST  
 POSTTEST

DATA SET IDENTIFIER	CONFIGURATION	SCHD.		PARAMETERS/VALUES						No. of Runs	DELTA Z/L <sub>R</sub>								
		α	β	PWR	PWR	AX/L <sub>R</sub>	α <sub>0</sub>	M <sub>∞</sub>	δ <sub>EA</sub>		δ <sub>ED</sub>	.119	.151	.182	.228	.352	.599	.908	1.0
RT0684	MDAC ORBITER	A	0	0.0	0.0	.391	10.0	3.0	0.0	0.0	6								
685						-.143					6			2901	2918	2919	2934	2935	2938
686						-.019					5			2902	2917	2920	2933	2936	
687						.043					4			2903	2916	2921	2932		
688						-.105					6			2904	2915	2922			
689						.167					4			2905	2914	2923	2931	2937	
690						.228					5			2906	2913	2924			
691						.351					5			2907	2912	2925	2930		
692						.501	Y				6			2908	2911	2926	2929		
693						-.391	-5.0				8	2601	2618	2619	2636	2637	2652	2653	2656
694						-.143					8	2602	2617	2620	2635	2638	2651	2654	
695						-.019					7	2603	2616	2621	2634	2639	2650		
696						.043					6	2604	2615	2622	2633	2640			
697						.105					8	2605	2614	2623	2632	2641	2649	2655	
698						.167					6	2606	2613	2624	2631	2642			
699						.228					7	2607	2612	2625	2630	2636	2648		
700						.351					7	2608	2611	2626	2629	2644	2647		
701						.522	Y	Y	Y	Y	8	2609	2610	2627	2628	2645	2646	2656	Y

1            7            13            19            25            31            37            43            49            55            61            67            7576

ALPHA    CLM    ICM    ICA    ICBL    ICY    IGVN    DELTA    7

COEFFICIENTS: \_\_\_\_\_ IDPVAR(1) | IDPVAR(2) | NDV

α or β            A = -10° to +10° ONE DATA POINT PER DEGREE

SCHEDULES \_\_\_\_\_



TEST VA.1163 DATA SET COLLATION SHEET

PRETEST  
 POSTTEST

DATA SET IDENTIFIER	CONFIGURATION	SCHD.		PARAMETERS/VALUES						No. of Runs	DELTA Z/%R									
		A	B	PWR	PWR	AX/P	α	M <sub>0</sub>	SEP		δ <sub>0</sub>	.113	.119	.151	.182	.211	.352	.599	.908	10.0
RT8 702	MPAC ORBITER	A	0	50.0	100.0	-.391	0.0	3.0	0.0	0.0	8	3001	2301	2317	2319	2336	2337	2352	2353	2356
703						-.143					7	3002	2302	2317	2320	2335		2351	2354	
704						-.019					7	3003	2303	2316	2321	2334	2339	2350		
705						.043					6	3004	2304	2315	2322	2333	2340			
706						.105					8	3005	2305	2314	2323	2332	2341	2344	2355	
707						.167					6	3006	2306	2313	2324	2331	2342			
708						.228					7	3007	2307	2312	2325	2330	2343	2348		
709						.351					7	3008	2308	2311	2326	2329	2344	2347		
710						.501	Y				8	3009	2309	2310	2327	2328	2345	2346	2356	Y
711						-.391	5.0				7			2501	2518	2519	2536	2537	2549	Y
712						-.143					7			2502	2517	2520	2535	2538	2546	
713						-.019					6			2503	2516	2521	2534	2539		
714						.043					5			2504	2515	2522	2533			
715						.105					7			2505	2514	2523	2532	2540	2545	
716						.167					5			2506	2513	2524	2531			
717						.228					6			2507	2512	2525	2530	2541		
718						.351					6			2508	2511	2526	2529	2542		
719						.522	Y	Y	Y	Y	7			2509	2510	2527	2528	2543	2544	Y

1            7            13            19            25            31            37            43            49            55            61            67            75 76

ALPHA QCLM    ICN    ICA    ICB    CY    CYN    DELTA    7  
 COEFFICIENTS: \_\_\_\_\_ |IDPVAR(1)| IDPVAR(2) |NDV  
 α or β                      A = -10° TO +10° ONE DATA POINT PER DEGREE            
 SCHEDULES \_\_\_\_\_  
 \_\_\_\_\_

TEST VA 1163 DATA SET COLLATION SHEET

PRETEST  
 POSTTEST

DATA SET IDENTIFIER	CONFIGURATION	SCHD.		PARAMETERS/VALUES						No. of Runs	DELTA Z/L <sub>B</sub>								
		a	B	PWR	PWR	AX/L <sub>B</sub>	α <sub>i</sub>	M <sub>∞</sub>	δ <sub>02</sub>		δ <sub>00</sub>	.119	.151	.182	.228	.352	.589	.908	10.0
RT8720	MDHC ORBITER	A	0	50.0	100.0	3.391	10.0	3.0	0.0	L.C.	6			2801	2818	2819	2834	2835	2838
721						-.143					6			2802	2817	2820	2833	2836	
722						-.019					5			2803	2816	2821	2832		
723						.043					4			2804	2815	2822			
724						.105					6			2805	2814	2823	2831	2837	
725						.167					4			2806	2813	2824			
726						.228					5			2807	2812	2825	2830		
727						.351					5			2808	2811	2826	2829		
728						.501	Y				6			2809	2810	2827	2828	2838	Y
729						-.391	-5.0				8	2701	2718	2719	2736	2737	2752	2753	2756
730						-.143					8	2702	2719	2720	2735	2738	2751	2754	
731						-.019					7	2703	2716	2721	2734	2739	2750		
732						.043					6	2704	2715	2722	2733	2740			
733						.105					8	2705	2714	2723	2732	2741	2749	2755	
734						.167					6	2706	2713	2734	2731	2742			
735						.228					7	2707	2712	2725	2730	2743	2748		
736						.351					7	2708	2711	2726	2729	2744	2747		
737						.532	Y	Y	Y	Y	8	2709	2710	2727	2728	2745	2746	2756	Y

1 7 13 19 25 31 37 43 49 55 61 67 7576

ALPHA QCLM ICN ICA ICBL ICY ICYN DELTAM 7

COEFFICIENTS: \_\_\_\_\_ IDEVAR(1) IDEVAR(2) NDV

a or β \_\_\_\_\_

SCHEDULES \_\_\_\_\_

A = -10° TO +10° ONE DATA POINT PER DEGREE



TEST VA 1163 DATA SET COLLATION SHEET

55

PRETEST  
 POSTTEST

DATA SET IDENTIFIER	CONFIGURATION	SCHD.		PARAMETERS/VALUES							No. of Runs	DELTA Z/2R				
		α	β	PWR	PWR	AX/L	α <sub>i</sub>	M <sub>0</sub>	δ <sub>0</sub>	δ <sub>0</sub>						
RTB 756	ADAC #REITER	A	0	1000	0.0	-371	0.0	3.0	0.0	0.0	1	5001				
757						-143						5002				
758						-019						5003				
759						.043						5004				
760						.105						5005				
761						.167						5006				
762						.228						5007				
763						.351						5008				
764					√	√	.522					5009				
765					0.0	0.0	-391					5101				
766						-143						5102				
767						-019						5103				
768						.043						5104				
769						.105						5105				
770						.167						5106				
771						.228						5107				
772						.351						5108				
773					√	√	.522	√	√	√	√	5109				

1      7      13      19      25      31      37      43      49      55      61      67      7576

ALPHA    CLM    ICN    ICA    ICBL    ICY    ICYN    DELTA    7

COEFFICIENTS: \_\_\_\_\_ IDPVAR(1) IDPVAR(2) HDV

α or β      A = -10° to +10° ONE DATA POINT PER DEGREE

SCHEDULES \_\_\_\_\_

TEST VA 1163 DATA SET COLLATION SHEET

95

PRETEST  
 POSTTEST

DATA SET IDENTIFIER	CONFIGURATION	SCHD.		PARAMETERS/VALUES						No. of Runs	DELTA Z/LR								
		a	B	PWR	PWR	AX/A	α	M <sub>0</sub>	δ <sub>0</sub>		β <sub>0</sub>	119	151	182	220	352	527	908	1010
RYA 774	1.125 DIAMETER	A	0	50.0	100.0	-.351	0.0	4.0	0.0	0.0	7	5301	5318	5319	5336	5337	5352		
775						-.143					7	5302	5317	5320	5335	5338	5351		
776						-.019					7	5303	5316	5321	5334	5339	5350		
777						-.043					6	5304	5315	5322	5333	5340			
778						-.105					7	5305	5314	5327	5330	5341	5348		
779						-.167					6	5306	5313	5324	5331	5340			
780						-.228					7	5307	5312	5325	5330	5343	5348		
781						-.351					7	5308	5311	5326	5329	5344	5347		
782						-.522					7	5309	5310	5327	5328	5345	5346		
783						-.391		6.0			6	5401	5410	5419	5420	5437			
784						-.143						5402	5417	5420	5435	5438			
785						-.019						5403	5416	5421	5434	5439			
786						-.043						5404	5415	5422	5433	5440			
787						-.105						5405	5414	5427	5432	5441			
788						-.167						5406	5413	5401	5431	5442			
789						-.228						5407	5412	5425	5430	5445			
790						-.351						5408	5411	5426	5429	5444			
791						-.522						5409	5410	5427	5428	5445			

1 7 11 19 25 31 37 43 49 55 61 67 7576

ALPHABETIC ICM CA ICR1 CY CYN DELTAD 7

COEFFICIENTS: IDPVAR(1) IDPVAR(2) MDV

a or B A = -10° TO +10° ONE DATA POINT PER DEGREE

SCHEDULES \_\_\_\_\_

TEST VA 1163 DATA SET COLLATION SHEET

PRETEST  
 POSTTEST

DATA SET IDENTIFIER	CONFIGURATION	SCHD.		PARAMETERS/VALUES						No. of Runs	DELTA Z/LR			
		a	B	PWR	PWR/AX/PA	$\alpha$	M <sub>0</sub>	$\delta\alpha$	$\delta\beta$		.119	.151	10.0	
RTB 772	ALPHA CLM	A	0	50	100	-51	0.0	6.0	0.0	0.2	3	550	557	559
773						-10						552	557	
774						-019						553	556	
775						043						554	555	
776						.105						555	554	
777						.167						556	553	
778						.221						557	552	
779						.351						558	551	
800						.52						559	550	

7 13 19 25 31 37 43 49 55 61 67 73 79

ALPHA CLM ICN ICA ICB CY ICY IDELT.BZ  
 COEFFICIENTS: A = -10° TO +10° ONE DATA POINT PER DEGREE  
 a or B  
 SCHEDULES

PRETEST  
 POSTTEST

DATA SET IDENTIFIER	CONFIGURATION	SCHED.		PARAMETERS/VALUES							No. of Runs	DELTA Z/R							
		A	B	PWR	PWR	ΔX/L <sub>0</sub>	α <sub>i</sub>	M <sub>0</sub>	δ <sub>0</sub>	δ <sub>0</sub>		.113	.119	.151	.182	.229	.352	.579	.908
RTB 801	MDAC ORBITER	A	0	0.0	0.0	-391	0.0	2.0	0.0	0.0	8	3356	3356	3356	3356	3356	3356	3356	3356
802							5.0		0.0	0.0		3544	3544	3544	3544	3544	3544	3544	3544
803							10.0		0.0	0.0		3838	3838	3838	3838	3838	3838	3838	3838
804							0.0		20.0	-20.0		4445	4445	4445	4445	4445	4445	4445	4445
805				Y	Y		0.0		0.0	0.0		3956	3956	3956	3956	3956	3956	3956	3956
806						50.0	100.0		0.0	0.0		3456	3456	3456	3456	3456	3456	3456	3456
807							5.0		0.0	0.0		3644	3644	3644	3644	3644	3644	3644	3644
808							10.0		0.0	0.0		4038	4038	4038	4038	4038	4038	4038	4038
809				Y	Y		0.0		20.0	-20.0		4557	4557	4557	4557	4557	4557	4557	4557
810						0.0	0.0		-5.0	0.0		3756	3756	3756	3756	3756	3756	3756	3756
811							5.0	3.0				2444	2444	2444	2444	2444	2444	2444	2444
812				Y	Y		10.0					2938	2938	2938	2938	2938	2938	2938	2938
813						50.0	100.0		0.0			2356	2356	2356	2356	2356	2356	2356	2356
814							5.0					2544	2544	2544	2544	2544	2544	2544	2544
815							10.0					2838	2838	2838	2838	2838	2838	2838	2838
816				Y	Y		-5.0					2756	2756	2756	2756	2756	2756	2756	2756
817						0.0	0.0		-5.0			2656	2656	2656	2656	2656	2656	2656	2656
818	MDAC ORBITER (Param = 5 Param)	Y	Y			50.0	100.0	Y	0.0	Y	Y	5256	5256	5256	5256	5256	5256	5256	5256

1                    7                    13                    19                    25                    31                    37                    43                    49                    55                    61                    67                    75 76

ALPHA, CLM, ICN, ICA, ICB, L, CY, CYN, DELTA Z, 7

COEFFICIENTS: A = -10° to +10° ONE DATA POINT PER DEGREE | IDPVAR(1) | IDPVAR(2) | NDV

α or β \_\_\_\_\_  
 SCHEDULES \_\_\_\_\_

TEST VA 1163 DATA SET COLLATION SHEET

PRETEST  
 POSTTEST

DATA SET IDENTIFIER	CONFIGURATION	SCHD.		PARAMETERS/VALUES							No. of Runs	DELTA Z/°B						
		α	β	PWR	PWR	AX/P	α <sub>i</sub>	M <sub>0</sub>	δ <sub>EP</sub>	δ <sub>EP</sub>		.119	.151	.182	.228	.352	.599	.908
RTB 819	INDAC ORBITER	A	D	0.0	0.0	-391	0.0	5.0	0.0	0.0	7	361	361	361	361	361	361	361
820							5.0					640	640	640	640	640	640	640
821							10.0					1128	1128	1128	1128	1128	1128	1128
822				↓	↓		-5.0					740	740	740	740	740	740	740
823						50.0	100.0	0.0				460	460	460	460	460	460	460
824								5.0				540	540	540	540	540	540	540
825								10.0				1029	1029	1029	1029	1029	1029	1029
826								-5.0				847	847	847	847	847	847	847
827				↓	↓			-10.0				1228	1228	1228	1228	1228	1228	1228
828						100.0	100.0	0.0				1334	1334	1334	1334	1334	1334	1334
829				↓	↓			5.0				1527	1527	1527	1527	1527	1527	1527
830						50.0	50.0	0.0				1834	1834	1834	1834	1834	1834	1834
831				↓	↓			5.0				1627	1627	1627	1627	1627	1627	1627
832						0.0	0.0	0.0	↓	20.0	-20.0	1934	1934	1934	1934	1934	1934	1934
833						50.0	100.0	0.0	4.0	0.0	0.0	5346	5346	5346	5346	5346	5346	5346
834				↓	↓	50.0	100.0	0.0	6.0	↓	↓	5445	5445	5445	5445	5445	5445	5445

1      7      13      19      25      31      37      43      49      55      61      67      7576

ALPHA CLM    ICN    ICA    ICB    CY    CYN    DELTA    7

COEFFICIENTS:    A = -10° to +10° ONE DATA POINT PER DEGREE    IDPVAR(1) | IDPVAR(2) | NDV

α or β

SCHEDULES



PRETEST  
 POSTTEST

DATA SET IDENTIFIER	CONFIGURATION	SCHD.		PARAMETERS/VALUES							No. of Runs	DELTA Z/1/R							
		α	β	PWR	PWR	ΔX/1/R	α	M <sub>0</sub>	δ <sub>0</sub>	δ <sub>0</sub>		.113	.119	.151	.182	.220	.352	.599	.908
RT8R35	MDAC BOOSTER	A	0	0.0	0.0	-391	0.0	2.0	0.0	0.0	8	3353	3353	3353	3353	3353	3353	3353	3353
837							10.0					3835	3835	3835	3835	3835	3835	3835	3835
838				↓	↓		-5.0					3753	3753	3753	3753	3753	3753	3753	3753
839				50.0	100.0		0.0					3454	3454	3454	3454	3454	3454	3454	3454
840				↓	↓		5.0					3647	3647	3647	3647	3647	3647	3647	3647
841				↓	↓		10.0					4035	4035	4035	4035	4035	4035	4035	4035
842				0.0	0.0		0.0		↓	↓		3953	3953	3953	3953	3953	3953	3953	3953
843				↓	↓		0.0		20.0	-20.0		4442	4442	4442	4442	4442	4442	4442	4442
844				50.0	100.0		0.0	↓	20.0	-20.0		4554	4554	4554	4554	4554	4554	4554	4554
845				0.0	0.0		0.0	3.0	0.0	0.0		2253	2253	2253	2253	2253	2253	2253	2253
846				↓	↓		5.0					2447	2447	2447	2447	2447	2447	2447	2447
847				↓	↓		10.0					2935	2935	2935	2935	2935	2935	2935	2935
848				↓	↓		-5.0					2653	2653	2653	2653	2653	2653	2653	2653
849				50.0	100.0		0.0					2353	2353	2353	2353	2353	2353	2353	2353
850				↓	↓		5.0					2547	2547	2547	2547	2547	2547	2547	2547
851				↓	↓		10.0					2835	2835	2835	2835	2835	2835	2835	2835
852				↓	↓		-5.0					2753	2753	2753	2753	2753	2753	2753	2753
853	MDAC BOOSTER (NO CANALS)						0.0					3223	3223	3223	3223	3223	3223	3223	3223
854	MDAC BOOSTER (P <sub>0</sub> = 52.0)	Y	Y	Y	Y	Y	0.0	Y	Y	Y	Y	5253	5253	5253	5253	5253	5253	5253	5253

1                    7                    13                    19                    25                    31                    37                    43                    49                    55                    61                    67                    7576

ALPHA    CLM    ICN    ISA    ICBL    ICY    ICYN    DELTA    7

COEFFICIENTS: \_\_\_\_\_ ⇒ |IDPVAR(1)| IDPVAR(2) |NDV  
 α or β            A = -10° TO +10° ONE DATA POINT PER DEGREE  
 SCHEDULES \_\_\_\_\_

TEST VA 1163 DATA SET COLLATION SHEET

67

PRETEST  
 POSTTEST

DATA SET IDENTIFIER	CONFIGURATION	SCHD.		PARAMETERS/VALUES							No. of Runs	DELTA Z/L <sub>R</sub>						
		α	β	PWR	PWR	AX/L <sub>R</sub>	α <sub>2</sub>	M <sub>∞</sub>	δ <sub>eg</sub>	δ <sub>eo</sub>		.119	.151	.182	.228	.352	.599	.908
ATR 855	MDAC BOOSTER	A	0	0.0	0.0	-391	0.0	5.0	0.0	0.0	7	355	355	355	355	355	355	355
856							5.0					637	637	637	637	637	637	637
857							10.0					1131	1131	1131	1131	1131	1131	1131
858				↓	↓		-5.0					737	737	737	737	737	737	737
859							50.0	100.0	0.0			454	454	454	454	454	454	454
860							5.0					537	537	537	537	537	537	537
861							10.0					1032	1032	1032	1032	1032	1032	1032
862							-5.0					850	850	850	850	850	850	850
863				↓	↓		-10.0					1231	1231	1231	1231	1231	1231	1231
864							100.0	100.0	0.0			1334	1334	1334	1334	1334	1334	1334
865				↓	↓		5.0					1527	1527	1527	1527	1527	1527	1527
866							50.0	50.0	0.0			1834	1834	1834	1834	1834	1834	1834
867				↓	↓		5.0			↓	↓	1627	1627	1627	1627	1627	1627	1627
868							0.0	0.0	0.0	↓	20.0	-20.0	1934	1934	1934	1934	1934	1934
869							50.0	100.0			4.0	0.0	0.0	5352	5352	5352	5352	5352
870									6.0					5437	5437	5437	5437	5437
871	MDAC BOOSTER (NO CAMERA)	↓	↓	↓	↓	↓	↓	↓	6.0	↓	↓	↓	↓	5519	5519	5519	5519	5519

1            7            13            19            25            31            37            43            49            55            61            67            7576

ALPHA, C, L, M, ICH, ICA, ICB, ICY, IGY, DELTA, ?

COEFFICIENTS: \_\_\_\_\_ IDPVAR(1) IDPVAR(2) NDV

A = -10° to +10° ONE DATA POINT PER DEGREE

α or β

SCHEDULES

TEST VA 1163 DATA SET COLLATION SHEET

PRETEST

POSTTEST

DATA SET IDENTIFIER	CONFIGURATION	SCHD.		PARAMETERS/VALUES							No. of Runs	MACH NUMBER				
		$\alpha$	$\beta$	PWR	PWR	AX/L	$\alpha_i$	$\delta_{e0}$	$\delta_{e0}$	AZ/L		2.0	3.0	5.0		
RTB 872	MDAC LAUNCH (ONE BALANCE)	A	0	100.0	0.0	10A	0.0	0.0	0.0	.105	3	5701	5701	5601		
873	MDAC LAUNCH (ONE BALANCE)			1.0							3	5702	5702	5602		
874	MDAC LAUNCH (ONE BALANCE NO CANARD)			100.0							1	5901				
875	MDAC LAUNCH (ONE BALANCE NO CANARD)			0.0	↓	↓	↓	↓	↓	↓	1	5902				
876	MDAC ORBITER (NO GRIT)			-	0.0	-	-	-	0.0	-	2	102	103			
877	MDAC ORBITER (GRIT ON)			-	0.0	-	-	-	0.0	-	2	101	105			
878	MDAC ORBITER (R=1.0X10 <sup>6</sup> )			-	0.0	-	-	-	0.0	-	1		106			
879	MDAC ORBITER (R=4.0X10 <sup>6</sup> )			-	0.0	-	-	-	0.0	-	1		105			
880	MDAC BOOSTER (NO GRIT)			0.0	-	-	-	0.0	-	-	2	102	103			
881	MDAC BOOSTER (GRIT ON)			0.0	-	-	-	0.0	-	-	2	101	105			
882	MDAC BOOSTER (R=1.0X10 <sup>6</sup> )			0.0	-	-	-	0.0	-	-	1		106			
883	MDAC BOOSTER (R=4.0X10 <sup>6</sup> )			0.0	-	-	-	0.0	-	-	1		105			

1      7      13      19      25      31      37      43      49      55      61      67      75 76

G.L.M.    I.C.N.    I.C.A.    I.C.B.L.    I.C.Y.    I.C.Y.N.    6

COEFFICIENTS: \_\_\_\_\_ IDPVAR(1) IDPVAR(2) NDV

$\alpha$  or  $\beta$

SCHEDULES \_\_\_\_\_

## TEST FACILITY DESCRIPTION

Tunnel A is a continuous, closed-circuit, variable density wind tunnel with an automatically driven flexible-plate-type nozzle and a 40- by 40-inch test section. The tunnel can be operated at Mach numbers from 1.5 to 6 at maximum stagnation pressures from 29 to 200 psia, respectively, and stagnation temperatures up to 750°R ( $M_{\infty} = 6$ ). Minimum operating pressures range from about one-tenth to one-twentieth of the maximum at each Mach number. For a more comprehensive description of Tunnel A, see Reference 3.



TEST CONDITIONS  
TEST VA 1163

MACH NUMBER	REYNOLDS NUMBER per unit length	DYNAMIC PRESSURE (pounds/sq. inch)	STAGNATION TEMPERATURE (degrees Fahrenheit)
<u>5.01 ± .01</u>	<u>1.09 x 10<sup>6</sup>, ft<sup>-1</sup></u>	<u>0.73</u>	<u>132 ± 5°</u>

BALANCE UTILIZED: 4.00-Y-36-050 (ORBITER)

CAPACITY:	CAL:	ACCURACY:	COEFFICIENT TOLERANCE:	NEAR MAX VALUE, %
			NEAR MIN. VALUE	
NF ± 200 lbs	± .75 lbs.	± 0.2 lbs	± .01	2.1
SF ± 200 lbs	± .25 lbs.	± 0.1 lbs	± .006	—
AF 50 lbs	25 lbs.	± 0.1 lbs	± .006	7.3
PM ± 680 in-lbs	± 100 in-lbs	± 0.1 in-lbs	± .005	7.3
YM ± 680 in-lbs	± 35 in-lbs	± 0.1 in-lbs	± .002	—
RM ± 100 in-lbs	± 20 in-lbs	± 0.05 in-lbs	± .0005	—

COMMENTS: Same as on previous page.

TEST CONDITIONS  
TEST VA 1163

MACH NUMBER	REYNOLDS NUMBER per unit length	DYNAMIC PRESSURE (pounds/sq. inch)	STAGNATION TEMPERATURE (degrees Fahrenheit)
3.00 ± 0.1	$1.65 \times 10^7$	2.02	120
"	$0.96 \times 10^7$	1.17	120

BALANCE UTILIZED: 406-V-36-037 (Buster)

CAPACITY:	CAL:	ACCURACY:	COEFFICIENT TOLERANCE: (1...2%)	
			MEAS. BY NBS	REC. BY YEAR 92
BP ± 150 lbs	± 50	± 0.2		
SP ± 150 lbs	± 25	± 0.1		
AP ± 75 lbs	± 25	± 0.05		
PK ± 510 in lbs	± 125	± 0.1		
TH ± 510 in lbs	± 125	± 0.2		
BK ± 100 in lbs	± 25	± 0.05		

- COMMENTS:
1. Coefficient tolerances include uncertainties in tunnel conditions and moment transfer distances as well as balance uncertainties
  2. Uncertainty in  $\alpha$  and incidence angle = ± 0.1 deg
  3. Uncertainty in X/L and Z/L = ± 0.002

TEST CONDITIONS  
TEST VA 1163

MACH NUMBER	REYNOLDS NUMBER per unit length	DYNAMIC PRESSURE (pounds/sq. inch)	STAGNATION TEMPERATURE (degrees Fahrenheit)
3.00 ± .01	$1.65 \times 10^6$	2.02	120
"	$0.96 \times 10^6$	1.17	120

BALANCE UTILIZED: 400-Y-36-050 (ORBITER)

CAPACITY:	CAL:	ACCURACY:	COEFFICIENT TOLERANCE: (g <sub>w</sub> = .02)	
			NEAR MIN VALUE	NEAR MAX. VALUE, %
NP: 200 lbs	± 75	± 0.2	± 0.00	± 1.2
SF: 200 lbs	± 25	± 0.1	± 0.00	—
AF: 50 lbs	± 25	± 0.1	± 0.00	± 2.0
PH: 200 lbs	± 100	± 0.1	± 0.00	± 1
YM: 650 lbs	± 35	± 0.1	± 0.00	—
RY: 100 lbs	± 20	± 0.05	± 0.00	—

COMMENTS: Same as on previous page



TEST CONDITIONS  
TEST VA1163

MACH NUMBER	REYNOLDS NUMBER per unit length	DYNAMIC PRESSURE (pounds/sq. inch)	STAGNATION TEMPERATURE (degrees Fahrenheit)
3.00 = 01	177 x 10 <sup>6</sup>	2.76	120
"	328 x 10 <sup>6</sup>	5.07	120

BALANCE UTILIZED: 400-Y-36-050 (OEBITEE)

CAPACITY:	CAL:	ACCURACY:	COEFFICIENT TOLERANCE: (90% - 70%)	
			NEAR MIN VALUE	NEAR MAX VALUE, %
VF: 200 lbs	±75	±0.3	±0.15	±0.15
SP: 200 lbs	±25	±0.1	±0.15	±0.15
AF: 50 lbs	±5	±0.1	±0.15	±0.15
FX: 20 lbs	±100	±0.1	±0.15	±0.15
YH: 20 lbs	±35	±0.1	±0.15	±0.15
RM: 20 lbs	±20	±0.05	±0.15	±0.15

COOLANTS: Same as on previous page

TEST CONDITIONS  
TEST VA1163

MACH NUMBER	REYNOLDS NUMBER per unit length	DYNAMIC PRESSURE (pounds/sq. inch)	STAGNATION TEMPERATURE (degree Fahrenheit)
2.00 ± .01	1.77 × 10 <sup>6</sup> ft <sup>-1</sup>	2.76	120
"	3.28 × 10 <sup>6</sup> ft <sup>-1</sup>	5.07	120

BALANCE UTILIZED: 4.06-Y-36-037 (BOOSTER)

CAPACITY:

NF	± 150 lbs
SF	± 150 lbs
AP	± 25 lbs
PH	± 510 in-lbs
YM	± 510 in-lbs
KM	± 100 in-lbs

CAL:

± 50
± 25
± 25
± 125
± 40
± 20

ACCURACY:

± 0.2
± 0.1
± 0.05
± 0.4
± 0.2
± 0.05

COEFFICIENT

TOLERANCE: (2<sub>00</sub> = 2<sup>00</sup>)

NEAR MIN VALUE	NEAR MAX VALUE, %
± 0.0015	± 0.5
± 0.0008	---
± 0.0004	± 0.2
± 0.0002	± 0.1
± 0.0001	---
± 0.0001	---

- COMMENTS: 1. Coefficient tolerances include uncertainties in tunnel conditions and moment transfer distances as well as balance uncertainties.
2. Uncertainty in  $\alpha$  and incidence angle = ± 0.1 deg
  3. Uncertainty in X/L and Z/L = ± 0.002.

## DATA REDUCTION

### FOR SADSAC

In the continuous pitch mode of data acquisition the wind tunnel parameters and model nozzle pressures were recorded at the beginning of each pitch sweep. The outputs of both balances and the angle of attack were scanned continuously at a rate of 67 times each second. Forty scans of these inputs were averaged to compute each data point, and when combined with the pitch rate of approximately 1-degree per second, a data point was computed every 0.6 degree. Linear interpolations were made between data points to obtain the data for even increments of booster angle of attack, and the data were tabulated in 1-degree increments of booster angle of attack from -10 to +10 degrees.

Schlieren photographs were automatically taken at pre-selected angles of attack during each pitch sweep. For these tests a photograph was taken near maximum, zero, and minimum angles of attack. Opening the camera shutter provided a photograph indicator record on the data tape which was used by the computer to calculate the booster angle of attack at which the photograph was taken. The camera shutter speed combined with the model pitching rate yielded an uncertainty in the tabulated photograph angle of attack of approximately  $\pm 0.2$  degree. A report containing a summary of all schlieren photographs will be published by AEDC.

The measured force and moment data for both models were corrected for balance tare and reduced about the respective moment reference points and the body axis system. The dimensional data used to reduce the orbiter measured data to coefficient form are listed and defined below:

$$S_{\text{ref}} = \text{Orbiter wing planform area} = 23.689 \text{ in.}^2 (0.164 \text{ ft}^2)$$

$$l_{\text{ref}} = \text{Orbiter wing mean aerodynamic chord} = 4.193 \text{ in.}$$

$$b = \text{Orbiter wing equivalent span} = 6.5 \text{ in.} (0.542 \text{ ft})$$

The moment reference point (MRP) for the orbiter data is 4.917 inches aft of the nose, on the lateral center line, and 1.390 inches below the top fuselage surface. The dimensional data used to reduce the booster measured data to coefficient form are listed below:

$$S_{\text{ref}} = 44.444 \text{ in.}^2 = \text{model reference area based on a full scale reference area of } 10,000 \text{ ft}^2 \text{ (see Data Report DMS-DR-1054, page 6)}$$

$$l_{\text{ref}} = b = 13.333 \text{ in.} = \text{model reference length based on a full scale reference length and span of } 200 \text{ ft (see Data Report DMS-DR-1054, page 6)}$$

The moment reference point applicable to the booster data is 7.528 inches aft of the model nose, on the booster lateral center line, and 1.194 inches above the bottom fuselage surface.

The  $\Delta X$  and  $\Delta Z$  distances were referenced to the moment reference points of the orbiter and booster and the booster body axis system. For example, the  $\Delta X$  distance is parallel to the longitudinal axis of the booster and between the moment reference points on the orbiter and booster. The  $\Delta Z$  is perpendicular

to the longitudinal axis of the booster and that distance between the moment reference points on the orbiter and booster. Values for  $\Delta X$  and  $\Delta Z$  are positive when the orbiter moment reference point (MRP) is forward and above the booster MRP. Both  $\Delta X$  and  $\Delta Z$  were normalized using the booster fuselage length of 16.184 inches.

The reference lengths used to reduce the orbiter data, booster data and normalize the  $\Delta X$  and  $\Delta Z$  data were different; these different values are listed and discussed above. The large negative values of pitching moment coefficient for the orbiter at a  $-0.391$  value of  $\Delta X/l_B$  and booster power on condition were apparent because the orbiter was in the plume of the booster.

For each dual balance test run the orbiter and booster data were separated and assembled into data sets utilizing  $\Delta Z/l_B$  (SADSAC parameter name DELTAZ) as the first independent variable (IDPVAR(1)) and booster angle of attack as the second independent variable (IDPVAR(2)) (see collation sheets). Test data applicable to a  $\Delta Z/l_B$  value of 10.0 are interference free data.

#### DATA NOMINALIZING

Varying balance and sting deflections which were caused by variations in model attitude and test conditions prevented the data from being obtained at constant values of  $\alpha_1$  and  $\Delta z/l_B$ . The differences between the nominal values and the values obtained during a test run were acceptable at the higher Mach numbers because of low aerodynamic loads. However, the differences

became appreciable at the lower Mach numbers. At the lower Mach numbers (Mach numbers of 2 and 3) pitch-plane coefficients (CN, CLM, and CA) for the booster and orbiter models were cross-plotted versus  $\alpha_I$  at each booster angle of attack and test condition to adjust the coefficients to nominal  $\alpha_I$  values. These values were then cross-plotted versus  $\Delta z/l_B$  to adjust the coefficients to nominal  $\Delta z/l_B$  values. This nominalizing was accomplished with a digital computer data fairing routine which used third degree polynomials determined by the coordinates and the slope at adjacent data points.

SUMMARY DATA PLOT INDEX

TITLE	DATASETS	PLOTTED COEFFICIENT VARYING	CONDITION VARYING	PAGES
AEDC VA 1163 MDAC Booster and Orbiter Test Data at Mach Number 5	RT8001 THRU RT8141	(A)	Separation Distance	1 - 423

PLOTTED COEFFICIENT SCHEDULE:

(A)  $C_{LM}$ ,  $C_N$ , and  $C_A$  vs.  $\alpha$

FIGURES



Notes:

1. Positive directions of force coefficients, moment coefficients, and angles are indicated by arrows.
2. For clarity, origins of wind and stability axes have been displaced from the center of gravity.

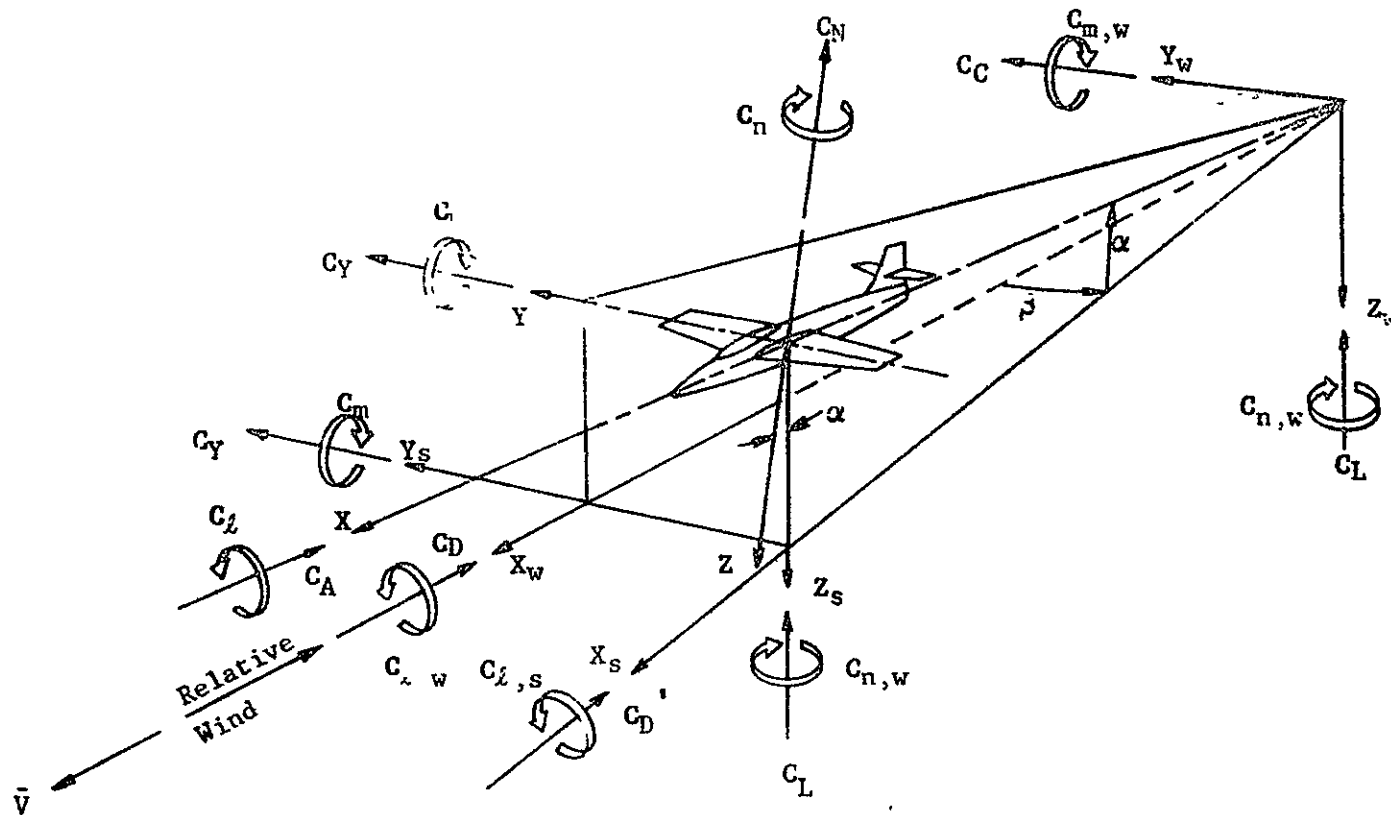

Figure 1. Axis systems, showing direction and sense of force and moment coefficients, angle of attack, and sideslip angle

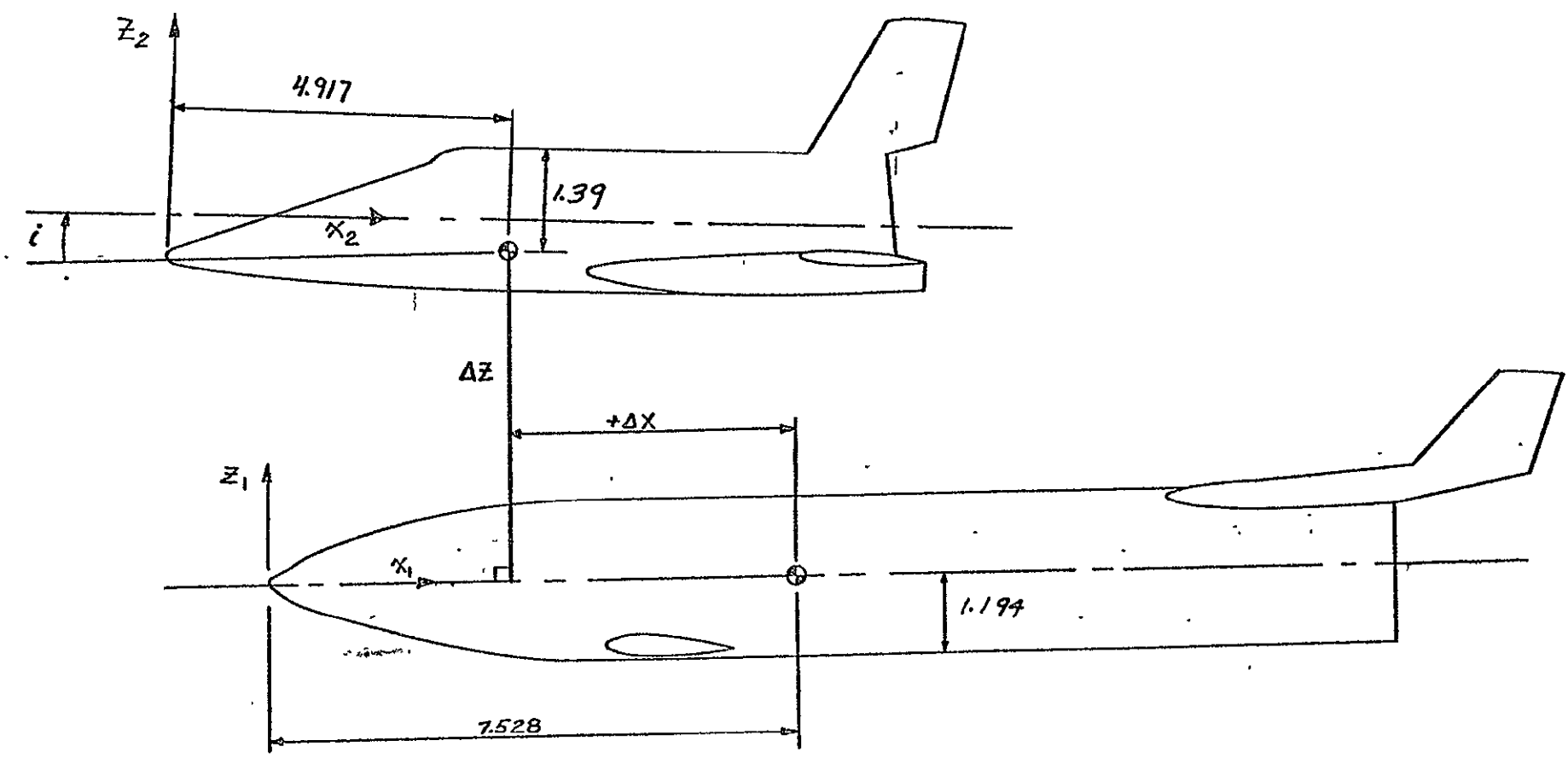

Fig. 2 - Separation Nomenclature and Moment Reference Points

40-INCH SUPERSONIC TUNNEL A

Scale - 1/5

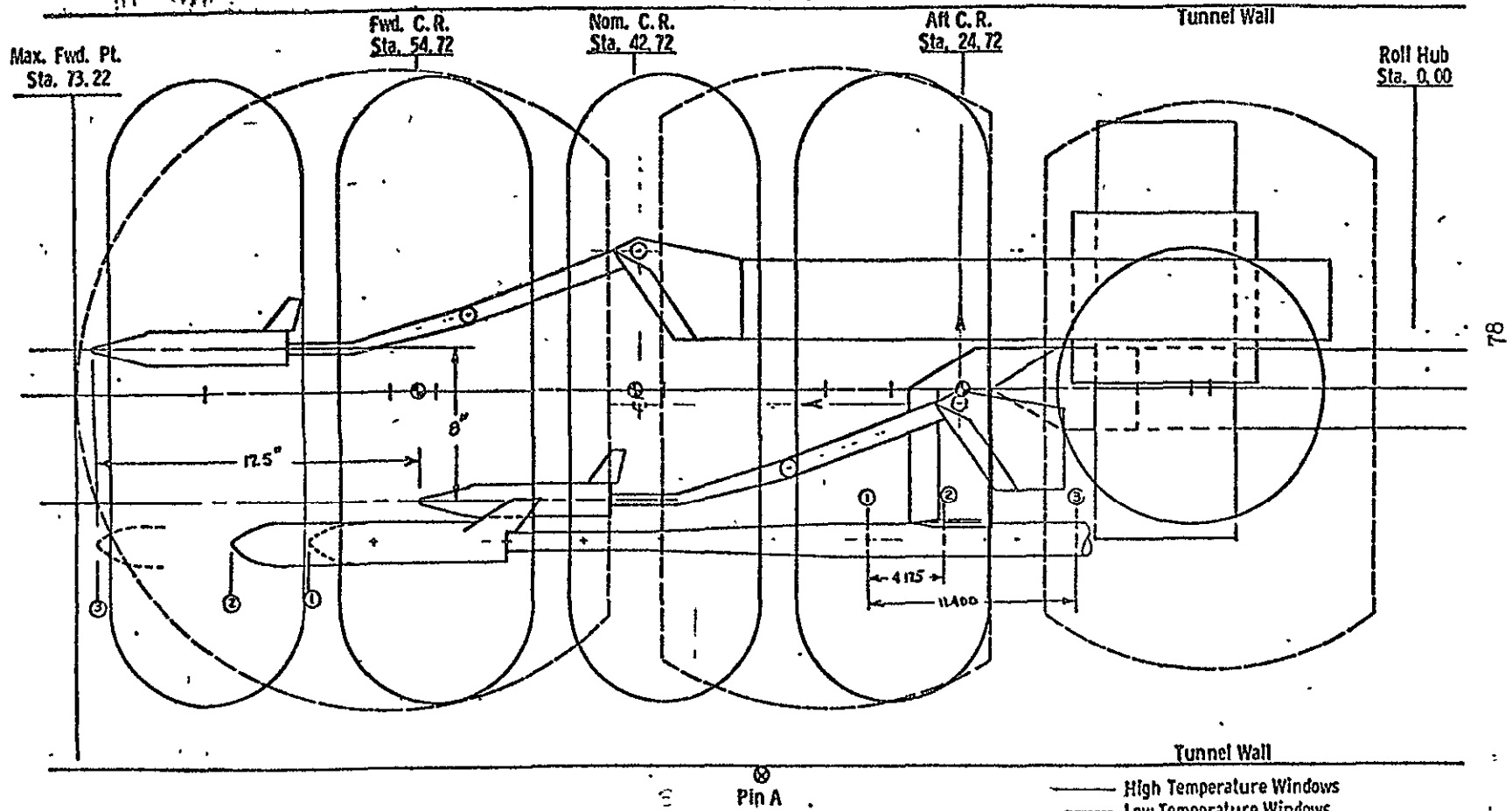

Figure 3 - General arrangement of models in tunnel

81

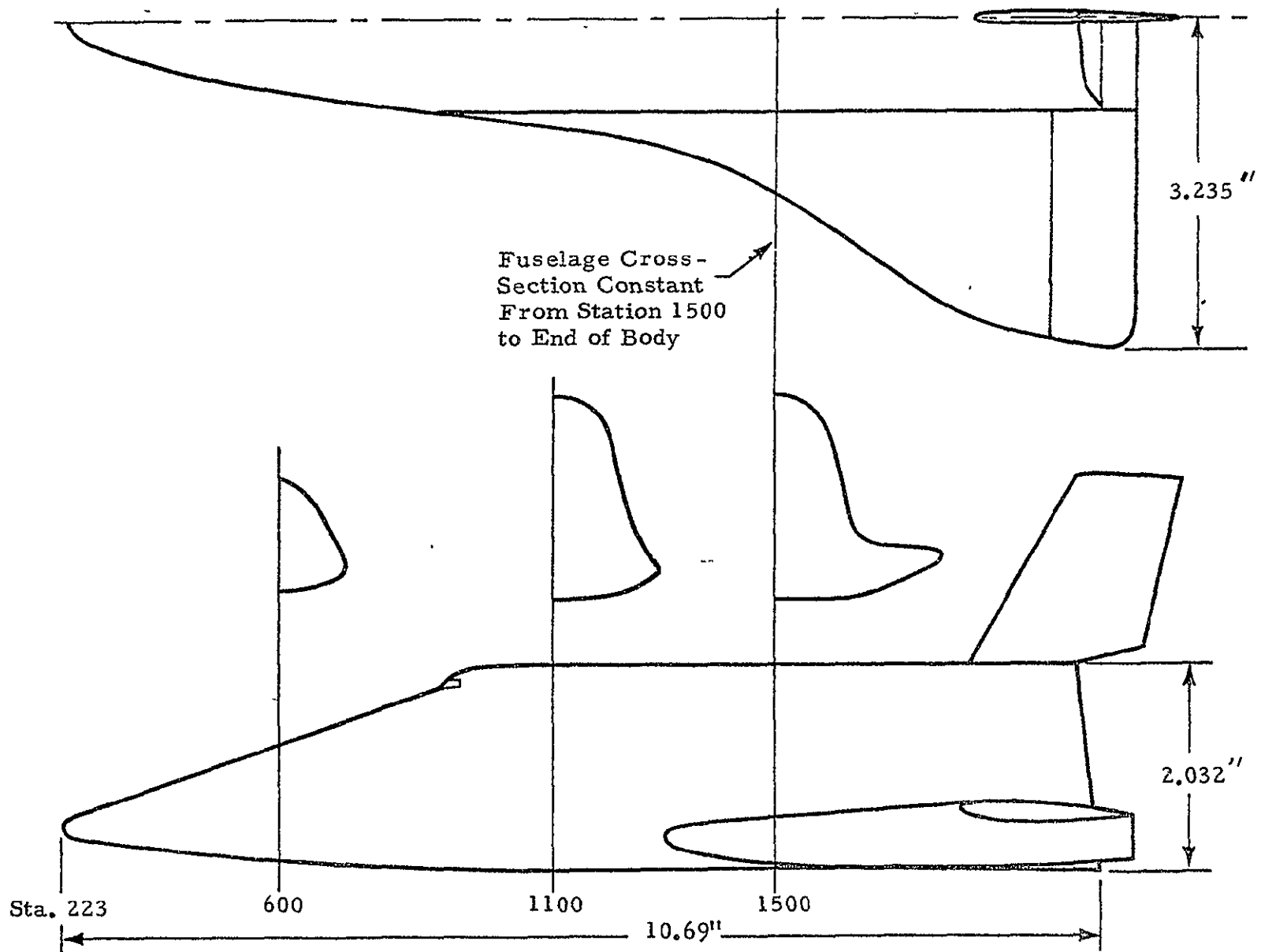

Fig. 4 - Modifications to Orbiter Model

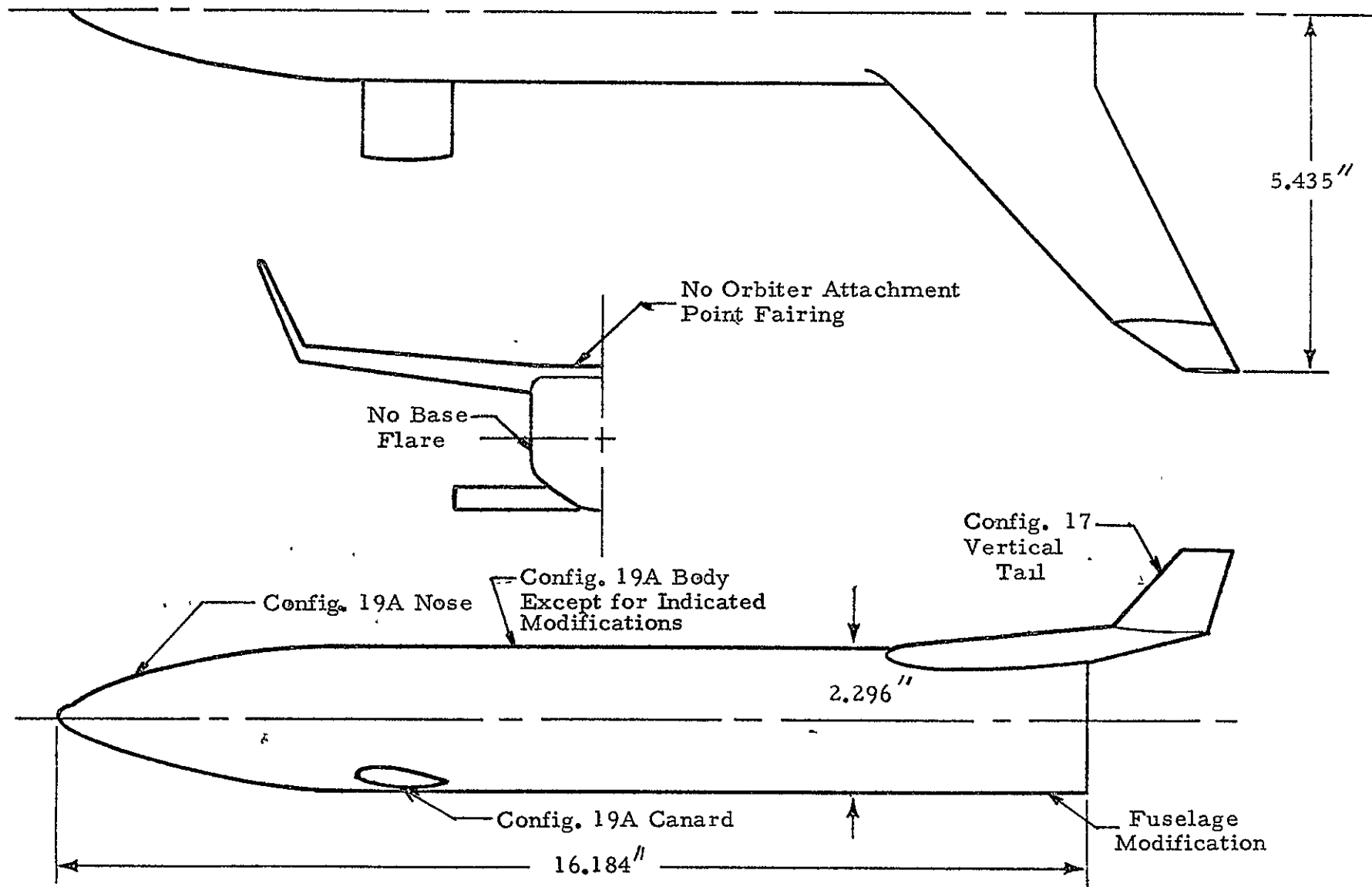
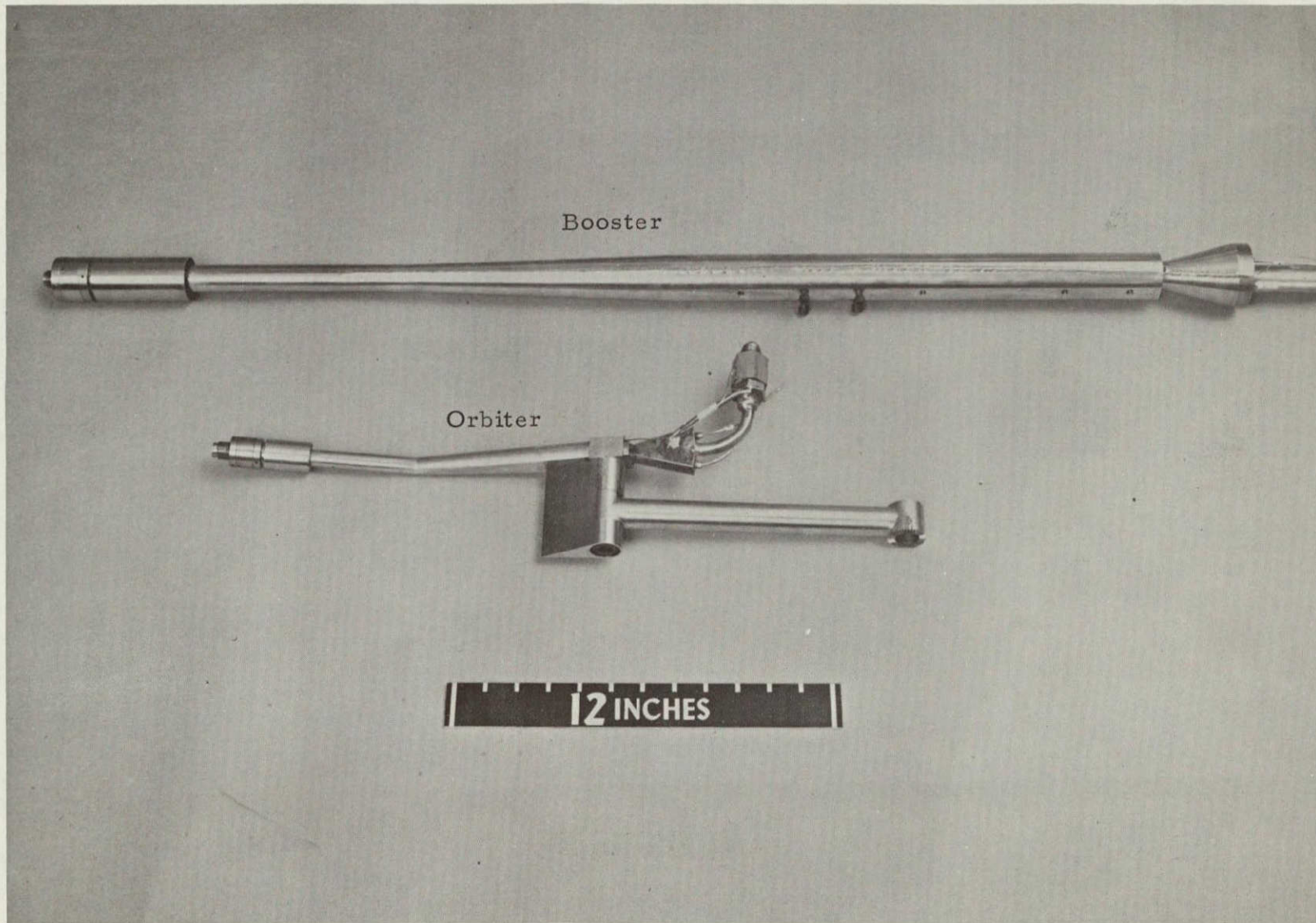

Fig. 5 - Modifications to Booster Model

U.S. AIR FORCE PHOTO-AEDC  
ARO INC. OPERATING CONTRACTOR  
ARNOLD A.F. STATION TENN.

Not cleared for public release without  
prior written approval of the responsible  
Air Force Office of Information.



81

3901

(5-14-71) VA1163 SPACE SHUTTLE NOZZLES

Figure 6. Photograph of Booster and Orbiter Sting Nozzle Hardware

U.S. AIR FORCE PHOTO-AEDC  
ARO INC. OPERATING CONTRACTOR  
ARNOLD A.F. STATION TENN.

Not cleared for public release without  
prior written approval of the responsible  
Air Force Office of Information.

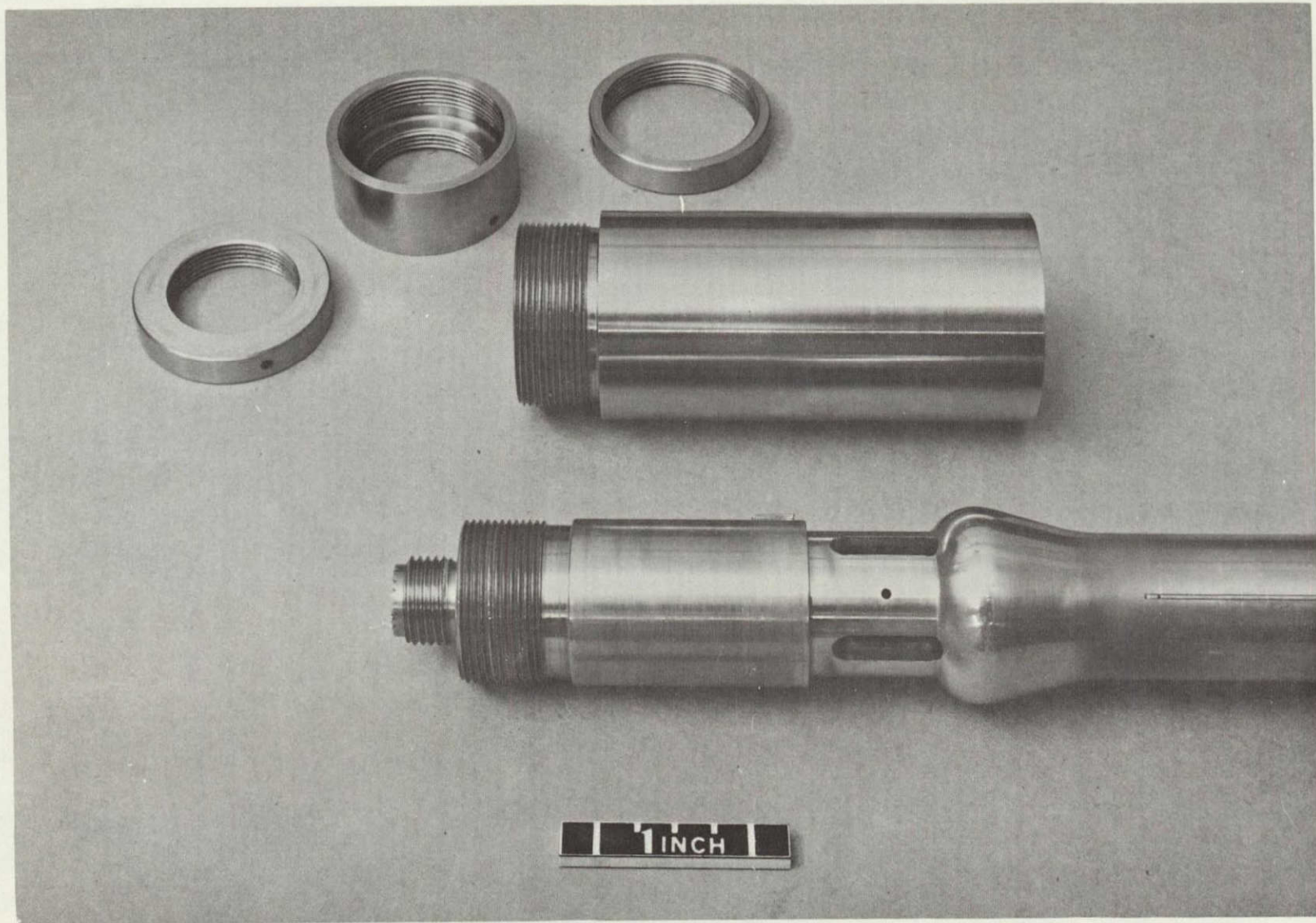

82

3895

(5-14-71) VA1163 SPACE SHUTTLE NOZZLES

Figure 7. Photograph of Booster Nozzle Hardware

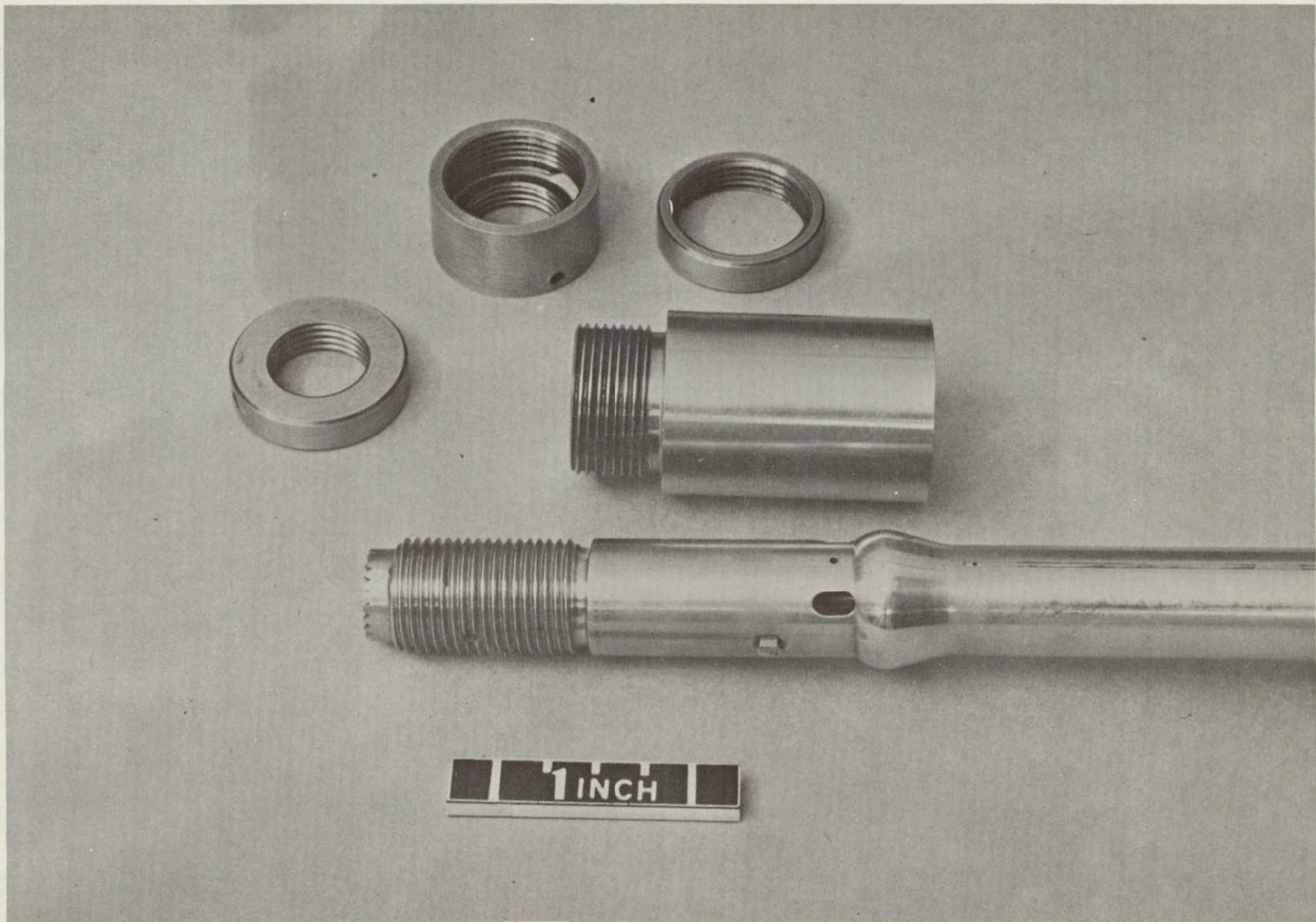



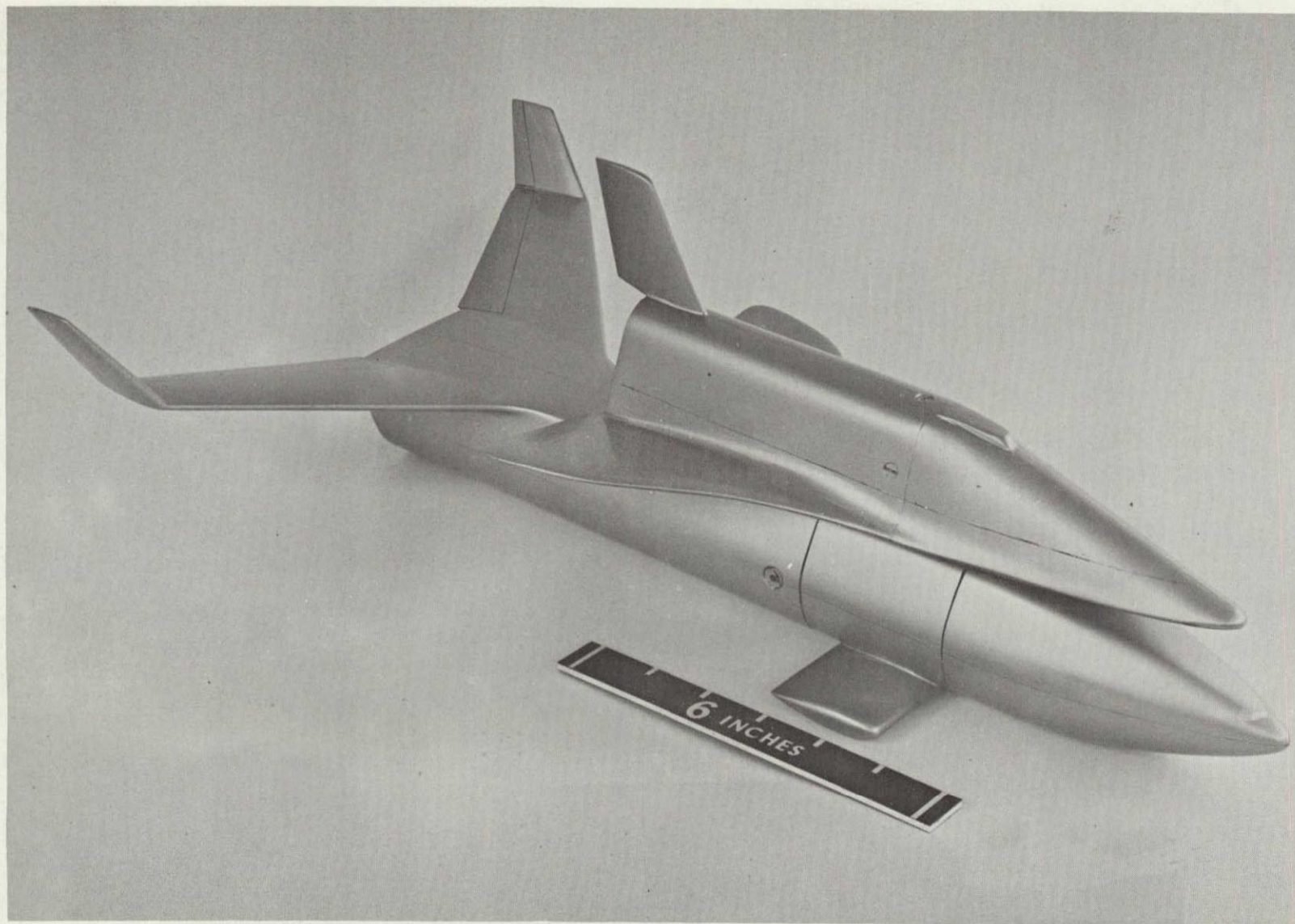

84

Figure 9. Photograph of MDAC Booster and Orbiter Models

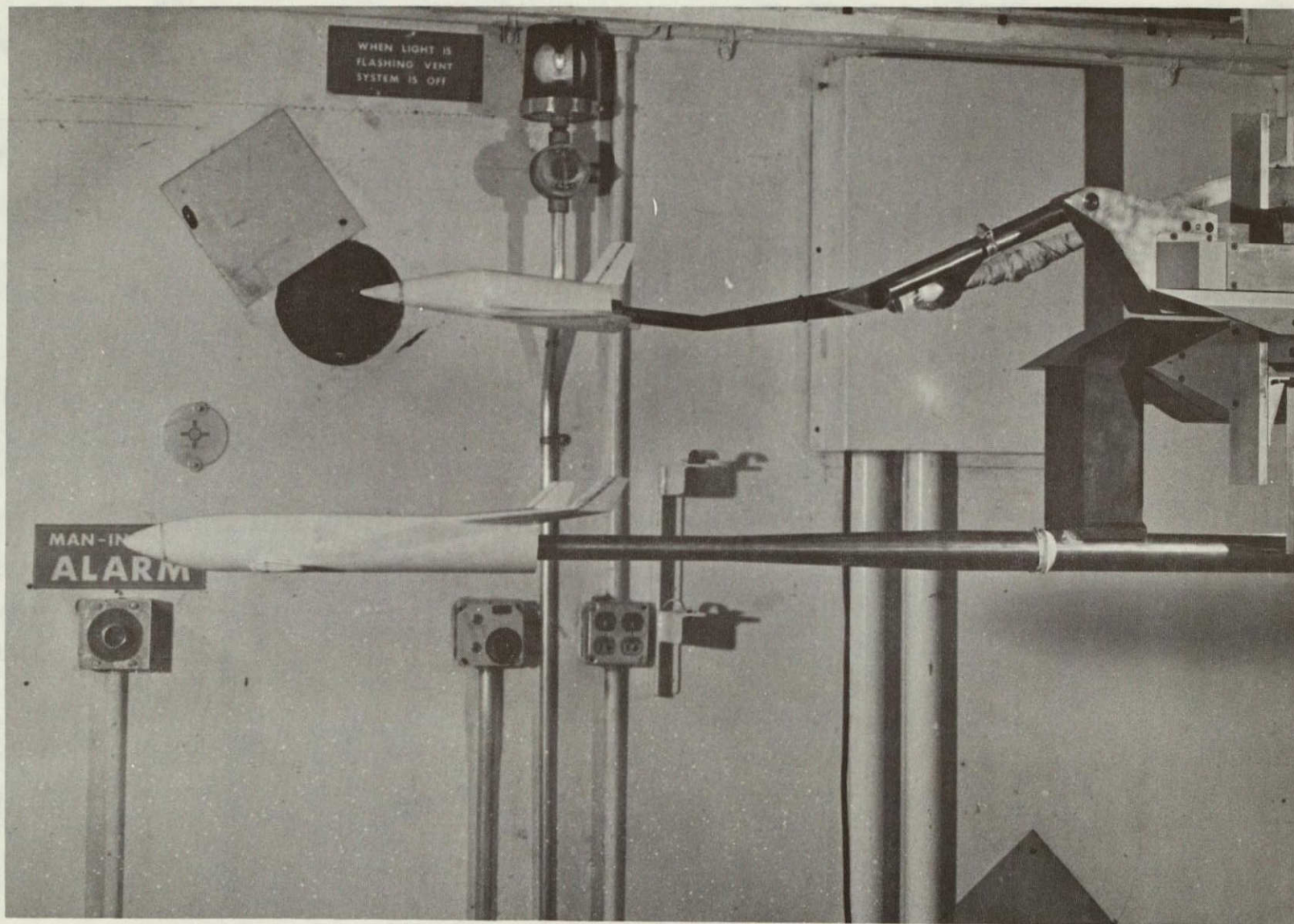

85

Figure 10. Photograph of Side View of Models and Separation Hardware

NOT REPRODUCIBLE

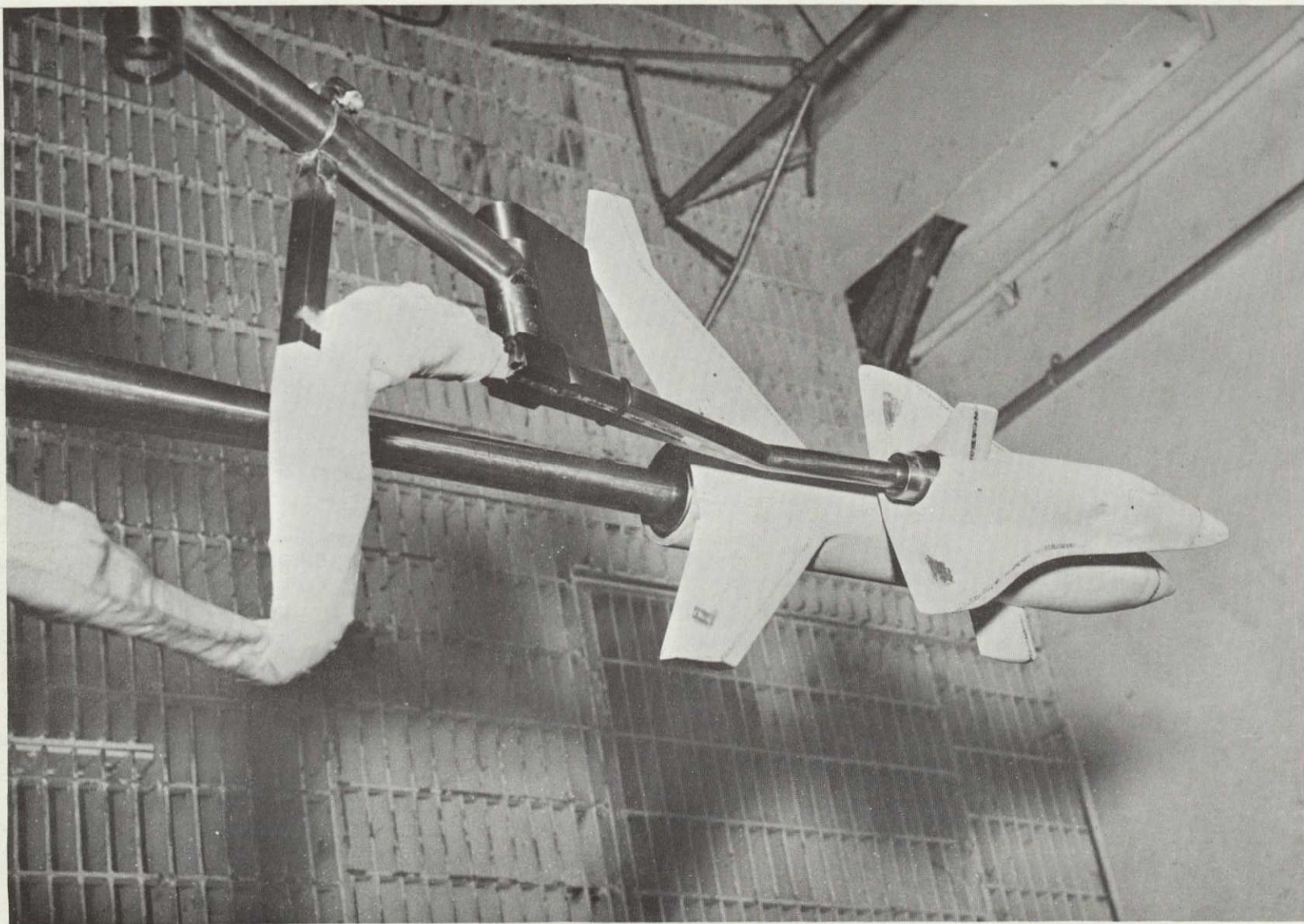

98

Figure 11. Photograph of Top View of Models and Associated Separation Hardware

MODEL COMPONENT: BODY - MDAC Orbiter

GENERAL DESCRIPTION: Basic fuselage contours including canopy with modified  
aft fuselage cross sections; cross-sectional shape constant from station 1500  
to end of fuselage - model scale 1/180.

DRAWING NUMBER: 255 BJ 00060, Rev. B

<u>DIMENSIONS:</u>	<u>FULL-SCALE</u>	<u>MODEL SCALE</u>
Length	<u>156.4</u>	<u>.869</u>
Max. Width	<u>27.1</u>	<u>.150</u>
Max. Depth	<u>30.3</u>	<u>.168</u>
Fineness Ratio	<u>          </u>	<u>          </u>
Area		
Max. Cross-Sectional	<u>          </u>	<u>          </u>
Planform	<u>          </u>	<u>          </u>
Wetted	<u>          </u>	<u>          </u>
Base	<u>          </u>	<u>          </u>

MODEL COMPONENT: Wing - MDAC Orbiter

GENERAL DESCRIPTION: Model Scale 1/180

DRAWING NUMBER: 255 BJ 00050, Rev. B

DIMENSIONS: FULL-SCALE MODEL SCALE

TOTAL DATA

Area, ft <sup>2</sup>		
Planform	<u>5330.0</u>	<u>.164</u>
Wetted		
Span (equivalent), FT	<u>97.5</u>	<u>.542</u>
Aspect Ratio	<u>1.79</u>	<u>1.79</u>
Rate of Taper		
Taper Ratio	<u>.230</u>	<u>.230</u>
Diehedral Angle, degrees	<u>10.0</u>	<u>10.0</u>
Incidence Angle, degrees	<u>2.0</u>	<u>2.0</u>
Aerodynamic Twist, degrees	<u>0</u>	<u>0</u>
Sweep Back Angles, degrees		
Leading Edge	<u>55.0</u>	<u>55.0</u>
Trailing Edge	<u>0</u>	<u>0</u>
0.25 Element Line	<u>47.0</u>	<u>47.0</u>
Chords:		
Root (Wing Sta. 0.0), INCHES	<u>1084.8</u>	<u>6.027</u>
Tip, (equivalent), INCHES	<u>219.6</u>	<u>1.387</u>
MAC, inches	<u>754.3</u>	<u>4.193</u>
Fus. Sta. of .25 MAC		
W.P. of .25 MAC		
Airfoil Section		
Root (B.L. 162)	<u>0010-64</u>	<u>0010-64</u>
Tip (B.L. 540)	<u>0009-64</u>	<u>0009-64</u>

EXPOSED DATA

Area, ft <sup>2</sup>	<u>3147.3</u>	<u>.097</u>
Span, (equivalent), FT	<u>70.5</u>	<u>.392</u>
Aspect Ratio	<u>1.58</u>	<u>1.58</u>
Taper Ratio		
Chords		
Root, inches	<u>855.0</u>	<u>4.750</u>
Tip, inches	<u>219.6</u>	<u>1.387</u>
MAC	<u>607.2</u>	<u>3.373</u>
Fus. Sta. of .25 MAC		
W.P. of .25 MAC		

MODEL COMPONENT: Elevon - MDAC Orbiter

GENERAL DESCRIPTION: Model Scale 1/180

\_\_\_\_\_  
\_\_\_\_\_  
\_\_\_\_\_

DRAWING NUMBER: 255 BJ 00050, Rev. B

<u>DIMENSIONS:</u>	<u>FULL-SCALE</u>	<u>MODEL SCALE</u>
Area, ft <sup>2</sup>	<u>820.9</u>	<u>.025</u>
Span (equivalent), INCHES	<u>335.2</u>	<u>2.140</u>
Inb'd equivalent chord, INCHES	<u>153.6</u>	<u>.353</u>
Outb'd equivalent chord, INCHES	<u>153.6</u>	<u>.353</u>
Ratio Elevator chord/horizontal tail chord		
At Inb'd equiv. chord	<u>          </u>	<u>          </u>
At Outb'd equiv. chord	<u>          </u>	<u>          </u>
Sweep Back Angles, degrees		
Leading Edge	<u>0</u>	<u>0</u>
Trailing Edge	<u>0</u>	<u>0</u>
Hingeline	<u>0</u>	<u>0</u>
Area Moment (Normal to hinge line)	<u>          </u>	<u>          </u>

MODEL COMPONENT: Vertical Tail - MDAC Orbiter

GENERAL DESCRIPTION: Model Scale 1/180

DRAWING NUMBER: 255 BJ 00050, Rev. B

DIMENSIONS: FULL-SCALE MODEL SCALE

TOTAL DATA

Area, ft <sup>2</sup>		
Planform	580.0	.013
Wetted		
Span (equivalent), ft.	27.5	.153
Aspect Ratio		
Rate of Taper		
Taper Ratio	.638	.638
Diehedral Angle, degrees		
Incidence Angle, degrees		
Aerodynamic Twist, degrees		
Toe-In Angle		
Cant Angle		
Sweep Back Angles, degrees		
Leading Edge	30.0	30.0
Trailing Edge	13.4	13.4
0.25 Element Line	26.2	26.2
Chords:		
Root, inches	309.6	1.720
Tip, (equivalent), inches	196.8	1.093
MAC, inches	21.4	.119
Fus. Sta. of .25 MAC		
W.P. of .25 MAC		
Airfoil Section		
Root	0009-64	0009-64
Tip	0009-64	0009-64

EXPOSED DATA

Area, ft <sup>2</sup>	580.0	.018
Span, (equivalent), ft	27.5	.153
Aspect Ratio		
Taper Ratio	.638	.638
Chords		
Root, inches	309.6	1.720
Tip, inches	196.8	1.093
MAC, inches	21.4	.119
Fus. Sta. of .25 MAC		
W.P. of .25 MAC		

MODEL COMPONENT: BODY - MDAC Booster

GENERAL DESCRIPTION: Configuration 19A fuselage without base flare and boattail  
Model Scale 1/180

DRAWING NUMBER: 256-19-0001, Rev. A

<u>DIMENSIONS:</u>	<u>FULL-SCALE</u>	<u>MODEL SCALE</u>
Length (Ft)	<u>241.7</u>	<u>1.343</u>
Max. Width (Ft)	<u>34.0</u>	<u>.189</u>
Max. Depth (Ft)	<u>34.0</u>	<u>.189</u>
Fineness Ratio	<u>          </u>	<u>          </u>
Area		
Max. Cross-Sectional	<u>          </u>	<u>          </u>
Planform	<u>          </u>	<u>          </u>
Wetted	<u>          </u>	<u>          </u>
Base	<u>          </u>	<u>          </u>





MODEL COMPONENT: Vertical Tails - MDAC Booster

GENERAL DESCRIPTION: Configuration 17 Vertical Tails

Model Scale 1/180

DRAWING NUMBER: 256-17-0001, Rev. A

DIMENSIONS: FULL-SCALE MODEL SCALE

TOTAL DATA (Values for one)

Area		
Planform (true)	438	.014
(Side Projection)	397	.012
Span (equivalent), inches	276	1.533
Aspect Ratio	1.21	1.21
Rate of Taper		
Taper Ratio	.520	.520
Toe-In Angle	0	0
Cant Angle	25	25
Sweep Back Angles, degrees		
Leading Edge	40	40
Trailing Edge		
0.25 Element Line		
Chords:		
Root	300	1.667
Tip, (equivalent), inches	156	.867
MAC, inches	236	1.311
Fus. Sta. of .25 MAC		
W.P. of .25 MAC		
Airfoil Section		
Root	NACA 61A-009	NACA 61A-009
Tip	NACA 61A-009	NACA 61A-009

EXPOSED DATA

Area		
Span, (equivalent)		
Aspect Ratio		
Taper Ratio		
Chords		
Root		
Tip		
MAC		
Fus. Sta. of .25 MAC		
W.P. of .25 MAC		

MODEL COMPONENT: Elevon - MDAC Booster

GENERAL DESCRIPTION: Configuration 19A Elevons

Model Scale 1/180

DRAWING NUMBER: 256-19-0001, Rev. A

<u>DIMENSIONS:</u>	<u>FULL-SCALE</u>	<u>MODEL SCALE</u>
Area	<u>617 ft<sup>2</sup></u>	<u>.0191 ft<sup>2</sup></u>
Span (equivalent)	<u>650 in.</u>	<u>3.611 in.</u>
Inb'd equivalent chord	<u>180 in.</u>	<u>.9999 in.</u>
Outb'd equivalent chord	<u>93 in.</u>	<u>.5166 in.</u>
Ratio Elevator chord/horizontal tail chord		
At Inb'd equiv. chord	<u>.33</u>	<u>.3</u>
At Outb'd equiv. chord	<u>.3</u>	<u>.3</u>
Sweep Back Angles, degrees		
Leading Edge	<u>33</u>	<u>33</u>
Tailing Edge	<u>27</u>	<u>27</u>
Hingeline	<u>33</u>	<u>33</u>
Area Moment (Normal to hinge line), Ft <sup>3</sup>	<u>2998</u>	<u>.00004</u>

MODEL COMPONENT: Canard - MDAC Booster

GENERAL DESCRIPTION: Configuration 19A Canard

Model Scale 1/160

DRAWING NUMBER: 256-19-001, Rev. A

<u>DIMENSIONS:</u>	<u>FULL-SCALE</u>	<u>MODEL SCALE</u>
Theo. Area, Ft <sup>2</sup>	<u>1660</u>	<u>.051</u>
Exp Area, Ft <sup>2</sup>	<u>1215</u>	<u>.033</u>
Aspect Ratio	<u>3.0</u>	<u>3.0</u>
Chord (Incl. Flap), Ft	<u>23.625</u>	<u>.131</u>
Airfoil (360 In. Theo Chord)	NACA <u>63-018</u>	NACA <u>63-018</u>

NOMENCLATURE

(General)

<u>SYMBOL</u>	<u>SADSAC SYMBOL</u>	<u>DEFINITION</u>
$\alpha$	ALPHA	angle of attack, angle between the projection of the wind $X_w$ -axis on the body X, Z-plane and the body X-axis; degrees
$\beta$	BETA	sideslip angle, angle between the wind $X_w$ -axis and the projection of this axis on the body X-Z-plane; degrees
$\psi$	PSI	yaw angle, angle of rotation about the body Z-axis, positive when the positive X-axis is rotated toward the positive Y-axis; degrees
$\phi$	PHI	roll angle, angle of rotation about the body X-axis, positive when the positive Y-axis is rotated toward the positive Z-axis; degrees
$\rho$		air density; $K_g/m^3$ , slugs/ft <sup>3</sup>
$a$		speed of sound; m/sec, ft/sec
$V$		speed of vehicle relative to surrounding atmosphere; m/sec, ft/sec
$q$	Q(PST) Q(PST)	dynamic pressure; $1/2\rho V^2$ , psi, psf
$M$	MACH	Mach number; $V/a$
$RN/L$	$RN/L$	Reynolds number per unit length; million/ft
$p$		static pressure; psi
$P$		total pressure; psi
$C_p$	CP	pressure coefficient; $(p-p_\infty)/q$

$C_p$

$C_F$

NOMENCLATURE (Continued)

Reference & C. G. Definitions

<u>SYMBOL</u>	<u>SADSAC SYMBOL</u>	<u>DEFINITION</u>
S		wing area; $m^2$ , $ft^2$
S	SREF	reference area; $m^2$ , $ft^2$
$\bar{c}$		wing mean aerodynamic chord or reference chord; m, ft, in (see $l_{ref}$ or LREF)
$l_{ref}$	LREF	reference length; m, ft, in.; (see $\bar{c}$ )
$b_{ref}$	BREF	wing span or reference span; m, ft, in
$A_b$		base area; $m^2$ , $ft^2$ , $in^2$
c. g.		center of gravity
MRP	MRP	abbreviation for moment reference point
	XMRP	abbreviation for moment reference point on X-axis
	YMRP	abbreviation for moment reference point on Y-axis
	ZMRP	abbreviation for moment reference point on Z-axis

NOMENCLATURE (Continued)

Axis System General

<u>SYMBOL</u>	<u>DEFINITION</u>
F	force; F, lbs
M	moment; M, in-lb

<u>Subscript</u>	<u>Definition</u>
N	normal force
A	axial force
L	lift force
D	drag force
Y	force or moment about the Y axis
Z	moment about the Z axis
X	moment about the X axis
s	stability axis system
w	wind axis system
ref	reference conditions
$\infty$	free stream conditions
t	total conditions
b	base

NOMENCLATURE (Continued)  
Body & Stability Axis System

<u>SYMBOL</u>	<u>SADSAC SYMBOL</u>	<u>DEFINITION</u>
<u>Body Axis System</u>		
$C_N$	CN	normal force coefficient; $F_N/qS$
$C_A$	CA	axial force coefficient; $F_A/qS$
$C_{A_b}$	CAB	base axial force coefficient; $\left[ \begin{matrix} -1 \\ -1 \end{matrix} \right] \left[ \frac{(P_b - P_\infty)}{q} \right] (A_b/S)$
$C_{A_f}$	CAF	forebody axial force coefficient; $C_A - C_{A_b}$
$C_n$	CYN	yawing moment coefficient; $M_Z/qS b_{ref}$
$C_l$	CBL	rolling moment coefficient; $M_X/qS b_{ref}$
<u>Common to Both Axis Systems</u>		
$C_m$	CLM	pitching moment coefficient; $M_Y/qS l_{ref}$
$C_y$	CY	side force coefficient; $F_Y/qS$
<u>Stability Axis System</u>		
$C_L$	CL	lift force coefficient; $F_L/qS$
$C_D$	CD	drag force coefficient; $F_D/qS$
$C_{D_b}$	CDB	base drag coefficient
$C_{D_f}$	CDF	forebody drag coefficient; $C_D - C_{D_b}$
$C_n$	CLN	yawing moment coefficient; $M_{Z,s}/qS b_{ref}$
$C_l$	CSL	rolling moment coefficient; $M_{X,s}/qS b_{ref}$
L/D	L/D	lift-to-drag ratio; $C_L/C_D$
L/D <sub>f</sub>	L/DF	lift to forebody drag ratio; $C_L/C_{D_f}$



NOMENCLATURE (Continued)

Surface Definitions

<u>SYMBOL</u>	<u>SADSAC SYMBOL</u>	<u>DEFINITION</u>
$i_t$	HORIZT	horizontal tail incidence; positive when trailing edge down; degrees
$\delta$		symmetrical surface deflection angle; degrees; positive deflections are:
	AILERON	aileron - total aileron deflection; (left aileron - right aileron)/2
	CANARD	canard - trailing edge down
	ELEVON	elevon - trailing edge down
	ELEVATOR	elevator - trailing edge down
	FLAP	flap - trailing edge down
	RUDDER	rudder - trailing edge to the left
	SPOILER	spoiler - trailing edge down
	TAB	tab - trailing edge down with respect to control surface
$\delta$		antisymmetrical surface deflection angle, degrees; positive trailing edge down:
	AIL-L	left aileron - trailing edge down
	AIL-R	right aileron - trailing edge down
	ELVN-L	left elevon - trailing edge down
	ELVN-R	right elevon - trailing edge down
	SPLR-L	left spoiler - trailing edge down
	SPLR-R	right spoiler - trailing edge down

<u>SURFACE SUBSCRIPTS</u>	<u>DEFINITION</u>
a	aileron
b	base
c	canard
e	elevator or elevon
f	flap
r	rudder or ruddervator
s	spoiler
t	tail

ADDITIONS AND CHANGES TO NOMENCLATURE

<u>SYMBOL</u>	<u>SADSAC SYMBOL</u>	<u>DEFINITION</u>
$i_T$		tail incidence positive when trailing edge down, deg
$V$		velocity of vehicle relative to surrounding atmosphere; m/sec, ft/sec
$\alpha_B$	ALPHAB	booster angle of attack, angle between the projection of the wind $X_w$ -axis on the body X, Z-plane and the body X-axis; deg
$\beta$	BETA	sideslip angle, angle between the wind $X_w$ -axis and the projection of this axis on the body X-Z-plane; deg
$\gamma$		ratio of specific heats
$\Gamma$	DIHDR L	wing dihedral angle; deg
$\rho$		air density; $K_g/m^3$ , slugs/ft <sup>3</sup>
$\alpha_I$	ALPHAI	incidence angle between the orbiter and booster on the XZ plane
$\alpha_O$	ALPHAO	orbiter angle of attack, $\alpha_O = \alpha_B + \alpha_I$
$PWR_B$	BSTPOW	booster power, percent of full thrust
$PWR_O$	ORBPOW	orbiter power, percent of full thrust
$\delta_{eB}$	ELVBST	booster elevon deflection angle, positive is trailing edge down
$\delta_{eO}$	ELVORB	orbiter elevon deflection angle, positive is trailing edge down

ADDITIONS AND CHANGES TO NOMENCLATURE (CONTINUED)

<u>SYMBOL</u>	<u>SADSAC SYMBOL</u>	<u>DEFINITION</u>
$X/l_B$	DELTA X	distance between the MRP on the orbiter and booster measured parallel to the longitudinal axis of the booster, positive when the orbiter MRP is forward of the booster MRP, the distance has been normalized with respect to the booster fuselage length (16.184 inches)
$Z/l_B$	DELTA Z	distance between the MRP on the orbiter and booster measured normal to the longitudinal axis of the booster, positive when the orbiter MRP is above the booster MRP, the distance has been normalized with respect to the booster fuselage length (16.184 inches)

## REFERENCES

1. Sims, Joseph L., "Plume Simulation for Space Shuttle Abort Staging Aerodynamic Testing," Memo S&E-AERO-AF-70-6, December 1970.
2. Baker, L. R., "Calibration of the Propulsion Simulation Nozzles for the Space Shuttle Booster and Orbiter Models for the Abort/Separation Staging Experimental Program," LMSC/HREC D225144, June 1971.
3. "Test Facilities Handbook" (8th Edition), Arnold Engineering Development Center, December 1969.

A tabulated data listing, consisting of all aero data sets, both original and those created in arriving at the plotted material to be presented subsequently, is available as an addendum to this report. The tabular listing is made up in two sections:

- (a) a brief summary list of all data sets containing the identifier, the descriptor, and the resident dependent variables.
- (b) a full list of all data sets containing all resident or selected aerodynamic coefficients of the data sets as well as the above mentioned information.

The listing is currently sent on limited distribution to the following organizations:

NASA AMES	Mr. V. Stevens
NASA MSC	Mr. Ray Nelson
AEDC	Mr. L. L. Trimmer
IMSC/HREC	Mr. D. A. Love
NASA LaRC	Mr. J. P. Decker
NASA MSFC	Mr. K. L. Blackwell

If copies of this listing are desired, please contact the above or the cognizant SADSAC personnel who, for this data, is:

J. L. Glynn  
Department 2780  
Chrysler Corporation Space Division  
New Orleans, La. 70129

(504) 255-2304

PLOTTED DATA

# AEDC VA 1163 MDAC BOOSTER AND ORBITER TEST DATA AT MACH NUMBER 5

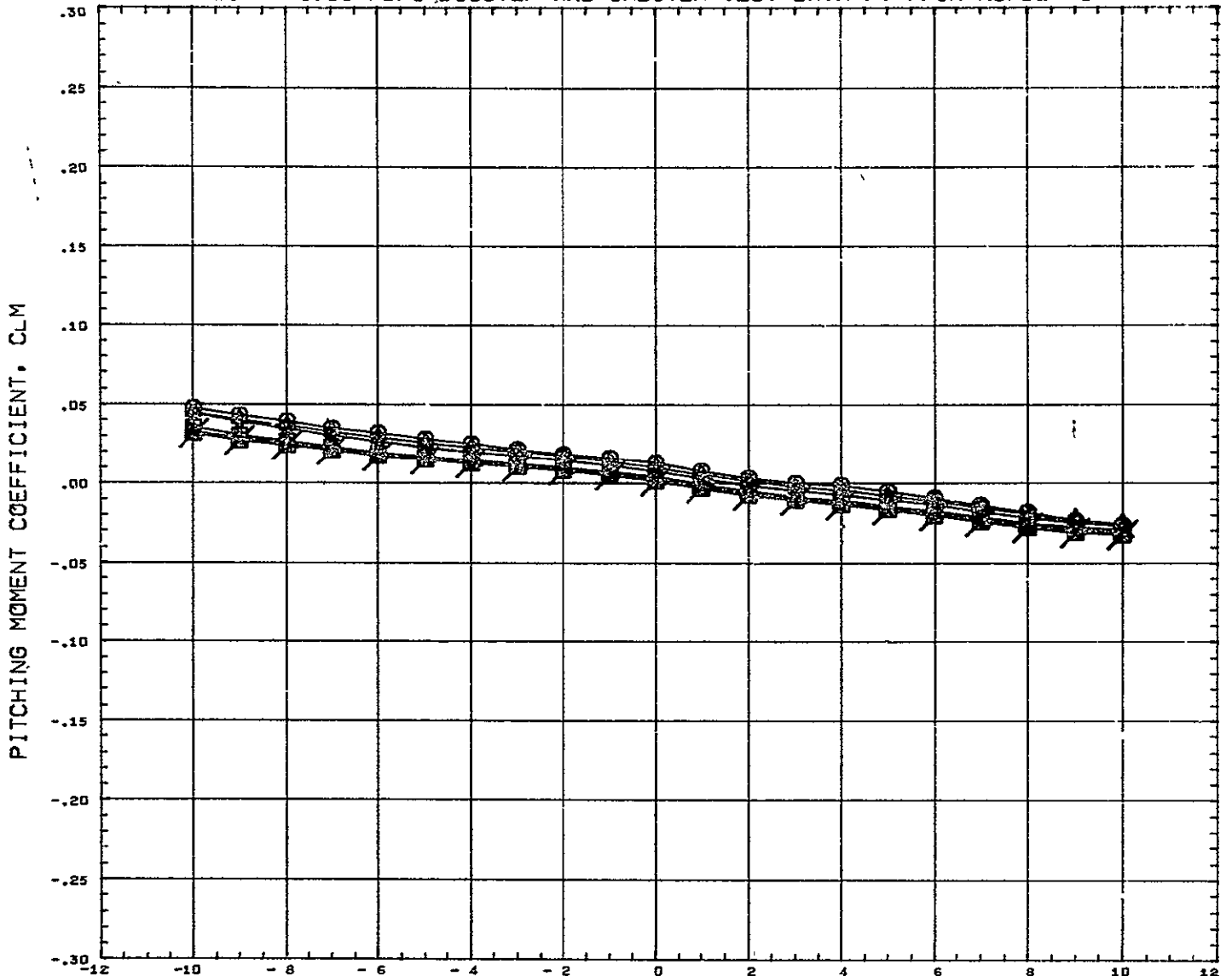

SYMBOL	DELTA Z	PARAMETRIC VALUES				REFERENCE INFORMATION	
0.120		BSTFOW	0.000	ORBPOW	0.000	REFS	44.4440° SQ IN
0.151		DELTA X	0.391	ALPHA I	0.000	REFL	13.3330 IN
0.182		1ACH	5.020	ELVBST	0.000	REFB	13.3330 IN
0.228		ELVORB	0.000	BETA	0.000	XMRP	7.5280 IN
0.352						YMRP	0.0000 IN
0.599						ZMRP	1.1940 IN
0.908						SCALE	0 0055
10.000		REFERENCE FILE					







AEDC VA 1163 MDAC BOOSTER AND ORBITER TEST DATA AT MACH NUMBER 5

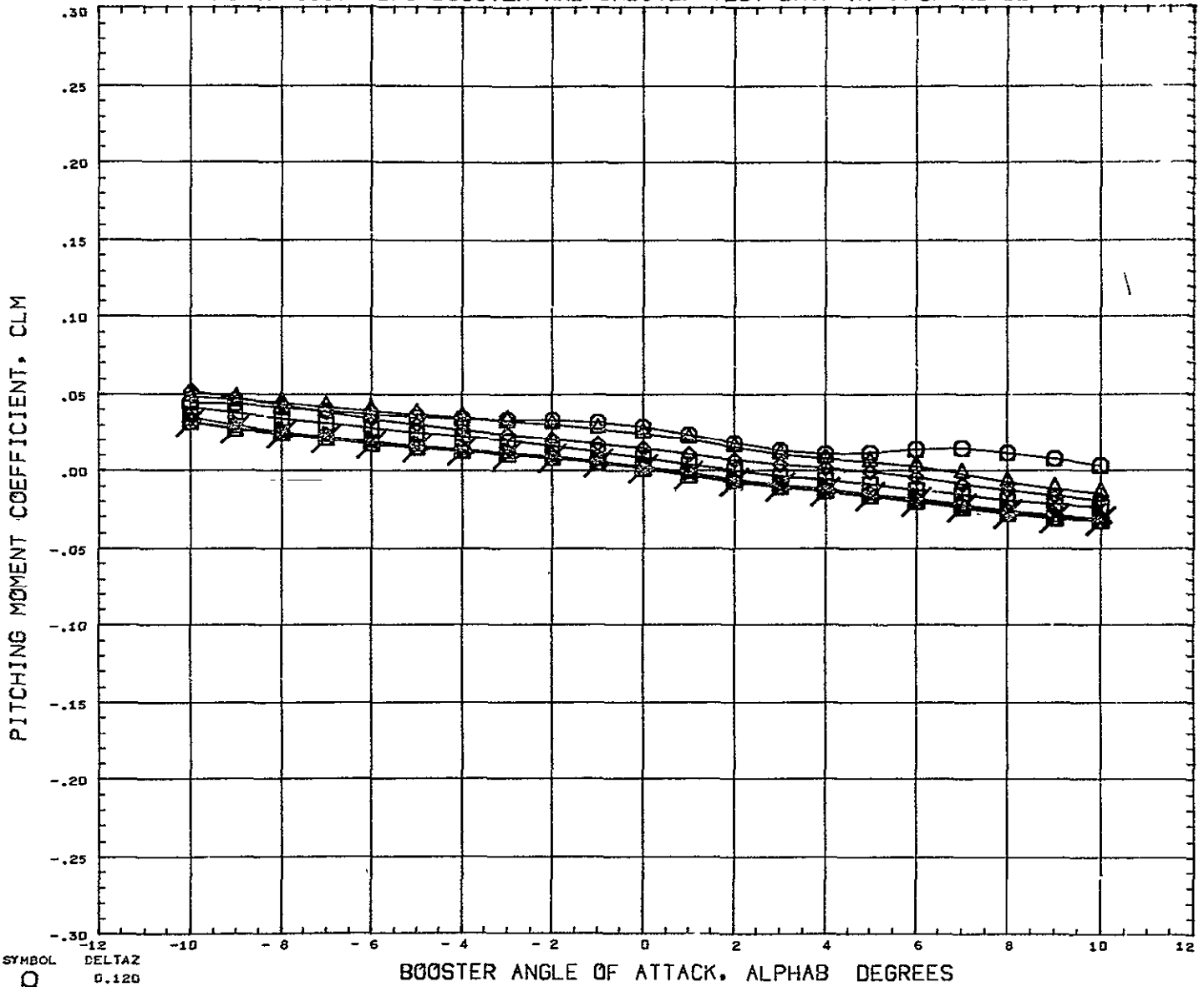

SYMBOL	DELTA Z	PARAMETRIC VALUES				REFERENCE INFORMATION		
0.120		BSTPOW	0.000	ORBPOW	0.000	REFS	77.4440	SG IN
0.151		DELTA X	0.143	ALPHA I	0.000	REFL	13.3330	IN
0.182		MACH	5.020	ELVBST	0.000	REFB	13.3330	IN
0.228		ELVORB	0.000	BETA	0.000	XMRP	7.5280	IN
0.352						YMRP	0.0000	IN
0.599						ZMRP	1.1540	IN
0.908						SCALE	0.0055	
10.000		REFERENCE FILE						

AEDC VA 1163 MDAC BOOSTER AND ORBITER TEST DATA AT MACH NUMBER 5

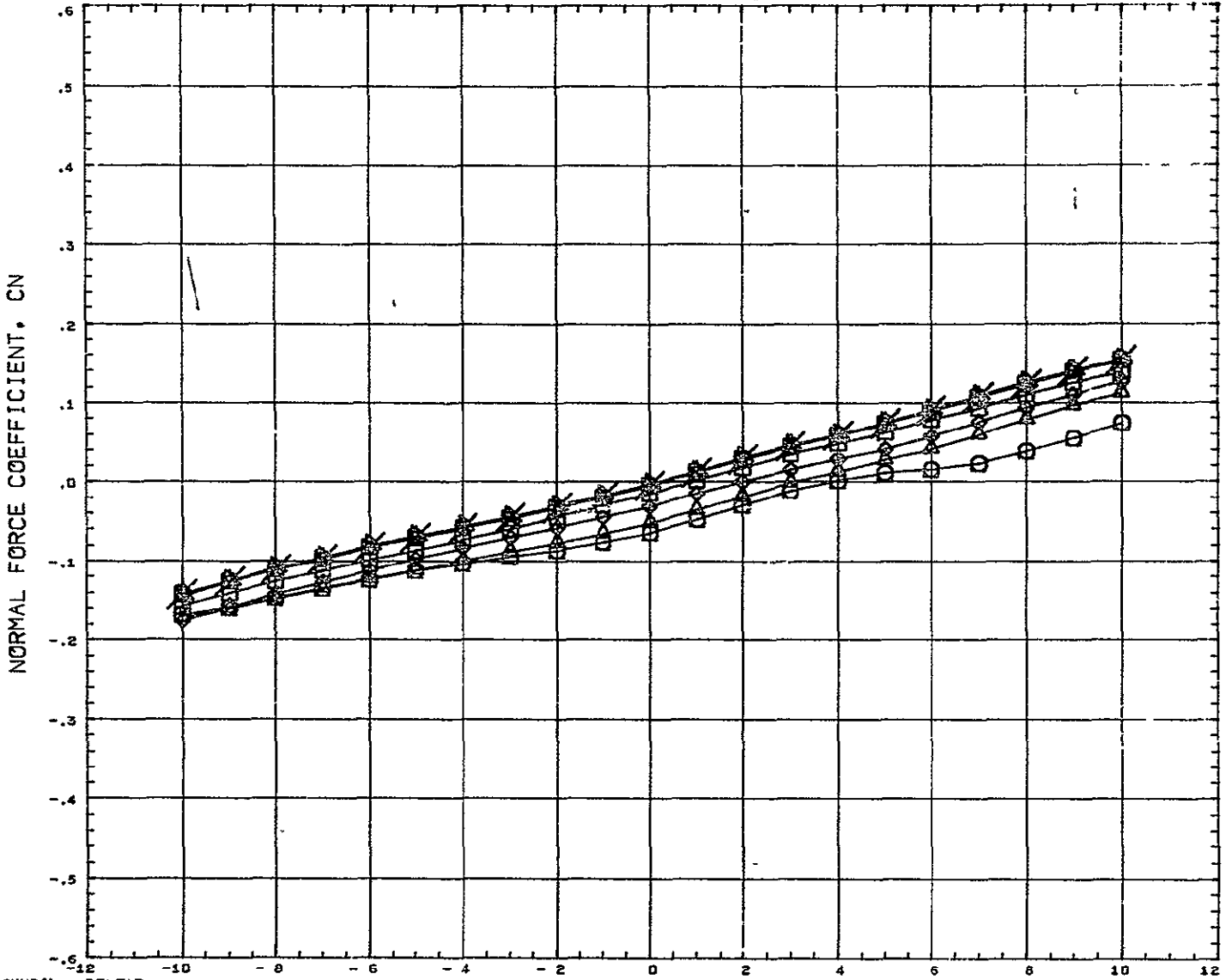

SYMBOL	DELTAZ	PARAMETRIC VALUES				REFERENCE INFORMATION		
0.120		BSTPOW	0.000	ORBPOW	0.000	REFS	44.4440	SQ IN
0.151		DELTAZ	- 0.143	ALPHA1	0.000	REFL	13.3330	IN
0.182		MACH	5.020	ELVBST	0.000	REFB	13.3330	IN
0.228		ELVORB	0.000	BETA	0.000	XMRP	7.5200	IN
0.352						YMRP	0.0000	IN
0.599						ZMRP	1.1940	IN
0.908						SCALE	0.0055	
10.000		REFERENCE FILE						

# AEDC VA 1163 MDAC BOOSTER AND ORBITER TEST DATA AT MACH NUMBER 5

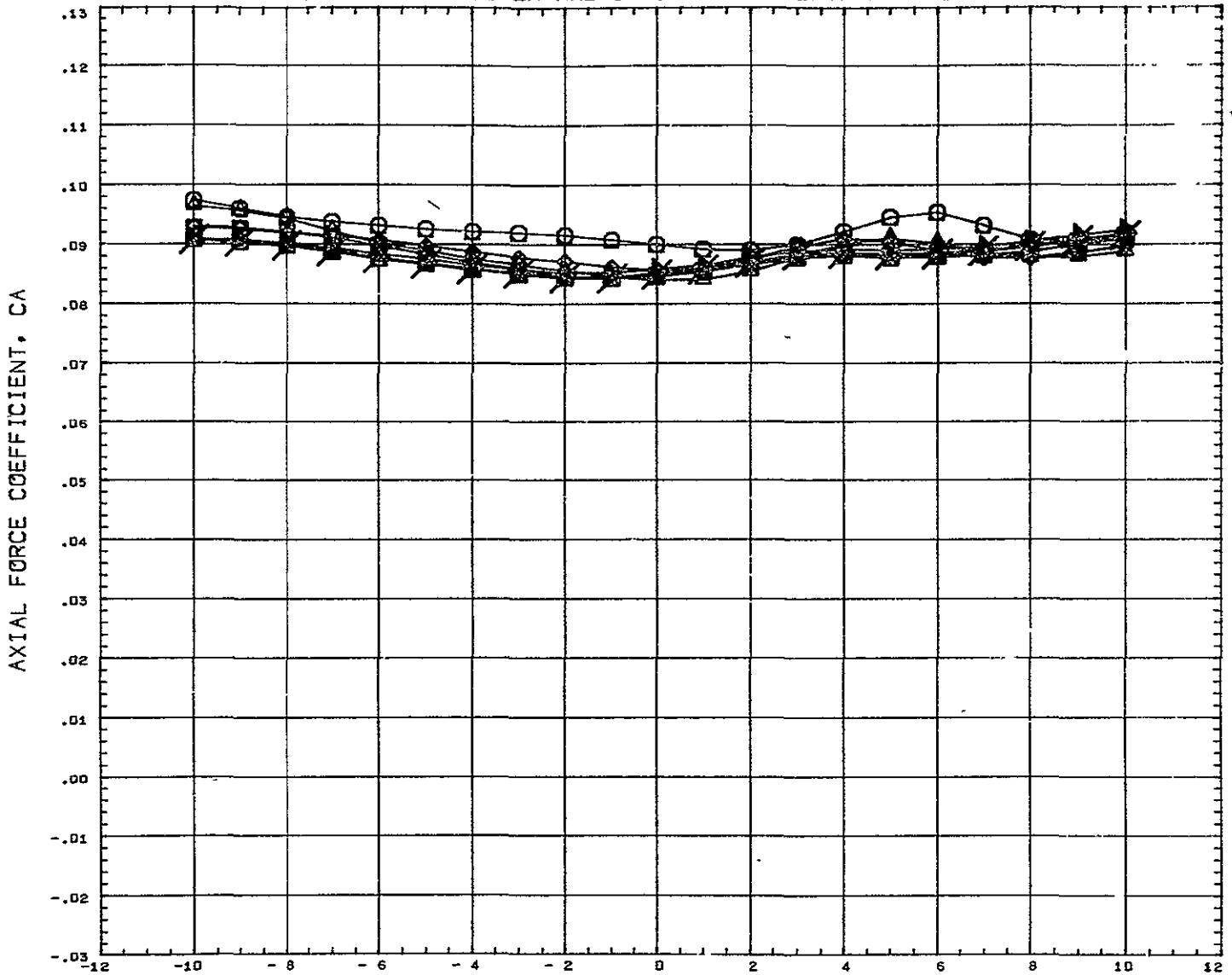

SYMBOL ○ □ ◇ △ ▲ ▼ ◆ ◆	DELTA Z 0.120 0.151 0.182 0.228 0.352 0.599 0.908 10.000	PARAMETRIC VALUES BSTPOW    0.000    ORBPOW    0.000 DELTAX    0.143    ALPHAI    0.000 MACH       5.020    ELVBST    0.000 ELVORB    0.000    BETA       0.000 REFERENCE FILE	REFERENCE INFORMATION REFS       4.4440    SQ IN REFL       13.3330    IN REFB       13.3330    IN XHRF       7.5280    IN YHRF       0.0000    IN ZHRF       1.1340    IN SCALE      0.0055
--	--	---	---

# AEDC VA 1163 MDAC BOOSTER AND ORBITER TEST DATA AT MACH NUMBER 5

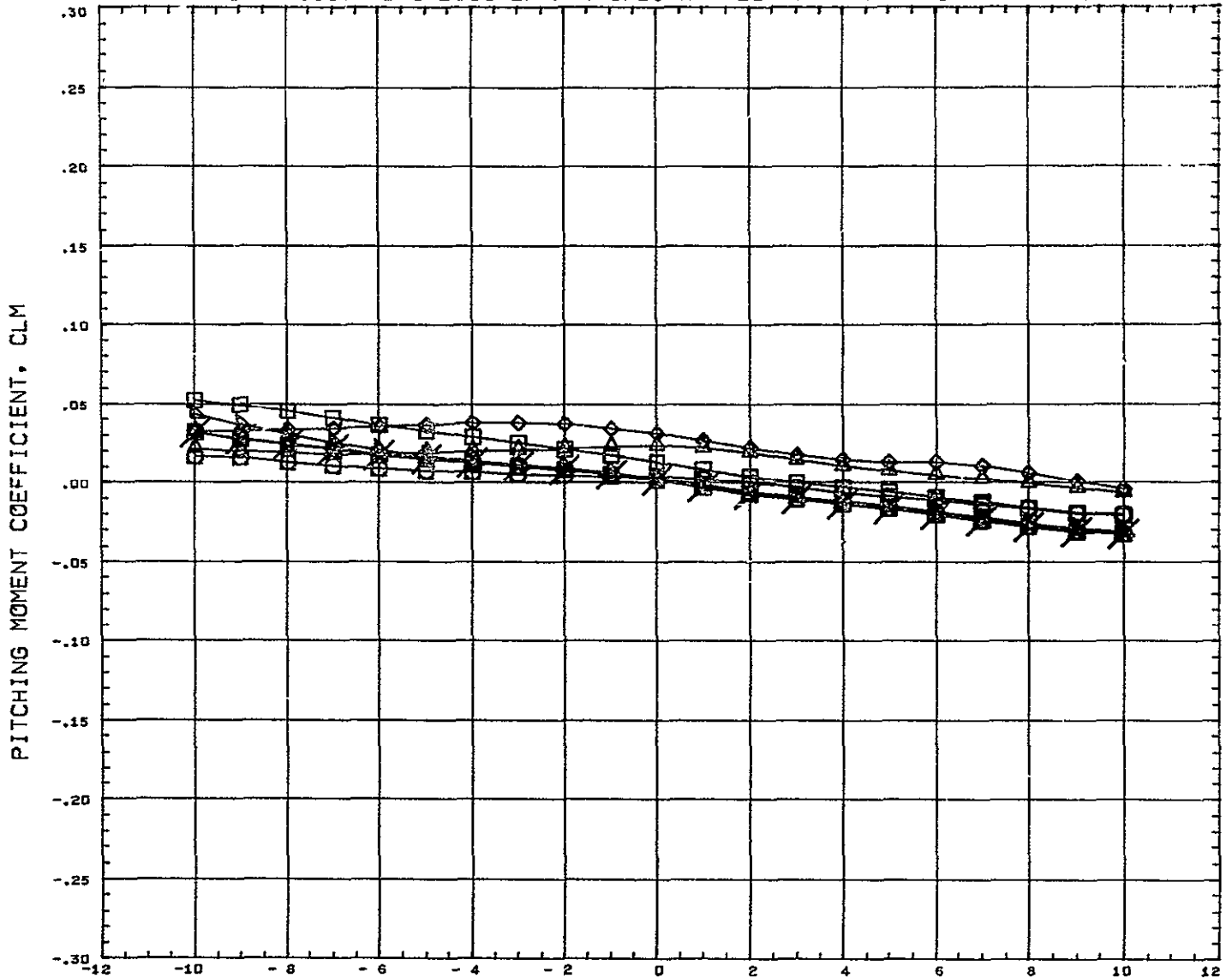

SYMBOL	DELTAZ	BOOSTER ANGLE OF ATTACK, ALPHAB DEGREES				REFERENCE INFORMATION		
	0.120					REFS	1.4440	SQ IN
	0.151					REFL	13.3330	IN
	0.182	BSTPOW	0.000	ORBPOW	0.000	REFB	13.3330	IN
	0.220	DELTAZ	-0.019	ALPHA1	0.000	XMRP	7.5280	IN
	0.352	MACH	5.020	ELVBST	0.000	YMRP	0.0000	IN
	0.599	ELVORB	0.000	BETA	0.000	ZMRP	1.1940	IN
	0.900					SCALE	0.0055	
	10.000	REFERENCE FILE						

# AEDC VA 1163 MDAC BOOSTER AND ORBITER TEST DATA AT MACH NUMBER 5

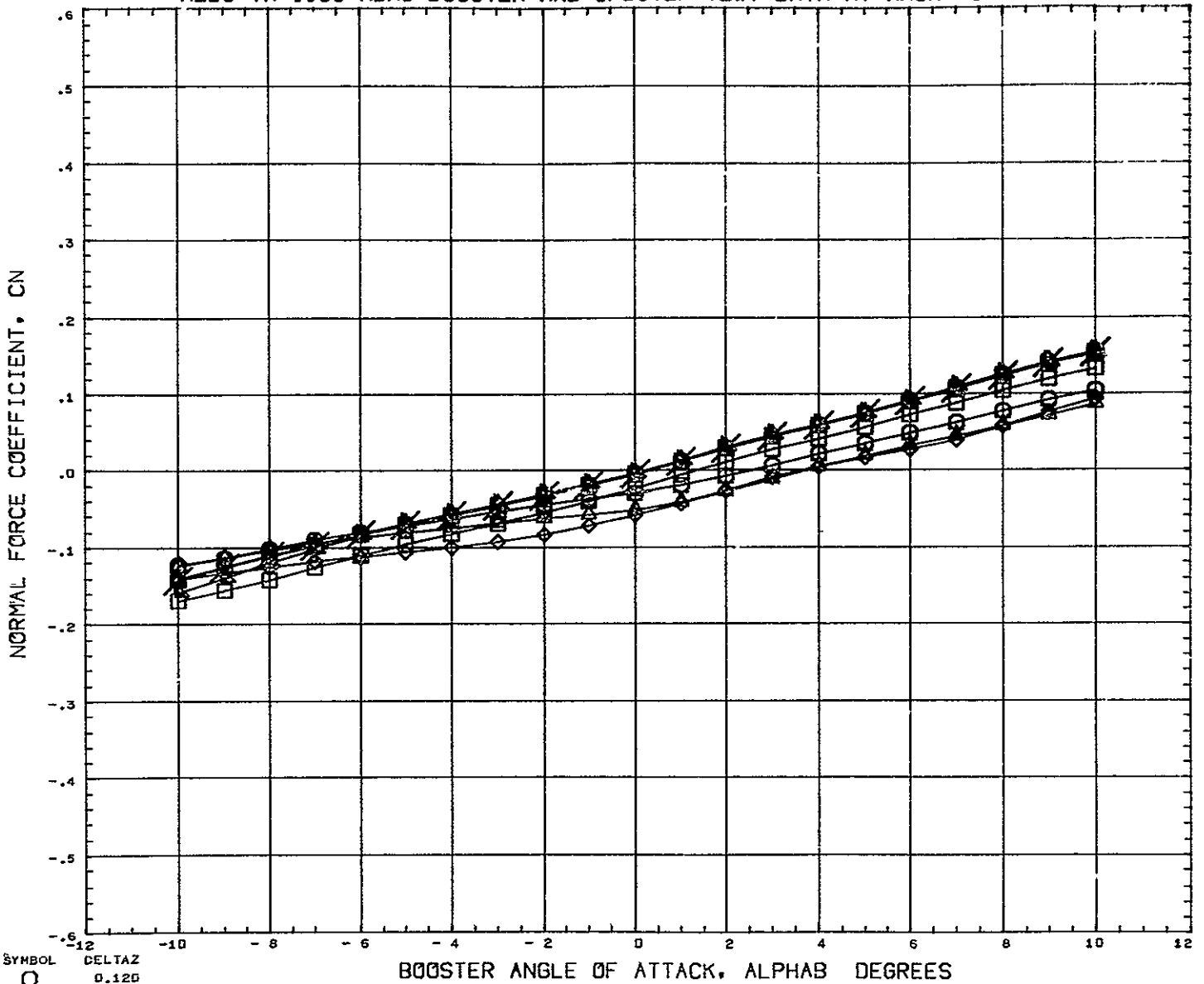

SYMBOL ○ □ ◇ △ ▽ × ○	DELTAZ 0.120 0.151 0.182 0.228 0.352 0.599 0.908 10.000	PARAMETRIC VALUES BSTFOW    0.000    ORBPOW    0.000 DELTAX    - 0.019    ALPHAI    0.000 YACH       5.020    ELVBST    0.000 ELVORB    0.000    BETA       0.000 REFERENCE FILE	REFERENCE INFORMATION REFS       11.4440    SQ IN REFL       13.3330    IN REFB       13.3330    IN XMRF       7.5280    IN YMRF       0.0000    IN ZMRF       1.1540    IN SCALE      0.0055
---	---	---	--

# AEDC VA 1163 MDAC BOOSTER AND ORBITER TEST DATA AT MACH NUMBER 5

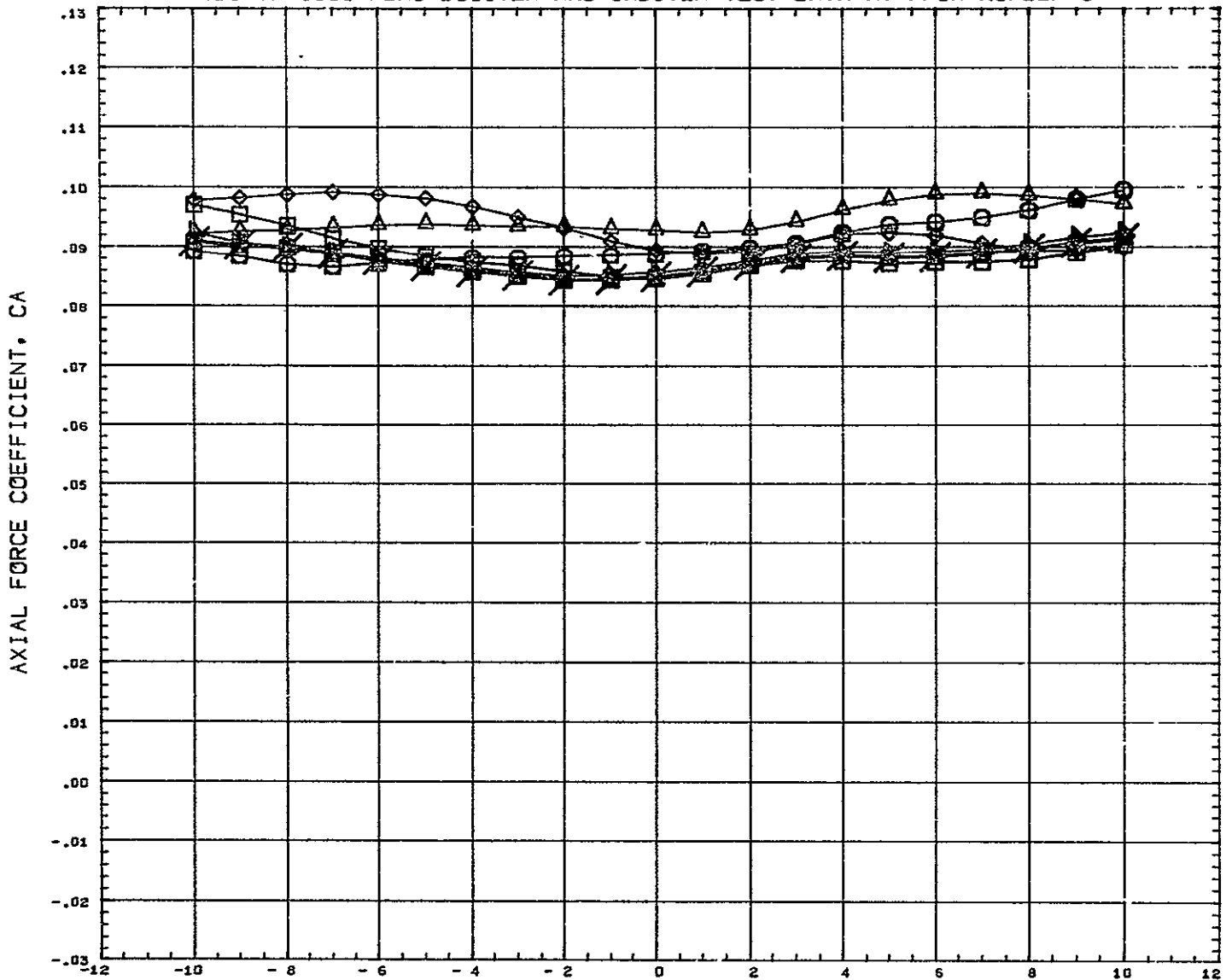

SYMBOL <del>0.120</del> <del>0.151</del> <del>0.182</del> <del>0.228</del> <del>0.352</del> <del>0.599</del> <del>0.908</del> <del>10.000</del>	DELTAZ 0.120 0.151 0.182 0.228 0.352 0.599 0.908 10.000	PARAMETRIC VALUES BSTPOW 0.000 ORBPOW 0.000 DELTAX - 0.019 ALPHAI 0.000 ACH 5.020 ELVBST 0.000 ELVORB 0.000 BETA 0.000	REFERENCE INFORMATION REFS 77.4440 SG IN REFL 13.3330 IN REFB 13.3330 IN XMRF 7.5280 IN YMRF 0.0000 IN ZMRF 1.1940 IN SCALE 0.0055
---	---	--	---

# AEDC VA 1163 MDAC BOOSTER AND ORBITER TEST DATA AT MACH NUMBER 5

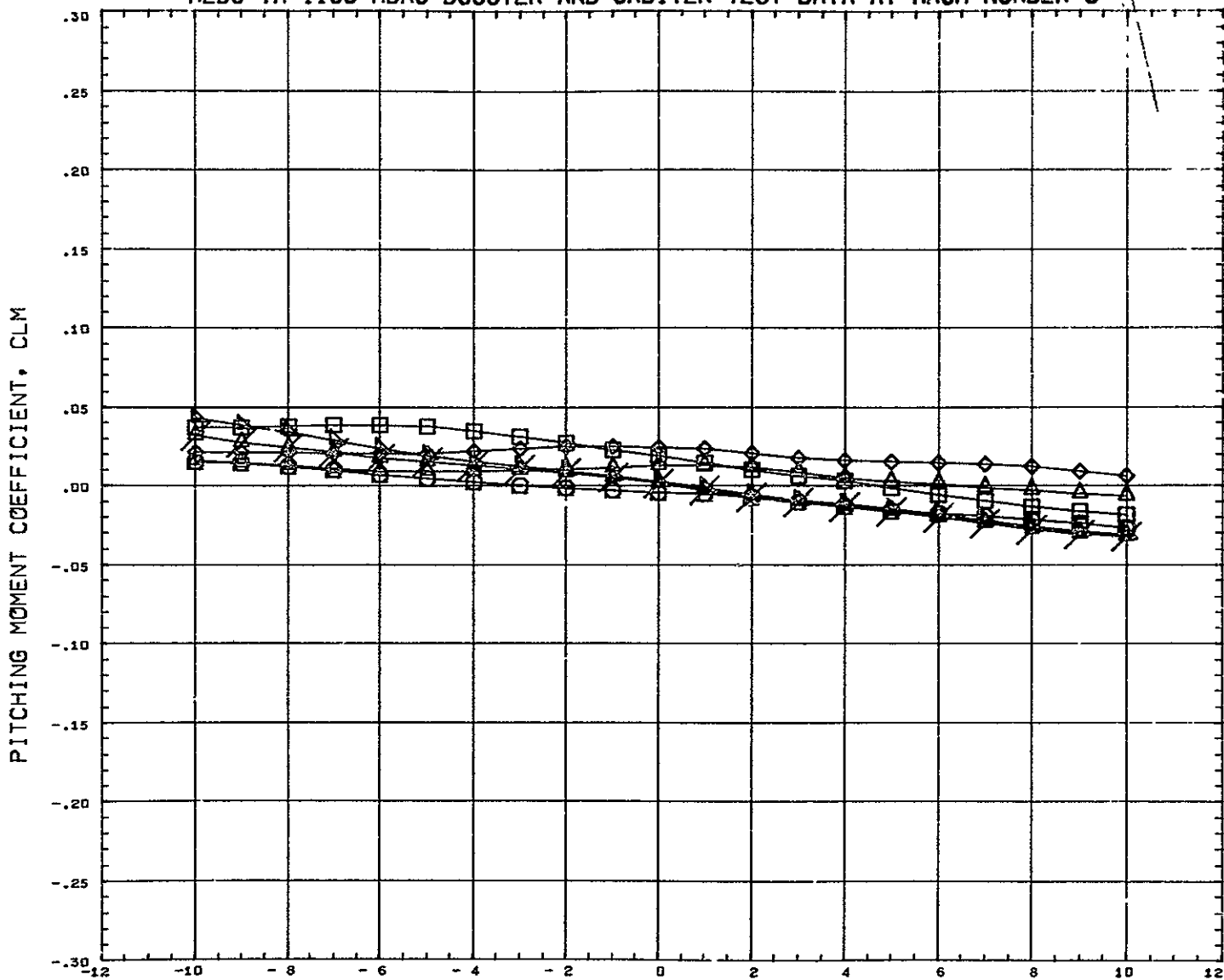

SYMBOL ◻ ◊ △ ○ ×	DELTAZ 0.120 0.151 0.182 0.228 0.352 10.000	<b>PARAMETRIC VALUES</b> BSTFOW 0.000 ORBFOW 0.000 DELTAX 0.043 ALPHAI 0.000 1ACH 5.020 ELVBST 0.000 ELVORB 0.000 BETA 0.000	<b>REFERENCE INFORMATION</b> NEFS 44.4440 SQ IN REFL 13.3330 IN REFB 13.3330 IN XMRP 7.5280 IN YMRP 0.0000 IN ZMRP 1.1940 IN SCALE 0.0055
---------------------------------	---	--	--

REFERENCE FILE



# AEDC VA 1163 MDAC BOOSTER AND ORBITER TEST DATA AT MACH NUMBER 3

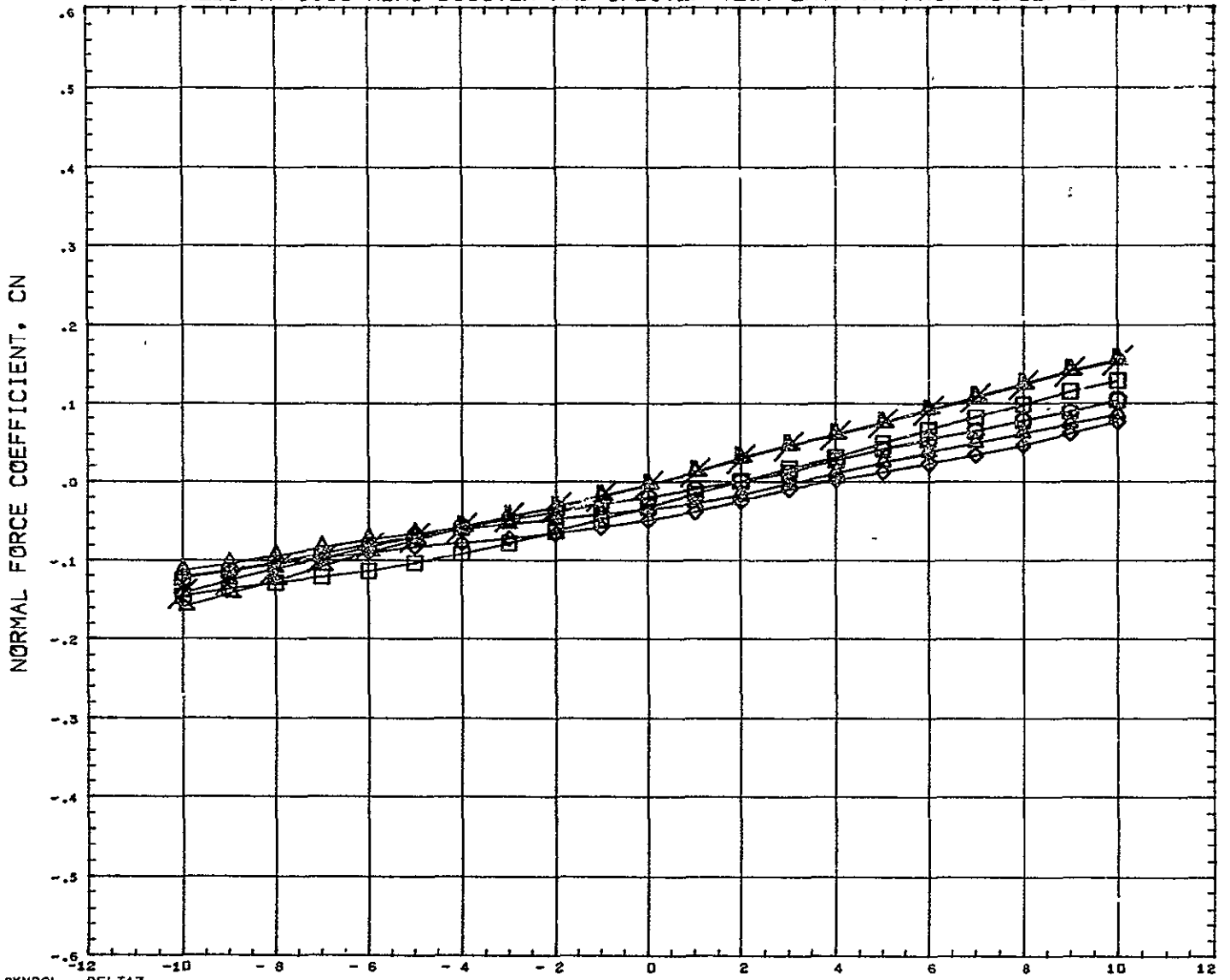

SYMBOL ○ □ ◇ ▲ ▼	DELTAZ 0.120 0.151 0.182 0.228 0.352 10.000	PARAMETRIC VALUES BSTPOW 0.000 ORBPOW 0.000 DELTAX 0.043 ALPHAI 0.000 IACH 5.020 ELVBST 0.000 ELVORB 0.000 BETA 0.000	REFERENCE INFORMATION REFS 1.4440 SQ IN REFL 13.3330 IN REFB 13.3330 IN XMRP 7.5280 IN YMRP 0.0000 IN ZMRP 1.1540 IN SCALE 0.0055
REFERENCE FILE			

# AEDC VA 1163 MDAC BOOSTER AND ORBITER TEST DATA AT MACH NUMBER 5

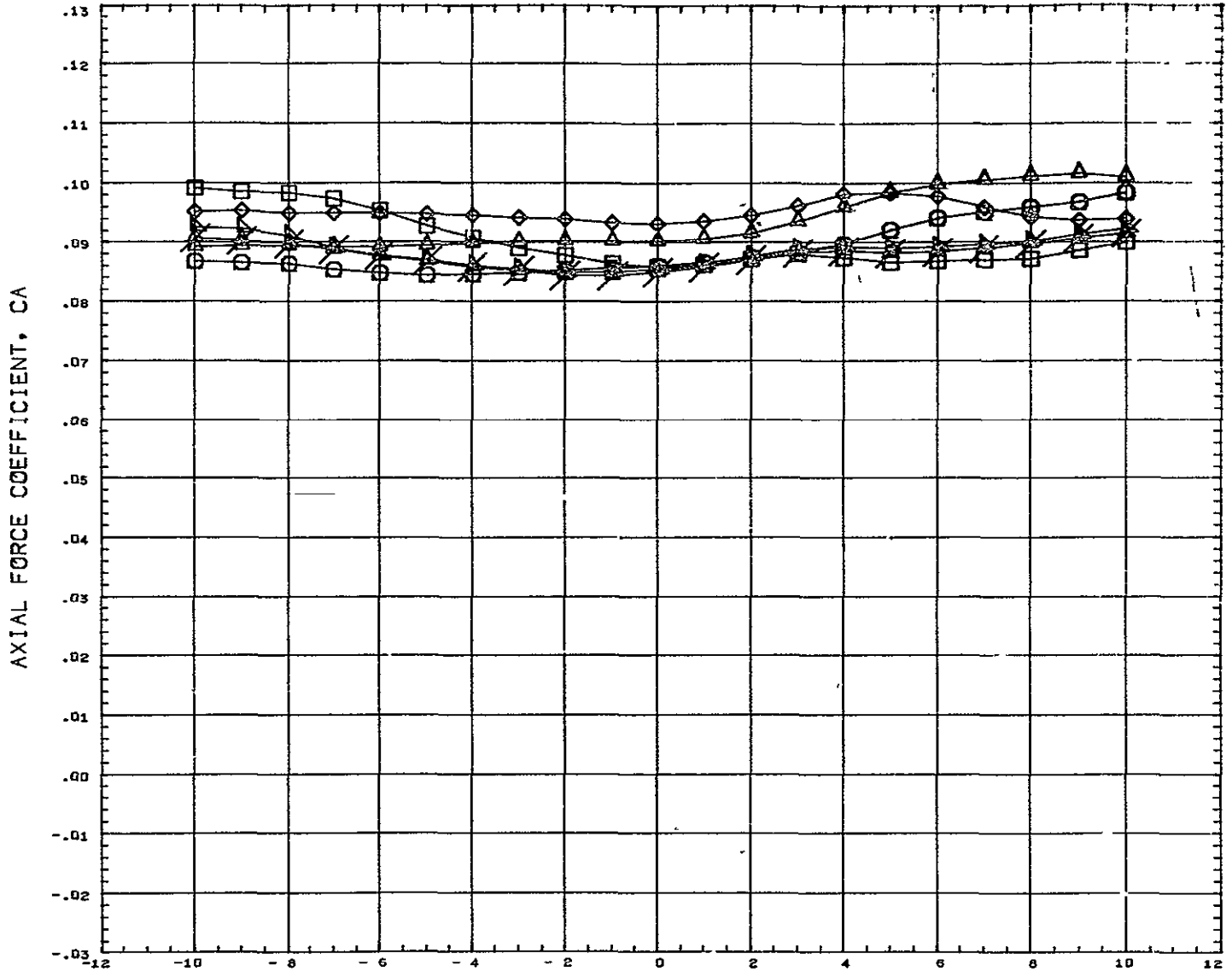

SYMBOL ○ ◇ □ △	DELTA Z 0.120 0.151 0.182 0.228 0.352 10.000	PARAMETRIC VALUES BSTPCW 0.000 ORBPCW 0.000 DELTAX 0.043 ALPHAI 0.000 IACH 5.020 ELVBST 0.000 ELVORB 0.000 BETA 0.000	REFERENCE INFORMATION REFS : .4440 SQ IN REFL 13.3330 IN REFB 13.3330 IN XHRP 7.5280 IN YHRP 0.0000 IN ZHRP 1.1540 IN SCALE 0.0055
----------------------------	--	---	---

REFERENCE FILE

# AEDC VA 1163 MDAC BOOSTER AND ORBITER TEST DATA AT MACH NUMBER 5

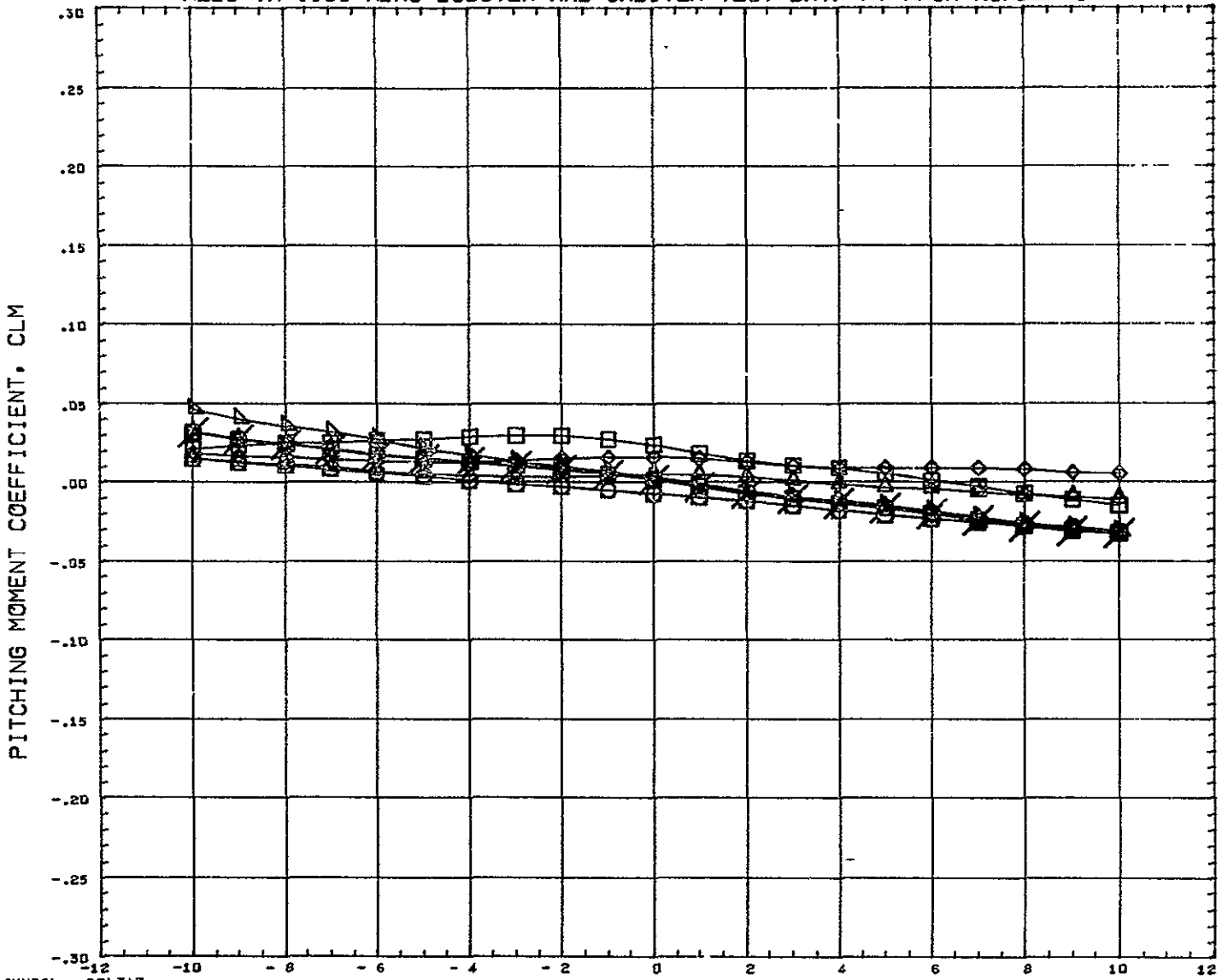

SYMBOL	DELTA Z	PARAMETRIC VALUES				REFERENCE INFORMATION		
□	0.120					REFS	--.4440	SG IN
◇	0.151					REFL	13.3330	IN
△	0.182	BSTFOW	0.000	ORBPOW	0.000	REFB	13.3330	IN
▽	0.228	DELTA X	0.105	ALPHA I	0.000	XMRP	7.5280	IN
○	0.352	MACH	5.020	ELVBST	0.000	YMRP	0.0000	IN
×	0.599	ELVORB	0.000	BETA	0.000	ZMRP	1.1540	IN
○	0.908					SCALE	0.0055	
○	10.000	REFERENCE FILE						

# AEDC VA 1163 MDAC BOOSTER AND ORBITER TEST DATA AT MACH NUMBER 5

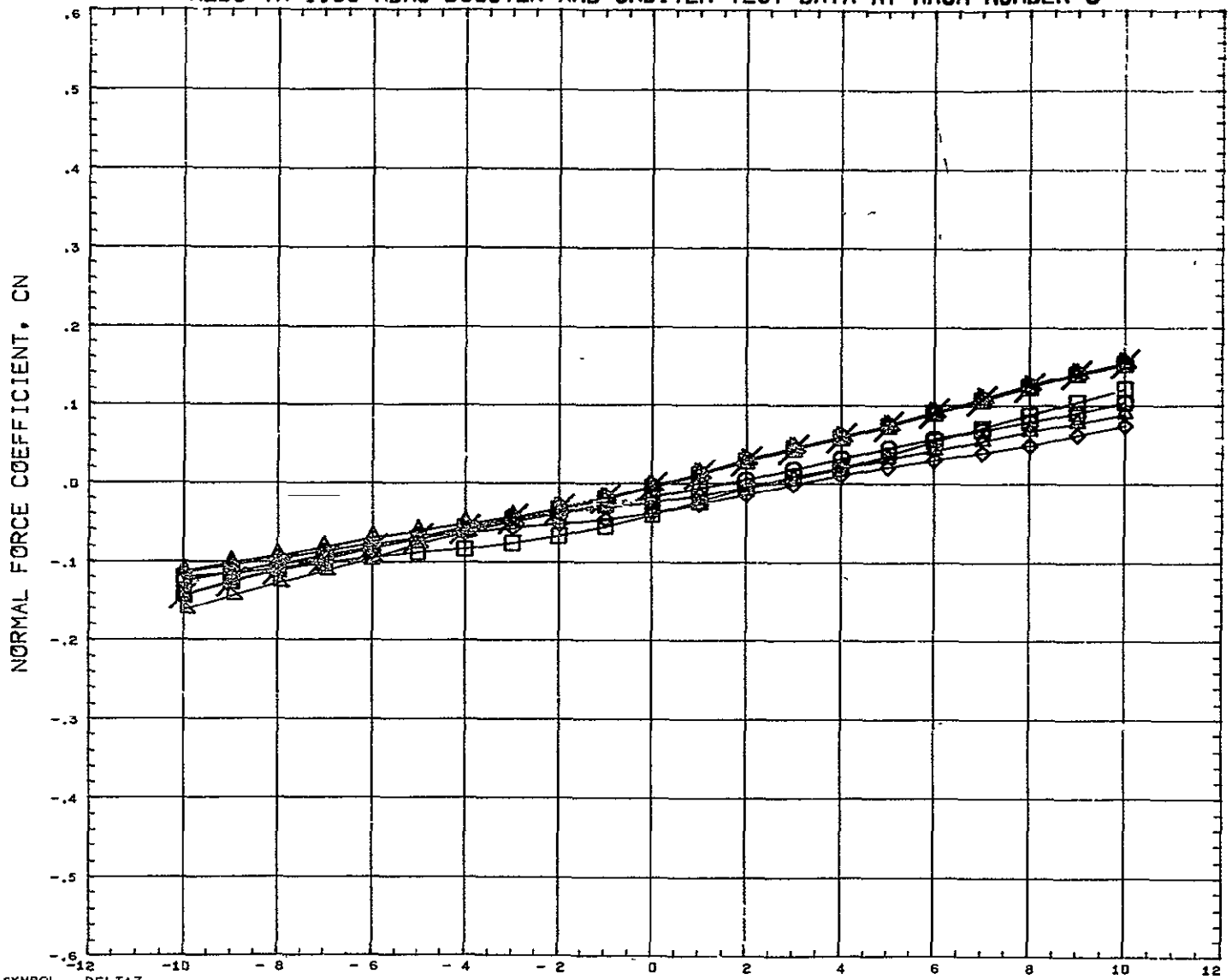

SYMBOL	DELTAZ	PARAMETRIC VALUES				REFERENCE INFORMATION		
○	0.120							
◇	0.151							
△	0.182	BSTPOW	0.000	ORBPOW	0.000	RLFS	7.4440	90 IN
□	0.220	DELTAZ	0.105	ALPHA1	0.000	REFL	13.3330	IN
◇	0.352	ACH	5.020	ELVBST	0.000	REFB	13.3330	IN
△	0.599	ELVORB	0.000	BETA	0.000	XMRP	7.5280	IN
◇	0.900					YMRP	0.0000	IN
△	10.000	REFERENCE FILE				ZMRP	1.1940	IN
						SCALE	0.0055	

# AEDC VA 1163 MDAC BOOSTER AND ORBITER TEST DATA AT MACH NUMBER 5

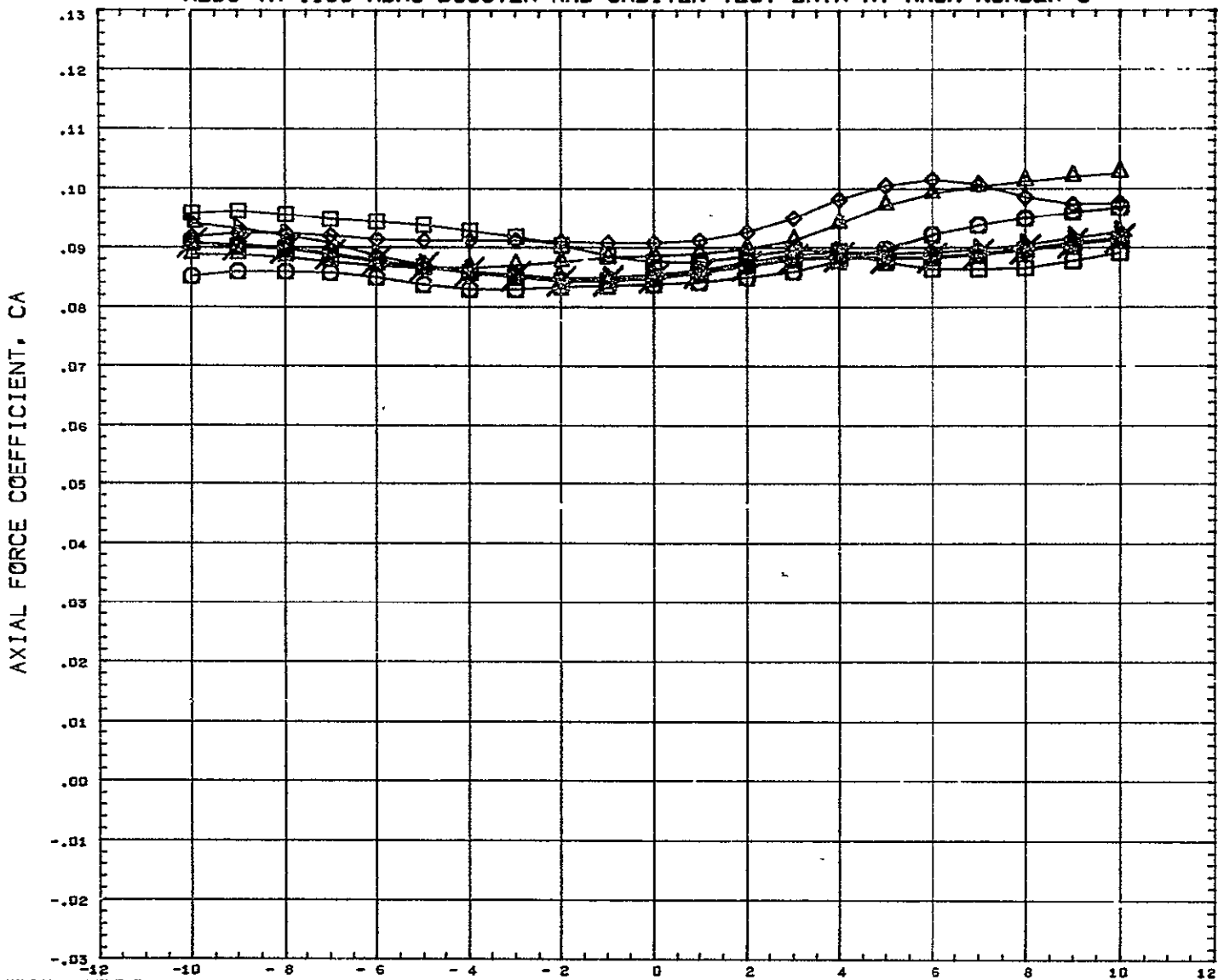

SYMBOL	DELTA Z	PARAMETRIC VALUES				REFERENCE INFORMATION		
□	0.120							
◇	0.151							
◇	0.182	BSTPOW	0.000	ORBPOW	0.000	PEFS	11.4440	50 IN
◇	0.228	DELTA X	0.105	ALPHA I	0.000	REFL	13.3330	IN
◇	0.352	MACH	5.020	ELVBST	0.000	REFB	13.3330	IN
◇	0.599	ELVORB	0.000	BETA	0.000	XMRP	7.5280	IN
◇	0.908					YMRP	0.0000	IN
◇	10.000	REFERENCE FILE				ZMRP	1.1840	IN
						SCALE	0.0055	

# AEDC VA 1163 MDAC BOOSTER AND ORBITER TEST DATA AT MACH NUMBER 5

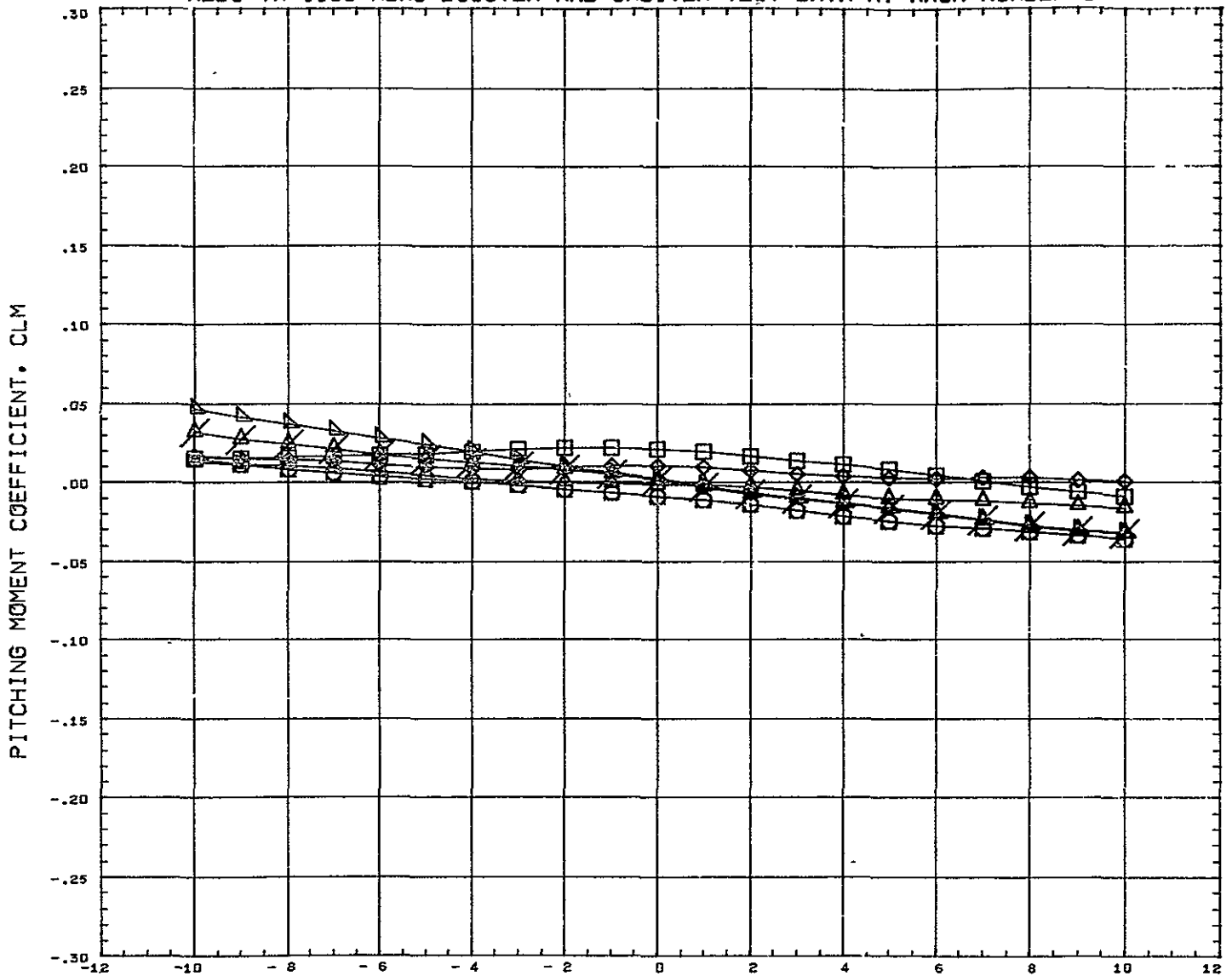

SYMBOL ○ ◊ □ △ ×	DELTAZ 0.120 0.151 0.182 0.228 0.352 10.000	PARAMETRIC VALUES BSTPOW    0.000    ORBPOW    0.000 DELTAX    0.167    ALPHA1    0.000 MACH      5.020    ELVBST    0.000 ELVORB    0.000    BETA      0.000	REFERENCE INFORMATION REFS      11.4440    SQ IN REFL      13.3350    IN REFB      13.3330    IN XMRF      7.5280    IN YMRP      0.0500    IN ZMRP      1.1940    IN SCALE     0.0055
---------------------------------	---	---	---

REFERENCE FILE

# AEDC VA 1163 MDAC BOOSTER AND ORBITER TEST DATA AT MACH NUMBER 5

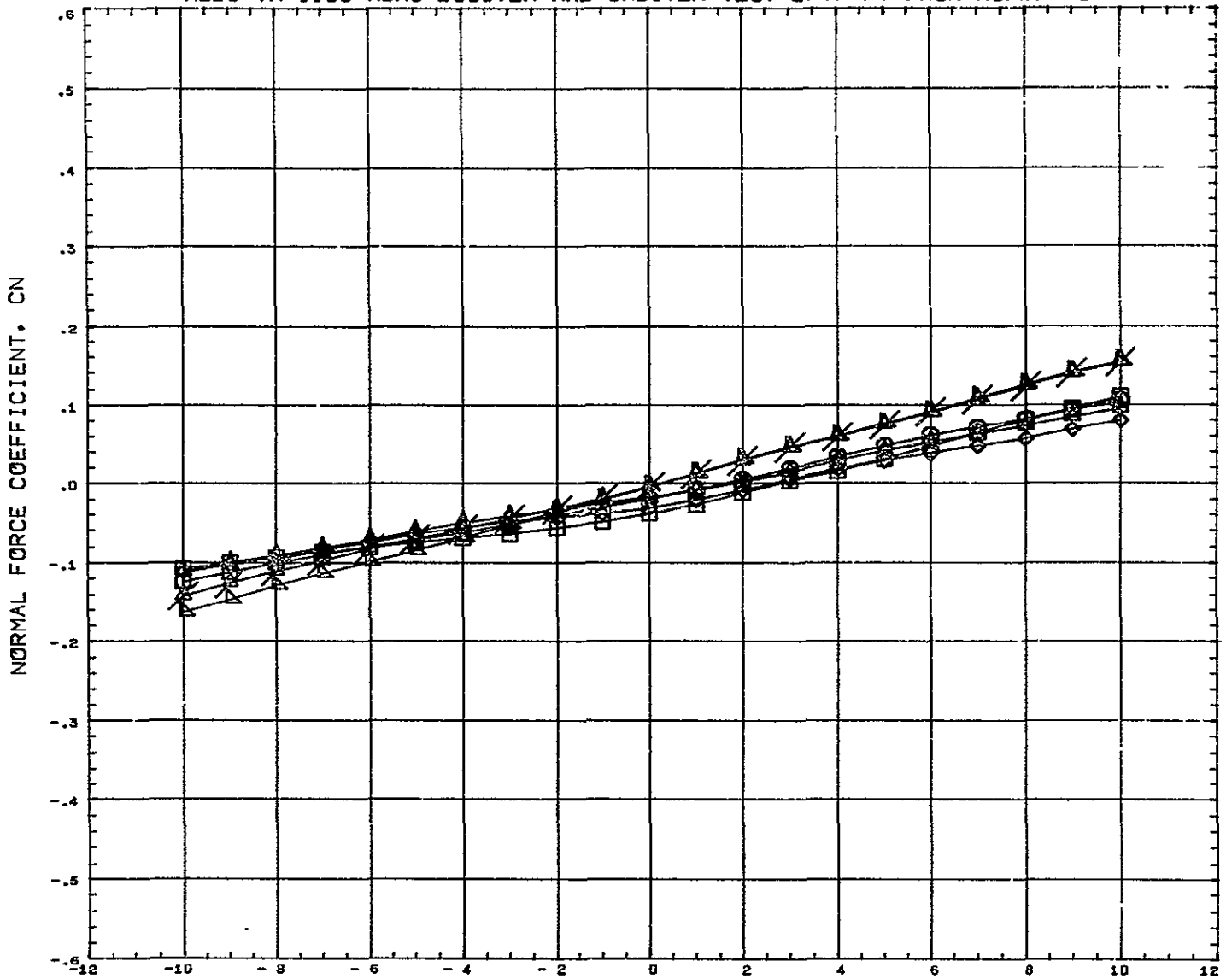

SYMBOL ○ □ △ ◇	DELTAZ 0.120 0.151 0.182 0.228 0.352 10.000	PARAMETRIC VALUES RSTPOW 0.000 ORBPOW 0.000 DELTAX 0.167 ALPHAI 0.000 MACH 5.020 ELVBST 0.000 ELVORB 0.000 BETA 0.000	REFERENCE INFORMATION PEFS 44.4440 SQ IN REFL 13.3330 IN REFB 13.3330 IN XMRP 7.5280 IN YMRP 0.0000 IN ZMRP 1.1940 IN SCALE 0.0055
----------------------------	---	---	---

REFERENCE FILE

# AEDC VA 1163 MDAC BOOSTER AND ORBITER TEST DATA AT MACH NUMBER 5

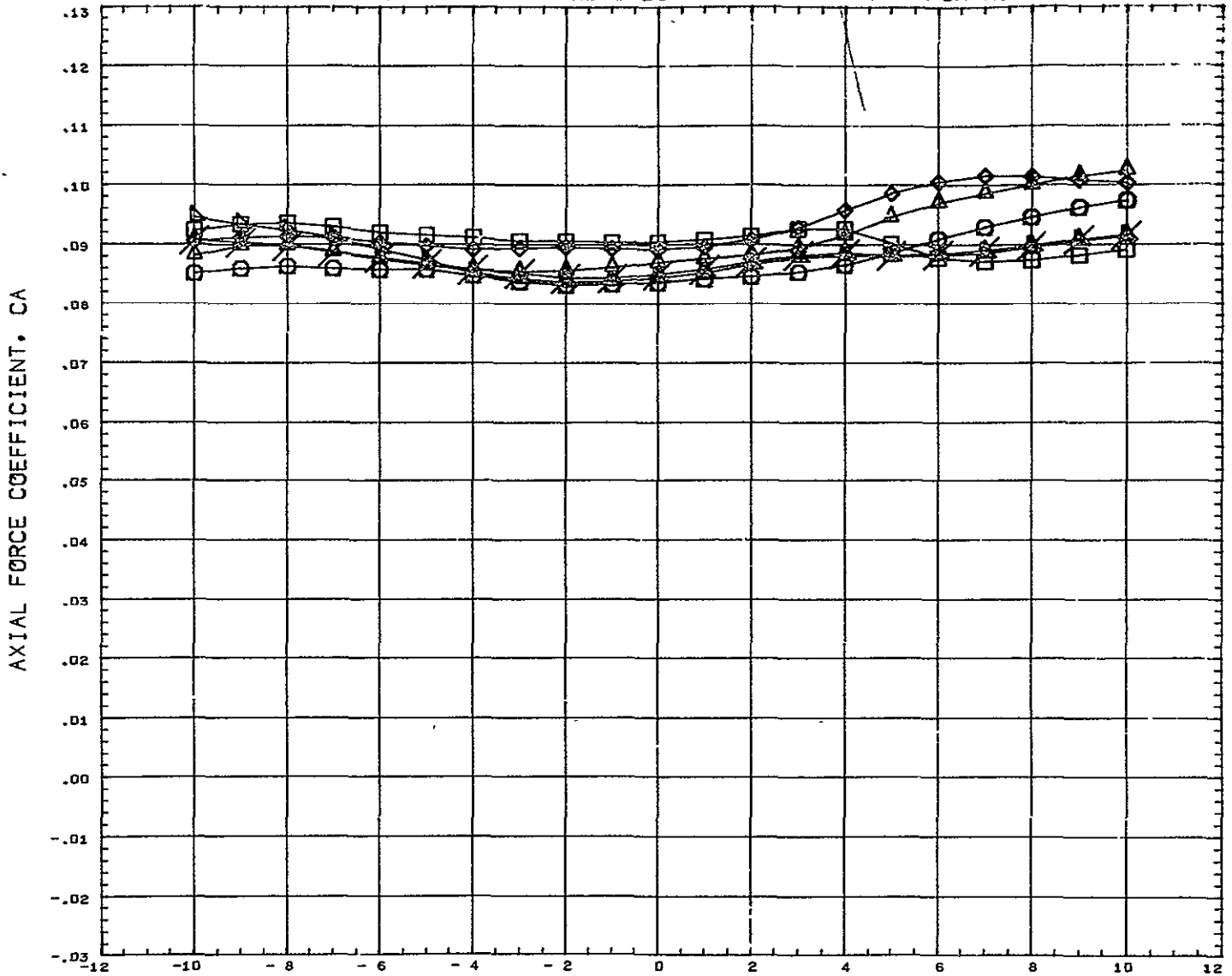

SYMBOL 	DELTAZ 0.120 0.151 0.182 0.220 0.352 10.000	<b>PARAMETRIC VALUES</b> BSTPOW 0.000 ORBPOW 0.000 DELTAX 0.167 ALPHA1 0.000 MACH 5.020 ELVBST 0.000 ELVORB 0.000 BETA 0.000	<b>REFERENCE INFORMATION</b> REFS 4'.4440 SQ IN REFL 13.3330 IN REFB 13.3330 IN XMRP 7.5280 IN YMRP 0.0000 IN ZMRP 1.1940 IN SCALE 0.0055
------------	---	--	--

REFERENCE FILE



# AEDC VA 1163 MDAC BOOSTER AND ORBITER TEST DATA AT MACH NUMBER 5

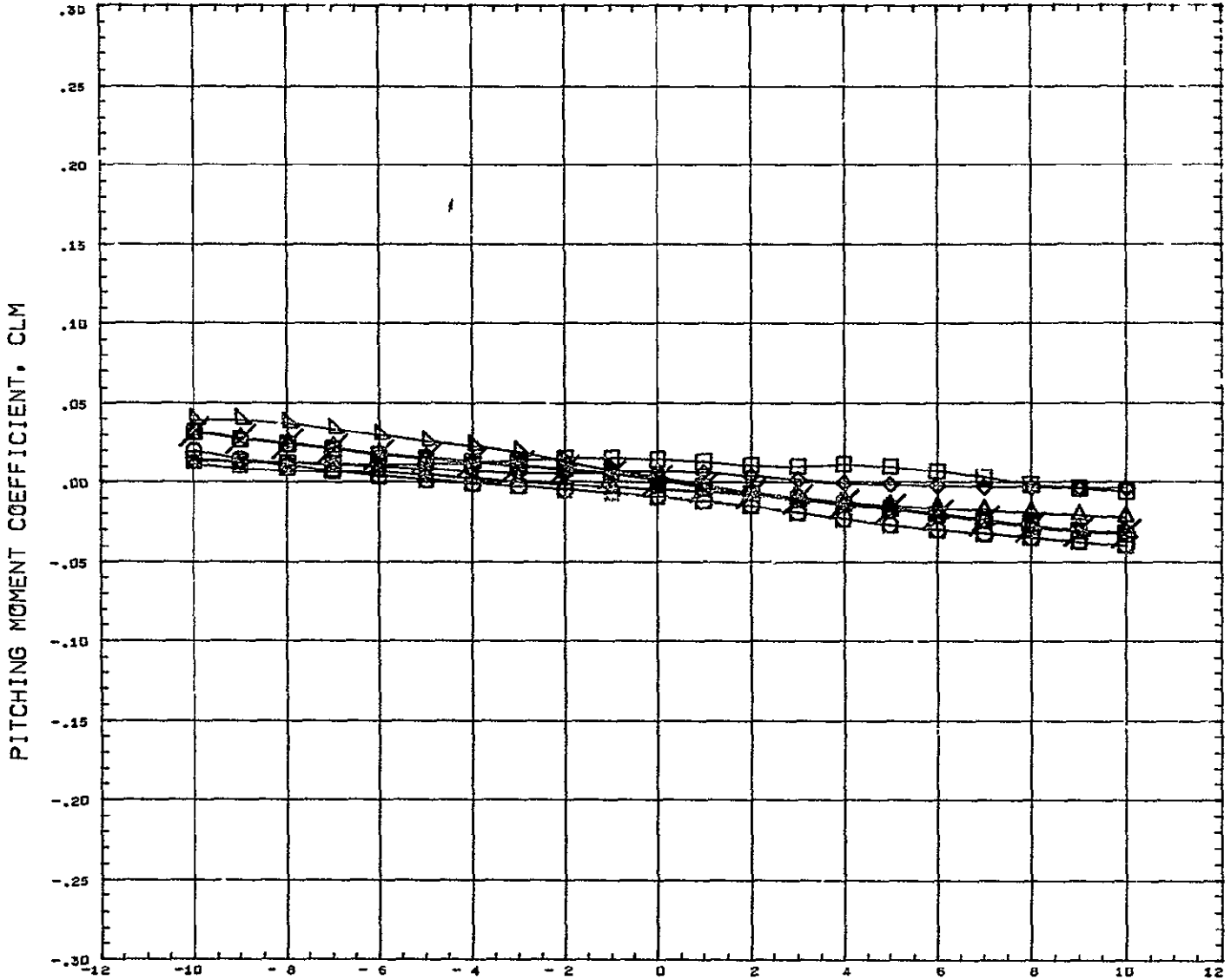

SYMBOL	DELTA Z	PARAMETRIC VALUES				REFERENCE INFORMATION		
○	0.120							
◇	0.151							
□	0.192	BSTPOW	0.000	ORBPOW	0.000	REFS	44.4440	59 IN
△	0.228	DELTA X	0.228	ALPHA I	0.000	REFL	13.3330	IN
▽	0.352	ACH	5.020	ELVBST	0.000	REFB	13.3330	IN
◇	0.599	ELVORB	0.000	BETA	0.000	XMRP	7.5280	IN
○	0.900					YMRP	0.0000	IN
○	10.000	REFERENCE FILE				ZMRP	1.1940	IN
						SCALE	0.0055	

# AEDC VA 1163 MDAC BOOSTER AND ORBITER TEST DATA AT MACH NUMBER 5

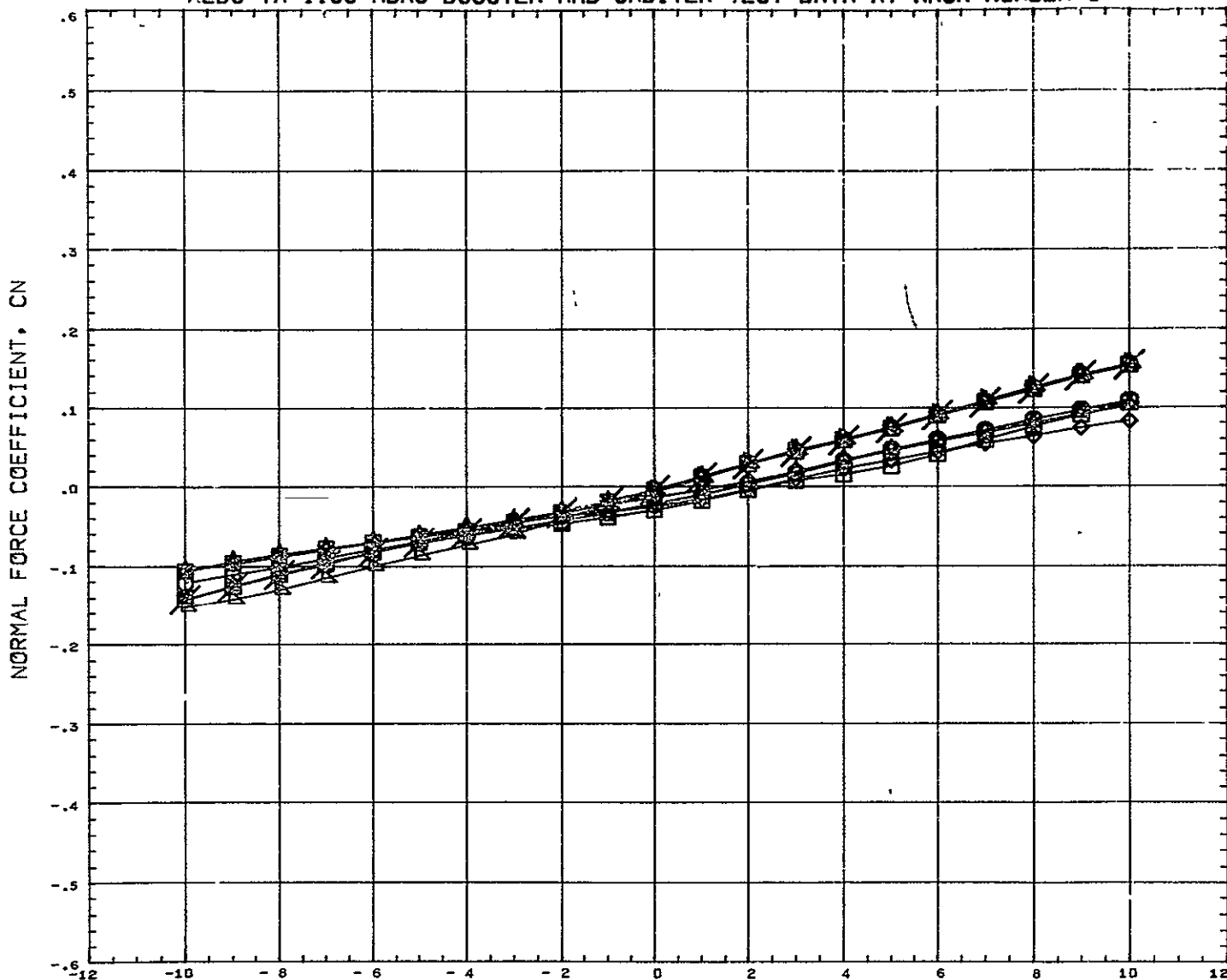

SYMBOL <del>○</del> <del>□</del> <del>◇</del> <del>△</del>	DELTAX 0.120 0.151 0.182 0.228 0.352 0.599 0.908 10.000	PARAMETRIC VALUES BSTFOW 0.000 CRBFOW 0.000 DELTAX 0.228 ALPHAI 0.000 MACH 5.020 ELVBST 0.000 ELVORB 0.000 BETA 0.000 REFERENCE FILE	REFERENCE INFORMATION REFS 44.4440 SQ IN REFL 13.3330 IN REFB 13.3330 IN XMRP 7.5280 IN YMRP 0.0000 IN ZMRP 1.1940 IN SCALE 0.0055
---	---	---	---

# AEDC VA 1163 MDAC BOOSTER AND ORBITER TEST DATA AT MACH NUMBER 5

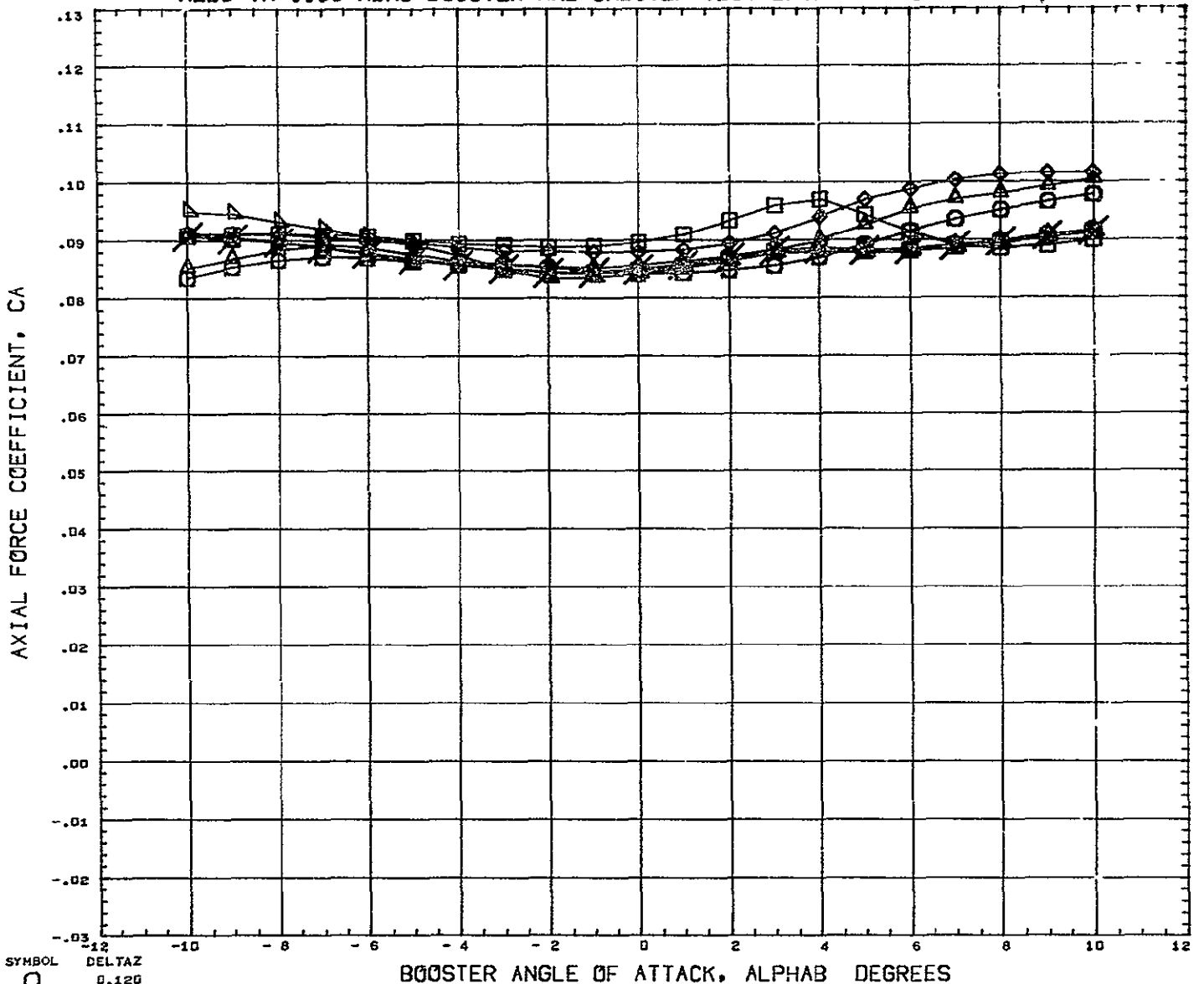

SYMBOL <del>0.120</del> <del>0.151</del> <del>0.182</del> <del>0.228</del> <del>0.352</del> <del>0.599</del> <del>0.908</del> <del>10.000</del>	DELTAZ 0.120 0.151 0.182 0.228 0.352 0.599 0.908 10.000	PARAMETRIC VALUES BSTPCW 0.000 ORBPOW 0.000 DELTAX 0.228 ALPHAI 0.000 'ACH 5.020 ELVBST 0.000 ELVORB 0.000 BETA 0.000	REFERENCE INFORMATION REFS 4 .4440 SQ IN REFL 13.3330 IN REFB 13.3330 IN YMRP 7.5280 IN YMRP 0.0000 IN ZMRP 1.1940 IN SCALE 0.0055
---	---	---	---

# AEDC VA 1163 MDAC BOOSTER AND ORBITER TEST DATA AT MACH NUMBER 5

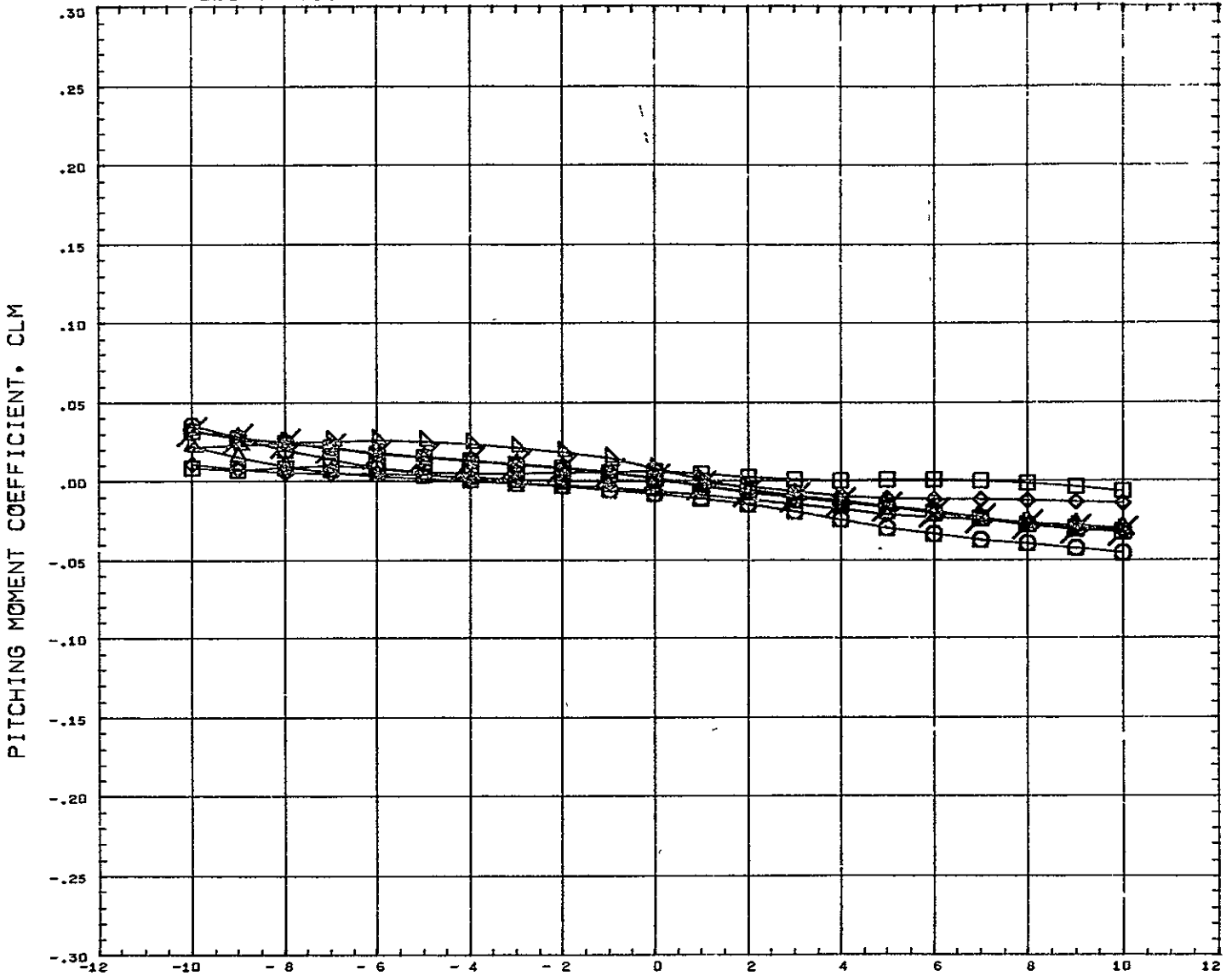

SYMBOL <del>○</del> <del>◇</del> <del>□</del> <del>△</del> <del>▽</del> <del>◇</del> <del>○</del> <del>◇</del> <del>□</del> <del>△</del> <del>▽</del> <del>◇</del> <del>○</del>	DELTA Z 0.120 0.151 0.182 0.228 0.352 0.599 0.908 10.000 REFERENCE FILE	PARAMETRIC VALUES BSTPOW 0.000 ORBPOW 0.000 DELTAX 0.351 ALPHAI 0.000 ACH 5.020 ELVBST 0.000 ELVORB 0.000 BETA 0.000	REFERENCE INFORMATION REFS 1.4440 SQ IN REFL 13.3330 IN REFB 13.3330 IN YHRP 7.5280 IN YHRF 0.0000 IN ZHRF 1.1940 IN SCALE 0.0055
--	--	--	--

# AEDC VA 1163 MDAC BOOSTER AND ORBITER TEST DATA AT MACH NUMBER 3

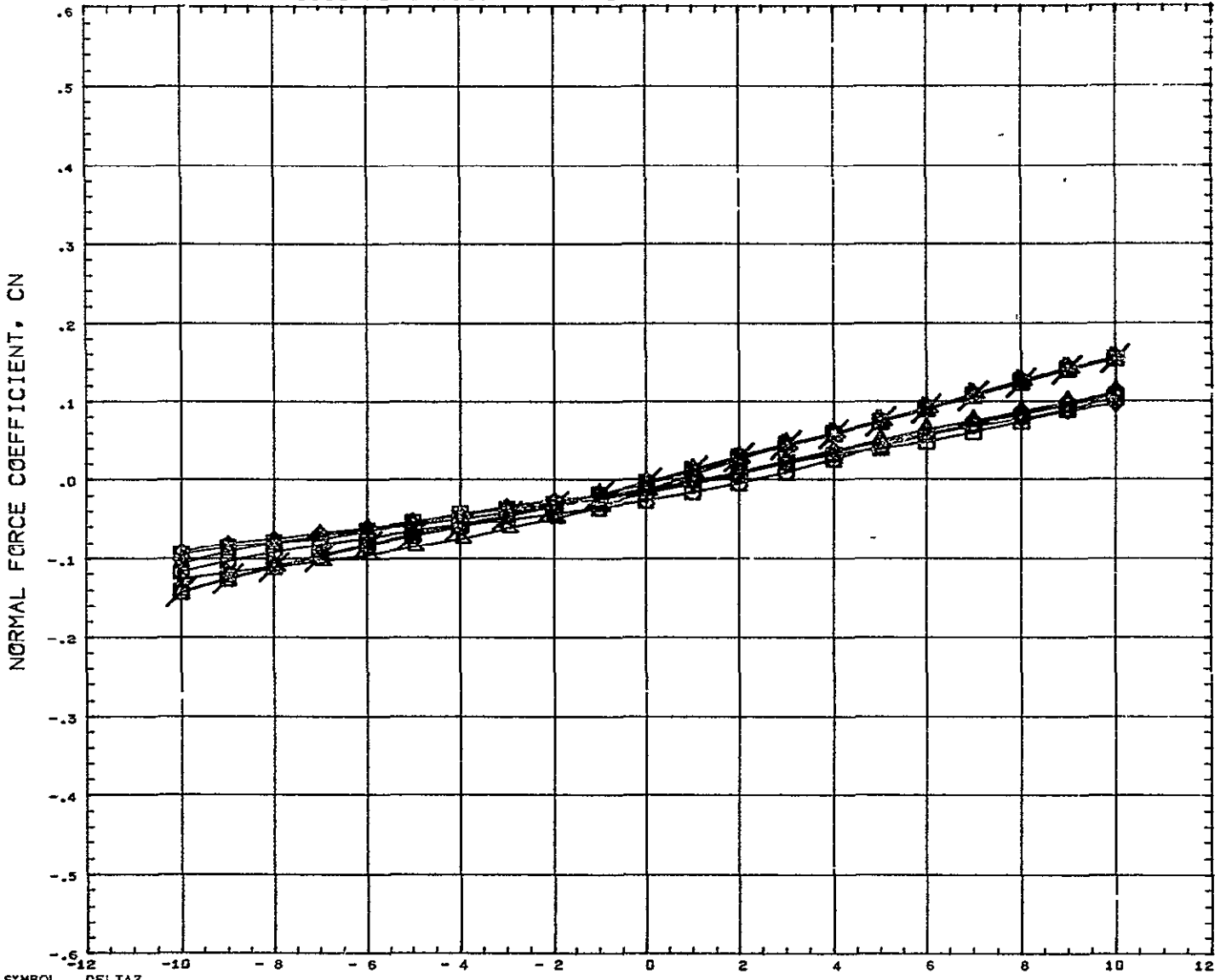

SYMBOL <del>○</del> <del>◇</del> <del>□</del> <del>△</del> <del>▽</del> <del>◇</del> <del>○</del> <del>◇</del> <del>□</del> <del>△</del> <del>▽</del> <del>◇</del> <del>○</del>	DELTA Z 0.120 0.151 0.182 0.228 0.352 0.599 0.908 10.000	PARAMETRIC VALUES BSTPOW 0.000 ORBPOW 0.000 DELTAX 0.351 ALPHAI 0.000 MACH 3.020 ELVBST 0.000 ELVORB 0.000 BETA 0.000 REFERENCE FILE	REFERENCE INFORMATION REFS 11.4440 SQ IN REFL 13.3330 IN REFB 13.3330 IN XMRP 7.5280 IN YMRP 0.0000 IN ZMRP 1.1640 IN SCALE 0.0055
--	--	---	---

# AEDC VA 1163 MDAC BOOSTER AND ORBITER TEST DATA AT MACH NUMBER 5

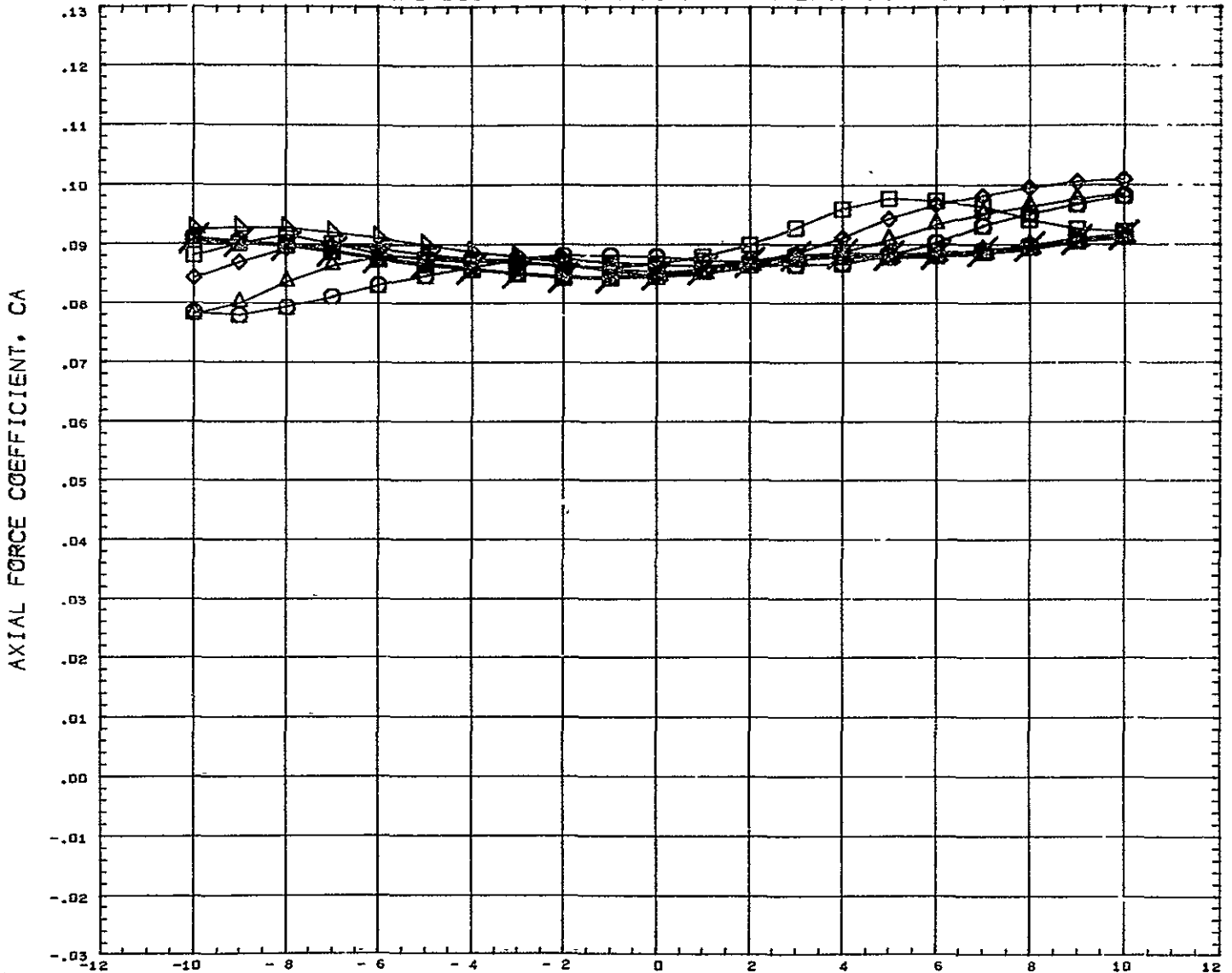

SYMBOL ○ ◻ △ ◊ ◇ ◈ ◉ ◊ ◈ ◉	DELTAX 0.120 0.151 0.182 0.228 0.352 0.599 0.908 10.000	PARAMETRIC VALUES BSTPOW 0.000 ORBPOW 0.000 DELTAX 0.351 ALPHAI 0.000 MACH 5.020 ELVBST 0.000 ELVORB 0.000 BETA 0.000	REFERENCE INFORMATION REFS 41.4440 SQ IN REFL 13.3330 IN REFB 13.3330 IN XMRP 7.5260 IN YMRP 0.0000 IN ZMRP 1.1540 IN SCALE 0.0055
--	---	---	---

# AEDC VA 1163 MDAC BOOSTER AND ORBITER TEST DATA AT MACH NUMBER 5

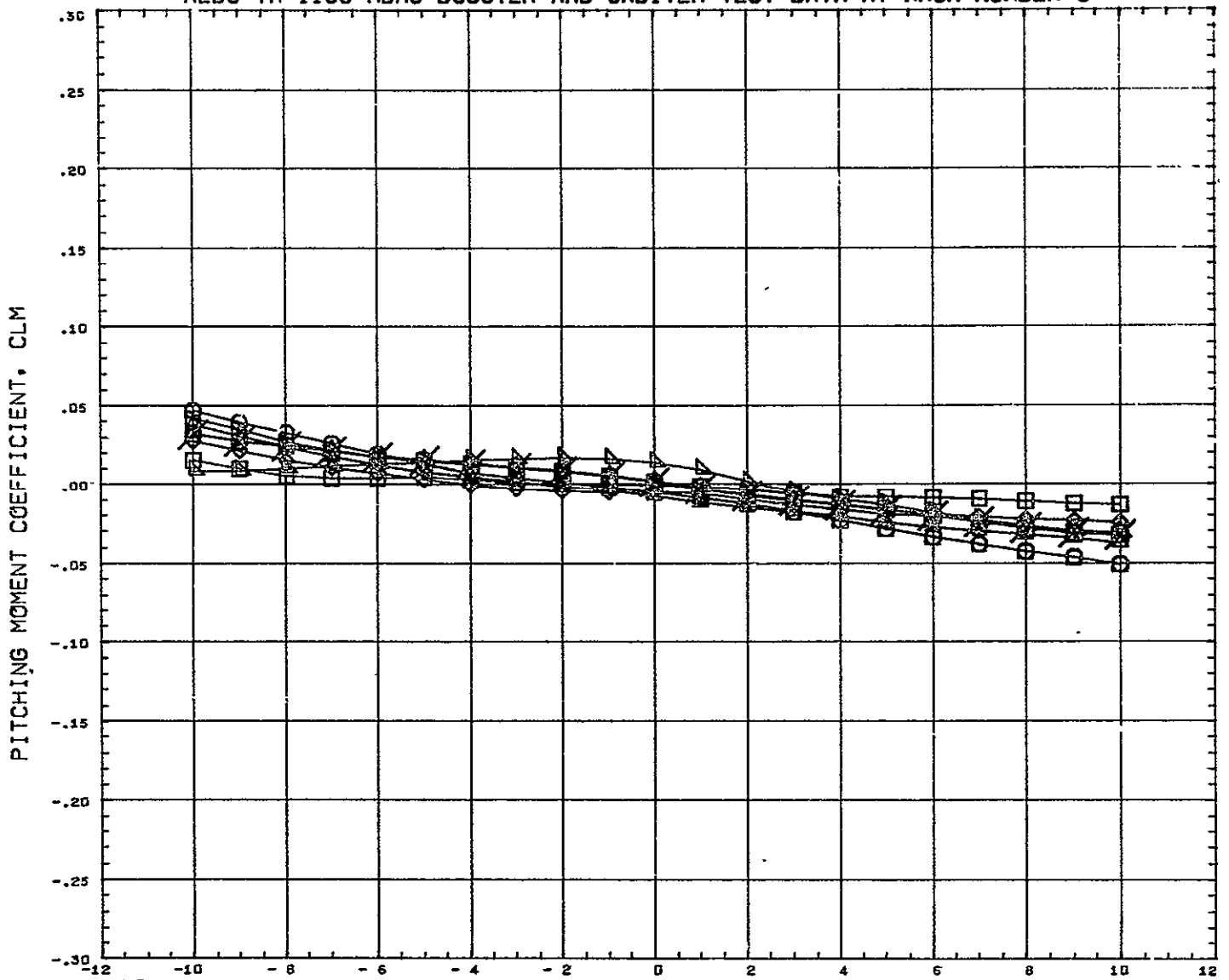

SYMBOL	DELTA Z	PARAMETRIC VALUES				REFERENCE INFORMATION	
○	0.120						
□	0.151						
△	0.182	BSTPOW	0.000	ORBPOW	0.000	REFS	4.4440 IN
◇	0.228	DELTA X	0.522	ALPHA I	0.000	REFL	13.3330 IN
◇	0.352	ICH	5.020	ELVBST	0.000	REFB	13.3330 IN
◇	0.599	ELVORB	0.000	BFTA	0.000	XMRP	7.5280 IN
◇	0.908					YMRP	0.0000 IN
◇	10.000	REFERENCE FILE				ZMRP	1.1940 IN
						SCALE	0.0055

# AEDC VA 1163 MDAC BOOSTER AND ORBITER TEST DATA AT MACH NUMBER 3

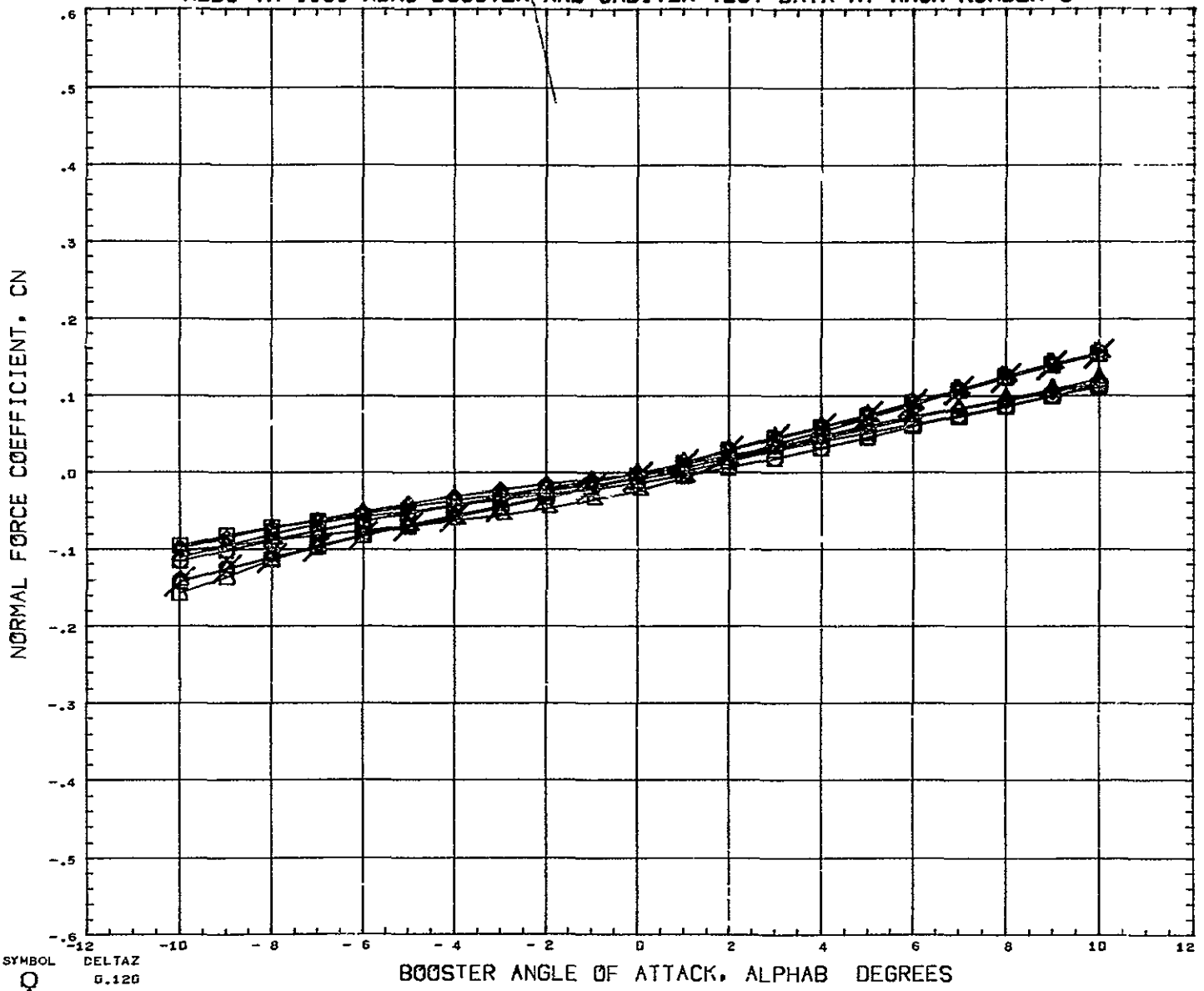

SYMBOL	DELTA Z	PARAMETRIC VALUES				REFERENCE INFORMATION	
○	0.120						
□	0.151						
◇	0.182	BSTPOW	0.000	ORBPOW	0.000	RCFS	77.4440 SQ IN
△	0.228	DELTA X	0.522	ALPHA I	0.000	PEFL	13.3335 IN
▽	0.352	ACH	5.020	ELVBST	0.000	REFB	13.3330 IN
◇	0.599	ELVORB	0.000	BETA	0.000	XMRP	7.5280 IN
△	0.908					YMRP	0.0000 IN
▽	10.000	REFERENCE FILE				ZMRP	1.1940 IN
◇						SCALE	0.0055



# AEDC VA 1163 MDAC BOOSTER AND ORBITER TEST DATA AT MACH NUMBER 5

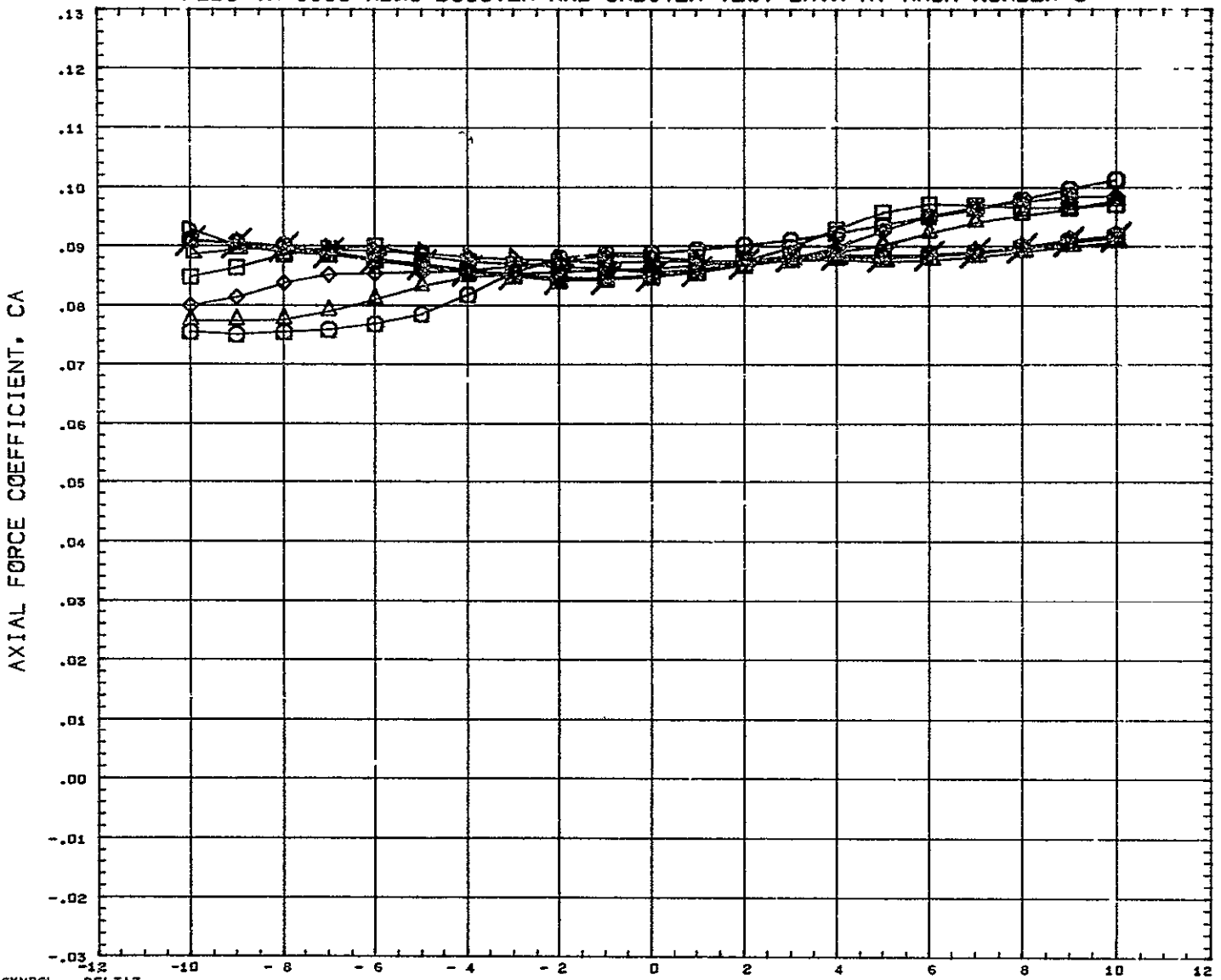

SYMBOL	DELTA Z	PARAMETRIC VALUES				REFERENCE INFORMATION		
○	0.120	BSTPOW	0.000	ORBPOW	0.000	REFS	11.4449	SQ IN
◇	0.151	DELTA X	0.522	ALPHA I	0.000	REFL	13.3330	IN
◊	0.182	MACH	5.020	ELVBST	0.000	REFB	13.3330	IN
◡	0.228	ELVORB	0.000	BETA	0.000	XMRP	7.5280	IN
◢	0.352	REFERENCE FILE				YMRP	0.0000	IN
◣	0.599					ZMRP	1.1940	IN
◤	0.908					SCALE	0.0055	
◥	10.000							

# AEDC VA 1163 MDAC BOOSTER AND ORBITER TEST DATA AT MACH NUMBER 5

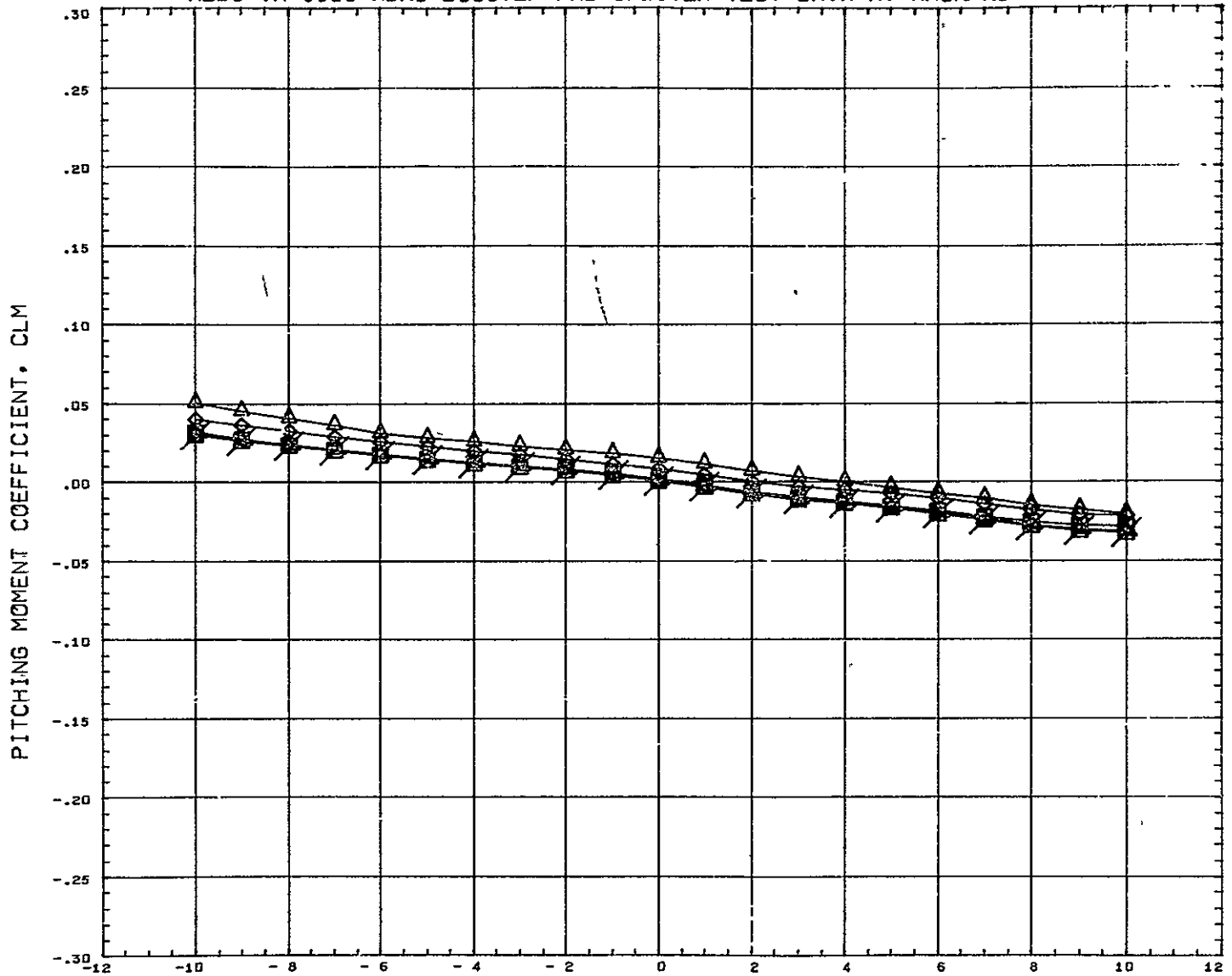

SYMBOL △ ◇ □ ○	DELTAX 0.151 0.182 0.228 0.352 0.599 10.000	PARAMETRIC VALUES BSTFOW    0.000    ORBPOW    0.000 DELTAX    - 0.390    ALPHAI    5.100 INCH       5.010    ELVBST    0.000 ELVORB    0.000    BETA       0.000	REFERENCE INFORMATION REFS       44 4440    SQ IN REFL       13.3330    IN REFB       13.3330    IN XMRF       7.5280    IN YMRP       0.0000    IN ZMRP       1.1940    IN SCALE       0.0055
----------------------------	---	---	---

REFERENCE FILE

# AEDC VA 1163 MDAC BOOSTER AND ORBITER TEST DATA AT MACH NUMBER 5

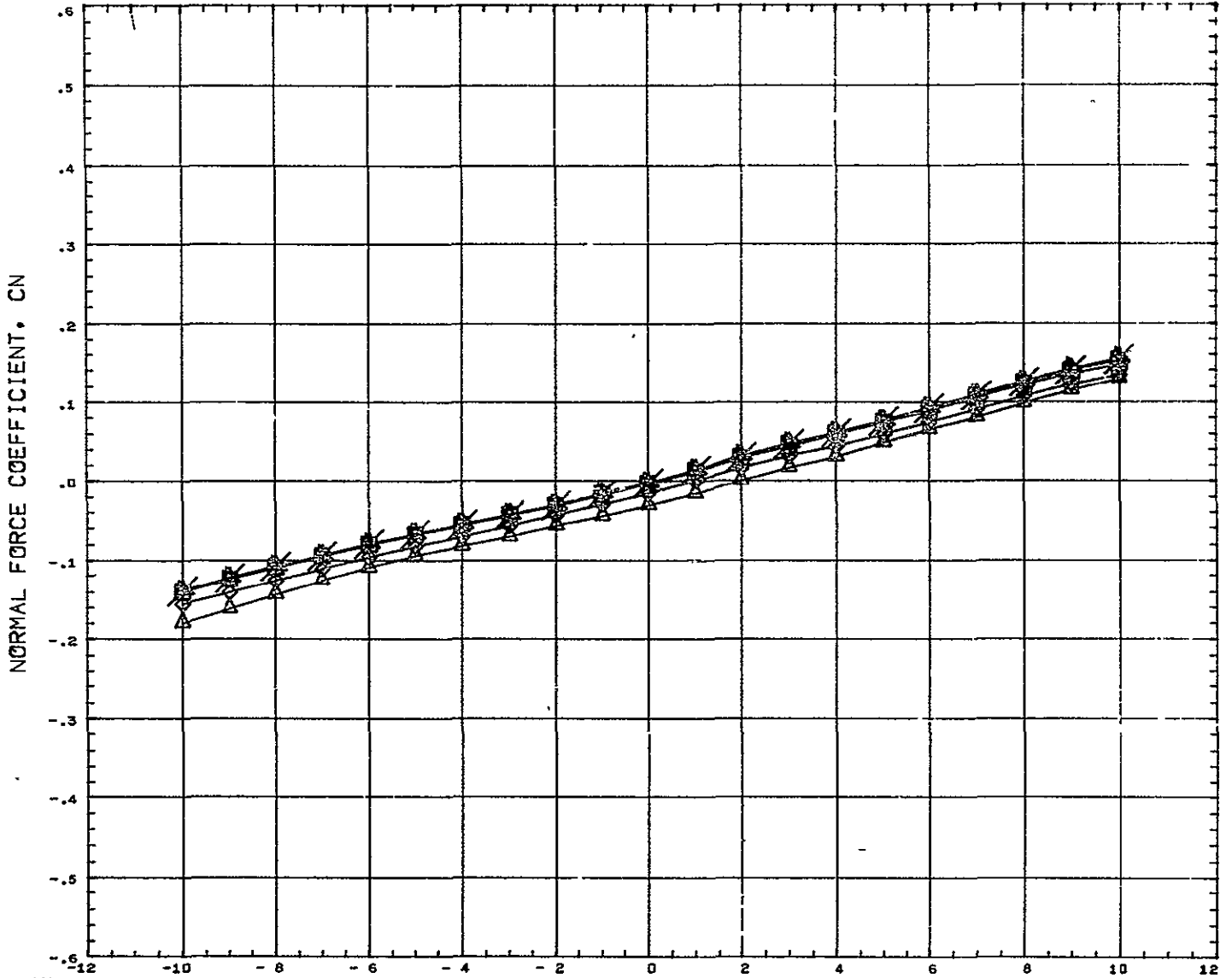

SYMBOL	DELTAZ	PARAMETRIC VALUES				REFERENCE INFORMATION	
△	0.151					REFS	44.444C SQ IN
◇	0.102					REFL	13.3330 IN
□	0.228	BSTPOV	0.000	ORBPOV	0.000	REFB	13.3330 IN
▣	0.352	DELTAZ	- 0.390	ALPHA1	5.100	XMRP	7.6200 IN
◻	0.599	MACH	5.010	ELVBST	0.000	YMRP	0.0050 IN
△	10.000	ELVORB	0.000	BETA	0.000	ZMRP	1.1940 IN
						SCALE	0.0055

REFERENCE FILE

# AEDC VA 1163 MDAC BOOSTER AND ORBITER TEST DATA AT MACH NUMBER 5

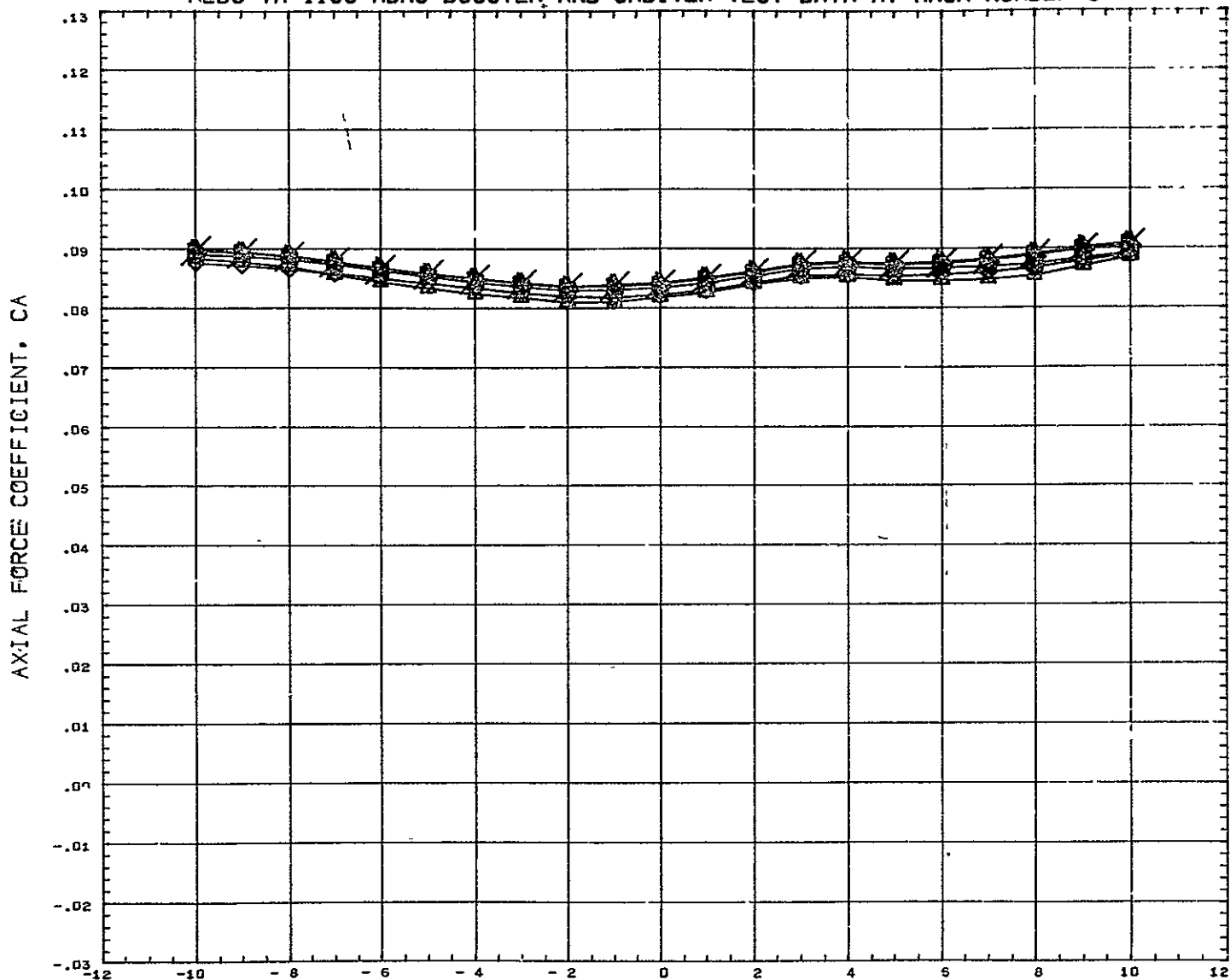

SYMBOL	DELTAZ	PARAMETRIC VALUES				REFERENCE INFORMATION	
△	0.151						
◇	0.182						
□	0.228	BSTPOW	0.000	ORBPOW	0.000	REFS	44.4440 IN
◇	0.352	DELTAZ	0.390	ALPHA1	5.100	REFL	13.3330 IN
◇	0.599	MACH	5.010	ELVBST	0.000	REFB	13.3330 IN
◇	10.000	ELVORB	0.000	BETA	0.000	XMRP	7.5280 IN
						YMRP	0.0000 IN
						ZMRP	1.1040 IN
						SCALE	0.0055

REFERENCE FILE

# AEDC VA 1163 MDAC BOOSTER AND ORBITER TEST DATA AT MACH NUMBER 5

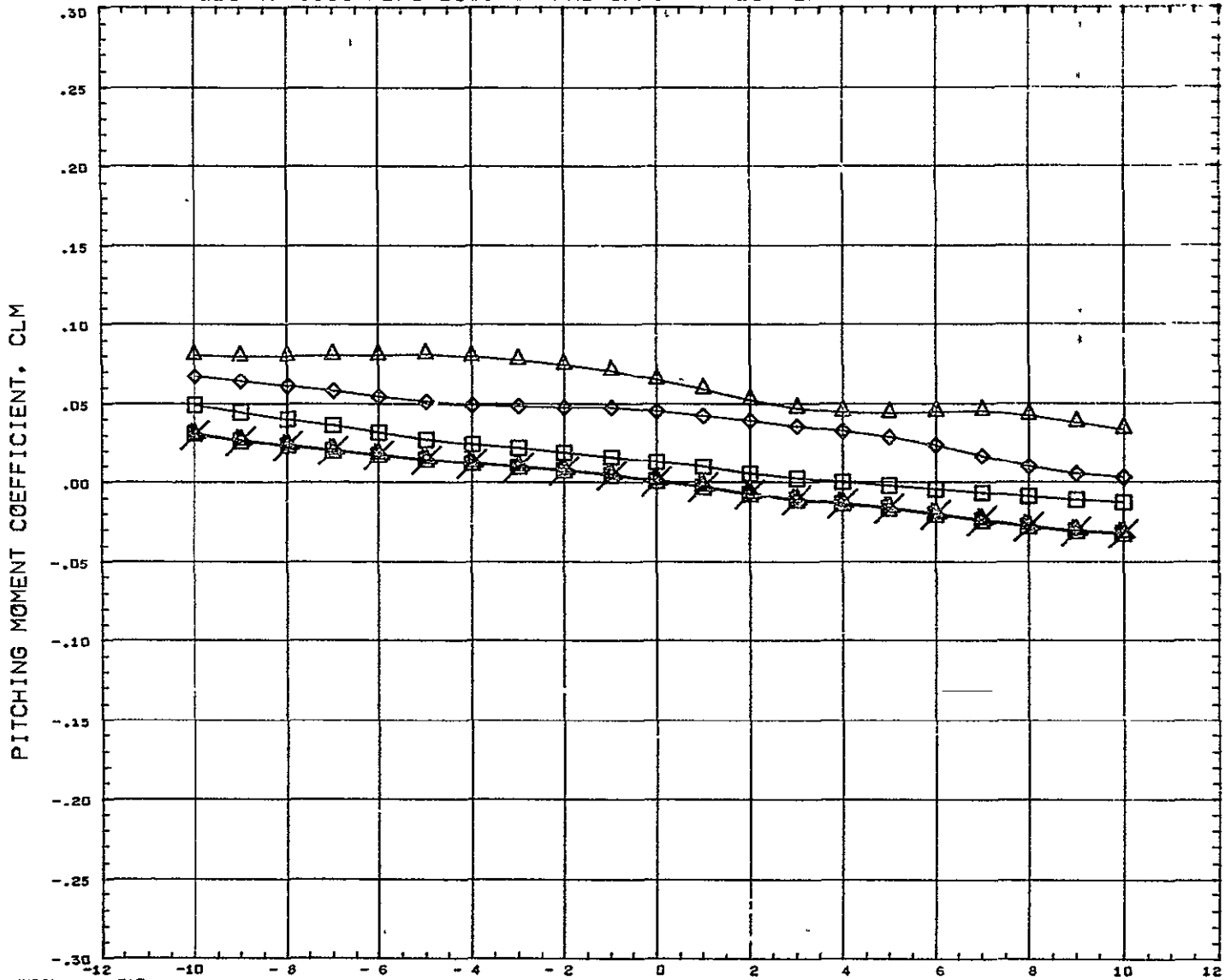

SYMBOL △ ◇ □ ○ ×	DELTAZ 0.151 0.182 0.228 0.352 0.599 10.000	<table border="0" style="width: 100%;"> <tr> <th colspan="4" style="text-align: left;">PARAMETRIC VALUES</th> </tr> <tr> <td>BSTFOW</td><td>0.000</td><td>ORBPOW</td><td>0.000</td> </tr> <tr> <td>DELTAZ</td><td>0.143</td><td>ALPHA1</td><td>5.100</td> </tr> <tr> <td>MACH</td><td>5.010</td><td>ELVBST</td><td>0.000</td> </tr> <tr> <td>ELVORB</td><td>0.000</td><td>BETA</td><td>0.000</td> </tr> </table>	PARAMETRIC VALUES				BSTFOW	0.000	ORBPOW	0.000	DELTAZ	0.143	ALPHA1	5.100	MACH	5.010	ELVBST	0.000	ELVORB	0.000	BETA	0.000	<table border="0" style="width: 100%;"> <tr> <th colspan="3" style="text-align: left;">REFERENCE INFORMATION</th> </tr> <tr> <td>REFS</td><td>44.4440</td><td>SQ IN</td> </tr> <tr> <td>REFL</td><td>13.3330</td><td>IN</td> </tr> <tr> <td>REFB</td><td>13.3330</td><td>IN</td> </tr> <tr> <td>XHRF</td><td>7.9280</td><td>IN</td> </tr> <tr> <td>YHRF</td><td>0.0000</td><td>IN</td> </tr> <tr> <td>ZHRF</td><td>1.1940</td><td>IN</td> </tr> <tr> <td>SCALE</td><td>0.0055</td><td></td> </tr> </table>	REFERENCE INFORMATION			REFS	44.4440	SQ IN	REFL	13.3330	IN	REFB	13.3330	IN	XHRF	7.9280	IN	YHRF	0.0000	IN	ZHRF	1.1940	IN	SCALE	0.0055	
PARAMETRIC VALUES																																															
BSTFOW	0.000	ORBPOW	0.000																																												
DELTAZ	0.143	ALPHA1	5.100																																												
MACH	5.010	ELVBST	0.000																																												
ELVORB	0.000	BETA	0.000																																												
REFERENCE INFORMATION																																															
REFS	44.4440	SQ IN																																													
REFL	13.3330	IN																																													
REFB	13.3330	IN																																													
XHRF	7.9280	IN																																													
YHRF	0.0000	IN																																													
ZHRF	1.1940	IN																																													
SCALE	0.0055																																														

REFERENCE FILE

# AEDC VA 1163 MDAC BOOSTER AND ORBITER TEST DATA AT MACH NUMBER 5

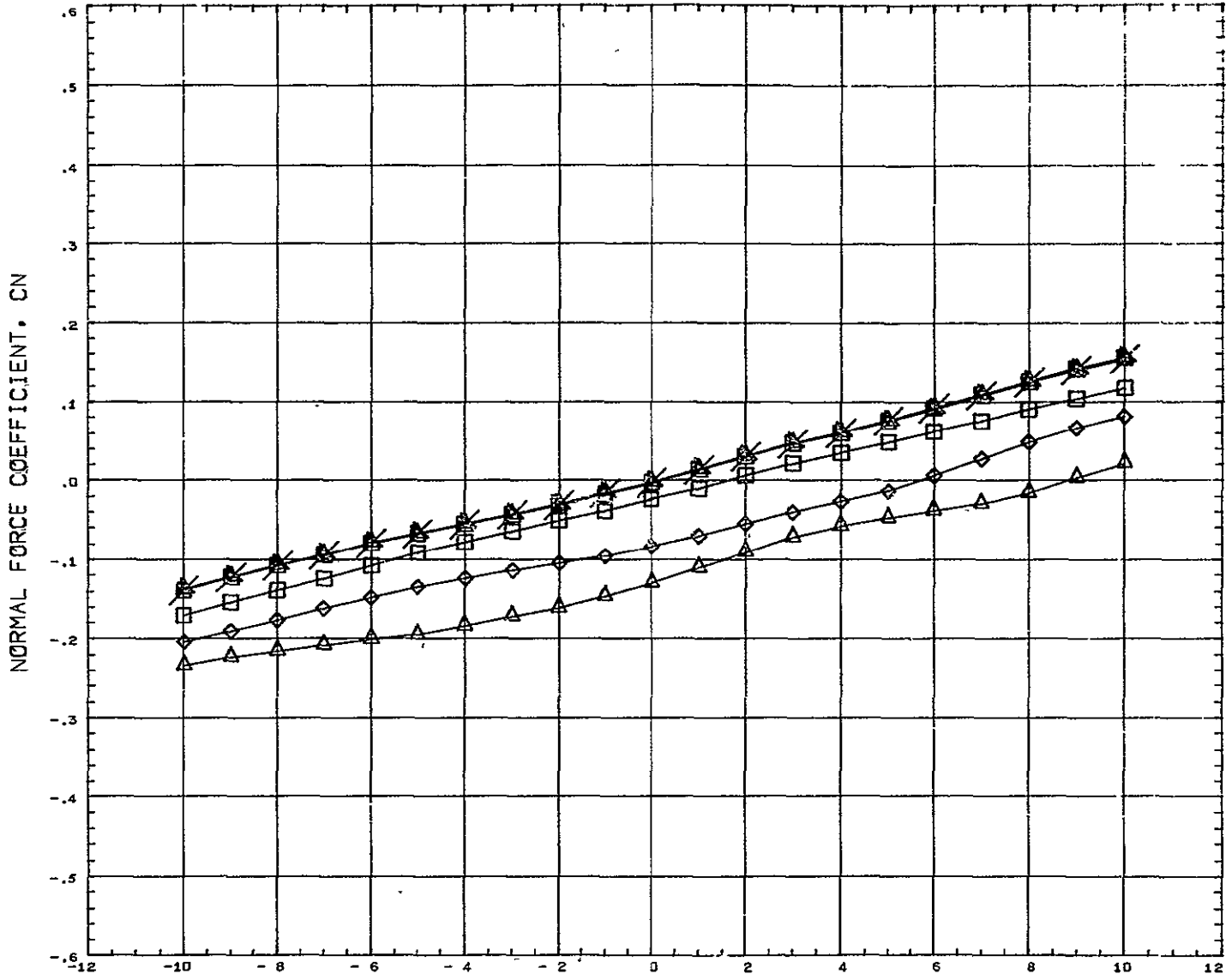

SYMBOL △ ◇ □ ▽ ○ ×	DELTA Z 0.151 0.182 0.228 0.352 0.599 10.000	PARAMETRIC VALUES BSTPOW    0.000    ORBPOW    0.000 DELTA X    0.143    ALPHA1    5.100 CH         5.010    ELVBST    0.000 ELVORB    0.000    BETA      0.000	REFERENCE INFORMATION REFS       4.4440    SQ IN REFL       13.3330    IN REFB       13.3330    IN XMRP       7.5280    IN YMRP       0.0000    IN ZMRP       1.1940    IN SCALE      0.0055
REFERENCE FILE			

# AEDC VA 1163 MDAC BOOSTER AND ORBITER TEST DATA AT MACH NUMBER 5

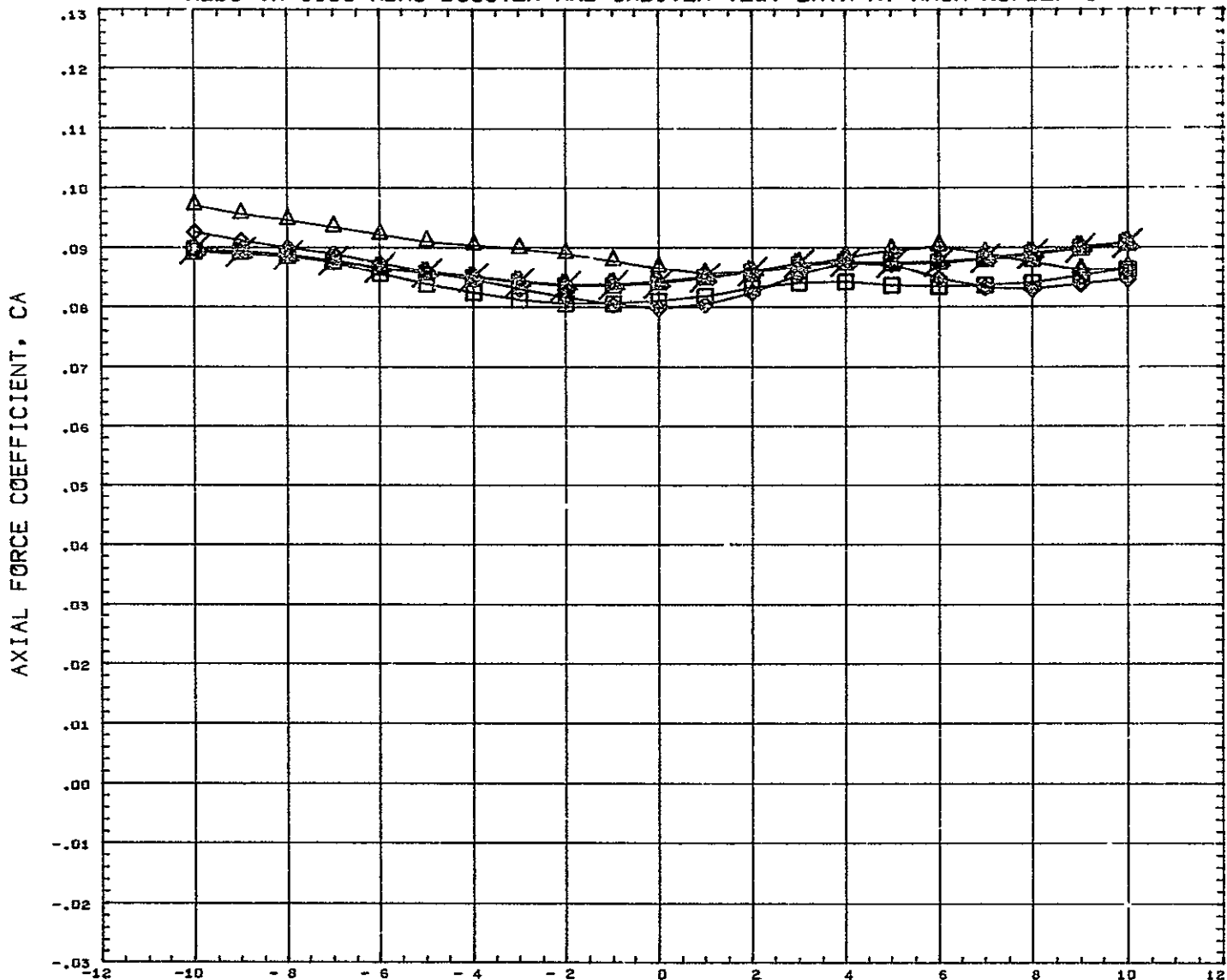

SYMBOL △ ◇ □ ○ ×	DELTAZ 0.151 0.182 0.228 0.352 0.599 10.000	PARAMETRIC VALUES BSTPOW    0.000    ORBPOW    0.000 DELTAX    - 0.143    ALPHAI    5.100 MACH       5.010    ELVBST    0.000 ELVORB    0.000    BETA       0.000	REFERENCE INFORMATION REFS       1.444C    S9 IN REFL       13.333D   IN REFB       13.333D   IN YMRP       7.528D    IN YMRF       9.000D    IN ZMRP       1.194D    IN SCALE       0.0055
REFERENCE FILE			

# AEDC VA 1163 MDAC BOOSTER AND ORBITER TEST DATA AT MACH NUMBER 5

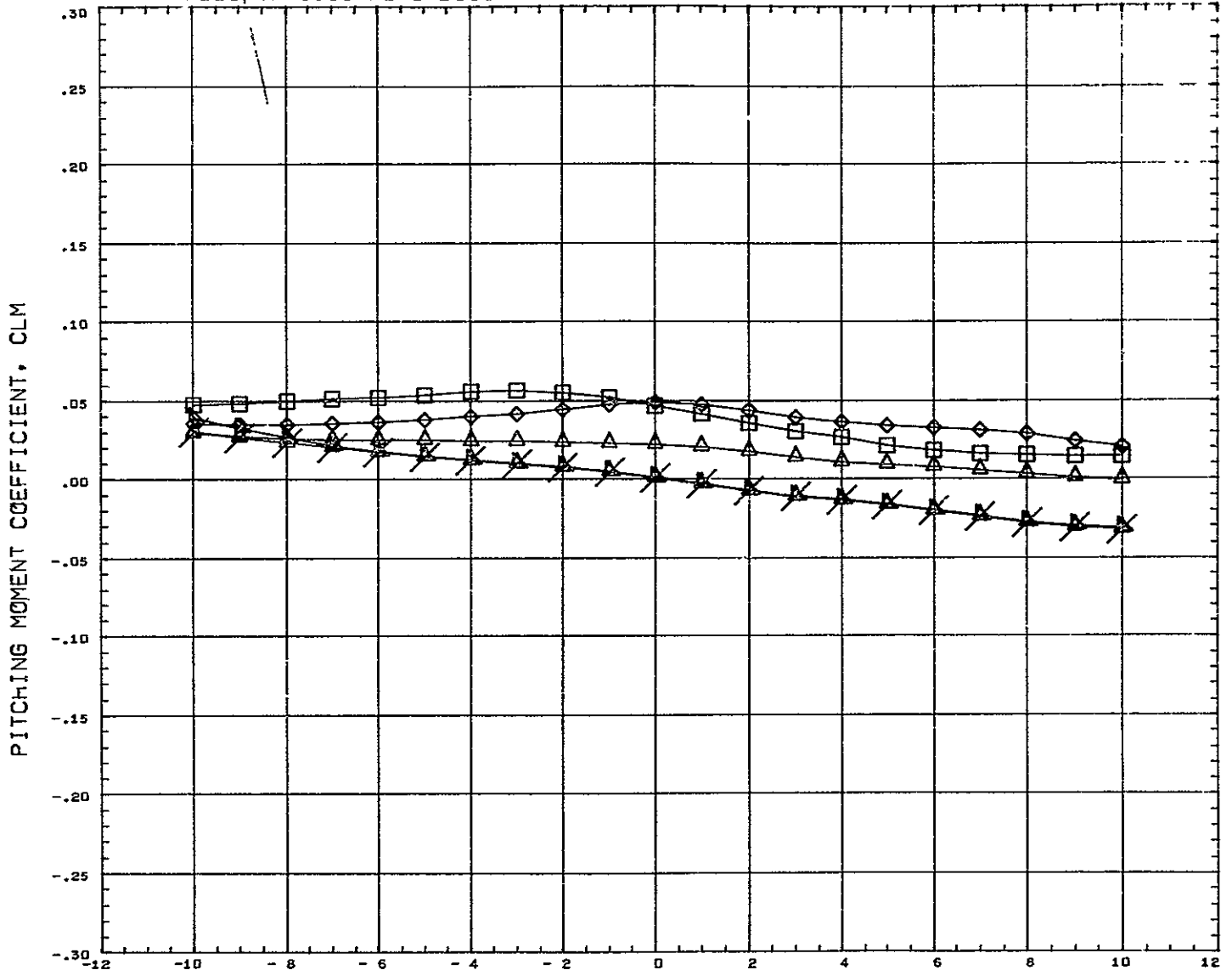

SYMBOL ◻ ◊ ◻ ◻ ◻	DELTAZ 0.151 0.182 0.228 0.352 10.000	<table border="0" style="width: 100%;"> <tr> <th colspan="4" style="text-align: left;">PARAMETRIC VALUES</th> </tr> <tr> <td>BSTFOW</td><td>0.000</td><td>ORBFOW</td><td>0.000</td> </tr> <tr> <td>DELTA X</td><td>0.019</td><td>ALPHA I</td><td>5.100</td> </tr> <tr> <td>MACH</td><td>5.010</td><td>ELVBST</td><td>0.000</td> </tr> <tr> <td>ELVORB</td><td>0.000</td><td>SETA</td><td>0.000</td> </tr> </table>	PARAMETRIC VALUES				BSTFOW	0.000	ORBFOW	0.000	DELTA X	0.019	ALPHA I	5.100	MACH	5.010	ELVBST	0.000	ELVORB	0.000	SETA	0.000	<table border="0" style="width: 100%;"> <tr> <th colspan="2" style="text-align: left;">REFERENCE INFORMATION</th> </tr> <tr> <td>REFS</td><td>1.4440 SQ IN</td> </tr> <tr> <td>REFL</td><td>13.3330 IN</td> </tr> <tr> <td>REFB</td><td>13.3330 IN</td> </tr> <tr> <td>XMRP</td><td>7.5200 IN</td> </tr> <tr> <td>YMRP</td><td>0.0000 IN</td> </tr> <tr> <td>ZMRP</td><td>1.1940 IN</td> </tr> <tr> <td>SCALE</td><td>0.0055</td> </tr> </table>	REFERENCE INFORMATION		REFS	1.4440 SQ IN	REFL	13.3330 IN	REFB	13.3330 IN	XMRP	7.5200 IN	YMRP	0.0000 IN	ZMRP	1.1940 IN	SCALE	0.0055
PARAMETRIC VALUES																																							
BSTFOW	0.000	ORBFOW	0.000																																				
DELTA X	0.019	ALPHA I	5.100																																				
MACH	5.010	ELVBST	0.000																																				
ELVORB	0.000	SETA	0.000																																				
REFERENCE INFORMATION																																							
REFS	1.4440 SQ IN																																						
REFL	13.3330 IN																																						
REFB	13.3330 IN																																						
XMRP	7.5200 IN																																						
YMRP	0.0000 IN																																						
ZMRP	1.1940 IN																																						
SCALE	0.0055																																						

REFERENCE FILE



# AEDC VA 1163 MDAC BOOSTER AND ORBITER TEST DATA AT MACH NUMBER 5

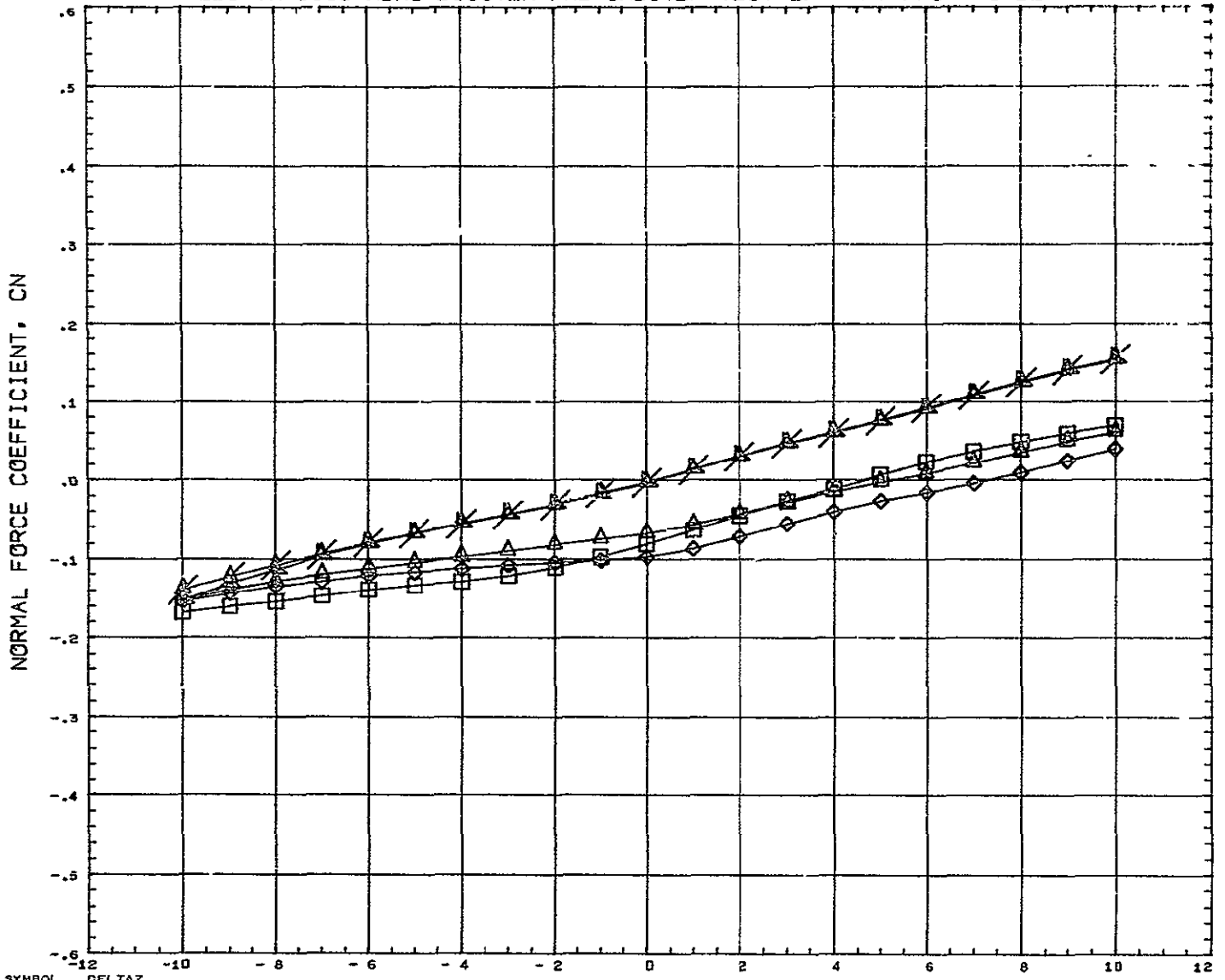

SYMBOL △ ◇ □ ○ ×	DELTA Z 0.151 0.182 0.228 0.352 10.000	PARAMETRIC VALUES BSTFOW    0.000    ORBPOW    0.000 DELTAX    - 0.019    ALPHA1    5.100 MACH       5.010    ELVBST    0.000 ELVORB    0.000    BETA       0.000	REFERENCE INFORMATION REFS       42.4440    SQ IN REFL       13.3330    IN REFB       13.3330    IN XNRF       7.5280    IN YNRF       0.0000    IN ZNRF       1.1940    IN SCALE      0.0055
REFERENCE FILE			

# AEDC VA 1163 MDAC BOOSTER AND ORBITER TEST DATA AT MACH NUMBER 5

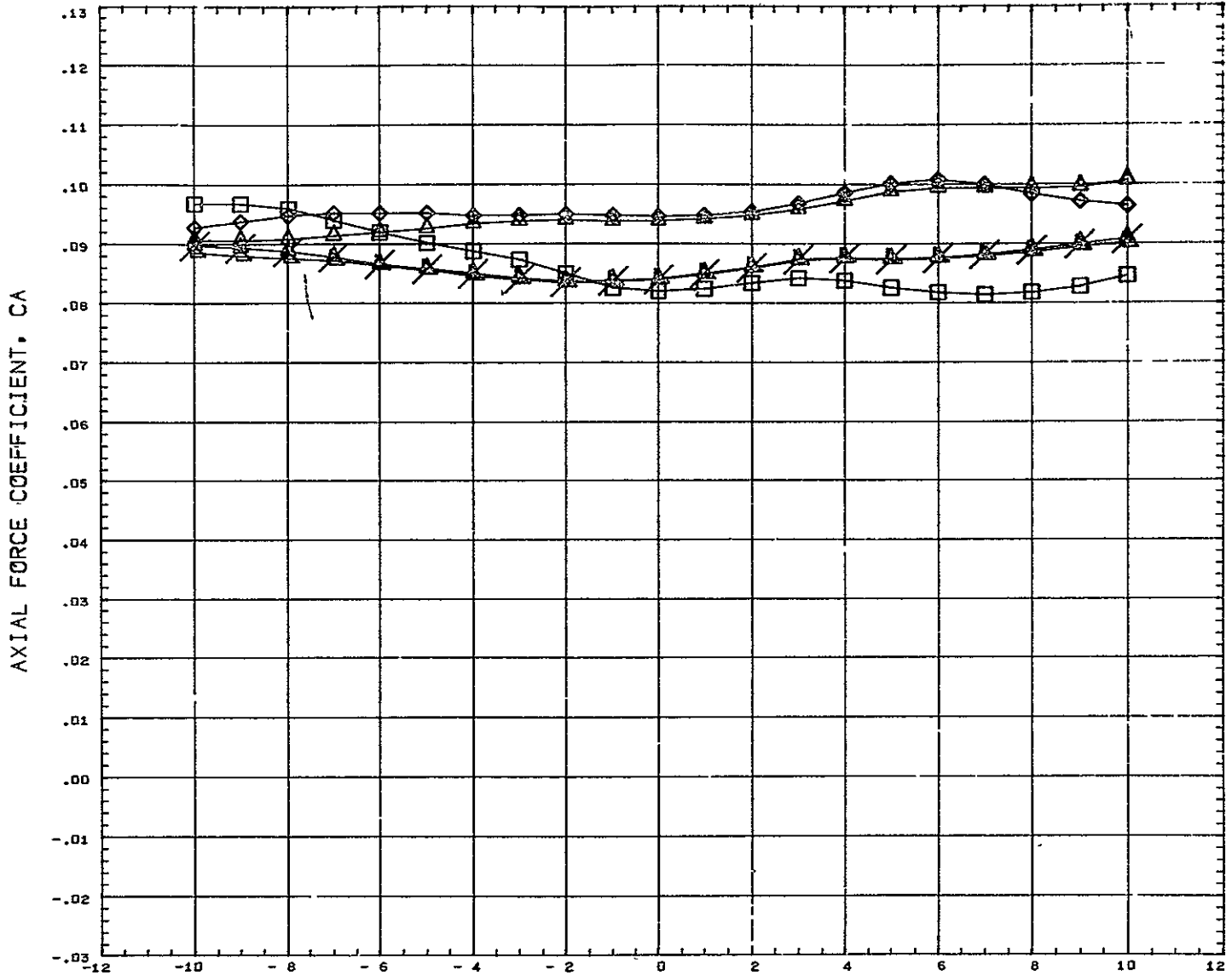

SYMBOL △ ◇ ▽ ×	DELTAZ 0.151 0.182 0.228 0.352 10.000	PARAMETRIC VALUES BSTFOW    0.000    ORBPOW    0 000 DELTAX    - 0.019    ALPHA1    5.100 MACH       5.010    ELVBST    0 000 ELVORB    0.000    BETA       0 000	REFERENCE INFORMATION REFS       44,4440    SQ IN REFL       13.3330    IN REFB       13.3330    IN XMRP       7.5280    IN YMRP       0.0000    IN ZMRP       1.1940    IN SCALE       0.0055
REFERENCE FILE			

# AEDC VA 1163 MDAC BOOSTER AND ORBITER TEST DATA AT MACH NUMBER 5

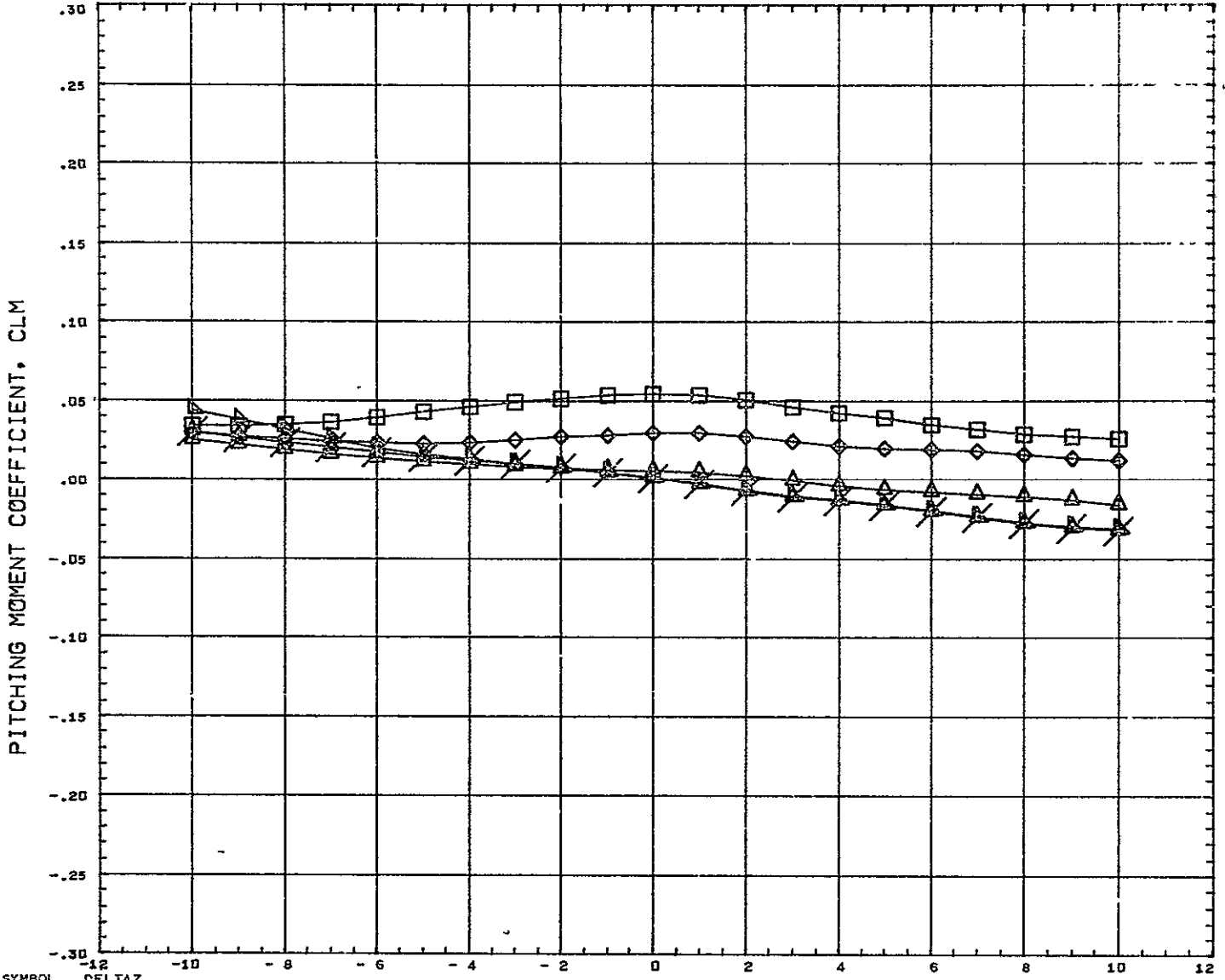

SYMBOL △ ◇ □ ▽ ×	DELTAZ 0.151 0.192 0.228 0.352 10.000	PAPAMETRIC VALUES BSTPOW 0.000 ORBPOW 0.000 DELTAX 0.043 ALPHAI 5.100 IACH 5.010 ELVBST 0.000 ELVORB 0.000 BETA 0.000	REFERENCE INFORMATION REFS 11.444C SQ IN REFL 13.333J IN REFB 13.333G IN XNRF 7.528D IN YNRF 0.0000 IN ZNRF 1.154G IN SCALE 0.0055
REFERENCE FILE			

# AEDC VA 1163 MDAC BOOSTER AND ORBITER TEST DATA AT MACH NUMBER 5

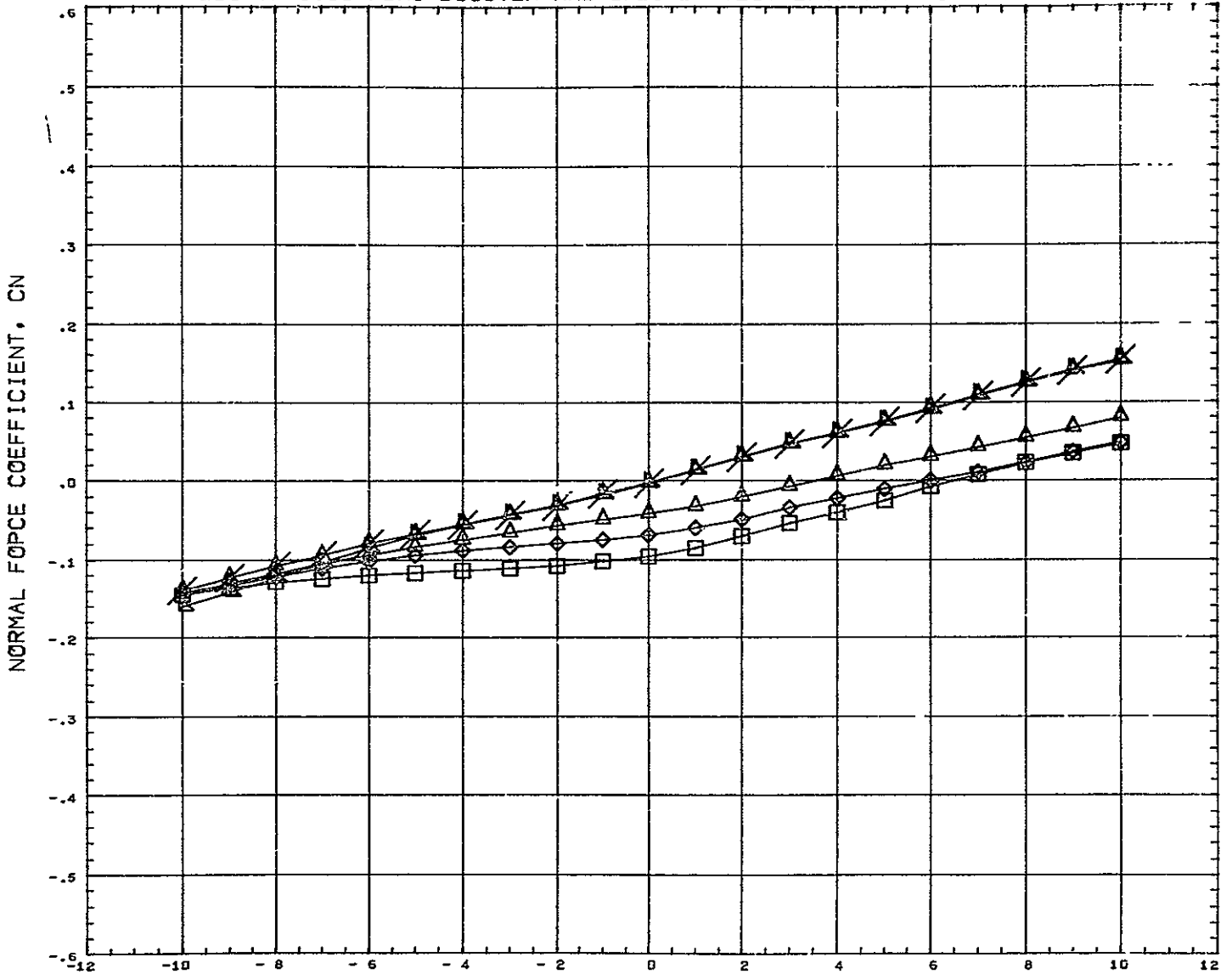

SYMBOL △ ◇ □ ○ ×	DELTAX 0.151 0.182 0.228 0.352 10.000	PARAMETRIC VALUES BSTPOW 0.000 ORBPOW 0.000 DELTAX 0.043 ALPHA1 5.100 MACH 5.010 ELVBST 0.000 ELVORB 0.000 BETA 0.000	REFERENCE INFORMATION REFS 44.444D SQ IN REFL 13.333D IN RFFB 13.333D IN XMRF 7.528D IN YMRF 0 000D IN ZMRF 1 194D IN SCALE 0 0055
REFERENCE FILE			

# AEDC VA 1163 MDAC BOOSTER AND ORBITER TEST DATA AT MACH NUMBER 15

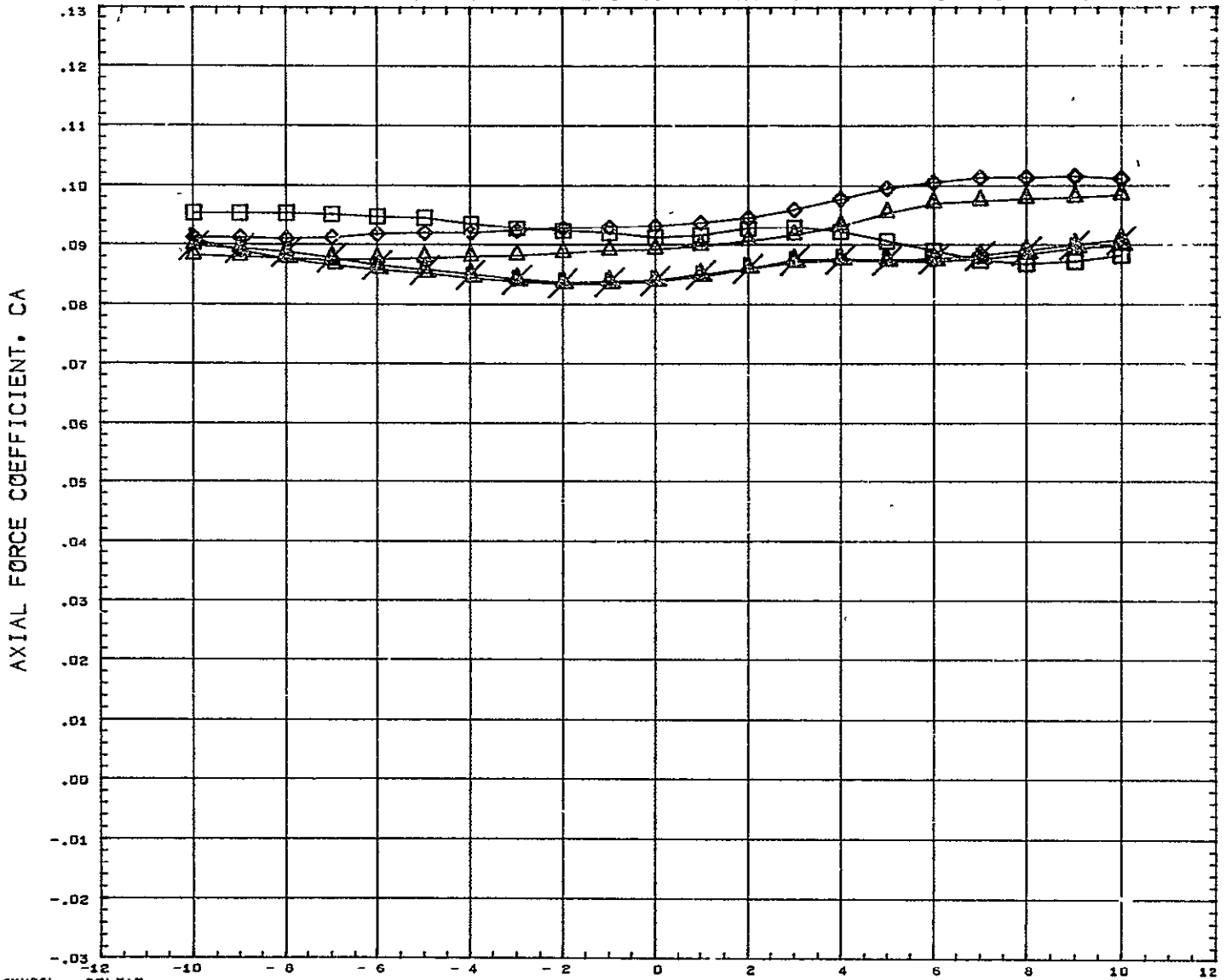

SYMBOL △ ◇ □ ×	DELTA Z 0.151 0.182 0.228 0.352 10.000	<b>PARAMETRIC VALUES</b> BSTFOW    0.000    ORBPOW    0.000 DELTAX    0.043    ALPHAI    5.100 ACH        5.010    ELVBST    0.000 ELVORB    0.000    BETA      0.000	<b>REFERENCE INFORMATION</b> REFS       4.4440    SQ IN REFL       13.3330    IN REFB       13.3330    IN XMRP       7.5280    IN YMRP       0.0000    IN ZMRP       1.1949    IN SCALE      0.0055
REFERENCE FILE			

# AEDC VA 1163 MDAC BOOSTER AND ORBITER TEST DATA AT MACH NUMBER 5

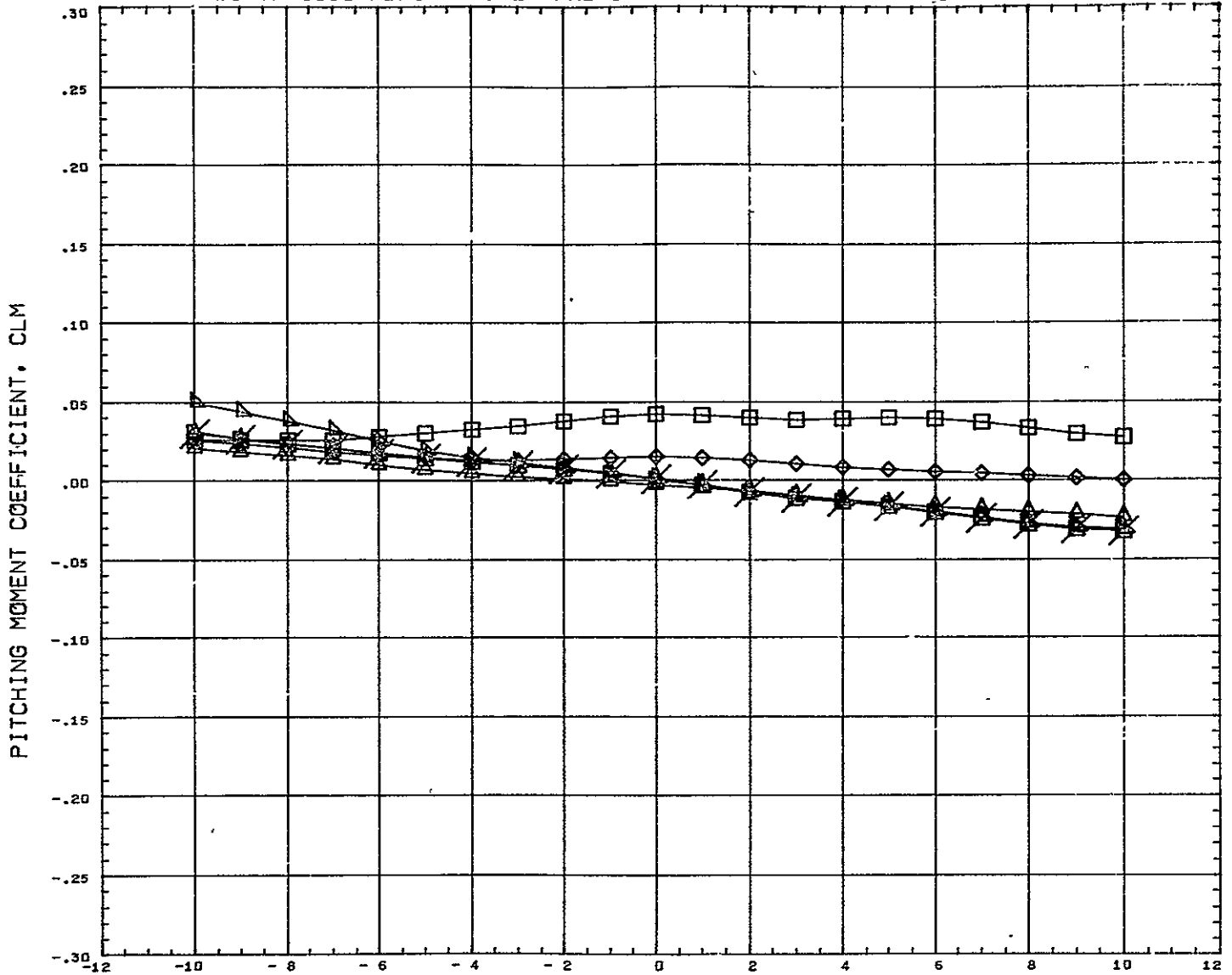

SYMBOL △ ◇ □ ▽ ×	DELTAZ 0.151 0.182 0.228 0.352 0.599 10.000	PARAMETRIC VALUES BSTPOW 0.000 ORBPOW 0.000 DELTAX 0.105 ALPHAI 5.100 ACH 5.010 ELVBST 0.000 ELVORB 0.000 BETA1 0.000	REFERENCE INFORMATION REFS 11.4140 SQ IN REFL 13.3330 IN REFB 13.3330 IN XMRF 7.5280 IN YMRP 0.0000 IN ZMRP 1.1940 IN SCALE 0.0055
---------------------------------	---	---	---

REFERENCE FILE

# AEDC VA 1163 MDAC BOOSTER AND ORBITER TEST DATA AT MACH NUMBER 5

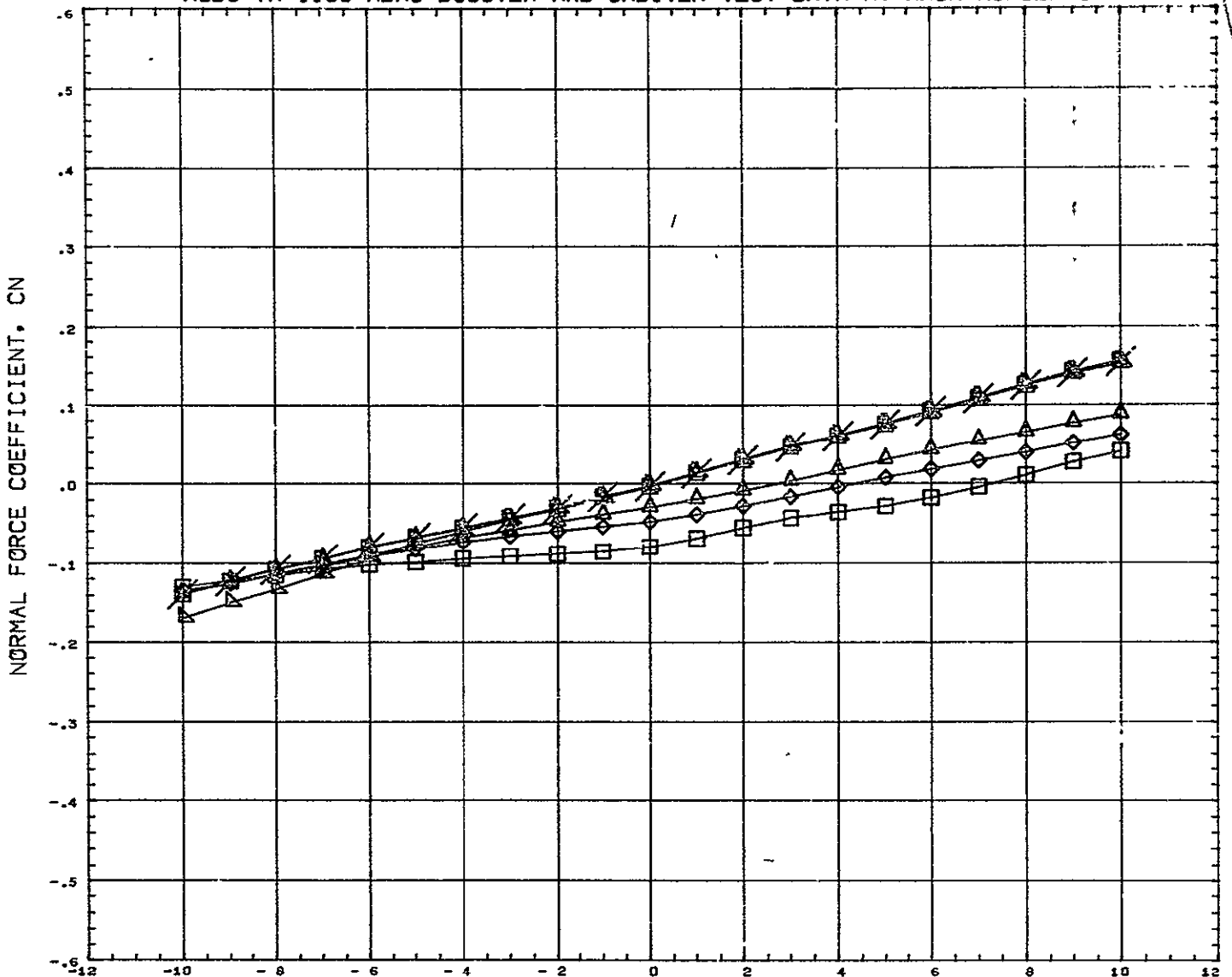

SYMBOL △ ◇ □ ○ ×	DELTAZ 0.151 0.182 0.228 0.352 0.599 10.000 ELVORB	PARAMETRIC VALUES BSTFOW 0.000 DELTAX 0.105 MACH 5.010 ORBFOV 0.000 ALPHAI 5.100 ELVBST 0.000 BETA 0.000	REFERENCE INFORMATION REFS 44.4440 SQ IN REFL 13.3330 IN REFB 13.3330 IN XMRP 7.5280 IN YMRP 0.0000 IN ZMRP 1.1943 IN SCALE 0.0055
---------------------------------	---	---	---

REFERENCE FILE

# AEDC VA 1163 MDAC BOOSTER AND ORBITER TEST DATA AT MACH NUMBER 5

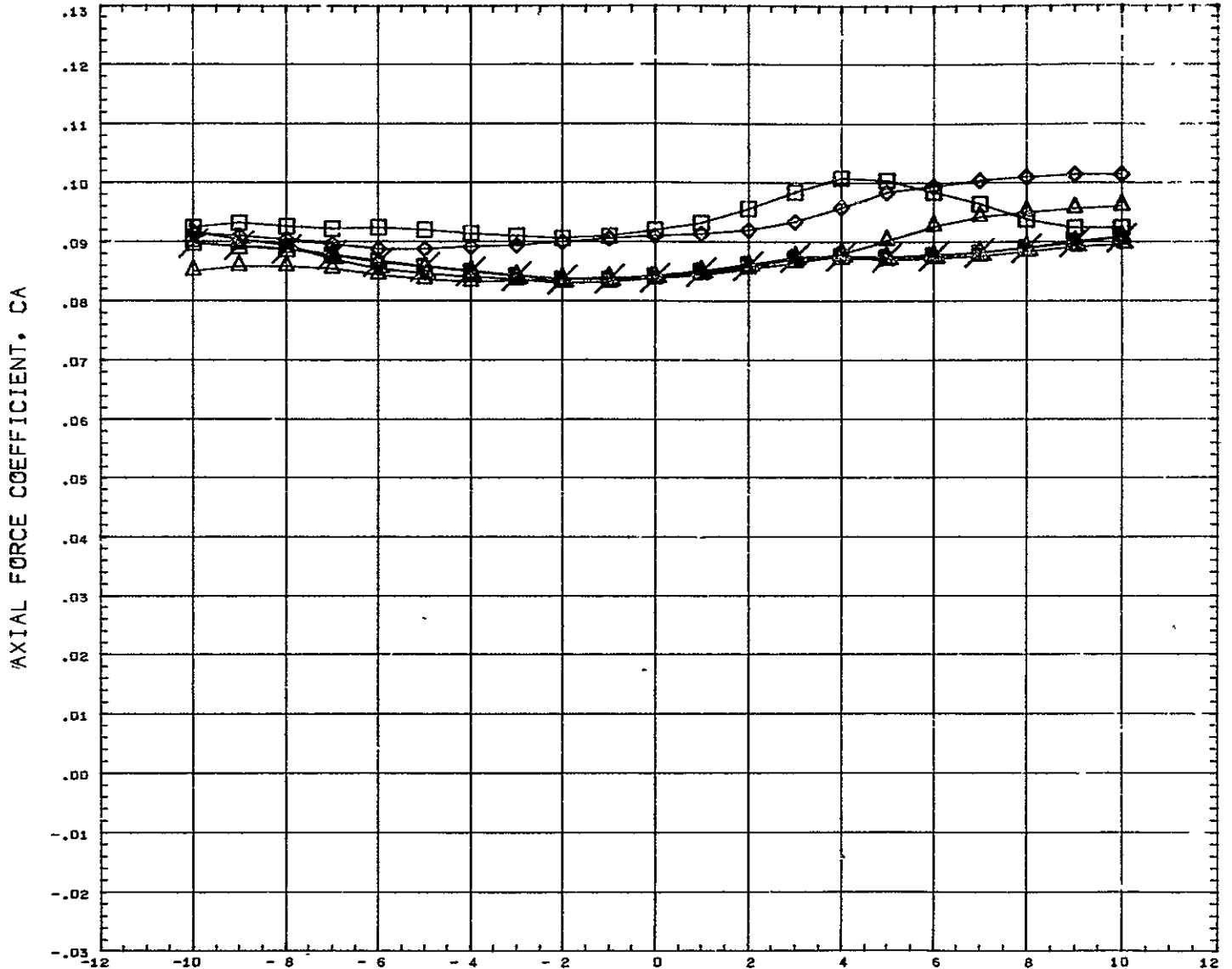

SYMBOL	DELTA Z
△	0.151
◇	0.182
□	0.228
▽	0.352
⊗	0.599
⊗	10.000

PARAMETRIC VALUES			
BSTFOW	0.000	ORBFOW	0.000
DELTA X	0.105	ALPHA I	5.100
MACH	5.010	ELVBST	0.000
ELVORB	0.000	BETA	0.000

REFERENCE INFORMATION		
REFS	44.4447	SQ IN
REFL	13.3330	IN
REFB	13.3330	IN
XMRP	7.5280	IN
YMRP	0.0000	IN
ZMRP	1.1940	IN
SCALE	0.0055	

REFERENCE FILE



# AEDC VA 1163 MDAC BOOSTER AND ORBITER TEST DATA AT MACH NUMBER 5

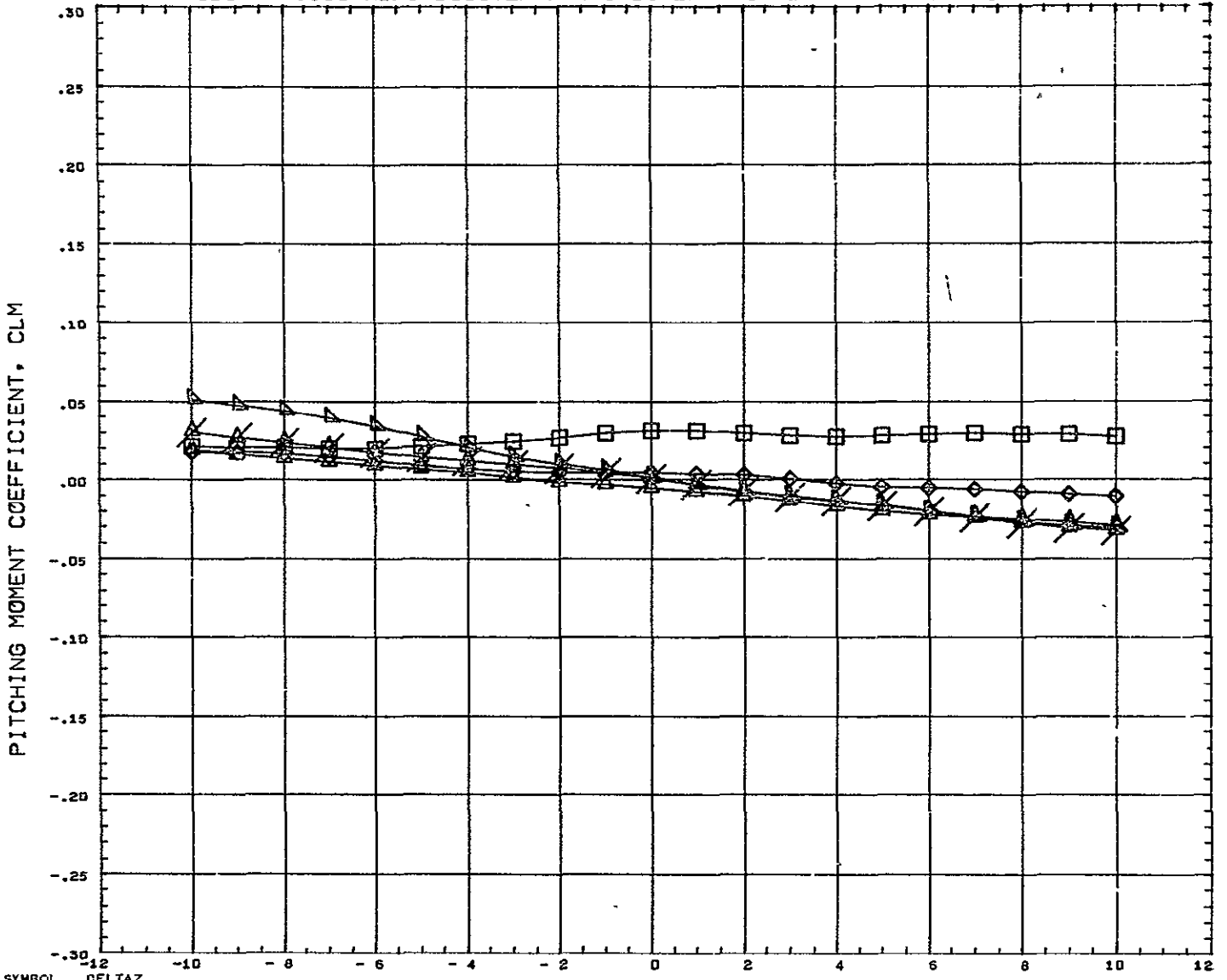

SYMBOL △ ◇ □ ○ ×	DELTAZ 0.151 0.162 0.228 0.352 10.000	<table border="0" style="width: 100%;"> <tr> <th colspan="4" style="text-align: left;">PARAMETRIC VALUES</th> </tr> <tr> <td>BSTPOW</td><td>0.000</td><td>ORBPOW</td><td>0.000</td> </tr> <tr> <td>DELTA X</td><td>0.167</td><td>ALPHA I</td><td>5.100</td> </tr> <tr> <td>ACH</td><td>5.010</td><td>ELVBST</td><td>0.000</td> </tr> <tr> <td>ELVORB</td><td>0.000</td><td>BETA</td><td>0.000</td> </tr> </table>	PARAMETRIC VALUES				BSTPOW	0.000	ORBPOW	0.000	DELTA X	0.167	ALPHA I	5.100	ACH	5.010	ELVBST	0.000	ELVORB	0.000	BETA	0.000	<table border="0" style="width: 100%;"> <tr> <th colspan="3" style="text-align: left;">REFERENCE INFORMATION</th> </tr> <tr> <td>REFS</td><td>44.4440</td><td>SR IN</td> </tr> <tr> <td>REFL</td><td>13.3330</td><td>IN</td> </tr> <tr> <td>REFB</td><td>13.3330</td><td>IN</td> </tr> <tr> <td>XMRP</td><td>7.5280</td><td>IN</td> </tr> <tr> <td>YMRP</td><td>0.0000</td><td>IN</td> </tr> <tr> <td>ZMRP</td><td>1.1940</td><td>IN</td> </tr> <tr> <td>SCALE</td><td>0.0055</td><td></td> </tr> </table>	REFERENCE INFORMATION			REFS	44.4440	SR IN	REFL	13.3330	IN	REFB	13.3330	IN	XMRP	7.5280	IN	YMRP	0.0000	IN	ZMRP	1.1940	IN	SCALE	0.0055	
PARAMETRIC VALUES																																															
BSTPOW	0.000	ORBPOW	0.000																																												
DELTA X	0.167	ALPHA I	5.100																																												
ACH	5.010	ELVBST	0.000																																												
ELVORB	0.000	BETA	0.000																																												
REFERENCE INFORMATION																																															
REFS	44.4440	SR IN																																													
REFL	13.3330	IN																																													
REFB	13.3330	IN																																													
XMRP	7.5280	IN																																													
YMRP	0.0000	IN																																													
ZMRP	1.1940	IN																																													
SCALE	0.0055																																														

REFERENCE FILE

# AEDC VA 1163 MDAC BOOSTER AND ORBITER TEST DATA AT MACH NUMBER 5

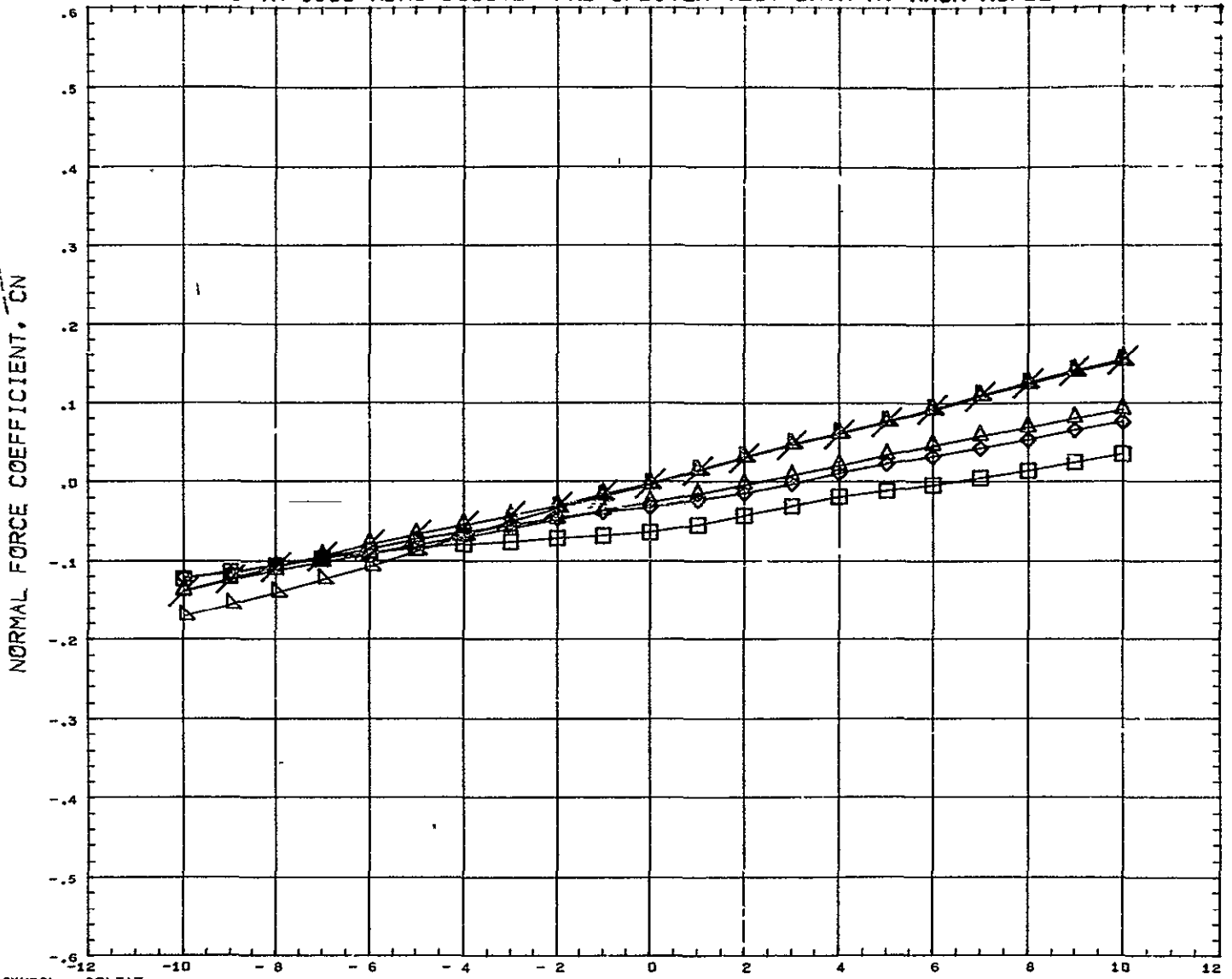

SYMBOL △ ◇ □ ×	DELTAZ 0.151 0.182 0.228 0.352 10.000	PARAMETRIC VALUES BSTPOW 0.000 ORBPOW 0.000 DELTAX 0.167 ALPHAI 5.100 MACH 5.010 ELVBST 0.000 ELVORB 0.000 BETA 0.000	REFERENCE INFORMATION REFS 11.4440 SQ IN PEFL 13.3335 IN REFB 13.3339 IN XMRF 7.5280 IN YMRF 0.0000 IN ZMRF 1.1940 IN SCALE 0.0055
----------------------------	--	---	---

REFERENCE FILE

# AEDC VA 1163 MDAC BOOSTER AND ORBITER TEST DATA AT MACH NUMBER 5

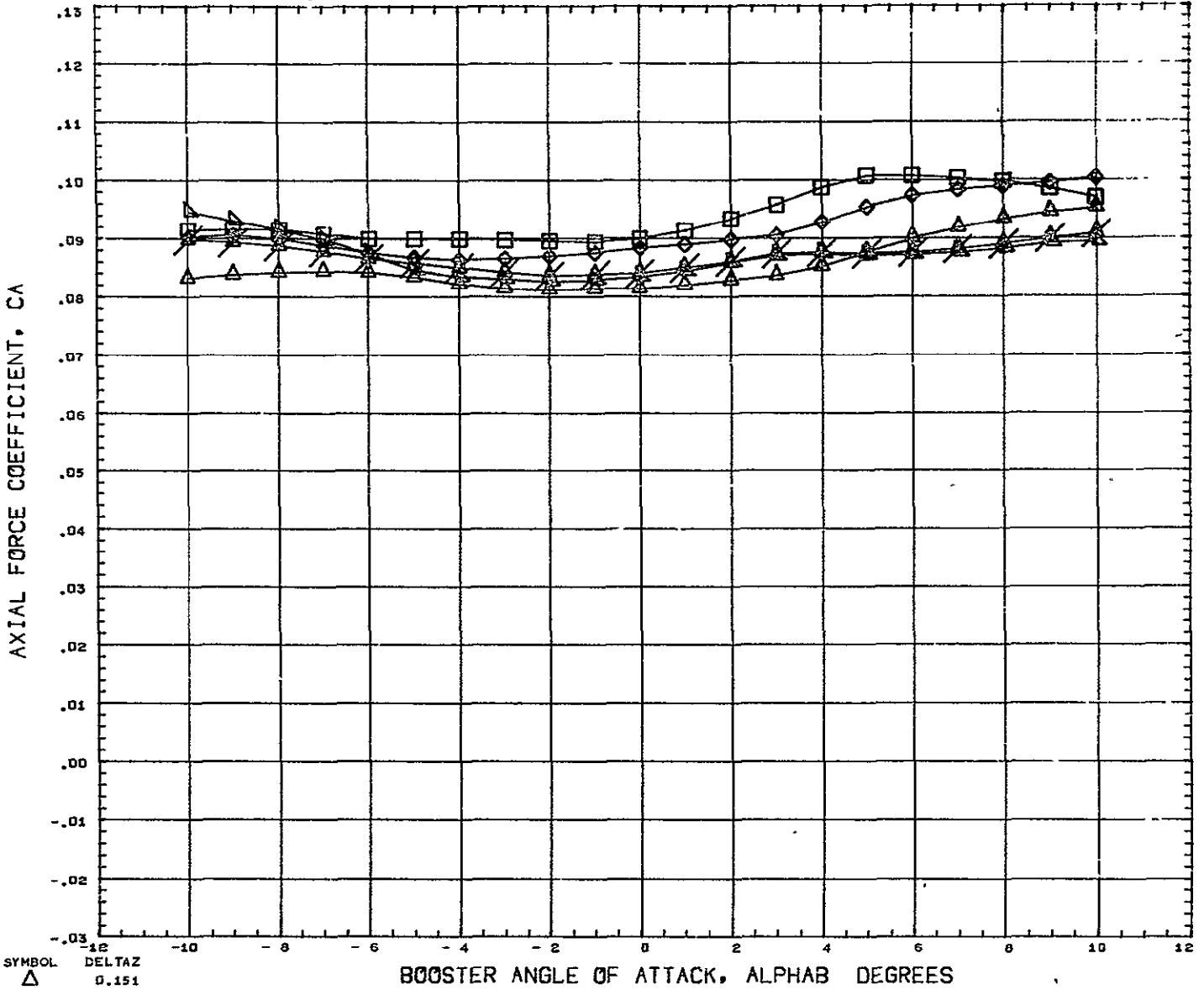

SYMBOL △ ◇ □ ▽ ×	DELTAZ 0.151 0.182 0.228 0.352 10.000	<table border="0" style="width: 100%;"> <tr> <th colspan="4" style="text-align: left; padding-left: 20px;">PARAMETRIC VALUES</th> </tr> <tr> <td style="padding-right: 20px;">BSTPCW</td> <td style="padding-right: 20px;">0.000</td> <td style="padding-right: 20px;">ORPCW</td> <td>0.000</td> </tr> <tr> <td>DELTAZ</td> <td>0.167</td> <td>ALPHA1</td> <td>5.100</td> </tr> <tr> <td>MACH</td> <td>5.010</td> <td>ELVBS</td> <td>0.000</td> </tr> <tr> <td>ELVOR</td> <td>0.000</td> <td>DETA</td> <td>0.000</td> </tr> </table>	PARAMETRIC VALUES				BSTPCW	0.000	ORPCW	0.000	DELTAZ	0.167	ALPHA1	5.100	MACH	5.010	ELVBS	0.000	ELVOR	0.000	DETA	0.000	<table border="0" style="width: 100%;"> <tr> <th colspan="2" style="text-align: left;">REFERENCE INFORMATION</th> </tr> <tr> <td>REFS</td> <td>44.4440 SQ IN</td> </tr> <tr> <td>REFL</td> <td>13.3330 IN</td> </tr> <tr> <td>REFB</td> <td>13.3330 IN</td> </tr> <tr> <td>XMRP</td> <td>7.5280 IN</td> </tr> <tr> <td>YMRP</td> <td>0.0000 IN</td> </tr> <tr> <td>ZMRP</td> <td>1.1940 IN</td> </tr> <tr> <td>SCALE</td> <td>0.0055</td> </tr> </table>	REFERENCE INFORMATION		REFS	44.4440 SQ IN	REFL	13.3330 IN	REFB	13.3330 IN	XMRP	7.5280 IN	YMRP	0.0000 IN	ZMRP	1.1940 IN	SCALE	0.0055
PARAMETRIC VALUES																																							
BSTPCW	0.000	ORPCW	0.000																																				
DELTAZ	0.167	ALPHA1	5.100																																				
MACH	5.010	ELVBS	0.000																																				
ELVOR	0.000	DETA	0.000																																				
REFERENCE INFORMATION																																							
REFS	44.4440 SQ IN																																						
REFL	13.3330 IN																																						
REFB	13.3330 IN																																						
XMRP	7.5280 IN																																						
YMRP	0.0000 IN																																						
ZMRP	1.1940 IN																																						
SCALE	0.0055																																						

REFERENCE FILE

# AEDC VA 1163 MDAC BOOSTER AND ORBITER TEST DATA AT MACH NUMBER 5

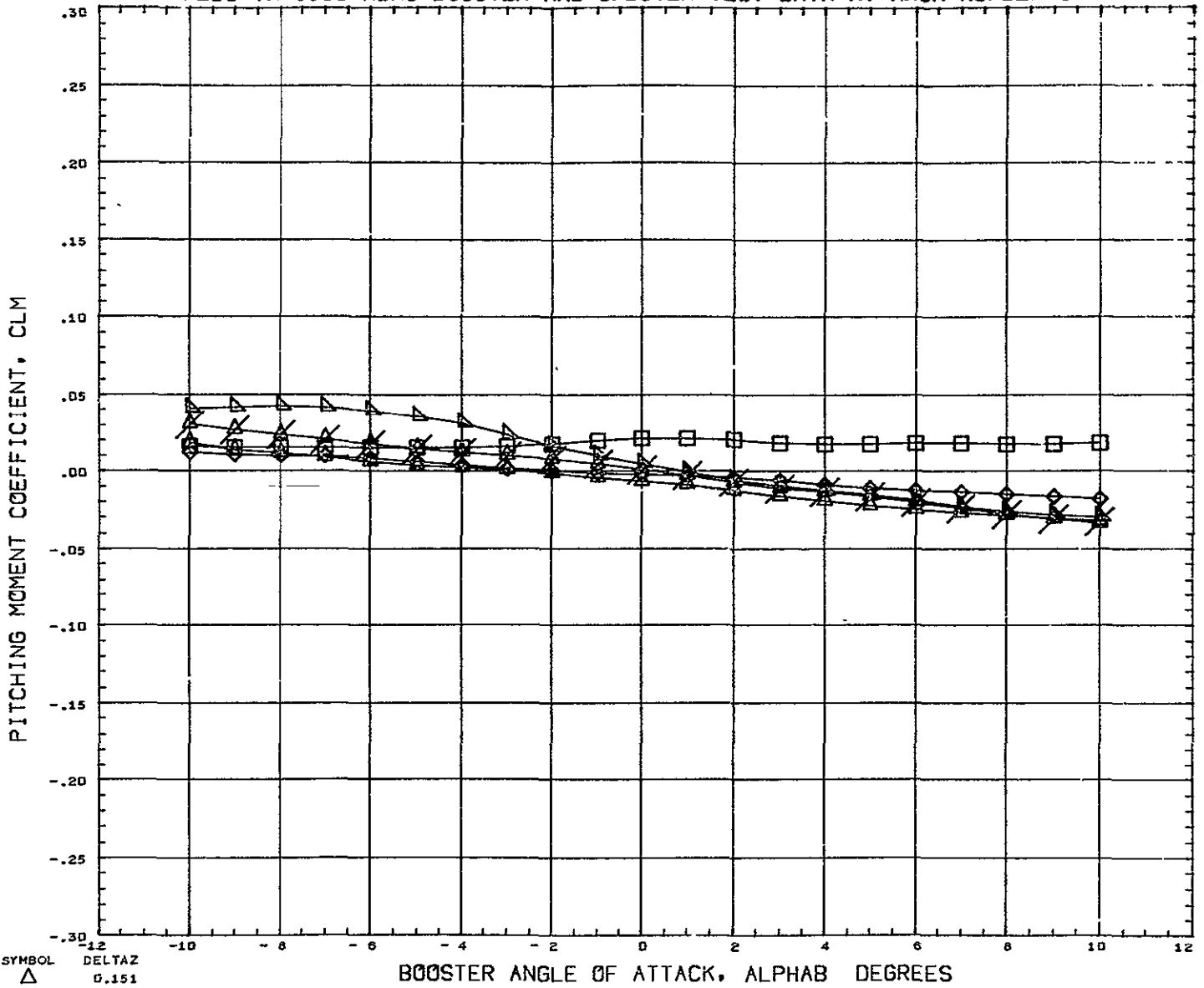

SYMBOL    DELTA Z  
 △        0.151  
 ◇        0.182  
 □        0.228  
 ×        0.352  
 10.000

PARAMETRIC VALUES  
 BSTPOW    0.000    ORBFOW    0.000  
 DELTAX    0.228    ALPHA1    5.100  
 MACH       5.010    ELVBST    0.000  
 ELVORB    0.000    BETA       0.000

REFERENCE INFORMATION  
 REFS       --.4440    SQ IN  
 REFL       13.3330    IN  
 REFB       13.3330    IN  
 XMRP       7.5280    IN  
 YMRP       0.0000    IN  
 ZMRP       1.1540    IN  
 SCALE       0.0055

REFERENCE FILE

# AEDC VA 1163 MDAC BOOSTER AND ORBITER TEST DATA AT MACH NUMBER 5

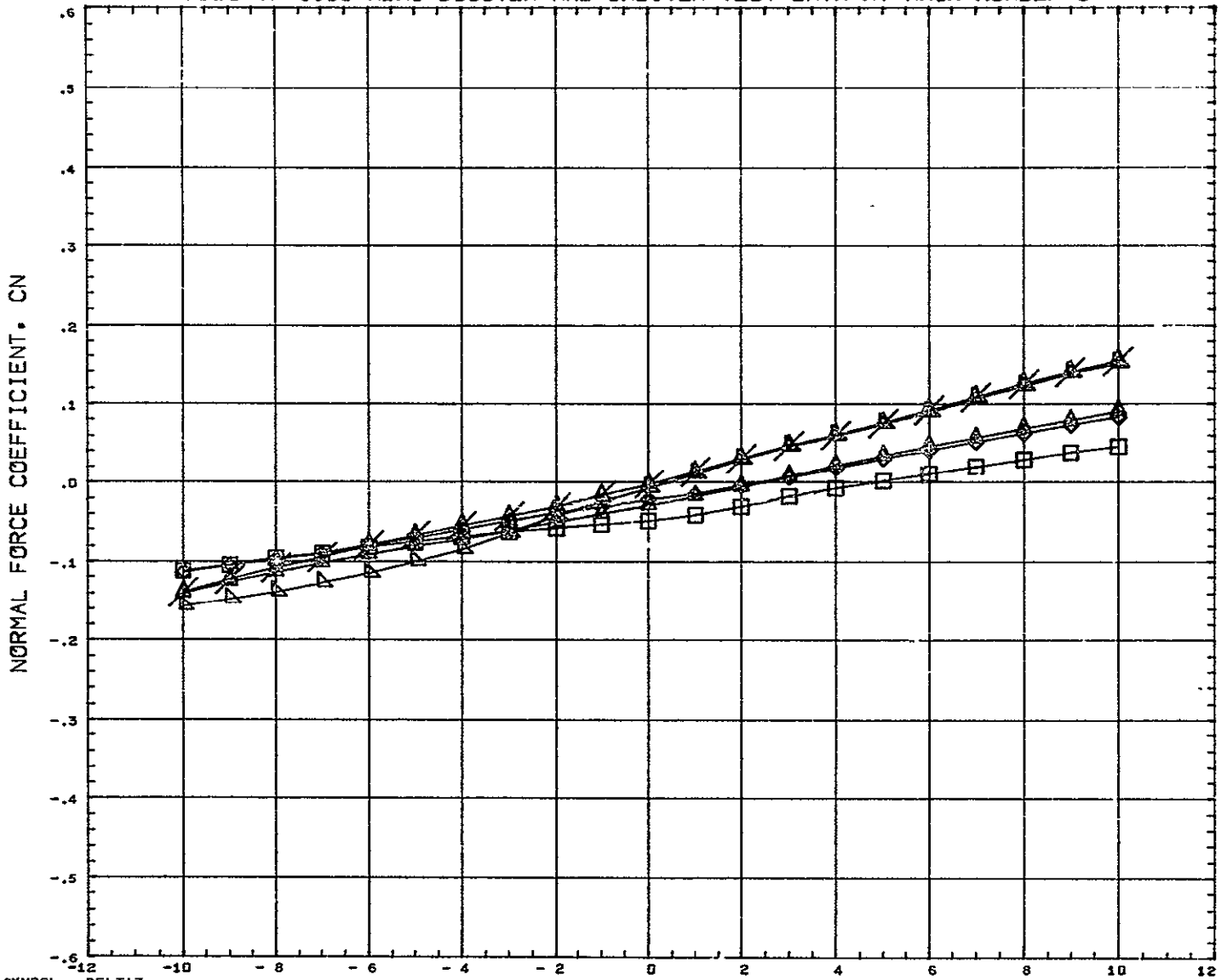

SYMBOL △ ◇ □ ○ ×	DELTAZ 0.151 0.182 0.228 0.352 10.000	<table border="0" style="width: 100%;"> <tr> <th colspan="4" style="text-align: left; padding-left: 20px;">PARAMETRIC VALUES</th> </tr> <tr> <td style="padding-left: 20px;">BSTOPW</td><td>0.000</td><td style="padding-left: 20px;">ORBPOW</td><td>0.000</td></tr> <tr> <td style="padding-left: 20px;">DELTAX</td><td>0.228</td><td style="padding-left: 20px;">ALPHAI</td><td>5.100</td></tr> <tr> <td style="padding-left: 20px;">ELVORB</td><td>0.000</td><td style="padding-left: 20px;">ELVBST</td><td>0.000</td></tr> <tr> <td style="padding-left: 20px;"></td><td></td><td style="padding-left: 20px;">BETA</td><td>0.000</td></tr> </table>	PARAMETRIC VALUES				BSTOPW	0.000	ORBPOW	0.000	DELTAX	0.228	ALPHAI	5.100	ELVORB	0.000	ELVBST	0.000			BETA	0.000	<table border="0" style="width: 100%;"> <tr> <th colspan="3" style="text-align: left;">REFERENCE INFORMATION</th> </tr> <tr> <td style="padding-left: 20px;">REFS</td><td>4.4440</td><td style="padding-left: 20px;">SQ IN</td></tr> <tr> <td style="padding-left: 20px;">REFL</td><td>13.3330</td><td style="padding-left: 20px;">IN</td></tr> <tr> <td style="padding-left: 20px;">REFB</td><td>13.3330</td><td style="padding-left: 20px;">IN</td></tr> <tr> <td style="padding-left: 20px;">XHRP</td><td>7.5280</td><td style="padding-left: 20px;">IN</td></tr> <tr> <td style="padding-left: 20px;">YMRP</td><td>0.0000</td><td style="padding-left: 20px;">IN</td></tr> <tr> <td style="padding-left: 20px;">ZMRP</td><td>1.1340</td><td style="padding-left: 20px;">IN</td></tr> <tr> <td style="padding-left: 20px;">SCALE</td><td>0.0055</td><td></td></tr> </table>	REFERENCE INFORMATION			REFS	4.4440	SQ IN	REFL	13.3330	IN	REFB	13.3330	IN	XHRP	7.5280	IN	YMRP	0.0000	IN	ZMRP	1.1340	IN	SCALE	0.0055	
PARAMETRIC VALUES																																															
BSTOPW	0.000	ORBPOW	0.000																																												
DELTAX	0.228	ALPHAI	5.100																																												
ELVORB	0.000	ELVBST	0.000																																												
		BETA	0.000																																												
REFERENCE INFORMATION																																															
REFS	4.4440	SQ IN																																													
REFL	13.3330	IN																																													
REFB	13.3330	IN																																													
XHRP	7.5280	IN																																													
YMRP	0.0000	IN																																													
ZMRP	1.1340	IN																																													
SCALE	0.0055																																														

# AEDC VA 1163 MDAC BOOSTER AND ORBITER TEST DATA AT MACH NUMBER 5

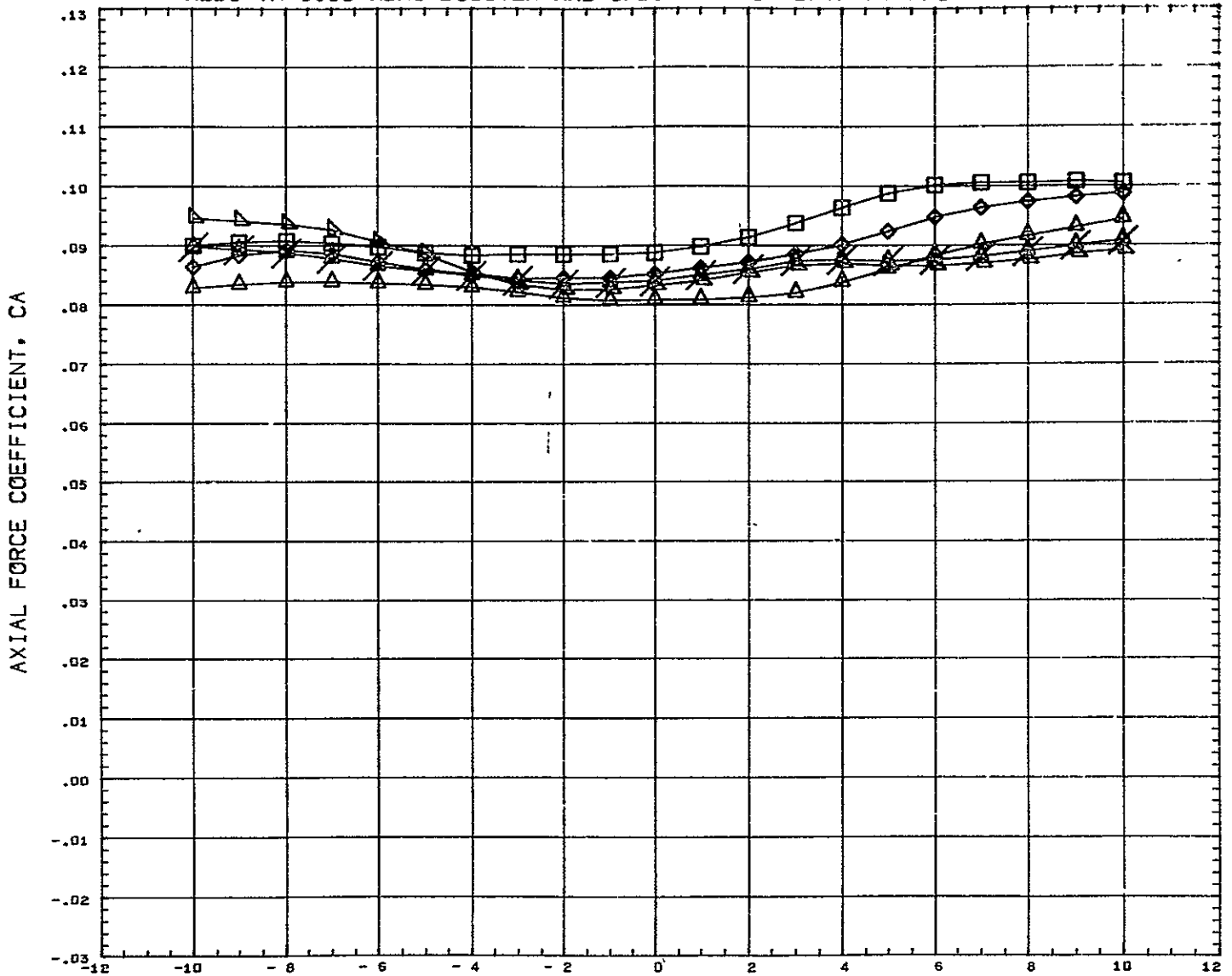

SYMBOL △ ◇ □ △	DELTAZ 0.151 0.182 0.228 0.352 10.000	<table border="0" style="width: 100%;"> <tr> <th colspan="4" style="text-align: left;">PARAMETRIC VALUES</th> </tr> <tr> <td>BSTPOW</td> <td>0.000</td> <td>ORBPOW</td> <td>0.000</td> </tr> <tr> <td>DELTAZ</td> <td>0.228</td> <td>ALPHAI</td> <td>5.100</td> </tr> <tr> <td>MACH</td> <td>5.010</td> <td>ELVBST</td> <td>0.000</td> </tr> <tr> <td>ELVORB</td> <td>0.000</td> <td>BETA</td> <td>0.000</td> </tr> </table>	PARAMETRIC VALUES				BSTPOW	0.000	ORBPOW	0.000	DELTAZ	0.228	ALPHAI	5.100	MACH	5.010	ELVBST	0.000	ELVORB	0.000	BETA	0.000	<table border="0" style="width: 100%;"> <tr> <th colspan="3" style="text-align: left;">REFERENCE INFORMATION</th> </tr> <tr> <td>REFS</td> <td>44 4440</td> <td>SQ IN</td> </tr> <tr> <td>REFL</td> <td>13.3330</td> <td>IN</td> </tr> <tr> <td>REFB</td> <td>13.3330</td> <td>IN</td> </tr> <tr> <td>XMRP</td> <td>7.5280</td> <td>IN</td> </tr> <tr> <td>YMRP</td> <td>0.0000</td> <td>IN</td> </tr> <tr> <td>ZMRP</td> <td>1.1940</td> <td>IN</td> </tr> <tr> <td>SCALE</td> <td>0.0055</td> <td></td> </tr> </table>	REFERENCE INFORMATION			REFS	44 4440	SQ IN	REFL	13.3330	IN	REFB	13.3330	IN	XMRP	7.5280	IN	YMRP	0.0000	IN	ZMRP	1.1940	IN	SCALE	0.0055	
PARAMETRIC VALUES																																															
BSTPOW	0.000	ORBPOW	0.000																																												
DELTAZ	0.228	ALPHAI	5.100																																												
MACH	5.010	ELVBST	0.000																																												
ELVORB	0.000	BETA	0.000																																												
REFERENCE INFORMATION																																															
REFS	44 4440	SQ IN																																													
REFL	13.3330	IN																																													
REFB	13.3330	IN																																													
XMRP	7.5280	IN																																													
YMRP	0.0000	IN																																													
ZMRP	1.1940	IN																																													
SCALE	0.0055																																														

REFERENCE FILE

# AEDC VA 1163 MDAC BOOSTER AND ORBITER TEST DATA AT MACH NUMBER 5

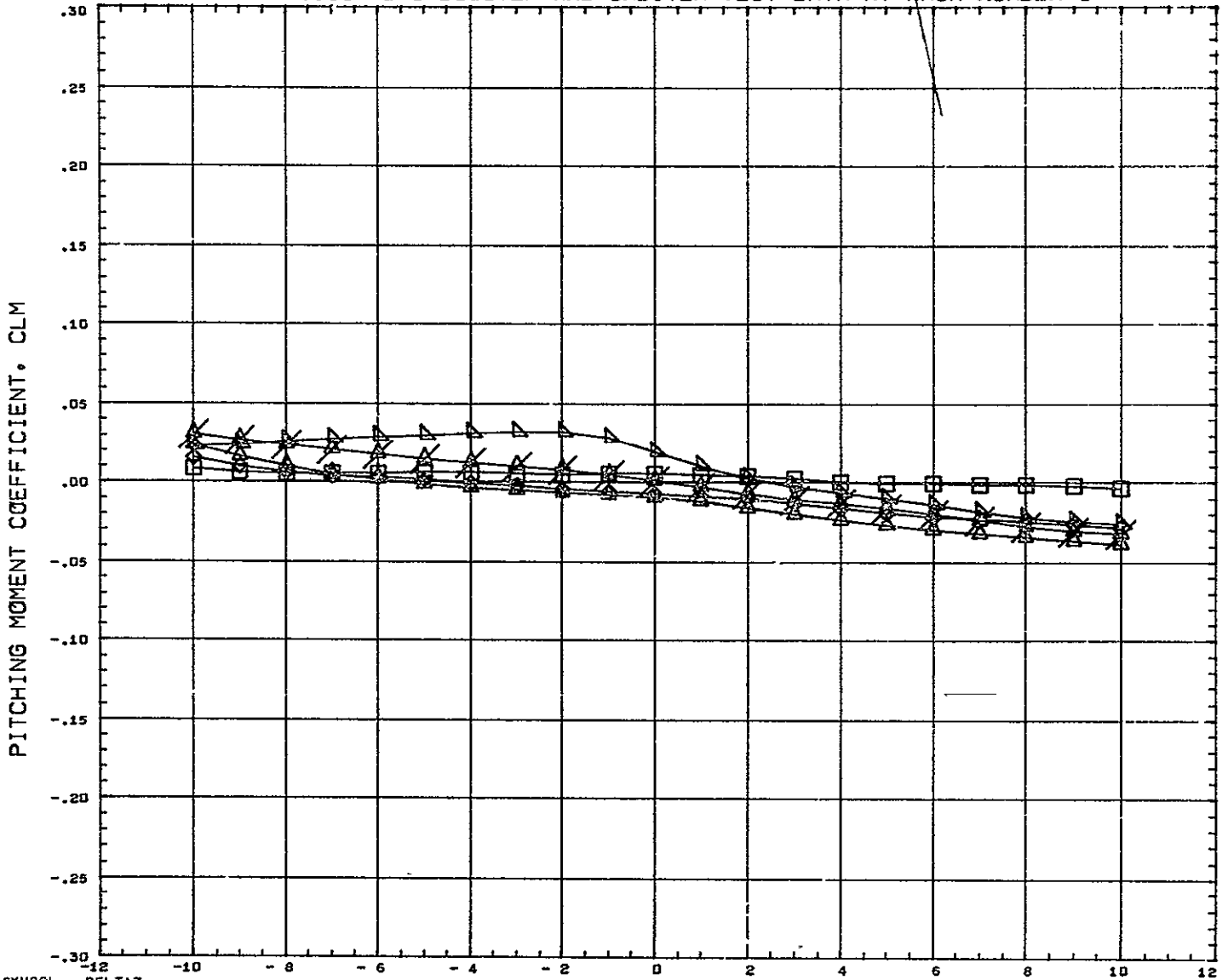

SYMBOL △ ◇ □ ▲	DELTAX 0.151 0.182 0.228 0.352 10.000	PARAMETRIC VALUES BSTFOW 0.000 ORBFOW 0.000 DELTAX 0.352 ALPHAI 5.100 I.CH 5.010 ELVBST 0.000 ELVORB 0.000 BETA 0.000	REFERENCE INFORMATION REFS 44.4440 SQ IN REFL 13.3330 IN REFB 13.3330 IN XMRP 7.5280 IN YMRP 0.0000 IN ZMRP 1.1940 IN SCALE 0.0055
REFERENCE FILE			

# AEDC VA 1163 MDAC BOOSTER AND ORBITER TEST DATA AT MACH NUMBER 5

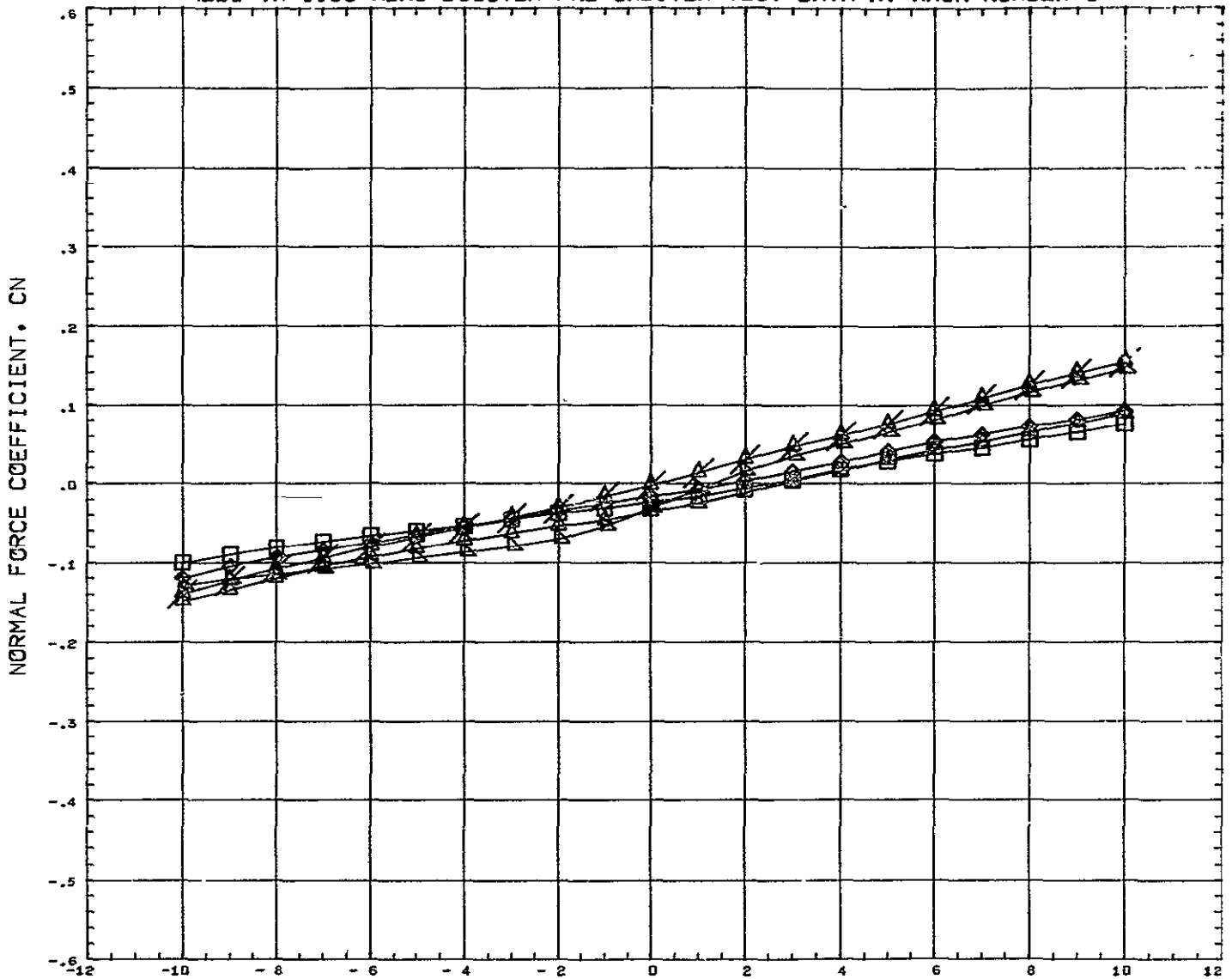

SYMBOL △ □ ◇ ○ ×	DELTAX 0.151 0.182 0.228 0.352 10.000	PARAMETRIC VALUES BSTPOW    0.000    ORBPOW    0.000 DELTAX    0.352    ALPHAI    5.100 MACH      5.010    ELVBST    0.000 ELVORB    0.000    BETA      0.000	REFERENCE INFORMATION REFS      +4.4440    SQ IN REFL      13.3330    IN REFB      13.3330    IN XMRP      7.5280    IN YMRP      0.0000    IN ZMRP      1.1940    IN SCALE     0.0055
---------------------------------	--	---	---

REFERENCE FILE



# AEDC VA 1163 MDAC BOOSTER AND ORBITER TEST DATA AT MACH NUMBER 5

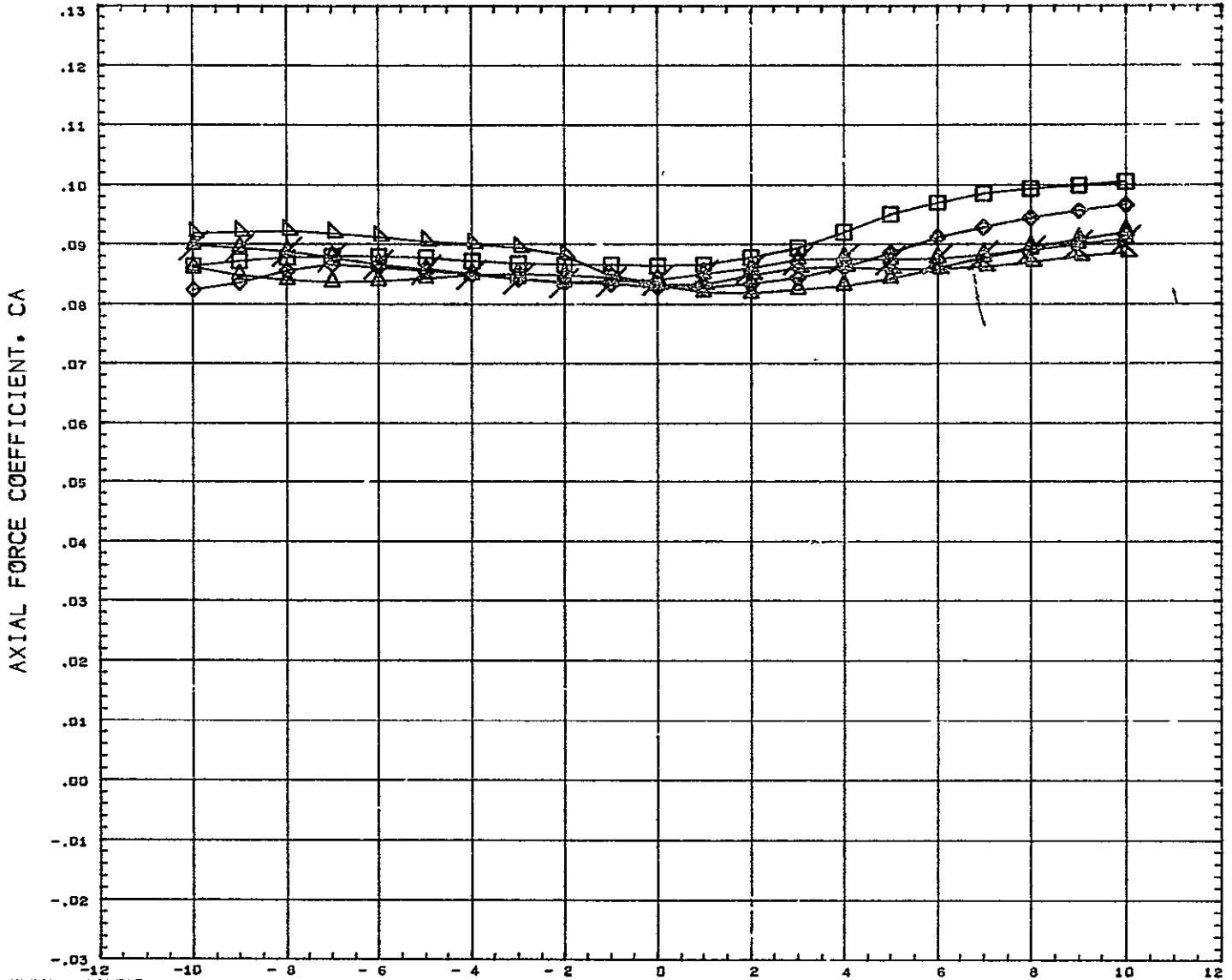

SYMBOL ◇ ◊ ◻ △ ○ ×	DELTA Z 0.151 0.182 0.228 0.352 10.000	MACH 5.010	ELVORB 0.000	PARAMETRIC VALUES BSTPOW 0.000    ORBPOW 0.000 DELTAX 0.352    ALPHAI 5.100 ELVBST 0.000    BETA 0.000	REFERENCE INFORMATION REFS 44.4440    SQ IN REFL 13.3330    IN REFB 13.3330    IN XMRP 7.5220    IN YMRP 0.0000    IN ZMRP 1.1940    IN SCALE 0.0055
--------------------------------------	---	---------------	-----------------	---	---

REFERENCE FILE

# AEDC VA 1163 MDAC BOOSTER AND ORBITER TEST DATA AT MACH NUMBER 5

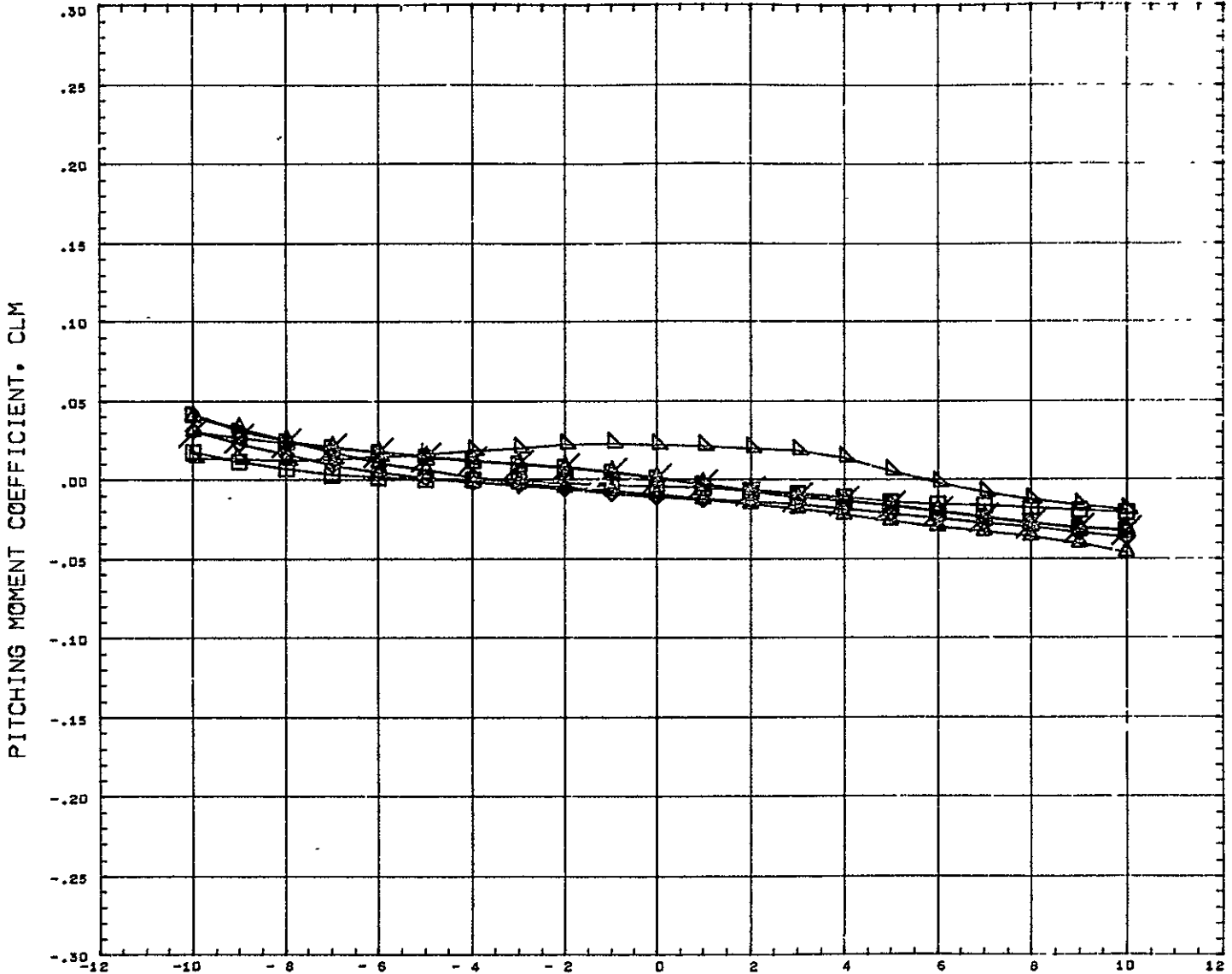

SYMBOL △ ◇ □ ▽ ▲	DELTA Z 0.151 0.102 0.228 0.352 0.599 10.000	<table border="0" style="width: 100%;"> <tr> <th colspan="4" style="text-align: center;">PARAMETRIC VALUES</th> </tr> <tr> <td>BSTPOW</td> <td>0.000</td> <td>ORBPOW</td> <td>0.000</td> </tr> <tr> <td>PLTAX</td> <td>0.522</td> <td>ALPHA1</td> <td>5.100</td> </tr> <tr> <td>MACH</td> <td>5.010</td> <td>ELVBST</td> <td>0.000</td> </tr> <tr> <td>ELVORB</td> <td>0.000</td> <td>BETA</td> <td>0.000</td> </tr> </table>	PARAMETRIC VALUES				BSTPOW	0.000	ORBPOW	0.000	PLTAX	0.522	ALPHA1	5.100	MACH	5.010	ELVBST	0.000	ELVORB	0.000	BETA	0.000	<table border="0" style="width: 100%;"> <tr> <th colspan="3" style="text-align: center;">REFERENCE INFORMATION</th> </tr> <tr> <td>REFS</td> <td>44.444C</td> <td>SQ IN</td> </tr> <tr> <td>REFL</td> <td>13.3330</td> <td>IN</td> </tr> <tr> <td>REFB</td> <td>13.3330</td> <td>IN</td> </tr> <tr> <td>XMRP</td> <td>7.5280</td> <td>IN</td> </tr> <tr> <td>YMRP</td> <td>0.0000</td> <td>IN</td> </tr> <tr> <td>ZMRP</td> <td>1.1940</td> <td>IN</td> </tr> <tr> <td>SCALE</td> <td>0.0055</td> <td></td> </tr> </table>	REFERENCE INFORMATION			REFS	44.444C	SQ IN	REFL	13.3330	IN	REFB	13.3330	IN	XMRP	7.5280	IN	YMRP	0.0000	IN	ZMRP	1.1940	IN	SCALE	0.0055	
PARAMETRIC VALUES																																															
BSTPOW	0.000	ORBPOW	0.000																																												
PLTAX	0.522	ALPHA1	5.100																																												
MACH	5.010	ELVBST	0.000																																												
ELVORB	0.000	BETA	0.000																																												
REFERENCE INFORMATION																																															
REFS	44.444C	SQ IN																																													
REFL	13.3330	IN																																													
REFB	13.3330	IN																																													
XMRP	7.5280	IN																																													
YMRP	0.0000	IN																																													
ZMRP	1.1940	IN																																													
SCALE	0.0055																																														

REFERENCE FILE

# AEDC VA 1163 MDAC BOOSTER AND ORBITER TEST DATA AT MACH NUMBER 5

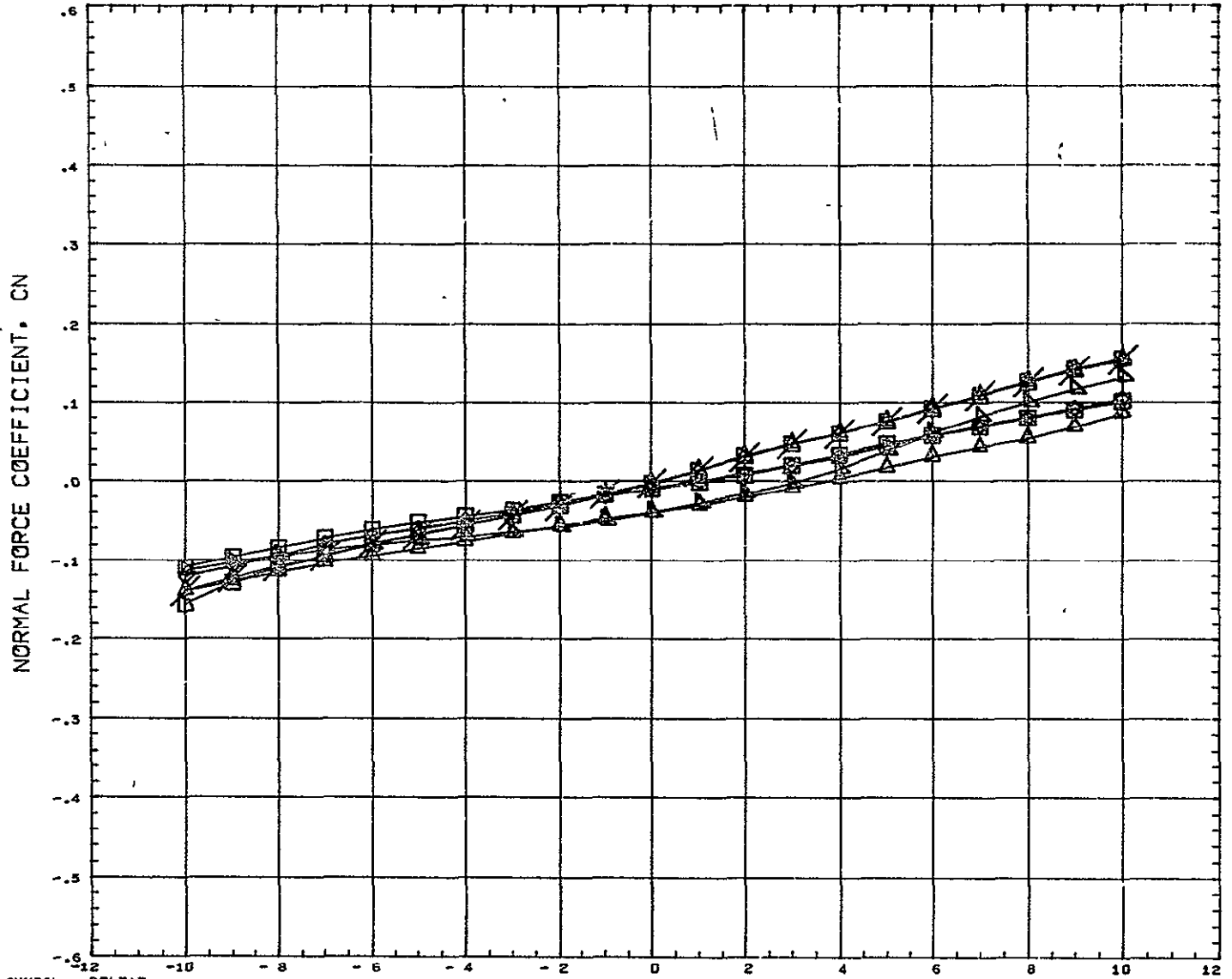

SYMBOL △ ◊ ◻ ○ ×	DELTAZ 0.151 0.182 0.228 0.352 0.599 10.000	<b>PARAMETRIC VALUES</b> BSTPCW 0.000 ORBPCW 0.000 DELTAX 0.522 ALPHAI 5.100 MACH 5.010 ELVBST 0.000 ELVORB 0.000 BETA 0.000	<b>REFERENCE INFORMATION</b> REFS 44.4440 SQ IN REFL 13.3330 IN REFB 13.3330 IN XMRP 7.5280 IN YMRP 0.0000 IN ZMRP 1.1940 IN SCALE 0.0055
REFERENCE FILE			

# AEDC VA 1163 MDAC BOOSTER AND ORBITER TEST DATA AT MACH NUMBER 5

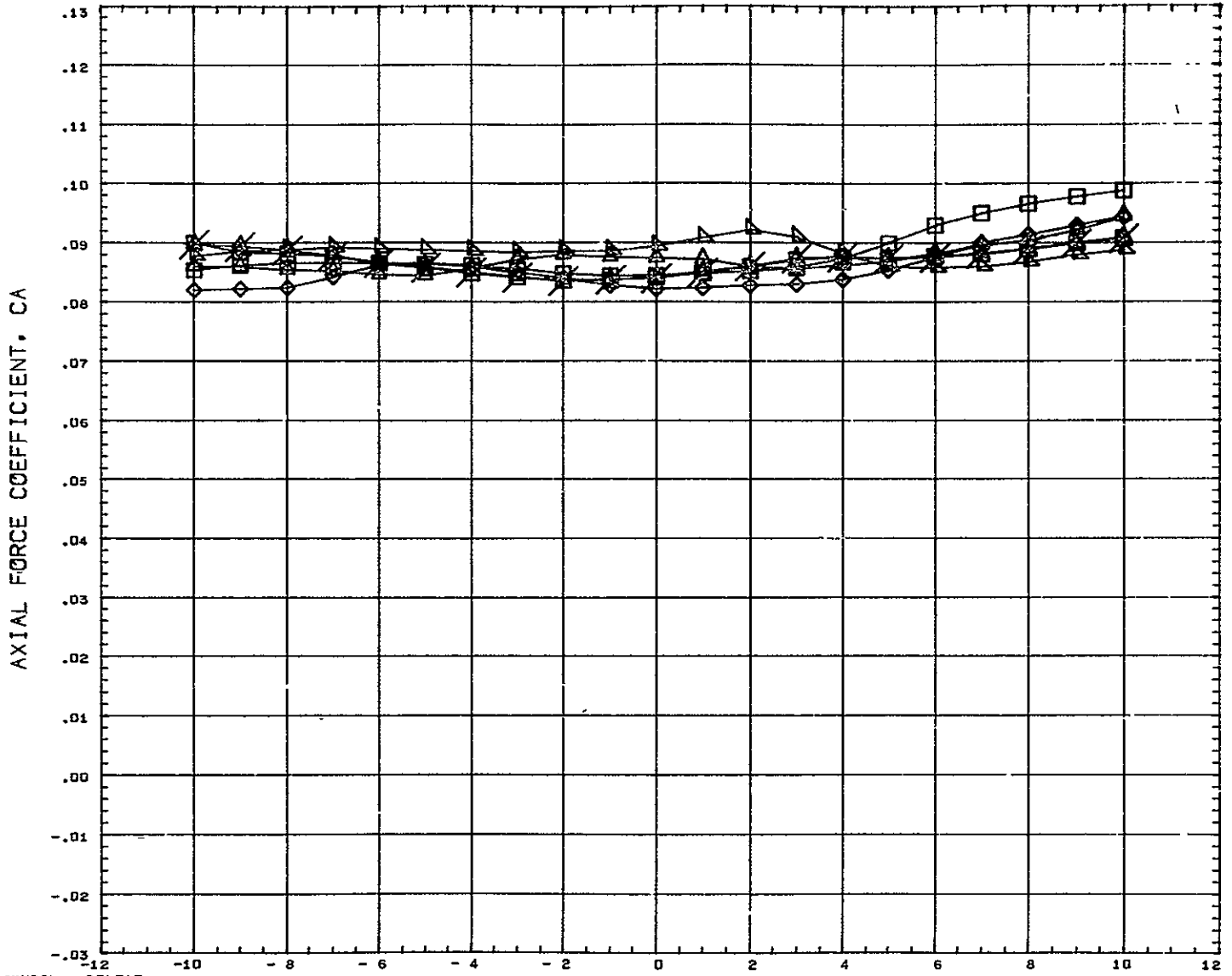

SYMBOL	DELTAZ	PARAMETRIC VALUES				REFERENCE INFORMATION	
△	0.151					REFS	47.4440 SQ IN
◇	0.182					REFL	13.3330 IN
□	0.228	BSTPOW	0.000	ORBPOW	0.000	REFB	13.3330 IN
○	0.352	DELTAZ	0.522	ALPHA1	5.100	XMRF	7.5280 IN
×	0.599	F CH	5.010	ELVBST	0.000	YMRF	0.0000 IN
△	10.000	ELVORB	0.000	BETA	0.000	ZMRF	1.1940 IN
						SCALE	0.0055

REFERENCE FILE

# AEDC VA 1163 MDAC BOOSTER AND ORBITER TEST DATA AT MACH NUMBER 5

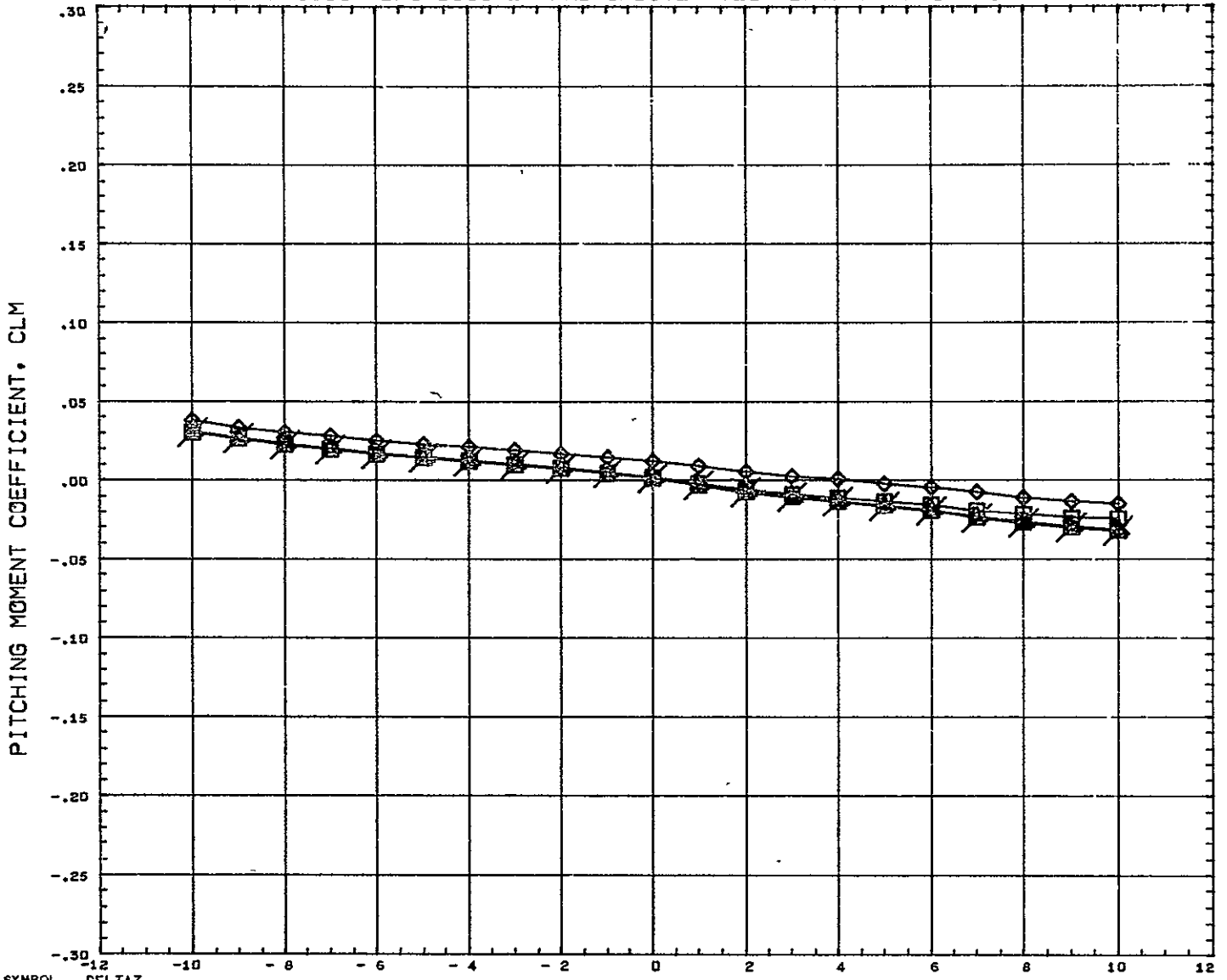

SYMBOL 	DELTAZ 0.182 0.228 0.352 0.599 10.000	<b>PARAMETRIC VALUES</b> BSTFOW    0.000    ORBPOW    0.000 DELTAX    - 0.391    ALPHA1    10.100 MACH       5.010    ELVBST    0.000 ELVORB     0.000    BETA       0.000	<b>REFERENCE INFORMATION</b> REFS       -4.4440    SQ IN REFL       13.3330    IN REFB       13.3330    IN XMRP       7.5280    IN YMRP       0.0000    IN ZMRP       1.1940    IN SCALE       0.0055
REFERENCE FILE			

# AEDC VA 1163 MDAC BOOSTER AND ORBITER TEST DATA AT MACH NUMBER 5

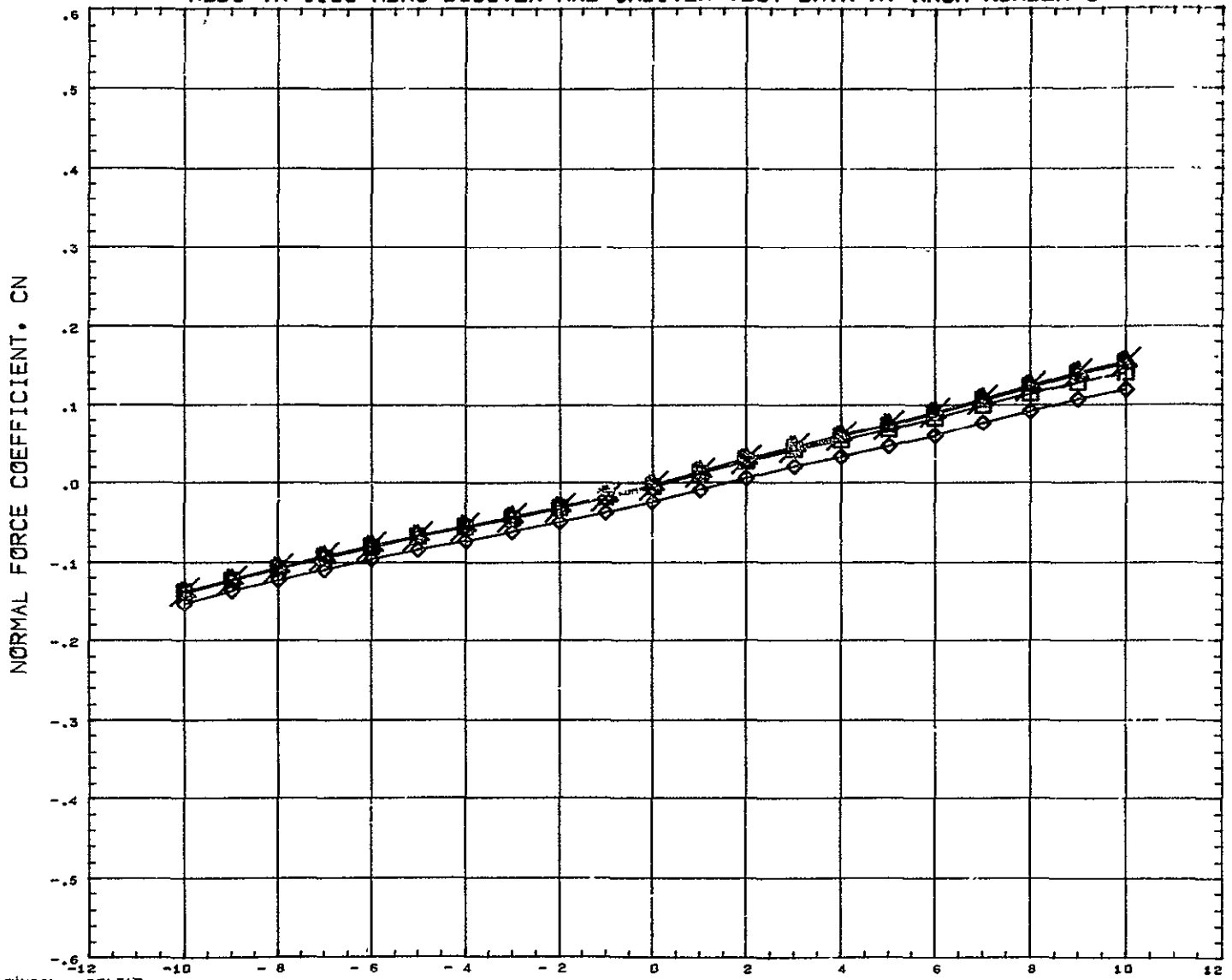

SYMBOL 	DELTAZ 0.182 0.228 0.352 0.599 10.000	PARAMETRIC VALUES BSTPOW 0.000 ORBPOW 0.000 DELTAX - 0.391 ALPHAI 10.100 P.CH 5.010 ELVBST 0.000 ELVORB 0.000 BETA 0.000	REFERENCE INFORMATION REFS 44.4440 SQ IN REFL 13.3330 IN REFB 13.3330 IN XMRP 7.5280 IN YMRP 0.0000 IN ZMRP 1.1940 IN SCALE 0.0055	
REFERENCE FILE				

# AEDC VA 1163 MDAC BOOSTER AND ORBITER TEST DATA AT MACH NUMBER 5

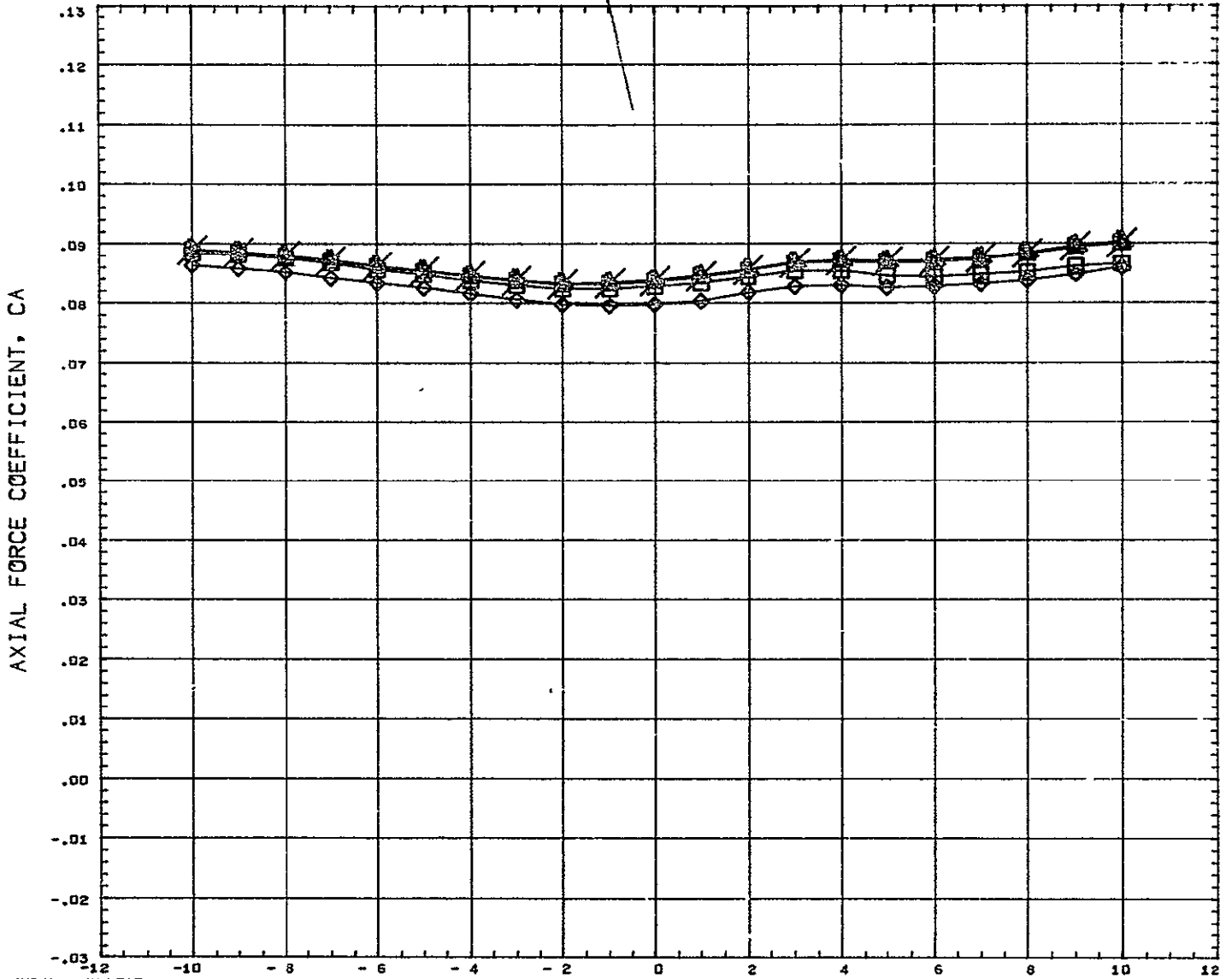

SYMBOL 	DELTAZ 0.182 0.228 0.352 0.599 10.000	PARAMETRIC VALUES BSTPOW    0.000    ORBPOW    0.000 DELTAX    - 0.391    ALPHA1    10.100 MACH       5.010    ELVBST    0.000 ELVORB     0.000    BETA       0.000	REFERENCE INFORMATION REFS       44.4440    SQ IN REFL       13.3330    IN REFB       13.3330    IN XMRP       7.5280    IN YMRP       0.0000    IN ZHRP       1.1940    IN SCALE      0.0055
REFERENCE FILE			

# AEDC VA 1163 MDAC BOOSTER AND ORBITER TEST DATA AT MACH NUMBER 5

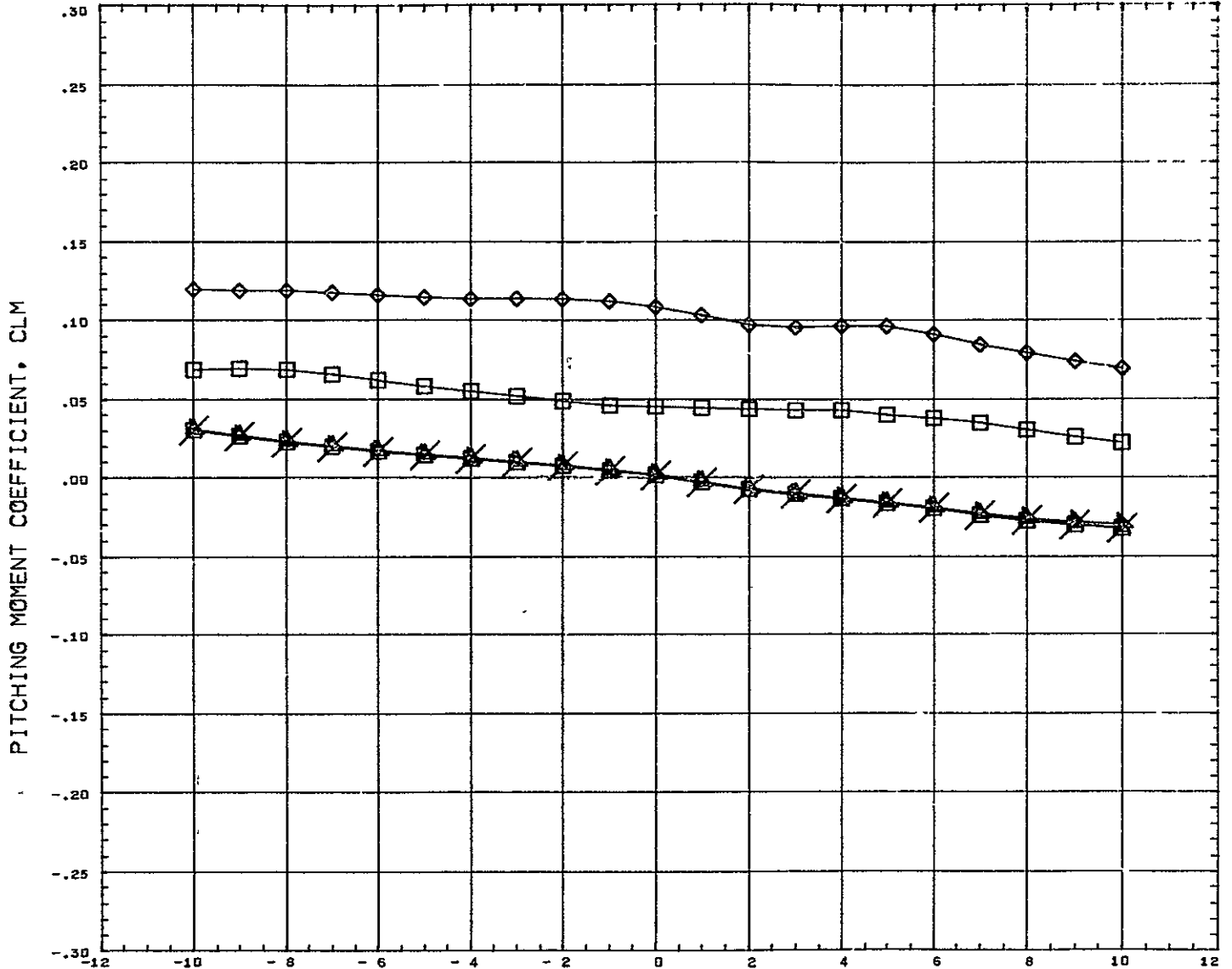

SYMBOL ◇ □ △	DELTAZ 0.182 0.228 0.352 0.599 10.000	PARAMETRIC VALUES BSTPOW 0.000 ORBPOW 0.000 DELTAX - 0.143 ALPHAI 10.100 MACH 5.010 ELVBST 0.000 ELVORB 0.000 BETA 0.000	REFERENCE INFORMATION REFS 44.4440 SQ IN REFL 13.3330 IN REFB 13.3330 IN XMRF 7.5280 IN YMRF 0.0000 IN ZMRF 1.1940 IN SCALE 0.0055
-----------------------	--	--	---

REFERENCE FILE



# AEDC VA 1163 MDAC BOOSTER AND ORBITER TEST DATA AT MACH NUMBER 5

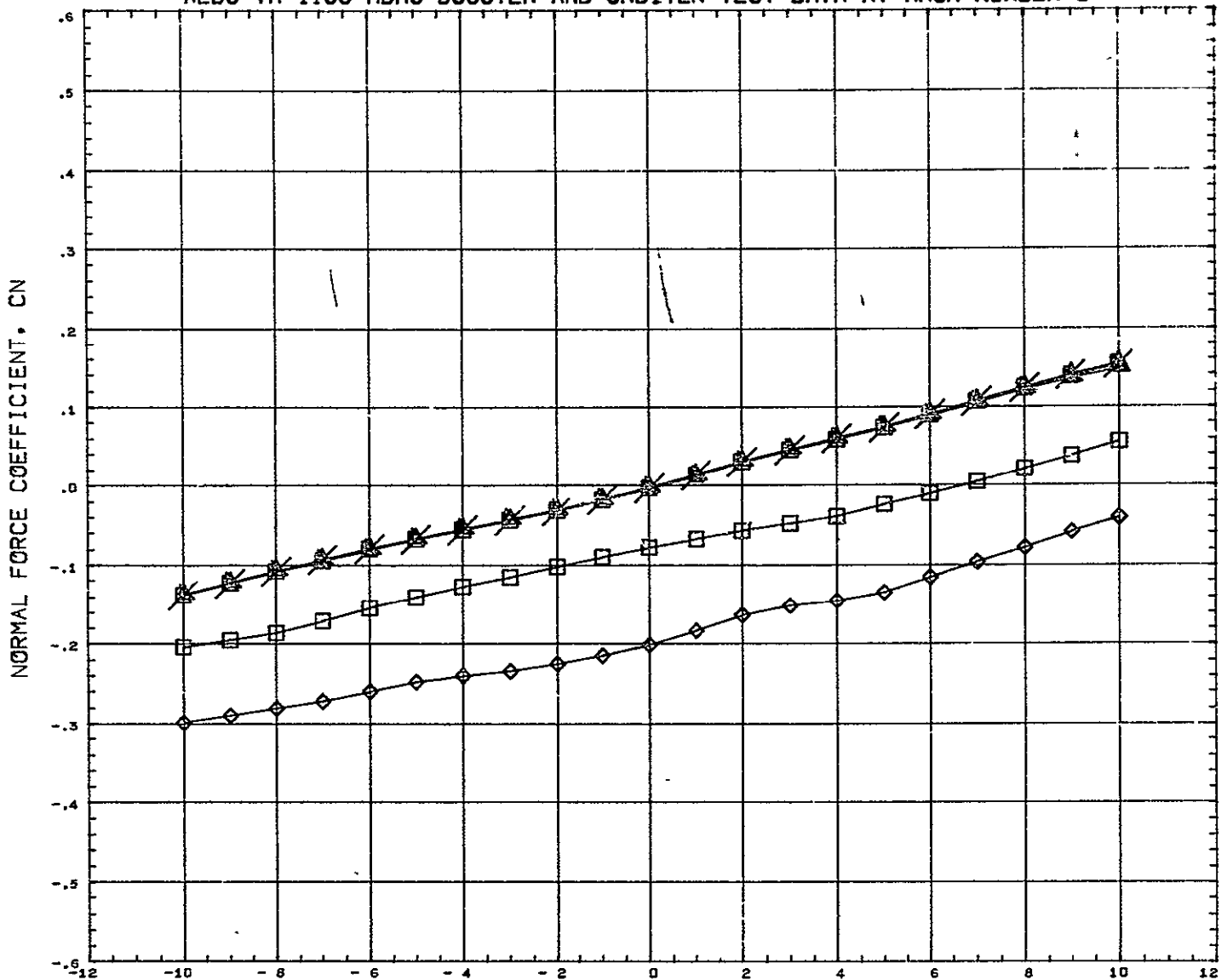

SYMBOL ◇ □ △	DELTA Z 0.182 0.228 0.352 0.599 10.000	PARAMETRIC VALUES BSTFOW    0.000    ORBPOW    0.000 DELTA X   - 0.143    ALPHAI    10.100 ACH        5.010    ELVBST    0.000 ELVORB    0.000    BETA      0.000	REFERENCE INFORMATION REFS       44.4440    SQ IN REFL       13.3330    IN REFB       13.3330    IN XHRF       7.5280    IN YHRF       0.0000    IN ZHRF       1.1944    IN SCALE      0.0055
REFERENCE FILE			

# AEDC VA 1163 MDAC BOOSTER AND ORBITER TEST DATA AT MACH NUMBER 5

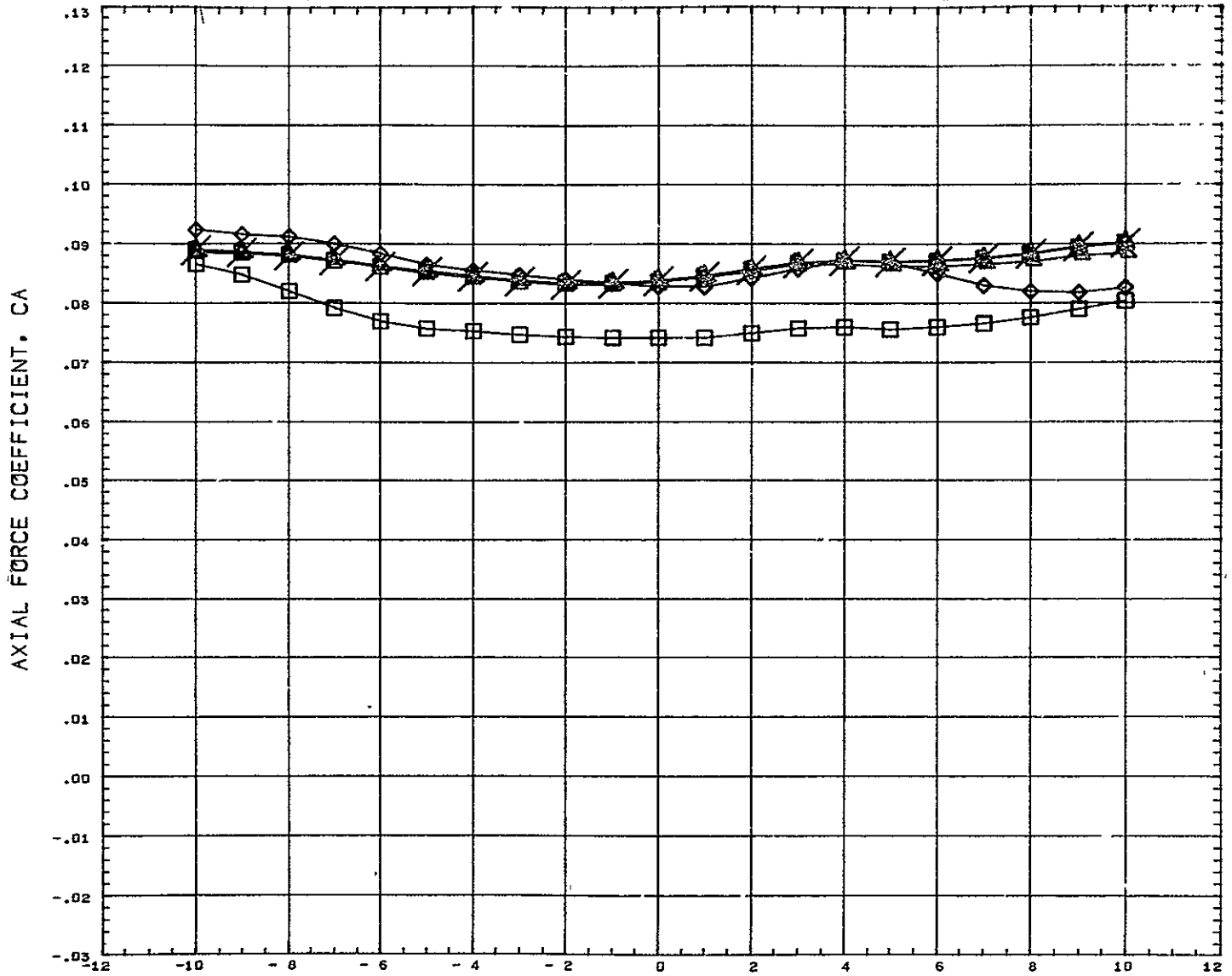

SYMBOL ◇ □ △	DELTAZ 0.182 0.228 0.352 0.599 10.000	PARAMETRIC VALUES BSTPOW 0.000 ORBPOW 0.000 DELTAX - 0.143 ALPHAI 10.100 MACH 5.010 ELVBST 0.000 ELVORB 0.000 BETA 0.000	REFERENCE INFORMATION REFS 1.4440 SQ IN REFL 13.3330 IN REFB 13.3330 IN XMRP 7.5280 IN YMRP 0.0000 IN ZMRP 1.1940 IN SCALE 0.0055
-----------------------	--	--	--

REFERENCE FILE

# AEDC VA 1163 MDAC BOOSTER AND ORBITER TEST DATA AT MACH NUMBER 5

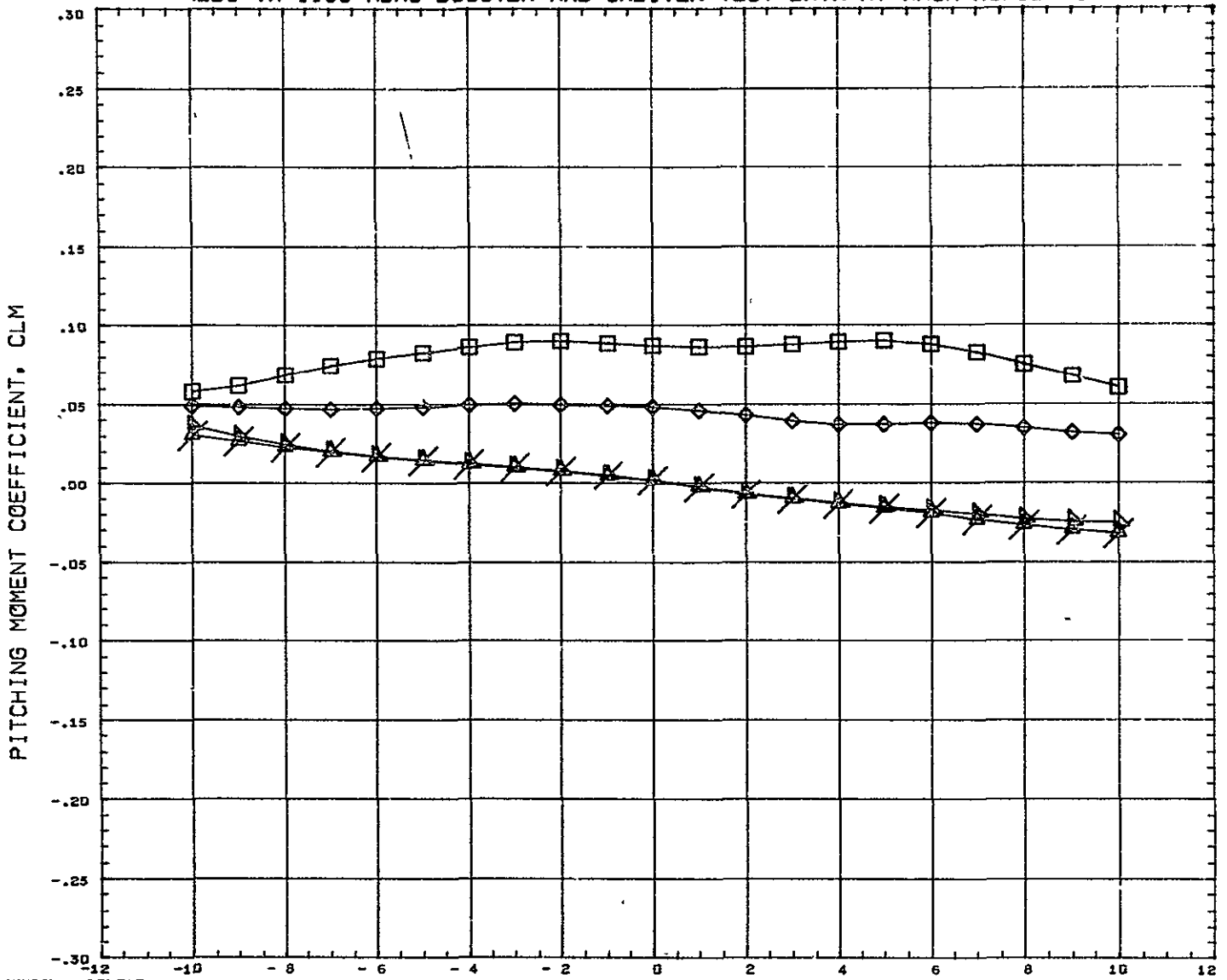

SYMBOL ◇ □ ▲	DELTAZ 0.182 0.228 0.352 10.000	PARAMETRIC VALUES BSTPOW 0.000 ORBPOW 0.000 DELTAX - 0.019 ALPHA1 10.100 MACH 5.010 ELVBST 0.000 ELVORB 0.000 BETA 0.000	REFERENCE INFORMATION REFS 44.4440 SQ IN REFL 13.3330 IN REFB 13.3330 IN XMRP 7.5280 IN YMRP 0.0000 IN ZMRP 1.1946 IN SCALE 0.0055
REFERENCE FILE			

# AEDC VA 1163 MDAC BOOSTER AND ORBITER TEST DATA AT MACH NUMBER 5

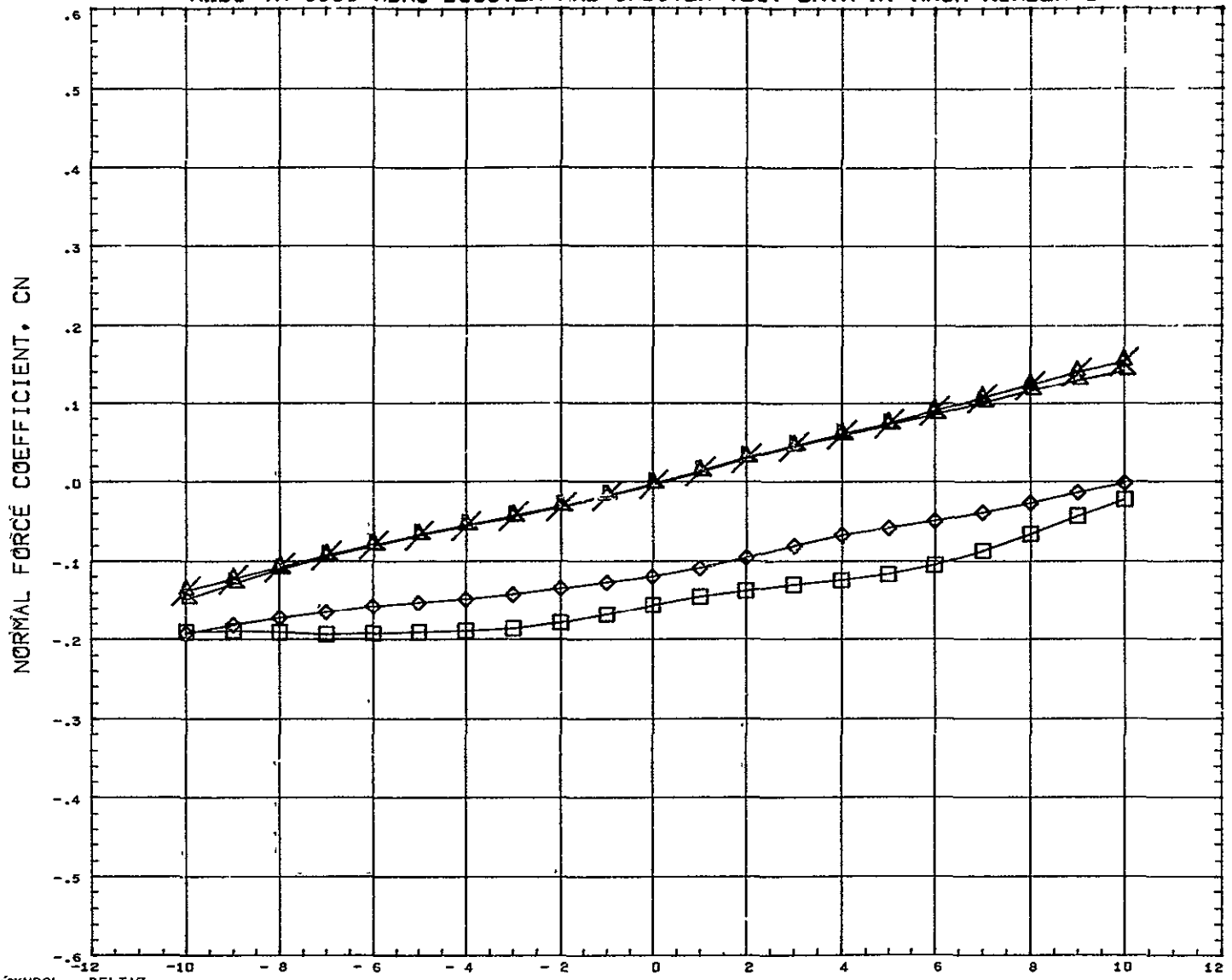

SYMBOL 	DELTAZ 0.182 0.228 0.352 10.000	PARAMETRIC VALUES BSTPOW    0.000    ORBPOW    0.000 DELTAX   - 0.019    ALPHAI    10.100 XCH        5.010    ELVBST    0.000 ELVORB    0.000    BETA      0.000	REFERENCE INFORMATION RCFS      4' 4440    S0 IN REFL      13 3330    IN REFB      13.3330    IN XMRP      7.5280    IN YMRP      0.0000    IN ZMRP      1.1940    IN SCALE     0.0055
REFERENCE FILE			

# AEDC VA 1163 MDAC BOOSTER AND ORBITER TEST DATA AT MACH NUMBER 5

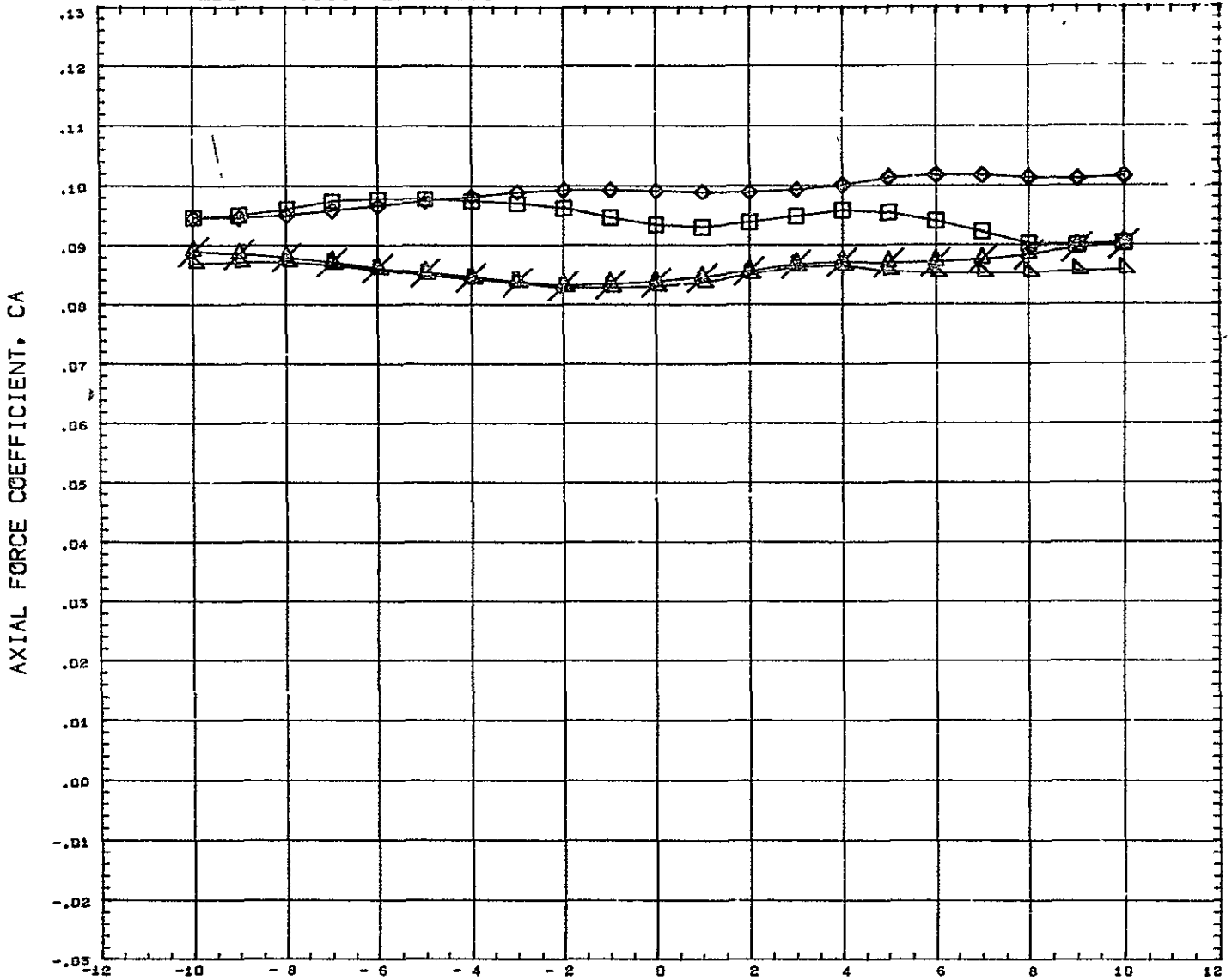

SYMBOL ◇ □ △	DELTAZ 0.182 0.228 0.352 10.000	<b>PARAMETRIC VALUES</b> BSTFOW    0.000    ORBFOV    0.000 DELTAX    - 0.019    ALPHAI    10.100 MACH       5.010    ELVBST    0.000 ELVORB    0.000    BETA       0.000	<b>REFERENCE INFORMATION</b> REFS       1 4440    SQ IN REFL       13.3330    IN REFB       13.3330    IN XMRF       7.5280    IN YMRP       0.0000    IN ZMRP       1.1940    IN SCALE       0.0055
REFERENCE FILE			

# AEDC VA 1163 MDAC BOOSTER AND ORBITER TEST DATA AT MACH NUMBER 5

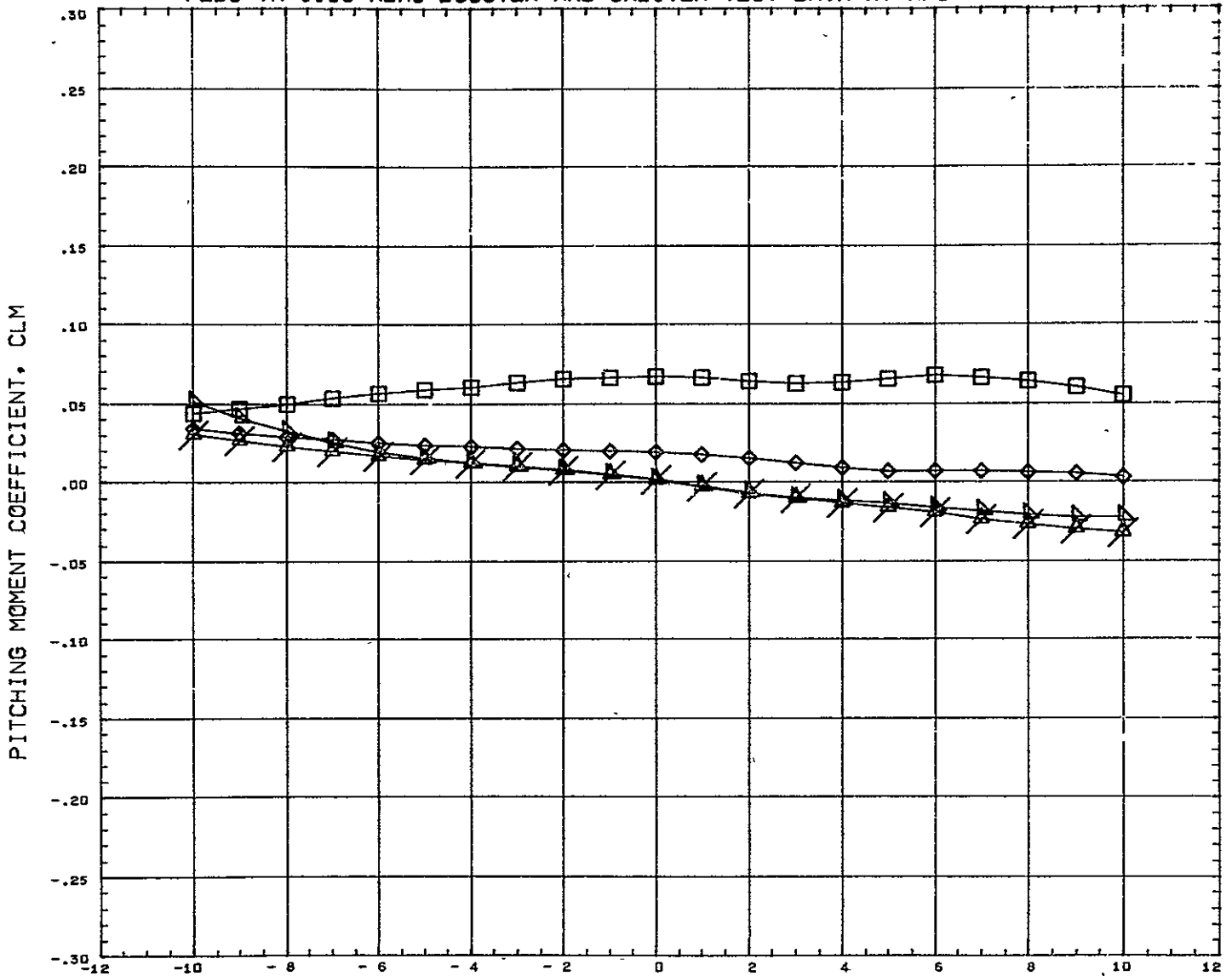

SYMBOL ◇ □ △	DELTAZ 0.182 0.228 0.352 10.000	PARAMETRIC VALUES BSTPOW 0.000 ORBPOW 0.000 DELTAX 0.043 ALPHAI 10.100 ACH 5.010 ELVBST 0.000 ELVORB 0.000 BLTA 0.000	REFERENCE INFORMATION REFS 1.4440 SR IN REFL 13.3330 IN REFB 13.3330 IN YMRP 7.5280 IN YMRP 0.0000 IN ZMRP 1.1940 IN SCALE 0.0055
REFERENCE FILE			

# AEDC VA 1163 MDAC BOOSTER AND ORBITER TEST DATA AT MACH NUMBER 5

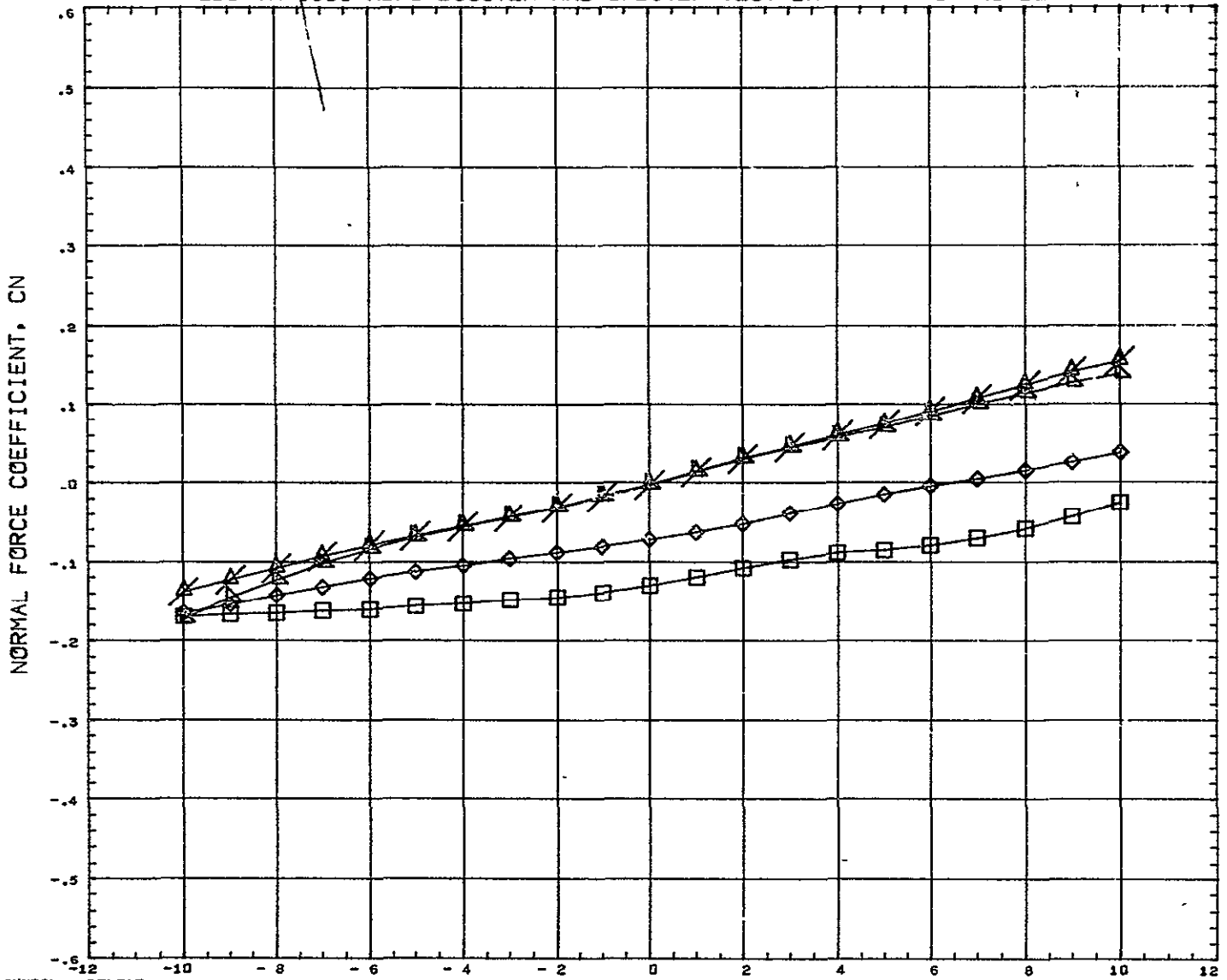

SYMBOL ◇ □ △	DELTAZ 0.182 0.228 0.352 10.000	PARAMETRIC VALUES BSTFOW 0.000 ORBPOW 0.000 DELTAX 0.043 ALPHAI 10 100 MACH 5.010 ELVBST 0.000 ELVORB 0.000 BETA 0.000	REFERENCE INFORMATION REFS 1.4440 SQ IN REFL 13.3330 IN REFB 13.3330 IN XMRP 7.5280 IN YMRP 0.0000 IN ZMRP 1.1940 IN SCALE 0.0055
REFERENCE FILE			

# AEDC VA 1163 MDAC BOOSTER AND ORBITER TEST DATA AT MACH NUMBER 5

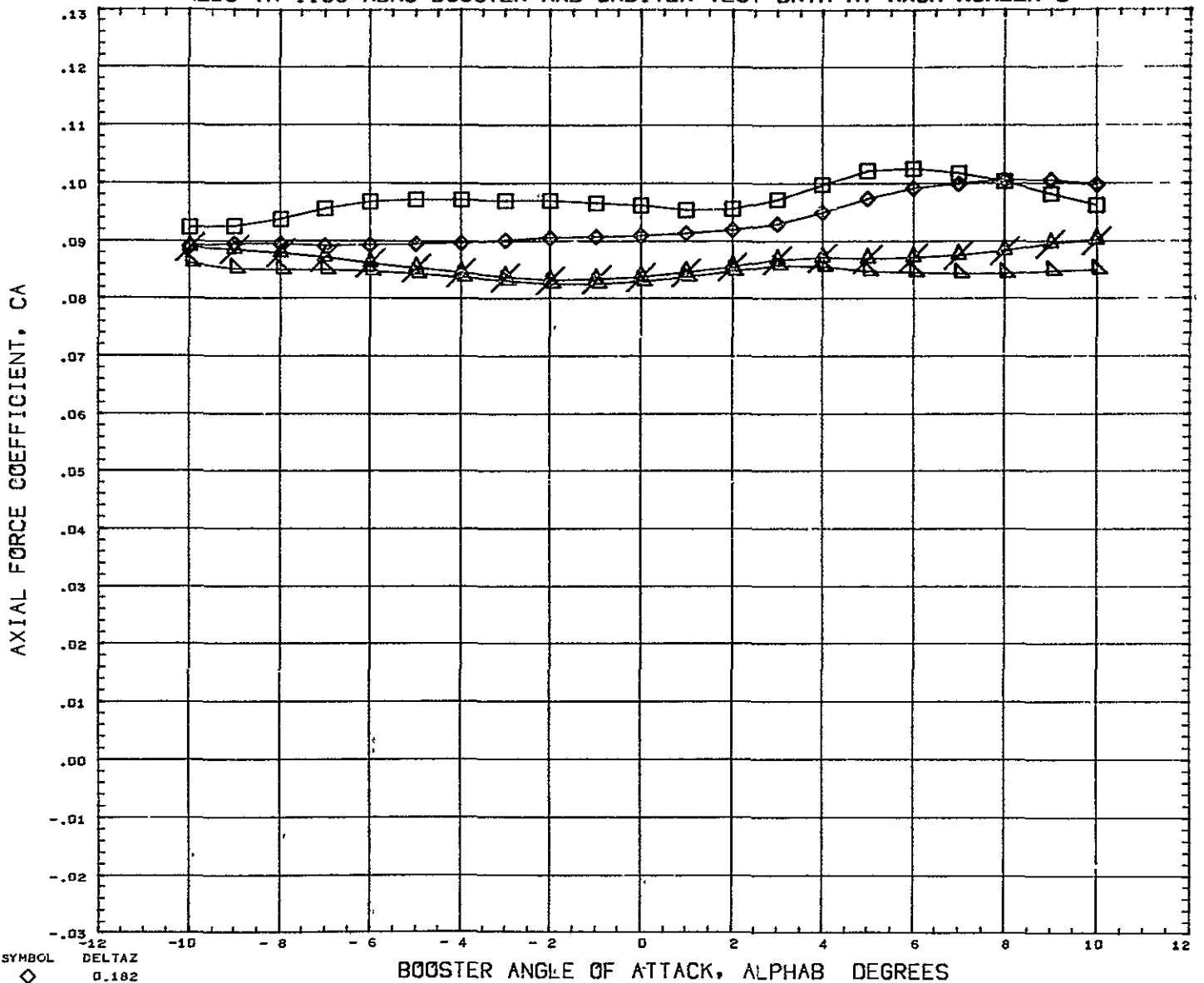

SYMBOL  
 ◇  
 □  
 △

DELTA Z  
 0.182  
 0.228  
 0.352  
 10.000

PARAMETRIC VALUES

BSTPOW	0.000	ORBPOW	0.000
DELTA X	0.043	ALPHA I	10.100
MACH	5.010	ELVBST	0.600
ELVORB	0.000	BETA	0.000

REFERENCE INFORMATION

REFS	77.4440	SQ IN
REFL	13.3330	IN
REFB	13.3330	IN
XMRP	7.5280	IN
YMRP	0.0000	IN
ZMRP	1.1945	IN
SCALE	0.0055	

REFERENCE FILE



# AEDC VA 1163 MDAC BOOSTER AND ORBITER TEST DATA AT MACH NUMBER 5

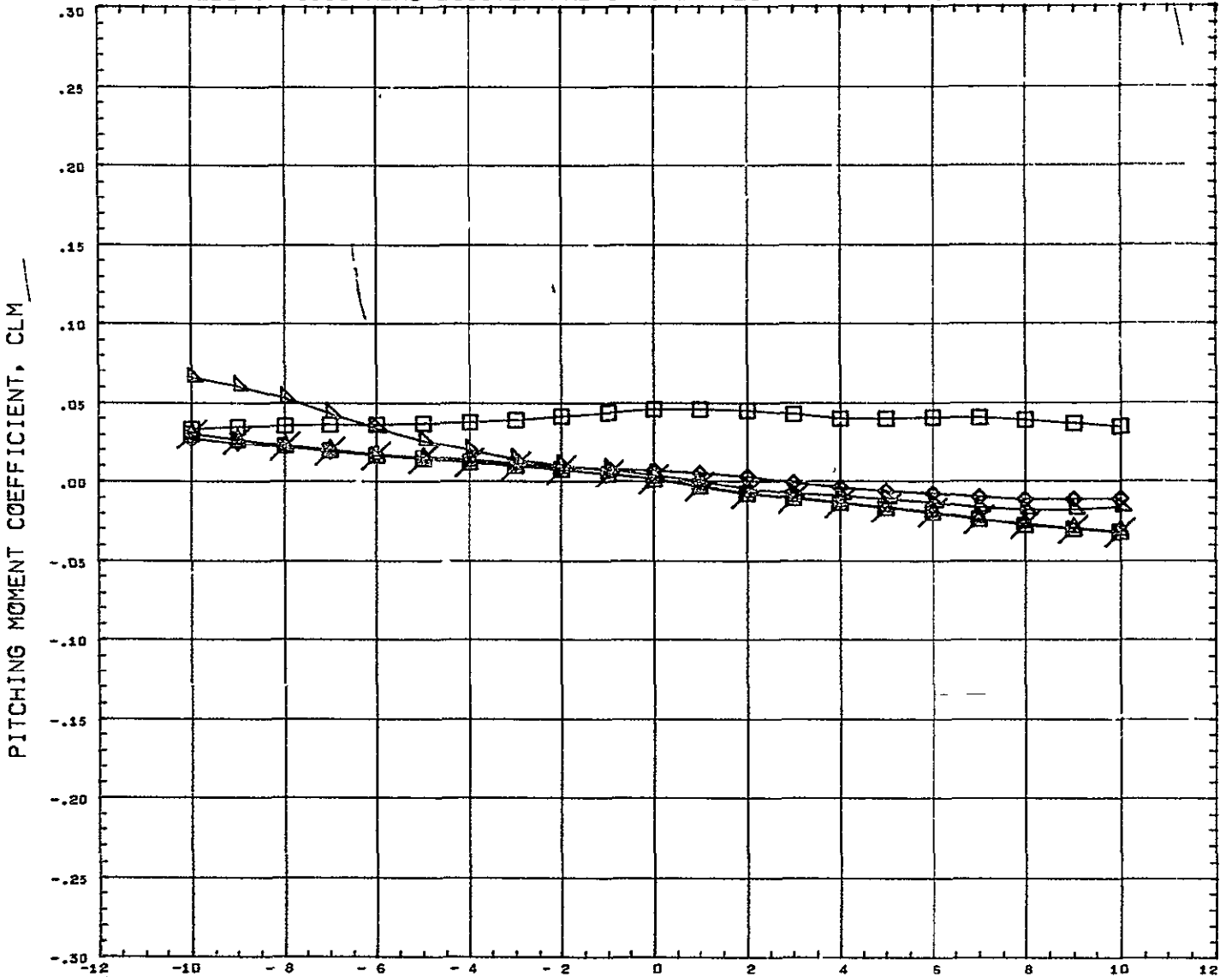

SYMBOL 	DELTA Z 0.182 0.228 0.352 0.599 10.000	PARAMETRIC VALUES BSTPOW 0.000    ORBPOW 0.000 DELTAX 0.105    ALPHAI 10.100 MACH 5.015    ELYBST 0.000 ELVORB 0.000    BETA 0.000	REFERENCE INFORMATION REFS 44.4440    SQ IN REFL 13.3330    IN REFB 13.3330    IN XMRP 7.5280    IN YMRP 0.0000    IN ZMRP 1.1940    IN SCALE 0.0055
------------	---	--	---

REFERENCE FILE

# AEDC VA 1163 MDAC BOOSTER AND ORBITER TEST DATA AT MACH NUMBER 5

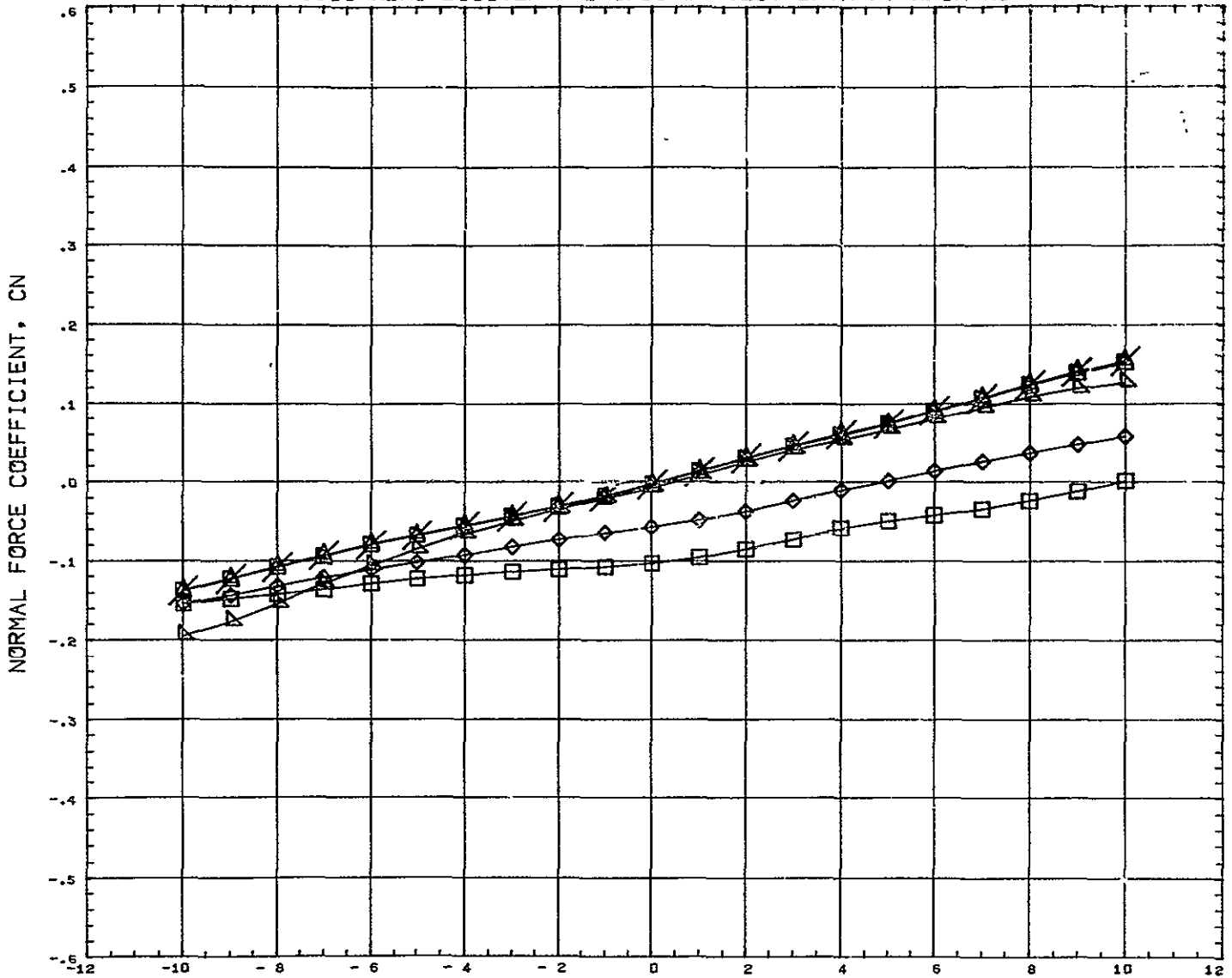

SYMBOL ◇ ◊ △ × *	DELTAZ 0.182 0.228 0.352 0.599 10.000	PARAMETRIC VALUES BSTPOW 5.000 ORBPOW 0.000 DELTAX 0.105 ALPHAI 10.100 MACH 5.010 FLVBST 0.000 ELVORB 0.000 BETA 0.000	REFERENCE INFORMATION REFC 44.4440 SQ IN REFL 13.3330 IN REFB 13.3330 IN XMRP 7.5280 IN YMRP 0.0000 IN ZMRP 1.1940 IN SCALE 0.0055
REFERENCE FILE			

# AEDC VA 1163 MDAC BOOSTER AND ORBITER TEST DATA AT MACH NUMBER 5

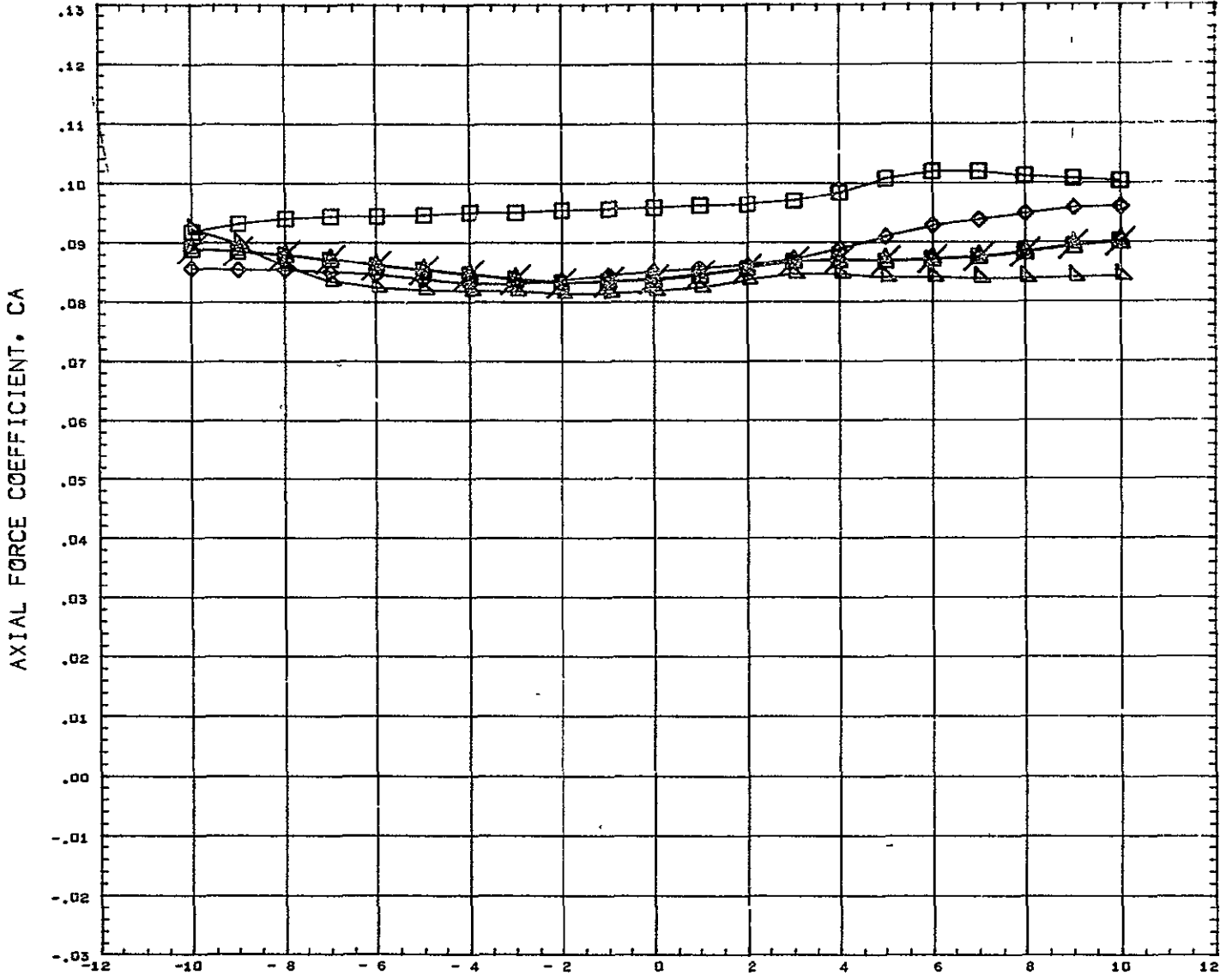

SYMBOL	DELTA Z	PARAMETRIC VALUES				REFERENCE INFORMATION		
◊	0.182					REFS	44.4440	90 IN
◻	0.228					REFL	13.3330	IN
△	0.352	DSTPOW	0.000	ORBPOW	0.000	REFB	13.3330	IN
✕	0.599	DPLTAX	0.105	ALPHA1	10.100	XMRP	7.5280	IN
	10.000	MACH	5.010	ELVBST	0.000	YMRP	0.0000	IN
		ELVORB	0.000	BETA	0.000	ZMRP	1.1940	IN
						SCALE	0.0055	
		REFERENCE FILE						

# AEDC VA 1163 MDAC BOOSTER AND ORBITER TEST DATA AT MACH NUMBER 5

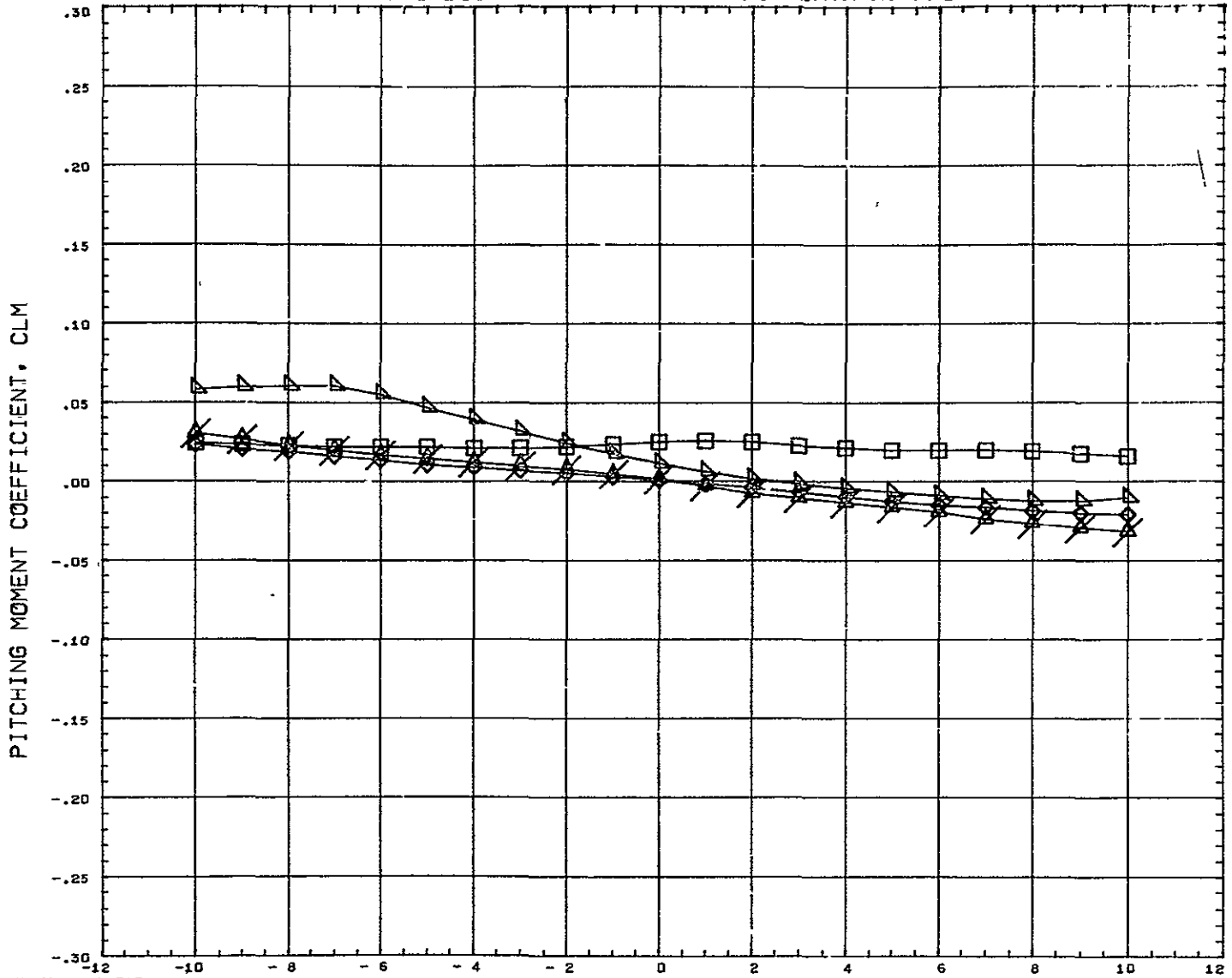

SYMBOL ◇ □ △ ×	DELTAZ 0.182 0.228 0.352 10.000	PARAMETRIC VALUES BSTPOW 0.000 ORBPOW 0.000 DELTAX 0.167 ALPHAI 10.100 MACH 5.010 ELVBST 0.000 ELVORB 0.000 BETA 0.000	REFERENCE INFORMATION REFS ++ 4440 SQ IN REFL 13.3330 IN REFB 13.3330 IN XMRP 7.5280 IN YMRP 0.0000 IN ZMRP 1.1940 IN SCALE 0.0055
----------------------------	---	--	---

REFERENCE FILE

# AEDC VA 1163 MDAC BOOSTER AND ORBITER TEST DATA AT MACH NUMBER 5

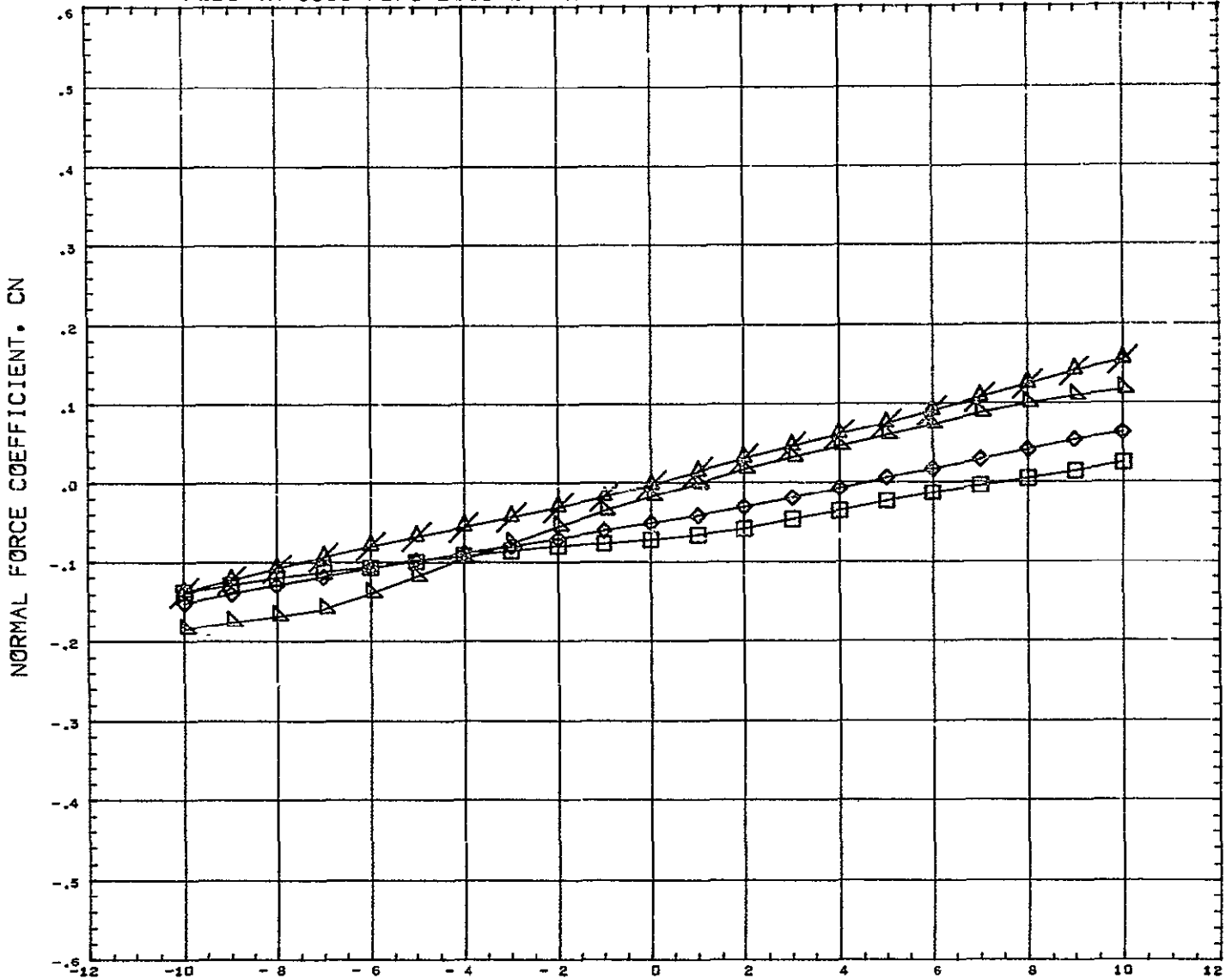

SYMBOL 	DELTA Z 0.182 0.228 0.352 10.000	<table border="0" style="width: 100%;"> <tr> <th colspan="4" style="text-align: left; padding-left: 20px;">PARAMETRIC VALUES</th> </tr> <tr> <td style="padding-left: 20px;">BSTPOW</td> <td>0.000</td> <td style="padding-left: 20px;">ORBPOW</td> <td>0.000</td> </tr> <tr> <td style="padding-left: 20px;">DFLTAX</td> <td>0.167</td> <td style="padding-left: 20px;">ALPHA I</td> <td>10.100</td> </tr> <tr> <td style="padding-left: 20px;">MACH</td> <td>5.010</td> <td style="padding-left: 20px;">ELVBST</td> <td>0.000</td> </tr> <tr> <td style="padding-left: 20px;">ELVORB</td> <td>0.000</td> <td style="padding-left: 20px;">BETA</td> <td>0.000</td> </tr> </table>	PARAMETRIC VALUES				BSTPOW	0.000	ORBPOW	0.000	DFLTAX	0.167	ALPHA I	10.100	MACH	5.010	ELVBST	0.000	ELVORB	0.000	BETA	0.000	<table border="0" style="width: 100%;"> <tr> <th colspan="3" style="text-align: left; padding-left: 20px;">REFERENCE INFORMATION</th> </tr> <tr> <td style="padding-left: 20px;">REFS</td> <td>44.4440</td> <td style="padding-left: 20px;">SQ IN</td> </tr> <tr> <td style="padding-left: 20px;">REFL</td> <td>13.3330</td> <td style="padding-left: 20px;">IN</td> </tr> <tr> <td style="padding-left: 20px;">REFB</td> <td>13.3330</td> <td style="padding-left: 20px;">IN</td> </tr> <tr> <td style="padding-left: 20px;">XMRP</td> <td>7.5280</td> <td style="padding-left: 20px;">IN</td> </tr> <tr> <td style="padding-left: 20px;">YMRP</td> <td>0.0000</td> <td style="padding-left: 20px;">IN</td> </tr> <tr> <td style="padding-left: 20px;">ZMRP</td> <td>1.1940</td> <td style="padding-left: 20px;">IN</td> </tr> <tr> <td style="padding-left: 20px;">SCALE</td> <td>0.0055</td> <td></td> </tr> </table>	REFERENCE INFORMATION			REFS	44.4440	SQ IN	REFL	13.3330	IN	REFB	13.3330	IN	XMRP	7.5280	IN	YMRP	0.0000	IN	ZMRP	1.1940	IN	SCALE	0.0055	
PARAMETRIC VALUES																																															
BSTPOW	0.000	ORBPOW	0.000																																												
DFLTAX	0.167	ALPHA I	10.100																																												
MACH	5.010	ELVBST	0.000																																												
ELVORB	0.000	BETA	0.000																																												
REFERENCE INFORMATION																																															
REFS	44.4440	SQ IN																																													
REFL	13.3330	IN																																													
REFB	13.3330	IN																																													
XMRP	7.5280	IN																																													
YMRP	0.0000	IN																																													
ZMRP	1.1940	IN																																													
SCALE	0.0055																																														
REFERENCE FILE																																															

# AEDC VA 1163 MDAC BOOSTER AND ORBITER TEST DATA AT MACH NUMBER 5

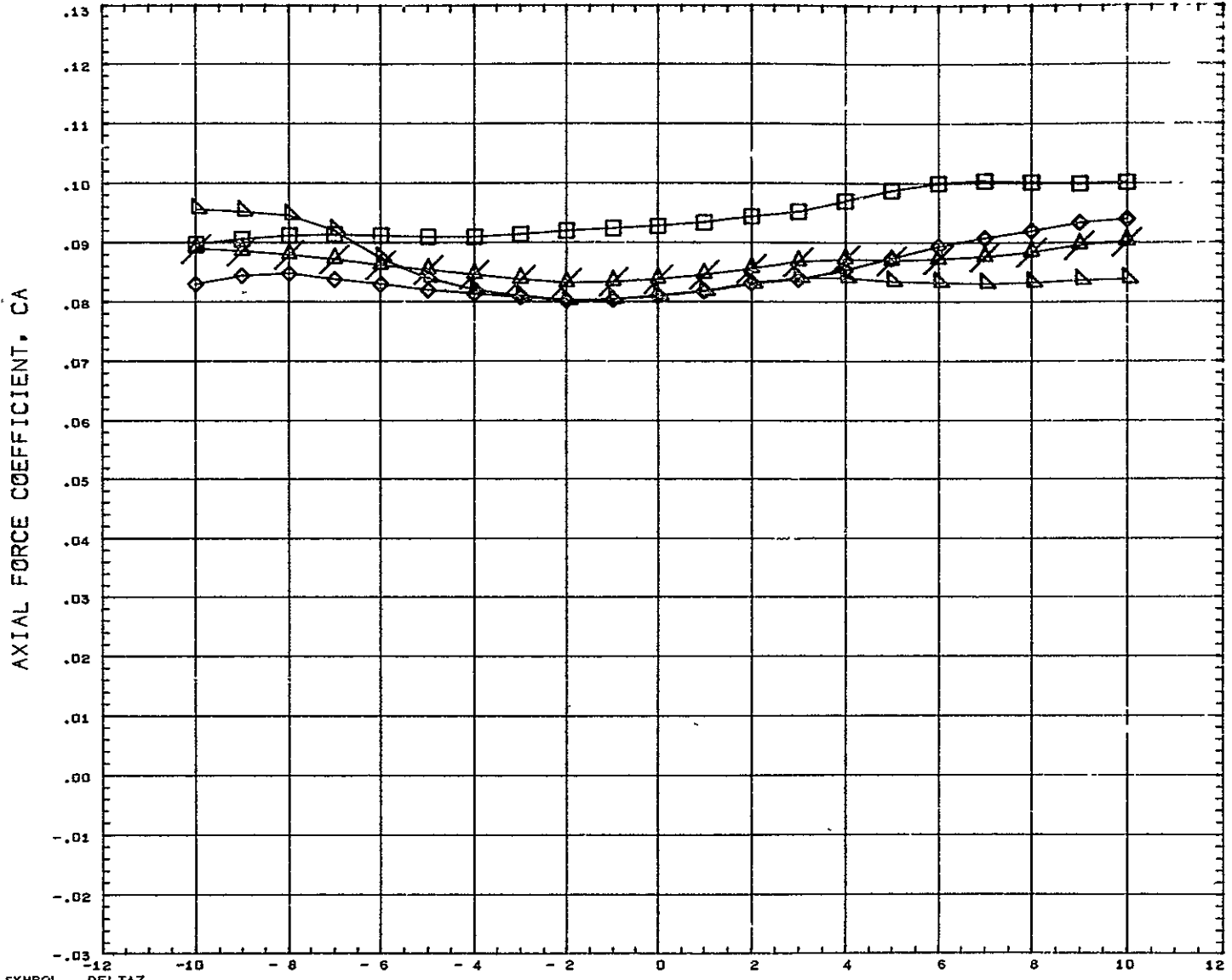

SYMBOL ◇ □ ▲ ▼	DELTAZ 0.182 0.228 0.352 10.000	PARAMETRIC VALUES BSTPOW 0.000 ORBPOW 0.000 DELTAX 0.167 ALPHAI 10.100 MACH 5.010 ELVBST 0.000 ELVORB 0.000 BETA 0.000	REFERENCE INFORMATION REFS 44.4440 SQ IN REFL 13.3330 IN REFB 13.3330 IN XMRP 7.5280 IN YMRP 0.0000 IN ZMRP 1.1940 IN SCALE 0.0055
----------------------------	---	--	---

REFERENCE FILE

# AEDC VA 1163 MDAC BOOSTER AND ORBITER TEST DATA AT MACH NUMBER 5

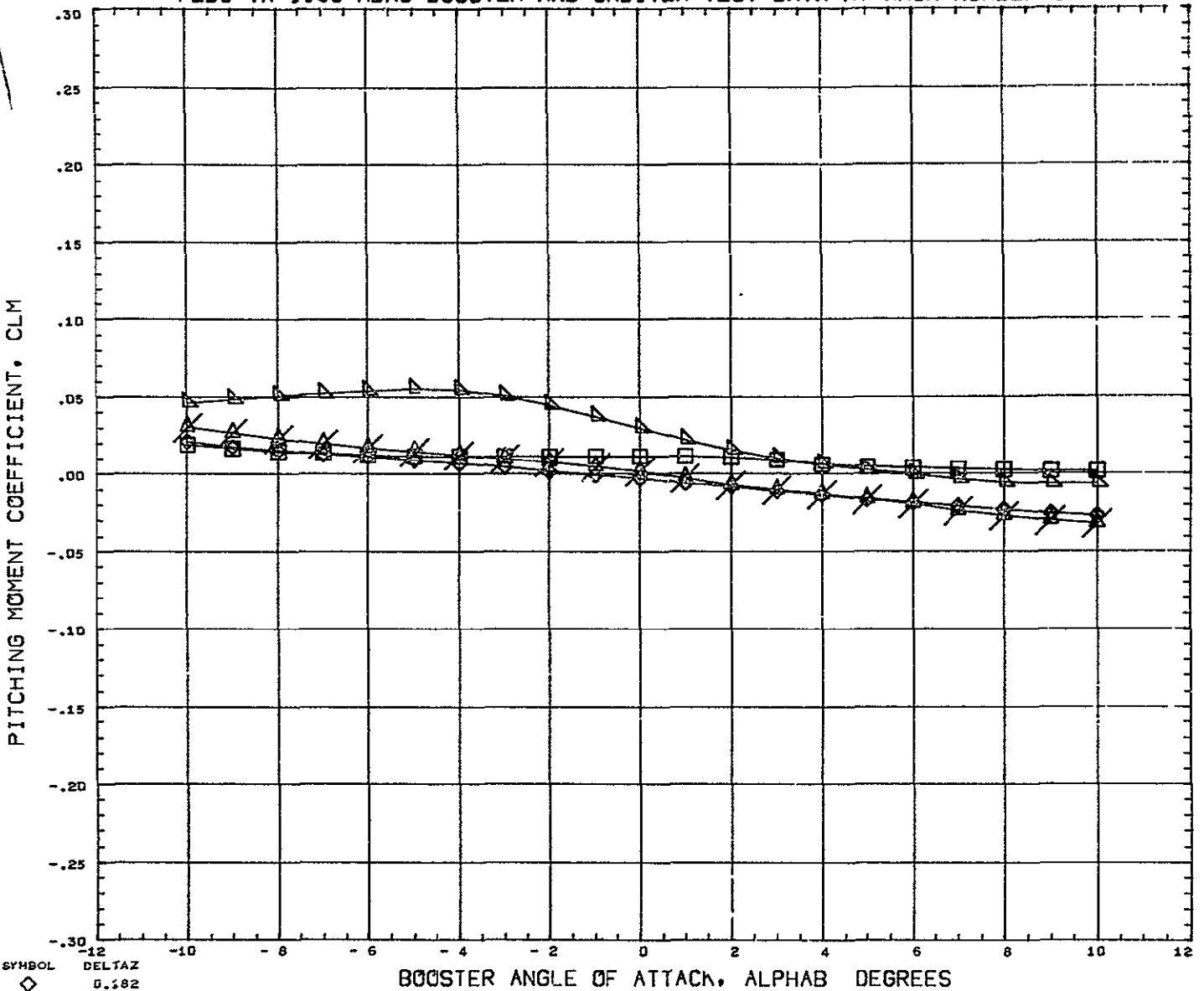

SYMBOL ◇ □ △ ×	DELTAZ 0.182 0.228 0.352 10.000	PARAMETRIC VALUES BSTPOW 0.000    ORBPOW 0.000 DELTAX 0.228    ALPHAI 10.100 MACH 5.010    ELVBST 0.000 ELVORB 0.000    BETA 0.000	REFERENCE INFORMATION REFS 44.4440    SQ IN REFL 13.3330    IN REFB 13.3330    IN XMRP 7.5280    IN YMRP 0.0000    IN ZMRP 1.1940    IN SCALE 0.0055
----------------------------	---	--	---

REFERENCE FILE

# AEDC VA 1163 MDAC BOOSTER AND ORBITER TEST DATA AT MACH NUMBER 5

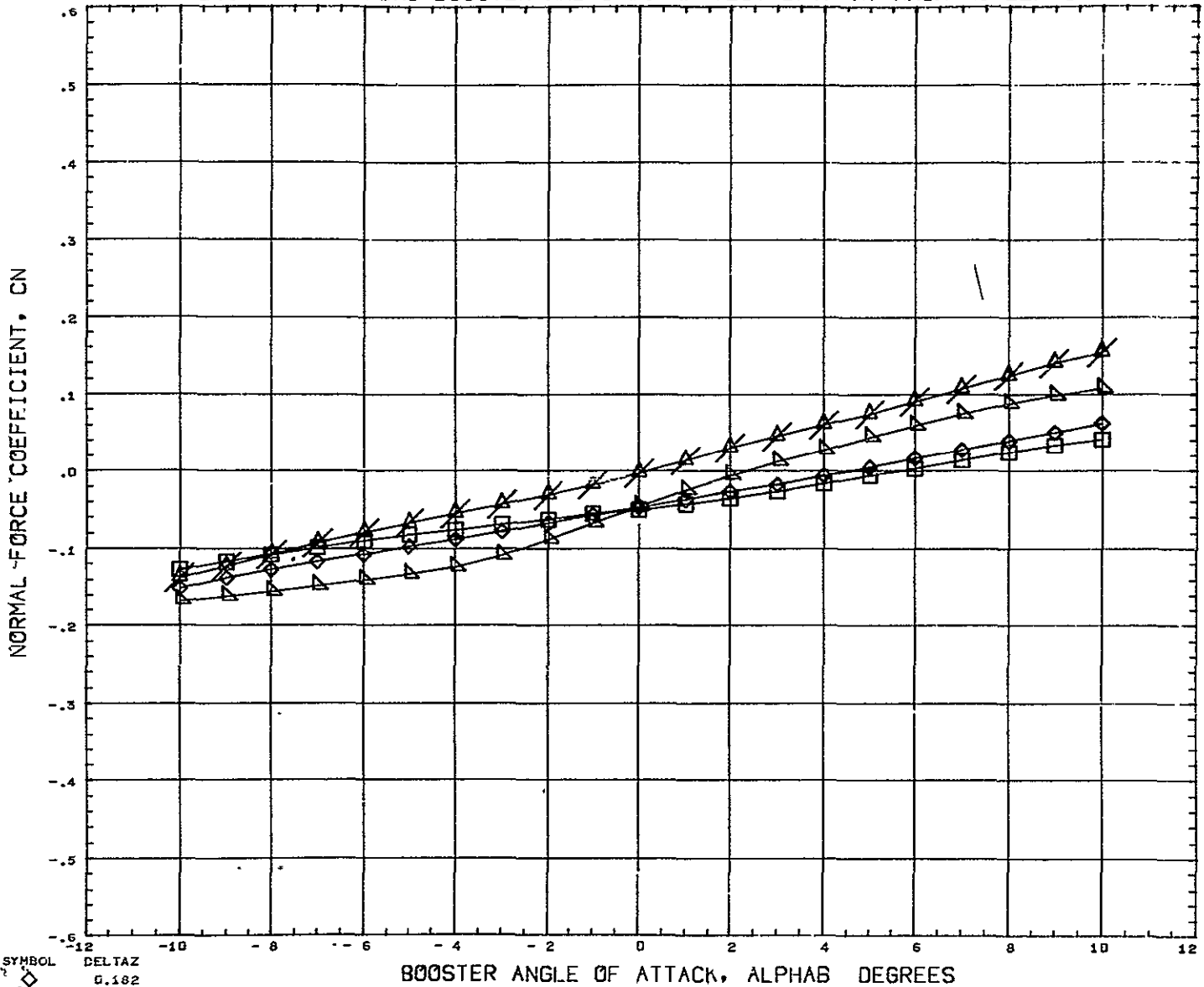

SYMBOL  
 □  
 ◇  
 △  
 ×

DELTA Z  
 0.182  
 0.228  
 0.352  
 10.000

PARAMETRIC VALUES  
 BSTPOW 0.000 ORBFOW 0.000  
 DELTAX 0.228 ALPHAI 10.100  
 MACH 5.010 ELVBST 0.000  
 ELVORB 0.000 BETA 0.000

REFERENCE INFORMATION  
 REFS 44.4440 SQ IN  
 REFL 13.3330 IN  
 REFB 13.3330 IN  
 XMRP 7.5280 IN  
 YMRP 0.0000 IN  
 ZMRP 1.1940 IN  
 SCALE 0.0055

REFERENCE FILE



# AEDC VA 1163 MDAC BOOSTER AND ORBITER TEST DATA AT MACH NUMBER 5

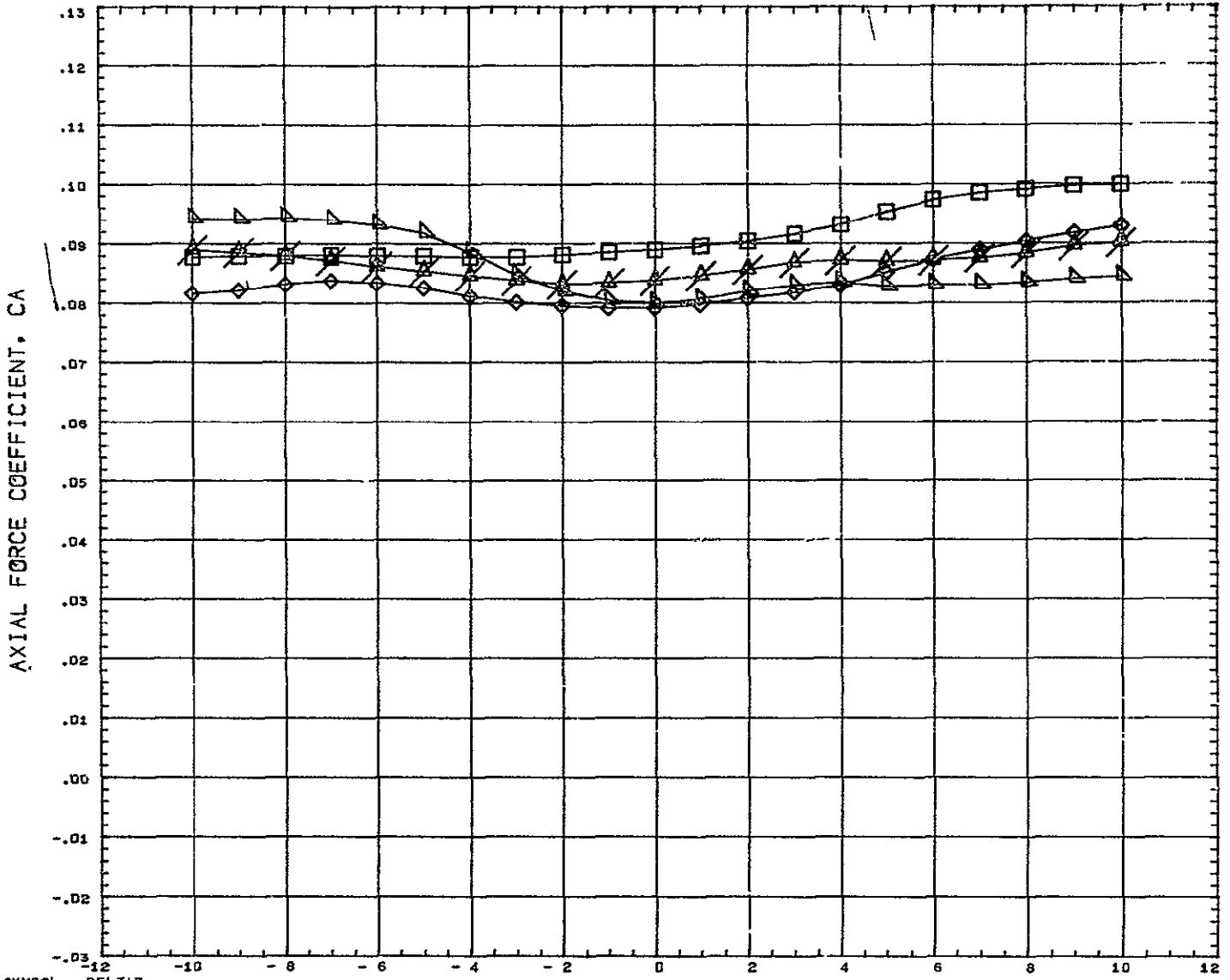

SYMBOL ◊ ◻ △ ×	DELTAX 0.182 0.228 0.352 10.000	PARAMETRIC VALUES BSTPOW 0.000    ORBPOW 0.000 DELTAX 0.228    ALPHAI 10.100 FACH 5.010    ELVBST 0.000 ELVORB 0.000    BETA 0.000	REFERENCE INFORMATION REFS 44.4440    SQ IN REFL 13.3330    IN REFB 13.3330    IN XHRF 7.5280    IN YHRP 0.0005    IN ZHRP 1.1940    IN SCALE 0.0055
REFERENCE FILE			

# AEDC VA 1163 MDAC BOOSTER AND ORBITER TEST DATA AT MACH NUMBER 5

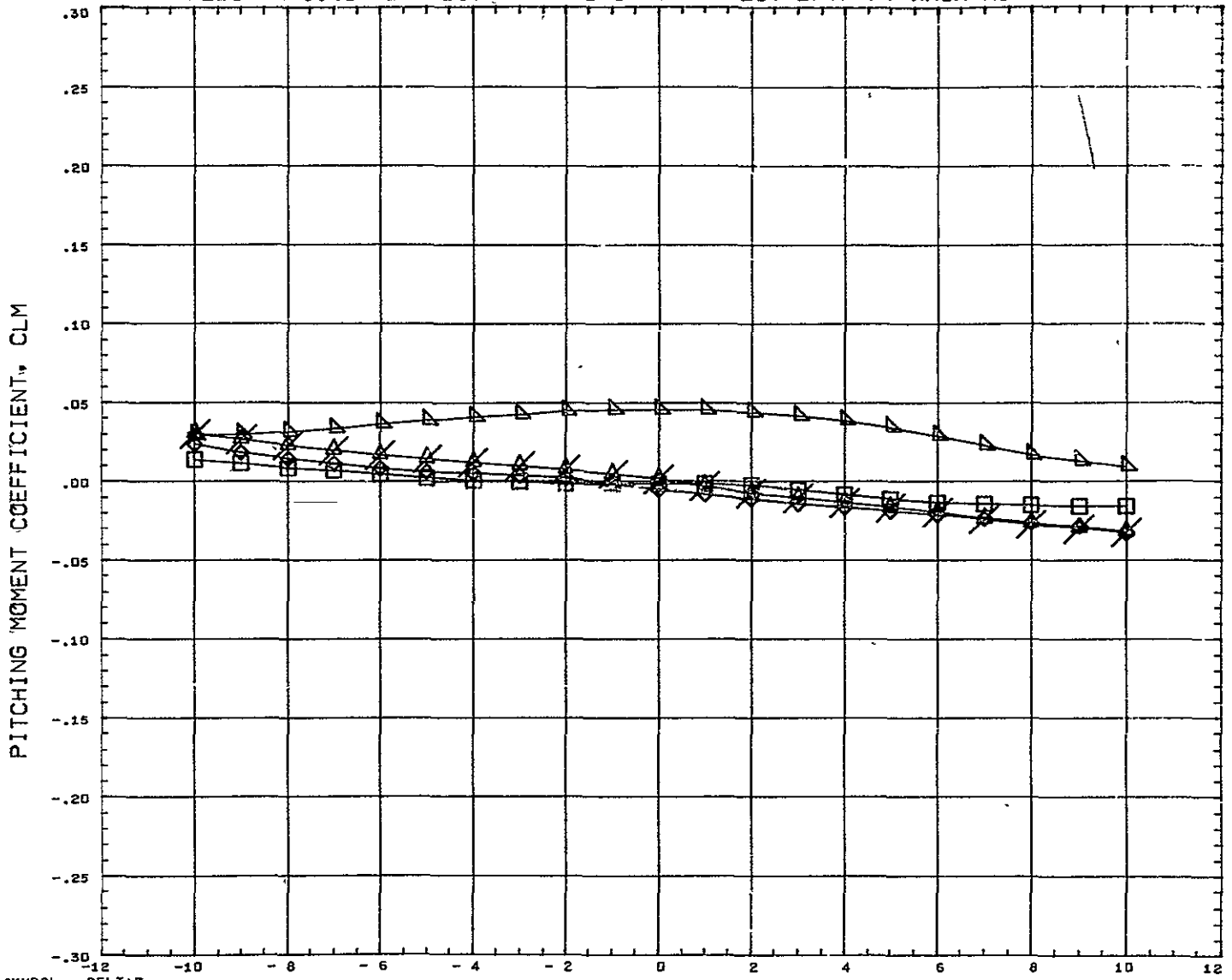

SYMBOL 	DELTAZ 0.182 0.228 0.352 10.000	PARAMETRIC VALUES BSTPOW 0.000 ORBPOW 0.000 DELTAX 0.352 ALPHAI 10.100 MACH 5.010 ELVBST 0.000 ELVORB 0.000 BETA 0.000	REFERENCE INFORMATION REFS 44.4440 SQ IN REFL 13.3330 IN REFB 13.3330 IN XMRP 7.5280 IN YMRP 0.0005 IN ZMRP 1.1940 IN SCALE 0.0055
REFERENCE FILE			

# AEDC VA 1163 MDAC BOOSTER AND ORBITER TEST DATA AT MACH NUMBER 5

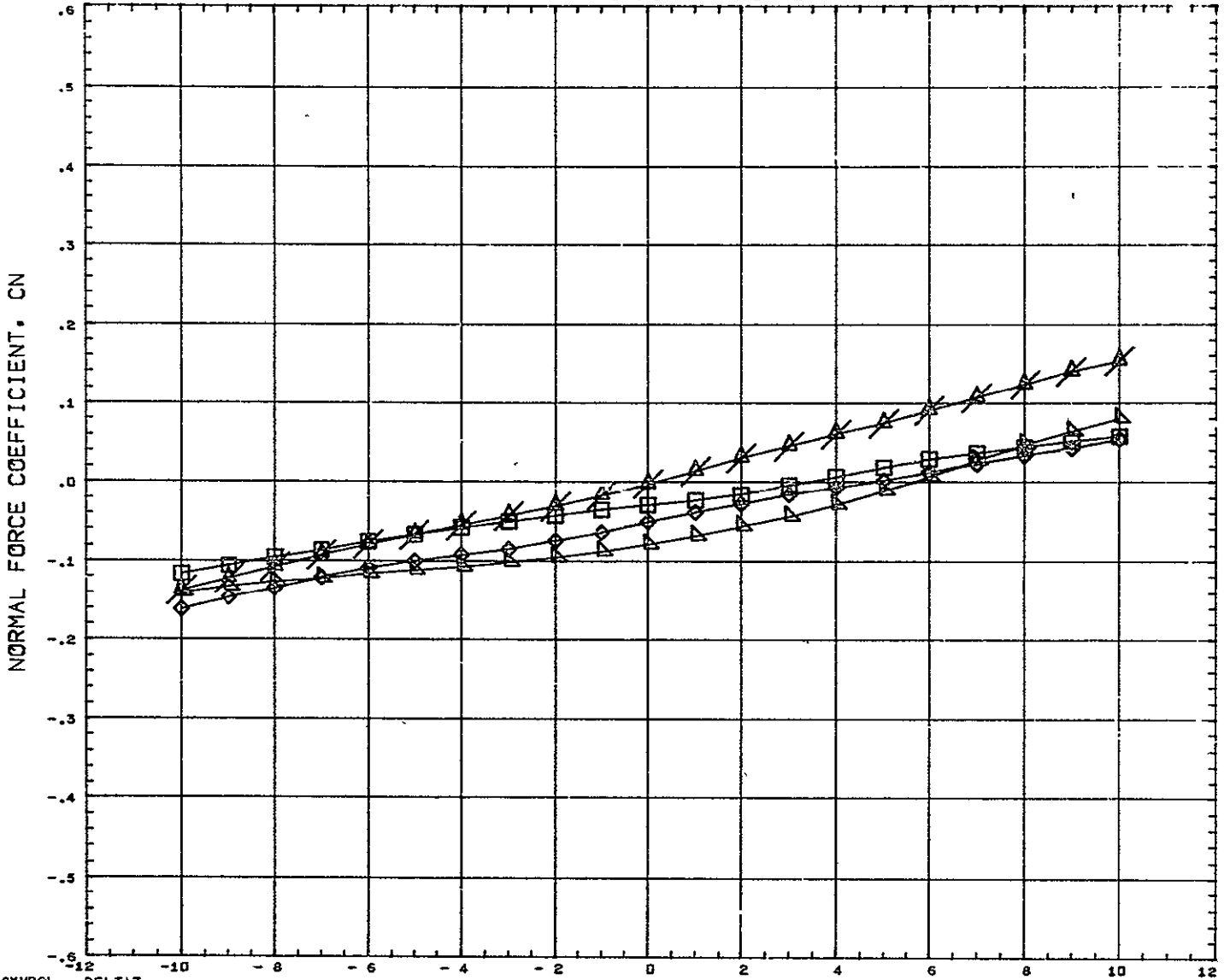

SYMBOL ◇ □ △ ×	DELTAX 0.182 0.228 0.352 10.000	<b>PARAMETRIC VALUES</b> BSTFOW 0.000    ORBFOW 0.000 DELTAX 0.352    ALPHAI 10.100 MACH 5.010    ELVBST 0.000 ELVORB 0.000    BETA 0.000	<b>REFERENCE INFORMATION</b> REFS 44.4440    SQ IN REFL 13.3330    IN REFB 13.3330    IN XMRP 7.5280    IN YMRP 0.0000    IN ZMRP 1.1940    IN SCALE 0.0055
REFERENCE FILE			

# AEDC VA 1163 MDAC BOOSTER AND ORBITER TEST DATA AT MACH NUMBER 5

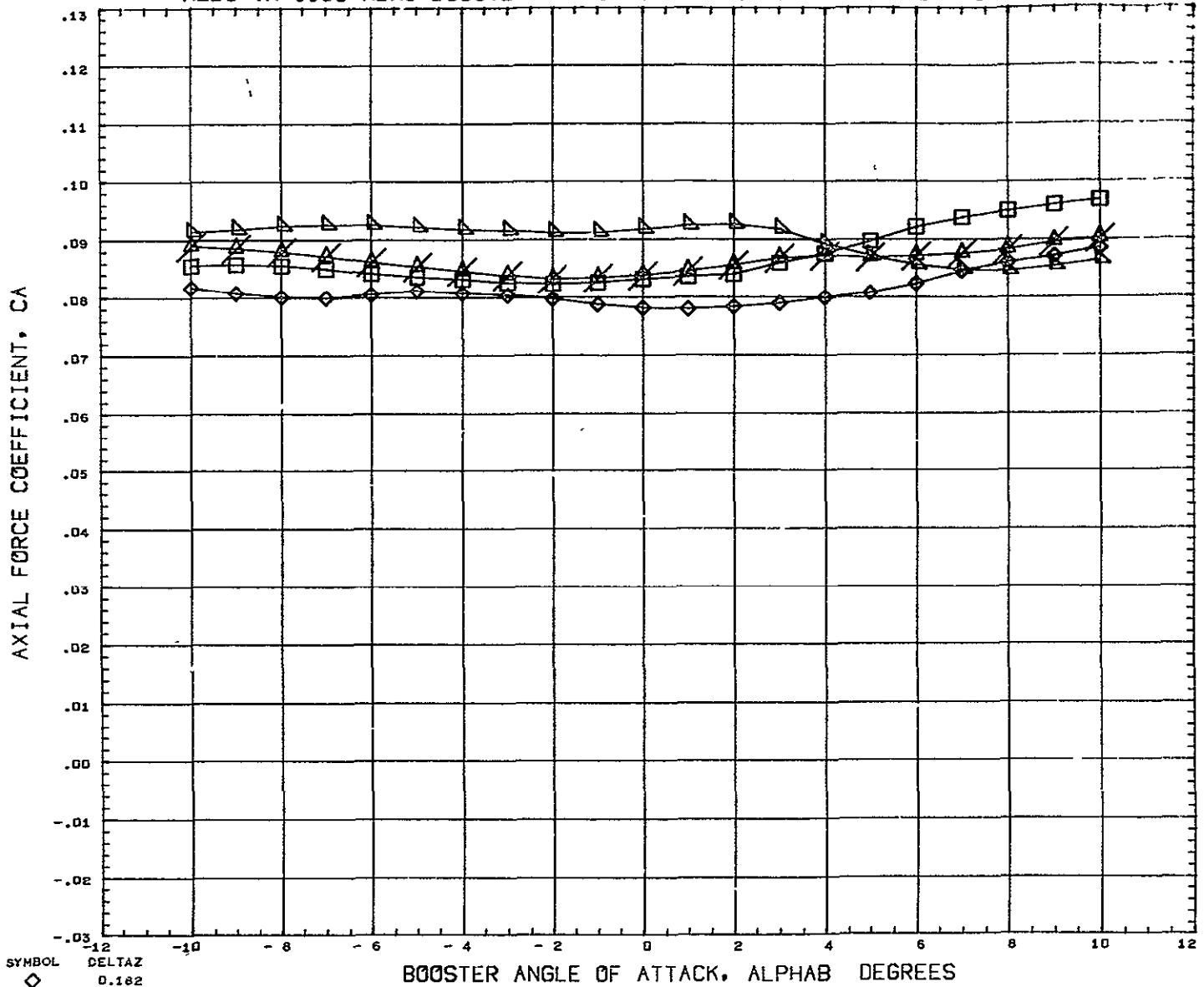

SYMBOL  
 ◇ 0.182  
 □ 0.228  
 △ 0.352  
 × 10.000

PARAMETRIC VALUES  
 BSTFOW 0.000 ORBPOW 0.000  
 DFLTAX 0.352 ALPHAI 10.100  
 MACH 5.010 ELVBST 0.000  
 ELVORB 0.000 BETA 0.000

REFERENCE INFORMATION  
 REFS 44.4440 SQ IN  
 REFL 13.3330 IN  
 REFB 13.3330 IN  
 XMRP 7.5280 IN  
 YMRP 0.0000 IN  
 ZMRP 1.1940 IN  
 SCALE 0.0055

REFERENCE FILE

# AEDC VA 1163 MDAC BOOSTER AND ORBITER TEST DATA AT MACH NUMBER 5

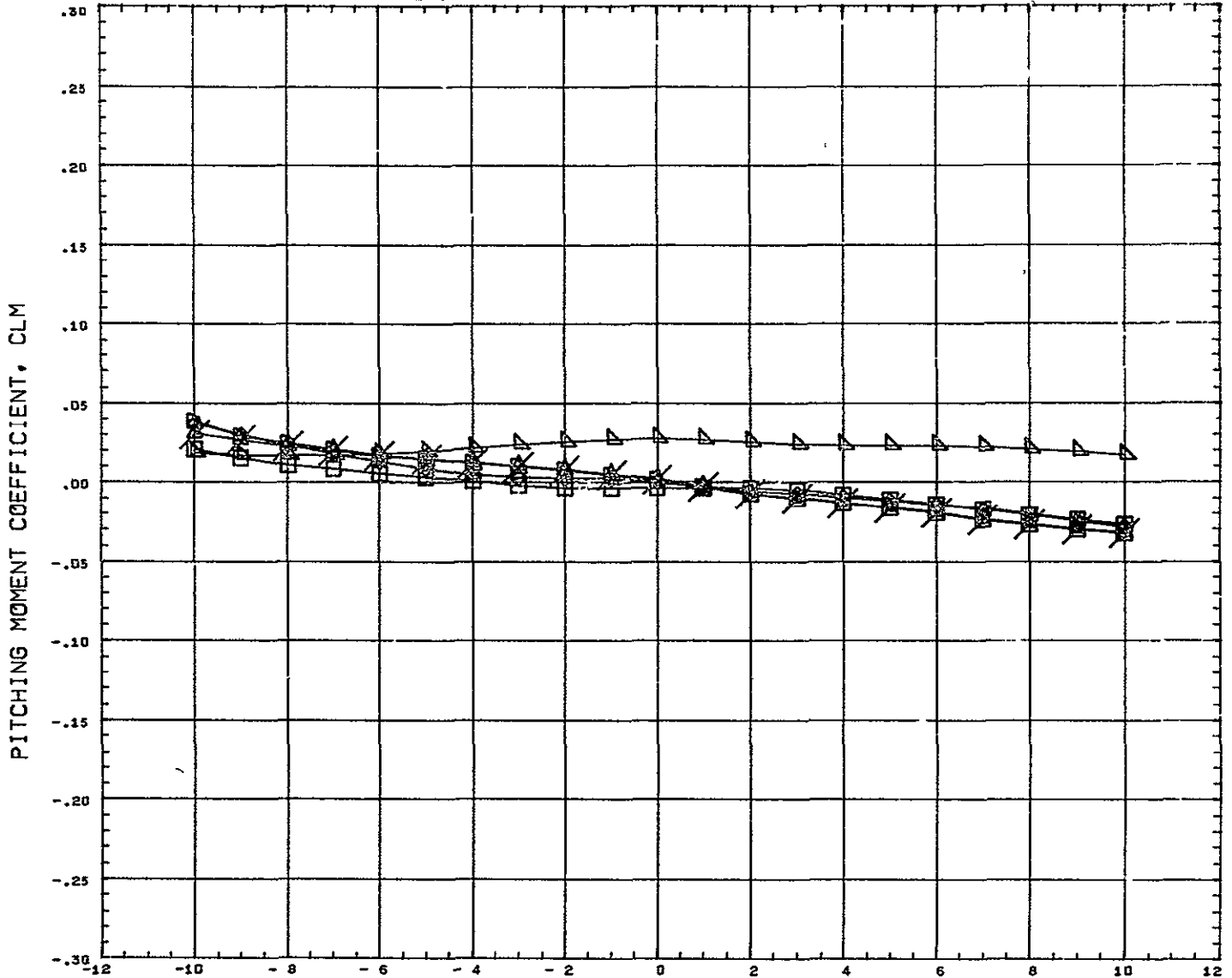

SYMBOL 	DELTA Z 0.182 0.228 0.352 0.599 10.000	PARAMETRIC VALUES BSTPOW 0.000 ORBPOW 0.000 DELTAX 0.501 ALPHAI 10.100 MACH 5.010 ELVBST 0.000 ELVORB 0.000 BETA 0.000	REFERENCE INFORMATION REFS 44.4440 SQ IN REFL 13.3330 IN REFB 13.3330 IN XMRP 7.5286 IN YMRP 0.0000 IN ZMRP 1.1940 IN SCALE 0.5055
------------	---	--	---

REFERENCE FILE

# AEDC VA 1163 MDAC BOOSTER AND ORBITER TEST DATA AT MACH NUMBER 5

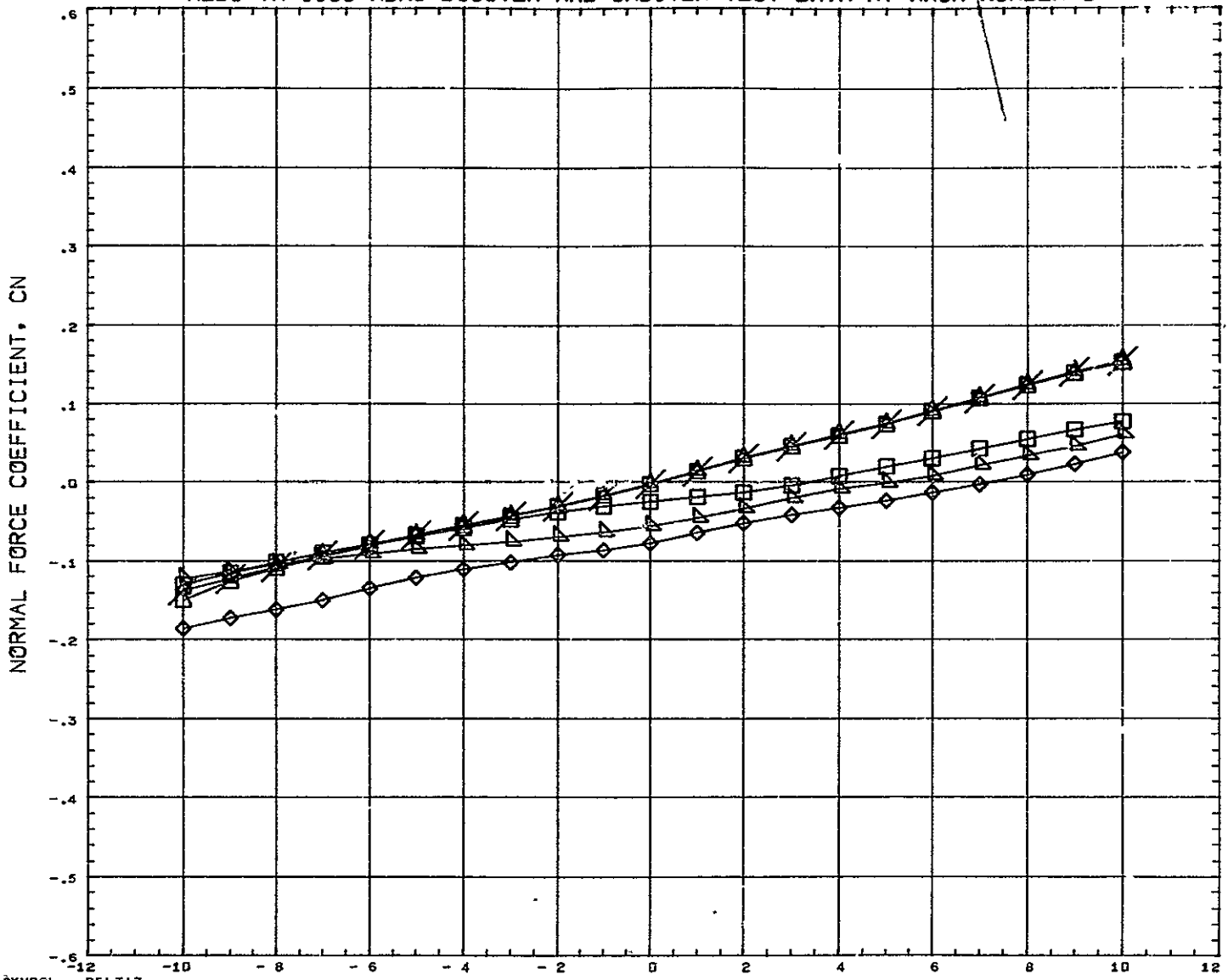

SYMBOL ◇ □ △ ✕	DELTA Z 0.162 0.228 0.352 0.599 10.000	PARAMETRIC VALUES BSTPOW    0.000    ORBPOW    0.000 DELTAX    0.501    ALPHAI    10.100 MACH       5.010    ELVBST    0.000 ELVORB    0.000    BETA       0.000	REFERENCE INFORMATION REFS       44.444°    SQ IN REFL       13.3330    IN REFB       13.3330    IN XHRP       7.5280    IN YHRP       0.000L    IN ZHRP       1.1940    IN SCALE       0.0055
REFERENCE FILE			

# AEDC VA 1163 MDAC BOOSTER AND ORBITER TEST DATA AT MACH NUMBER 5

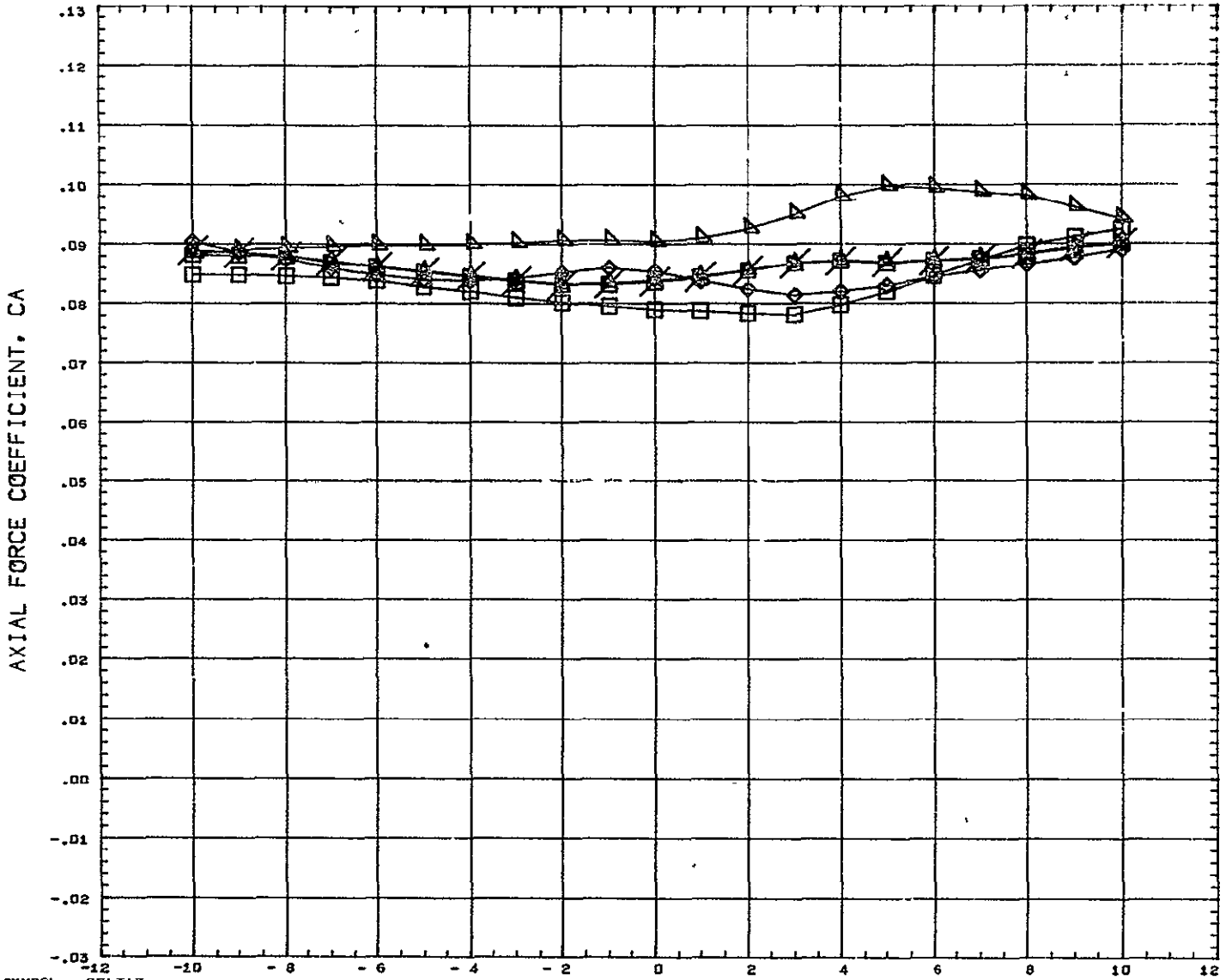

SYMBOL 	DELTAZ 0.182 0.228 0.352 0.599 10.000	<table border="0" style="width: 100%;"> <tr> <th colspan="4" style="text-align: left;">PARAMETRIC VALUES</th> </tr> <tr> <td>BSTPOW</td><td>0.000</td><td>ORBPOW</td><td>0.000</td> </tr> <tr> <td>DELTAZ</td><td>0.501</td><td>ALPHA1</td><td>10.100</td> </tr> <tr> <td>MACH</td><td>5.010</td><td>ELVBST</td><td>0.000</td> </tr> <tr> <td>ELVORB</td><td>0.000</td><td>BETA</td><td>0.000</td> </tr> </table>	PARAMETRIC VALUES				BSTPOW	0.000	ORBPOW	0.000	DELTAZ	0.501	ALPHA1	10.100	MACH	5.010	ELVBST	0.000	ELVORB	0.000	BETA	0.000	<table border="0" style="width: 100%;"> <tr> <th colspan="3" style="text-align: left;">REFERENCE INFORMATION</th> </tr> <tr> <td>REFS</td><td>44.4440</td><td>SQ IN</td> </tr> <tr> <td>REFL</td><td>13.3330</td><td>IN</td> </tr> <tr> <td>REFB</td><td>13.3330</td><td>IN</td> </tr> <tr> <td>XMRP</td><td>7.5200</td><td>IN</td> </tr> <tr> <td>YMRP</td><td>0.0000</td><td>IN</td> </tr> <tr> <td>ZMRP</td><td>1.1940</td><td>IN</td> </tr> <tr> <td>SCALE</td><td>0.0055</td><td></td> </tr> </table>	REFERENCE INFORMATION			REFS	44.4440	SQ IN	REFL	13.3330	IN	REFB	13.3330	IN	XMRP	7.5200	IN	YMRP	0.0000	IN	ZMRP	1.1940	IN	SCALE	0.0055	
PARAMETRIC VALUES																																															
BSTPOW	0.000	ORBPOW	0.000																																												
DELTAZ	0.501	ALPHA1	10.100																																												
MACH	5.010	ELVBST	0.000																																												
ELVORB	0.000	BETA	0.000																																												
REFERENCE INFORMATION																																															
REFS	44.4440	SQ IN																																													
REFL	13.3330	IN																																													
REFB	13.3330	IN																																													
XMRP	7.5200	IN																																													
YMRP	0.0000	IN																																													
ZMRP	1.1940	IN																																													
SCALE	0.0055																																														

# AEDC VA 1163 MDAC BOOSTER AND ORBITER TEST DATA AT MACH NUMBER 5

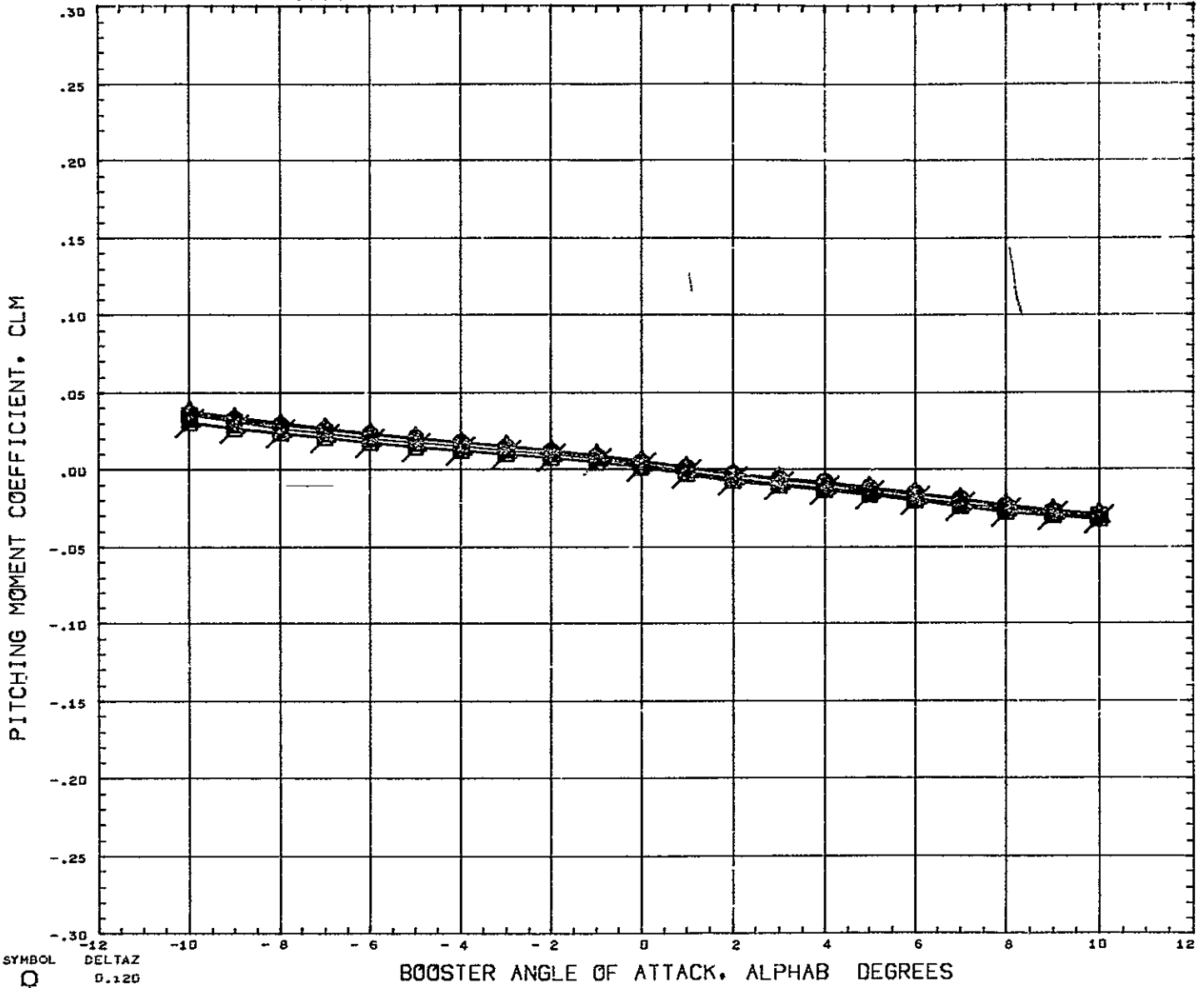

SYMBOL <del>AD</del>	DELTAZ 0.120 0.151 0.182 0.228 0.352 0.599 10.000	PARAMETRIC VALUES BSTFOW 0.000 ORBFOV 0.000 DFLTAX - 0.391 ALPHAI - 4.900 MACH 5.010 ELVBST 0.000 ELVORB 0.000 BETA 0.000	REFERENCE INFORMATION REFS 44 4440 SQ IN REFL 13 3330 IN REFB 13 3330 IN XMRP 7.5280 IN YMRP 0.0000 IN ZMRP 1 1940 IN SCALE 0 0055
-------------------------	--	---	---

REFERENCE FILE



# AEDC VA 1163 MDAC BOOSTER AND ORBITER TEST DATA AT MACH NUMBER 5

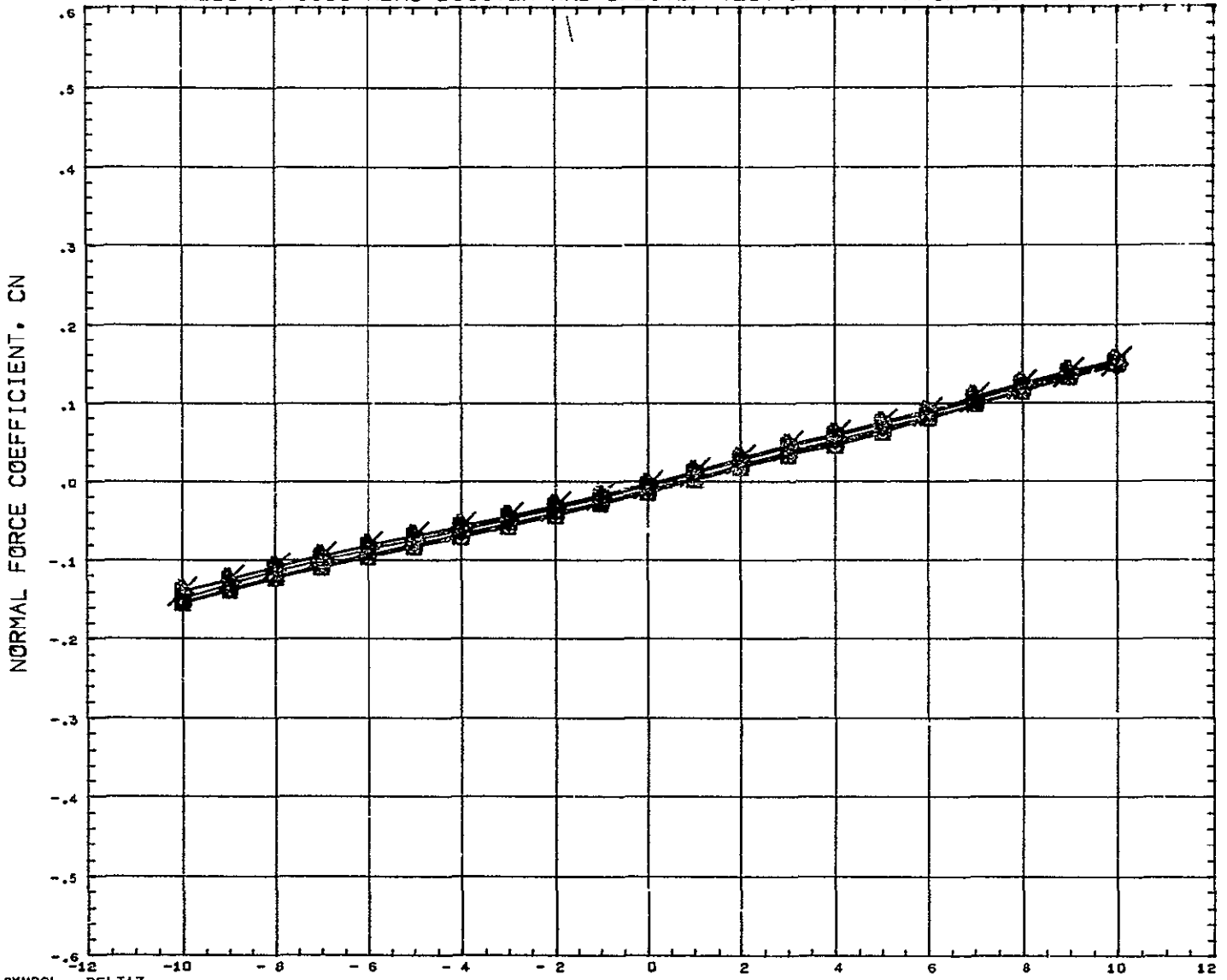

SYMBOL ○ □ ◇ △ ×	DELTAZ 0.120 0.151 0.182 0.228 0.352 0.599 10.000	PARAMETRIC VALUES BSTFOW    0.000    ORBFOW    0.000 DFLTAX    - 0.391    ALPHAI    - 4.900 MACH       5.010    ELVBST    0.000 ELVORB     0.000    BETA       0.000	REFERENCE INFORMATION REFS       44.4440    SQ IN REFL       13.3330    IN REFB       13.3330    IN XMRP       7.5280    IN YMRP       0.0000    IN ZMRP       1.1940    IN SCALE      0.0055
		REFERENCE FILE	

# AEDC VA 1163 MDAC BOOSTER AND ORBITER TEST DATA AT MACH NUMBER 5

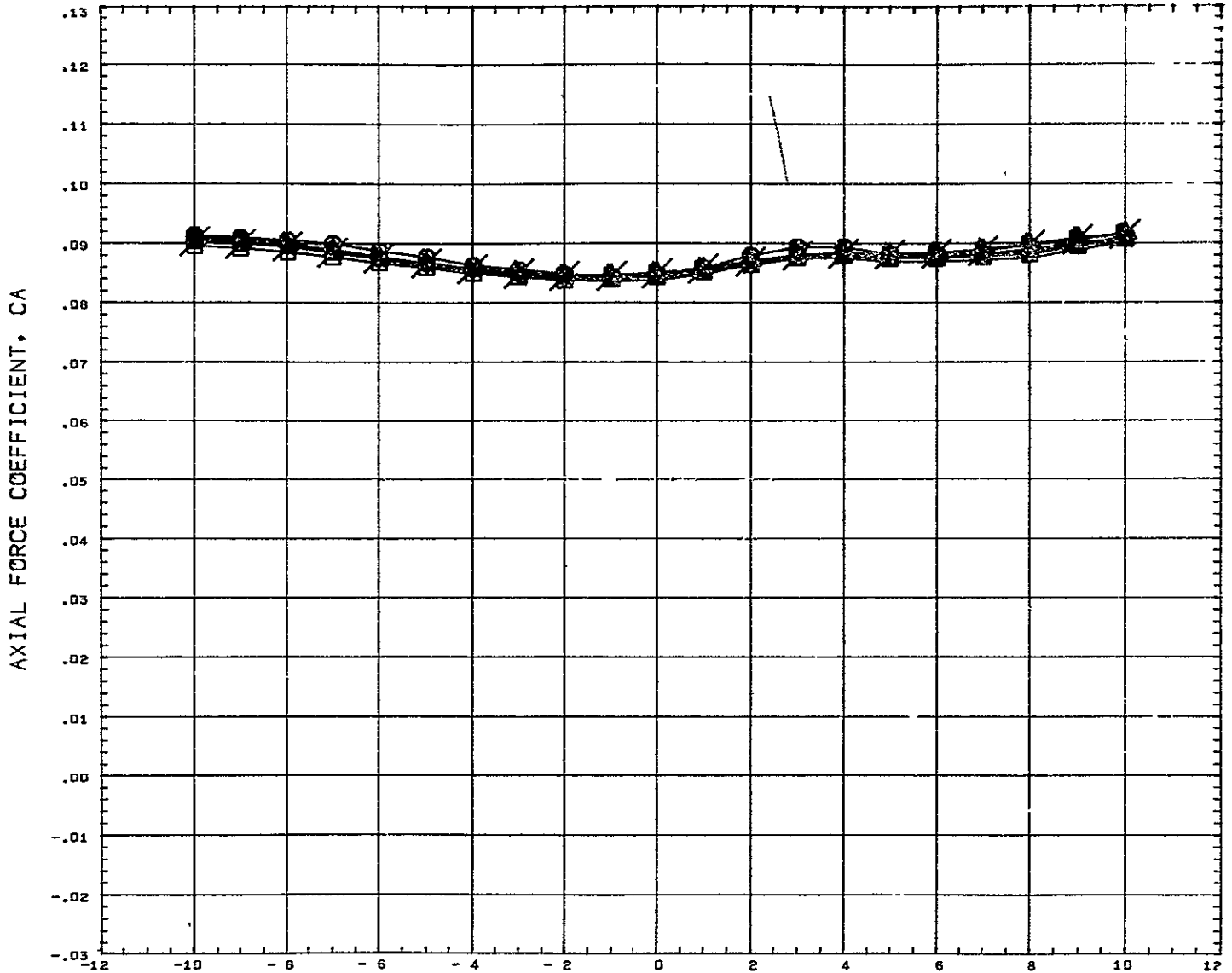

SYMBOL	DELTAZ	PARAMETRIC VALUES				REFERENCE INFORMATION		
◇	0.120	BSTPOW	0.000	ORBPOW	0.000	REFS	44 4420	SQ IN
◇	0.151	DELTAZ	- 0.391	ALPHA1	- 4.900	REFL	13 3330	IN
◇	0.182	MACH	5.010	ELVBST	0.000	XMRP	7 5280	IN
◇	0.228	ELVORB	0.000	BETA	0.000	YMRP	0 0000	IN
◇	0.352					ZMRP	1 1940	IN
◇	0.599					SCALE	0 0055	
◇	10.000							

REFERENCE FILE

# AEDC VA 1163 MDAC BOOSTER AND ORBITER TEST DATA AT MACH NUMBER 5

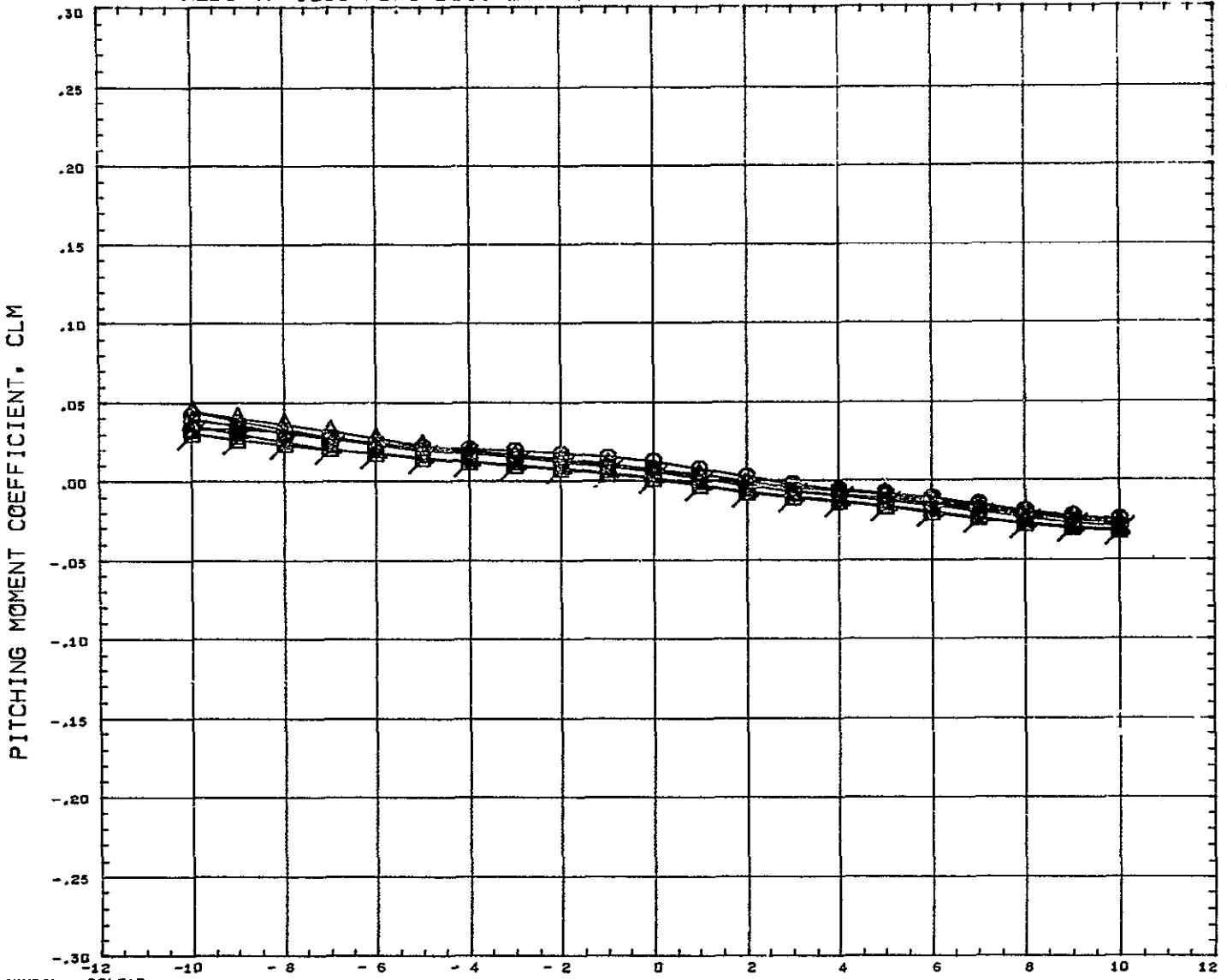

SYMBOL 	DELTAX 0.120 0.151 0.182 0.228 0.352 0.599 10.000	PARAMETRIC VALUES BSTPOW    0.000    ORBPOW    0.000 DELTAX    - 0.143    ALPHAI    - 4.900 MACH      5.010    ELVBST    0.000 ELVORB    0.000    BETA      0.000	REFERENCE INFORMATION REFS      44.4440    SQ IN REFL      13.3330    IN REFB      13.3330    IN XHRF      7.5280    IN YHRF      0.0000    IN ZHRF      1.1940    IN SCALE     0.0055
REFERENCE FILE			

# AEDC VA 1163 MDAC BOOSTER AND ORBITER TEST DATA AT MACH NUMBER 5

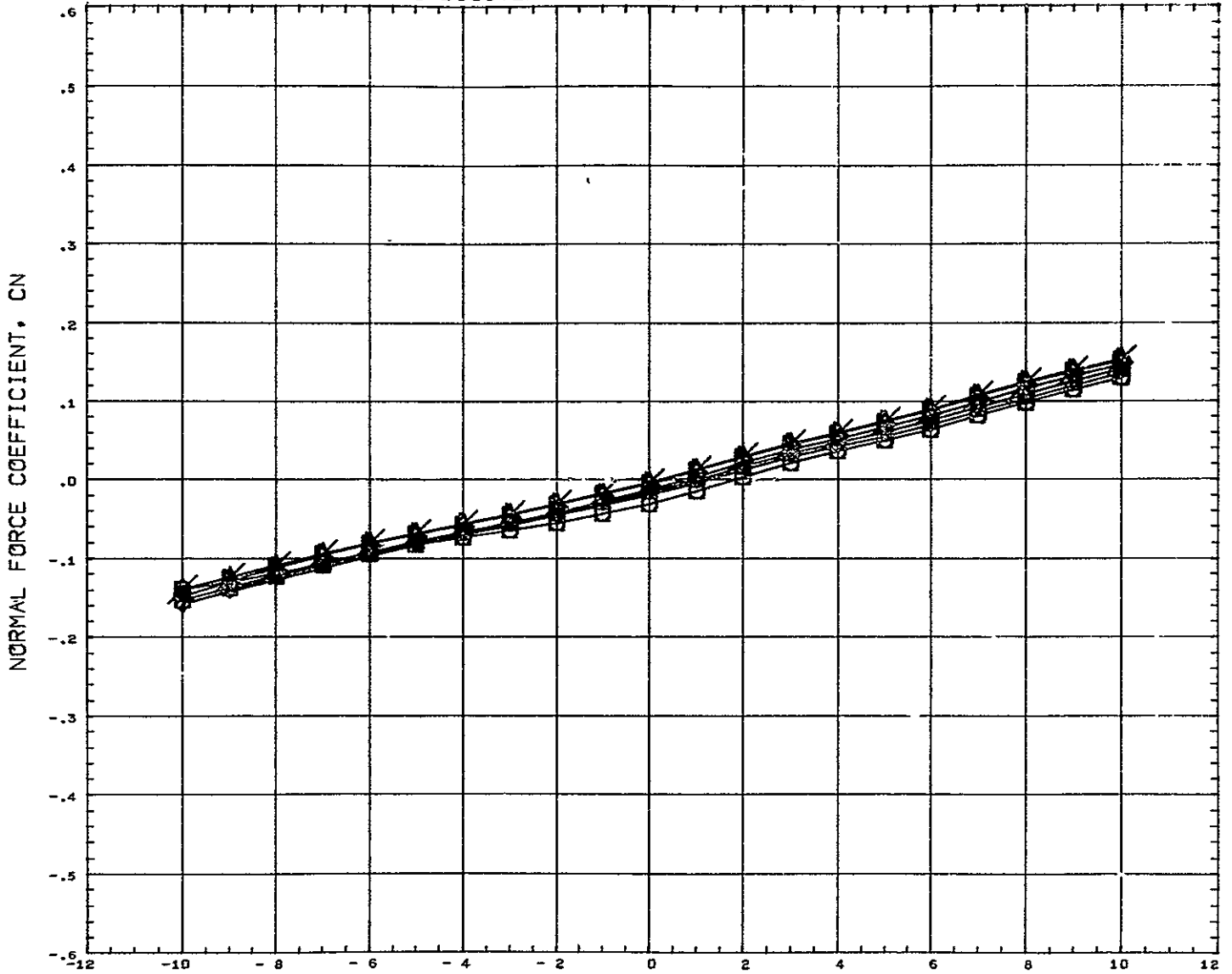

SYMBOL ○ ◇ □ △ ×	DELTAZ 0.120 0.151 0.182 0.228 0.352 0.599 10.000	BOOSTER ANGLE OF ATTACK, ALPHAB DEGREES	PARAMETRIC VALUES BSTPOW    0.000    ORBPOW    0.000 DELTAX    - 0.143    ALPHAI    - 4.900 MACH       5.010    ELVBST    0.000 ELVORB     0.000    BETA       0.000	REFERENCE INFORMATION REFS       44.4440    SQ IN REFL       13.3330    IN REFB       13.3330    IN XMRP       7.5280    IN YMRP       0.0000    IN ZMRP       1.1940    IN SCALE      0.0055
REFERENCE FILE				

# AEDC VA 1163 MDAC BOOSTER AND ORBITER TEST DATA AT MACH NUMBER 5

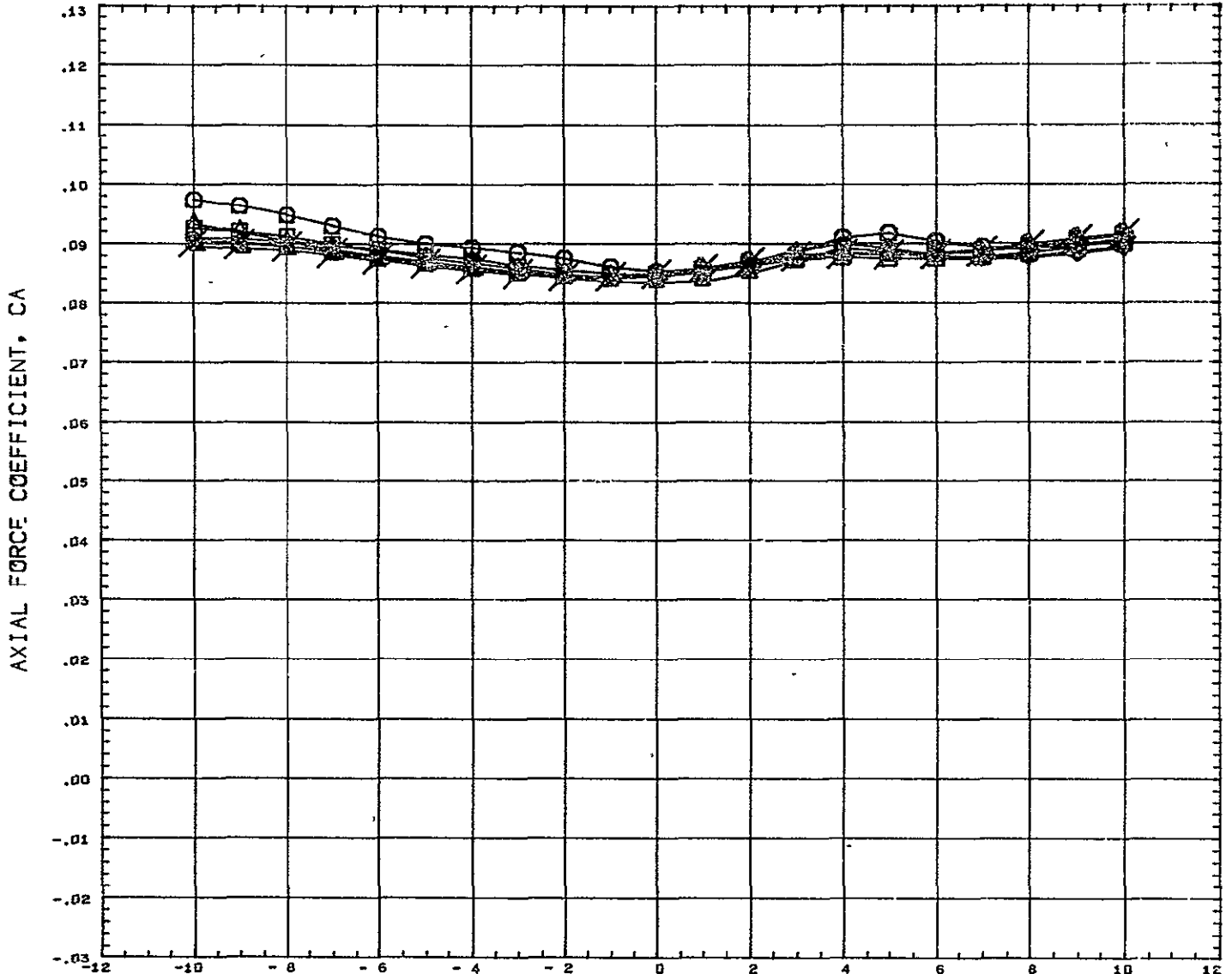

SYMBOL <del>AD</del>	DELTAX 0.120 0.151 0.182 0.228 0.352 0.599 10.000	PARAMETRIC VALUES BSTPOW    0.000    ORBPOW    0.000 DELTAX    - 0.143    ALPHAI    - 4.900 MACH       5.010    ELVBST    0.000 ELVORB    0.000    BETA      0.000	REFERENCE INFORMATION REFC       44.4440    SQ IN REFL       13.3330    IN REFB       13.3330    IN XMRF       7.5280    IN YMRP       0.6000    IN ZMRP       1.1940    IN SCALE      0.0055
REFERENCE FILE			

# AEDC VA 1163 MDAC BOOSTER AND ORBITER TEST DATA AT MACH NUMBER 5

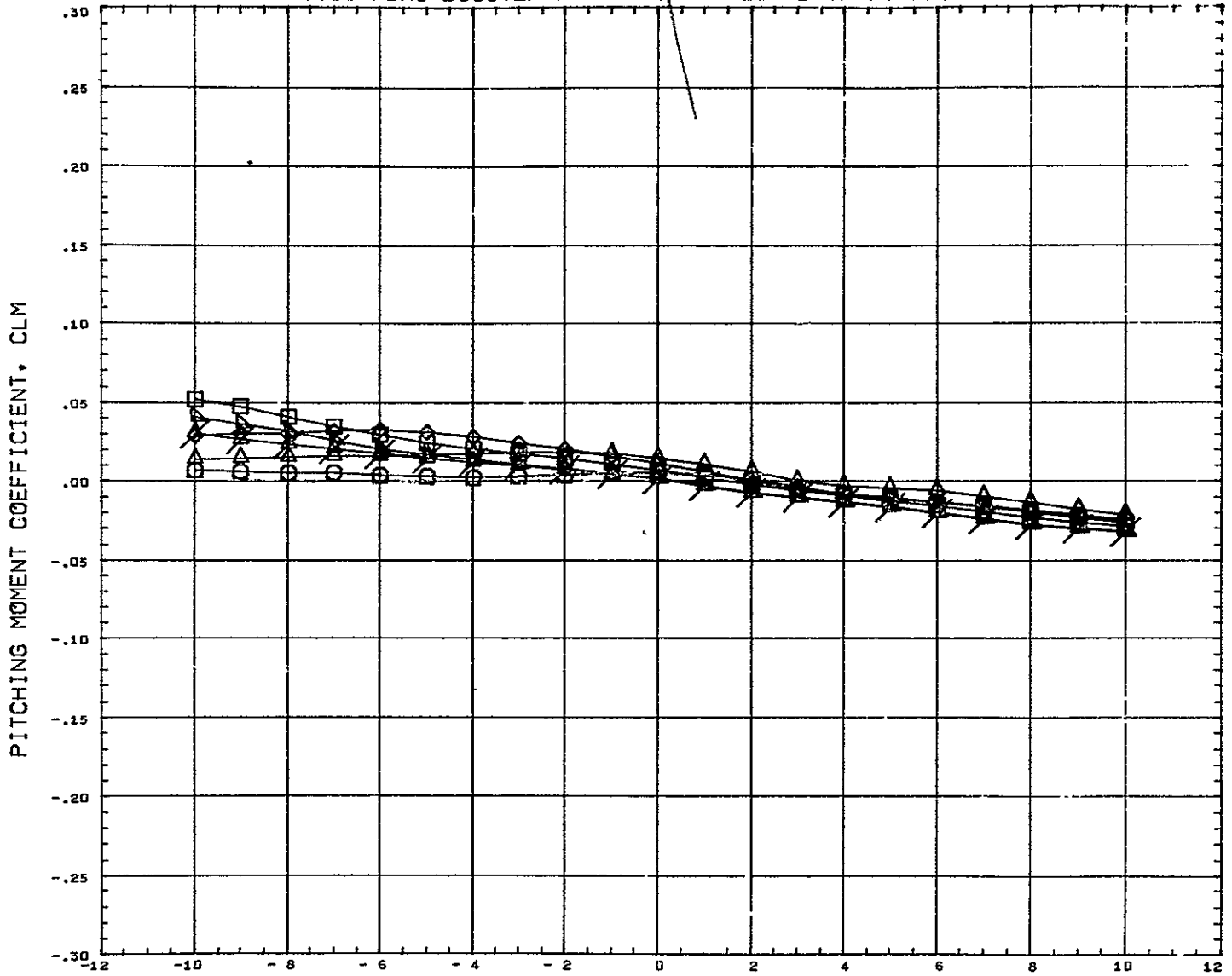

SYMBOL ○ ◇ □ △	DELTA Z 0.120 0.151 0.182 0.228 0.352 10.000	<table border="0" style="width: 100%;"> <tr> <th colspan="4" style="text-align: left; padding-left: 20px;">PARAMETRIC VALUES</th> </tr> <tr> <td style="padding-right: 10px;">BSTFOW</td> <td style="padding-right: 10px;">0.000</td> <td style="padding-right: 10px;">ORBPOW</td> <td>0.000</td> </tr> <tr> <td>DELTA X</td> <td>- 0.019</td> <td>ALPHA I</td> <td>- 4.900</td> </tr> <tr> <td>MACH</td> <td>5.010</td> <td>ELVBST</td> <td>0.000</td> </tr> <tr> <td>ELVORB</td> <td>0.000</td> <td>BETA</td> <td>0.000</td> </tr> </table>	PARAMETRIC VALUES				BSTFOW	0.000	ORBPOW	0.000	DELTA X	- 0.019	ALPHA I	- 4.900	MACH	5.010	ELVBST	0.000	ELVORB	0.000	BETA	0.000	<table border="0" style="width: 100%;"> <tr> <th colspan="3" style="text-align: left;">REFERENCE INFORMATION</th> </tr> <tr> <td>REFS</td> <td>44.4440</td> <td>SQ IN</td> </tr> <tr> <td>REFL</td> <td>13.3330</td> <td>IN</td> </tr> <tr> <td>REFB</td> <td>13.3330</td> <td>IN</td> </tr> <tr> <td>XMRP</td> <td>7.5280</td> <td>IN</td> </tr> <tr> <td>YMRP</td> <td>0.0000</td> <td>IN</td> </tr> <tr> <td>ZMRP</td> <td>1.1940</td> <td>IN</td> </tr> <tr> <td>SCALE</td> <td>0.0055</td> <td></td> </tr> </table>	REFERENCE INFORMATION			REFS	44.4440	SQ IN	REFL	13.3330	IN	REFB	13.3330	IN	XMRP	7.5280	IN	YMRP	0.0000	IN	ZMRP	1.1940	IN	SCALE	0.0055	
PARAMETRIC VALUES																																															
BSTFOW	0.000	ORBPOW	0.000																																												
DELTA X	- 0.019	ALPHA I	- 4.900																																												
MACH	5.010	ELVBST	0.000																																												
ELVORB	0.000	BETA	0.000																																												
REFERENCE INFORMATION																																															
REFS	44.4440	SQ IN																																													
REFL	13.3330	IN																																													
REFB	13.3330	IN																																													
XMRP	7.5280	IN																																													
YMRP	0.0000	IN																																													
ZMRP	1.1940	IN																																													
SCALE	0.0055																																														

REFERENCE FILE

# AEDC VA 1163 MDAC BOOSTER AND ORBITER TEST DATA AT MACH NUMBER 5

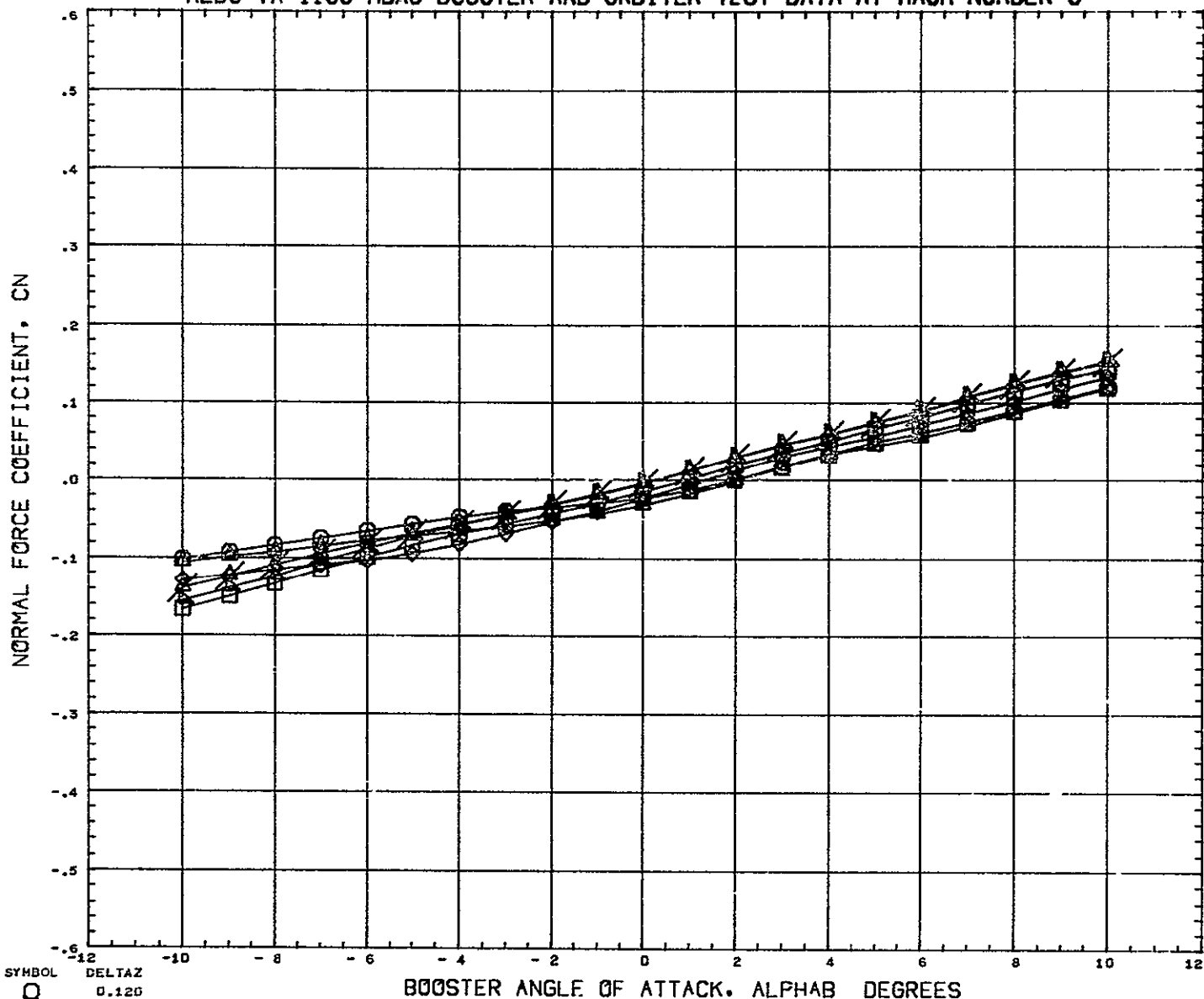

SYMBOL ○ ◇ □ △ ▲	DELTA Z 0.120 0.151 0.182 0.228 0.352 10.000	PARAMETRIC VALUES BSTPOW    0.000    ORBPOW    0.000 _LTAX    - 0.019    ALPHAI    - 4.900 MACH     5.010    ELVBST    0.000 ELVORB    0.000    BETA      0.000	REFERENCE INFORMATION REFS     44.4440    SQ IN REFL     13.3330    IN REFB     13.3330    IN XMRP     7.5280    IN YMRP     0.0000    IN ZMRP     1.1940    IN SCALE    0.0055
---------------------------------	--	---	--

REFERENCE FILE

# AEDC VA 1163 MDAC BOOSTER AND ORBITER TEST DATA AT MACH NUMBER 5

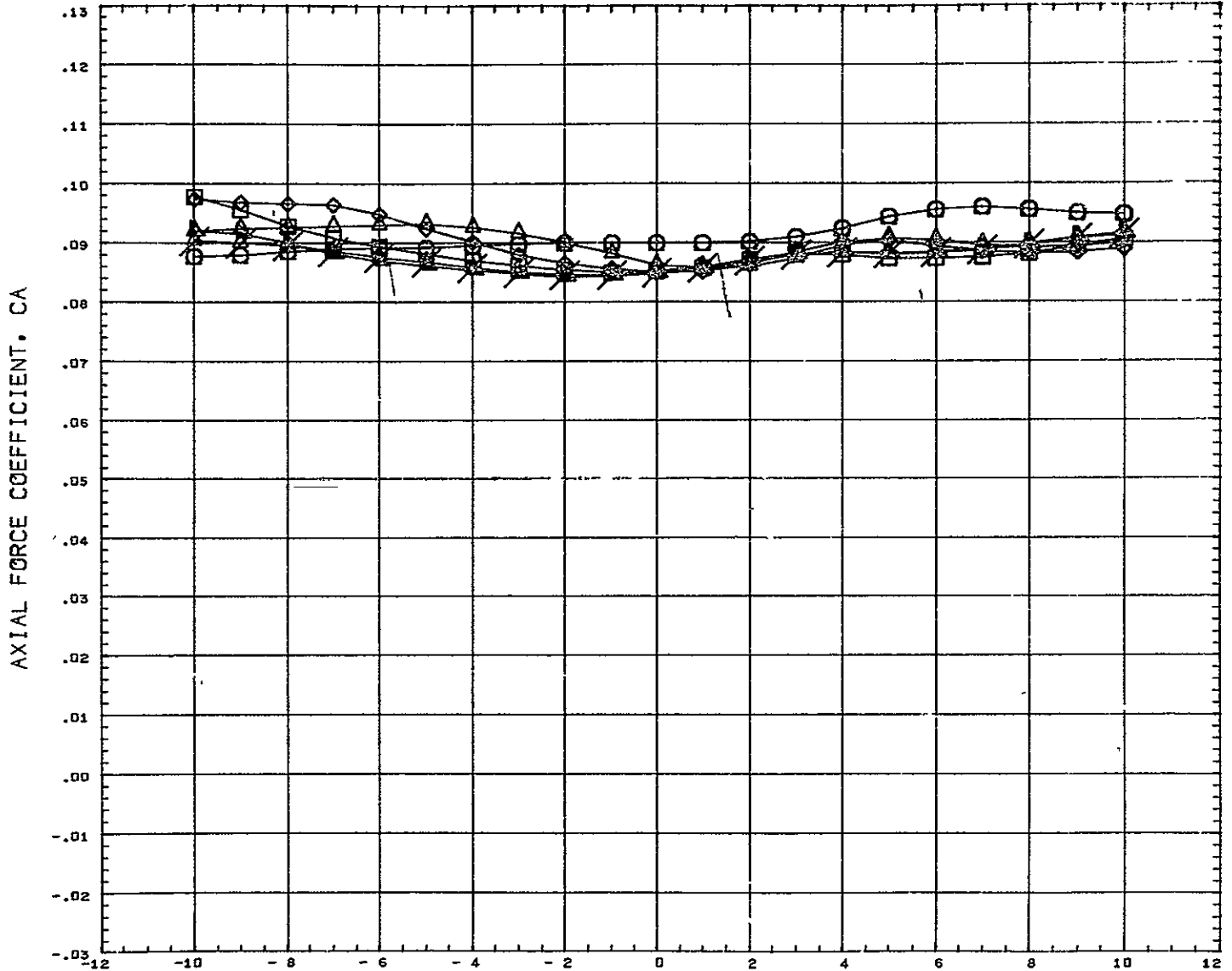

SYMBOL ○ □ △ ◇ ◊ ◓	DELTAZ 0.120 0.151 0.182 0.228 0.352 10.000	<table border="0" style="width: 100%;"> <tr> <th colspan="4" style="text-align: center;">PARAMETRIC VALUES</th> </tr> <tr> <td>BSTPOW</td> <td>0.000</td> <td>ORBPOW</td> <td>0.000</td> </tr> <tr> <td>PLTAX</td> <td>0.019</td> <td>ALPHA1</td> <td>4.900</td> </tr> <tr> <td>MACH</td> <td>5.010</td> <td>ELVBST</td> <td>0.000</td> </tr> <tr> <td>ELVORB</td> <td>0.000</td> <td>BETA</td> <td>0.000</td> </tr> </table>	PARAMETRIC VALUES				BSTPOW	0.000	ORBPOW	0.000	PLTAX	0.019	ALPHA1	4.900	MACH	5.010	ELVBST	0.000	ELVORB	0.000	BETA	0.000	<table border="0" style="width: 100%;"> <tr> <th colspan="3" style="text-align: center;">REFERENCE INFORMATION</th> </tr> <tr> <td>REFS</td> <td>44.4440</td> <td>SQ IN</td> </tr> <tr> <td>REFL</td> <td>13.3330</td> <td>IN</td> </tr> <tr> <td>REFB</td> <td>13.3330</td> <td>IN</td> </tr> <tr> <td>XNRP</td> <td>7.5280</td> <td>IN</td> </tr> <tr> <td>YNRP</td> <td>0.0000</td> <td>IN</td> </tr> <tr> <td>ZNRP</td> <td>1.1940</td> <td>IN</td> </tr> <tr> <td>SCALE</td> <td>0.0055</td> <td></td> </tr> </table>	REFERENCE INFORMATION			REFS	44.4440	SQ IN	REFL	13.3330	IN	REFB	13.3330	IN	XNRP	7.5280	IN	YNRP	0.0000	IN	ZNRP	1.1940	IN	SCALE	0.0055	
PARAMETRIC VALUES																																															
BSTPOW	0.000	ORBPOW	0.000																																												
PLTAX	0.019	ALPHA1	4.900																																												
MACH	5.010	ELVBST	0.000																																												
ELVORB	0.000	BETA	0.000																																												
REFERENCE INFORMATION																																															
REFS	44.4440	SQ IN																																													
REFL	13.3330	IN																																													
REFB	13.3330	IN																																													
XNRP	7.5280	IN																																													
YNRP	0.0000	IN																																													
ZNRP	1.1940	IN																																													
SCALE	0.0055																																														

1 REFERENCE FILE



# AEDC VA 1163 MDAC BOOSTER AND ORBITER TEST DATA AT MACH NUMBER 5

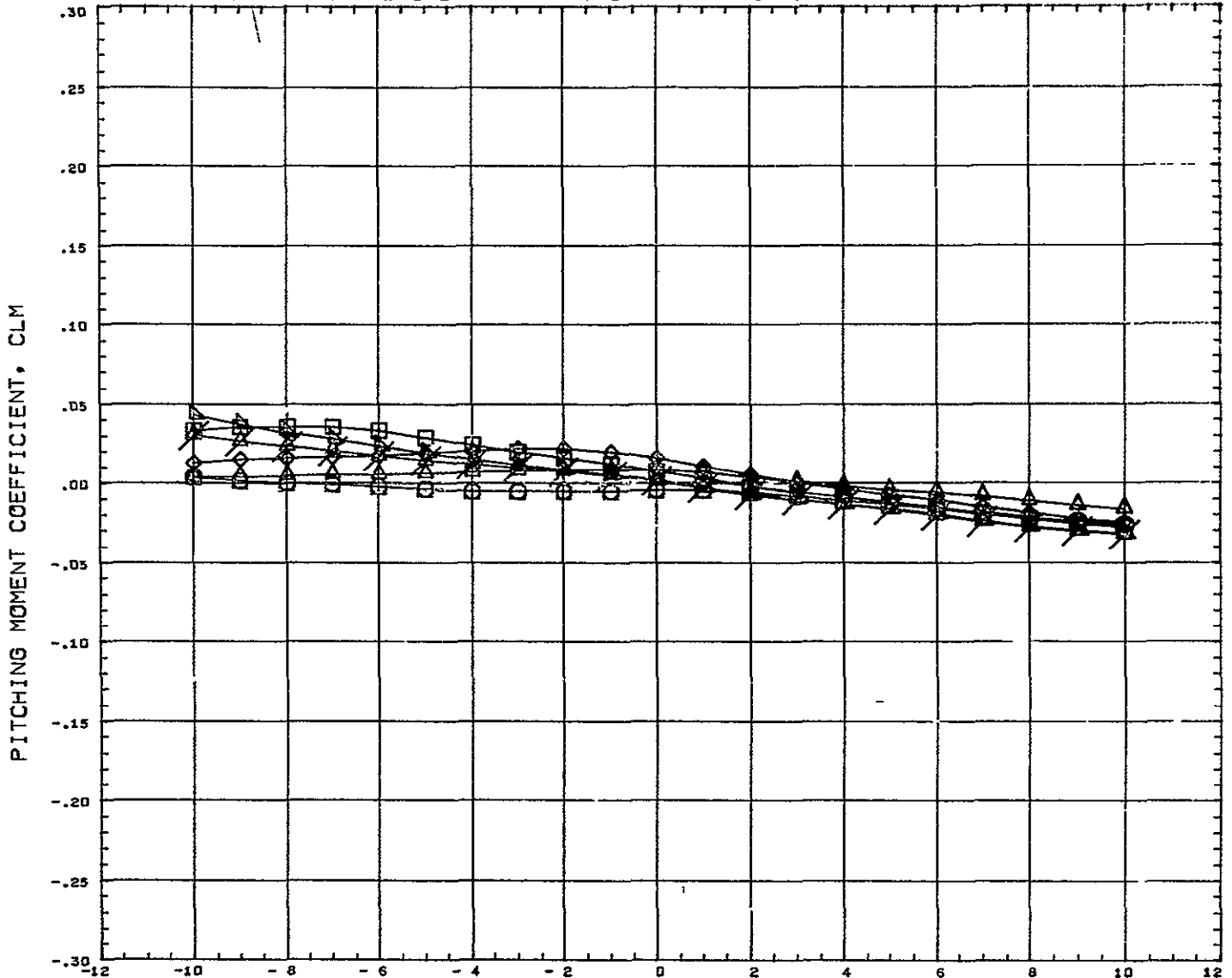

SYMBOL	DELTA Z	PARAMETRIC VALUES				REFERENCE INFORMATION		
○	0.120							
◇	0.151							
□	0.182	BSTPOW	0.000	CRBPOW	0.000	REFS	44.4440	SQ IN
△	0.228	DF_TAX	0.043	ALPHA_I	- 4.900	REFL	13.3330	IN
▽	0.352	MACH	5.010	EL^BST	0.000	REFB	13.3330	IN
△	10.000	ELVORB	0.000	BETA	0.000	XMRP	7.5280	IN
						YMRP	0.0000	IN
						ZMRP	1.1940	IN
						SCALE	0.0055	

REFERENCE FILE

# AEDC VA 1163 MDAC BOOSTER AND ORBITER TEST DATA AT MACH NUMBER 5

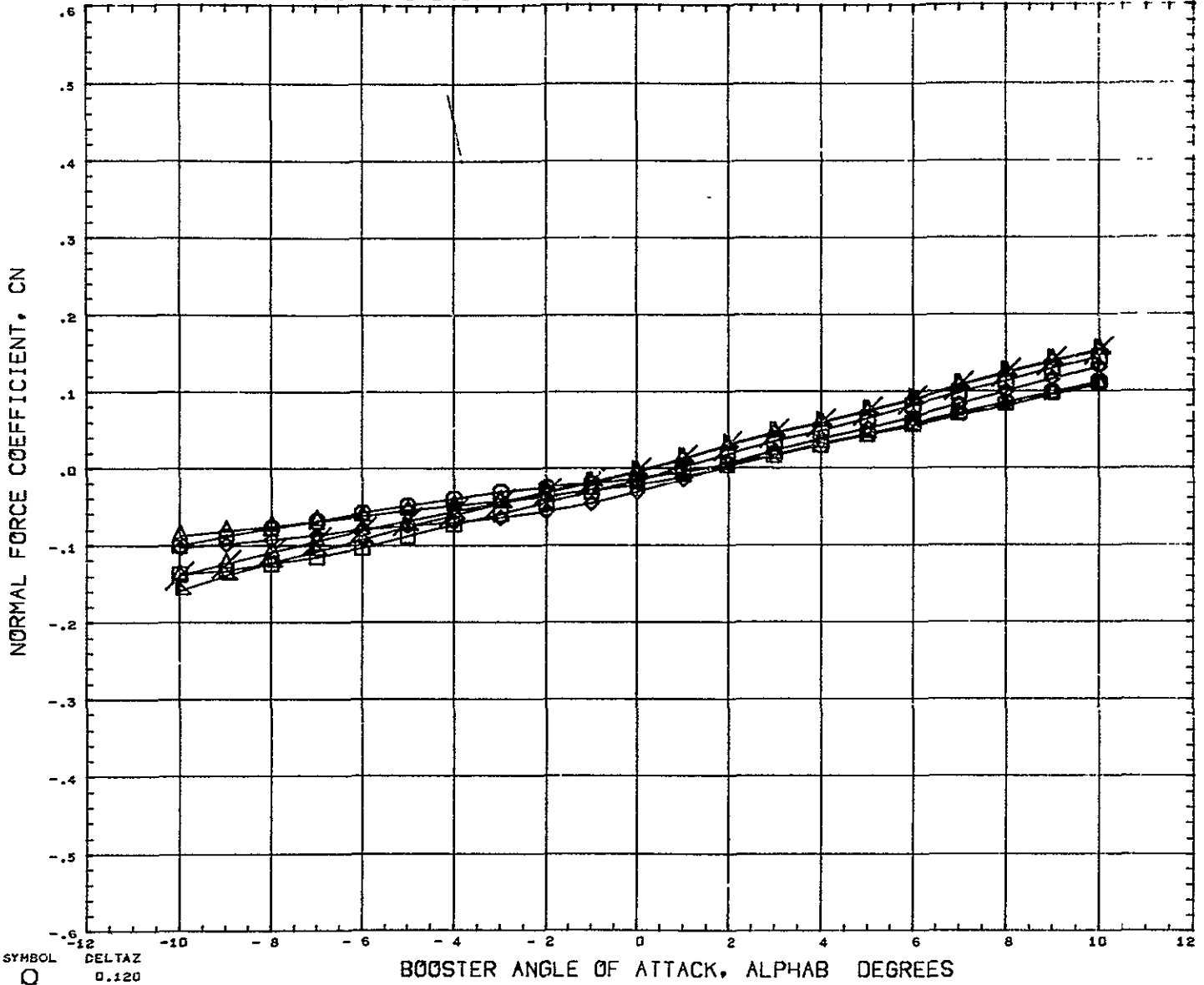

SYMBOL	DELTAZ	PARAMETRIC VALUES			
○	0.120	BSTPOW	0.000	ORBPOW	0.000
△	0.151	DELTAZ	0.043	ALPHA1	-4.900
◇	0.182	MACH	5.010	ELVBST	0.000
□	0.228	ELVORB	0.000	BETA	0.000
×	0.352				
△	10.000				

REFERENCE INFORMATION		
REFS	44.4440	SQ IN
REFL	13.3330	IN
REFB	13.3330	IN
XMRP	7.5200	IN
YMRP	0.0000	IN
ZMRP	1.1940	IN
SCALE	0.0055	

REFERENCE FILE

# AEDC VA 1163 MDAC BOOSTER AND ORBITER TEST DATA AT MACH NUMBER 5

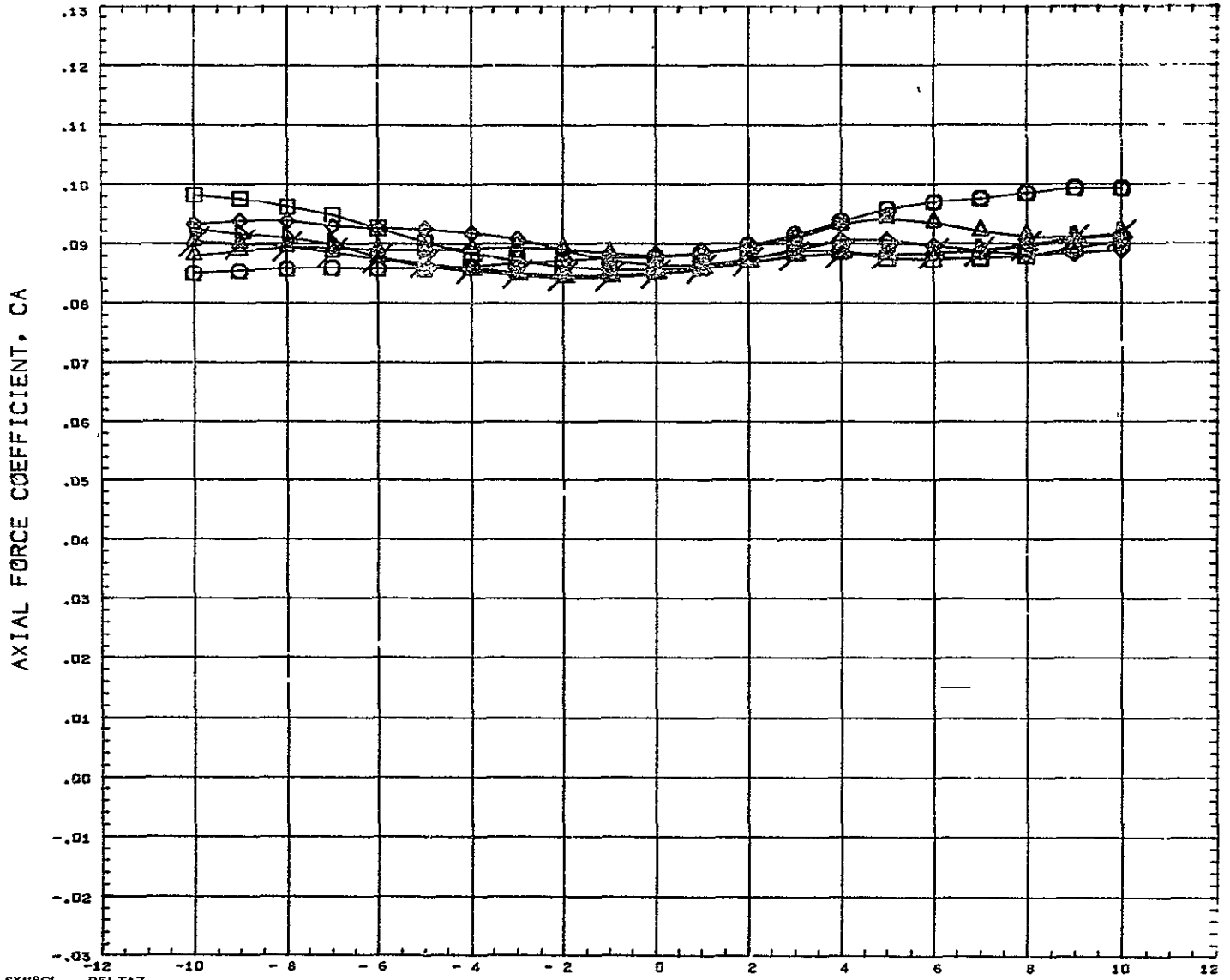

SYMBOL 	DELTA Z 0.120 0.151 0.182 0.228 0.352 10.000	<table border="0" style="width: 100%;"> <tr> <th colspan="4" style="text-align: center;">PARAMETRIC VALUES</th> </tr> <tr> <td>BSTPOW</td> <td>0.000</td> <td>ORBPOK</td> <td>0.000</td> </tr> <tr> <td>DELTA X</td> <td>0.043</td> <td>ALPHA I</td> <td>- 4.900</td> </tr> <tr> <td>MACH</td> <td>5.010</td> <td>ELVBST</td> <td>0.000</td> </tr> <tr> <td>ELVORB</td> <td>0.000</td> <td>BETA</td> <td>0.000</td> </tr> </table>	PARAMETRIC VALUES				BSTPOW	0.000	ORBPOK	0.000	DELTA X	0.043	ALPHA I	- 4.900	MACH	5.010	ELVBST	0.000	ELVORB	0.000	BETA	0.000	<table border="0" style="width: 100%;"> <tr> <th colspan="3" style="text-align: center;">REFERENCE INFORMATION</th> </tr> <tr> <td>REFS</td> <td>44.4440</td> <td>89 IN</td> </tr> <tr> <td>REFL</td> <td>13.3330</td> <td>IN</td> </tr> <tr> <td>REFB</td> <td>13.3330</td> <td>IN</td> </tr> <tr> <td>XMRP</td> <td>7.5280</td> <td>IN</td> </tr> <tr> <td>YMRP</td> <td>0.0000</td> <td>IN</td> </tr> <tr> <td>ZMRP</td> <td>1.1940</td> <td>IN</td> </tr> <tr> <td>SCALE</td> <td>0.0055</td> <td></td> </tr> </table>	REFERENCE INFORMATION			REFS	44.4440	89 IN	REFL	13.3330	IN	REFB	13.3330	IN	XMRP	7.5280	IN	YMRP	0.0000	IN	ZMRP	1.1940	IN	SCALE	0.0055	
PARAMETRIC VALUES																																															
BSTPOW	0.000	ORBPOK	0.000																																												
DELTA X	0.043	ALPHA I	- 4.900																																												
MACH	5.010	ELVBST	0.000																																												
ELVORB	0.000	BETA	0.000																																												
REFERENCE INFORMATION																																															
REFS	44.4440	89 IN																																													
REFL	13.3330	IN																																													
REFB	13.3330	IN																																													
XMRP	7.5280	IN																																													
YMRP	0.0000	IN																																													
ZMRP	1.1940	IN																																													
SCALE	0.0055																																														

REFERENCE FILE

# AEDC VA 1163 MDAC BOOSTER AND ORBITER TEST DATA AT MACH NUMBER 5

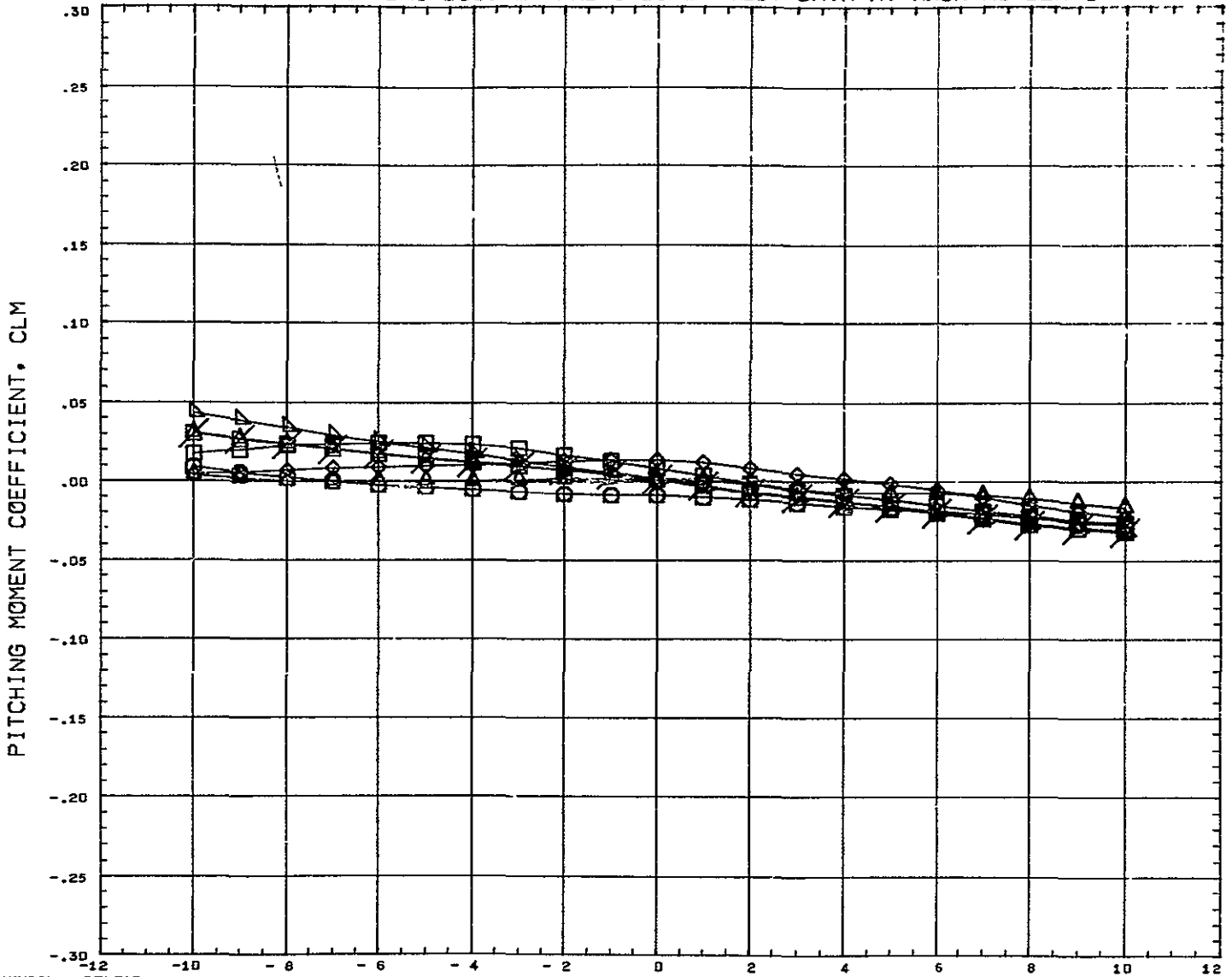

SYMBOL	DELTAZ	PARAMETRIC VALUES		REFERENCE INFORMATION	
□	0.120	BSTFOW	0.000	ORBFOV	0.000
◇	0.151	ZLTAX	0.105	ALPHA1	- 4.900
◇	0.182	MACH	5.010	E_VBST	0.000
◇	0.228	ELVORB	0.000	BETA	0.000
◇	0.352				
◇	0.599				
◇	10.000				
		REFERENCE FILE			
				REFS	44.4440 SQ IN
				REFL	13.3330 IN
				REFB	13.3330 IN
				XMRP	7.5286 IN
				YMRP	0.0000 IN
				ZMRP	1.1940 IN
				SCALE	0.0055

# AEDC VA 1163 MDAC BOOSTER AND ORBITER TEST DATA AT MACH NUMBER 5

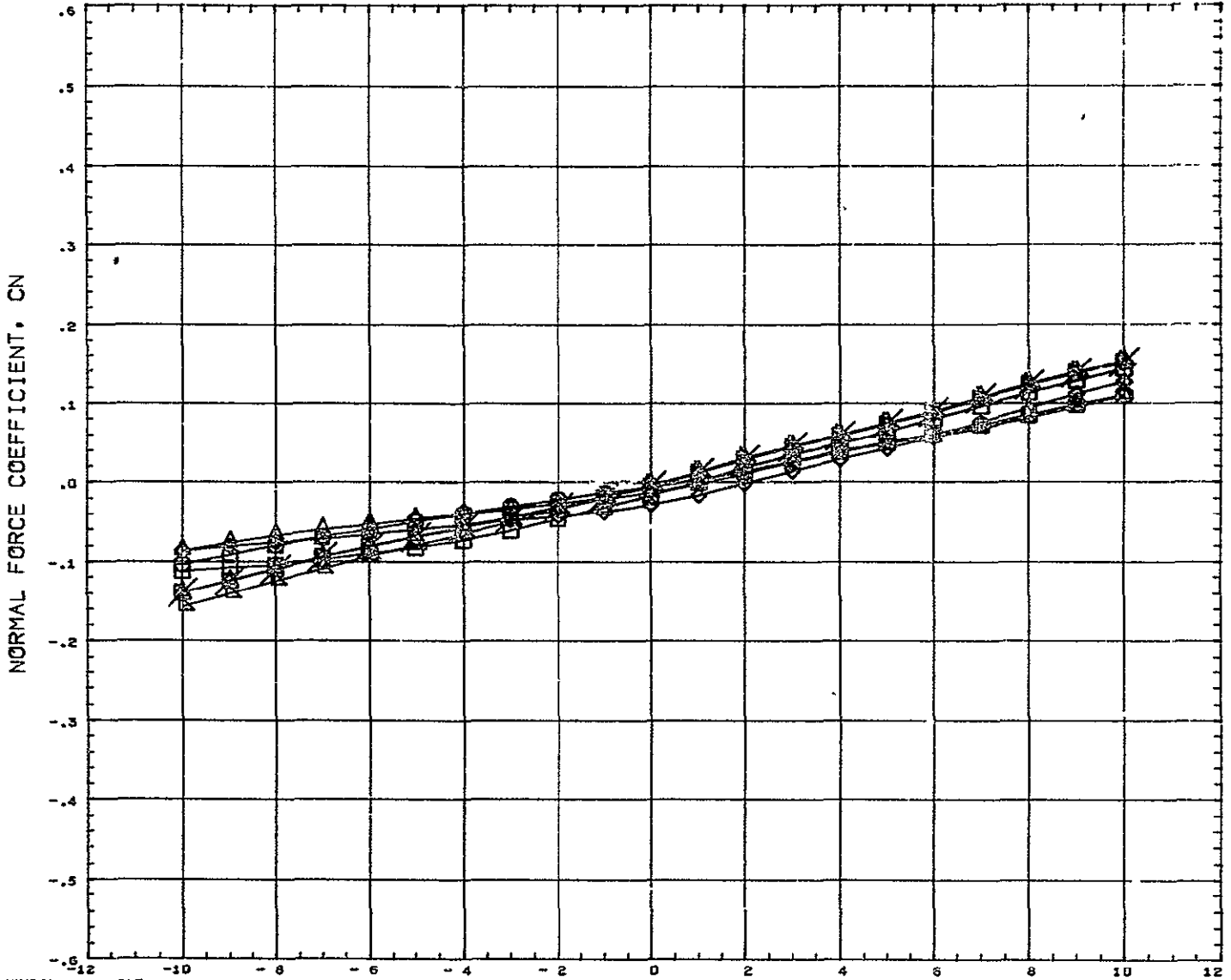

SYMBOL	DELTA Z	PARAMETRIC VALUES				REFERENCE INFORMATION		
○	0.120							
△	0.151							
◇	0.182	BSTPOW	0.000	ORBPOW	0.000	REFS	44.4440	SG IN
□	0.228	FLTAX	0.105	ALPHA1	4.900	REFL	13.3330	IN
▽	0.352	MACH	5.010	ELVBST	0.000	REFB	13.3330	IN
◇	0.599	ELVORB	0.000	BETA	0.000	XMRP	7.5280	IN
○	10.000					YMRP	0.0000	IN
						ZMRP	1.1940	IN
						SCALE	0.0055	

REFERENCE FILE

# AEDC VA 1163 MDAC BOOSTER AND ORBITER TEST DATA AT MACH NUMBER 5

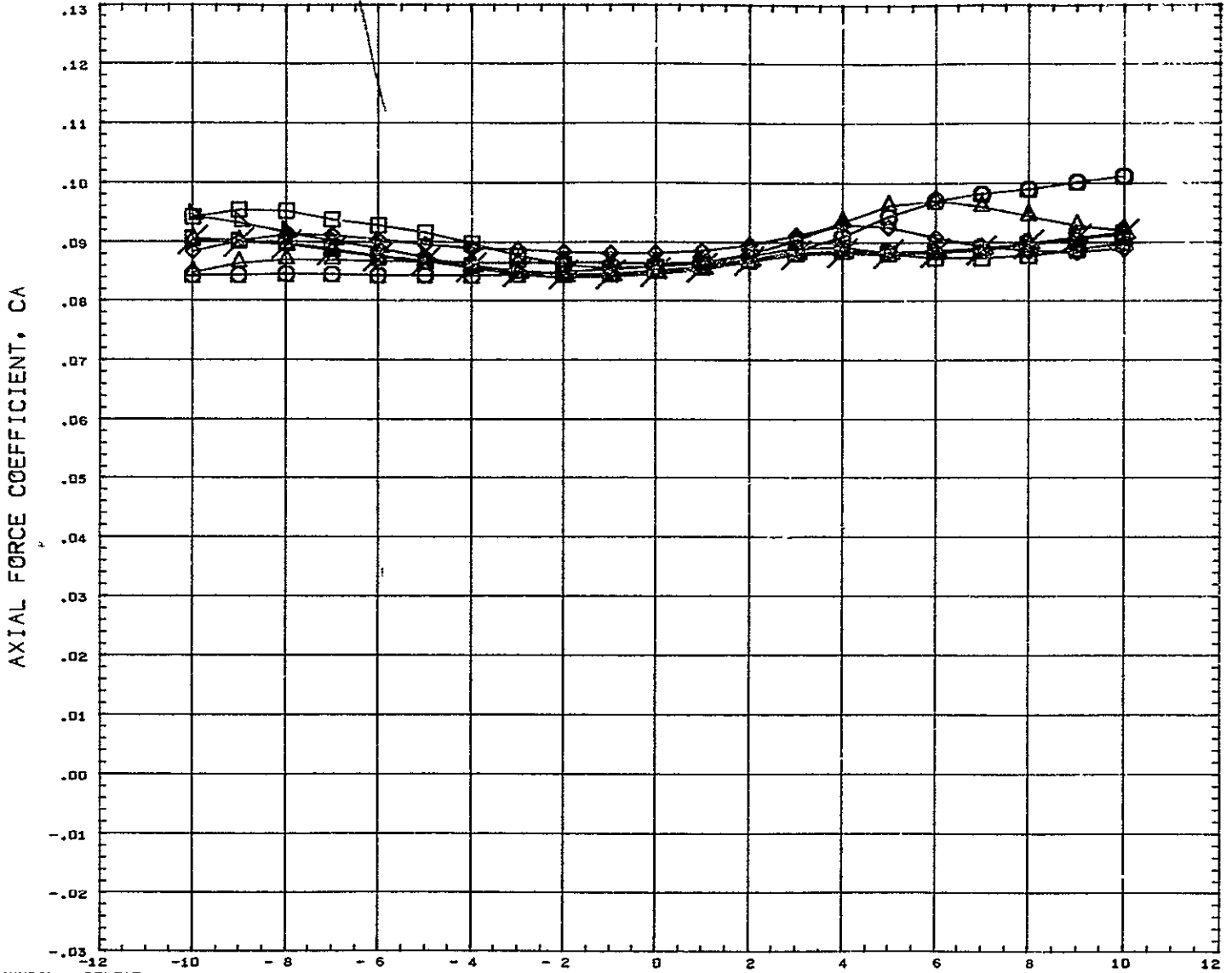

SYMBOL 	DELTAZ 0.120 0.151 0.182 0.228 0.352 0.599 10.000	<b>PARAMETRIC VALUES</b> BSTFOW    0.000    ORBFOV    0.000 DELTAX    0.105    ALPHAI    - 4.900 MACH       5.010    ELVBST    0.000 ELVORB    0.000    BETA       0.000	<b>REFERENCE INFORMATION</b> REFS       44.4449    SQ IN REFL       13.3330    IN REFB       13.3330    IN XMRF       7.5280    IN YMRP       0.0000    IN ZMRP       1.1940    IN SCALE       0.0055
REFERENCE FILE			

# AEDC VA 1163 MDAC BOOSTER AND ORBITER TEST DATA AT MACH NUMBER 5

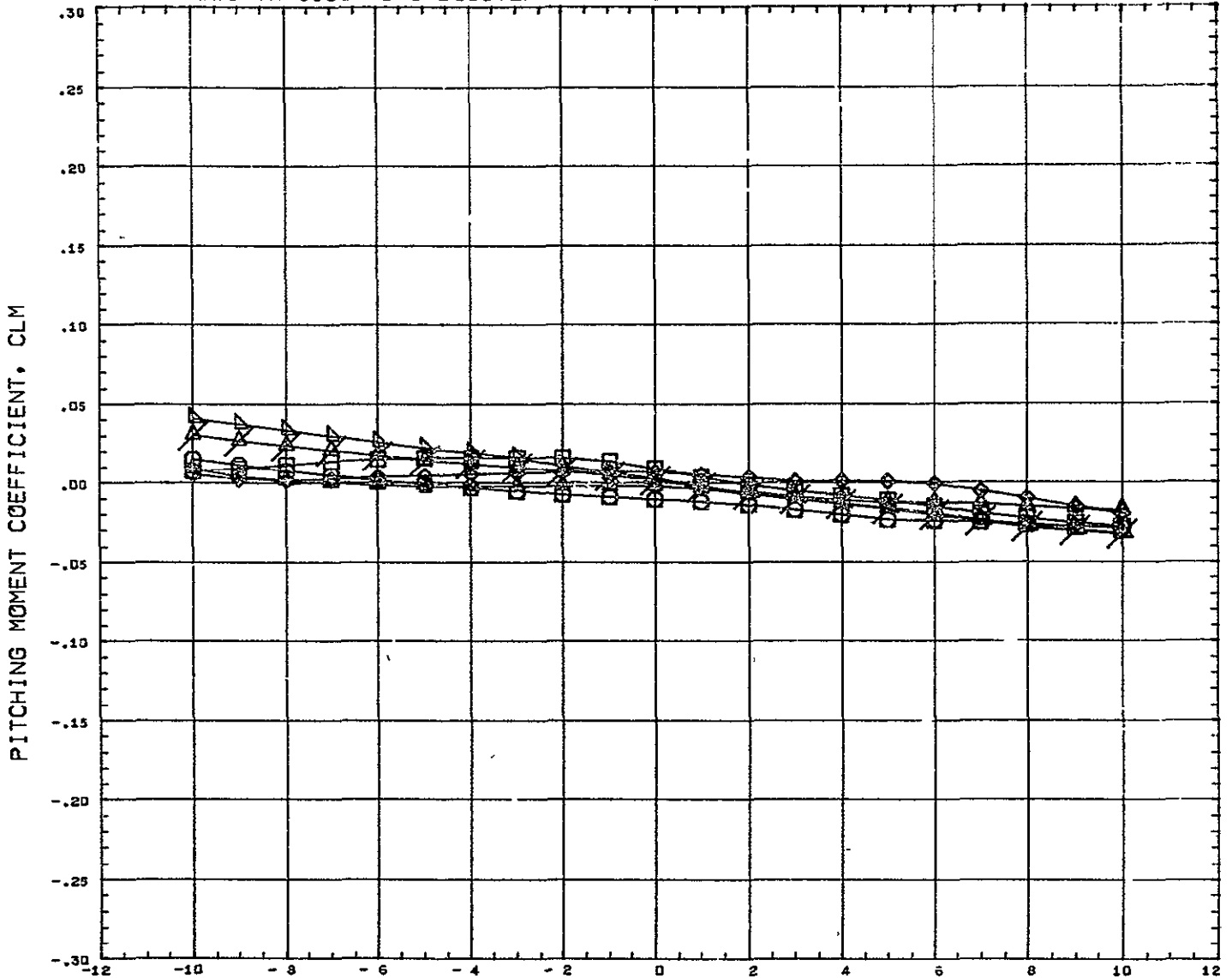

SYMBOL	DELTA Z	PARAMETRIC VALUES				REFERENCE INFORMATION	
○	0.120						
◇	0.151						
△	0.182	BSTPOW	0.000	ORBPOW	0.000	REFS	44.4445 SQ IN
□	0.228	DELTA X	0.167	ALPHA I	-4.900	REFL	13.3330 IN
▽	0.352	MACH	5.010	ELVBST	0.000	REFB	13.3330 IN
◇	10.000	ELVORB	0.000	BETA	0.000	XMRP	7.5200 IN
						YMRP	0.0000 IN
						ZMRP	1.1940 IN
						SCALE	0.0055

REFERENCE FILE

# AEDC VA 1163 MDAC BOOSTER AND ORBITER TEST DATA AT MACH NUMBER 5

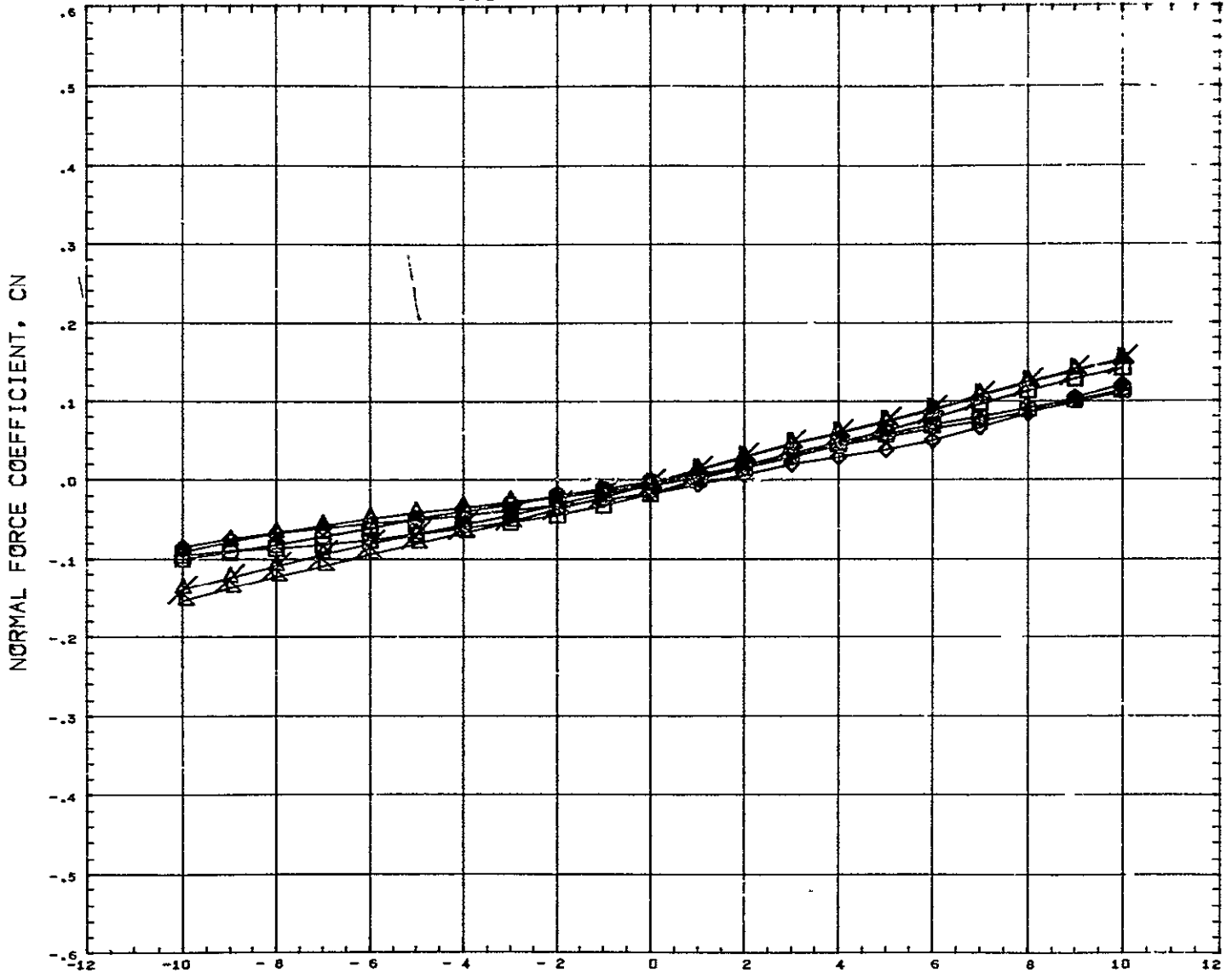

SYMBOL ○ ◊ ◻ △	DELTA Z 0.120 0.151 0.182 0.228 0.352 10.000	PARAMETRIC VALUES BSTFOW 0.000 ORBPOW 0.000 LITAX 0.167 ALPHAI - 4.900 MACH 5.010 ELVBST 0.000 ELVORB 0.000 BETA 0.000	REFERENCE INFORMATION REFS 44.4440 SQ IN REFL 13.3330 IN REFB 13.3330 IN XMRP 7.5280 IN YMRP 0.0000 IN ZMRP 1.1940 IN SCALE 0.0055
----------------------------	--	--	---

REFERENCE FILE



# AEDC VA 1163 MDAC BOOSTER AND ORBITER TEST DATA AT MACH NUMBER 5

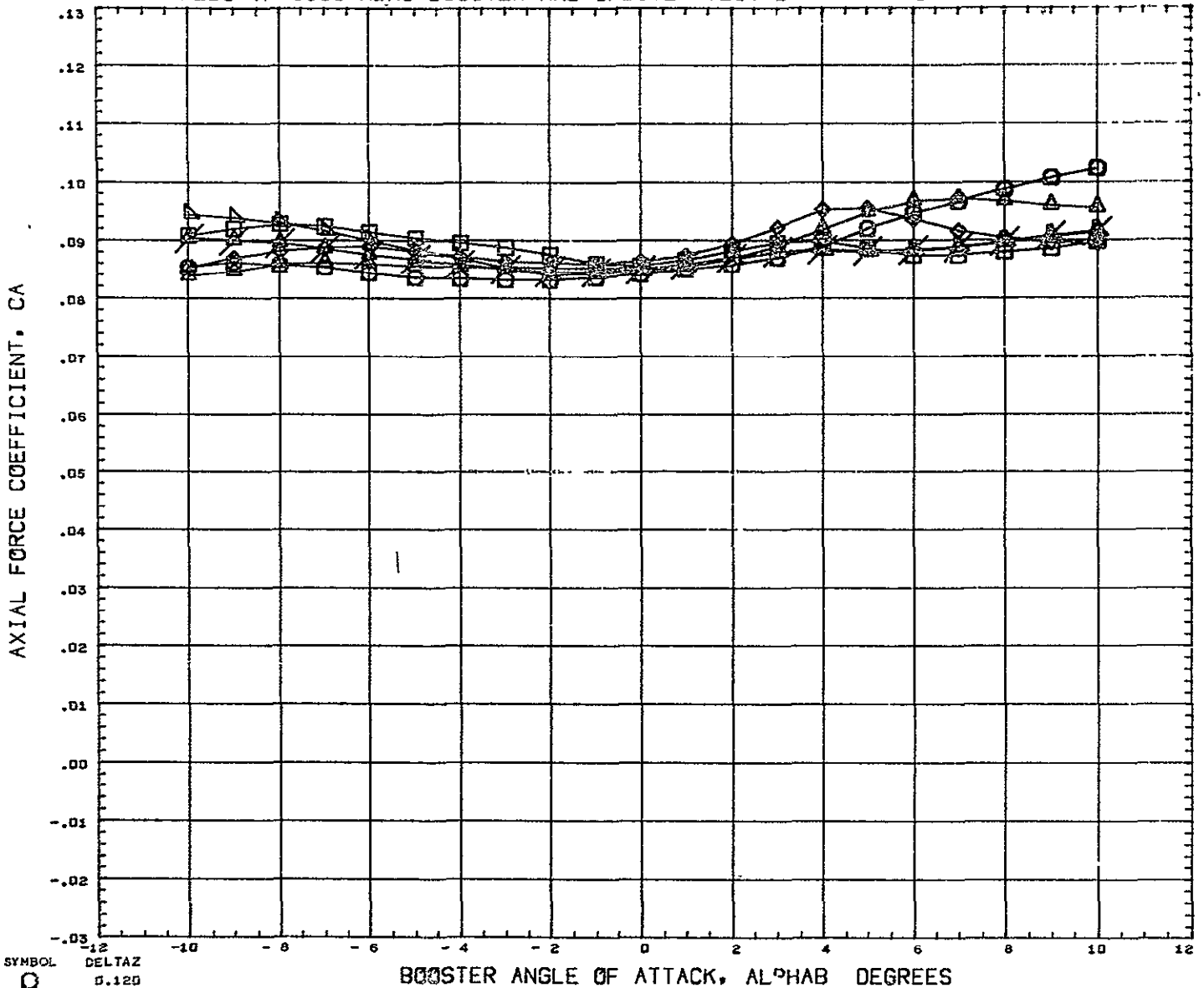

SYMBOL ○ ◇ □ △	DELTAZ 0.120 0.151 0.182 0.228 0.352 10.000	PARAMETRIC VALUES BSTPOW    0.000    ORBPOW    0.000 DELTAX    0.167    ALPHAI    - 4.900 MACH       5.010    ELVBST    0.000 ELVORB    0.000    BETA       0.000	REFERENCE INFORMATION REFS       44.4440    SQ IN REFL       13.3330    IN REFB       13.3330    IN XMRP       7.5280    IN YMRP       0.0000    IN ZMRP       1.1940    IN SCALE       0.0055
----------------------------	---	---	---

REFERENCE FILE

# AEDC VA 1163 MDAC BOOSTER AND ORBITER TEST DATA AT MACH NUMBER 5

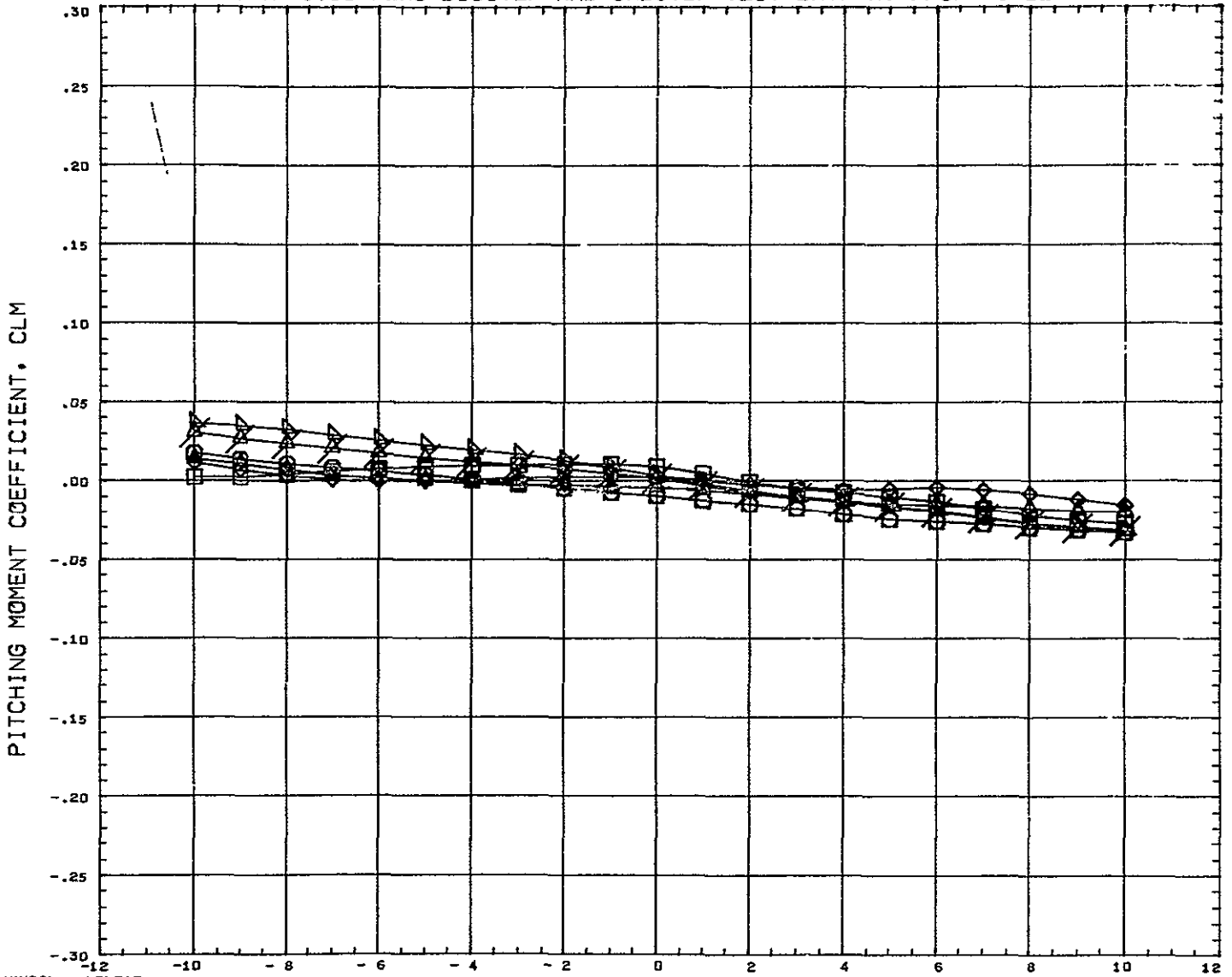

SYMBOL ○ □ ◇ △	DELTAZ 0.120 0.151 0.182 0.228 0.352 10.000	<b>PARAMETRIC VALUES</b> BSTFOW 0.000 ORBPOW 0.000 DELTAX 0.228 ALPHAI - 4.900 MACH 5.010 ELVBST 0.000 ELVORB 0.000 BETA 0.000	<b>REFERENCE INFORMATION</b> REFS 44.4440 SQ IN REFL 13.3330 IN REFB 13.3330 IN XMRP 7.5280 IN YMRP 0.0000 IN ZMRP 1.1940 IN SCALE 0.0055
----------------------------	---	--	--

REFERENCE FILE

# AEDC VA 1163 MDAC BOOSTER AND ORBITER TEST DATA AT MACH NUMBER 5

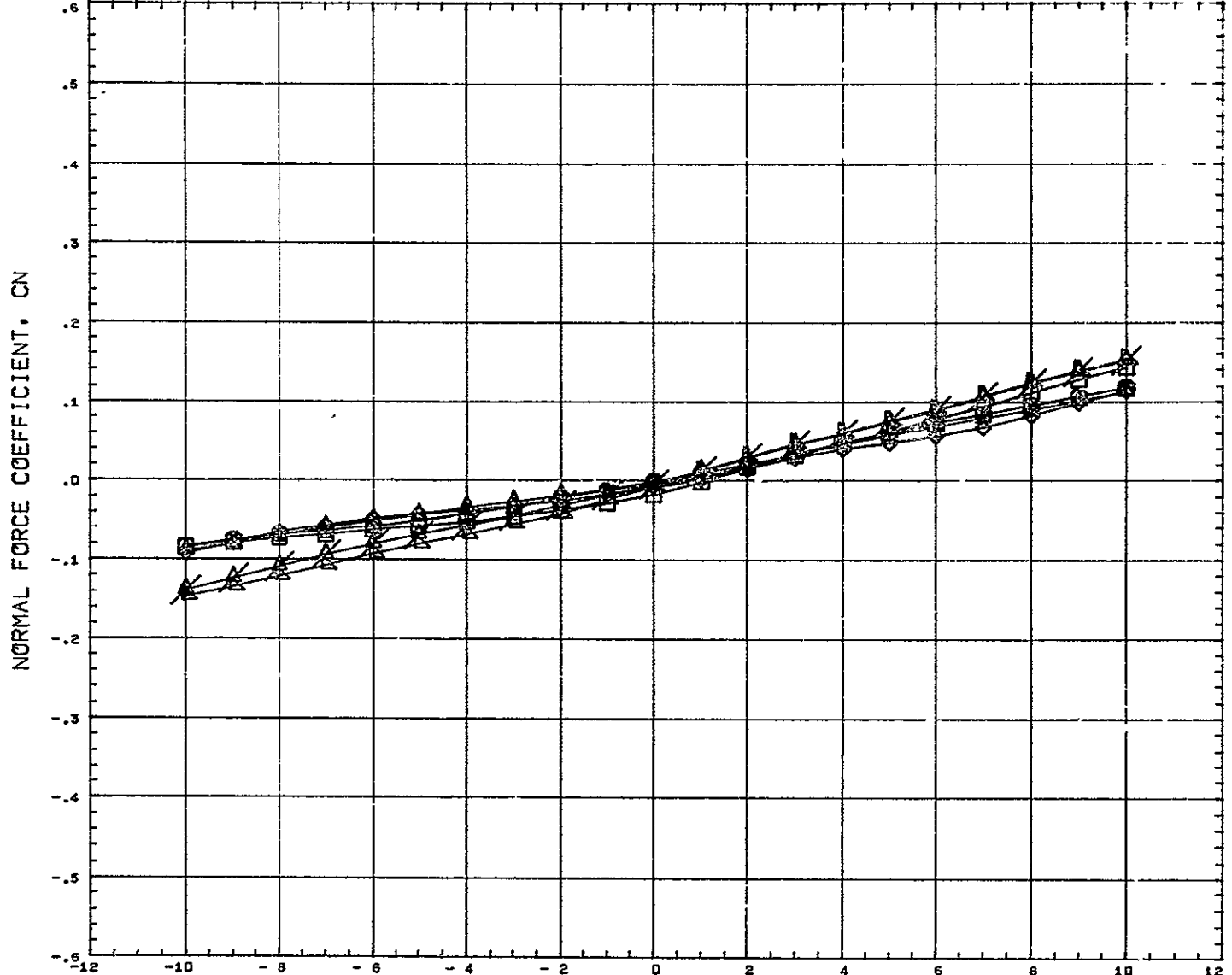

SYMBOL	DELTA Z	BOOSTER ANGLE OF ATTACK, ALPHA DEGREES				REFERENCE INFORMATION	
<div style="display: flex; flex-direction: column; align-items: center;"> <div style="margin-bottom: 2px;">□</div> <div style="margin-bottom: 2px;">◇</div> <div style="margin-bottom: 2px;">△</div> <div style="margin-bottom: 2px;">○</div> </div>	0.120 0.151 0.182 0.228 0.352 10.000	BSTFOW DELTAX MACH ELVORB	PARAMETRIC VALUES 0.000 0.228 5.010 0.000	ORBFW ALPHAI ELVBST BETA	0.000 - 4.900 0.000 0.000	REFS REFL REFB XMRP YMRP ZMRP SCALE	44.4440 13.3330 13.3330 7.5280 0.0000 1.1940 0.0055 SQ IN IN IN IN IN
REFERENCE FILE							

# AEDC VA 1163 MDAC BOOSTER AND ORBITER TEST DATA AT MACH NUMBER 5

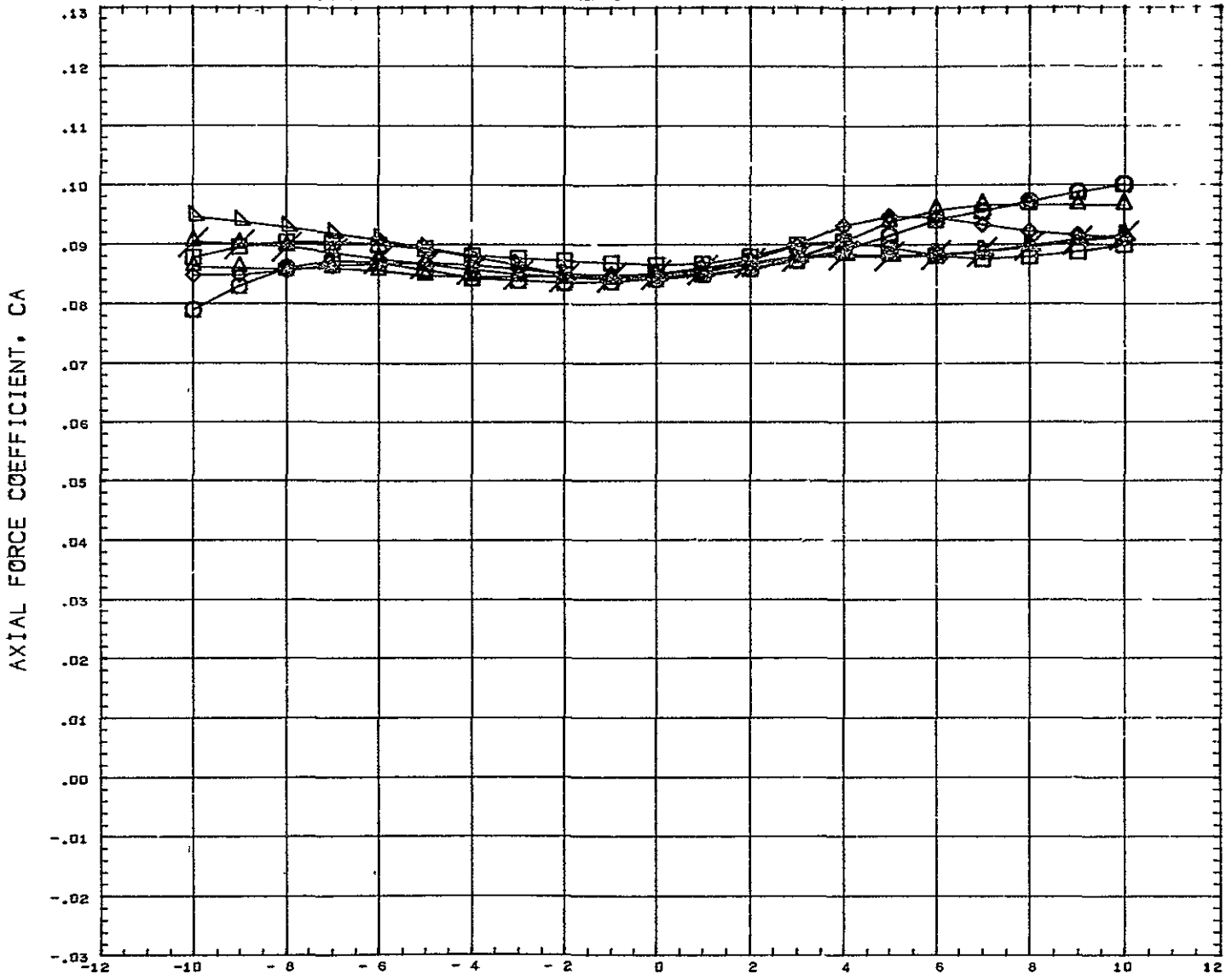

SYMBOL ○ ◇ □ △	DELTAZ 0.120 0.151 0.182 0.228 0.352 10.000	PARAMETRIC VALUES BSTPOW 0.000 ORBPOW 0.000 DELTAX 0.228 ALPHAI - 1.900 ACH 5.010 ELVBST 0.000 ELVORB 0.000 BETA 0.000	REFERENCE INFORMATION REFS 44 4440 SQ IN REFL 13 3330 IN REFB 13 3330 IN XMRP 7 5280 IN YMRP 0.0000 IN ZMRP 1.1940 IN SCALE 0.0055
----------------------------	---	--	---

REFERENCE FILE

AEDC VA 1163 MDAC BOOSTER AND ORBITER TEST DATA AT MACH NUMBER 5

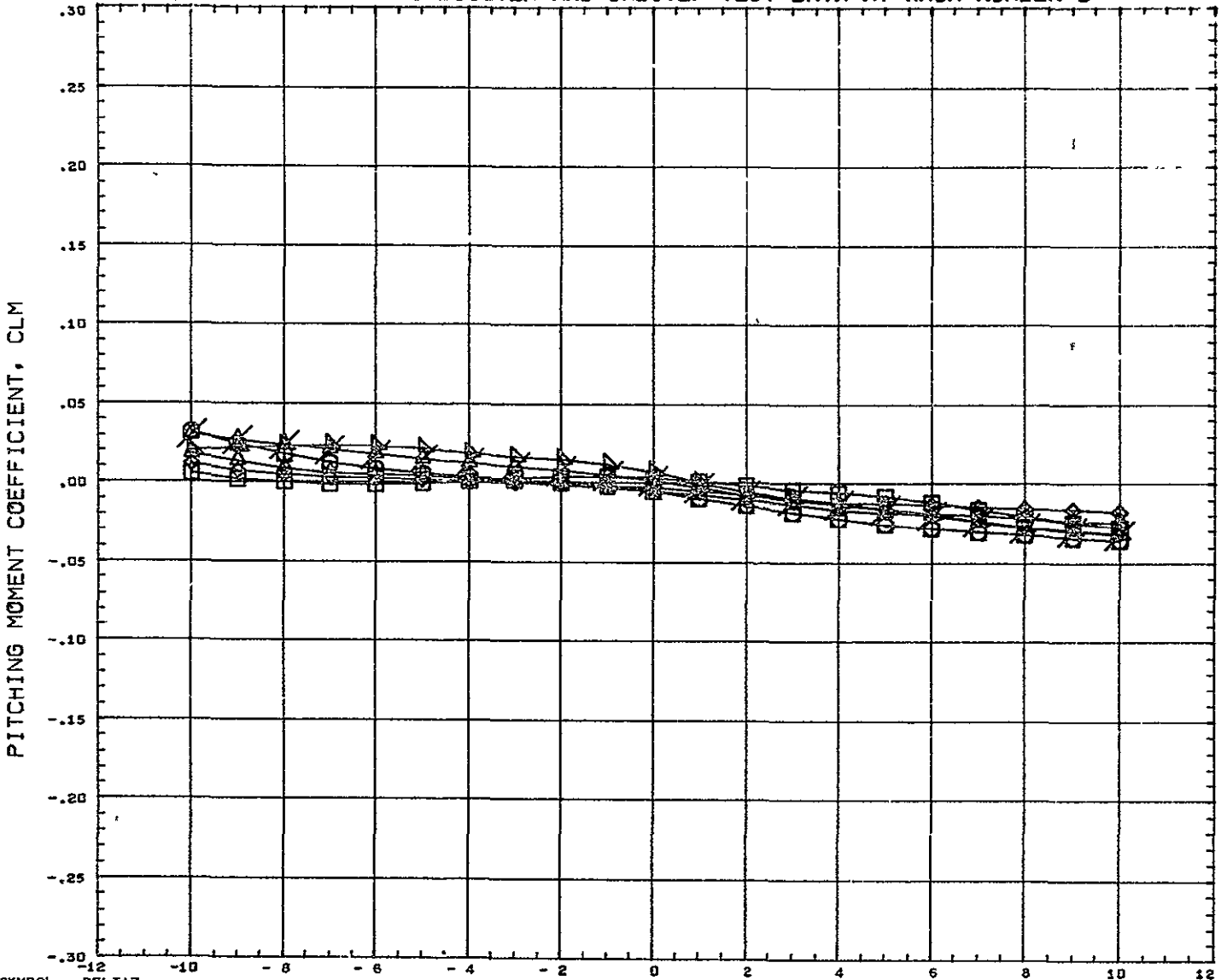

SYMBOL	DELTA Z	PARAMETRIC VALUES				REFERENCE INFORMATION		
○	0.120	BSTPOW	0.000	ORBPOW	0.000	REFS	44.4440	50 IN
◇	0.151	DELTA X	0.352	ALPHA I	-4.900	REFL	13.3330	IN
◇	0.182	MACH	5.010	ELVBST	0.000	REFB	13.3330	IN
◇	0.228	ELVORB	0.000	BETA	0.000	XHRP	7.5280	IN
△	0.352					YHRP	0.0000	IN
△	10.000					ZHRP	1.1940	IN
						SCALE	0.0055	

REFERENCE FILE

# AEDC VA 1163 MDAC BOOSTER AND ORBITER TEST DATA AT MACH NUMBER 5

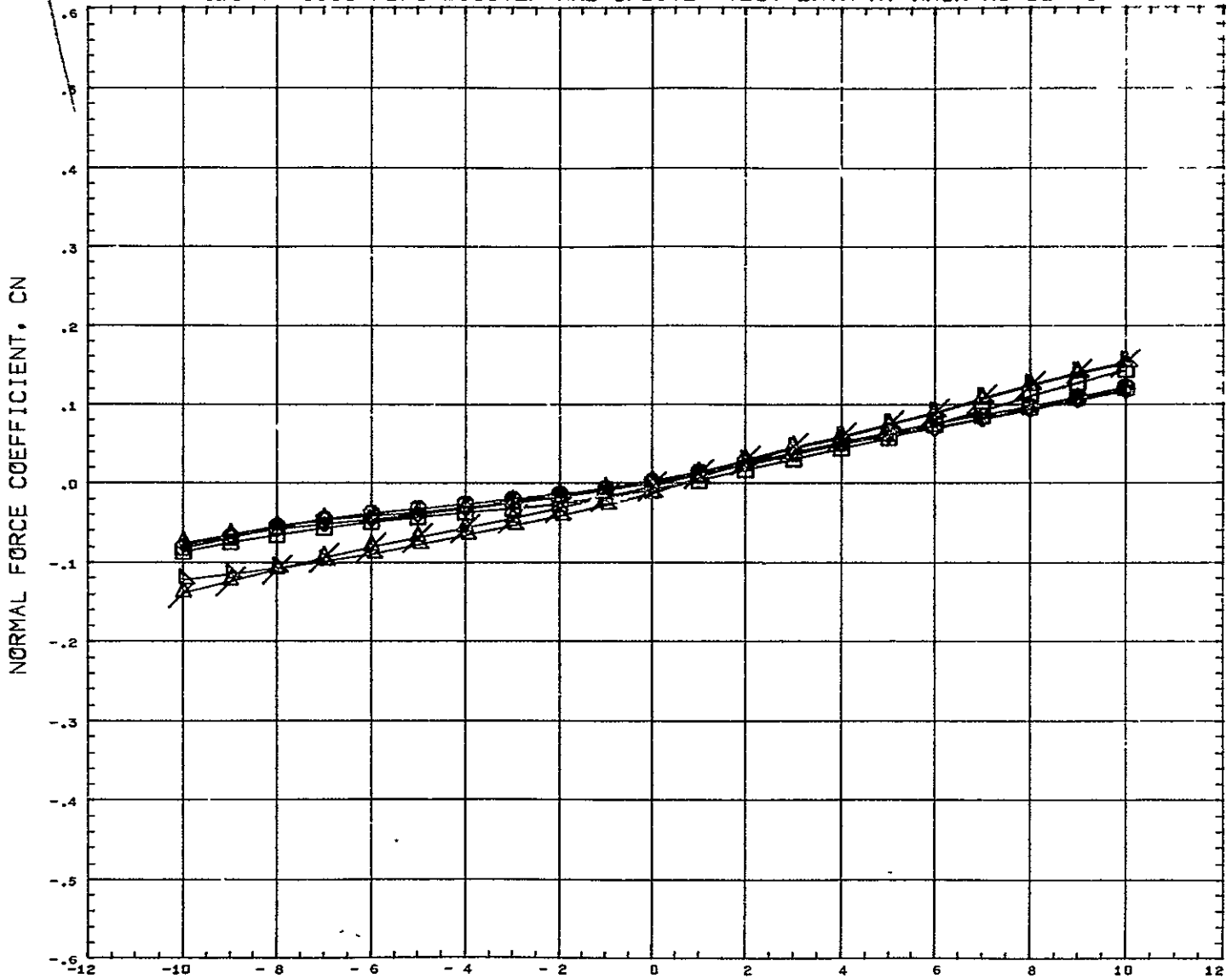

SYMBOL ○ □ △ ◇	DELTAX 0.120 0.151 0.182 0.228 0.352 10.000	PARAMETRIC VALUES BSTPOW 0.000 ORBPOW 0.000 DELTAX 0.352 ALPHAI - 4.900 ACH 5.010 ELVBST 0.000 ELVORB 0.000 BETA 0.000	REFERENCE INFORMATION REFS 4' 4440 SQ IN REFL 13.3330 IN REFB 13.3330 IN XMRP 7.5280 IN YMRP 0.0000 IN ZMRP 1.1940 IN SCALE 0.0055
----------------------------	---	--	---

REFERENCE FILE

# AEDC VA 1163 MDAC BOOSTER AND ORBITER TEST DATA AT MACH NUMBER 5

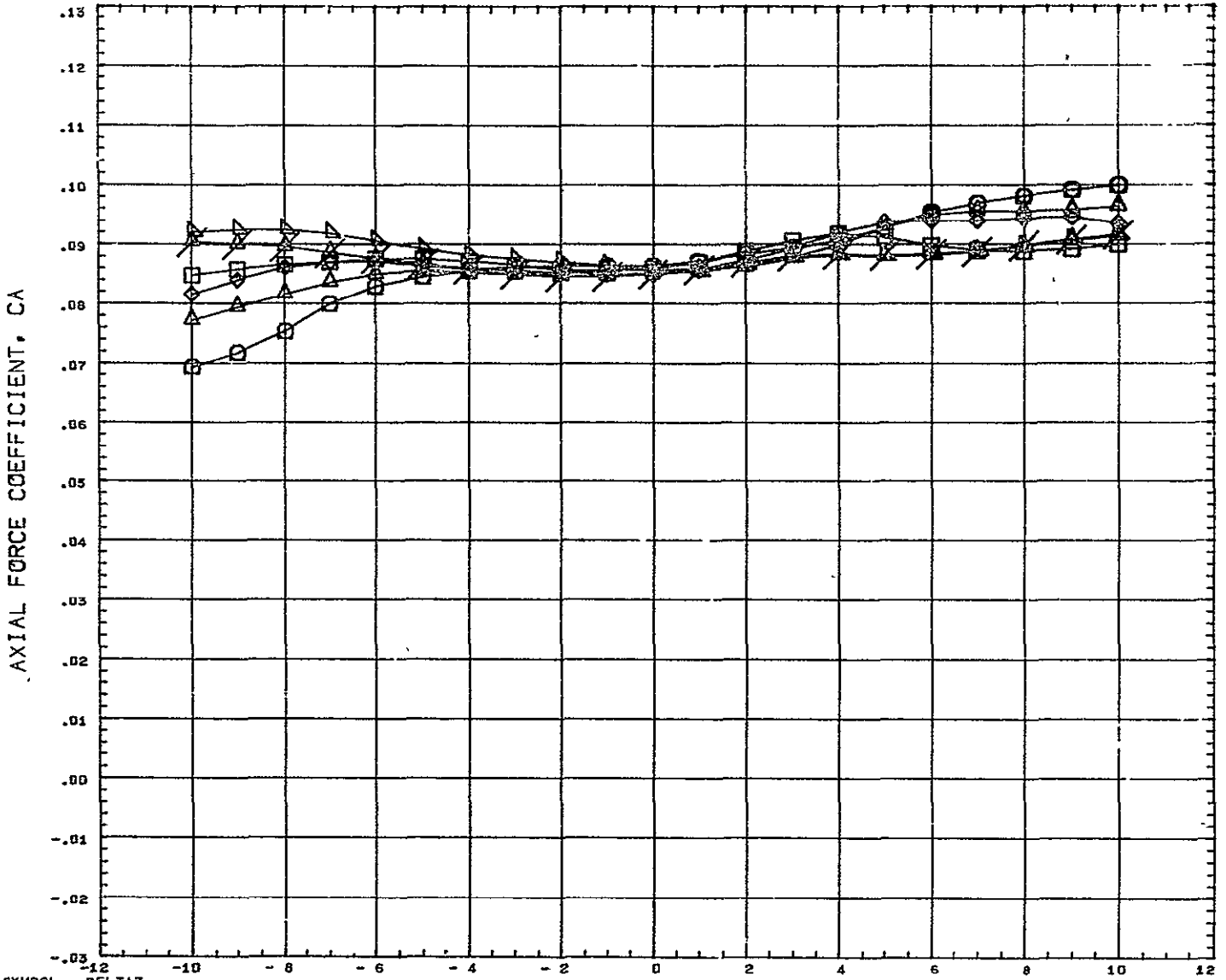

SYMBOL ○ □ △ ◇ ○	DELTA Z 0.120 0.151 0.182 0.228 0.352 10.000	<table border="0" style="width: 100%;"> <tr> <th colspan="4" style="text-align: center;">PARAMETRIC VALUES</th> </tr> <tr> <td>BSTPOW</td> <td>0.000</td> <td>ORBPOW</td> <td>0.000</td> </tr> <tr> <td>DELTA X</td> <td>0.352</td> <td>ALPHA_I</td> <td>4.900</td> </tr> <tr> <td>MACH</td> <td>5.010</td> <td>ELVBST</td> <td>0.000</td> </tr> <tr> <td>ELVORB</td> <td>0.000</td> <td>BETA</td> <td>0.000</td> </tr> </table>	PARAMETRIC VALUES				BSTPOW	0.000	ORBPOW	0.000	DELTA X	0.352	ALPHA_I	4.900	MACH	5.010	ELVBST	0.000	ELVORB	0.000	BETA	0.000	<table border="0" style="width: 100%;"> <tr> <th colspan="3" style="text-align: center;">REFERENCE INFORMATION</th> </tr> <tr> <td>REFS</td> <td>41.4440</td> <td>SG IN</td> </tr> <tr> <td>REFL</td> <td>13.333C</td> <td>IN</td> </tr> <tr> <td>REFB</td> <td>13.333D</td> <td>IN</td> </tr> <tr> <td>XMRP</td> <td>7.5280</td> <td>IN</td> </tr> <tr> <td>YMRP</td> <td>0.0000</td> <td>IN</td> </tr> <tr> <td>ZMRP</td> <td>1.1940</td> <td>IN</td> </tr> <tr> <td>SCALE</td> <td>0.0055</td> <td></td> </tr> </table>	REFERENCE INFORMATION			REFS	41.4440	SG IN	REFL	13.333C	IN	REFB	13.333D	IN	XMRP	7.5280	IN	YMRP	0.0000	IN	ZMRP	1.1940	IN	SCALE	0.0055	
PARAMETRIC VALUES																																															
BSTPOW	0.000	ORBPOW	0.000																																												
DELTA X	0.352	ALPHA_I	4.900																																												
MACH	5.010	ELVBST	0.000																																												
ELVORB	0.000	BETA	0.000																																												
REFERENCE INFORMATION																																															
REFS	41.4440	SG IN																																													
REFL	13.333C	IN																																													
REFB	13.333D	IN																																													
XMRP	7.5280	IN																																													
YMRP	0.0000	IN																																													
ZMRP	1.1940	IN																																													
SCALE	0.0055																																														

REFERENCE FILE

# AEDC VA 1163 MDAC BOOSTER AND ORBITER TEST DATA AT MACH NUMBER 5

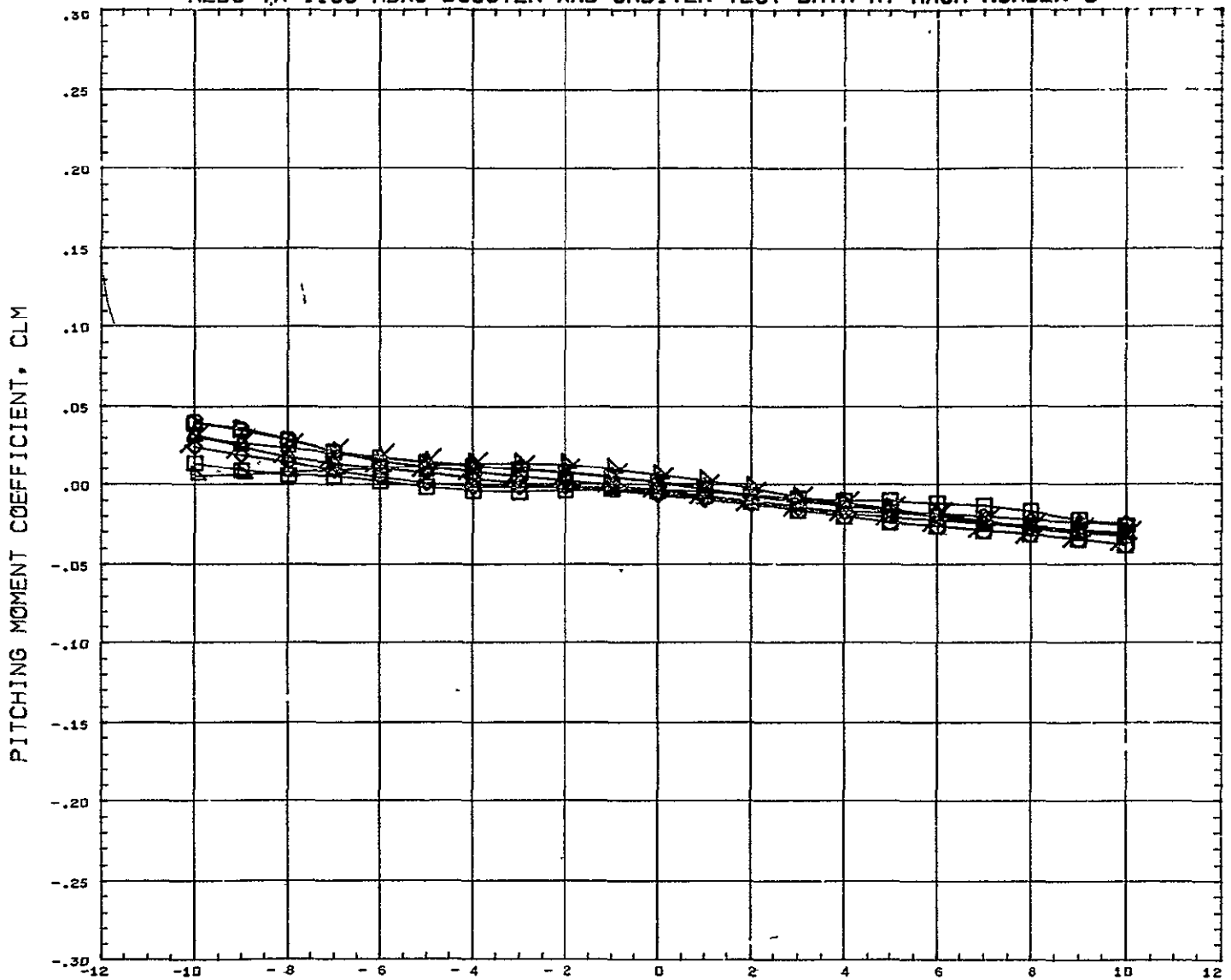

SYMBOL ○ ◇ □ △ X	DELTA Z 0.120 0.151 0.182 0.228 0.352 0.599 10.000	PARAMETRIC VALUES BSTPOW 0.000 ORBPOW 0.000 DELTAY 0.522 ALPHAI - 4.900 MACH 5.010 ELVBST 0.000 ELVORB 0.000 BETA 0.000	REFERENCE INFORMATION REFS 44.4440 SQ IN REFL 13.3330 IN REFB 13.3330 IN XMRP 7.5280 IN YMRP 0.0000 IN ZMRP 1.1940 IN SCALE 0.0055
REFERENCE FILE			



# AEDC VA 1163 MDAC BOOSTER AND ORBITER TEST DATA AT MACH NUMBER 5

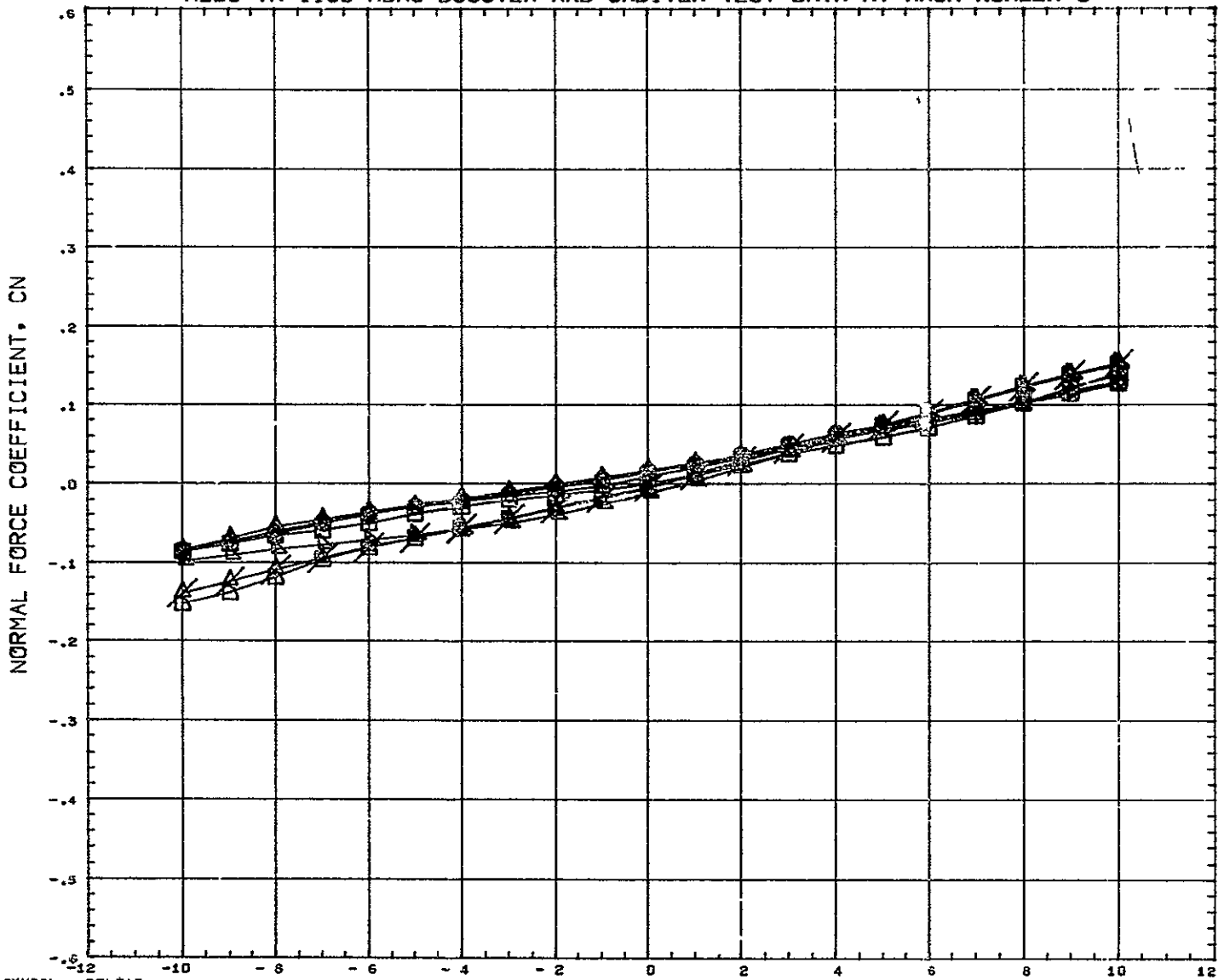

SYMBOL	DELTAZ	PARAMETRIC VALUES				REFERENCE INFORMATION		
○	0.120	BSTPOW	0.000	ORBPOW	0.050	REFS	1.4440	S3 IN
□	0.151	DELTAZ	0.522	ALPHAI	4.900	REFL	13.3330	IN
△	0.182	ACH	5.010	ELVBST	0.000	REFB	13.3330	IN
◇	0.228	ELVORB	0.000	BETA	0.000	XMRP	7.5280	IN
○	0.352					YMRP	0.0000	IN
△	0.599					ZMRP	1.1940	IN
◇	10.000					SCALE	0.0055	

REFERENCE FILE

# AEDC VA 1163 MDAC BOOSTER AND ORBITER TEST DATA AT MACH NUMBER 5

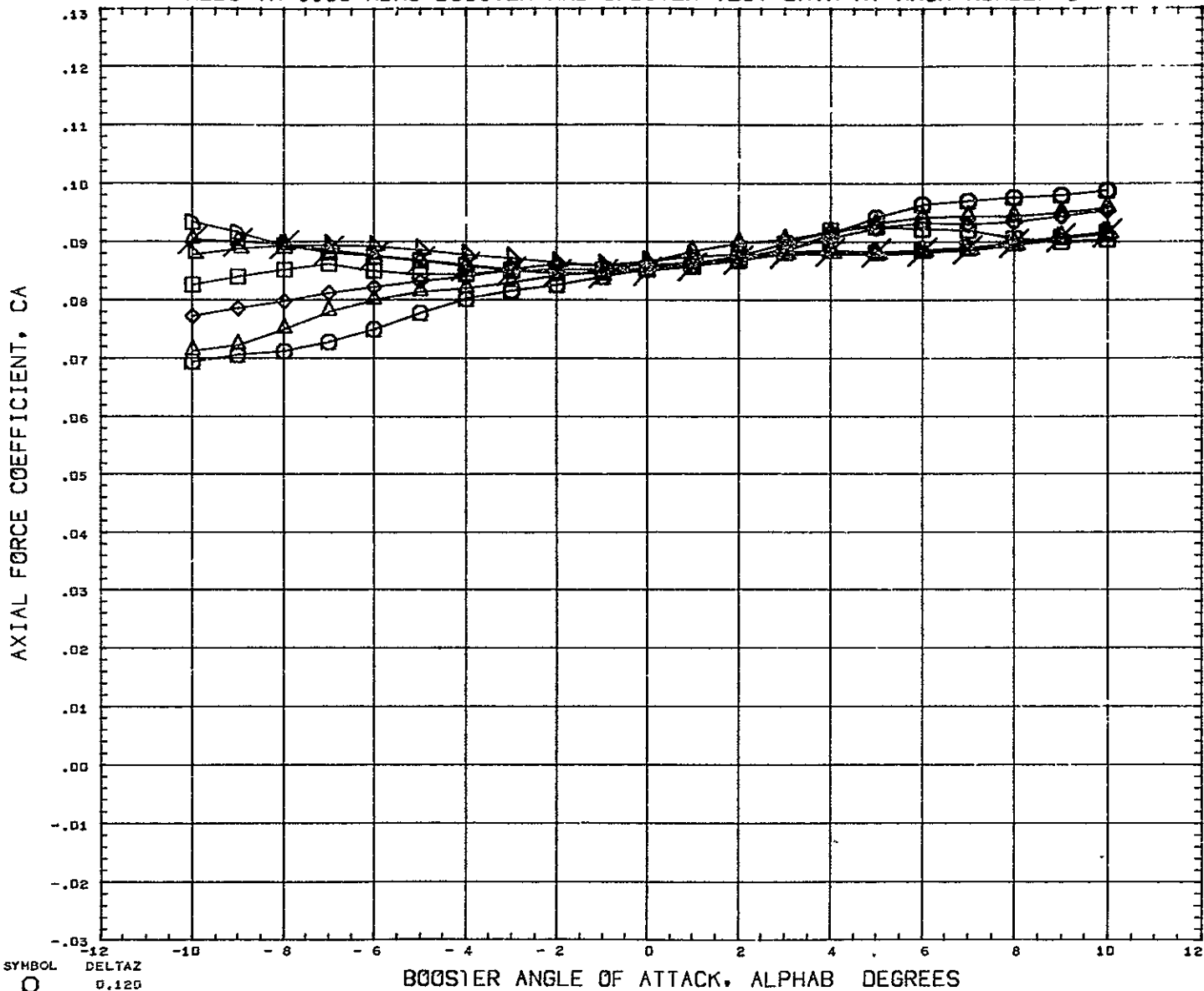

SYMBOL ○ ◊ □ △ ▲	DELTAZ 0.120 0.151 0.182 0.228 0.352 0.599 10.000	PARAMETRIC VALUES BSTFOW    0.000    ORBPOW    0.000 DELTAX    0.522    ALPHAI    - 4.900 MACH       5.010    ELVBST    0.000 ELVORB    0.000    BETA       0.000	REFERENCE INFORMATION REFS       44.4440    SQ IN REFL       13.3330    IN REFB       13.3330    IN XMRF       7.5280    IN YMRP       0.0000    IN ZMRP       1.1940    IN SCALE      0.0055
		REFERENCE FILE	

# AEDC VA 1163 MDAC BOOSTER AND ORBITER TEST DATA AT MACH NUMBER 5

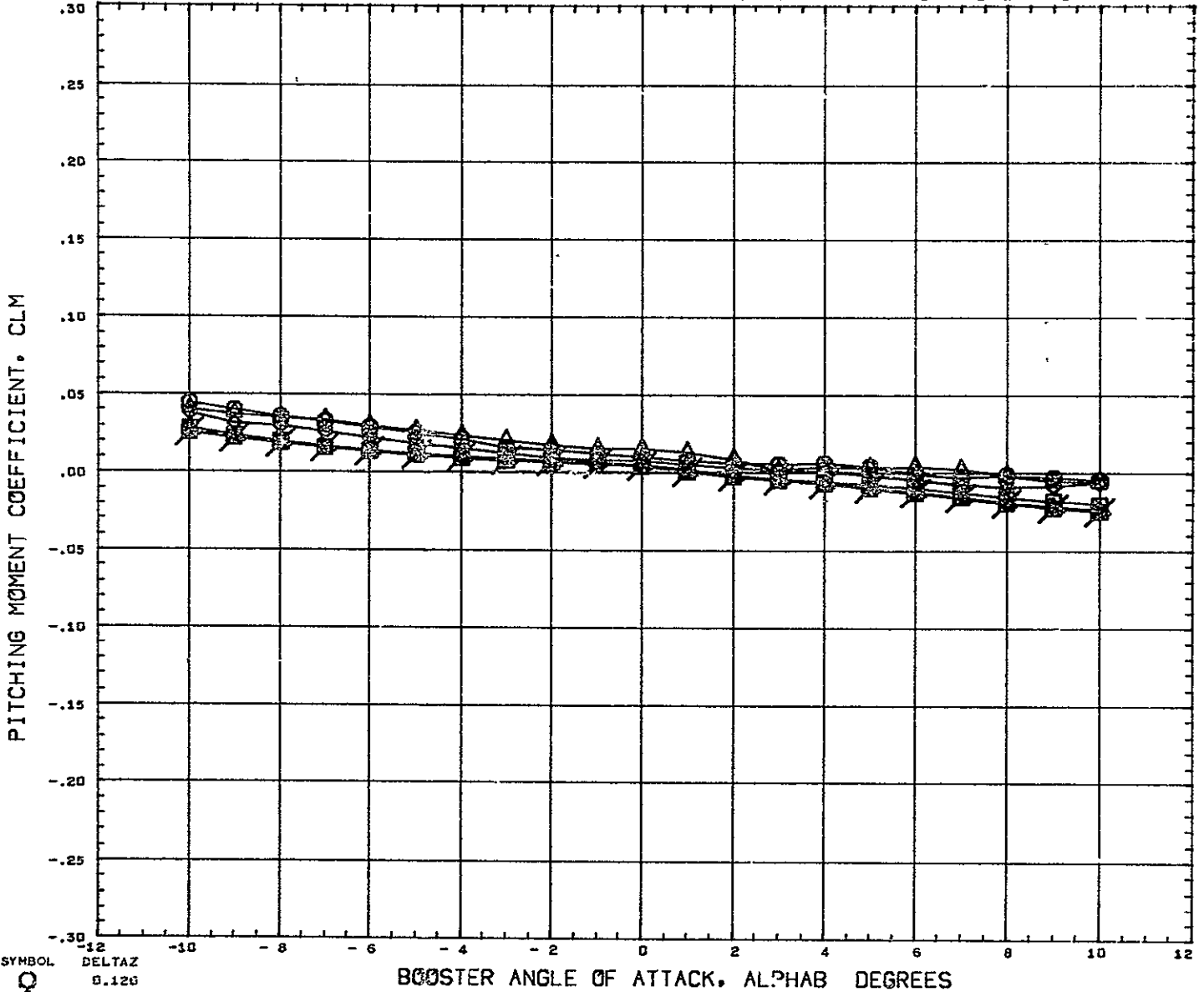

SYMBOL <del>0.120</del> <del>0.151</del> <del>0.182</del> <del>0.228</del> <del>0.352</del> <del>0.599</del> <del>0.906</del> <del>10.000</del>	DELTAZ 0.120 0.151 0.182 .ELTAX - 0.391 MACH 5.010 ELVORB 0.000 REFERENCE FILE	<b>PARAMETRIC VALUES</b> BSTPOW 50.000 ORBPOW 100.000 ALPHAI 0.000 ELVBST 0.000 BETA 0.000	<b>REFERENCE INFORMATION</b> REFS 44.4440 SQ IN REFL 13.3330 IN REFB 13.3330 IN XMRF 7.5280 IN YMRF 0.0000 IN ZMRF 1.1940 IN SCALE 0.0055
---	---	--	--

# AEDC VA 1163 MDAC BOOSTER AND ORBITER TEST DATA AT MACH NUMBER 5

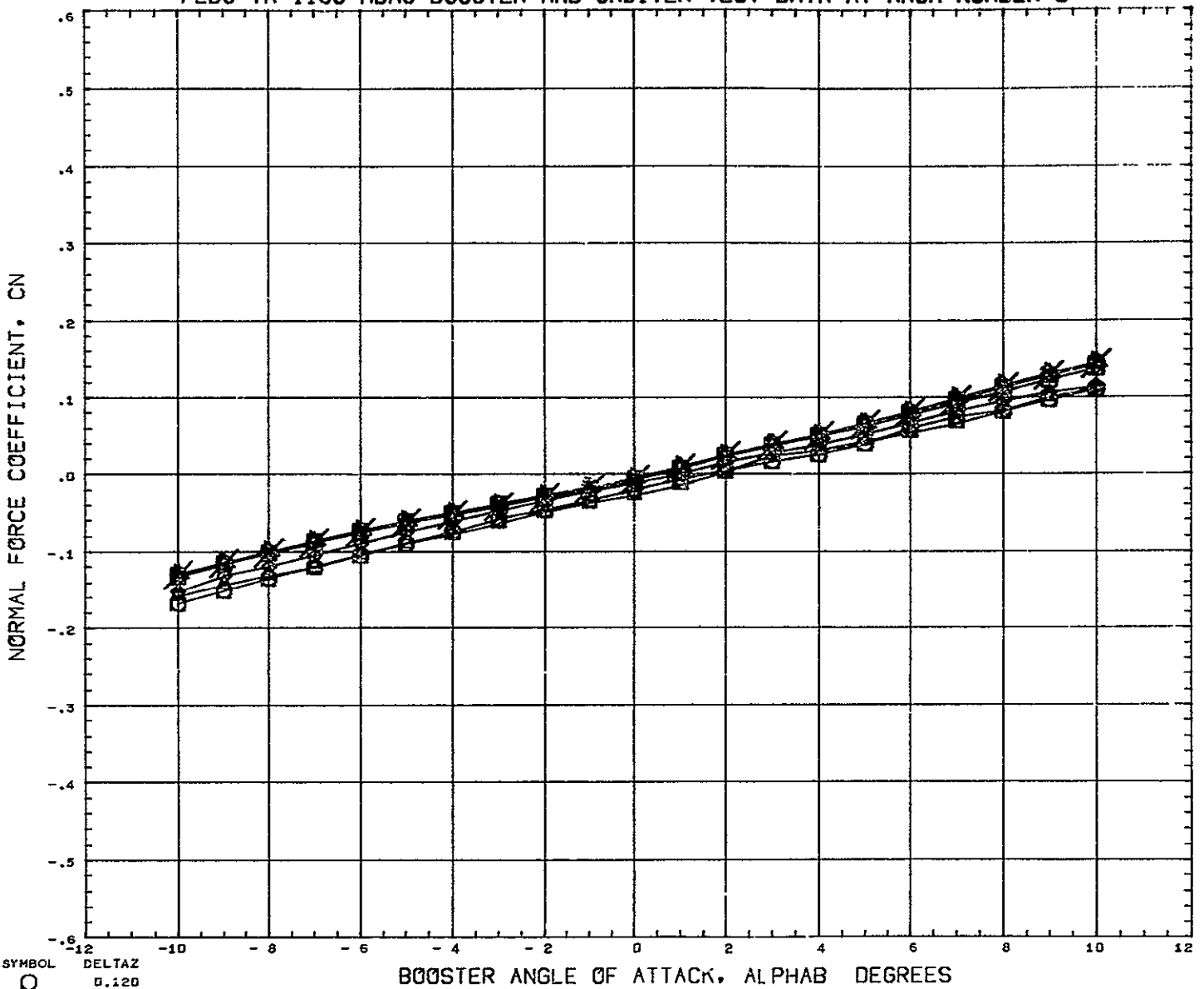

SYMBOL $\circ$ $\square$ $\triangle$ $\diamond$ $\times$	DELTAZ 0.120 0.151 0.182 0.228 0.352 0.599 0.998 10.000	PARAMETRIC VALUES BSTPOW 50.000 ORBPOW 100.000 DELTAX - 0.391 ALPHAI 0.000 MACH 5.010 ELVBST 0.000 ELVORB 0.000 BETA 0.000 REFERENCE FILE	REFERENCE INFORMATION REFS 44.4440 SQ IN REFL 13.3330 IN REFB 13.3330 IN XMRP 7.5280 IN YMRP 0.0000 IN ZMRP 1.1940 IN SCALE 0.0055
---	---	--	---

# AEDC VA 1163 MDAC BOOSTER AND ORBITER TEST DATA AT MACH NUMBER 5

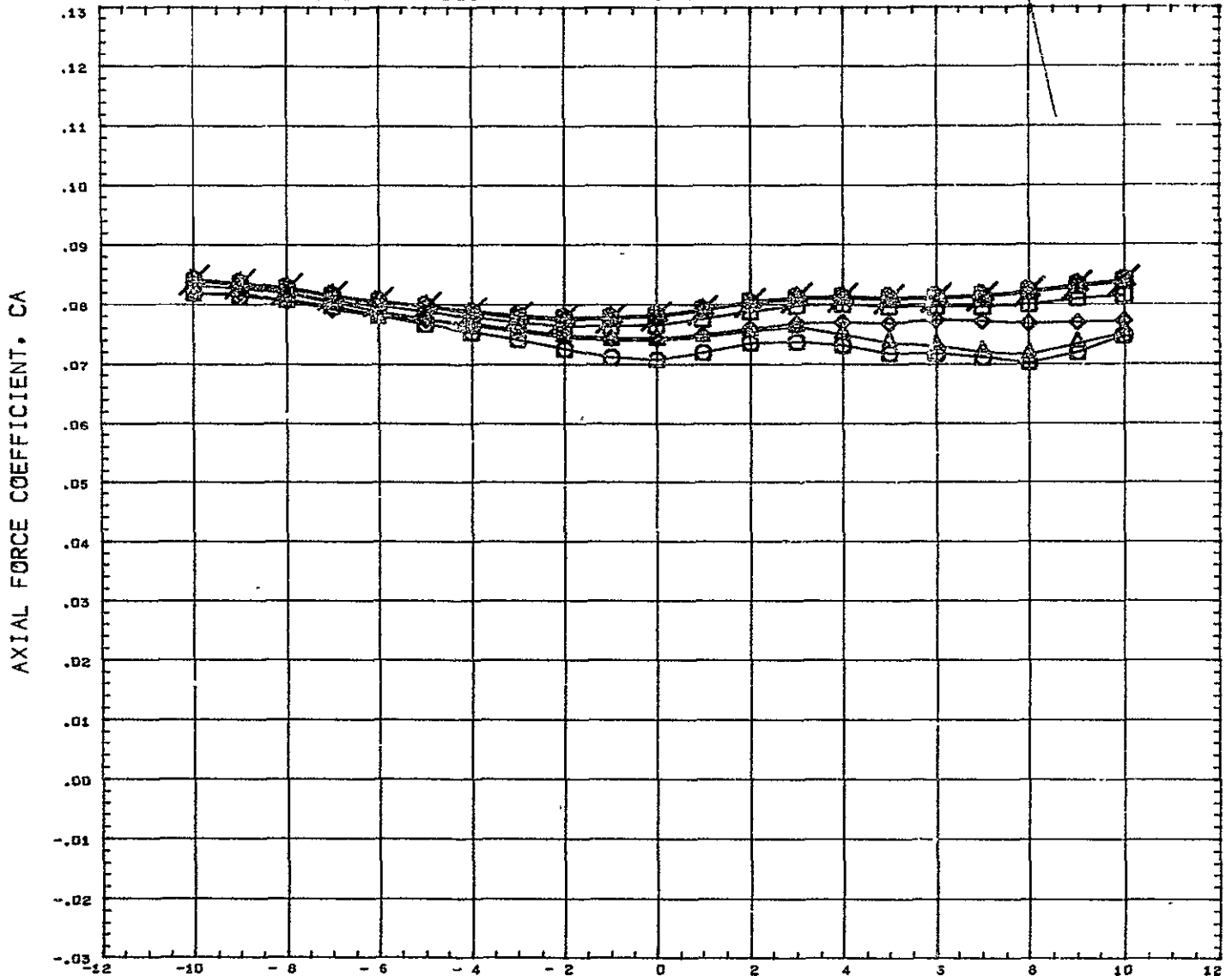

SYMBOL	DELTA Z	PARAMETRIC VALUES				REFERENCE INFORMATION		
0.120								
0.151								
0.192	BSTPOW	50.000	ORBPOW	100.000	REFS	44.4440	SQ IN	
0.228	DELTA X	0.391	ALPHA I	0.000	REFL	13.3335	IN	
0.352	MACH	5.010	ELVBST	0.000	REFB	13.3330	IN	
0.599	ELVORB	0.000	BETA	0.000	XMRP	7.5280	IN	
0.808					YMRP	0.0000	IN	
10.000	REFERENCE FILE				ZMRP	1.1940	IN	
					SCALE	0.0055		

# AEDC VA 1163 MDAC BOOSTER AND ORBITER TEST DATA AT MACH NUMBER 5

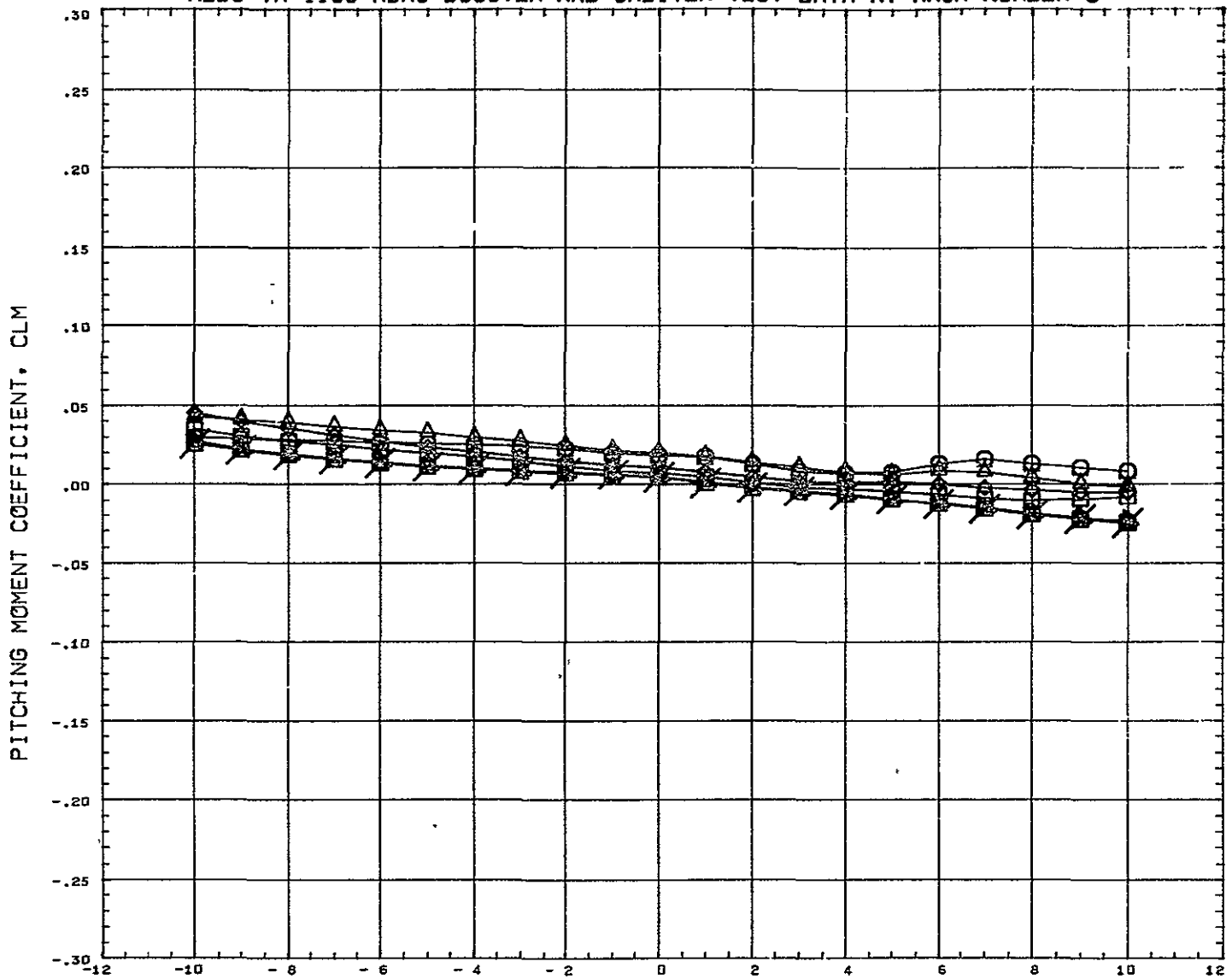

SYMBOL <del>○</del> <del>□</del> <del>◇</del> <del>△</del> <del>▽</del> <del>◇</del> <del>○</del>	DELTAZ 0.120 0.151 0.182 0.228 0.352 0.599 0.908 10.000	REFERENCE FILE  PARAMETRIC VALUES BSTFOW 50.000 ORBPOW 100.000 DELTAX - 0.143 ALPHAI 0.000 MACH 5.010 ELVBST 0.000 ELVORB 0.000 BETA 0.000	REFERENCE INFORMATION REFS 44.4440 SQ IN REFL 13 3330 IN REFB 13 3330 IN XMRF 7 5280 IN YMRF 0 0000 IN ZMRF 1.1940 IN SCALE 0.0055
--	---	--	---

# AEDC VA 1163 MDAC BOOSTER AND ORBITER TEST DATA AT MACH NUMBER 5

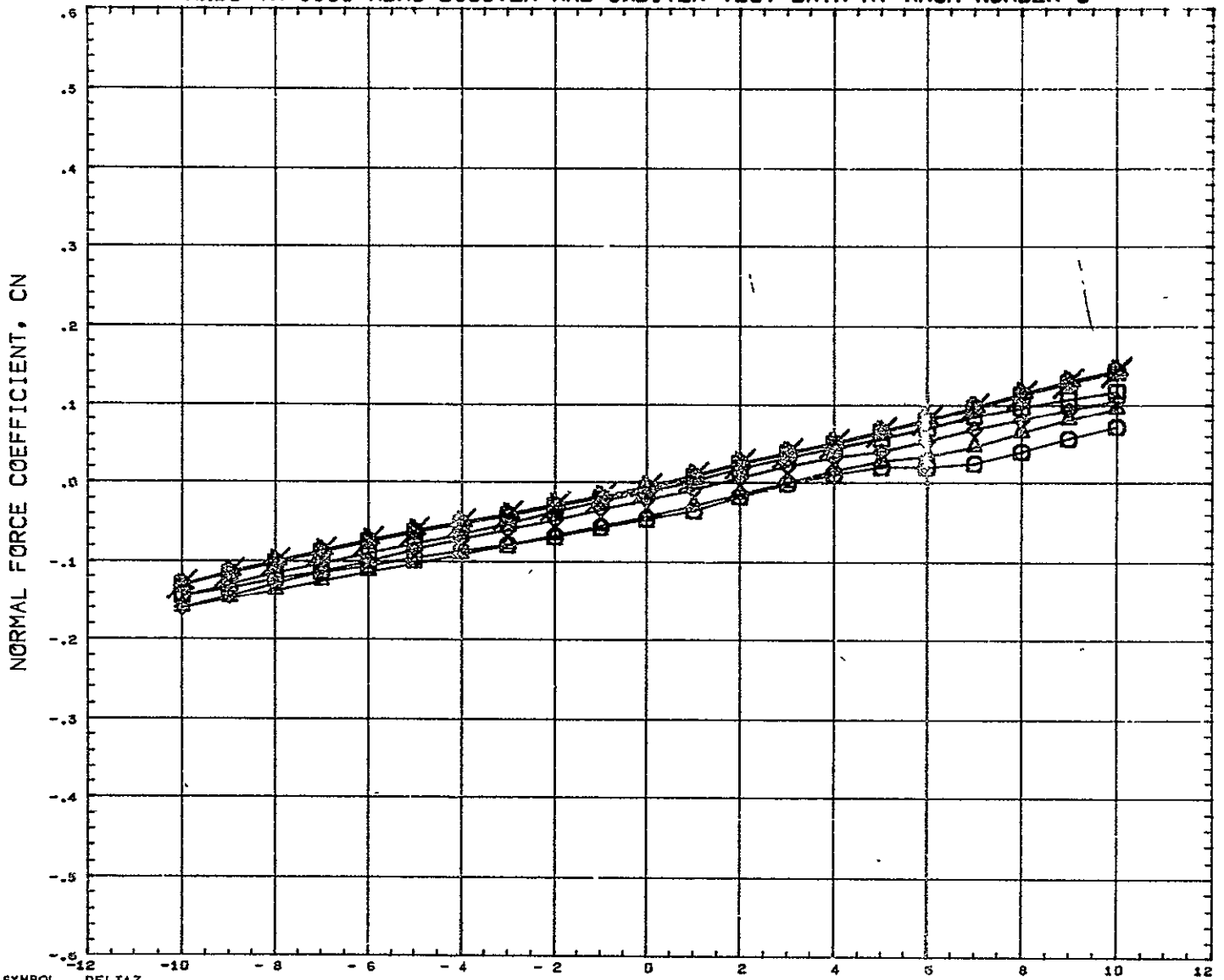

SYMBOL <del>□</del> <del>◇</del> <del>△</del> <del>○</del> <del>□</del> <del>◇</del> <del>△</del> <del>○</del>	DELTAZ 0.120 0.151 0.182 0.228 0.352 0.599 0.908 10.000	PARAMETRIC VALUES BSTFOW 50.000 ORBFOV 100.000 DELTAX - 0.143 ALPHAI 0.000 MA.H 5.010 ELVBST 0.000 ELVORB 0.000 BETA 0.000	REFERENCE INFORMATION REFS 44.4440 SQ IN REFL 13.3330 IN REFB 13.3330 IN XMRP 7.5280 IN YMRP 0.0000 IN ZMRP 1.1940 IN SCALE 0.0055
	BOOSTER ANGLE OF ATTACK, ALPHAB DEGREES		

# AEDC VA 1163 MDAC BOOSTER AND ORBITER TEST DATA AT MACH NUMBER 5

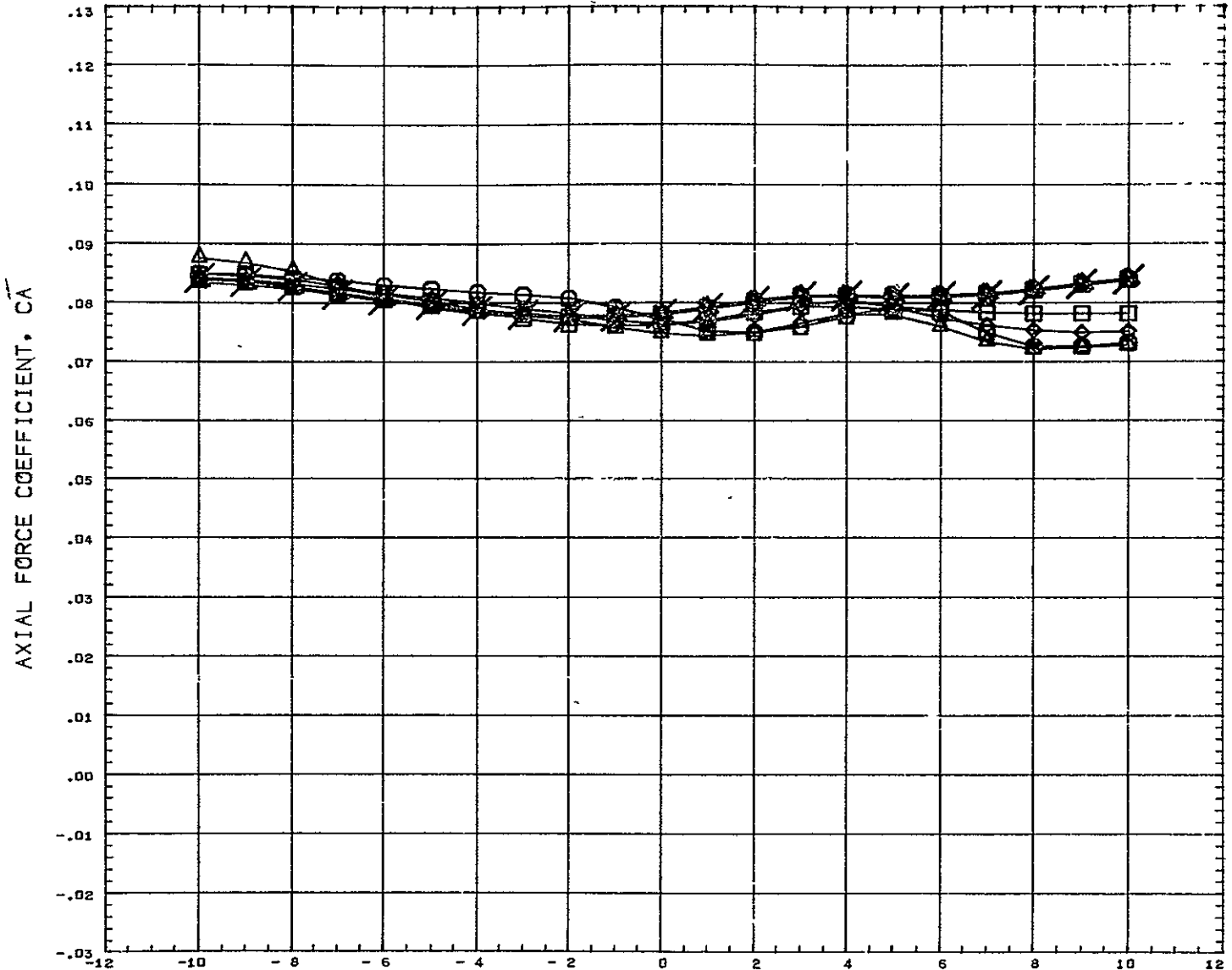

SYMBOL	DELTA Z	PARAMETRIC VALUES				REFERENCE INFORMATION		
○	0.120							
○	0.151							
○	0.182	BSTPOW	50.000	ORBPOW	100.000	REFS	44.4440	SQ IN
○	0.228	DELTA Z	0.143	ALPHA I	0.000	REFL	13.3330	IN
○	0.352	MACH	5.010	ELVBST	0.000	REFB	13.3330	IN
○	0.599	ELVORB	0.000	BETA	0.000	XMRP	7.5280	IN
○	0.958					YMRP	0.0000	IN
○	16.000	REFERENCE FILE				ZMRP	1.1940	IN
						SCALE	0.0055	



# AEDC VA 1163 MDAC BOOSTER AND ORBITER TEST DATA AT MACH NUMBER 5

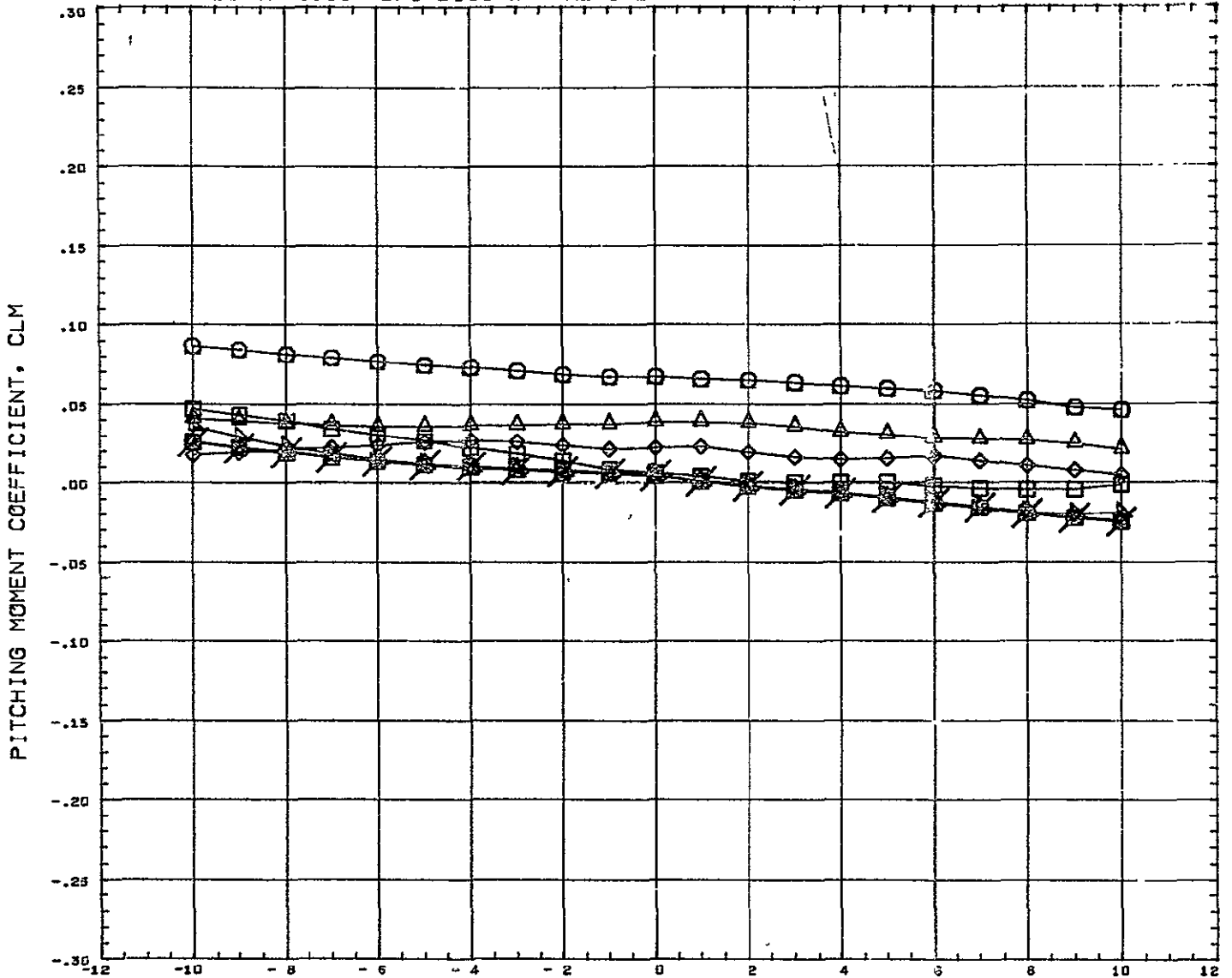

SYMBOL ○ □ △ ◇ ☆ * ✱ ✶ ✷ ✸ ✹ ✺ ✻ ✼ ✽ ✾ ✿ ✻ ✼ ✽ ✾ ✿	DELTAZ 0.120 0.151 0.182 0.228 0.352 0.599 0.908 10.000	BOOSTER ANGLE OF ATTACK, ALPHAB DEGREES  PARAMETRIC VALUES BSTFOW 50.000 ORBFOV 300.000 DE' TAX - 0.019 ALFHAI 0.000 MACH 5.010 ELVSST 0.000 ELVORB 0.000 BETA 0.000	REFERENCE INFORMATION REFS 44.4440 SQ IN REFL 13.3330 IN REFB 13.3330 IN XMRF 7.5289 IN YMRF 0.0000 IN ZMRF 1.1940 IN SCALE 0.0055
--	---	--	---

# AEDC VA 1163 MDAC BOOSTER AND ORBITER TEST DATA AT MACH NUMBER 5

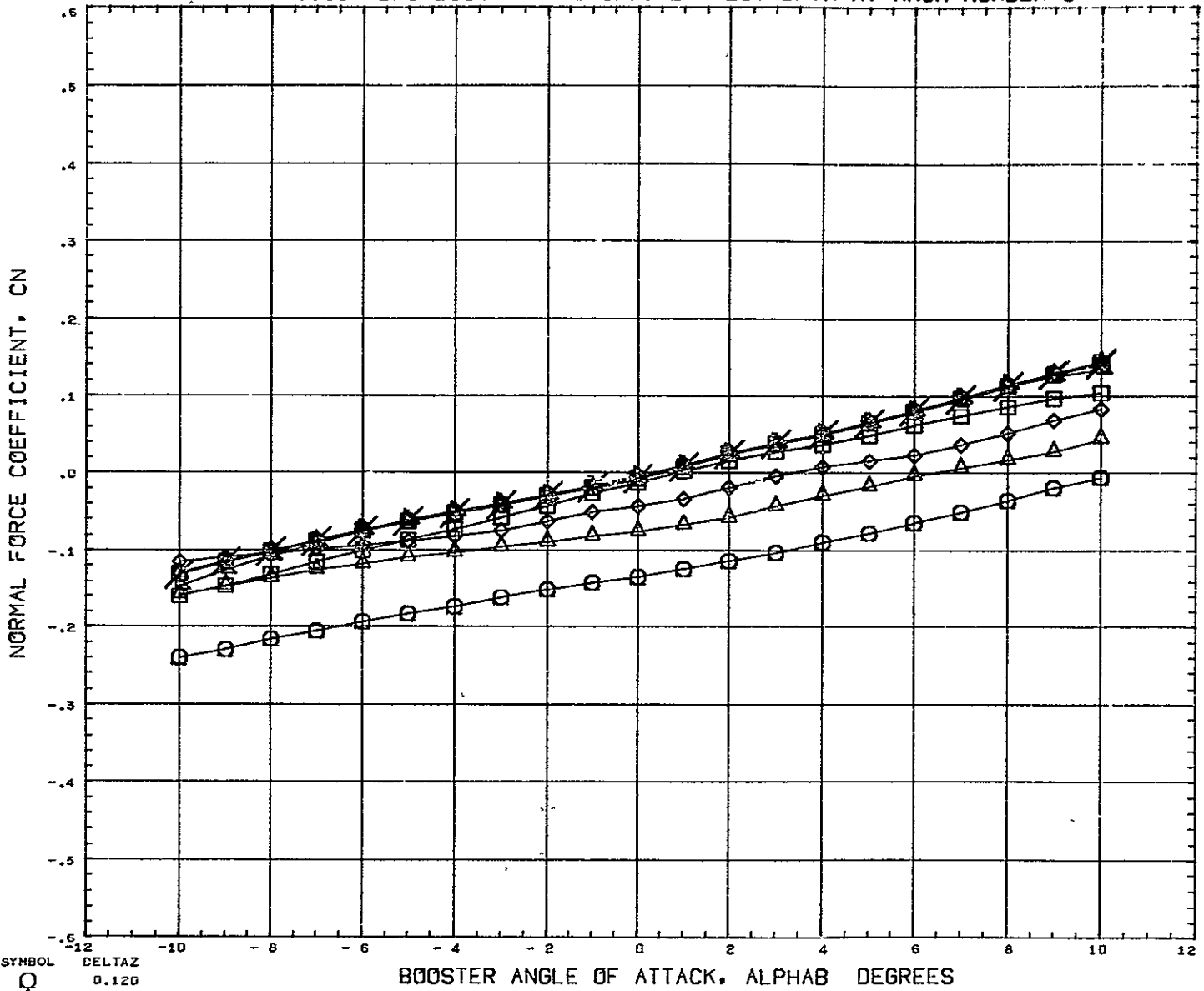

SYMBOL  
~~○~~  
~~◇~~  
~~□~~  
~~△~~  
~~▽~~  
~~×~~

DELTA Z  
 0.120  
 0.151  
 0.182  
 0.228  
 0.352  
 0.599  
 0.908  
 10.000

PARAMETRIC VALUES  
 BSTPOW 50.000 ORBPOW 100.000  
 DELTAX - 0.019 ALPHAI 0.000  
 MA.H 5.010 ELVBST 0.000  
 ELVORB 0.000 BETA 0.000  
 REFERENCE FILE

REFERENCE INFORMATION  
 REFS 44 4440 SQ IN  
 REFL 13 3330 IN  
 REFB 13 3330 IN  
 XMRF 7.5280 IN  
 YMRF 0 0000 IN  
 ZMRF 1.1940 IN  
 SCALE 0.0055

# AEDC VA 1163 MDAC BOOSTER AND ORBITER TEST DATA AT MACH NUMBER 5

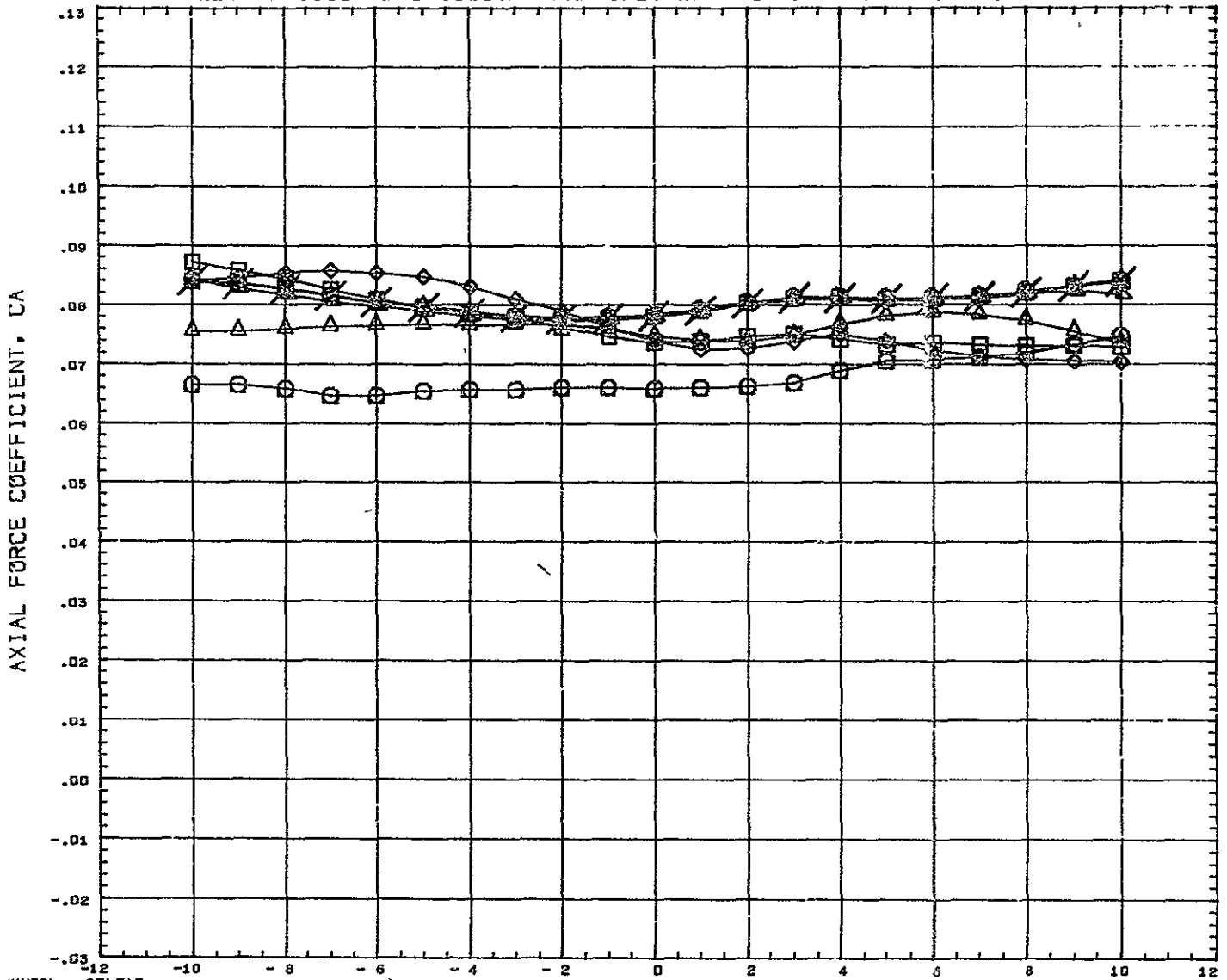

SYMBOL ○ △ ◇ □ ◊ × ○	DELTAX 0.120 0.151 0.182 0.228 0.352 0.599 0.908 10.000	PARAMETRIC VALUES BSTPOW 50.000 ORBPOW 100.000 DELTAX - 0.019 ALPHAI 0.000 MACH 5.010 ELVBST 0.000 ELVORB 0.000 BETA 0.000	REFERENCE INFORMATION REFS 4+ .440 SQ IN REFL 13.3330 IN REFB 13.3330 IN XMRP 7.5280 IN YMRP 0.0000 IN ZMRP 1.1940 IN SCALE 0.0055
---	---	--	---

# AEDC VA 1163 MDAC BOOSTER AND ORBITER TEST DATA AT MACH NUMBER 5

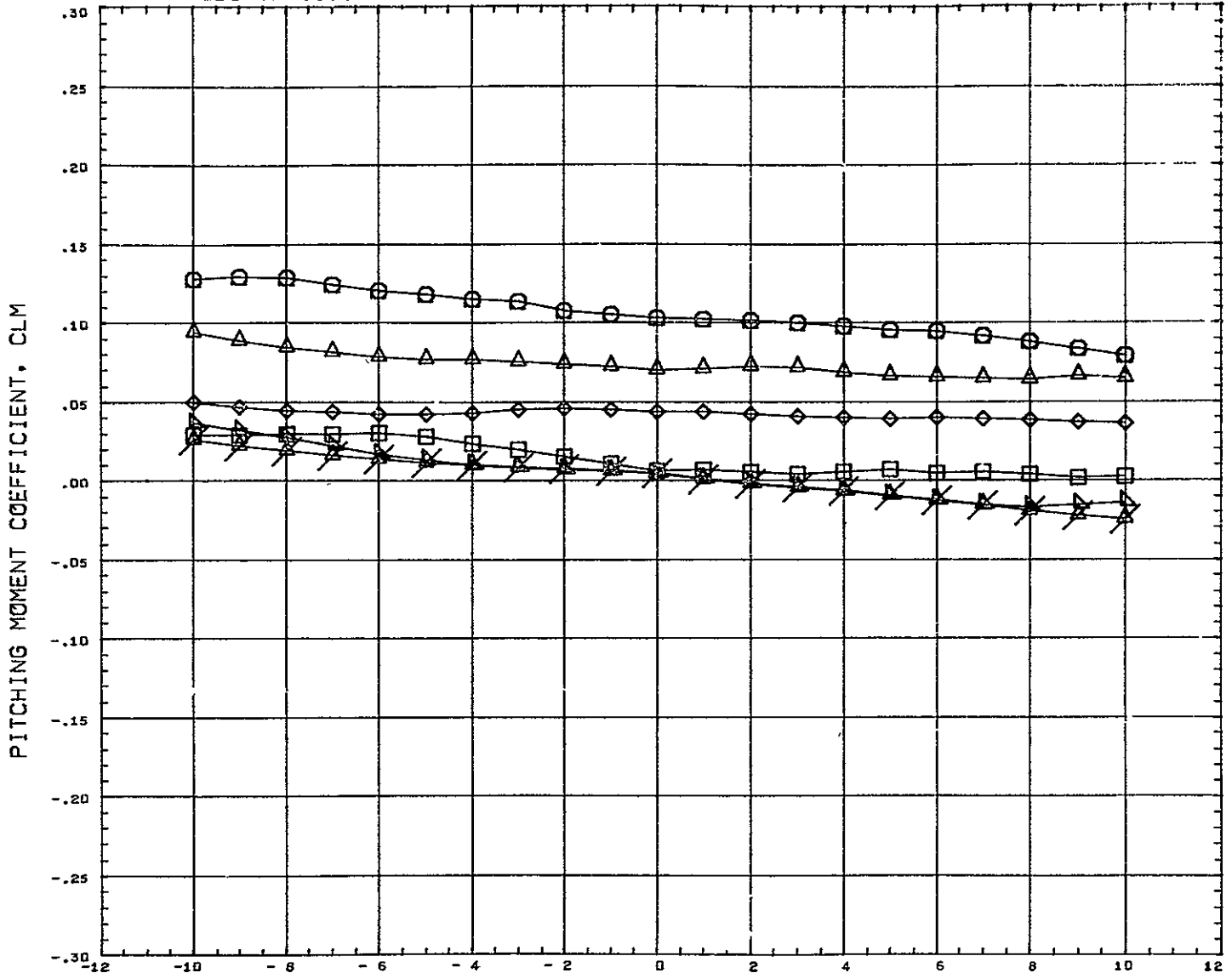

SYMBOL ○ △ ◇ □ ×	DELTAX 0.120 0.151 0.182 0.228 0.352 10.000	PARAMETRIC VALUES BSTFOW 50.000 ORBPOW 100.000 DELTAX 0.042 ALPHA1 0.000 FCH 5.010 ELVBST 0.000 ELVORB 0.000 BETA 0.000	REFERENCE INFORMATION REFS 11.4440 SQ IN REFL 13.3330 IN REFB 13.3330 IN XMRF 7.5280 IN YMRF 0.0000 IN ZMRF 1.1940 IN SCALE 0.0055
---------------------------------	---	---	---

REFERENCE FILE

# AEDC VA 1163 MDAC BOOSTER AND ORBITER TEST DATA AT MACH NUMBER 5

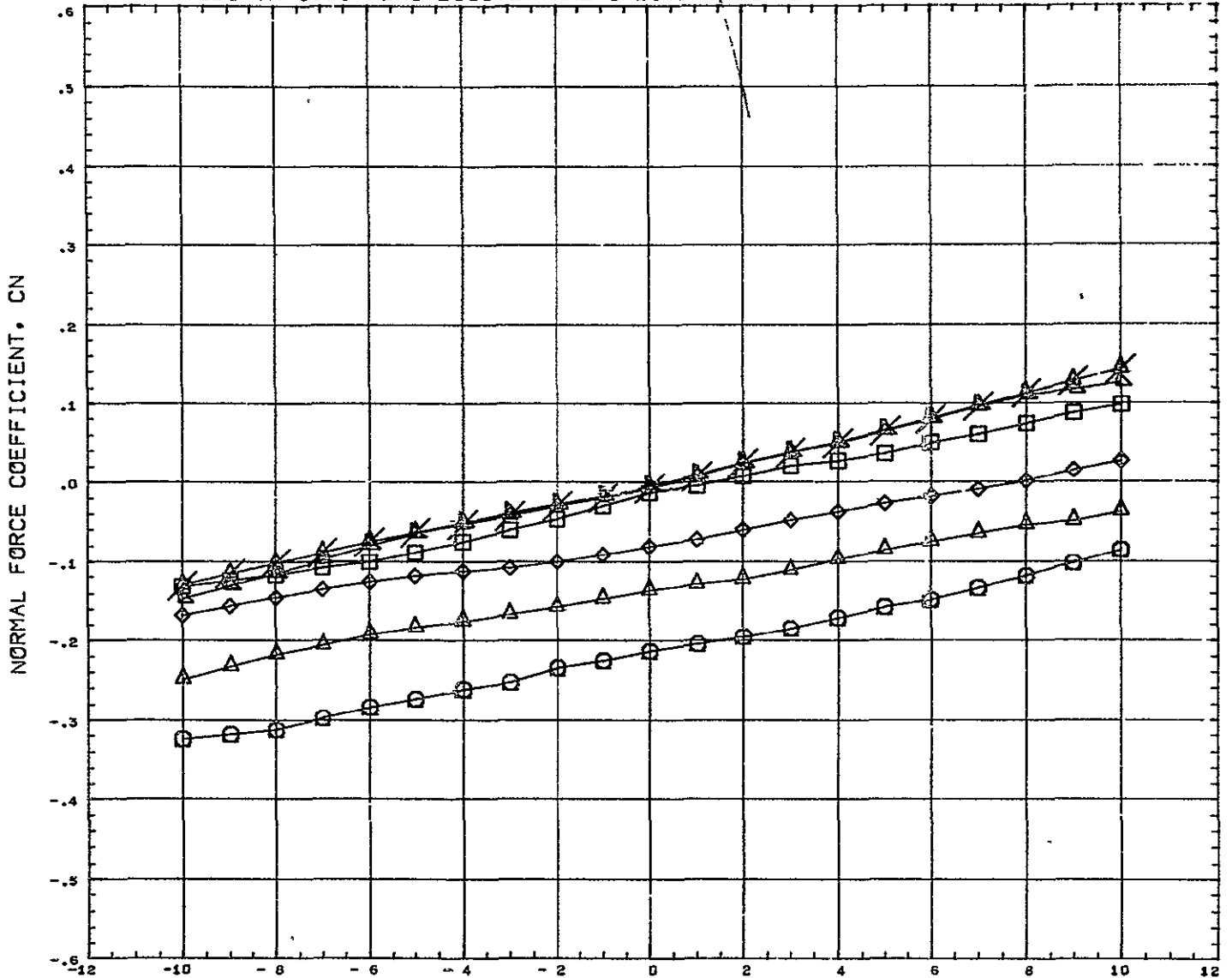

SYMBOL ○ ◇ □ △ ▽ ×	DELTA Z 0.120 0.151 0.182 0.228 0.352 10.000	PARAMETRIC VALUES BSTPOW 50.000 ORBPOW 100.000 DELTAX 0.042 ALPHAI 0.000 MACH 5.010 ELVBST 0.000 ELVORB 0.000 BETA 0.000	REFERENCE INFORMATION REFS 44.4440 SQ IN REFL 13.3330 IN REFB 13.3330 IN XMRP 7.5280 IN YMRP 0.0000 IN ZMRP 1.1940 IN SCALE 0.0055
REFERENCE FILE			

# AEDC VA 1163 MDAC BOOSTER AND ORBITER TEST DATA AT MACH NUMBER 5

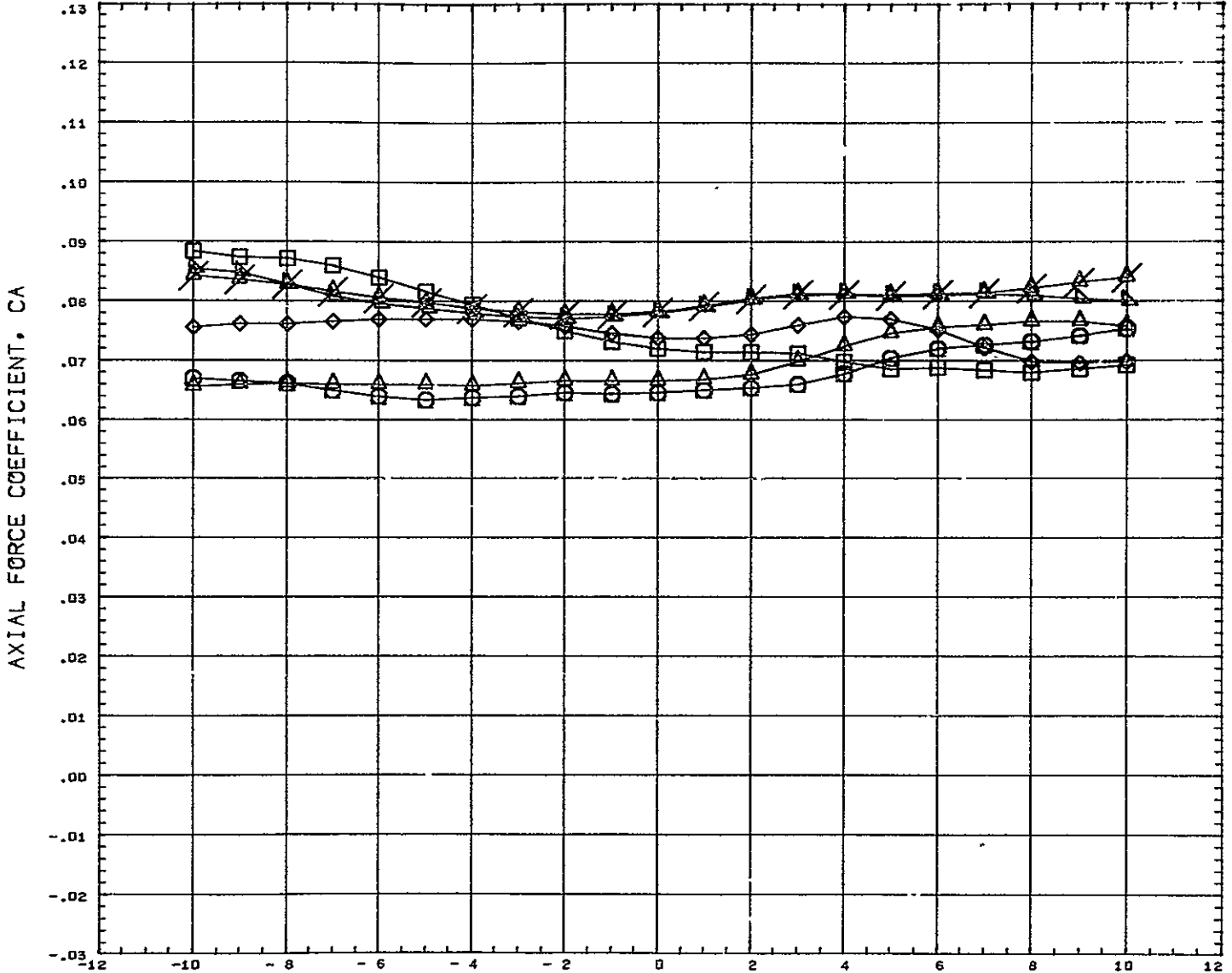

SYMBOL ○ ◇ □ △ ×	DELTA Z 0.120 0.151 0.182 0.228 0.352 10.000	PARAMETRIC VALUES BSTPOW 50.000 ORBFOW 100.000 FLTAX 0.042 ALPHAI 0.000 MACH 5.010 ELVBST 0.000 ELVORB 0.000 BETA 0.000	REFERENCE INFORMATION REFS 44.4440 SQ IN REFL 13 3330 IN REFB 13 3330 IN XMRP 7.5280 IN YMRP 0.0000 IN ZMRP 1.1940 IN SCALE 0.0055
---------------------------------	--	---	---

1 REFERENCE FILE

# AEDC VA 1163 MDAC BOOSTER AND ORBITER TEST DATA AT MACH NUMBER 5

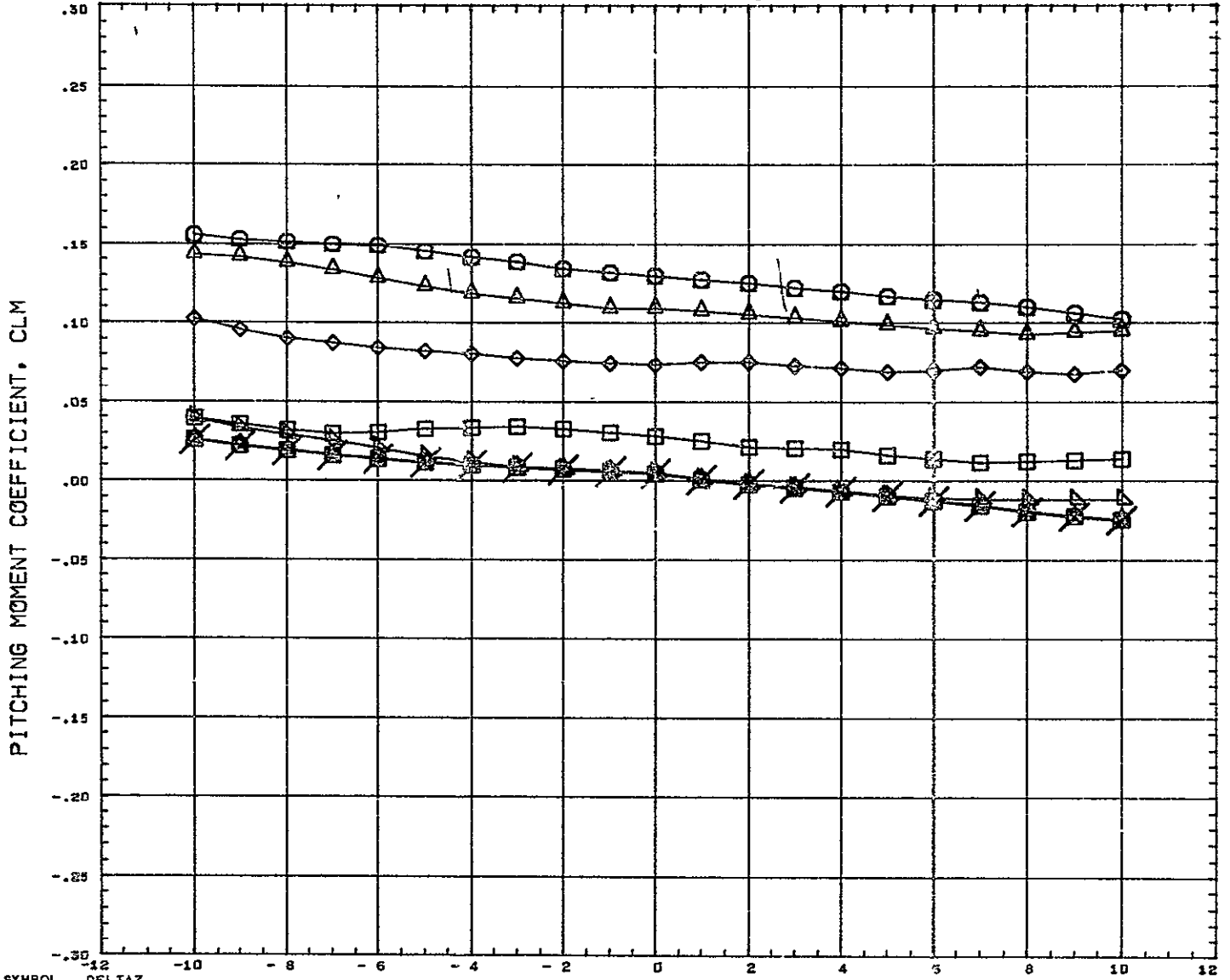

SYMBOL 	<table border="0" style="width: 100%;"> <tr> <td style="width: 30%;">DELTAZ</td> <td colspan="2">0.120</td> </tr> <tr> <td></td> <td colspan="2">0.151</td> </tr> <tr> <td></td> <td colspan="2">0.182</td> </tr> <tr> <td></td> <td colspan="2">0.220</td> </tr> <tr> <td></td> <td colspan="2">0.352</td> </tr> <tr> <td></td> <td colspan="2">0.599</td> </tr> <tr> <td></td> <td colspan="2">0.908</td> </tr> <tr> <td></td> <td colspan="2">10.000</td> </tr> </table> <table border="0" style="width: 100%; margin-top: 10px;"> <tr> <th colspan="4" style="text-align: center;">PARAMETRIC VALUES</th> </tr> <tr> <td style="width: 25%;">BSTPOW</td> <td style="width: 25%;">50.000</td> <td style="width: 25%;">ORBPOW</td> <td style="width: 25%;">300.000</td> </tr> <tr> <td>DELTA X</td> <td>0.104</td> <td>ALPHA I</td> <td>0.000</td> </tr> <tr> <td>MACH</td> <td>5.010</td> <td>ELVBST</td> <td>0.000</td> </tr> <tr> <td>ELVORB</td> <td>0.000</td> <td>BETA</td> <td>0.000</td> </tr> </table>	DELTAZ	0.120			0.151			0.182			0.220			0.352			0.599			0.908			10.000		PARAMETRIC VALUES				BSTPOW	50.000	ORBPOW	300.000	DELTA X	0.104	ALPHA I	0.000	MACH	5.010	ELVBST	0.000	ELVORB	0.000	BETA	0.000	<table border="0" style="width: 100%;"> <tr> <th colspan="3" style="text-align: center;">REFERENCE INFORMATION</th> </tr> <tr> <td style="width: 30%;">REFS</td> <td style="width: 30%;">44.4440</td> <td style="width: 40%;">SQ IN</td> </tr> <tr> <td>REFL</td> <td>13.3330</td> <td>IN</td> </tr> <tr> <td>REFB</td> <td>13.3330</td> <td>IN</td> </tr> <tr> <td>XMRP</td> <td>7.5280</td> <td>IN</td> </tr> <tr> <td>YMRP</td> <td>0.0000</td> <td>IN</td> </tr> <tr> <td>ZMRP</td> <td>1.1940</td> <td>IN</td> </tr> <tr> <td>SCALE</td> <td>0.0055</td> <td></td> </tr> </table>	REFERENCE INFORMATION			REFS	44.4440	SQ IN	REFL	13.3330	IN	REFB	13.3330	IN	XMRP	7.5280	IN	YMRP	0.0000	IN	ZMRP	1.1940	IN	SCALE	0.0055	
DELTAZ	0.120																																																																					
	0.151																																																																					
	0.182																																																																					
	0.220																																																																					
	0.352																																																																					
	0.599																																																																					
	0.908																																																																					
	10.000																																																																					
PARAMETRIC VALUES																																																																						
BSTPOW	50.000	ORBPOW	300.000																																																																			
DELTA X	0.104	ALPHA I	0.000																																																																			
MACH	5.010	ELVBST	0.000																																																																			
ELVORB	0.000	BETA	0.000																																																																			
REFERENCE INFORMATION																																																																						
REFS	44.4440	SQ IN																																																																				
REFL	13.3330	IN																																																																				
REFB	13.3330	IN																																																																				
XMRP	7.5280	IN																																																																				
YMRP	0.0000	IN																																																																				
ZMRP	1.1940	IN																																																																				
SCALE	0.0055																																																																					

# AEDC VA 1163 MDAC BOOSTER AND ORBITER TEST DATA AT MACH NUMBER 5

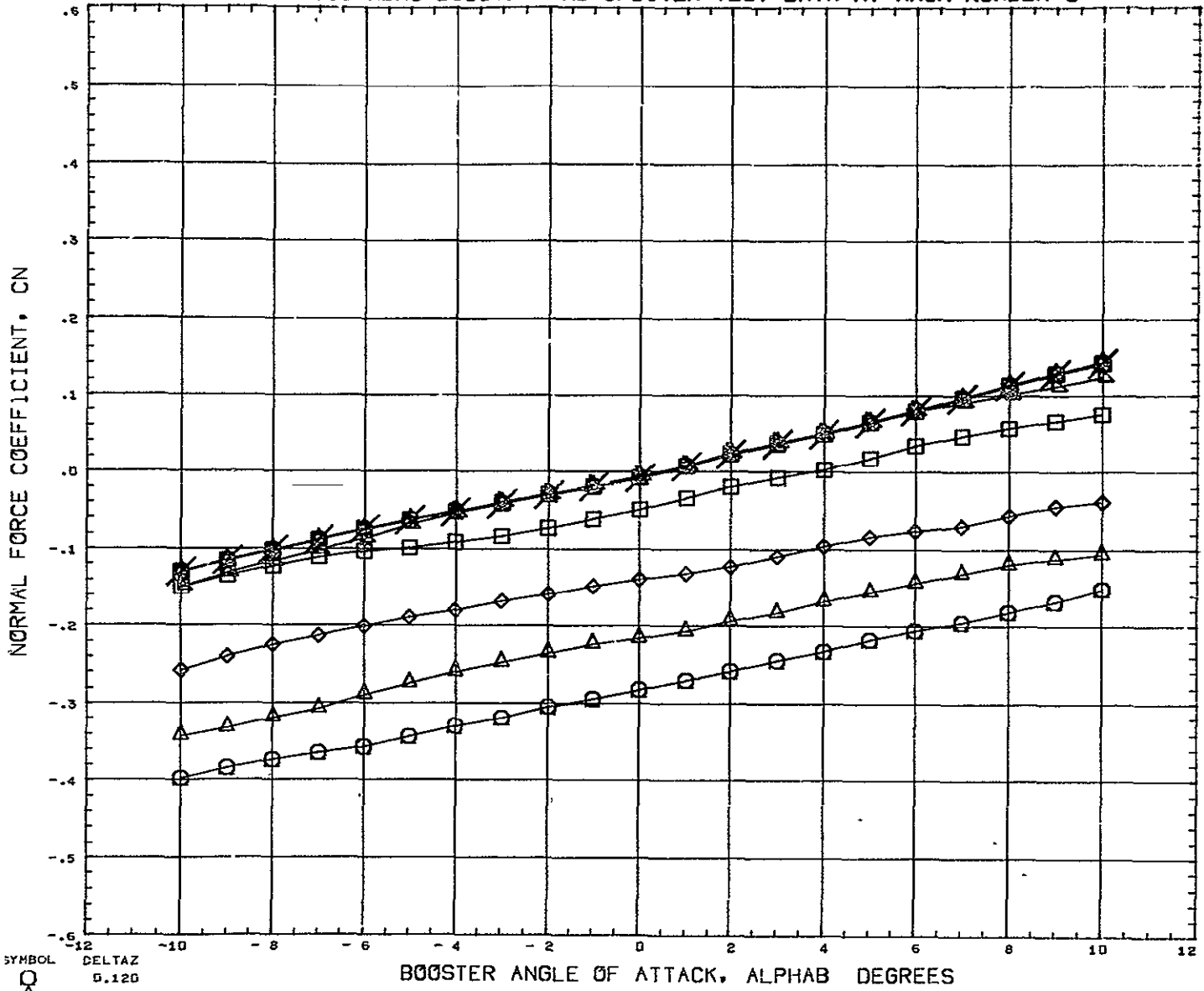

SYMBOL <del>□</del> <del>◇</del> <del>△</del> <del>○</del> <del>×</del>	DELTAZ 0.120 0.151 0.182 0.228 0.352 0.599 0.908 10.000	PARAMETRIC VALUES BSTFOW 50.000 ORBPOW 100.000 DELTAX 0.164 ALPHAI 0.000 MA H 5.010 ELVBST 0.000 ELVORB 0.000 BETA 0.000 REFERENCE FILE	REFERENCE INFORMATION REFS 4 440 SQ IN REFL 13 3330 IN REFB 13 3330 IN XHRF 7.5280 IN YHRF 0.0000 IN ZHRF 1.1940 IN SCALE 0.0055
--	---	--	---



# AEDC VA 1163 MDAC BOOSTER AND ORBITER TEST DATA AT MACH NUMBER 5

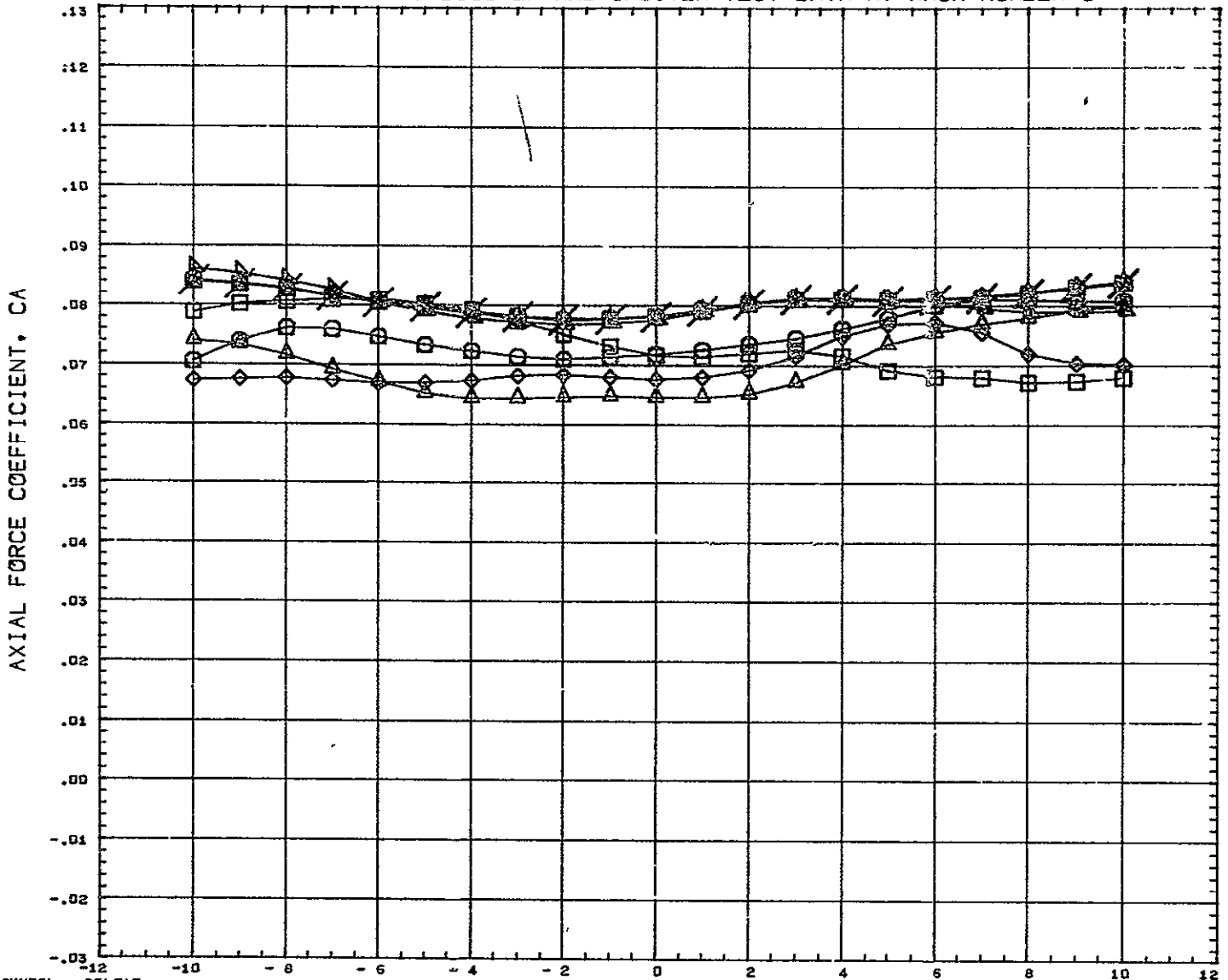

SYMBOL	DELTA Z	PARAMETRIC VALUES				REFERENCE INFORMATION		
○	0.120							
◇	0.151							
□	0.182	BSTPOW	50.000	ORSPOW	100.000	REFS	44.4440	SR IN
△	0.228	DELTA X	0.104	ALPHA I	0.000	REFL	13.3330	IN
◇	0.352	MACH	5.010	ELVBST	0.000	REFB	13.3330	IN
◇	0.599	ELVORB	0.000	BETA	0.000	XMRP	7.5280	JN
◇	0.808					YMRP	0.0000	IN
◇	10.000	REFERENCE FILE				ZMRP	1.1940	IN
						SCALE	0.0055	

# AEDC VA 1163 MDAC BOOSTER AND ORBITER TEST DATA AT MACH NUMBER 5

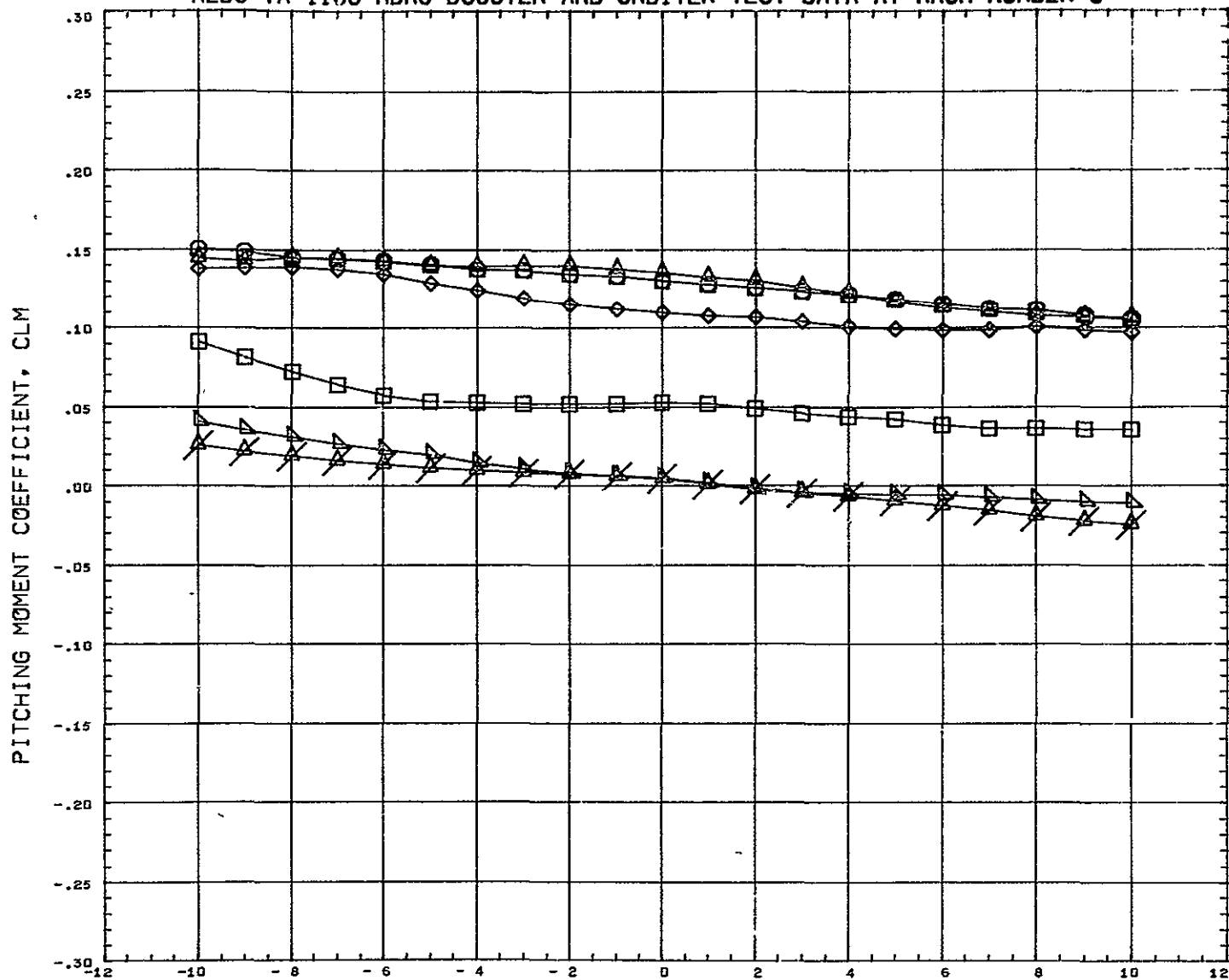

SYMBOL ○ ◇ □ △ ×	DELTAZ 0.120 0.151 0.182 0.228 0.352 10.000	PARAMETRIC VALUES BSTPOW 50.000 ORBPOW 100.000 DFLTAX 0.166 ALPHAI 0.000 MACH 5.010 ELVBST 0.000 ELVORB 9.000 BETA 0.000	REFERENCE INFORMATION REFS 44.4440 SQ IN REFL 13.3330 IN REFB 13.3330 IN XMRP 7.5280 IN YMRP 0.0000 IN ZMRP 1.1940 IN SCALE 0.0055
---------------------------------	---	--	---

REFERENCE FILE

# AEDC VA 1163 MDAC BOOSTER AND ORBITER TEST DATA AT MACH NUMBER 5

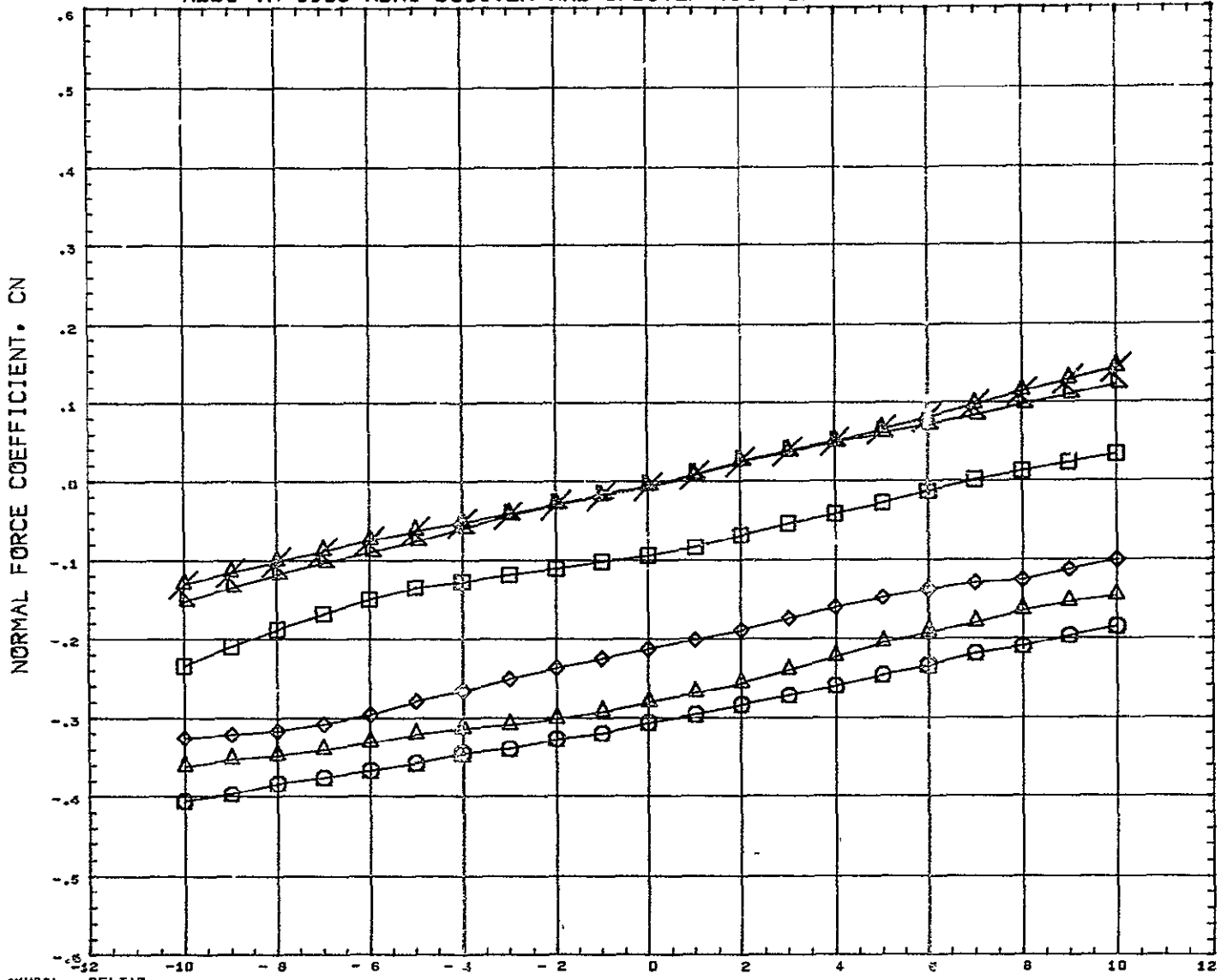

SYMBOL 	DELTA Z 0.120 0.151 0.182 0.228 0.352 10.000	<b>PARAMETRIC VALUES</b> BSTPOW 50.000 ORBPOW 100.000 DELTAX 0.166 ALPHA1 0.000 H CH 5.010 ELVBST 0.000 ELVORB 0.000 BETA 0.000	<b>REFERENCE INFORMATION</b> REFS 41.4440 SQ IN REFL 13.3330 IN REFB 13.3330 IN XMRF 7.5280 IN YMRF 0.0000 IN ZMRF 1.1940 IN SCALE 0.0055
REFERENCE FILE			

# AEDC VA 1163 MDAC BOOSTER AND ORBITER TEST DATA AT MACH NUMBER 5

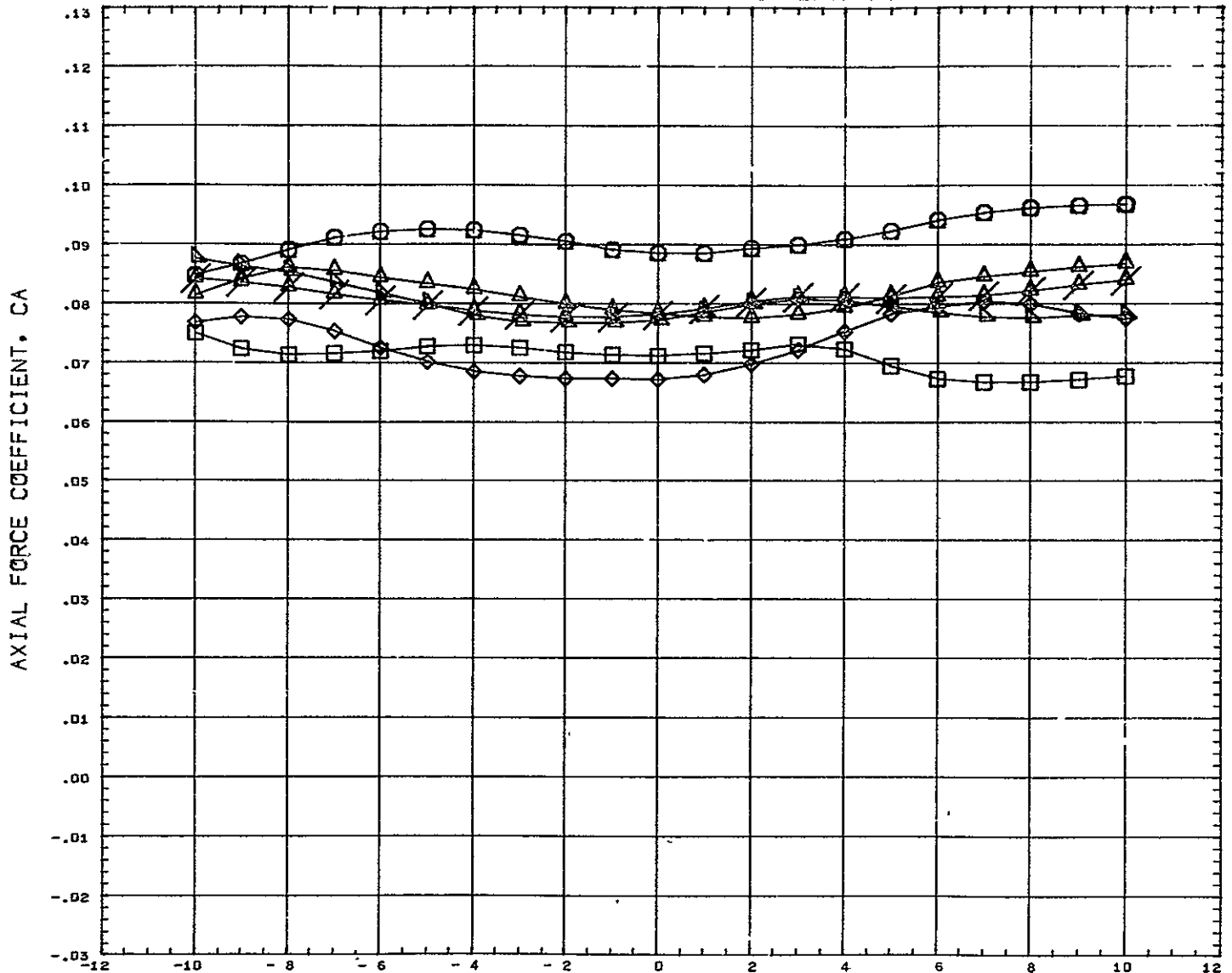

SYMBOL ○ △ ◇ □ ×	DELTAZ 0.120 0.151 0.182 0.228 0.352 10.000	PARAMETRIC VALUES BSTFOW 50.000 DELTAY 0.166 ACH 5.010 ELVORB 0.000 ORBFOW 100.000 ALPHAI 0.000 ELVBST 0.000 BETA 0.000	REFERENCE INFORMATION REFS 4 4440 REFL 13.3330 REFB 13.3330 XMRP 7 5280 YMRP 9.0000 ZMRP 1.1940 SCALE 0.0055	SR IN IN IN IN IN IN
---------------------------------	---	---	---	-------------------------------------

REFERENCE FILE

### AEDC VA 1163 MDAC BOOSTER AND ORBITER TEST DATA AT MACH NUMBER 5

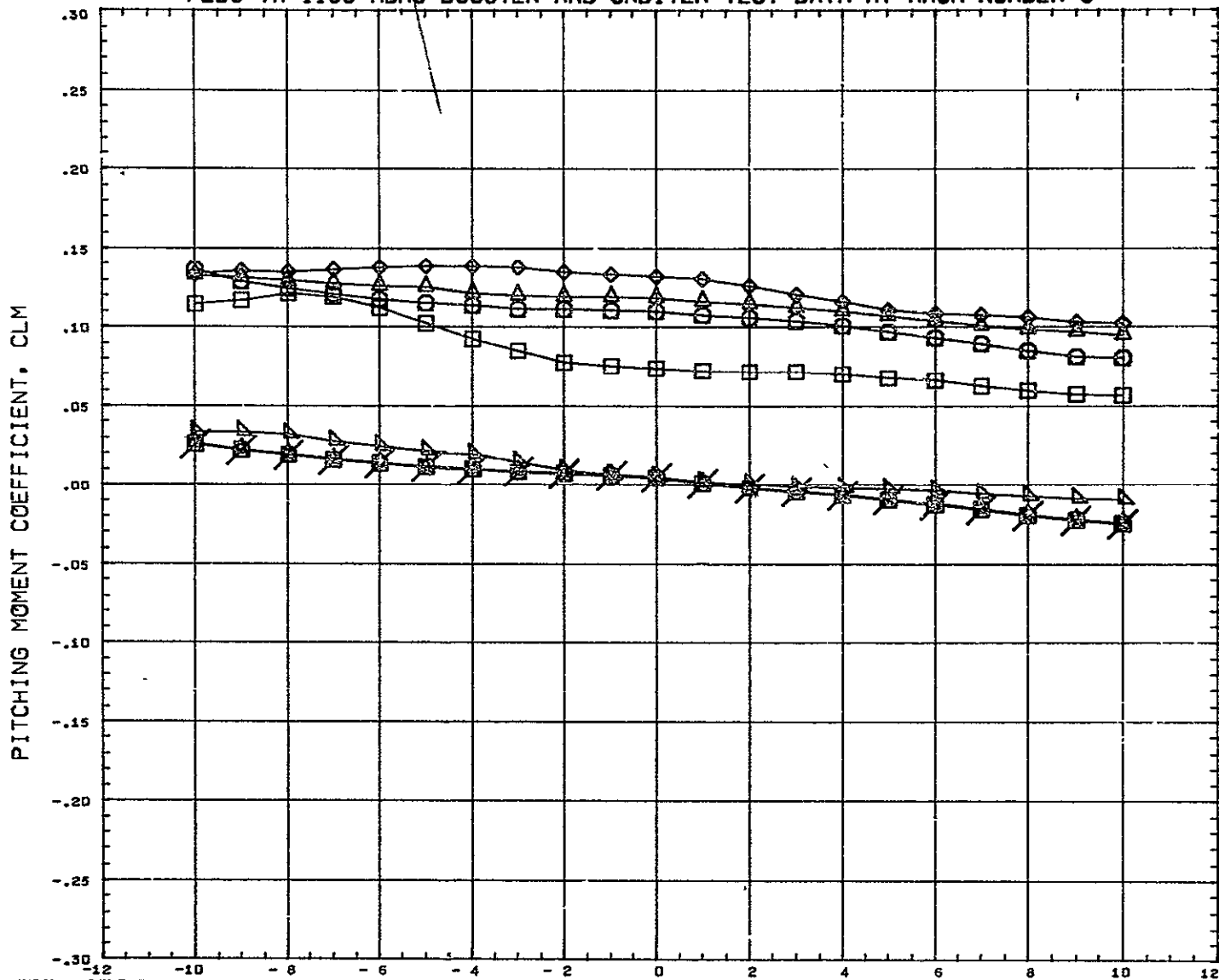

SYMBOL 	DELTAZ 0.120 0.151 0.132 0.228 0.352 0.599 0.908 10.000	PARAMETRIC VALUES BSTFOW 50.000 ORBPOW 100.000 DELTAX 0.228 ALPHAI 0.000 ACH 5.010 ELVBST 0.000 ELVORB 0.000 BETA 0.000 REFERENCE FILE	REFERENCE INFORMATION REFS 44.4440 SQ IN REFL 13.3330 IN REFB 13.3330 IN XMRP 7.5280 IN YMRP 0.0000 IN ZMRP 1.1940 IN SCALE 0.0055
------------	---	---	---

# AEDC VA 1163 MDAC BOOSTER AND ORBITER TEST DATA AT MACH NUMBER 5

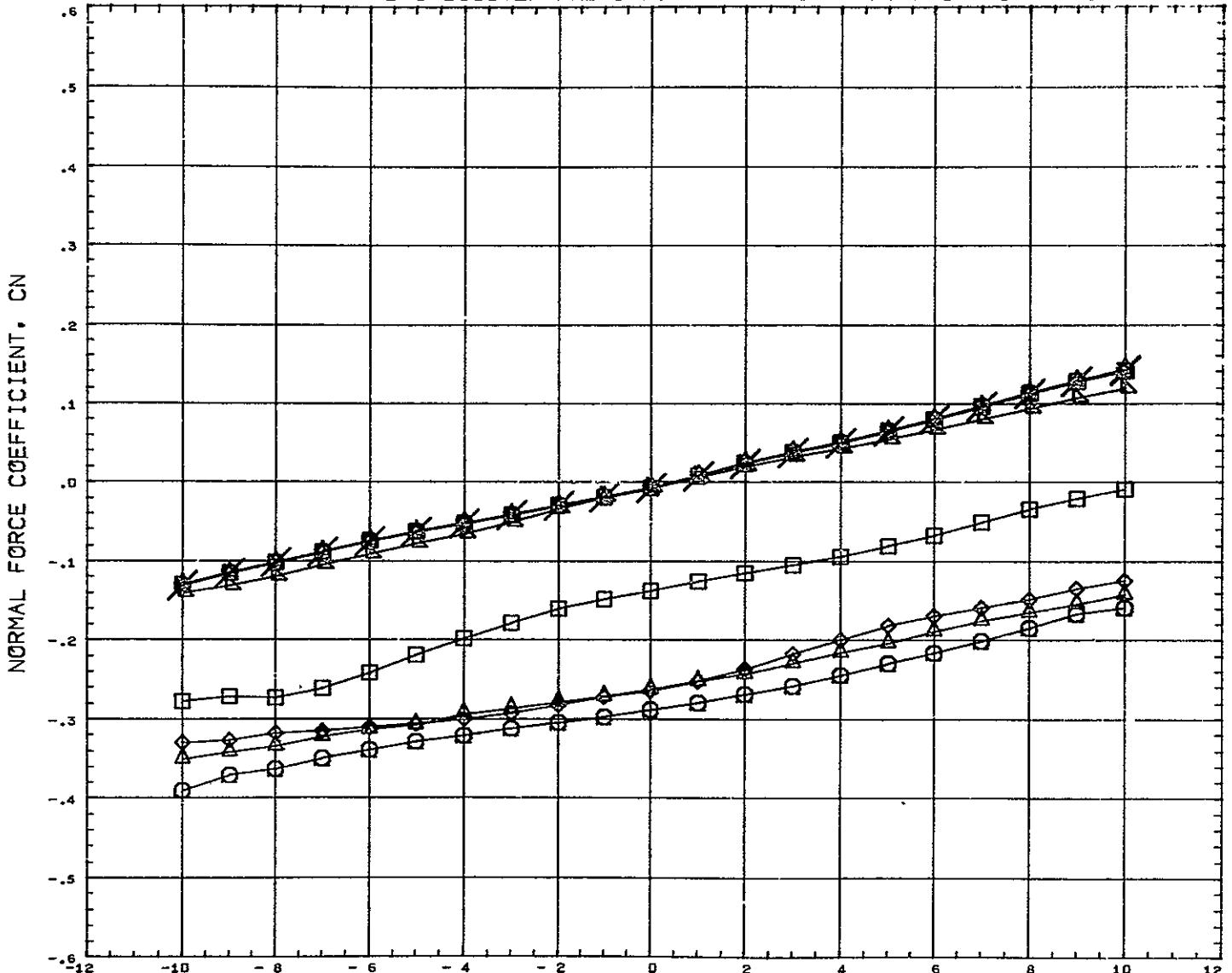

SYMBOL	DELTA Z	PARAMETRIC VALUES				REFERENCE INFORMATION	
<del>○</del>	0.120						
<del>◇</del>	0.151						
<del>△</del>	0.182	BSTPOW	50.000	ORBPOW	100.000	REFS	44.4440 SQ IN
<del>□</del>	0.228	FLTAX	0.228	ALPHAI	0.000	REFL	13.3330 IN
<del>◇</del>	0.352	MACH	5.010	ELVBST	0.000	REFB	13.3330 IN
<del>△</del>	0.599	ELVORB	0.000	BETA	0.000	XMRP	7.5200 IN
<del>○</del>	0.908					YMRP	0.0000 IN
<del>□</del>	19.000	REFERENCE FILE				ZMRP	1.1940 IN
						SCALE	0.0055

# AEDC VA 1163 MDAC BOOSTER AND ORBITER TEST DATA AT MACH NUMBER 5

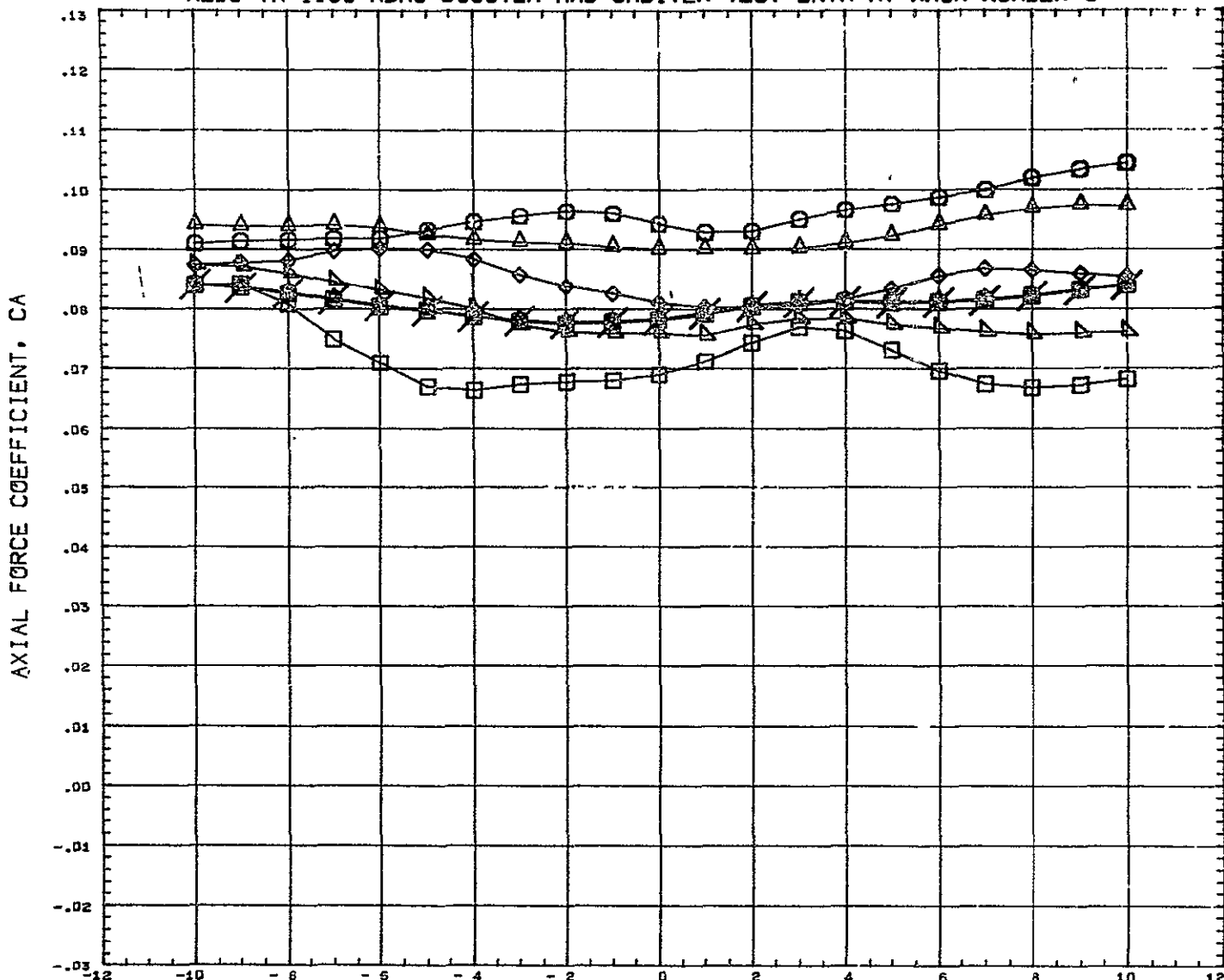

SYMBOL	DELTA Z	PARAMETRIC VALUES				REFERENCE INFORMATION	
○	0.120						
◇	0.151						
○	0.182	BSTPOW	50.000	ORBPOW	100.000	REFS	44.4440 SQ IN
□	0.228	DELTA X	0.228	ALPHA I	0.000	REFL	13.3330 IN
△	0.352	MACH	5.010	ELVBST	0.000	REFB	13.3330 IN
◇	0.599	ELVORB	0.000	BETA	0.000	XMRP	7.5280 IN
○	0.908					YMRP	0.0000 IN
△	10.000	REFERENCE FILE				ZMRP	1.1940 IN
						SCALE	0.0055

# AEDC VA 1163 MDAC BOOSTER AND ORBITER TEST DATA AT MACH NUMBER 5

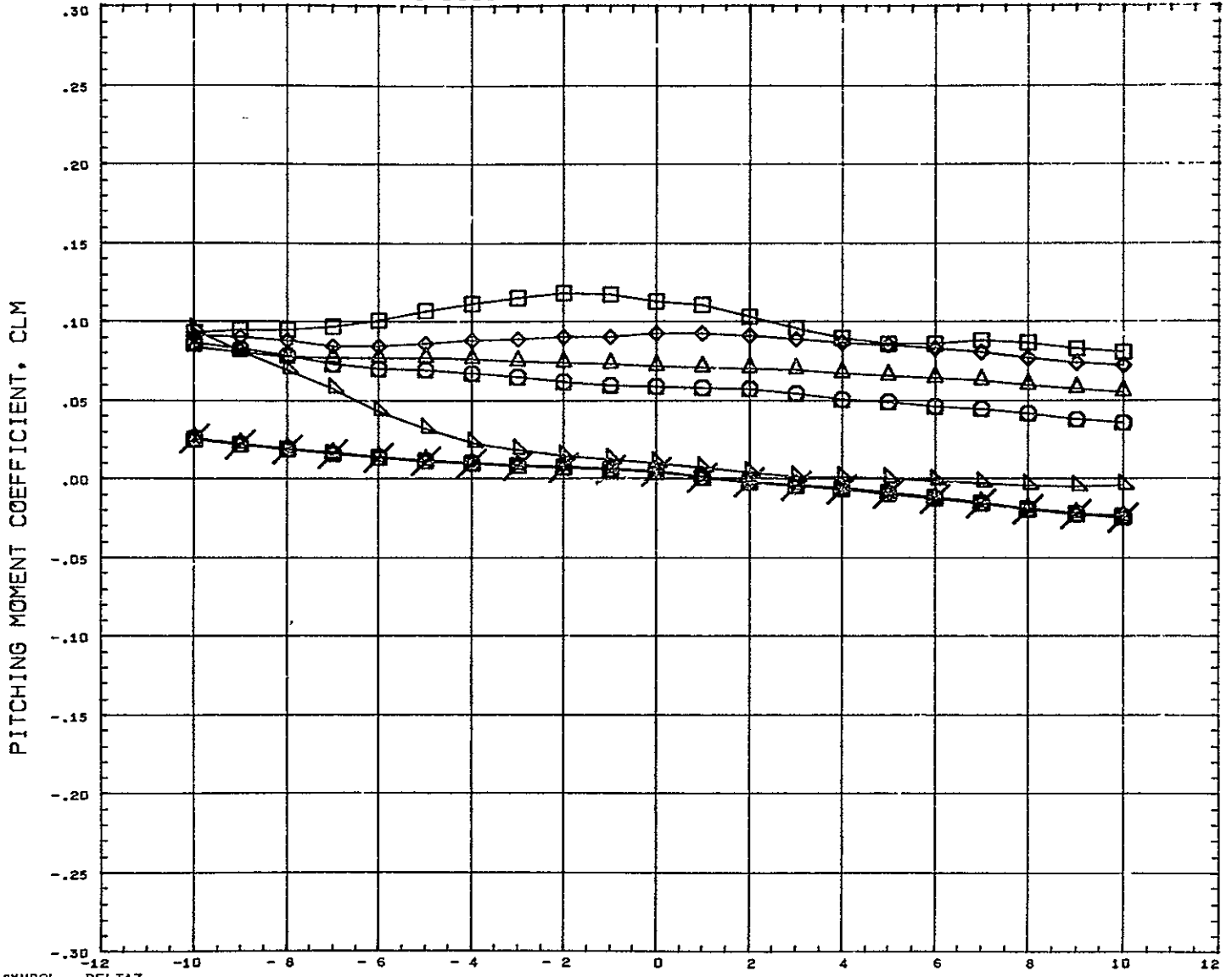

SYMBOL ○ ◇ △ □ △ ○ × ○	DELTAZ 0.120 0.151 0.182 0.228 0.352 0.599 0.908 10.000	<table border="0" style="width: 100%;"> <tr> <th colspan="4" style="text-align: center;">PARAMETRIC VALUES</th> </tr> <tr> <td>BSTPOW</td> <td>50.000</td> <td>ORBPOW</td> <td>100.000</td> </tr> <tr> <td>DELTAZ</td> <td>0.351</td> <td>ALPHA1</td> <td>0.000</td> </tr> <tr> <td>MACH</td> <td>5.010</td> <td>ELVBST</td> <td>0.000</td> </tr> <tr> <td>ELVORB</td> <td>0.000</td> <td>BETA</td> <td>0.000</td> </tr> </table> <p>REFERENCE FILE</p>	PARAMETRIC VALUES				BSTPOW	50.000	ORBPOW	100.000	DELTAZ	0.351	ALPHA1	0.000	MACH	5.010	ELVBST	0.000	ELVORB	0.000	BETA	0.000	<table border="0" style="width: 100%;"> <tr> <th colspan="2" style="text-align: center;">REFERENCE INFORMATION</th> </tr> <tr> <td>REFS</td> <td>44.4440 SQ IN</td> </tr> <tr> <td>REFL</td> <td>13.3330 IN</td> </tr> <tr> <td>REFB</td> <td>13.3330 IN</td> </tr> <tr> <td>XMRP</td> <td>7.5280 IN</td> </tr> <tr> <td>YMRP</td> <td>0.0000 IN</td> </tr> <tr> <td>ZMRP</td> <td>1.1940 IN</td> </tr> <tr> <td>SCALE</td> <td>0.0055</td> </tr> </table>	REFERENCE INFORMATION		REFS	44.4440 SQ IN	REFL	13.3330 IN	REFB	13.3330 IN	XMRP	7.5280 IN	YMRP	0.0000 IN	ZMRP	1.1940 IN	SCALE	0.0055
PARAMETRIC VALUES																																							
BSTPOW	50.000	ORBPOW	100.000																																				
DELTAZ	0.351	ALPHA1	0.000																																				
MACH	5.010	ELVBST	0.000																																				
ELVORB	0.000	BETA	0.000																																				
REFERENCE INFORMATION																																							
REFS	44.4440 SQ IN																																						
REFL	13.3330 IN																																						
REFB	13.3330 IN																																						
XMRP	7.5280 IN																																						
YMRP	0.0000 IN																																						
ZMRP	1.1940 IN																																						
SCALE	0.0055																																						



# AEDC VA 1163 MDAC BOOSTER AND ORBITER TEST DATA AT MACH NUMBER 5

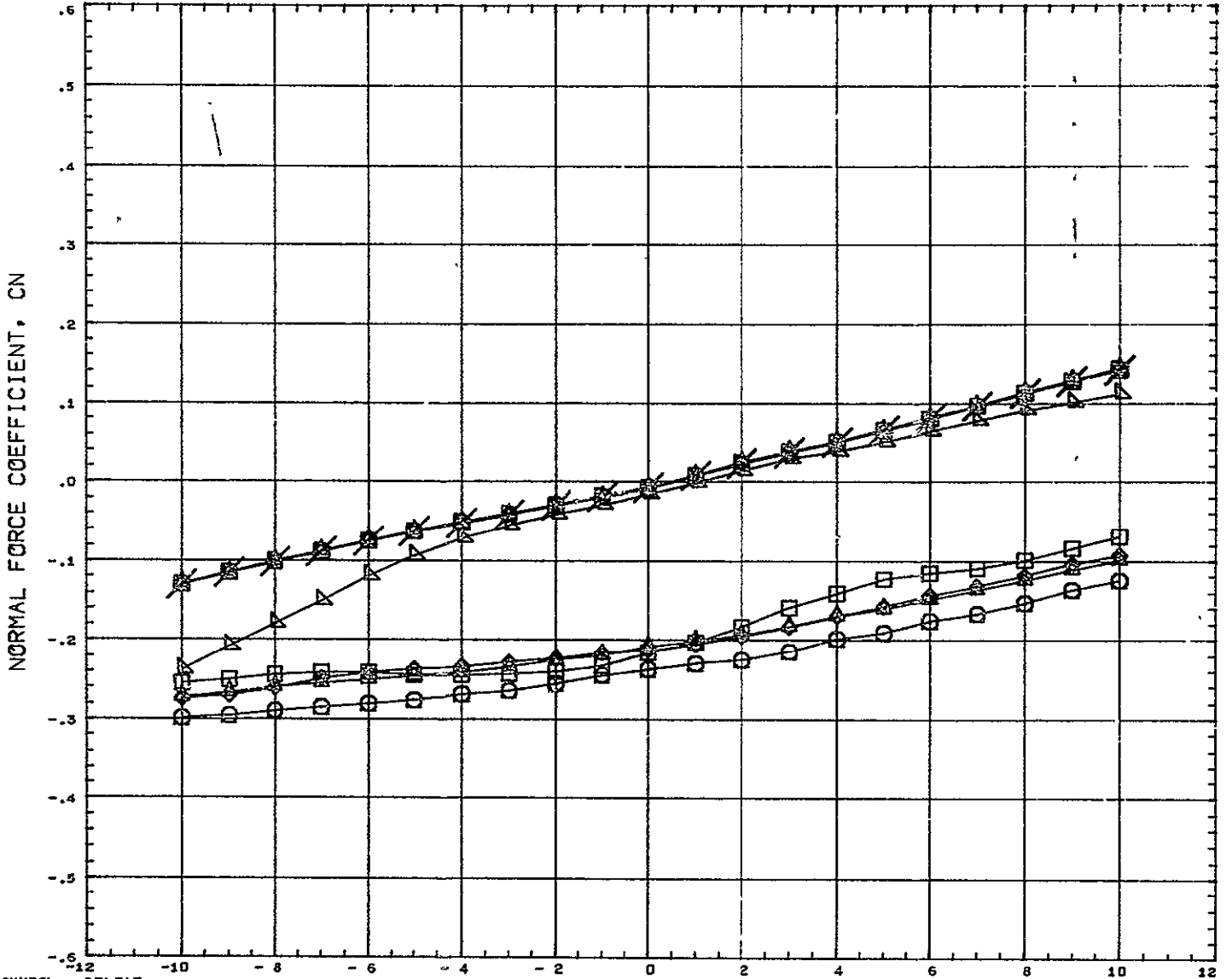

SYMBOL	DELTAZ	PARAMETRIC VALUES				REFERENCE INFORMATION	
○	0.120						
□	0.151						
△	0.182	BSTPOW	50.000	ORBPOW	100.000	REFS	77.4440 SQ IN
◇	0.228	DELTAZ	0.351	ALPHA1	0.000	REFL	13.3330 IN
◇	0.352	MACH	5.010	ELVBST	0.000	REFB	13.3330 IN
◇	0.599	ELVORB	0.000	BETA	0.000	XMRP	7.5280 IN
◇	0.908					YMRP	0.0000 IN
◇	10.000	REFERENCE FILE				ZMRP	1.1940 IN
						SCALE	0.0055

# AEDC VA 1163 MDAC BOOSTER AND ORBITER TEST DATA AT MACH NUMBER 5

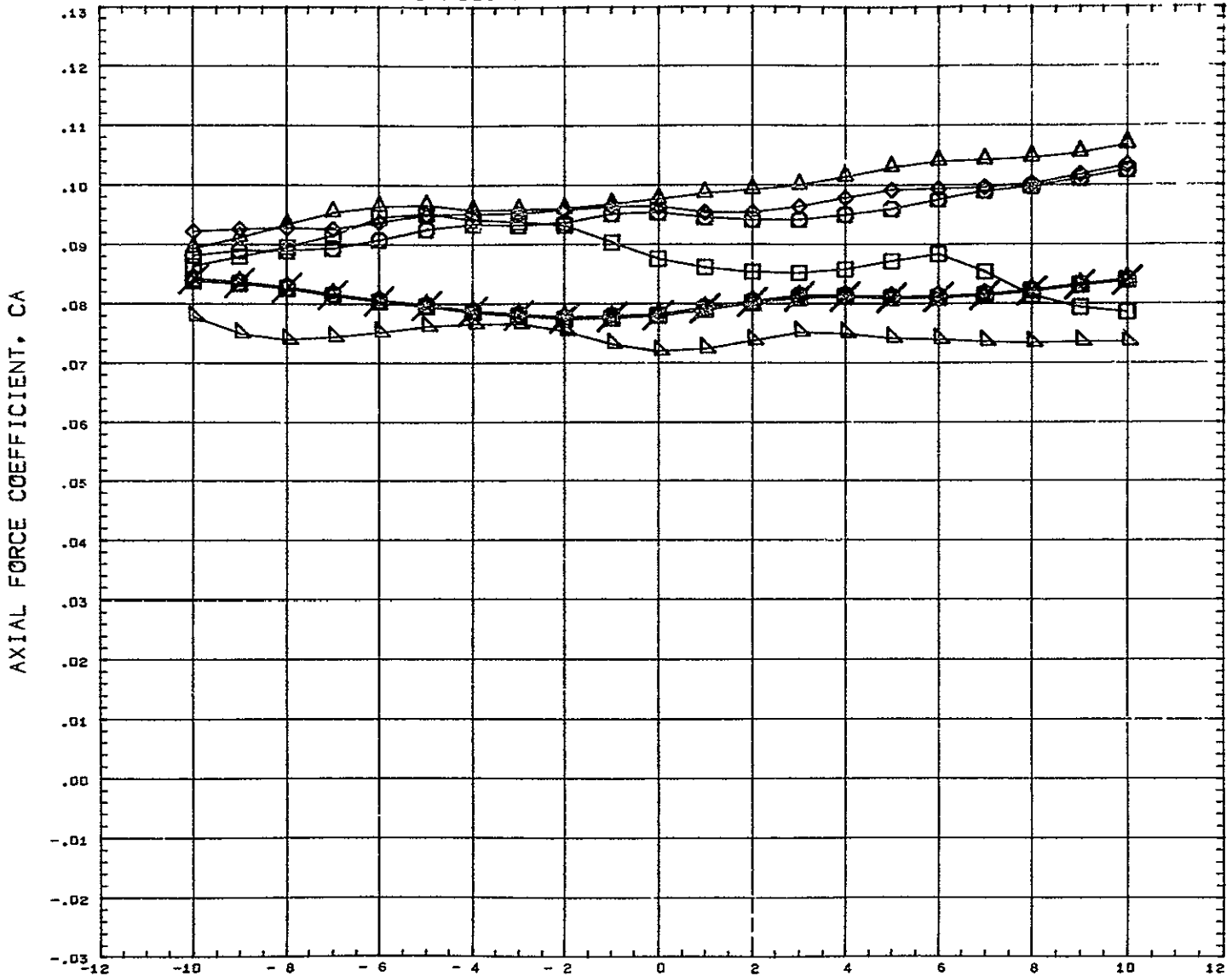

SYMBOL ◇ ◻ △ ○ × ◻ △ × ◻ △	DELTAZ 0.120 0.151 0.182 0.228 0.352 0.599 0.908 10.000	REFERENCE FILE  PARAMETRIC VALUES BSTPOW 50.000 ORBPOW 100.000 DELTAX 0.351 ALPHAI 0.000 CH 5.010 ELVBST 0.000 ELVORB 0.000 BETA 0.000	REFERENCE INFORMATION REFS 44.4440 SQ IN REFL 13.3330 IN REFB 13.3330 IN XMRP 7.5280 IN YMRP 0.0000 IN ZMRP 1.1940 IN SCALE 0.0055
--	---	--	---

# AEDC VA 1163 MDAC BOOSTER AND ORBITER TEST DATA AT MACH NUMBER 5

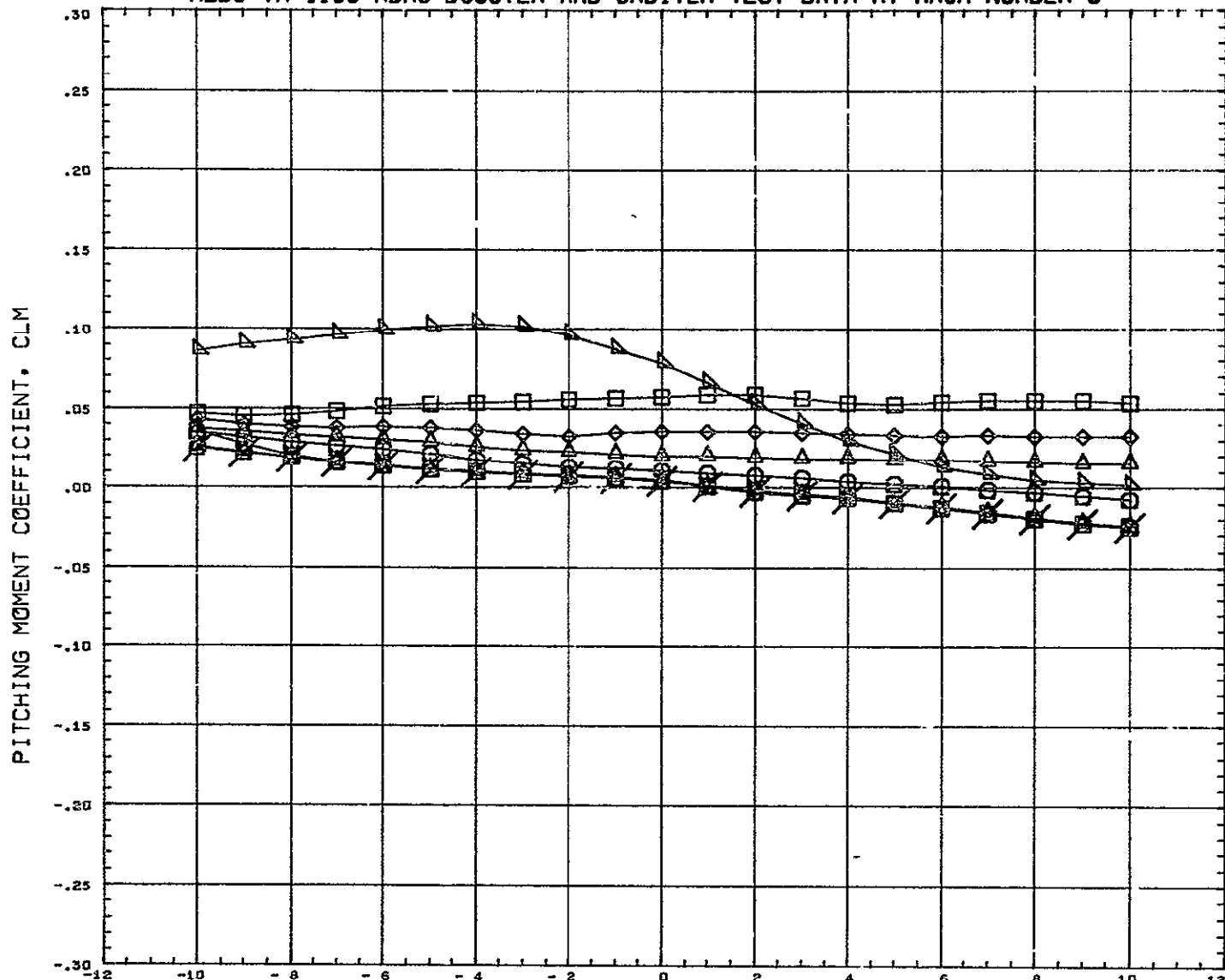

SYMBOL	DELTA Z	PARAMETRIC VALUES				REFERENCE INFORMATION		
○	0.120							
○	0.151							
◇	0.182	BSTPOW	50.000	ORBPOW	100.000	REFS	44.444C	SQ IN
□	0.220	DELTA X	0.522	ALPHA I	0.000	REFL	13.3330	IN
△	0.352	MACH	5.010	ELVBST	0.000	REFB	13.3330	IN
○	0.099	ELVORB	0.000	BETA	0.000	XMRP	7.5280	IN
○	0.908					YMRP	0.000C	IN
○	10.000	REFERENCE FILE				ZMRP	1.1940	IN
						SCALE	0.0055	

# AEDC VA 1163 MDAC BOOSTER AND ORBITER TEST DATA AT MACH NUMBER 5

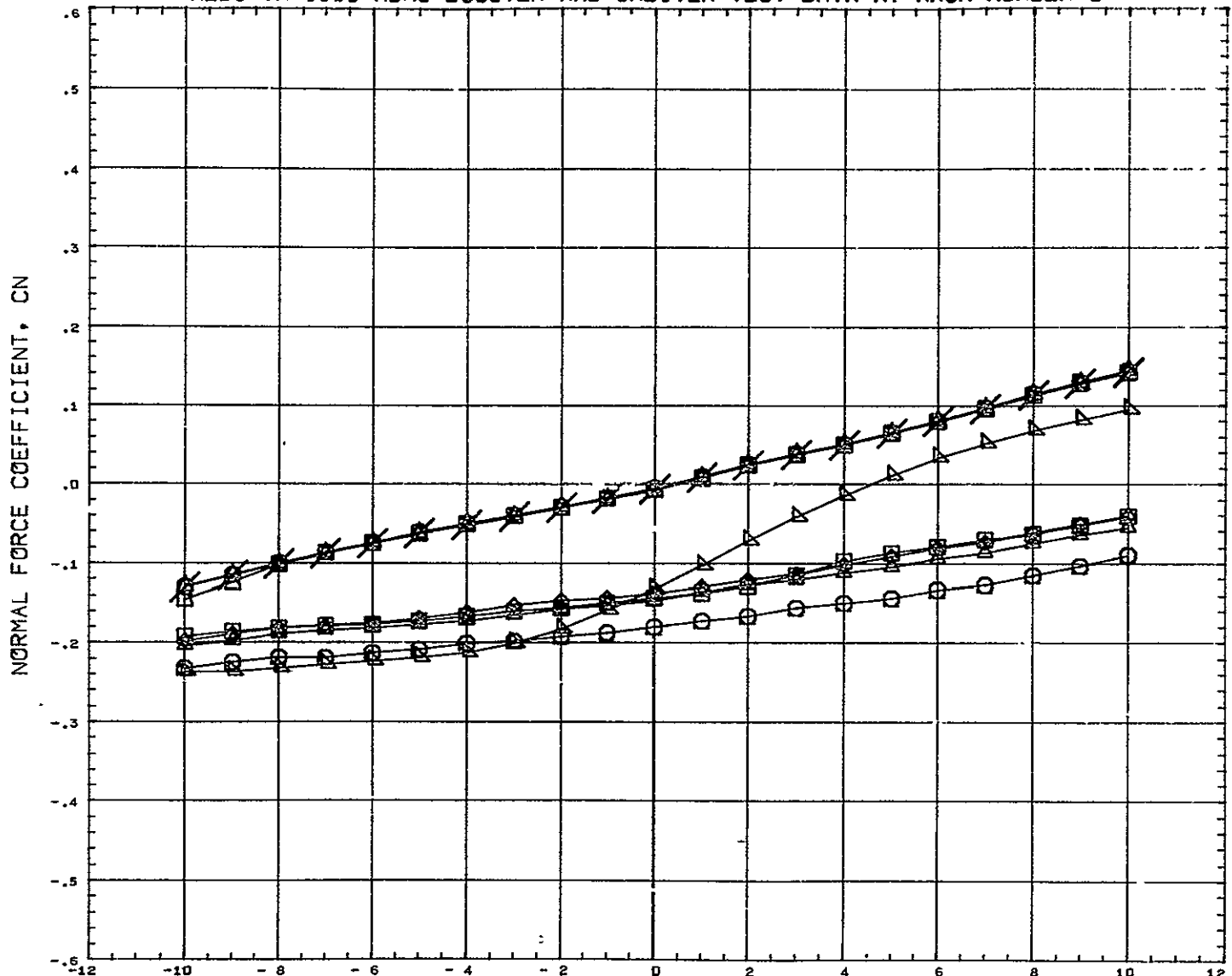

SYMBOL	DELTA Z	PARAMETRIC VALUES				REFERENCE INFORMATION		
○	0.120							
○	0.151							
○	0.182	BSTPOW	50.000	ORBPOW	100.000	REFS	44.4440	SQ IN
○	0.228	DELTA Z	0.522	ALPHA I	0.000	REFL	13.3330	IN
○	0.352	MACH	5.010	EL/BST	0.000	REFB	13.3330	IN
○	0.599	ELVORB	0.000	BETA	0.000	XMRP	7.5200	IN
○	0.908					YMRP	0.0000	IN
○	10.000	REFERENCE FILE				ZMRP	1.1940	IN
○						SCALE	0.0055	

# AEDC VA 1163 MDAC BOOSTER AND ORBITER TEST DATA AT MACH NUMBER 5

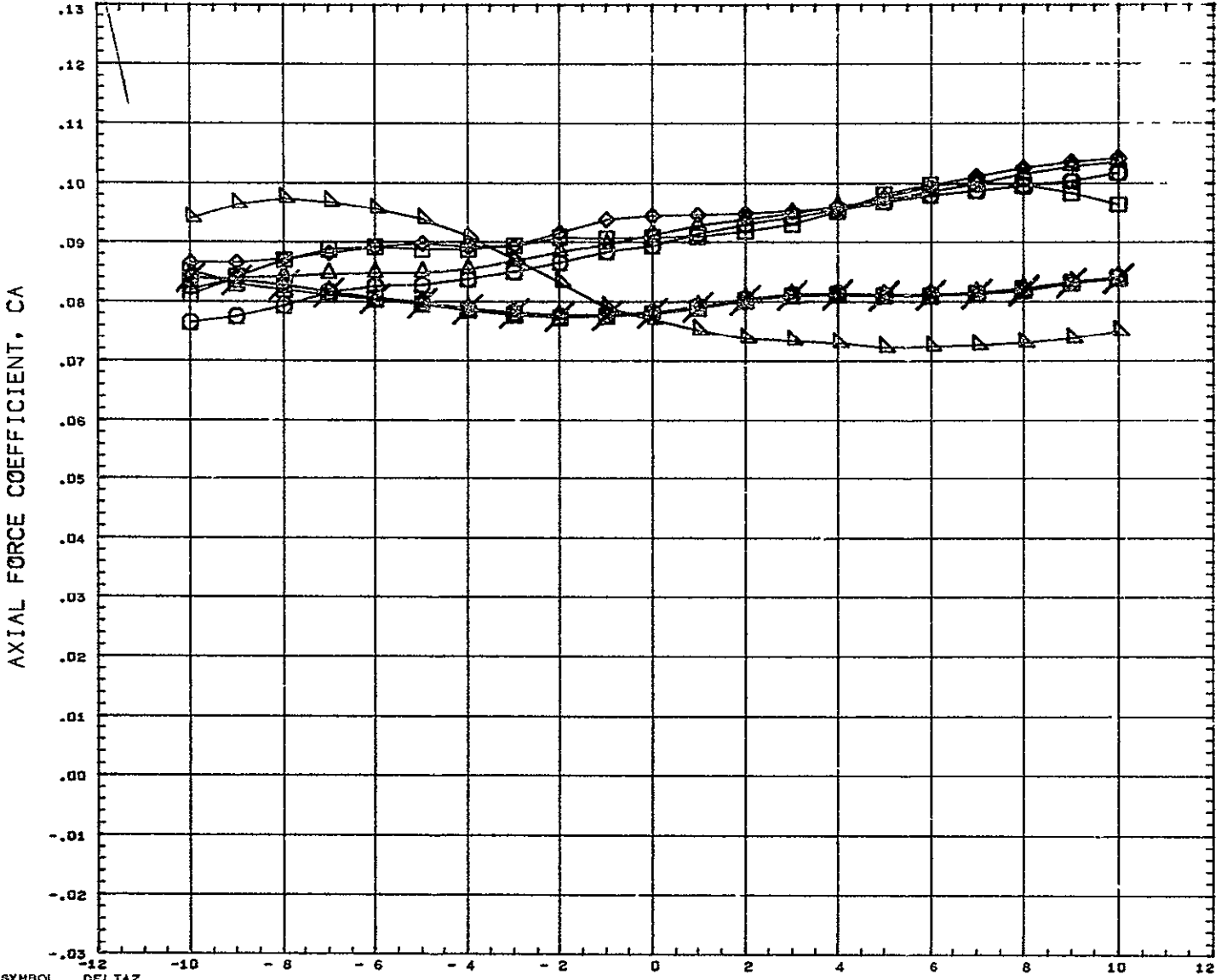

SYMBOL ○ □ △ ◇ ×	DELTAX 0.120 0.151 0.182 0.226 0.352 0.599 0.908 10.000	PARAMETRIC VALUES BSTFOW 50.000 ORBPOW 100.000 DELTAX 0.522 ALPHAI 0.000 MACH 5.010 ELVBST 0.000 ELVORB 0.000 BETA 0.000	REFERENCE INFORMATION REFS 7.4440 SQ IN REFL 13.3330 IN REFB 13.3330 IN XMRP 7.5280 IN YMRP 0.0000 IN ZMRP 1.1940 IN SCALE 0.0055
	BOOSTER ANGLE OF ATTACK, ALPHAB DEGREES		
	REFERENCE FILE		

# AEDC VA 1163 MDAC BOOSTER AND ORBITER TEST DATA AT MACH NUMBER 5

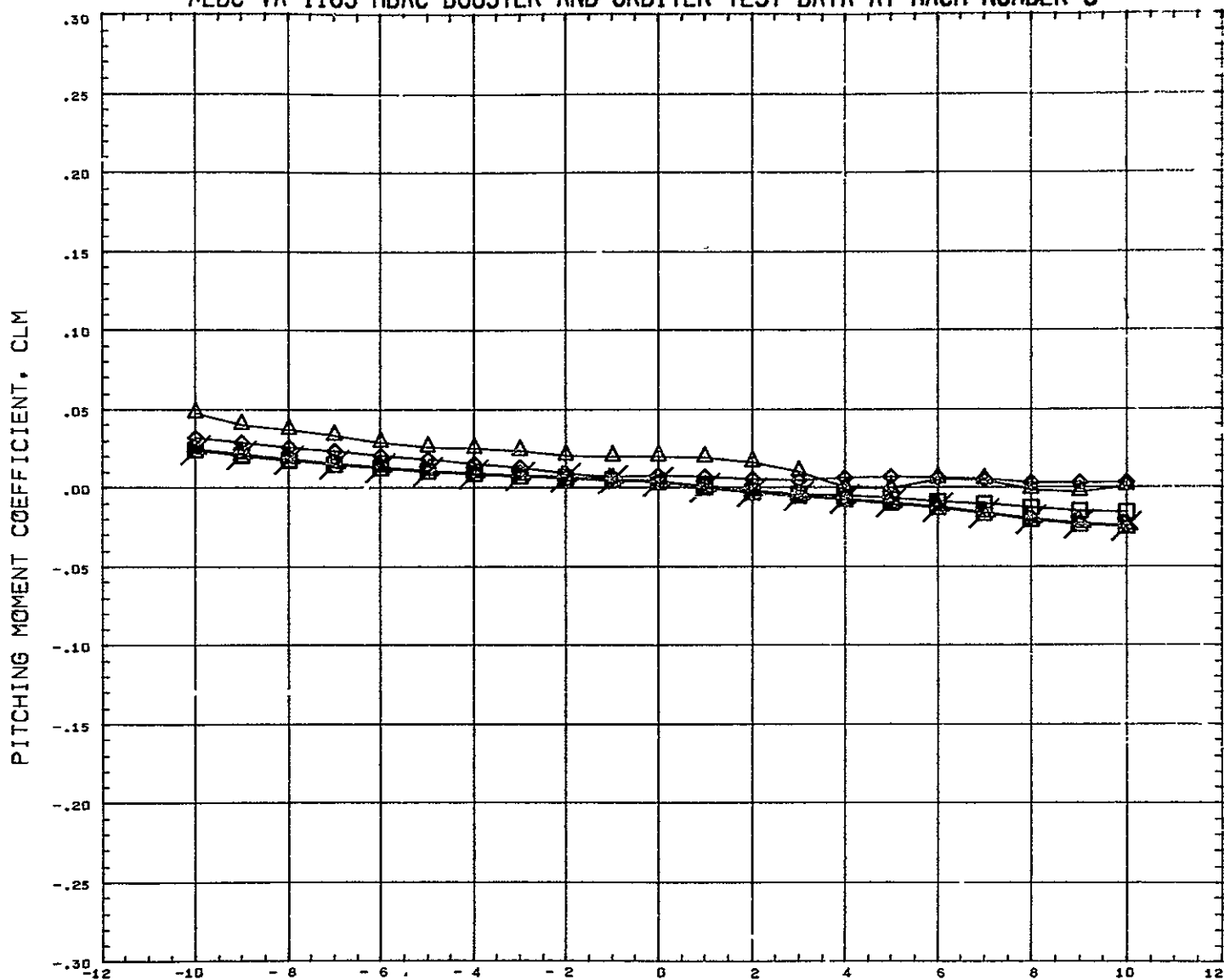

SYMBOL △ ◇ □ ×	DELTAZ 0.151 0.182 0.228 0.352 0.599 10.000	<table border="0" style="width: 100%;"> <tr> <th colspan="4" style="text-align: center;">PARAMETRIC VALUES</th> </tr> <tr> <td>BSTFOW</td> <td>50.000</td> <td>ORBFOW</td> <td>100.000</td> </tr> <tr> <td>DELTAZ</td> <td>- 0.390</td> <td>ALPHA1</td> <td>5.100</td> </tr> <tr> <td>MACH</td> <td>5.010</td> <td>ELVBST</td> <td>0.000</td> </tr> <tr> <td>ELVORB</td> <td>0.000</td> <td>BETA</td> <td>0.000</td> </tr> </table>	PARAMETRIC VALUES				BSTFOW	50.000	ORBFOW	100.000	DELTAZ	- 0.390	ALPHA1	5.100	MACH	5.010	ELVBST	0.000	ELVORB	0.000	BETA	0.000	<table border="0" style="width: 100%;"> <tr> <th colspan="3" style="text-align: center;">REFERENCE INFORMATION</th> </tr> <tr> <td>REFS</td> <td>44 4440</td> <td>SQ IN</td> </tr> <tr> <td>REFL</td> <td>13.3330</td> <td>IN</td> </tr> <tr> <td>REFB</td> <td>13.3330</td> <td>IN</td> </tr> <tr> <td>XMRF</td> <td>7.5280</td> <td>IN</td> </tr> <tr> <td>YMRF</td> <td>0.0000</td> <td>IN</td> </tr> <tr> <td>ZMRF</td> <td>1.1940</td> <td>IN</td> </tr> <tr> <td>SCALE</td> <td>0 0055</td> <td></td> </tr> </table>	REFERENCE INFORMATION			REFS	44 4440	SQ IN	REFL	13.3330	IN	REFB	13.3330	IN	XMRF	7.5280	IN	YMRF	0.0000	IN	ZMRF	1.1940	IN	SCALE	0 0055	
PARAMETRIC VALUES																																															
BSTFOW	50.000	ORBFOW	100.000																																												
DELTAZ	- 0.390	ALPHA1	5.100																																												
MACH	5.010	ELVBST	0.000																																												
ELVORB	0.000	BETA	0.000																																												
REFERENCE INFORMATION																																															
REFS	44 4440	SQ IN																																													
REFL	13.3330	IN																																													
REFB	13.3330	IN																																													
XMRF	7.5280	IN																																													
YMRF	0.0000	IN																																													
ZMRF	1.1940	IN																																													
SCALE	0 0055																																														

REFERENCE FILE

# AEDC VA 1163 MDAC BOOSTER AND ORBITER TEST DATA AT MACH NUMBER 5

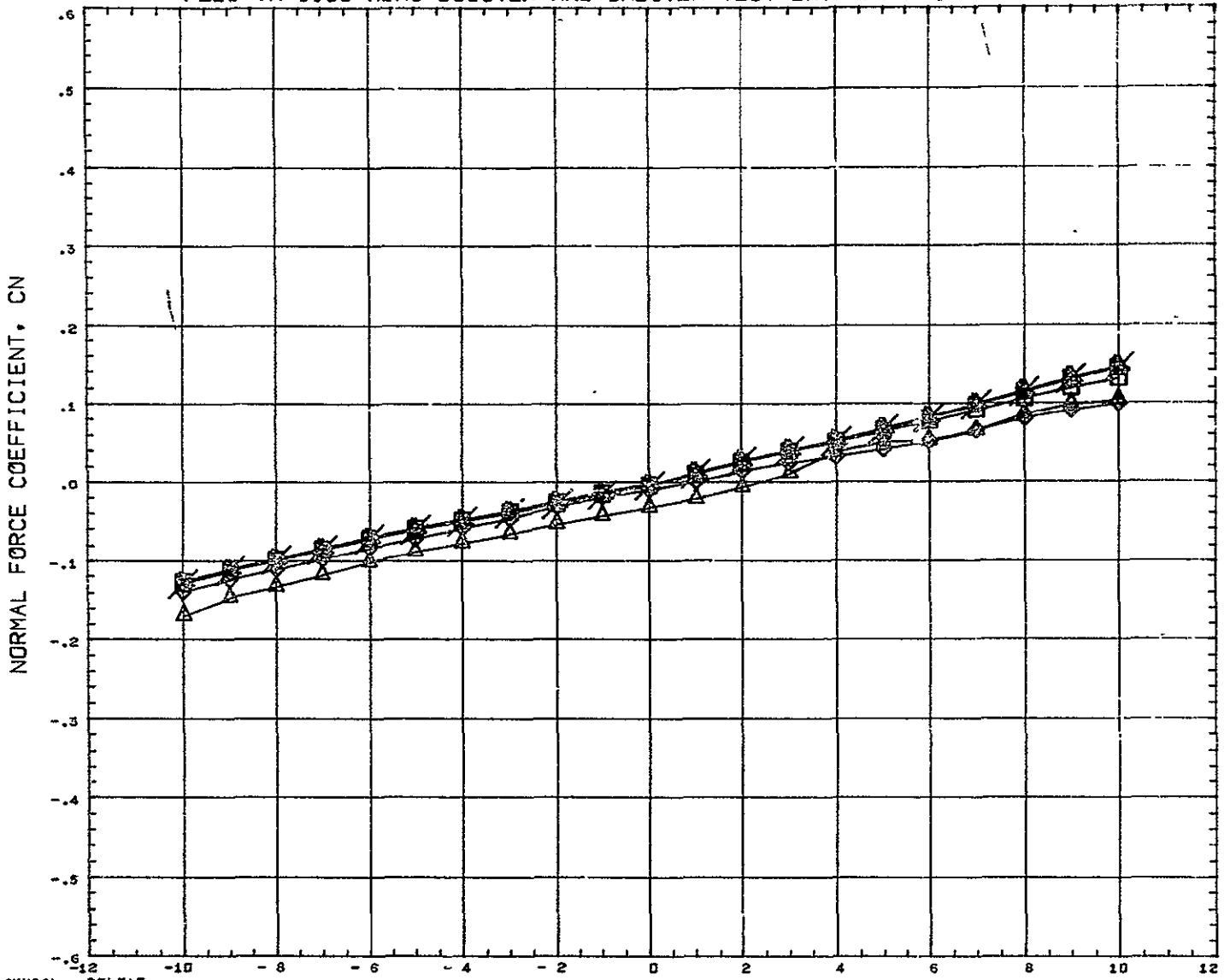

SYMBOL	DELTAZ	PARAMETRIC VALUES				REFERENCE INFORMATION		
△	0.151							
◊	0.182							
◻	0.228	BSTPOW	50.000	ORBPOW	100.000	REFS	44 4440	SQ IN
◇	0.352	DELTAZ	- 0.390	ALPHAI	5.100	REFL	13.3330	IN
▽	0.599	ACH	5.010	ELVBST	0.000	REFB	13.3330	IN
◊	10.000	ELVORB	0.000	BETA	0.000	XHRP	7.5280	IN
						YHRP	0.0000	IN
						ZHRP	1.1940	IN
						SCALE	0.0055	

REFERENCE FILE

# AEDC VA 1163 MDAC BOOSTER AND ORBITER TEST DATA AT MACH NUMBER 5

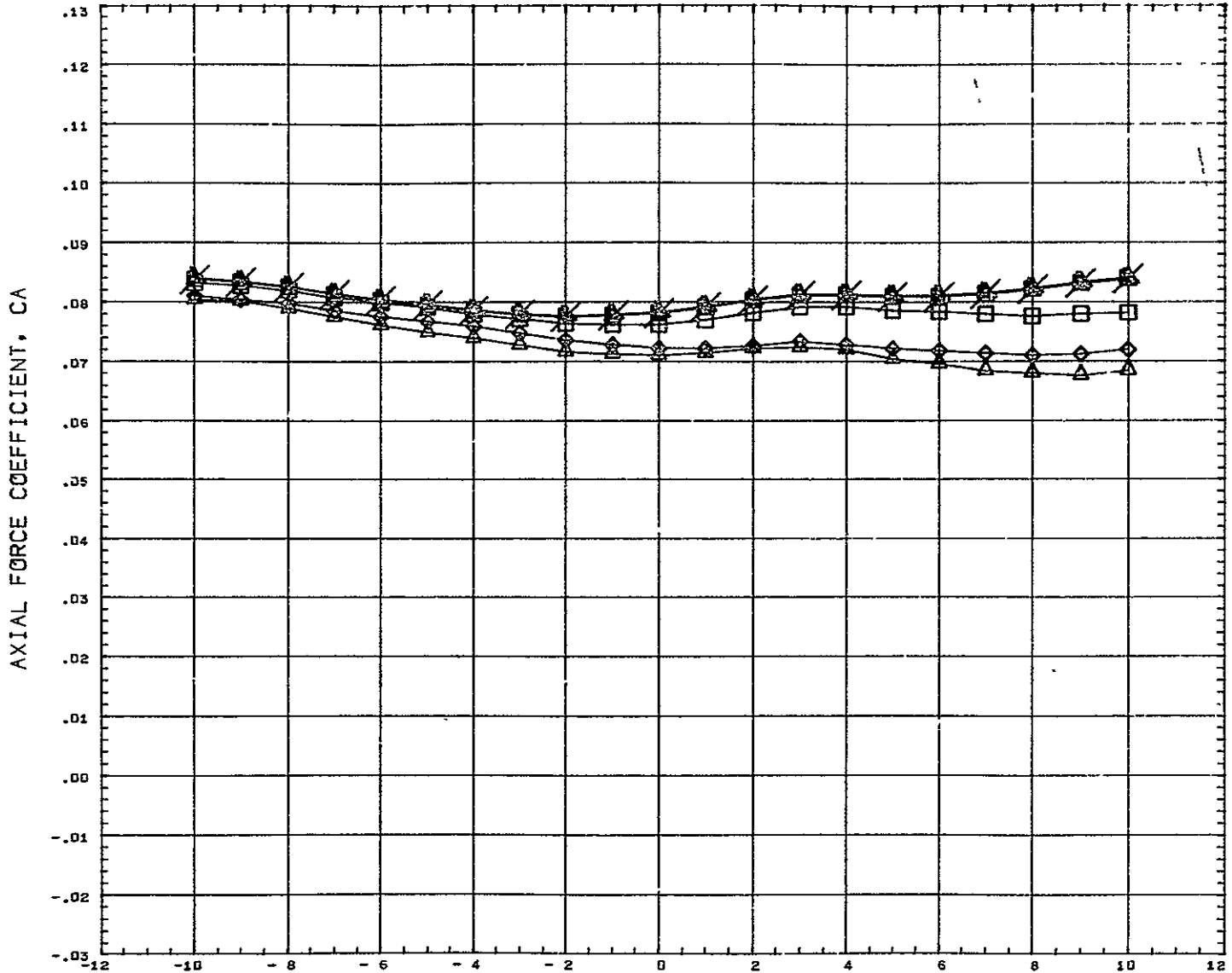

SYMBOL $\triangle$ $\diamond$ $\square$ $\circ$ $\triangle$ with slash	DELTAZ 0.151 0.182 0.228 0.352 0.599 10.000	PARAMETRIC VALUES BSTPOW 50.000 ORBPOW 100.000 DELTAX - 0.390 ALPHAI 5.100 MACH 5.010 ELVBST 0.000 ELVORB 0.000 BETA 0.000	REFERENCE INFORMATION REFS 44.4440 SQ IN REFL 13.3330 IN REFB 13.3330 IN XMRP 7.5280 IN YMRP 0.0000 IN ZMRP 1.1940 IN SCALE 0.0055
---	---	--	---

REFERENCE FILE



# AEDC VA 1163 MDAC BOOSTER AND ORBITER TEST DATA AT MACH NUMBER 5

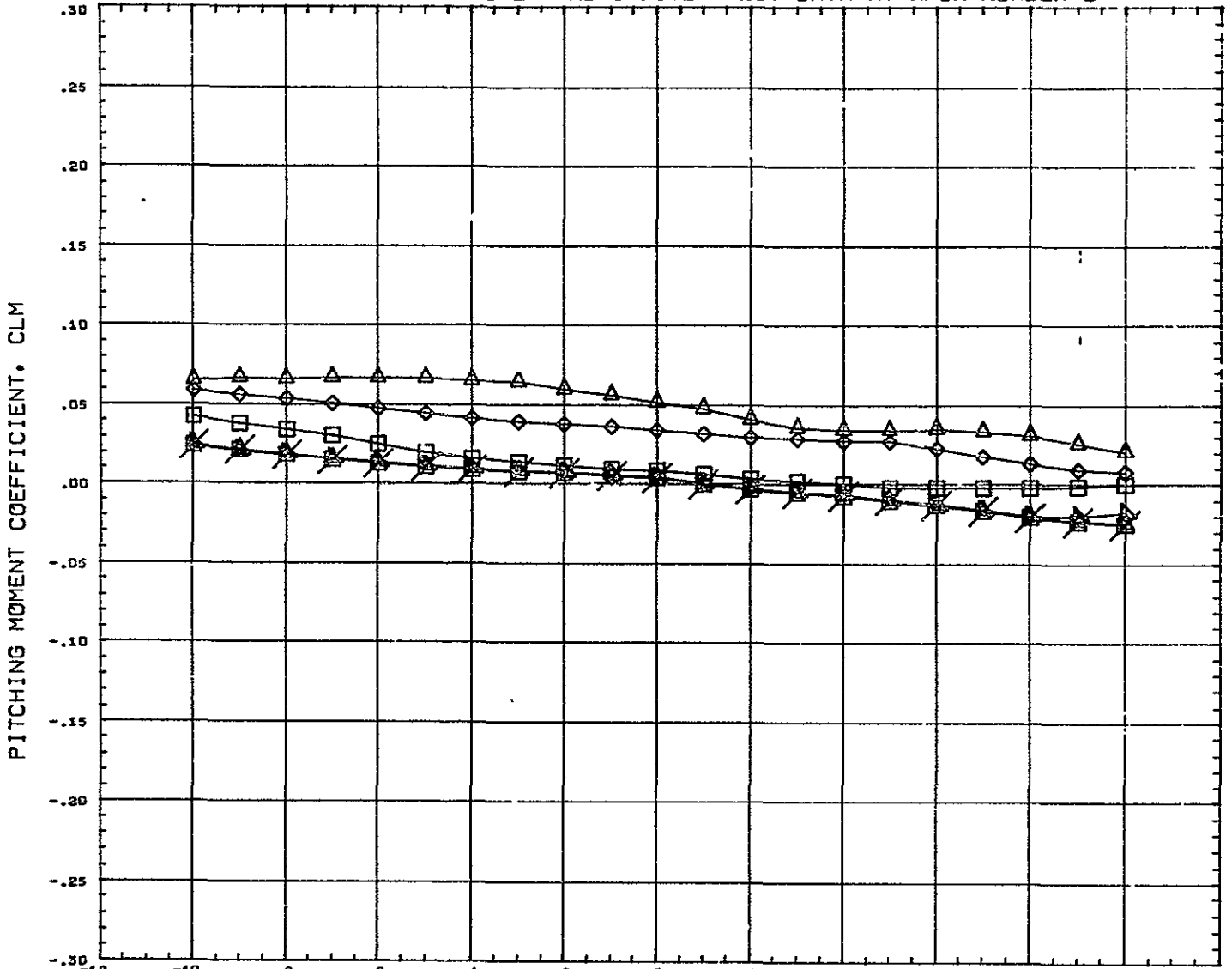

SYMBOL	DELTA Z	PARAMETRIC VALUES				REFERENCE INFORMATION	
△	0.151	BSTPOW	50.000	ORBPOW	100.000	REFS	44.4440 SQ IN
◇	0.182	DELTA X	- 0.143	ALPHA1	5.100	REFL	13.3330 IN
□	0.228	MACH	5.010	ELVBST	0.000	REFB	13.3330 IN
▽	0.352	CLVORB	0.000	BETA	0.000	XMRP	7.5280 IN
⊗	0.599					YMRP	0.0000 IN
⊗	10.000					ZMRP	1.1940 IN
						SCALE	0.0055

REFERENCE FILE

# AEDC VA 1163 MDAC BOOSTER AND ORBITER TEST DATA AT MACH NUMBER 5

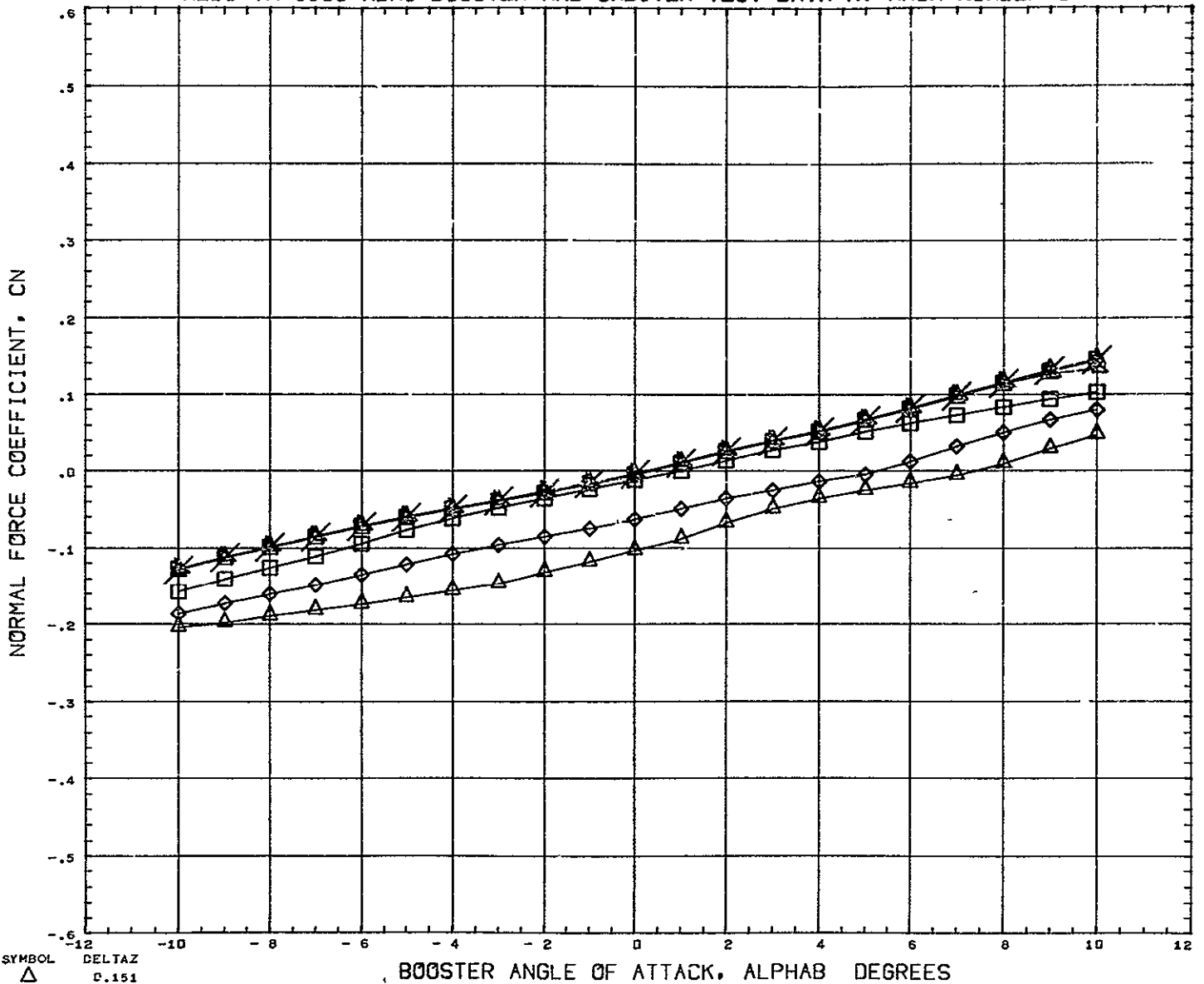

SYMBOL △ ◇ □ ○ ×	DELTAZ 0.151 0.182 0.228 0.352 0.599 10.000	<table border="0" style="width: 100%;"> <tr> <th colspan="4" style="text-align: center;">PARAMETRIC VALUES</th> </tr> <tr> <td>BSTFCW</td> <td>50.000</td> <td>ORBFCW</td> <td>100.000</td> </tr> <tr> <td>DELTAZ</td> <td>0.143</td> <td>ALPHA1</td> <td>5.100</td> </tr> <tr> <td>MACH</td> <td>5.010</td> <td>ELVBST</td> <td>0.000</td> </tr> <tr> <td>ELVORB</td> <td>0.000</td> <td>BETA</td> <td>0.000</td> </tr> </table>	PARAMETRIC VALUES				BSTFCW	50.000	ORBFCW	100.000	DELTAZ	0.143	ALPHA1	5.100	MACH	5.010	ELVBST	0.000	ELVORB	0.000	BETA	0.000	<table border="0" style="width: 100%;"> <tr> <th colspan="3" style="text-align: center;">REFERENCE INFORMATION</th> </tr> <tr> <td>REFS</td> <td>4.4440</td> <td>SQ IN</td> </tr> <tr> <td>REFL</td> <td>13.3330</td> <td>IN</td> </tr> <tr> <td>REFB</td> <td>13.3330</td> <td>IN</td> </tr> <tr> <td>XMRP</td> <td>7.5280</td> <td>IN</td> </tr> <tr> <td>YMRP</td> <td>0.0000</td> <td>IN</td> </tr> <tr> <td>ZMRP</td> <td>1.1940</td> <td>IN</td> </tr> <tr> <td>SCALE</td> <td>0.0055</td> <td></td> </tr> </table>	REFERENCE INFORMATION			REFS	4.4440	SQ IN	REFL	13.3330	IN	REFB	13.3330	IN	XMRP	7.5280	IN	YMRP	0.0000	IN	ZMRP	1.1940	IN	SCALE	0.0055	
PARAMETRIC VALUES																																															
BSTFCW	50.000	ORBFCW	100.000																																												
DELTAZ	0.143	ALPHA1	5.100																																												
MACH	5.010	ELVBST	0.000																																												
ELVORB	0.000	BETA	0.000																																												
REFERENCE INFORMATION																																															
REFS	4.4440	SQ IN																																													
REFL	13.3330	IN																																													
REFB	13.3330	IN																																													
XMRP	7.5280	IN																																													
YMRP	0.0000	IN																																													
ZMRP	1.1940	IN																																													
SCALE	0.0055																																														

REFERENCE FILE  
2A

# AEDC VA 1163 MDAC BOOSTER AND ORBITER TEST DATA AT MACH NUMBER 5

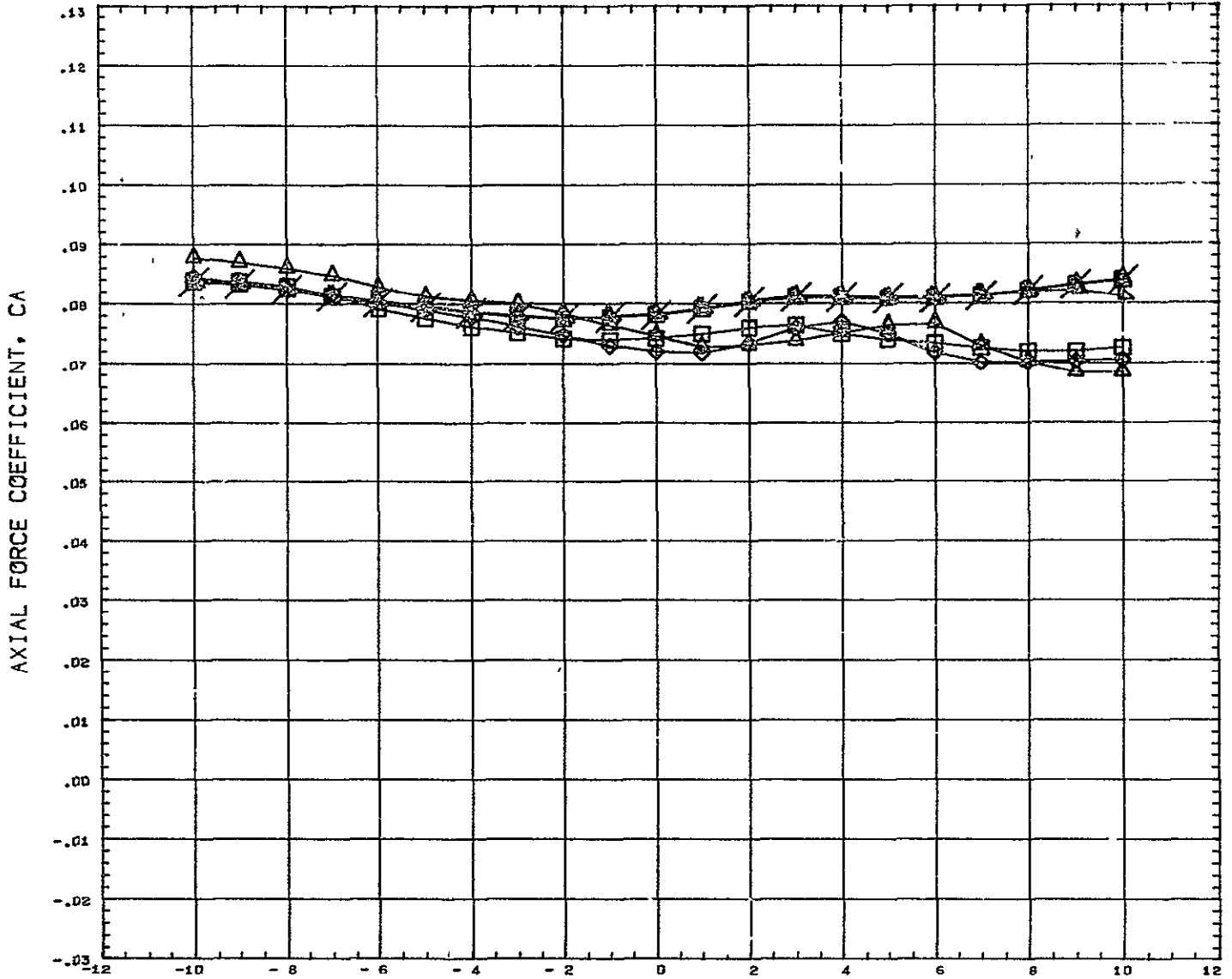

SYMBOL	DELTAZ	PARAMETRIC VALUES				REFERENCE INFORMATION		
△	0.151							
◇	0.182							
□	0.228	BS1POW	50.000	ORBPOW	100.000	REFS	4.4440	S3 IN
◇	0.352	DELTAZ	-0.143	ALPHA1	5.100	REFL	13.3336	IN
◇	0.599	L1CH	5.010	ELVBST	0.000	REFB	13.3339	IN
△	10.000	ELVORB	0.000	BETA	0.000	XMRP	7.5280	IN
						YNRP	0.0000	IN
						ZNRP	1.1940	IN
						SCALE	0.0055	

REFERENCE FILE

# AEDC VA 1163 MDAC BOOSTER AND ORBITER TEST DATA AT MACH NUMBER 5

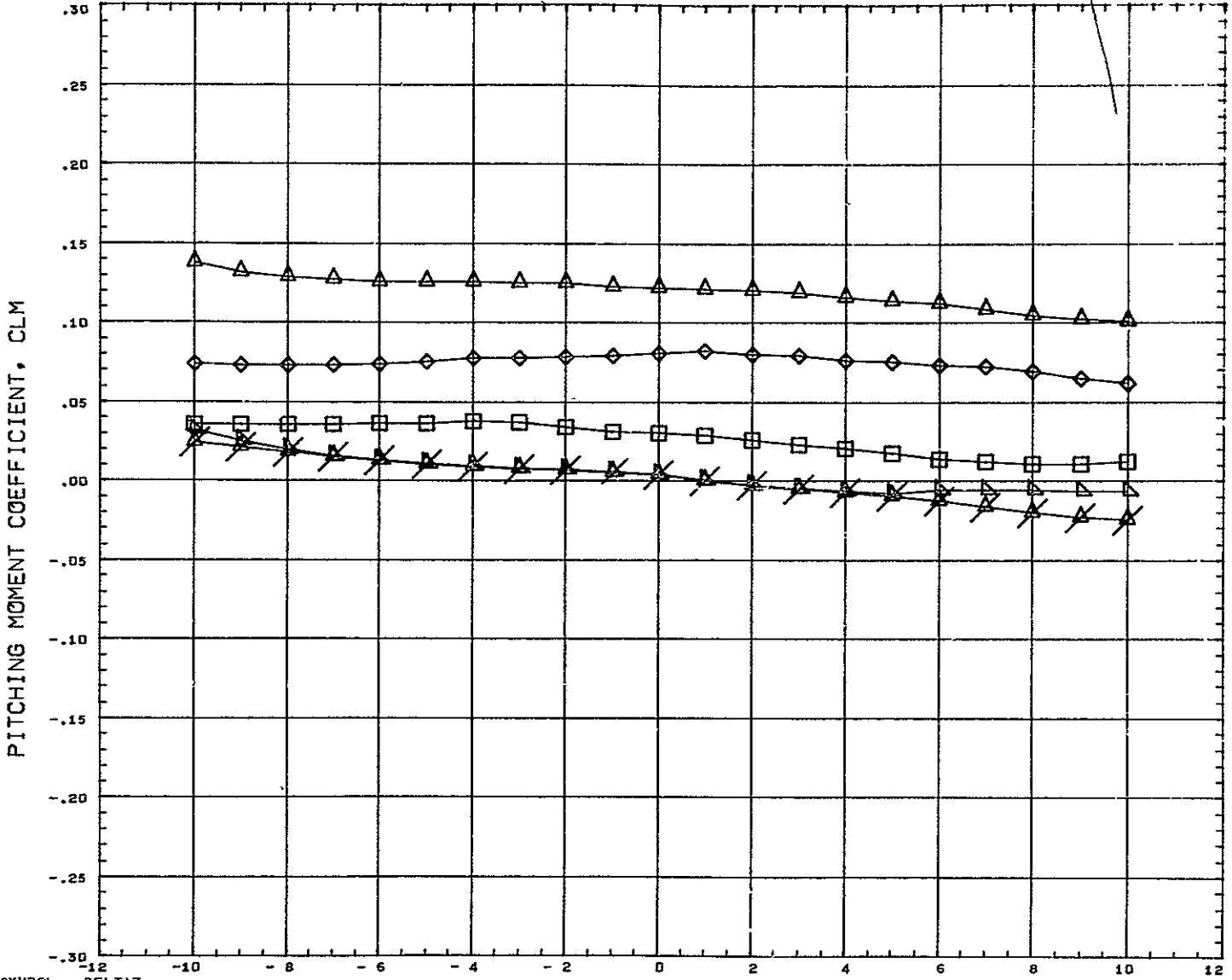

SYMBOL △ ◇ □ × ▽	DELTAZ 0.151 0.182 0.228 0.352 10.000	PARAMETRIC VALUES BSTPOW 50.000 ORBPOW 100.000 DELTAX - 0.019 ALPHA1 5.100 MACH 5.010 ELVBST 0.000 ELVORB 0.000 BETA 0.000	REFERENCE INFORMATION REFS 44.444D SQ III REFL 13.3330 IN REFB 13.3330 IN XMRP 7.5280 IN YMRP 0 0000 IN ZMRP 1 1840 IN SCALE 0 0055
REFERENCE FILE			

# AEDC VA 1163 MDAC BOOSTER AND ORBITER TEST DATA AT MACH NUMBER 5

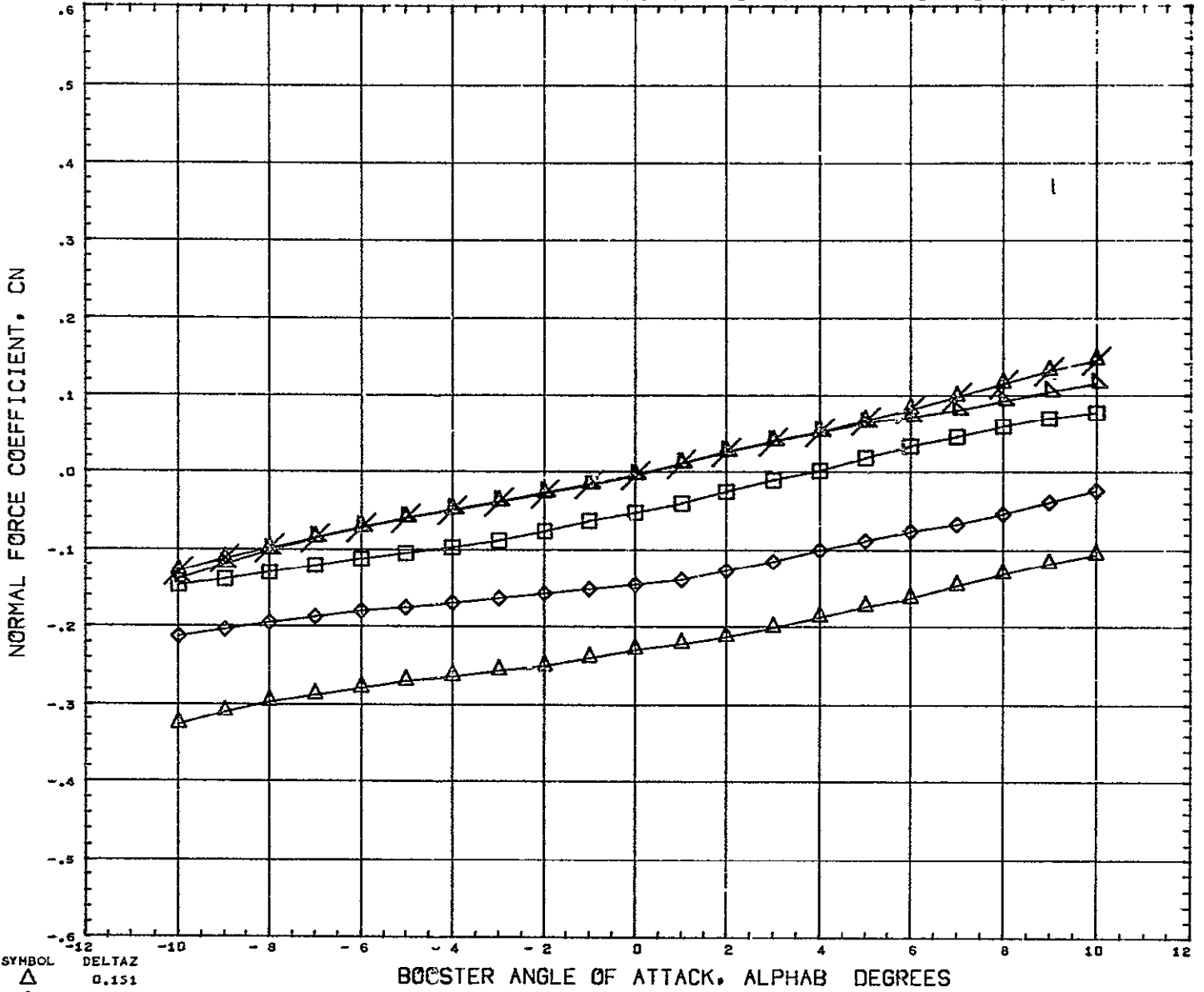

SYMBOL    DELTA Z  
 △        0.151  
 ◇        0.182  
 □        0.228  
 △/       0.352  
 10.000

PARAMETRIC VALUES  
 BSTPOW    50.000    ORBPOW    100.000  
 PFLTAX    - 0.019    ALPHAI    5.100  
 MACH       5.010    ELVBST    0.000  
 ELVORB    0.000    BETA       0.000

REFERENCE INFORMATION  
 REFS       44.444P    SQ IN  
 REFL       13.3330    IN  
 REFB       13.3330    IN  
 XMRP       7.5280    IN  
 YMRP       0.0060    IN  
 ZMRP       1.1940    IN  
 SCALE       0.0055

REFERENCE FILE

# AEDC VA 1163 MDAC BOOSTER AND ORBITER TEST DATA AT MACH NUMBER 5

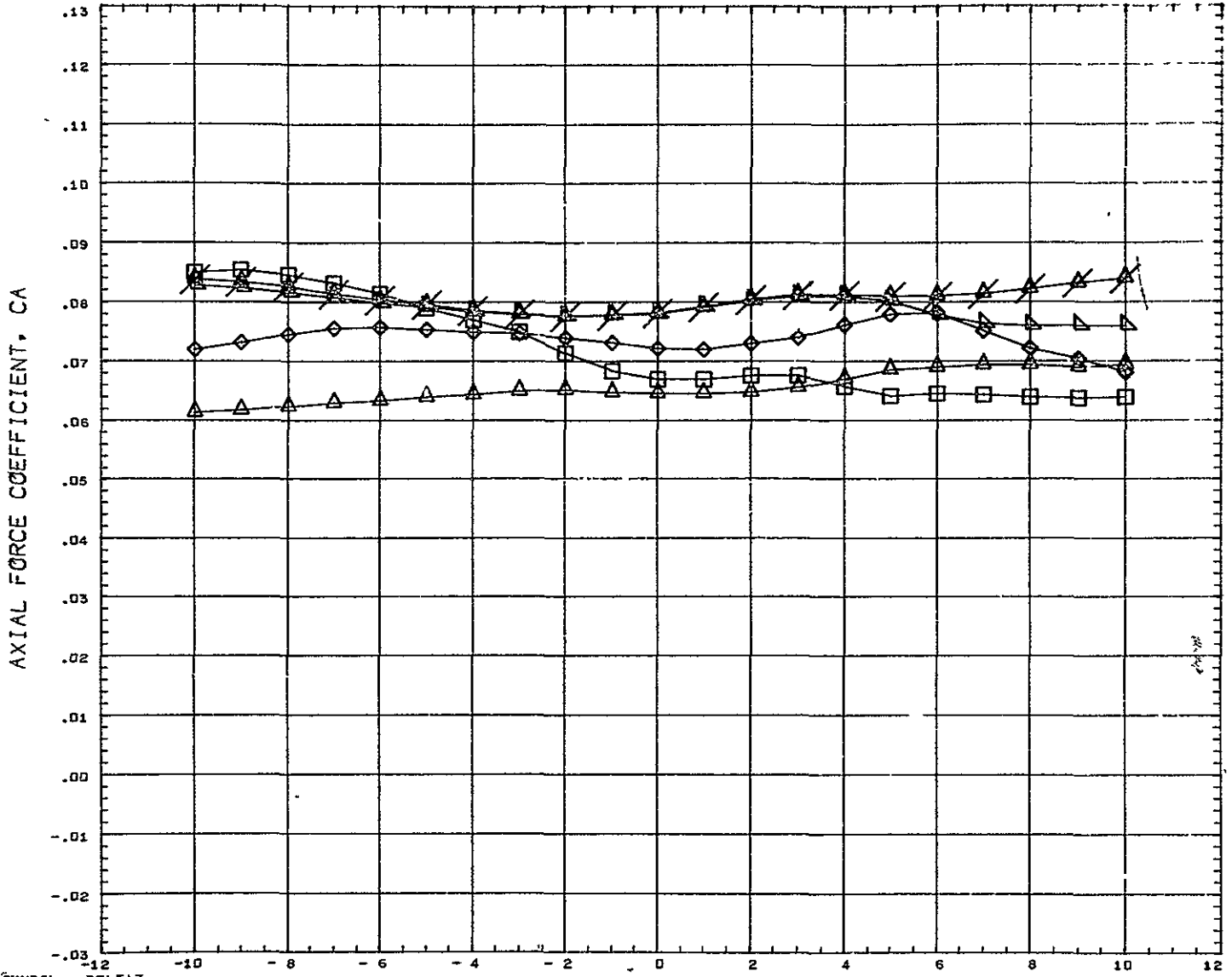

SYMBOL ◻ ◊ ◻ ◻ ◻	DELTAZ 0.151 0.182 0.228 0.352 10.000	PARAMETRIC VALUES BSTPOW 50.000 ORBPOW 100.000 DELTAX - 0.019 ALPHAI 5.100 MACH 5.010 ELVBST 0.000 ELVORB 0.000 BETA 0.000	REFERENCE INFORMATION REFS 44.444J SQ IN REFL 13.3330 IN REFB 13.3330 IN XMRF 7.5280 IN YMRF 0.0000 IN ZMRF 1.1940 IN SCALE 0.0055
---------------------------------	--	--	---

REFERENCE FILE

# AEDC VA 1163 MDAC BOOSTER AND ORBITER TEST DATA AT MACH NUMBER 5

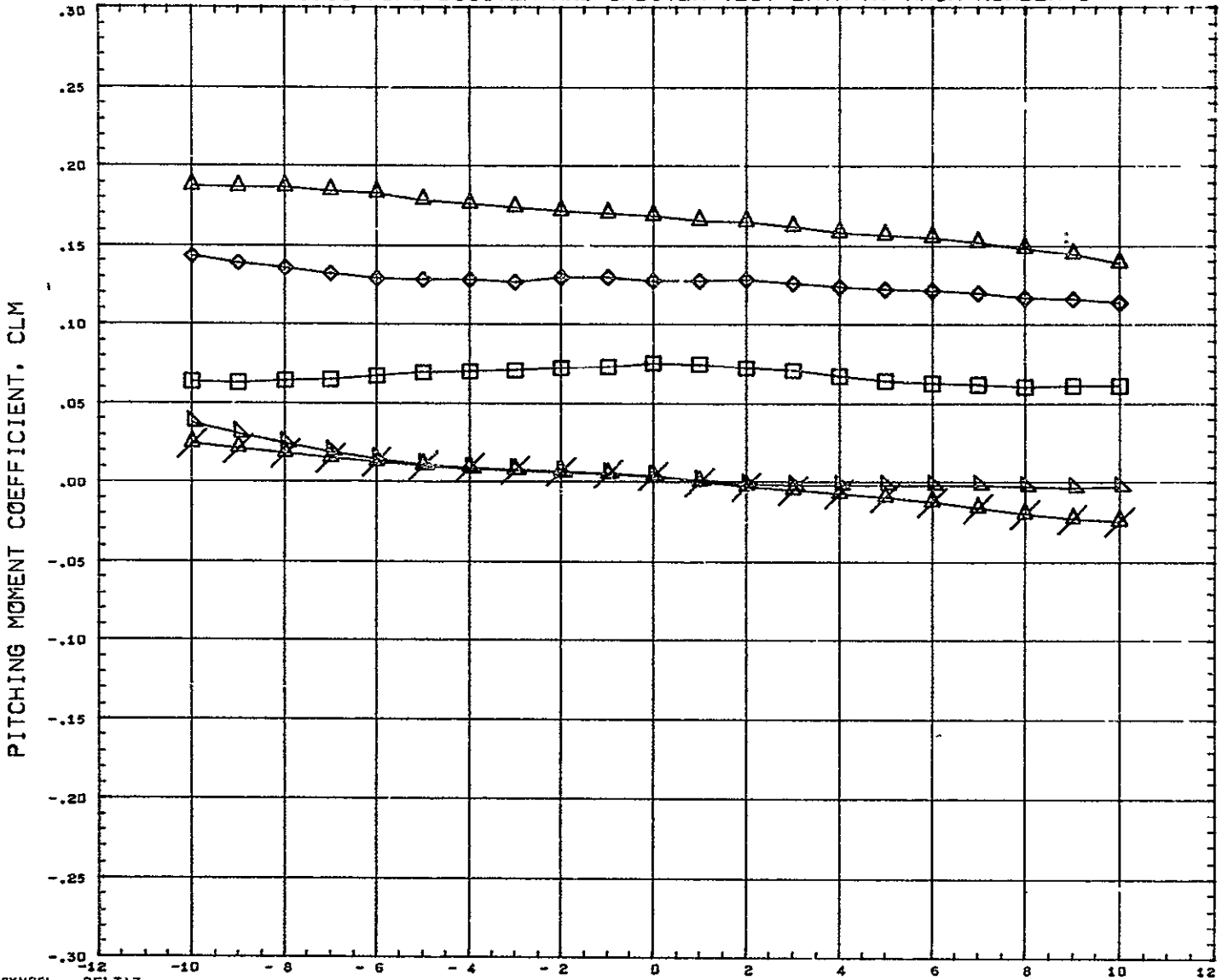

SYMBOL △ ◇ □ ×	DELTAZ 0.151 0.162 0.228 0.352 10.000	PARAMETRIC VALUES BSTPOW 50.000 ORBPOW 100.000 DELTAX 0.043 ALPHAI 5.100 MACH 5.010 ELVBST 0.000 ELVORB 0.000 BETA 0.000	REFERENCE INFORMATION REFS 44.4440 SQ 'IN REFL 13.3330 IN REFB 13.3330 IN XMRF 7.5280 IN YMRP 0.0000 IN ZMRP 1.1940 IN SCALE 0.0055
REFERENCE FILE			

# AEDC VA 1163 MDAC BOOSTER AND ORBITER TEST DATA AT MACH NUMBER 5

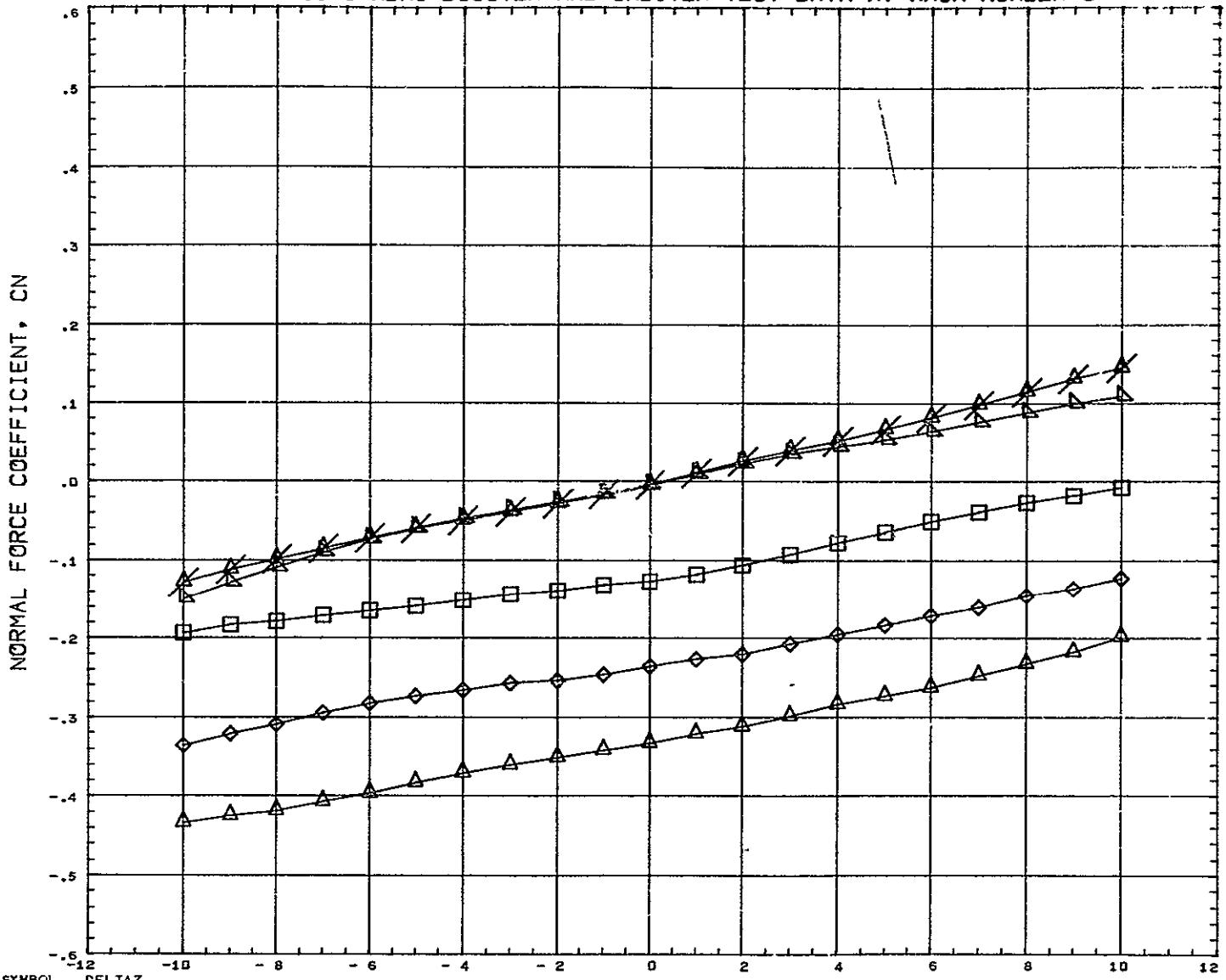

SYMBOL △ ◇ □ △/	DELTAZ 0.151 0.182 0.228 0.352 10.000	PARAMETRIC VALUES BSTPOW 50.000 ORBPOW 100.000 DELTAX 0.043 ALPHAI 5.100 MACH 5.010 ELVBST 0.000 ELVORB 0.000 BETA 0.000	REFERENCE INFORMATION REFS 44.4440 SQ IN REFL 13.3330 IN REFB 13.3330 IN XMRP 7.5280 IN YMRP 0.0000 IN ZMRP 1.1940 IN SCALE 0.0055
-----------------------------	--	--	---

REFERENCE FILE



# AEDC VA 1163 MDAC BOOSTER AND ORBITER TEST DATA AT MACH NUMBER 5

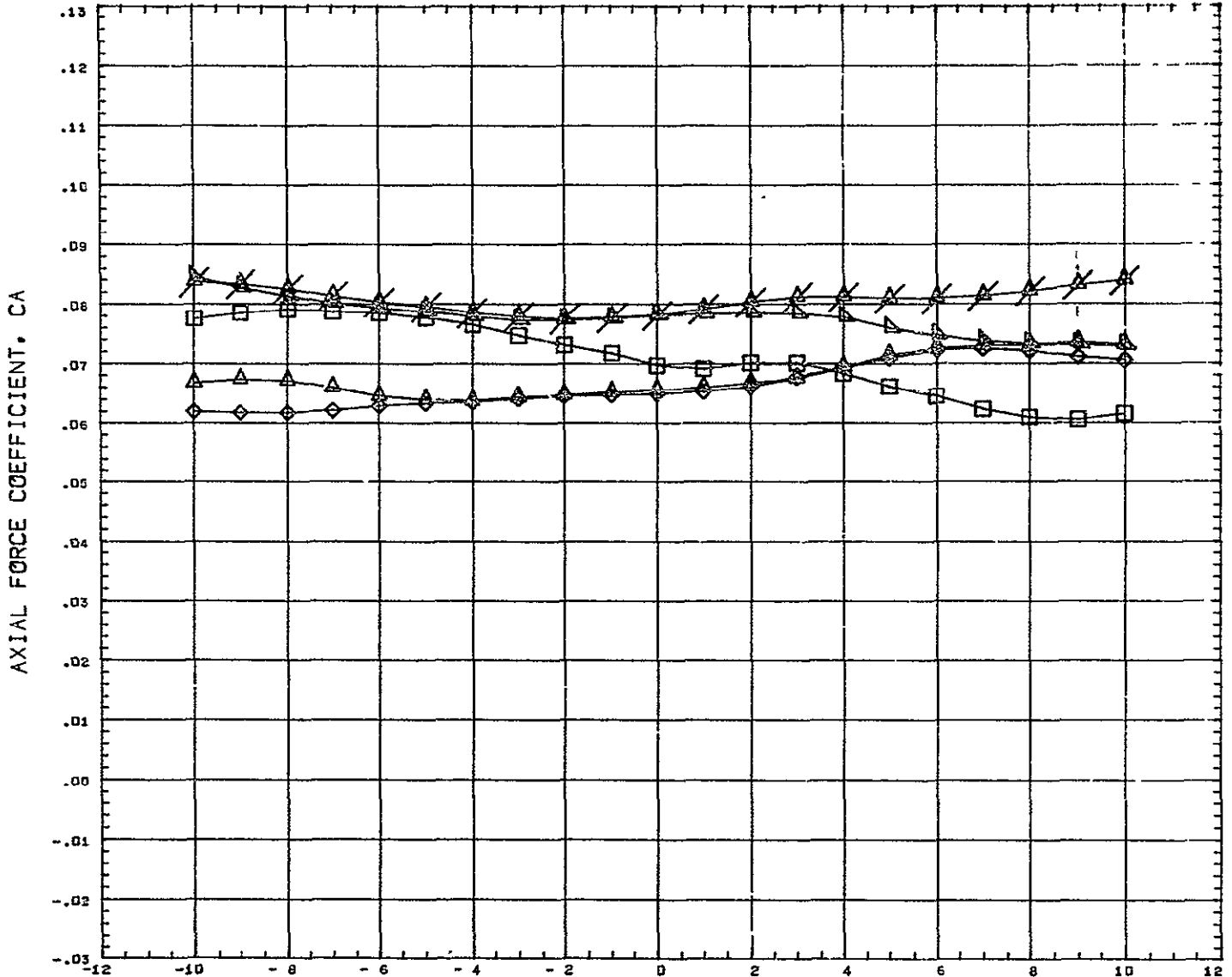

SYMBOL △ ◇ □ ×	DELTAX 0.151 0.182 0.228 0.352 10.000	PARAMETRIC VALUES BSTPOW 50.000 ORBPOW 100.000 DELTAX 0.043 ALPHAI 5.100 MACH 5.010 ELVBST 0.000 ELVORB 0.000 BETA 0.000	REFERENCE INFORMATION REFS 44.4440 SQ IN REFL 13 3330 IN REFB 13 3330 IN XMRP 7.5280 IN YMRP 0.0000 IN ZMRP 1.1940 IN SCALE 0.0055
----------------------------	--	--	---

REFERENCE FILE

# AEDC VA 1163 MDAC BOOSTER AND ORBITER TEST DATA AT MACH NUMBER 5

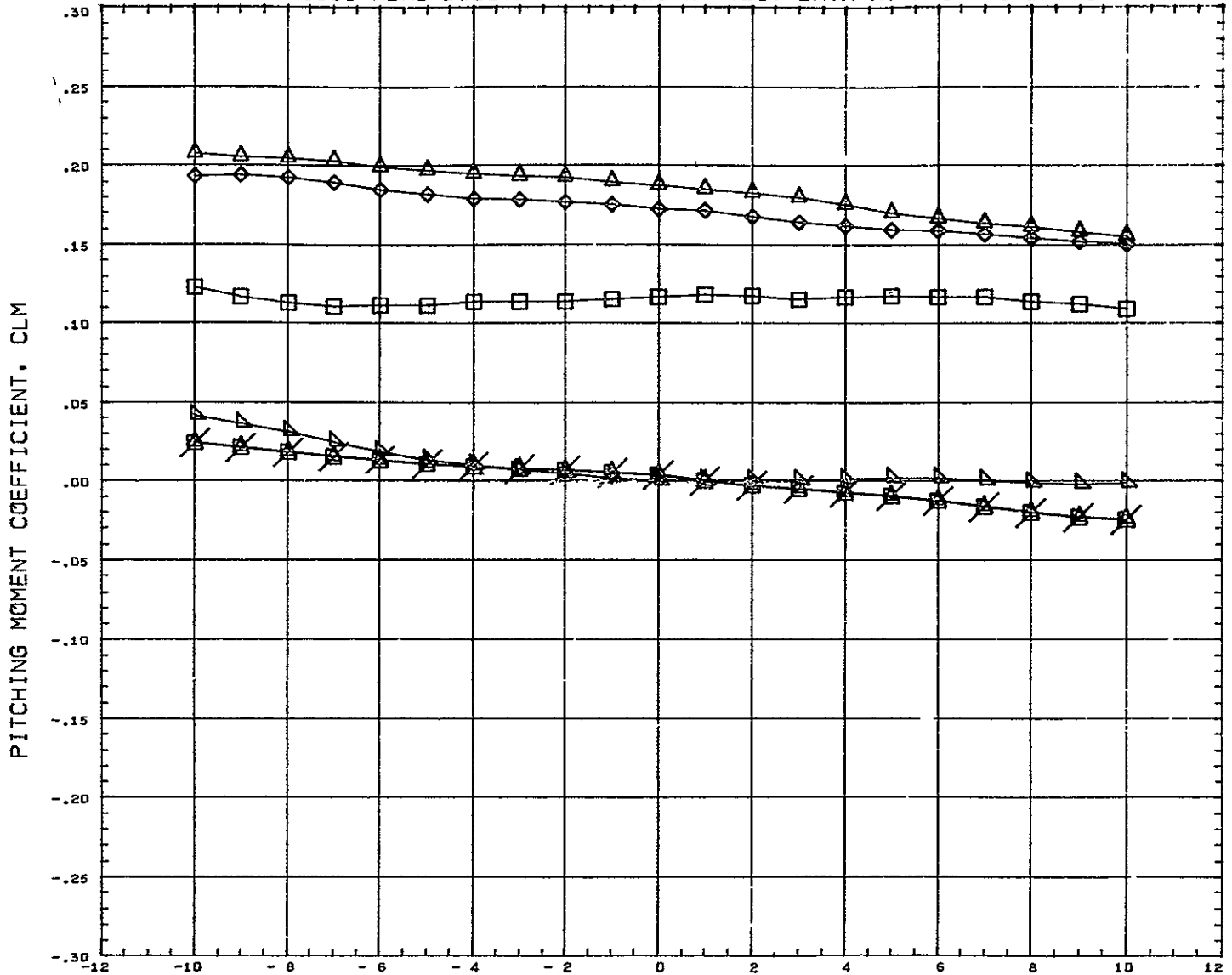

SYMBOL △ ◇ □ ▽ △ ×	DELTAZ 0.151 0.182 0.228 0.352 0.599 10.000	<b>PARAMETRIC VALUES</b> BSTPOW 50.000 ORBPOW 100.000 PLTAX 0.105 ALPHA1 5.100 MACH 5.010 ELVBST 0.000 ELVORB 0.000 BETA 0.000	<b>REFERENCE INFORMATION</b> REFS 44.4440 SQ IN REFL 13.3330 IN REFB 13.3330 IN XMRF 7.5280 IN YMRF 0.0000 IN ZMRF 1.1940 IN SCALE 0.0055
--------------------------------------	---	--	--

REFERENCE FILE

# AEDC VA 1163 MDAC BOOSTER AND ORBITER TEST DATA AT MACH NUMBER 5

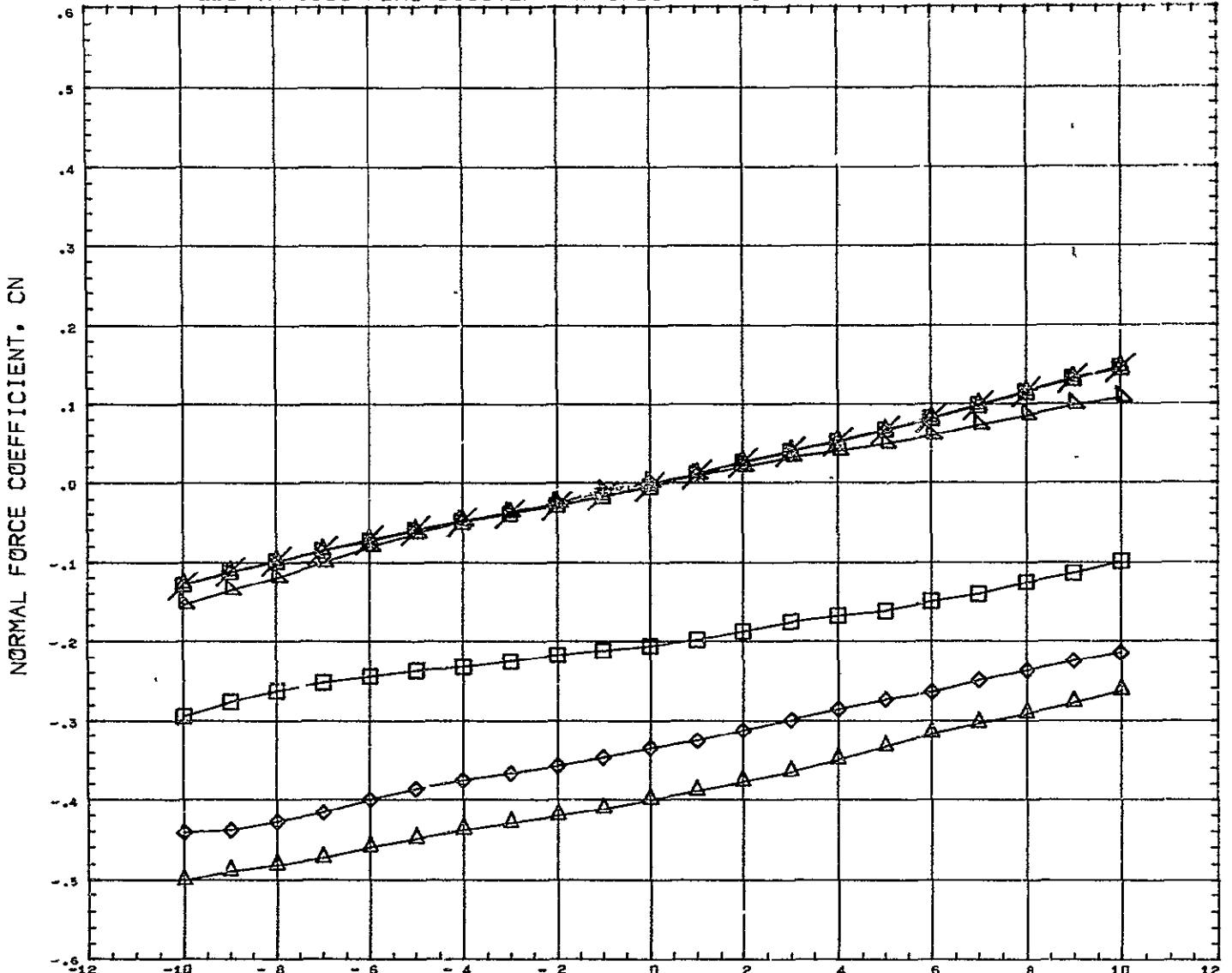

SYMBOL ◇ □ △ ◆	DELTAZ 0.151 0.182 0.228 0.352 0.599 10.000	PARAMETRIC VALUES BSTPOW 50.000 ORBPOW 100.000 DELTAX 0.105 ALPHAI 5.100 MACH 5.010 ELVBST 0.000 ELVORB 0.000 BETA 0.000	REFERENCE INFORMATION REFS 44.4440 SQ IN REFL 13.3330 IN REFB 13.3330 IN XMRP 7.5280 IN YMRP 0.0000 IN ZMRP 1.1940 IN SCALE 0.0055
----------------------------	---	--	---

REFERENCE FILE

# AEDC VA 1163 MDAC BOOSTER AND ORBITER TEST DATA AT MACH NUMBER 5

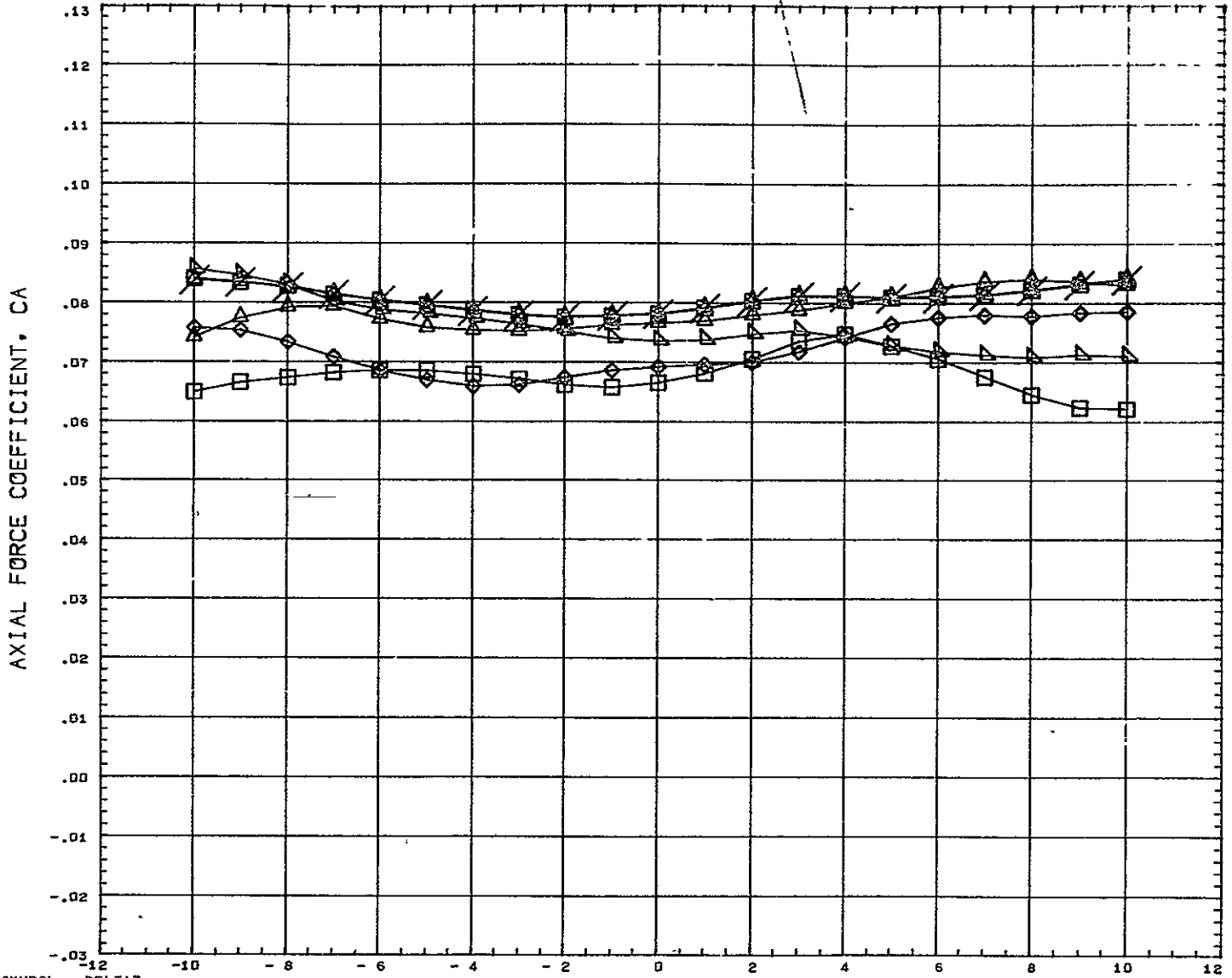

SYMBOL △ ◇ □ ▽ ×	DELTAZ 0.151 0.182 0.228 0.352 0.599 10.000	PARAMETRIC VALUES BSTPOW 50.000 ORBPOW 100.000 DELTAX 0.105 ALPHAI 5.100 ACH 5.010 ELVBST 0.000 ELVORB 0.000 BETA 0.000	REFERENCE INFORMATION REFS 4 4440 SQ IN REFL 13 3335 IN REFB 13 3330 IN XMRF 7.5280 IN YMRF 0 0000 IN ZMRF 1.1940 IN SCALE 0 0055
REFERENCE FILE			

# AEDC VA 1163 MDAC BOOSTER AND ORBITER TEST DATA AT MACH NUMBER 5

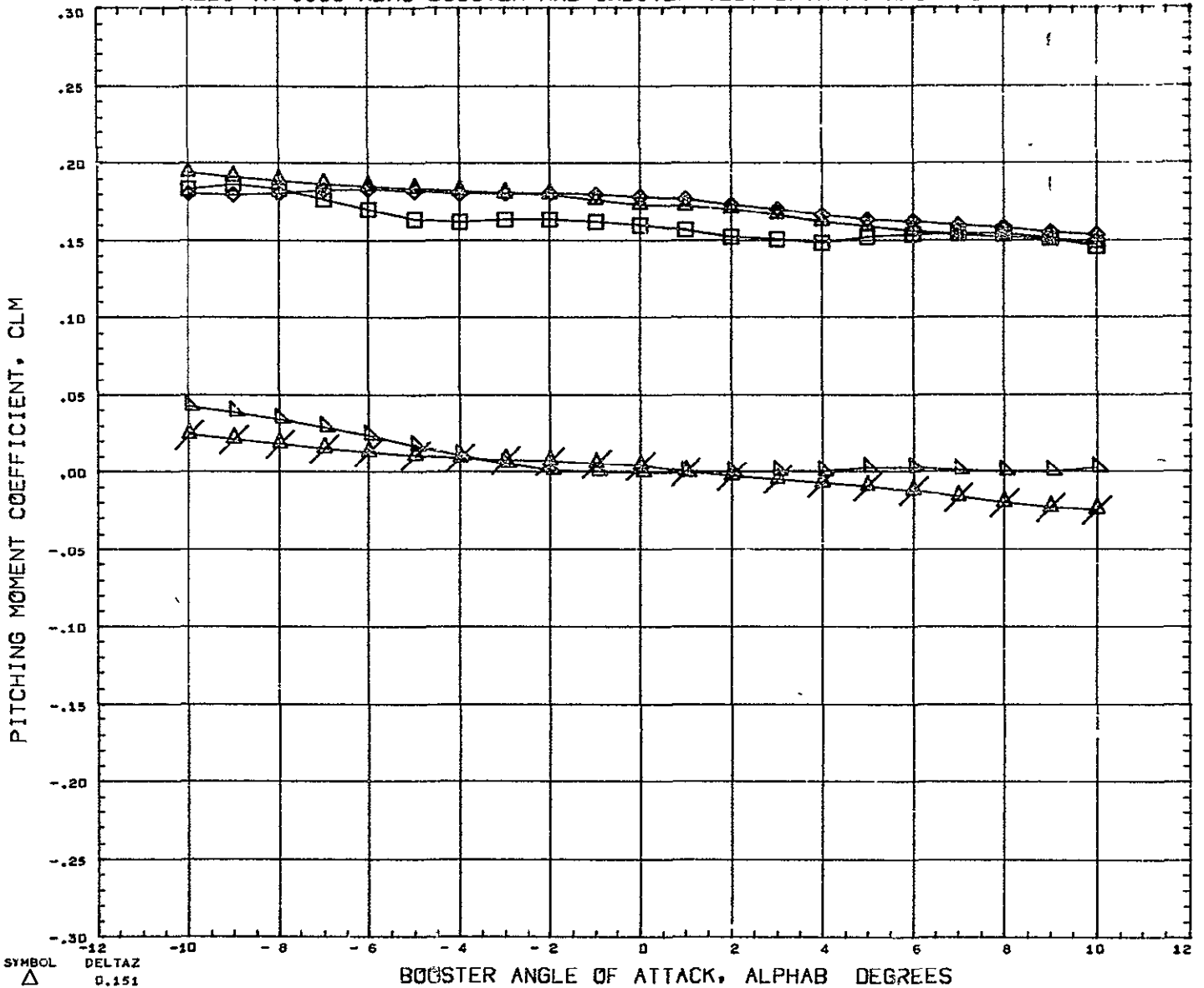

SYMBOL △ ◇ □ △ with cross	DELTA Z 0.151 0.192 0.228 0.352 10.000	PARAMETRIC VALUES BSTPOW 50.000 ORBPOW 100.000 DELTAX 0.167 ALPHAI 5.100 MACH 5.010 ELVBST 0.000 ELVORB 0.000 BETA 0.000	REFERENCE INFORMATION REFS 44.4440 SQ IN REFL 13.3330 IN REFB 13.3330 IN XMRP 7.5280 IN YMRP 0.0000 IN ZMRP 1.1940 IN SCALE 0.0055
---------------------------------------	---	--	---

REFERENCE FILE

# AEDC VA 1163 MDAC BOOSTER AND ORBITER TEST DATA AT MACH NUMBER 5

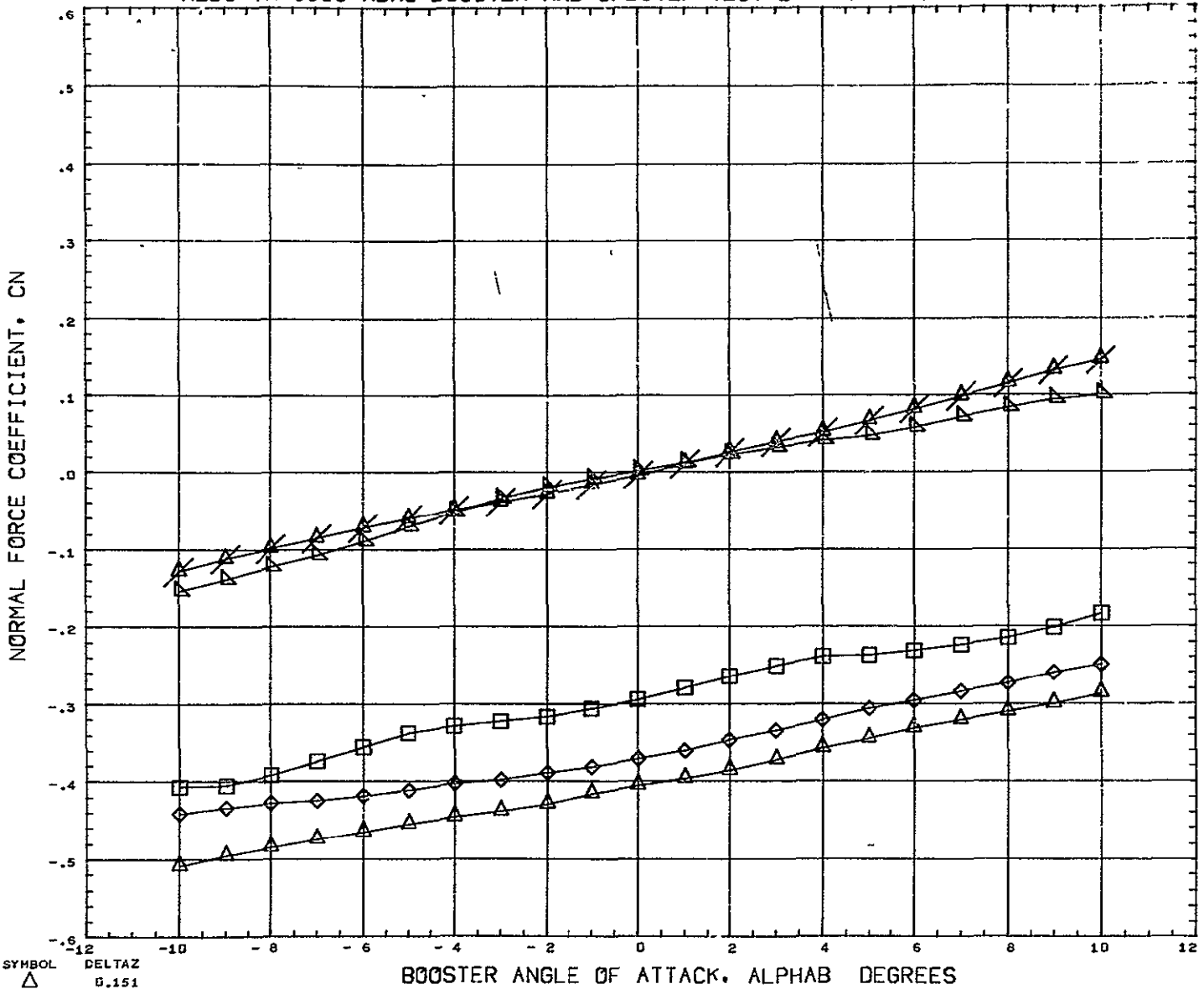

SYMBOL △ □ ◇ ▽	DELTAZ 0.151 0.182 0.228 0.352 10.000	PARAMETRIC VALUES BSTPOW 50.000 ORBPOW 100.000 DELTAX 0.167 ALPHAI 5.100 MACH 5.010 ELVBST 0.000 ELVORB 0.000 BETA 0.000	REFERENCE INFORMATION REFS 44 4440 SQ IN REFL 13.3330 IN REFB 13.3330 IN XMRF 7.5280 IN YMRF 0.0000 IN ZMRF 1.1940 IN SCALE 0.0055
----------------------------	--	--	---

REFERENCE FILE

# AEDC VA 1163 MDAC BOOSTER AND ORBITER TEST DATA AT MACH NUMBER 5

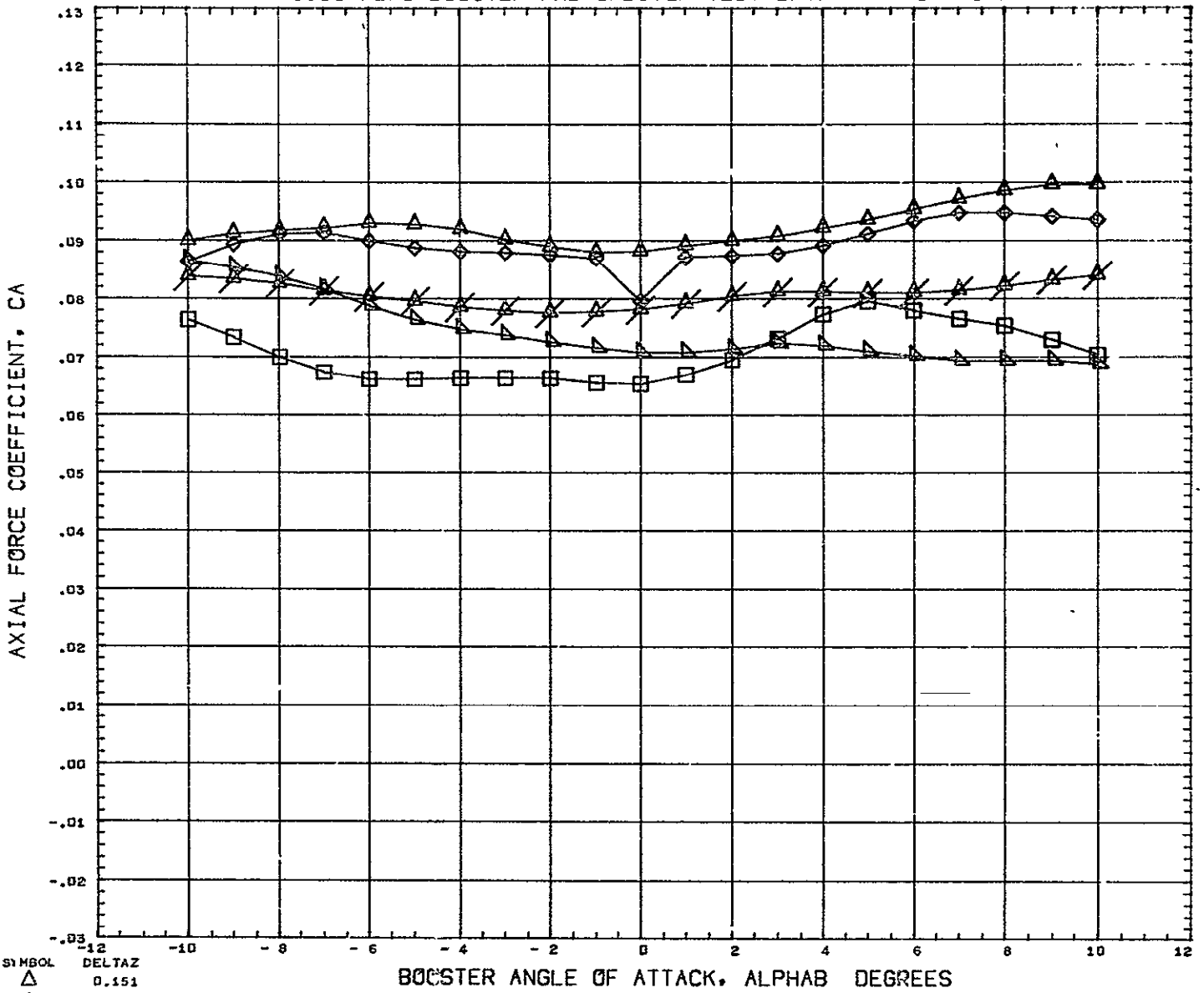

SYMBOL △ ◇ □ ×	DELTA Z 0.151 0.192 0.228 0.352 10.000	PARAMETRIC VALUES BSTPOW 50.000 ORBPOW 100.000 DELTAX 0.167 ALPHA1 5.100 MACH 5.010 ELVBST 0.000 LLVORB 0.000 BETA 0.000	REFERENCE INFORMATION REFS 44 4440 SQ IN REFL 13 3330 IN REFB 13.3330 IN XHRF 7.5280 IN YHRF 0.0000 IN ZHRF 1.1940 IN SCALE 0.0055
REFERENCE FILE			

# AEDC VA 1163 MDAC BOOSTER AND ORBITER TEST DATA AT MACH NUMBER 5

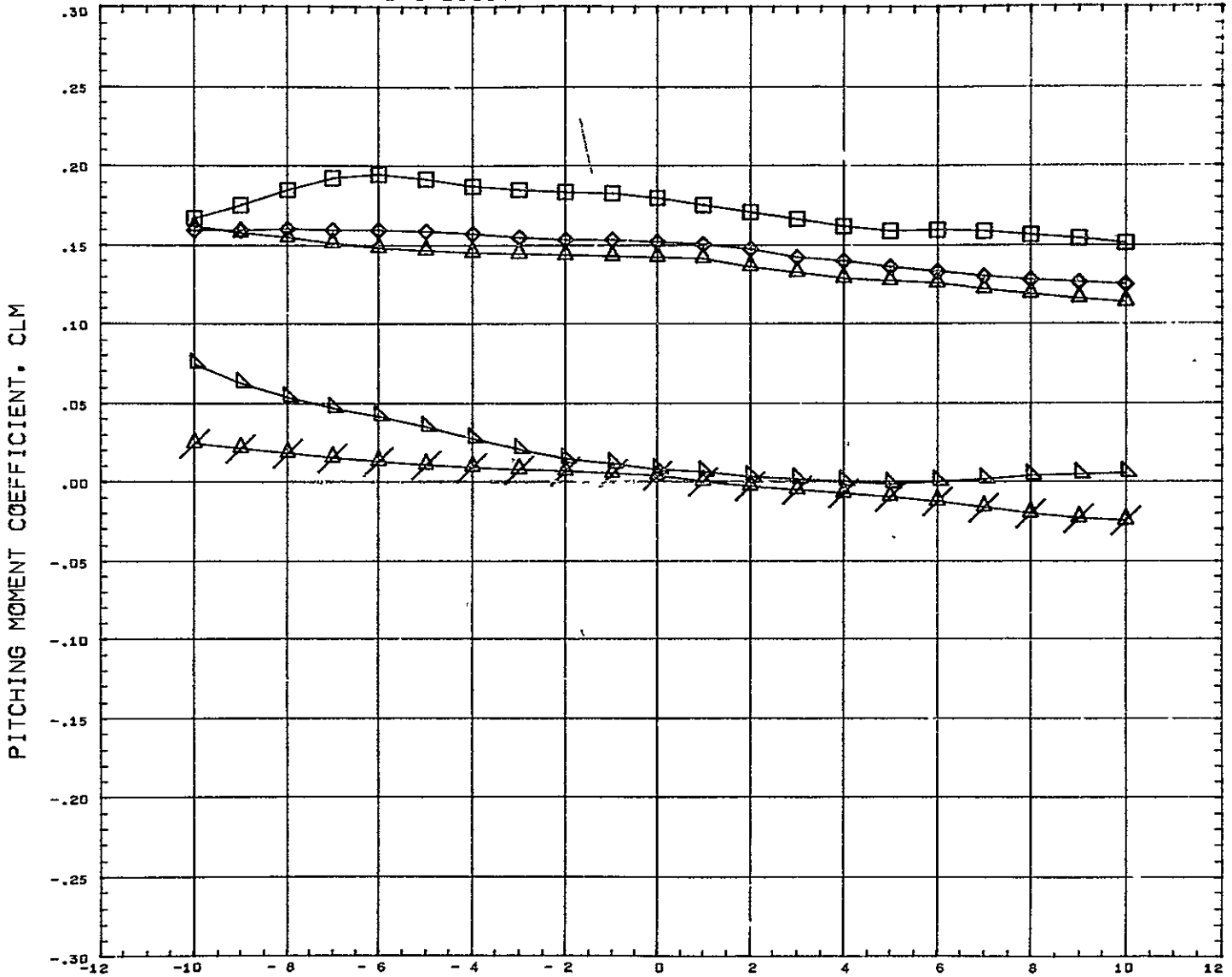

SYMBOL	DELTAZ	PARAMETRIC VALUES				REFERENCE INFORMATION		
□	0.151	BSTPOW	50.000	ORBPOW	100.000	REFS	44.444E	SO IN
◇	0.182	DELTAZ	0.228	ALPHAI	5.100	REFL	13.335D	IN
△	0.352	MACH	5.010	ELVBST	0.000	REFB	13.333D	IN
×	10.000	ELVORB	0.000	BETA	0.000	XMRP	7.529D	IN
						YMRP	0.000D	IN
						ZMRP	1.194D	IN
						SCALE	0.0055	

REFERENCE FILE



# AEDC VA 1163 MDAC BOOSTER AND ORBITER TEST DATA AT MACH NUMBER 5

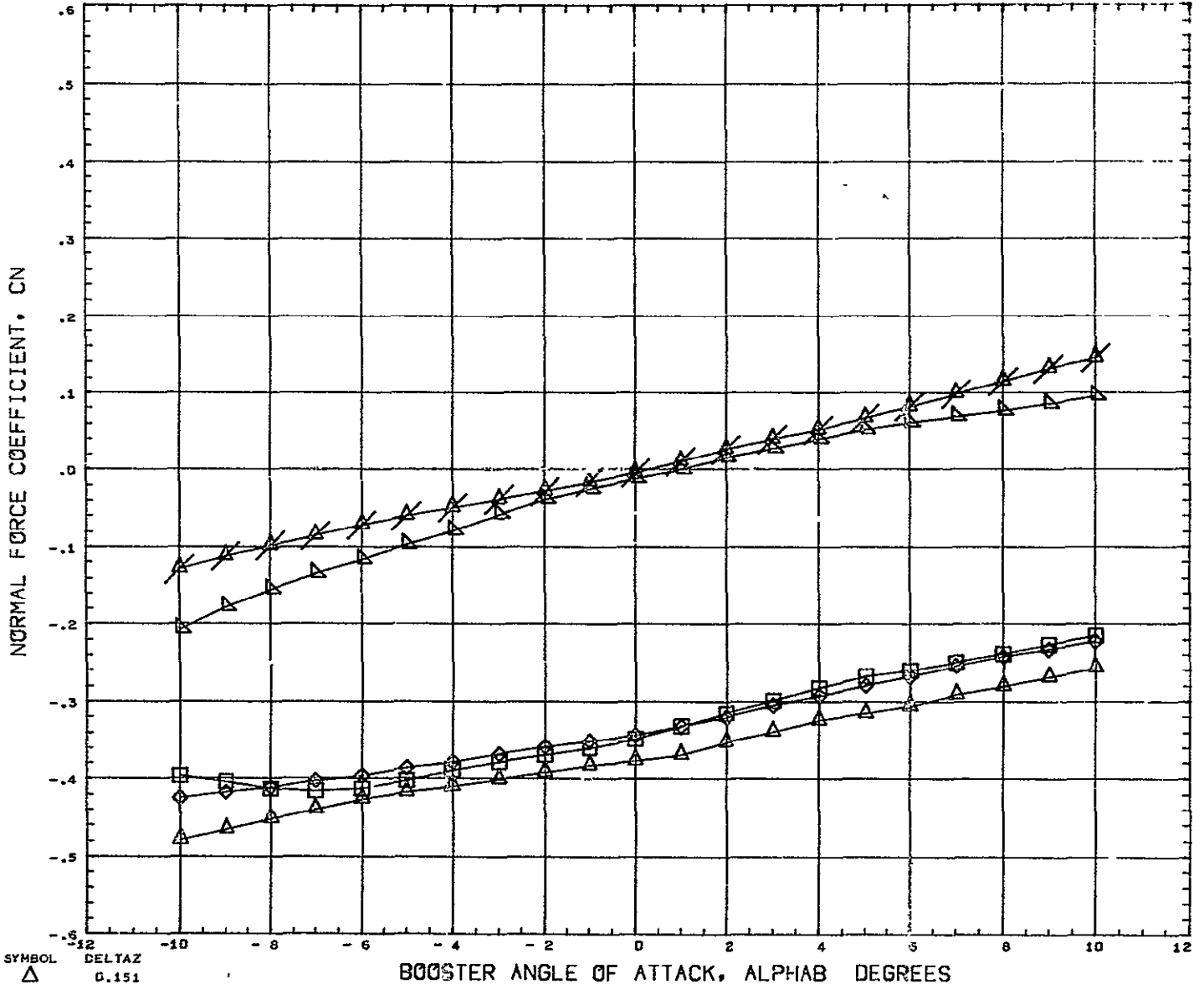

SYMBOL △ ◊ □ ◻ ×	DELTA Z 0.151 0.192 0.228 0.352 10.000	PARAMETRIC VALUES BSTPOW 50.000 ORBPOW 00.000 DPTAX 0.228 ALPHA1 5.160 MACH 5.010 ELVBST 0.000 ELVORB 0.000 BETA 0.000	REFERENCE INFORMATION REFS 44.4440 SQ IN REFL 13.3330 IN REFB 13.3330 IN XMRP 7.5280 IN YMRP 0.0000 IN ZMRP 1.1940 IN SCALE 0 0055
---------------------------------	---	--	---

REFERENCE FILE

# AEDC VA 1163 MDAC BOOSTER AND ORBITER TEST DATA AT MACH NUMBER 5

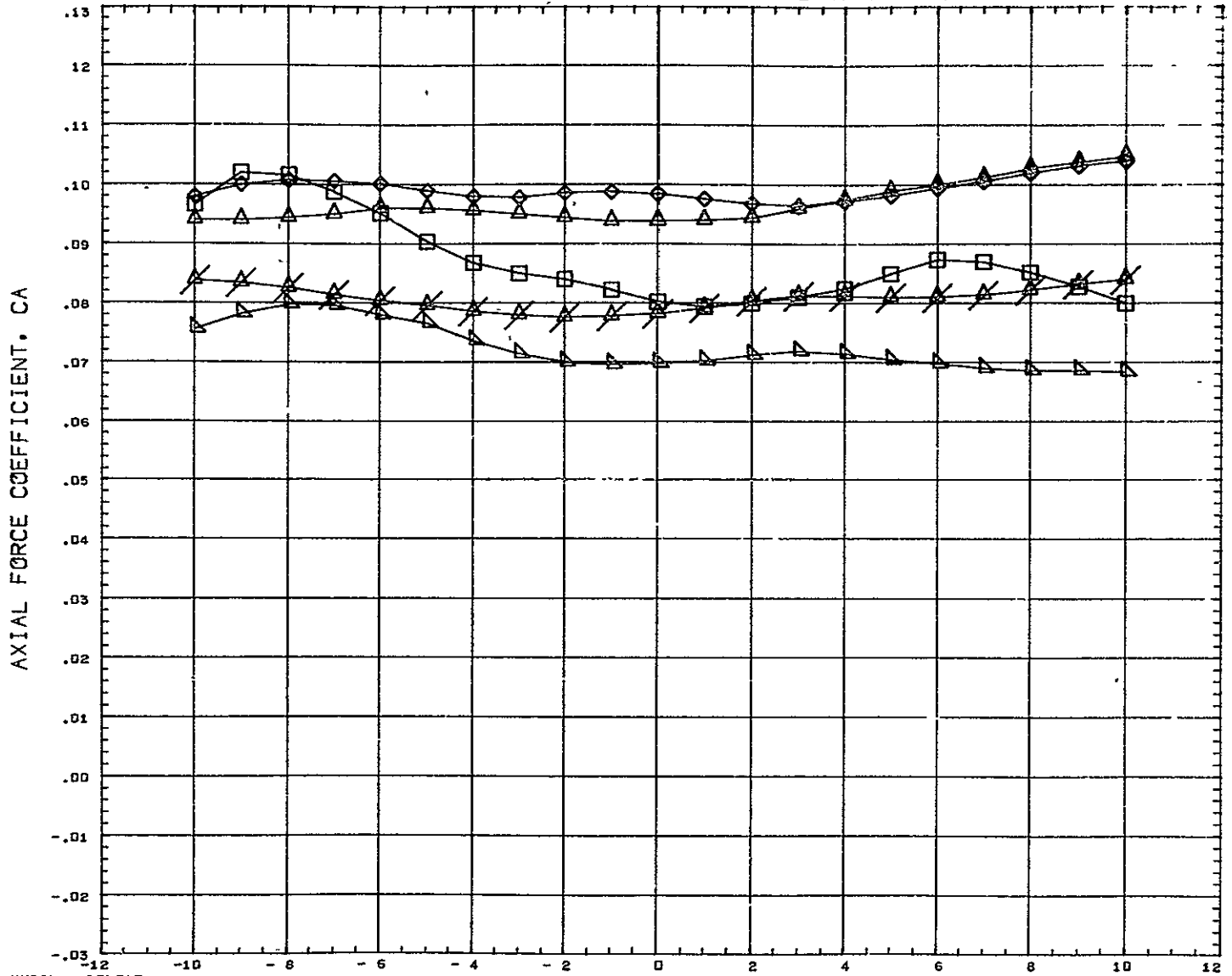

SYMBOL △ ◇ □ ×	DELTA Z 0.151 0.182 0.228 0.352 10.000	<table border="0" style="width: 100%;"> <tr> <th colspan="4" style="text-align: left; padding-left: 20px;">PARAMETRIC VALUES</th> </tr> <tr> <td style="padding-right: 10px;">BSTPOW</td> <td style="padding-right: 10px;">50.000</td> <td style="padding-right: 10px;">ORBFOW</td> <td>100.000</td> </tr> <tr> <td style="padding-right: 10px;">DF TAX</td> <td style="padding-right: 10px;">0.228</td> <td style="padding-right: 10px;">ALPHA1</td> <td>5.100</td> </tr> <tr> <td style="padding-right: 10px;">MACH</td> <td style="padding-right: 10px;">5.010</td> <td style="padding-right: 10px;">ELVBST</td> <td>0.000</td> </tr> <tr> <td style="padding-right: 10px;">ELVORB</td> <td style="padding-right: 10px;">0.000</td> <td style="padding-right: 10px;">BETA</td> <td>0.000</td> </tr> </table>	PARAMETRIC VALUES				BSTPOW	50.000	ORBFOW	100.000	DF TAX	0.228	ALPHA1	5.100	MACH	5.010	ELVBST	0.000	ELVORB	0.000	BETA	0.000	<table border="0" style="width: 100%;"> <tr> <th colspan="3" style="text-align: left;">REFERENCE INFORMATION</th> </tr> <tr> <td style="padding-right: 10px;">REFS</td> <td style="padding-right: 10px;">44.4440</td> <td>SQ IN</td> </tr> <tr> <td style="padding-right: 10px;">REFL</td> <td style="padding-right: 10px;">13.3330</td> <td>IN</td> </tr> <tr> <td style="padding-right: 10px;">REFB</td> <td style="padding-right: 10px;">13.3330</td> <td>IN</td> </tr> <tr> <td style="padding-right: 10px;">XMRP</td> <td style="padding-right: 10px;">7 5280</td> <td>IN</td> </tr> <tr> <td style="padding-right: 10px;">YMRP</td> <td style="padding-right: 10px;">0.0000</td> <td>IN</td> </tr> <tr> <td style="padding-right: 10px;">ZMRP</td> <td style="padding-right: 10px;">1 1940</td> <td>IN</td> </tr> <tr> <td style="padding-right: 10px;">SCALE</td> <td style="padding-right: 10px;">0 0055</td> <td></td> </tr> </table>	REFERENCE INFORMATION			REFS	44.4440	SQ IN	REFL	13.3330	IN	REFB	13.3330	IN	XMRP	7 5280	IN	YMRP	0.0000	IN	ZMRP	1 1940	IN	SCALE	0 0055	
PARAMETRIC VALUES																																															
BSTPOW	50.000	ORBFOW	100.000																																												
DF TAX	0.228	ALPHA1	5.100																																												
MACH	5.010	ELVBST	0.000																																												
ELVORB	0.000	BETA	0.000																																												
REFERENCE INFORMATION																																															
REFS	44.4440	SQ IN																																													
REFL	13.3330	IN																																													
REFB	13.3330	IN																																													
XMRP	7 5280	IN																																													
YMRP	0.0000	IN																																													
ZMRP	1 1940	IN																																													
SCALE	0 0055																																														

REFERENCE FILE

# AEDC VA 1163 MDAC BOOSTER AND ORBITER TEST DATA AT MACH NUMBER 5

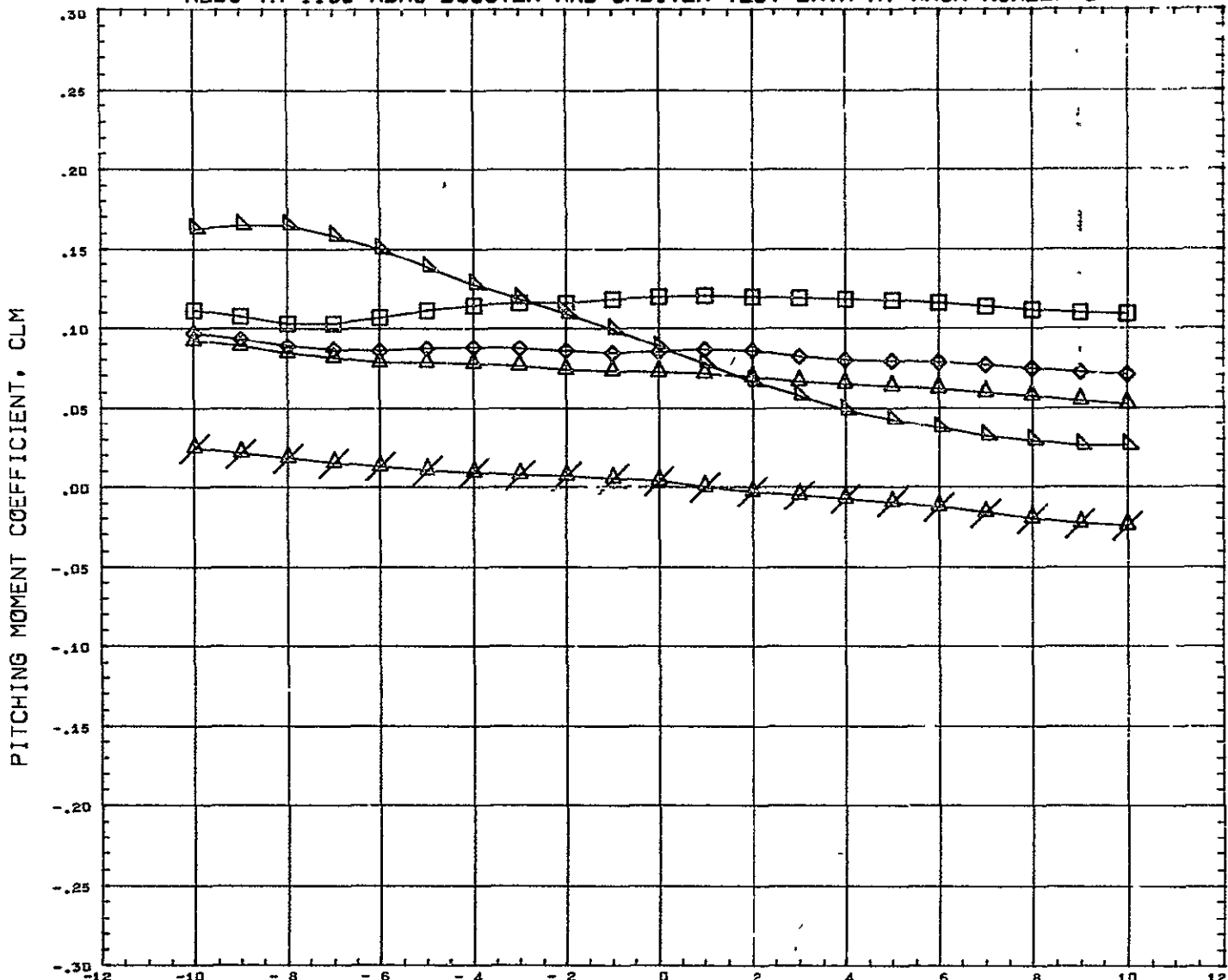

SYMBOL ◻ ◊ △ ○ ×	DELTA Z 0.151 0.182 0.228 0.352 10.000	PARAMETRIC VALUES BSTPOW 50.000 ORBPOW 100.000 DELTAX 0.352 ALPHA1 5.100 MACH 5.010 ELVBST 0.000 ELVORB 0.000 BETA 0.000	REFERENCE INFORMATION REFS 44.444C SQ IN REFL 13.3330 IN REFB 13.3330 IN XMRP 7.5280 IN YMRP 0.0000 IN ZMRP 1.1940 IN SCALE 0.0055
---------------------------------	---	--	---

REFERENCE FILE

# AEDC VA 1163 MDAC BOOSTER AND ORBITER TEST DATA AT MACH NUMBER 5

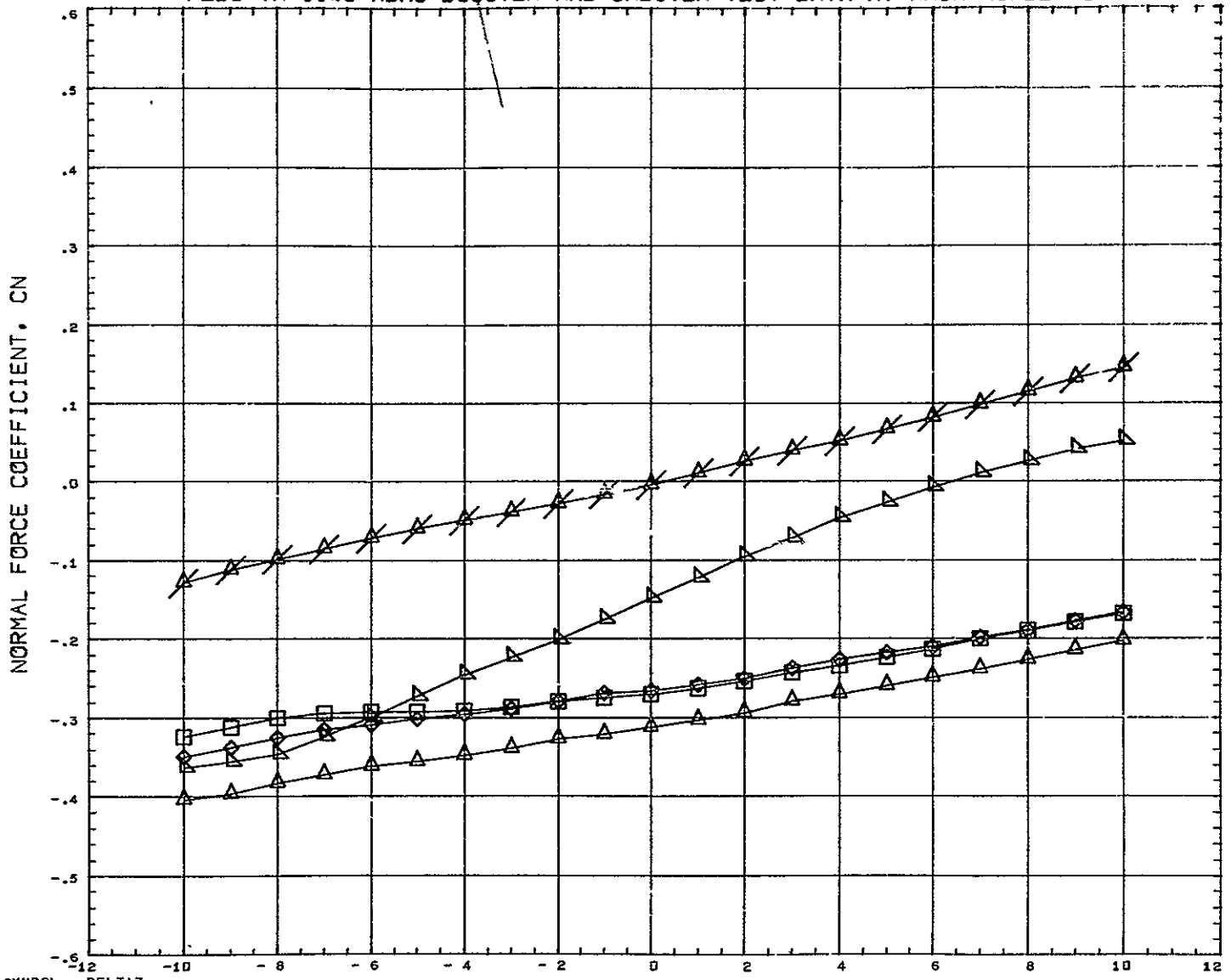

SYMBOL △ ◇ □ ▽	DELTAX 0.151 0.182 0.228 0.352 10.000	PARAMETRIC VALUES BSTPOW 50.000 ORBFOW 100.000 DELTAX 0.352 ALPHAI 5.100 MACH 5.010 ELVBST 0.000 ELVORB 0.000 BETA 0.000	REFERENCE INFORMATION REFS 44 4440 SQ IN REFL 13.3330 IN REFB 13.3330 IN XMRP 7.5280 IN YMRP 0.0000 IN ZMRP 1.1940 IN SCALE 0.0055
----------------------------	--	--	---

REFERENCE FILE

# AEDC VA 1163 MDAC BOOSTER AND ORBITER TEST DATA AT MACH NUMBER 5

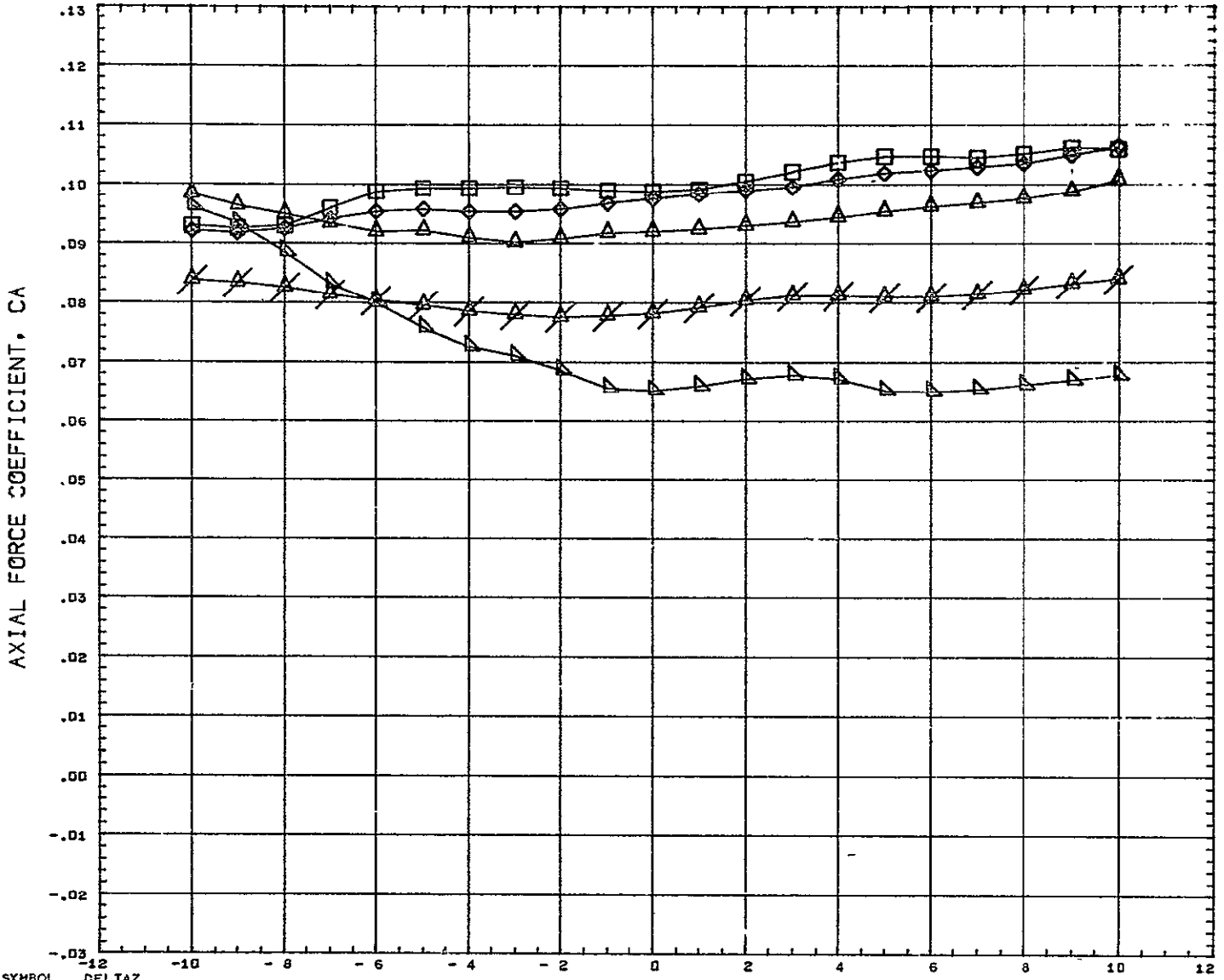

SYMBOL ◻ ◊ ◻ × ▽	DELTAZ 0.151 0.102 0.228 0.352 10.000	<table border="0" style="width: 100%;"> <tr> <th colspan="4" style="text-align: left;">PARAMETRIC VALUES</th> </tr> <tr> <td>BSTPOW</td><td>50.000</td><td>ORBPOW</td><td>100.000</td></tr> <tr> <td>DELTAZ</td><td>0.352</td><td>ALPHA1</td><td>5.100</td></tr> <tr> <td>MACH</td><td>5.010</td><td>ELVBST</td><td>0.000</td></tr> <tr> <td>ELVORB</td><td>0.000</td><td>BETA</td><td>0.000</td></tr> </table>	PARAMETRIC VALUES				BSTPOW	50.000	ORBPOW	100.000	DELTAZ	0.352	ALPHA1	5.100	MACH	5.010	ELVBST	0.000	ELVORB	0.000	BETA	0.000	<table border="0" style="width: 100%;"> <tr> <th colspan="3" style="text-align: left;">REFERENCE INFORMATION</th> </tr> <tr> <td>REFS</td><td>44.4440</td><td>SQ IN</td></tr> <tr> <td>REFL</td><td>13.3330</td><td>IN</td></tr> <tr> <td>REFB</td><td>13.3330</td><td>IN</td></tr> <tr> <td>XNRF</td><td>7.5280</td><td>IN</td></tr> <tr> <td>YNRF</td><td>0.0000</td><td>IN</td></tr> <tr> <td>ZNRF</td><td>1.1940</td><td>IN</td></tr> <tr> <td>SCALE</td><td>0.0055</td><td></td></tr> </table>	REFERENCE INFORMATION			REFS	44.4440	SQ IN	REFL	13.3330	IN	REFB	13.3330	IN	XNRF	7.5280	IN	YNRF	0.0000	IN	ZNRF	1.1940	IN	SCALE	0.0055	
PARAMETRIC VALUES																																															
BSTPOW	50.000	ORBPOW	100.000																																												
DELTAZ	0.352	ALPHA1	5.100																																												
MACH	5.010	ELVBST	0.000																																												
ELVORB	0.000	BETA	0.000																																												
REFERENCE INFORMATION																																															
REFS	44.4440	SQ IN																																													
REFL	13.3330	IN																																													
REFB	13.3330	IN																																													
XNRF	7.5280	IN																																													
YNRF	0.0000	IN																																													
ZNRF	1.1940	IN																																													
SCALE	0.0055																																														
REFERENCE FILE																																															

# AEDC VA 1163 MDAC BOOSTER AND ORBITER TEST DATA AT MACH NUMBER 5

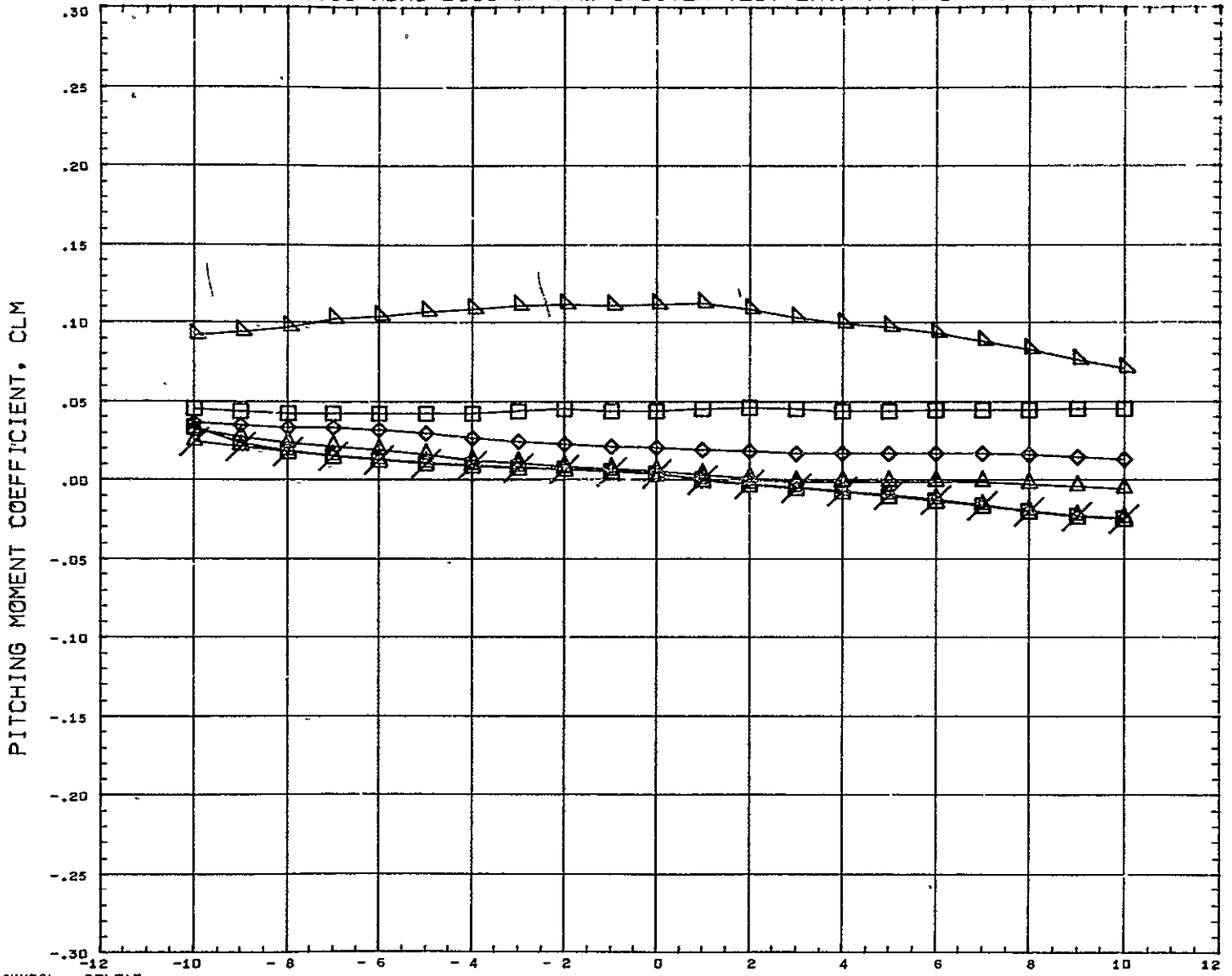

SYMBOL ◊ ◻ ○ ×	DELTAZ 0.151 0.182 0.228 0.352 0.599 10.000	PARAMETRIC VALUES BSTPOW 50.000 ORBFOW 100.000 DELTAX 0.522 ALPHAI 5.160 MACH 5.010 ELVBST 0.000 ELVORB 0.000 BETA 0.000	REFERENCE INFORMATION REFS 44.4445 SQ IN REFL 13.3330 IN REFB 13.3330 IN XMRP 7.5280 IN YMRP 0.0000 IN ZMRP 1.1940 IN SCALE 0.0055
----------------------------	---	--	---

REFERENCE FILE

# AEDC VA 1163 MDAC BOOSTER AND ORBITER TEST DATA AT MACH NUMBER 5

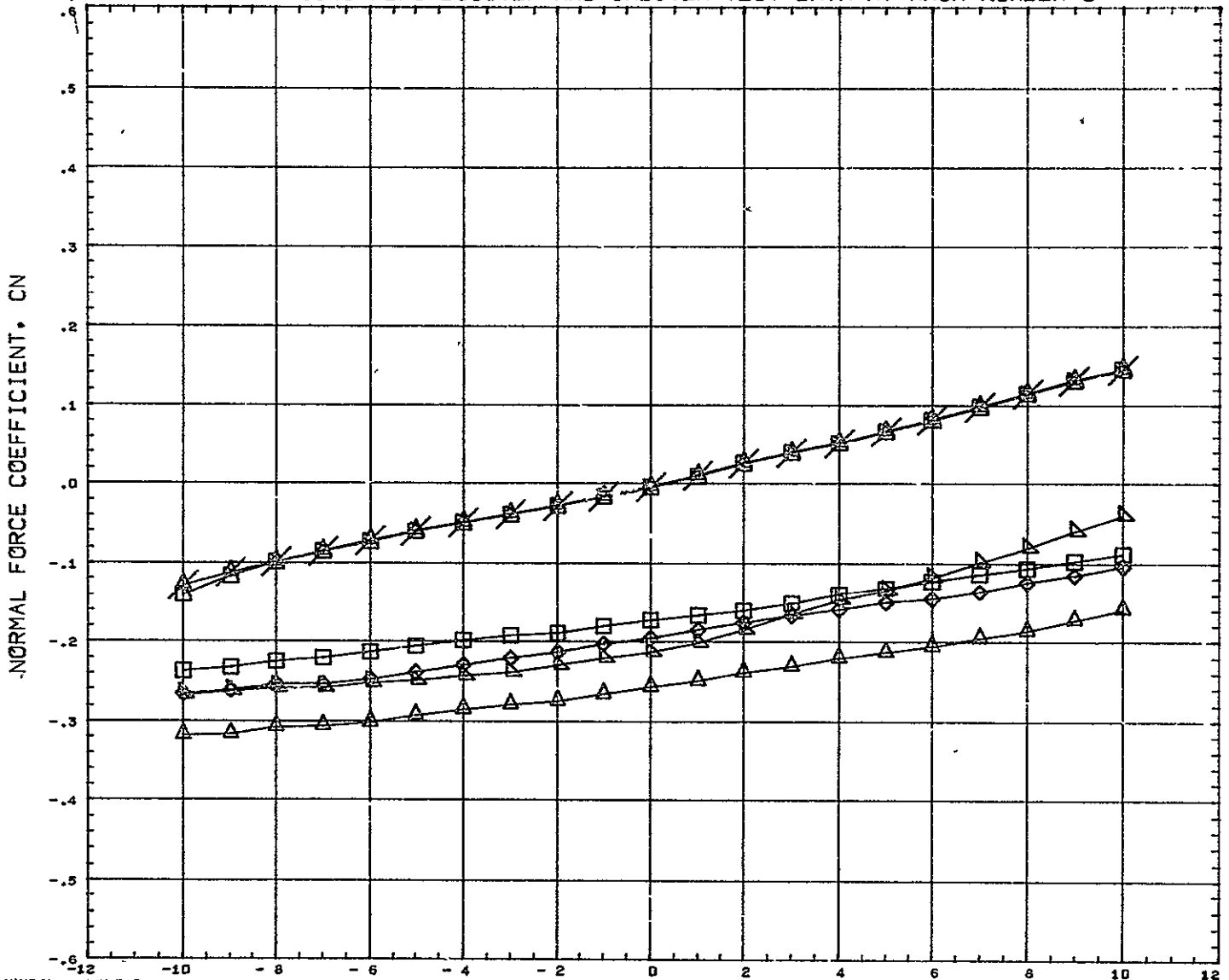

<table border="0"> <tr><td>△</td><td>0.151</td></tr> <tr><td>◇</td><td>0.102</td></tr> <tr><td>□</td><td>0.228</td></tr> <tr><td>▽</td><td>0.352</td></tr> <tr><td>⊗</td><td>0.599</td></tr> <tr><td>⊗</td><td>10.000</td></tr> </table>	△	0.151	◇	0.102	□	0.228	▽	0.352	⊗	0.599	⊗	10.000	<table border="0"> <tr><td>DELTA Z</td><td>0.151</td></tr> <tr><td>DELTA X</td><td>0.102</td></tr> <tr><td>BSTPOW</td><td>50.000</td></tr> <tr><td>DELTA X</td><td>0.522</td></tr> <tr><td>MACH</td><td>5.010</td></tr> <tr><td>ELVORB</td><td>0.000</td></tr> </table>	DELTA Z	0.151	DELTA X	0.102	BSTPOW	50.000	DELTA X	0.522	MACH	5.010	ELVORB	0.000	<table border="0"> <tr><td colspan="4">PARAMETRIC VALUES</td></tr> <tr><td>ORBPOW</td><td>100.000</td><td></td><td></td></tr> <tr><td>ALPHA I</td><td>5.100</td><td></td><td></td></tr> <tr><td>ELVBST</td><td>0.000</td><td></td><td></td></tr> <tr><td>BETA</td><td>0.000</td><td></td><td></td></tr> </table>	PARAMETRIC VALUES				ORBPOW	100.000			ALPHA I	5.100			ELVBST	0.000			BETA	0.000			<table border="0"> <tr><td colspan="3">REFERENCE INFORMATION</td></tr> <tr><td>REFS</td><td>44.4440</td><td>SG IN</td></tr> <tr><td>REFL</td><td>13.3330</td><td>IN</td></tr> <tr><td>REFB</td><td>13.3330</td><td>IN</td></tr> <tr><td>XMRP</td><td>7.5280</td><td>IN</td></tr> <tr><td>YMRP</td><td>0.0000</td><td>IN</td></tr> <tr><td>ZMRP</td><td>1.1940</td><td>IN</td></tr> <tr><td>SCALE</td><td>0.0055</td><td></td></tr> </table>	REFERENCE INFORMATION			REFS	44.4440	SG IN	REFL	13.3330	IN	REFB	13.3330	IN	XMRP	7.5280	IN	YMRP	0.0000	IN	ZMRP	1.1940	IN	SCALE	0.0055	
△	0.151																																																																						
◇	0.102																																																																						
□	0.228																																																																						
▽	0.352																																																																						
⊗	0.599																																																																						
⊗	10.000																																																																						
DELTA Z	0.151																																																																						
DELTA X	0.102																																																																						
BSTPOW	50.000																																																																						
DELTA X	0.522																																																																						
MACH	5.010																																																																						
ELVORB	0.000																																																																						
PARAMETRIC VALUES																																																																							
ORBPOW	100.000																																																																						
ALPHA I	5.100																																																																						
ELVBST	0.000																																																																						
BETA	0.000																																																																						
REFERENCE INFORMATION																																																																							
REFS	44.4440	SG IN																																																																					
REFL	13.3330	IN																																																																					
REFB	13.3330	IN																																																																					
XMRP	7.5280	IN																																																																					
YMRP	0.0000	IN																																																																					
ZMRP	1.1940	IN																																																																					
SCALE	0.0055																																																																						

REFERENCE FILE

# AEDC VA 1163 MDAC BOOSTER AND ORBITER TEST DATA AT MACH NUMBER 5

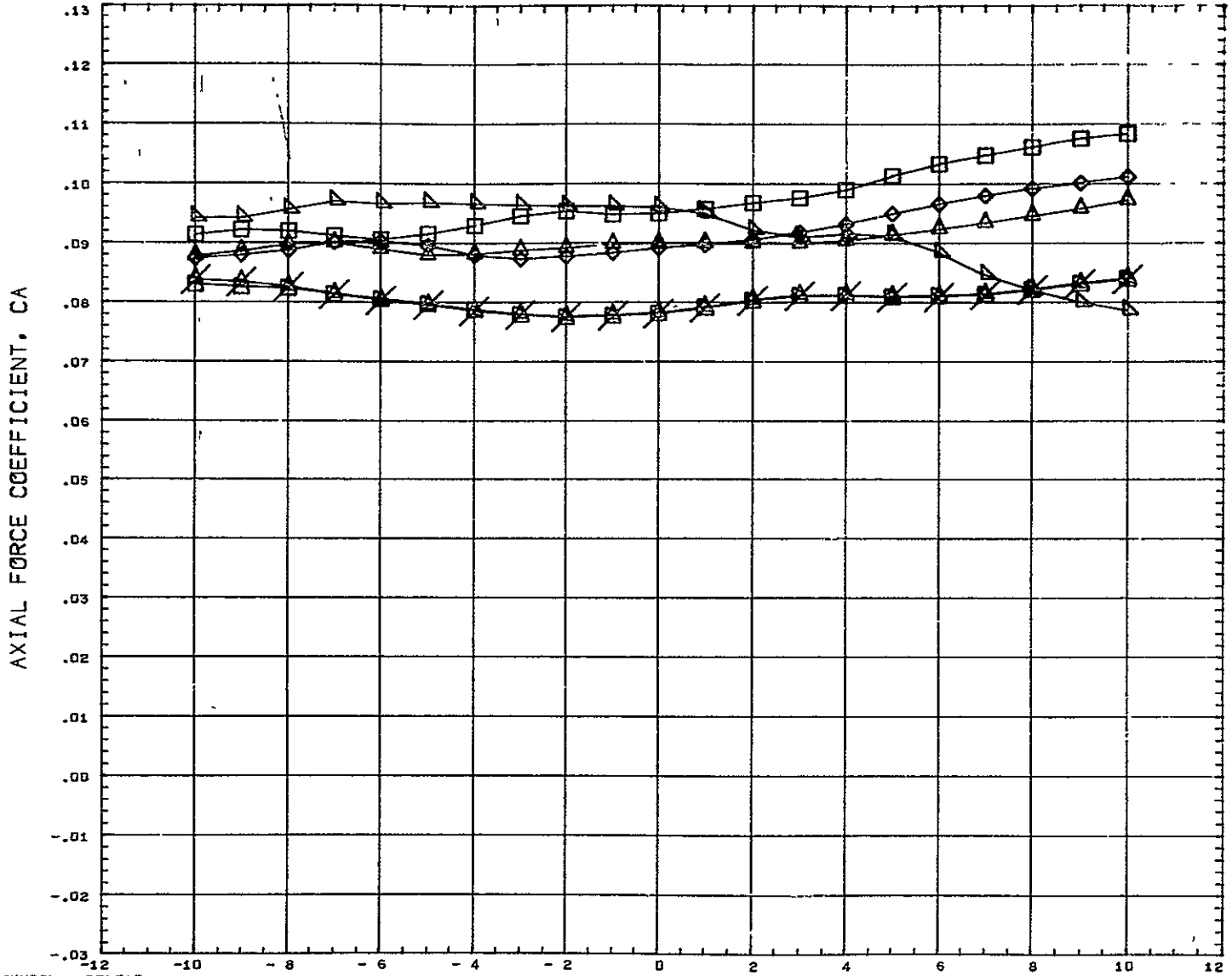

SYMBOL	DELTAZ 0.151 0.182 0.238 0.352 0.599 10.000	PARAMETRIC VALUES BSTFOW 50.000 ORBPOW 100.000 DELTAX 0.522 ALPHAI 5.100 MACH 5.010 ELVBST 0.000 ELVORB 0.000 BETA 0.000	REFERENCE INFORMATION REFS 77.4440 SQ IN REFL 13.3330 IN REFB 13.3330 IN XMRP 7.5280 IN YMRP 0.0000 IN ZMRP 1.1940 IN SCALE 0.0055
--------	---	--	---

REFERENCE FILE



# AEDC VA 1163 MDAC BOOSTER AND ORBITER TEST DATA AT MACH NUMBER 5

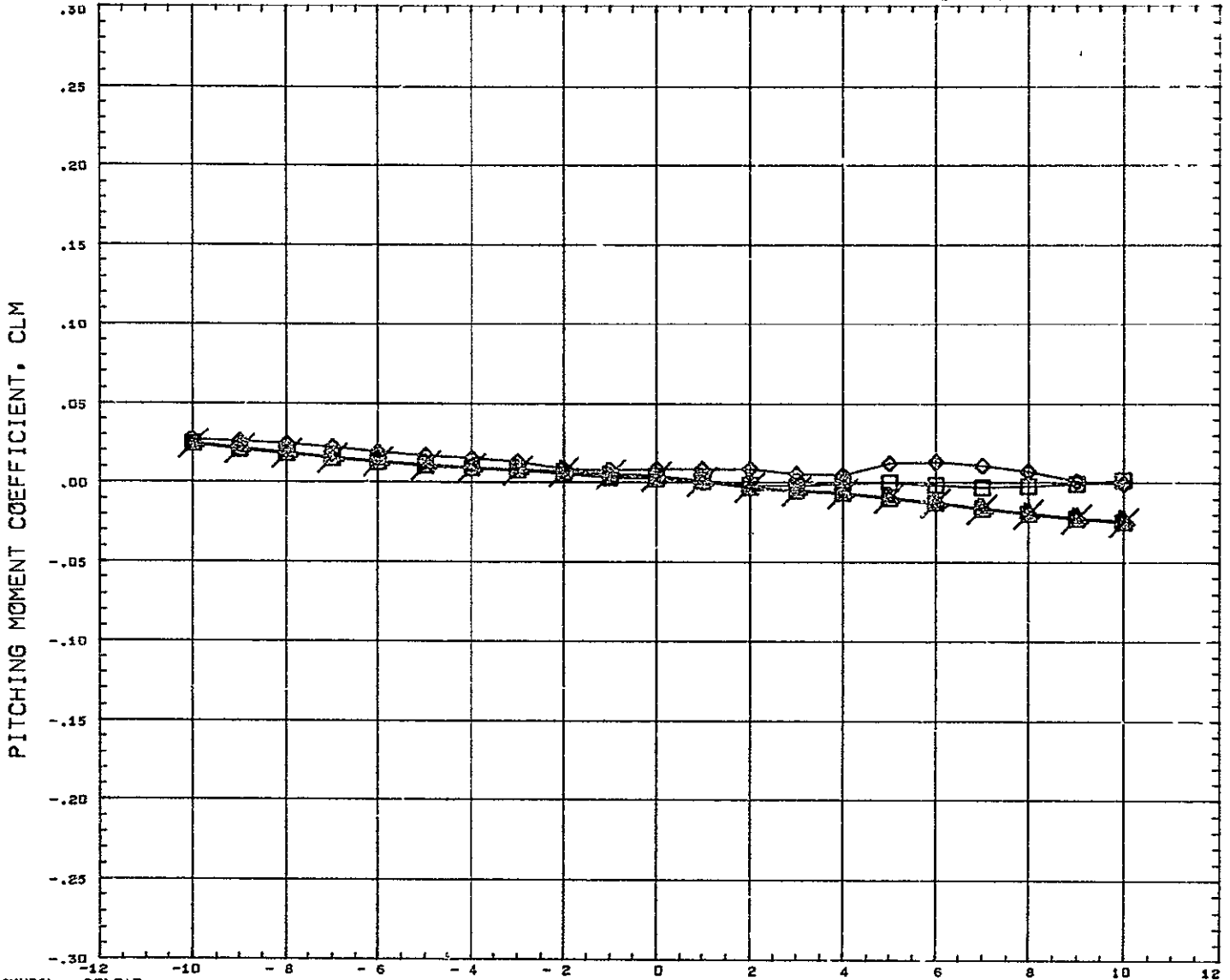

SYMBOL 	DELTAZ 0.182 0.228 0.352 0.599 10.000	PARAMETRIC VALUES BSTPOW 50.000 ORBPOW 100.000 DELTAX - 0.391 ALPHAI 10.100 MACH 5.010 ELVBST 0.000 ELVORB 0.000 BETA 0.000	REFERENCE INFORMATION REFS 44.4445 SQ IN REFL 13.3330 IN REFB 13.3330 IN XMRP 7.5280 IN YMRP 0.0000 IN ZMRP 1.1940 IN SCALE 0.0055
DATA HIST. CODE M			

# AEDC VA 1163 MDAC BOOSTER AND ORBITER TEST DATA AT MACH NUMBER 5

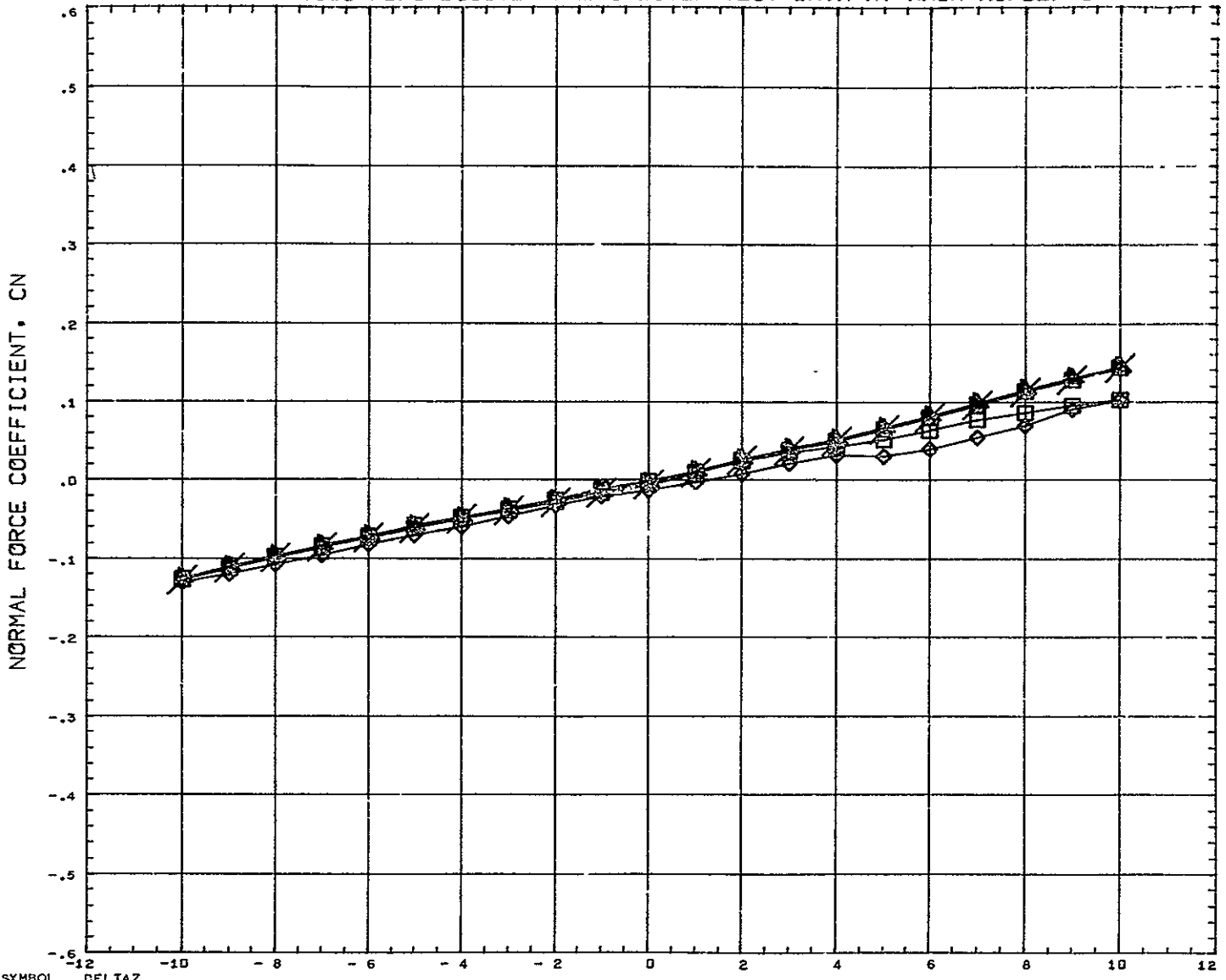

SYMBOL ◇ □ ▽ △	DELTAZ 0.182 0.228 0.352 0.599 10.000	<table border="0" style="width: 100%;"> <tr> <th colspan="4" style="text-align: center;">PARAMETRIC VALUES</th> </tr> <tr> <td>BSTPOW</td> <td>50.000</td> <td>ORBPOW</td> <td>100.000</td> </tr> <tr> <td>DELTAZ</td> <td>0.391</td> <td>ALPHA1</td> <td>10.100</td> </tr> <tr> <td>MACH</td> <td>5.010</td> <td>ELVBST</td> <td>0.000</td> </tr> <tr> <td>ELVORB</td> <td>0.000</td> <td>BETA</td> <td>0.000</td> </tr> </table>	PARAMETRIC VALUES				BSTPOW	50.000	ORBPOW	100.000	DELTAZ	0.391	ALPHA1	10.100	MACH	5.010	ELVBST	0.000	ELVORB	0.000	BETA	0.000	<table border="0" style="width: 100%;"> <tr> <th colspan="3" style="text-align: center;">REFERENCE INFORMATION</th> </tr> <tr> <td>REFS</td> <td>44 4440</td> <td>SG IN</td> </tr> <tr> <td>REFL</td> <td>13.3330</td> <td>IN</td> </tr> <tr> <td>REFB</td> <td>13.3330</td> <td>IN</td> </tr> <tr> <td>XMRP</td> <td>7.5280</td> <td>IN</td> </tr> <tr> <td>YMRP</td> <td>0.0005</td> <td>IN</td> </tr> <tr> <td>ZMRP</td> <td>1.1940</td> <td>IN</td> </tr> <tr> <td>SCALE</td> <td>0.0055</td> <td></td> </tr> </table>	REFERENCE INFORMATION			REFS	44 4440	SG IN	REFL	13.3330	IN	REFB	13.3330	IN	XMRP	7.5280	IN	YMRP	0.0005	IN	ZMRP	1.1940	IN	SCALE	0.0055	
PARAMETRIC VALUES																																															
BSTPOW	50.000	ORBPOW	100.000																																												
DELTAZ	0.391	ALPHA1	10.100																																												
MACH	5.010	ELVBST	0.000																																												
ELVORB	0.000	BETA	0.000																																												
REFERENCE INFORMATION																																															
REFS	44 4440	SG IN																																													
REFL	13.3330	IN																																													
REFB	13.3330	IN																																													
XMRP	7.5280	IN																																													
YMRP	0.0005	IN																																													
ZMRP	1.1940	IN																																													
SCALE	0.0055																																														

DATA HIST CODE M

# AEDC VA 1163 MDAC BOOSTER AND ORBITER TEST DATA AT MACH NUMBER 5

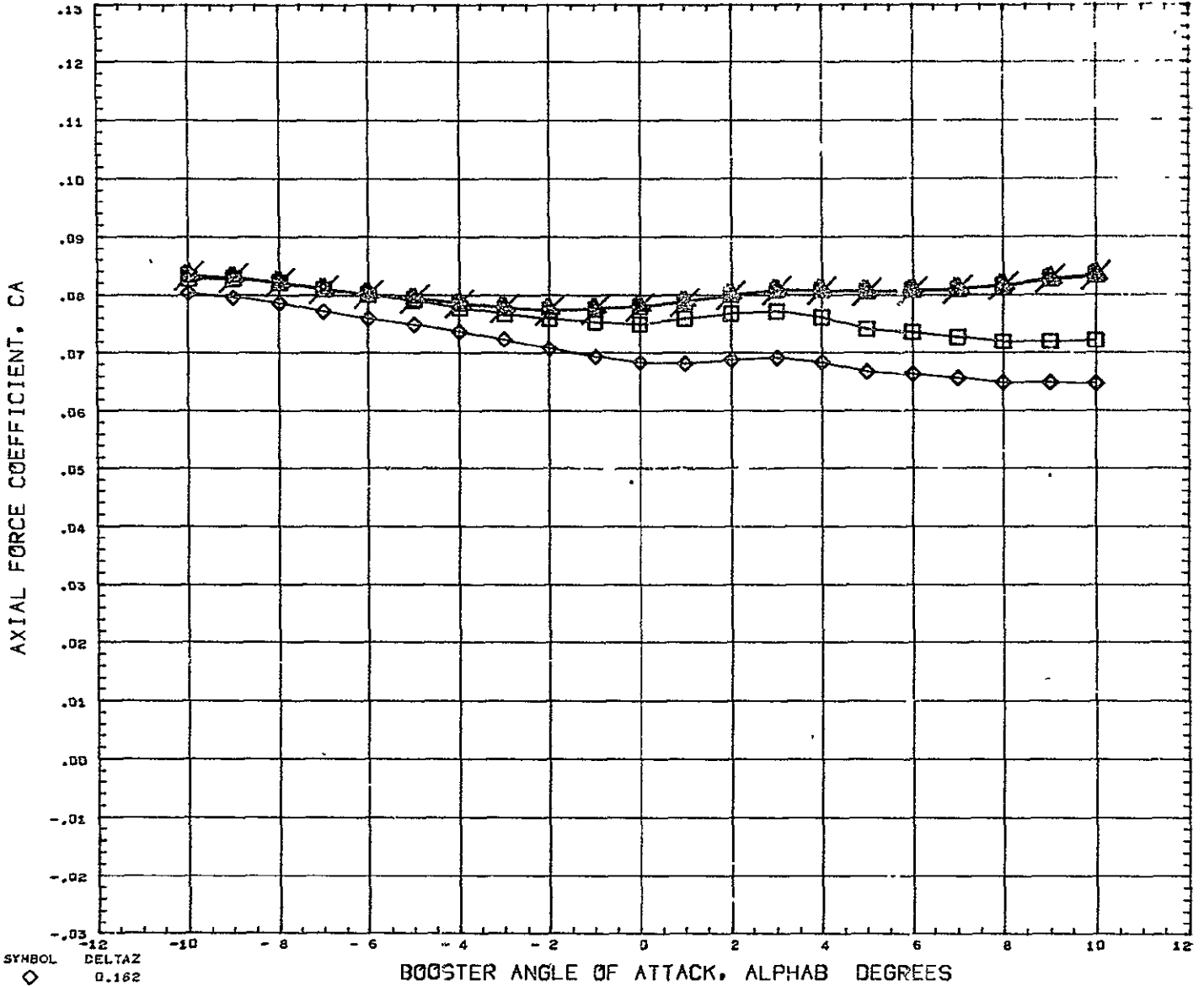

SYMBOL ◇ □ △	DELTAZ 0.162 0.228 0.352 0.599 10.000	PARAMETRIC VALUES BSTPOW 50.000 ORBPOW 100.000 DELTAX - 0.391 ALPHAI 10.100 MACH 5.010 ELVBST 0.000 ELVORB 0.000 BETA 0.000	REFERENCE INFORMATION REFS 44.4440 SQ IN REFL 13.3330 IN REFB 13.3330 IN XMRP 7.5280 IN YMRP 0.0000 IN ZMRP 1.1940 IN SCALE 0.0055
DATA HIST. CODE M			

# AEDC VA 1163 MDAC BOOSTER AND ORBITER TEST DATA AT MACH NUMBER 5

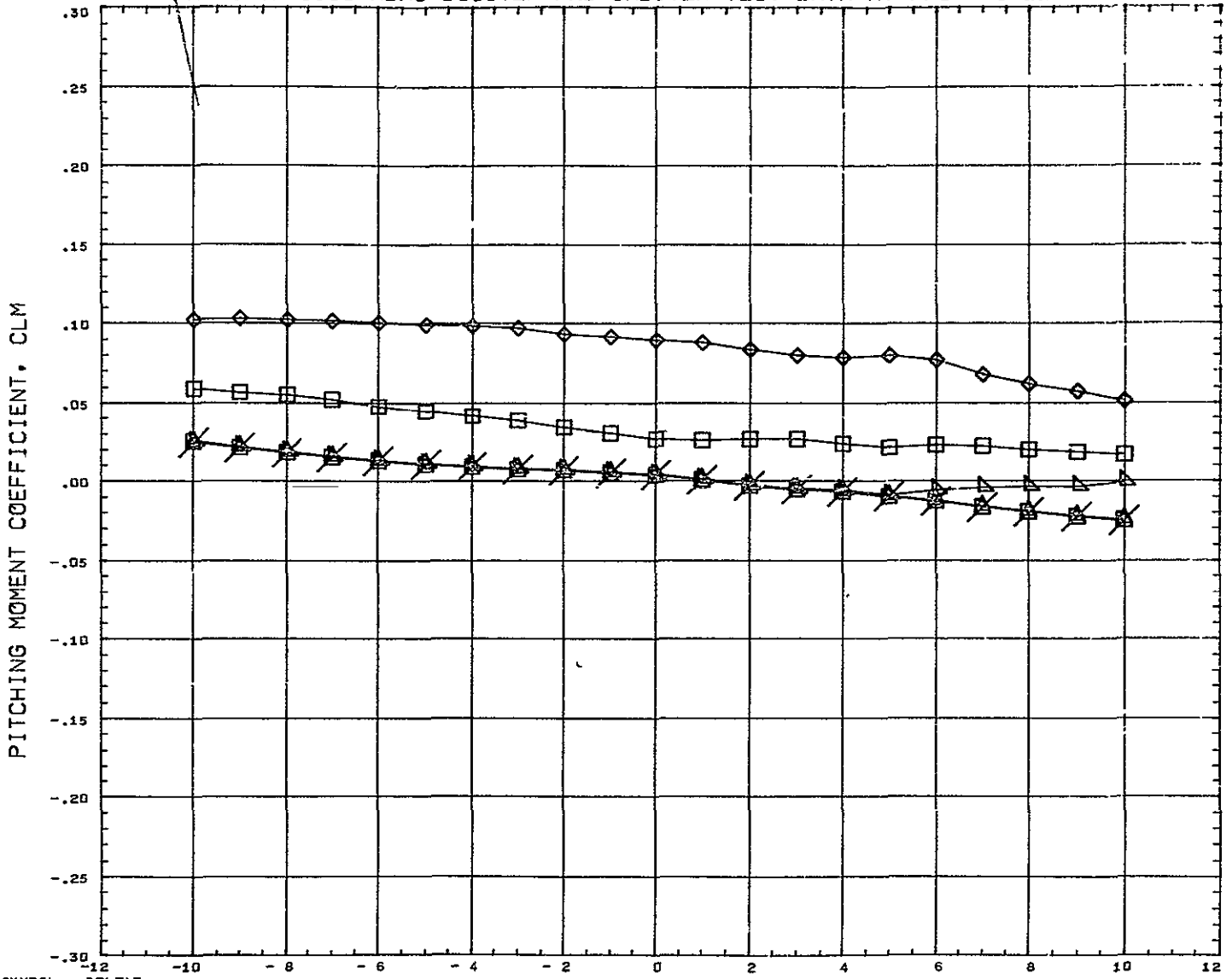

SYMBOL ◇ □ △ ×	DELTAZ 0.192 0.228 0.352 0.599 10.000	PARAMETRIC VALUES BSTPOW 50.000 ORBFOV 100.000 DELTAX - 0.143 ALPHA1 10.100 MACH 5.010 ELVBST 0.000 ELVORB 0.000 BETA 0.000	REFERENCE INFORMATION REFS 44.4440 SQ IN REFL 13.3330 IN REFB 13.3330 IN XMRP 7.5200 IN YMRP 0.0000 IN ZMRP 1.1940 IN SCALE 0.0055
----------------------------	--	---	---

REFERENCE FILE

# AEDC VA 1163 MDAC BOOSTER AND ORBITER TEST DATA AT MACH NUMBER 5

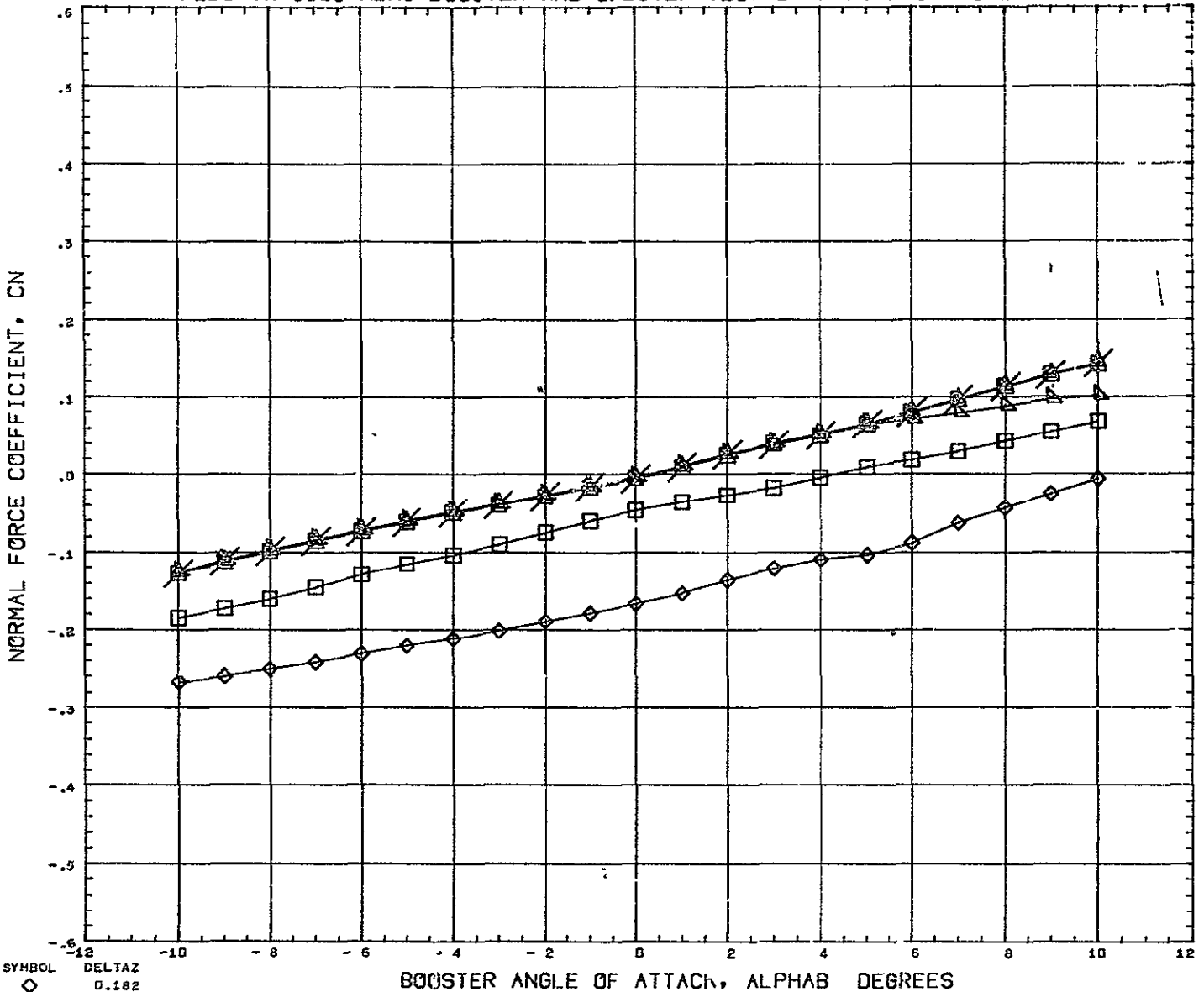

SYMBOL ◇ □ △	DELTAX 0.182 0.228 0.352 0.599 10.000	PARAMETRIC VALUES BSTPOW 50.000 ORBPOW 100.000 DELTAX - 0.143 ALPHAI 10.199 MACH 5.010 ELVBST 0.000 ELVORB 0.000 BETA 0.000	REFERENCE INFORMATION REFS 44.4440 SQ IN REFL 13.3330 IN REFB 13.3330 IN XMRP 7.5280 IN YMRP 0.0000 IN ZMRP 1.1940 IN SCALE 0.0055
-----------------------	--	---	---

REFERENCE FILE

# AEDC VA 1163 MDAC BOOSTER AND ORBITER TEST DATA AT MACH NUMBER 5

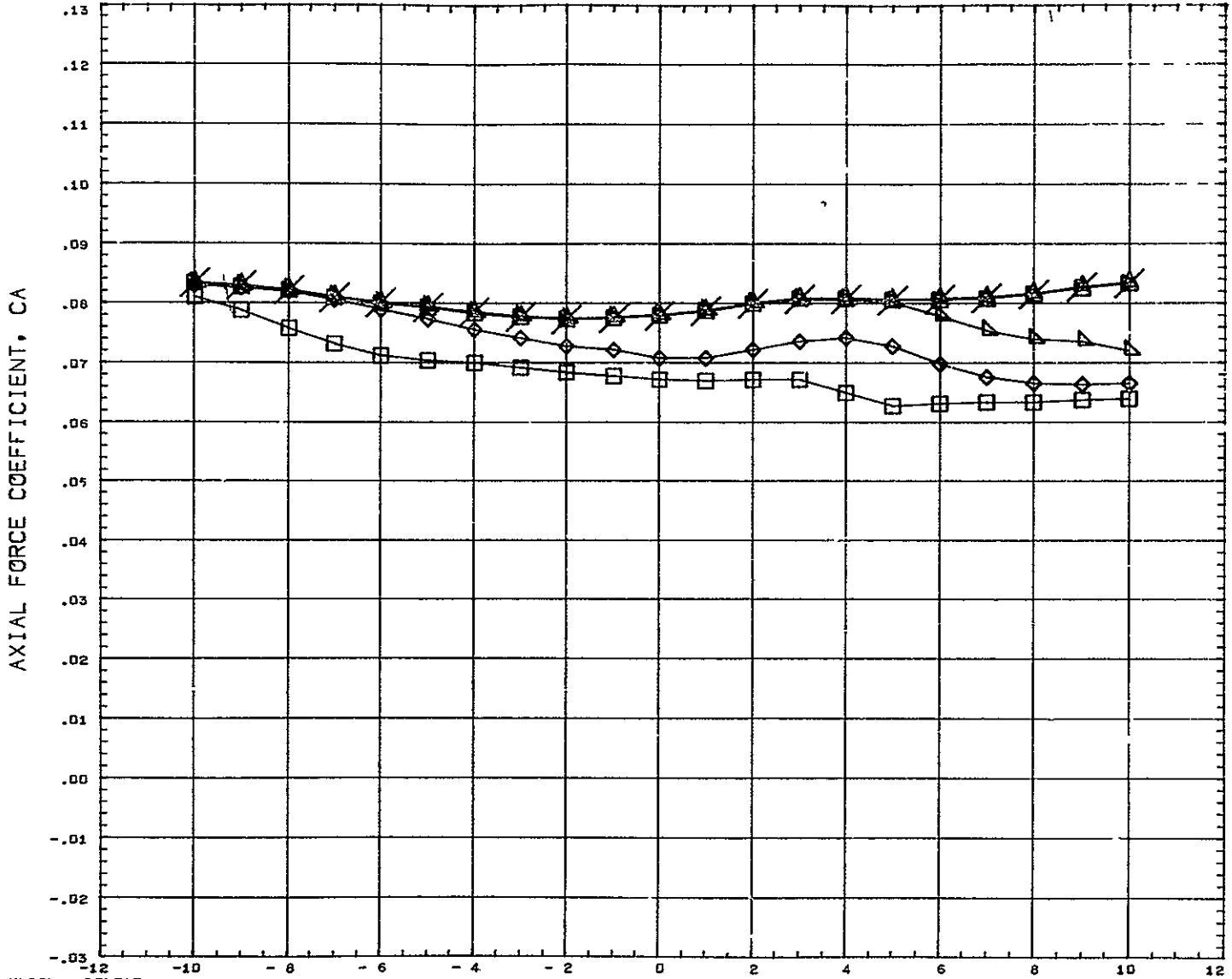

SYMBOL	DELTAZ	PARAMETRIC VALUES		REFERENCE INFORMATION	
◻	0.182			REFS	444B SR IN
◊	0.228			REFL	13.3336 IN
△	0.352	BSTFOW	50.000	REFB	13.3330 IN
✕	0.599	DELTAZ	0.143	XMRP	7.5280 IN
	10.000	MACH	5.010	YMRP	0.0000 IN
		ELVORB	0.000	ZMRP	1.1940 IN
		BETA	0.000	SCALE	0.0055

REFERENCE FILE

# AEDC VA 1163 MDAC BOOSTER AND ORBITER TEST DATA AT MACH NUMBER 5

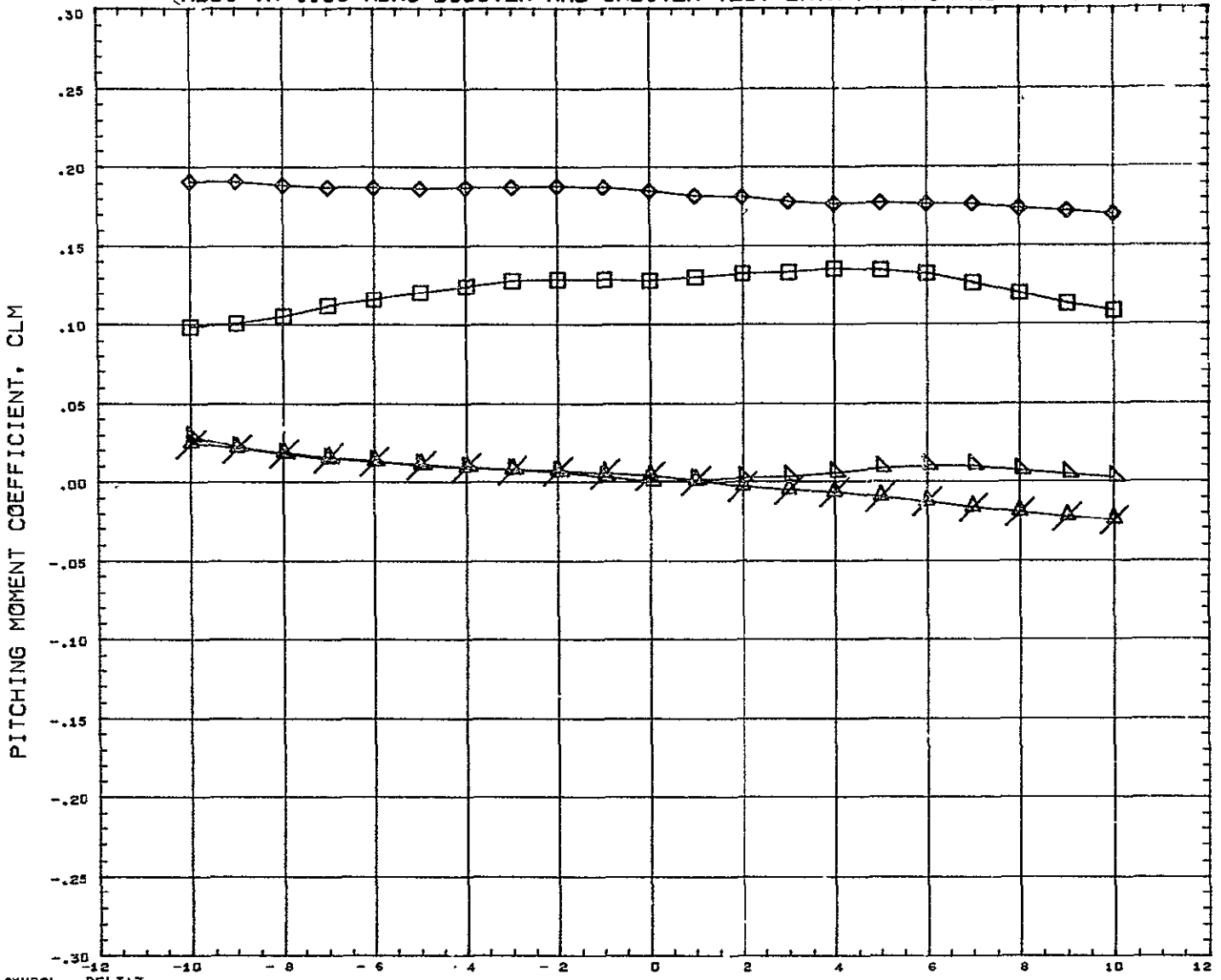

SYMBOL ◇ □ △	DELTAZ 0.182 0.228 0.352 10.000	<table border="0" style="width: 100%;"> <tr> <th colspan="4" style="text-align: center;">PARAMETRIC VALUES</th> </tr> <tr> <td style="width: 25%;">BSTFOW</td> <td style="width: 25%;">50.000</td> <td style="width: 25%;">ORBPOW</td> <td style="width: 25%;">100.000</td> </tr> <tr> <td>DELTAZ</td> <td>- 0.019</td> <td>ALPHA1</td> <td>10.100</td> </tr> <tr> <td>M CH</td> <td>5.010</td> <td>ELVBST</td> <td>0.000</td> </tr> <tr> <td>ELVORB</td> <td>0.000</td> <td>BETA</td> <td>0.000</td> </tr> </table>	PARAMETRIC VALUES				BSTFOW	50.000	ORBPOW	100.000	DELTAZ	- 0.019	ALPHA1	10.100	M CH	5.010	ELVBST	0.000	ELVORB	0.000	BETA	0.000	<table border="0" style="width: 100%;"> <tr> <th colspan="3" style="text-align: center;">REFERENCE INFORMATION</th> </tr> <tr> <td style="width: 33%;">REFS</td> <td style="width: 33%;">44 4440</td> <td style="width: 33%;">SQ IN</td> </tr> <tr> <td>REFL</td> <td>13.3330</td> <td>IN</td> </tr> <tr> <td>REFB</td> <td>13.3330</td> <td>IN</td> </tr> <tr> <td>XMRP</td> <td>7.5280</td> <td>IN</td> </tr> <tr> <td>YMRP</td> <td>0.0000</td> <td>IN</td> </tr> <tr> <td>ZMRP</td> <td>1.1940</td> <td>IN</td> </tr> <tr> <td>SCALE</td> <td>0.0035</td> <td></td> </tr> </table>	REFERENCE INFORMATION			REFS	44 4440	SQ IN	REFL	13.3330	IN	REFB	13.3330	IN	XMRP	7.5280	IN	YMRP	0.0000	IN	ZMRP	1.1940	IN	SCALE	0.0035	
PARAMETRIC VALUES																																															
BSTFOW	50.000	ORBPOW	100.000																																												
DELTAZ	- 0.019	ALPHA1	10.100																																												
M CH	5.010	ELVBST	0.000																																												
ELVORB	0.000	BETA	0.000																																												
REFERENCE INFORMATION																																															
REFS	44 4440	SQ IN																																													
REFL	13.3330	IN																																													
REFB	13.3330	IN																																													
XMRP	7.5280	IN																																													
YMRP	0.0000	IN																																													
ZMRP	1.1940	IN																																													
SCALE	0.0035																																														
REFERENCE FILE																																															

# AEDC VA 1163 MDAC BOOSTER AND ORBITER TEST DATA AT MACH NUMBER 5

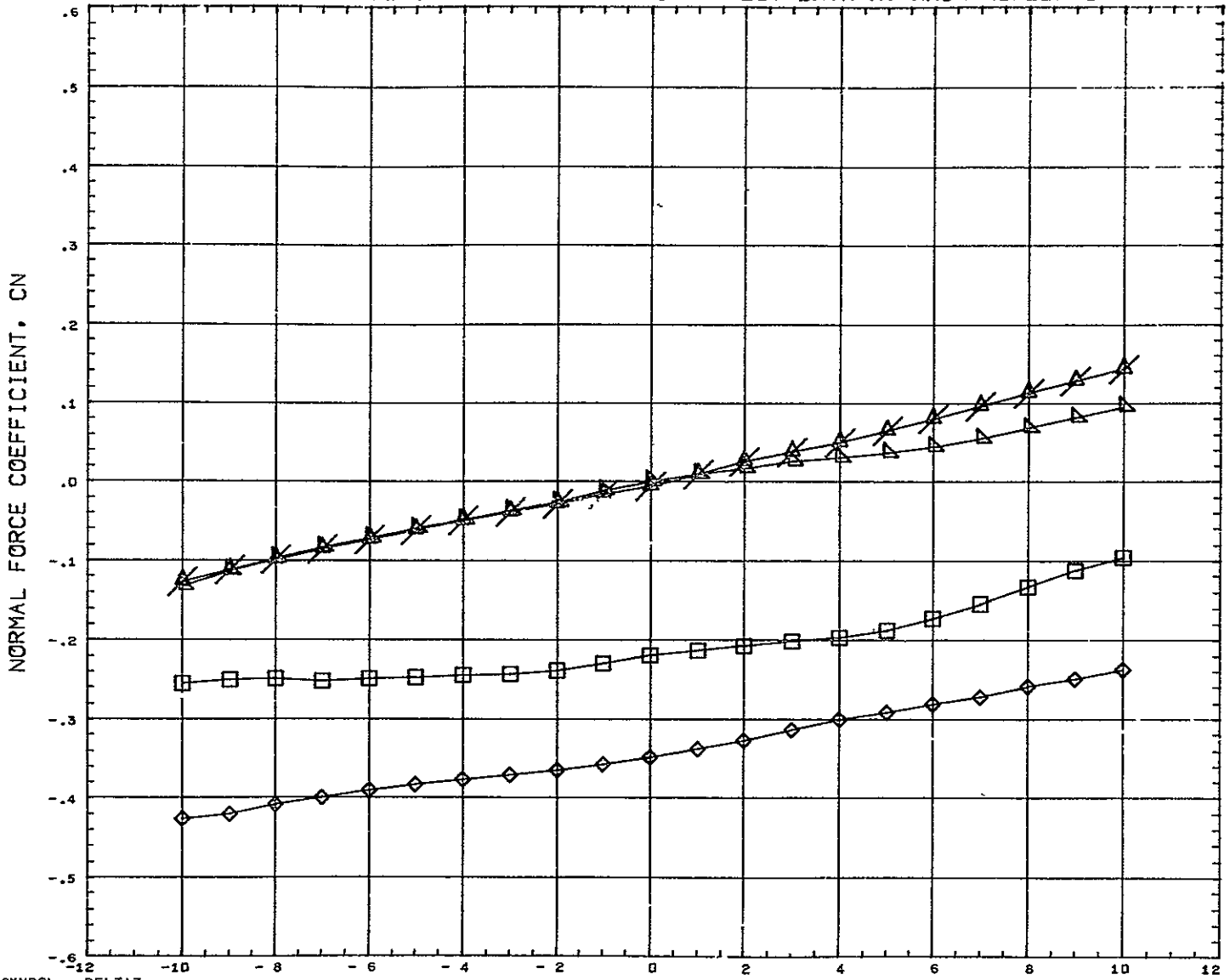

SYMBOL ◇ □ ▲	DELTAZ 0.182 0.228 0.352 10.000	PARAMETRIC VALUES BSTFOW 50.000 ORBFOW 100.000 DELTAX - 0.019 ALPHAI 10.160 Y CH 5.010 ELVBST 0.000 ELVORB 0.000 BETA 0.000	REFERENCE INFORMATION RFFS 44 4440 SQ IN REFL 13 3330 IN REFB 13 3330 IN XMRP 7.5280 IN YMRP 0.0000 IN ZMRP 1 1940 IN SCALE 0.0055
-----------------------	---	---	---

REFERENCE FILE



AEDC VA 1163 MDAC BOOSTER AND ORBITER TEST DATA AT MACH NUMBER 5

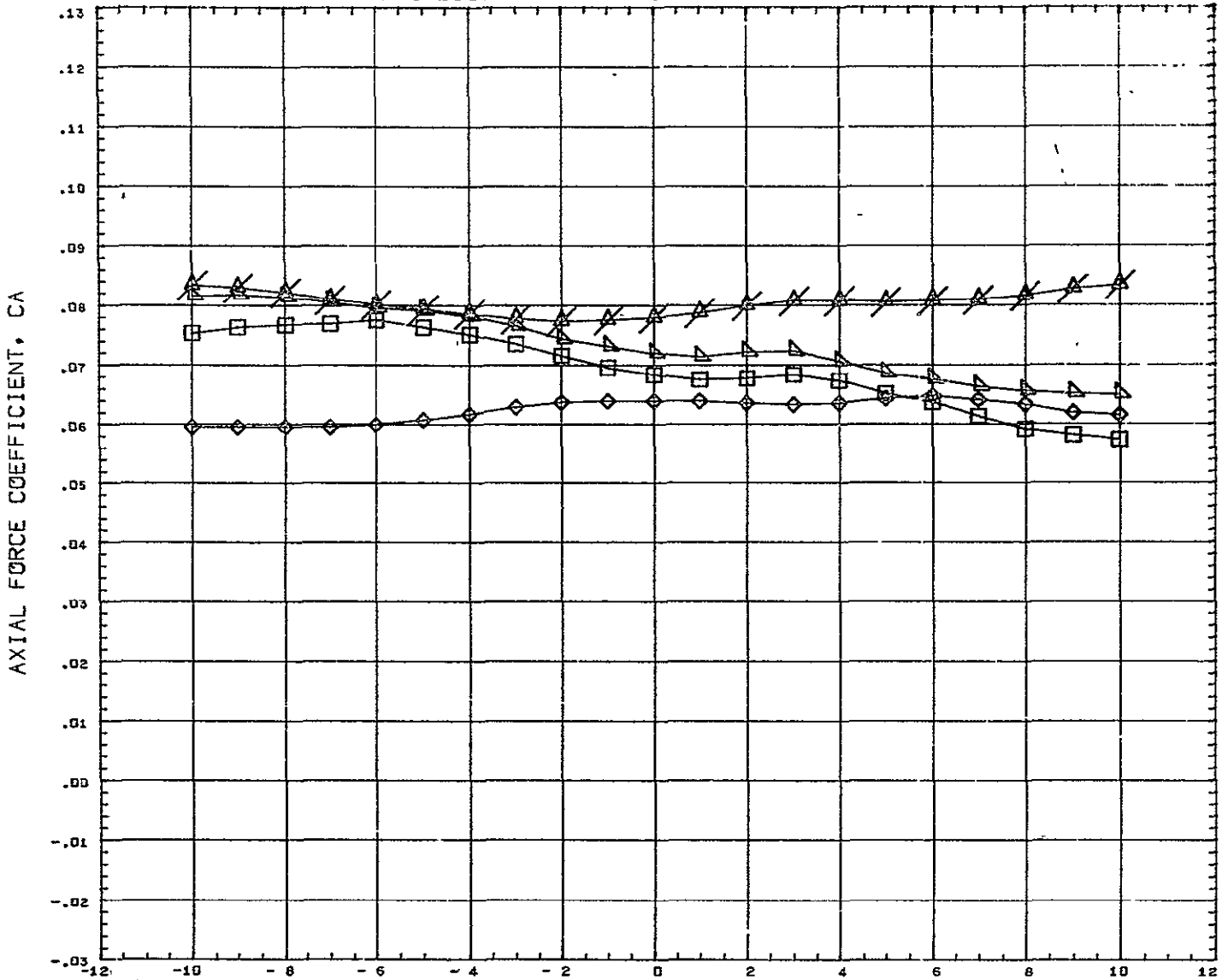

SYMBOL	DELTA Z	PARAMETRIC VALUES				REFERENCE INFORMATION		
◇	0.182	BSTFOW	50.000	ORBPOW	100.000	REFS	44 4440	SQ IN
□	0.228	DELTA X	- 0.019	ALPHA I	10.100	REFL	15.3330	IN
△	0.352	MACH	5.010	ELVBST	0.000	REFB	13.3330	IN
	10.000	ELVORB	0.000	BETA	0.000	XMRP	7 5280	IN
						YMRP	0 0000	IN
						ZMRP	1.1940	IN
						SCALE	0.0055	
		REFERENCE FILE						

# AEDC VA 1163 MDAC BOOSTER AND ORBITER TEST DATA AT MACH NUMBER 5

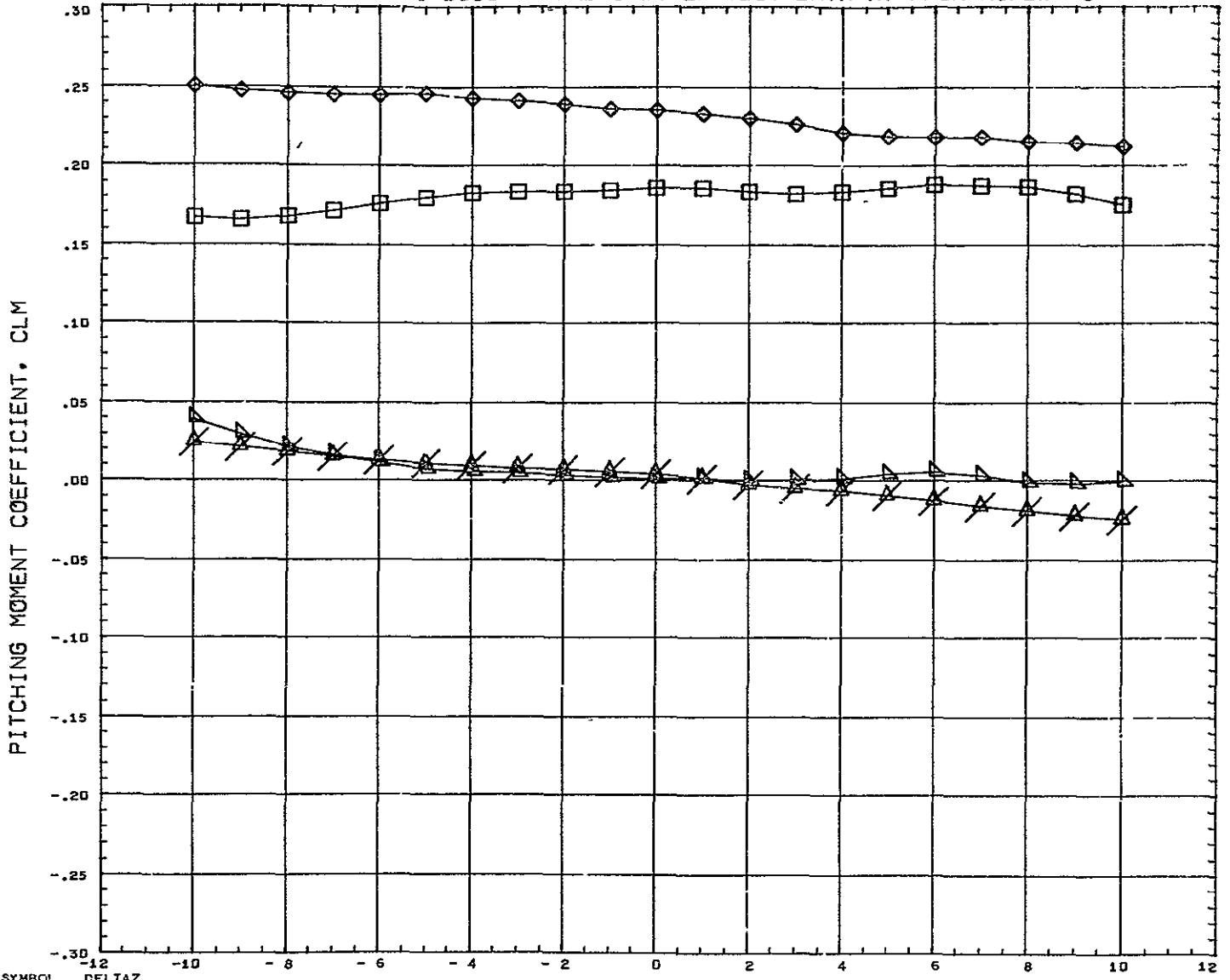

SYMBOL ◇ □ △	DELTAZ 0.162 0.228 0.352 10.000, 3	PARAMETRIC VALUES BSTPOW 50.000 ORBPOW 100.000 DELTAX 0.043 ALPHAI 10.100 MACH 5.010 ELVBST 0.000 ELVORB 0.000 BETA 0.000	REFERENCE INFORMATION REFS 22.4440 SQ IN REFL 13.3330 IN REFB 13.3330 IN XMRP 7.5280 IN YMRP 0.0005 IN ZMRP 1.1940 IN SCALE 0.0055
-----------------------	--	---	---

# AEDC VA 1163 MDAC BOOSTER AND ORBITER TEST DATA AT MACH NUMBER 5

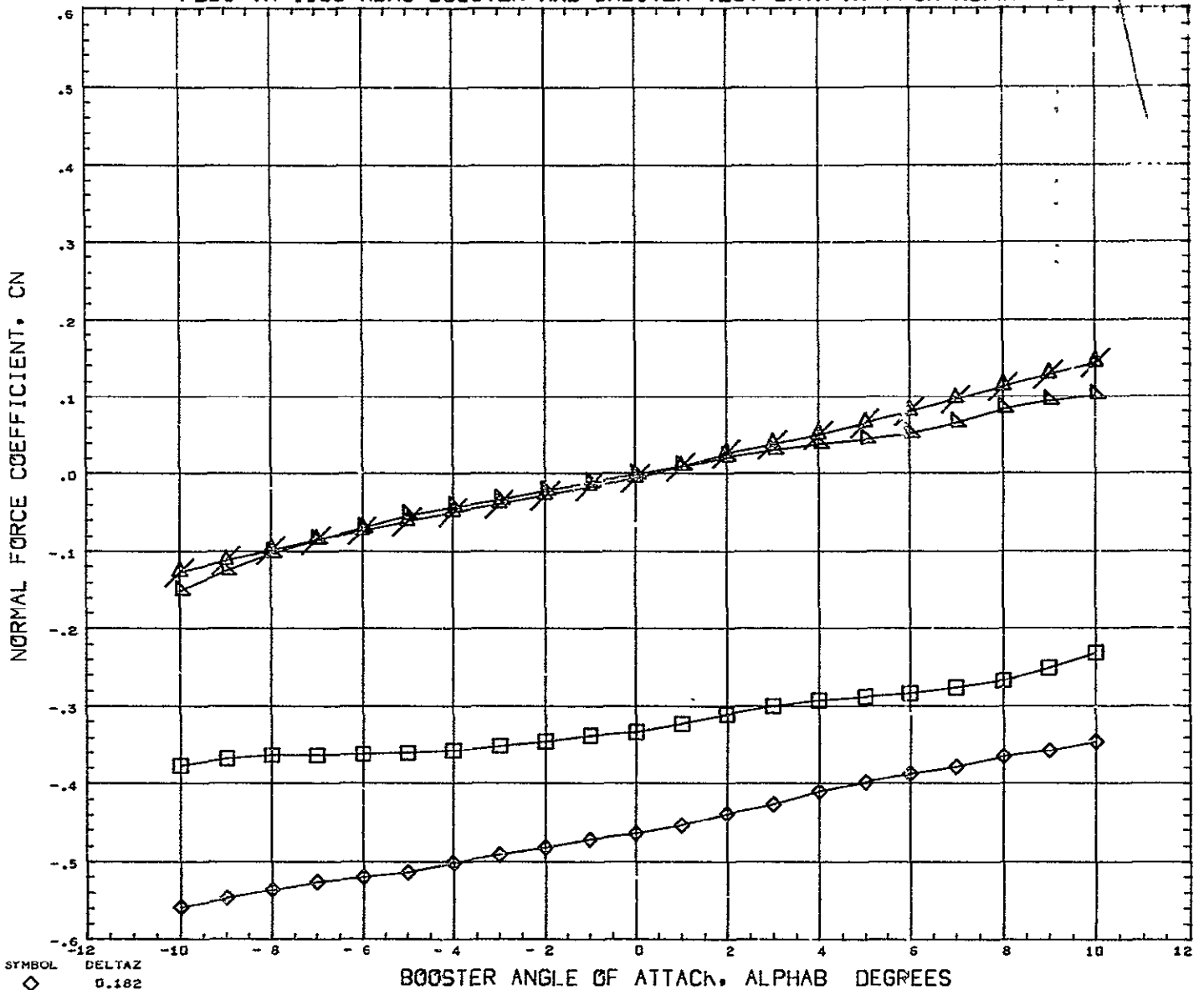

<table border="0"> <tr><td>◇</td><td>DELTA Z</td><td>0.182</td></tr> <tr><td>□</td><td>0.228</td><td></td></tr> <tr><td>△</td><td>0.352</td><td></td></tr> <tr><td>▽</td><td>10.000</td><td></td></tr> </table>	◇	DELTA Z	0.182	□	0.228		△	0.352		▽	10.000		<table border="0"> <tr><td colspan="4">PARAMETRIC VALUES</td></tr> <tr><td>BSTPOW</td><td>50.000</td><td>ORBPOW</td><td>100.000</td></tr> <tr><td>DELTA X</td><td>0.043</td><td>ALPHA I</td><td>10.180</td></tr> <tr><td>MACH</td><td>5.010</td><td>ELVBST</td><td>0.000</td></tr> <tr><td>ELVORB</td><td>0.000</td><td>BETA</td><td>0.000</td></tr> </table>	PARAMETRIC VALUES				BSTPOW	50.000	ORBPOW	100.000	DELTA X	0.043	ALPHA I	10.180	MACH	5.010	ELVBST	0.000	ELVORB	0.000	BETA	0.000	<table border="0"> <tr><td colspan="3">REFERENCE INFORMATION</td></tr> <tr><td>REFS</td><td>44.4440</td><td>\$0 IN</td></tr> <tr><td>REFL</td><td>13.3330</td><td>IN</td></tr> <tr><td>REFB</td><td>13.3330</td><td>IN</td></tr> <tr><td>XMRP</td><td>7.5280</td><td>IN</td></tr> <tr><td>YMRP</td><td>0.0005</td><td>IN</td></tr> <tr><td>ZMRP</td><td>1.1949</td><td>IN</td></tr> <tr><td>SCALE</td><td>0 0055</td><td></td></tr> </table>	REFERENCE INFORMATION			REFS	44.4440	\$0 IN	REFL	13.3330	IN	REFB	13.3330	IN	XMRP	7.5280	IN	YMRP	0.0005	IN	ZMRP	1.1949	IN	SCALE	0 0055	
◇	DELTA Z	0.182																																																								
□	0.228																																																									
△	0.352																																																									
▽	10.000																																																									
PARAMETRIC VALUES																																																										
BSTPOW	50.000	ORBPOW	100.000																																																							
DELTA X	0.043	ALPHA I	10.180																																																							
MACH	5.010	ELVBST	0.000																																																							
ELVORB	0.000	BETA	0.000																																																							
REFERENCE INFORMATION																																																										
REFS	44.4440	\$0 IN																																																								
REFL	13.3330	IN																																																								
REFB	13.3330	IN																																																								
XMRP	7.5280	IN																																																								
YMRP	0.0005	IN																																																								
ZMRP	1.1949	IN																																																								
SCALE	0 0055																																																									
REFERENCE FILE																																																										

# AEDC VA 1163 MDAC BOOSTER AND ORBITER TEST DATA AT MACH NUMBER 5

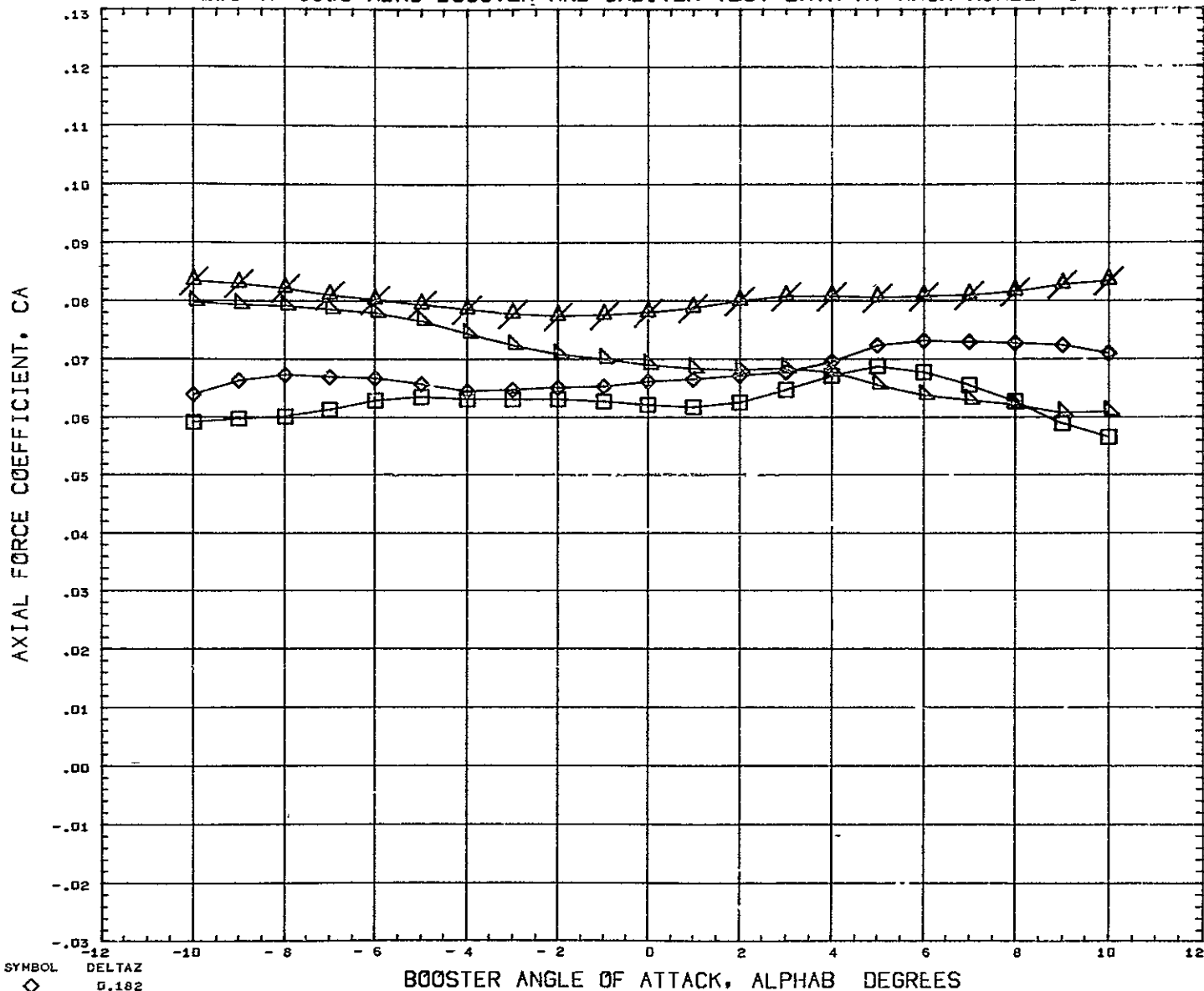

SYMBOL ◆ ◻ ▲ ✕	DELTAZ 0.182 0.228 0.352 10.000	<b>PARAMETRIC VALUES</b> BSTPOW 50.000 ORBPOW 100.000 DELTAX 0.043 ALPHAI 10.100 MACH 5.010 ELVBST 0.000 ELVORB 0.000 BETA 0.000	<b>REFERENCE INFORMATION</b> REFS 44.4440 SQ IN REFL 13.3330 IN REFB 13.3330 IN XMRF 7.5280 IN YMRF 0.0000 IN ZMRF 1.1940 IN SCALE 0.0055
	REFERENCE FILE		

# AEDC VA 1163 MDAC BOOSTER AND ORBITER TEST DATA AT MACH NUMBER 5

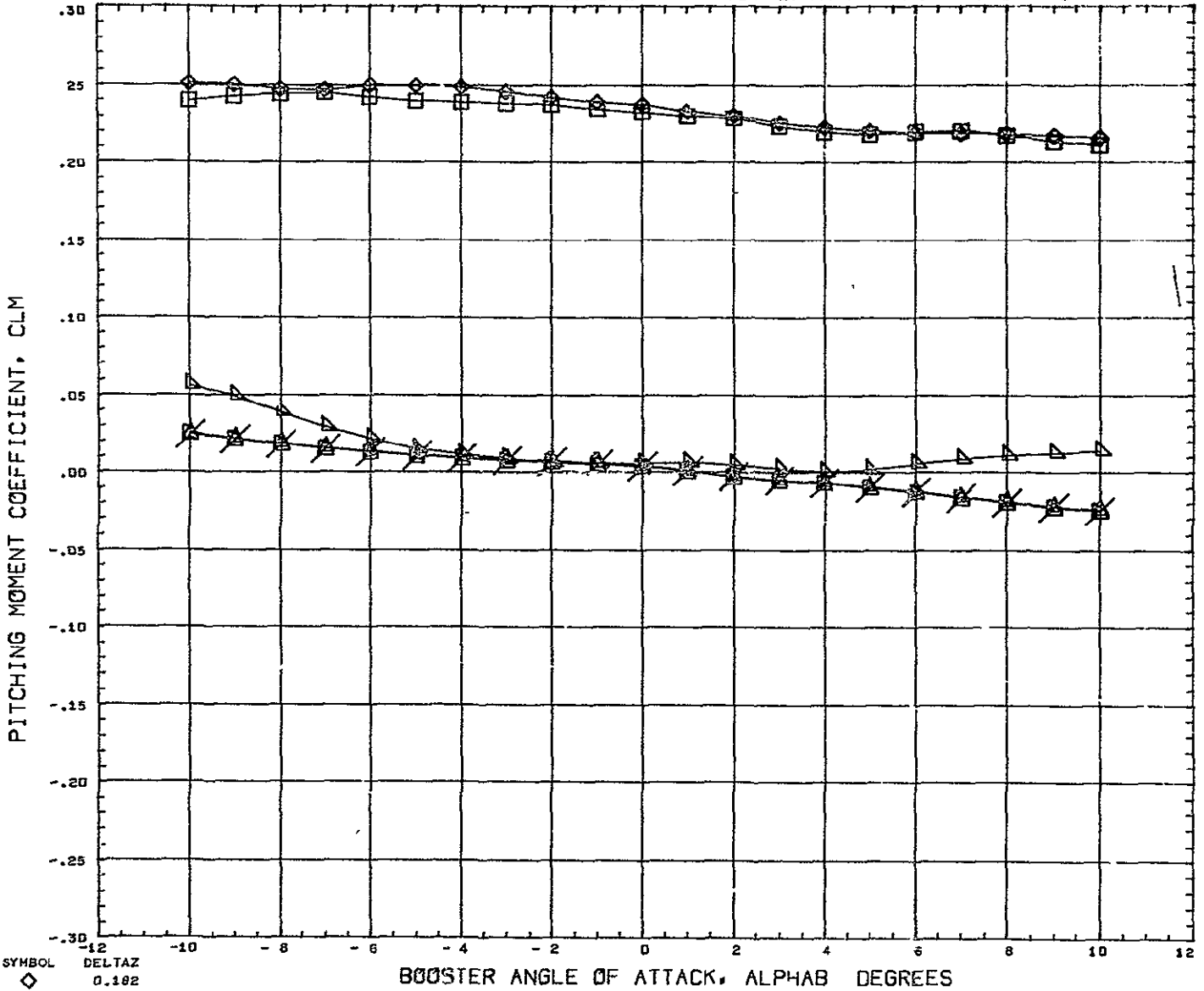

SYMBOL ◇ □ △ ×	DELTAZ 0.182 0.228 0.352 0.599 10.000	PARAMETRIC VALUES BSTPOW 50.000 ORBPOW 100.000 DFLTAX 0.105 ALPHA1 10.100 MACH 5.010 ELVBST 0.000 ELVORB 0.000 BCTA 0.000	REFERENCE INFORMATION REFS 44.4440 SQ IN REFL 13.3330 IN REFB 13.3330 IN XMRP 7.5288 IN YMRP 0.0008 IN ZMRP 1.1940 IN SCALE 0.0055
REFERENCE FILE			

# AEDC VA 1163 MDAC BOOSTER AND ORBITER TEST DATA AT MACH NUMBER 5

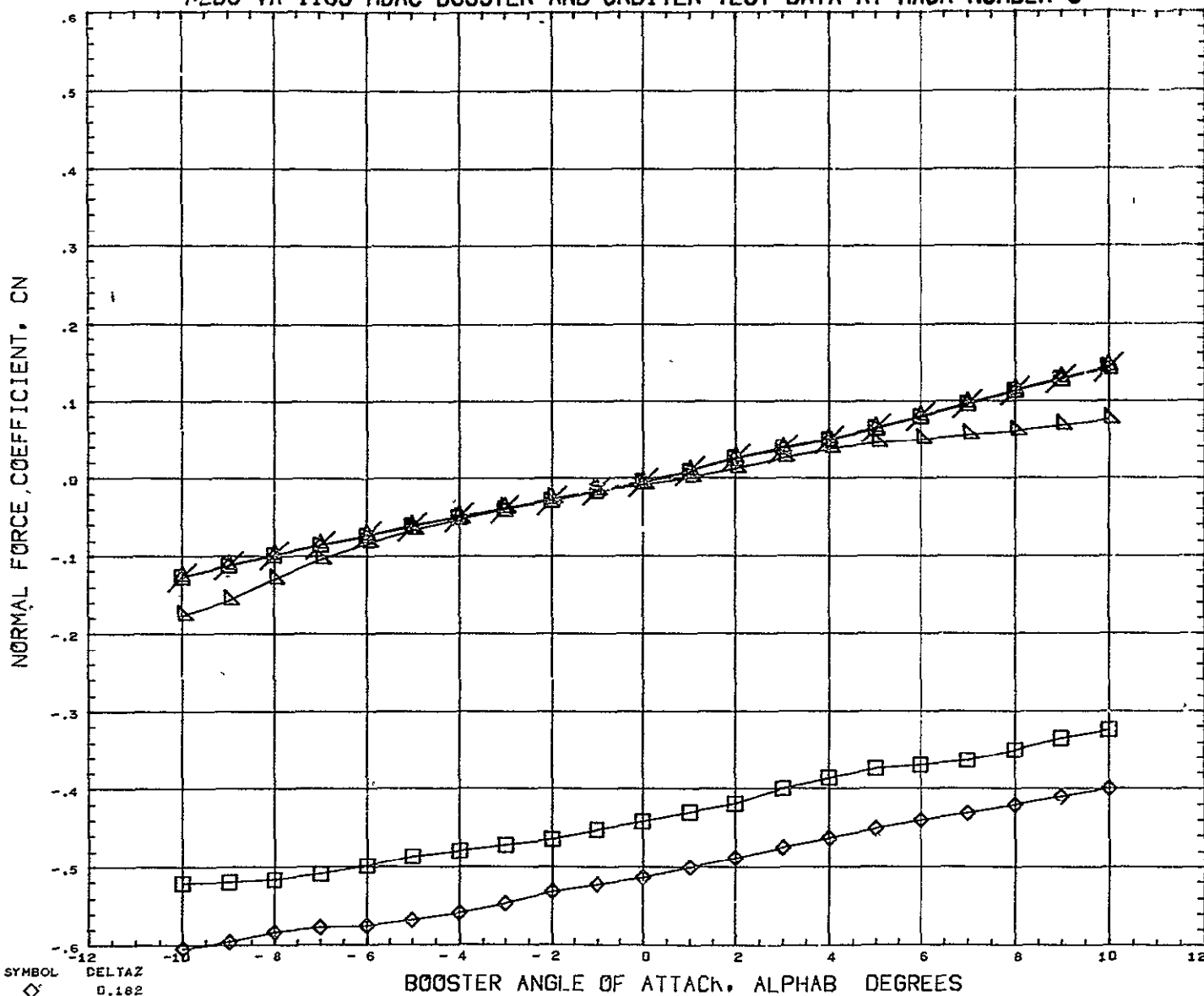

SYMBOL ◊ ◻ △	DELTAX 0.182 0.228 0.352 0.599 10.000	PARAMETRIC VALUES BSTPOW 50.000 ORBFOW 100.000 DELTAX 0.105 ALPHAI 10.100 MACH 5.010 ELVBST 0.000 ELVORB 0.000 BETA 0.000	REFERENCE INFORMATION REFS 44.4440 SQ IN REFL 13.3330 IN REFB 13.3330 IN XHRF 7.5200 IN YHRF 0.0000 IN ZHRF 1.1940 IN SCALE 0.0055
-----------------------	--	---	---

REFERENCE FILE

# AEDC VA 1163 MDAC BOOSTER AND ORBITER TEST DATA AT MACH NUMBER 5

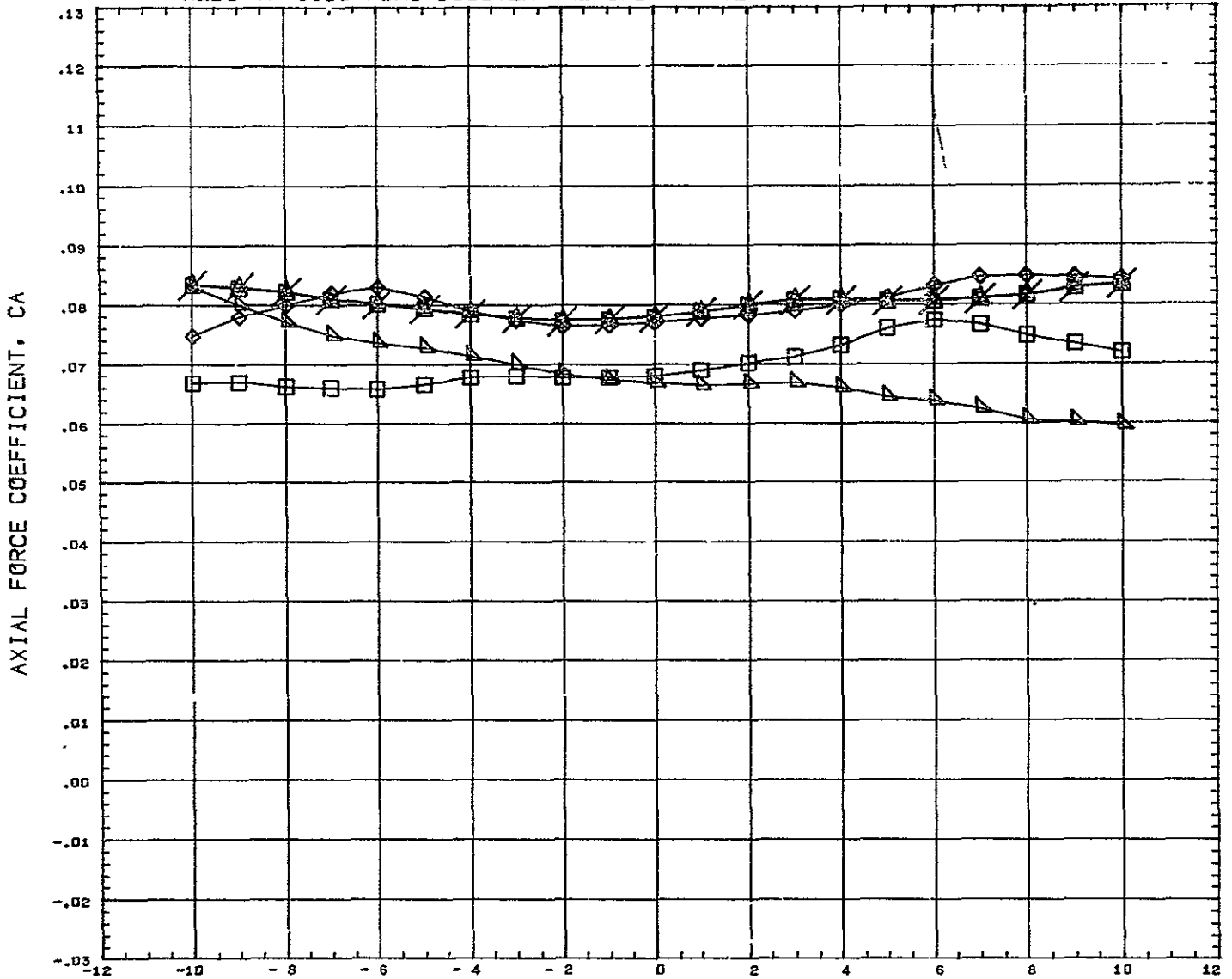

SYMBOL ◇ □ △ ✕	DELTAZ 0.102 0.228 0.352 0.599 10.000	PARAMETRIC VALUES BSTPOW 50.000 ORBPOW 100.000 DELTAX 0.105 ALPHAI 10.100 Y CH 5.010 ELVBST 0.000 ELVORB 0.000 BETA 0.000	REFERENCE INFORMATION REFS 44 4440 SQ IN REFL 13 3330 IN REFB 13 3330 IN XMRP 7 5280 IN YMRP 0 0000 IN ZMRP 1.1940 IN SCALE 0 0055
REFERENCE FILE			

# AEDC VA 1163 MDAC BOOSTER AND ORBITER TEST DATA AT MACH NUMBER 5

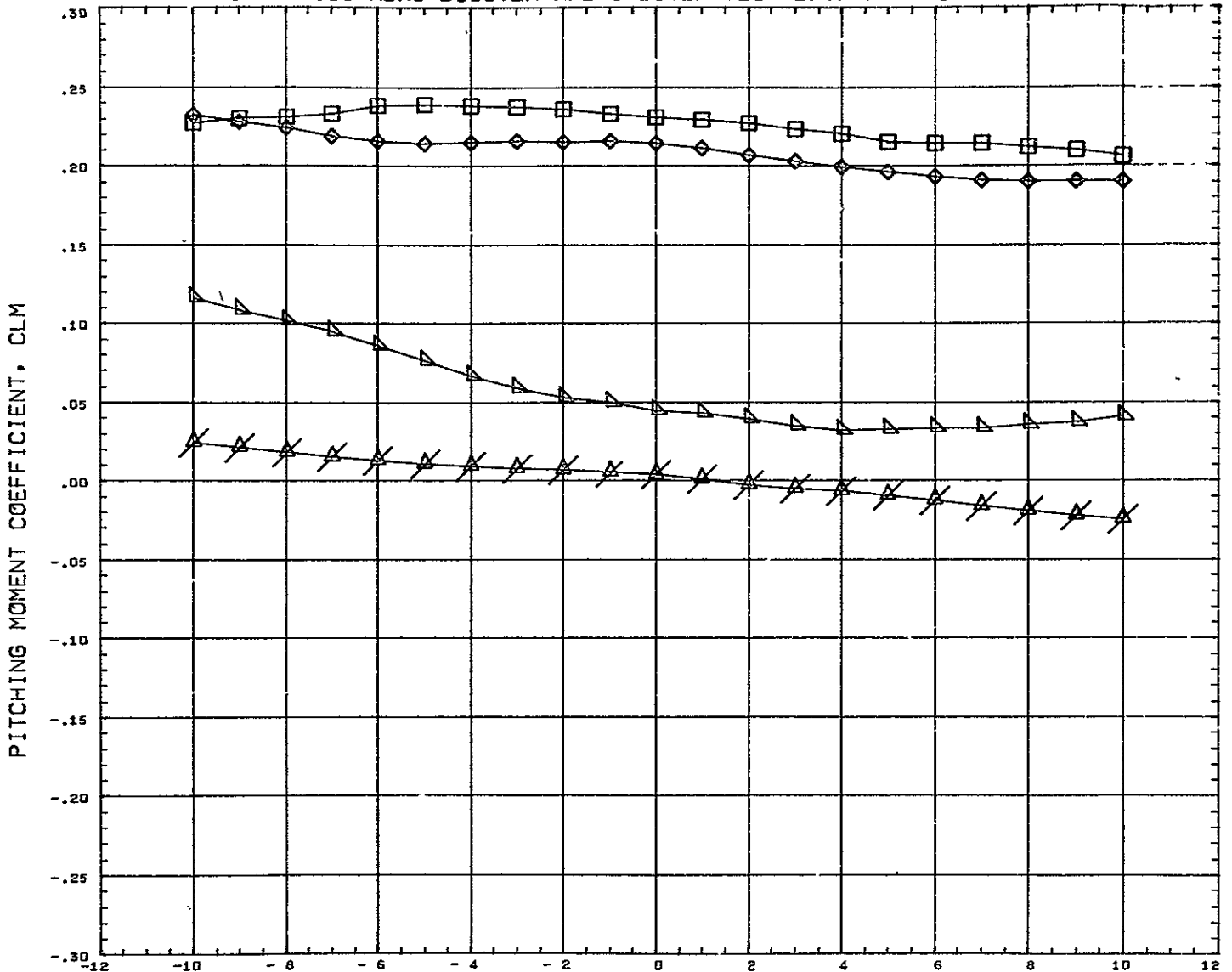

SYMBOL ◇ □ ×	DELTAZ 0.182 0.228 0.352 10.000	PARAMETRIC VALUES BSTPOW 50.000 ORBPOW 100.000 DELTAX 0.166 ALPHAI 10 100 ACH 5.010 ELVBST 0.000 ELVORB 0.000 BLTA 0.000	REFERENCE INFORMATION PEFS 44 4440 SQ IN REFL 13 3330 IN REFB 13 3330 IN XMRP 7.5200 IN YMRP 0.0000 IN ZMRP 1.1940 IN SCALE 0 0055
-----------------------	---	--	---

REFERENCE FILE



# AFDC VA 1163 MDAC BOOSTER AND ORBITER TEST DATA AT MACH NUMBER 5

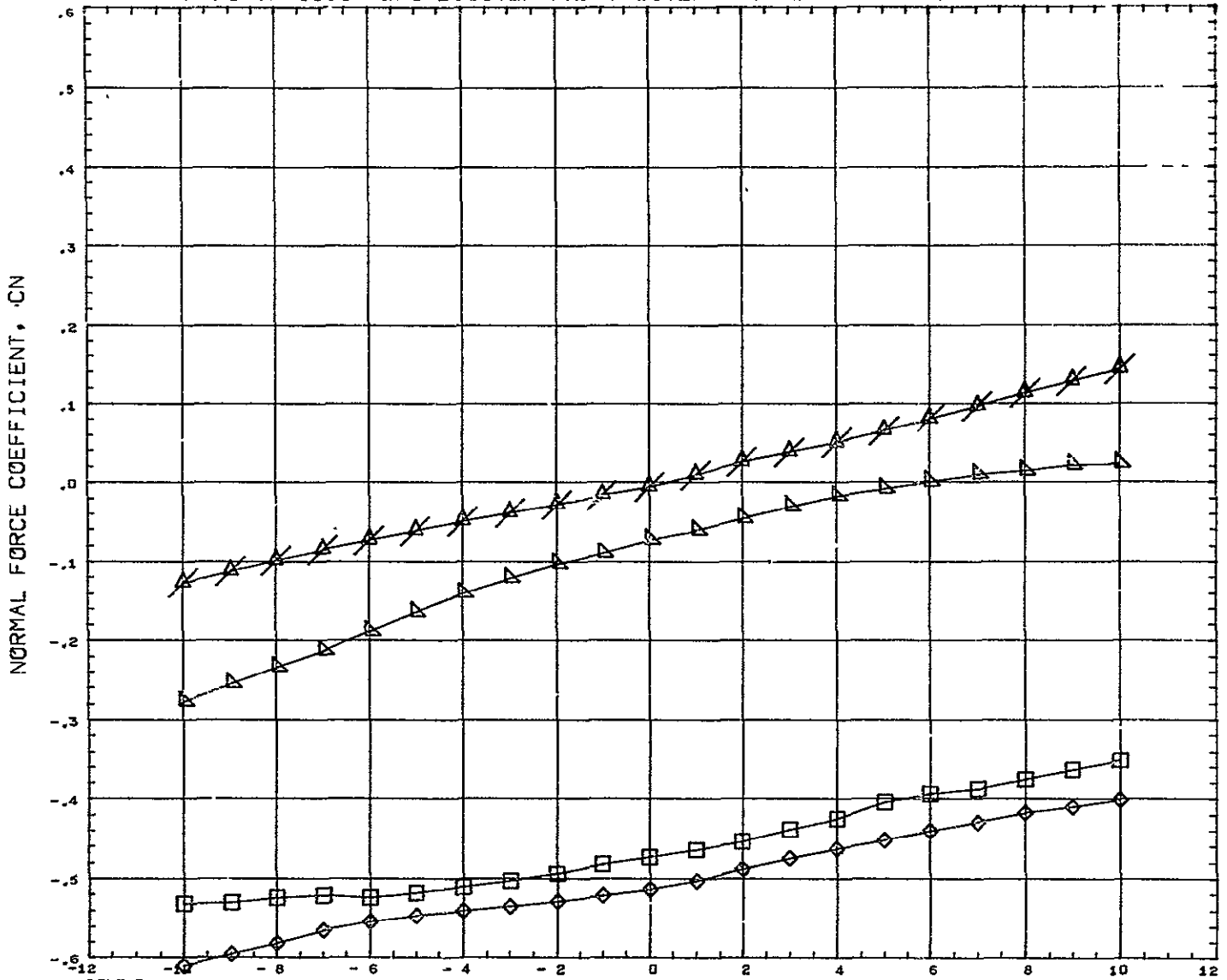

SYMBOL ◊ ◻ △ ×	DELTAX 0.162 0.228 0.352 10.000	PARAMETRIC VALUES BSTFOW 50.000 ORBPOW 100.000 DELTAX 0.166 ALPHAI 10.100 I CH 5.010 ELVBST 0.000 ELVORB 0.000 BETA 0.000	REFERENCE INFORMATION REFS 44.4440 SQ IN REFL 13.333C IN REFB 13.3330 IN XMRP 7.9280 IN YMRP 0.0000 IN ZMRP 1.1940 IN SCALE 0.0055
REFERENCE FILE			

# AEDC VA 1163 MDAC BOOSTER AND ORBITER TEST DATA AT MACH NUMBER 5

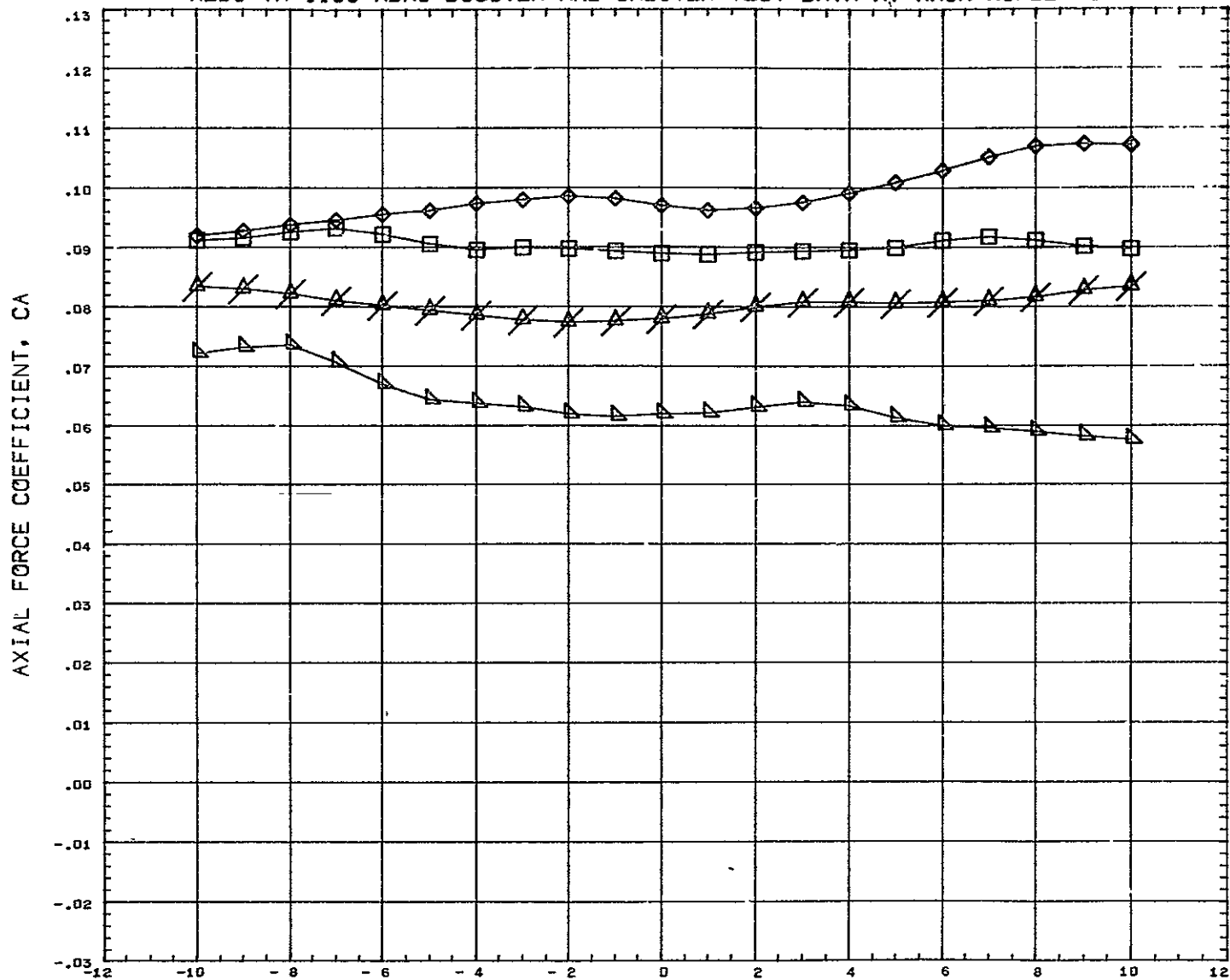

BOOSTER ANGLE OF ATTACK, ALPHAB DEGREES

SYMBOL ◇ □ △ △	DELTAZ 0.182 0.228 0.352 10.000	<table border="0" style="width: 100%;"> <tr> <th colspan="4" style="text-align: left;">PARAMETRIC VALUES</th> </tr> <tr> <td>BSTPOW</td><td>50.000</td><td>ORBPOW</td><td>100.000</td></tr> <tr> <td>DELTAZ</td><td>0.166</td><td>ALPHA1</td><td>10.100</td></tr> <tr> <td>MACH</td><td>5.010</td><td>ELVBST</td><td>0.000</td></tr> <tr> <td>ELVORB</td><td>0.000</td><td>BETA</td><td>0.000</td></tr> </table>	PARAMETRIC VALUES				BSTPOW	50.000	ORBPOW	100.000	DELTAZ	0.166	ALPHA1	10.100	MACH	5.010	ELVBST	0.000	ELVORB	0.000	BETA	0.000	<table border="0" style="width: 100%;"> <tr> <th colspan="3" style="text-align: left;">REFERENCE INFORMATION</th> </tr> <tr> <td>REFS</td><td>11.444C</td><td>50 IN</td></tr> <tr> <td>REFL</td><td>13.3330</td><td>IN</td></tr> <tr> <td>REFB</td><td>13.3330</td><td>IN</td></tr> <tr> <td>XMRP</td><td>7.5280</td><td>IN</td></tr> <tr> <td>YMRP</td><td>0.0000</td><td>IN</td></tr> <tr> <td>ZMRP</td><td>1.1940</td><td>IN</td></tr> <tr> <td>SCALE</td><td>0.0055</td><td></td></tr> </table>	REFERENCE INFORMATION			REFS	11.444C	50 IN	REFL	13.3330	IN	REFB	13.3330	IN	XMRP	7.5280	IN	YMRP	0.0000	IN	ZMRP	1.1940	IN	SCALE	0.0055	
PARAMETRIC VALUES																																															
BSTPOW	50.000	ORBPOW	100.000																																												
DELTAZ	0.166	ALPHA1	10.100																																												
MACH	5.010	ELVBST	0.000																																												
ELVORB	0.000	BETA	0.000																																												
REFERENCE INFORMATION																																															
REFS	11.444C	50 IN																																													
REFL	13.3330	IN																																													
REFB	13.3330	IN																																													
XMRP	7.5280	IN																																													
YMRP	0.0000	IN																																													
ZMRP	1.1940	IN																																													
SCALE	0.0055																																														

REFERENCE FILE

# AEDC VA 1163 MDAC BOOSTER AND ORBITER TEST DATA AT MACH NUMBER 5

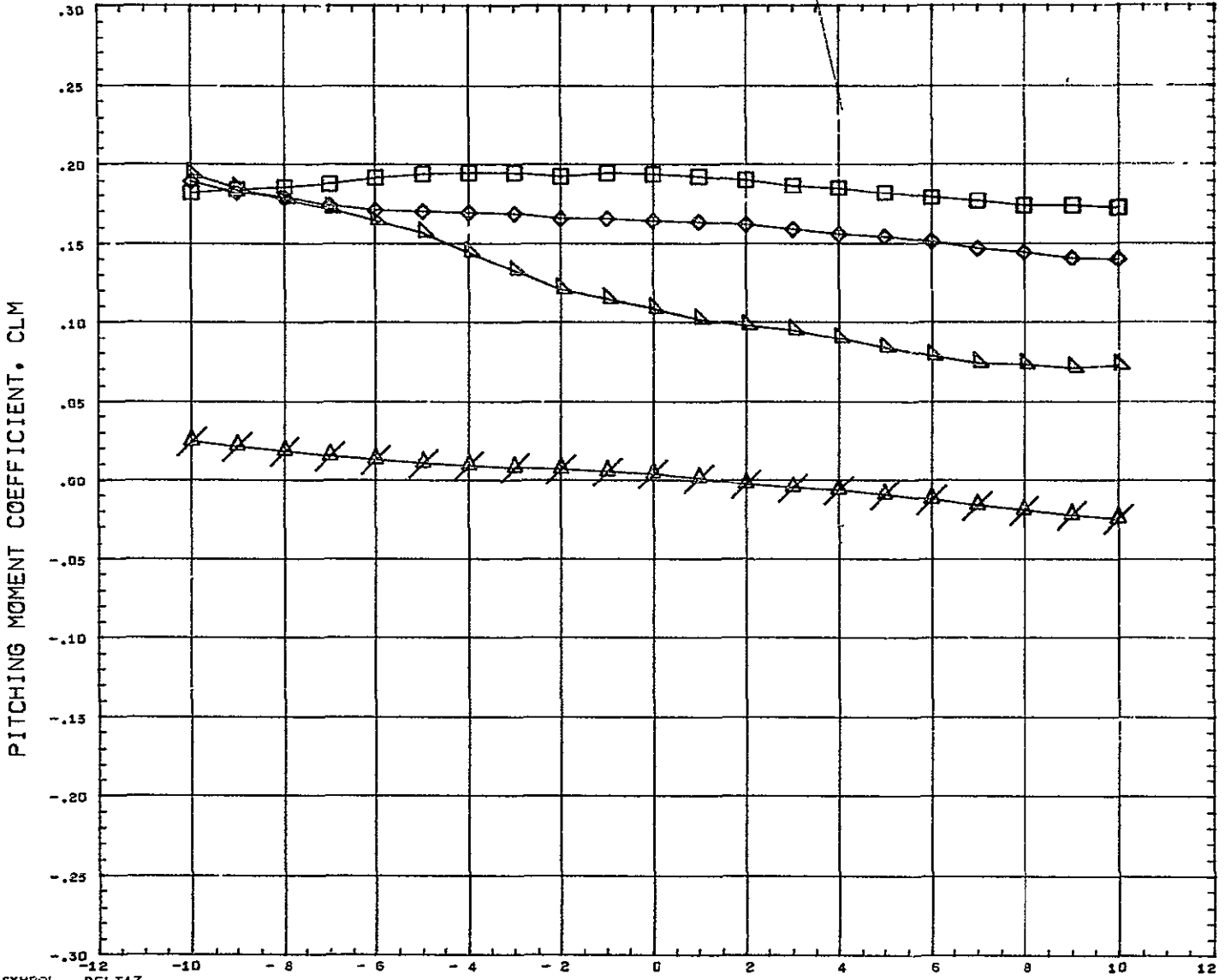

SYMBOL ◇ □ ▲	DELTAZ 0.162 0.228 0.352 10.000	PARAMETRIC VALUES BSTPOW 50.000 ORBPOW 100.000 DELTAX 0.228 ALPHAI 10.100 ACH 5.010 ELVBST 0.000 ELVORB 0.000 BLTA 0.000	REFERENCE INFORMATION REFS 1.4440 SQ IN REFL 13.3330 IN REFB 13.3330 IN XMRP 7.5280 IN YMRP 0.0000 IN ZMRP 1.1940 IN SCALE 0.0055
REFERENCE FILE			

# AEDC VA 1163 MDAC BOOSTER AND ORBITER TEST DATA AT MACH NUMBER 5,

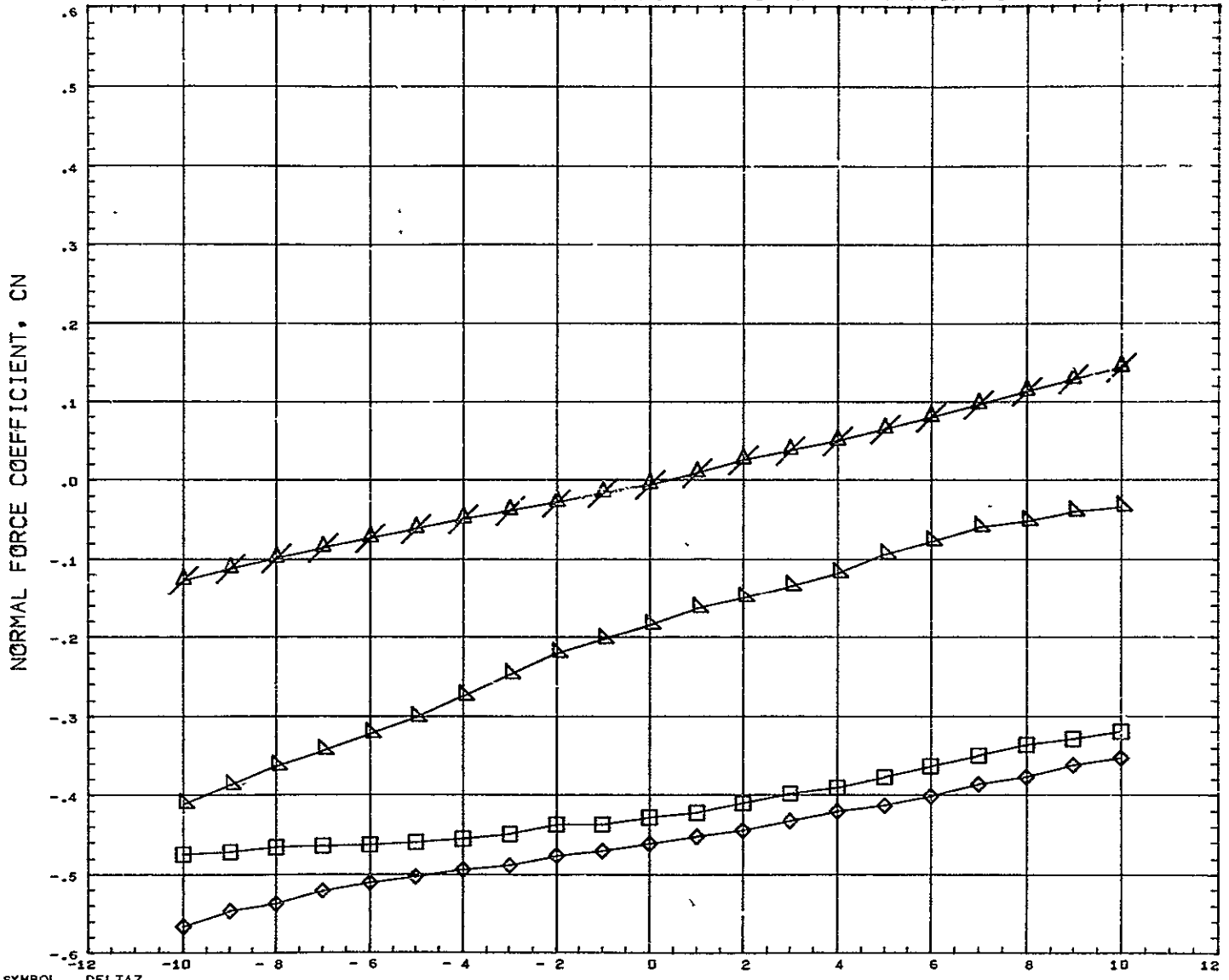

SYMBOL ◇ □ △	DELTAZ 0.182 0.228 0.352 10.000	PARAMETRIC VALUES BSTPOW 50.000 ORBPOW 100.000 DELTAX 0.228 ALPHAI 10.100 ACH 5.010 ELVBST 0.000 ELVORB 0.000 BETA 0.000	REFERENCE INFORMATION REFS 4.4440 SQ IN REFL 13.3330 IN REFB 13.3330 IN XMRP 7.5280 IN YHRP 0.0000 IN ZHRP 1.1940 IN SCALE 0.0055
REFERENCE FILE			

# AEDC VA 1163 MDAC BOOSTER AND ORBITER TEST DATA AT MACH NUMBER 5

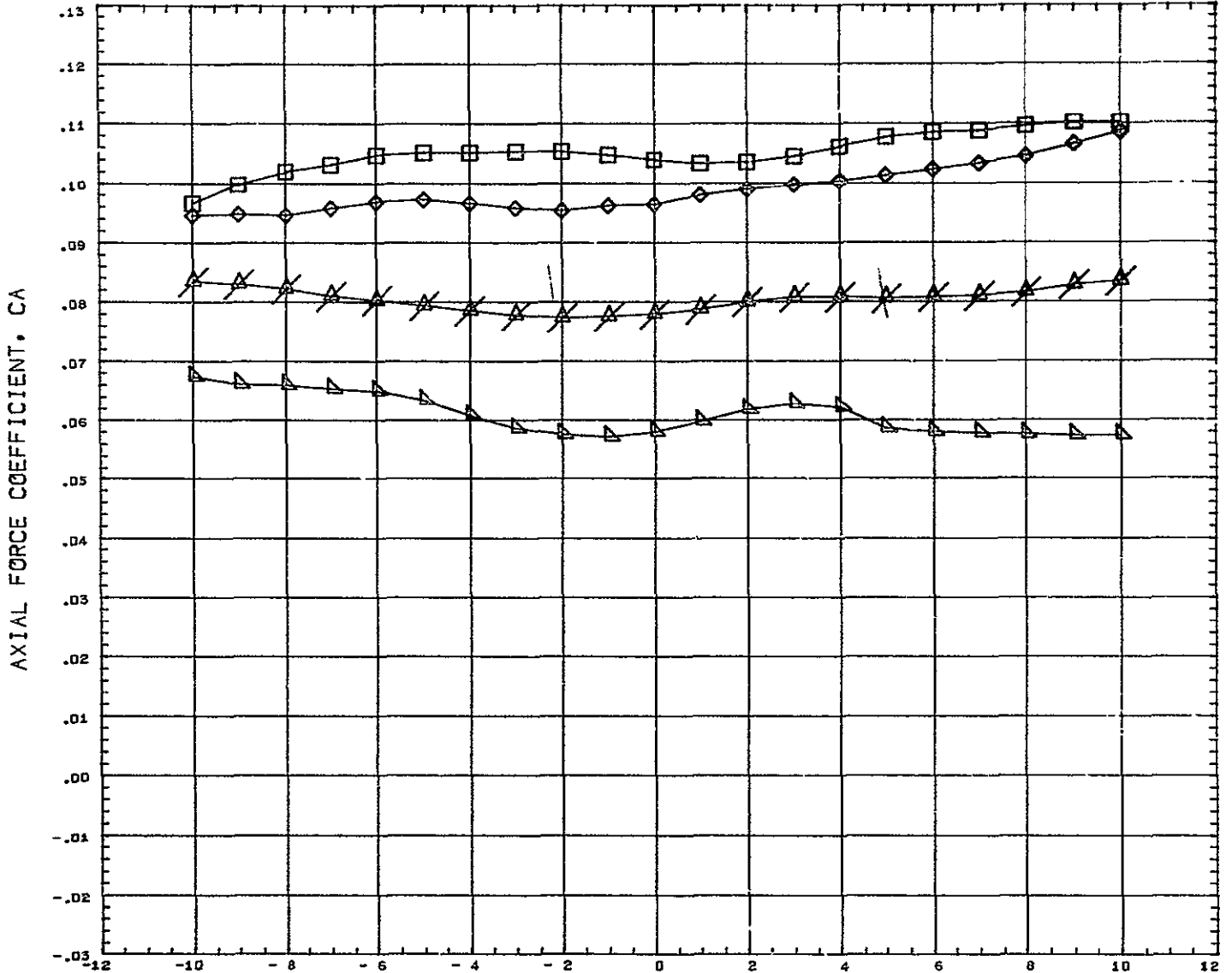

SYMBOL ◊ ◻ △	DELTA Z 0.182 0.228 0.352 10.000	<b>PARAMETRIC VALUES</b> BSTPOW 50.000 ORBPOW 100.000 DELTAX 0.228 ALPHA1 10.100 MACH 5.010 ELVBST 0.000 ELVORB 0.000 BETA 0.000	<b>REFERENCE INFORMATION</b> REFS 44.4440 SQ IN REFL 13.3330 IN REFB 13.3330 IN XMRP 7.5280 IN YMRP 0.0000 IN ZMRP 1.1940 IN SCALE 0.0055
REFERENCE FILE			

# AEDC VA 1163 MDAC BOOSTER AND ORBITER TEST DATA AT MACH NUMBER 5

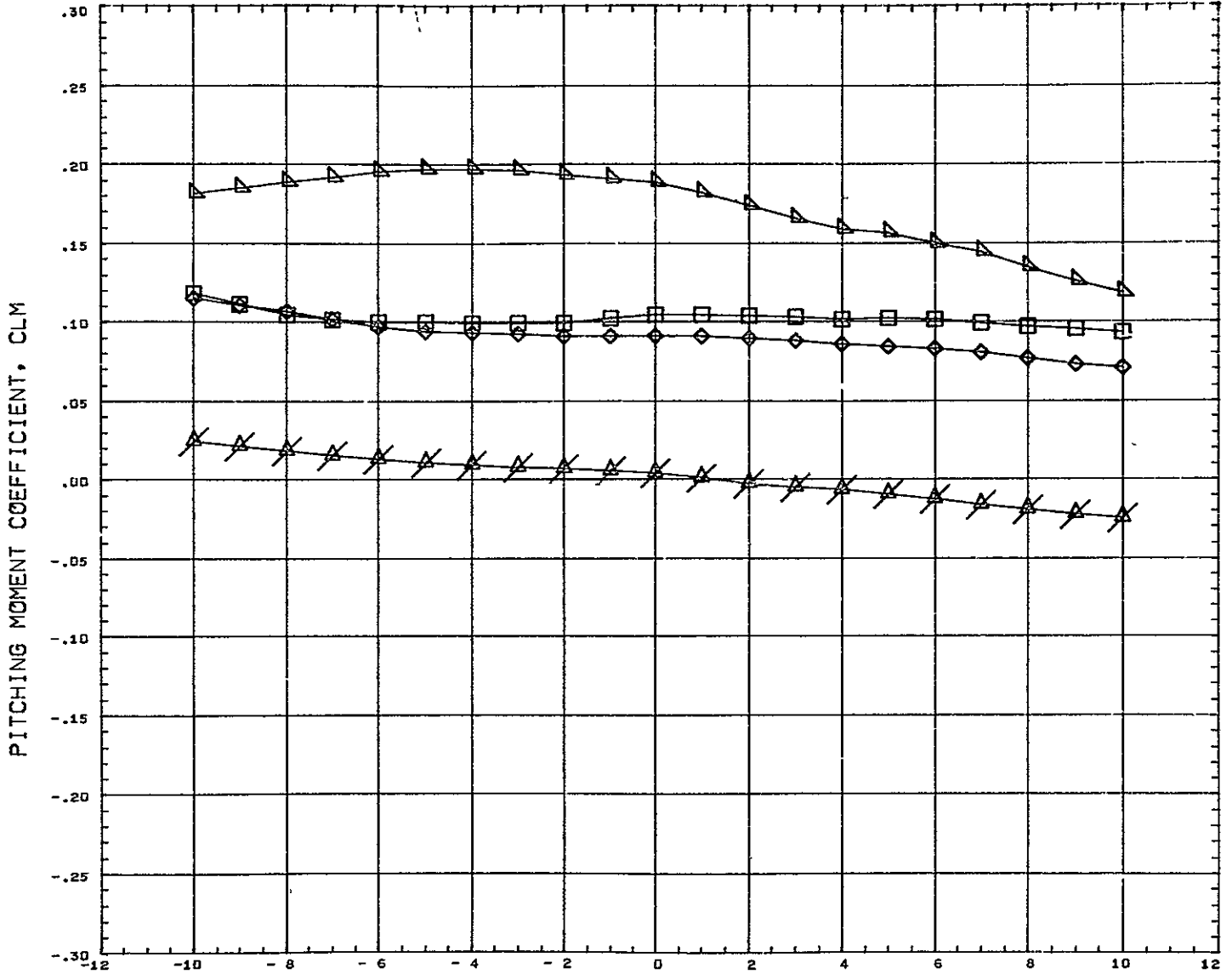

SYMBOL 	DELTAX 0.182 0.228 0.352 10.000	<table border="0" style="width: 100%;"> <tr> <th colspan="4" style="text-align: left; padding-left: 20px;">PARAMETRIC VALUES</th> </tr> <tr> <td style="padding-right: 20px;">BSTPOW</td> <td>50.000</td> <td style="padding-right: 20px;">ORBPOW</td> <td>100.000</td> </tr> <tr> <td>DELTA</td> <td>0.352</td> <td>ALPHA1</td> <td>10.100</td> </tr> <tr> <td>MACH</td> <td>5.010</td> <td>ELVBST</td> <td>0.000</td> </tr> <tr> <td>ELVORB</td> <td>0.000</td> <td>BETA</td> <td>0.000</td> </tr> </table>	PARAMETRIC VALUES				BSTPOW	50.000	ORBPOW	100.000	DELTA	0.352	ALPHA1	10.100	MACH	5.010	ELVBST	0.000	ELVORB	0.000	BETA	0.000	<table border="0" style="width: 100%;"> <tr> <th colspan="3" style="text-align: left;">REFERENCE INFORMATION</th> </tr> <tr> <td>REFS</td> <td>44.4440</td> <td>SQ IN</td> </tr> <tr> <td>REFL</td> <td>13.3330</td> <td>IN</td> </tr> <tr> <td>REFB</td> <td>13.3330</td> <td>IN</td> </tr> <tr> <td>XMRP</td> <td>7.5200</td> <td>IN</td> </tr> <tr> <td>YMRP</td> <td>0.0000</td> <td>IN</td> </tr> <tr> <td>ZMRP</td> <td>1.1940</td> <td>IN</td> </tr> <tr> <td>SCALE</td> <td>0.0055</td> <td></td> </tr> </table>	REFERENCE INFORMATION			REFS	44.4440	SQ IN	REFL	13.3330	IN	REFB	13.3330	IN	XMRP	7.5200	IN	YMRP	0.0000	IN	ZMRP	1.1940	IN	SCALE	0.0055	
PARAMETRIC VALUES																																															
BSTPOW	50.000	ORBPOW	100.000																																												
DELTA	0.352	ALPHA1	10.100																																												
MACH	5.010	ELVBST	0.000																																												
ELVORB	0.000	BETA	0.000																																												
REFERENCE INFORMATION																																															
REFS	44.4440	SQ IN																																													
REFL	13.3330	IN																																													
REFB	13.3330	IN																																													
XMRP	7.5200	IN																																													
YMRP	0.0000	IN																																													
ZMRP	1.1940	IN																																													
SCALE	0.0055																																														

REFERENCE FILE

# AEDC VA 1163 MDAC BOOSTER AND ORBITER TEST DATA AT MACH NUMBER 5

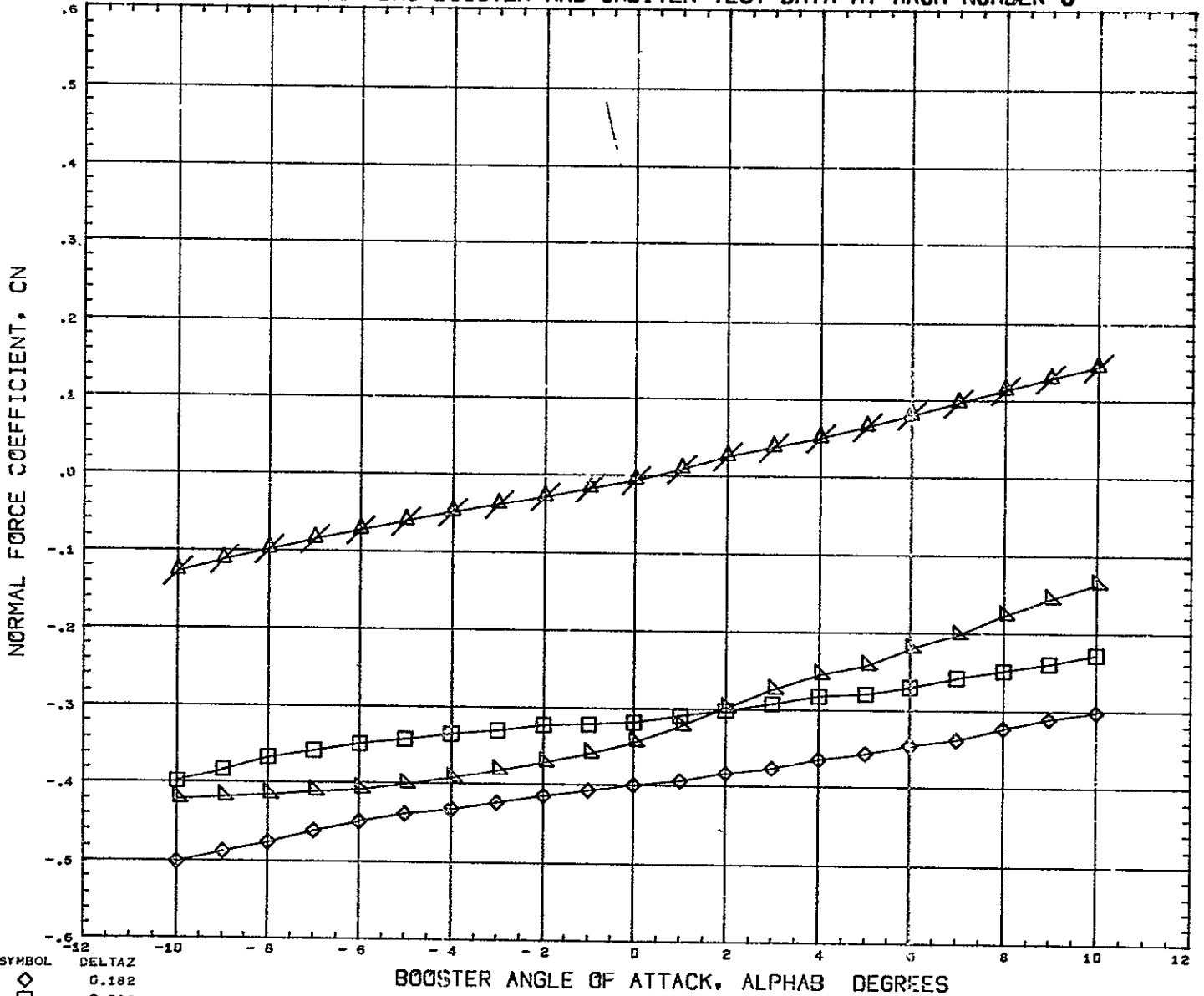

SYMBOL ◇ □ x	DELTA Z 0.182 0.228 0.352 10.000	PARAMETRIC VALUES BSTPCW 50.000 ORBPOW 100.000 DE' TAX 0.352 ALPHA 10 100 MACH 5.010 ELVBST 0.000 ELVORB 0.000 BETA 0.000	REFERENCE INFORMATION REFS 44.4440 SQ IN REFL 13.3330 IN REFB 13.3330 IN XHRP 7.5280 IN YHRP 0.0000 IN ZHRP 1.1940 IN SCALE 0.0055
REFERENCE FILE			

# AEDC VA 1163 MDAC BOOSTER AND ORBITER TEST DATA AT MACH NUMBER 5

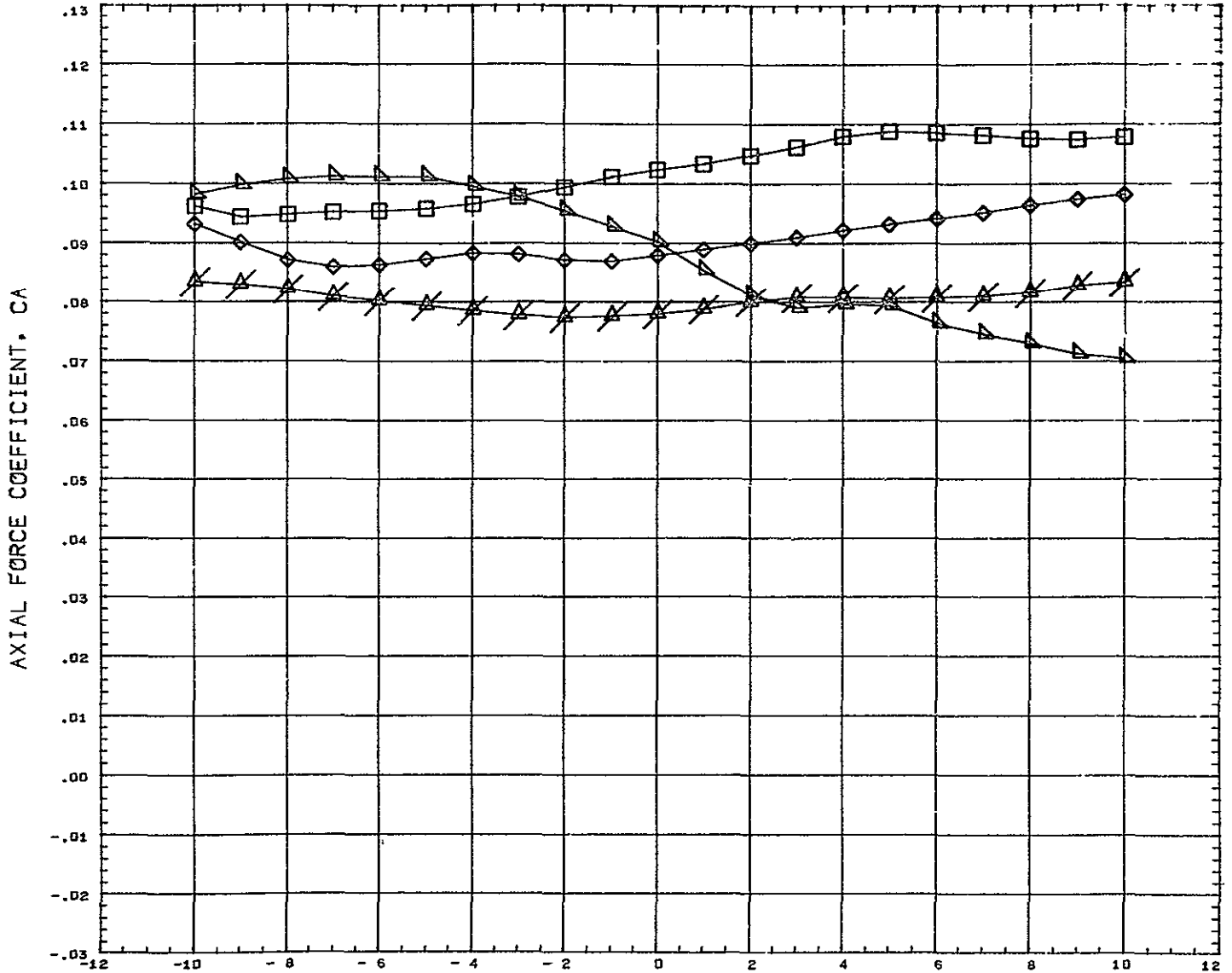

SYMBOL ◇ □ △ ×	DELTA Z 0.182 0.228 0.352 10.000	PARAMETRIC VALUES BSTPOW 50.000 ORBPOW 100.000 DELTAX 0.352 ALPHA1 10.100 MACH 5.010 ELVBST 0.000 ELVORB 0.000 BETA 0.000	REFERENCE INFORMATION REFS 44.444G SQ IN REFL 13.3330 IN REFB 13.3330 IN XMRP 7.5280 IN YMRP 0.0000 IN ZMRP 1.1940 IN SCALE 0.0055
----------------------------	--	---	---



# AEDC VA 1163 MDAC BOOSTER AND ORBITER TEST DATA AT MACH NUMBER 5

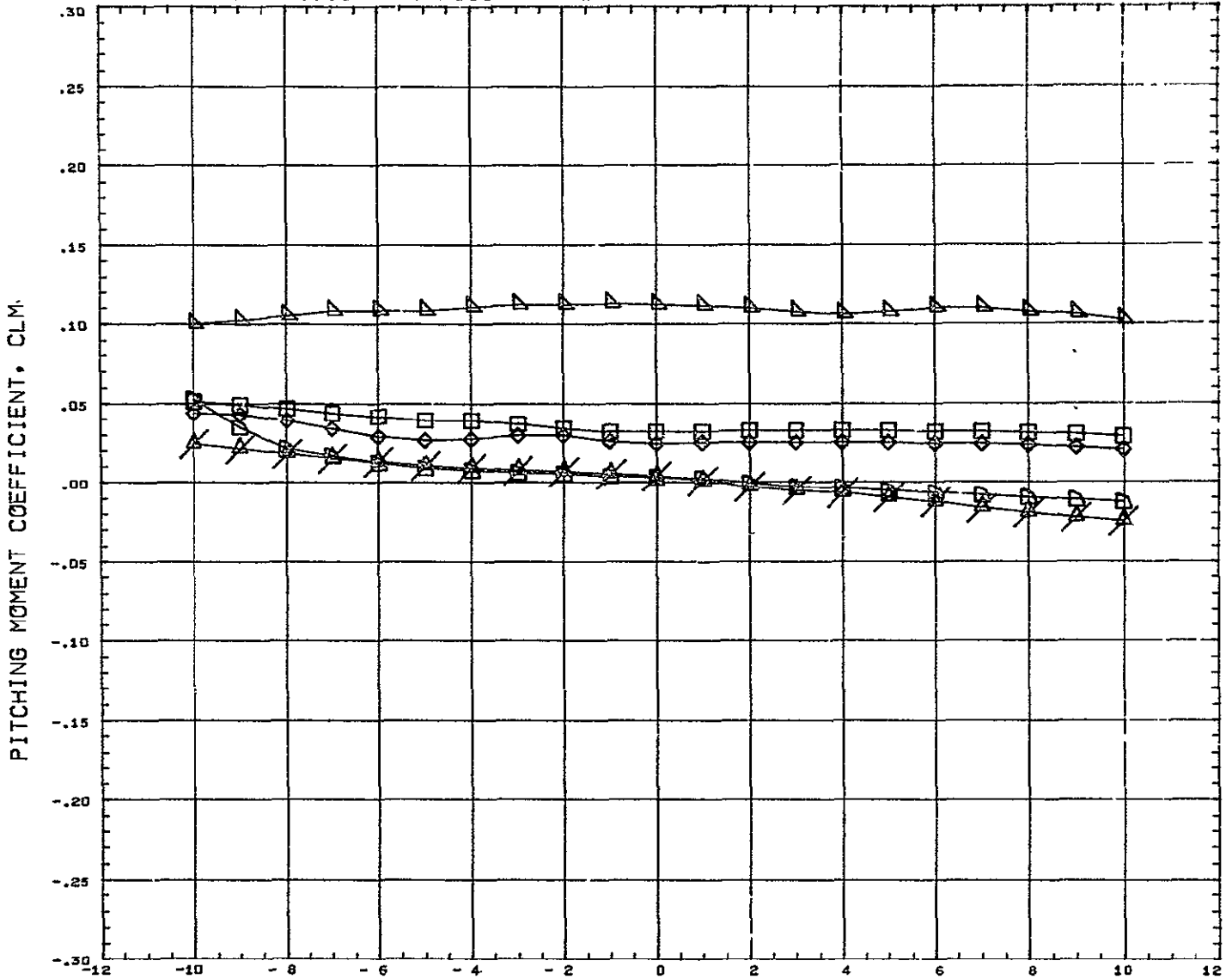

SYMBOL 	DELTAZ 0.182 0.228 0.352 0.539 10.000	<table border="0" style="width: 100%;"> <tr> <th colspan="4" style="text-align: left; padding-left: 20px;">PARAMETRIC VALUES</th> </tr> <tr> <td style="padding-right: 10px;">BSTPCW</td> <td style="padding-right: 10px;">50.000</td> <td style="padding-right: 10px;">ORBPOW</td> <td>100.000</td> </tr> <tr> <td>DELTA X</td> <td>0.501</td> <td>ALPHA I</td> <td>10.100</td> </tr> <tr> <td>MACH</td> <td>5.010</td> <td>ELVBST</td> <td>0.000</td> </tr> <tr> <td>ELVORB</td> <td>0.000</td> <td>BETA</td> <td>0.000</td> </tr> </table>	PARAMETRIC VALUES				BSTPCW	50.000	ORBPOW	100.000	DELTA X	0.501	ALPHA I	10.100	MACH	5.010	ELVBST	0.000	ELVORB	0.000	BETA	0.000	<table border="0" style="width: 100%;"> <tr> <th colspan="3" style="text-align: left; padding-left: 20px;">REFERENCE INFORMATION</th> </tr> <tr> <td style="padding-right: 10px;">REFS</td> <td style="padding-right: 10px;">77.4440</td> <td>SO IN</td> </tr> <tr> <td>REFL</td> <td>13.3330</td> <td>IN</td> </tr> <tr> <td>REFB</td> <td>13.3330</td> <td>IN</td> </tr> <tr> <td>XMRP</td> <td>7.5280</td> <td>IN</td> </tr> <tr> <td>YMRP</td> <td>0.0000</td> <td>IN</td> </tr> <tr> <td>ZMRP</td> <td>1.1940</td> <td>IN</td> </tr> <tr> <td>SCALE</td> <td>0.0055</td> <td></td> </tr> </table>	REFERENCE INFORMATION			REFS	77.4440	SO IN	REFL	13.3330	IN	REFB	13.3330	IN	XMRP	7.5280	IN	YMRP	0.0000	IN	ZMRP	1.1940	IN	SCALE	0.0055	
PARAMETRIC VALUES																																															
BSTPCW	50.000	ORBPOW	100.000																																												
DELTA X	0.501	ALPHA I	10.100																																												
MACH	5.010	ELVBST	0.000																																												
ELVORB	0.000	BETA	0.000																																												
REFERENCE INFORMATION																																															
REFS	77.4440	SO IN																																													
REFL	13.3330	IN																																													
REFB	13.3330	IN																																													
XMRP	7.5280	IN																																													
YMRP	0.0000	IN																																													
ZMRP	1.1940	IN																																													
SCALE	0.0055																																														

REFERENCE FILE

# AEDC VA 1163 MDAC BOOSTER AND ORBITER TEST DATA AT MACH NUMBER 5

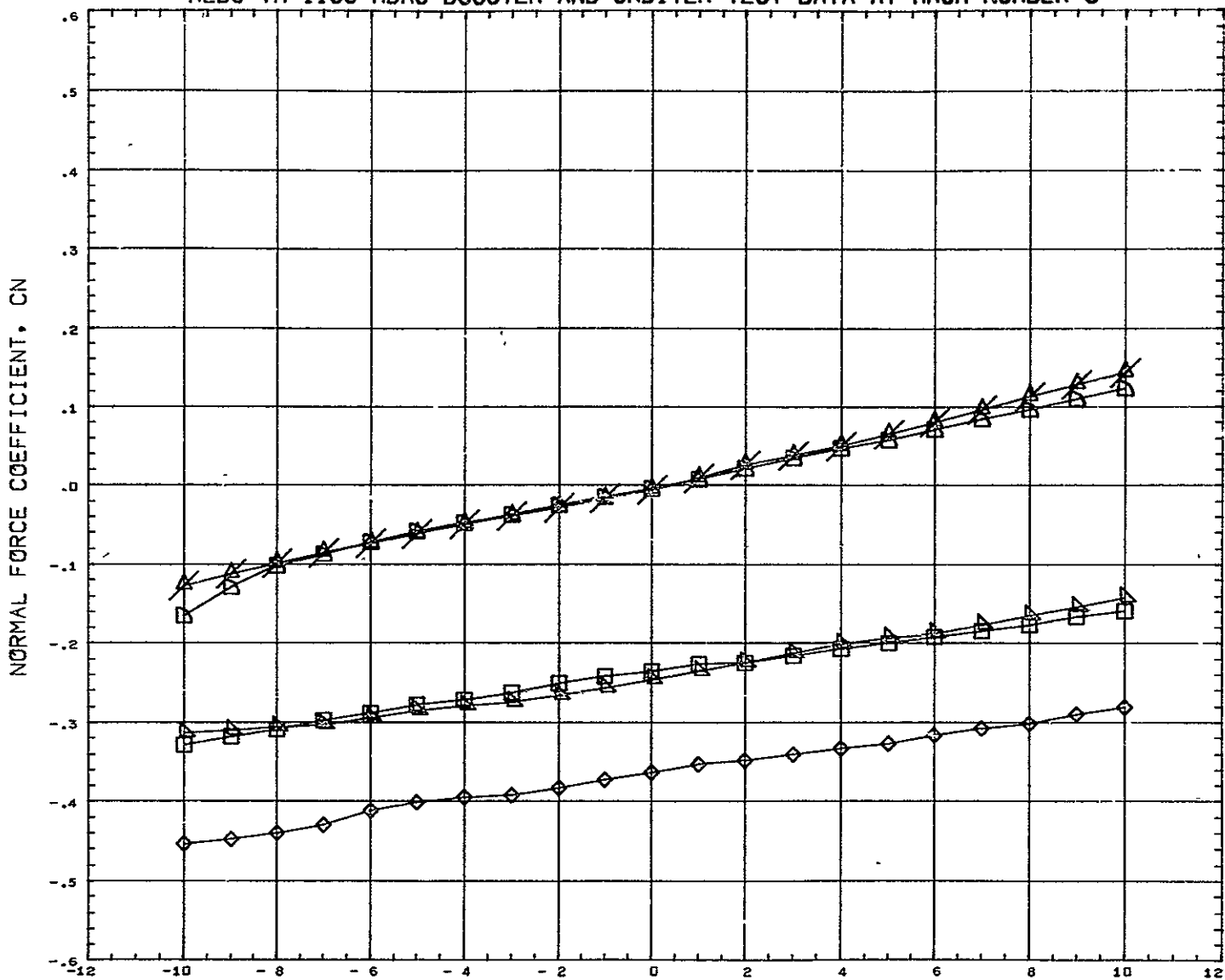

SYMBOL ◇ □ △ ▲	DELTAZ 0.182 0.228 0.352 0.599 10.000	PARAMETRIC VALUES BSTPOW 50.000 ORBPOW 100.000 DELTAX 0.501 ALPHAI 10.100 MACH 5.010 ELVBST 0.000 ELVORB 0.000 BETA 0.000	REFERENCE INFORMATION RCFS 1.4440 SQ IN PEFL 13.3330 IN REFB 13.3330 IN XMRP 7.5280 IN YMRP 0.0000 IN ZMRP 1.1940 IN SCALE 0.0055
----------------------------	--	---	--

REFERENCE FILE

# AEDC VA 1163 MDAC BOOSTER AND ORBITER TEST DATA AT MACH NUMBER 5

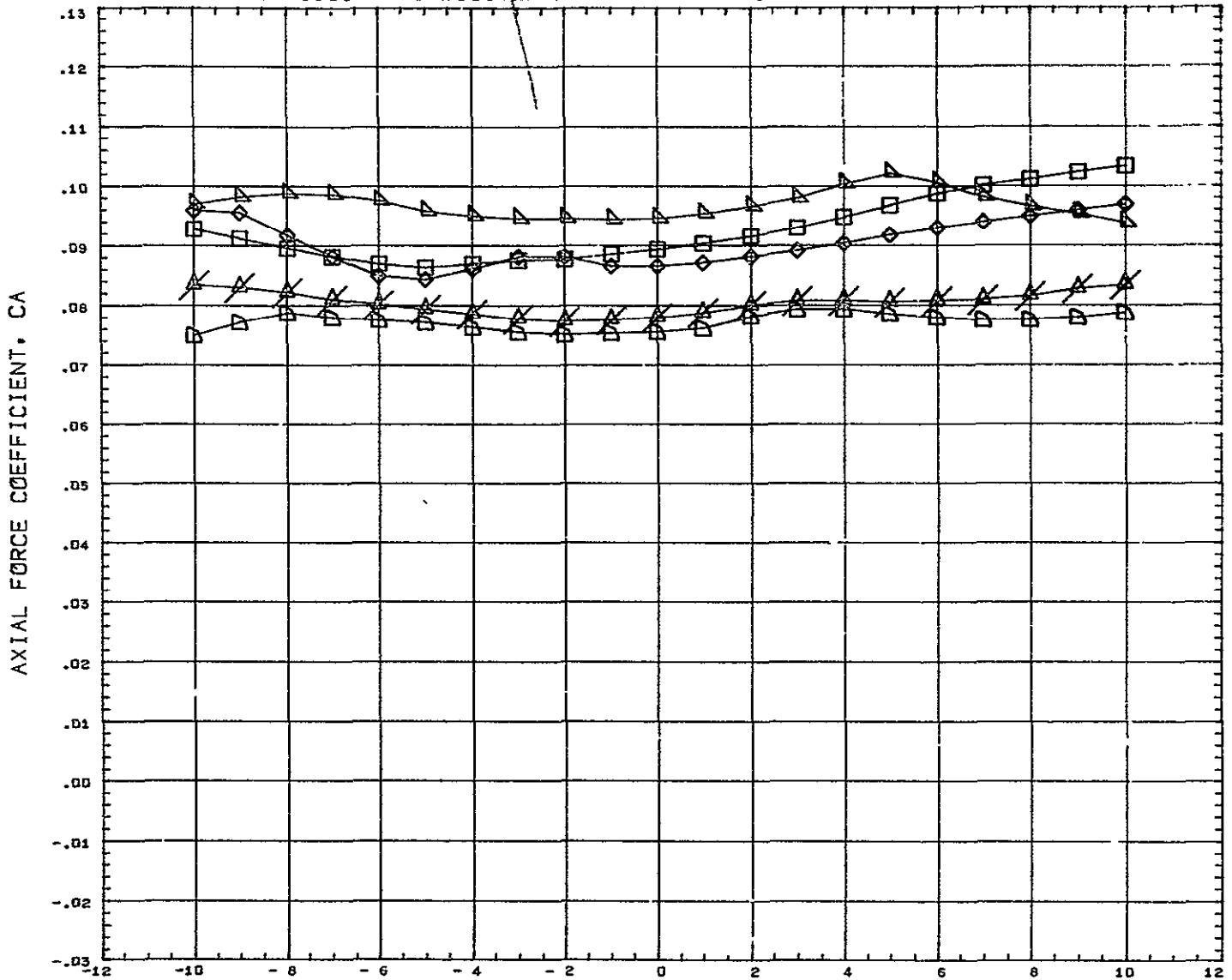

SYMBOL 	DELTAX 0.182 0.228 0.352 0.599 10.000	PARAMETRIC VALUES BSTFOW 50.000 ORBPOW 100.000 DELTAX 0.501 ALPHAI 10.100 ELVORB 0.000 ELVBST 0.000 BETA 0.000	REFERENCE INFORMATION REFS 1.4440 SQ IN REFL 13.3330 IN REFB 13.3330 IN XMRP 7.5280 IN YMRP 0.0000 IN ZMRP 1.1940 IN SCALE 0.0055
------------	--	--	--

REFERENCE FILE

# AEDC VA 1163 MDAC BOOSTER AND ORBITER TEST DATA AT MACH NUMBER 5

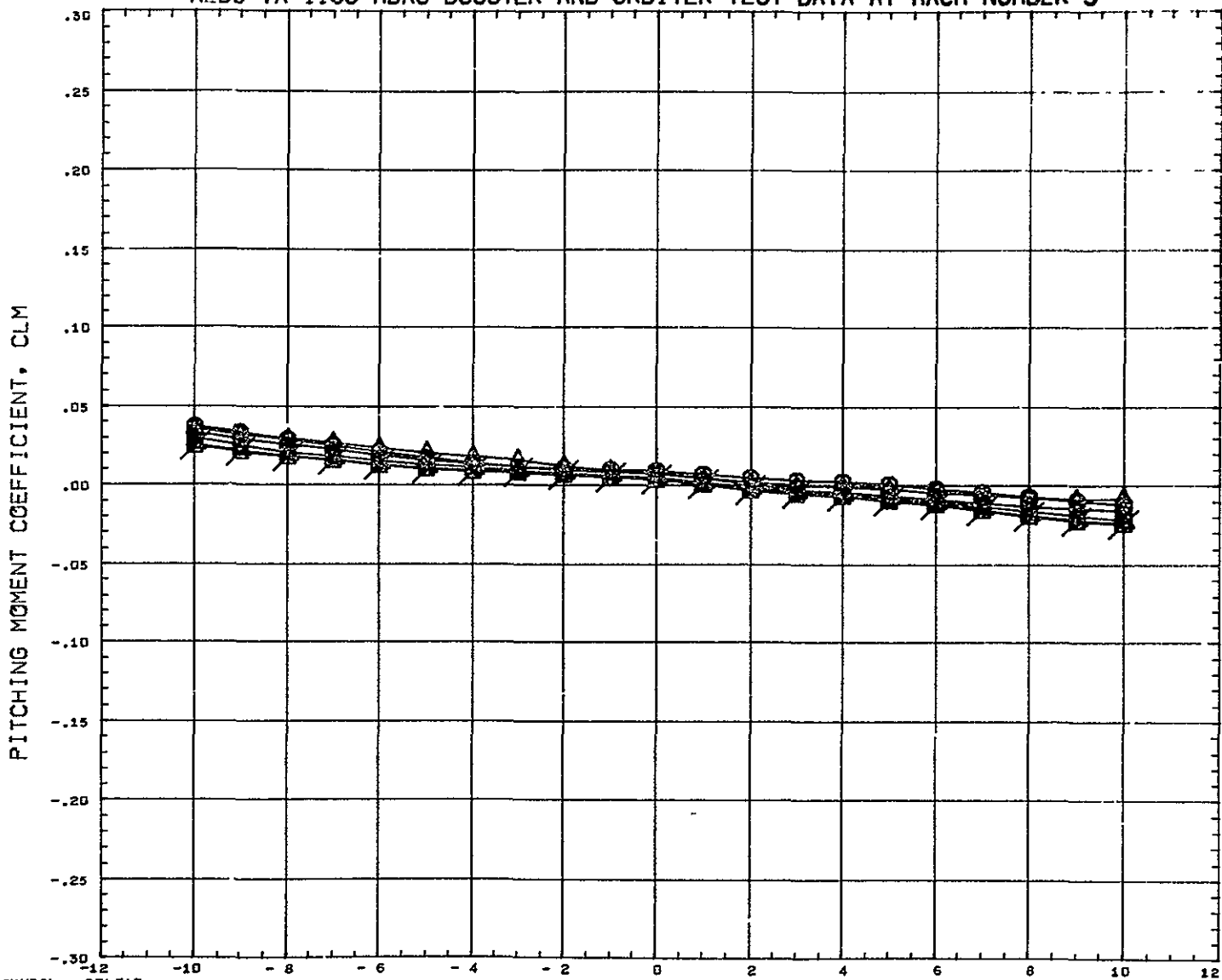

SYMBOL	DELTA Z	PARAMETRIC VALUES		REFERENCE INFORMATION						
$\Delta$ $\square$ $\diamond$ $\circ$ $\triangle$ $\times$ $\square$ $\diamond$ $\circ$ $\triangle$ $\times$	0.120	BSTPOW	50.000	ORBPOW	100.000	REFS	4	4440	SQ	IN
	0.151	DELTA X	- 0.391	ALPHA I	- 4.900	REFL	13	3330	IN	IN
	0.182	M CH	5.010	ELVBST	0.000	REFB	13	3330	IN	IN
	0.228	ELVORB	0.000	BEJA	0.000	XMRP	7.5280	IN	IN	IN
	0.352					YMRP	0.0000	IN	IN	IN
	0.599					ZMRP	1.1940	IN	IN	IN
	10.000	REFERENCE FILE				SCALE	0.0055			

# AEDC VA 1163 MDAC BOOSTER AND ORBITER TEST DATA AT MACH NUMBER 5

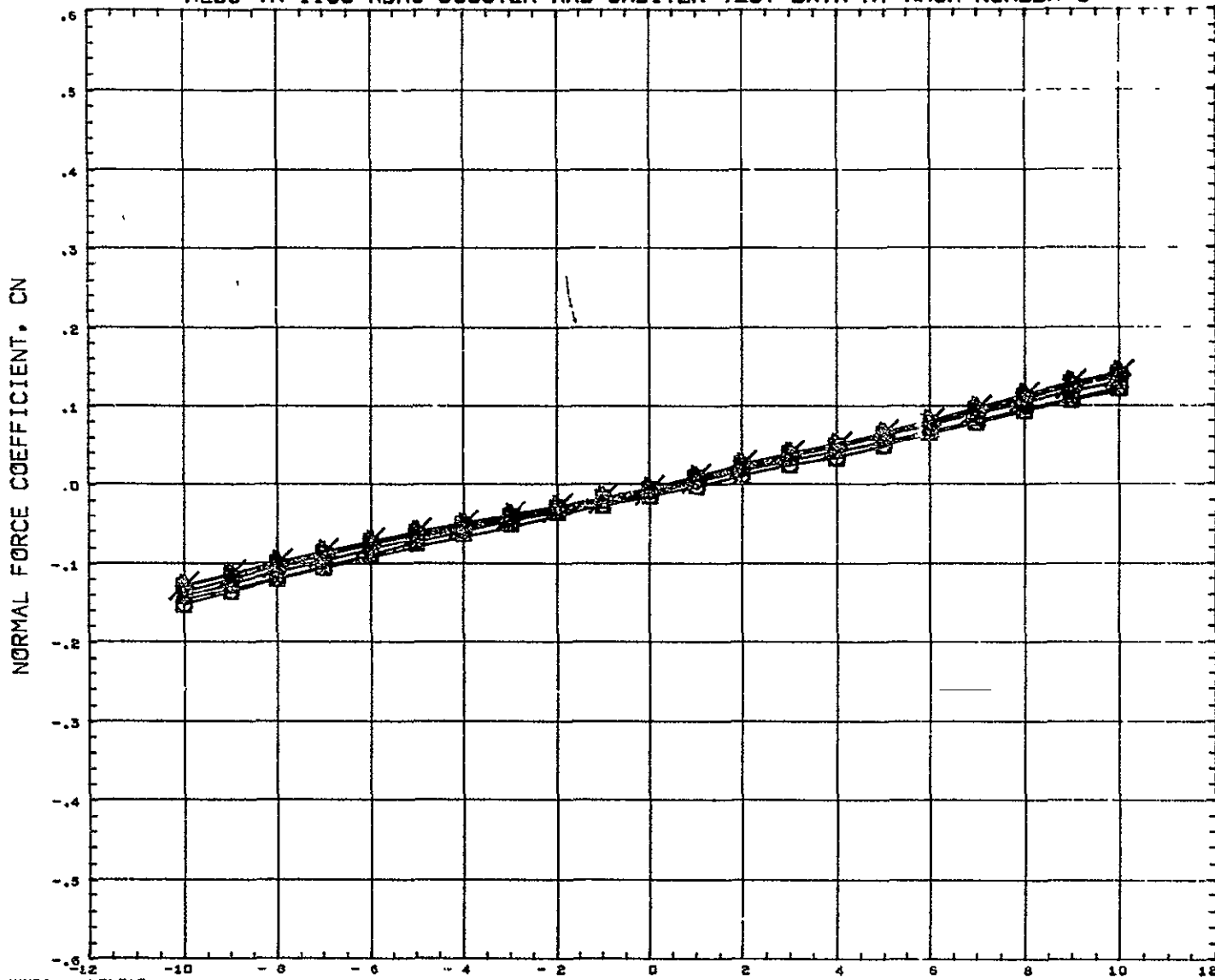

SYMBOL ○ ◇ □ △ ×	DELTAX 0.120 0.151 0.182 0.228 0.352 0.599 10.000	PARAMETRIC VALUES BSTPOW 50.000    ORBPOW 100.000 DELTAX - 0.391    ALPHAI - 4.900 IICH 5.010    ELVBST 0.000 ELVORB 0.000    BETA 0.000	REFERENCE INFORMATION REFS 1,4440    90 IN REFL 13.3330    IN REFB 13.3330    IN XHRP 7.5280    IN YHRP 0.0000    IN ZHRP 1.1940    IN SCALE 0.0055
REFERENCE FILE			

# AEDC VA 1163 MDAC BOOSTER AND ORBITER TEST DATA AT MACH NUMBER 5

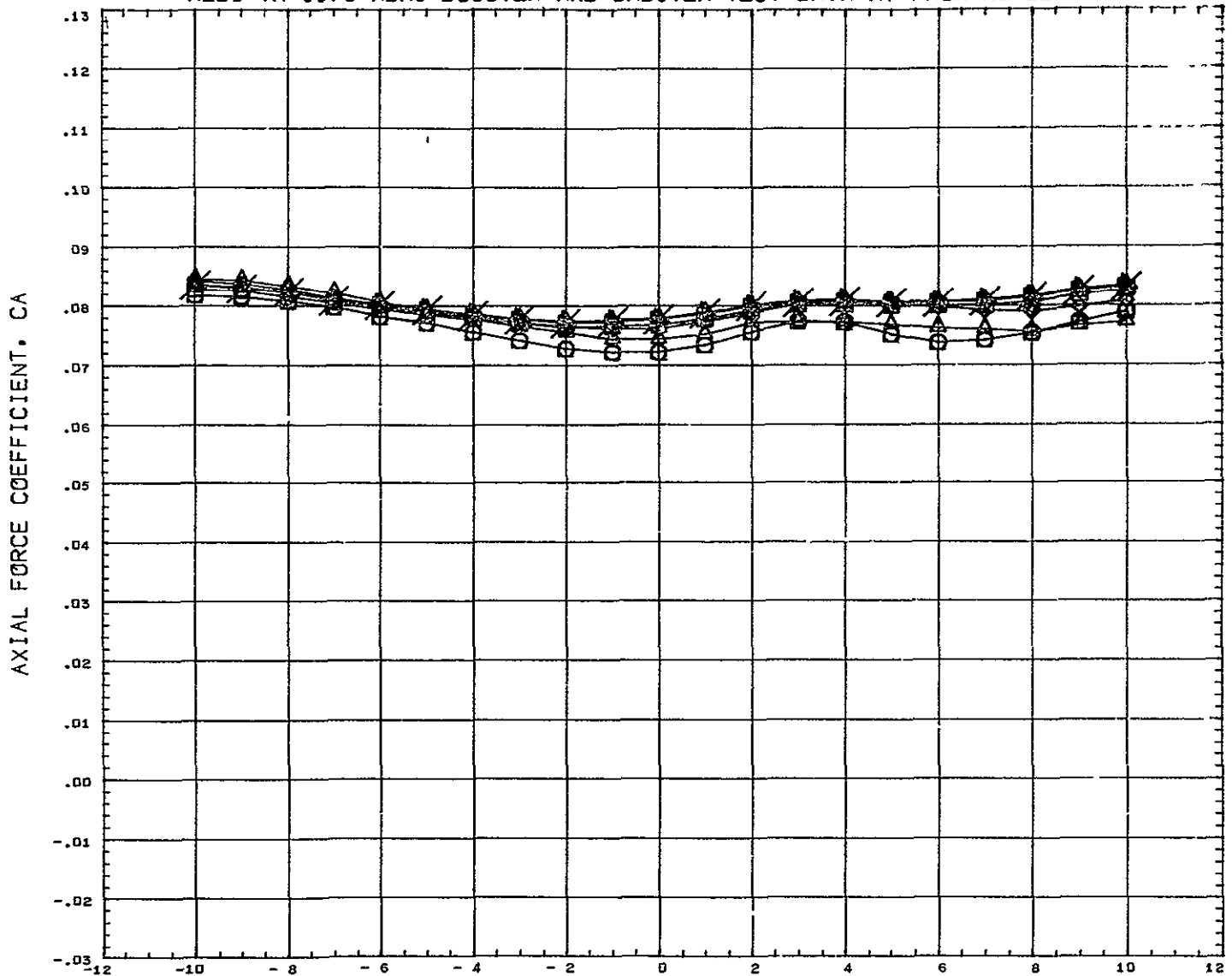

SYMBOL ○ ◇ △ □ ×	DELTAZ 0.120 0.151 0.182 0.228 0.352 0.599 10.000	<b>PARAMETRIC VALUES</b> BSTFOW 50.000 ORBPOW 100.000 DELTAX - 0.391 ALPHAI - 4.900 MACH 5.010 ELVBST 0.000 ELVORB 0.000 BETA 0.000	<b>REFERENCE INFORMATION</b> REFS 44.4440 SQ IN REFL 13.3330 IN REFB 13.3330 IN XNRP 7.5280 IN YNRP 0.0000 IN ZNRP 1.1940 IN SCALE 0.0055
	1 REFERENCE FILE		

# AEDC VA 1163 MDAC BOOSTER AND ORBITER TEST DATA AT MACH NUMBER 5

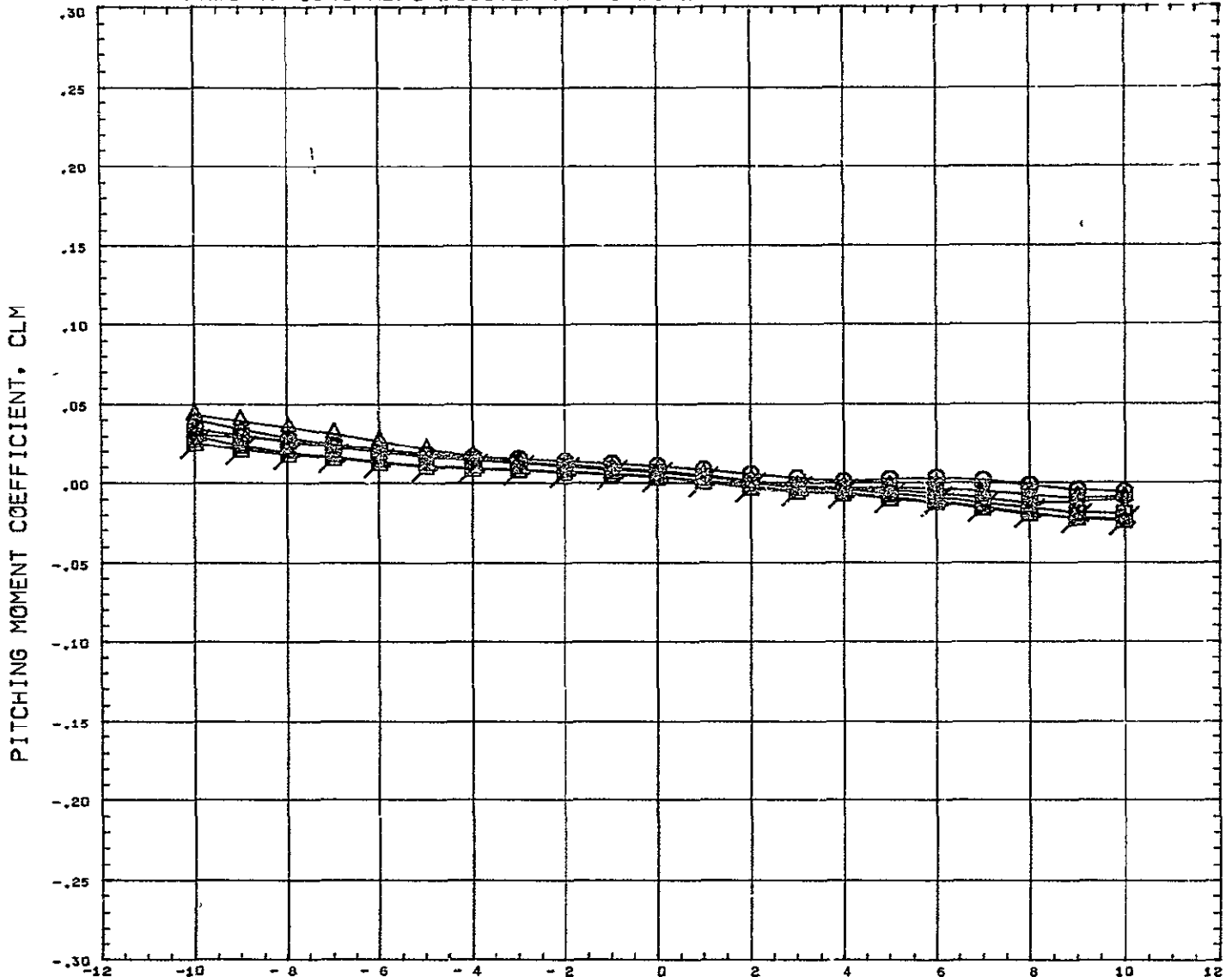

SYMBOL 0.120 0.151 0.182 0.228 0.352 0.599 10.000 	DELTAZ 0.120 0.151 0.182 0.228 0.352 0.599 10.000	PARAMETRIC VALUES BSTFOW 50.000 ORBPOW 100.000 DELTAX - 0.143 ALPHAI - 4.900 MACH 5.010 ELVBST 0.000 ELVORB 0.000 BETA 0.000	REFERENCE INFORMATION REFS 44.4440 SQ IN REFL 13.3330 IN REFB 13.3330 IN XMRP 7.5280 IN YMRP 0.0000 IN ZMRP 1.1940 IN SCALE 0.0055
REFERENCE FILE			

# AEDC VA 1163 MDAC BOOSTER AND ORBITER TEST DATA AT MACH NUMBER 5

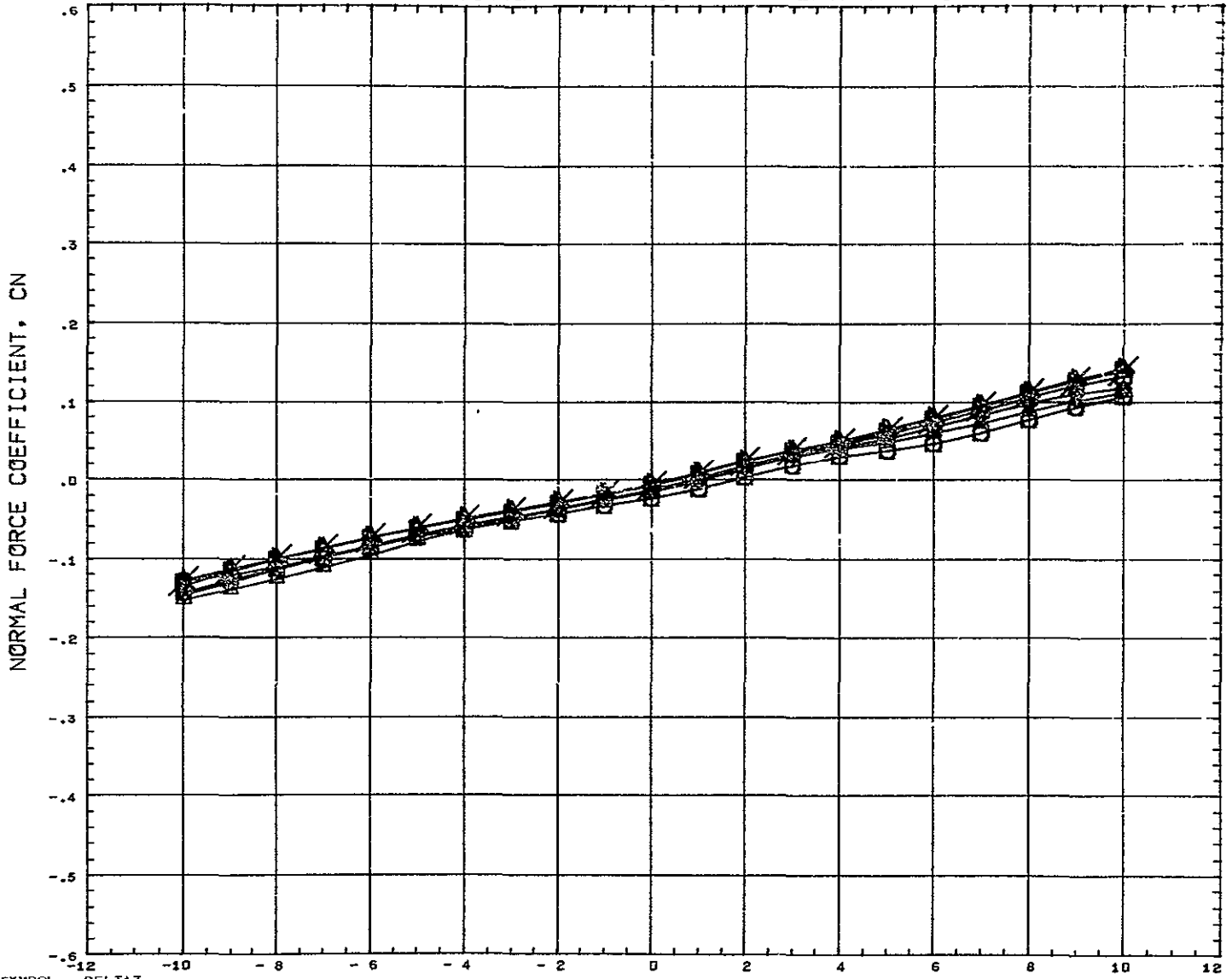

SYMBOL 	DELTAX 0.120 0.151 0.182 0.228 0.352 0.599 10.000	PARAMETRIC VALUES BSTPOW 50.000 ORBFOW 100.000 DELTAX - 0.143 ALPHAI - 4.900 MACH 5.010 ELVBST 0.000 ELVORB 0.000 BETA 0.000	REFERENCE INFORMATION REFS 44.4440 SQ IN REFL 13.3330 IN REFB 13.3330 IN XMRP 7.5280 IN YMRP 0.0000 IN ZMRP 1.1940 IN SCALE 0.0055
REFERENCE FILE			



# AEDC VA 1163 MDAC BOOSTER AND ORBITER TEST DATA AT MACH NUMBER 5

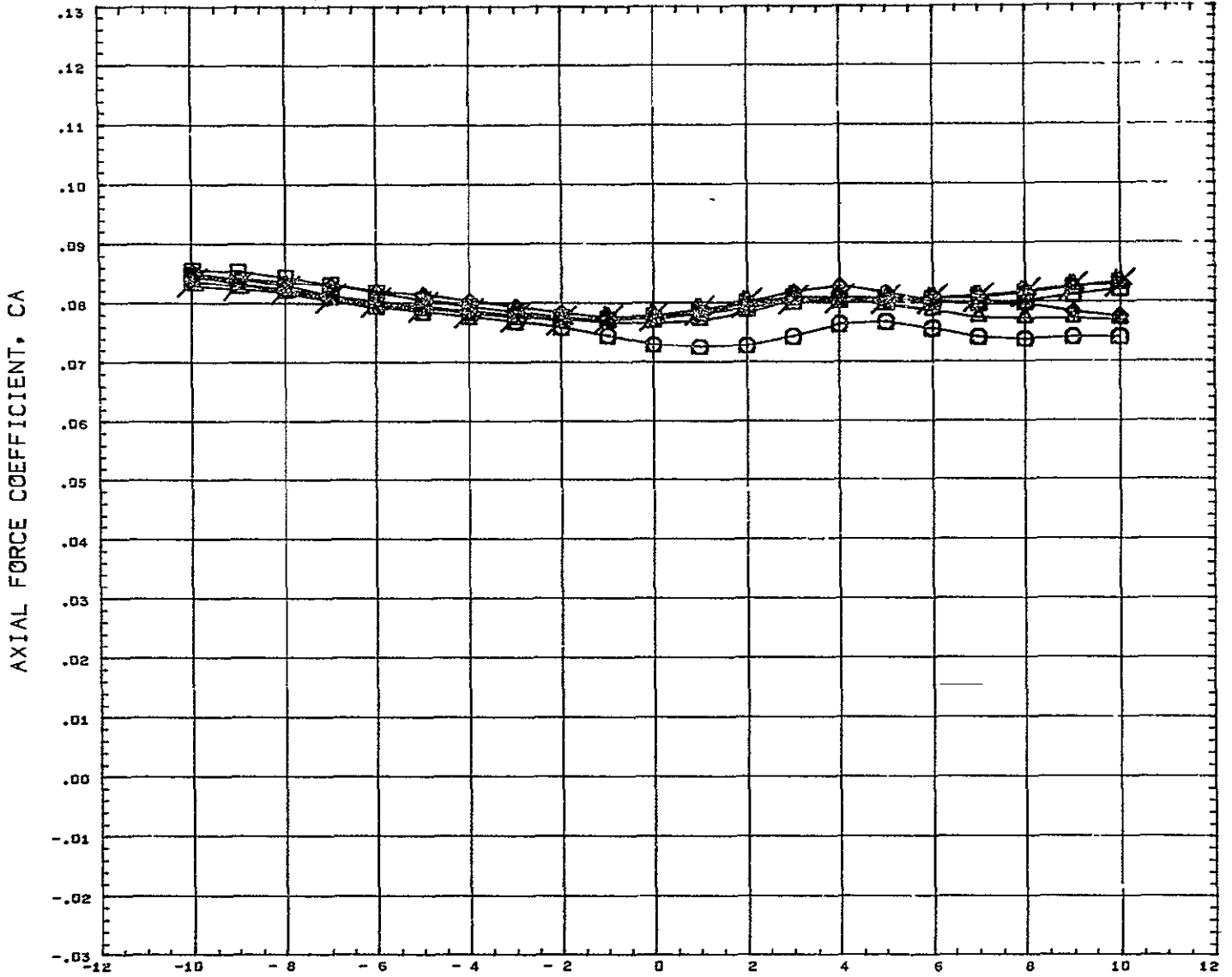

SYMBOL ○ □ △ ◇ ×	DELTAZ 0.120 0.151 0.182 0.228 0.352 0.599 10.000	<b>PARAMETRIC VALUES</b> BSTPOW    50.000    ORBPOW    100.000 DELTAX    - 0.143    ALPHAI    - 4.900 MACH       5.010    ELVBST    0.000 ELVORB     0.000    BETA       0.000	<b>REFERENCE INFORMATION</b> REFS       11.4440    SQ IN REFL       13.3330    IN REFB       13.3330    IN XMRP       7.5280    IN YMRP       0.0000    IN ZMRP       1.1940    IN SCALE      0.0055
REFERENCE FILE			

# AEDC VA 1163 MDAC BOOSTER AND ORBITER TEST DATA AT MACH NUMBER 5

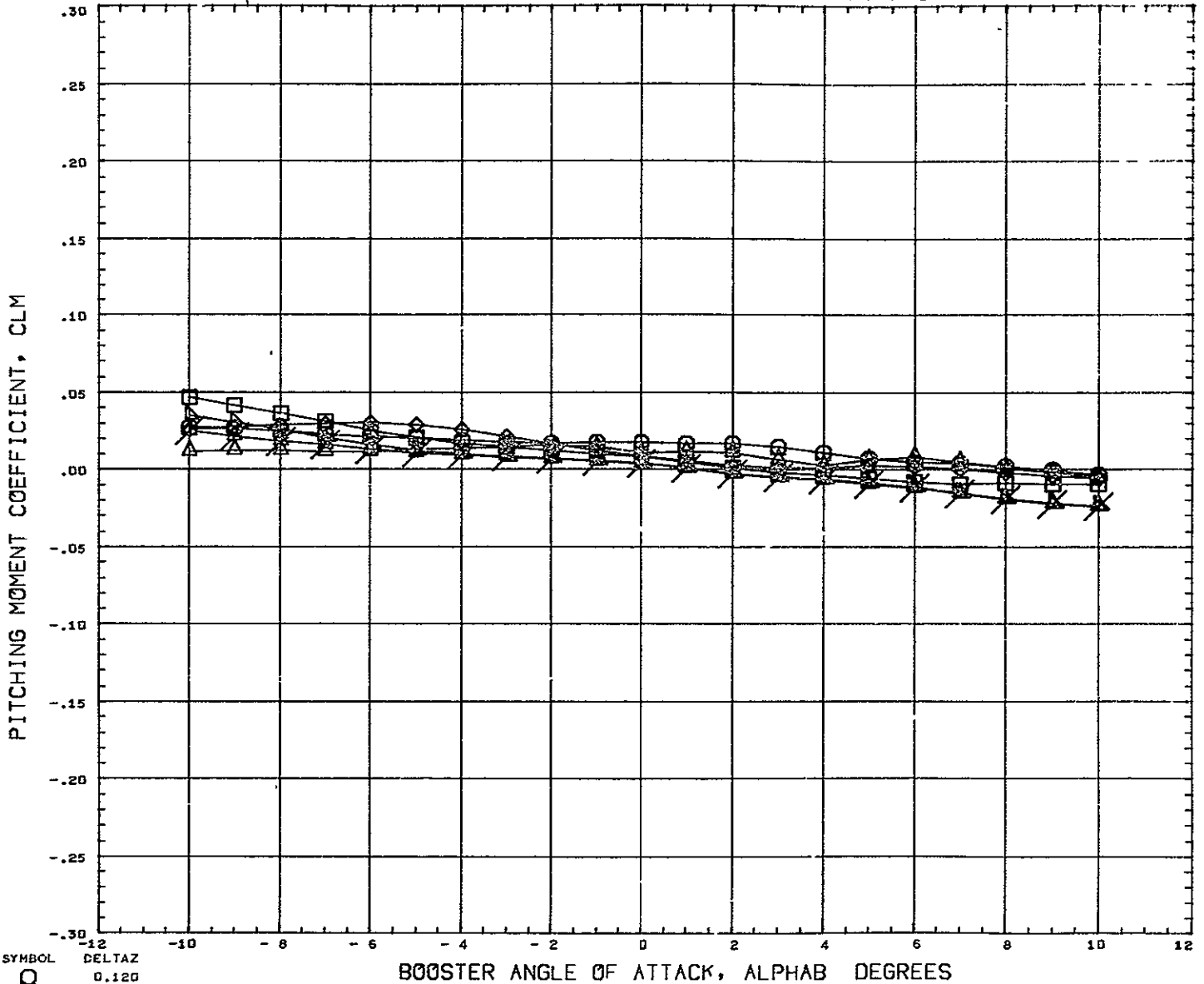

SYMBOL	DELTAZ	PARAMETRIC VALUES			
○	0.120	BSTFOW	50.000	ORBFOW	100.000
◇	0.151	DELTAZ	0.019	ALPHAI	4.900
△	0.182	M.H	5.010	ELVBST	0.000
□	0.228	ELVORB	0.000	BETA	0.000
○	0.352				
△	10.000				

REFERENCE INFORMATION		
REFS	44 4440	SQ IN
REFL	13.3330	IN
REFB	13.3330	IN
XMRP	7.5280	IN
YMRP	0.0000	IN
ZMRP	1.1940	IN
SCALE	0.0055	

REFERENCE FILE

AEDC VA 1163 MDAC BOOSTER AND ORBITER TEST DATA AT MACH NUMBER 5

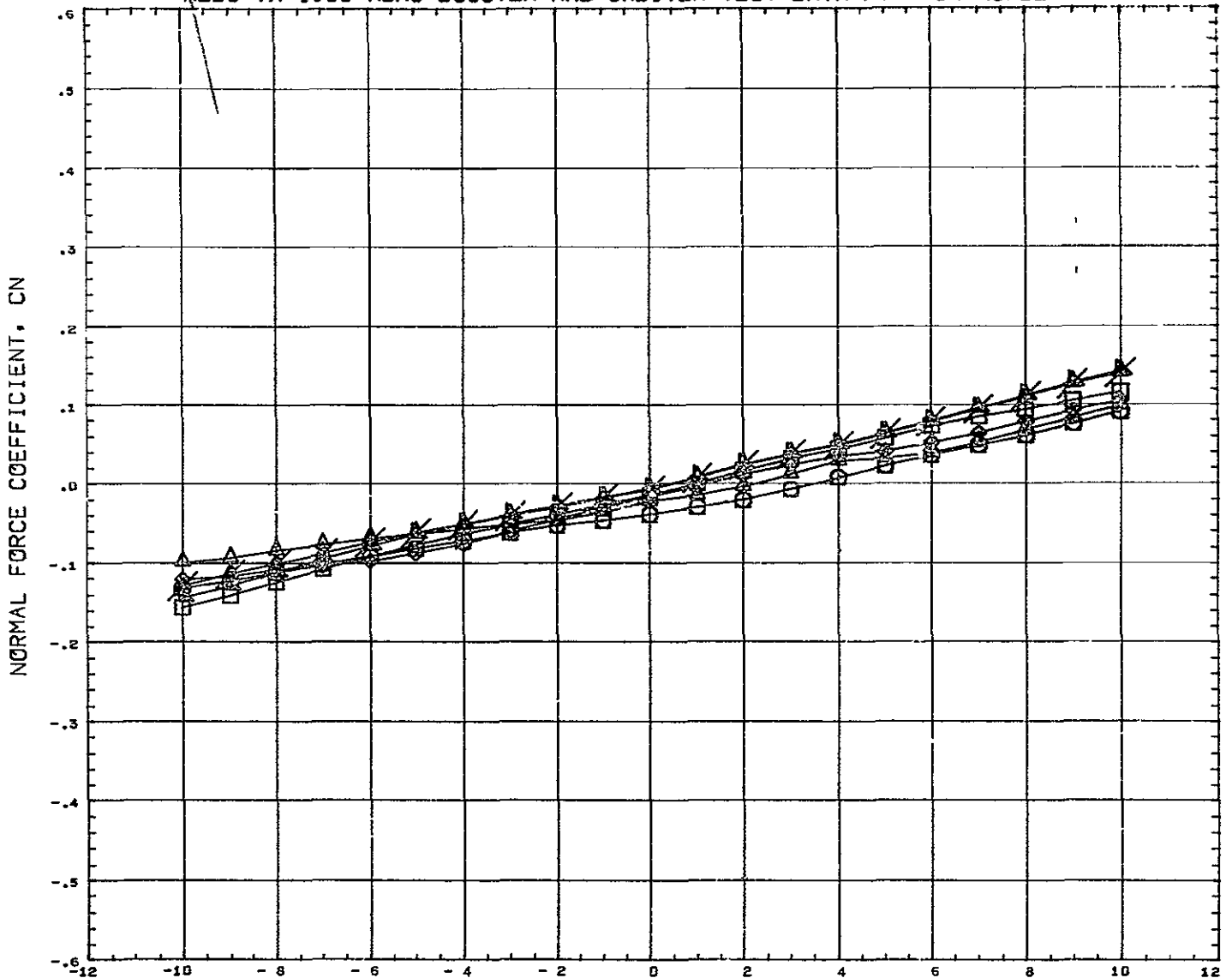

SYMBOL	DELTAZ	PARAMETRIC VALUES				REFERENCE INFORMATION	
△	0.120	BSTPOW	50.000	ORBPOW	100.000	REFS	44.4440 IN
◻	0.151	DELTAZ	- 0.019	ALPHA1	- 4.900	REFL	13.3330 IN
◊	0.182	MACH	5.010	ELVBST	0.000	REFB	13.3330 IN
○	0.228	ELVORB	0.000	BETA	0.000	XMRF	7.5280 IN
×	0.352					YMRF	0.0000 IN
	10.000					ZMRF	1.1940 IN
						SCALE	0.0055

REFERENCE FILE

# AEDC VA 1163 MDAC BOOSTER AND ORBITER TEST DATA AT MACH NUMBER 5

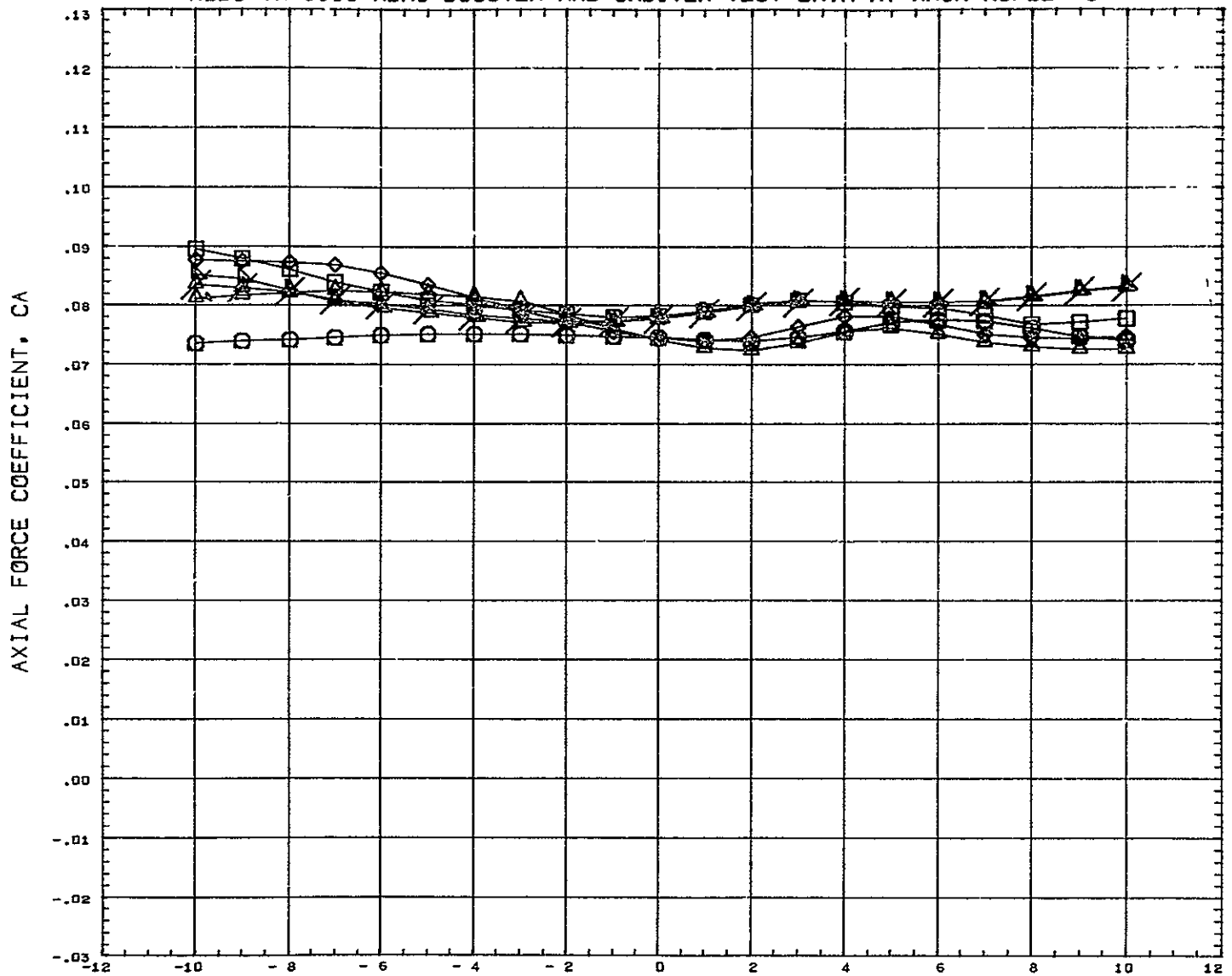

SYMBOL ○ ◇ □ △	DELTAZ 0.120 0.151 0.182 0.228 0.352 10.000	<table border="0" style="width: 100%;"> <tr> <th colspan="4" style="text-align: center;">PARAMETRIC VALUES</th> </tr> <tr> <td>BSTPOW</td> <td>50.000</td> <td>ORBPOW</td> <td>100.000</td> </tr> <tr> <td>DELTAZ</td> <td>0.019</td> <td>ALPHA1</td> <td>4.900</td> </tr> <tr> <td>MACH</td> <td>5.010</td> <td>ELVBST</td> <td>0.000</td> </tr> <tr> <td>ELVORB</td> <td>0.000</td> <td>BETA</td> <td>0.000</td> </tr> </table>	PARAMETRIC VALUES				BSTPOW	50.000	ORBPOW	100.000	DELTAZ	0.019	ALPHA1	4.900	MACH	5.010	ELVBST	0.000	ELVORB	0.000	BETA	0.000	<table border="0" style="width: 100%;"> <tr> <th colspan="3" style="text-align: center;">REFERENCE INFORMATION</th> </tr> <tr> <td>REFS</td> <td>4.4440</td> <td>SQ IN</td> </tr> <tr> <td>REFL</td> <td>13.3330</td> <td>IN</td> </tr> <tr> <td>REFB</td> <td>13.3330</td> <td>IN</td> </tr> <tr> <td>XMRP</td> <td>7.5280</td> <td>IN</td> </tr> <tr> <td>YMRP</td> <td>0.0000</td> <td>IN</td> </tr> <tr> <td>ZMRP</td> <td>1.1940</td> <td>IN</td> </tr> <tr> <td>SCALE</td> <td>0.0055</td> <td></td> </tr> </table>	REFERENCE INFORMATION			REFS	4.4440	SQ IN	REFL	13.3330	IN	REFB	13.3330	IN	XMRP	7.5280	IN	YMRP	0.0000	IN	ZMRP	1.1940	IN	SCALE	0.0055	
PARAMETRIC VALUES																																															
BSTPOW	50.000	ORBPOW	100.000																																												
DELTAZ	0.019	ALPHA1	4.900																																												
MACH	5.010	ELVBST	0.000																																												
ELVORB	0.000	BETA	0.000																																												
REFERENCE INFORMATION																																															
REFS	4.4440	SQ IN																																													
REFL	13.3330	IN																																													
REFB	13.3330	IN																																													
XMRP	7.5280	IN																																													
YMRP	0.0000	IN																																													
ZMRP	1.1940	IN																																													
SCALE	0.0055																																														

REFERENCE FILE

# AEDC VA 1163 MDAC BOOSTER AND ORBITER TEST DATA AT MACH NUMBER 5

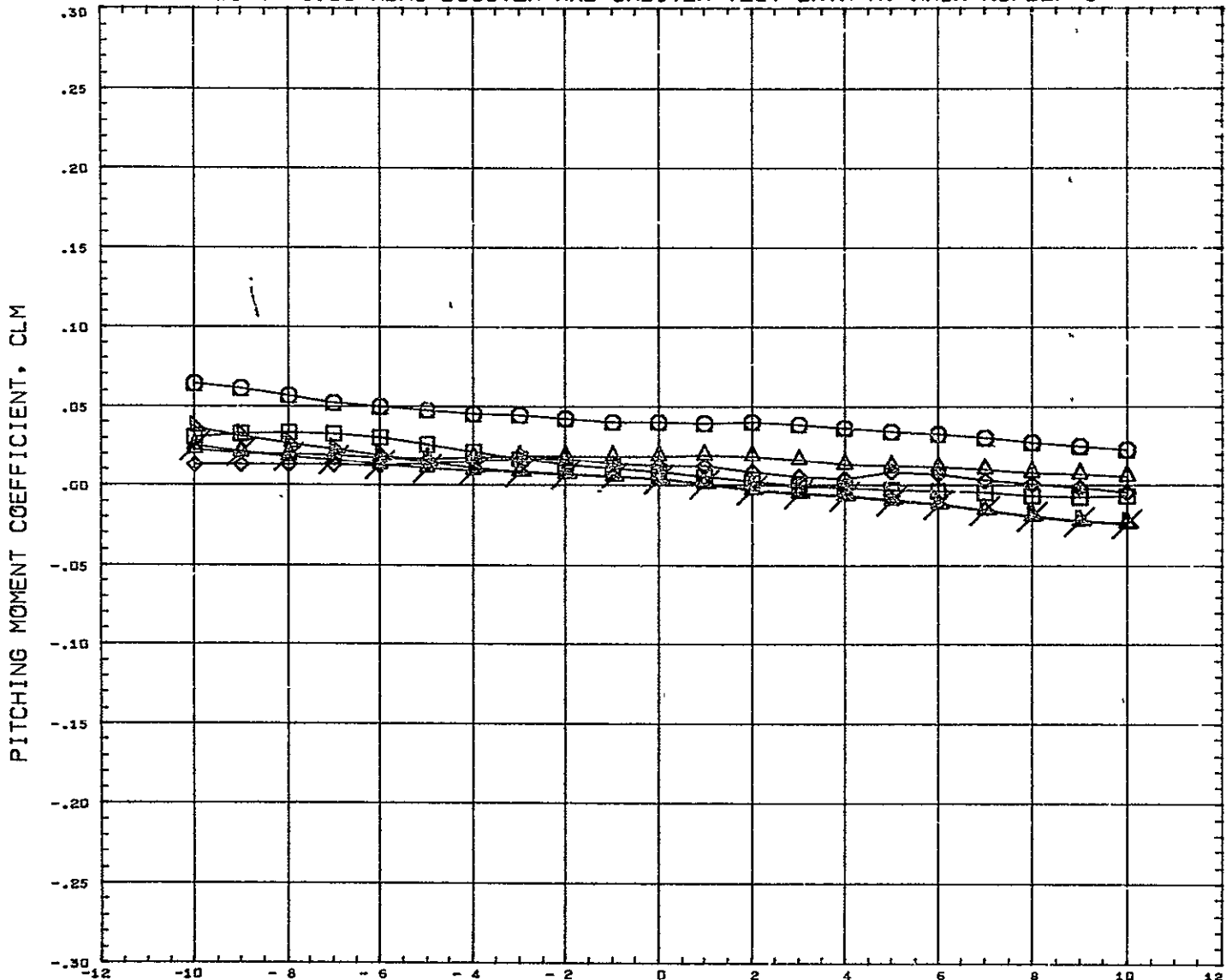

SYMBOL ○ ◇ □ △ ×	DELTAZ 0.120 0.151 0.192 0.228 0.352 10.000	<table border="0" style="width: 100%;"> <tr> <th colspan="4" style="text-align: center;">PARAMETRIC VALUES</th> </tr> <tr> <td>BSTPOW</td> <td>50.000</td> <td>ORBPOW</td> <td>100.000</td> </tr> <tr> <td>DELTAZ</td> <td>0.043</td> <td>ALPHA1</td> <td>- 4.980</td> </tr> <tr> <td>MACH</td> <td>5.010</td> <td>ELVBST</td> <td>0.000</td> </tr> <tr> <td>ELVORB</td> <td>0.000</td> <td>BETA</td> <td>0.000</td> </tr> </table>	PARAMETRIC VALUES				BSTPOW	50.000	ORBPOW	100.000	DELTAZ	0.043	ALPHA1	- 4.980	MACH	5.010	ELVBST	0.000	ELVORB	0.000	BETA	0.000	<table border="0" style="width: 100%;"> <tr> <th colspan="3" style="text-align: center;">REFERENCE INFORMATION</th> </tr> <tr> <td>REFS</td> <td>44 4440</td> <td>SQ IN</td> </tr> <tr> <td>REFL</td> <td>13.3330</td> <td>IN</td> </tr> <tr> <td>REFB</td> <td>13.3330</td> <td>IN</td> </tr> <tr> <td>XHRP</td> <td>7.5280</td> <td>IN</td> </tr> <tr> <td>YHRP</td> <td>0.0000</td> <td>IN</td> </tr> <tr> <td>ZHRP</td> <td>1.1940</td> <td>IN</td> </tr> <tr> <td>SCALE</td> <td>0.0055</td> <td></td> </tr> </table>	REFERENCE INFORMATION			REFS	44 4440	SQ IN	REFL	13.3330	IN	REFB	13.3330	IN	XHRP	7.5280	IN	YHRP	0.0000	IN	ZHRP	1.1940	IN	SCALE	0.0055	
PARAMETRIC VALUES																																															
BSTPOW	50.000	ORBPOW	100.000																																												
DELTAZ	0.043	ALPHA1	- 4.980																																												
MACH	5.010	ELVBST	0.000																																												
ELVORB	0.000	BETA	0.000																																												
REFERENCE INFORMATION																																															
REFS	44 4440	SQ IN																																													
REFL	13.3330	IN																																													
REFB	13.3330	IN																																													
XHRP	7.5280	IN																																													
YHRP	0.0000	IN																																													
ZHRP	1.1940	IN																																													
SCALE	0.0055																																														

REFERENCE FILE

# AEDC VA 1163 MDAC BOOSTER AND ORBITER TEST DATA AT MACH NUMBER 5

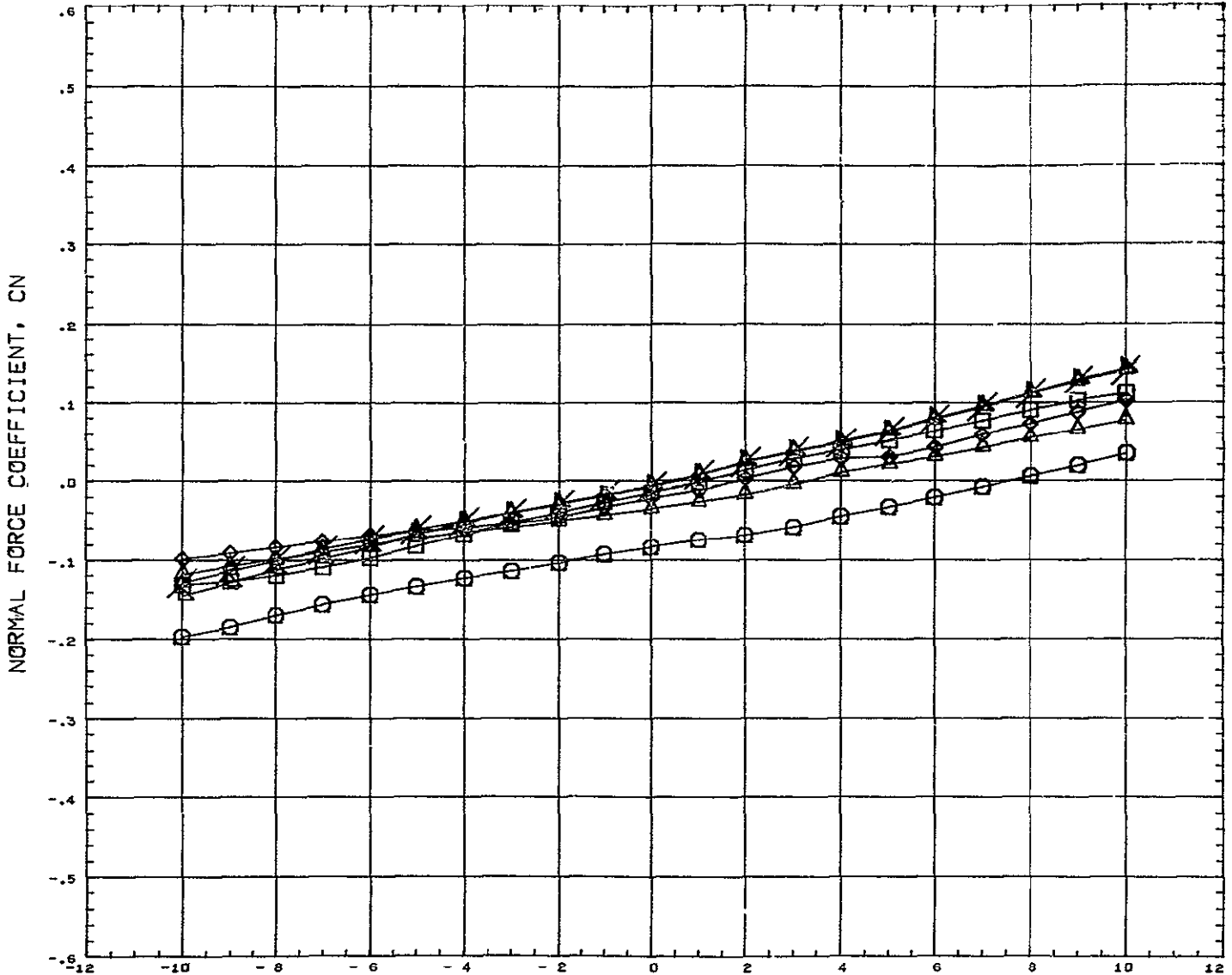

SYMBOL 	DELTA Z 0.120 0.151 0.182 0.220 0.352 10.000	<b>PARAMETRIC VALUES</b> BSTFOW 50.000 ORB FOW 100.000 DELTAX 0.043 ALPHAI - 4.900 MACH 5.010 ELVBST 0.000 ELVORB 0.000 BETA 0.000	<b>REFERENCE INFORMATION</b> REFS 44.4440 SQ IN REFL 13 3330 IN REFB 13 3330 IN XHRP 7.5280 IN YHRP 0.0000 IN ZHRP 1.1940 IN SCALE 0.0055
------------	--	--	--

REFERENCE FILE

# AEDC VA 1163 MDAC BOOSTER AND ORBITER TEST DATA AT MACH NUMBER 5

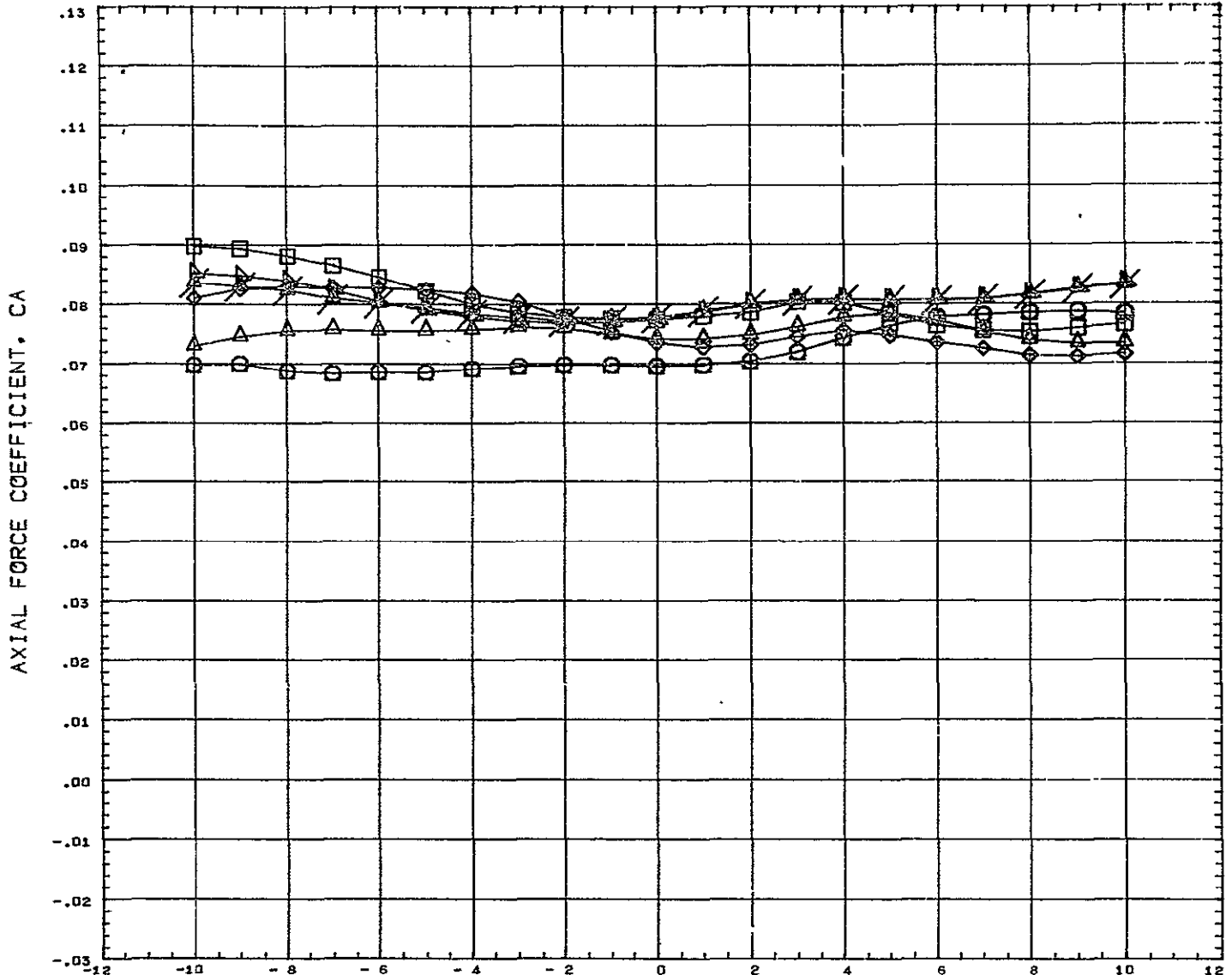

SYMBOL ○ ◊ ◻ △ ×	DELTA Z 0.120 0.151 0.182 0.228 0.352 10.000	PARAMETRIC VALUES BSTPOW 50.000 ORBPOW 100.000 DRLTAX 0.043 ALPHA1 - 4.900 MACH 5.010 ELV0ST 0.000 ELVORB 0.000 BETA 0.000	REFERENCE INFORMATION REFS 44.4440 SQ IN REFL 13.3330 IN REFB 13.3330 IN XHRF 7.5280 IN YHRF 0.0000 IN ZHRF 1.1940 IN SCALE 0.0055
---------------------------------	--	--	---

REFERENCE FILE

# AEDC VA 1163 MDAC BOOSTER AND ORBITER TEST DATA AT MACH NUMBER 5

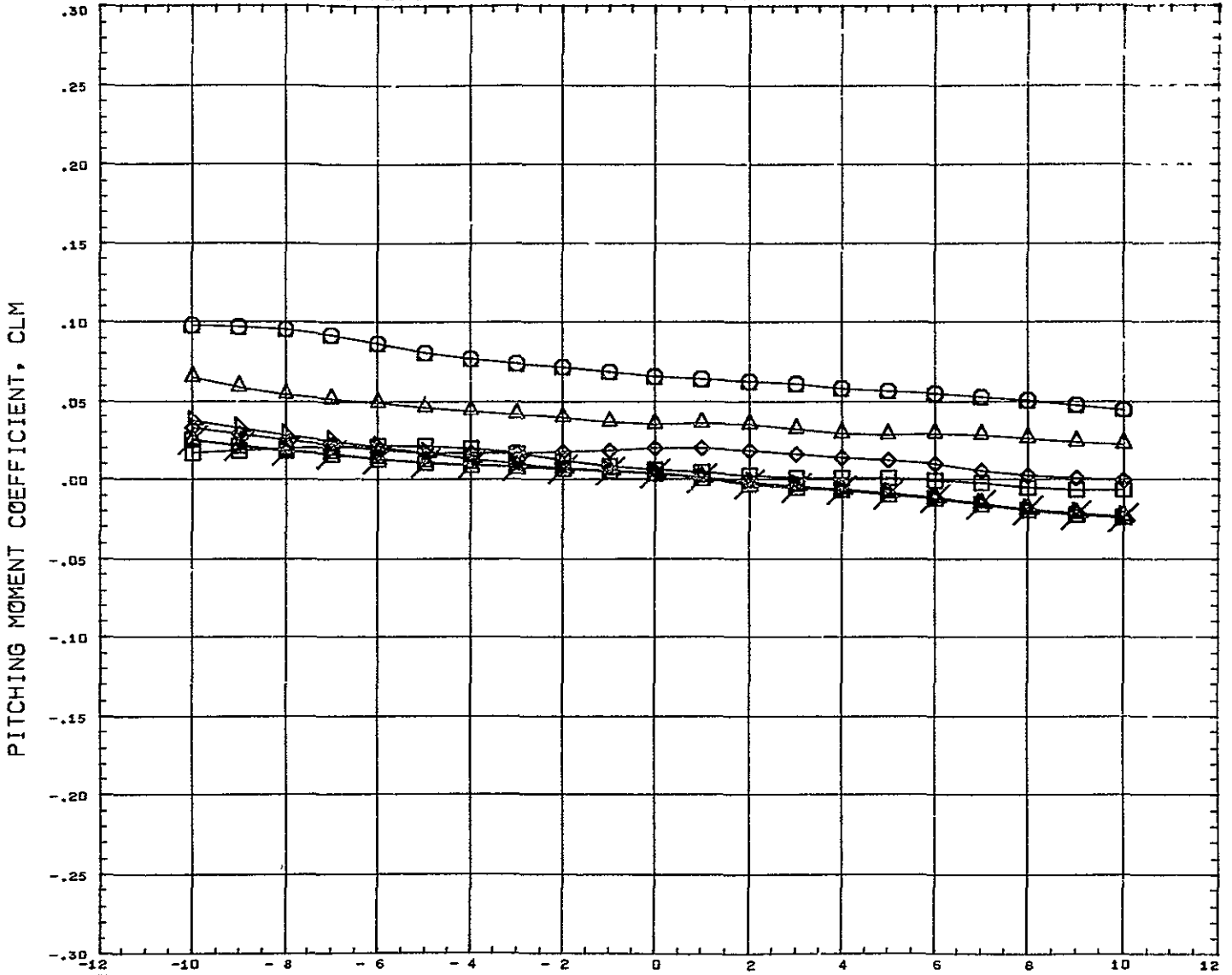

SYMBOL □ △ ◇ ×	DELTAZ 0.120 0.151 0.182 0.228 0.352 0.599 10.000	<b>PARAMETRIC VALUES</b> BSTPOW 50.000 ORBPOW 100.000 DELTAX 0.105 ALPHAI - 1.900 IACH 5.010 ELVBST 0.000 ELVORB 0.000 BETA 0.000	<b>REFERENCE INFORMATION</b> REFS 44 4446 SQ IN REFL 13.3330 IN REFB 13.3330 IN XMRP 7.5280 IN YMRP 0.0000 IN ZMRP 1.1940 IN SCALE 0.0055
REFERENCE FILE			



# AEDC VA 1163 MDAC BOOSTER AND ORBITER TEST DATA AT MACH NUMBER 5

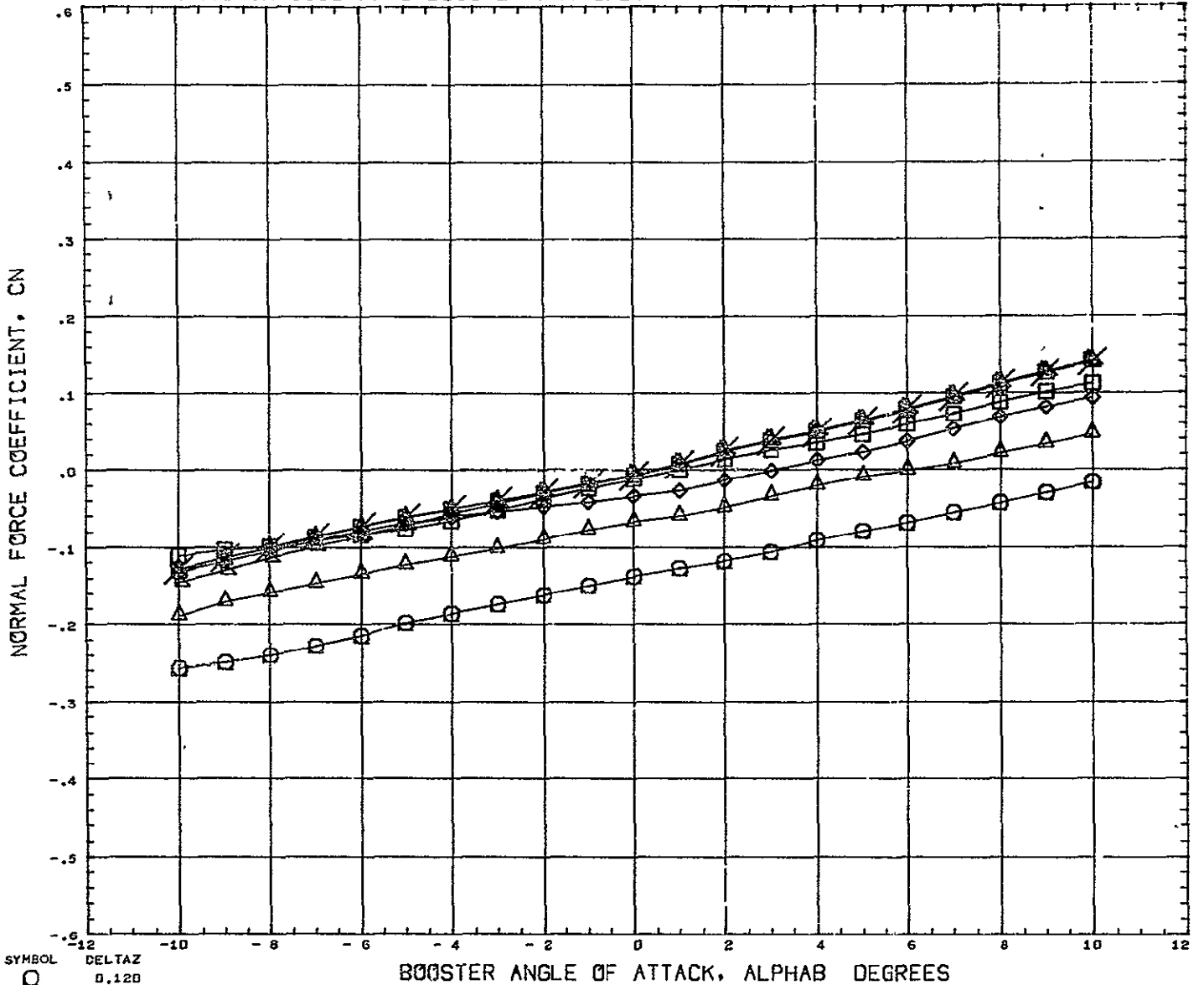

SYMBOL ○ ◇ □ △ ×	DELTA Z 0.120 0.151 0.182 0.228 0.352 0.599 10.000	PARAMETRIC VALUES BSTPOW 50.000 ORBPOW 100.000 DELTAX 0.105 ALPHA1 - 4.900 MACH 5.010 ELVBST 0.000 ELVORB 0.000 BETA 0.000	REFERENCE INFORMATION REFS 44.4440 SQ IN REFL 13.3330 IN REFB 13.3330 IN XMRP 7.5280 IN YMRP 0.0000 IN ZMRP 1.1940 IN SCALE 0.0055
---------------------------------	---	--	---

REFERENCE FILE

# AEDC VA 1163 MDAC BOOSTER AND ORBITER TEST DATA AT MACH NUMBER 5

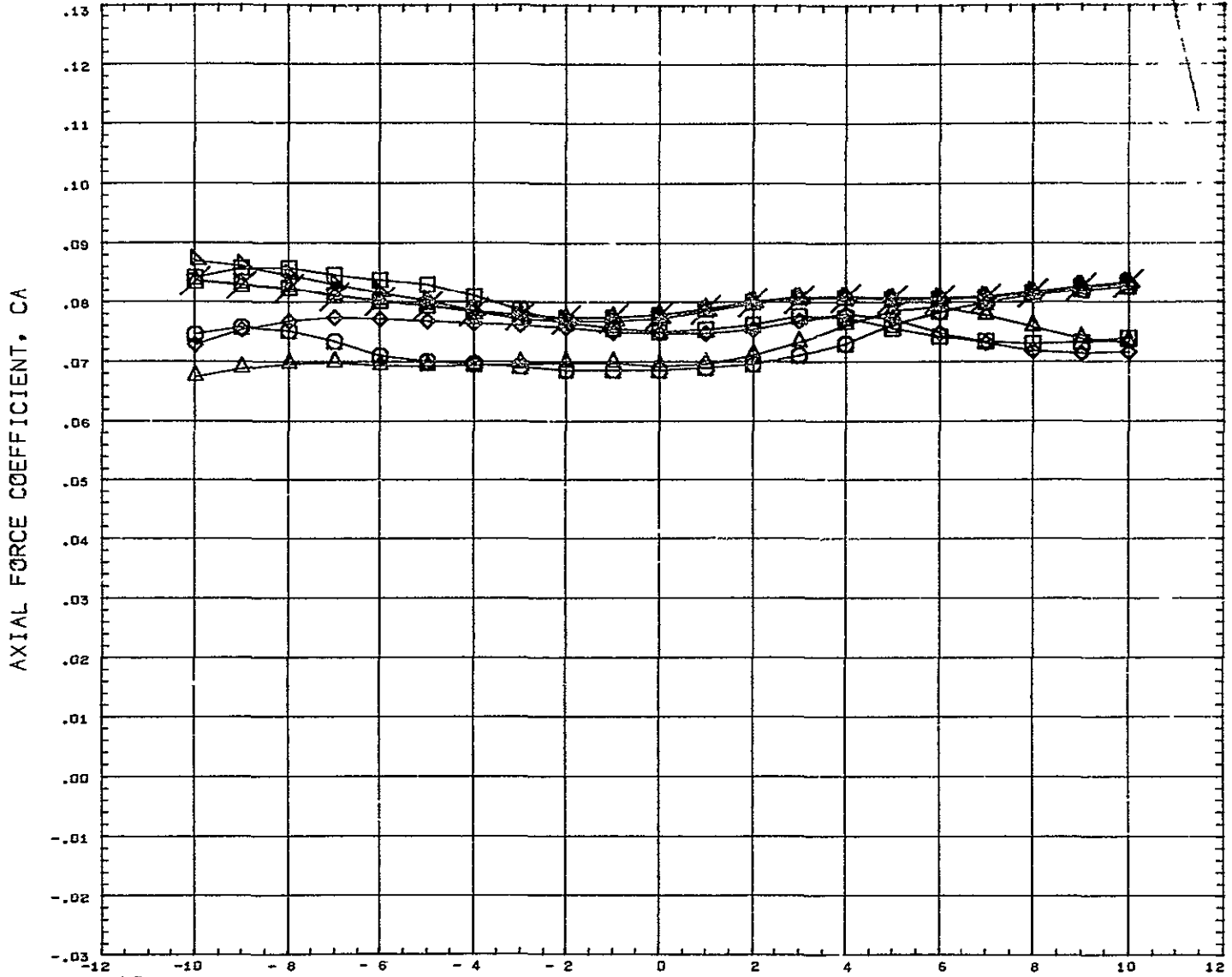

SYMBOL 	DELTAZ 0.120 0.151 0.182 0.228 0.352 0.599 10.000	PARAMETRIC VALUES BSTPOW 50.000 ORBPOW 100.000 DELTAX 0.105 ALPHAI - 4.900 MA_H 5.010 ELVBST 0.000 ELVORB 0.000 BETA 0.000	REFERENCE INFORMATION REFS 44.4440 SQ IN REFL 13.3330 IN REFB 13.3330 IN XHRF 7.5280 IN YHRF 0.0000 IN ZHRF 1.1940 IN SCALE 0.0055
------------	--	--	---

REFERENCE FILE

# AEDC VA 1163 MDAC BOOSTER AND ORBITER TEST DATA AT MACH NUMBER 5

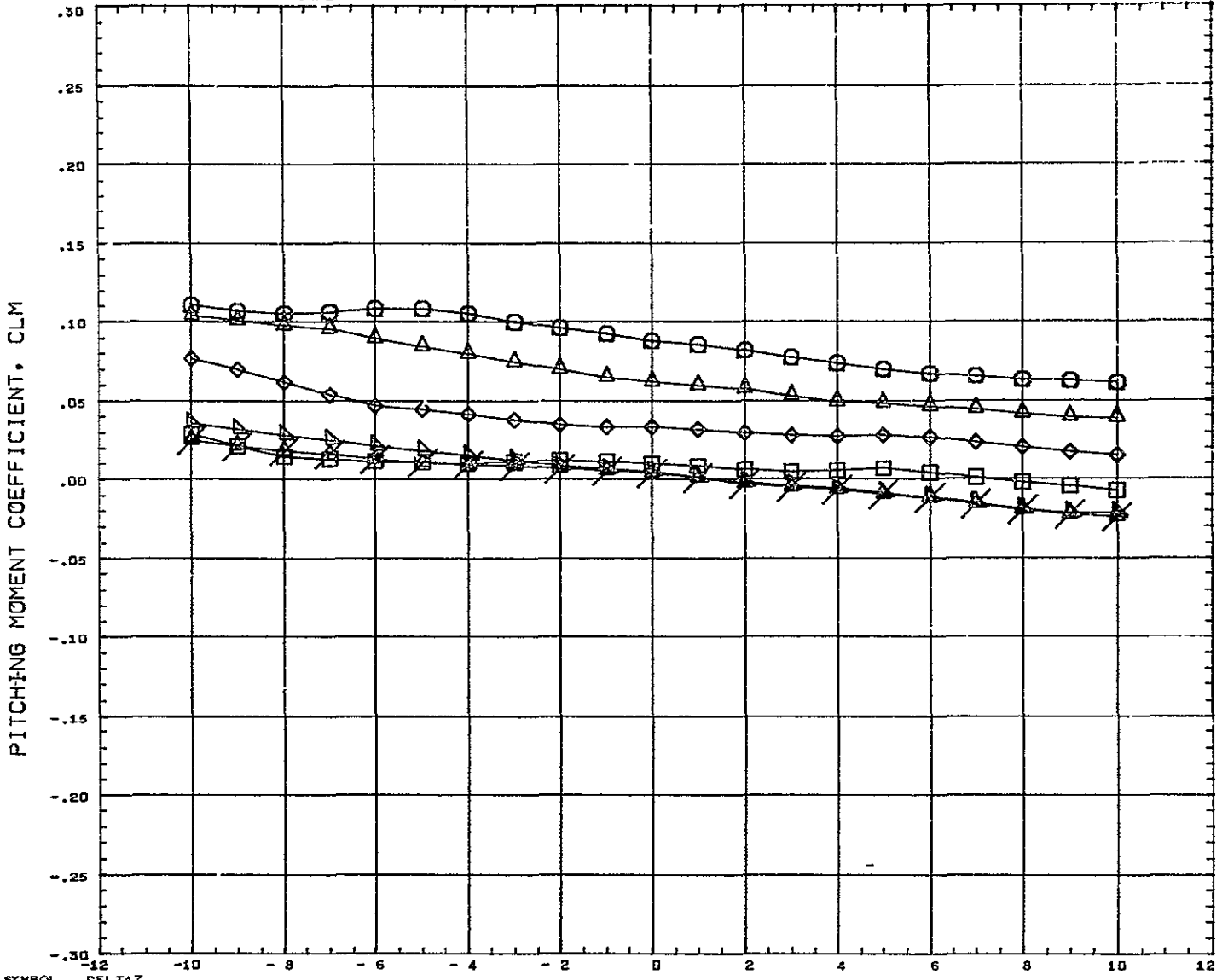

SYMBOL ○ ◇ △ □ ×	DELTAZ 0.120 0.151 0.182 0.228 0.352 10.000	PARAMETRIC VALUES BSTPOW 50.000 ORBPOW 100.000 DELTAX 0.167 ALPHAI - 4.900 ACH 5.010 ELVBST 0.000 ELVORB 0.000 BETA 0.000	REFERENCE INFORMATION REFS 11.4440 SQ IN REFL 13.3330 IN REFB 13.3330 IN XMRF 7.5280 IN YMRF 0.0000 IN ZMRF 1.1940 IN SCALE 0.0055
---------------------------------	---	---	---

REFERENCE FILE

# AEDC VA 1163 MDAC BOOSTER AND ORBITER TEST DATA AT MACH NUMBER 5

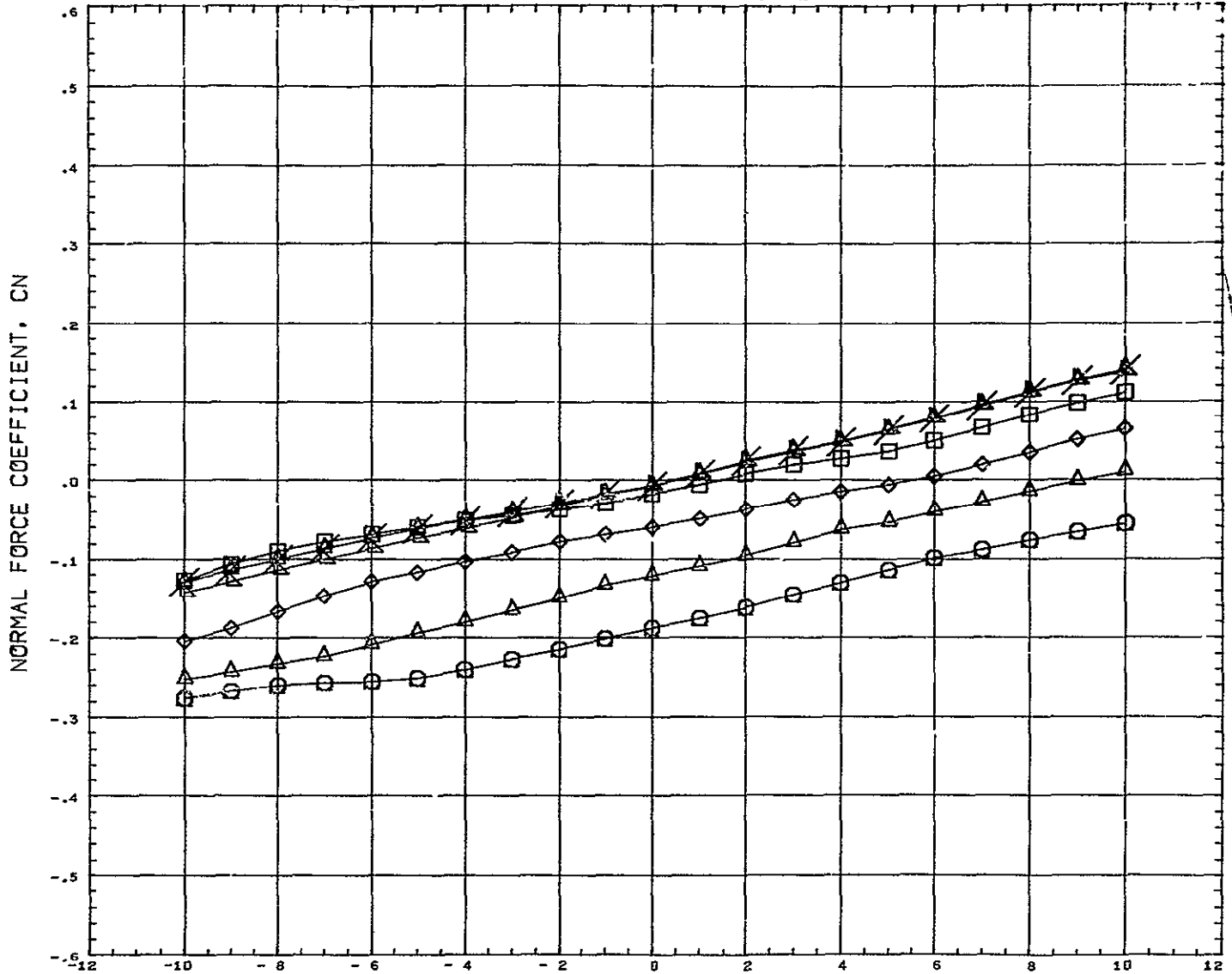

SYMBOL ○ □ ◇ △ ▽ ×	DELTAZ 0.120 0.151 0.182 0.228 0.352 10.000	PARAMETRIC VALUES BSTFOW 50.000 ORBPOW 100.000 DELTAX 0.167 LPHAI - 4.900 M CH 5.01G ELVBST 0.000 ELVORB 0.000 BE'A 0.000	REFERENCE INFORMATION REFS 44 4440 SQ IN REFL 13.3330 IN REFB 13 3330 IN XMRP 7.5280 IN YMRP 0 0000 IN ZMRP 1.1940 IN SCALE 0.0055
--------------------------------------	---	---	---

REFERENCE FILE

# AEDC VA 1163 MDAC BOOSTER AND ORBITER TEST DATA AT MACH NUMBER 5

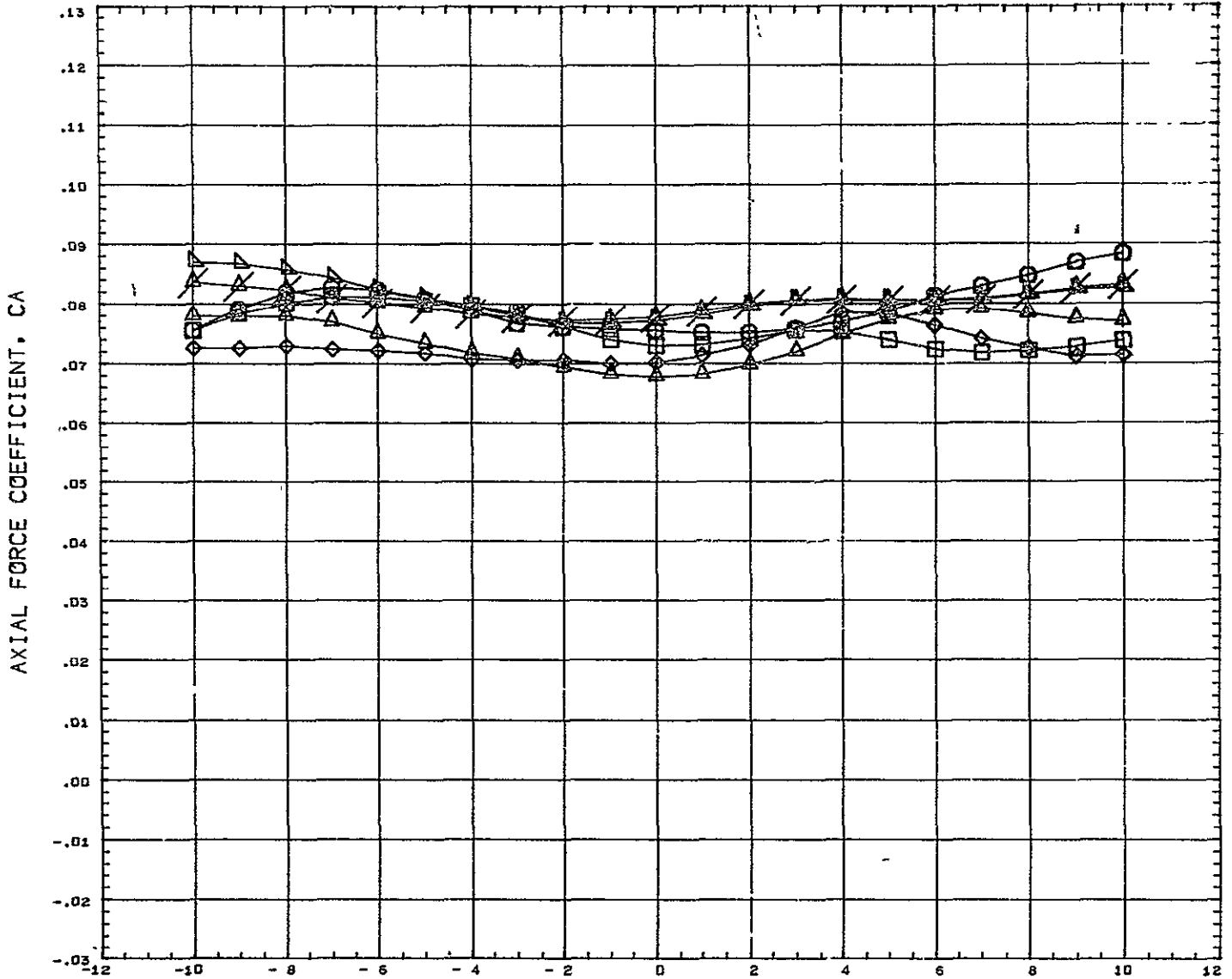

SYMBOL	DELTA Z	PARAMETRIC VALUES				REFERENCE INFORMATION		
○	0.120							
◇	0.151							
□	0.182	BSTPOW	50.000	ORBPOW	100.000	REFS	44.4440	SG IN
△	0.228	DELTA X	0.167	ALPHA I	-4.900	REFL	13.3330	IN
▽	0.352	MACH	5.010	ELVBST	0.000	REFB	13.3330	IN
◇	10.000	ELVORB	0.000	BETA	0.000	XMRP	7.5280	IN
						YMRP	0.0000	IN
						ZMRP	1.1940	IN
						SCALE	0.0055	

REFERENCE FILE

# AEDC VA 1163 MDAC BOOSTER AND ORBITER TEST DATA AT MACH NUMBER 5

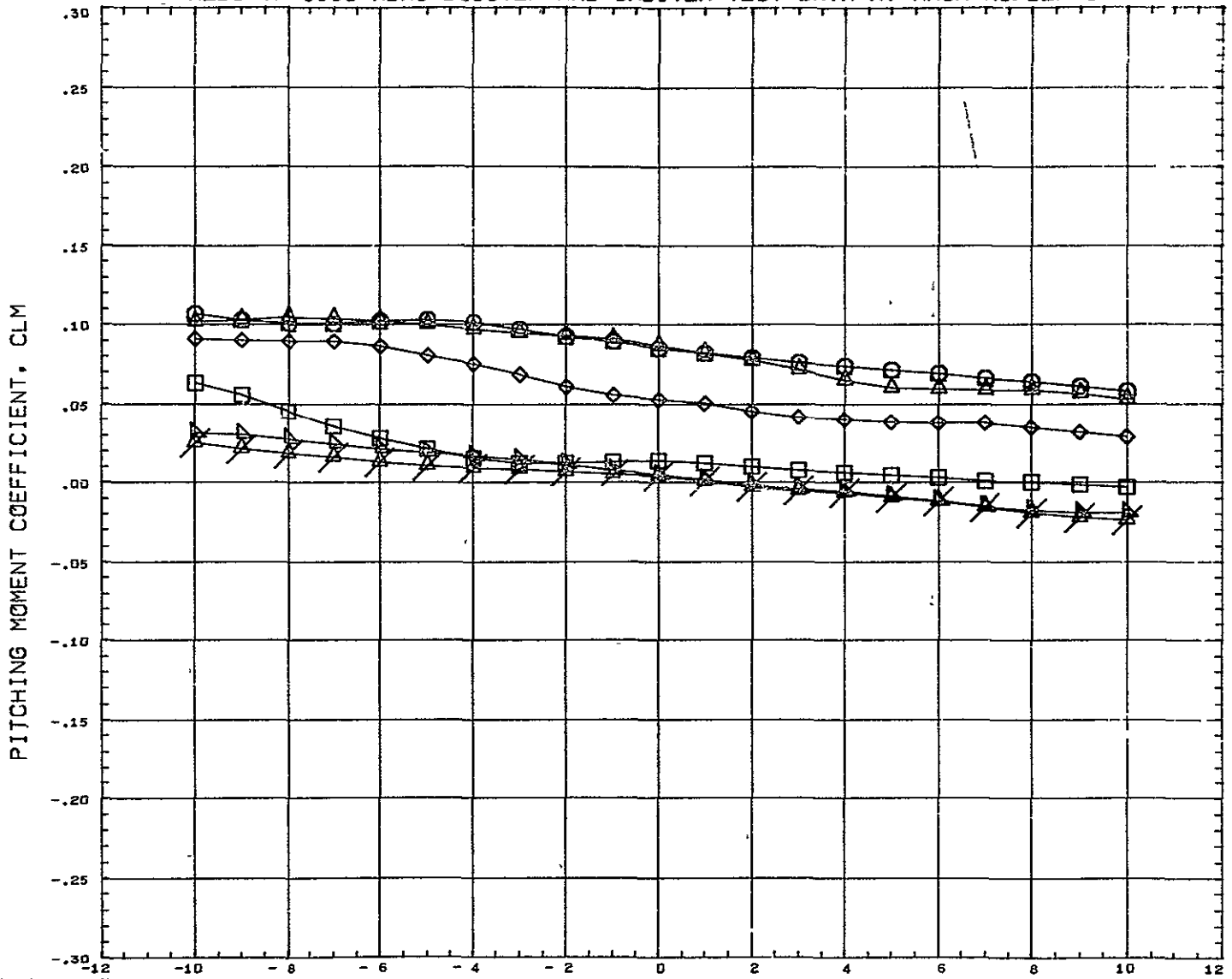

BOOSTER ANGLE OF ATTACK, ALPHA DEGREES

SYMBOL ○ □ ◇ △ ×	DELTAZ 0.120 0.151 0.182 0.228 0.352 10.000	PARAMETRIC VALUES BSTPOW 50.000 ORBPOW 100.000 DELTAX 0.228 ALPHA1 - 4.900 MACH 5.010 ELVBST 0.000 ELVORB 0.000 BETA 0.000	REFERENCE INFORMATION REFS 44.4440 SQ IN REFL 13 3330 IN REFB 13 3330 IN XMRP 7.5280 IN YMRP 0 0000 IN ZMRP 1.1940 IN SCALE 0.0055
---------------------------------	---	--	---

REFERENCE FILE

# AEDC VA 1163 MDAC BOOSTER AND ORBITER TEST DATA AT MACH NUMBER 5

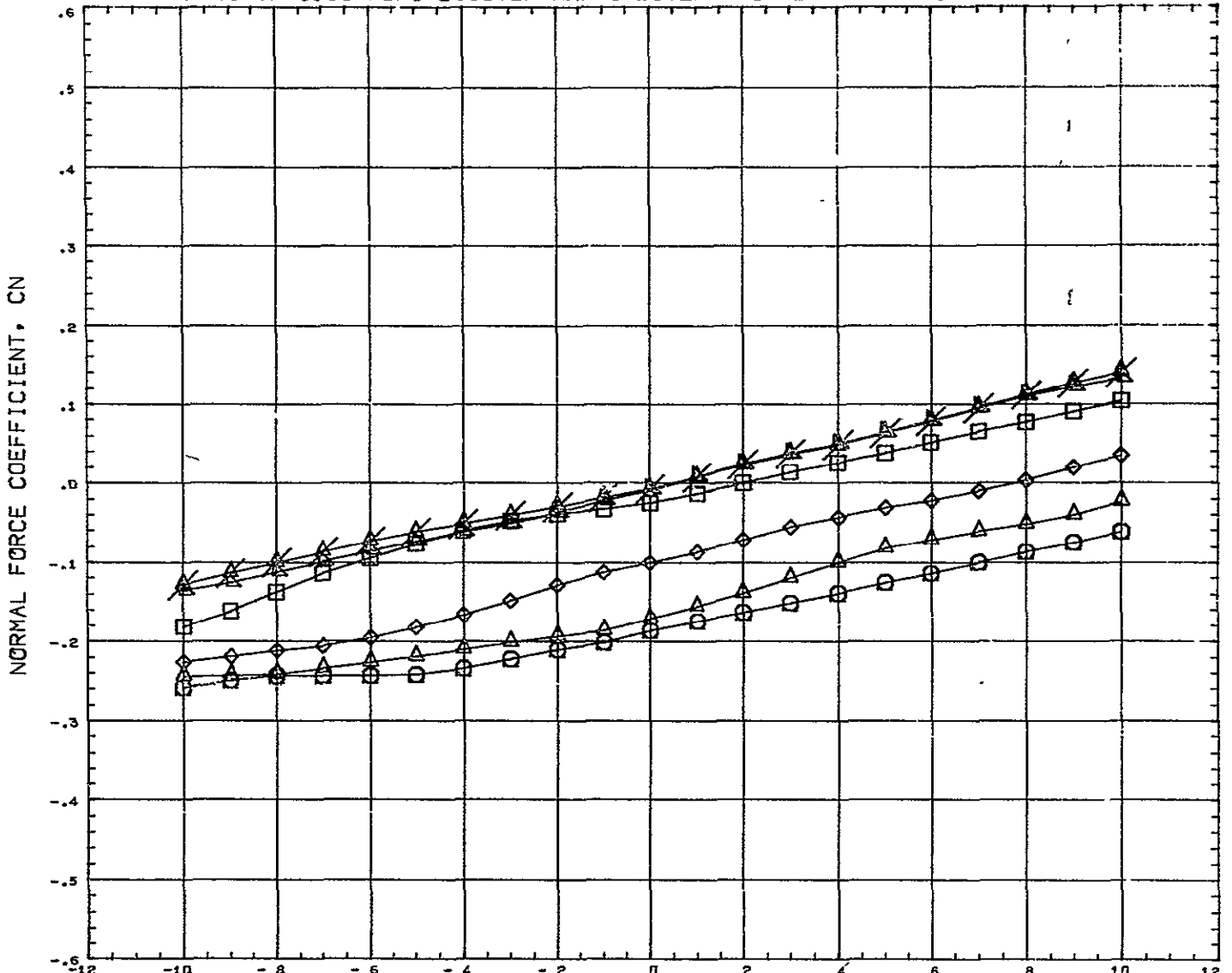

SYMBOL ○ ◇ □ △ ● ▲	DELTA Z 0.120 0.151 0.182 0.228 0.352 10.000	PARAMETRIC VALUES BSTPOW 50.000 ORBPOW 100.000 PFLTAX 0.228 ALPHAI - 4.900 MACH 5.010 ELVBST 0.000 ELVORB 0.000 BETA 0.000	REFERENCE INFORMATION REFS 44.4440 SQ IN REFL 13.3330 IN REFB 13.3330 IN XMRP 7.5280 IN YMRP 0.0000 IN ZMRP 1.1340 IN SCALE 0.0055
--------------------------------------	--	--	---

REFERENCE FILE

# AEDC VA 1163 MDAC BOOSTER AND ORBITER TEST DATA AT MACH NUMBER 5

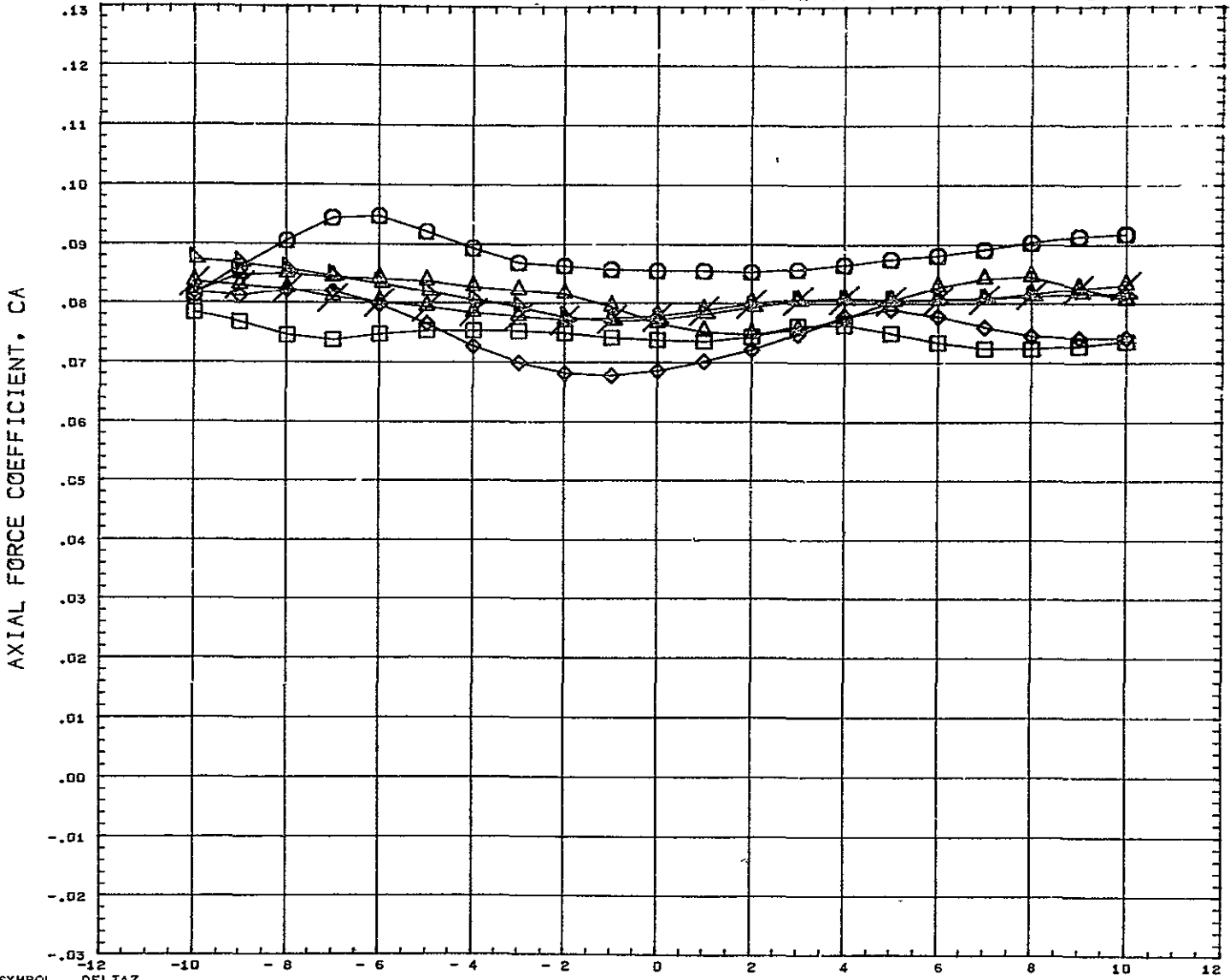

BOOSTER ANGLE OF ATTACK, ALPHA DEGREES

SYMBOL 	DELTAZ 0.120 0.151 0.182 0.228 0.352 10.000	<table border="0" style="width: 100%;"> <tr> <th colspan="4" style="text-align: left; padding-left: 20px;">PARAMETRIC VALUES</th> </tr> <tr> <td style="padding-right: 10px;">BSTFOW</td> <td style="padding-right: 10px;">50.000</td> <td style="padding-right: 10px;">ORBPOW</td> <td>100.000</td> </tr> <tr> <td style="padding-right: 10px;">DELTAZ</td> <td style="padding-right: 10px;">0.228</td> <td style="padding-right: 10px;">ALPHA1</td> <td>- 1.900</td> </tr> <tr> <td style="padding-right: 10px;">MACH</td> <td style="padding-right: 10px;">5.010</td> <td style="padding-right: 10px;">ELVBST</td> <td>0.000</td> </tr> <tr> <td style="padding-right: 10px;">ELVORB</td> <td style="padding-right: 10px;">0.000</td> <td style="padding-right: 10px;">BETA</td> <td>0.000</td> </tr> </table>	PARAMETRIC VALUES				BSTFOW	50.000	ORBPOW	100.000	DELTAZ	0.228	ALPHA1	- 1.900	MACH	5.010	ELVBST	0.000	ELVORB	0.000	BETA	0.000	<table border="0" style="width: 100%;"> <tr> <th colspan="3" style="text-align: left;">REFERENCE INFORMATION</th> </tr> <tr> <td style="padding-right: 10px;">REFS</td> <td style="padding-right: 10px;">44.4440</td> <td>SQ IN</td> </tr> <tr> <td style="padding-right: 10px;">REFL</td> <td style="padding-right: 10px;">13.3330</td> <td>IN</td> </tr> <tr> <td style="padding-right: 10px;">REFB</td> <td style="padding-right: 10px;">13.3330</td> <td>IN</td> </tr> <tr> <td style="padding-right: 10px;">XMRP</td> <td style="padding-right: 10px;">7.5280</td> <td>IN</td> </tr> <tr> <td style="padding-right: 10px;">YMRP</td> <td style="padding-right: 10px;">0.0000</td> <td>IN</td> </tr> <tr> <td style="padding-right: 10px;">ZMRP</td> <td style="padding-right: 10px;">1.1940</td> <td>IN</td> </tr> <tr> <td style="padding-right: 10px;">SCALE</td> <td style="padding-right: 10px;">0.0055</td> <td></td> </tr> </table>	REFERENCE INFORMATION			REFS	44.4440	SQ IN	REFL	13.3330	IN	REFB	13.3330	IN	XMRP	7.5280	IN	YMRP	0.0000	IN	ZMRP	1.1940	IN	SCALE	0.0055	
PARAMETRIC VALUES																																															
BSTFOW	50.000	ORBPOW	100.000																																												
DELTAZ	0.228	ALPHA1	- 1.900																																												
MACH	5.010	ELVBST	0.000																																												
ELVORB	0.000	BETA	0.000																																												
REFERENCE INFORMATION																																															
REFS	44.4440	SQ IN																																													
REFL	13.3330	IN																																													
REFB	13.3330	IN																																													
XMRP	7.5280	IN																																													
YMRP	0.0000	IN																																													
ZMRP	1.1940	IN																																													
SCALE	0.0055																																														

REFERENCE FILE



# AEDC VA 1163 MDAC BOOSTER AND ORBITER TEST DATA AT MACH NUMBER 5

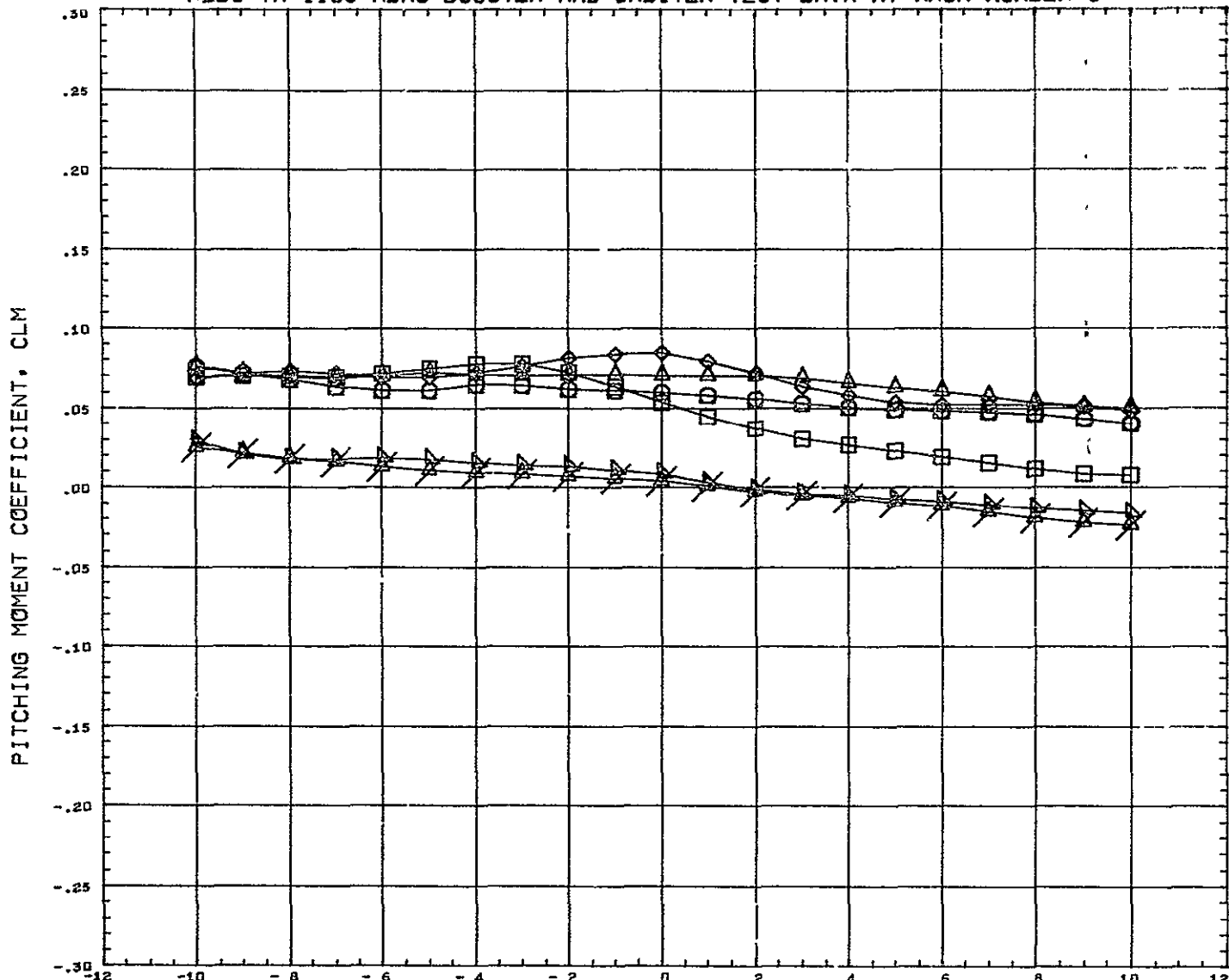

SYMBOL ◇ □ △ ×	DELTAZ 0.120 0.151 0.182 0.228 0.352 10.000	PARAMETRIC VALUES BSTPOW 50.000 ORBPOW 100.000 DELTAX 0.352 ALPHAI - 4.900 MACH 5.010 ELVBST 0.000 ELVORB 0.000 BETA 0.000	REFERENCE INFORMATION RLFS 44.4440 SQ IN REFL 13.3330 IN REFB 13.3330 IN XMRP 7.5280 IN YMRP 0.0000 IN ZMRP 1.1940 IN SCALE 0.0055
----------------------------	---	--	---

REFERENCE FILE

# AEDC VA 1163 MDAC BOOSTER AND ORBITER TEST DATA AT MACH NUMBER 5

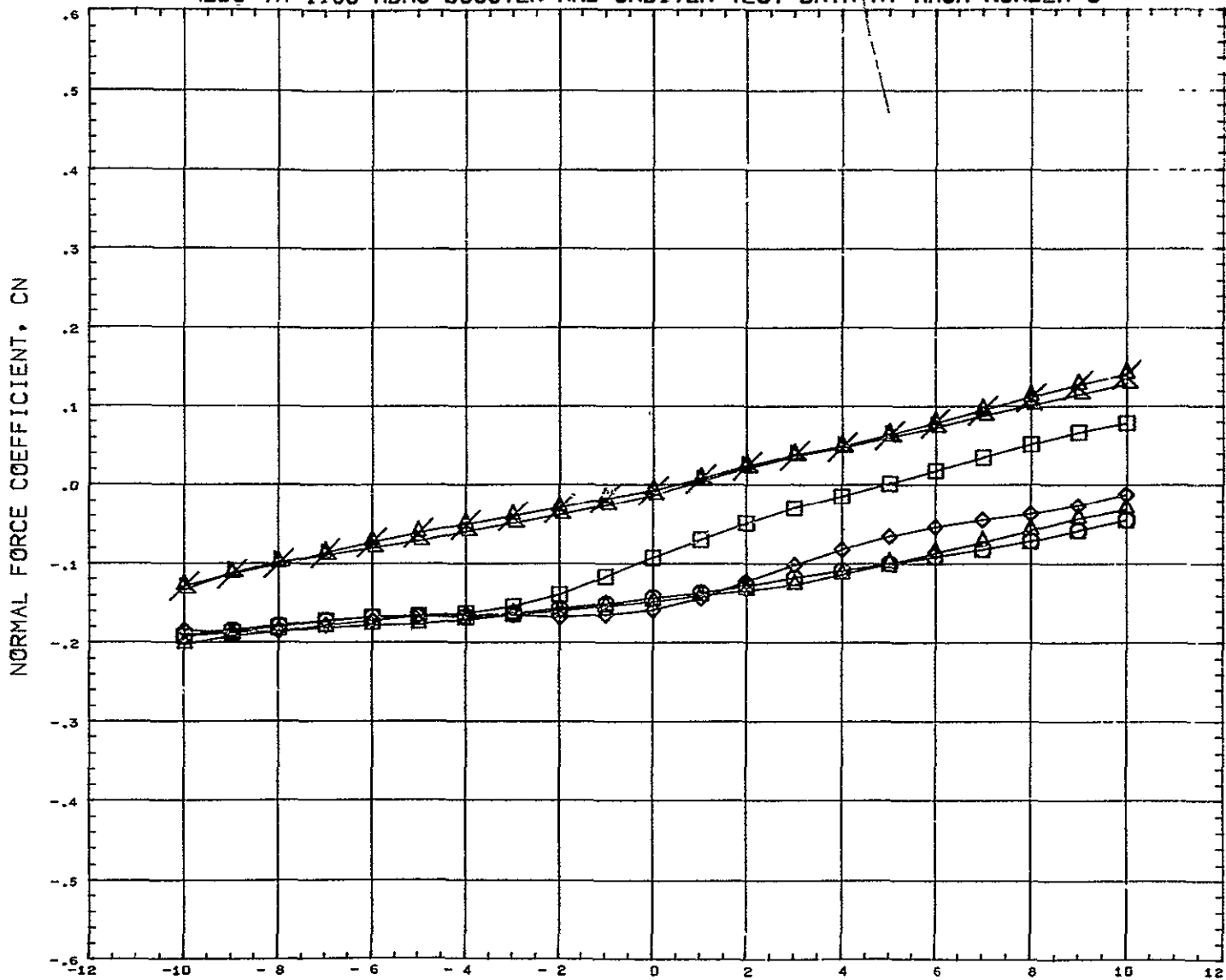

SYMBOL  
 ○  
 ◇  
 □  
 △  
 ▽

DELTAX  
 0.120  
 0.151  
 0.182  
 0.228  
 0.352  
 10.000

PARAMETRIC VALUES

BSTPOW	50.000	ORBPOW	100.000
DELTA X	0.352	ALPHA I	- 4.900
MACH	5.010	ELVBST	0.000
ELVORB	0.000	BETA	0.000

REFERENCE INFORMATION

REFS	44.444J	SQ IN
REFL	13.3330	IN
REFB	13.3330	IN
XMRP	7.5280	IN
YMRP	0.0000	IN
ZMRP	1.1940	IN
SCALE	0.0055	

REFERENCE FILE

# AEDC VA 1163 MDAC BOOSTER AND ORBITER TEST DATA AT MACH NUMBER 5

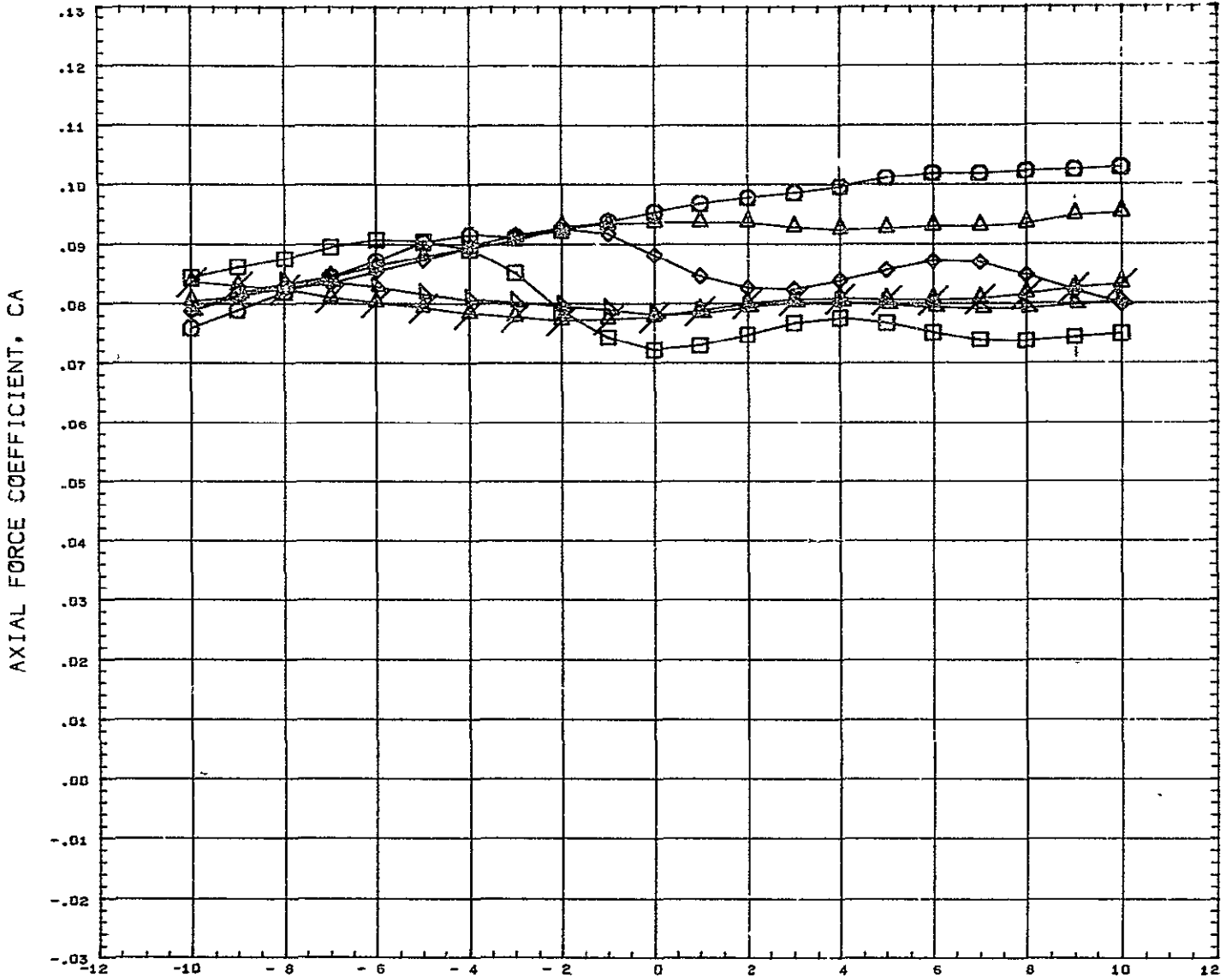

SYMBOL ○ △ ◇ □ ×	DELTAX 0.120 0.151 0.182 0.228 0.352 10.000	PARAMETRIC VALUES BSTPOW 50.000 ORBPOW 100.000 DELTAX 0.352 ALPHA1 - 4.900 F.CH 5.010 ELVBST 0.000 ELVORB 0.000 BETA 0.000	REFERENCE INFORMATION RLFS 44.4440 SQ IN REFL 13.3330 IN REFB 13.3330 IN XMRP 7.5280 IN YMRP 0.0000 IN ZMRP 1.1940 IN SCALE 0.0055
---------------------------------	---	--	---

REFERENCE FILE

### AEDC VA 1163 MDAC BOOSTER AND ORBITER TEST DATA AT MACH NUMBER 5

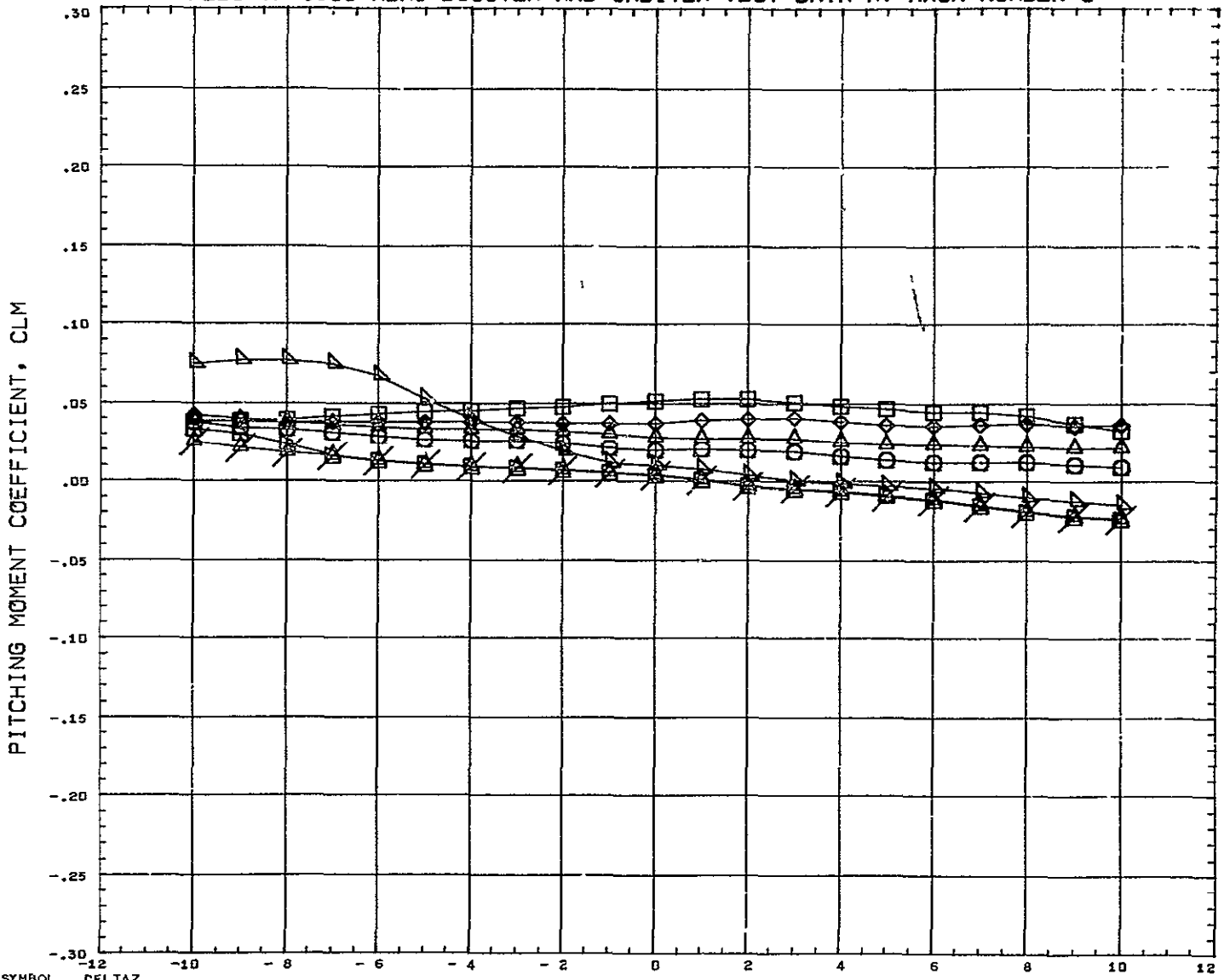

SYMBOL ▽ ◻ ◊ ○ ×	DELTAZ 0.120 0.151 0.182 0.228 0.352 0.599 10.000	PARAMETRIC VALUES BSTPOW 50.000 ORBPOW 100.000 DELTAX 0.522 ALPHAI - 4.900 MACH 5.010 ELVBST 0.000 ELVORB 0.000 BETA 0.000	REFERENCE INFORMATION REFS 11.4240 SQ IN REFL 13.3330 IN REFB 13.3330 IN XHRP 7.5280 IN YHRP 0.0000 IN ZHRP 1.1940 IN SCALE 0.0055
---------------------------------	--	--	---

1 REFERENCE FILE

# AEDC VA 1163 MDAC BOOSTER AND ORBITER TEST DATA AT MACH NUMBER 5

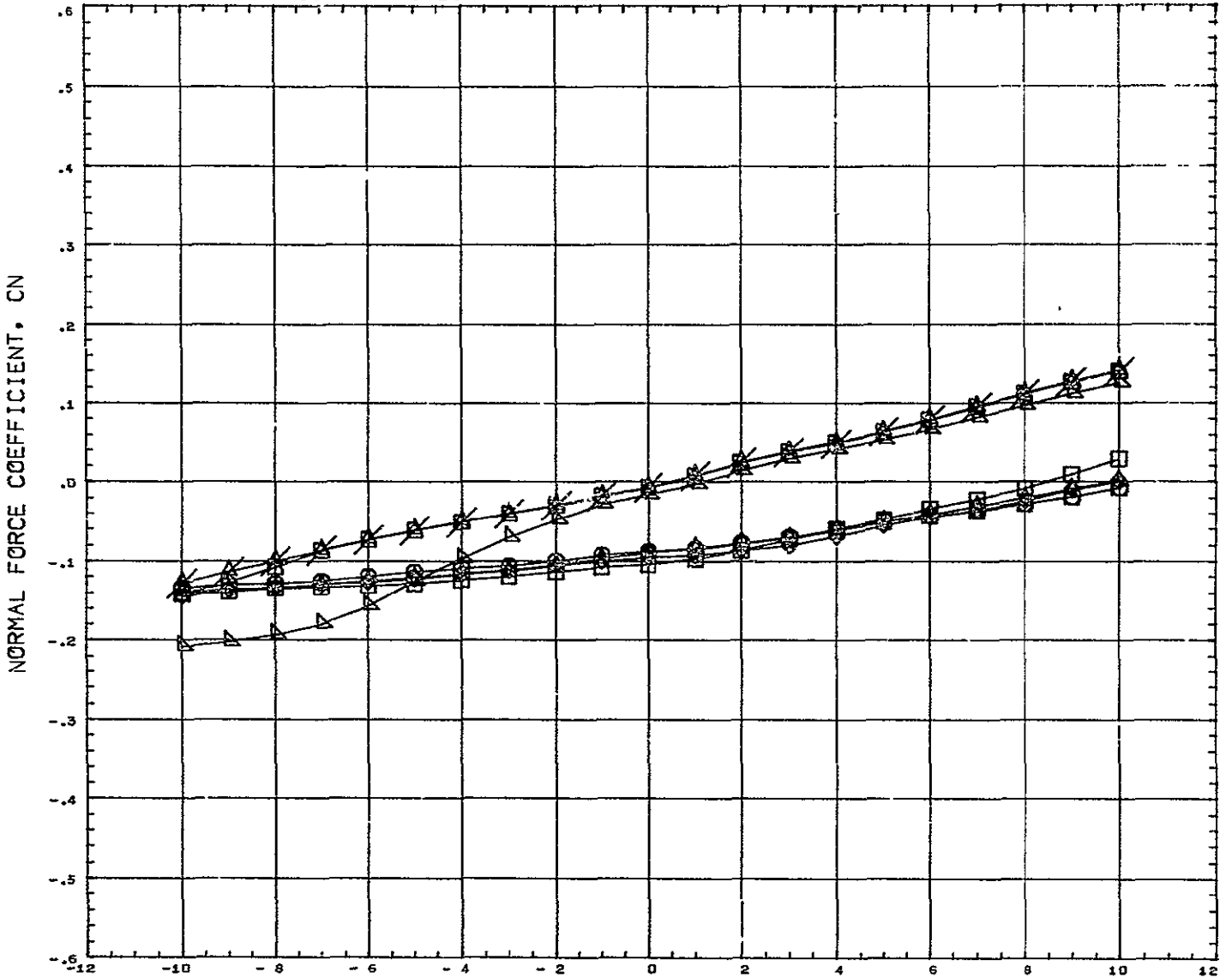

SYMBOL ○ □ ◇ △ ▲	DELTA Z 0.120 0.151 0.182 0.228 0.352 0.599 10.000	<b>PARAMETRIC VALUES</b> BSTPCW 50.000 ORBPCW 100.000 DELTA X 0.522 ALPHA I - 4.900 ACH 5.010 ELVBST 0.000 ELVORB 0.000 BETA 0.000	<b>REFERENCE INFORMATION</b> PEFS 41.4440 SQ IN REFL 13.3330 IN REFB 13.3330 IN XMRP 7.5280 IN YMRP 0.0000 IN ZMRP 1.1940 IN SCALE 0.0055
REFERENCE FILE			



# AEDC VA 1163 MDAC BOOSTER AND ORBITER TEST DATA AT MACH NUMBER 5

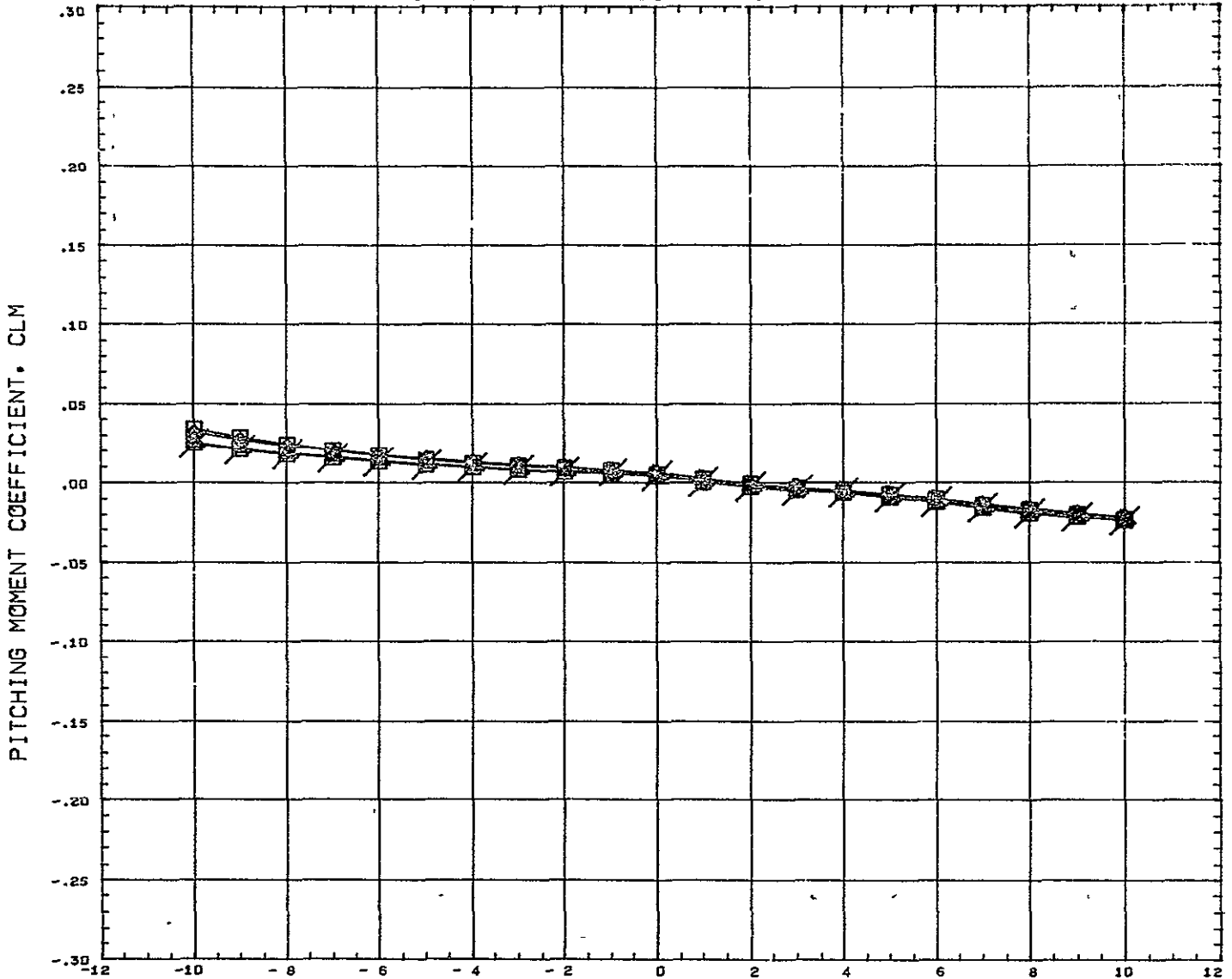

SYMBOL 	DELTA Z 0.182 0.223 0.352 0.599 10.000	PARAMETRIC VALUES BSTPOW 50.000 ORBPOW 100.000 DELTAX - 0.391 ALPHAI - 10.000 MACH 5.010 ELVBST 0.000 ELVORB 0.000 BETA 0.000	REFERENCE INFORMATION REFS 44.4440 SQ IN REFL 13.3330 IN REFB 13.3330 IN XMRP 7.5280 IN YMRP 0.0000 IN ZMRP 1.1940 IN SCALE 0.0055
------------	---	---	---

REFERENCE FILE

# AEDC VA 1163 MDAC BOOSTER AND ORBITER TEST DATA AT MACH NUMBER 5

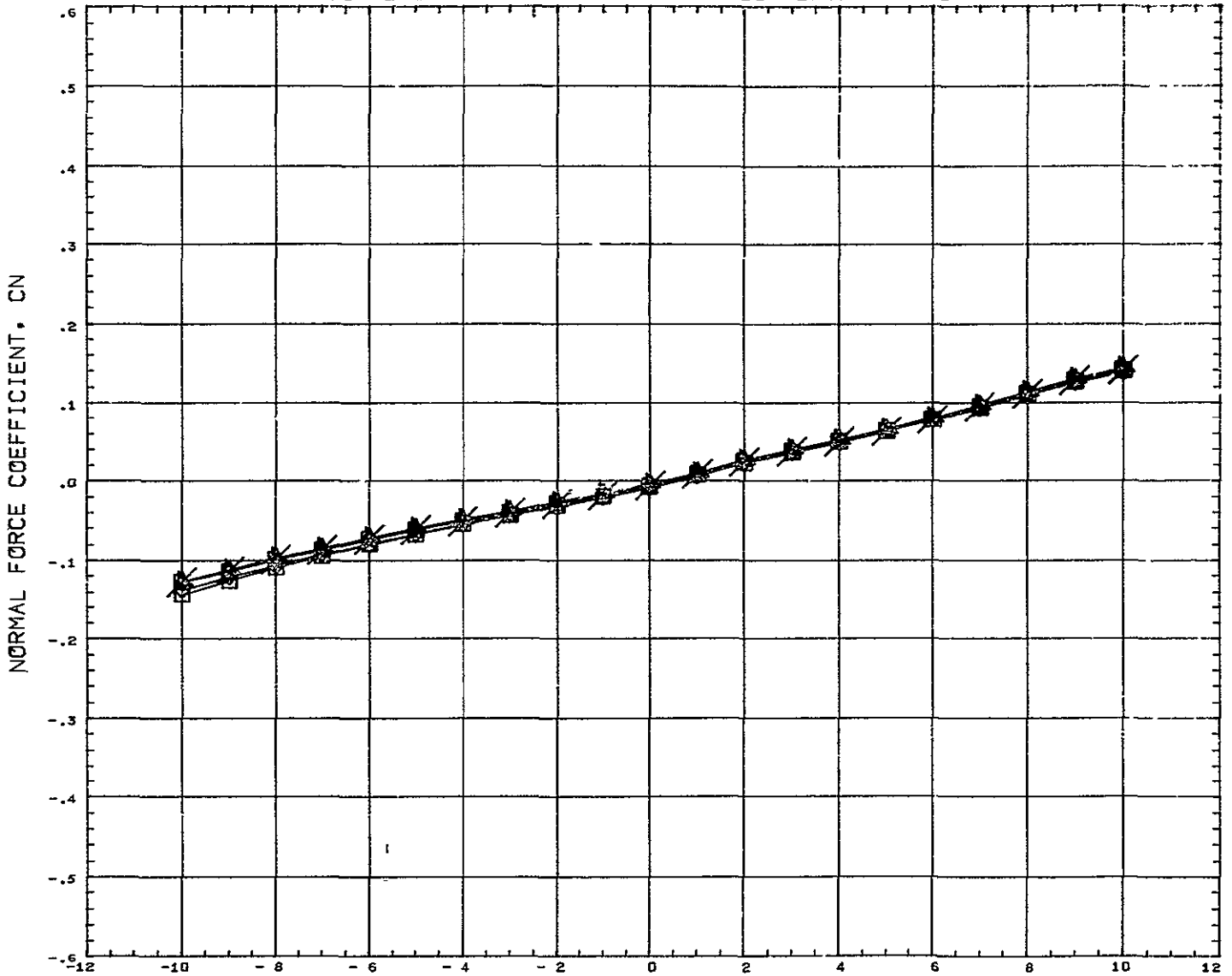

SYMBOL ◊ □ ▽ △ ✕	DELTAZ 0.182 0.228 0.352 0.599 10.000 MACH ELVORB	<table border="0" style="width: 100%;"> <tr> <th colspan="4" style="text-align: center;">PARAMETRIC VALUES</th> </tr> <tr> <td>.BSTPOW</td><td>50.000</td><td>ORBPOW</td><td>100.000</td> </tr> <tr> <td>DELTA X</td><td>- 0.391</td><td>ALPHA I</td><td>- 10.000</td> </tr> <tr> <td>ELV BST</td><td>0.000</td><td>BETA</td><td>0.000</td> </tr> </table>	PARAMETRIC VALUES				.BSTPOW	50.000	ORBPOW	100.000	DELTA X	- 0.391	ALPHA I	- 10.000	ELV BST	0.000	BETA	0.000	<table border="0" style="width: 100%;"> <tr> <th colspan="2" style="text-align: center;">REFERENCE INFORMATION</th> </tr> <tr> <td>REFS</td><td>44.4440 SQ IN</td> </tr> <tr> <td>REFL</td><td>13.3330 IN</td> </tr> <tr> <td>REFB</td><td>13.3330 IN</td> </tr> <tr> <td>XMRF</td><td>7.5280 IN</td> </tr> <tr> <td>YMRF</td><td>0.0000 IN</td> </tr> <tr> <td>ZMRF</td><td>1.1940 IN</td> </tr> <tr> <td>SCALE</td><td>0.0055</td> </tr> </table>	REFERENCE INFORMATION		REFS	44.4440 SQ IN	REFL	13.3330 IN	REFB	13.3330 IN	XMRF	7.5280 IN	YMRF	0.0000 IN	ZMRF	1.1940 IN	SCALE	0.0055
PARAMETRIC VALUES																																			
.BSTPOW	50.000	ORBPOW	100.000																																
DELTA X	- 0.391	ALPHA I	- 10.000																																
ELV BST	0.000	BETA	0.000																																
REFERENCE INFORMATION																																			
REFS	44.4440 SQ IN																																		
REFL	13.3330 IN																																		
REFB	13.3330 IN																																		
XMRF	7.5280 IN																																		
YMRF	0.0000 IN																																		
ZMRF	1.1940 IN																																		
SCALE	0.0055																																		

REFERENCE FILE



# AEDC VA 1163 MDAC BOOSTER AND ORBITER TEST DATA AT MACH NUMBER 5

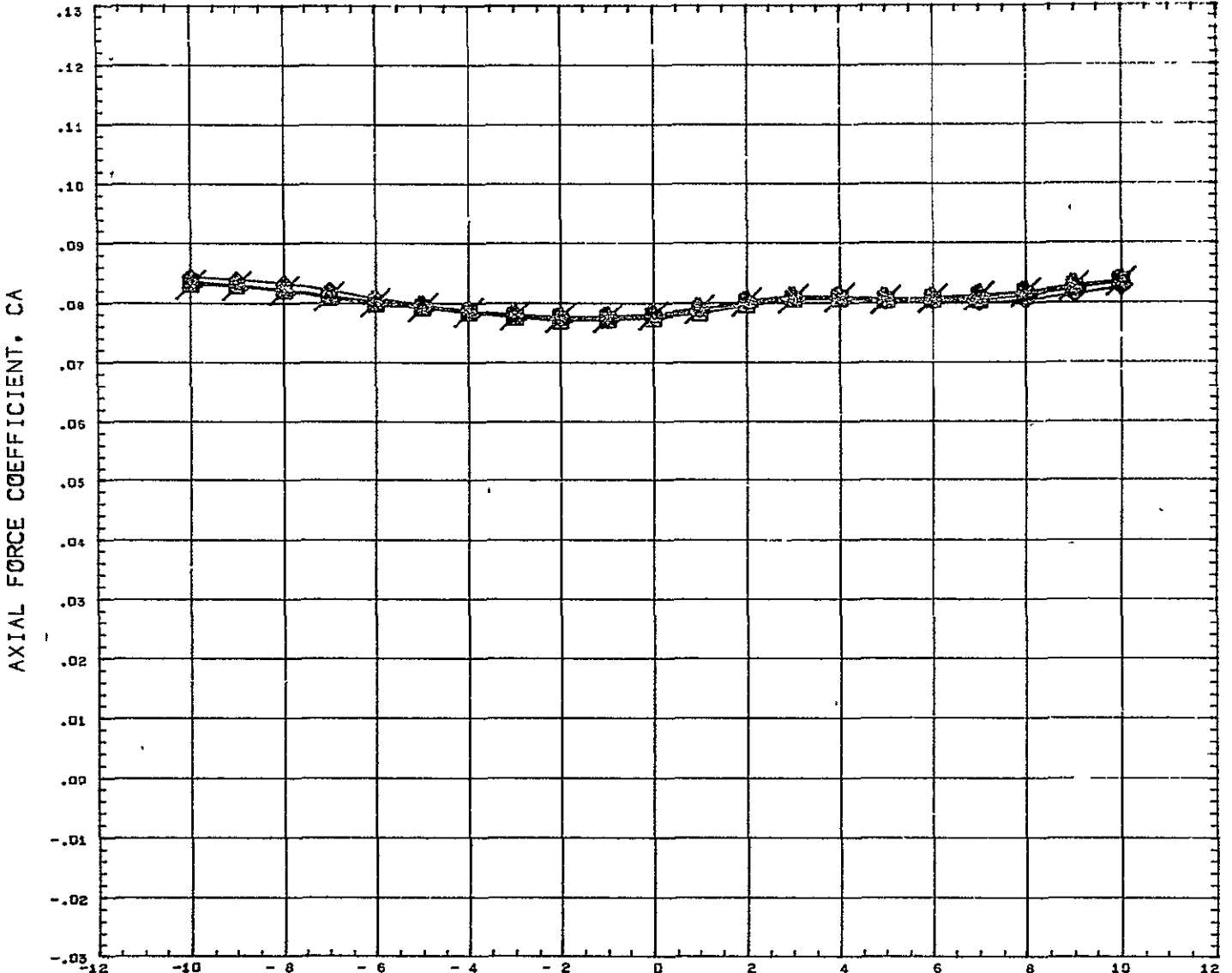

SYMBOL 	DELTA Z 0.182 0.228 0.352 0.599 10.000	PARAMETRIC VALUES BSTPOW 50.000 ORBPOW 100.000 PELTAX - 0.391 ALPHAI - 10.000 MACH 5.010 ELYBST 0.000 ELVORB 0.000 BETA 0.000	REFERENCE INFORMATION REFS 44.4440 SQ IN REFL 13.3330 IN REFB 13.3330 IN XMRP 7.5280 IN YMRP 0.0000 IN ZMRP 1.1940 IN SCALE 0.0055
------------	---	---	---

REFERENCE FILE

# AEDC VA 1163 MDAC BOOSTER AND ORBITER TEST DATA AT MACH NUMBER 5

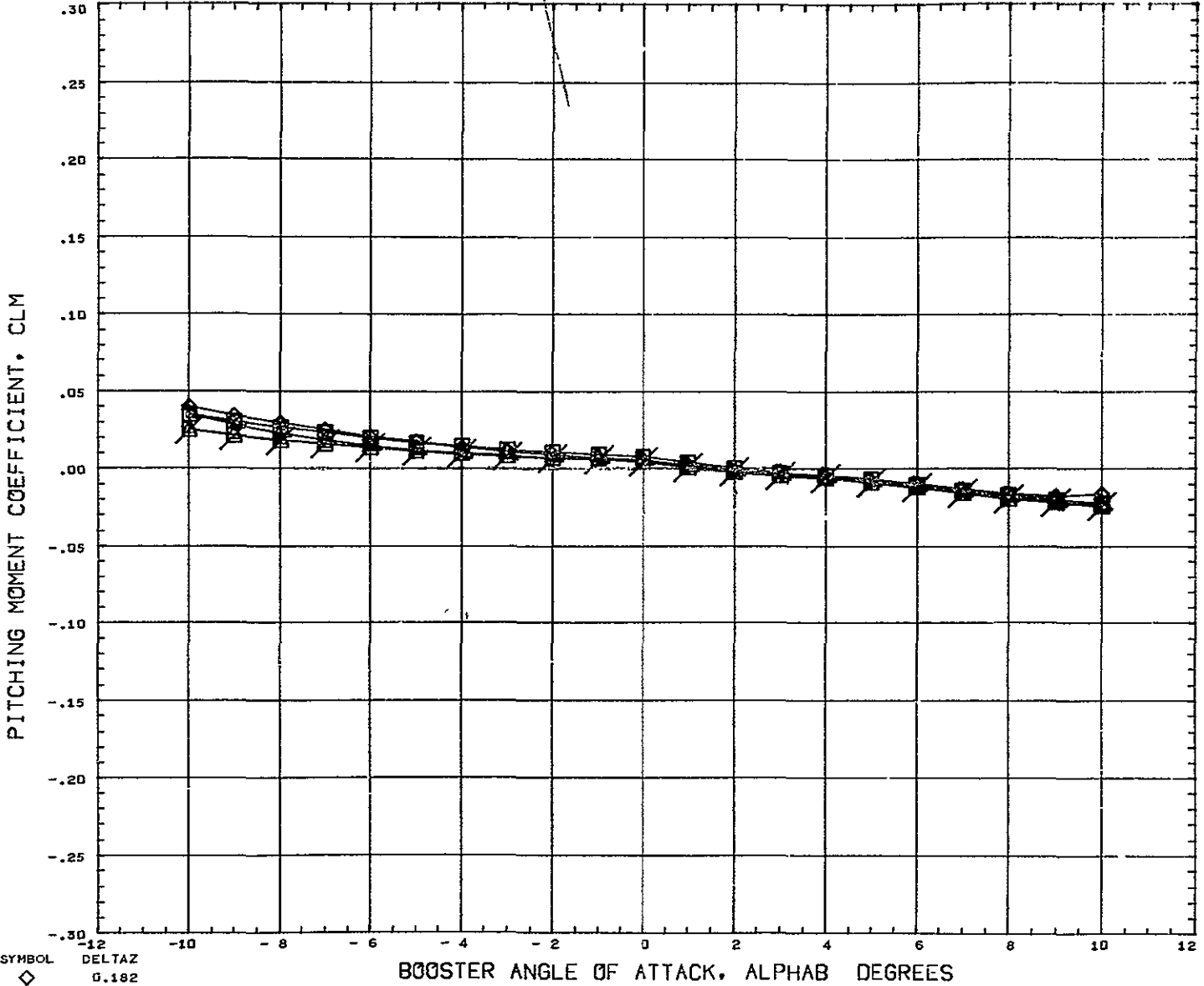

SYMBOL ◇ □ ◇ □ ◇ □	DELTA Z 0.182 0.228 0.352 0.599 10.000	PARAMETRIC VALUES BSTPOW    50.000    ORBPOW    100.000 DF' TAX    - 0.143    ALPHAI    - 10.000 MACH       5.010    ELVST     0 000 ELVORB    0.000    BETA      0.000	REFERENCE INFORMATION REFS       44.4440    SQ IN REFL       13 3330    IN REFB       13 3330    IN XMRP       7.5280    IN YMRP       0 0000    IN ZMRP       1 1940    IN SCALE      0 0055
REFERENCE FILE			

# AEDC VA 1163 MDAC BOOSTER AND ORBITER TEST DATA AT MACH NUMBER 5

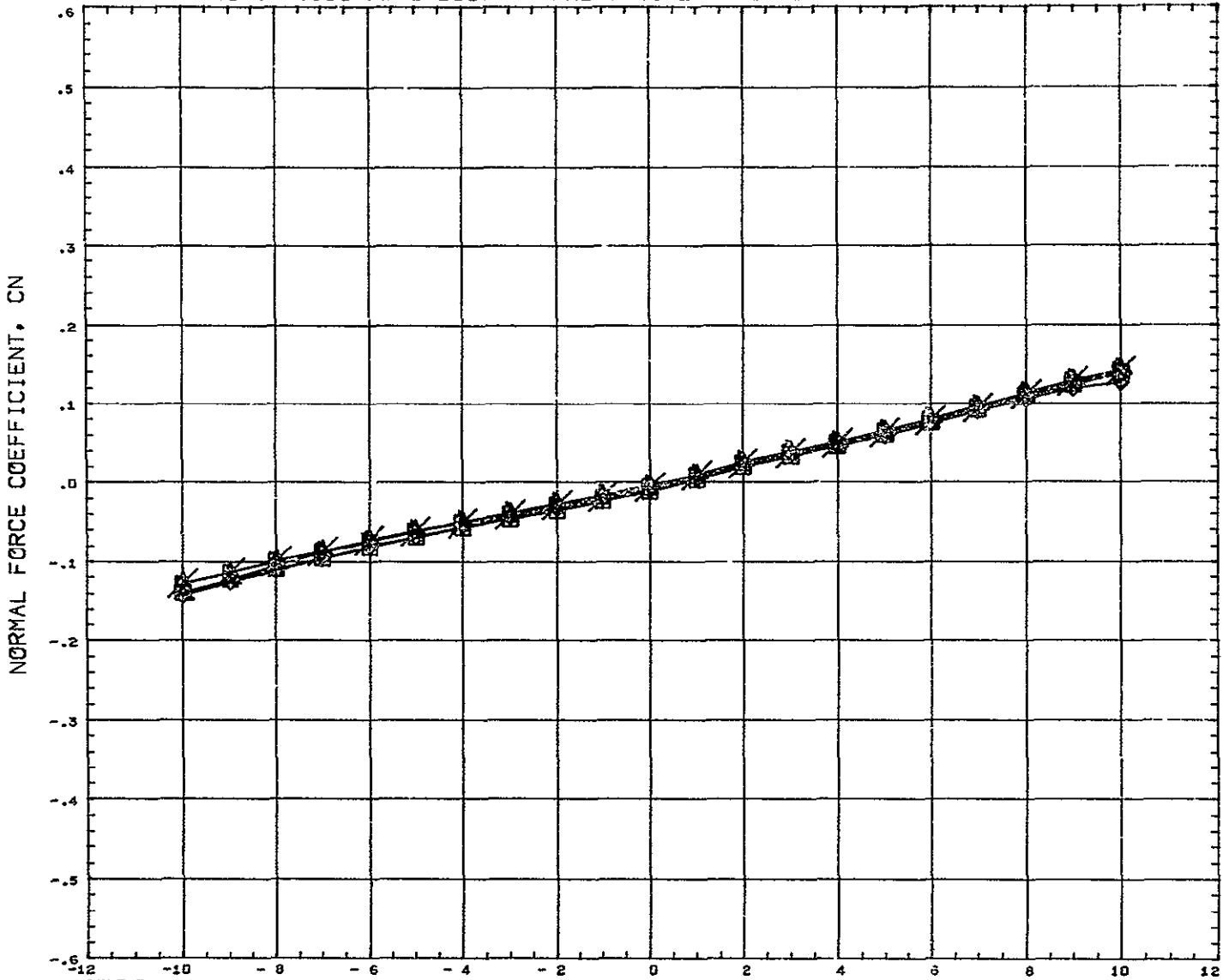

SYMBOL 	DELTAX 0.132 0.228 0.352 0.599 10.000	PARAMETRIC VALUES BSTPOW 50.000 ORBPOW 100.000 DELTAX - 0.143 ALPHAI - 10.000 MACH 5.010 ELVBST 0.000 ELVORB 0.000 BETA 0.000	REFERENCE INFORMATION REFS 44.4440 SQ IN REFL 13.3330 IN REFB 13.3330 IN XMRF 7.5280 IN YMRF 0.0000 IN ZMRF 1.1940 IN SCALE 0.0055
BOOSTER ANGLE OF ATTACK, ALPHA DEGREES			
REFERENCE FILE			

# AEDC VA 1163 MDAC BOOSTER AND ORBITER TEST DATA AT MACH NUMBER 5

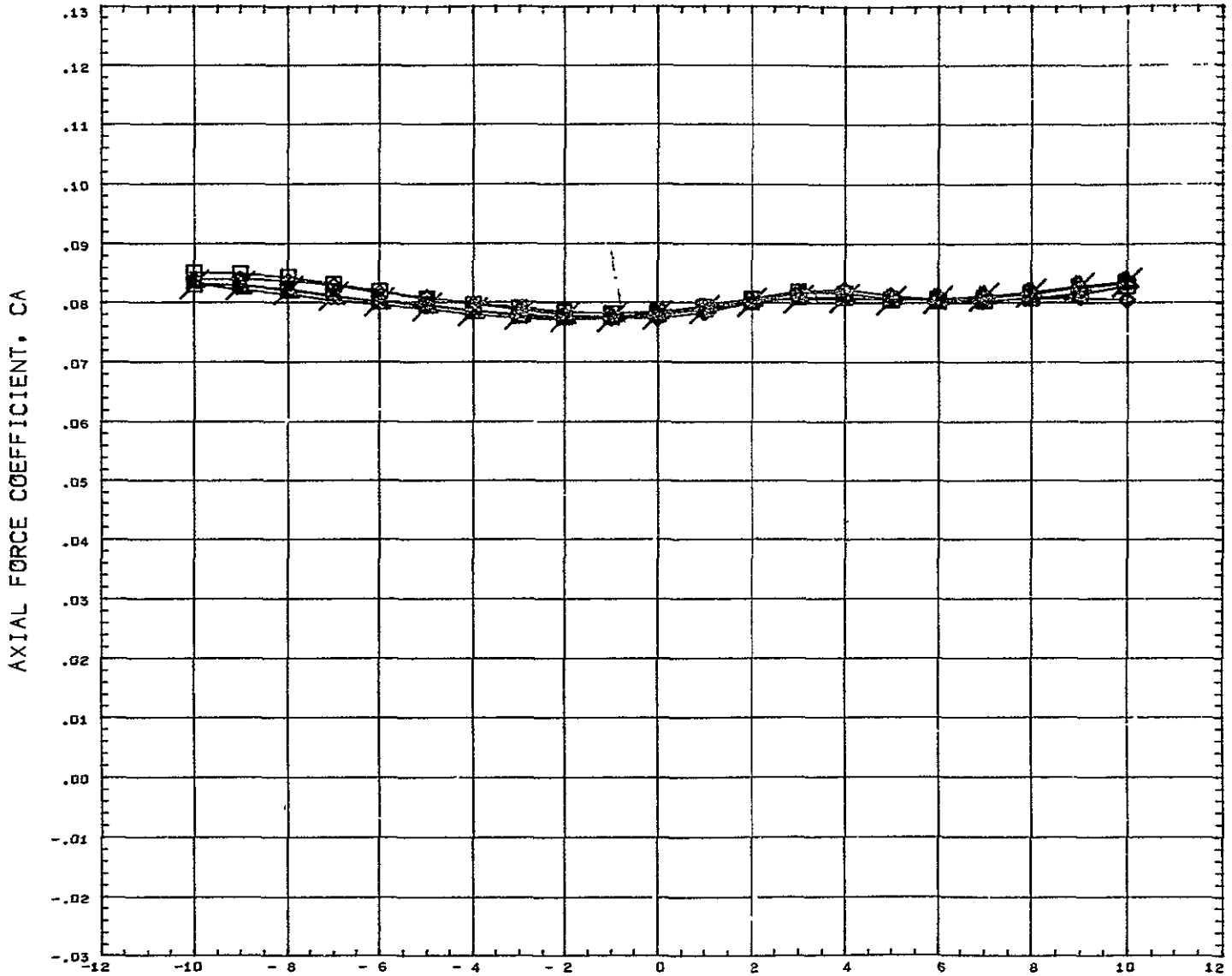

SYMBOL ◊ ◻ ◻ ◻ ◻	DELTA Z 0.182 0.228 0.352 0.599 10.000	<table border="0" style="width: 100%;"> <tr> <th colspan="4" style="text-align: center;">PARAMETRIC VALUES</th> </tr> <tr> <td>BSTPOW</td> <td>50.000</td> <td>ORBPOW</td> <td>100.000</td> </tr> <tr> <td>DELTA X</td> <td>0.143</td> <td>ALPHA I</td> <td>-10.000</td> </tr> <tr> <td>r CH</td> <td>5.010</td> <td>ELVBST</td> <td>0.000</td> </tr> <tr> <td>ELVORB</td> <td>0.000</td> <td>BETA</td> <td>0.000</td> </tr> </table>	PARAMETRIC VALUES				BSTPOW	50.000	ORBPOW	100.000	DELTA X	0.143	ALPHA I	-10.000	r CH	5.010	ELVBST	0.000	ELVORB	0.000	BETA	0.000	<table border="0" style="width: 100%;"> <tr> <th colspan="3" style="text-align: center;">REFERENCE INFORMATION</th> </tr> <tr> <td>REFS</td> <td>4 4440</td> <td>50 IN</td> </tr> <tr> <td>REFL</td> <td>13.3330</td> <td>IN</td> </tr> <tr> <td>REFB</td> <td>13.3330</td> <td>IN</td> </tr> <tr> <td>XMRP</td> <td>7.5280</td> <td>IN</td> </tr> <tr> <td>YMRP</td> <td>0.0000</td> <td>IN</td> </tr> <tr> <td>ZMRP</td> <td>1.1940</td> <td>IN</td> </tr> <tr> <td>SCALE</td> <td>0 0055</td> <td></td> </tr> </table>	REFERENCE INFORMATION			REFS	4 4440	50 IN	REFL	13.3330	IN	REFB	13.3330	IN	XMRP	7.5280	IN	YMRP	0.0000	IN	ZMRP	1.1940	IN	SCALE	0 0055	
PARAMETRIC VALUES																																															
BSTPOW	50.000	ORBPOW	100.000																																												
DELTA X	0.143	ALPHA I	-10.000																																												
r CH	5.010	ELVBST	0.000																																												
ELVORB	0.000	BETA	0.000																																												
REFERENCE INFORMATION																																															
REFS	4 4440	50 IN																																													
REFL	13.3330	IN																																													
REFB	13.3330	IN																																													
XMRP	7.5280	IN																																													
YMRP	0.0000	IN																																													
ZMRP	1.1940	IN																																													
SCALE	0 0055																																														

REFERENCE FILE

# AEDC VA 1163 MDAC BOOSTER AND ORBITER TEST DATA AT MACH NUMBER 5

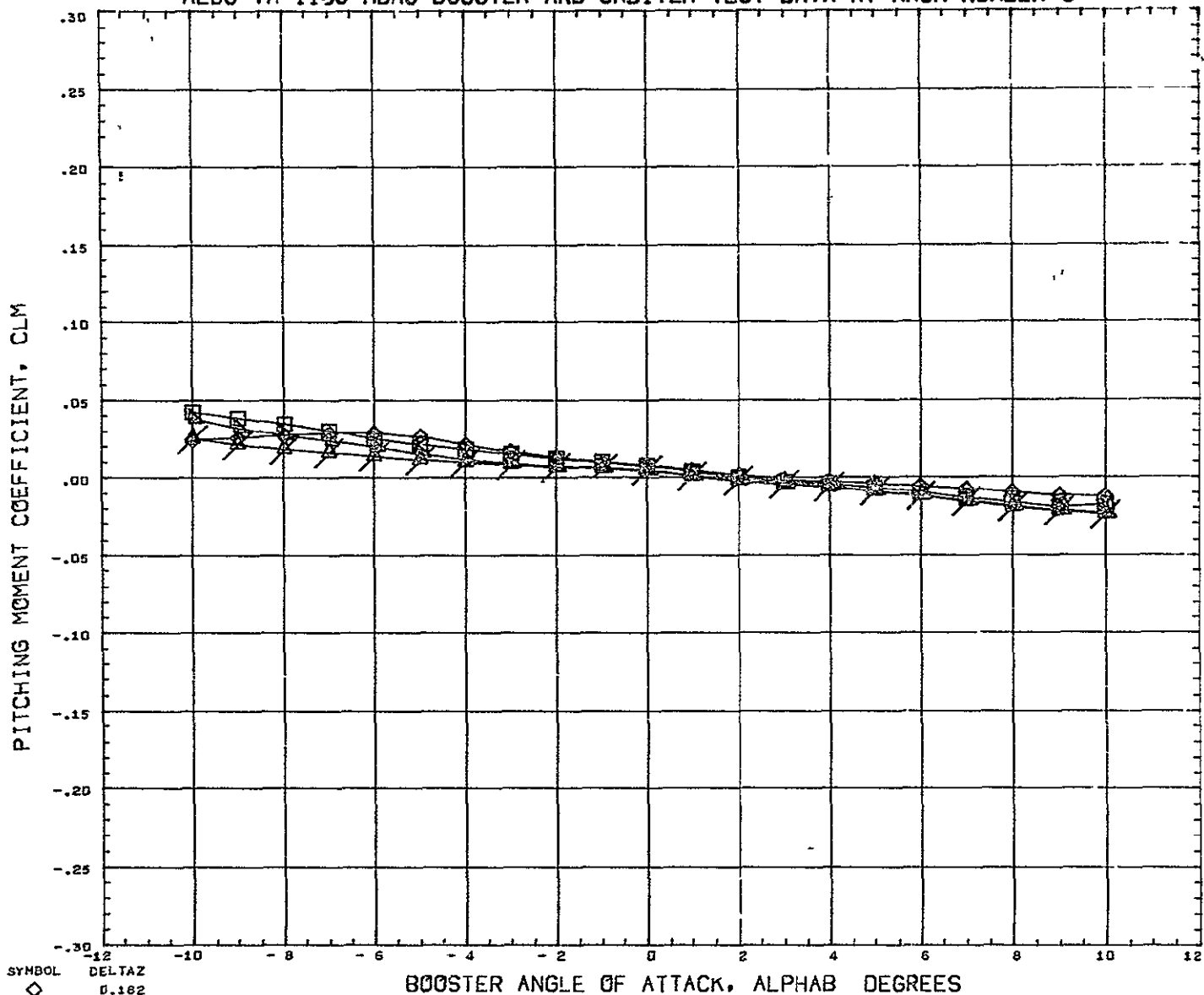

SYMBOL ◇ □ △	DELTAZ 0.182 0.228 0.352 10.000	PARAMETRIC VALUES BSTFOW 50.000 ORBPOW 100.000 DFLTAX - 0.019 ALPHAI - 10.000 MACH 5.010 ELVBST 0.000 ELVORB 0.000 BETA 0.000	REFERENCE INFORMATION REFS 44.4440 SQ IN REFL 13.3330 IN REFB 13.3330 IN XMRF 7.5200 IN YMRF 0.0000 IN ZMRF 1.1940 IN SCALE 0.0055
REFERENCE FILE			

# AEDC VA 1163 MDAC BOOSTER AND ORBITER TEST DATA AT MACH NUMBER 5

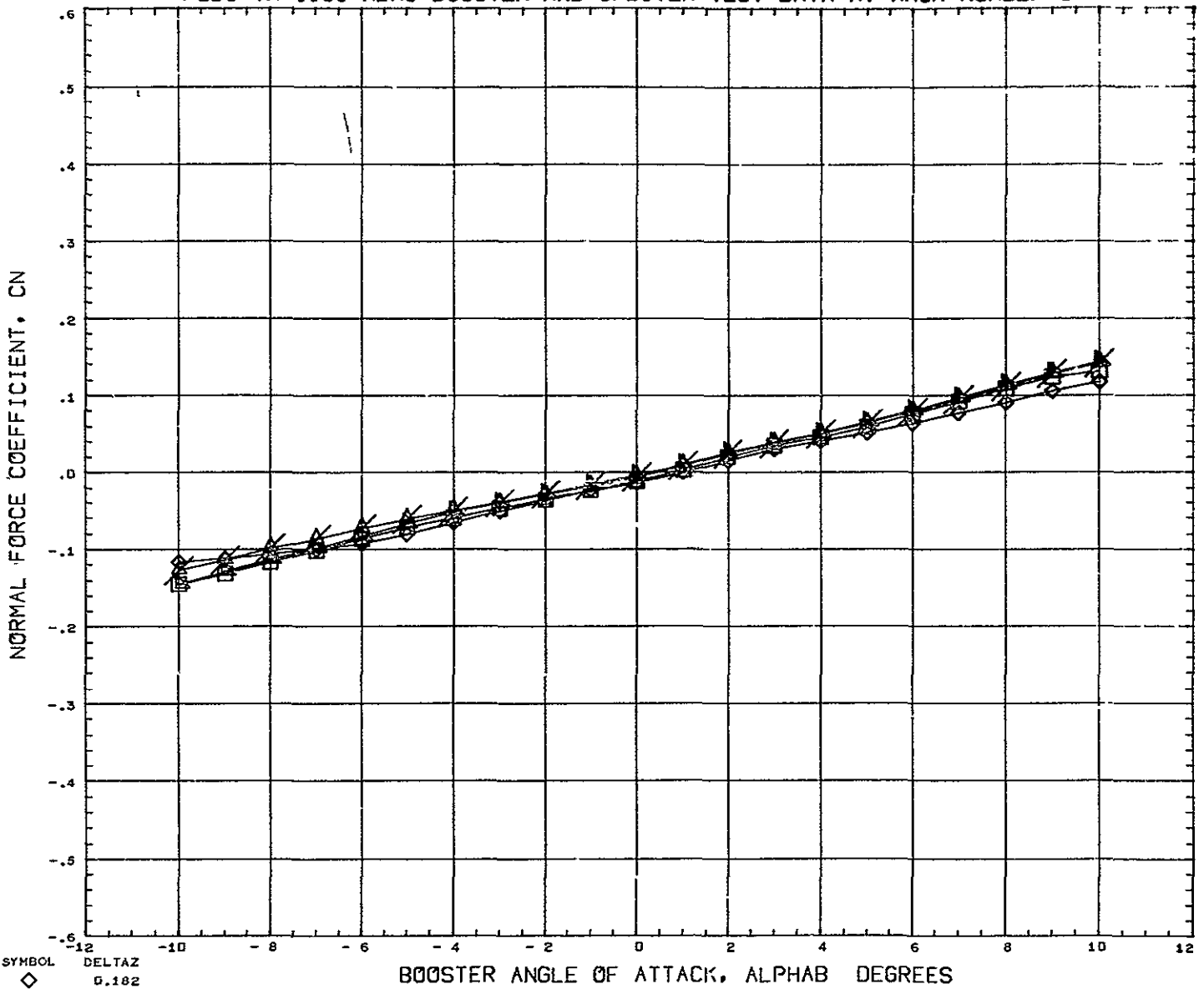

SYMBOL ◇ □ △	DELTAZ 0.182 0.228 0.352 10.000	PARAMETRIC VALUES BSTPOW    50.000    ORBPOW    100.000 DELTAX    - 0.019    ALPHAI    - 10.000 MACH       5.010    ELVBST    0.000 ELVORB     0.000    BETA       0.000	REFERENCE INFORMATION REFS       4.4440    SQ IN REFL       13.3330    IN REFB       13.3330    IN XMRP       7.5280    IN YMRP       0.0000    IN ZMRP       1.1940    IN SCALE       0.0055
-----------------------	---	--	--

REFERENCE FILE

# AEDC VA 1163 MDAC BOOSTER AND ORBITER TEST DATA AT MACH NUMBER 5

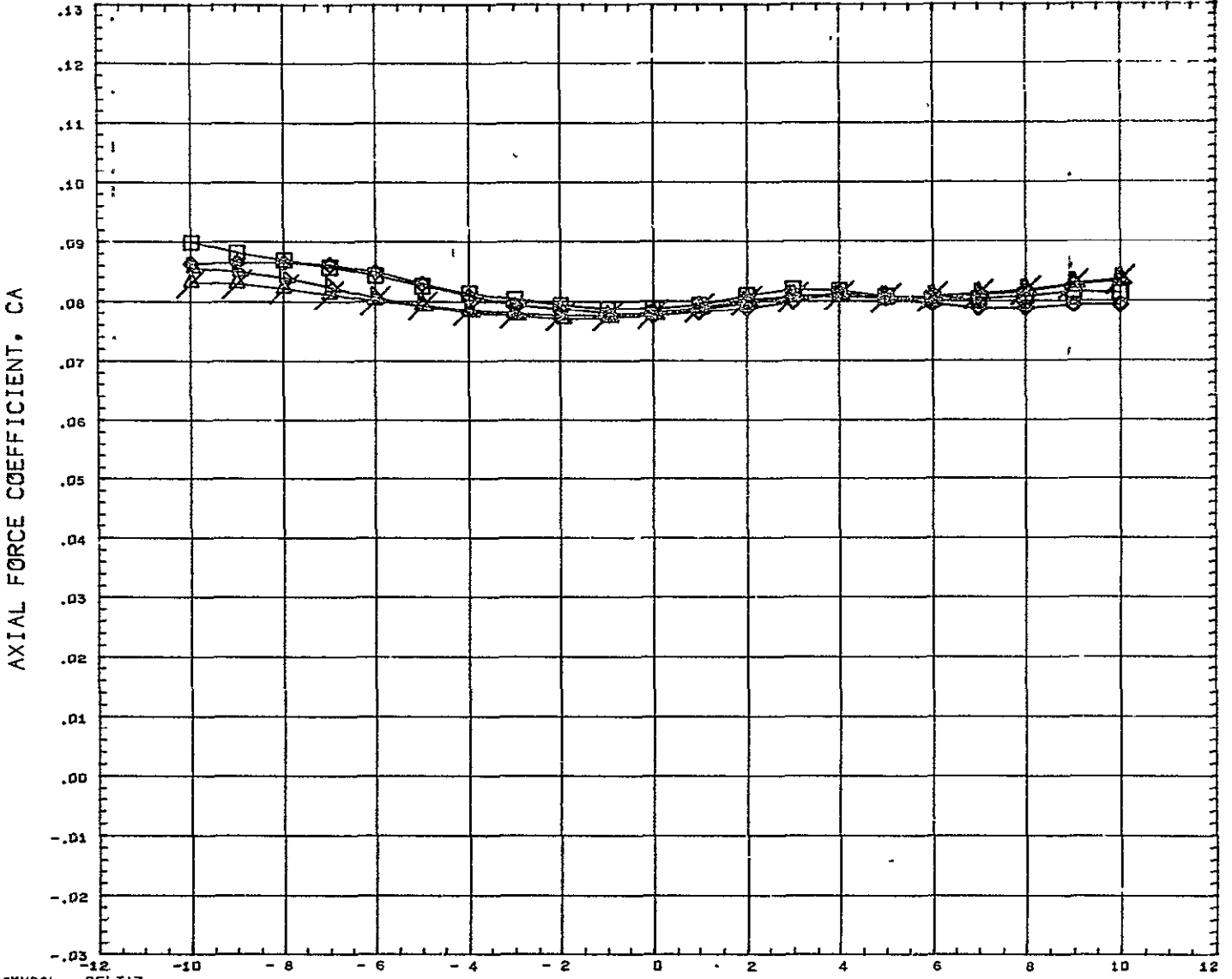

SYMBOL ◊ ◻ △ ▽	-DELTAZ 0.182 0.228 0.352 10.000	<table border="0" style="width: 100%;"> <tr> <th colspan="4" style="text-align: center;">PARAMETRIC VALUES</th> </tr> <tr> <td>BSTPOW</td><td>50.000</td><td>ORBPOW</td><td>100.000</td> </tr> <tr> <td>DELTAZ</td><td>- 0.019</td><td>ALPHA1</td><td>- 10.000</td> </tr> <tr> <td>MACH</td><td>5.010</td><td>ELVBST</td><td>0.000</td> </tr> <tr> <td>ELVORB</td><td>0.000</td><td>BETA</td><td>0.000</td> </tr> </table>	PARAMETRIC VALUES				BSTPOW	50.000	ORBPOW	100.000	DELTAZ	- 0.019	ALPHA1	- 10.000	MACH	5.010	ELVBST	0.000	ELVORB	0.000	BETA	0.000	<table border="0" style="width: 100%;"> <tr> <th colspan="2" style="text-align: center;">REFERENCE INFORMATION</th> </tr> <tr> <td>REFS</td><td>1.444C SQ IN</td> </tr> <tr> <td>REFL</td><td>13.333u IN</td> </tr> <tr> <td>REFB</td><td>13.333G IN</td> </tr> <tr> <td>AMRP</td><td>7.5280 IN</td> </tr> <tr> <td>YMRP</td><td>0.0000 IN</td> </tr> <tr> <td>ZMRP</td><td>1.1943 IN</td> </tr> <tr> <td>SCALE</td><td>0.0055</td> </tr> </table>	REFERENCE INFORMATION		REFS	1.444C SQ IN	REFL	13.333u IN	REFB	13.333G IN	AMRP	7.5280 IN	YMRP	0.0000 IN	ZMRP	1.1943 IN	SCALE	0.0055
PARAMETRIC VALUES																																							
BSTPOW	50.000	ORBPOW	100.000																																				
DELTAZ	- 0.019	ALPHA1	- 10.000																																				
MACH	5.010	ELVBST	0.000																																				
ELVORB	0.000	BETA	0.000																																				
REFERENCE INFORMATION																																							
REFS	1.444C SQ IN																																						
REFL	13.333u IN																																						
REFB	13.333G IN																																						
AMRP	7.5280 IN																																						
YMRP	0.0000 IN																																						
ZMRP	1.1943 IN																																						
SCALE	0.0055																																						
REFERENCE FILE																																							

# AEDC VA 1163 MDAC BOOSTER AND ORBITER TEST DATA AT MACH NUMBER 5

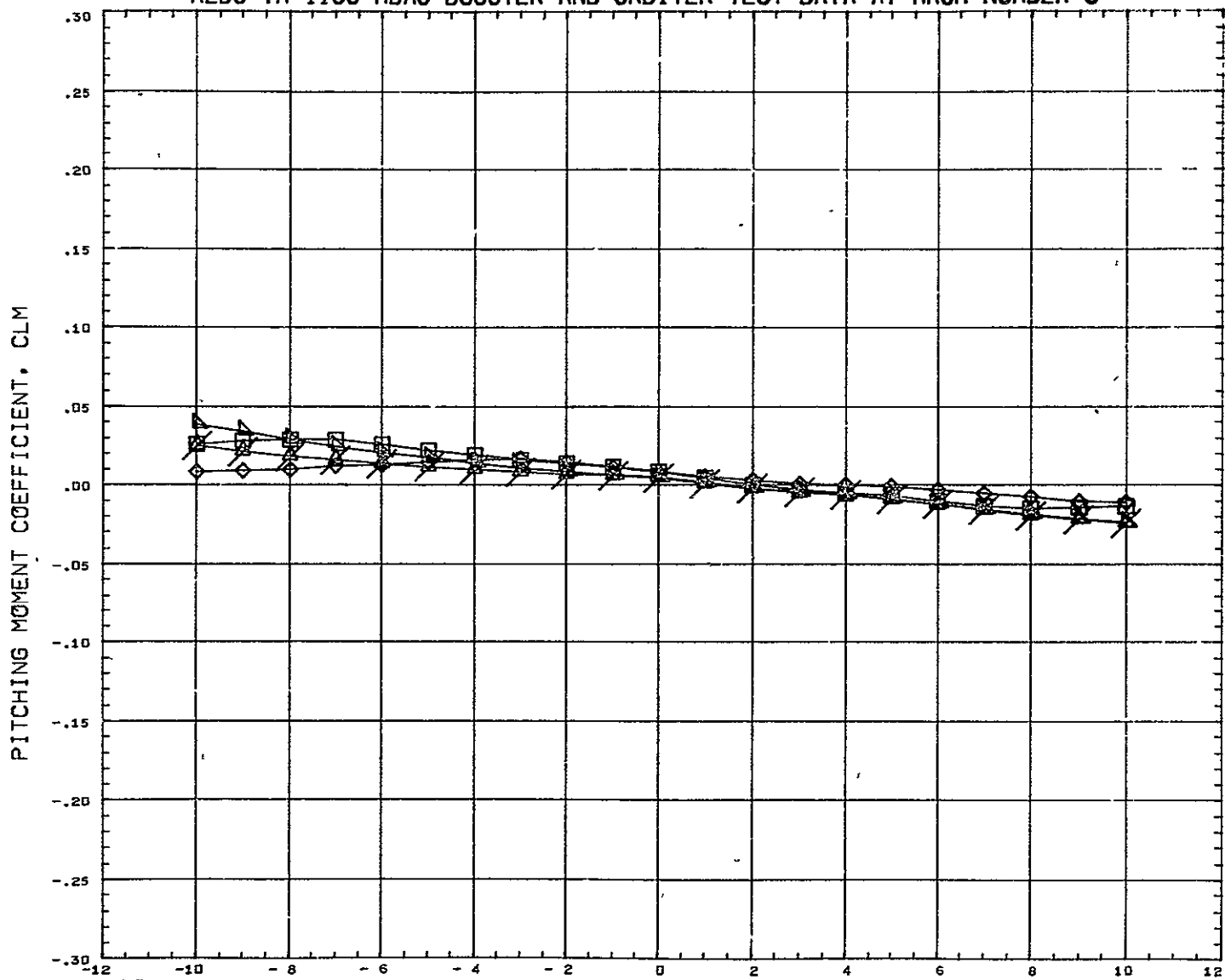

SYMBOL ◇ □ △ ○	DELTAZ 0.182 0.228 0.352 10.000	PARAMETRIC VALUES BSTPCW 50.000 ORBPOW 100.000 DELTAX 0.043 ALPHAI -10.000 ACH 5.010 ELVBST 0.000 ELVORB 0.000 BETA 0.000	REFERENCE INFORMATION REFS 4 4440 SQ IN REFL 13.3330 IN REFB 13.3330 IN XMRF 7 5280 IN YMRF 0.0000 IN ZMRF 1.1940 IN SCALE 0.0055
----------------------------	---	---	--

REFERENCE FILE



# AEDC VA 1163 MDAC BOOSTER AND ORBITER TEST DATA AT MACH NUMBER 5

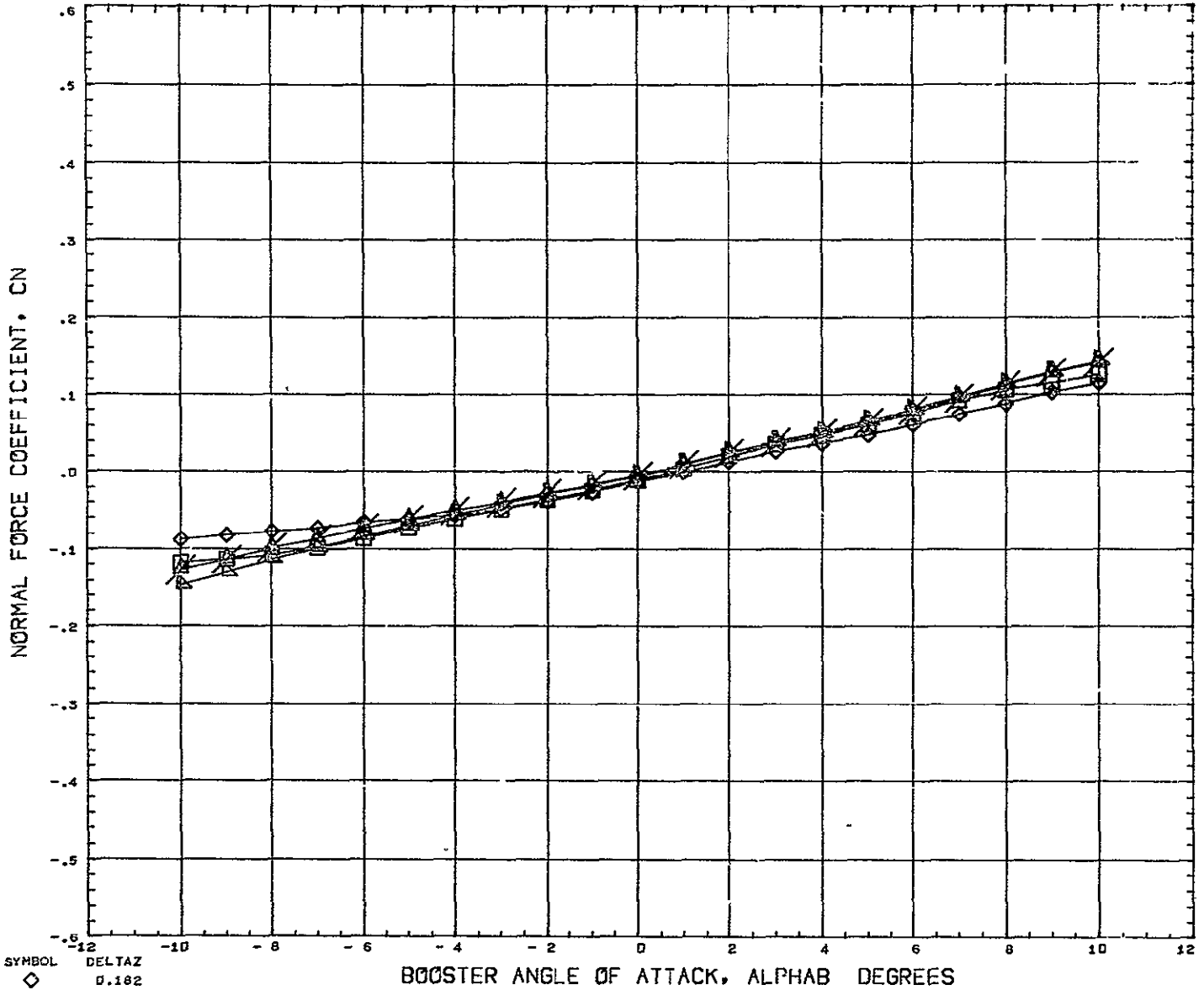

SYMBOL  
 ◇  
 □  
 △  
 ×

DELTA Z  
 0.102  
 0.228  
 0.352  
 10.000

PARAMETRIC VALUES  
 BSTFOW 50.000 ORBFOV 100.000  
 ZLTAX 0.043 ALPHAI - 10.000  
 MACH 5.010 E-VBST 0.000  
 ELVORB 0.000 BETA 0.000

REFERENCE INFORMATION  
 REFS 44.4440 SQ IN  
 REFL 13.3330 IN  
 REFB 13.3330 IN  
 XMRP 7.5280 IN  
 YMRP 0.0000 IN  
 ZMRP 1.1940 IN  
 SCALE 0 0055

REFERENCE FILE

# AEDC VA 1163 MDAC BOOSTER AND ORBITER TEST DATA AT MACH NUMBER 5

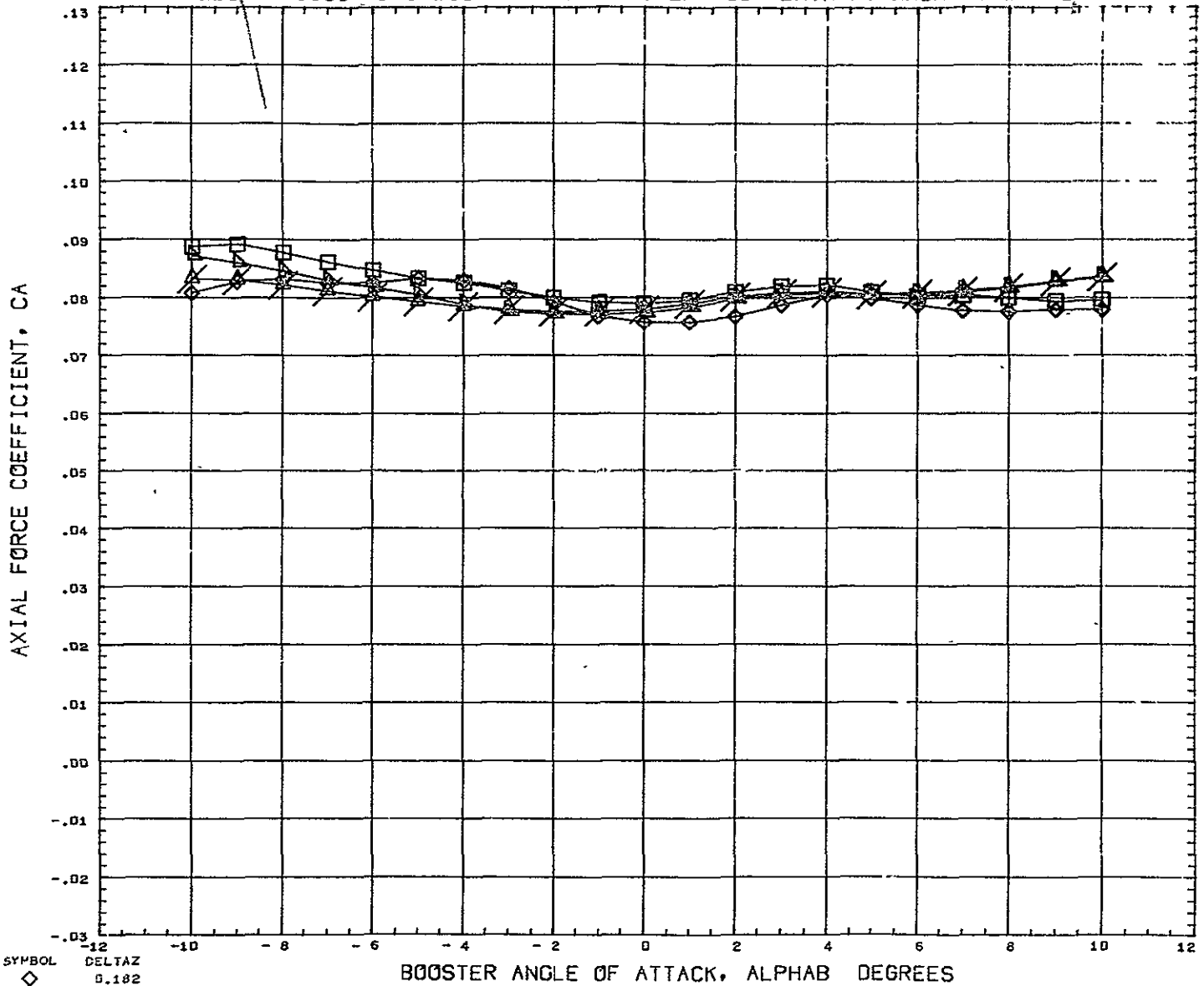

SYMBOL 	DELTAX 0.182 0.228 0.362 10.000	PARAMETRIC VALUES BSTPOW 50.000 ORBPOW 100.000 ELTAX 0.043 ALPHAI -10.000 MACH 5.010 ELVBST 0.000 ELVORB 0.000 BETA 0.000	REFERENCE INFORMATION REFS 44.4440 SQ IN REFL 13.3330 IN PEPB 13.3330 IN XMRP 7.5280 IN YMRP 0.0000 IN ZMRP 1.1940 IN SCALE 0.0055
REFERENCE FILE			

AEDC VA 1163 MDAC BOOSTER AND ORBITER TEST DATA AT MACH NUMBER 5

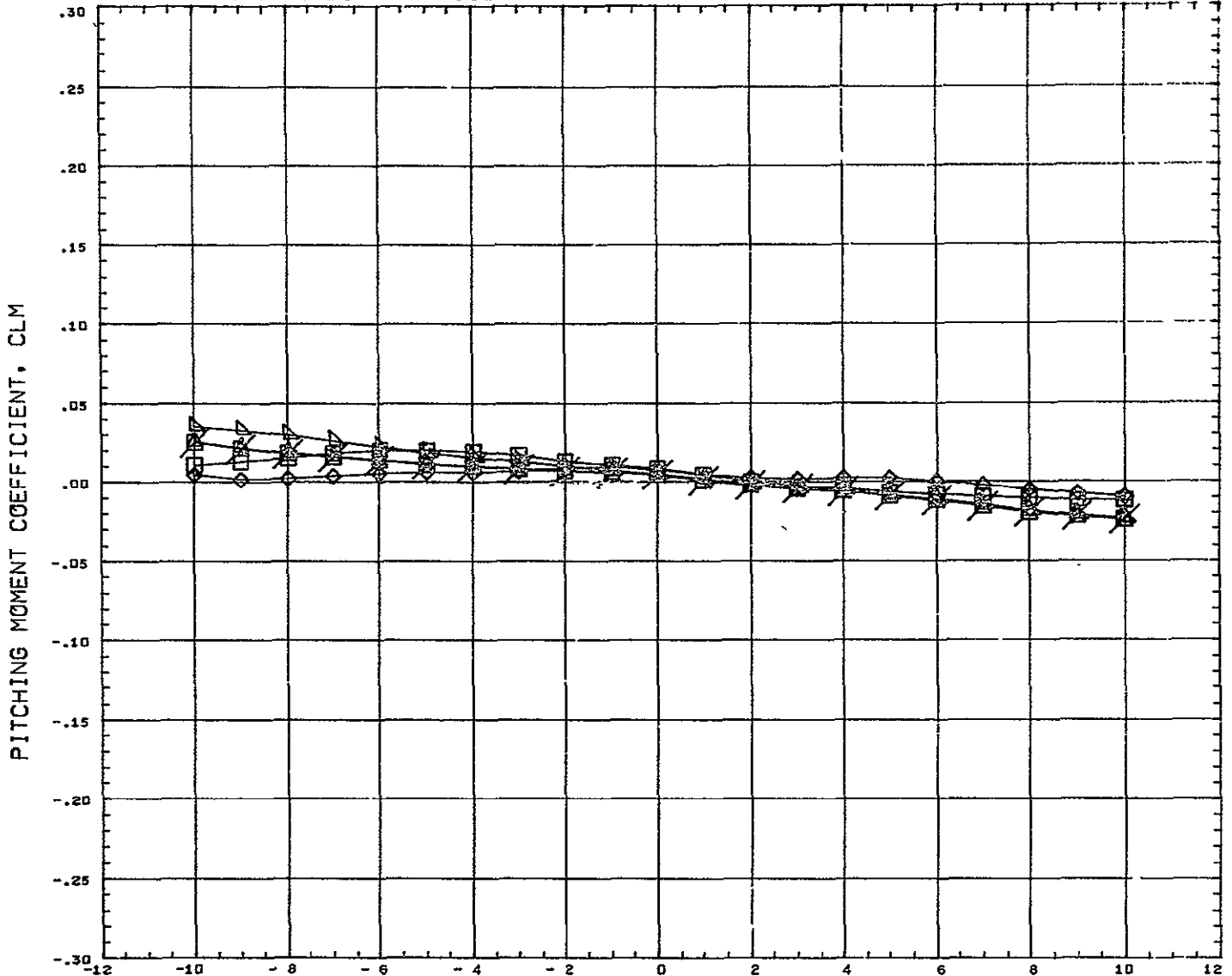

SYMBOL	DELTA Z	PARAMETRIC VALUES				REFERENCE INFORMATION		
◇	0.182	BSTPOW	50.000	ORBPOW	100.000	REFS	44.4440	SQ III
□	0.228	D'LTAX	0.105	ALPHA1	-10.000	REFL	13.3330	IN
◇	0.352	MACH	5.010	ELVBST	0.000	REFB	13.3330	IN
◇	0.599	ELVORB	0.000	BETA	0.000	XMRP	7.5280	IN
◇	10.000					YMRP	0.0000	IN
						ZMRP	1.1540	IN
						SCALE	0.0055	

REFERENCE FILE

# AEDC VA 1163 MDAC BOOSTER AND ORBITER TEST DATA AT MACH NUMBER 5

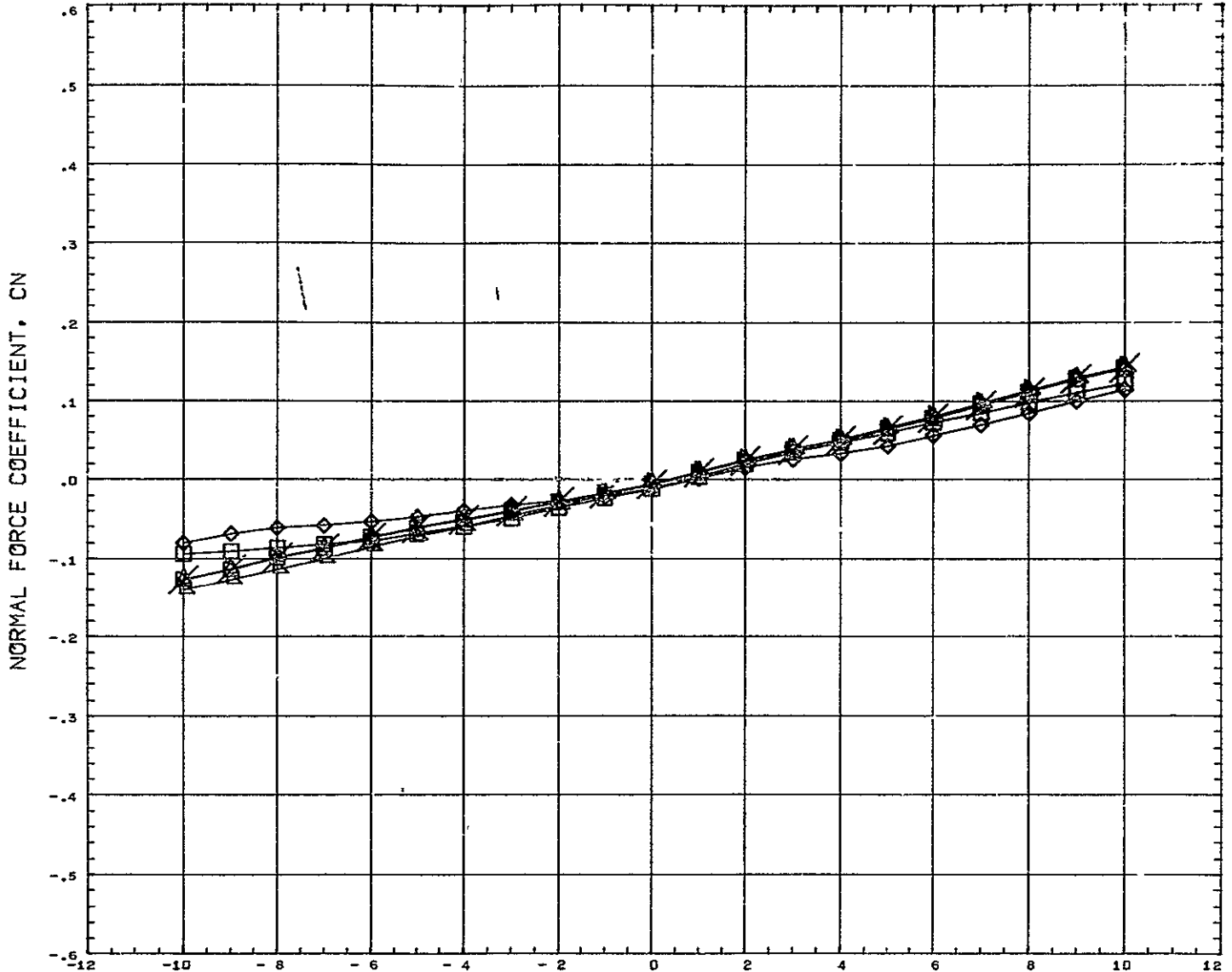

SYMBOL ◇ □ △	DELTAX 0.182 0.228 0.352 0.599 10.000	PARAMETRIC VALUES BSTPOW 50.000    ORBPOW 100.000 DELTAX 0.182    ALPHAI - 10.000 MACH 5.010    ELVBST 0.000 ELVORB 0.000    BETA 0.000	REFERENCE INFORMATION REFS 44.4440    SQ IN REFL 13.3330    IN REFB 13.3330    IN XMRF 7.5280    IN YMRF 0.0000    IN ZMRF 1.1940    IN SCALE 0.0055
-----------------------	--	---	---

REFERENCE FILE

# AEDC VA 1163 MDAC BOOSTER AND ORBITER TEST DATA AT MACH NUMBER 5

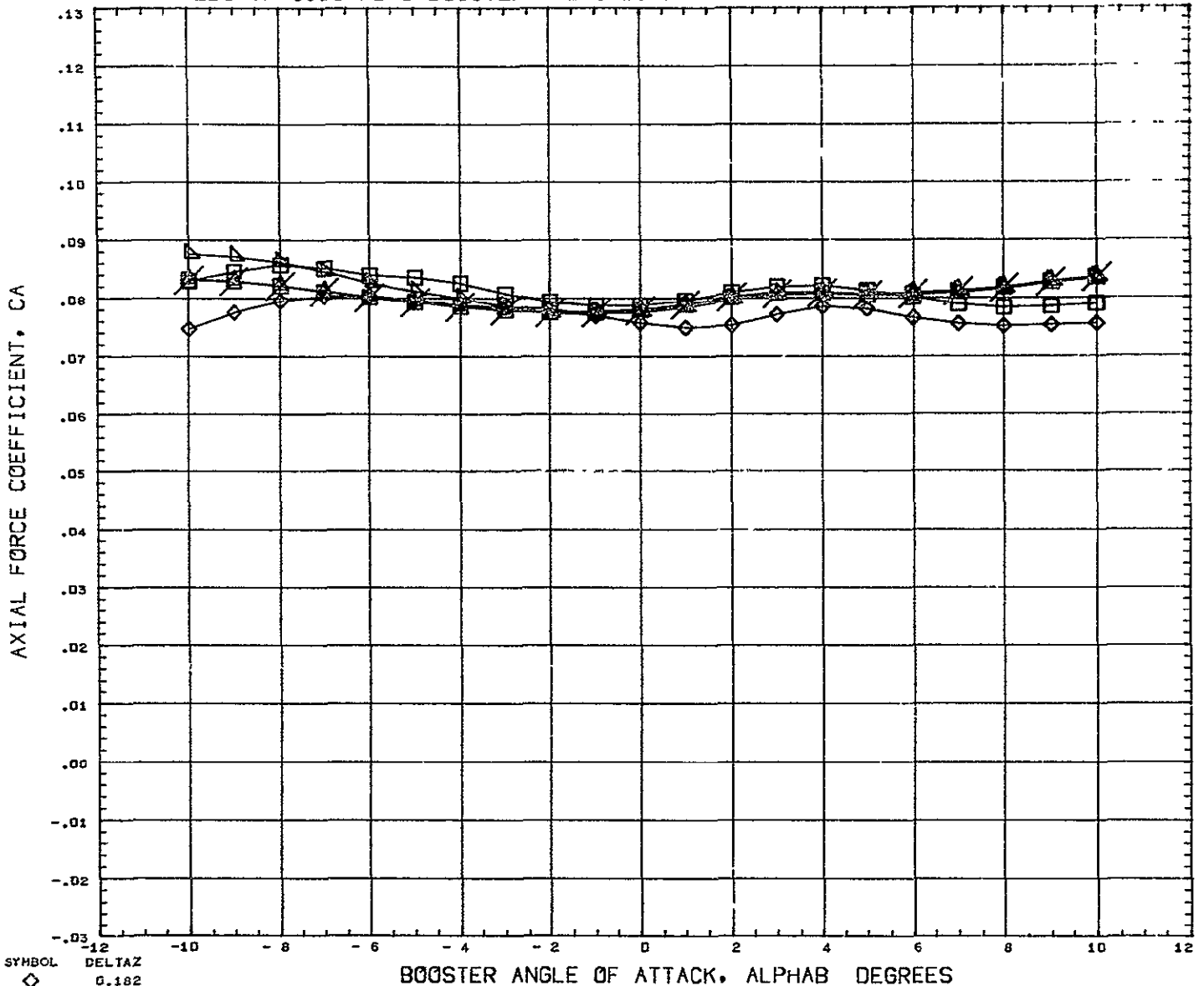

SYMBOL ◇ □ △ ×	DELTA Z 0.182 0.228 0.352 0.599 10.000	PARAMETRIC VALUES BSTFOW 50.000 ORBPOW 100.000 D <sup>o</sup> LTAx 0.105 ALPHAI - 10.000 MACH 5.010 ELVBST 0.000 ELVORB 0.000 BETA 0.000	REFERENCE INFORMATION REFS 44.4440 SQ IN REFL 13.3330 IN REFB 13.3330 IN XMRP 7.5280 IN YMRP 0.0000 IN ZMRP 1.1940 IN SCALE 0.0055
----------------------------	---	--	---

REFERENCE FILE

# AEDC VA 1163 MDAC BOOSTER AND ORBITER TEST DATA AT MACH NUMBER 5

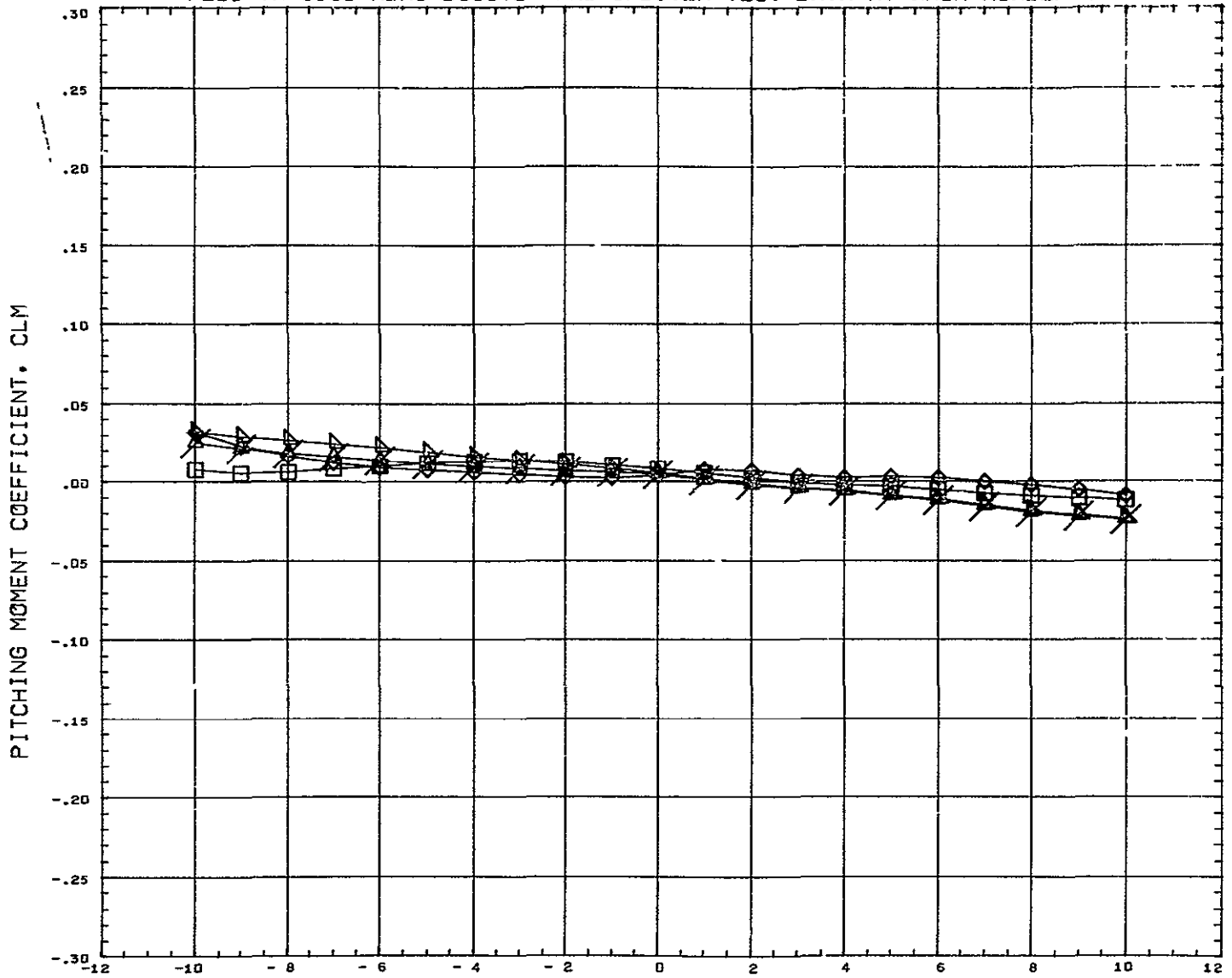

SYMBOL ◇ □ ▲	DELTAZ 0.182 0.228 0.352 10.000	<table border="0" style="width: 100%;"> <tr> <th colspan="4" style="text-align: left; padding-left: 20px;">PARAMETRIC VALUES</th> </tr> <tr> <td style="padding-right: 20px;">BSTPOW</td> <td>50.000</td> <td style="padding-right: 20px;">ORBPOW</td> <td>100.000</td> </tr> <tr> <td>DELTAZ</td> <td>0.167</td> <td>ALPHAI</td> <td>-10.000</td> </tr> <tr> <td>MACH</td> <td>5.010</td> <td>ELVBST</td> <td>0.000</td> </tr> <tr> <td>ELVORB</td> <td>0.000</td> <td>BETA</td> <td>0.000</td> </tr> </table>	PARAMETRIC VALUES				BSTPOW	50.000	ORBPOW	100.000	DELTAZ	0.167	ALPHAI	-10.000	MACH	5.010	ELVBST	0.000	ELVORB	0.000	BETA	0.000	<table border="0" style="width: 100%;"> <tr> <th colspan="3" style="text-align: left;">REFERENCE INFORMATION</th> </tr> <tr> <td>REFS</td> <td>44 4440</td> <td>SQ IN</td> </tr> <tr> <td>REFL</td> <td>13 3330</td> <td>IN</td> </tr> <tr> <td>REFB</td> <td>13 3330</td> <td>IN</td> </tr> <tr> <td>XMRP</td> <td>7 5280</td> <td>IN</td> </tr> <tr> <td>YMRP</td> <td>0 0000</td> <td>IN</td> </tr> <tr> <td>ZMRP</td> <td>1 1940</td> <td>IN</td> </tr> <tr> <td>SCALE</td> <td>0.0055</td> <td></td> </tr> </table>	REFERENCE INFORMATION			REFS	44 4440	SQ IN	REFL	13 3330	IN	REFB	13 3330	IN	XMRP	7 5280	IN	YMRP	0 0000	IN	ZMRP	1 1940	IN	SCALE	0.0055	
PARAMETRIC VALUES																																															
BSTPOW	50.000	ORBPOW	100.000																																												
DELTAZ	0.167	ALPHAI	-10.000																																												
MACH	5.010	ELVBST	0.000																																												
ELVORB	0.000	BETA	0.000																																												
REFERENCE INFORMATION																																															
REFS	44 4440	SQ IN																																													
REFL	13 3330	IN																																													
REFB	13 3330	IN																																													
XMRP	7 5280	IN																																													
YMRP	0 0000	IN																																													
ZMRP	1 1940	IN																																													
SCALE	0.0055																																														

REFERENCE FILE

# AEDC VA 1163 MDAC BOOSTER AND ORBITER TEST DATA AT MACH NUMBER 5

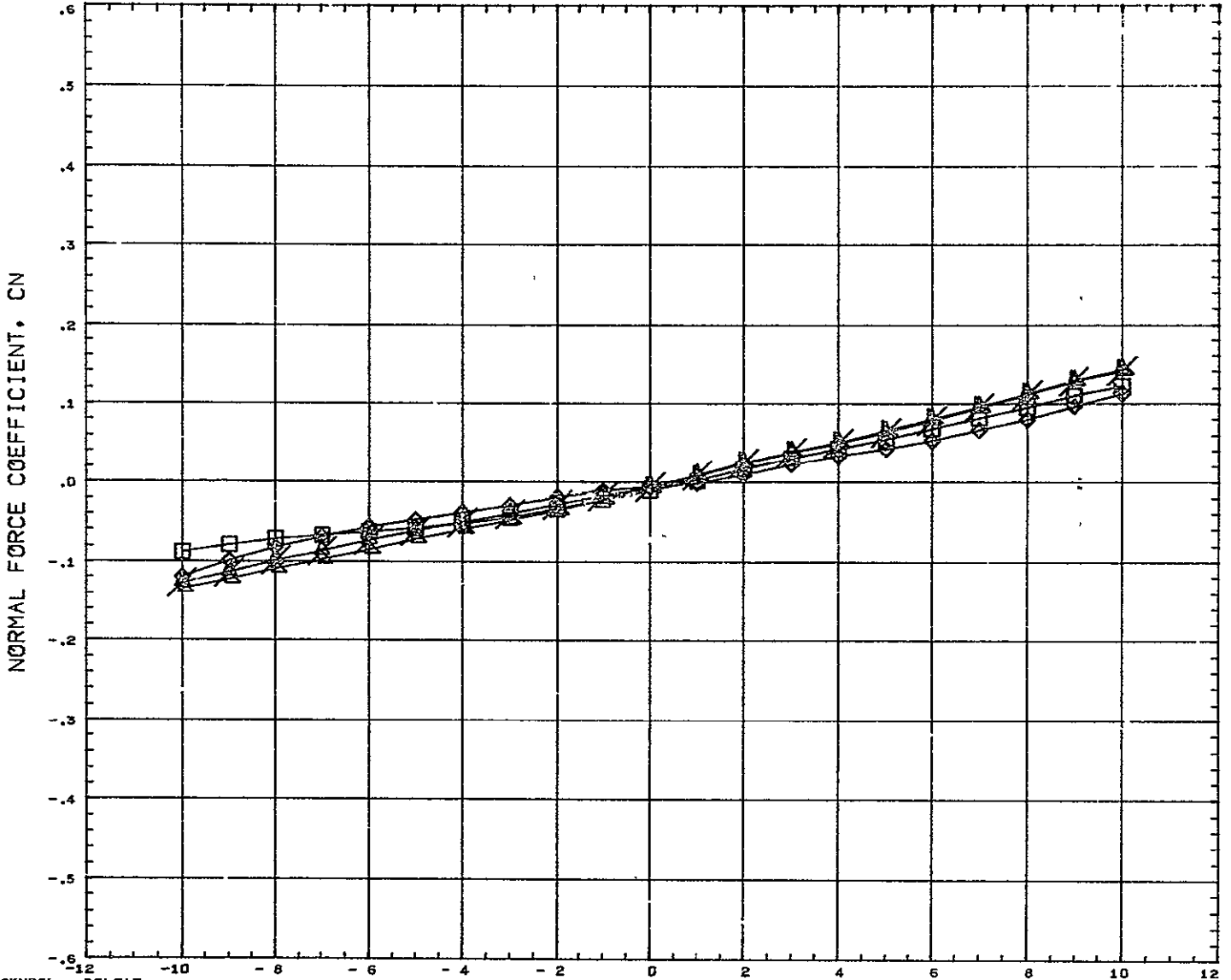

SYMBOL ◻ ◊ ▲ ▼	DELTAX 0.182 0.228 0.352 10.000	PARAMETRIC VALUES BSTPOW 50.000 ORBPOW 100.000 DELTAX 0.167 ALPHAI - 10.000 MACH 5.010 ELVBST 0.000 ELVORB 0.000 BETA 0.000	REFERENCE INFORMATION RCFS 47.4440 SQ IN REFL 13.3330 IN REFB 13.3330 IN XMRP 7.5280 IN YMRP 0.0000 IN ZMRP 1.1940 IN SCALE 0.0055
REFERENCE FILE			

# AEDC VA 1163 MDAC BOOSTER AND ORBITER TEST DATA AT MACH NUMBER 5

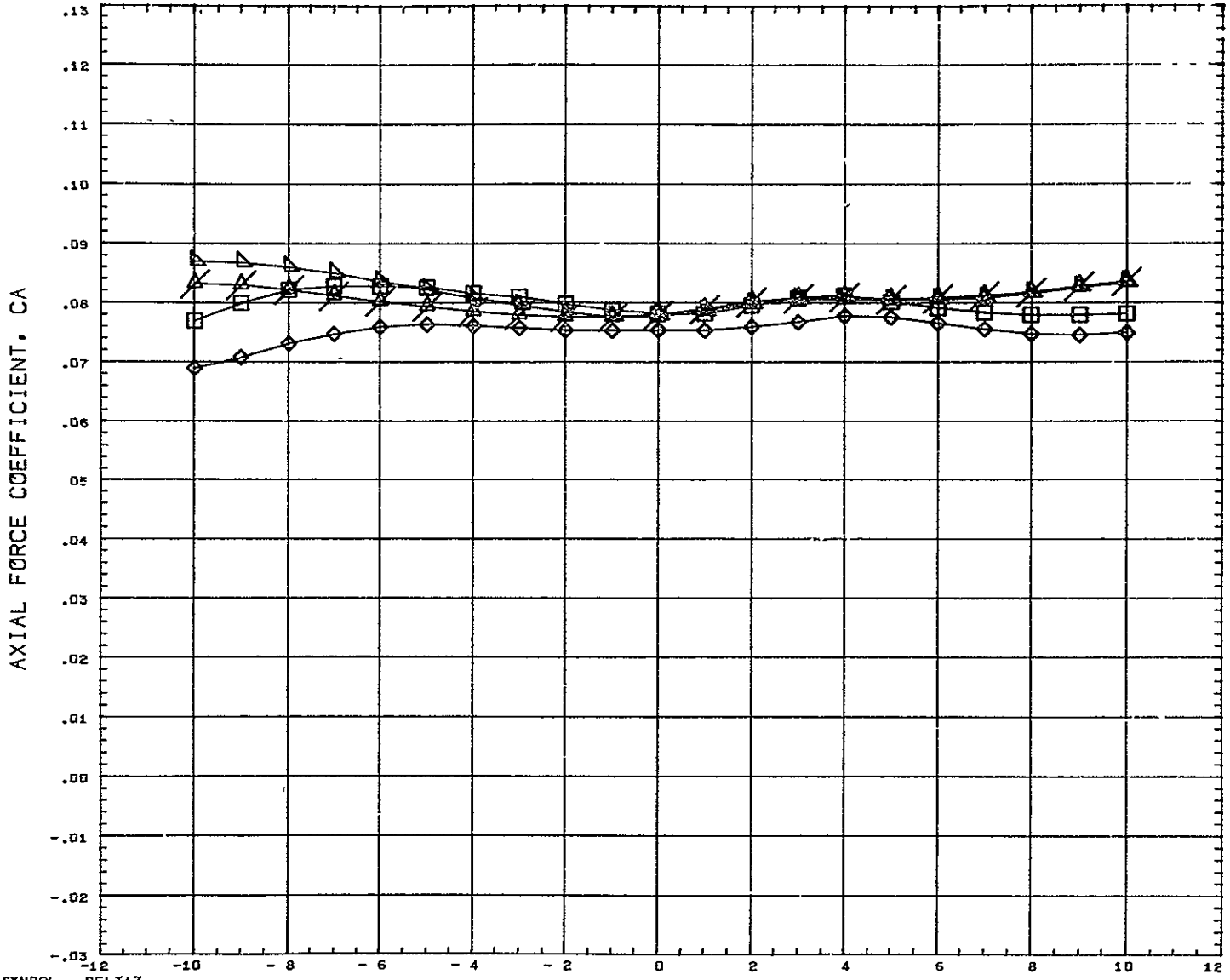

SYMBOL 	DELTAZ 0.182 0.228 0.352 10.000	<table border="0" style="width: 100%;"> <tr> <th colspan="4" style="text-align: center;">PARAMETRIC VALUES</th> </tr> <tr> <td>BSTPOW</td><td>50.000</td><td>ORBPOW</td><td>100.000</td> </tr> <tr> <td>DELTAZ</td><td>0.167</td><td>ALPHA1</td><td>-10.000</td> </tr> <tr> <td>CH</td><td>5.010</td><td>ELVBST</td><td>0.000</td> </tr> <tr> <td>ELVORB</td><td>0.000</td><td>BETA</td><td>0.000</td> </tr> </table>	PARAMETRIC VALUES				BSTPOW	50.000	ORBPOW	100.000	DELTAZ	0.167	ALPHA1	-10.000	CH	5.010	ELVBST	0.000	ELVORB	0.000	BETA	0.000	<table border="0" style="width: 100%;"> <tr> <th colspan="2" style="text-align: center;">REFERENCE INFORMATION</th> </tr> <tr> <td>REFS</td><td>44.4440 SQ IN</td> </tr> <tr> <td>REFL</td><td>13.3330 IN</td> </tr> <tr> <td>REFB</td><td>13.3330 IN</td> </tr> <tr> <td>XMRP</td><td>7.5288 IN</td> </tr> <tr> <td>YMRP</td><td>0.0000 IN</td> </tr> <tr> <td>ZMRP</td><td>1.1940 IN</td> </tr> <tr> <td>SCALE</td><td>0.0055</td> </tr> </table>	REFERENCE INFORMATION		REFS	44.4440 SQ IN	REFL	13.3330 IN	REFB	13.3330 IN	XMRP	7.5288 IN	YMRP	0.0000 IN	ZMRP	1.1940 IN	SCALE	0.0055
PARAMETRIC VALUES																																							
BSTPOW	50.000	ORBPOW	100.000																																				
DELTAZ	0.167	ALPHA1	-10.000																																				
CH	5.010	ELVBST	0.000																																				
ELVORB	0.000	BETA	0.000																																				
REFERENCE INFORMATION																																							
REFS	44.4440 SQ IN																																						
REFL	13.3330 IN																																						
REFB	13.3330 IN																																						
XMRP	7.5288 IN																																						
YMRP	0.0000 IN																																						
ZMRP	1.1940 IN																																						
SCALE	0.0055																																						
REFERENCE FILE																																							



# AEDC VA 1163 MDAC BOOSTER AND ORBITER TEST DATA AT MACH NUMBER 5

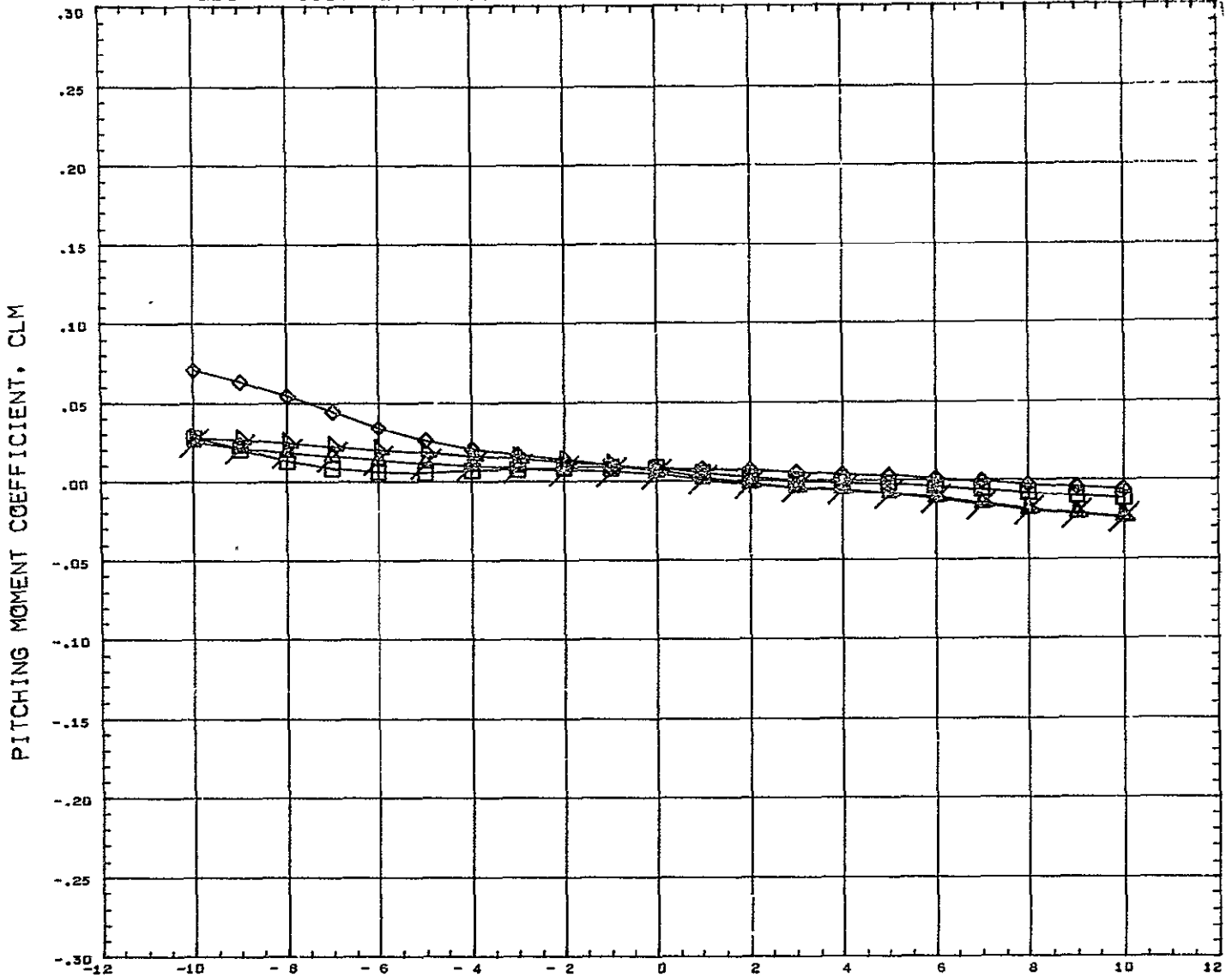

SYMBOL 	DELTAX 0.182 0.228 0.352 10.000	PARAMETRIC VALUES BSTFOW 50.000 ORBPOW 100.000 DELTAX 0.228 ALPHAI - 10.000 F CH 5.010 ELVBST 0.000 ELVORB 0.000 BETA 0.000	REFERENCE INFORMATION REFS 1.4440 SQ IN REFL 13.3330 IN REFB 13.3330 IN XMRP 7.5280 IN YMRP 0.0005 IN ZMRP 1.1940 IN SCALE 0.0055
REFERENCE FILE			

# AEDC VA 1163 MDAC BOOSTER AND ORBITER TEST DATA AT MACH NUMBER 5

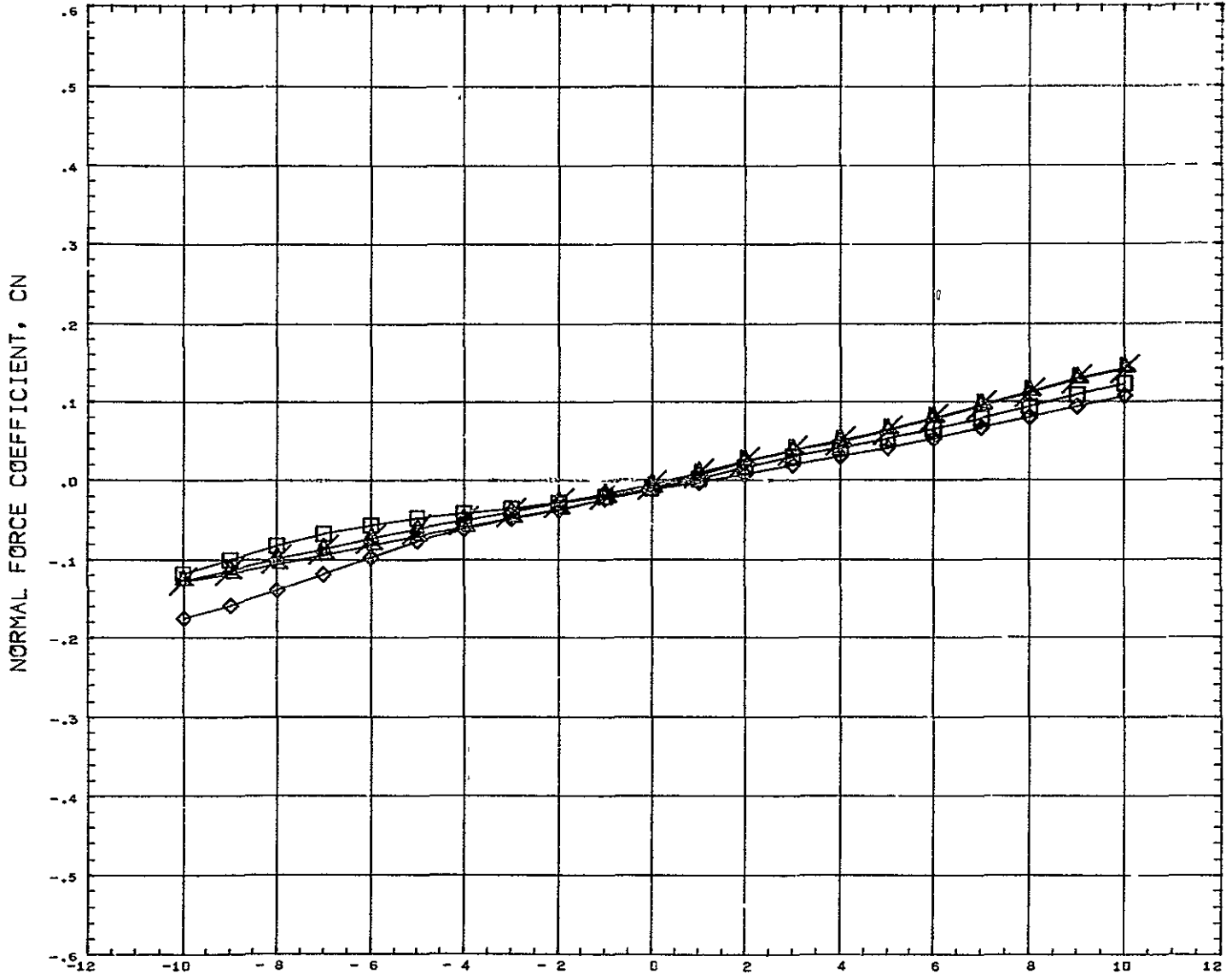

SYMBOL ◇ □ △ ×	DELTA Z 0.182 0.228 0.352 10.000	PARAMETRIC VALUES BSTPOW 50.000    ORBPOW 100.000 PTLTAX 0.228    ALPHAI - 10.000 MACH 5.010    ELVBST 0.000 ELVORB 0.000    BETA 0.000	REFERENCE INFORMATION REFS 44.4440    SQ IN REFL 13.3330    IN REFB 13.3330    IN XMRF 7.5280    IN YMRF 0.0000    IN ZMRF 1.1940    IN SCALE 0.0055
----------------------------	--	---	---

REFERENCE FILE

# AEDC VA 1163 MDAC BOOSTER AND ORBITER TEST DATA AT MACH NUMBER 5

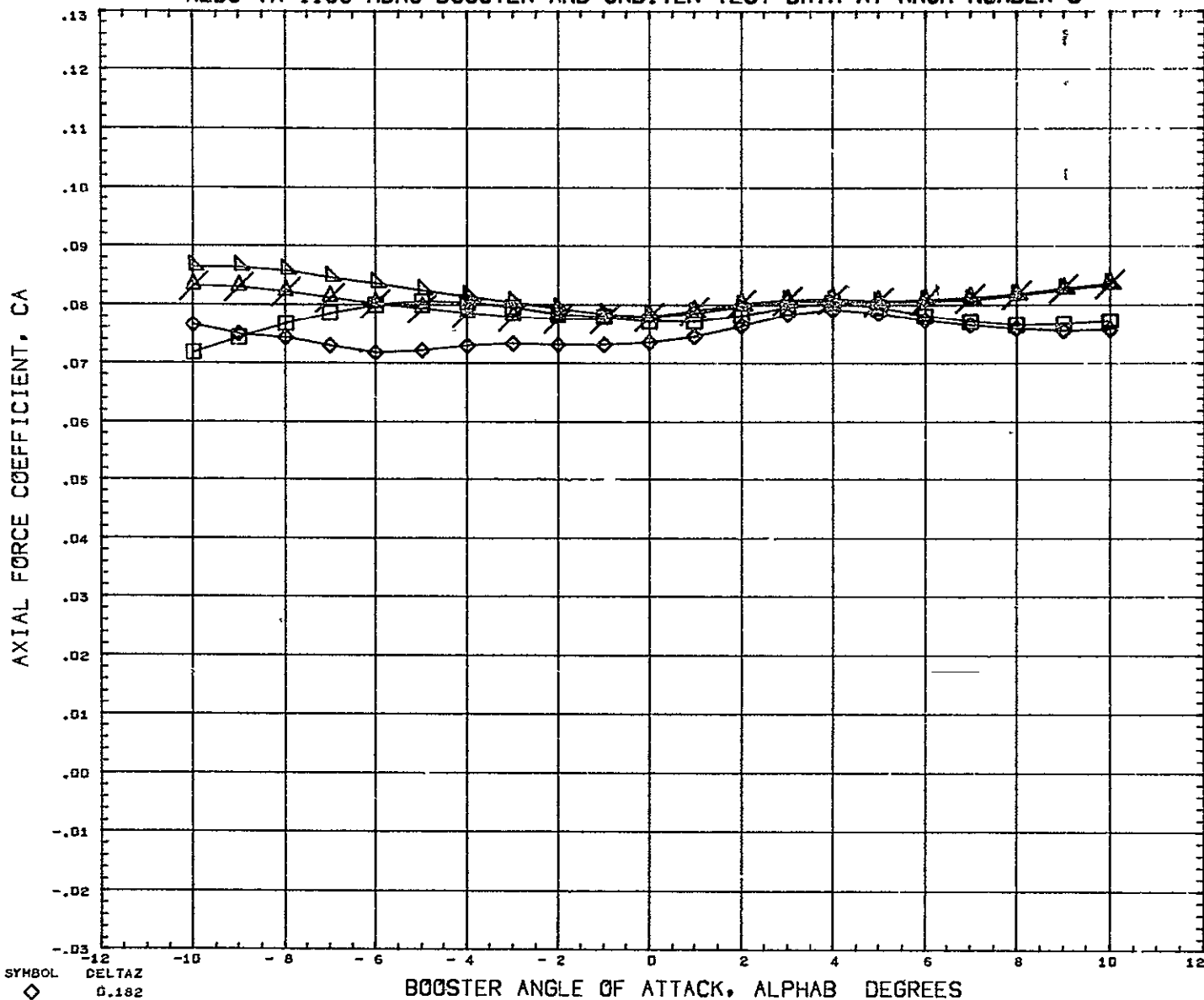

SYMBOL ◇ □ △ ○	DELTAZ 0.182 0.228 0.352 10.000	PARAMETRIC VALUES BSTPOW 50.000 ORBPOW 100.000 CLTAX 0.228 ALPHAI -10.000 MACH 5.010 ELVBST 0.000 ELVORB 0.000 BETA 0.000	REFERENCE INFORMATION REFS 44.4440 SQ IN REFL 13.3330 IN REFB 13.3330 IN XMRP 7.5280 IN YMRP 0.0000 IN ZMRP 1.1940 IN SCALE 0.0055
----------------------------	---	---	---

REFERENCE FILE

# AEDC VA 1163 MDAC BOOSTER AND ORBITER TEST DATA AT MACH NUMBER 5

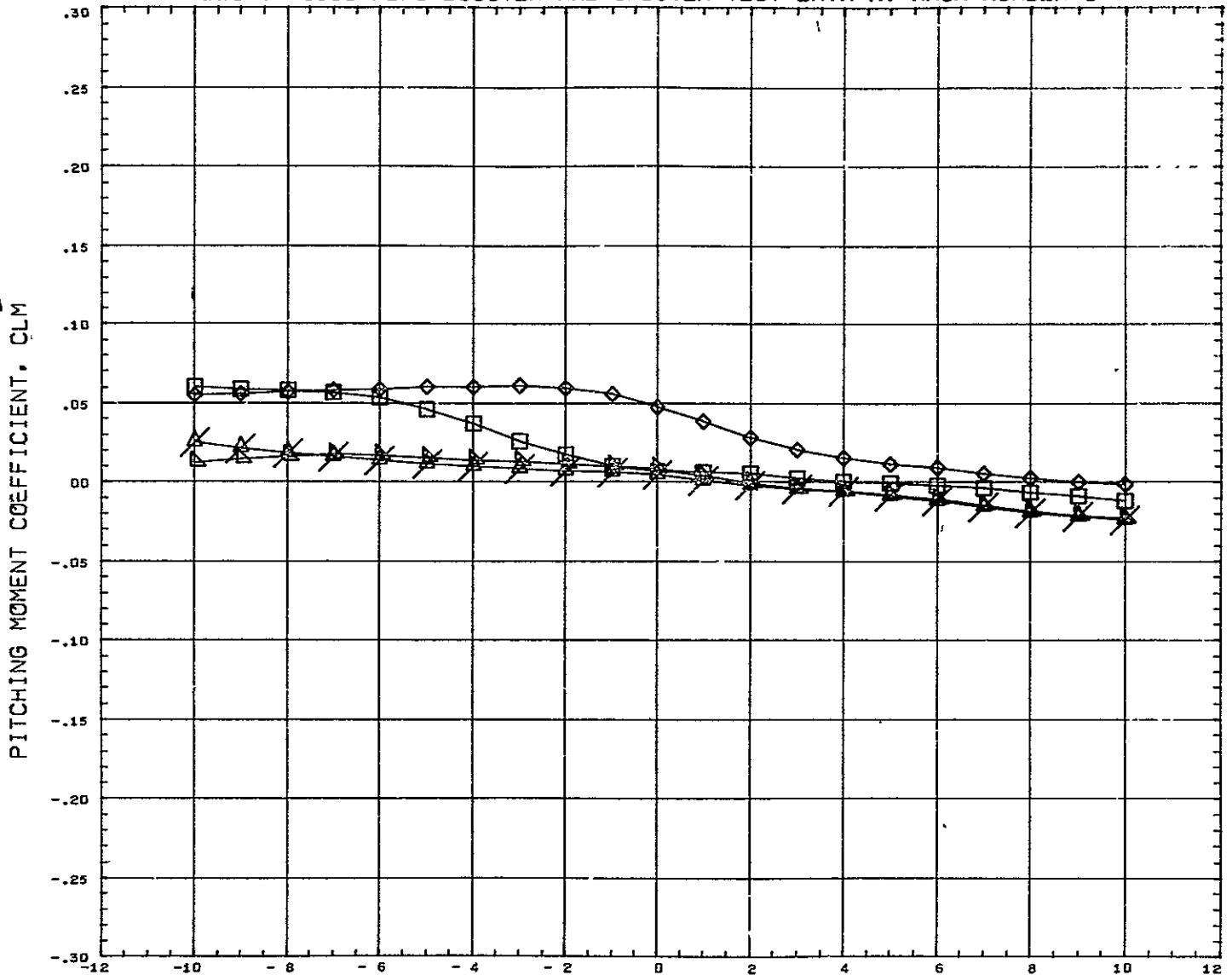

SYMBOL ◇ □ △	DELTAZ 0.182 0.228 0.352 10.000	PARAMETRIC VALUES BSTPOW 50.000 ORBPOW 100.000 DELTAX 9.352 ALPHAI - 10.000 F.CH 5.010 ELVBST 0.000 ELVORB 0.000 BETA 0.000	REFERENCE INFORMATION REFS 4.4440 SQ IN REFL 13.3330 IN REFB 13.3330 IN XMRP 7.5280 IN YMRP 0.0005 IN ZMRP 1.1946 IN SCALE 0.0055
-----------------------	---	---	--

REFERENCE FILE

# AEDC VA 1163 MDAC BOOSTER AND ORBITER TEST DATA AT MACH NUMBER 5

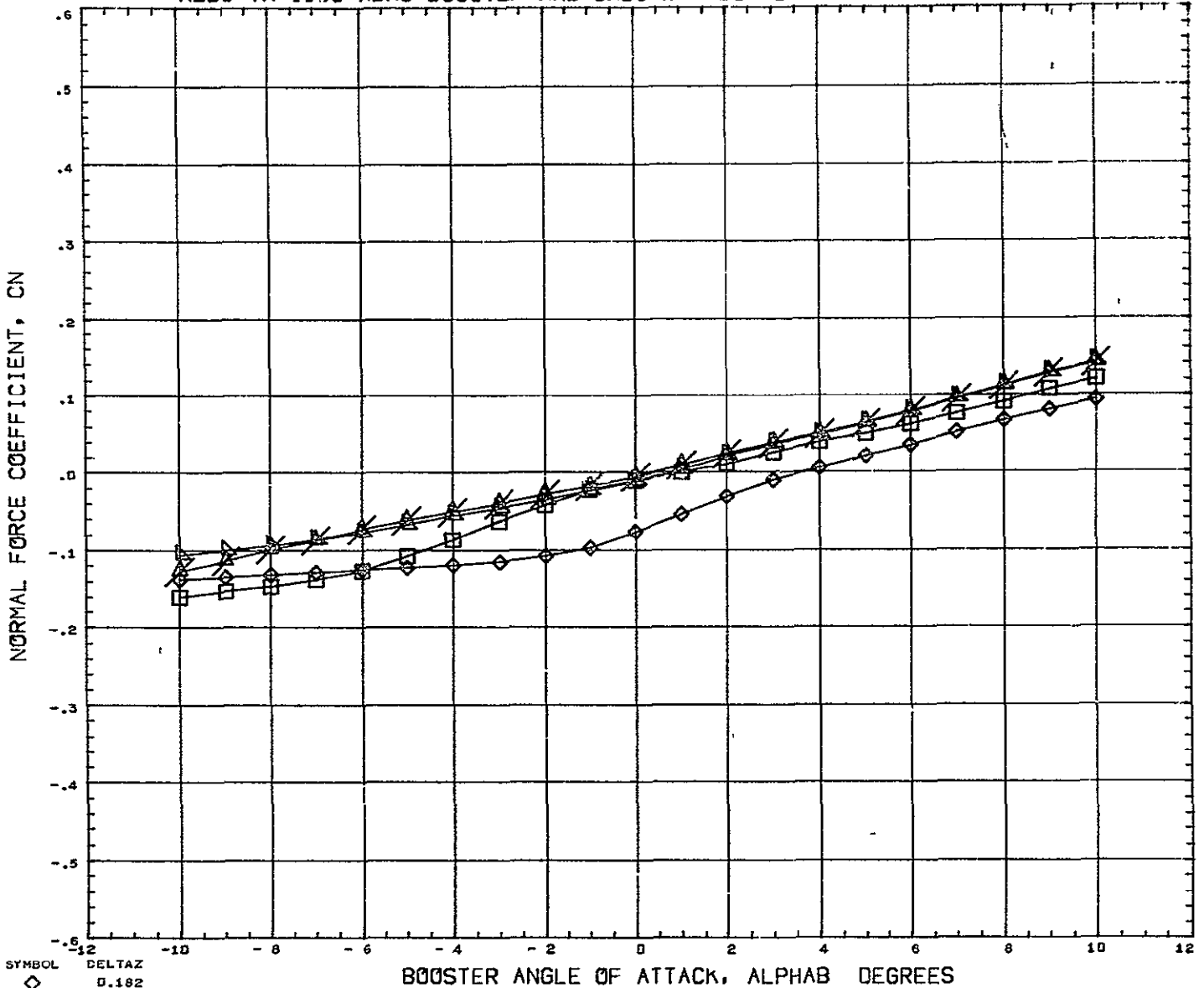

SYMBOL ◇ □ △ ○	DELTAX 0.182 0.228 0.352 10.000	PARAMETRIC VALUES BSTFOW 50.000 ORBPOW 100.000 DFLTAX 0.352 ALPHAI - 10.000 MACH 5.010 ELVBST 0.000 ELVORB 0.000 BETA 0.000	REFERENCE INFORMATION REFS 44.4440 SQ IN REFL 13.3330 IN REFB 13.3330 IN XHRP 7.5280 IN YHRP 0.0000 IN ZHRP 1.1940 IN SCALE 0.0055
REFERENCE FILE			

# AEDC VA 1163 MDAC BOOSTER AND ORBITER TEST DATA AT MACH NUMBER 5

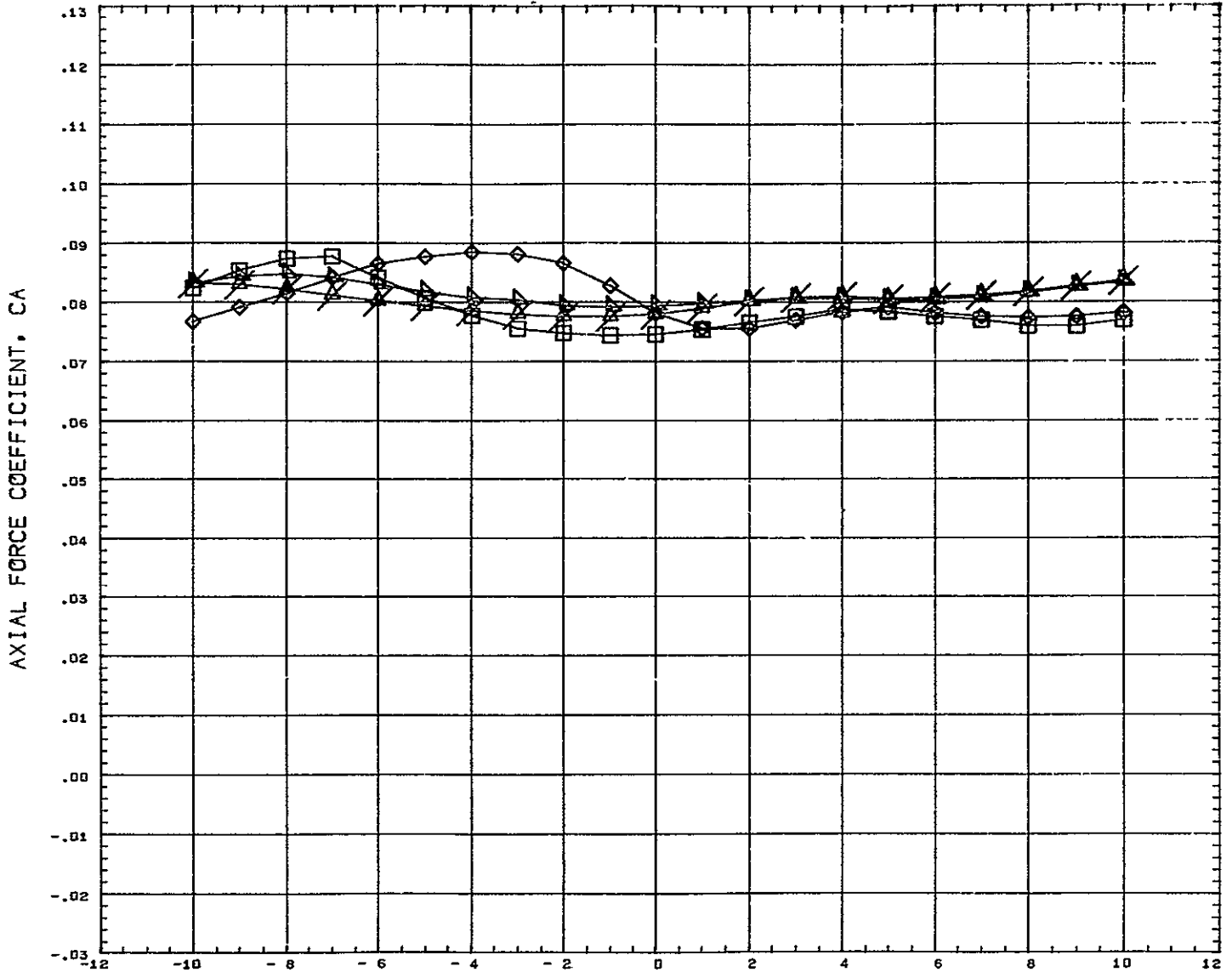

SYMBOL ◇ □ △ ×	DELTAX 0.182 0.228 0.352 10.000	PARAMETRIC VALUES BSTFOW 50.000 ORBPOW 100.000 DELTAX 0.352 ALPHAI - 10.000 MACH 5.010 ELVBST 0.000 ELVORB 0.000 BETA 0.000	REFERENCE INFORMATION REFS 44.4440 SQ IN REFL 13.3330 IN REFB 13.3330 IN XMRP 7.5280 IN YMRP 0.0000 IN ZMRP 1.1940 IN SCALE 0.0055
" REFERENCE FILE			

# AEDC VA 1163 MDAC BOOSTER AND ORBITER TEST DATA AT MACH NUMBER 5

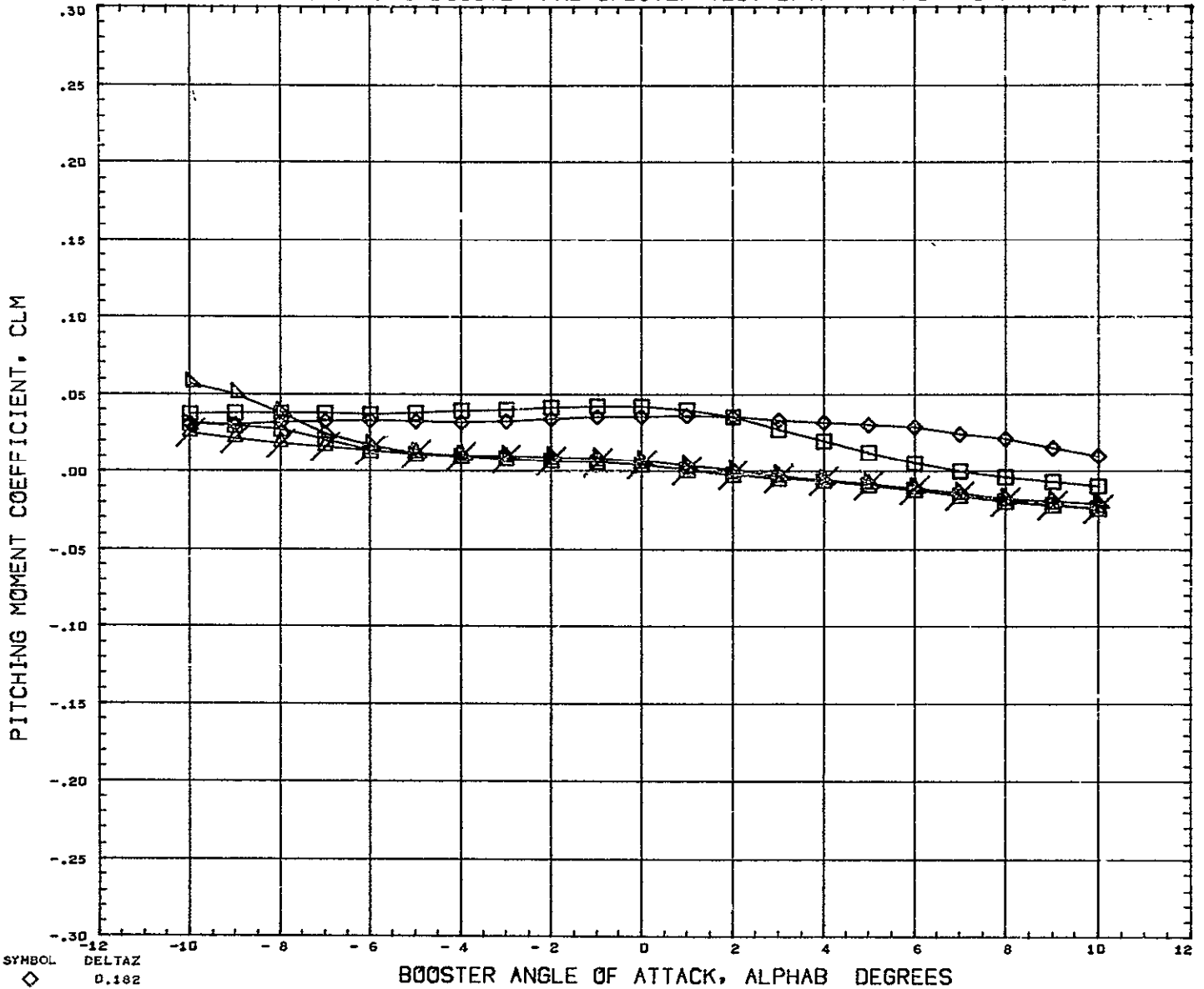

SYMBOL    	DELTA Z 0.182 0.228 0.352 0.599 10.000 ELVORB 0.000	PARAMETRIC VALUES BSTFOW 50.000 ORBPOW 100.000 DELTAX 0.521 ALPHAI -10.000 MACH 5.010 ELVBST 0.000 BETA 0.000	REFERENCE INFORMATION REFS 44.4440 SQ IN REFL 13.3330 IN REFB 13.3330 IN XMRP 7.5280 IN YHRF 0.0000 IN ZHRF 1.1340 IN SCALE 0.0055
------------------------	---	---	---

REFERENCE FILE

# AEDC VA 1163 MDAC BOOSTER AND ORBITER TEST DATA AT MACH NUMBER 5

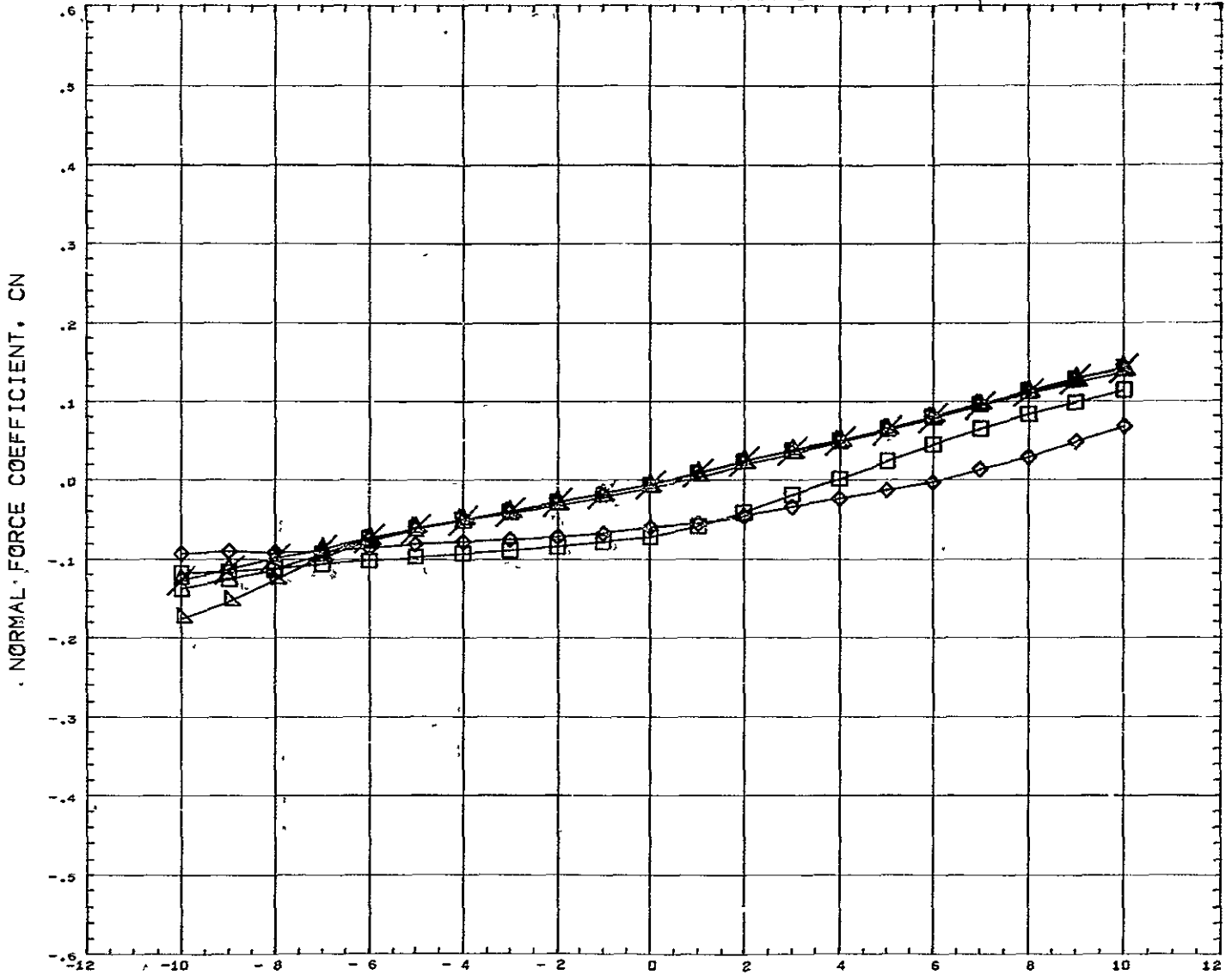

SYMBOL ◇ □ △ × ○	DELTA Z 0.182 0.228 0.352 0.599 10.000 ELVORB 0.000	PARAMETRIC VALUES BSTPOW 50.000 ORBPOW 100.000 DFLTAX 0.521 ALPHA1 - 10.000 MACH 5.010 ELVBST 0.000 BETA 0.000	REFERENCE INFORMATION REFS 44.4440 SQ IN REFL 13.3330 IN REFB 13.3330 IN XMRP 7.5280 IN YMRP 0.0000 IN ZMRP 1.1940 IN SCALE 0.0055
---------------------------------	---	--	---

REFERENCE FILE



# AEDC VA 1163 MDAC BOOSTER AND ORBITER TEST DATA AT MACH NUMBER 5

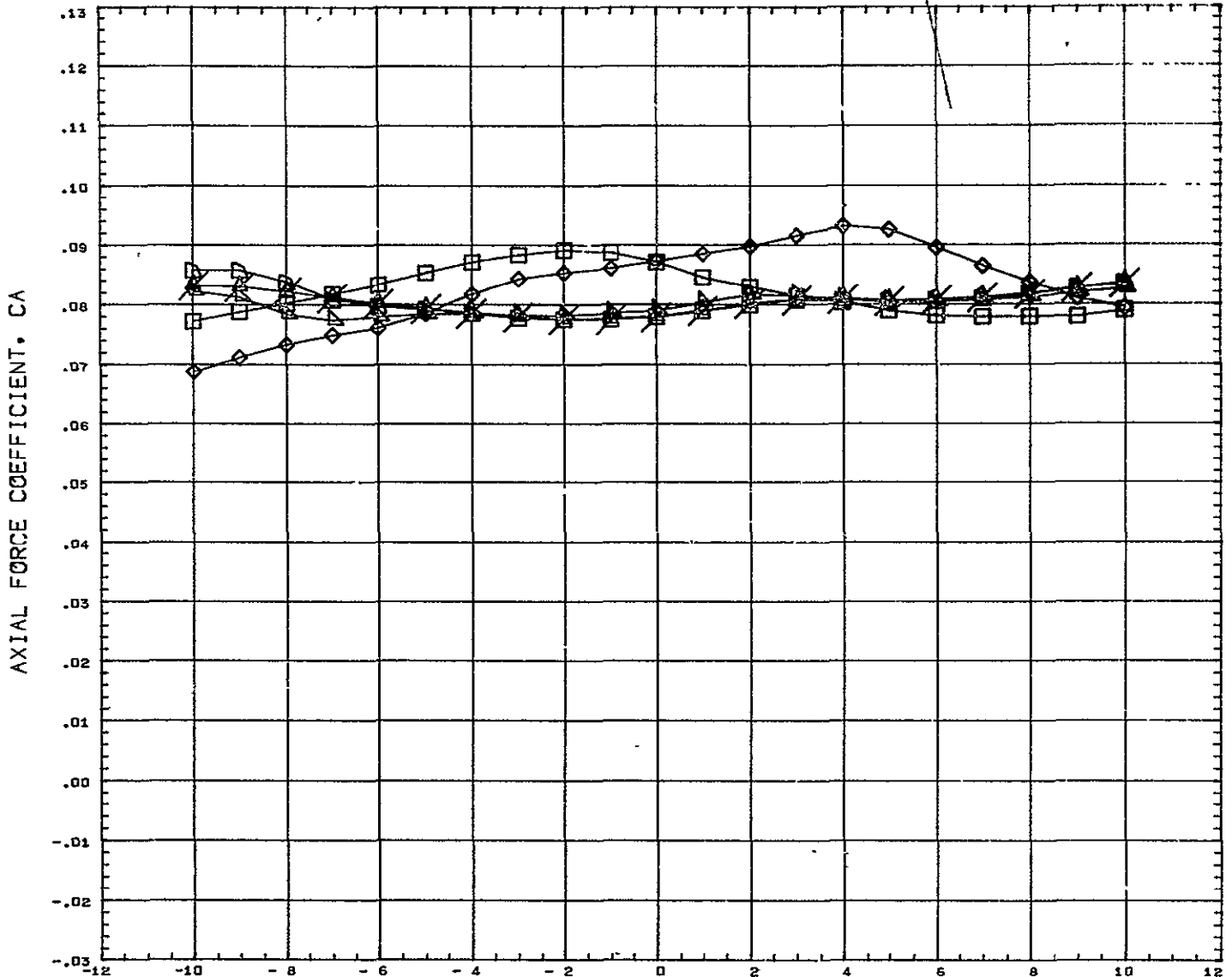

SYMBOL    	DELTAZ 0.182 0.228 0.352 0.599 10.000	PARAMETRIC VALUES BSTFOW 50.000 ORBPOW 100.000 DELTAX 0.521 ALPHAI - 10.000 4ACH 5.010 ELVBST 0.000 ELVORB 0.000 BETA 0.000	REFERENCE INFORMATION REFS 44 444J SQ IN REFL 13.3330 IN REFB 13.3330 IN XHRF 7.5280 IN YHRF 0.0090 IN ZHRF 1.1940 IN SCALE 0.0055
------------------------	--	---	---

REFERENCE FILE

# AEDC VA 1163 MDAC BOOSTER AND ORBITER TEST DATA AT MACH NUMBER 5

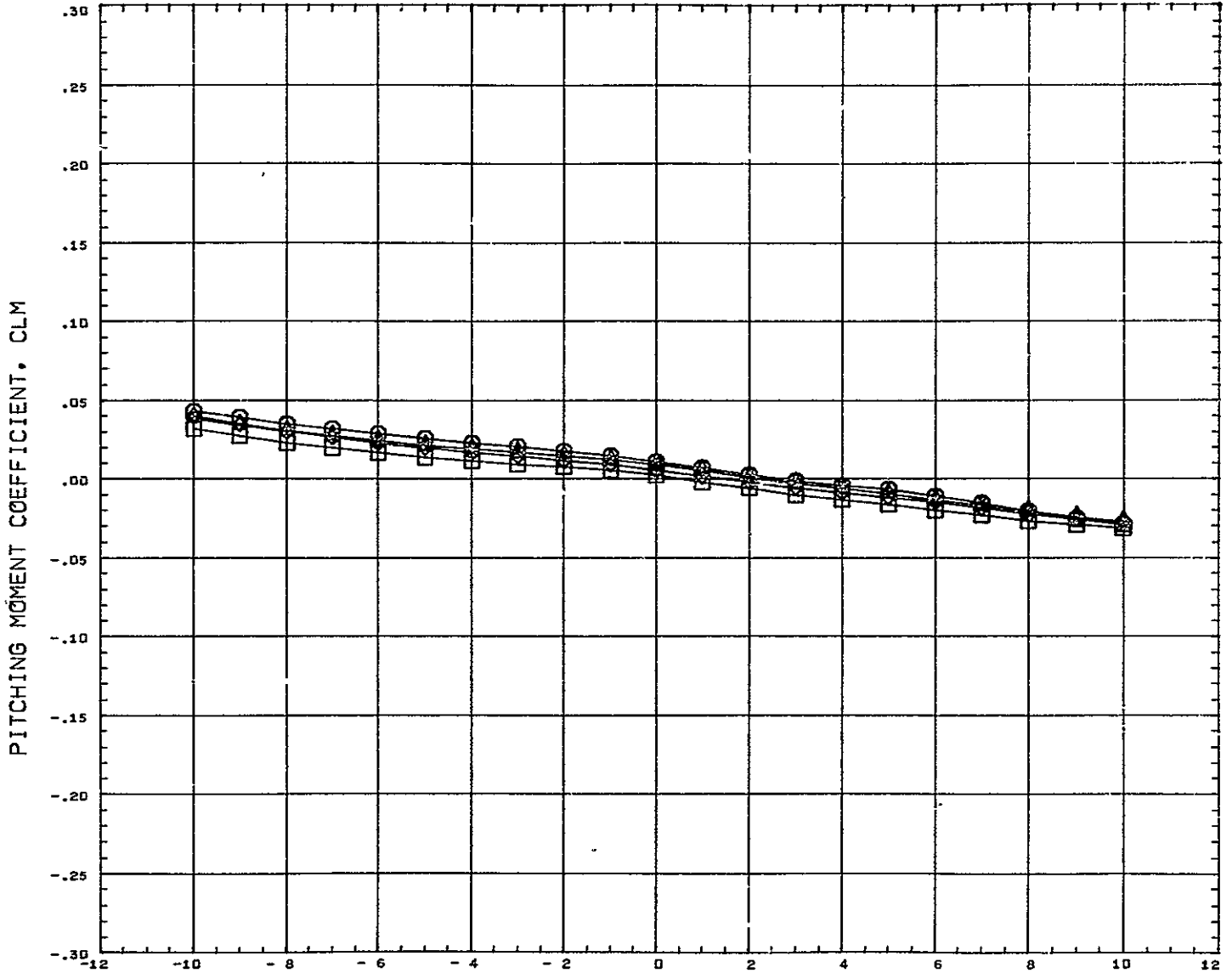

SYMBOL ○ △ ◇ □	DELTAZ 0.120 0.151 0.182 0.228	PARAMETRIC VALUES BSTPOW 0.000 ORBPOW 0.000 DELTAX - 0.391 ALPHA1 0.000 MACH 5.020 ELVBST 0.000 ELVORB 0.000 BETA 0.000	REFERENCE INFORMATION REFS 44.4440 SQ IN REFL 13.3330 IN REFB 13.3330 IN XMRP 7.5280 IN YMRP 0.0000 IN ZMRP 1.1940 IN SCALE 0.0055
----------------------------	--	---	---

REFERENCE FILE

# AEDC VA 1163 MDAC BOOSTER AND ORBITER TEST DATA AT MACH NUMBER 5

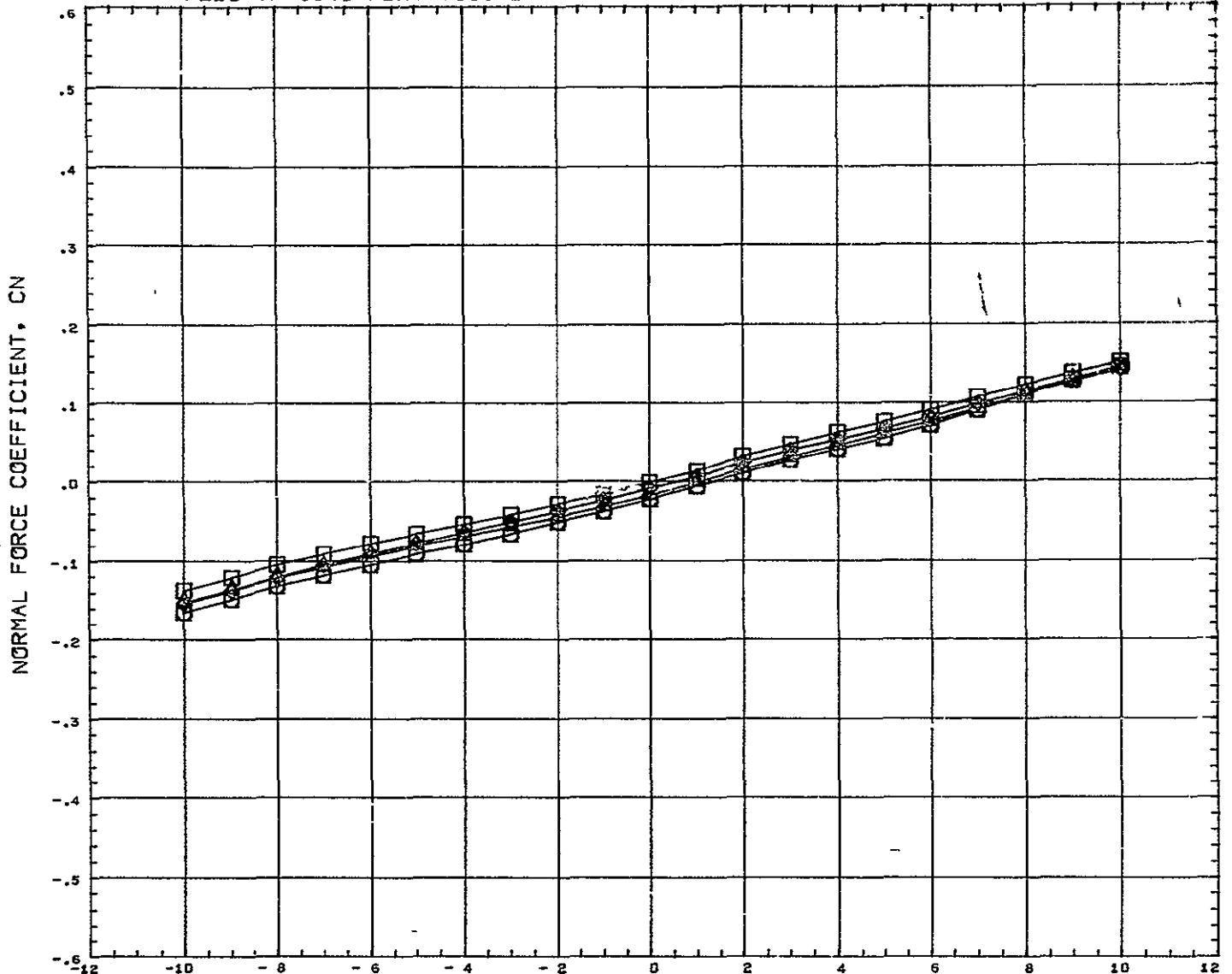

SYMBOL ○ △ ◇ □	DELTAZ 0.120 0.151 0.182 0.228	PARAMETRIC VALUES BSTPOW 0.000 ORBPOW 0.000 DELTAX - 0.391 ALPHAI 0.000 MACH 5.020 ELVBST 0.000 ELVORB 0.000 BETA 0.000	REFERENCE INFORMATION REFS 44.4440 SQ IN REFL 13.3330 IN REFB 13.3330 IN XMRF 7.5280 IN YMRP 0.0000 IN ZMRP 1.1940 IN SCALE 0.0055
REFERENCE FILE			

# AEDC VA 1163 MDAC BOOSTER AND ORBITER TEST DATA AT MACH NUMBER 5

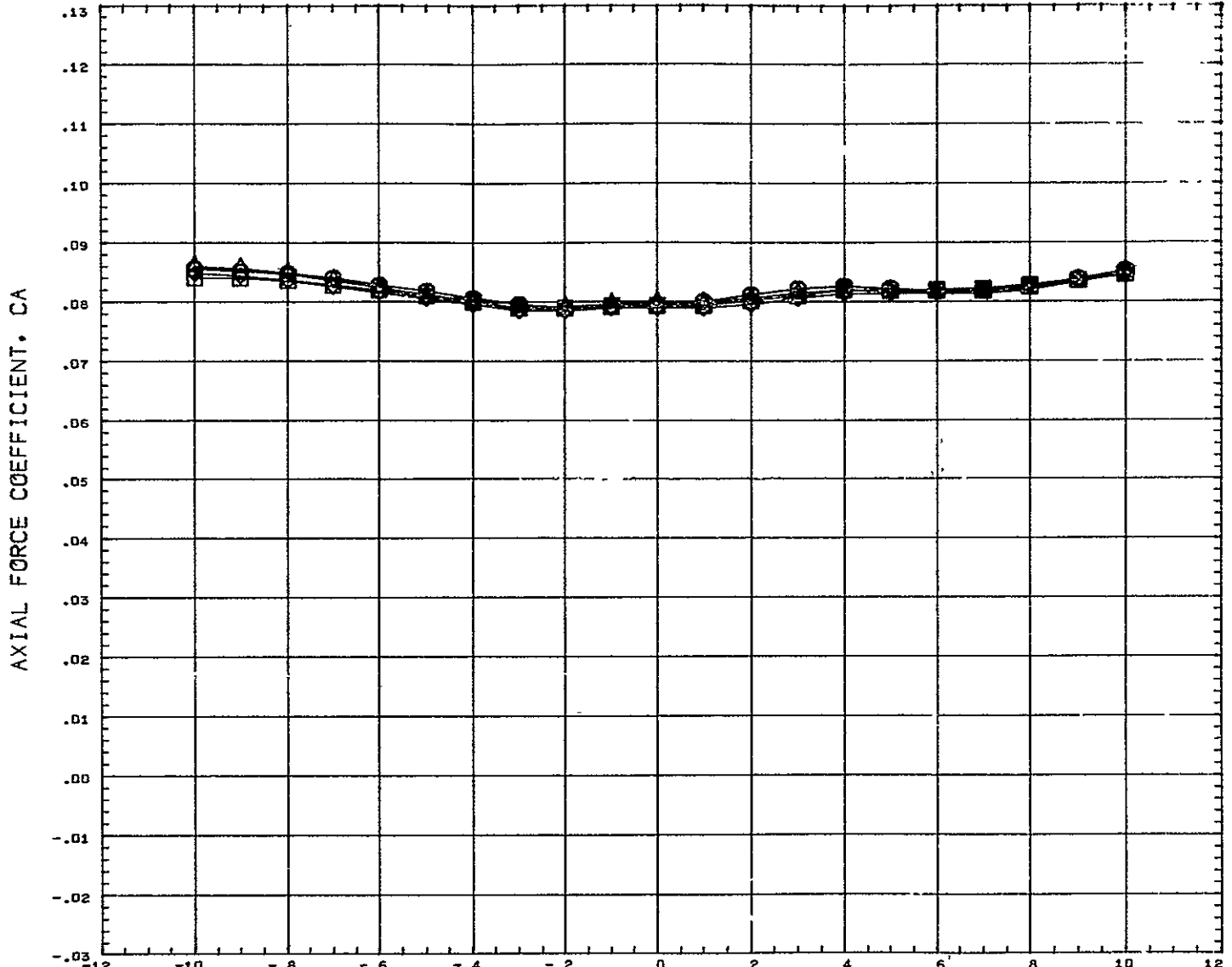

SYMBOL ○ ◇ □	DELTA Z 0.120 0.151 0.182 0.228	<b>PARAMETRIC VALUES</b> BSTPOW 0.000 ORBPOW 0.000 LTAX - 0.391 ALPHA1 0.000 MACH 5.020 ELVBST 0.000 ELVORB 0.000 BETA 0.000	<b>REFERENCE INFORMATION</b> REFS 44.4440 SQ IN REFL 13.3330 IN REFB 13.3330 IN XMRP 7.5280 IN YMRP 0.0000 IN ZMRP 1.1940 IN SCALE 0.0055
-----------------------	---	--	--

1 REFERENCE FILE

# AEDC VA 1163 MDAC BOOSTER AND ORBITER TEST DATA AT MACH NUMBER 5

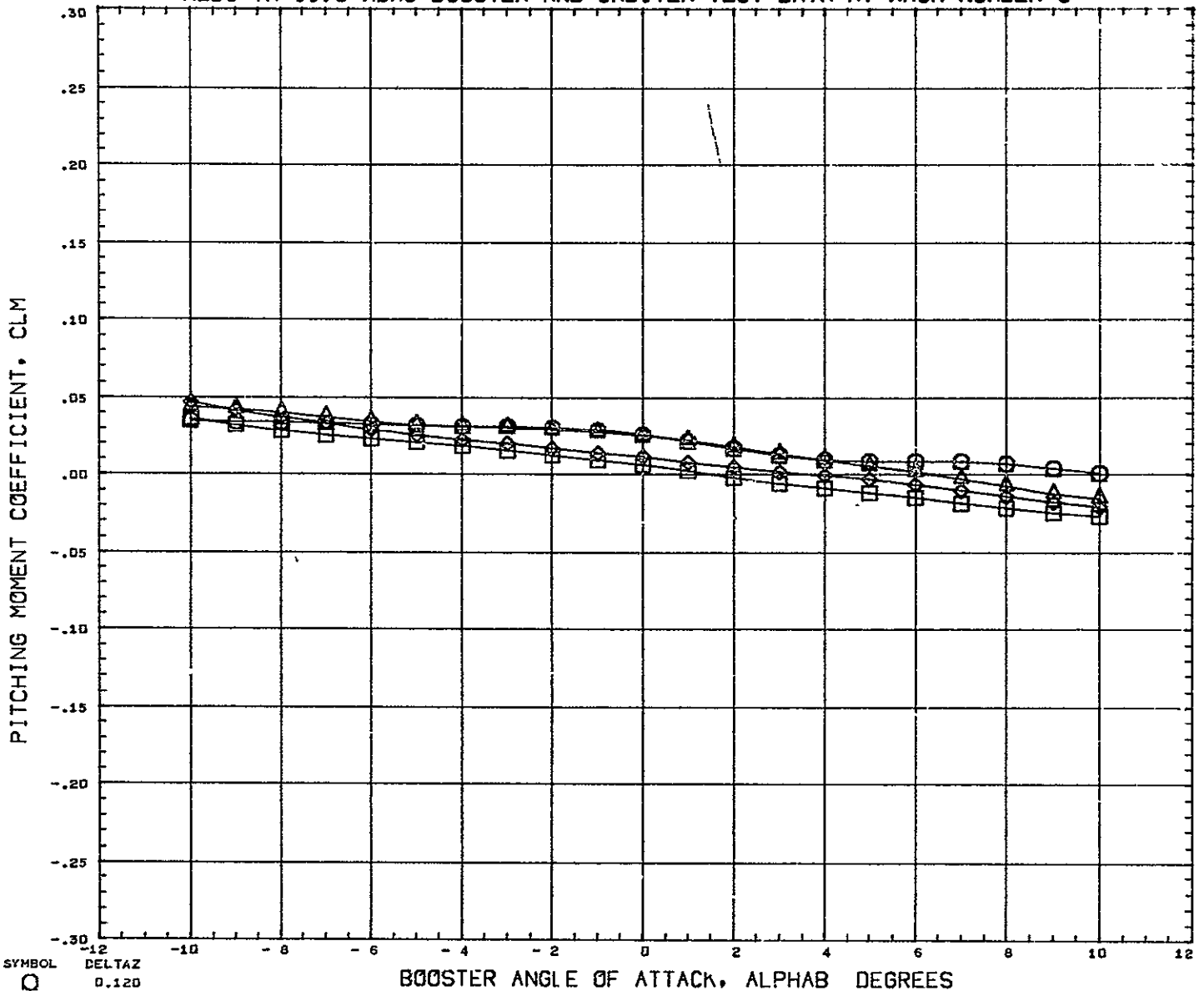

SYMBOL	DELTA Z	PARAMETRIC VALUES				REFERENCE INFORMATION		
○	0.120	BSTPOW	0.000	ORBPOW	0.000	REFS	44.4440	SQ IN
△	0.151	DELTA X	- 0.143	ALPHA I	0.000	REFL	13.3330	IN
◇	0.182	MACH	5.020	ELVBST	0.000	REFB	13.3330	IN
□	0.228	ELVORB	0.000	BETA	0.000	XMRP	7.5280	IN
						YMRP	0.0000	IN
						ZMRP	1.1940	IN
						SCALE	0.0055	
		REFERENCE FILE						

# AEDC VA 1163 MDAC BOOSTER AND ORBITER TEST DATA AT MACH NUMBER 5

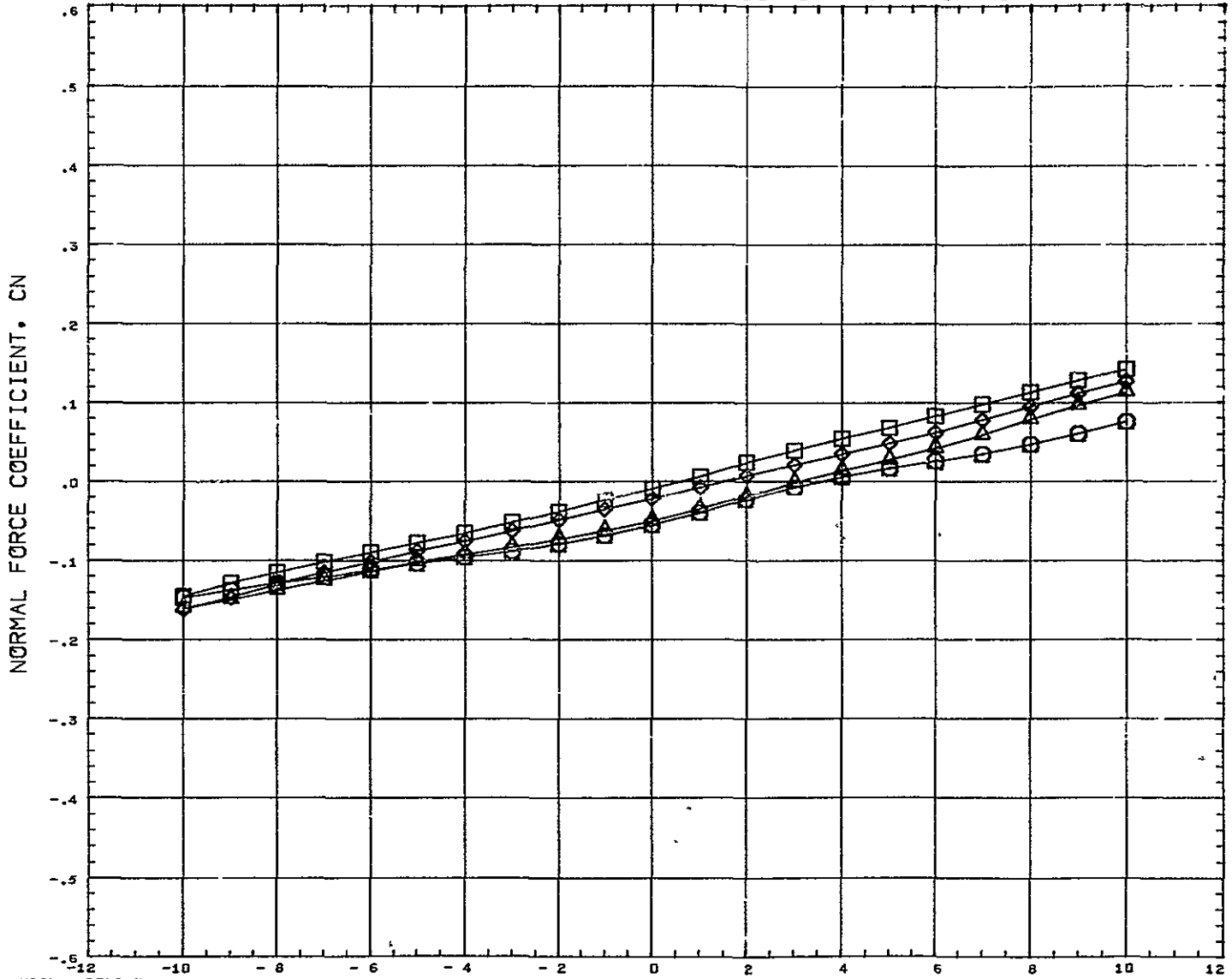

SYMBOL	○ △ ◇ □	DELTAZ 0.120 0.151 0.182 0.228  PARAMETRIC VALUES BSTPOW 0.000 ORBPOW 0.000 DELTAX - 0.143 ALPHAI 0.000 MACH 5.020 ELVBST 0.000 ELVORB 0.000 BETA 0.000	REFERENCE INFORMATION REFS 77.4440 SQ IN REFL 13.3330 IN REFB 13.3330 IN XMRP 7.5280 IN YMRP 0.0000 IN ZMRP 1.1940 IN SCALE 0.0055
REFERENCE FILE			

# AEDC VA 1163 MDAC BOOSTER AND ORBITER TEST DATA AT MACH NUMBER 5

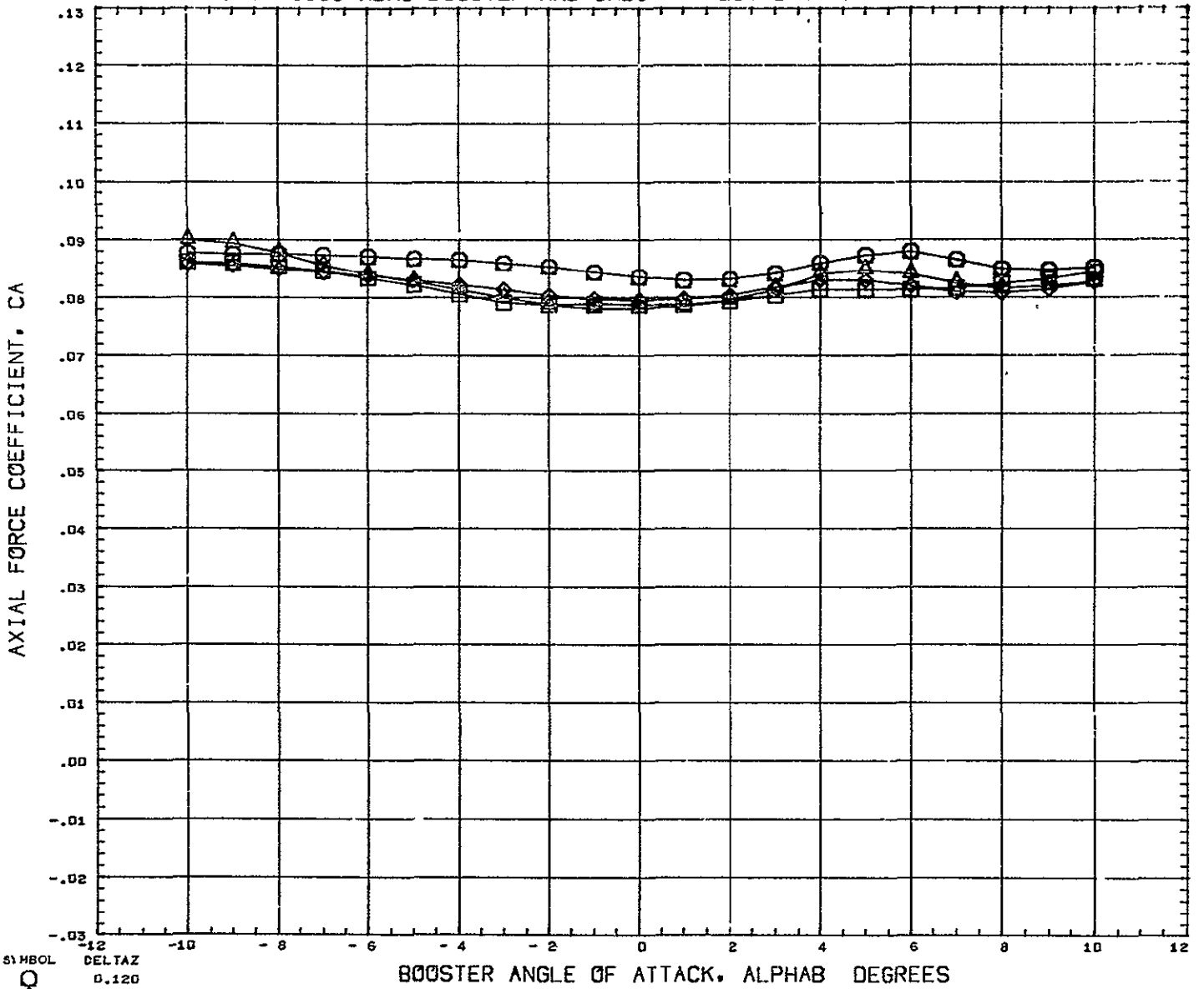

SYMBOL ◊ △ ◻	DELTAZ 0.120 0.151 0.182 0.228	PARAMETRIC VALUES BSTFOW    0.000    ORBFOW    0.000 DELTAX    - 0.143    ALPHA1    0.000 MACH       5.020    ELVBST    4.000 LLVORB    0.000    BETA       0.000	REFERENCE INFORMATION REFS       44.4440    SQ IN REFL       13.3330    IN REFB       13.3330    IN XMRP       7.5280    IN YMRP       0.0000    IN ZMRP       1.1940    IN SCALE      0.0055
REFERENCE FILE			

# AEDC VA 1163 MDAC BOOSTER AND ORBITER TEST DATA AT MACH NUMBER 5

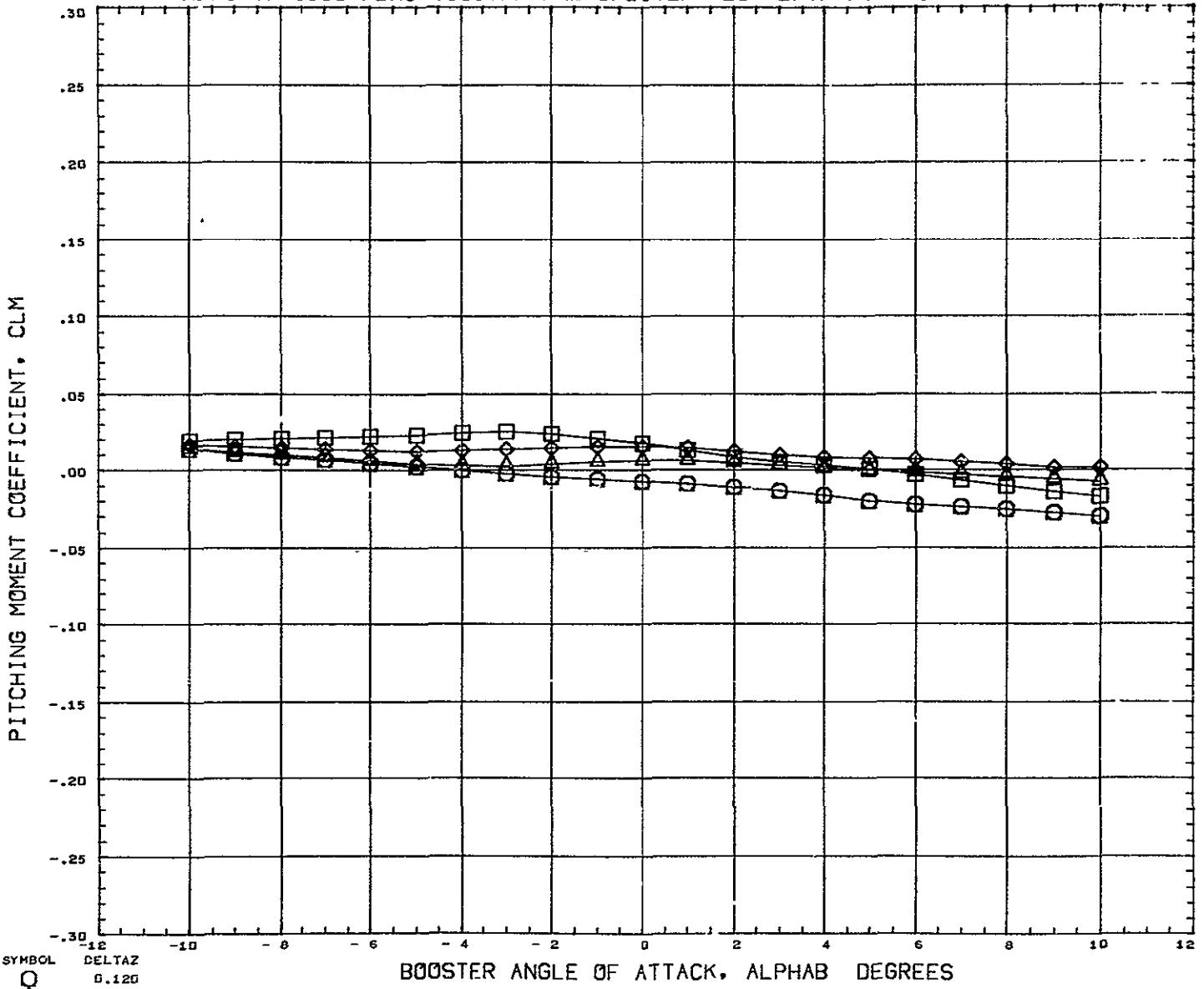

SYMBOL ◻ ◊ △ ○	DELTAZ 0.120 0.151 0.182 0.228	PARAMETRIC VALUES BSTPOW    0.000    ORBPOW    0.000 DELTAX    0.105    ALPHAI    0.000 M CH       5.020    ELVBST    0.000 ELVORB    0.000    BETA      0.000	REFERENCE INFORMATION REFS      44.4440    SQ IN REFL      13.3330    IN REFB      13.3330    IN XMRP      7.5280    IN YMRP      0.0000    IN ZMRP      1.1940    IN SCALE     0.0055
----------------------------	--	--	---

REFERENCE FILE



# AEDC VA 1163 MDAC BOOSTER AND ORBITER TEST DATA AT MACH NUMBER 5

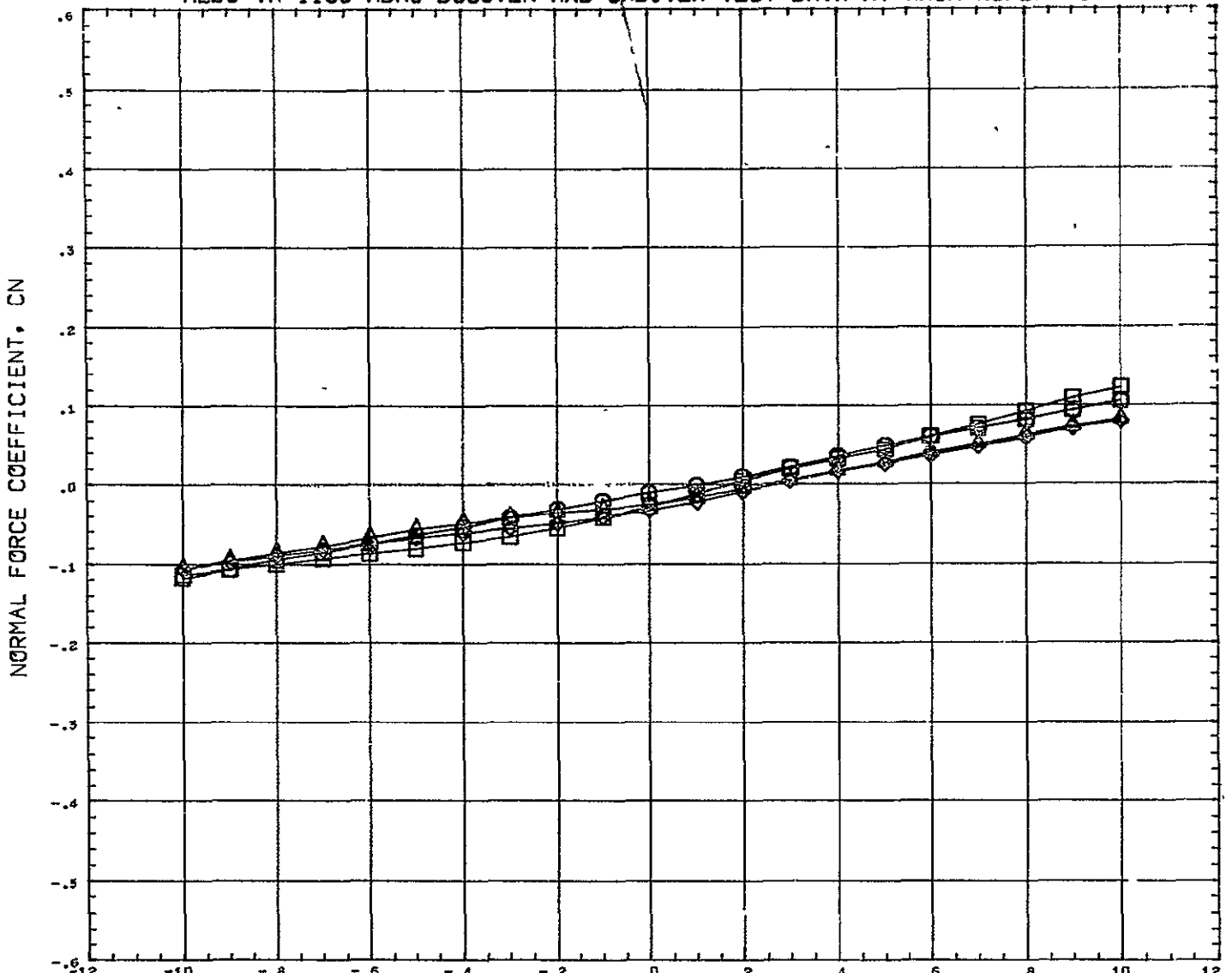

SYMBOL	DELTA Z	PARAMETRIC VALUES				REFERENCE INFORMATION	
○	0.120	BSTPOW	0.000	ORBPOW	0.000	REFS	44.4440 SQ IN
◇	0.151	MACH	5.020	ELVBSST	0.000	REFL	13.3330 IN
□	0.228	ELVORB	0.000	BETA	0.000	REFB	13.3330 IN
						XMR°	7.5280 IN
						YHRF	0.0000 IN
						ZHRF	1.1940 IN
						SCALE	0.0055

REFERENCE FILE

# AEDC VA 1163 MDAC BOOSTER AND ORBITER TEST DATA AT MACH NUMBER 5

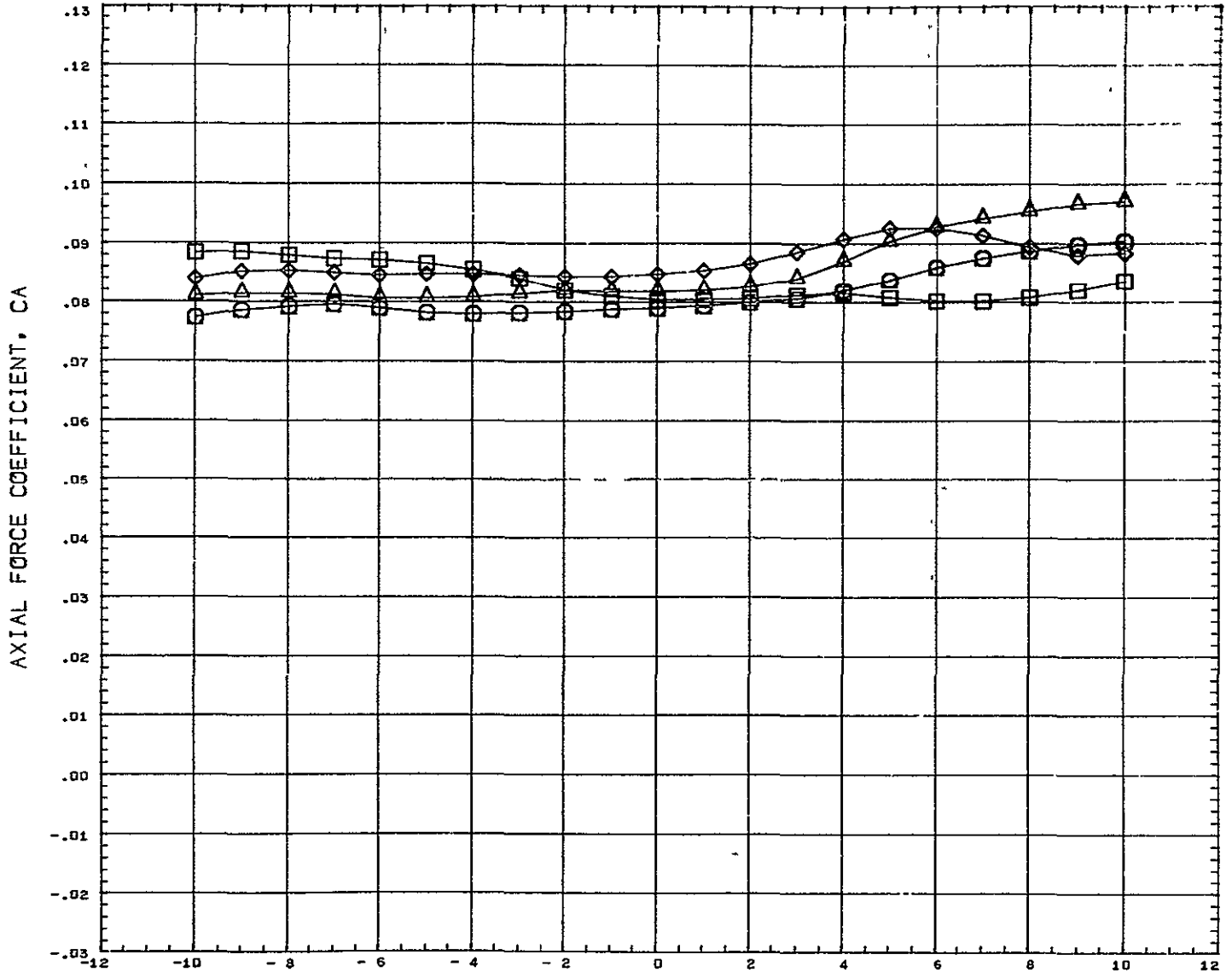

SYMBOL ◻ ◊ ◻ ◻	DELTAZ 0.120 0.151 0.182 0.228	<table border="0" style="width: 100%;"> <tr> <th colspan="4" style="text-align: left; padding-left: 20px;">PARAMETRIC VALUES</th> </tr> <tr> <td style="padding-left: 20px;">BSTFOW</td><td>0.000</td><td>ORBFOW</td><td>0.000</td></tr> <tr> <td style="padding-left: 20px;">DELTAZ</td><td>0.105</td><td>ALPHAI</td><td>0.000</td></tr> <tr> <td style="padding-left: 20px;">MACH</td><td>5.020</td><td>ELVBST</td><td>0.000</td></tr> <tr> <td style="padding-left: 20px;">ELVORB</td><td>0.000</td><td>BETA</td><td>0.000</td></tr> </table>	PARAMETRIC VALUES				BSTFOW	0.000	ORBFOW	0.000	DELTAZ	0.105	ALPHAI	0.000	MACH	5.020	ELVBST	0.000	ELVORB	0.000	BETA	0.000	<table border="0" style="width: 100%;"> <tr> <th colspan="3" style="text-align: left;">REFERENCE INFORMATION</th> </tr> <tr> <td>REFS</td><td>44.4440</td><td>SQ IN</td></tr> <tr> <td>REFL</td><td>13.3330</td><td>IN</td></tr> <tr> <td>REFB</td><td>13.3330</td><td>IN</td></tr> <tr> <td>XMRP</td><td>7.5280</td><td>IN</td></tr> <tr> <td>YMRP</td><td>0.0000</td><td>IN</td></tr> <tr> <td>ZMRP</td><td>1.1940</td><td>IN</td></tr> <tr> <td>SCALE</td><td>0.0055</td><td></td></tr> </table>	REFERENCE INFORMATION			REFS	44.4440	SQ IN	REFL	13.3330	IN	REFB	13.3330	IN	XMRP	7.5280	IN	YMRP	0.0000	IN	ZMRP	1.1940	IN	SCALE	0.0055	
PARAMETRIC VALUES																																															
BSTFOW	0.000	ORBFOW	0.000																																												
DELTAZ	0.105	ALPHAI	0.000																																												
MACH	5.020	ELVBST	0.000																																												
ELVORB	0.000	BETA	0.000																																												
REFERENCE INFORMATION																																															
REFS	44.4440	SQ IN																																													
REFL	13.3330	IN																																													
REFB	13.3330	IN																																													
XMRP	7.5280	IN																																													
YMRP	0.0000	IN																																													
ZMRP	1.1940	IN																																													
SCALE	0.0055																																														
		01 REFERENCE FILE																																													

# AEDC VA 1163 MDAC BOOSTER AND ORBITER TEST DATA AT MACH NUMBER 5

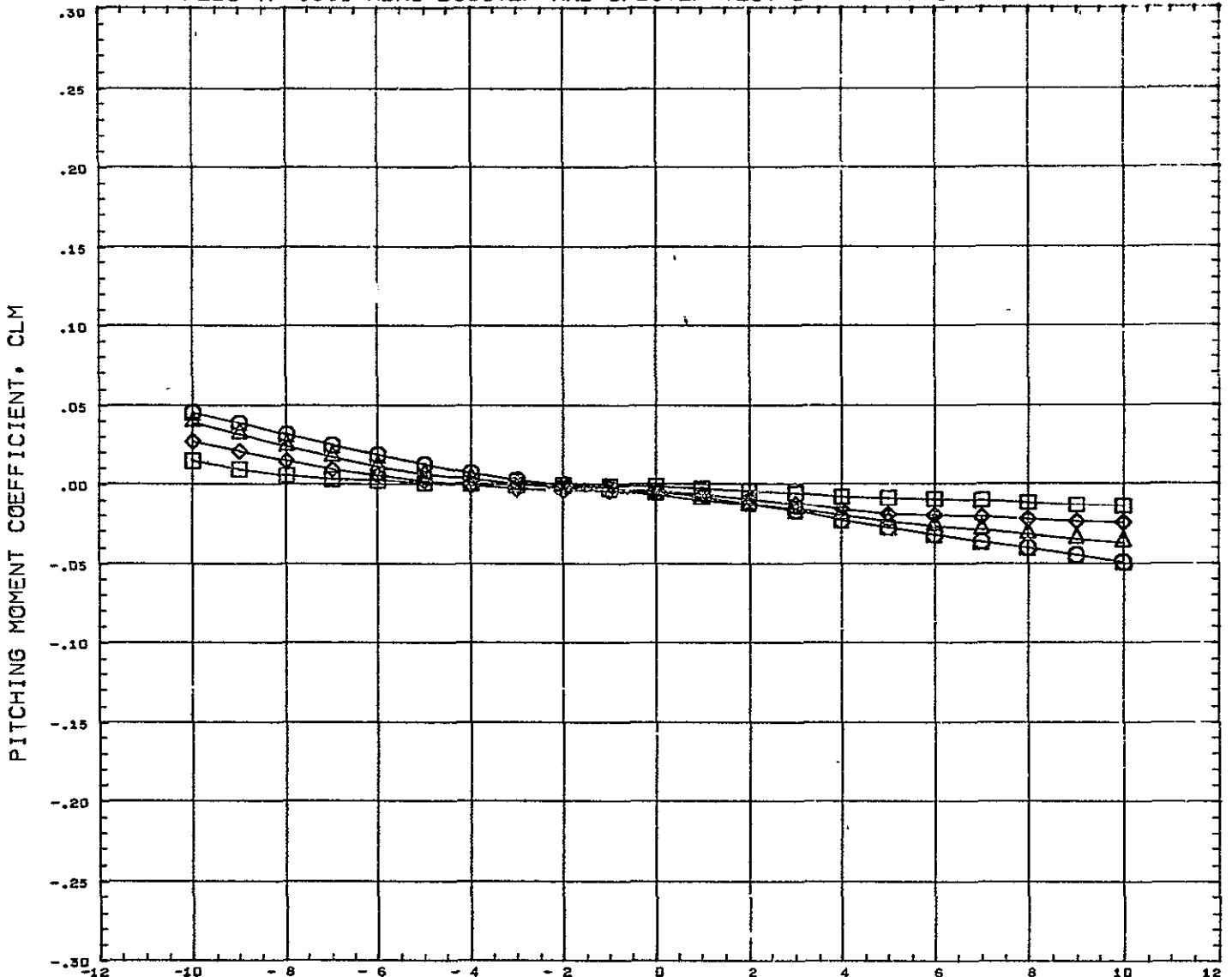

SYMBOL ○ ◇ △ □	DELTA Z 0.120 0.151 0.182 0.228	PARAMETRIC VALUES BSTFOW 0.000    ORBPOW 0.000 DELTAX 0.521    ALPHAI 0.000 MACH 5.020    ELVBST 0.000 ELVORB 0.000    BETA 0.000	REFERENCE INFORMATION REFS 44.4440    SQ IN REFL 13.3330    IN REFB 13.3330    IN XHRF 7.5280    IN YHRF 0.0000    IN ZHRF 1.1940    IN SCALE 0.0055
----------------------------	---	---	---

REFERENCE FILE

# AEDC VA 1163 MDAC BOOSTER AND ORBITER TEST DATA AT MACH NUMBER 5

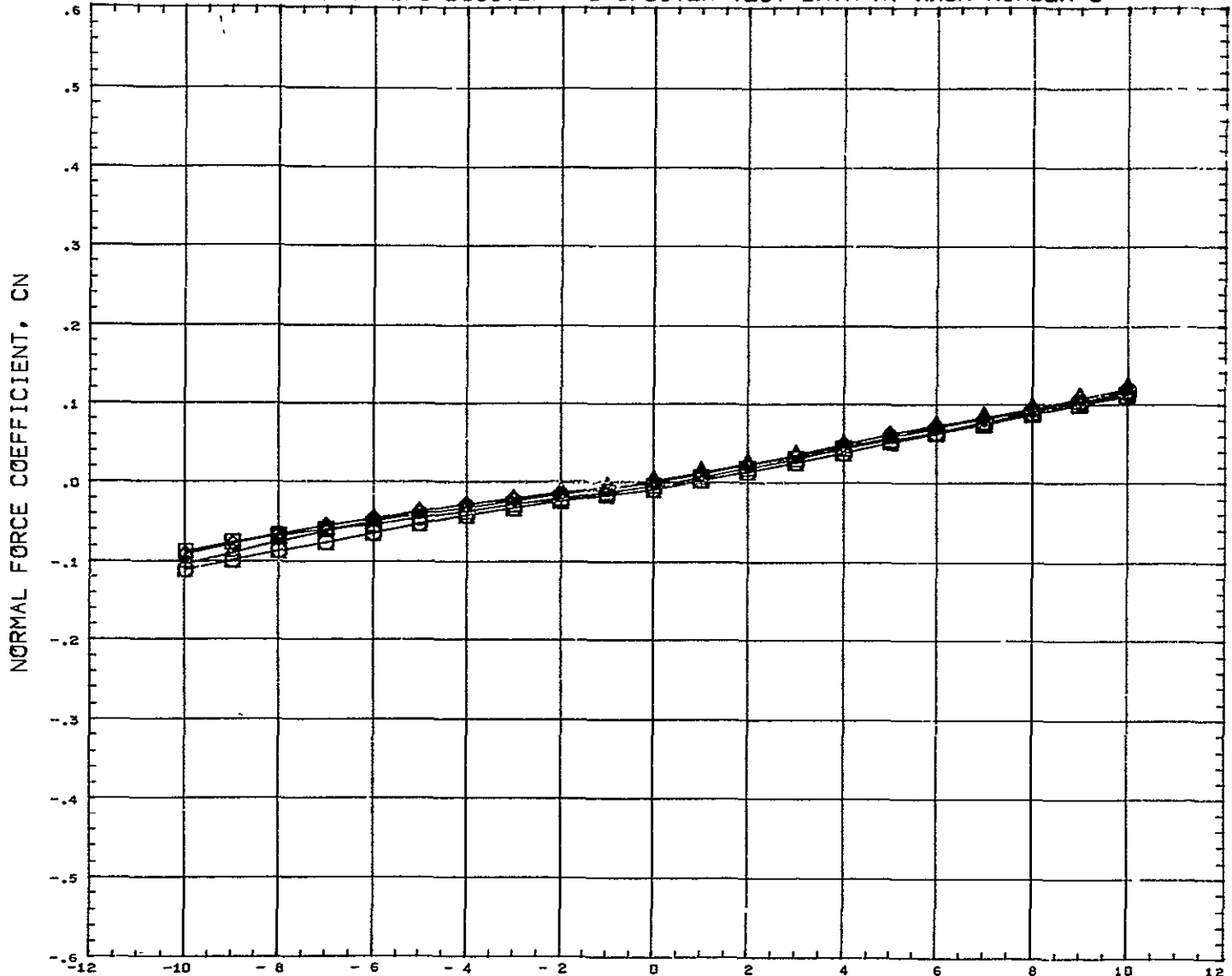

SYMBOL ○ △ ◇ □	DELTAZ 0.120 0.151 0.182 0.228	PARAMETRIC VALUES BSTPOW 0.000 ORBPOW 0.000 DELTAX 0.521 ALPHAI 0.000 MACH 5.020 ELVBST 0.000 ELVORB 0.000 BETA 0.000	REFERENCE INFORMATION REFS 44.4440 SQ IN REFL 13.3330 IN REFB 13.3330 IN XHRP 7.5280 IN YHRP 0.0000 IN ZHRP 1.1940 IN SCALE 0.0055
----------------------------	--	---	---

REFERENCE FILE

# AEDC VA 1163 MDAC BOOSTER AND ORBITER TEST DATA AT MACH NUMBER 5

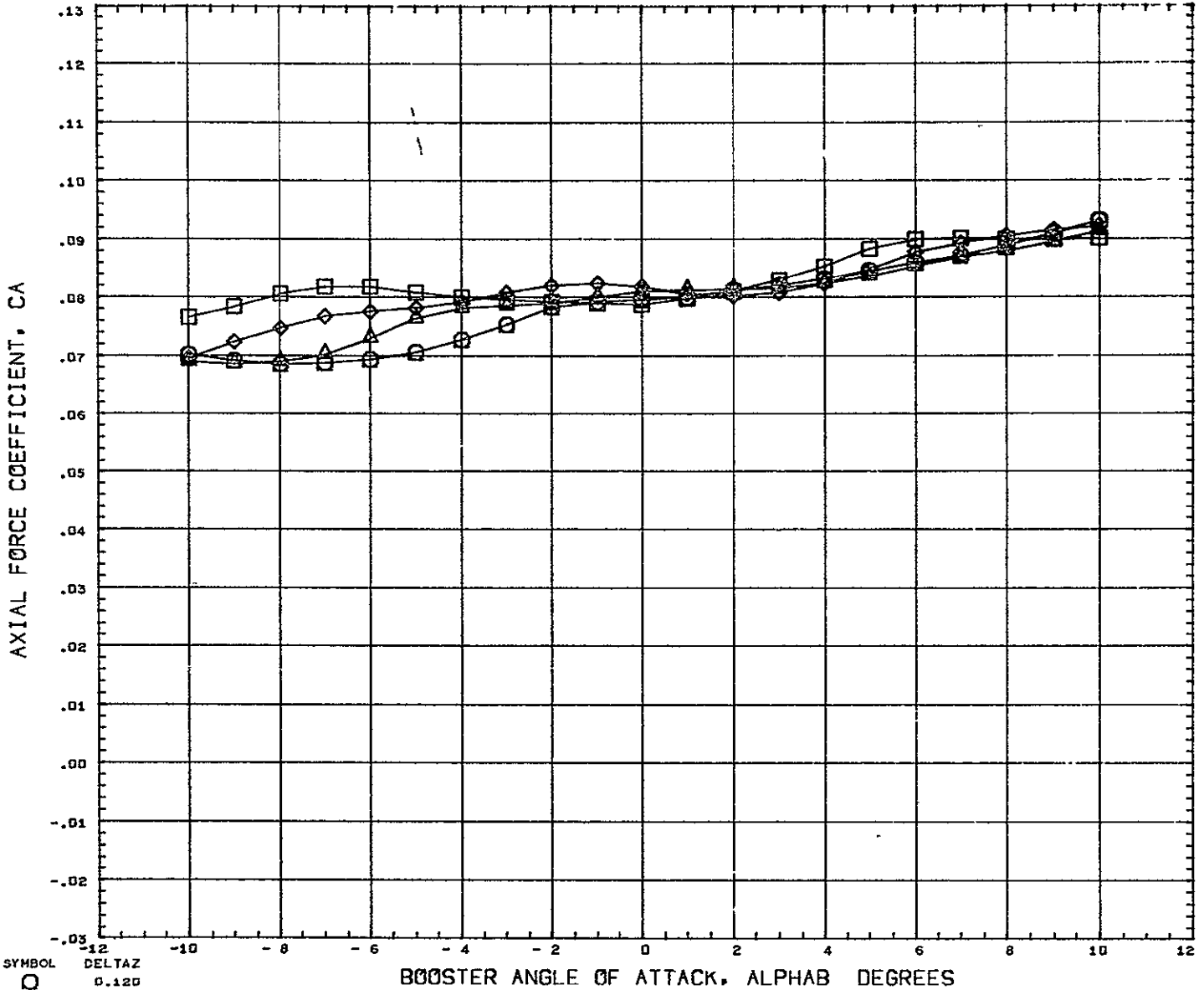

SYMBOL ○ △ ◇ □	DELTA Z 0.120 0.151 0.182 0.228	PARAMETRIC VALUES BSTFOW 0.000 ORBPOW 0.000 DFLTAX 0.521 ALPHAI 0.000 MACH 5.020 ELVBST 0.000 ELVORB 0.000 BETA 0.000	REFERENCE INFORMATION REFS 44.4440 SQ IN REFL 13.3330 IN REFB 13.3330 IN XHRF 7.5280 IN YHRF 0.0006 IN ZHRF 1.1940 IN SCALE 0.0055
----------------------------	---	---	---

REFERENCE FILE

# AEDC VA 1163 MDAC BOOSTER AND ORBITER TEST DATA AT MACH NUMBER 5

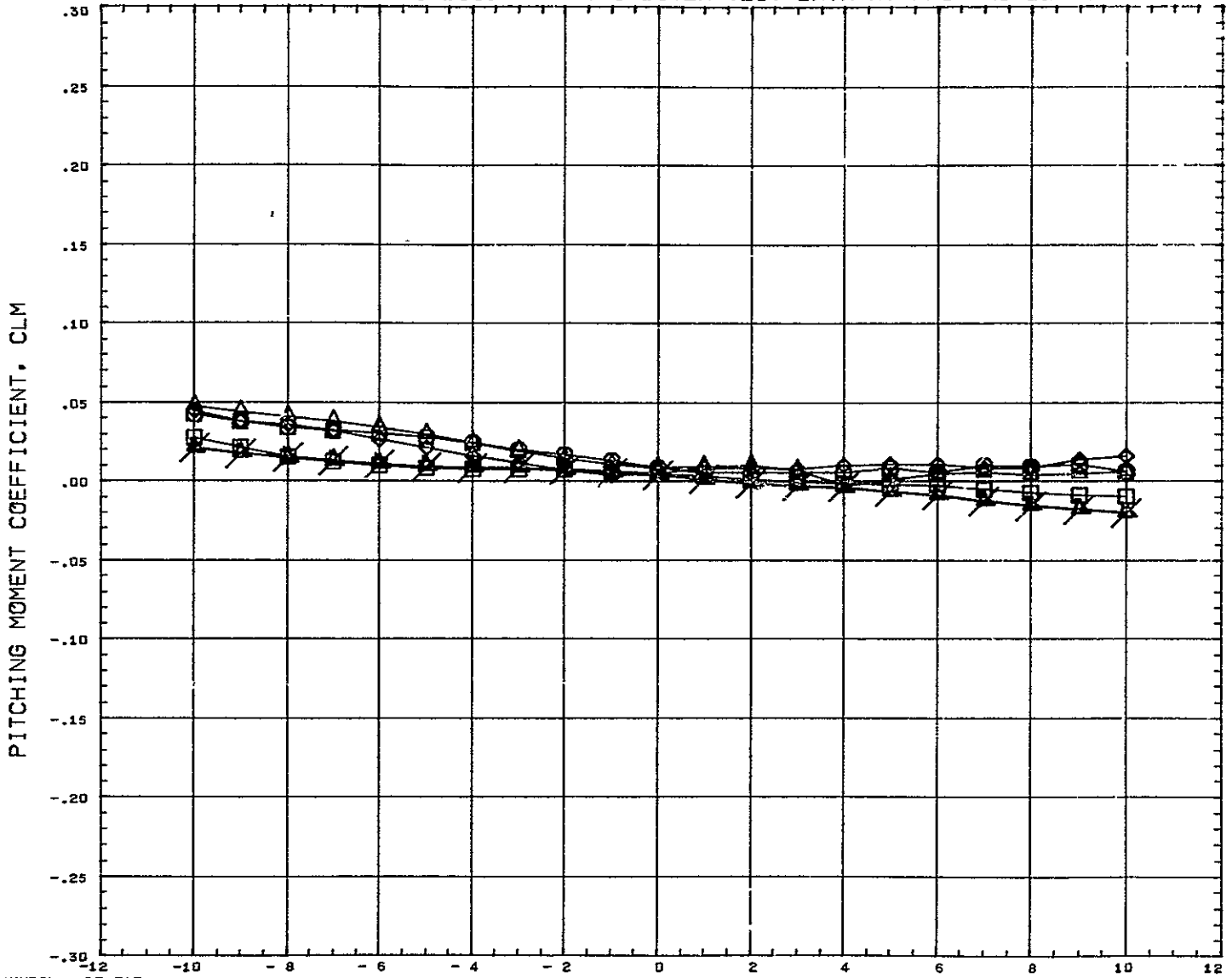

SYMBOL ○ ◊ □ △ ▲	DELTAZ 0.120 0.151 0.182 0.228 0.352 10.000	<table border="0" style="width: 100%;"> <tr> <th colspan="4" style="text-align: center;">PARAMETRIC VALUES</th> </tr> <tr> <td>BSTFOW</td> <td>100.000</td> <td>ORBFOW</td> <td>100.000</td> </tr> <tr> <td>DELTAZ</td> <td>0.391</td> <td>ALPHA1</td> <td>0.000</td> </tr> <tr> <td>MACH</td> <td>5.010</td> <td>ELVBST</td> <td>0.000</td> </tr> <tr> <td>ELVORB</td> <td>0.000</td> <td>BETA</td> <td>0.000</td> </tr> </table>	PARAMETRIC VALUES				BSTFOW	100.000	ORBFOW	100.000	DELTAZ	0.391	ALPHA1	0.000	MACH	5.010	ELVBST	0.000	ELVORB	0.000	BETA	0.000	<table border="0" style="width: 100%;"> <tr> <th colspan="3" style="text-align: center;">REFERENCE INFORMATION</th> </tr> <tr> <td>REFS</td> <td>44.4440</td> <td>SQ IN</td> </tr> <tr> <td>REFL</td> <td>13.3330</td> <td>IN</td> </tr> <tr> <td>REFB</td> <td>13.3330</td> <td>IN</td> </tr> <tr> <td>XMRP</td> <td>7.5280</td> <td>IN</td> </tr> <tr> <td>YMRP</td> <td>0.0000</td> <td>IN</td> </tr> <tr> <td>ZMRP</td> <td>1.1940</td> <td>IN</td> </tr> <tr> <td>SCALE</td> <td>0.0055</td> <td></td> </tr> </table>	REFERENCE INFORMATION			REFS	44.4440	SQ IN	REFL	13.3330	IN	REFB	13.3330	IN	XMRP	7.5280	IN	YMRP	0.0000	IN	ZMRP	1.1940	IN	SCALE	0.0055	
PARAMETRIC VALUES																																															
BSTFOW	100.000	ORBFOW	100.000																																												
DELTAZ	0.391	ALPHA1	0.000																																												
MACH	5.010	ELVBST	0.000																																												
ELVORB	0.000	BETA	0.000																																												
REFERENCE INFORMATION																																															
REFS	44.4440	SQ IN																																													
REFL	13.3330	IN																																													
REFB	13.3330	IN																																													
XMRP	7.5280	IN																																													
YMRP	0.0000	IN																																													
ZMRP	1.1940	IN																																													
SCALE	0.0055																																														

REFERENCE FILE

# AEDC VA 1163 MDAC BOOSTER AND ORBITER TEST DATA AT MACH NUMBER 5

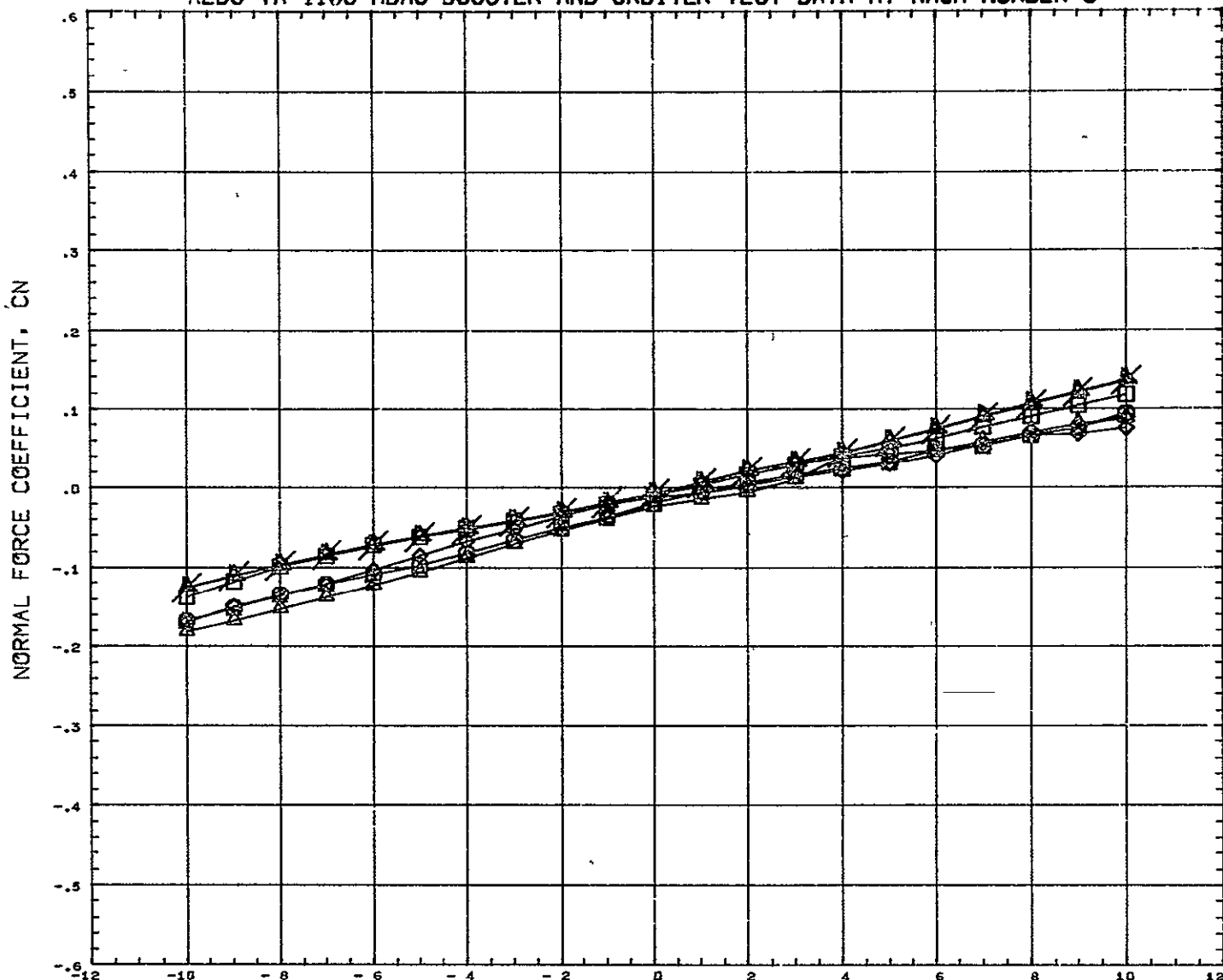

SYMBOL ○ ◊ □ △	DELTA Z 0.120 0.151 0.182 0.220 0.352 10.000	PARAMETRIC VALUES BSTFOW 100.000 ORBPOW 100.000 DFLTAX - 0.391 ALPHAI 0.000 MACH 5.010 ELV8ST 0.000 ELVORB 0.000 BETA 0.000	REFERENCE INFORMATION REFS 44.4440 SQ IN REFL 13.3330 IN REFB 13.3330 IN XMRP 7.5280 IN YMRP 0.0000 IN ZMRP 1.1940 IN SCALE 0.0055
----------------------------	--	---	---

REFERENCE FILE

# AEDC VA 1163 MDAC BOOSTER AND ORBITER TEST DATA AT MACH NUMBER 5

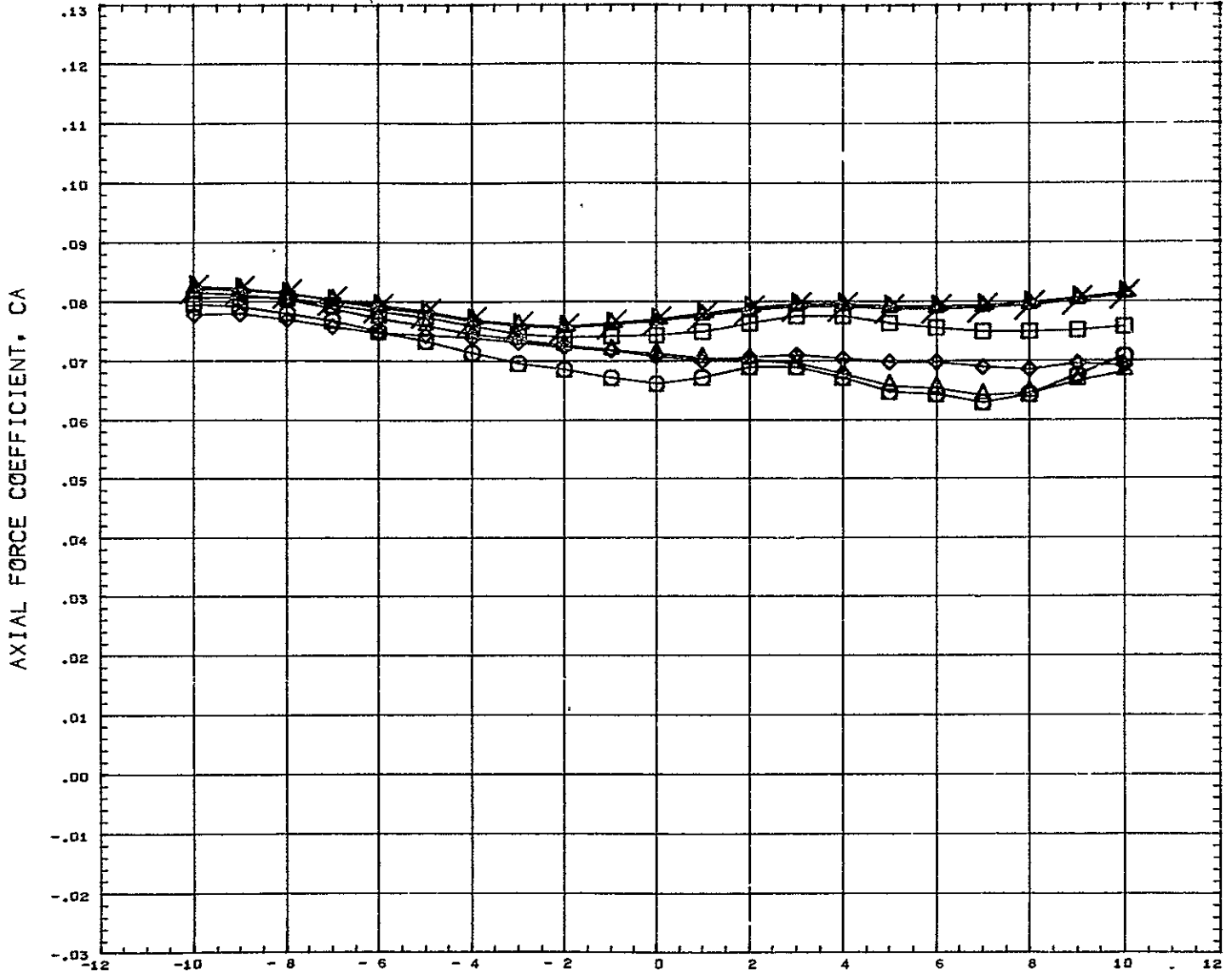

SYMBOL	DELTAZ	PARAMETRIC VALUES				REFERENCE INFORMATION		
○	0.120					REFS	44.4440	SQ IN
◇	0.151					REFL	13.3330	IN
□	0.182	BSTPOW	100.000	ORBPOW	100.000	REFB	13.3330	IN
△	0.228	DFTAX	- 0.391	ALPHA1	0.000	XMRP	7.5280	IN
▽	0.352	MACH	5.010	ELVBST	0.000	YMRP	0.0000	IN
◇	10.000	ELVORB	9.000	BETA	0.000	ZMRP	1.1940	IN
						SCALE	0.0055	

REFERENCE FILE



# AEDC VA 1163 MDAC BOOSTER AND ORBITER TEST DATA AT MACH NUMBER 5

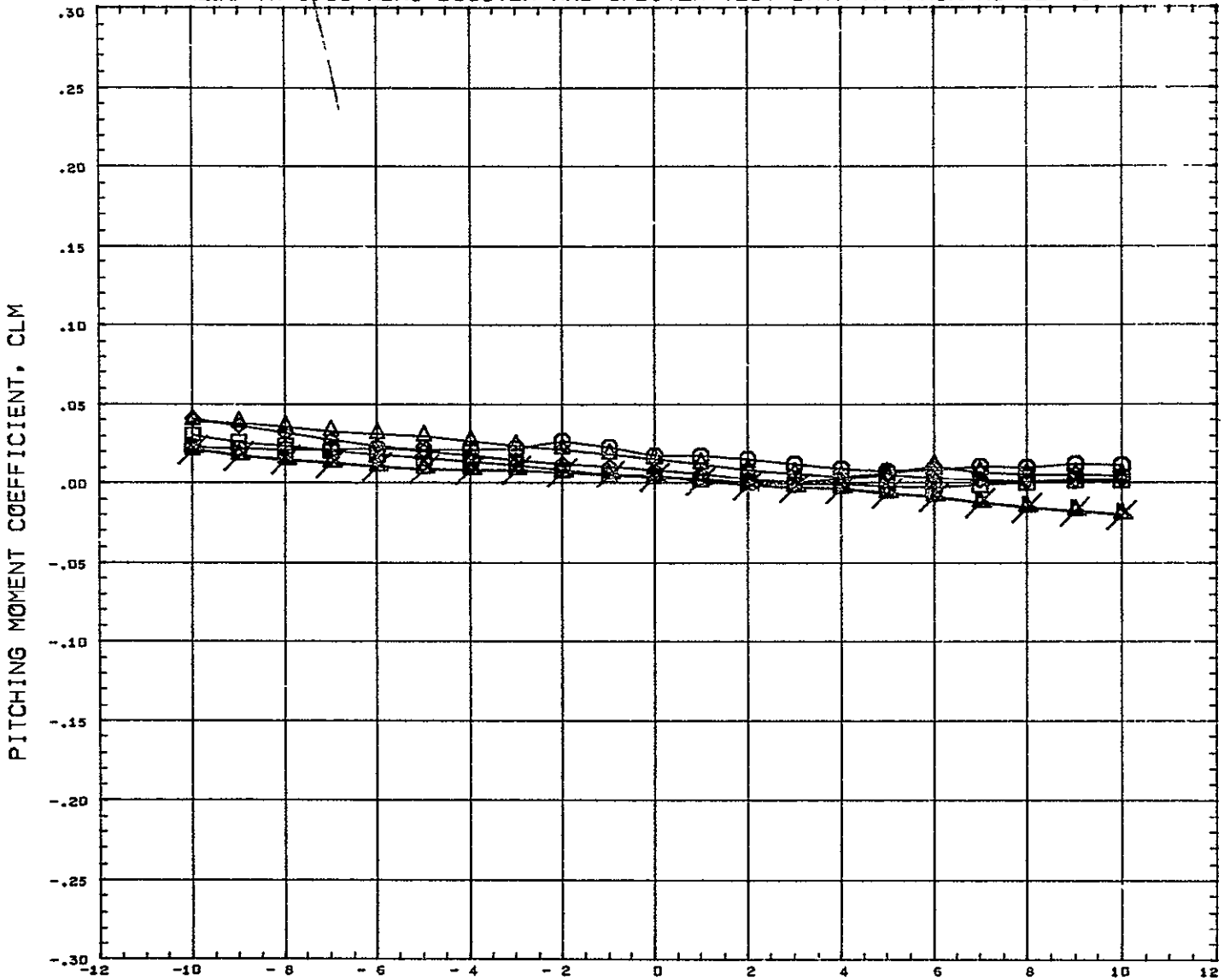

SYMBOL	DELTA Z	PARAMETRIC VALUES				REFERENCE INFORMATION		
○	0.120							
◇	0.151							
◇	0.182	BSTPOW	100.000	ORBPOW	100.000	REFS	44.4440	50 IN
□	0.220	DELTA X	- 0.143	ALPHA I	0.000	REFL	13.3330	IN
△	0.352	MACH	5.010	ELVBST	0.000	REFB	13.3330	IN
△	10.000	ELVORB	0.000	BETA	0.000	XMRP	7.5280	IN
						YMRP	0.0000	IN
						ZMRP	1.1940	IN
						SCALE	0.0055	

REFERENCE FILE

# AEDC VA 1163 MDAC BOOSTER AND ORBITER TEST DATA AT MACH NUMBER 5

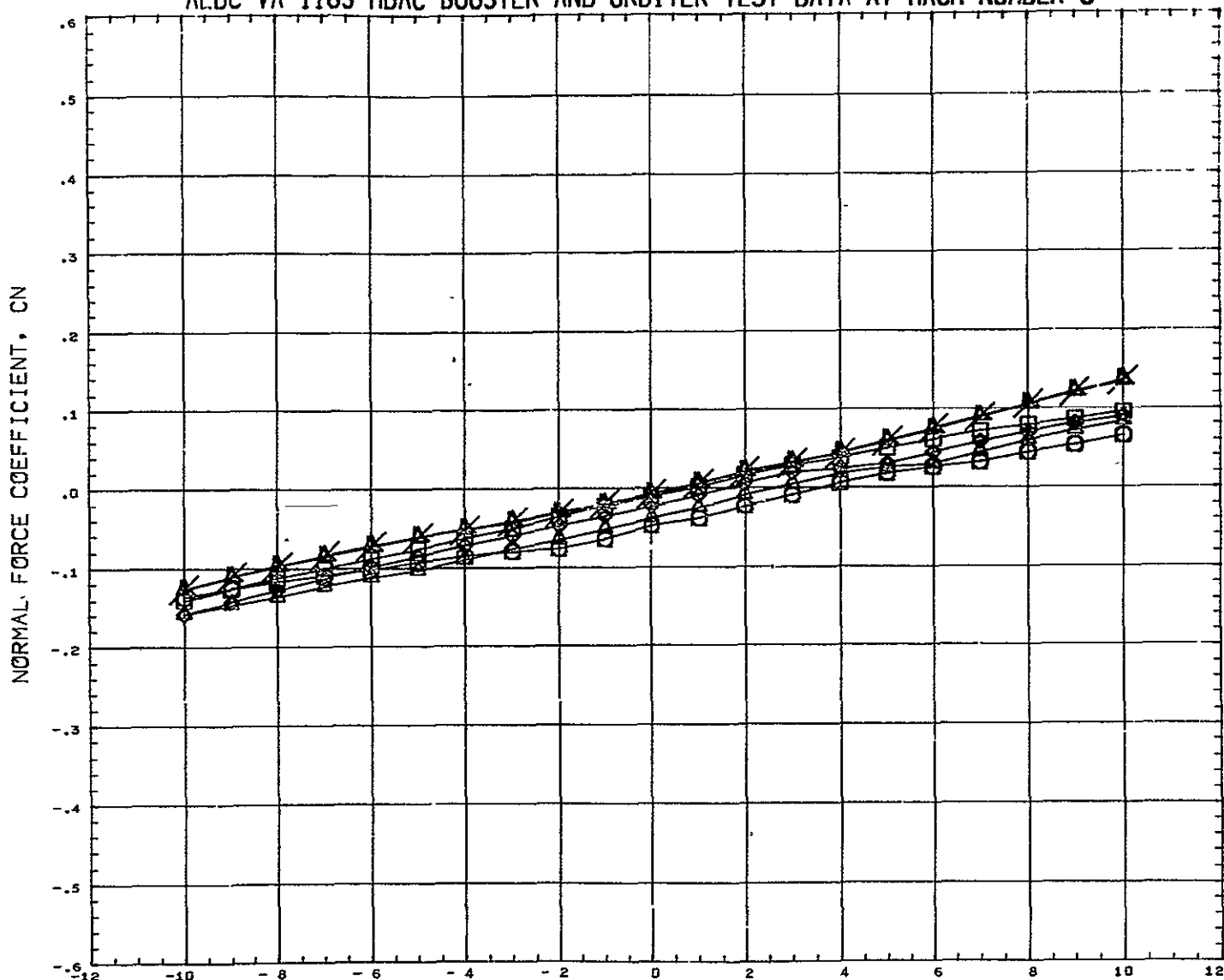

SYMBOL	DELTA Z		
○	0.120		
◇	0.151	PARAMETRIC VALUES	
□	0.182	BSTPOW 100.000	ORBPOW 100.000
△	0.228	DELTA X - 0.143	ALPHA I 0.000
▲	0.352	Y CH 5.010	ELVBST 0.000
	10.000	ELVORB 0.000	BETA 0.000
			REFERENCE INFORMATION
			REFS 44 4440 SR IN
			REFL 13 3330 IN
			REFB 13 3330 IN
			XMRP 7.5280 IN
			YMRP 0.0000 IN
			ZMRP 1.1940 IN
			SCALE 0.0055

REFERENCE FILE

# AEDC VA 1163 MDAC BOOSTER AND ORBITER TEST DATA AT MACH NUMBER 5

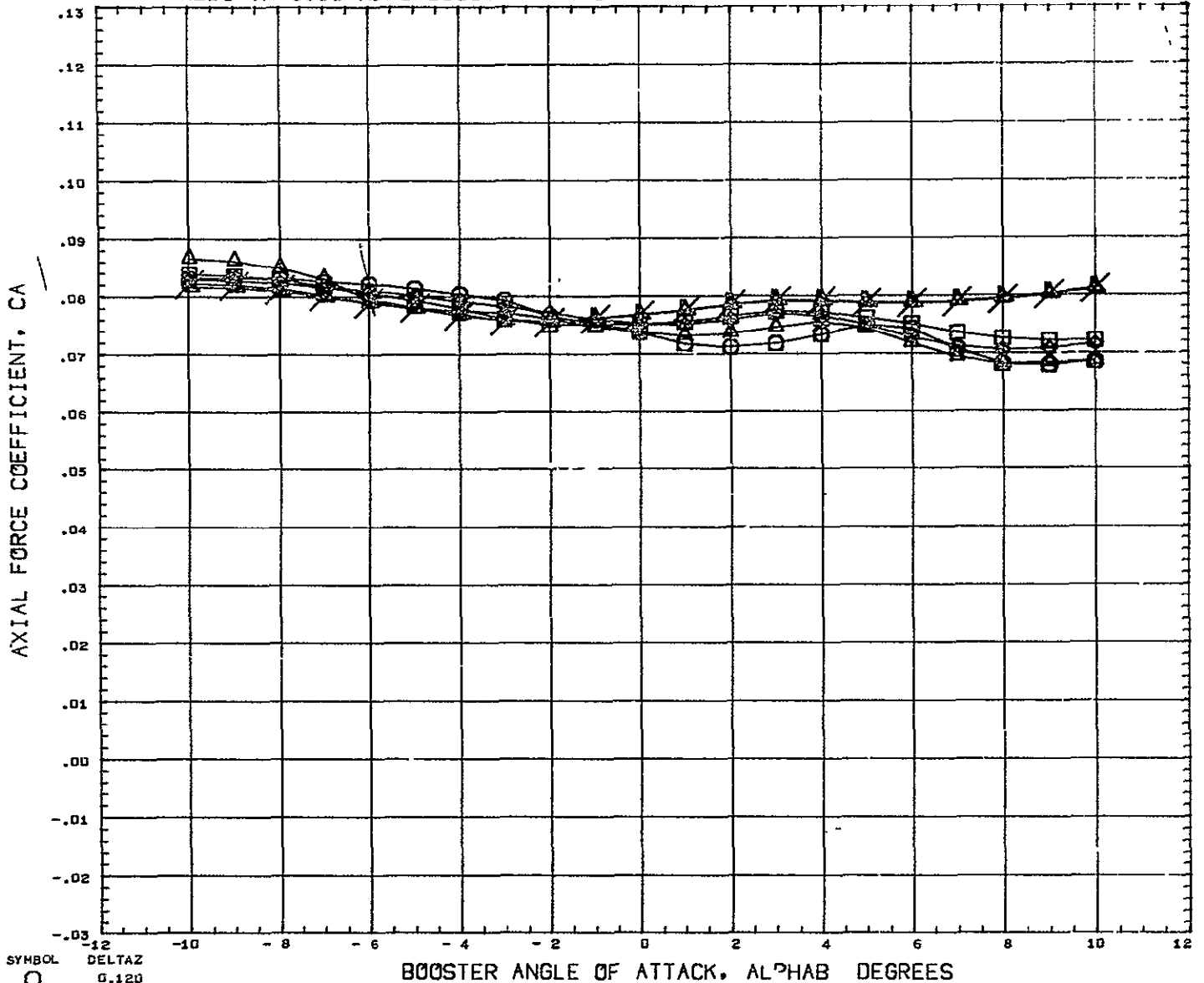

SYMBOL ○ △ □ ◇ ×	DELTAZ 0.120 0.151 0.182 0.228 0.352 10.000	PARAMETRIC VALUES BSTPOW 100.000 ORBPOW 100.000 ELTAX - 0.143 ALPHAI 0.000 MACH 5.010 ELVBST 0.000 ELVORB 0.000 BETA 0.000	REFERENCE INFORMATION REFS 44 4440 SQ IN REFL 13.3330 IN REFB 13.3330 IN XMRP 7.5250 IN YMRP 0.0000 IN ZMRP 1.1940 IN SCALE 0.0055
---------------------------------	---	--	---

REFERENCE FILE

# AEDC VA 1163 MDAC BOOSTER AND ORBITER TEST DATA AT MACH NUMBER 5

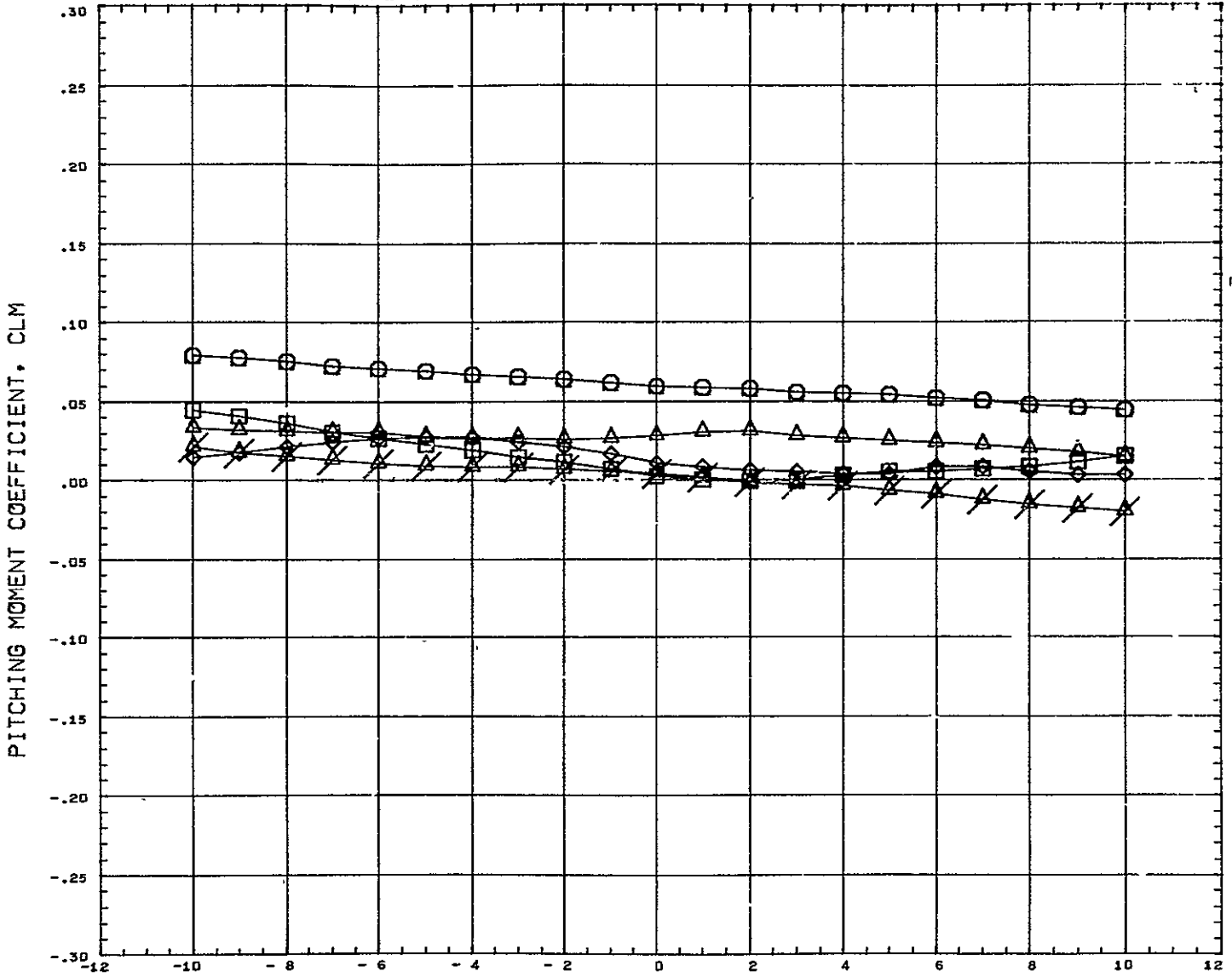

SYMBOL ○ □ △ ◇ ⊠ ×	DELTA Z 0.120 0.151 0.182 0.228 10.000	<table border="0" style="width: 100%;"> <tr> <th colspan="4" style="text-align: center;">PARAMETRIC VALUES</th> </tr> <tr> <td>.BSTPOW</td><td>100.000</td><td>ORBPOW</td><td>100.000</td> </tr> <tr> <td>CF.TAX</td><td>- 0.019</td><td>ALPHA1</td><td>0.000</td> </tr> <tr> <td>MACH</td><td>5.010</td><td>ELVBST</td><td>0.000</td> </tr> <tr> <td>ELVORB</td><td>0.000</td><td>BETA</td><td>0.000</td> </tr> </table>	PARAMETRIC VALUES				.BSTPOW	100.000	ORBPOW	100.000	CF.TAX	- 0.019	ALPHA1	0.000	MACH	5.010	ELVBST	0.000	ELVORB	0.000	BETA	0.000	<table border="0" style="width: 100%;"> <tr> <th colspan="3" style="text-align: center;">REFERENCE INFORMATION</th> </tr> <tr> <td>REFS</td><td>44.4440</td><td>SQ IN</td> </tr> <tr> <td>REFL</td><td>13.3330</td><td>IN</td> </tr> <tr> <td>REFB</td><td>13.3330</td><td>IN</td> </tr> <tr> <td>XMRP</td><td>7.5285</td><td>IN</td> </tr> <tr> <td>YMRP</td><td>0.0000</td><td>IN</td> </tr> <tr> <td>ZMRP</td><td>1.1940</td><td>IN</td> </tr> <tr> <td>SCALE</td><td>0.0055</td><td></td> </tr> </table>	REFERENCE INFORMATION			REFS	44.4440	SQ IN	REFL	13.3330	IN	REFB	13.3330	IN	XMRP	7.5285	IN	YMRP	0.0000	IN	ZMRP	1.1940	IN	SCALE	0.0055	
PARAMETRIC VALUES																																															
.BSTPOW	100.000	ORBPOW	100.000																																												
CF.TAX	- 0.019	ALPHA1	0.000																																												
MACH	5.010	ELVBST	0.000																																												
ELVORB	0.000	BETA	0.000																																												
REFERENCE INFORMATION																																															
REFS	44.4440	SQ IN																																													
REFL	13.3330	IN																																													
REFB	13.3330	IN																																													
XMRP	7.5285	IN																																													
YMRP	0.0000	IN																																													
ZMRP	1.1940	IN																																													
SCALE	0.0055																																														

REFERENCE FILE

# AEDC VA 1163 MDAC BOOSTER AND ORBITER TEST DATA AT MACH NUMBER 5

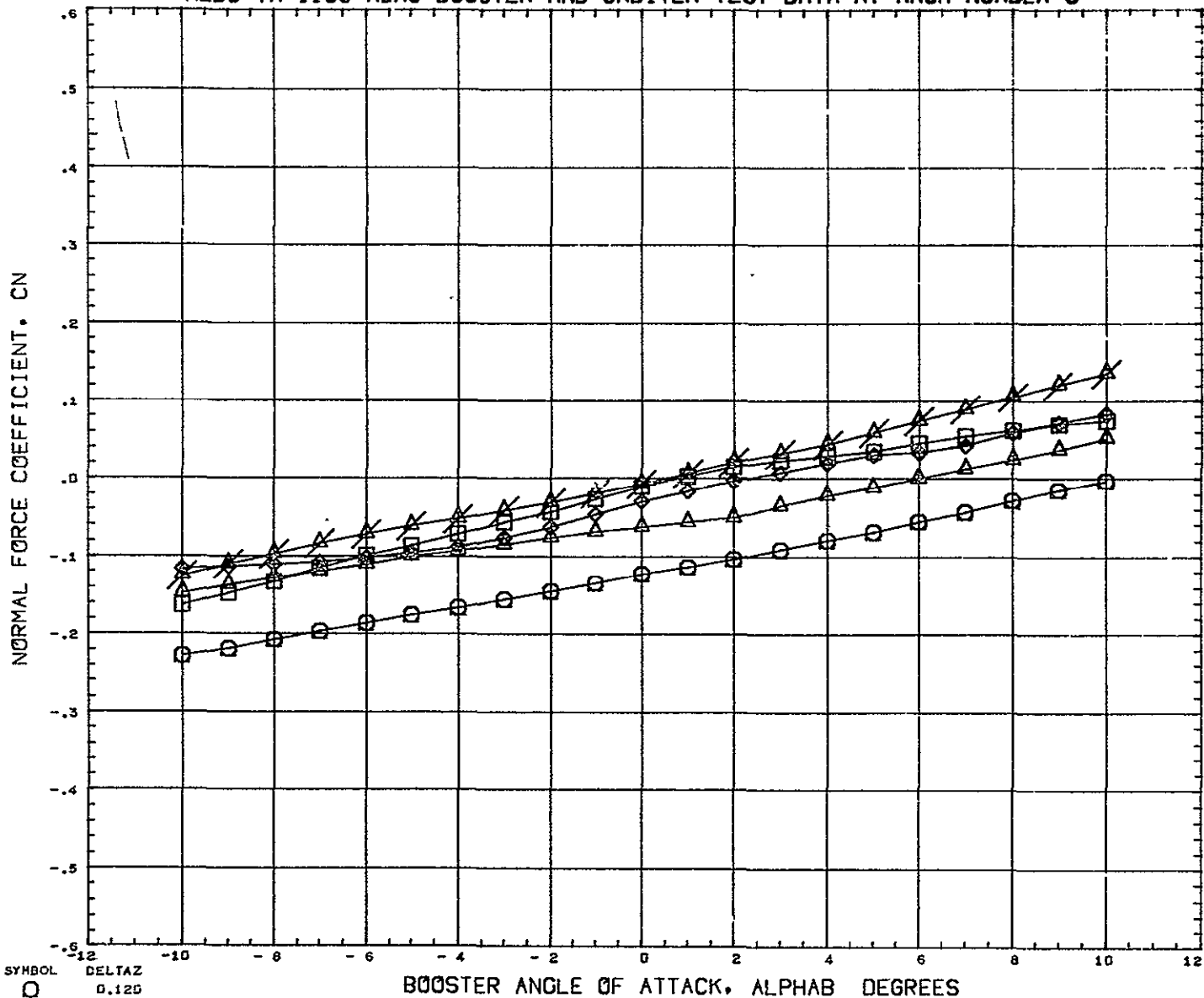

SYMBOL	DELTA Z	PARAMETRIC VALUES		REFERENCE INFORMATION	
○	0.125	BSTPOW	100.000	ORBPOW	100.000
□	0.151	DELTA X	-0.019	ALPHA I	0.000
◇	0.182	MACH	5.010	ELVBST	0.000
△	0.228	ELVORB	0.000	BETA	0.000
×	10.000				
		REFERENCE FILE			
				REFS	44.444J SQ IN
				REFL	13.3330 IN
				REFB	13.3330 IN
				XHRF	7.5280 IN
				YHRF	0.0000 IN
				ZHRF	1.1940 IN
				SCALE	0 0055

# AEDC VA 1163 MDAC BOOSTER AND ORBITER TEST DATA AT MACH NUMBER 5

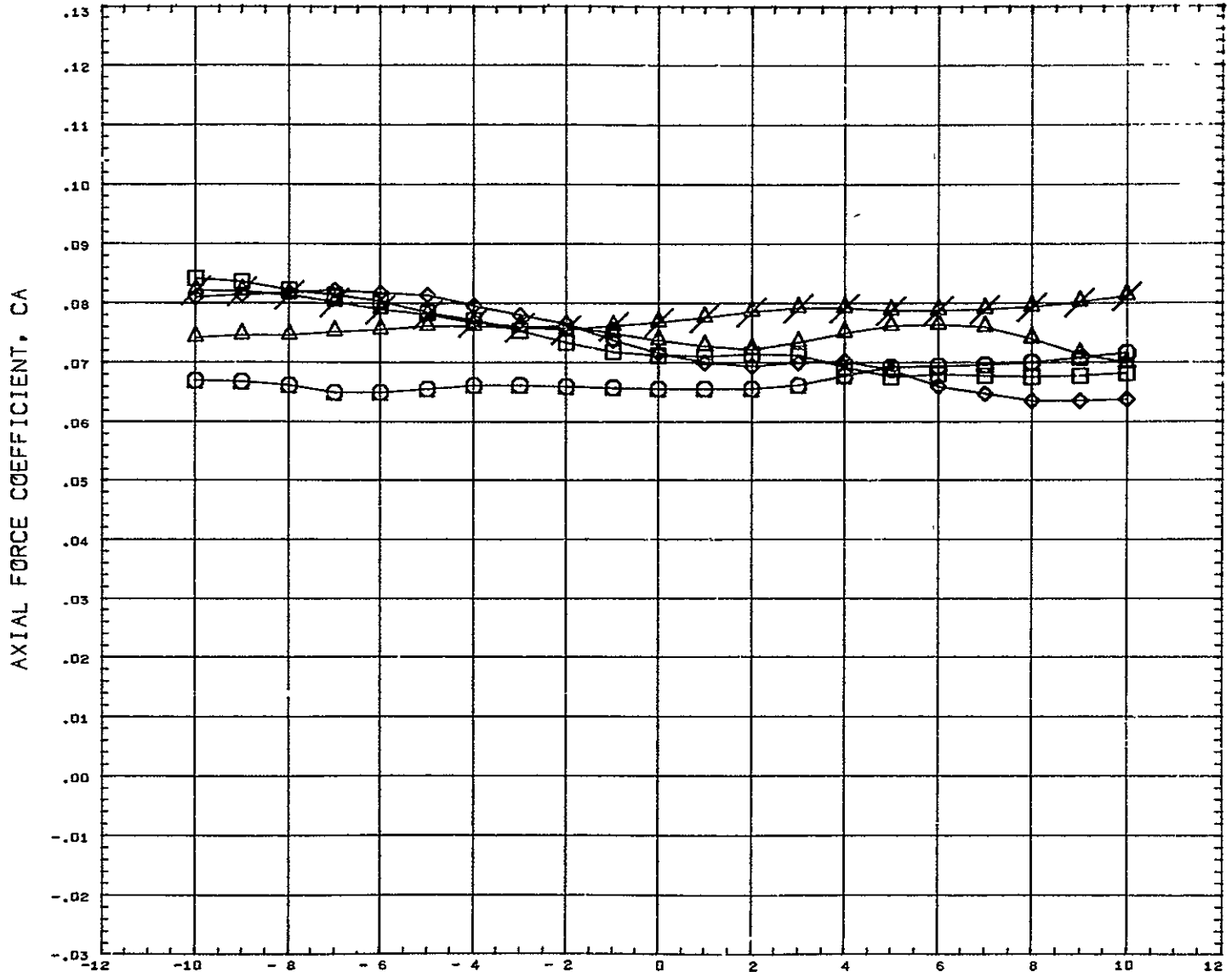

SYMBOL ○ △ ◇ □ ×	DELTA Z 0.120 0.151 0.182 0.228 10.000  DELTA X -0.019 5.016 0.000  ELVORB 0.000	PARAMETRIC VALUES BSTPOW 100.000 ORBPOW 100.000 ALPHAI 0.000 ELVBST 0.000 BETA 0.000	REFERENCE INFORMATION REFS 44.4440 SQ IN REFL 13.3330 IN REFB 13.3330 IN XMRF 7.5280 IN YMRP 0.0000 IN ZMRP 1.1940 IN SCALE 0.0055
---------------------------------	---	--	---

REFERENCE FILE

# AEDC VA 1163 MDAC BOOSTER AND ORBITER TEST DATA AT MACH NUMBER 5

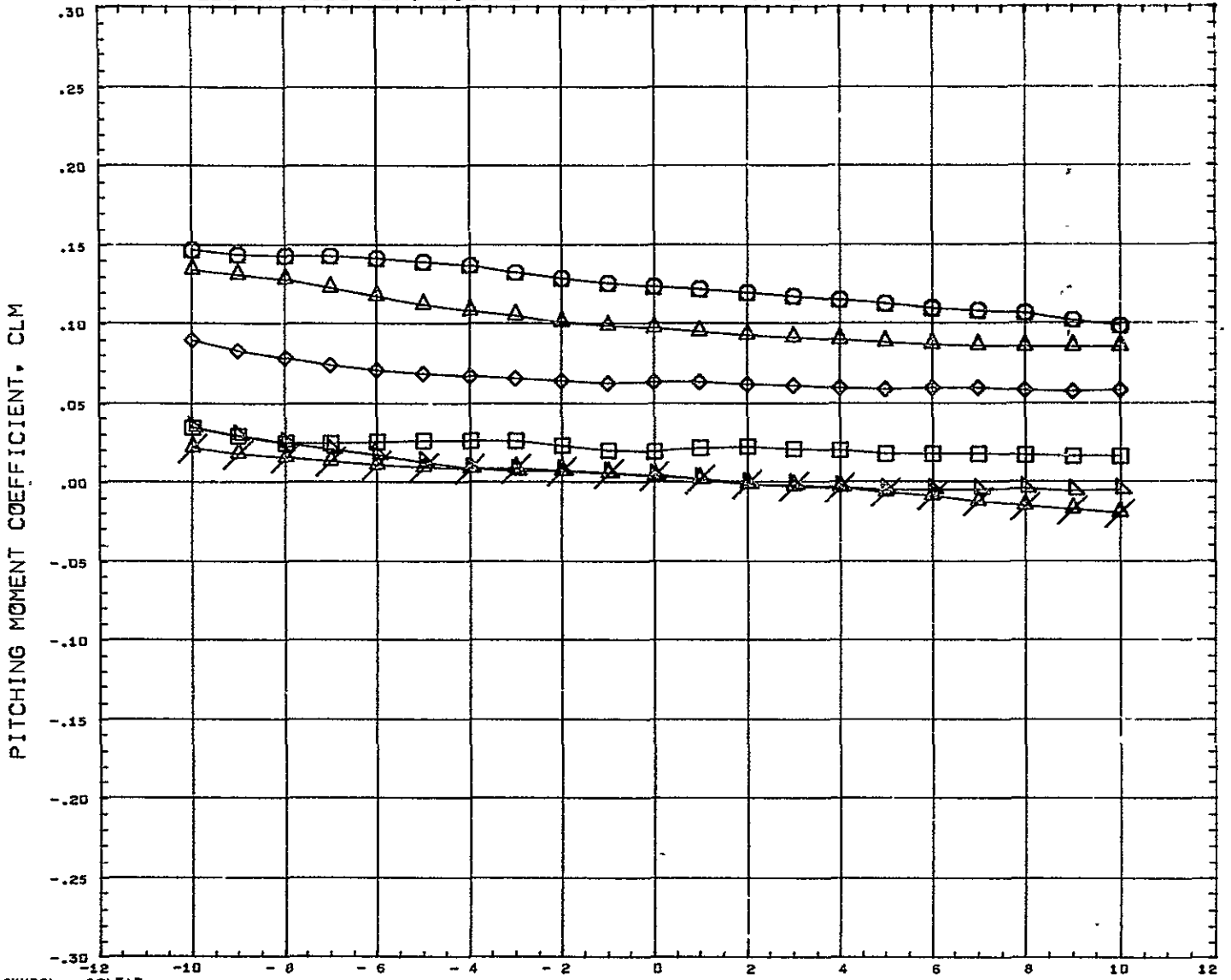

SYMBOL ○ △ ◇ □ ×	DELTAZ 0.120 0.151 0.182 0.228 0.352 10.000	BOOSTER ANGLE OF ATTACK, ALPHA DEGREES  PARAMETRIC VALUES BSTPOW 100.000 ORBPOW 100.000 DELTAX 0.104 ALPHAI 0.000 MACH 5.010 ELVBST 0.000 ELVORB 0.000 BETA 0.000	REFERENCE INFORMATION REFS 1.4440 SG IN REFL 13.3330 IN REFB 13.3330 IN XMRP 7.5280 IN YMRP 0.0000 IN ZMRP 1.1940 IN SCALE 0.0055
REFERENCE FILE			

# AEDC VA 1163 MDAC BOOSTER AND ORBITER TEST DATA AT MACH NUMBER 5

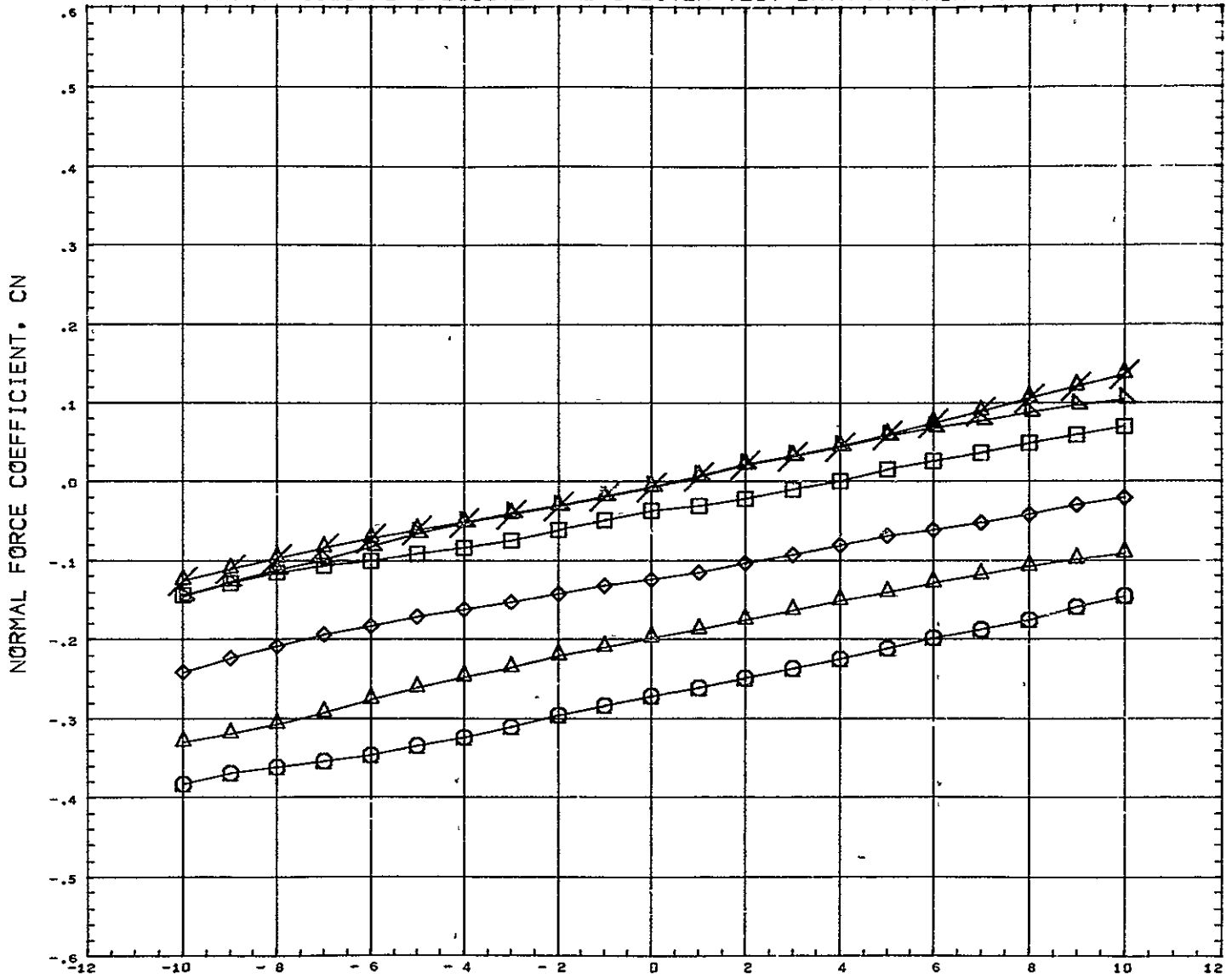

SYMBOL ○ △ ◇ □ ×	DELTAX 0.120 0.151 0.182 0.228 0.352 10.000	PARAMETRIC VALUES BSTPOW 100.000 ORBPOW 100.000 DELTAX 0.104 ALPHA1 0.000 MACH 5.010 ELVSST 0.000 ELVORB 0.000 BETA 0.000	REFERENCE INFORMATION REFS 44.4440 SQ IN REFL 13.3330 IN REFB 13.3330 IN XMRP 7.5280 IN YMRP 0.0000 IN ZMRP 1.1940 IN SCALE 0.0055
---------------------------------	---	---	---



# AEDC VA 1163 MDAC BOOSTER AND ORBITER TEST DATA AT MACH NUMBER 5

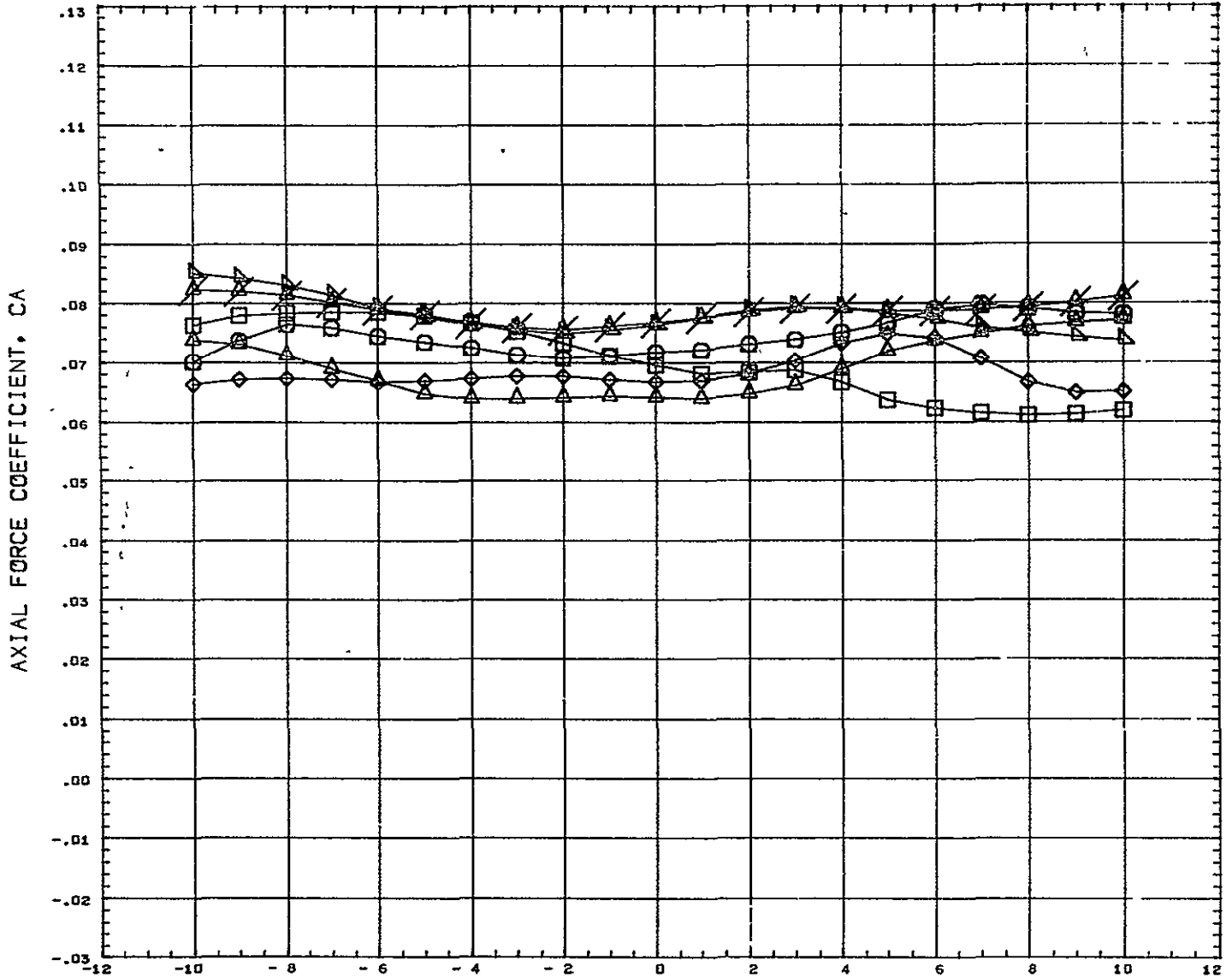

SYMBOL ○ □ ◇ △ ×	DELTAX 0.120 0.151 0.182 0.228 0.352 10.000	<table border="0" style="width: 100%;"> <tr> <th colspan="4" style="text-align: left;">PARAMETRIC VALUES</th> </tr> <tr> <td>BSTFOW</td> <td>100.000</td> <td>ORBFOW</td> <td>150.000</td> </tr> <tr> <td>DELTA</td> <td>0.104</td> <td>ALPHA</td> <td>0.000</td> </tr> <tr> <td>Y CH</td> <td>5.010</td> <td>ELVST</td> <td>0.000</td> </tr> <tr> <td>ELVORB</td> <td>0.000</td> <td>BETA</td> <td>0.000</td> </tr> </table>	PARAMETRIC VALUES				BSTFOW	100.000	ORBFOW	150.000	DELTA	0.104	ALPHA	0.000	Y CH	5.010	ELVST	0.000	ELVORB	0.000	BETA	0.000	<table border="0" style="width: 100%;"> <tr> <th colspan="3" style="text-align: left;">REFERENCE INFORMATION</th> </tr> <tr> <td>REFS</td> <td>44 4440</td> <td>SQ IN</td> </tr> <tr> <td>REFL</td> <td>13.3330</td> <td>IN</td> </tr> <tr> <td>REFB</td> <td>13.3330</td> <td>IN</td> </tr> <tr> <td>XNRP</td> <td>7.5280</td> <td>IN</td> </tr> <tr> <td>YNRP</td> <td>0.0000</td> <td>IN</td> </tr> <tr> <td>ZNRP</td> <td>1.1940</td> <td>IN</td> </tr> <tr> <td>SCALE</td> <td>0.0055</td> <td></td> </tr> </table>	REFERENCE INFORMATION			REFS	44 4440	SQ IN	REFL	13.3330	IN	REFB	13.3330	IN	XNRP	7.5280	IN	YNRP	0.0000	IN	ZNRP	1.1940	IN	SCALE	0.0055	
PARAMETRIC VALUES																																															
BSTFOW	100.000	ORBFOW	150.000																																												
DELTA	0.104	ALPHA	0.000																																												
Y CH	5.010	ELVST	0.000																																												
ELVORB	0.000	BETA	0.000																																												
REFERENCE INFORMATION																																															
REFS	44 4440	SQ IN																																													
REFL	13.3330	IN																																													
REFB	13.3330	IN																																													
XNRP	7.5280	IN																																													
YNRP	0.0000	IN																																													
ZNRP	1.1940	IN																																													
SCALE	0.0055																																														

REFERENCE FILE

# AEDC VA 1163 MDAC BOOSTER AND ORBITER TEST DATA AT MACH NUMBER 5

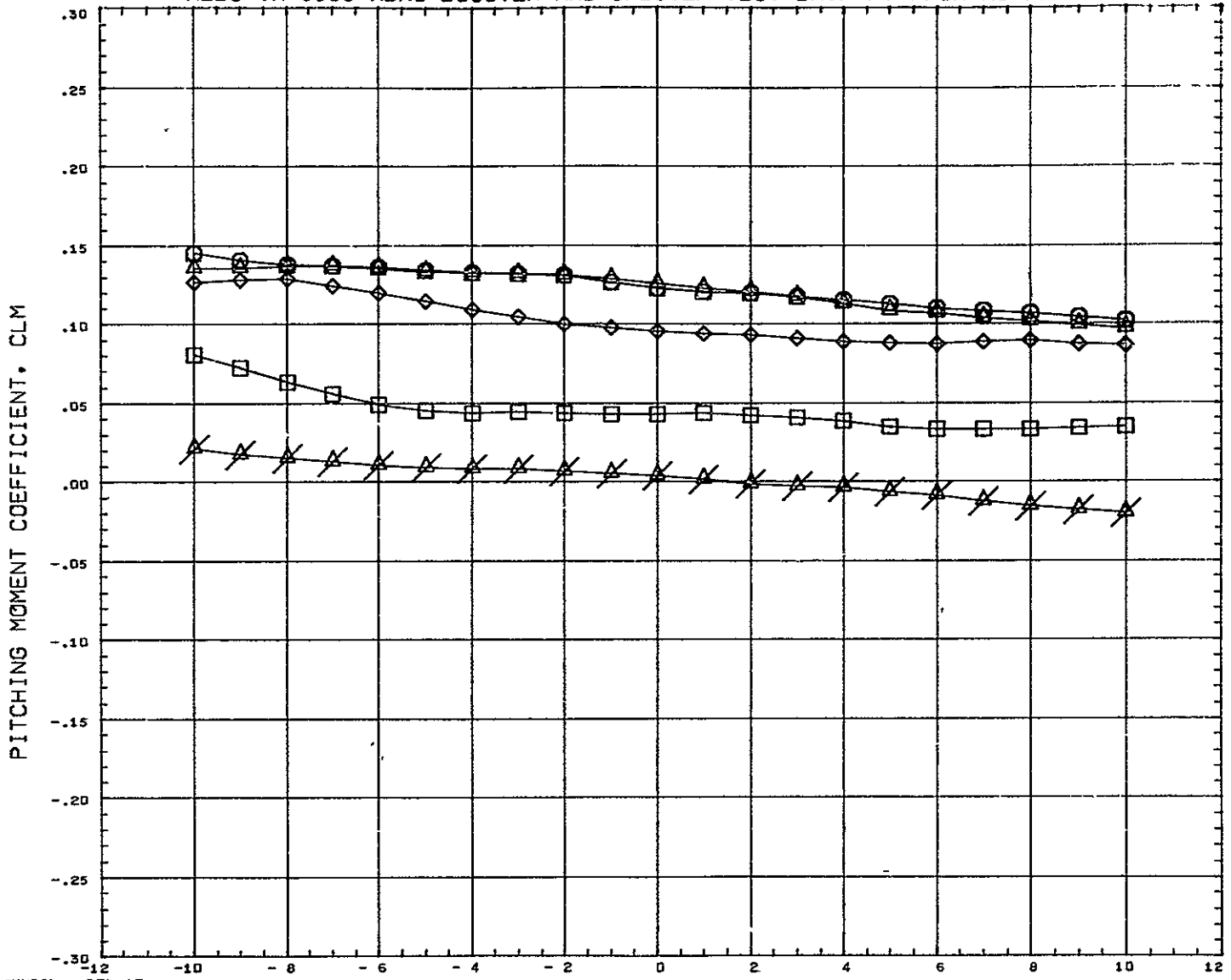

SYMBOL ○ ◇ □ △	DELTA Z 0.120 0.151 0.182 0.228 10.000	PARAMETRIC VALUES BSTFOW 100.000 ORB FOW 100.000 DELTAX 0.166 ALPHA 0.000 MACH 5.010 ELVBST 0.000 ELVORB 0.000 BETA 0.000	REFERENCE INFORMATION REFS 44.4440 SQ IN REFL 13.3330 IN REFB 13.3330 IN XMRF 7.5280 IN YMRF 0.0000 IN ZMRF 1.194C IN SCALE 0.0055
----------------------------	---	---	---

AEDC VA 1163 MDAC BOOSTER AND ORBITER TEST DATA AT THROAT NUMBER 5

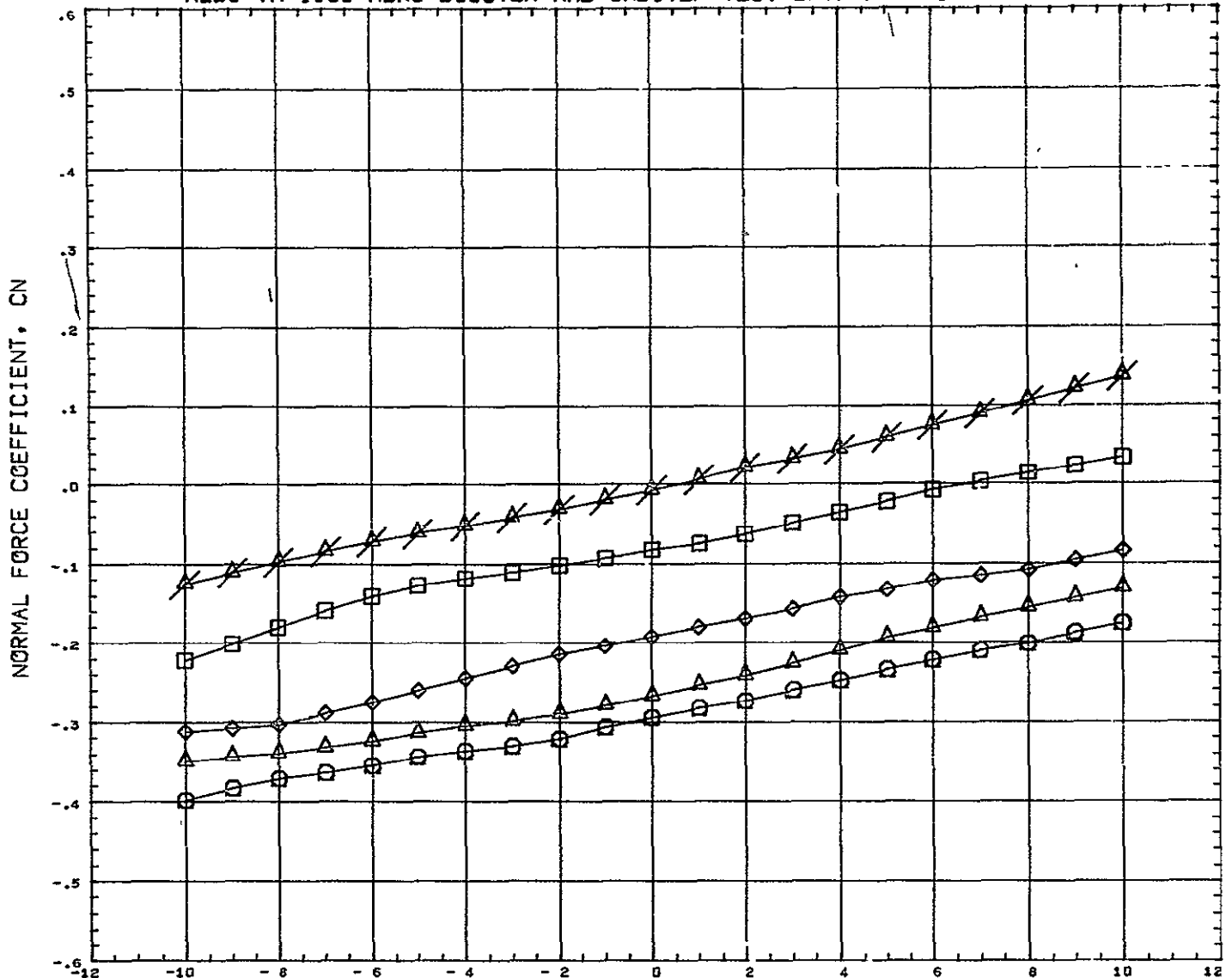

SYMBOL	DELTA Z	PARAMETRIC VALUES				REFERENCE INFORMATION		
○	0.120	BSTPOW	100.000	ORBPOW	100.000	REFS	44.4440	SG IN
◇	0.151	DELTA X	0.166	ALPHA I	0.000	REFL	13.3330	IN
△	0.182	MACH	5.010	ILVBST	0.000	REFB	13.3330	IN
□	0.228	C_VORB	0.000	BETA	0.000	XMRP	7.5230	IN
⊗	10.000					YMRP	0.0000	IN
						ZMRP	1.1940	IN
						SCALE	0.0055	

REFERENCE FILE

# AEDC VA 1163 MDAC BOOSTER AND ORBITER TEST DATA AT MACH NUMBER 5

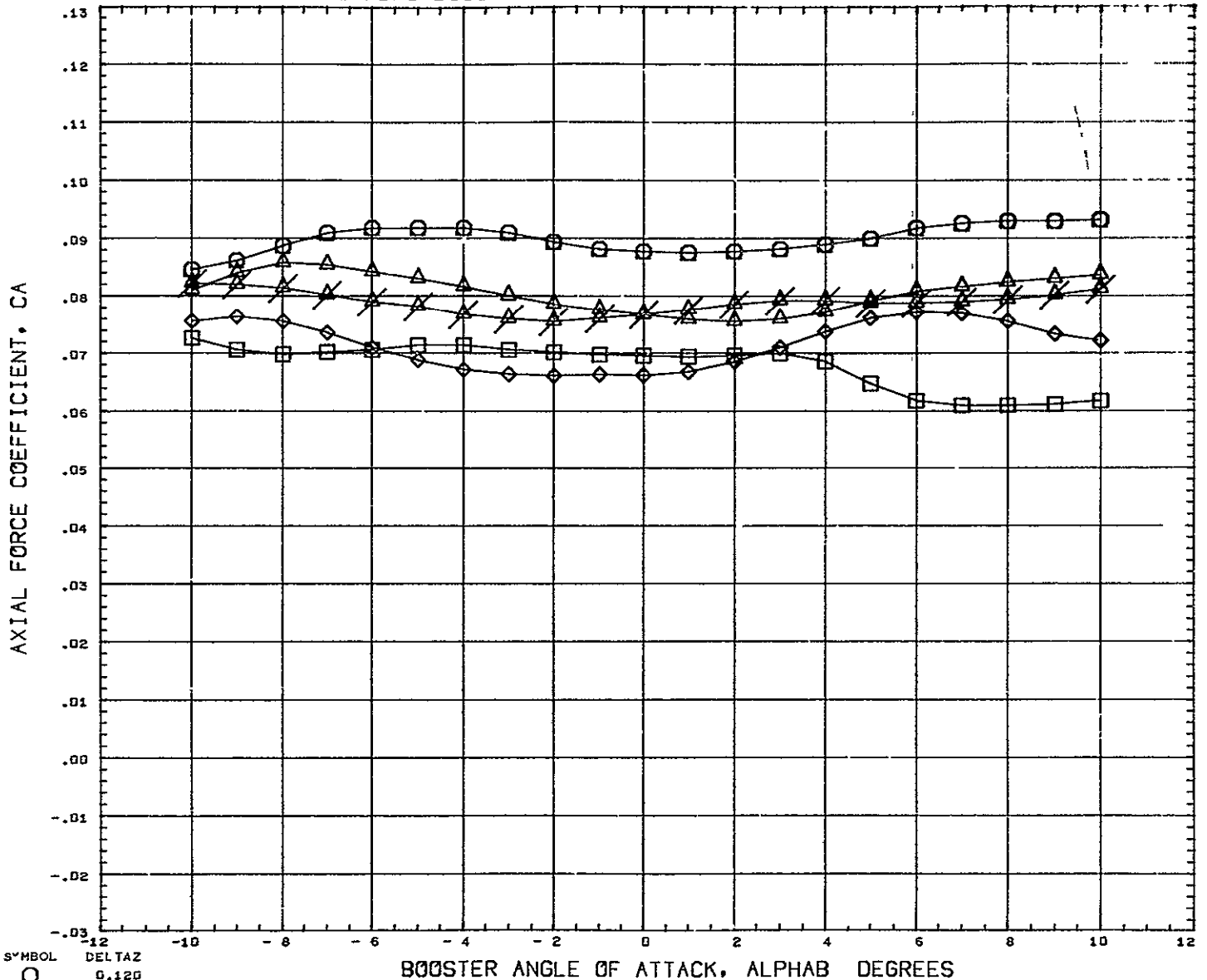

SYMBOL ○ △ ◇ □ ×	DELTAX 0.120 0.151 0.182 0.228 10.000	PARAMETRIC VALUES BSTPOW 100.000 ORBPOW 100.000 DELTAX 0.166 ALPHAI 0.000 MACH 5.010 ELVBST 0.000 LVORB 0.000 BETA 0.000	REFERENCE INFORMATION REFS 44.4440 SQ IN REFL 13.3330 IN REFB 13.3330 IN XMRP 7.5280 IN YMRP 0.0000 IN ZMRP 1.1940 IN SCALE 0.0055
REFERENCE FILE			

AEDC VA 1163 MDAC BOOSTER AND ORBITER TEST DATA AT MACH NUMBER 5

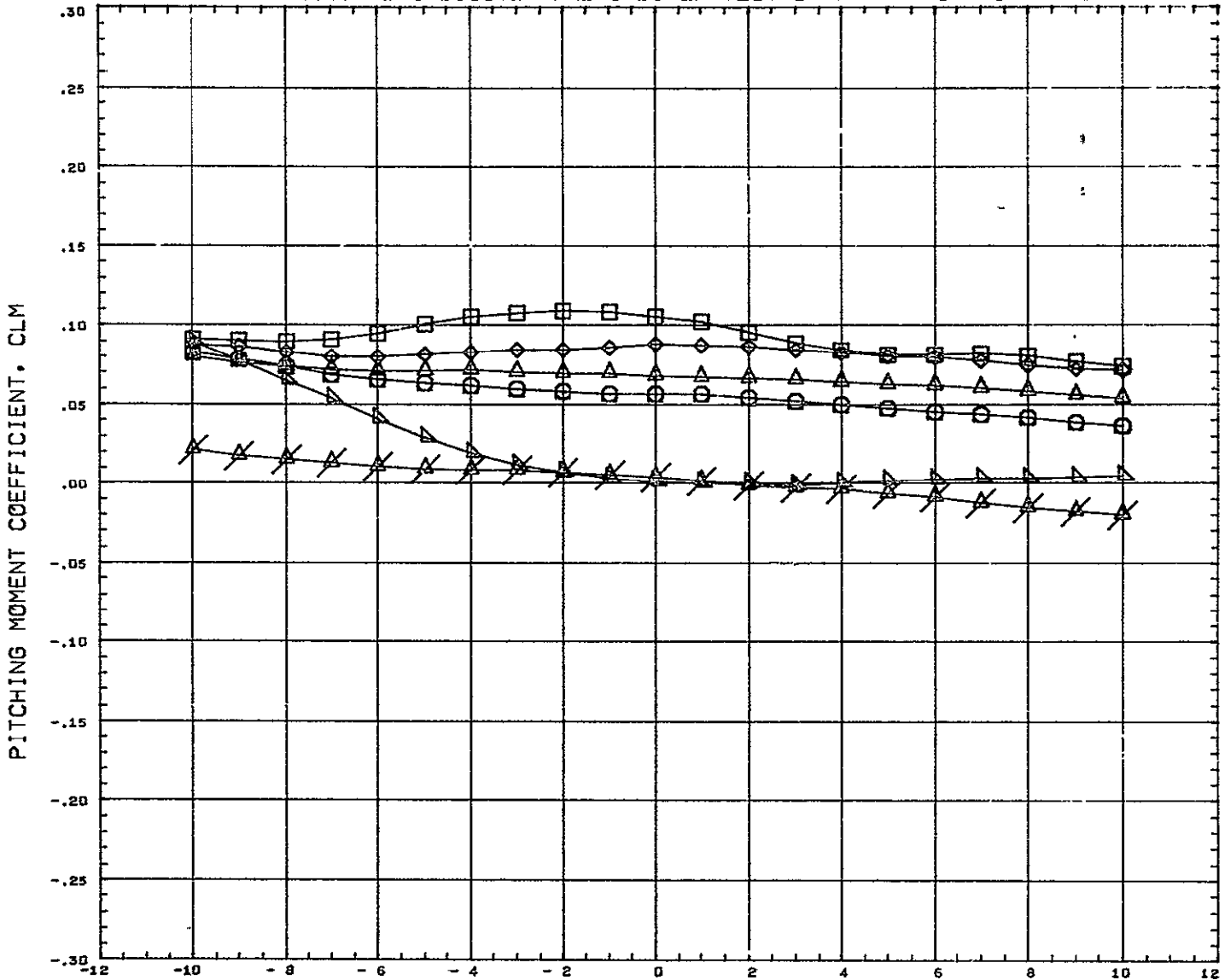

SYMBOL	DELTA Z	PARAMETRIC VALUES				REFERENCE INFORMATION		
○	0.120	BSTPOW	100.000	ORBPOW	100.000	REFS	44.4440	SQ IN
◇	0.151	DELTA X	0.351	ALPHA I	0.000	REFL	10.3330	IN
△	0.182	MACH	5.010	ELVBST	0.000	REFB	13.3330	IN
□	0.228	LLVORB	0.000	BETA	0.000	XMRP	7.5280	IN
×	0.352					YMRP	0.0000	IN
	10.000					ZMRP	1.1940	IN
						SCALE	0.0055	

REFERENCE FILE

# AEDC VA 1163 MDAC BOOSTER AND ORBITER TEST DATA AT MACH NUMBER 5

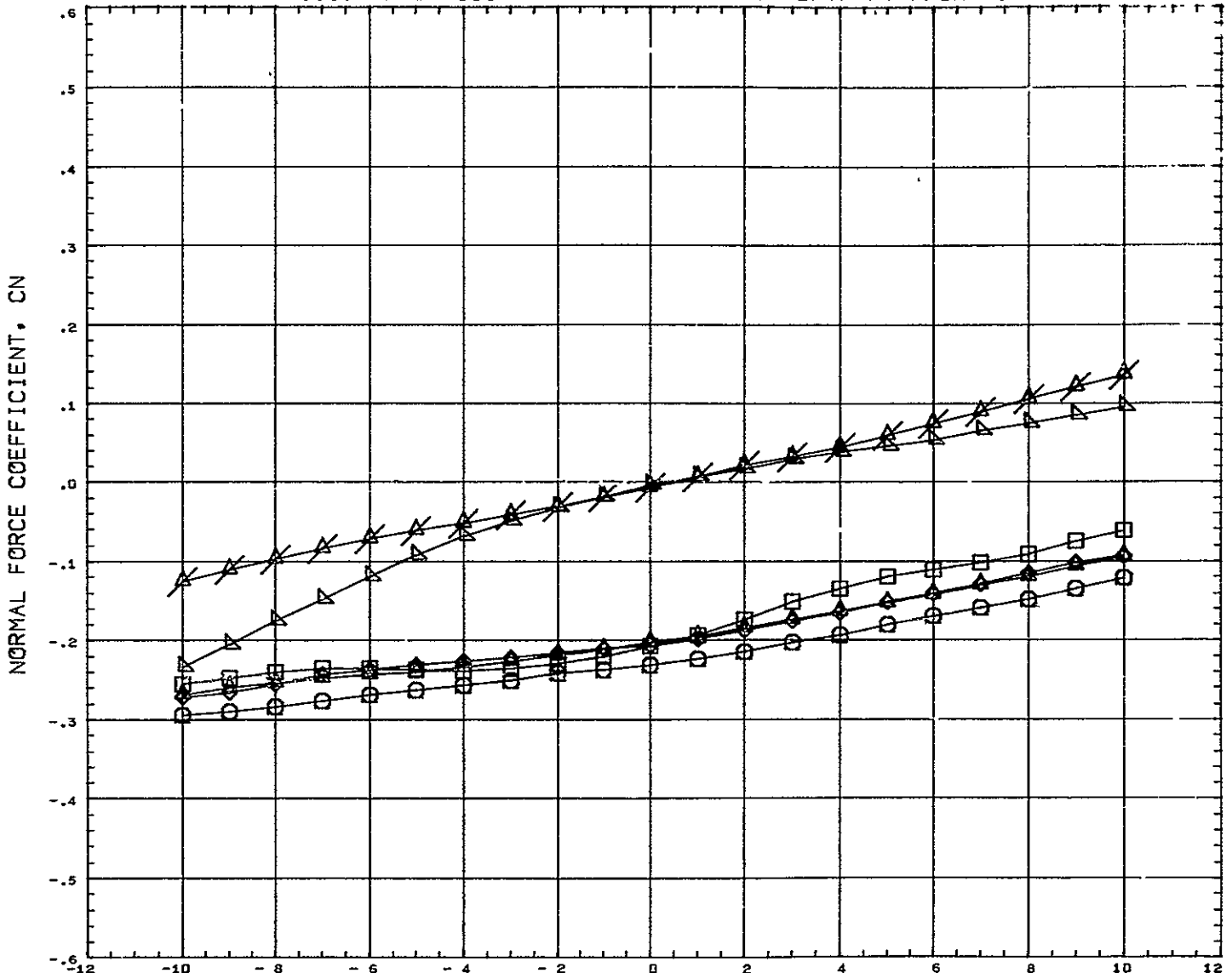

SYMBOL 	DELTA Z 0.120 0.151 0.182 0.228 0.352 10.000	PARAMETRIC VALUES BSTPOW 100.000 CRBPOW 100.000 DF TAX 0.351 ALPHAI 0.000 MACH 5.010 ELVBST 0.000 ELVORB 0.000 BETA 0.000	REFERENCE INFORMATION REFS 44.4440 SQ IN REFL 13.3330 IN REFB 13.3330 IN XMRP 7.5280 IN YMRP 0.0000 IN ZMRP 1.1940 IN SCALE 0.0055
------------	--	---	---

REFERENCE FILE

# AEDC VA 1163 MDAC BOOSTER AND ORBITER TEST DATA AT MACH NUMBER 5

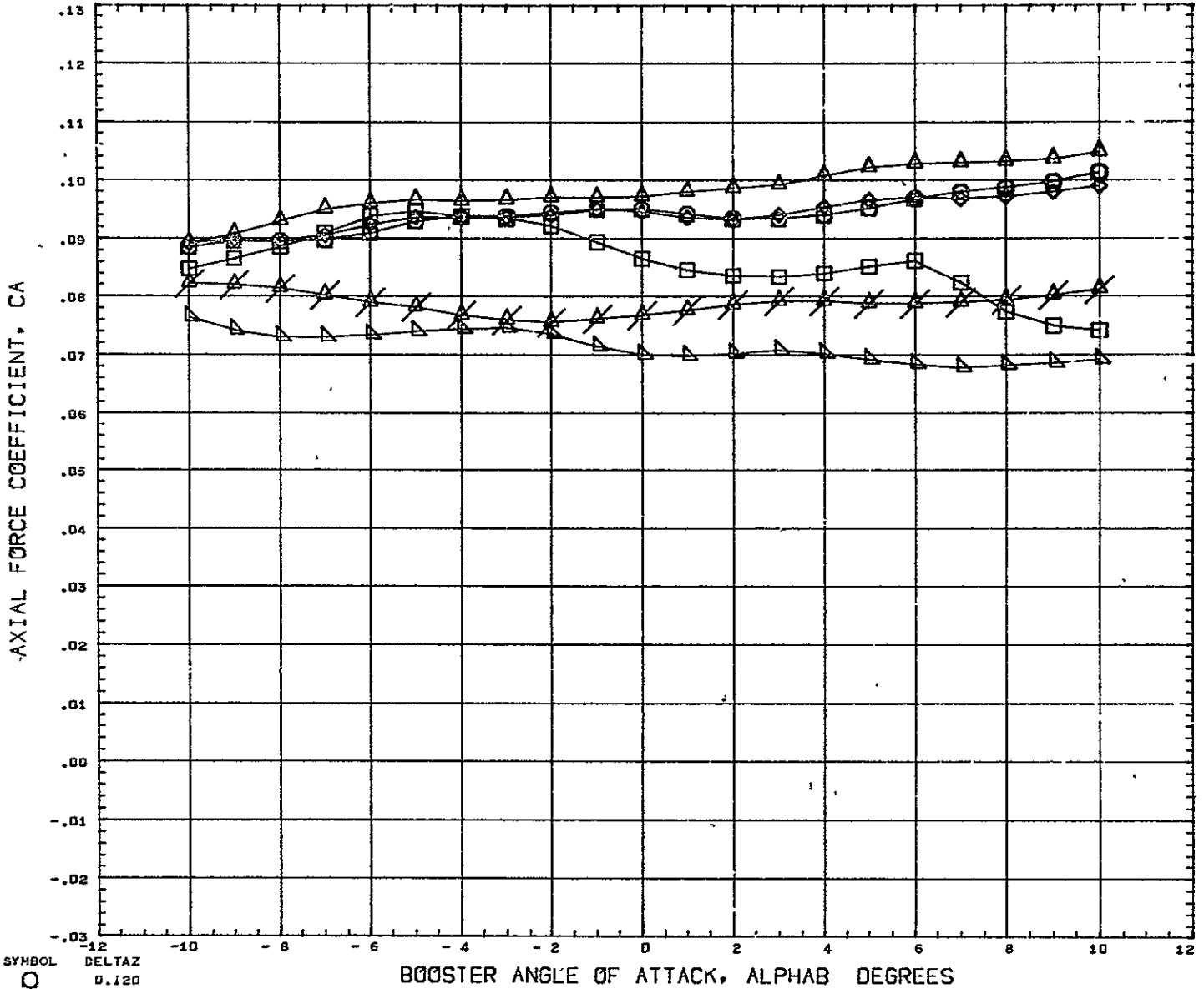

SYMBOL ○ ◊ □ △ ×	DELTAX 0.120 0.151 0.182 0.228 0.352 10.000	PARAMETRIC VALUES BSTFOW 100.000 ORBPOW 100.000 DELTAX 0.351 ALPHAI 0.000 MACH 5.010 ELVBST 0.000 ELVORB 0.000 BETA 0.000	REFERENCE INFORMATION REFS 44.4440 SQ IN REFL 13.3330 IN REFB 13.3330 IN XMRP 7.5280 IN YMRP 0.0000 IN ZMRP 1.1940 IN SCALE 0.0055
---------------------------------	---	---	---

REFERENCE FILE

# AEDC VA 1163 MDAC BOOSTER AND ORBITER TEST DATA AT MACH NUMBER 5

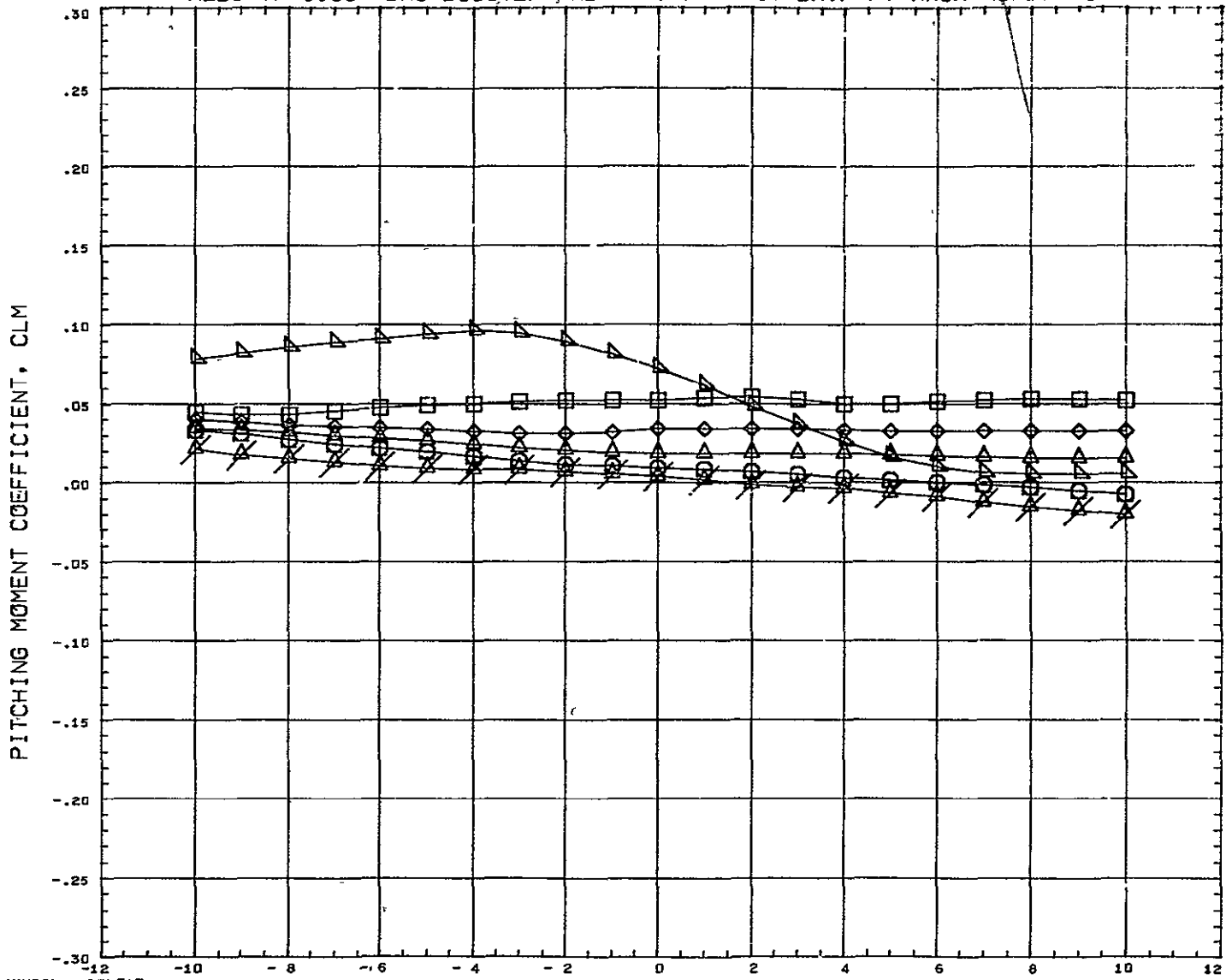

SYMBOL △ ◇ □ ○ ×	DELTAZ 0.120 0.151 0.182 0.228 0.352 10.000	BOOSTER ANGLE OF ATTACK, ALPHA DEGREES  PARAMETRIC VALUES BSTFOW 100.000 ORBFOV 100.000 DELTAX 0.522 ALPHAI 0.000 MACH 5.010 ELVBST 0.000 ELVORB 0.000 BETA 0.000	REFERENCE INFORMATION REFS 44.4440 SQ IN REFL 13.3330 IN REFB 13.3330 IN XMRP 7.5280 IN YMRP 0.0050 IN ZMRP 1.1940 IN SCALE 0.0055
---------------------------------	---	---	---

REFERENCE FILE



# AEDC VA 1163 MDAC BOOSTER AND ORBITER TEST DATA AT MACH NUMBER 5

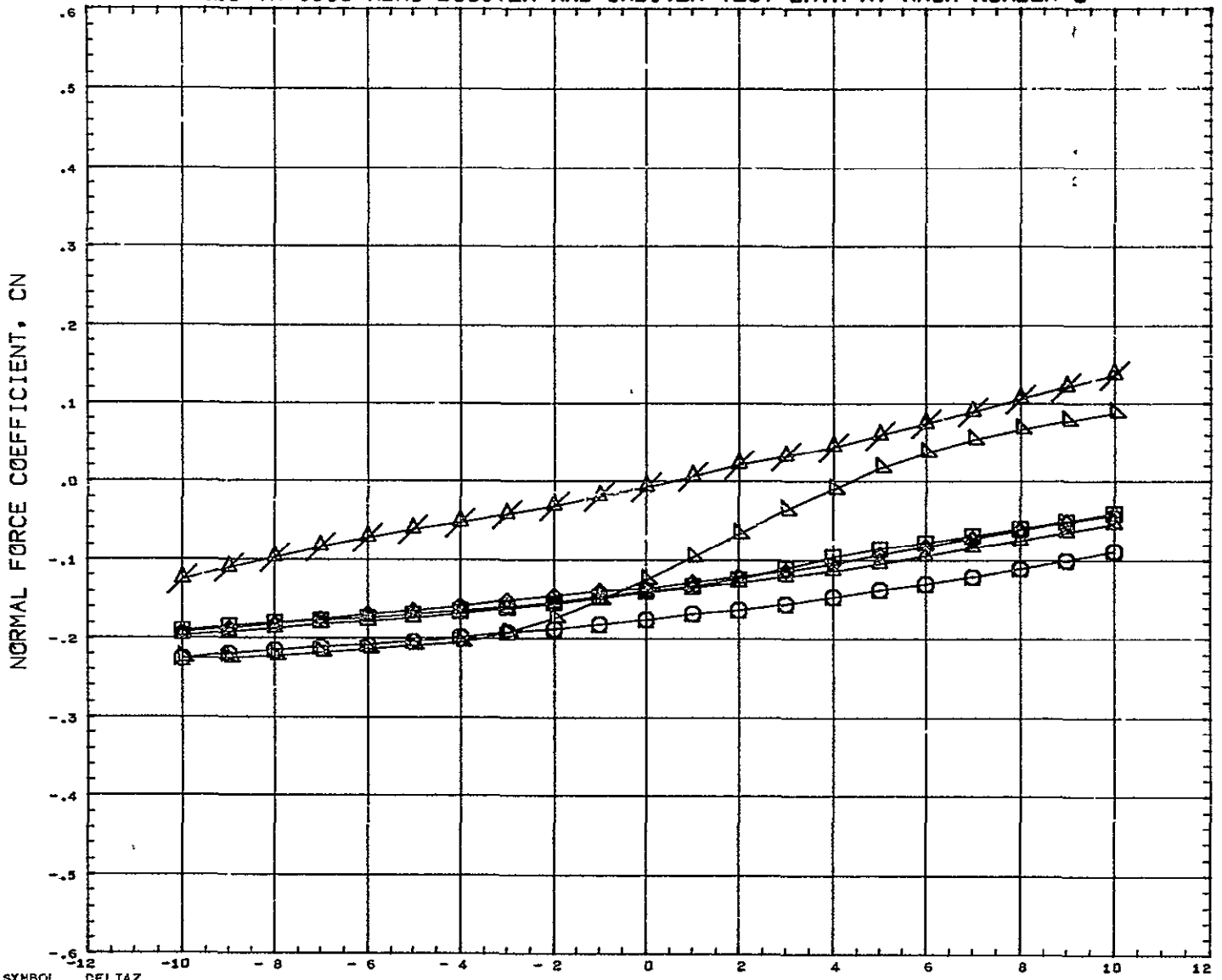

SYMBOL ○ △ □ ◇ ×	DELTA Z 0.120 0.151 0.182 0.228 0.352 10.000	PARAMETRIC VALUES BSTPCW 100.000    ORBPCW 100.000 DELTAX 0.522      ALPHAI 0.000 M CH 5.010        ELVBST 0.000 ELVORB 0.000     BEIA 0.000	REFERENCE INFORMATION REFS 44.4440      SQ IN REFL 13.3330     IN REFB 13.3330     IN XHRP 7.5280      IN YHRP 0.0000      IN ZHRP 1.1940      IN SCALE 0.0055
REFERENCE FILE			

# AEDC VA 1163 MDAC BOOSTER AND ORBITER TEST DATA AT MACH NUMBER 5

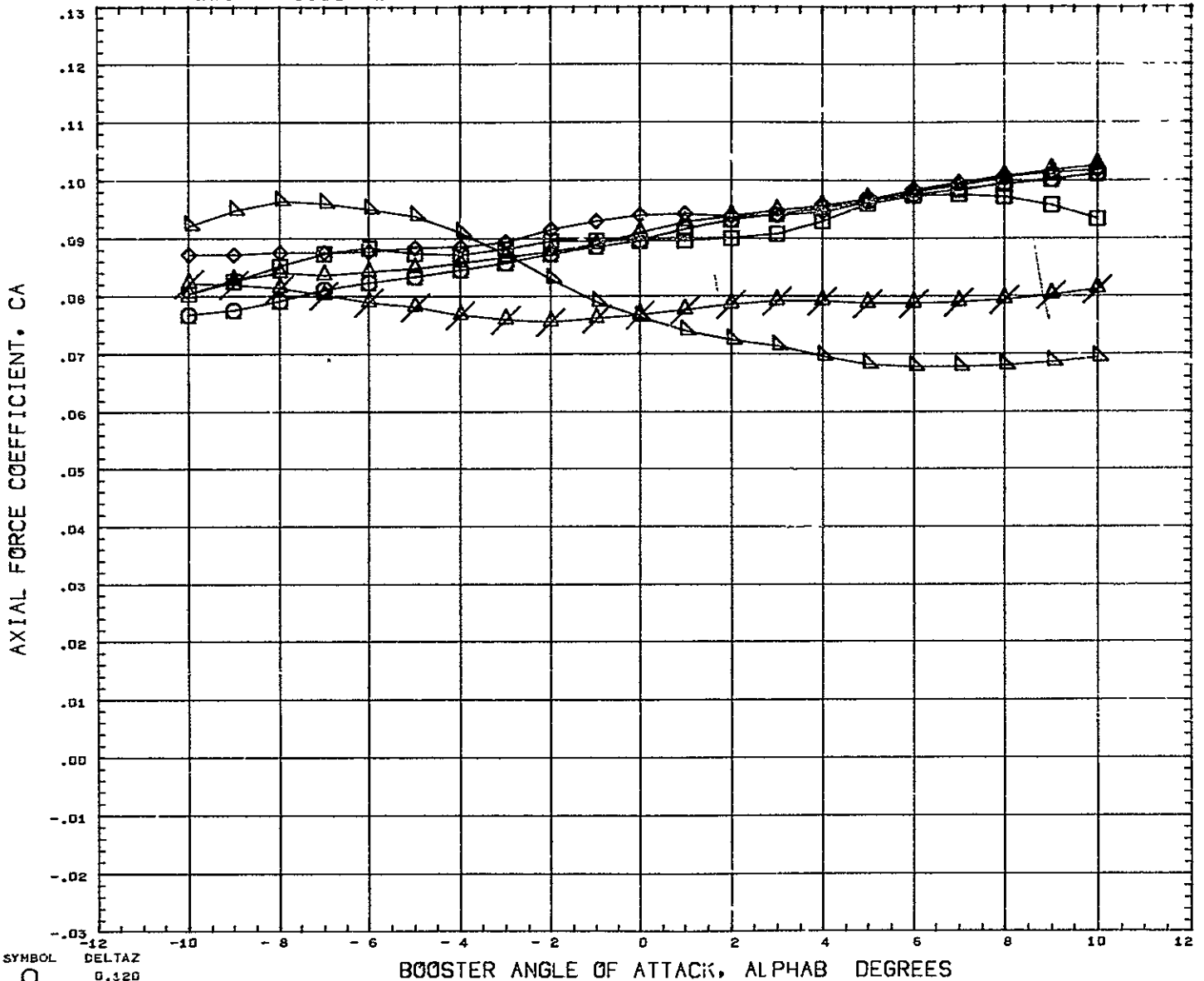

SYMBOL ○ ◻ △ ◇ ×	DELTAZ 0.120 0.151 0.182 0.228 0.352 10.000	PARAMETRIC VALUES BSTPOW 100.000 ORBPOW 100.000 DELTAX 0.522 ALPHAI 0.000 MACH 5.010 ELVBST 0.000 ELVORB 0.000 BETA 0.000	REFERENCE INFORMATION REFS 4,4440 SQ IN REFL 13,3330 IN REFB 13,3330 IN XMRP 7,5280 IN YMRP 0,0000 IN ZMRP 1,1940 IN SCALE 0,0055
---------------------------------	---	---	--

REFERENCE FILE

# AEDC VA 1163 MDAC BOOSTER AND ORBITER TEST DATA AT MACH NUMBER 5

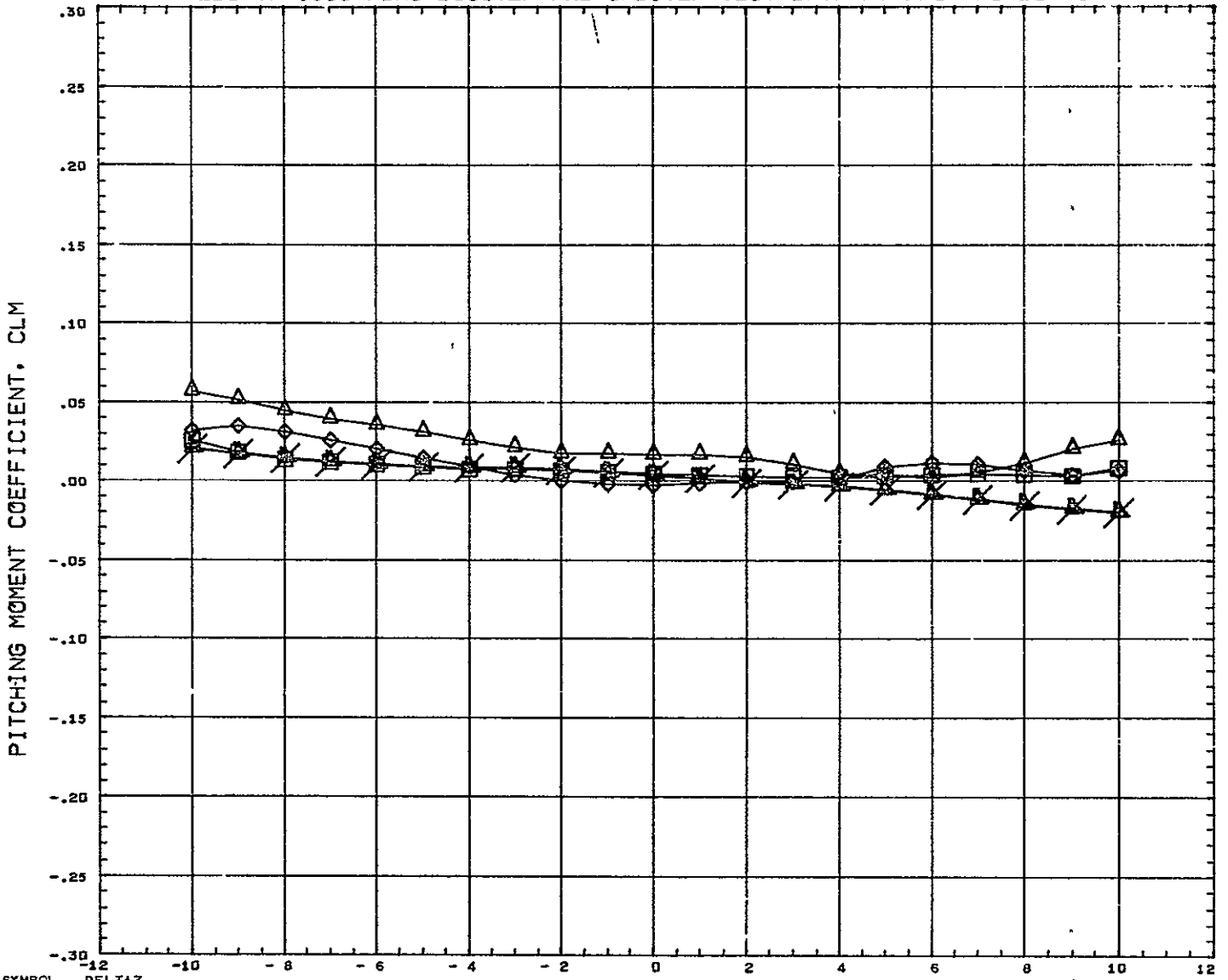

SYMBOL △ ◇ □ ×	DELTAZ 0.151 0.182 0.228 0.352 10.000	<b>PARAMETRIC VALUES</b> BSTFOW 100.000 ORBPOW 100.000 DELTAX - 0.391 ALPHAI 5.000 WACH 5.010 ELVBST 0.000 ELVORB 0.000 BETA 0.000	<b>REFERENCE INFORMATION</b> REFS 44.4440 SQ IN REFL 13.3330 IN REFB 13.3330 IN XMRP 7.5280 IN YMRP 0.0000 IN ZMRP 1.1940 IN SCALE 0.0055
----------------------------	--	--	--

REFERENCE FILE

# AEDC VA 1163 MDAC BOOSTER AND ORBITER TEST DATA AT MACH NUMBER 5

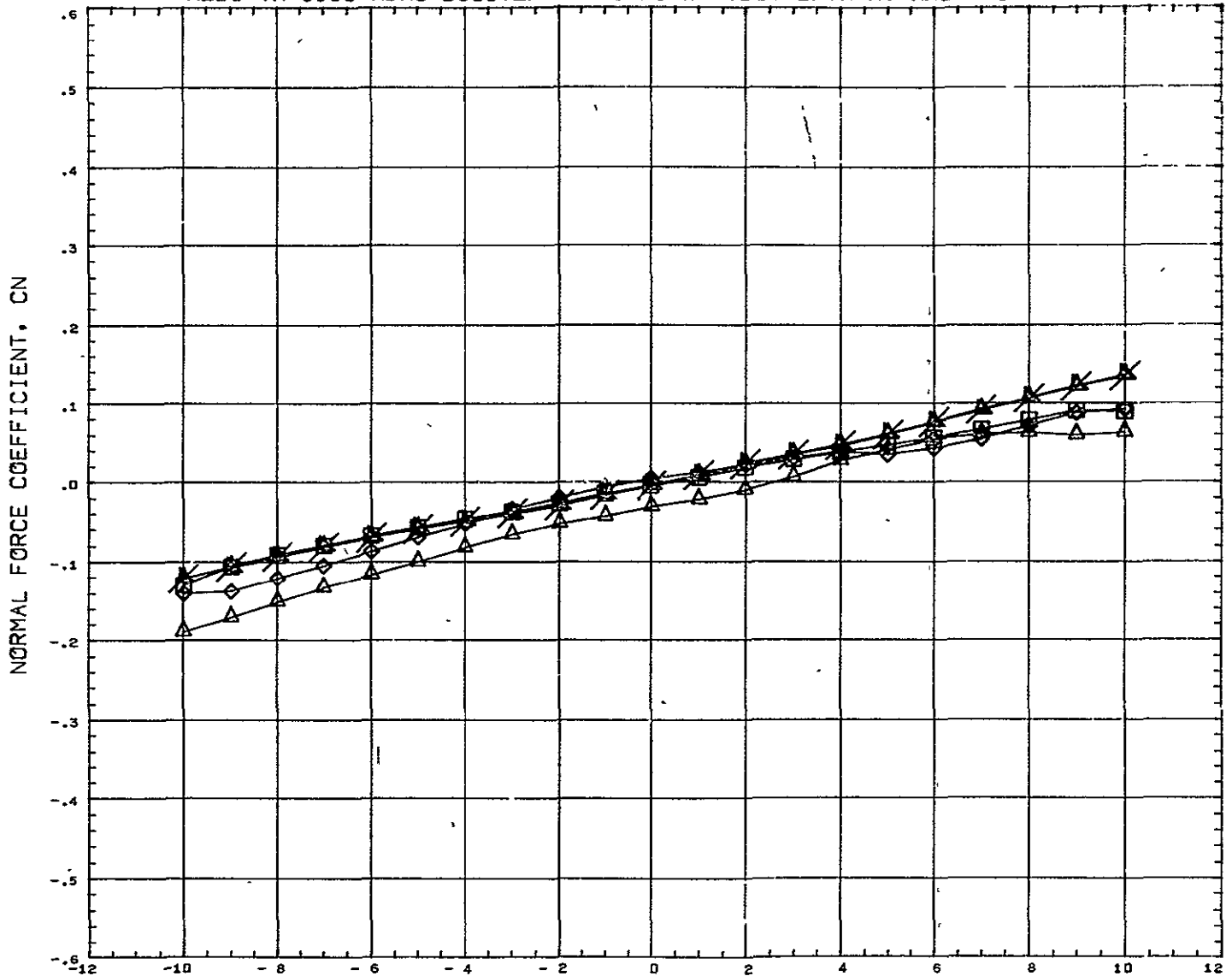

SYMBOL △ ◇ □ ×	DELTAZ 0.151 0.182 0.228 0.352 10.000	<table border="0" style="width: 100%;"> <tr> <th colspan="4" style="text-align: center;">PARAMETRIC VALUES</th> </tr> <tr> <td>BSTPOW</td> <td>100.000</td> <td>ORBPOW</td> <td>100.000</td> </tr> <tr> <td>ZLTAX</td> <td>- 0.391</td> <td>ALPHA1</td> <td>5.000</td> </tr> <tr> <td>MACH</td> <td>5.010</td> <td>ELVBST</td> <td>0.000</td> </tr> <tr> <td>ELVORB</td> <td>0.000</td> <td>BETA</td> <td>0.000</td> </tr> </table>	PARAMETRIC VALUES				BSTPOW	100.000	ORBPOW	100.000	ZLTAX	- 0.391	ALPHA1	5.000	MACH	5.010	ELVBST	0.000	ELVORB	0.000	BETA	0.000	<table border="0" style="width: 100%;"> <tr> <th colspan="3" style="text-align: center;">REFERENCE INFORMATION</th> </tr> <tr> <td>REFS</td> <td>44.4440</td> <td>50 IN</td> </tr> <tr> <td>REFL</td> <td>13.3330</td> <td>IN</td> </tr> <tr> <td>REFB</td> <td>13.3330</td> <td>IN</td> </tr> <tr> <td>XMRF</td> <td>7.5280</td> <td>IN</td> </tr> <tr> <td>YMRF</td> <td>0.0000</td> <td>IN</td> </tr> <tr> <td>ZMRF</td> <td>1.1940</td> <td>IN</td> </tr> <tr> <td>SCALE</td> <td>0.0055</td> <td></td> </tr> </table>	REFERENCE INFORMATION			REFS	44.4440	50 IN	REFL	13.3330	IN	REFB	13.3330	IN	XMRF	7.5280	IN	YMRF	0.0000	IN	ZMRF	1.1940	IN	SCALE	0.0055	
PARAMETRIC VALUES																																															
BSTPOW	100.000	ORBPOW	100.000																																												
ZLTAX	- 0.391	ALPHA1	5.000																																												
MACH	5.010	ELVBST	0.000																																												
ELVORB	0.000	BETA	0.000																																												
REFERENCE INFORMATION																																															
REFS	44.4440	50 IN																																													
REFL	13.3330	IN																																													
REFB	13.3330	IN																																													
XMRF	7.5280	IN																																													
YMRF	0.0000	IN																																													
ZMRF	1.1940	IN																																													
SCALE	0.0055																																														

# AEDC VA 1163 MDAC BOOSTER AND ORBITER TEST DATA AT MACH NUMBER 5

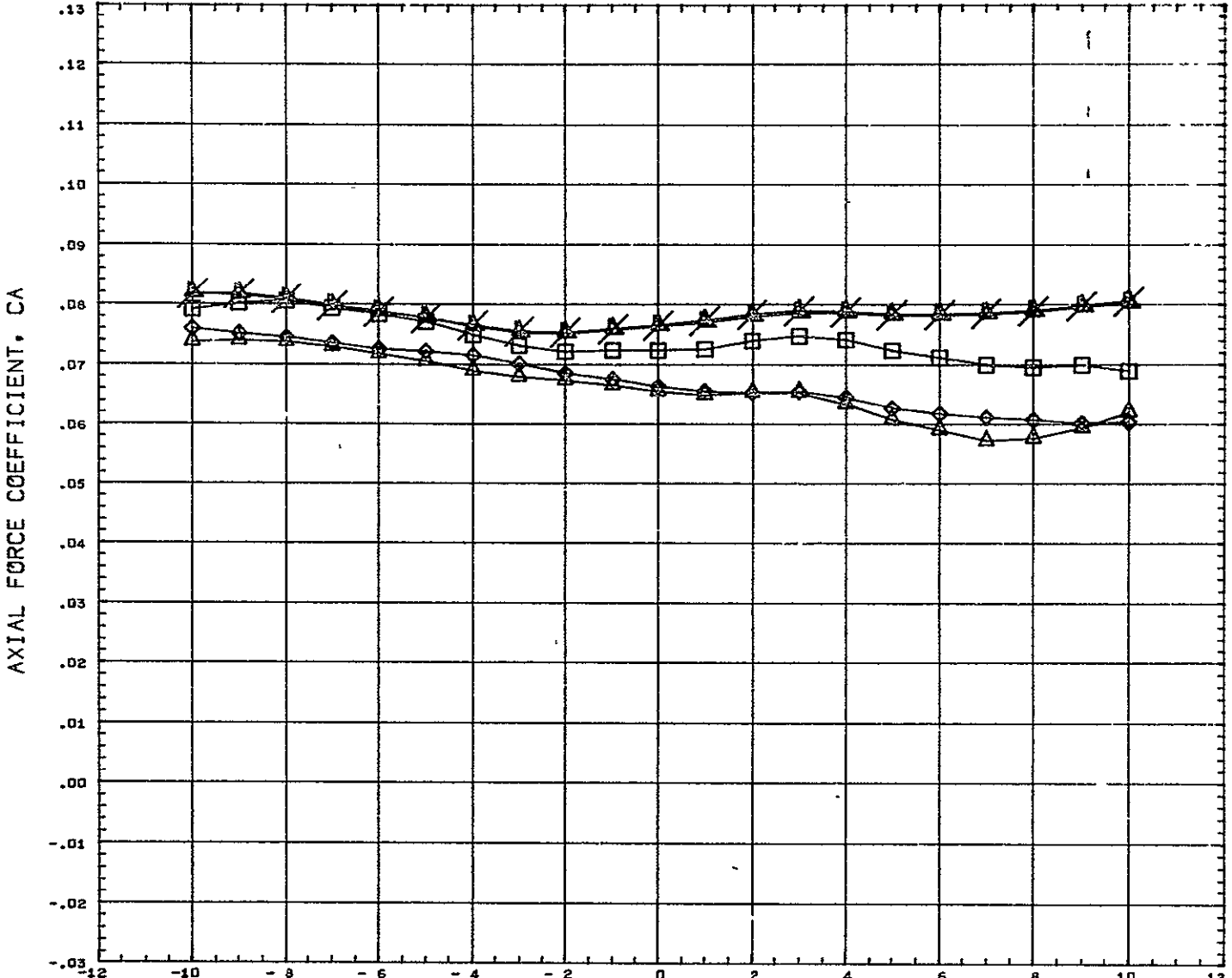

SYMBOL ◊ ◊ ◊ ◊	DELTAZ 0.151 0.182 0.228 0.352 10.000	<table border="0" style="width: 100%;"> <tr> <th colspan="4" style="text-align: center;">PARAMETRIC VALUES</th> </tr> <tr> <td>BSTPOW</td><td>100.000</td><td>ORBPOW</td><td>100.000</td> </tr> <tr> <td>DFLTAX</td><td>- 0.391</td><td>ALPHAI</td><td>5.000</td> </tr> <tr> <td>MACH</td><td>5.010</td><td>ELVBST</td><td>0.000</td> </tr> <tr> <td>ELVORB</td><td>0.000</td><td>BETA</td><td>0.000</td> </tr> </table>	PARAMETRIC VALUES				BSTPOW	100.000	ORBPOW	100.000	DFLTAX	- 0.391	ALPHAI	5.000	MACH	5.010	ELVBST	0.000	ELVORB	0.000	BETA	0.000	<table border="0" style="width: 100%;"> <tr> <th colspan="3" style="text-align: center;">REFERENCE INFORMATION</th> </tr> <tr> <td>REFS</td><td>44.4440</td><td>SQ IN</td> </tr> <tr> <td>REFL</td><td>13.3330</td><td>IN</td> </tr> <tr> <td>REFB</td><td>13.3330</td><td>IN</td> </tr> <tr> <td>XMRP</td><td>7.5280</td><td>IN</td> </tr> <tr> <td>YMRP</td><td>0.0000</td><td>IN</td> </tr> <tr> <td>ZMRP</td><td>1.1940</td><td>IN</td> </tr> <tr> <td>SCALE</td><td>0.0055</td><td></td> </tr> </table>	REFERENCE INFORMATION			REFS	44.4440	SQ IN	REFL	13.3330	IN	REFB	13.3330	IN	XMRP	7.5280	IN	YMRP	0.0000	IN	ZMRP	1.1940	IN	SCALE	0.0055	
PARAMETRIC VALUES																																															
BSTPOW	100.000	ORBPOW	100.000																																												
DFLTAX	- 0.391	ALPHAI	5.000																																												
MACH	5.010	ELVBST	0.000																																												
ELVORB	0.000	BETA	0.000																																												
REFERENCE INFORMATION																																															
REFS	44.4440	SQ IN																																													
REFL	13.3330	IN																																													
REFB	13.3330	IN																																													
XMRP	7.5280	IN																																													
YMRP	0.0000	IN																																													
ZMRP	1.1940	IN																																													
SCALE	0.0055																																														
REFERENCE FILE																																															



# AEDC VA 1163 MDAC BOOSTER AND ORBITER TEST DATA AT MACH NUMBER 5

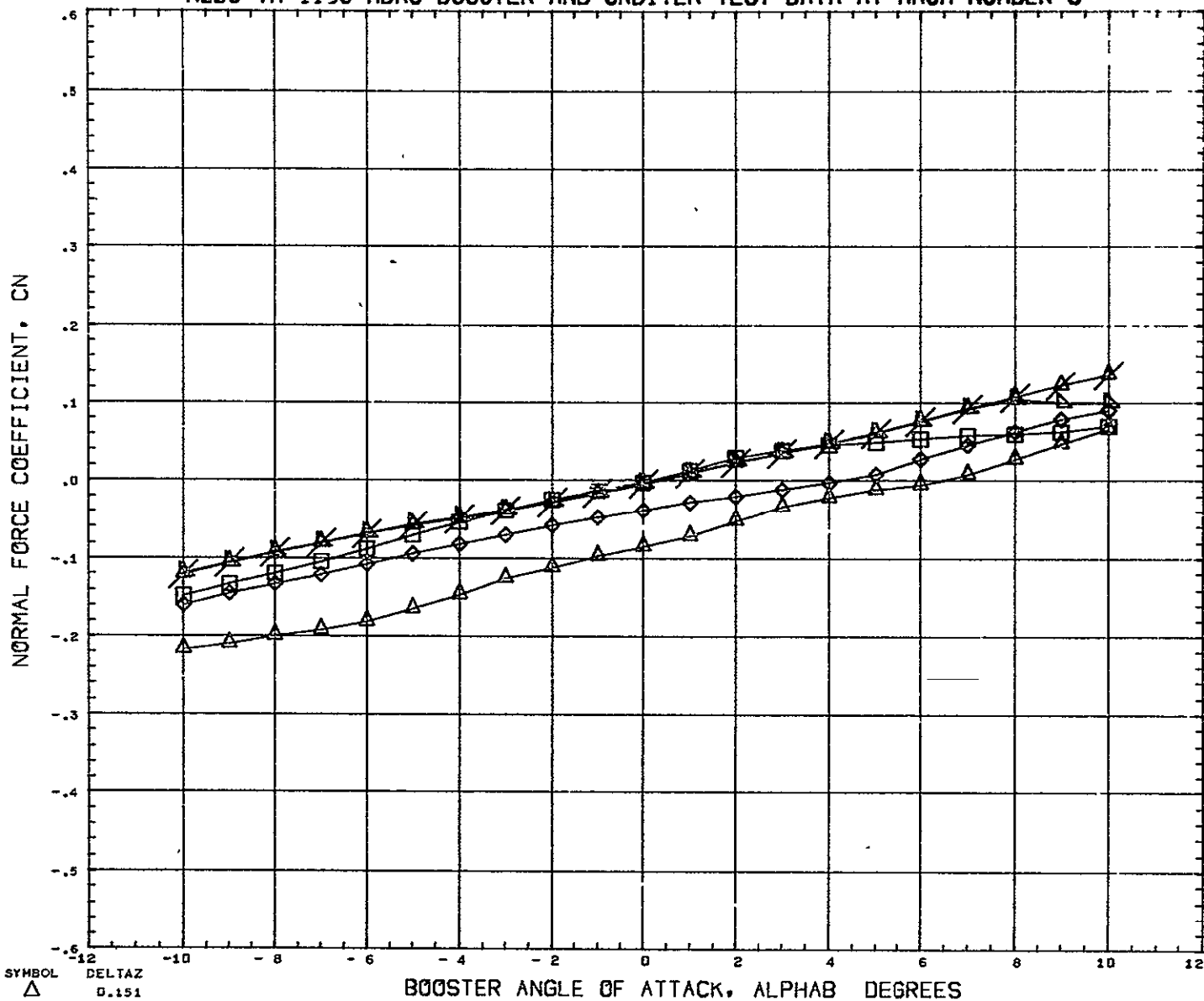

SYMBOL △ ◇ □ ▣	DELTA Z 0.151 0.182 0.228 0.352 10.000	PARAMETRIC VALUES BSTPOW 100.000 ORBPOW 100.000 DFLTAX - 0.143 ALPHAI 5.000 MACH 5.010 ELVBST 0.000 ELVORB 5.000 BETA 0.000	REFERENCE INFORMATION REFS 44.4440 SQ IN REFL 13.3330 IN REFB 13.3330 IN XMRP 7.5280 IN YHRF 0.0006 IN ZHRP 1.1940 IN SCALE 0.0055
----------------------------	---	---	---

REFERENCE FILE

# AEDC VA 1163 MDAC BOOSTER AND ORBITER TEST DATA AT MACH NUMBER 5

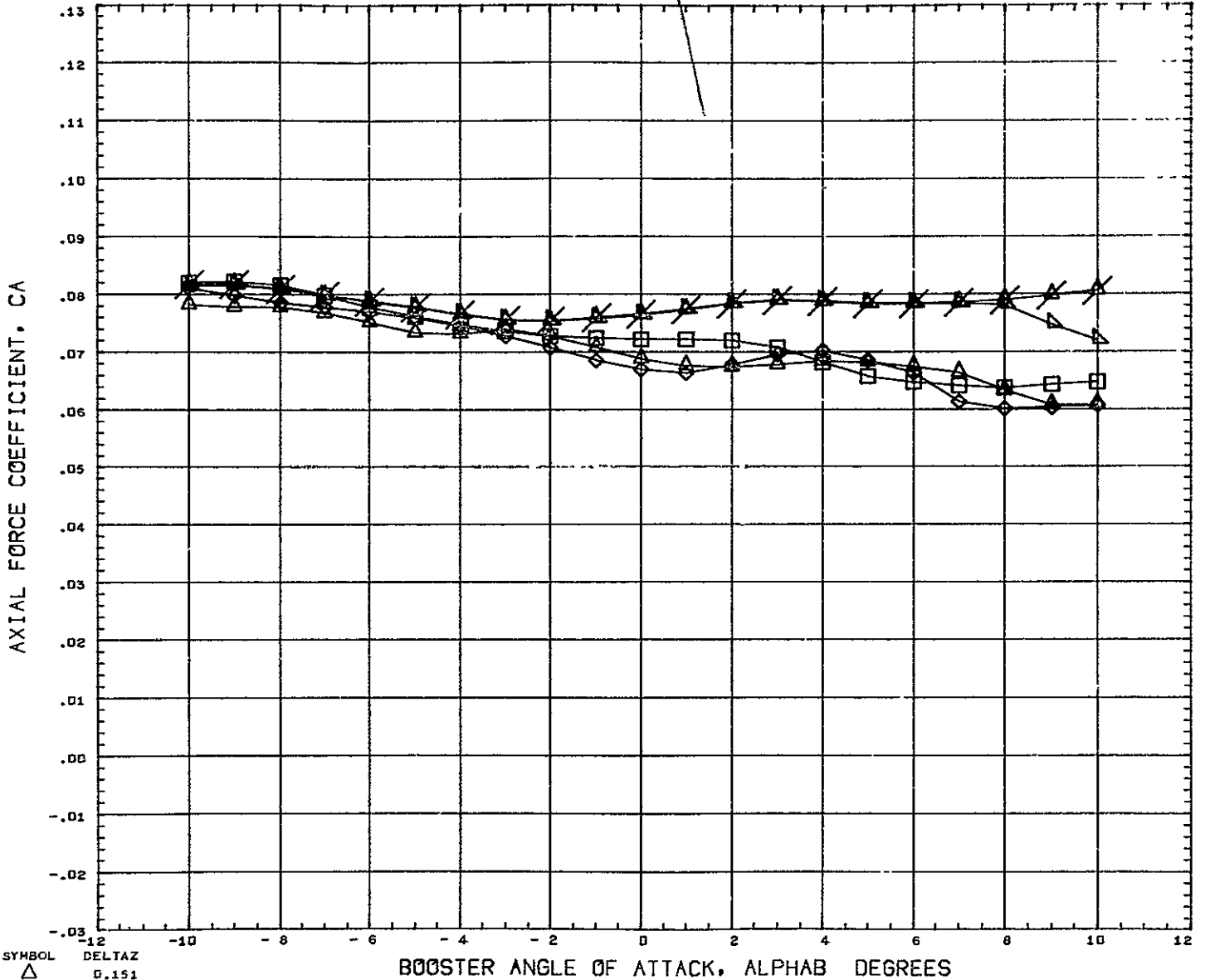

SYMBOL △ ◇ □ ○ ×	DELTAZ 0.151 0.182 0.228 0.352 10.000	PARAMETRIC VALUES BSTFOW 100.000 ORBPOW 100.000 DELTAX - 0.143 ALPHAI 5.000 MACH 5.010 ELVBST 0.000 ELVORB 0.000 BETA 0.000	REFERENCE INFORMATION REFS 44.4449 SQ IN REFL 13.3330 IN REFB 13.3330 IN XMR <sup>2</sup> 7.5280 IN YMRP 0.000L IN ZMRP 1.1940 IN SCALE 0.0055
---------------------------------	--	---	---

REFERENCE FILE



# AEDC VA 1163 MDAC BOOSTER AND ORBITER TEST DATA AT MACH NUMBER 5

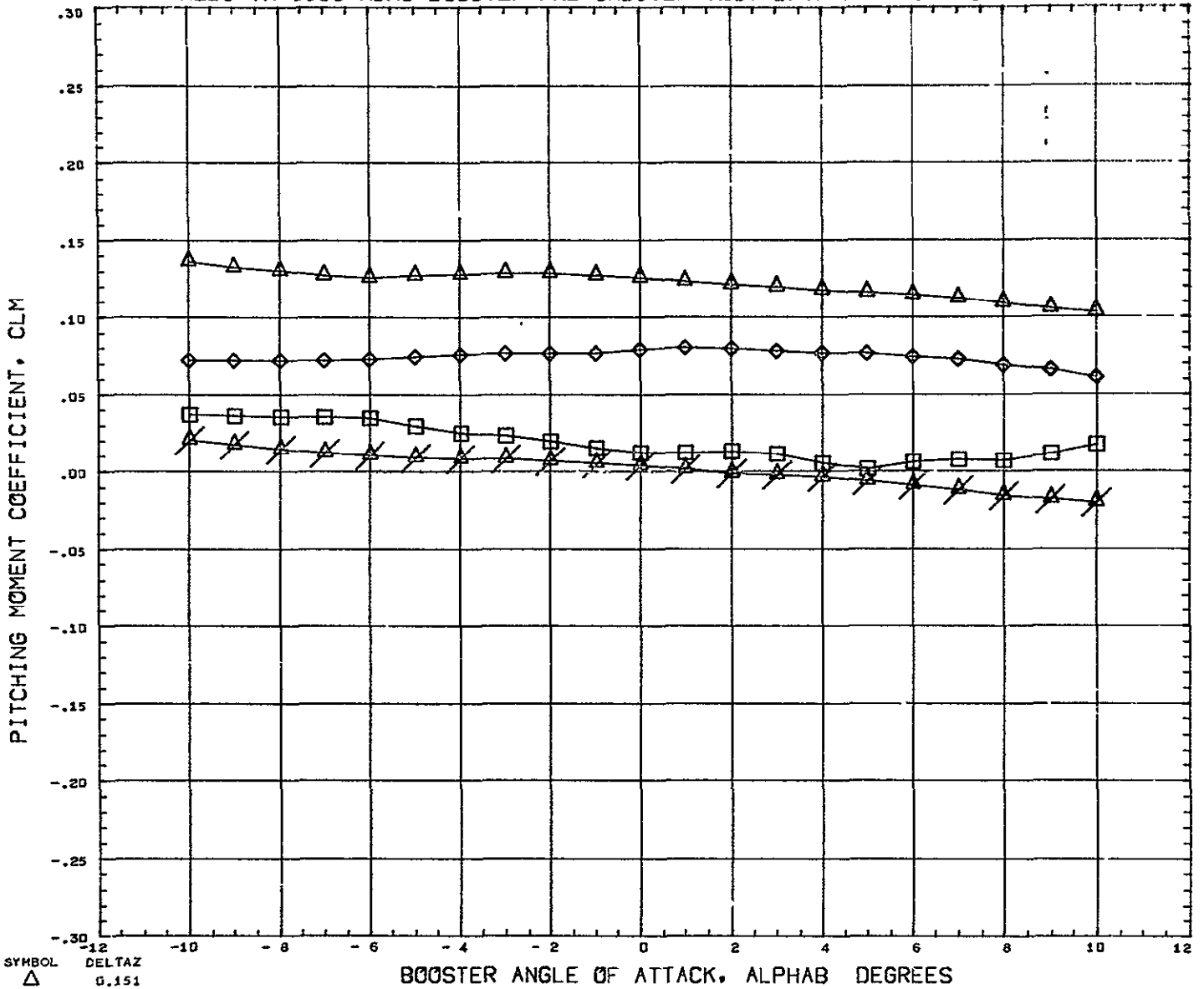

SYMBOL △ ◇ □ ×	DELTAZ 0.151 0.182 0.228 10.000	PARAMETRIC VALUES BSTPOW 100.000 ORBPOW 100.000 FCLTAX - 0.019 ALPHAI 5.000 MACH 5.010 ELVBST 0.000 ELVORB 0.000 BETA 0.000	REFERENCE INFORMATION REFS 44.4440 SQ IN REFL 13.3330 IN REFB 13.3330 IN XMRP 7.5260 IN YMRP 0.0000 IN ZMRP 1.1940 IN SCALE 0.0055
REFERENCE FILE			

# AEDC VA 1163 MDAC BOOSTER AND ORBITER TEST DATA AT MACH NUMBER 5

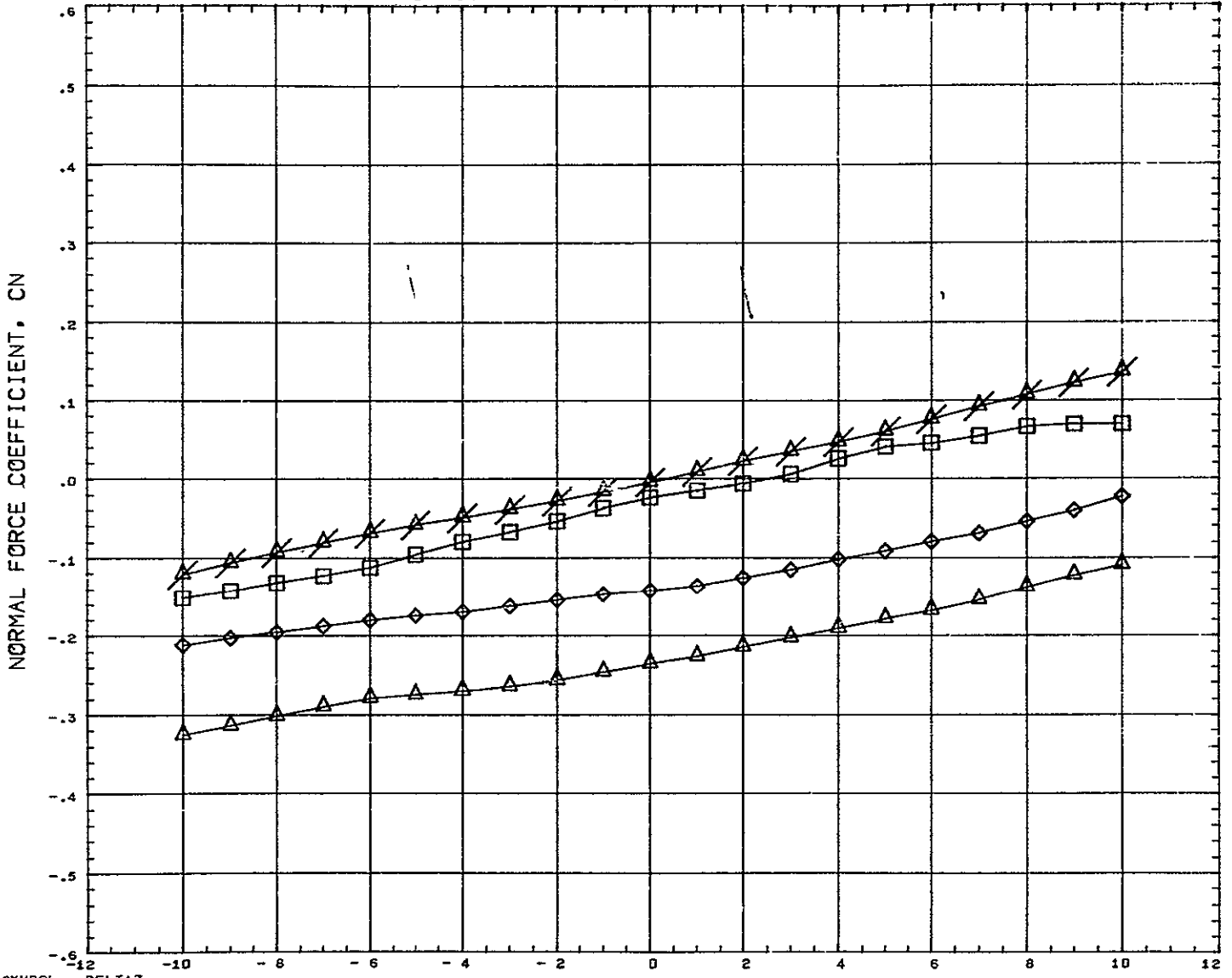

SYMBOL △ ◇ □ ▽	DELTAZ 0.151 0.182 0.228 10.000	<table border="0" style="width: 100%;"> <tr> <th colspan="4" style="text-align: left; padding-left: 20px;">PARAMETRIC VALUES</th> </tr> <tr> <td style="padding-right: 10px;">BSTPOW</td> <td>100.000</td> <td style="padding-right: 10px;">ORBPOW</td> <td>100.000</td> </tr> <tr> <td style="padding-right: 10px;">DELTAZ</td> <td>- 0.019</td> <td style="padding-right: 10px;">ALPHA1</td> <td>5.000</td> </tr> <tr> <td style="padding-right: 10px;">MACH</td> <td>5.010</td> <td style="padding-right: 10px;">ELVBST</td> <td>0.000</td> </tr> <tr> <td style="padding-right: 10px;">ELVORB</td> <td>0.000</td> <td style="padding-right: 10px;">BETA</td> <td>0.000</td> </tr> </table>	PARAMETRIC VALUES				BSTPOW	100.000	ORBPOW	100.000	DELTAZ	- 0.019	ALPHA1	5.000	MACH	5.010	ELVBST	0.000	ELVORB	0.000	BETA	0.000	<table border="0" style="width: 100%;"> <tr> <th colspan="2" style="text-align: left;">REFERENCE INFORMATION</th> </tr> <tr> <td style="padding-right: 10px;">REFS</td> <td>44.4446 SQ IN</td> </tr> <tr> <td style="padding-right: 10px;">REFL</td> <td>13.3330 IN</td> </tr> <tr> <td style="padding-right: 10px;">REFB</td> <td>13.3330 IN</td> </tr> <tr> <td style="padding-right: 10px;">XMRP</td> <td>7.5280 IN</td> </tr> <tr> <td style="padding-right: 10px;">YMRP</td> <td>0.0000 IN</td> </tr> <tr> <td style="padding-right: 10px;">ZMRP</td> <td>1.1940 IN</td> </tr> <tr> <td style="padding-right: 10px;">SCALE</td> <td>0.0055</td> </tr> </table>	REFERENCE INFORMATION		REFS	44.4446 SQ IN	REFL	13.3330 IN	REFB	13.3330 IN	XMRP	7.5280 IN	YMRP	0.0000 IN	ZMRP	1.1940 IN	SCALE	0.0055
PARAMETRIC VALUES																																							
BSTPOW	100.000	ORBPOW	100.000																																				
DELTAZ	- 0.019	ALPHA1	5.000																																				
MACH	5.010	ELVBST	0.000																																				
ELVORB	0.000	BETA	0.000																																				
REFERENCE INFORMATION																																							
REFS	44.4446 SQ IN																																						
REFL	13.3330 IN																																						
REFB	13.3330 IN																																						
XMRP	7.5280 IN																																						
YMRP	0.0000 IN																																						
ZMRP	1.1940 IN																																						
SCALE	0.0055																																						
REFERENCE FILE																																							

# AEDC VA 1163 MDAC BOOSTER AND ORBITER TEST DATA AT MACH NUMBER 5

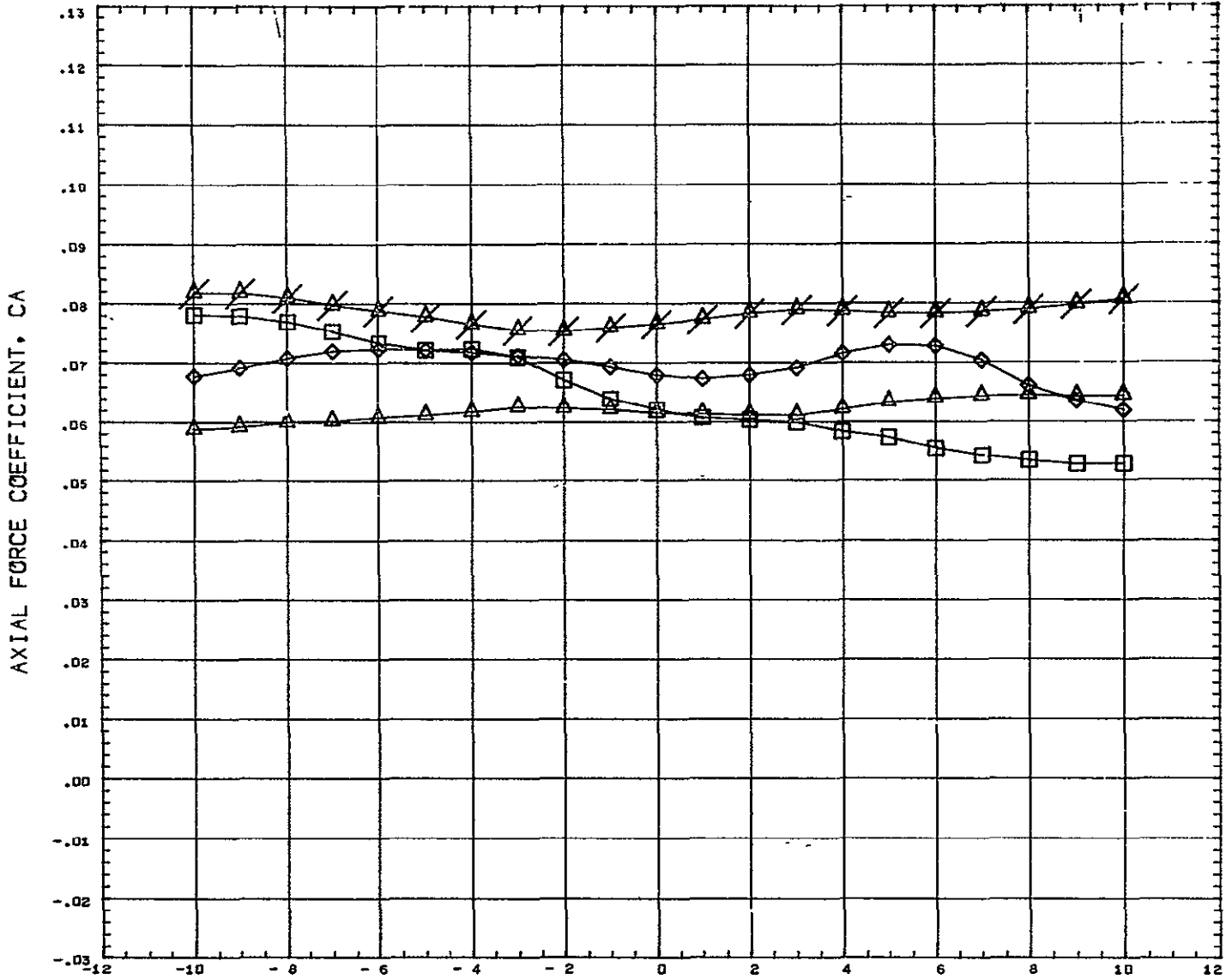

SYMBOL △ ◇ □ ✕	DELTA Z 0.151 0.182 0.228 10.000	PARAMETRIC VALUES BSTPOW 100.000    ORBPOW 100.000 DFLTAX - 0.019    ALPHAI 5.000 MACH 5.010        ELVBST 0.000 ELVORB 0.000      BETA 0.000	REFERENCE INFORMATION REFS 44.4440    SQ IN REFL 13.3330    IN REFB 13.3330    IN XMRF 7.5280     IN YMRP 0.0000    IN ZMRP 1.1940     IN SCALE 0.0055
----------------------------	--	---	---

REFERENCE FILE

# AEDC VA 1163 MDAC BOOSTER AND ORBITER TEST DATA AT MACH NUMBER 5

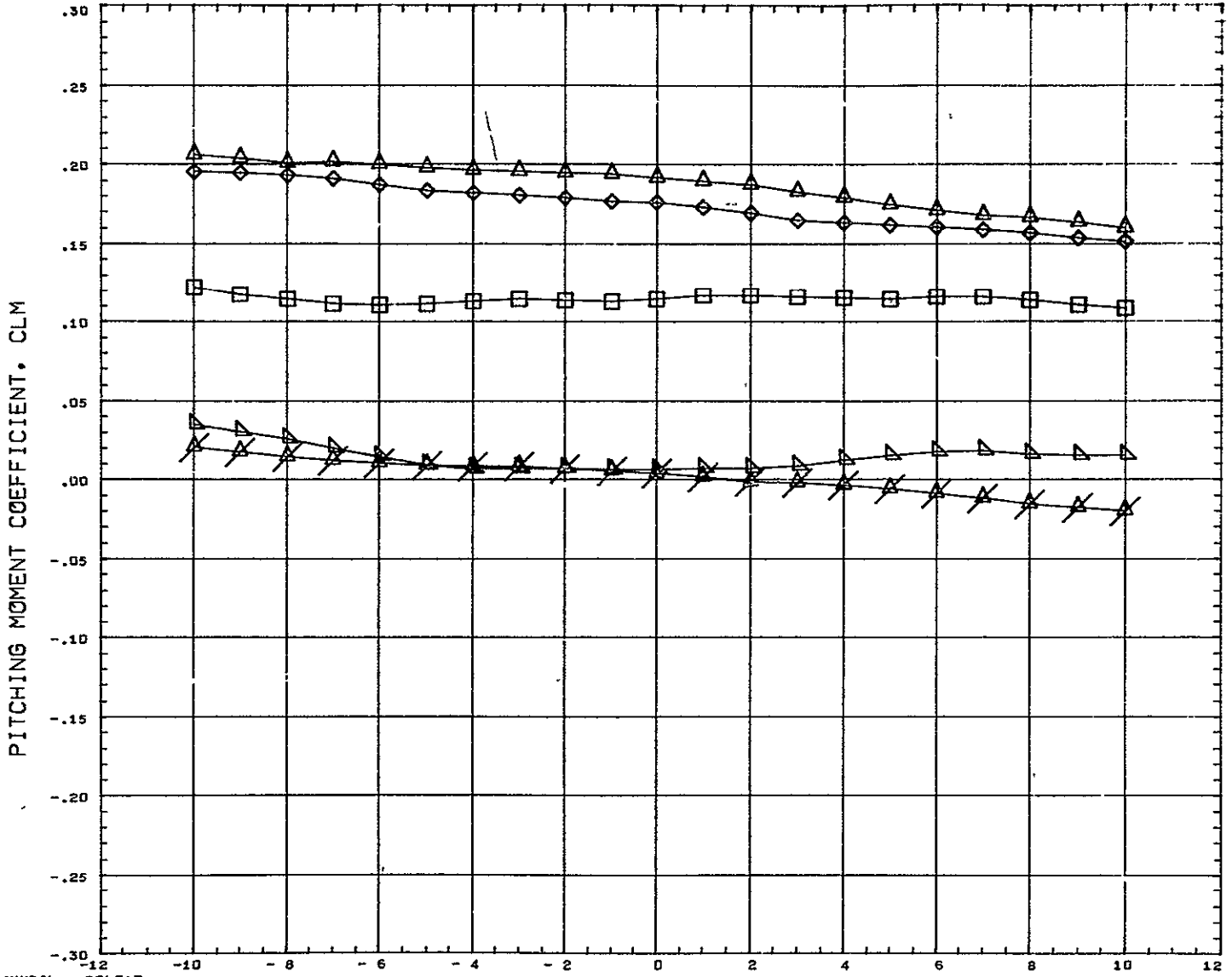

SYMBOL △ ◇ □ ×	DELTAZ 0.151 0.182 0.228 0.352 10.000	PARAMETRIC VALUES BSTPOW 100.000 ORBPOW 100.000 DELTAX 0.104 ALPHAI 5.000 MACH 5.010 ELVBST 0.000 ELVORB 0.000 BETA 0.000	REFERENCE INFORMATION REFS 44.4440 SQ IN REFL 13.3330 IN REFB 13.3330 IN XMRP 7.5280 IN YMRP 0.0000 IN ZMRP 1.1940 IN SCALE 0.0055
		REFERENCE FILE	

# AEDC VA 1163 MDAC BOOSTER AND ORBITER TEST DATA AT MACH NUMBER 5

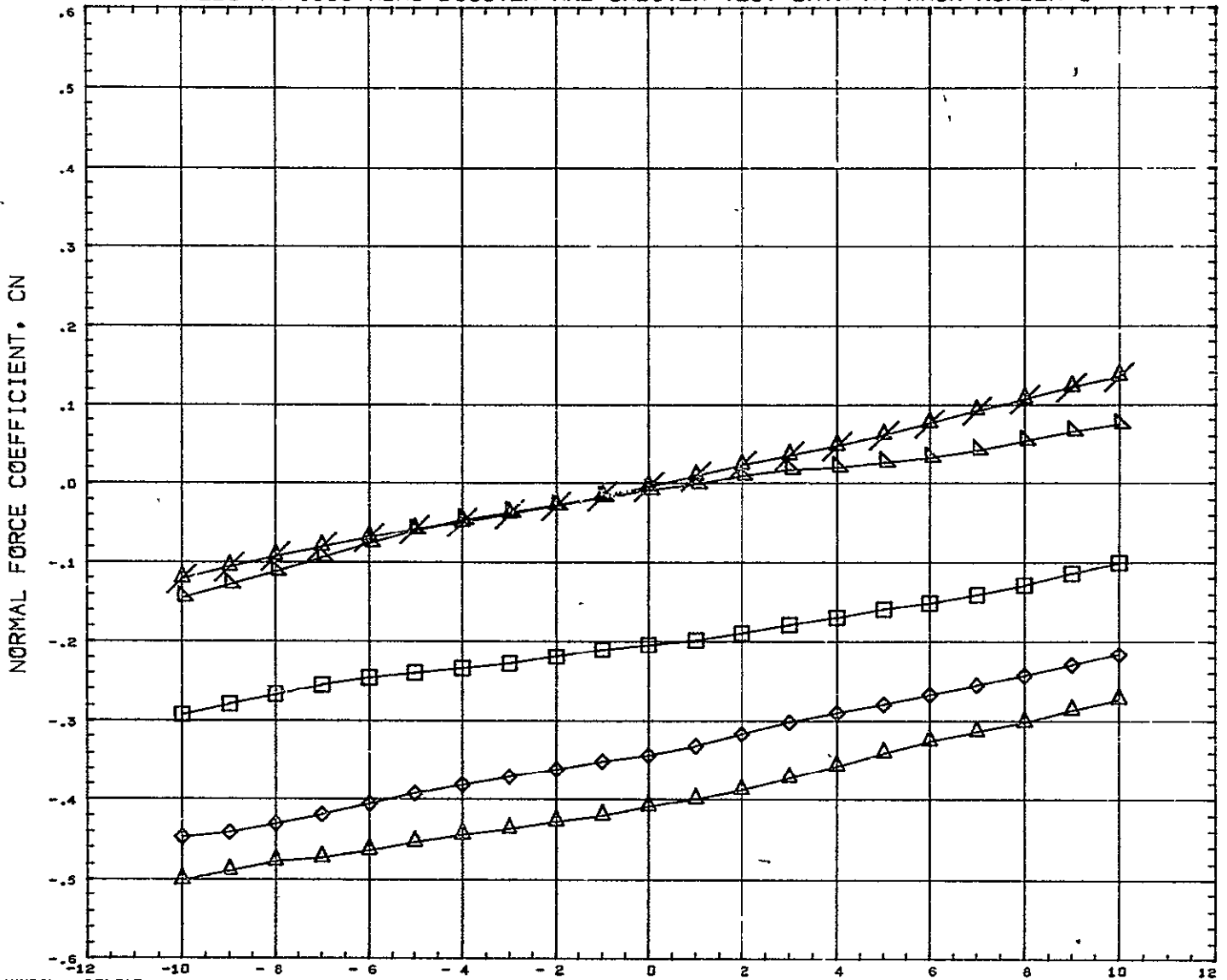

SYMBOL △ ◇ □ ▽ ×	DELTAX 0.151 0.182 0.228 0.352 10.000	<table border="0" style="width: 100%;"> <tr> <th colspan="4" style="text-align: center;">PARAMETRIC VALUES</th> </tr> <tr> <td>BSTPOW</td> <td>100.000</td> <td>ORBPOW</td> <td>100.000</td> </tr> <tr> <td>DELTA</td> <td>0.104</td> <td>ALPHA</td> <td>5.000</td> </tr> <tr> <td>MACH</td> <td>5.010</td> <td>ELVBST</td> <td>0.000</td> </tr> <tr> <td>ELVORB</td> <td>0.000</td> <td>BETA</td> <td>0.000</td> </tr> </table>	PARAMETRIC VALUES				BSTPOW	100.000	ORBPOW	100.000	DELTA	0.104	ALPHA	5.000	MACH	5.010	ELVBST	0.000	ELVORB	0.000	BETA	0.000	<table border="0" style="width: 100%;"> <tr> <th colspan="3" style="text-align: center;">REFERENCE INFORMATION</th> </tr> <tr> <td>REFS</td> <td>44.4440</td> <td>SQ IN</td> </tr> <tr> <td>REFL</td> <td>13.3330</td> <td>IN</td> </tr> <tr> <td>REFB</td> <td>13.3330</td> <td>IN</td> </tr> <tr> <td>XMRP</td> <td>7.5280</td> <td>IN</td> </tr> <tr> <td>YMRP</td> <td>0.0000</td> <td>IN</td> </tr> <tr> <td>ZMRP</td> <td>1.1940</td> <td>IN</td> </tr> <tr> <td>SCALE</td> <td>0.0055</td> <td></td> </tr> </table>	REFERENCE INFORMATION			REFS	44.4440	SQ IN	REFL	13.3330	IN	REFB	13.3330	IN	XMRP	7.5280	IN	YMRP	0.0000	IN	ZMRP	1.1940	IN	SCALE	0.0055	
PARAMETRIC VALUES																																															
BSTPOW	100.000	ORBPOW	100.000																																												
DELTA	0.104	ALPHA	5.000																																												
MACH	5.010	ELVBST	0.000																																												
ELVORB	0.000	BETA	0.000																																												
REFERENCE INFORMATION																																															
REFS	44.4440	SQ IN																																													
REFL	13.3330	IN																																													
REFB	13.3330	IN																																													
XMRP	7.5280	IN																																													
YMRP	0.0000	IN																																													
ZMRP	1.1940	IN																																													
SCALE	0.0055																																														

REFERENCE FILE

# AEDC VA 1163 MDAC BOOSTER AND ORBITER TEST DATA AT MACH NUMBER 5

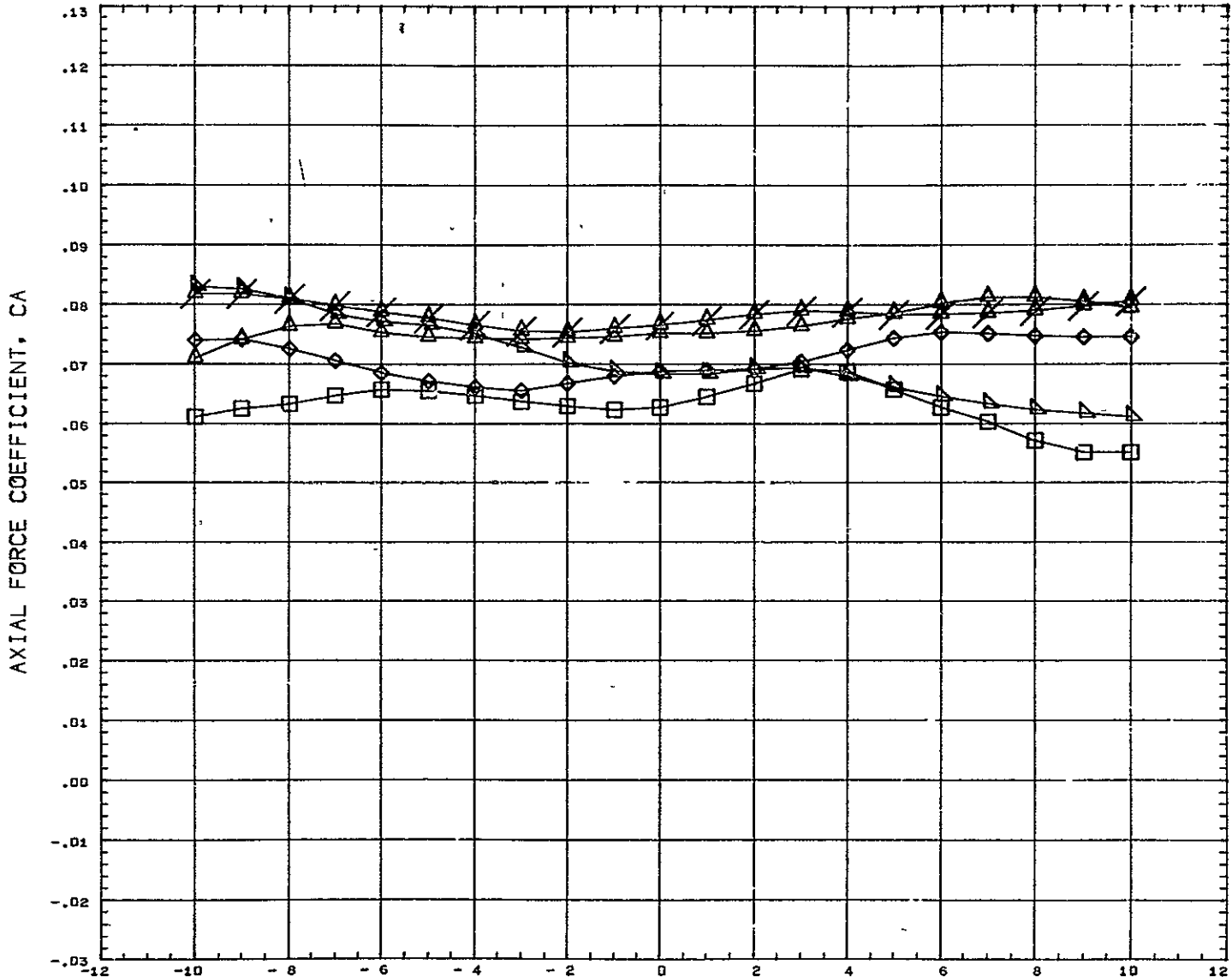

SYMBOL ◊ ◻ △ ×	DELTA Z 0.151 0.182 0.228 0.352 10.000 ELVORB	PARAMETRIC VALUES BSTPOW 100.000 ORBPOW 100.000 DELTAX 0.104 ALPHAI 5.000 MACH 5.010 ELVBST 0.000 ELVORB 0.000 BETA 0.000	REFERENCE INFORMATION REFS 44.444E SQ IN REFL 13.3330 IN REFB 13.3330 IN XMRP 7.5280 IN YMRP 0.0000 IN ZMRP 1.1940 IN SCALE 0 0055
----------------------------	---	---	---

REFERENCE FILE

# AEDC VA 1163 MDAC BOOSTER AND ORBITER TEST DATA AT MACH NUMBER 5

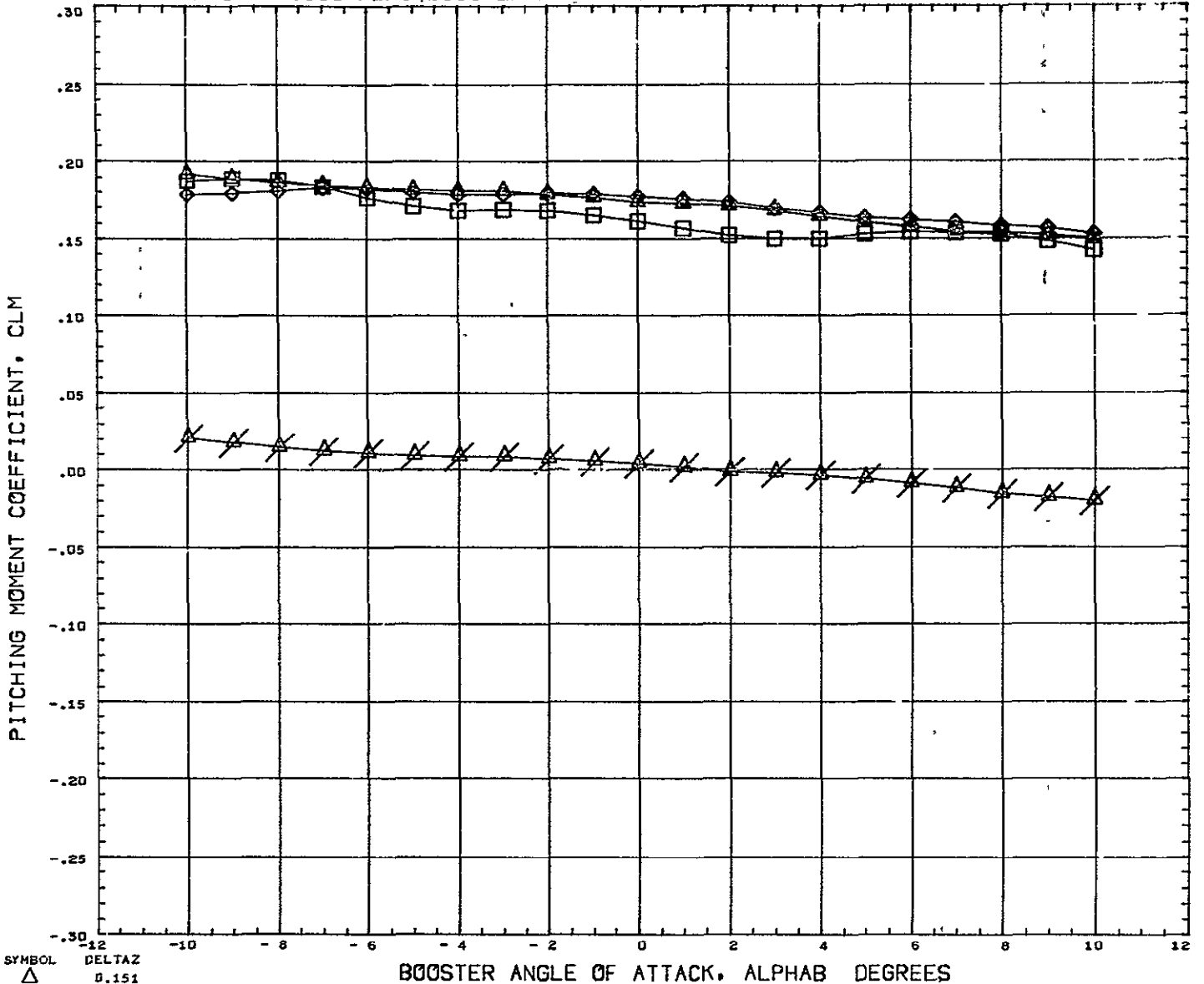

SYMBOL △ □ ×	DELTAZ 0.151 0.182 0.228 10.000	PARAMETRIC VALUES BSTFOW 100.000 ORBPOW 100.000 DELTAX 0.166 ALPHAI 5.000 MACH 5.010 ELVBST 0.000 ELVORB 0.000 BETA 0.000	REFERENCE INFORMATION REFS 44.4440 SQ IN REFL 13.3330 IN REFB 13.3330 IN XMRP 7.5280 IN YMRP 0.0000 IN ZMRP 1.1940 IN SCALE 0.0055
-----------------------	---	---	---

REFERENCE FILE

# AEDC VA 1163 MDAC BOOSTER AND ORBITER TEST DATA AT MACH NUMBER 5

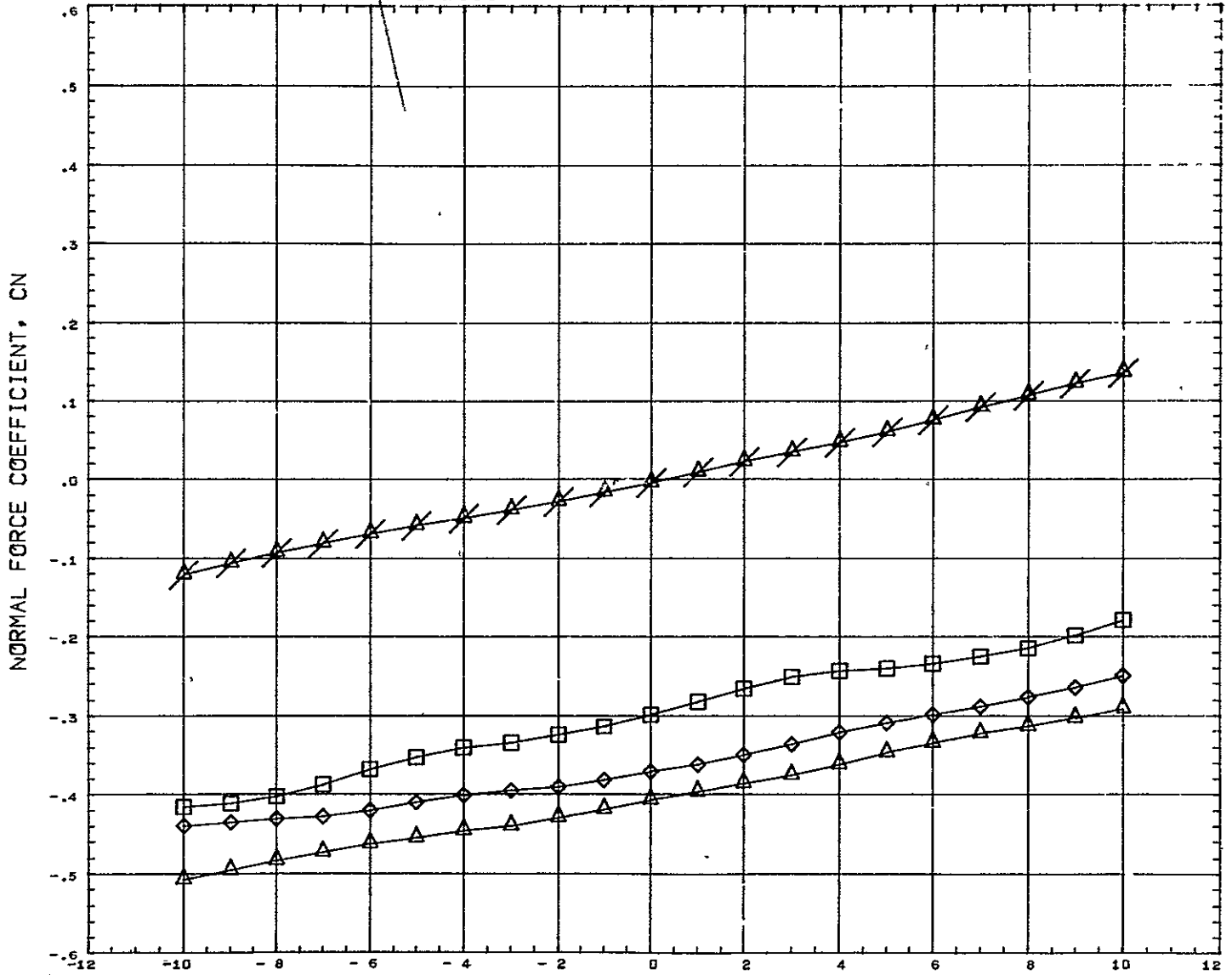

SYMBOL △ ◇ □ ▽	DELTAZ 0.151 0.162 0.228 10.000	PARAMETRIC VALUES BSTFOW 100.000 ORBPOW 100.000 DELTAX 0.166 ALPHAI 5.000 MACH 5.010 ELVBST 0.000 ELVORB 0.000 BETA 0.000	REFERENCE INFORMATION REFS 44.4440 SQ IN REFL 13.3330 IN REFB 13.3330 IN XMRP 7.5280 IN YMRP 0.0000 IN ZMRP 1.1940 IN SCALE 0.0055
----------------------------	---	---	---

REFERENCE FILE



# AEDC VA 1163 MDAC BOOSTER AND ORBITER TEST DATA AT MACH NUMBER 5

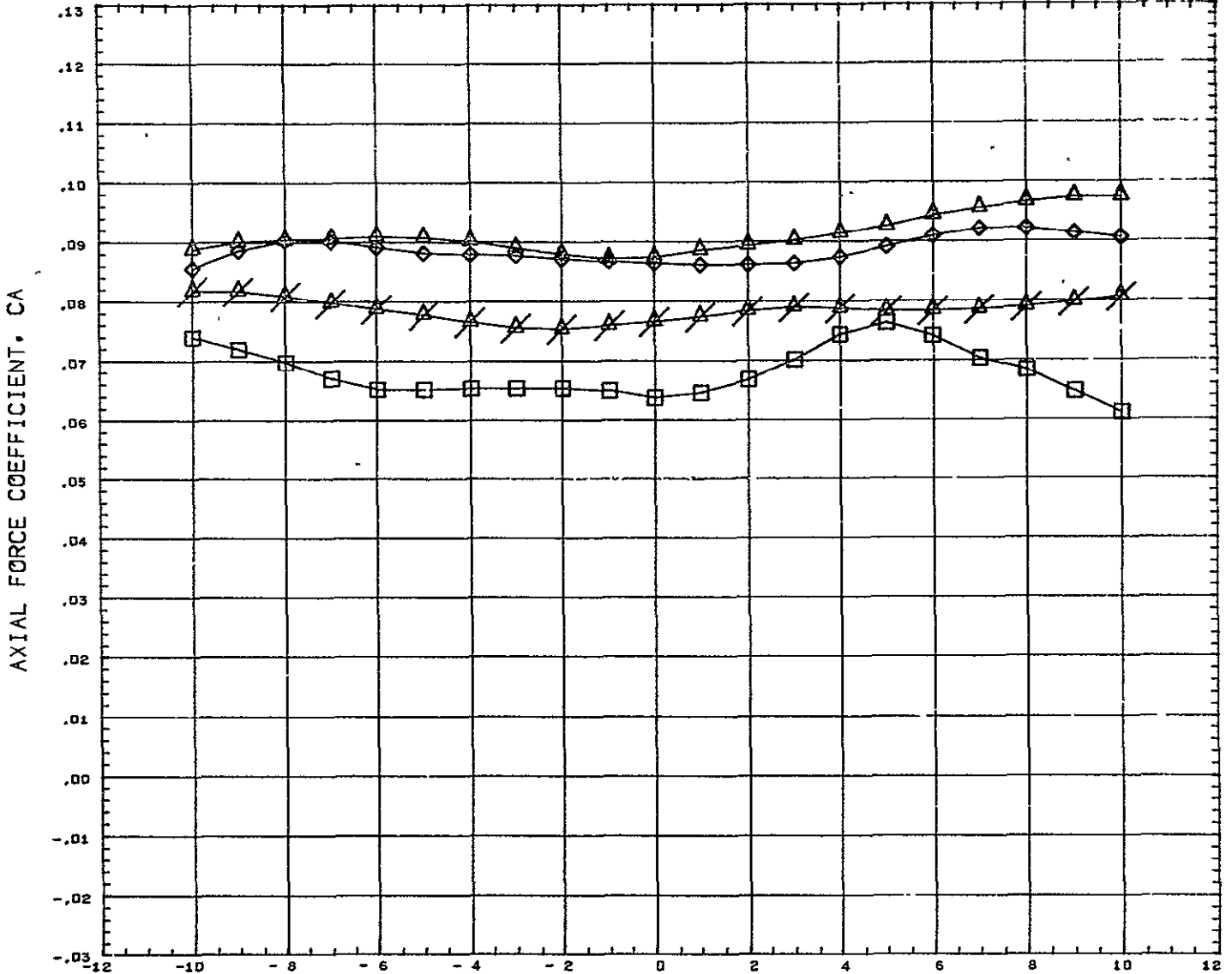

SYMBOL △ ◇ □ ✕	DELTAZ 0.151 0.182 0.228 10.000	PARAMETRIC VALUES BSTPOW 100.000 ORBFCW 100.000 DELTAX 0.166 ALPHAI 5.000 MACH 5.010 EI VBST 0.000 ELVORB 0.000 BETA 0.000	REFERENCE INFORMATION REFS 44.4440 SQ IN REFL 13.3330 IN REFB 13.3330 IN XMRP 7.5280 IN YMRP 0.0000 IN ZMRP 1.1940 IN SCALE 0.0055
REFERENCE FILE			

# AEDC VA 1163 MDAC BOOSTER AND ORBITER TEST DATA AT MACH NUMBER 5

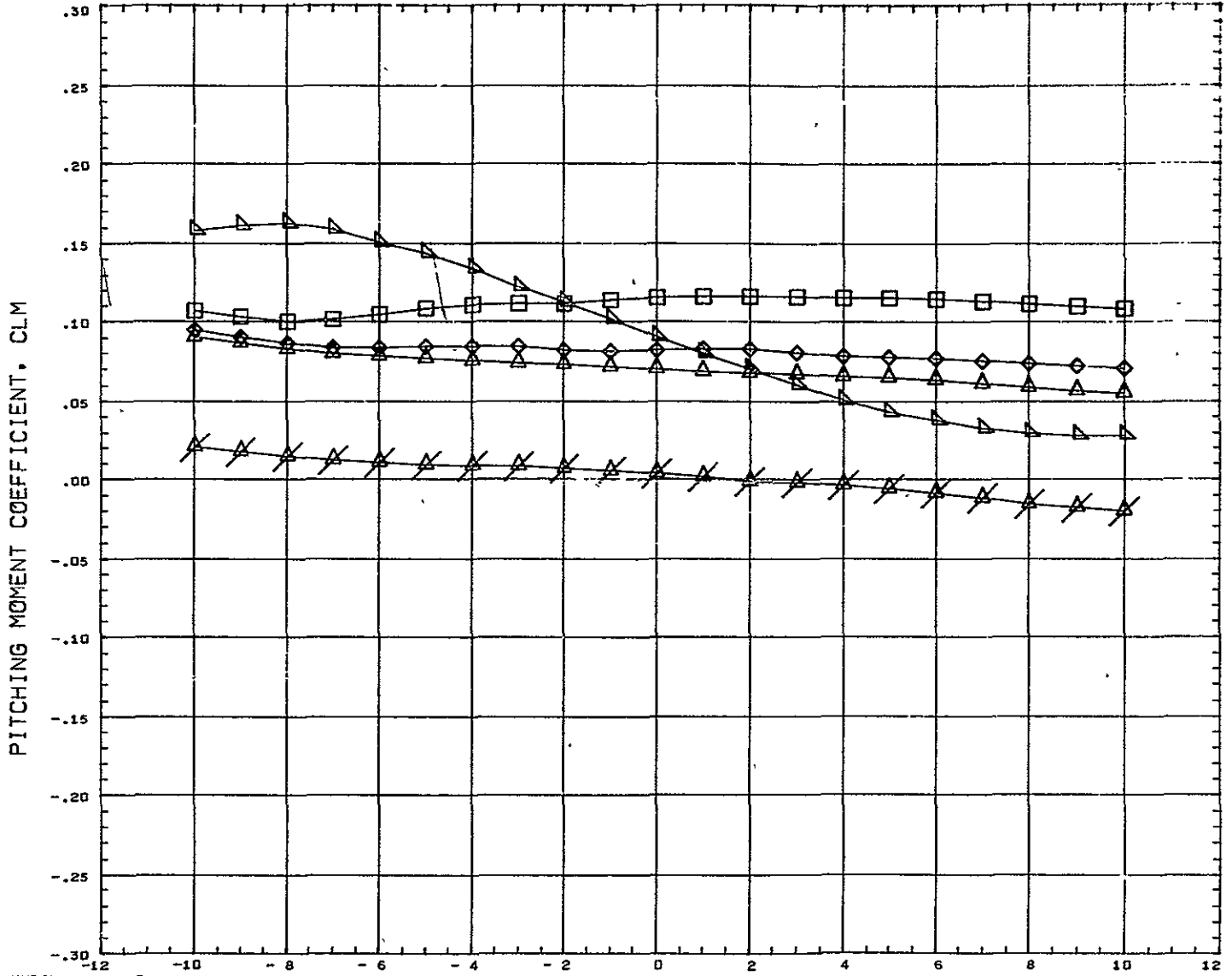

SYMBOL △ ◇ □ ○ ×	DELTAZ 0.151 0.182 0.228 0.352 10.000	<table border="0" style="width: 100%;"> <tr> <th colspan="4" style="text-align: center;">PARAMETRIC VALUES</th> </tr> <tr> <td>BSTPOW</td> <td>100.000</td> <td>ORBPOW</td> <td>100.000</td> </tr> <tr> <td>DELTAZ</td> <td>0.351</td> <td>ALPHA1</td> <td>5.000</td> </tr> <tr> <td>MACH</td> <td>5.010</td> <td>ELVBST</td> <td>0.000</td> </tr> <tr> <td>ELVORB</td> <td>0.000</td> <td>BETA</td> <td>0.000</td> </tr> </table>	PARAMETRIC VALUES				BSTPOW	100.000	ORBPOW	100.000	DELTAZ	0.351	ALPHA1	5.000	MACH	5.010	ELVBST	0.000	ELVORB	0.000	BETA	0.000	<table border="0" style="width: 100%;"> <tr> <th colspan="3" style="text-align: center;">REFERENCE INFORMATION</th> </tr> <tr> <td>REFS</td> <td>44.4440</td> <td>SQ IN</td> </tr> <tr> <td>REFL</td> <td>13.3330</td> <td>IN</td> </tr> <tr> <td>REFB</td> <td>13.3330</td> <td>IN</td> </tr> <tr> <td>XMPF</td> <td>7.5280</td> <td>IN</td> </tr> <tr> <td>YMRP</td> <td>0.0000</td> <td>IN</td> </tr> <tr> <td>ZMRP</td> <td>1.1940</td> <td>IN</td> </tr> <tr> <td>SCALE</td> <td>0.0055</td> <td></td> </tr> </table>	REFERENCE INFORMATION			REFS	44.4440	SQ IN	REFL	13.3330	IN	REFB	13.3330	IN	XMPF	7.5280	IN	YMRP	0.0000	IN	ZMRP	1.1940	IN	SCALE	0.0055	
PARAMETRIC VALUES																																															
BSTPOW	100.000	ORBPOW	100.000																																												
DELTAZ	0.351	ALPHA1	5.000																																												
MACH	5.010	ELVBST	0.000																																												
ELVORB	0.000	BETA	0.000																																												
REFERENCE INFORMATION																																															
REFS	44.4440	SQ IN																																													
REFL	13.3330	IN																																													
REFB	13.3330	IN																																													
XMPF	7.5280	IN																																													
YMRP	0.0000	IN																																													
ZMRP	1.1940	IN																																													
SCALE	0.0055																																														

REFERENCE FILE

# AEDC VA 1163 MDAC BOOSTER AND ORBITER TEST DATA AT MACH NUMBER 5

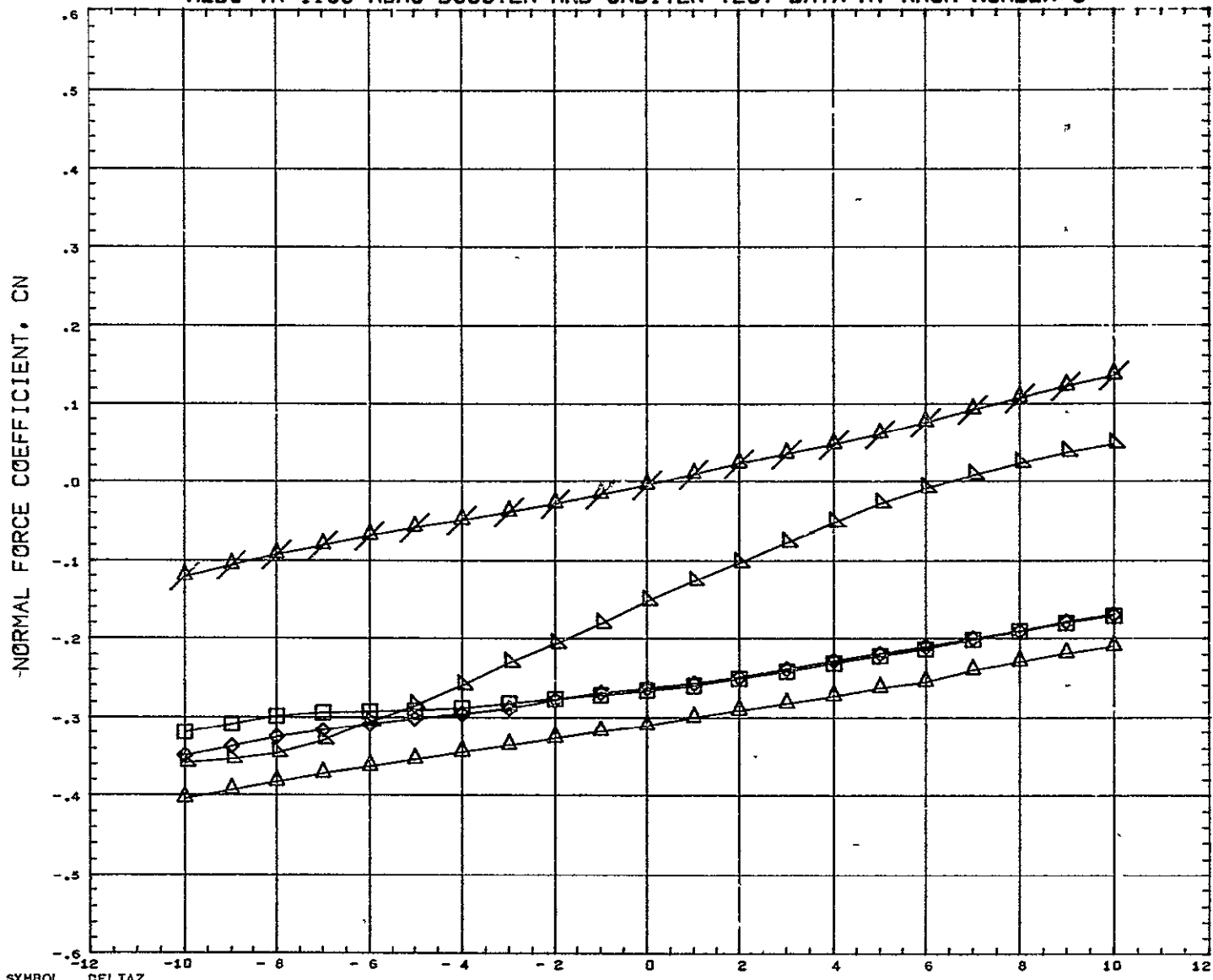

SYMBOL △ ◇ □ ○ ×	DELTAZ 0.151 0.182 0.228 0.352 10.000	<table border="0" style="width: 100%;"> <tr> <th colspan="4" style="text-align: center;">PARAMETRIC VALUES</th> </tr> <tr> <td>BSTFOW</td><td>100.000</td><td>ORBPOW</td><td>100.000</td> </tr> <tr> <td>DELTAZ</td><td>0.351</td><td>ALPHA1</td><td>5.000</td> </tr> <tr> <td>MACH</td><td>5.010</td><td>ELVBST</td><td>0.000</td> </tr> <tr> <td>ELVORB</td><td>0.000</td><td>BETA</td><td>0.000</td> </tr> </table>	PARAMETRIC VALUES				BSTFOW	100.000	ORBPOW	100.000	DELTAZ	0.351	ALPHA1	5.000	MACH	5.010	ELVBST	0.000	ELVORB	0.000	BETA	0.000	<table border="0" style="width: 100%;"> <tr> <th colspan="3" style="text-align: center;">REFERENCE INFORMATION</th> </tr> <tr> <td>REFS</td><td>44.4440</td><td>SQ IN</td> </tr> <tr> <td>REFL</td><td>13.3330</td><td>IN</td> </tr> <tr> <td>REFB</td><td>13.3330</td><td>IN</td> </tr> <tr> <td>XMRP</td><td>7.5280</td><td>IN</td> </tr> <tr> <td>YMRP</td><td>0.0000</td><td>IN</td> </tr> <tr> <td>ZMRP</td><td>1.1940</td><td>IN</td> </tr> <tr> <td>SCALE</td><td>0.0055</td><td></td> </tr> </table>	REFERENCE INFORMATION			REFS	44.4440	SQ IN	REFL	13.3330	IN	REFB	13.3330	IN	XMRP	7.5280	IN	YMRP	0.0000	IN	ZMRP	1.1940	IN	SCALE	0.0055	
PARAMETRIC VALUES																																															
BSTFOW	100.000	ORBPOW	100.000																																												
DELTAZ	0.351	ALPHA1	5.000																																												
MACH	5.010	ELVBST	0.000																																												
ELVORB	0.000	BETA	0.000																																												
REFERENCE INFORMATION																																															
REFS	44.4440	SQ IN																																													
REFL	13.3330	IN																																													
REFB	13.3330	IN																																													
XMRP	7.5280	IN																																													
YMRP	0.0000	IN																																													
ZMRP	1.1940	IN																																													
SCALE	0.0055																																														

REFERENCE FILE

# AEDC VA 1163 MDAC BOOSTER AND ORBITER TEST DATA AT MACH NUMBER 5

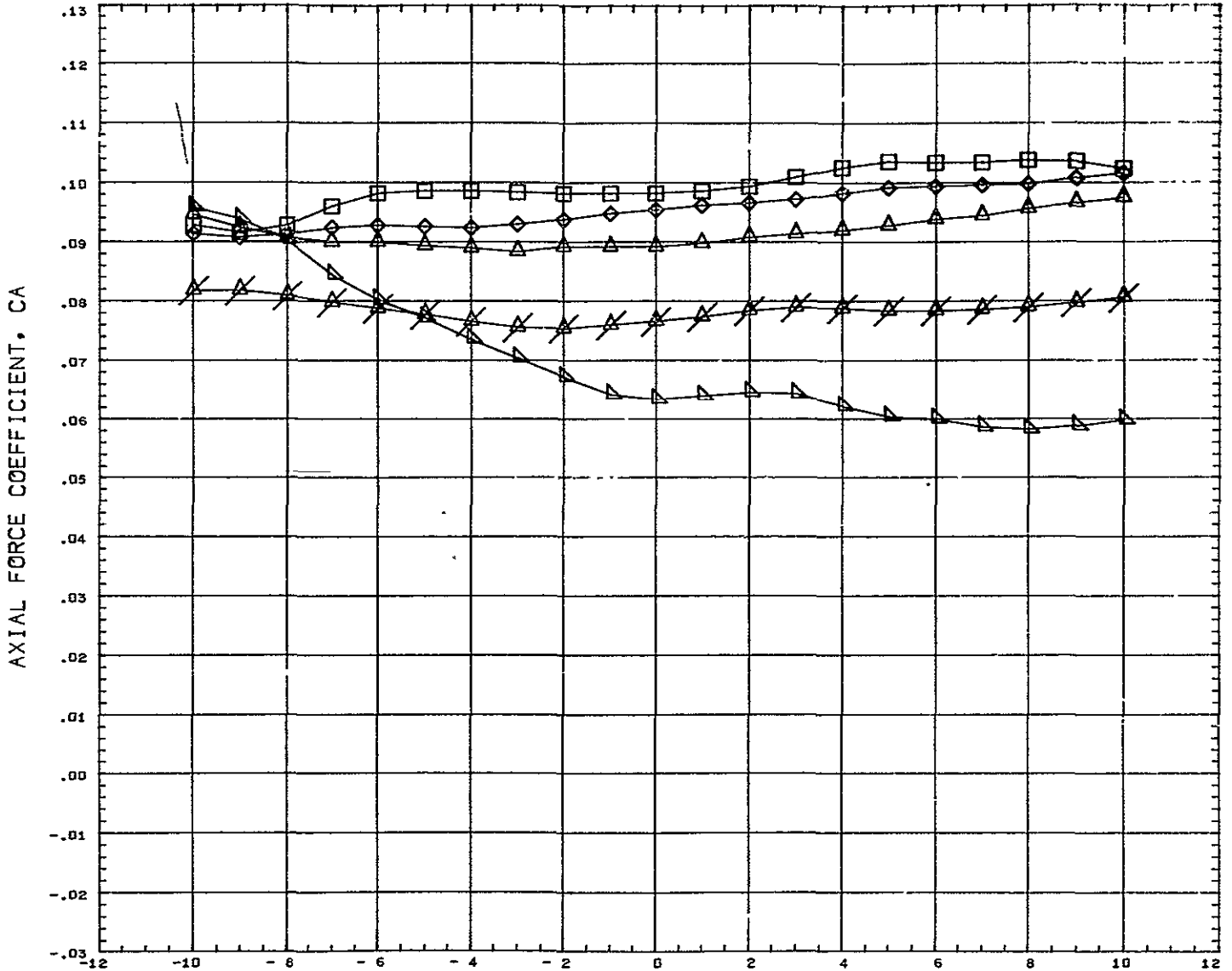

SYMBOL ◇ □ △ × ▽	DELTAZ 0.151 0.182 0.228 0.352 10.000	PARAMETRIC VALUES BSTPOW 100.000 ORBPOW 100.000 FILTAX 0.351 ALPHAI 5.000 MACH 5.010 ELVBST 0.000 ELVORB 0.000 BETA 0.000	REFERENCE INFORMATION REFS 44.4440 SQ IN REFL 13.3330 IN REFB 13.3330 IN XMRP 7.5280 IN YMRP 0.0000 IN ZMRP 1.1940 IN SCALE 0.0055
REFERENCE FILE			

# AEDC VA 1163 MDAC BOOSTER AND ORBITER TEST DATA AT MACH NUMBER 5

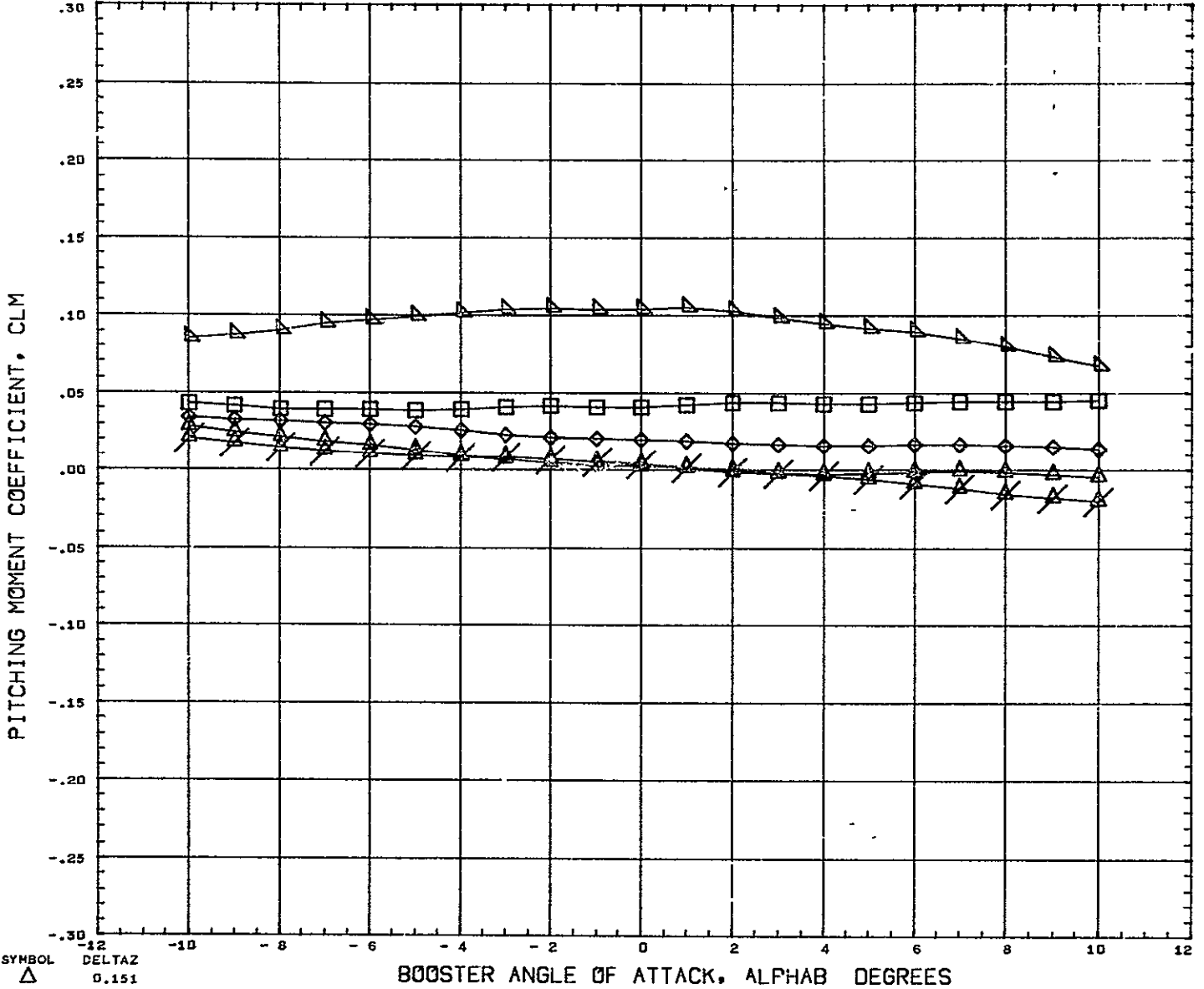

SYMBOL	DELTA Z	PARAMETRIC VALUES		REFERENCE INFORMATION				
△	0.151	BSTPOW	100.000	CRBPOW	100.000	REFS	44.4449	SQ IN
□	0.192	I .LTAX	0.521	ALPHA I	5.000	REFL	13.3330	IN
◇	0.228	MACH	5.010	ELVBST	0.000	REFB	13.3330	IN
⊗	10.000	ELVORB	0.000	BETA	0.000	XMRP	7.5280	IN
						YMRP	0.0000	IN
						ZMRP	1.1940	IN
						SCALE	0.0055	

REFERENCE FILE

# AEDC VA 1163 MDAC BOOSTER AND ORBITER TEST DATA AT MACH NUMBER 5

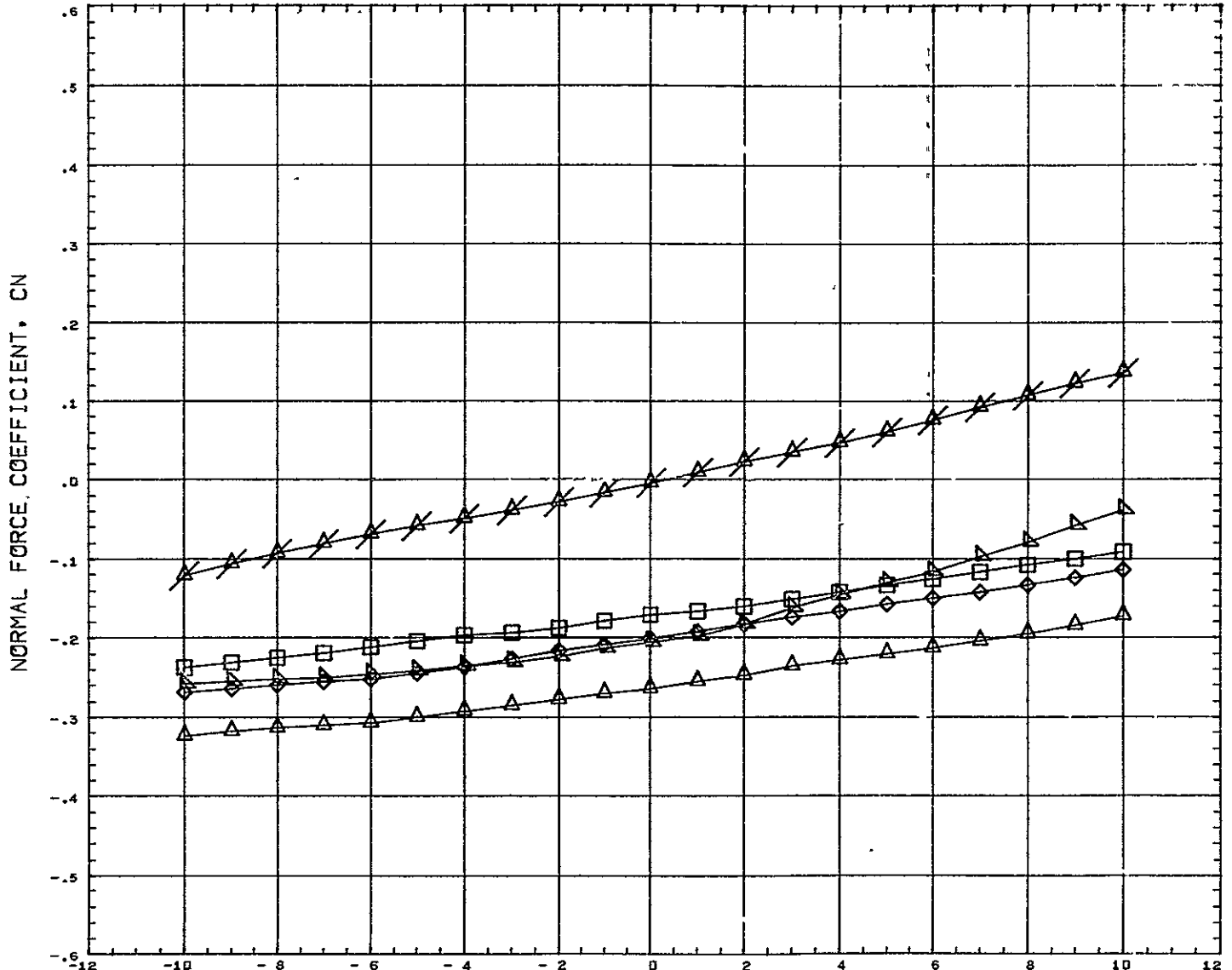

SYMBOL △ ◇ □ ○ ×	DELTAZ 0.151 0.182 0.228 0.352 10.000	PARAMETRIC VALUES BSTPOW 100.000 ORBPOW 100.000 ELTAX 0.521 ALPHA1 5.000 MACH 5.010 ELVBST 0.000 ELVORB 0.000 BETA 0.000	REFERENCE INFORMATION REFS 44.4440 SQ IN REFL 13 3330 IN REFB 13 3330 IN XMRF 7.5280 IN YMRF 0 0000 IN ZMRF 1 1940 IN SCALE 0.0055
---------------------------------	--	--	---

# AEDC VA 1163 MDAC BOOSTER AND ORBITER TEST DATA AT MACH NUMBER 5

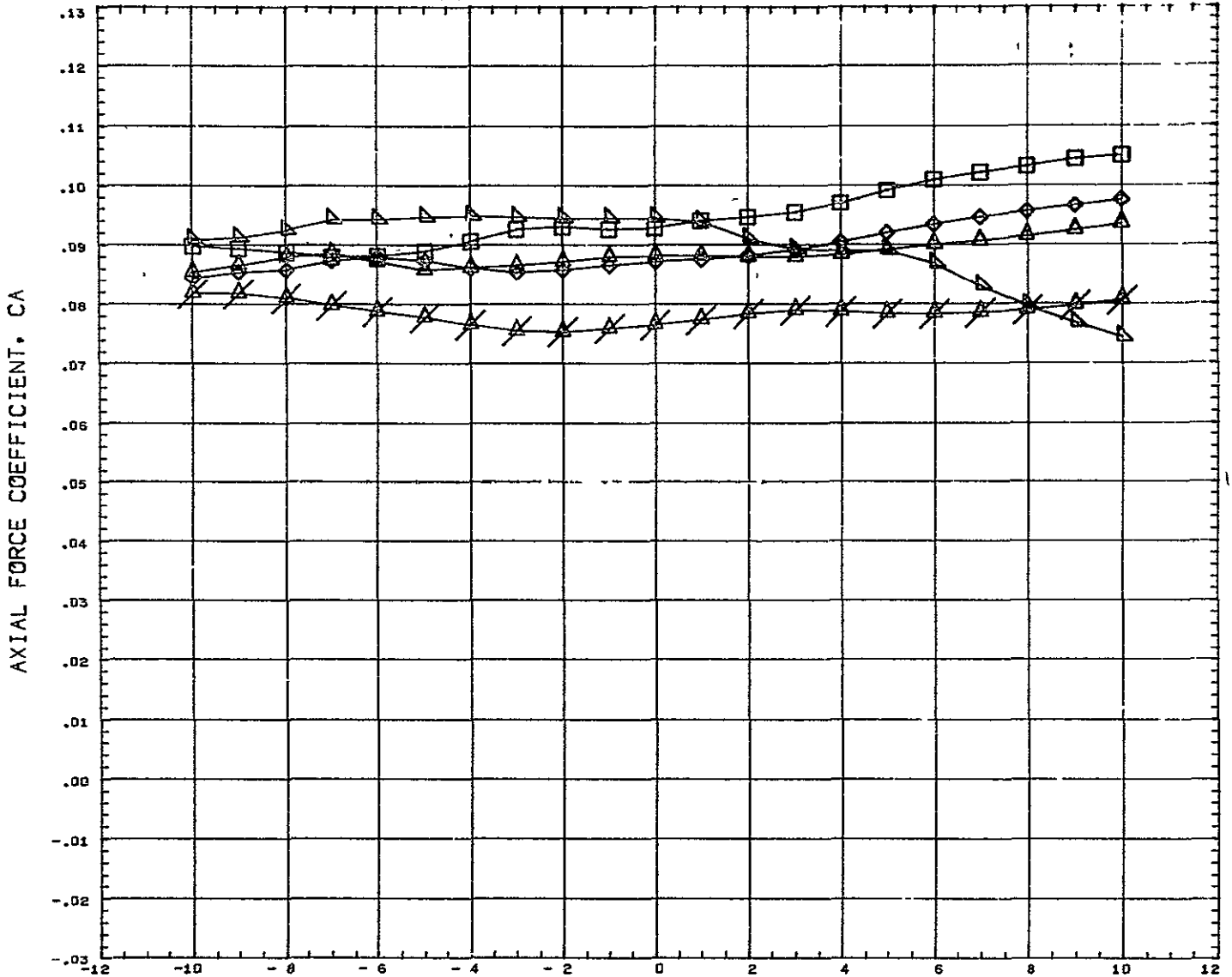

SYMBOL ◊ ◈ △ ○ ×	DELTAZ 0.151 0.182 0.228 0.352 10.000	PARAMETRIC VALUES BSTPOW 100.000 ORBPOW 100.000 DELTAX 0.521 ALPHAI 5.000 MACH 5.010 ELVBST 0.000 ELVORB 0.000 BETA 0.000	REFERENCE INFORMATION REFS 44.4440 SQ IN REFL 13.3330 IN REFB 13.3330 IN XMRP 7.5280 IN YMRP 0.0000 IN ZMRP 1.1940 IN SCALE 0.0055
REFERENCE FILE			

# AEDC VA 1163 MDAC BOOSTER AND ORBITER TEST DATA AT MACH NUMBER 5

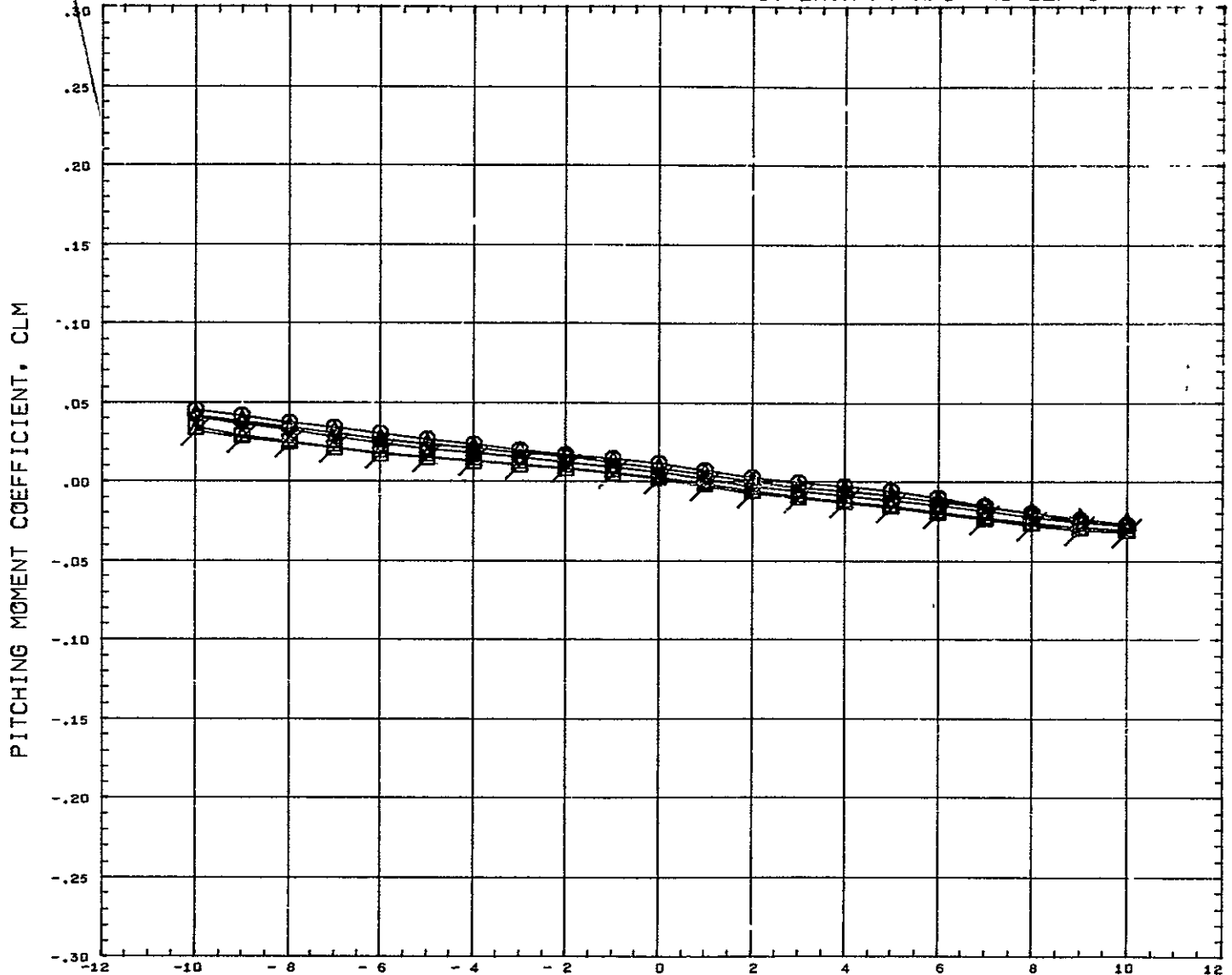

<table border="0"> <tr><td>○</td><td>0.120</td></tr> <tr><td>△</td><td>0.151</td></tr> <tr><td>◇</td><td>0.182</td></tr> <tr><td>□</td><td>0.228</td></tr> <tr><td>⊗</td><td>10.000</td></tr> </table>	○	0.120	△	0.151	◇	0.182	□	0.228	⊗	10.000	<table border="0"> <tr><td>DELTAZ</td><td>0.120</td></tr> <tr><td>DELTAZ</td><td>0.151</td></tr> <tr><td>DELTAZ</td><td>0.182</td></tr> <tr><td>DELTAZ</td><td>0.228</td></tr> <tr><td>DELTAZ</td><td>10.000</td></tr> </table>	DELTAZ	0.120	DELTAZ	0.151	DELTAZ	0.182	DELTAZ	0.228	DELTAZ	10.000	<table border="0"> <tr><td colspan="4" style="text-align: center;">PARAMETRIC VALUES</td></tr> <tr><td>BSTPOW</td><td>0.000</td><td>ORBPOW</td><td>100.000</td></tr> <tr><td>DELTAZ</td><td>0.391</td><td>ALPHA1</td><td>0.000</td></tr> <tr><td>MACH</td><td>5.010</td><td>ELVBST</td><td>0.000</td></tr> <tr><td>ELVORB</td><td>0.000</td><td>BETA</td><td>0.000</td></tr> </table>	PARAMETRIC VALUES				BSTPOW	0.000	ORBPOW	100.000	DELTAZ	0.391	ALPHA1	0.000	MACH	5.010	ELVBST	0.000	ELVORB	0.000	BETA	0.000	<table border="0"> <tr><td colspan="3" style="text-align: center;">REFERENCE INFORMATION</td></tr> <tr><td>REFS</td><td>44 444C</td><td>SQ IN</td></tr> <tr><td>REFL</td><td>13.3330</td><td>IN</td></tr> <tr><td>REFB</td><td>13.3330</td><td>IN</td></tr> <tr><td>XMRP</td><td>7 5280</td><td>IN</td></tr> <tr><td>YMRP</td><td>0 0000</td><td>IN</td></tr> <tr><td>ZMRP</td><td>1.1940</td><td>IN</td></tr> <tr><td>SCALE</td><td>0.0055</td><td></td></tr> </table>	REFERENCE INFORMATION			REFS	44 444C	SQ IN	REFL	13.3330	IN	REFB	13.3330	IN	XMRP	7 5280	IN	YMRP	0 0000	IN	ZMRP	1.1940	IN	SCALE	0.0055	
○	0.120																																																																		
△	0.151																																																																		
◇	0.182																																																																		
□	0.228																																																																		
⊗	10.000																																																																		
DELTAZ	0.120																																																																		
DELTAZ	0.151																																																																		
DELTAZ	0.182																																																																		
DELTAZ	0.228																																																																		
DELTAZ	10.000																																																																		
PARAMETRIC VALUES																																																																			
BSTPOW	0.000	ORBPOW	100.000																																																																
DELTAZ	0.391	ALPHA1	0.000																																																																
MACH	5.010	ELVBST	0.000																																																																
ELVORB	0.000	BETA	0.000																																																																
REFERENCE INFORMATION																																																																			
REFS	44 444C	SQ IN																																																																	
REFL	13.3330	IN																																																																	
REFB	13.3330	IN																																																																	
XMRP	7 5280	IN																																																																	
YMRP	0 0000	IN																																																																	
ZMRP	1.1940	IN																																																																	
SCALE	0.0055																																																																		
REFERENCE FILE																																																																			



# AEDC VA 1163 MDAC BOOSTER AND ORBITER TEST DATA AT MACH NUMBER 5

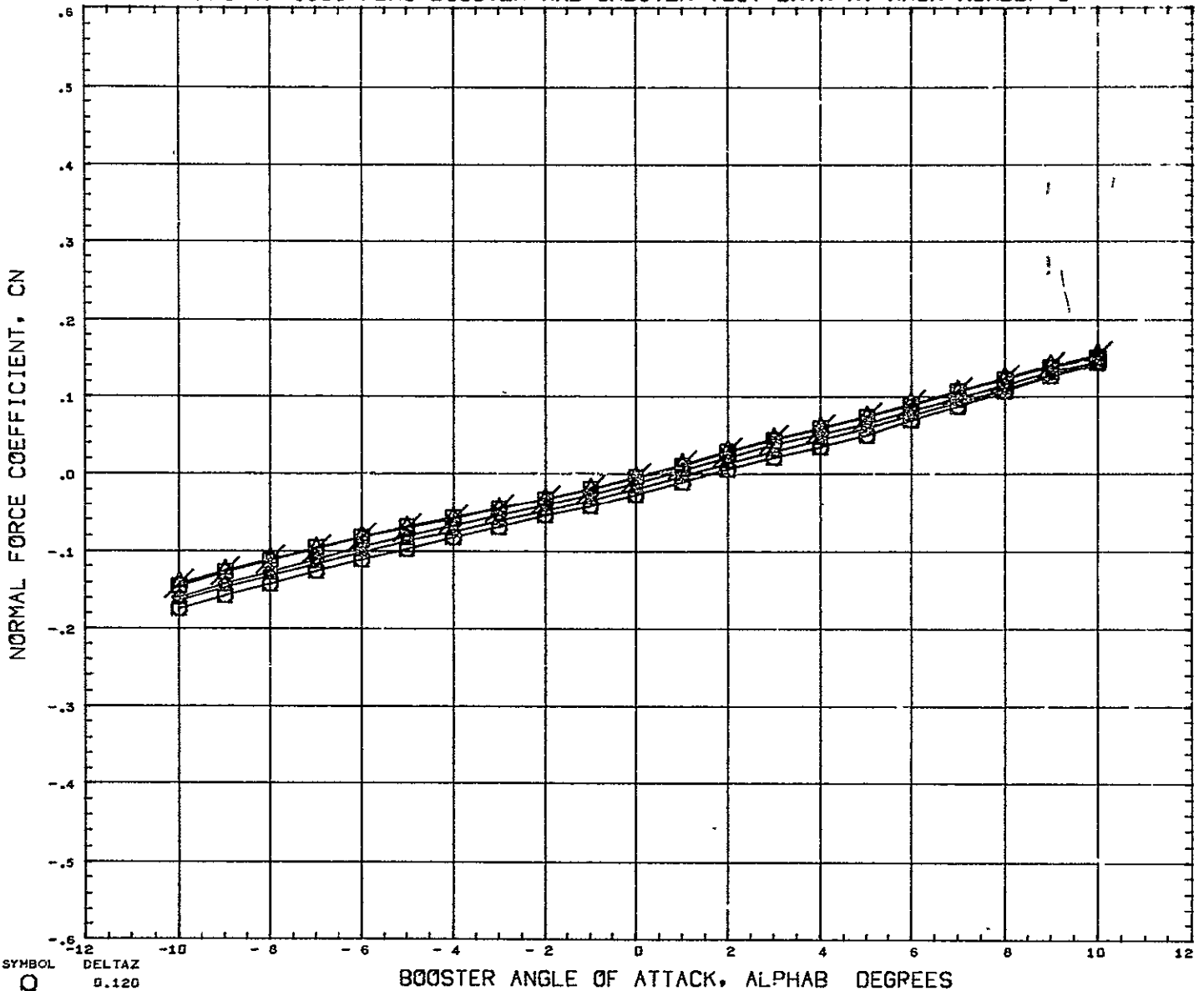

SYMBOL

DELTA Z  
 0.120  
 0.151  
 0.182  
 0.228  
 10.000

PARAMETRIC VALUES  
 BSTFOW 0.000 ORBPOW 100.000  
 DELTAX - 0.391 ALPHA1 0.000  
 MACH 5.010 ELVBST 0.000  
 ELVORB 0.000 BETA 0.000

REFERENCE INFORMATION  
 REFS 44.4443 SQ IN  
 REFL 13.3330 IN  
 REFB 13.3330 IN  
 XMRP 7.5280 IN  
 YMRP 0.0000 IN  
 ZMRP 1.1940 IN  
 SCALE 0.0055

REFERENCE FILE

# AEDC VA 1163 MDAC BOOSTER AND ORBITER TEST DATA AT MACH NUMBER 5

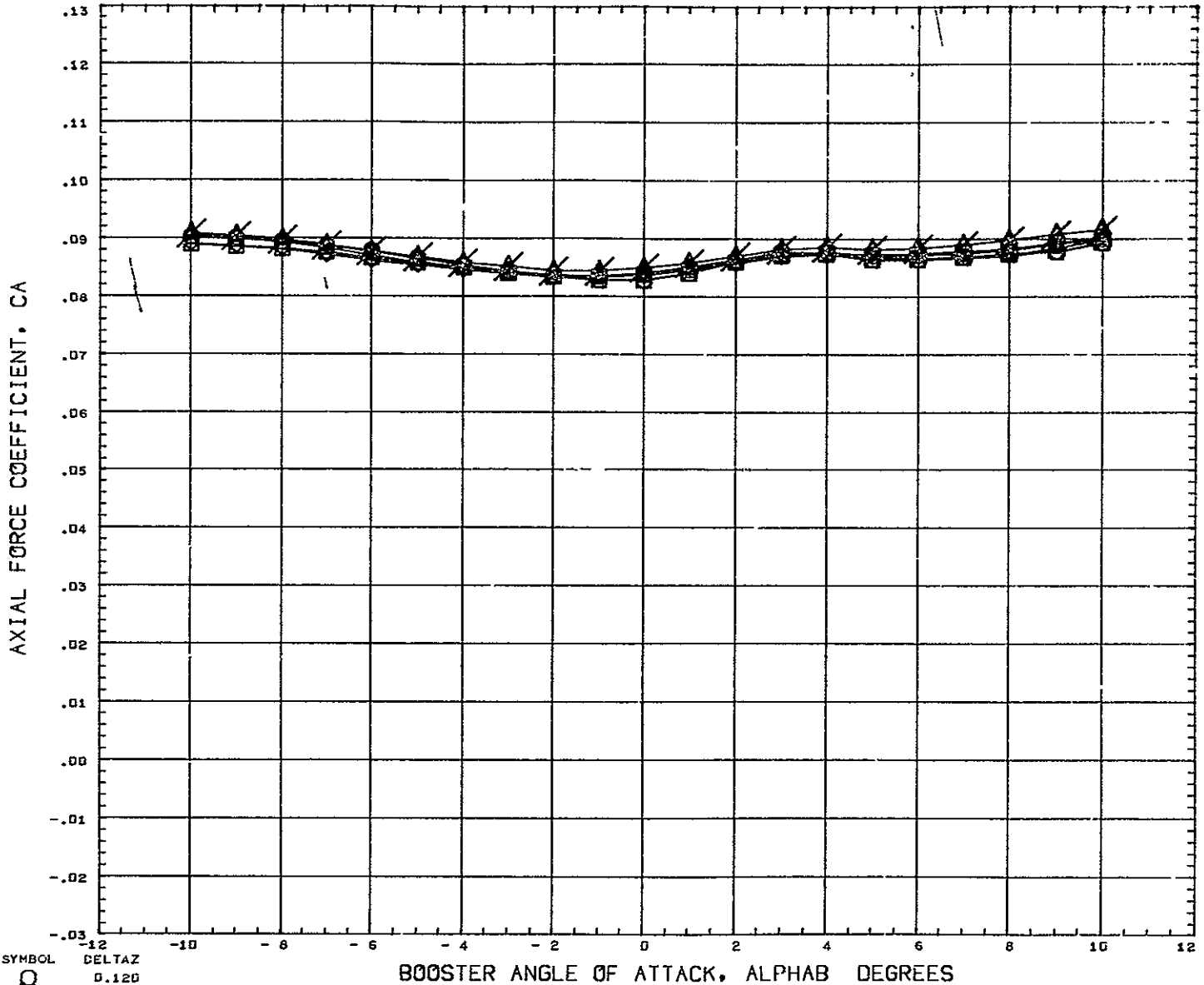

SYMBOL ○ ◇ □ △	DELTAZ 0.120 0.151 0.182 0.228 10.000	PARAMETRIC VALUES BSTPOW    0.000    ORBPOW    100.000 ELTAX    - 0.391    ALPHAI    0.000 MACH     5.010    ELVBST    0.000 ELVORB    0.000    BETA     0.000	REFERENCE INFORMATION REFS     44 444U    SQ IN REFL     13.3330    IN REFB     13.3330    IN XHRF     7.5280    IN YHRF     0.0000    IN ZHRF     1 1940    IN SCALE    0.0055
	REFERENCE FILE		

# AEDC VA 1163 MDAC BOOSTER AND ORBITER TEST DATA AT MACH NUMBER 5

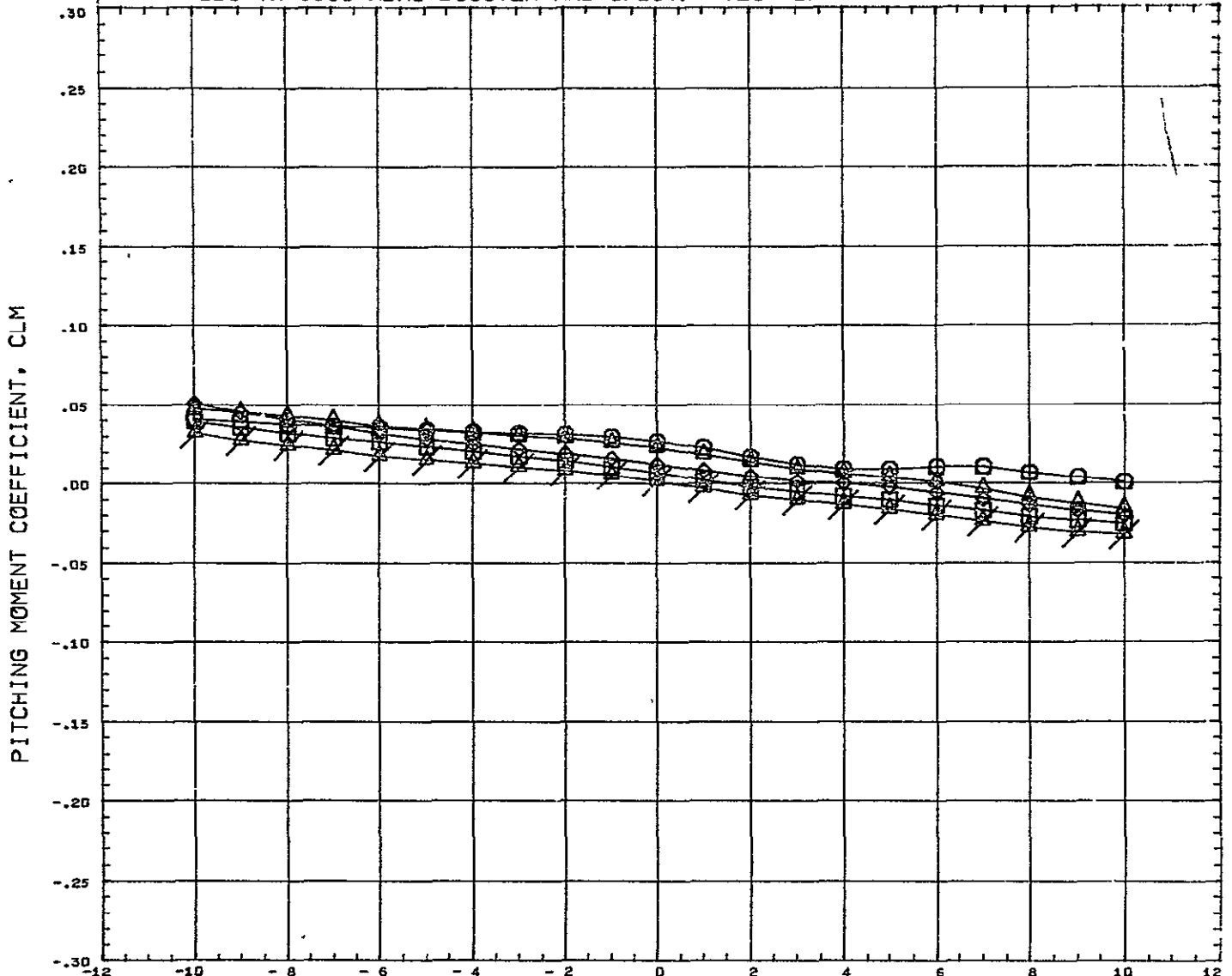

SYMBOL ○ ◊ □ △	DELTAZ 0.120 0.151 0.182 0.228 10.000	PARAMETRIC VALUES BSTPOW 0.000 ORBPOW 100.000 DELTAX - 0.143 ALPHAI 0.000 MACH 5.010 ELVBST 0.000 ELVORB 0.000 BETA 0.000	REFERENCE INFORMATION REFS 44.4440 SQ IN REFL 13.3330 IN REFB 13.3330 IN XMRP 7.5280 IN YMRP 0.0050 IN ZMRP 1.1940 IN SCALE 0.0055
REFERENCE FILE			

# AEDC VA-1163 MDAC BOOSTER AND ORBITER TEST DATA AT MACH NUMBER 5

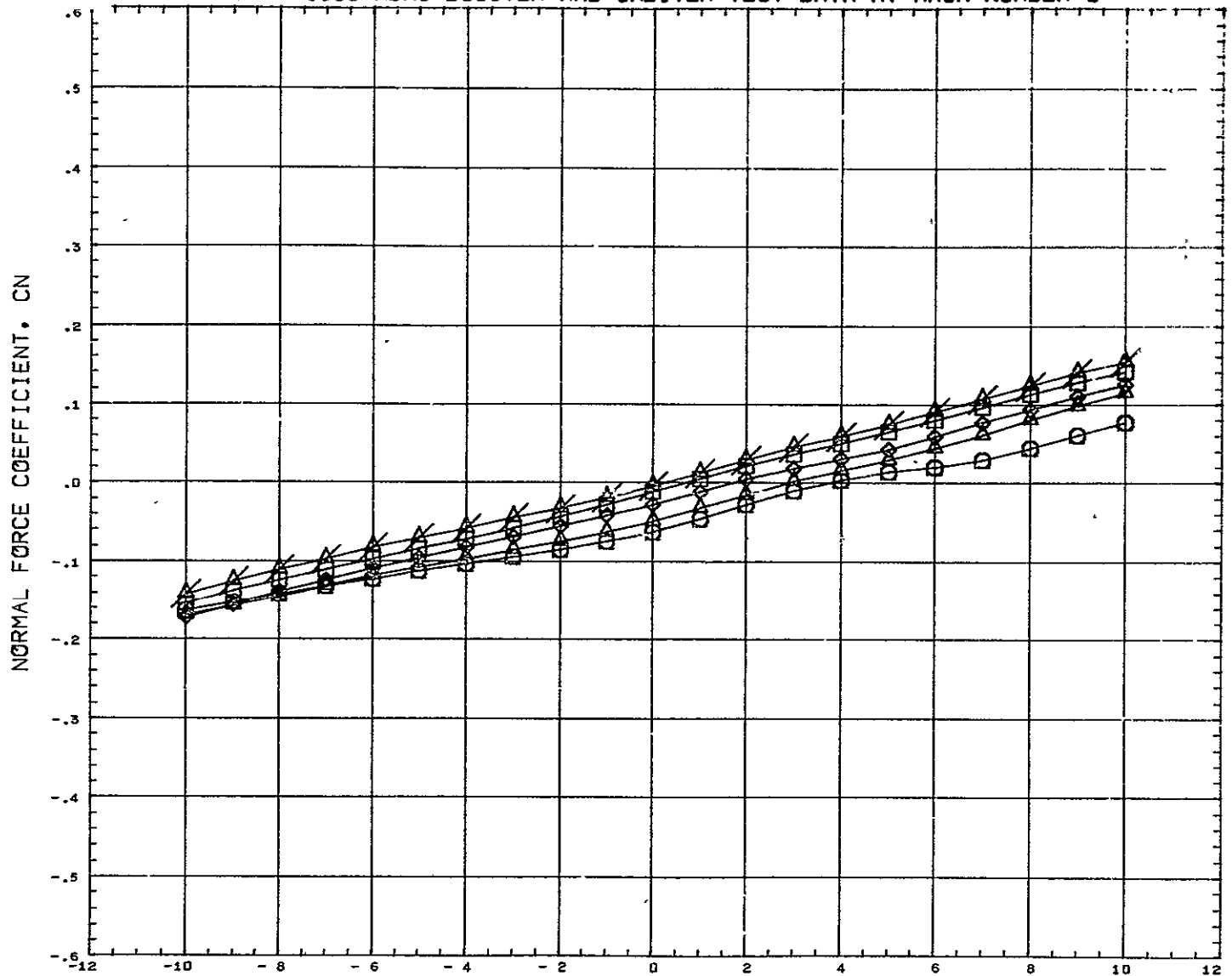

SYMBOL ○ △ □ ◇ ×	DELTAZ 0.120 0.151 0.182 0.228, 10.000	<b>PARAMETRIC VALUES</b> BSTPCW 0.000 ORBPCW 100.000 DELTAX - 0.143 ALPHAI 0.000 MACH 5.010 ELVBST 0.000 ELVORB 0.000 BETA 0.000	<b>REFERENCE INFORMATION</b> REFS 24.4440 SQ IN REFL 13.3330 IN REFB 13.3330 IN XMRP 7.5280 IN YMRP 0.0000 IN ZMRP 1.1940 IN SCALE 0.0055
---------------------------------	---	--	--

REFERENCE FILE

# AEDC VA 1163 MDAC BOOSTER AND ORBITER TEST DATA AT MACH NUMBER 5

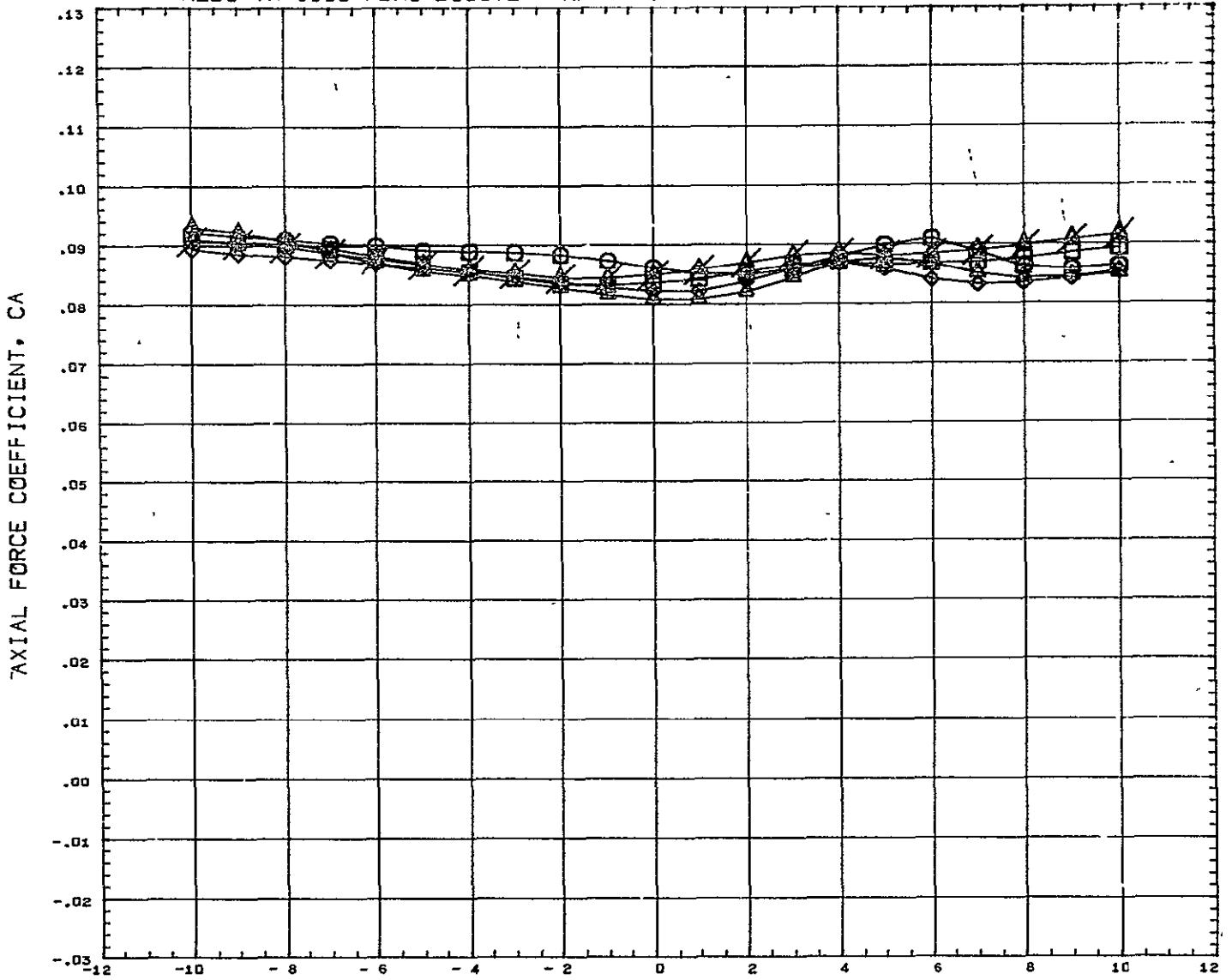

SYMBOL	DELTAZ	PARAMETRIC VALUES				REFERENCE INFORMATION		
○	0.120					REFS	11.4440	SO IN
△	0.151					REFL	13.3330	IN
◇	0.182	BSTFOW	0.000	ORBPOW	100.000	REFB	13.3330	IN
□	0.228	DELTAZ	- 0.143	ALPHA1	0.000	XMRP	7.5280	IN
X	10.000	MACH	5.010	ELVBST	0.000	YMRP	0.0000	IN
		ELVORB	0.000	BETA	0.000	ZMRP	1.1940	IN
						SCALE	0.0055	

REFERENCE FILE

# AEDC VA 1163 MDAC BOOSTER AND ORBITER TEST DATA AT MACH NUMBER 5

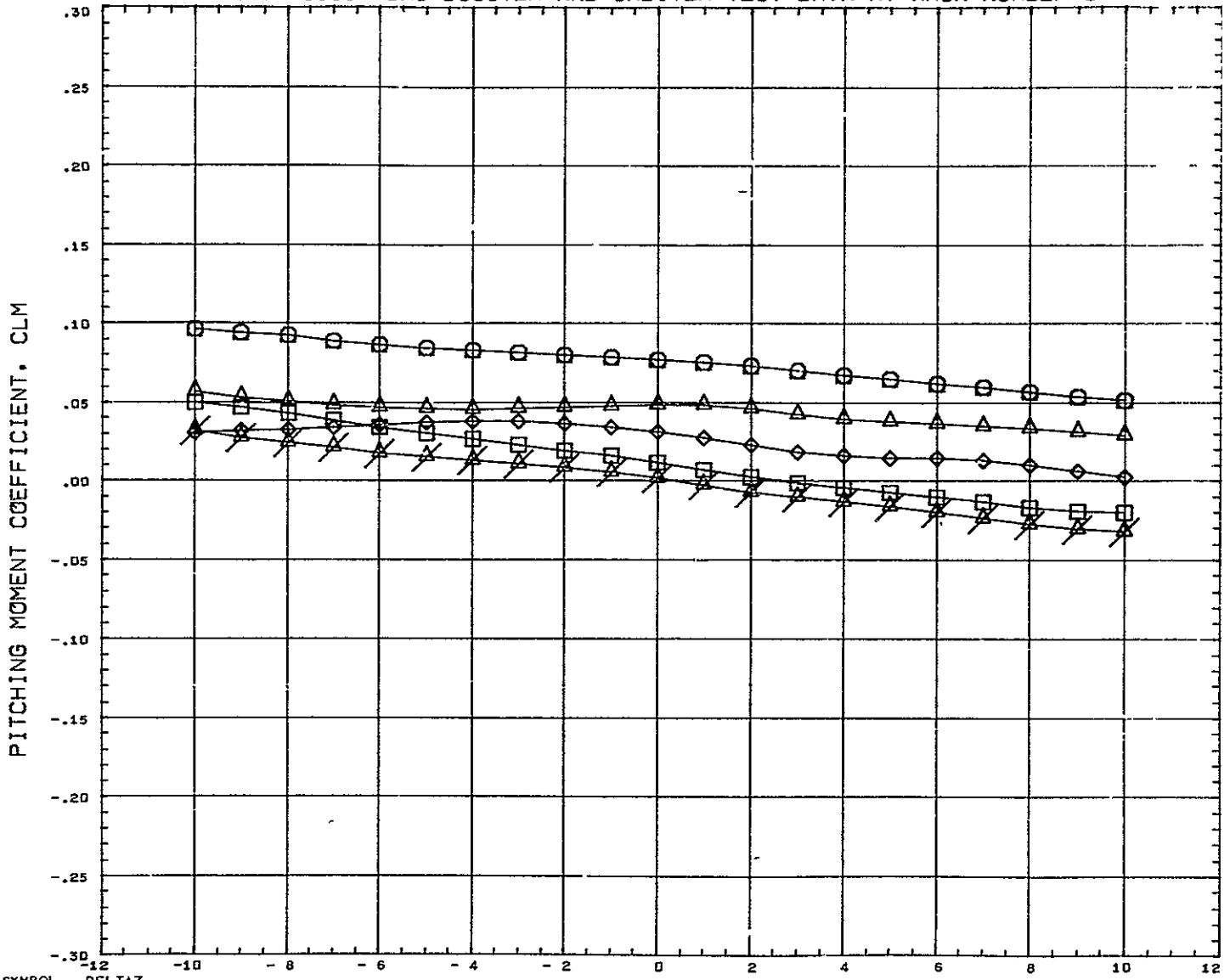

SYMBOL ○ △ ◇ □ ×	DELTA Z 0.120 0.151 0.182 0.228 10.000	PARAMETRIC VALUES BSTPOW    0.000    ORBPOW    100.000 DELTAX    - 0.019    ALPHA1    0.000 MACH       5.010    ELVBST    0.000 ELVORB    0.000    BETA       0.000	REFERENCE INFORMATION REFS       4440       SQ IN REFL       13.3330    IN REFB       13.3330    IN XHRP       7.5280    IN YHRP       0.0000    IN ZHRP       1.1940    IN SCALE      0.0055
1    REFERENCE FILE			

# AEDC VA 1163 MDAC BOOSTER AND ORBITER TEST DATA AT MACH NUMBER 5

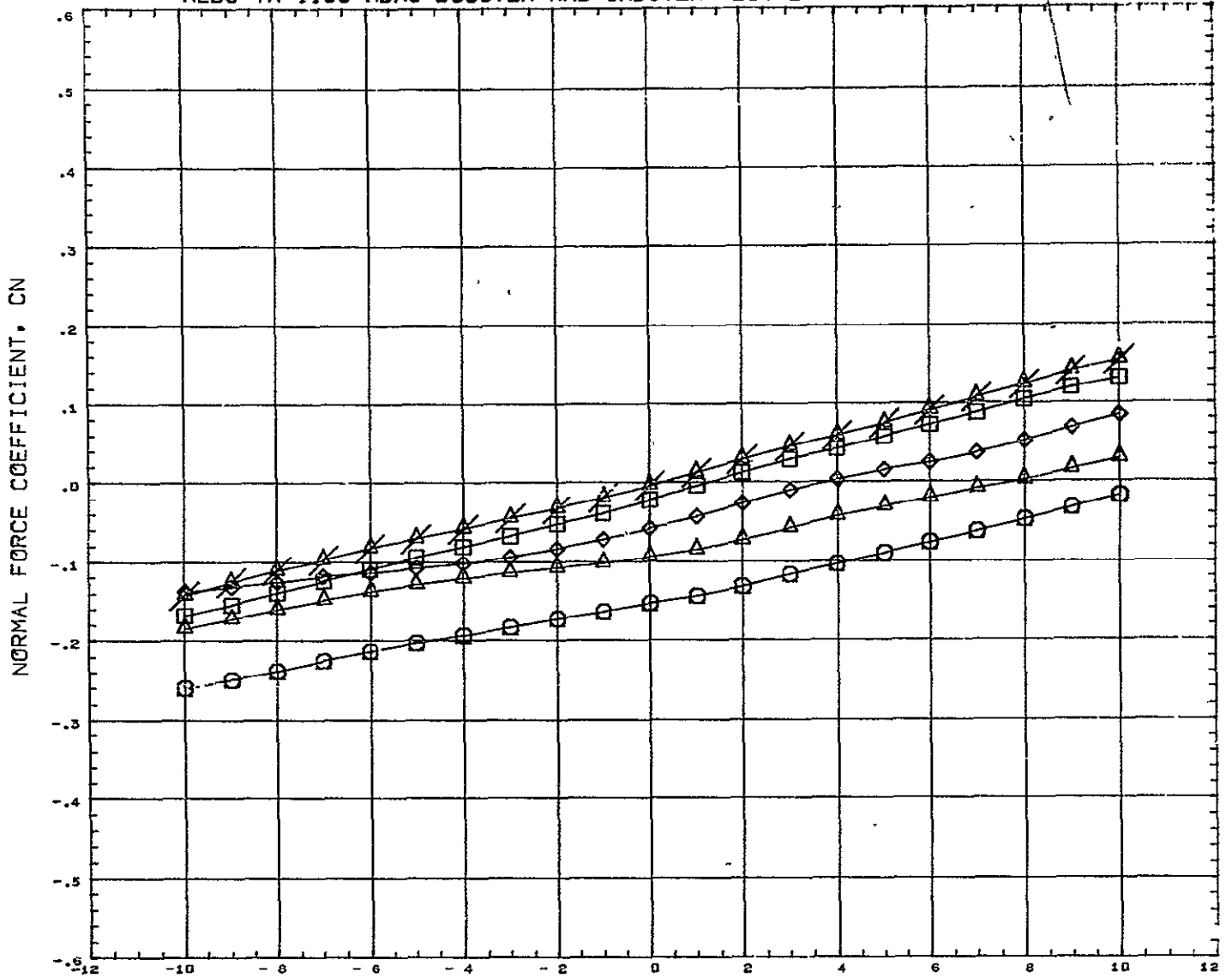

SYMBOL ○ □ ◇ △ ×	DELTA Z 0.120 0.151 0.182 0.228 10.000	<table border="0" style="width: 100%;"> <tr> <th colspan="4" style="text-align: left; padding-left: 20px;">PARAMETRIC VALUES</th> </tr> <tr> <td style="padding-right: 20px;">BSTPOW</td> <td style="padding-right: 20px;">0.000</td> <td style="padding-right: 20px;">ORBPOW</td> <td>100.000</td> </tr> <tr> <td>DELTA X</td> <td>- 0.019</td> <td>ALPHA I</td> <td>0.000</td> </tr> <tr> <td>MACH</td> <td>5.010</td> <td>ELVBST</td> <td>0.000</td> </tr> <tr> <td>ELVORB</td> <td>0.000</td> <td>BETA</td> <td>0.000</td> </tr> </table>	PARAMETRIC VALUES				BSTPOW	0.000	ORBPOW	100.000	DELTA X	- 0.019	ALPHA I	0.000	MACH	5.010	ELVBST	0.000	ELVORB	0.000	BETA	0.000	<table border="0" style="width: 100%;"> <tr> <th colspan="3" style="text-align: left;">REFERENCE INFORMATION</th> </tr> <tr> <td>REFS</td> <td>44.4440</td> <td>50 IN</td> </tr> <tr> <td>REFL</td> <td>13.3330</td> <td>IN</td> </tr> <tr> <td>REFB</td> <td>13.3330</td> <td>IN</td> </tr> <tr> <td>XHRP</td> <td>7.5280</td> <td>IN</td> </tr> <tr> <td>YHRP</td> <td>0.0000</td> <td>IN</td> </tr> <tr> <td>ZHRP</td> <td>1.1940</td> <td>IN</td> </tr> <tr> <td>SCALE</td> <td>0.0055</td> <td></td> </tr> </table>	REFERENCE INFORMATION			REFS	44.4440	50 IN	REFL	13.3330	IN	REFB	13.3330	IN	XHRP	7.5280	IN	YHRP	0.0000	IN	ZHRP	1.1940	IN	SCALE	0.0055	
PARAMETRIC VALUES																																															
BSTPOW	0.000	ORBPOW	100.000																																												
DELTA X	- 0.019	ALPHA I	0.000																																												
MACH	5.010	ELVBST	0.000																																												
ELVORB	0.000	BETA	0.000																																												
REFERENCE INFORMATION																																															
REFS	44.4440	50 IN																																													
REFL	13.3330	IN																																													
REFB	13.3330	IN																																													
XHRP	7.5280	IN																																													
YHRP	0.0000	IN																																													
ZHRP	1.1940	IN																																													
SCALE	0.0055																																														

REFERENCE FILE

# AEDC VA 1163 MDAC BOOSTER AND ORBITER TEST DATA AT MACH NUMBER 5

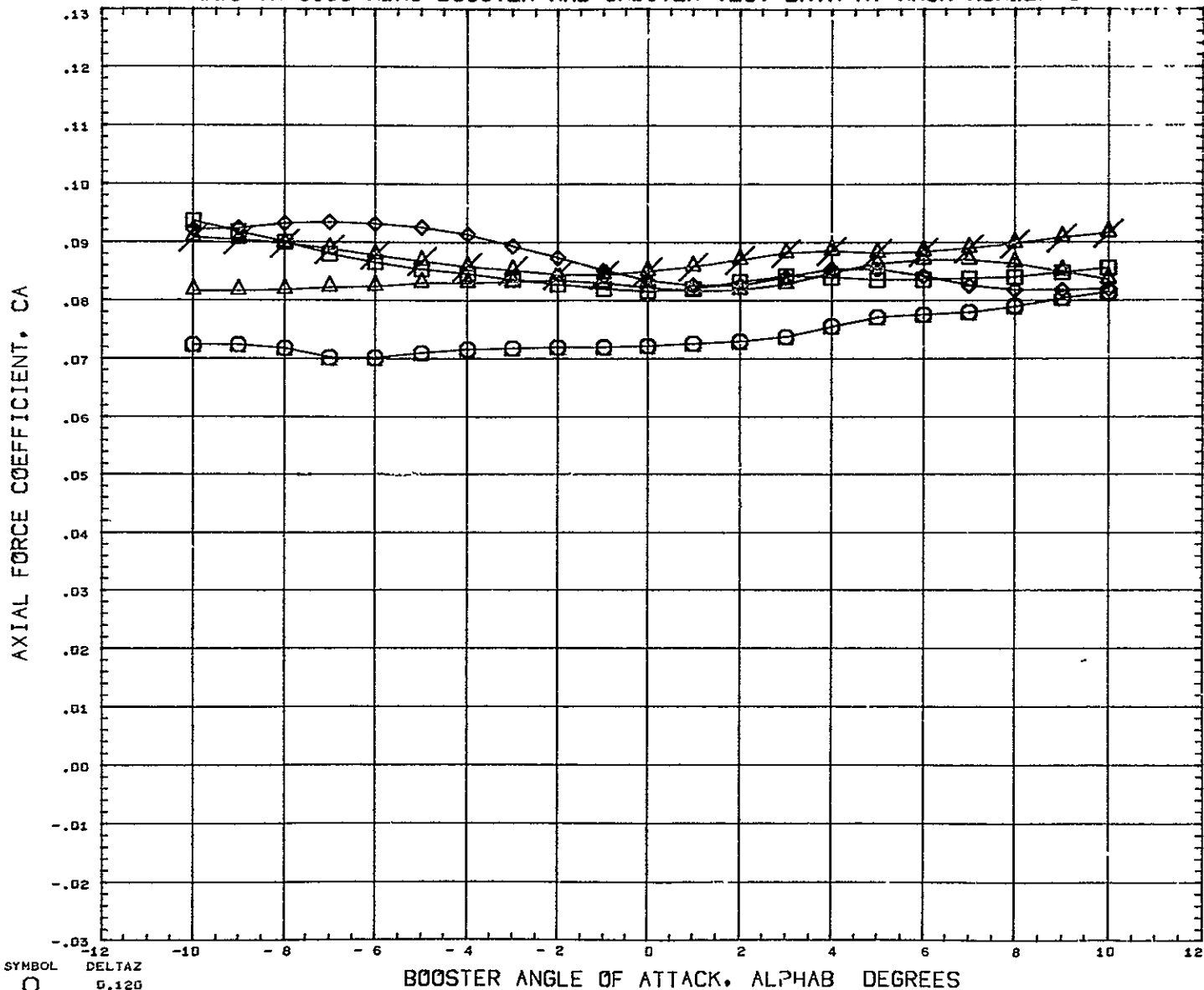

SYMBOL

○  
◇  
△  
□  
×

DELTA Z  
0.120  
0.151  
0.182  
0.228  
10.000  
,  
,  
,  
,  
,

BSTPOW  
JELTAX  
MACH  
ELVORB

PARAMETRIC VALUES

0.000 ORBPOW 100.000  
- 0.019 ALPHA1 0.000  
5.010 ELVBST 0.000  
0.000 BETA 0.000

REFERENCE INFORMATION

REFS 44.4440 SQ IN  
REFL 13.3330 IN  
REFB 13.3330 IN  
XMRP 7.5230 IN  
YMRP 0.0000 IN  
ZMRP 1.1940 IN  
SCALE 0.0055

REFERENCE FILE



# AEDC VA 1163 MDAC BOOSTER AND ORBITER TEST DATA AT MACH NUMBER 5

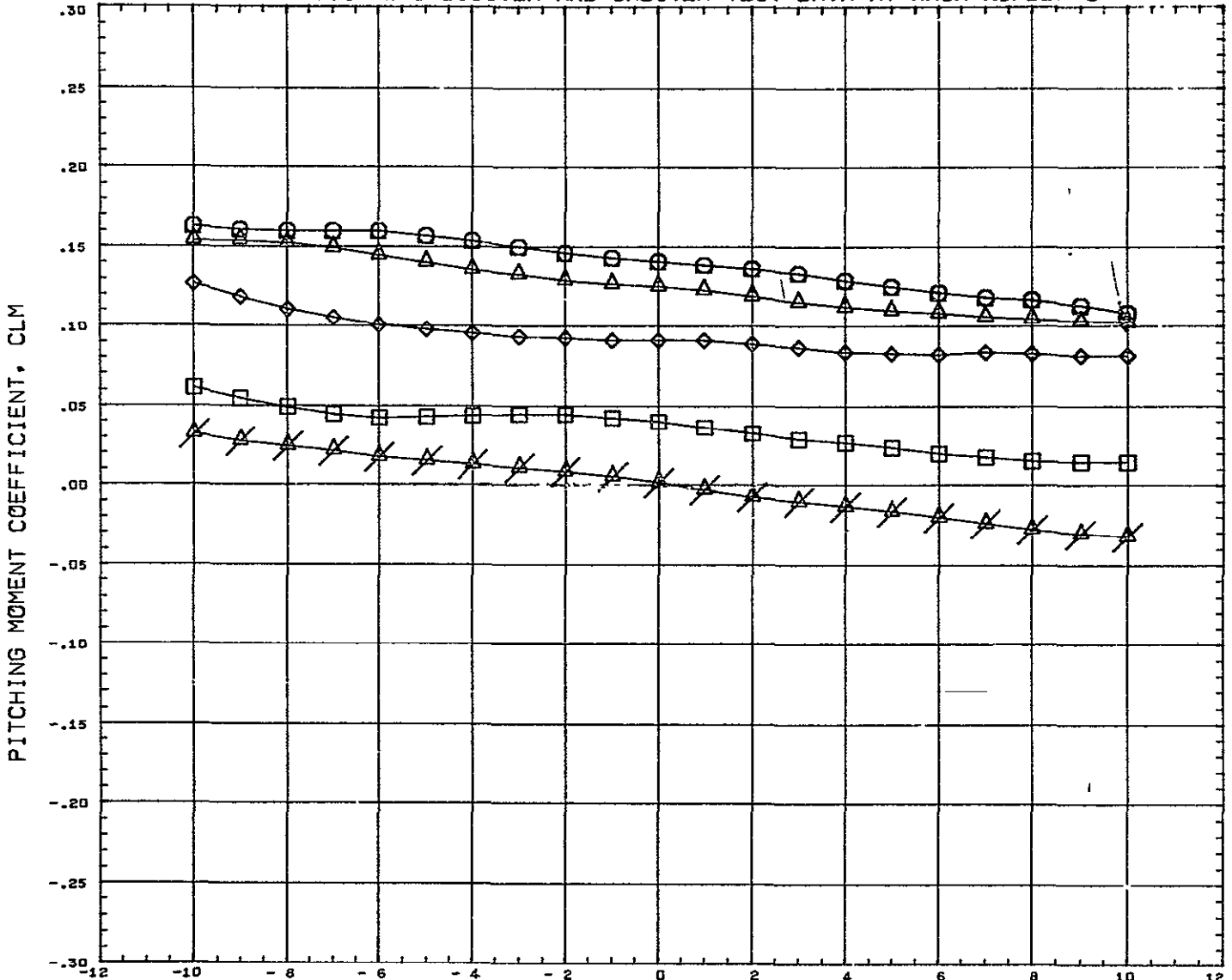

SYMBOL ○ ◇ □ △ ×	DELTAZ 0.120 0.151 0.182 0.226 10.000	PARAMETRIC VALUES BSTPOW 0.000 CRBPOW 100.000 DELTAX 0.164 ALPHAI 0.000 MACH 5.010 ELVBST 0.000 ELVORB 0.000 BETA 0.000	REFERENCE INFORMATION REFS 44.4440 SQ IN REFL 13.3330 IN REFB 13.3330 IN XMPF 7.5260 IN YMRP 0.0000 IN ZMRP 1.1940 IN SCALE 0.0055
---------------------------------	--	---	---

REFERENCE FILE

# AEDC VA 1163 MDAC BOOSTER AND ORBITER TEST DATA AT MACH NUMBER 5

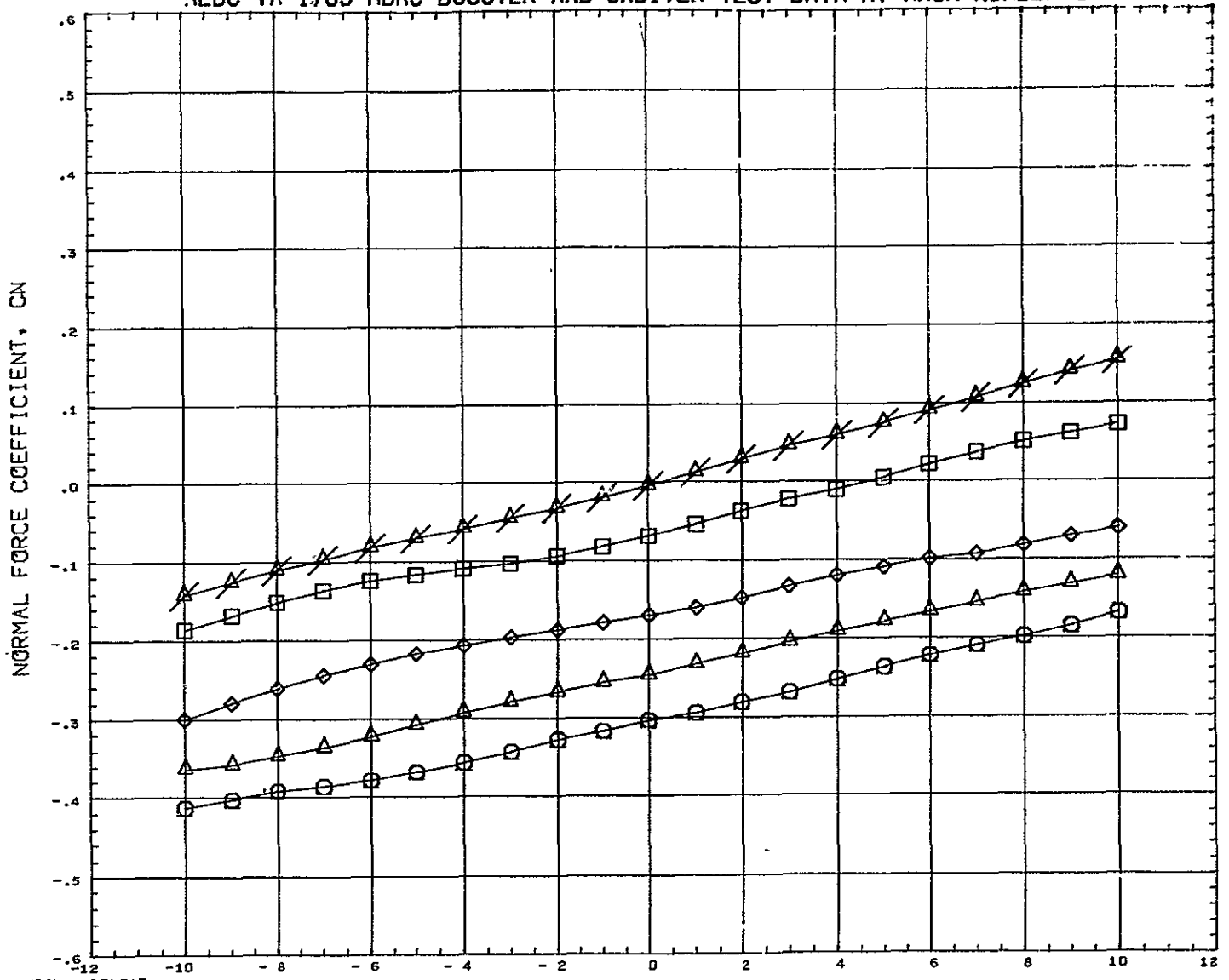

SYMBOL ○ □ ◇ △ ×	DELTAX 0.120 0.151 0.182 0.228 10.000	PARAMETRIC VALUES BSTPOW 0.000    ORBPOW 100.000 DELTAX 0.104    ALPHAI 0.000 MACH 5.010    ELVBST 0.000 ELVORB 0.000    BETA 0.000	REFERENCE INFORMATION REFS 44.4445    SQ IN REFL 13.3330    IN REFB 13.3330    IN XMRF 7.5280    IN YMRF 0.0000    IN ZMRF 1.1940    IN SCALE 0.0055
---------------------------------	--	---	---

1 REFERENCE FILE

# AEDC VA 1163 MDAC BOOSTER AND ORBITER TEST DATA AT MACH NUMBER 5

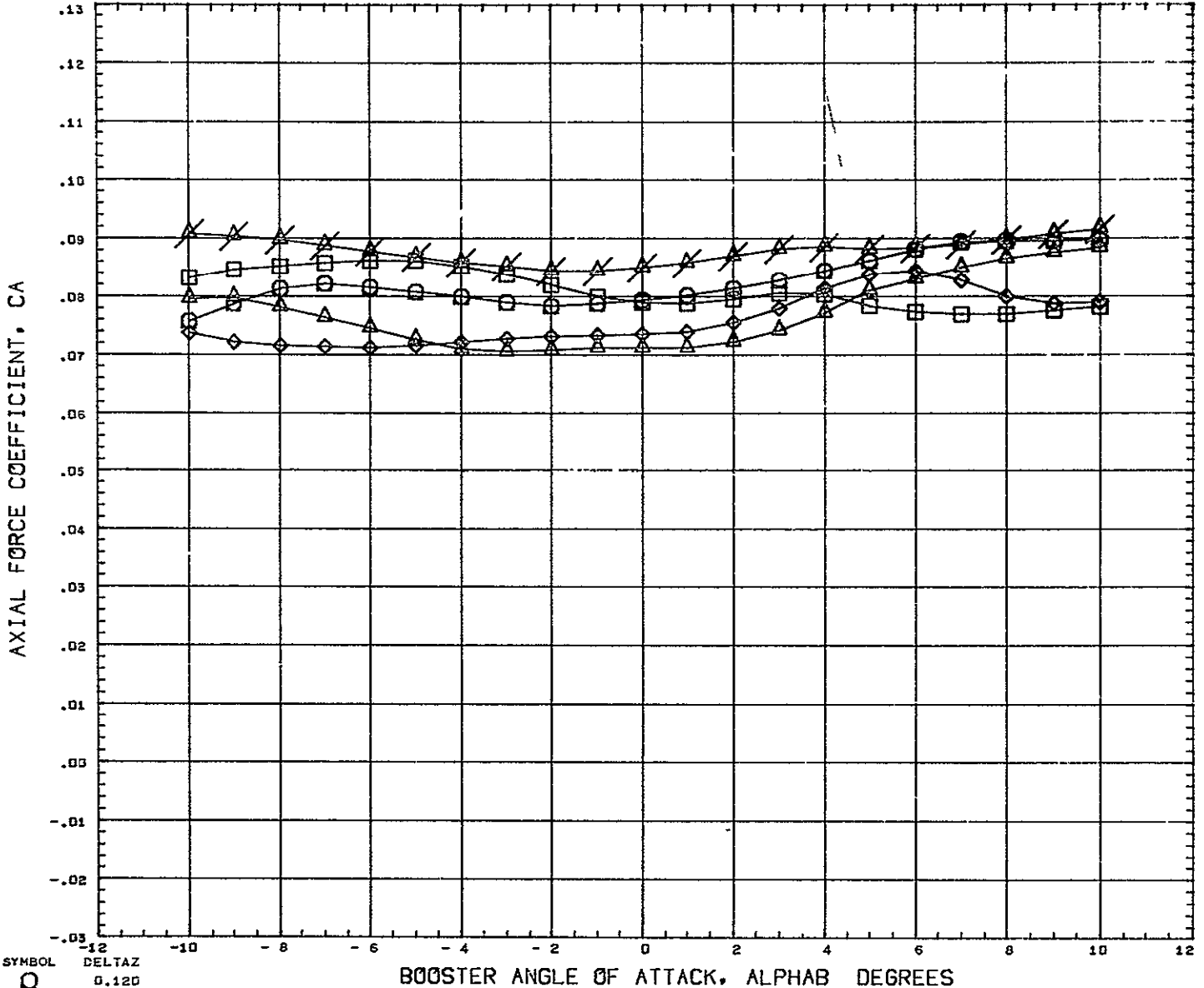

SYMBOL 	DELTA Z 0.120 0.151 0.182 0.228 10.000	PARAMETRIC VALUES BSTFOW 0.000 ORBPOW 100.000 DELTAX 0.104 ALPHA1 0.000 MACH 5.010 ELVBST 0.000 ELVORB 0.000 BETA 0.000	REFERENCE INFORMATION REFS 44.4440 SQ IN REFL 13.3330 IN REFB 13.3330 IN XMRP 7.5280 IN YMRP 0.0000 IN ZMRP 1.1940 IN SCALE 0.0055
------------	---	---	---

REFERENCE FILE

# AEDC VA 1163 MDAC BOOSTER AND ORBITER TEST DATA AT MACH NUMBER 5

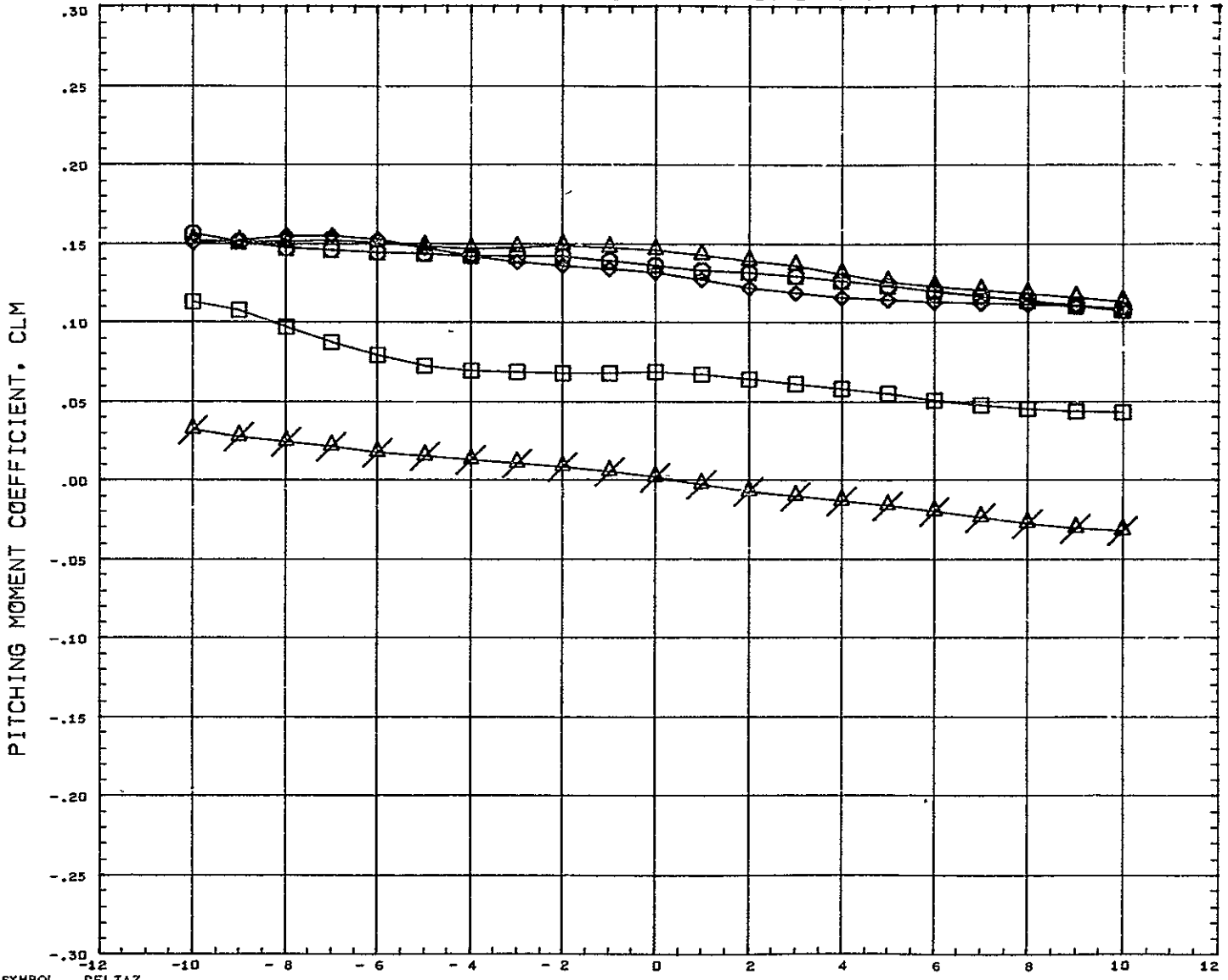

SYMBOL 	DELTAZ 0.120 0.151 0.182 0.228 10.000	<b>PARAMETRIC VALUES</b> BSTFOW    0.000    ORBFOW    100.000 DELTAX    0.166    ALPHAI    0.000 MACH       5.010    ELVBST    0.000 ELVORB    0.000    BETA       0.000	<b>REFERENCE INFORMATION</b> REFS       -4.4440    SQ IN REF.       13.3330    IN REFB       13.3330    IN XMRP       7.5280    IN YMRP       0.0000    IN ZMRP       1.1940    IN SCALE       0.0055
REFERENCE FILE			

# AEDC VA 1163 MDAC BOOSTER AND ORBITER TEST DATA AT MACH NUMBER 5

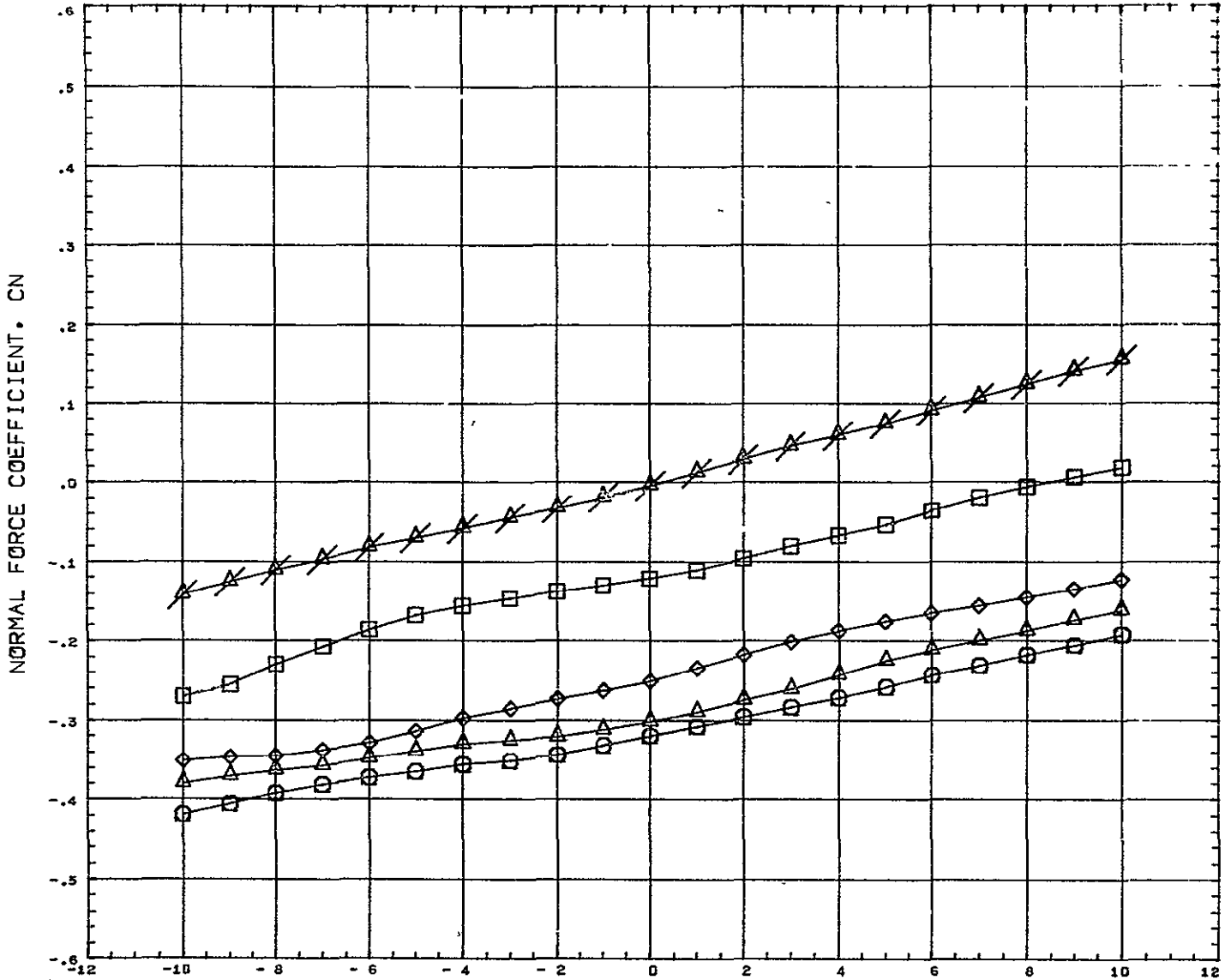

SYMBOL 	DELTAZ 0.120 0.151 0.182 0.228 10.000	PARAMETRIC VALUES BSTPOW 0.000 ORBPOW 100.000 DELTAX 0.166 ALPHAI 0.000 MA.H 5.010 ELVBST 0.000 ELVORB 0.000 BETA 0.000	REFERENCE INFORMATION REFS 44.440 SQ IN REFL 13.3330 IN REFB 13.3330 IN XMRP 7.5280 IN YMRP 0.0000 IN ZMRP 1.1940 IN SCALE 0.0055
REFERENCE FILE			

# AEDC VA 1163 MDAC BOOSTER AND ORBITER TEST DATA AT MACH NUMBER 5

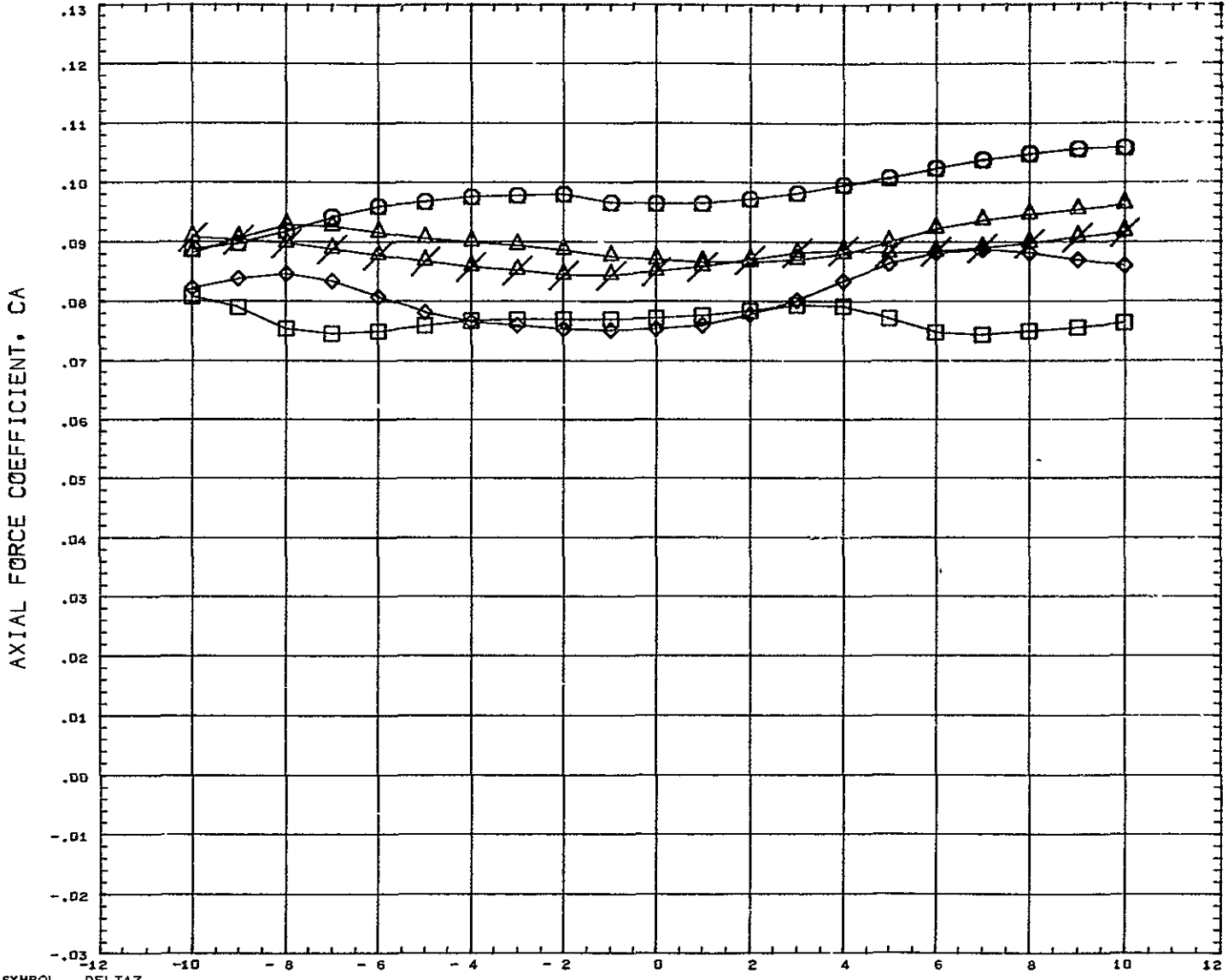

SYMBOL ○ △ ◇ □ ×	DELTAZ 0.120 0.151 0.182 0.228 10.000	<table border="0" style="width: 100%;"> <tr> <th colspan="4" style="text-align: left;">PARAMETRIC VALUES</th> </tr> <tr> <td>BSTPOW</td><td>0.000</td><td>ORBPOW</td><td>100.000</td> </tr> <tr> <td>DELTAZ</td><td>0.166</td><td>ALPHA1</td><td>0.000</td> </tr> <tr> <td>H CH</td><td>5.010</td><td>ELVBST</td><td>0.000</td> </tr> <tr> <td>ELVORB</td><td>0.000</td><td>BETA</td><td>0.000</td> </tr> </table>	PARAMETRIC VALUES				BSTPOW	0.000	ORBPOW	100.000	DELTAZ	0.166	ALPHA1	0.000	H CH	5.010	ELVBST	0.000	ELVORB	0.000	BETA	0.000	<table border="0" style="width: 100%;"> <tr> <th colspan="3" style="text-align: left;">REFERENCE INFORMATION</th> </tr> <tr> <td>REFS</td><td>44.4440</td><td>SQ IN</td> </tr> <tr> <td>REFL</td><td>13.3330</td><td>IN</td> </tr> <tr> <td>REFB</td><td>13.3330</td><td>IN</td> </tr> <tr> <td>XMRP</td><td>7.5280</td><td>IN</td> </tr> <tr> <td>YMRP</td><td>0.0000</td><td>IN</td> </tr> <tr> <td>ZMRP</td><td>1.1940</td><td>IN</td> </tr> <tr> <td>SCALE</td><td>0.0055</td><td></td> </tr> </table>	REFERENCE INFORMATION			REFS	44.4440	SQ IN	REFL	13.3330	IN	REFB	13.3330	IN	XMRP	7.5280	IN	YMRP	0.0000	IN	ZMRP	1.1940	IN	SCALE	0.0055	
PARAMETRIC VALUES																																															
BSTPOW	0.000	ORBPOW	100.000																																												
DELTAZ	0.166	ALPHA1	0.000																																												
H CH	5.010	ELVBST	0.000																																												
ELVORB	0.000	BETA	0.000																																												
REFERENCE INFORMATION																																															
REFS	44.4440	SQ IN																																													
REFL	13.3330	IN																																													
REFB	13.3330	IN																																													
XMRP	7.5280	IN																																													
YMRP	0.0000	IN																																													
ZMRP	1.1940	IN																																													
SCALE	0.0055																																														

REFERENCE FILE

# AEDC VA 1163 MDAC BOOSTER AND ORBITER TEST DATA AT MACH NUMBER 5

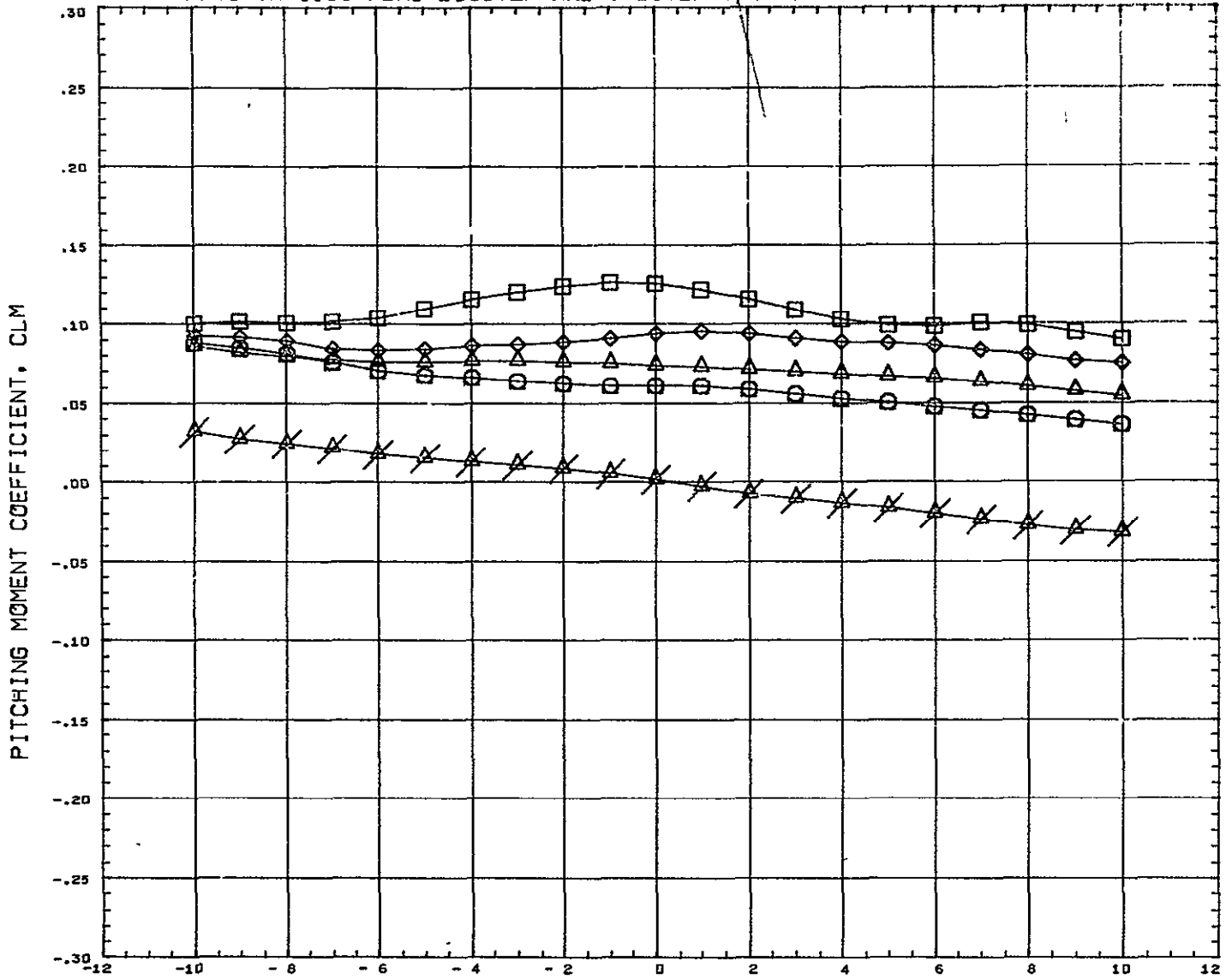

SYMBOL ○ △ ◇ □ ×	DELTA Z 0.120 0.151 0.162 0.228 10.000	<table border="0" style="width: 100%;"> <tr> <th colspan="4" style="text-align: left;">PARAMETRIC VALUES</th> </tr> <tr> <td style="width: 25%;">BSTFOW</td> <td style="width: 25%;">0.000</td> <td style="width: 25%;">ORBFOV</td> <td style="width: 25%;">100.000</td> </tr> <tr> <td>DELTA X</td> <td>0.351</td> <td>ALPHA I</td> <td>0.000</td> </tr> <tr> <td>ACH</td> <td>5.010</td> <td>ELVBST</td> <td>0.000</td> </tr> <tr> <td>ELVORB</td> <td>0.000</td> <td>BETA</td> <td>0.000</td> </tr> </table>	PARAMETRIC VALUES				BSTFOW	0.000	ORBFOV	100.000	DELTA X	0.351	ALPHA I	0.000	ACH	5.010	ELVBST	0.000	ELVORB	0.000	BETA	0.000	<table border="0" style="width: 100%;"> <tr> <th colspan="3" style="text-align: left;">REFERENCE INFORMATION</th> </tr> <tr> <td style="width: 33%;">REFS</td> <td style="width: 33%;">1.4440</td> <td style="width: 33%;">SQ IN</td> </tr> <tr> <td>REFL</td> <td>13.3330</td> <td>IN</td> </tr> <tr> <td>REFB</td> <td>13.3330</td> <td>IN</td> </tr> <tr> <td>XMRP</td> <td>7.5200</td> <td>IN</td> </tr> <tr> <td>YMRP</td> <td>0.0000</td> <td>IN</td> </tr> <tr> <td>ZMRP</td> <td>1.1940</td> <td>IN</td> </tr> <tr> <td>SCALE</td> <td>0.0055</td> <td></td> </tr> </table>	REFERENCE INFORMATION			REFS	1.4440	SQ IN	REFL	13.3330	IN	REFB	13.3330	IN	XMRP	7.5200	IN	YMRP	0.0000	IN	ZMRP	1.1940	IN	SCALE	0.0055	
PARAMETRIC VALUES																																															
BSTFOW	0.000	ORBFOV	100.000																																												
DELTA X	0.351	ALPHA I	0.000																																												
ACH	5.010	ELVBST	0.000																																												
ELVORB	0.000	BETA	0.000																																												
REFERENCE INFORMATION																																															
REFS	1.4440	SQ IN																																													
REFL	13.3330	IN																																													
REFB	13.3330	IN																																													
XMRP	7.5200	IN																																													
YMRP	0.0000	IN																																													
ZMRP	1.1940	IN																																													
SCALE	0.0055																																														

REFERENCE FILE

# AEDC VA 1163 MDAC BOOSTER AND ORBITER TEST DATA AT MACH NUMBER 5

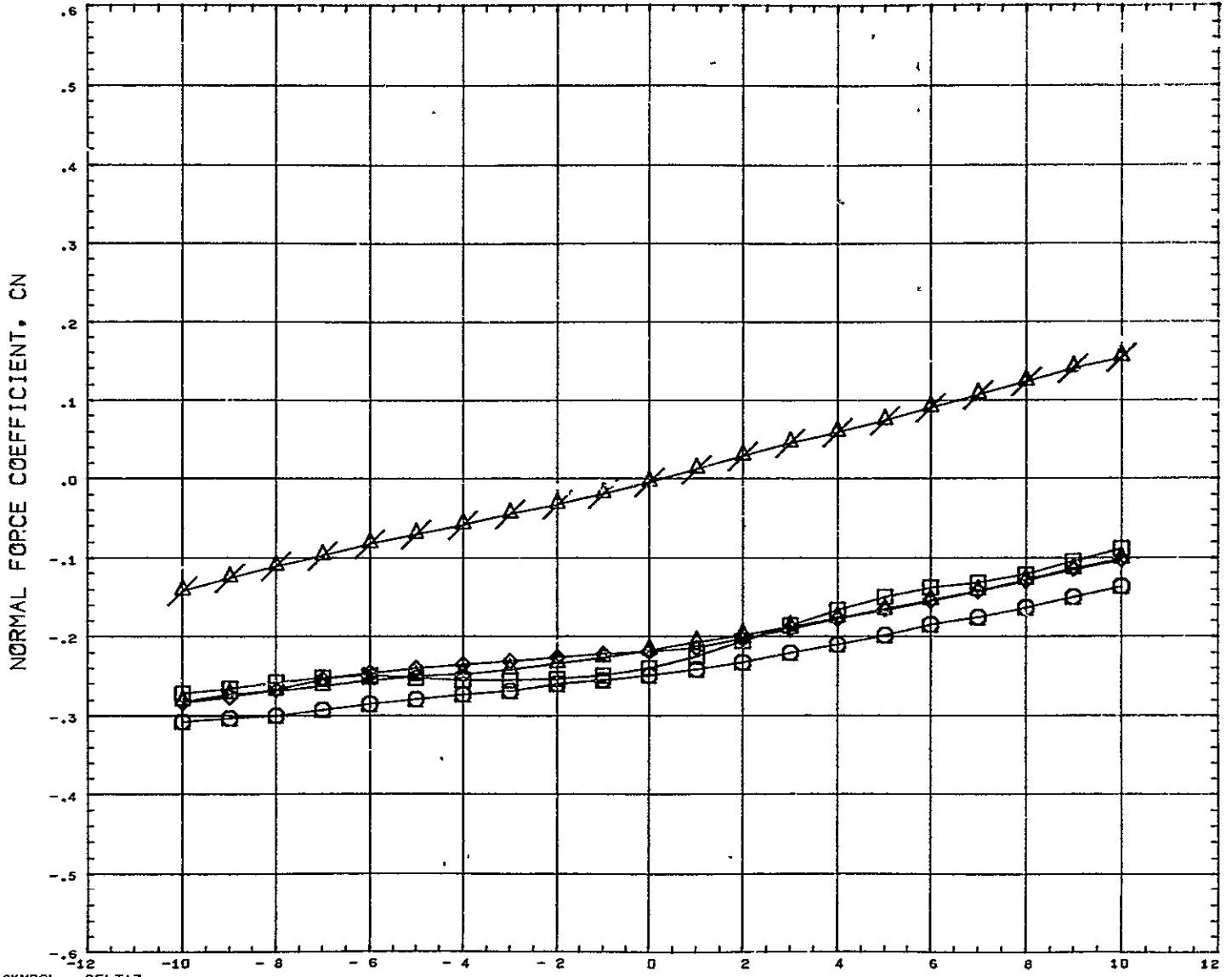

SYMBOL ○ △ ◇ □ △	DELTAX 0.120 0.151 0.182 0.228 10.000	PARAMETRIC VALUES BSTPOW 0.000 ORBPOW 100.000 DELTAX 0.351 ALPHAI 0.000 MACH 5.010 ELVBST 0.000 ELVORB 0.000 BETA 0.000	REFERENCE INFORMATION REFS 44 4440 SQ IN REFL 13.3330 IN REFB 13.3330 IN XMRP 7.5280 IN YMRP 0.0000 IN ZMRP 1.1940 IN SCALE 0 0055
---------------------------------	--	---	---

1 . REFERENCE FILE



# AEDC VA 1163 MDAC BOOSTER AND ORBITER TEST DATA AT MACH NUMBER 5

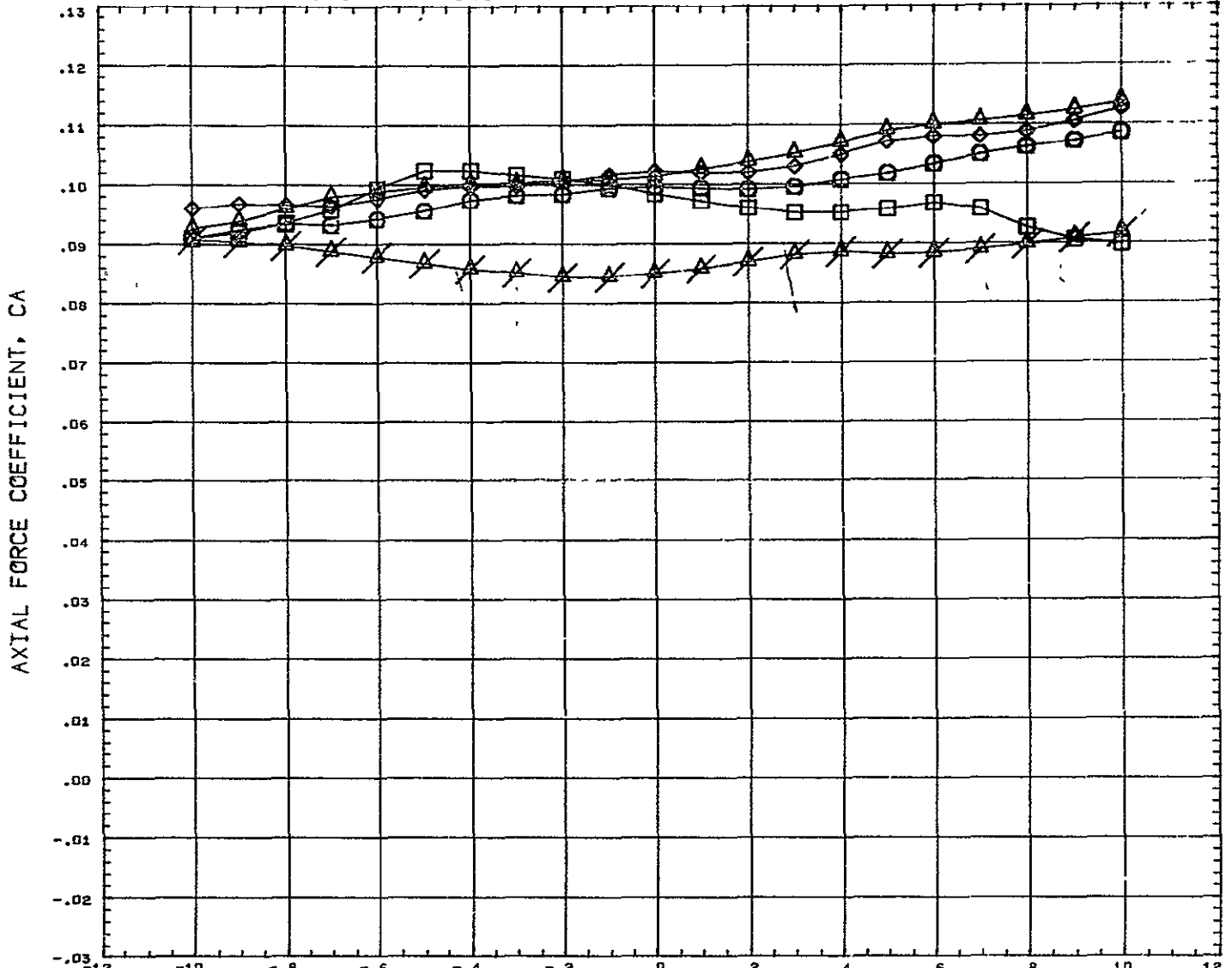

SYMBOL ◇ ◊ □ △ ×	DELTAZ 0.120 0.151 0.182 0.228 10.000	PARAMETRIC VALUES BSTPOW 0.000 ORBPOW 100.000 DELTAX 0.351 ALPHAI 0.000 MACH 5.010 ELVBST 0.000 ELVORB 0.000 BETA 0.000	REFERENCE INFORMATION REFS 44.4440 SQ IN REFL 13.3330 IN REFB 13.3330 IN XMRP 7.5280 IN YHRP 0.0000 IN ZHRP 1.1940 IN SCALE 0.0055
REFERENCE FILE			

# AEDC VA 1163 MDAC BOOSTER AND ORBITER TEST DATA AT MACH NUMBER 5

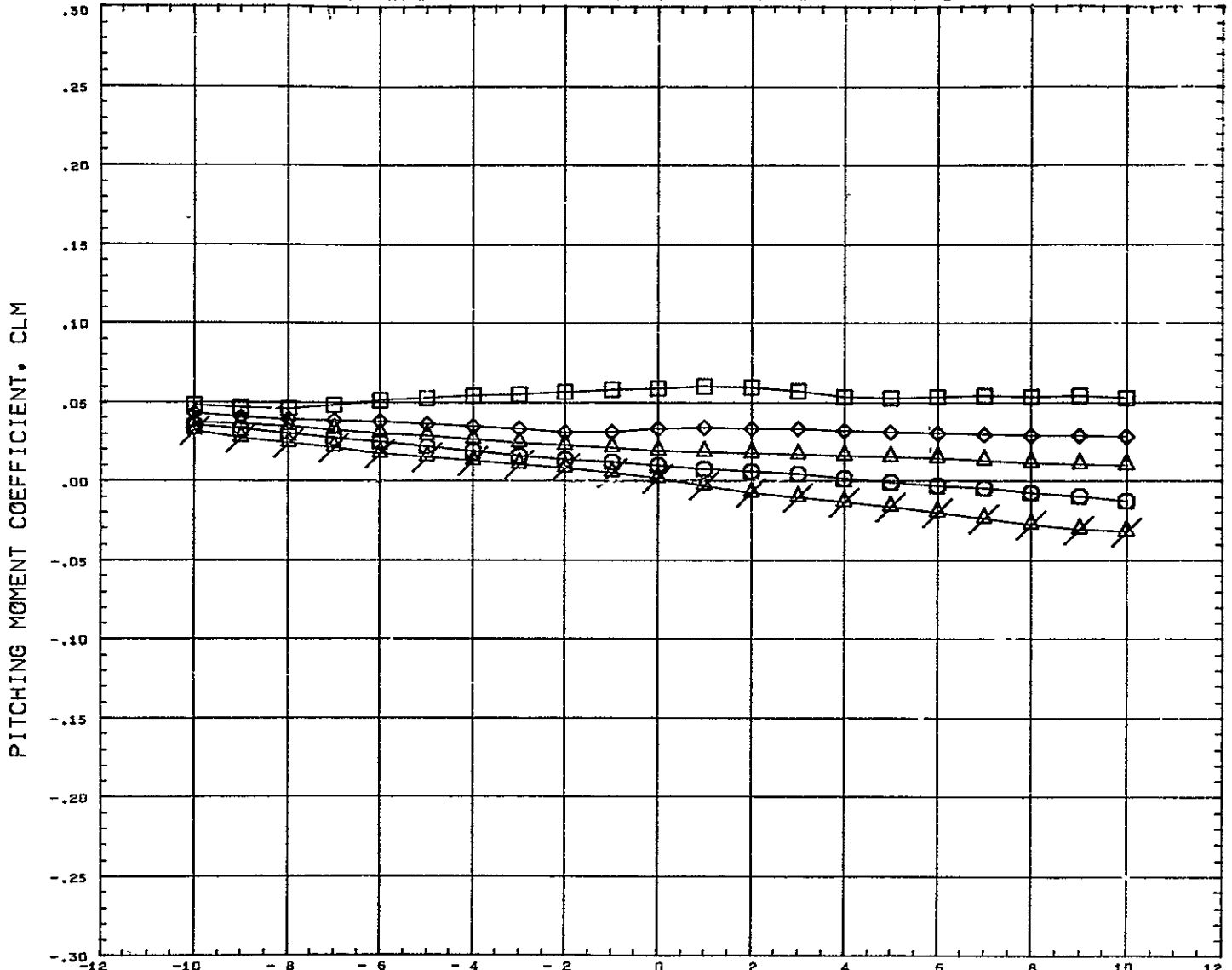

SYMBOL 	DELTAZ 0.120 0.151 0.182 0.228 10.000	PARAMETRIC VALUES BSTFOW 0.000 ORBFOV 100.000 DELTAX 0.522 ALPHAI 0.000 MACH 5.010 ELVBST 0.000 ELVORB 0.000 BETA 0.000	REFERENCE INFORMATION REFS 44.4440 SQ IN REFL 13.3330 IN REFB 13.3330 IN XMRF 7.5280 IN YMRF 0.0060 IN ZMRF 1.1940 IN SCALE 0.0055
------------	--	---	---

REFERENCE FILE

# AEDC VA 1163 MDAC BOOSTER AND ORBITER TEST DATA AT MACH NUMBER 5

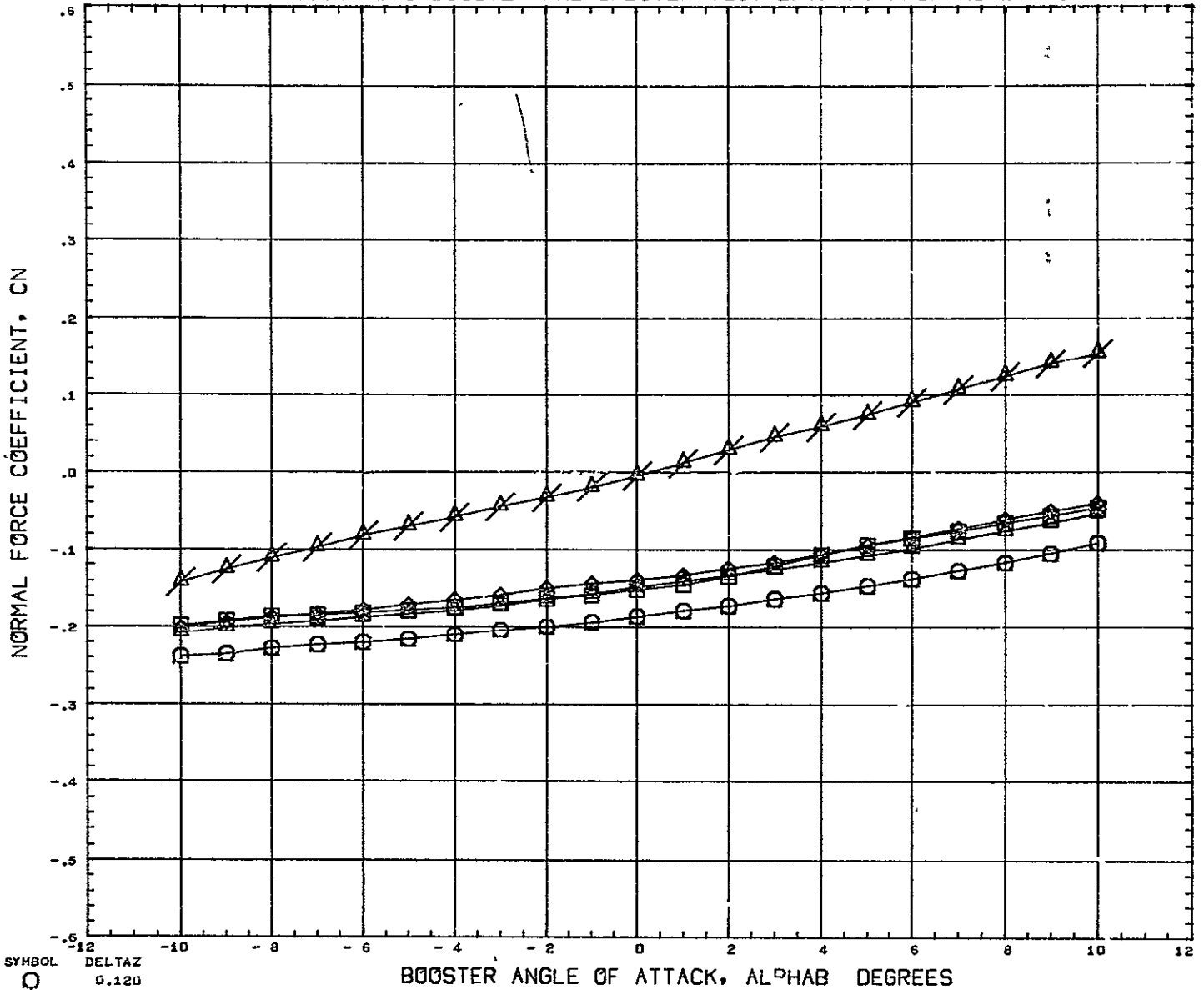

SYMBOL ○ ◊ □ △ ×	DELTA Z 0.120 0.151 0.182 0.228 10.000	PARAMETRIC VALUES BSTPOW 0.000 ORBPOW 100.000 ELTAX 0.522 ALFHAI 0.000 MACH 5.010 ELVBST 0.000 ELVORB 0.000 BETA 0.000	REFERENCE INFORMATION REFS 44.4440 SQ IN REFL 13.3330 IN REFB 13.3330 IN XMRP 7.5280 IN YMRP 0.0000 IN ZMRP 1.1940 IN SCALE 0.0055
---------------------------------	---	--	---

REFERENCE FILE

# AEDC VA 1163 MDAC BOOSTER AND ORBITER TEST DATA AT MACH NUMBER 5

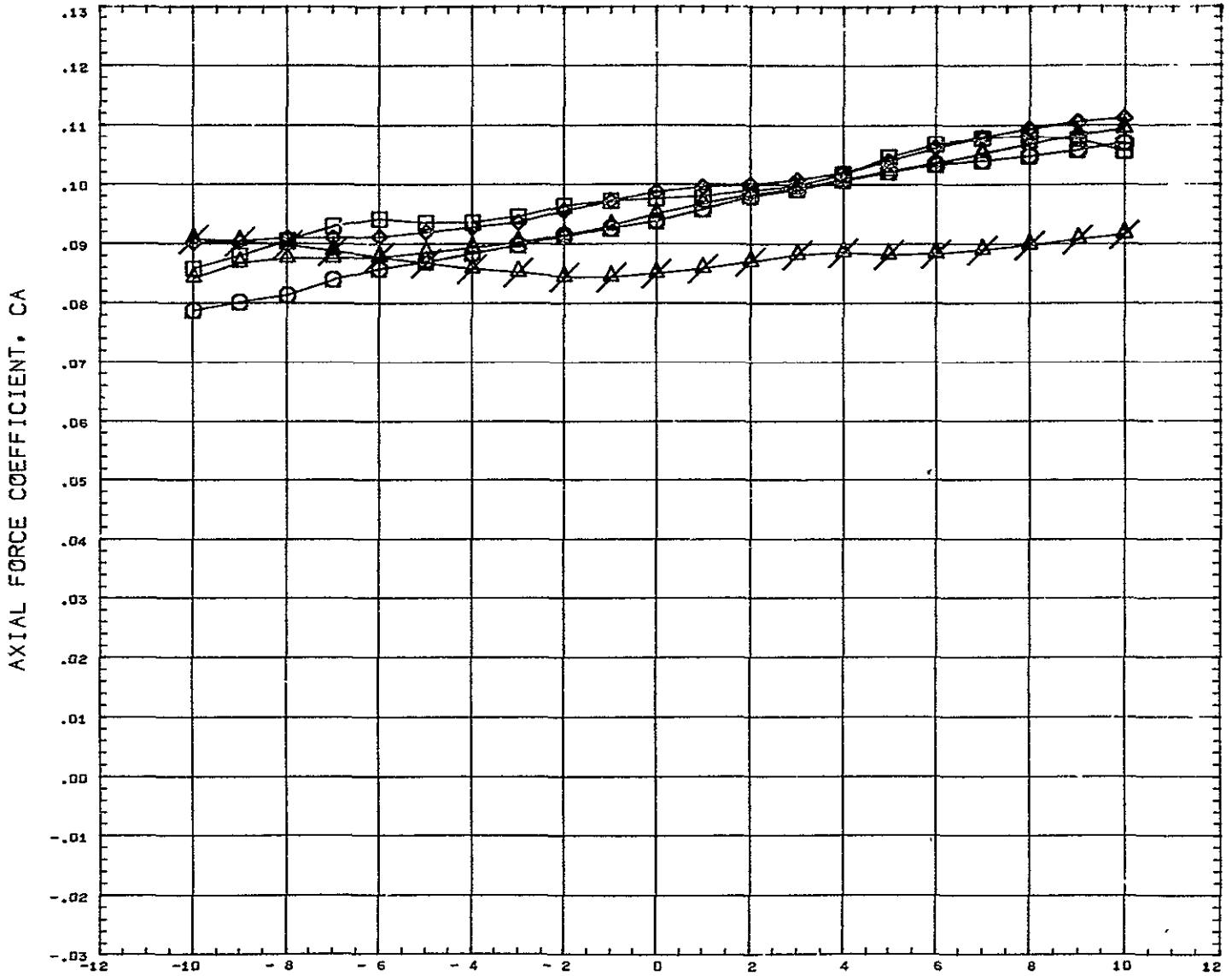

SYMBOL 	DELTAX 0.120 0.151 0.182 0.228 10.000	<b>PARAMETRIC VALUES</b> BSTPOW    0.000    ORBPOW    100.000 DELTAX    0.522    ALPHAI    0.000 MACH      5.010    ELVBST    0.000 ELVORB    0.000    BETA      0.000	<b>REFERENCE INFORMATION</b> REFS      44.4440    SQ IN REFL      13.3330    IN REFB      13.3330    IN XMRP      7.5200    IN YMRP      0.0000    IN ZMRP      1.1940    IN SCALE     0.0055
REFERENCE FILE			

# AEDC VA 1163 MDAC BOOSTER AND ORBITER TEST DATA AT MACH NUMBER 5

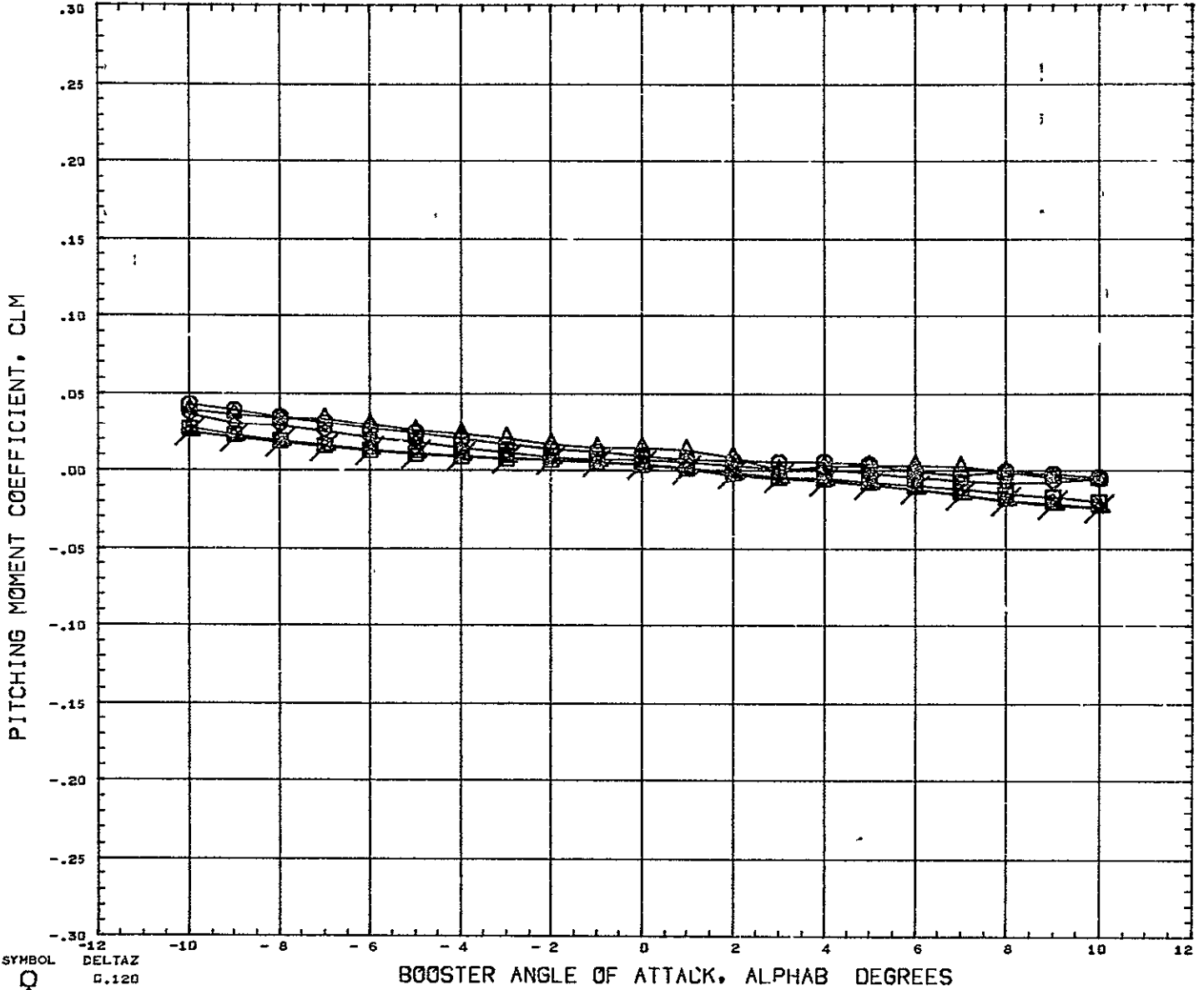

SYMBOL	DELTAZ	PARAMETRIC VALUES				REFERENCE INFORMATION	
○	0.120					REFS	44.4440 SQ IN
◇	0.151	BSTFOW	50.000	ORBPOW	50.000	REFL	13.3330 IN
□	0.182	DELTAZ	- 0.391	ALPHA1	0.000	REFB	13.3330 IN
△	0.228	MACH	5.010	ELYBST	0.000	XMRP	7.5280 IN
▽	0.352	ELVORB	0.000	BETA	0.000	YMRP	0.0500 IN
	10.000					ZMRP	1.1940 IN
						SCALE	0.0055

REFERENCE FILE

# AEDC VA 1163 MDAC BOOSTER AND ORBITER TEST DATA AT MACH NUMBER 5

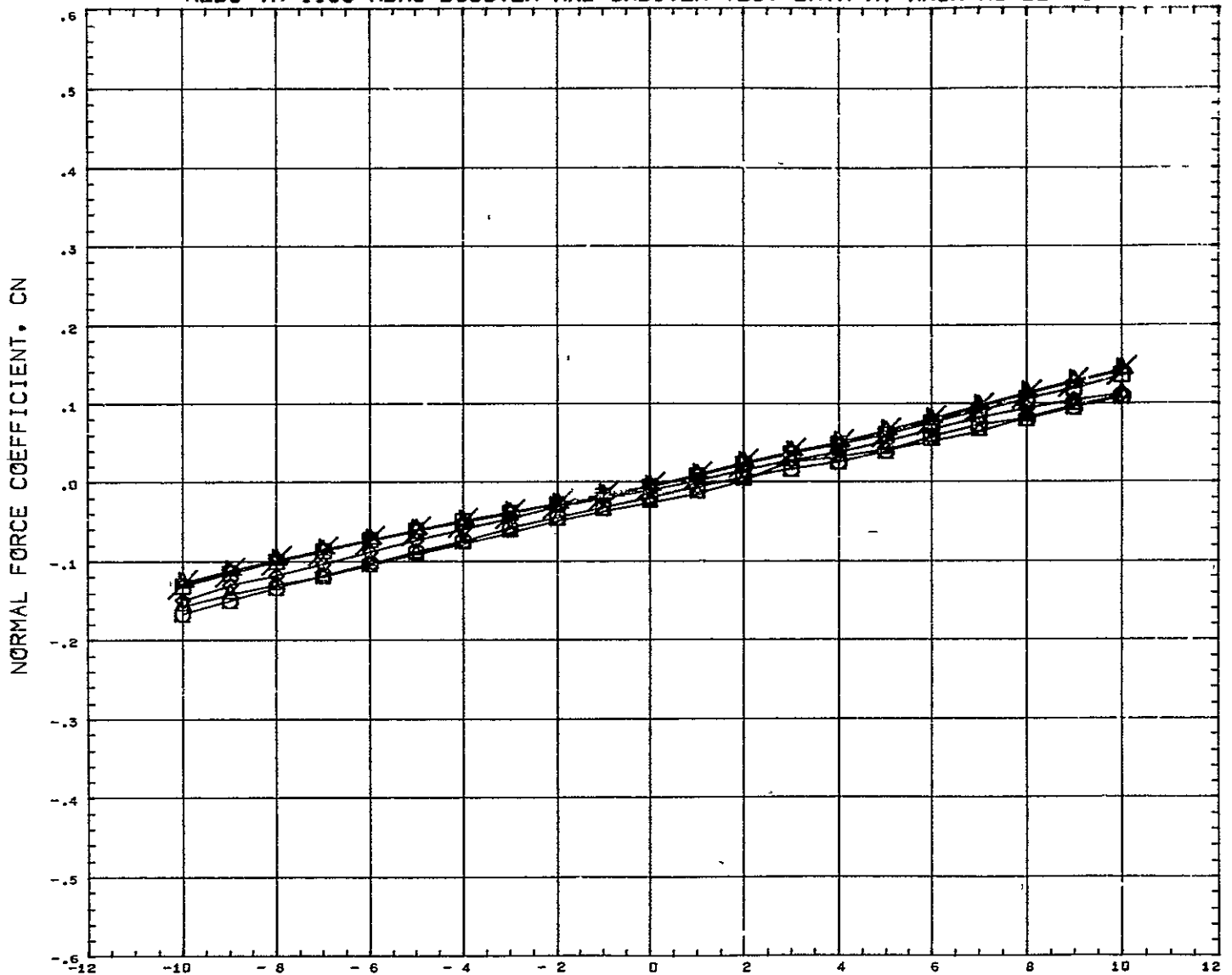

SYMBOL	DELTAZ	PARAMETRIC VALUES				REFERENCE INFORMATION		
○	0.120	BSTPOW	50.000	ORBPOW	50.000	REFS	2.4440	SQ IN
△	0.151	DELTAZ	0.391	ALPHA1	0.000	REFL	13.3330	IN
◇	0.182	1ACH	5.010	ELVBST	0.000	REFB	13.3330	IN
□	0.228	ELVORB	0.000	BETA	0.000	XMRP	7.5280	IN
▽	0.352					YMRP	0.0050	IN
▲	10.000					ZMRP	1.1940	IN
						SCALE	0.0055	

REFERENCE FILE

# AEDC VA 1163 MDAC BOOSTER AND ORBITER TEST DATA AT MACH NUMBER 5

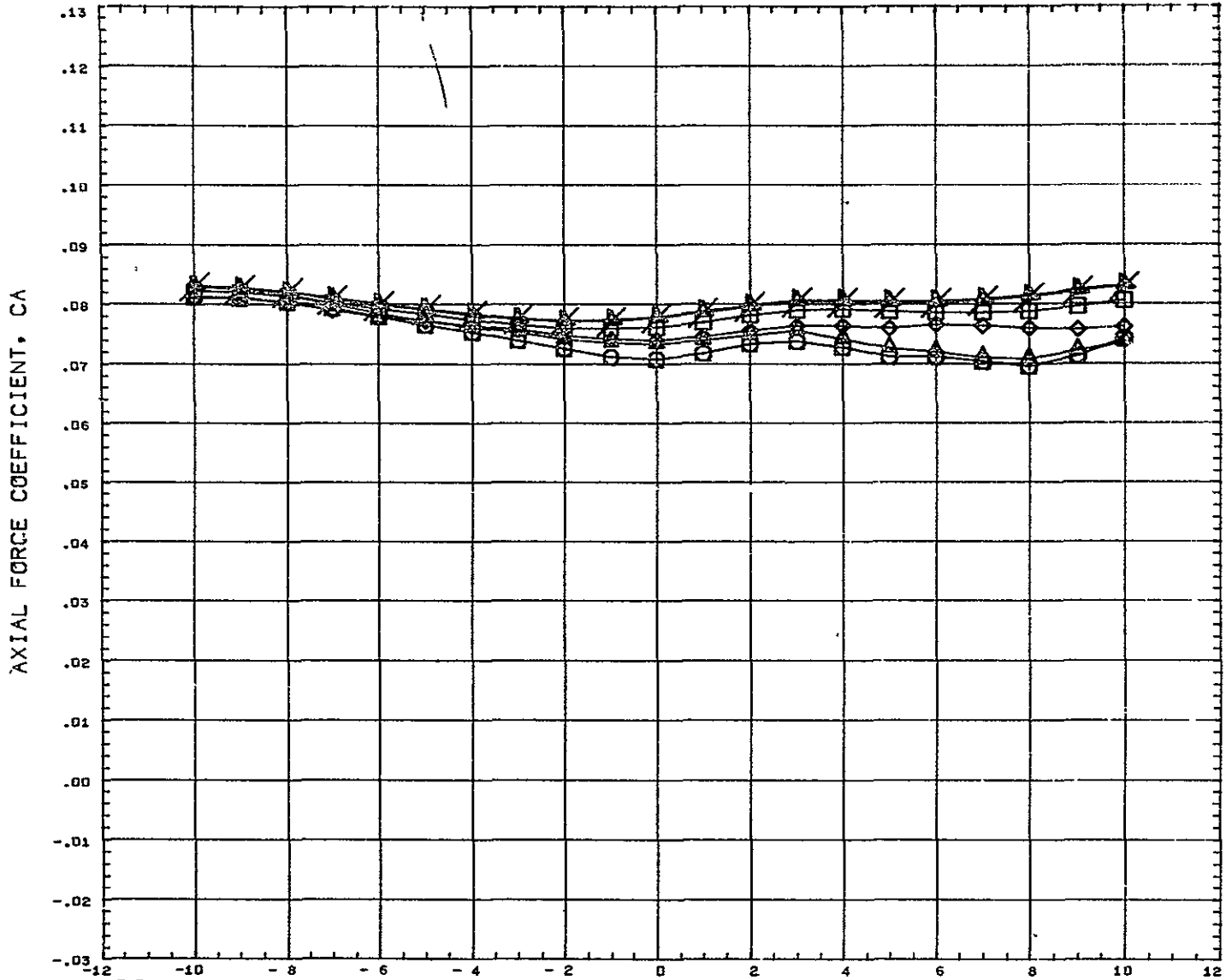

SYMBOL	DELTA Z	PARAMETRIC VALUES				REFERENCE INFORMATION		
○	0.120					REFS	44.4440	50 IN
◇	0.151					REFL	13.3330	IN
□	0.182	BSTFCW	50.000	ORBPOW	50.000	REFB	13.3330	IN
△	0.228	DELTA X	- 0.391	ALPHA I	0.000	XMRP	7.5280	IN
▽	0.352	MACH	5.010	ELVBST	0.000	YMRP	0.0690	IN
×	10.000	ELVORB	0.000	BETA	0.000	ZMRP	1.1940	IN
						SCALE	0.0055	

REFERENCE FILE

# AEDC VA 1163 MDAC BOOSTER AND ORBITER TEST DATA AT MACH NUMBER 5

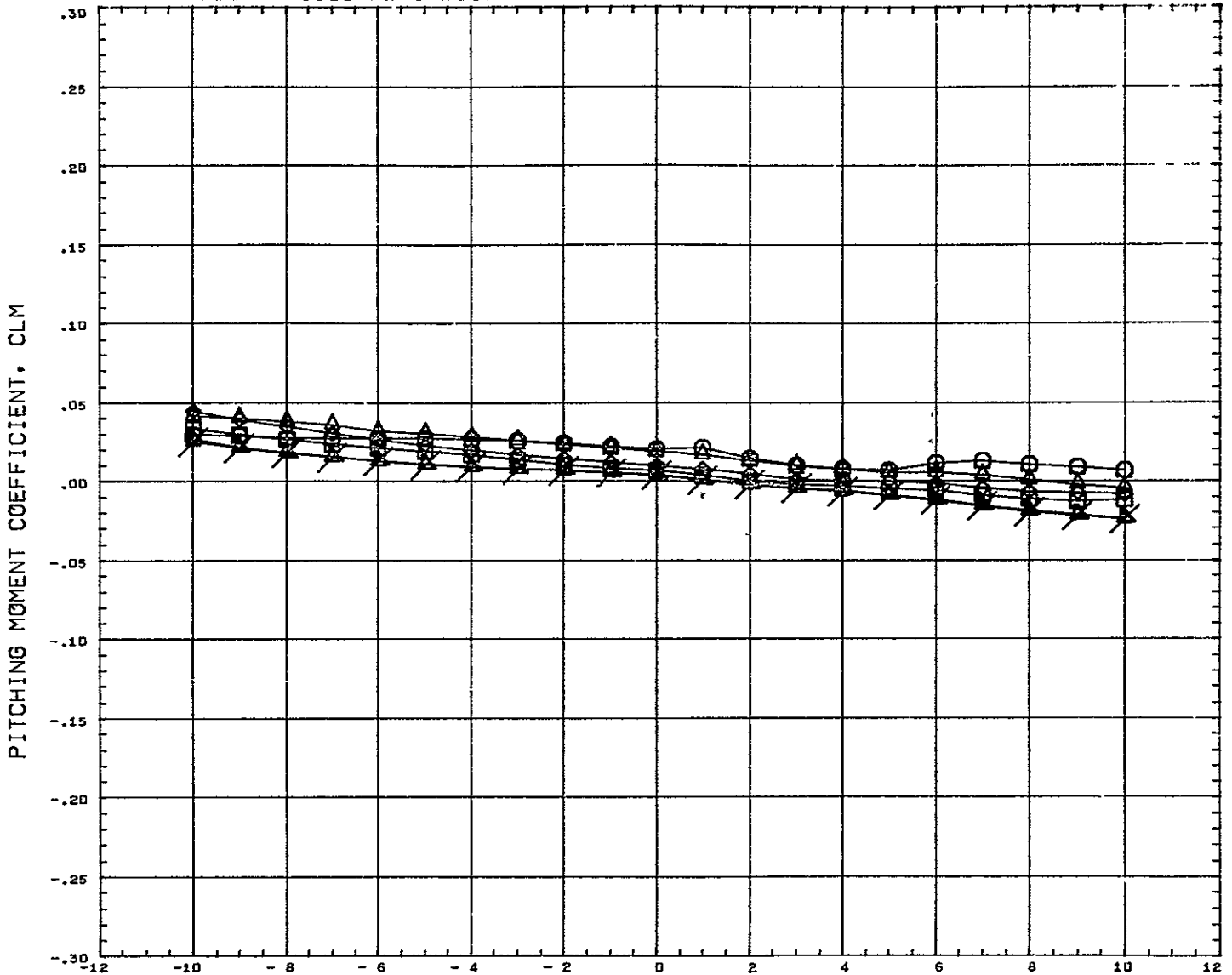

SYMBOL ○ ◇ □ △	DELTAZ 0.120 0.151 0.182 0.228 0.352 10.000	<b>PARAMETRIC VALUES</b> BSTPOW 50.000 ORBPOW 50.000 DELTAX - 0.143 ALPHAI 0.000 MACH 5.010 ELVBST 0.000 ELVORB 0.000 BETA 0.000	<b>REFERENCE INFORMATION</b> REFS 44.4440 SQ IN REFL 13.3330 IN REFB 13.3330 IN XMRP 7.5280 IN YMRP 0.0000 IN ZMRP 1.1940 IN SCALE 0.0055
----------------------------	---	--	--

REFERENCE FILE



# AEDC VA 1163 MDAC BOOSTER AND ORBITER TEST DATA AT MACH NUMBER 5

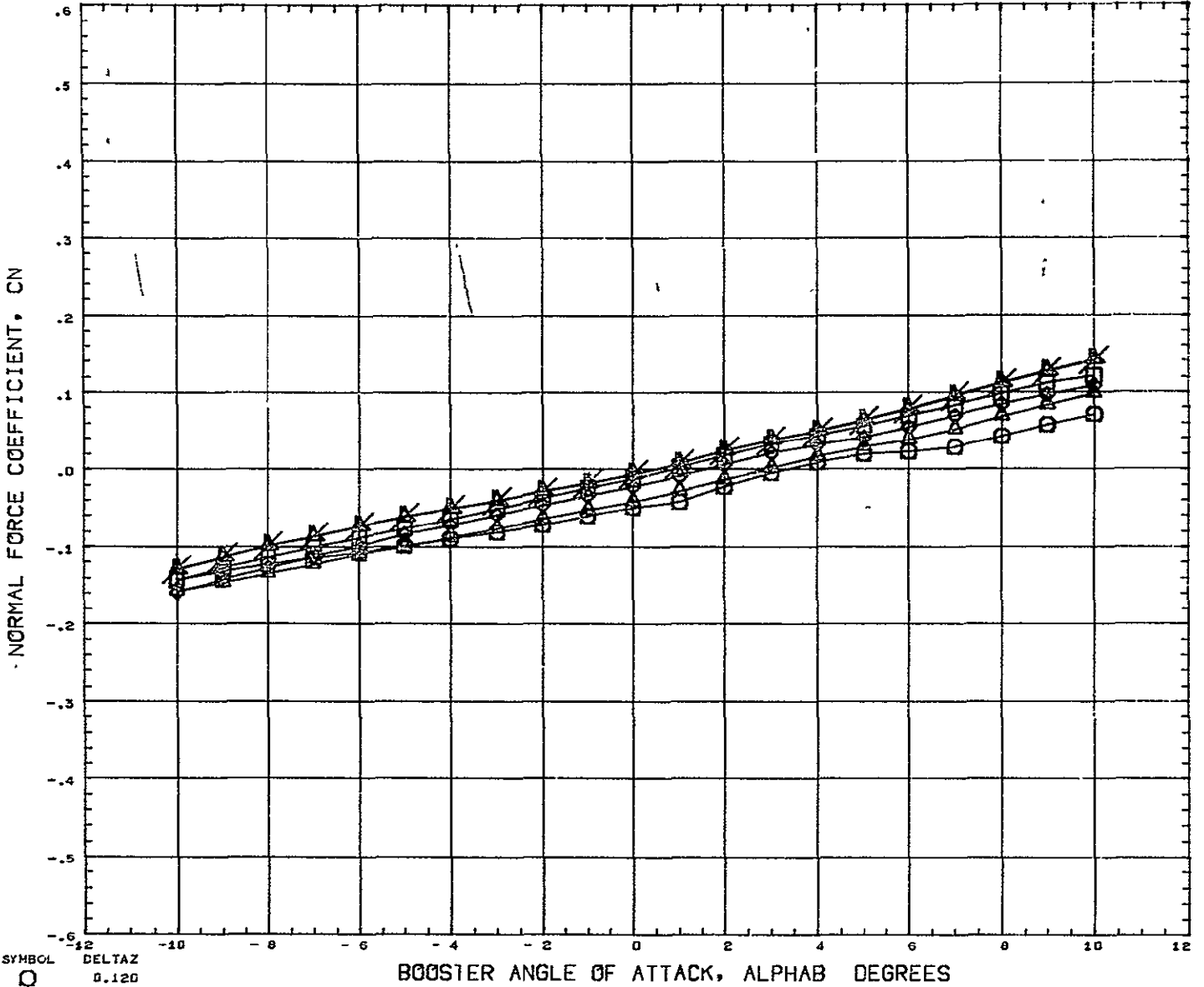

SYMBOL ○ ◇ □ △	DELTAX 0.120 0.151 0.182 0.228 0.352 10.000	PARAMETRIC VALUES BSTPOW 50.000 ORBPOW 50.000 DELTAX - 0.143 ALPHAI 0.000 MACH 5.010 ELVBST 0.000 ELVORB 0.000 BETA 0.000	REFERENCE INFORMATION REFS 44.4440 SQ IN REFL 13.3330 IN REFB 13.3330 IN XMRP 7.5280 IN YMRP 0.0000 IN ZMRP 1.1940 IN SCALE 0.0055
----------------------------	---	---	---

REFERENCE FILE

# AEDC VA 1163 MDAC BOOSTER AND ORBITER TEST DATA AT MACH NUMBER 5

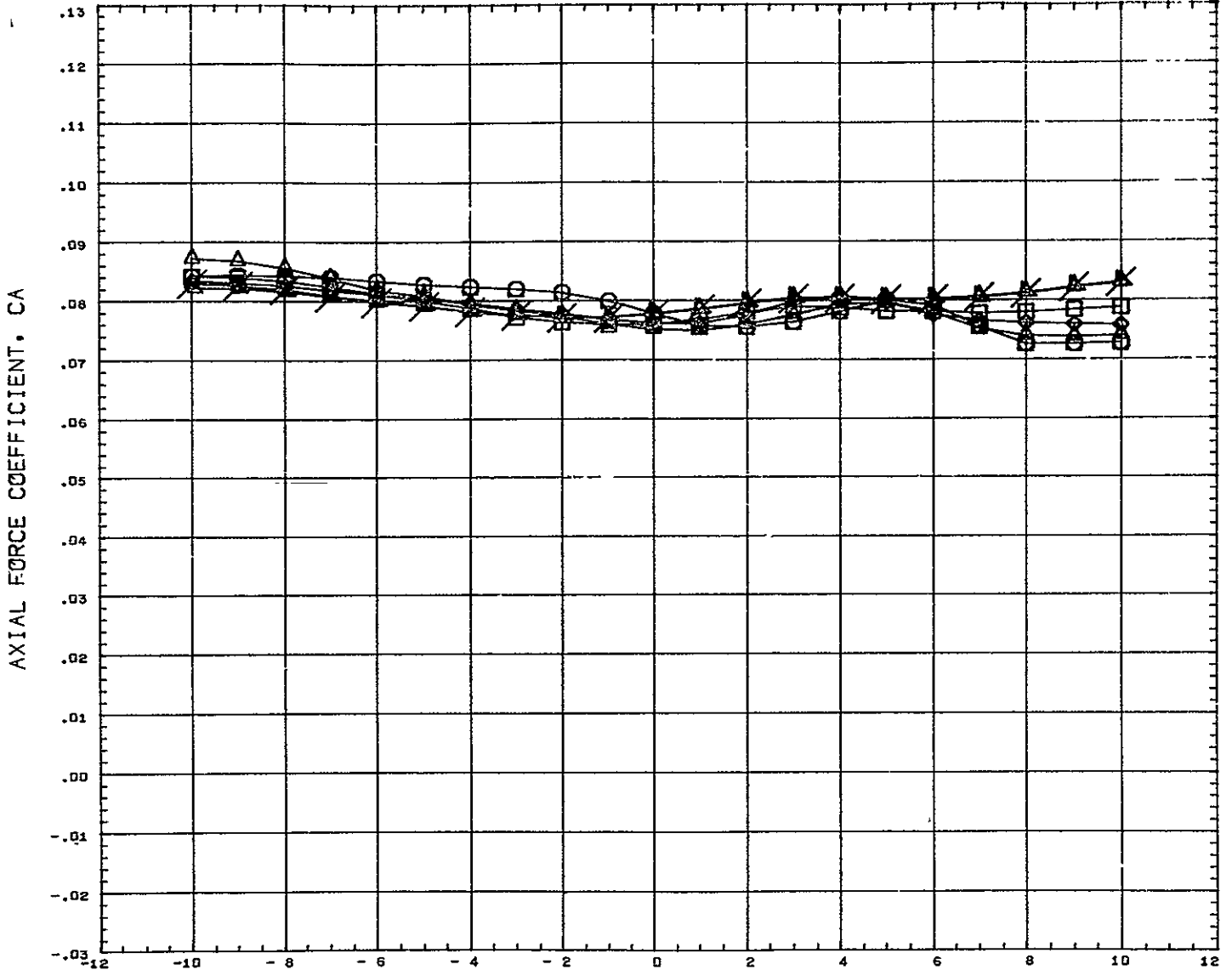

SYMBOL ○ □ △ ◇ ▲	DELTAZ 0.120 0.151 0.182 0.228 0.352 10.000	<b>PARAMETRIC VALUES</b> BSTPOW 50.000 ORBPOW 50.000 ELTAX - 0.143 ALPHA1 0.000 MACH 5.010 ELVBST 0.000 ELVORB 0.000 BETA 0.000	<b>REFERENCE INFORMATION</b> REFS 44.4440 SQ IN REFL 13.3330 IN REPB 13.3330 IN XMRP 7.5280 IN YMRP 0.0000 IN ZMRP 1.1940 IN SCALE 0.0055
---------------------------------	---	---	--

REFERENCE FILE

# AEDC VA 1163 MDAC BOOSTER AND ORBITER TEST DATA AT MACH NUMBER 5

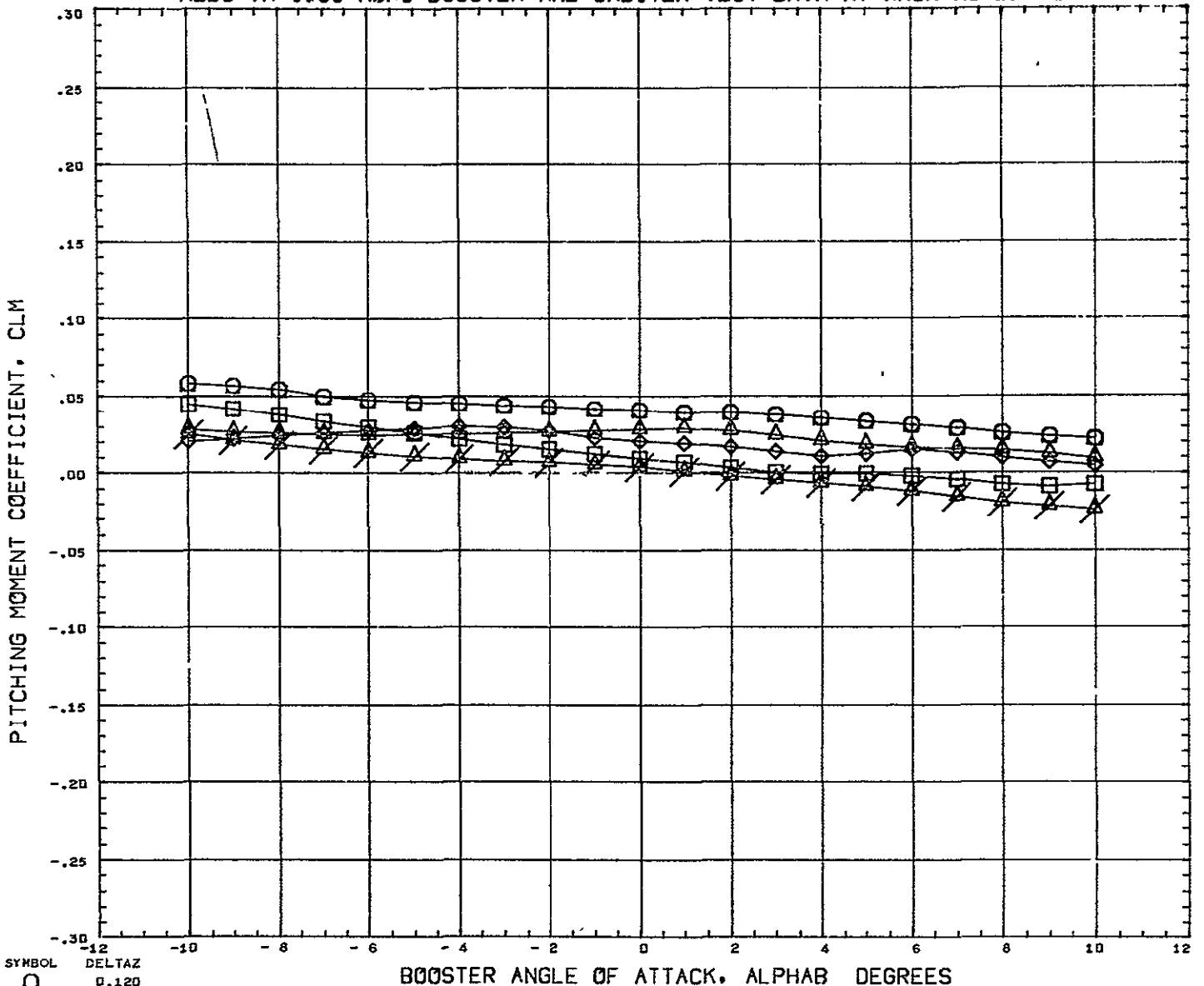

SYMBOL ○ ◇ △ □ ×	DELTAZ 0.120 0.151 0.182 0.228 10.000	<table border="0" style="width: 100%;"> <tr> <th colspan="4" style="text-align: center;">PARAMETRIC VALUES</th> </tr> <tr> <td>BSTPOW</td> <td>50.000</td> <td>ORBPOW</td> <td>50.000</td> </tr> <tr> <td>DELTAZ</td> <td>- 0.019</td> <td>ALPHA1</td> <td>0.000</td> </tr> <tr> <td>MACH</td> <td>5.010</td> <td>FLVBST</td> <td>0.000</td> </tr> <tr> <td>ELVORB</td> <td>0.000</td> <td>BETA</td> <td>0.000</td> </tr> </table>	PARAMETRIC VALUES				BSTPOW	50.000	ORBPOW	50.000	DELTAZ	- 0.019	ALPHA1	0.000	MACH	5.010	FLVBST	0.000	ELVORB	0.000	BETA	0.000	<table border="0" style="width: 100%;"> <tr> <th colspan="3" style="text-align: center;">REFERENCE INFORMATION</th> </tr> <tr> <td>REFS</td> <td>44.4440</td> <td>SQ IN</td> </tr> <tr> <td>REFL</td> <td>13.3330</td> <td>IN</td> </tr> <tr> <td>REFB</td> <td>13.3330</td> <td>IN</td> </tr> <tr> <td>XMRP</td> <td>7.5280</td> <td>IN</td> </tr> <tr> <td>YMRP</td> <td>0.0000</td> <td>IN</td> </tr> <tr> <td>ZMRP</td> <td>1.1940</td> <td>IN</td> </tr> <tr> <td>SCALE</td> <td>0.0055</td> <td></td> </tr> </table>	REFERENCE INFORMATION			REFS	44.4440	SQ IN	REFL	13.3330	IN	REFB	13.3330	IN	XMRP	7.5280	IN	YMRP	0.0000	IN	ZMRP	1.1940	IN	SCALE	0.0055	
PARAMETRIC VALUES																																															
BSTPOW	50.000	ORBPOW	50.000																																												
DELTAZ	- 0.019	ALPHA1	0.000																																												
MACH	5.010	FLVBST	0.000																																												
ELVORB	0.000	BETA	0.000																																												
REFERENCE INFORMATION																																															
REFS	44.4440	SQ IN																																													
REFL	13.3330	IN																																													
REFB	13.3330	IN																																													
XMRP	7.5280	IN																																													
YMRP	0.0000	IN																																													
ZMRP	1.1940	IN																																													
SCALE	0.0055																																														

REFERENCE FILE

# AEDC VA-1163 MDAC BOOSTER AND ORBITER TEST DATA AT MACH NUMBER 5

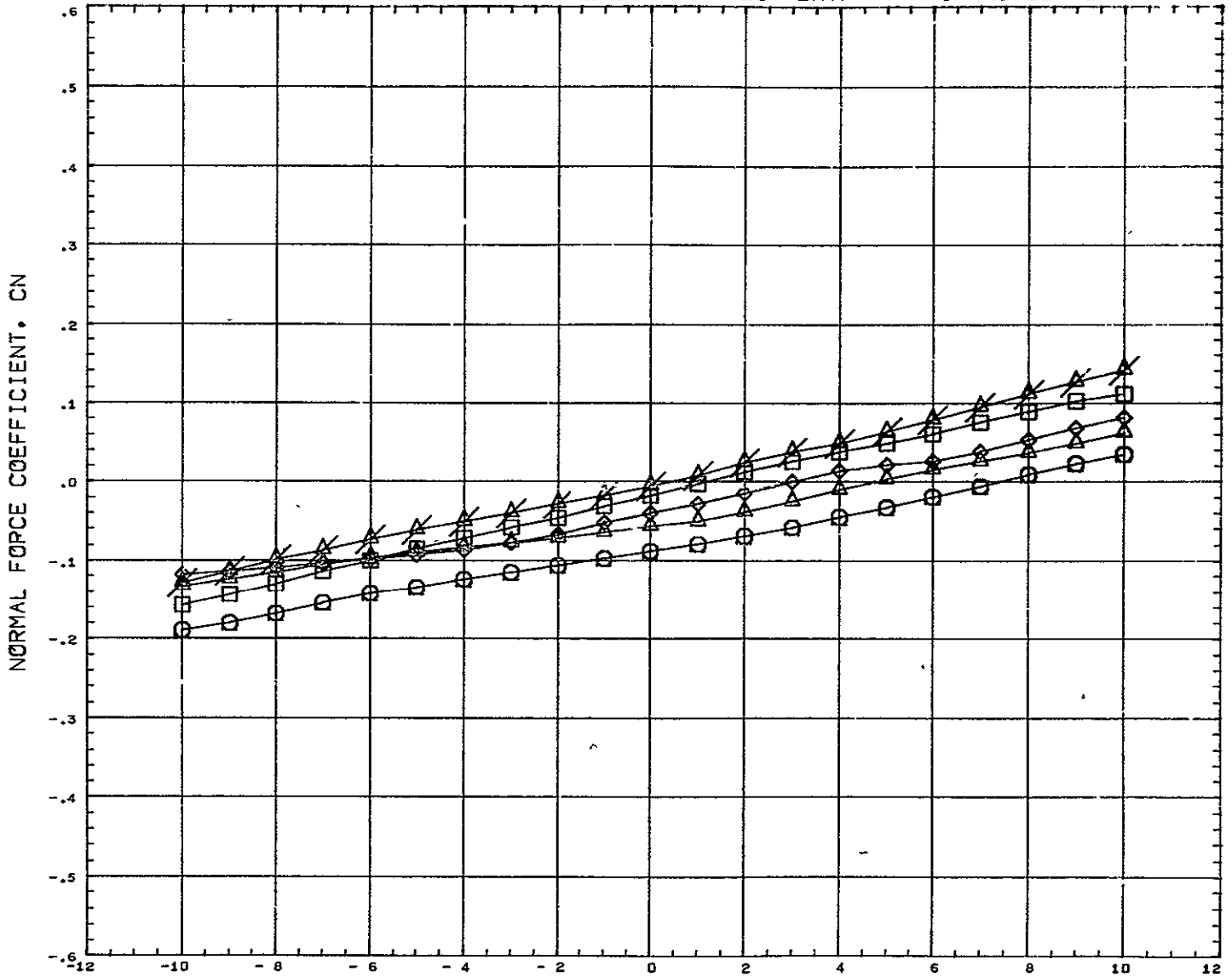

SYMBOL ○ △ ◇ □ ×	DELTAZ 0.120 0.151 0.182 0.228 10.000	PARAMETRIC VALUES BSTPOW 50.000    ORBPOW 50.000 DELTAX - 0.019    ALPHAI 0.000 MACH 5.010    ELVBST 0.000 ELVORB 0.000    BETA 0.000	REFERENCE INFORMATION REFS 44.4440    SQ IN REFL 13.3335    IN REFB 13.3330    IN XMRP 7.5280    IN YMRP 0.0000    IN ZMRP 1.1940    IN SCALE 0.0055
REFERENCE FILE AEDC VA-1163 MDAC BOOSTER IN PROXIMITY TO ORBITER (RT8109)		11 JUN 71 PAGE 326	

# AEDC VA 1163 MDAC BOOSTER AND ORBITER TEST DATA AT MACH NUMBER 5

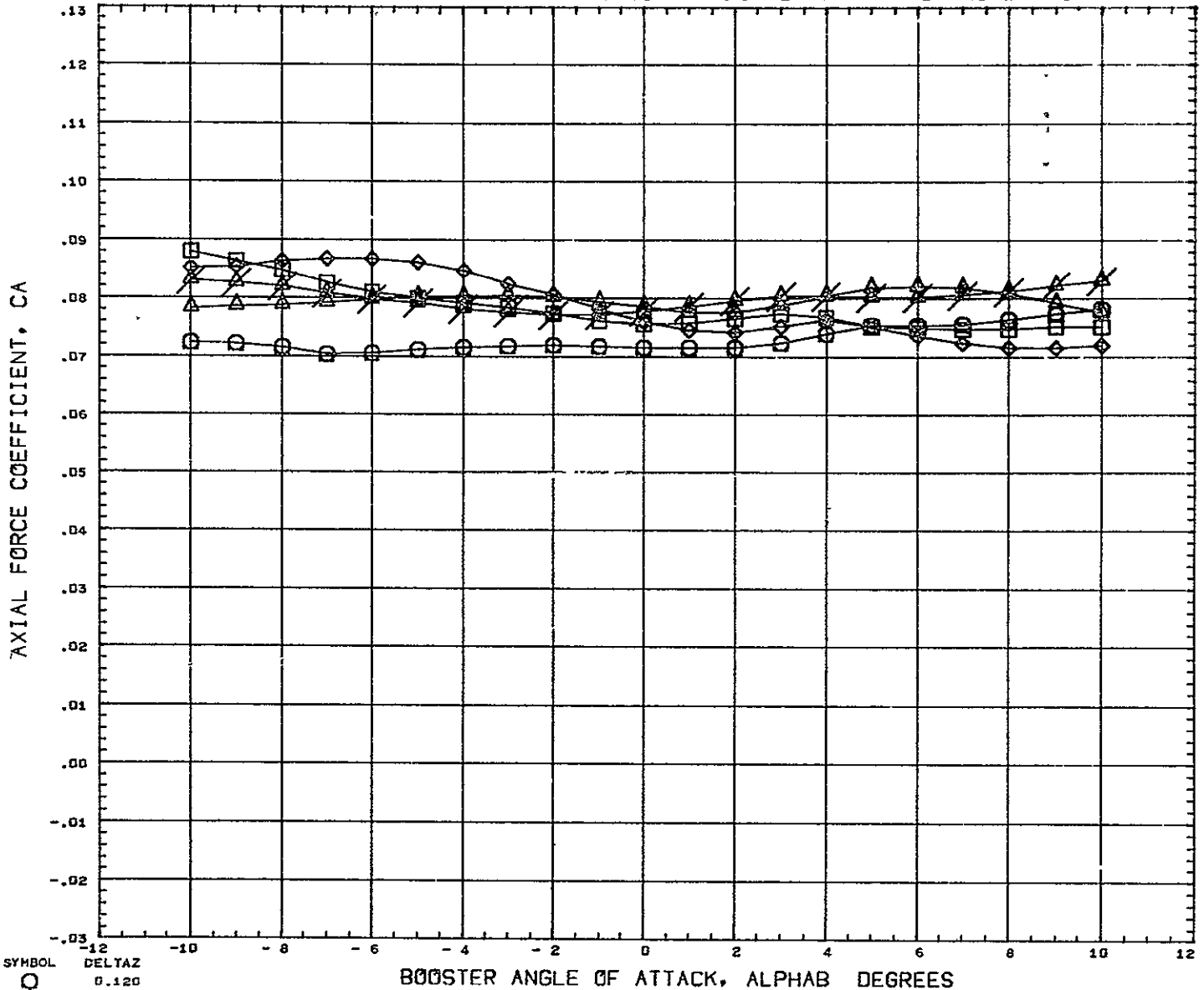

SYMBOL ○ ◇ □ △	DELTAZ 0.120 0.151 0.192 0.228 10.000	PARAMETRIC VALUES BSTPOW 50.000 ORBPOW 50.000 DELTAX - 0.019 ALPHAI 0.000 MACH 5.010 ELVBST 0.000 ELVORB 0.000 BETA 0.000	REFERENCE INFORMATION REFS 44.4440 SQ IN REFL 13.3330 IN REFB 13.3330 IN XHRF 7.5280 IN YHRF 0.0000 IN ZHRF 1.1940 IN SCALE 0.0055
----------------------------	--	---	---

REFERENCE FILE

# AEDC VA 1163 MDAC BOOSTER AND ORBITER TEST DATA AT MACH NUMBER 5

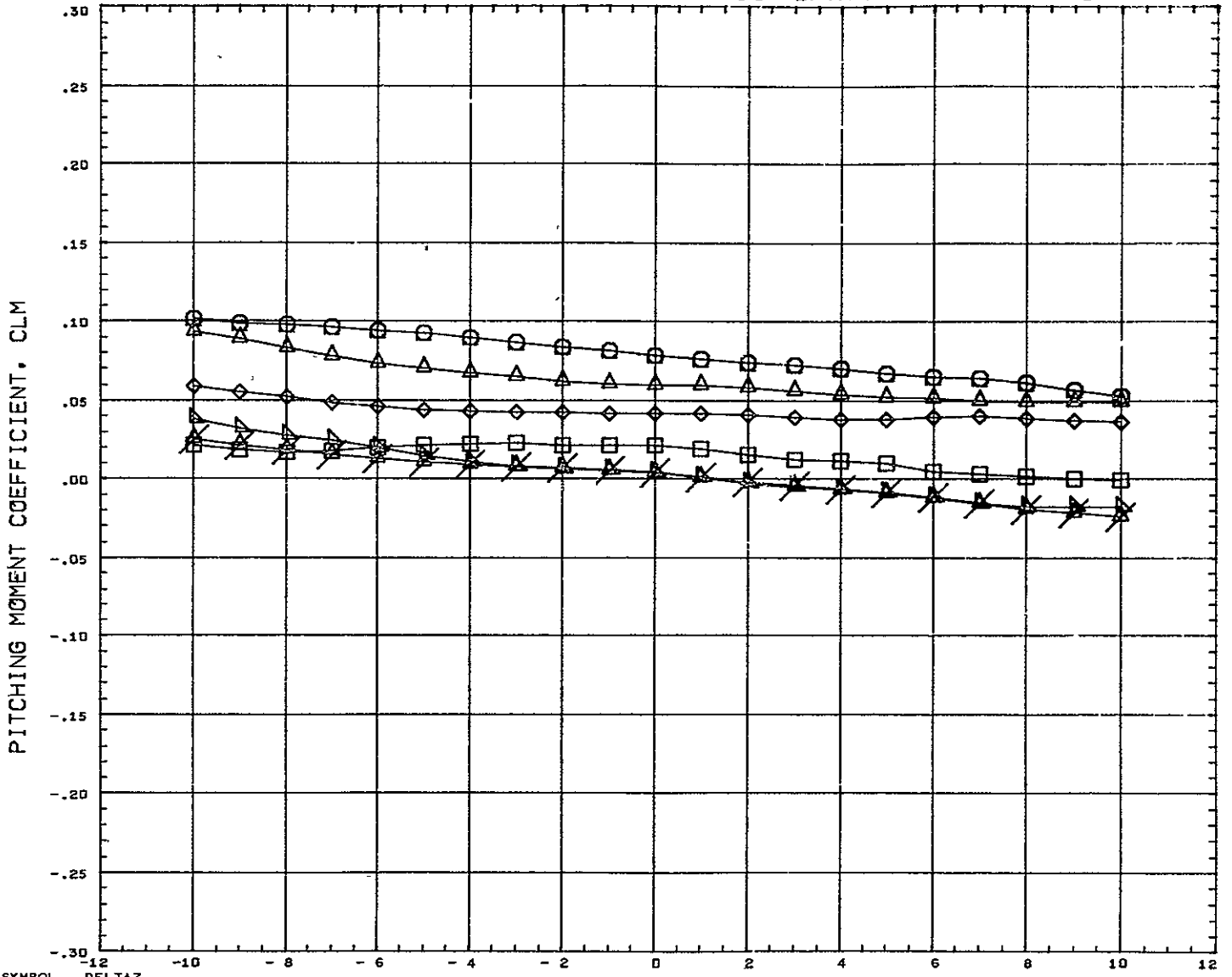

SYMBOL ○ ◇ △ □ ×	DELTA Z 0.120 0.151 0.182 0.226 0.352 10.000	<table border="0" style="width: 100%;"> <tr> <th colspan="4" style="text-align: center;">PARAMETRIC VALUES</th> </tr> <tr> <td>BSTPOW</td> <td>50.000</td> <td>ORBPOW</td> <td>50.000</td> </tr> <tr> <td>DELTA X</td> <td>0.104</td> <td>ALPHA I</td> <td>0.000</td> </tr> <tr> <td>MACH</td> <td>5.010</td> <td>ELVBST</td> <td>0.000</td> </tr> <tr> <td>ELVORB</td> <td>0.000</td> <td>BETA</td> <td>0.000</td> </tr> </table>	PARAMETRIC VALUES				BSTPOW	50.000	ORBPOW	50.000	DELTA X	0.104	ALPHA I	0.000	MACH	5.010	ELVBST	0.000	ELVORB	0.000	BETA	0.000	<table border="0" style="width: 100%;"> <tr> <th colspan="3" style="text-align: center;">REFERENCE INFORMATION</th> </tr> <tr> <td>REFS</td> <td>44 4440</td> <td>SQ IN</td> </tr> <tr> <td>REFL</td> <td>13 3330</td> <td>IN</td> </tr> <tr> <td>REFB</td> <td>13 3330</td> <td>IN</td> </tr> <tr> <td>XMRP</td> <td>7.5280</td> <td>IN</td> </tr> <tr> <td>YMRP</td> <td>0.0000</td> <td>IN</td> </tr> <tr> <td>ZMRP</td> <td>1.1940</td> <td>IN</td> </tr> <tr> <td>SCALE</td> <td>0.0055</td> <td></td> </tr> </table>	REFERENCE INFORMATION			REFS	44 4440	SQ IN	REFL	13 3330	IN	REFB	13 3330	IN	XMRP	7.5280	IN	YMRP	0.0000	IN	ZMRP	1.1940	IN	SCALE	0.0055	
PARAMETRIC VALUES																																															
BSTPOW	50.000	ORBPOW	50.000																																												
DELTA X	0.104	ALPHA I	0.000																																												
MACH	5.010	ELVBST	0.000																																												
ELVORB	0.000	BETA	0.000																																												
REFERENCE INFORMATION																																															
REFS	44 4440	SQ IN																																													
REFL	13 3330	IN																																													
REFB	13 3330	IN																																													
XMRP	7.5280	IN																																													
YMRP	0.0000	IN																																													
ZMRP	1.1940	IN																																													
SCALE	0.0055																																														

1.1 REFERENCE FILE

# AEDC VA 1163 MDAC BOOSTER AND ORBITER TEST DATA AT MACH NUMBER 5

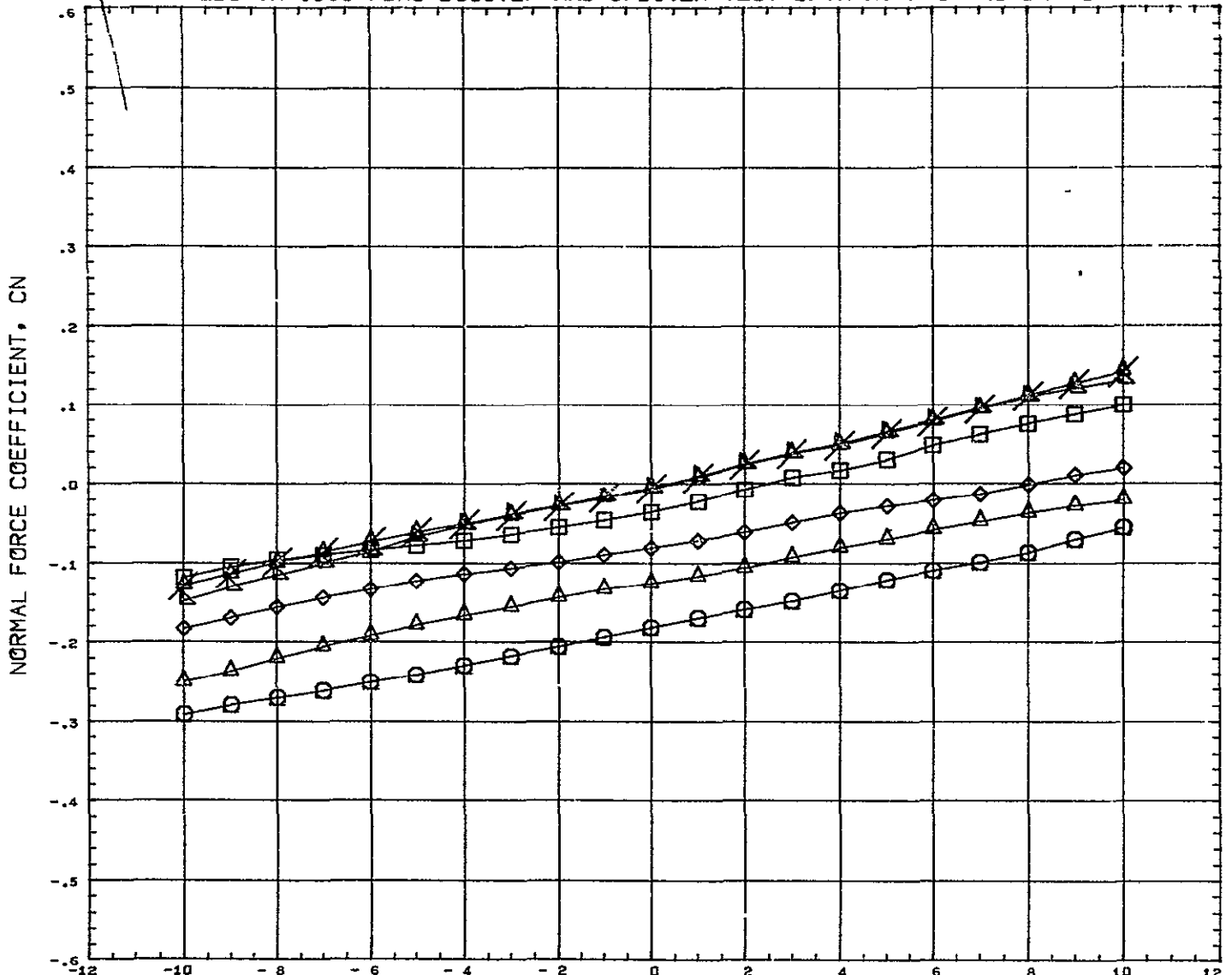

SYMBOL ○ ◇ △ □ ▽ ×	DELTA Z 0.120 0.151 0.182 0.228 0.352 10.000	PARAMETRIC VALUES BSTFOW 50.000 ORBPOW 50.000 DFLTAX 0.104 ALPHAI 0.000 MACH 5.010 ELVBST 0.000 ELVORB 0.000 BETA 0.000	REFERENCE INFORMATION REFS 44.4440 SQ IN REFL 13.3330 IN REFB 13.3330 IN XHRP 7.5280 IN YHRP 0.0000 IN ZHRP 1.1940 IN SCALE 0.0055
--------------------------------------	--	---	---

REFERENCE FILE

# AEDC VA 1163 MDAC BOOSTER AND ORBITER TEST DATA AT MACH NUMBER 5

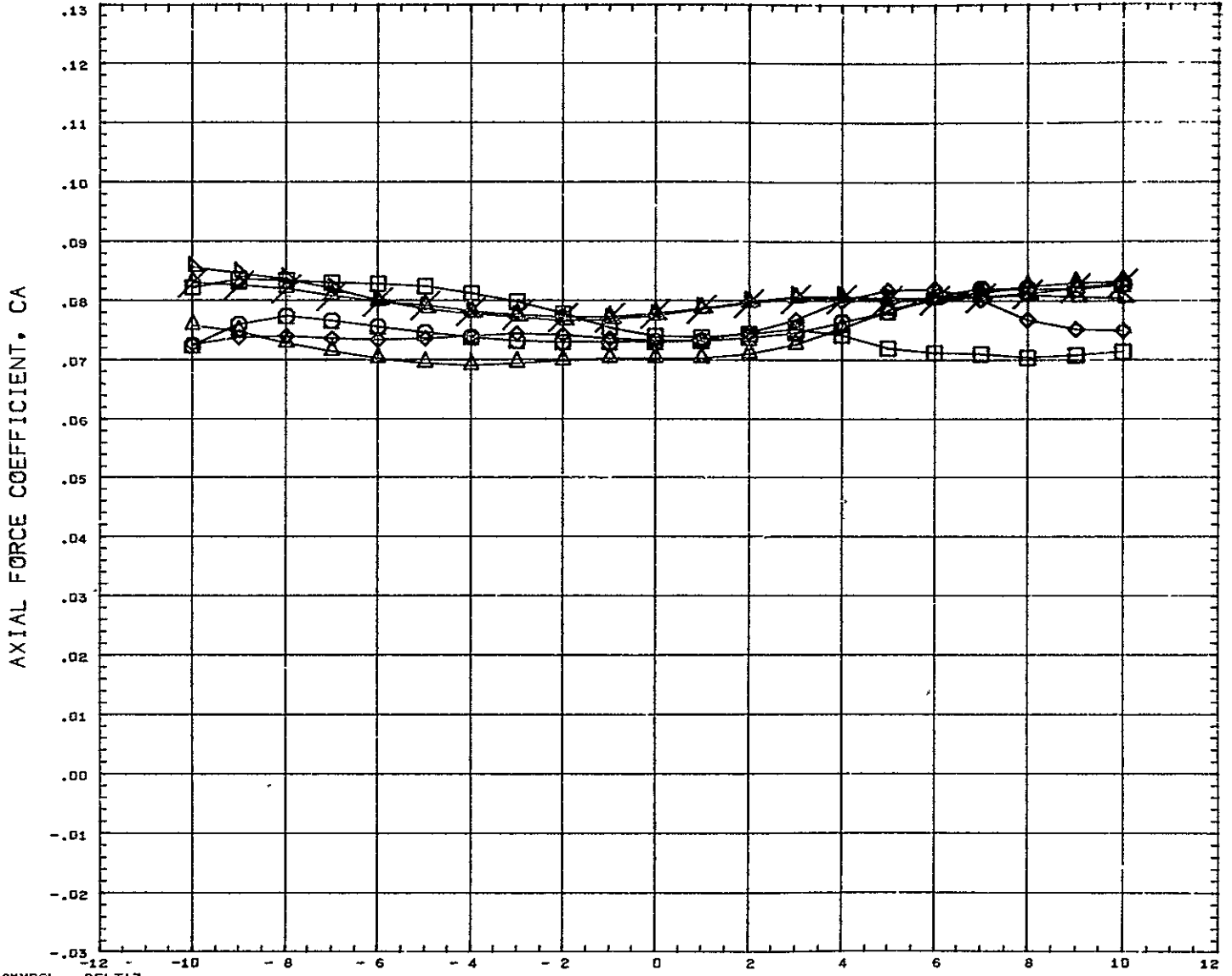

SYMBOL 	DELTA Z 0.126 0.151 0.182 0.228 0.352 10.000	<b>PARAMETRIC VALUES</b> BSTFOW 50.000 ORBFOV 50.000 ELTAX 0.104 ALPHAI 0.000 MACH 5.010 ELVBST 0.000 ELVORB 0.000 BETA 0.000	<b>REFERENCE INFORMATION</b> REFS 44.4440 SQ IN REFL 13.3330 IN REFB 13.3330 IN XMRP 7.5250 IN YMRP 0.0000 IN ZMRP 1.1940 IN SCALE 0.0055
------------	--	---	--

REFERENCE FILE



# AEDC VA 1163 MDAC BOOSTER AND ORBITER TEST DATA AT MACH NUMBER 5

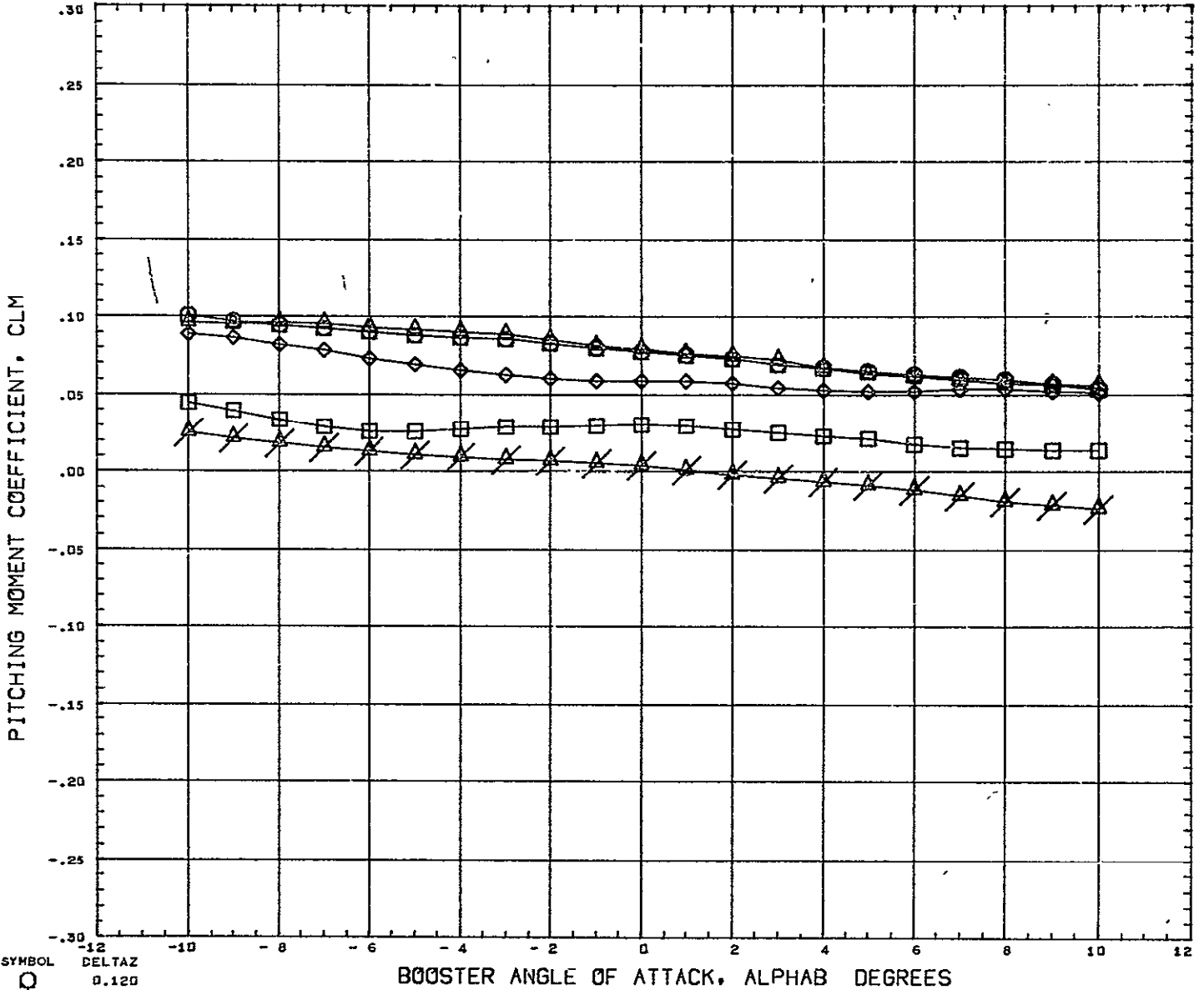

SYMBOL ○ ◇ □ △	DELTAZ 0.120 0.151 0.182 0.228 10.000	PARAMETRIC VALUES BSTPOW 50.000 ORBPOW 50.000 DELTAX 0.166 ALPHA1 0.000 MACH 5.010 ELVBST 0.000 ELVORB 0.000 BETA 0.000	REFERENCE INFORMATION REFS 44.4440 SQ IN REFL 13.3330 IN REFB 13.3330 IN XMRF 7.5280 IN YMRP 0.0000 IN ZMRP 1.1940 IN SCALE 0.0055
----------------------------	--	---	---

REFERENCE FILE

# AEDC VA 1163 MDAC BOOSTER AND ORBITER TEST DATA AT MACH NUMBER 5

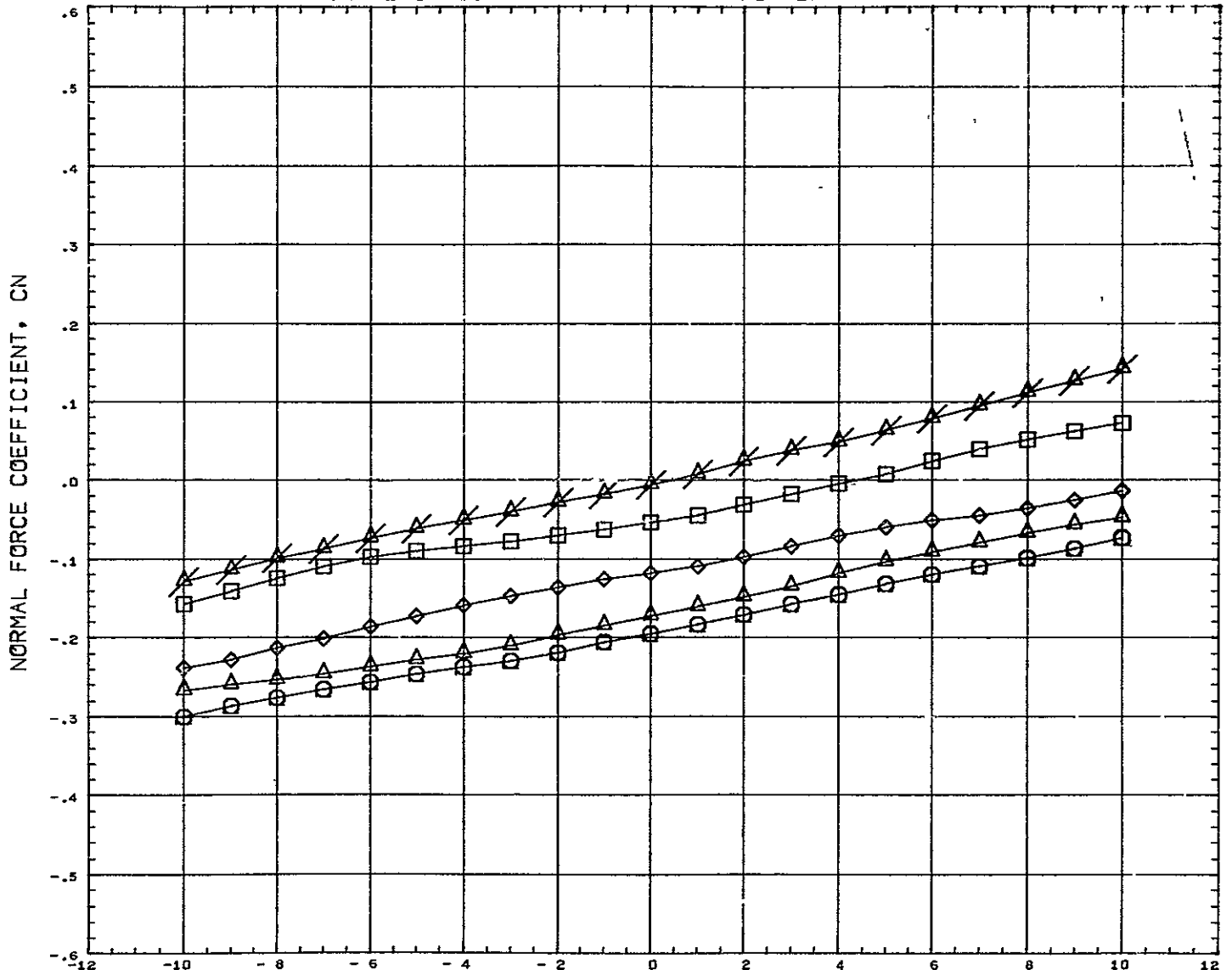

SYMBOL ○ △ ◇ □ ×	DELTA Z 0.120 0.151 0.182 0.228 10.000	PARAMETRIC VALUES BSTPOW 50.000 ORBPOW 50.000 DELTAX 0.166 ALPHAI 0.000 MACH 5.010 ELVBST 0.000 ELVORB 0.000 BETA 0.000	REFERENCE INFORMATION REFS 44.4445 SQ IN REFL 13.3330 IN REFB 13.3330 IN XMRF 7.5280 IN YMRF 0.0000 IN ZMRF 1.1940 IN SCALE 0.0055
---------------------------------	---	---	---

REFERENCE FILE

# AEDC VA 1163 MDAC BOOSTER AND ORBITER TEST DATA AT MACH NUMBER 5

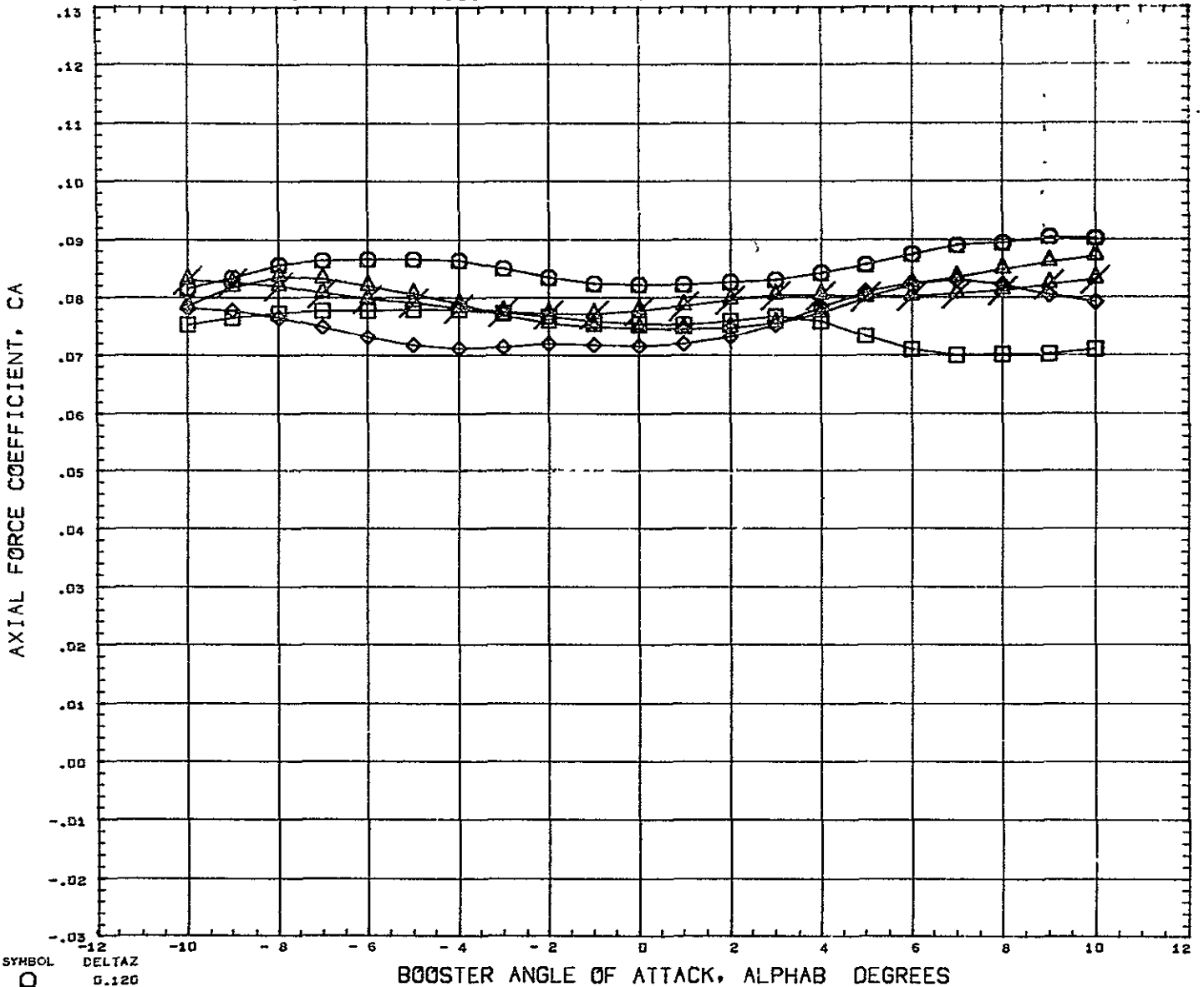

SYMBOL ○ □ △ ◇ ×	DELTAZ 0.120 0.151 0.182 0.228 10.000	PARAMETRIC VALUES BSTPOW 50.000 ORBPOW 50.000 DELTAX 0.166 ALPHAI 0.000 MACH 5.010 ELVBST 0.000 ELVORB 0.000 BETA 0.000	REFERENCE INFORMATION REFS 44.4449 SQ IN REFL 13.3330 IN REFB 13.3330 IN XMRP 7.5280 IN YMRP 0.0003 IN ZMRP 1.1940 IN SCALE 0.0055
---------------------------------	--	---	---

REFERENCE FILE

# AEDC VA 1163 MDAC BOOSTER AND ORBITER TEST DATA AT MACH NUMBER 5

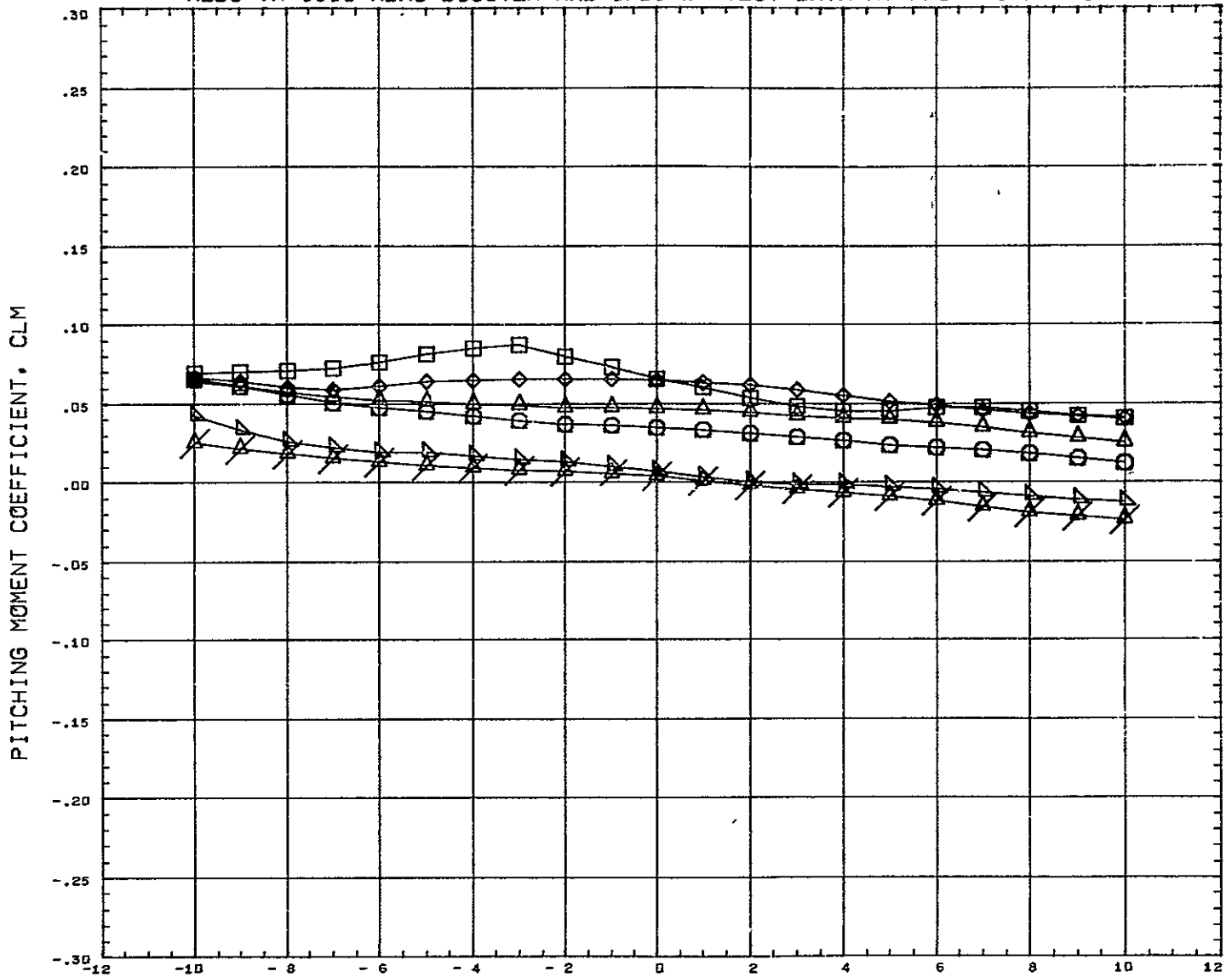

SYMBOL 	DELTAZ 0.120 0.151 0.182 0.228 0.352 10.000	<b>PARAMETRIC VALUES</b> BSTFOW 50.000 ORBPOW 50.000 DELTAX 0.351 ALPHAI 0.000 MACH 5.010 ELVBST 0.000 ELVORB 0.000 BETA 0.000	<b>REFERENCE INFORMATION</b> REFS 44.4440 SQ IN REFL 13.3330 IN REFB 13.3330 IN XMRP 7.5280 IN YMRP 0.0000 IN ZMRP 1.1940 IN SCALE 0.0055
------------	---	--	--

# AEDC VA 1163 MDAC BOOSTER AND ORBITER TEST DATA AT MACH NUMBER 5

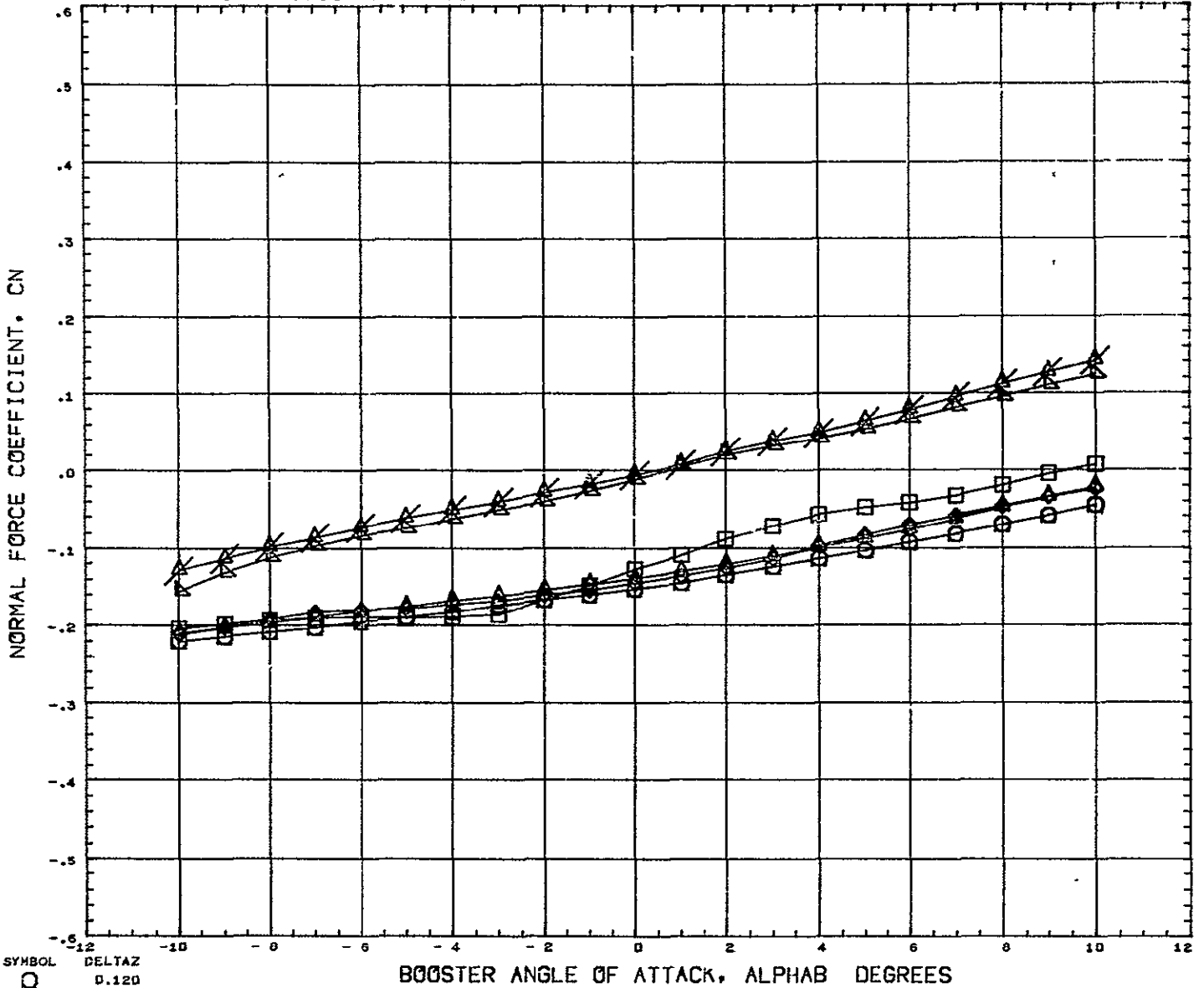

SYMBOL ○ ◊ △ □	DELTAZ 0.120 0.151 0.182 0.228 0.352 10.000	PARAMETRIC VALUES BSTPOW 50.000 ORBPOW 50.000 DFCTAX 0.351 ALPHAI 0.000 MACH 5.010 ELVBST 0.000 ELVORB 0.000 BETA 0.000	REFERENCE INFORMATION REFS 44.4440 SQ IN REFL 13.3330 IN REFB 13.3330 IN XMRP 7.5280 IN YMRP 0.0000 IN ZMRP 1.1940 IN SCALE 0.0055
----------------------------	---	---	---

REFERENCE FILE

# AEDC VA 1163 MDAC BOOSTER AND ORBITER TEST DATA AT MACH NUMBER 5

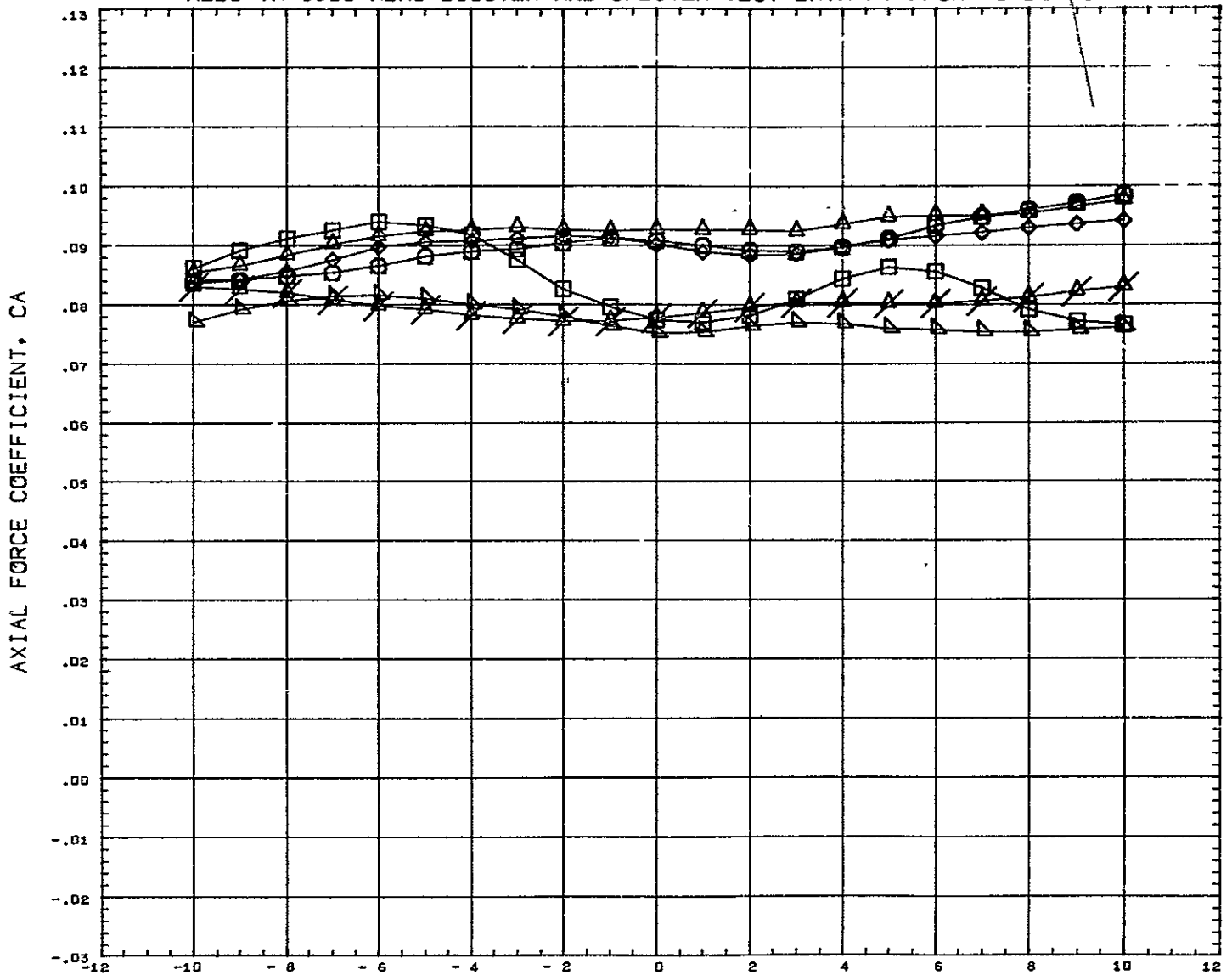

SYMBOL 	DELTAX 0.120 0.151 0.182 0.228 0.352 10.000	PARAMETRIC VALUES BSTPOW 50.000 DELTAX 0.351 MACH 5.010 ELVORB 0.000 ORBPOW 50.000 ALPHAI 0.000 ELVBST 0.000 BETA 0.000	REFERENCE INFORMATION PEFS 41.4440 SQ IN REFL 13.3333 IN REFB 13.3330 IN XMRP 7.5280 IN YMRP 0.0000 IN ZMRP 1.1940 IN SCALE 0.0055
------------	---	---	---

REFERENCE FILE

# AEDC VA 1163 MDAC BOOSTER AND ORBITER TEST DATA AT MACH NUMBER 5

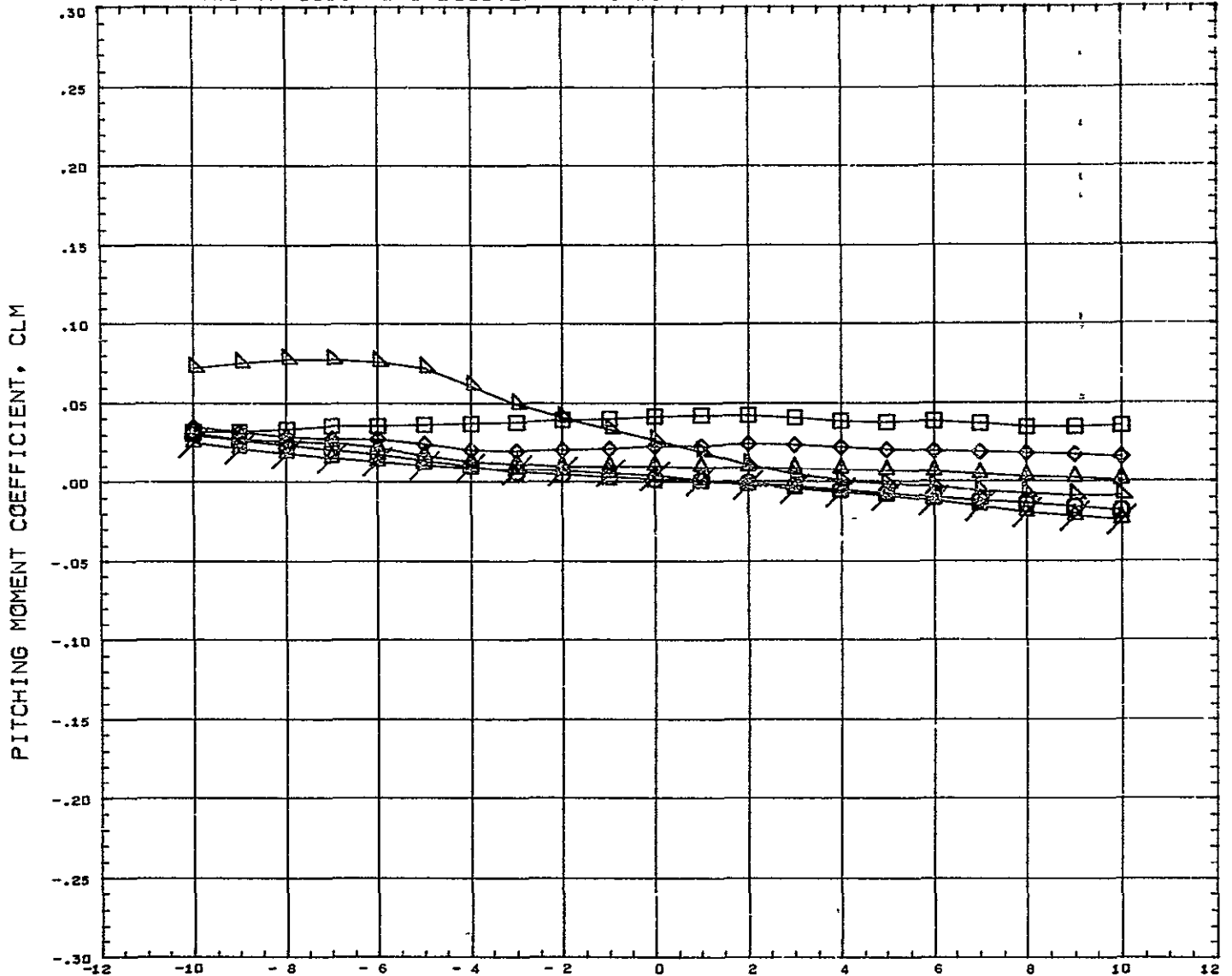

SYMBOL ○ ◇ □ △ ×	DELTA Z 0.120 0.151 0.182 0.228 0.352 10.000	PARAMETRIC VALUES BSTPOW 50.000 ORBPOW 50.000 DELTAX 0.522 ALPHAI 0.000 MACH 5.010 ELVBST 0.000 ELVORB 0.000 BETA 0.000	REFERENCE INFORMATION REFS 44.4440 SQ IN REFL 13.3330 IN REFB 13.3330 IN XMRP 7.5280 IN YMRP 0.0005 IN ZMRP 1.1940 IN SCALE 0.0055
---------------------------------	--	---	---

REFERENCE FILE

# AEDC VA 1163 MDAC BOOSTER AND ORBITER TEST DATA AT MACH NUMBER 5

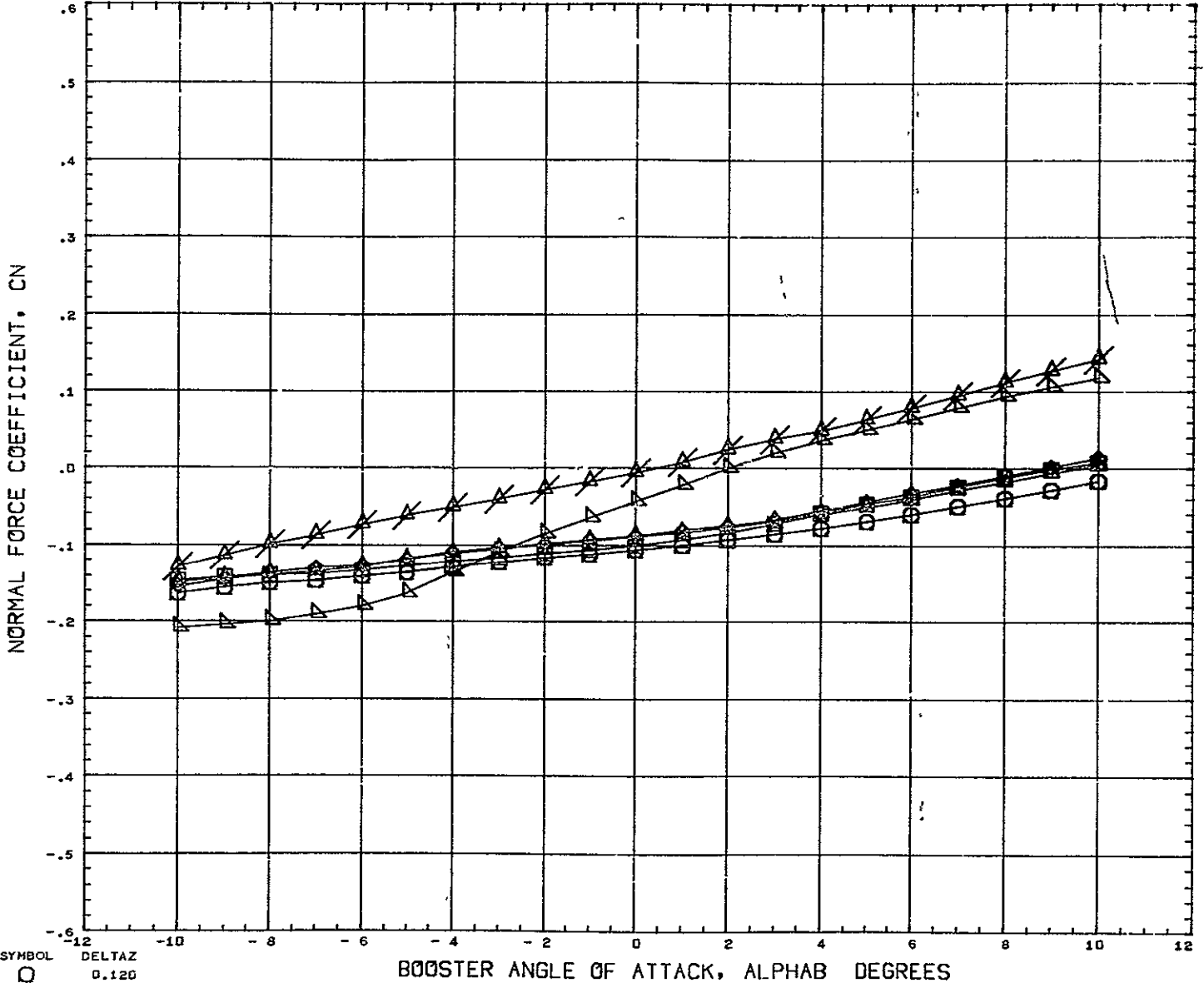

SYMBOL ○ □ ◇ ○ △	DELTAZ 0.120 0.151 0.182 0.228 0.352 10.000	PARAMETRIC VALUES BSTPOW 50.000 ORBPOW 50.000 CLTAX 0.522 ALPHA1 0.000 MACH 5.010 ELVBST 0.000 ELVORB 0.000 BETA 0.000	REFERENCE INFORMATION REFS 44.4440 SQ IN REFL 13.3330 IN REFB 13.3330 IN XMRP 7.5280 IN YMRP 0.0000 IN ZMRP 1.1940 IN SCALE 0.0055
---------------------------------	---	--	---

1 REFERENCE FILE



# AEDC VA 1163 MDAC BOOSTER AND ORBITER TEST DATA AT MACH NUMBER 5

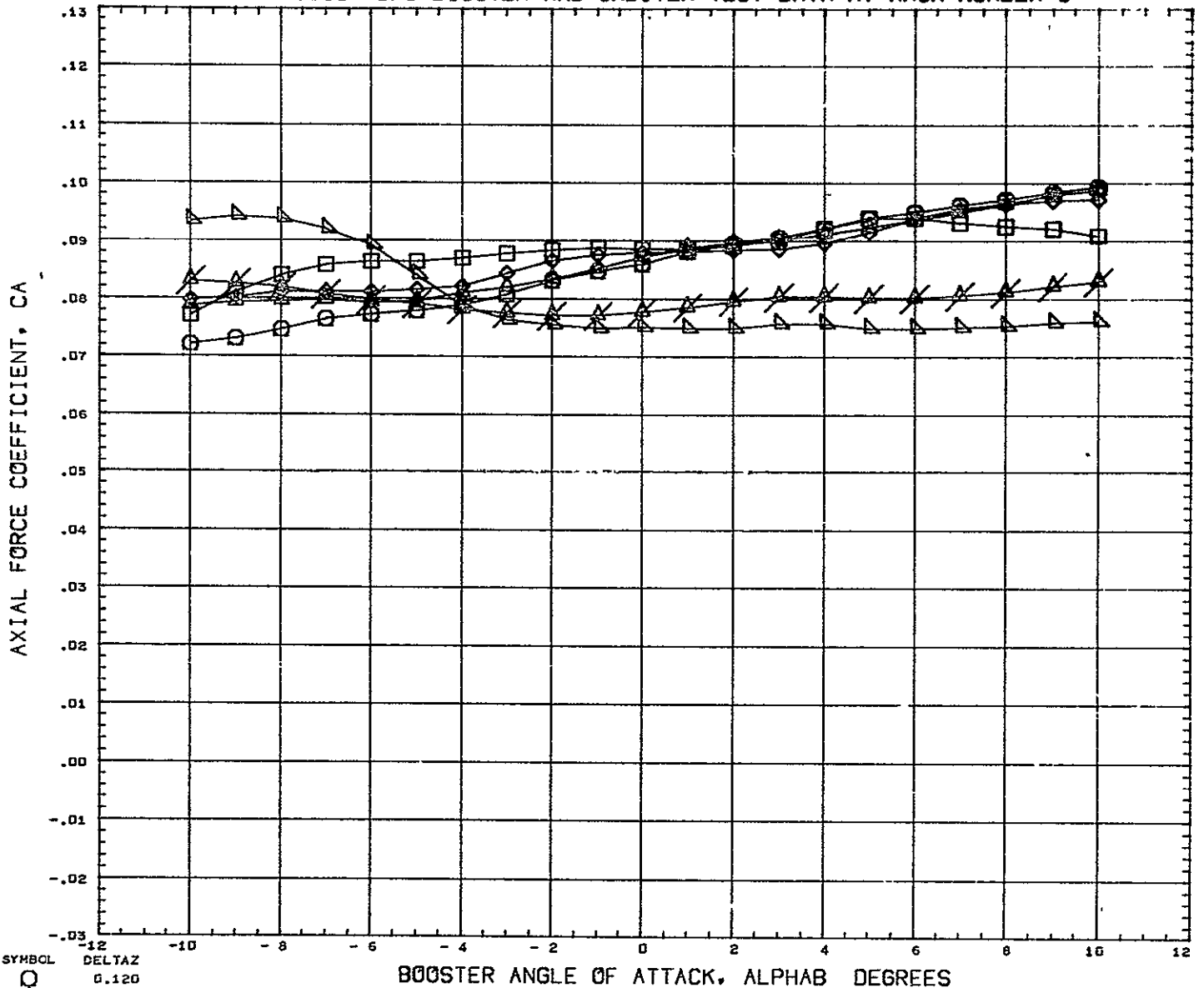

SYMBOL	DELTA Z	PARAMETRIC VALUES				REFERENCE INFORMATION		
<div style="display: flex; flex-direction: column; gap: 5px;"> <span>○</span> <span>□</span> <span>◇</span> <span>△</span> <span>×</span> </div>	0.120 0.151 0.182 0.228 0.352 10.000	BSTFOW 50.000 PLTAX 0.522 MACH 5.010 ELVORB 0.000	ORBPOW 50.000 ALPHA1 0.000 ELVBST 0.000 BETA 0.000	REFS 44.444E REFL 13.3330 REFB 13.3330 XMRF 7.5280 YMRF 0.0000 ZMRF 1.1940 SCALE 0.0055	SQ IN IN IN IN IN IN			
	REFERENCE FILE							

# AEDC VA 1163 MDAC BOOSTER AND ORBITER TEST DATA AT MACH NUMBER 5

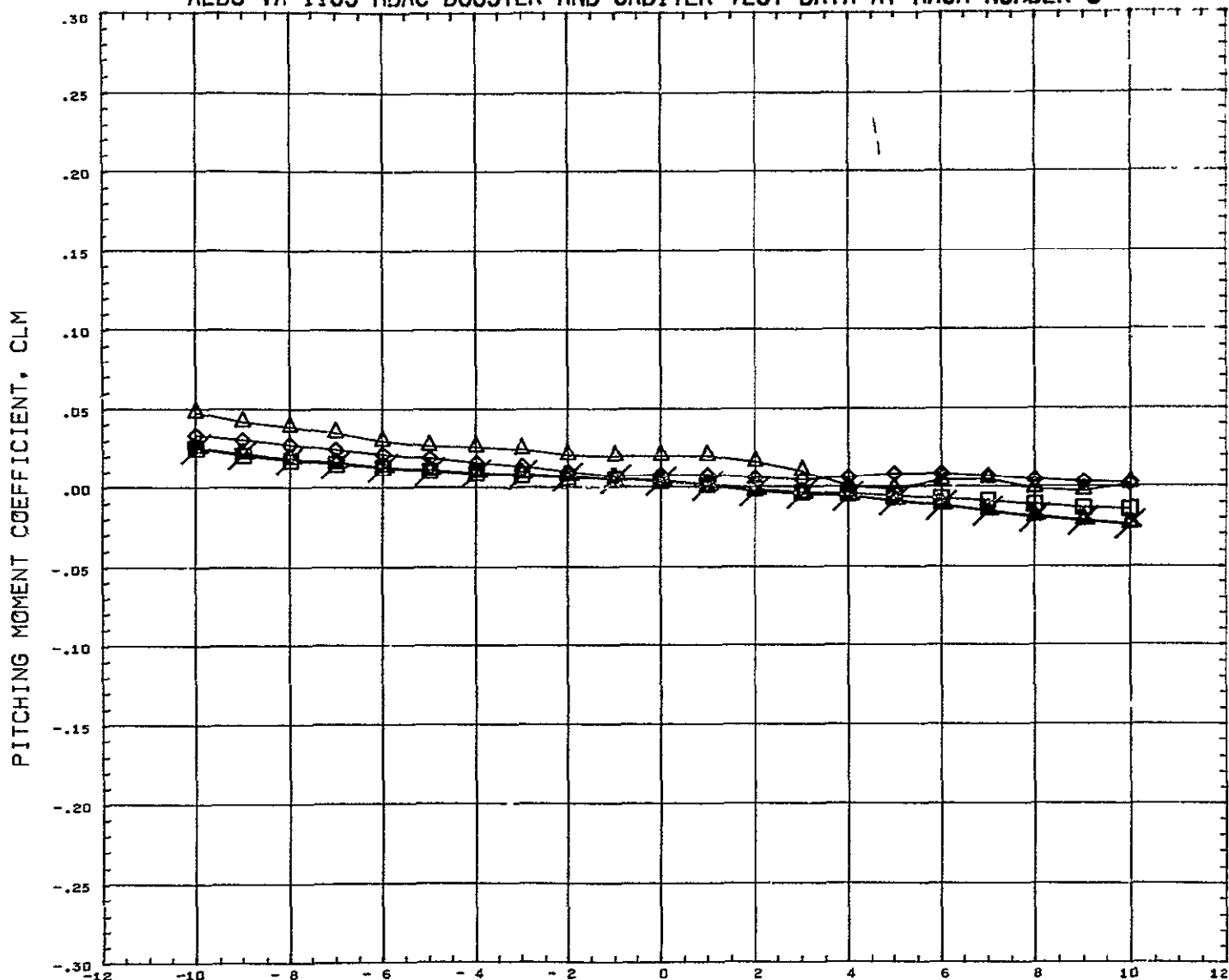

SYMBOL △ ◻ ◊ ×	DELTAZ 0.151 0.182 0.228 0.352 10.000 ,	<table border="0" style="width: 100%;"> <tr> <th colspan="4" style="text-align: left; padding-left: 20px;">PARAMETRIC VALUES</th> </tr> <tr> <td style="padding-left: 20px;">BSTPOW</td> <td>50.000</td> <td style="padding-left: 20px;">ORBPOW</td> <td>50.000</td> </tr> <tr> <td style="padding-left: 20px;">DELTAX</td> <td>- 0.391</td> <td style="padding-left: 20px;">ALPHA1</td> <td>5.000</td> </tr> <tr> <td style="padding-left: 20px;">MACH</td> <td>5.010</td> <td style="padding-left: 20px;">ELVBST</td> <td>0.000</td> </tr> <tr> <td style="padding-left: 20px;">ELVORB</td> <td>0.000</td> <td style="padding-left: 20px;">BETA</td> <td>0.000</td> </tr> </table>	PARAMETRIC VALUES				BSTPOW	50.000	ORBPOW	50.000	DELTAX	- 0.391	ALPHA1	5.000	MACH	5.010	ELVBST	0.000	ELVORB	0.000	BETA	0.000	<table border="0" style="width: 100%;"> <tr> <th colspan="3" style="text-align: left;">REFERENCE INFORMATION</th> </tr> <tr> <td style="padding-left: 20px;">REFC</td> <td>44.4440</td> <td>sq IN</td> </tr> <tr> <td style="padding-left: 20px;">REFL</td> <td>13.3330</td> <td>IN</td> </tr> <tr> <td style="padding-left: 20px;">REFB</td> <td>13.3330</td> <td>IN</td> </tr> <tr> <td style="padding-left: 20px;">XMRP</td> <td>7.5280</td> <td>IN</td> </tr> <tr> <td style="padding-left: 20px;">YMRP</td> <td>0.0000</td> <td>IN</td> </tr> <tr> <td style="padding-left: 20px;">ZMRP</td> <td>1.1940</td> <td>IN</td> </tr> <tr> <td style="padding-left: 20px;">SCALE</td> <td>0.0055</td> <td></td> </tr> </table>	REFERENCE INFORMATION			REFC	44.4440	sq IN	REFL	13.3330	IN	REFB	13.3330	IN	XMRP	7.5280	IN	YMRP	0.0000	IN	ZMRP	1.1940	IN	SCALE	0.0055	
PARAMETRIC VALUES																																															
BSTPOW	50.000	ORBPOW	50.000																																												
DELTAX	- 0.391	ALPHA1	5.000																																												
MACH	5.010	ELVBST	0.000																																												
ELVORB	0.000	BETA	0.000																																												
REFERENCE INFORMATION																																															
REFC	44.4440	sq IN																																													
REFL	13.3330	IN																																													
REFB	13.3330	IN																																													
XMRP	7.5280	IN																																													
YMRP	0.0000	IN																																													
ZMRP	1.1940	IN																																													
SCALE	0.0055																																														

1. REFERENCE FILE

2.

# AEDC VA 1163 MDAC BOOSTER AND ORBITER TEST DATA AT MACH NUMBER 5

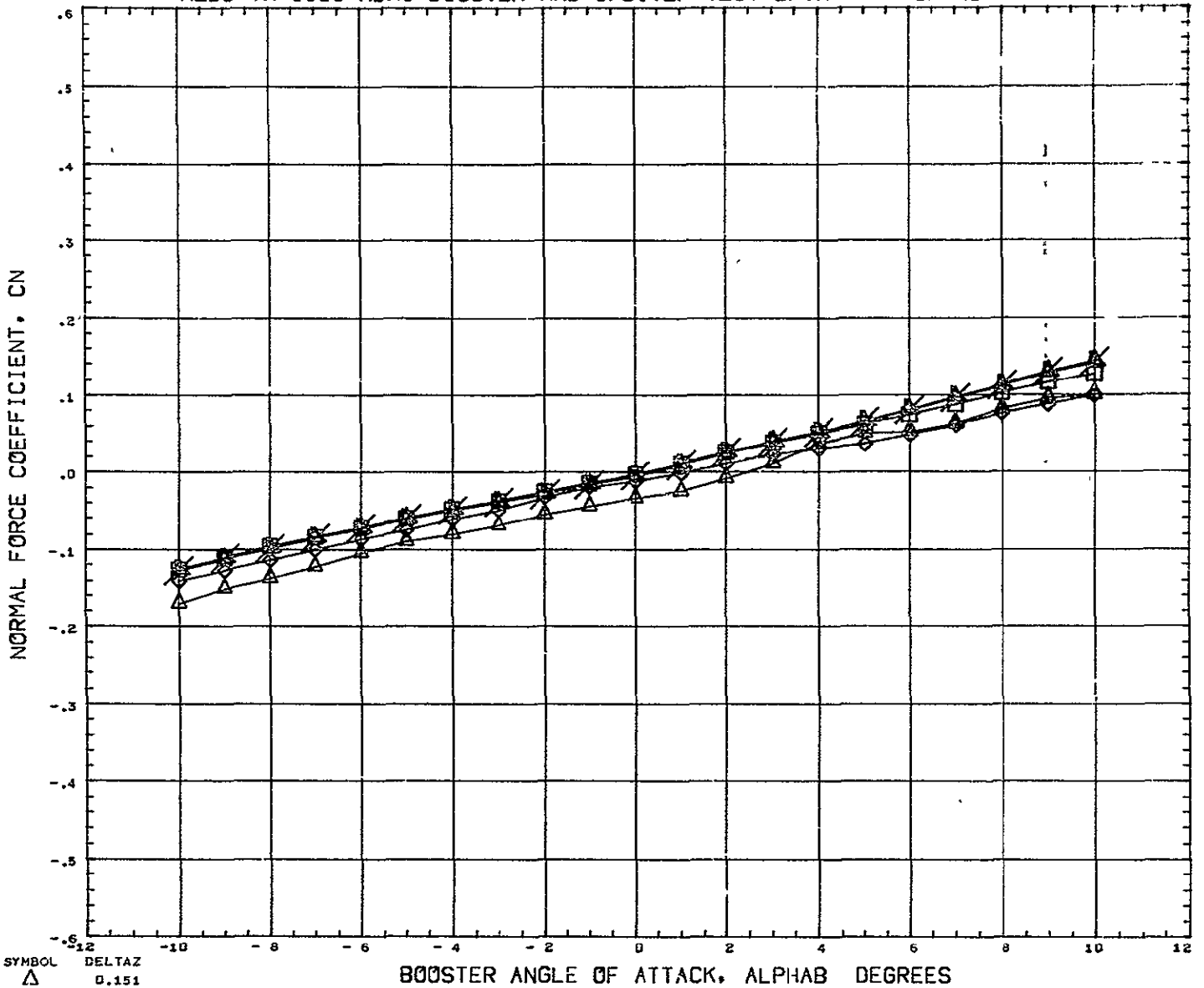

SYMBOL △ ◇ □ ×	DELTA Z 0.151 0.192 0.228 0.352 10.000	PARAMETRIC VALUES BSTPOW 50.000 ORBPOW 50.000 JELTAX - 0.391 ALPHAI 5.000 MACH 5.010 ELVBST 0.000 ELVORB 0.000 BETA 0.000	REFERENCE INFORMATION REFS 44.4440 SQ IN REFL 13.3330 IN REFB 13.3330 IN XMRP 7.5280 IN YMRP 0.0000 IN ZMRP 1.1940 IN SCALE 0.0055
----------------------------	---	---	---

REFERENCE FILE

# AEDC VA 1163 MDAC BOOSTER AND ORBITER TEST DATA AT MACH NUMBER 5

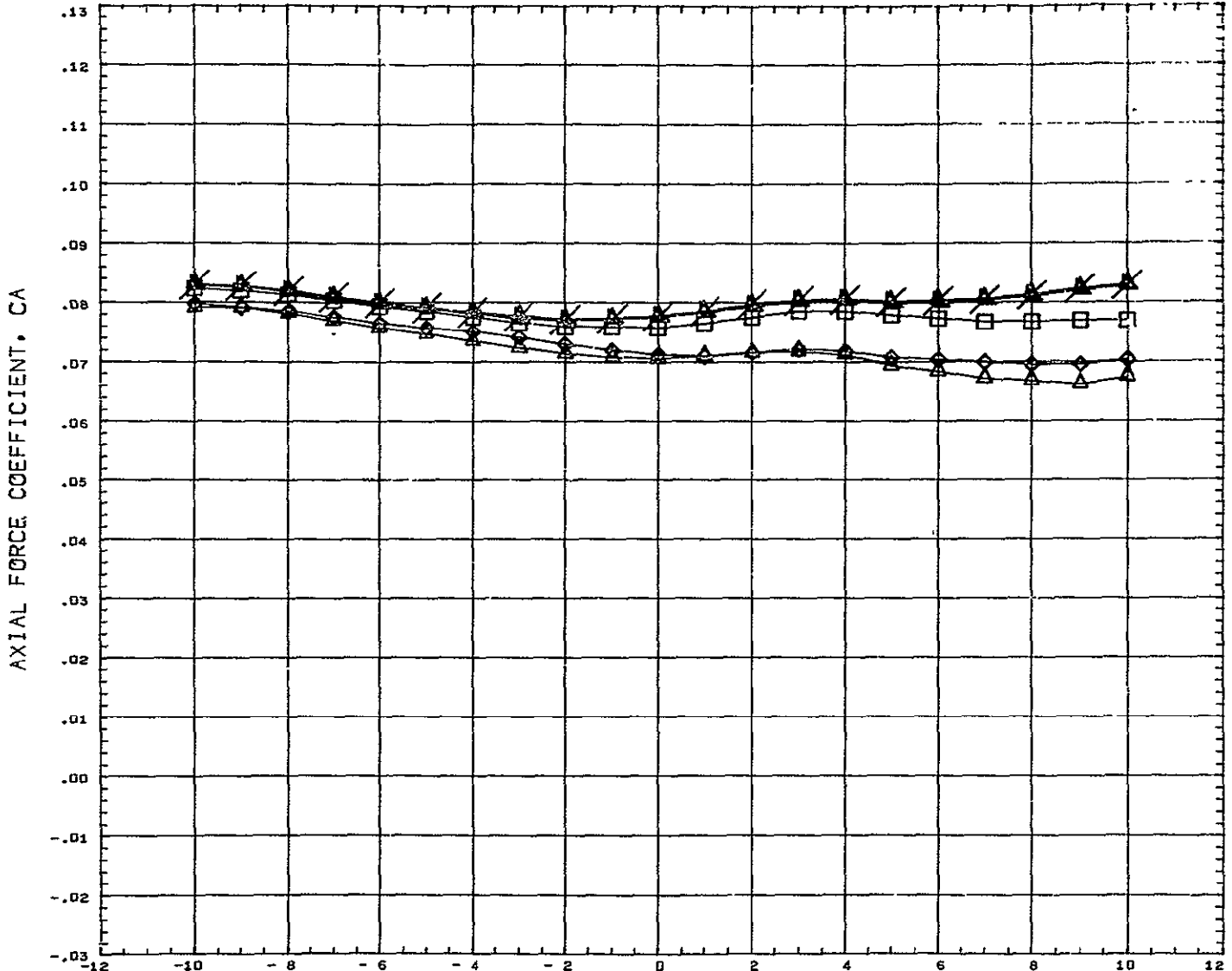

SYMBOL △ ◇ □ ×	DELTAZ 0.151 0.182 0.228 0.352 10.000	<table border="0" style="width: 100%;"> <tr> <th colspan="4" style="text-align: center;">PARAMETRIC VALUES</th> </tr> <tr> <td>BSTPOW</td><td>50.000</td><td>ORBPOW</td><td>50.000</td> </tr> <tr> <td>DELTAZ</td><td>0.391</td><td>ALPHA1</td><td>5.000</td> </tr> <tr> <td>MACH</td><td>5.010</td><td>ELVBST</td><td>0.000</td> </tr> <tr> <td>ELVORB</td><td>0.000</td><td>BETA</td><td>0.000</td> </tr> </table>	PARAMETRIC VALUES				BSTPOW	50.000	ORBPOW	50.000	DELTAZ	0.391	ALPHA1	5.000	MACH	5.010	ELVBST	0.000	ELVORB	0.000	BETA	0.000	<table border="0" style="width: 100%;"> <tr> <th colspan="3" style="text-align: center;">REFERENCE INFORMATION</th> </tr> <tr> <td>REFS</td><td>44.4440</td><td>SQ IN</td> </tr> <tr> <td>REFL</td><td>13.3330</td><td>IN</td> </tr> <tr> <td>REFB</td><td>13.3330</td><td>IN</td> </tr> <tr> <td>XMRP</td><td>7.5280</td><td>IN</td> </tr> <tr> <td>YMRP</td><td>0.0000</td><td>IN</td> </tr> <tr> <td>ZMRP</td><td>1.1940</td><td>IN</td> </tr> <tr> <td>SCALE</td><td>0.0055</td><td></td> </tr> </table>	REFERENCE INFORMATION			REFS	44.4440	SQ IN	REFL	13.3330	IN	REFB	13.3330	IN	XMRP	7.5280	IN	YMRP	0.0000	IN	ZMRP	1.1940	IN	SCALE	0.0055	
PARAMETRIC VALUES																																															
BSTPOW	50.000	ORBPOW	50.000																																												
DELTAZ	0.391	ALPHA1	5.000																																												
MACH	5.010	ELVBST	0.000																																												
ELVORB	0.000	BETA	0.000																																												
REFERENCE INFORMATION																																															
REFS	44.4440	SQ IN																																													
REFL	13.3330	IN																																													
REFB	13.3330	IN																																													
XMRP	7.5280	IN																																													
YMRP	0.0000	IN																																													
ZMRP	1.1940	IN																																													
SCALE	0.0055																																														

REFERENCE FILE

# AEDC VA 1163 MDAC BOOSTER AND ORBITER TEST DATA AT MACH NUMBER 5

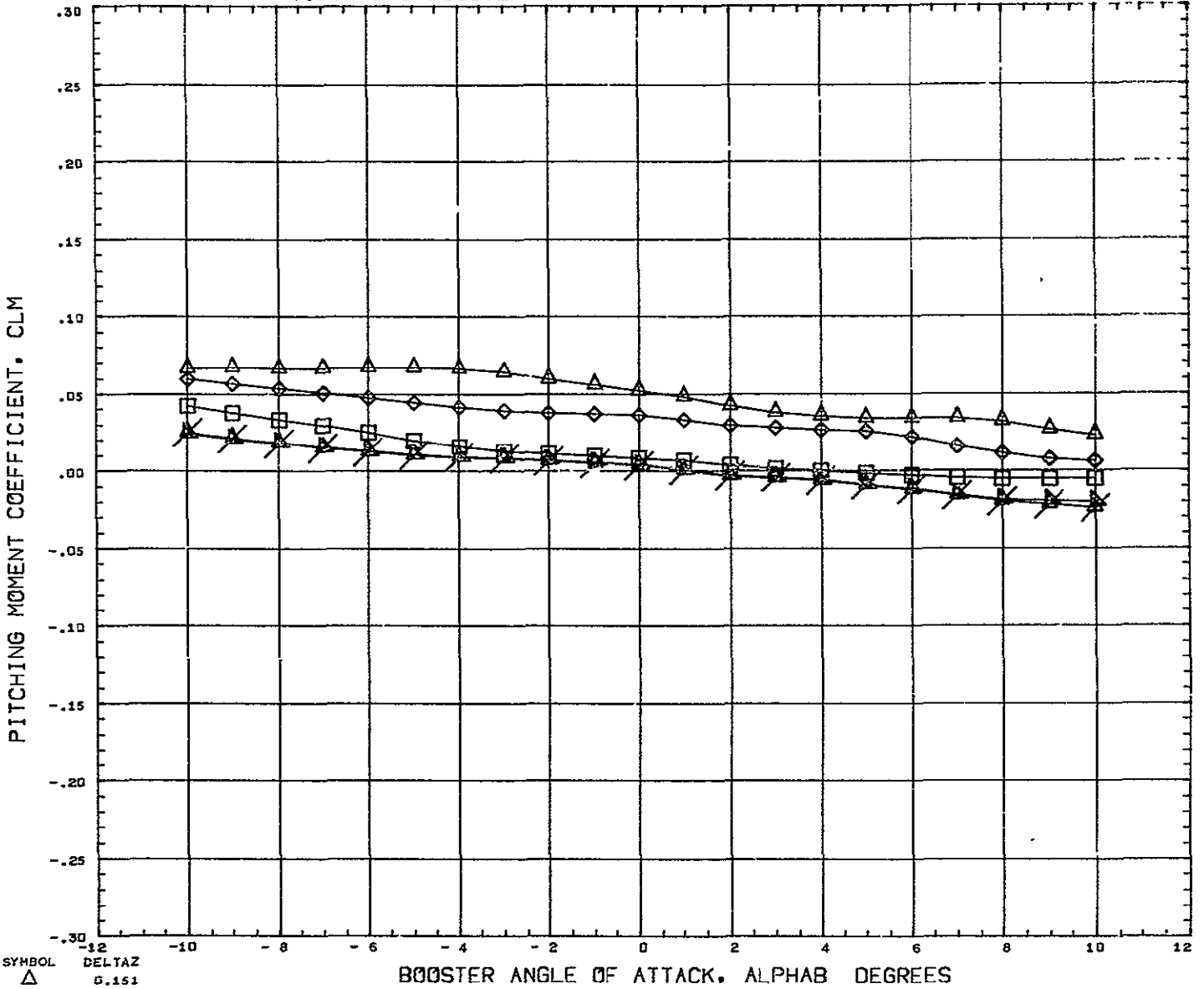

SYMBOL	DELTA Z	PARAMETRIC VALUES				REFERENCE INFORMATION	
△	0.151	BSTPOW	50.000	ORBPOW	50.000	REFS	44.4440 SQ IN
◇	0.162	ELTAX	- 0.143	ALPHA I	5.000	REFL	13.3330 IN
□	0.228	MACH	5.010	ELVBST	0.000	REFB	13.3330 IN
×	0.352	ELVORB	0.000	BETA	0.000	XMRP	7.5240 IN
	10.000					YMRP	0.0000 IN
						ZMRP	1.1940 IN
						SCALE	0.7055

REFERENCE FILE

# AEDC VA 1163 MDAC BOOSTER AND ORBITER TEST DATA AT MACH NUMBER 5

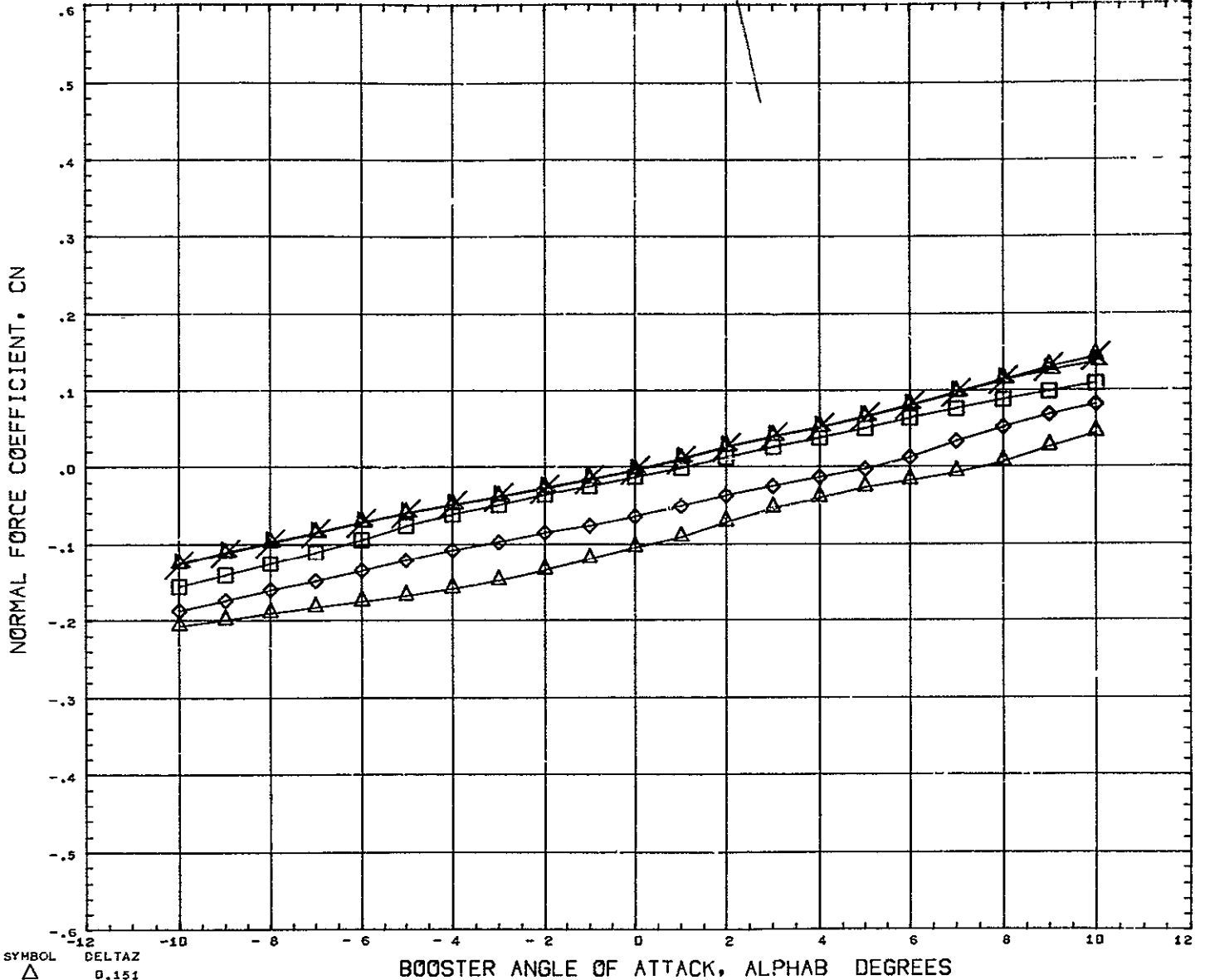

SYMBOL △ ◇ □ ▽ ×	DELTAZ 0.151 0.182 0.228 0.352 10.000	PARAMETRIC VALUES BSTPOW 50.000 ORBPOW 50.000 DELTAX - 0.143 ALPHAI 5.000 MACH 5.010 ELVBST 0.000 ELVORB 0.000 BETA 0.000	REFERENCE INFORMATION REFS 44.4440 SQ IN REFL 13.3330 IN REFB 13.3330 IN XHRF 7.5280 IN YHRF 0.0000 IN ZHRF 1.1940 IN SCALE 0.0055
---------------------------------	--	---	---

# AEDC VA 1163 MDAC BOOSTER AND ORBITER TEST DATA AT MACH NUMBER 5

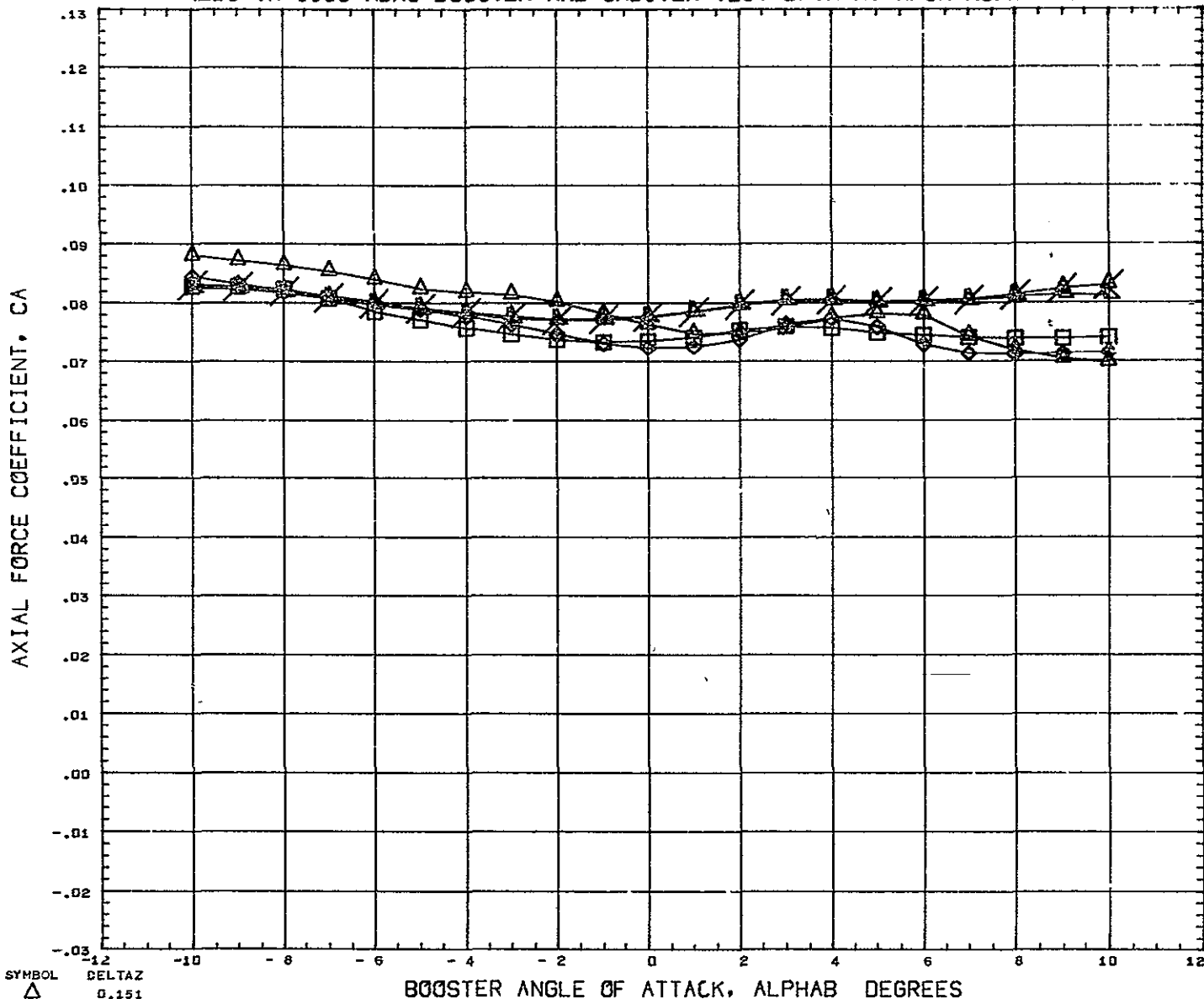

SYMBOL △ ◇ □ ○ ×	DELTA Z 0.151 0.102 0.228 0.352 10.000	PARAMETRIC VALUES BSTPOW 50.000 ORBPOW 50.000 DELTAX - 0.143 ALPHAI 5.000 MACH 5.010 ELVBST 0.000 ELVORB 0.000 BETA 0.000	REFERENCE INFORMATION REFS 44.4440 SQ IN REFL 13.3330 IN REFB 13.3330 IN XHRF 7.5200 IN YMRP 0.0000 IN ZMRP 1.1940 IN SCALE 0.0055
---------------------------------	---	---	---

REFERENCE FILE

# AEDC VA 1163 MDAC BOOSTER AND ORBITER TEST DATA AT MACH NUMBER 5

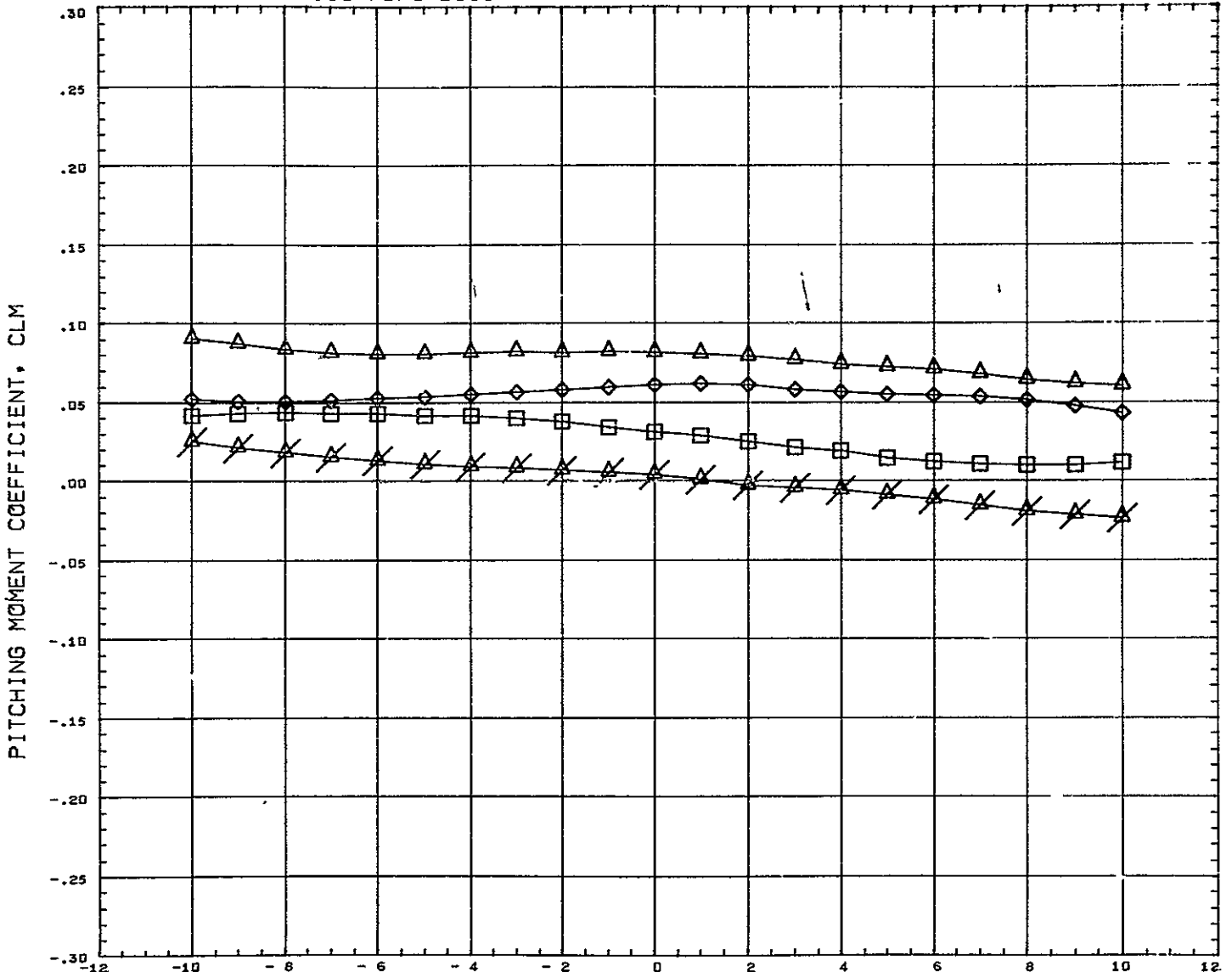

SYMBOL △ ◇ □ ×	DELTAZ 0.151 0.182 0.228 10.000	PARAMETRIC VALUES BSTFOW 50.000 ORBFOW 50.000 DELTAX - 0.019 ALPHAI 5.000 MACH 5.010 FLVBST 0.000 ELVORB 0.000 BETA 0.000	REFERENCE INFORMATION REFS 44.4440 SQ IN REFL 13.3330 IN REFB 13.3330 IN XMRP 7.5200 IN YMRP 0.0000 IN ZMRP 1.1940 IN SCALE 0.0055
		REFERENCE FILE	



# AEDC VA 1163 MDAC BOOSTER AND ORBITER TEST DATA AT MACH NUMBER 5

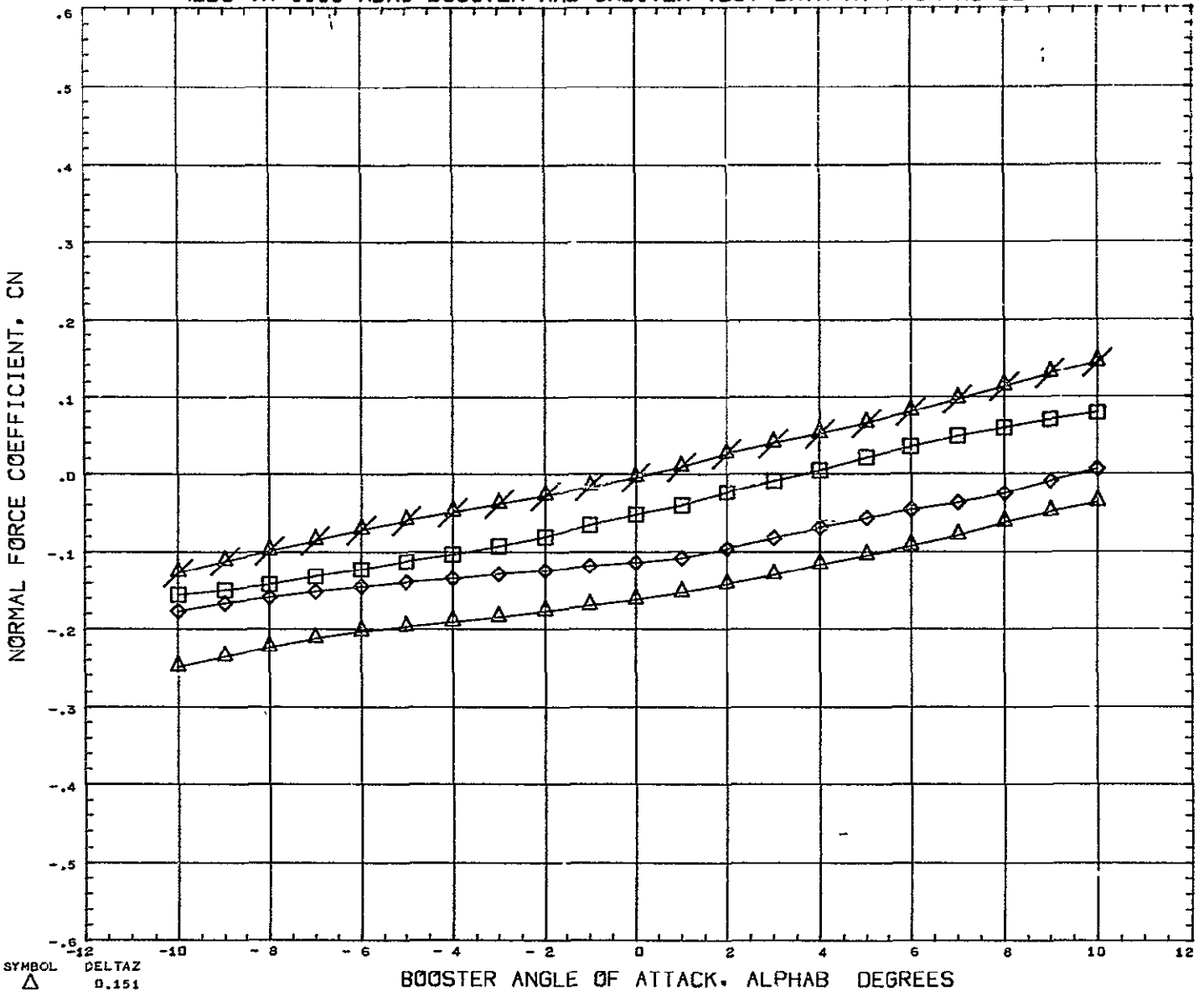

<table border="0"> <tr><td>△</td><td>0.151</td></tr> <tr><td>◇</td><td>0.182</td></tr> <tr><td>□</td><td>0.228</td></tr> <tr><td>⊗</td><td>10.000</td></tr> </table>	△	0.151	◇	0.182	□	0.228	⊗	10.000	<table border="0"> <tr><td colspan="4" style="text-align: center;">PARAMETRIC VALUES</td></tr> <tr><td>BSTPOW</td><td>50.000</td><td>ORBPow</td><td>50.000</td></tr> <tr><td>DELTAZ</td><td>- 0.019</td><td>ALPHA1</td><td>5.000</td></tr> <tr><td>MACH</td><td>5.010</td><td>ELVBST</td><td>0.000</td></tr> <tr><td>ELVORB</td><td>0.000</td><td>BETA</td><td>0.000</td></tr> </table>	PARAMETRIC VALUES				BSTPOW	50.000	ORBPow	50.000	DELTAZ	- 0.019	ALPHA1	5.000	MACH	5.010	ELVBST	0.000	ELVORB	0.000	BETA	0.000	<table border="0"> <tr><td colspan="2" style="text-align: center;">REFERENCE INFORMATION</td></tr> <tr><td>REFS</td><td>44.4440 SQ IN</td></tr> <tr><td>REFL</td><td>13.3330 IN</td></tr> <tr><td>REFB</td><td>13.3330 IN</td></tr> <tr><td>XMRP</td><td>7.5280 IN</td></tr> <tr><td>YMRP</td><td>0.0000 IN</td></tr> <tr><td>ZMRP</td><td>1.1940 IN</td></tr> <tr><td>SCALE</td><td>0.0055</td></tr> </table>	REFERENCE INFORMATION		REFS	44.4440 SQ IN	REFL	13.3330 IN	REFB	13.3330 IN	XMRP	7.5280 IN	YMRP	0.0000 IN	ZMRP	1.1940 IN	SCALE	0.0055
△	0.151																																													
◇	0.182																																													
□	0.228																																													
⊗	10.000																																													
PARAMETRIC VALUES																																														
BSTPOW	50.000	ORBPow	50.000																																											
DELTAZ	- 0.019	ALPHA1	5.000																																											
MACH	5.010	ELVBST	0.000																																											
ELVORB	0.000	BETA	0.000																																											
REFERENCE INFORMATION																																														
REFS	44.4440 SQ IN																																													
REFL	13.3330 IN																																													
REFB	13.3330 IN																																													
XMRP	7.5280 IN																																													
YMRP	0.0000 IN																																													
ZMRP	1.1940 IN																																													
SCALE	0.0055																																													

REFERENCE FILE

# AEDC VA 1163 MDAC BOOSTER AND ORBITER TEST DATA AT MACH NUMBER 5

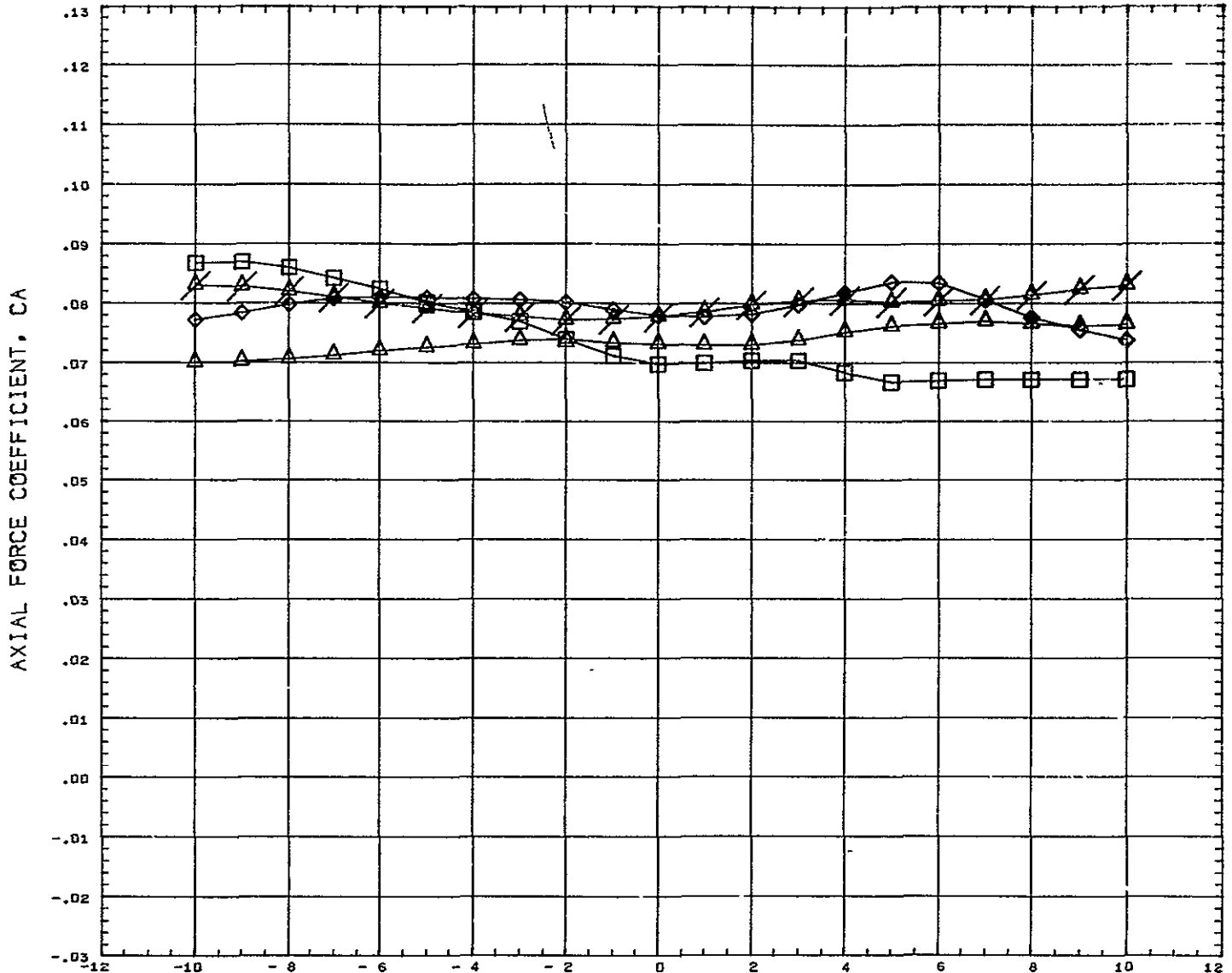

<table border="0"> <tr><td>△</td><td>DELTAZ</td><td>0.151</td></tr> <tr><td>◇</td><td>0.182</td><td></td></tr> <tr><td>□</td><td>0.228</td><td></td></tr> <tr><td>×</td><td>10.000</td><td></td></tr> </table>	△	DELTAZ	0.151	◇	0.182		□	0.228		×	10.000		<table border="0"> <tr><td colspan="4">PARAMETRIC VALUES</td></tr> <tr><td>BSTPOW</td><td>50.000</td><td>ORBPOW</td><td>50.000</td></tr> <tr><td>DELTAZ</td><td>0.019</td><td>ALPHA1</td><td>5.000</td></tr> <tr><td>MACH</td><td>5.010</td><td>ELVBST</td><td>0.000</td></tr> <tr><td>ELVORB</td><td>0.000</td><td>BETA</td><td>0.000</td></tr> </table>	PARAMETRIC VALUES				BSTPOW	50.000	ORBPOW	50.000	DELTAZ	0.019	ALPHA1	5.000	MACH	5.010	ELVBST	0.000	ELVORB	0.000	BETA	0.000	<table border="0"> <tr><td colspan="3">REFERENCE INFORMATION</td></tr> <tr><td>REFS</td><td>44.4440</td><td>SQ IN</td></tr> <tr><td>REFL</td><td>13.3330</td><td>IN</td></tr> <tr><td>REFB</td><td>13.3330</td><td>IN</td></tr> <tr><td>XMRP</td><td>7.5280</td><td>IN</td></tr> <tr><td>YMRP</td><td>0.0000</td><td>IN</td></tr> <tr><td>ZMRP</td><td>1.1940</td><td>IN</td></tr> <tr><td>SCALE</td><td>0.0051</td><td></td></tr> </table>	REFERENCE INFORMATION			REFS	44.4440	SQ IN	REFL	13.3330	IN	REFB	13.3330	IN	XMRP	7.5280	IN	YMRP	0.0000	IN	ZMRP	1.1940	IN	SCALE	0.0051	
△	DELTAZ	0.151																																																								
◇	0.182																																																									
□	0.228																																																									
×	10.000																																																									
PARAMETRIC VALUES																																																										
BSTPOW	50.000	ORBPOW	50.000																																																							
DELTAZ	0.019	ALPHA1	5.000																																																							
MACH	5.010	ELVBST	0.000																																																							
ELVORB	0.000	BETA	0.000																																																							
REFERENCE INFORMATION																																																										
REFS	44.4440	SQ IN																																																								
REFL	13.3330	IN																																																								
REFB	13.3330	IN																																																								
XMRP	7.5280	IN																																																								
YMRP	0.0000	IN																																																								
ZMRP	1.1940	IN																																																								
SCALE	0.0051																																																									

REFERENCE FILE

# AEDC VA 1163 MDAC BOOSTER AND ORBITER TEST DATA AT MACH NUMBER 5

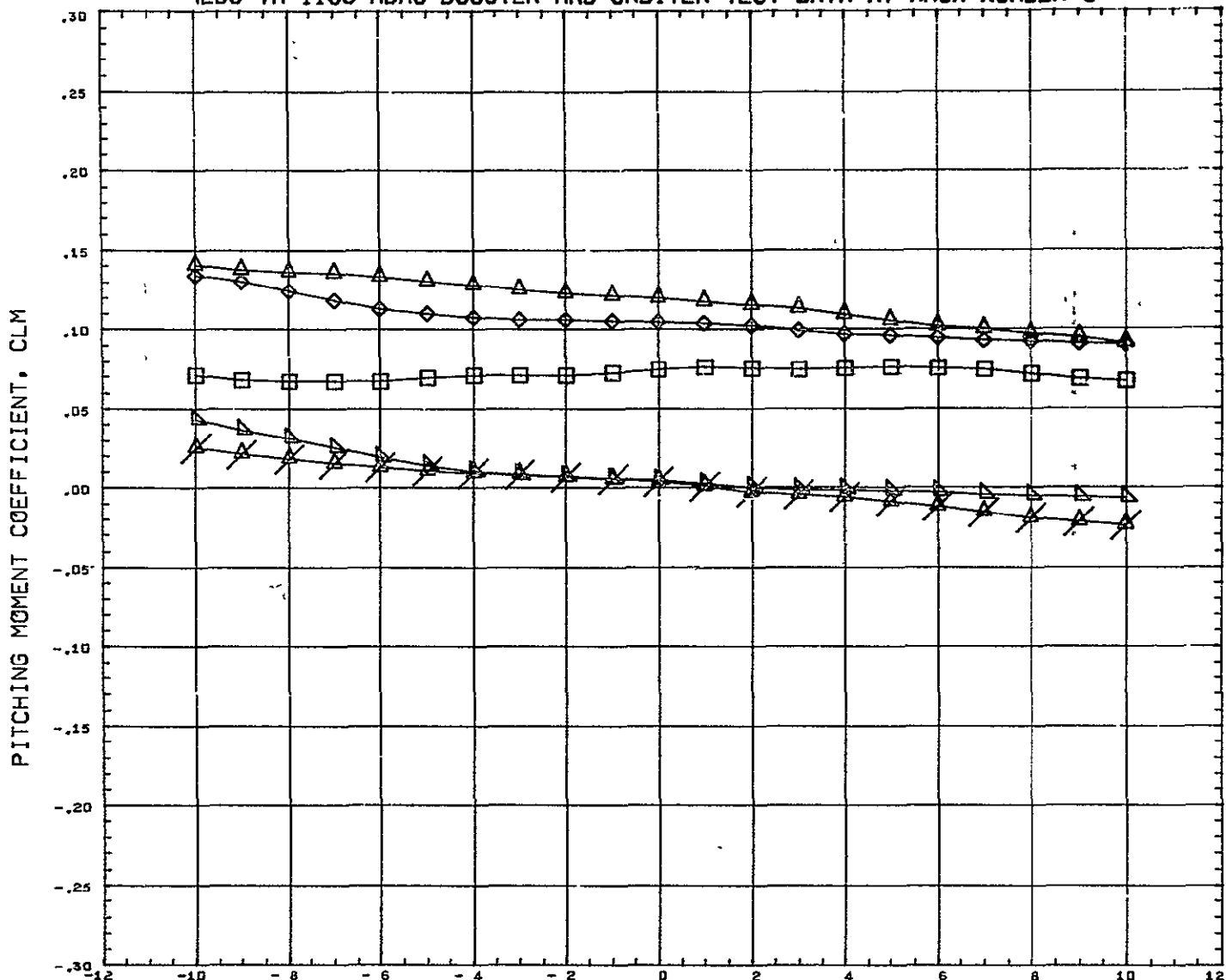

SYMBOL △ ◇ □ ×	DELTAZ 0.151 0.182 0.228 0.352 10.000	PARAMETRIC VALUES BSTPCW 50.000 ORBPOW 50.000 DELTAX 0.104 ALPHAI 5.000 MACH 5.010 ELVBST 0.000 ELVORB 0.000 BETA 0.000	REFERENCE INFORMATION REFS 44.4440 SQ IN REFL 13.3330 IN REFB 13.3330 IN XMRP 7.5280 IN YMRP 0.0000 IN ZMRP 1.1940 IN SCALE 0.0055
REFERENCE FILE			

# AEDC VA 1163 MDAC BOOSTER AND ORBITER TEST DATA AT MACH NUMBER 5

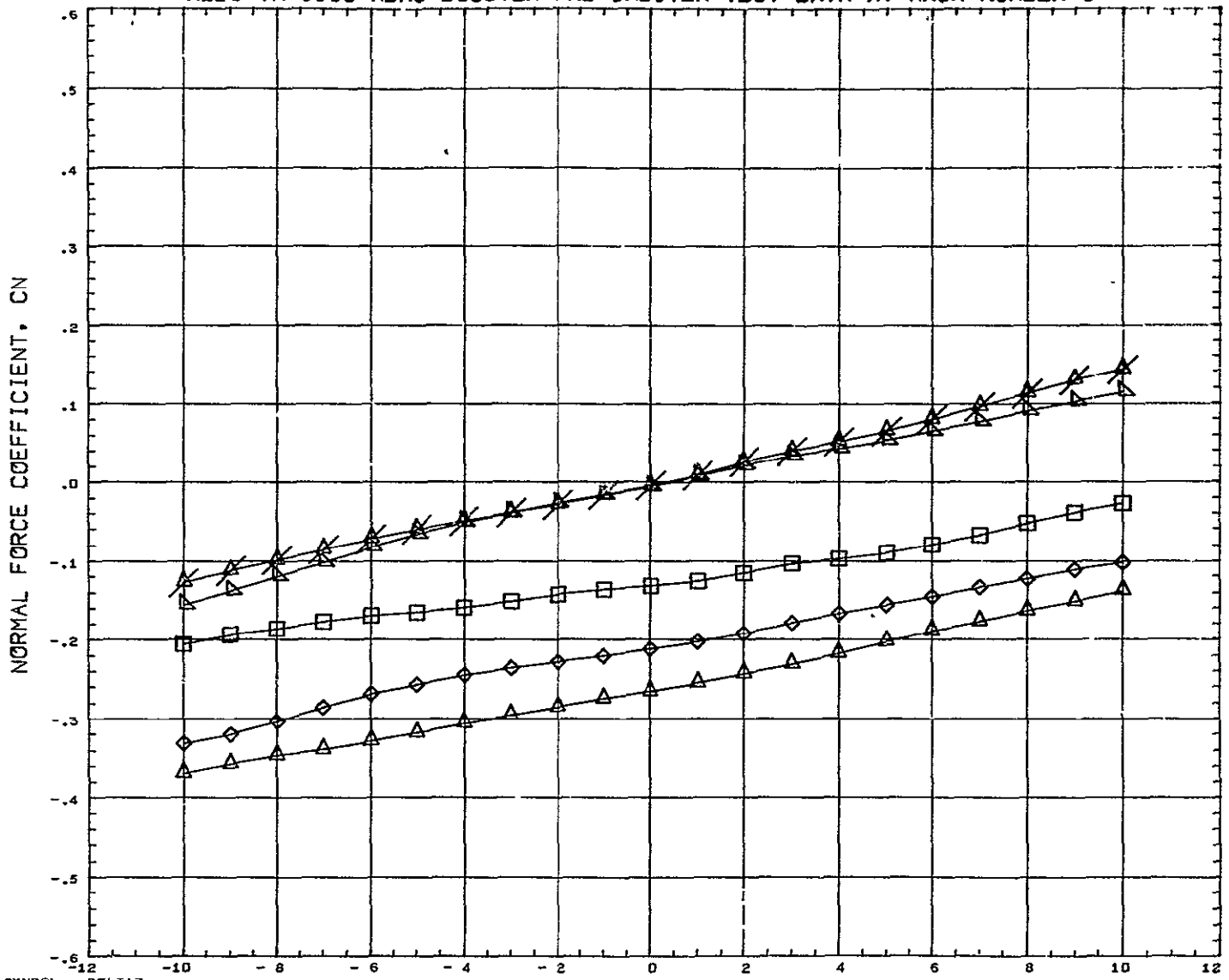

SYMBOL △ ◇ □ ▲ ▼	DELTA Z 0.151 0.182 0.228 0.352 10.000	PARAMETRIC VALUES BSTPOW 50.000    ORBPOW 50.000 DELTAX 0.104    ALPHAI 5.000 MACH 5.010    ELVBST 0.000 ELVORB 0.000    BETA 0.000	REFERENCE INFORMATION PEFS 44.4440    SQ IN REFL 13.3330    IN REFB 13.3330    IN XMRP 7.5280    IN YMRP 0.0000    IN ZMRP 1.1940    IN SCALE 0.0055
---------------------------------	---	---	---

REFERENCE FILE

# AEDC VA 1163 MDAC BOOSTER AND ORBITER TEST DATA AT MACH NUMBER 5

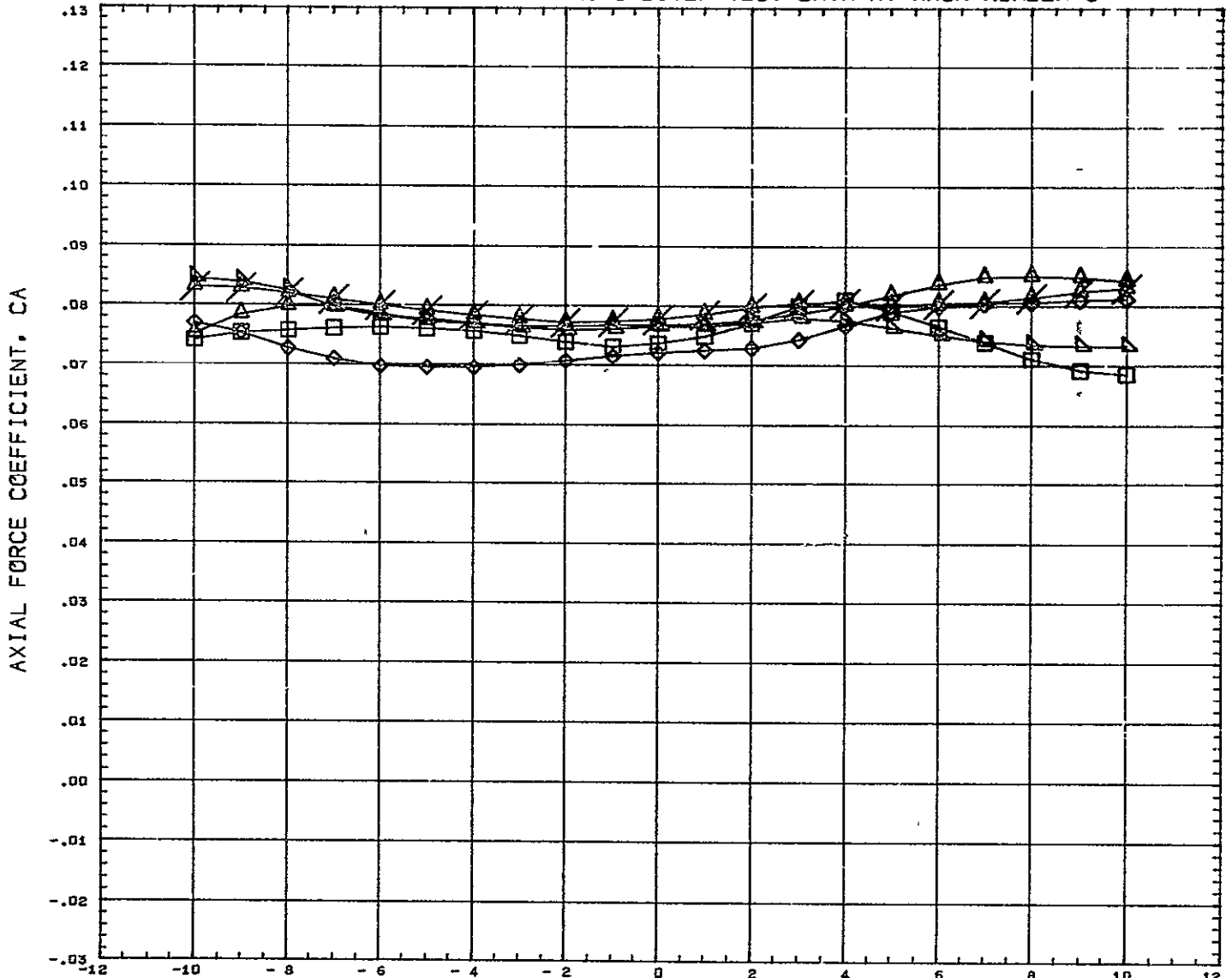

SYMBOL △ ◇ □ ✕	DELTAZ 0.151 0.182 0.228 0.352 10.000	PARAMETRIC VALUES BSTFOW 50.000 ORBPOW 50.000 DELTAX 0.104 ALPHAI 5.000 MACH 5.010 ELVBST 0.000 ELVORB 0.000 BETA 0.000	REFERENCE INFORMATION REFS 44.4440 SQ IN REFL 13.3330 IN REFB 13.3330 IN XMRF 7.5280 IN YMRF 0.0000 IN ZMRF 1.1940 IN SCALE 0.0055
----------------------------	--	---	---

REFERENCE FILE

# AEDC VA 1163 MDAC BOOSTER AND ORBITER TEST DATA AT MACH NUMBER 5

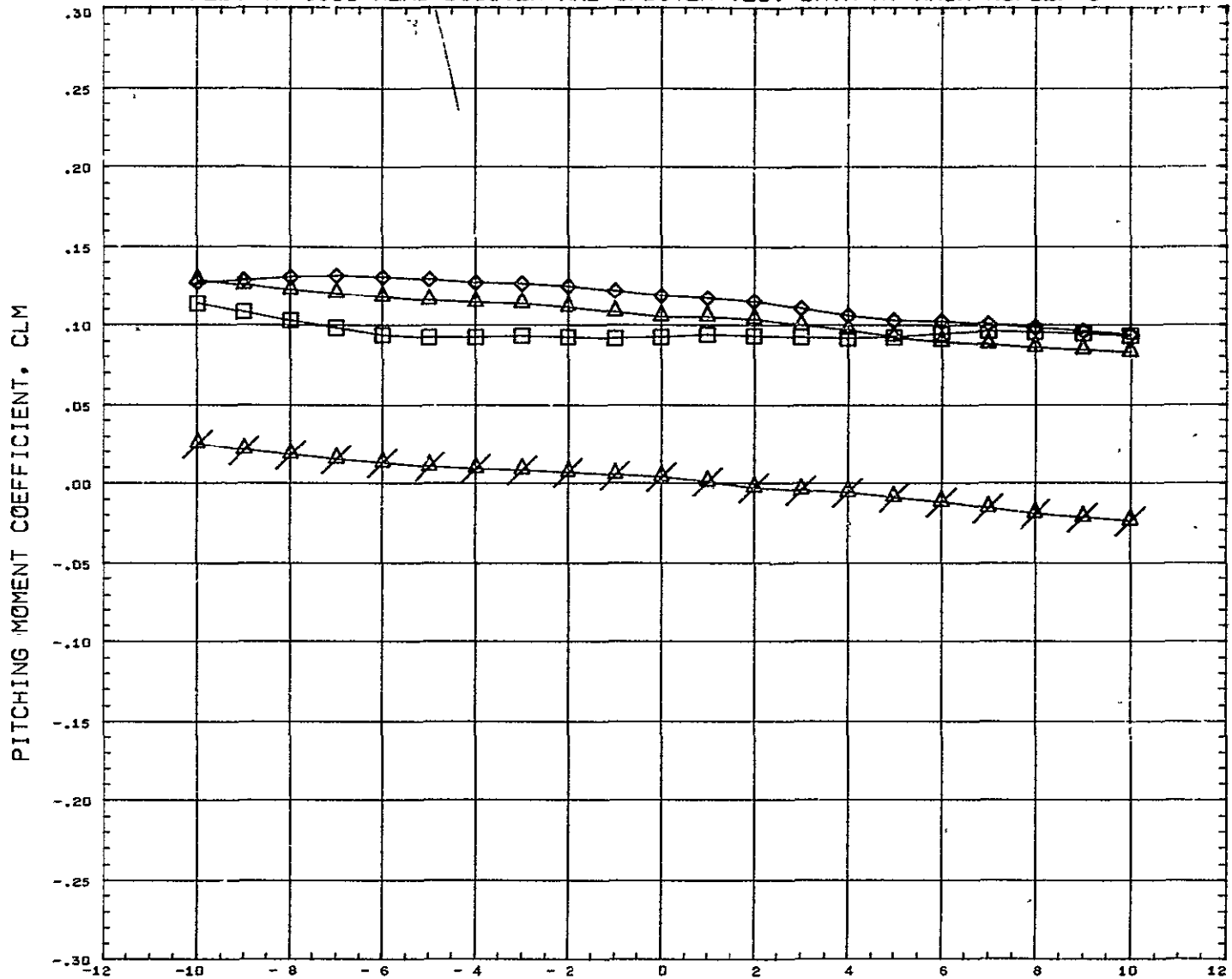

SYMBOL △ ◇ □ ×	DELTAZ 0.151 0.182 0.228 10.000	<table border="0" style="width: 100%;"> <tr> <th colspan="4" style="text-align: left;">PARAMETRIC VALUES</th> </tr> <tr> <td>BSTPOW</td><td>50.000</td><td>ORBPOW</td><td>50.000</td> </tr> <tr> <td>DELTA X</td><td>0.166</td><td>ALPHA I</td><td>5.000</td> </tr> <tr> <td>ACH</td><td>5.010</td><td>ELVBST</td><td>0.000</td> </tr> <tr> <td>ELVORB</td><td>0.000</td><td>BCTA</td><td>0.000</td> </tr> </table>	PARAMETRIC VALUES				BSTPOW	50.000	ORBPOW	50.000	DELTA X	0.166	ALPHA I	5.000	ACH	5.010	ELVBST	0.000	ELVORB	0.000	BCTA	0.000	<table border="0" style="width: 100%;"> <tr> <th colspan="3" style="text-align: left;">REFERENCE INFORMATION</th> </tr> <tr> <td>REFS</td><td>44.4440</td><td>SG IN</td> </tr> <tr> <td>REFL</td><td>13.3330</td><td>IN</td> </tr> <tr> <td>REFB</td><td>13.3330</td><td>IN</td> </tr> <tr> <td>XMRF</td><td>7.5280</td><td>IN</td> </tr> <tr> <td>YMRF</td><td>0.0000</td><td>IN</td> </tr> <tr> <td>ZMRF</td><td>1.1940</td><td>IN</td> </tr> <tr> <td>SCALE</td><td>0.0055</td><td></td> </tr> </table>	REFERENCE INFORMATION			REFS	44.4440	SG IN	REFL	13.3330	IN	REFB	13.3330	IN	XMRF	7.5280	IN	YMRF	0.0000	IN	ZMRF	1.1940	IN	SCALE	0.0055	
PARAMETRIC VALUES																																															
BSTPOW	50.000	ORBPOW	50.000																																												
DELTA X	0.166	ALPHA I	5.000																																												
ACH	5.010	ELVBST	0.000																																												
ELVORB	0.000	BCTA	0.000																																												
REFERENCE INFORMATION																																															
REFS	44.4440	SG IN																																													
REFL	13.3330	IN																																													
REFB	13.3330	IN																																													
XMRF	7.5280	IN																																													
YMRF	0.0000	IN																																													
ZMRF	1.1940	IN																																													
SCALE	0.0055																																														

REFERENCE FILE

AEDC VA 1163 MDAC BOOSTER AND ORBITER TEST DATA AT MACH NUMBER 5

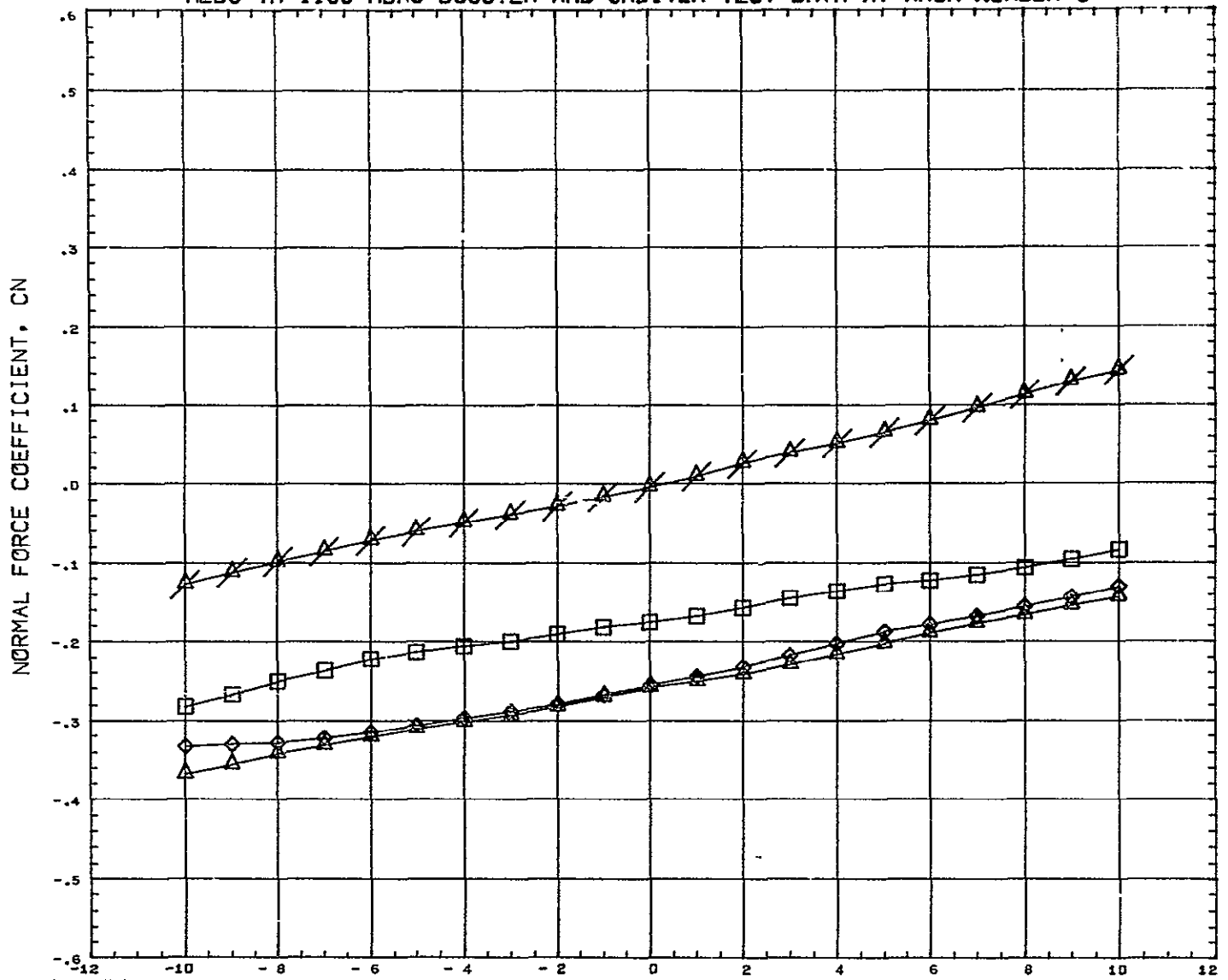

SYMBOL	DELTA Z	PARAMETRIC VALUES				REFERENCE INFORMATION	
△	0.151	BSTPOW	50.000	ORBPOW	50.000	REFS	44.4440 SQ IN
◇	0.182	DELTA X	0.166	ALPHA I	5.000	REFL	13.3330 IN
□	0.228	MACH	5.010	ELVBS	0.000	REFB	13.3330 IN
×	0.050	ELVORB	0.000	BETA	0.000	XMRP	7.5280 IN
						YMRP	0.0000 IN
						ZMRP	1.1940 IN
						SCALE	0.0055

REFERENCE FILE

# AEDC VA 1163 MDAC BOOSTER AND ORBITER TEST DATA AT MACH NUMBER 5

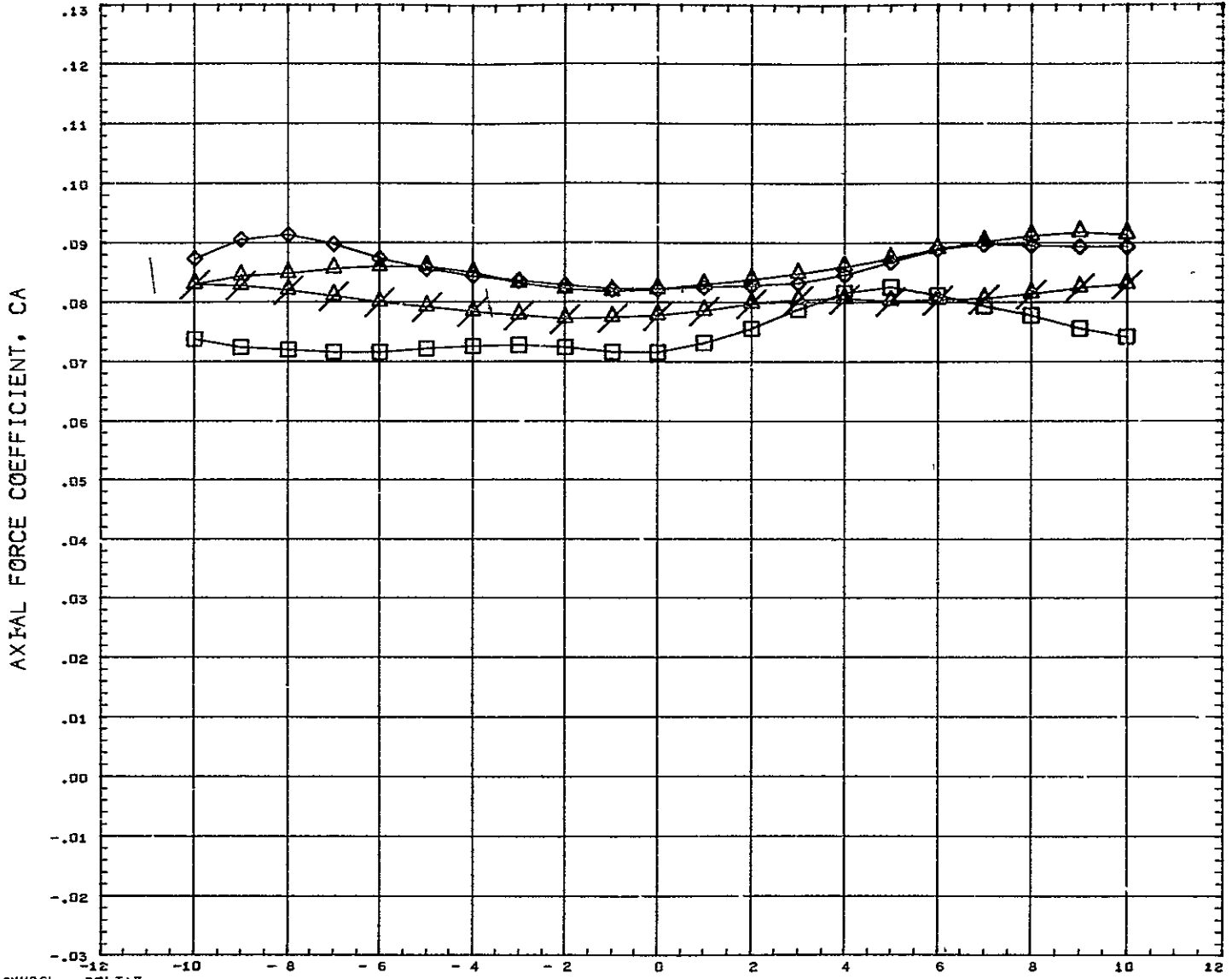

SYMBOL △ ◇ □ ×	DELTAX 0.151 0.182 0.228 10.000	PARAMETRIC VALUES BSTPOW 50.000 ORBPOW 50.000 DELTAX 0.166 ALPHAI 5.000 MACH 5.010 ELVBST 0.000 ELVORB 0.000 BETA 0.000	REFERENCE INFORMATION REFS 44.4440 SQ IN REFL 13.3330 IN REFB 13.3330 IN XMRP 7.5280 IN YMRP 0.0000 IN ZMRP 1.1940 IN SCALE 0.0055
REFERENCE FILE			



# AEDC VA 1163 MDAC BOOSTER AND ORBITER TEST DATA AT MACH NUMBER 5

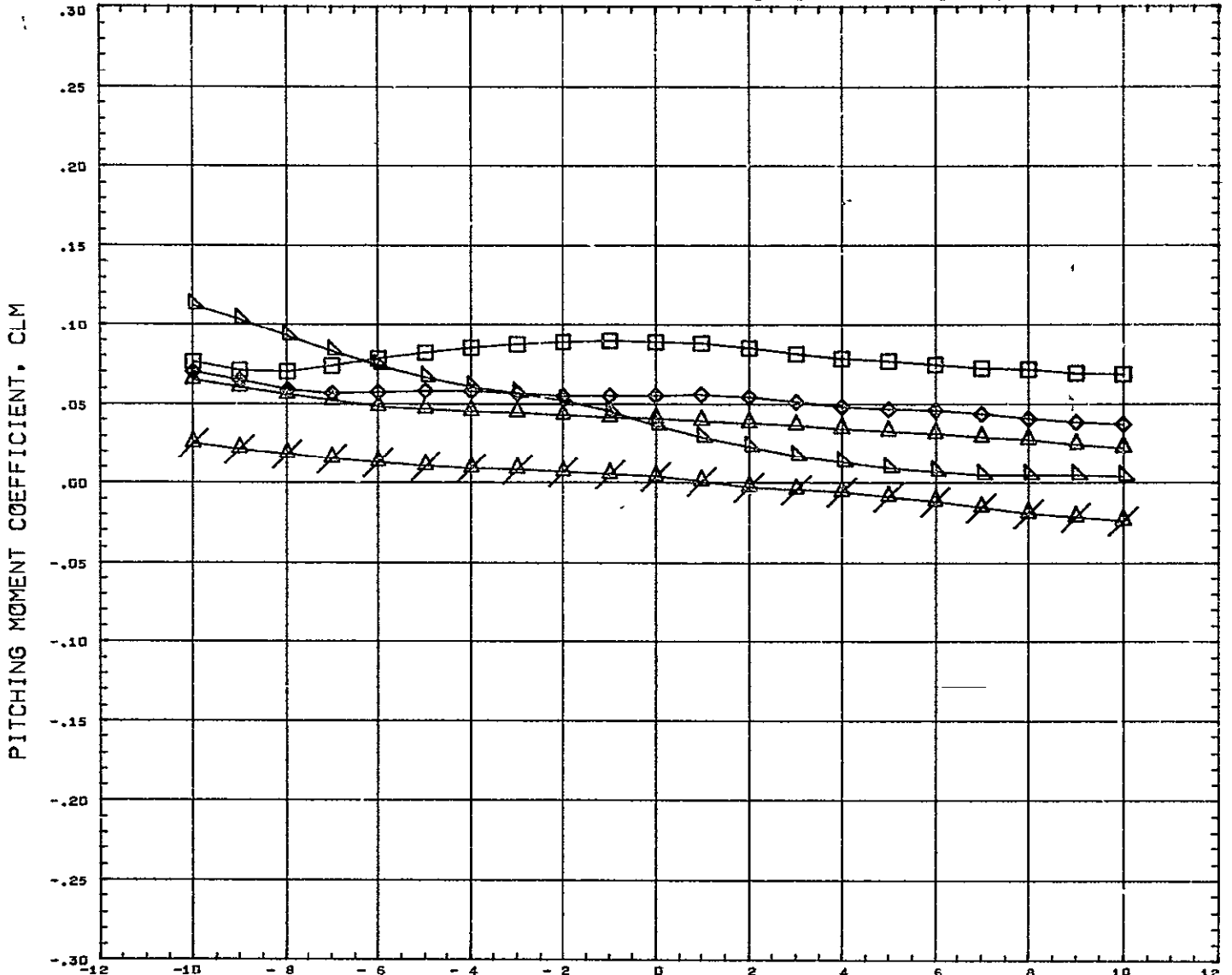

SYMBOL ◻ ◊ △ ▽ ×	DELTA Z 0.151 0.182 0.228 0.352 10.000	PARAMETRIC VALUES BSTFOW 50.000 ORBPOW 50.000 DELTAX 0.351 ALPHAI 5.000 MACH 5.010 ELVBST 0.000 ELVORB 0.000 BETA 0.000	REFERENCE INFORMATION REFS 44.4440 SQ IN REFL 13.3330 IN REFB 13.3330 IN XMRP 7.5280 IN YMRP 0.0000 IN ZMRP 1.1940 IN SCALE 0.0055
REFERENCE FILE			

# AEDC VA 1163 MDAC BOOSTER AND ORBITER TEST DATA AT MACH NUMBER 5

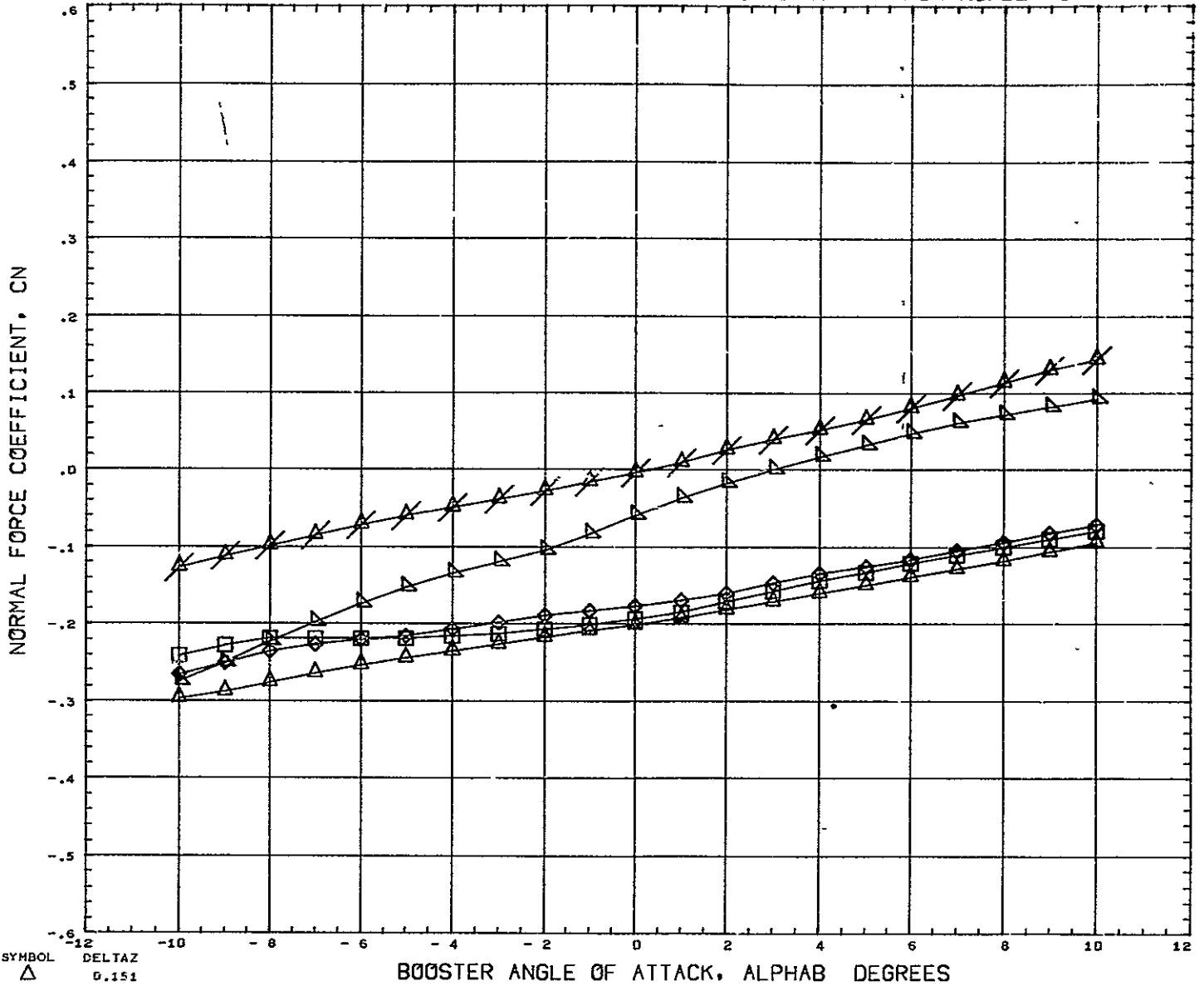

SYMBOL △ ◇ □ ⊠	DELTA Z 0.151 0.182 0.228 0.352 10.000	<b>PARAMETRIC VALUES</b> BSTPOW 50.000 ORBPOW 50.000 DELTAX 0.351 ALPHAI 5.000 MACH 5.010 ELVBST 0.000 ELVORB 0.000 BETA 0.000	<b>REFERENCE INFORMATION</b> REFS 44.4440 SQ IN REFL 13.3330 IN REFB 13.3330 IN XMRF 7.5280 IN YMRF 0.0000 IN ZMRF 1.1940 IN SCALE 0.0055
----------------------------	---	--	--

82 REFERENCE FILE

# AEDC VA 1163 MDAC BOOSTER AND ORBITER TEST DATA AT MACH NUMBER 5

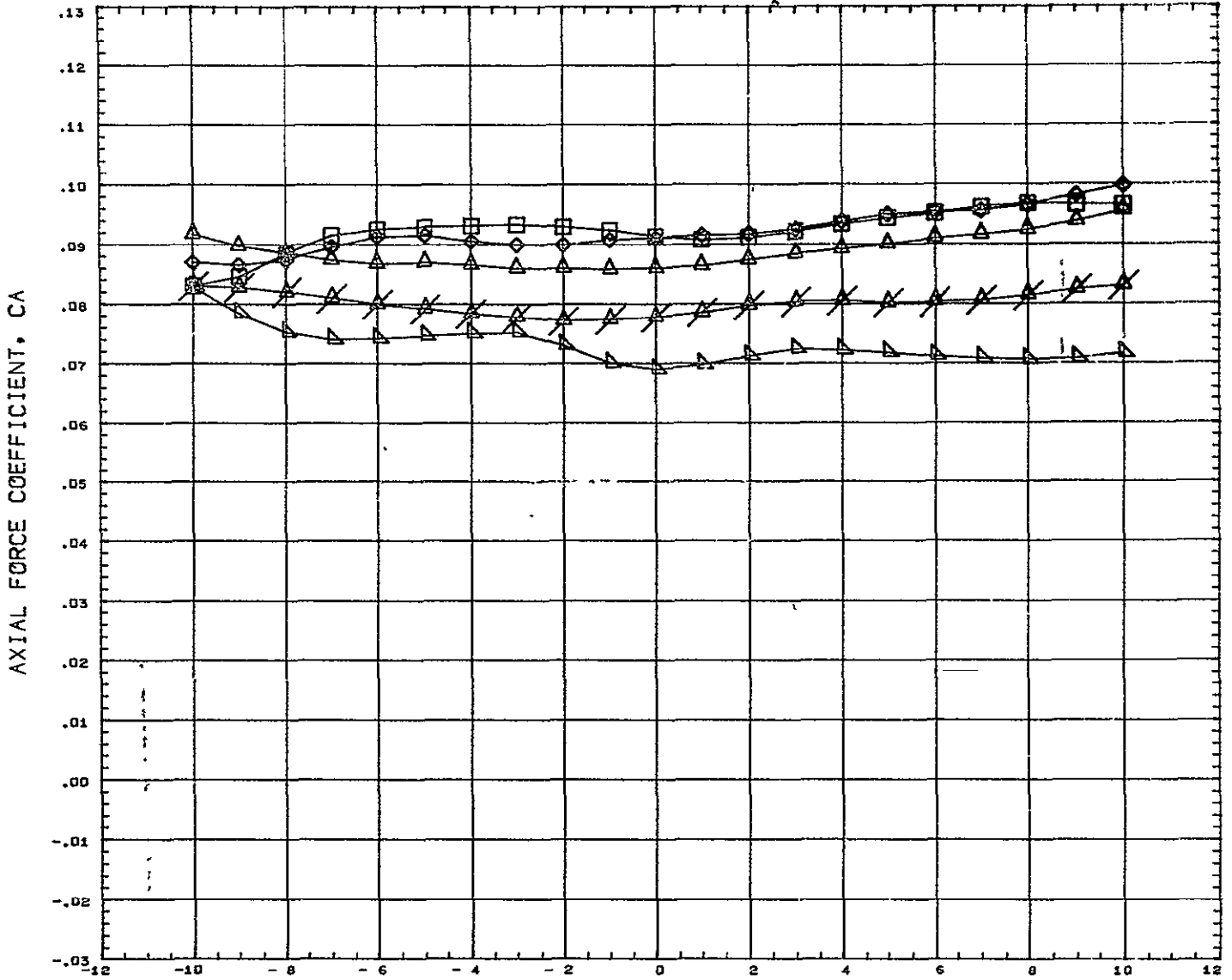

SYMBOL △ ◇ □ ○ ×	DELTAZ 0.151 0.182 0.220 0.352 10.000	PARAMETRIC VALUES BSTPOW 50.000 ORBPOW 50.000 DELTAX 0.351 ALPHAI 5.000 MACH 5.010 ELVBST 0.000 ELVORB 0.000 BETA 0.000	REFERENCE INFORMATION REFS 44.4440 SQ IN REFL 13.3330 IN REFB 13.3330 IN XMRP 7.5280 IN YMRP 0.0090 IN ZMRP 1.1940 IN SCALE 0.0055
---------------------------------	--	---	---

REFERENCE FILE

# AEDC VA 1163 MDAC BOOSTER AND ORBITER TEST DATA AT MACH NUMBER 5

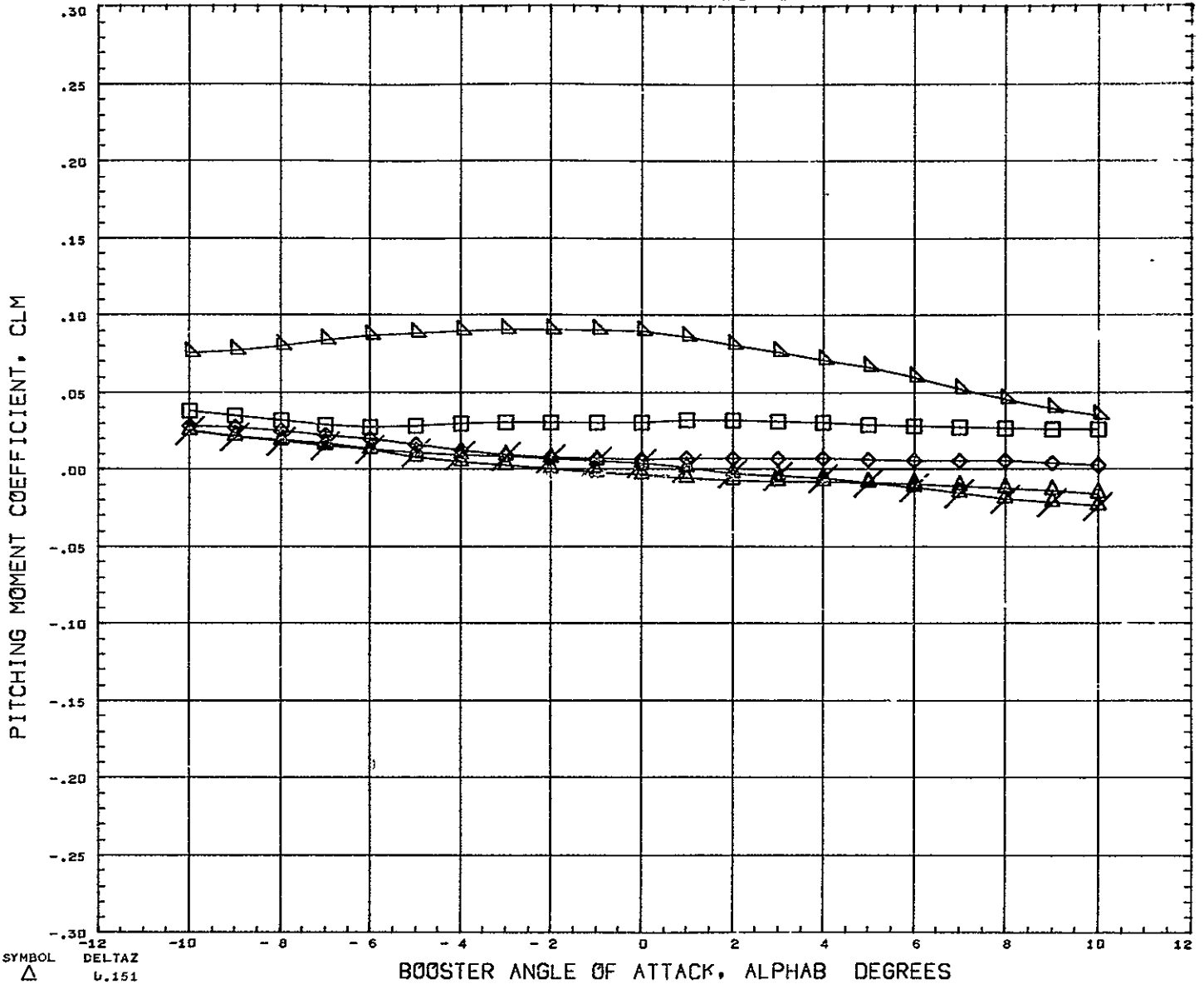

SYMBOL △ ◻ ◇ ○ ×	DELTAZ 0.151 0.182 0.228 0.352 10.000	PARAMETRIC VALUES BSTFOW 50.000 ORBPOW 50.000 DELTAX 0.521 ALPHAI 5.000 MACH 5.010 ELVBST 0.000 ELVORB 0.000 BETA 0.000	REFERENCE INFORMATION REFS 44.4440 SQ IN REFL 13.3330 IN REFB 13.3330 IN XMRP 7.5280 IN YMRP 0.0500 IN ZMRP 1.1940 IN SCALE 0.0055
---------------------------------	--	---	---

100 REFERENCE FILE

# AEDC VA 1163 MDAC BOOSTER AND ORBITER TEST DATA AT MACH NUMBER 5

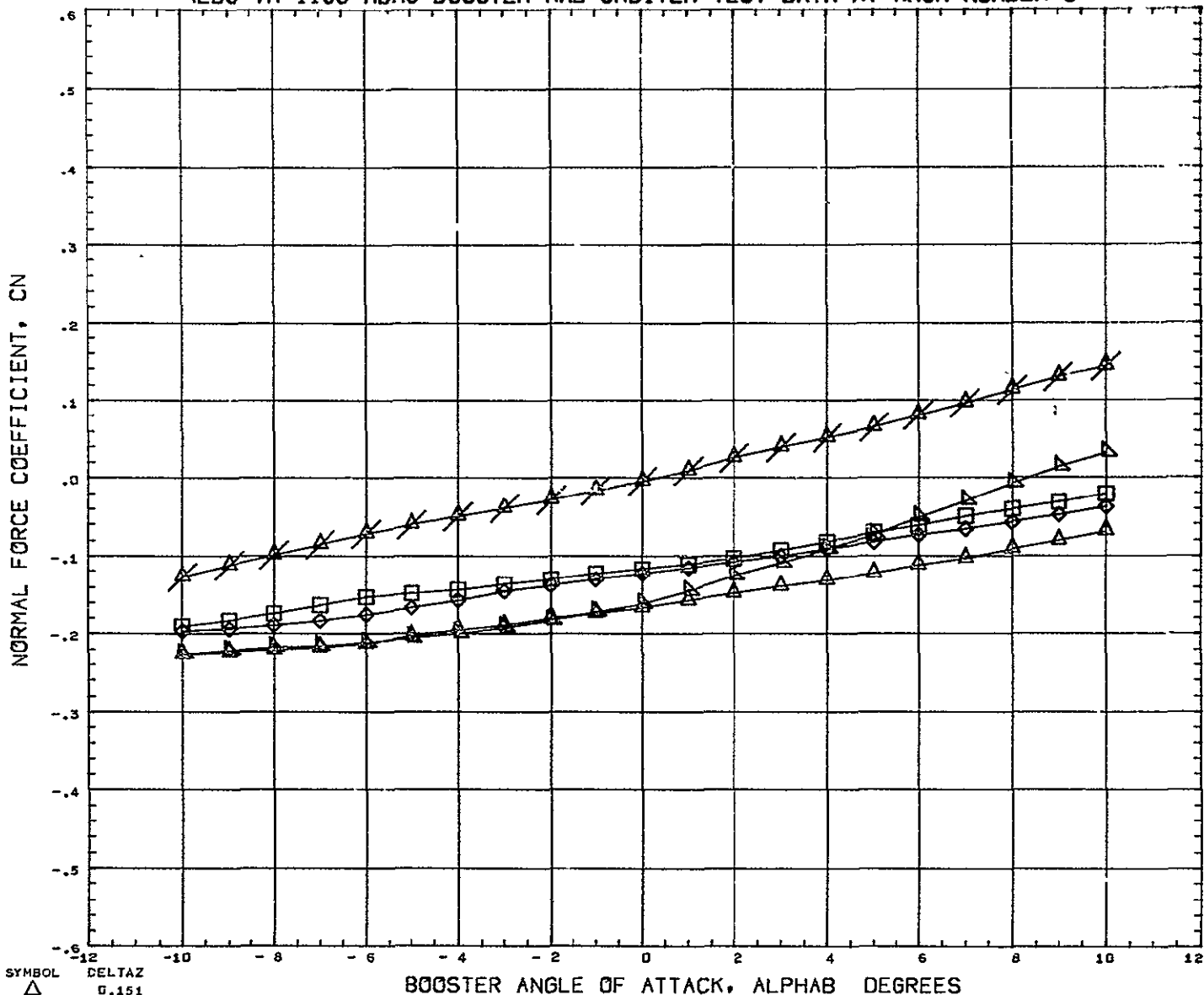

SYMBOL △ ◇ □ ○ ×	DELTA Z 0.151 0.182 0.228 0.352 10.000 ELVORB	PARAMETRIC VALUES BSTFCW 50.000 ORBPOW 50.000 DELTAX 0.521 ALPHAI 5.000 MACH 5.010 ELVBST 0.000 BETA 0.000	REFERENCE INFORMATION REFS 44.4440 SQ IN REFL 13.3330 IN REFB 13.3330 IN XMPP 7.5280 IN YMRP 0.0000 IN ZMRP 1.1940 IN SCALE 0.0055
---------------------------------	---	--	---

REFERENCE FILE

# AEDC VA 1163 MDAC BOOSTER AND ORBITER TEST DATA AT MACH NUMBER 5

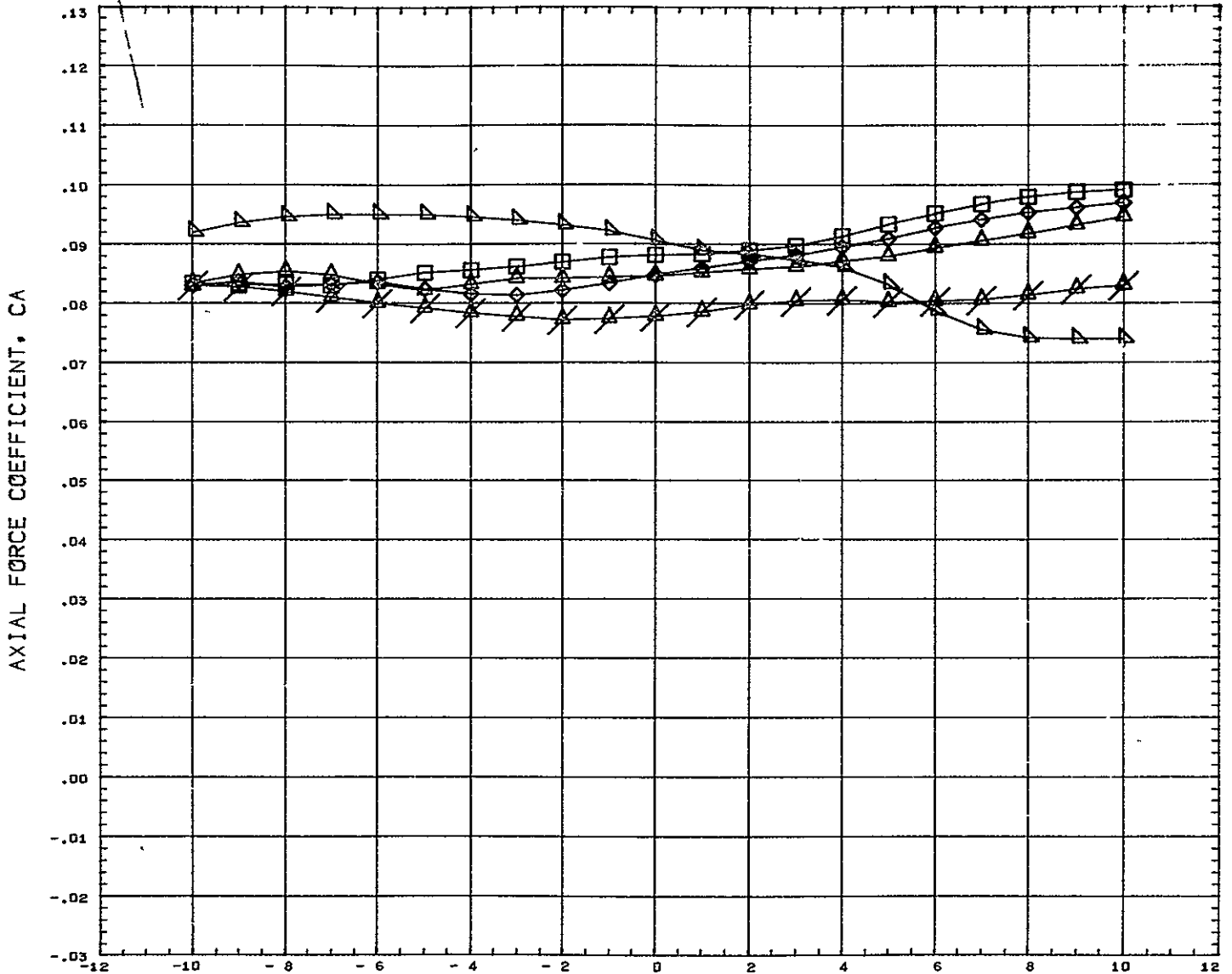

SYMBOL	DELTAZ	PARAMETRIC VALUES				REFERENCE INFORMATION		
△	0.151					REFS	44.44#0	SQ IN
◇	0.182					REFL	13.3330	IN
□	0.228	BSTPOW	50.000	ORBPOW	50.000	REFB	13.3330	IN
○	0.352	DELTAZ	0.521	ALPHA1	5.000	XMRP	7.5280	IN
×	10.000	MACH	5.010	ELVBST	0.000	YMRP	0.0000	IN
		ELVORB	0.000	BETA	0.000	ZMRP	1.1940	IN
						SCALE	0.0055	
	1	REFERENCE FILE						

# AEDC VA 1163 MDAC BOOSTER AND ORBITER TEST DATA AT MACH NUMBER 5

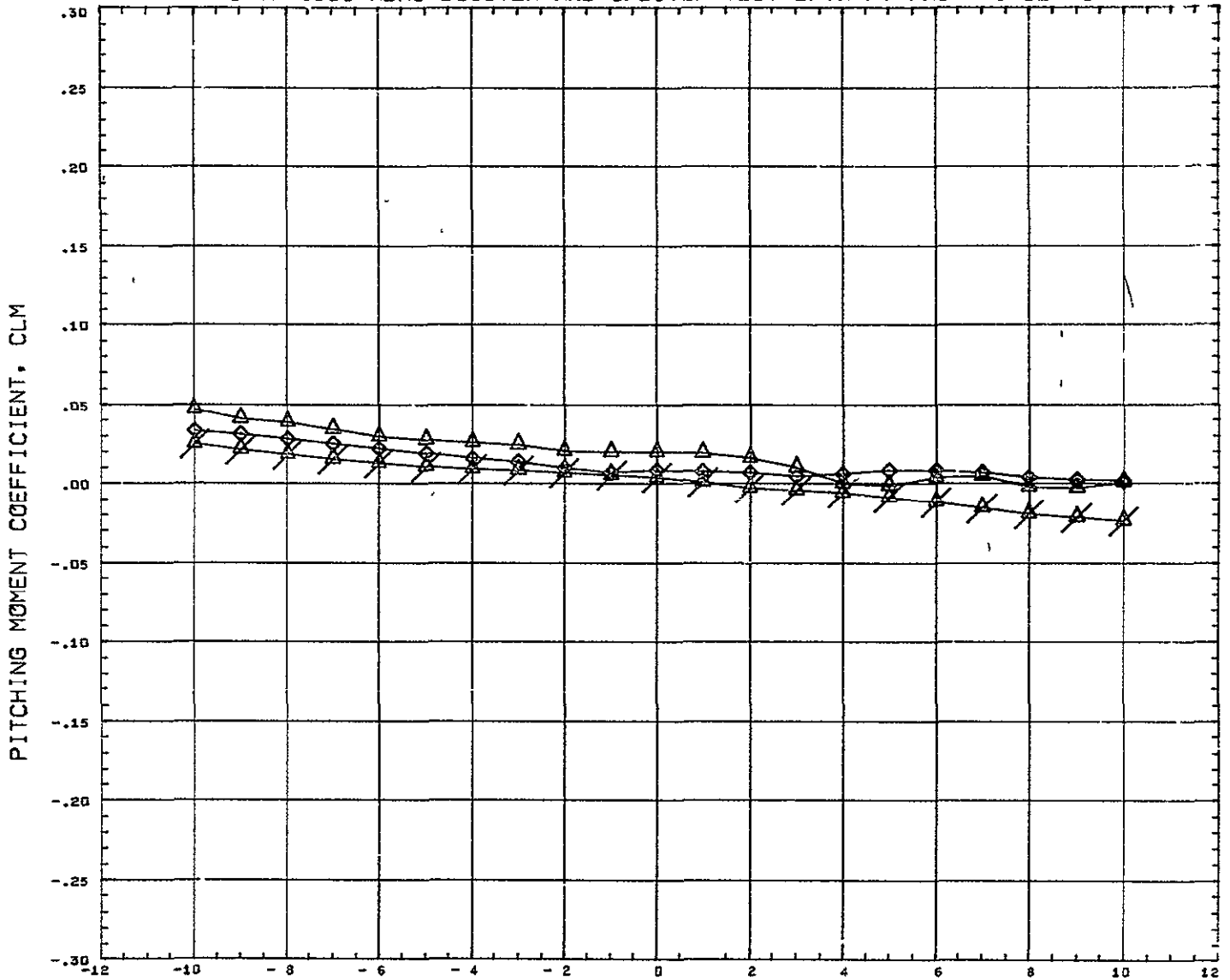

SYMBOL    DELTAZ  
 △        0.151  
 ◇        0.182  
 ✕        10.000

BOOSTER ANGLE OF ATTACK, ALPHAB DEGREES

PARAMETRIC VALUES  
 9STPOW    50.000    ORBPOW    25.000  
 DELTAX    - 0.391    ALPHA1    5.000  
 MACH      5.010    ELVBST    0.000  
 ELVORB    0.000    BETA      0.000

REFERENCE INFORMATION  
 REFS      44.444C    SQ IN  
 REFL      13.333D    IN  
 REFB      13.333D    IN  
 XMRP      7.5280    IN  
 YMRP      0.0000    IN  
 ZMRP      1.1540    IN  
 SCALE     0.0055

REFERENCE FILE

# AEDC VA 1163 MDAC BOOSTER AND ORBITER TEST DATA AT MACH NUMBER 5

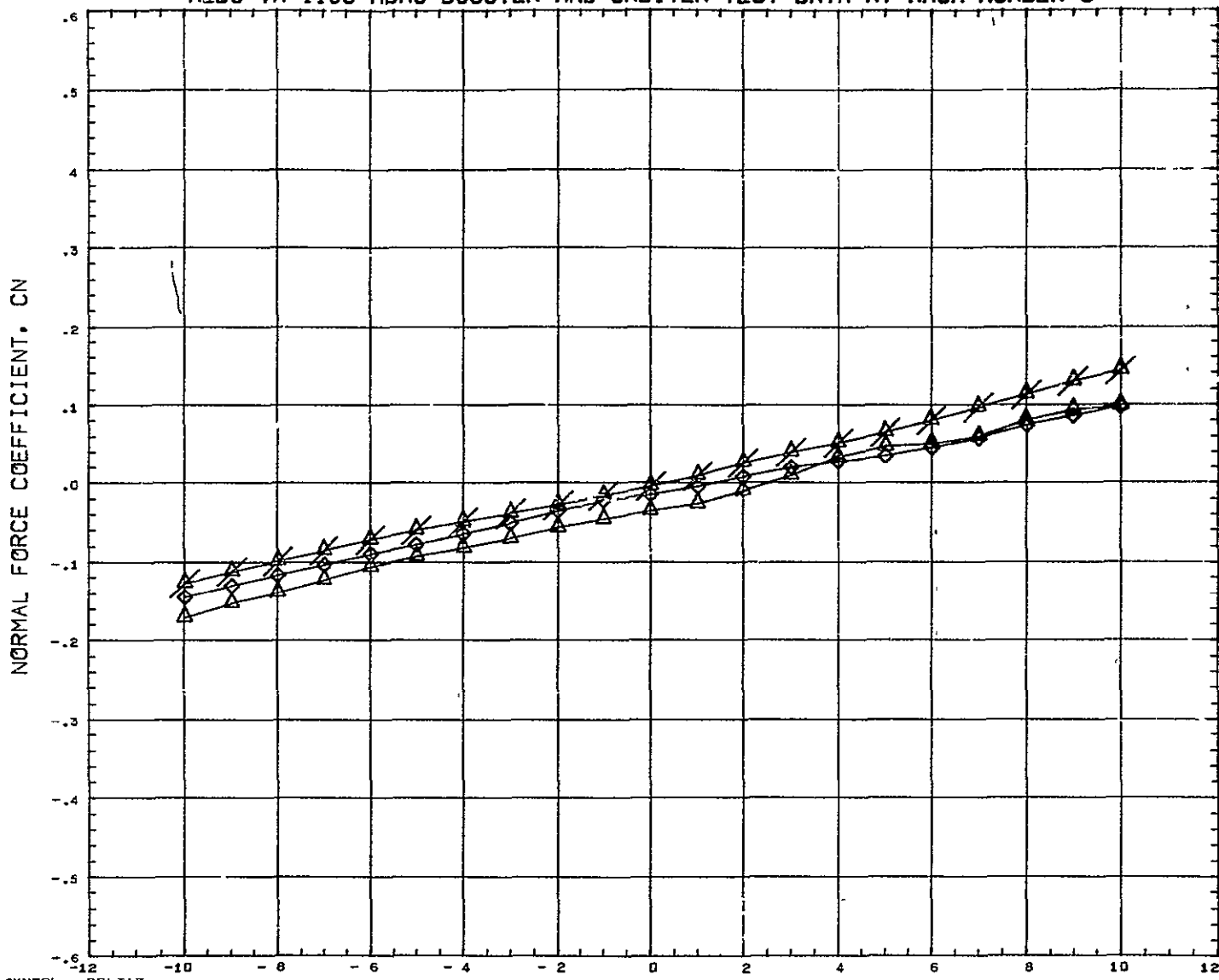

SYMBOL △ ◇ △x	DELTAZ 0.151 0.182 10.000	<table border="0" style="width: 100%;"> <tr> <th colspan="4" style="text-align: left;">PARAMETRIC VALUES</th> </tr> <tr> <td>BSTFOW</td><td>50.000</td><td>ORBFOV</td><td>25.000</td> </tr> <tr> <td>DELTAZ</td><td>-0.391</td><td>ALPHA1</td><td>5.000</td> </tr> <tr> <td>ACH</td><td>5.010</td><td>ELVBST</td><td>0.000</td> </tr> <tr> <td>ELVORB</td><td>0.000</td><td>BETA</td><td>0.000</td> </tr> </table>	PARAMETRIC VALUES				BSTFOW	50.000	ORBFOV	25.000	DELTAZ	-0.391	ALPHA1	5.000	ACH	5.010	ELVBST	0.000	ELVORB	0.000	BETA	0.000	<table border="0" style="width: 100%;"> <tr> <th colspan="3" style="text-align: left;">REFERENCE INFORMATION</th> </tr> <tr> <td>REFS</td><td>44.4440</td><td>SG IN</td> </tr> <tr> <td>REFL</td><td>13.3330</td><td>IN</td> </tr> <tr> <td>REFB</td><td>13.3330</td><td>IN</td> </tr> <tr> <td>XHRF</td><td>7.5280</td><td>IN</td> </tr> <tr> <td>YHRF</td><td>0.0000</td><td>IN</td> </tr> <tr> <td>ZHRF</td><td>1.1940</td><td>IN</td> </tr> <tr> <td>SCALE</td><td>0.0055</td><td></td> </tr> </table>	REFERENCE INFORMATION			REFS	44.4440	SG IN	REFL	13.3330	IN	REFB	13.3330	IN	XHRF	7.5280	IN	YHRF	0.0000	IN	ZHRF	1.1940	IN	SCALE	0.0055	
PARAMETRIC VALUES																																															
BSTFOW	50.000	ORBFOV	25.000																																												
DELTAZ	-0.391	ALPHA1	5.000																																												
ACH	5.010	ELVBST	0.000																																												
ELVORB	0.000	BETA	0.000																																												
REFERENCE INFORMATION																																															
REFS	44.4440	SG IN																																													
REFL	13.3330	IN																																													
REFB	13.3330	IN																																													
XHRF	7.5280	IN																																													
YHRF	0.0000	IN																																													
ZHRF	1.1940	IN																																													
SCALE	0.0055																																														
REFERENCE FILE																																															



AEDC VA 1163 MDAC BOOSTER AND ORBITER TEST DATA AT MACH NUMBER 5

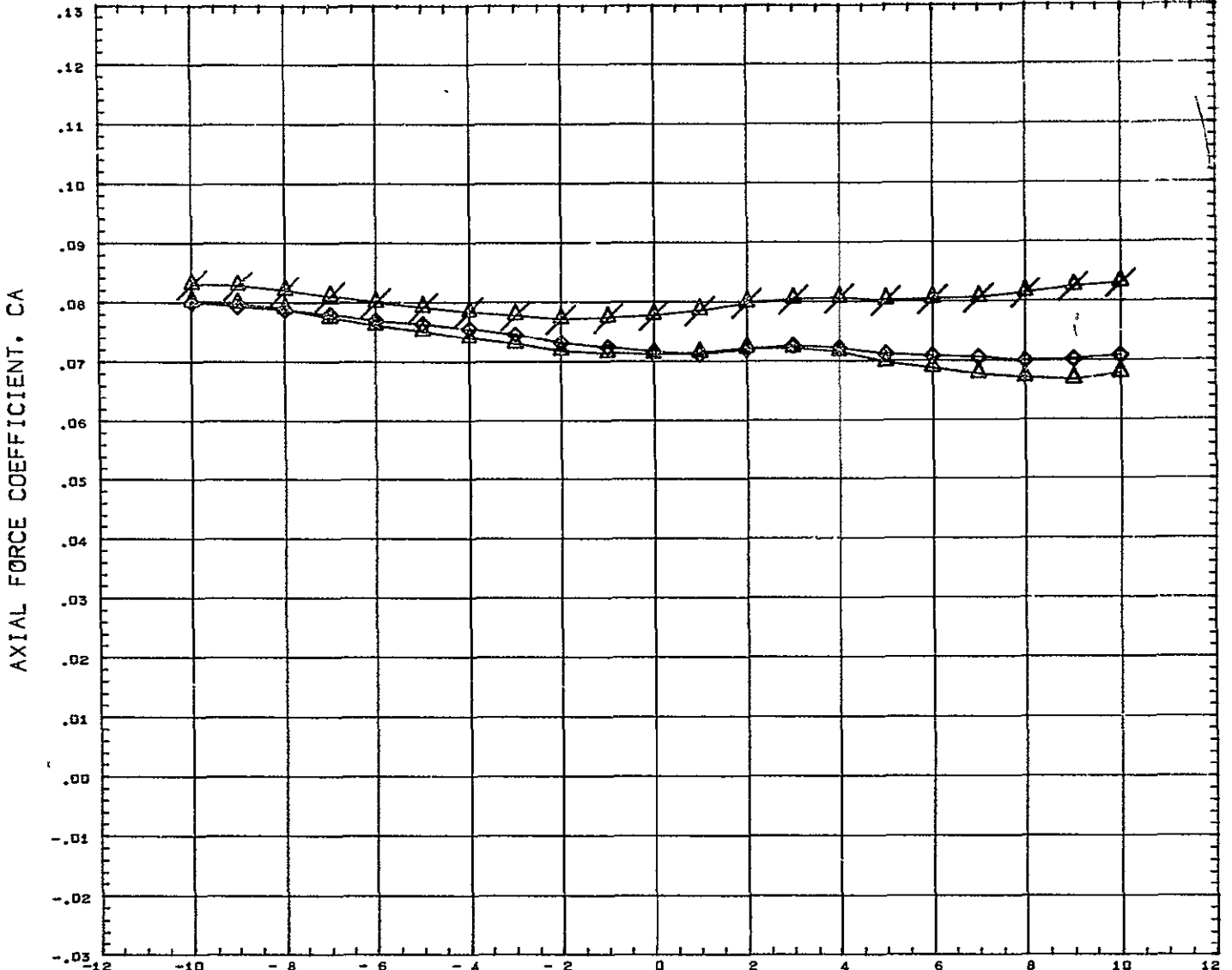

SYMBOL	DELTAZ	PARAMETRIC VALUES				REFERENCE INFORMATION		
△	0.151	BSTFOW	50.000	ORBPOW	25.000	REFS	44.4440	50 IN
◇	0.182	DELTAZ	- 0.391	ALPHA1	5.000	REFL	13.3330	1N
△	10.000	MACH	5.010	ELVBST	0.000	REFB	13.3330	1N
		ELVORB	0.000	BETA	0.000	XHRF	7.5280	1N
						YHRF	0.0000	1N
						ZHRF	1.1940	1N
						SCALE	0.0055	
		REFERENCE FILE						

# AEDC VA 1163 MDAC BOOSTER AND ORBITER TEST DATA AT MACH NUMBER 5

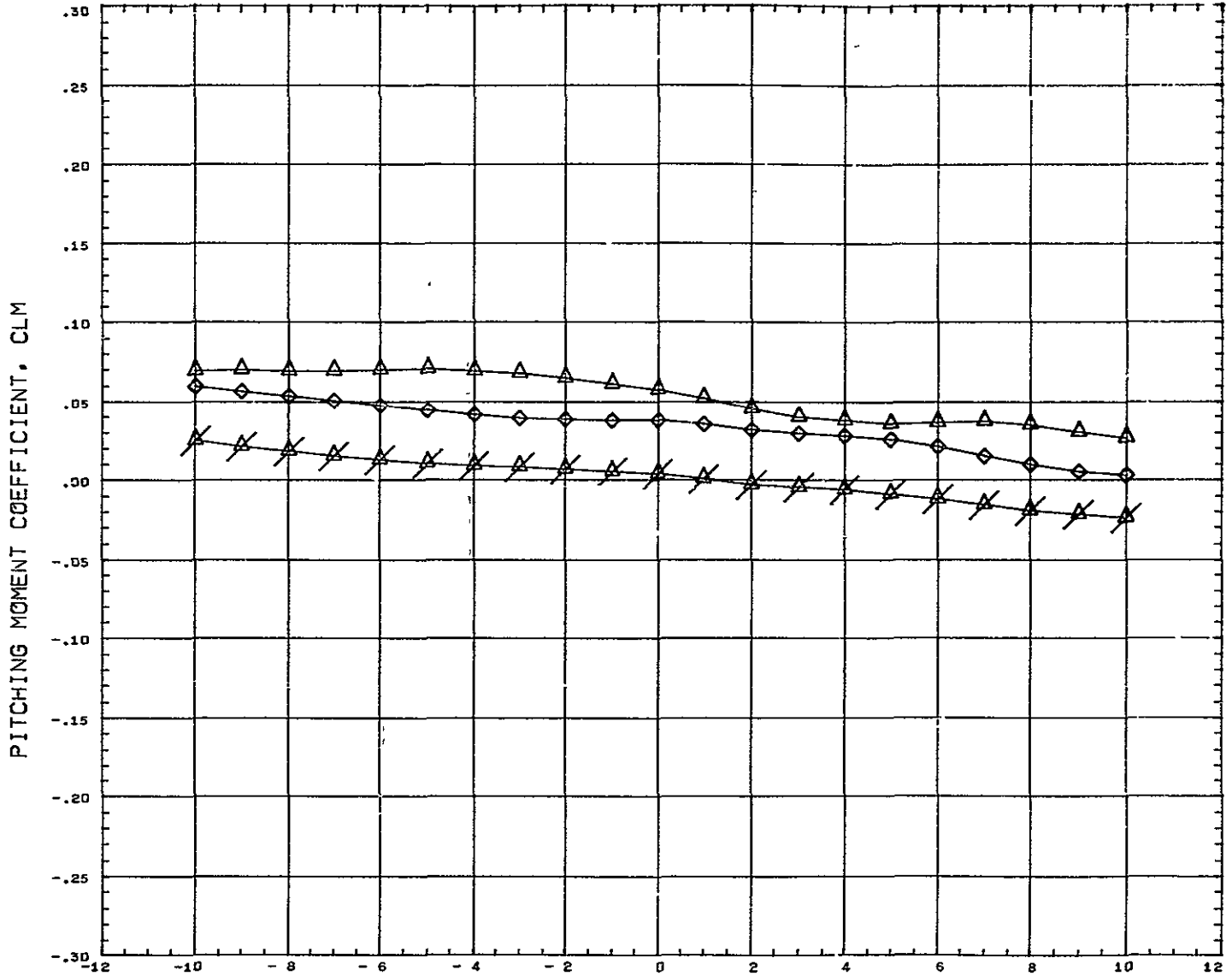

SYMBOL    DELTA Z  
 ◊         0.151  
 ◊         0.182  
 ✕         10.000

BOOSTER ANGLE OF ATTACK, ALPHA B DEGREES

PARAMETRIC VALUES  
 BSTPOW    50.000    ORBPOW    25.000  
 DELTAX    0.143    ALPHAI    5.000  
 MACH      5.010    ELVBST    0.000  
 ELVORB    0.000    BETA      0.000

REFERENCE INFORMATION  
 REFS      44.4440    SQ IN  
 REFL      13.3330    IN  
 REFB      13.3330    IN  
 XMRP      7.5280    IN  
 YMRP      0.0000    IN  
 ZMRP      1.1940    IN  
 SCALE     0.0055

REFERENCE FILE

# AEDC VA 1163 MDAC BOOSTER AND ORBITER TEST DATA AT MACH NUMBER 5

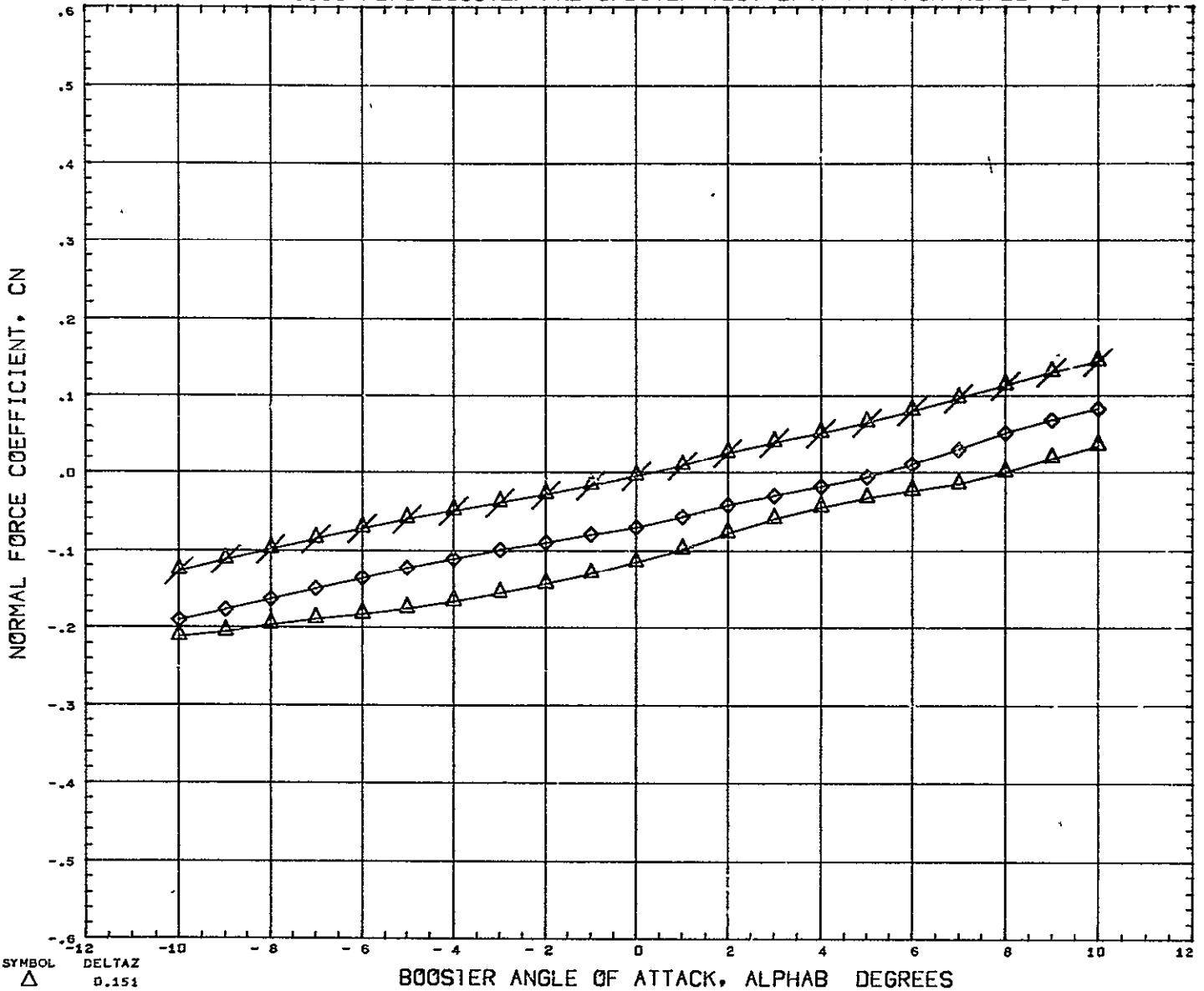

SYMBOL	DELTA Z	PARAMETRIC VALUES		REFERENCE INFORMATION				
△	0.151	BSTPOW	50.000	ORBPOW	25.000	REFS	44.4440	SQ IN
◇	0.182	PETAX	-0.143	ALPHA1	5.000	REFL	13.3330	IN
⊗	10.000	MACH	5.010	ELVBST	0.000	REFB	13.3330	IN
		ELVORB	0.000	BETA	0.000	XMRP	7.5280	IN
						YMRP	0.0000	IN
						ZMRP	1.1940	IN
						SCALE	0.0055	IN

REFERENCE FILE

# AEDC VA 1163 MDAC BOOSTER AND ORBITER TEST DATA AT MACH NUMBER 5

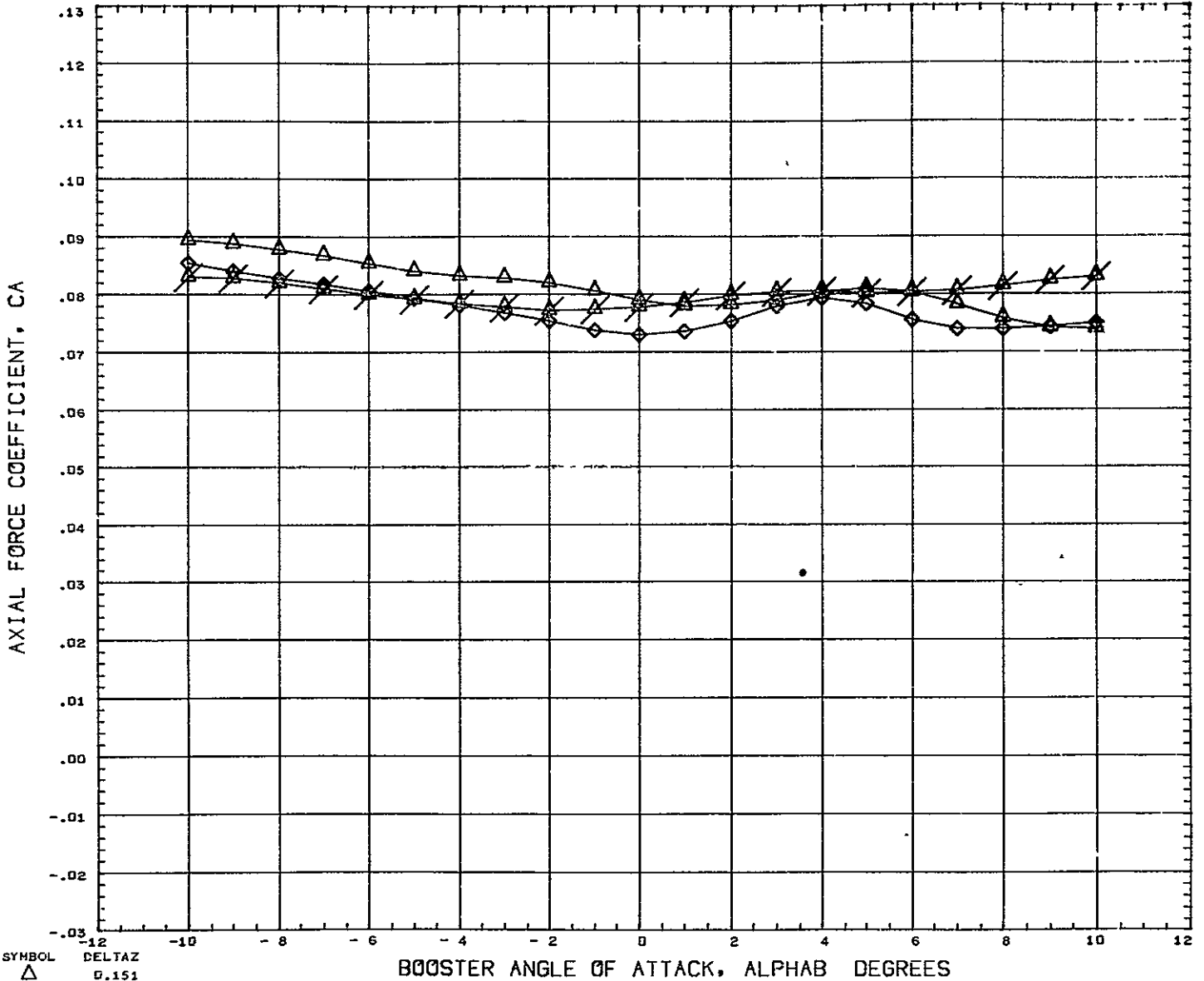

SYMBOL  
 △  
 ◇  
 ⊗

DELTA Z  
 0.151  
 0.182  
 10.000

PARAMETRIC VALUES  
 BSTPOW 50.000 ORBPOW 25.000  
 DELTAX - 0.143 ALPHAI 5.000  
 MACH 5.010 ELVBST 0.000  
 ELVORB 0.000 BETA 0.000

REFERENCE INFORMATION  
 REFS 44.4440 SQ IN  
 REFL 13.3330 IN  
 REFB 13.3330 IN  
 XMRP 7.5280 IN  
 YMRP 0.0000 IN  
 ZMRP 1.1940 IN  
 SCALE 0.0055

182 REFERENCE FILE

# AEDC VA 1163 MDAC BOOSTER AND ORBITER TEST DATA AT MACH NUMBER 5

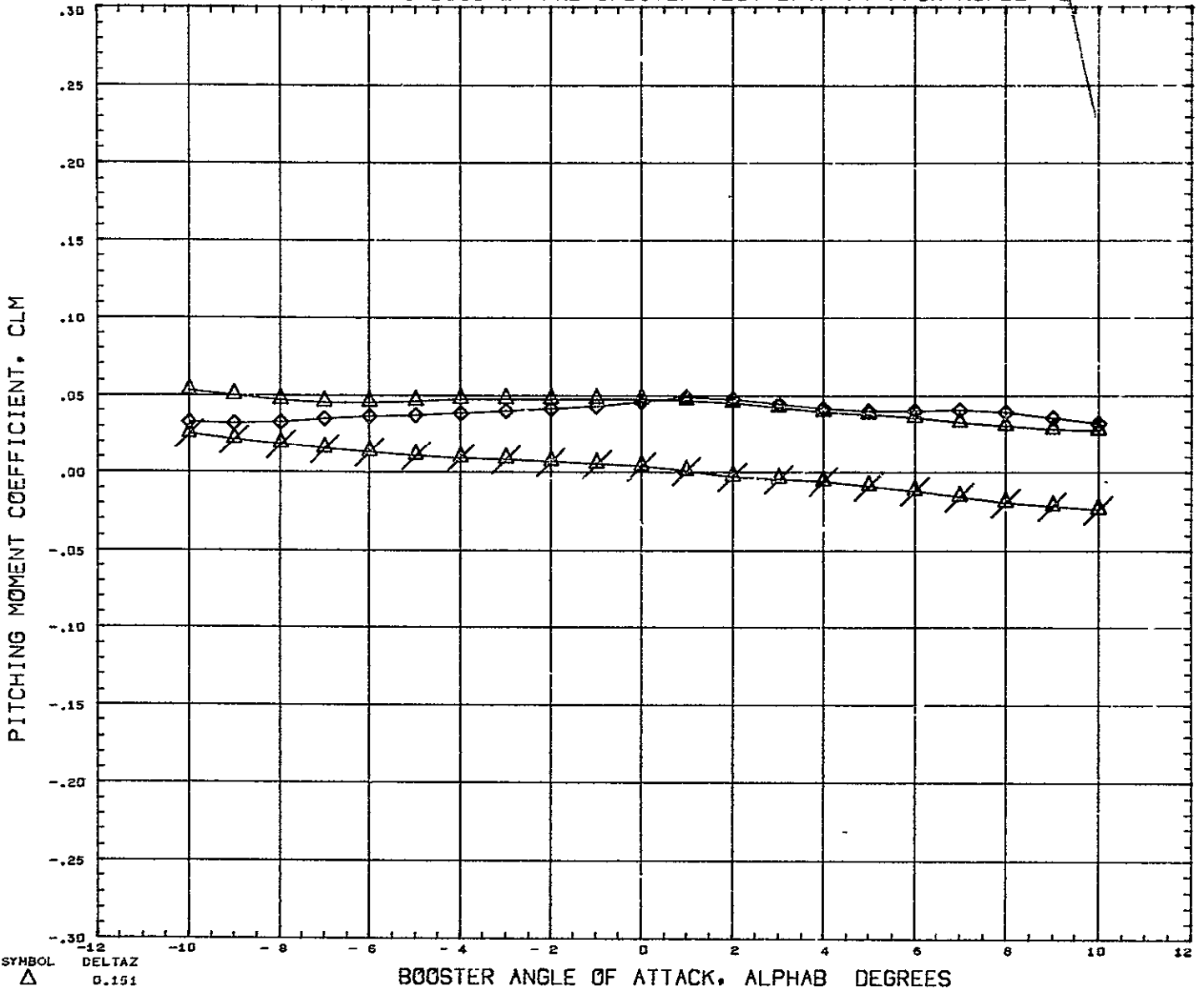

SYMBOL    DELTAZ  
 △        0.151  
 ◇        0.182  
 ×        10.000

PARAMETRIC VALUES

BSTPOW	50.000	ORBPOW	25.000
DELTAZ	- 0.019	ALPHA1	5.000
MACH	5.010	ELVBST	0.000
ELVORB	0.000	BETA	0.000

REFERENCE INFORMATION

REFS	44 4440	SQ IN
REFL	13.3330	IN
REFB	13.3330	IN
XMRP	7.5280	IN
YMRP	0.0000	IN
ZMRP	1.1940	IN
SCALE	0.0055	

REFERENCE FILE

# AEDC VA 1163 MDAC BOOSTER AND ORBITER TEST DATA AT MACH NUMBER 5

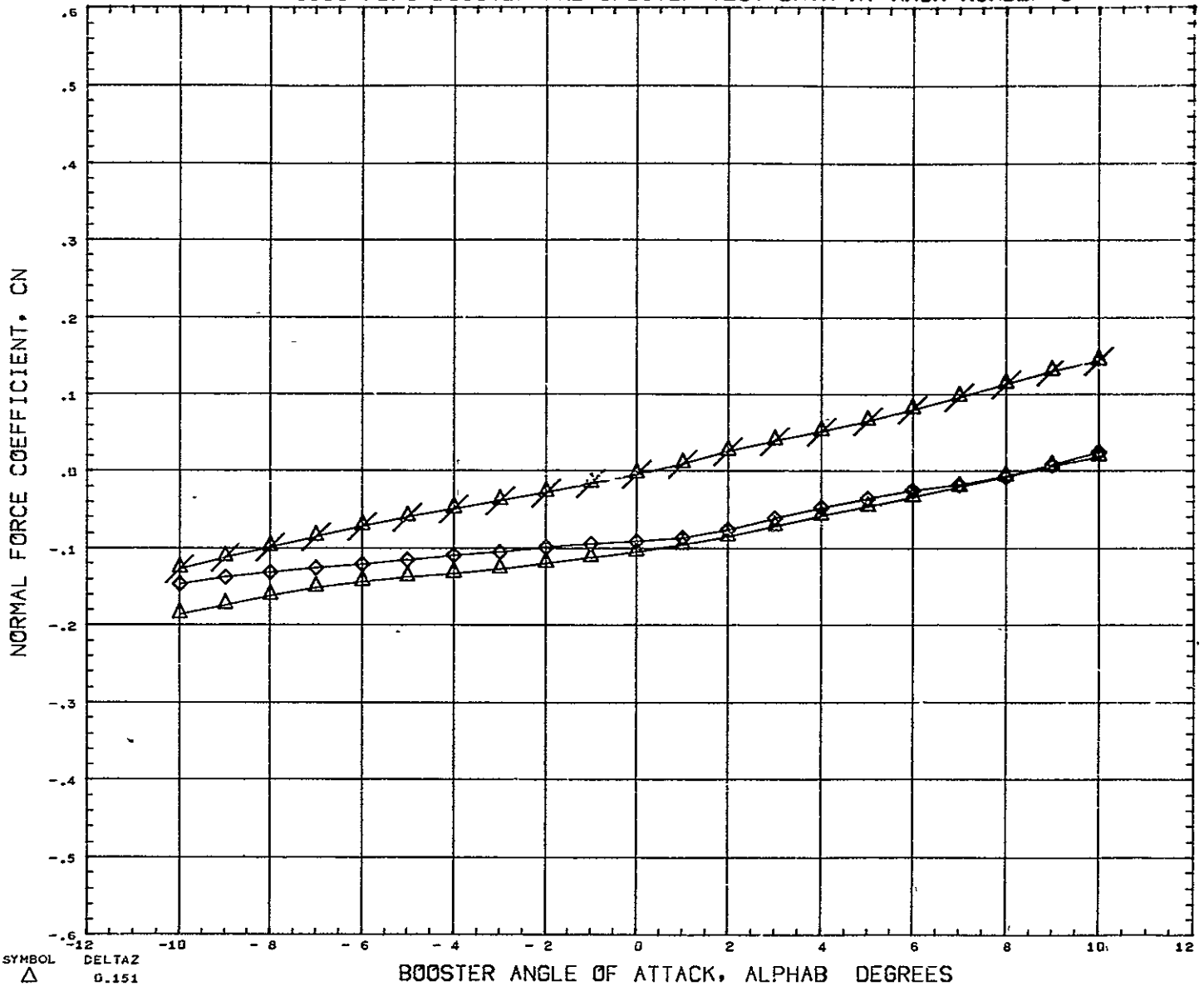

SYMBOL △ ◇ ×	DELTA Z 0.151 0.182 10.000	PARAMETRIC VALUES BSTPOW 50.000 ORBPOW 25.000 DFLTAX - 0.019 ALPHAI 5.000 MACH 5.010 ELVBST 0.000 ELVORB 0.000 BETA 0.000	REFERENCE INFORMATION REFS 44.4440 SQ IN REFL 13.3330 IN REFB 13.3330 IN XHRF 7.5280 IN YHRF 0.0000 IN ZHRF 1.1940 IN SCALE 0.0055
-----------------------	-------------------------------------	---	---

REFERENCE FILE

# AEDC VA 1163 MDAC BOOSTER AND ORBITER TEST DATA AT MACH NUMBER 5

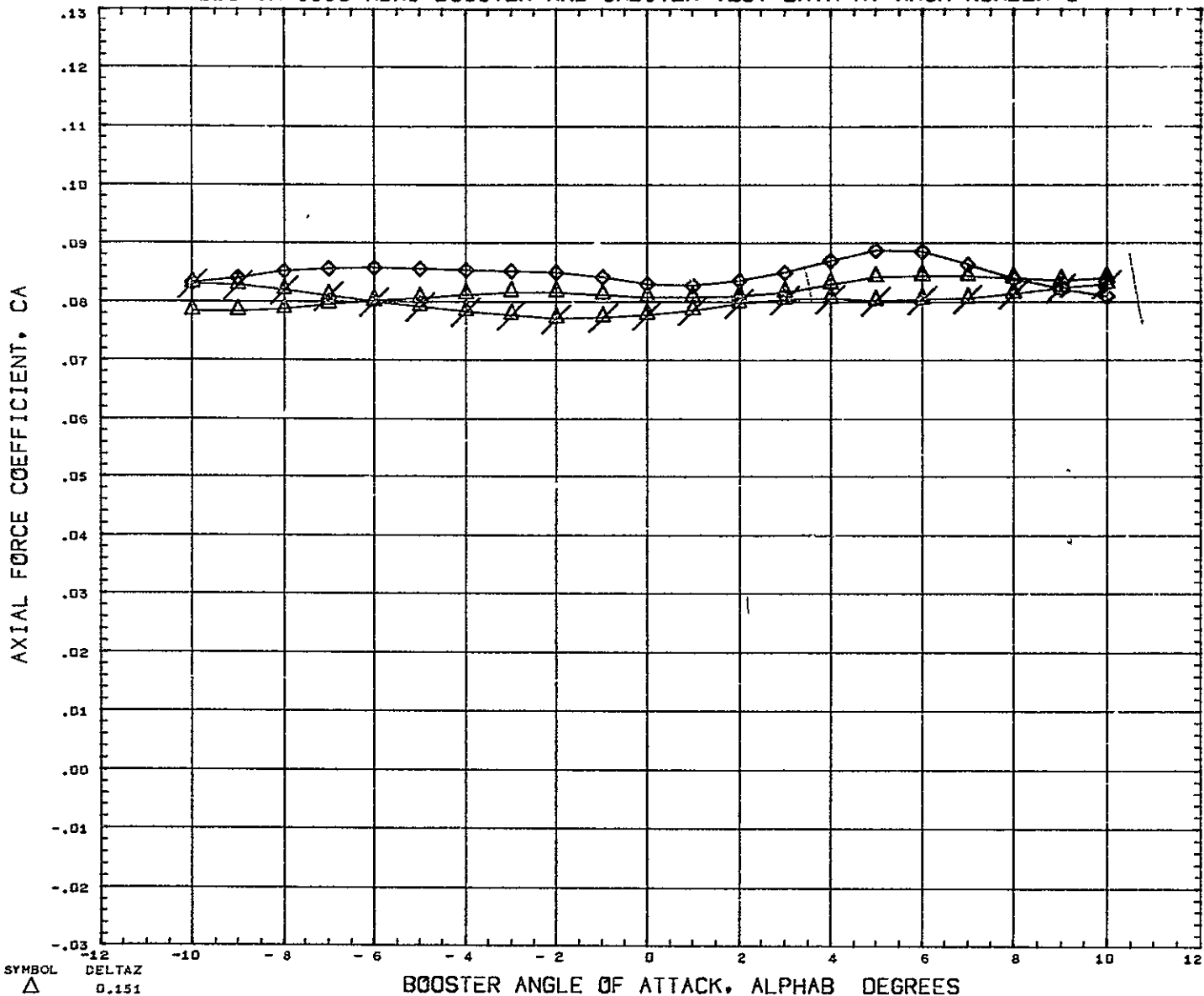

SYMBOL  $\Delta$  0.151  
 $\diamond$  0.182  
 $\times$  10.000

BOOSTER ANGLE OF ATTACK, ALPHAB DEGREES

PARAMETRIC VALUES  
 BSTPOW 50.000 ORBPOW 25.000  
 DELTAX - 0.019 ALPHAI 5.000  
 MACH 5.010 ELVBST 0.000  
 ELVORB 0.000 BETA 0.000

REFERENCE INFORMATION  
 REFS 44.4440 SQ IN  
 REFL 13.3330 IN  
 REFB 13.3330 IN  
 XMRP 7.5200 IN  
 YMRP 0.0000 IN  
 ZMRP 1.1940 IN  
 SCALE 0.0055

REFERENCE FILE

# AEDC VA 1163 MDAC BOOSTER AND ORBITER TEST DATA AT MACH NUMBER 5

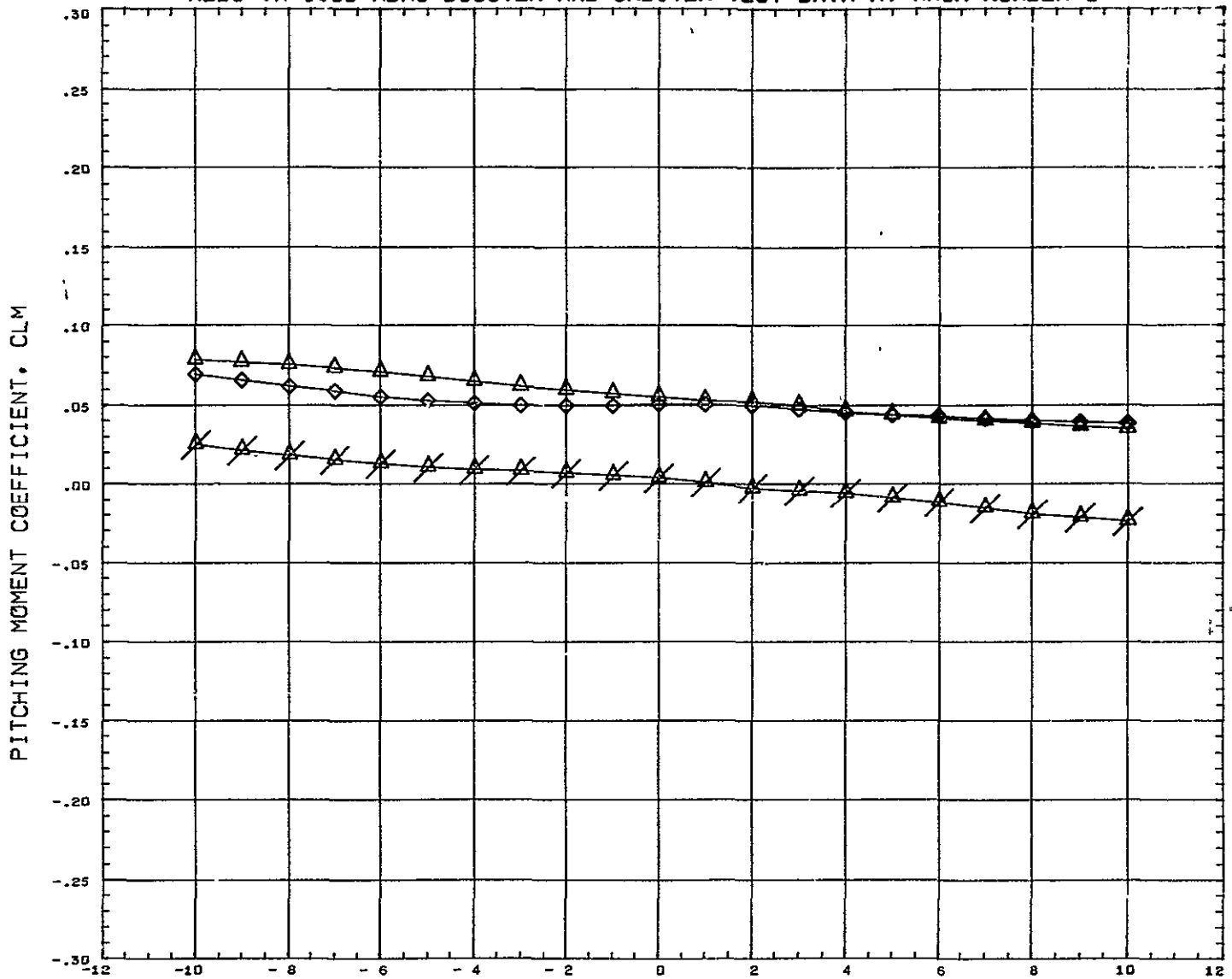

SYMBOL  
 △ 0.151  
 ◇ 0.182  
 ⊗ 10.000

PARAMETRIC VALUES  
 BSTPOW 50.000 ORBPOW 25.000  
 DELTAX 0.104 ALPHA1 5.000  
 MACH 5.010 ELVBST 0.000  
 ELVORB 0.000 BETA 0.000

REFERENCE INFORMATION  
 REFS 44.4440 SQ IN  
 REFL 13.3330 IN  
 REFB 13.3330 IN  
 XMRP 7.5280 IN  
 YMRP 0.0000 IN  
 ZMRP 1.1945 IN  
 SCALE 0.0055

DATA HIST. CODE M



# AEDC VA 1163 MDAC BOOSTER AND ORBITER TEST DATA AT MACH NUMBER 5

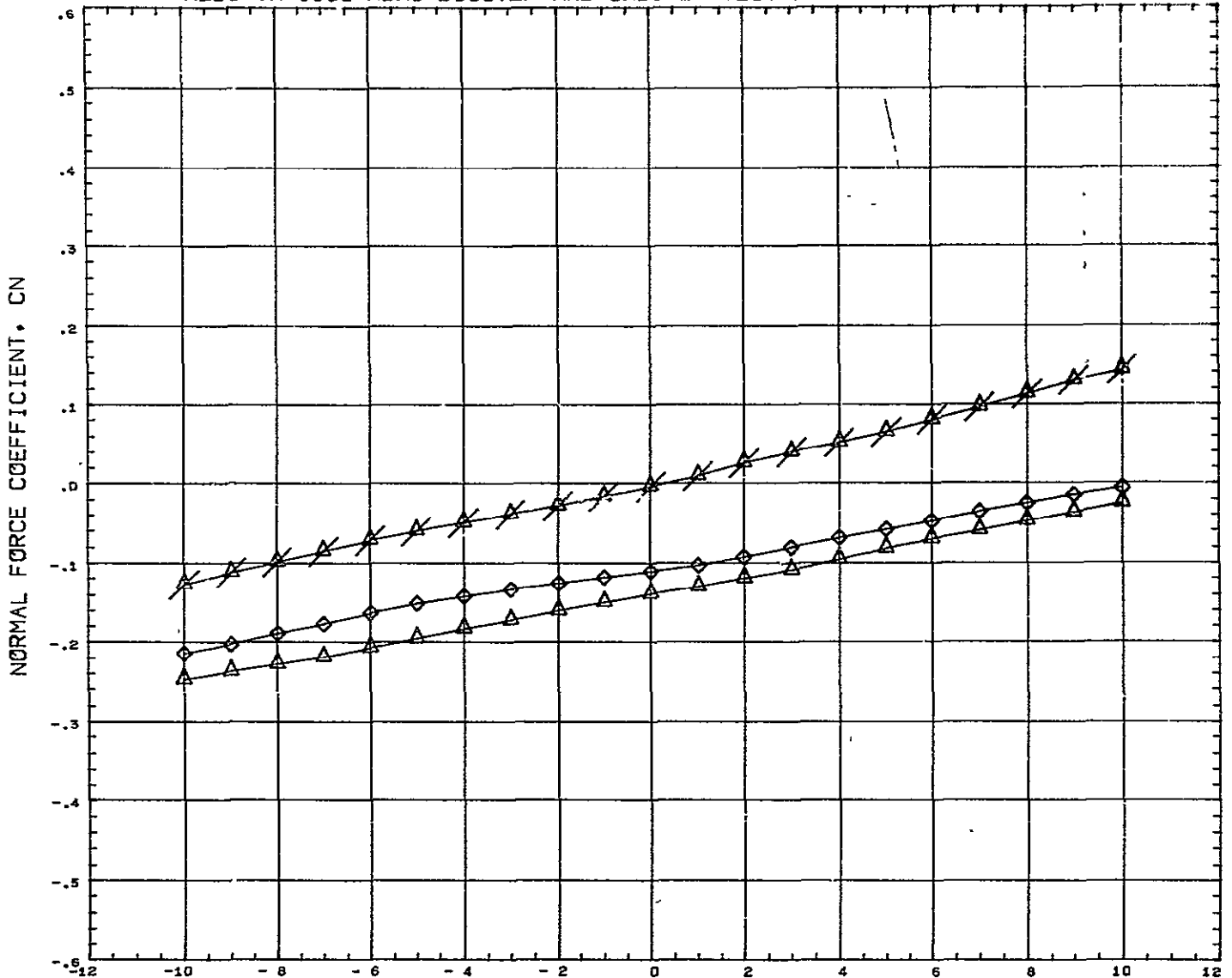

SYMBOL ◇ △	DELTAZ 0.151 0.182 10.000	<b>PARAMETRIC VALUES</b> BSTPOW 50.000 ORBPOW 25.000 DELTAX 0.104 ALPHAI 5.000 M CH 5.010 ELVBST 0.000 ELVORB 0.000 BETA 0.000	<b>REFERENCE INFORMATION</b> REFS 44.4440 SQ IN REFL 13.3330 IN REFB 13.3330 IN XMRF 7.5280 IN YMRF 0.0000 IN ZMRF 1.1940 IN SCALE 0.0055
DATA HIST. CODE M			

# AEDC VA 1163 MDAC BOOSTER AND ORBITER TEST DATA AT MACH NUMBER 5

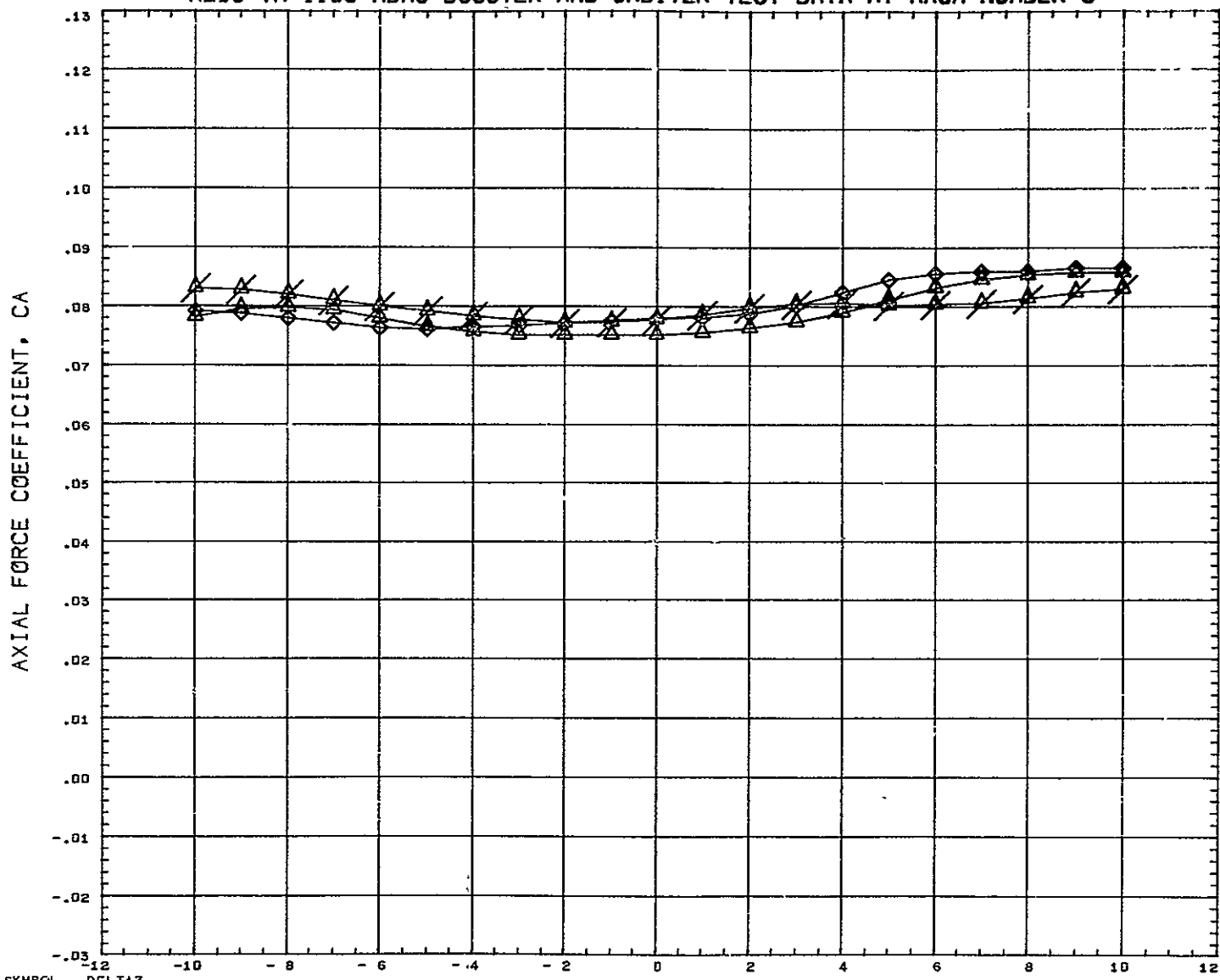

SYMBOL  $\Delta$  DELTAZ  
 $\diamond$  0.151  
 $\times$  0.182  
 10.000

BOOSTER ANGLE OF ATTACK, ALPHAB DEGREES

PARAMETRIC VALUES			
BSTPOW	50.000	ORBPOW	25.000
DELTAZ	0.104	ALPHA1	5.000
M CH	5.010	ELVBST	0.000
ELVORB	0.000	BETA	0.000

REFERENCE INFORMATION		
REFS	44.4440	SQ IN
REFL	13.3330	IN
REFB	13.3330	IN
XNRP	7.5280	IN
YNRP	0.0000	IN
ZNRP	1.1940	IN
SCALE	0.0055	

DATA HIST. CODE M

# AEDC VA 1163 MDAC BOOSTER AND ORBITER TEST DATA AT MACH NUMBER 5

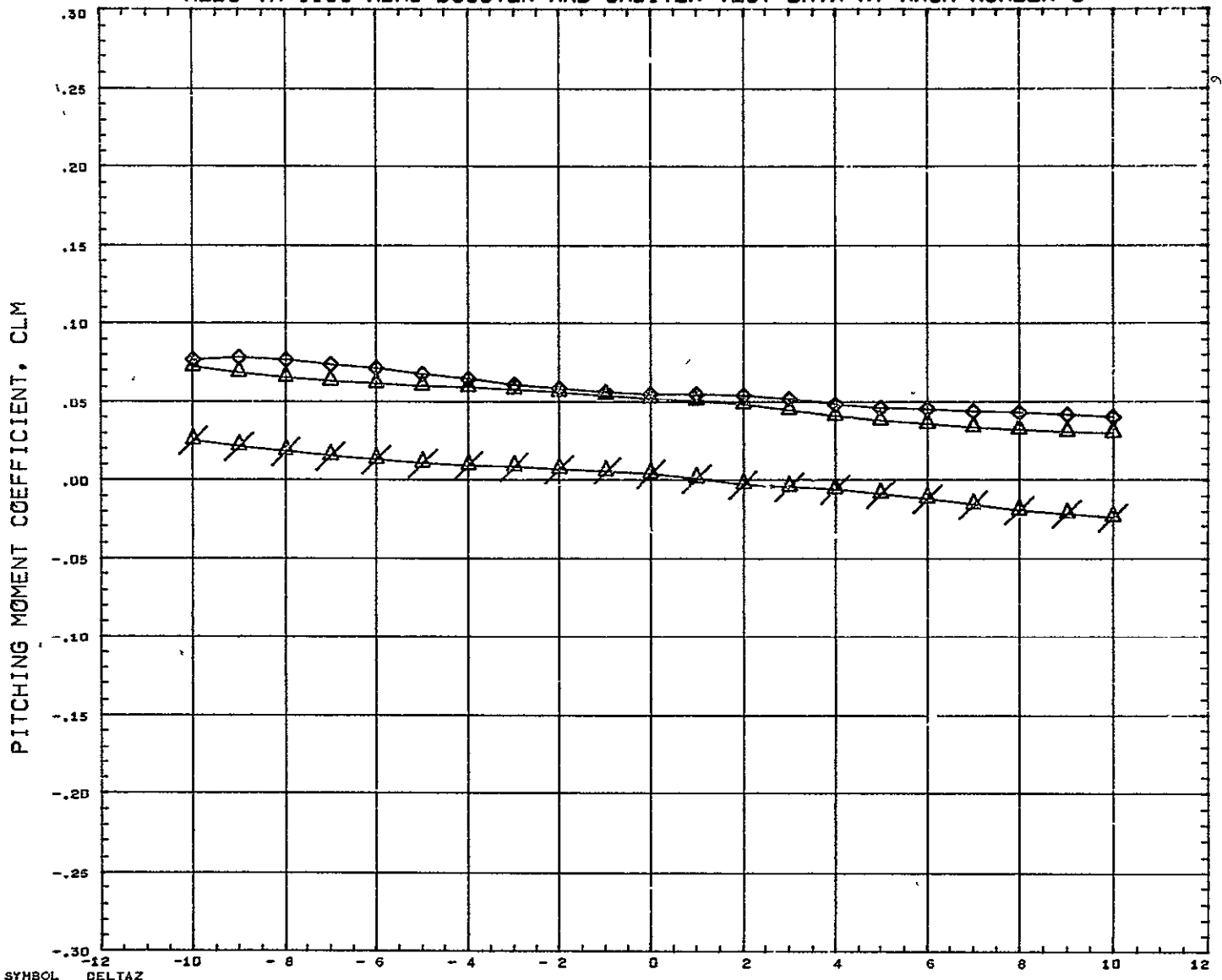

SYMBOL △ ◇ △	DELTAX 0.151 0.182 10.000	<b>PARAMETRIC VALUES</b> BSTPOW 50.000 ORBPOW 25.000 DELTAX 0.166 ALPHAI 5.000 MACH 5.010 ELVBST 0.000 ELVORB 0.000 BETA 0.000	<b>REFERENCE INFORMATION</b> REFS 44.4440 SQ IN REFL 13.3330 IN REFB 13.3330 IN XMRP 7.5280 IN YMRP 0.0000 IN ZMRP 1.1940 IN SCALE 0.0055
DATA HIST. CODE M			

# AEDC VA 1163 MDAC BOOSTER AND ORBITER TEST DATA AT MACH NUMBER 5

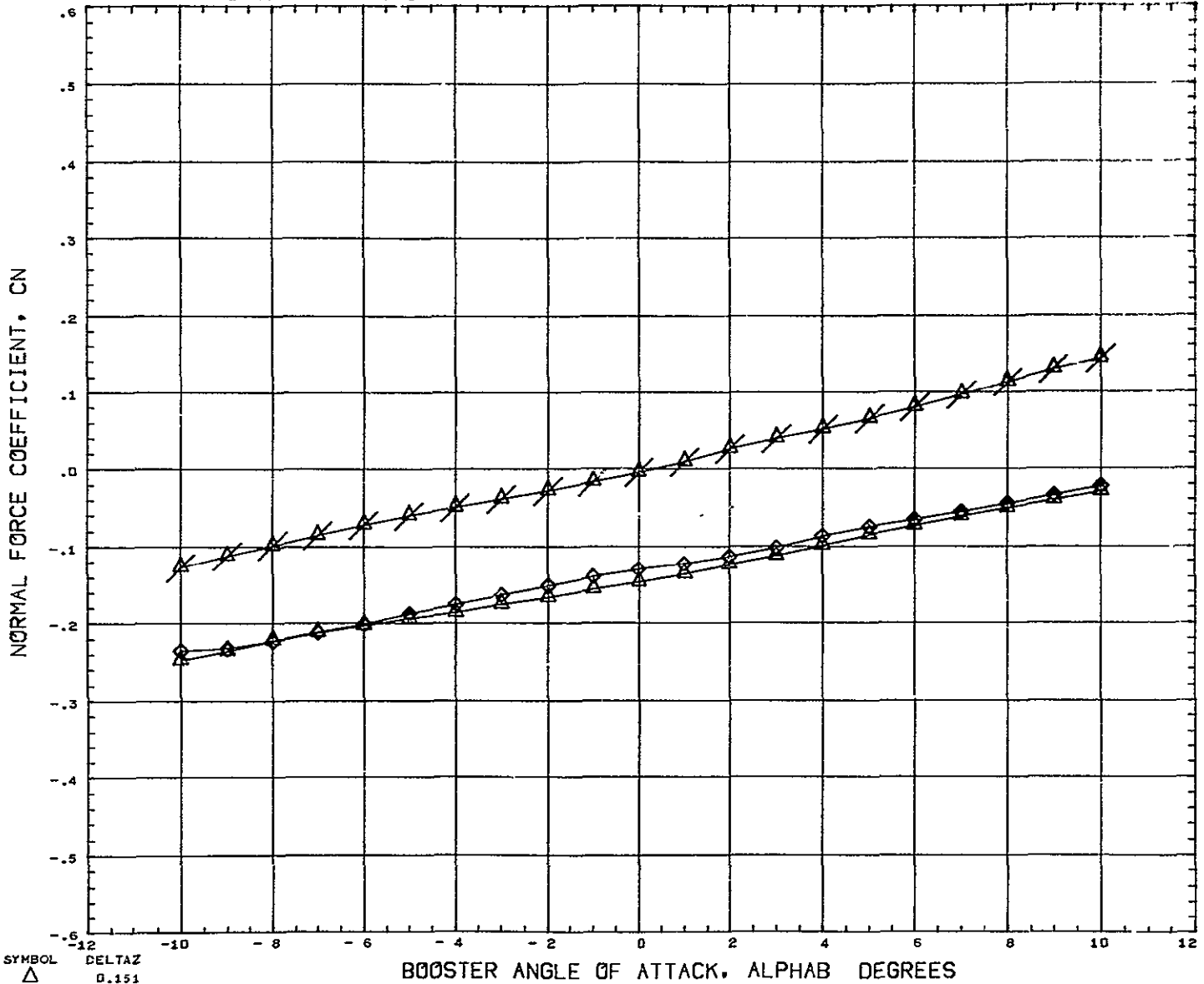

SYMBOL △ ◇ △	DELTA Z 0.151 0.182 10.000	PARAMETRIC VALUES BSTFOW 50.000 ORBPOW 25.000 DELTAX 0.166 ALPHAI 5.000 MACH 5.010 ELVBST 0.000 ELVORB 0.000 BETA 0.000	REFERENCE INFORMATION REFS 44.4440 SQ IN REFL 13.3330 IN REFB 13.3330 IN XMRP 7.5280 IN YMRP 0.0000 IN ZMRP 1.1940 IN SCALE 0.0055
-----------------------	-------------------------------------	---	---

DATA HIST. CODE M

# AEDC VA 1163 MDAC BOOSTER AND ORBITER TEST DATA AT MACH NUMBER 5

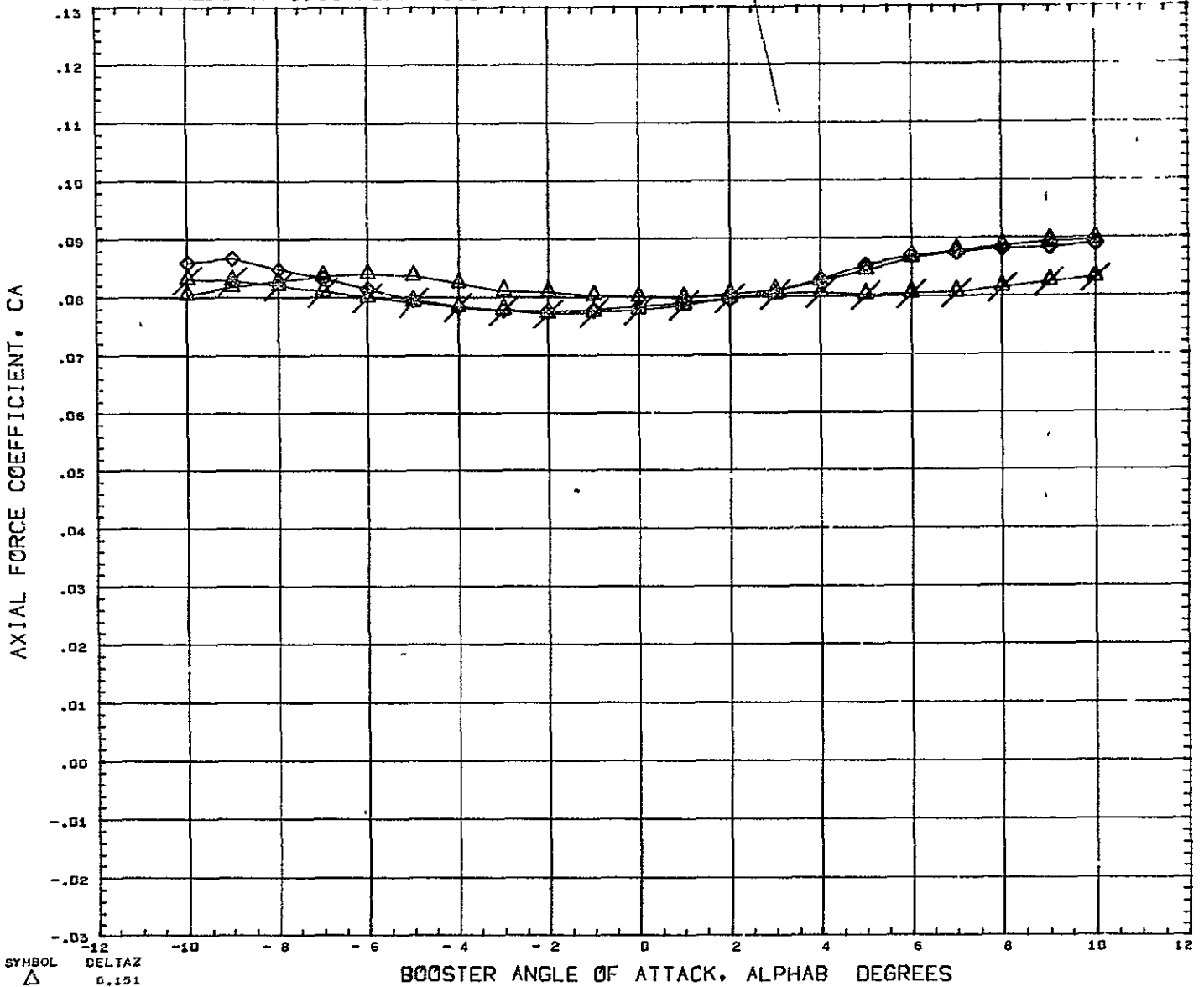

SYMBOL	DELTA Z	PARAMETRIC VALUES		REFERENCE INFORMATION				
△	0.151	BSTPOW	50.000	ORBPOW	25.000	REFS	44.4440	SQ IN
◇	0.182	DELTA X	0.166	ALPHA I	5.000	REFL	13.3330	IN
×	10.000	MACH	5.010	ELVBST	0.000	REFB	13.3350	IN
		ELVORB	0.000	BETA	0.000	XHRF	7.5280	IN
						YHRF	0.0000	IN
						ZHRF	1.1940	IN
						SCALE	0.0055	
		DATA HIST. CODE	M					

# AEDC VA 1163 MDAC BOOSTER AND ORBITER TEST DATA AT MACH NUMBER 5

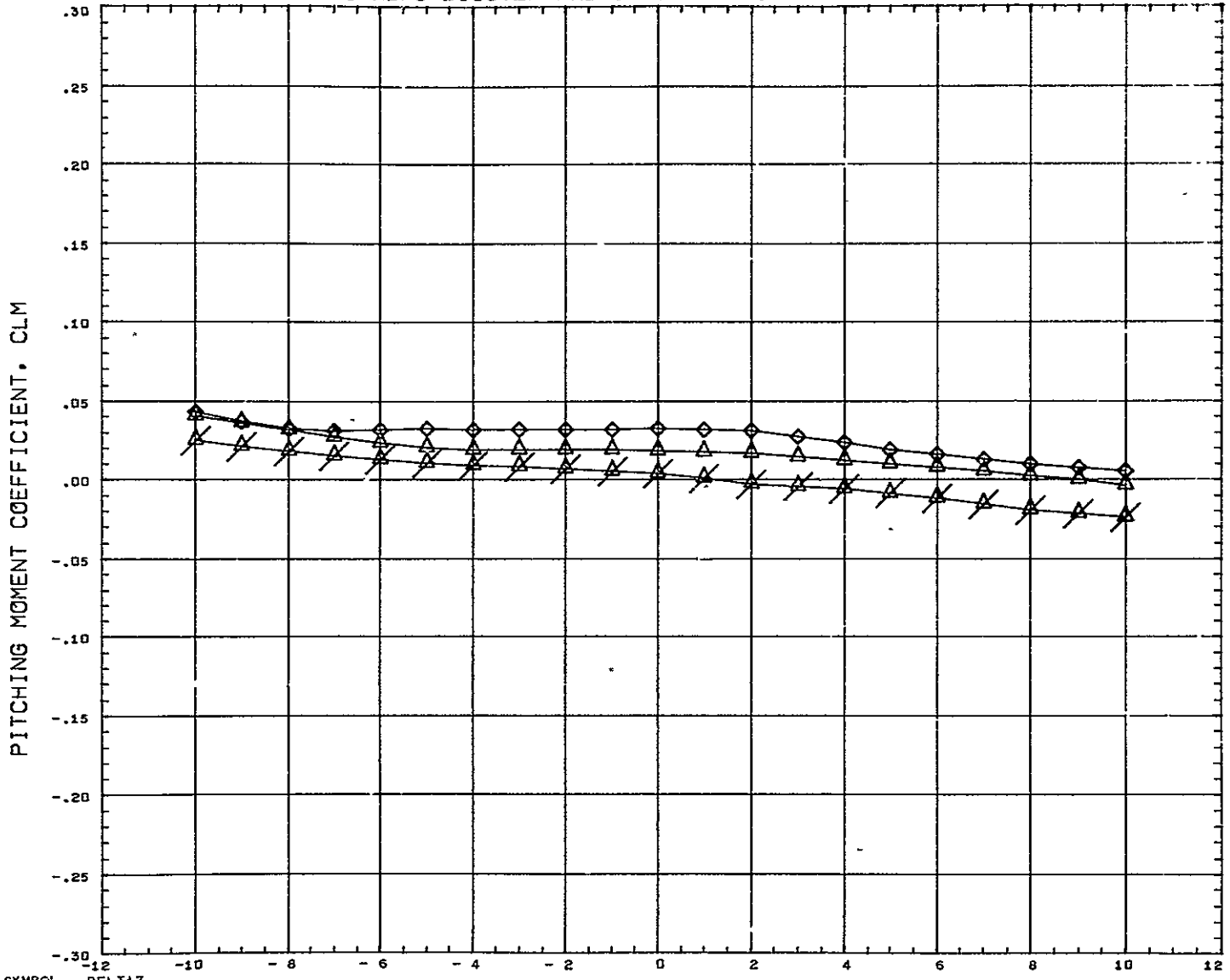

SYMBOL △ ◇ ×	DELTAZ 0.151 0.182 10.000	<table border="0" style="width: 100%;"> <tr> <th colspan="4" style="text-align: left; padding-left: 20px;">PARAMETRIC VALUES</th> </tr> <tr> <td style="padding-right: 20px;">BSTPOW</td><td>50.000</td><td style="padding-right: 20px;">ORBPOW</td><td>25.000</td></tr> <tr> <td>DELTAZ</td><td>0.351</td><td>ALPHA1</td><td>5.000</td></tr> <tr> <td>MACH</td><td>5.010</td><td>ELVBST</td><td>0.000</td></tr> <tr> <td>ELVORB</td><td>0.000</td><td>BETA</td><td>0.000</td></tr> </table>	PARAMETRIC VALUES				BSTPOW	50.000	ORBPOW	25.000	DELTAZ	0.351	ALPHA1	5.000	MACH	5.010	ELVBST	0.000	ELVORB	0.000	BETA	0.000	<table border="0" style="width: 100%;"> <tr> <th colspan="3" style="text-align: left;">REFERENCE INFORMATION</th> </tr> <tr> <td>REFS</td><td>44.4440</td><td>SQ IN</td></tr> <tr> <td>REFL</td><td>13.3330</td><td>IN</td></tr> <tr> <td>REFB</td><td>13.3330</td><td>IN</td></tr> <tr> <td>XMRP</td><td>7.5200</td><td>IN</td></tr> <tr> <td>YMRP</td><td>0.0000</td><td>IN</td></tr> <tr> <td>ZMRP</td><td>1.1940</td><td>IN</td></tr> <tr> <td>SCALE</td><td>0.0055</td><td></td></tr> </table>	REFERENCE INFORMATION			REFS	44.4440	SQ IN	REFL	13.3330	IN	REFB	13.3330	IN	XMRP	7.5200	IN	YMRP	0.0000	IN	ZMRP	1.1940	IN	SCALE	0.0055	
PARAMETRIC VALUES																																															
BSTPOW	50.000	ORBPOW	25.000																																												
DELTAZ	0.351	ALPHA1	5.000																																												
MACH	5.010	ELVBST	0.000																																												
ELVORB	0.000	BETA	0.000																																												
REFERENCE INFORMATION																																															
REFS	44.4440	SQ IN																																													
REFL	13.3330	IN																																													
REFB	13.3330	IN																																													
XMRP	7.5200	IN																																													
YMRP	0.0000	IN																																													
ZMRP	1.1940	IN																																													
SCALE	0.0055																																														
DATA HIST. CODE M																																															

# AEDC VA 1163 MDAC BOOSTER AND ORBITER TEST DATA AT MACH NUMBER 5

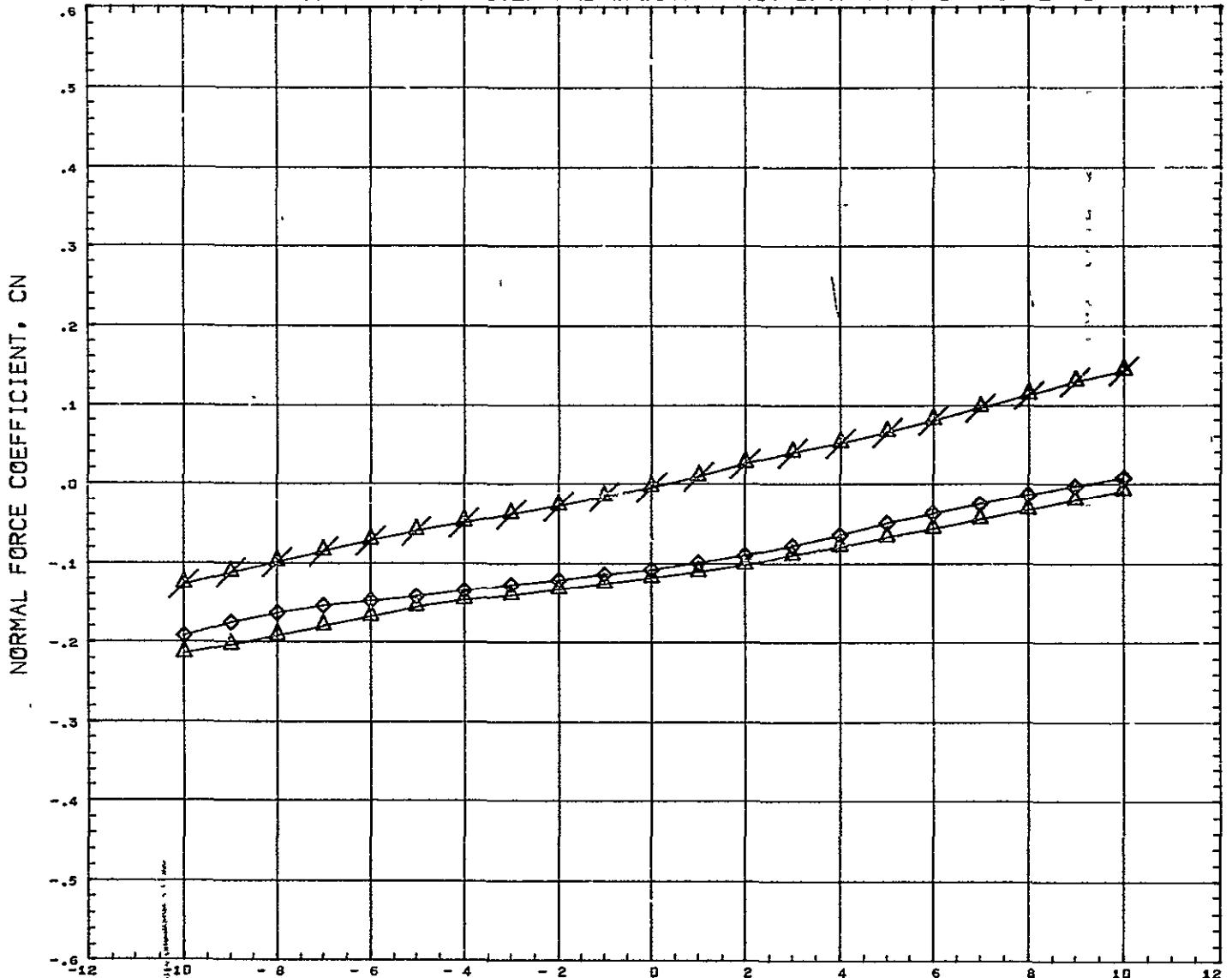

SYMBOL    DELTAZ  
 ◊         0.251  
 ◊         0.182  
 ◊         10.000

PARAMETRIC VALUES  
 BSTPOW    50.000    ORBPOW    25.000  
 DELTAX    0.351     ALPHAI    5.000  
 ELVCH     5.010     ELVBST    0.000  
 ELVORB    0.000     BETA      0.000

REFERENCE INFORMATION  
 REFS       44.4440    SQ IN  
 REFL       13.3330    IN  
 REFB       13.3330    IN  
 XMRF       7.5280     IN  
 YMRF       0.0000    IN  
 ZMRF       1.1940     IN  
 SCALE      0.0055

DATA HIST. CODE    M

# AEDC VA 1163 MDAC BOOSTER AND ORBITER TEST DATA AT MACH NUMBER 5

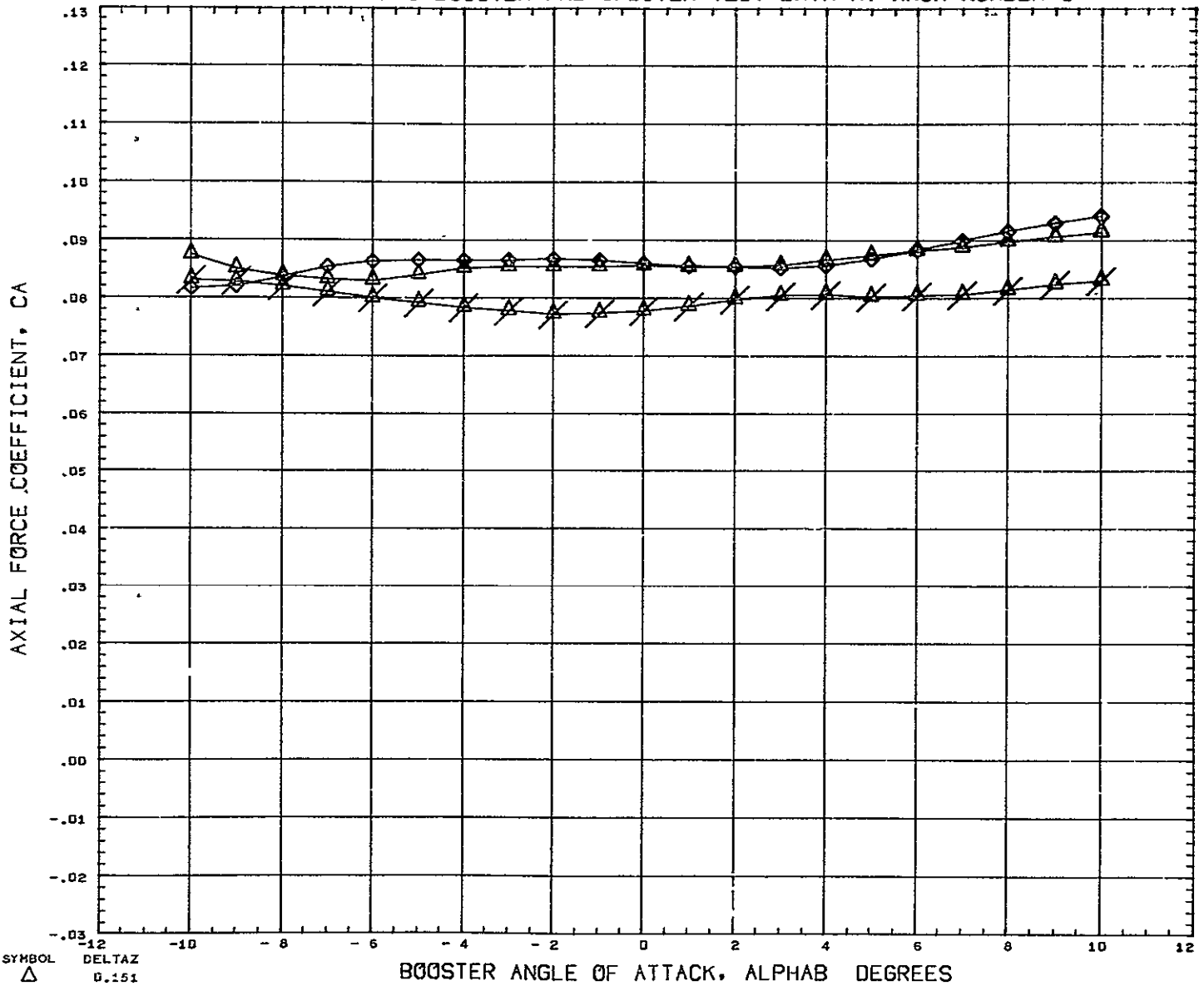

SYMBOL △ ◇ ×	DELTAZ 0.151 0.182 10.000	<table border="0" style="width: 100%;"> <tr> <th colspan="4" style="text-align: center;">PARAMETRIC VALUES</th> </tr> <tr> <td>BSTPOW</td><td>50.000</td><td>ORBPOW</td><td>25.000</td> </tr> <tr> <td>DELTAZ</td><td>0.351</td><td>ALPHA1</td><td>5.000</td> </tr> <tr> <td>MACH</td><td>5.010</td><td>ELVBST</td><td>0.000</td> </tr> <tr> <td>ELVORB</td><td>0.000</td><td>BETA</td><td>0.000</td> </tr> </table>	PARAMETRIC VALUES				BSTPOW	50.000	ORBPOW	25.000	DELTAZ	0.351	ALPHA1	5.000	MACH	5.010	ELVBST	0.000	ELVORB	0.000	BETA	0.000	<table border="0" style="width: 100%;"> <tr> <th colspan="3" style="text-align: center;">REFERENCE INFORMATION</th> </tr> <tr> <td>REFS</td><td>44.4440</td><td>SQ IN</td> </tr> <tr> <td>REFL</td><td>13.3330</td><td>IN</td> </tr> <tr> <td>REFB</td><td>13.3330</td><td>IN</td> </tr> <tr> <td>XMRP</td><td>7.5280</td><td>IN</td> </tr> <tr> <td>YMRP</td><td>0.0000</td><td>IN</td> </tr> <tr> <td>ZMRP</td><td>1.1940</td><td>IN</td> </tr> <tr> <td>SCALE</td><td>0.0055</td><td></td> </tr> </table>	REFERENCE INFORMATION			REFS	44.4440	SQ IN	REFL	13.3330	IN	REFB	13.3330	IN	XMRP	7.5280	IN	YMRP	0.0000	IN	ZMRP	1.1940	IN	SCALE	0.0055	
PARAMETRIC VALUES																																															
BSTPOW	50.000	ORBPOW	25.000																																												
DELTAZ	0.351	ALPHA1	5.000																																												
MACH	5.010	ELVBST	0.000																																												
ELVORB	0.000	BETA	0.000																																												
REFERENCE INFORMATION																																															
REFS	44.4440	SQ IN																																													
REFL	13.3330	IN																																													
REFB	13.3330	IN																																													
XMRP	7.5280	IN																																													
YMRP	0.0000	IN																																													
ZMRP	1.1940	IN																																													
SCALE	0.0055																																														
DATA HIST. CODE    M																																															



# AEDC VA 1163 MDAC BOOSTER AND ORBITER TEST DATA AT MACH NUMBER 5

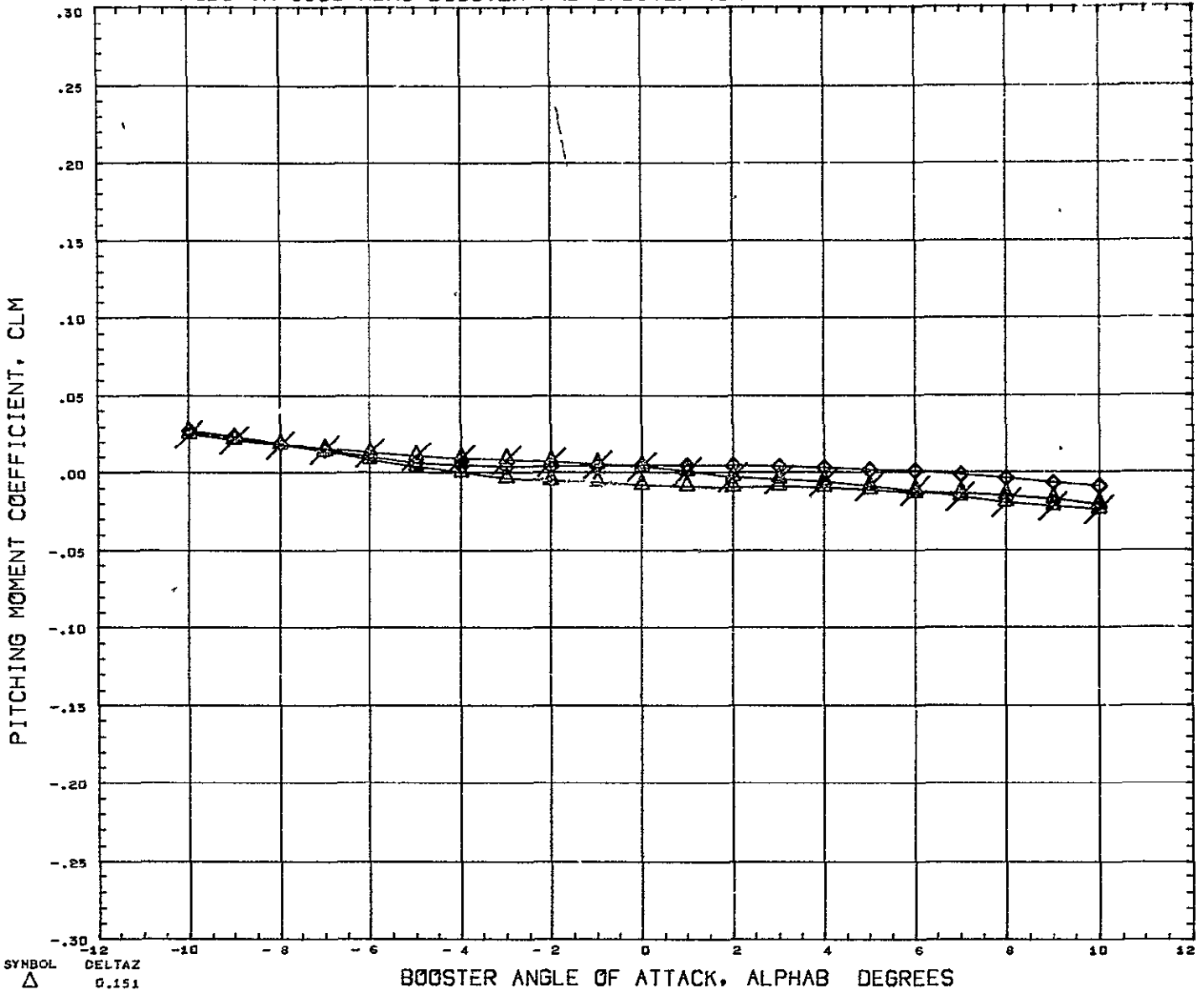

SYMBOL ◊ ◊ △	DELTA Z 0.151 0.182 10.000	<b>PARAMETRIC VALUES</b> BSTFOW 50.000 CRBFOV 25.000 DELTAX 9.521 ALPHAI 5.000 MACH 5.010 ELVBST 0.000 ELVORB 0.000 BETA 0.000	<b>REFERENCE INFORMATION</b> REFS 44.4440 SQ IN REFL 13.3330 IN REFB 13.3330 IN XMRF 7.5280 IN YMRP 0.0009 IN ZMRP 1.1940 IN SCALE 0.0055
DATA HIST. CODE M			

# AEDC VA 1163 MDAC BOOSTER AND ORBITER TEST DATA AT MACH NUMBER 5.

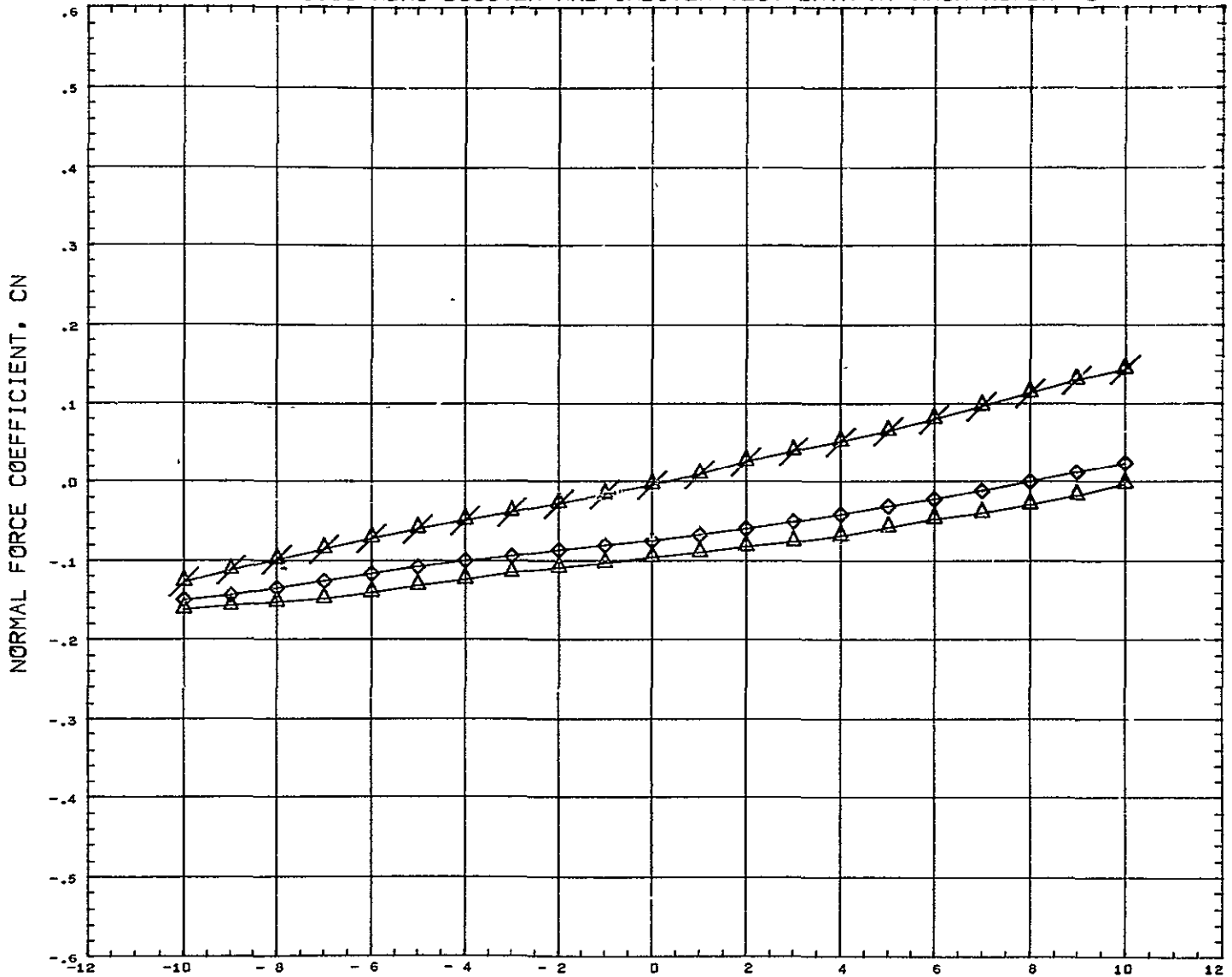

SYMBOL  
 △ 0.151  
 ◇ 0.182  
 △/ 10.000

BOOSTER ANGLE OF ATTACK, ALPHAB DEGREES

PARAMETRIC VALUES

BSTPOW	50.000	ORBPOW	25.000
DELTA X	0.521	ALPHA I	5.000
MACH	5.010	ELVBST	0.000
ELVORB	0.000	BETA	0.000

REFERENCE INFORMATION

REFS	44.4440	SQ IN
REFL	13.3330	IN
REFB	13.3330	IN
XMRP	7.5280	IN
YMRP	0.0000	IN
ZMRP	1.1940	IN
SCALE	0.0055	

DATA HIST. CODE M

# AEDC VA 1163 MDAC BOOSTER AND ORBITER TEST DATA AT MACH NUMBER 5

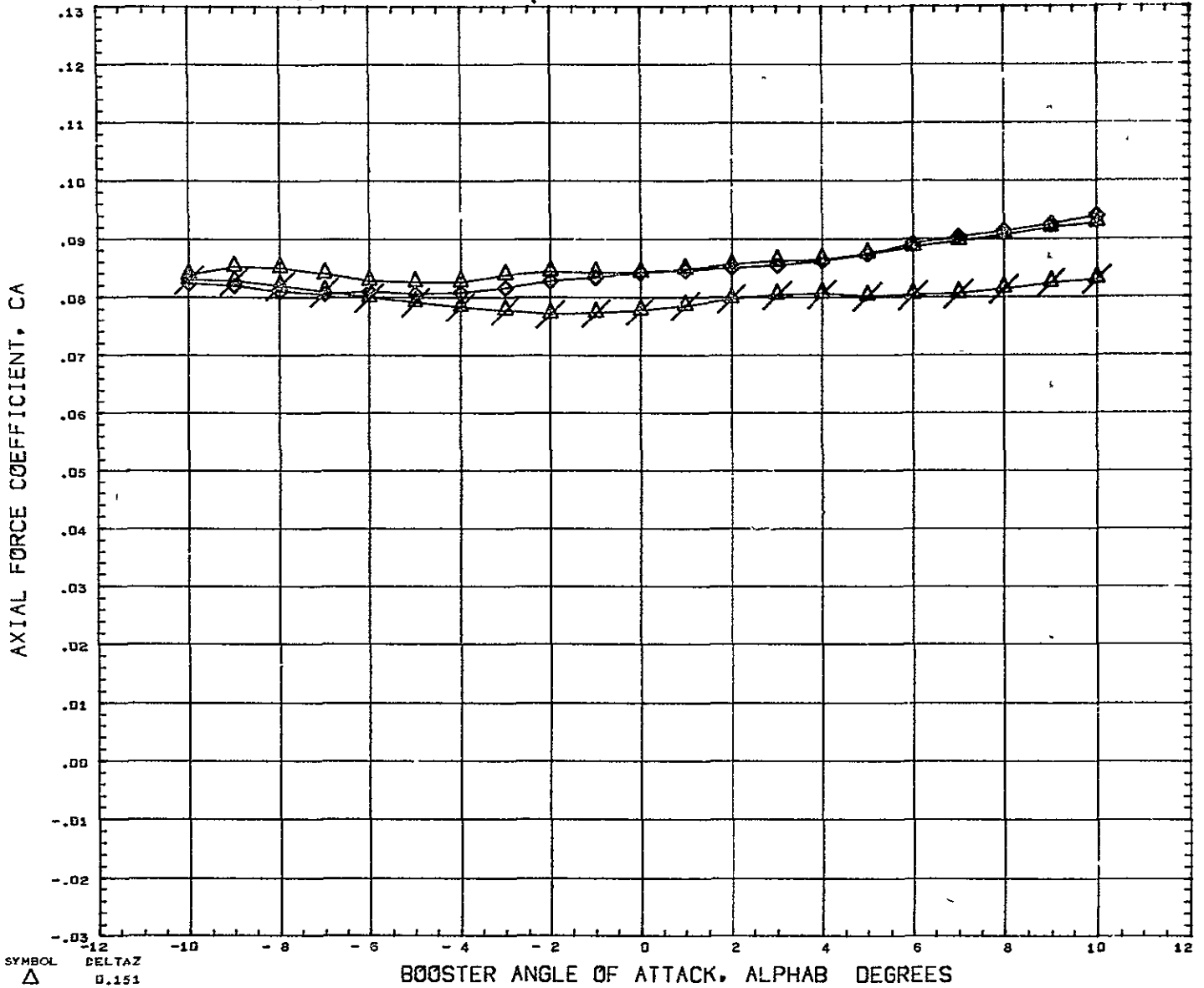

SYMBOL    DELTAZ  
 △        0.151  
 ◇        0.182  
 ✕        10.000

PARAMETRIC VALUES  
 BSTPOW    50.000    ORBPOW    25.000  
 DELTAX    0.521    ALPHAI    5.000  
 MACH       5.010    ELVBST    0.000  
 ELVORB    0.000    BETA       0.000

REFERENCE INFORMATION  
 REFS       44.4440    SQ IN  
 REFL       13.3330    IN  
 REFB       13.3330    IN  
 XMRP       7.5280    IN  
 YMRP       0.0000    IN  
 ZMRP       1.1940    IN  
 SCALE       0.0055

DATA HIST. CODE    M

# AEDC VA 1163 MDAC BOOSTER AND ORBITER TEST DATA AT MACH NUMBER 5

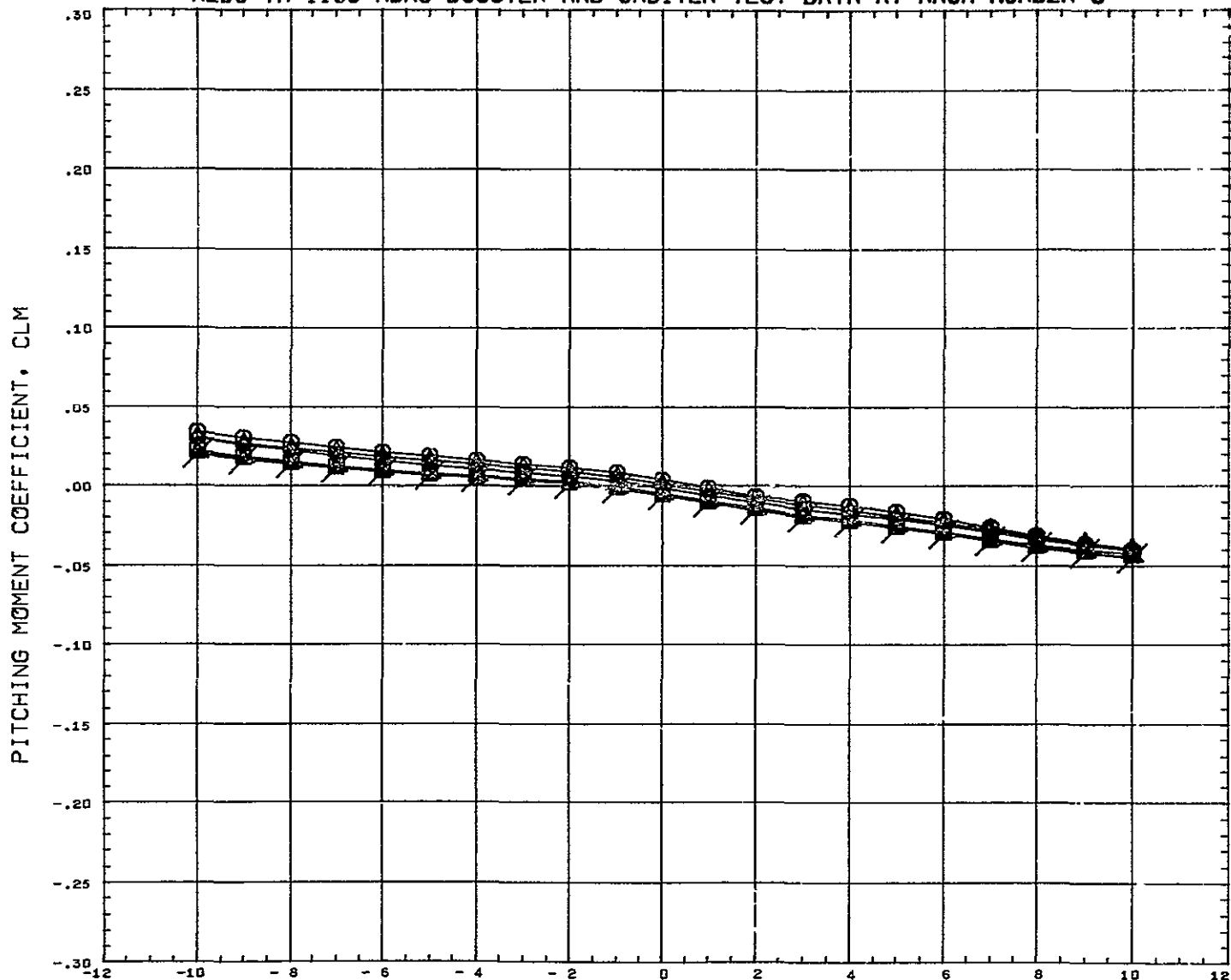

SYMBOL ○ ◇ □ △	DELTAZ 0.120 0.151 0.182 0.228 0.352 10.000	<b>PARAMETRIC VALUES</b> BSTPOW    0.000    ORBPOW    0.000 DELTAX    - 0.391    ALPHAI    0.000 MACH       5.010    ELVBST    20.000 ELVORB    - 20.000    BETA       0.000	<b>REFERENCE INFORMATION</b> REFS       44.4440    SQ IN REFL       13 3330    IN REFB       13 3330    IN XHRF       7.5280    IN YHRF       0 0000    IN ZHRF       1.1940    IN SCALE      0 0055    IN
	<b>BOOSTER ANGLE OF ATTACK, ALPHAB DEGREES</b>		
	1    DATA HIST. CODE    M		

# AEDC VA 1163 MDAC BOOSTER AND ORBITER TEST DATA AT MACH NUMBER 5

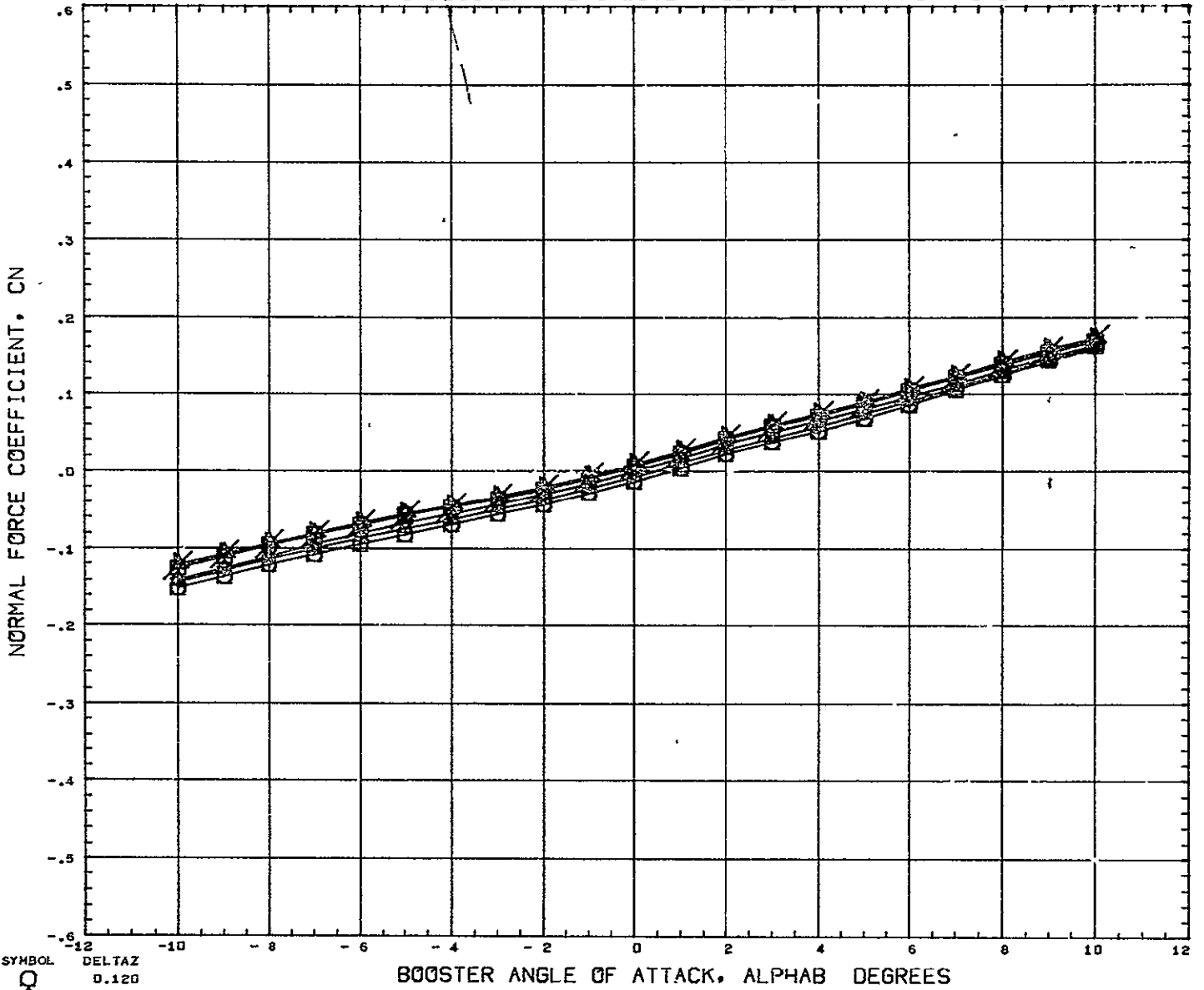

SYMBOL ○ △ □ ◇ ▲ ▼	DELTA Z 0.120 0.151 0.182 0.228 0.352 10.000	<table border="0" style="width: 100%;"> <tr> <th colspan="4" style="text-align: center;">PARAMETRIC VALUES</th> </tr> <tr> <td>BSTPOW</td><td>0.000</td><td>ORBPOW</td><td>0.000</td> </tr> <tr> <td>DELTA X</td><td>- 0.391</td><td>ALPHA I</td><td>0.000</td> </tr> <tr> <td>MACH</td><td>5.010</td><td>ELVBST</td><td>20.000</td> </tr> <tr> <td>ELVORB</td><td>- 20.000</td><td>BETA</td><td>0.000</td> </tr> </table>	PARAMETRIC VALUES				BSTPOW	0.000	ORBPOW	0.000	DELTA X	- 0.391	ALPHA I	0.000	MACH	5.010	ELVBST	20.000	ELVORB	- 20.000	BETA	0.000	<table border="0" style="width: 100%;"> <tr> <th colspan="3" style="text-align: center;">REFERENCE INFORMATION</th> </tr> <tr> <td>REFS</td><td>44.4440</td><td>50 IN</td> </tr> <tr> <td>REFL</td><td>13.3330</td><td>IN</td> </tr> <tr> <td>REFB</td><td>13.3330</td><td>IN</td> </tr> <tr> <td>XMRP</td><td>7.5280</td><td>IN</td> </tr> <tr> <td>YMRP</td><td>0.0010</td><td>IN</td> </tr> <tr> <td>ZMRP</td><td>1.1940</td><td>IN</td> </tr> <tr> <td>SCALE</td><td>0.0055</td><td></td> </tr> </table>	REFERENCE INFORMATION			REFS	44.4440	50 IN	REFL	13.3330	IN	REFB	13.3330	IN	XMRP	7.5280	IN	YMRP	0.0010	IN	ZMRP	1.1940	IN	SCALE	0.0055	
PARAMETRIC VALUES																																															
BSTPOW	0.000	ORBPOW	0.000																																												
DELTA X	- 0.391	ALPHA I	0.000																																												
MACH	5.010	ELVBST	20.000																																												
ELVORB	- 20.000	BETA	0.000																																												
REFERENCE INFORMATION																																															
REFS	44.4440	50 IN																																													
REFL	13.3330	IN																																													
REFB	13.3330	IN																																													
XMRP	7.5280	IN																																													
YMRP	0.0010	IN																																													
ZMRP	1.1940	IN																																													
SCALE	0.0055																																														
DATA HIST. CODE    M																																															

# AEDC VA 1163 MDAC BOOSTER AND ORBITER TEST DATA AT MACH NUMBER 5

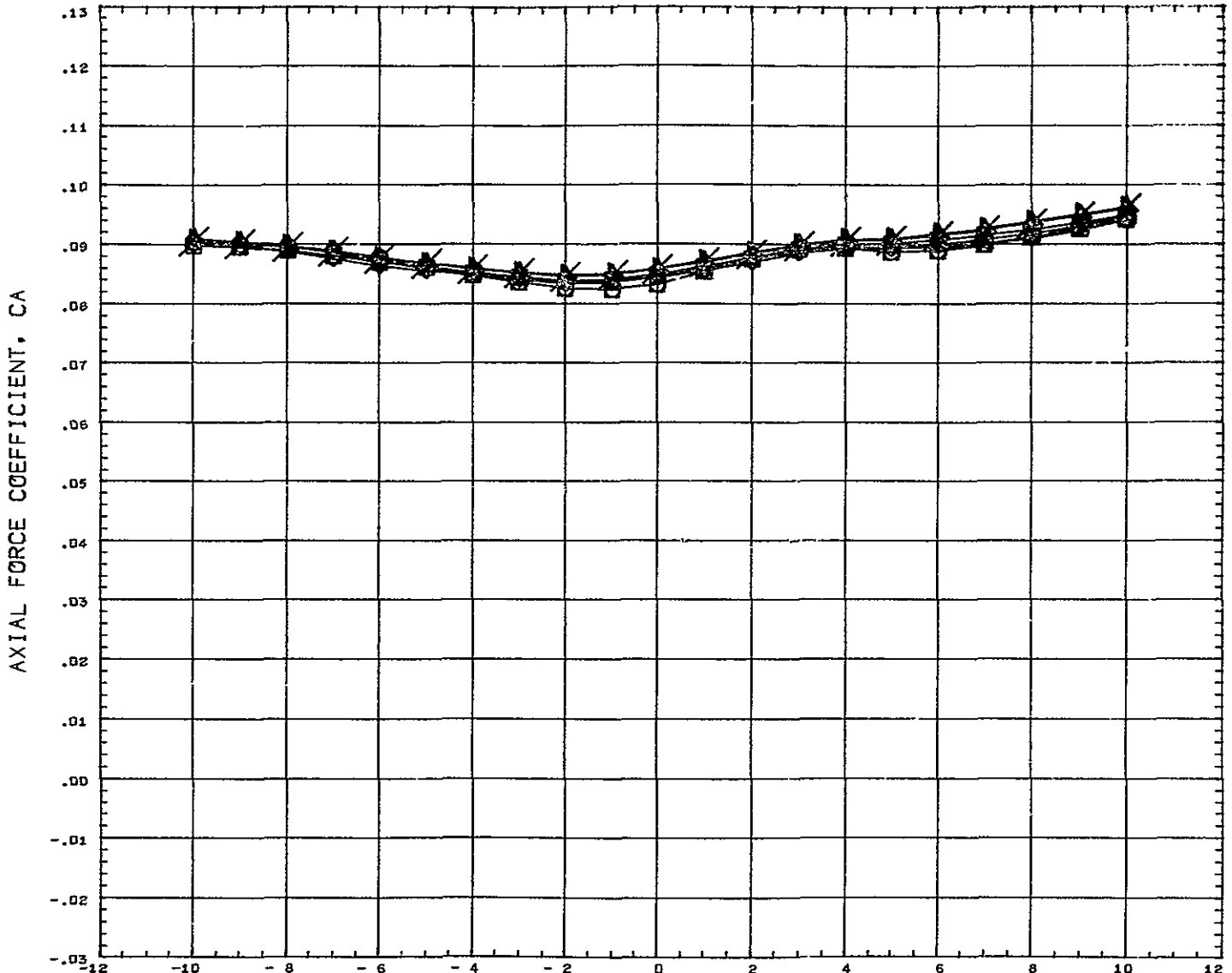

SYMBOL ○ ◇ □ △	DELTAZ 0.120 0.151 0.182 0.228 0.352 10.000	PARAMETRIC VALUES BSTFOW    0.000    ORBFOV    0.000 DELTAX   - 0.391    ALPHAI    0.000 MACH       5.010    ELVBST    20.000 ELVORB   - 20.000    BETA       0.000	REFERENCE INFORMATION REFS       44.4410    SQ IN REFL       13.3330    IN REFB       13.3330    IN XMRP       7.5280    IN YMRP       0.0000    IN ZMRP       1.1940    IN SCALE      0.0055
	DATA HIST. CODE    H		

# AEDC VA 1163 MDAC BOOSTER AND ORBITER TEST DATA AT MACH NUMBER 5

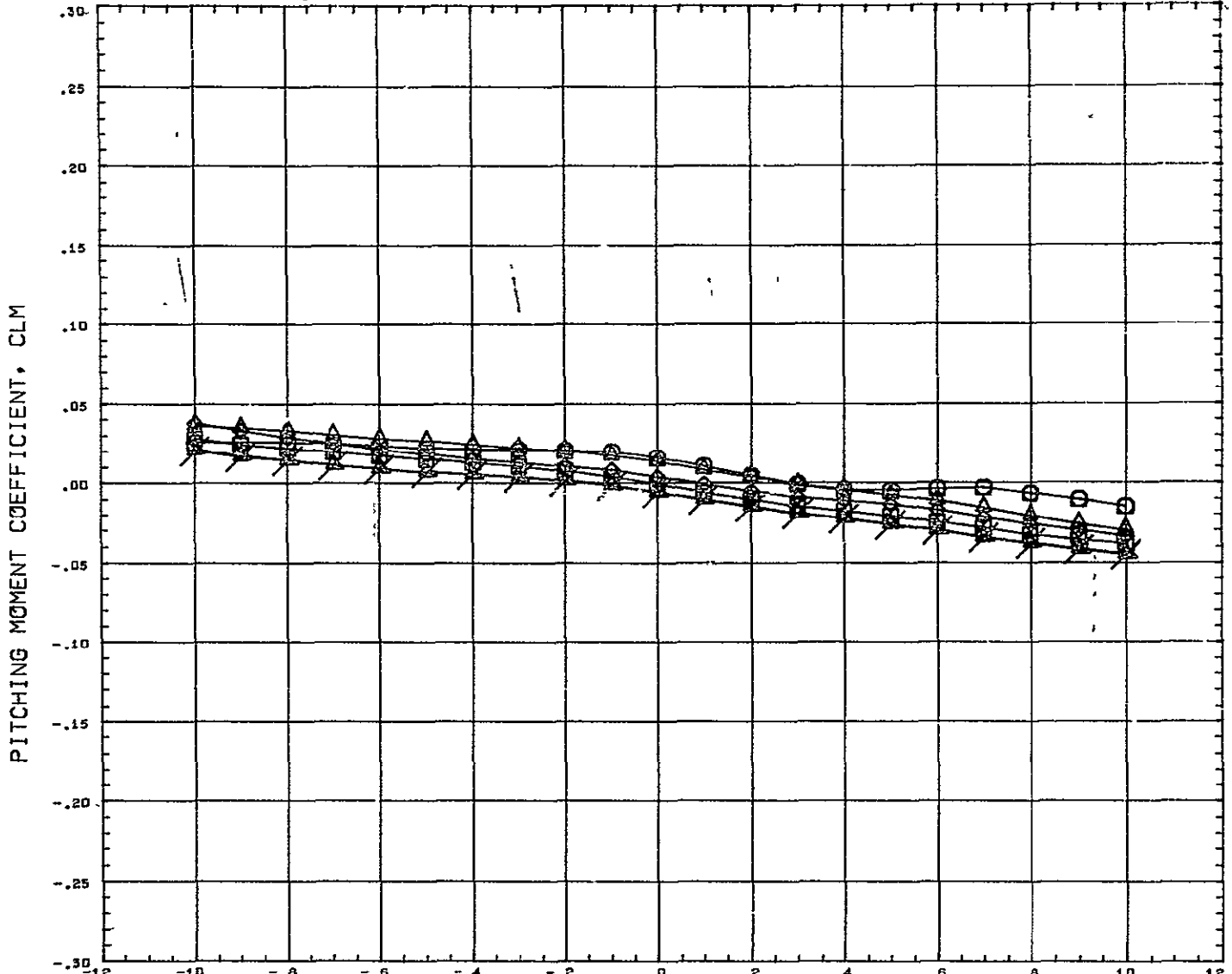

SYMBOL ○ △ □ ◇ ▲ ▼ ◆ ◆	DELTAZ 0.120 0.151 0.182 0.228 0.352 10.000	PARAMETRIC VALUES BSTFOW 0.000 ORBPOW 0.000 DELTAX - 0.143 ALPHAI 0.000 MACH 5.010 ELVBST 20.000 ELVORB - 20.000 BETA 0.000	REFERENCE INFORMATION REFS 44.4440 SQ IN REFL 13.3330 IN REFB 13.3330 IN XMRF 7.5280 IN YMRF 0.0000 IN ZMRF 1.1940 IN SCALE 0.0055
DATA HIST. CODE M			

# AEDC VA 1163 MDAC BOOSTER AND ORBITER TEST DATA AT MACH NUMBER 5

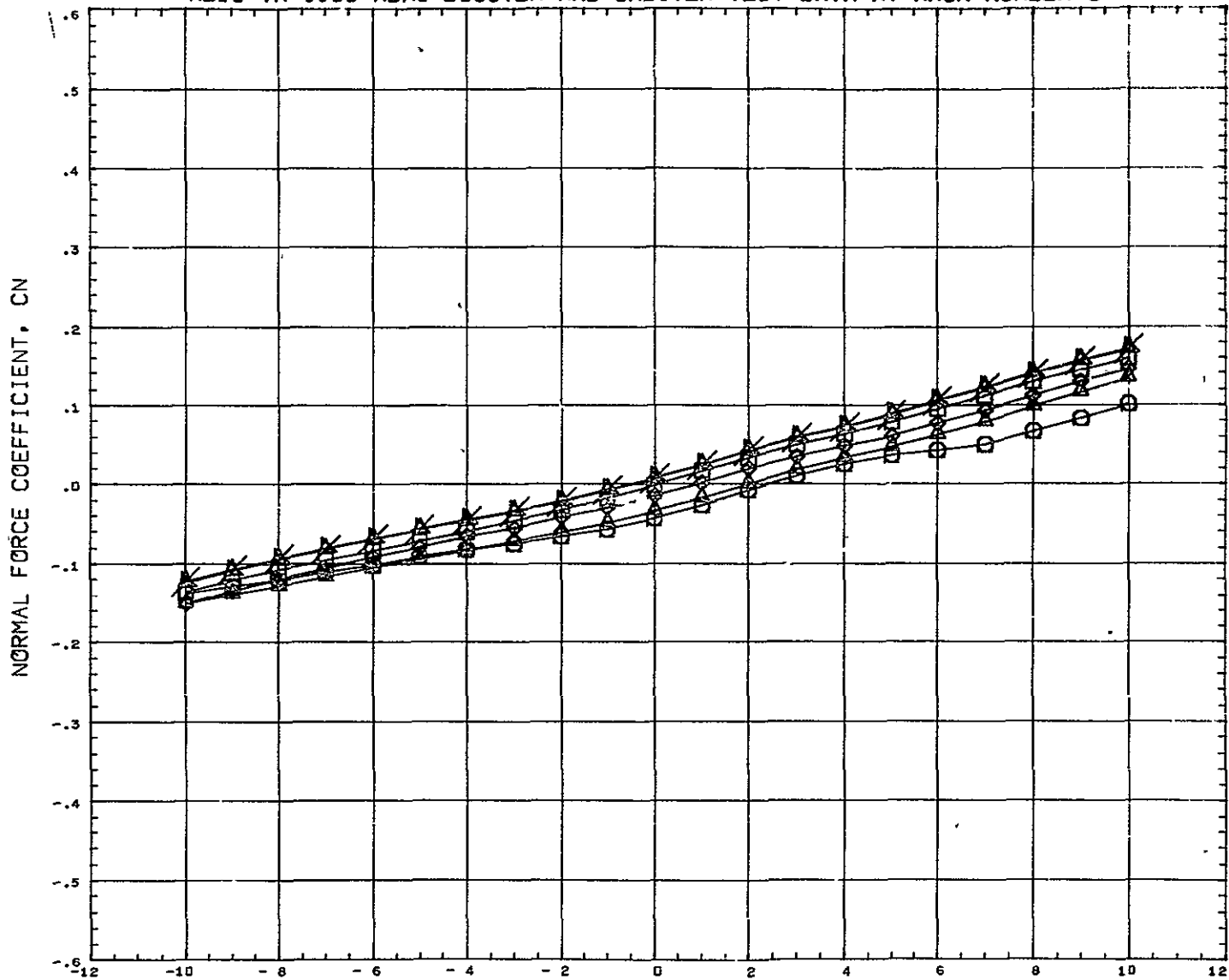

SYMBOL ○ □ △ ◇	DELTAZ 0.120 0.151 0.182 0.220 0.352 10.000	PARAMETRIC VALUES BSTPOW    0.000    ORBPOW    0.000 DELTAX    - 0.143    ALPHA1    0.000 M CH       5.010    ELVBST    20.000 ELVORB    - 20.000    BETA       0.000	REFERENCE INFORMATION REFS       4.4440    SQ IN REFL       13.3330    IN REFB       13.3330    IN XMRP       7.5280    IN YMRP       0.0000    IN ZMRP       1.1940    IN SCALE       0.0055
DATA HIST. CODE    M			



# AEDC VA 1163 MDAC BOOSTER AND ORBITER TEST DATA AT MACH NUMBER 5

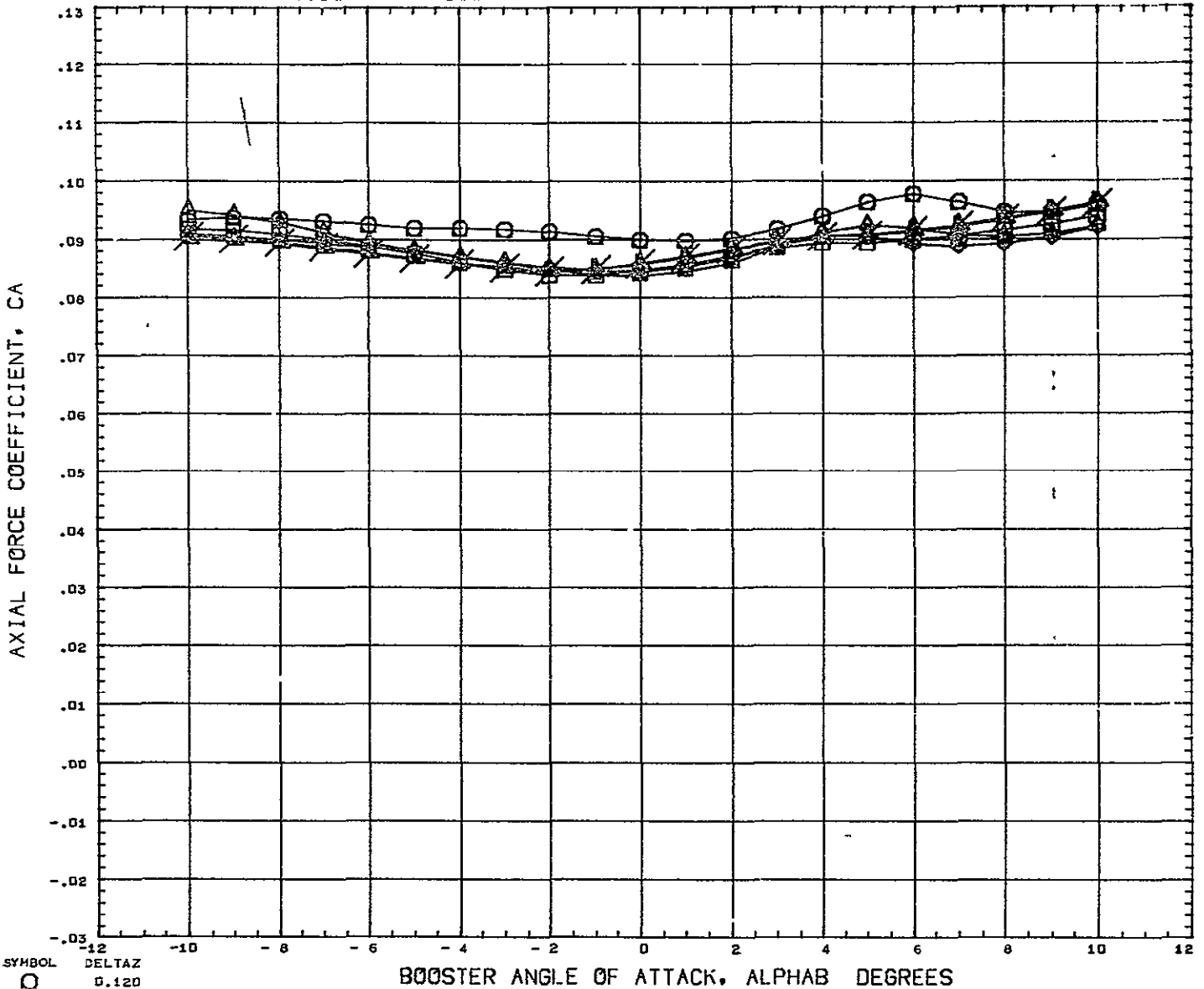

SYMBOL ○ ◇ □ △ ▲	DELTAZ 0.120 0.151 0.182 0.228 0.352 10.000	PARAMETRIC VALUES BSTFOW 0.000 ORBPOW 0.000 DELTAX - 0.143 ALPHAI 0.000 ACH 5.010 ELVBST 20.000 ELVORB - 20.000 BETA 0.000	REFERENCE INFORMATION REFS 44.4440 SQ IN REFL 13.3330 IN REFB 13.3330 IN XMRP 7.5280 IN YMRP 0.0000 IN ZMRP 1.1940 IN SCALE 0 0055
DATA HIST. CODE M			

# AEDC VA 1163 MDAC BOOSTER AND ORBITER TEST DATA AT MACH NUMBER 5

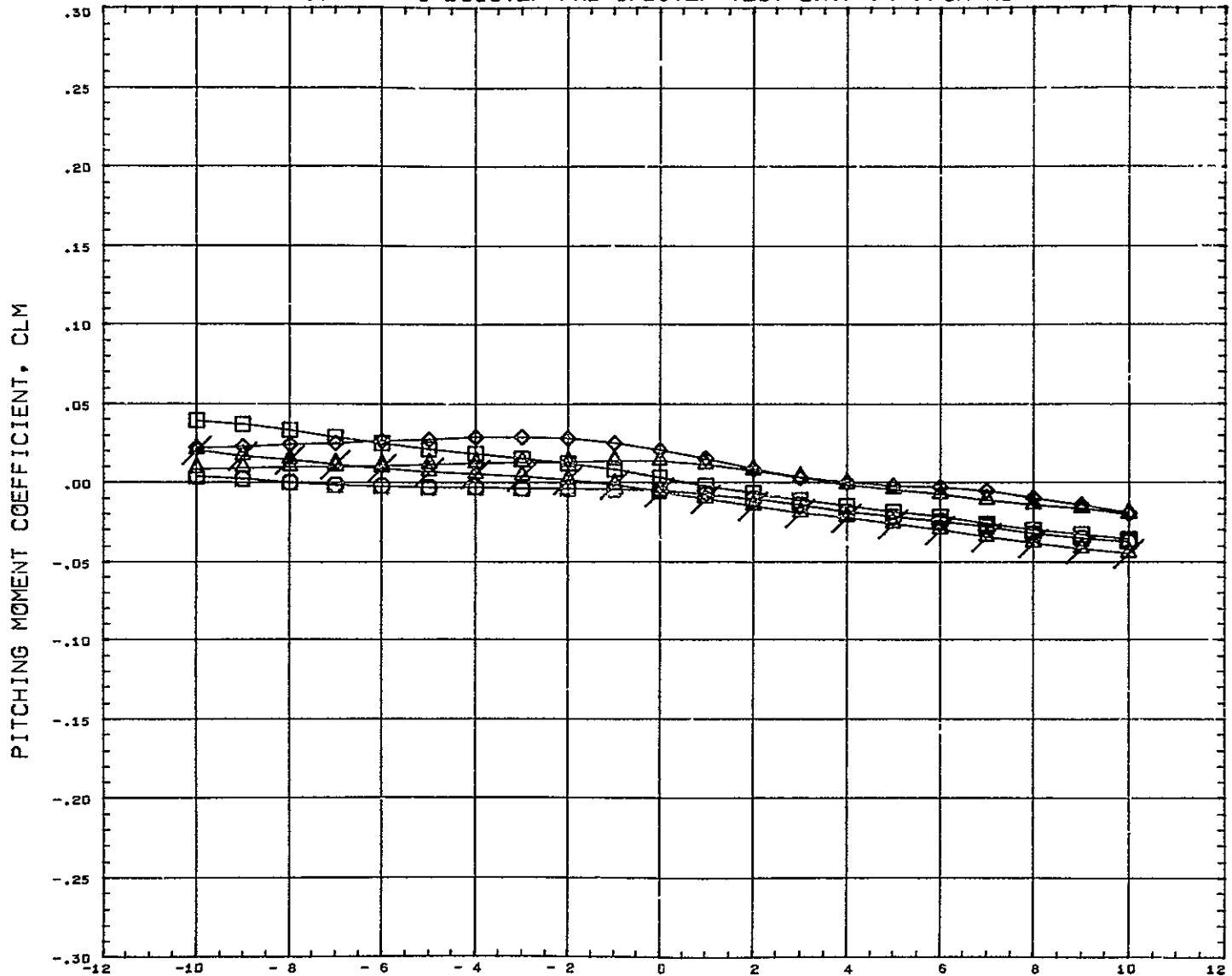

SYMBOL ○ □ ◇ △ ×	DELTAZ 0.120 0.151 0.182 0.228 10.000	PARAMETRIC VALUES BSTPOW 0.000 ORBPOW 0.000 DELTAX - 0.019 ALPHAI 0.000 H, CH 5.010 ELVBST 20.000 ELVORB - 20.000 BETA' 0.000	REFERENCE INFORMATION REFS 44.4440 SQ IN REFL 13.3330 IN REFB 13.3330 IN XMRP 7.5280 IN YMRP 0.0000 IN ZMRP 1.1940 IN SCALE 0.0055
---------------------------------	--	---	---

DATA HIST. CODE M

# AEDC VA 1163 MDAC BOOSTER AND ORBITER TEST DATA AT MACH NUMBER 5

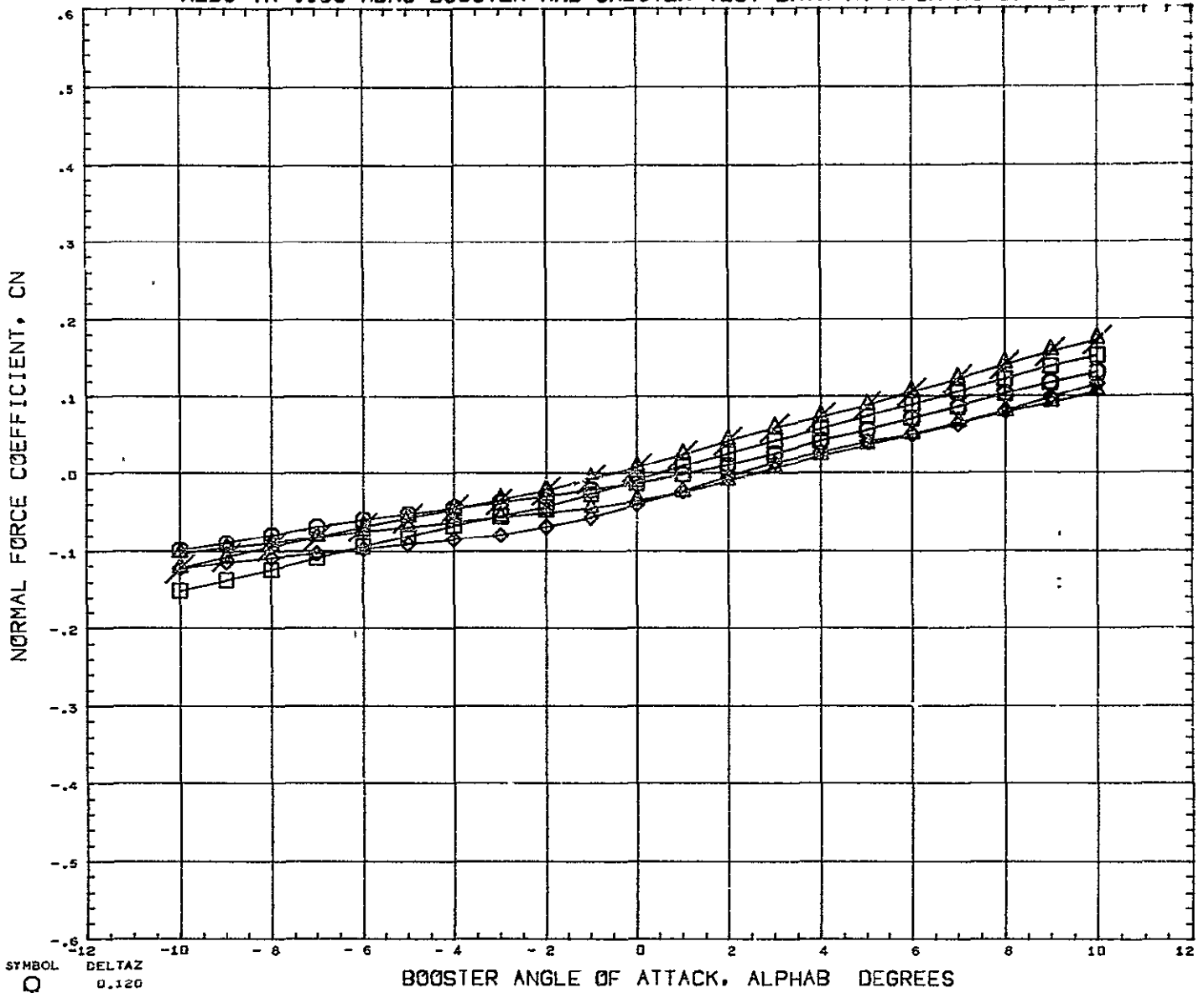

SYMBOL 	DELTAZ 0.120 0.151 0.182 0.228 10.000	PARAMETRIC VALUES BSTPOW    0.000    ORBPOW    0.000 PFLTAX   - 0.019    ALPHAI    0.000 MACH       5.010    ELVBST    20.000 ELVORB    - 20.000    BETA       0.000	REFERENCE INFORMATION REFS       44.4440    SQ IN REFL       13.3330    IN REFB       13.3330    IN XMRP       7.5280    IN YMRP       0.0000    IN ZMRP       1.1940    IN SCALE       0.0055
DATA HIST CODE    M			

# AEDC VA 1163 MDAC BOOSTER AND ORBITER TEST DATA AT MACH NUMBER 5

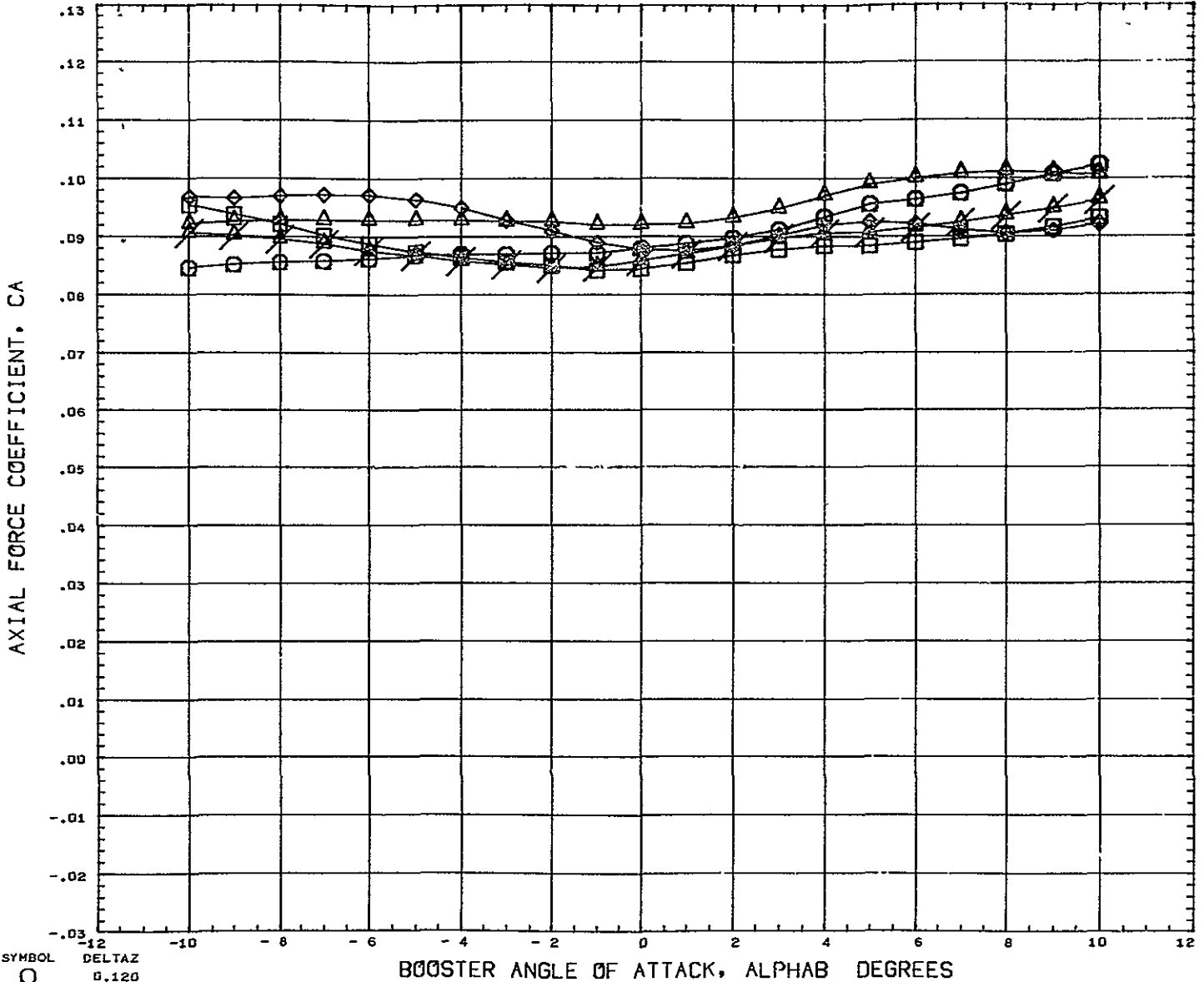

SYMBOL ○ ◇ □ △ ×	DELTA Z 0.120 0.151 0.182 0.228 10.000	PARAMETRIC VALUES BSTPOW    0.000    ORBPOW    0.000 .ELTAX    - 0.019    ALPHAI    0.000 MACH      5.010    ELVBST    20.000 ELVORB    - 20.000    BETA      0.000	REFERENCE INFORMATION REFS      44 4440    SQ IN REFL      13 3350    IN REFB      13 3350    IN XMRF      7.5280    IN YMRF      0 0000    IN ZMRF      1.1940    IN SCALE     0.0055
	DATA HIST. CODE    H		

# AEDC VA 1163 MDAC BOOSTER AND ORBITER TEST DATA AT MACH NUMBER 5

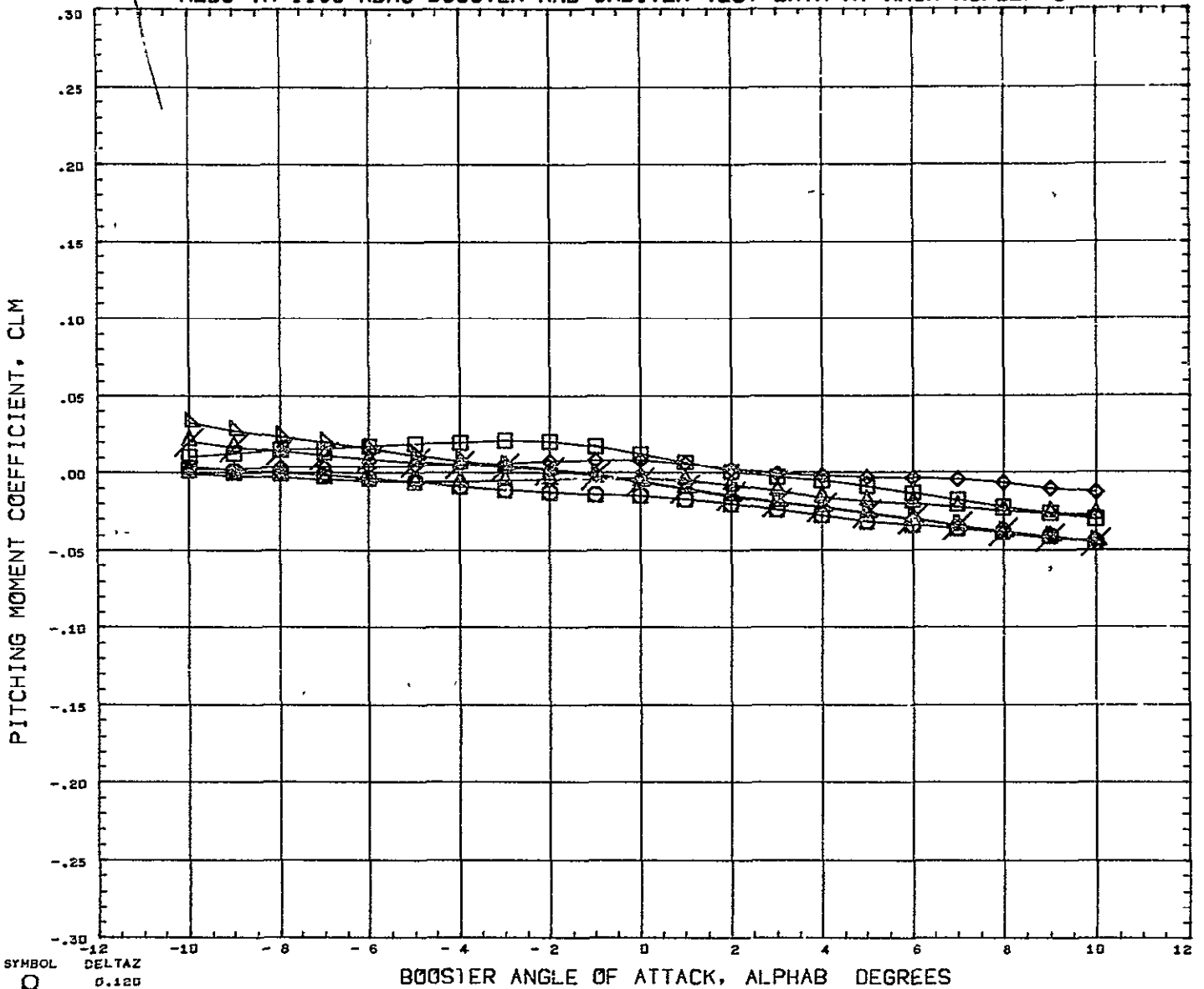

SYMBOL ○ □ △ ◇ ×	DELTAX 0.120 0.151 0.182 0.228 0.352 10.000	PARAMETRIC VALUES BSTPOW    0.000    ORBPOW    0.000 DELTAX    0.104    ALPHAI    0.000 MACH      5.016    ELVBST    20.000 ELVORB    -20.000    BETA      0.000	REFERENCE INFORMATION REFS      44.4440    SQ IN REFL      13.3330    IN REFB      13.3330    IN XHRP      7.5280    IN YHRP      0.0000    IN ZHRP      1.1940    IN SCALE     0.0055
DATA HIST. CODE    M			

# AEDC VA 1163 MDAC BOOSTER AND ORBITER TEST DATA AT MACH NUMBER 5

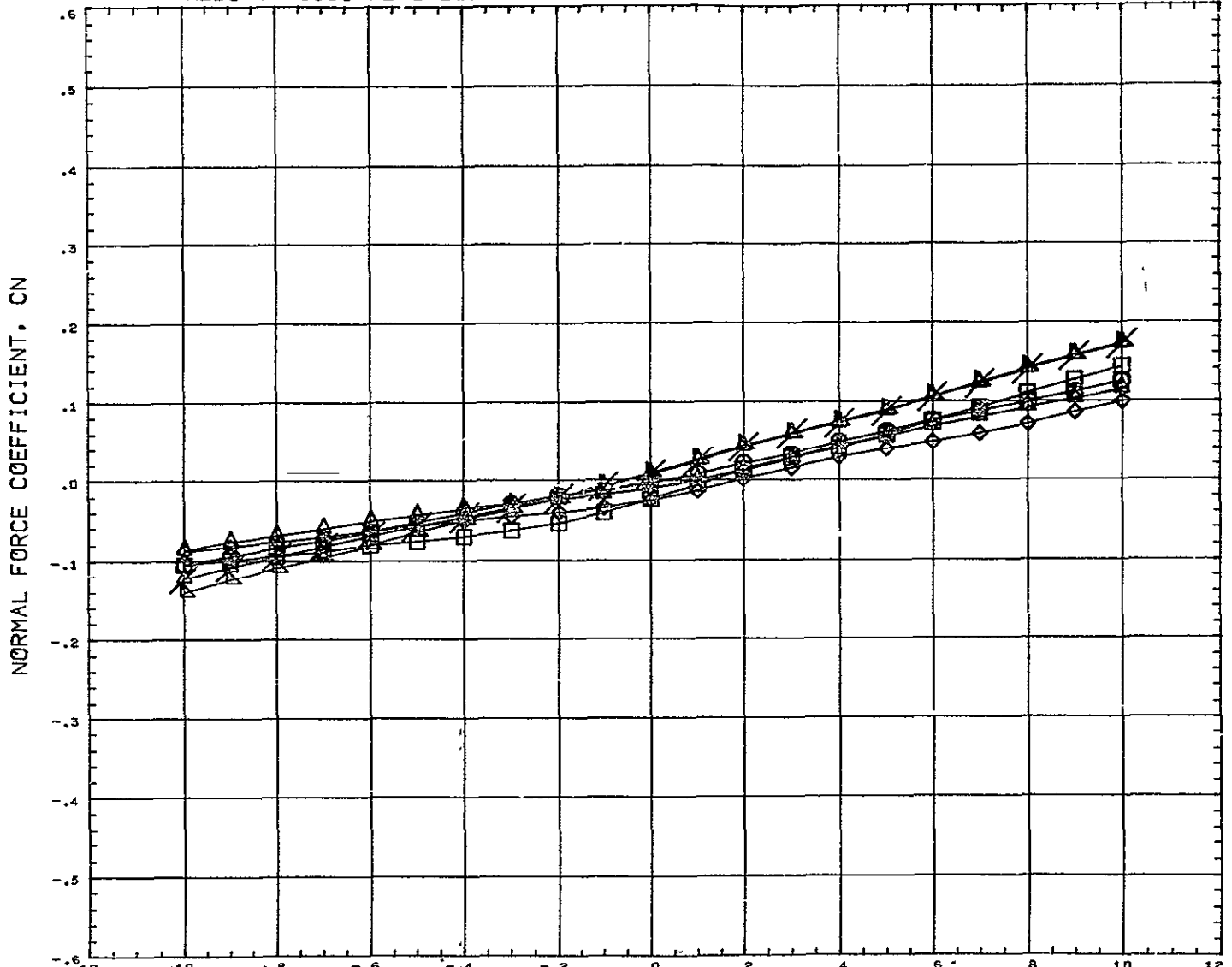

SYMBOL ○ □ ◇ △	DELTAZ 0.120 0.151 0.182 0.228 0.352 10.000	PARAMETRIC VALUES BSTFOW 0.000 ORBFOW 0.000 DELTAX 0.104 ALPHAI 0.000 MACH 5.010 ELVBST 20.000 ELVORB -20.000 BETA 0.000	REFERENCE INFORMATION REFS 44.4440 SQ IN REFL 13.3330 IN REFB 13.3330 IN XMRP 7.5280 IN YMRP 0.0000 IN ZMRP 1.1940 IN SCALE 0.0055
----------------------------	---	--	---

DATA HIST. CODE M

# AEDC VA 1163 MDAC BOOSTER AND ORBITER TEST DATA AT MACH NUMBER 5

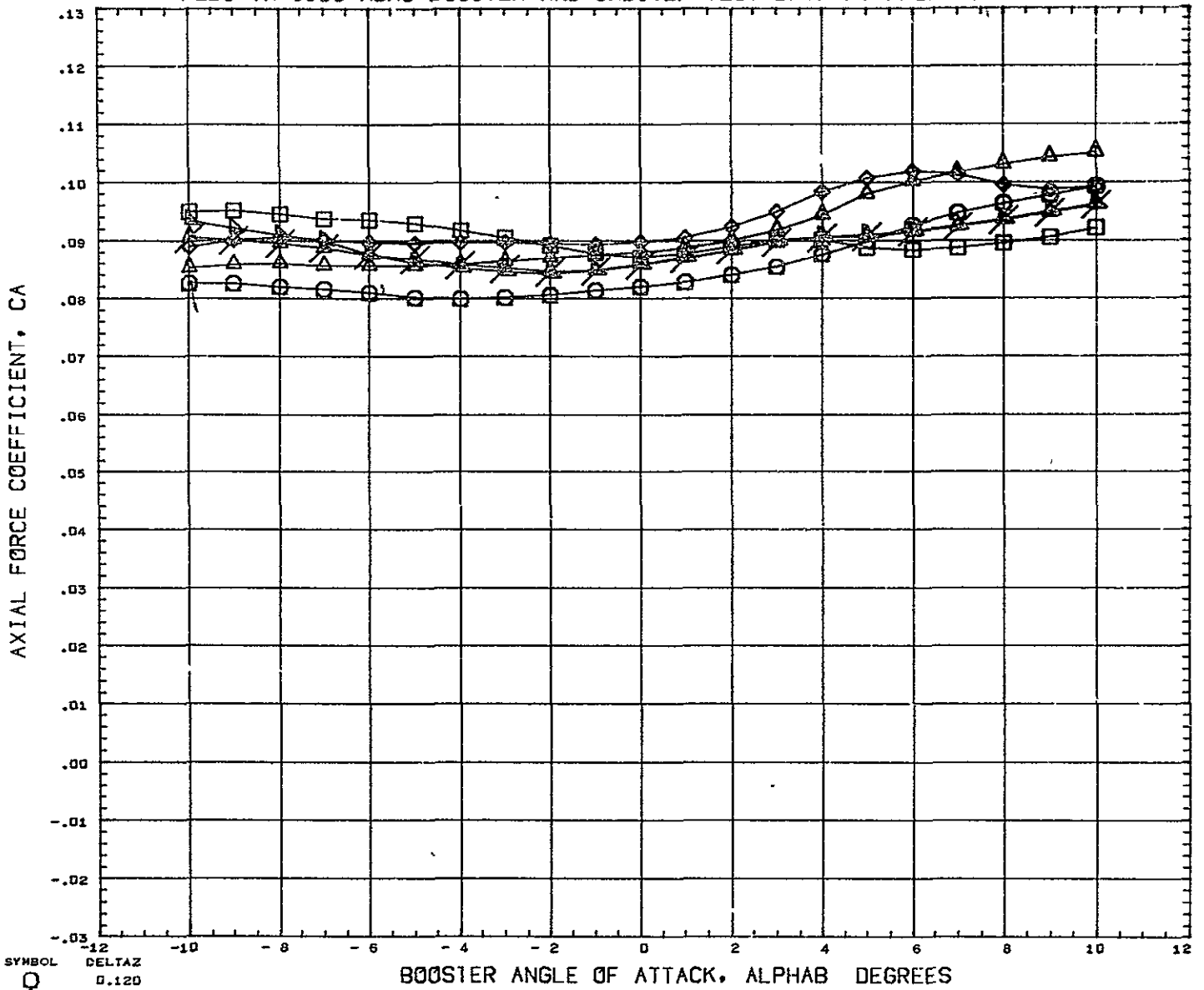

SYMBOL 	DELTAZ 0.120 0.151 0.182 0.228 0.352 10.000	PARAMETRIC VALUES BSTPOW 0.000 ORBPOW 0.000 PFLTAX 0.104 ALPHAI 0.000 MACH 5.010 ELVBST 20.000 ELVORB - 20.000 BETA 0.000	REFERENCE INFORMATION REFS 44.4440 SQ IN REFL 13.3330 IN REFB 13.3330 IN XMRP 7.5280 IN YMRP 0.0000 IN ZMRP 1.1940 IN SCALE 0.0055
DATA HIST. CODE M			

# AEDC VA 1163 MDAC BOOSTER AND ORBITER TEST DATA AT MACH NUMBER 5

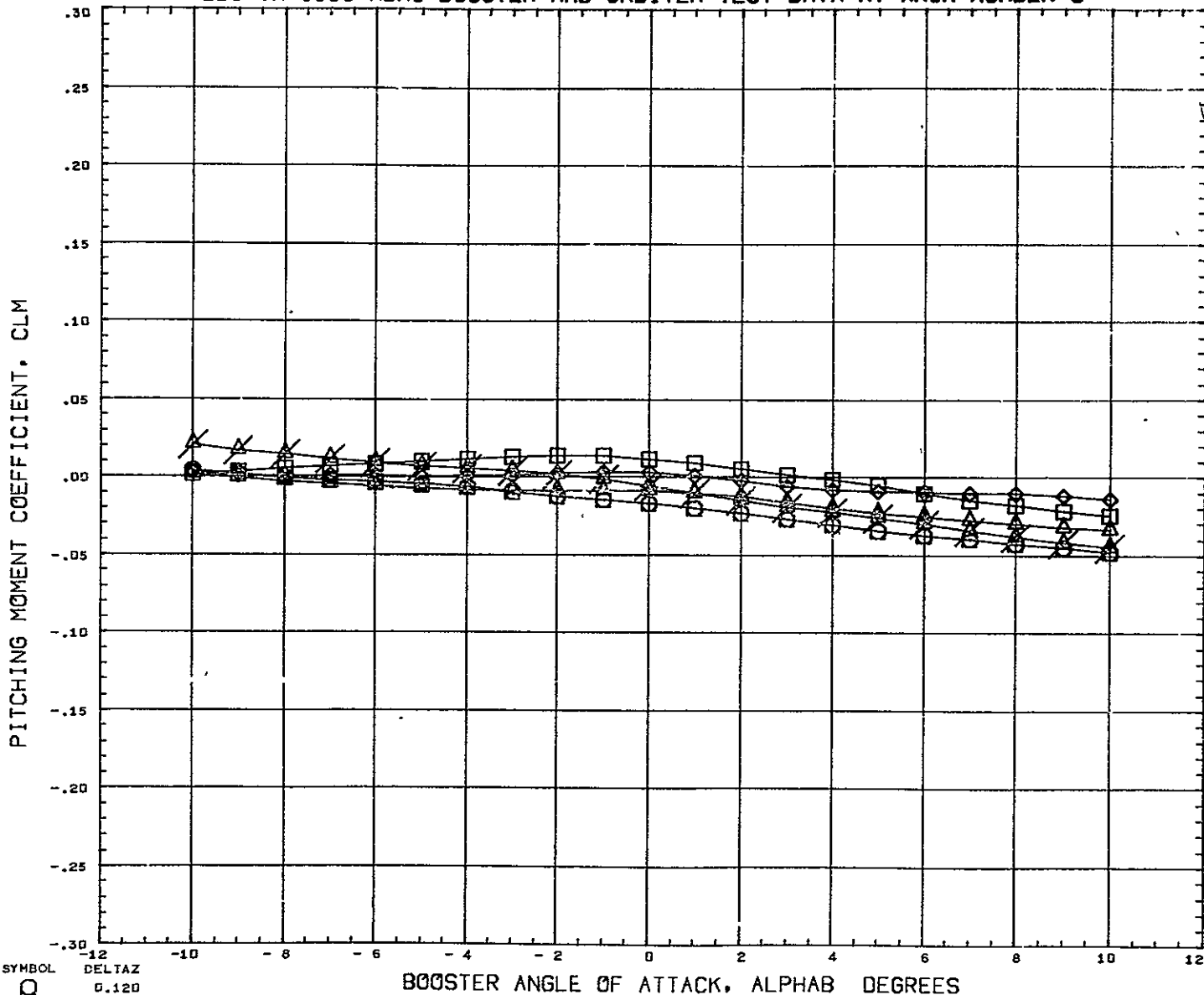

SYMBOL ○ □ ◇ △ ×	DELTA Z 0.120 0.151 0.182 0.228 10.000	PARAMETRIC VALUES BSTPOW 0.000 ORBPOW 0.000 DELTAX 0.166 ALPHAI 0.000 ACH 5.010 ELVBST 20.000 ELVORB - 20.000 BETA 0.000	REFERENCE INFORMATION REFS 44.4440 SQ IN REFL 13 3330 IN REFB 13 3330 IN XMRF 7.5280 IN YMRF 0.0000 IN ZMRF 1.1940 IN SCALE 0.0055
---------------------------------	---	--	---

1 DATA HIST. CODE M



# AEDC VA 1163 MDAC BOOSTER AND ORBITER TEST DATA AT MACH NUMBER 5

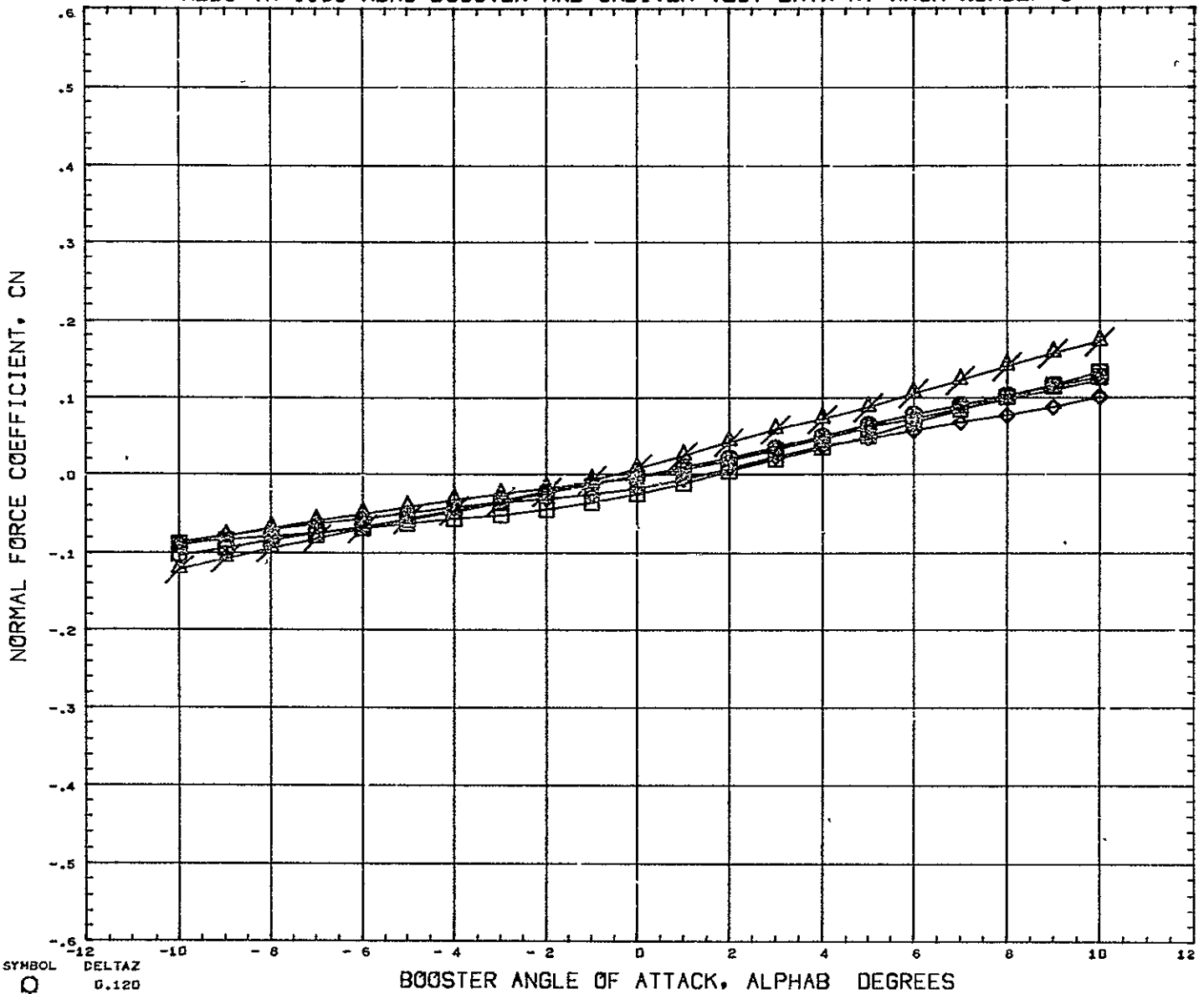

SYMBOL □ ◇ △ ×	DELTAZ 0.120 0.151 0.182 0.228 10.000	PARAMETRIC VALUES BSTFOW 0.000 ORBPOW 0.000 DELTAX 0.166 ALPHAI 0.000 MACH 5.010 ELVBST 20.000 ELVORB -20.000 BETA 0.000	REFERENCE INFORMATION REFS 44.4440 SQ IN REFL 13.3330 IN REFB 13.3330 IN XMRP 7.5200 IN YMRP 0.0000 IN ZMRP 1.1940 IN SCALE 0.0055
DATA HIST. CODE M			

# AEDC VA 1163 MDAC BOOSTER AND ORBITER TEST DATA AT MACH NUMBER 5

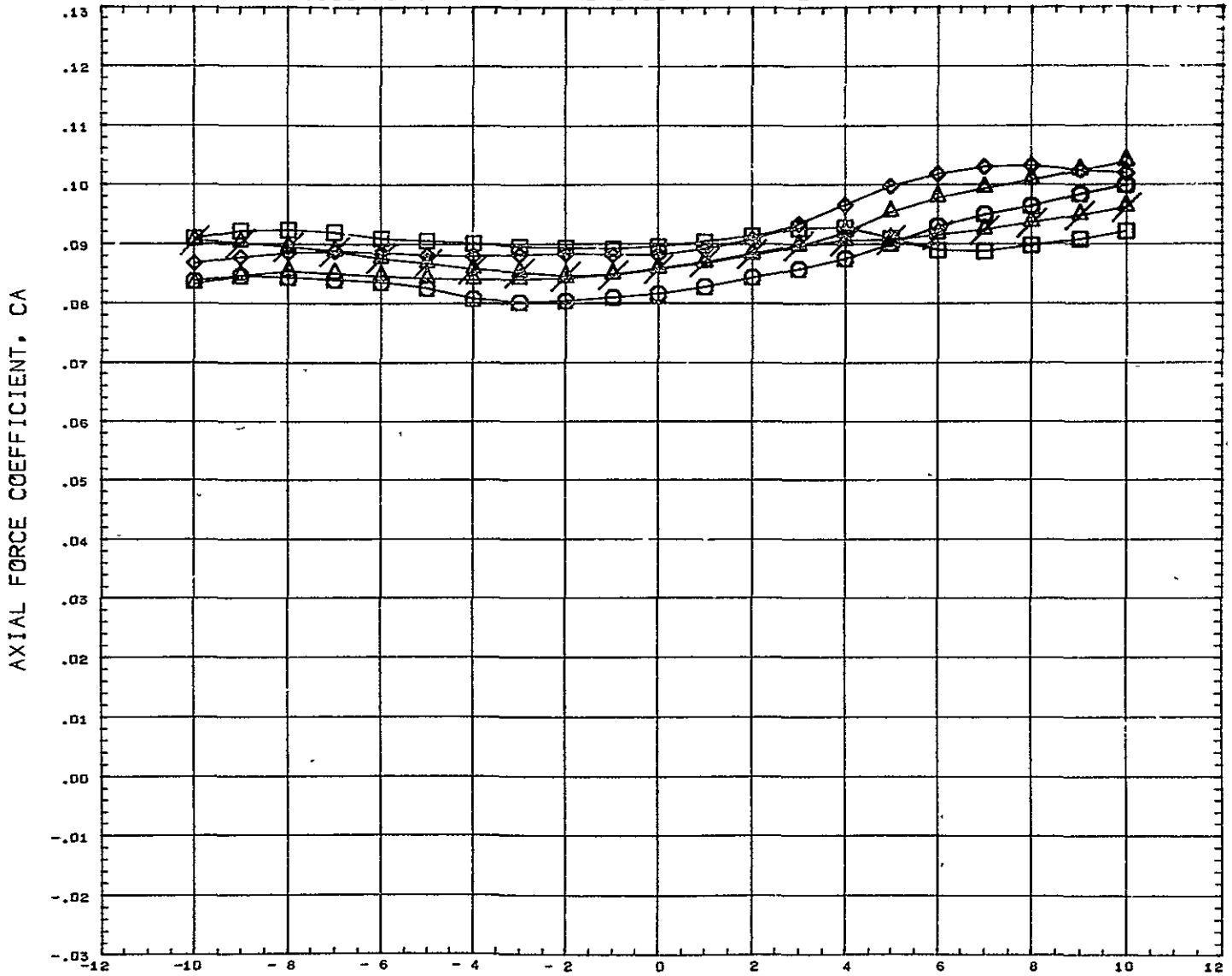

SYMBOL ◇ □ △ ○ ×	DELTA Z 0.120 0.151 0.182 0.228 10.000	PARAMETRIC VALUES BSTPOW 0.000 ORBPOW 0.000 DELTAX 0.166 ALPHAI 0.000 ACH 5.010 ELVBST 20.000 ELVORB -20.000 BCTA 0.000	REFERENCE INFORMATION REFS 4.4440 SQ IN REFL 13.3330 IN REFB 13.3330 IN XMRF 7.5280 IN YMRP 0.0000 IN ZMRP 1.1940 IN SCALE 0.0055
DATA HIST. CODE M			

# AEDC VA 1163 MDAC BOOSTER AND ORBITER TEST DATA AT MACH NUMBER 5

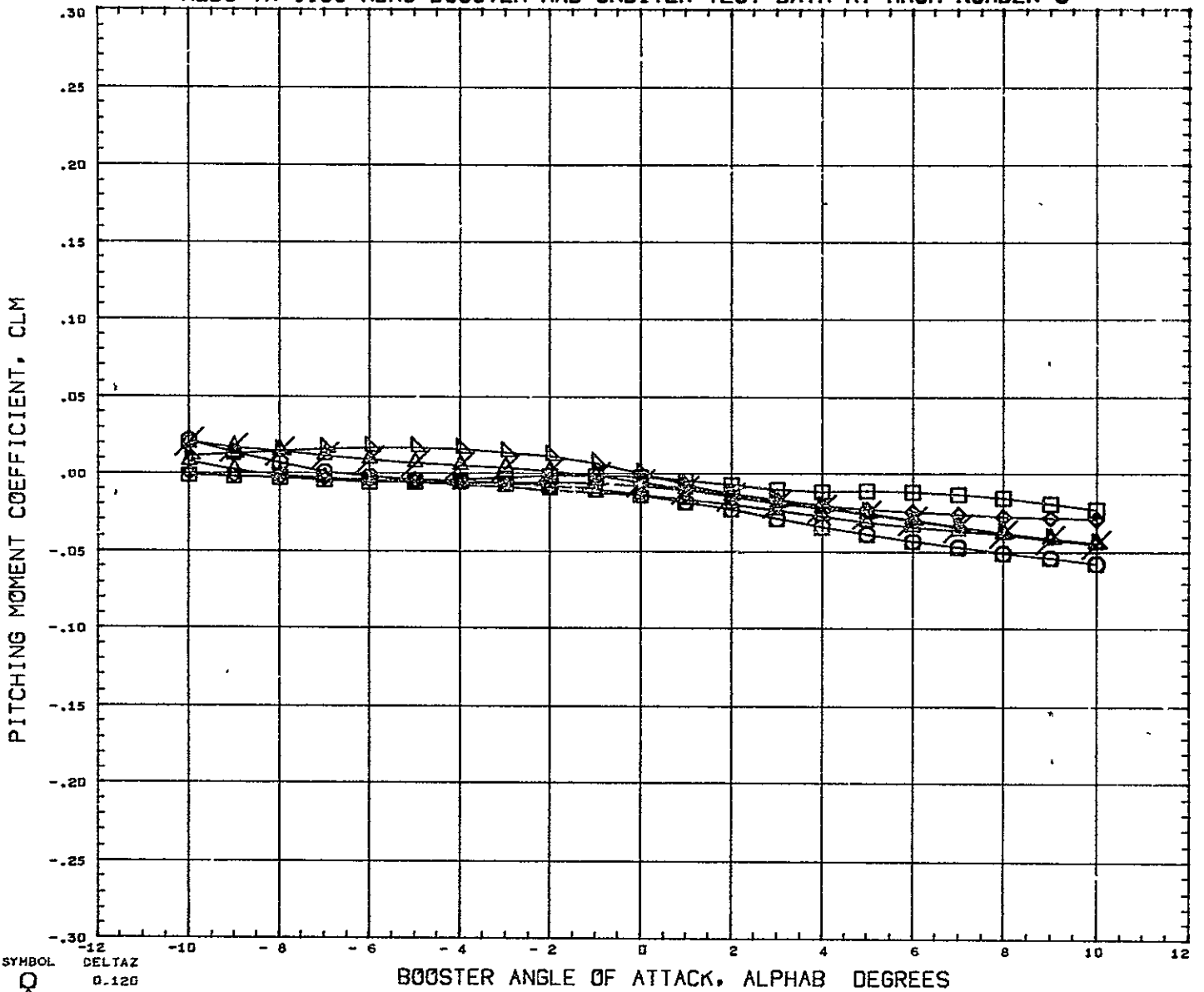

SYMBOL ○ ◇ □ △	DELTA Z 0.126 0.151 0.182 0.228 0.352 10.000	<table border="0" style="width: 100%;"> <tr> <th colspan="4" style="text-align: left; padding-left: 20px;">PARAMETRIC VALUES</th> </tr> <tr> <td style="padding-left: 20px;">BSTPOW</td> <td>0.000</td> <td>ORBPOW</td> <td>0.000</td> </tr> <tr> <td style="padding-left: 20px;">DELTA X</td> <td>0.352</td> <td>ALPHA I</td> <td>0.000</td> </tr> <tr> <td style="padding-left: 20px;">MACH</td> <td>5.010</td> <td>ELVST</td> <td>20.000</td> </tr> <tr> <td style="padding-left: 20px;">ELVORB</td> <td>-20.000</td> <td>BETA</td> <td>0.000</td> </tr> </table>	PARAMETRIC VALUES				BSTPOW	0.000	ORBPOW	0.000	DELTA X	0.352	ALPHA I	0.000	MACH	5.010	ELVST	20.000	ELVORB	-20.000	BETA	0.000	<table border="0" style="width: 100%;"> <tr> <th colspan="3" style="text-align: left;">REFERENCE INFORMATION</th> </tr> <tr> <td style="padding-left: 20px;">REFS</td> <td>44.4440</td> <td>SN IN</td> </tr> <tr> <td style="padding-left: 20px;">REFL</td> <td>13.3330</td> <td>IN</td> </tr> <tr> <td style="padding-left: 20px;">REFB</td> <td>13.3330</td> <td>IN</td> </tr> <tr> <td style="padding-left: 20px;">XMRP</td> <td>7.5280</td> <td>IN</td> </tr> <tr> <td style="padding-left: 20px;">YMRP</td> <td>0.0000</td> <td>IN</td> </tr> <tr> <td style="padding-left: 20px;">ZMRP</td> <td>1.1940</td> <td>IN</td> </tr> <tr> <td style="padding-left: 20px;">SCALE</td> <td>0.0055</td> <td></td> </tr> </table>	REFERENCE INFORMATION			REFS	44.4440	SN IN	REFL	13.3330	IN	REFB	13.3330	IN	XMRP	7.5280	IN	YMRP	0.0000	IN	ZMRP	1.1940	IN	SCALE	0.0055	
PARAMETRIC VALUES																																															
BSTPOW	0.000	ORBPOW	0.000																																												
DELTA X	0.352	ALPHA I	0.000																																												
MACH	5.010	ELVST	20.000																																												
ELVORB	-20.000	BETA	0.000																																												
REFERENCE INFORMATION																																															
REFS	44.4440	SN IN																																													
REFL	13.3330	IN																																													
REFB	13.3330	IN																																													
XMRP	7.5280	IN																																													
YMRP	0.0000	IN																																													
ZMRP	1.1940	IN																																													
SCALE	0.0055																																														
DATA HIST. CODE    M																																															

# AEDC VA 1163 MDAC BOOSTER AND ORBITER TEST DATA AT MACH NUMBER 5

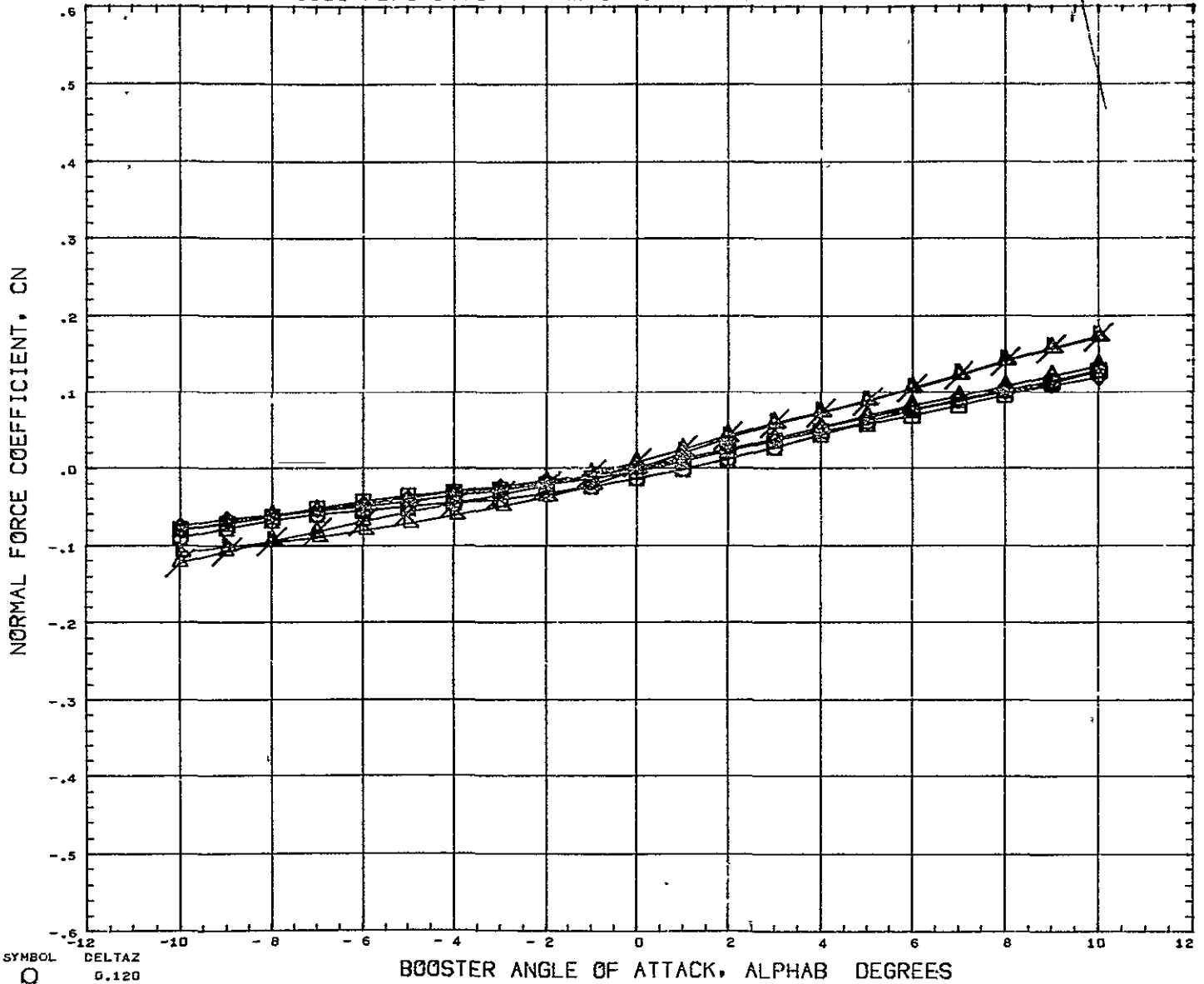

SYMBOL ○ ◇ □ △	DELTA Z 0.120 0.151 0.182 0.228 0.352 10.000	PARAMETRIC VALUES BSTFOW 0.000 ORB FOW 0.000 DELTA X 0.352 ALPHA I 0.000 MACH 5.010 ELV BST 20.000 ELV GRB -20.000 BETA 0.000	REFERENCE INFORMATION REFS 44.4440 SQ IN REFL 13.3330 IN REFB 13.3330 IN XMR F 7.5280 IN YMR F 0.0000 IN ZMR F 1.1940 IN SCALE 0.0055
----------------------------	--	---	--

DATA HIST. CODE M

# AEDC VA 1163 MDAC BOOSTER AND ORBITER TEST DATA AT MACH NUMBER 5

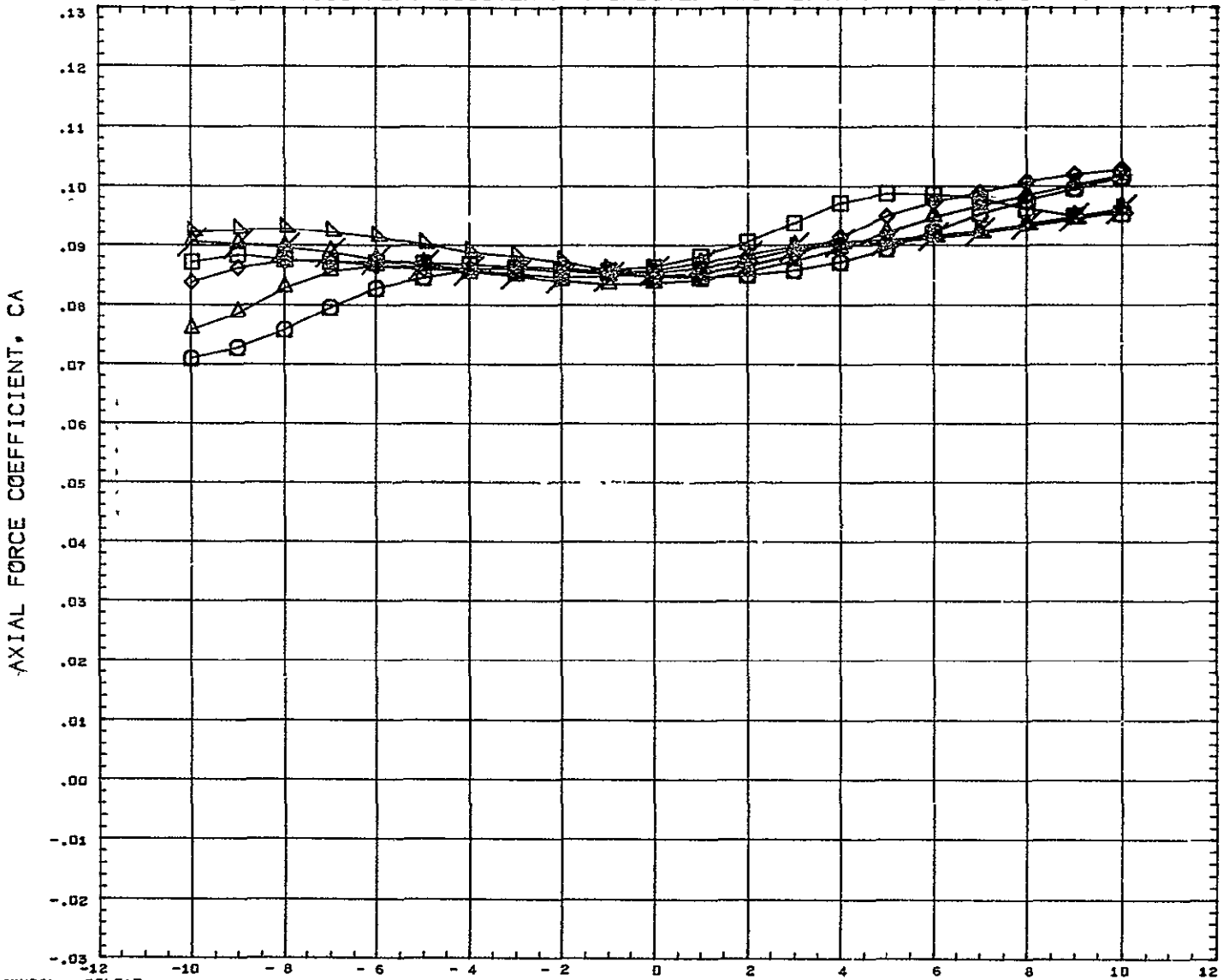

SYMBOL	DELTA Z	PARAMETRIC VALUES				REFERENCE INFORMATION	
○	0.126						
◇	0.151						
△	0.182	BSTPOW	0.000	ORBPOW	0.000	REFS	44.4440 SQ IN
□	0.228	DELTA X	0.352	ALPHA I	0.000	REFL	13.3330 IN
◇	0.352	MACH	5.010	ELVBST	20.000	REFB	13.3330 IN
△	10.000	ELVORB	-20.000	BETA	0.000	XMRP	7.5280 IN
						YMRP	0.0000 IN
						ZMRP	1.1940 IN
						SCALE	0.0055

DATA HIST. CODE M

# AEDC VA 1163 MDAC BOOSTER AND ORBITER TEST DATA AT MACH NUMBER 5

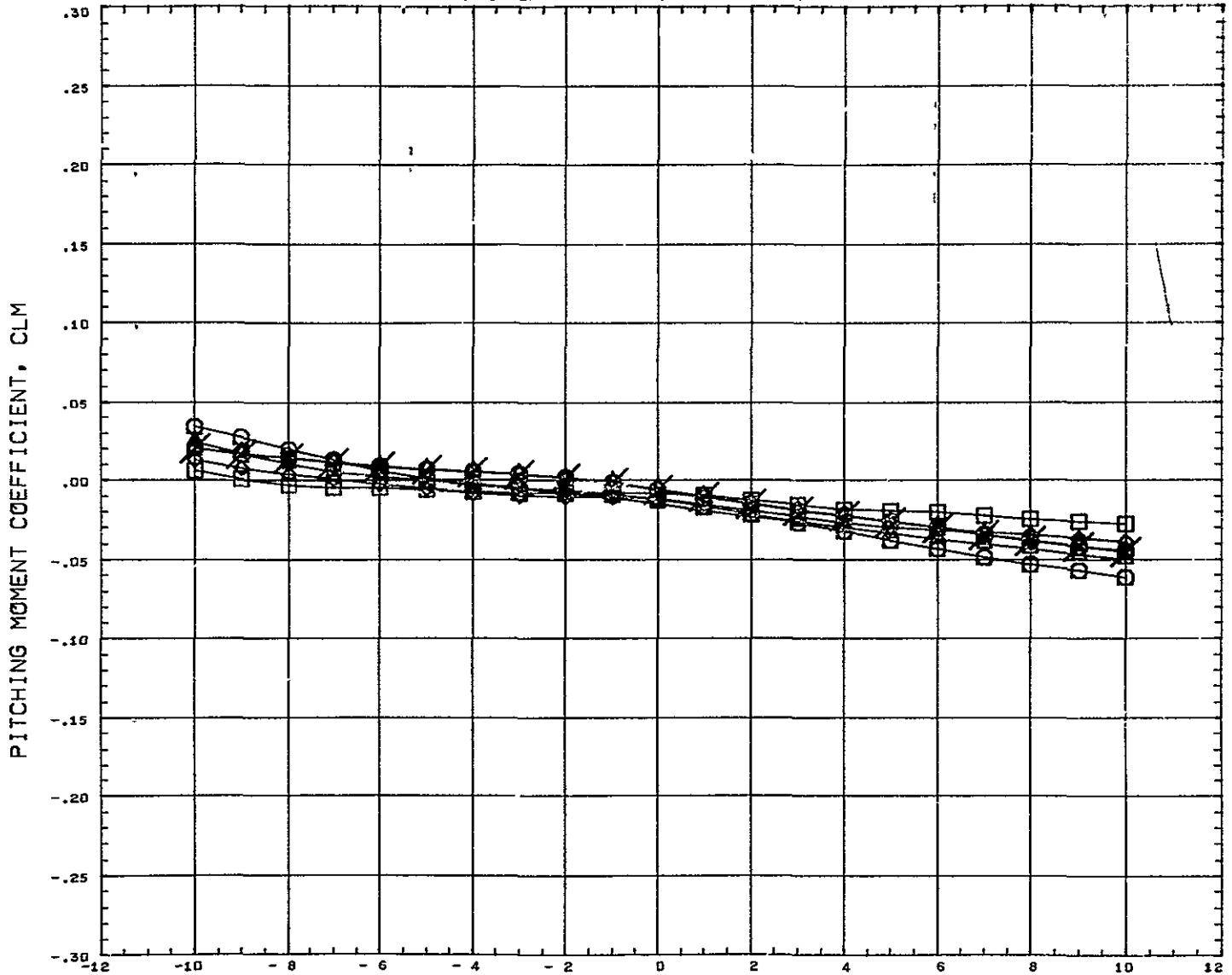

SYMBOL ○ △ ◇ □ ⊗ ⊗	DELTAZ 0.120 0.151 0.182 0.228 0.908 10.000	PARAMETRIC VALUES BSTPOW    0.000    ORBPOW    0.000 DELTAX    0.522    ALPHAI    0.000 MACH      5.010    ELYBST    20.000 ELVORB    -20.000    BETA      0.000	REFERENCE INFORMATION REFS      44.4440    SQ IN REFL      13.3330    IN REFB      13.3330    IN XMRP      7.5280    IN YMRP      0.0000    IN ZMRP      1.1940    IN SCALE     0.0055
REFERENCE FILE			

# AEDC VA 1163 MDAC BOOSTER AND ORBITER TEST DATA AT MACH NUMBER 5

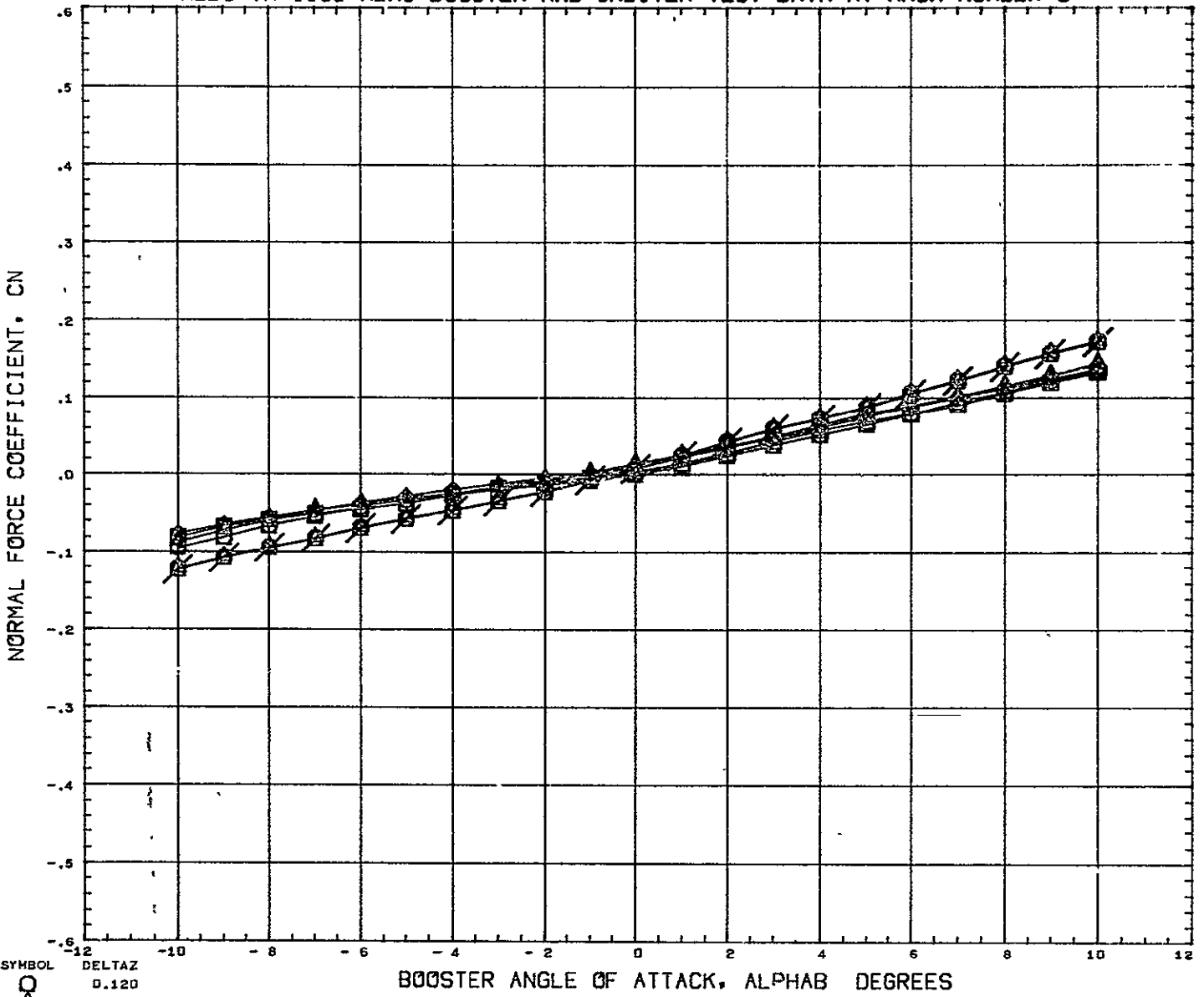

SYMBOL ○ □ ◇ △ ×	DELTAX 0.120 0.151 0.182 0.228 0.908 10.000	PARAMETRIC VALUES BSTFOW 0.000 DELTAX 0.522 MACH 5.010 ELVORB -20.000 ORBFOV 0.000 ALPHAI 0.000 ELVBST 20.000 BETA 0.000	REFERENCE INFORMATION REFS 44.444J SQ IN REFL 13.3330 IN REFB 13.3330 IN XMRF 7.5280 IN YMRF 0.0000 IN ZMRF 1.1940 IN SCALE 0.0055
---------------------------------	---	--	---

REFERENCE FILE

# AEDC VA 1163 MDAC BOOSTER AND ORBITER TEST DATA AT MACH NUMBER 5

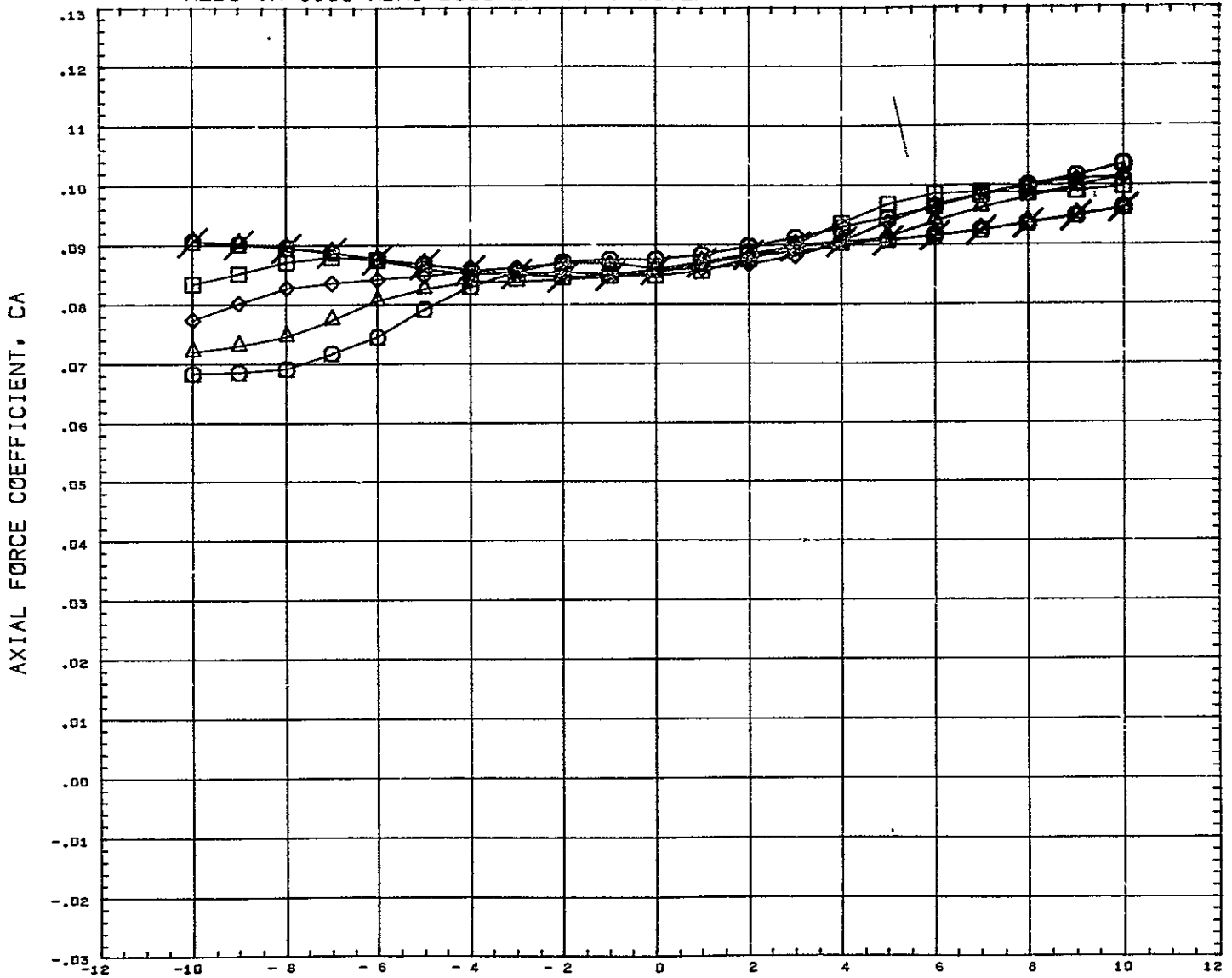

SYMBOL ○ □ △ ◇ ⊗	DELTAZ 0.120 0.151 0.182 0.228 0.908 10.000	<b>PARAMETRIC VALUES</b> BSTPOW    0.000    ORBPOW    0.000 DELTAX    0.522    ALPHAI    0.000 MACH      5.010    ELVBST    20.000 ELVORB    -20.000    BETA      0.000	<b>REFERENCE INFORMATION</b> REFS      44.4440    SQ IN REFL      13.3330    IN REFB      13.3330    IN XMRP      7.5280    IN YMRP      0.0000    IN ZMRP      1.1940    IN SCALE     0.0055
REFERENCE FILE			



# AEDC VA 1163 MDAC BOOSTER AND ORBITER TEST DATA AT MACH NUMBER 5

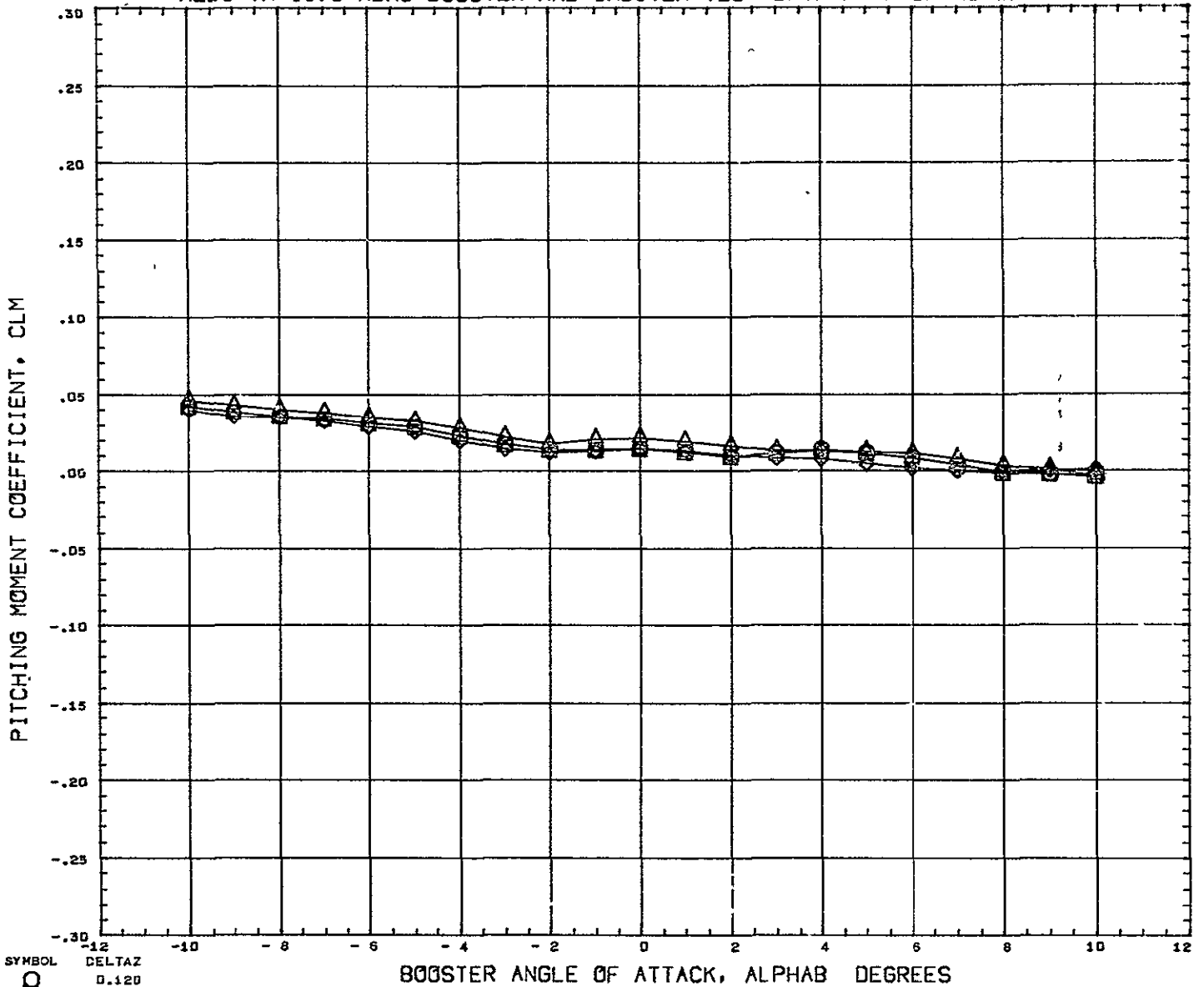

SYMBOL ◊ △ ○	DELTAZ 0.120 0.151 0.182	<b>PARAMETRIC VALUES</b> BSTPOW 100.000 ORBPOW 100.000 DELTAX - 0.390 ALPHAI 0.000 MACH 5.010 ELVBST 20.000 ELVORB - 20.000 BETA 0.000	<b>REFERENCE INFORMATION</b> REFS 44.4440 SQ IN REFL 13.3330 IN REFB 13.3330 IN XMRP 7.5280 IN YMRP 0.0000 IN ZMRP 1.1940 IN SCALE 0.0055
REFERENCE FILE			

# AEDC VA 1163 MDAC BOOSTER AND ORBITER TEST DATA AT MACH NUMBER 5

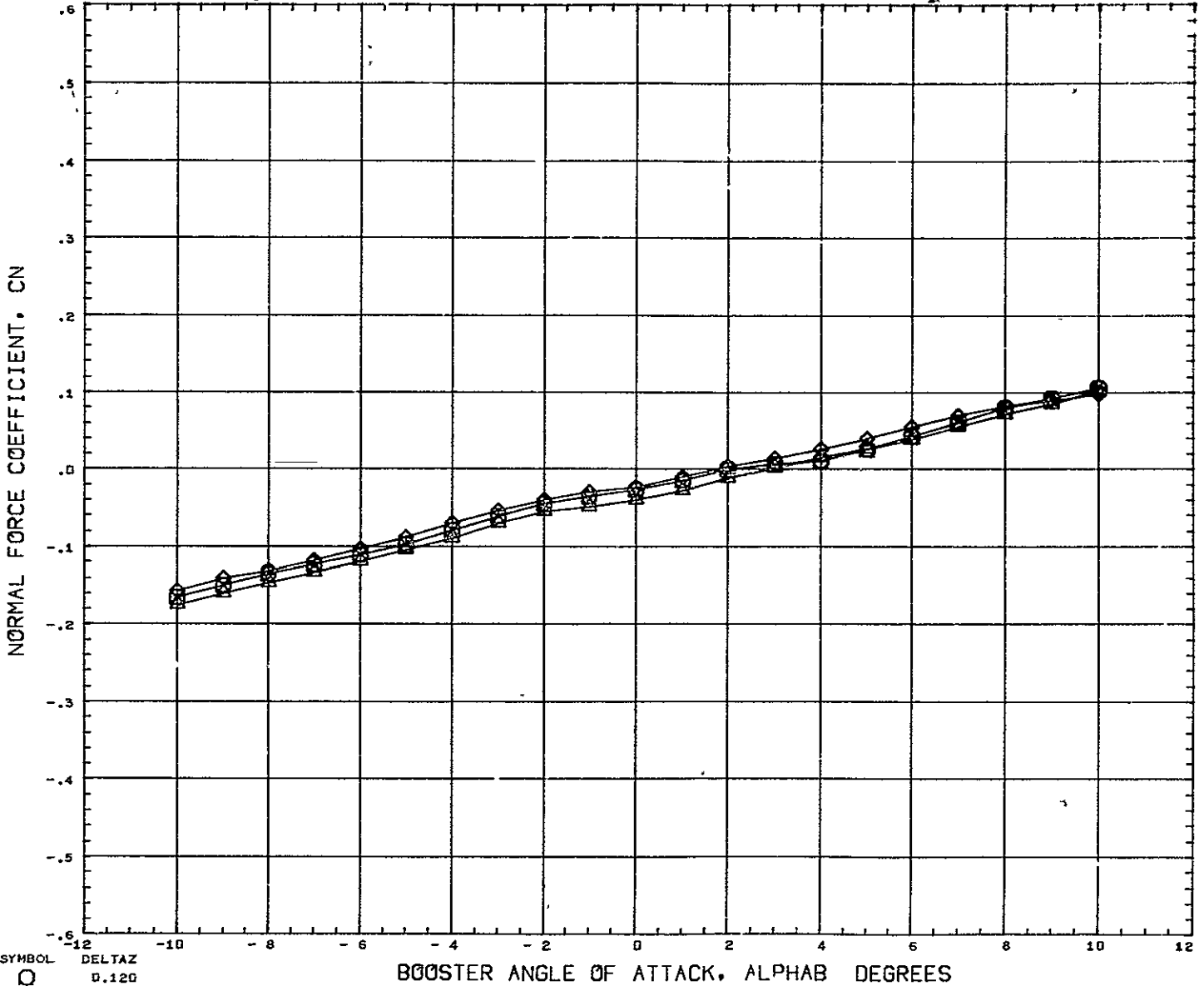

SYMBOL	DELTAZ	PARAMETRIC VALUES				REFERENCE INFORMATION			
□	0.120	BSTPOW	100.000	ORBPOW	100.000	REFS	44 4440	SQ	IN
△	0.151	DELTAZ	- 0.390	ALPHA1	0.000	REFL	13 3330	IN	
◇	0.182	MACH	5.010	ELVBST	20.000	REFB	13 3330	IN	
		ELVORB	- 20.000	BETA	0.000	XMRP	7.5280	IN	
						YMRP	0.0000	IN	
						ZMRP	1.1940	IN	
						SCALE	0.0055		
	15	REFERENCE FILE							

# AEDC VA 1163 MDAC BOOSTER AND ORBITER TEST DATA AT MACH NUMBER 5

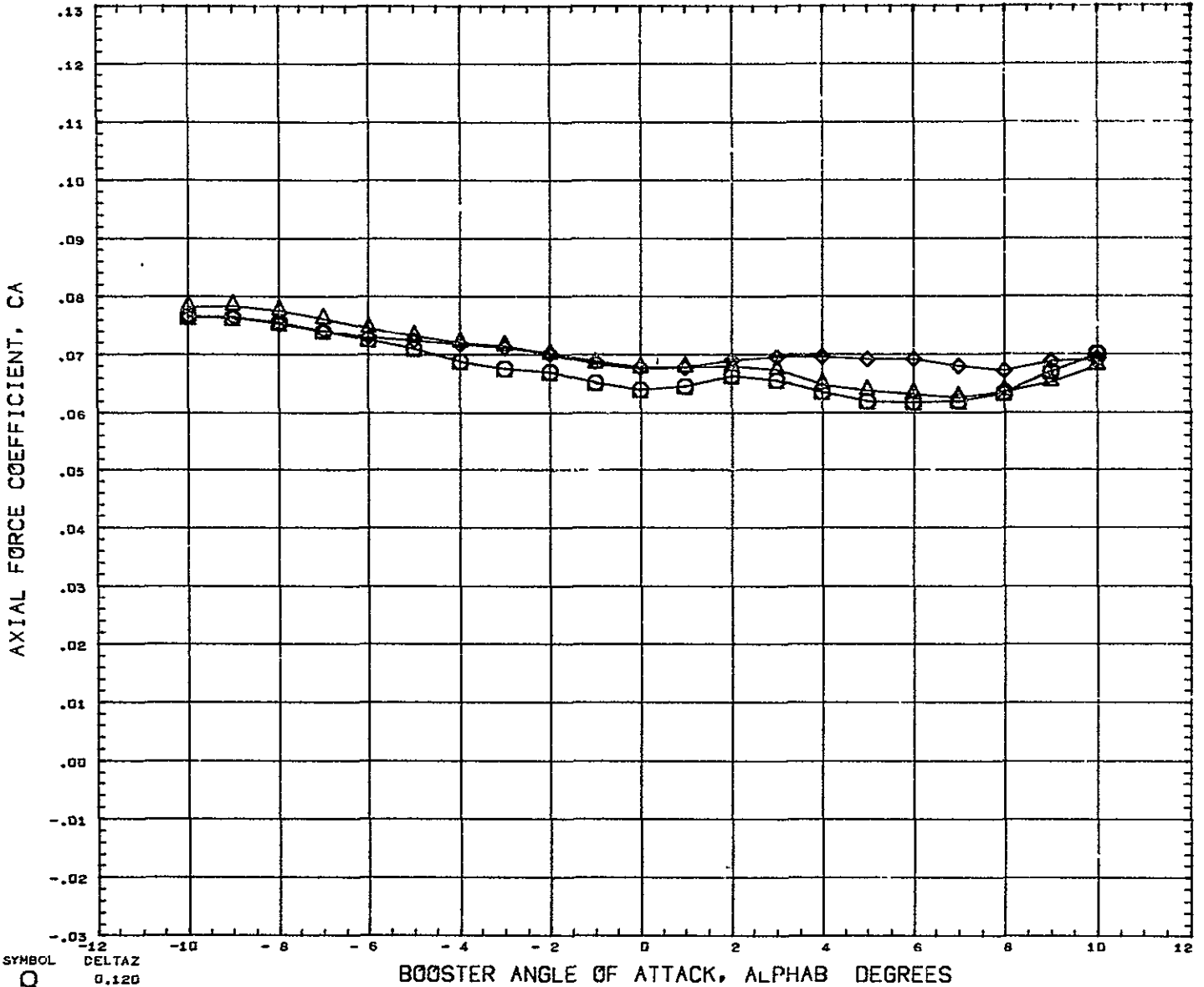

SYMBOL □ △ ◇	DELTA Z 0.120 0.151 0.182	<b>PARAMETRIC VALUES</b> BSTPCW 100.000    ORBPCW 100.000 ELTAX - 0.390    ALPHAI 0.000 MACH 5.010    ELYBST 20.000 ELVORB - 20.000    BETA 0.000	<b>REFERENCE INFORMATION</b> REFS 44.4440    SQ IN REFL 13.3330    IN REFB 13.3330    IN XMRP 7.5280    IN YMRP 0.0000    IN ZMRP 1.1940    IN SCALE 0.0055
REFERENCE FILE			

# AEDC VA 1163 MDAC BOOSTER AND ORBITER TEST DATA AT MACH NUMBER 5

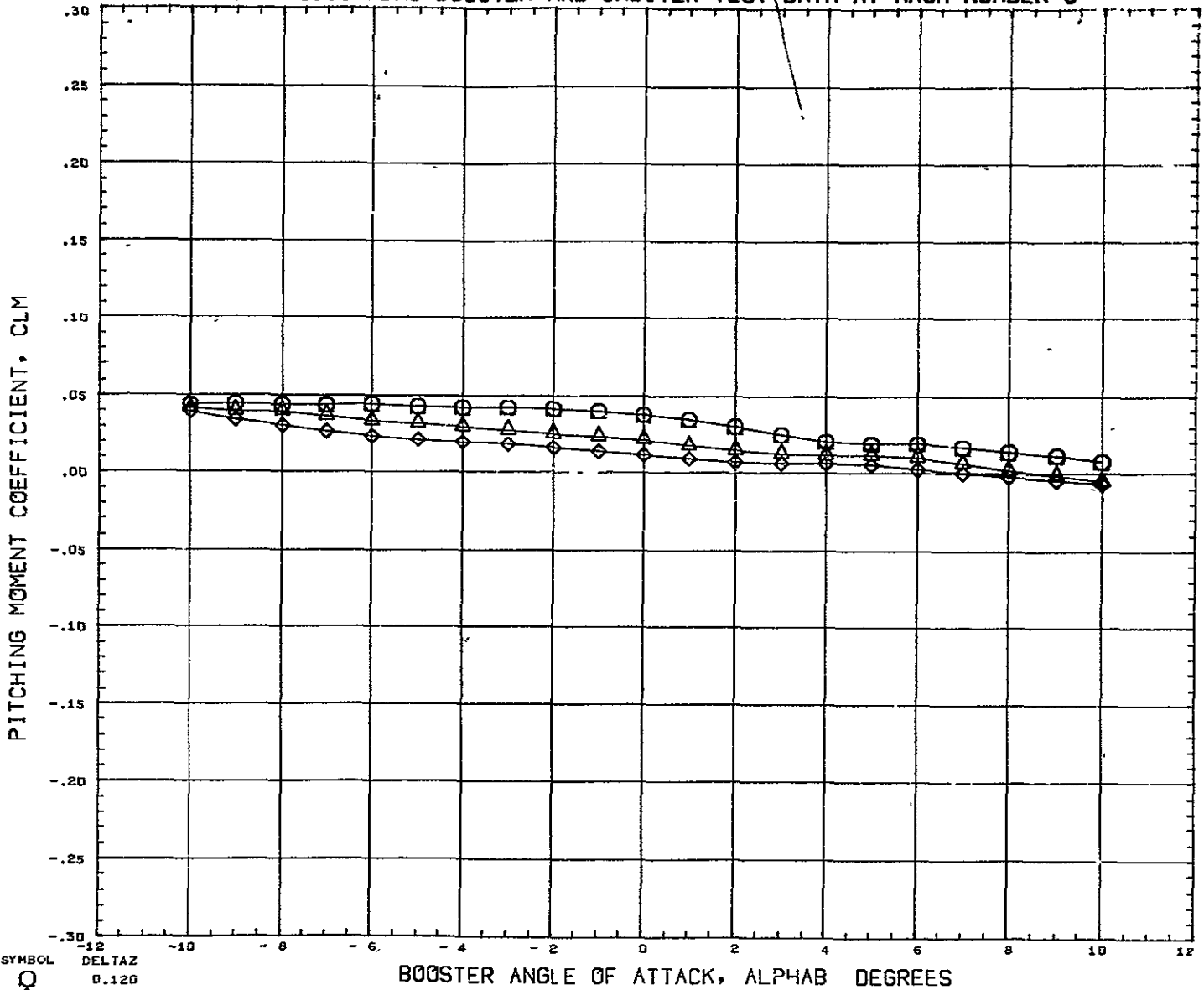

SYMBOL ○ △ ◇	DELTA Z 0.120 0.151 0.162	<b>PARAMETRIC VALUES</b> ,BSTPOW 100.000 ORBPOW 100.000 ,JELTAX - 0.143 ALPHAI 0.000 ,MACH 5.010 ELVBST 20.000 ,ELVORB - 20.000 BETA 0.000	<b>REFERENCE INFORMATION</b> REFS 44.4440 SQ IN REFL 13.3330 IN REFB 13.3330 IN XMRP 7.5280 IN YMRP 0.0000 IN ZMRP 1.1940 IN SCALE 0.0055
	51 :DATA HIST. CODE #C ;		

# AEDC VA 1163 MDAC BOOSTER AND ORBITER TEST DATA AT MACH NUMBER 5

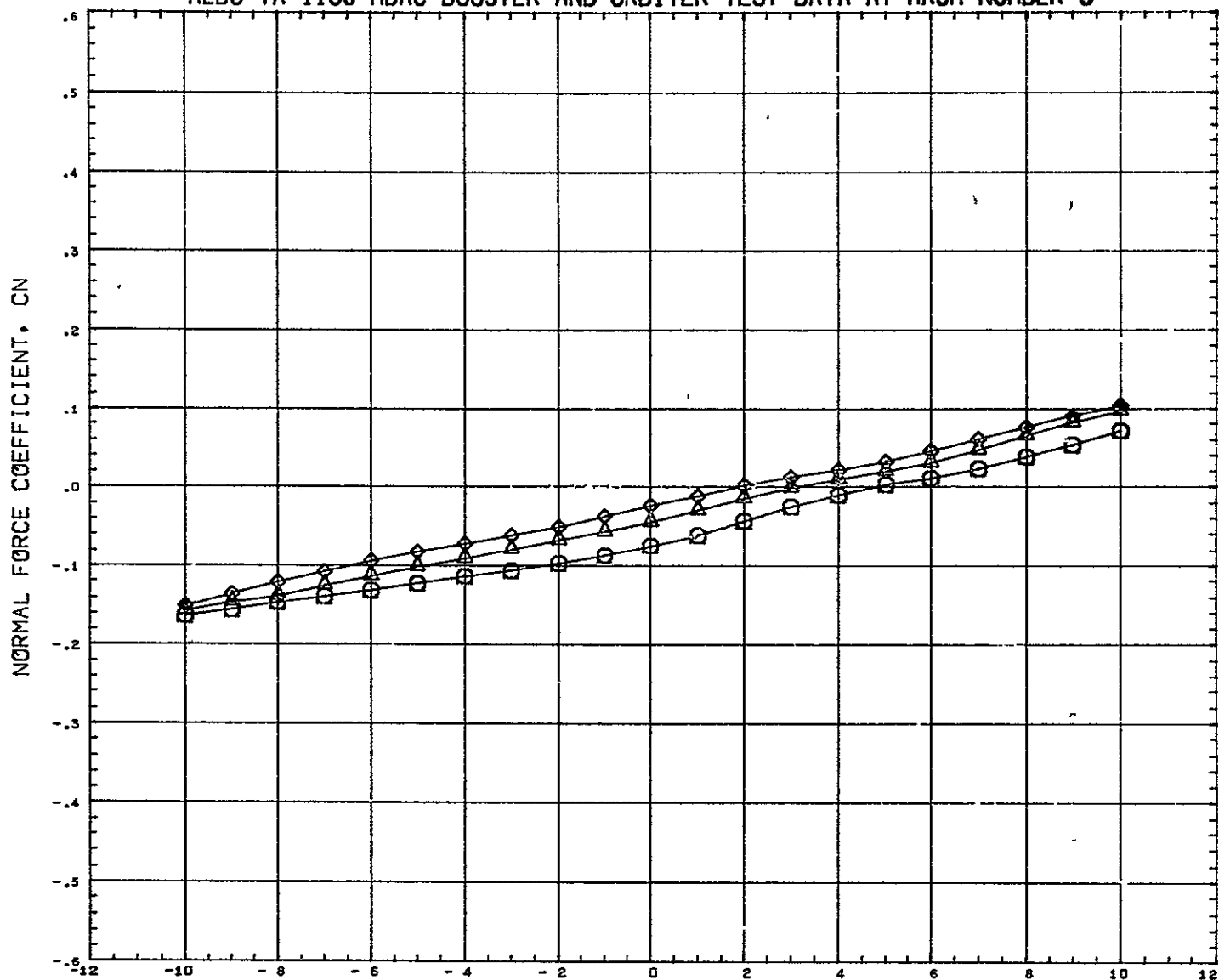

SYMBOL ○ △ ◇	DELTA Z 0.120 0.151 0.182	<table border="0" style="width: 100%;"> <tr> <th colspan="4" style="text-align: center;">PARAMETRIC VALUES</th> </tr> <tr> <td>BSTPOW</td><td>100,000</td><td>ORBPOW</td><td>100,000</td> </tr> <tr> <td>JELTAX</td><td>- 0.143</td><td>ALPHA1</td><td>0,000</td> </tr> <tr> <td>MACH</td><td>5.010</td><td>ELVBST</td><td>20,000</td> </tr> <tr> <td>ELVORB</td><td>- 20,000</td><td>BETA</td><td>0,000</td> </tr> </table>	PARAMETRIC VALUES				BSTPOW	100,000	ORBPOW	100,000	JELTAX	- 0.143	ALPHA1	0,000	MACH	5.010	ELVBST	20,000	ELVORB	- 20,000	BETA	0,000	<table border="0" style="width: 100%;"> <tr> <th colspan="3" style="text-align: center;">REFERENCE INFORMATION</th> </tr> <tr> <td>REFS</td><td>44.4440</td><td>SQ IN</td> </tr> <tr> <td>REFL</td><td>13.3330</td><td>IN</td> </tr> <tr> <td>REFB</td><td>13.3330</td><td>IN</td> </tr> <tr> <td>XMRP</td><td>7.5280</td><td>IN</td> </tr> <tr> <td>YMRP</td><td>0.0000</td><td>IN</td> </tr> <tr> <td>ZMRP</td><td>1.1940</td><td>IN</td> </tr> <tr> <td>SCALE</td><td>0.0055</td><td></td> </tr> </table>	REFERENCE INFORMATION			REFS	44.4440	SQ IN	REFL	13.3330	IN	REFB	13.3330	IN	XMRP	7.5280	IN	YMRP	0.0000	IN	ZMRP	1.1940	IN	SCALE	0.0055	
PARAMETRIC VALUES																																															
BSTPOW	100,000	ORBPOW	100,000																																												
JELTAX	- 0.143	ALPHA1	0,000																																												
MACH	5.010	ELVBST	20,000																																												
ELVORB	- 20,000	BETA	0,000																																												
REFERENCE INFORMATION																																															
REFS	44.4440	SQ IN																																													
REFL	13.3330	IN																																													
REFB	13.3330	IN																																													
XMRP	7.5280	IN																																													
YMRP	0.0000	IN																																													
ZMRP	1.1940	IN																																													
SCALE	0.0055																																														
		DATA HIST. CODE    #6																																													

# AEDC VA 1163 MDAC BOOSTER AND ORBITER TEST DATA AT MACH NUMBER 5

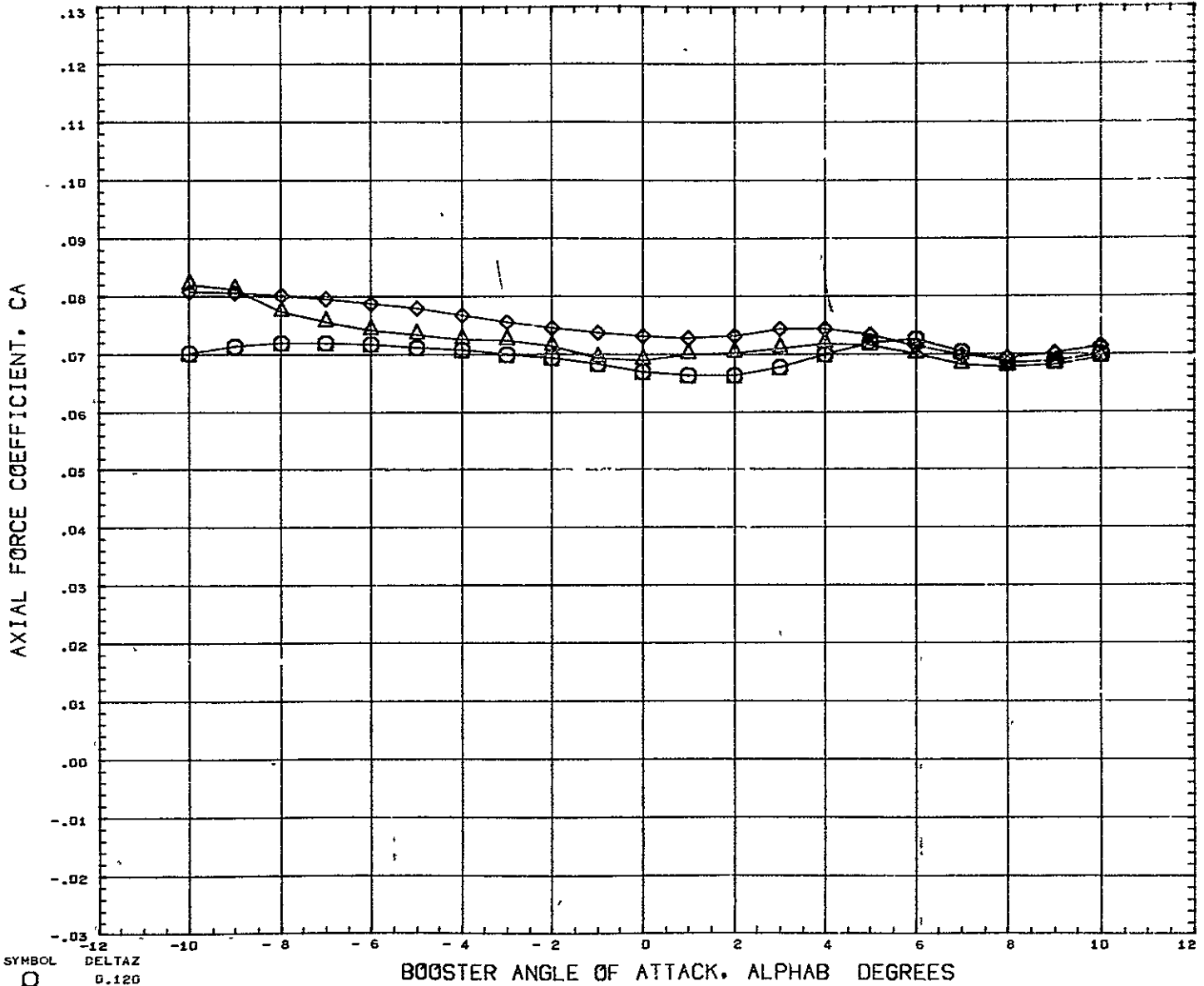

SYMBOL ◊ ◻ ◻	DELTAZ 0.120 0.151 0.182	<b>PARAMETRIC VALUES</b> BSTPOW 100.000 ORBFOW 100.000 DELTAX - 0.143 ALPHAI 0.000 MACH 5.010 ELVBST 20.000 ELVORB - 20.000 BETA 0.000	<b>REFERENCE INFORMATION</b> REFS 44.4440 SQ IN REFL 13.3330 IN REFB 13.3330 IN XMRP 7.5280 IN YMRP 0.0000 IN ZMRP 1.1940 IN SCALE 0.0055
		DATA HIST. CODE *6	

# AEDC VA 1163 MDAC BOOSTER AND ORBITER TEST DATA AT MACH NUMBER 5

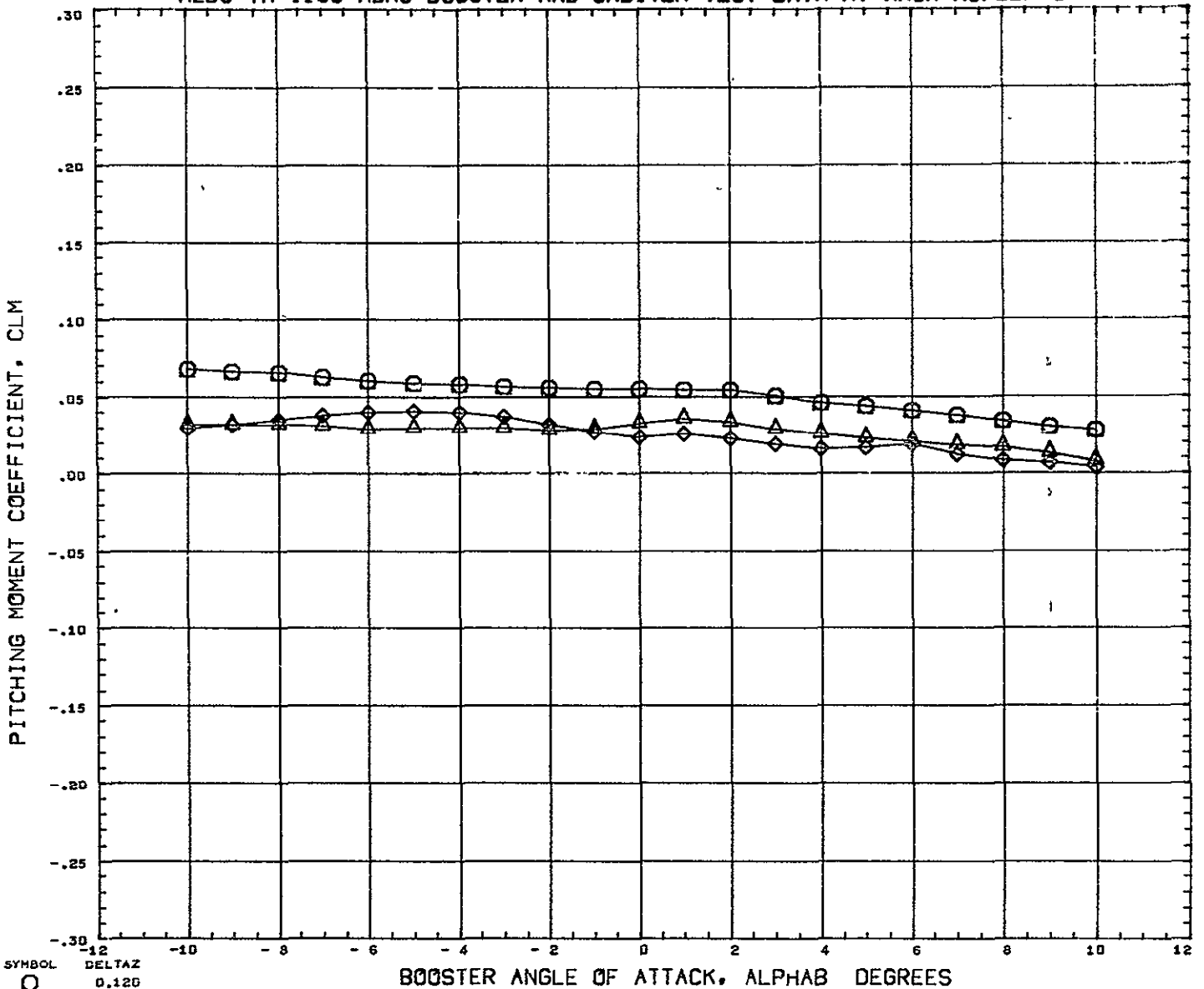

SYMBOL ○ △ ◇	DELTA Z 0.120 0.151 0.182	<b>PARAMETRIC VALUES</b> BSTPOW 100.000    ORBPOW 100.000 DELTAX - 0.019    ALPHA1 0.000 MACH 5.010        ELYBST 20.000 ELVORB - 20.000    BETA 0.000	<b>REFERENCE INFORMATION</b> REFS 44.4440    SQ IN REFL 13.3330    IN REFB 13.3330    IN XMRP 7.5280    IN YMRP 0.0000    IN ZMRP 1.1940    IN SCALE 0.0055
REFERENCE FILE			

# AEDC VA 1163 MDAC BOOSTER AND ORBITER TEST DATA AT MACH NUMBER 5

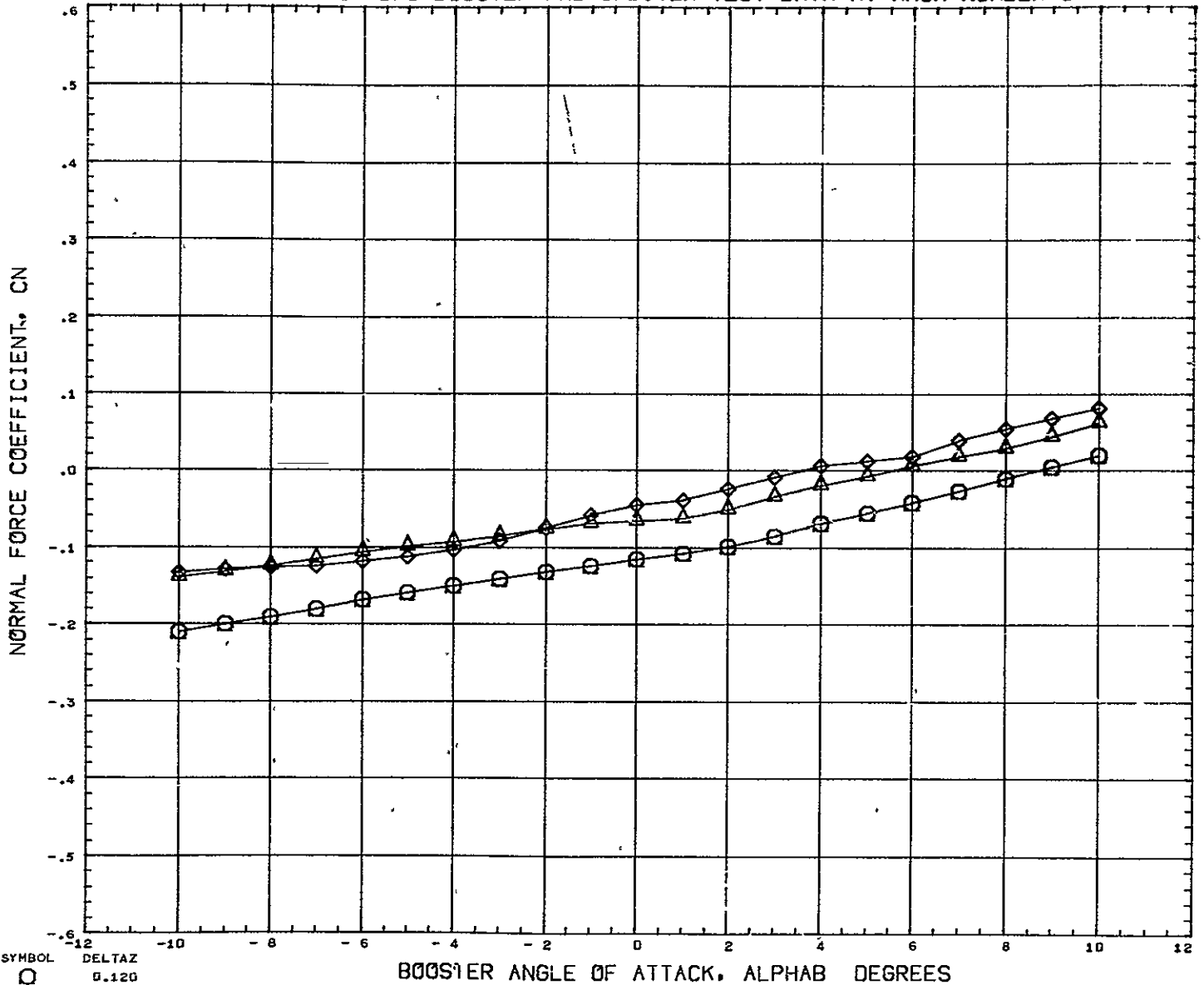

SYMBOL	DELTAZ		
◇	0.120		
△	0.151	PARAMETRIC VALUES	REFERENCE INFORMATION
□	0.182	BSTPOW 100.000	ORBPOW 100.000
		DELTAZ - 0.019	ALPHA1 0.000
		MACH 5.010	ELVBST 20.000
		ELVORB - 20.000	BETA 0.000
			REFS 44.4440 SQ IN
			REFL 13.3330 IN
			REFB 13.3330 IN
			XMRP 7.5280 IN
			YMRP 0.0000 IN
			ZMRP 1.1940 IN
			SCALE 0.0055

1 REFERENCE FILE



# AEDC VA 1163 MDAC BOOSTER AND ORBITER TEST DATA AT MACH NUMBER 5

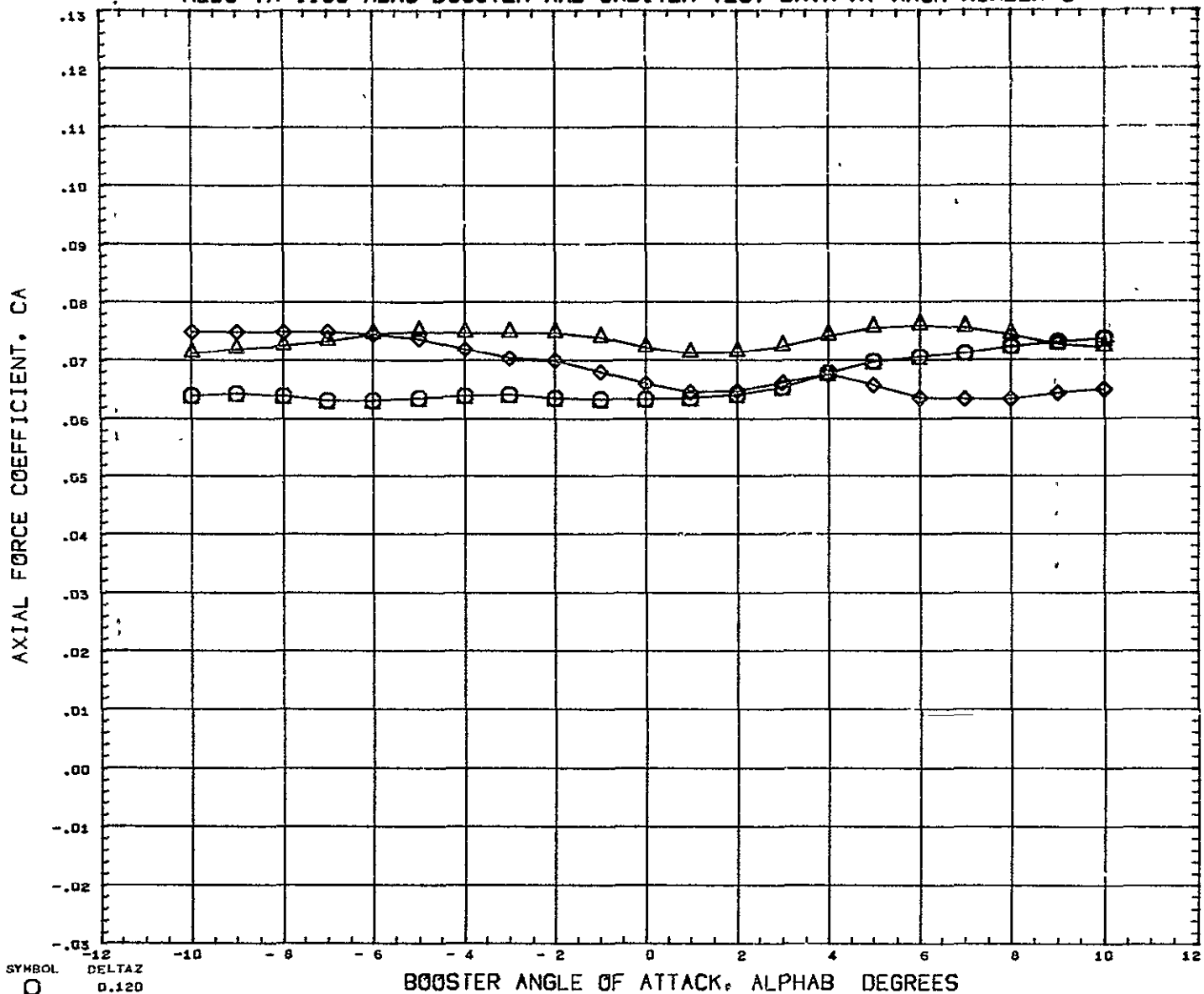

SYMBOL ◇    △    □	DELTAZ 0.120 0.151 0.182	<b>PARAMETRIC VALUES</b> BSTPOW    100.000    ORBPOW    100.000 DELTAX    - 0.019    ALPHAI    0.000 MACH       5.010    ELVBST    20.000 ELVORB    - 20.000    BETA       0.000	<b>REFERENCE INFORMATION</b> REFS       44.444C    SQ IN REFL       13.333B    IN REFB       13.333B    IN XMR <sup>2</sup> 7.5280    IN YMRP       0.0050    IN ZMRP       1.1940    IN SCALE       0.0055
REFERENCE FILE			

# AEDC VA 1163 MDAC BOOSTER AND ORBITER TEST DATA AT MACH NUMBER 5

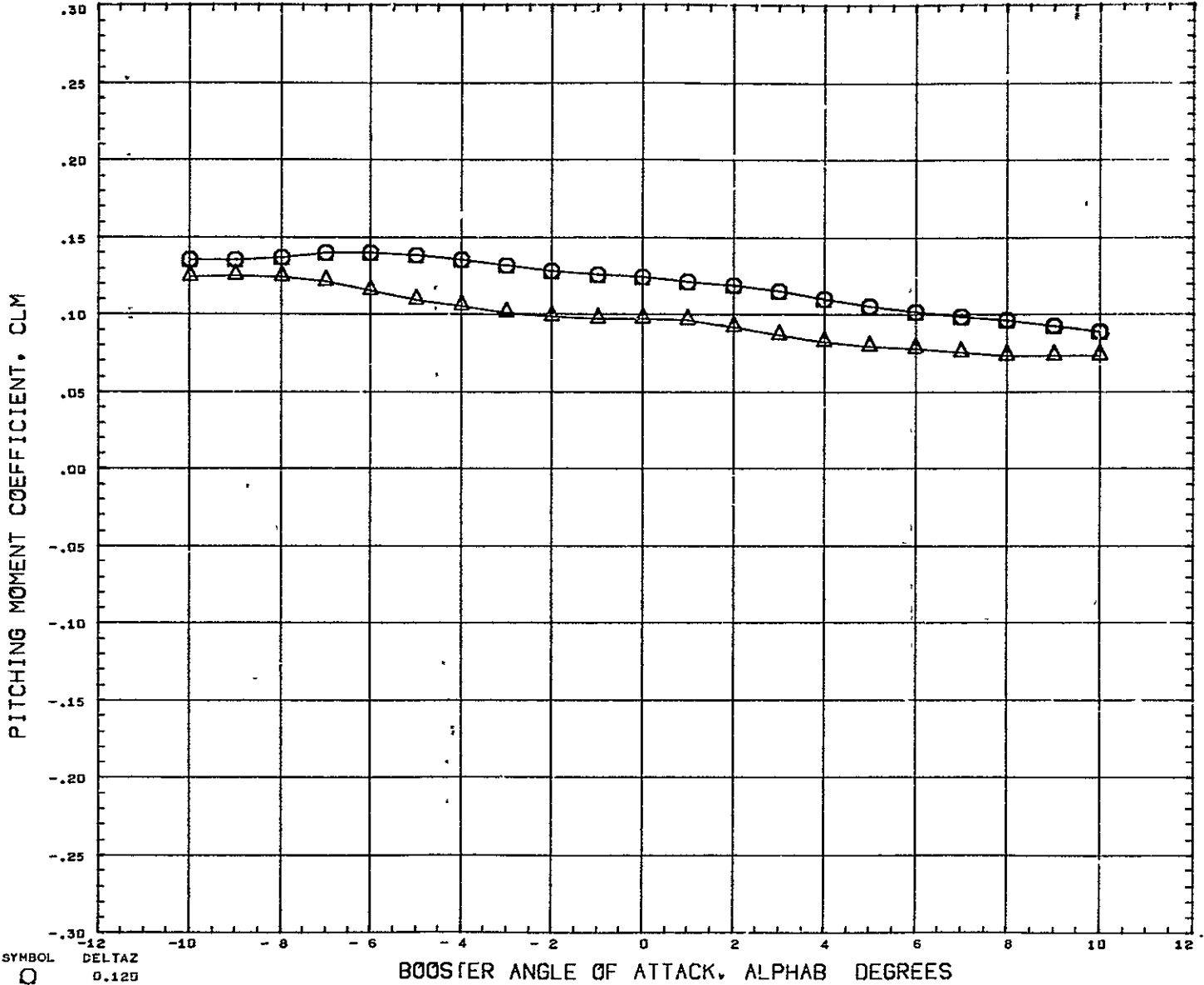

SYMBOL ○ △	DELTAZ 0.125 0.151	<b>PARAMETRIC VALUES</b> BSTPOW 100.000 ORBPOW 100.000 DELTAX 0.104 ALPHAI 0.000 MACH 5.016 ELVBST 20.000 ELVORB -20.000 BETA 0.000	<b>REFERENCE INFORMATION</b> REFS 44.444G SQ IN REFL 13.3330 IN REFB 13.3330 IN XMRP 7.5280 IN YMRP 0.0650 IN ZMRP 1.1940 IN SCALE 0.0055
>1 REFERENCE FILE B			

# AEDC VA 1163 MDAC BOOSTER AND ORBITER TEST DATA AT MACH NUMBER 5

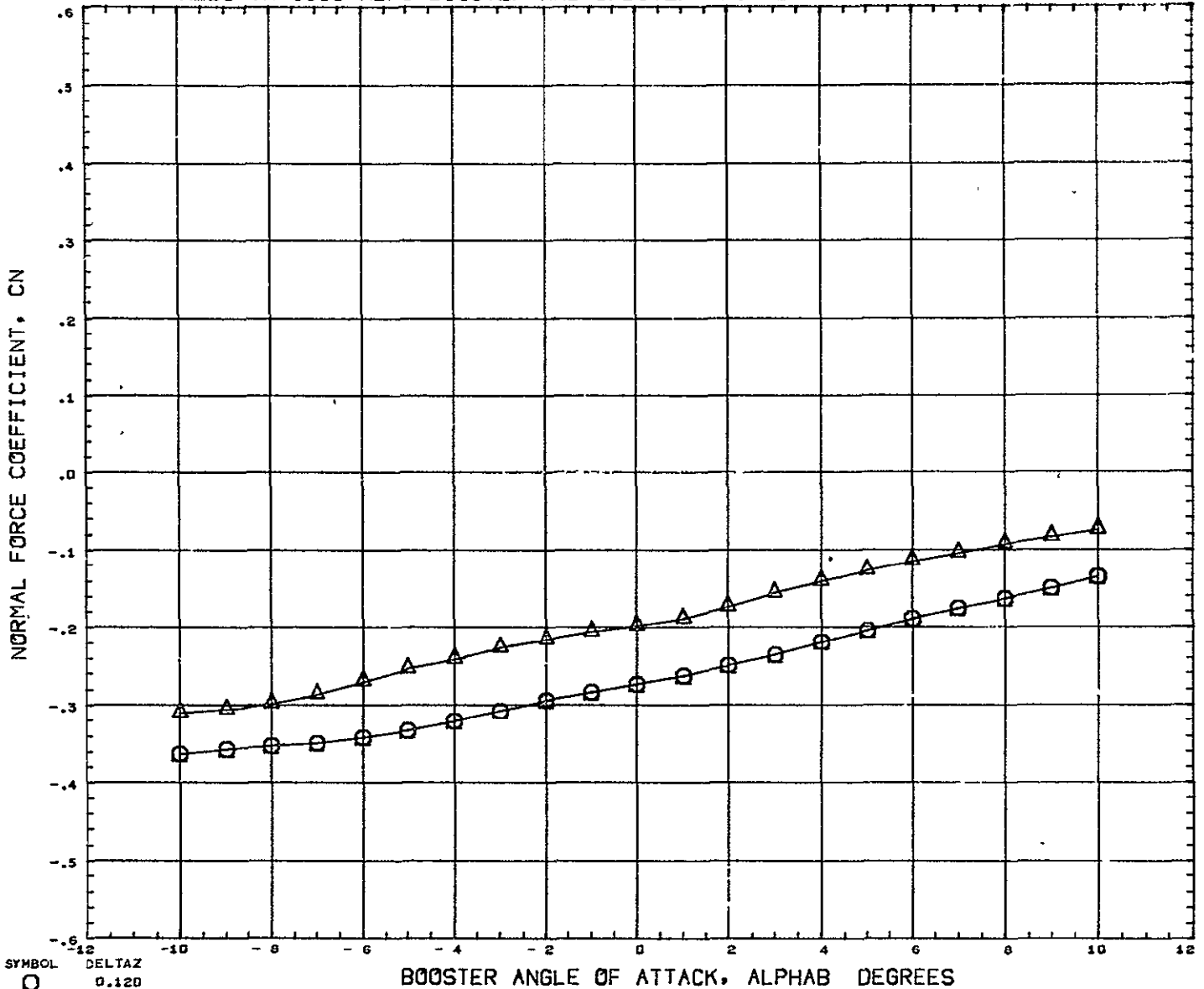

SYMBOL    DELTA Z  
 ○        0.120  
 △        0.151

PARAMETRIC VALUES  
 BSTPOW 100.000    ORBPOW 100.000  
 CLTAX 0.104        ALPHAI 0.000  
 MACH 5.010        ELVBST 20.000  
 ELVORB - 20.000    BETA 0.000

REFERENCE INFORMATION  
 REFS 44.4440    SQ IN  
 REFL 13.3330    IN  
 REFB 13.3330    IN  
 XMRP 7.5280    IN  
 YMRP 0.0000    IN  
 ZMRP 1.1940    IN  
 SCALE 0.0055

REFERENCE FILE

# AEDC VA 1163 MDAC BOOSTER AND ORBITER TEST DATA AT MACH NUMBER 5

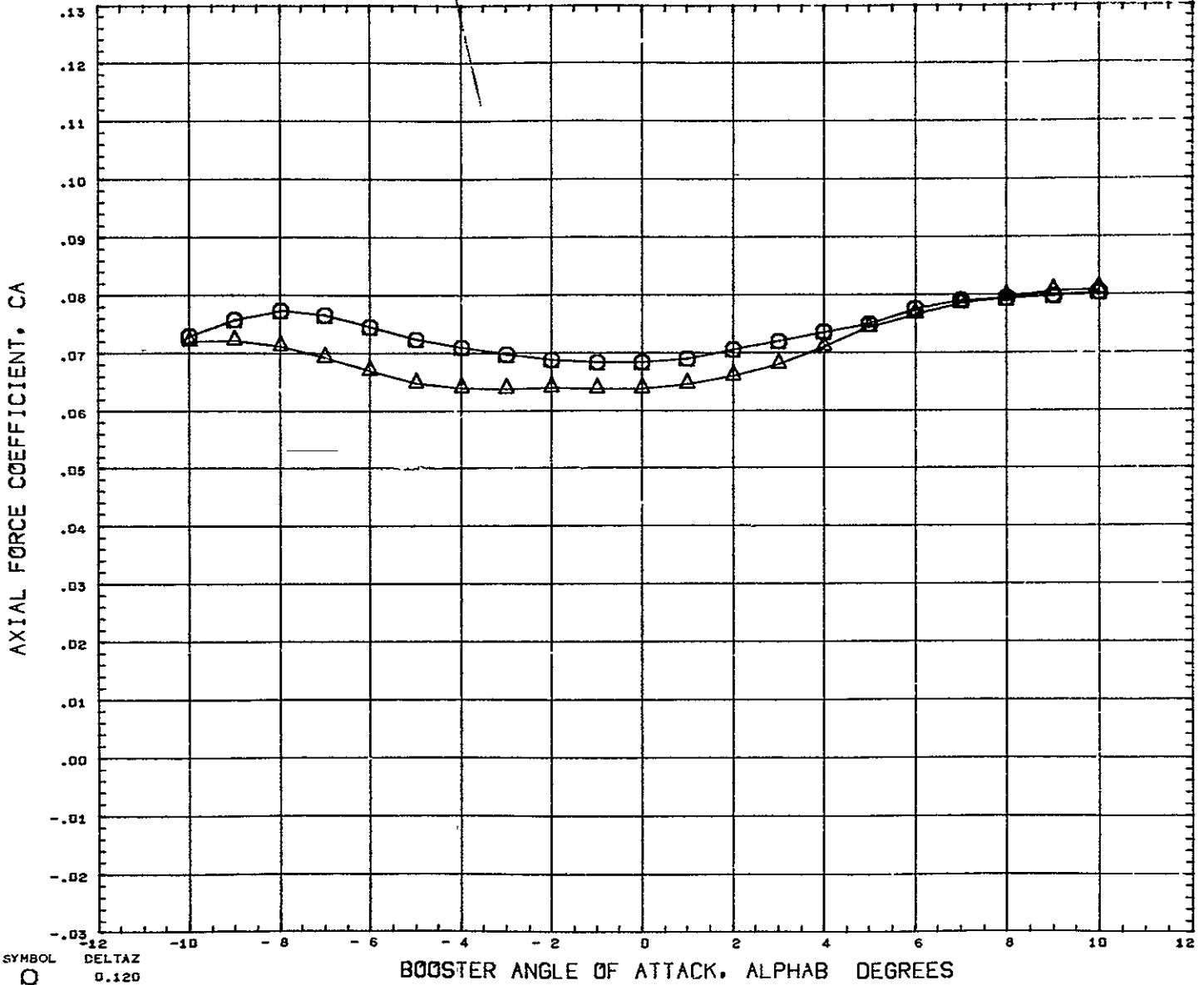

SYMBOL  
 ○ 0.120  
 △ 0.151

PARAMETRIC VALUES

BSTPOW	100.000	ORBPOW	100.000
D_LTAX	0.104	ALPHA1	0.000
MACH	5.010	ELVBST	20.000
ELVORB	-20.000	BETA	0.000

REFERENCE INFORMATION

REFS	44.4440	SQ	IN
REFL	13.3330	IN	
REFB	13.3330	IN	
XMRP	7.5280	IN	
YMRP	0.0000	IN	
ZMRP	1.1940	IN	
SCALE	0.0055		

REFERENCE FILE

# AEDC VA 1163 MDAC BOOSTER AND ORBITER TEST DATA AT MACH NUMBER 5

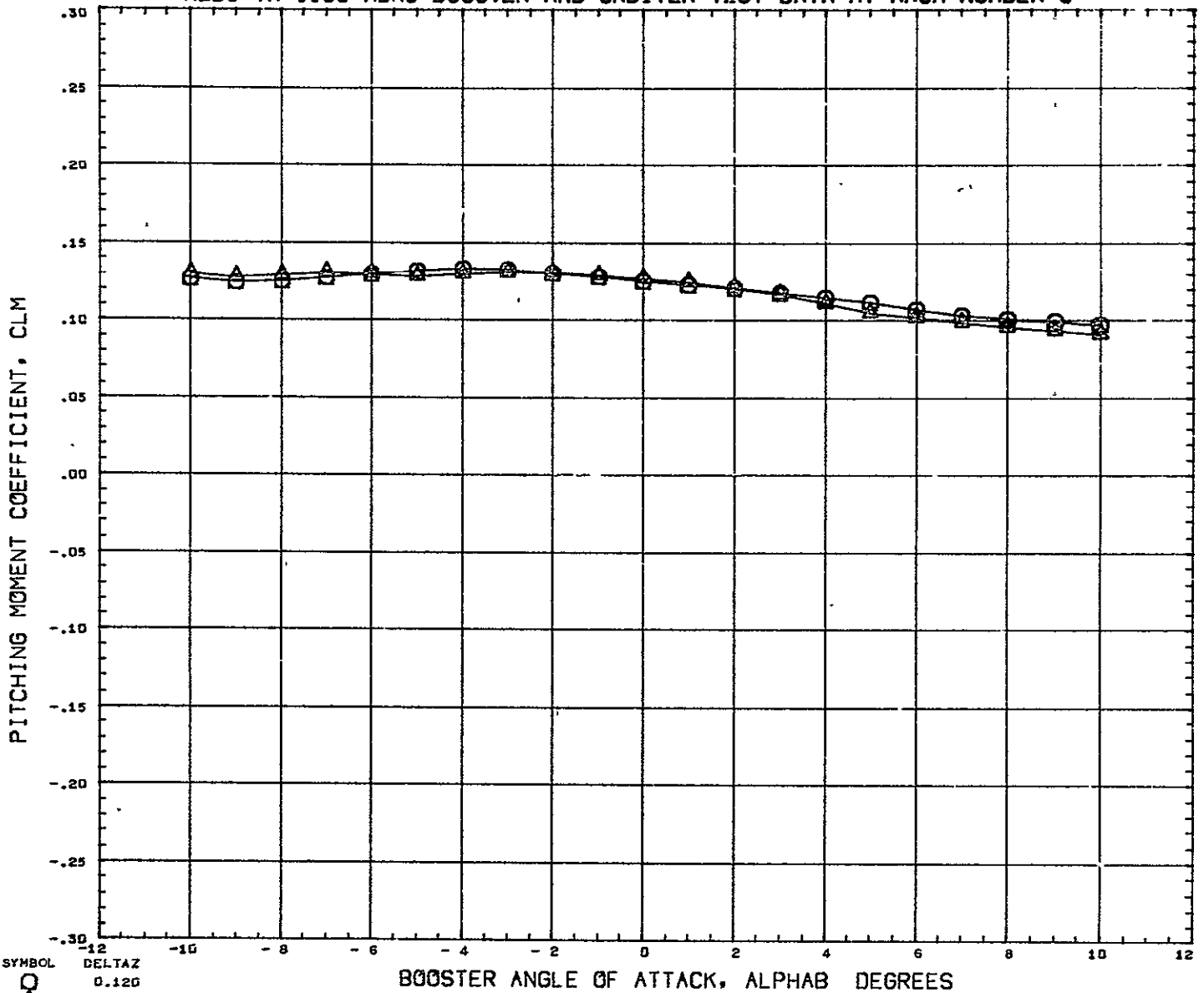

SYMBOL    DELTAAZ  
 ○        0.120  
 △        0.151

PARAMETRIC VALUES

BSTPOW	100.000	ORBPOW	100.000
JELTAX	0.167	ALPHA1	0.000
MACH	5.010	ELVST	20.000
ELVORB	-20.000	BETA	0.000

REFERENCE INFORMATION

REFS	44.4440	SG IN
REFL	13.3330	IN
REFB	13.3330	IN
XMRP	7.5280	IN
YMRP	0.0000	IN
ZMRP	1.1940	IN
SCALE	0.0055	

REFERENCE FILE

# AEDC VA 1163 MDAC BOOSTER AND ORBITER TEST DATA AT MACH NUMBER 5

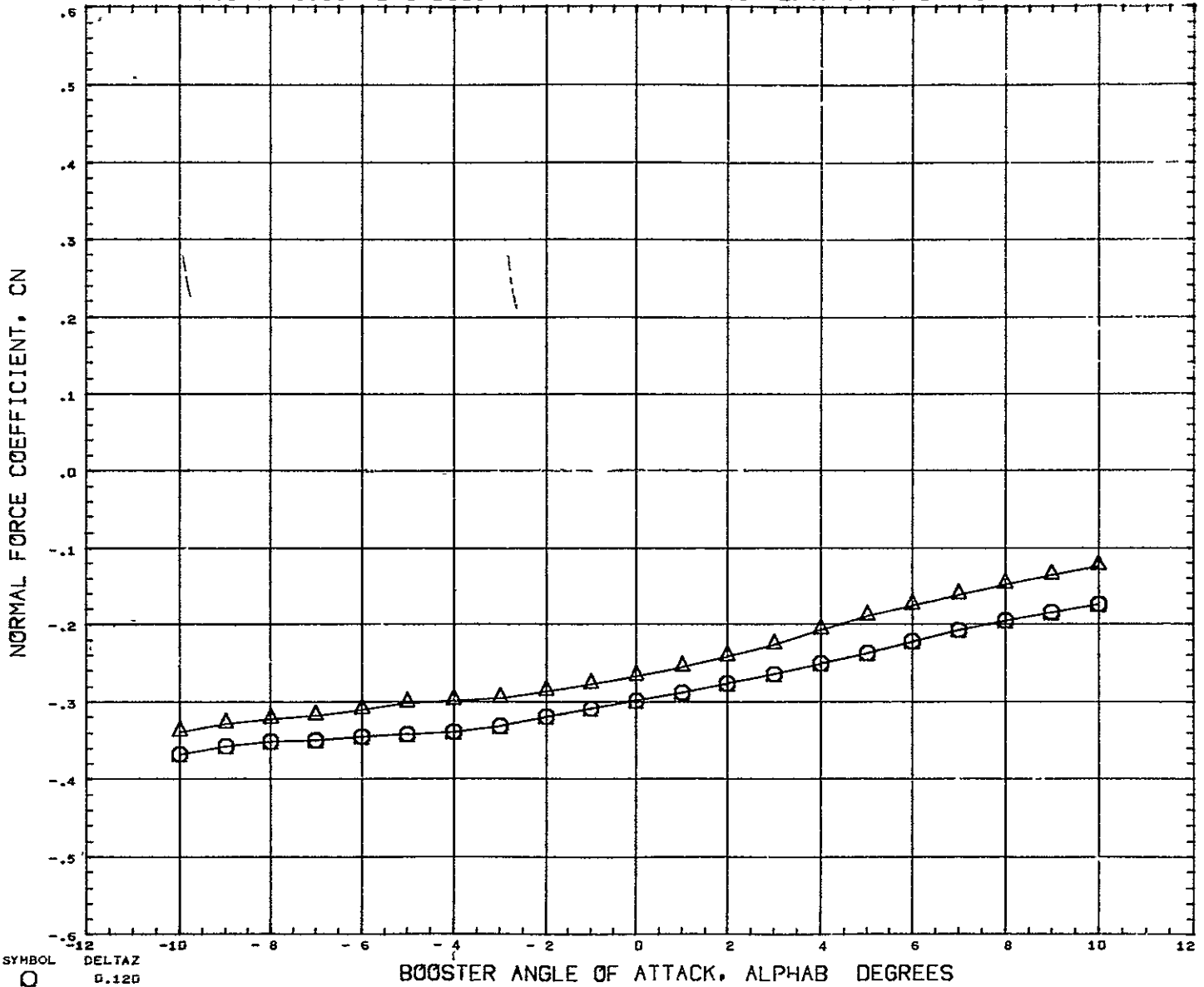

SYMBOL  
 ○ DELTA Z  
 0.120  
 △ 0.151

**PARAMETRIC VALUES**

BSTPOW	100.000	ORBPOW	100.000
JELTAX	0.167	ALPHA1	0.000
MACH	5.010	ELVBST	20.000
ELVORB	-20.000	BETA	0.000

**REFERENCE INFORMATION**

REFS	44.4440	SQ IN
REFL	13.3330	IN
REFB	13.3330	IN
XMRP	7.5280	IN
YMRP	0.0000	IN
ZMRP	1.1940	IN
SCALE	0.0055	

REFERENCE FILE

# AEDC VA 1163 MDAC BOOSTER AND ORBITER TEST DATA AT MACH NUMBER 5

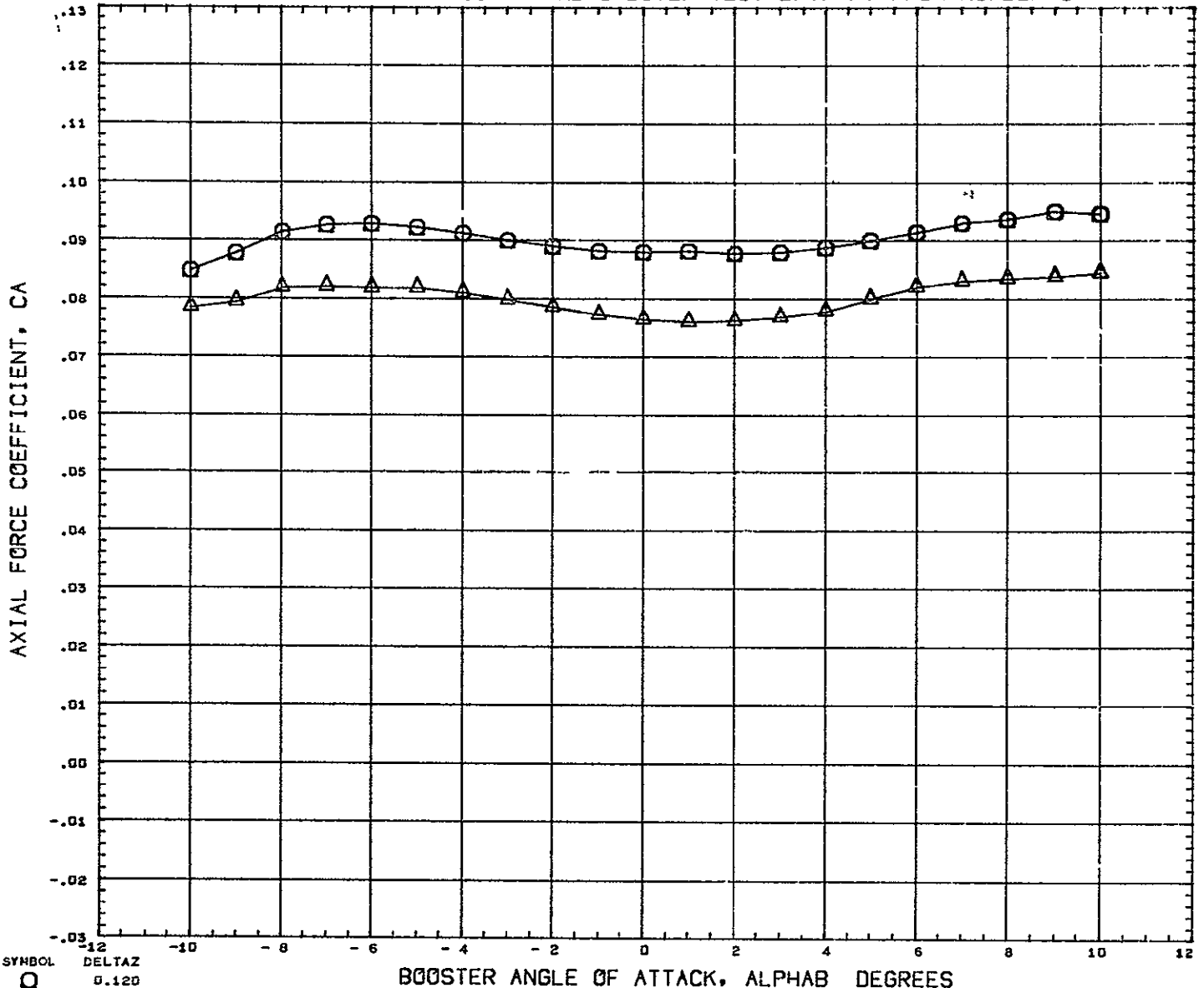

SYMBOL  $\square$  DELTAZ 0.120  
 $\triangle$  0.151

PARAMETRIC VALUES  
 BSTPOW 100.000 ORBPOW 100.000  
 DELTAX 0.167 ALPHAI 0.000  
 MACH 5.010 ELVBST 20.000  
 ELVORB -20.000 BETA 0.000

REFERENCE INFORMATION  
 REFS 44.4440 SQ IN  
 REFL 13.3330 IN  
 REFB 13.3330 IN  
 XMRP 7.5280 IN  
 YMRP 0.0000 IN  
 ZMRP 1.1940 IN  
 SCALE 0.0055

REFERENCE FILE

# AEDC VA 1163 MDAC BOOSTER AND ORBITER TEST DATA AT MACH NUMBER 5

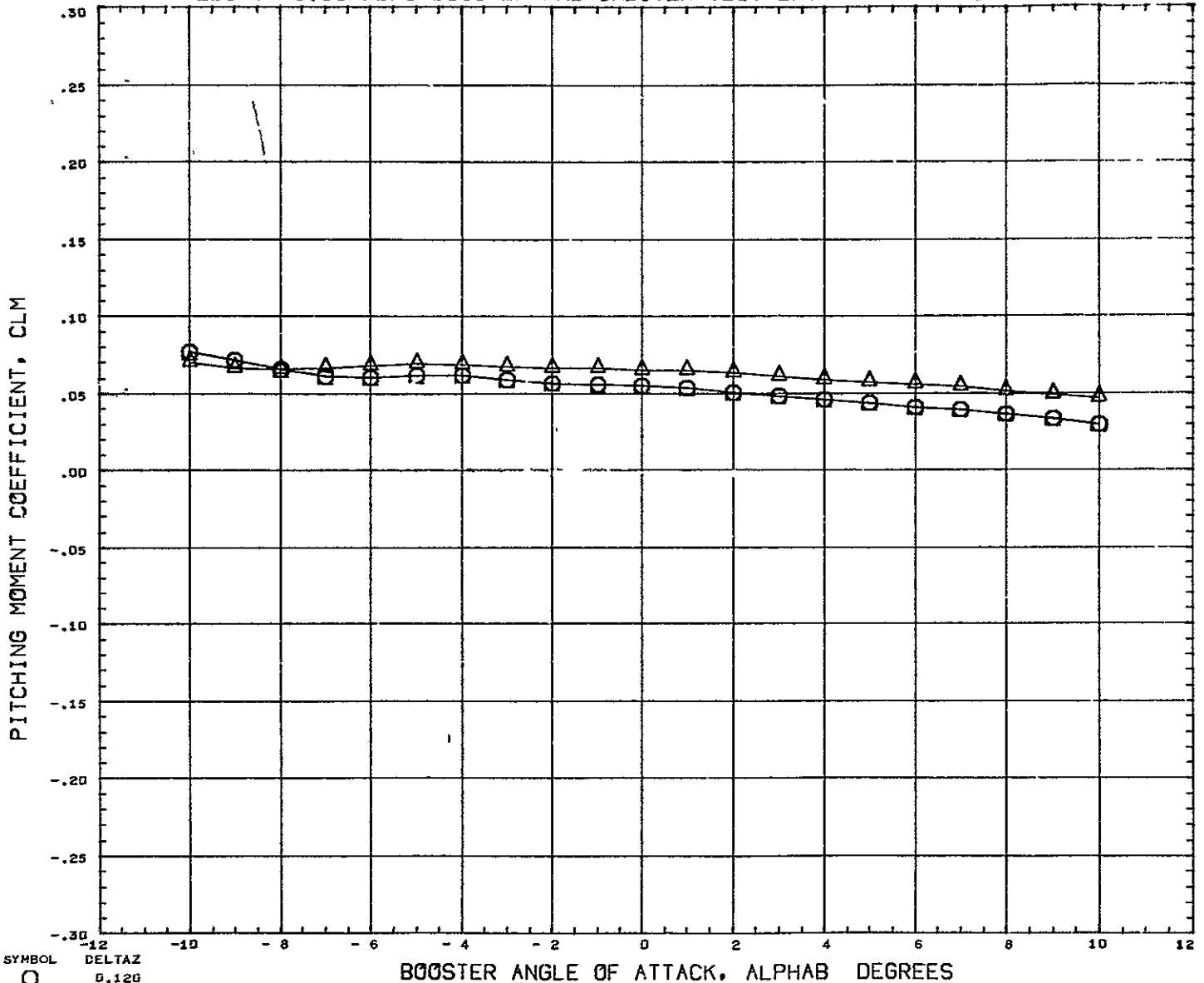

SYMBOL ○ △	DELTAX 0.120 0.151	<b>PARAMETRIC VALUES</b> BSTPOW 100.000 ORBPOW 100.000 DELTAX 0.352 ALPHAI 0.000 MACH 5.010 ELVBST 20.000 ELVORB -20.000 BETA 0.000	<b>REFERENCE INFORMATION</b> REFS 44.4440 SQ IN REFL 13.3330 IN REFB 13.3330 IN XMRP 7.5280 IN YMRP 0.0000 IN ZMRP 1.1940 IN SCALE 0.0055
------------------	--------------------------	---	--

5. REFERENCE FILE



# AEDC VA 1153 MDAC BOOSTER AND ORBITER TEST DATA AT MACH NUMBER 5

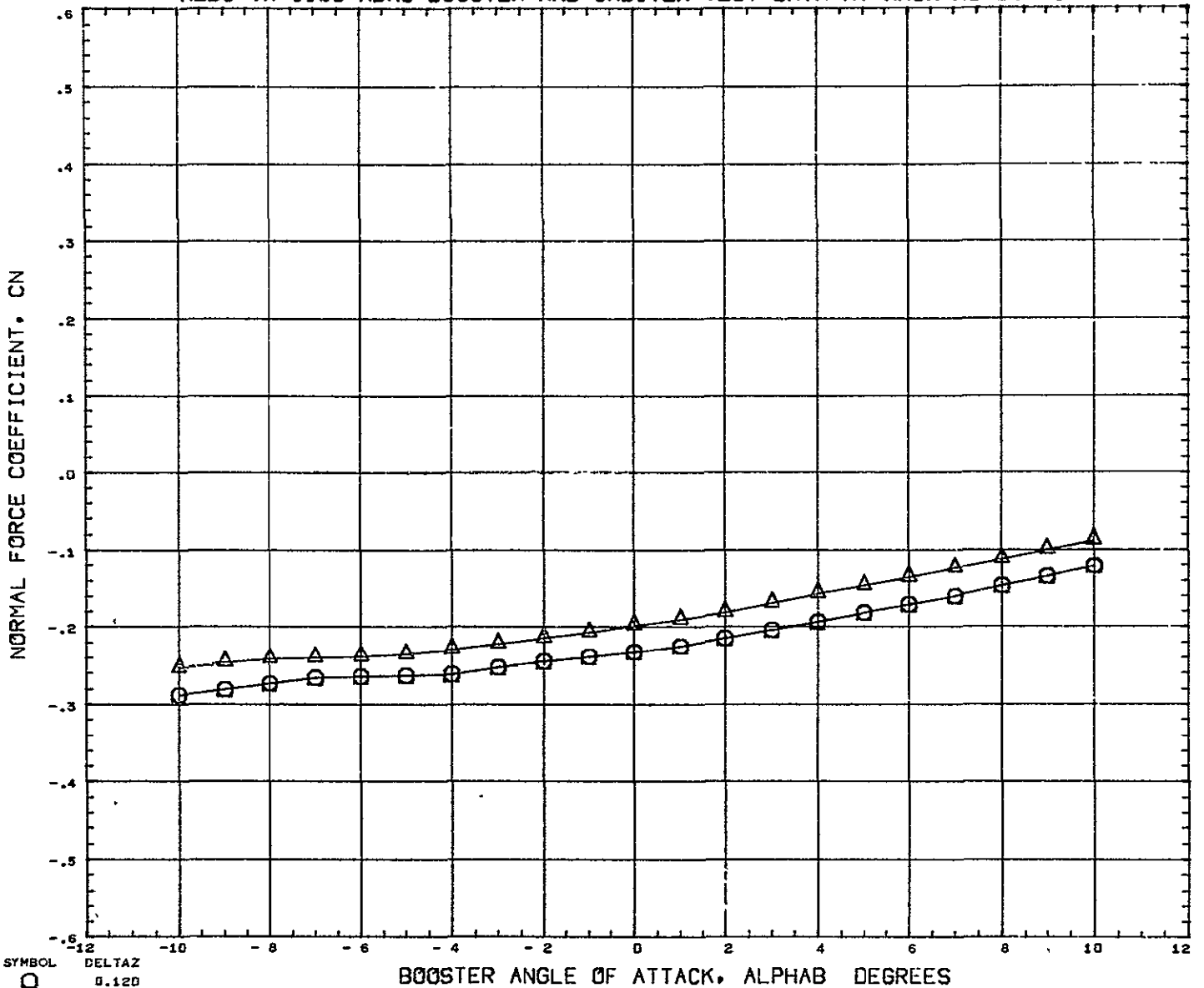

SYMBOL	DELTA Z	PARAMETRIC VALUES		REFERENCE INFORMATION	
○	0.120	BSTPOW	100.000	ORBPOW	100.000
△	0.151	SLTAX	0.352	ALPHA1	0.000
		MACH	5.010	ELVBST	20.000
		ELVORB	-20.000	BETA	0.000
				REFS	44.4440 SQ IN
				REFL	13.3330 IN
				REFB	13.3330 IN
				XMRP	7.5280 IN
				YMRP	0.0000 IN
				ZMRP	1.1940 IN
				SCALE	0.0055
		REFERENCE FILE			

# AEDC VA 1163 MDAC BOOSTER AND ORBITER TEST DATA AT MACH NUMBER 5

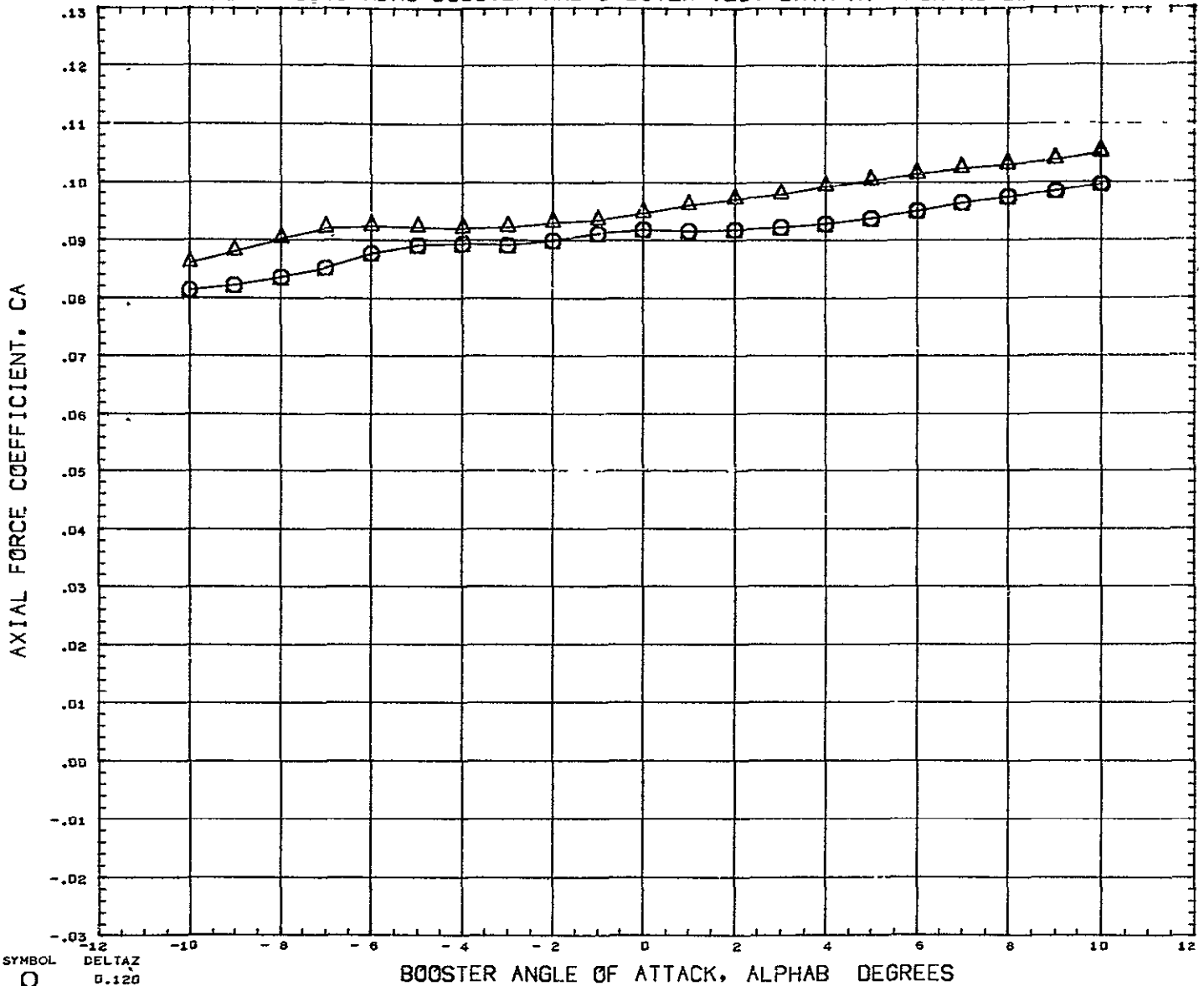

SYMBOL  $\Delta$  DELTAZ  
            $\circ$  0.120  
           0.151

PARAMETRIC VALUES  
 BSTPOW 100.000 ORBPOW 100.000  
 DELTAX 0.352 ALPHAI 0.000  
 MACH 5.010 CLVBST 20.000  
 ELVORB -20.000 BETA 0.000

REFERENCE INFORMATION  
 REFS 44.4440 SQ IN  
 REFL 13.3330 IN  
 REFB 13.3330 IN  
 XNRF 7.5280 IN  
 YNRF 0.0000 IN  
 ZNRF 1.194E IN  
 SCALE 0.0055

51 REFERENCE FILE

# AEDC VA 1163 MDAC BOOSTER AND ORBITER TEST DATA AT MACH NUMBER 5

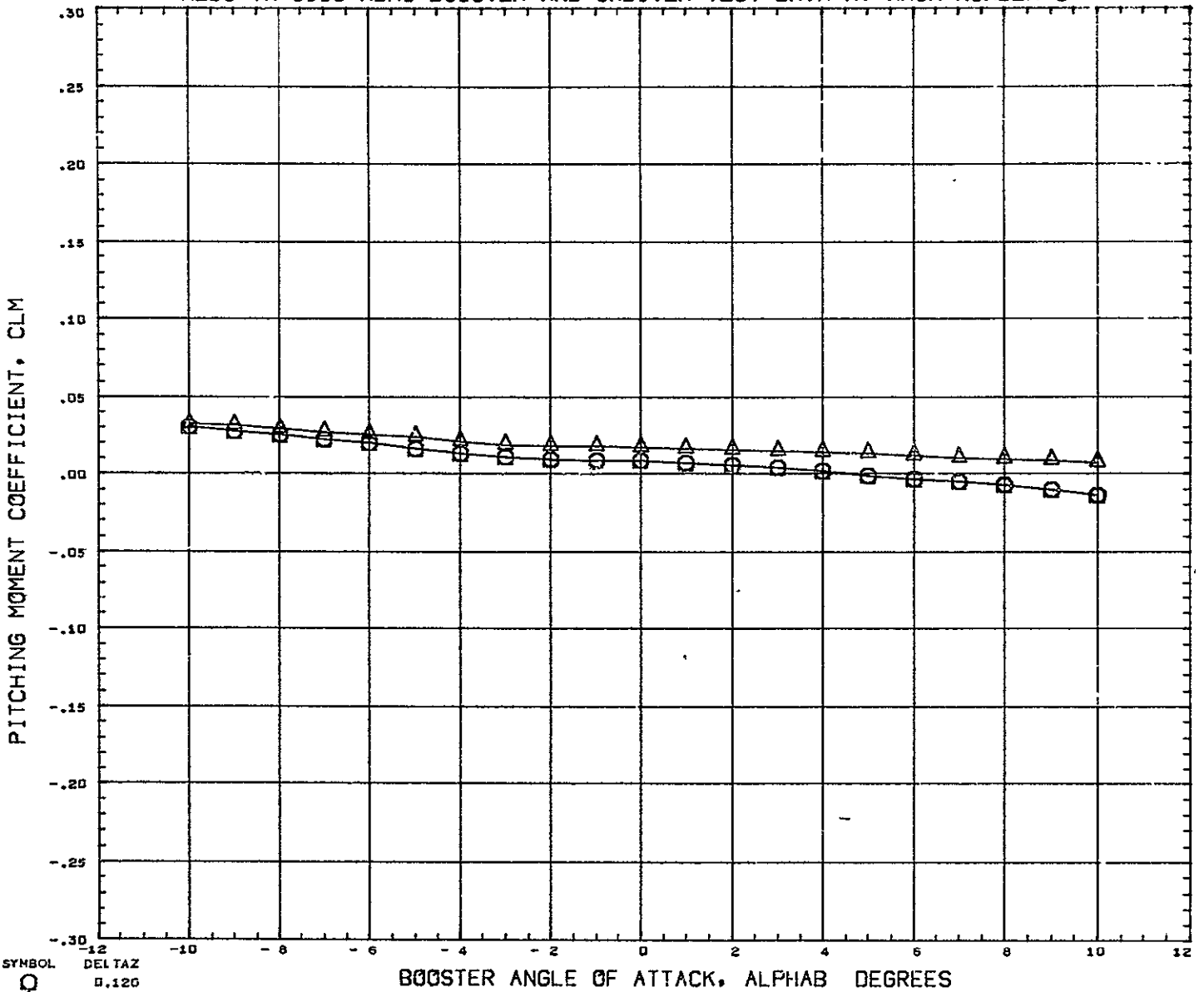

SYMBOL    DELTA Z  
 ○         0.126  
 △         0.151

PARAMETRIC VALUES  
 BSTPOW 100.000    CRBPOW 100.000  
 .ELTAX  0.522     ALPHAI  0.000  
 MACH    5.010     ELVBST 20.000  
 ELVORB  -20.000    BETA    0.000

REFERENCE INFORMATION  
 REFS     44.4440    SQ IN  
 REFL     13.3330    IN  
 REFB     13.3330    IN  
 XMRP     7.5280    IN  
 YMRP     0.0000    IN  
 ZMRP     1.1940    IN  
 SCALE    0.0055

REFERENCE FILE

# AEDC VA 1163 MDAC BOOSTER AND ORBITER TEST DATA AT MACH NUMBER 5

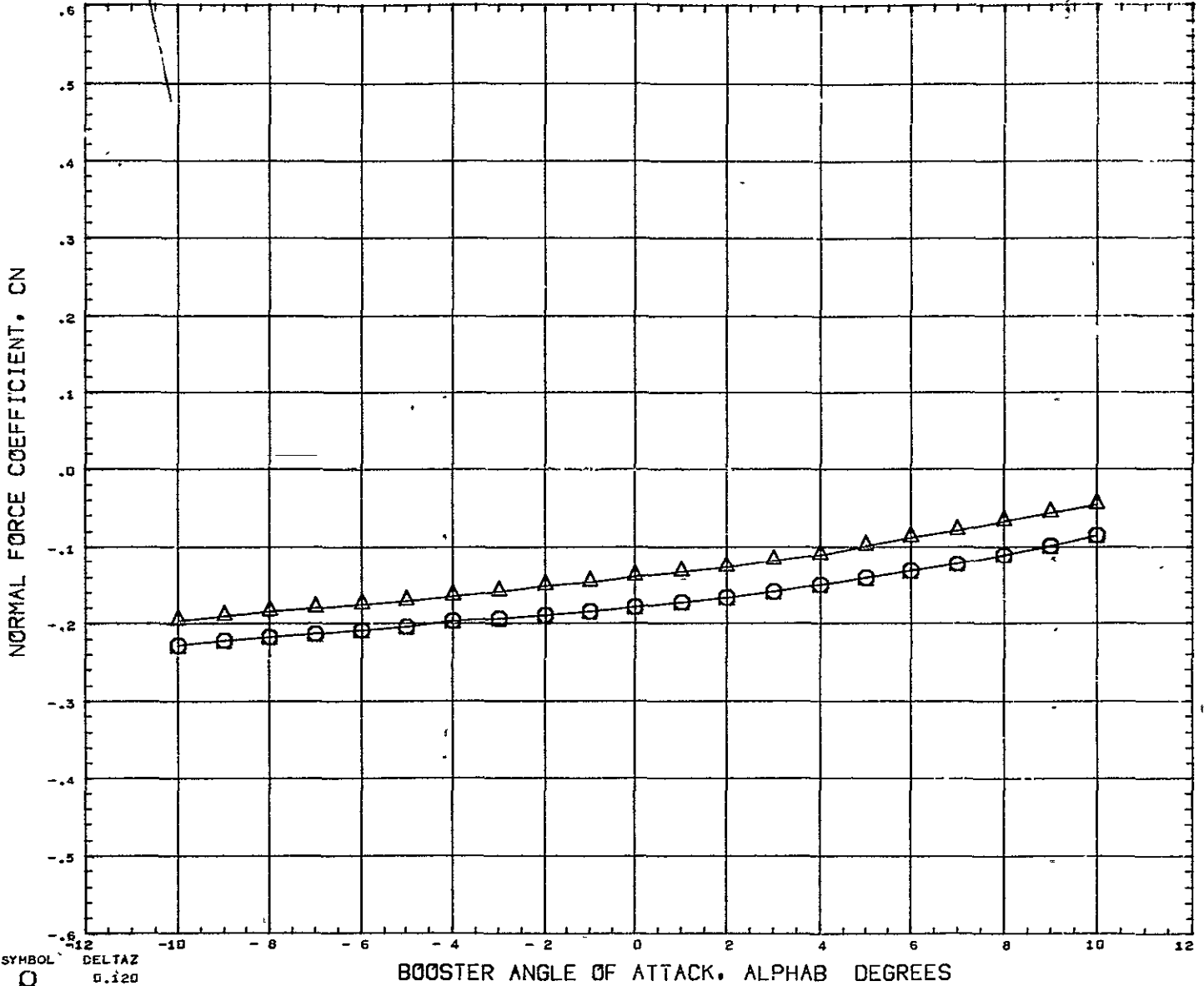

SYMBOL  
 ○ 0.120  
 △ 0.151

PARAMETRIC VALUES  
 BSTPOW 100.000 ORBPOW 100.000  
 DELTAX 0.522 ALPHAI 0.000  
 MACH 5.010 ELVBST 20.000  
 ELVORB -20.000 BETA 0.000

REFERENCE INFORMATION  
 REFS 44.4440 SQ IN  
 REFL 13.3330 IN  
 REFB 13.3330 IN  
 XMRP 7.5280 IN  
 YMRP 0.0000 IN  
 ZMRP 1.1945 IN  
 SCALE 0.0055

151 REFERENCE FILE

# AEDC VA-1163 MDAC BOOSTER AND ORBITER TEST DATA AT MACH NUMBER 5

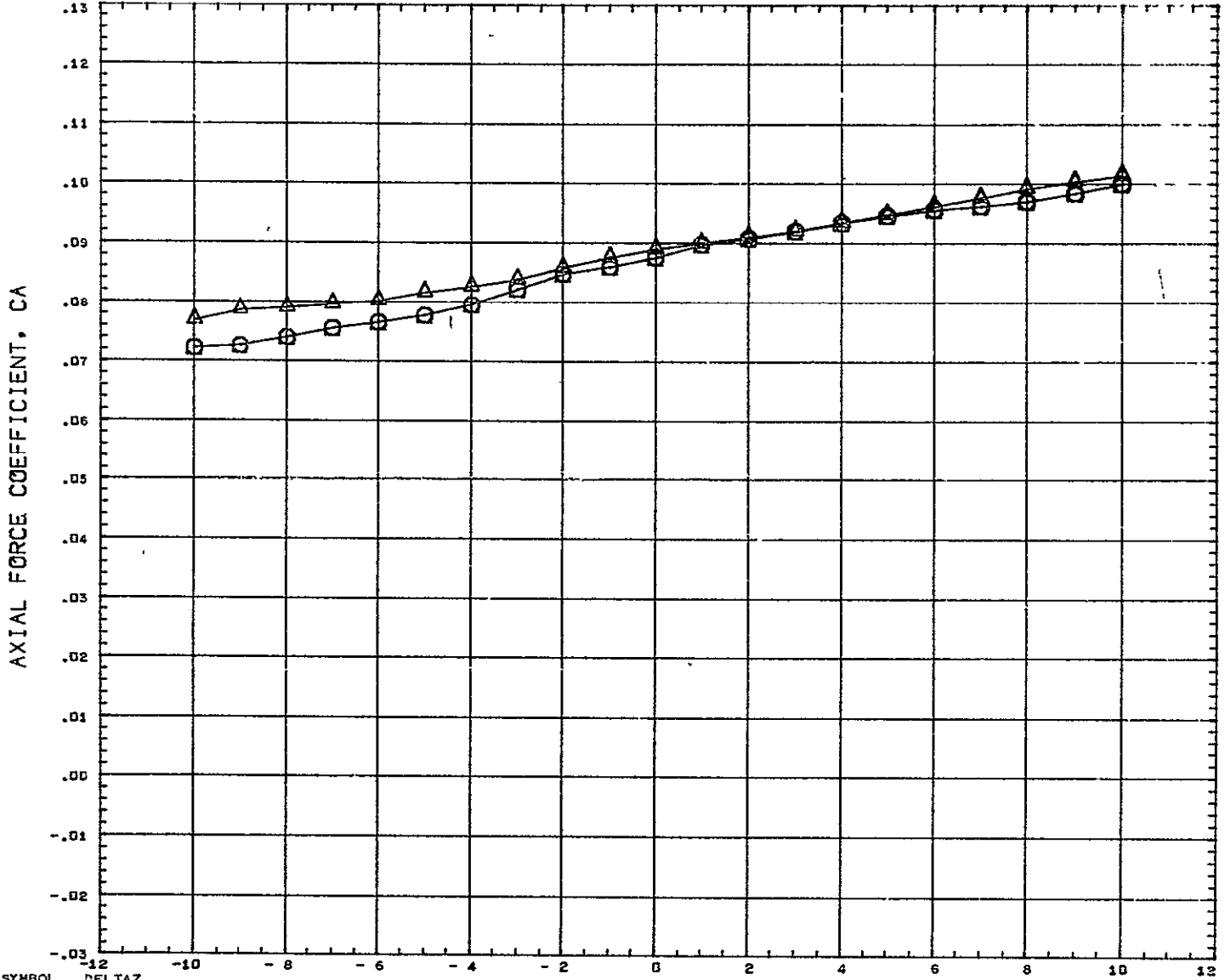

SYMBOL  
 ○  
 △

DELTA Z  
 0.120  
 0.151

BOOSTER ANGLE OF ATTACK, ALPHA B DEGREES

PARAMETRIC VALUES

BSTPOW	100.000	ORBPOW	100.000
DELTA X	0.522	ALPHA I	0.000
MACH	5.010	ELVBST	20.000
ELVORB	-20.000	BETA	0.000

REFERENCE INFORMATION

REFS	44.4440	Sq IN
REFL	13.3330	IN
REFB	13.3330	IN
XMRP	7.5280	IN
YMRP	0.0000	IN
ZMRP	1.1940	IN
SCALE	0.0055	

REFERENCE FILE