

DMS-DR-1249

CR-120,053

APRIL 1972

—SPACE SHUTTLE—

**AERODYNAMIC STABILITY AND
DRAG CHARACTERISTICS OF A
PARALLEL BURN/SRM ASCENT
CONFIGURATION AT MACH
NUMBERS FROM 0.6 TO 4.96**

by

J. Frank Sims, MSFC

Thomas Hamilton, NSI

MSFC 14-INCH
TRISONIC WIND TUNNEL

Marshall Space
Flight Center

N A S A



Reproduced by
**NATIONAL TECHNICAL
INFORMATION SERVICE**
U S Department of Commerce
Springfield VA 22151

This document should be
referenced as NASA CR-120,053

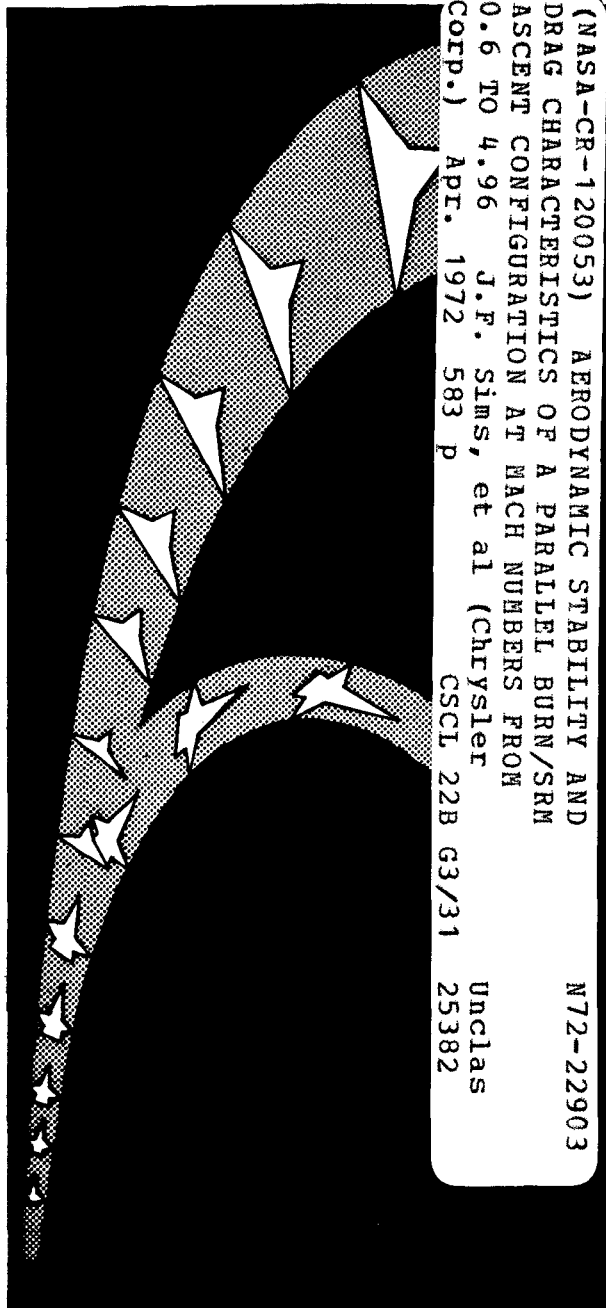

(NASA-CR-120053) AERODYNAMIC STABILITY AND
DRAG CHARACTERISTICS OF A PARALLEL BURN/SRM
ASCENT CONFIGURATION AT MACH NUMBERS FROM
0.6 TO 4.96 J.F. Sims, et al (Chrysler
Corp.) APT. 1972 583 p CACL 22B G3/31 N72-22903
Unclas 25382

SADSAC SPACE SHUTTLE
AEROTHERMODYNAMIC
DATA MANAGEMENT SYSTEM

CONTRACT NAS3-4016
MARSHALL SPACE FLIGHT CENTER



CAT. 31

NASA Series Number: S-1054

DMS-DR-1249
CR-120,053
APRIL, 1972

SADSAC/SPACE SHUTTLE
WIND TUNNEL TEST DATA REPORT

CONFIGURATION: MSC 040C-2/2-156 PARALLEL BURN ASCENT CONFIGURATION

TEST PURPOSE: AERODYNAMIC STABILITY AND DRAG CHARACTERISTICS OF BASELINE
AND VARIATIONS OF A SOLID ROCKET MOTOR ASCENT CONFIGURATION

TEST FACILITY: NASA/MSFC 14 x 14 - INCH TRISONIC WIND TUNNEL

TESTING AGENCY: NORTHROP SERVICES, INC., HUNTSVILLE, ALABAMA

TEST NO. & DATE: MSFC TWT 534 (68 HRS); 22 March 1972

FACILITY COORDINATOR: Mr. Jim Weaver (MSFC)

PROJECT ENGINEER(S): Mr. Frank Sims (MSFC)
Mr. Thomas Hamilton (NSI)

DATA MANAGEMENT SERVICES

LIAISON: *John E. Vaughn* DATA OPERATIONS: *Henry C. Zimmerle*
John E. Vaughn Henry C. Zimmerle

RELEASE APPROVAL: *J. S. Kemp*
FOR D. Kemp, Supervisor
Aero Thermo Data Group

CONTRACT NAS 8-4016

AMENDMENT 158

DRL 297-84a

This report has been prepared by Chrysler Corporation Space Division under a Data Management Contract to the NASA. Chrysler assumes no responsibility for the data presented herein other than its display characteristics.

FACILITY COORDINATOR:

Mr. Jim Weaver
S&E-AERO-AAE
Marshall Space Flight Center
Huntsville, Alabama 35812

Phone: (205) 453-2512

PROJECT ENGINEERS:

Mr. Frank Sims
S&E-AERO-AAE
Marshall Space Flight Center
Huntsville, Alabama 35812

Phone: (205) 453-2512

Mr. Thomas Hamilton
Northrop Services, Inc.
6025 Technology Drive
P. O. Box 1484
Huntsville, Alabama 35807

Phone: (205) 837-0580 (Ext. 301)

SADSAC LIAISON:

Mr. John E. Vaughn
Chrysler Corporation Huntsville Division
102 Wynn Drive
Huntsville, Alabama 35805

Phone: (205) 895-1560

SADSAC OPERATIONS:

Mr. Henry C. Zimmerle
Chrysler Corporation Space Division
P. O. Box 29200
New Orleans, Louisiana 70129

Phones: (504) 255-2174
255-2304

TABLE OF CONTENTS

Abstract	1
Nomenclature	2
Configurations Investigated	6
Test Facility Description	7
Data Reduction	8
Tables:	
I Test Conditions	9
II Data Set Collation Sheets	10
III Dimensional Data	12
IV Index of Model Figures	18
V Index of Data Figures	19
Figures	
Model	21
Plotted Data	34

AERODYNAMIC STABILITY AND DRAG CHARACTERISTICS OF
A PARALLEL BURN/SRM ASCENT CONFIGURATION AT
MACH NUMBERS FROM 0.6 TO 4.96

By J. Frank Sims and Thomas Hamilton

ABSTRACT

Experimental aerodynamic investigations were conducted in the NASA/MSFC 14-Inch Trisonic Wind Tunnel during March 1972 on a .003366 scale model of a solid rocket motor version of the space shuttle ascent configuration. The configuration consisted of a parallel burn solid rocket motor booster on an external H-0 centerline tank orbiter. Six component aerodynamic force and moment data were recorded over an angle of attack range from -10° to 10° at zero degrees sideslip and over a sideslip range from -10° to 10° at 0° , $+6^{\circ}$ and -6° angle of attack. Mach number ranged from 0.6 to 4.96.

The purpose of the test was to define the performance and stability characteristics of the complete ascent configuration and build-up, and to determine the effects of variations in tank diameter, orbiter incidence, fairings, and positioning of the solid rocket motors and tank fins.

NOMENCLATURE
General

<u>SYMBOL</u>	<u>SADSAC SYMBOL</u>	<u>DEFINITION</u>
a		speed of sound; m/sec, ft/sec
C _p	CP	pressure coefficient; $(p_1 - p_\infty)/q$
M	MACH	Mach number; V/a
p		pressure; N/m ² , psf
q	Q(NSM) Q(PSF)	dynamic pressure; $1/2\rho V^2$, N/m ² , psf
RN/L	RN/L	unit Reynolds number; per m, per ft
V		velocity; m/sec, ft/sec
α	ALPHA	angle of attack, degrees
β	BETA	angle of sideslip, degrees
ψ	PSI	angle of yaw, degrees
ϕ	PHI	angle of roll, degrees
ρ		mass density; kg/m ³ , slugs/ft ³

Reference & C.G. Definitions

A _b		base area; m ² , ft ²
b	BREF	wing span or reference span; m, ft
c.g.		center of gravity
$\frac{l_{REF}}{c}$	LREF	reference length or wing mean aerodynamic chord; m, ft
S	SREF	wing area or reference area; m ² , ft ²
	MRP	moment reference point
	XMRP	moment reference point on X axis
	YMRP	moment reference point on Y axis
	ZMRP	moment reference point on Z axis

SUBSCRIPTS

b	base
l	local
s	static conditions
t	total conditions
∞	free stream

NOMENCLATURE (Continued)

Body-Axis System

<u>SYMBOL</u>	<u>SADSAC SYMBOL</u>	<u>DEFINITION</u>
C_N	CN	normal-force coefficient; $\frac{\text{normal force}}{qS}$
C_A	CA	axial-force coefficient; $\frac{\text{axial force}}{qS}$
C_Y	CY	side-force coefficient; $\frac{\text{side force}}{qS}$
C_{A_b}	CAB	base-force coefficient; $\frac{\text{base force}}{qS}$ $-A_b(p_b - p_\infty)/qS$
C_{A_f}	CAF	forebody axial force coefficient, $C_A - C_{A_b}$
C_m	CIM	pitching-moment coefficient; $\frac{\text{pitching moment}}{qS_{REF}}$
C_n	CYN	yawing-moment coefficient; $\frac{\text{yawing moment}}{qS_b}$
C_l	CBL	rolling-moment coefficient; $\frac{\text{rolling moment}}{qS_b}$

Stability-Axis System

C_L	CL	lift coefficient; $\frac{\text{lift}}{qS}$
C_D	CD	drag coefficient; $\frac{\text{drag}}{qS}$
C_{D_b}	CDB	base-drag coefficient; $\frac{\text{base drag}}{qS}$
C_{D_f}	CDF	forebody drag coefficient; $C_D - C_{D_b}$
C_Y	CY	side-force coefficient; $\frac{\text{side force}}{qS}$
C_m	CIM	pitching-moment coefficient; $\frac{\text{pitching moment}}{qS_{REF}}$
C_n	CLN	yawing-moment coefficient; $\frac{\text{yawing moment}}{qS_b}$
C_l	CSL	rolling-moment coefficient; $\frac{\text{rolling moment}}{qS_b}$
L/D	L/D	lift-to-drag ratio; C_L/C_D

ADDITIONS TO SADSAC NOMENCLATURE
FOR
MSFC TWT TEST NO. 534

<u>SYMBOL</u>	<u>SADSAC SYMBOL</u>	<u>DEFINITION</u>
α	ALPHA	angle of attack measured to the H-O tank longitudinal centerline, degrees.
α_1	ϕ RBIN	orbiter fuselage incidence angle measured from the H-O tank longitudinal centerline, positive nose up; degrees.
θ_s	THETS	solid rocket motor circumferential position angle, measured from the H-O tank horizontal centerline (see figure 6); degrees.
$C_{N\alpha}$	DCN/DA	derivative of normal force coefficient with respect to alpha, (alpha = ± 5); per degree.
$C_{m\alpha}$	DCIMDA	derivative of pitching moment coefficient with respect to alpha (alpha = ± 5); per degree.
$C_{Y\beta}$	DCY/DB	derivative of side force coefficient with respect to beta (beta = ± 5); per degree.
$C_{n\beta}$	DCYNDB	derivative of yawing moment coefficient with respect to beta (beta = ± 5); body axis system; per degree.
$C_{l\beta}$	DCBLDB	derivative of rolling moment coefficient with respect to beta (beta = ± 5); body axis system; per degree.
$\left(\frac{X_{ac}}{l_B}\right)_P$	XAC/LP	longitudinal position of the aerodynamic center or neutral point of static longitudinal stability, as a fraction of body length $[XMRP/l_B - (C_{m\alpha}/C_{N\alpha}) (c/l_B)]$
$\left(\frac{X_{ac}}{l_B}\right)_Y$	XAC/LY	longitudinal position of the aerodynamic center or neutral point of static directional stability, as a fraction of body length $[XMRP/l_B - (C_{n\beta}/C_{Y\beta}) (b/l_B)]$
l_B		H-O tank length to model base (see figure 4)

ADDITIONS TO SADSAC NOMENCLATURE
 FOR
 MSFC TWT TEST NO. 534
 (Continued)

<u>SYMBOL</u>	<u>SADSAC SYMBOL</u>	<u>DEFINITION</u>
$(C_{Af})_{\alpha = 0}$	CAFAF ϕ	forebody axial force coefficient at zero alpha.
C_{AbO}	CAB ϕ	orbiter base-force coefficient, - $A_{bO} (p_{bO} - p_{\infty})/qS$
C_{AbS}	CABS	solid rocket motor base-force coefficient, - $A_{bS} (p_{bS} - p_{\infty})/qS$
$C_{AbH\phi}$	CABH ϕ	H-O tank base-force coefficient, - $A_{bH\phi} (p_{bH\phi} - p_{\infty})/qS$
C_{Ab}	CAB	total base-force coefficient, $C_{AbO} + C_{AbS} + C_{AbH\phi}$

CONFIGURATIONS INVESTIGATED

The various model components tested are listed below. Table II details the combinations of the components tested. Table III gives pertinent dimensional information for each component while Figures 2 through 9 depict the various components. Solid rocket motor position and orbiter incidence angle are defined as parameters in the additions to SADSAC nomenclature.

<u>SYMBOL</u>	<u>DESCRIPTION</u>
O1	Baseline O4OC-2 orbiter
T1	346-inch diameter H-O tank
T2	400-inch diameter H-O tank
T3	346-inch diameter H-O tank with cylindrical base
S1	Baseline booster, two 156-inch diameter solid rocket motors
S2	S1 with 7° flare added at base
S3	S1 with nose faired to H-O tank
F1	Two 525-ft ² fins, $\Gamma = 45^\circ$
F2	One 525-ft ² fin, $\Gamma = 0^\circ$, base position
F3	One 525-ft ² fin, $\Gamma = 0^\circ$, mid position

All dimensions for models constructed for this test were obtained from 1/100-scale drawings of the O4OC-2 and O48 ascent configurations dated 3 March 1972, supplemented by basic dimensional data supplied by MSC.

The orbiter model is not an exact scaled reproduction of the O4OC-2. An 0.002456-scale model of the GAC H-33 orbiter was used as a base for developing the test model. An O4OC-2 wing and V-tail stabilizer were added to this basic body.

The orbiter wing was mistakenly attached at an incidence angle of -1.5 degrees rather than the baseline +1.5 degrees. All data used from this report should be corrected for this error.

TEST FACILITY DESCRIPTION

The Marshall Space Flight Center 14" x 14" Trisonic Wind Tunnel is an intermittent blowdown tunnel which operates by high pressure air flowing from storage to either vacuum or atmospheric conditions. A Mach number range from .2 to 5.85 is covered by utilizing two interchangeable test sections. The transonic section permits testing at Mach 0.20 through 2.50, and the supersonic section permits testing at Mach 2.74 through 5.85. Mach numbers between .2 and .9 are obtained by using a controllable diffuser. The range from .95 to 1.3 is achieved through the use of plenum suction and perforated walls. Mach numbers of 1.44, 1.93 and 2.50 are produced by interchangeable sets of fixed contour nozzle blocks. Above Mach 2.50 a set of fixed contour nozzle blocks are tilted and translated automatically to produce any desired Mach number in .25 increments.

Air is supplied to a 6000 cubic foot storage tank at approximately -40°F dew point and 500 psi. The compressor is a three-stage reciprocating unit driven by a 1500 hp motor.

The tunnel flow is established and controlled with a servo actuated gate valve. The controlled air flows through the valve diffuser into the stilling chamber and heat exchanger where the air temperature can be controlled from ambient to approximately 180°F . The air then passes through the test section which contains the nozzle blocks and test region.

Downstream of the test section is a hydraulically controlled pitch sector that provides a total angle of attack range of 20° ($\pm 10^{\circ}$). Sting offsets are available for obtaining various maximum angles of attack up to 25° .

DATA REDUCTION

1. MOMENT REFERENCE CENTER (See Figure 10)

	<u>FULL SCALE</u>	<u>MODEL SCALE</u>
X =	1037 in (Aft of H-O Tank Nose)	3.490
Y =	0	0
Z =	48 in (Above H-O Tank Centerline)	0.1616 in

2. REFERENCE DIMENSIONS

	<u>FULL SCALE</u>	<u>MODEL SCALE</u>
Reference Area (s)	3,000 ft ²	4.895 in ²
Reference Length (b)	1,047.2 in	3.525 in
Reference Length (\bar{c})	785.385 in	2.644 in

3. MODEL BASE AREAS

O1	-	0.486 in ²
S1	-	0.550 in ²
S2	-	0.660 in ²
T1	-	1.066 in ²
T2	-	1.423 in ²

TABLE I

TEST CONDITIONS
TEST TWT 534

MACH NUMBER	REYNOLDS NUMBER per unit length	DYNAMIC PRESSURE (pounds/sq. inch)	STAGNATION TEMPERATURE (degrees Fahrenheit)
0.6	4.5/FT	3.93	100° (Nominal)
0.8	5.4	5.85	100°
0.9	5.8	6.72	100°
1.1	6.1	7.92	100°
1.2	6.1	8.29	100°
1.96	7.1	10.20	100°
2.74	4.7	6.36	130°
4.96	5.1	3.07	130°

BALANCE UTILIZED: * MSFC #231 and #227

CAPACITY:
(231)
NF 122#
SF 52#
AF 20#
PM 122 in-#
YM 53 in-#
RM 30 in-#

CAPACITY:
(227)
250#
80#
25#
250 in-#
100 in-#
50 in-#

COEFFICIENT
TOLERANCE:

COMMENTS:
* Zero shifts occurred during run 124 (d/s R65020) on balance #231. All subsequent runs thereafter utilized balance #227.

TABLE II.
 TEST MSFC 534 DATA SET/RUN NUMBER
 COLLATION SUMMARY

SHEET 1 of 2
 PRETEST
 POSTTEST

DATA SET IDENTIFIER	CONFIGURATION	SCHD.		PARAMETERS/VALUES		NO. of RUNS	MACH NUMBERS (OR ALTERNATE INDEPENDENT VARIABLE)									
		A	B	Δi	Θ_s		0.6	0.8	0.9	1.1	1.2	1.96	2.74	4.96		
R65001	T1	A	0	-	-		1	2	3	4	5	98	147	146		
02	T1, O1	A	0	-1.5	-		6	7	8	9	10	101	141	140		
03	T1, O1	0	B	-1.5	-		15	14	13	12	11	102	142	143		
04	T1, O1, S1	A	0	-1.5	21		25	24	23	22	21	105	139	139		
05	T1, O1, S1	0	B	-1.5	21		79	90	81	19	20	106	137	136		
06	T1, O1	6	B	-1.5	21		162	161	160	159	158	157	154			
07	T1, O1	-6	B	-1.5	21		163		164		165	156	155			
08	T1, O1	A	0	-3.0	-		28		27		26	100	144			
09	T1, O1	A	0	0	-		29		30		31	99	145			
10	T1, O1, S1	A	0	-1.5	0		34		33	74	32	104	150			
11	T1, O1, S1	0	B	-1.5	0		78		77	75	76	103	151			
12	T1, O1, S1, F1	A	0	-1.5	21		35		36	37	38	108	134			
13	T1, O1, S1, F1	0	B	-1.5	21		83		82	84	85	107	135			
14	T1, O1, S1, F2	A	0	-1.5	21		41		40		39	109	133			
15	T1, O1, S1, F2	0	B	-1.5	21		89		88	87	86	110	132			
16	T1, O1, S1, F3	0	B	-1.5	21		90		91	92	93	111	131			
17	T1, O1, S2	A	0	-1.5	21		42	43	44	45	46	113	129			
18	T1, O1, S2	0	B	-1.5	21		97		96	95	94	112	130			
19	T2	A	0	-	-		50		49	48	47	115	127			
20	T2, O1	A	0	-1.5	-		51	52	53	54	55	116	124			

TEST RUN NUMBERS

1	7	13	19	25	31	37	43	49	55	61	67	73	76
CLM	CN	1CY	PBL	1CYN	CAF	PABP	PABS	CAEHP	PAB	IDPVAR (1)	IDPVAR (2)	NDV	

COEFFICIENTS:

A OR B SCHEDULES

A) $\alpha = -10^\circ$ to 10° , $\Delta\alpha = 2^\circ$
 B) $\beta = -10^\circ$ to 10° , $\Delta\beta = 2^\circ$

TABLE III. DIMENSIONAL DATA

MODEL COMPONENT: WING, DOUBLE DELTA

GENERAL DESCRIPTION: MSC ORBITER O40C-2

DRAWING NUMBER: _____

DIMENSIONS:	THEORETICAL		ACTUAL MEASURED
	FULL-SCALE INCHES	MODEL SCALE INCHES	MODEL SCALE
<u>TOTAL DATA</u>			
Area			
Planform	585048	6.628	
Wetted			
Span (equivalent)	1047.2	3.525	
Aspect Ratio	1.874	1.874	
Rate of Taper	0.101	0.101	
Taper Ratio	0.101	0.101	
Dihedral Angle, degrees	7.75	-1.7	
Incidence Angle, degrees	1.5	1.5	
Aerodynamic Twist, degrees			
Toe-In Angle			
Cant Angle			
Sweep Back Angles, degrees			
Leading Edge	75/35	75/35	
Trailing Edge	-19.591	-19.591	
0.25 Element Line			
Chords:			
Root (Wing Sta. 0.0)	1367.8	4.602	
Tip, (equivalent)	138.28	0.465	
MAC	785.386	2.644	
Fus. Sta. of .25 MAC			
W.P. of .25 MAC			
B.L. of .25 MAC			
Airfoil Section			
Root			
Tip			
<u>EXPOSED DATA</u>			
Area	348628	3.950	
Span, (equivalent)	843.2	2.838	
Aspect Ratio	2.039	2.039	
Taper Ratio	0.145	0.145	
Chords			
Root	950.135	3.198	
Tip	138.23	0.465	
MAC	523.645	1.763	
Fus. Sta. of .25 MAC			
W.P. of .25 MAC			
B.L. of .25 MAC			

TABLE III. DIMENSIONAL DATA (CONTINUED)

MODEL COMPONENT: "V" TAIL STABILIZER

GENERAL DESCRIPTION: MSC ORBITER 040C-2

DRAWING NUMBER: _____

DIMENSIONS:	THEORETICAL		ACTUAL MEASURED
	TOTAL DATA	FULL-SCALE INCHES	MODEL SCALE INCHES
Area			
Planform			
Wetted			
Span (equivalent)			
Aspect Ratio			
Rate of Taper			
Taper Ratio			
Dihedral Angle, degrees	75°	75°	
Incidence Angle, degrees	0°	0°	
Aerodynamic Twist, degrees	0°	0°	
Toe-In Angle	0°	0°	
Cant Angle	15°	15°	
Sweep Back Angles, degrees			
Leading Edge	45°	45°	
Trailing Edge	15°	15°	
0.25 Element Line			
Chords:			
Root (Wing Sta. 0.0)			
Tip, (equivalent)			
MAC			
Fus. Sta. of .25 MAC			
W.P. of .25 MAC			
B.L. of .25 MAC			
Airfoil Section			
Root	NACA 0012-64		
Tip	NACA 0012-64		
EXPOSED DATA			
Area	37067.8	0.420	
Span, (equivalent)	232.4	0.782	
Aspect Ratio	1.44	1.44	
Taper Ratio	0.31	0.31	
Chords			
Root	244.2	0.830	
Tip	74.1	0.249	
MAC	174.0	0.586	
Fus. Sta. of .25 MAC	1,447.86		
W.P. of .25 MAC	574.25		
B.L. of .25 MAC	612.06		

TABLE III. DIMENSIONAL DATA (CONTINUED)

MODEL COMPONENT: BODY - T1

GENERAL DESCRIPTION: 346-INCH DIAMETER H-O TANK

DRAWING NUMBER: _____

<u>DIMENSIONS:</u>	<u>THEORETICAL</u>		<u>ACTUAL MEASURED</u>
	<u>FULL-SCALE</u> IN/IN ²	<u>MODEL SCALE</u> IN/IN ²	<u>MODEL SCALE</u> IN/IN ²
Length	<u>1815</u>	<u>6.109</u>	<u>6.120</u>
Max. Width	<u>346</u>	<u>1.165</u>	<u>1.165</u>
Max. Depth	<u>346</u>	<u>1.165</u>	<u>1.165</u>
Fineness Ratio	_____	_____	_____
Area			
Max. Cross-Sectional	<u>94,025</u>	<u>1.066</u>	<u>1.066</u>
Planform	_____	_____	_____
Wetted	_____	_____	_____
Base	<u>94,025</u>	<u>1.066</u>	<u>1.066</u>

TABLE III. DIMENSIONAL DATA (CONTINUED)

MODEL COMPONENT: BODY - T2

GENERAL DESCRIPTION: 400 INCH DIAMETER H-O TANK

DRAWING NUMBER:

<u>DIMENSIONS:</u>	<u>THEORETICAL</u>		<u>ACTUAL MEASURED</u>
	<u>FULL-SCALE</u> <u>IN/IN²</u>	<u>MODEL SCALE</u> <u>IN/IN²</u>	<u>MODEL SCALE</u> <u>IN/IN²</u>
Length	<u>1760</u>	<u>5.924</u>	<u>6.290</u>
Max. Width	<u>400</u>	<u>1.346</u>	<u>1.346</u>
Max. Depth	<u>400</u>	<u>1.346</u>	<u>1.346</u>
Fineness Ratio	<u>4.4/1</u>	<u>4.4/1</u>	<u>4.67/1</u>
Area			
Max. Cross-Sectional	<u>125,664</u>	<u>1.423</u>	<u>1.423</u>
Planform	<u> </u>	<u> </u>	<u> </u>
Wetted	<u> </u>	<u> </u>	<u> </u>
Base	<u>125,664</u>	<u>1.423</u>	<u>1.423</u>

TABLE III: DIMENSIONAL DATA (CONTINUED)

MODEL COMPONENT: FIN (F1, F2, F3)

GENERAL DESCRIPTION: FINS FOR BASELINE H-O TANK T1

DRAWING NUMBER: _____

DIMENSIONS:	THEORETICAL		ACTUAL MEASURED
	FULL-SCALE	MODEL SCALE IN/IN ²	MODEL SCALE
<u>TOTAL DATA</u>			
Area			
Planform	_____	_____	_____
Wetted	_____	_____	_____
Span (equivalent)	_____	_____	_____
Aspect Ratio	_____	_____	_____
Rate of Taper	_____	_____	_____
Taper Ratio	_____	_____	_____
Dihedral Angle, degrees	_____	45°/0°/0°	_____
Incidence Angle, degrees	_____	0	_____
Aerodynamic Twist, degrees	_____	0	_____
Toe-In Angle	_____	0	_____
Cant Angle	_____	_____	_____
Sweep Back Angles, degrees	_____	_____	_____
Leading Edge	_____	35° 36'	_____
Trailing Edge	_____	0	_____
0.25 Element Line	_____	_____	_____
Chords:			
Root (Wing Sta. 0.0)	_____	_____	_____
Tip, (equivalent)	_____	_____	_____
MAC	_____	_____	_____
Fus. Sta. of .25 MAC	_____	_____	_____
W.P. of .25 MAC	_____	_____	_____
B.L. of .25 MAC	_____	_____	_____
Airfoil Section	_____	_____	_____
Root	_____	_____	_____
Tip	_____	_____	_____
<u>EXPOSED DATA</u>			
Area	_____	0.8587	_____
Span, (equivalent)	_____	1.218	_____
Aspect Ratio	_____	1.728	_____
Taper Ratio	_____	_____	_____
Chords			
Root	_____	1.141	_____
Tip	_____	0.269	_____
MAC	_____	_____	_____
Fus. Sta. of .25 MAC	_____	_____	_____
W.P. of .25 MAC	_____	_____	_____
B.L. of .25 MAC	_____	_____	_____

TABLE III. DIMENSIONAL DATA (CONCLUDED)

MODEL COMPONENT: BODY - S

GENERAL DESCRIPTION: 156-INCH DIAMETER SOLID ROCKET BODY

(See figure 5 for S1 and S2 base configurations, figure 7 for description of S3 nose fairing)

DRAWING NUMBER:

<u>DIMENSIONS:</u>	<u>THEORETICAL</u>		<u>ACTUAL MEASURED</u>
	<u>FULL-SCALE</u> <u>IN/IN²</u>	<u>MODEL SCALE</u> <u>IN/IN²</u>	<u>MODEL SCALE</u> <u>IN/IN²</u>
Length	<u>1160</u>	<u>3.905</u>	<u>3.914</u>
Max. Width	<u>156</u>	<u>0.525</u>	<u>0.525</u>
Max. Depth	<u>156</u>	<u>0.525</u>	<u>0.525</u>
Fineness Ratio	<u>7.436/1</u>	<u>7.438/1</u>	<u>7.455/1</u>
Area			
Max. Cross-Sectional	<u>19,113</u>	<u>0.216</u>	<u>0.216</u>
Planform	<u> </u>	<u> </u>	<u> </u>
Wetted	<u> </u>	<u> </u>	<u> </u>
Base	<u>19,113</u>	<u>0.216</u>	<u>0.216</u>

TABLE IV. INDEX TO MODEL FIGURES

FIGURE	TITLE	PAGE
1.	Axis System	22
2.	Reference 1/100 Scale Dwg. MSC-SDD dated 28 Feb. 1972 (Orbiter Configuration O40C-2)	23
3.	Reference 1/100 Scale Dwg. MSC-SSD dated 3 March 1972 (SRM Parallel Burn Launch Configuration)	24
4.	H-O Tanks T_1 and T_2	25
5.	Solid Rocket Motors (S_1, S_2, S_3)	26
6.	Solid Rocket Motor (SRM) Locations	27
7.	Solid Rocket Motor S_3 (Fairing Added to S_1)	28
8.	Fins F_1, F_2, F_3	29
9.	Fin Locations	30
10.	Moment Reference Center, Orbiter and Solid Rocket Motor Locations	31
11.	Configuration T_1O_1 Installed in MSFC 14 x 14 Inch Trisonic Wind Tunnel	32
12.	Configuration $T_1O_1S_1$ Installed in MSFC 14 x 14 Inch Trisonic Wind Tunnel	33

TABLE V. INDEX OF DATA FIGURES

TITLE	PLOTTED		CONDITIONS VARYING	PAGES
	COEFFICIENTS SCHEME			
Configuration Build-up Effect on Longitudinal Characteristics (346 inch tank)	A		Configuration, MACH	1-48
Configuration Build-up Effect on Lateral/Directional Characteristics (346 inch tank)	B		Configuration, MACH	49-80
Configuration Build-up Effect on Longitudinal Characteristics (400 inch tank)	A		Configuration, MACH	81-128
Tank Diameter Effects on Longitudinal Characteristics	A		Configuration, MACH	129-176
Tank Diameter Effects on Lateral/Directional Characteristics	B		Configuration, MACH	177-208
Effect of Orbiter Incidence on Longitudinal Characteristics	A		ϕ RBIN, MACH	209-256
Effect of SRM Circumferential Location on Longitudinal Characteristics	A		THEMS, MACH	257-304
Effect of SRM Circumferential Location on Lateral/Directional Characteristics	B		THEMS, MACH	305-336
Effect of SRM Nose and End Fairings on Longitudinal Characteristics	A		Configuration, MACH	337-384
Effect of SRM End Fairing on Lateral/Directional Characteristics	B		Configuration, MACH	385-416
Effect of Tank End Fairing on Longitudinal Characteristics	A		Configuration, MACH	417-464

TABLE V. INDEX OF DATA FIGURES
(CONCLUDED)

TITLE	PLOTTED COEFFICIENTS SCHEDULE	CONDITIONS VARYING	PAGES
Effect of Angle of Attack on the Baseline Configuration, Lateral/Directional Characteristics	B	ALPHA, MACH	465-496
Effect of Fin Location on Longitudinal Characteristics	A	Configuration, MACH	497-544
Effect of Fin Location on Lateral/Directional Characteristics	B	Configuration, MACH	545-576
Baseline Longitudinal Derivatives as a Function of Mach Number	C	Configuration	577-578
Baseline Lateral/Directional Derivatives as a Function of Mach Number	D	Configuration, ALPHA	579-580

PLOTTED COEFFICIENTS SCHEDULE:

- (A) CIM, CN, CA, CAF, CAB vs. ALPHA
CN vs. CIM
- (B) CY, CYN, CBL vs. BETA
CY vs. CYN
- (C) DCN/DA, DCIMDA, XAC/IP, CAFAFØ vs. MACH
- (D) DCY/DB, DCYNDB, DCBLDB, XAC/LY vs. MACH

MODEL FIGURES

- Notes:
1. Positive directions of force coefficients moment coefficients, and angles are indicated by arrows.
 2. For clarity, origins of wind and stability axes have been displaced from the center of gravity.

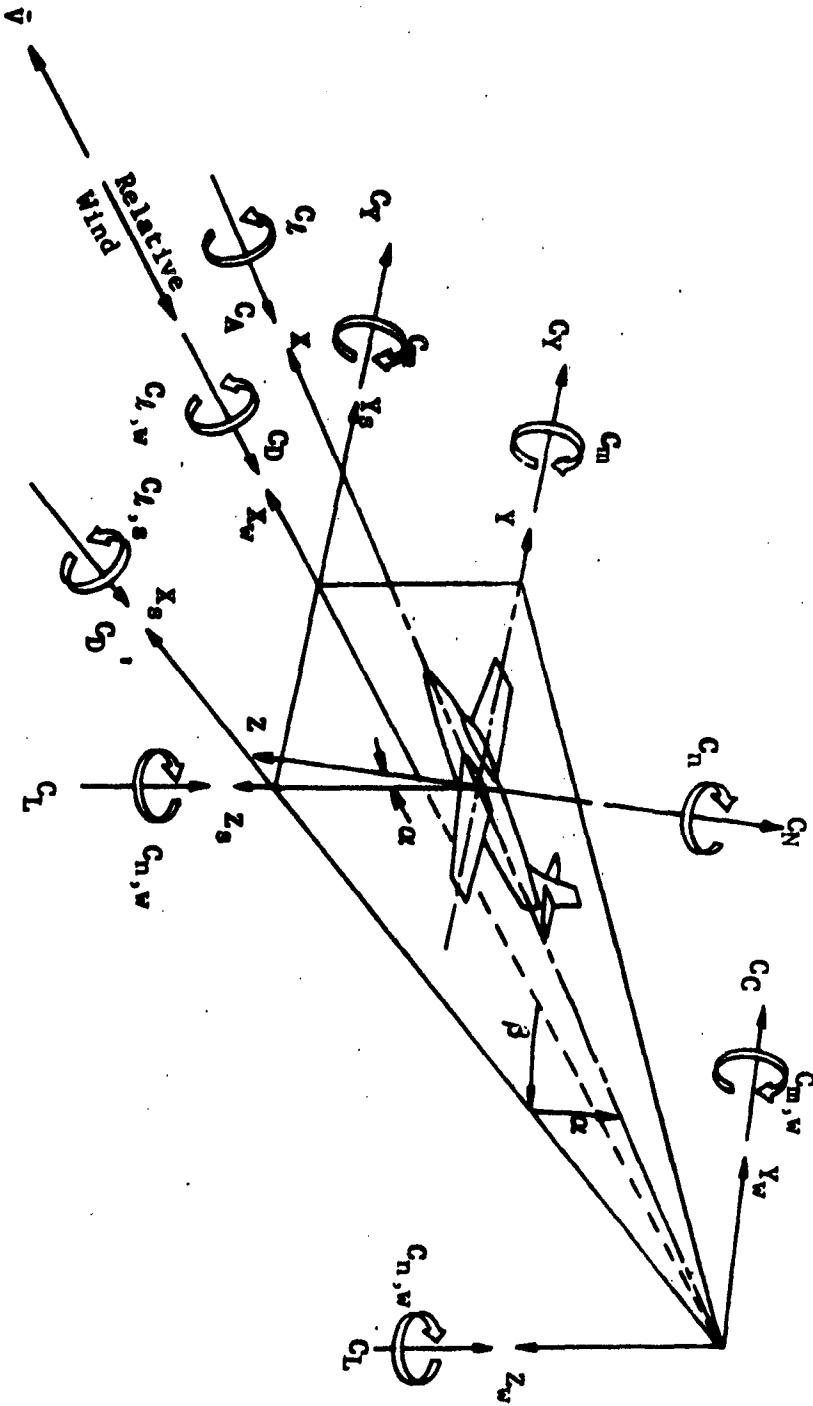
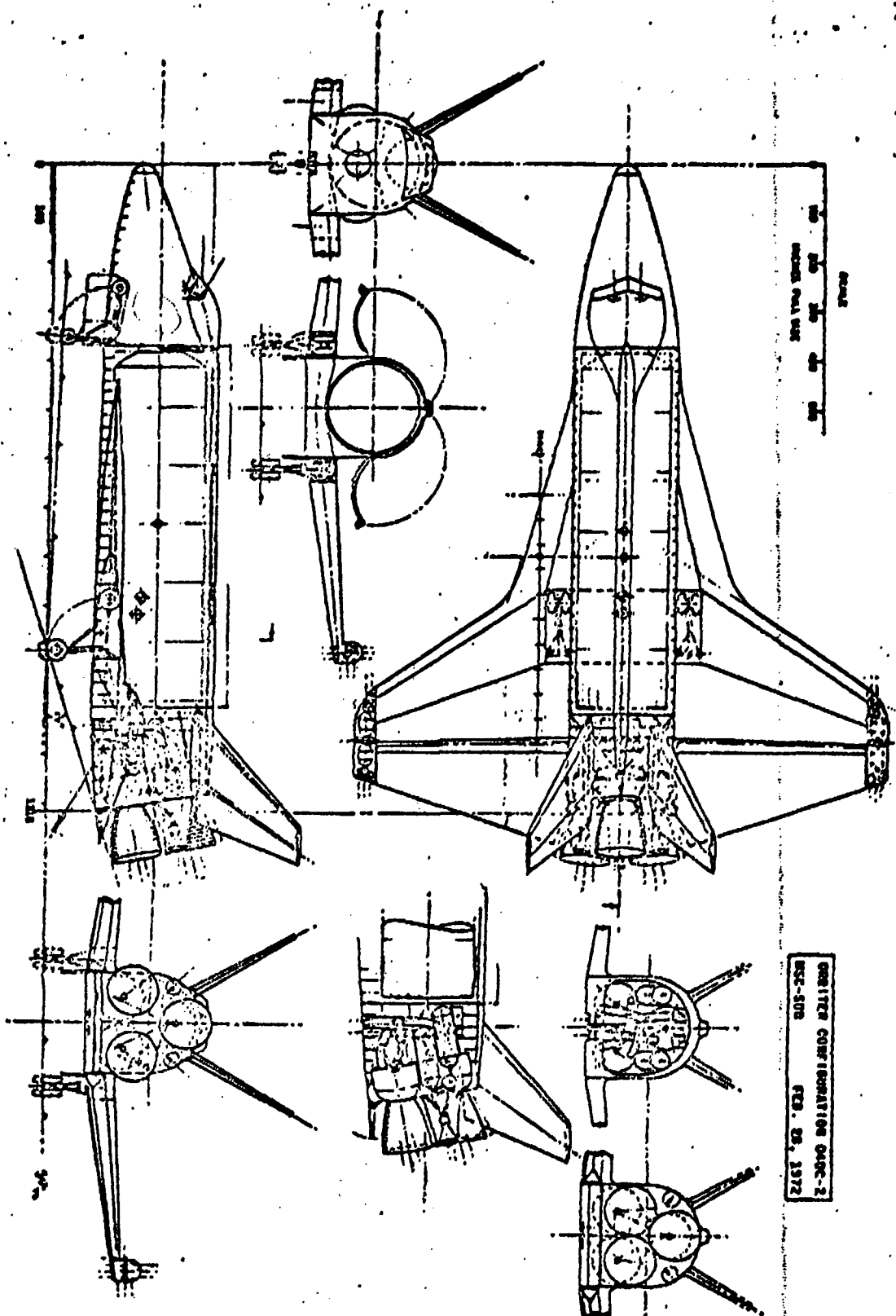
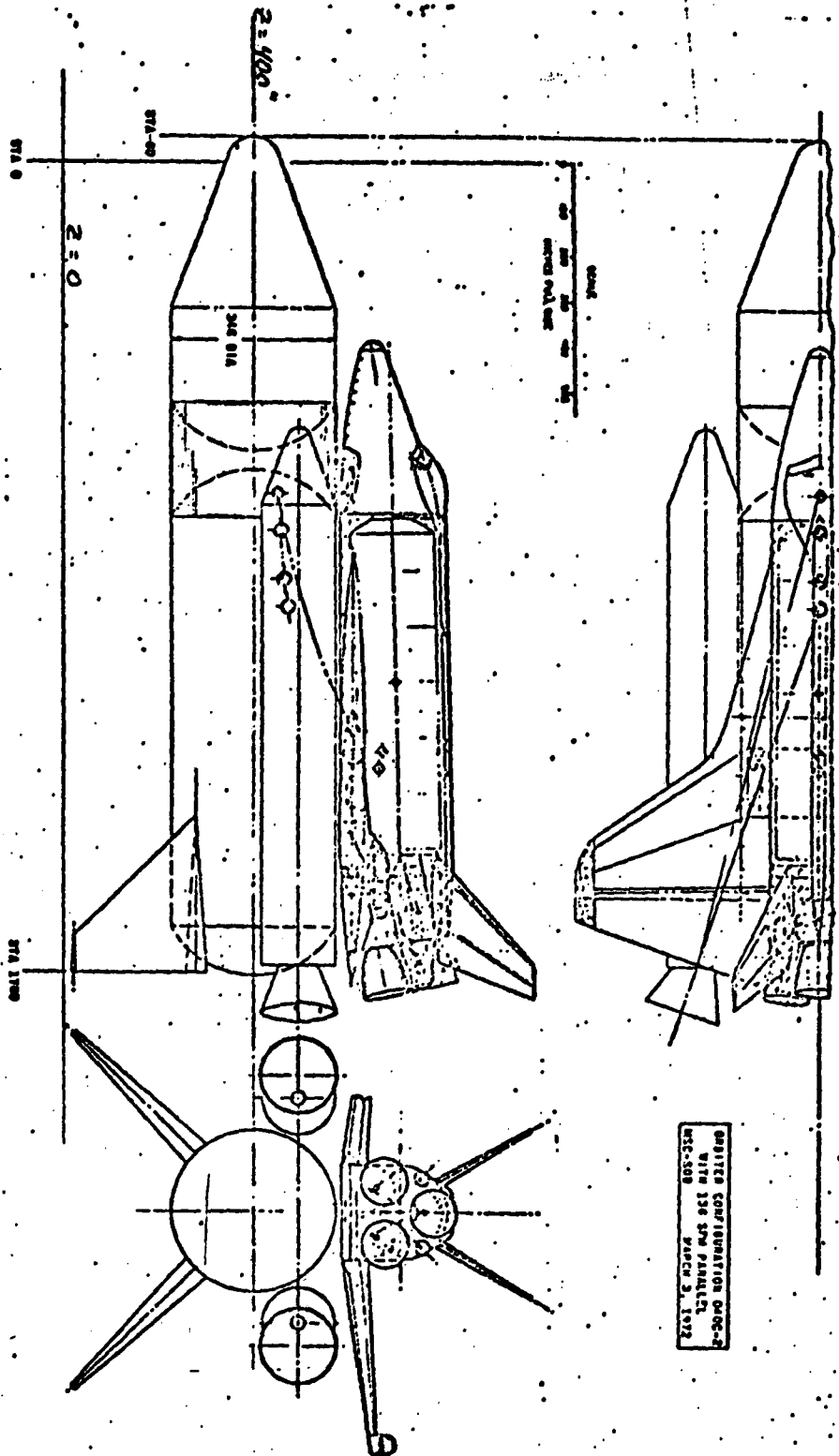

Figure 1. Axis systems, showing direction and sense of force and moment coefficients, angle of attack, and sideslip angle



ORBITER CONFIGURATION O40C-2
 MSC-50B FEB. 28, 1972

FIGURE 2. REFERENCE 1/100 SCALE DWG MSC-SDD DATED 28 FEB 1972 (ORBITER CONFIGURATION O40C-2)



ANALYSIS CONFIGURATION 0405-4
 WITH 336 SPW PARALLEL
 MSC-508 MARCH 21, 1972

Figure 3. REFERENCE 1/100 SCALE DWG MSC-508 DATED 3 MARCH 1972
 (SRM Parallel Burn Launch Configuration)

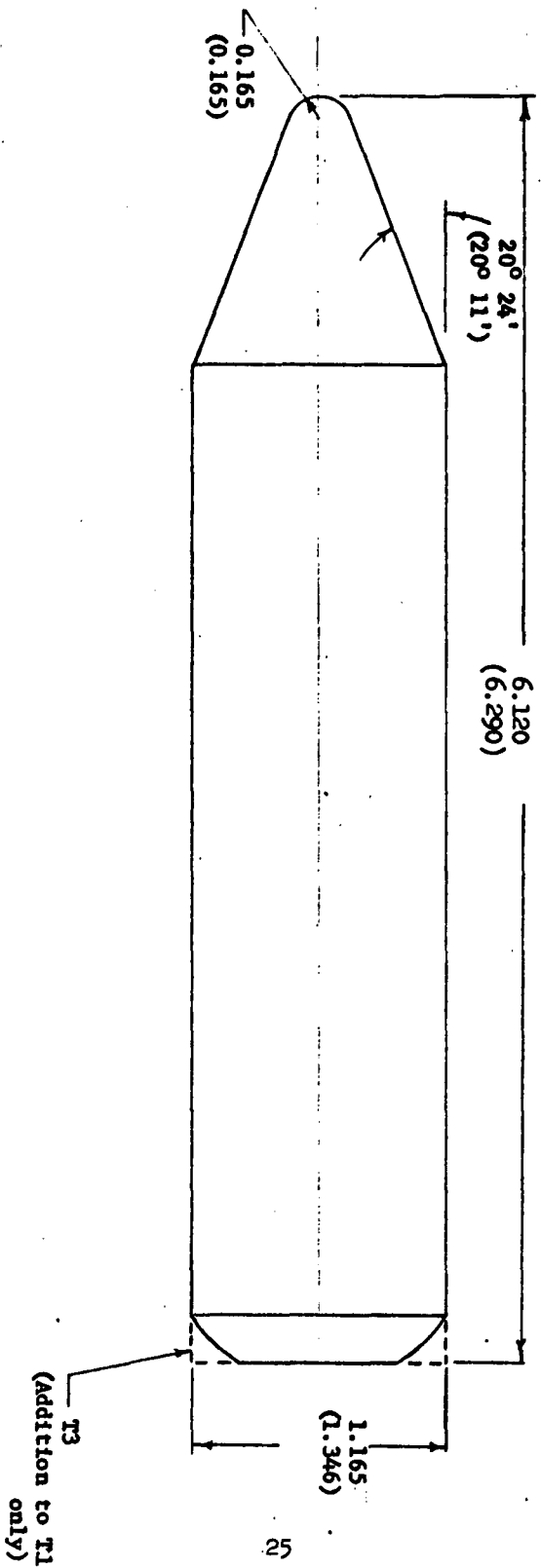

Figure 4. H-O TANK T1 (T2)

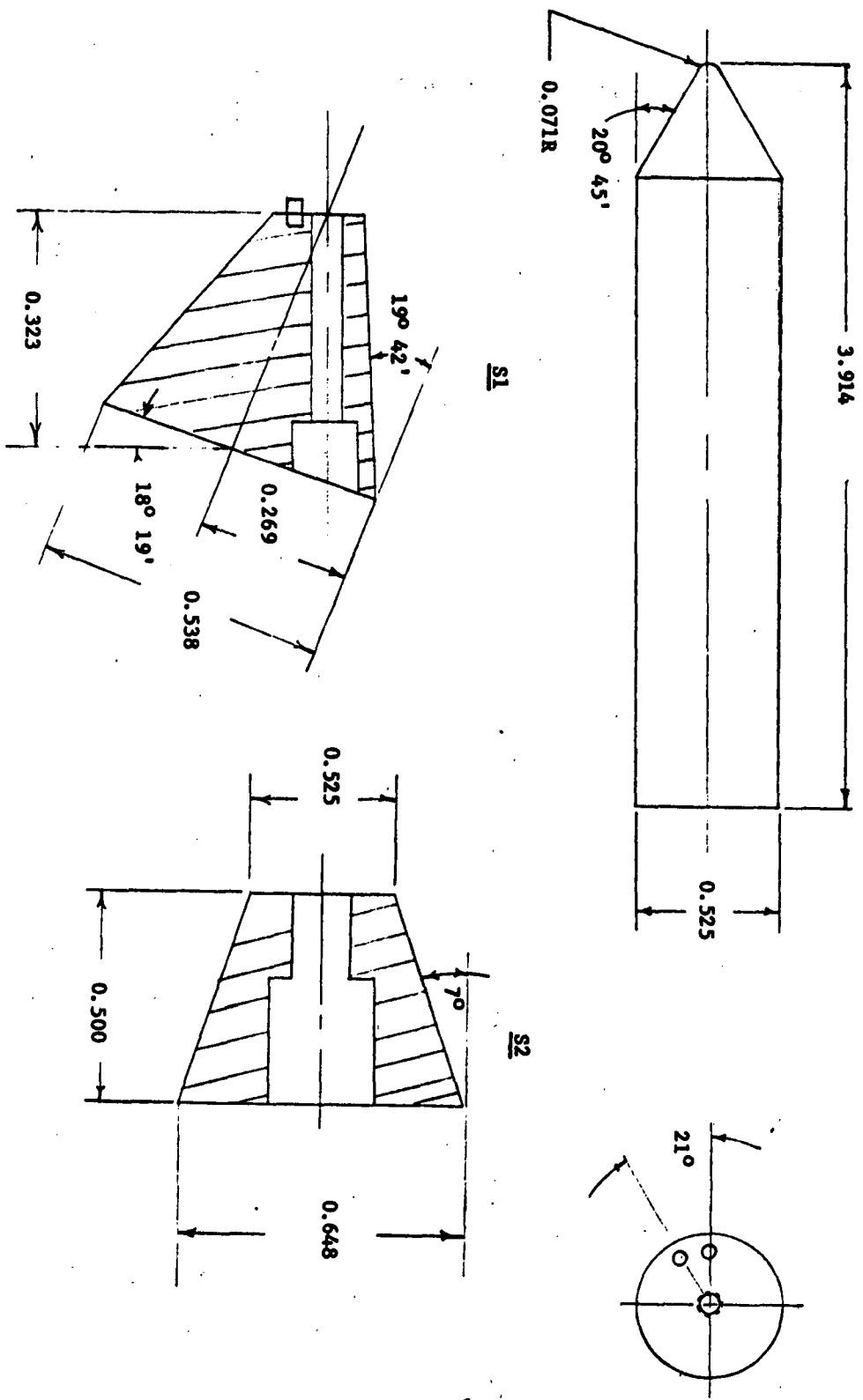

Figure 5. SOLID ROCKET MOTOR (S1, S2, S3)

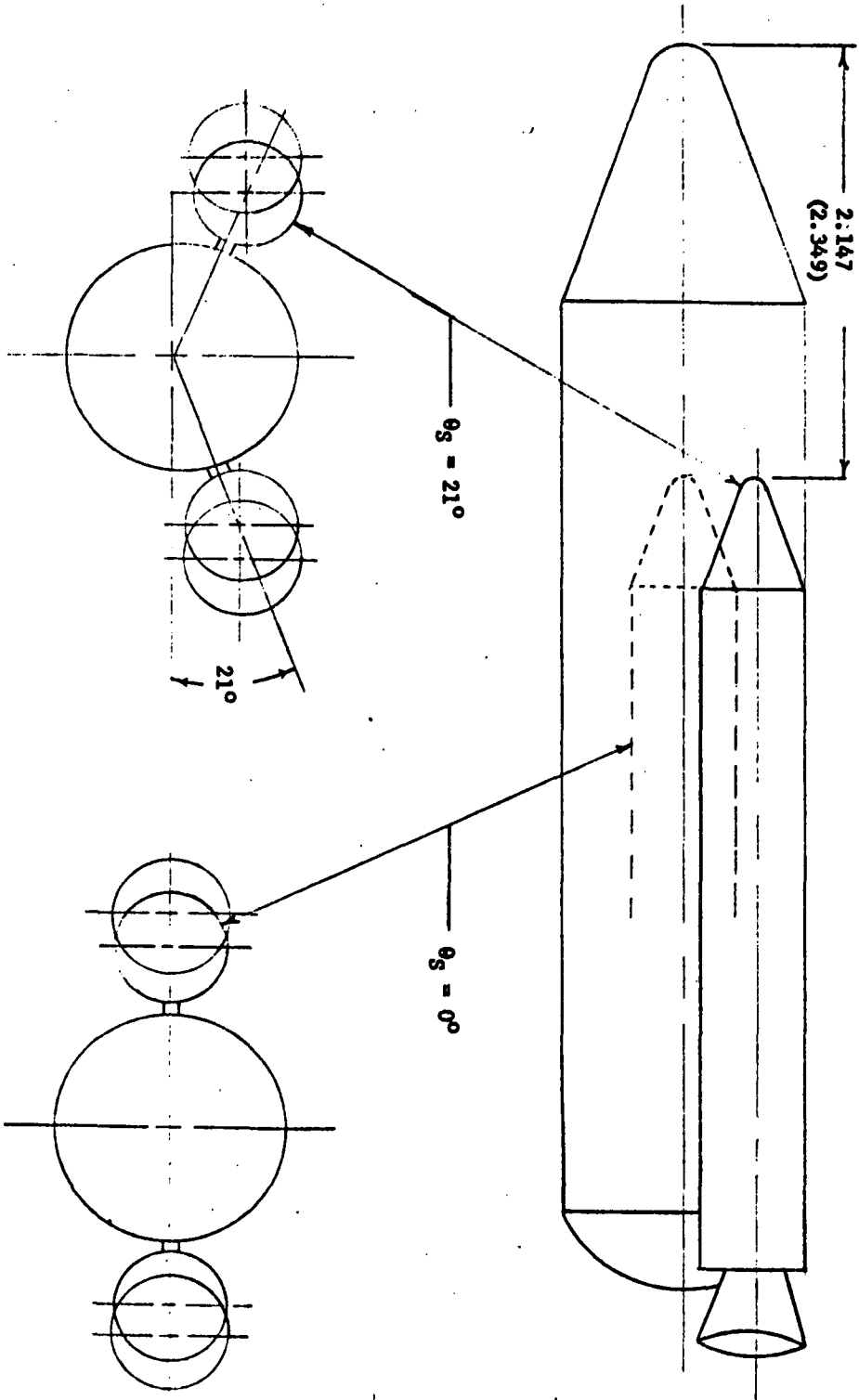

Figure 6. SOLID ROCKET MOTOR LOCATIONS T1 and (T2)

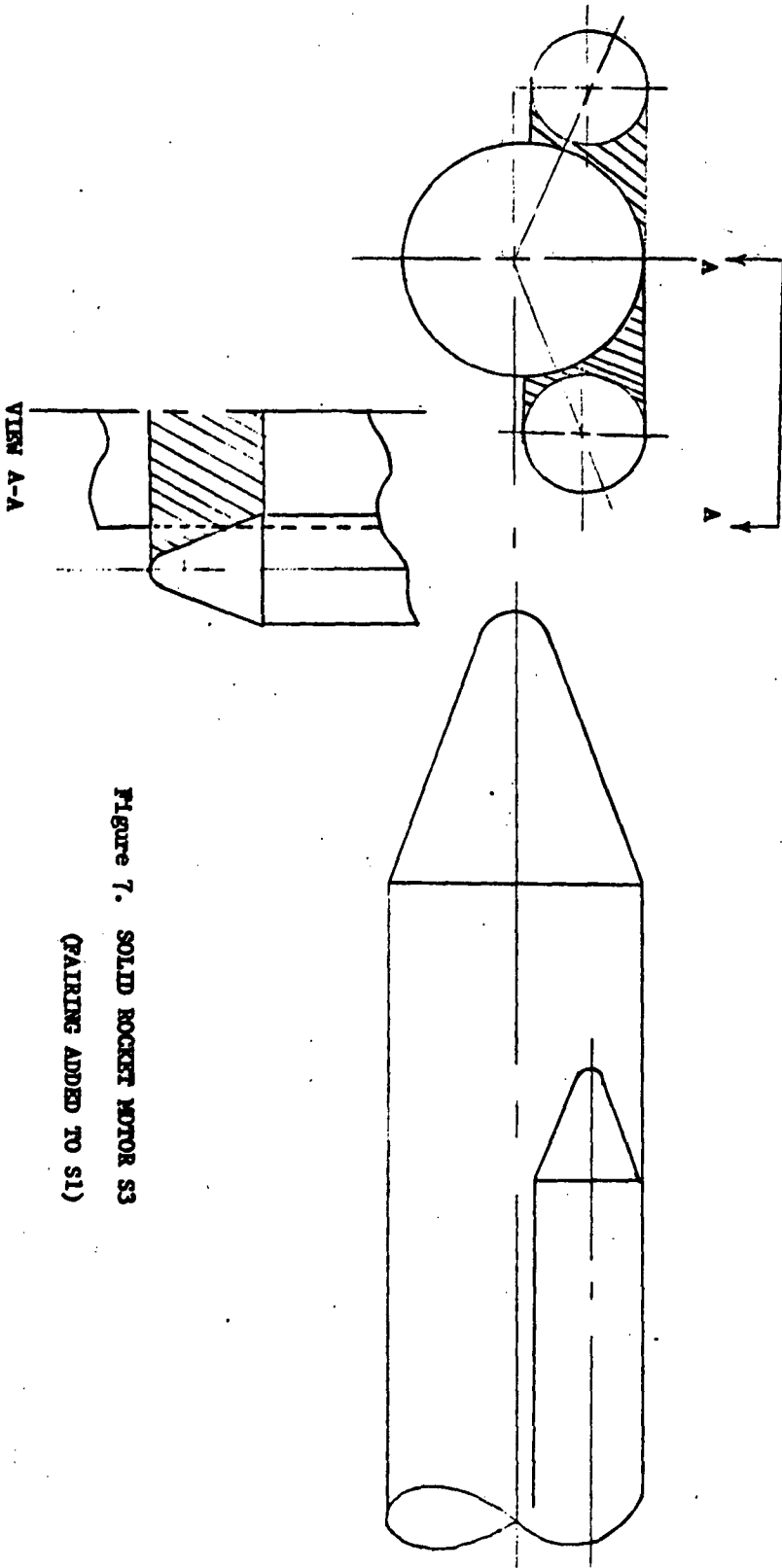

Figure 7. SOLID ROCKET MOTOR S3
(FAIRING ADDED TO S1)

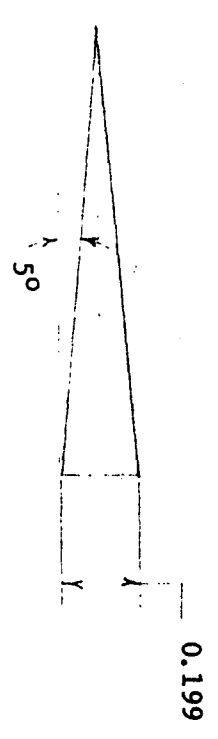
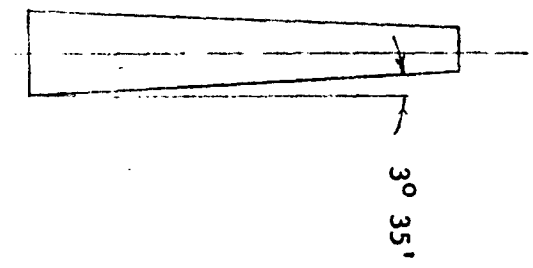
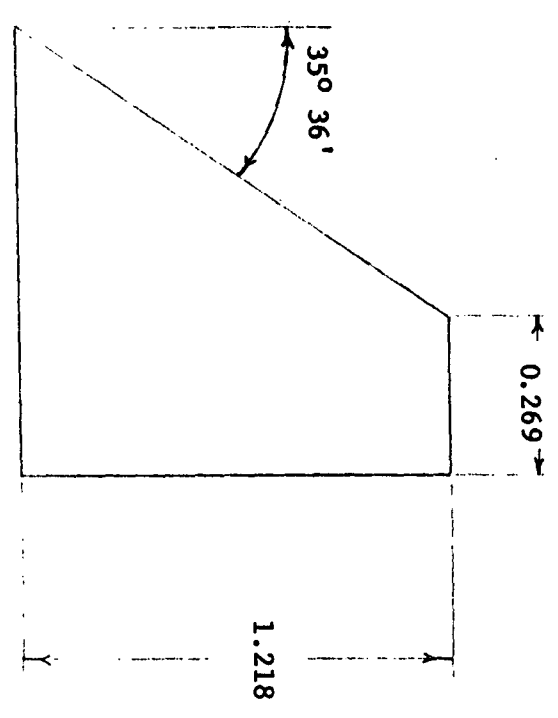
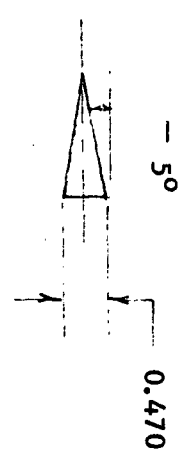

Figure 8. FIN (F1) 2 EACH, (F2) and (F3) 1 EACH

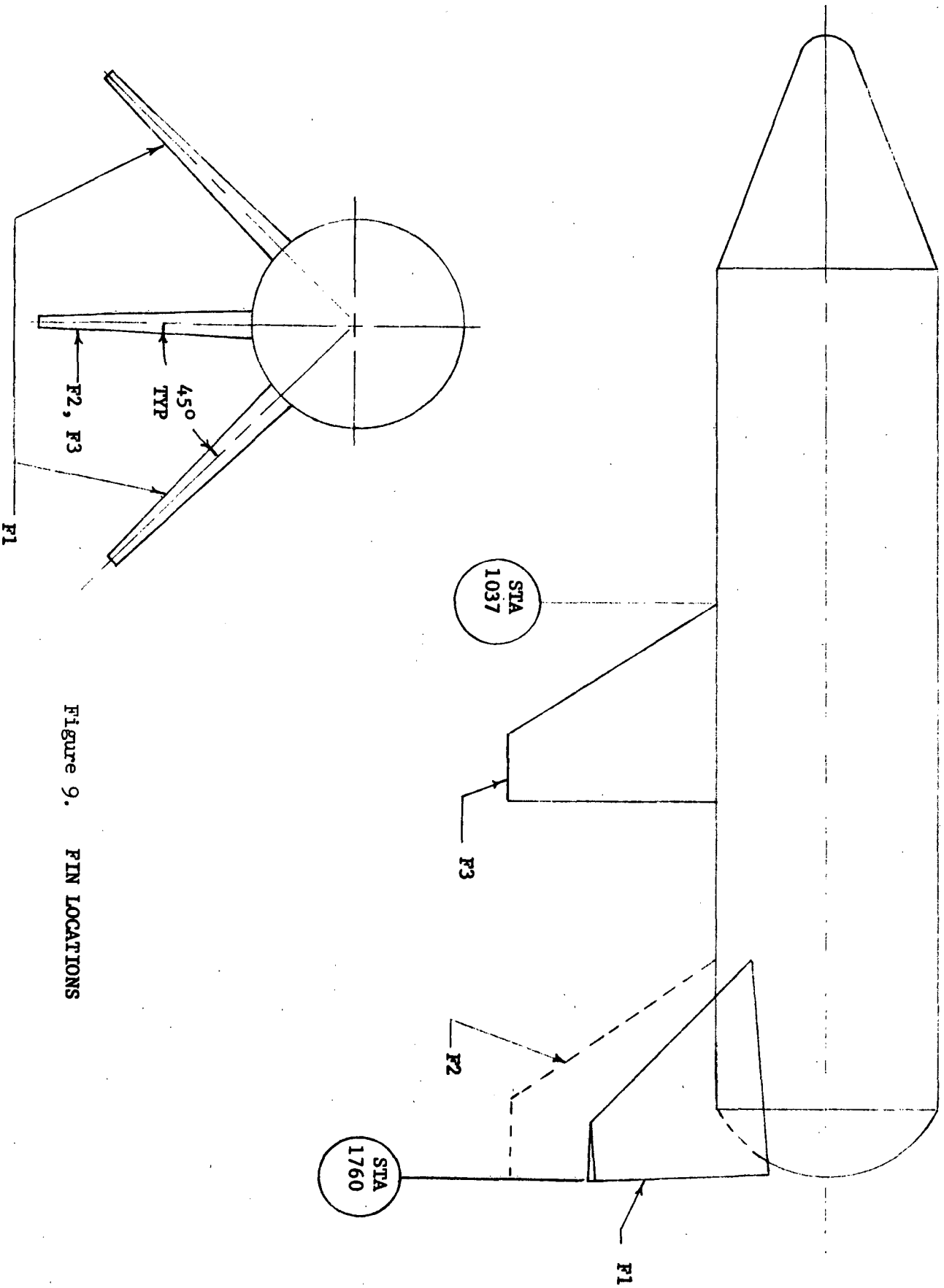

Figure 9. FIN LOCATIONS

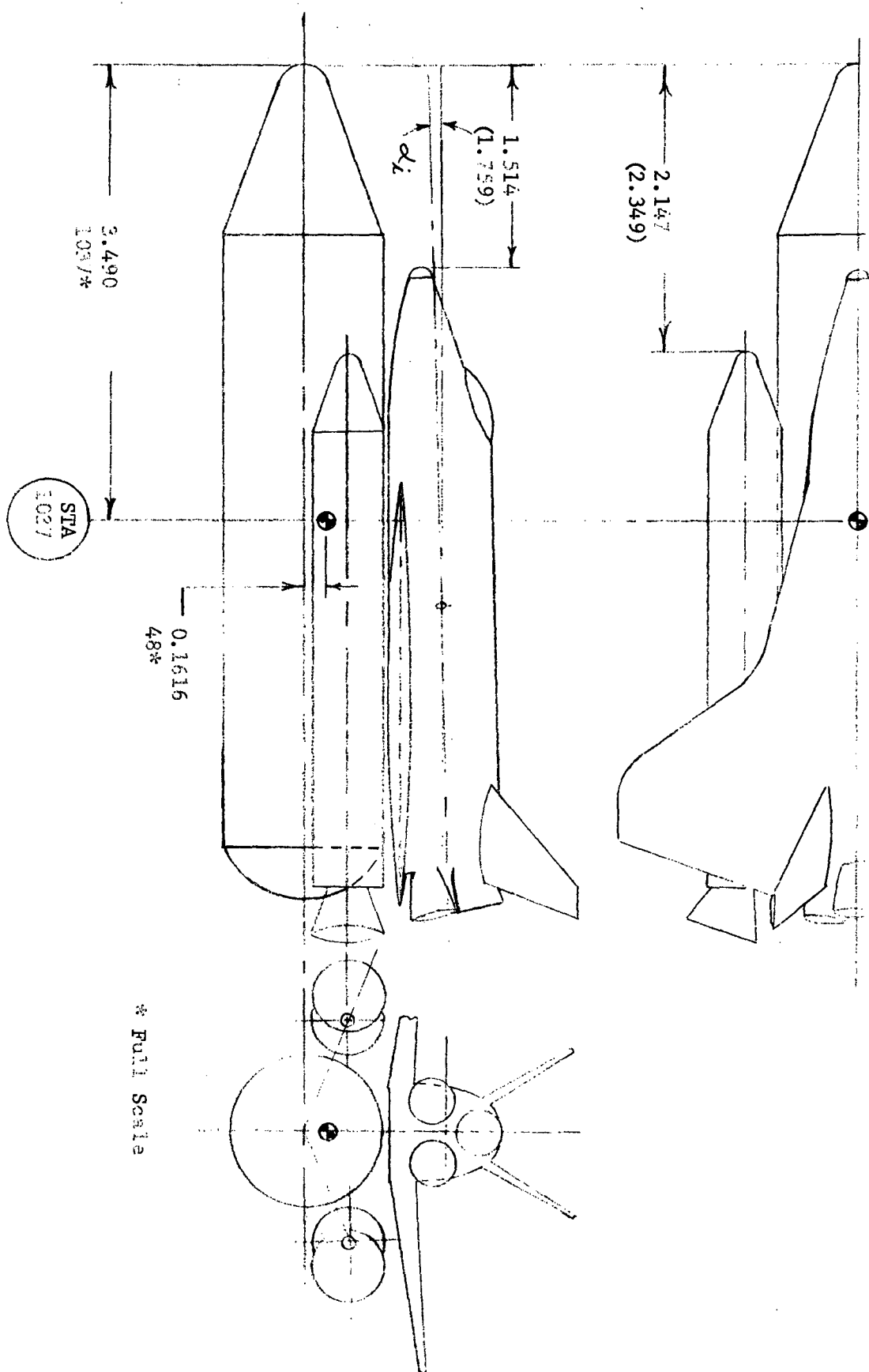

FIGURE 10. MOMENT REFERENCE CENTER, ORBITER, AND SOLID ROCKET MOTOR LOCATIONS T1 and (T2)

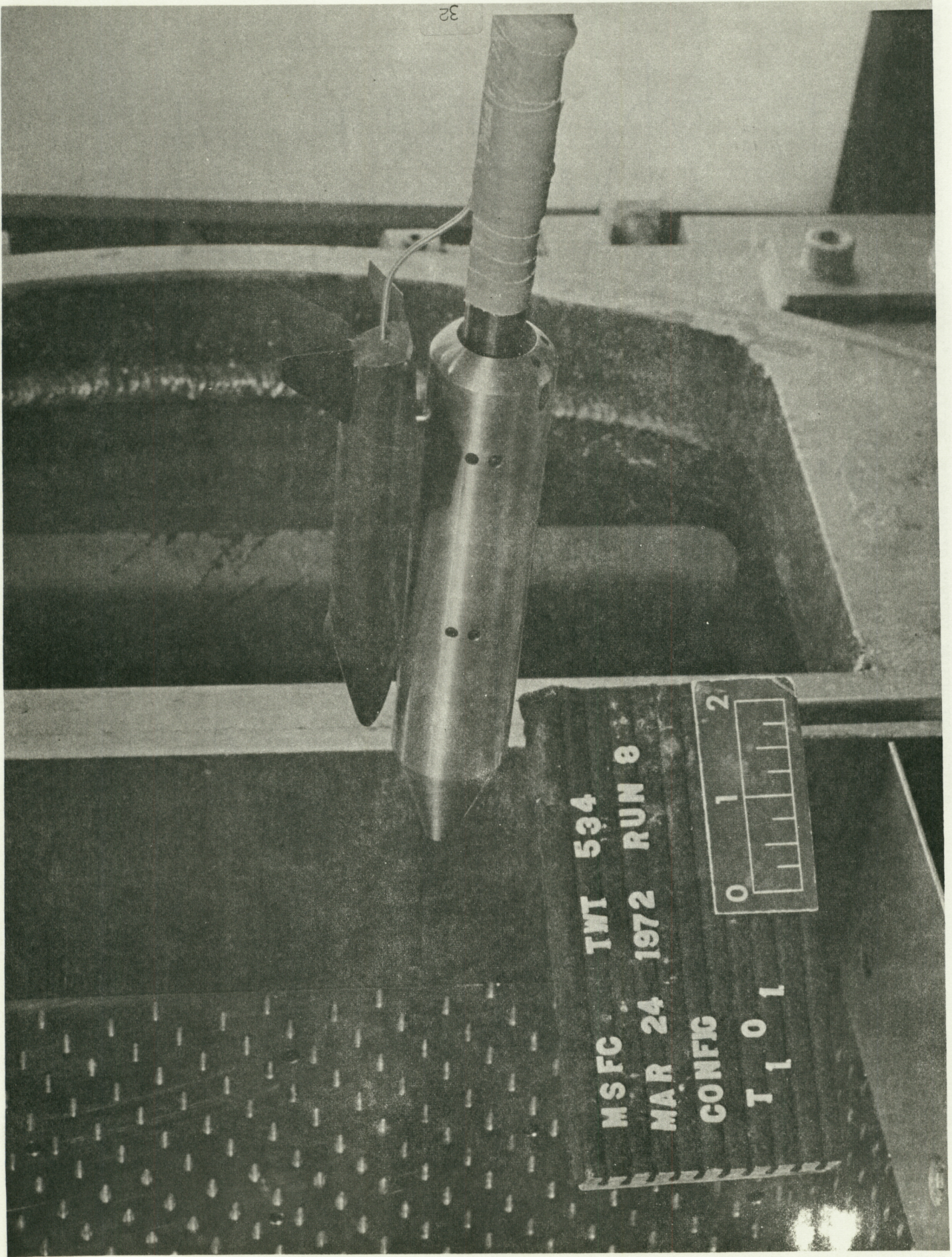

FIGURE 11. CONFIGURATION T₁ O₁ INSTALLED IN MSFC 14x14 INCH TRISONIC WIND TUNNEL

NASA-MSFC
S&E-Aero-AE

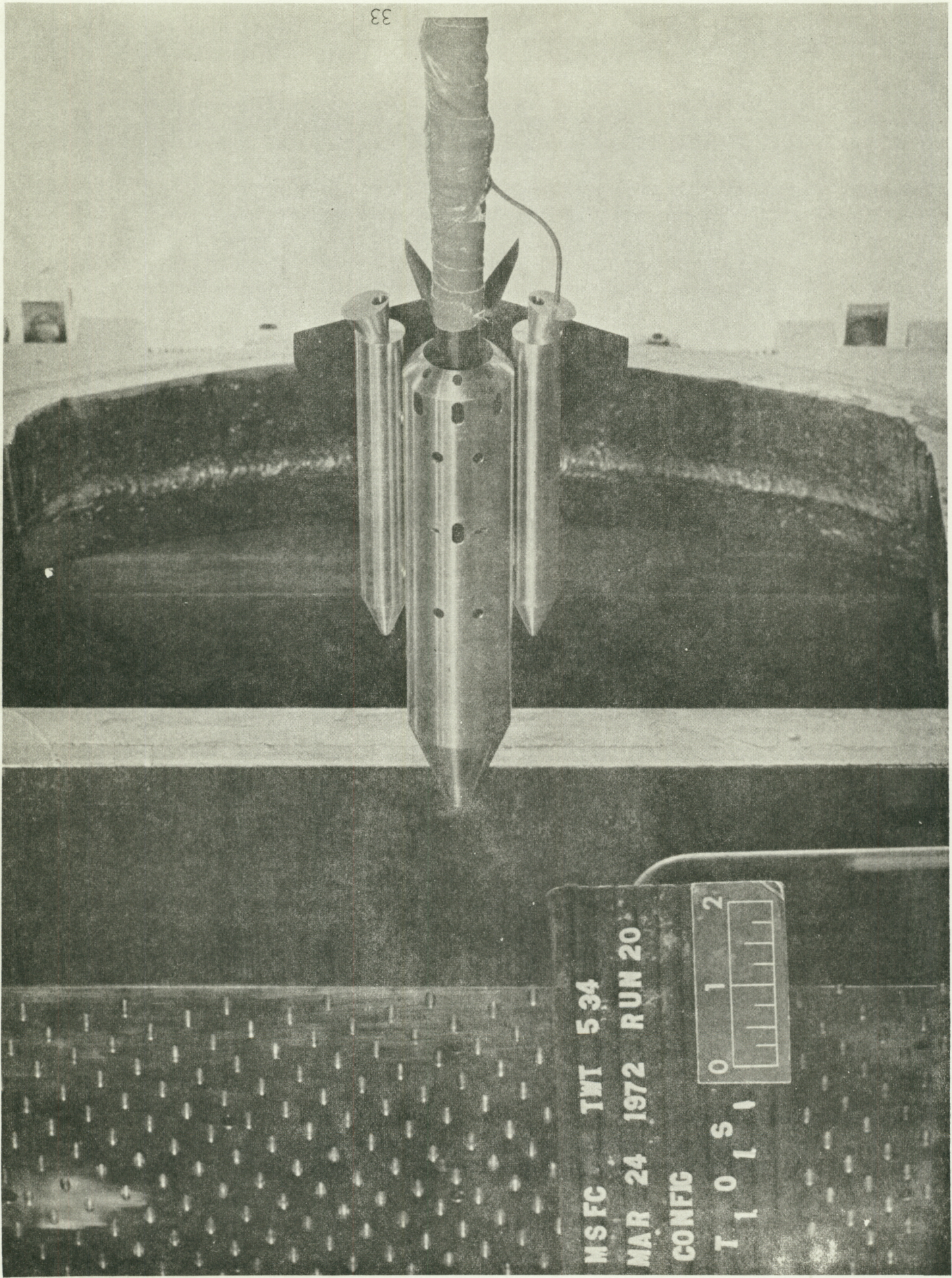

FIGURE 12. CONFIGURATION T₁ O₁ S₁ INSTALLED IN MSFC 14x14 INCH TRISONIC WIND TUNNEL

NASA - MSFC
S&E - Aero - AE

P L O T T E D D A T A

Tabulations of the plotted data and corresponding source data are available from SADSAC Operations.

CONFIGURATION BUILD-UP EFFECT ON LONGITUDINAL CHARACTERISTICS (346 INCH TANK)

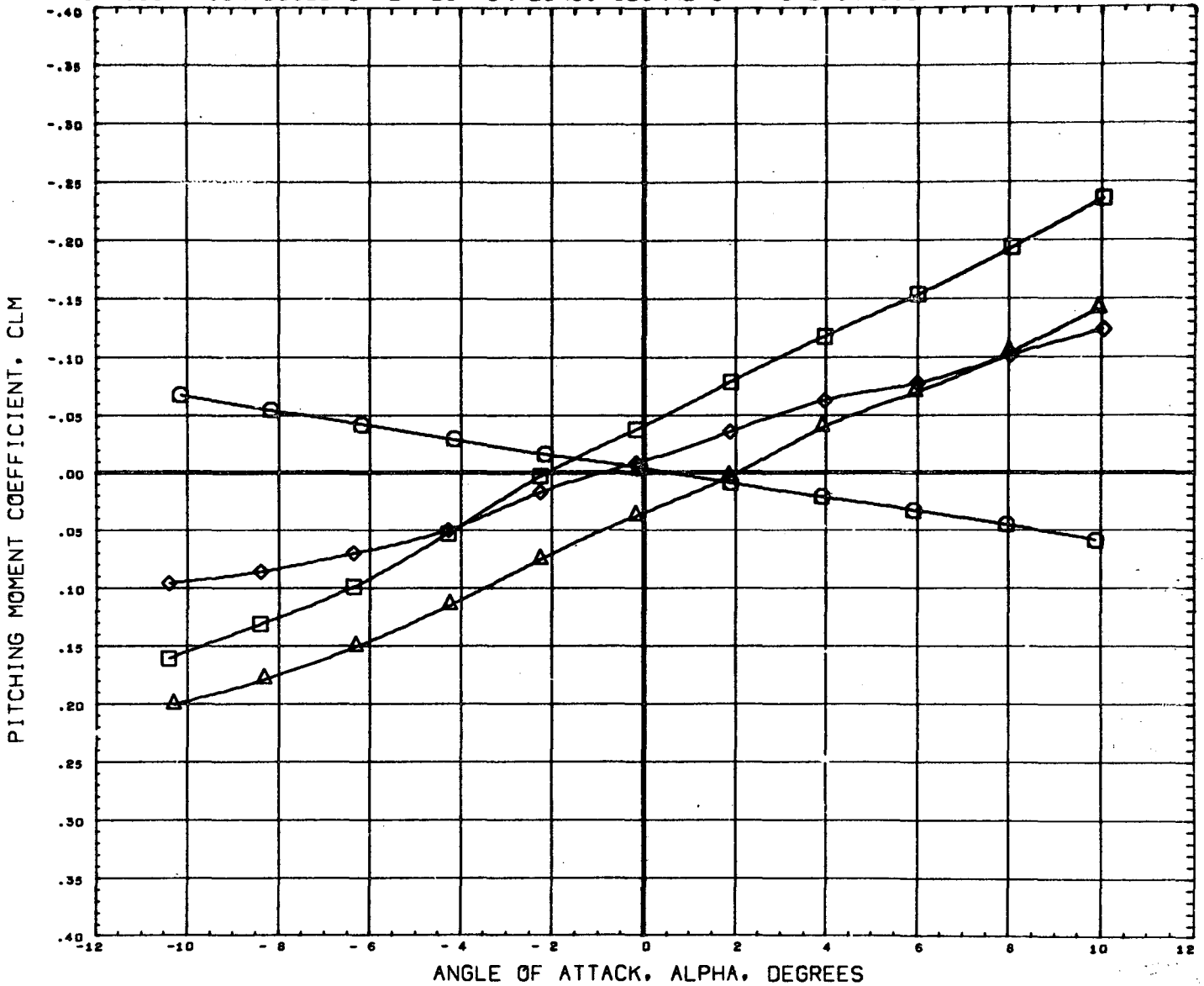

DATA SET SYMBOL	CONFIGURATION DESCRIPTION	ORBIN	THETS	BETA	REFERENCE INFORMATION
(B65001)	MSFC TWT 534 SHUTTLE LAUNCH	T1		0.000	SREF 4.8950 SQ. IN
(B65002)	MSFC TWT 534 SHUTTLE LAUNCH	T101	-1.500	0.000	LREF 2.6440 IN.
(B65004)	MSFC TWT 534 SHUTTLE LAUNCH	T101S1	-1.500	21.000	BREF 3.5250 IN.
(B65012)	MSFC TWT 534 SHUTTLE LAUNCH	T101S1F1	-1.500	21.000	0.000
					XMRP 3.4900 IN.
					YMRP 0.0000 IN.
					ZMRP 0.1616 IN.
					SCALE 0.0034

MACH .60

CONFIGURATION BUILD-UP EFFECT ON LONGITUDINAL CHARACTERISTICS (346 INCH TANK)

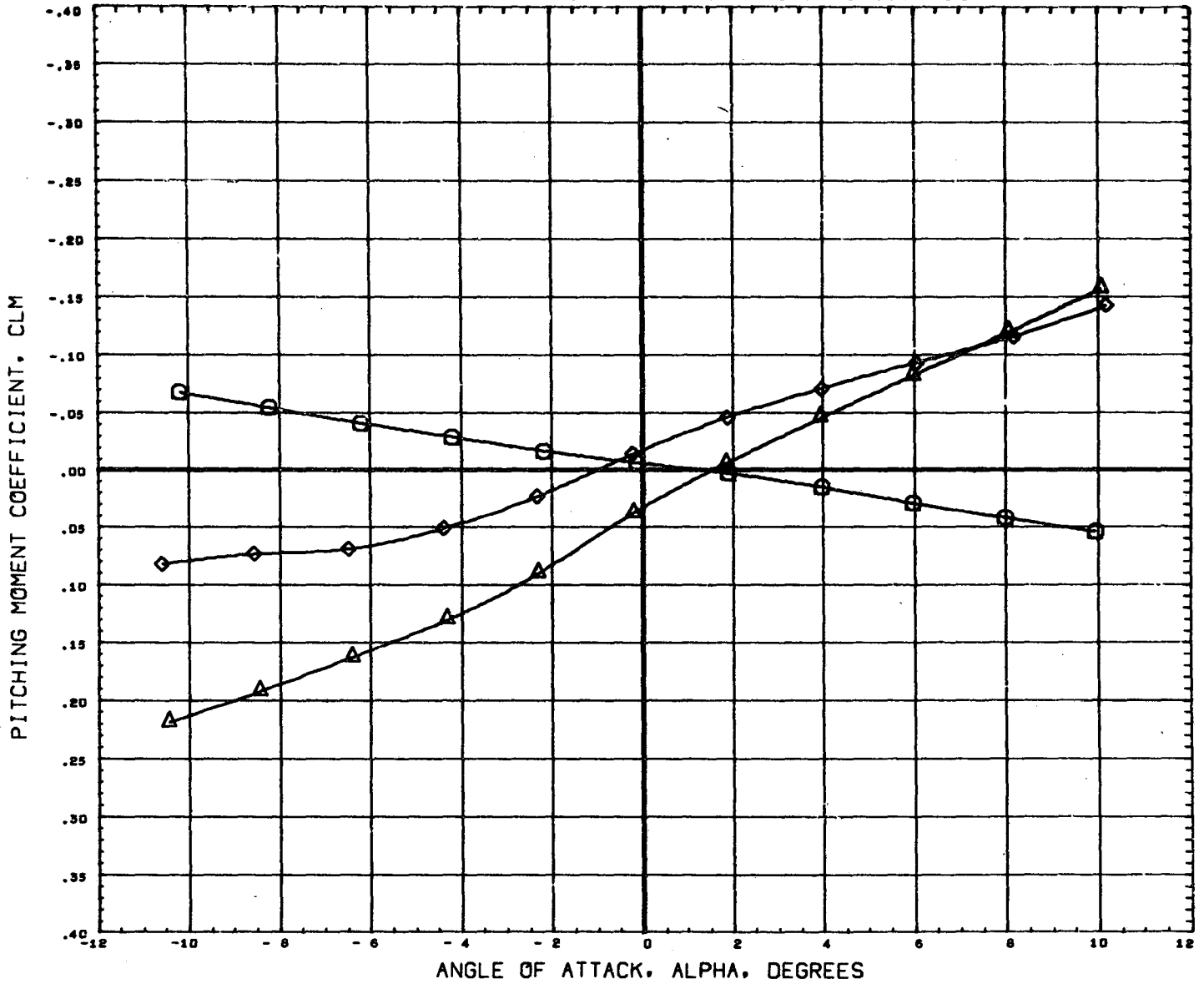

DATA SET SYMBOL	CONFIGURATION DESCRIPTION	ORBIN	THETS	BETA	REFERENCE INFORMATION
(B65001)	MSFC TWT 534 SHUTTLE LAUNCH T1			0.000	SREF 4.8950 SQ. IN
(B65002)	MSFC TWT 534 SHUTTLE LAUNCH T101	-1.500		0.000	LREF 2.6440 IN.
(B65004)	MSFC TWT 534 SHUTTLE LAUNCH T101S1	-1.500	21.000	0.000	BREF 3.5250 IN.
(B65012)	DATA NOT AVAILABLE FOR ALL CONDITIONS	-1.500	21.000	0.000	XMRP 3.4900 IN.
					YMRP 0.0000 IN.
					ZMRP 0.1616 IN.
					SCALE 0.0034

MACH .80

PAGE 2

CONFIGURATION BUILD-UP EFFECT ON LONGITUDINAL CHARACTERISTICS (346 INCH TANK)

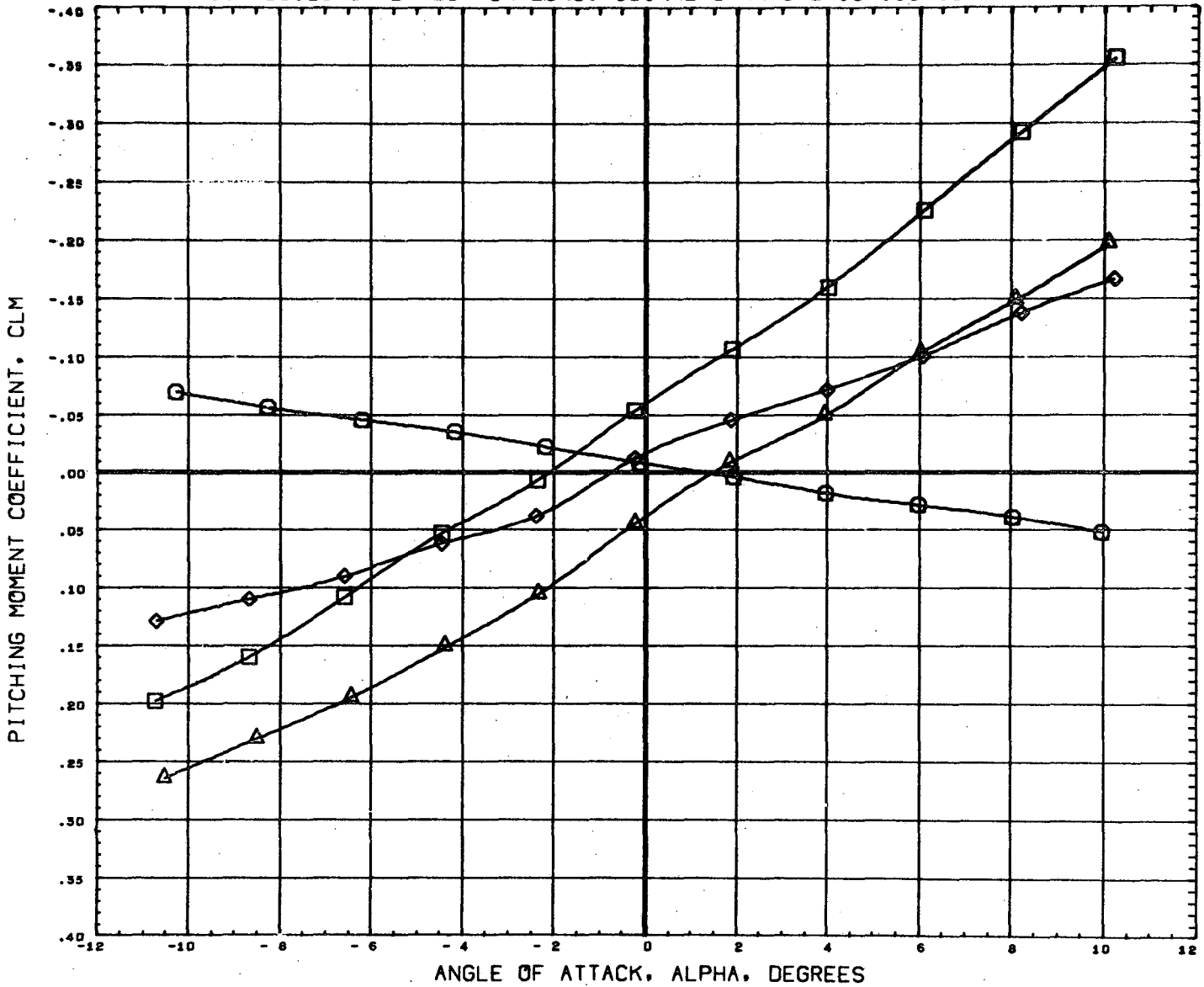

DATA SET SYMBOL	CONFIGURATION DESCRIPTION	ORBIN	THETS	BETA	REFERENCE INFORMATION	
(865001)	MSFC TWT 534 SHUTTLE LAUNCH	T1		0.000	SREF	4.8950 SQ. IN
(865002)	MSFC TWT 534 SHUTTLE LAUNCH	T101	-1.500	0.000	LREF	2.6440 IN.
(865004)	MSFC TWT 534 SHUTTLE LAUNCH	T101S1	-1.500	21.000	BREF	3.5250 IN.
(865012)	MSFC TWT 534 SHUTTLE LAUNCH	T101S1F1	-1.500	21.000	XMRP	3.4900 IN.
					YMRP	0.0000 IN.
					ZMRP	0.1616 IN.
					SCALE	0.0034

MACH .90

CONFIGURATION BUILD-UP EFFECT ON LONGITUDINAL CHARACTERISTICS (346 INCH TANK)

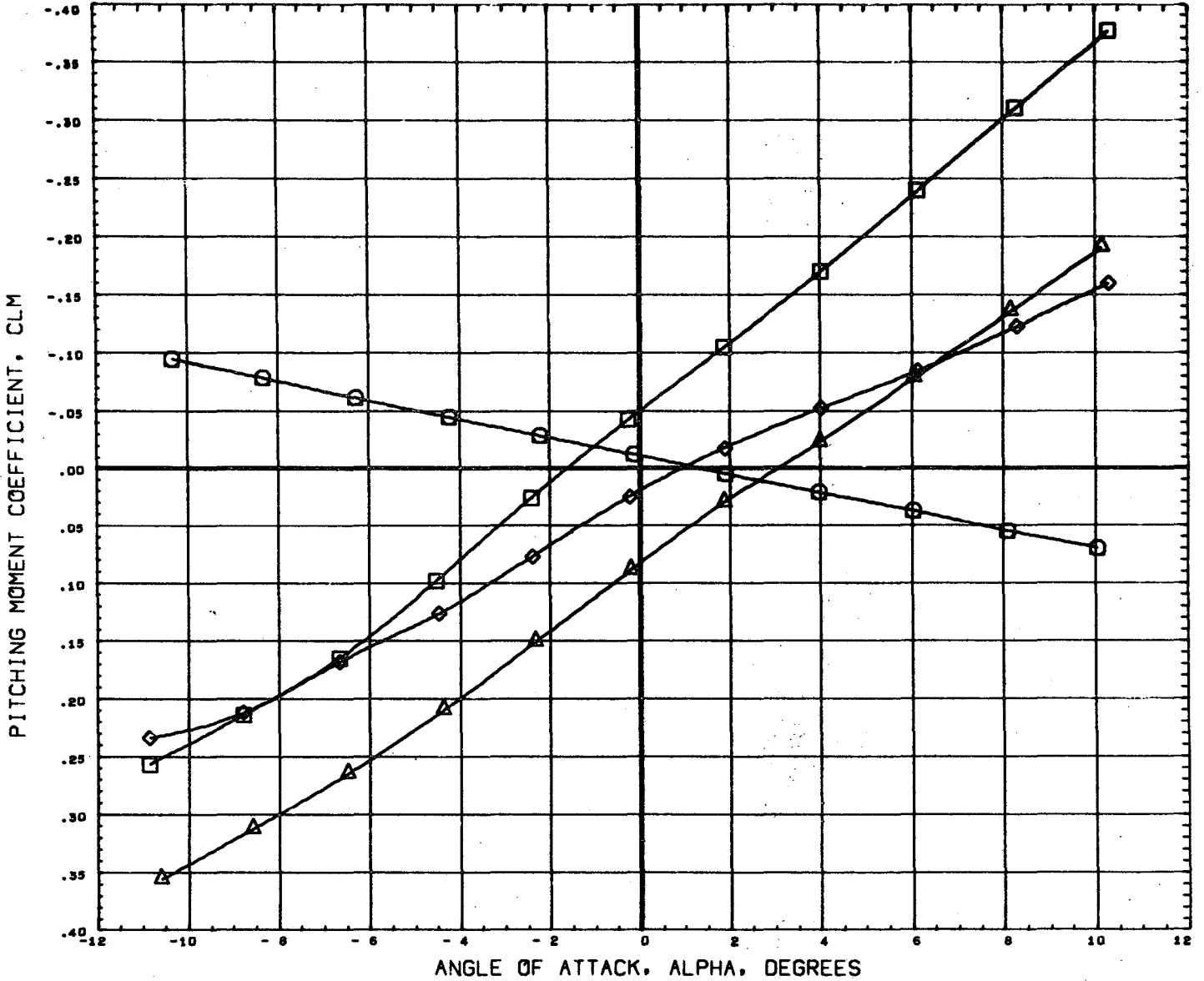

DATA SET SYMBOL	CONFIGURATION DESCRIPTION	T1	ORBIN	THETS	BETA	REFERENCE INFORMATION
(B65001)	MSFC TWT 534 SHUTTLE LAUNCH	T1	-1.500		0.000	SREF 4.8950 SQ. IN
(B65002)	MSFC TWT 534 SHUTTLE LAUNCH	T101	-1.500		0.000	LREF 2.6440 IN.
(B65004)	MSFC TWT 534 SHUTTLE LAUNCH	T101S1	-1.500	21.000	0.000	BREF 3.5250 IN.
(B65012)	MSFC TWT 534 SHUTTLE LAUNCH	T101S1F1	-1.500	21.000	0.000	XMRP 3.4900 IN.
						YMRP 0.0000 IN.
						ZMRP 0.1616 IN.
						SCALE 0.0034

CONFIGURATION BUILD-UP EFFECT ON LONGITUDINAL CHARACTERISTICS (346 INCH TANK)

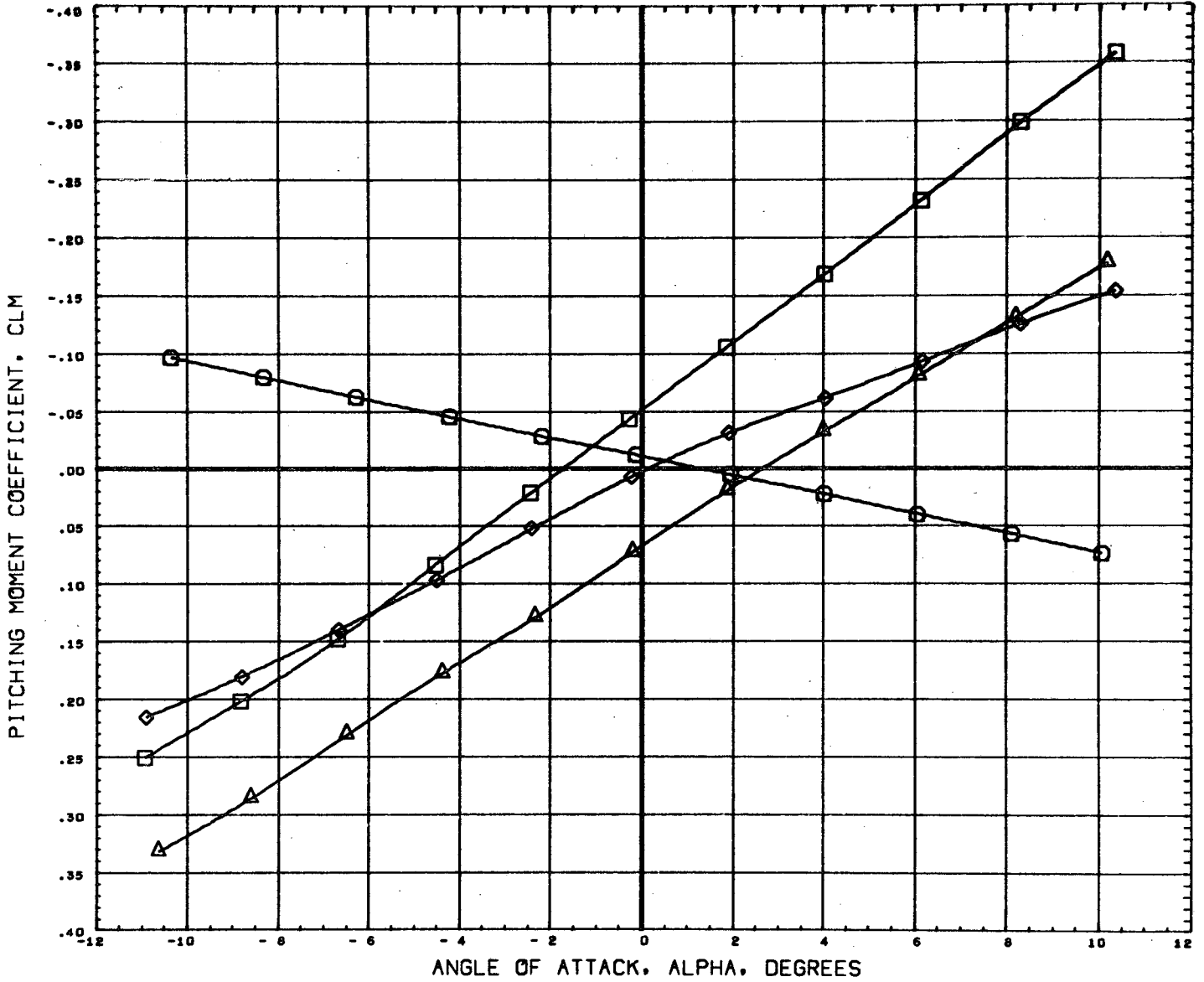

DATA SET SYMBOL	CONFIGURATION DESCRIPTION	T1	ORBIN	THETS	BETA	REFERENCE INFORMATION
(B65001)	MSFC TWT 534 SHUTTLE LAUNCH	T1			0.000	SREF 4.8950 SQ. IN
(B65002)	MSFC TWT 534 SHUTTLE LAUNCH	T101	-1.500		0.000	LREF 2.6440 IN.
(B65004)	MSFC TWT 534 SHUTTLE LAUNCH	T101S1	-1.500	21.000	0.000	BREF 3.5250 IN.
(B65012)	MSFC TWT 534 SHUTTLE LAUNCH	T101S1F1	-1.500	21.000	0.000	XMRP 3.4900 IN.
						YMRP 0.0000 IN.
						ZMRP 0.1616 IN.
						SCALE 0.0034

CONFIGURATION BUILD-UP EFFECT ON LONGITUDINAL CHARACTERISTICS (346 INCH TANK)

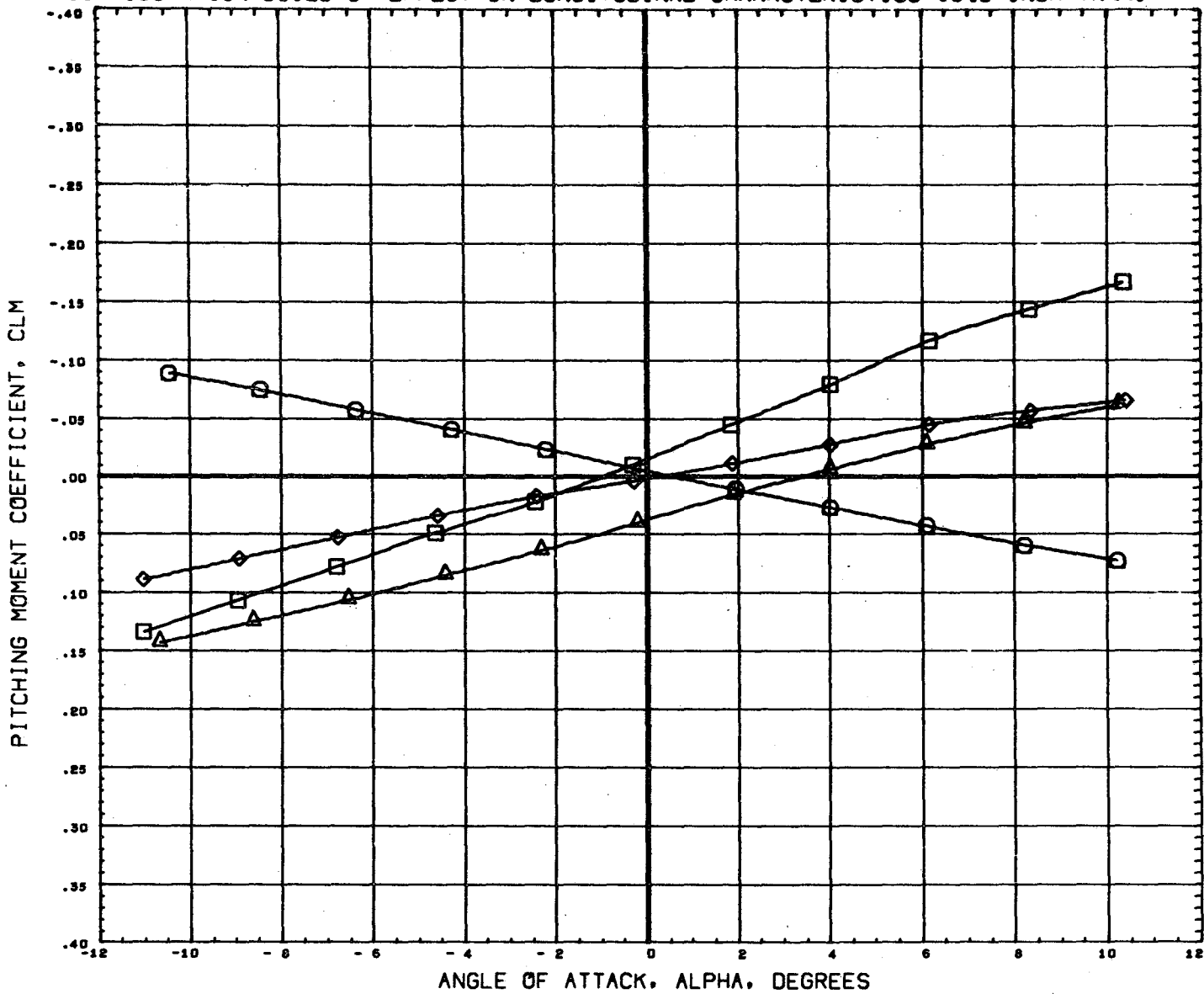

DATA SET SYMBOL	CONFIGURATION DESCRIPTION	ORBIN	THETS	BETA	REFERENCE INFORMATION
(B65001)	MSFC TWT 534 SHUTTLE LAUNCH	T1		0.000	SREF 4.8950 SQ. IN
(B65002)	MSFC TWT 534 SHUTTLE LAUNCH	T101	-1.500	0.000	LREF 2.6440 IN.
(B65004)	MSFC TWT 534 SHUTTLE LAUNCH	T101S1	-1.500	21.000	BREF 3.5250 IN.
(B65012)	MSFC TWT 534 SHUTTLE LAUNCH	T101S1F1	-1.500	21.000	0.000
					XMRP 3.4900 IN.
					YMRP 0.0000 IN.
					ZMRP 0.1616 IN.
					SCALE 0.0034

MACH 1.97

PAGE 6

CONFIGURATION BUILD-UP EFFECT ON LONGITUDINAL CHARACTERISTICS (346 INCH TANK)

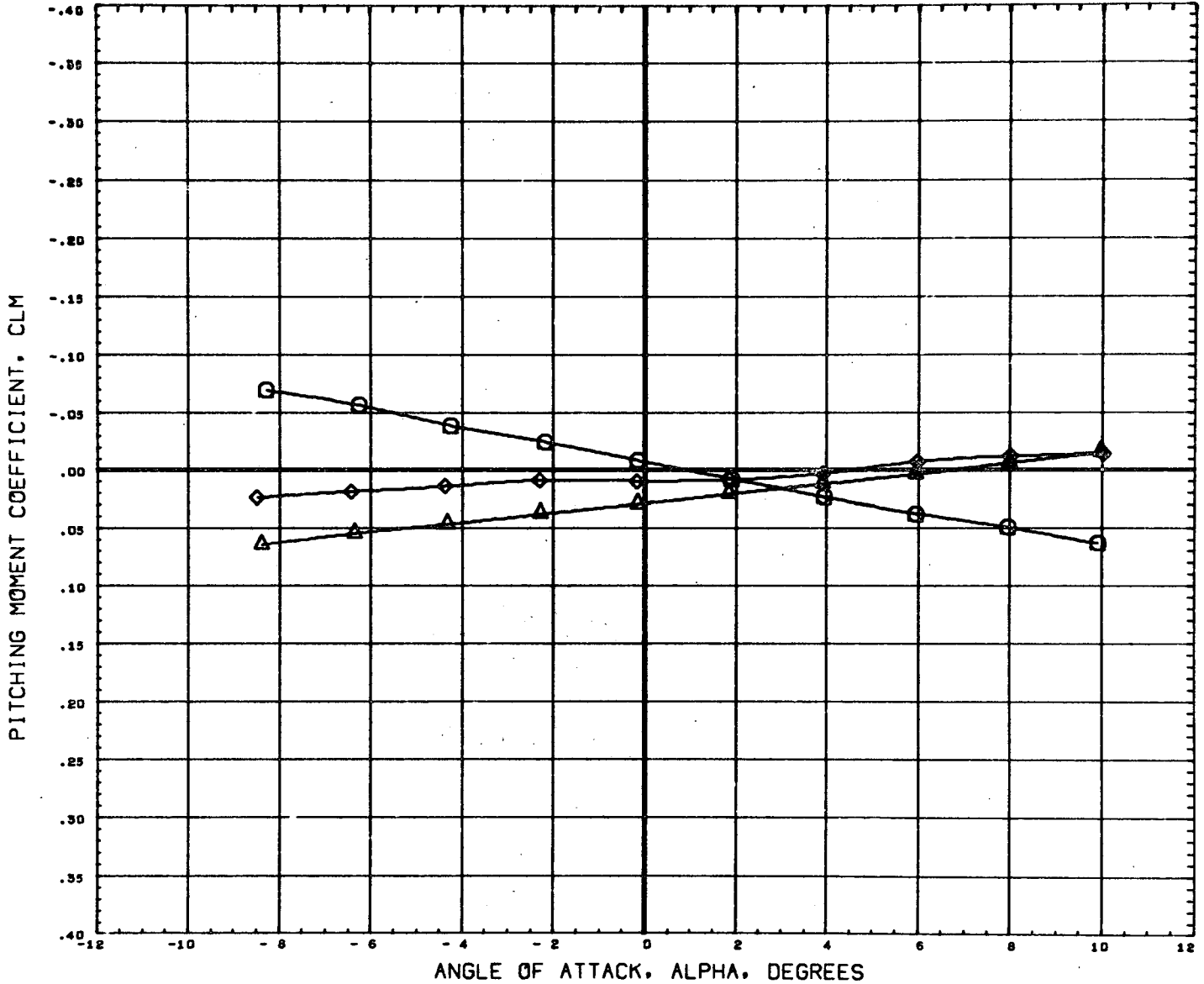

DATA SET SYMBOL	CONFIGURATION DESCRIPTION	ORBIN	THETS	BETA	REFERENCE INFORMATION
(B65001)	MSFC TWT 534 SHUTTLE LAUNCH T1	-1.500		0.000	SREF 4.8950 SQ. IN
(B65002)	MSFC TWT 534 SHUTTLE LAUNCH T1O1	-1.500		0.000	LREF 2.6440 IN.
(B65004)	MSFC TWT 534 SHUTTLE LAUNCH T1O1S1	-1.500	21.000	0.000	BREF 3.5250 IN.
(B65012)	DATA NOT AVAILABLE FOR ALL CONDITIONS	-1.500	21.000	0.000	XMRP 3.4900 IN.
					YMRP 0.0000 IN.
					ZMRP 0.1616 IN.
					SCALE 0.0034

MACH 2.74

PAGE 7

CONFIGURATION BUILD-UP EFFECT ON LONGITUDINAL CHARACTERISTICS (346 INCH TANK)

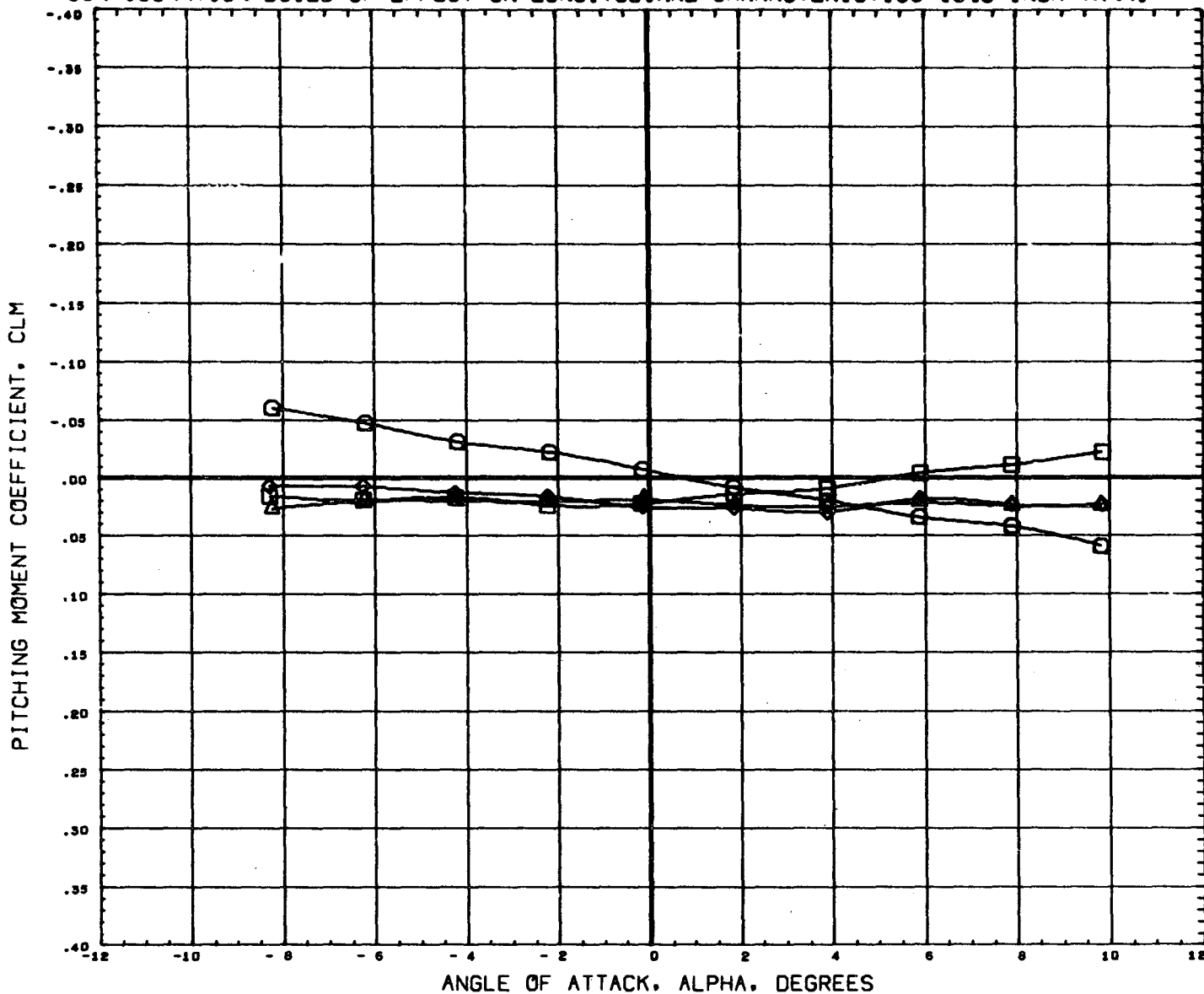

DATA SET SYMBOL	CONFIGURATION DESCRIPTION	ORBIN	THETS	BETA	REFERENCE INFORMATION
(B65001)	MSFC TWT 534 SHUTTLE LAUNCH	T1		0.000	SREF 4.8950 SQ. IN
(B65002)	MSFC TWT 534 SHUTTLE LAUNCH	T101	-1.500	0.000	LREF 2.6440 IN.
(B65004)	MSFC TWT 534 SHUTTLE LAUNCH	T10191	-1.500	21.000	BREF 3.5250 IN.
(B65012)	MSFC TWT 534 SHUTTLE LAUNCH	T101S1F1	-1.500	21.000	0.0000 IN.
					ZMRP 0.1616 IN.
					SCALE 0.0034

CONFIGURATION BUILD-UP EFFECT ON LONGITUDINAL CHARACTERISTICS (346 INCH TANK)

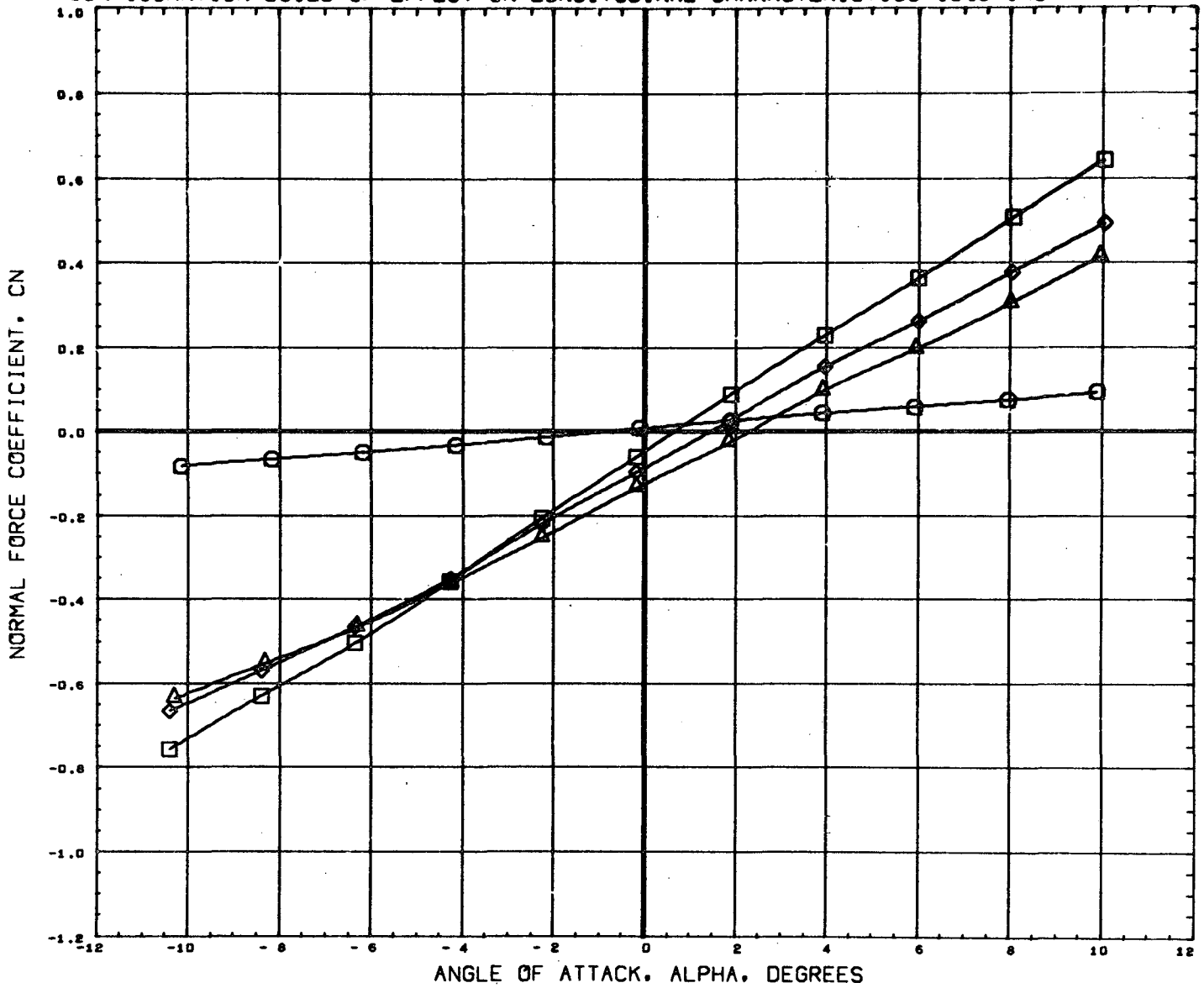

DATA SET SYMBOL	CONFIGURATION DESCRIPTION	ORBIN	THETS	BETA	REFERENCE INFORMATION
(B65001)	MSFC TWT 534 SHUTTLE LAUNCH T1			0.000	SREF 4.8950 SQ. IN
(B65002)	MSFC TWT 534 SHUTTLE LAUNCH T101	-1.500		0.000	LREF 2.6440 IN.
(B65004)	MSFC TWT 534 SHUTTLE LAUNCH T101S1	-1.500	21.000	0.000	BREF 3.5250 IN.
(B65012)	MSFC TWT 534 SHUTTLE LAUNCH T101S1F1	-1.500	21.000	0.000	XMRP 3.4900 IN. YMRP 0.0000 IN. ZMRP 0.1616 IN. SCALE 0.0034

MACH .60

CONFIGURATION BUILD-UP EFFECT ON LONGITUDINAL CHARACTERISTICS (346 INCH TANK)

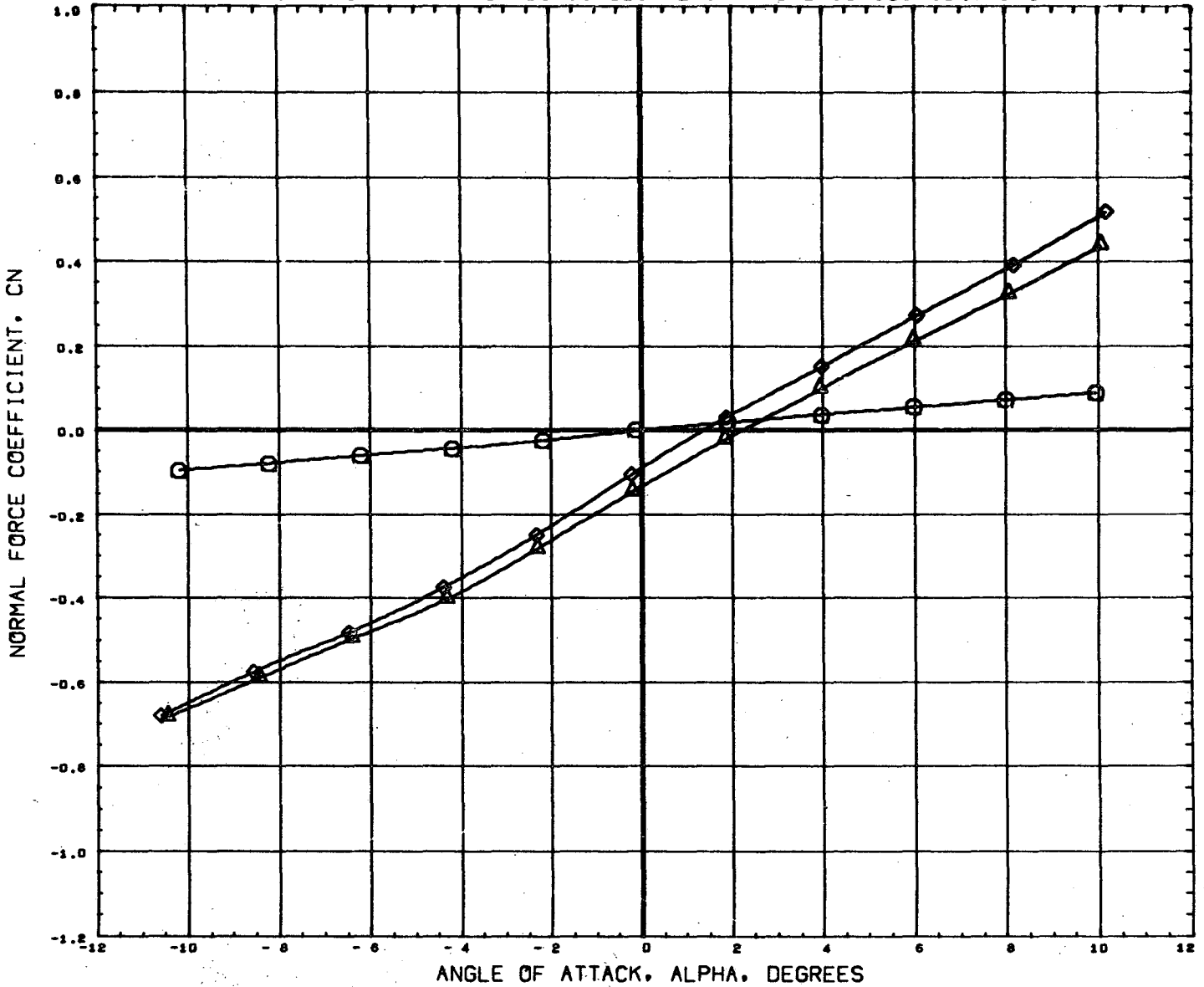

DATA SET SYMBOL	CONFIGURATION DESCRIPTION	ORBIN	THETS	BETA	REFERENCE INFORMATION
(B65001)	MSFC TWT 534 SHUTTLE LAUNCH T1			0.000	SREF 4.8950 SQ. IN
(B65002)	MSFC TWT 534 SHUTTLE LAUNCH T101	-1.500		0.000	LREF 2.6440 IN.
(B65004)	MSFC TWT 534 SHUTTLE LAUNCH T101S1	-1.500	21.000	0.000	BREF 3.5250 IN.
(B65012)	DATA NOT AVAILABLE FOR ALL CONDITIONS	-1.500	21.000	0.000	XNRP 3.4900 IN.
					YNRP 0.0000 IN.
					ZMRP 0.1616 IN.
					SCALE 0.0034

MACH .80

CONFIGURATION BUILD-UP EFFECT ON LONGITUDINAL CHARACTERISTICS (346 INCH TANK)

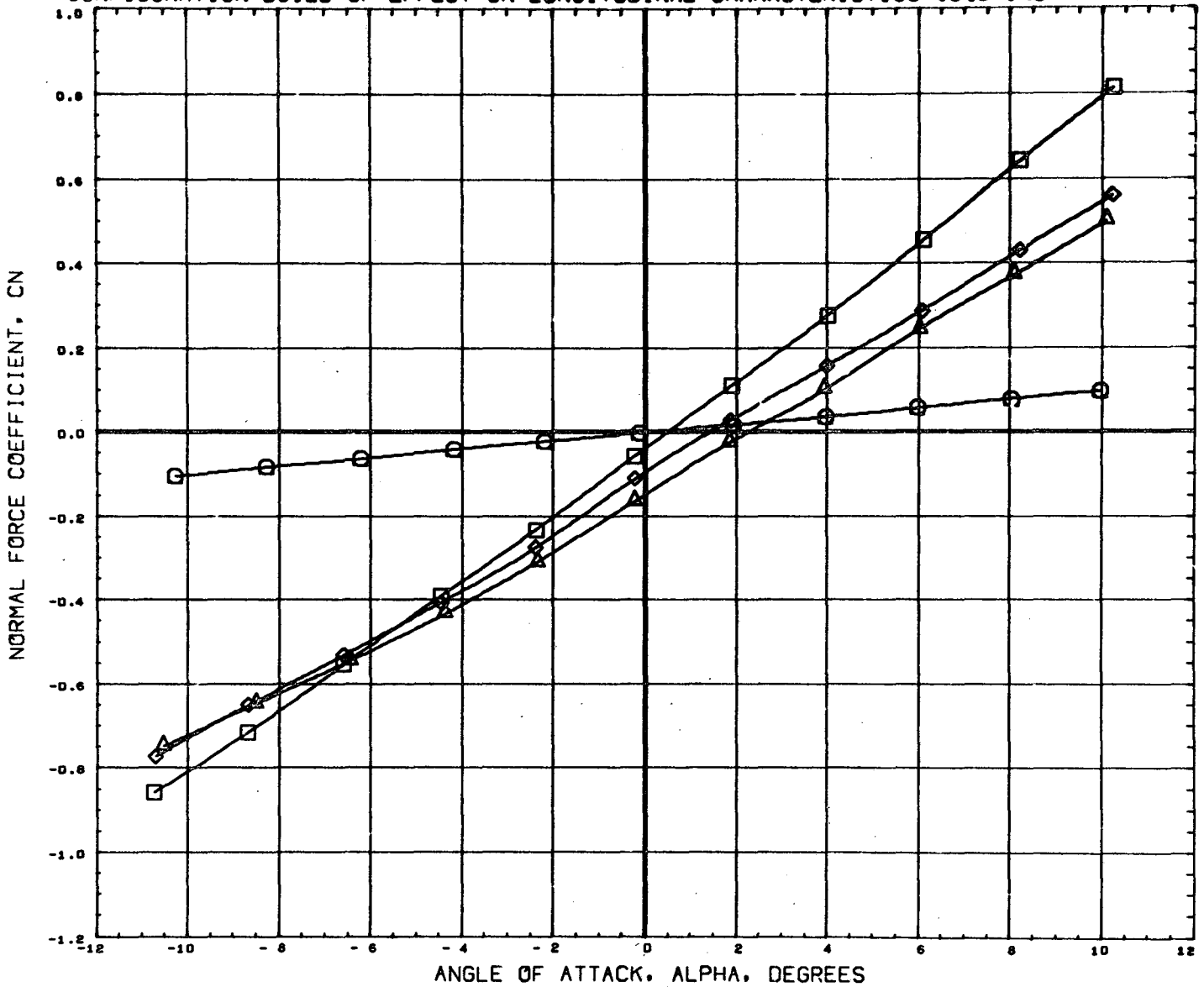

DATA SET SYMBOL	CONFIGURATION DESCRIPTION	T1	ORBIN	THETS	BETA	REFERENCE INFORMATION
(B65D01)	MSFC TWT 534 SHUTTLE LAUNCH	T1	-1.500		0.000	SREF 4.8950 SQ. IN
(B65D02)	MSFC TWT 534 SHUTTLE LAUNCH	T1O1	-1.500		0.000	LREF 2.6440 IN.
(B65D04)	MSFC TWT 534 SHUTTLE LAUNCH	T1O1S1	-1.500	21.000	0.000	BREF 3.5250 IN.
(B65D12)	MSFC TWT 534 SHUTTLE LAUNCH	T1O1S1F1	-1.500	21.000	0.000	XMRP 3.4900 IN.
						YMRP 0.0000 IN.
						ZMRP 0.1616 IN.
						SCALE 0.0034

MACH .90

PAGE 11

CONFIGURATION BUILD-UP EFFECT ON LONGITUDINAL CHARACTERISTICS (346 INCH TANK)

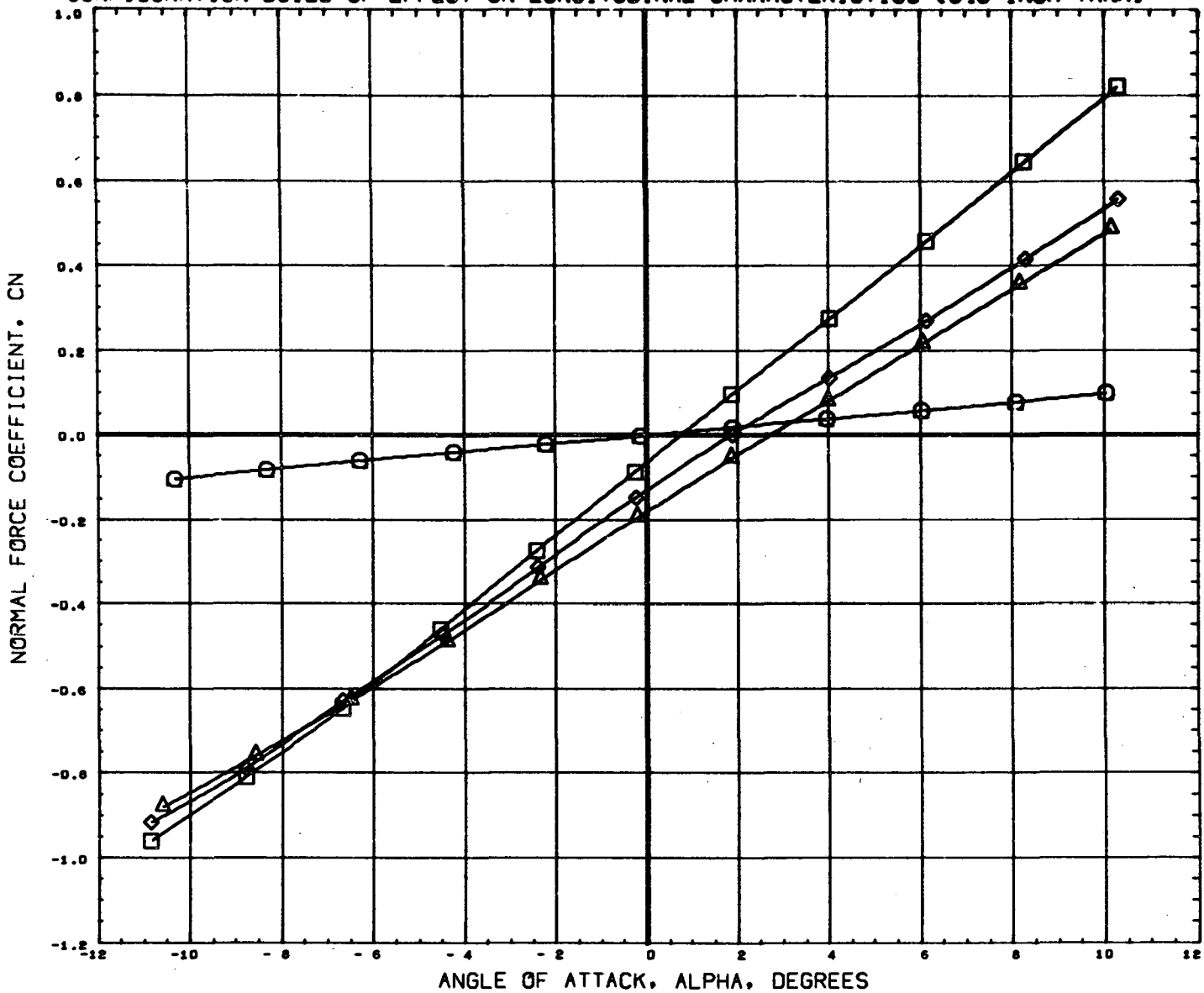

DATA SET SYMBOL	CONFIGURATION DESCRIPTION	ORBIN	THETS	BETA	REFERENCE INFORMATION
(B65001)	NSFC TWT 534 SHUTTLE LAUNCH T1			0.000	SREF 4.8950 SQ. IN
(B65002)	NSFC TWT 534 SHUTTLE LAUNCH T101	-1.500		0.000	LREF 2.6440 IN.
(B65004)	NSFC TWT 534 SHUTTLE LAUNCH T101S1	-1.500	21.000	0.000	BREF 3.5250 IN.
(B65012)	NSFC TWT 534 SHUTTLE LAUNCH T101S1F1	-1.500	21.000	0.000	XNRP 3.4900 IN.
					YNRP 0.0000 IN.
					ZNRP 0.1616 IN.
					SCALE 0.0034

MACH 1.10

CONFIGURATION BUILD-UP EFFECT ON LONGITUDINAL CHARACTERISTICS (346 INCH TANK)

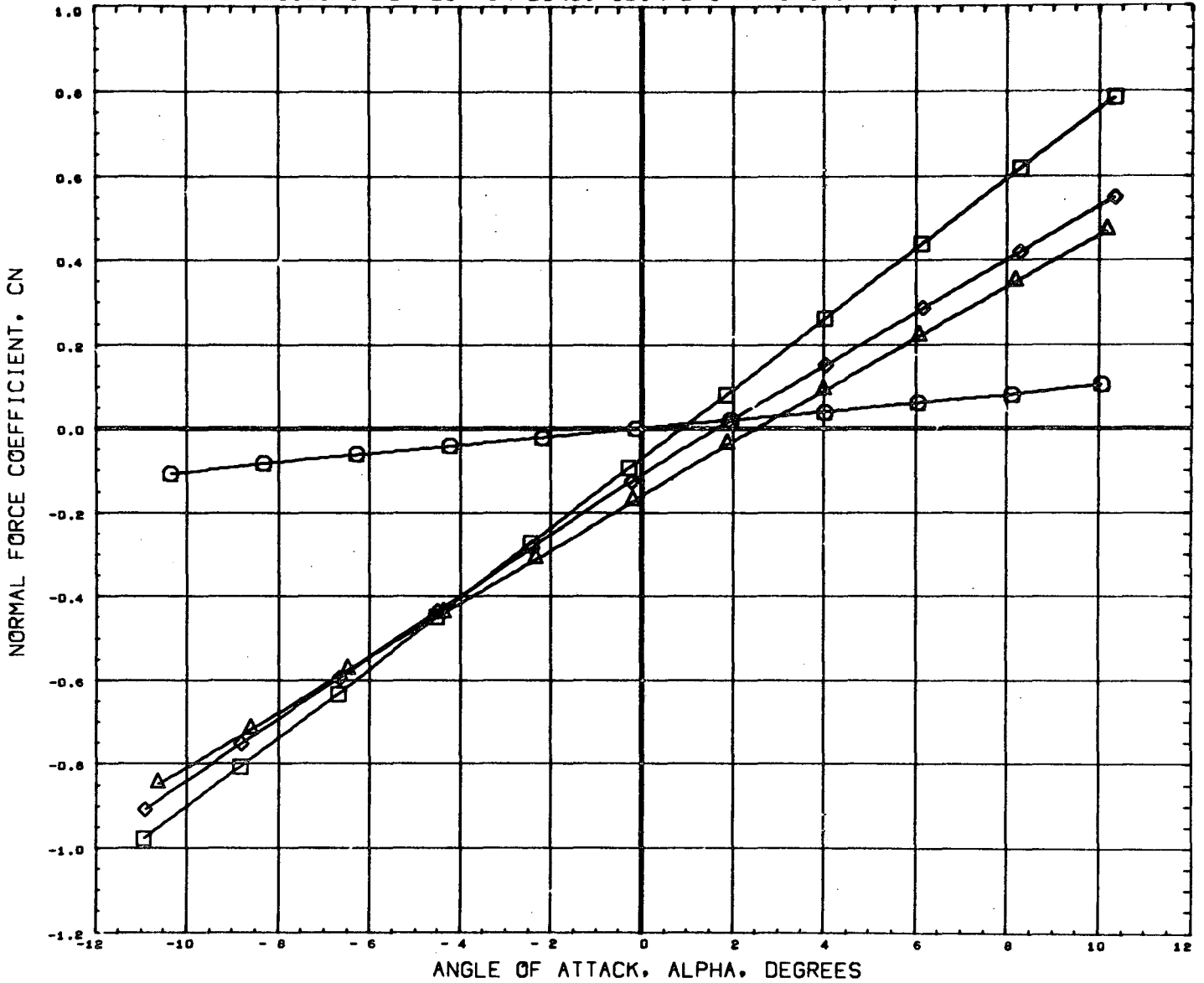

DATA SET SYMBOL	CONFIGURATION DESCRIPTION	ORBIN	THETS	BETA	REFERENCE INFORMATION
(B65001)	MSFC TWT 534 SHUTTLE LAUNCH	T1		0.000	SREF 4.8950 SQ. IN
(B65002)	MSFC TWT 534 SHUTTLE LAUNCH	T101	-1.500	0.000	LREF 2.6440 IN.
(B65004)	MSFC TWT 534 SHUTTLE LAUNCH	T101S1	-1.500	21.000	BREF 3.5250 IN.
(B65012)	MSFC TWT 534 SHUTTLE LAUNCH	T101S1F1	-1.500	21.000	0.000
					XMRP 3.4900 IN.
					YMRP 0.0000 IN.
					ZMRP 0.1616 IN.
					SCALE 0.0034

MACH 1.20

CONFIGURATION BUILD-UP EFFECT ON LONGITUDINAL CHARACTERISTICS (346 INCH TANK)

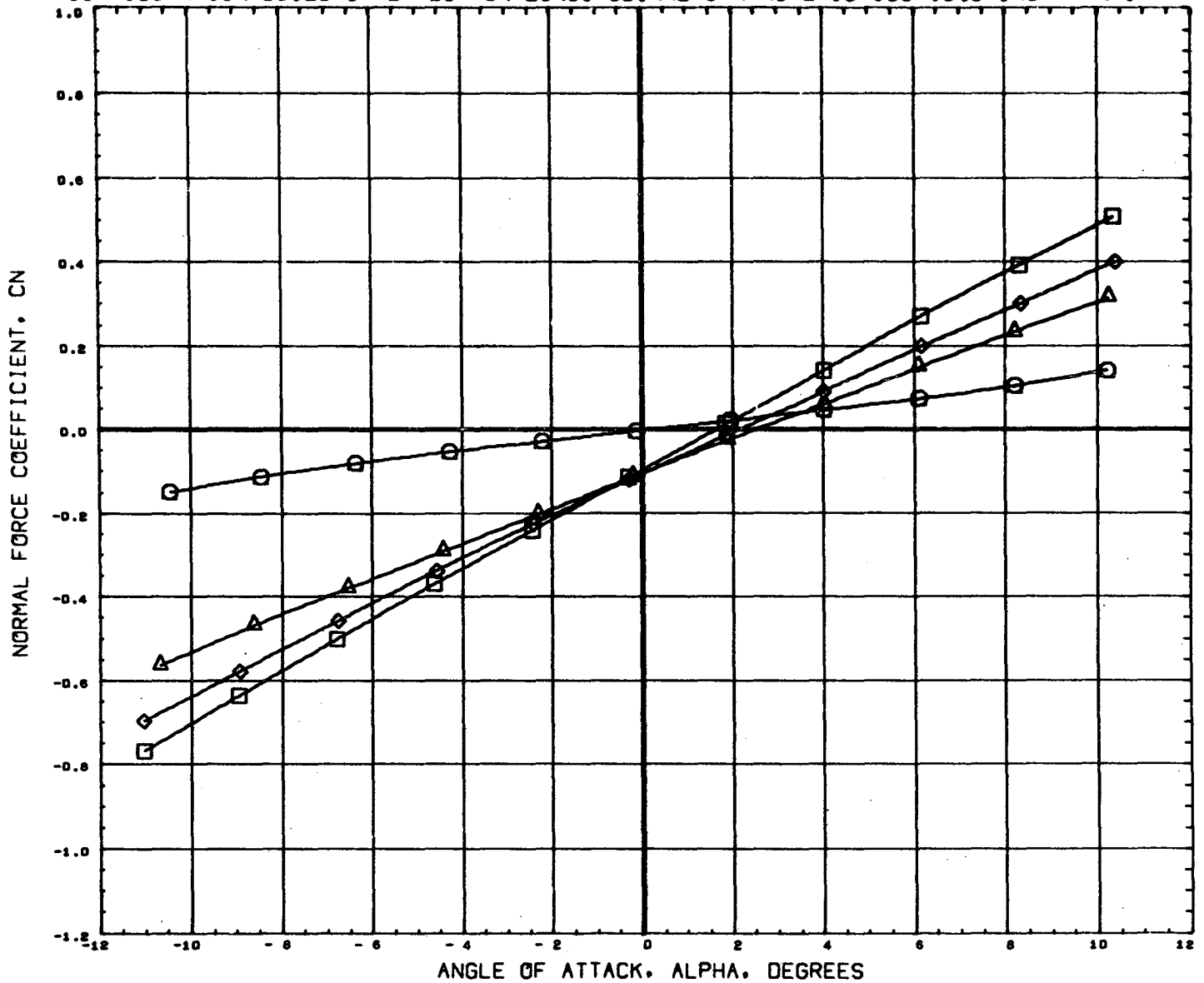

DATA SET SYMBOL	CONFIGURATION DESCRIPTION	ORBIN	THETS	BETA	REFERENCE INFORMATION
(B65001)	MSFC TWT 534 SHUTTLE LAUNCH	T1		0.000	SREF 4.8950 SQ. IN
(B65002)	MSFC TWT 534 SHUTTLE LAUNCH	T101	-1.500	0.000	LREF 2.6440 IN.
(B65004)	MSFC TWT 534 SHUTTLE LAUNCH	T101S1	-1.500	21.000	BREF 3.5250 IN.
(B65012)	MSFC TWT 534 SHUTTLE LAUNCH	T101S1F1	-1.500	21.000	0.000
					XNRP 3.4900 IN.
					YNRP 0.0000 IN.
					ZNRP 0.1616 IN.
					SCALE 0.0034

CONFIGURATION BUILD-UP EFFECT ON LONGITUDINAL CHARACTERISTICS (346 INCH TANK)

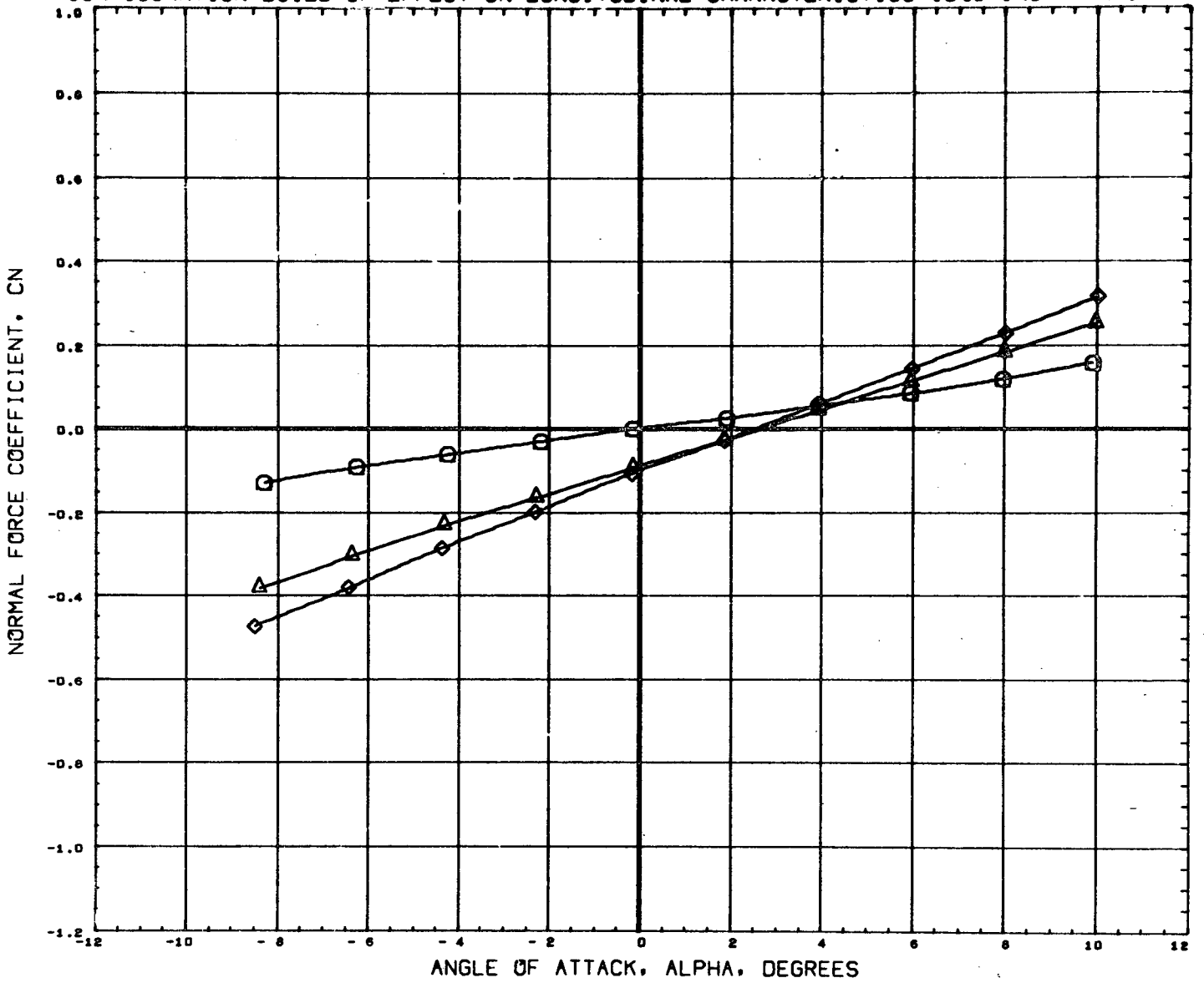

DATA SET SYMBOL	CONFIGURATION DESCRIPTION	ORBIN	THETS	BETA	REFERENCE INFORMATION
(B65001)	MSFC TWT 534 SHUTTLE LAUNCH T1			0.000	SREF 4.0950 SQ. IN
(B65002)	MSFC TWT 534 SHUTTLE LAUNCH T101	-1.500		0.000	LREF 2.6440 IN.
(B65004)	MSFC TWT 534 SHUTTLE LAUNCH T101S1	-1.500	21.000	0.000	BREF 3.5250 IN.
(B65012)	DATA NOT AVAILABLE FOR ALL CONDITIONS	-1.500	21.000	0.000	XNRP 3.4900 IN.
					YNRP 0.0000 IN.
					ZNRP 0.1616 IN.
					SCALE 0.0034

MACH 2.74

CONFIGURATION BUILD-UP EFFECT ON LONGITUDINAL CHARACTERISTICS (346 INCH TANK)

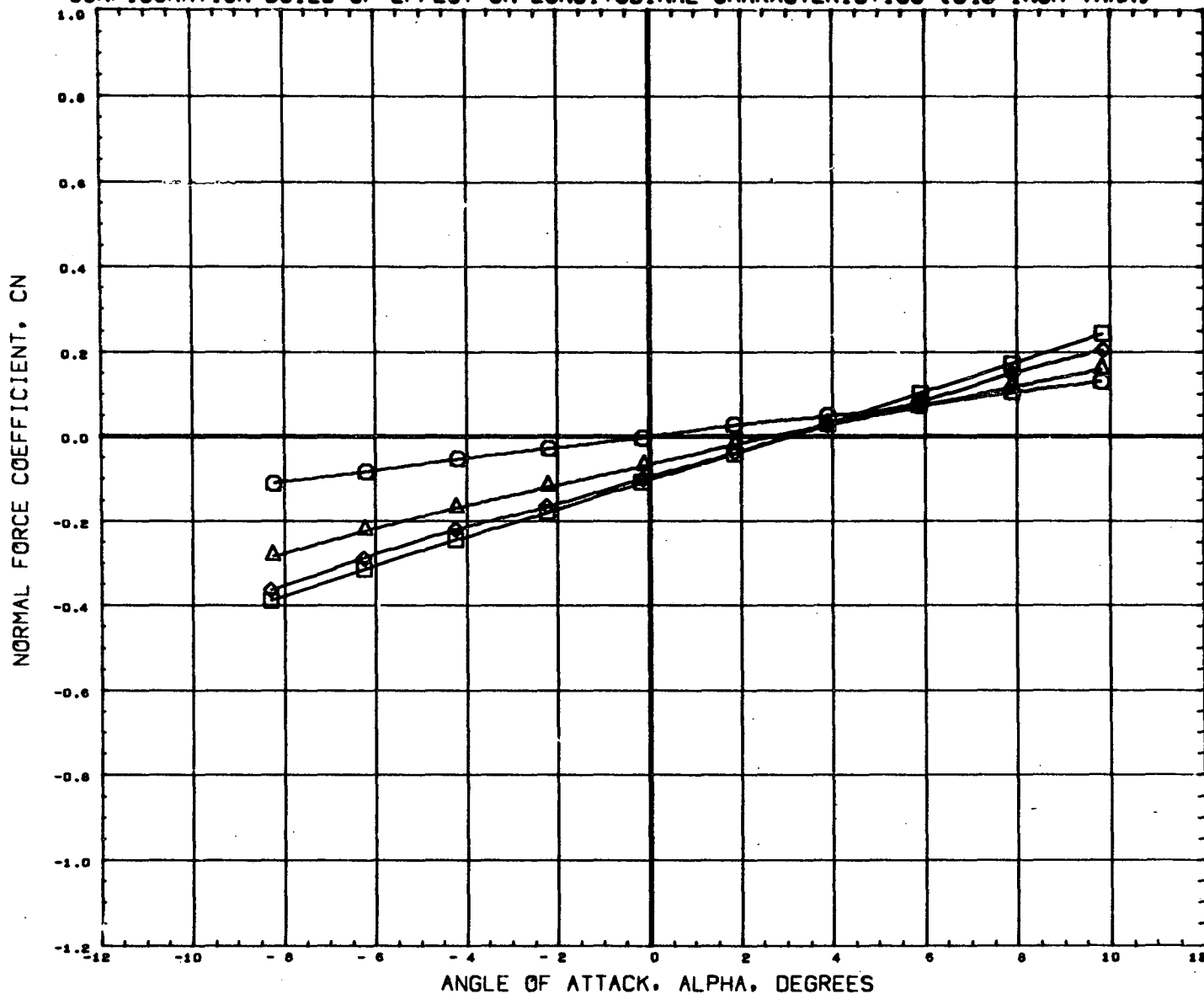

DATA SET SYMBOL	CONFIGURATION DESCRIPTION	T1	ORBIN	THETS	BETA	REFERENCE INFORMATION
(B65001)	MSFC TWT 534 SHUTTLE LAUNCH	T1	-1.500		0.000	SREF 4.8950 SQ. IN
(B65002)	MSFC TWT 534 SHUTTLE LAUNCH	T1O1	-1.500		0.500	LREF 2.6440 IN.
(B65004)	MSFC TWT 534 SHUTTLE LAUNCH	T1O1S1	-1.500	21.000	0.000	BREF 3.5250 IN.
(B65012)	MSFC TWT 534 SHUTTLE LAUNCH	T1O1S1F1	-1.500	21.000	0.000	XMRP 3.4900 IN. YMRP 0.0000 IN. ZMRP 0.1616 IN. SCALE 0.0034

CONFIGURATION BUILD-UP EFFECT ON LONGITUDINAL CHARACTERISTICS (346 INCH TANK)

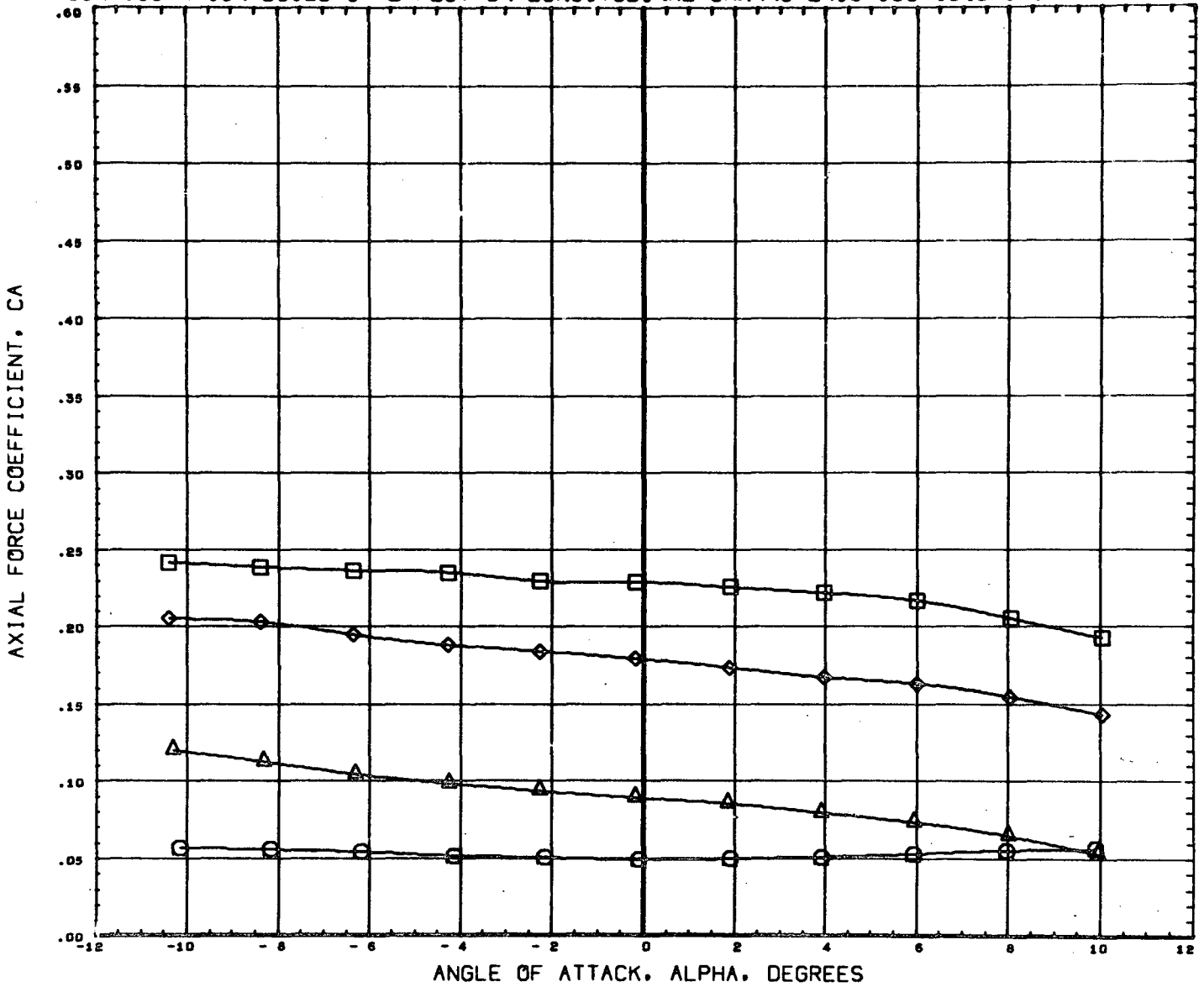

DATA SET SYMBOL	CONFIGURATION DESCRIPTION	ORBIN	THETS	BETA	REFERENCE INFORMATION
(B65001)	MSFC TWT 534 SHUTTLE LAUNCH	T1		0.000	SREF 4.8950 SQ. IN
(B65002)	MSFC TWT 534 SHUTTLE LAUNCH	T101	-1.500	0.000	LREF 2.6440 IN.
(B65004)	MSFC TWT 534 SHUTTLE LAUNCH	T101S1	-1.500	21.000	BREF 3.5250 IN.
(B65012)	MSFC TWT 534 SHUTTLE LAUNCH	T101S1F1	-1.500	21.000	XNRP 3.4900 IN.
					YNRP 0.0000 IN.
					ZNRP 0.1616 IN.
					SCALE 0.0034

MACH .60

CONFIGURATION BUILD-UP EFFECT ON LONGITUDINAL CHARACTERISTICS (346 INCH TANK)

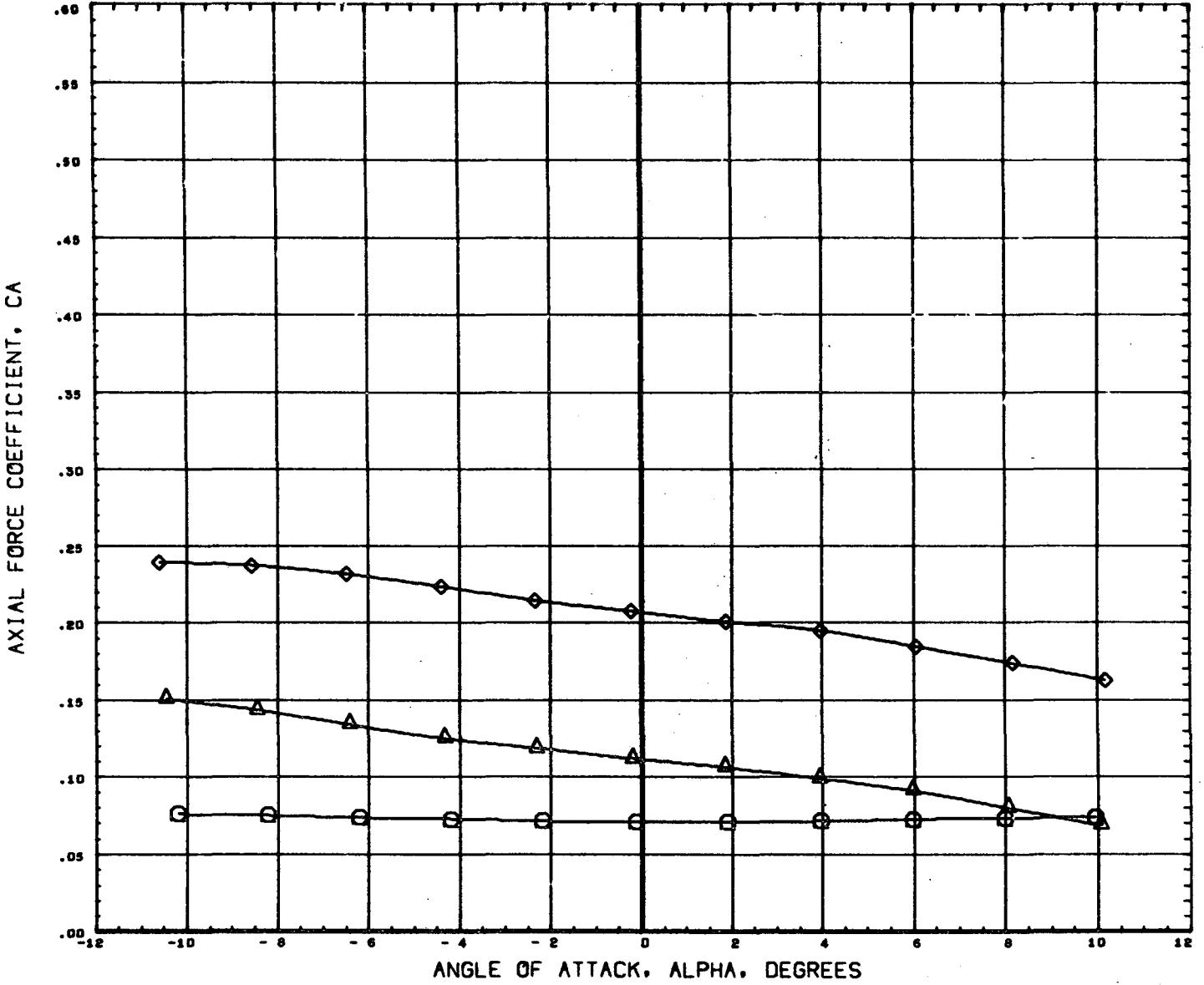

DATA SET SYMBOL	CONFIGURATION DESCRIPTION	ORBIN	THETS	BETA	REFERENCE INFORMATION
(B65001)	MSFC TWT 534 SHUTTLE LAUNCH T1	-1.500		0.000	SREF 4.8950 SQ. IN
(B65002)	MSFC TWT 534 SHUTTLE LAUNCH T101	-1.500		0.000	LREF 2.6440 IN.
(B65004)	MSFC TWT 534 SHUTTLE LAUNCH T101S1	-1.500	21.000	0.000	BREF 3.5250 IN.
(B65012)	DATA NOT AVAILABLE FOR ALL CONDITIONS	-1.500	21.000	0.000	XMRP 3.4900 IN.
					YMRP 0.0000 IN.
					ZMRP 0.1616 IN.
					SCALE 0.0034

CONFIGURATION BUILD-UP EFFECT ON LONGITUDINAL CHARACTERISTICS (346 INCH TANK)

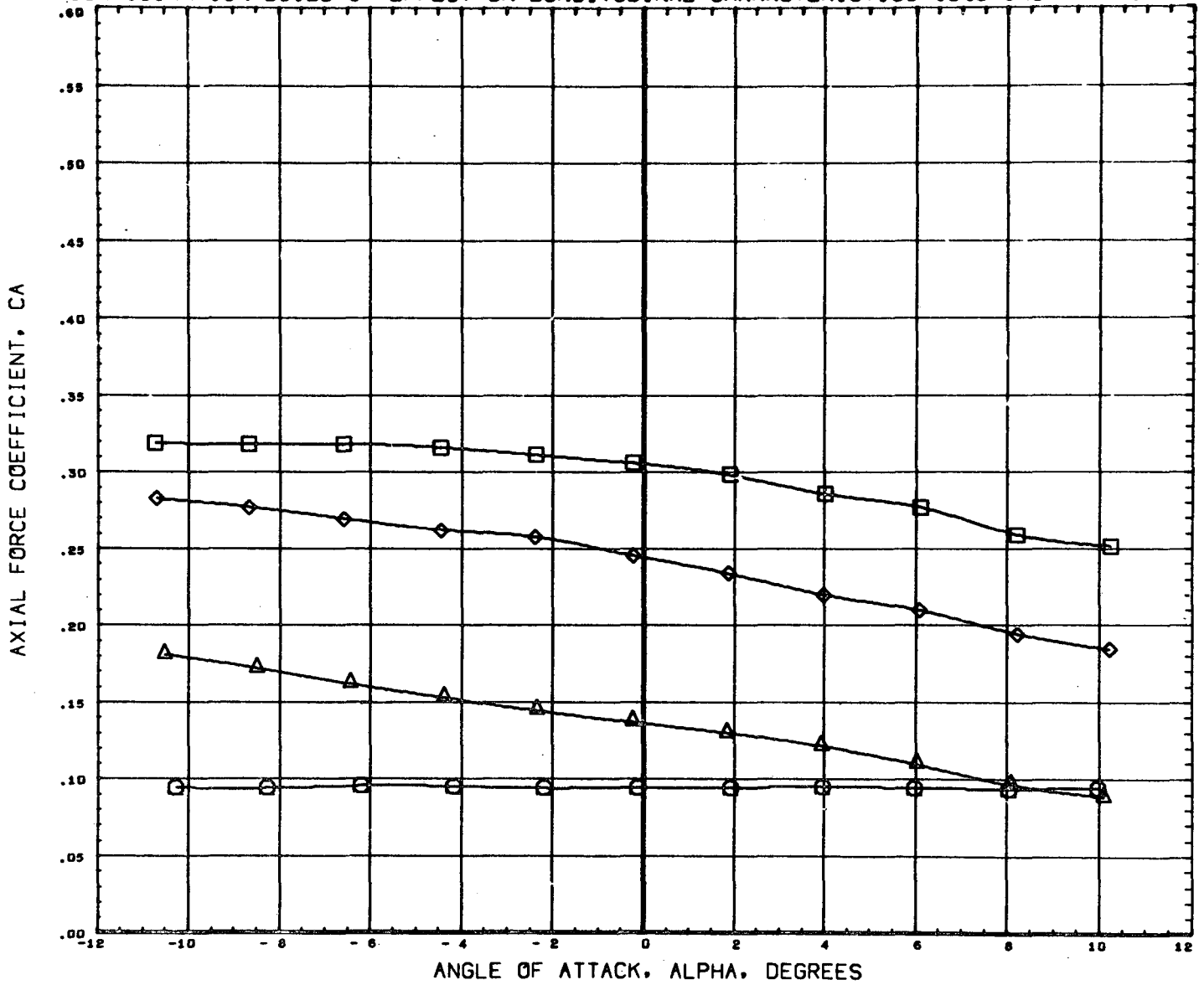

DATA SET SYMBOL	CONFIGURATION DESCRIPTION	T1	ORBIN	THETS	BETA	REFERENCE INFORMATION
(B65001)	NSFC TWT 534 SHUTTLE LAUNCH	T1			0.000	SREF 4.8950 SQ. IN
(B65002)	NSFC TWT 534 SHUTTLE LAUNCH	T1O1	-1.500		0.000	LREF 2.6440 IN.
(B65004)	NSFC TWT 534 SHUTTLE LAUNCH	T1O1S1	-1.500	21.000	0.000	BREF 3.5250 IN.
(B65012)	NSFC TWT 534 SHUTTLE LAUNCH	T1O1S1F1	-1.500	21.000	0.000	XMRP 3.4900 IN. YMRP 0.0000 IN. ZMRP 0.1616 IN. SCALE 0.0034

MACH .90

CONFIGURATION BUILD-UP EFFECT ON LONGITUDINAL CHARACTERISTICS (346 INCH TANK)

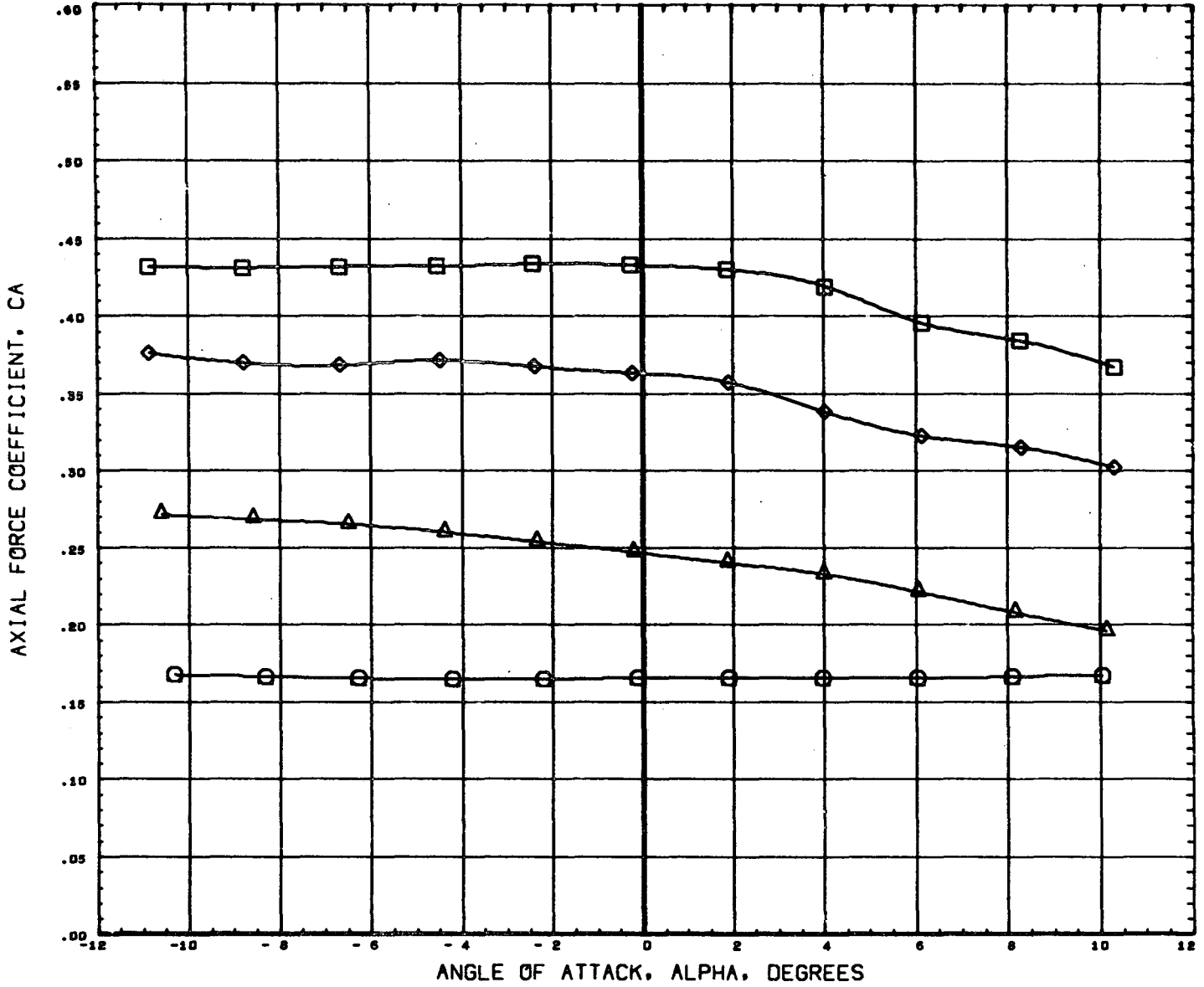

DATA SET SYMBOL	CONFIGURATION DESCRIPTION	T1	ORBIN	THETS	BETA	REFERENCE INFORMATION
(B65001)	MSFC TWT 534 SHUTTLE LAUNCH	T1			0.000	SREF 4.8950 SQ. IN
(B65002)	MSFC TWT 534 SHUTTLE LAUNCH	T101	-1.500		0.000	LREF 2.6440 IN.
(B65004)	MSFC TWT 534 SHUTTLE LAUNCH	T101S1	-1.500	21.000	0.000	BREF 3.5250 IN.
(B65012)	MSFC TWT 534 SHUTTLE LAUNCH	T101S1F1	-1.500	21.000	0.000	XMRP 3.4900 IN.
						YMRP 0.0000 IN.
						ZMRP 0.1616 IN.
						SCALE 0.0034

CONFIGURATION BUILD-UP EFFECT ON LONGITUDINAL CHARACTERISTICS (346 INCH TANK)

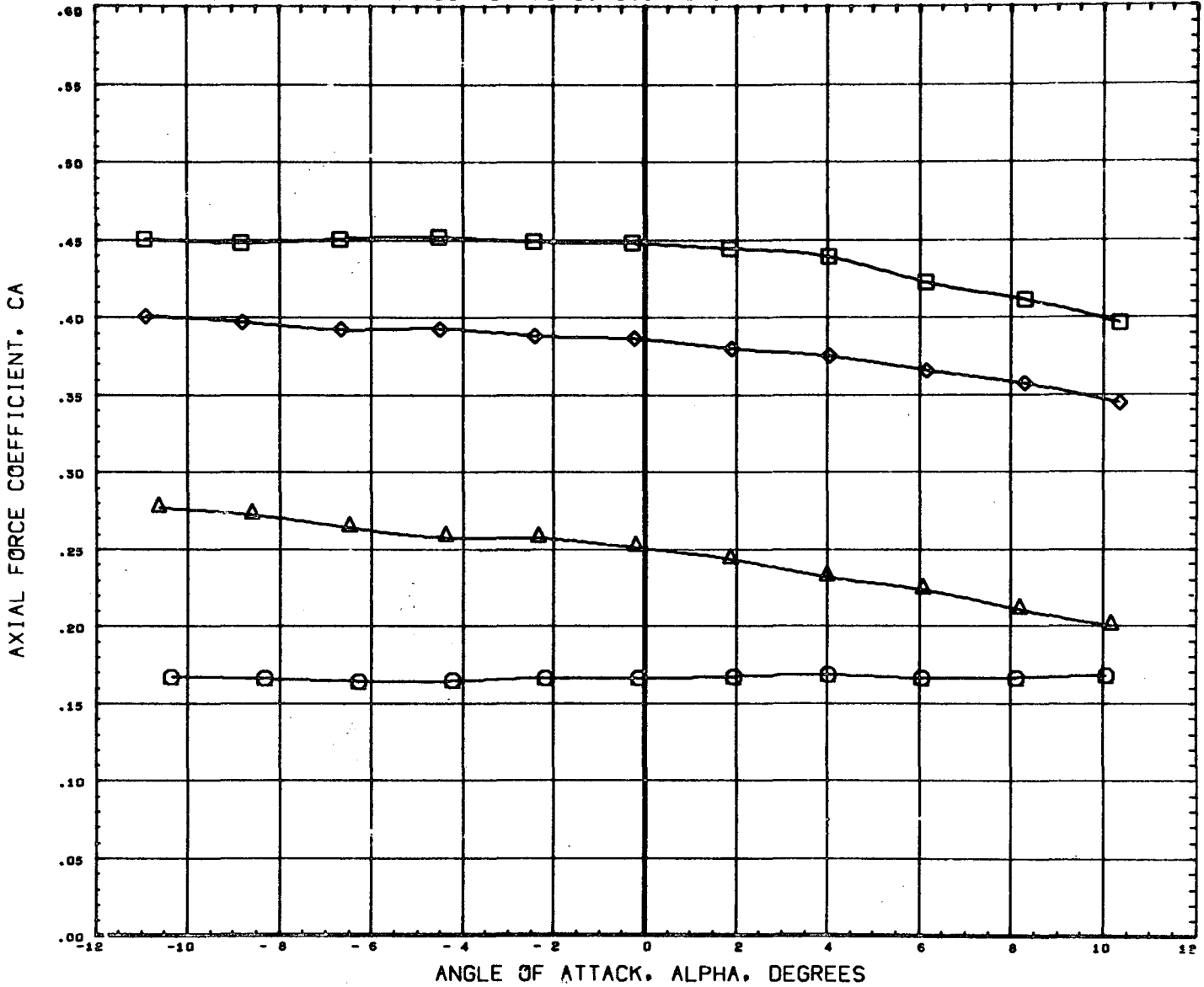

DATA SET SYMBOL	CONFIGURATION DESCRIPTION	ORBIN	THETS	BETA	REFERENCE INFORMATION
(B65001)	MSFC TWT 534 SHUTTLE LAUNCH T1			0.000	SREF 4.8950 SQ. IN
(B65002)	MSFC TWT 534 SHUTTLE LAUNCH T101	-1.500		0.000	LREF 2.6440 IN.
(B65004)	MSFC TWT 534 SHUTTLE LAUNCH T101S1	-1.500	21.000	0.000	BREF 3.5250 IN.
(B65012)	MSFC TWT 534 SHUTTLE LAUNCH T101S1F1	-1.500	21.000	0.000	XMRP 3.4900 IN.
					YMRP 0.0000 IN.
					ZMRP 0.1616 IN.
					SCALE 0.0034

CONFIGURATION BUILD-UP EFFECT ON LONGITUDINAL CHARACTERISTICS (346 INCH TANK)

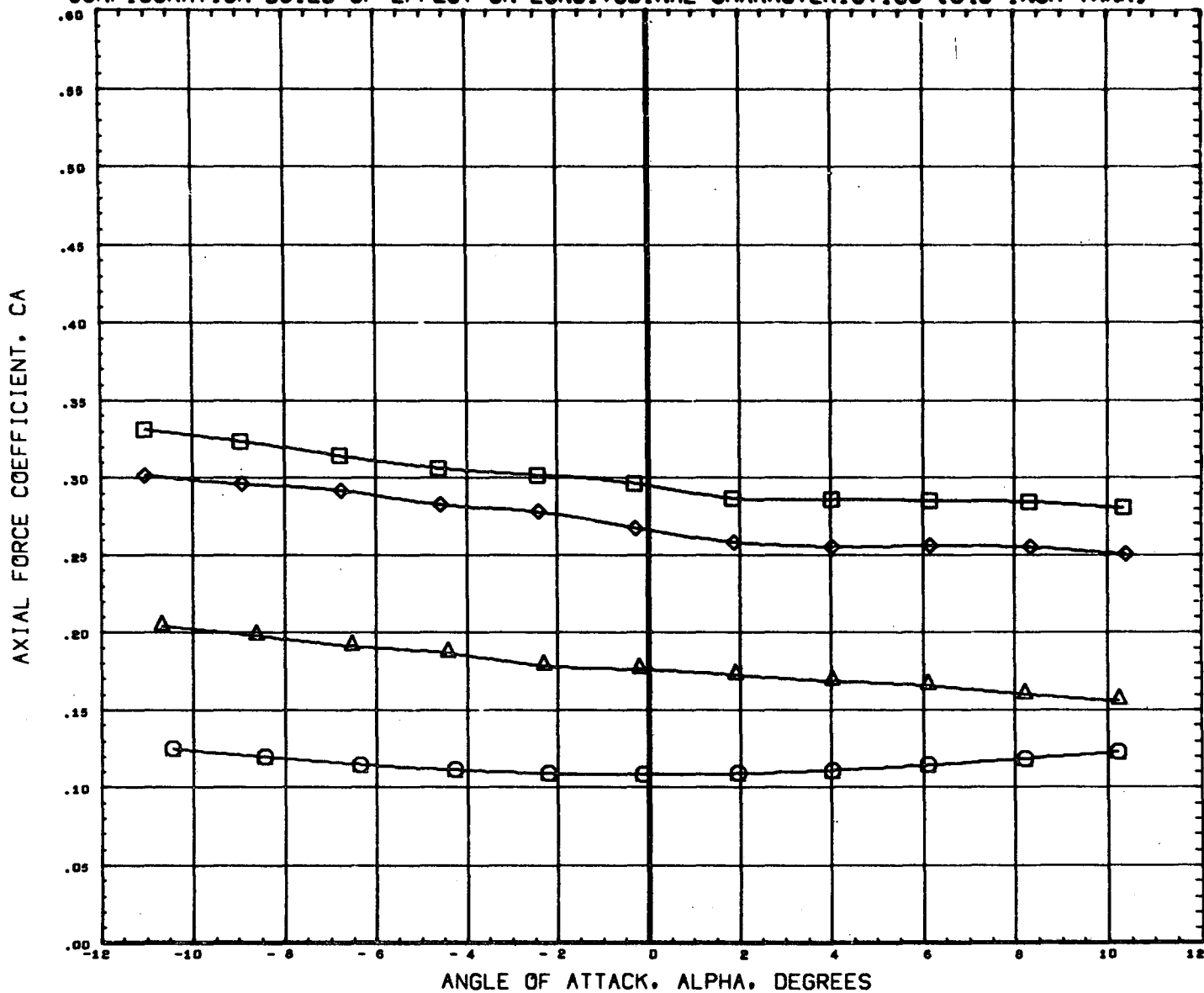

DATA SET SYMBOL	CONFIGURATION DESCRIPTION	ORBIN	THETS	BETA	REFERENCE INFORMATION
(B65001)	MSFC TWT 534 SHUTTLE LAUNCH	T1		0.000	SREF 4.8950 SQ. IN
(B65002)	MSFC TWT 534 SHUTTLE LAUNCH	T1O1	-1.500	0.000	LREF 2.6440 IN.
(B65004)	MSFC TWT 534 SHUTTLE LAUNCH	T1O1S1	-1.500	21.000	BREF 3.5250 IN.
(B65012)	MSFC TWT 534 SHUTTLE LAUNCH	T1O1S1F1	-1.500	21.000	0.000
					XMRP 3.4900 IN.
					YMRP 0.0000 IN.
					ZMRP 0.1616 IN.
					SCALE 0.0034

MACH 1.97

PAGE 22

CONFIGURATION BUILD-UP EFFECT ON LONGITUDINAL CHARACTERISTICS (346 INCH TANK)

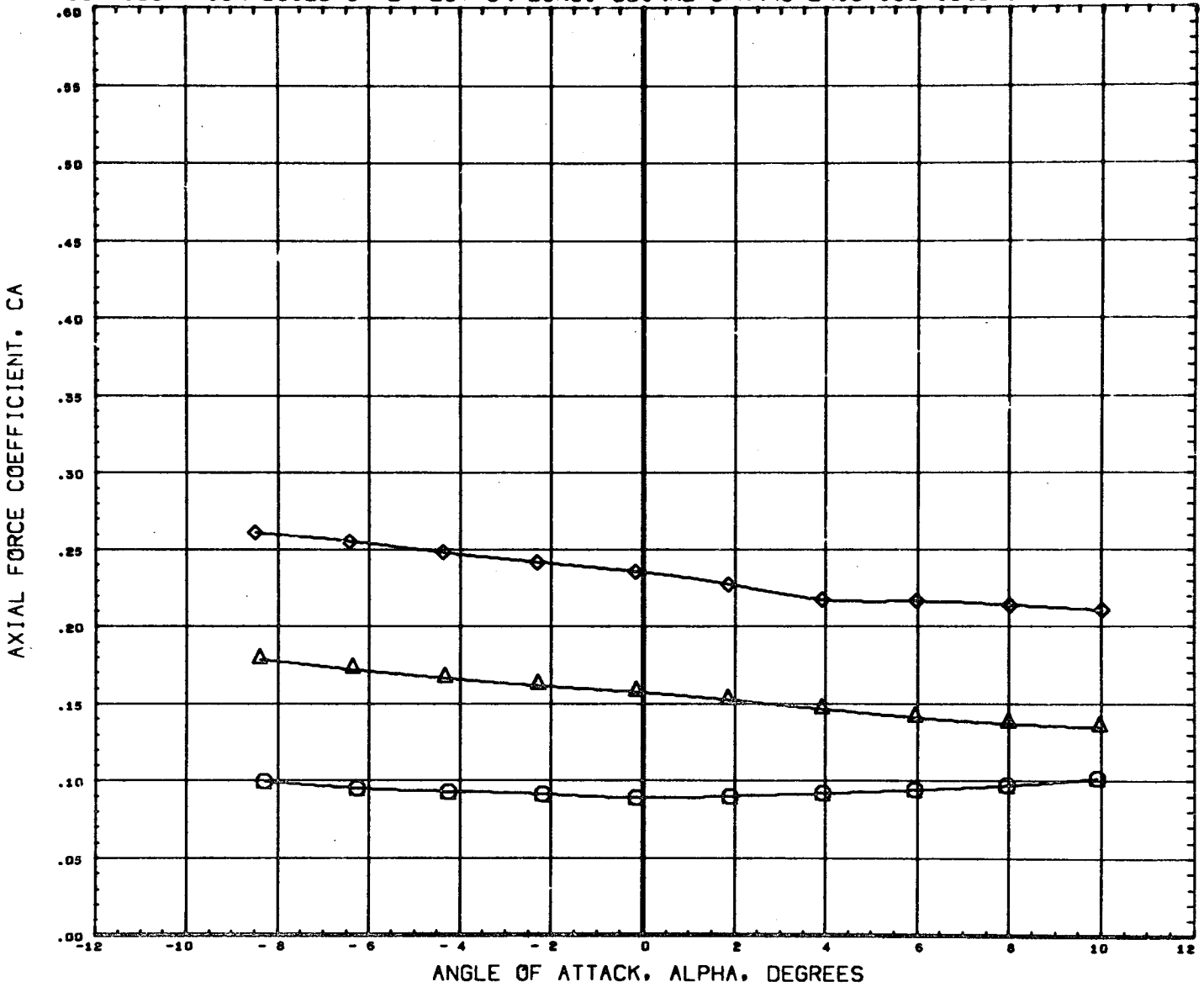

DATA SET SYMBOL	CONFIGURATION DESCRIPTION	ORBIN	THETS	BETA	REFERENCE INFORMATION
(B65001)	MSFC TWT 534 SHUTTLE LAUNCH T1			0.000	SREF 4.8950 SQ. IN
(B65002)	MSFC TWT 534 SHUTTLE LAUNCH T101	-1.500		0.000	LREF 2.6440 IN.
(B65004)	MSFC TWT 534 SHUTTLE LAUNCH T101S1	-1.500	21.000	0.000	BREF 3.5250 IN.
(B65012)	DATA NOT AVAILABLE FOR ALL CONDITIONS	-1.500	21.000	0.000	XMRP 3.4900 IN.
					YMRP 0.0000 IN.
					ZMRP 0.1616 IN.
					SCALE 0.0034

CONFIGURATION BUILD-UP EFFECT ON LONGITUDINAL CHARACTERISTICS (346 INCH TANK)

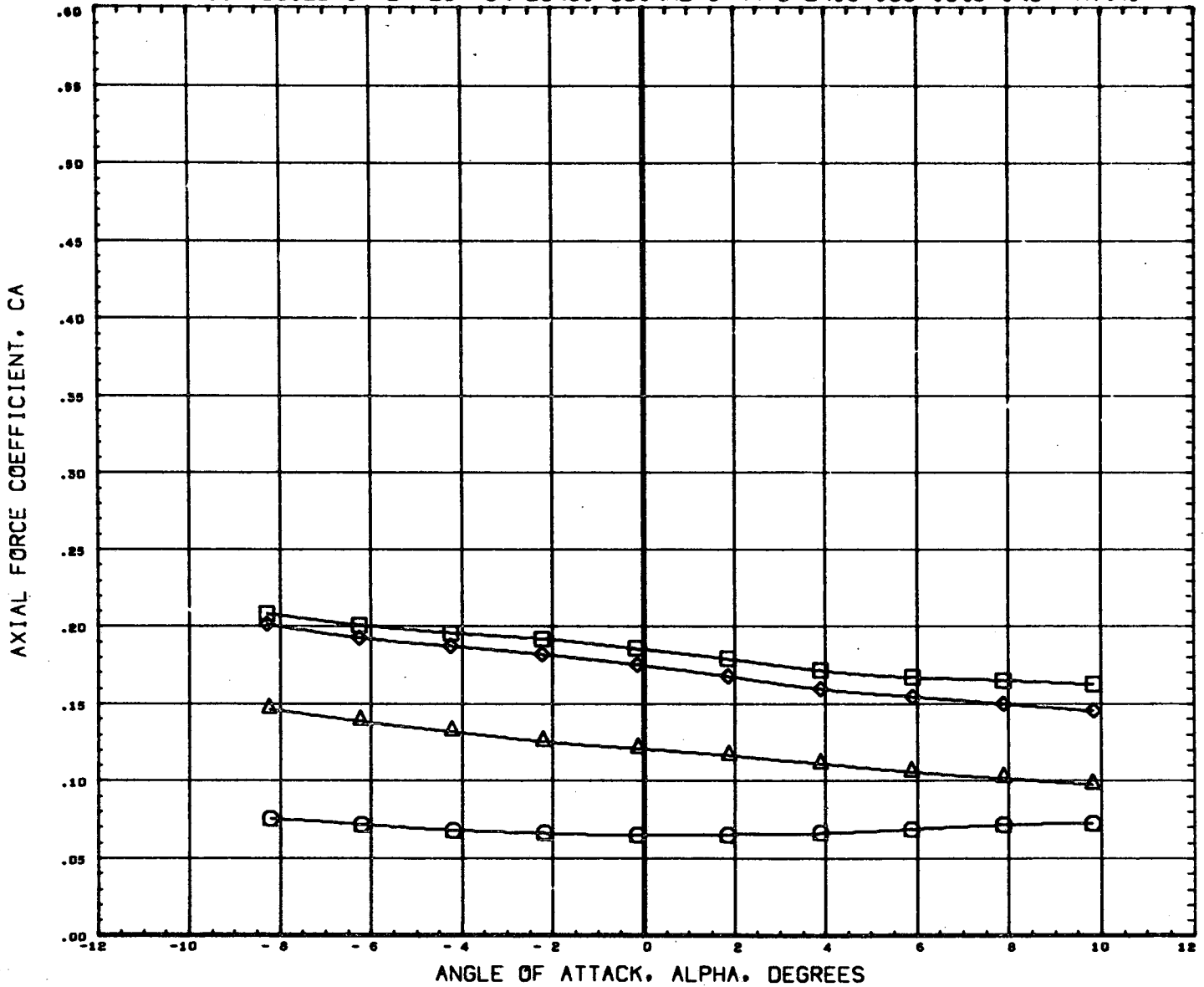

DATA SET SYMBOL	CONFIGURATION DESCRIPTION	T1	ORBIN	THETS	BETA	REFERENCE INFORMATION
(B65001)	MSFC TWT 534 SHUTTLE LAUNCH	T1			0.000	SREF 4.8950 SQ. IN
(B65002)	MSFC TWT 534 SHUTTLE LAUNCH	T101	-1.500		0.000	LREF 2.6440 IN.
(B65004)	MSFC TWT 534 SHUTTLE LAUNCH	T101S1	-1.500	21.000	0.000	BREF 3.5250 IN.
(B65012)	MSFC TWT 534 SHUTTLE LAUNCH	T101S1F1	-1.500	21.000	0.000	XMRP 3.4900 IN.
						YMRP 0.0000 IN.
						ZMRP 0.1616 IN.
						SCALE 0.0034

MACH 4.96

PAGE 24

CONFIGURATION BUILD-UP EFFECT ON LONGITUDINAL CHARACTERISTICS (346 INCH TANK)

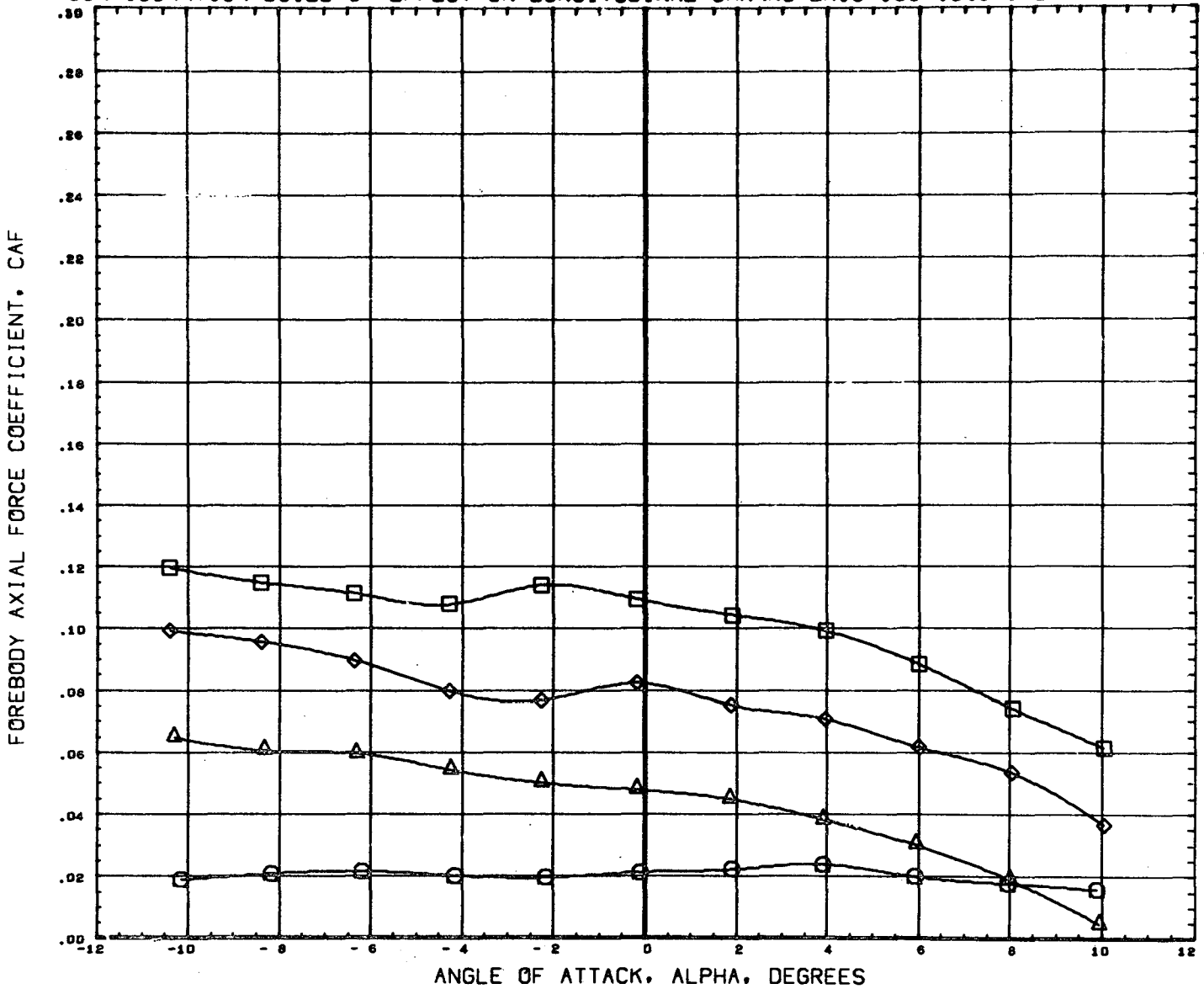

DATA SET SYMBOL	CONFIGURATION DESCRIPTION	ORBIN	THETS	BETA	REFERENCE INFORMATION
(B65001)	MSFC TWT 534 SHUTTLE LAUNCH	T1		0.000	SREF 4.8950 SQ. IN
(B65002)	MSFC TWT 534 SHUTTLE LAUNCH	T101	-1.500	0.000	LREF 2.6440 IN.
(B65004)	MSFC TWT 534 SHUTTLE LAUNCH	T101S1	-1.500	21.000	BREF 3.5250 IN.
(B65012)	MSFC TWT 534 SHUTTLE LAUNCH	T101S1F1	-1.500	21.000	XMRP 3.4900 IN.
					YMRP 0.0000 IN.
					ZMRP 0.1616 IN.
					SCALE 0.0034

CONFIGURATION BUILD-UP EFFECT ON LONGITUDINAL CHARACTERISTICS (346 INCH TANK)

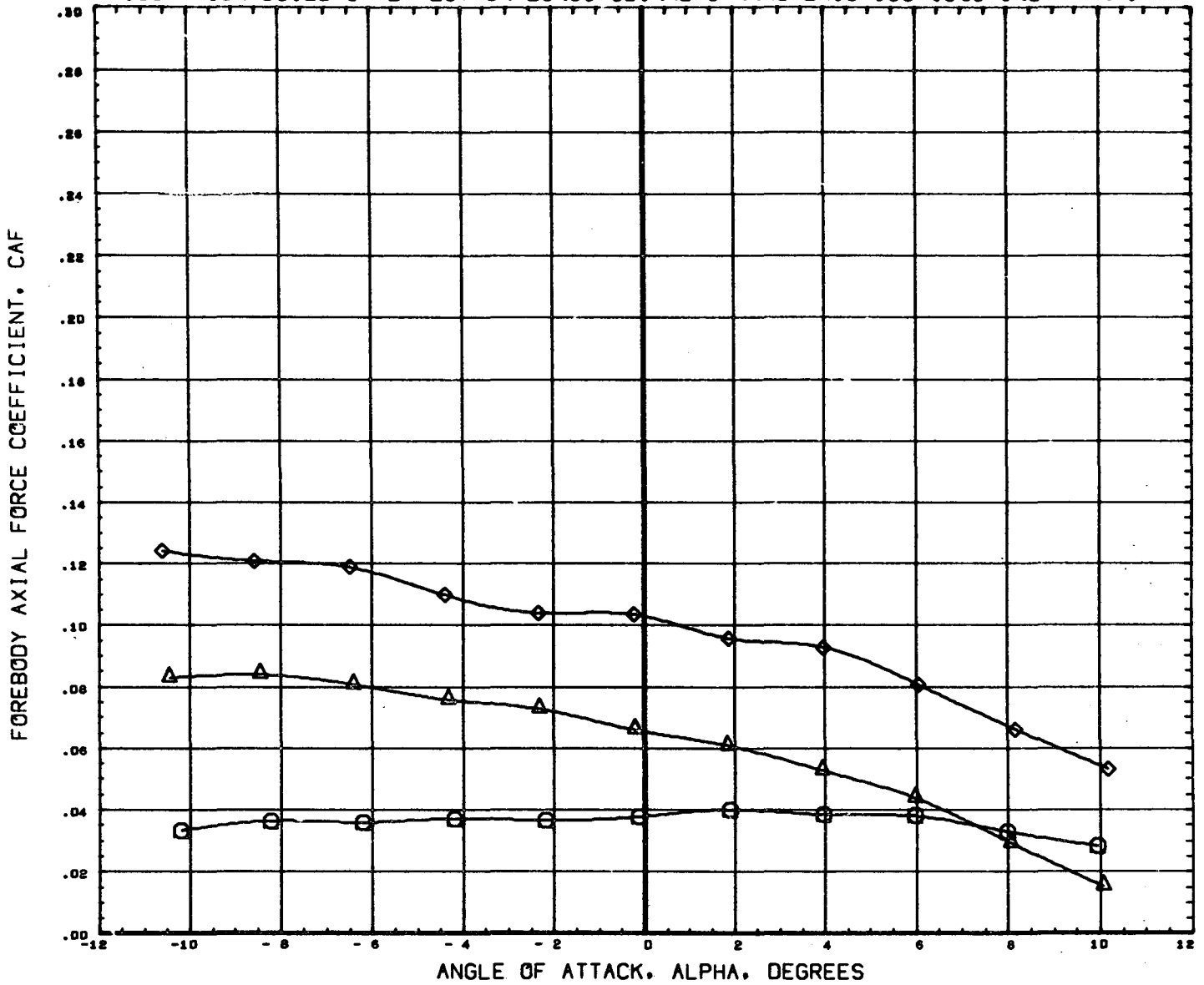

DATA SET SYMBOL	CONFIGURATION DESCRIPTION	ORBIN	THETS	BETA	REFERENCE INFORMATION
(B65001)	MSFC TWT 534 SHUTTLE LAUNCH T1			0.000	SREF 4.8950 SQ. IN
(B65002)	MSFC TWT 534 SHUTTLE LAUNCH T101	-1.500		0.000	LREF 2.6440 IN.
(B65004)	MSFC TWT 534 SHUTTLE LAUNCH T101S1	-1.500	21.000	0.000	BREF 3.5250 IN.
(B65012)	DATA NOT AVAILABLE FOR ALL CONDITIONS	-1.500	21.030	0.000	XMRP 3.4900 IN.
					YMRP 0.0000 IN.
					ZMRP 0.1616 IN.
					SCALE 0.0034

CONFIGURATION BUILD-UP EFFECT ON LONGITUDINAL CHARACTERISTICS (346 INCH TANK)

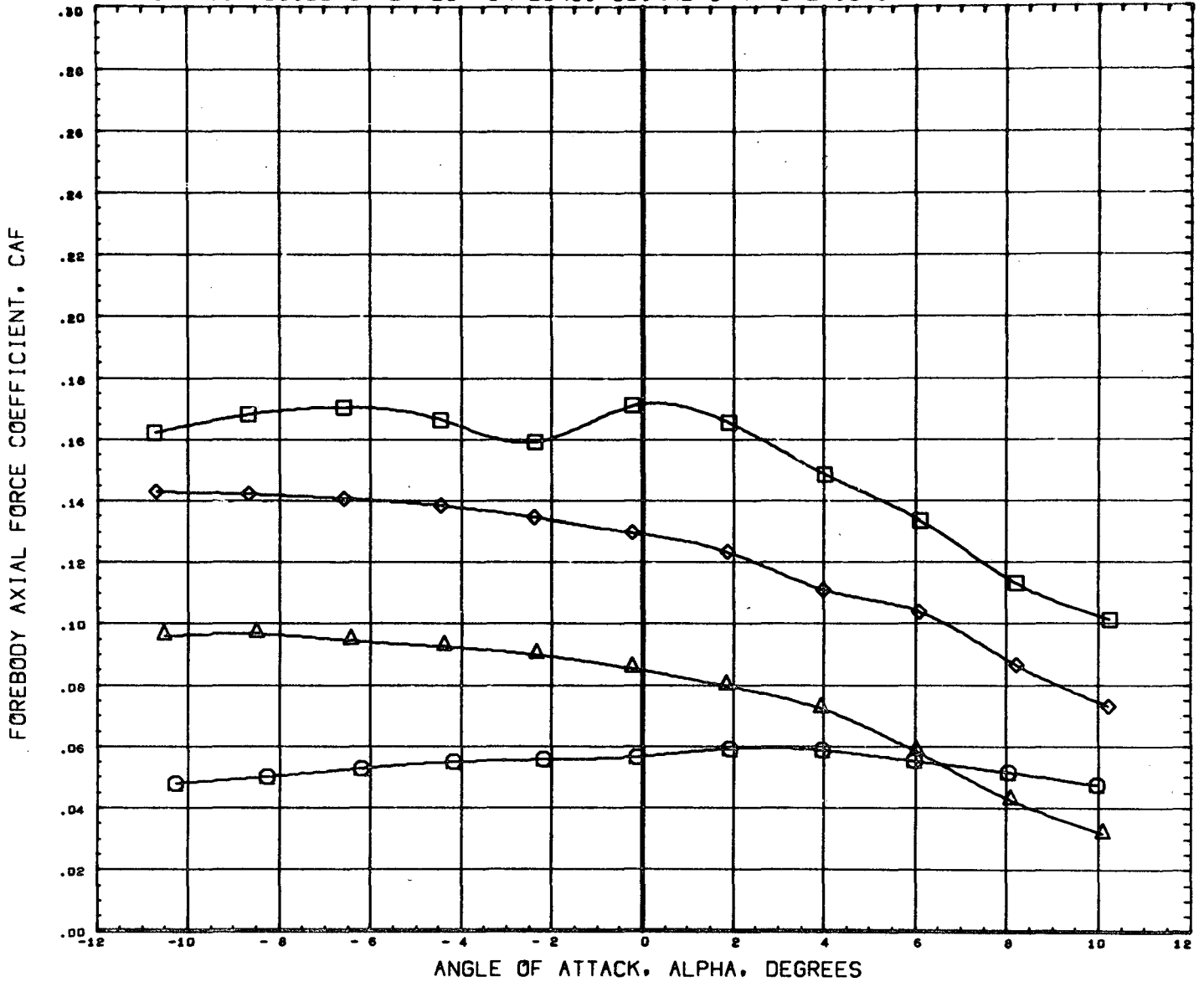

DATA SET SYMBOL	CONFIGURATION DESCRIPTION	ORBIN	THETS	BETA	REFERENCE INFORMATION
(B65001)	MSFC TWT 534 SHUTTLE LAUNCH	T1		0.000	SREF 4.9950 SQ. IN
(B65002)	MSFC TWT 534 SHUTTLE LAUNCH	T101	-1.500	0.000	LREF 2.6440 IN.
(B65004)	MSFC TWT 534 SHUTTLE LAUNCH	T101S1	-1.500	21.000	BREF 3.5250 IN.
(B65012)	MSFC TWT 534 SHUTTLE LAUNCH	T101S1F1	-1.500	21.000	XMRP 3.4900 IN.
					YMRP 0.0000 IN.
					ZMRP 0.1616 IN.
					SCALE 0.0034

MACH .90

CONFIGURATION BUILD-UP EFFECT ON LONGITUDINAL CHARACTERISTICS (346 INCH TANK)

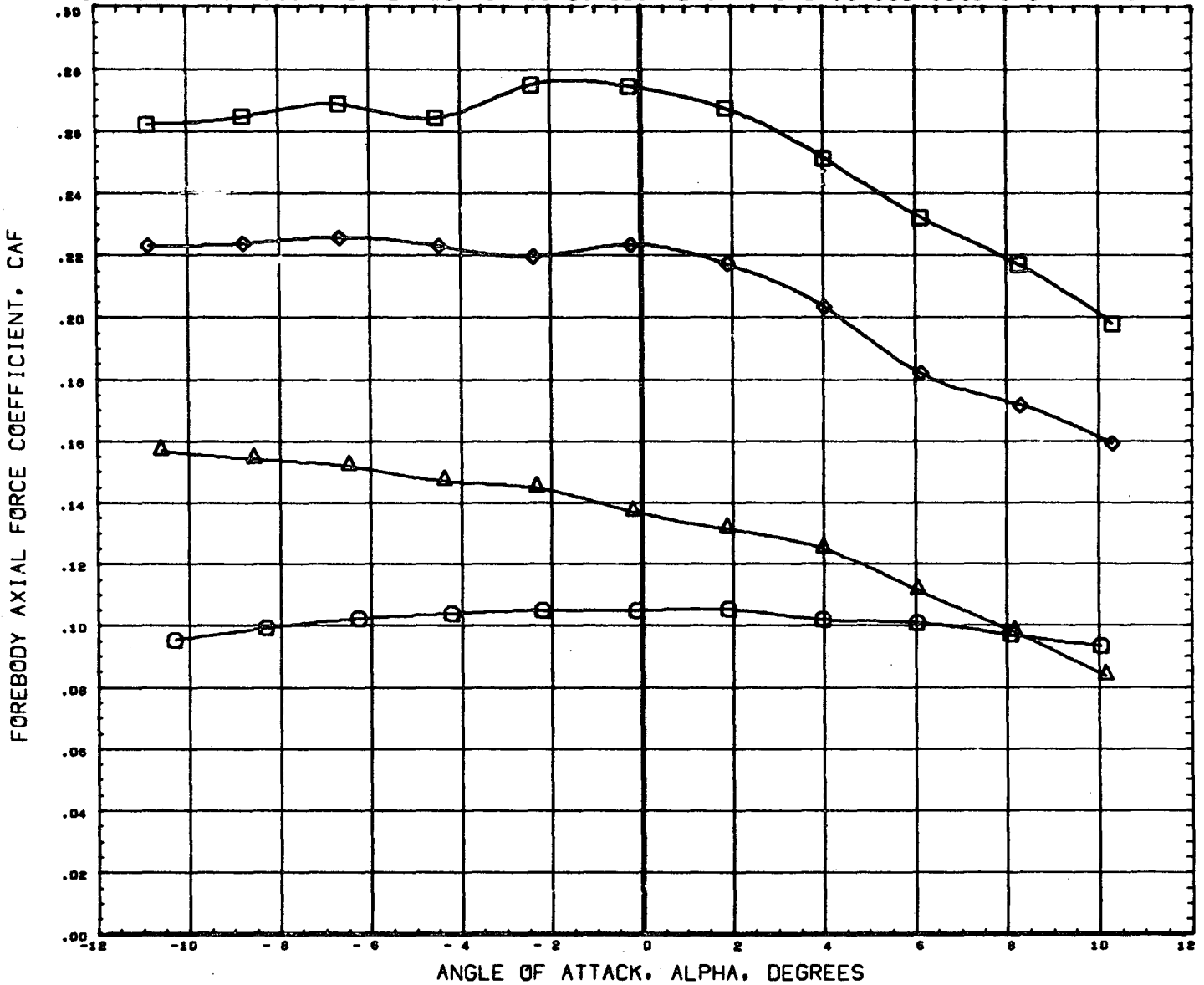

DATA SET SYMBOL	CONFIGURATION DESCRIPTION	ORBIN	THETS	BETA	REFERENCE INFORMATION
(B65001)	MSFC TWT 534 SHUTTLE LAUNCH	T1		0.000	SREF 4.8950 SQ. IN
(B65002)	MSFC TWT 534 SHUTTLE LAUNCH	T101	-1.500	0.000	LREF 2.6440 IN.
(B65004)	MSFC TWT 534 SHUTTLE LAUNCH	T101S1	-1.500	21.000	BREF 3.5250 IN.
(B65012)	MSFC TWT 534 SHUTTLE LAUNCH	T101S1F1	-1.500	21.000	0.000
					XMRP 3.4900 IN.
					YMRP 0.0000 IN.
					ZMRP 0.1616 IN.
					SCALE 0.0034

MACH 1.10

CONFIGURATION BUILD-UP EFFECT ON LONGITUDINAL CHARACTERISTICS (346 INCH TANK)

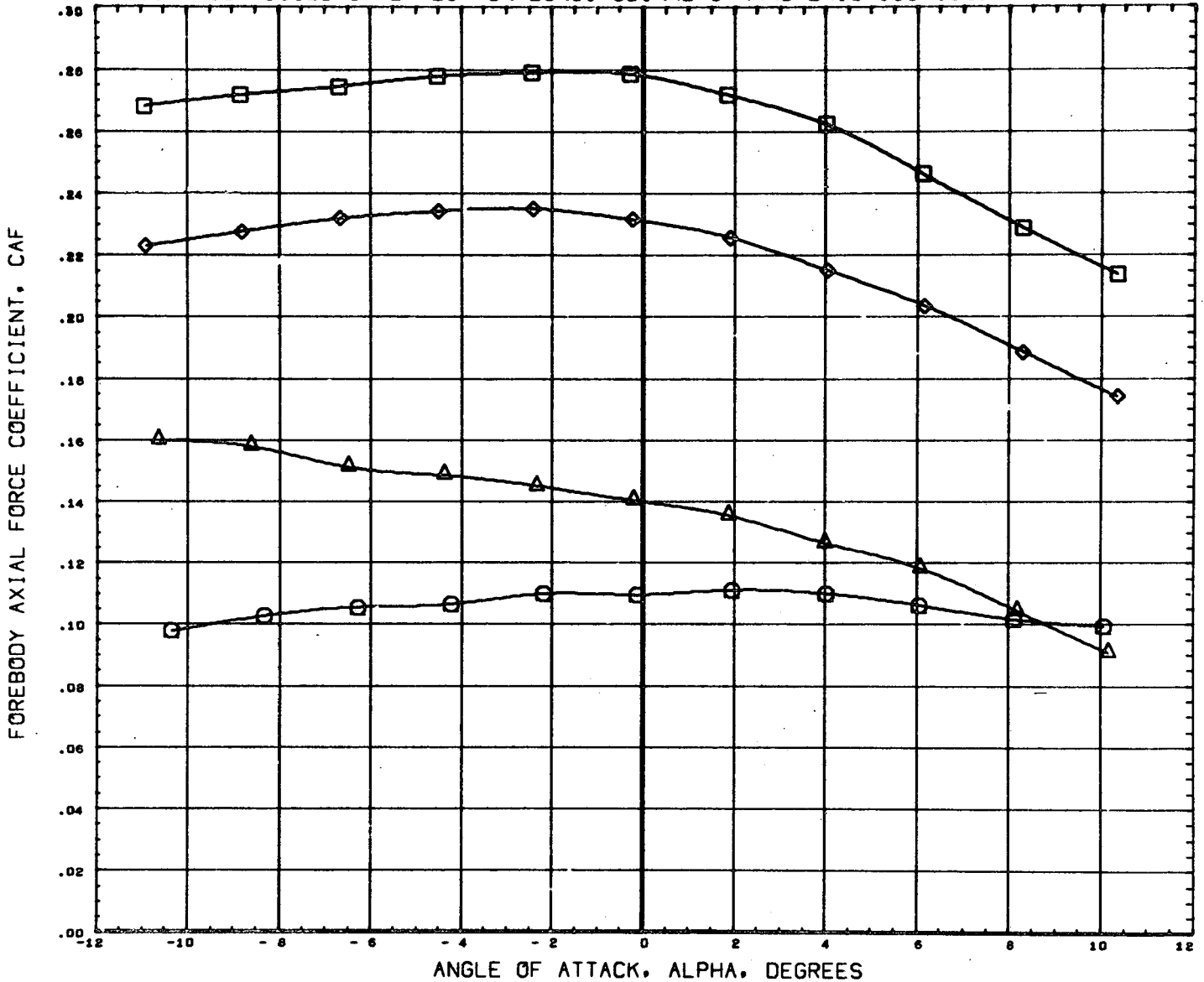

DATA SET SYMBOL	CONFIGURATION DESCRIPTION	T1	ORBIN	THETS	BETA	REFERENCE INFORMATION
(B65001)	MSFC TWT 534 SHUTTLE LAUNCH	T1			0.000	SREF 4.8950 SQ. IN
(B65002)	MSFC TWT 534 SHUTTLE LAUNCH	T101	-1.500		0.000	LREF 2.6440 IN.
(B65004)	MSFC TWT 534 SHUTTLE LAUNCH	T101S1	-1.500	21.000	0.000	BREF 3.5250 IN.
(B65012)	MSFC TWT 534 SHUTTLE LAUNCH	T101S1F1	-1.500	21.000	0.000	XMRP 3.4900 IN.
						YMRP 0.0000 IN.
						ZMRP 0.1616 IN.
						SCALE 0.0034

MACH 1.20

CONFIGURATION BUILD-UP EFFECT ON LONGITUDINAL CHARACTERISTICS (346 INCH TANK)

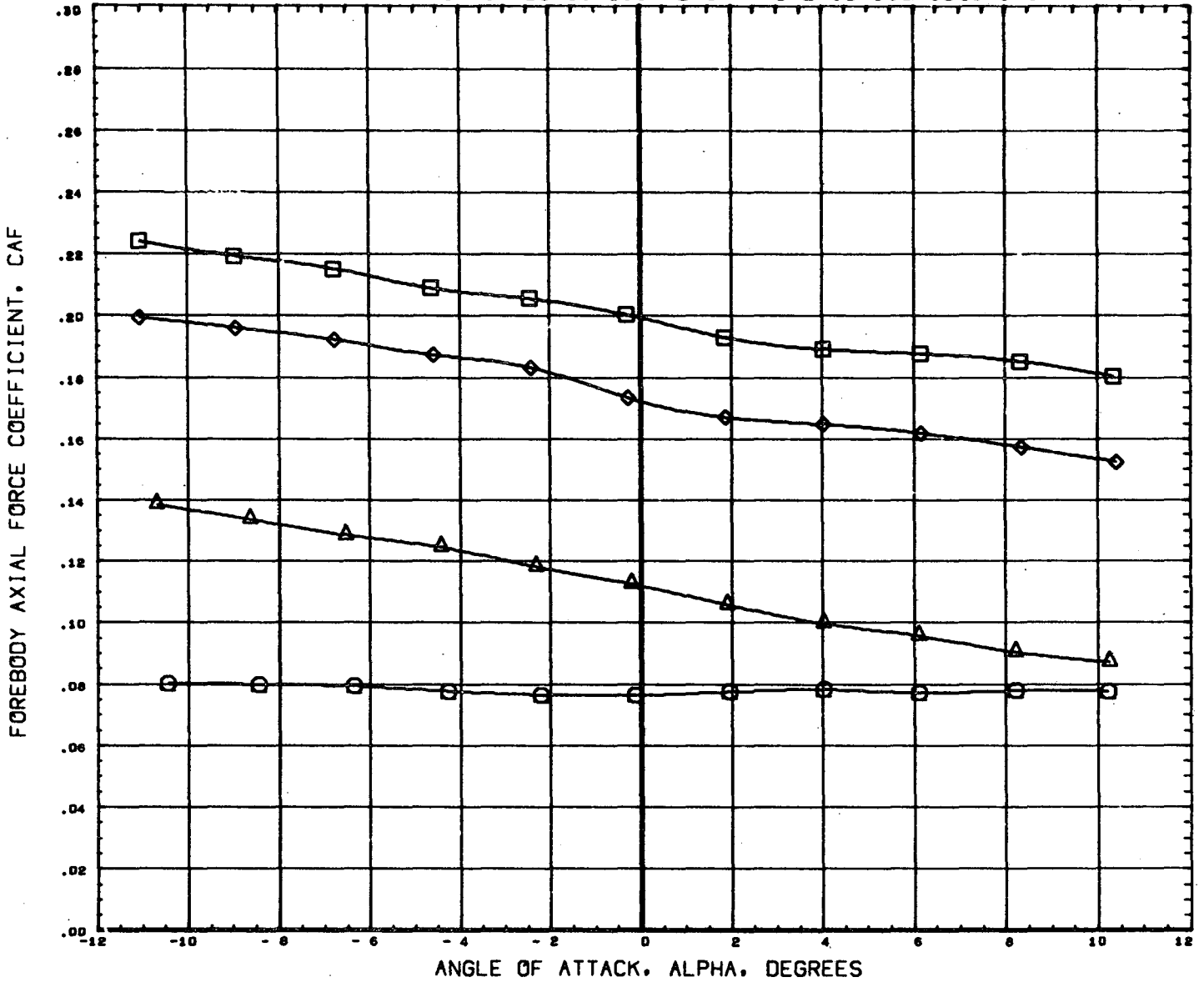

DATA SET SYMBOL	CONFIGURATION DESCRIPTION	ORBIN	THETS	BETA	REFERENCE INFORMATION
(B65001)	MSFC TWT 534 SHUTTLE LAUNCH T1			0.000	SREF 4.8950 SQ. IN
(B65002)	MSFC TWT 534 SHUTTLE LAUNCH T101	-1.500		0.000	LREF 2.6440 IN.
(B65004)	MSFC TWT 534 SHUTTLE LAUNCH T101S1	-1.500	21.000	0.000	BREF 3.5250 IN.
(B65012)	MSFC TWT 534 SHUTTLE LAUNCH T101S1F1	-1.500	21.000	0.000	XMRP 3.4900 IN. YMRP 0.0000 IN. ZMRP 0.1616 IN. SCALE 0.0034

CONFIGURATION BUILD-UP EFFECT ON LONGITUDINAL CHARACTERISTICS (346 INCH TANK)

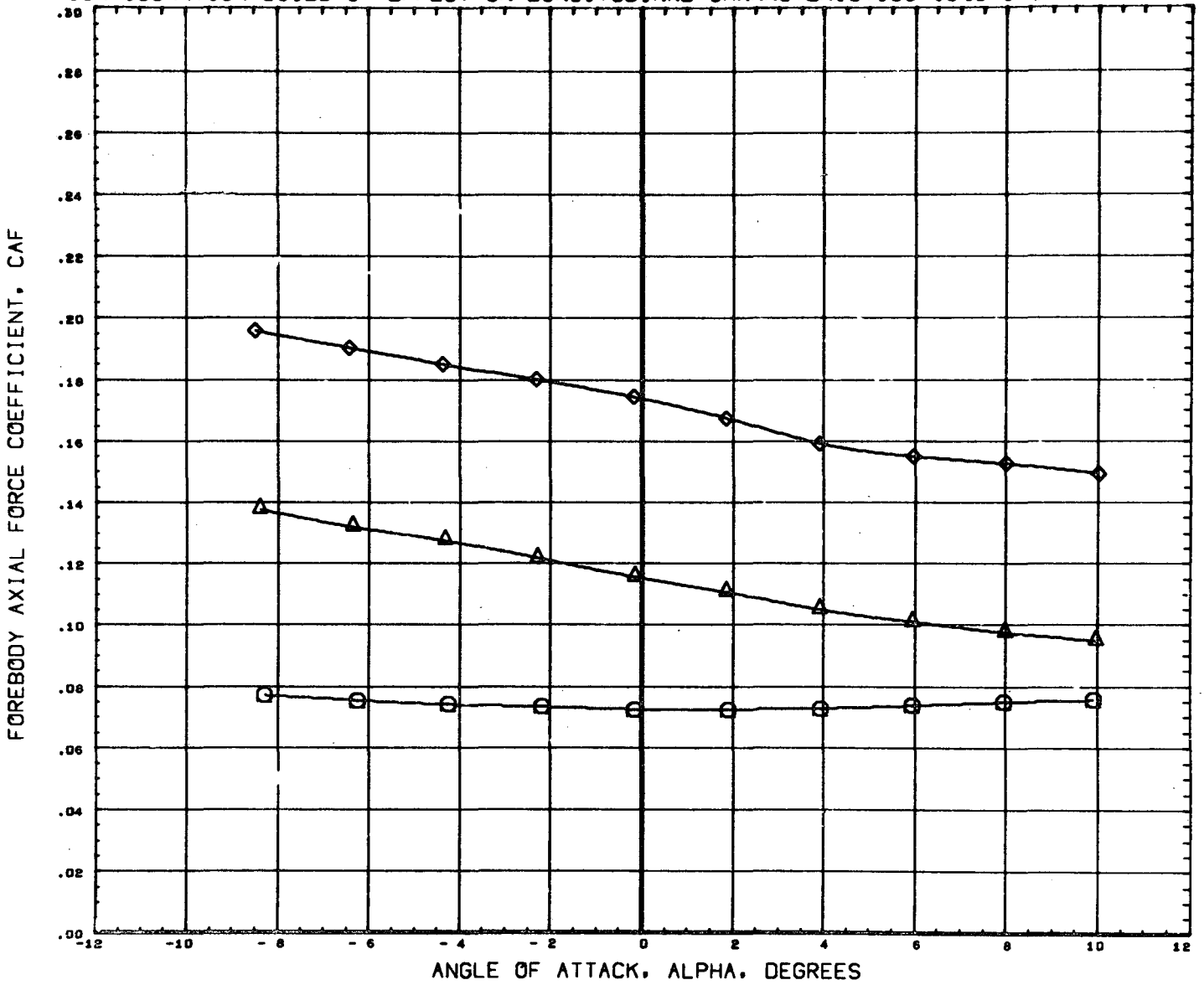

DATA SET SYMBOL	CONFIGURATION DESCRIPTION	ORBIN	THETS	BETA	REFERENCE INFORMATION
(B65001)	MSFC TWT 534 SHUTTLE LAUNCH T1			0.000	SREF 4.8950 SQ. IN
(B65002)	MSFC TWT 534 SHUTTLE LAUNCH T101	-1.500		0.000	LREF 2.6440 IN.
(B65004)	MSFC TWT 534 SHUTTLE LAUNCH T101S1	-1.500	21.000	0.000	BREF 3.5250 IN.
(B65012)	DATA NOT AVAILABLE FOR ALL CONDITIONS	-1.500	21.000	0.000	XMRP 3.4900 IN.
					YMRP 0.0000 IN.
					ZMRP 0.1616 IN.
					SCALE 0.0034

MACH 2.74

CONFIGURATION BUILD-UP EFFECT ON LONGITUDINAL CHARACTERISTICS (346 INCH TANK)

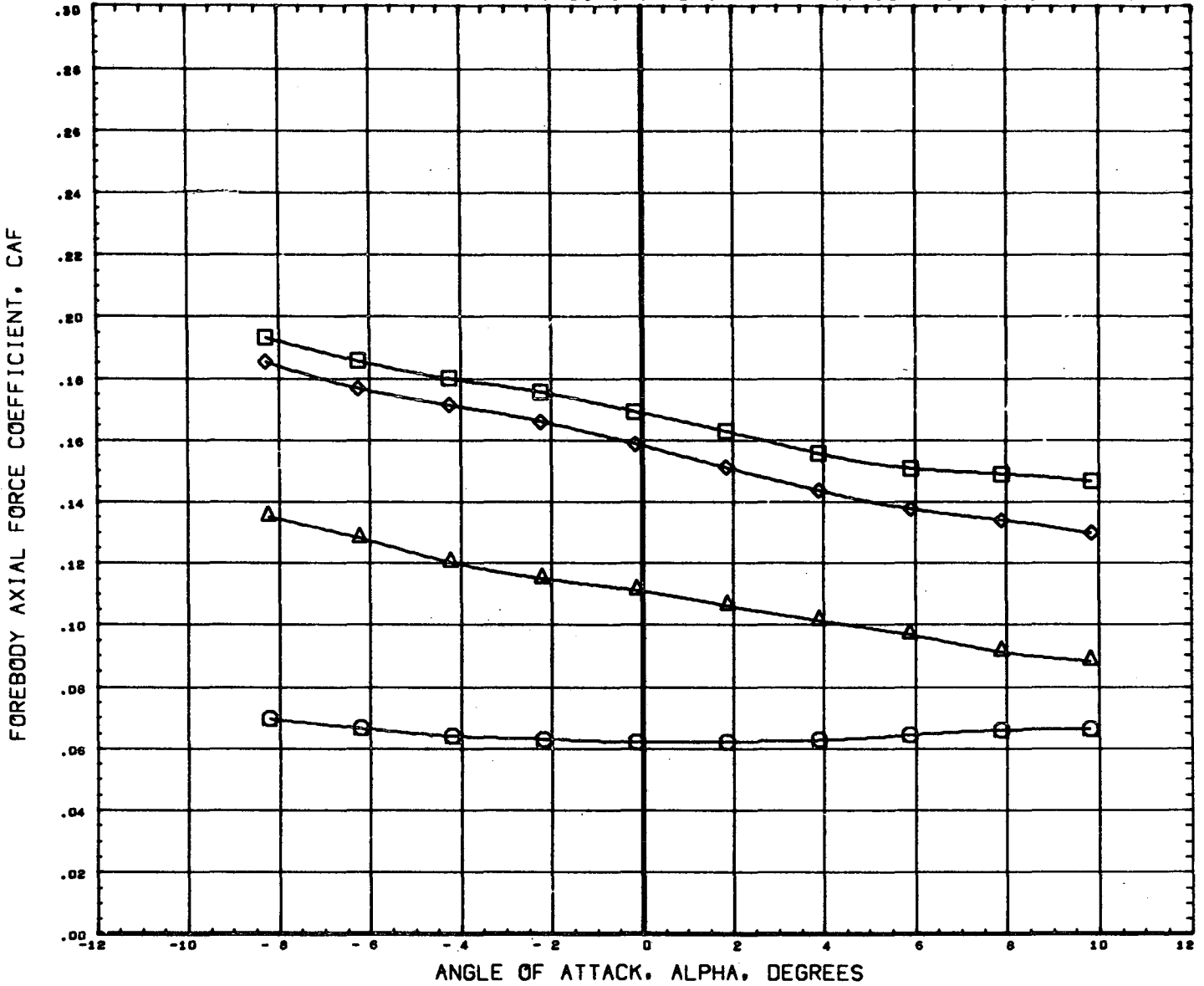

DATA SET SYMBOL	CONFIGURATION DESCRIPTION	ORBIN	THETS	BETA	REFERENCE INFORMATION
(B65001)	MSFC TWT 534 SHUTTLE LAUNCH	T1		0.000	SREF 4.0950 SQ. IN
(B65002)	MSFC TWT 534 SHUTTLE LAUNCH	T1O1	-1.500	0.000	LREF 2.6440 IN.
(B65004)	MSFC TWT 534 SHUTTLE LAUNCH	T1O1S1	-1.300	21.000	BREF 3.5250 IN.
(B65012)	MSFC TWT 534 SHUTTLE LAUNCH	T1O1S1F1	-1.500	21.000	0.000 IN.
					XNRP 3.4900 IN.
					YNRP 0.0000 IN.
					ZNRP 0.1616 IN.
					SCALE 0.3034

CONFIGURATION BUILD-UP EFFECT ON LONGITUDINAL CHARACTERISTICS (346 INCH TANK)

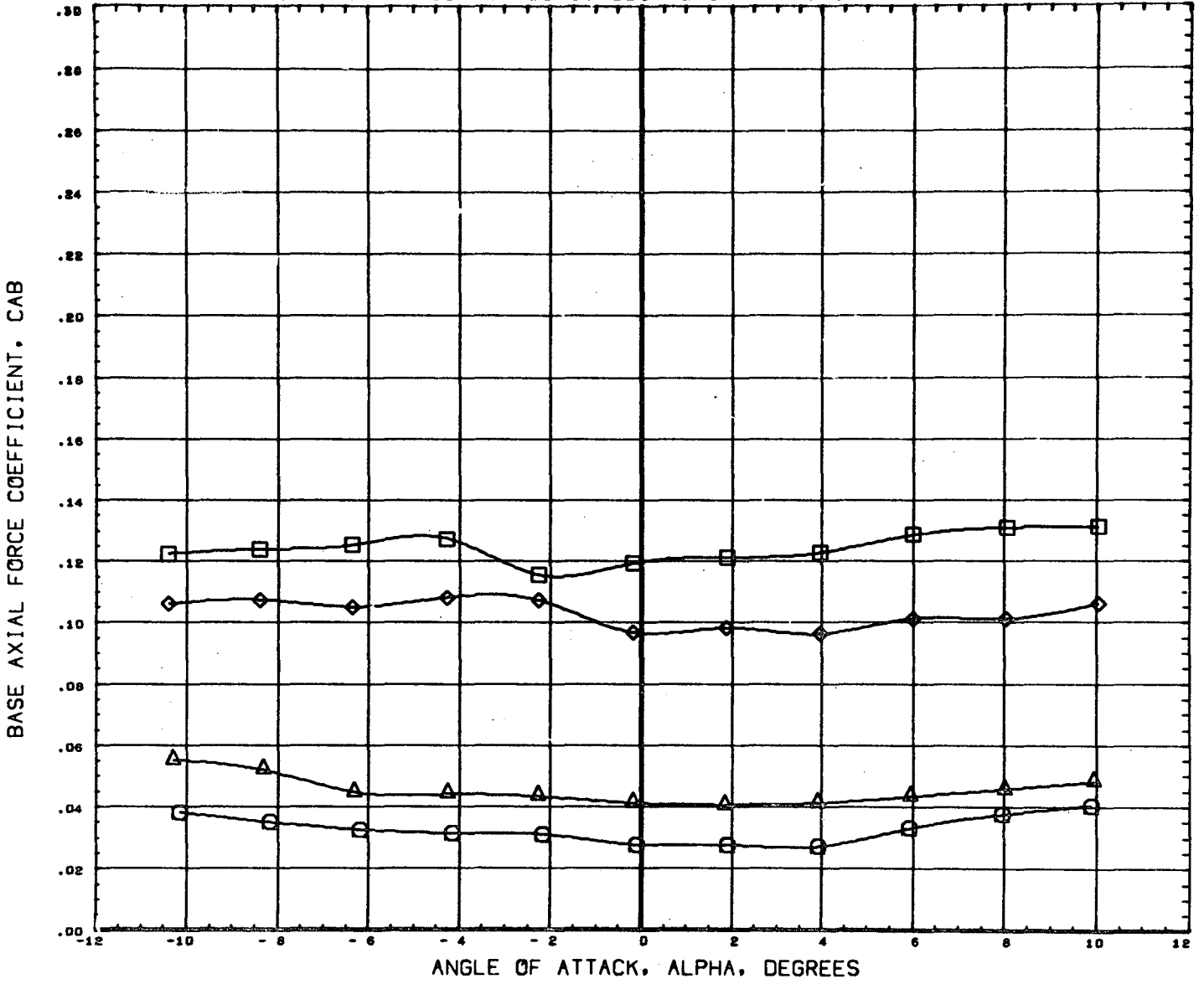

DATA SET SYMBOL	CONFIGURATION DESCRIPTION	ORBIN	THETS	BETA	REFERENCE INFORMATION
(B65001)	MSFC TWT 534 SHUTTLE LAUNCH	T1		0.000	SREF 4.8950 SQ. IN
(B65002)	MSFC TWT 534 SHUTTLE LAUNCH	T101	-1.500	0.000	LREF 2.6440 IN.
(B65004)	MSFC TWT 534 SHUTTLE LAUNCH	T101S1	-1.500	21.000	BREF 3.5250 IN.
(B65012)	MSFC TWT 534 SHUTTLE LAUNCH	T101S1F1	-1.500	21.000	0.0000 IN.
					YHRP 3.4900 IN.
					YHRP 0.0000 IN.
					ZHRP 0.1616 IN.
					SCALE 0.0034

MACH .60

CONFIGURATION BUILD-UP EFFECT ON LONGITUDINAL CHARACTERISTICS (346 INCH TANK)

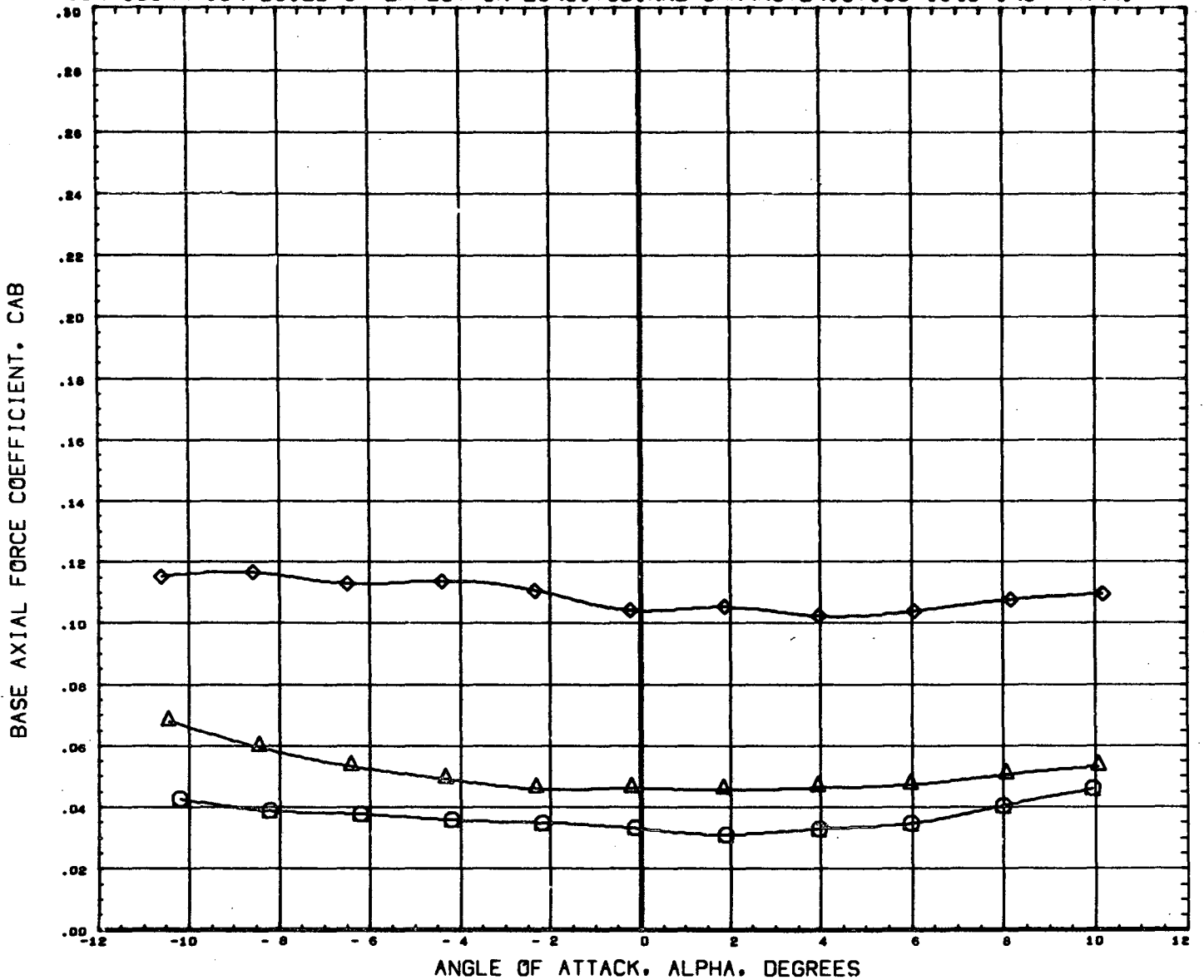

DATA SET SYMBOL	CONFIGURATION DESCRIPTION	ORBIN	THETS	BETA	REFERENCE INFORMATION
(B65001)	MSFC TWT 534 SHUTTLE LAUNCH T1	-1.500		0.000	SREF 4.8950 SQ. IN
(B65002)	MSFC TWT 534 SHUTTLE LAUNCH T101	-1.500		0.000	LREF 2.6440 IN.
(B65004)	MSFC TWT 534 SHUTTLE LAUNCH T101S1	-1.500	21.000	0.000	BREF 3.5250 IN.
(B65012)	DATA NOT AVAILABLE FOR ALL CONDITIONS	-1.500	21.000	0.000	XMRP 3.4900 IN.
					YMRP 0.0000 IN.
					ZMRP 0.1616 IN.
					SCALE 0.0034

CONFIGURATION BUILD-UP EFFECT ON LONGITUDINAL CHARACTERISTICS (346 INCH TANK)

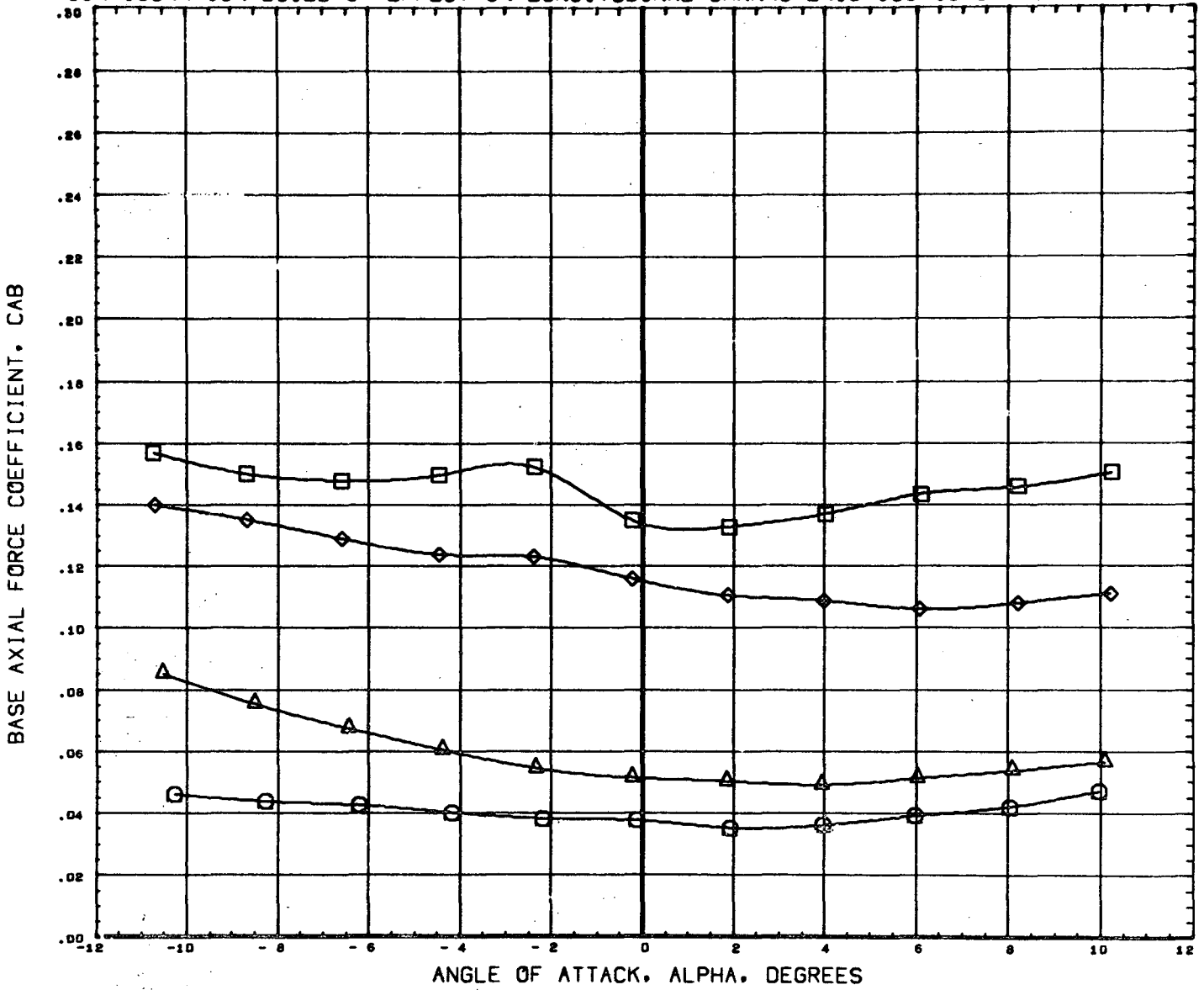

DATA SET SYMBOL	CONFIGURATION DESCRIPTION	T1	ORBIN	THETS	BETA	REFERENCE INFORMATION
(B65001)	MSFC TWT 534 SHUTTLE LAUNCH	T1			0.000	SREF 4.8950 SQ. IN
(B65002)	MSFC TWT 534 SHUTTLE LAUNCH	T1O1	-1.500		0.000	LREF 2.6440 IN.
(B65004)	MSFC TWT 534 SHUTTLE LAUNCH	T1O1S1	-1.500	21.000	0.000	BREF 3.5250 IN.
(B65012)	MSFC TWT 534 SHUTTLE LAUNCH	T1O1S1F1	-1.500	21.000	0.000	XMRP 3.4900 IN.
						YMRP 0.0000 IN.
						ZMRP 0.1616 IN.
						SCALE 0.0034

MACH .90

CONFIGURATION BUILD-UP EFFECT ON LONGITUDINAL CHARACTERISTICS (346 INCH TANK)

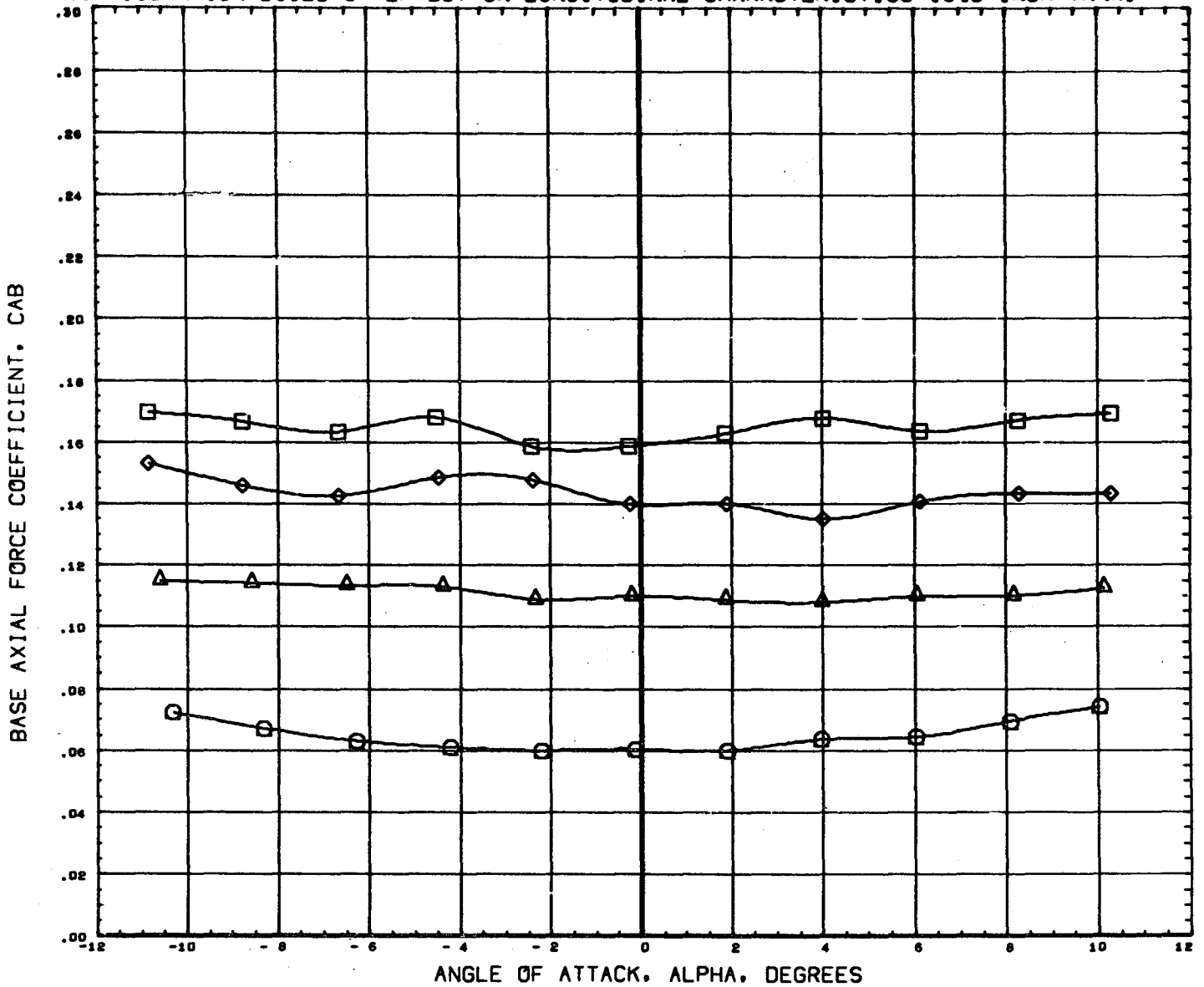

DATA SET SYMBOL	CONFIGURATION DESCRIPTION	ORBIN	THETS	BETA	REFERENCE INFORMATION
(B65001)	MSFC TWT 534 SHUTTLE LAUNCH	T1		0.000	SREF 4.8950 99. IN
(B65002)	MSFC TWT 534 SHUTTLE LAUNCH	T101	-1.500	0.000	LREF 2.6440 IN.
(B65004)	MSFC TWT 534 SHUTTLE LAUNCH	T101S1	-1.500	21.000	BREF 3.5250 IN.
(B65012)	MSFC TWT 534 SHUTTLE LAUNCH	T101S1F1	-1.500	21.000	0.000
					XMRP 3.4900 IN.
					YMRP 0.0000 IN.
					ZMRP 0.1616 IN.
					SCALE 0.0034

CONFIGURATION BUILD-UP EFFECT ON LONGITUDINAL CHARACTERISTICS (346 INCH TANK)

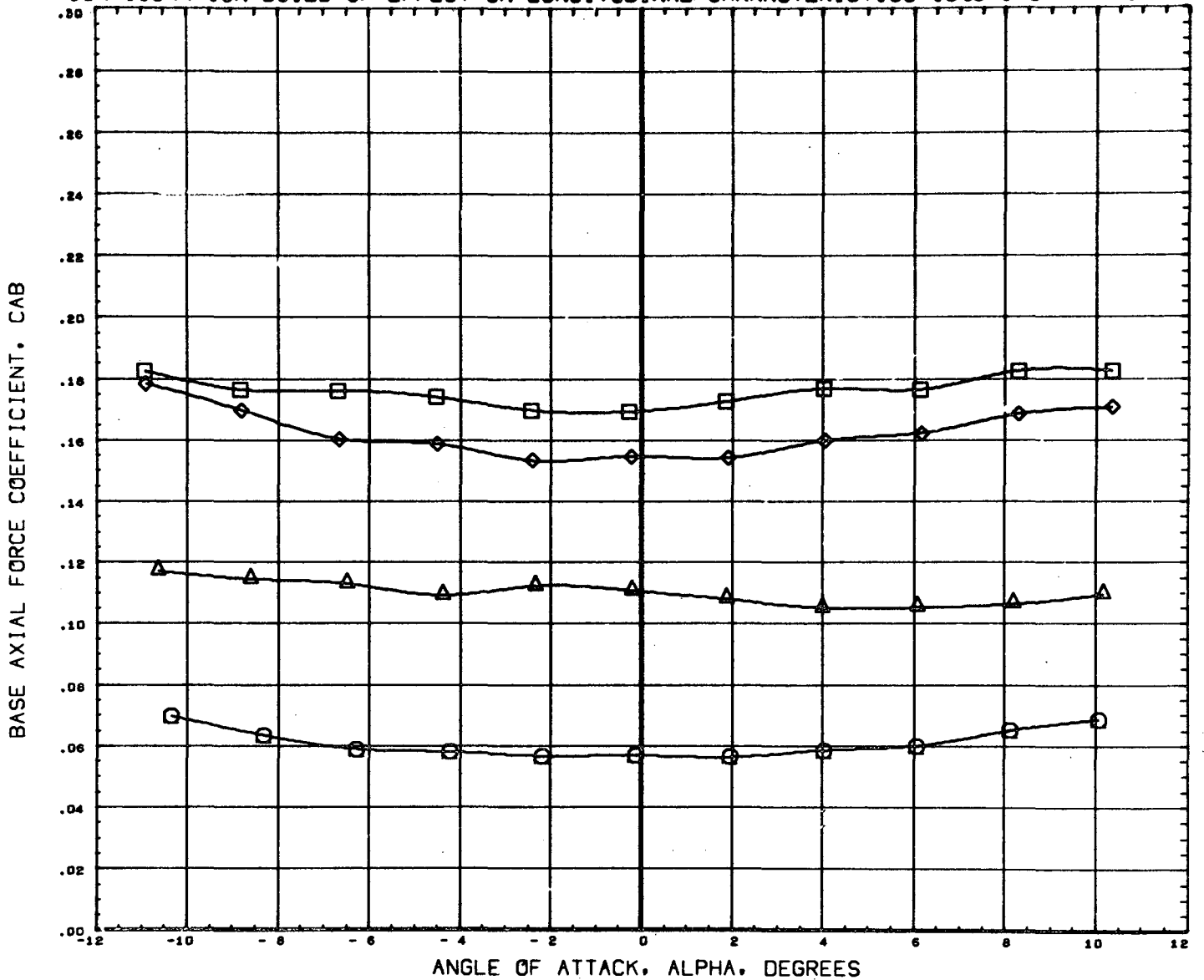

DATA SET SYMBOL	CONFIGURATION DESCRIPTION	T1	ORBIN	THETS	BETA	REFERENCE INFORMATION
(B65001)	MSFC TWT 534 SHUTTLE LAUNCH	T1	-1.500	0.000	0.000	SREF 4.8950 SQ. IN
(B65002)	MSFC TWT 534 SHUTTLE LAUNCH	T101	-1.500	0.000	0.000	LREF 2.6440 IN.
(B65004)	MSFC TWT 534 SHUTTLE LAUNCH	T101S1	-1.500	21.000	0.000	BREF 3.5250 IN.
(B65012)	MSFC TWT 534 SHUTTLE LAUNCH	T101S1F1	-1.500	21.000	0.000	XMRP 3.4900 IN.
						YMRP 0.0000 IN.
						ZMRP 0.1616 IN.
						SCALE 0.0034

MACH 1.20

CONFIGURATION BUILD-UP EFFECT ON LONGITUDINAL CHARACTERISTICS (346 INCH TANK)

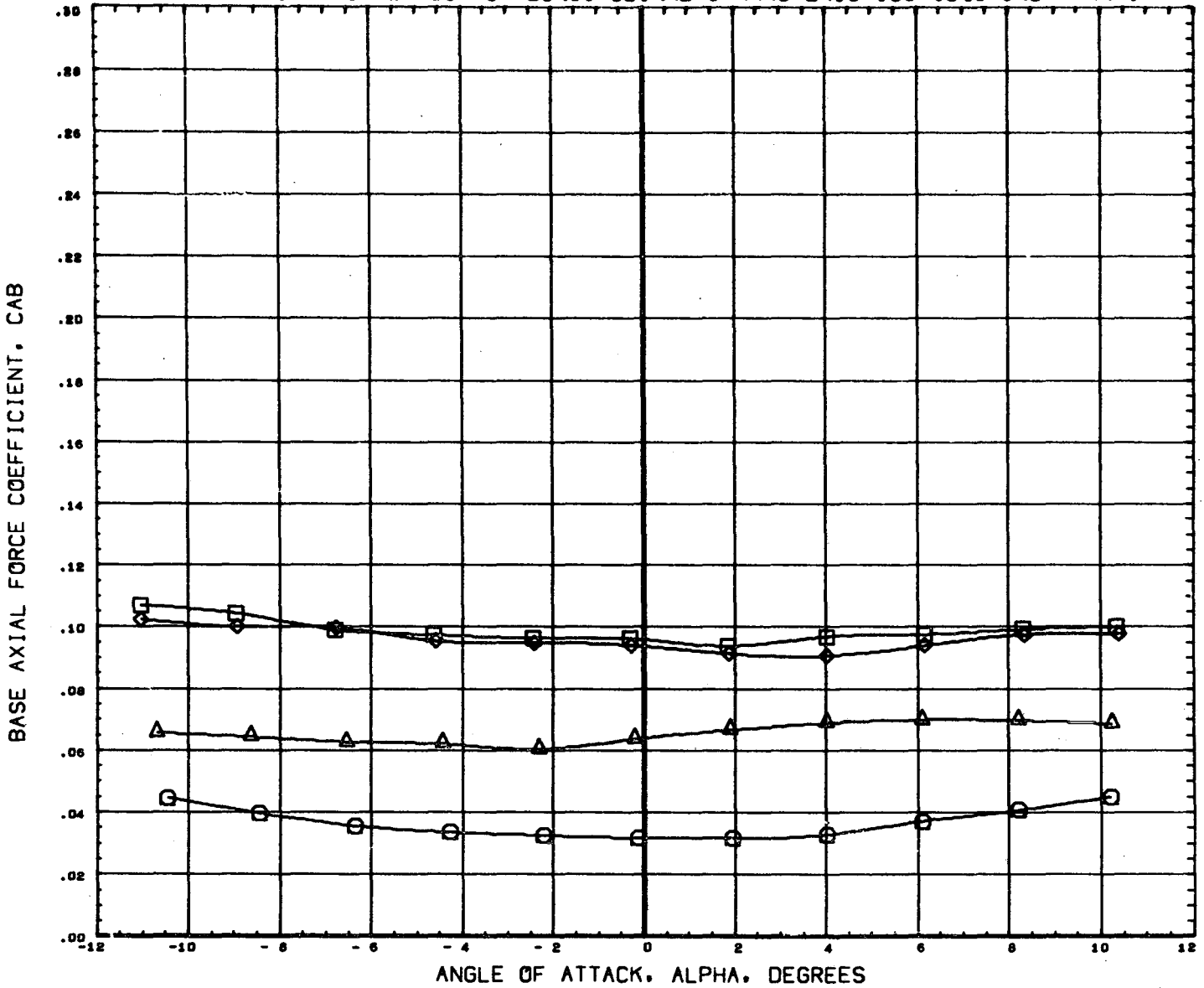

DATA SET SYMBOL	CONFIGURATION DESCRIPTION	T1	ORBIN	THETS	BETA	REFERENCE INFORMATION
(B65001)	MSFC TWT 534 SHUTTLE LAUNCH	T1			0.000	SREF 4.8950 SQ. IN
(B65002)	MSFC TWT 534 SHUTTLE LAUNCH	T101	-1.500		0.000	LREF 2.6440 IN.
(B65004)	MSFC TWT 534 SHUTTLE LAUNCH	T101S1	-1.500	21.000	0.000	BREF 3.5250 IN.
(B65012)	MSFC TWT 534 SHUTTLE LAUNCH	T101S1F1	-1.500	21.000	0.000	XNRP 3.4900 IN.
						YNRP 0.0000 IN.
						ZNRP 0.1616 IN.
						SCALE 0.0034

CONFIGURATION BUILD-UP EFFECT ON LONGITUDINAL CHARACTERISTICS (346 INCH TANK)

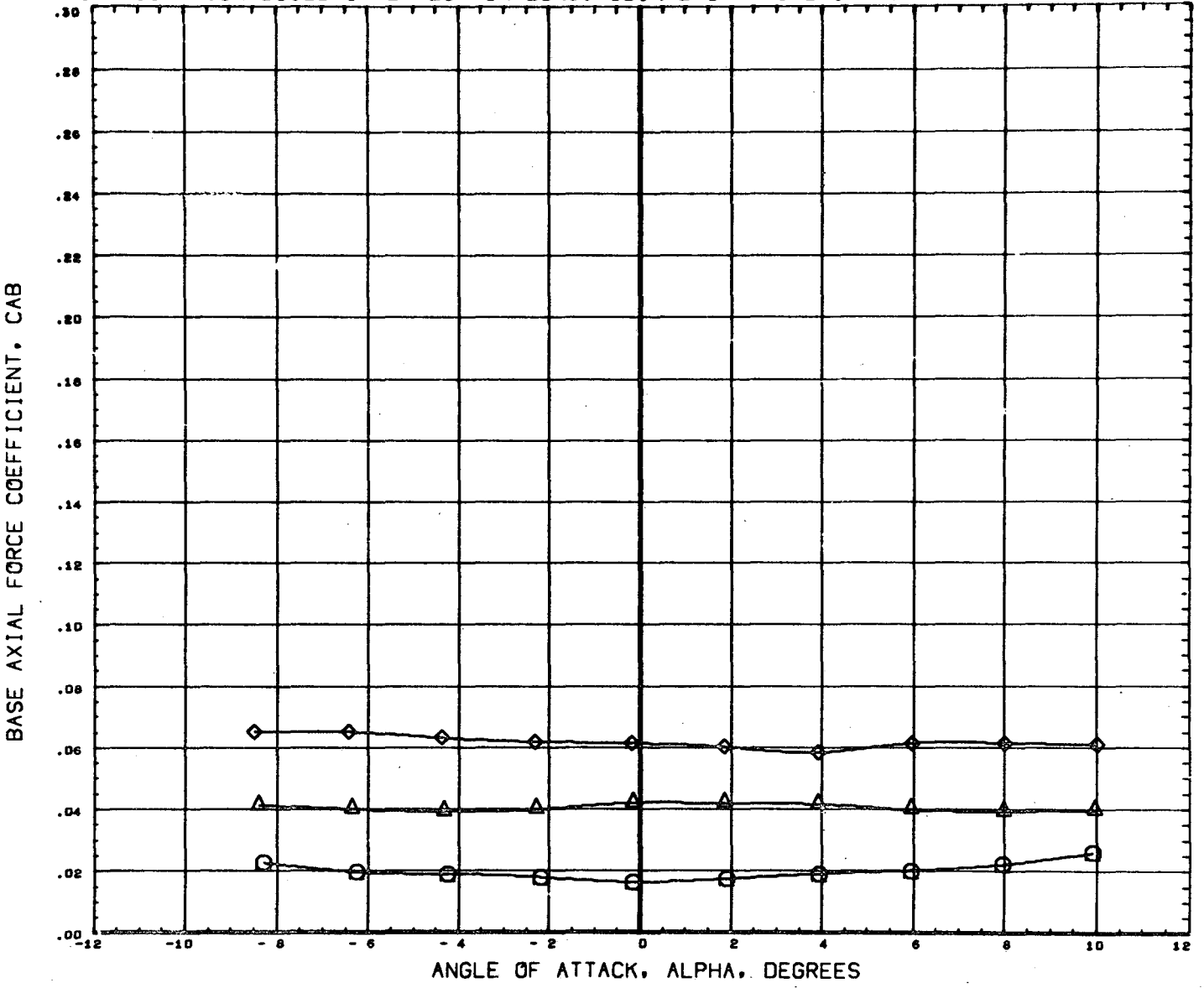

DATA SET SYMBOL	CONFIGURATION DESCRIPTION	ORBIN	THETS	BETA	REFERENCE INFORMATION
(B65001)	MSFC TWT 534 SHUTTLE LAUNCH T1			0.000	SREF 4.8950 SQ. IN
(B65002)	MSFC TWT 534 SHUTTLE LAUNCH T101	-1.500		0.000	LREF 2.6440 IN.
(B65004)	MSFC TWT 534 SHUTTLE LAUNCH T101S1	-1.500	21.000	0.000	BREF 3.5250 IN.
(B65012)	DATA NOT AVAILABLE FOR ALL CONDITIONS	-1.500	21.000	0.000	XNRP 3.4900 IN.
					YNRP 0.0000 IN.
					ZNRP 0.1616 IN.
					SCALE 0.0034

CONFIGURATION BUILD-UP EFFECT ON LONGITUDINAL CHARACTERISTICS (346 INCH TANK)

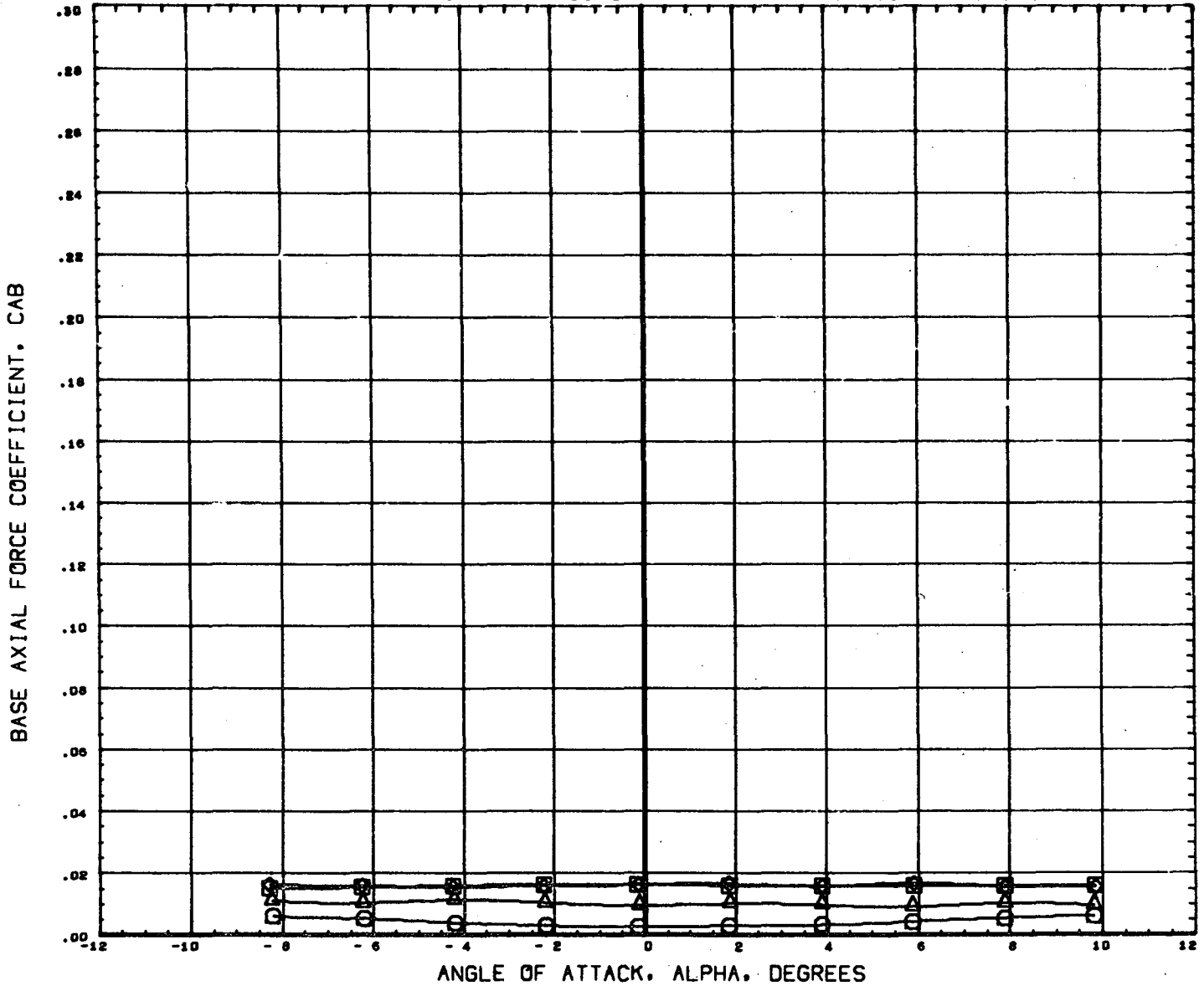

DATA SET SYMBOL	CONFIGURATION DESCRIPTION	ORBIN	THETS	BETA	REFERENCE INFORMATION
(B65001)	MSFC TWT 534 SHUTTLE LAUNCH	T1		0.000	SREF 4.8950 SQ. IN
(B65002)	MSFC TWT 534 SHUTTLE LAUNCH	T101	-1.500	0.000	LREF 2.6440 IN.
(B65004)	MSFC TWT 534 SHUTTLE LAUNCH	T101S1	-1.500	21.000	BREF 3.9250 IN.
(B65012)	MSFC TWT 534 SHUTTLE LAUNCH	T101S1F1	-1.500	21.000	XMRP 3.4900 IN.
					YMRP 0.0000 IN.
					ZMRP 0.1616 IN.
					SCALE 0.0034

MACH 4.96

PAGE 40

CONFIGURATION BUILD-UP EFFECT ON LONGITUDINAL CHARACTERISTICS (346 INCH TANK)

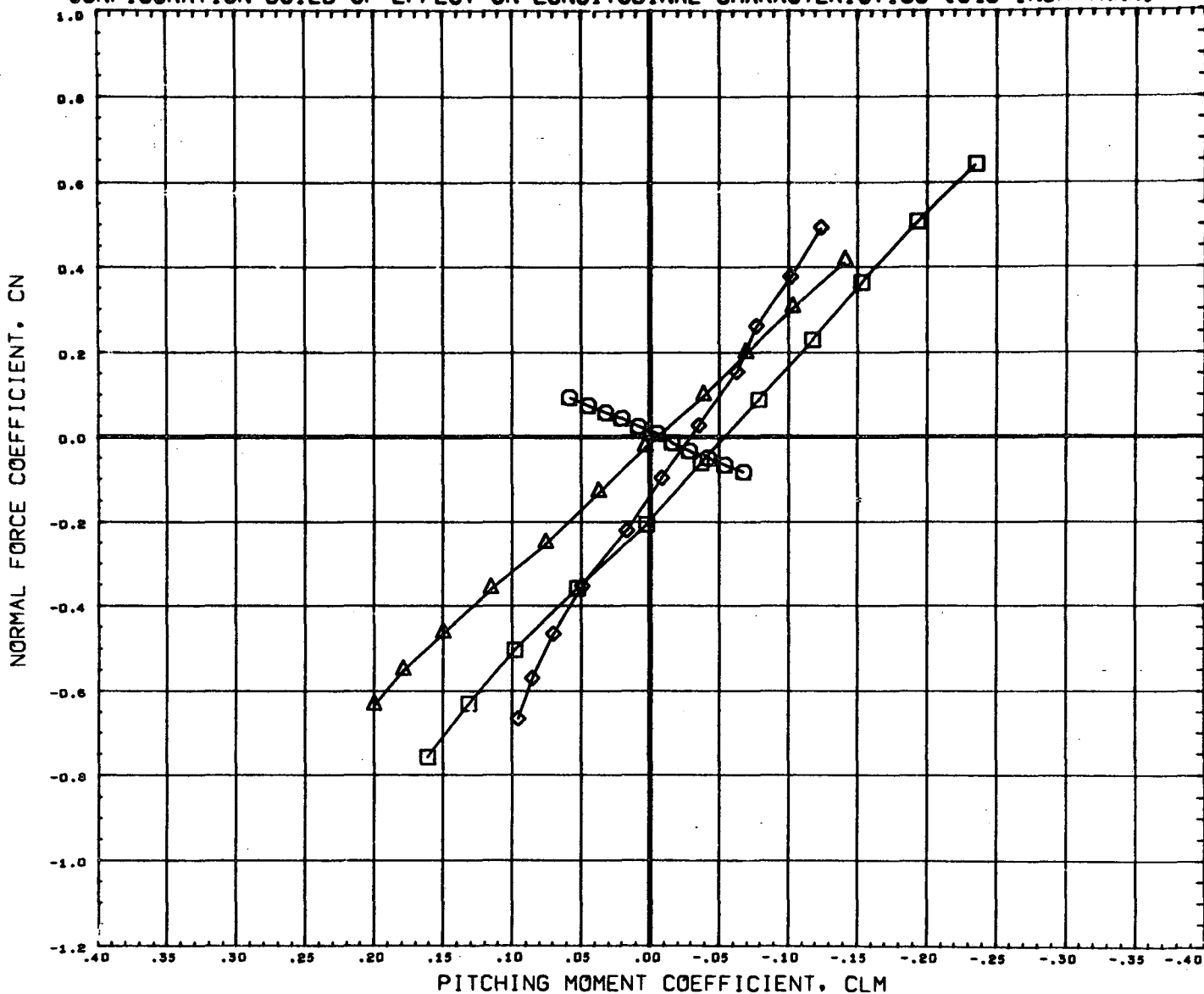

DATA SET SYMBOL	CONFIGURATION DESCRIPTION	ORBIN	THETS	BETA	REFERENCE INFORMATION
(B65001)	MSFC TWT 534 SHUTTLE LAUNCH	T1		0.000	SREF 4.8950 SQ. IN
(B65002)	MSFC TWT 534 SHUTTLE LAUNCH	T101	-1.500	0.000	LREF 2.6440 IN.
(B65004)	MSFC TWT 534 SHUTTLE LAUNCH	T101S1	-1.500	21.000	BREF 3.5250 IN.
(B65012)	MSFC TWT 534 SHUTTLE LAUNCH	T101S1F1	-1.500	21.000	0.000 IN.
					XMRP 3.4900 IN.
					YMRP 0.0000 IN.
					ZMRP 0.1616 IN.
					SCALE 0.0034

MACH .60

CONFIGURATION BUILD-UP EFFECT ON LONGITUDINAL CHARACTERISTICS (346 INCH TANK)

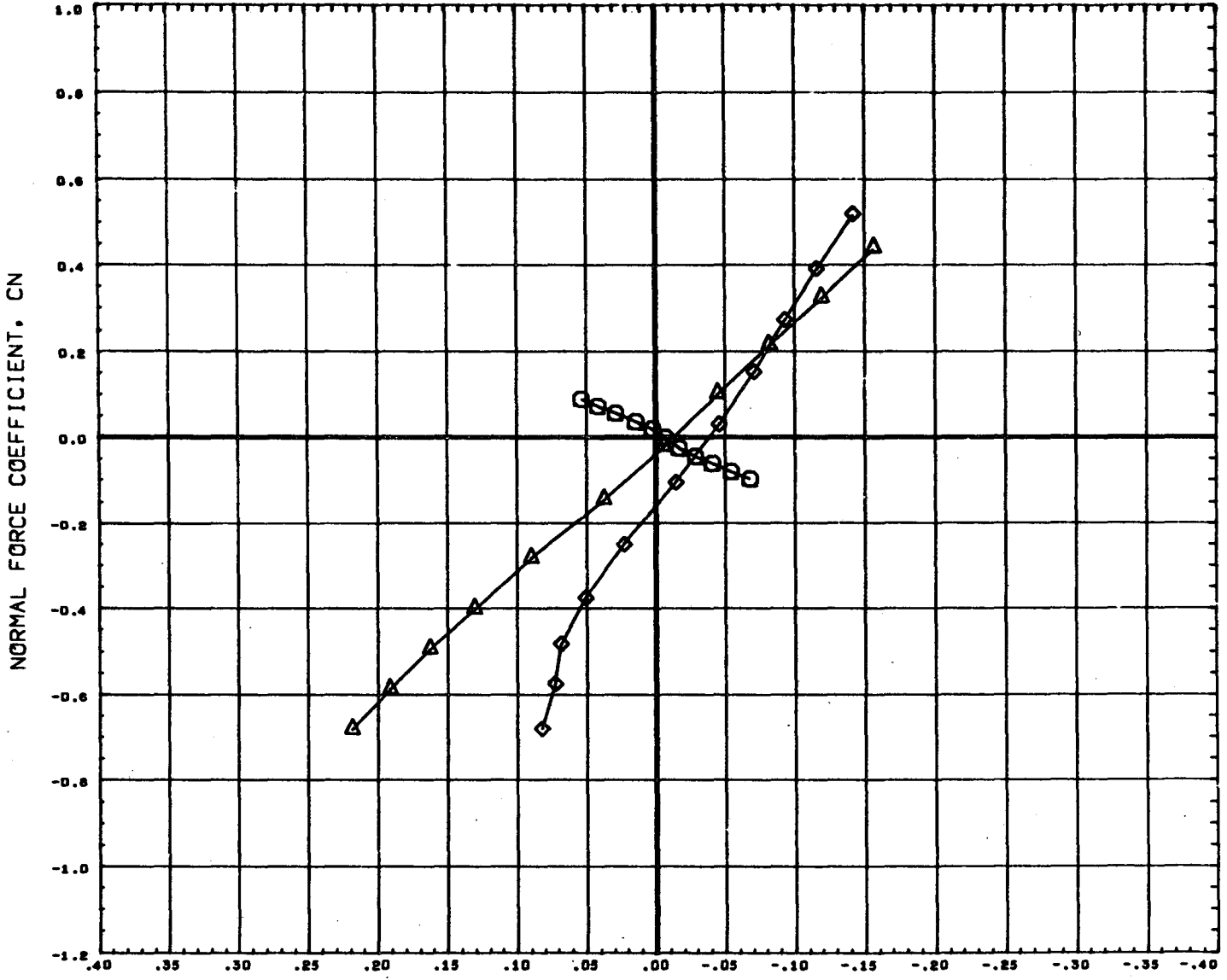

DATA SET SYMBOL	CONFIGURATION DESCRIPTION	ORBIN	THETS	BETA	REFERENCE INFORMATION
(B65001)	MSFC TWT 534 SHUTTLE LAUNCH T1			0.000	SREF 4.8950 SQ. IN
(B65002)	MSFC TWT 534 SHUTTLE LAUNCH T101	-1.500		0.000	LREF 2.6440 IN.
(B65004)	MSFC TWT 534 SHUTTLE LAUNCH T101S1	-1.500	21.000	0.000	BREF 3.5250 IN.
(B65012)	DATA NOT AVAILABLE FOR ALL CONDITIONS	-1.500	21.000	0.000	XMRP 3.4900 IN.
					YMRP 0.0000 IN.
					ZMRP 0.1616 IN.
					SCALE 0.0034

CONFIGURATION BUILD-UP EFFECT ON LONGITUDINAL CHARACTERISTICS (346 INCH TANK)

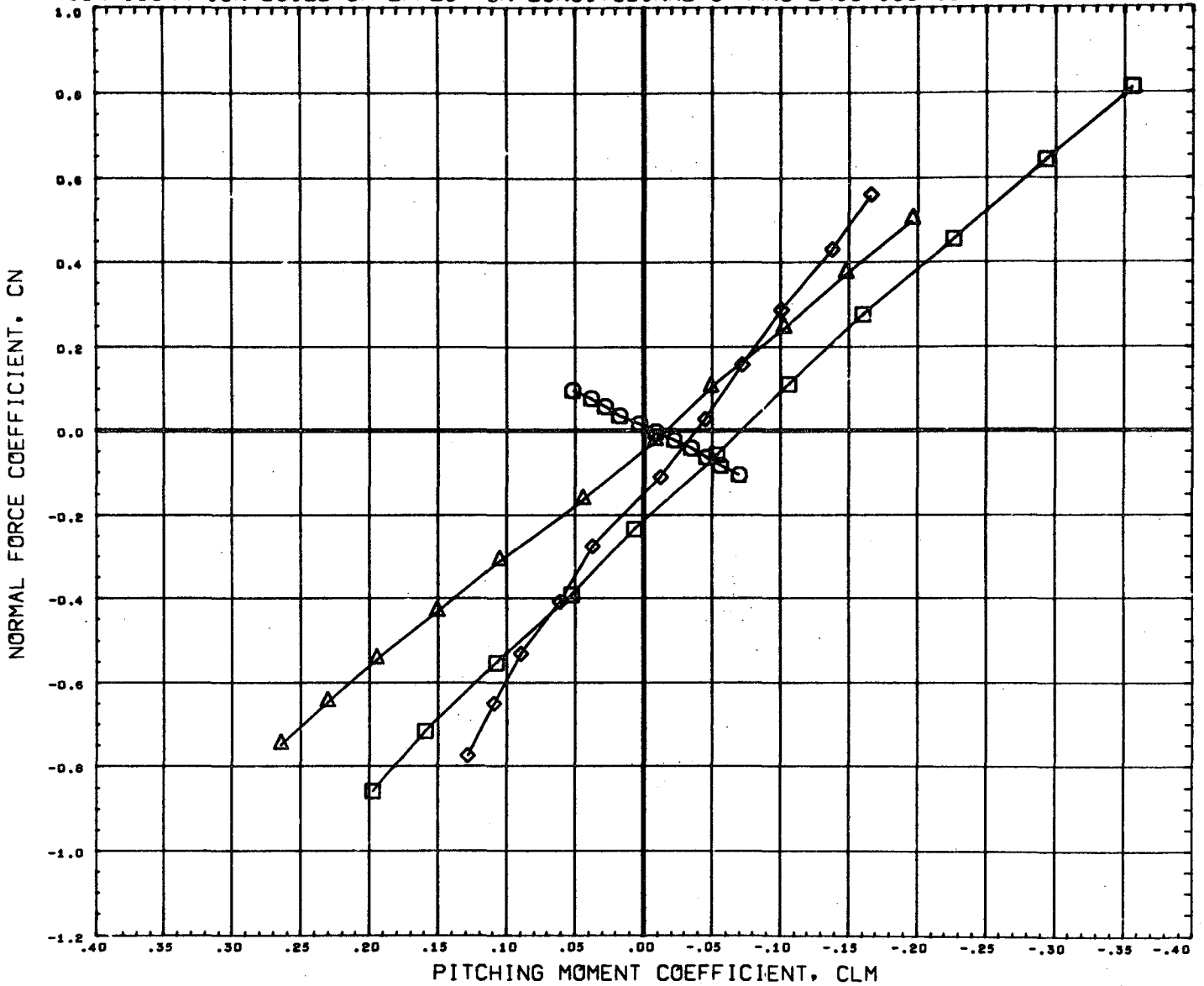

DATA SET SYMBOL	CONFIGURATION DESCRIPTION	T1	ORBIN	THETS	BETA	REFERENCE INFORMATION
(B65001)	MSFC TWT 534 SHUTTLE LAUNCH	T1	-1.500		0.000	SREF 4.8950 SQ. IN
(B65002)	MSFC TWT 534 SHUTTLE LAUNCH	T1O1	-1.500		0.000	LREF 2.6440 IN.
(B65004)	MSFC TWT 534 SHUTTLE LAUNCH	T1O1S1	-1.500	21.000	0.000	BREF 3.5250 IN.
(B65012)	MSFC TWT 534 SHUTTLE LAUNCH	T1O1S1F1	-1.500	21.000	0.000	XMRP 3.4900 IN. YMRP 0.0000 IN. ZMRP 0.1616 IN. SCALE 0.0034

MACH .90

CONFIGURATION BUILD-UP EFFECT ON LONGITUDINAL CHARACTERISTICS (346 INCH TANK)

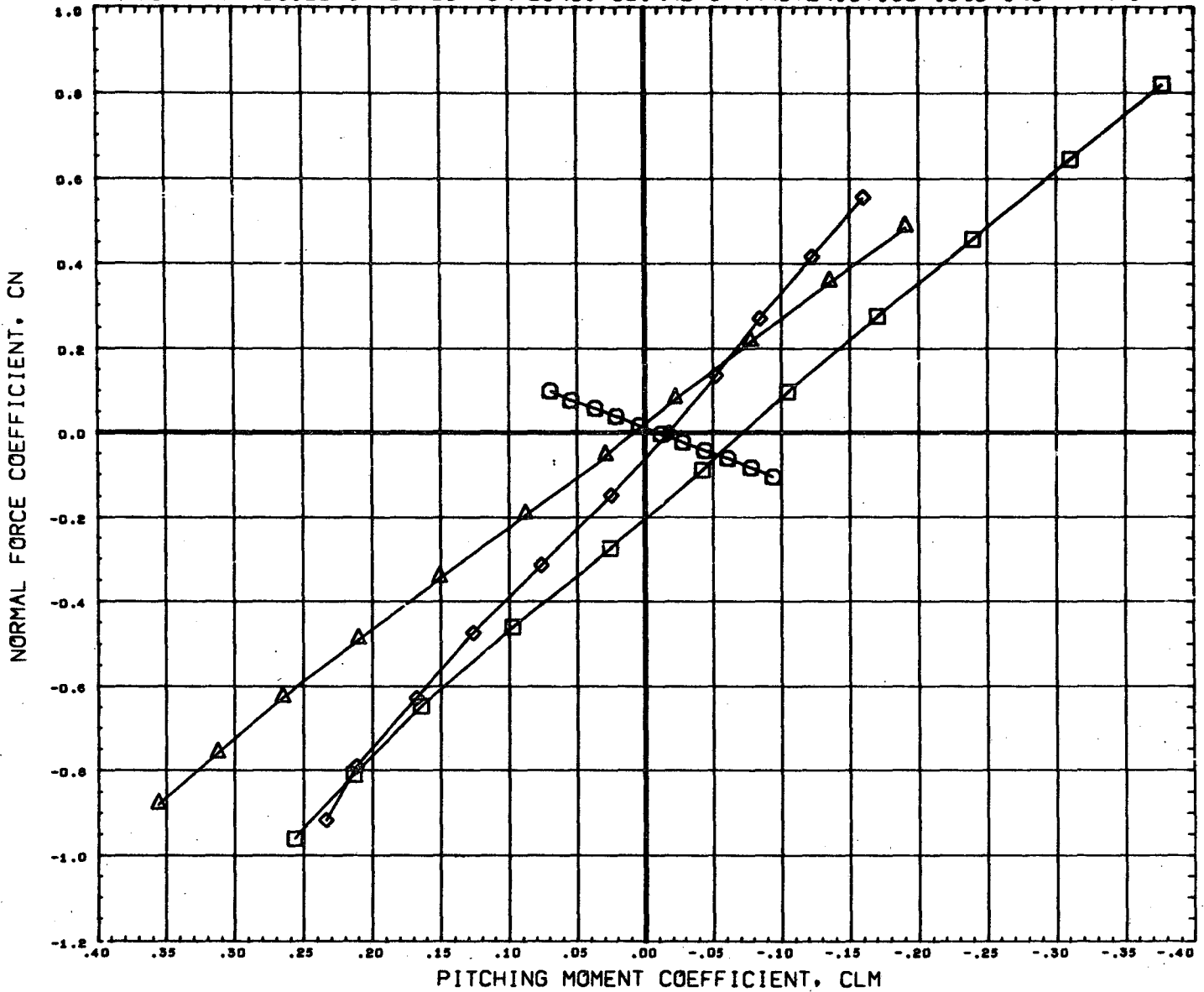

DATA SET SYMBOL	CONFIGURATION DESCRIPTION	ORBIN	THETS	BETA	REFERENCE INFORMATION
(B65001)	MSFC TWT 534 SHUTTLE LAUNCH	T1		0.000	SREF 4.8950 SQ. IN
(B65002)	MSFC TWT 534 SHUTTLE LAUNCH	T101	-1.500	0.000	LREF 2.6440 IN.
(B65004)	MSFC TWT 534 SHUTTLE LAUNCH	T101S1	-1.500	21.000	BREF 3.5250 IN.
(B65012)	MSFC TWT 534 SHUTTLE LAUNCH	T101S1F1	-1.500	21.000	XMRP 3.4900 IN.
					YMRP 0.0000 IN.
					ZMRP 0.1616 IN.
					SCALE 0.0034

MACH 1.10

CONFIGURATION BUILD-UP EFFECT ON LONGITUDINAL CHARACTERISTICS (346 INCH TANK)

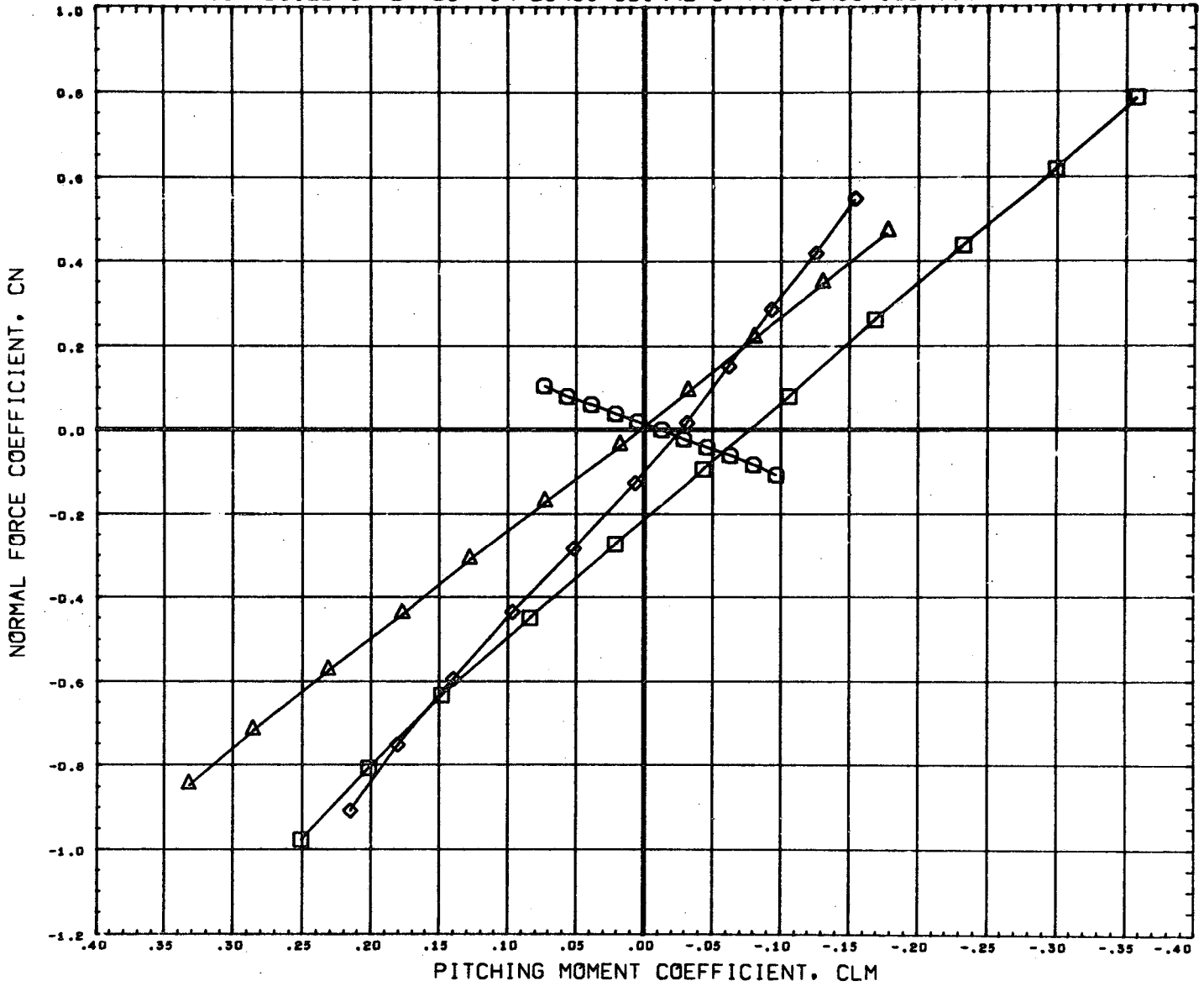

DATA SET SYMBOL	SYMBOL	CONFIGURATION DESCRIPTION	T1	ORBIN	THETS	BETA	REFERENCE INFORMATION
(B65001)	○	MSFC TWT 534 SHUTTLE LAUNCH	T1			0.000	SREF 4.8950 Sq. IN
(B65002)	△	MSFC TWT 534 SHUTTLE LAUNCH	T101	-1.500		0.000	LREF 2.6440 IN.
(B65004)	◇	MSFC TWT 534 SHUTTLE LAUNCH	T101S1	-1.500	21.000	0.000	BREF 3.5250 IN.
(B65012)	□	MSFC TWT 534 SHUTTLE LAUNCH	T101S1F1	-1.500	21.000	0.000	XMRP 3.4900 IN.
							YMRP 0.0000 IN.
							ZMRP 0.1616 IN.
							SCALE 0.0034

MACH 1.20

CONFIGURATION BUILD-UP EFFECT ON LONGITUDINAL CHARACTERISTICS (346 INCH TANK)

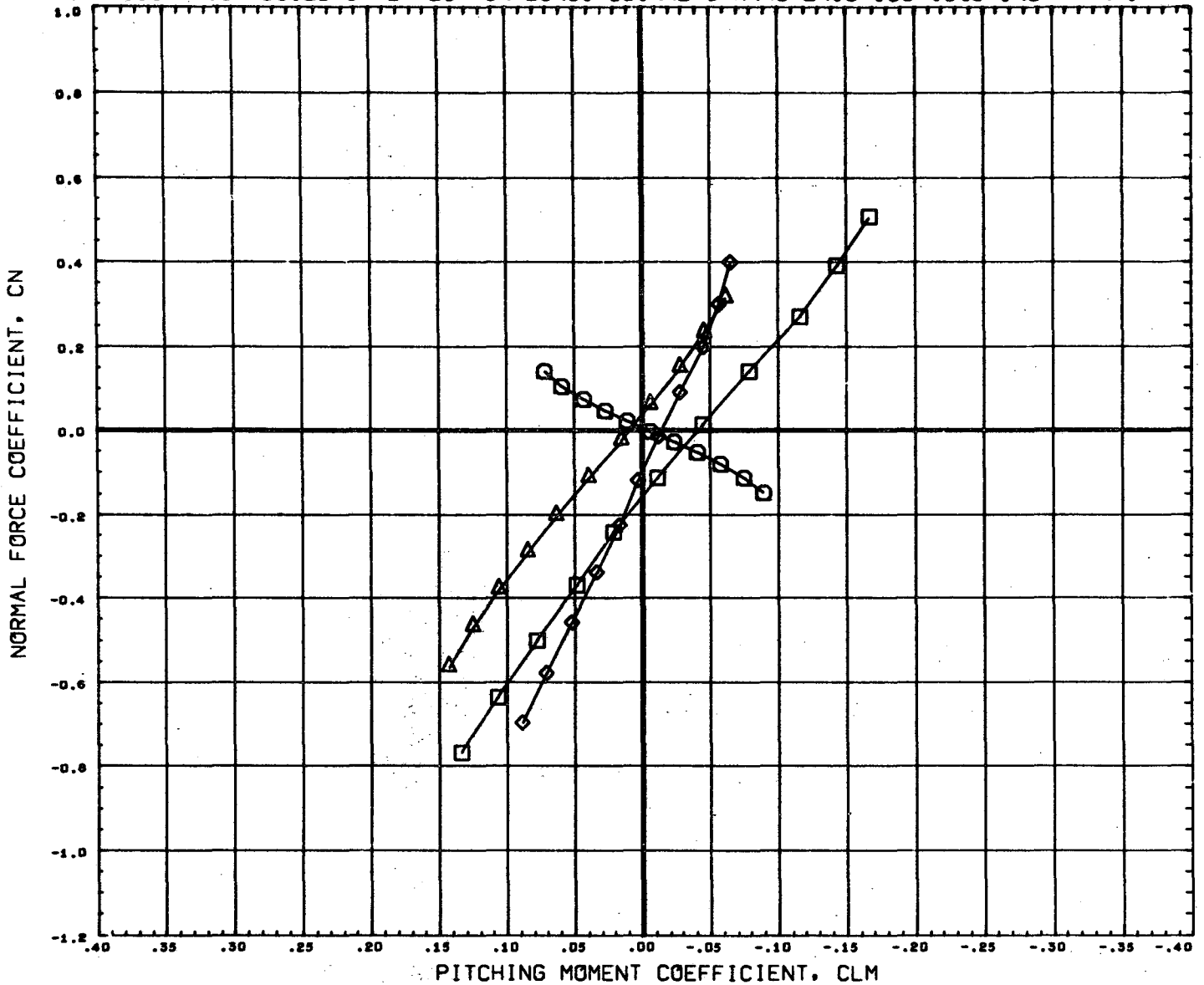

DATA SET SYMBOL	CONFIGURATION DESCRIPTION	T1	ORBIN	THETS	BETA	REFERENCE INFORMATION
(865001)	MSFC TWT 534 SHUTTLE LAUNCH	T1	-1.500	21.000	0.000	SREF 4.8950 SQ. IN
(865002)	MSFC TWT 534 SHUTTLE LAUNCH	T101	-1.500	21.000	0.000	LREF 2.6440 IN.
(865004)	MSFC TWT 534 SHUTTLE LAUNCH	T101S1	-1.500	21.000	0.000	BREF 3.5250 IN.
(865012)	MSFC TWT 534 SHUTTLE LAUNCH	T101S1F1	-1.500	21.000	0.000	XMRP 3.4900 IN.
						YMRP 0.0000 IN.
						ZMRP 0.1616 IN.
						SCALE 0.0034

CONFIGURATION BUILD-UP EFFECT ON LONGITUDINAL CHARACTERISTICS (346 INCH TANK)

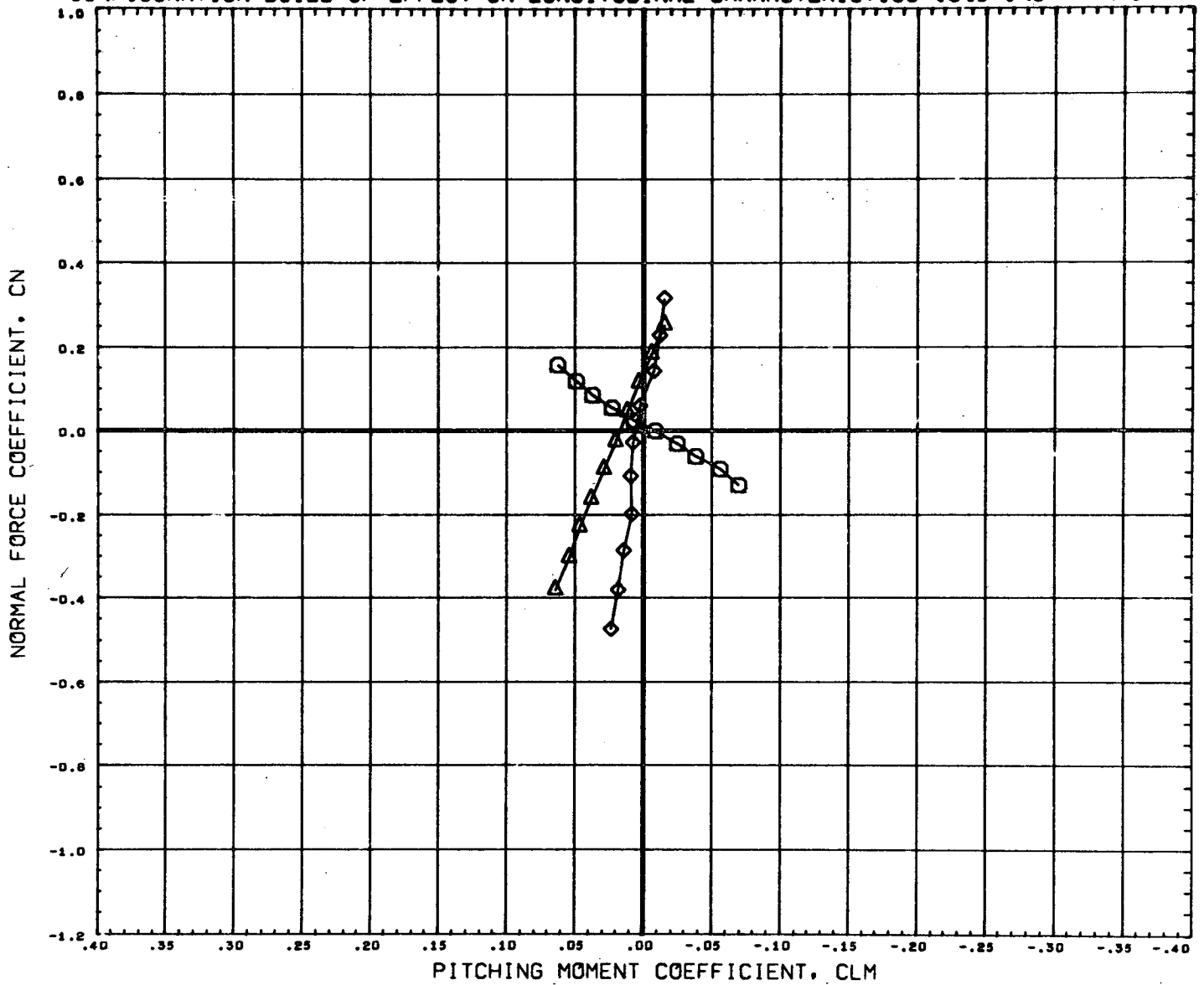

DATA SET SYMBOL	CONFIGURATION DESCRIPTION	ORBIN	THETS	BETA	REFERENCE INFORMATION
(B65001)	MSFC TWT 534 SHUTTLE LAUNCH T1			0.000	SREF 4.8950 SQ. IN
(B65002)	MSFC TWT 534 SHUTTLE LAUNCH T101	-1.500		0.000	LREF 2.6440 IN.
(B65004)	MSFC TWT 534 SHUTTLE LAUNCH T101S1	-1.500	21.000	0.000	BREF 3.5250 IN.
(B65012)	DATA NOT AVAILABLE FOR ALL CONDITIONS	-1.500	21.000	0.000	XNRP 3.4900 IN.
					YNRP 0.0000 IN.
					ZMRP 0.1616 IN.
					SCALE 0.0034

MACH 2.74

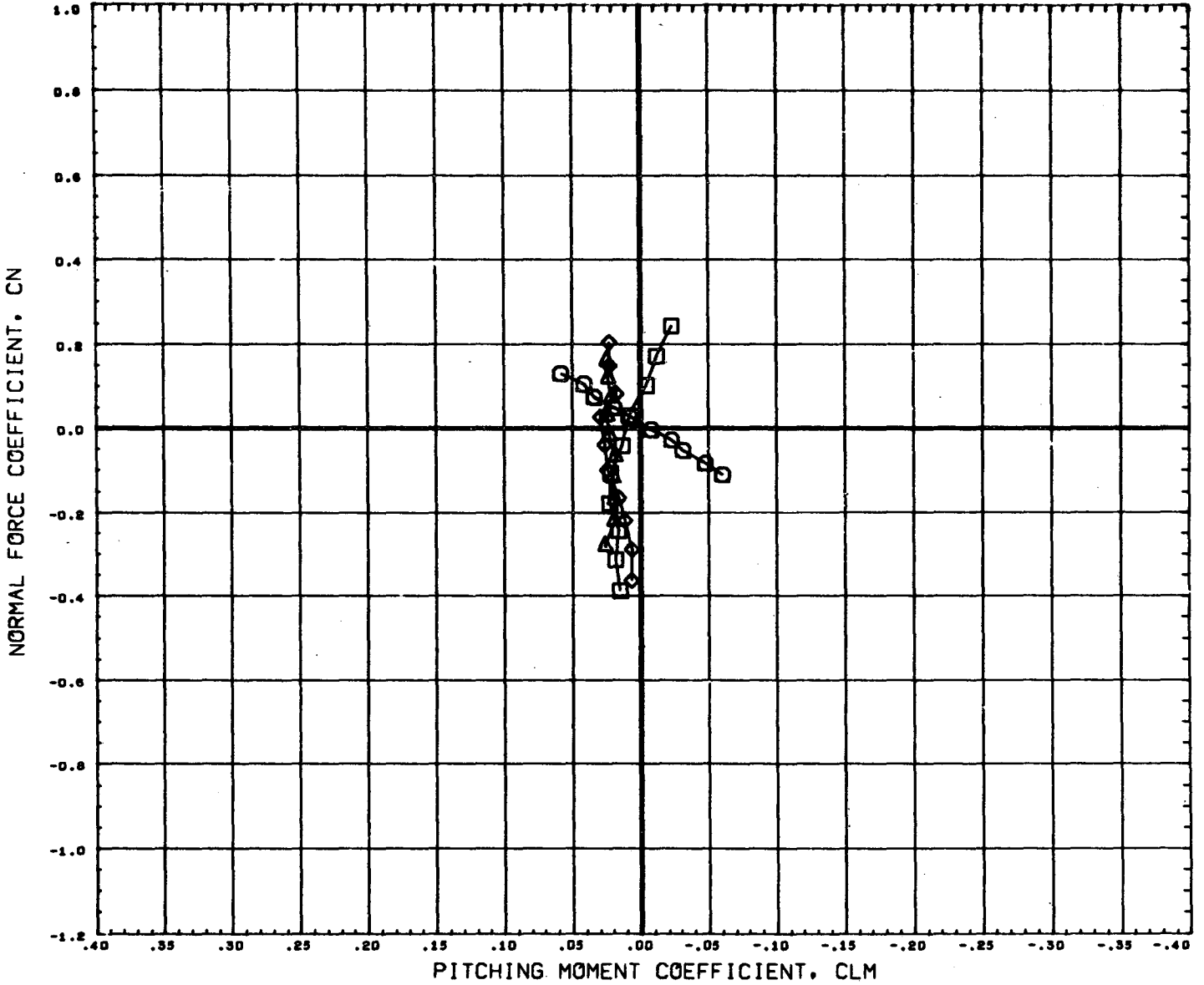

CONFIGURATION BUILD-UP EFFECT ON LONGITUDINAL CHARACTERISTICS (346 INCH TANK)

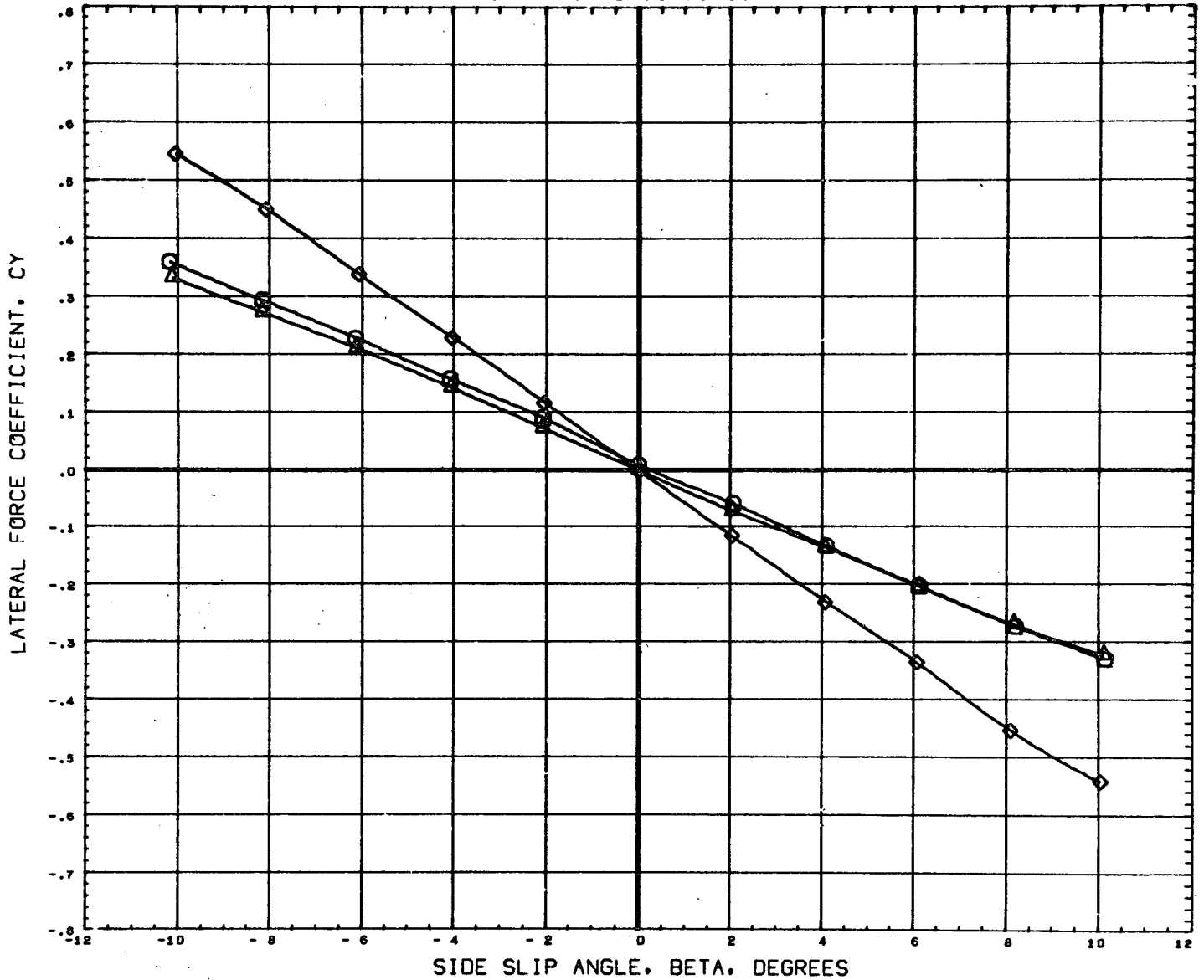

DATA SET SYMBOL	CONFIGURATION DESCRIPTION	T1	ORBIN	THETS	BETA	REFERENCE INFORMATION
(B65001)	MSFC TWT 534 SHUTTLE LAUNCH	T1	-1.500		0.000	SREF 4.8950 SQ. IN
(B65002)	MSFC TWT 534 SHUTTLE LAUNCH	T101	-1.500		0.000	LREF 2.6440 IN.
(B65004)	MSFC TWT 534 SHUTTLE LAUNCH	T101S1	-1.500	21.000	0.000	BREF 3.5250 IN.
(B65012)	MSFC TWT 534 SHUTTLE LAUNCH	T10191F1	-1.500	21.000	0.000	XMRP 3.4900 IN.
						YMRP 0.0000 IN.
						ZMRP 0.1616 IN.
						SCALE 0.0034

CONFIGURATION BUILD-UP EFFECT ON LATERAL/DIRECTIONAL CHARACT. (346 INCH TANK)



DATA SET SYMBOL	CONFIGURATION DESCRIPTION	ORBIN	THETS	ALPHA	REFERENCE INFORMATION
(B65003) 	MSFC TWT 534 SHUTTLE LAUNCH	T101	-1.500	0.000	SREF 4.8950 SQ. IN
(B65005) 	MSFC TWT 534 SHUTTLE LAUNCH	T101S1	-1.500	21.000	LREF 2.6440 IN.
(B65013) 	MSFC TWT 534 SHUTTLE LAUNCH	T101S1F1	-1.500	21.000	BREF 3.5250 IN.
					XMRP 3.4900 IN.
					YMRP 0.0000 IN.
					ZMRP 0.1616 IN.
					SCALE 0.0034

MACH .60

CONFIGURATION BUILD-UP EFFECT ON LATERAL/DIRECTIONAL CHARACT. (346 INCH TANK)

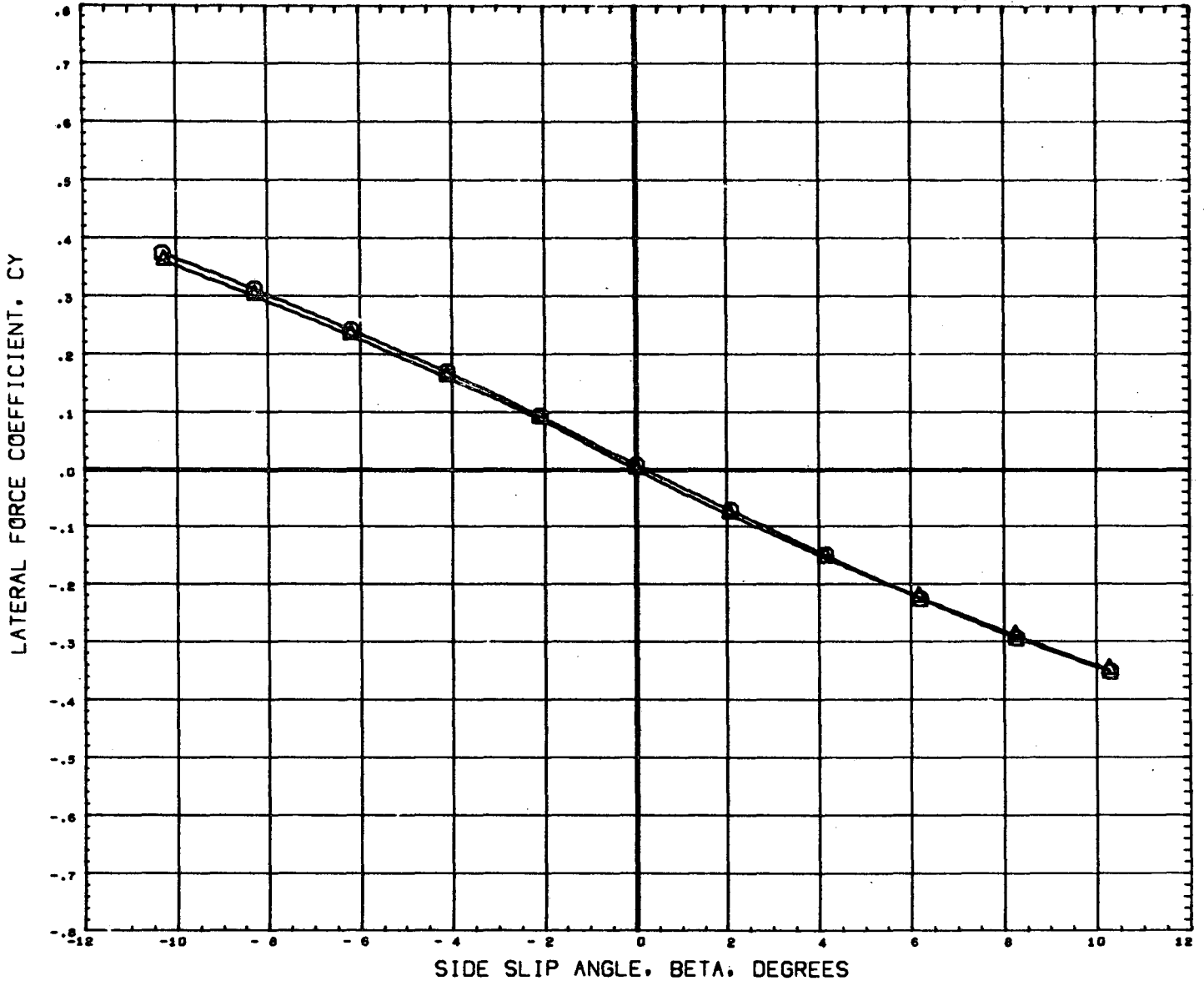

DATA SET SYMBOL	CONFIGURATION DESCRIPTION	ORBIN	THETS	ALPHA	REFERENCE INFORMATION
(B65003)	MSFC TWT 534 SHUTTLE LAUNCH T101	-1.500		0.000	SREF 4.8950 sq. IN
(B65005)	MSFC TWT 534 SHUTTLE LAUNCH T101S1	-1.500	21.000	0.000	LREF 2.6440 IN.
(B65013)	DATA NOT AVAILABLE FOR ALL CONDITIONS	-1.500	21.000	0.000	BREF 3.5250 IN.
					XMRP 3.4900 IN.
					YMRP 0.0000 IN.
					ZMRP 0.1616 IN.
					SCALE 0.0034

MACH .80

CONFIGURATION BUILD-UP EFFECT ON LATERAL/DIRECTIONAL CHARACT. (346 INCH TANK)

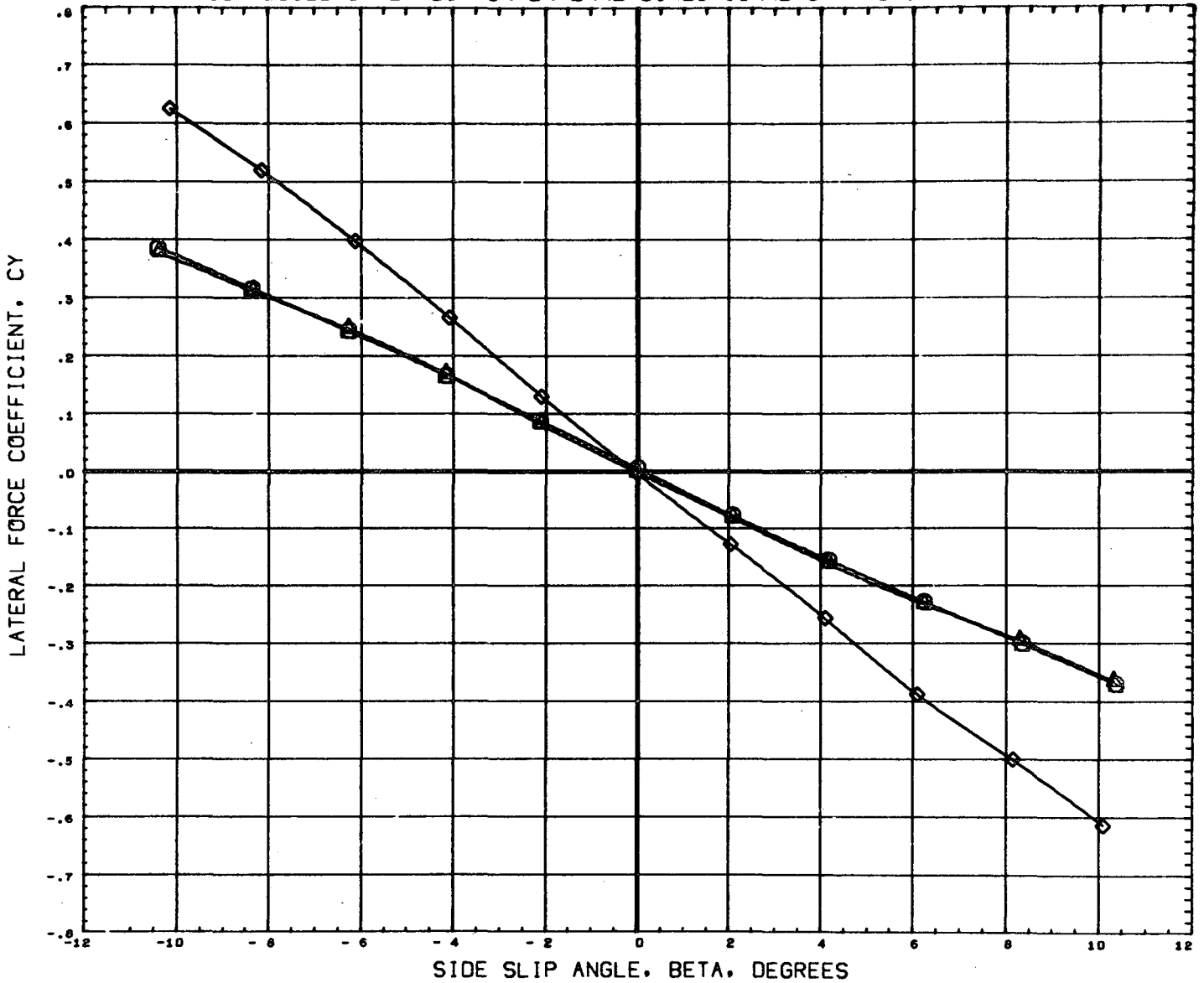

DATA SET SYMBOL	CONFIGURATION DESCRIPTION	ORBIN	THETS	ALPHA	REFERENCE INFORMATION
(B65003)	MSFC TWT 534 SHUTTLE LAUNCH	T101	-1.500	0.000	SREF 4.8950 SQ. IN
(B65005)	MSFC TWT 534 SHUTTLE LAUNCH	T101S1	-1.500	21.000	LREF 2.6440 IN.
(B65013)	MSFC TWT 534 SHUTTLE LAUNCH	T101S1F1	-1.500	21.000	BREF 3.5250 IN.
					XMRP 3.4900 IN.
					YMRP 0.0000 IN.
					ZMRP 0.1616 IN.
					SCALE 0.0034

MACH .90

CONFIGURATION BUILD-UP EFFECT ON LATERAL/DIRECTIONAL CHARACT. (346 INCH TANK)

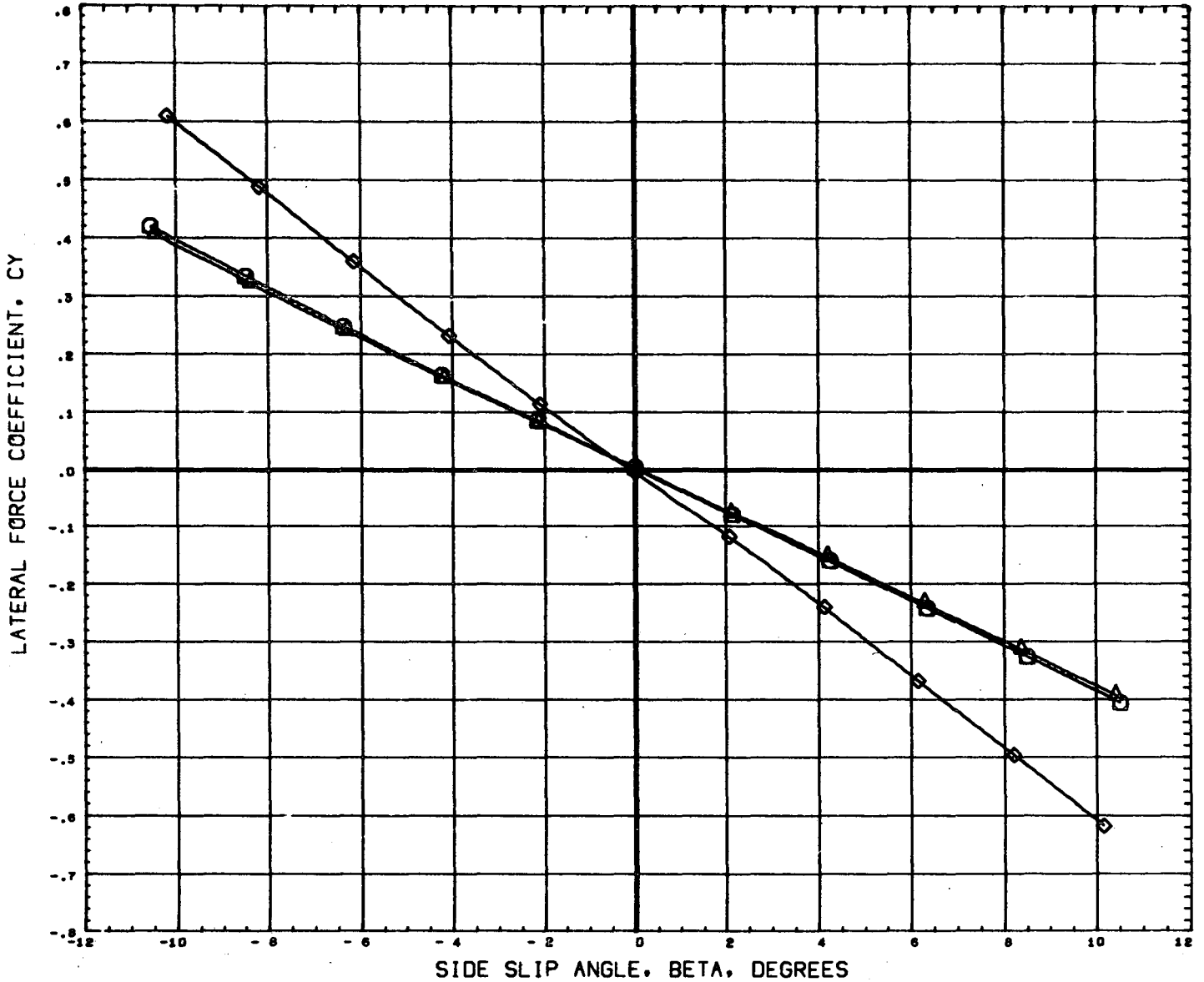

DATA SET SYMBOL	CONFIGURATION DESCRIPTION	ORBIN	THETS	ALPHA	REFERENCE INFORMATION
(B65003)	MSFC TWT 534 SHUTTLE LAUNCH	T101	-1.500	0.000	SREF 4.8950 90. IN
(B65005)	MSFC TWT 534 SHUTTLE LAUNCH	T101S1	-1.500	21.000	LREF 2.6440 IN.
(B65013)	MSFC TWT 534 SHUTTLE LAUNCH	T101S1F1	-1.500	21.000	BREF 3.5250 IN.
					XMRP 3.4900 IN.
					YMRP 0.0000 IN.
					ZMRP 0.1616 IN.
					SCALE 0.0034

CONFIGURATION BUILD-UP EFFECT ON LATERAL/DIRECTIONAL CHARACT. (346 INCH TANK)

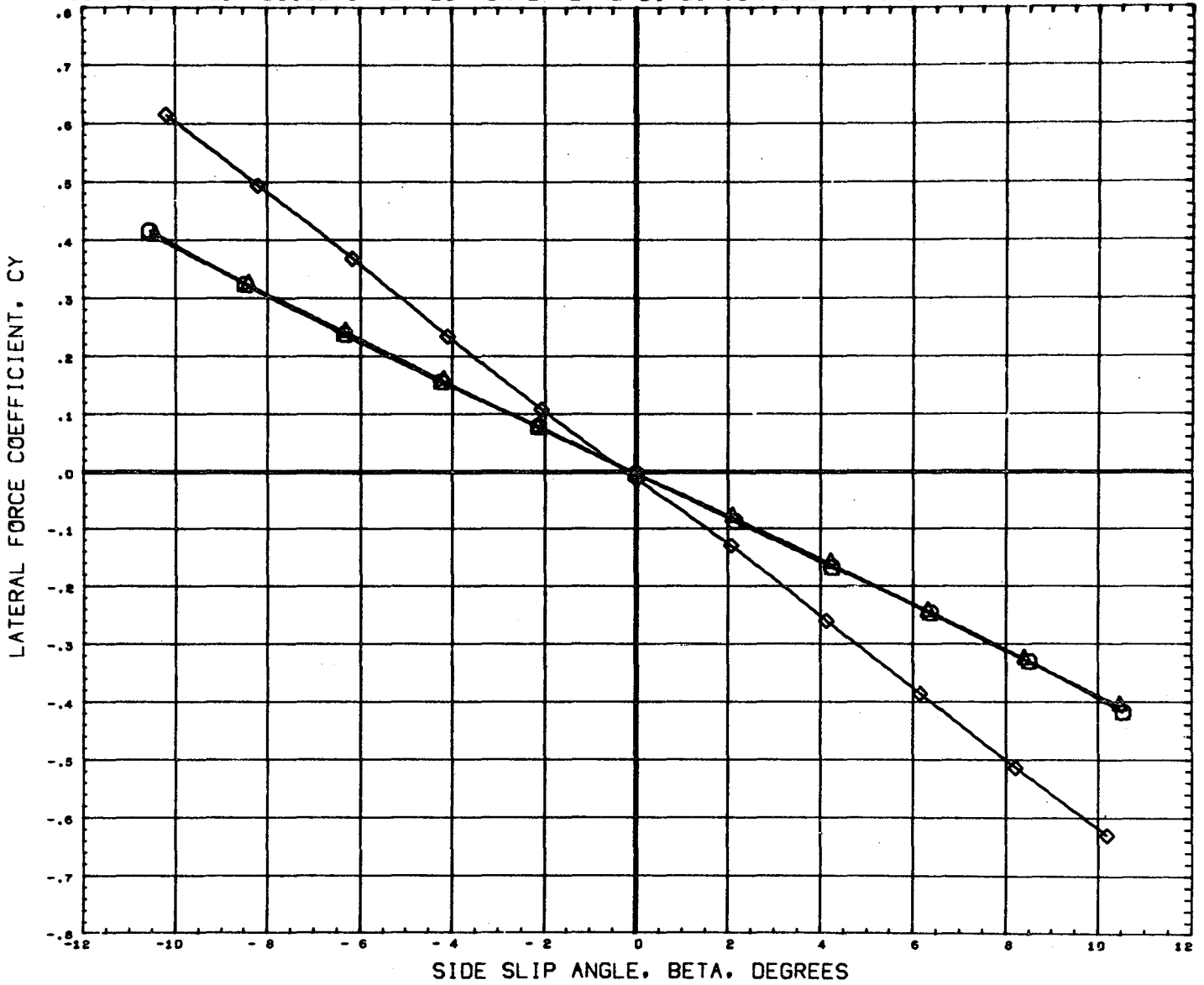

DATA SET SYMBOL	CONFIGURATION DESCRIPTION	ORBIN	THETS	ALPHA	REFERENCE INFORMATION
(B65003)	MSFC TWT 534 SHUTTLE LAUNCH	T101	-1.500	0.000	SREF 4.8950 SQ. IN
(B65005)	MSFC TWT 534 SHUTTLE LAUNCH	T101S1	-1.500	21.000	LREF 2.6440 IN.
(B65013)	MSFC TWT 534 SHUTTLE LAUNCH	T101S1F1	-1.500	21.000	BREF 3.5250 IN.
					XMRP 3.4900 IN.
					YMRP 0.0000 IN.
					ZMRP 0.1616 IN.
					SCALE 0.0034

MACH 1.20

PAGE 53

CONFIGURATION BUILD-UP EFFECT ON LATERAL/DIRECTIONAL CHARACT. (346 INCH TANK)

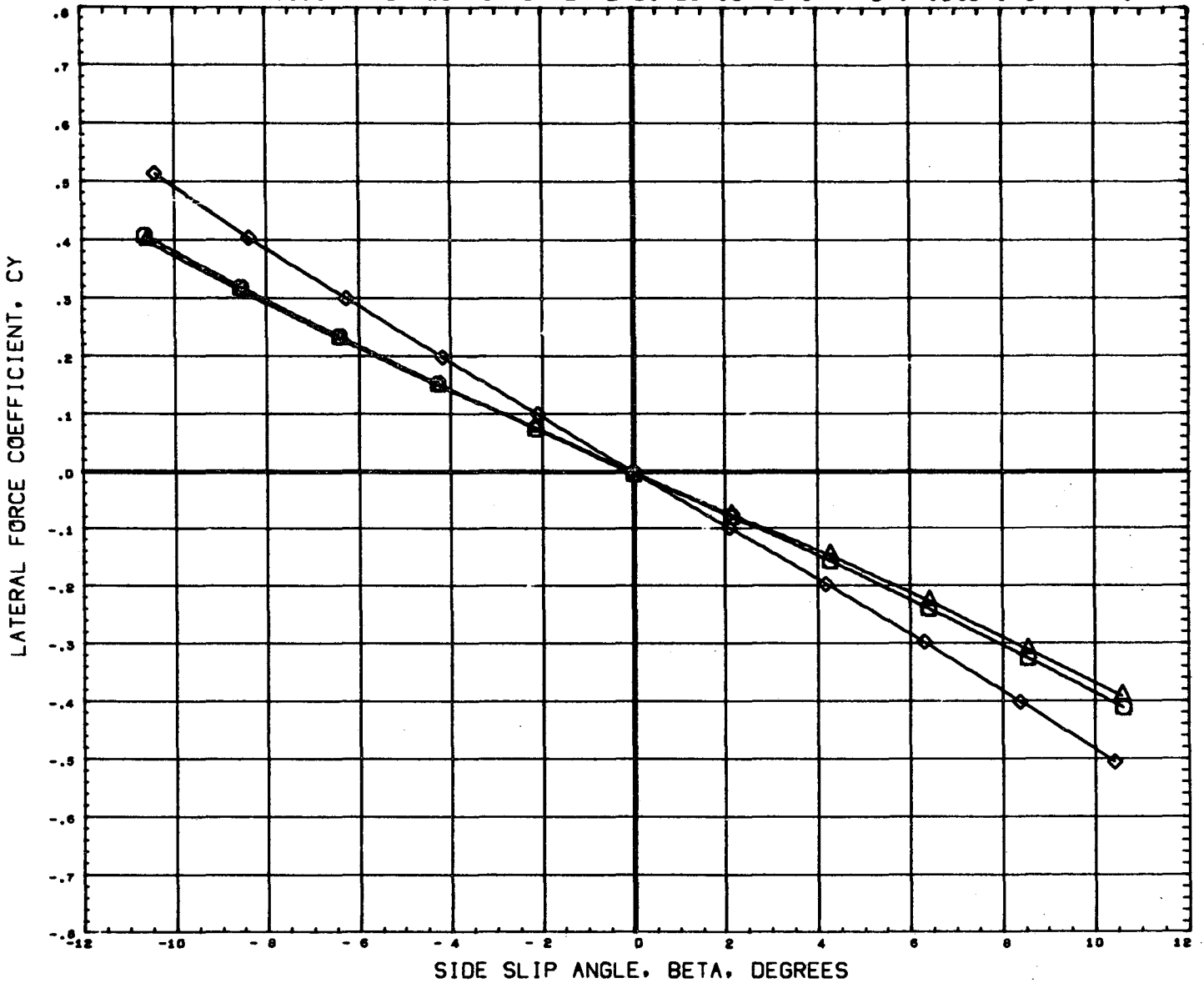

DATA SET SYMBOL	CONFIGURATION DESCRIPTION	ORBIN	THETS	ALPHA	REFERENCE INFORMATION
(B65003)	MSFC TWT 534 SHUTTLE LAUNCH	-1.500		0.000	SREF 4.8950 SQ. IN
(B65005)	MSFC TWT 534 SHUTTLE LAUNCH	-1.500	21.003	0.000	LREF 2.6440 IN.
(B65013)	MSFC TWT 534 SHUTTLE LAUNCH	-1.500	21.000	0.000	BREF 3.5250 IN.
					XMRP 3.4900 IN.
					YMRP 0.0000 IN.
					ZMRP 0.1616 IN.
					SCALE 0.0034

MACH 1.96

CONFIGURATION BUILD-UP EFFECT ON LATERAL/DIRECTIONAL CHARACT. (346 INCH TANK)

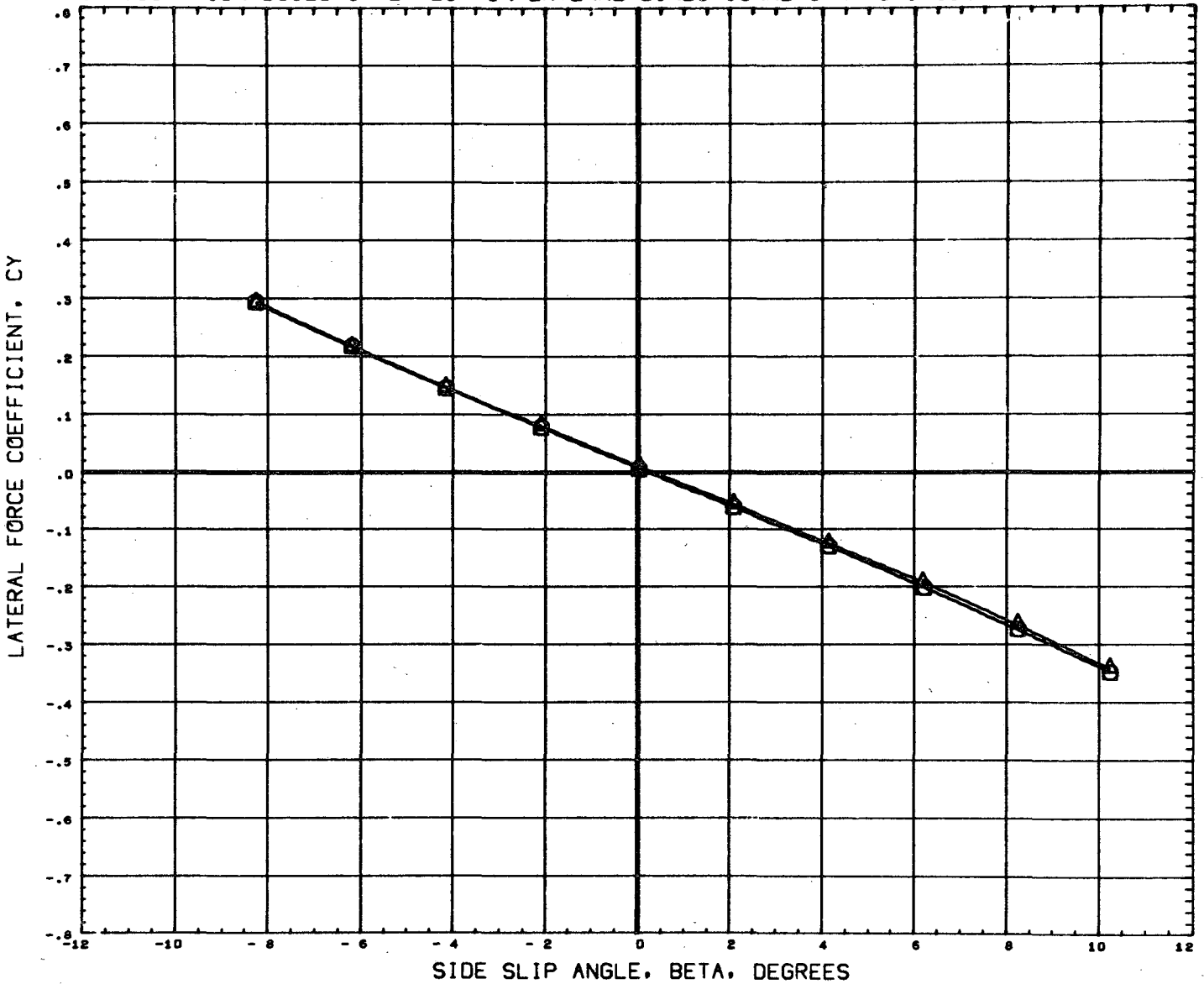

DATA SET SYMBOL	CONFIGURATION DESCRIPTION	ORBIN	THETS	ALPHA	REFERENCE INFORMATION
(B65003)	MSFC TWT 534 SHUTTLE LAUNCH T101	-1.500		0.000	SREF 4.8950 SQ. IN
(B65005)	MSFC TWT 534 SHUTTLE LAUNCH T101S1	-1.500	21.000	0.000	LREF 2.6440 IN.
(B65013)	DATA NOT AVAILABLE FOR ALL CONDITIONS	-1.500	21.000	0.000	BREF 3.5250 IN.
					XMRP 3.4900 IN.
					YMRP 0.0000 IN.
					ZMRP 0.1616 IN.
					SCALE 0.0034

MACH 2.74

CONFIGURATION BUILD-UP EFFECT ON LATERAL/DIRECTIONAL CHARACT. (346 INCH TANK)

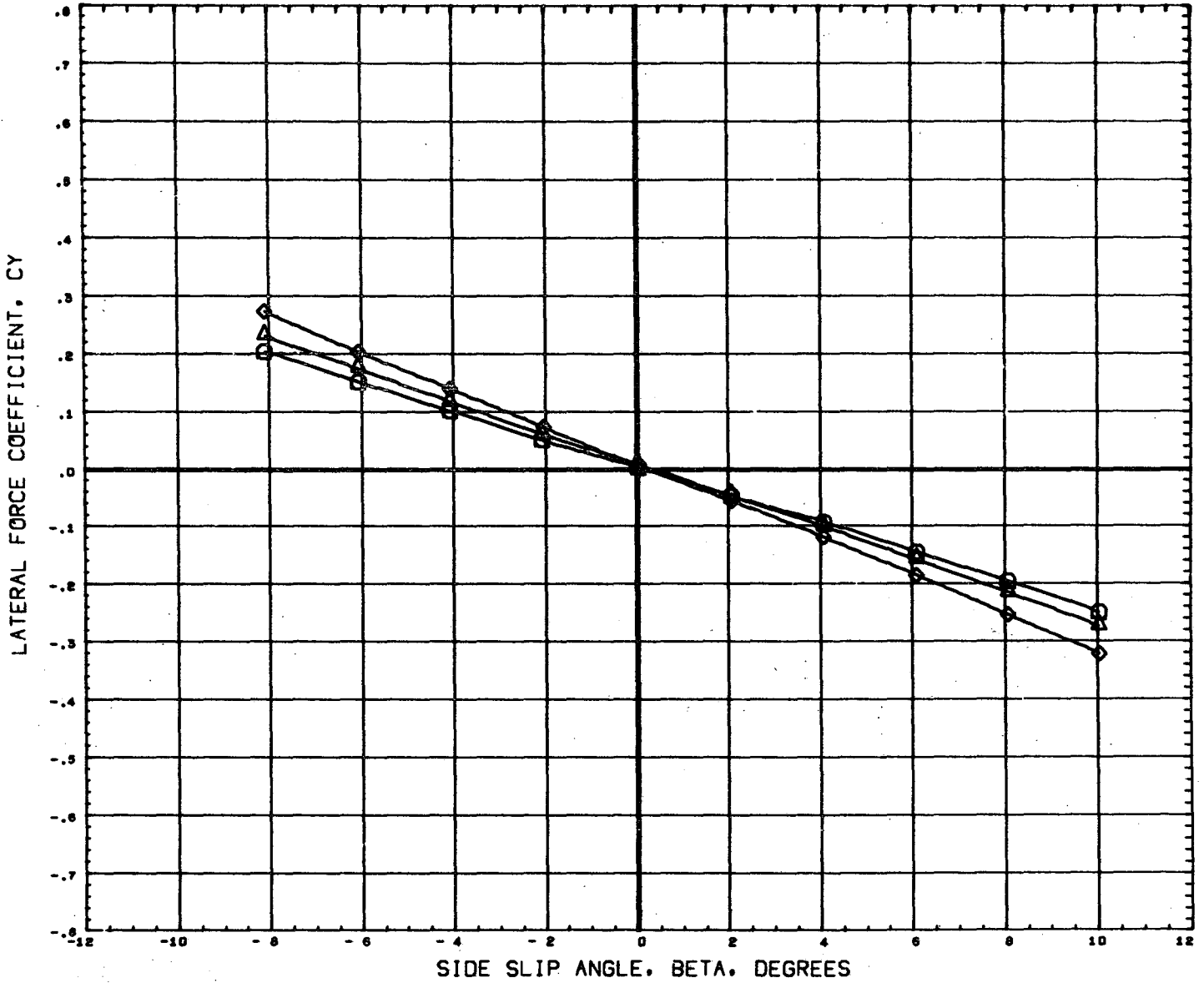

DATA SET SYMBOL	CONFIGURATION DESCRIPTION	ORBIN	THETS	ALPHA	REFERENCE INFORMATION
(B65003)	MSFC TWT 534 SHUTTLE LAUNCH	T101	-1.500	0.000	SREF 4.8950 SQ. IN
(B65005)	MSFC TWT 534 SHUTTLE LAUNCH	T101S1	-1.500	21.000	LREF 2.6440 IN.
(B65013)	MSFC TWT 534 SHUTTLE LAUNCH	T101S1F1	-1.500	21.000	BREF 3.5250 IN.
					XMRP 3.4900 IN.
					YMRP 0.0000 IN.
					ZMRP 0.1616 IN.
					SCALE 0.0034

CONFIGURATION BUILD-UP EFFECT ON LATERAL/DIRECTIONAL CHARACT. (346 INCH TANK)

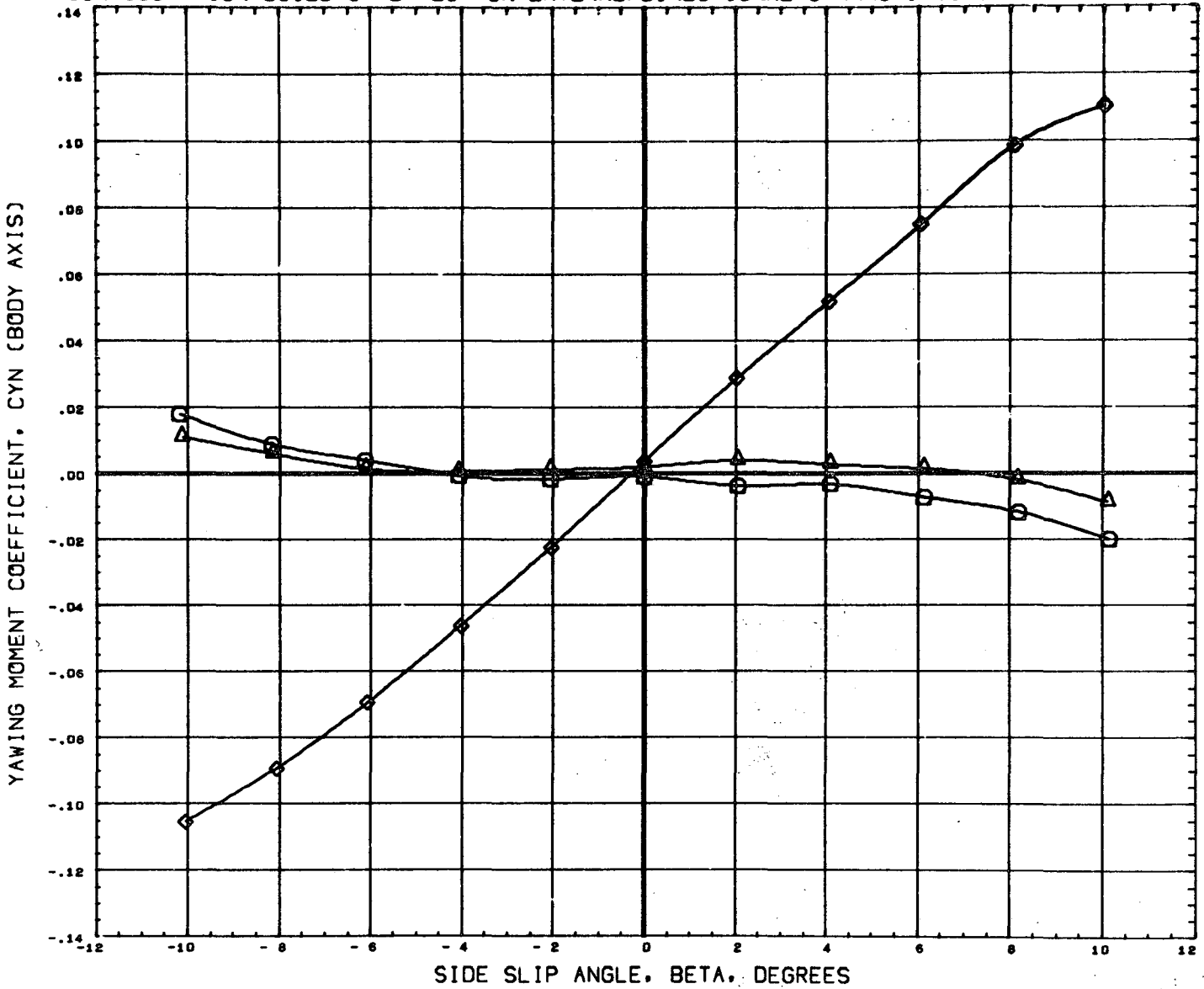

DATA SET SYMBOL	CONFIGURATION DESCRIPTION	ORBIN	THETS	ALPHA	REFERENCE INFORMATION
(B65D03)	MSFC TWT 534 SHUTTLE LAUNCH	T101	-1.500	0.000	SREF 4.8950 SQ. IN
(B65D05)	MSFC TWT 534 SHUTTLE LAUNCH	T101S1	-1.500	21.000	LREF 2.6440 IN.
(B65D13)	MSFC TWT 534 SHUTTLE LAUNCH	T101S1F1	-1.500	21.000	BREF 3.5250 IN.
					XMRP 3.4900 IN.
					YMRP 0.0000 IN.
					ZMRP 0.1616 IN.
					SCALE 0.0034

MACH .60

CONFIGURATION BUILD-UP EFFECT ON LATERAL/DIRECTIONAL CHARACT. (346 INCH TANK)

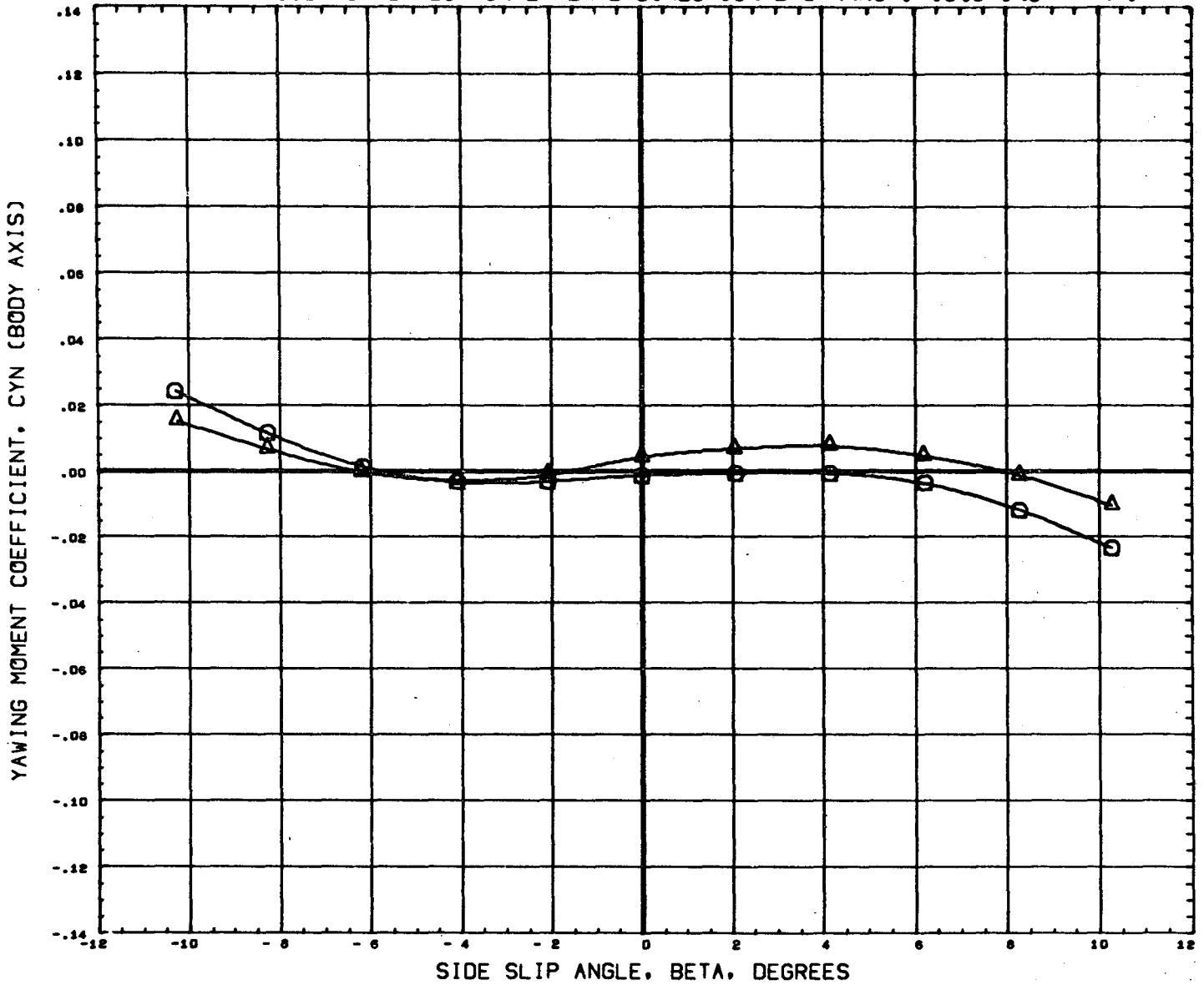

DATA SET SYMBOL	CONFIGURATION DESCRIPTION	ORBIN	THETS	ALPHA	REFERENCE INFORMATION
(B65003)	MSFC TWT 534 SHUTTLE LAUNCH T101	-1.500		0.000	SREF 4.8950 90. IN
(B65005)	MSFC TWT 534 SHUTTLE LAUNCH T101S1	-1.500	21.000	0.000	LREF 2.6440 IN.
(B65013)	DATA NOT AVAILABLE FOR ALL CONDITIONS	-1.500	21.000	0.000	BREF 3.5250 IN.
					XMRP 3.4900 IN.
					YMRP 0.0000 IN.
					ZMRP 0.1616 IN.
					SCALE 0.0034

CONFIGURATION BUILD-UP EFFECT ON LATERAL/DIRECTIONAL CHARACT. (346 INCH TANK)

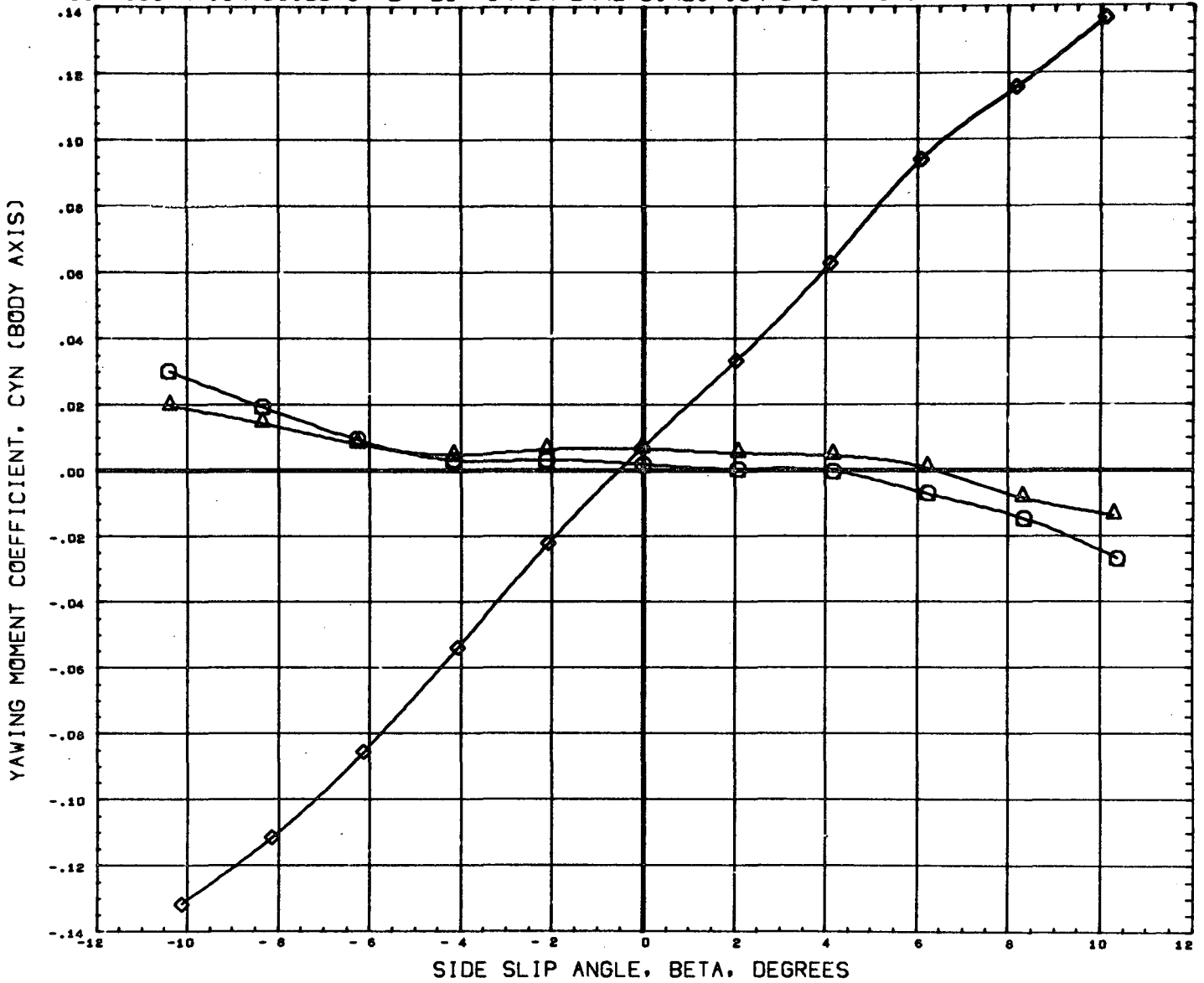

DATA SET SYMBOL	CONFIGURATION DESCRIPTION	ORBIN	THETS	ALPHA	REFERENCE INFORMATION
(865003)	MSFC TWT 534 SHUTTLE LAUNCH	T101	-1.500	0.000	SREF 4.8950 sq. IN
(865005)	MSFC TWT 534 SHUTTLE LAUNCH	T101S1	-1.500	21.000	LREF 2.6440 IN.
(865013)	MSFC TWT 534 SHUTTLE LAUNCH	T101S1F1	-1.500	21.000	BREF 3.9250 IN.
					XHRP 3.4900 IN.
					YHRP 0.0000 IN.
					ZHRP 0.1616 IN.
					SCALE 0.0034

MACH .90

CONFIGURATION BUILD-UP EFFECT ON LATERAL/DIRECTIONAL CHARACT. (346 INCH TANK)

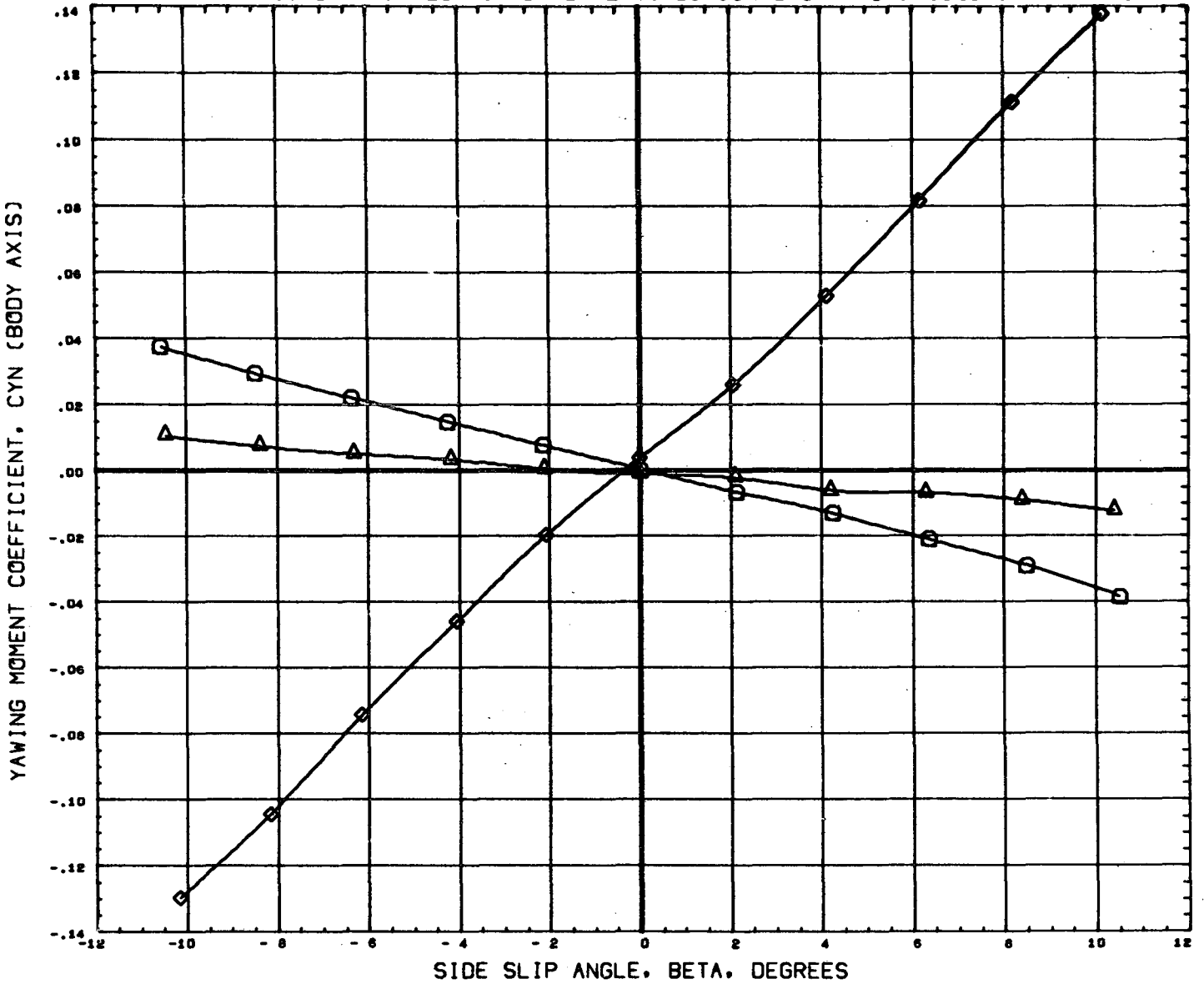

DATA SET SYMBOL	CONFIGURATION DESCRIPTION	ORBIN	THETS	ALPHA	REFERENCE INFORMATION
(865003)	MSFC TWT 534 SHUTTLE LAUNCH	T101	-1.500	0.000	SREF 4.8950 SQ. IN
(865005)	MSFC TWT 534 SHUTTLE LAUNCH	T101S1	-1.500	21.000	LREF 2.6440 IN.
(865013)	MSFC TWT 534 SHUTTLE LAUNCH	T101S1F1	-1.500	21.000	BREF 3.5250 IN.
					XMRP 3.4900 IN.
					YMRP 0.0000 IN.
					ZMRP 0.1616 IN.
					SCALE 0.0034

CONFIGURATION BUILD-UP EFFECT ON LATERAL/DIRECTIONAL CHARACT. (346 INCH TANK)

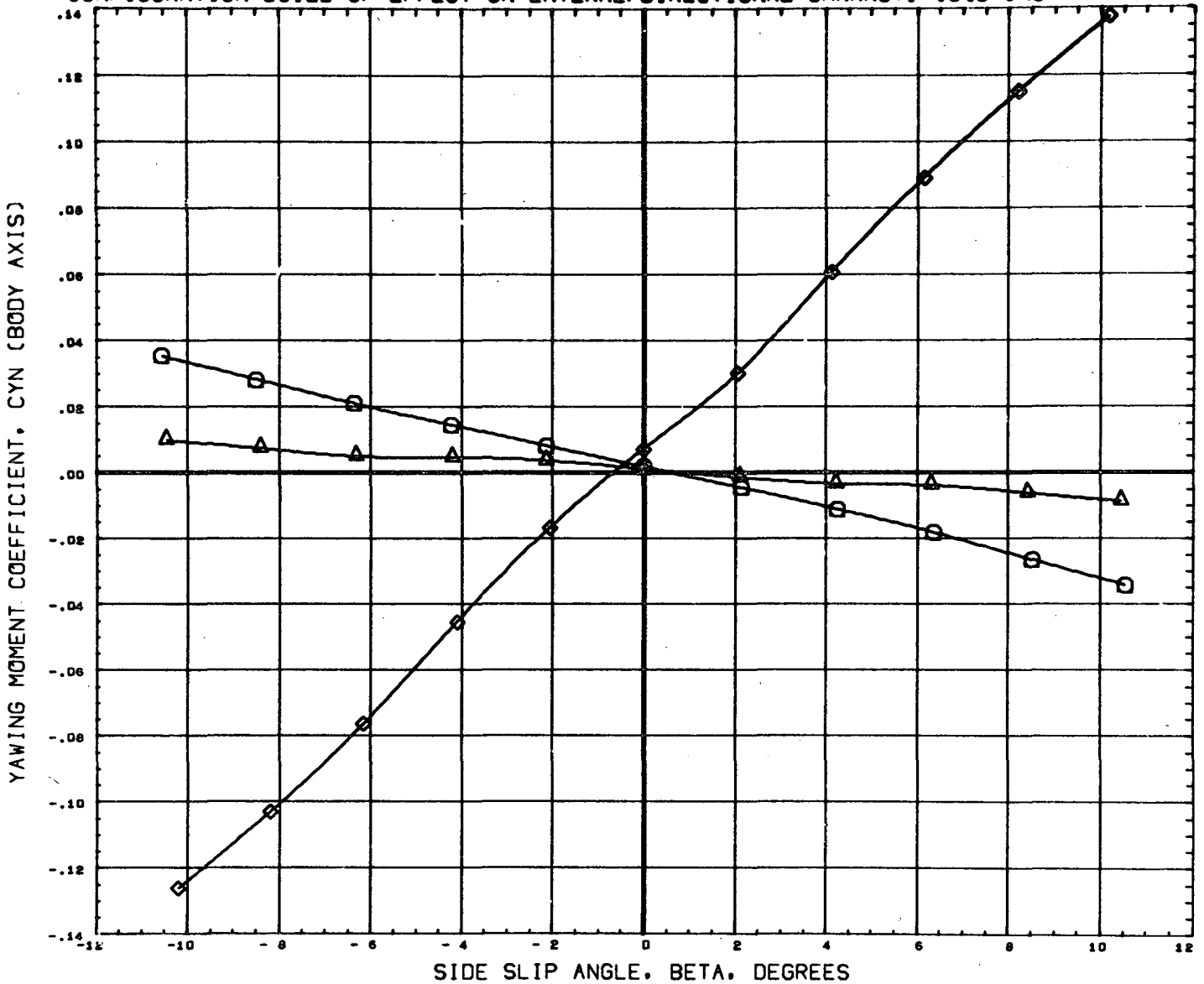

DATA SET SYMBOL	CONFIGURATION DESCRIPTION	ORBIN	THETS	ALPHA	REFERENCE INFORMATION
(B65003)	MSFC TWT 534 SHUTTLE LAUNCH	T101	-1.500	0.000	SREF 4.8950 SQ. IN
(B65005)	MSFC TWT 534 SHUTTLE LAUNCH	T101S1	-1.500	21.000	LREF 2.6440 IN.
(B65013)	MSFC TWT 534 SHUTTLE LAUNCH	T101S1F1	-1.500	21.000	BREF 3.5250 IN.
					XMRP 3.4900 IN.
					YMRP 0.0000 IN.
					ZMRP 0.1616 IN.
					SCALE 0.0034

MACH 1.20

CONFIGURATION BUILD-UP EFFECT ON LATERAL/DIRECTIONAL CHARACT. (346 INCH TANK)

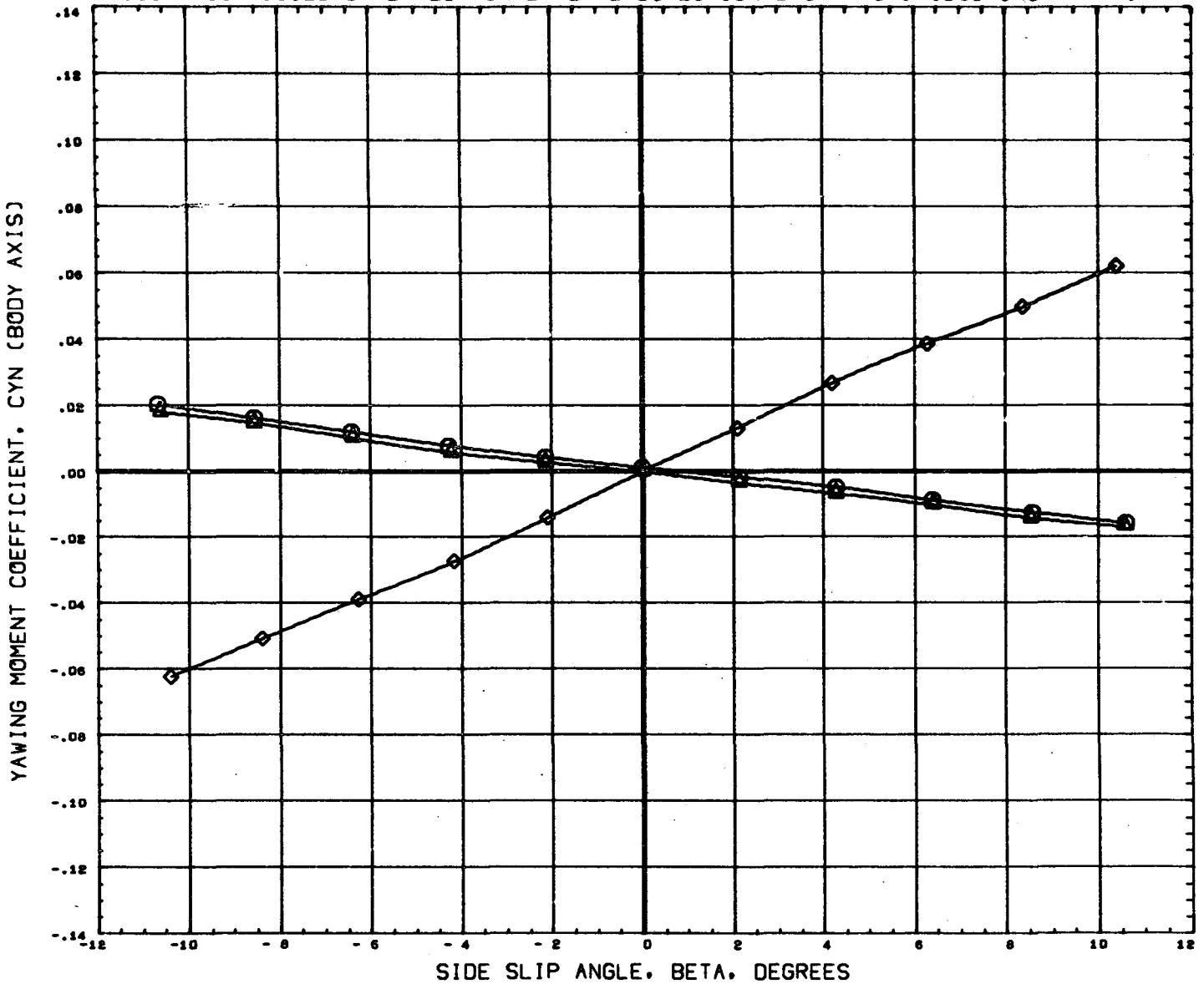

DATA SET SYMBOL	CONFIGURATION DESCRIPTION	ORBIN	TNETS	ALPHA	REFERENCE INFORMATION
(B65003)	MSFC TWT 534 SHUTTLE LAUNCH	T101	-1.500	0.000	SREF 4.8950 SQ. IN
(B65005)	MSFC TWT 534 SHUTTLE LAUNCH	T101S1	-1.500	21.000	LREF 2.6440 IN.
(B65013)	MSFC TWT 534 SHUTTLE LAUNCH	T101S1F1	-1.500	21.000	0.000
					BREF 3.5250 IN.
					XMRP 3.4900 IN.
					YMRP 0.0000 IN.
					ZMRP 0.1616 IN.
					SCALE 0.0034

CONFIGURATION BUILD-UP EFFECT ON LATERAL/DIRECTIONAL CHARACT. (346 INCH TANK)

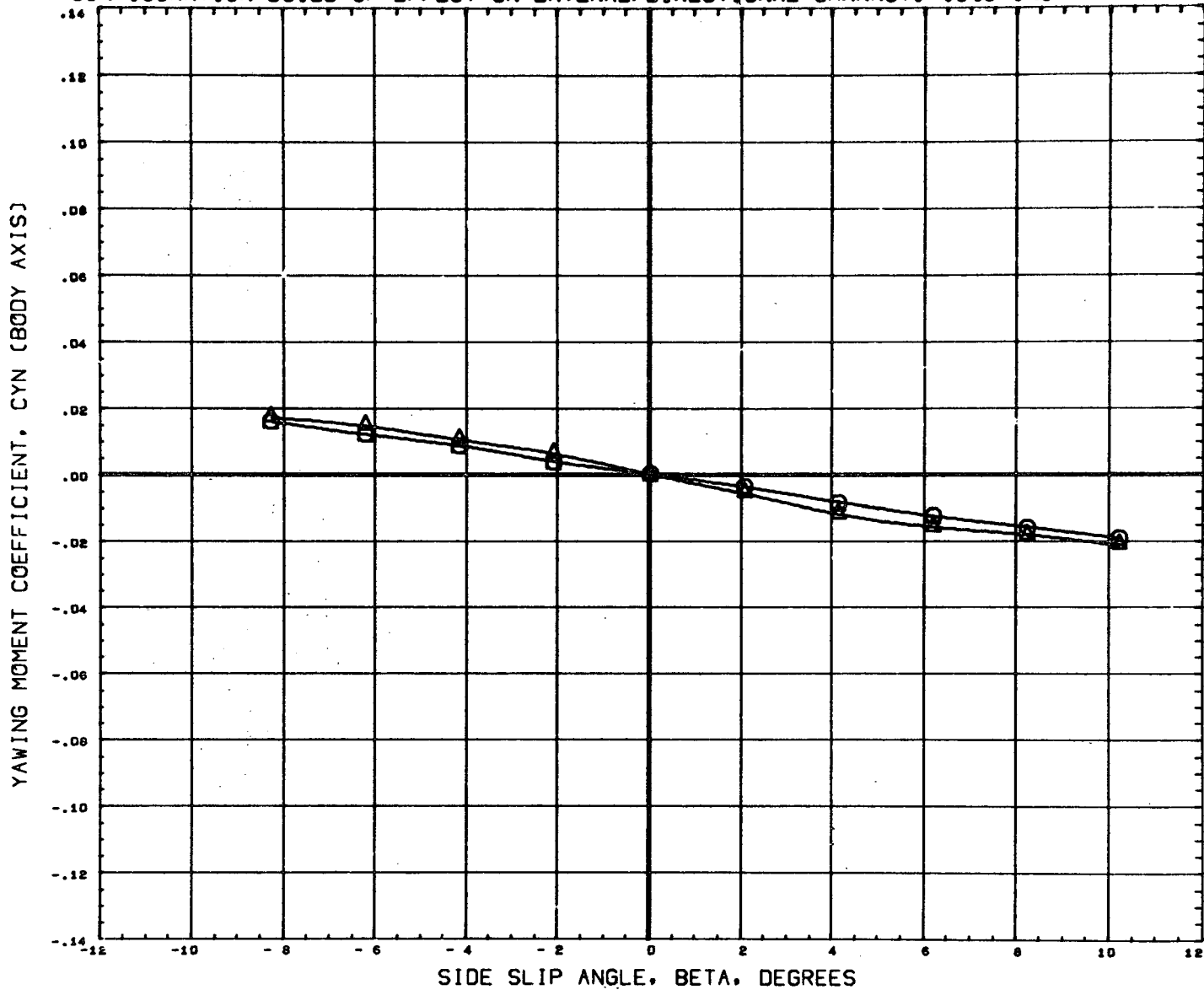

DATA SET SYMBOL	CONFIGURATION DESCRIPTION
(B65003)	MSFC TWT 534 SHUTTLE LAUNCH T101
(B65005)	MSFC TWT 534 SHUTTLE LAUNCH T101S1
(B65013)	DATA NOT AVAILABLE FOR ALL CONDITIONS

ORBIN	THETS	ALPHA
-1.500		0.000
-1.500	21.000	0.000
-1.500	21.000	0.000

REFERENCE INFORMATION		
SREF	4.8950	SQ. IN
LREF	2.6440	IN.
BREF	3.5250	IN.
XMRP	3.4900	IN.
YMRP	0.0000	IN.
ZMRP	0.1616	IN.
SCALE	0.0034	

MACH 2.74

PAGE 63

CONFIGURATION BUILD-UP EFFECT ON LATERAL/DIRECTIONAL CHARACT. (346 INCH TANK)

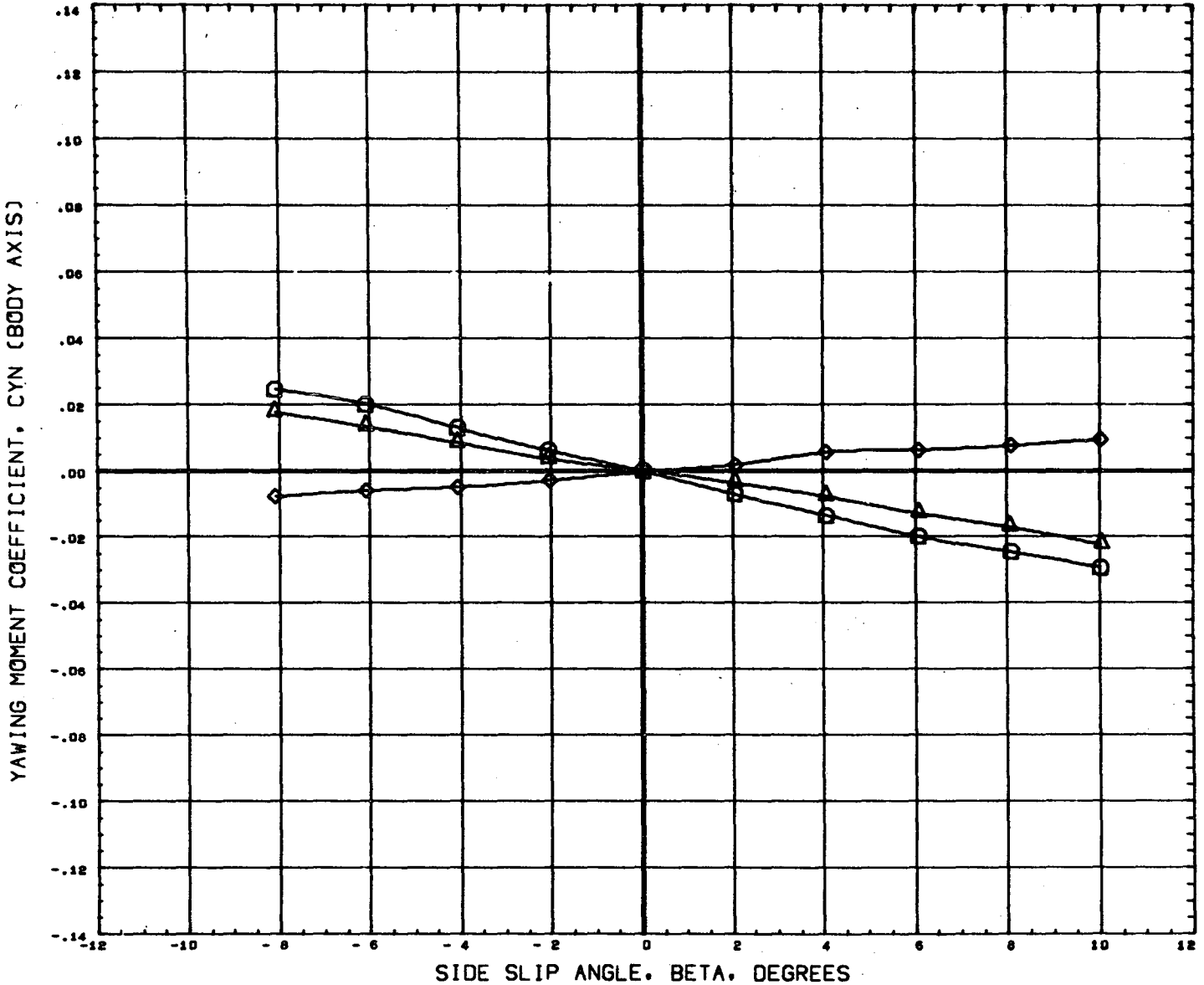

DATA SET SYMBOL	CONFIGURATION DESCRIPTION	T101	ORBIN	THETS	ALPHA	REFERENCE INFORMATION
(B65003)	MSFC TWT 534 SHUTTLE LAUNCH	T101	-1.500	21.000	0.000	SREF 4.8950 SQ. IN
(B65005)	MSFC TWT 534 SHUTTLE LAUNCH	T101S1	-1.500	21.000	0.000	LREF 2.6440 IN.
(B65013)	MSFC TWT 534 SHUTTLE LAUNCH	T101S1F1	-1.500	21.000	0.000	BREF 3.5250 IN.
						XMRP 3.4900 IN.
						YMRP 0.0000 IN.
						ZMRP 0.1616 IN.
						SCALE 0.0034

CONFIGURATION BUILD-UP EFFECT ON LATERAL/DIRECTIONAL CHARACT. (346 INCH TANK)

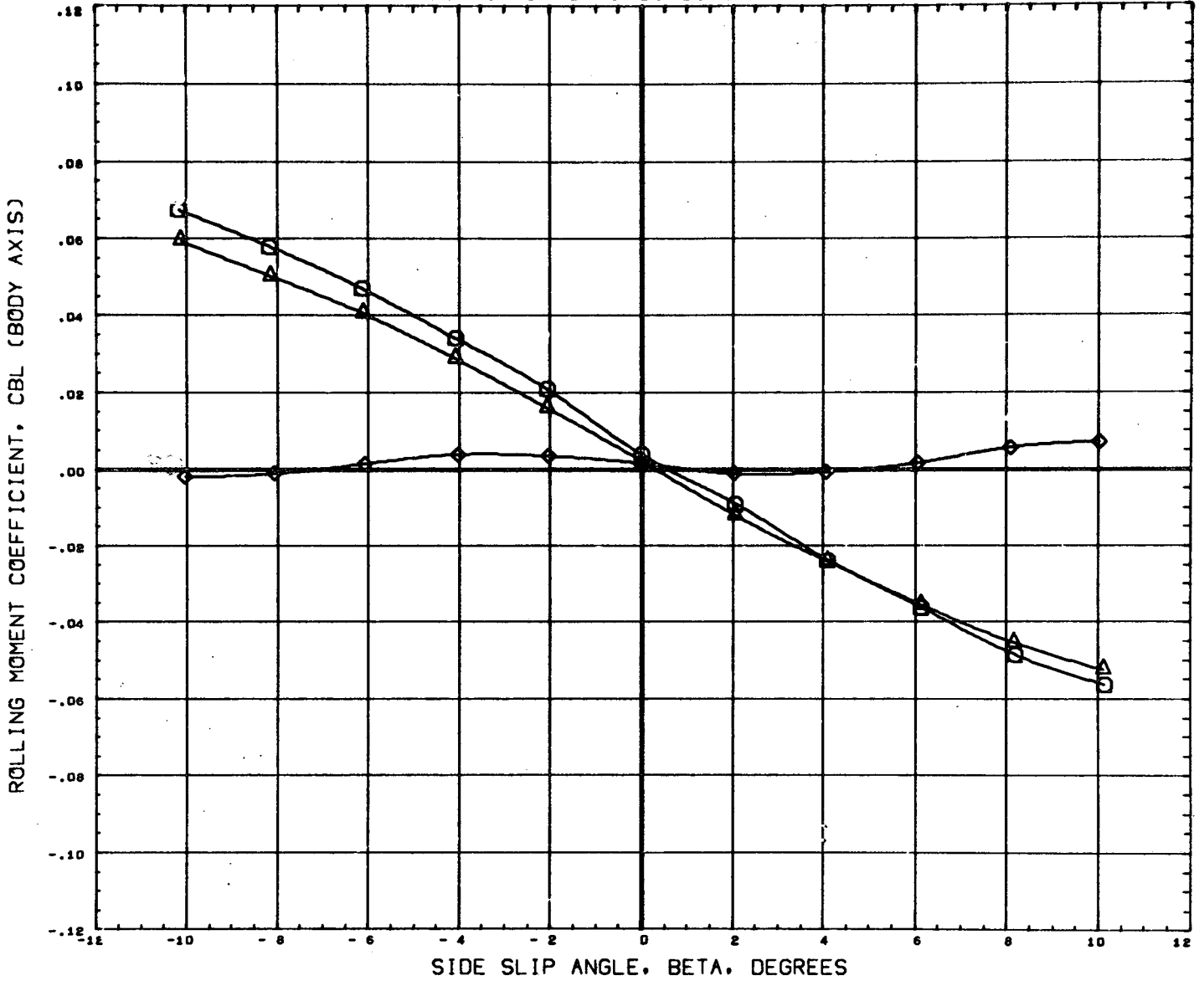

DATA SET SYMBOL	CONFIGURATION DESCRIPTION	ORBIN	THETS	ALPHA	REFERENCE INFORMATION	
(B65003)	MSFC TWT 534 SHUTTLE LAUNCH	-1.500		0.000	SREF	4.8950 SQ. IN
(B65005)	MSFC TWT 534 SHUTTLE LAUNCH	-1.500	21.000	0.000	LREF	2.6440 IN.
(B65013)	MSFC TWT 534 SHUTTLE LAUNCH	-1.500	21.000	0.000	BREF	3.5250 IN.
					XMRP	3.4900 IN.
					YMRP	0.0000 IN.
					ZMRP	0.1616 IN.
					SCALE	0.0034

MACH .60

CONFIGURATION BUILD-UP EFFECT ON LATERAL/DIRECTIONAL CHARACT. (346 INCH TANK)

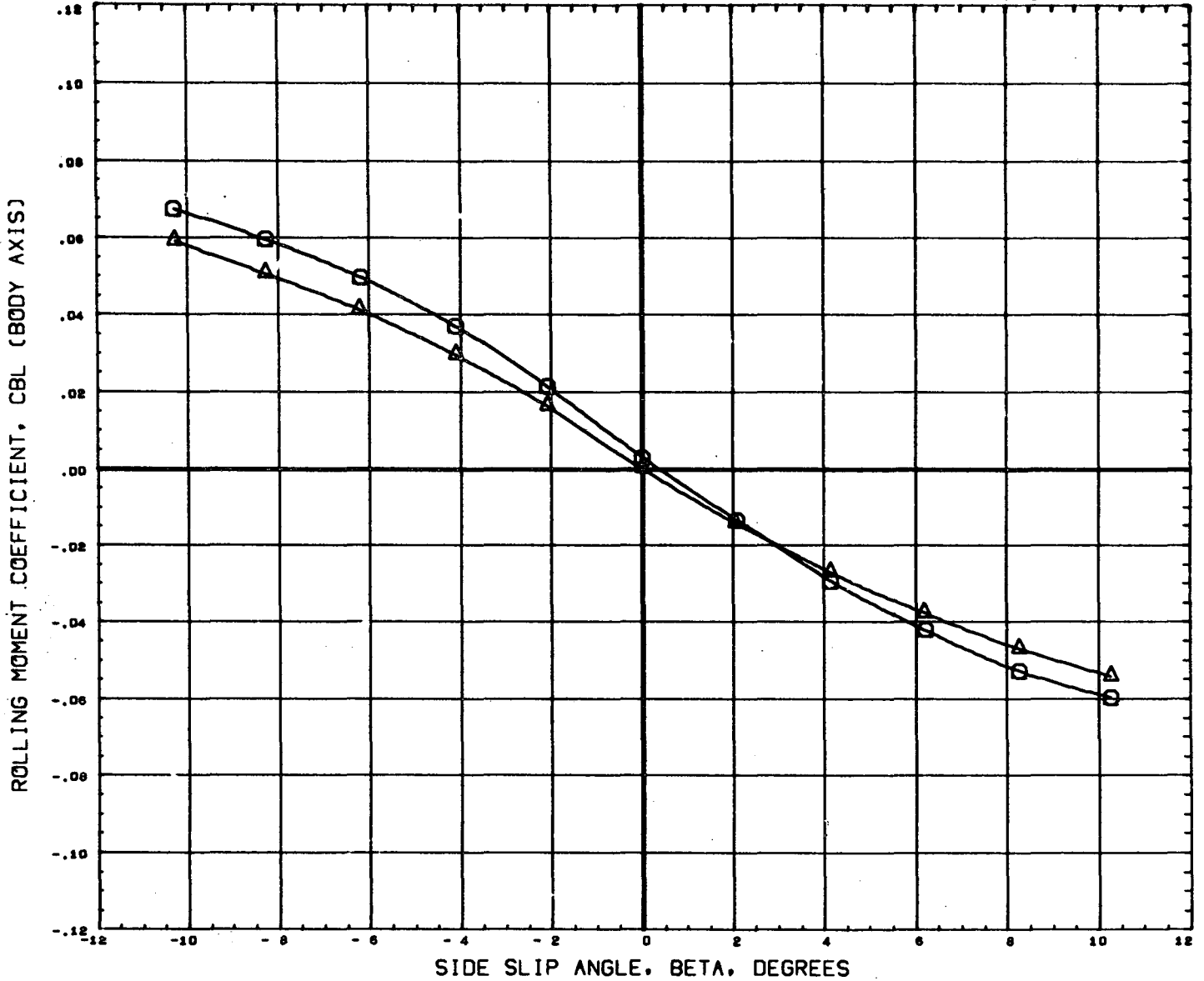

DATA SET SYMBOL	CONFIGURATION DESCRIPTION	ORBIN	THETS	ALPHA	REFERENCE INFORMATION	
(865003)	MSFC TWT 534 SHUTTLE LAUNCH T101	-1.500		0.000	SREF	4.8950 SQ. IN
(865005)	MSFC TWT 534 SHUTTLE LAUNCH T101S1	-1.500	21.00J	0.000	LREF	2.6440 IN.
(865013)	DATA NOT AVAILABLE FOR ALL CONDITIONS	-1.500	21.000	0.000	BREF	3.5250 IN.
					XMRP	3.4900 IN.
					YMRP	0.0000 IN.
					ZMRP	0.1616 IN.
					SCALE	0.0034

CONFIGURATION BUILD-UP EFFECT ON LATERAL/DIRECTIONAL CHARACT. (346 INCH TANK)

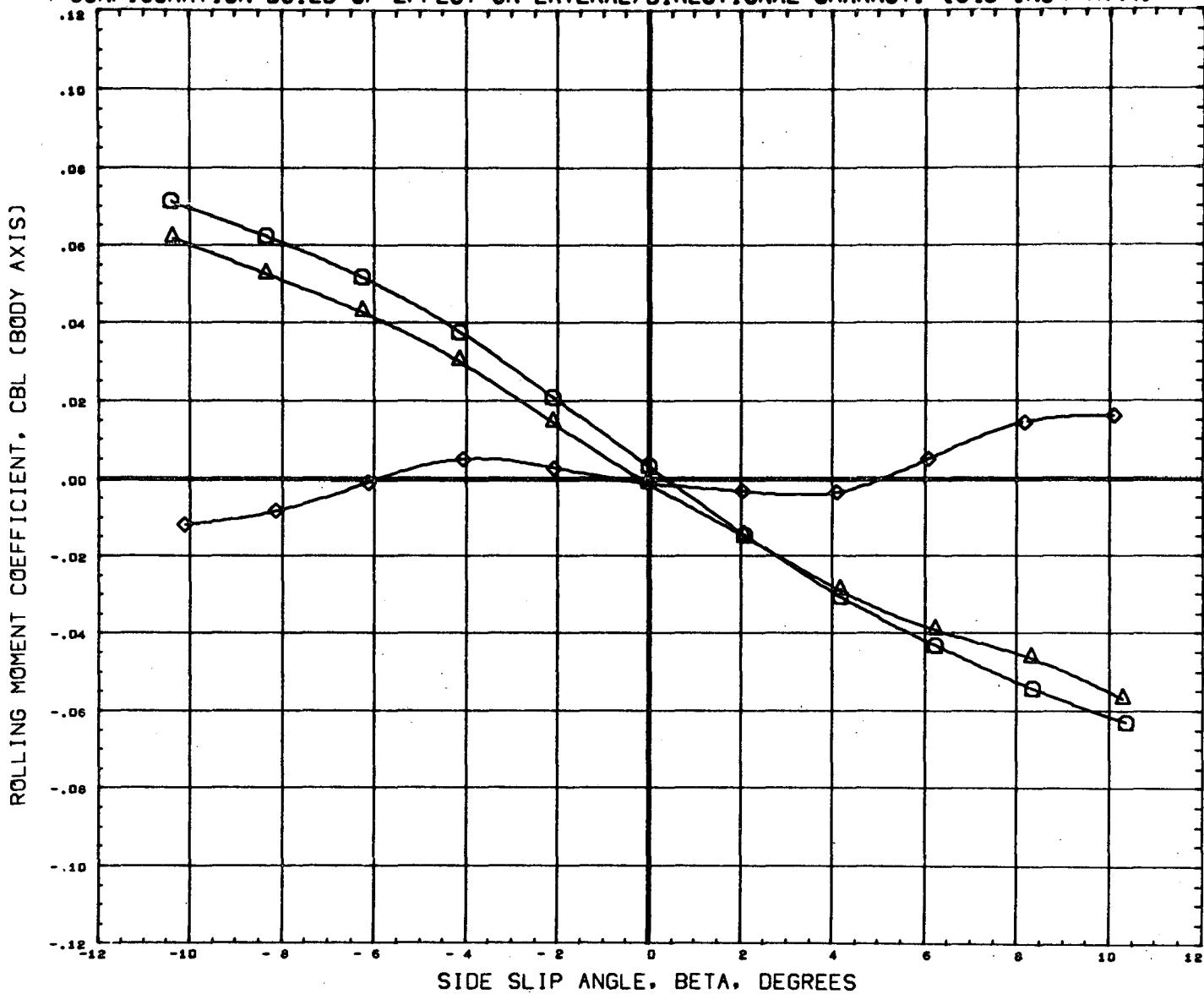

DATA SET SYMBOL	CONFIGURATION DESCRIPTION	ORBIN	THETS	ALPHA	REFERENCE INFORMATION
(B65003)	MSFC TWT 534 SHUTTLE LAUNCH	T101	-1.500	0.000	SREF 4.8950 SQ. IN
(B65005)	MSFC TWT 534 SHUTTLE LAUNCH	T101S1	-1.500	21.000	LREF 2.6440 IN.
(B65013)	MSFC TWT 534 SHUTTLE LAUNCH	T101S1F1	-1.500	21.000	BREF 3.5250 IN.
					XNRP 3.4900 IN.
					YNRP 0.0000 IN.
					ZNRP 0.1616 IN.
					SCALE 0.0034

MACH .90

CONFIGURATION BUILD-UP EFFECT ON LATERAL/DIRECTIONAL CHARACT. (346 INCH TANK)

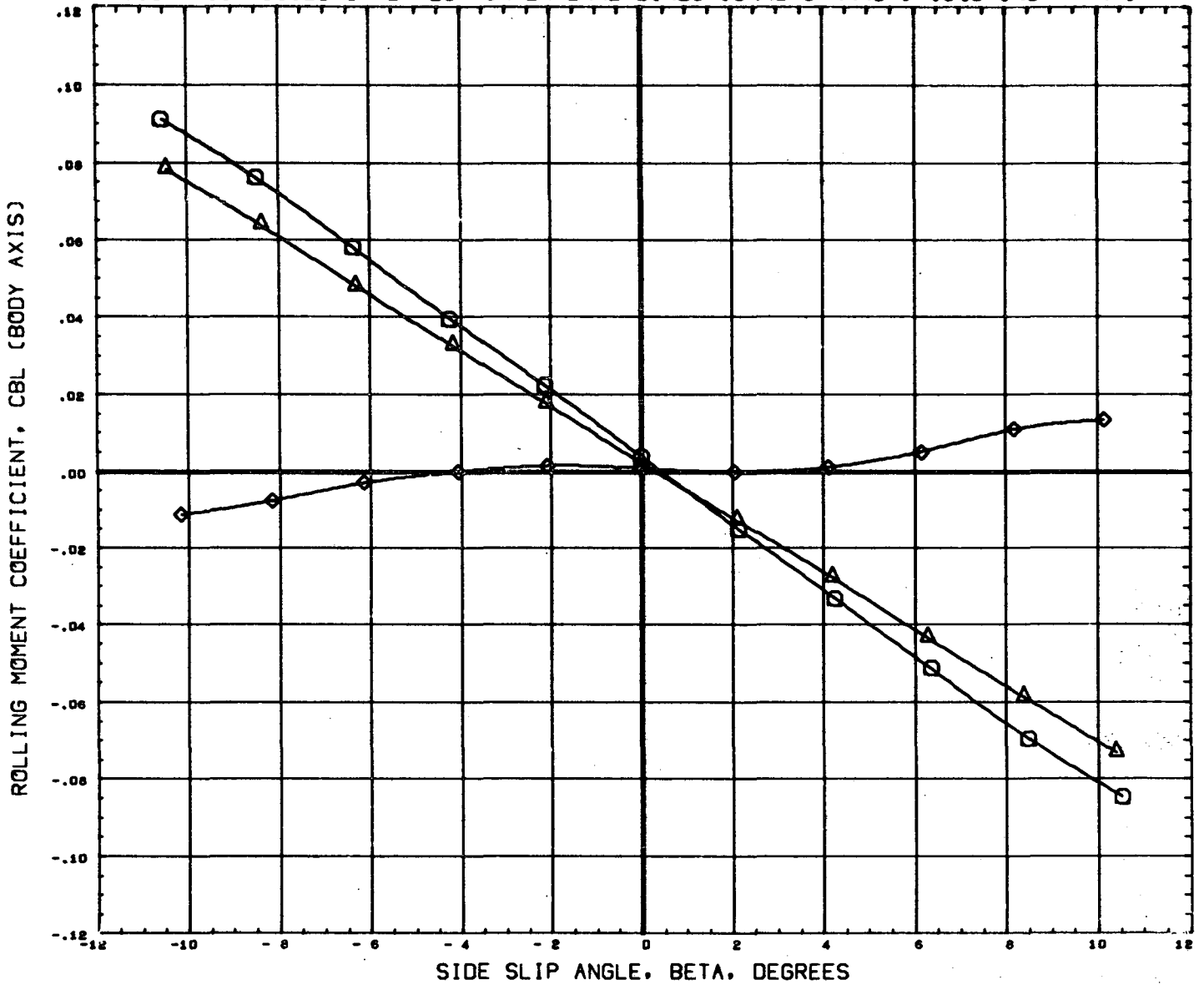

DATA SET SYMBOL	CONFIGURATION DESCRIPTION	T101	ORBIN	THETS	ALPHA	REFERENCE INFORMATION	
(B65003)	MSFC TWT 534 SHUTTLE LAUNCH	T101	-1.500	0.000	0.000	SREF	4.8950 SQ. IN
(B65005)	MSFC TWT 534 SHUTTLE LAUNCH	T101S1	-1.500	21.060	0.000	LREF	2.6440 IN.
(B65013)	MSFC TWT 534 SHUTTLE LAUNCH	T101S1F1	-1.500	21.000	0.000	BREF	3.5250 IN.
						XMRP	3.4900 IN.
						YMRP	0.0000 IN.
						ZMRP	0.1616 IN.
						SCALE	0.0034

CONFIGURATION BUILD-UP EFFECT ON LATERAL/DIRECTIONAL CHARACT. (346 INCH TANK)

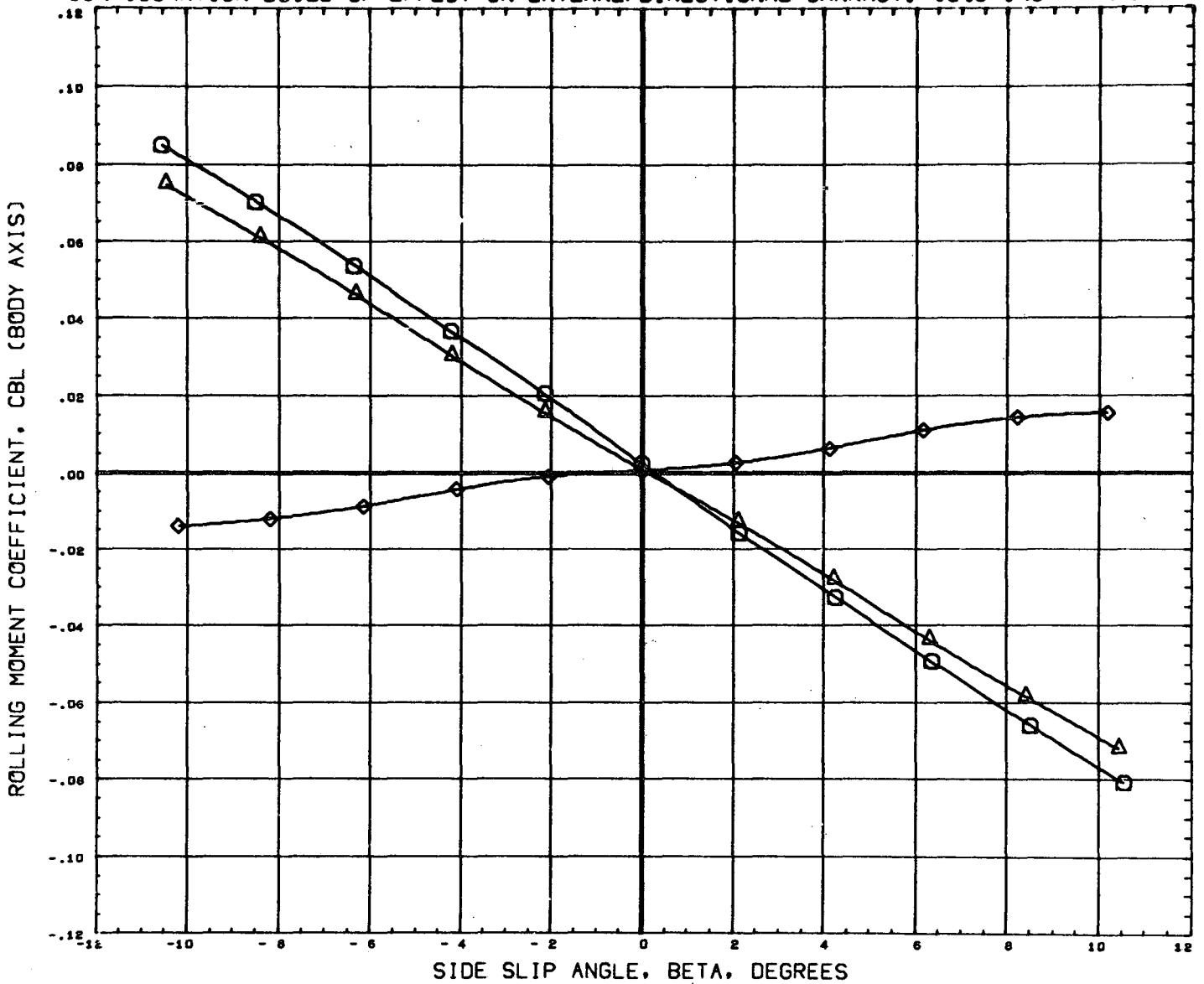

DATA SET SYMBOL	CONFIGURATION DESCRIPTION	ORBIN	THETS	ALPHA	REFERENCE INFORMATION
(B65003)	MSFC TWT 534 SHUTTLE LAUNCH	T101	-1.500	0.000	SREF 4.8950 SQ. IN
(B65005)	MSFC TWT 534 SHUTTLE LAUNCH	T101S1	-1.500	21.00J	LREF 2.6440 IN.
(B65013)	MSFC TWT 534 SHUTTLE LAUNCH	T101S1F1	-1.500	21.000	BREF 3.5250 IN.
					XMRP 3.4900 IN.
					YMRP 0.0000 IN.
					ZMRP 0.1616 IN.
					SCALE 0.0034

MACH 1.20

CONFIGURATION BUILD-UP EFFECT ON LATERAL/DIRECTIONAL CHARACT. (346 INCH TANK)

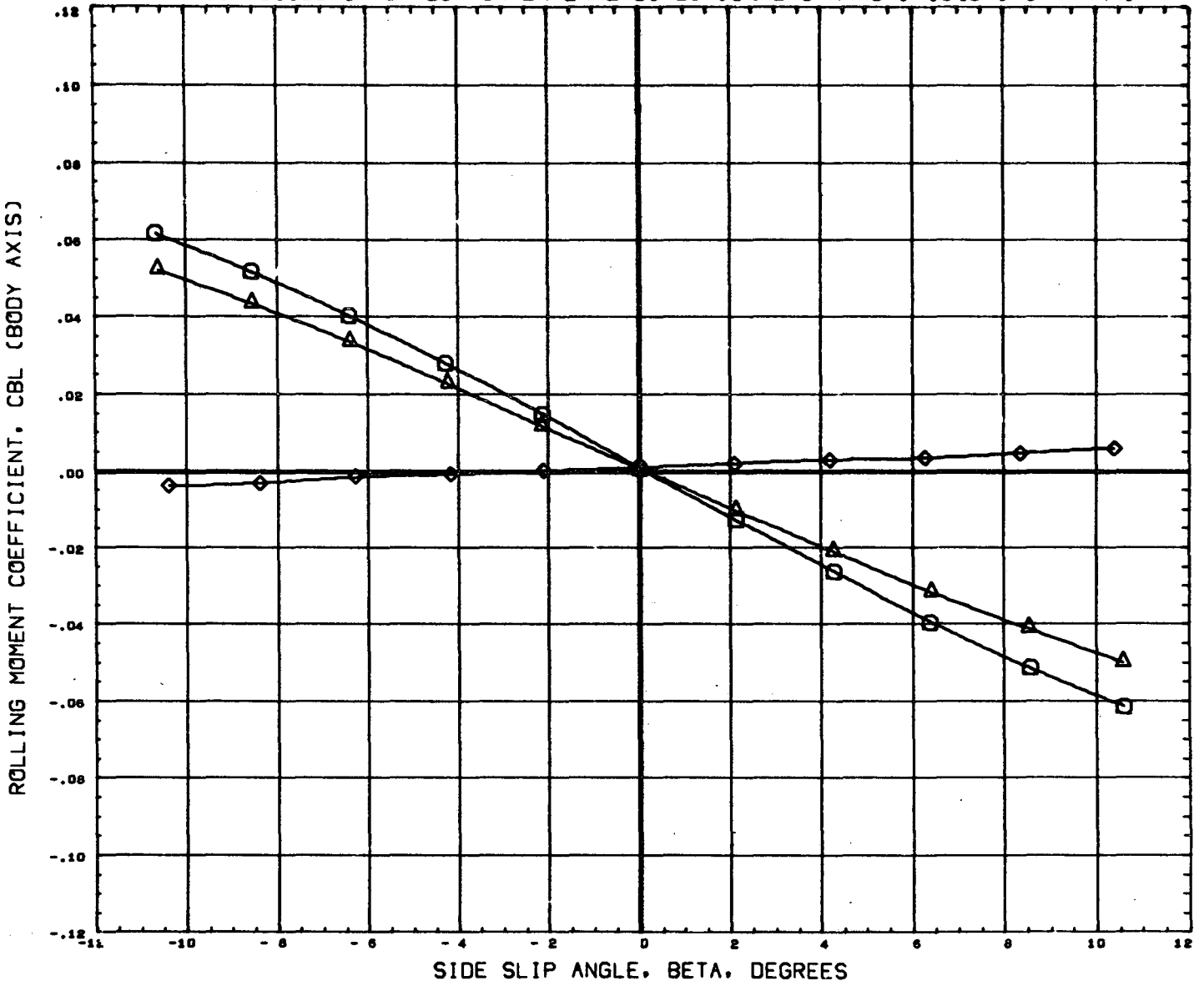

DATA SET SYMBOL	CONFIGURATION DESCRIPTION	T101	ORBIN	THETS	ALPHA	REFERENCE INFORMATION	
(B65003)	MSFC TWT 534 SHUTTLE LAUNCH	T101	-1.500		0.000	SREF	4.8950 SQ. IN
(B65005)	MSFC TWT 534 SHUTTLE LAUNCH	T101S1	-1.500	21.000	0.000	LREF	2.6440 IN.
(B65013)	MSFC TWT 534 SHUTTLE LAUNCH	T101S1F1	-1.500	21.000	0.000	BREF	3.5250 IN.
						XMRP	3.4900 IN.
						YMRP	0.0000 IN.
						ZMRP	0.1616 IN.
						SCALE	0.0034

CONFIGURATION BUILD-UP EFFECT ON LATERAL/DIRECTIONAL CHARACT. (346 INCH TANK)

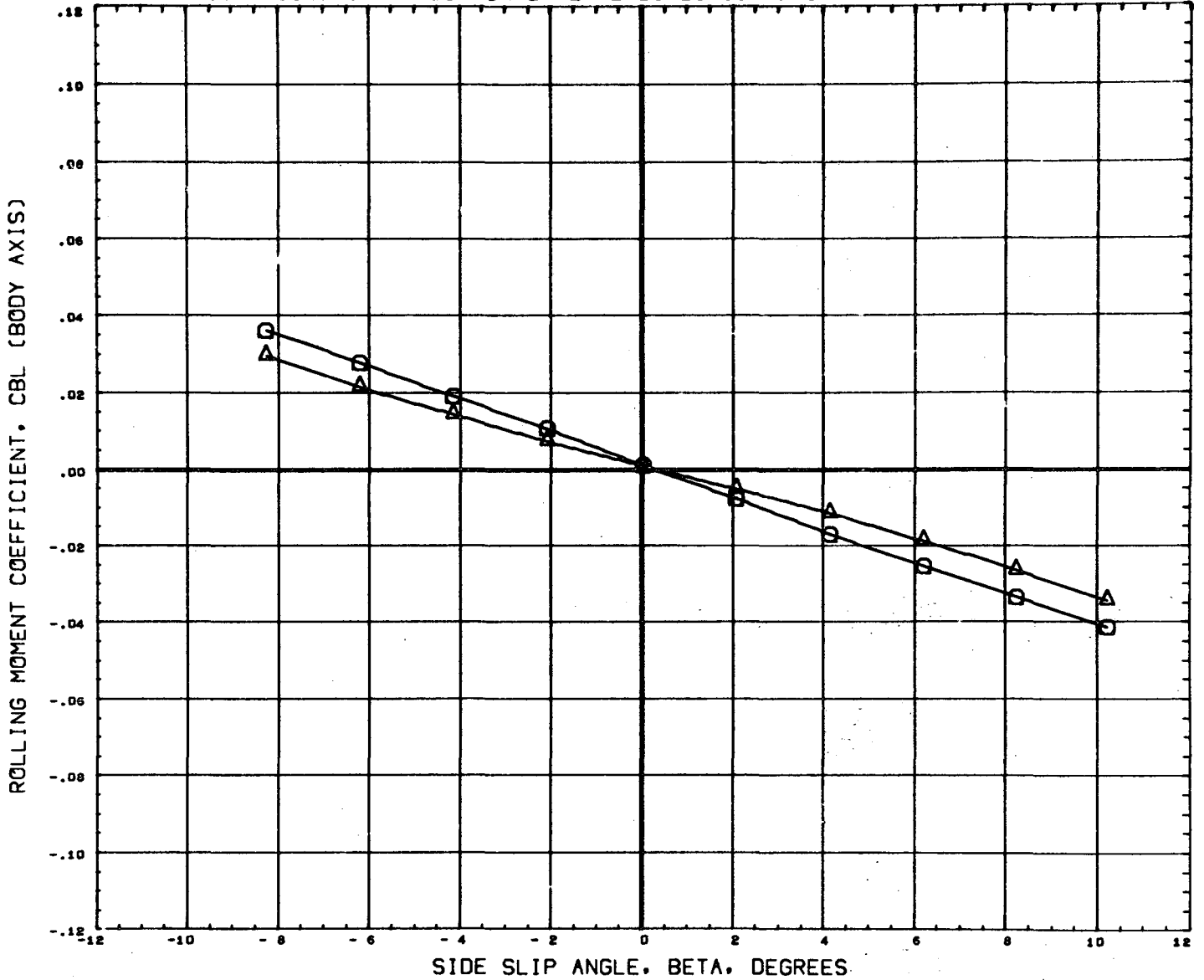

DATA SET SYMBOL	CONFIGURATION DESCRIPTION	ORBIN	THETS	ALPHA	REFERENCE INFORMATION
(865003)	MSFC TWT 534 SHUTTLE LAUNCH T101	-1.500		0.000	SREF 4.8950 99. IN
(865005)	MSFC TWT 534 SHUTTLE LAUNCH T101S1	-1.500	21.000	0.000	LREF 2.6440 IN.
(865013)	DATA NOT AVAILABLE FOR ALL CONDITIONS	-1.500	21.000	0.000	BREF 3.5250 IN.
					XMRP 3.4900 IN.
					YMRP 0.0000 IN.
					ZMRP 0.1616 IN.
					SCALE 0.0034

MACH 2.74

CONFIGURATION BUILD-UP EFFECT ON LATERAL/DIRECTIONAL CHARACT. (346 INCH TANK)

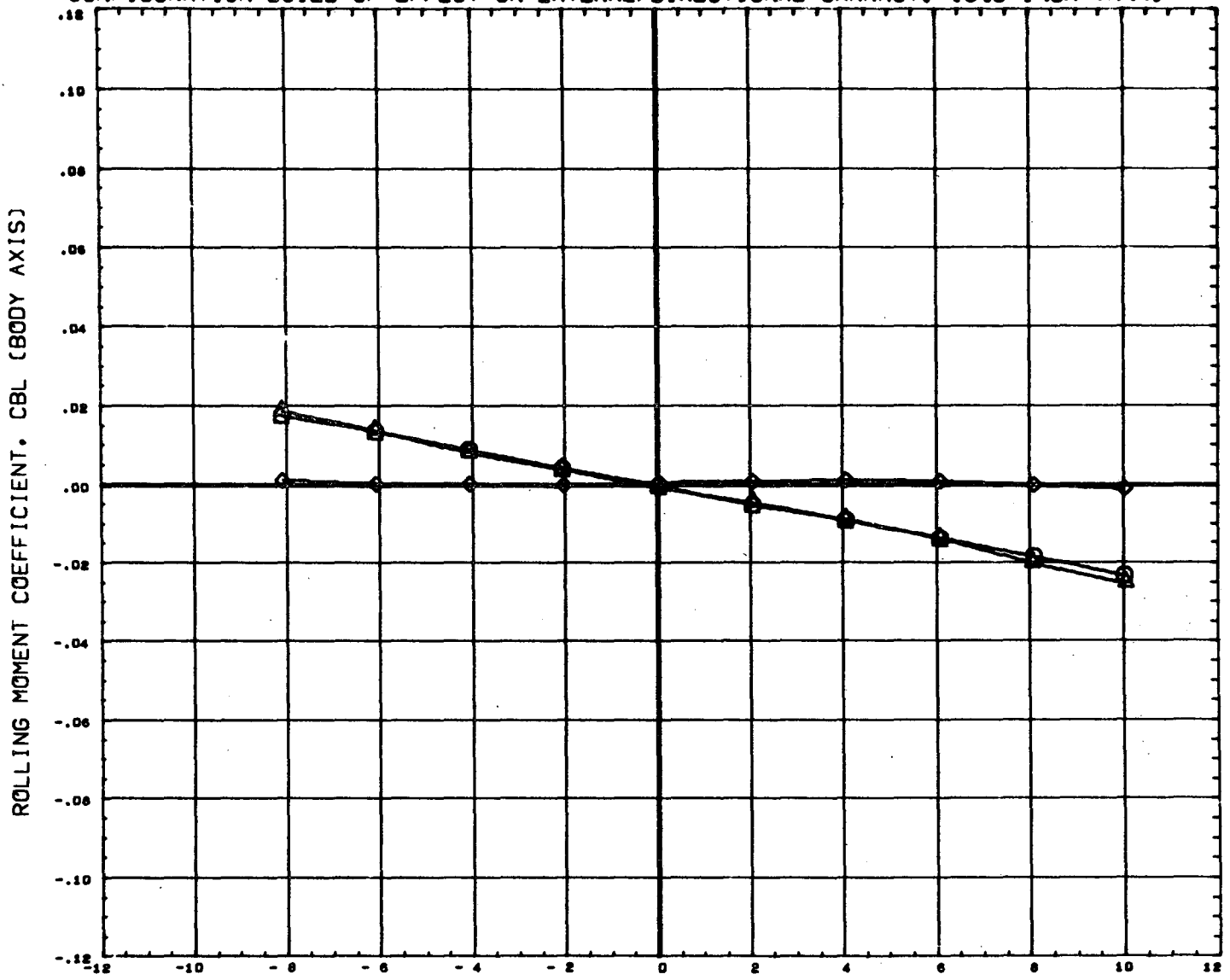

SIDE SLIP ANGLE, BETA, DEGREES

DATA SET SYMBOL	CONFIGURATION DESCRIPTION	ORBIN	THETS	ALPHA	REFERENCE INFORMATION
(B69003)	MSFC TWT 534 SHUTTLE LAUNCH	T101	-1.500	0.000	SREF 4.8950 SQ. IN
(B69005)	MSFC TWT 534 SHUTTLE LAUNCH	T101S1	-1.500	21.000	LREF 2.6440 IN.
(B69013)	MSFC TWT 534 SHUTTLE LAUNCH	T101S1F1	-1.500	21.000	BREF 3.5250 IN.
					XMRP 3.4900 IN.
					YMRP 0.0000 IN.
					ZMRP 0.1616 IN.
					SCALE 0.0034

CONFIGURATION BUILD-UP EFFECT ON LATERAL/DIRECTIONAL CHARACT. (346 INCH TANK)

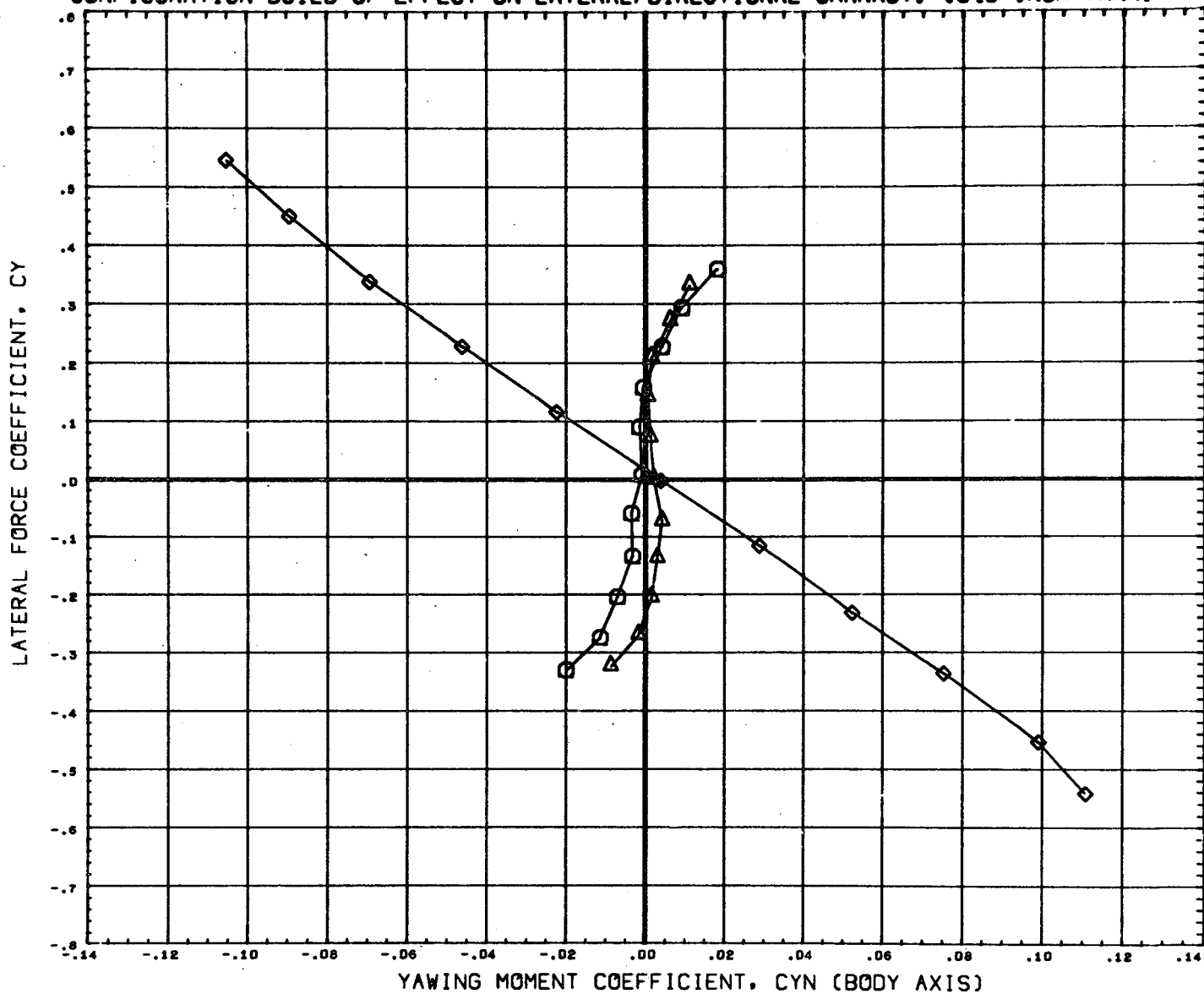

DATA SET SYMBOL	CONFIGURATION DESCRIPTION	ORBIN	THETS	ALPHA	REFERENCE INFORMATION
(B65003)	MSFC TWT 534 SHUTTLE LAUNCH	T101	-1.500	0.000	SREF 4.8950 sq. IN
(B65005)	MSFC TWT 534 SHUTTLE LAUNCH	T101S1	-1.500	21.000	LREF 2.6440 IN.
(B65013)	MSFC TWT 534 SHUTTLE LAUNCH	T101S1F1	-1.500	21.000	BREF 3.9250 IN.
					XMRP 3.4900 IN.
					YMRP 0.0000 IN.
					ZMRP 0.1616 IN.
					SCALE 0.0034

MACH .60

CONFIGURATION BUILD-UP EFFECT ON LATERAL/DIRECTIONAL CHARACT. (346 INCH TANK)

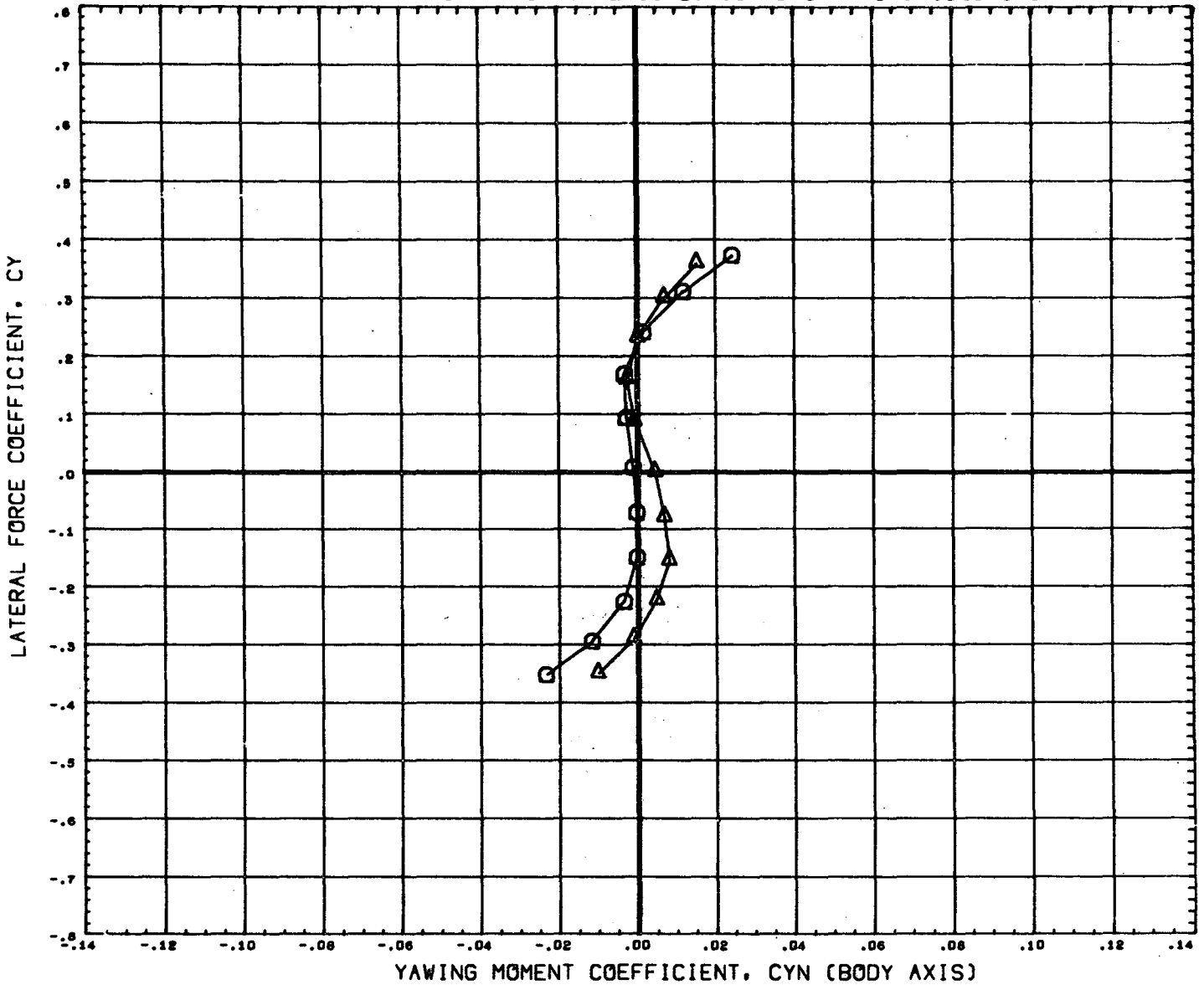

DATA SET SYMBOL	CONFIGURATION DESCRIPTION	ORBIT	THETS	ALPHA	REFERENCE INFORMATION
(B65003)	MSFC TWT 534 SHUTTLE LAUNCH T101	-1.500		0.000	SREF 4.8950 90. IN
(B65005)	MSFC TWT 534 SHUTTLE LAUNCH T101S1	-1.500	21.000	0.000	LREF 2.6440 IN.
(B65013)	DATA NOT AVAILABLE FOR ALL CONDITIONS	-1.500	21.000	0.000	BREF 3.5250 IN.
					XMRP 3.4900 IN.
					YMRP 0.0000 IN.
					ZMRP 0.1616 IN.
					SCALE 0.0034

CONFIGURATION BUILD-UP EFFECT ON LATERAL/DIRECTIONAL CHARACT. (346 INCH TANK)

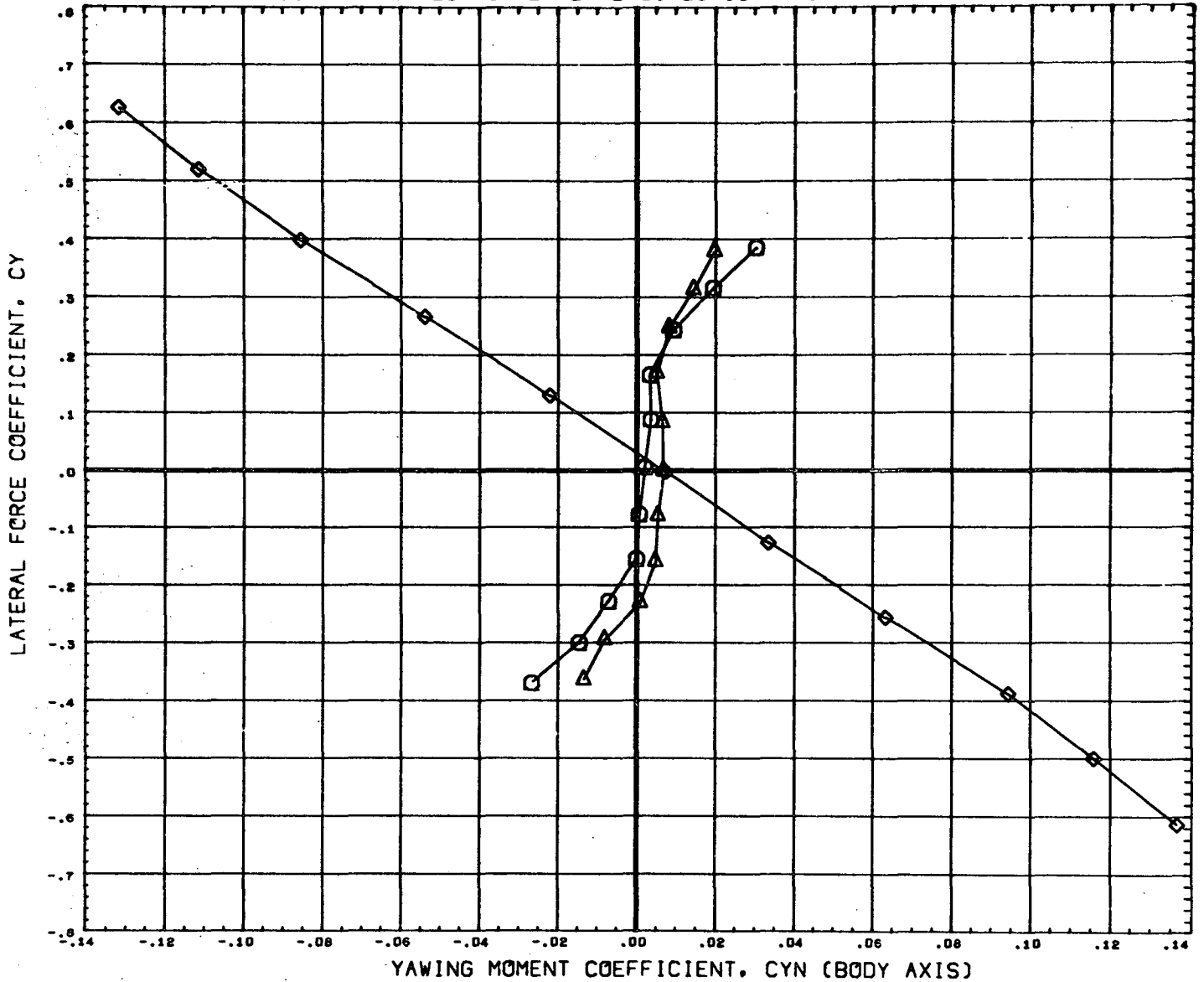

DATA SET SYMBOL	CONFIGURATION DESCRIPTION	ORBIT	THETS	ALPHA	REFERENCE INFORMATION	
(B65003)	MSFC TWT 534 SHUTTLE LAUNCH	T101	-1.500	0.000	SREF 4.8950 SQ. IN	
(B65005)	MSFC TWT 534 SHUTTLE LAUNCH	T101S1	-1.500	21.000	0.000	LREF 2.6440 IN.
(B65013)	MSFC TWT 534 SHUTTLE LAUNCH	T101S1F1	-1.500	21.000	0.000	BREF 3.5250 IN.
						XMRP 3.4900 IN.
						YMRP 0.0000 IN.
						ZMRP 0.1616 IN.
						SCALE 0.0034

CONFIGURATION BUILD-UP EFFECT ON LATERAL/DIRECTIONAL CHARACT. (346 INCH TANK)

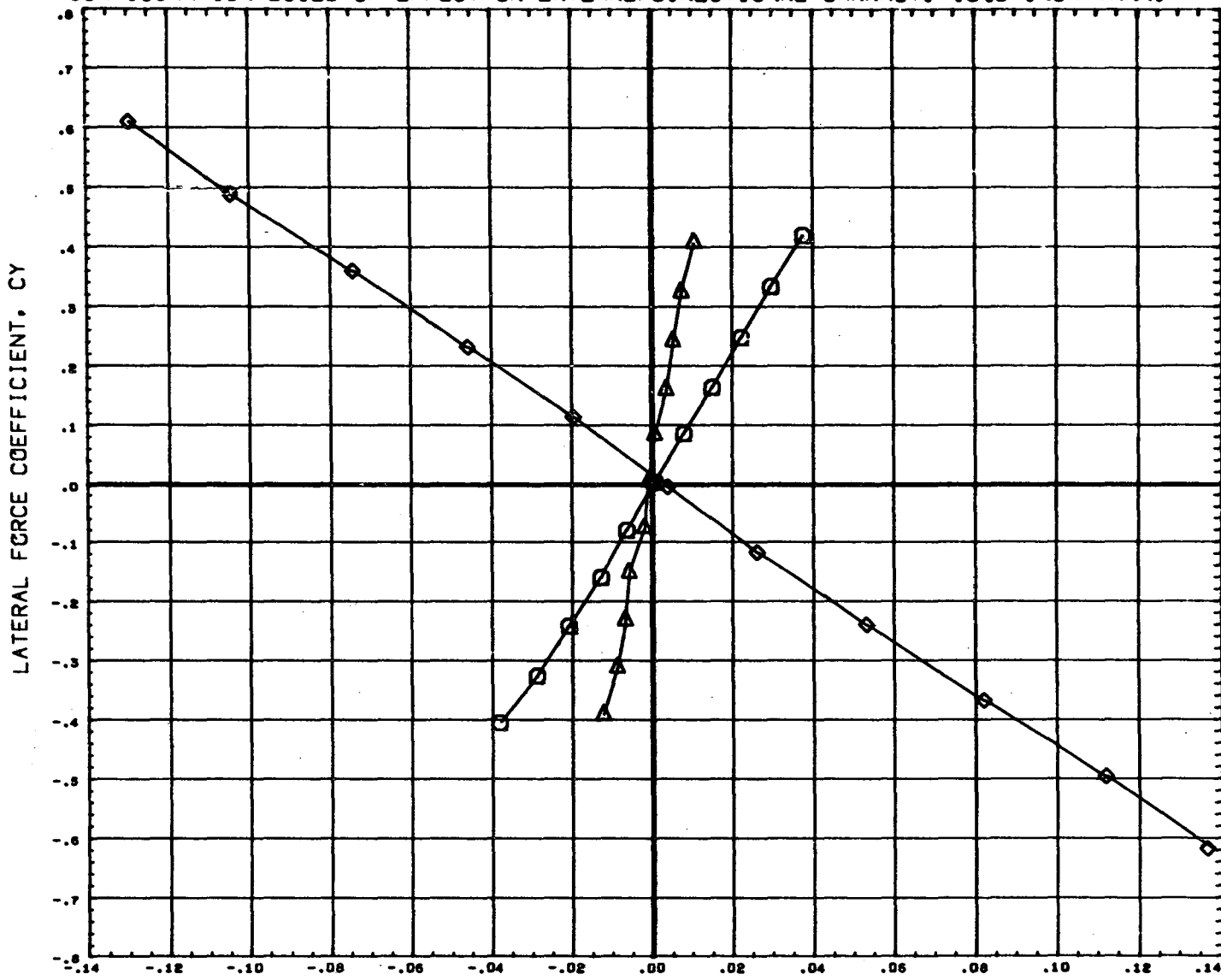

YAWING MOMENT COEFFICIENT, CYN (BODY AXIS)

DATA SET SYMBOL	CONFIGURATION DESCRIPTION	ORBIN	THETS	ALPHA	REFERENCE INFORMATION	
(B65003)	MSFC TWT 534 SHUTTLE LAUNCH	T101	-1.500	0.000	SREF 4.8950 sq. IN	
(B65005)	MSFC TWT 534 SHUTTLE LAUNCH	T101S1	-1.500	21.000	0.000	LREF 2.6440 IN.
(B65013)	MSFC TWT 534 SHUTTLE LAUNCH	T101S1F1	-1.500	21.000	0.000	BREF 3.5250 IN.
					XMRP 3.4900 IN.	
					YMRP 0.0000 IN.	
					ZMRP 0.1616 IN.	
					SCALE 0.0034	

CONFIGURATION BUILD-UP EFFECT ON LATERAL/DIRECTIONAL CHARACT. (346 INCH TANK)

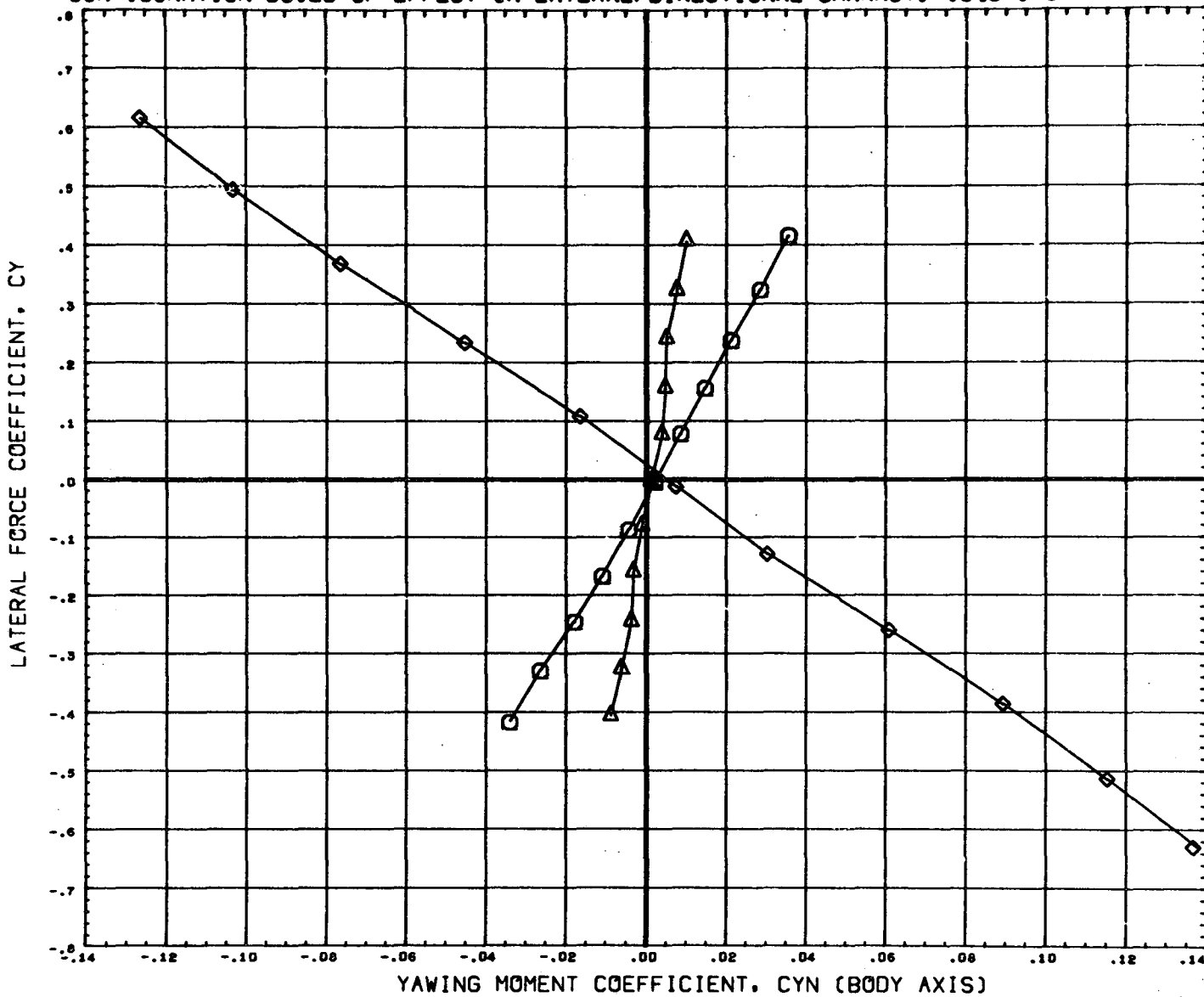

DATA SET SYMBOL	CONFIGURATION DESCRIPTION	ORBIN	THETS	ALPHA	REFERENCE INFORMATION
(B65003)	MSFC TWT 534 SHUTTLE LAUNCH	T101	-1.500	0.000	SREF 4.8950 SQ. IN
(B65005)	MSFC TWT 534 SHUTTLE LAUNCH	T101S1	-1.500	21.000	LREF 2.6440 IN.
(B65013)	MSFC TWT 534 SHUTTLE LAUNCH	T101S1F1	-1.500	21.000	BREF 3.5250 IN.
					XMRP 3.4900 IN.
					YMRP 0.0000 IN.
					ZMRP 0.1616 IN.
					SCALE 0.0034

MACH 1.20

CONFIGURATION BUILD-UP EFFECT ON LATERAL/DIRECTIONAL CHARACT. (346 INCH TANK)

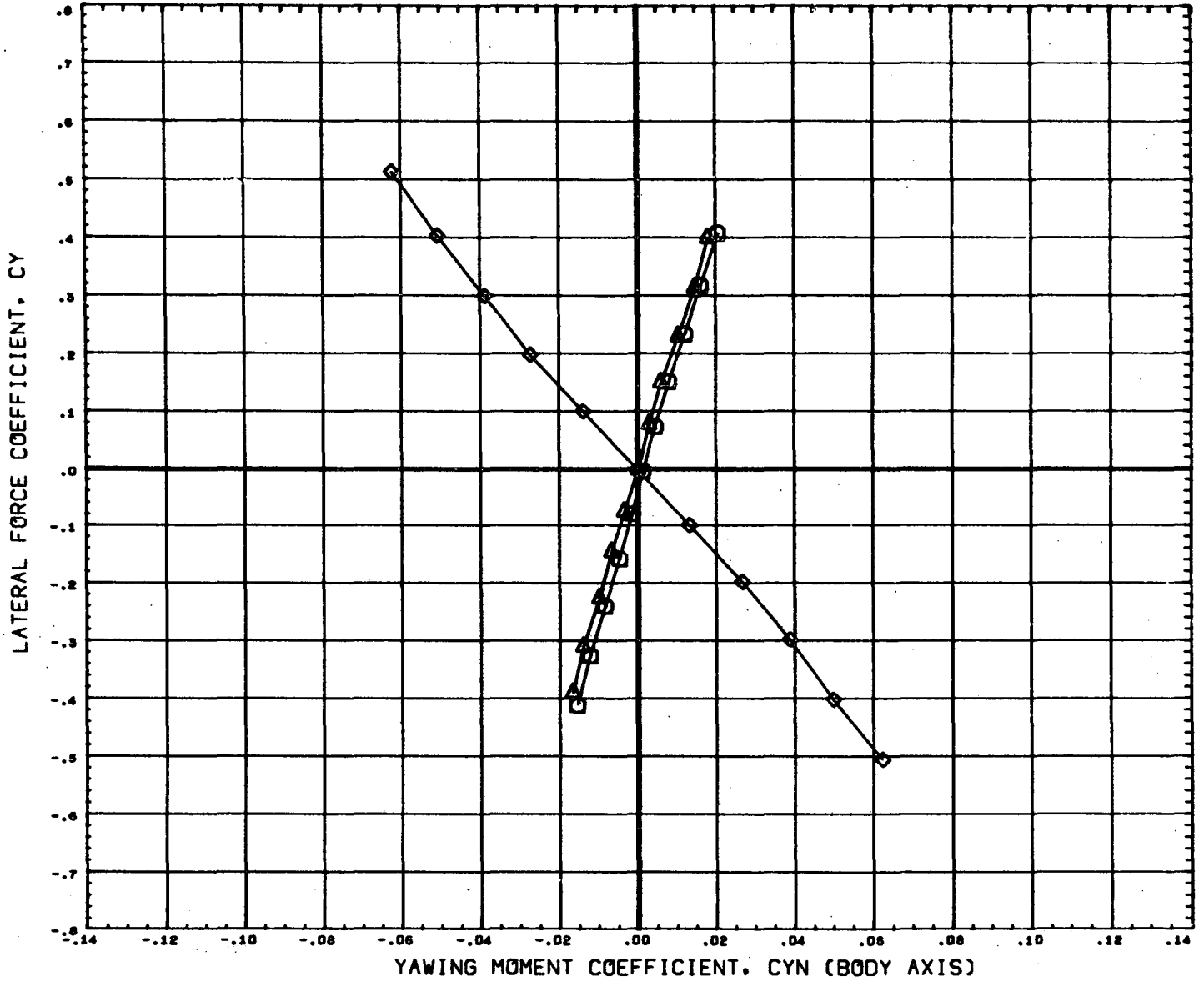

DATA SET SYMBOL	CONFIGURATION DESCRIPTION	ORBIN	THETS	ALPHA	REFERENCE INFORMATION
(B65003)	MSFC TWT 534 SHUTTLE LAUNCH	T101	-1.500	0.000	SREF 4.8950 90. IN
(B65005)	MSFC TWT 534 SHUTTLE LAUNCH	T101S1	-1.500 21.000	0.000	LREF 2.6440 IN.
(B65013)	MSFC TWT 534 SHUTTLE LAUNCH	T101S1F1	-1.500 21.000	0.000	BREF 3.5250 IN.
					XNRP 3.4900 IN.
					YNRP 0.0000 IN.
					ZNRP 0.1616 IN.
					SCALE 0.0034

CONFIGURATION BUILD-UP EFFECT ON LATERAL/DIRECTIONAL CHARACT. (346 INCH TANK)

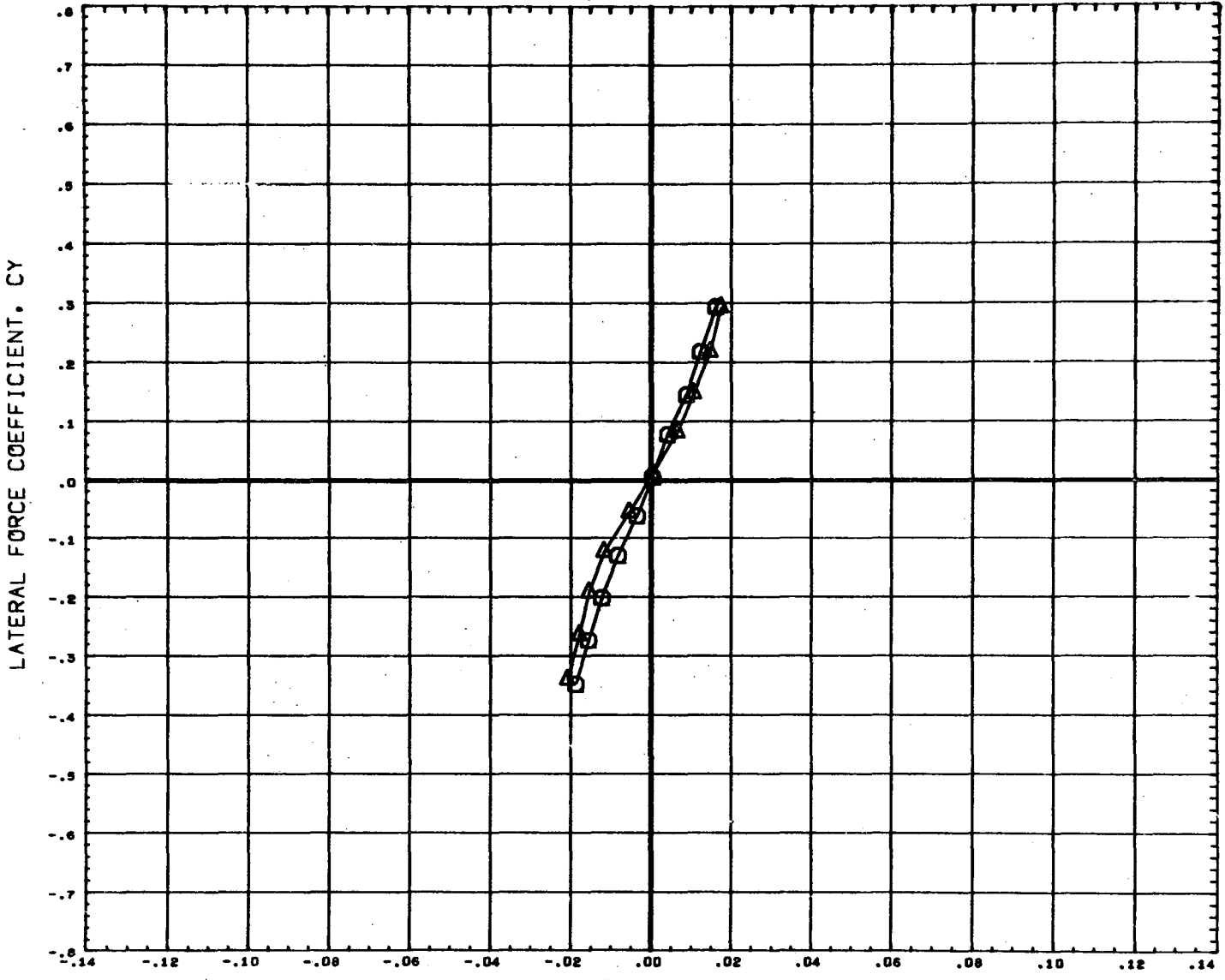

YAWING MOMENT COEFFICIENT, CYN (BODY AXIS)

DATA SET SYMBOL	CONFIGURATION DESCRIPTION	ORBIN	THETS	ALPHA	REFERENCE INFORMATION
(B65003)	MSFC TWT 534 SHUTTLE LAUNCH T101	-1.500	21.000	0.000	SREF 4.8950 SQ. IN
(B65005)	MSFC TWT 534 SHUTTLE LAUNCH T101S1	-1.500	21.000	0.000	LREF 2.6440 IN.
(B65013)	DATA NOT AVAILABLE FOR ALL CONDITIONS	-1.500	21.000	0.000	BREF 3.5250 IN.
					XMRP 3.4900 IN.
					YMRP 0.0000 IN.
					ZMRP 0.1616 IN.
					SCALE 0.0034

CONFIGURATION BUILD-UP EFFECT ON LATERAL/DIRECTIONAL CHARACT. (346 INCH TANK)

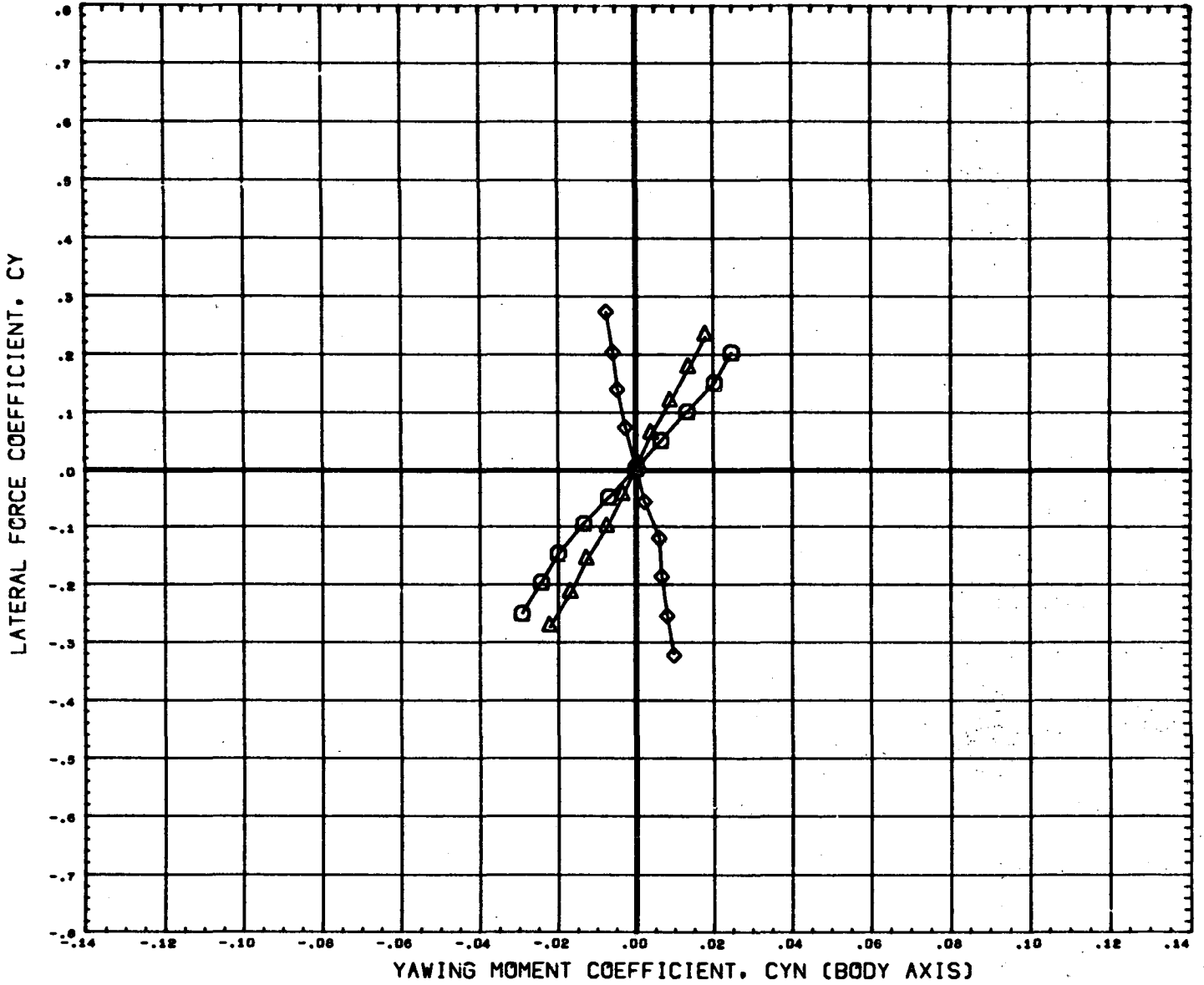

DATA SET SYMBOL	CONFIGURATION DESCRIPTION	ORBIN	THETS	ALPHA	REFERENCE INFORMATION
(865003) ○	NSFC TWT 534 SHUTTLE LAUNCH T101	-1.500		0.000	SREF 4.8950 sq. IN
(865005) △	NSFC TWT 534 SHUTTLE LAUNCH T101S1	-1.500	21.000	0.000	LREF 2.6440 IN.
(865013) ◇	NSFC TWT 534 SHUTTLE LAUNCH T101S1F1	-1.500	21.000	0.000	BREF 3.5250 IN.
					XMRP 3.4900 IN.
					YMRP 0.0000 IN.
					ZMRP 0.1616 IN.
					SCALE 0.0034

CONFIGURATION BUILD-UP EFFECT ON LONGITUDINAL CHARACTERISTICS (400 INCH TANK)

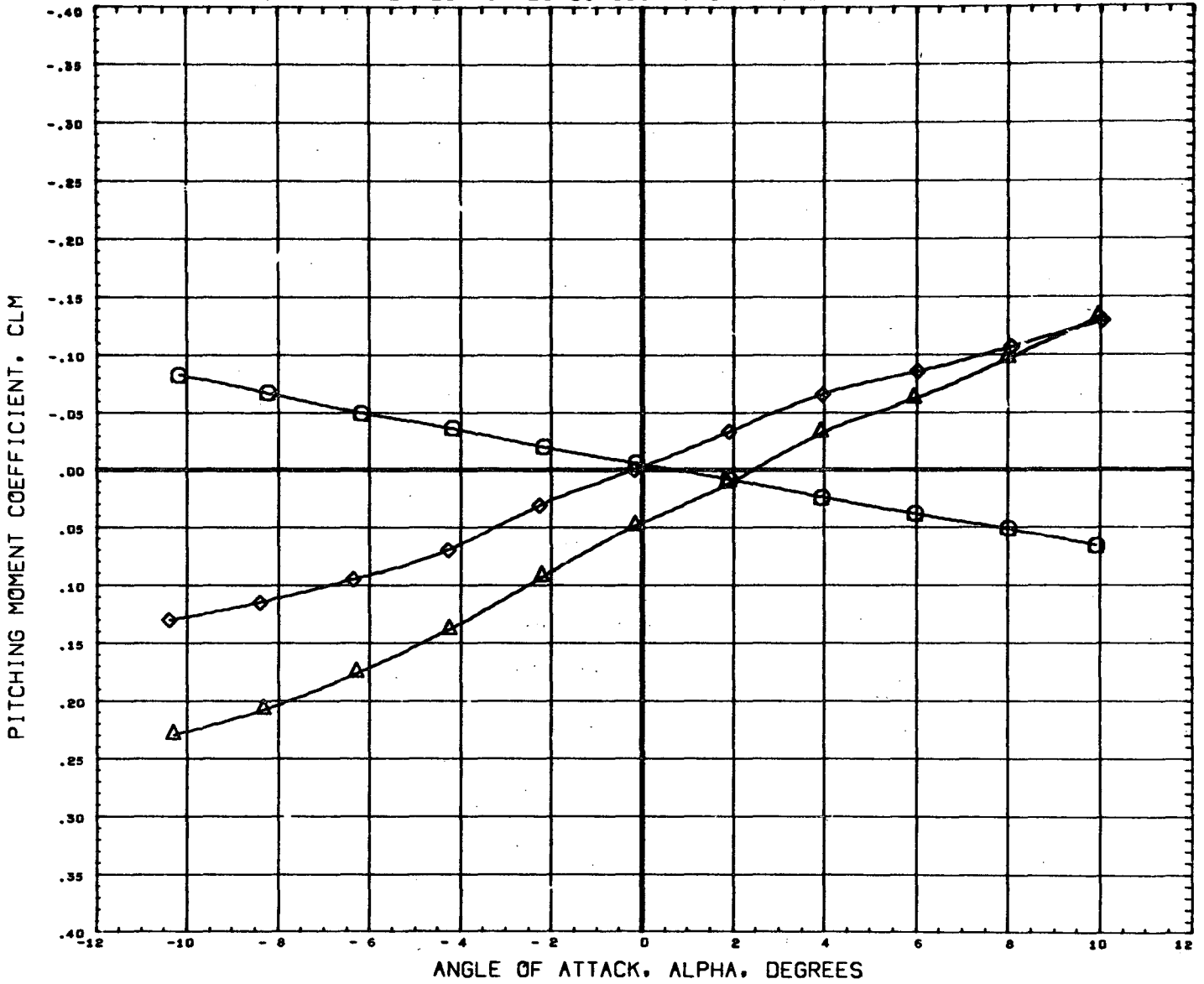

DATA SET SYMBOL	CONFIGURATION DESCRIPTION	ORBIN	THETS	BETA	REFERENCE INFORMATION	
(B65019)	MSFC TWT 534 SHUTTLE LAUNCH	T2		0.000	SREF 4.8950 SQ. IN	
(B65020)	MSFC TWT 534 SHUTTLE LAUNCH	T201	-1.500	0.000	LREF 2.6440 IN.	
(B65022)	MSFC TWT 534 SHUTTLE LAUNCH	T201S1	-1.500	21.000	0.000	BREF 3.5250 IN. XNRP 3.4900 IN. YMRP 0.0000 IN. ZMRP 0.1616 IN. SCALE 0.0034

MACH .60

CONFIGURATION BUILD-UP EFFECT ON LONGITUDINAL CHARACTERISTICS (400 INCH TANK)

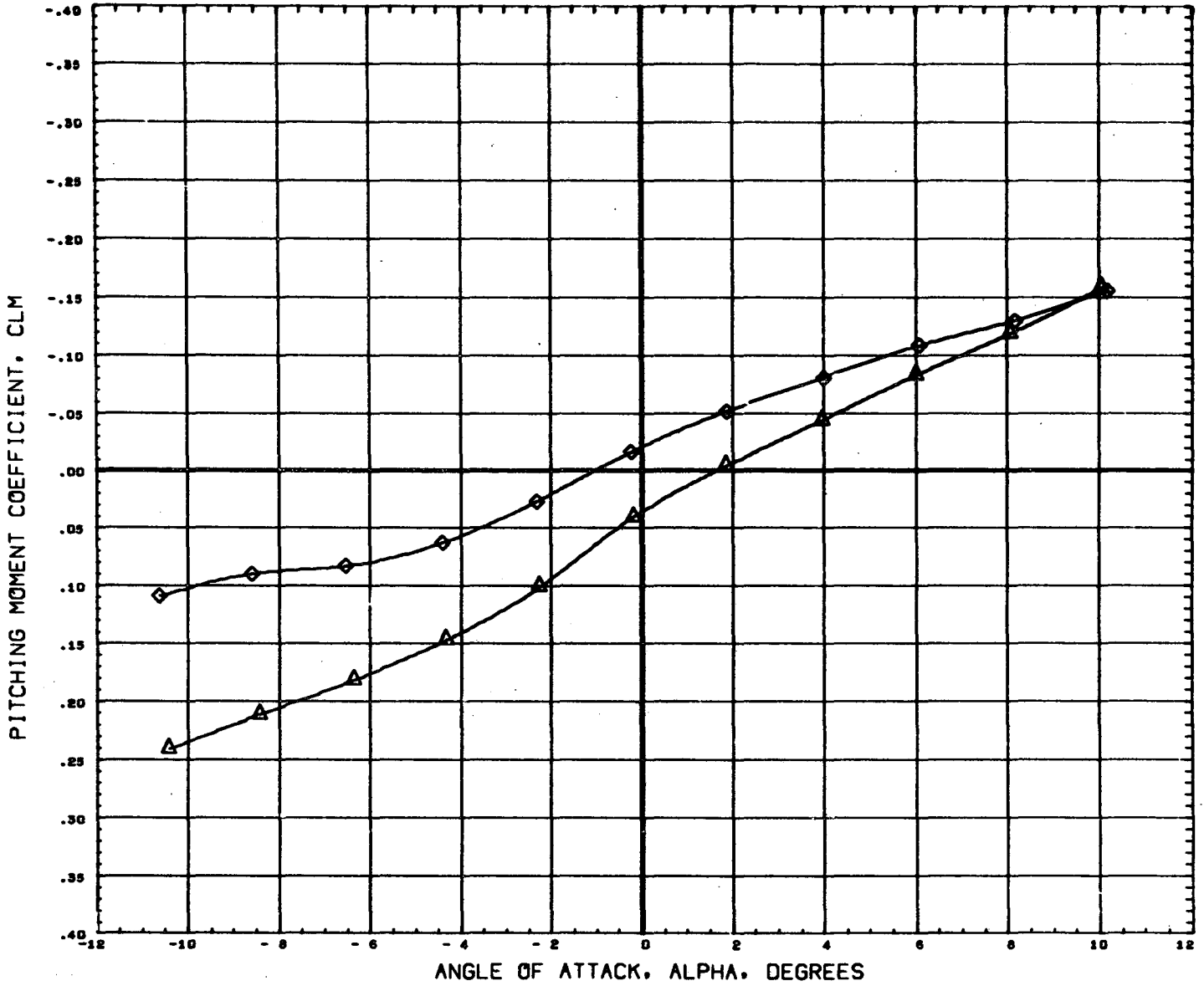

DATA SET SYMBOL	CONFIGURATION DESCRIPTION	ORBIN	THETS	BETA	REFERENCE INFORMATION
(B65D19)	DATA NOT AVAILABLE FOR ALL CONDITIONS			0.000	SREF 4.8950 SQ. IN
(B65D20)	NSFC TWT 534 SHUTTLE LAUNCH T201	-1.500		0.000	LREF 2.6440 IN.
(B65D22)	NSFC TWT 534 SHUTTLE LAUNCH T201S1	-1.500	21.000	0.000	BREF 3.5250 IN.
					XMRP 3.4900 IN.
					YMRP 0.0000 IN.
					ZMRP 0.1616 IN.
					SCALE 0.0034

CONFIGURATION BUILD-UP EFFECT ON LONGITUDINAL CHARACTERISTICS (400 INCH TANK)

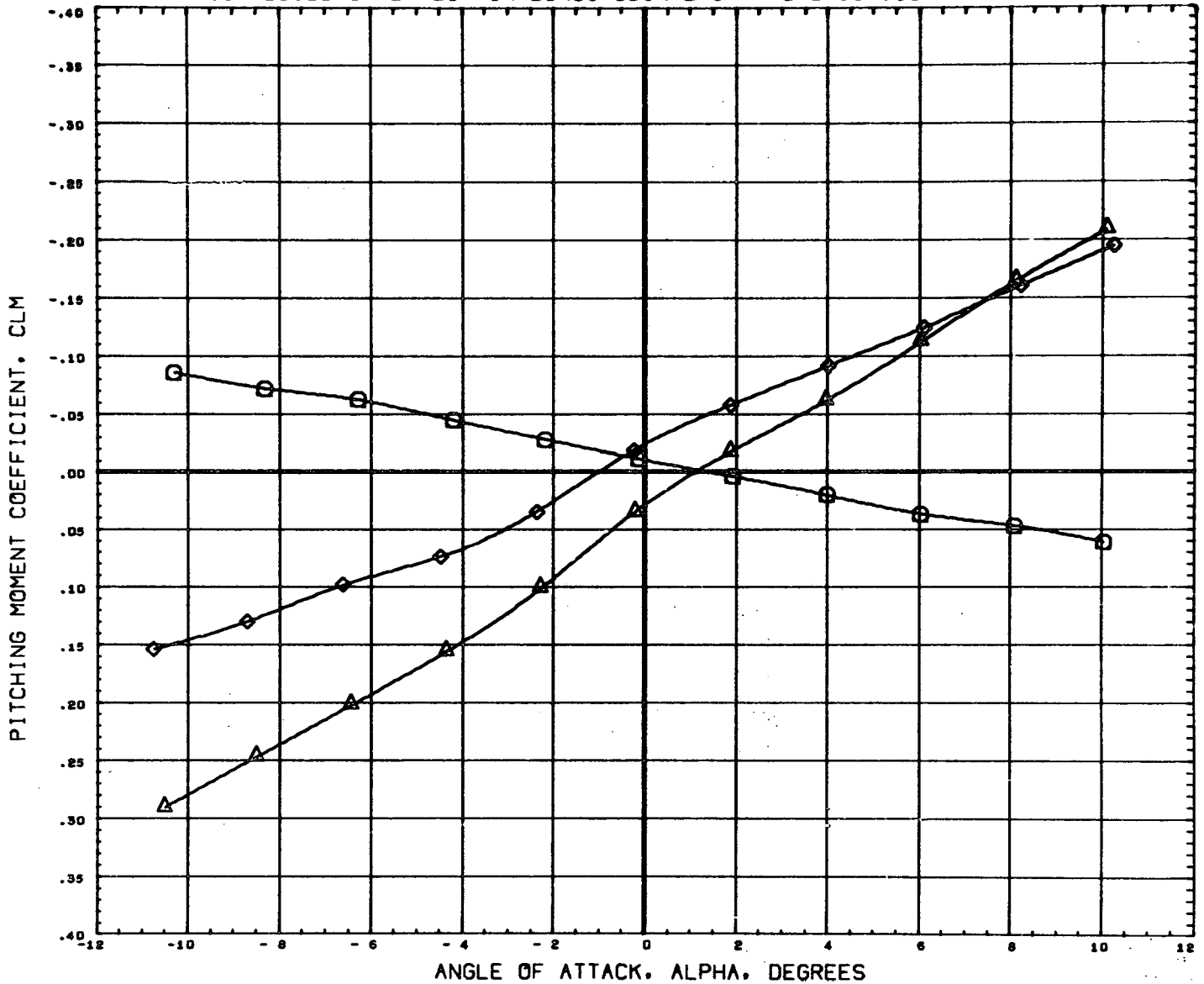

DATA SET SYMBOL	CONFIGURATION DESCRIPTION	T2	ORBIN	THETS	BETA	REFERENCE INFORMATION
(B65019)	MSFC TWT 534 SHUTTLE LAUNCH	T2	-1.500		0.000	SREF 4.8950 SQ. IN
(B65020)	MSFC TWT 534 SHUTTLE LAUNCH	T2O1	-1.500		0.000	LREF 2.6440 IN.
(B65022)	MSFC TWT 534 SHUTTLE LAUNCH	T2O1S1	-1.500	21.000	0.000	BREF 3.5250 IN.
						XMRP 3.4900 IN.
						YMRP 0.0000 IN.
						ZMRP 0.1616 IN.
						SCALE 0.0034

MACH .90

CONFIGURATION BUILD-UP EFFECT ON LONGITUDINAL CHARACTERISTICS (400 INCH TANK)

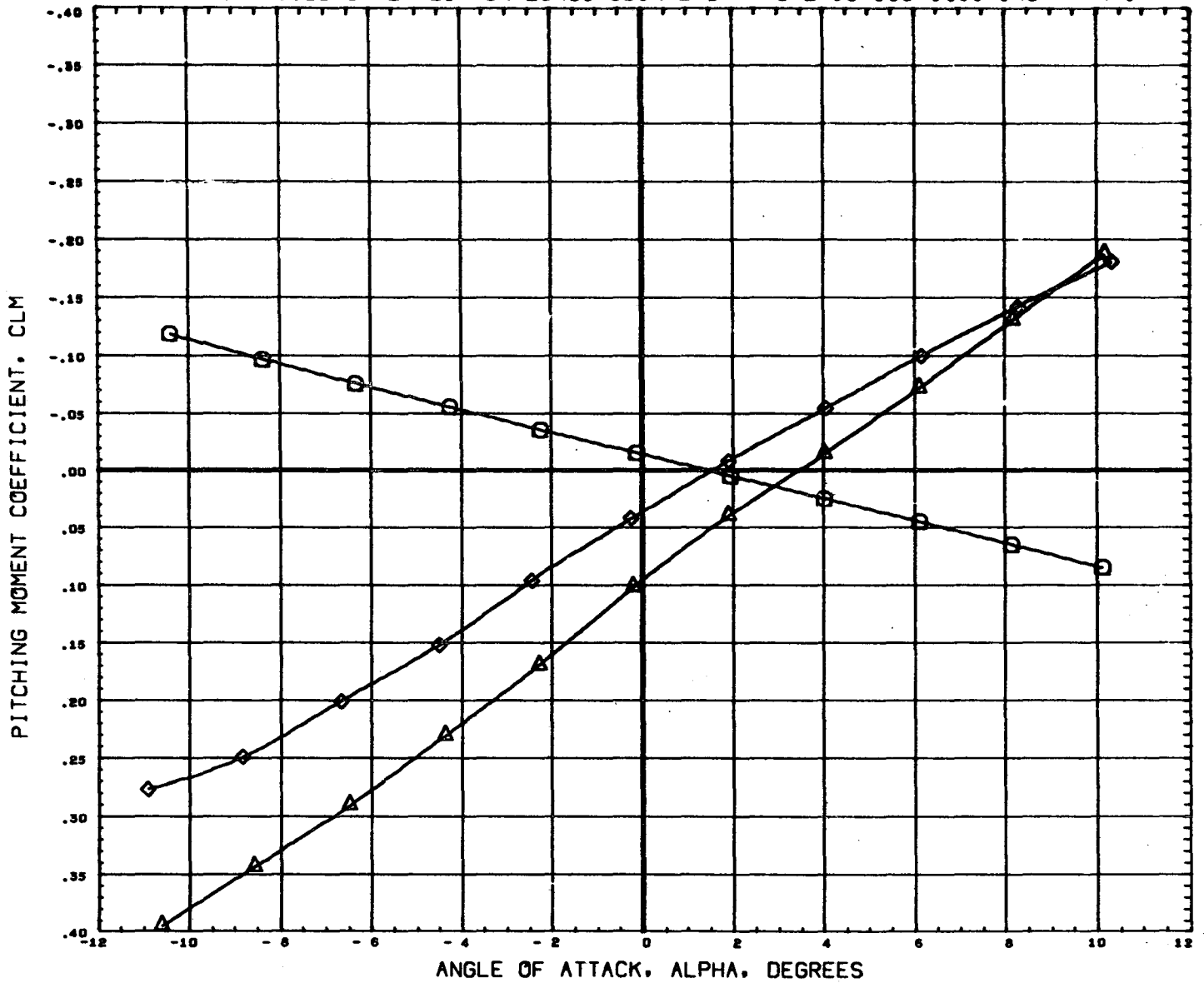

DATA SET SYMBOL	CONFIGURATION DESCRIPTION	ORBIN	THETS	BETA	REFERENCE INFORMATION	
(B65019)	MSFC TWT 534 SHUTTLE LAUNCH	T2		0.000	SREF 4.8950 SQ. IN	
(B65020)	MSFC TWT 534 SHUTTLE LAUNCH	T201	-1.500	0.000	LREF 2.6440 IN.	
(B65022)	MSFC TWT 534 SHUTTLE LAUNCH	T201S1	-1.500	21.000	0.000	BREF 3.5250 IN. XMRP 3.4900 IN. YMRP 0.0000 IN. ZMRP 0.1616 IN. SCALE 0.0034

MACH 1.10

CONFIGURATION BUILD-UP EFFECT ON LONGITUDINAL CHARACTERISTICS (400 INCH TANK)

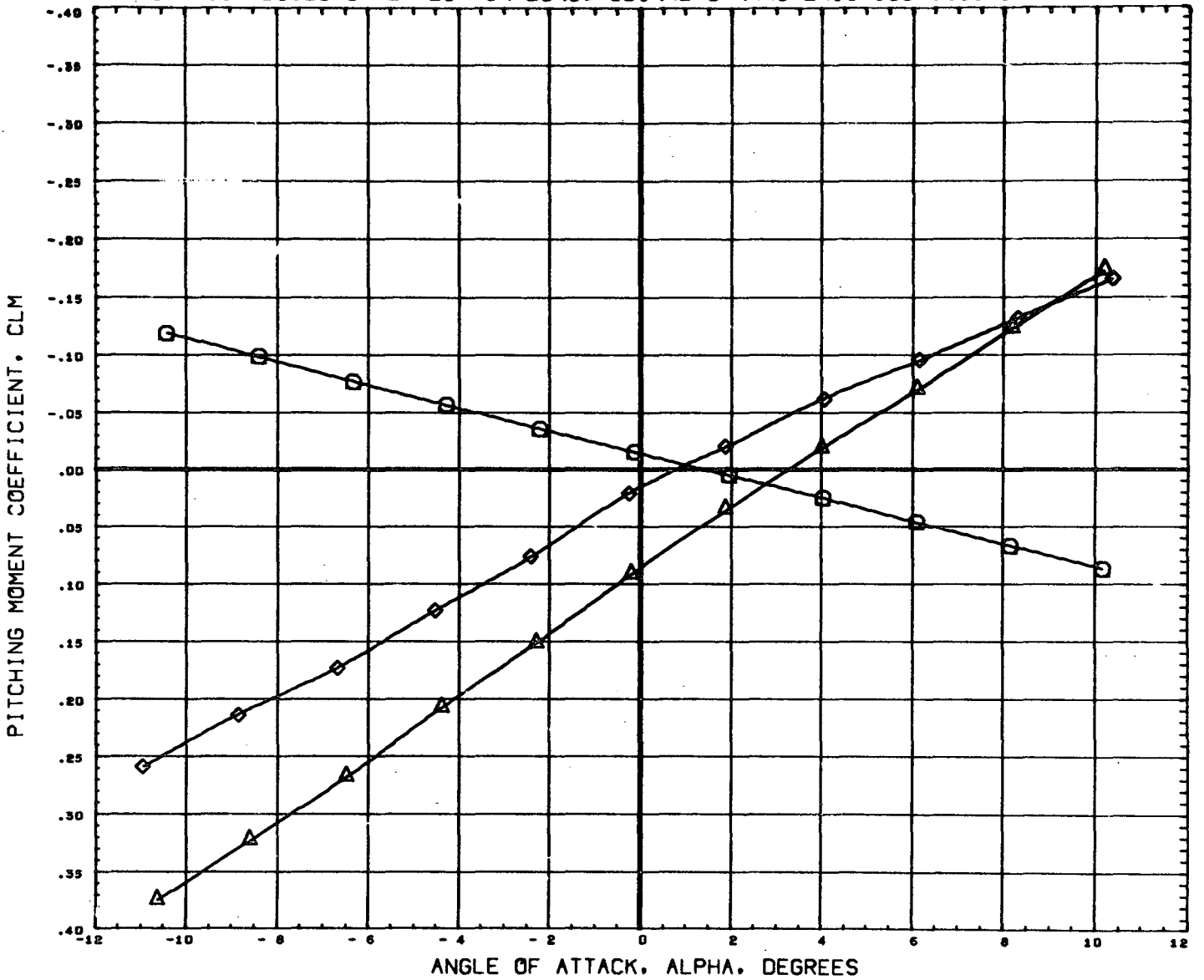

DATA SET SYMBOL	CONFIGURATION DESCRIPTION	T2	ORBIN	THETS	BETA	REFERENCE INFORMATION	
(B65019)	MSFC TWT 534 SHUTTLE LAUNCH	T2	-1.500		0.000	SREF	4.8950 SQ. IN
(B65020)	MSFC TWT 534 SHUTTLE LAUNCH	T2O1	-1.500	21.000	0.000	LREF	2.6440 IN.
(B65022)	MSFC TWT 534 SHUTTLE LAUNCH	T2O1S1	-1.500	21.000	0.000	BREF	3.5250 IN.
						XMRP	3.4900 IN.
						YMRP	0.0000 IN.
						ZMRP	0.1616 IN.
						SCALE	0.0034

MACH 1.20

CONFIGURATION BUILD-UP EFFECT ON LONGITUDINAL CHARACTERISTICS (400 INCH TANK)

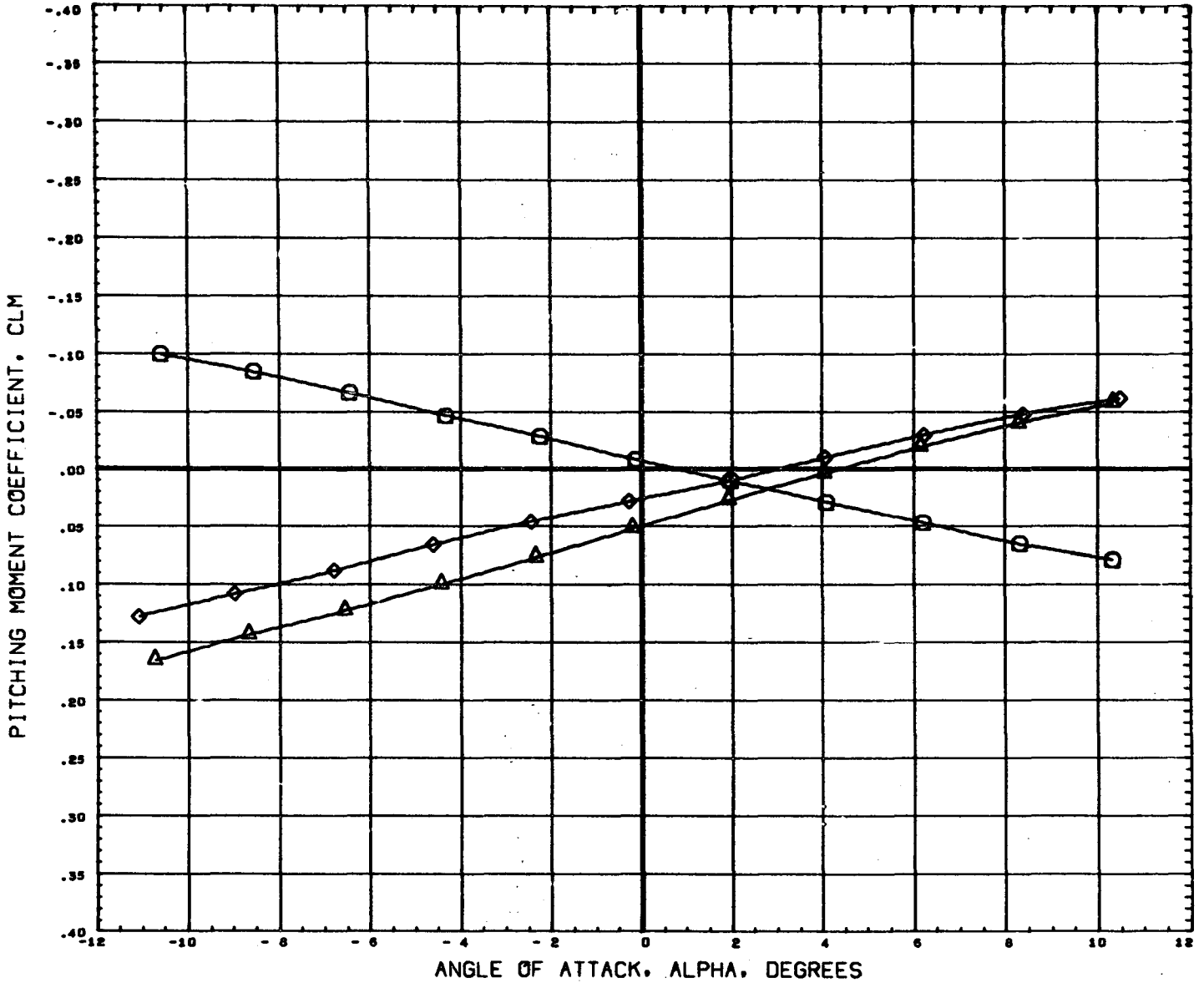

DATA SET SYMBOL	CONFIGURATION DESCRIPTION	ORBIN	THETS	BETA	REFERENCE INFORMATION
(B65019)	MSFC TWT 534 SHUTTLE LAUNCH T2			0.000	SREF 4.8950 SQ. IN
(B65020)	MSFC TWT 534 SHUTTLE LAUNCH T201	-1.500		0.000	LREF 2.6440 IN.
(B65022)	MSFC TWT 534 SHUTTLE LAUNCH T201S1	-1.500	21.000	0.000	BREF 3.5250 IN.
					XMRP 3.4900 IN.
					YMRP 0.0000 IN.
					ZMRP 0.1616 IN.
					SCALE 0.0034

CONFIGURATION BUILD-UP EFFECT ON LONGITUDINAL CHARACTERISTICS (400 INCH TANK)

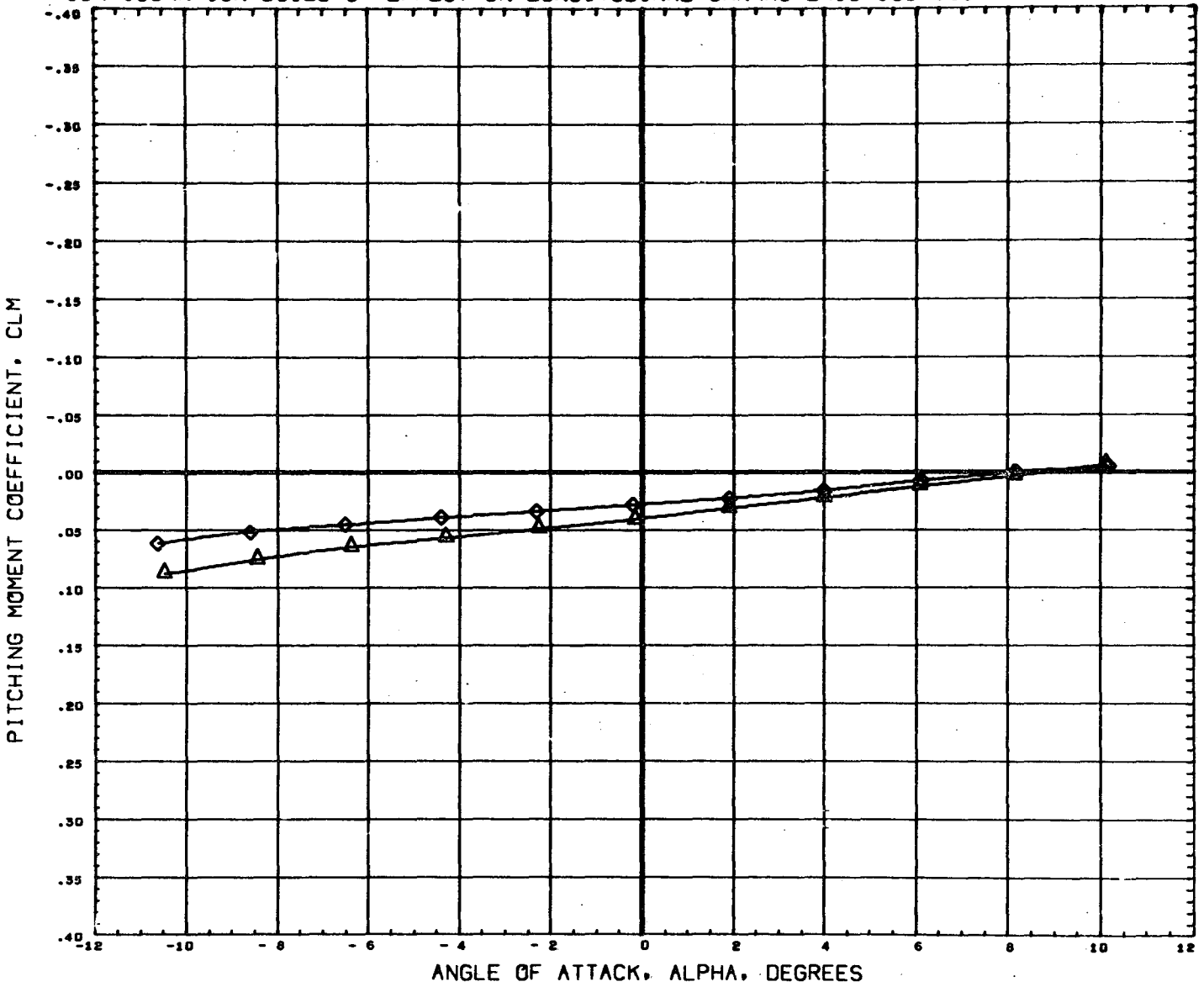

DATA SET SYMBOL	CONFIGURATION DESCRIPTION	ORBIN	THETS	BETA	REFERENCE INFORMATION
(B65019)	DATA NOT AVAILABLE FOR ALL CONDITIONS			0.000	SREF 4.8950 SQ. IN
(B65020)	MSFC TWT 534 SHUTTLE LAUNCH T201	-1.500		0.000	LREF 2.6440 IN.
(B65022)	MSFC TWT 534 SHUTTLE LAUNCH T201S1	-1.500	21.000	0.000	BREF 3.5250 IN.
					XMRP 3.4900 IN.
					YMRP 0.0000 IN.
					ZMRP 0.1616 IN.
					SCALE 0.0034

MACH 2.74

CONFIGURATION BUILD-UP EFFECT ON LONGITUDINAL CHARACTERISTICS (400 INCH TANK)

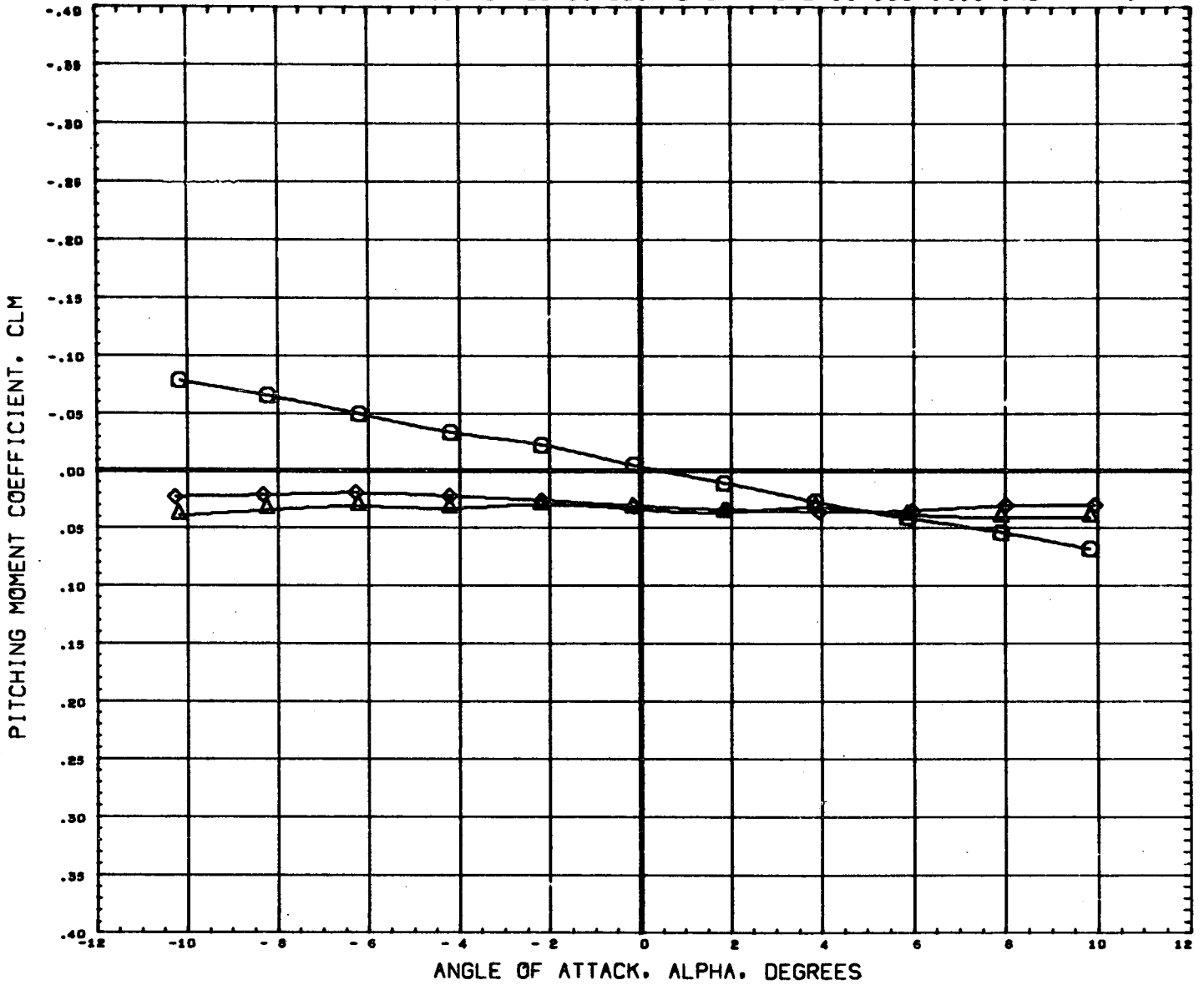

DATA SET SYMBOL	CONFIGURATION DESCRIPTION	ORBIN	THETS	BETA	REFERENCE INFORMATION	
(B65019)	MSFC TWT 534 SHUTTLE LAUNCH	T2		0.000	SREF 4.8950 SQ. IN	
(B65020)	MSFC TWT 534 SHUTTLE LAUNCH	T201	-1.500	0.000	LREF 2.6440 IN.	
(B65022)	MSFC TWT 534 SHUTTLE LAUNCH	T201S1	-1.500	21.000	0.000	BREF 3.5250 IN.
					XMRP 3.4900 IN.	
					YMRP 0.0000 IN.	
					ZMRP 0.1616 IN.	
					SCALE 0.0034	

MACH 4.96

CONFIGURATION BUILD-UP EFFECT ON LONGITUDINAL CHARACTERISTICS (400 INCH TANK)

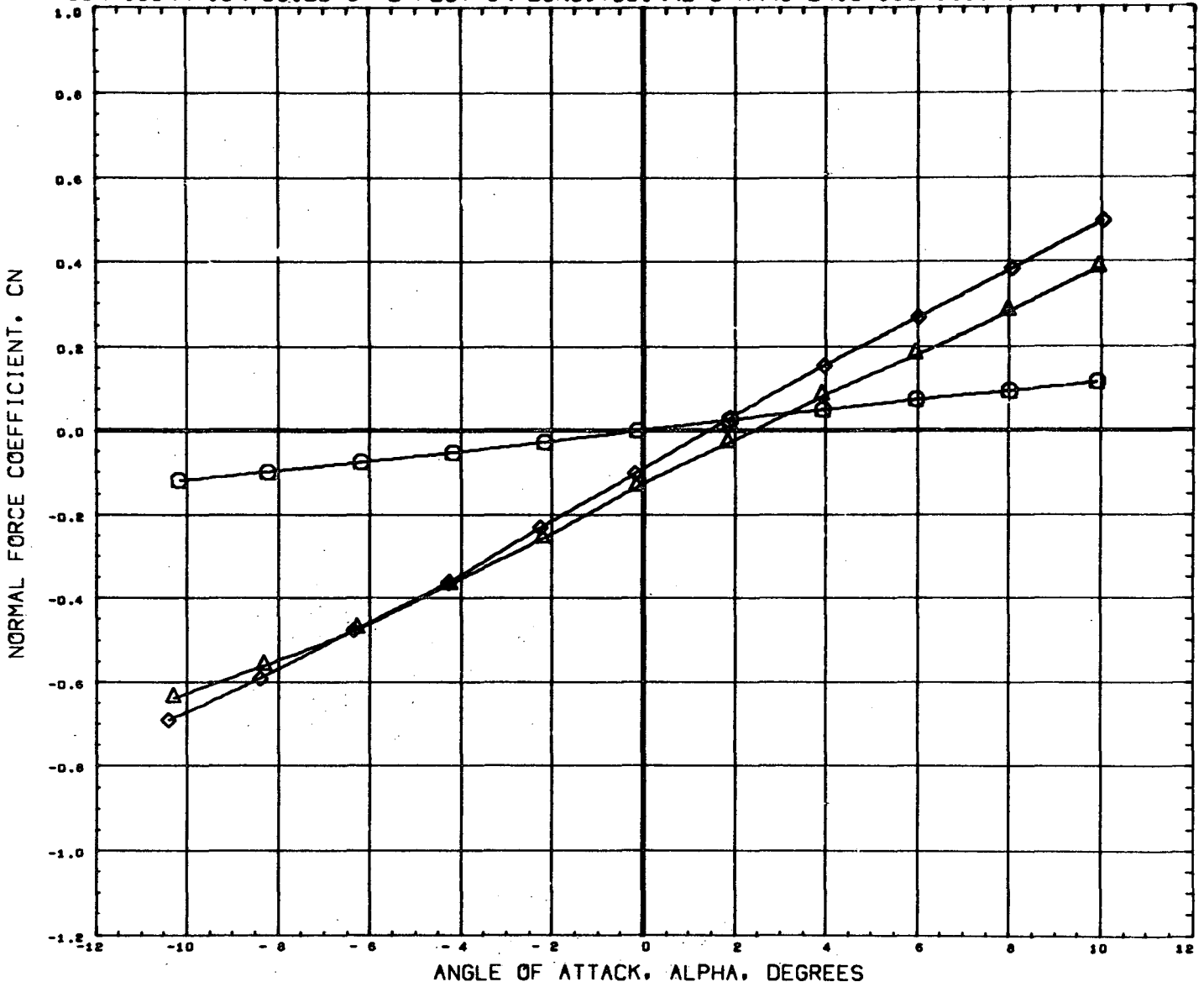

DATA SET SYMBOL	CONFIGURATION DESCRIPTION	ORBIN	THETS	BETA	REFERENCE INFORMATION
(B65019)	MSFC TWT 534 SHUTTLE LAUNCH T2			0.000	SREF 4.8950 SQ. IN
(B65020)	MSFC TWT 534 SHUTTLE LAUNCH T201	-1.500		0.000	LREF 2.6440 IN.
(B65022)	MSFC TWT 534 SHUTTLE LAUNCH T201S1	-1.500	21.000	0.000	BREF 3.5250 IN.
					XMRP 3.4900 IN.
					YMRP 0.0000 IN.
					ZMRP 0.1616 IN.
					SCALE 0.0034

MACH .60

CONFIGURATION BUILD-UP EFFECT ON LONGITUDINAL CHARACTERISTICS (400 INCH TANK)

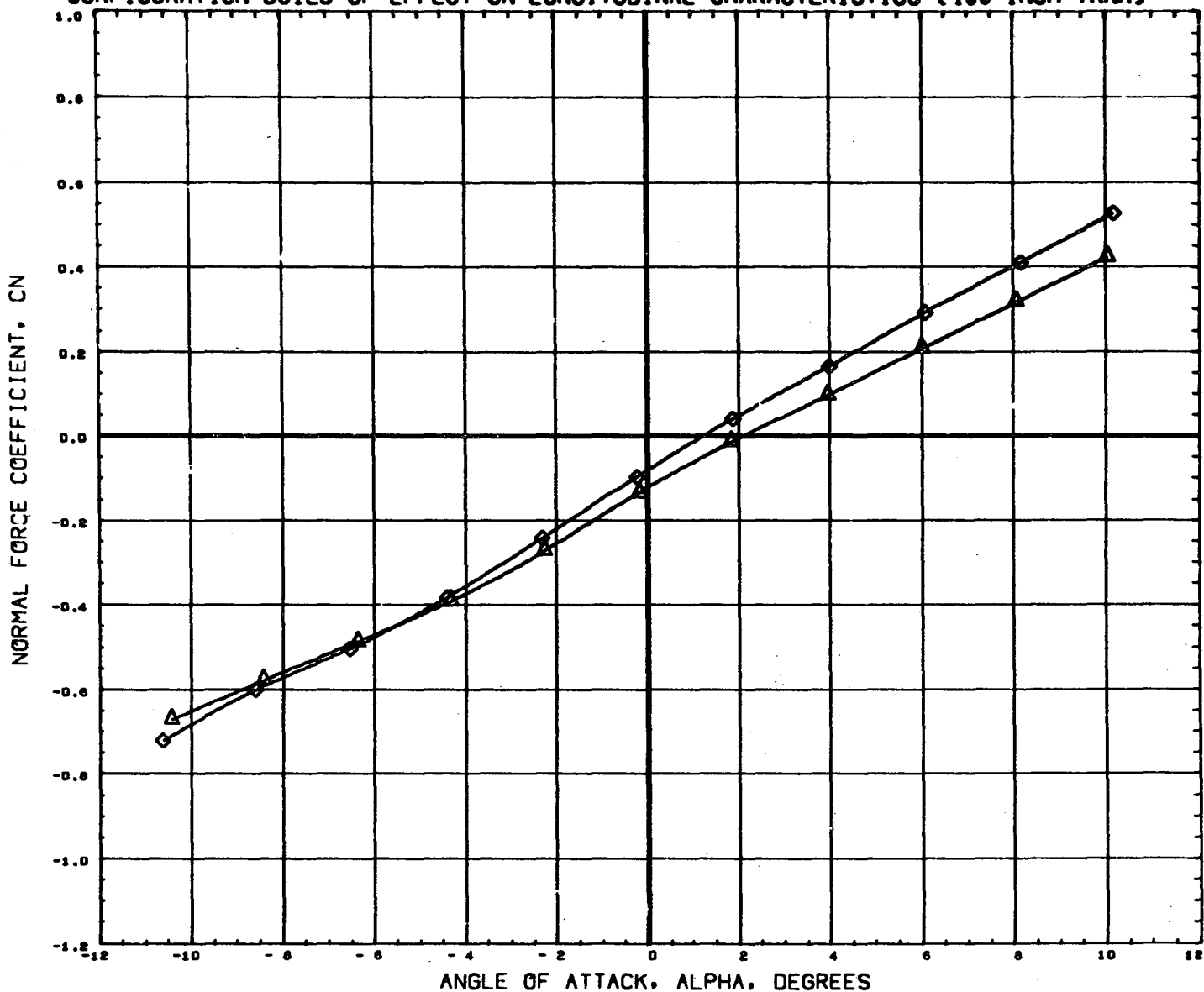

DATA SET SYMBOL	CONFIGURATION DESCRIPTION	ORBIN	THETS	BETA	REFERENCE INFORMATION
(B65019)	DATA NOT AVAILABLE FOR ALL CONDITIONS			0.000	SREF 4.8950 SQ. IN
(B65020)	MSFC TWT 534 SHUTTLE LAUNCH T201	-1.500		0.000	LREF 2.6440 IN.
(B65022)	MSFC TWT 534 SHUTTLE LAUNCH T201S1	-1.500	21.000	0.000	BREF 3.5250 IN.
					XMRP 3.4900 IN.
					YMRP 0.0000 IN.
					ZMRP 0.1616 IN.
					SCALE 0.0034

CONFIGURATION BUILD-UP EFFECT ON LONGITUDINAL CHARACTERISTICS (400 INCH TANK)

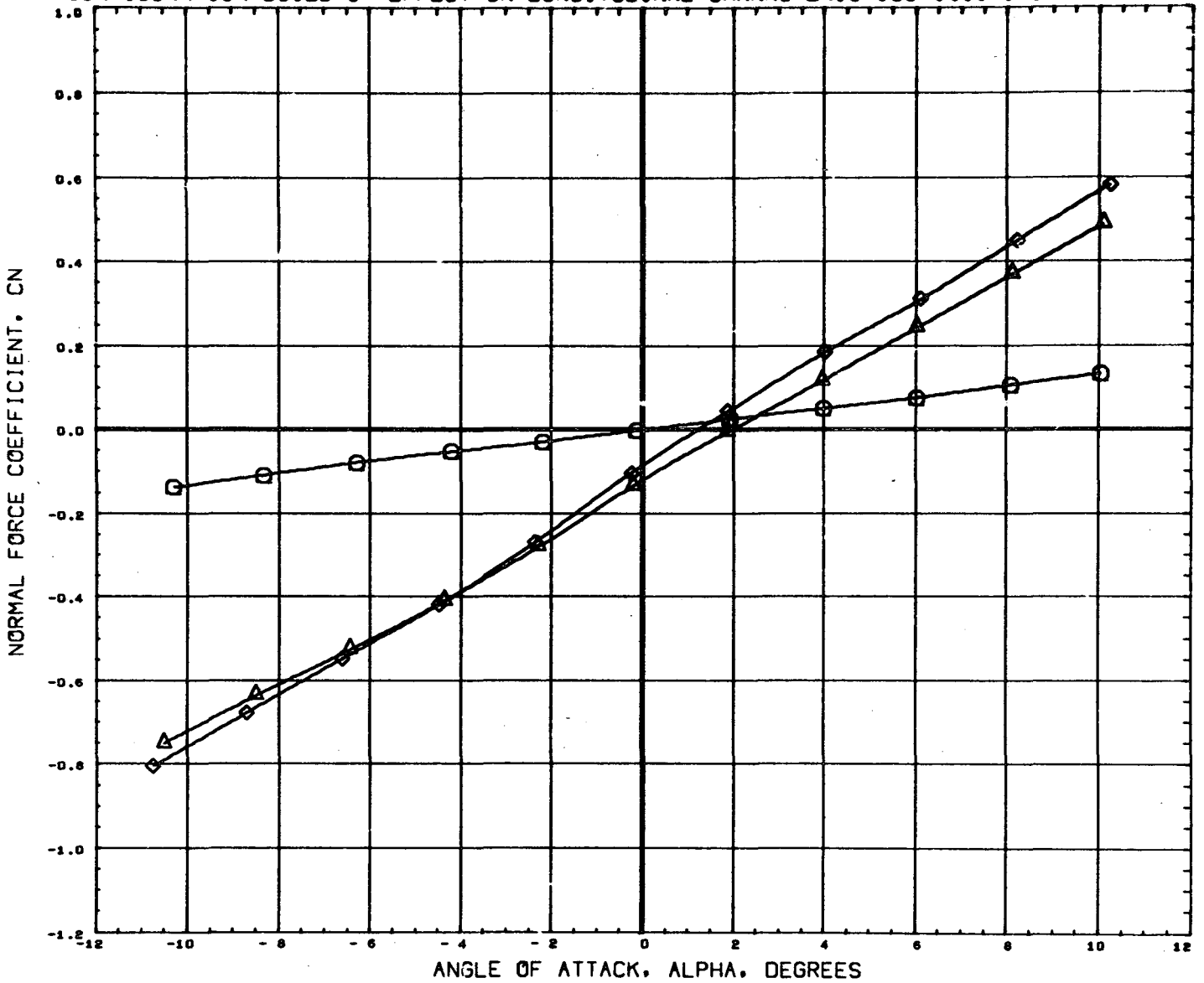

DATA SET SYMBOL	CONFIGURATION DESCRIPTION	T2	ORBIN	THETS	BETA	REFERENCE INFORMATION
(865019)	MSFC TWT 534 SHUTTLE LAUNCH	T2			0.000	SREF 4.8950 SQ. IN
(865020)	MSFC TWT 534 SHUTTLE LAUNCH	T201	-1.500		0.000	LREF 2.6440 IN.
(865022)	MSFC TWT 534 SHUTTLE LAUNCH	T201S1	-1.500	21.000	0.000	BREF 3.5250 IN.
						XMRP 3.4900 IN.
						YMRP 0.0000 IN.
						ZMRP 0.1616 IN.
						SCALE 0.0034

MACH .90

CONFIGURATION BUILD-UP EFFECT ON LONGITUDINAL CHARACTERISTICS (400 INCH TANK)

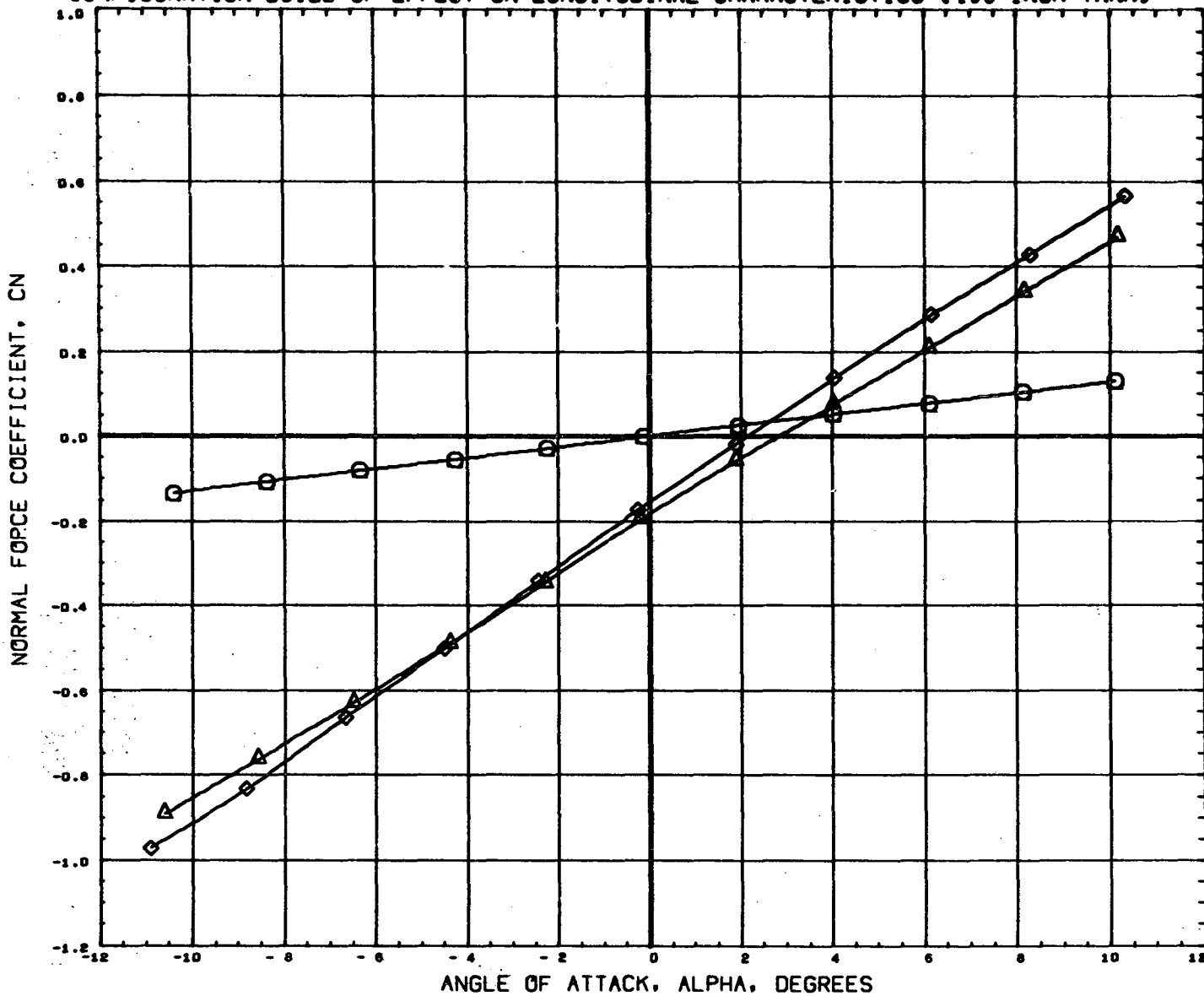

DATA SET SYMBOL	CONFIGURATION DESCRIPTION	ORBIN	THETS	BETA	REFERENCE INFORMATION
(865019) ○	MSFC TWT 534 SHUTTLE LAUNCH T2			0.000	SREF 4.8950 sq. IN
(865020) △	MSFC TWT 534 SHUTTLE LAUNCH T201	-1.500		0.000	LREF 2.6440 IN.
(865022) ◇	MSFC TWT 534 SHUTTLE LAUNCH T201S1	-1.500	21.000	0.000	BREF 3.5250 IN.
					XMRP 3.4900 IN.
					YMRP 0.0000 IN.
					ZMRP 0.1616 IN.
					SCALE 0.0034

MACH 1.10

CONFIGURATION BUILD-UP EFFECT ON LONGITUDINAL CHARACTERISTICS (400 INCH TANK)

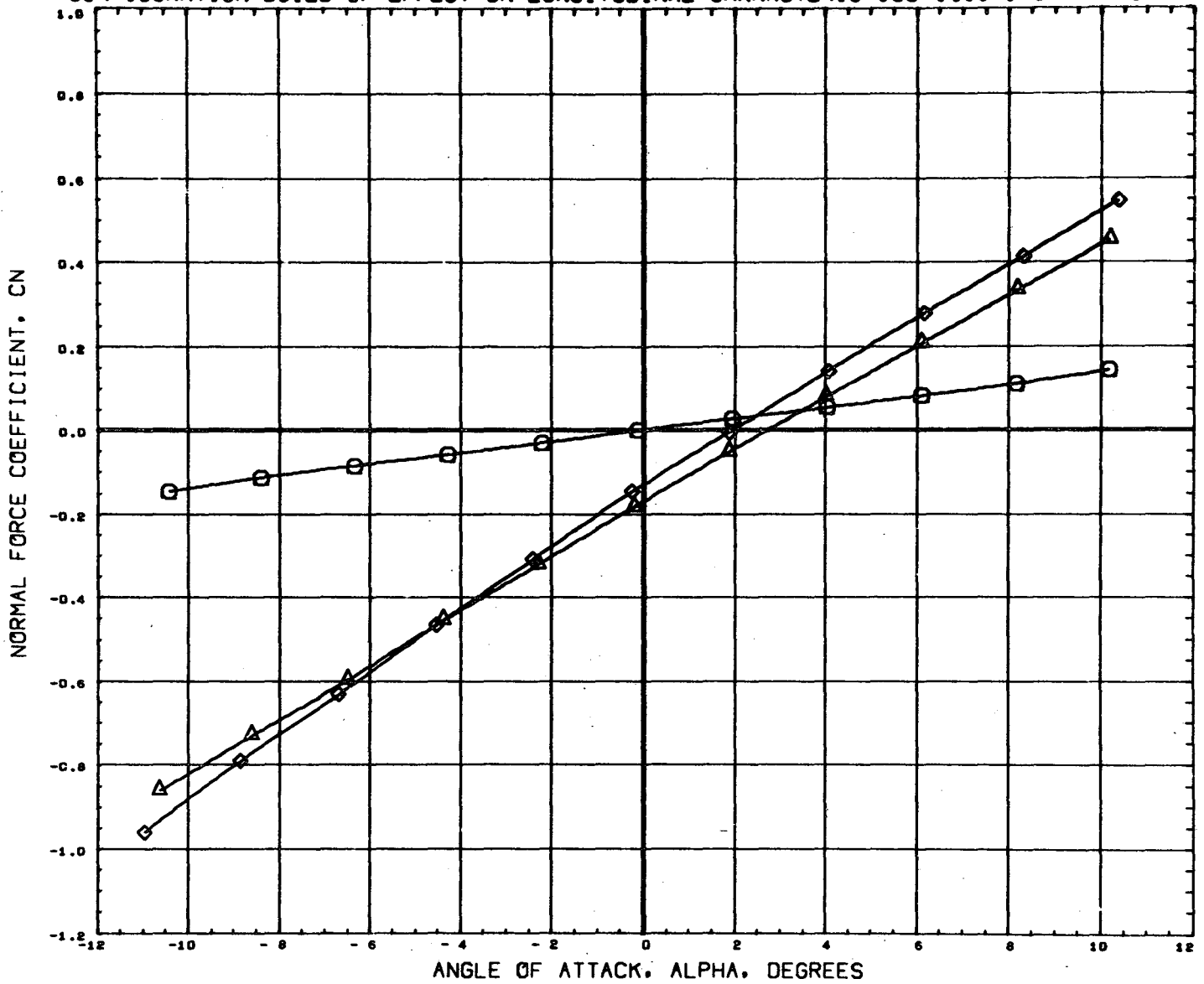

DATA SET SYMBOL	CONFIGURATION DESCRIPTION	ORBIN	THETS	BETA	REFERENCE INFORMATION	
(B65D19)	MSFC TWT 534 SHUTTLE LAUNCH	T2		0.000	SREF 4.8950 SQ. IN	
(B65D20)	MSFC TWT 534 SHUTTLE LAUNCH	T201	-1.500	0.000	LREF 2.6440 IN.	
(B65D22)	MSFC TWT 534 SHUTTLE LAUNCH	T201S1	-1.500	21.000	0.000	BREF 3.5250 IN.
					XMRP 3.4900 IN.	
					YMRP 0.0000 IN.	
					ZMRP 0.1616 IN.	
					SCALE 0.5034	

MACH 1.20

PAGE 93

CONFIGURATION BUILD-UP EFFECT ON LONGITUDINAL CHARACTERISTICS (400 INCH TANK)

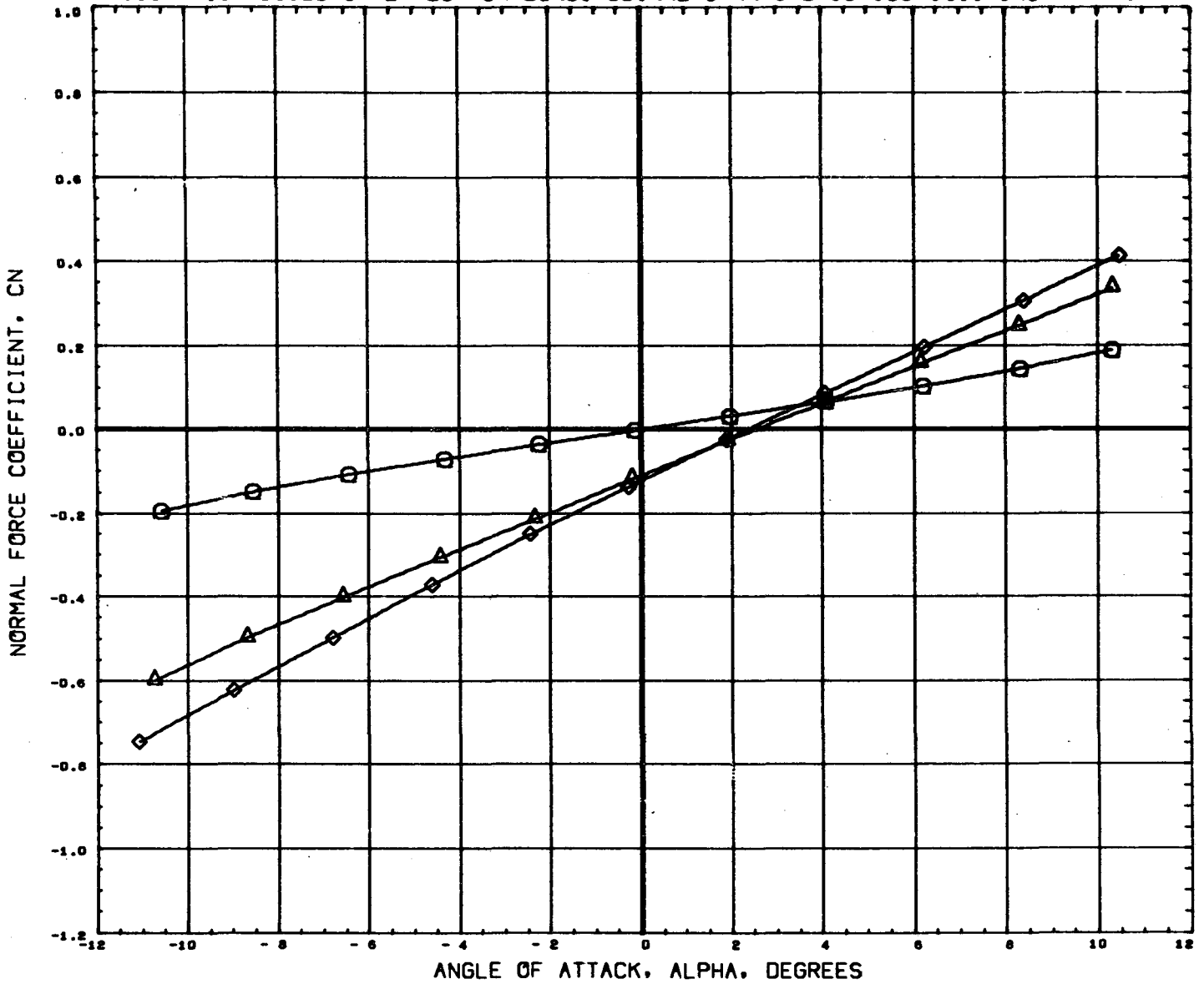

DATA SET SYMBOL	CONFIGURATION DESCRIPTION	T2	ORBIN	THETS	BETA	REFERENCE INFORMATION
(B65019)	MSFC TWT 534 SHUTTLE LAUNCH	T2	-1.500		0.000	SREF 4.8950 SQ. IN.
(B65020)	MSFC TWT 534 SHUTTLE LAUNCH	T201	-1.500		0.000	LREF 2.6440 IN.
(B65022)	MSFC TWT 534 SHUTTLE LAUNCH	T201S1	-1.500	21.000	0.000	BREF 3.5250 IN.
						XMRP 3.4900 IN.
						YMRP 0.0000 IN.
						ZMRP 0.1616 IN.
						SCALE 0.0034

MACH 1.97

CONFIGURATION BUILD-UP EFFECT ON LONGITUDINAL CHARACTERISTICS (400 INCH TANK)

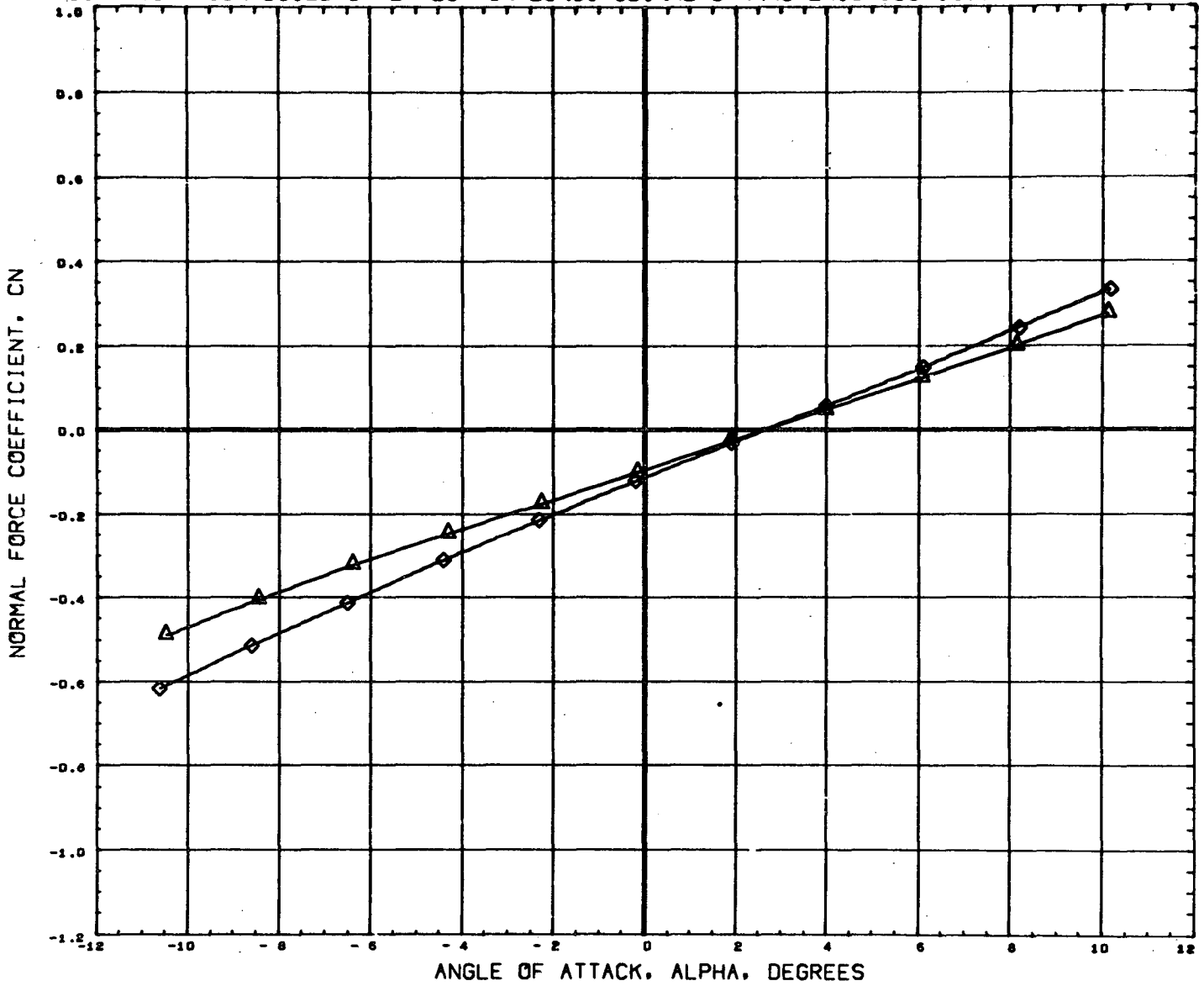

DATA SET SYMBOL	CONFIGURATION DESCRIPTION	ORBIN	THETS	BETA	REFERENCE INFORMATION
(B65019)	DATA NOT AVAILABLE FOR ALL CONDITIONS			0.000	SREF 4.8950 SQ. IN
(B65020)	MSFC TWT 534 SHUTTLE LAUNCH T201	-1.500		0.000	LREF 2.6440 IN.
(B65022)	MSFC TWT 534 SHUTTLE LAUNCH T201S1	-1.500	21.000	0.000	BREF 3.5250 IN.
					XMRP 3.4900 IN.
					YMRP 0.0000 IN.
					ZMRP 0.1616 IN.
					SCALE 0.0034

MACH 2.74

PAGE 95

CONFIGURATION BUILD-UP EFFECT ON LONGITUDINAL CHARACTERISTICS (400 INCH TANK)

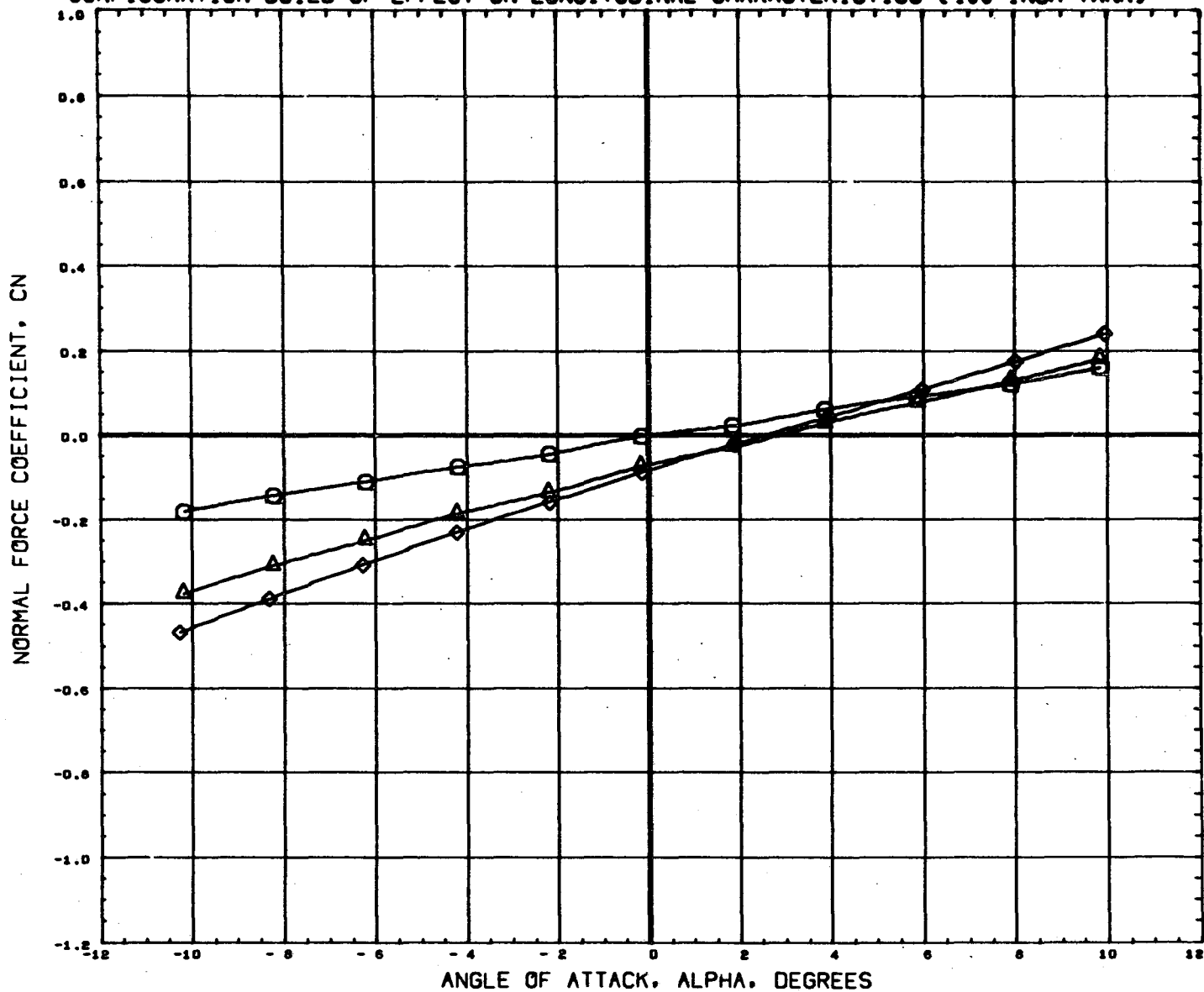

DATA SET SYMBOL	CONFIGURATION DESCRIPTION	T2	ORBIN	THETS	BETA	REFERENCE INFORMATION
(865019)	MSFC TWT 534 SHUTTLE LAUNCH	T2			0.000	SREF 4.8950 SQ. IN
(865020)	MSFC TWT 534 SHUTTLE LAUNCH	T201	-1.500		0.000	LREF 2.6440 IN.
(865022)	MSFC TWT 534 SHUTTLE LAUNCH	T201S1	-1.500	21.000	0.000	BREF 3.5250 IN.
						XMRP 3.4900 IN.
						YMRP 0.0000 IN.
						ZMRP 0.1616 IN.
						SCALE 0.0034

MACH 4.96

PAGE 96

CONFIGURATION BUILD-UP EFFECT ON LONGITUDINAL CHARACTERISTICS (400 INCH TANK)

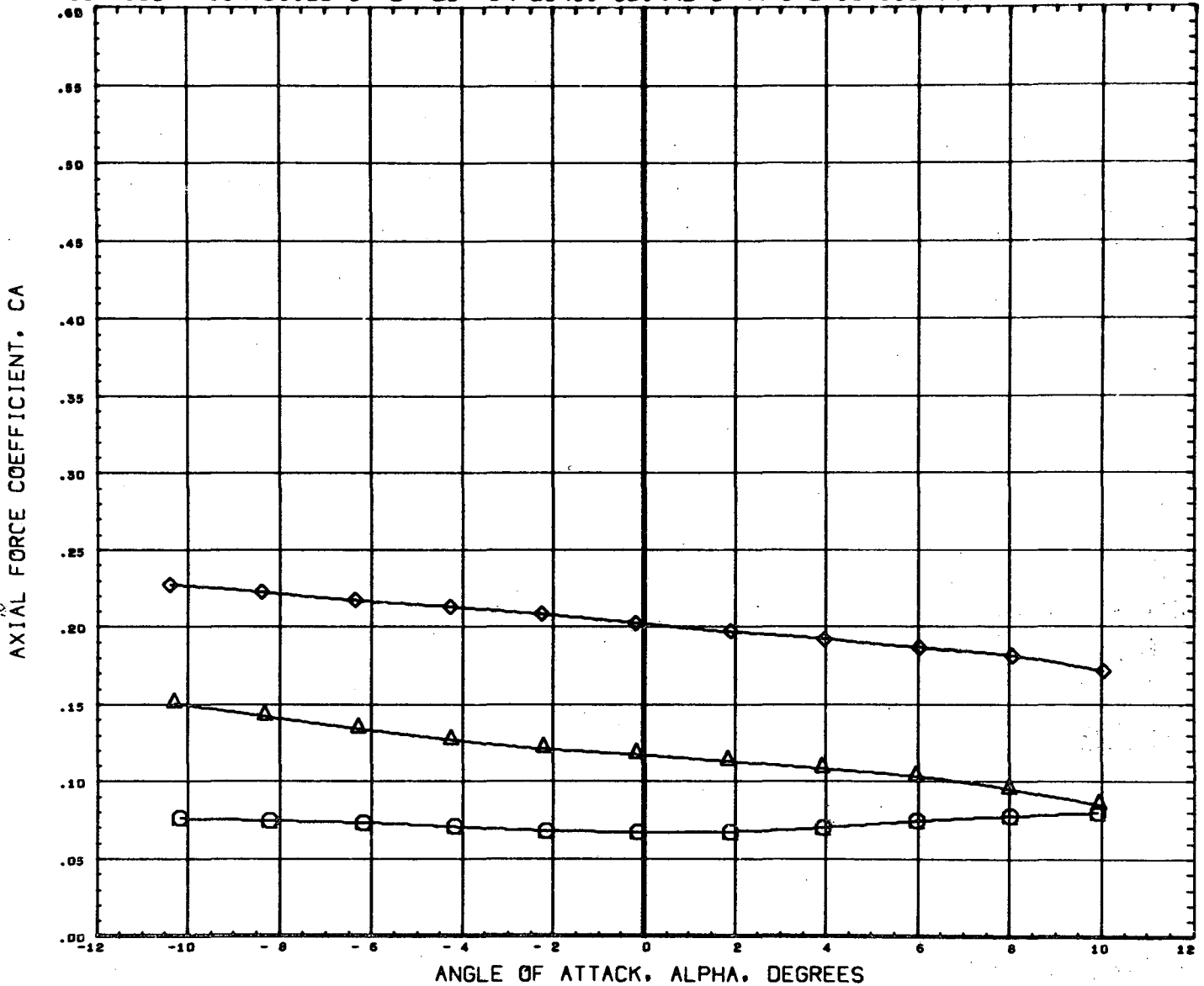

DATA SET SYMBOL	CONFIGURATION DESCRIPTION	T2	ORBIN	THETS	BETA	REFERENCE INFORMATION
(B65019)	MSFC TWT 534 SHUTTLE LAUNCH	T2	-1.500		0.000	SREF 4.8950 SQ. IN
(B65020)	MSFC TWT 534 SHUTTLE LAUNCH	T201	-1.500		0.000	LREF 2.6440 IN.
(B65022)	MSFC TWT 534 SHUTTLE LAUNCH	T201S1	-1.500	21.000	0.000	BREF 3.5250 IN.
						XMRP 3.4900 IN.
						YMRP 0.0000 IN.
						ZMRP 0.1616 IN.
						SCALE 0.0034

MACH .60

CONFIGURATION BUILD-UP EFFECT ON LONGITUDINAL CHARACTERISTICS (400 INCH TANK)

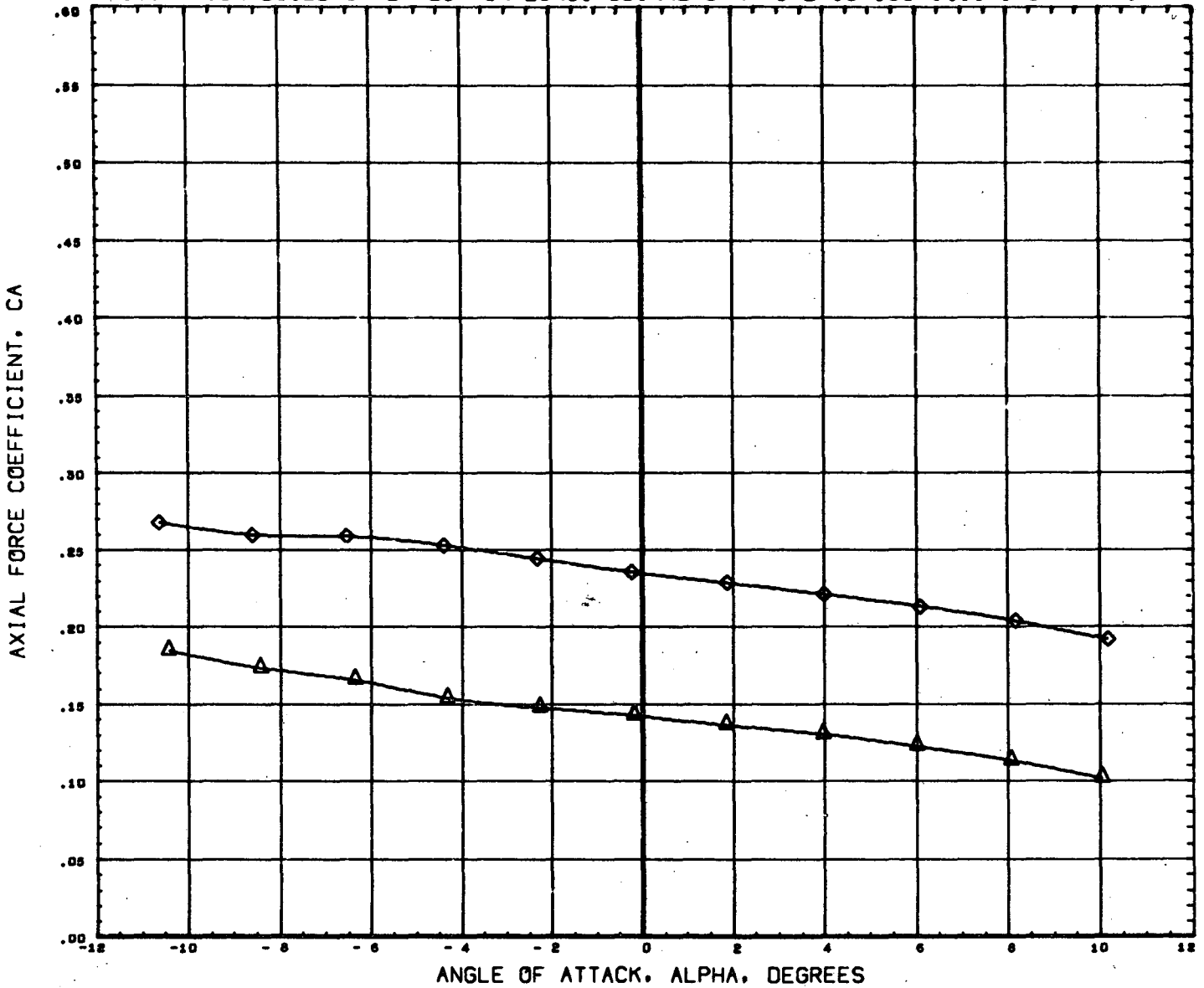

DATA SET SYMBOL	CONFIGURATION DESCRIPTION	ORBIN	THETS	BETA	REFERENCE INFORMATION
(B65019)	DATA NOT AVAILABLE FOR ALL CONDITIONS			0.000	SREF 4.8950 SQ. IN
(B65020)	MSFC TWT 534 SHUTTLE LAUNCH T201	-1.500		0.000	LREF 2.6440 IN.
(B65022)	MSFC TWT 534 SHUTTLE LAUNCH T201s1	-1.500	21.000	0.000	BREF 3.9250 IN.
					XHRP 3.4900 IN.
					YHRP 0.0000 IN.
					ZHRP 0.1616 IN.
					SCALE 0.0034

CONFIGURATION BUILD-UP EFFECT ON LONGITUDINAL CHARACTERISTICS (400 INCH TANK)

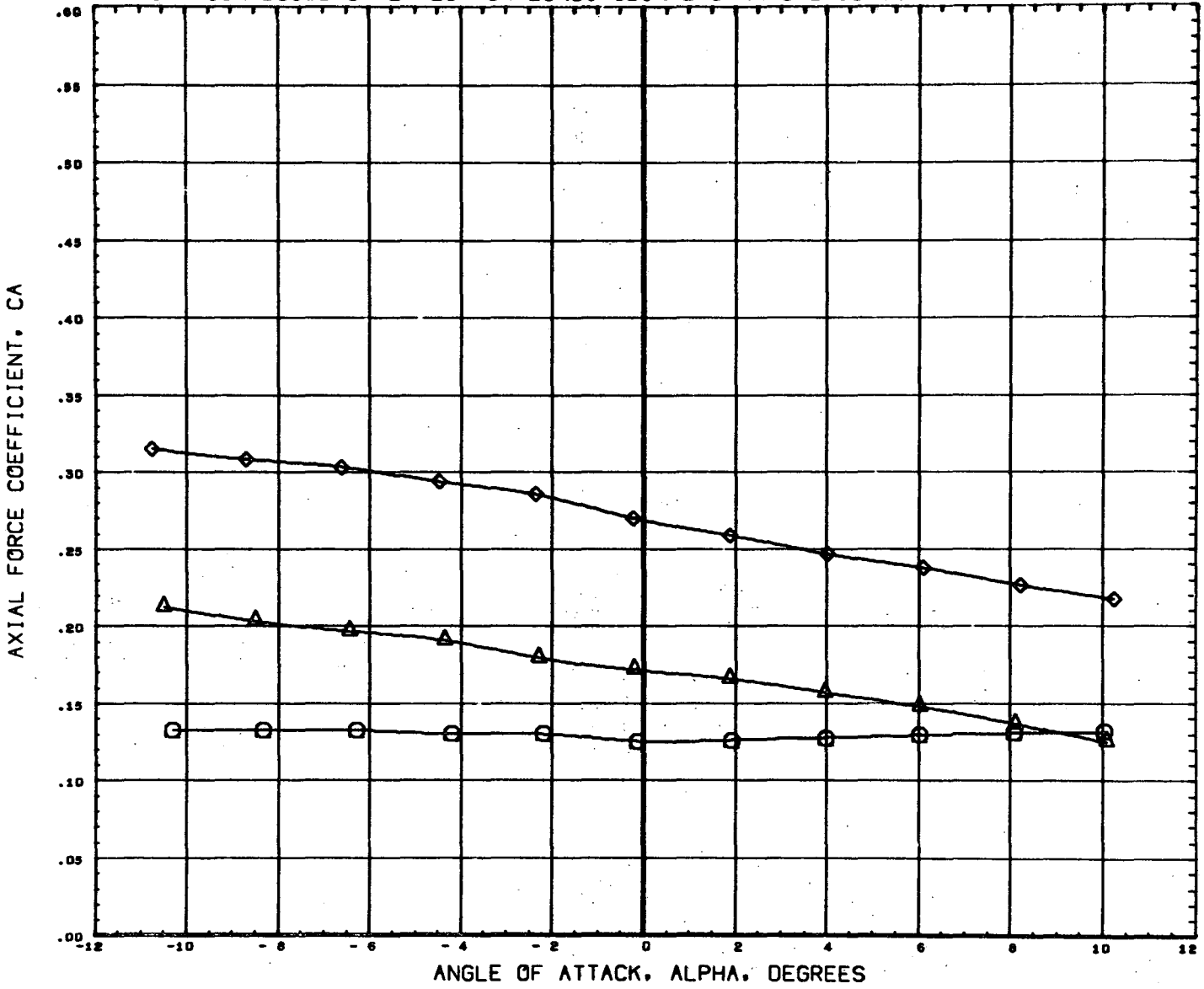

DATA SET SYMBOL	CONFIGURATION DESCRIPTION	ORBIN	THETS	BETA	REFERENCE INFORMATION	
(B65019)	MSFC TWT 534 SHUTTLE LAUNCH	T2		0.000	SREF 4.8950 SQ. IN	
(B65020)	MSFC TWT 534 SHUTTLE LAUNCH	T201	-1.500	0.000	LREF 2.6440 IN.	
(B65022)	MSFC TWT 534 SHUTTLE LAUNCH	T201S1	-1.500	21.000	0.000	BREF 3.5250 IN. XMRP 3.4900 IN. YMRP 0.0000 IN. ZMRP 0.1616 IN. SCALE 0.0034

MACH .90

CONFIGURATION BUILD-UP EFFECT ON LONGITUDINAL CHARACTERISTICS (400 INCH TANK)

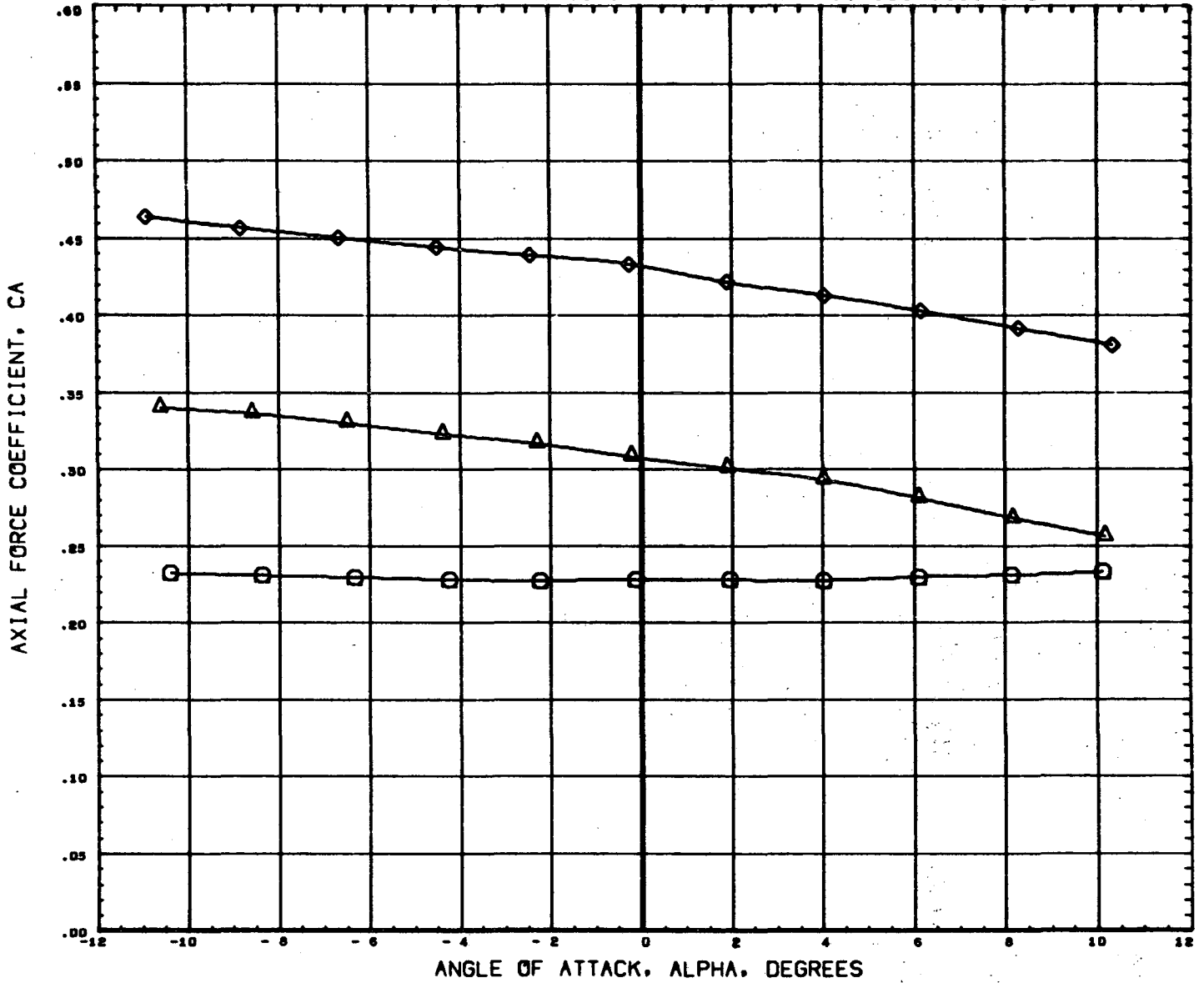

DATA SET SYMBOL	CONFIGURATION DESCRIPTION	T2	ORBIN	THETS	BETA	REFERENCE INFORMATION
(865019)	MSFC TWT 534 SHUTTLE LAUNCH	T2	-1.500		0.000	SREF 4.8950 SQ. IN
(865020)	MSFC TWT 534 SHUTTLE LAUNCH	T201	-1.500		0.000	LREF 2.6440 IN.
(865022)	MSFC TWT 534 SHUTTLE LAUNCH	T201S1	-1.500	21.000	0.000	BREF 3.5250 IN.
						XMRP 3.4900 IN.
						YMRP 0.0000 IN.
						ZMRP 0.1616 IN.
						SCALE 0.0034

MACH 1.10

PAGE 100

CONFIGURATION BUILD-UP EFFECT ON LONGITUDINAL CHARACTERISTICS (400 INCH TANK)

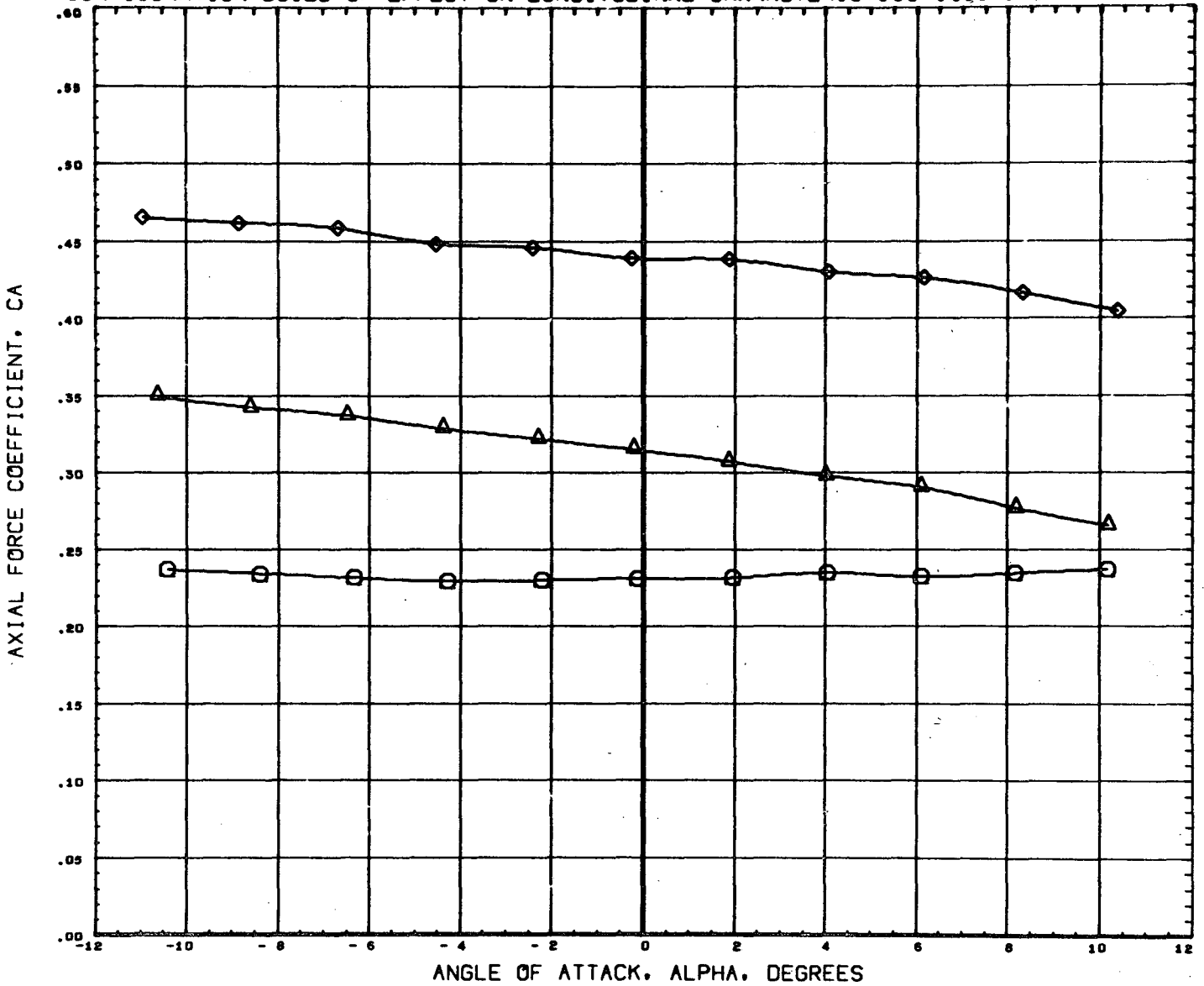

DATA SET SYMBOL	CONFIGURATION DESCRIPTION	ORBIN	THETS	BETA	REFERENCE INFORMATION	
(B65019)	MSFC TWT 534 SHUTTLE LAUNCH	T2		0.000	SREF 4.8950 SQ. IN	
(B65020)	MSFC TWT 534 SHUTTLE LAUNCH	T201	-1.500	0.000	LREF 2.6440 IN.	
(B65022)	MSFC TWT 534 SHUTTLE LAUNCH	T201S1	-1.500	21.000	0.000	BREF 3.5250 IN.
					XMRP 3.4900 IN.	
					YMRP 0.0000 IN.	
					ZMRP 0.1616 IN.	
					SCALE 0.0034	

MACH 1.20

CONFIGURATION BUILD-UP EFFECT ON LONGITUDINAL CHARACTERISTICS (400 INCH TANK)

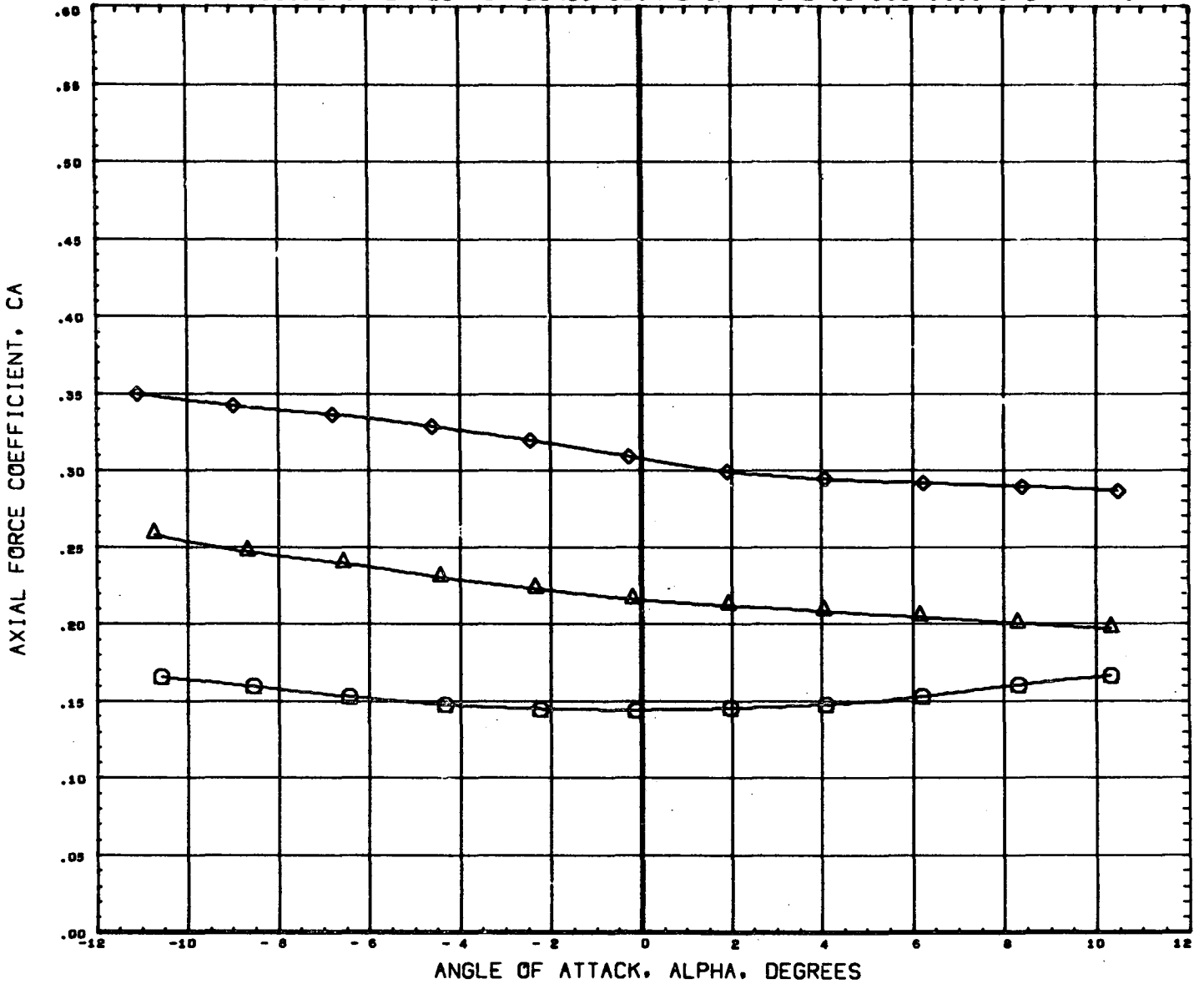

DATA SET SYMBOL	CONFIGURATION DESCRIPTION	ORBIN	THETS	BETA	REFERENCE INFORMATION	
(B65019)	MSFC TWT 534 SHUTTLE LAUNCH	T2		0.000	SREF 4.8950 SQ. IN	
(B65020)	MSFC TWT 534 SHUTTLE LAUNCH	T201	-1.500	0.000	LREF 2.6440 IN.	
(B65022)	MSFC TWT 534 SHUTTLE LAUNCH	T201S1	-1.500	21.000	0.000	BREF 3.5250 IN.
					XMRP 3.4900 IN.	
					YMRP 0.0000 IN.	
					ZMRP 0.1616 IN.	
					SCALE 0.0034	

MACH 1.97

CONFIGURATION BUILD-UP EFFECT ON LONGITUDINAL CHARACTERISTICS (400 INCH TANK)

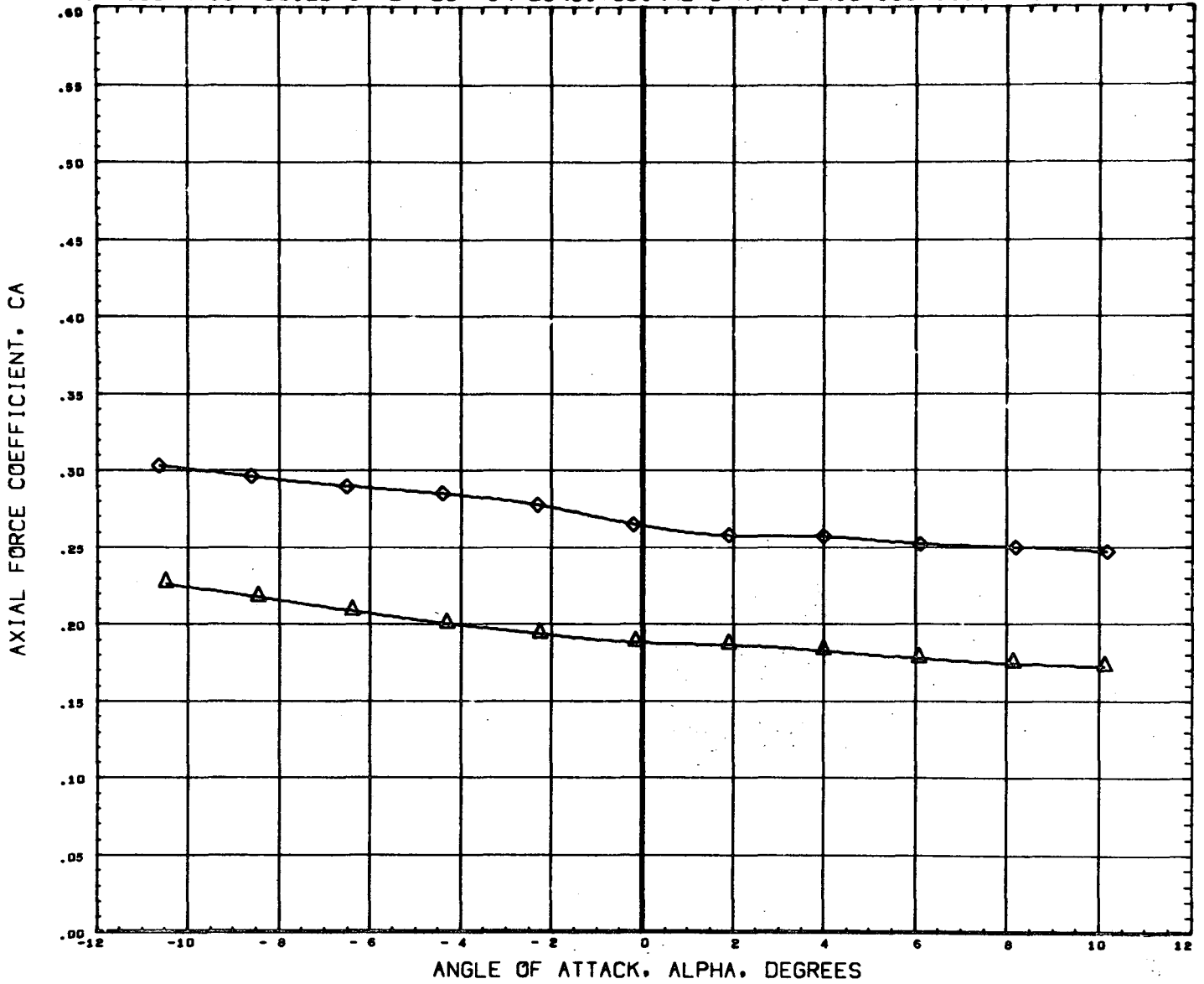

DATA SET SYMBOL	CONFIGURATION DESCRIPTION	ORBIN	THETS	BETA	REFERENCE INFORMATION
(B65019)	DATA NOT AVAILABLE FOR ALL CONDITIONS			0.000	SREF 4.8950 SQ. IN.
(B65020)	MSFC TWT 534 SHUTTLE LAUNCH T201	-1.500		0.000	LREF 2.6440 IN.
(B65022)	MSFC TWT 534 SHUTTLE LAUNCH T201S1	-1.500	21.000	0.000	BREF 3.5250 IN.
					XMRP 3.4900 IN.
					YMRP 0.0000 IN.
					ZMRP 0.1616 IN.
					SCALE 0.0034

CONFIGURATION BUILD-UP EFFECT ON LONGITUDINAL CHARACTERISTICS (400 INCH TANK)

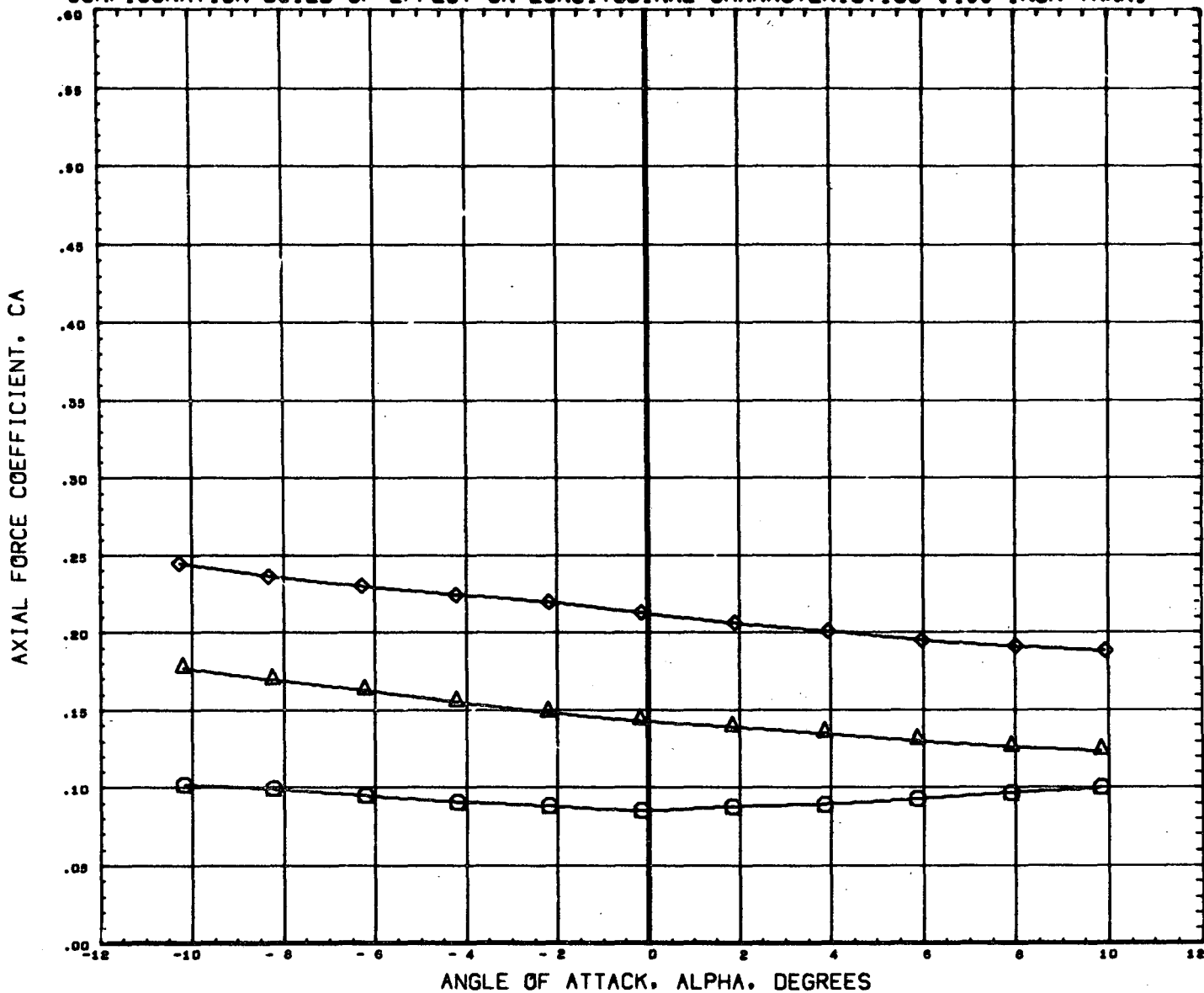

DATA SET SYMBOL	CONFIGURATION DESCRIPTION	ORBIN	THETS	BETA	REFERENCE INFORMATION
(B65019)	MSFC TWT 534 SHUTTLE LAUNCH	T2		0.000	SREF 4.8950 99. IN
(B65020)	MSFC TWT 534 SHUTTLE LAUNCH	T201	-1.500	0.000	LREF 2.6440 IN.
(B65022)	MSFC TWT 534 SHUTTLE LAUNCH	T20181	-1.500 21.000	0.000	BREF 3.5250 IN.
					XMRP 3.4900 IN.
					YMRP 0.0000 IN.
					ZMRP 0.1616 IN.
					SCALE 0.0034

MACH 4.96

CONFIGURATION BUILD-UP EFFECT ON LONGITUDINAL CHARACTERISTICS (400 INCH TANK)

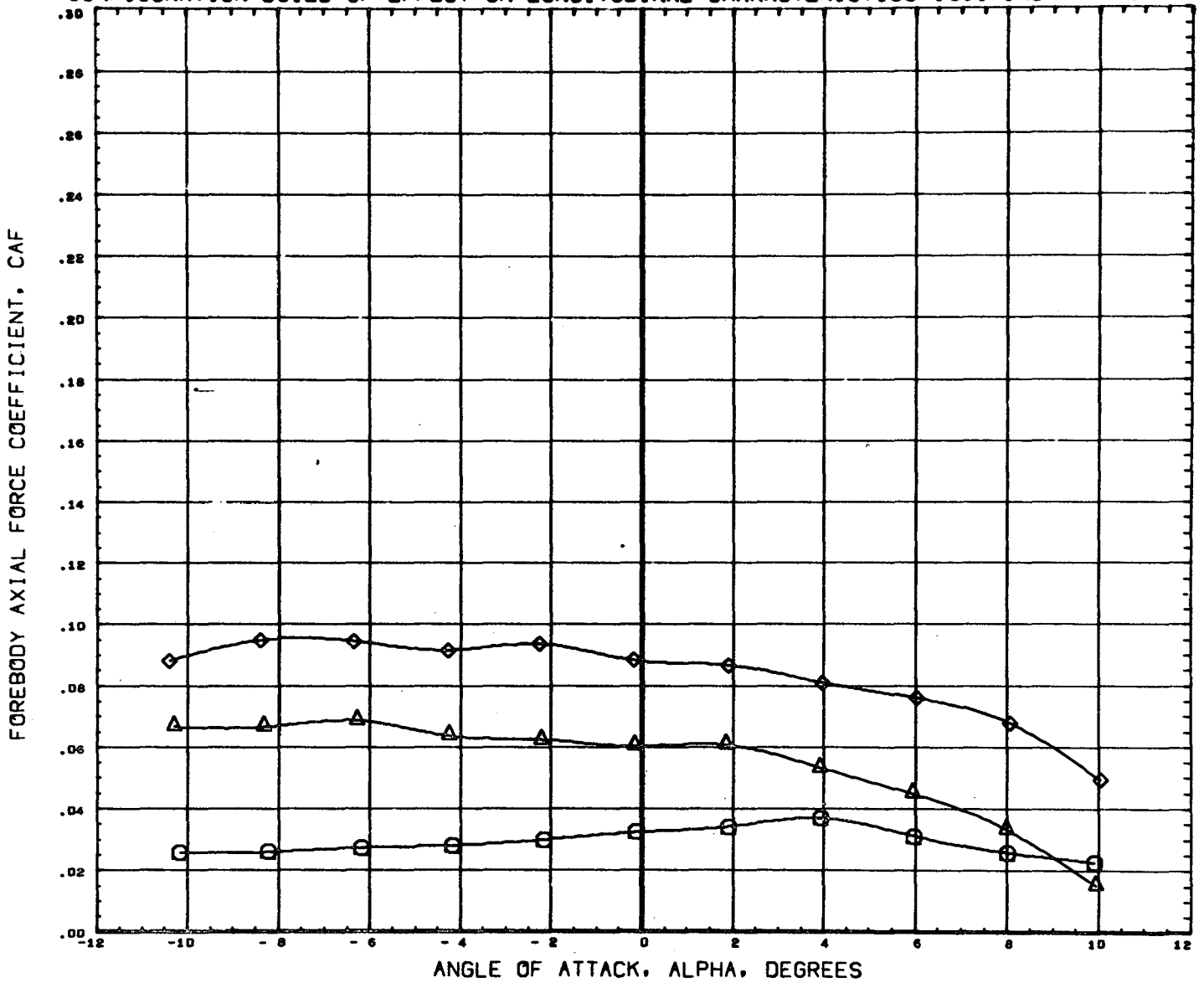

DATA SET SYMBOL	CONFIGURATION DESCRIPTION	ORBIN	THETS	BETA	REFERENCE INFORMATION
(B65019)	MSFC TWT 534 SHUTTLE LAUNCH	T2		0.000	SREF 4.8950 SQ. IN
(B65020)	MSFC TWT 534 SHUTTLE LAUNCH	T201	-1.500	0.000	LREF 2.6440 IN.
(B65022)	MSFC TWT 534 SHUTTLE LAUNCH	T201S1	-1.500	21.000	BREF 3.5250 IN.
					XMRP 3.4900 IN.
					YMRP 0.0000 IN.
					ZMRP 0.1616 IN.
					SCALE 0.0034

MACH .60

CONFIGURATION BUILD-UP EFFECT ON LONGITUDINAL CHARACTERISTICS (400 INCH TANK)

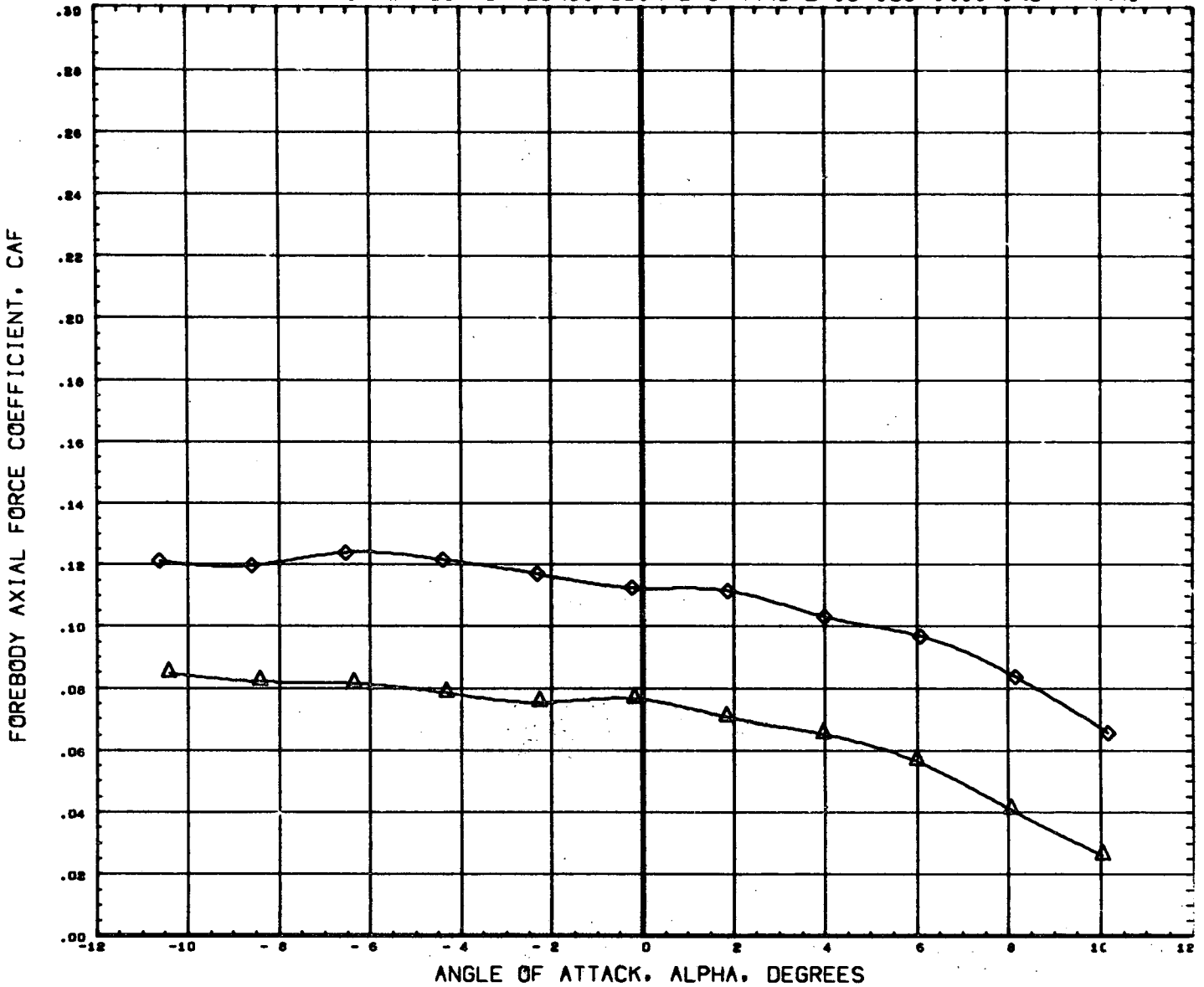

DATA SET SYMBOL	CONFIGURATION DESCRIPTION	ORBIN	THETS	BETA	REFERENCE INFORMATION
(B65019)	DATA NOT AVAILABLE FOR ALL CONDITIONS			0.000	SREF 4.8950 sq. IN
(B65020)	NSFC TWT 534 SHUTTLE LAUNCH T201	-1.500		0.000	LREF 2.6440 IN.
(B65022)	NSFC TWT 534 SHUTTLE LAUNCH T201S1	-1.500	21.000	0.000	BREF 3.5250 IN.
					XMRP 3.4900 IN.
					YMRP 0.0000 IN.
					ZMRP 0.1616 IN.
					SCALE 0.0034

MACH .80

CONFIGURATION BUILD-UP EFFECT ON LONGITUDINAL CHARACTERISTICS (400 INCH TANK)

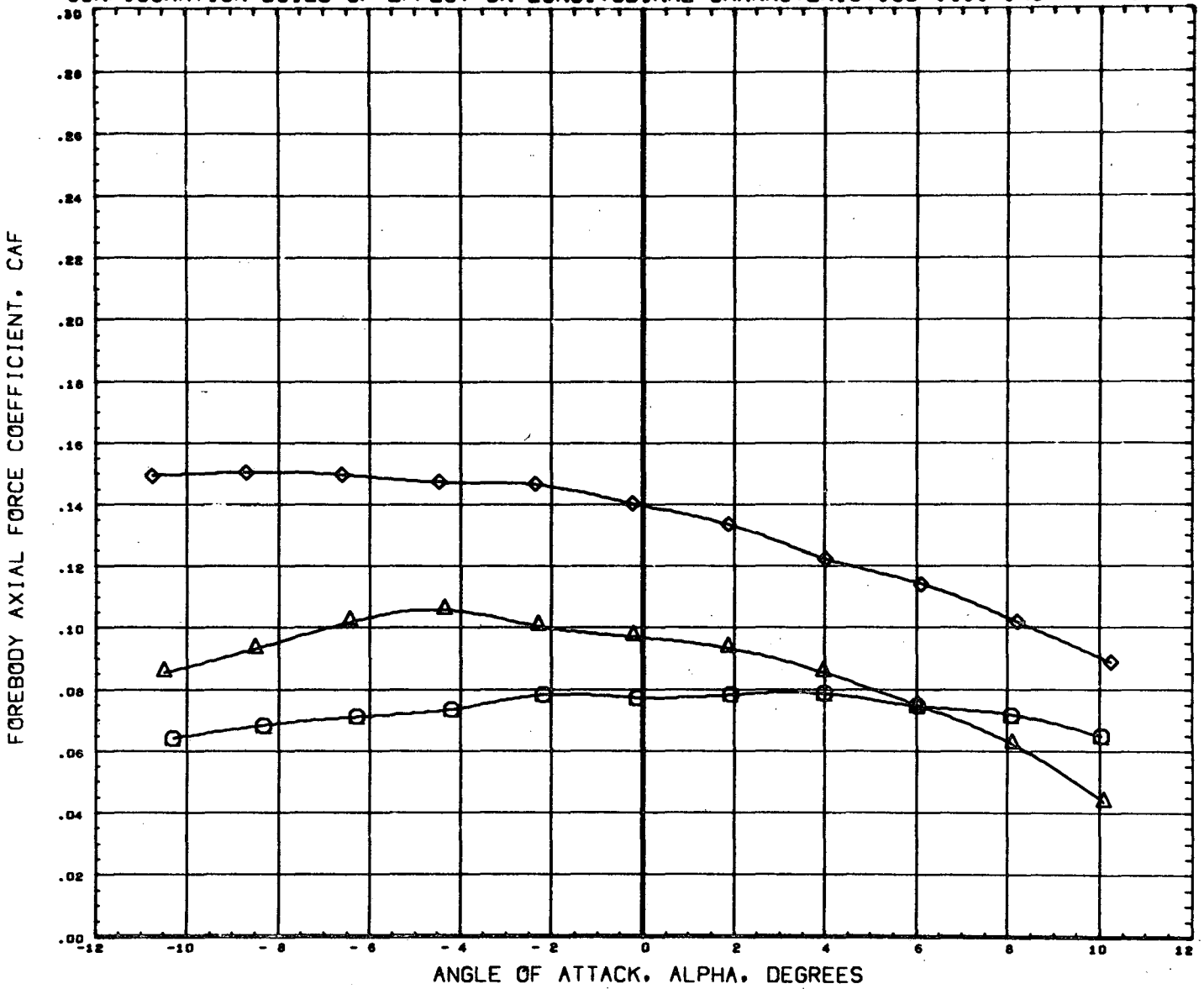

DATA SET SYMBOL	CONFIGURATION DESCRIPTION	ORBIN	THETS	BETA	REFERENCE INFORMATION	
(B65019)	MSFC TWT 534 SHUTTLE LAUNCH	T2		0.000	SREF 4.8950 SQ. IN	
(B65020)	MSFC TWT 534 SHUTTLE LAUNCH	T201	-1.500	0.000	LREF 2.6440 IN.	
(B65022)	MSFC TWT 534 SHUTTLE LAUNCH	T201S1	-1.500	21.000	0.000	BREF 3.5250 IN.
					XMRP 3.4900 IN.	
					YMRP 0.0000 IN.	
					ZMRP 0.1616 IN.	
					SCALE 0.0034	

MACH .90

PAGE 107

CONFIGURATION BUILD-UP EFFECT ON LONGITUDINAL CHARACTERISTICS (400 INCH TANK)

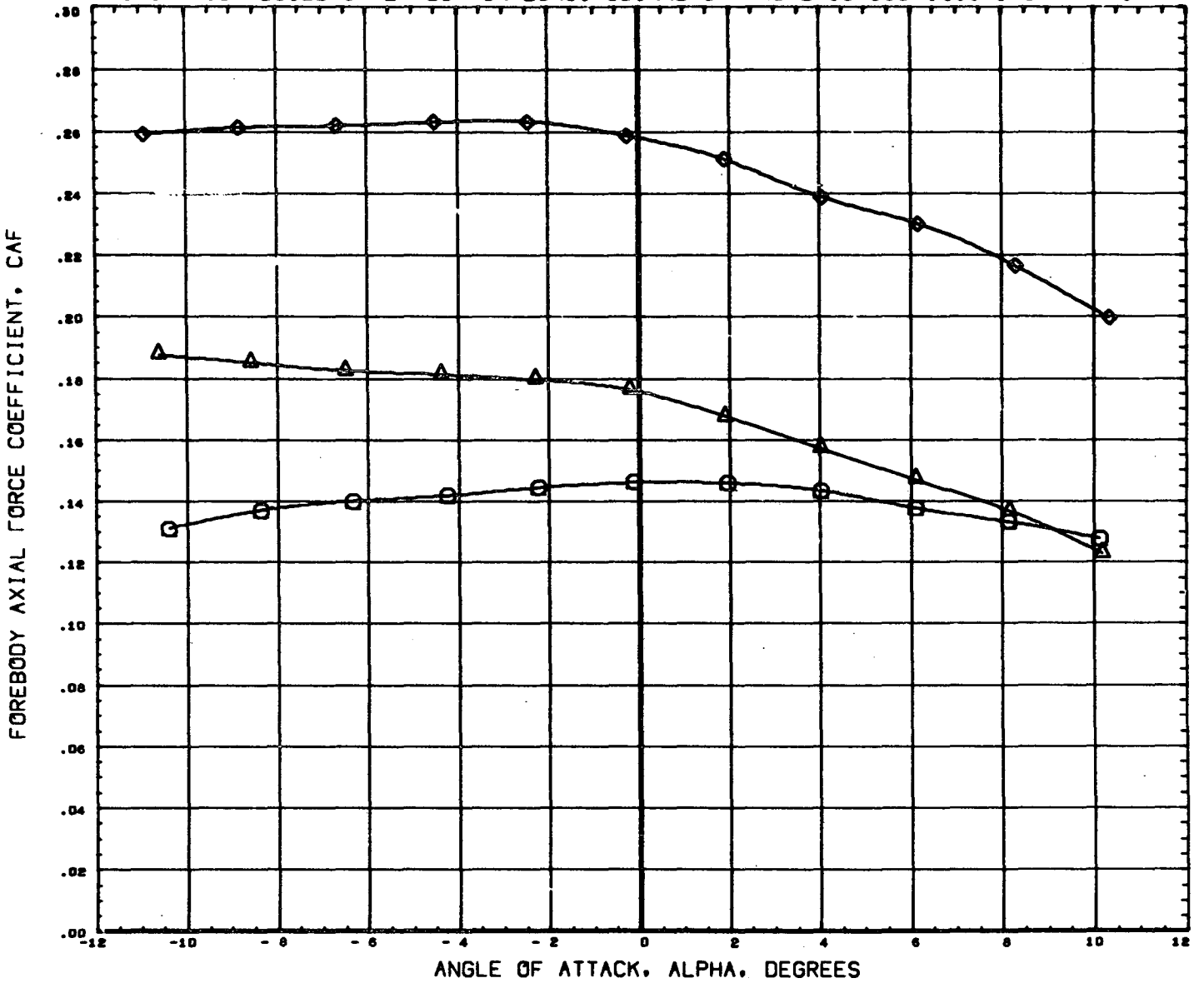

DATA SET SYMBOL	CONFIGURATION DESCRIPTION	ORBIN	THETS	BETA	REFERENCE INFORMATION
(B65019)	MSFC TWT 534 SHUTTLE LAUNCH	T2		0.000	SREF 4.8950 sq. IN
(B65020)	MSFC TWT 534 SHUTTLE LAUNCH	T201		0.000	LREF 2.6440 IN.
(B65022)	MSFC TWT 534 SHUTTLE LAUNCH	T201S1		0.000	BREF 3.5250 IN.
					XMRP 3.4900 IN.
					YMRP 0.0000 IN.
					ZMRP 0.1616 IN.
					SCALE 0.0034

CONFIGURATION BUILD-UP EFFECT ON LONGITUDINAL CHARACTERISTICS (400 INCH TANK)

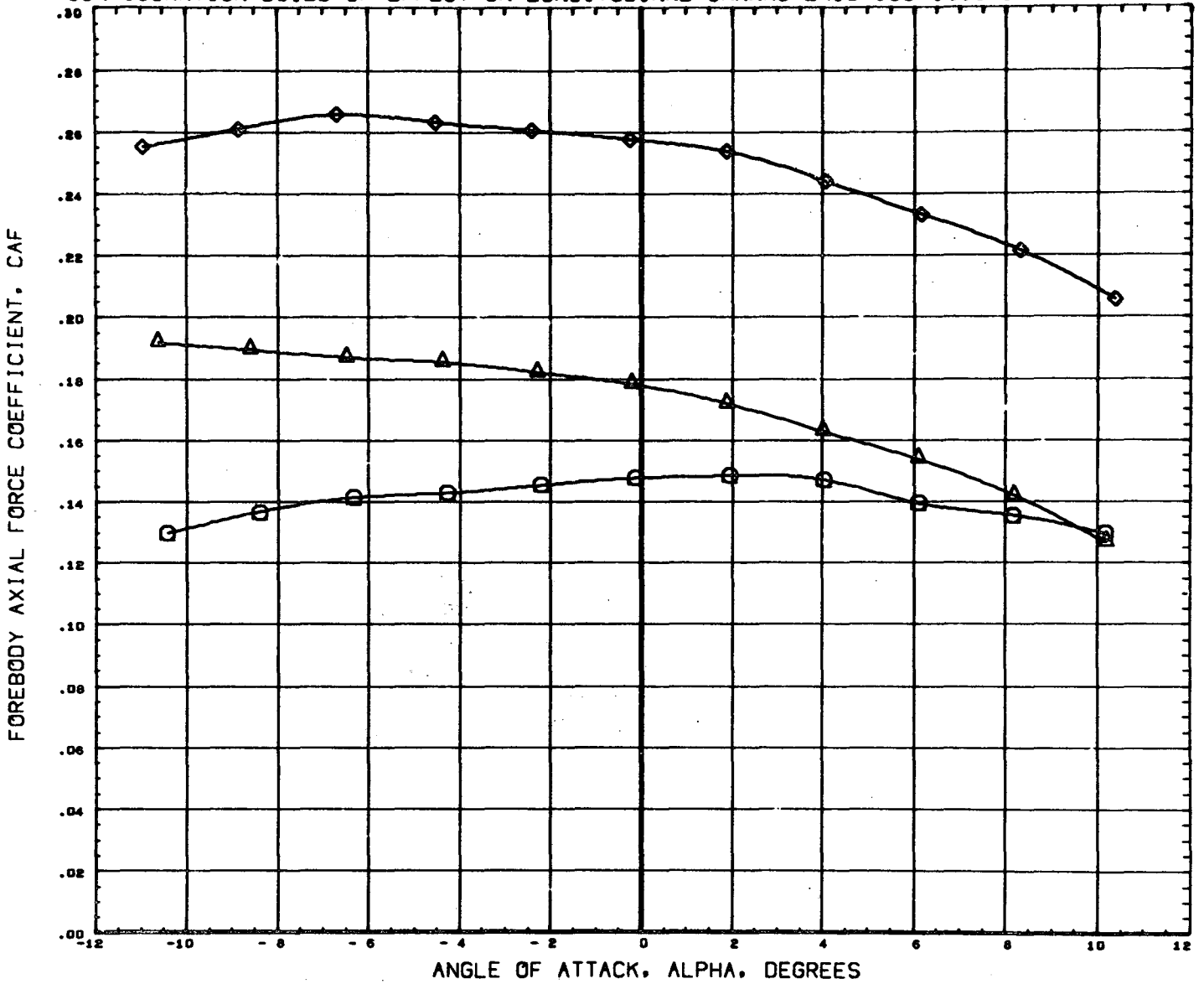

DATA SET SYMBOL	CONFIGURATION DESCRIPTION	ORBIN	THETS	BETA	REFERENCE INFORMATION	
(B65019)	MSFC TWT 534 SHUTTLE LAUNCH	T2		0.000	SREF 4.8950 SQ. IN	
(B65020)	MSFC TWT 534 SHUTTLE LAUNCH	T201	-1.500	0.000	LREF 2.6440 IN.	
(B65022)	MSFC TWT 534 SHUTTLE LAUNCH	T201S1	-1.500	21.000	0.000	BREF 3.5250 IN. XMRP 3.4900 IN. YMRP 0.0000 IN. ZMRP 0.1616 IN. SCALE 0.3034

MACH 1.20

PAGE 109

CONFIGURATION BUILD-UP EFFECT ON LONGITUDINAL CHARACTERISTICS (400 INCH TANK)

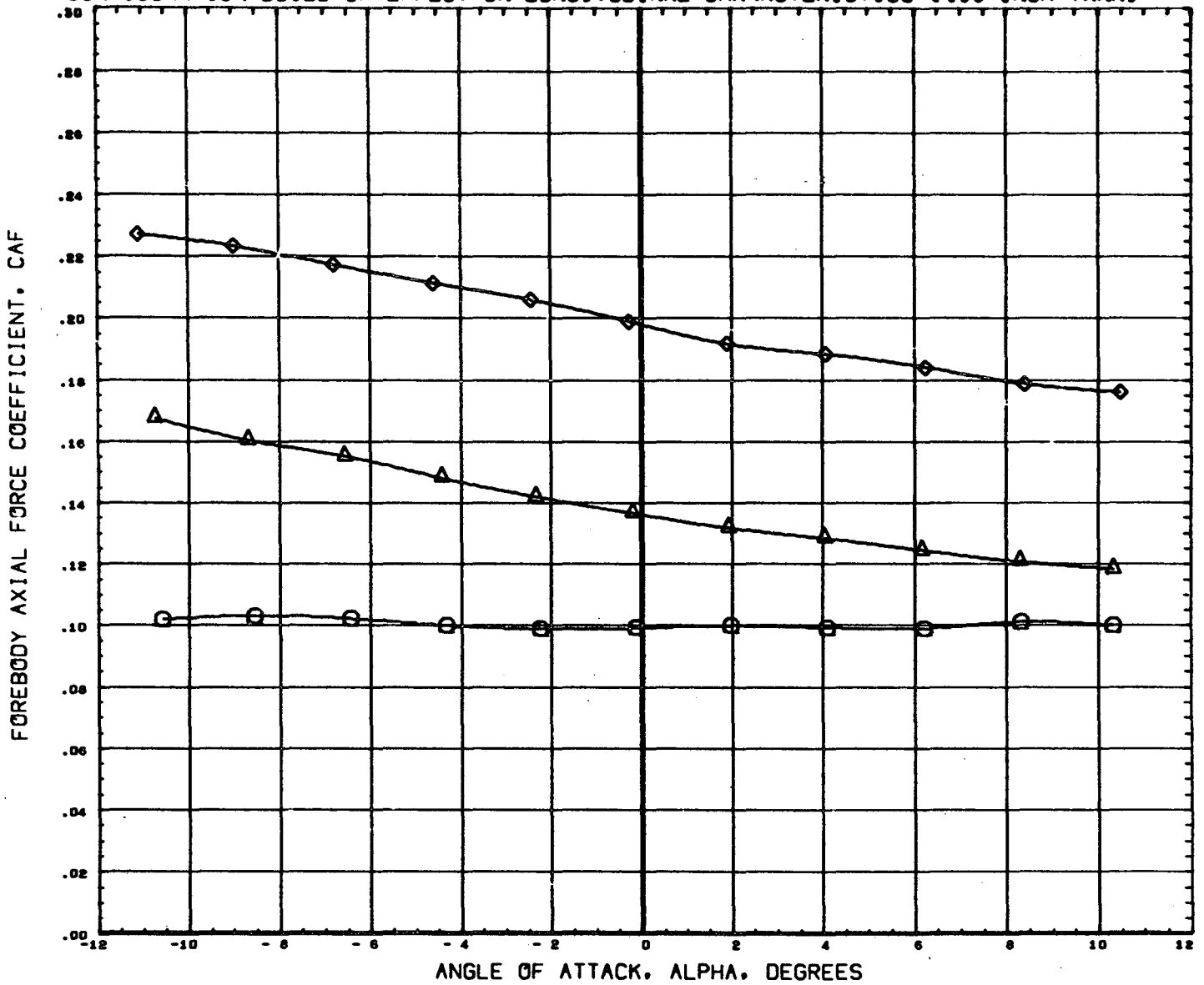

DATA SET SYMBOL	CONFIGURATION DESCRIPTION	ORBIN	THETS	BETA	REFERENCE INFORMATION	
(865019)	NSFC TWT 534 SHUTTLE LAUNCH	T2		0.000	SREF 4.8950 SQ. IN	
(865020)	NSFC TWT 534 SHUTTLE LAUNCH	T201	-1.500	0.000	LREF 2.6440 IN.	
(865022)	NSFC TWT 534 SHUTTLE LAUNCH	T201S1	-1.500	21.000	0.000	BREF 3.5250 IN.
					XMRP 3.4900 IN.	
					YMRP 0.0000 IN.	
					ZMRP 0.1616 IN.	
					SCALE 0.0034	

MACH 1.97

CONFIGURATION BUILD-UP EFFECT ON LONGITUDINAL CHARACTERISTICS (400 INCH TANK)

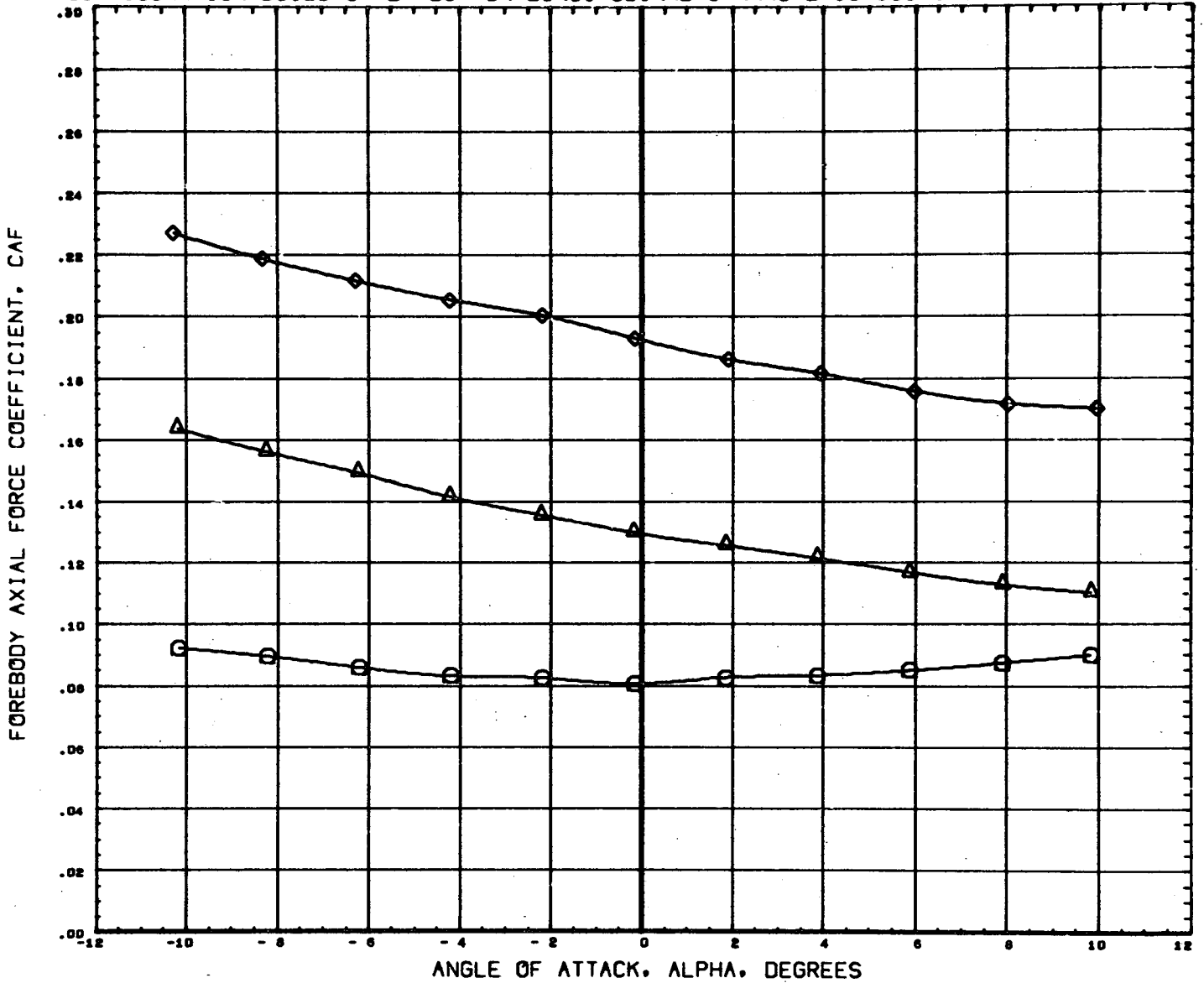

DATA SET SYMBOL	CONFIGURATION DESCRIPTION	T2	ORBIN	THETS	BETA	REFERENCE INFORMATION
(865019)	MSFC TWT 534 SHUTTLE LAUNCH	T2			0.000	SREF 4.8950 SQ. IN
(865020)	MSFC TWT 534 SHUTTLE LAUNCH	T201	-1.500		0.000	LREF 2.6440 IN.
(865022)	MSFC TWT 534 SHUTTLE LAUNCH	T201S1	-1.500	21.000	0.000	BREF 3.5250 IN.
						XMRP 3.4900 IN.
						YMRP 0.0000 IN.
						ZMRP 0.1616 IN.
						SCALE 0.0034

CONFIGURATION BUILD-UP EFFECT ON LONGITUDINAL CHARACTERISTICS (400 INCH TANK)

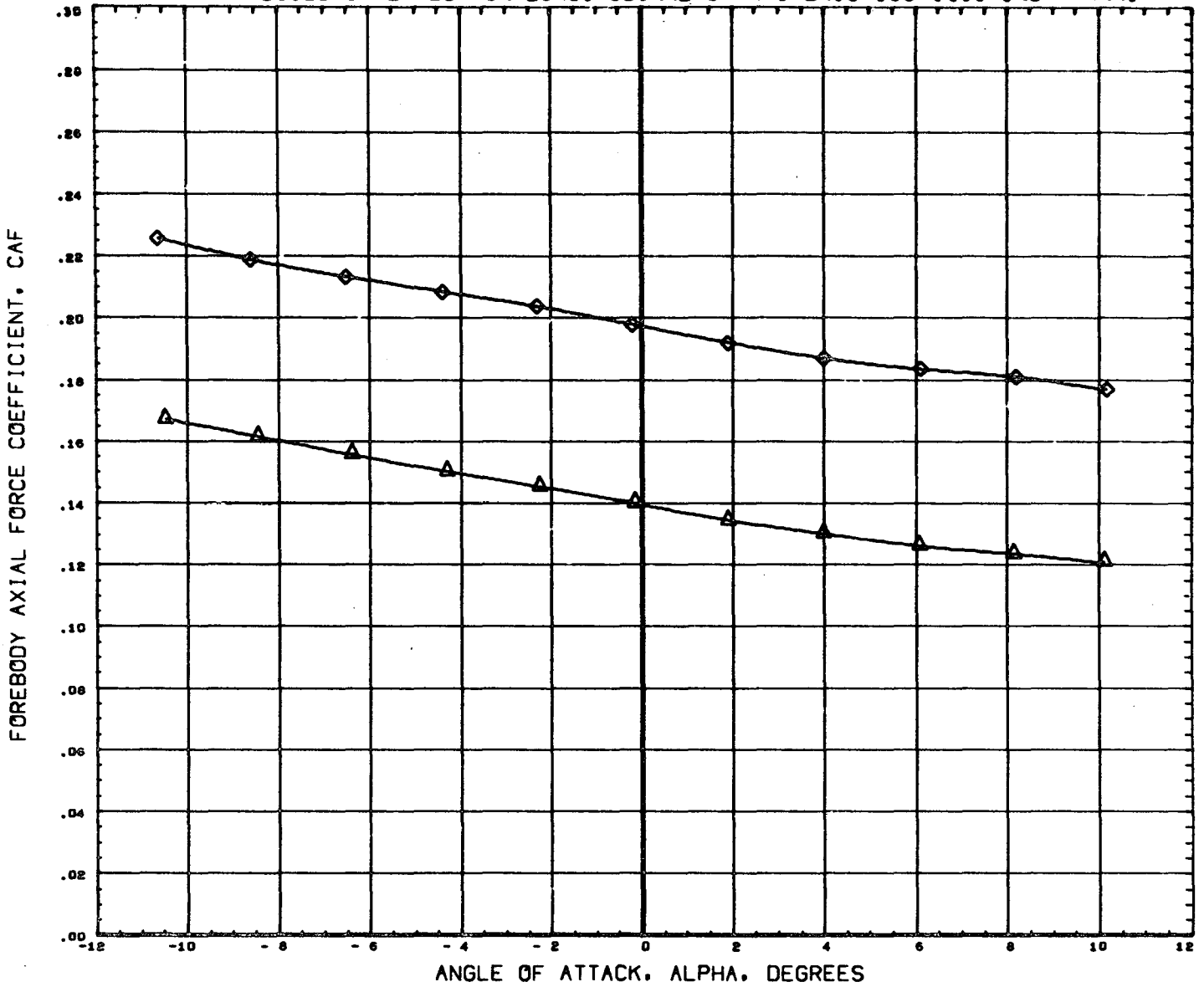

DATA SET SYMBOL	CONFIGURATION DESCRIPTION	ORBIN	THETS	BETA	REFERENCE INFORMATION
(B65019)	DATA NOT AVAILABLE FOR ALL CONDITIONS			0.000	SREF 4.8950 SQ. IN
(B65020)	MSFC TWT 534 SHUTTLE LAUNCH T201	-1.500		0.000	LREF 2.6440 IN.
(B65022)	MSFC TWT 534 SHUTTLE LAUNCH T201S1	-1.500	21.000	0.000	BREF 3.5250 IN.
					XMRP 3.4900 IN.
					YMRP 0.0000 IN.
					ZMRP 0.1616 IN.
					SCALE 0.0034

MACH 2.74

PAGE 111

CONFIGURATION BUILD-UP EFFECT ON LONGITUDINAL CHARACTERISTICS (400 INCH TANK)

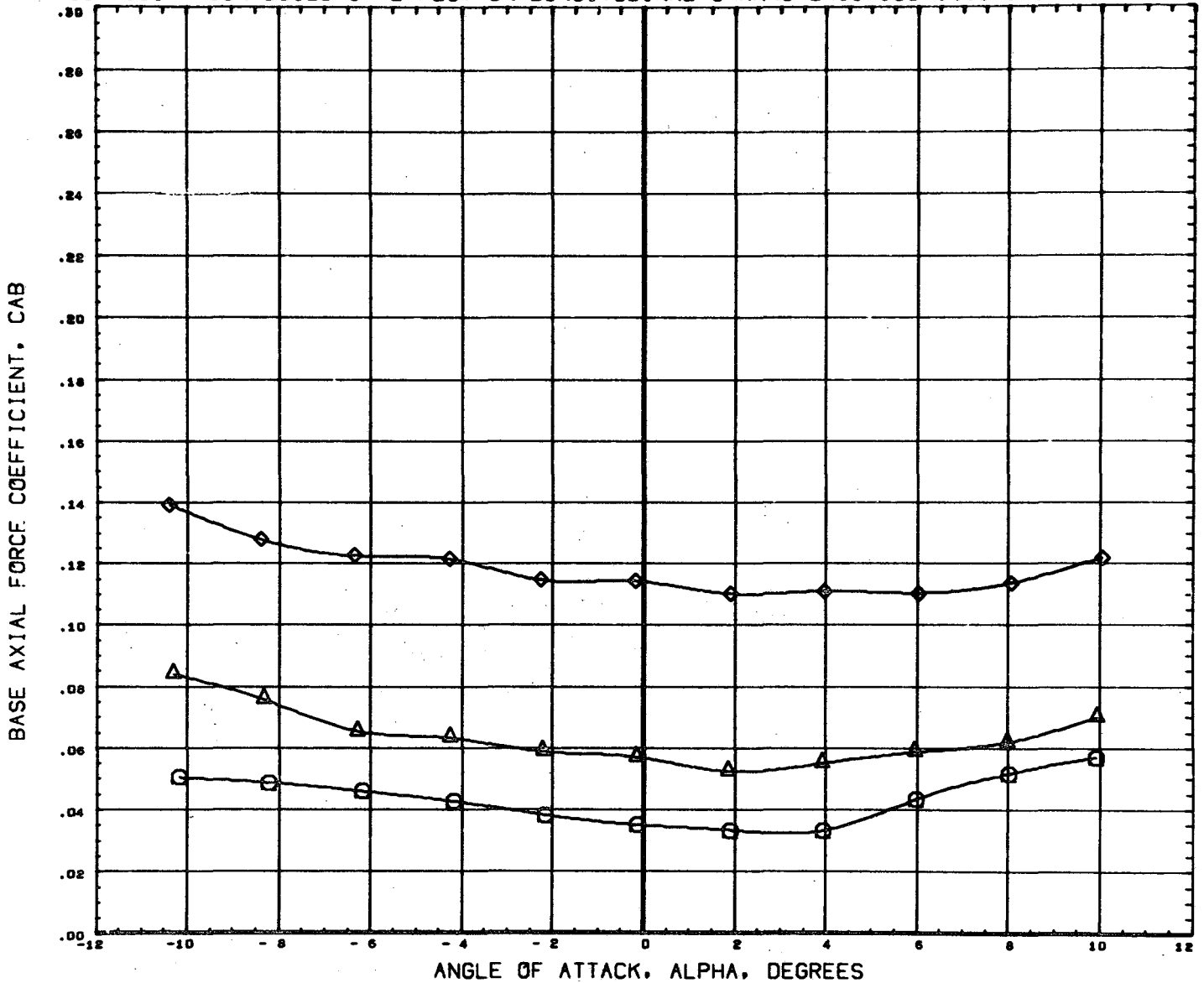

DATA SET SYMBOL	CONFIGURATION DESCRIPTION	ORBIN	THETS	BETA	REFERENCE INFORMATION	
(B65019)	MSFC TWT 534 SHUTTLE LAUNCH	T2		0.000	SREF 4.8950 SQ. IN	
(B65020)	MSFC TWT 534 SHUTTLE LAUNCH	T201	-1.500	0.000	LREF 2.6440 IN.	
(B65022)	MSFC TWT 534 SHUTTLE LAUNCH	T201S1	-1.500	21.000	0.000	BREF 3.5250 IN. XMRP 3.4900 IN. YMRP 0.0000 IN. ZMRP 0.1616 IN. SCALE 0.6034

MACH .60

CONFIGURATION BUILD-UP EFFECT ON LONGITUDINAL CHARACTERISTICS (400 INCH TANK)

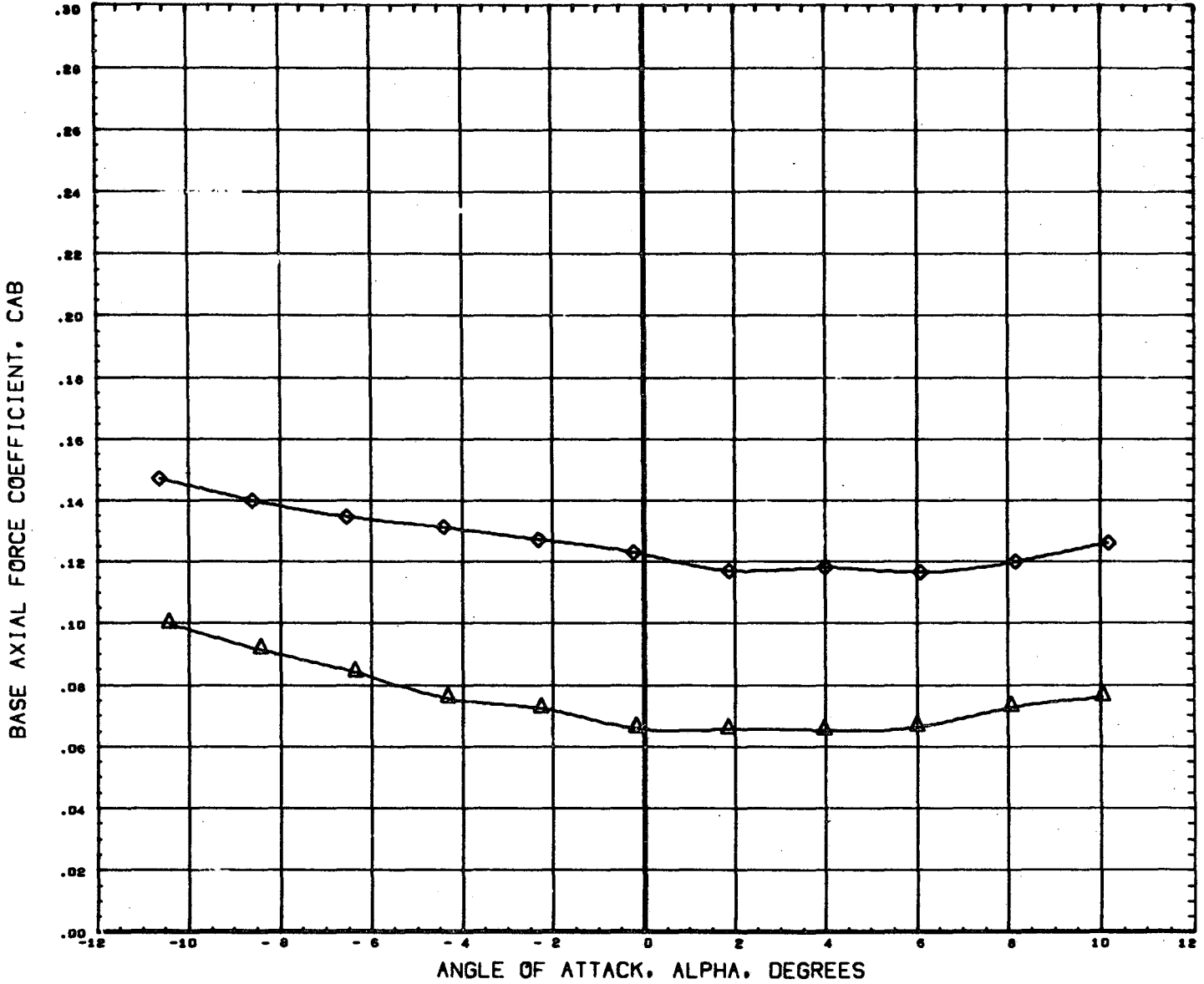

DATA SET SYMBOL	CONFIGURATION DESCRIPTION	ORBIN	THETS	BETA	REFERENCE INFORMATION
(B65019)	DATA NOT AVAILABLE FOR ALL CONDITIONS			0.000	SREF 4.8950 SQ. IN
(B65020)	NSFC TWT 534 SHUTTLE LAUNCH T201	-1.500		0.000	LREF 2.6440 IN.
(B65022)	NSFC TWT 534 SHUTTLE LAUNCH T201S1	-1.500	21.000	0.000	BREF 3.5250 IN.
					XMRP 3.4900 IN.
					YMRP 0.0000 IN.
					ZMRP 0.1616 IN.
					SCALE 0.0034

MACH .80

CONFIGURATION BUILD-UP EFFECT ON LONGITUDINAL CHARACTERISTICS (400 INCH TANK)

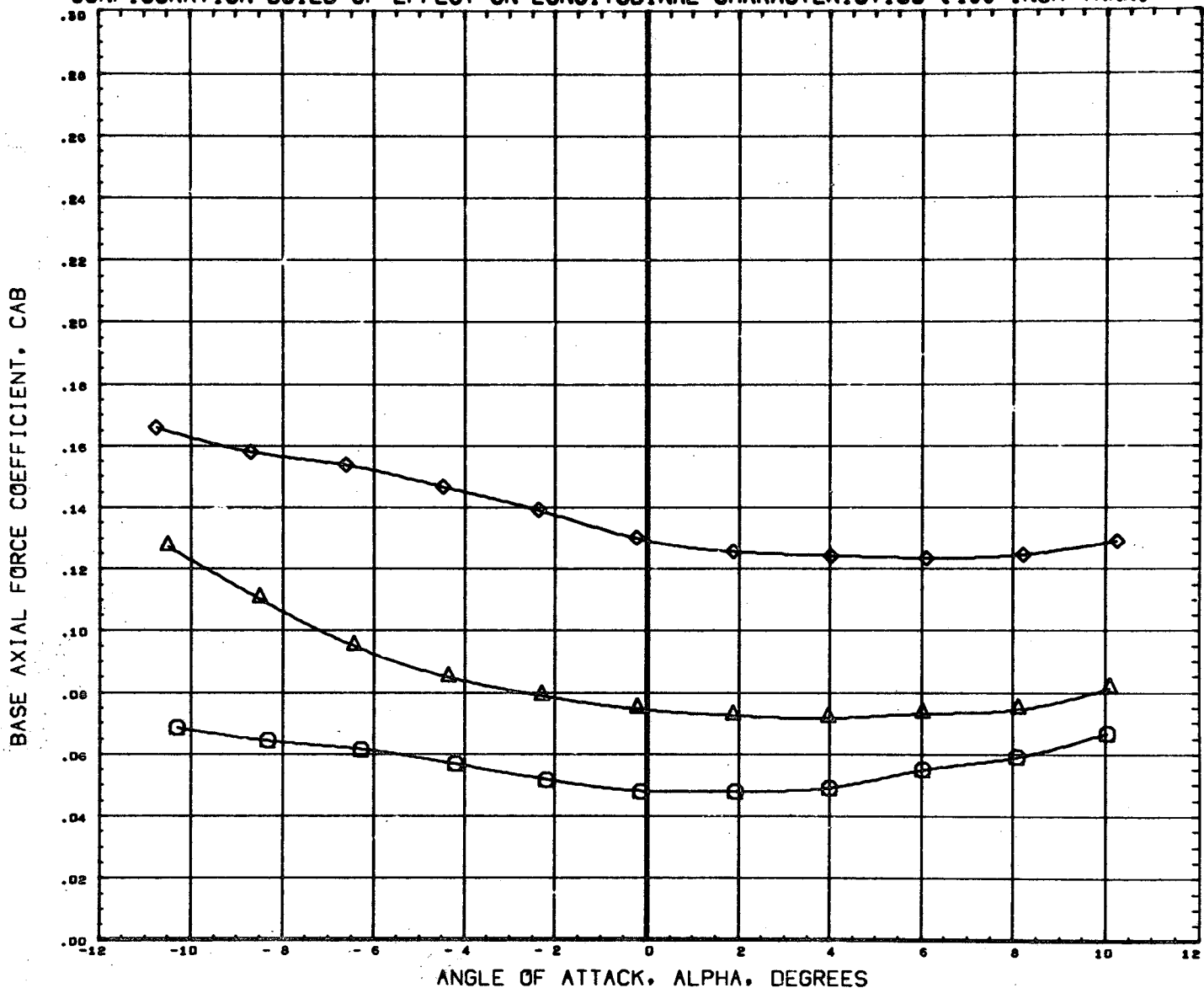

DATA SET SYMBOL	CONFIGURATION DESCRIPTION	ORBIN	THETS	BETA	REFERENCE INFORMATION
(B65019)	MSFC TWT 534 SHUTTLE LAUNCH	T2		0.000	SREF 4.8950 SQ. IN
(B65020)	MSFC TWT 534 SHUTTLE LAUNCH	T201	-1.500	0.000	LREF 2.6440 IN.
(B65022)	MSFC TWT 534 SHUTTLE LAUNCH	T201S1	-1.500	21.000	BREF 3.5250 IN.
					XMRP 3.4900 IN.
					YMRP 0.0000 IN.
					ZMRP 0.1616 IN.
					SCALE 0.0034

MACH .90

CONFIGURATION BUILD-UP EFFECT ON LONGITUDINAL CHARACTERISTICS (400 INCH TANK)

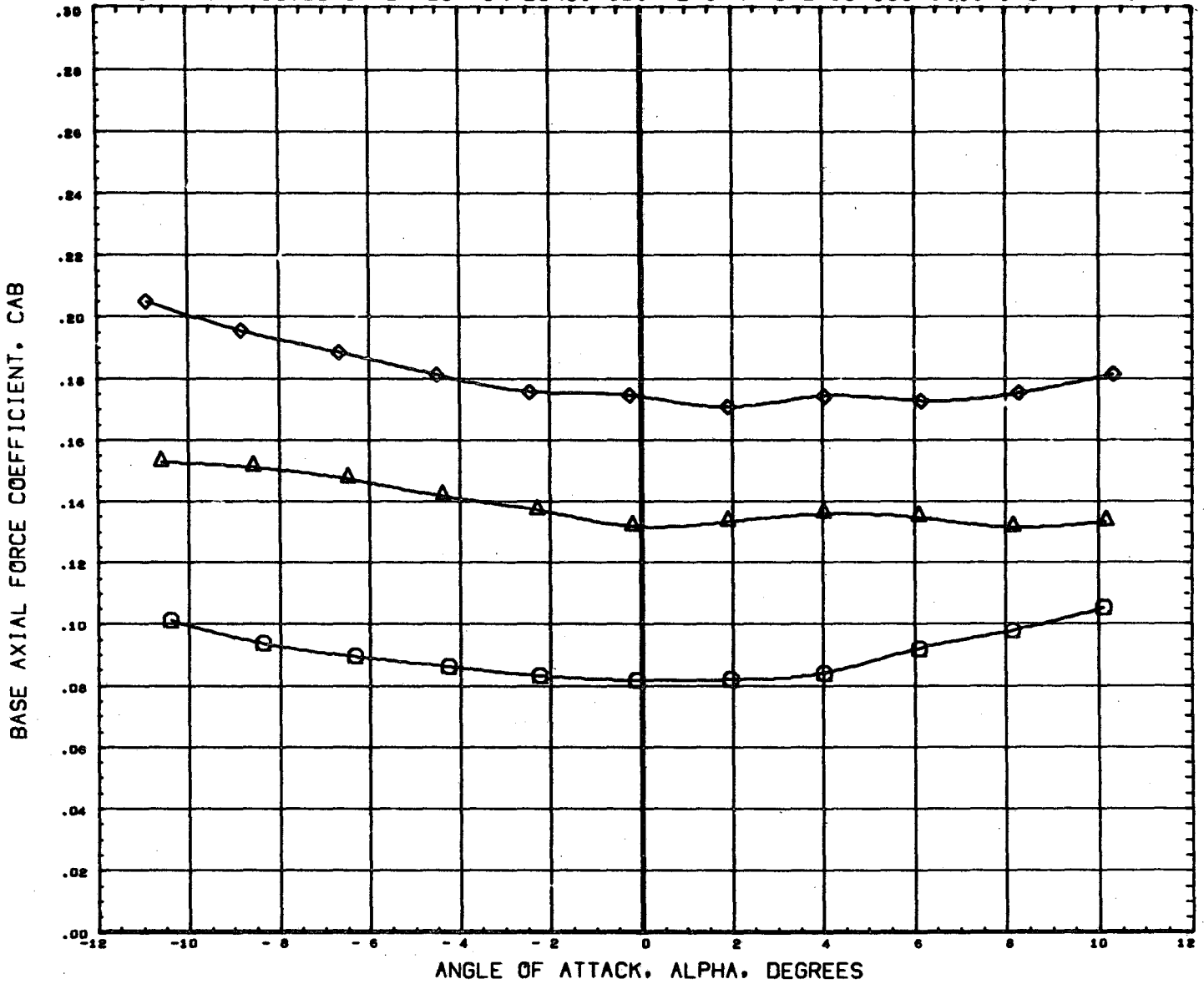

DATA SET SYMBOL	CONFIGURATION DESCRIPTION	T2	ORBIN	THETS	BETA	REFERENCE INFORMATION
(B65019) ○	MSFC TWT 534 SHUTTLE LAUNCH	T2			0.000	SREF 4.8950 sq. IN
(B65020) △	MSFC TWT 534 SHUTTLE LAUNCH	T201	-1.500		0.000	LREF 2.6440 IN.
(B65022) ◇	MSFC TWT 534 SHUTTLE LAUNCH	T201S1	-1.500	21.000	0.000	BREF 3.5250 IN.
						XMRP 3.4900 IN.
						YMRP 0.0000 IN.
						ZMRP 0.1616 IN.
						SCALE 0.0034

MACH 1.10

CONFIGURATION BUILD-UP EFFECT ON LONGITUDINAL CHARACTERISTICS (400 INCH TANK)

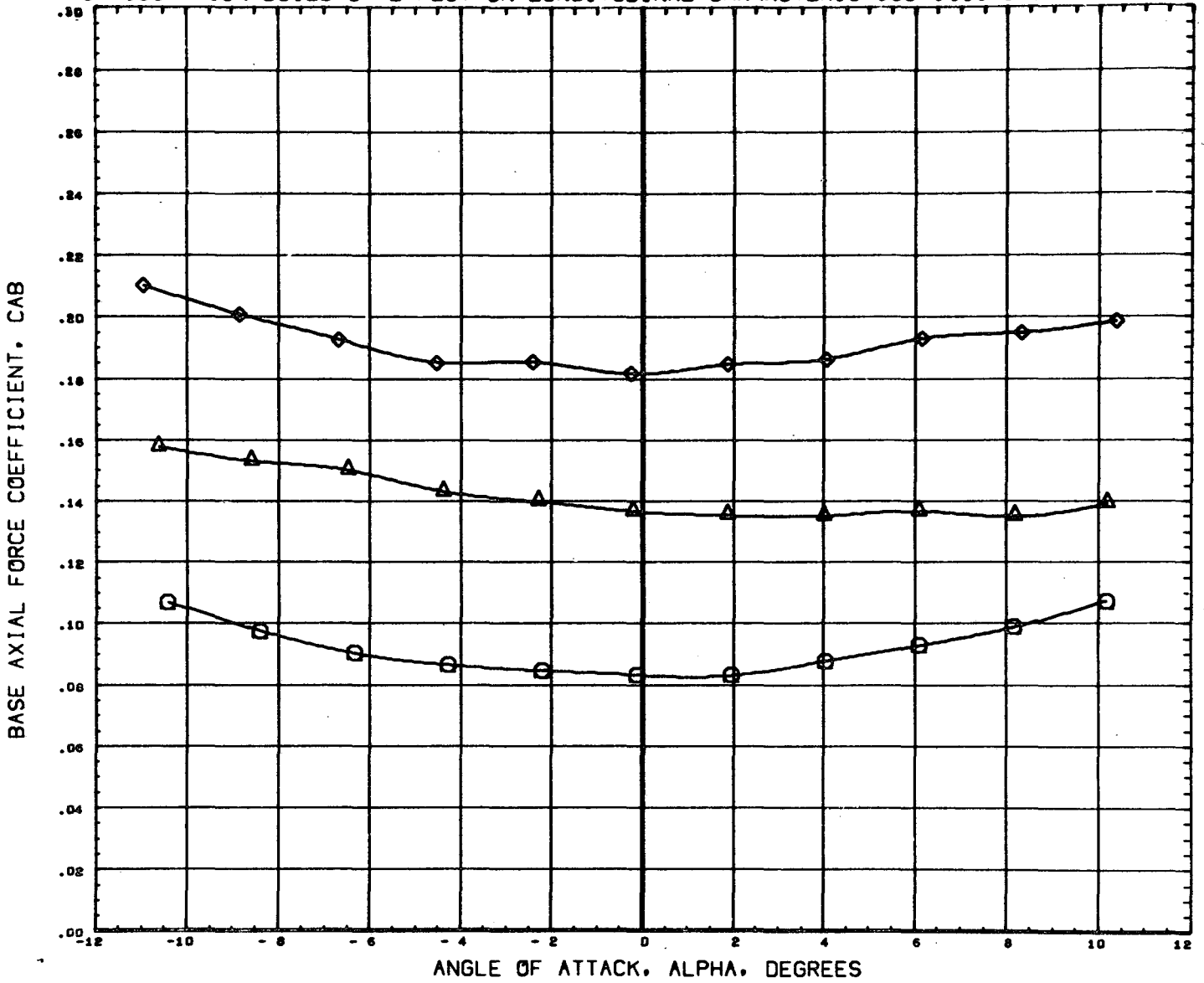

DATA SET SYMBOL	CONFIGURATION DESCRIPTION	T2	ORBIN	THETS	BETA	REFERENCE INFORMATION
(B65019)	MSFC TWT 534 SHUTTLE LAUNCH	T2			0.000	SREF 4.8950 SQ. IN
(B65020)	MSFC TWT 534 SHUTTLE LAUNCH	T201	-1.500		0.000	LREF 2.6440 IN.
(B65022)	MSFC TWT 534 SHUTTLE LAUNCH	T201S1	-1.500	21.000	0.000	BREF 3.3250 IN.
						XMRP 3.4900 IN.
						YMRP 0.0000 IN.
						ZMRP 0.1616 IN.
						SCALE 0.0034

MACH 1.20

CONFIGURATION BUILD-UP EFFECT ON LONGITUDINAL CHARACTERISTICS (400 INCH TANK)

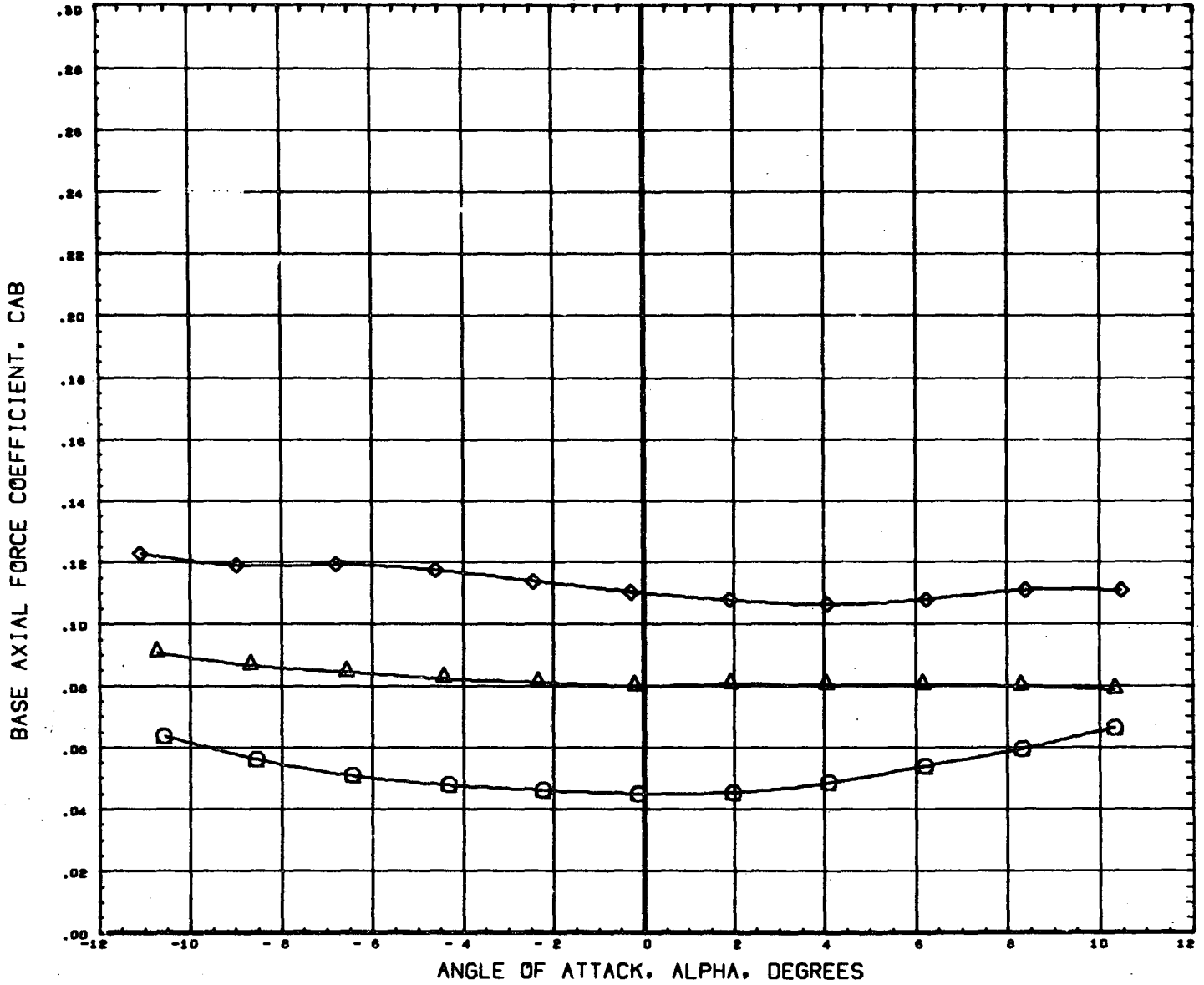

DATA SET SYMBOL	CONFIGURATION DESCRIPTION	T2	ORBIN	THETS	BETA	REFERENCE INFORMATION
(B65019)	MSFC TWT 534 SHUTTLE LAUNCH	T2	-1.500		0.000	SREF 4.8950 SQ. IN
(B65020)	MSFC TWT 534 SHUTTLE LAUNCH	T201	-1.500		0.000	LREF 2.6440 IN.
(B65022)	MSFC TWT 534 SHUTTLE LAUNCH	T201S1	-1.500	21.000	0.000	BREF 3.5250 IN.
						XMRP 3.4900 IN.
						YNRP 0.0000 IN.
						ZNRP 0.1616 IN.
						SCALE 0.0034

CONFIGURATION BUILD-UP EFFECT ON LONGITUDINAL CHARACTERISTICS (400 INCH TANK)

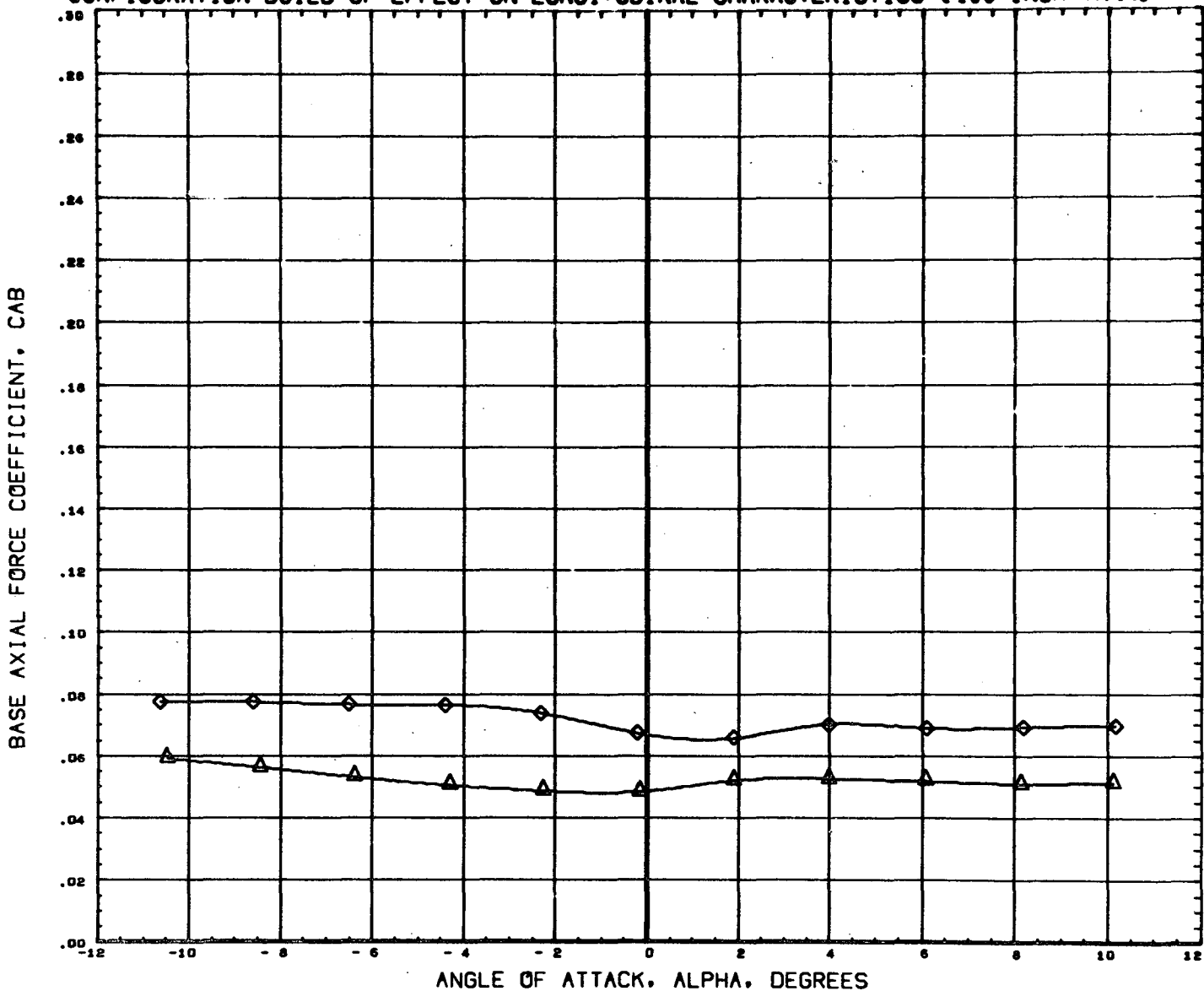

DATA SET SYMBOL	CONFIGURATION DESCRIPTION	ORBIN	THETS	BETA	REFERENCE INFORMATION
(B65019)	DATA NOT AVAILABLE FOR ALL CONDITIONS			0.000	SREF 4.8950 SQ. IN
(B65020)	MSFC TWT 534 SHUTTLE LAUNCH T201	-1.500		0.000	LREF 2.6440 IN.
(B65022)	MSFC TWT 534 SHUTTLE LAUNCH T201S1	-1.500	21.000	0.000	BREF 3.5250 IN.
					XMRP 3.4900 IN.
					YMRP 0.0000 IN.
					ZMRP 0.1616 IN.
					SCALE 0.0034

MACH 2.74

CONFIGURATION BUILD-UP EFFECT ON LONGITUDINAL CHARACTERISTICS (400 INCH TANK)

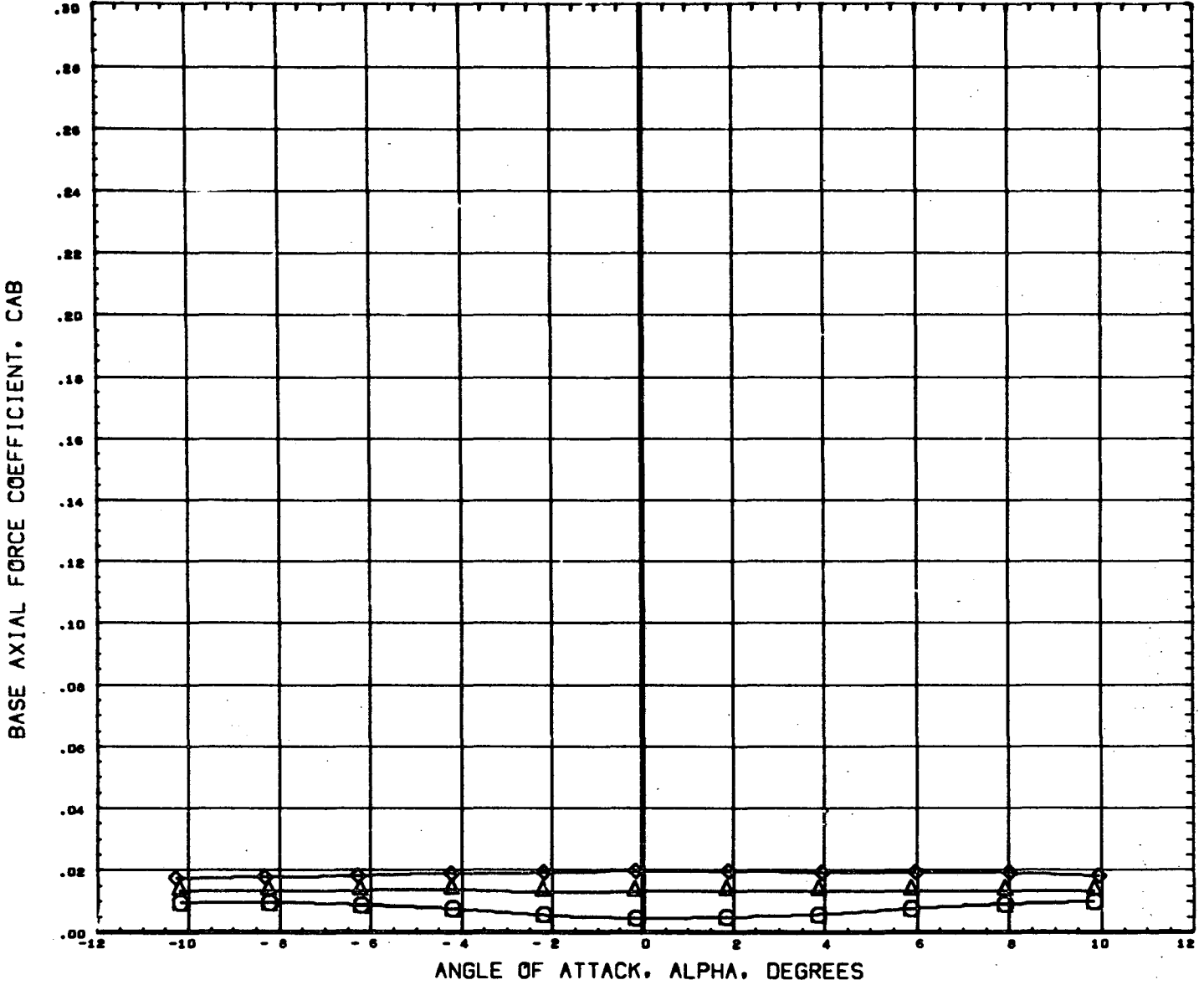

DATA SET SYMBOL	CONFIGURATION DESCRIPTION	T2	ORBIN	THETS	BETA	REFERENCE INFORMATION
(B65019)	MSFC TWT 534 SHUTTLE LAUNCH	T2	-1.500		0.000	SREF 4.8950 SQ. IN
(B65020)	MSFC TWT 534 SHUTTLE LAUNCH	T201	-1.500		0.000	LREF 2.6440 IN.
(B65022)	MSFC TWT 534 SHUTTLE LAUNCH	T201S1	-1.500	21.000	0.000	BREF 3.5250 IN.
						XMRP 3.4900 IN.
						YMRP 0.0000 IN.
						ZMRP 0.1616 IN.
						SCALE 0.0034

CONFIGURATION BUILD-UP EFFECT ON LONGITUDINAL CHARACTERISTICS (400 INCH TANK)

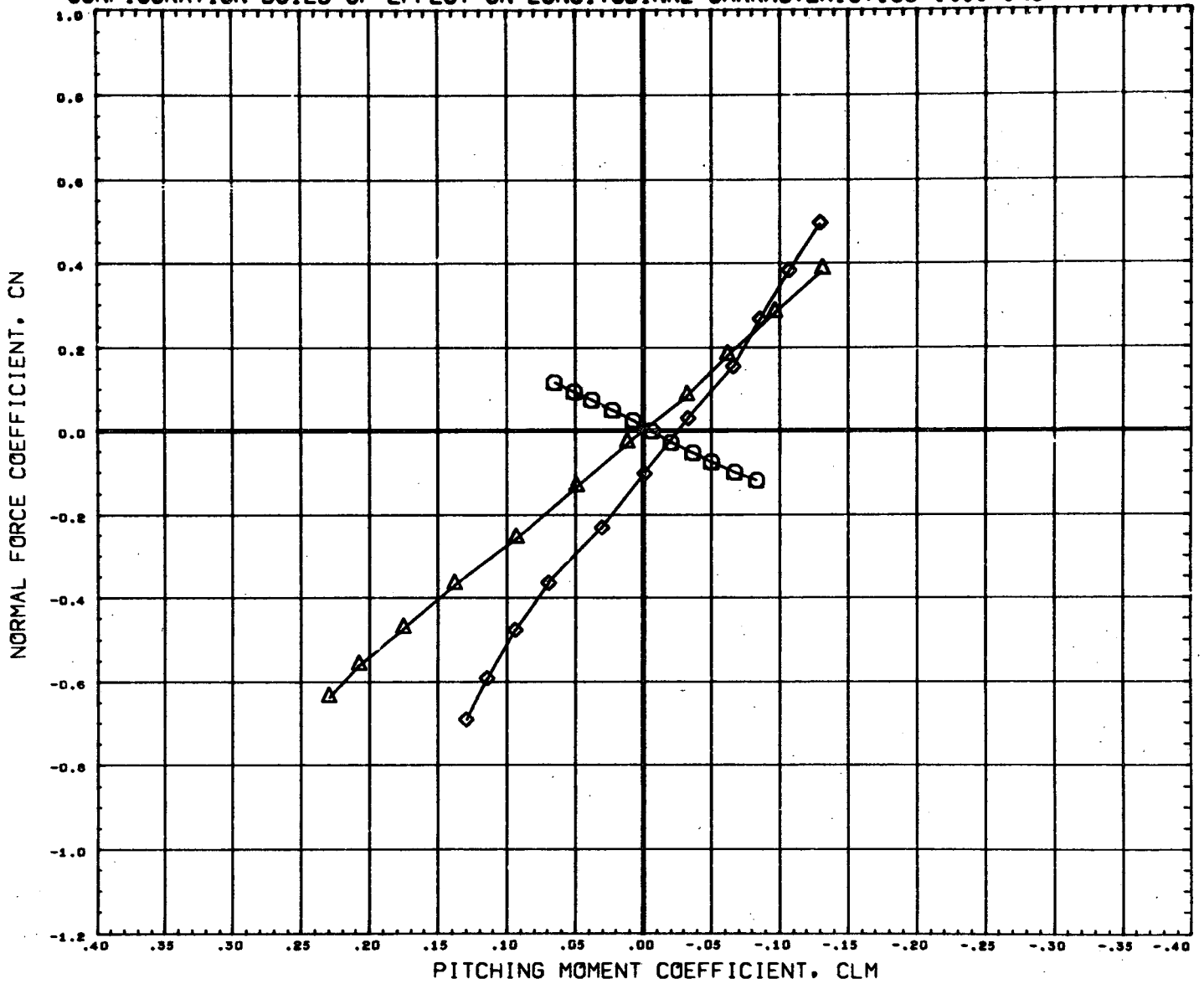

DATA SET SYMBOL	CONFIGURATION DESCRIPTION	ORBIN	THETS	BETA	REFERENCE INFORMATION	
(B65019)	MSFC TWT 534 SHUTTLE LAUNCH	T2		0.000	SREF 4.8950 SQ. IN	
(B65020)	MSFC TWT 534 SHUTTLE LAUNCH	T201	-1.500	0.000	LREF 2.6440 IN.	
(B65022)	MSFC TWT 534 SHUTTLE LAUNCH	T201S1	-1.500	21.000	0.000	BREF 3.5250 IN. XMRP 3.4900 IN. YMRP 0.0000 IN. ZMRP 0.1616 IN. SCALE 0.0034

MACH .60

CONFIGURATION BUILD-UP EFFECT ON LONGITUDINAL CHARACTERISTICS (400 INCH TANK)

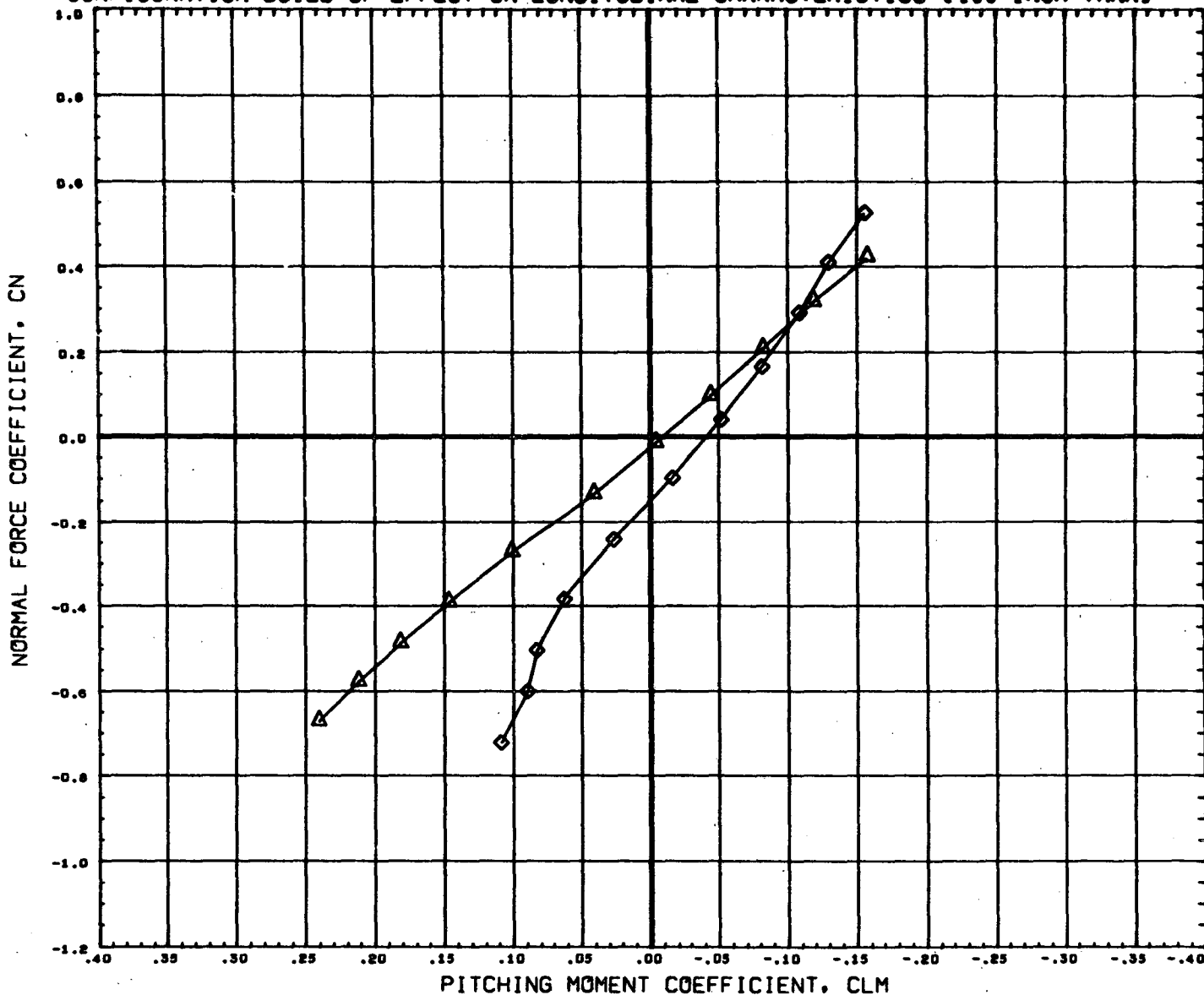

DATA SET SYMBOL	CONFIGURATION DESCRIPTION	ORBIN	THETS	BETA	REFERENCE INFORMATION
(B65019)	DATA NOT AVAILABLE FOR ALL CONDITIONS			0.000	SREF 4.8950 SQ. IN
(B65020)	NSFC TWT 534 SHUTTLE LAUNCH T201	-1.500		0.000	LREF 2.6440 IN.
(B65022)	NSFC TWT 534 SHUTTLE LAUNCH T201S1	-1.500	21.000	0.000	BREF 3.5250 IN.
					XMRP 3.4900 IN.
					YMRP 0.0000 IN.
					ZMRP 0.1616 IN.
					SCALE 0.0034

MACH .80

CONFIGURATION BUILD-UP EFFECT ON LONGITUDINAL CHARACTERISTICS (400 INCH TANK)

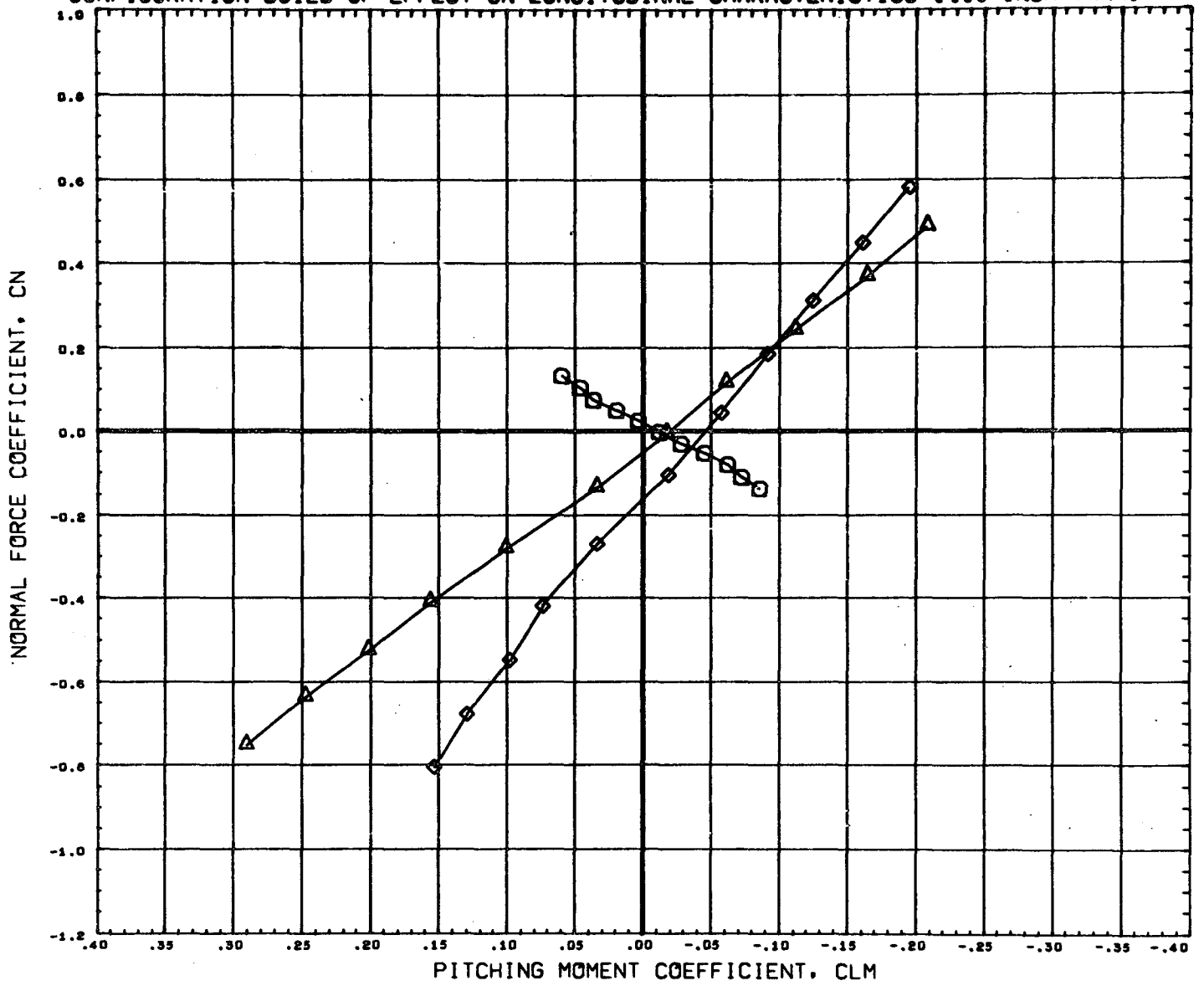

DATA SET SYMBOL	CONFIGURATION DESCRIPTION	T2	ORBIN	THETS	BETA	REFERENCE INFORMATION
(B65019)	MSFC TWT 534 SHUTTLE LAUNCH	T2	-1.500		0.000	SREF 4.8950 SQ. IN
(B65020)	MSFC TWT 534 SHUTTLE LAUNCH	T201	-1.500		0.000	LREF 2.6440 IN.
(B65022)	MSFC TWT 534 SHUTTLE LAUNCH	T201 S1	-1.500	21.000	0.000	BREF 3.5250 IN.
						XMRP 3.4900 IN.
						YMRP 0.0000 IN.
						ZMRP 0.1616 IN.
						SCALE 0.0034

MACH .90

CONFIGURATION BUILD-UP EFFECT ON LONGITUDINAL CHARACTERISTICS (400 INCH TANK)

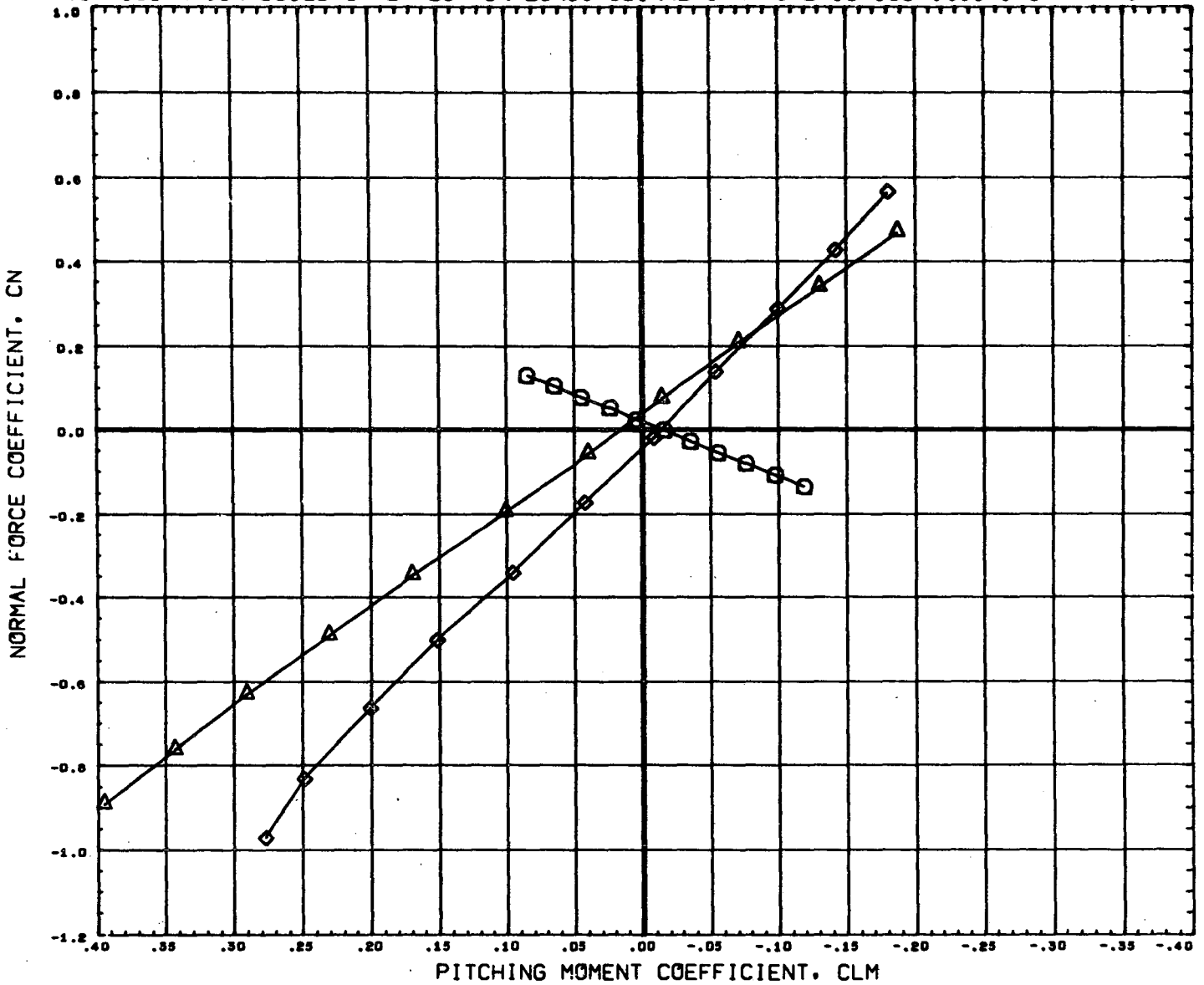

DATA SET SYMBOL	CONFIGURATION DESCRIPTION	T2	ORBIN	THETS	BETA	REFERENCE INFORMATION
(B65019)	NSFC TWT 534 SHUTTLE LAUNCH	T2	-1.500		0.000	SREF 4.8950 SQ. IN
(B65020)	NSFC TWT 534 SHUTTLE LAUNCH	T201	-1.500		0.000	LREF 2.6440 IN.
(B65022)	NSFC TWT 534 SHUTTLE LAUNCH	T201S1	-1.500	21.000	0.000	BREF 3.9250 IN.
						XWRP 3.4900 IN.
						YWRP 0.0000 IN.
						ZWRP 0.1616 IN.
						SCALE 0.0034

MACH 1.10

CONFIGURATION BUILD-UP EFFECT ON LONGITUDINAL CHARACTERISTICS (400 INCH TANK)

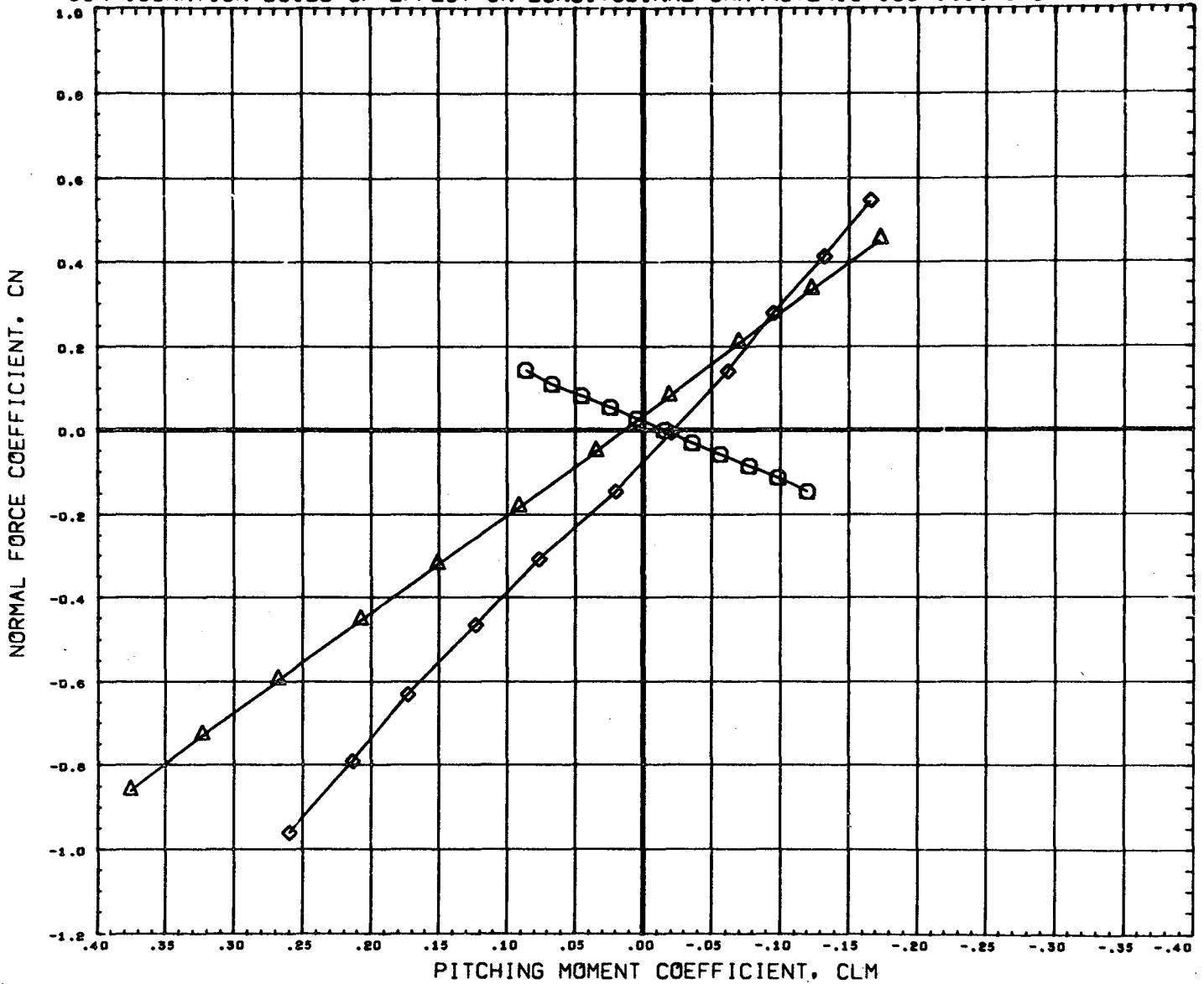

DATA SET SYMBOL	CONFIGURATION DESCRIPTION	ORBIN	THETS	BETA	REFERENCE INFORMATION	
(B65019)	MSFC TWT 534 SHUTTLE LAUNCH	T2		0.000	SREF 4.8950 SQ. IN	
(B65020)	MSFC TWT 534 SHUTTLE LAUNCH	T201	-1.500	0.000	LREF 2.6440 IN.	
(B65022)	MSFC TWT 534 SHUTTLE LAUNCH	T201S1	-1.500	21.000	0.000	BREF 3.5250 IN. XMRP 3.4900 IN. YMRP 0.0000 IN. ZMRP 0.1616 IN. SCALE 0.0034

MACH 1.20

PAGE 125

CONFIGURATION BUILD-UP EFFECT ON LONGITUDINAL CHARACTERISTICS (400 INCH TANK)

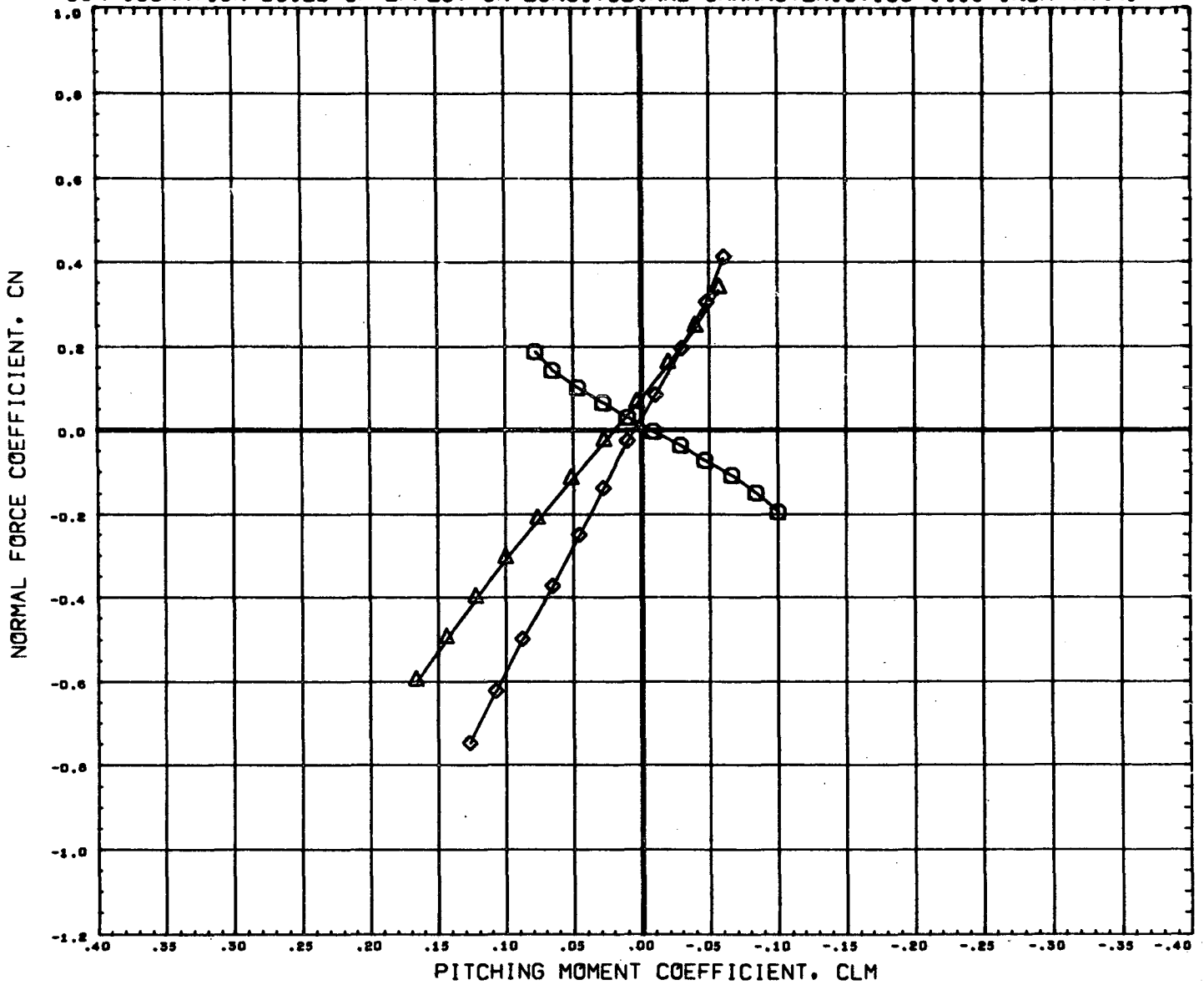

DATA SET SYMBOL	CONFIGURATION DESCRIPTION	T2	ORBIN	THETS	BETA	REFERENCE INFORMATION
(865019)	MSFC TWT 534 SHUTTLE LAUNCH	T2	-1.500		0.000	SREF 4.8950 SQ. IN
(865020)	MSFC TWT 534 SHUTTLE LAUNCH	T201	-1.500		0.000	LREF 2.6440 IN.
(865022)	MSFC TWT 534 SHUTTLE LAUNCH	T201S1	-1.500	21.000	0.000	BREF 3.5250 IN.
						XMRP 3.4900 IN.
						YMRP 0.0000 IN.
						ZMRP 0.1616 IN.
						SCALE 0.0034

CONFIGURATION BUILD-UP EFFECT ON LONGITUDINAL CHARACTERISTICS (400 INCH TANK)

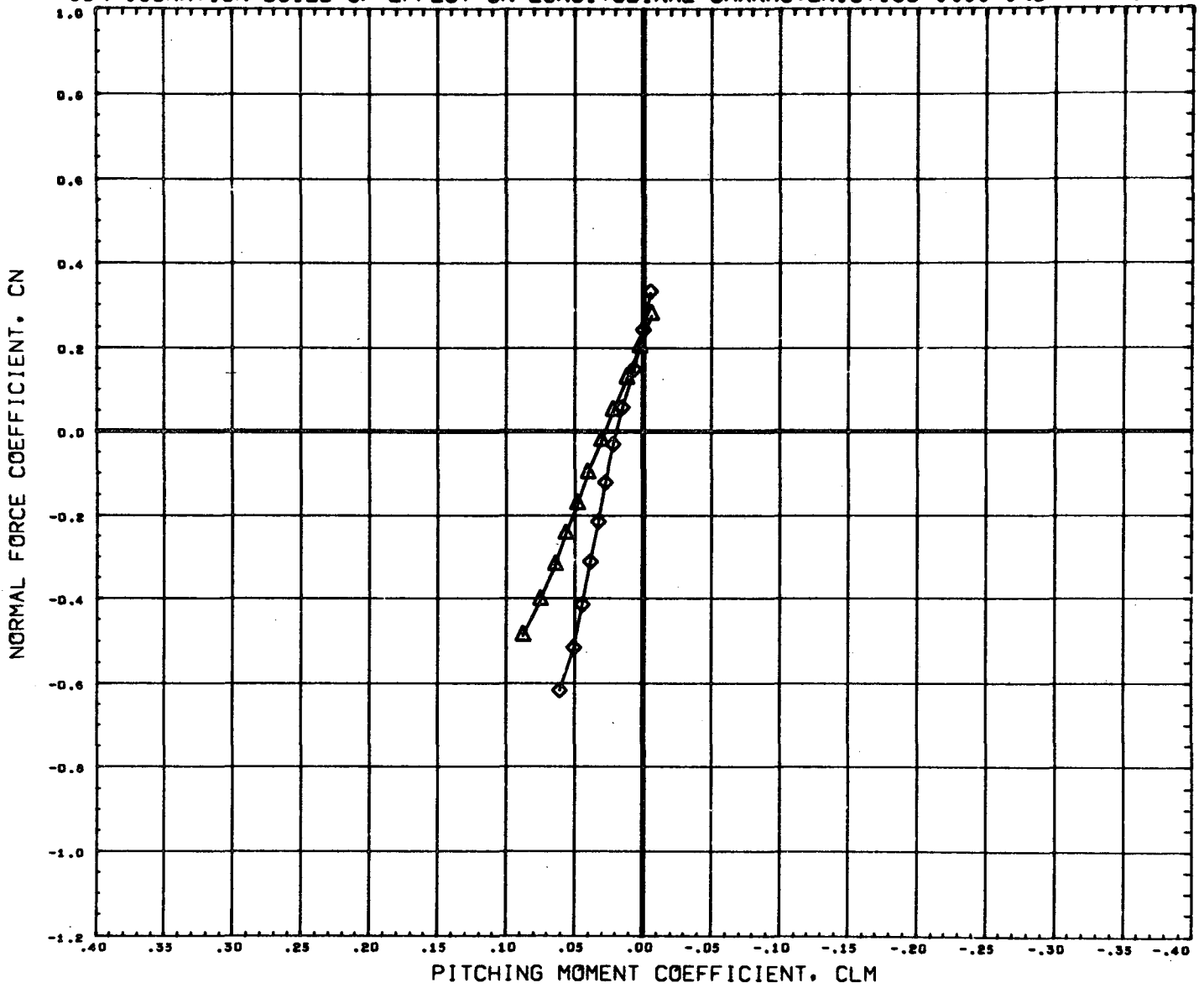

DATA SET SYMBOL	CONFIGURATION DESCRIPTION	ORBIN	THETS	BETA	REFERENCE INFORMATION
(B65019)	DATA NOT AVAILABLE FOR ALL CONDITIONS			0.000	SREF 4.8950 SQ. IN
(B65020)	MSFC TWT 534 SHUTTLE LAUNCH T201	-1.500		0.000	LREF 2.6440 IN.
(B65022)	MSFC TWT 534 SHUTTLE LAUNCH T201S1	-1.500	21.000	0.000	BREF 3.5250 IN.
					XNRP 3.4900 IN.
					YNRP 0.0000 IN.
					ZNRP 0.1616 IN.
					SCALE 0.0034

MACH 2.74

CONFIGURATION BUILD-UP EFFECT ON LONGITUDINAL CHARACTERISTICS (400 INCH TANK)

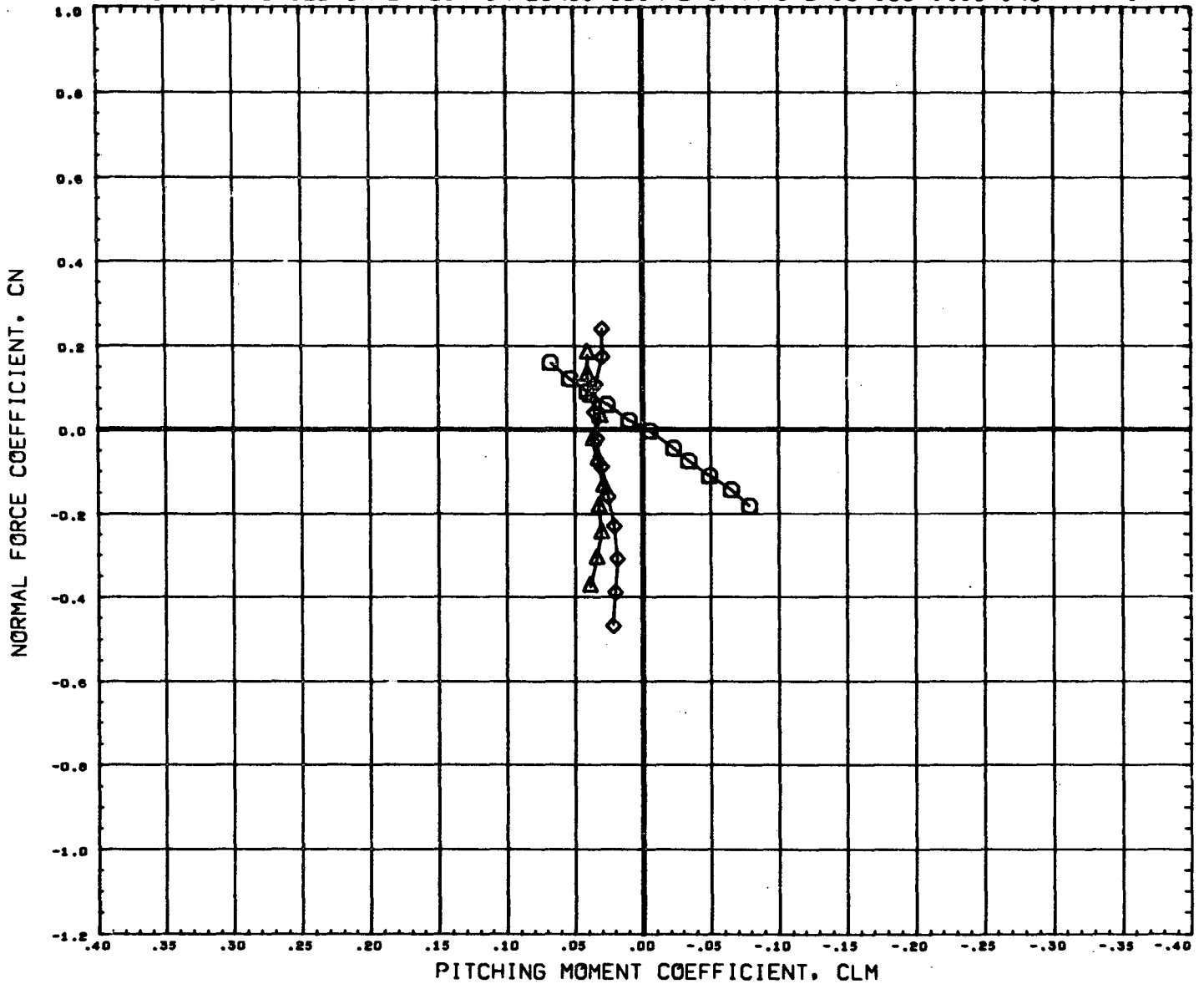

DATA SET SYMBOL	CONFIGURATION DESCRIPTION	T2	ORBIN	THETS	BETA	REFERENCE INFORMATION
(B65019)	MSFC TWT 534 SHUTTLE LAUNCH	T201	-1.500		0.000	SREF 4.8950 SQ. IN
(B65020)	MSFC TWT 534 SHUTTLE LAUNCH	T201S1	-1.500	21.000	0.000	LREF 2.6440 IN.
(B65022)	MSFC TWT 534 SHUTTLE LAUNCH	T201S1	-1.500	21.000	0.000	BREF 3.5250 IN.
						XMRP 3.4900 IN.
						YMRP 0.0000 IN.
						ZMRP 0.1616 IN.
						SCALE 0.0034

TANK DIAMETER EFFECTS ON LONGITUDINAL CHARACTERISTICS

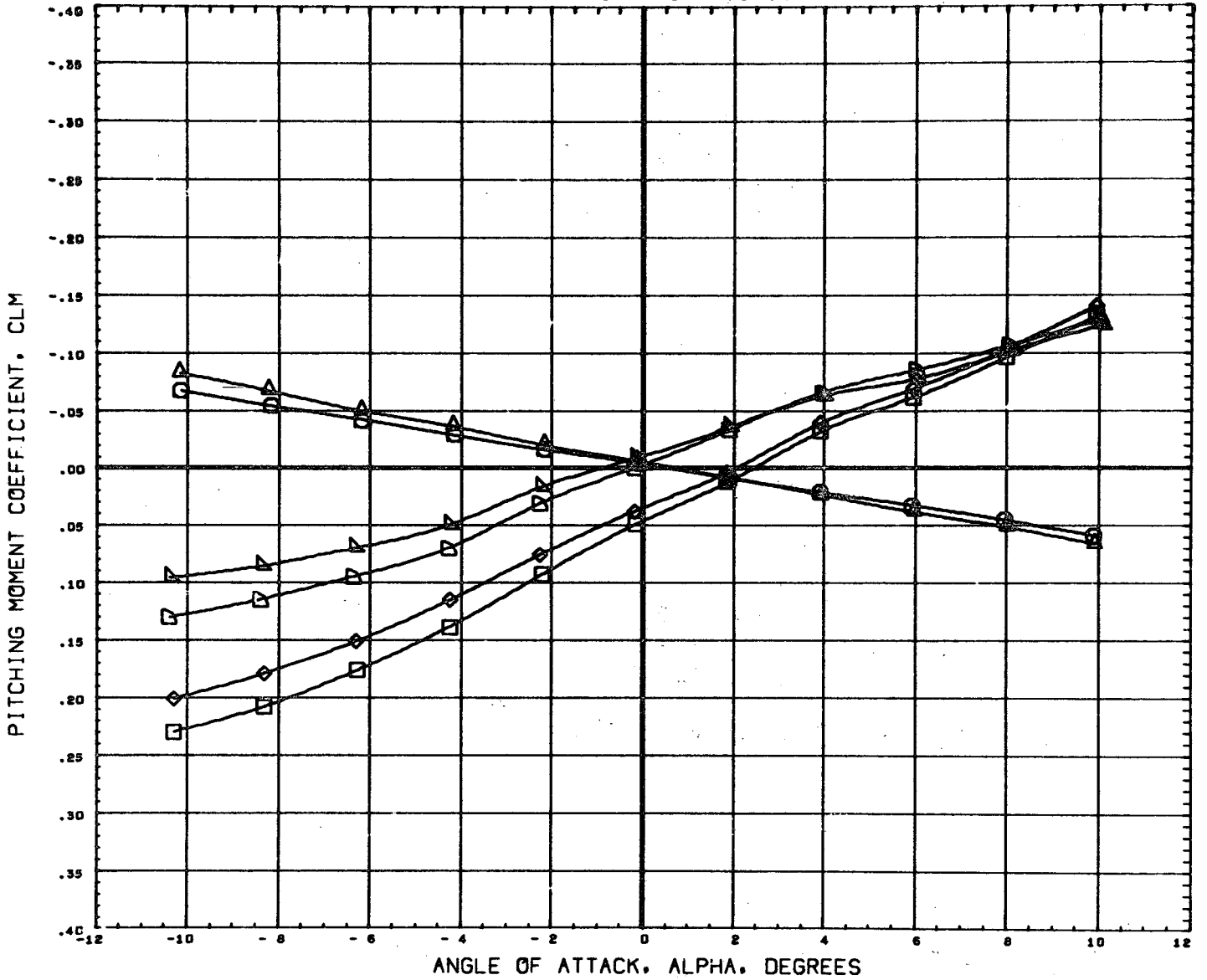

DATA SET SYMBOL	CONFIGURATION DESCRIPTION	ORBIN	THETS	BETA	REFERENCE INFORMATION
(B65001)	MSFC TWT 534 SHUTTLE LAUNCH	T1		0.000	SREF 4.8950 SQ. IN
(B65019)	MSFC TWT 534 SHUTTLE LAUNCH	T2		0.000	LREF 2.6440 IN.
(B65002)	MSFC TWT 534 SHUTTLE LAUNCH	T101	-1.500	0.000	BREF 3.5250 IN.
(B65020)	MSFC TWT 534 SHUTTLE LAUNCH	T201	-1.500	0.000	XNRP 3.4900 IN.
(B65004)	MSFC TWT 534 SHUTTLE LAUNCH	T101S1	-1.500	21.000	YNRP 0.0000 IN.
(B65022)	MSFC TWT 534 SHUTTLE LAUNCH	T201S1	-1.500	21.000	ZNRP 0.1616 IN.
					SCALE 0.0034

MACH .60

TANK DIAMETER EFFECTS ON LONGITUDINAL CHARACTERISTICS

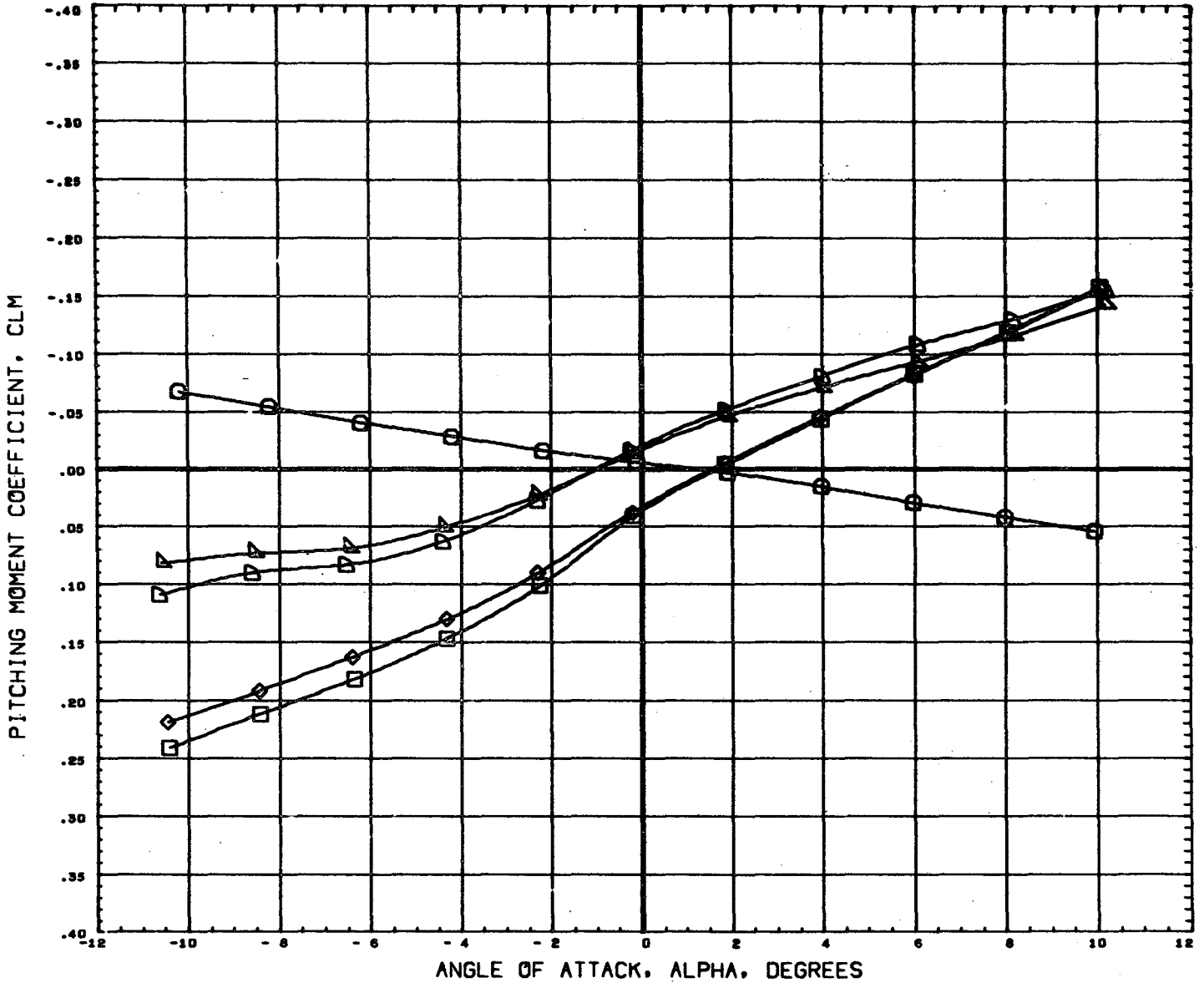

DATA SET SYMBOL	CONFIGURATION DESCRIPTION	ORBIN	THETS	BETA	REFERENCE INFORMATION
(B65001)	MSFC TWT 534 SHUTTLE LAUNCH T1			0.000	SREF 4.8950 SQ. IN
(B65019)	DATA NOT AVAILABLE FOR ALL CONDITIONS			0.000	LREF 2.6440 IN.
(B65002)	MSFC TWT 534 SHUTTLE LAUNCH T101	-1.500		0.000	BREF 3.5250 IN.
(B65020)	MSFC TWT 534 SHUTTLE LAUNCH T201	-1.500		0.000	XMRP 3.4900 IN.
(B65004)	MSFC TWT 534 SHUTTLE LAUNCH T101S1	-1.500	21.000	0.000	YMRP 0.0000 IN.
(B65022)	MSFC TWT 534 SHUTTLE LAUNCH T201S1	-1.500	21.000	0.000	ZMRP 0.1616 IN.
					SCALE 0.0034

MACH .80

PAGE 130

TANK DIAMETER EFFECTS ON LONGITUDINAL CHARACTERISTICS

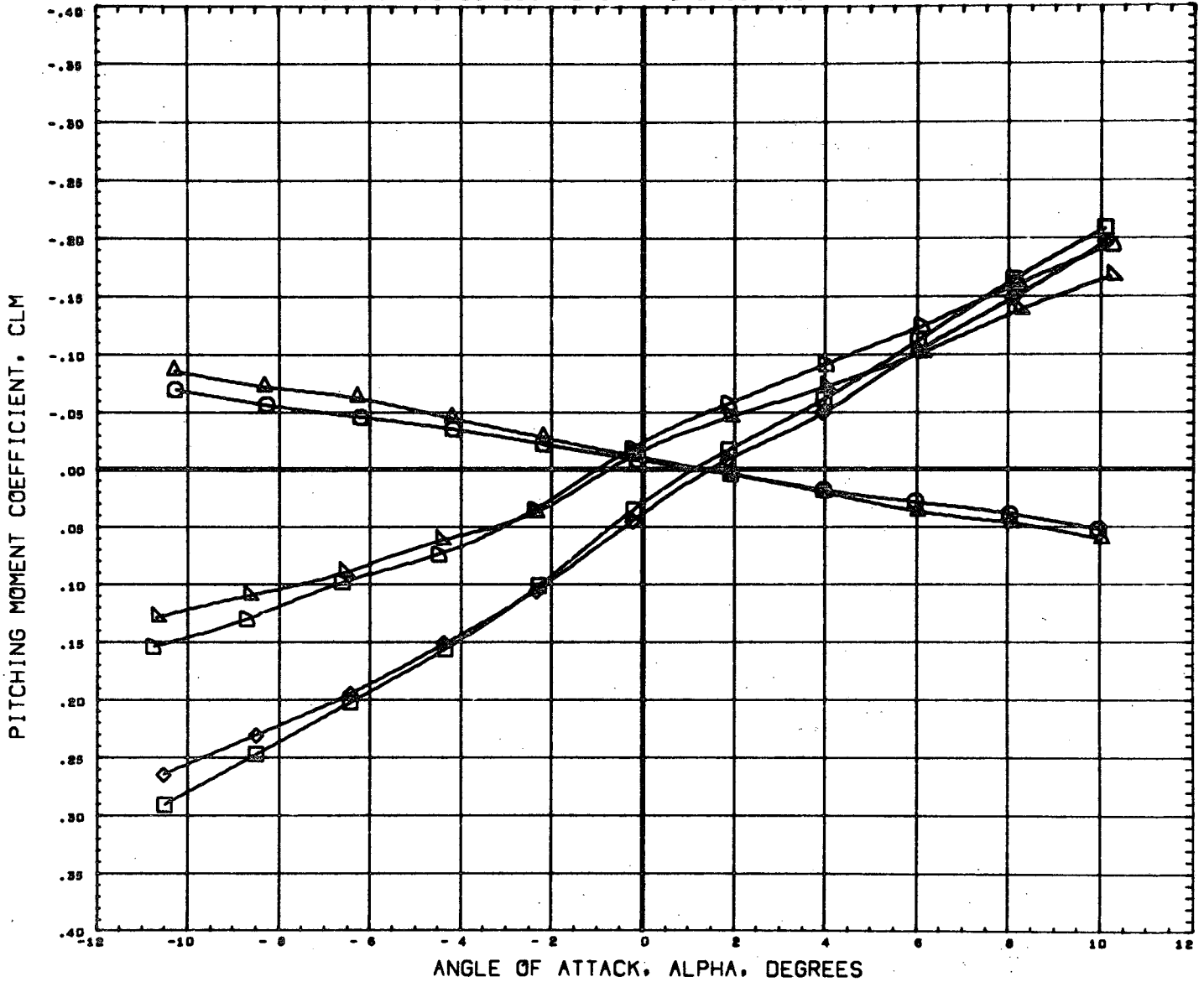

DATA SET SYMBOL	CONFIGURATION DESCRIPTION	T1	ORBIN	THETS	BETA	REFERENCE INFORMATION
(B65001)	MSFC TWT 534 SHUTTLE LAUNCH	T1			0.000	SREF 4.8950 SQ. IN
(B65019)	MSFC TWT 534 SHUTTLE LAUNCH	T2			0.000	LREF 2.6440 IN.
(B65002)	MSFC TWT 534 SHUTTLE LAUNCH	T101	-1.500		0.000	BREF 3.5250 IN.
(B65020)	MSFC TWT 534 SHUTTLE LAUNCH	T201	-1.500		0.000	XMRP 3.4900 IN.
(B65004)	MSFC TWT 534 SHUTTLE LAUNCH	T101S1	-1.500	21.000	0.000	YMRP 0.0000 IN.
(B65022)	MSFC TWT 534 SHUTTLE LAUNCH	T201S1	-1.500	21.000	0.000	ZMRP 0.1616 IN.
						SCALE 0.0034

MACH .90

PAGE 131

TANK DIAMETER EFFECTS ON LONGITUDINAL CHARACTERISTICS

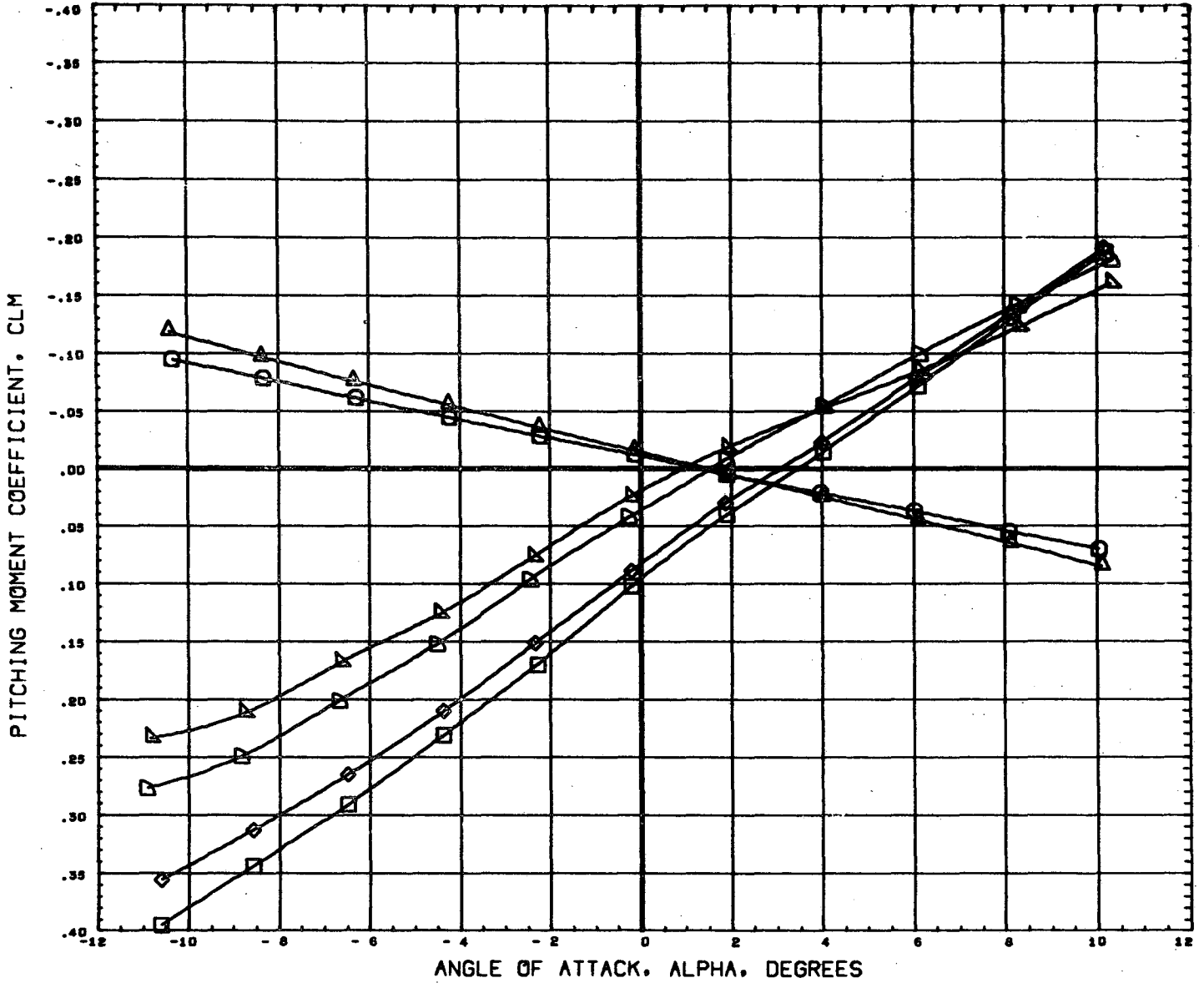

DATA SET SYMBOL	CONFIGURATION DESCRIPTION	ORBIN	THETS	BETA	REFERENCE INFORMATION
(B65001)	MSFC TWT 534 SHUTTLE LAUNCH	T1		0.000	SREF 4.8950 SQ. IN
(B65019)	MSFC TWT 534 SHUTTLE LAUNCH	T2		0.000	LREF 2.6440 IN.
(B65002)	MSFC TWT 534 SHUTTLE LAUNCH	T101	-1.500	0.000	BREF 3.5250 IN.
(B65020)	MSFC TWT 534 SHUTTLE LAUNCH	T201	-1.500	0.000	XMRP 3.4900 IN.
(B65004)	MSFC TWT 534 SHUTTLE LAUNCH	T101S1	-1.500	21.000	YMRP 0.0000 IN.
(B65022)	MSFC TWT 534 SHUTTLE LAUNCH	T201S1	-1.500	21.000	ZMRP 0.1616 IN.
					SCALE 0.0034

MACH 1.10

TANK DIAMETER EFFECTS ON LONGITUDINAL CHARACTERISTICS

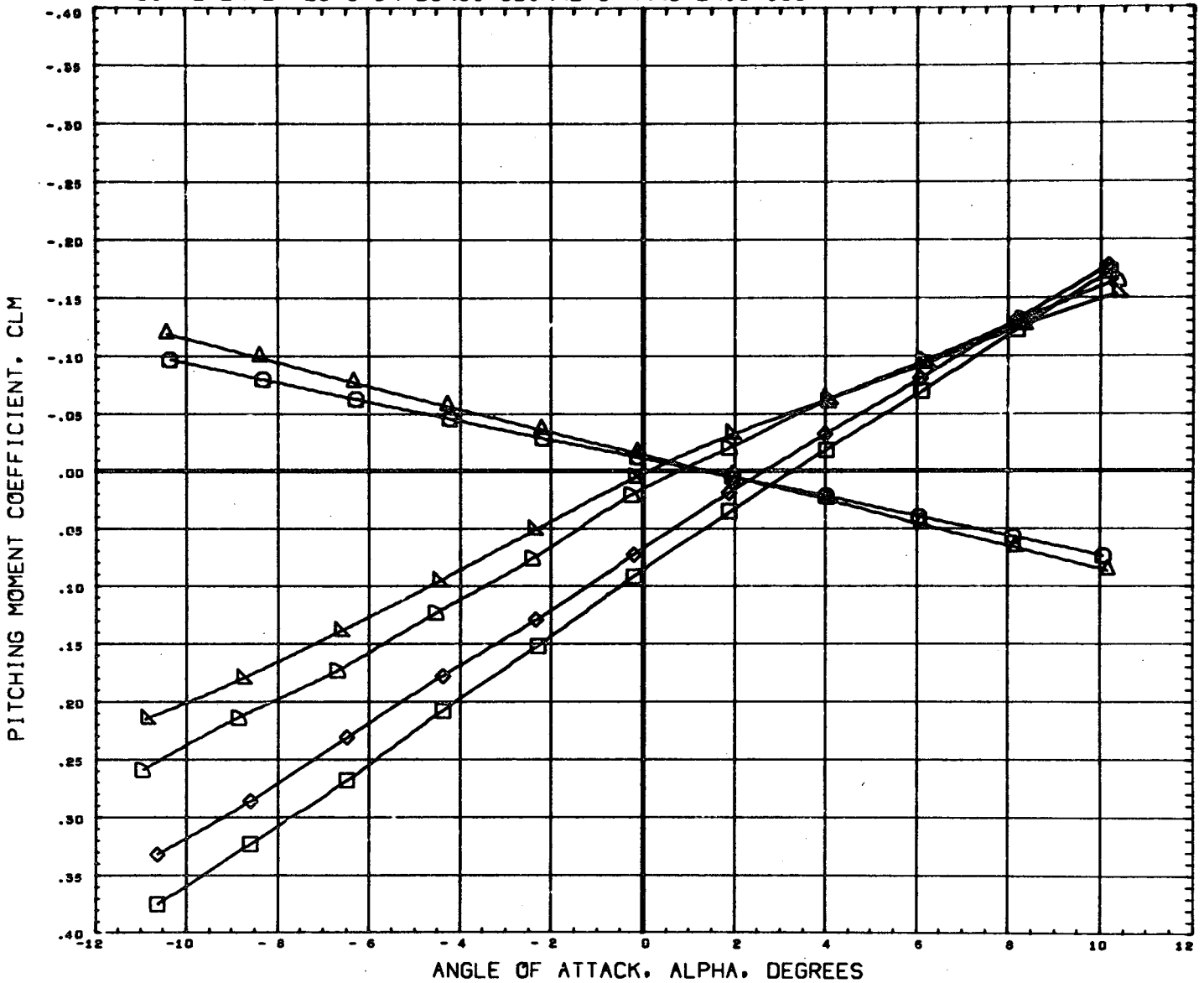

DATA SET SYMBOL	CONFIGURATION DESCRIPTION	ORBIN	THETS	BETA	REFERENCE INFORMATION
(B65001)	MSFC TWT 534 SHUTTLE LAUNCH	T1		0.000	SREF 4.8950 SQ. IN
(B65019)	MSFC TWT 534 SHUTTLE LAUNCH	T2		0.000	LREF 2.6440 IN.
(B65002)	MSFC TWT 534 SHUTTLE LAUNCH	T101	-1.500	0.000	BREF 3.5250 IN.
(B65020)	MSFC TWT 534 SHUTTLE LAUNCH	T201	-1.500	0.000	XMRP 3.4900 IN.
(B65004)	MSFC TWT 534 SHUTTLE LAUNCH	T101S1	-1.500	21.000	YMRP 0.0000 IN.
(B65022)	MSFC TWT 534 SHUTTLE LAUNCH	T201S1	-1.500	21.000	ZMRP 0.1616 IN.
					SCALE 0.0034

MACH 1.20

TANK DIAMETER EFFECTS ON LONGITUDINAL CHARACTERISTICS

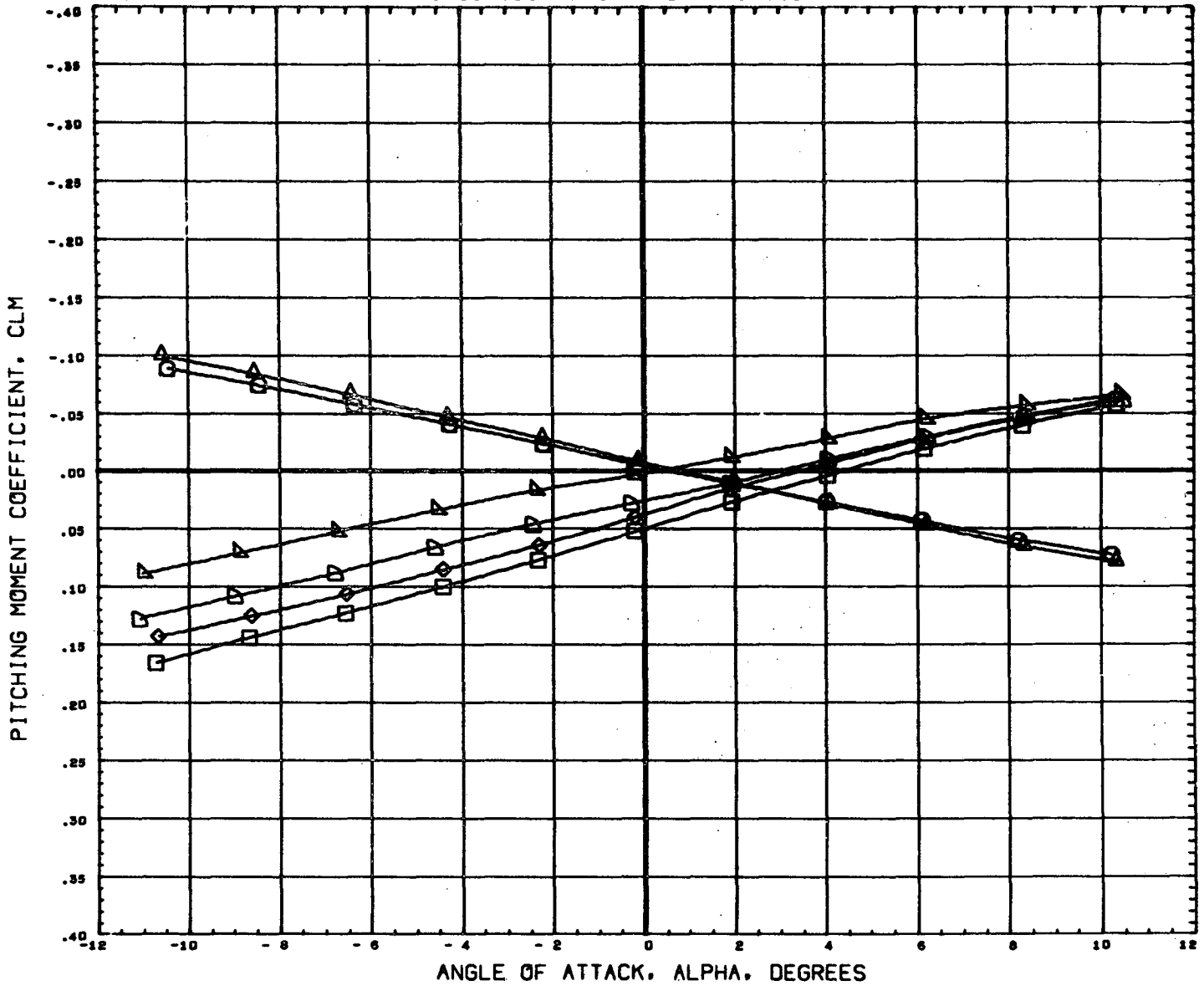

DATA SET SYMBOL	CONFIGURATION DESCRIPTION	ORBIN	THETS	BETA	REFERENCE INFORMATION
(065001)	MSFC TWT 534 SHUTTLE LAUNCH	T1		0.000	SREF 4.8950 SQ. IN
(065019)	MSFC TWT 534 SHUTTLE LAUNCH	T2		0.000	LREF 2.6440 IN.
(065002)	MSFC TWT 534 SHUTTLE LAUNCH	T101	-1.500	0.000	BREF 3.5250 IN.
(065020)	MSFC TWT 534 SHUTTLE LAUNCH	T201	-1.500	0.000	XNRP 3.4900 IN.
(065004)	MSFC TWT 534 SHUTTLE LAUNCH	T101S1	-1.500	21.000	YNRP 0.0000 IN.
(065022)	MSFC TWT 534 SHUTTLE LAUNCH	T201S1	-1.500	21.000	ZNRP 0.1616 IN.
					SCALE 0.0034

MACH 1.97

TANK DIAMETER EFFECTS ON LONGITUDINAL CHARACTERISTICS

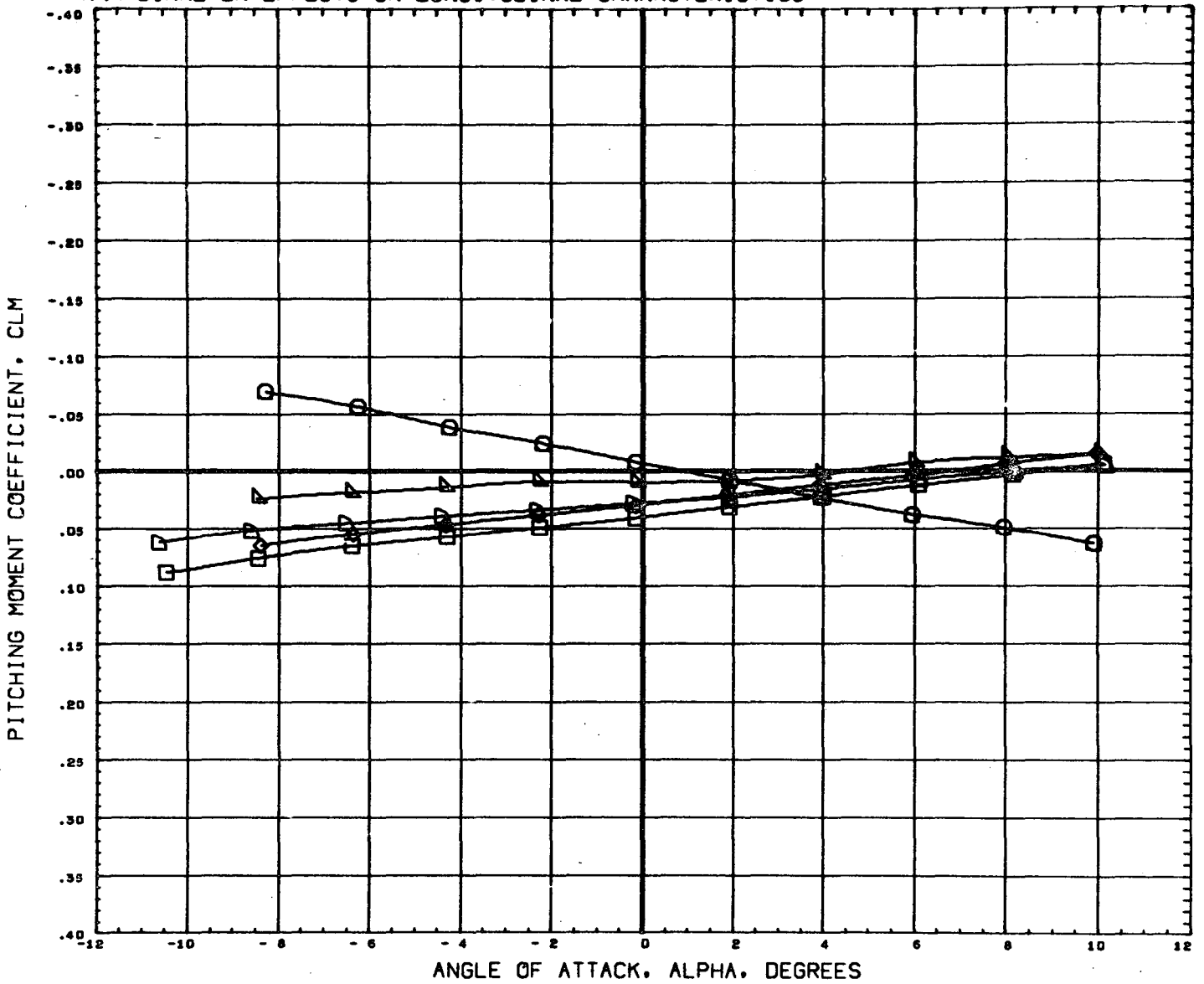

DATA SET SYMBOL	CONFIGURATION DESCRIPTION	ORBIN	THETS	BETA	REFERENCE INFORMATION
(865001)	MSFC TWT 534 SHUTTLE LAUNCH T1			0.000	SREF 4.8950 SQ. IN
(865019)	DATA NOT AVAILABLE FOR ALL CONDITIONS			0.000	LREF 2.6440 IN.
(865002)	MSFC TWT 534 SHUTTLE LAUNCH T101	-1.500		0.000	BREF 3.5250 IN.
(865020)	MSFC TWT 534 SHUTTLE LAUNCH T201	-1.500		0.000	XMRP 3.4900 IN.
(865004)	MSFC TWT 534 SHUTTLE LAUNCH T101S1	-1.500	21.000	0.000	YMRP 0.0000 IN.
(865022)	MSFC TWT 534 SHUTTLE LAUNCH T201S1	-1.500	21.000	0.000	ZMRP 0.1616 IN.
					SCALE 0.0034

MACH 2.74

PAGE 135

TANK DIAMETER EFFECTS ON LONGITUDINAL CHARACTERISTICS

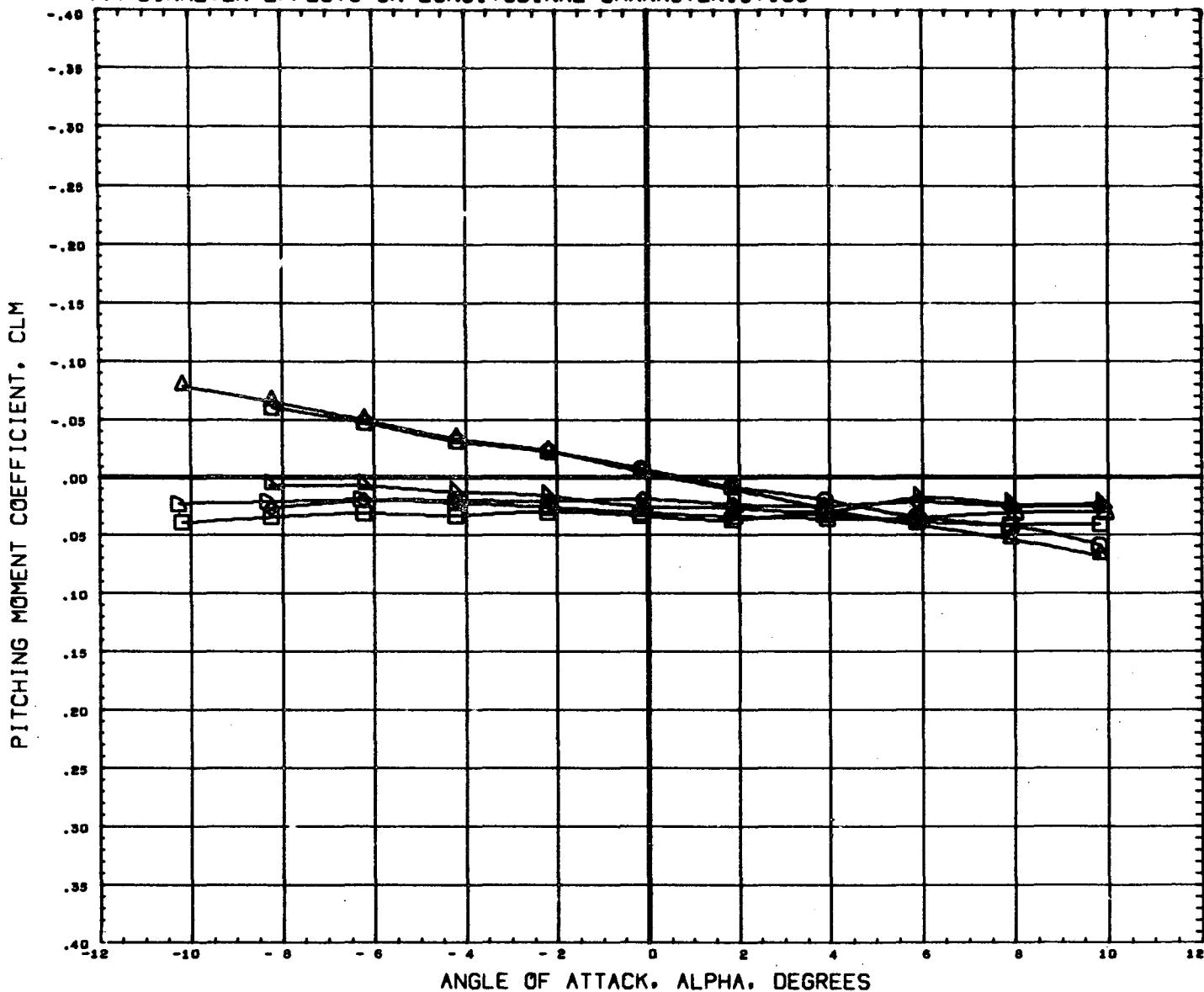

DATA SET SYMBOL	CONFIGURATION DESCRIPTION	ORBIN	THETS	BETA	REFERENCE INFORMATION
(B65001)	NSFC TWT 534 SHUTTLE LAUNCH	T1		0.000	SREF 4.8950 SQ. IN
(B65019)	NSFC TWT 534 SHUTTLE LAUNCH	T2		0.000	LREF 2.6440 IN.
(B65002)	NSFC TWT 534 SHUTTLE LAUNCH	T101	-1.500	0.000	BREF 3.5250 IN.
(B65020)	NSFC TWT 534 SHUTTLE LAUNCH	T201	-1.500	0.000	XMRP 3.4900 IN.
(B65004)	NSFC TWT 534 SHUTTLE LAUNCH	T101S1	-1.500	21.000	YMRP 0.0000 IN.
(B65022)	NSFC TWT 534 SHUTTLE LAUNCH	T201S1	-1.500	21.000	ZMRP 0.1616 IN.
					SCALE 0.0034

MACH 4.96

PAGE 136

TANK DIAMETER EFFECTS ON LONGITUDINAL CHARACTERISTICS

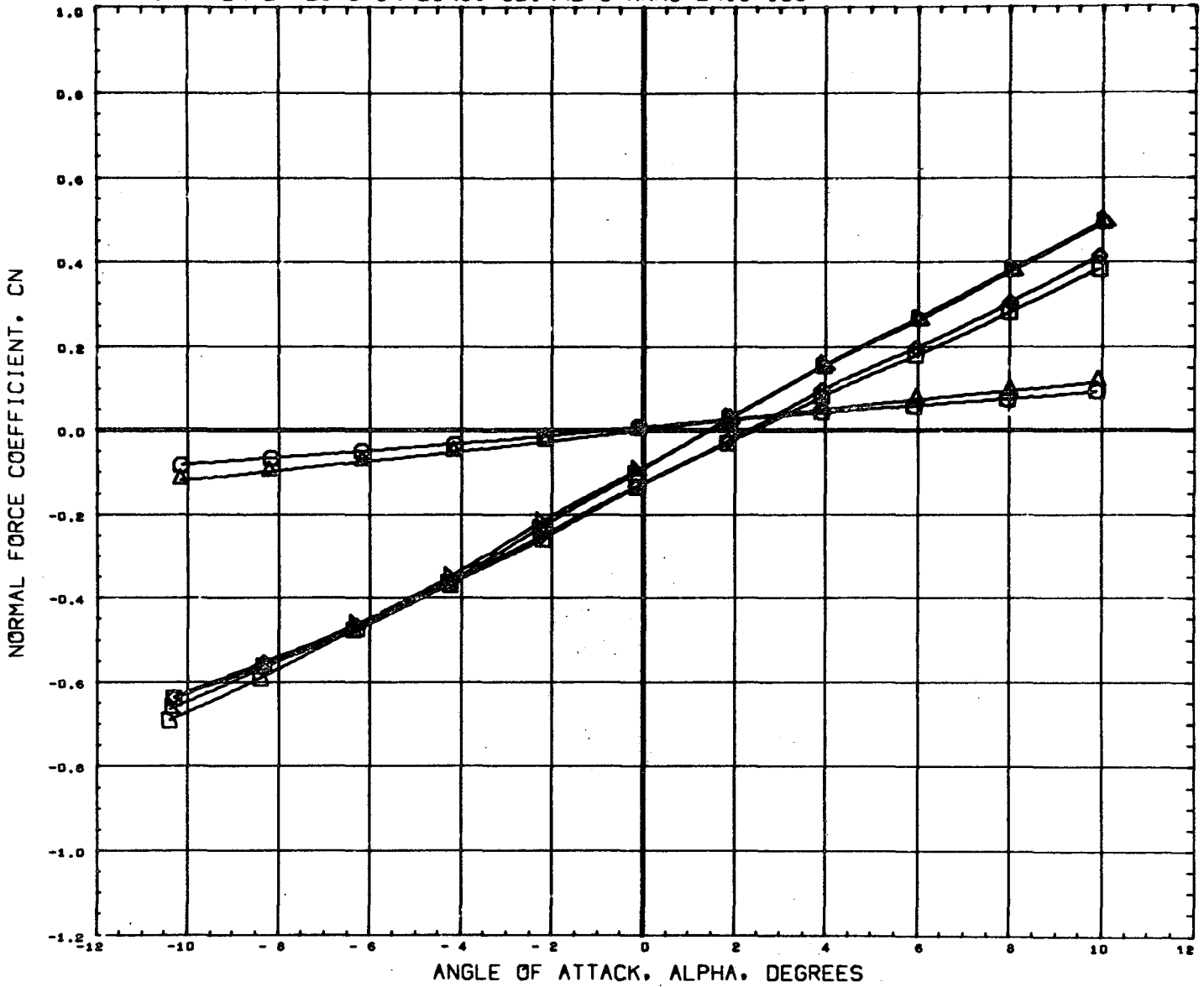

DATA SET SYMBOL	CONFIGURATION DESCRIPTION	T1	ORBIN	THETS	BETA	REFERENCE INFORMATION
(B65001)	MSFC TWT 534 SHUTTLE LAUNCH	T1			0.000	SREF 4.8950 SQ. IN
(B65019)	MSFC TWT 534 SHUTTLE LAUNCH	T2			0.000	LREF 2.6440 IN.
(B65002)	MSFC TWT 534 SHUTTLE LAUNCH	T101	-1.500		0.000	BREF 3.5250 IN.
(B65020)	MSFC TWT 534 SHUTTLE LAUNCH	T201	-1.500		0.000	XMRP 3.4900 IN.
(B65004)	MSFC TWT 534 SHUTTLE LAUNCH	T101S1	-1.500	21.000	0.000	YMRP 0.0000 IN.
(B65022)	MSFC TWT 534 SHUTTLE LAUNCH	T201S1	-1.500	21.000	0.000	ZMRP 0.1616 IN.
						SCALE 0.0034

MACH .60

PAGE 137

TANK DIAMETER EFFECTS ON LONGITUDINAL CHARACTERISTICS

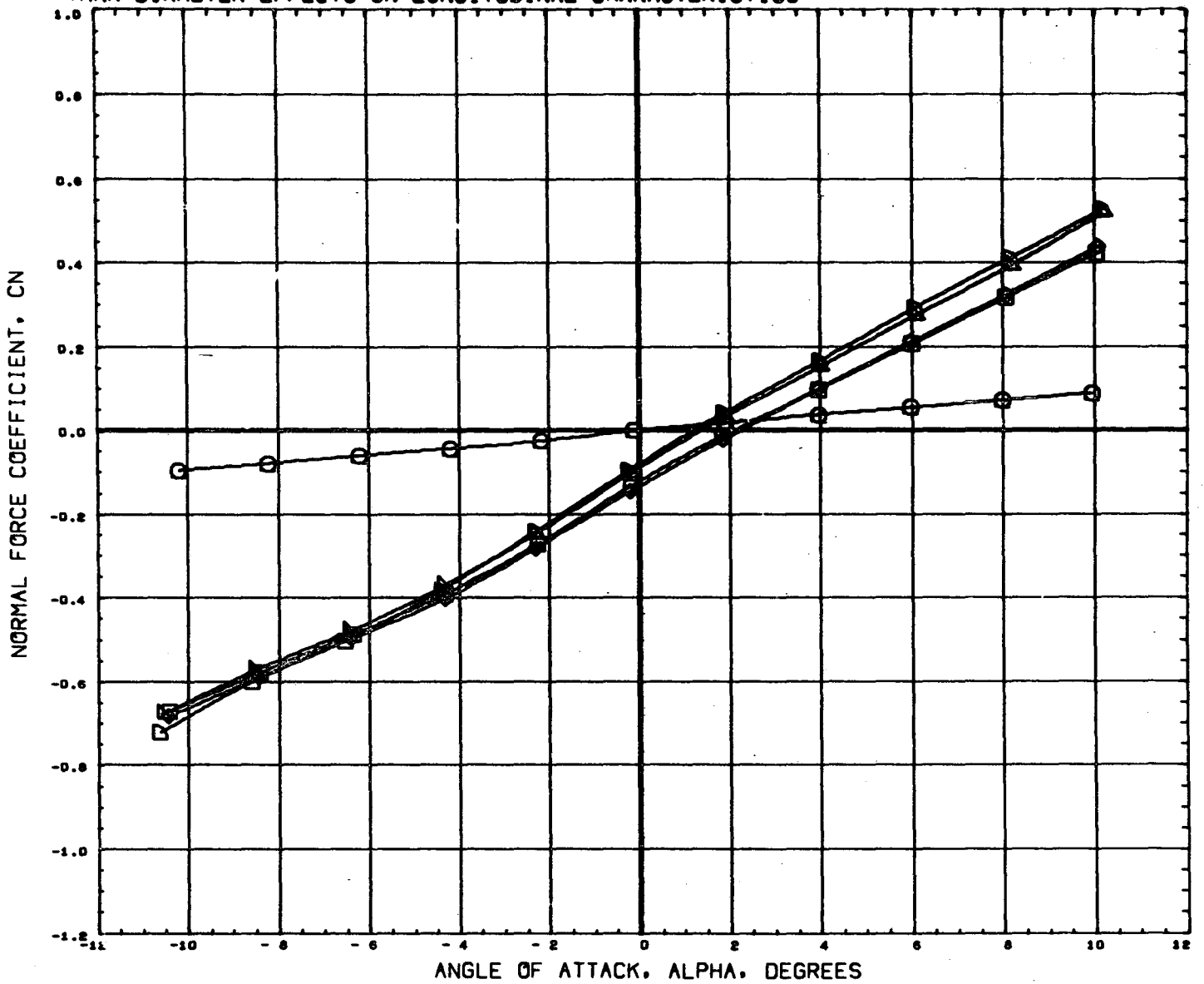

DATA SET SYMBOL	CONFIGURATION DESCRIPTION	ORBIN	THETS	BETA	REFERENCE INFORMATION
(865001)	MSFC TWT 534 SHUTTLE LAUNCH T1			0.000	SREF 4.8950 SQ. IN
(865019)	DATA NOT AVAILABLE FOR ALL CONDITIONS			0.000	LREF 2.6440 IN.
(865002)	MSFC TWT 534 SHUTTLE LAUNCH T101	-1.500		0.000	BREF 3.5250 IN.
(865020)	MSFC TWT 534 SHUTTLE LAUNCH T201	-1.500		0.000	XHRP 3.4900 IN.
(865004)	MSFC TWT 534 SHUTTLE LAUNCH T101S1	-1.500	21.000	0.000	YHRP 0.0000 IN.
(865022)	MSFC TWT 534 SHUTTLE LAUNCH T201S1	-1.500	21.000	0.000	ZHRP 0.1616 IN.
					SCALE 0.0034

MACH .80

PAGE 138

TANK DIAMETER EFFECTS ON LONGITUDINAL CHARACTERISTICS

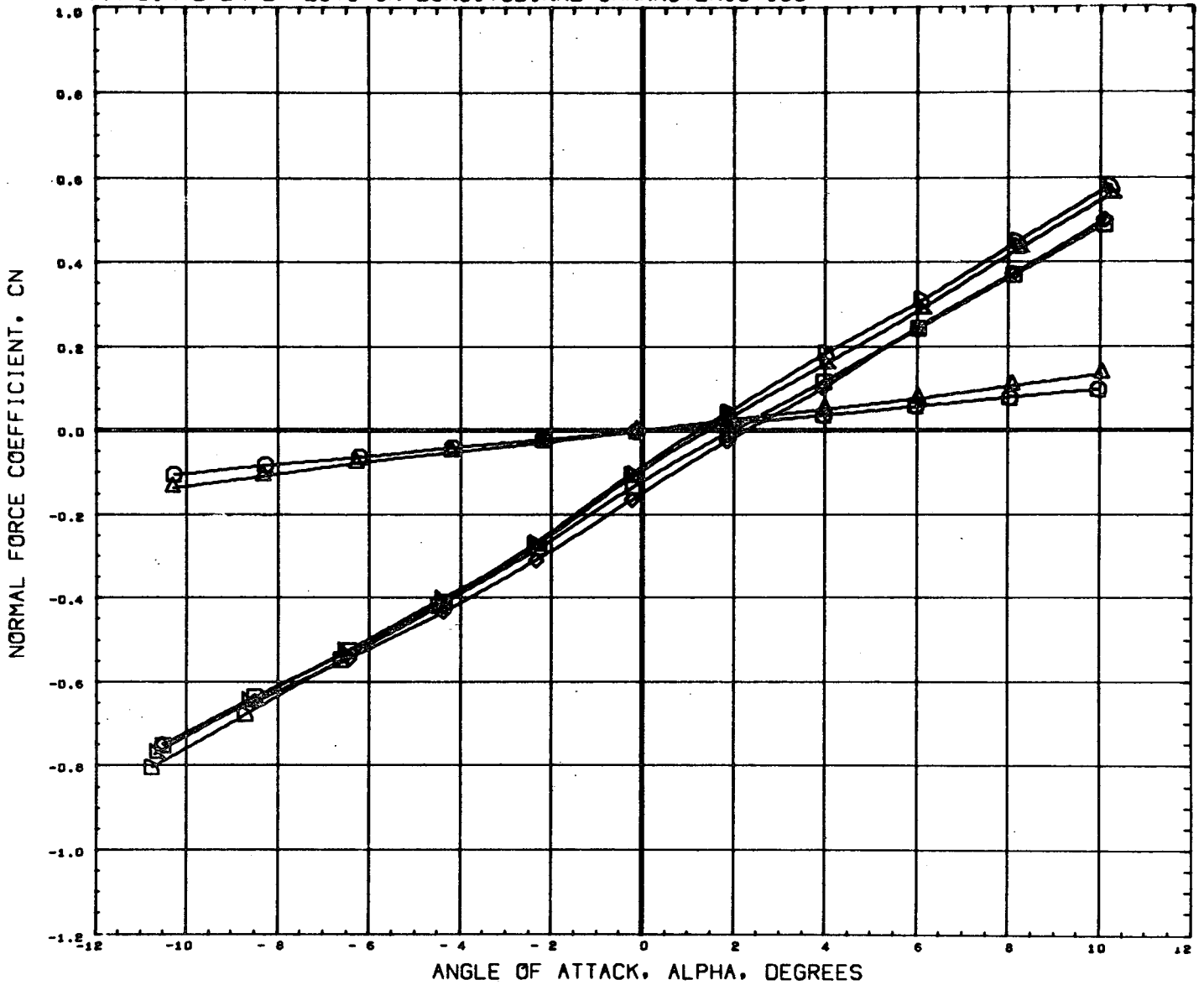

DATA SET SYMBOL	CONFIGURATION DESCRIPTION	ORBIN	THETS	BETA	REFERENCE INFORMATION
(B65001)	MSFC TWT 534 SHUTTLE LAUNCH	T1		0.000	SREF 4.8950 SQ. IN
(B65019)	MSFC TWT 534 SHUTTLE LAUNCH	T2		0.000	LREF 2.6440 IN.
(B65002)	MSFC TWT 534 SHUTTLE LAUNCH	T101	-1.500	0.000	BREF 3.5250 IN.
(B65020)	MSFC TWT 534 SHUTTLE LAUNCH	T201	-1.500	0.000	XNRP 3.4900 IN.
(B65004)	MSFC TWT 534 SHUTTLE LAUNCH	T101S1	-1.500	21.000	YNRP 0.0000 IN.
(B65022)	MSFC TWT 534 SHUTTLE LAUNCH	T201S1	-1.500	21.000	ZMRP 0.1616 IN.
					SCALE 0.0034

MACH .90

TANK DIAMETER EFFECTS ON LONGITUDINAL CHARACTERISTICS

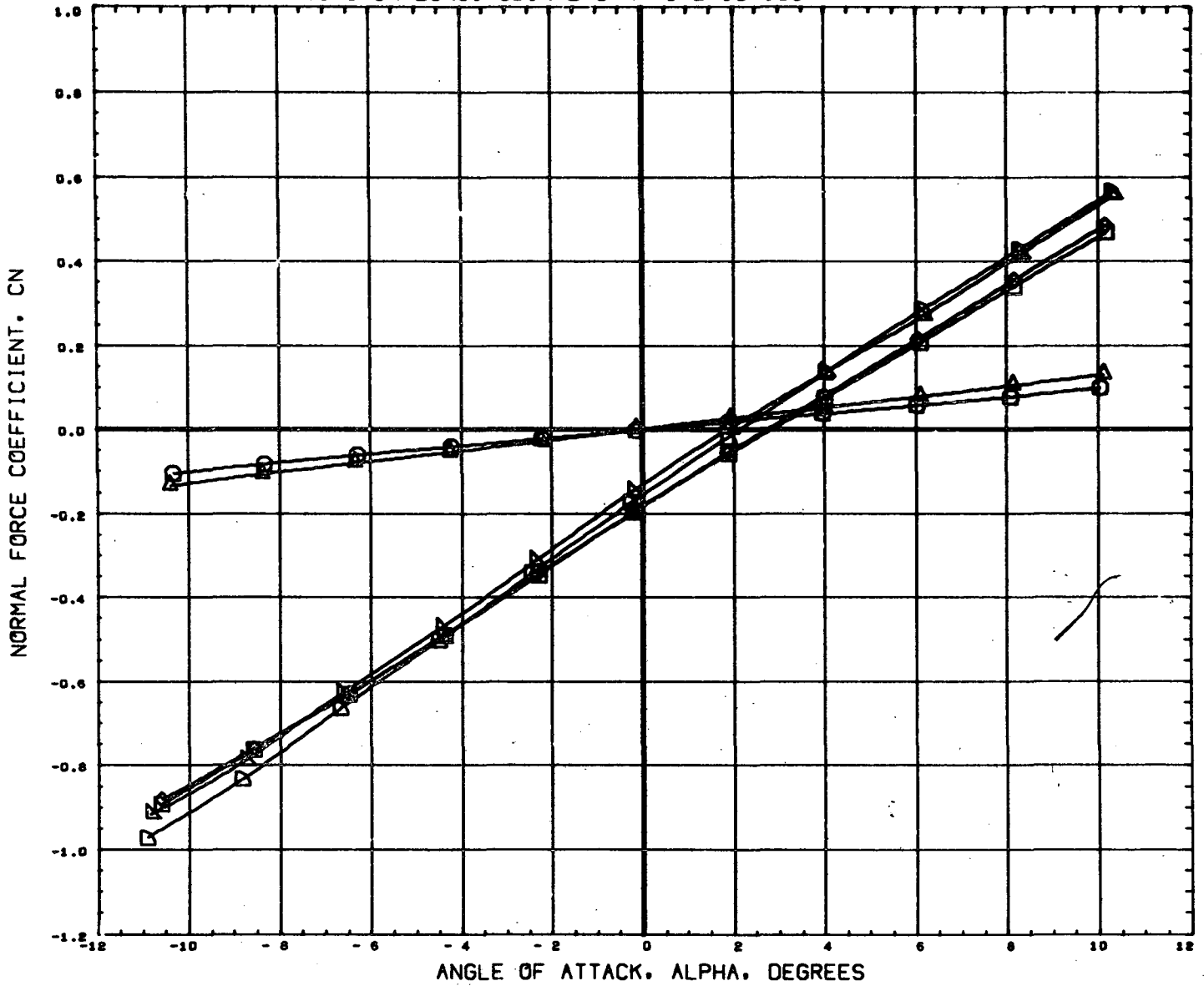

DATA SET SYMBOL	CONFIGURATION DESCRIPTION	ORBIN	THETS	BETA	REFERENCE INFORMATION
(B65001)	MSFC TWT 534 SHUTTLE LAUNCH	T1		0.000	SREF 4.8950 SQ. IN
(B65019)	MSFC TWT 534 SHUTTLE LAUNCH	T2		0.000	LREF 2.6440 IN.
(B65002)	MSFC TWT 534 SHUTTLE LAUNCH	T101		0.000	BREF 3.5250 IN.
(B65020)	MSFC TWT 534 SHUTTLE LAUNCH	T201	-1.500	0.000	XMRP 3.4900 IN.
(B65004)	MSFC TWT 534 SHUTTLE LAUNCH	T101S1	-1.500	21.000	YMRP 0.0000 IN.
(B65022)	MSFC TWT 534 SHUTTLE LAUNCH	T201S1	-1.500	21.000	ZMRP 0.1616 IN.
					SCALE 0.0034

MACH 1.10

PAGE 140

TANK DIAMETER EFFECTS ON LONGITUDINAL CHARACTERISTICS

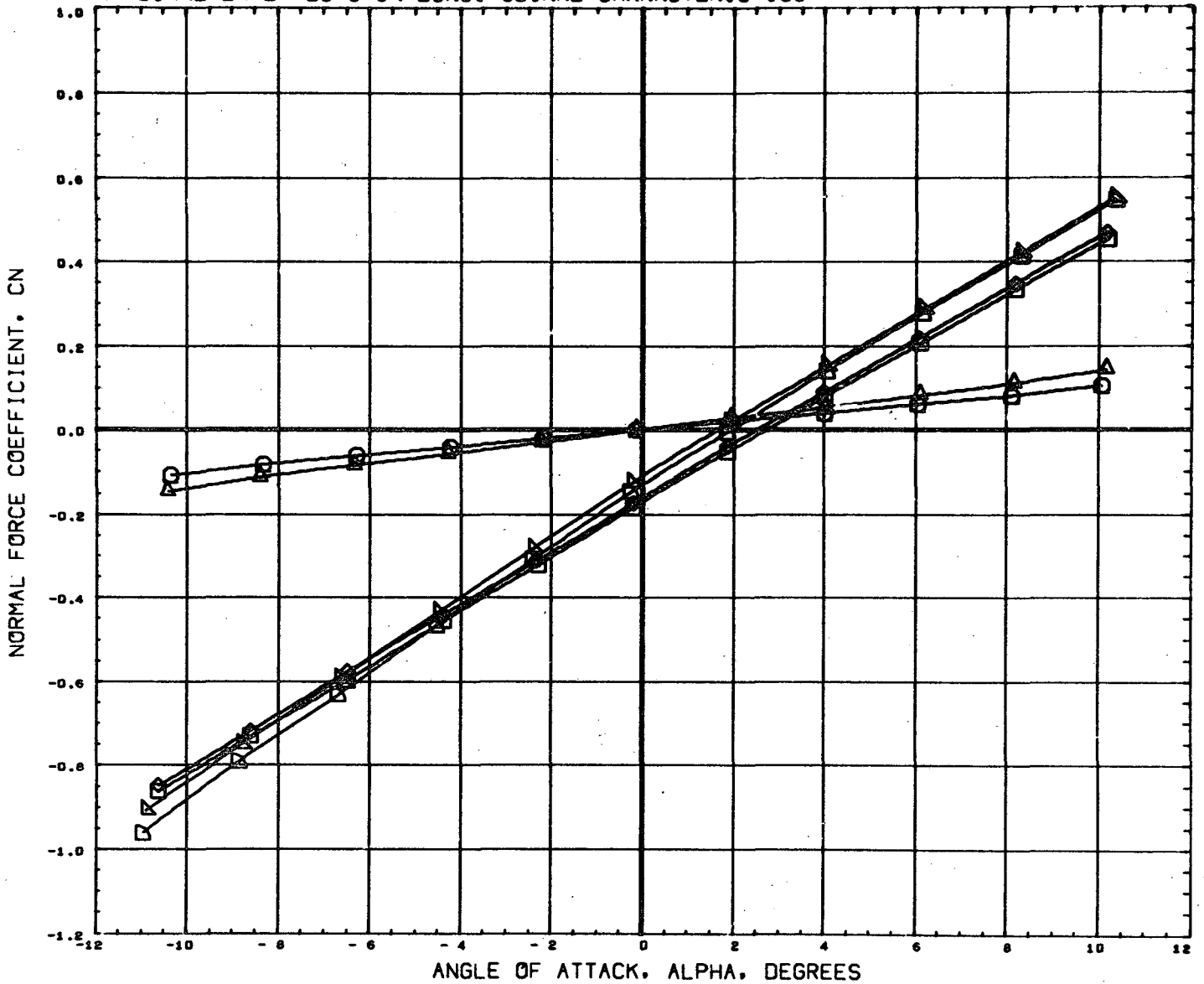

DATA SET SYMBOL	CONFIGURATION DESCRIPTION	ORBIN	THETS	BETA	REFERENCE INFORMATION
(B65001)	MSFC TWT 534 SHUTTLE LAUNCH	T1		0.000	SREF 4.8950 SQ. IN
(B65019)	MSFC TWT 534 SHUTTLE LAUNCH	T2		0.000	LREF 2.6440 IN.
(B65002)	MSFC TWT 534 SHUTTLE LAUNCH	T101	-1.500	0.000	BREF 3.5250 IN.
(B65020)	MSFC TWT 534 SHUTTLE LAUNCH	T201	-1.500	0.000	XMRP 3.4900 IN.
(B65004)	MSFC TWT 534 SHUTTLE LAUNCH	T101S1	-1.500	21.000	YMRP 0.0000 IN.
(B65022)	MSFC TWT 534 SHUTTLE LAUNCH	T201S1	-1.500	21.000	ZMRP 0.1616 IN.
					SCALE 0.0034

MACH 1.20

PAGE 141

TANK DIAMETER EFFECTS ON LONGITUDINAL CHARACTERISTICS

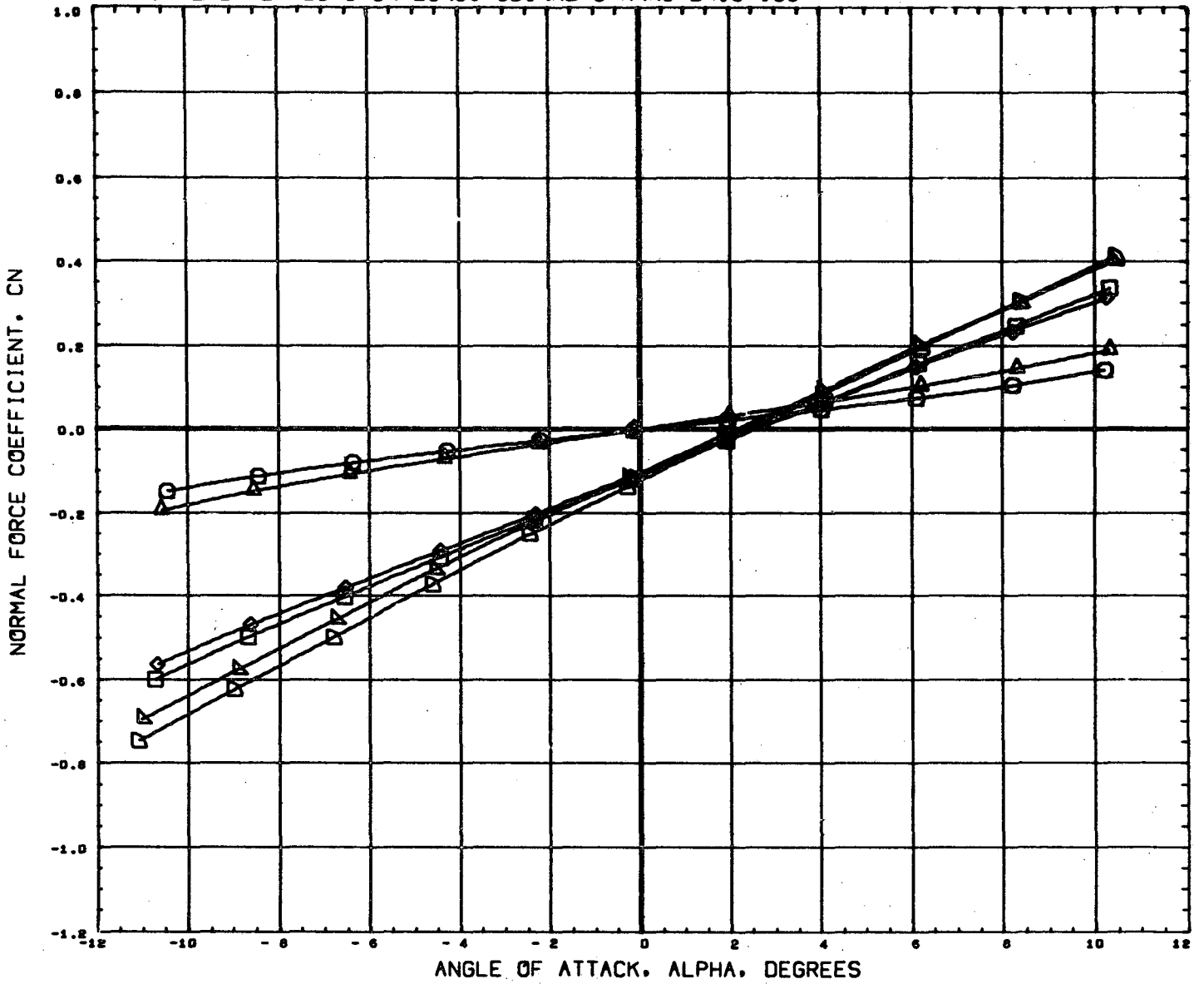

DATA SET SYMBOL	CONFIGURATION DESCRIPTION	T1	ORBIN	THETS	BETA	REFERENCE INFORMATION
(B65001)	MSFC TWT 534 SHUTTLE LAUNCH	T1			0.000	SREF 4.8950 SQ. IN
(B65019)	MSFC TWT 534 SHUTTLE LAUNCH	T2			0.000	LREF 2.6440 IN.
(B65002)	MSFC TWT 534 SHUTTLE LAUNCH	T101	-1.500		0.000	BREF 3.5250 IN.
(B65020)	MSFC TWT 534 SHUTTLE LAUNCH	T201	-1.500		0.000	XMRP 3.4900 IN.
(B65004)	MSFC TWT 534 SHUTTLE LAUNCH	T101S1	-1.500	21.000	0.000	YMRP 0.0000 IN.
(B65022)	MSFC TWT 534 SHUTTLE LAUNCH	T201S1	-1.500	21.000	0.000	ZMRP 0.1616 IN.
						SCALE 0.0034

MACH 1.97

PAGE 142

TANK DIAMETER EFFECTS ON LONGITUDINAL CHARACTERISTICS

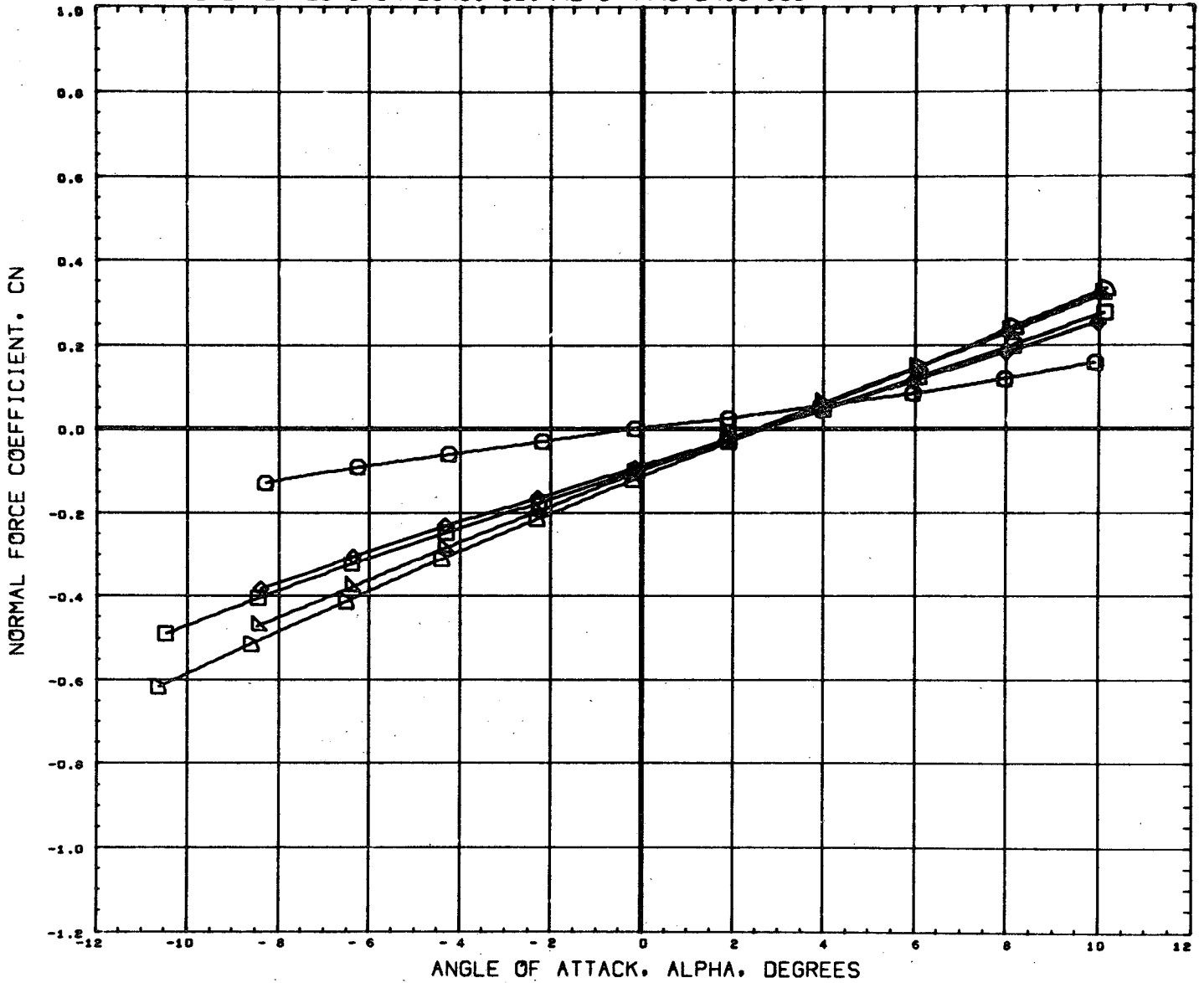

DATA SET SYMBOL	CONFIGURATION DESCRIPTION	ORBIN	THETS	BETA	REFERENCE INFORMATION
(B65001)	MSFC TWT 534 SHUTTLE LAUNCH T1			0.000	SREF 4.8950 SQ. IN
(B65019)	DATA NOT AVAILABLE FOR ALL CONDITIONS			0.000	LREF 2.6440 IN.
(B65002)	MSFC TWT 534 SHUTTLE LAUNCH T101	-1.500		0.000	BREF 3.5250 IN.
(B65020)	MSFC TWT 534 SHUTTLE LAUNCH T201	-1.500		0.000	XMRP 3.4900 IN.
(B65004)	MSFC TWT 534 SHUTTLE LAUNCH T101S1	-1.500	21.000	0.000	YMRP 0.0000 IN.
(B65022)	MSFC TWT 534 SHUTTLE LAUNCH T201S1	-1.500	21.000	0.000	ZMRP 0.1616 IN.
					SCALE 0.0034

MACH 2.74

TANK DIAMETER EFFECTS ON LONGITUDINAL CHARACTERISTICS

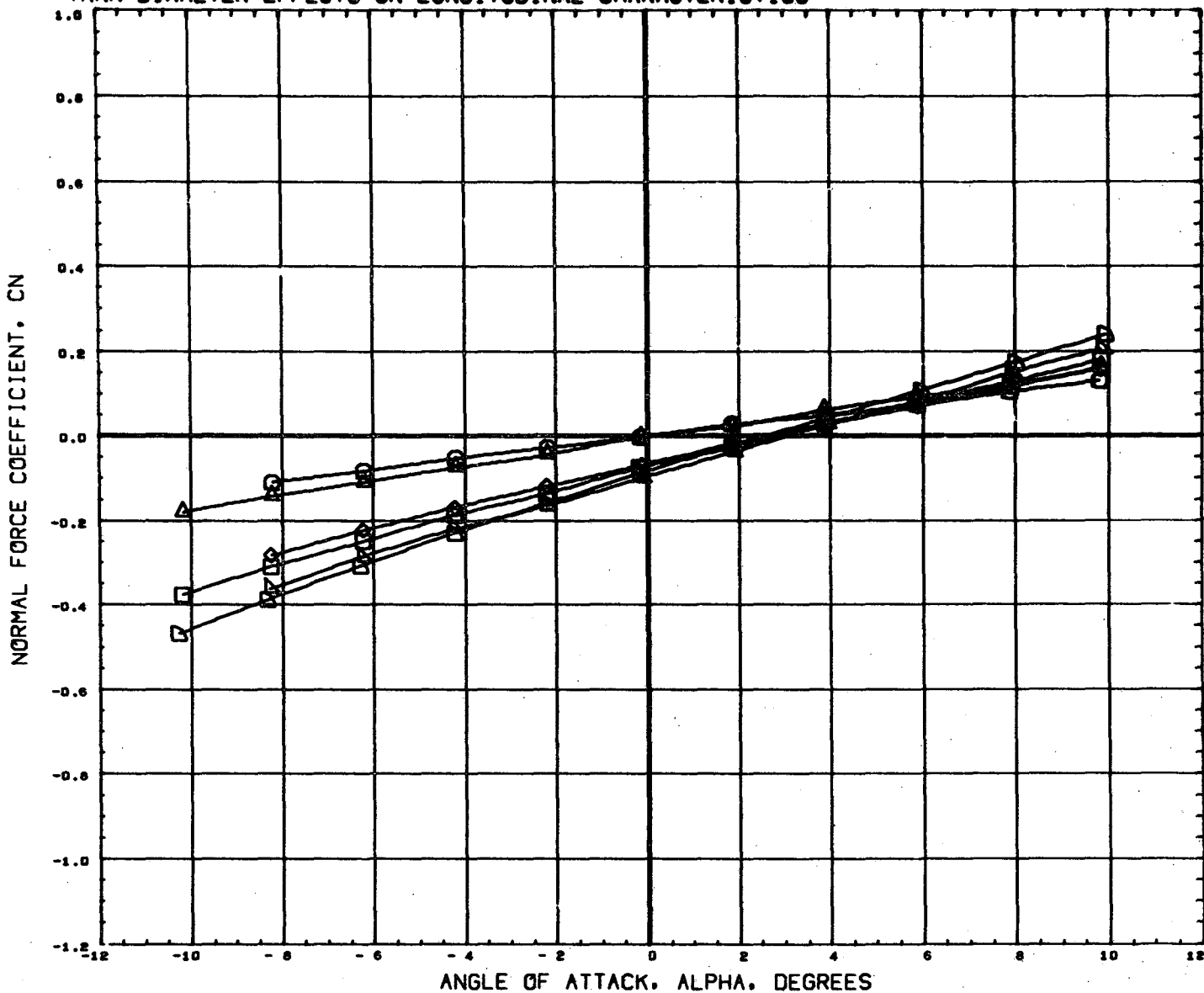

DATA SET SYMBOL	CONFIGURATION DESCRIPTION	ORBIN	THETS	BETA	REFERENCE INFORMATION
(B65001)	MSFC TWT 534 SHUTTLE LAUNCH	T1		0.000	SREF 4.8950 SQ. IN
(B65019)	MSFC TWT 534 SHUTTLE LAUNCH	T2		0.000	LREF 2.6440 IN.
(B65002)	MSFC TWT 534 SHUTTLE LAUNCH	T101	-1.500	0.000	BREF 3.5250 IN.
(B65020)	MSFC TWT 534 SHUTTLE LAUNCH	T201	-1.500	0.000	XMRP 3.4900 IN.
(B65004)	MSFC TWT 534 SHUTTLE LAUNCH	T101S1	-1.500	21.000	YMRP 0.0000 IN.
(B65022)	MSFC TWT 534 SHUTTLE LAUNCH	T201S1	-1.500	21.000	ZMRP 0.1616 IN.
					SCALE 0.0034

MACH 4.96

PAGE 144

TANK DIAMETER EFFECTS ON LONGITUDINAL CHARACTERISTICS

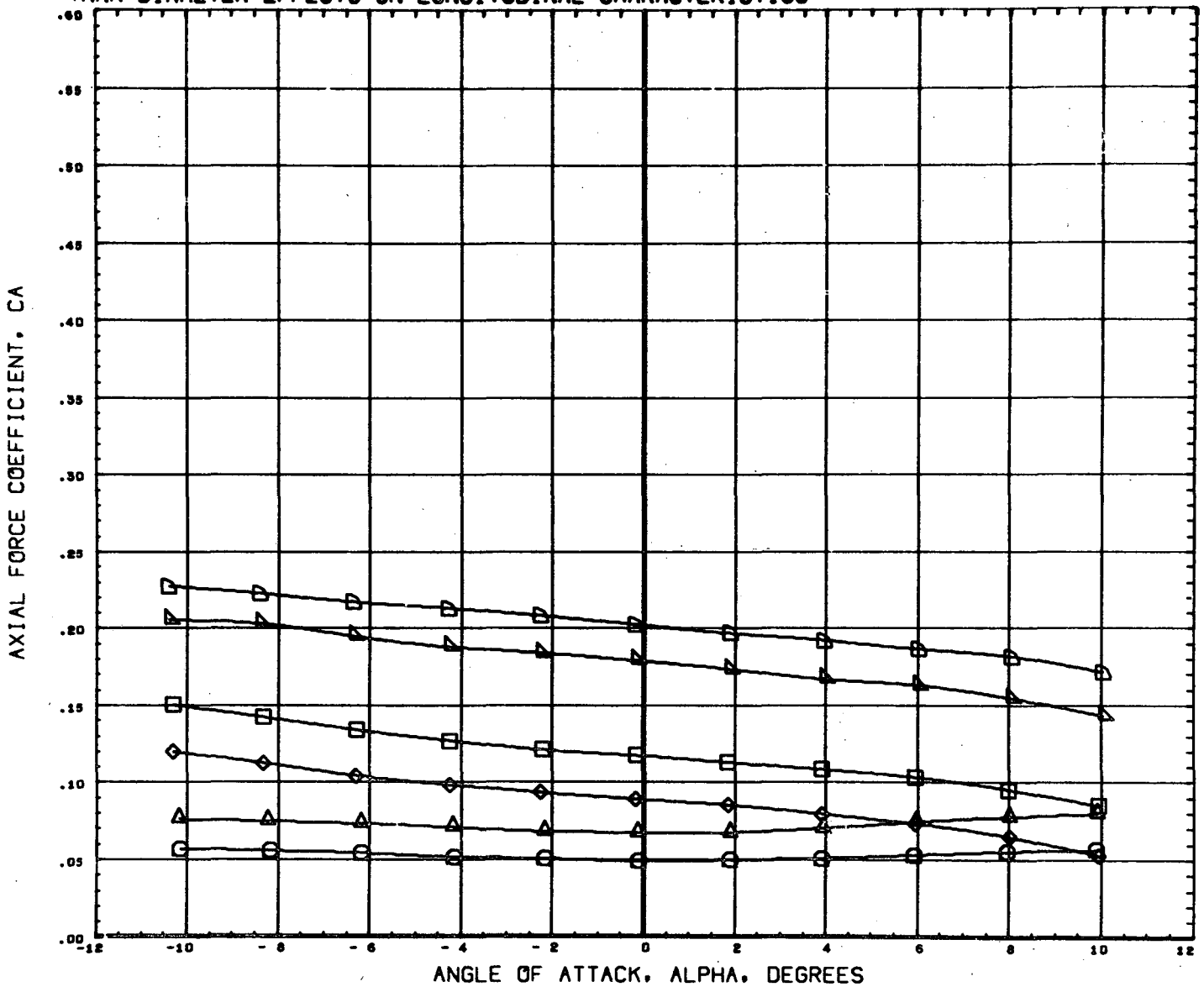

DATA SET SYMBOL	CONFIGURATION DESCRIPTION	T1	ORBIN	THETS	BETA	REFERENCE INFORMATION
(B65001)	MSFC TWT 534 SHUTTLE LAUNCH	T1			0.000	SREF 4.8950 SQ. IN
(B65019)	MSFC TWT 534 SHUTTLE LAUNCH	T2			0.000	LREF 2.6440 IN.
(B65002)	MSFC TWT 534 SHUTTLE LAUNCH	T101	-1.500		0.000	BREF 3.5250 IN.
(B65020)	MSFC TWT 534 SHUTTLE LAUNCH	T201	-1.500		0.000	XMRP 3.4900 IN.
(B65004)	MSFC TWT 534 SHUTTLE LAUNCH	T101S1	-1.500	21.000	0.000	YMRP 0.0000 IN.
(B65022)	MSFC TWT 534 SHUTTLE LAUNCH	T201S1	-1.500	21.000	0.000	ZMRP 0.1616 IN.
						SCALE 0.0034

MACH .60

PAGE 145

TANK DIAMETER EFFECTS ON LONGITUDINAL CHARACTERISTICS

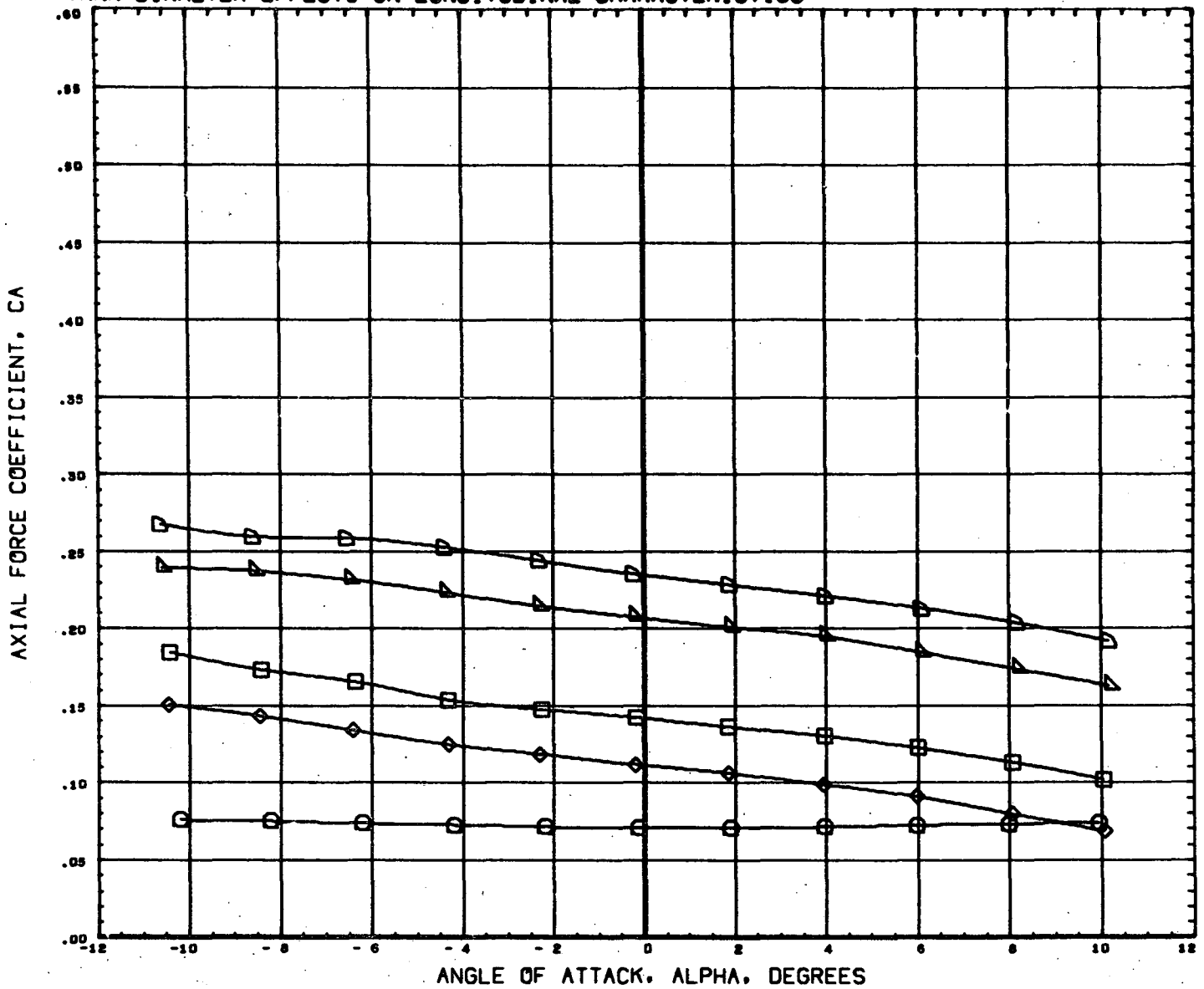

DATA SET SYMBOL	CONFIGURATION DESCRIPTION	ORBIN	THETS	BETA	REFERENCE INFORMATION
(B65001)	MSFC TWT 534 SHUTTLE LAUNCH T1			0.000	SREF 4.8950 SQ. IN
(B65019)	DATA NOT AVAILABLE FOR ALL CONDITIONS			0.000	LREF 2.6440 IN.
(B65002)	MSFC TWT 534 SHUTTLE LAUNCH T101	-1.500		0.000	BREF 3.5250 IN.
(B65020)	MSFC TWT 534 SHUTTLE LAUNCH T201	-1.500		0.000	XNRP 3.4900 IN.
(B65004)	MSFC TWT 534 SHUTTLE LAUNCH T101S1	-1.500	21.000	0.000	YNRP 0.0000 IN.
(B65022)	MSFC TWT 534 SHUTTLE LAUNCH T201S1	-1.500	21.000	0.000	ZNRP 0.1616 IN. SCALE 0.0034

MACH .80

PAGE 146

TANK DIAMETER EFFECTS ON LONGITUDINAL CHARACTERISTICS

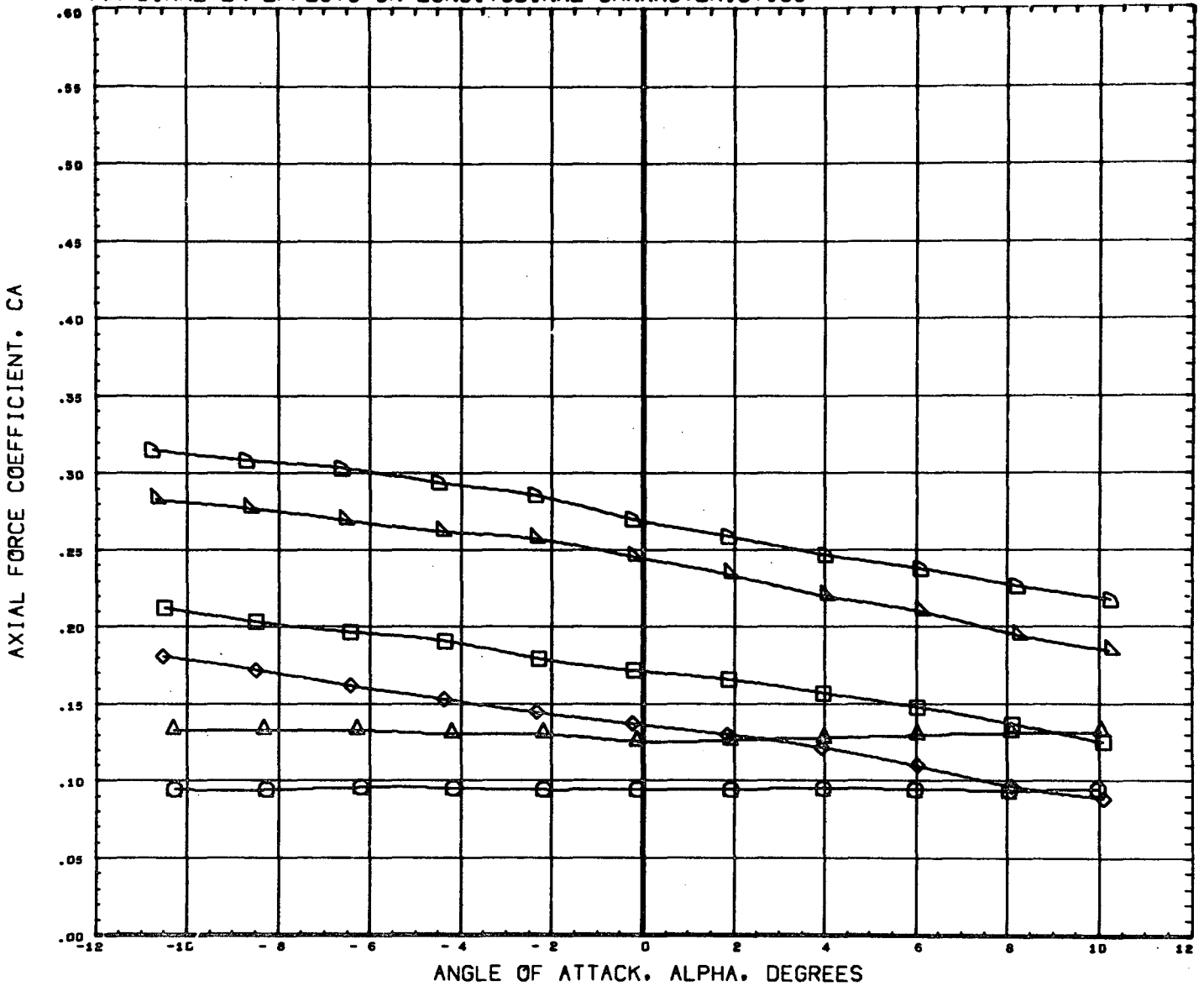

DATA SET SYMBOL	CONFIGURATION DESCRIPTION	ORBIN	THETS	BETA	REFERENCE INFORMATION
(B65001)	MSFC TWT 534 SHUTTLE LAUNCH	T1		0.000	SREF 4.8950 Sq. IN
(B65019)	MSFC TWT 534 SHUTTLE LAUNCH	T2		0.000	LREF 2.6440 IN.
(B65002)	MSFC TWT 534 SHUTTLE LAUNCH	T101	-1.500	0.000	BREF 3.5250 IN.
(B65020)	MSFC TWT 534 SHUTTLE LAUNCH	T201	-1.500	0.000	XMRP 3.4900 IN.
(B65004)	MSFC TWT 534 SHUTTLE LAUNCH	T101S1	-1.500	21.000	YMRP 0.0000 IN.
(B65022)	MSFC TWT 534 SHUTTLE LAUNCH	T201S1	-1.500	21.000	ZMRP 0.1616 IN.
					SCALE 0.0034

MACH .90

TANK DIAMETER EFFECTS ON LONGITUDINAL CHARACTERISTICS

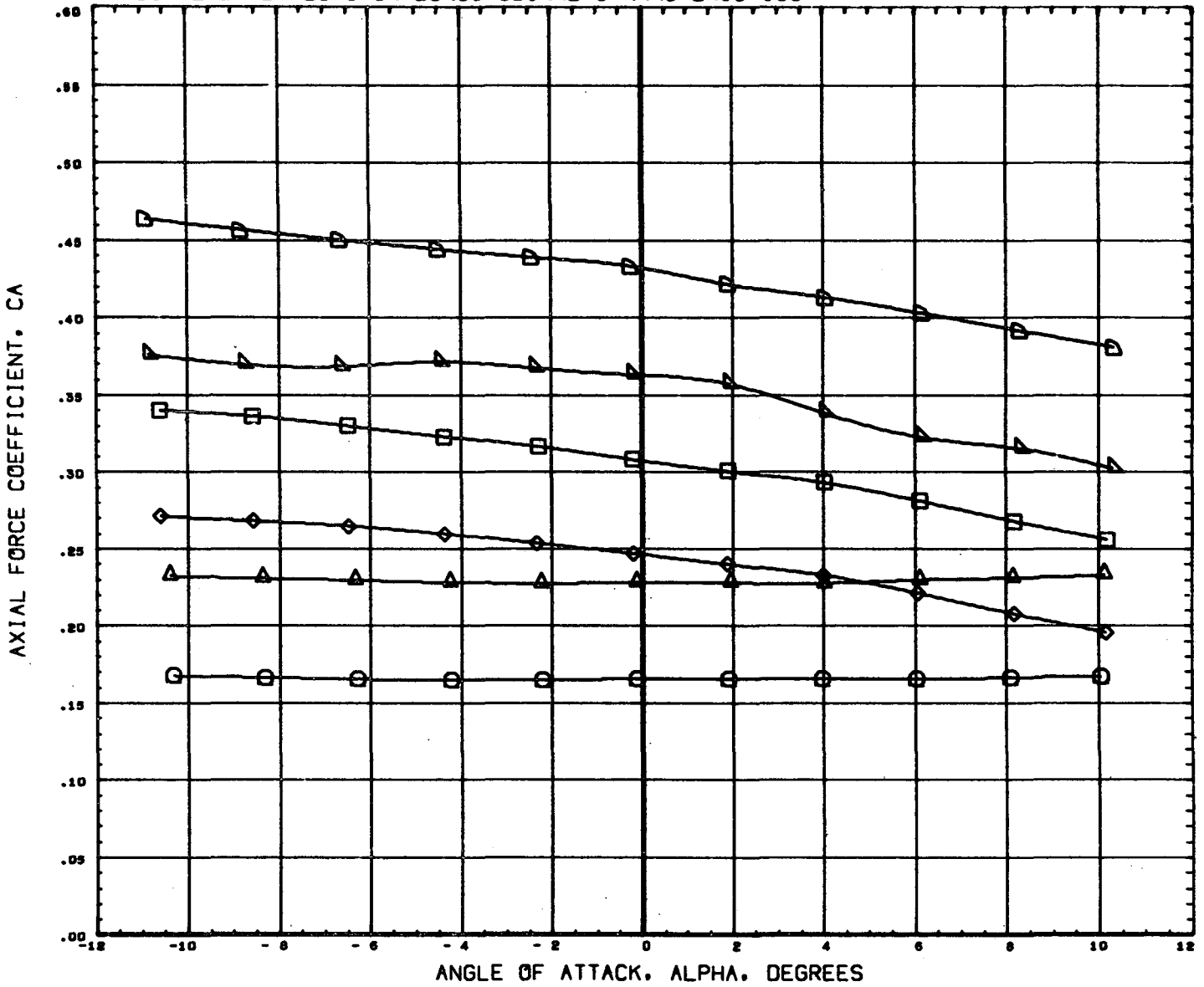

DATA SET SYMBOL	CONFIGURATION DESCRIPTION	T1	ORBIN	THETS	BETA	REFERENCE INFORMATION
(B65001)	MSFC TWT 534 SHUTTLE LAUNCH	T1			0.000	SREF 4.8950 SQ. IN
(B65019)	MSFC TWT 534 SHUTTLE LAUNCH	T2			0.000	LREF 2.6440 IN.
(B65002)	MSFC TWT 534 SHUTTLE LAUNCH	T101	-1.500		0.000	BREF 3.5250 IN.
(B65020)	MSFC TWT 534 SHUTTLE LAUNCH	T201	-1.500		0.000	XNRP 3.4900 IN.
(B65004)	MSFC TWT 534 SHUTTLE LAUNCH	T101S1	-1.500	21.000	0.000	YNRP 0.0000 IN.
(B65022)	MSFC TWT 534 SHUTTLE LAUNCH	T201S1	-1.500	21.000	0.000	ZNRP 0.1616 IN.
						SCALE 0.0034

MACH 1.10

PAGE 148

TANK DIAMETER EFFECTS ON LONGITUDINAL CHARACTERISTICS

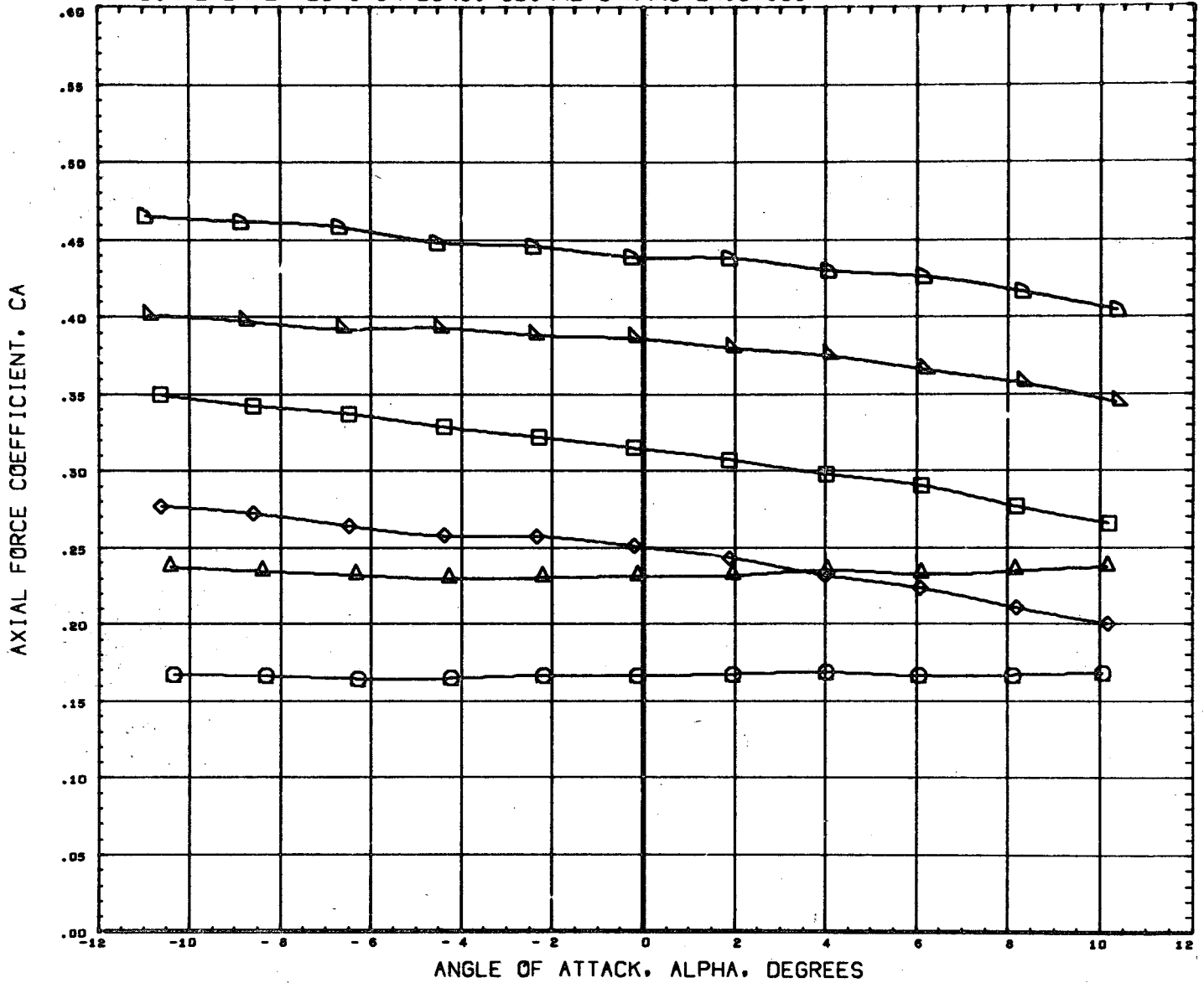

DATA SET SYMBOL	CONFIGURATION DESCRIPTION	T1	ORBIN	THETS	BETA	REFERENCE INFORMATION
(B65001)	MSFC TWT 534 SHUTTLE LAUNCH	T1			0.000	SREF 4.8950 SQ. IN
(B65019)	MSFC TWT 534 SHUTTLE LAUNCH	T2			0.000	LREF 2.6440 IN.
(B65002)	MSFC TWT 534 SHUTTLE LAUNCH	T101	-1.500		0.000	BREF 3.5250 IN.
(B65020)	MSFC TWT 534 SHUTTLE LAUNCH	T201	-1.500	21.000	0.000	XNRP 3.4900 IN.
(B65004)	MSFC TWT 534 SHUTTLE LAUNCH	T101S1	-1.500	21.000	0.000	YNRP 0.0000 IN.
(B65022)	MSFC TWT 534 SHUTTLE LAUNCH	T201S1	-1.500	21.000	0.000	ZNRP 0.1616 IN.
						SCALE 0.0034

MACH 1.20

PAGE 149

TANK DIAMETER EFFECTS ON LONGITUDINAL CHARACTERISTICS

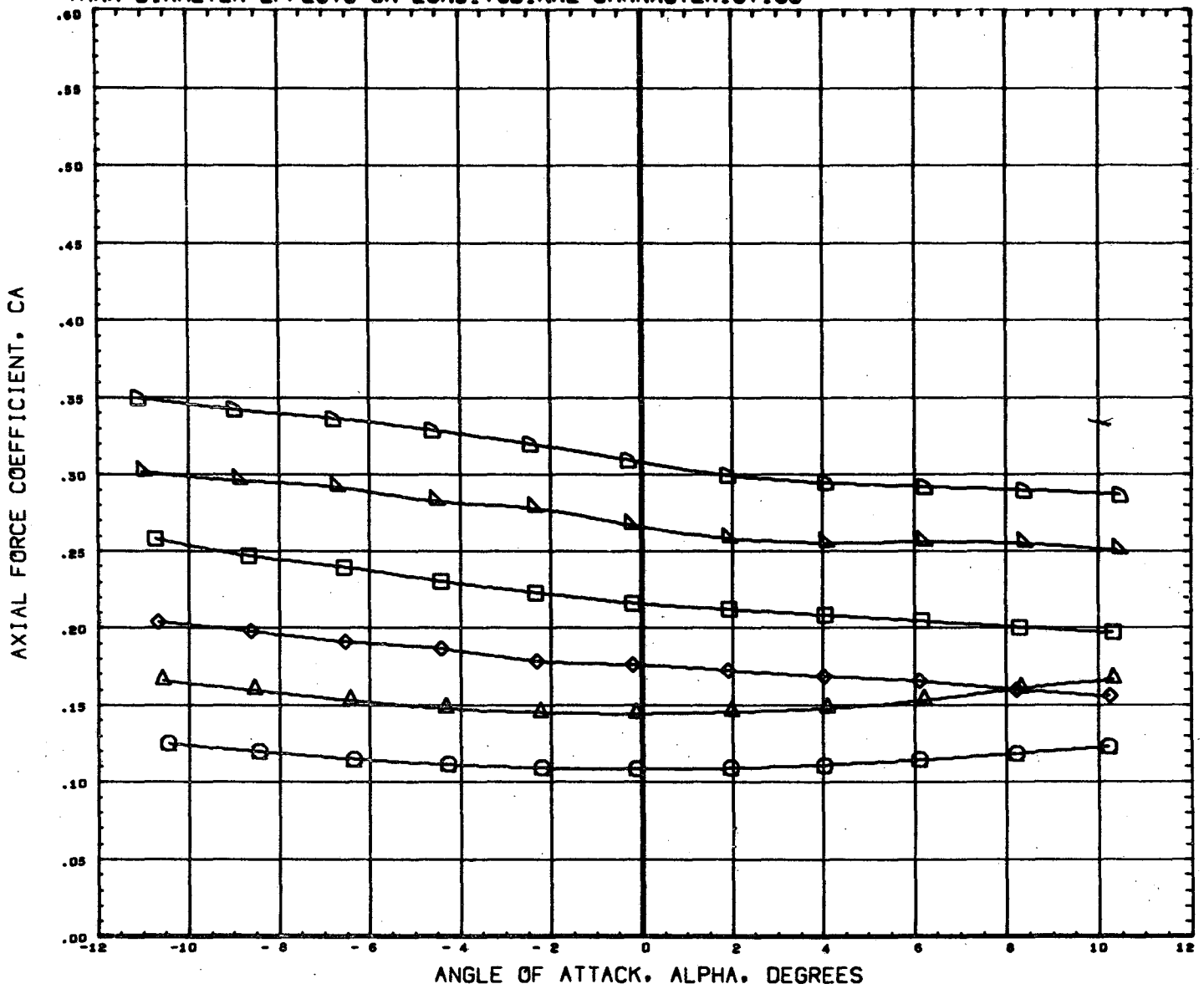

DATA SET SYMBOL	CONFIGURATION DESCRIPTION	T1	ORBIN	THETS	BETA	REFERENCE INFORMATION
(B65001)	MSFC TWT 534 SHUTTLE LAUNCH	T1			0.000	SREF 4.8950 SQ. IN
(B65019)	MSFC TWT 534 SHUTTLE LAUNCH	T2			0.000	LREF 2.6440 IN.
(B65002)	MSFC TWT 534 SHUTTLE LAUNCH	T1O1	-1.500		0.000	BREF 3.5250 IN.
(B65020)	MSFC TWT 534 SHUTTLE LAUNCH	T2O1	-1.500		0.000	XMRP 3.4900 IN.
(B65004)	MSFC TWT 534 SHUTTLE LAUNCH	T1O1S1	-1.500	21.000	0.000	YMRP 0.0000 IN.
(B65022)	MSFC TWT 534 SHUTTLE LAUNCH	T2O1S1	-1.500	21.000	0.000	ZMRP 0.1616 IN.
						SCALE 0.0034

TANK DIAMETER EFFECTS ON LONGITUDINAL CHARACTERISTICS

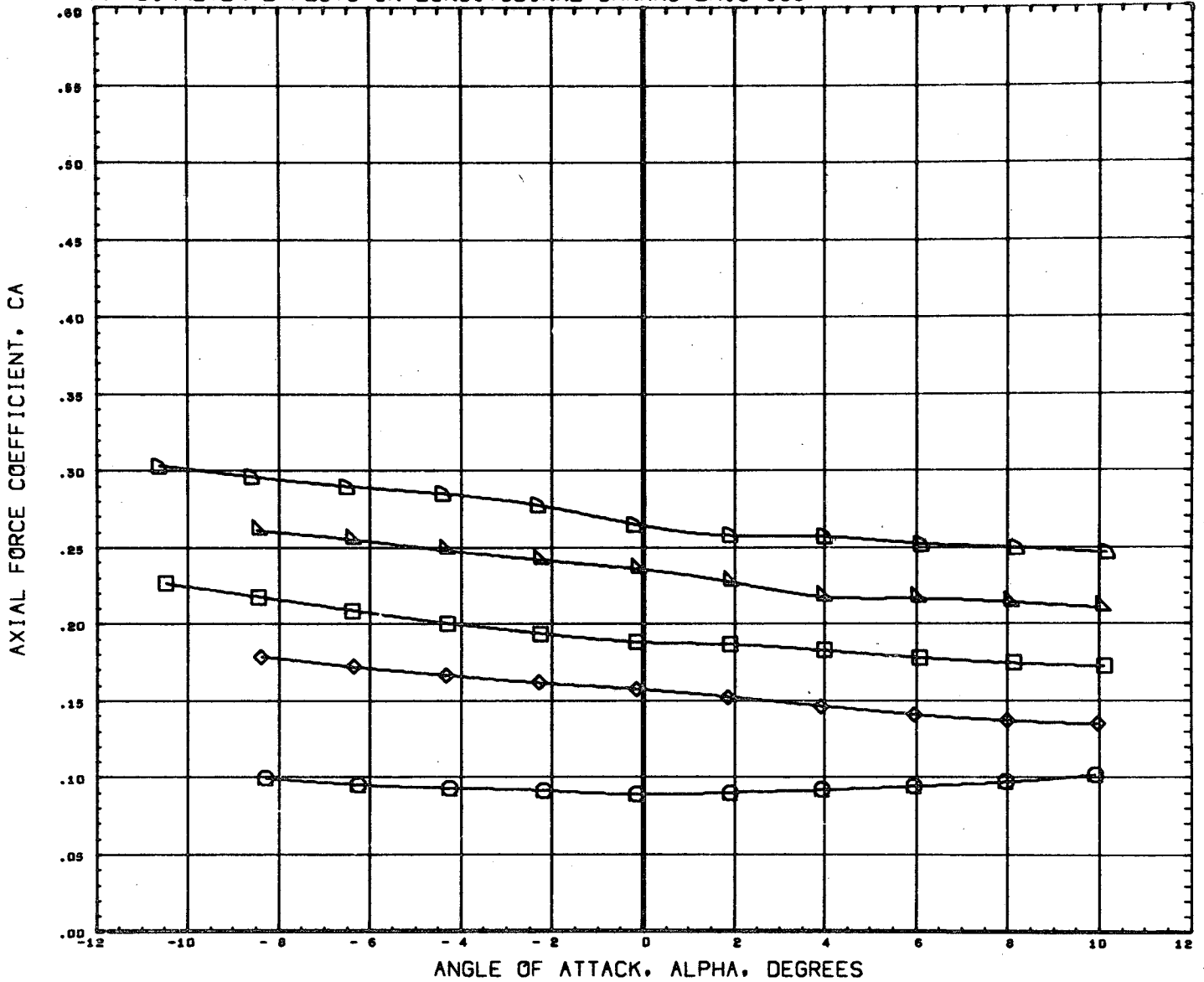

DATA SET SYMBOL	CONFIGURATION DESCRIPTION	T1	ORBIN	THETS	BETA	REFERENCE INFORMATION
(B65001)	MSFC TWT 534 SHUTTLE LAUNCH	T1			0.000	SREF 4.8950 SQ. IN
(B65019)	DATA NOT AVAILABLE FOR ALL CONDITIONS				0.000	LREF 2.6440 IN.
(B65002)	MSFC TWT 534 SHUTTLE LAUNCH	T101	-1.500		0.000	BREF 3.5250 IN.
(B65020)	MSFC TWT 534 SHUTTLE LAUNCH	T201	-1.500		0.000	XMRP 3.4900 IN.
(B65004)	MSFC TWT 534 SHUTTLE LAUNCH	T101S1	-1.500	21.000	0.000	YMRP 0.0000 IN.
(B65022)	MSFC TWT 534 SHUTTLE LAUNCH	T201S1	-1.500	21.000	0.000	ZMRP 0.1616 IN.
						SCALE 0.0034

MACH 2.74

PAGE 151

TANK DIAMETER EFFECTS ON LONGITUDINAL CHARACTERISTICS

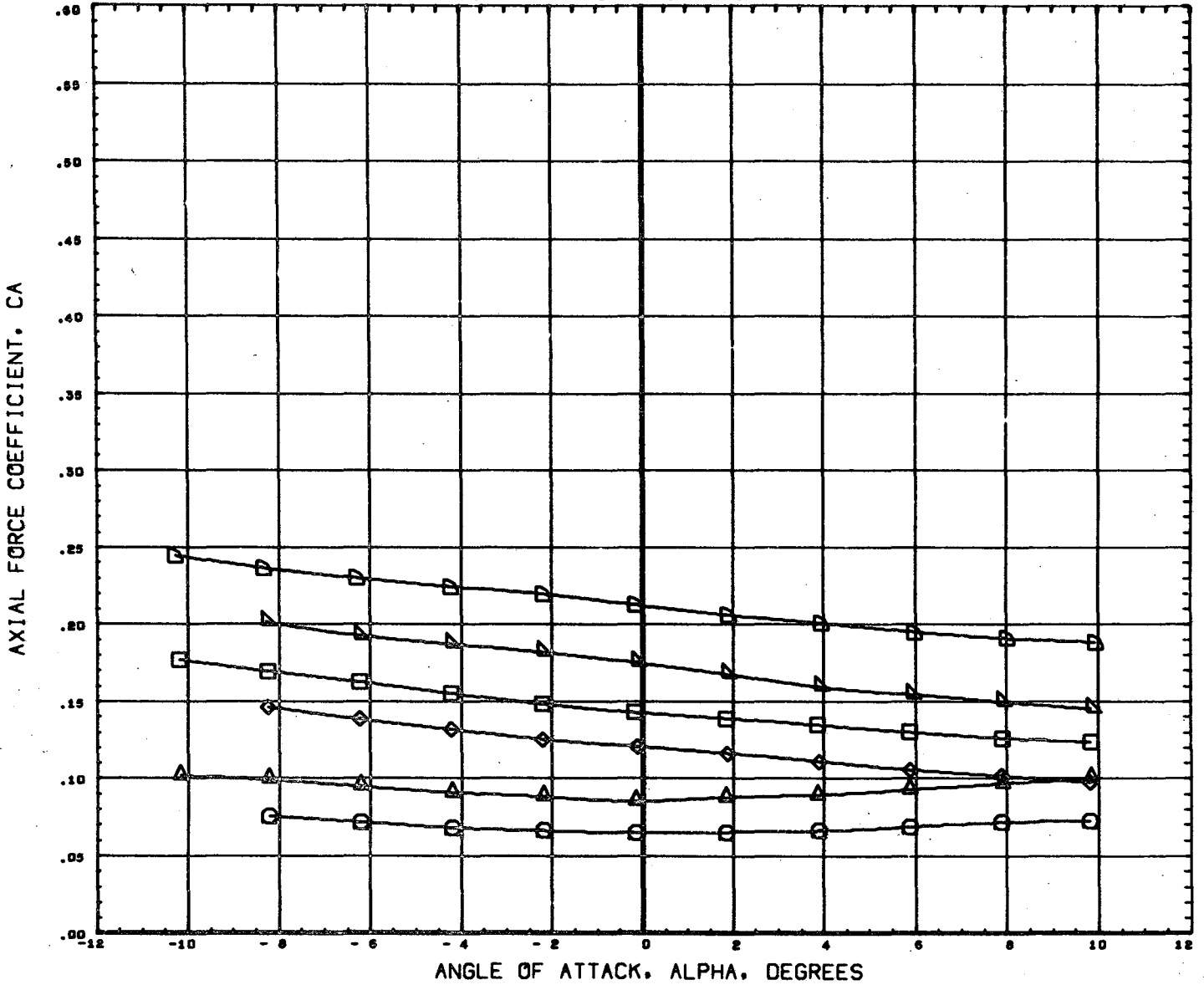

DATA SET SYMBOL	CONFIGURATION DESCRIPTION	ORBIT	THETS	BETA	REFERENCE INFORMATION
(865001)	MSFC TWT 534 SHUTTLE LAUNCH	T1		0.000	SREF 4.8950 90. IN
(865019)	MSFC TWT 534 SHUTTLE LAUNCH	T2		0.000	LREF 2.6440 IN.
(865002)	MSFC TWT 534 SHUTTLE LAUNCH	T101	-1.500	0.000	BREF 3.9250 IN.
(865020)	MSFC TWT 534 SHUTTLE LAUNCH	T201	-1.500	0.000	YNRP 3.4900 IN.
(865004)	MSFC TWT 534 SHUTTLE LAUNCH	T101S1	-1.500	21.000	YNRP 0.0000 IN.
(865022)	MSFC TWT 534 SHUTTLE LAUNCH	T201S1	-1.500	21.000	ZMRP 0.1616 IN.
					SCALE 0.0034

MACH 4.96

TANK DIAMETER EFFECTS ON LONGITUDINAL CHARACTERISTICS

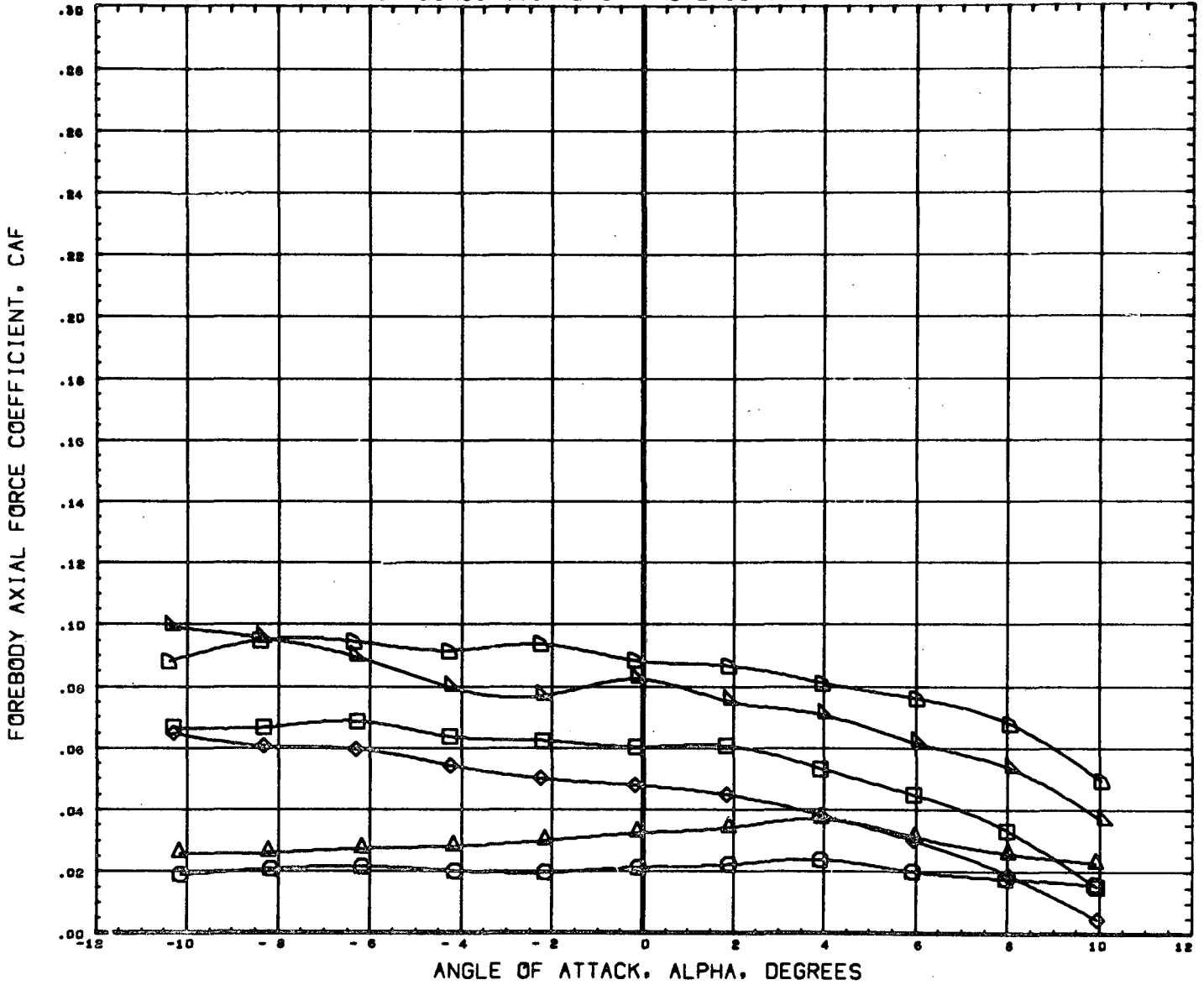

DATA SET SYMBOL	CONFIGURATION DESCRIPTION	T1	ORBIN	THETS	BETA	REFERENCE INFORMATION
(B65001)	MSFC TWT 534 SHUTTLE LAUNCH	T1			0.000	SREF 4.8950 SQ. IN
(B65019)	MSFC TWT 534 SHUTTLE LAUNCH	T2			0.000	LREF 2.6440 IN.
(B65002)	MSFC TWT 534 SHUTTLE LAUNCH	T101	-1.500		0.000	BREF 3.5250 IN.
(B65020)	MSFC TWT 534 SHUTTLE LAUNCH	T201	-1.500		0.000	XMRP 3.4900 IN.
(B65004)	MSFC TWT 534 SHUTTLE LAUNCH	T101S1	-1.500	21.000	0.000	YMRP 0.0000 IN.
(B65022)	MSFC TWT 534 SHUTTLE LAUNCH	T2C1S1	-1.500	21.000	0.000	ZMRP 0.1616 IN.
						SCALE 0.0034

MACH .60

TANK DIAMETER EFFECTS ON LONGITUDINAL CHARACTERISTICS

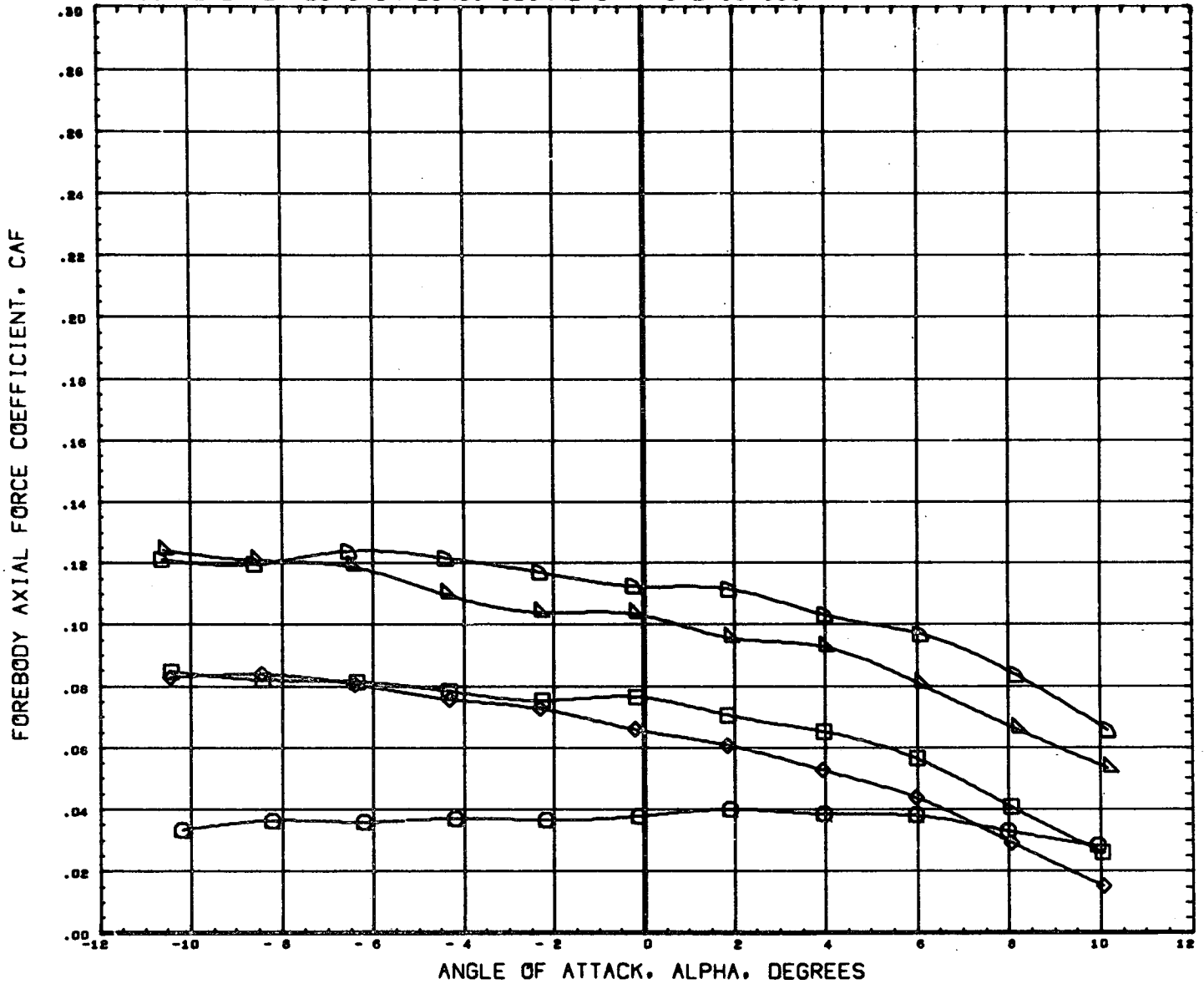

DATA SET SYMBOL	CONFIGURATION DESCRIPTION	ORBIN	THETS	BETA	REFERENCE INFORMATION
(B65001)	MSFC TWT 534 SHUTTLE LAUNCH T1			0.000	SREF 4.8950 SQ. IN
(B65019)	DATA NOT AVAILABLE FOR ALL CONDITIONS			0.000	LREF 2.6440 IN.
(B65002)	MSFC TWT 534 SHUTTLE LAUNCH T101	-1.500		0.000	BREF 3.5250 IN.
(B65020)	MSFC TWT 534 SHUTTLE LAUNCH T201	-1.500		0.000	XMRP 3.4900 IN.
(B65004)	MSFC TWT 534 SHUTTLE LAUNCH T101S1	-1.500	21.000	0.000	YMRP 0.0000 IN.
(B65022)	MSFC TWT 534 SHUTTLE LAUNCH T201S1	-1.500	21.000	0.000	ZMRP 0.1616 IN.
					SCALE 0.0034

MACH .80

PAGE 154

TANK DIAMETER EFFECTS ON LONGITUDINAL CHARACTERISTICS

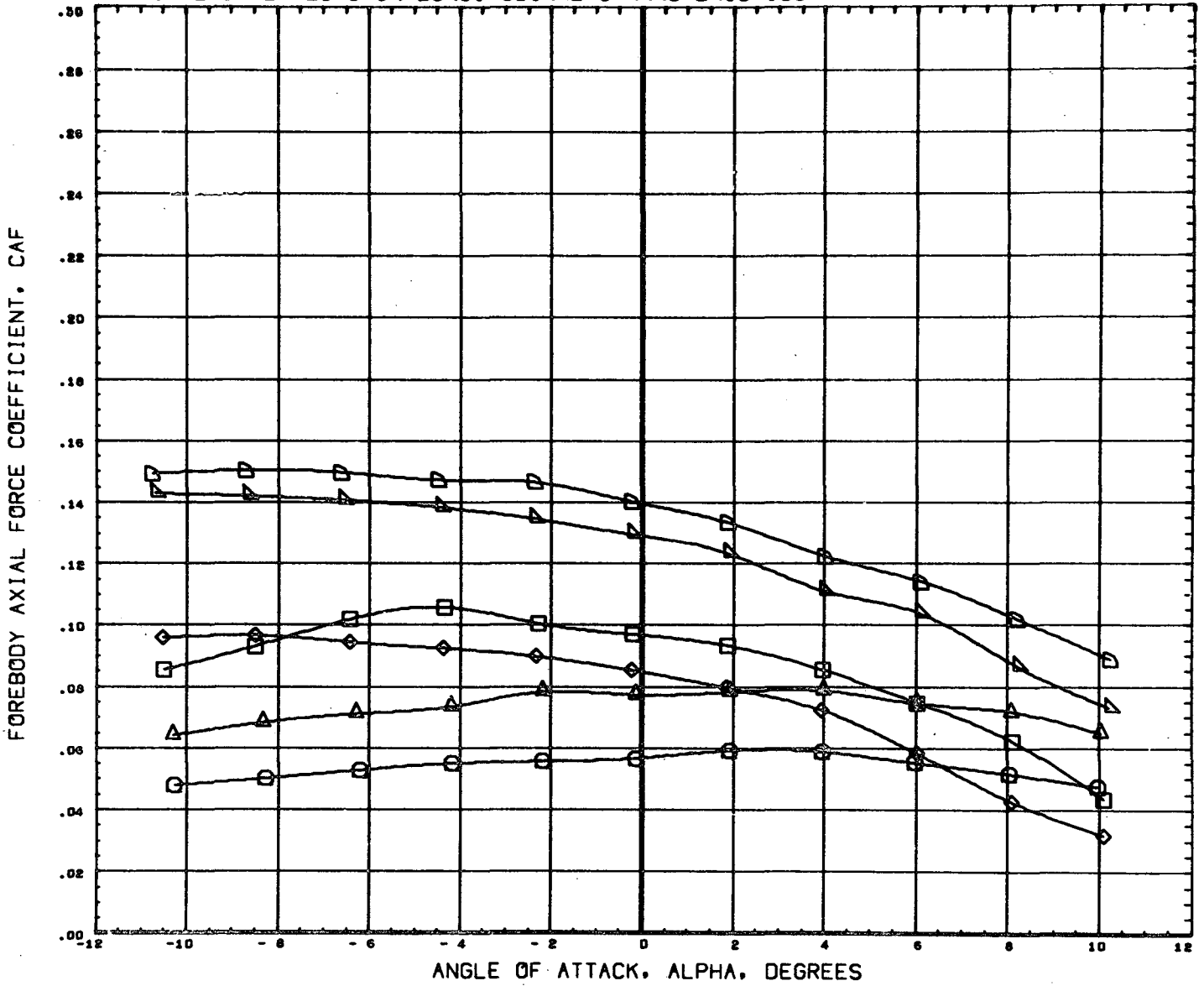

DATA SET SYMBOL	CONFIGURATION DESCRIPTION	T1	ORBIN	THETS	BETA	REFERENCE INFORMATION
(B65001)	MSFC TWT 534 SHUTTLE LAUNCH	T1			0.000	SREF 4.8950 SQ. IN
(B65019)	MSFC TWT 534 SHUTTLE LAUNCH	T2			0.000	LREF 2.6440 IN.
(B65002)	MSFC TWT 534 SHUTTLE LAUNCH	T101	-1.500		0.000	BREF 3.5250 IN.
(B65020)	MSFC TWT 534 SHUTTLE LAUNCH	T201	-1.500		0.000	XMRP 3.4900 IN.
(B65004)	MSFC TWT 534 SHUTTLE LAUNCH	T101S1	-1.500	21.000	0.000	YMRP 0.0000 IN.
(B65022)	MSFC TWT 534 SHUTTLE LAUNCH	T2C1S1	-1.500	21.000	0.000	ZMRP 0.1616 IN.
						SCALE 0.0034

MACH .90

TANK DIAMETER EFFECTS ON LONGITUDINAL CHARACTERISTICS

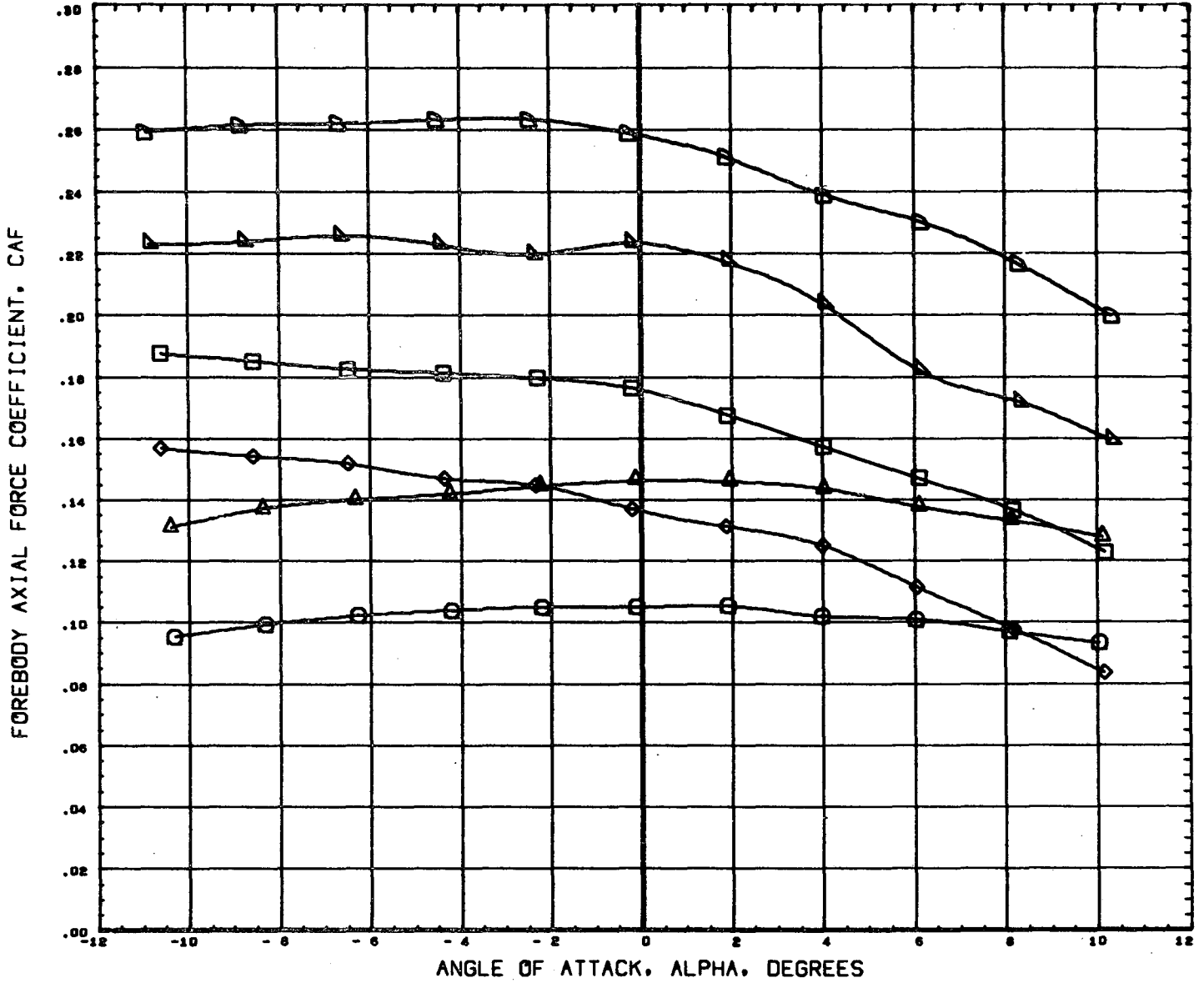

DATA SET SYMBOL	CONFIGURATION DESCRIPTION	ORBIN	THETS	BETA	REFERENCE INFORMATION
(B65001)	MSFC TWT 534 SHUTTLE LAUNCH	T1		0.000	SREF 4.8950 SQ. IN.
(B65019)	MSFC TWT 534 SHUTTLE LAUNCH	T2		0.000	LREF 2.6440 IN.
(B65002)	MSFC TWT 534 SHUTTLE LAUNCH	T101	-1.500	0.000	BREF 3.5250 IN.
(B65020)	MSFC TWT 534 SHUTTLE LAUNCH	T201	-1.500	0.000	XMRP 3.4900 IN.
(B65004)	MSFC TWT 534 SHUTTLE LAUNCH	T101S1	-1.500	21.000	YMRP 0.0000 IN.
(B65022)	MSFC TWT 534 SHUTTLE LAUNCH	T201S1	-1.500	21.000	ZMRP 0.1616 IN.
					SCALE 0.0034

TANK DIAMETER EFFECTS ON LONGITUDINAL CHARACTERISTICS

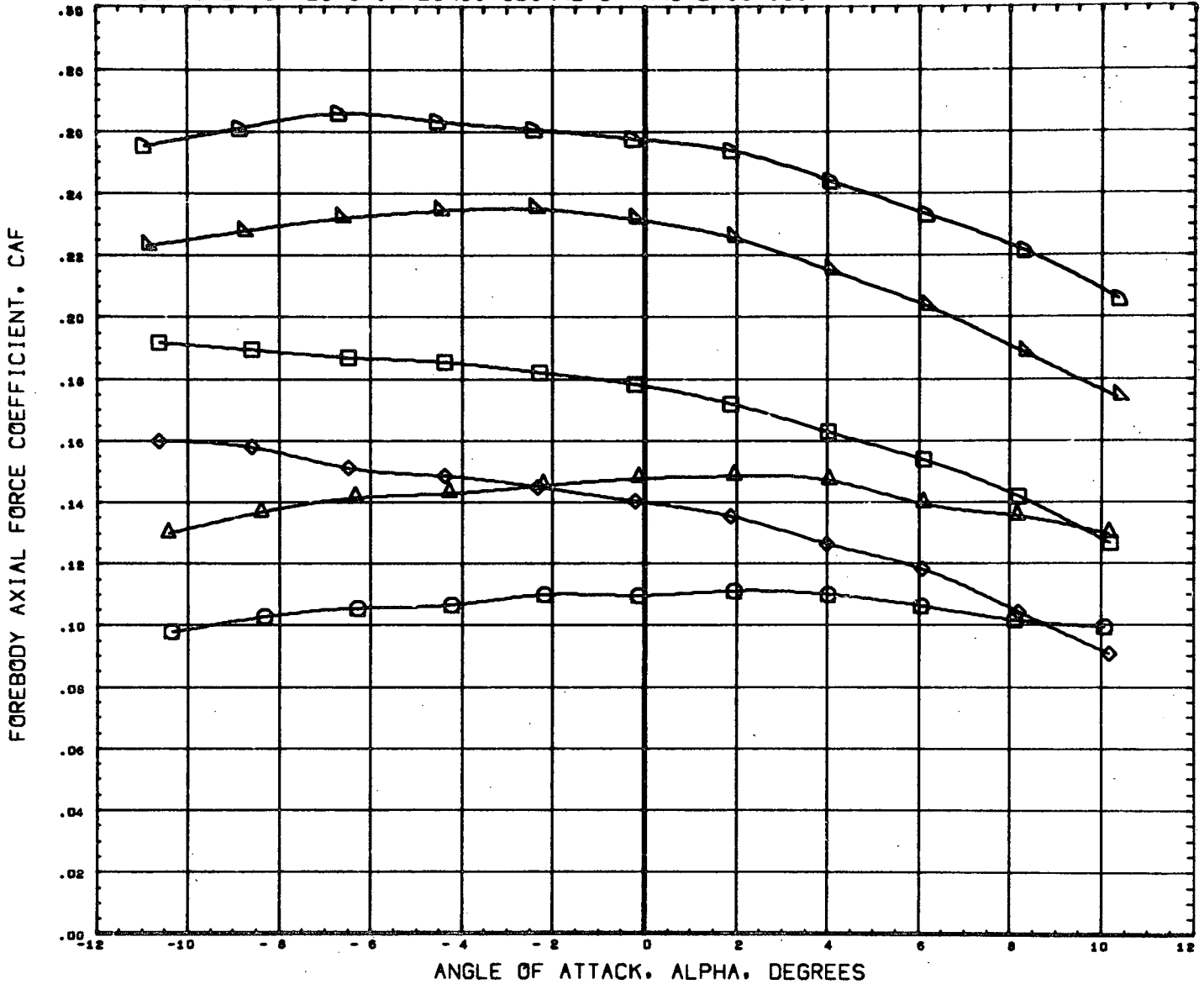

DATA SET SYMBOL	CONFIGURATION DESCRIPTION	ORBIN	THETS	BETA	REFERENCE INFORMATION
(B65001)	MSFC TWT 534 SHUTTLE LAUNCH	T1		0.000	SREF 4.8950 90. IN
(B65019)	MSFC TWT 534 SHUTTLE LAUNCH	T2		0.000	LREF 2.6440 IN.
(B65002)	MSFC TWT 534 SHUTTLE LAUNCH	T101	-1.500	0.000	BREF 3.5250 IN.
(B65020)	MSFC TWT 534 SHUTTLE LAUNCH	T201	-1.500	0.000	XNRP 3.4900 IN.
(B65004)	MSFC TWT 534 SHUTTLE LAUNCH	T101S1	-1.500	21.000	YNRP 0.0000 IN.
(B65022)	MSFC TWT 534 SHUTTLE LAUNCH	T201S1	-1.500	21.000	ZNRP 0.1616 IN.
					SCALE 0.0034

MACH 1.20

PAGE 157

TANK DIAMETER EFFECTS ON LONGITUDINAL CHARACTERISTICS

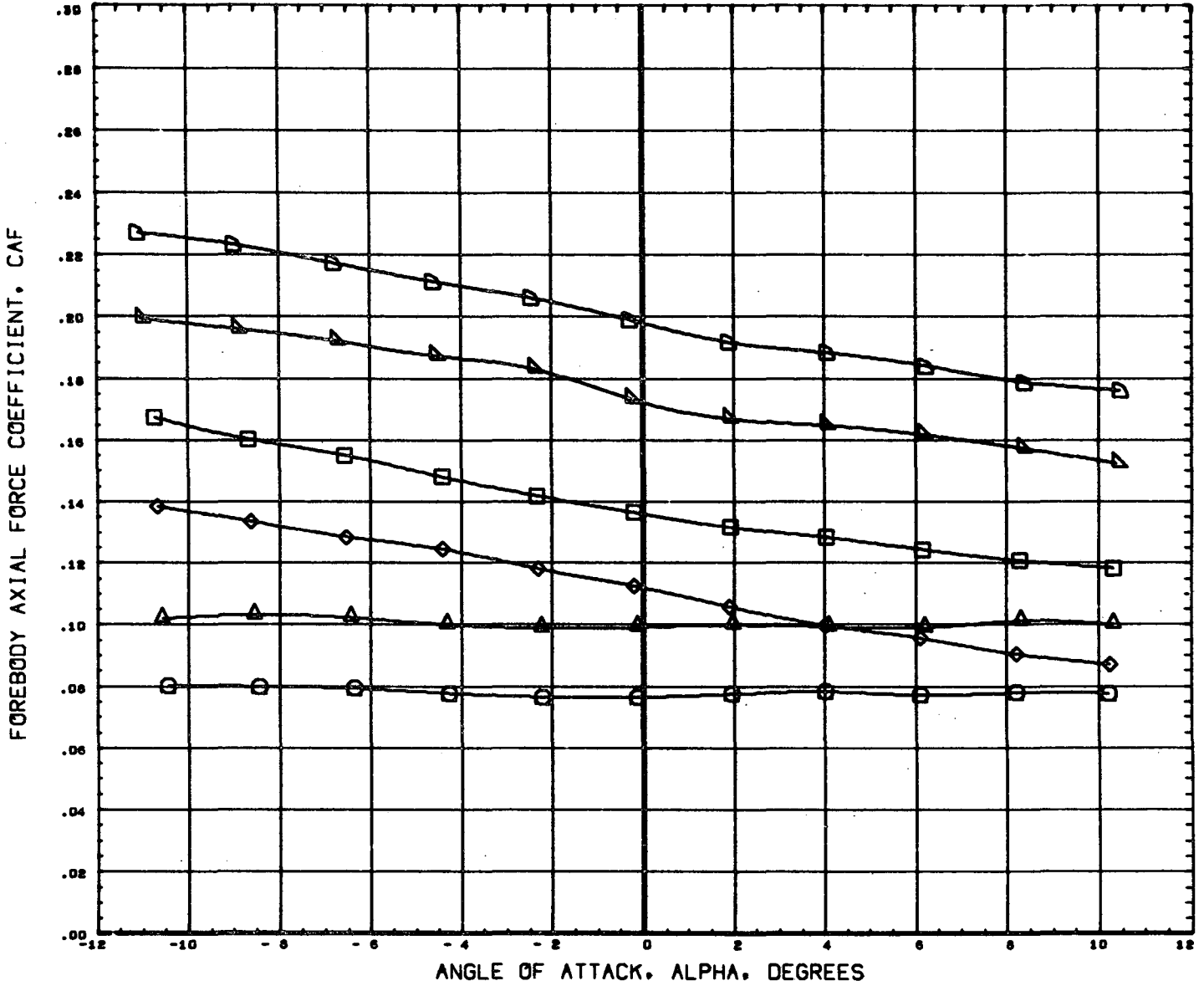

DATA SET SYMBOL	CONFIGURATION DESCRIPTION	T1	ORBIN	THETS	BETA	REFERENCE INFORMATION
(B65001)	MSFC TWT 534 SHUTTLE LAUNCH	T1			0.000	SREF 4.8950 SQ. IN
(B65019)	MSFC TWT 534 SHUTTLE LAUNCH	T2			0.000	LREF 2.6440 IN.
(B65002)	MSFC TWT 534 SHUTTLE LAUNCH	T101	-1.500		0.000	BREF 3.5250 IN.
(B65020)	MSFC TWT 534 SHUTTLE LAUNCH	T201	-1.500		0.000	XMRP 3.4900 IN.
(B65004)	MSFC TWT 534 SHUTTLE LAUNCH	T101S1	-1.500	21.000	0.000	YMRP 0.0000 IN.
(B65022)	MSFC TWT 534 SHUTTLE LAUNCH	T201S1	-1.500	21.000	0.000	ZMRP 0.1616 IN.
						SCALE 0.0034

TANK DIAMETER EFFECTS ON LONGITUDINAL CHARACTERISTICS

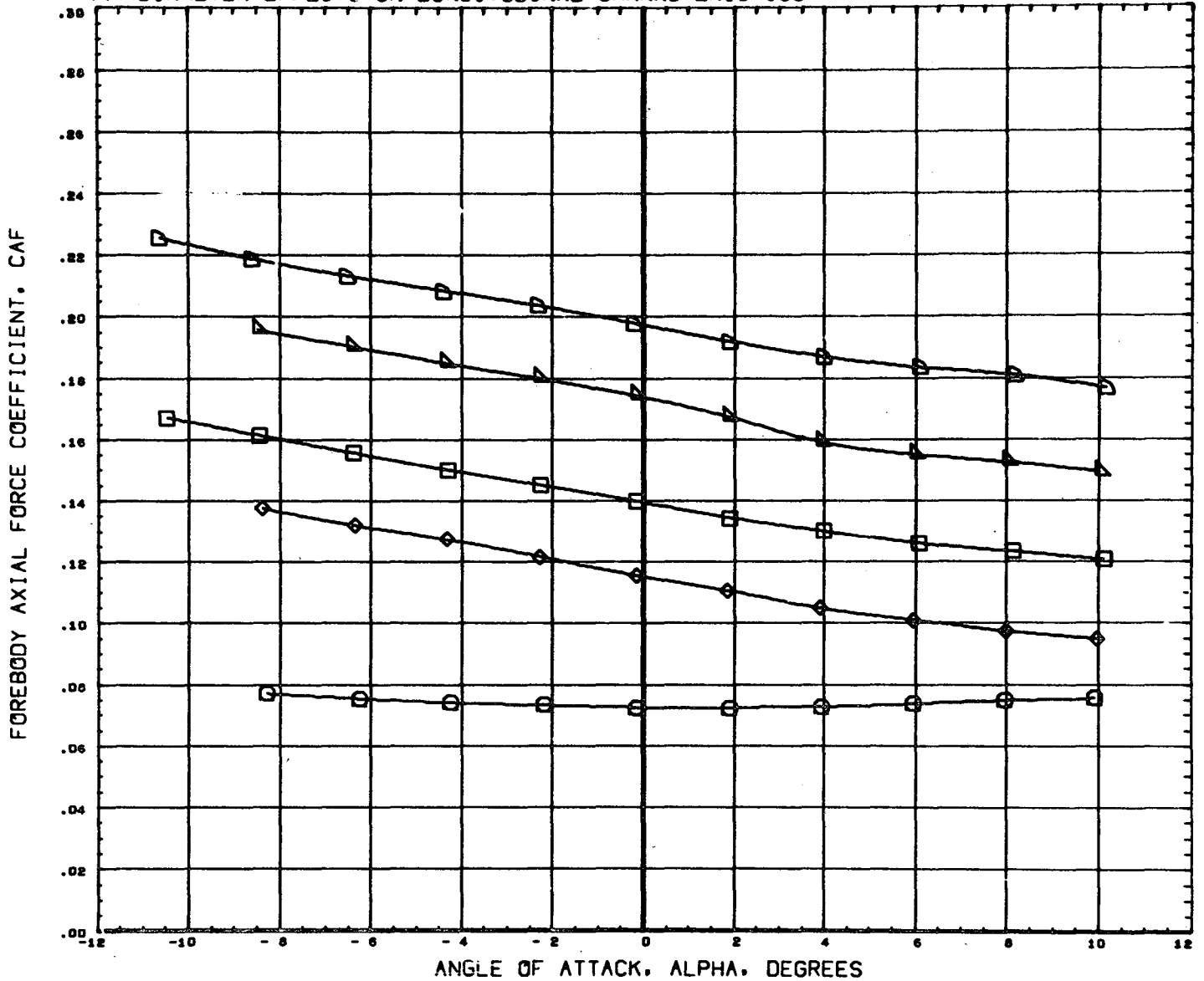

DATA SET SYMBOL	CONFIGURATION DESCRIPTION	ORBIT	THETA	BETA	REFERENCE INFORMATION
(B65001)	MSFC TWT 534 SHUTTLE LAUNCH T1			0.000	SREF 4.8950 SQ. IN
(B65019)	DATA NOT AVAILABLE FOR ALL CONDITIONS			0.000	LREF 2.6440 IN.
(B65002)	MSFC TWT 534 SHUTTLE LAUNCH T101	-1.500		0.000	BREF 3.3250 IN.
(B65020)	MSFC TWT 534 SHUTTLE LAUNCH T201	-1.500		0.000	XMRP 3.4900 IN.
(B65004)	MSFC TWT 534 SHUTTLE LAUNCH T101S1	-1.500	21.000	0.000	YMRP 0.0000 IN.
(B65022)	MSFC TWT 534 SHUTTLE LAUNCH T201S1	-1.500	21.000	0.000	ZMRP 0.1616 IN.
					SCALE 0.0034

MACH 2.74

PAGE 159

TANK DIAMETER EFFECTS ON LONGITUDINAL CHARACTERISTICS

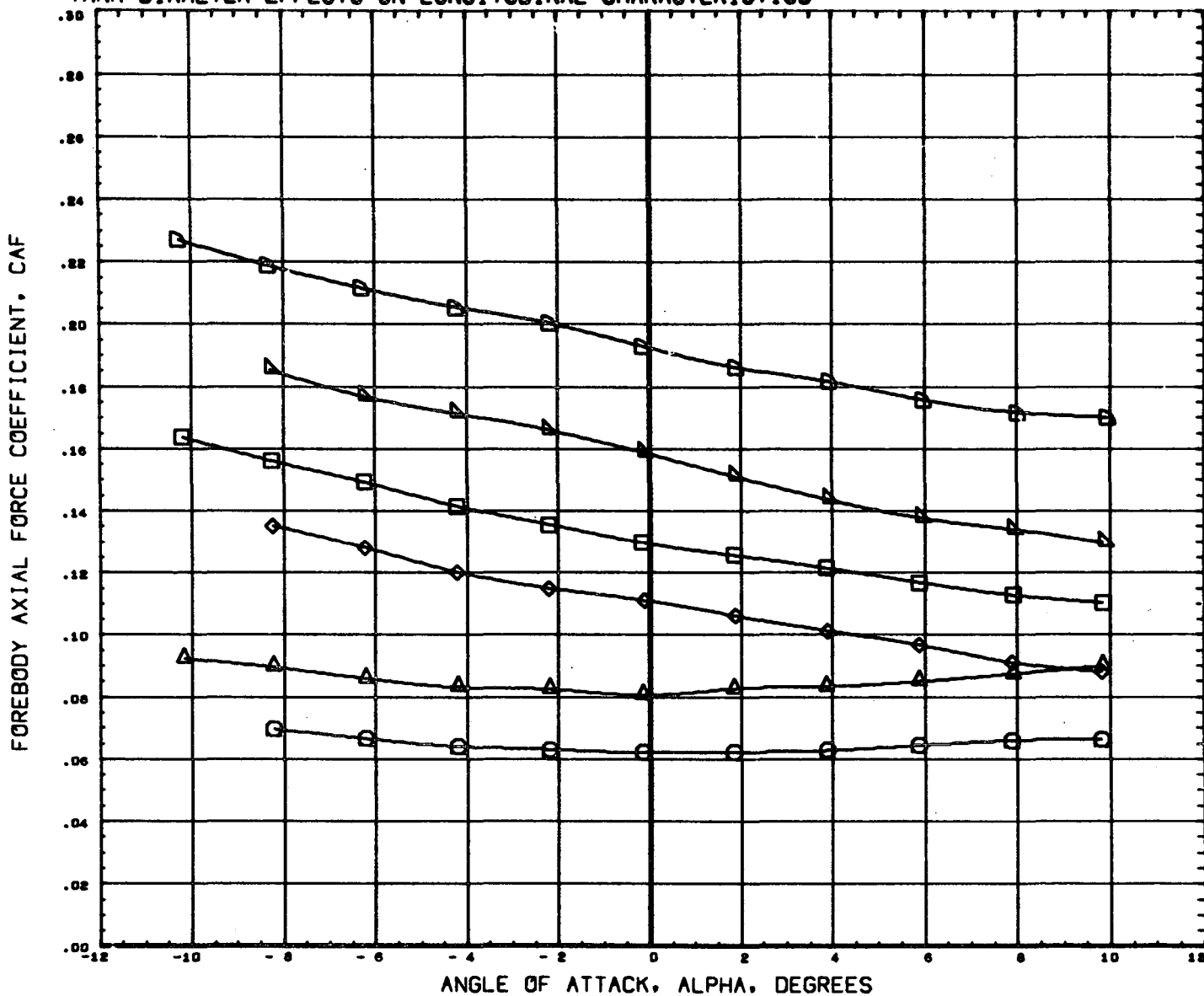

DATA SET SYMBOL	CONFIGURATION DESCRIPTION	T1	ORBIN	THETS	BETA	REFERENCE INFORMATION
(B65001)	MSFC TWT 534 SHUTTLE LAUNCH	T1			0.000	SREF 4.8950 sq. IN
(B65019)	MSFC TWT 534 SHUTTLE LAUNCH	T2			0.000	LREF 2.6440 IN.
(B65002)	MSFC TWT 534 SHUTTLE LAUNCH	T101	-1.500		0.000	BREF 3.5250 IN.
(B65020)	MSFC TWT 534 SHUTTLE LAUNCH	T201	-1.500		0.000	XMRP 3.4900 IN.
(B65004)	MSFC TWT 534 SHUTTLE LAUNCH	T101S1	-1.500	21.000	0.000	YMRP 0.0000 IN.
(B65022)	MSFC TWT 534 SHUTTLE LAUNCH	T201S1	-1.500	21.000	0.000	ZMRP 0.1616 IN.
						SCALE 0.0034

MACH

4.96

PAGE 160

TANK DIAMETER EFFECTS ON LONGITUDINAL CHARACTERISTICS

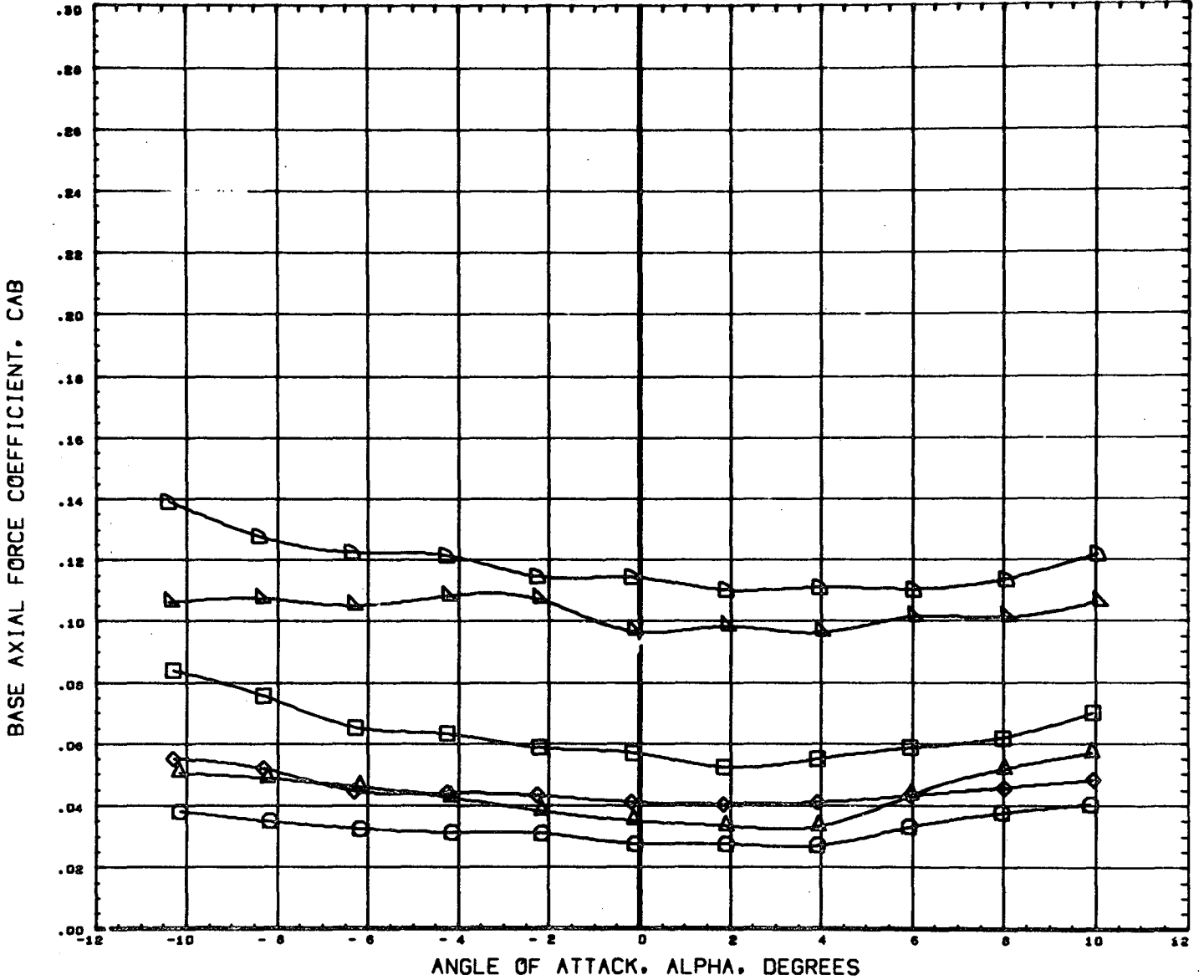

DATA SET SYMBOL	CONFIGURATION DESCRIPTION	T1	ORBIN	THETS	BETA	REFERENCE INFORMATION
(B65001)	MSFC TWT 534 SHUTTLE LAUNCH	T1			0.000	SREF 4.8950 SQ. IN
(B65019)	MSFC TWT 534 SHUTTLE LAUNCH	T2			0.000	LREF 2.6440 IN.
(B65002)	MSFC TWT 534 SHUTTLE LAUNCH	T101	-1.500		0.000	BREF 3.5250 IN.
(B65020)	MSFC TWT 534 SHUTTLE LAUNCH	T201	-1.500		0.000	XMRP 3.4900 IN.
(B65004)	MSFC TWT 534 SHUTTLE LAUNCH	T101S1	-1.500	21.000	0.000	YMRP 0.0000 IN.
(B65022)	MSFC TWT 534 SHUTTLE LAUNCH	T201S1	-1.500	21.000	0.000	ZMRP 0.1616 IN.
						SCALE 0.0034

MACH .60

PAGE 161

TANK DIAMETER EFFECTS ON LONGITUDINAL CHARACTERISTICS

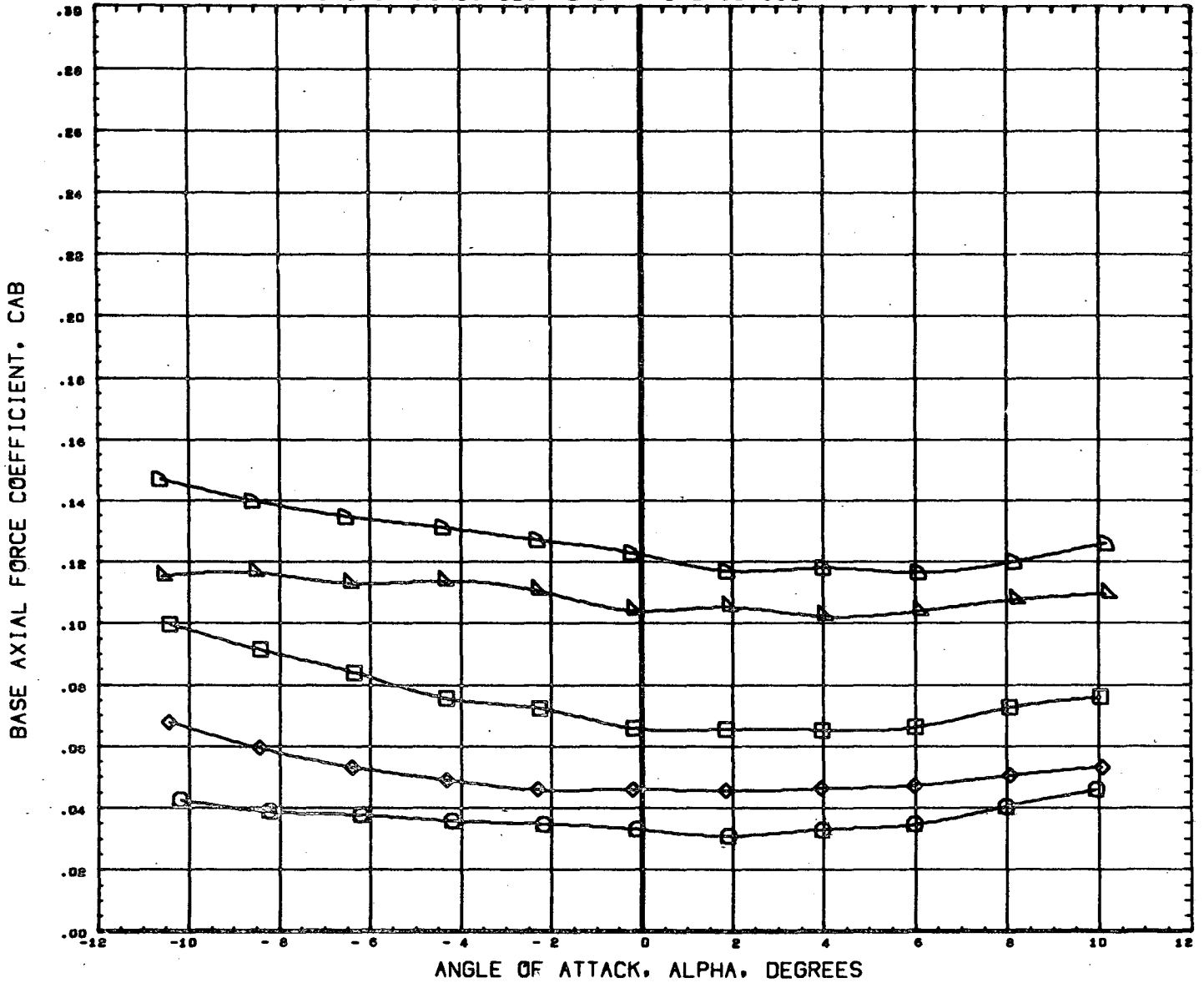

DATA SET SYMBOL	CONFIGURATION DESCRIPTION	T1	ORBIN	THETS	BETA	REFERENCE INFORMATION
(B65001)	MSFC TWT 534 SHUTTLE LAUNCH	T1			0.000	SREF 4.8950 SQ. IN
(B65019)	DATA NOT AVAILABLE FOR ALL CONDITIONS				0.000	LREF 2.6440 IN.
(B65002)	MSFC TWT 534 SHUTTLE LAUNCH	T101	-1.500		0.000	BREF 3.5250 IN.
(B65020)	MSFC TWT 534 SHUTTLE LAUNCH	T201	-1.500		0.000	XNRP 3.4900 IN.
(B65004)	MSFC TWT 534 SHUTTLE LAUNCH	T101S1	-1.500	21.000	0.000	YHRP 0.0000 IN.
(B65022)	MSFC TWT 534 SHUTTLE LAUNCH	T201S1	-1.500	21.000	0.000	ZHRP 0.1616 IN.
						SCALE 0.0034

TANK DIAMETER EFFECTS ON LONGITUDINAL CHARACTERISTICS

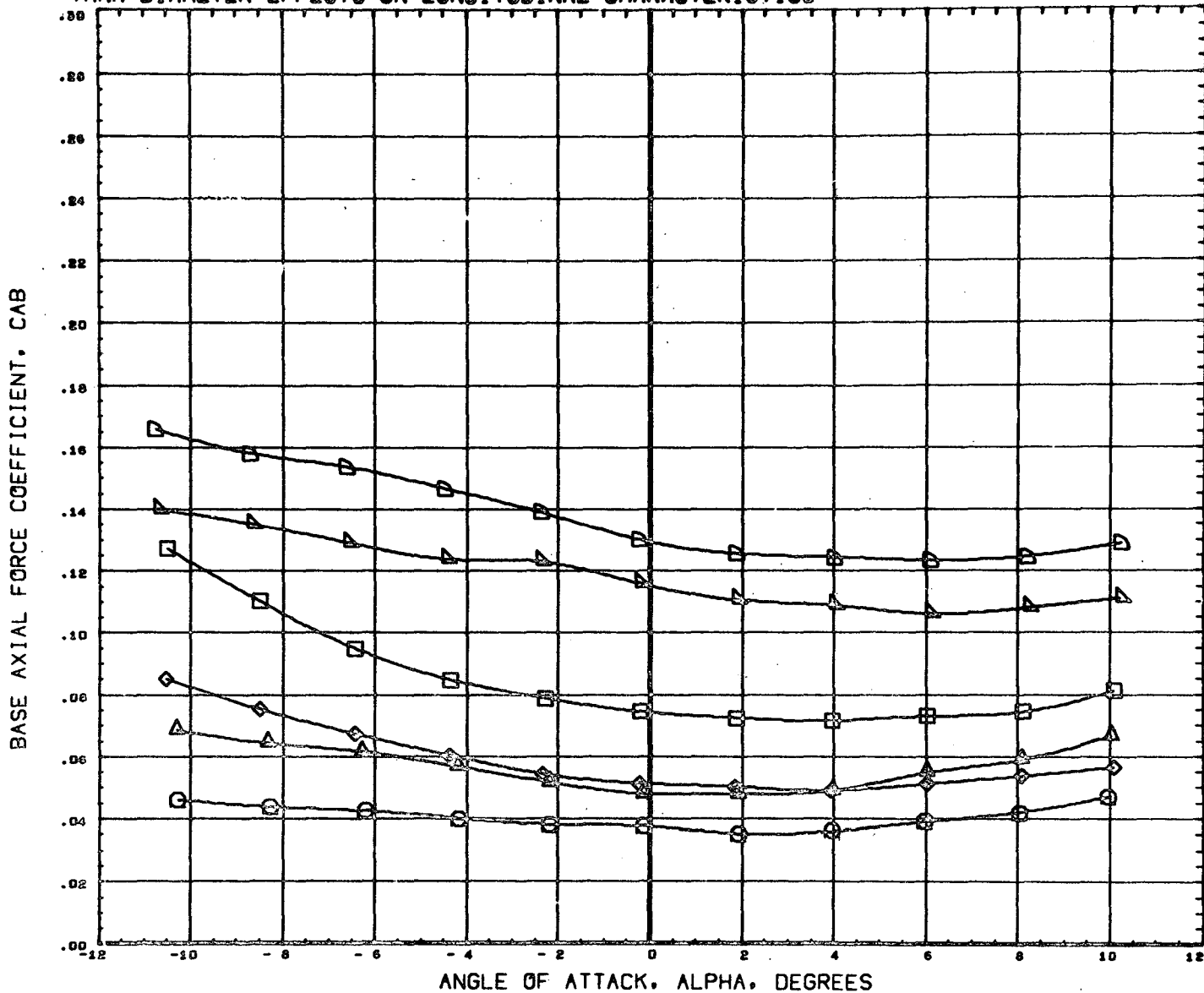

DATA SET SYMBOL	CONFIGURATION DESCRIPTION	T1	ORBIN	THETS	BETA	REFERENCE INFORMATION
(B65001)	MSFC TWT 534 SHUTTLE LAUNCH	T1			0.000	SREF 4.8950 SQ. IN
(B65019)	MSFC TWT 534 SHUTTLE LAUNCH	T2			0.000	LREF 2.6440 IN.
(B65002)	MSFC TWT 534 SHUTTLE LAUNCH	T101	-1.500		0.000	BREF 3.5250 IN.
(B65020)	MSFC TWT 534 SHUTTLE LAUNCH	T201	-1.500		0.000	XMRP 3.4900 IN.
(B65004)	MSFC TWT 534 SHUTTLE LAUNCH	T101S1	-1.500	21.000	0.000	YMRP 0.0000 IN.
(B65022)	MSFC TWT 534 SHUTTLE LAUNCH	T201S1	-1.500	21.000	0.000	ZMRP 0.1616 IN.
						SCALE 0.0034

MACH .90

PAGE 163

TANK DIAMETER EFFECTS ON LONGITUDINAL CHARACTERISTICS

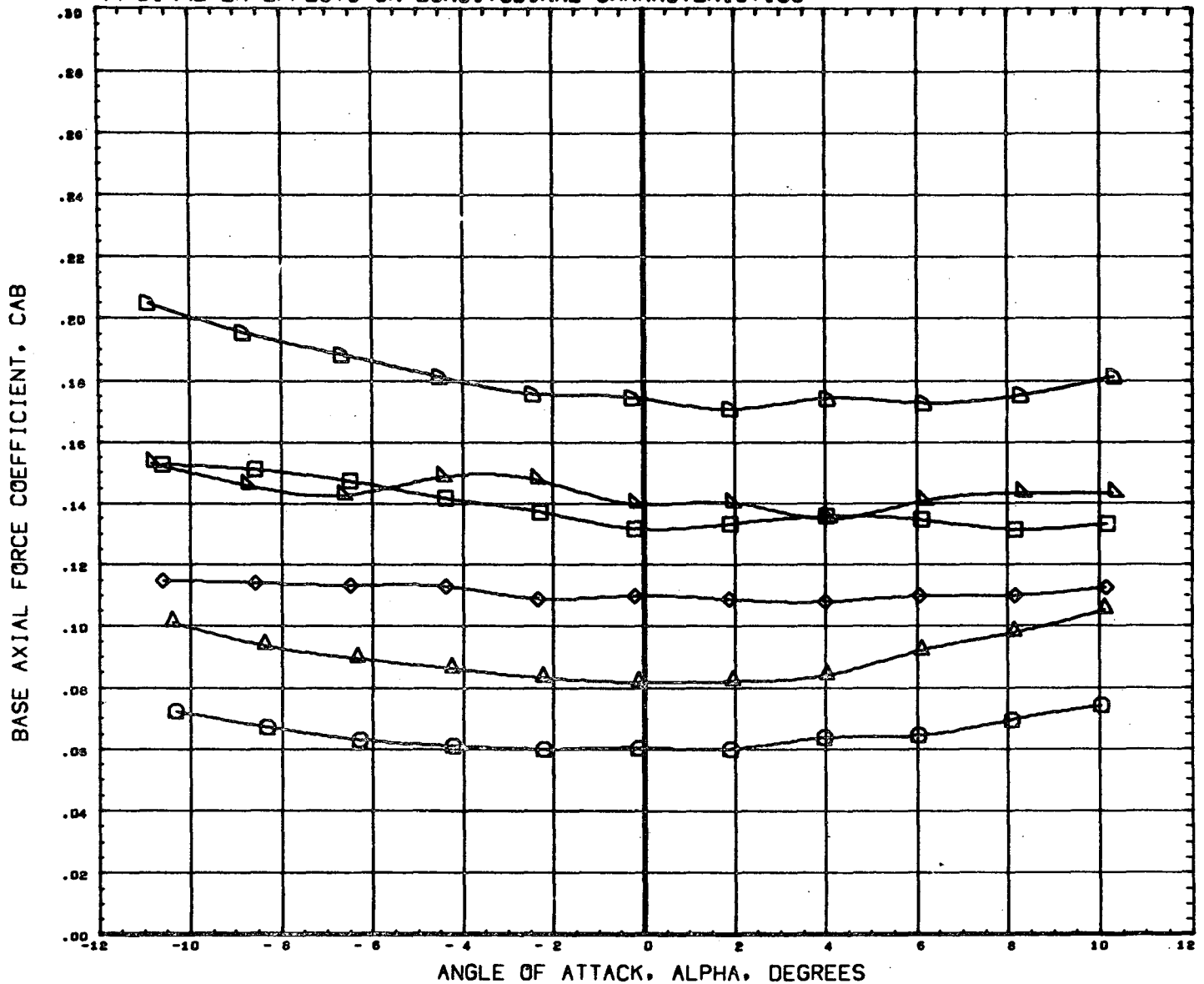

DATA SET SYMBOL	CONFIGURATION DESCRIPTION	T1	ORBIN	THETS	BETA	REFERENCE INFORMATION
(B65001)	MSFC TWT 534 SHUTTLE LAUNCH	T1			0.000	SREF 4.8950 SQ. IN
(B65019)	MSFC TWT 534 SHUTTLE LAUNCH	T2			0.000	LREF 2.6440 IN.
(B65002)	MSFC TWT 534 SHUTTLE LAUNCH	T101	-1.500		0.000	BREF 3.5250 IN.
(B65020)	MSFC TWT 534 SHUTTLE LAUNCH	T201	-1.500		0.000	XMRP 3.4900 IN.
(B65004)	MSFC TWT 534 SHUTTLE LAUNCH	T101S1	-1.500	21.000	0.000	YMRP 0.0000 IN.
(B65022)	MSFC TWT 534 SHUTTLE LAUNCH	T201S1	-1.500	21.000	0.000	ZMRP 0.1616 IN.
						SCALE 0.0034

MACH 1.10

PAGE 164

TANK DIAMETER EFFECTS ON LONGITUDINAL CHARACTERISTICS

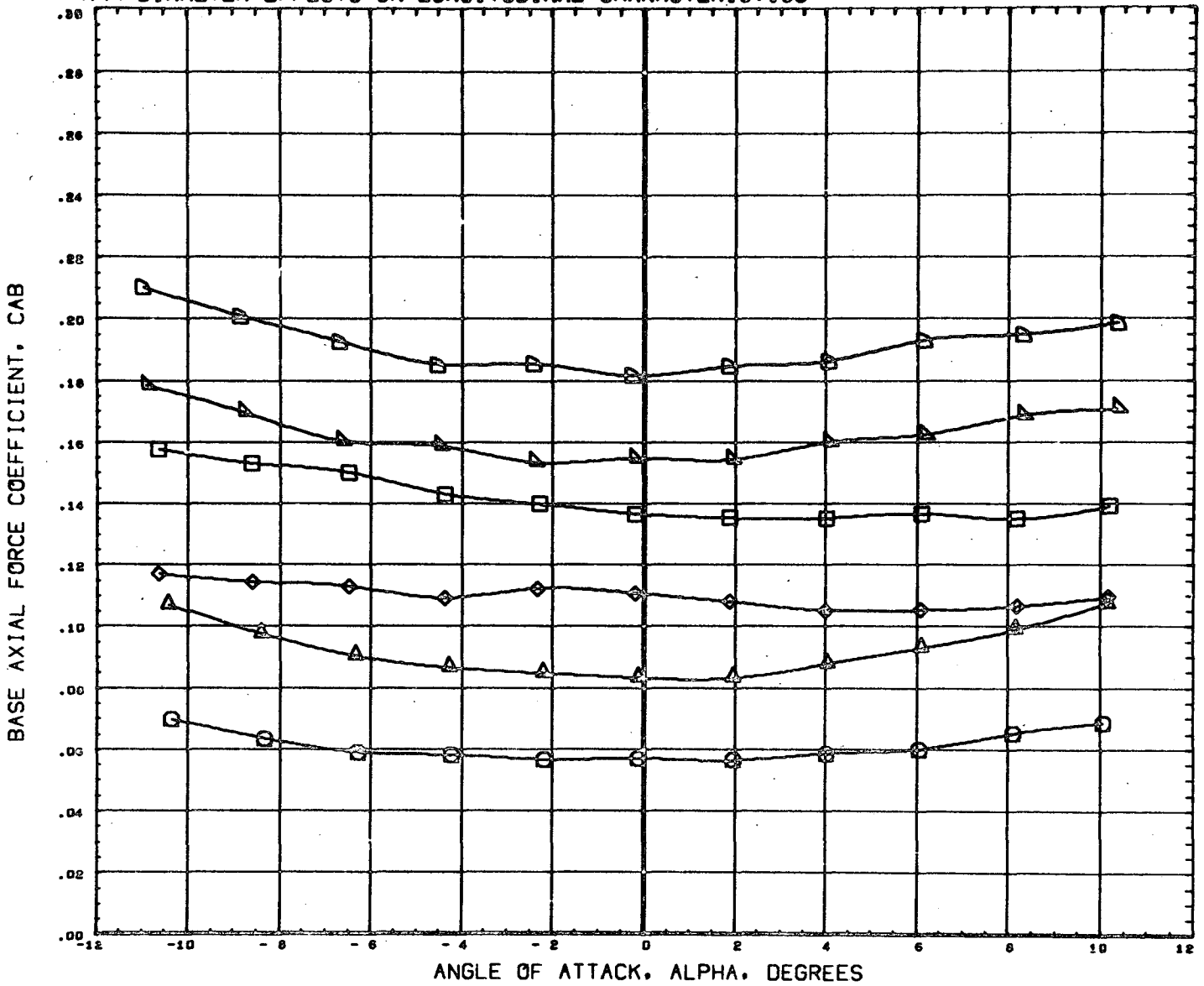

DATA SET SYMBOL	CONFIGURATION DESCRIPTION	ORBIN	THETS	BETA	REFERENCE INFORMATION
(B65001)	MSFC TWT 534 SHUTTLE LAUNCH	T1		0.000	SREF 4.8950 SQ. IN
(B65019)	MSFC TWT 534 SHUTTLE LAUNCH	T2		0.000	LREF 2.6440 IN.
(B65002)	MSFC TWT 534 SHUTTLE LAUNCH	T101	-1.500	0.000	BREF 3.5250 IN.
(B65020)	MSFC TWT 534 SHUTTLE LAUNCH	T201	-1.500	0.000	XMRP 3.4900 IN.
(B65004)	MSFC TWT 534 SHUTTLE LAUNCH	T101S1	-1.500	21.000	YMRP 0.0000 IN.
(B65022)	MSFC TWT 534 SHUTTLE LAUNCH	T201S1	-1.500	21.000	ZMRP 0.1616 IN.
					SCALE 0.0034

MACH 1.20

TANK DIAMETER EFFECTS ON LONGITUDINAL CHARACTERISTICS

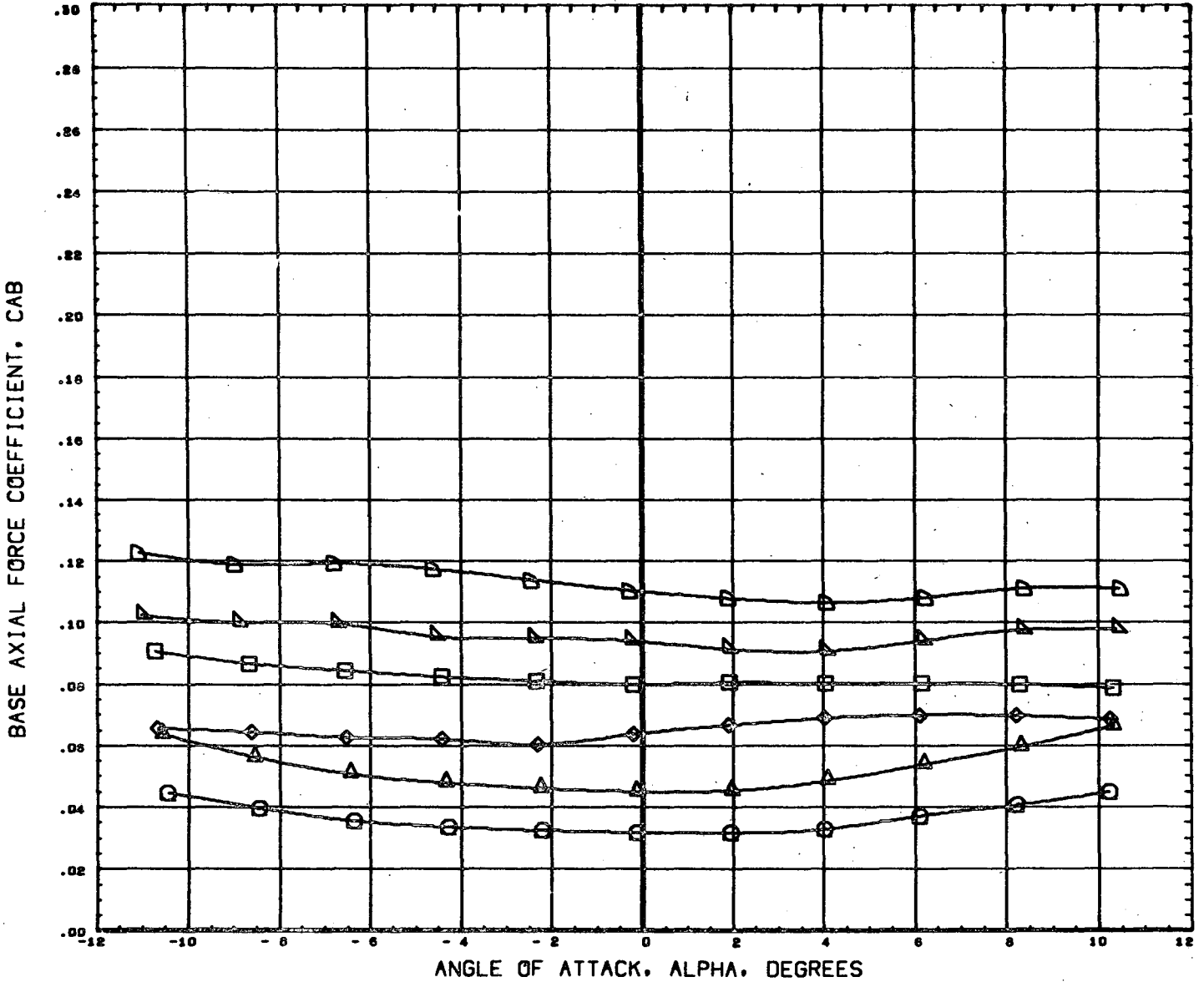

DATA SET SYMBOL	CONFIGURATION DESCRIPTION	ORBIN	THETS	BETA	REFERENCE INFORMATION
(B65001)	MSFC TWT 534 SHUTTLE LAUNCH	T1		0.000	SREF 4.8950 SQ. IN
(B65019)	MSFC TWT 534 SHUTTLE LAUNCH	T2		0.000	LREF 2.6440 IN.
(B65002)	MSFC TWT 534 SHUTTLE LAUNCH	T101	-1.500	0.000	BREF 3.5250 IN.
(B65020)	MSFC TWT 534 SHUTTLE LAUNCH	T201	-1.500	0.000	XMRP 3.4900 IN.
(B65004)	MSFC TWT 534 SHUTTLE LAUNCH	T101S1	-1.500	21.000	YMRP 0.0000 IN.
(B65022)	MSFC TWT 534 SHUTTLE LAUNCH	T201S1	-1.500	21.000	ZMRP 0.1616 IN.
					SCALE 0.0034

TANK DIAMETER EFFECTS ON LONGITUDINAL CHARACTERISTICS

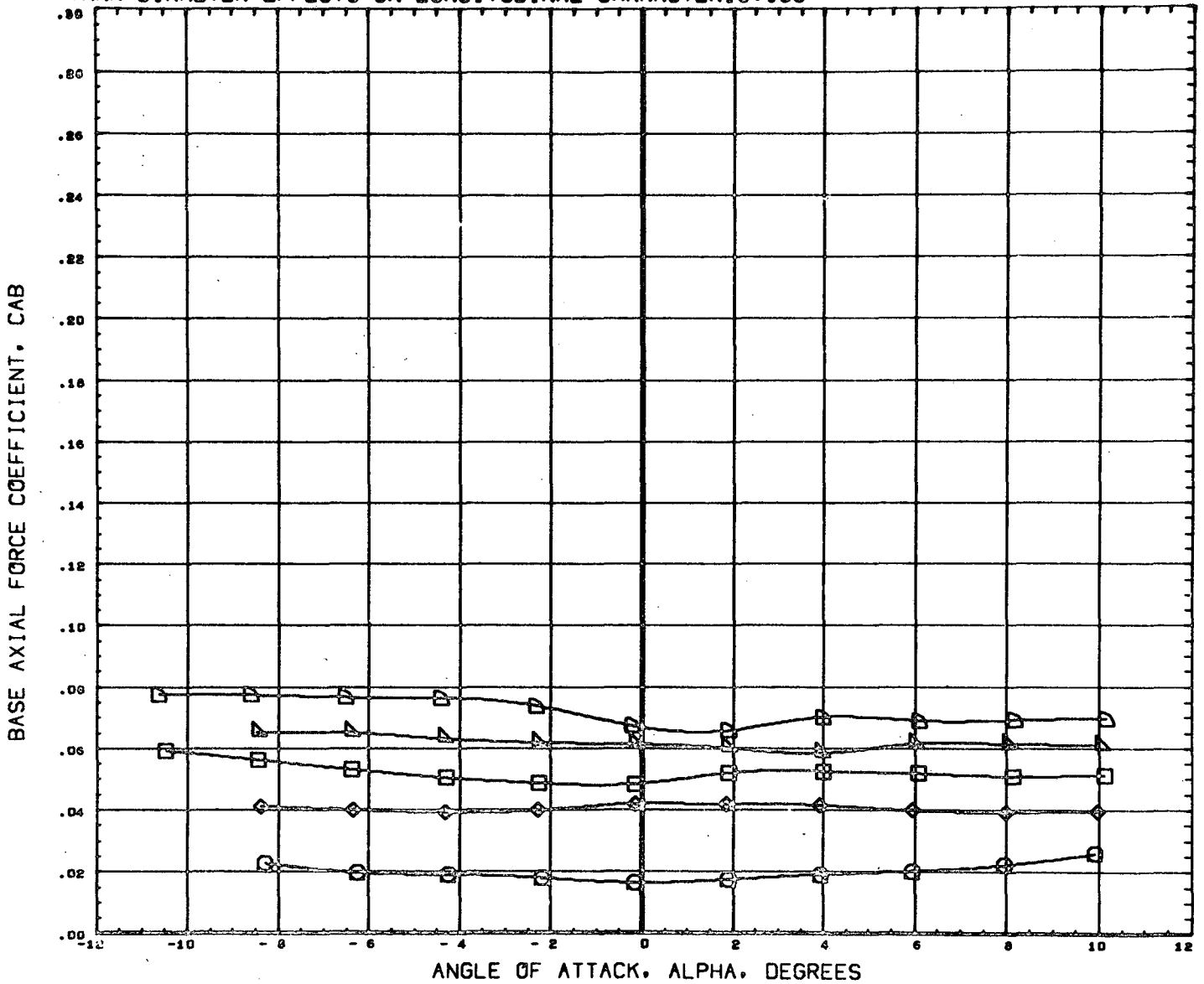

DATA SET SYMBOL	CONFIGURATION DESCRIPTION	ORBIT	THETA	BETA	REFERENCE INFORMATION
(B65001)	MSFC TWT 534 SHUTTLE LAUNCH T1			0.000	SREF 4.8950 sq. IN
(B65019)	DATA NOT AVAILABLE FOR ALL CONDITIONS			0.000	LREF 2.6440 IN.
(B65002)	MSFC TWT 534 SHUTTLE LAUNCH T1O1	-1.500		0.000	BREF 3.9250 IN.
(B65020)	MSFC TWT 534 SHUTTLE LAUNCH T2O1	-1.500		0.000	XMRP 3.4900 IN.
(B65004)	MSFC TWT 534 SHUTTLE LAUNCH T1O1S1	-1.500	21.000	0.000	YNRP 0.0000 IN.
(B65022)	MSFC TWT 534 SHUTTLE LAUNCH T2O1S1	-1.500	21.000	0.000	ZNRP 0.1616 IN.
					SCALE 0.0034

MACH 2.74

TANK DIAMETER EFFECTS ON LONGITUDINAL CHARACTERISTICS

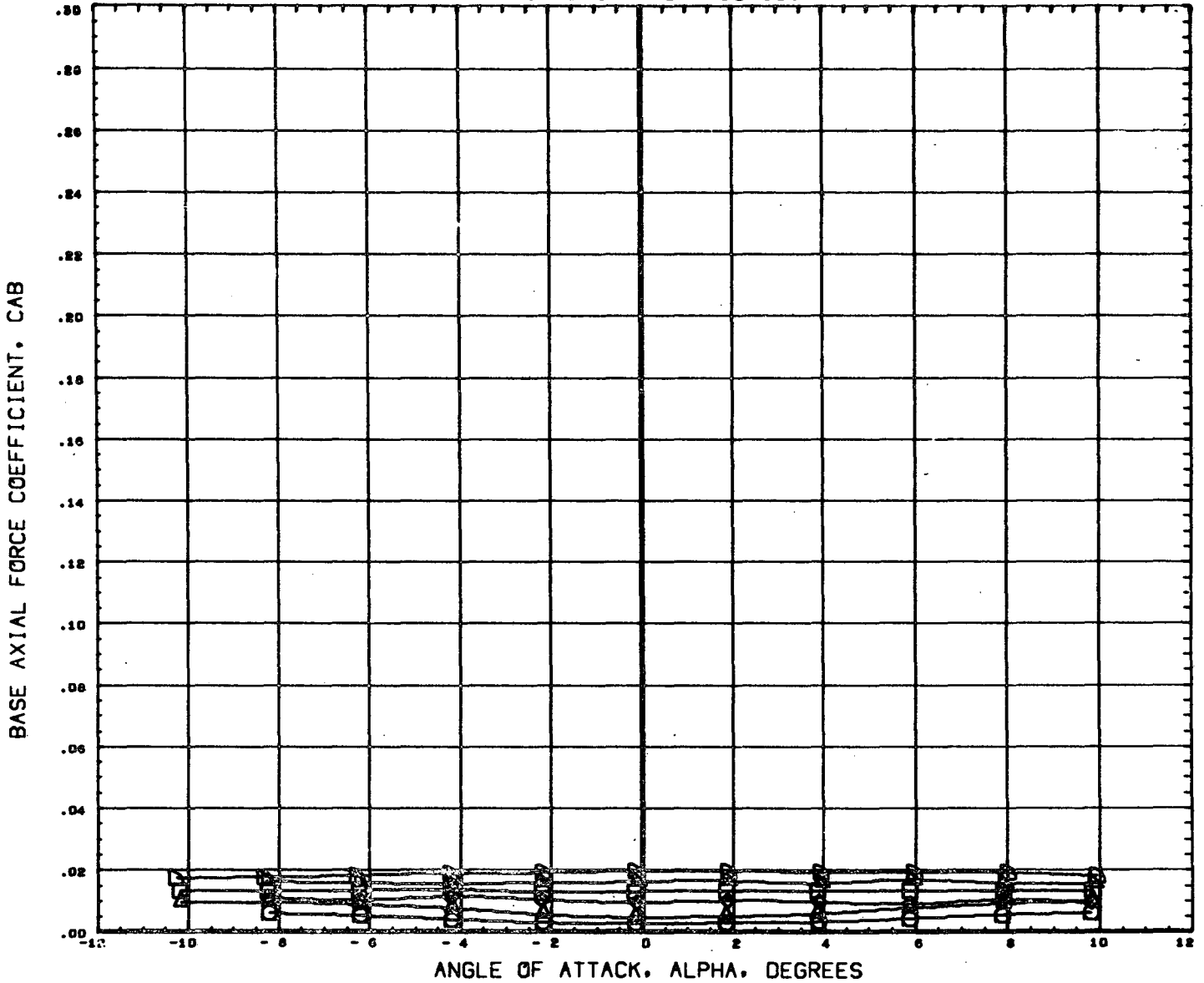

DATA SET SYMBOL	CONFIGURATION DESCRIPTION	ORBIN	THETS	BETA	REFERENCE INFORMATION
(B65001)	MSFC TWT 534 SHUTTLE LAUNCH	T1		0.000	SREF 4.8950 SQ. IN.
(B65019)	MSFC TWT 534 SHUTTLE LAUNCH	T2		0.000	LREF 2.6440 IN.
(B65002)	MSFC TWT 534 SHUTTLE LAUNCH	T101	-1.500	0.000	BREF 3.5250 IN.
(B65020)	MSFC TWT 534 SHUTTLE LAUNCH	T201	-1.500	0.000	XMRP 3.4900 IN.
(B65004)	MSFC TWT 534 SHUTTLE LAUNCH	T101S1	-1.500	21.000	YMRP 0.0000 IN.
(B65022)	MSFC TWT 534 SHUTTLE LAUNCH	T201S1	-1.500	21.000	ZMRP 0.1616 IN.
					SCALE 0.0034

MACH 4.96

PAGE 168

TANK DIAMETER EFFECTS ON LONGITUDINAL CHARACTERISTICS

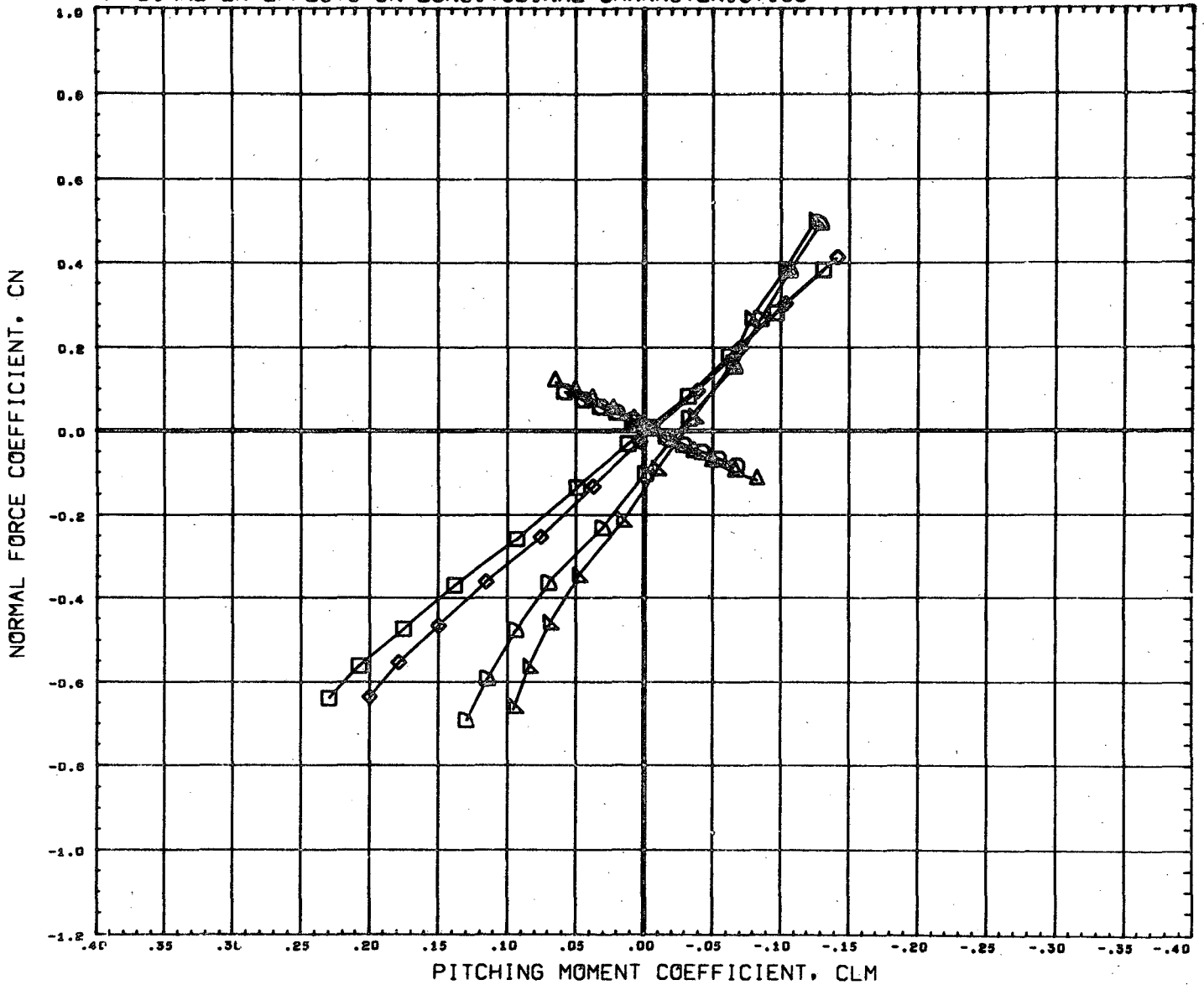

DATA SET SYMBOL	CONFIGURATION DESCRIPTION	ORBIN	THETS	BETA	REFERENCE INFORMATION
(B65001)	MSFC TWT 534 SHUTTLE LAUNCH	T1		0.000	SREF 4.8950 SQ. IN
(B65019)	MSFC TWT 534 SHUTTLE LAUNCH	T2		0.000	LREF 2.6440 IN.
(B65002)	MSFC TWT 534 SHUTTLE LAUNCH	T101	-1.500	0.000	BREF 3.5250 IN.
(B65020)	MSFC TWT 534 SHUTTLE LAUNCH	T201	-1.500	0.000	XMRP 3.4900 IN.
(B65004)	MSFC TWT 534 SHUTTLE LAUNCH	T101 S1	-1.500	21.000	YMRP 0.0000 IN.
(B65022)	MSFC TWT 534 SHUTTLE LAUNCH	T201 S1	-1.500	21.000	ZMRP 0.1616 IN.
					SCALE 0.0034

MACH .60

TANK DIAMETER EFFECTS ON LONGITUDINAL CHARACTERISTICS

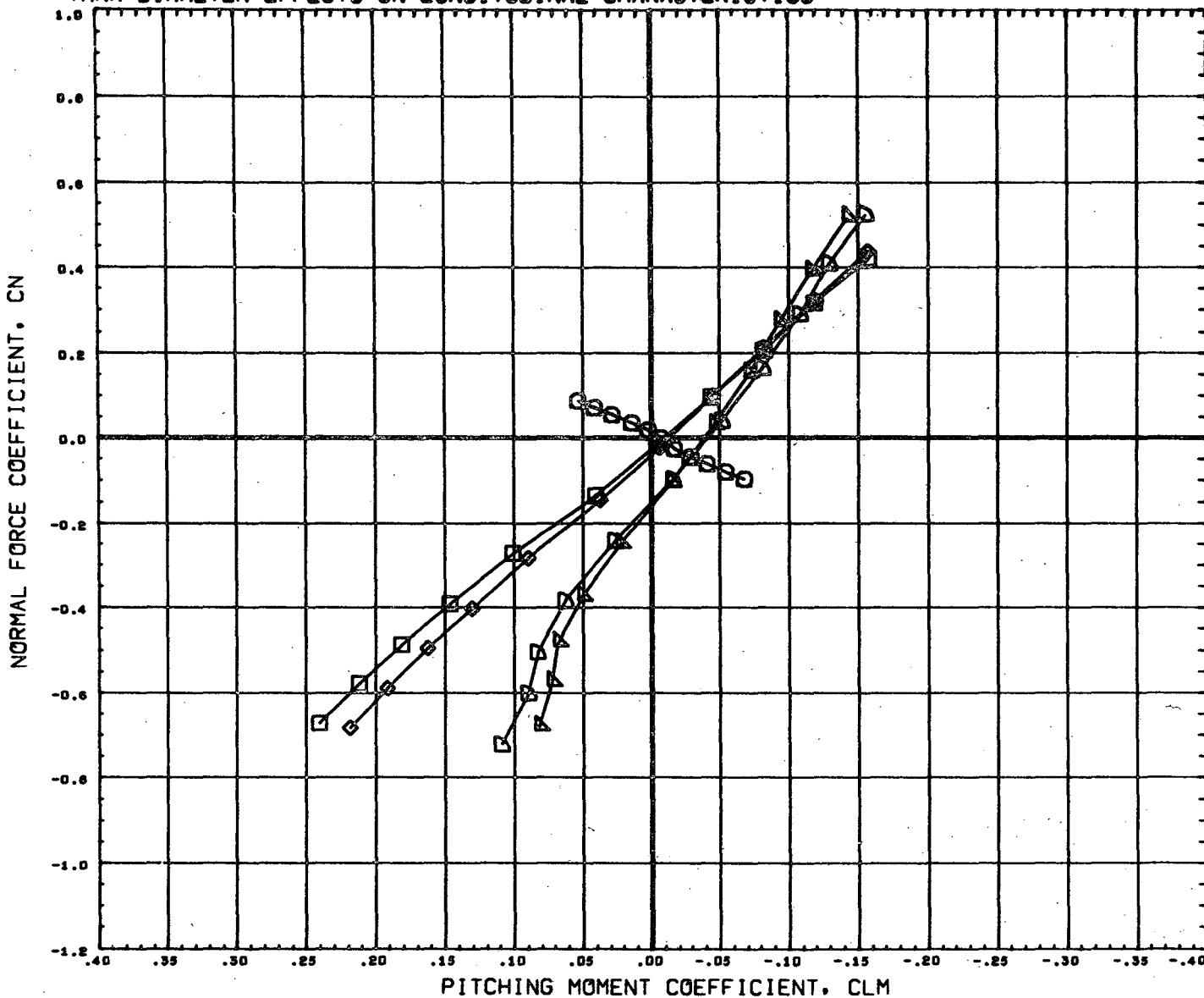

DATA SET SYMBOL	CONFIGURATION DESCRIPTION	T1	ORBIN	THETS	BETA	REFERENCE INFORMATION
(B65001)	MSFC TWT 534 SHUTTLE LAUNCH	T1			0.000	SREF 4.8950 SQ. IN
(B65019)	DATA NOT AVAILABLE FOR ALL CONDITIONS					
(B65002)	MSFC TWT 534 SHUTTLE LAUNCH	T101	-1.500		0.000	LREF 2.6440 IN.
(B65020)	MSFC TWT 534 SHUTTLE LAUNCH	T201	-1.500		0.000	BREF 3.5250 IN.
(B65004)	MSFC TWT 534 SHUTTLE LAUNCH	T101S1	-1.500	21.000	0.000	XMRP 3.4900 IN.
(B65022)	MSFC TWT 534 SHUTTLE LAUNCH	T201S1	-1.500	21.000	0.000	YMRP 0.0000 IN.
						ZMRP 0.1616 IN.
						SCALE 0.0034

TANK DIAMETER EFFECTS ON LONGITUDINAL CHARACTERISTICS

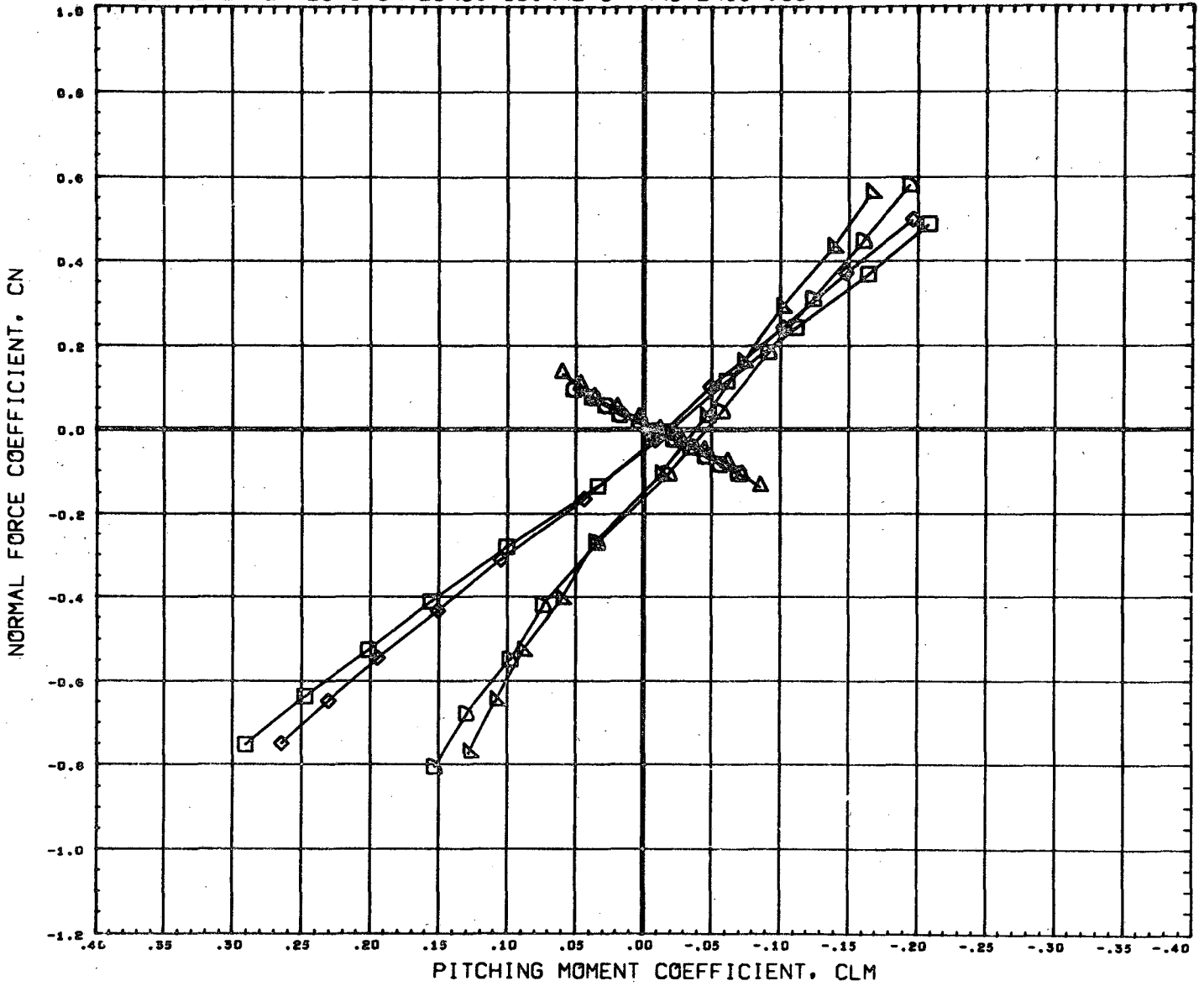

DATA SET SYMBOL	CONFIGURATION DESCRIPTION	ORBIN	THETS	BETA	REFERENCE INFORMATION
(B69001)	MSFC TWT 534 SHUTTLE LAUNCH	T1		0.000	SREF 4.8950 sq. IN
(B69019)	MSFC TWT 534 SHUTTLE LAUNCH	T2		0.000	LREF 2.6440 IN.
(B69002)	MSFC TWT 534 SHUTTLE LAUNCH	T101	-1.500	0.000	BREF 3.5250 IN.
(B69020)	MSFC TWT 534 SHUTTLE LAUNCH	T201	-1.500	0.000	XMRP 3.4900 IN.
(B69004)	MSFC TWT 534 SHUTTLE LAUNCH	T101S1	-1.500	21.000	YMRP 0.0000 IN.
(B69022)	MSFC TWT 534 SHUTTLE LAUNCH	T201S1	-1.500	21.000	ZMRP 0.1616 IN.
					SCALE 0.0034

TANK DIAMETER EFFECTS ON LONGITUDINAL CHARACTERISTICS

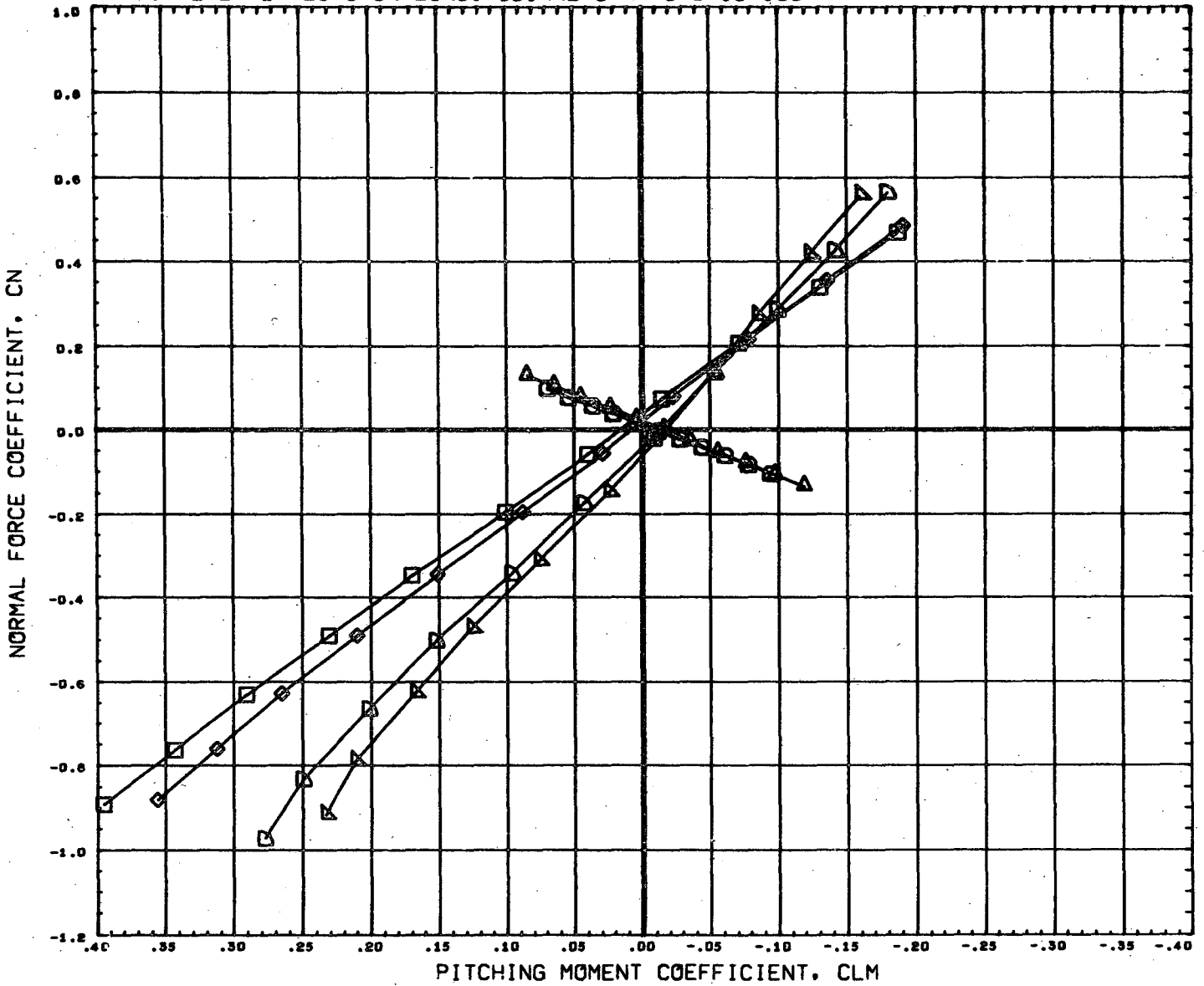

DATA SET SYMBOL	CONFIGURATION DESCRIPTION	ORBIN	THETS	BETA	REFERENCE INFORMATION
(869001)	MSFC TWT 534 SHUTTLE LAUNCH	T1		0.000	SREF 4.8950 90. IN
(869019)	MSFC TWT 534 SHUTTLE LAUNCH	T2		0.000	LREF 2.6440 IN.
(869002)	MSFC TWT 534 SHUTTLE LAUNCH	T101	-1.500	0.000	BREF 3.5250 IN.
(869020)	MSFC TWT 534 SHUTTLE LAUNCH	T201	-1.500	0.000	XMRP 3.4900 IN.
(869004)	MSFC TWT 534 SHUTTLE LAUNCH	T101S1	-1.500	21.000	YMRP 0.0000 IN.
(869022)	MSFC TWT 534 SHUTTLE LAUNCH	T201S1	-1.500	21.000	ZMRP 0.1616 IN.
					SCALE 0.0034

TANK DIAMETER EFFECTS ON LONGITUDINAL CHARACTERISTICS

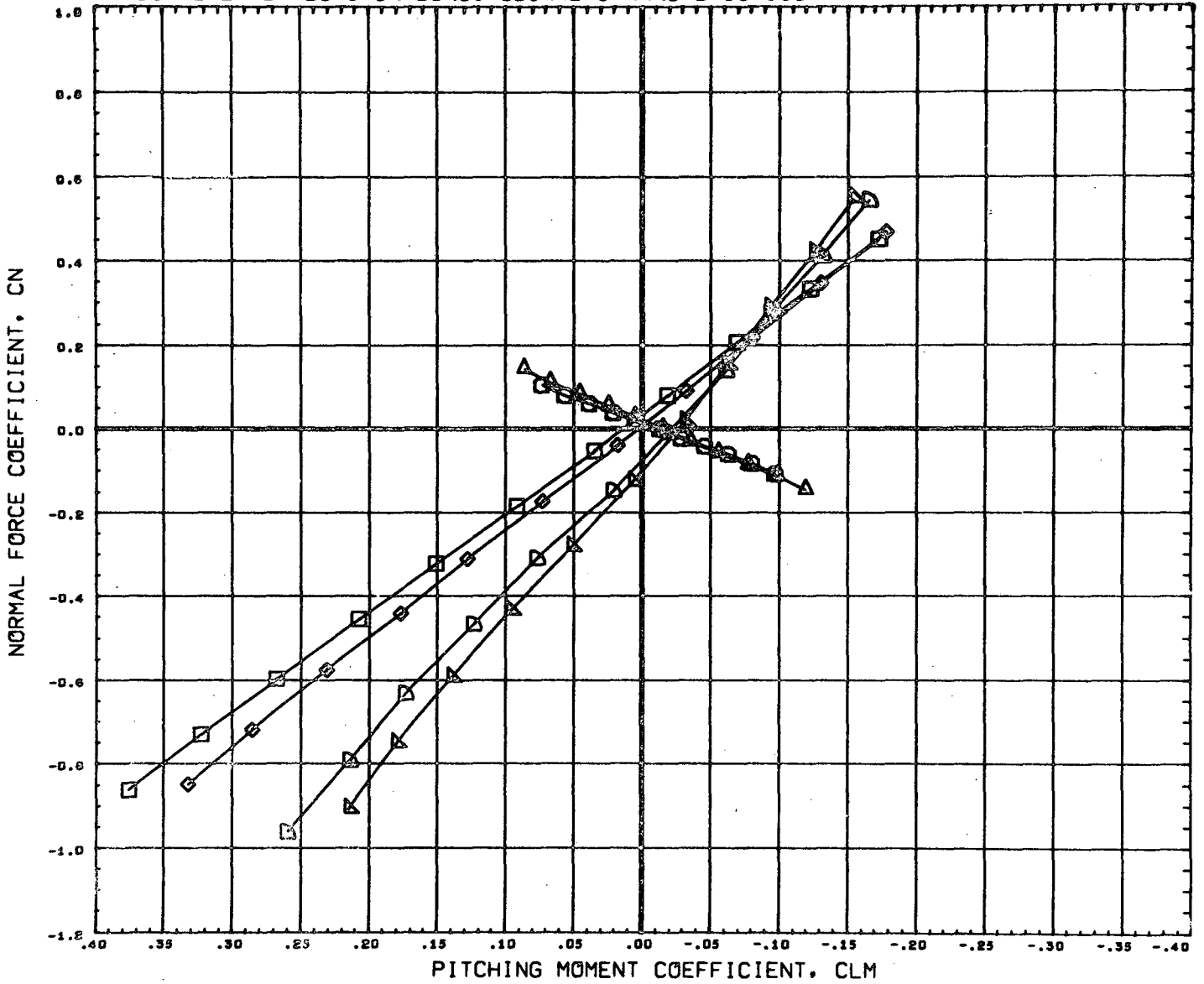

DATA SET SYMBOL	CONFIGURATION	DESCRIPTION	ORBIN	THETS	BETA	REFERENCE INFORMATION
(B69001)	MSFC TWT 534	SHUTTLE LAUNCH	T1		0.000	SREF 4.8950 SQ. IN
(B69019)	MSFC TWT 534	SHUTTLE LAUNCH	T2		0.000	LREF 2.6440 IN.
(B69002)	MSFC TWT 534	SHUTTLE LAUNCH	T101	-1.500	0.000	BREF 3.5250 IN.
(B69020)	MSFC TWT 534	SHUTTLE LAUNCH	T201	-1.500	0.000	XMRP 3.4900 IN.
(B69004)	MSFC TWT 534	SHUTTLE LAUNCH	T101S1	-1.500	21.000	YMRP 0.0000 IN.
(B69022)	MSFC TWT 534	SHUTTLE LAUNCH	T201S1	-1.500	21.000	ZMRP 0.1616 IN.
						SCALE 0.0034

MACH 1.20

TANK DIAMETER EFFECTS ON LONGITUDINAL CHARACTERISTICS

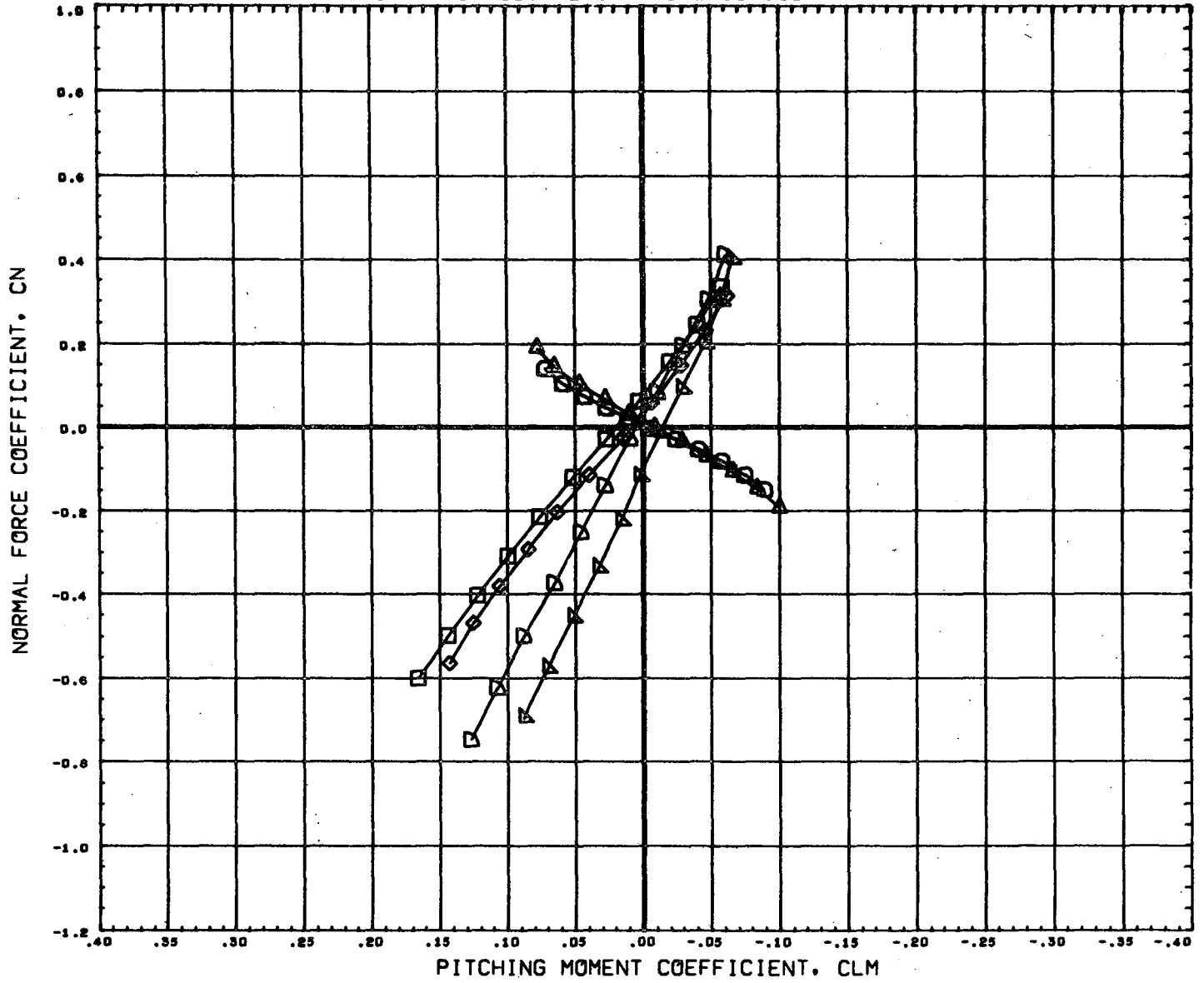

DATA SET SYMBOL	CONFIGURATION DESCRIPTION	T1	ORBIN	THETS	BETA	REFERENCE INFORMATION
(B65001)	MSFC TWT 534 SHUTTLE LAUNCH	T1			0.000	SREF 4.8950 SQ. IN
(B65019)	MSFC TWT 534 SHUTTLE LAUNCH	T2			0.000	LREF 2.6440 IN.
(B65002)	MSFC TWT 534 SHUTTLE LAUNCH	T101	-1.500		0.000	BREF 3.5250 IN.
(B65020)	MSFC TWT 534 SHUTTLE LAUNCH	T201	-1.500		0.000	XMRP 3.4900 IN.
(B65004)	MSFC TWT 534 SHUTTLE LAUNCH	T101S1	-1.500	21.000	0.000	YMRP 0.0000 IN.
(B65022)	MSFC TWT 534 SHUTTLE LAUNCH	T201S1	-1.500	21.000	0.000	ZMRP 0.1616 IN.
						SCALE 0.0034

MACH 1.97

TANK DIAMETER EFFECTS ON LONGITUDINAL CHARACTERISTICS

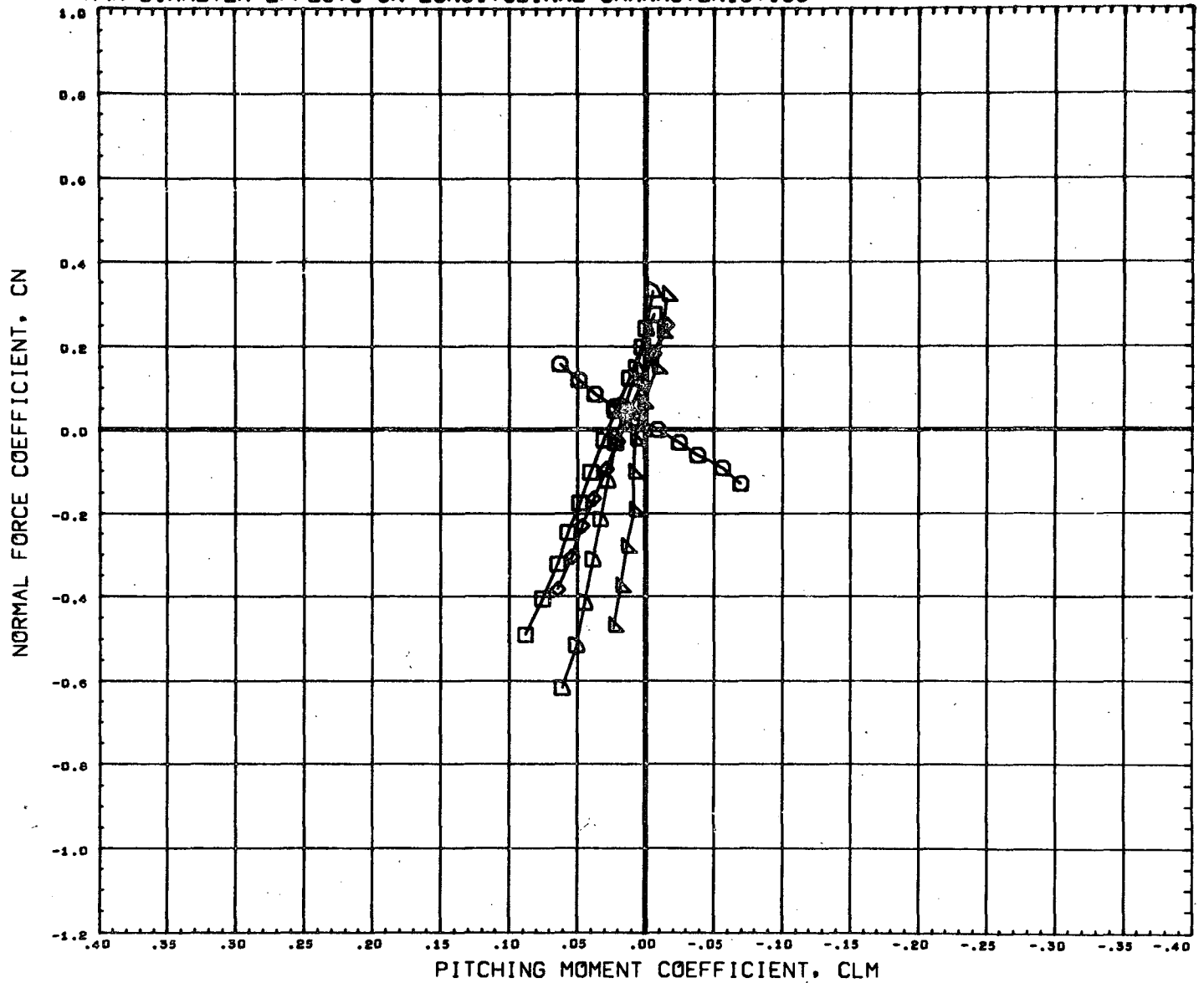

DATA SET SYMBOL	CONFIGURATION DESCRIPTION	ORBIN	THETS	BETA	REFERENCE INFORMATION
(B65001)	MSFC TWT 534 SHUTTLE LAUNCH	T1		0.000	SREF 4.8950 SQ. IN
(B65019)	DATA NOT AVAILABLE FOR ALL CONDITIONS			0.000	LREF 2.6440 IN.
(B65002)	MSFC TWT 534 SHUTTLE LAUNCH	T101	-1.500	0.000	BREF 3.5250 IN.
(B65020)	MSFC TWT 534 SHUTTLE LAUNCH	T201	-1.500	0.000	XHRP 3.4900 IN.
(B65004)	MSFC TWT 534 SHUTTLE LAUNCH	T101S1	-1.500	21.000	YHRP 0.0000 IN.
(B65022)	MSFC TWT 534 SHUTTLE LAUNCH	T201S1	-1.500	21.000	ZHRP 0.1616 IN.
					SCALE 0.0034

MACH 2.74

PAGE 175

TANK DIAMETER EFFECTS ON LONGITUDINAL CHARACTERISTICS

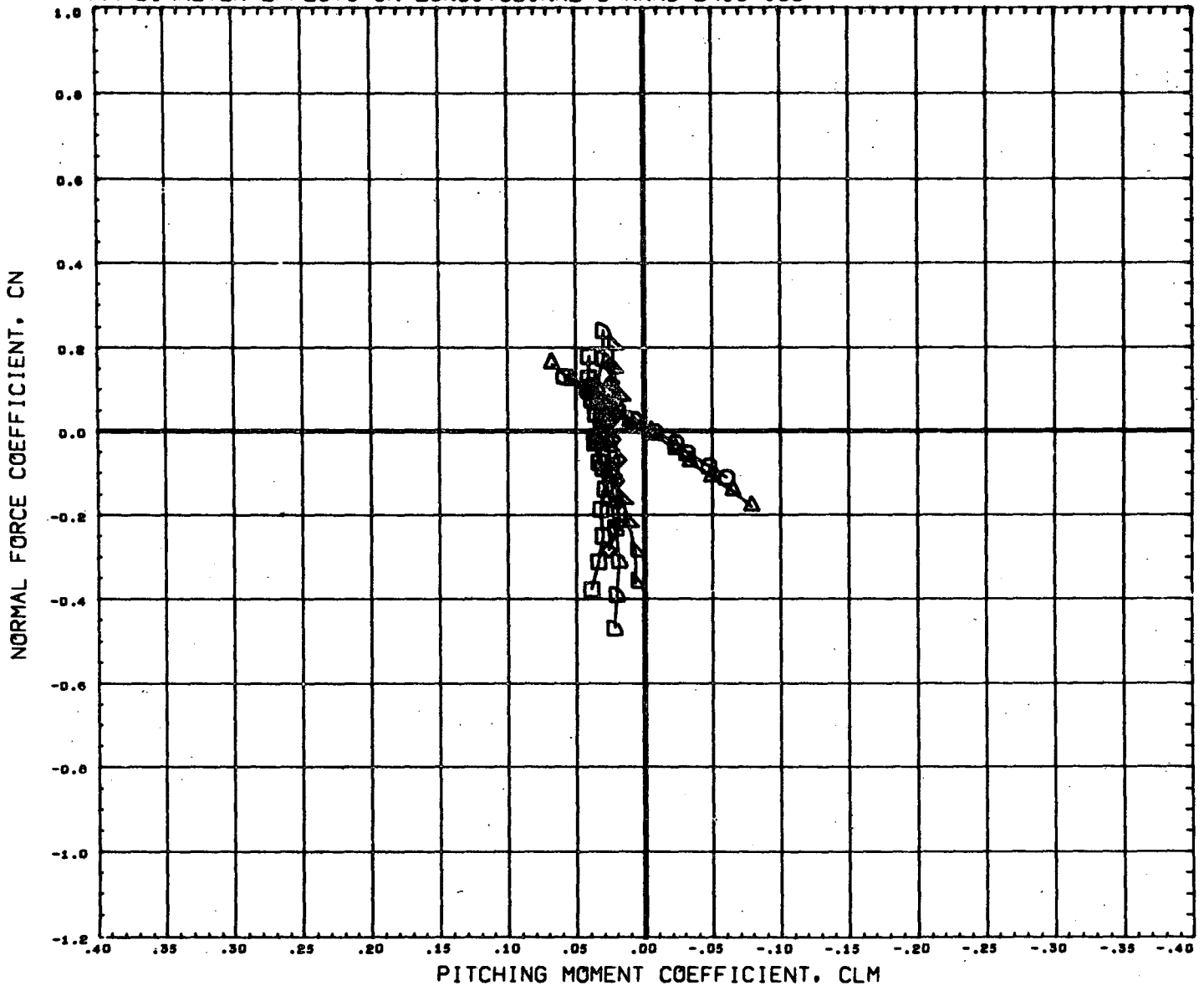

DATA SET SYMBOL	CONFIGURATION DESCRIPTION	T1	ORBIN	THETS	BETA	REFERENCE INFORMATION
(B65001)	MSFC TWT 534 SHUTTLE LAUNCH	T1			0.000	SREF 4.8950 SQ. IN
(B65019)	MSFC TWT 534 SHUTTLE LAUNCH	T2			0.000	LREF 2.6440 IN.
(B65002)	MSFC TWT 534 SHUTTLE LAUNCH	T101	-1.500		0.000	BREF 3.5250 IN.
(B65020)	MSFC TWT 534 SHUTTLE LAUNCH	T201	-1.500		0.000	XMRP 3.4900 IN.
(B65004)	MSFC TWT 534 SHUTTLE LAUNCH	T101S1	-1.500	21.000	0.000	YMRP 0.0000 IN.
(B65022)	MSFC TWT 534 SHUTTLE LAUNCH	T201S1	-1.500	21.000	0.000	ZMRP 0.1616 IN.
						SCALE 0.0034

TANK DIAMETER EFFECTS ON LATERAL/DIRECTIONAL CHARACTERISTICS

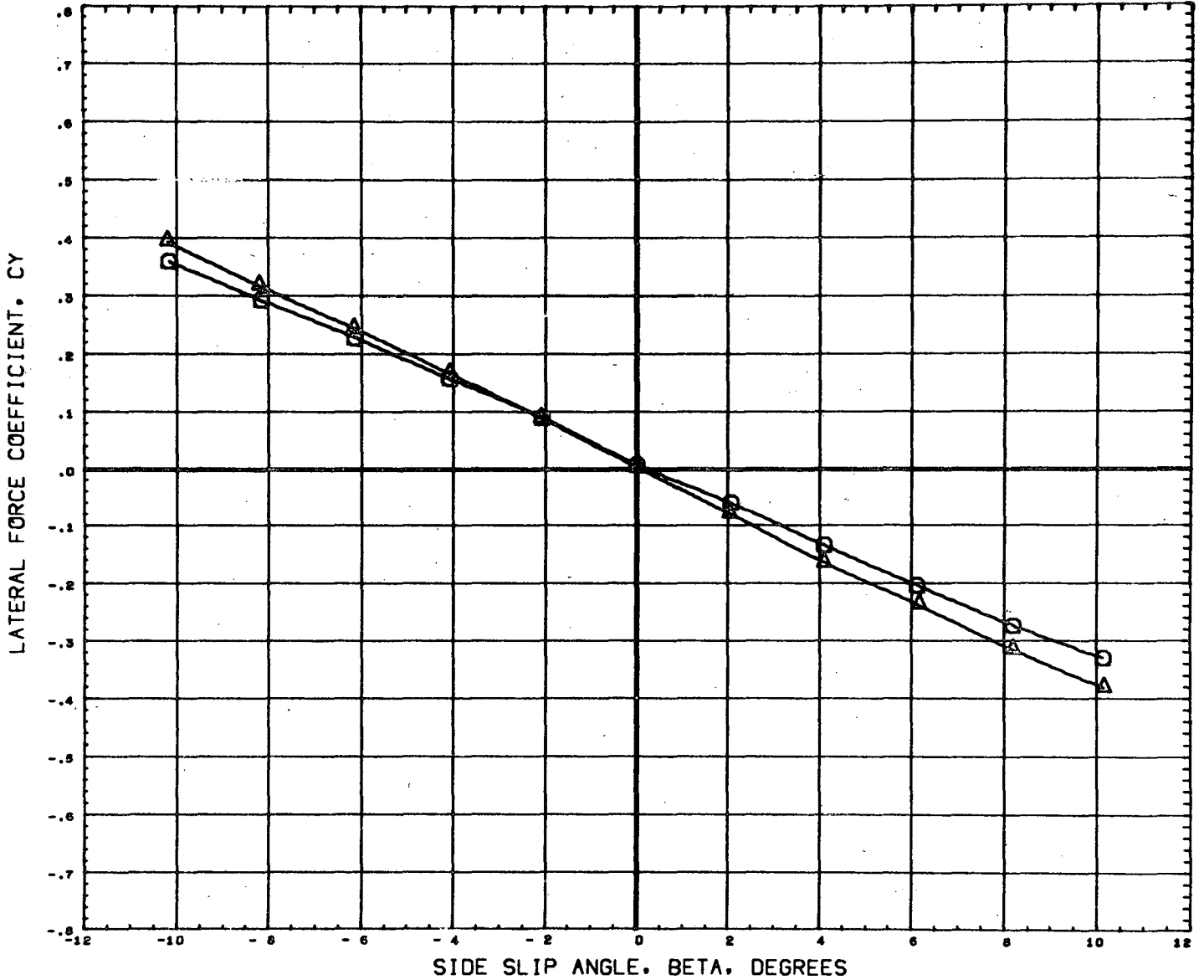

DATA SET SYMBOL	CONFIGURATION DESCRIPTION	ORBIN	THETS	ALPHA	REFERENCE INFORMATION
(B69003) ○	MSFC TWT 534 SHUTTLE LAUNCH	T101	-1.500	0.000	SREF 4.8950 SQ. IN
(B69021) △	MSFC TWT 534 SHUTTLE LAUNCH	T201	-1.500	0.000	LREF 2.6440 IN.
					BREF 3.5250 IN.
					XMRP 3.4900 IN.
					YMRP 0.0000 IN.
					ZMRP 0.1616 IN.
					SCALE 0.0034

MACH .60

TANK DIAMETER EFFECTS ON LATERAL/DIRECTIONAL CHARACTERISTICS

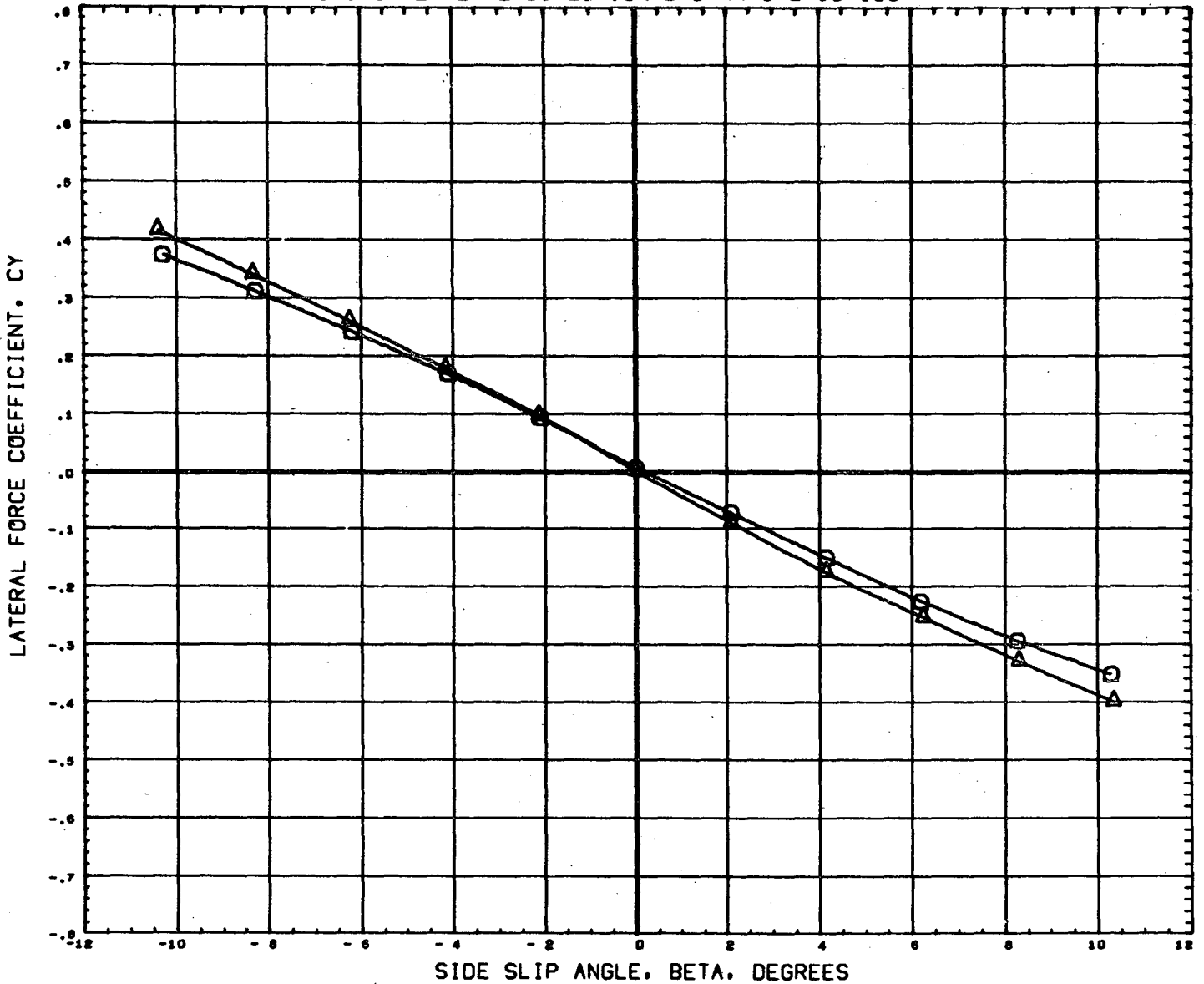

DATA SET SYMBOL	CONFIGURATION DESCRIPTION	ORBIT	THETS	ALPHA	REFERENCE INFORMATION
(865003)	MSFC TWT 534 SHUTTLE LAUNCH	T101	-1.500	0.000	SREF 4.0950 sq. IN
(865021)	MSFC TWT 534 SHUTTLE LAUNCH	T201	-1.500	0.000	LREF 2.6440 IN.
					BREF 3.5250 IN.
					XMRP 3.4900 IN.
					YMRP 0.0000 IN.
					ZMRP 0.1616 IN.
					SCALE 0.0034

MACH .80

TANK DIAMETER EFFECTS ON LATERAL/DIRECTIONAL CHARACTERISTICS

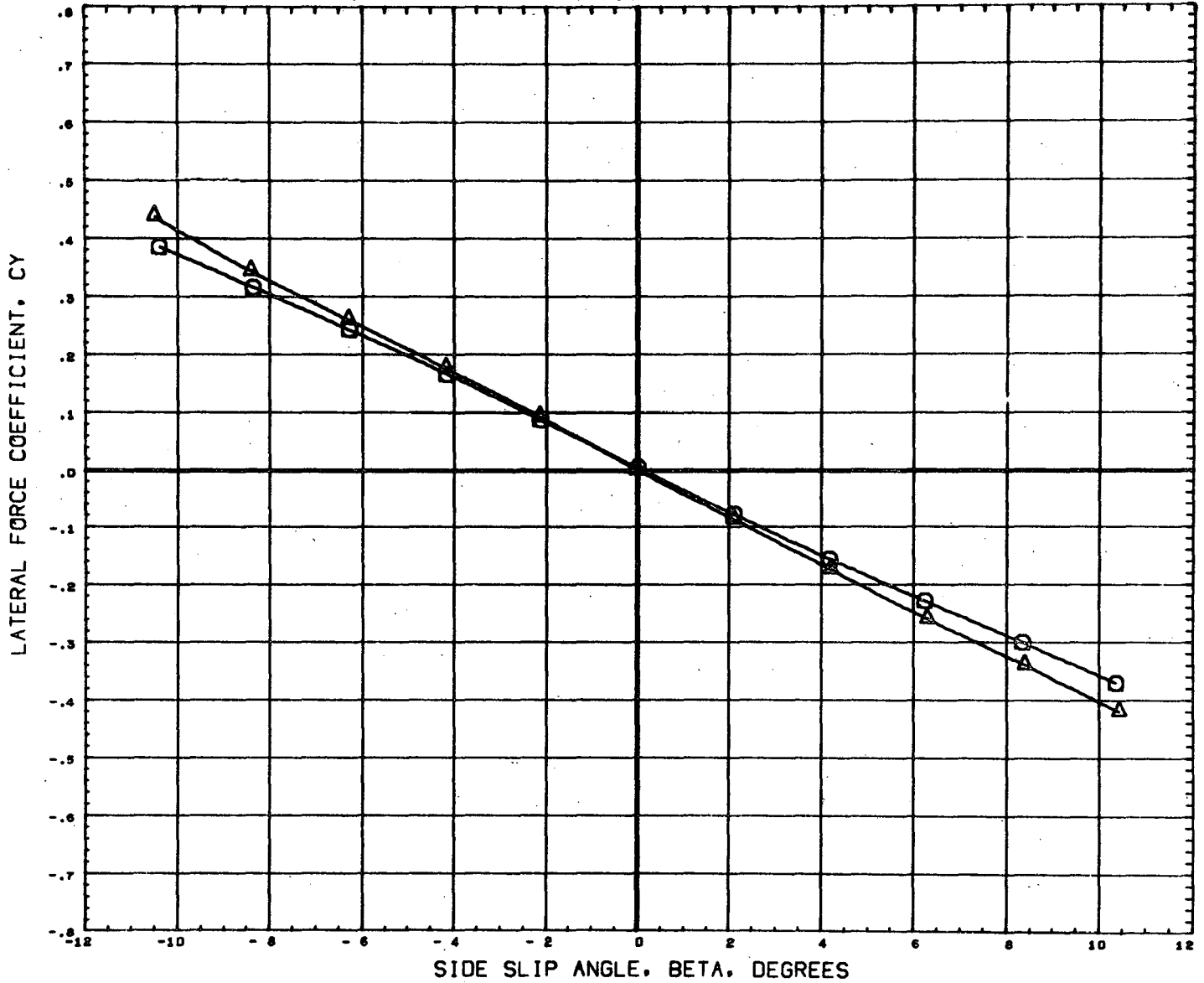

DATA SET SYMBOL	CONFIGURATION DESCRIPTION	ORBIN	THETS	ALPHA	REFERENCE INFORMATION
(B65003)	MSFC TWT 534 SHUTTLE LAUNCH	T101	-1.500	0.000	SREF 4.8950 SQ. IN
(B65021)	MSFC TWT 534 SHUTTLE LAUNCH	T201	-1.500	0.000	LREF 2.6440 IN.
					BREF 3.5250 IN.
					XMRP 3.4900 IN.
					YMRP 0.0000 IN.
					ZMRP 0.1616 IN.
					SCALE 0.0034

MACH .90

TANK DIAMETER EFFECTS ON LATERAL/DIRECTIONAL CHARACTERISTICS

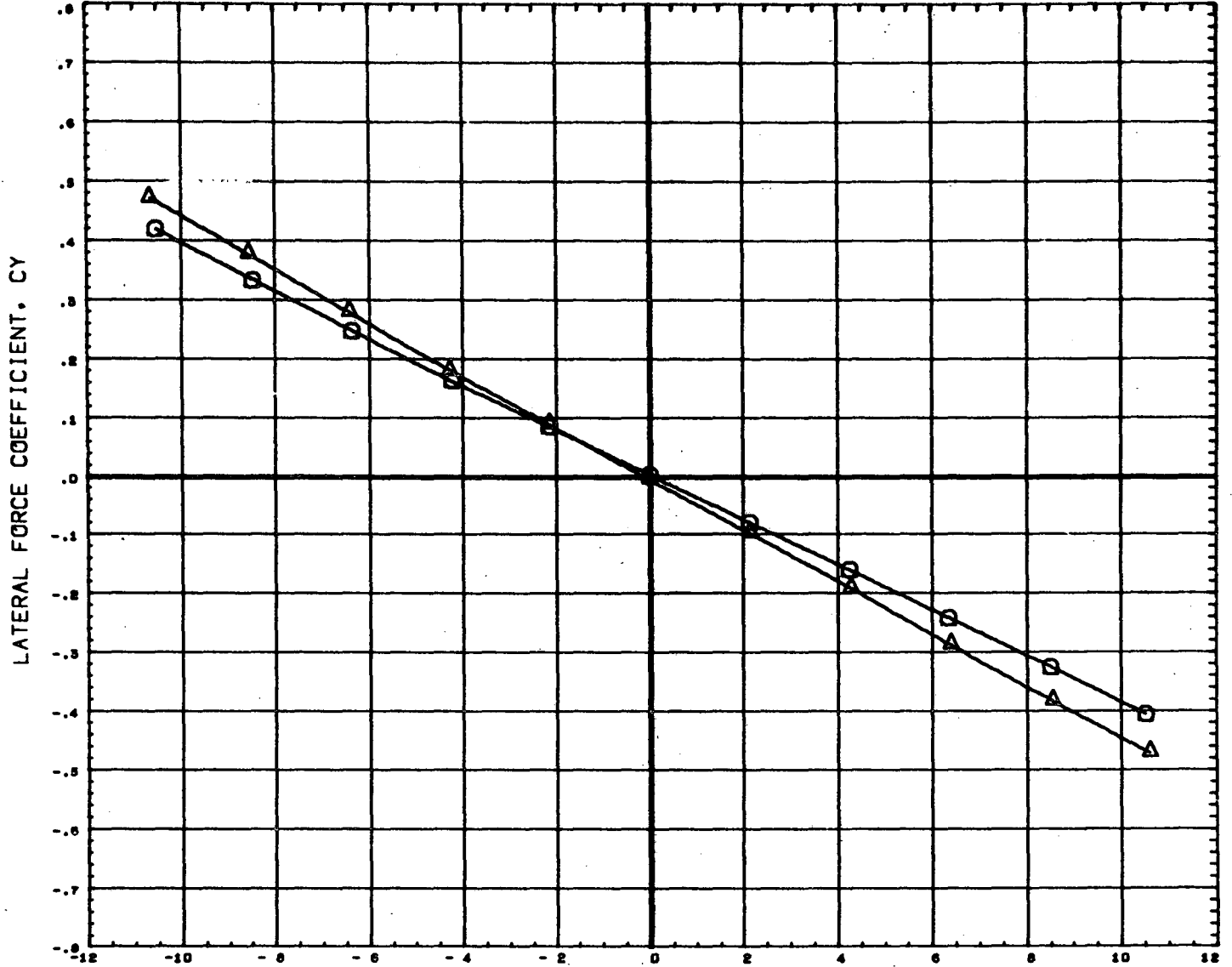

DATA SET SYMBOL	CONFIGURATION DESCRIPTION	ORBIN	THETS	ALPHA	REFERENCE INFORMATION
(B65003)	MSFC TWT 534 SHUTTLE LAUNCH T101	-1.500		0.000	SREF 4.8950 SQ. IN
(B65021)	MSFC TWT 534 SHUTTLE LAUNCH T201	-1.500		0.000	LREF 2.6440 IN.
					BREF 3.5250 IN.
					XMRP 3.4900 IN.
					YMRP 0.0000 IN.
					ZMRP 0.1616 IN.
					SCALE 0.0034

TANK DIAMETER EFFECTS ON LATERAL/DIRECTIONAL CHARACTERISTICS

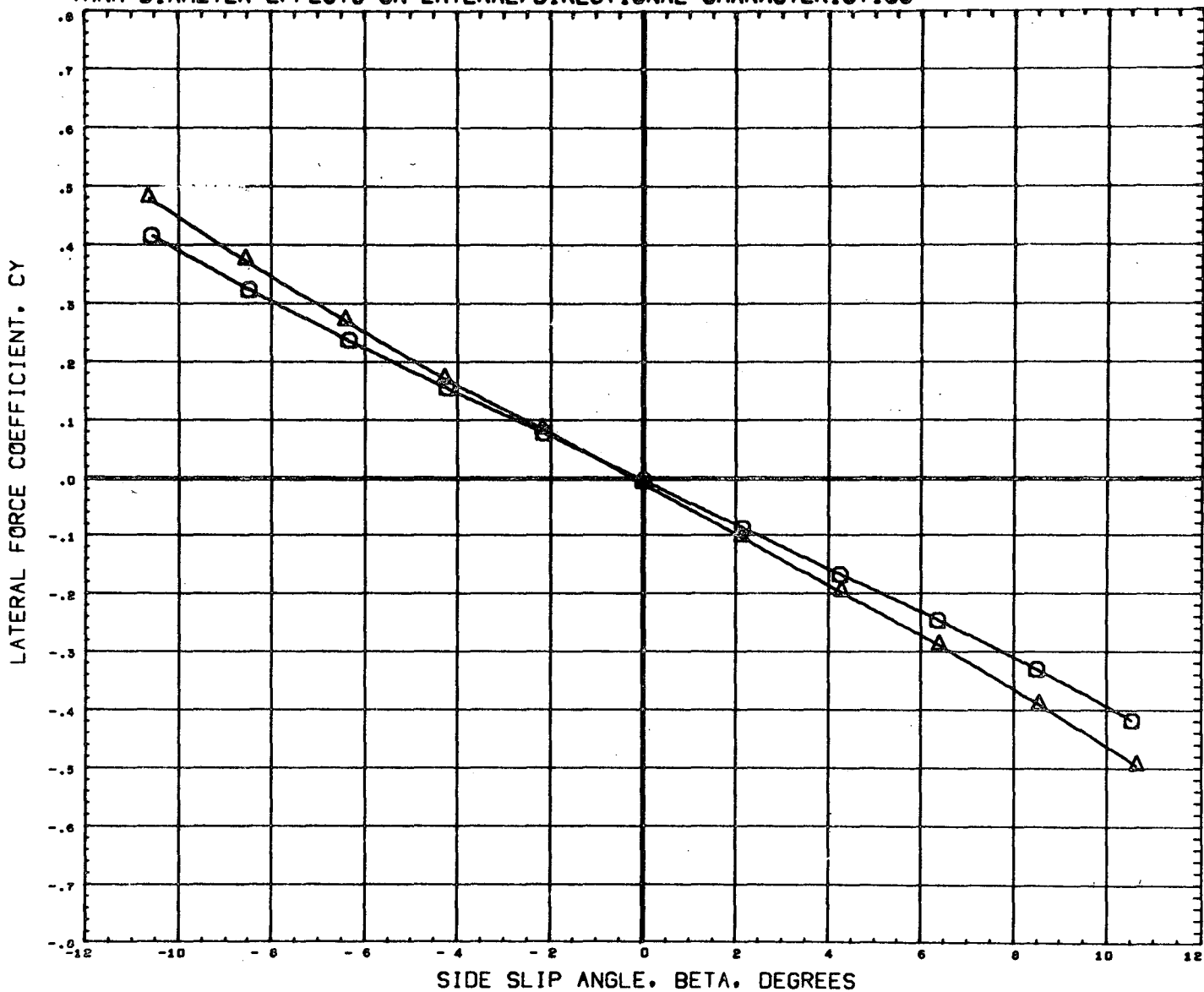

DATA SET SYMBOL	CONFIGURATION DESCRIPTION	ORBIN	THETS	ALPHA	REFERENCE INFORMATION
(B65003)	MSFC TWT 534 SHUTTLE LAUNCH	T101	-1.500	0.000	SREF 4.8950 SQ. IN
(B65021)	MSFC TWT 534 SHUTTLE LAUNCH	T201	-1.500	0.000	LREF 2.6440 IN.
					BREF 3.5250 IN.
					XMRP 3.4900 IN.
					YMRP 0.0000 IN.
					ZMRP 0.1616 IN.
					SCALE 0.0034

MACH 1.20

TANK DIAMETER EFFECTS ON LATERAL/DIRECTIONAL CHARACTERISTICS

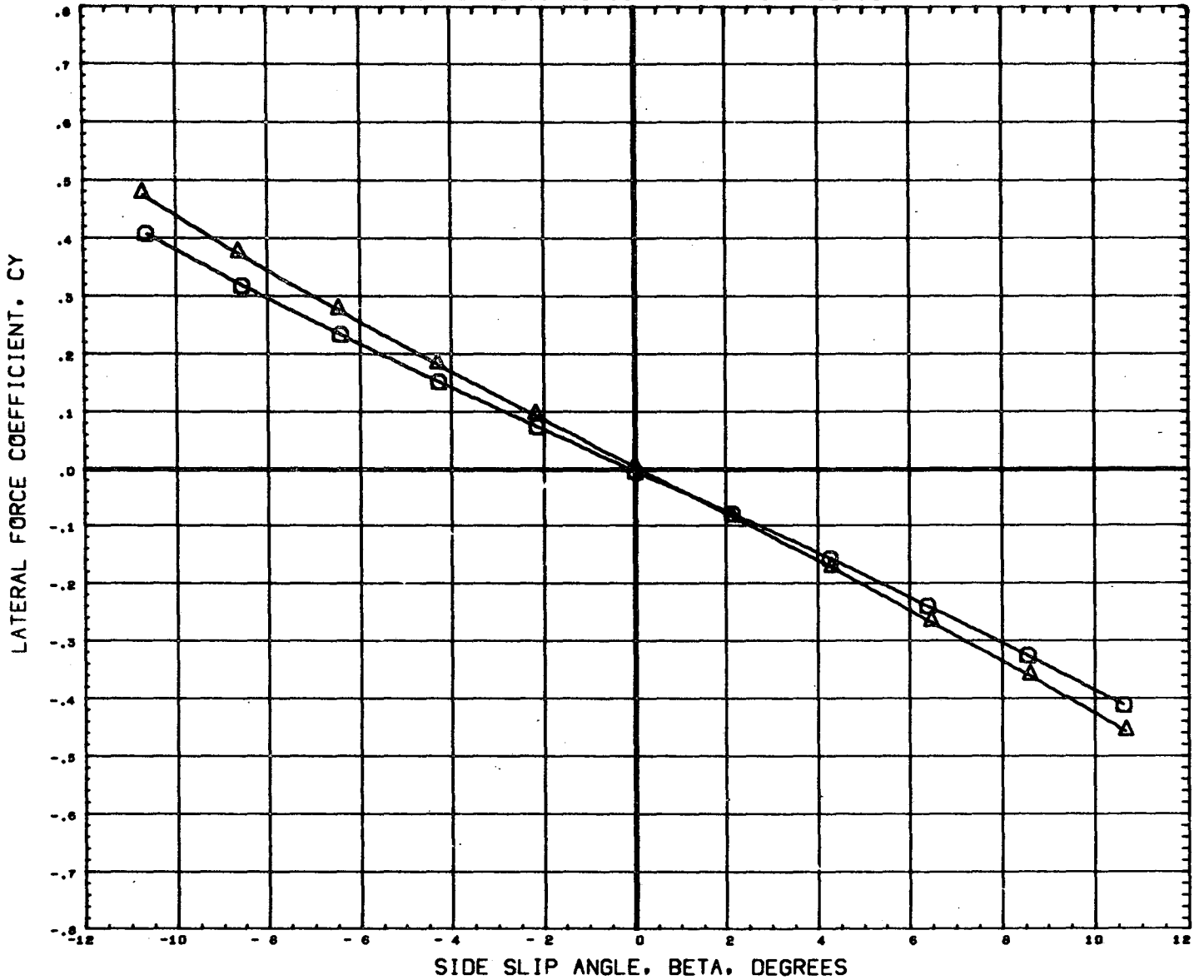

DATA SET SYMBOL	CONFIGURATION DESCRIPTION	ORBIN	THETS	ALPHA	REFERENCE INFORMATION
(B65003)	MSFC TWT 534 SHUTTLE LAUNCH	T101	-1.500	0.000	SREF 4.8950 IN.
(B65021)	MSFC TWT 534 SHUTTLE LAUNCH	T201	-1.500	0.000	LREF 2.6440 IN.
					BREF 3.5250 IN.
					XMRP 3.4900 IN.
					YMRP 0.0000 IN.
					ZMRP 0.1616 IN.
					SCALE 0.0034

TANK DIAMETER EFFECTS ON LATERAL/DIRECTIONAL CHARACTERISTICS

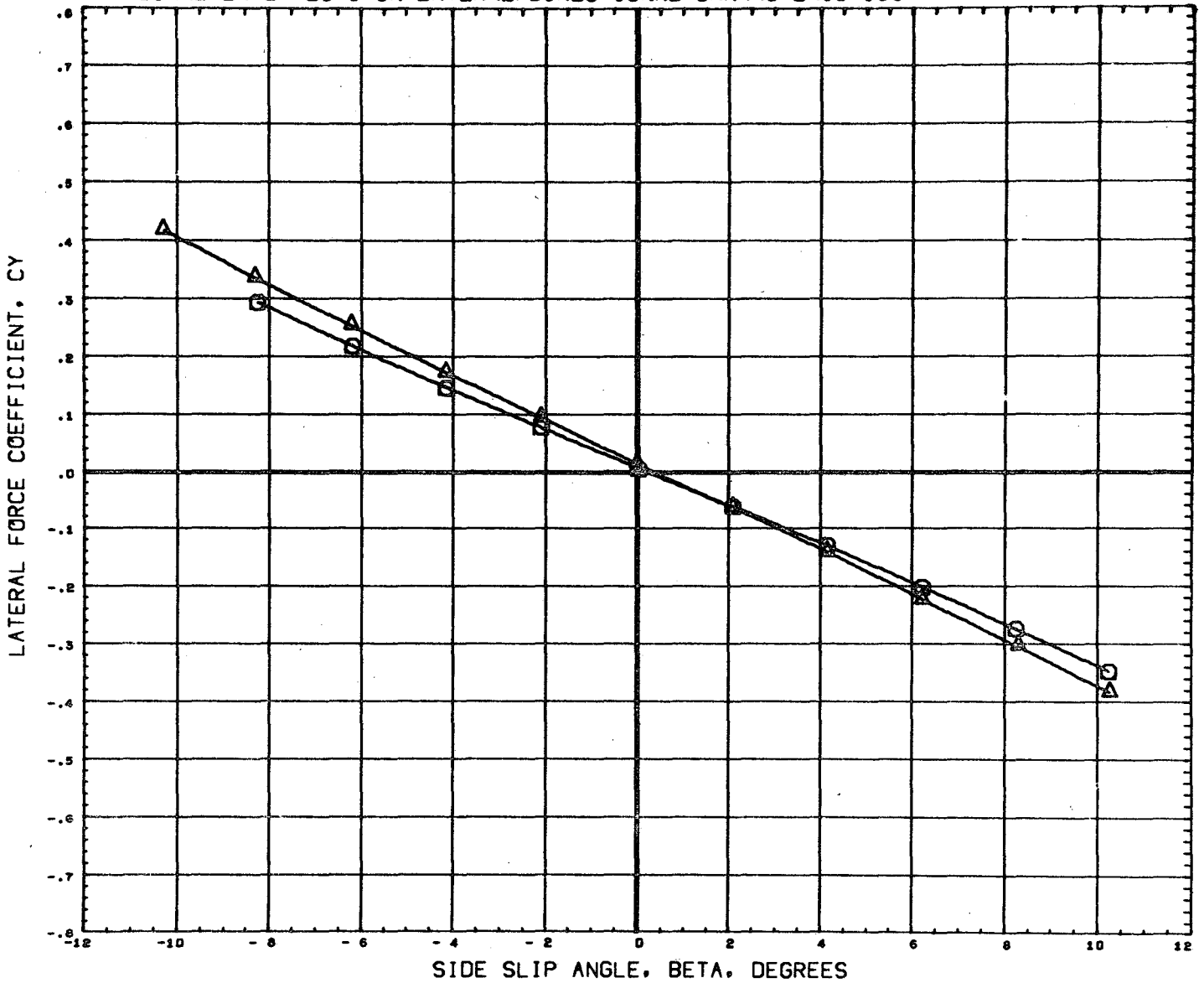

DATA SET SYMBOL	CONFIGURATION DESCRIPTION	ORBIN	THETS	ALPHA	REFERENCE INFORMATION
(B65003)	MSFC TWT 534 SHUTTLE LAUNCH	T101	-1.500	0.000	SREF 4.8950 SQ. IN
(B65021)	MSFC TWT 534 SHUTTLE LAUNCH	T201	-1.500	0.000	LREF 2.6440 IN.
					BREF 3.5250 IN.
					XMRF 3.4900 IN.
					YMRF 0.0000 IN.
					ZMRF 0.1616 IN.
					SCALE 0.0034

MACH 2.74

TANK DIAMETER EFFECTS ON LATERAL/DIRECTIONAL CHARACTERISTICS

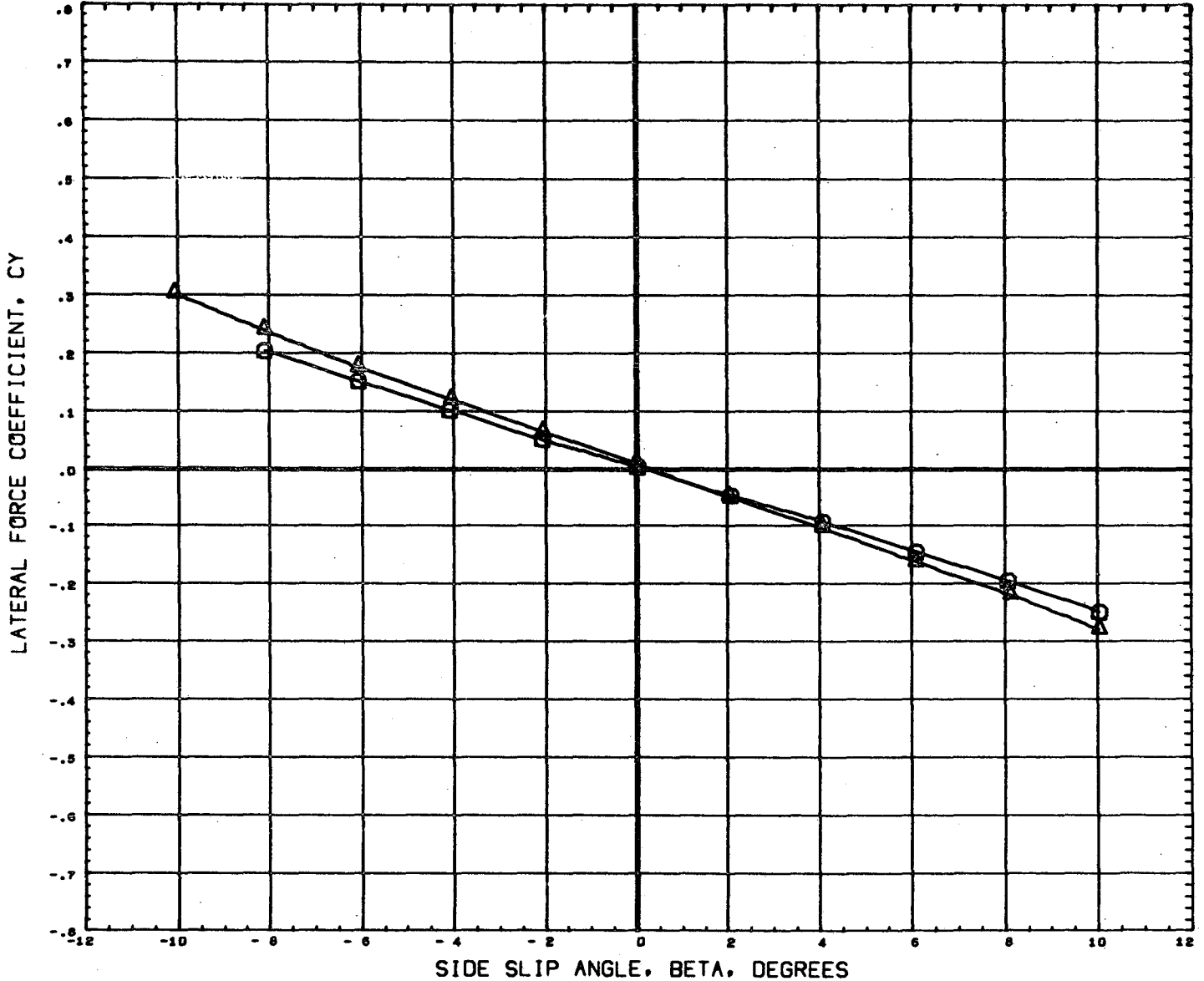

DATA SET SYMBOL	CONFIGURATION DESCRIPTION	ORBIN	THETS	ALPHA	REFERENCE INFORMATION
(B65003)	MSFC TWT 534 SHUTTLE LAUNCH	T101	-1.500	0.000	SREF 4.8950 SQ. IN
(B65021)	MSFC TWT 534 SHUTTLE LAUNCH	T201	-1.500	0.000	LREF 2.6440 IN.
					BREF 3.5250 IN.
					XMRP 3.4900 IN.
					YMRP 0.0000 IN.
					ZMRP 0.1616 IN.
					SCALE 0.0034

MACH 4.96

TANK DIAMETER EFFECTS ON LATERAL/DIRECTIONAL CHARACTERISTICS

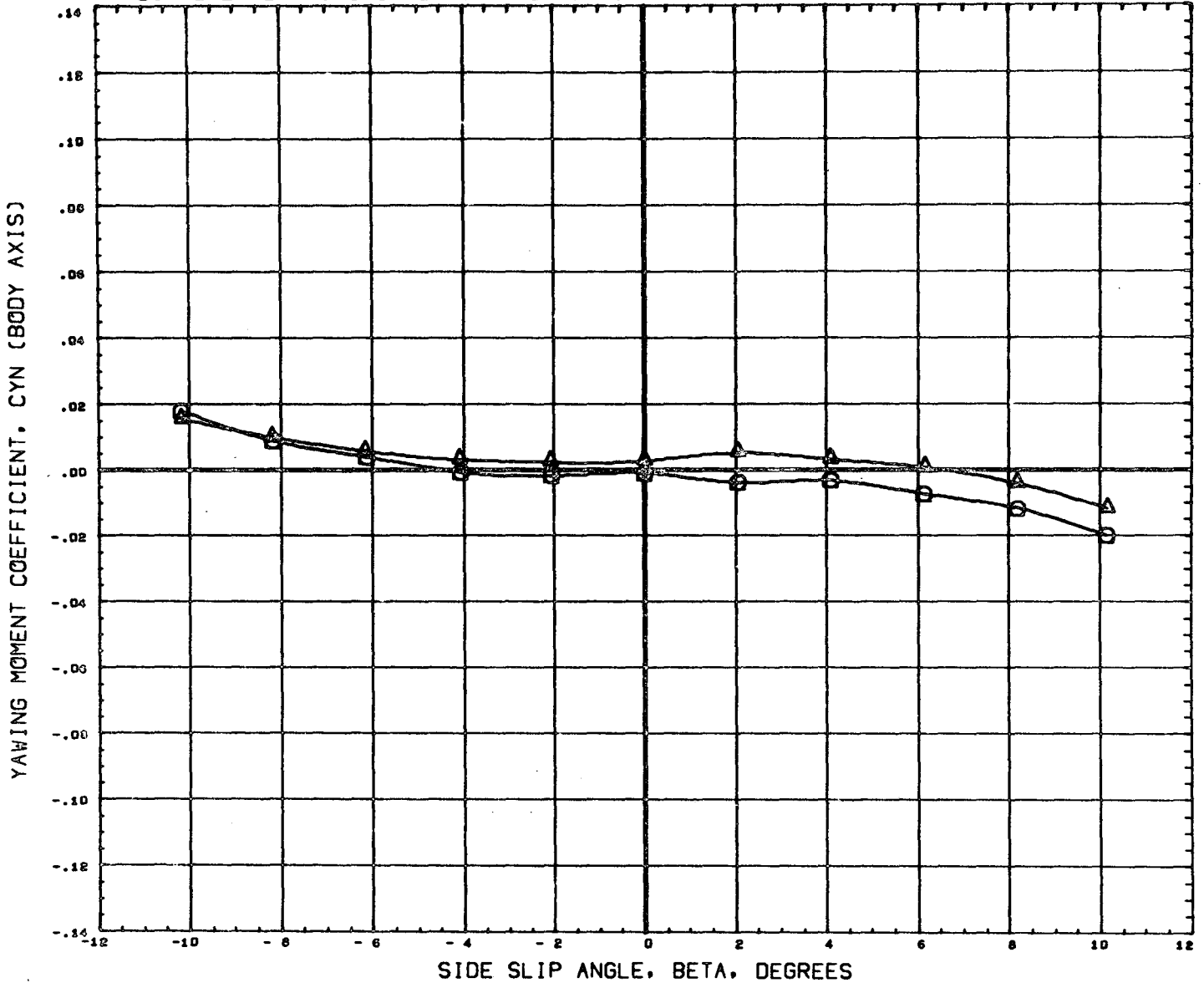

DATA SET SYMBOL	CONFIGURATION DESCRIPTION	ORBIN	THETS	ALPHA	REFERENCE INFORMATION
(B63003)	MSFC TWT 534 SHUTTLE LAUNCH	-1.500		0.000	SREF 4.8950 SQ. IN
(B63021)	MSFC TWT 534 SHUTTLE LAUNCH	-1.500		0.000	LREF 2.6440 IN.
					BREF 3.5250 IN.
					XMRP 3.4900 IN.
					YMRP 0.0000 IN.
					ZMRP 0.1616 IN.
					SCALE 0.0034

MACH .60

TANK DIAMETER EFFECTS ON LATERAL/DIRECTIONAL CHARACTERISTICS

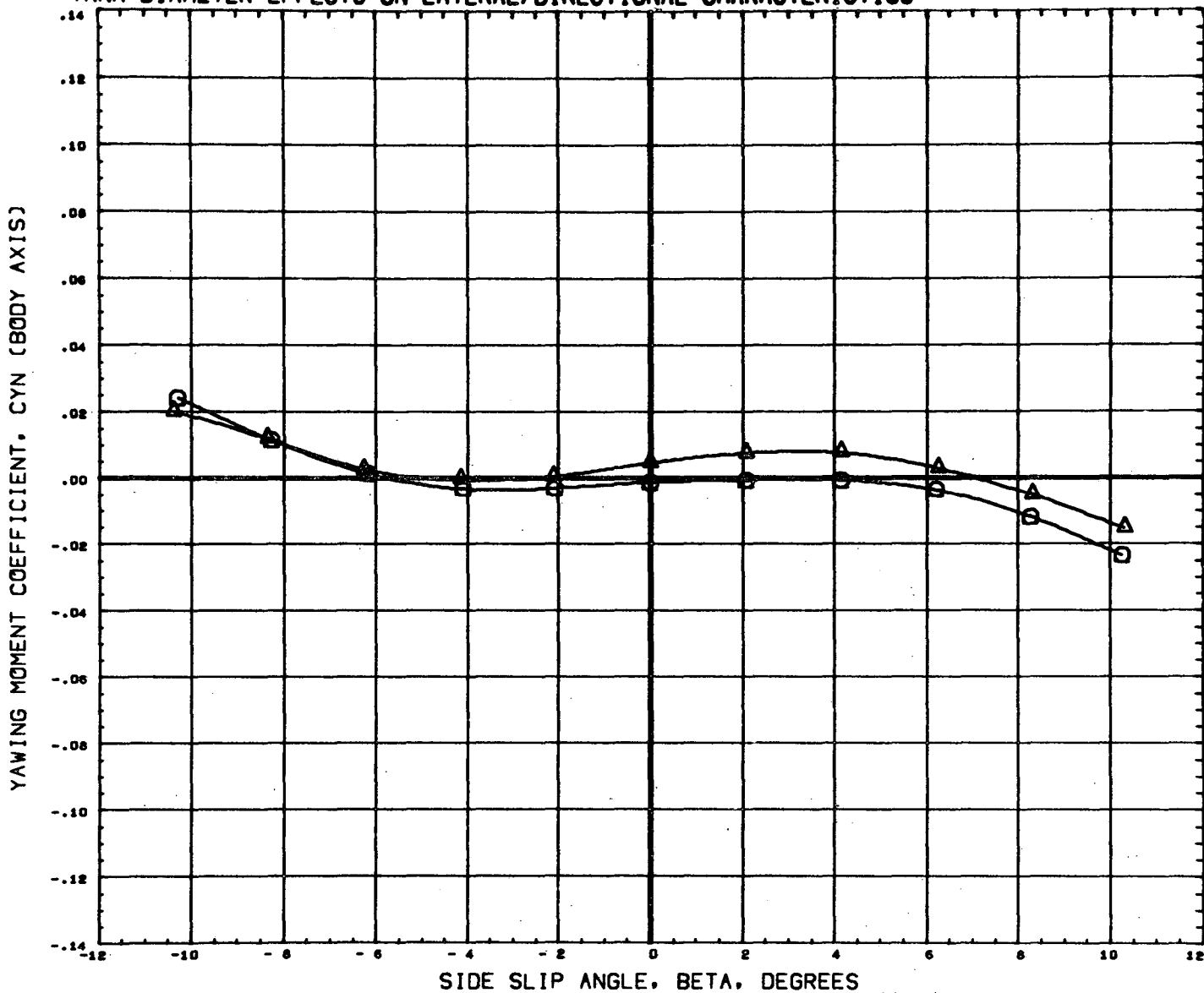

DATA SET SYMBOL	CONFIGURATION DESCRIPTION	ORBIN	THETS	ALPHA	REFERENCE INFORMATION
(B65003)	MSFC TWT 534 SHUTTLE LAUNCH T101	-1.500		0.000	SREF 4.6950 sq. IN
(B65021)	MSFC TWT 534 SHUTTLE LAUNCH T201	-1.500		0.000	LREF 2.6440 IN.
					BREF 3.5250 IN.
					XMRP 3.4900 IN.
					YMRP 0.0000 IN.
					ZMRP 0.1616 IN.
					SCALE 0.0034

TANK DIAMETER EFFECTS ON LATERAL/DIRECTIONAL CHARACTERISTICS

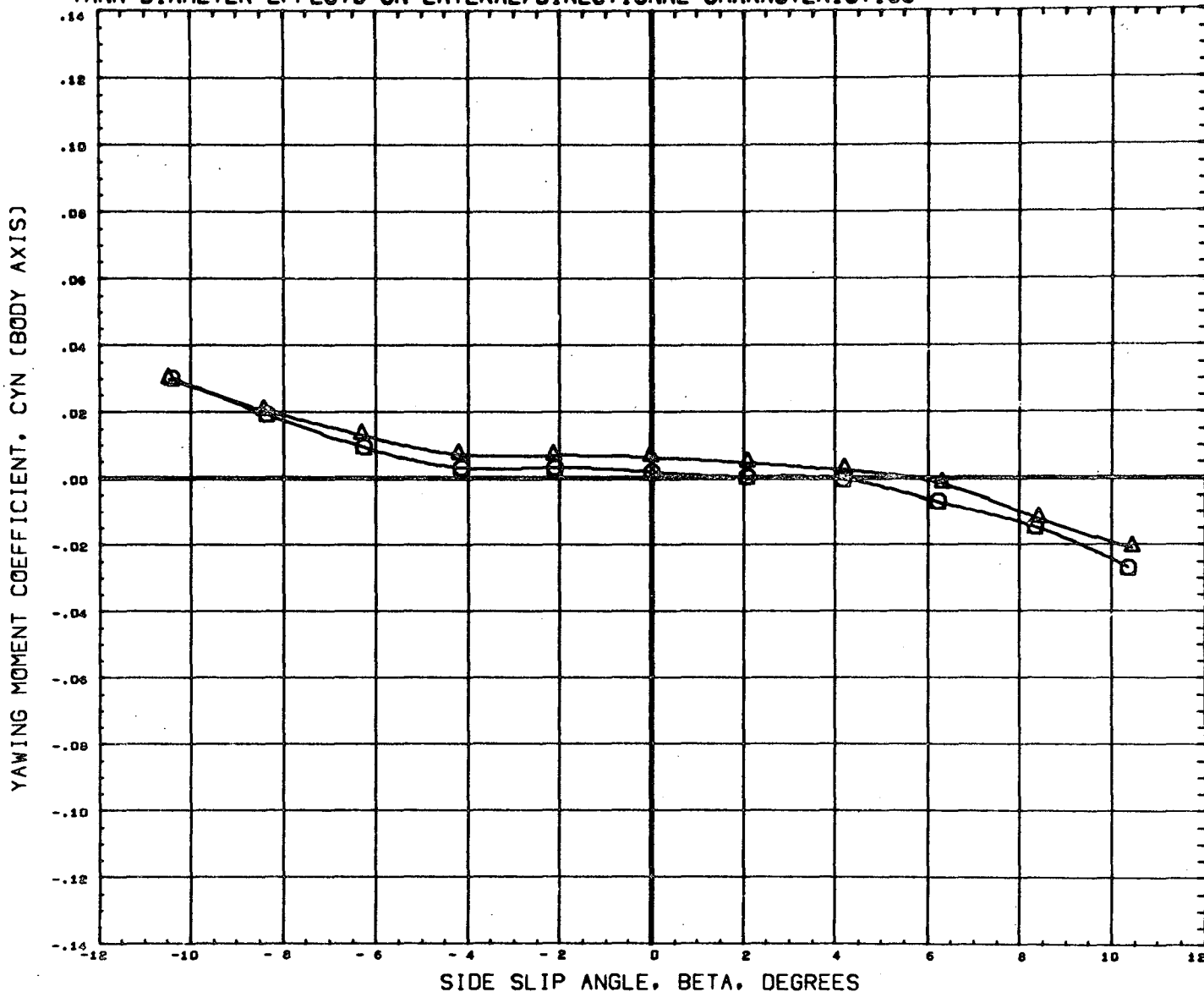

DATA SET SYMBOL	CONFIGURATION DESCRIPTION	ORBIN	THETS	ALPHA	REFERENCE INFORMATION
(B65003)	MSFC TWT 534 SHUTTLE LAUNCH	-1.500		0.000	SREF 4.8950 SQ. IN
(B65021)	MSFC TWT 534 SHUTTLE LAUNCH	-1.500		0.000	LREF 2.6440 IN.
					BREF 3.5250 IN.
					XMRP 3.4900 IN.
					YMRP 0.0000 IN.
					ZMRP 0.1616 IN.
					SCALE 0.0034

MACH .90

TANK DIAMETER EFFECTS ON LATERAL/DIRECTIONAL CHARACTERISTICS

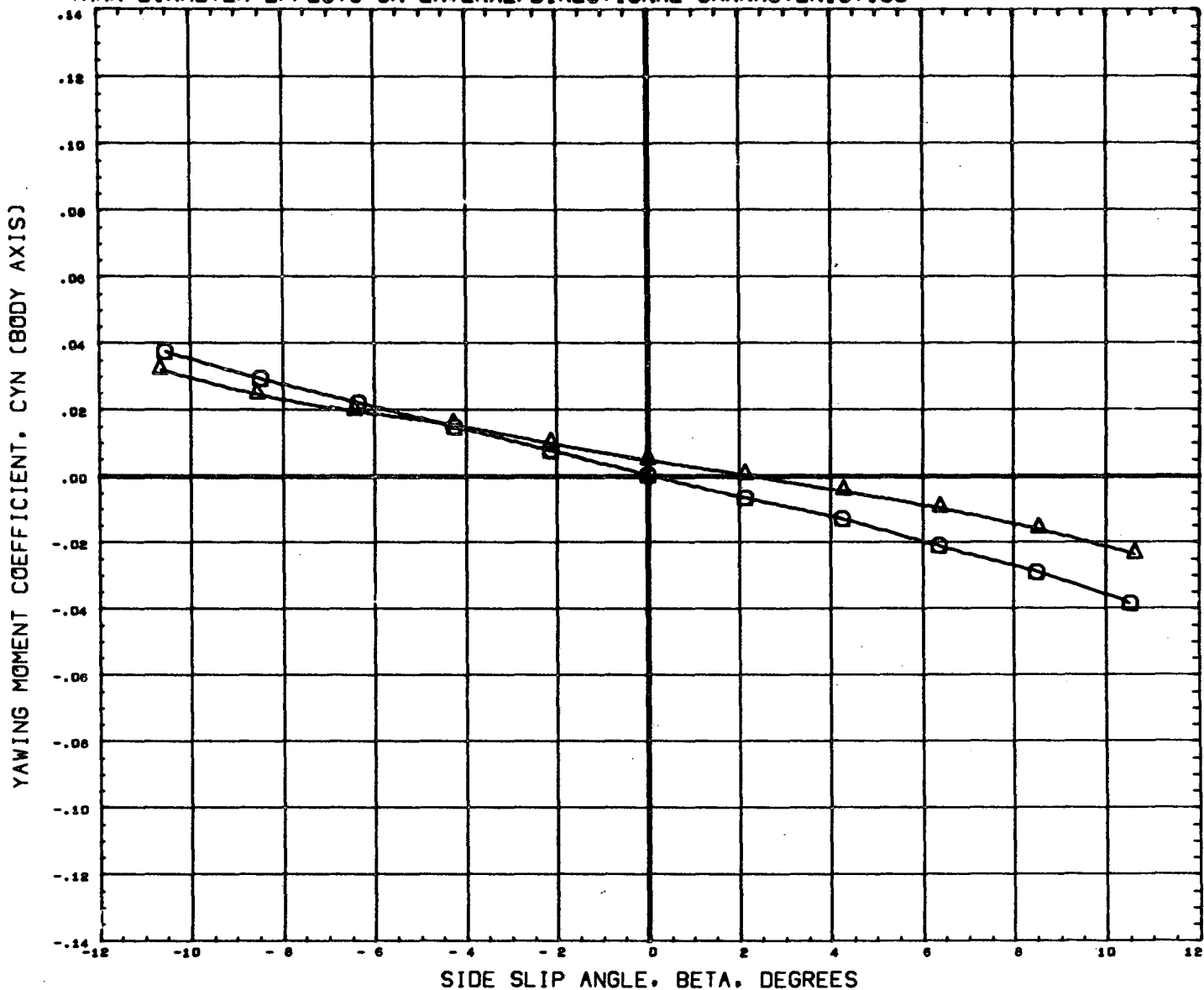

DATA SET SYMBOL	CONFIGURATION DESCRIPTION	ORBIT	THETS	ALPHA	REFERENCE INFORMATION
(B65009)	MSFC TWT 534 SHUTTLE LAUNCH	T101	-1.500	0.000	SREF 4.8950 SQ. IN
(B65021)	MSFC TWT 534 SHUTTLE LAUNCH	T201	-1.500	0.000	LREF 2.6440 IN.
					BREF 3.5250 IN.
					XNRP 3.4900 IN.
					YNRP 0.0000 IN.
					ZNRP 0.1616 IN.
					SCALE 0.0034

MACH 1.09

PAGE 188

TANK DIAMETER EFFECTS ON LATERAL/DIRECTIONAL CHARACTERISTICS

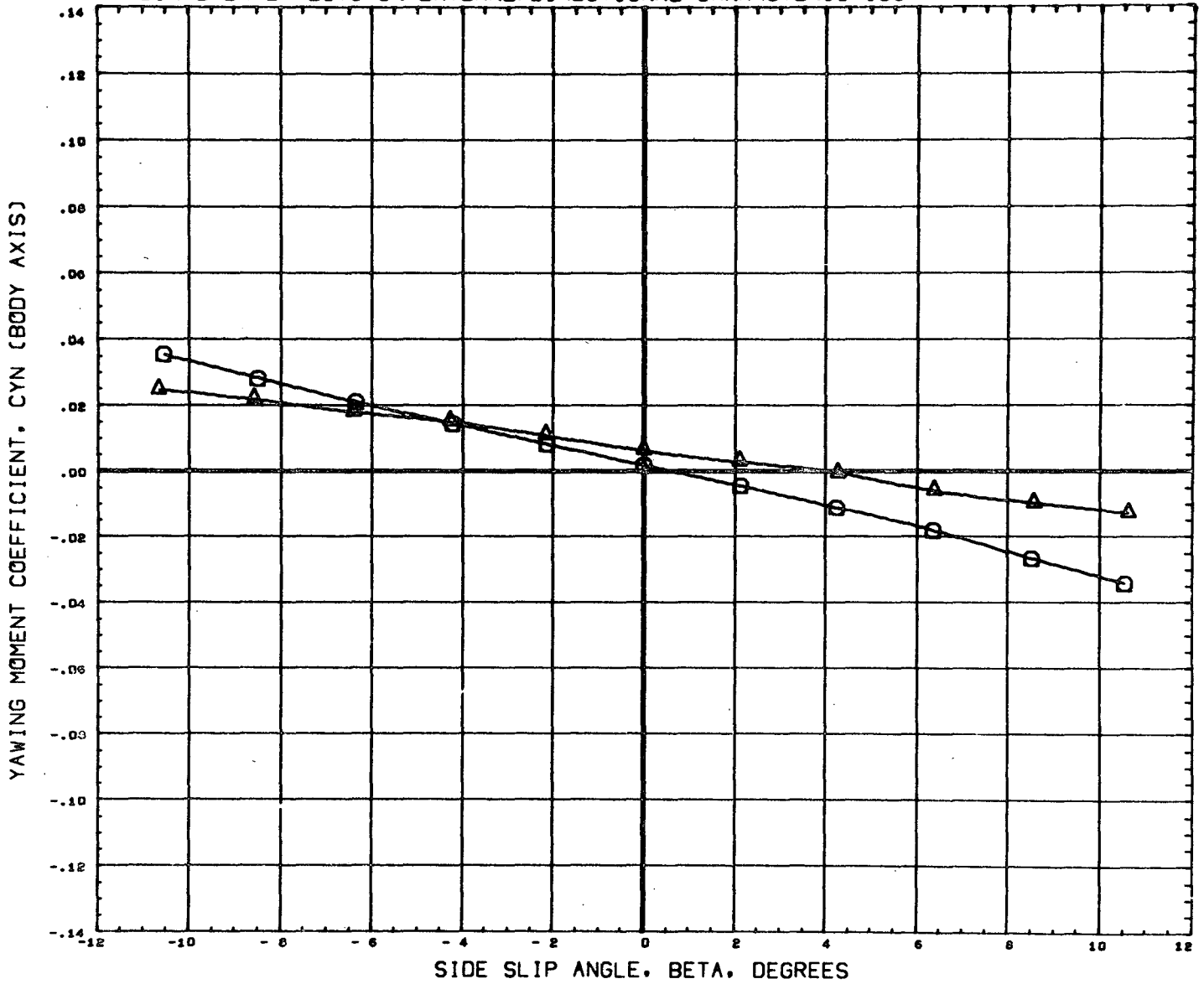

DATA SET SYMBOL	CONFIGURATION DESCRIPTION	ORBIN	THETS	ALPHA	REFERENCE INFORMATION
(B65003)	MSFC TWT 534 SHUTTLE LAUNCH	T101	-1.500	0.000	SREF 4.8950 SQ. IN
(B65021)	MSFC TWT 534 SHUTTLE LAUNCH	T201	-1.500	0.000	LREF 2.6440 IN.
					BREF 3.5250 IN.
					XMRP 3.4900 IN.
					YMRP 0.0000 IN.
					ZMRP 0.1616 IN.
					SCALE 0.0034

MACH 1.20

TANK DIAMETER EFFECTS ON LATERAL/DIRECTIONAL CHARACTERISTICS

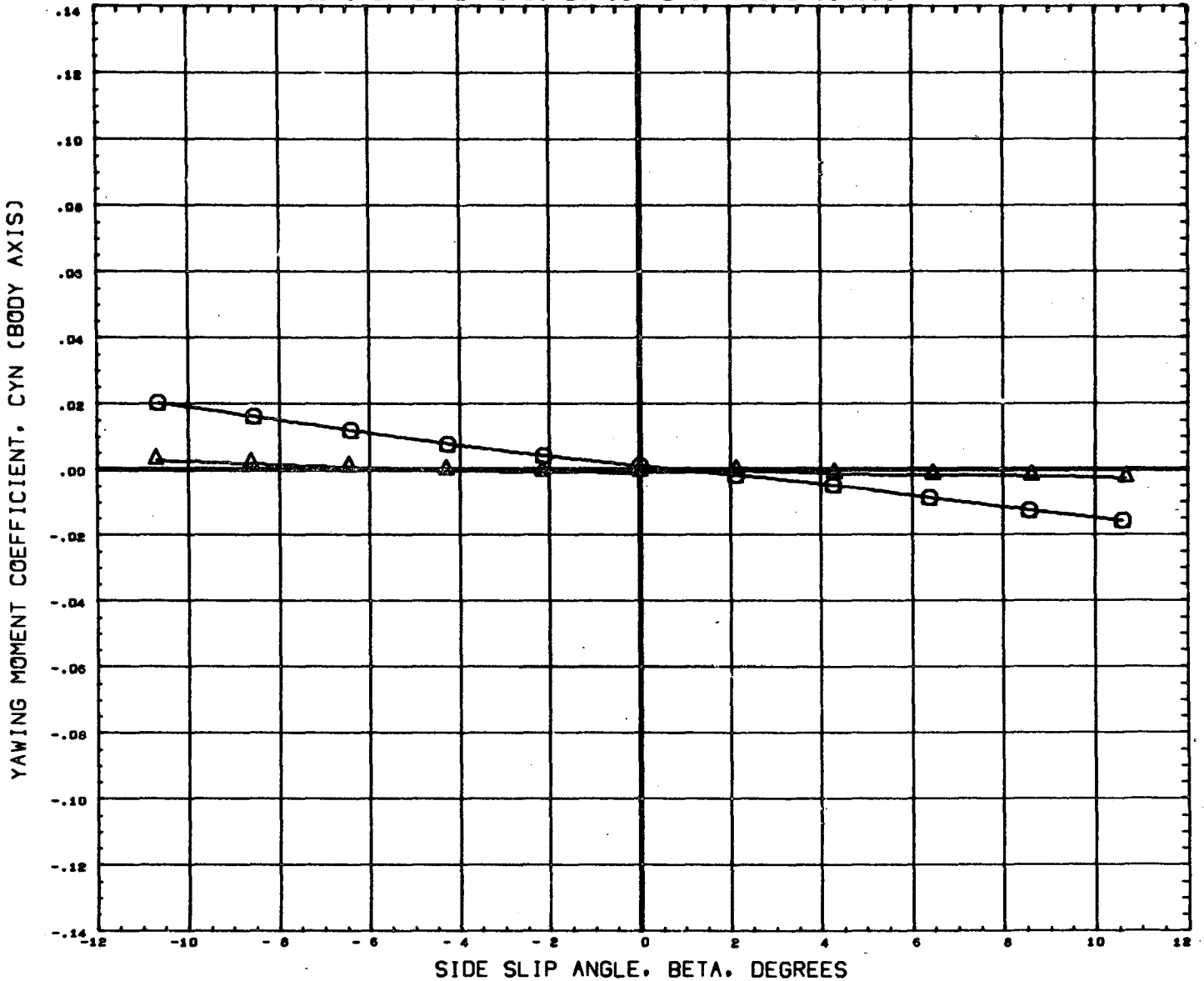

DATA SET SYMBOL	CONFIGURATION DESCRIPTION	ORBIN	THETS	ALPHA	REFERENCE INFORMATION
(B65003)	MSFC TWT 534 SHUTTLE LAUNCH	T101	-1.500	0.000	SREF 4.8950 96. IN
(B65021)	MSFC TWT 534 SHUTTLE LAUNCH	T201	-1.500	0.000	LREF 2.6440 IN.
					BREF 3.5250 IN.
					XNRP 3.4900 IN.
					YNRP 0.0000 IN.
					ZNRP 0.1616 IN.
					SCALE 0.0034

MACH 1.96

PAGE 190

TANK DIAMETER EFFECTS ON LATERAL/DIRECTIONAL CHARACTERISTICS

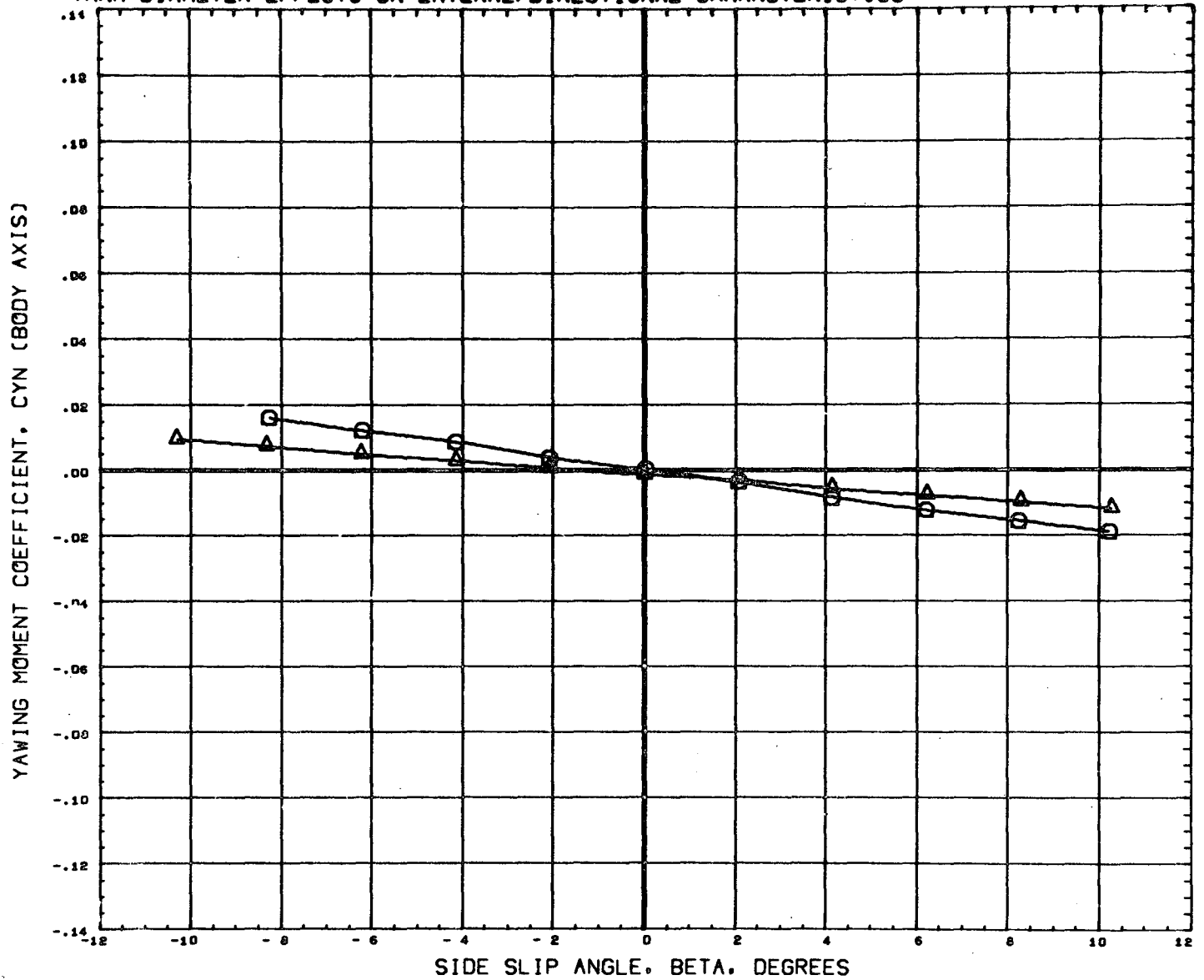

DATA SET SYMBOL	CONFIGURATION DESCRIPTION	ORBIN	THETS	ALPHA	REFERENCE INFORMATION
(B65003)	MSFC TWT 534 SHUTTLE LAUNCH	-1.500		0.000	SREF 4.8950 SQ. IN
(B65021)	MSFC TWT 534 SHUTTLE LAUNCH	-1.500		0.000	LREF 2.6440 IN.
					BREF 3.5250 IN.
					XMRP 3.4900 IN.
					YMRP 0.0000 IN.
					ZMRP 0.1616 IN.
					SCALE 0.0034

MACH 2.74

TANK DIAMETER EFFECTS ON LATERAL/DIRECTIONAL CHARACTERISTICS

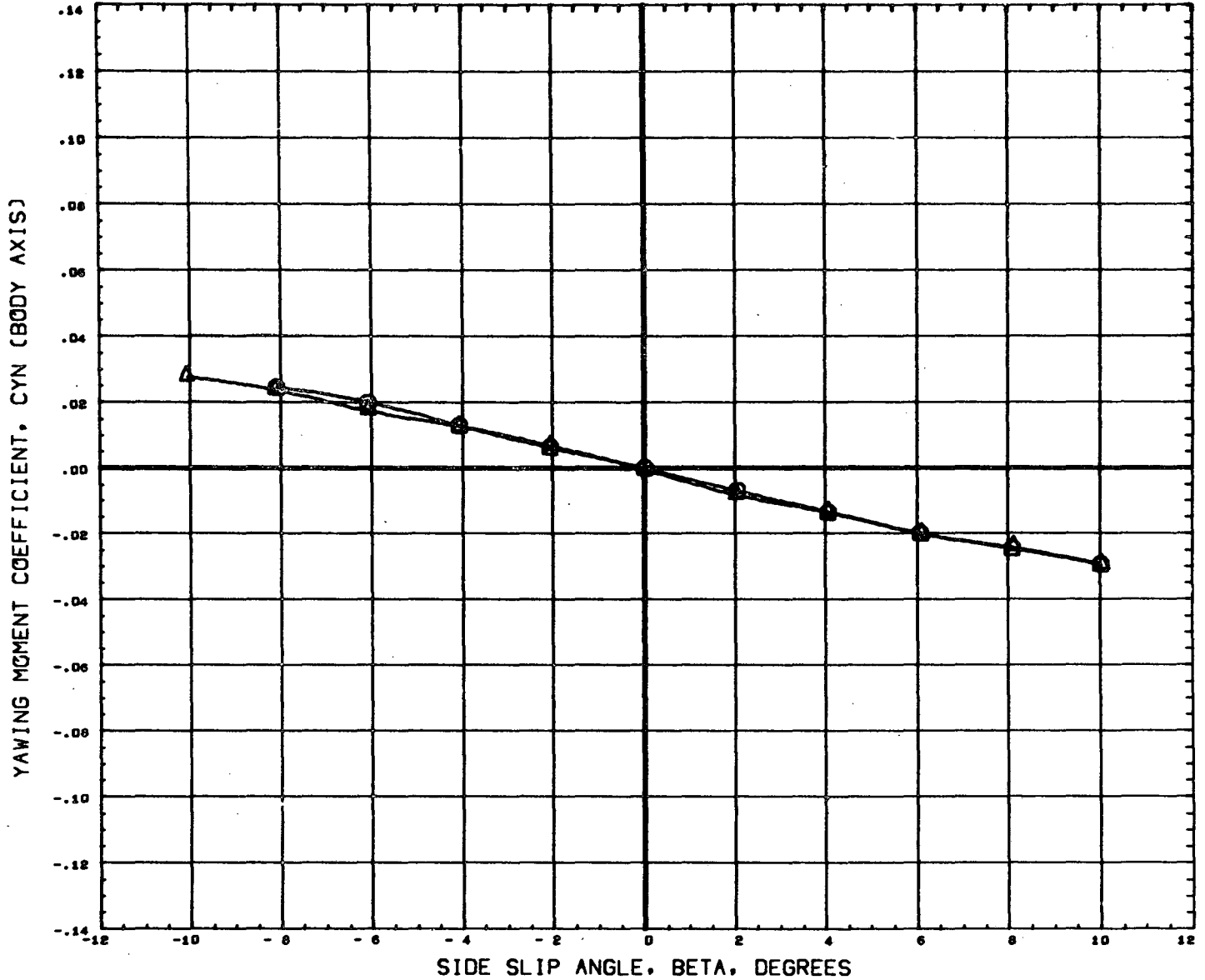

DATA SET SYMBOL	CONFIGURATION DESCRIPTION	ORBIN	THETS	ALPHA	REFERENCE INFORMATION
(B65003)	MSFC TWT 534 SHUTTLE LAUNCH	T101	-1.500	0.000	SREF 4.8950 SQ. IN.
(B65021)	MSFC TWT 534 SHUTTLE LAUNCH	T201	-1.500	0.000	LREF 2.6440 IN.
					BREF 3.5250 IN.
					XMRP 3.4900 IN.
					YMRP 0.0000 IN.
					ZMRP 0.1616 IN.
					SCALE 0.0034

MACH 4.96

TANK DIAMETER EFFECTS ON LATERAL/DIRECTIONAL CHARACTERISTICS

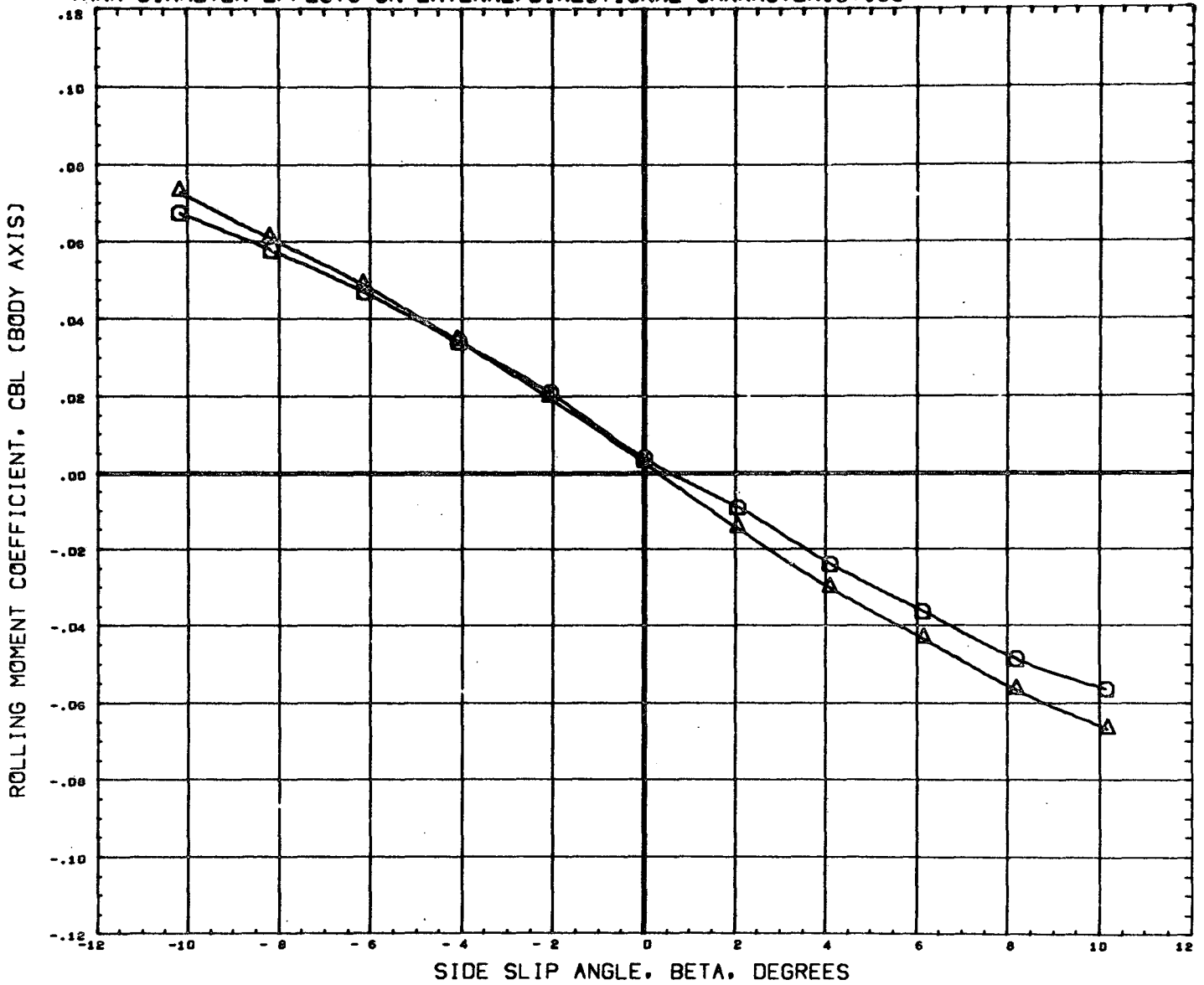

DATA SET SYMBOL	CONFIGURATION DESCRIPTION	ORBIN	THETS	ALPHA
(865003)	MSFC TWT 534 SHUTTLE LAUNCH	T101	-1.500	0.000
(865021)	MSFC TWT 534 SHUTTLE LAUNCH	T201	-1.500	0.000

REFERENCE INFORMATION	
SREF	4.8950 SQ. IN
LREF	2.6440 IN.
BREF	3.5250 IN.
XMRP	3.4900 IN.
YMRP	0.0000 IN.
ZMRP	0.1616 IN.
SCALE	0.0034

MACH .60

TANK DIAMETER EFFECTS ON LATERAL/DIRECTIONAL CHARACTERISTICS

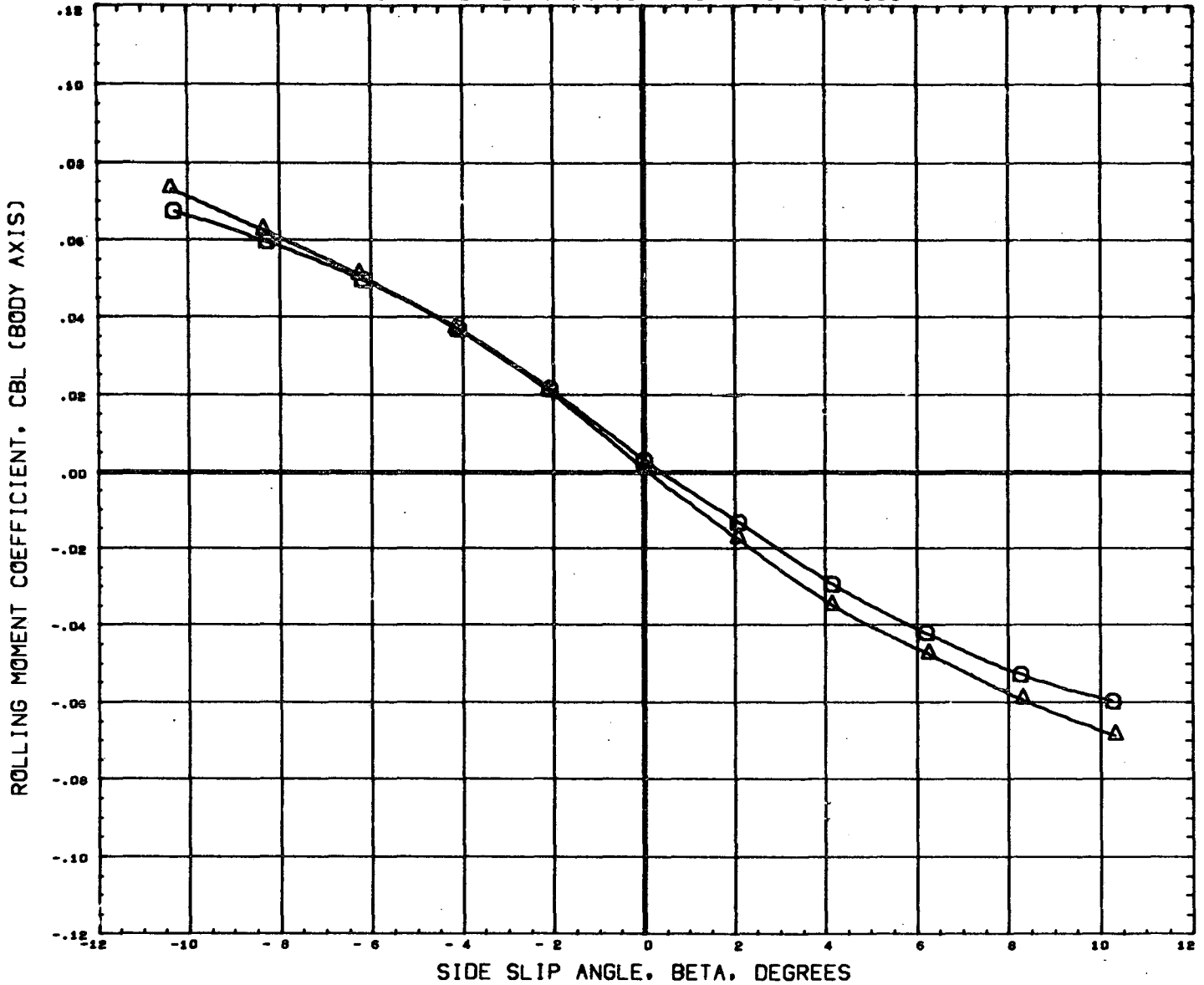

DATA SET SYMBOL	CONFIGURATION DESCRIPTION	ORBIN	THETS	ALPHA	REFERENCE INFORMATION
(B65003)	MSFC TWT 534 SHUTTLE LAUNCH	T101	-1.500	0.000	SREF 4.8950 SQ. IN
(B65021)	MSFC TWT 534 SHUTTLE LAUNCH	T201	-1.500	0.000	LREF 2.6440 IN.
					BREF 3.5250 IN.
					XMRP 3.4900 IN.
					YMRP 0.0000 IN.
					ZMRP 0.1616 IN.
					SCALE 0.0034

MACH .80

TANK DIAMETER EFFECTS ON LATERAL/DIRECTIONAL CHARACTERISTICS

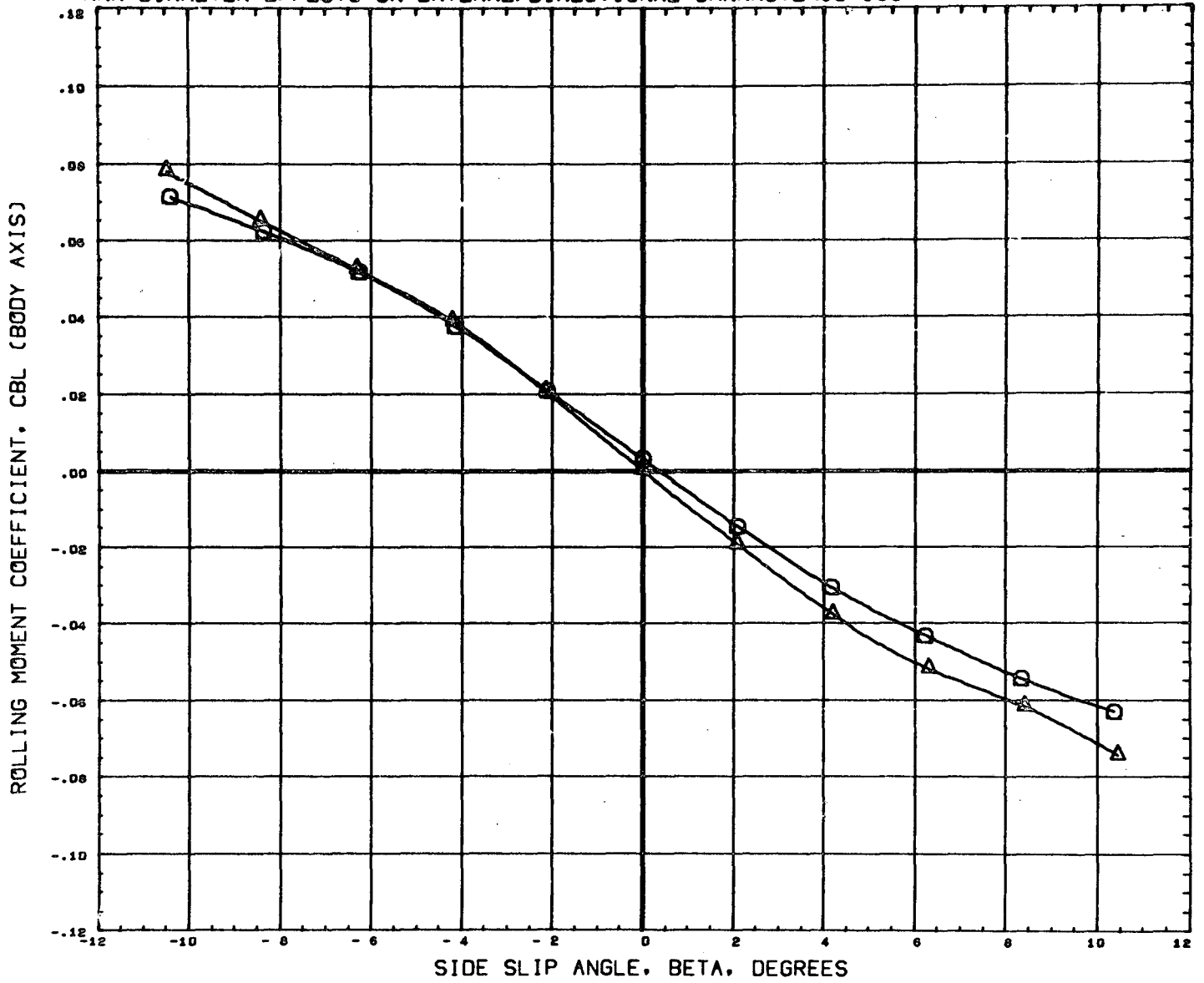

DATA SET SYMBOL	CONFIGURATION DESCRIPTION	ORBIN	THETS	ALPHA	REFERENCE INFORMATION
(B65003)	MSFC TWT 534 SHUTTLE LAUNCH	T101	-1.500	0.000	SREF 4.8950 Sq. IN.
(B65021)	MSFC TWT 534 SHUTTLE LAUNCH	T201	-1.500	0.000	LREF 2.6440 IN.
					BREF 3.5250 IN.
					XMRP 3.4900 IN.
					YMRP 0.0000 IN.
					ZMRP 0.1616 IN.
					SCALE 0.0034

MACH .90

TANK DIAMETER EFFECTS ON LATERAL/DIRECTIONAL CHARACTERISTICS

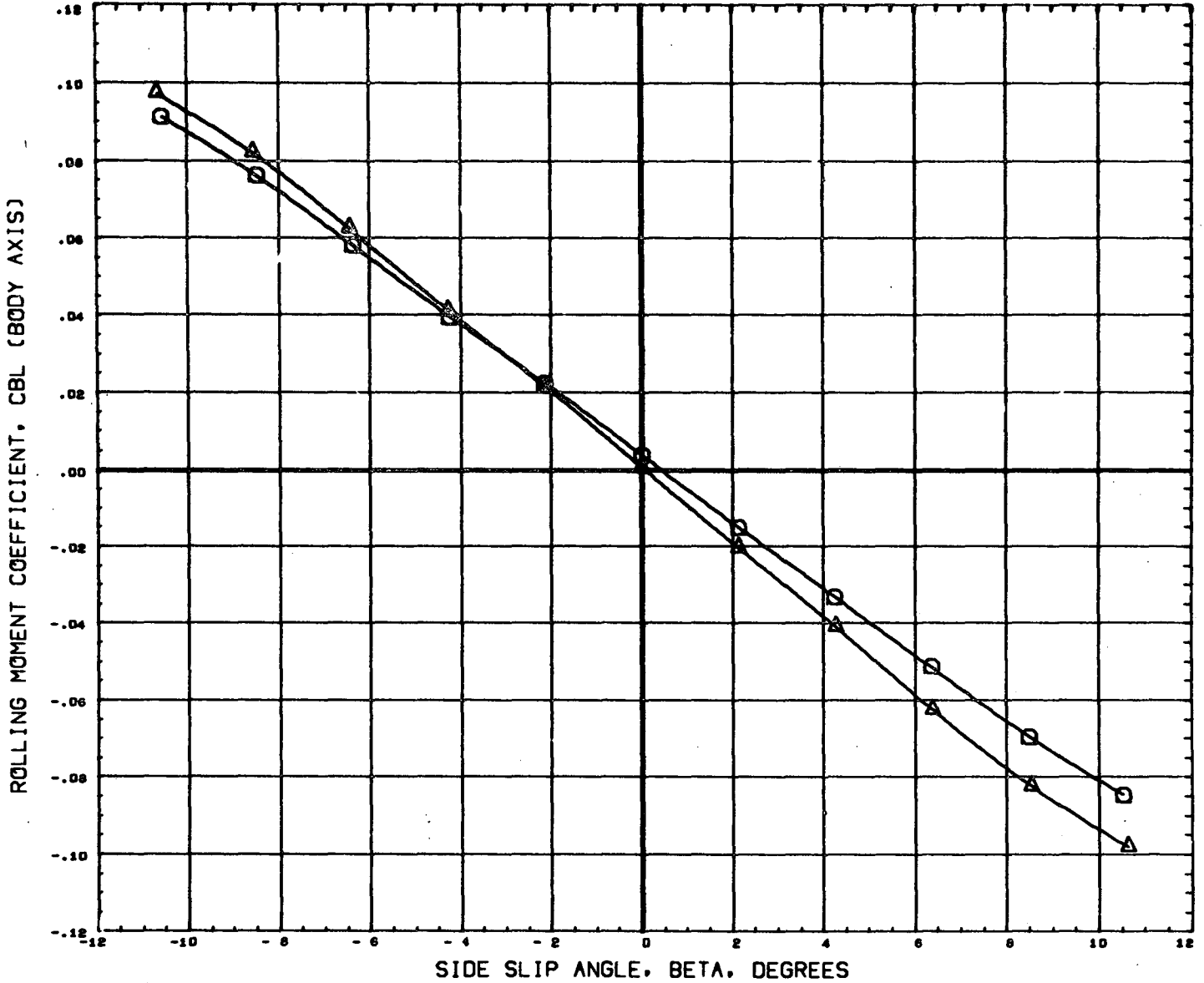

DATA SET SYMBOL	CONFIGURATION DESCRIPTION	ORBIN	THETS	ALPHA	REFERENCE INFORMATION
(B65003)	MSFC TWT 534 SHUTTLE LAUNCH	T101	-1.500	0.000	SREF 4.8950 sq. IN
(B65021)	MSFC TWT 534 SHUTTLE LAUNCH	T201	-1.500	0.000	LREF 2.6440 IN.
					BREF 3.5250 IN.
					XMRP 3.4900 IN.
					YMRP 0.0000 IN.
					ZMRP 0.1616 IN.
					SCALE 0.0034

TANK DIAMETER EFFECTS ON LATERAL/DIRECTIONAL CHARACTERISTICS

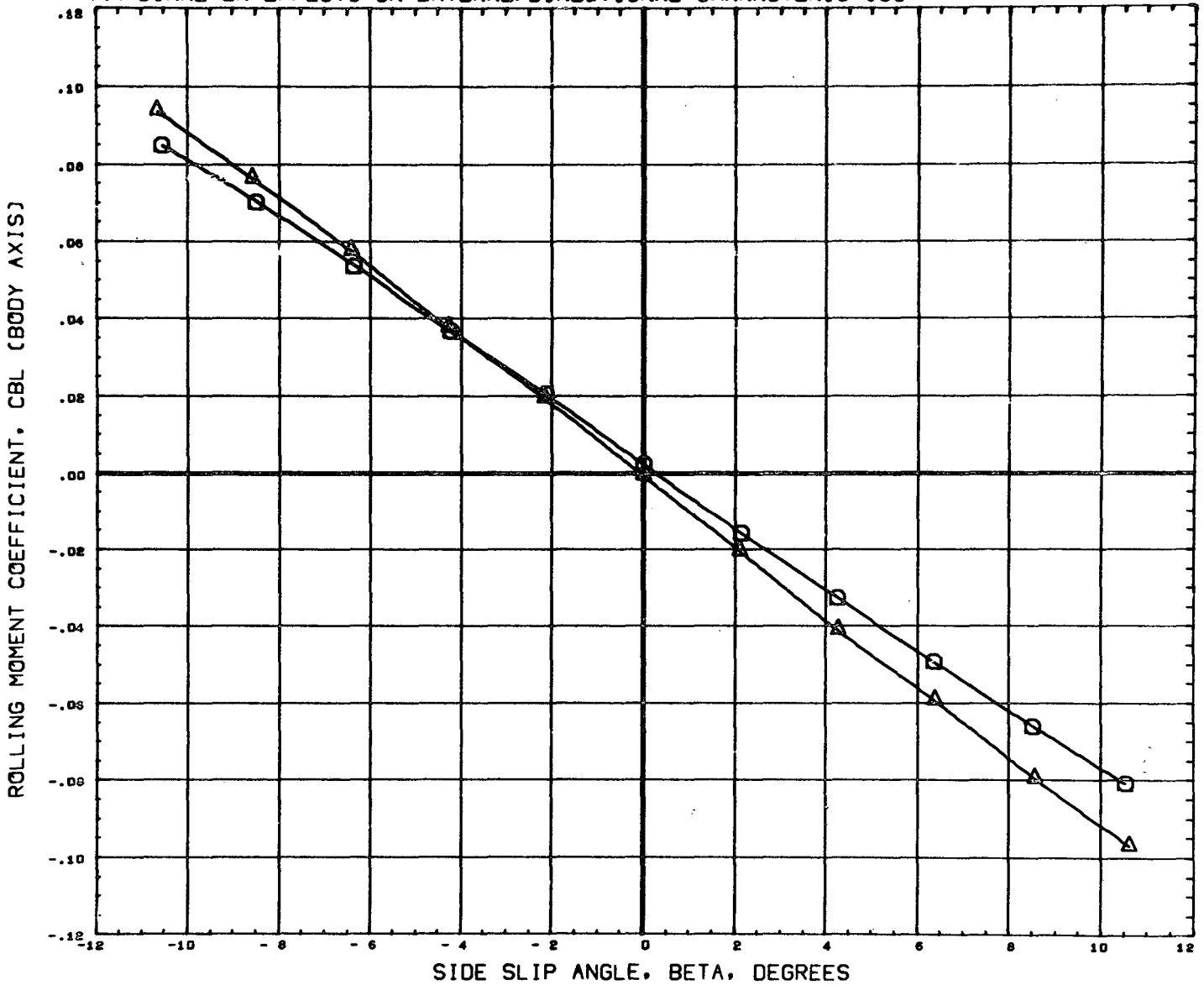

DATA SET SYMBOL	CONFIGURATION DESCRIPTION	ORBIN	THETS	ALPHA	REFERENCE INFORMATION
(865003) ○	MSFC TWT 534 SHUTTLE LAUNCH T101	-1.500		0.000	SREF 4.8950 SQ. IN
(865021) △	MSFC TWT 534 SHUTTLE LAUNCH T201	-1.500		0.000	LREF 2.6440 IN.
					BREF 3.5250 IN.
					XMRP 3.4900 IN.
					YMRP 0.0000 IN.
					ZMRP 0.1616 IN.
					SCALE 0.0034

MACH 1.20

TANK DIAMETER EFFECTS ON LATERAL/DIRECTIONAL CHARACTERISTICS

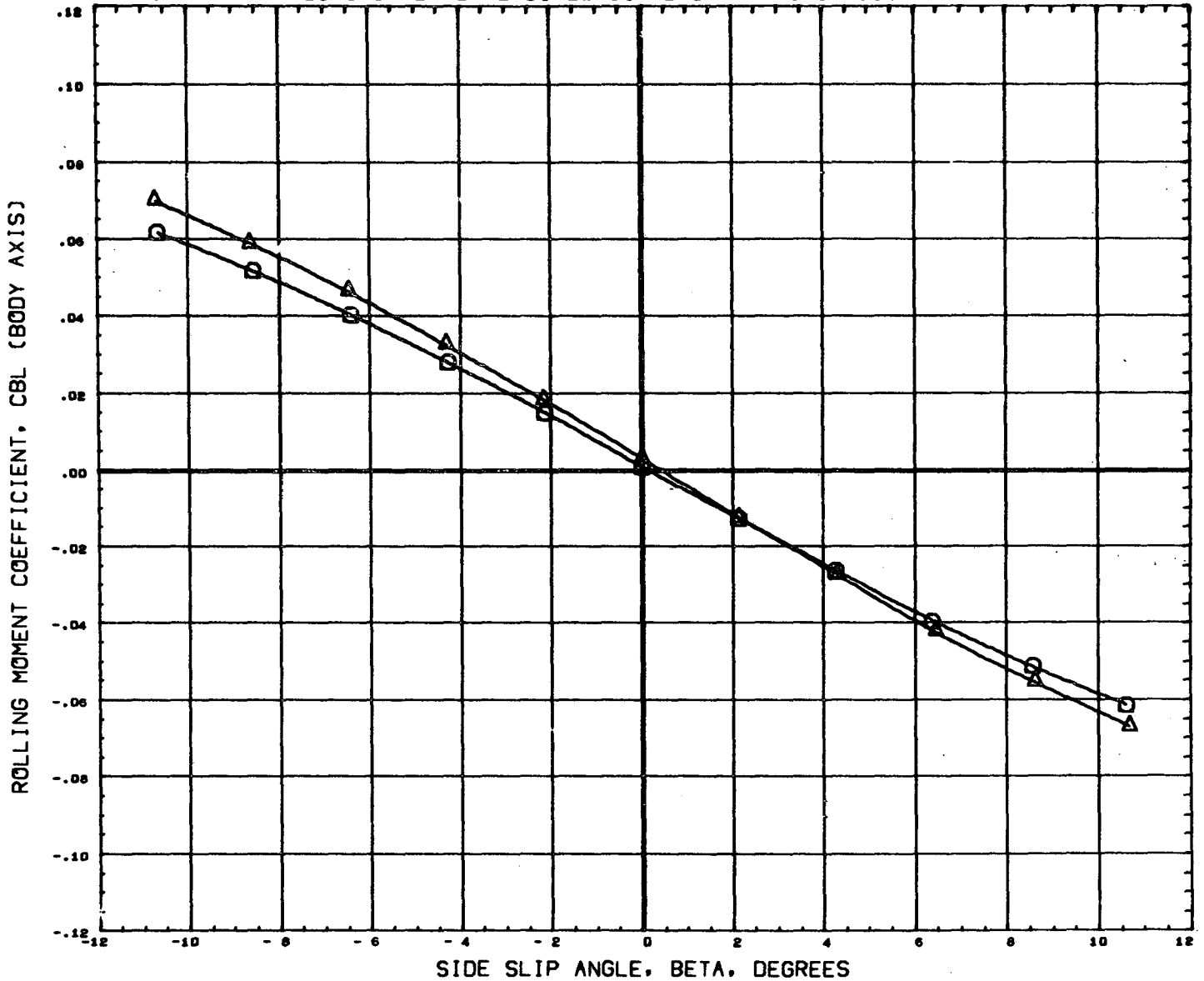

DATA SET SYMBOL	CONFIGURATION DESCRIPTION	ORBIN	THETS	ALPHA	REFERENCE INFORMATION
(865003)	MSFC TWT 534 SHUTTLE LAUNCH	T101	-1.500	0.000	SREF 4.8950 SQ. IN
(865021)	MSFC TWT 534 SHUTTLE LAUNCH	T201	-1.500	0.000	LREF 2.6440 IN.
					BREF 3.5250 IN.
					XMRP 3.4900 IN.
					YMRP 0.0000 IN.
					ZMRP 0.1616 IN.
					SCALE 0.0034

TANK DIAMETER EFFECTS ON LATERAL/DIRECTIONAL CHARACTERISTICS

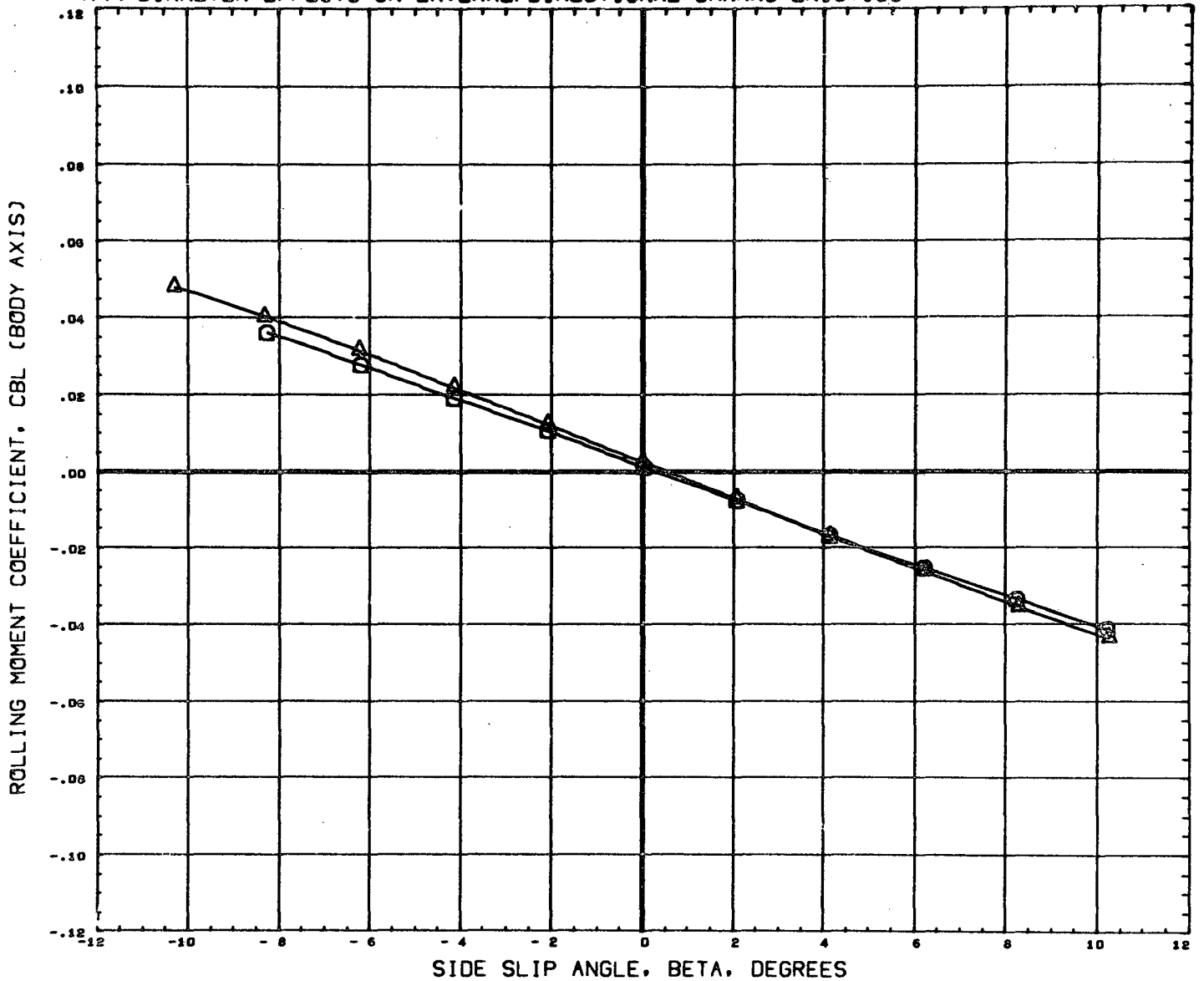

DATA SET SYMBOL	CONFIGURATION DESCRIPTION	ORBIN	THETS	ALPHA	REFERENCE INFORMATION
(B65003)	MSFC TWT 534 SHUTTLE LAUNCH	T101	-1.500	0.000	SREF 4.8950 SQ. IN
(B65021)	MSFC TWT 534 SHUTTLE LAUNCH	T201	-1.500	0.000	LREF 2.6440 IN.
					BREF 3.5250 IN.
					XMRP 3.4900 IN.
					YMRP 0.0000 IN.
					ZMRP 0.1616 IN.
					SCALE 0.0034

MACH 2.74

TANK DIAMETER EFFECTS ON LATERAL/DIRECTIONAL CHARACTERISTICS

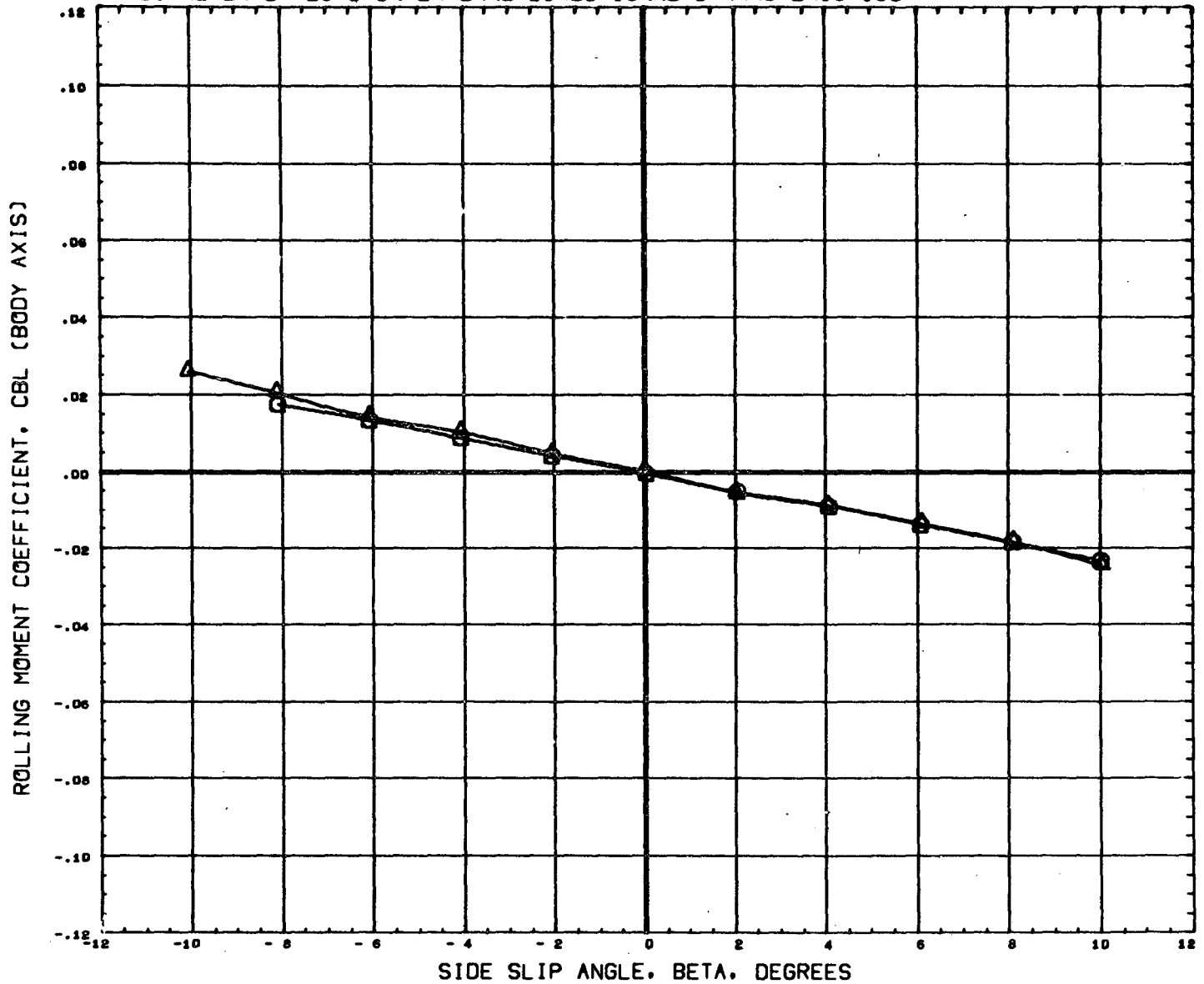

DATA SET SYMBOL	CONFIGURATION DESCRIPTION	ORBIN	THETS	ALPHA	REFERENCE INFORMATION
(865003)	NSFC TWT 534 SHUTTLE LAUNCH	-1.500		0.000	SREF 4.8950 SQ. IN
(865021)	NSFC TWT 534 SHUTTLE LAUNCH	-1.500		0.000	LREF 2.6440 IN.
					BREF 3.5250 IN.
					XMRP 3.4900 IN.
					YMRP 0.0000 IN.
					ZMRP 0.1616 IN.
					SCALE 0.0034

MACH 4.96

PAGE 200

TANK DIAMETER EFFECTS ON LATERAL/DIRECTIONAL CHARACTERISTICS

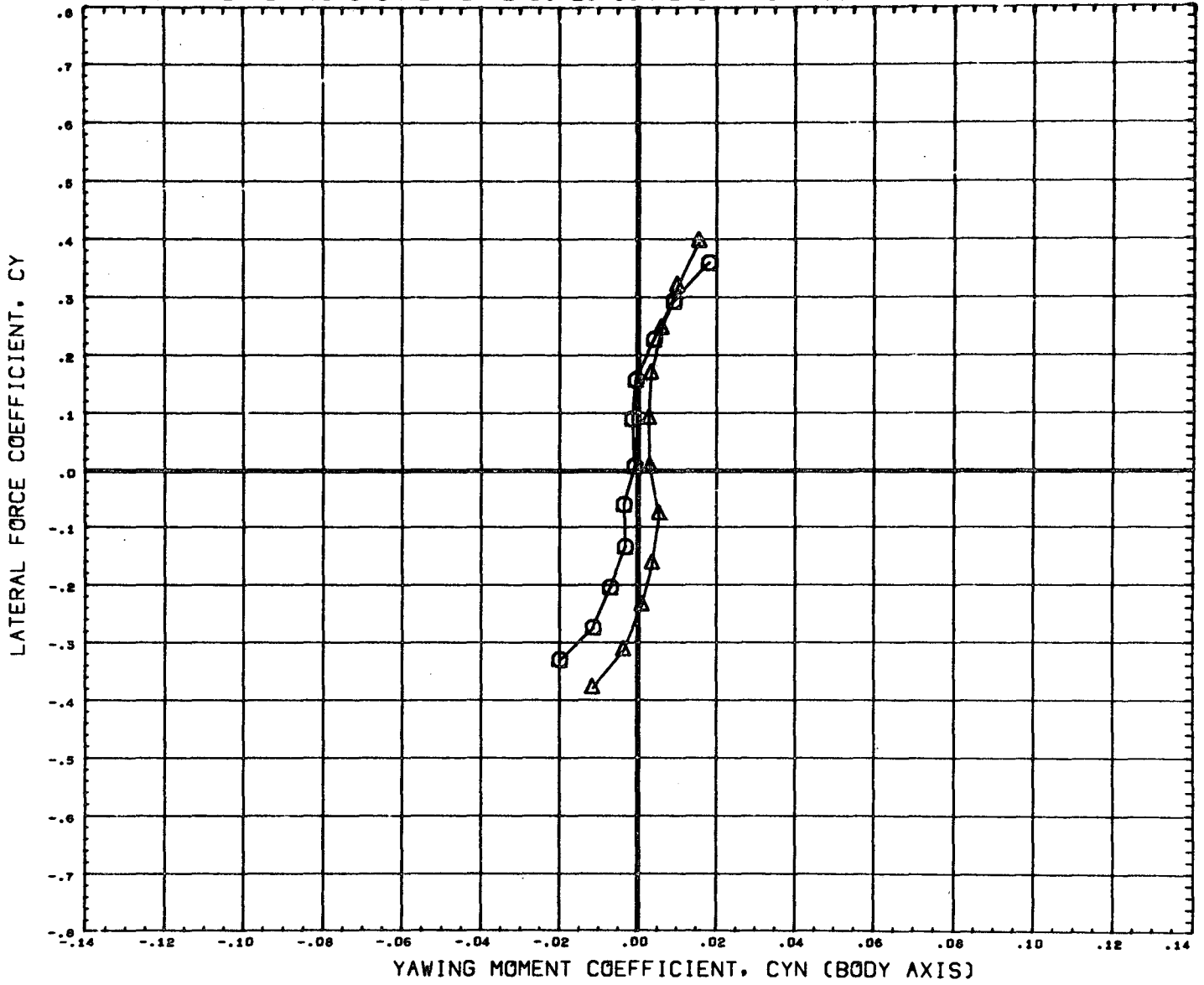

DATA SET SYMBOL	CONFIGURATION DESCRIPTION	ORBIN	THETS	ALPHA	REFERENCE INFORMATION
(B65003)	MSFC TWT 534 SHUTTLE LAUNCH	T101	-1.500	0.000	SREF 4.8950 SQ. IN
(B65021)	MSFC TWT 534 SHUTTLE LAUNCH	T201	-1.500	0.000	LREF 2.6440 IN.
					BREF 3.5250 IN.
					XMRP 3.4900 IN.
					YMRP 0.0000 IN.
					ZMRP 0.1616 IN.
					SCALE 0.0034

MACH .60

TANK DIAMETER EFFECTS ON LATERAL/DIRECTIONAL CHARACTERISTICS

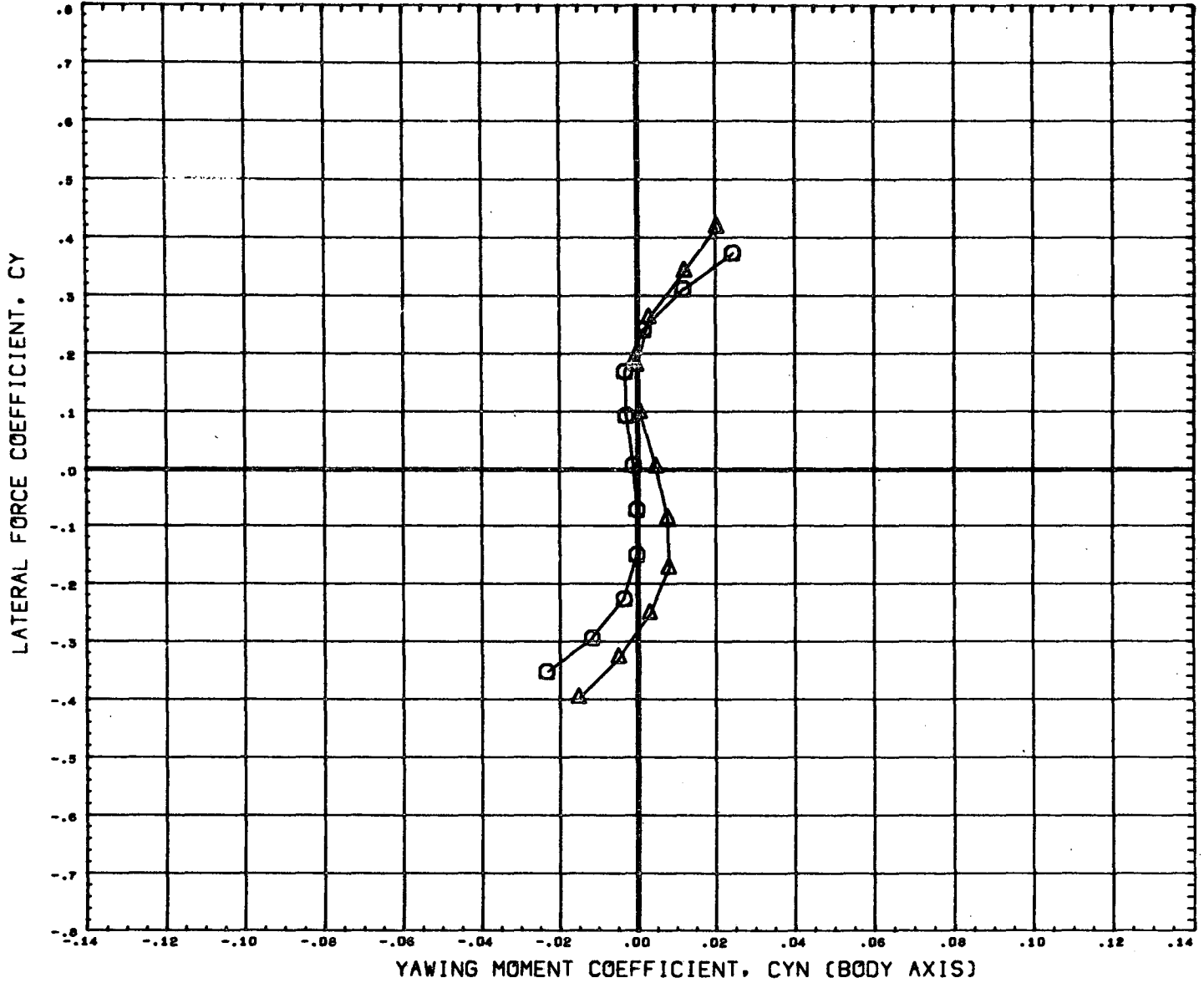

DATA SET SYMBOL	CONFIGURATION DESCRIPTION	ORBIN	THETS	ALPHA	REFERENCE INFORMATION
(B65003)	MSFC TWT 534 SHUTTLE LAUNCH	T101	-1.500	0.000	SREF 4.8950 SQ. IN
(B65021)	MSFC TWT 534 SHUTTLE LAUNCH	T201	-1.500	0.000	LREF 2.6440 IN.
					BREF 3.5250 IN.
					XMRP 3.4900 IN.
					YMRP 0.0000 IN.
					ZMRP 0.1616 IN.
					SCALE 0.0034

TANK DIAMETER EFFECTS ON LATERAL/DIRECTIONAL CHARACTERISTICS

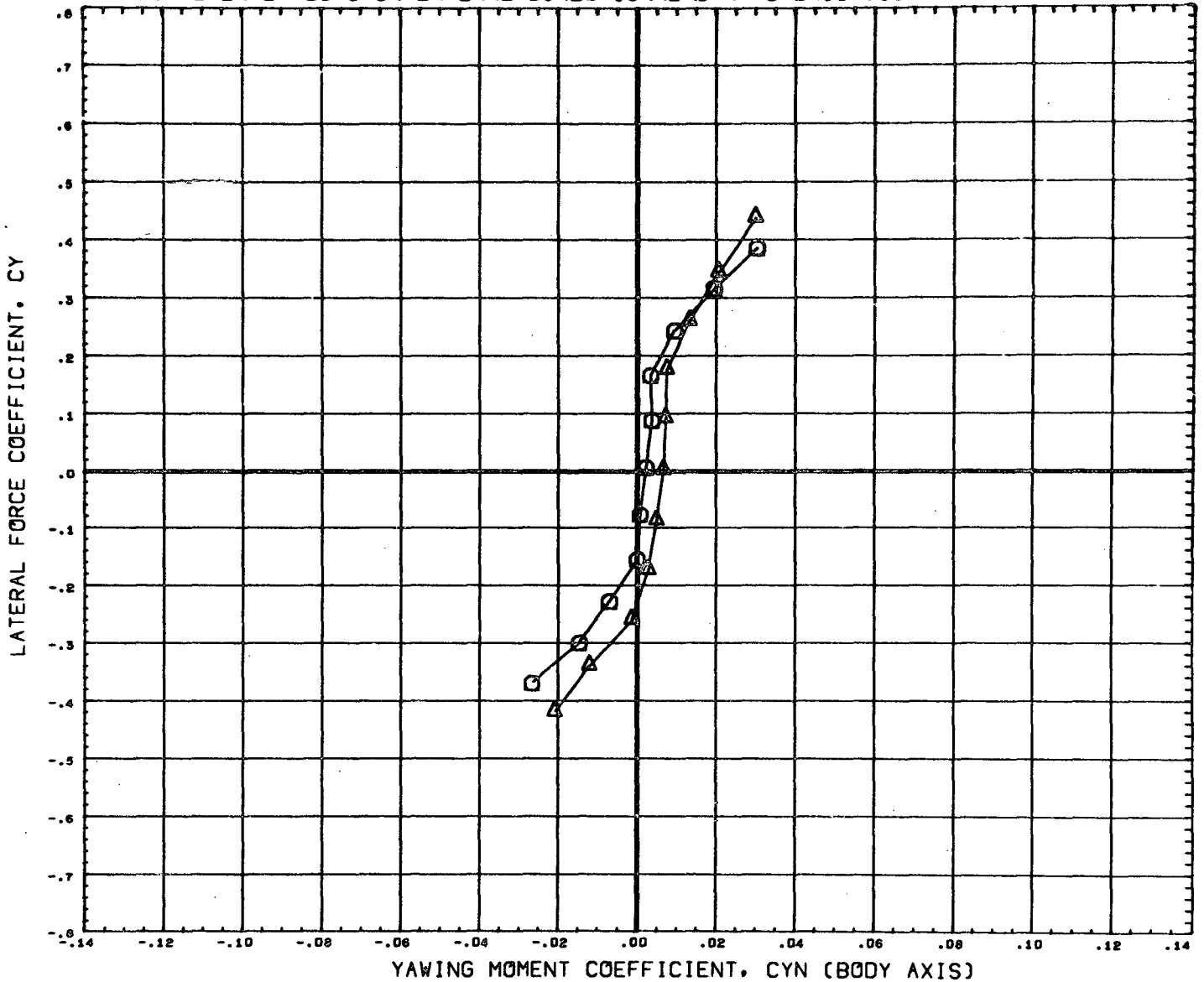

DATA SET SYMBOL	CONFIGURATION DESCRIPTION	ORBIN	THETS	ALPHA	REFERENCE INFORMATION
(B65003)	MSFC TWT 534 SHUTTLE LAUNCH	T101	-1.500	0.000	SREF 4.8950 SQ. IN
(B65021)	MSFC TWT 534 SHUTTLE LAUNCH	T201	-1.500	0.000	LREF 2.6440 IN.
					BREF 3.5250 IN.
					XMRP 3.4900 IN.
					YMRF 0.0000 IN.
					ZMRF 0.1616 IN.
					SCALE 0.0034

MACH .90

TANK DIAMETER EFFECTS ON LATERAL/DIRECTIONAL CHARACTERISTICS

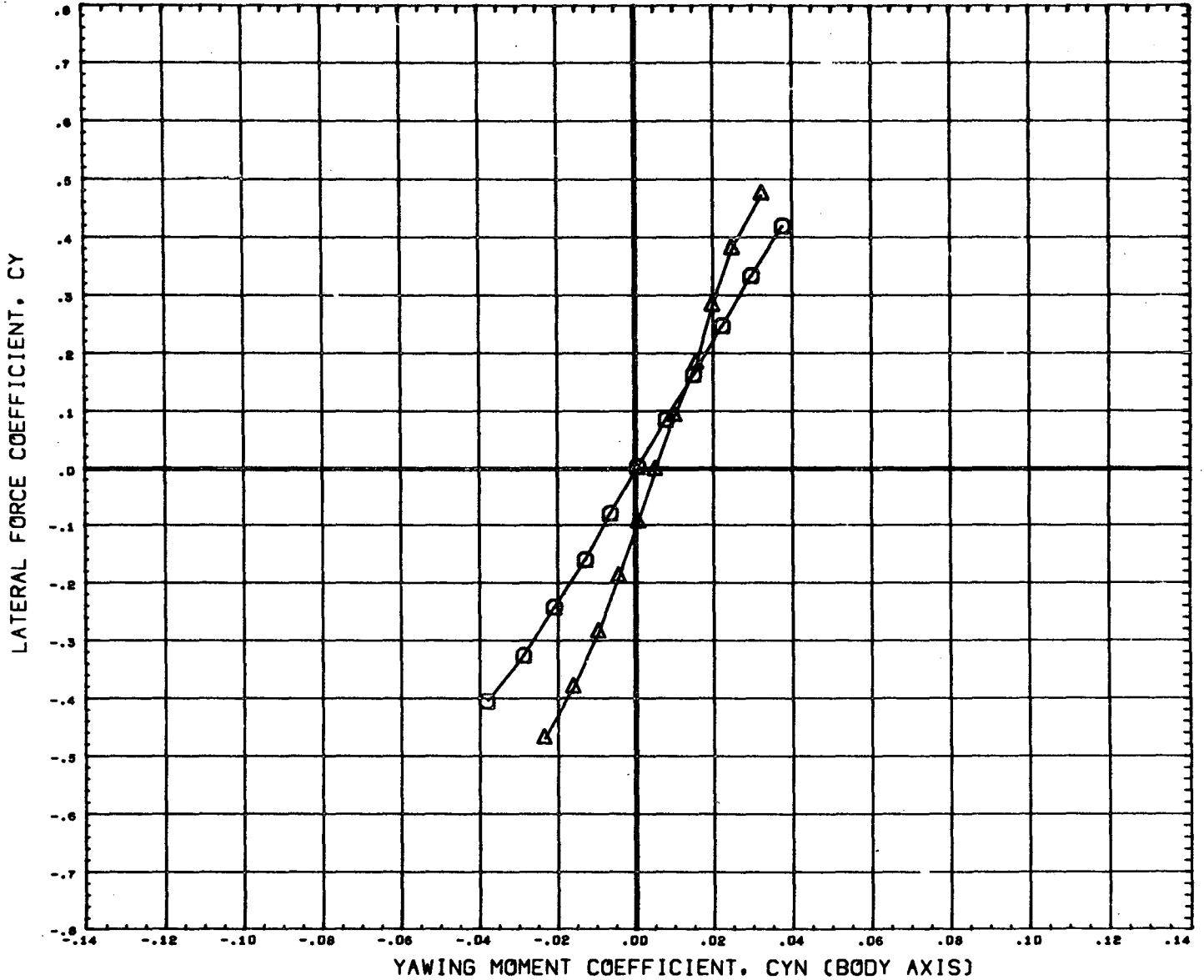

DATA SET SYMBOL	CONFIGURATION DESCRIPTION	ORBIN	THETS	ALPHA	REFERENCE INFORMATION
(B65003)	MSFC TWT 534 SHUTTLE LAUNCH	T101	-1.500	0.000	SREF 4.8950 SQ. IN
(B65021)	MSFC TWT 534 SHUTTLE LAUNCH	T201	-1.500	0.000	LREF 2.6440 IN.
					BREF 3.5250 IN.
					XMRP 3.4900 IN.
					YMRP 0.0000 IN.
					ZMRP 0.1616 IN.
					SCALE 0.0034

TANK DIAMETER EFFECTS ON LATERAL/DIRECTIONAL CHARACTERISTICS

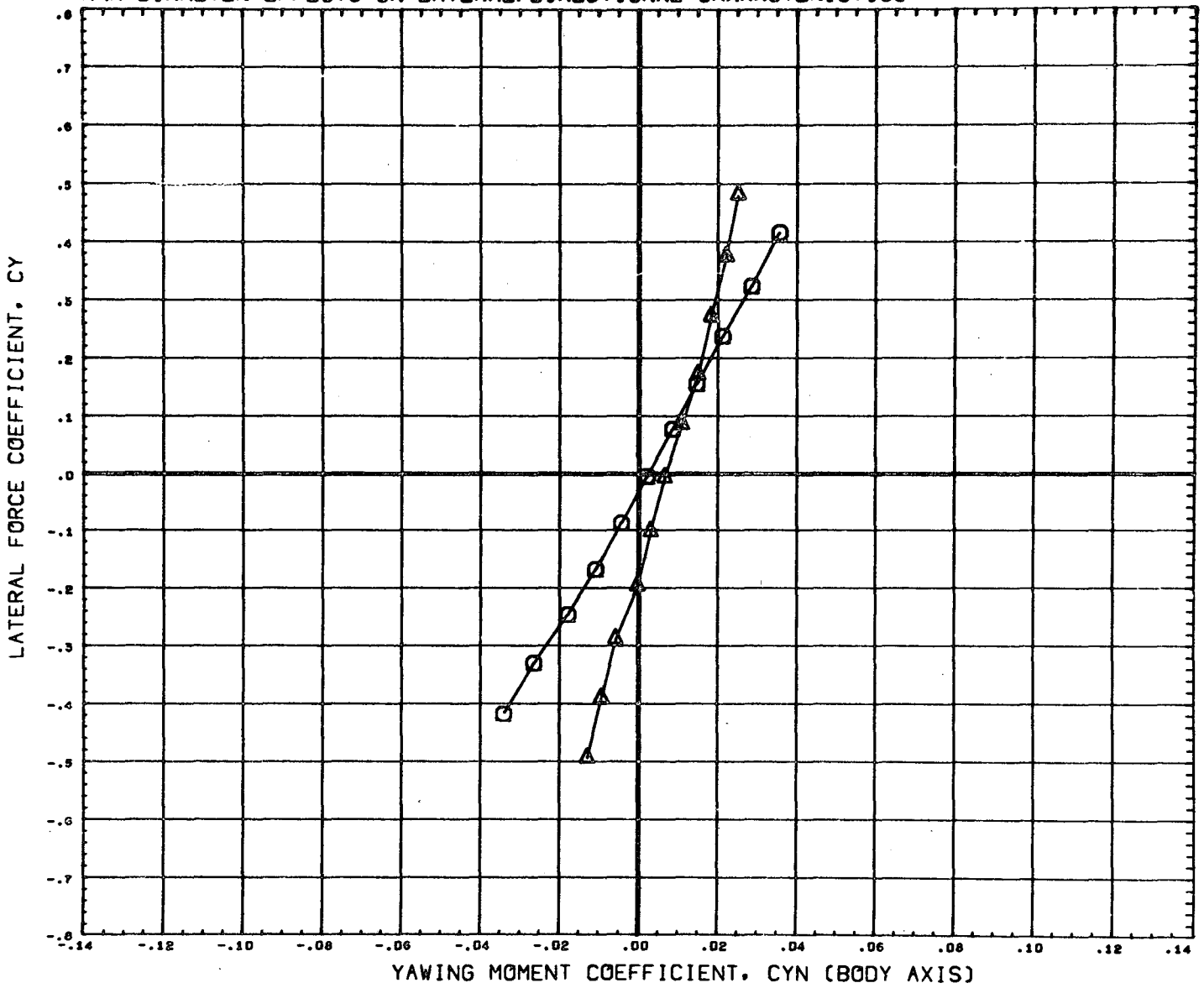

DATA SET SYMBOL	CONFIGURATION DESCRIPTION	ORBIN	THETS	ALPHA	REFERENCE INFORMATION
(B65003)	MSFC TWT 534 SHUTTLE LAUNCH	T101	-1.500	0.000	SREF 4.8950 SQ. IN
(B65021)	MSFC TWT 534 SHUTTLE LAUNCH	T201	-1.500	0.000	LREF 2.6440 IN.
					BREF 3.5250 IN.
					XMRP 3.4900 IN.
					YMRP 0.0000 IN.
					ZMRP 0.1616 IN.
					SCALE 0.0034

MACH 1.20

TANK DIAMETER EFFECTS ON LATERAL/DIRECTIONAL CHARACTERISTICS

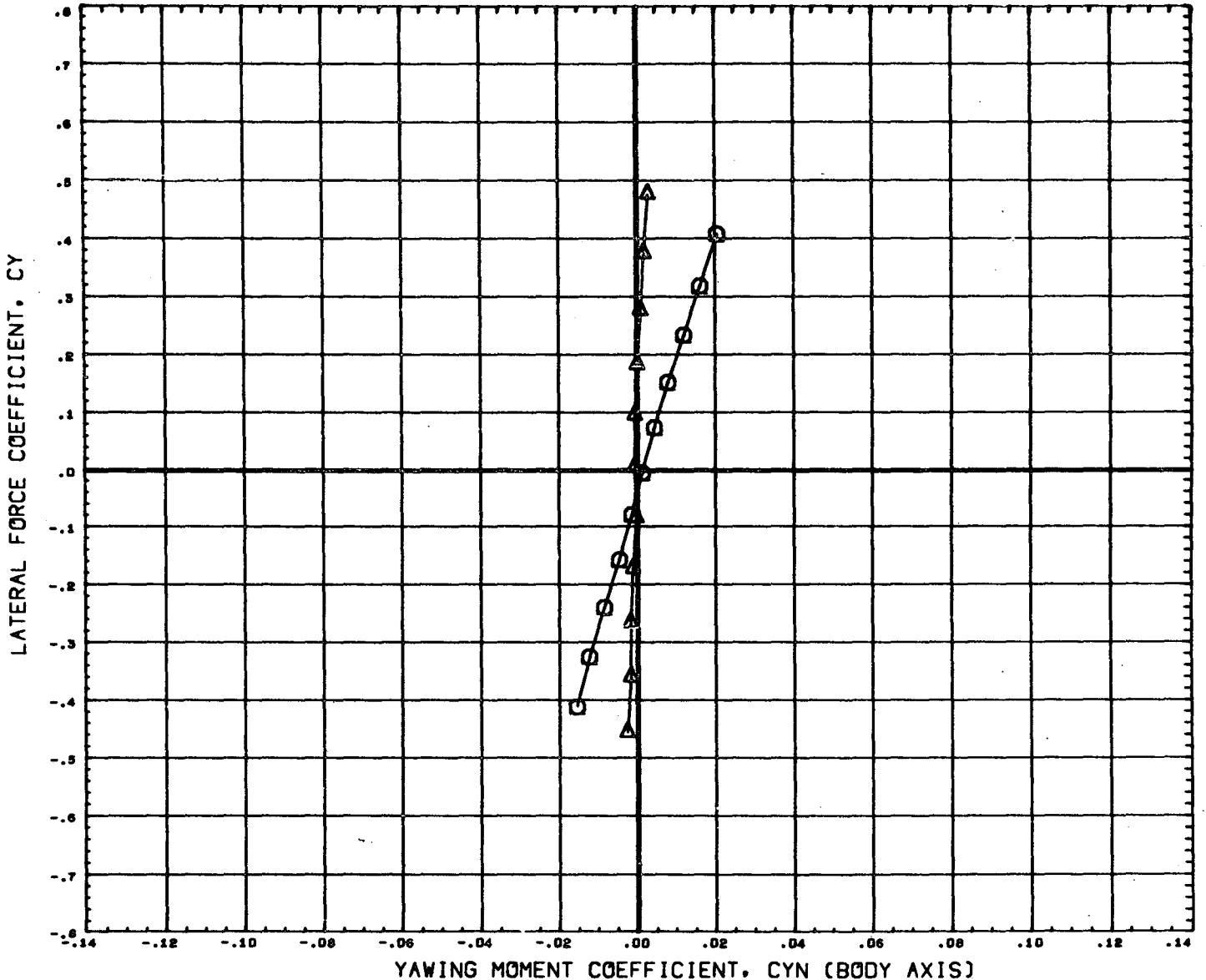

DATA SET SYMBOL	CONFIGURATION DESCRIPTION	ORBIN	THETS	ALPHA	REFERENCE INFORMATION
(B65005)	MSFC TWT 534 SHUTTLE LAUNCH	T101	-1.500	0.000	SREF 4.8950 SQ. IN
(B65021)	MSFC TWT 534 SHUTTLE LAUNCH	T201	-1.500	0.000	LREF 2.6440 IN.
					BREF 3.5250 IN.
					XMRP 3.4900 IN.
					YMRP 0.0000 IN.
					ZMRP 0.1616 IN.
					SCALE 0.0034

TANK DIAMETER EFFECTS ON LATERAL/DIRECTIONAL CHARACTERISTICS

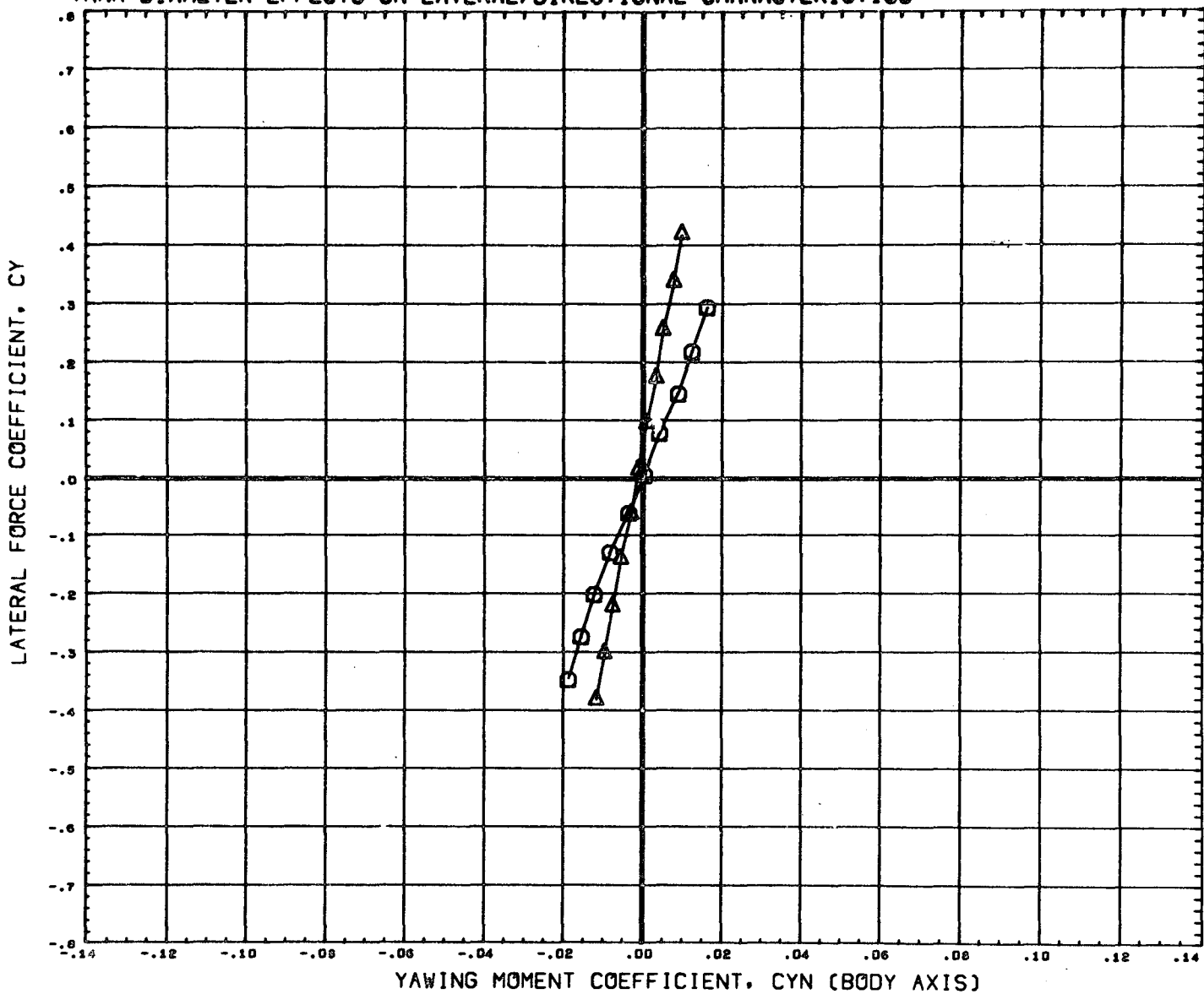

DATA SET SYMBOL	CONFIGURATION DESCRIPTION	T101	ORBIN	THETS	ALPHA	REFERENCE INFORMATION
(B65003)	MSFC TWT 534 SHUTTLE LAUNCH	T101	-1.500		0.000	SREF 4.8950 SQ. IN
(B65021)	MSFC TWT 534 SHUTTLE LAUNCH	T201	-1.500		0.000	LREF 2.6440 IN.
						BREF 3.5250 IN.
						XMRP 3.4900 IN.
						YMRP 0.0000 IN.
						ZMRP 0.1616 IN.
						SCALE 0.0034

MACH 2.74

TANK DIAMETER EFFECTS ON LATERAL/DIRECTIONAL CHARACTERISTICS

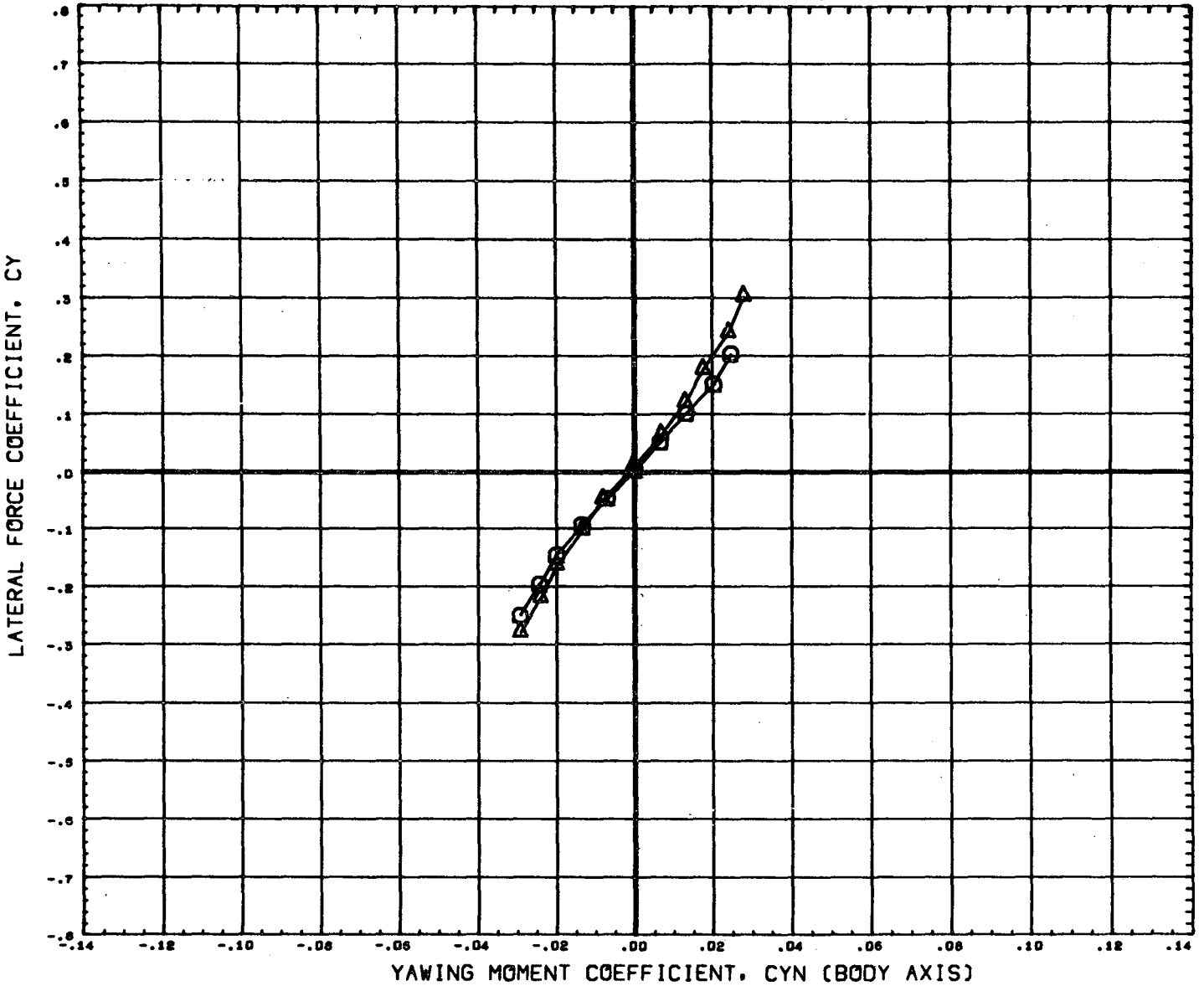

DATA SET SYMBOL	CONFIGURATION DESCRIPTION	ORBIN	THETS	ALPHA	REFERENCE INFORMATION
(B65003)	MSFC TWT 534 SHUTTLE LAUNCH	T101	-1.500	0.000	SREF 4.8950 SQ. IN
(B65021)	MSFC TWT 534 SHUTTLE LAUNCH	T201	-1.500	0.000	LREF 2.6440 IN.
					BREF 3.5250 IN.
					XMRP 3.4900 IN.
					YMRP 0.0000 IN.
					ZMRP 0.1616 IN.
					SCALE 0.0034

EFFECT OF ORBITER INCIDENCE ON LONGITUDINAL CHARACTERISTICS

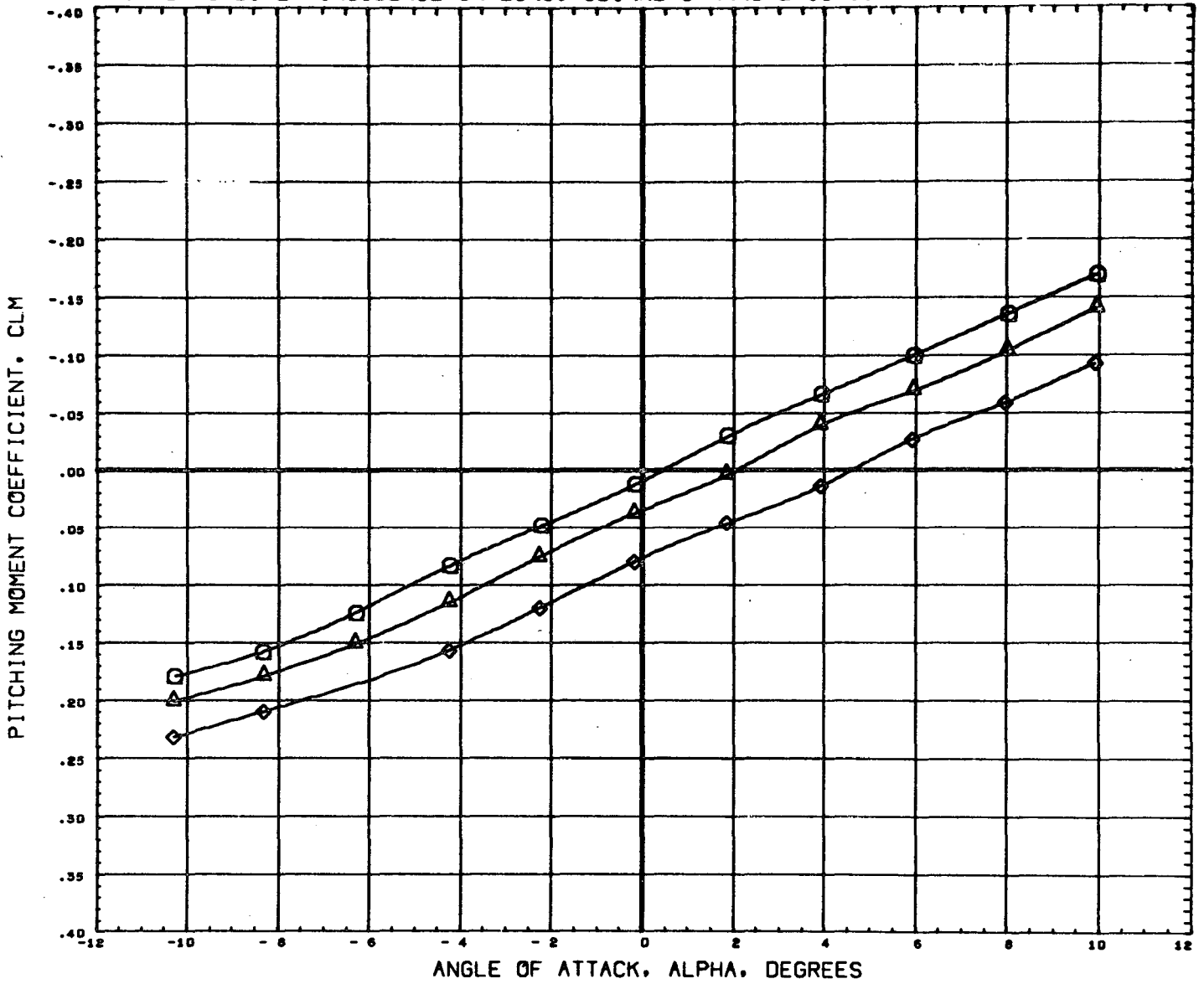

DATA SET SYMBOL	CONFIGURATION DESCRIPTION	ORBIN	THETS	BETA	REFERENCE INFORMATION
(B65009)	MSFC TWT 534 SHUTTLE LAUNCH	T101	0.000	0.000	SREF 4.8950 sq. IN
(B65002)	MSFC TWT 534 SHUTTLE LAUNCH	T101	-1.500	0.000	LREF 2.6440 IN.
(B65008)	MSFC TWT 534 SHUTTLE LAUNCH	T101	-3.000	0.000	BREF 3.5250 IN.
					XMRP 3.4900 IN.
					YMRP 0.0000 IN.
					ZMRP 0.1616 IN.
					SCALE 0.0034

MACH .60

EFFECT OF ORBITER INCIDENCE ON LONGITUDINAL CHARACTERISTICS

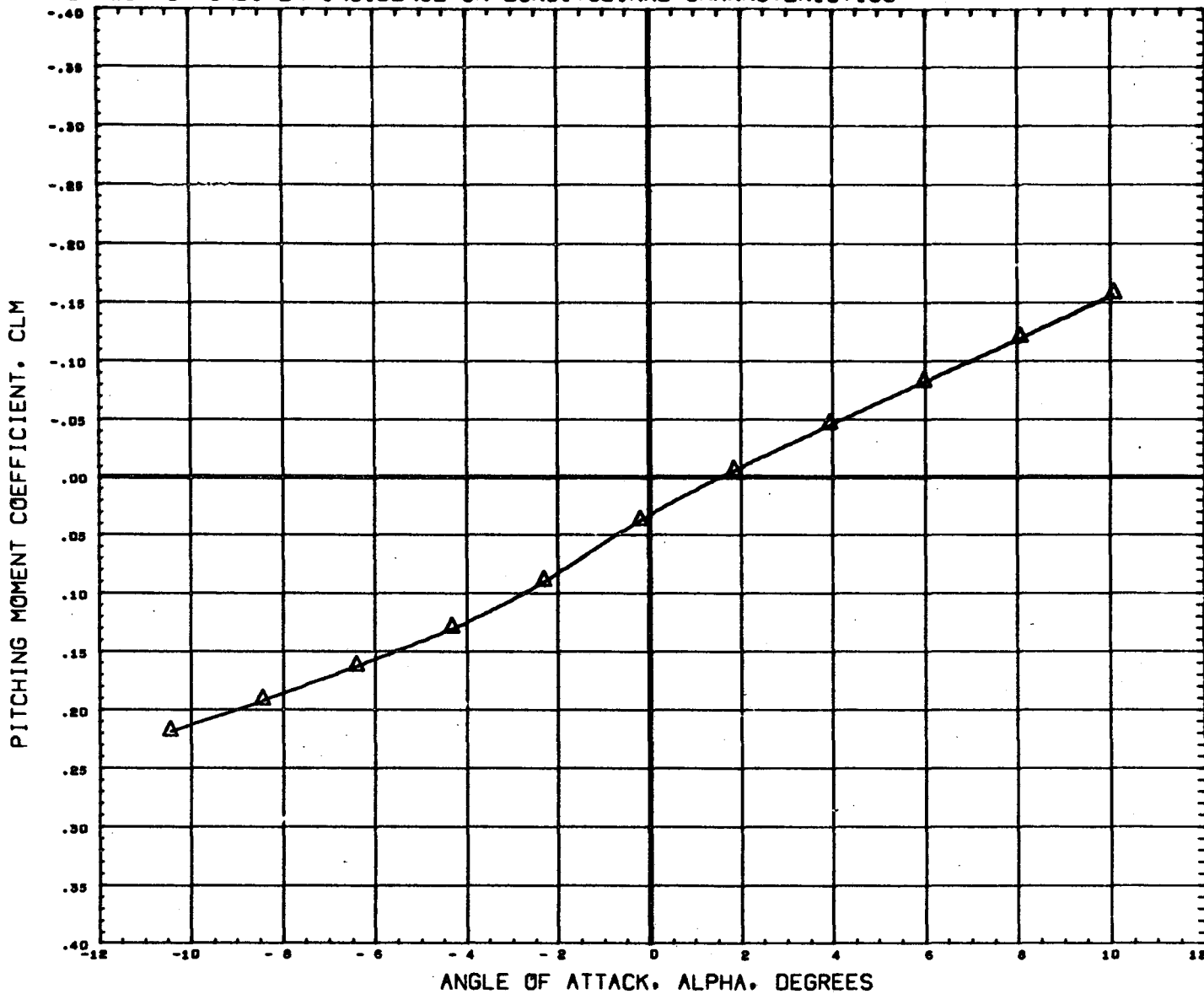

DATA SET SYMBOL	CONFIGURATION DESCRIPTION	ORBIN	THETS	BETA	REFERENCE INFORMATION
(B65009)	DATA NOT AVAILABLE FOR ALL CONDITIONS	0.000		0.000	SREF 4.8950 SQ. IN
(B65002)	NSFC TWT 534 SHUTTLE LAUNCH T101	-1.500		0.000	LREF 2.6440 IN.
(B65908)	DATA NOT AVAILABLE FOR ALL CONDITIONS	-3.000		0.000	BREF 3.5250 IN.
					XMRP 3.4900 IN.
					YMRP 0.0000 IN.
					ZMRP 0.1616 IN.
					SCALE 0.0034

MACH .80

EFFECT OF ORBITER INCIDENCE ON LONGITUDINAL CHARACTERISTICS

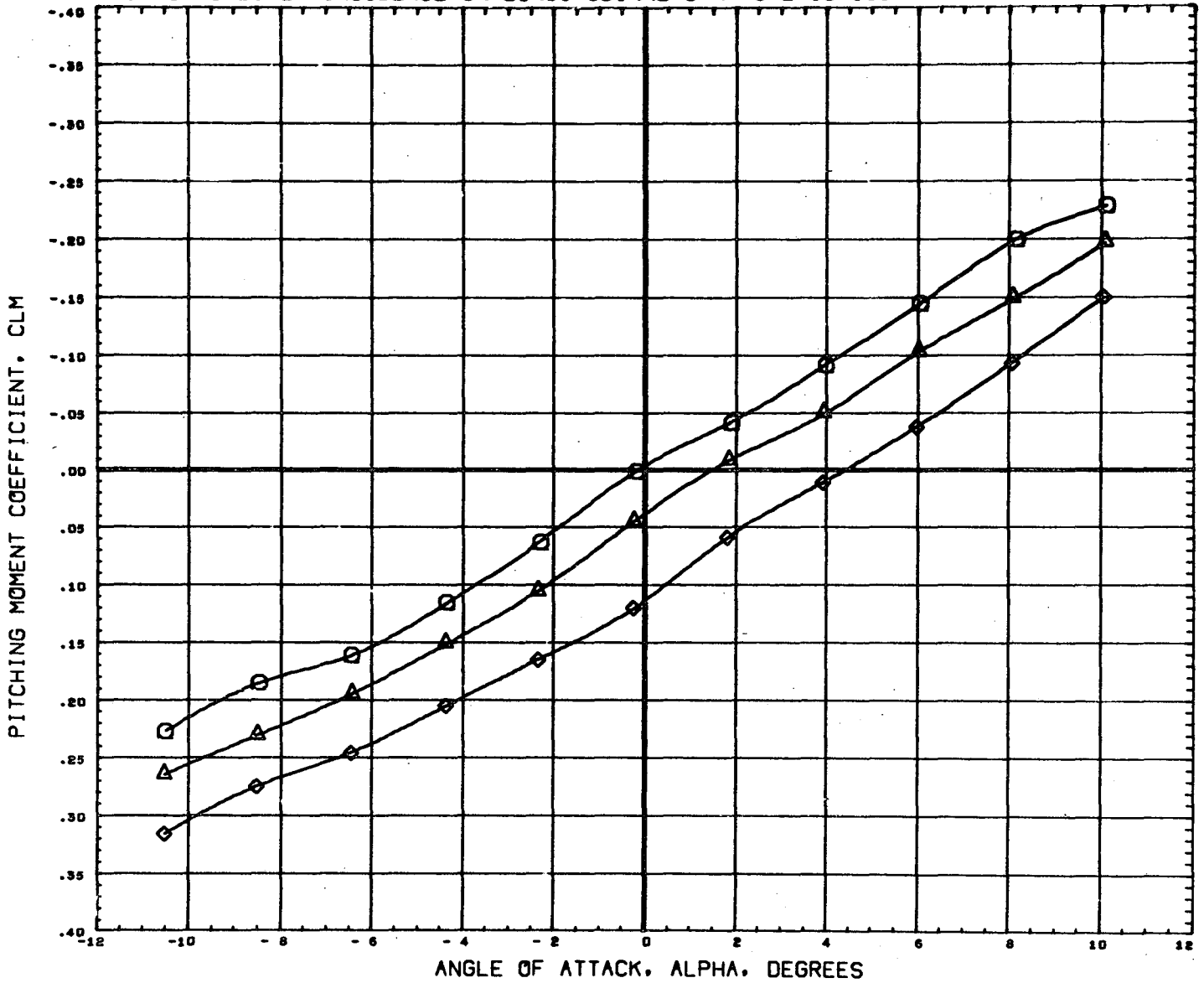

DATA SET SYMBOL	CONFIGURATION DESCRIPTION	ORBIN	THETS	BETA	REFERENCE INFORMATION
(865009)	NSFC TWT 534 SHUTTLE LAUNCH	T101	0.000	0.000	SREF 4.8950 SQ. IN
(865002)	NSFC TWT 534 SHUTTLE LAUNCH	T101	-1.500	0.000	LREF 2.6440 IN.
(865308)	NSFC TWT 534 SHUTTLE LAUNCH	T101	-3.000	0.000	BREF 3.5250 IN.
					XMRP 3.4900 IN.
					YMRP 0.0000 IN.
					ZMRP 0.1616 IN.
					SCALE 0.0034

MACH .90

EFFECT OF ORBITER INCIDENCE ON LONGITUDINAL CHARACTERISTICS

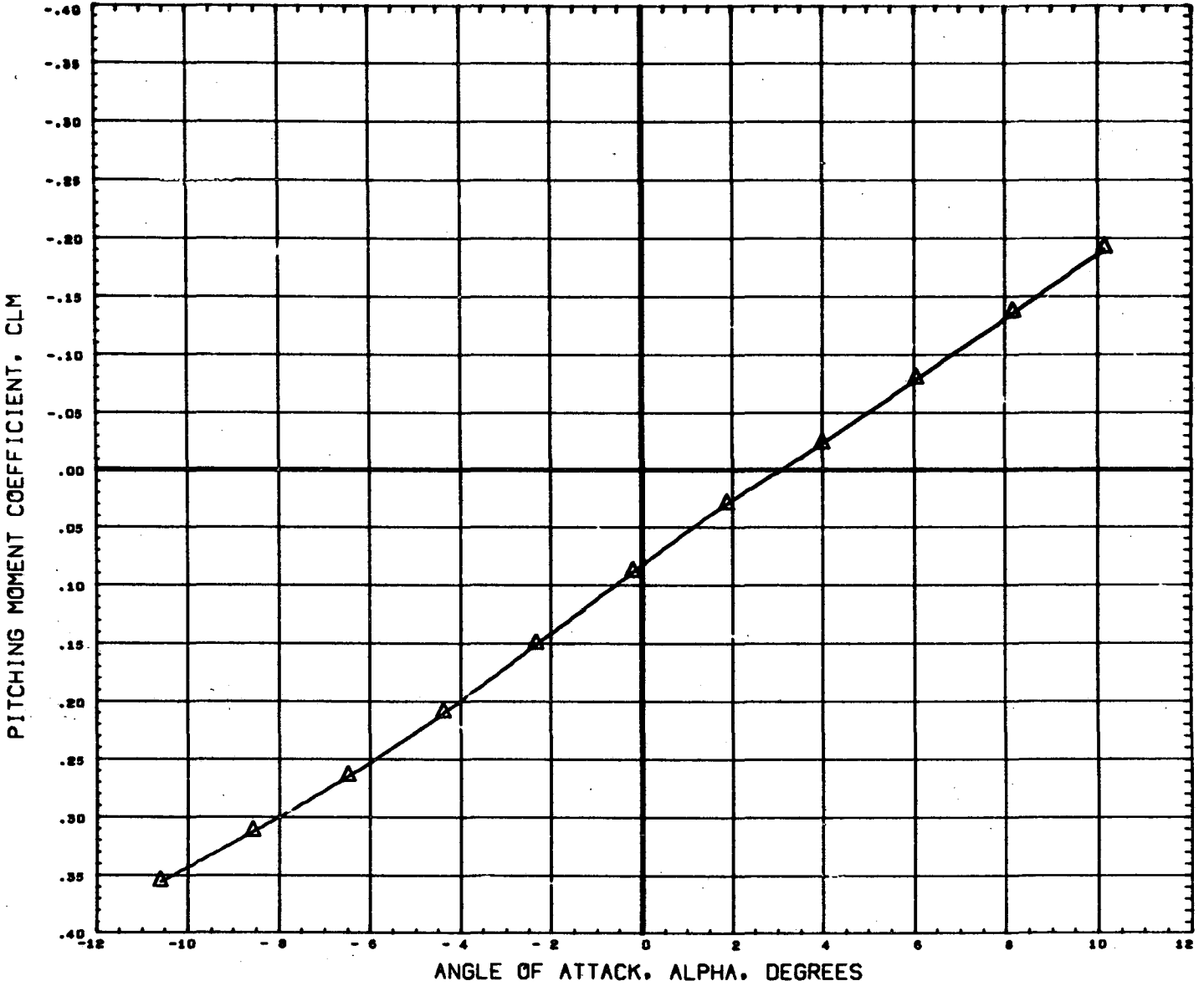

DATA SET SYMBOL	CONFIGURATION DESCRIPTION	ORBIN	THETS	BETA	REFERENCE INFORMATION
(B65009)	DATA NOT AVAILABLE FOR ALL CONDITIONS	0.000		0.000	SREF 4.6950 SQ. IN
(B65002)	MSFC TWT 534 SHUTTLE LAUNCH T101	-1.500		0.000	LREF 2.6440 IN.
(B65308)	DATA NOT AVAILABLE FOR ALL CONDITIONS	-3.000		0.000	BREF 3.5250 IN.
					XMRP 3.4900 IN.
					YMRP 0.0000 IN.
					ZMRP 0.1616 IN.
					SCALE 0.0034

MACH 1.10

EFFECT OF ORBITER INCIDENCE ON LONGITUDINAL CHARACTERISTICS

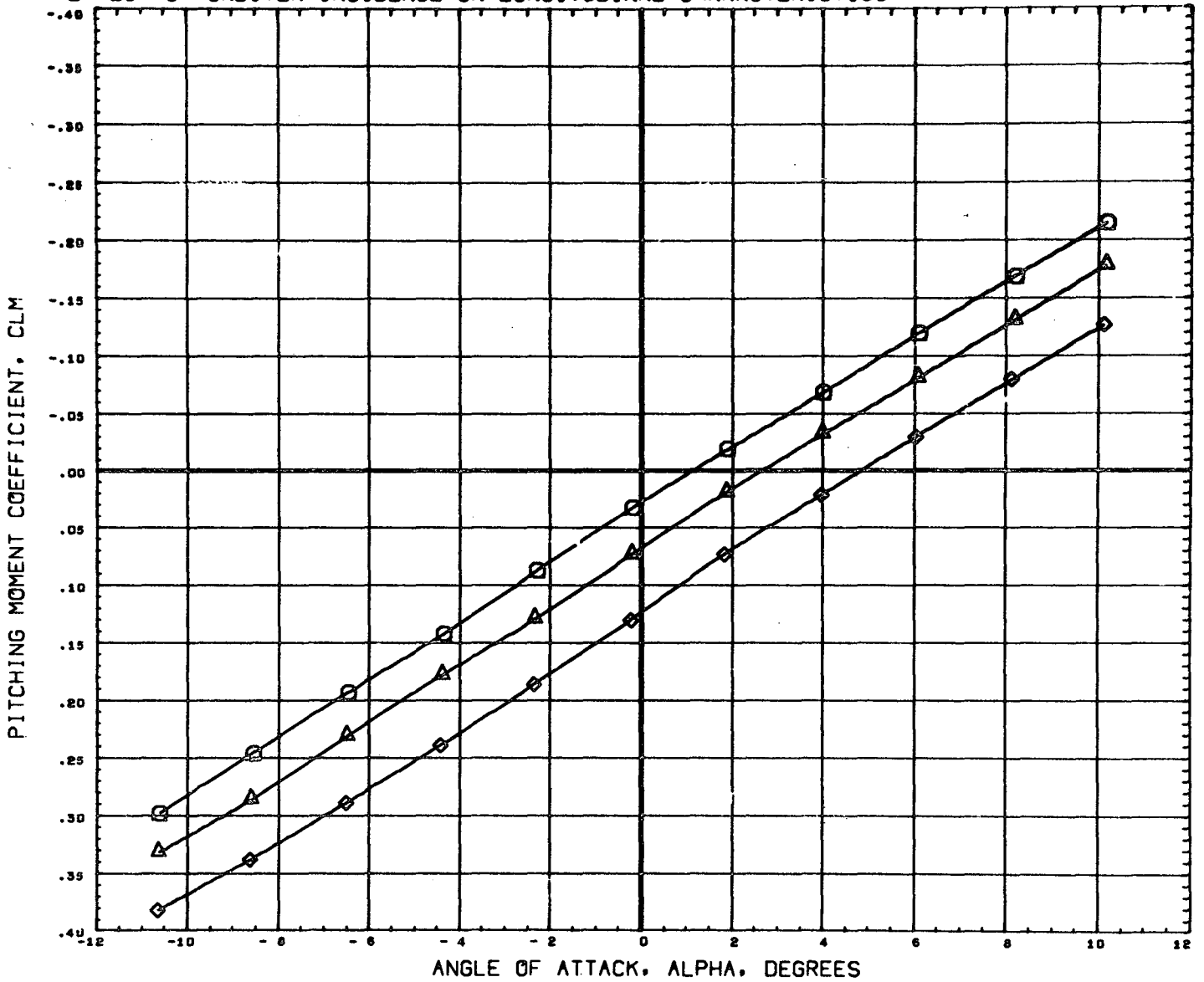

DATA SET SYMBOL	CONFIGURATION DESCRIPTION	T101	ORBIN	THETS	BETA	REFERENCE INFORMATION
(865009)	MSFC TWT 534 SHUTTLE LAUNCH	T101	0.000	0.000	0.000	SREF 4.8950 sq. IN
(865002)	MSFC TWT 534 SHUTTLE LAUNCH	T101	-1.500	0.000	0.000	LREF 2.6440 IN.
(865308)	MSFC TWT 534 SHUTTLE LAUNCH	T101	-3.000	0.000	0.000	BREF 3.5250 IN.
						XMRP 3.4900 IN.
						YMRP 0.0000 IN.
						ZMRP 0.1616 IN.
						SCALE 0.0034

MACH 1.20

PAGE 213

EFFECT OF ORBITER INCIDENCE ON LONGITUDINAL CHARACTERISTICS

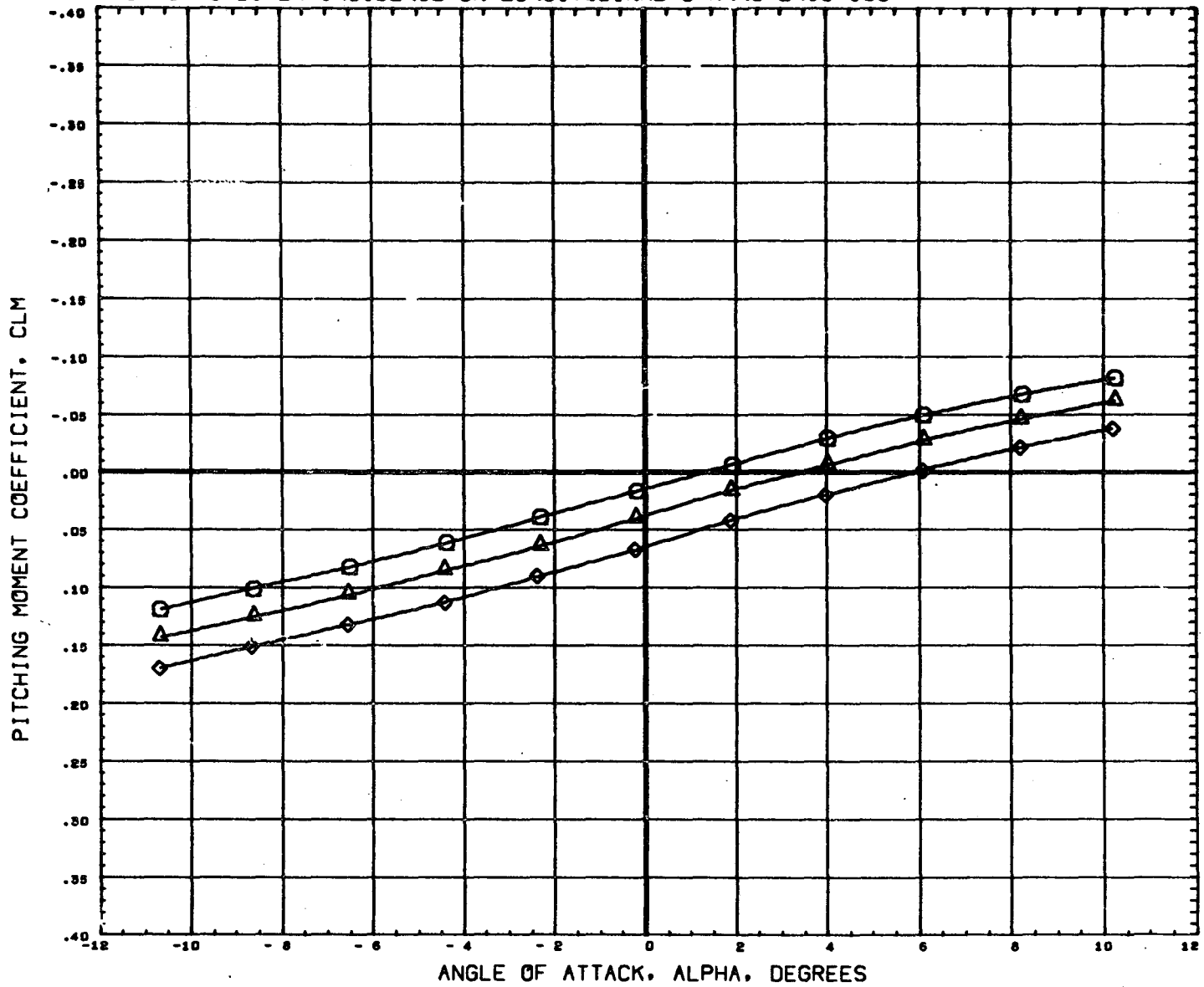

DATA SET SYMBOL	CONFIGURATION DESCRIPTION	ORBIN	THETS	BETA	REFERENCE INFORMATION
(865009)	NSFC TWT 534 SHUTTLE LAUNCH T101	0.000		0.000	SREF 4.8950 SQ. IN
(865002)	NSFC TWT 534 SHUTTLE LAUNCH T101	-1.500		0.000	LREF 2.6440 IN.
(865308)	NSFC TWT 534 SHUTTLE LAUNCH T101	-3.000		0.000	BREF 3.5250 IN.
					XMRP 3.4900 IN.
					YMRP 0.0000 IN.
					ZMRP 0.1616 IN.
					SCALE 0.0034

MACH 1.97

EFFECT OF ORBITER INCIDENCE ON LONGITUDINAL CHARACTERISTICS

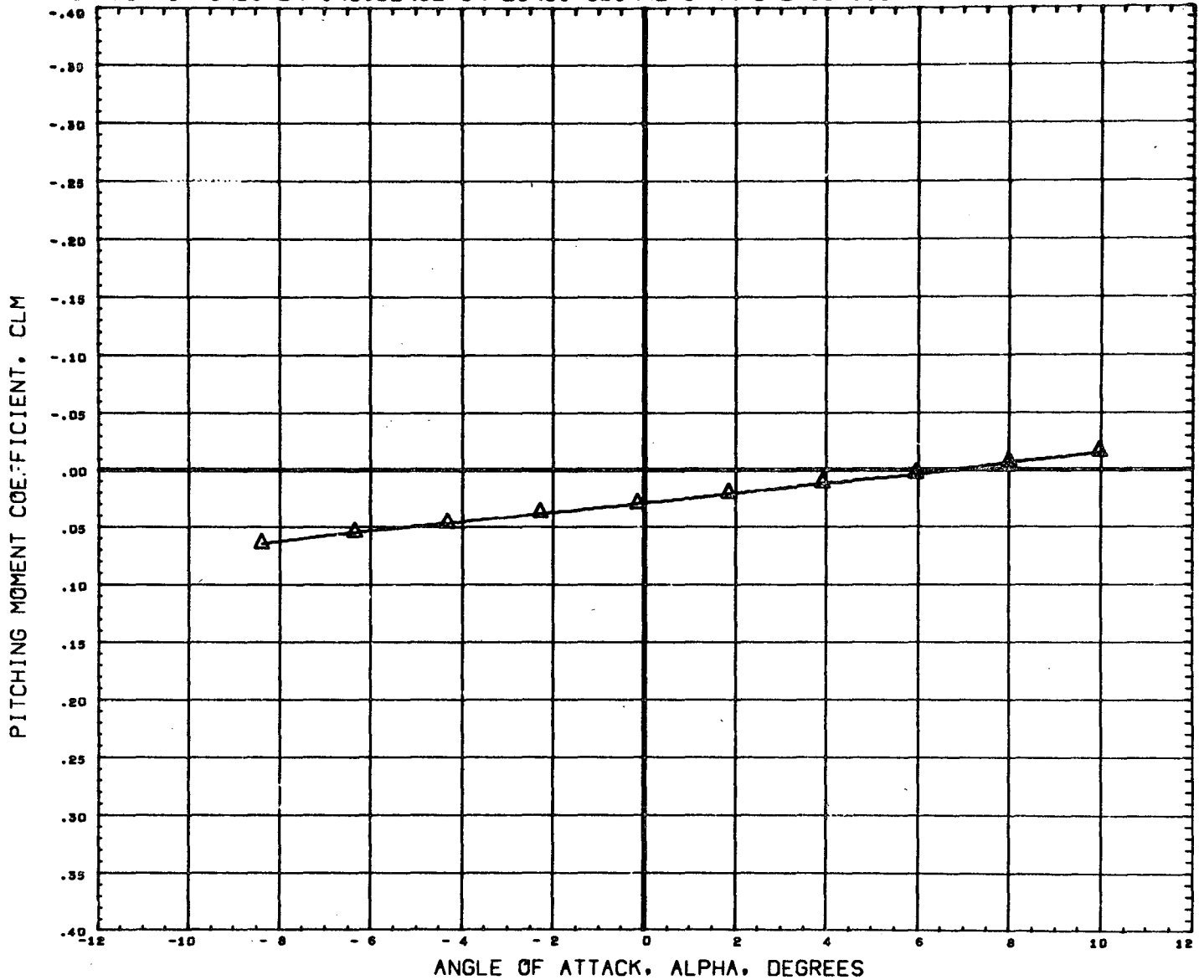

DATA SET SYMBOL	CONFIGURATION DESCRIPTION	ORBIN	THETS	BETA	REFERENCE INFORMATION
(B65009)	DATA NOT AVAILABLE FOR ALL CONDITIONS	0.000	0.000	0.000	SREF 4.8950 SQ. IN
(B65002)	MSFC TWT 534 SHUTTLE LAUNCH T101	-1.500	0.000	0.000	LREF 2.644D IN.
(B65006)	DATA NOT AVAILABLE FOR ALL CONDITIONS	-3.000	0.000	0.000	BREF 3.525D IN.
					XMRP 3.490D IN.
					YMRP 0.000D IN.
					ZMRP 0.1616 IN.
					SCALE 0.0034

MACH 2.74

EFFECT OF ORBITER INCIDENCE ON LONGITUDINAL CHARACTERISTICS

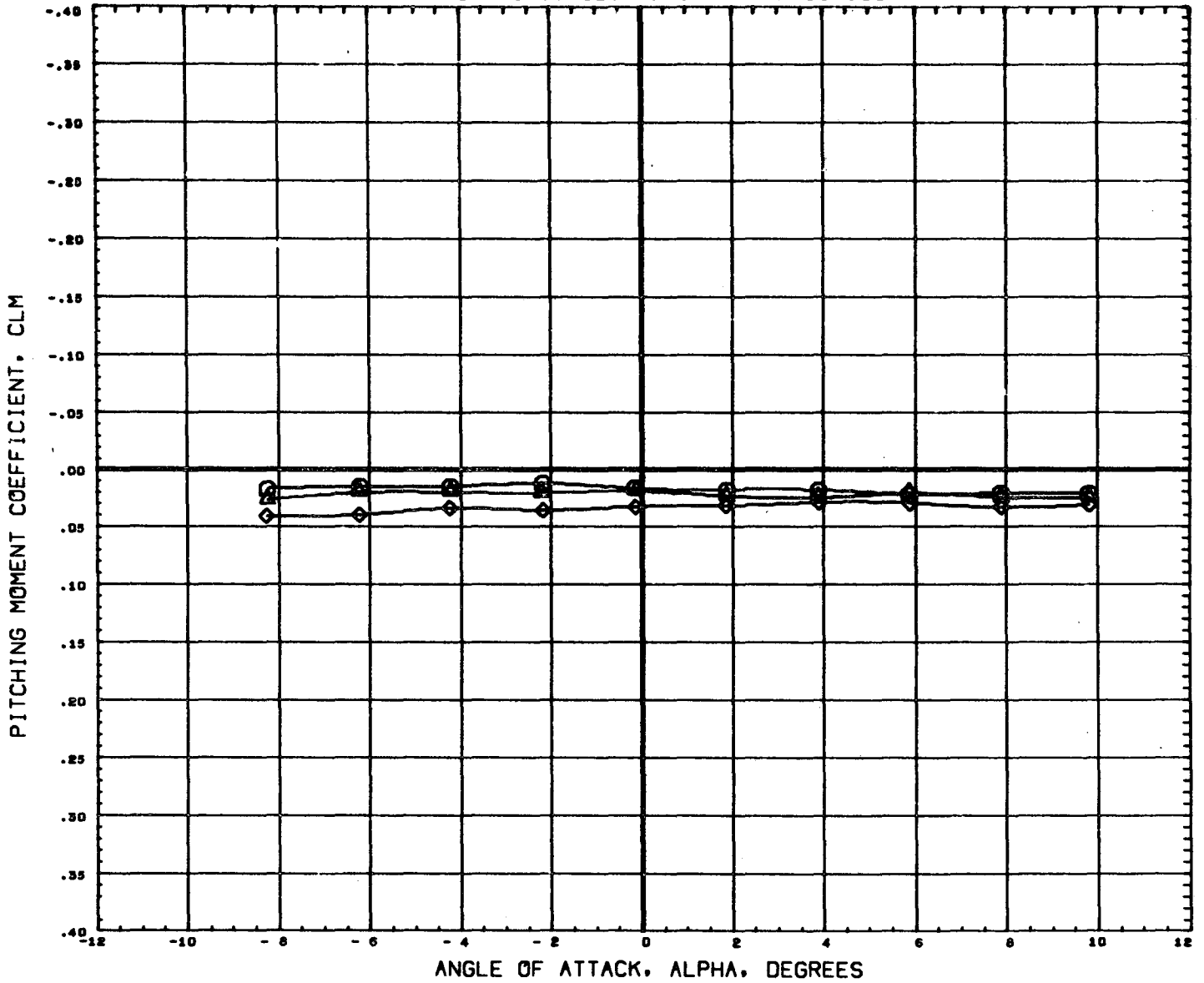

DATA SET SYMBOL	CONFIGURATION DESCRIPTION	ORBIN	THETS	BETA	REFERENCE INFORMATION
(B65009)	MSFC TWT 534 SHUTTLE LAUNCH T101	0.000		0.000	SREF 4.8950 SQ. IN
(B65002)	MSFC TWT 534 SHUTTLE LAUNCH T101	-1.500		0.000	LREF 2.6440 IN.
(B65508)	MSFC TWT 534 SHUTTLE LAUNCH T101	-3.000		0.000	BREF 3.5250 IN.
					XMRP 3.4900 IN.
					YMRP 0.0000 IN.
					ZMRP 0.1616 IN.
					SCALE 0.0034

EFFECT OF ORBITER INCIDENCE ON LONGITUDINAL CHARACTERISTICS

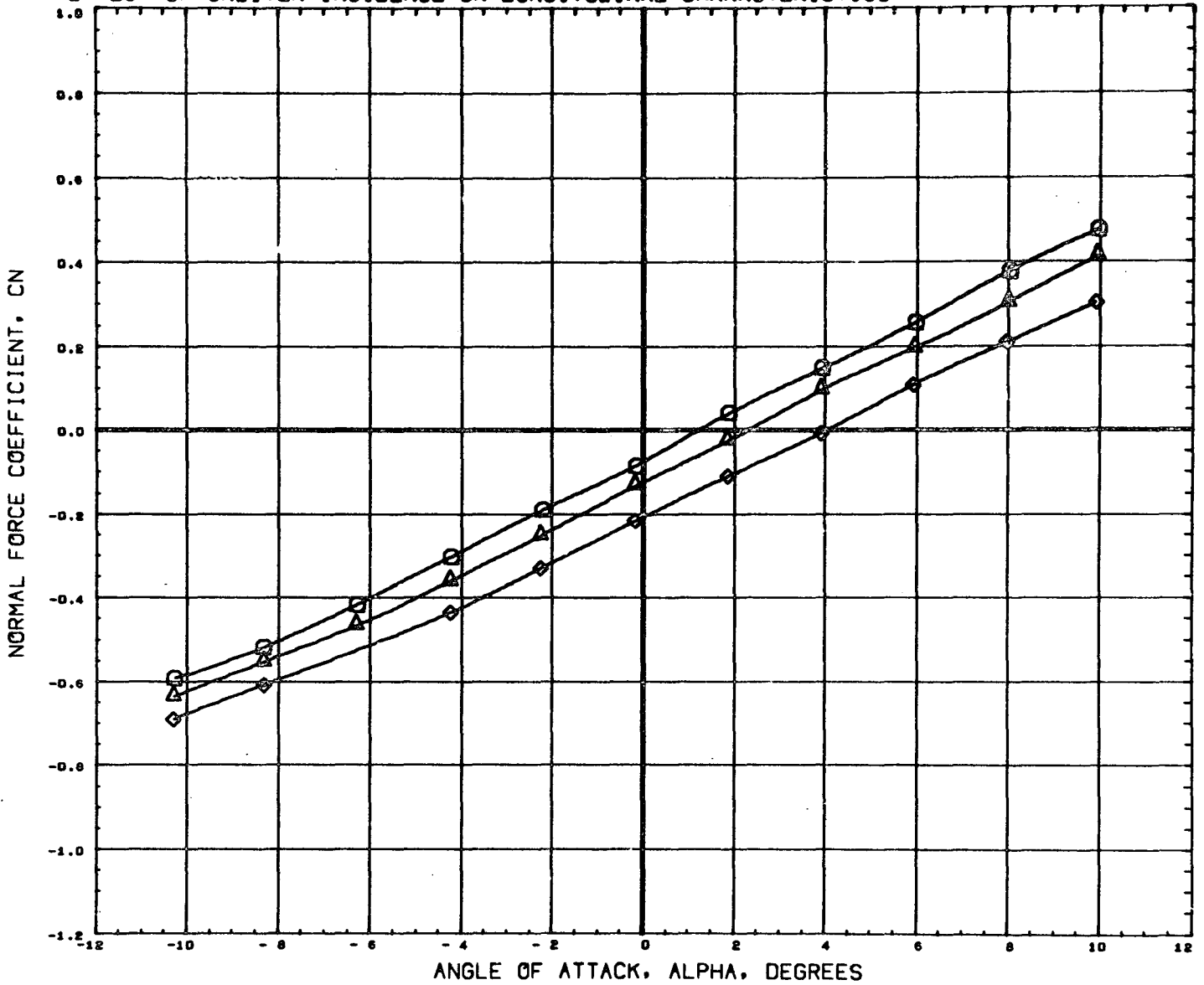

DATA SET SYMBOL	CONFIGURATION DESCRIPTION	ORBIN	THETS	BETA	REFERENCE INFORMATION
(B69009) ○	MSFC TWT 534 SHUTTLE LAUNCH T101	0.000		0.000	SREF 4.8950 SQ. IN
(B69002) △	MSFC TWT 534 SHUTTLE LAUNCH T101	-1.500		0.000	LREF 2.6440 IN.
(B69308) ◇	MSFC TWT 534 SHUTTLE LAUNCH T101	-3.000		0.000	BREF 3.9250 IN.
					XMRP 3.4900 IN.
					YMRP 0.0000 IN.
					ZMRP 0.1616 IN.
					SCALE 0.0034

MACH .60

EFFECT OF ORBITER INCIDENCE ON LONGITUDINAL CHARACTERISTICS

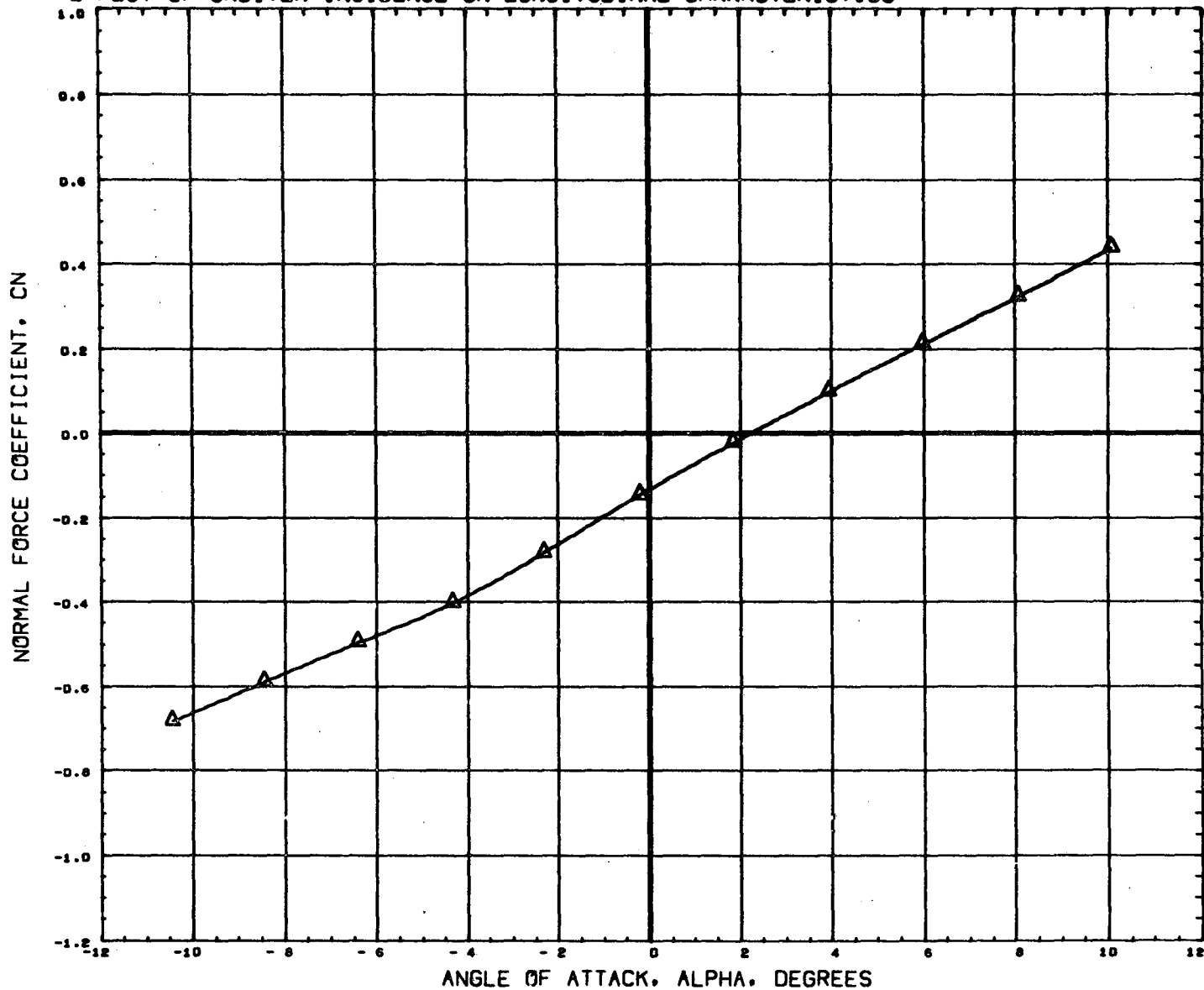

DATA SET SYMBOL	CONFIGURATION DESCRIPTION	ORBIN	THETS	BETA	REFERENCE INFORMATION	
(865009)	DATA NOT AVAILABLE FOR ALL CONDITIONS	0.000		0.000	SREF	4.8950 SQ. IN
(865002)	NSFC TWY 534 SHUTTLE LAUNCH T101	-1.500		0.000	LREF	2.6440 IN.
(865308)	DATA NOT AVAILABLE FOR ALL CONDITIONS	-3.000		0.000	BREF	3.5250 IN.
					XMRP	3.4900 IN.
					YMRP	0.0000 IN.
					ZMRP	0.1616 IN.
					SCALE	0.0054

MACH .80

EFFECT OF ORBITER INCIDENCE ON LONGITUDINAL CHARACTERISTICS

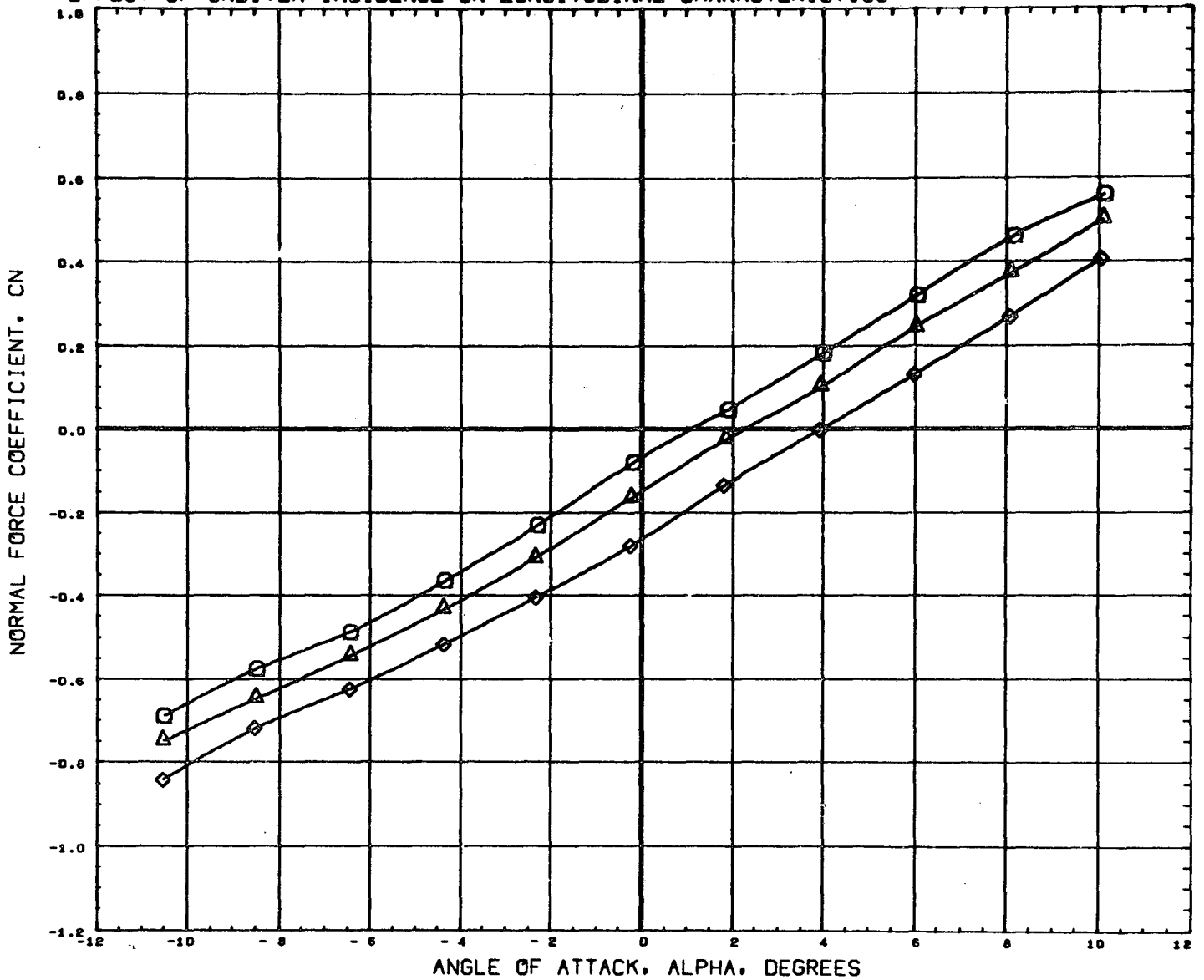

DATA SET SYMBOL	CONFIGURATION DESCRIPTION	ORBIN	THETS	BETA	REFERENCE INFORMATION
(B65001)	MSFC TWT 534 SHUTTLE LAUNCH T101	0.000	0.000	0.000	SREF 4.8950 SQ. IN
(B65002)	MSFC TWT 534 SHUTTLE LAUNCH T101	-1.500	0.000	0.000	LREF 2.6440 IN.
(B65003)	MSFC TWT 534 SHUTTLE LAUNCH T101	-3.000	0.000	0.000	BREF 3.9250 IN.
					XMRP 3.4900 IN.
					YMRP 0.0000 IN.
					ZMRP 0.1616 IN.
					SCALE 0.0034

MACH .90

EFFECT OF ORBITER INCIDENCE ON LONGITUDINAL CHARACTERISTICS

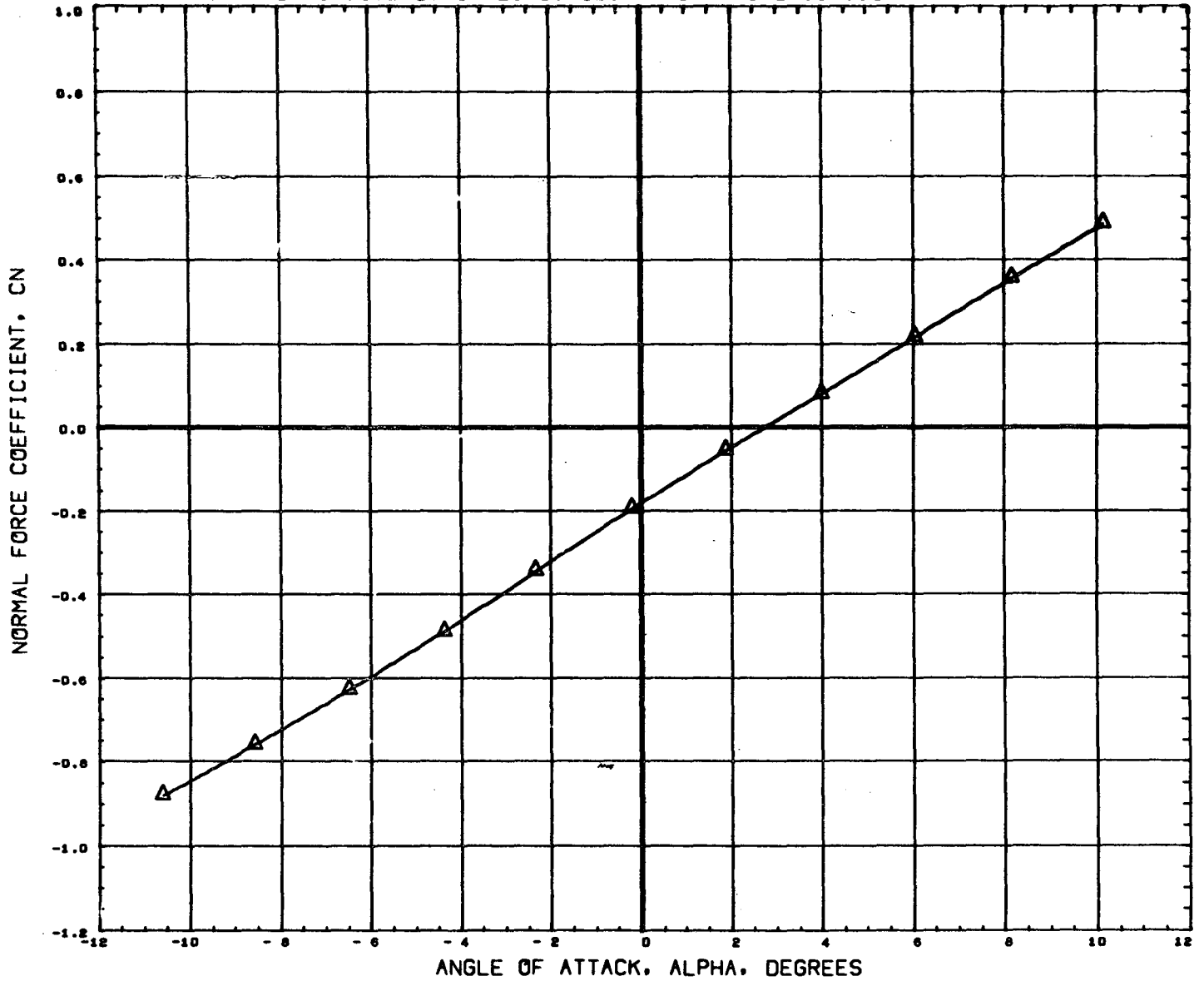

DATA SET SYMBOL	CONFIGURATION DESCRIPTION	ORBIN	THETS	BETA	REFERENCE INFORMATION	
(B65009)	DATA NOT AVAILABLE FOR ALL CONDITIONS	0.000		0.000	SREF	4.0950 SQ. IN
(B65002)	MSFC TWT 534 SHUTTLE LAUNCH T101	-1.500		0.000	LREF	2.6440 IN.
(B65506)	DATA NOT AVAILABLE FOR ALL CONDITIONS	-3.000		0.000	BREF	3.5250 IN.
					XMRP	3.4900 IN.
					YMRP	0.0000 IN.
					ZMRP	0.1616 IN.
					SCALE	0.0034

MACH 1.10

PAGE 220

EFFECT OF ORBITER INCIDENCE ON LONGITUDINAL CHARACTERISTICS

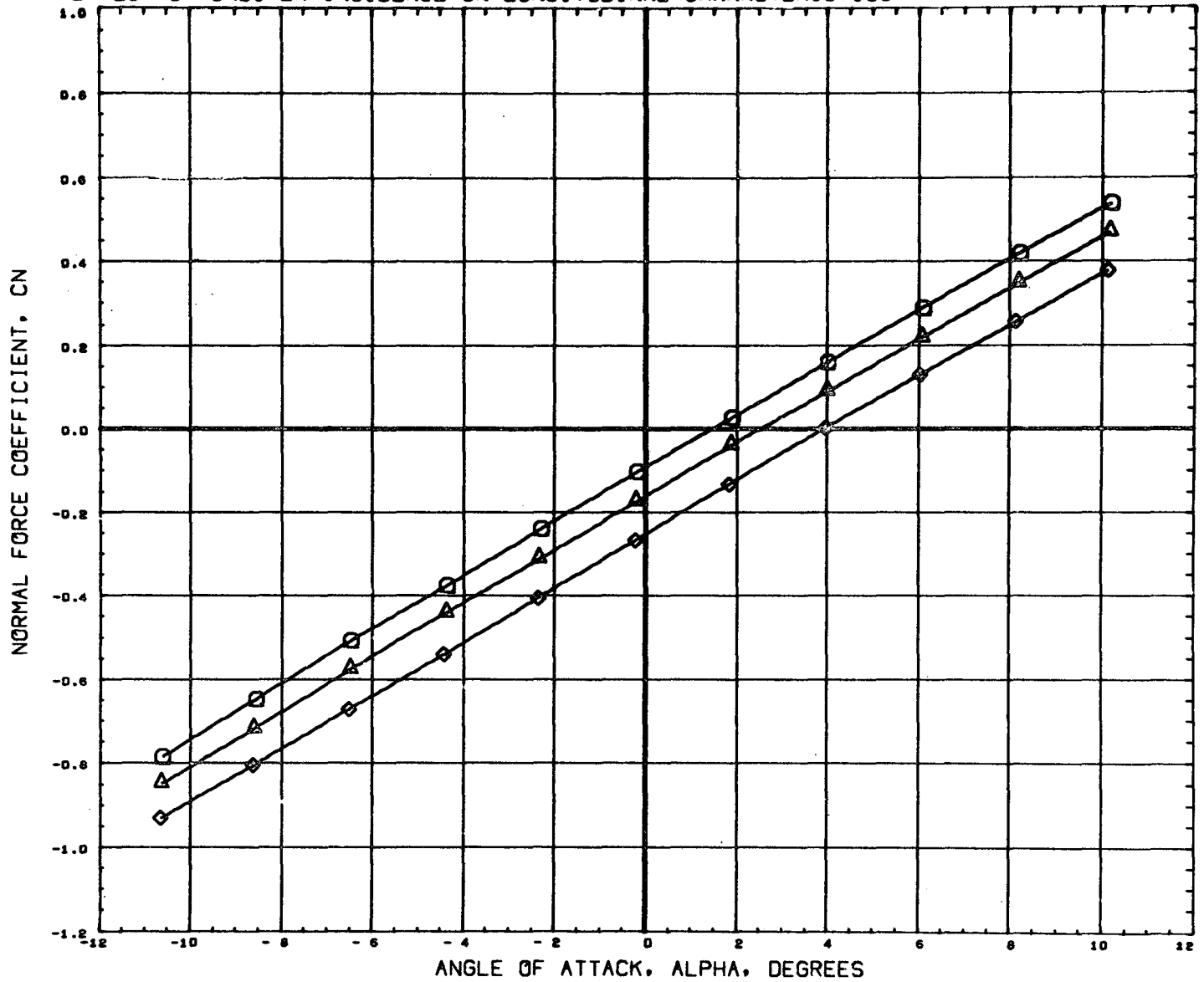

DATA SET SYMBOL	CONFIGURATION DESCRIPTION	ORBIN	THETS	BETA	REFERENCE INFORMATION
(B65009)	MSFC TWT 534 SHUTTLE LAUNCH	T101	0.000	0.000	SREF 4.6950 SQ. IN
(B65002)	MSFC TWT 534 SHUTTLE LAUNCH	T101	-1.500	0.000	LREF 2.6440 IN.
(B65008)	MSFC TWT 534 SHUTTLE LAUNCH	T101	-3.000	0.000	BREF 3.5250 IN.
					XMRF 3.4900 IN.
					YMRF 0.0000 IN.
					ZMRF 0.1616 IN.
					SCALE 0.0034

MACH 1.20

EFFECT OF ORBITER INCIDENCE ON LONGITUDINAL CHARACTERISTICS

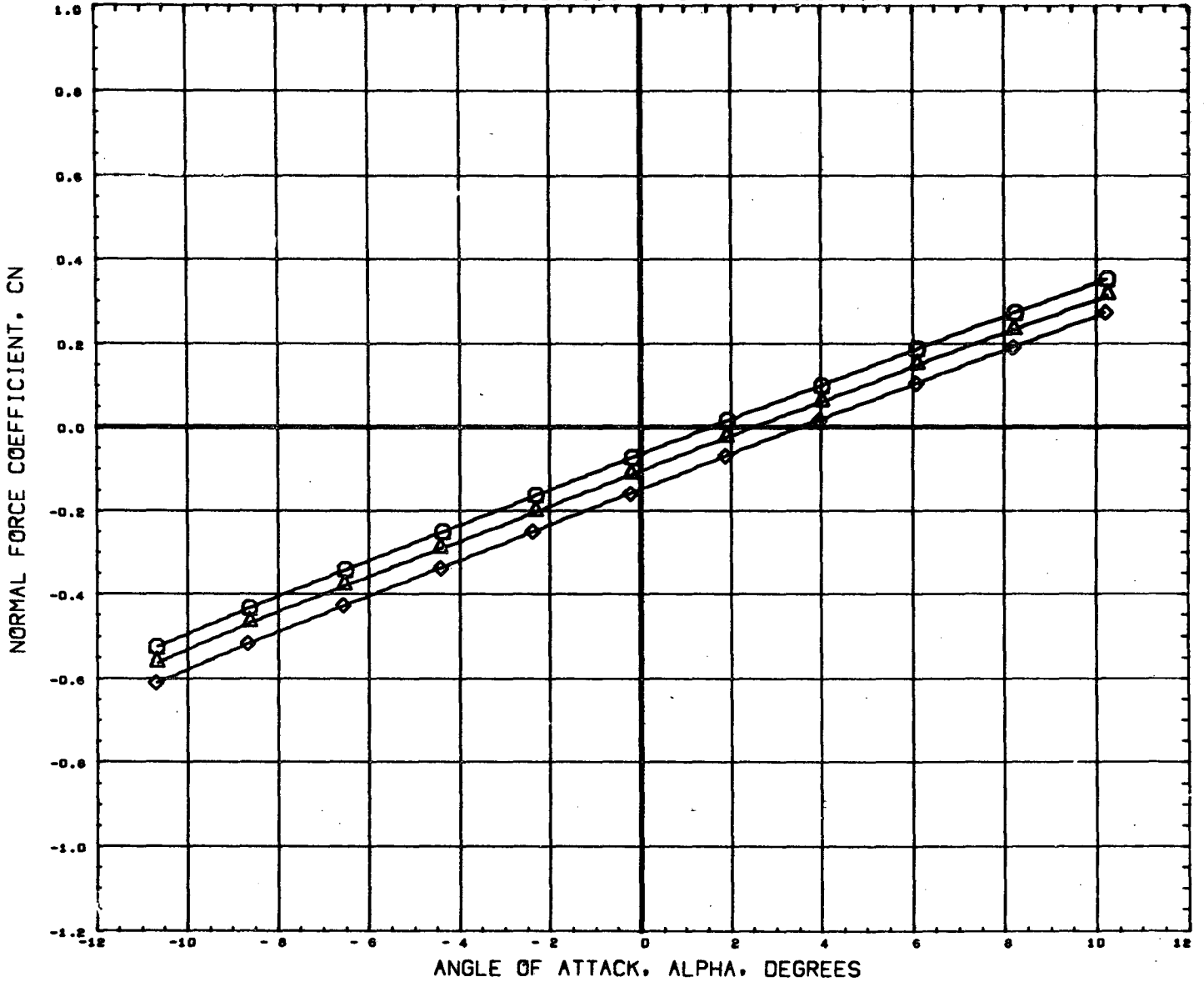

DATA SET SYMBOL	CONFIGURATION DESCRIPTION	ORBIN	THETS	BETA	REFERENCE INFORMATION
(B65009) ○	MSFC TWT 534 SHUTTLE LAUNCH T101	0.000		0.000	SREF 4.8950 SQ. IN
(B65002) △	MSFC TWT 534 SHUTTLE LAUNCH T101	-1.500		0.000	LREF 2.6440 IN.
(B65008) ◇	MSFC TWT 534 SHUTTLE LAUNCH T101	-3.000		0.000	BREF 3.5250 IN.
					XNRP 3.4900 IN.
					YNRP 0.0000 IN.
					ZMRP 0.1616 IN.
					SCALE 0.0034

EFFECT OF ORBITER INCIDENCE ON LONGITUDINAL CHARACTERISTICS

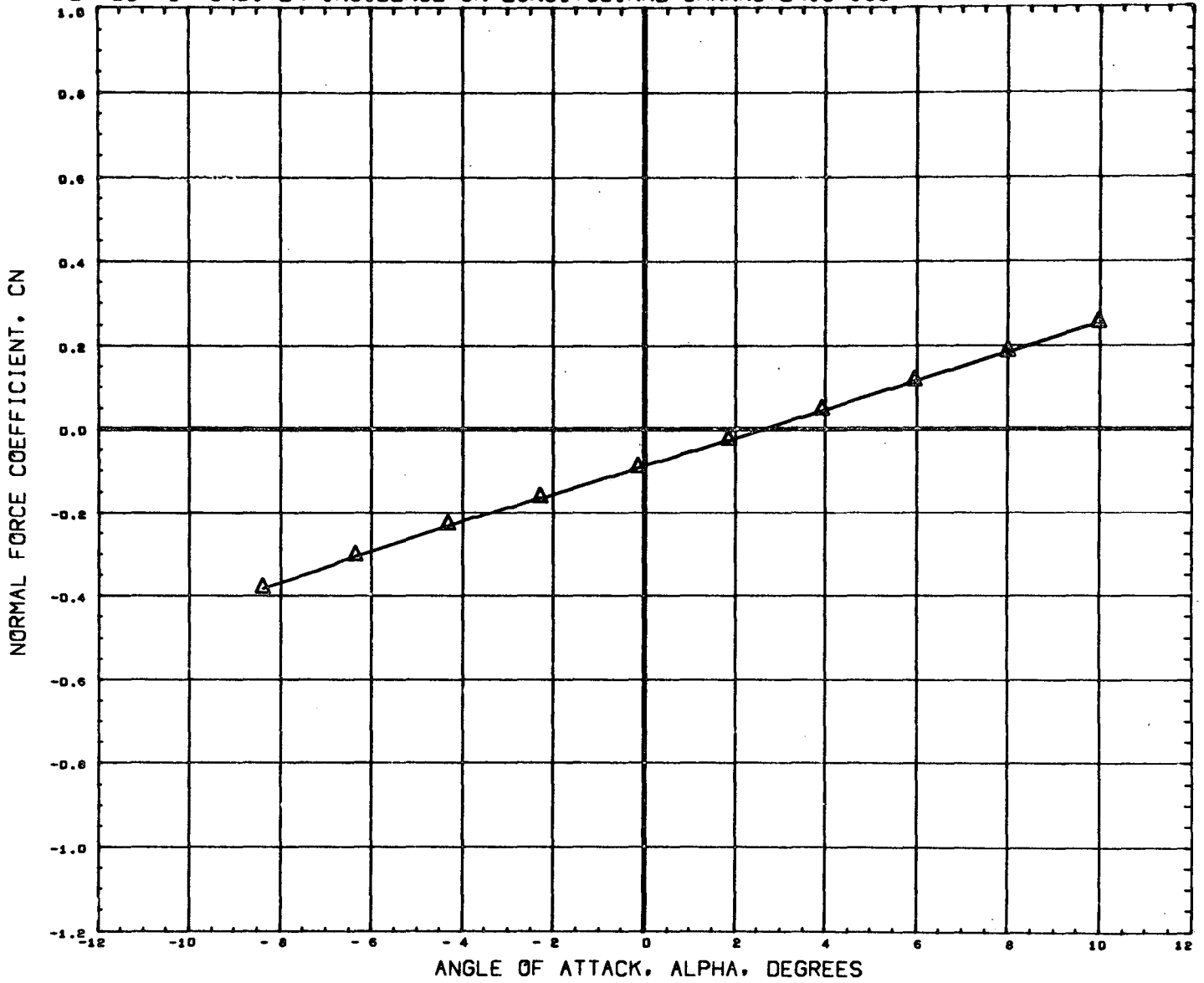

DATA SET SYMBOL	CONFIGURATION DESCRIPTION
(B65009)	DATA NOT AVAILABLE FOR ALL CONDITIONS
(B65002)	MSFC TWT 534 SHUTTLE LAUNCH T101
(B65508)	DATA NOT AVAILABLE FOR ALL CONDITIONS

ORBIN	THETS	BETA
0.000	0.000	0.000
-1.500	0.000	0.000
-3.000	0.000	0.000

REFERENCE INFORMATION		
SREF	4.8950	Sq. IN
LREF	2.6440	IN.
BREF	3.5250	IN.
XMRP	3.4900	IN.
YMRP	0.0000	IN.
ZMRP	0.1616	IN.
SCALE	0.0034	

MACH 2.74

EFFECT OF ORBITER INCIDENCE ON LONGITUDINAL CHARACTERISTICS

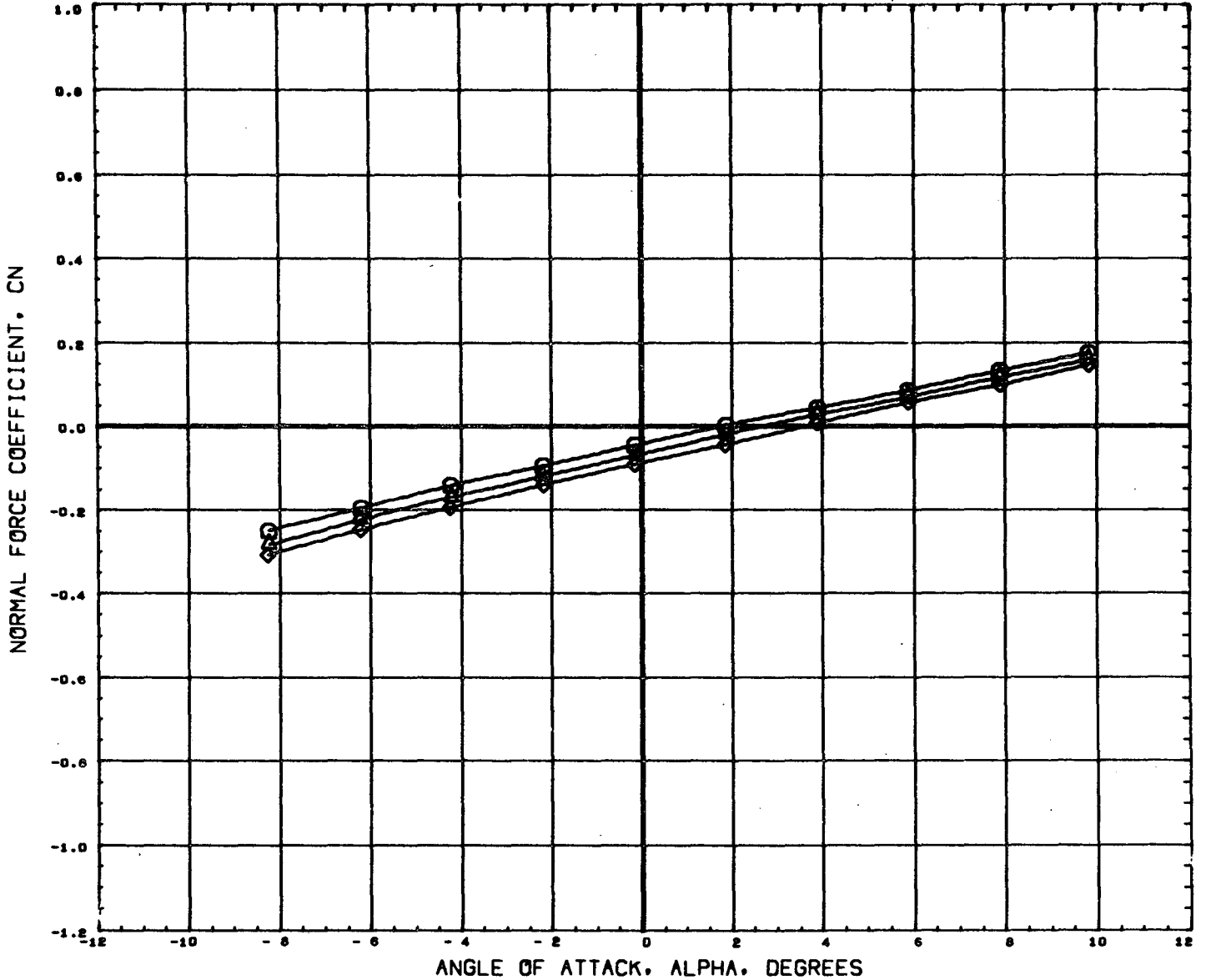

DATA SET SYMBOL	CONFIGURATION DESCRIPTION	ORBIN	THETS	BETA	REFERENCE INFORMATION	
(B65009)	MSFC TWT 534 SHUTTLE LAUNCH T101	0.000		0.000	SREF	4.8950 90. IN
(B65002)	MSFC TWT 534 SHUTTLE LAUNCH T101	-1.500		0.000	LREF	2.6440 IN.
(B65508)	MSFC TWT 534 SHUTTLE LAUNCH T101	-3.000		0.000	BREF	3.5250 IN.
					XMRP	3.4900 IN.
					YMRP	0.0000 IN.
					ZMRP	0.1616 IN.
					SCALE	0.0034

MACH 4.96

PAGE 224

EFFECT OF ORBITER INCIDENCE ON LONGITUDINAL CHARACTERISTICS

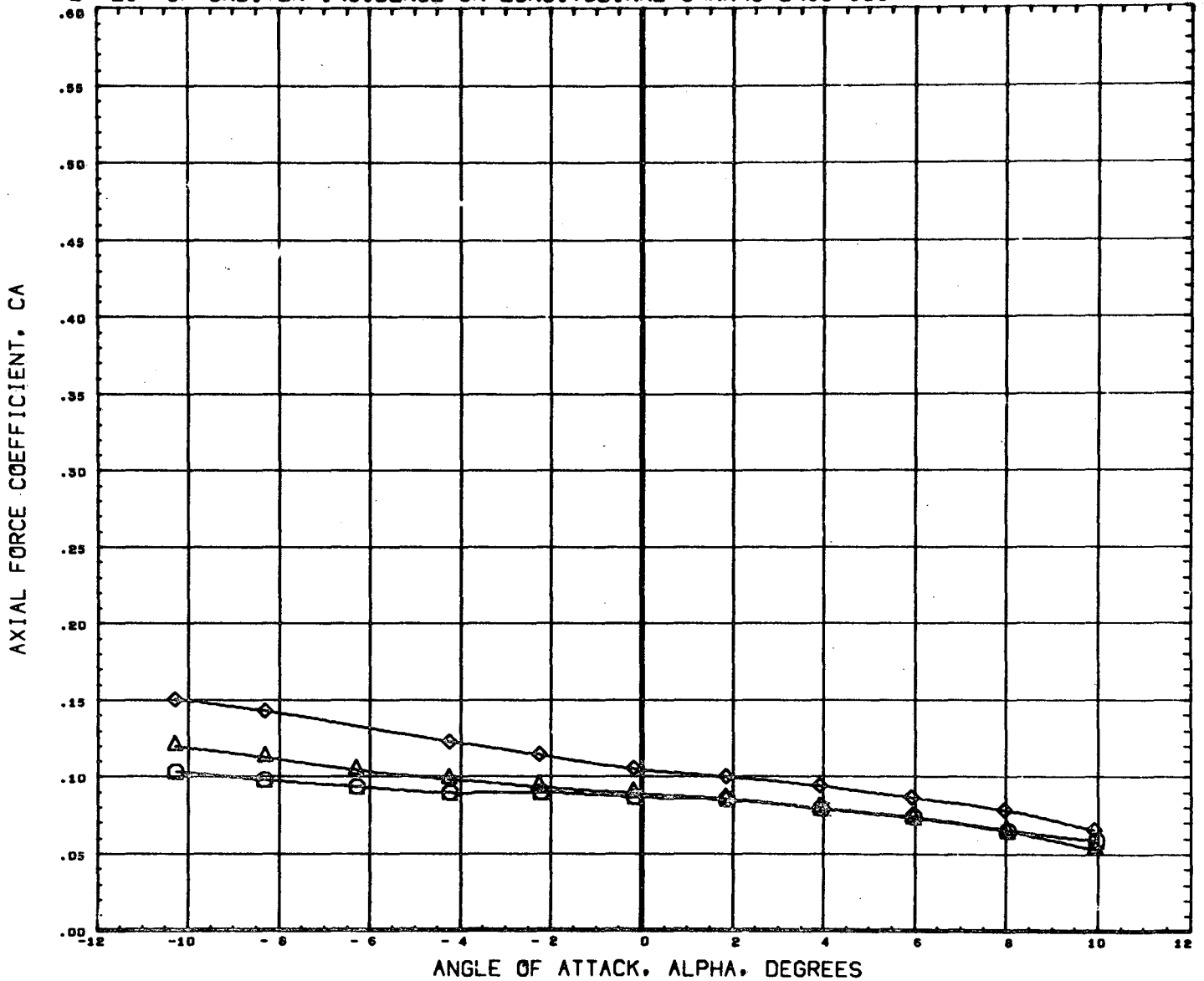

DATA SET SYMBOL	CONFIGURATION DESCRIPTION	ORBIN	THETS	BETA	REFERENCE INFORMATION
(865009)	MSFC TWT 534 SHUTTLE LAUNCH T101	0.000		0.000	SREF 4.8950 98. IN
(865002)	MSFC TWT 534 SHUTTLE LAUNCH T101	-1.500		0.000	LREF 2.6440 IN.
(865008)	MSFC TWT 534 SHUTTLE LAUNCH T101	-3.000		0.000	BREF 3.9250 IN.
					XMRP 3.4900 IN.
					YMRP 0.0000 IN.
					ZMRP 0.1616 IN.
					SCALE 0.0034

MACH .60

PAGE 225

EFFECT OF ORBITER INCIDENCE ON LONGITUDINAL CHARACTERISTICS

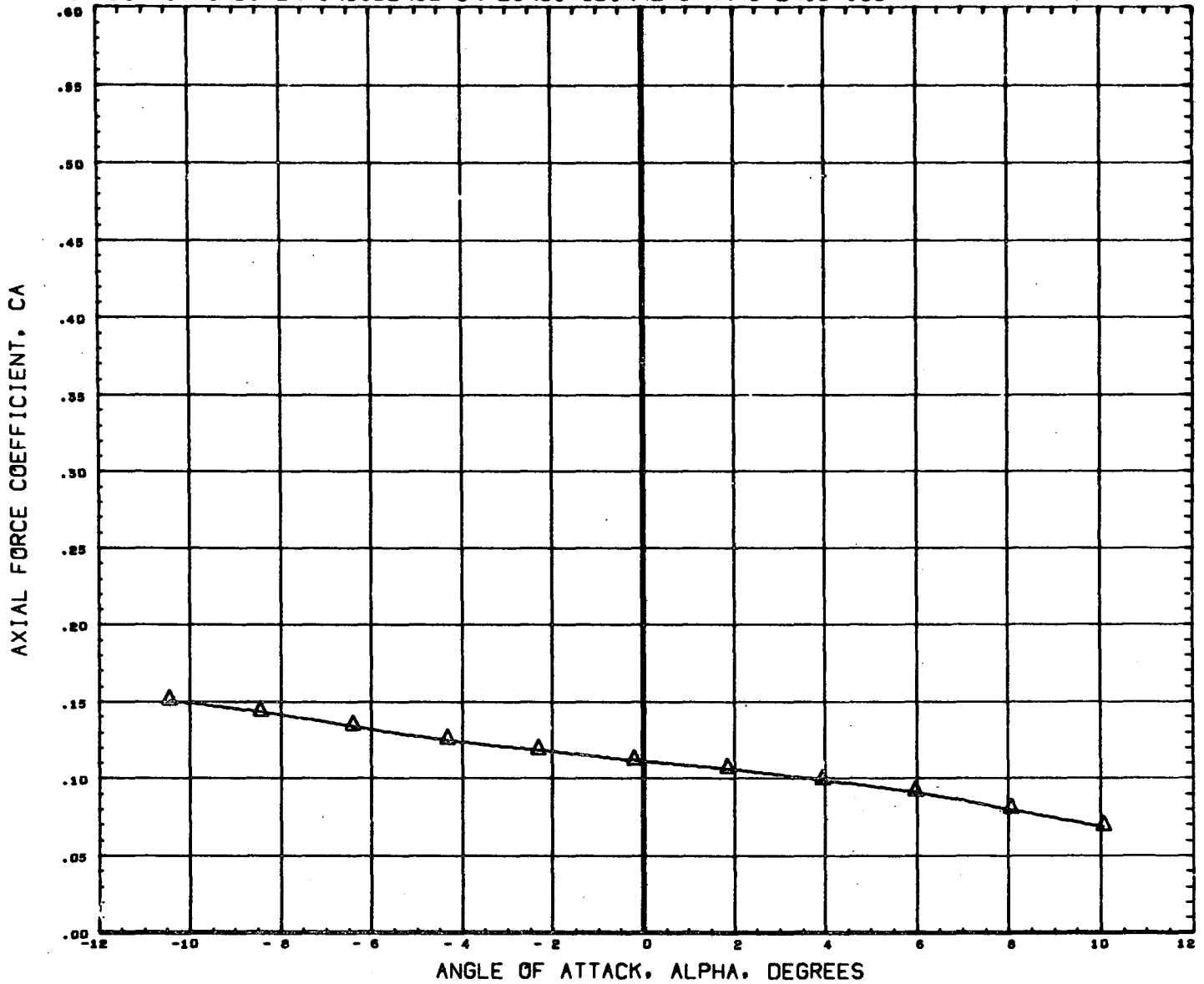

DATA SET SYMBOL	CONFIGURATION DESCRIPTION	ORBIN	THETS	BETA	REFERENCE INFORMATION
(B65009)	DATA NOT AVAILABLE FOR ALL CONDITIONS	0.000		0.000	SREF 4.8950 SQ. IN
(B65002)	NSFC TWT 534 SHUTTLE LAUNCH T101	-1.500		0.000	LREF 2.6440 IN.
(B65006)	DATA NOT AVAILABLE FOR ALL CONDITIONS	-3.000		0.000	BREF 3.5250 IN.
					XMRP 3.4900 IN.
					YMRP 0.0000 IN.
					ZMRP 0.1616 IN.
					SCALE 0.0034

MACH .80

EFFECT OF ORBITER INCIDENCE ON LONGITUDINAL CHARACTERISTICS

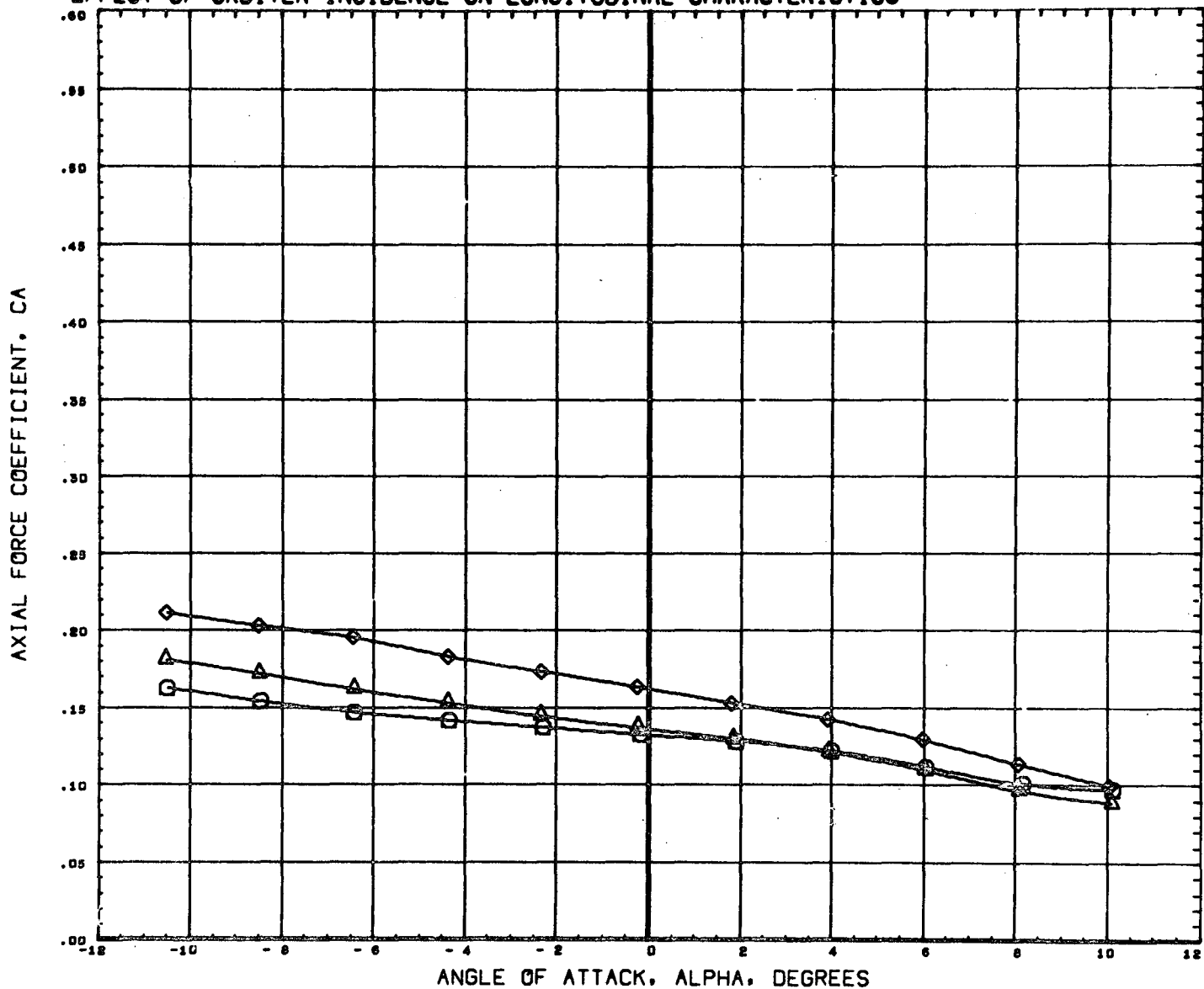

DATA SET SYMBOL	CONFIGURATION DESCRIPTION	ORBIN	THETS	BETA	REFERENCE INFORMATION
(899009)	MSFC TWT 534 SHUTTLE LAUNCH T101	0.000		0.000	SREF 4.8950 sq. IN
(899002)	MSFC TWT 534 SHUTTLE LAUNCH T101	-1.500		0.000	LREF 2.6440 IN.
(899008)	MSFC TWT 534 SHUTTLE LAUNCH T101	-3.000		0.000	BREF 3.5250 IN.
					XMRP 3.4900 IN.
					YMRP 0.0000 IN.
					ZMRP 0.1616 IN.
					SCALE 0.0034

MACH .90

EFFECT OF ORBITER INCIDENCE ON LONGITUDINAL CHARACTERISTICS

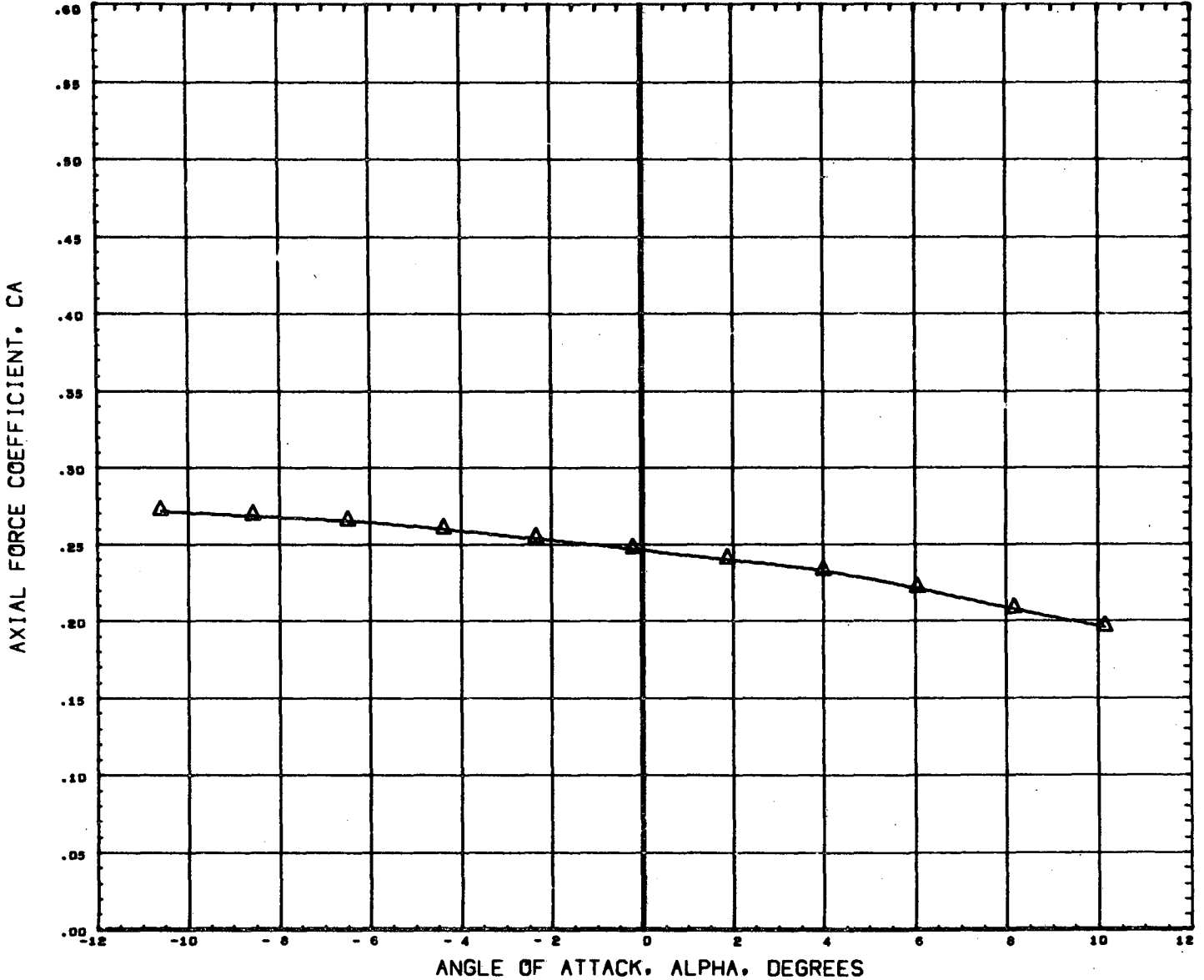

DATA SET SYMBOL	CONFIGURATION DESCRIPTION	ORBIN	THETS	BETA	REFERENCE INFORMATION	
(B65009)	DATA NOT AVAILABLE FOR ALL CONDITIONS	0.000		0.000	SREF	4.8950 SQ. IN
(B65002)	MSFC TWT 534 SHUTTLE LAUNCH T101	-1.500		0.000	LREF	2.6440 IN.
(B65008)	DATA NOT AVAILABLE FOR ALL CONDITIONS	-3.000		0.000	BREF	3.5250 IN.
					XNRP	3.4900 IN.
					YNRP	0.0600 IN.
					ZNRP	0.1616 IN.
					SCALE	0.0034

MACH 1.10

EFFECT OF ORBITER INCIDENCE ON LONGITUDINAL CHARACTERISTICS

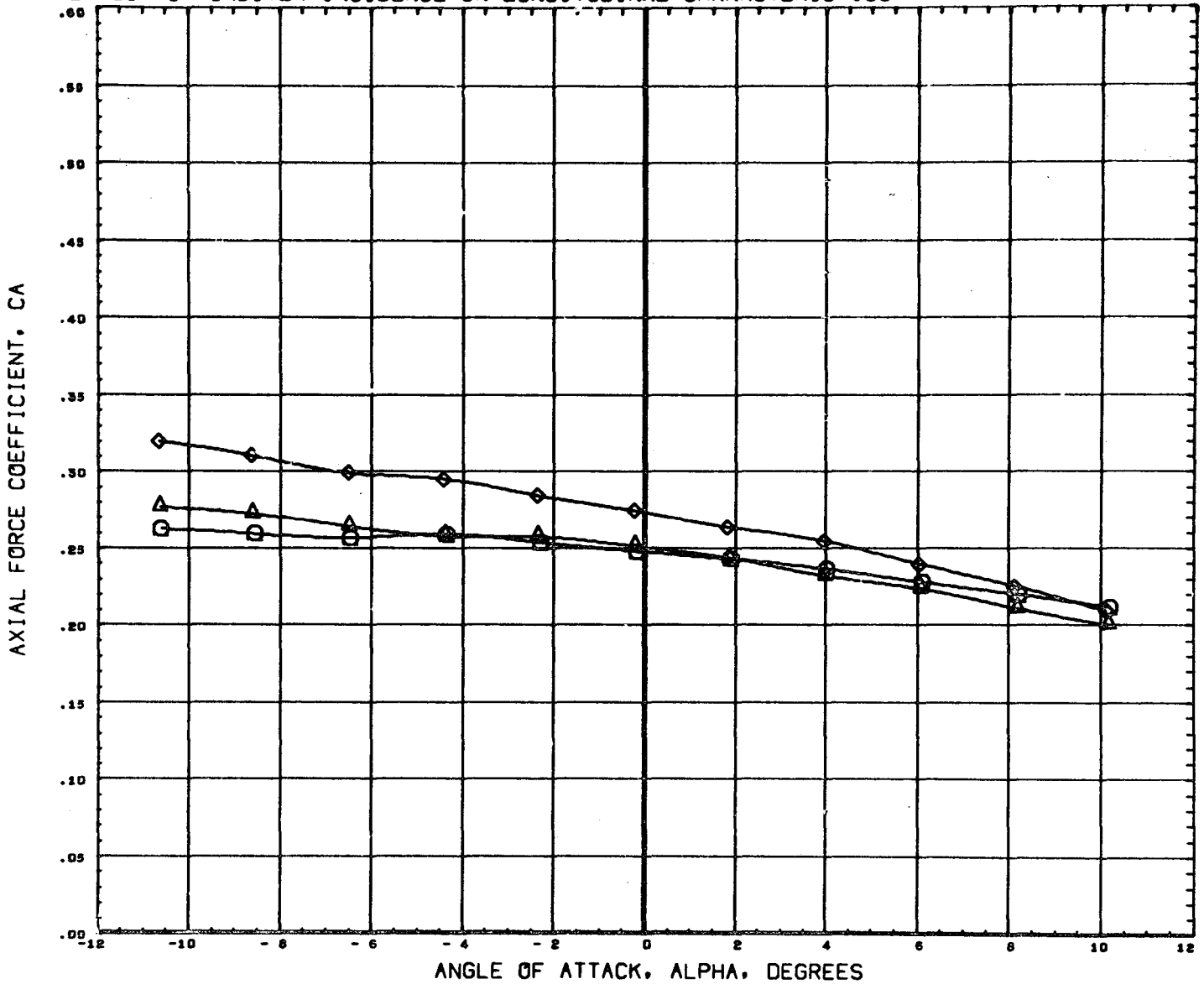

DATA SET SYMBOL	CONFIGURATION DESCRIPTION	ORBIN	THETS	BETA	REFERENCE INFORMATION
(B65009)	MSFC TWT 534 SHUTTLE LAUNCH	T101	0.000	0.000	SREF 4.8950 SQ. IN
(B65002)	MSFC TWT 534 SHUTTLE LAUNCH	T101	-1.500	0.000	LREF 2.6440 IN.
(B65008)	MSFC TWT 534 SHUTTLE LAUNCH	T101	-3.000	0.000	BREF 3.9250 IN.
					XNRP 3.4900 IN.
					YNRP 0.0000 IN.
					ZNRP 0.1616 IN.
					SCALE 0.0034

MACH 1.20

EFFECT OF ORBITER INCIDENCE ON LONGITUDINAL CHARACTERISTICS

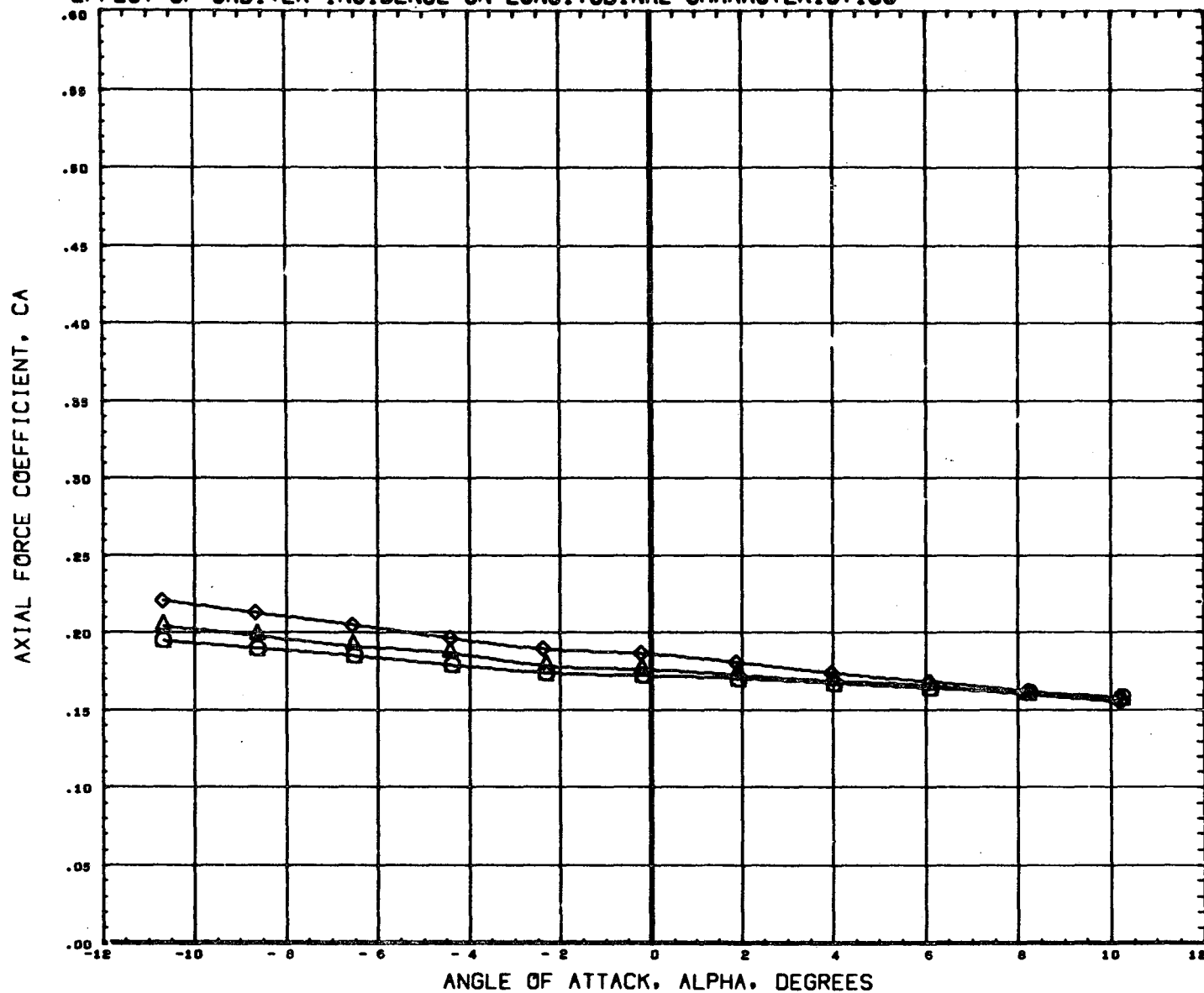

DATA SET SYMBOL	CONFIGURATION DESCRIPTION	T101	ORBIN	THETS	BETA	REFERENCE INFORMATION
(B65009)	MSFC TWT 534 SHUTTLE LAUNCH	T101	0.000		0.000	SREF 4.8950 SQ. IN
(B65002)	MSFC TWT 534 SHUTTLE LAUNCH	T101	-1.500		0.000	LREF 2.6440 IN.
(B65806)	MSFC TWT 534 SHUTTLE LAUNCH	T101	-3.000		0.000	BREF 3.5250 IN.
						XMRP 3.4900 IN.
						YMRP 0.0000 IN.
						ZMRP 0.1616 IN.
						SCALE 0.0034

MACH 1.97

EFFECT OF ORBITER INCIDENCE ON LONGITUDINAL CHARACTERISTICS

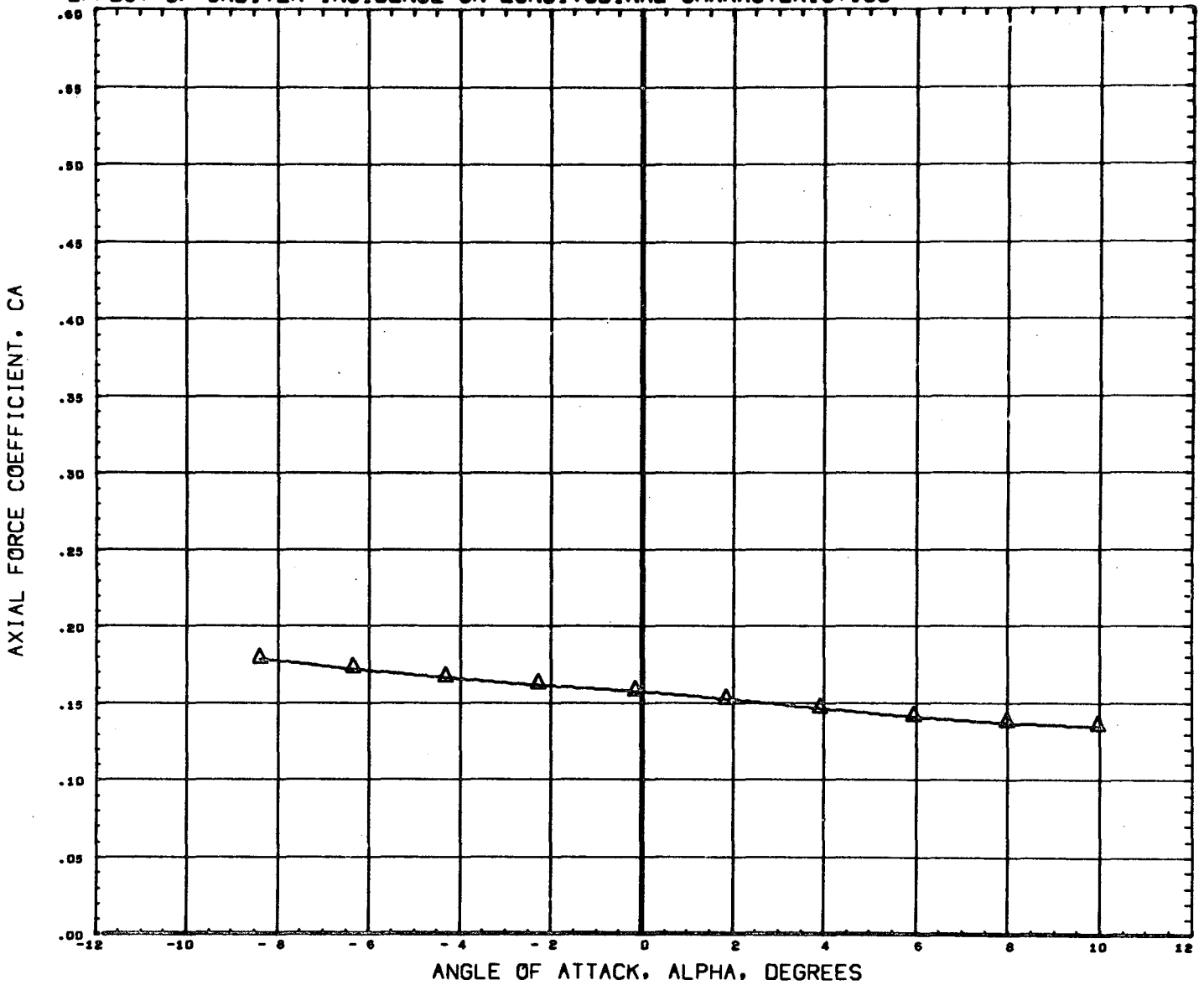

DATA SET SYMBOL	CONFIGURATION DESCRIPTION	ORBIN	THETS	BETA	REFERENCE INFORMATION
(B65009)	DATA NOT AVAILABLE FOR ALL CONDITIONS	0.000		0.000	SREF 4.8950 SQ. IN
(B65002)	MSFC TWT 534 SHUTTLE LAUNCH T101	-1.500		0.000	LREF 2.6440 IN.
(B65806)	DATA NOT AVAILABLE FOR ALL CONDITIONS	-3.000		0.000	BREF 3.5250 IN.
					XMRP 3.4900 IN.
					YMRP 0.0000 IN.
					ZMRP 0.1616 IN.
					SCALE 0.0034

MACH 2.74

EFFECT OF ORBITER INCIDENCE ON LONGITUDINAL CHARACTERISTICS

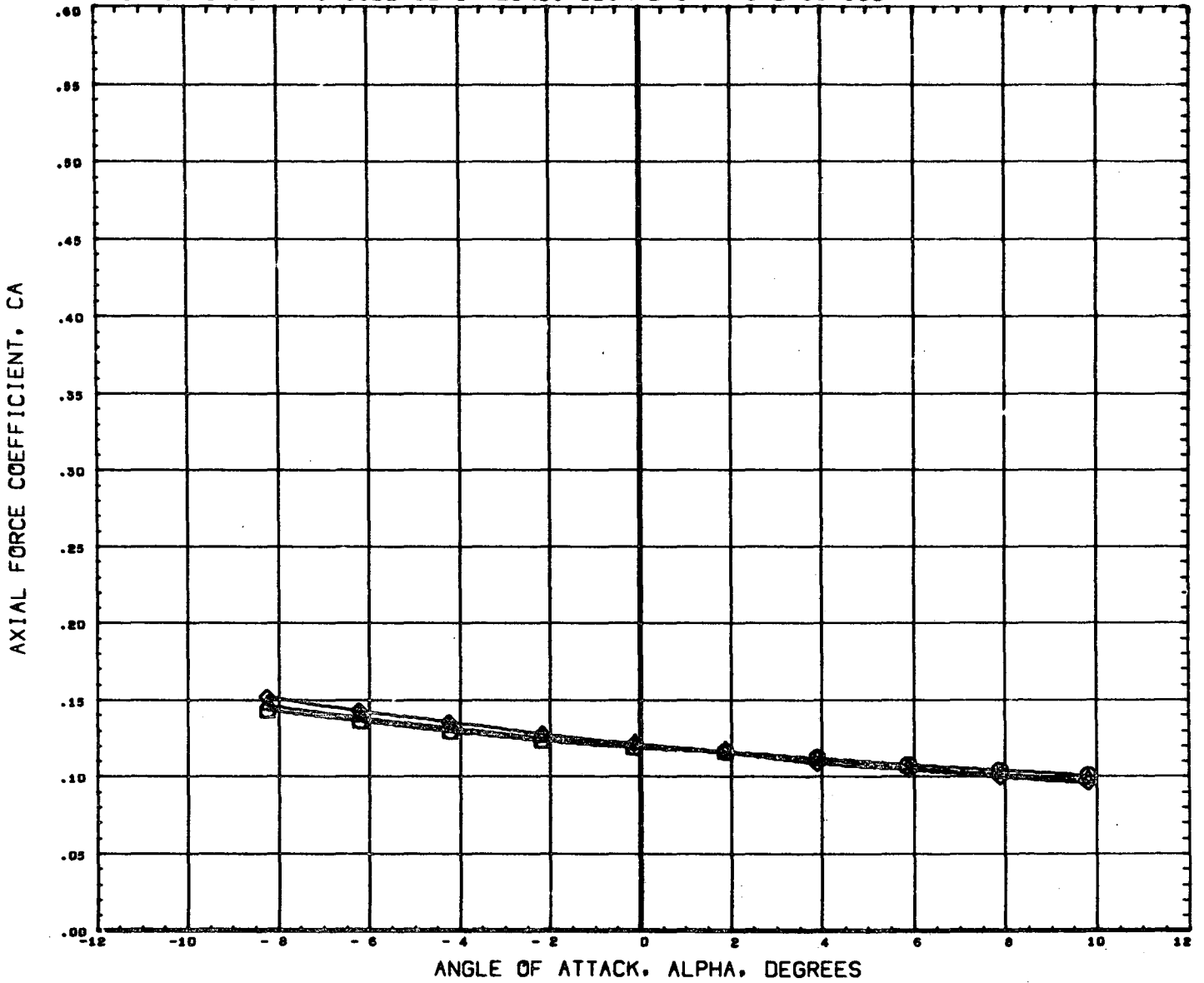

DATA SET SYMBOL	CONFIGURATION DESCRIPTION	ORBIN	THETS	BETA	REFERENCE INFORMATION
(B65009)	MSFC TWT 534 SHUTTLE LAUNCH	T101	0.000	0.000	SREF 4.8950 SQ. IN
(B65002)	MSFC TWT 534 SHUTTLE LAUNCH	T101	-1.500	0.000	LREF 2.6440 IN.
(B65008)	MSFC TWT 534 SHUTTLE LAUNCH	T101	-3.000	0.000	BREF 3.5250 IN.
					XMRP 3.4900 IN.
					YMRP 0.0000 IN.
					ZMRP 0.1616 IN.
					SCALE 0.0034

MACH 4.96

EFFECT OF ORBITER INCIDENCE ON LONGITUDINAL CHARACTERISTICS

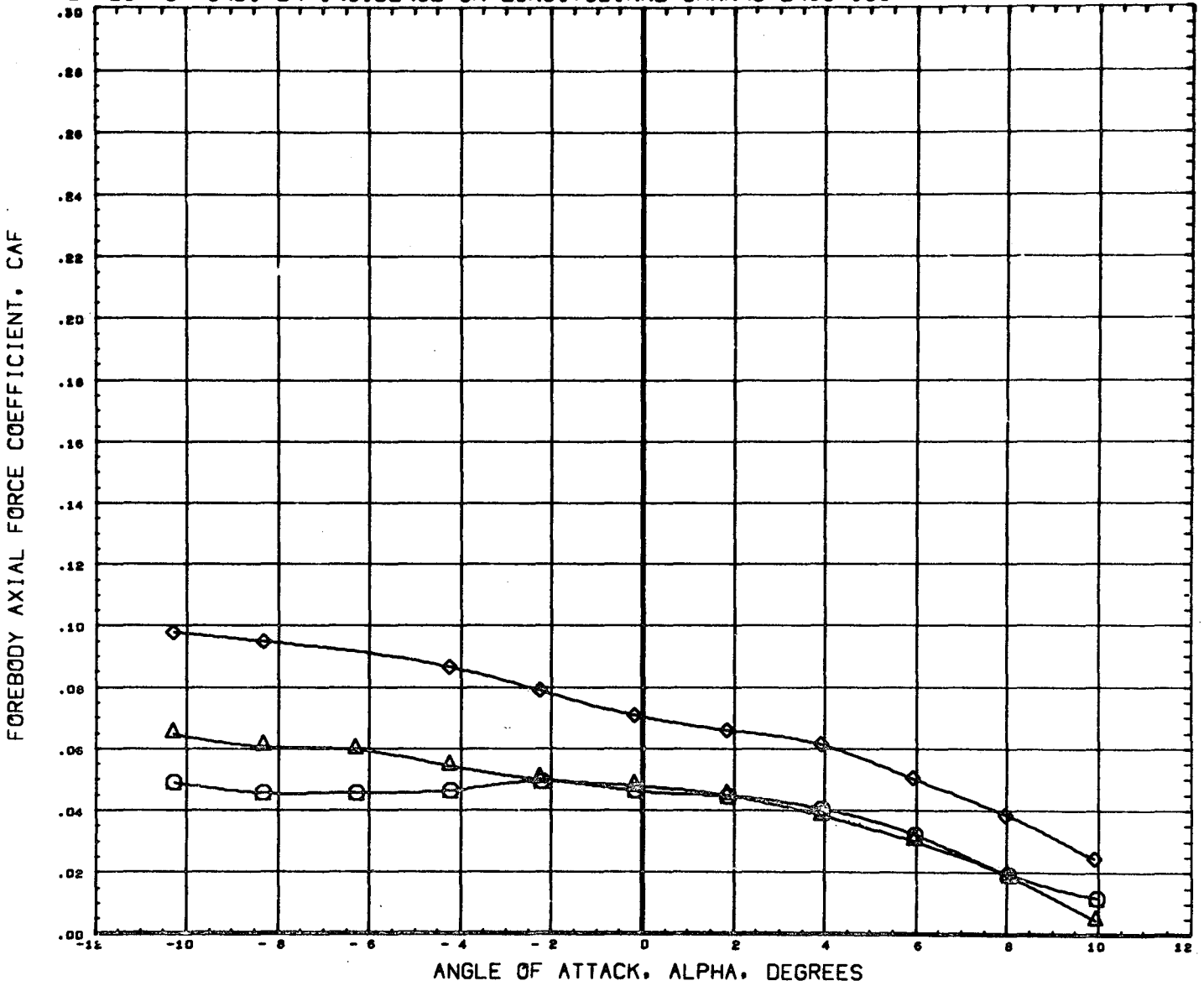

DATA SET SYMBOL	CONFIGURATION DESCRIPTION	ORBIN	THETS	BETA	REFERENCE INFORMATION
(B65009)	MSFC TWT 534 SHUTTLE LAUNCH	T101	0.000	0.000	SREF 4.8950 SQ. IN
(B65002)	MSFC TWT 534 SHUTTLE LAUNCH	T101	-1.500	0.000	LREF 2.6440 IN.
(B65500)	MSFC TWT 534 SHUTTLE LAUNCH	T101	-3.000	0.000	BREF 3.5250 IN.
					XMRP 3.4900 IN.
					YMRP 0.0000 IN.
					ZMRP 0.1616 IN.
					SCALE 0.0034

MACH .60

EFFECT OF ORBITER INCIDENCE ON LONGITUDINAL CHARACTERISTICS

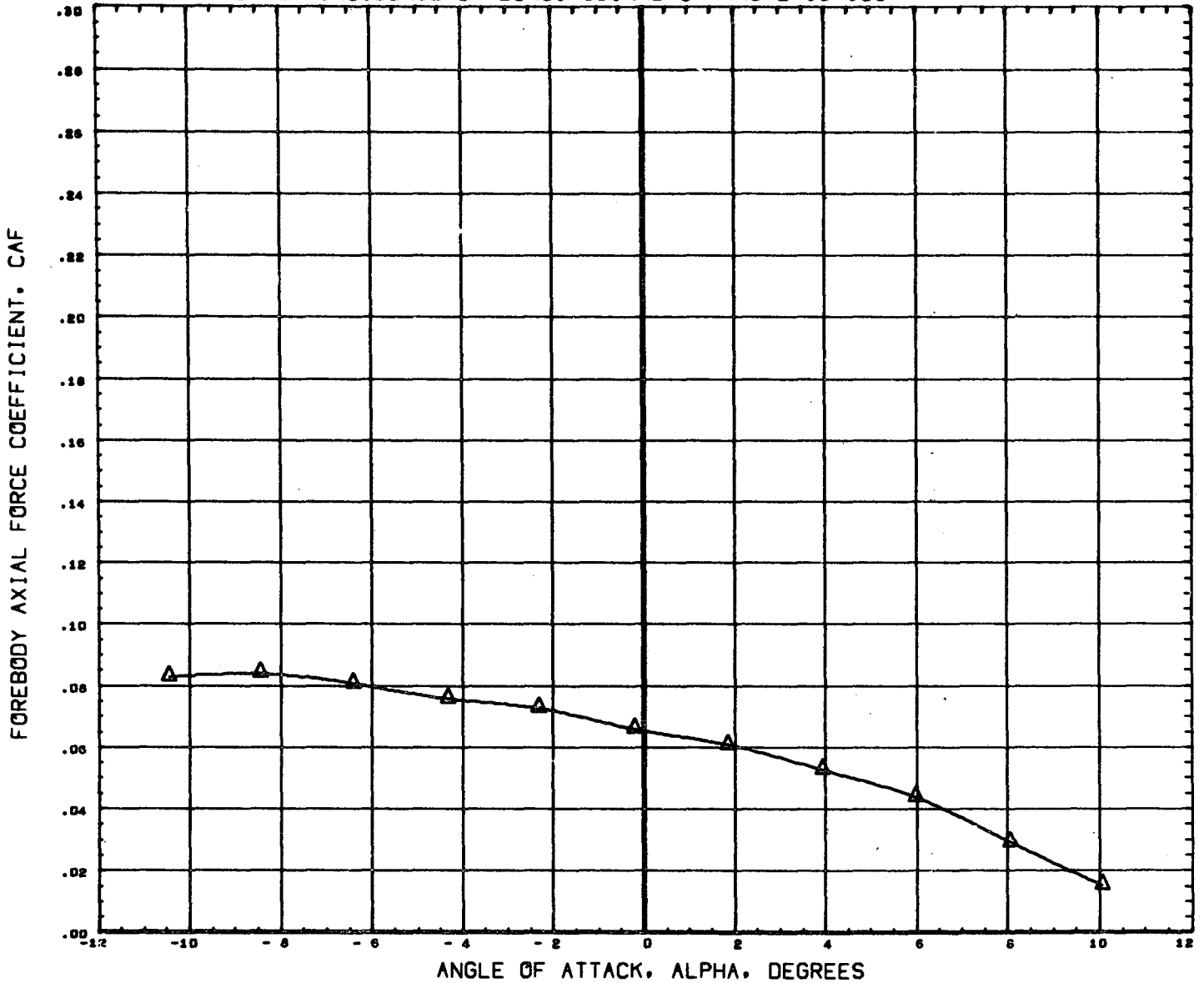

DATA SET SYMBOL	CONFIGURATION DESCRIPTION	ORBIN	THETS	BETA	REFERENCE INFORMATION
(B65009)	DATA NOT AVAILABLE FOR ALL CONDITIONS	0.000		0.000	SREF 4.8950 SQ. IN
(B65002)	MSFC TWT 534 SHUTTLE LAUNCH T101	-1.500		0.000	LREF 2.6440 IN.
(B65806)	DATA NOT AVAILABLE FOR ALL CONDITIONS	-3.000		0.000	BREF 3.5250 IN.
					YMRP 3.4900 IN.
					YMRP 0.0000 IN.
					ZMRP 0.1616 IN.
					SCALE 0.0034

EFFECT OF ORBITER INCIDENCE ON LONGITUDINAL CHARACTERISTICS

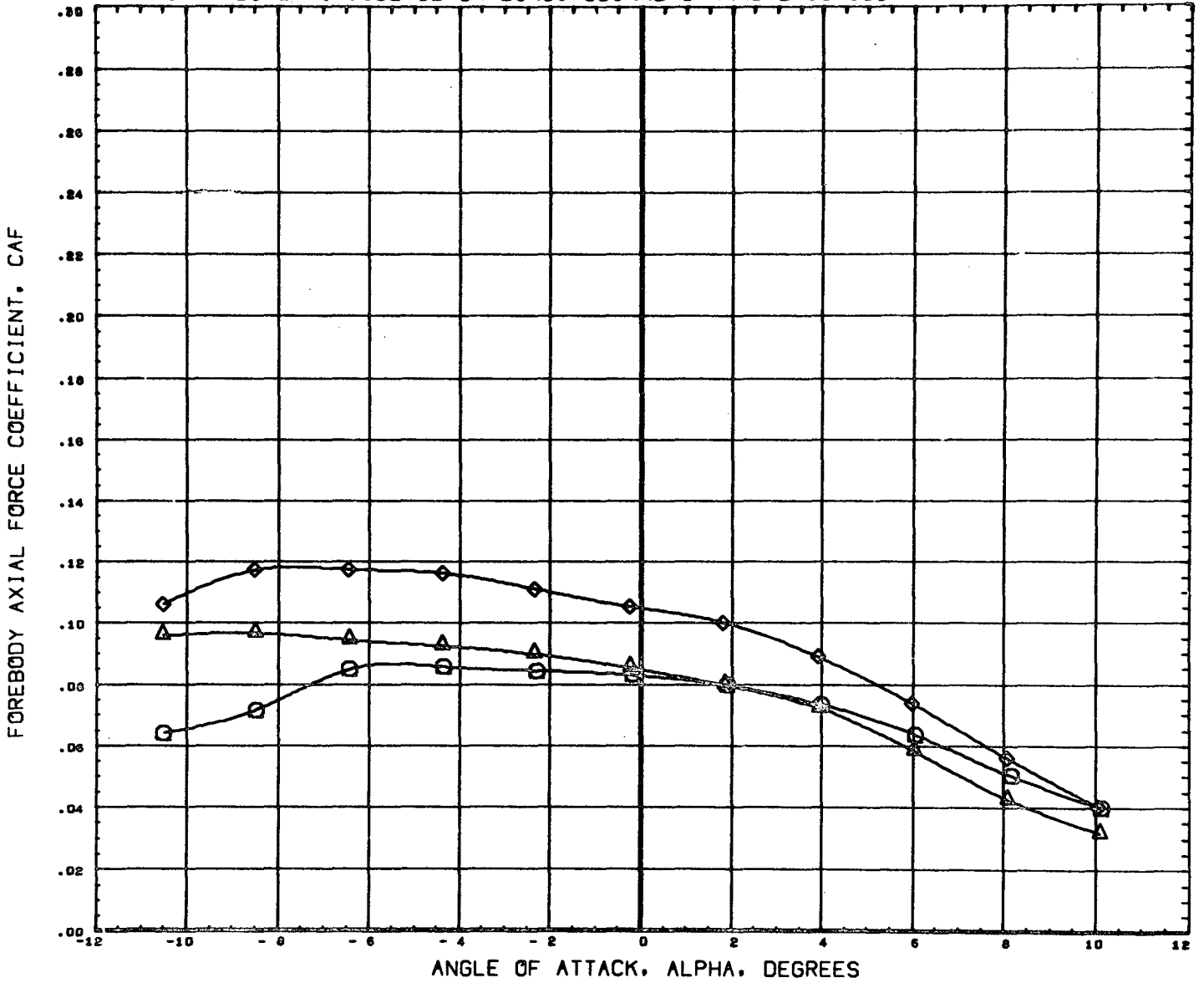

DATA SET SYMBOL	CONFIGURATION DESCRIPTION	ORBIN	THETS	BETA	REFERENCE INFORMATION
(B65009)	MSFC TWT 534 SHUTTLE LAUNCH	T101	0.000	0.000	SREF 4.8950 SQ. IN
(B65002)	MSFC TWT 534 SHUTTLE LAUNCH	T101	-1.500	0.000	LREF 2.6440 IN.
(B65008)	MSFC TWT 534 SHUTTLE LAUNCH	T101	-3.000	0.000	BREF 3.5250 IN.
					XMRP 3.4900 IN.
					YMRP 0.0000 IN.
					ZMRP 0.1616 IN.
					SCALE 0.0034

MACH .90

EFFECT OF ORBITER INCIDENCE ON LONGITUDINAL CHARACTERISTICS

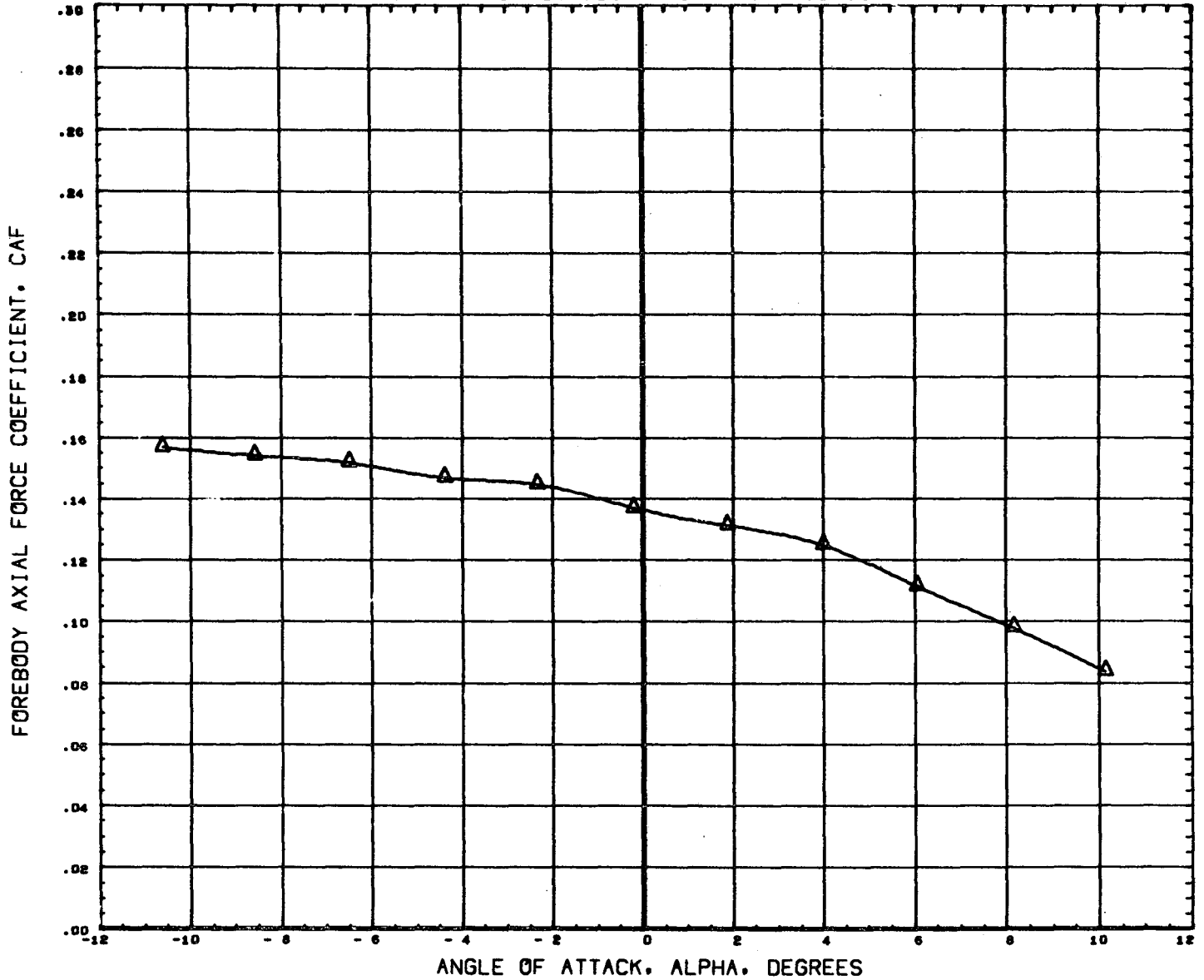

DATA SET SYMBOL	CONFIGURATION DESCRIPTION	ORBIN	THETS	BETA	REFERENCE INFORMATION
(865009)	DATA NOT AVAILABLE FOR ALL CONDITIONS	0.000		0.000	SREF 4.8950 SQ. IN
(865002)	NSFC TWT 534 SHUTTLE LAUNCH T101	-1.500		0.000	LREF 2.6440 IN.
(865006)	DATA NOT AVAILABLE FOR ALL CONDITIONS	-3.000		0.000	BREF 3.5250 IN.
					XMRP 3.4900 IN.
					YMRP 0.0000 IN.
					ZMRP 0.1616 IN.
					SCALE 0.0034

EFFECT OF ORBITER INCIDENCE ON LONGITUDINAL CHARACTERISTICS

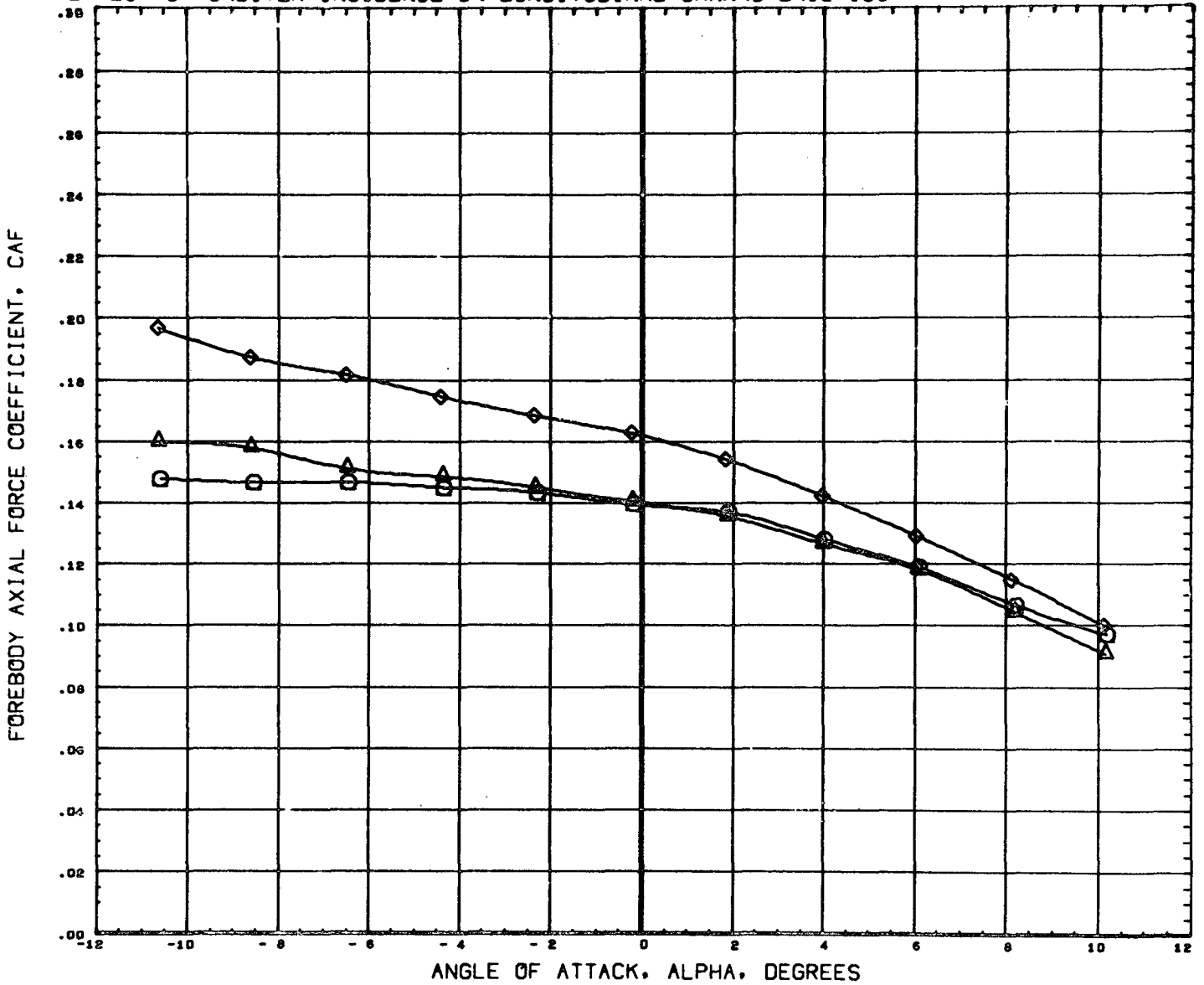

DATA SET SYMBOL	CONFIGURATION DESCRIPTION	ORBIN	THETS	BETA	REFERENCE INFORMATION
(B65009)	MSFC TWT 534 SHUTTLE LAUNCH	T101	0.000	0.000	SREF 4.8950 SQ. IN
(B65002)	MSFC TWT 534 SHUTTLE LAUNCH	T101	-1.500	0.000	LREF 2.6440 IN.
(B65008)	MSFC TWT 534 SHUTTLE LAUNCH	T101	-3.000	0.000	BREF 3.5250 IN.
					XMRP 3.4900 IN.
					YMRP 0.0000 IN.
					ZMRP 0.1616 IN.
					SCALE 0.0034

MACH 1.20

EFFECT OF ORBITER INCIDENCE ON LONGITUDINAL CHARACTERISTICS

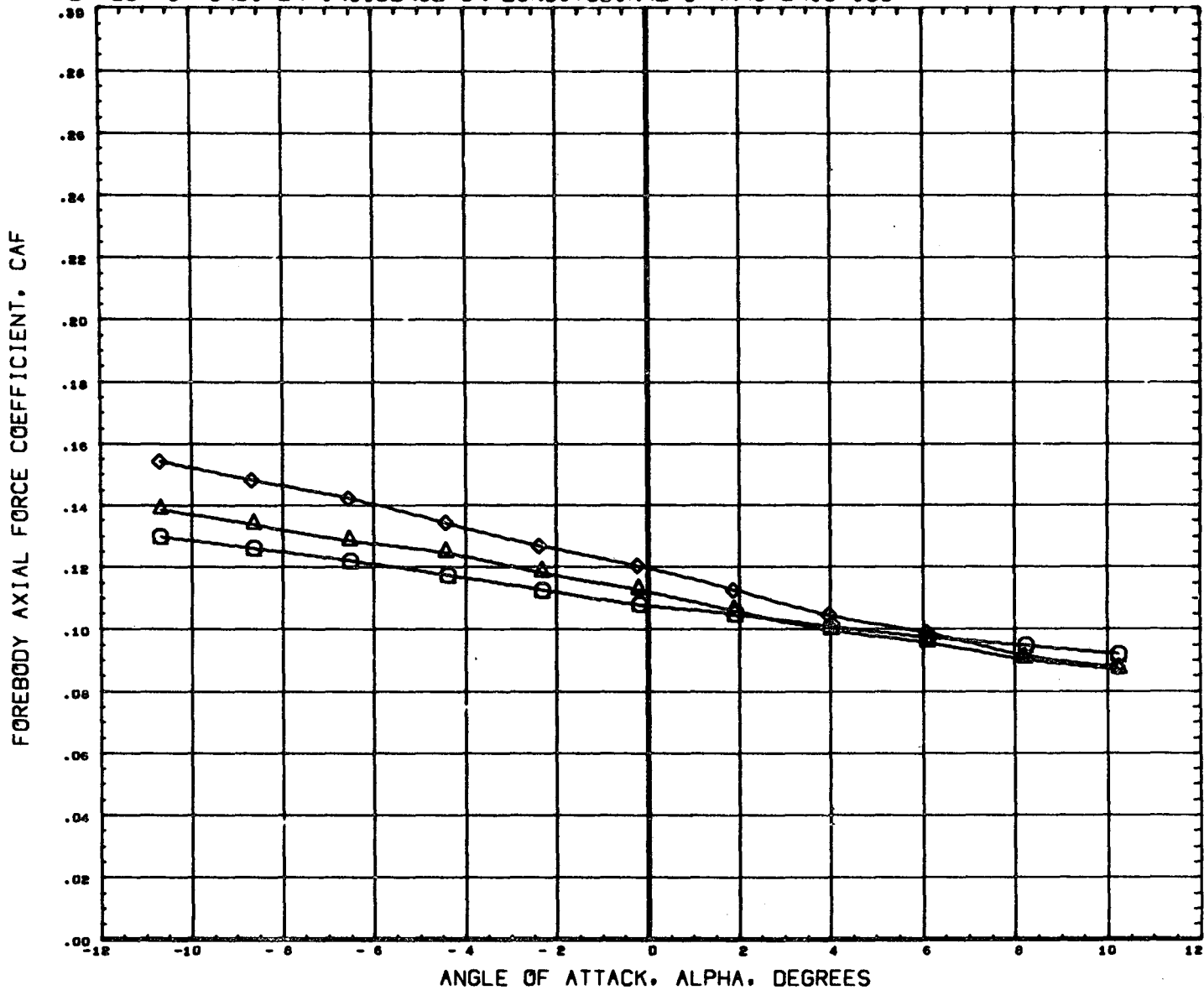

DATA SET SYMBOL	CONFIGURATION DESCRIPTION	ORBIN	THETS	BETA	REFERENCE INFORMATION
(B65009)	MSFC TWT 534 SHUTTLE LAUNCH	T101	0.000	0.000	SREF 4.8950 SQ. IN
(B65002)	MSFC TWT 534 SHUTTLE LAUNCH	T101	-1.500	0.000	LREF 2.6440 IN.
(B65008)	MSFC TWT 534 SHUTTLE LAUNCH	T101	-3.000	0.000	BREF 3.5250 IN.
					XMRP 3.4900 IN.
					YMRP 0.0000 IN.
					ZMRP 0.1616 IN.
					SCALE 0.0034

EFFECT OF ORBITER INCIDENCE ON LONGITUDINAL CHARACTERISTICS

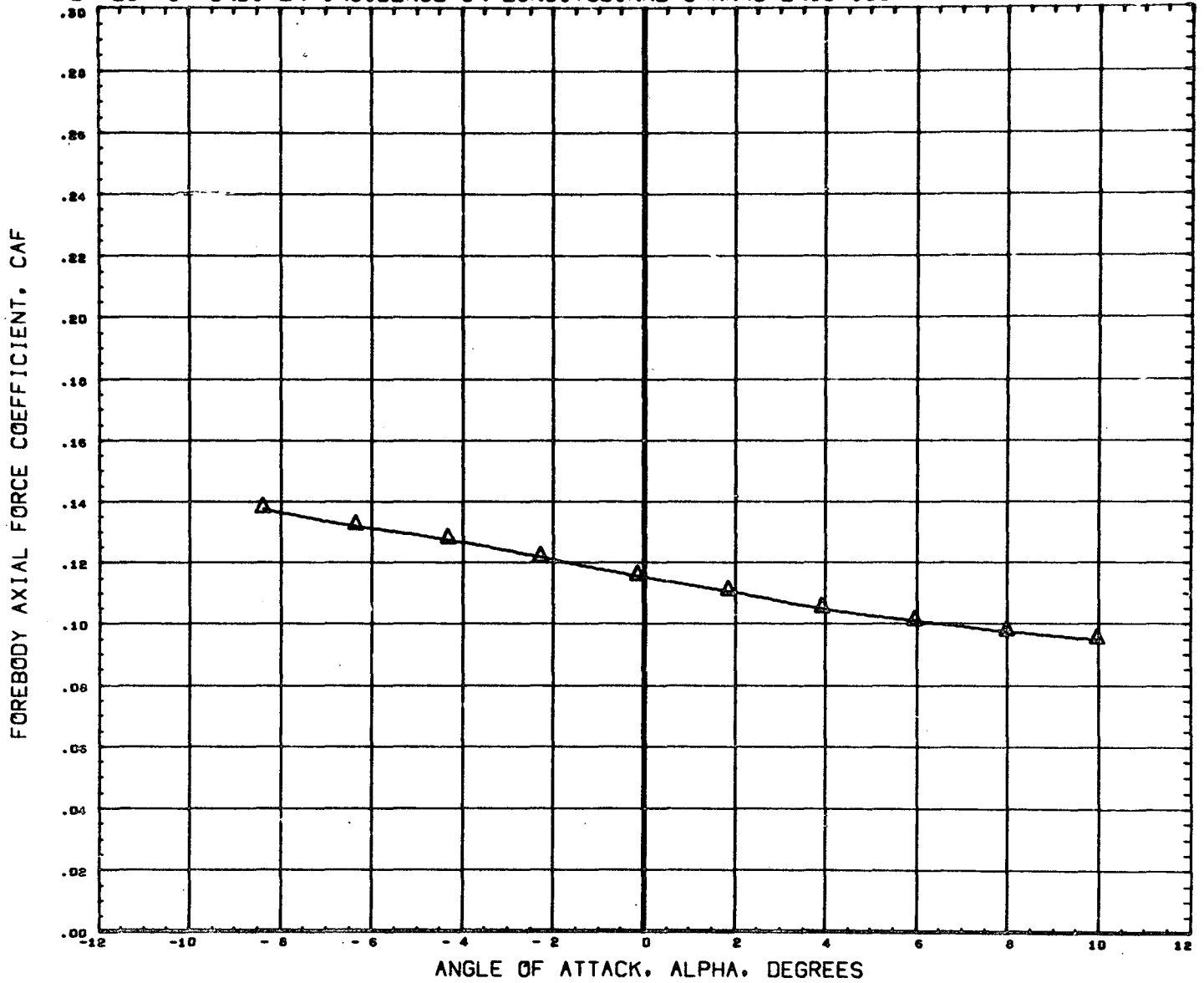

DATA SET SYMBOL	CONFIGURATION DESCRIPTION	ORBIN	THETS	BETA	REFERENCE INFORMATION
(B65009)	DATA NOT AVAILABLE FOR ALL CONDITIONS	0.000	0.000	0.000	SREF 4.8950 SQ. IN
(B65002)	MSFC TWT 534 SHUTTLE LAUNCH T101	-1.500	0.000	0.000	LREF 2.6440 IN.
(B65508)	DATA NOT AVAILABLE FOR ALL CONDITIONS	-3.000	0.000	0.000	BREF 3.5250 IN.
					XMRP 3.4900 IN.
					YNRP 0.0000 IN.
					ZNRP 0.1616 IN.
					SCALE 0.0034

MACH 2.74

EFFECT OF ORBITER INCIDENCE ON LONGITUDINAL CHARACTERISTICS

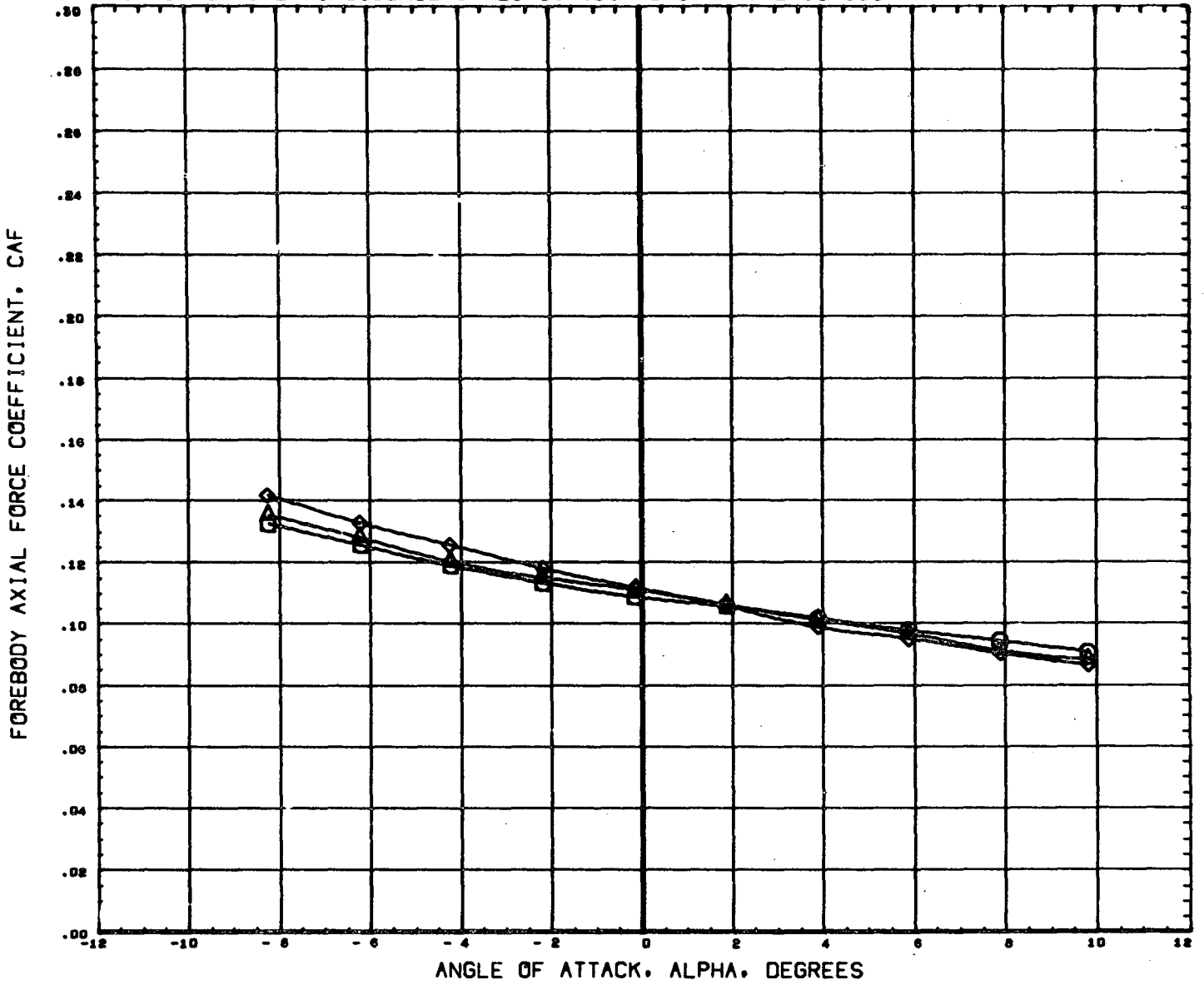

DATA SET SYMBOL	CONFIGURATION DESCRIPTION	ORBIN	THETS	BETA	REFERENCE INFORMATION
(B65009) \square	MSFC TWT 534 SHUTTLE LAUNCH T101	0.000	0.000	0.000	SREF 4.8950 SQ. IN
(B65002) \circ	MSFC TWT 534 SHUTTLE LAUNCH T101	-1.500	0.000	0.000	LREF 2.6440 IN.
(B65808) \diamond	MSFC TWT 534 SHUTTLE LAUNCH T101	-3.000	0.000	0.000	BREF 3.5250 IN.
					XWRP 3.4900 IN.
					YWRP 0.0000 IN.
					ZWRP 0.1616 IN.
					SCALE 0.0034

MACH 4.96

PAGE 240

EFFECT OF ORBITER INCIDENCE ON LONGITUDINAL CHARACTERISTICS

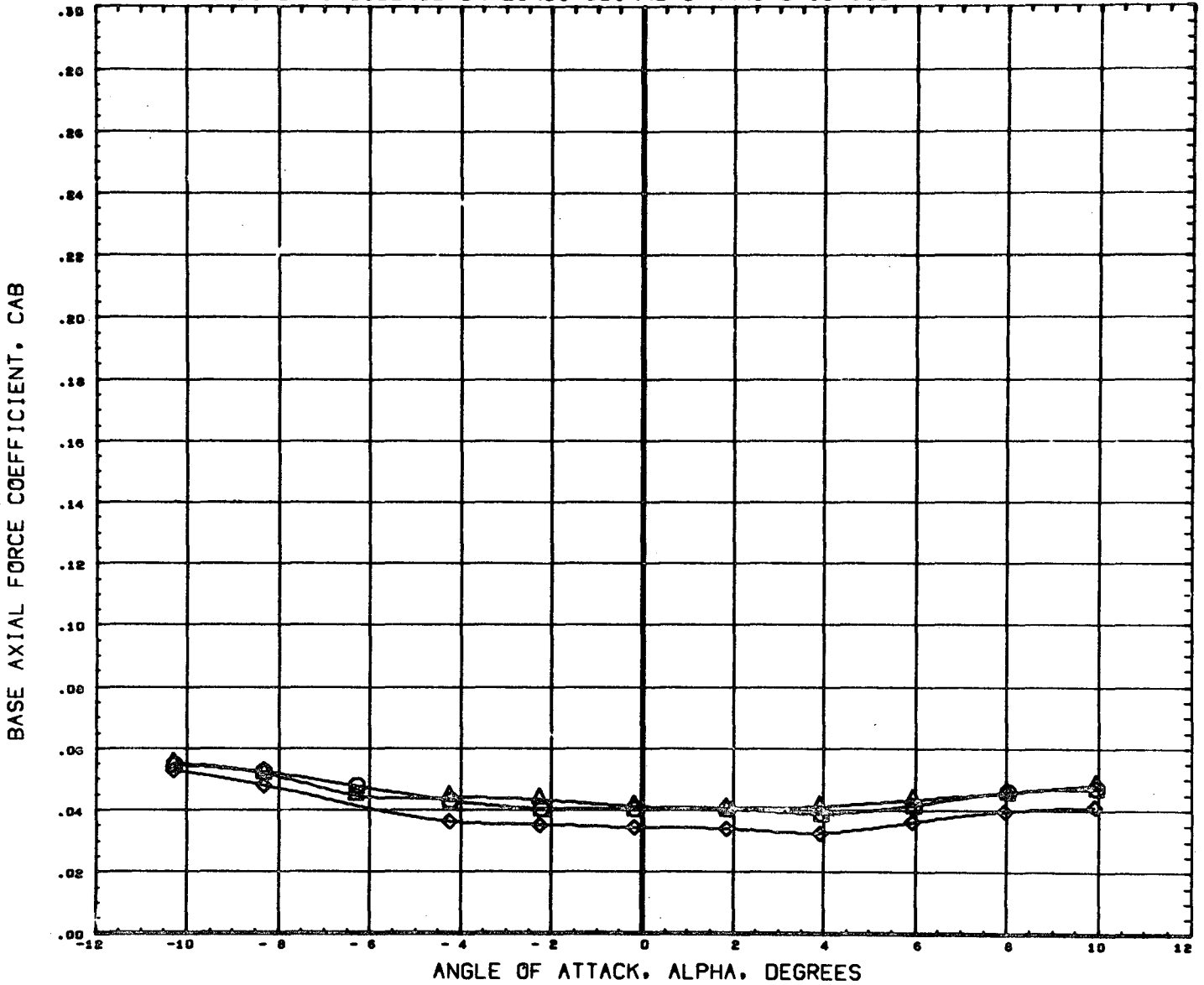

DATA SET SYMBOL	CONFIGURATION DESCRIPTION	ORBIN	THETS	BETA	REFERENCE INFORMATION
(B65009)	MSFC TWT 534 SHUTTLE LAUNCH	T101	0.000	0.000	SREF 4.8950 SQ. IN
(B65002)	MSFC TWT 534 SHUTTLE LAUNCH	T101	-1.500	0.000	LREF 2.6440 IN.
(B65008)	MSFC TWT 534 SHUTTLE LAUNCH	T101	-3.000	0.000	BREF 3.5250 IN.
					XMRP 3.4900 IN.
					YMRP 0.0000 IN.
					ZMRP 0.1616 IN.
					SCALE 0.0034

MACH .60

EFFECT OF ORBITER INCIDENCE ON LONGITUDINAL CHARACTERISTICS

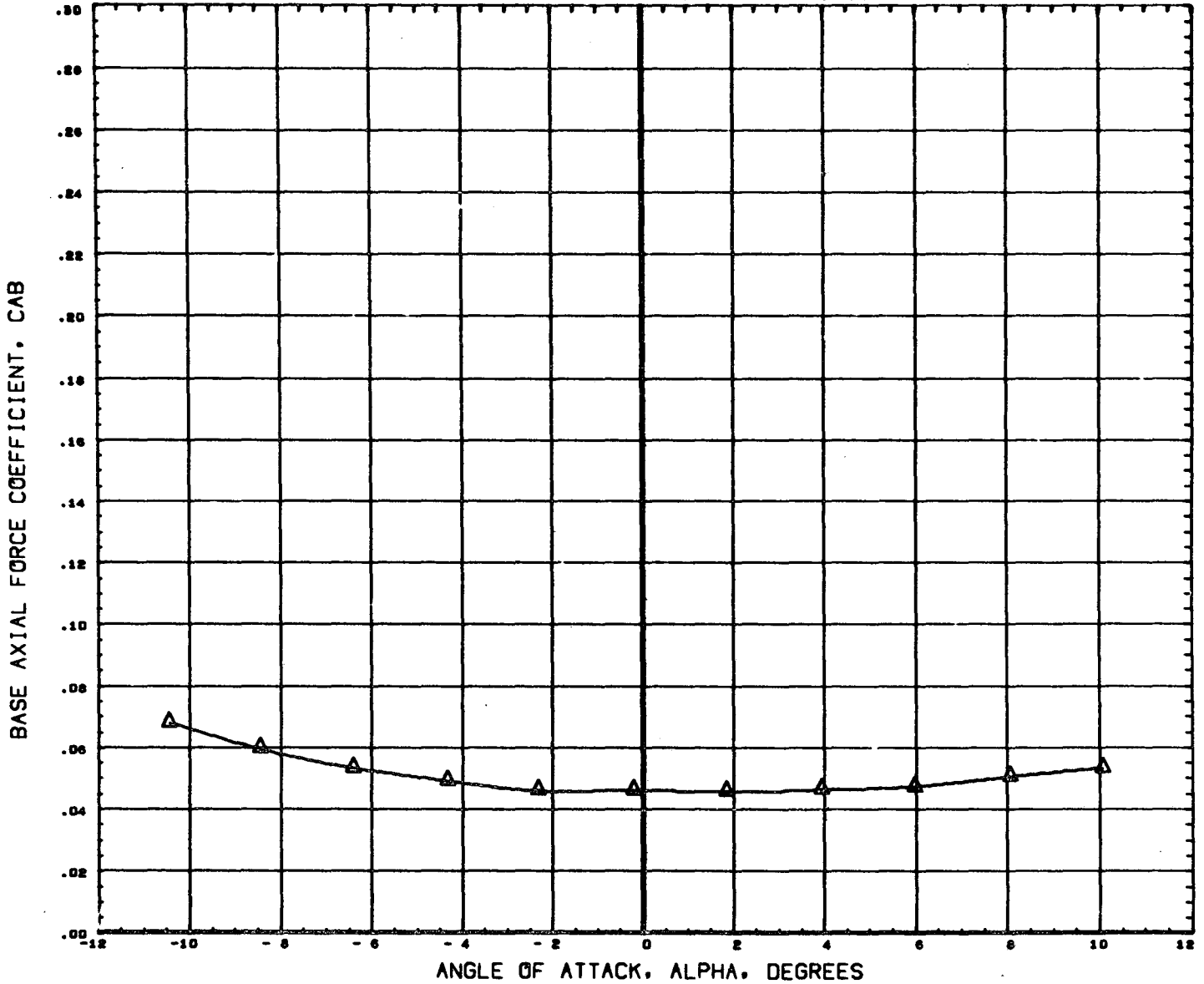

DATA SET SYMBOL	CONFIGURATION DESCRIPTION	ORBIN	THETS	BETA	REFERENCE INFORMATION
(B65009)	DATA NOT AVAILABLE FOR ALL CONDITIONS	0.000		0.000	SREF 4.8950 SQ. IN
(B65002)	MSFC TWT 534 SHUTTLE LAUNCH T101	-1.500		0.000	LREF 2.6440 IN.
(B65008)	DATA NOT AVAILABLE FOR ALL CONDITIONS	-3.000		0.000	BREF 3.5250 IN.
					XMRP 3.4900 IN.
					YMRP 0.0000 IN.
					ZMRP 0.1616 IN.
					SCALE 0.0034

EFFECT OF ORBITER INCIDENCE ON LONGITUDINAL CHARACTERISTICS

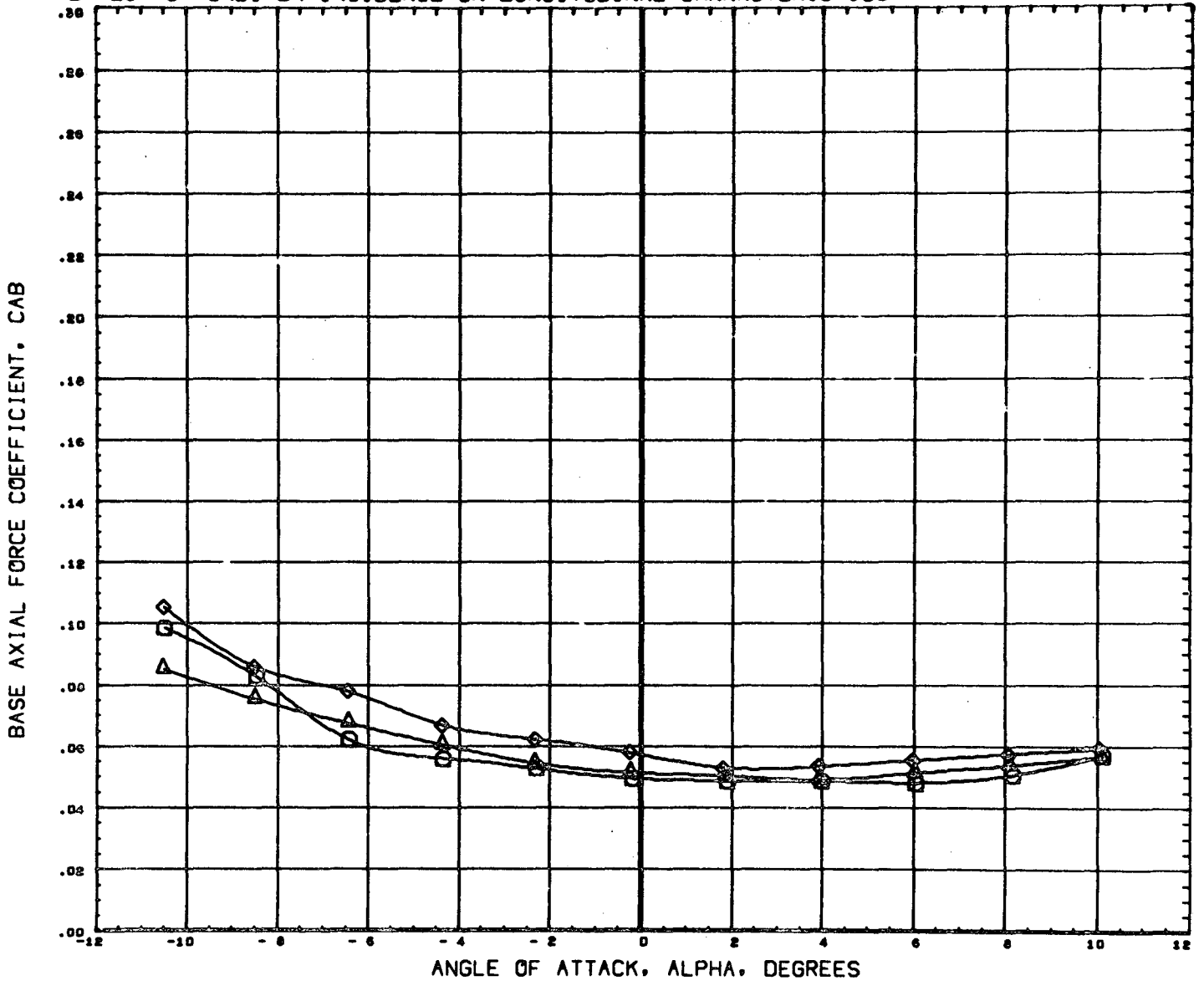

DATA SET SYMBOL	CONFIGURATION DESCRIPTION	ORBIN	THETS	BETA	REFERENCE INFORMATION
(B65001)	MSFC TWT 534 SHUTTLE LAUNCH T101	0.000		0.000	SREF 4.8950 sq. IN
(B65002)	MSFC TWT 534 SHUTTLE LAUNCH T101	-1.500		0.000	LREF 2.6440 IN.
(B65003)	MSFC TWT 534 SHUTTLE LAUNCH T101	-3.000		0.000	BREF 3.5250 IN.
					XMRP 3.4900 IN.
					YMRP 0.0000 IN.
					ZMRP 0.1616 IN.
					SCALE 0.0034

MACH .90

EFFECT OF ORBITER INCIDENCE ON LONGITUDINAL CHARACTERISTICS

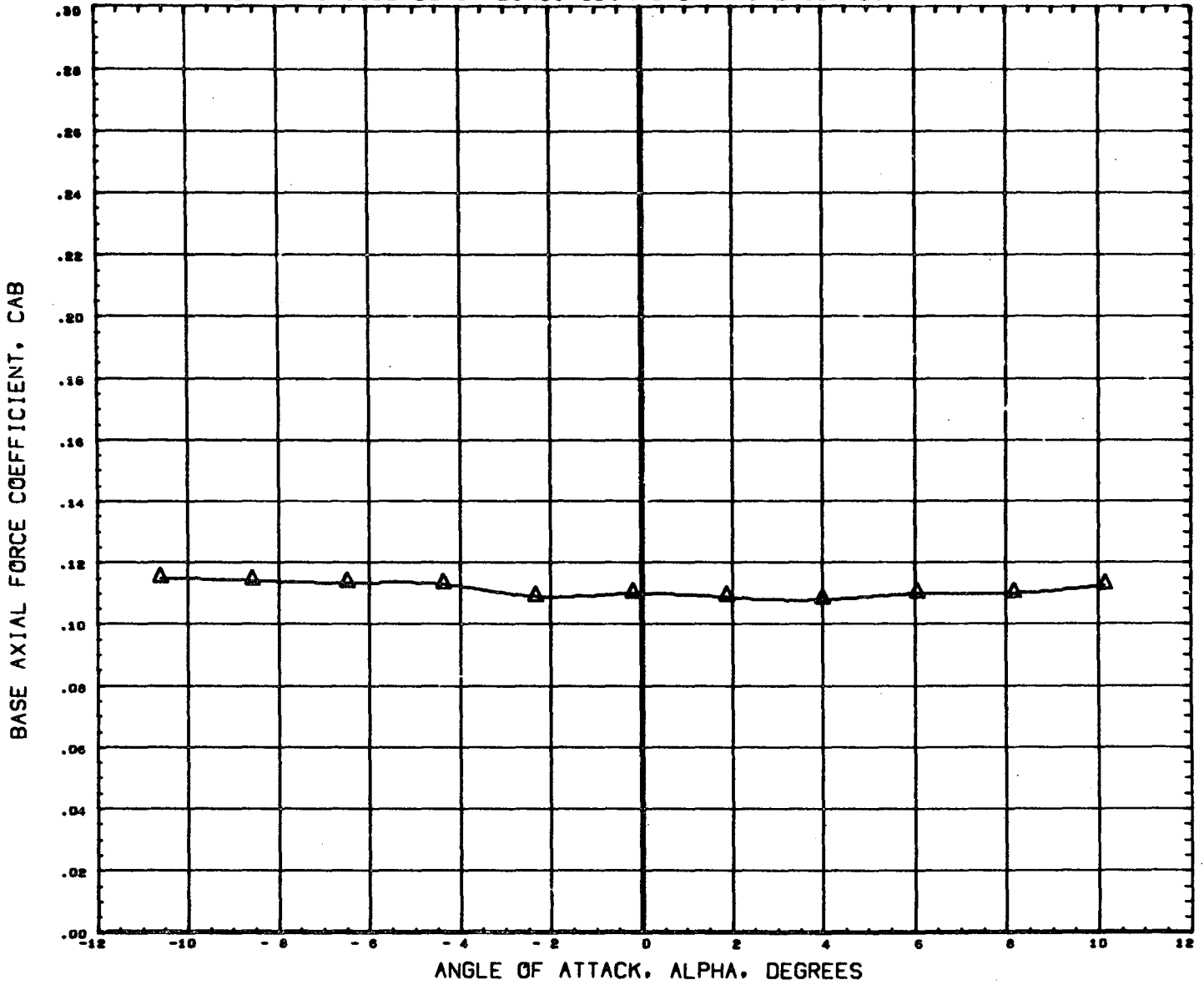

DATA SET SYMBOL	CONFIGURATION DESCRIPTION	ORBIN	THETS	BETA	REFERENCE INFORMATION
(865009)	DATA NOT AVAILABLE FOR ALL CONDITIONS	0.000		0.000	SREF 4.8950 SQ. IN
(865002)	MSFC TWT 534 SHUTTLE LAUNCH T101	-1.500		0.000	LREF 2.6440 IN.
(865008)	DATA NOT AVAILABLE FOR ALL CONDITIONS	-3.000		0.000	BREF 3.5250 IN.
					XMRP 3.4900 IN.
					YMRP 0.0000 IN.
					ZMRP 0.1616 IN.
					SCALE 0.0034

MACH 1.10

PAGE 244

EFFECT OF ORBITER INCIDENCE ON LONGITUDINAL CHARACTERISTICS

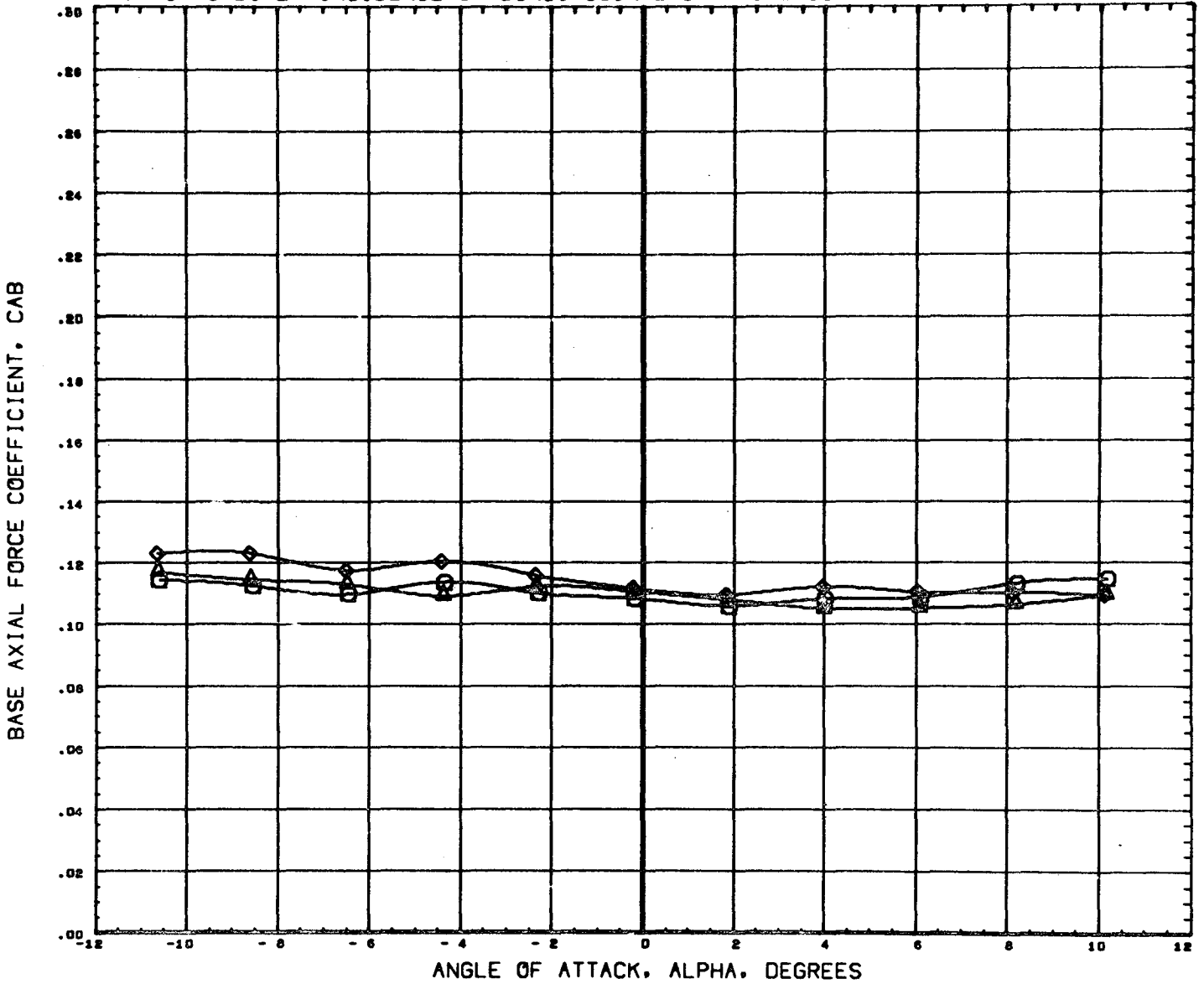

DATA SET SYMBOL	CONFIGURATION DESCRIPTION	ORBIN	THETS	BETA	REFERENCE INFORMATION
(B65009)	MSFC TWT 534 SHUTTLE LAUNCH	T101	0.000	0.000	SREF 4.8950 SQ. IN
(B65002)	MSFC TWT 534 SHUTTLE LAUNCH	T101	-1.500	0.000	LREF 2.6440 IN.
(B65508)	MSFC TWT 534 SHUTTLE LAUNCH	T101	-3.000	0.000	BREF 3.5250 IN.
					XMRP 3.4900 IN.
					YMRP 0.0000 IN.
					ZMRP 0.1616 IN.
					SCALE 0.0034

MACH 1.20

EFFECT OF ORBITER INCIDENCE ON LONGITUDINAL CHARACTERISTICS

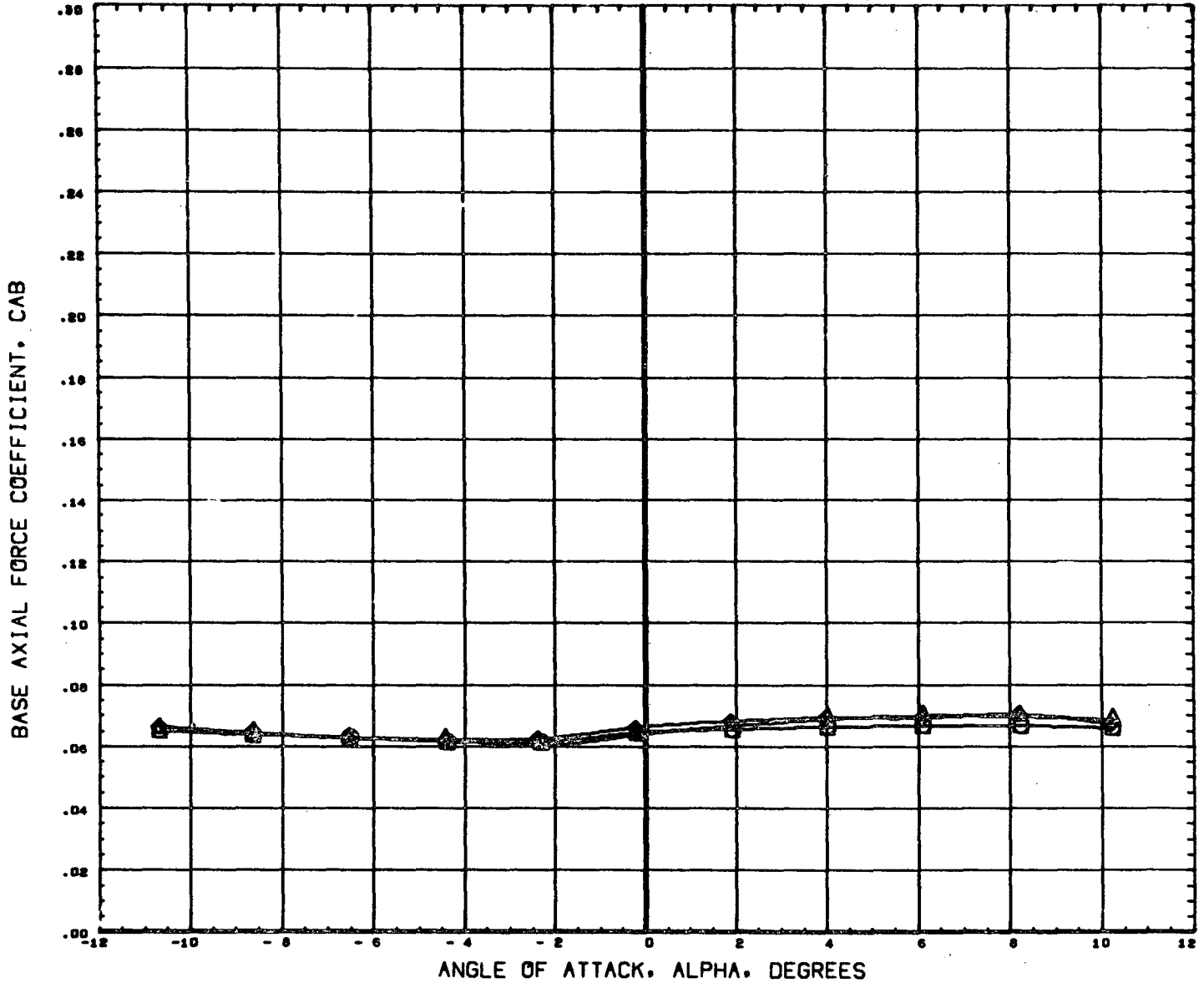

DATA SET SYMBOL	CONFIGURATION DESCRIPTION	ORBIN	THETS	BETA	REFERENCE INFORMATION
(865009)	MSFC TWT 534 SHUTTLE LAUNCH	T101	0.000	0.000	SREF 4.8950 SQ. IN
(865002)	MSFC TWT 534 SHUTTLE LAUNCH	T101	-1.500	0.000	LREF 2.6440 IN.
(865008)	MSFC TWT 534 SHUTTLE LAUNCH	T101	-3.000	0.000	BREF 3.5250 IN.
					XMRP 3.4900 IN.
					YMRP 0.0000 IN.
					ZMRP 0.1616 IN.
					SCALE 0.0034

EFFECT OF ORBITER INCIDENCE ON LONGITUDINAL CHARACTERISTICS

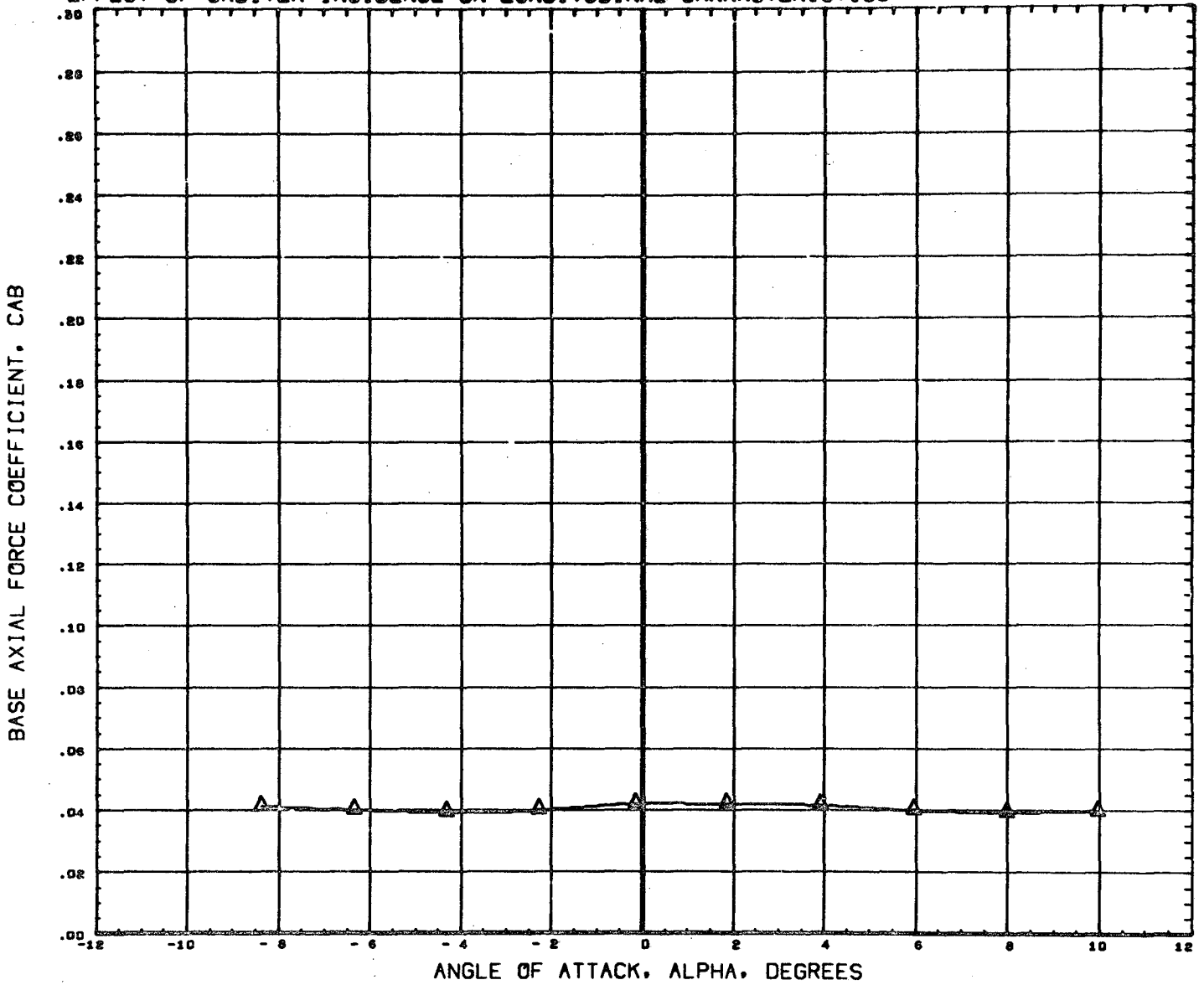

DATA SET SYMBOL	CONFIGURATION DESCRIPTION	ORBIN	THETS	BETA	REFERENCE INFORMATION
(B65009)	DATA NOT AVAILABLE FOR ALL CONDITIONS	0.000		0.000	SREF 4.8950 SQ. IN
(B65002)	MSFC TWT 534 SHUTTLE LAUNCH T101	-1.500		0.000	LREF 2.6440 IN.
(B65006)	DATA NOT AVAILABLE FOR ALL CONDITIONS	-3.000		0.000	BREF 3.5250 IN.
					XHRP 3.4900 IN.
					YHRP 0.0000 IN.
					ZHRP 0.1616 IN.
					SCALE 0.0034

MACH 2.74

PAGE 247

EFFECT OF ORBITER INCIDENCE ON LONGITUDINAL CHARACTERISTICS

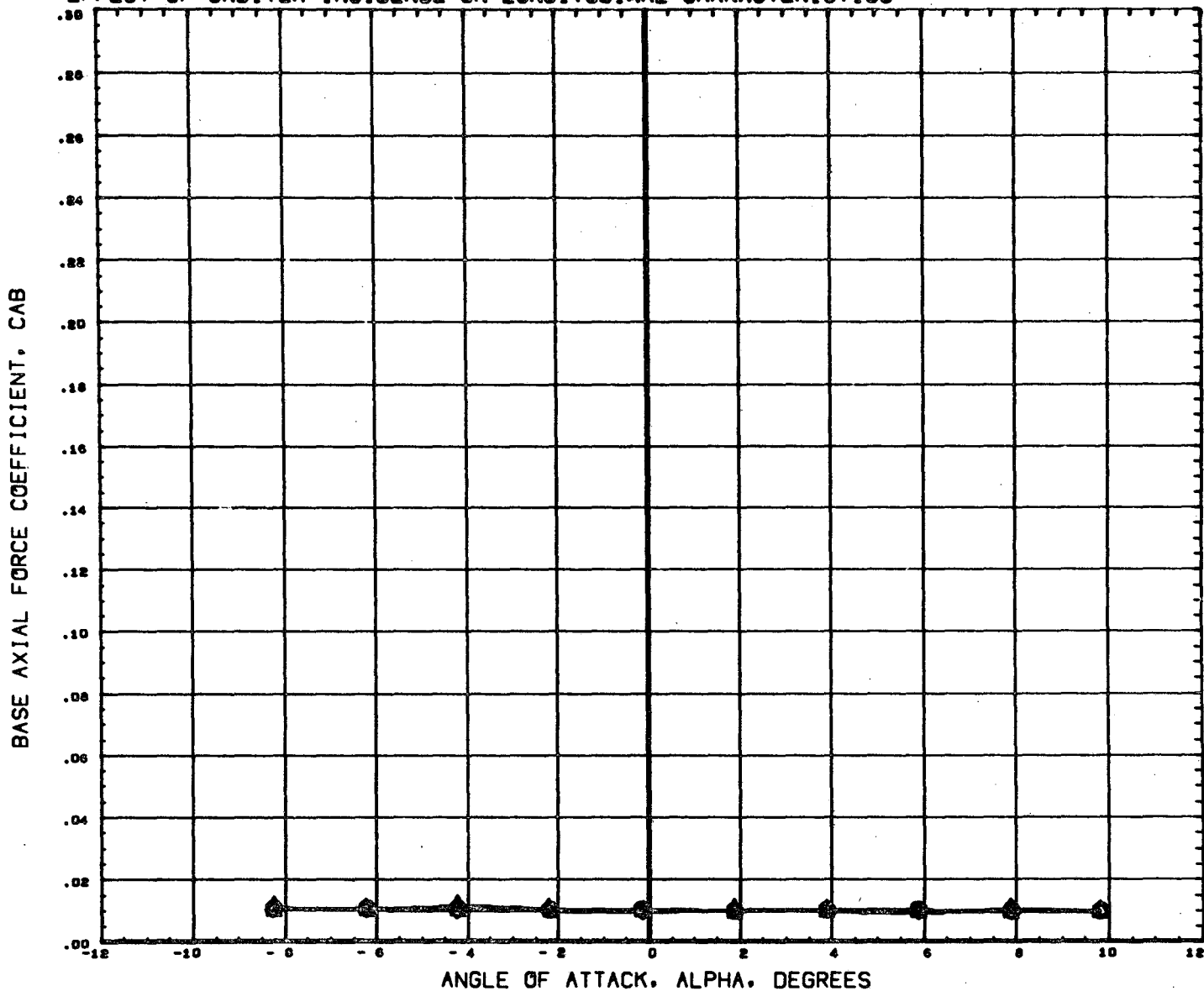

DATA SET SYMBOL	CONFIGURATION DESCRIPTION	ORBIN	THETS	BETA	REFERENCE INFORMATION
(B65009)	MSFC TWT 534 SHUTTLE LAUNCH	T101	0.000	0.000	SREF 4.8950 SQ. IN
(B65002)	MSFC TWT 534 SHUTTLE LAUNCH	T101	-1.500	0.000	LREF 2.6440 IN.
(B65008)	MSFC TWT 534 SHUTTLE LAUNCH	T101	-3.000	0.000	BREF 3.5250 IN.
					XNRP 3.4900 IN.
					YNRP 0.0000 IN.
					ZNRP 0.1616 IN.
					SCALE 0.0034

EFFECT OF ORBITER INCIDENCE ON LONGITUDINAL CHARACTERISTICS

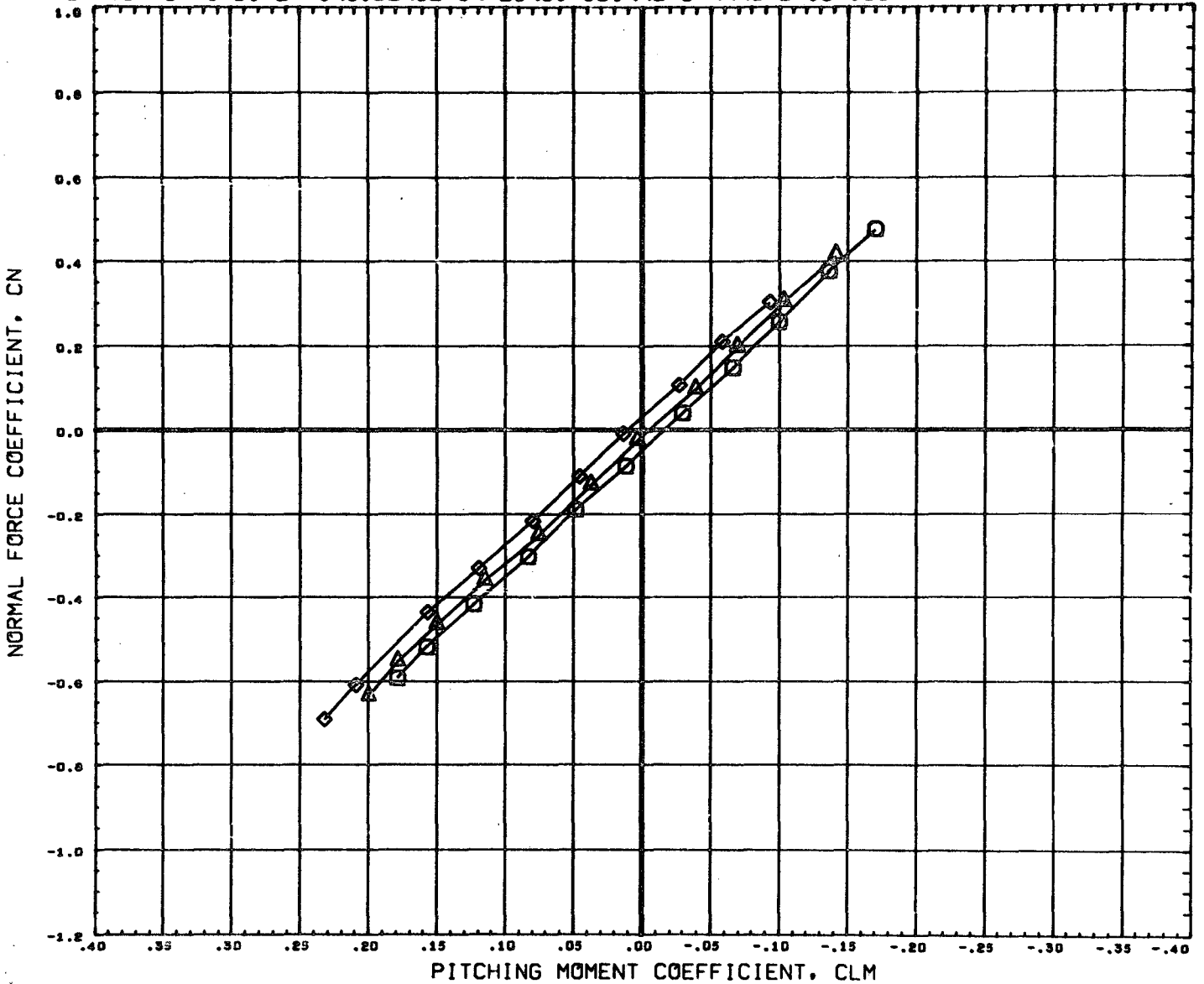

DATA SET SYMBOL	CONFIGURATION DESCRIPTION	ORBIN	THETS	BETA	REFERENCE INFORMATION
(B65000)	MSFC TWT 534 SHUTTLE LAUNCH T101	0.000	0.000	0.000	SREF 4.8950 sq. IN
(B65002)	MSFC TWT 534 SHUTTLE LAUNCH T101	-1.500	0.000	0.000	LREF 2.6440 IN.
(B65008)	MSFC TWT 534 SHUTTLE LAUNCH T101	-3.000	0.000	0.000	BREF 3.5250 IN.
					XMRP 3.4900 IN.
					YMRP 0.0000 IN.
					ZMRP 0.1616 IN.
					SCALE 0.0034

MACH .60

EFFECT OF ORBITER INCIDENCE ON LONGITUDINAL CHARACTERISTICS

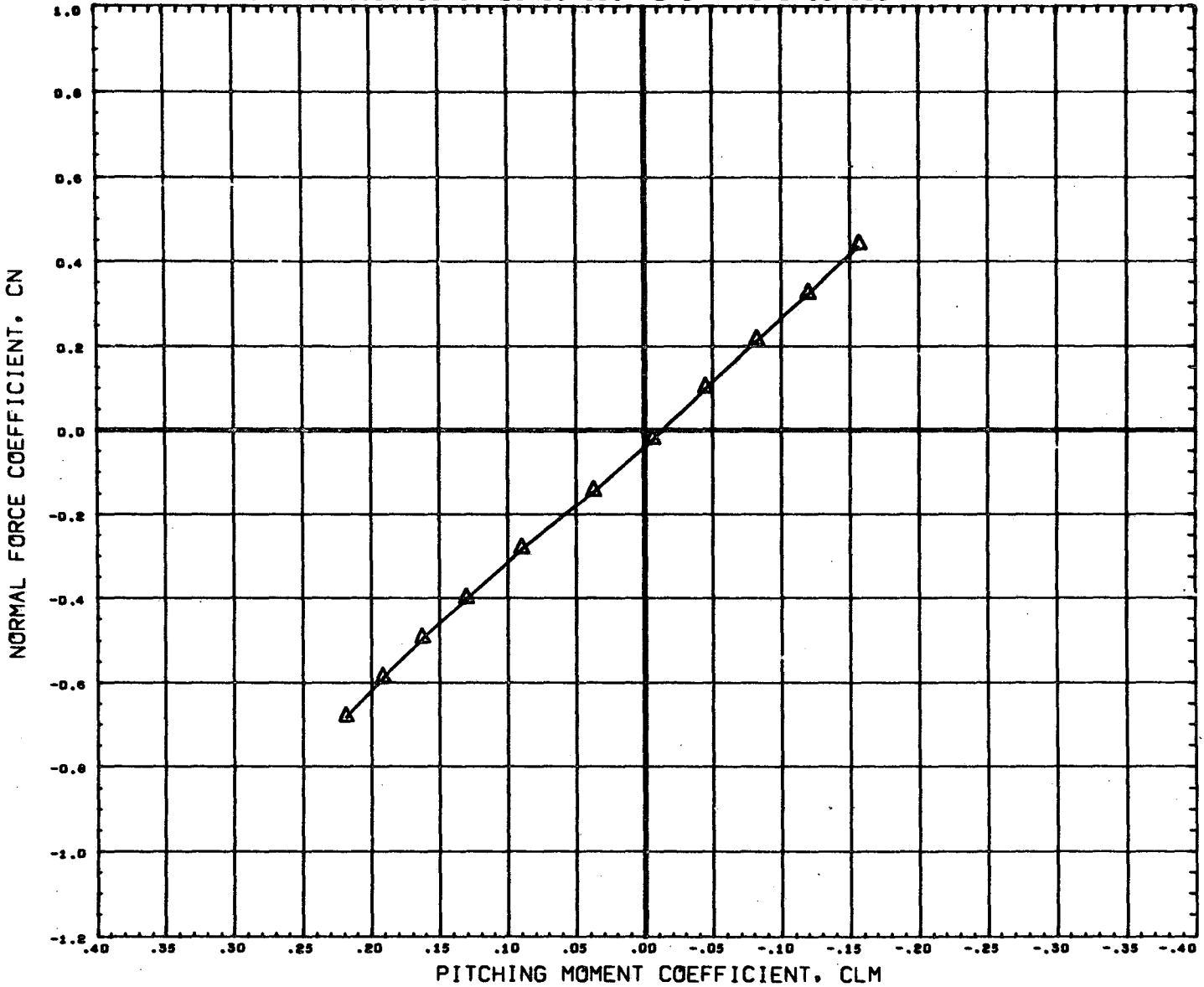

DATA SET SYMBOL	CONFIGURATION DESCRIPTION
(B63009)	DATA NOT AVAILABLE FOR ALL CONDITIONS
(B63002)	MSFC TWT 534 SHUTTLE LAUNCH T101
(B63008)	DATA NOT AVAILABLE FOR ALL CONDITIONS

ORBIN	THETS	BETA
0.000	0.000	0.000
-1.500	0.000	0.000
-3.000	0.000	0.000

REFERENCE INFORMATION		
SREF	4.8950	sq. IN
LREF	2.6440	IN.
BREF	3.9250	IN.
XMRP	3.4900	IN.
YMRP	0.0000	IN.
ZMRP	0.1616	IN.
SCALE	0.0034	

EFFECT OF ORBITER INCIDENCE ON LONGITUDINAL CHARACTERISTICS

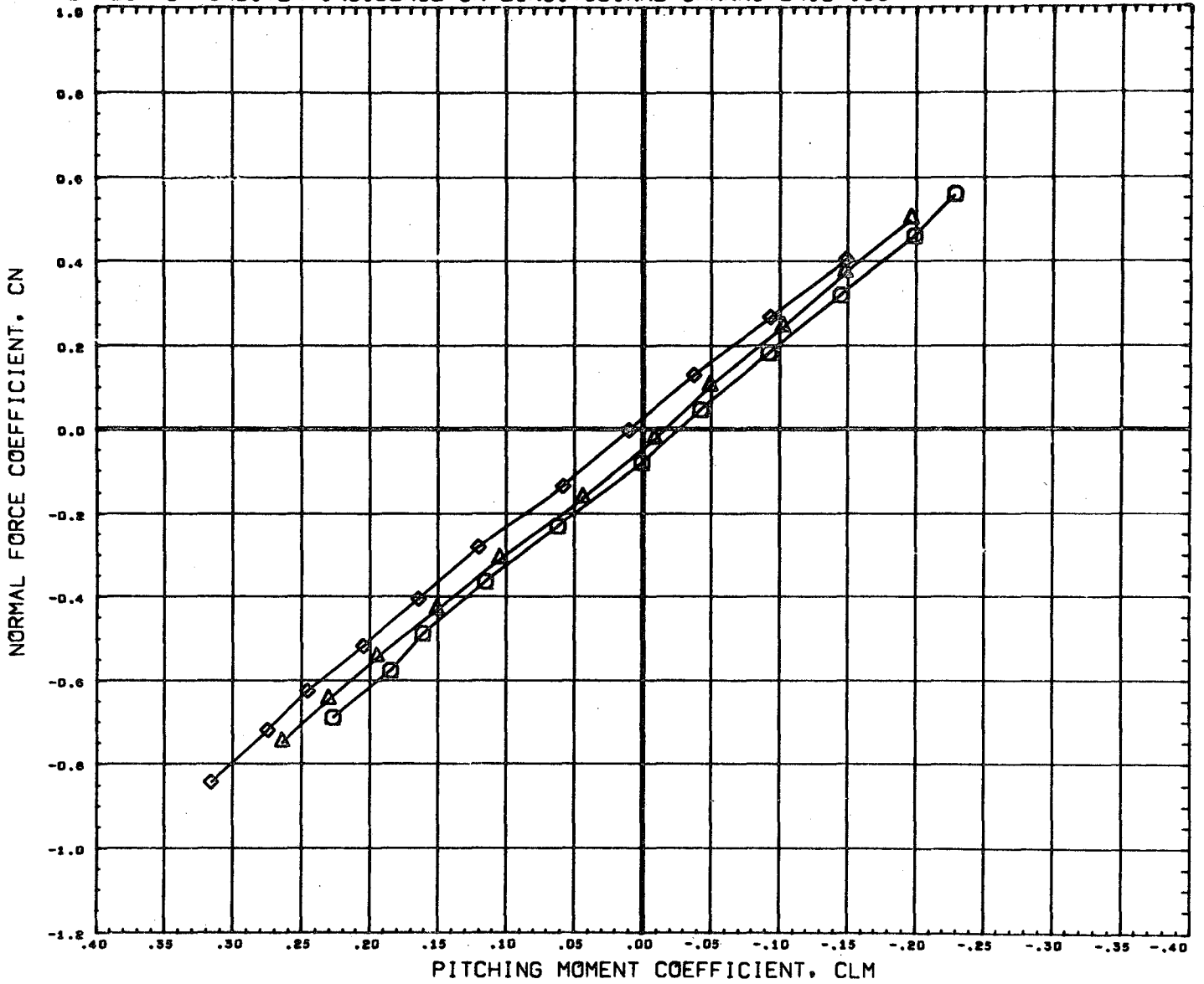

DATA SET SYMBOL	CONFIGURATION DESCRIPTION	ORBIN	THETS	BETA	REFERENCE INFORMATION
(B65009)	MSFC TWT 534 SHUTTLE LAUNCH	T101	0.000	0.000	SREF 4.8950 SQ. IN
(B65002)	MSFC TWT 534 SHUTTLE LAUNCH	T101	-1.500	0.000	LREF 2.6440 IN.
(B65008)	MSFC TWT 534 SHUTTLE LAUNCH	T101	-3.000	0.000	BREF 3.5250 IN.
					XMRP 3.4900 IN.
					YMRP 0.0000 IN.
					ZMRP 0.1616 IN.
					SCALE 0.0034

MACH .90

EFFECT OF ORBITER INCIDENCE ON LONGITUDINAL CHARACTERISTICS

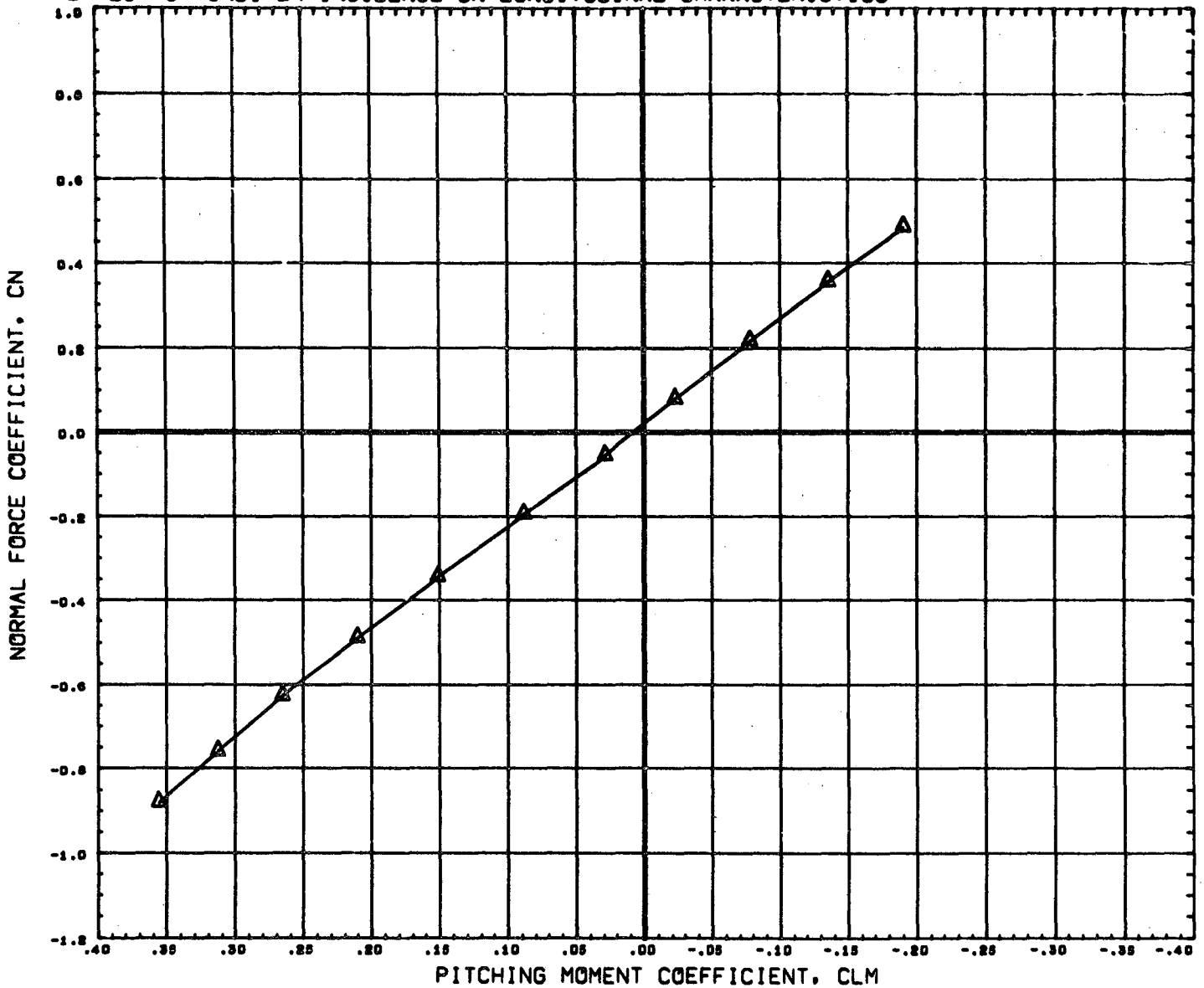

DATA SET SYMBOL CONFIGURATION DESCRIPTION
 (865009) DATA NOT AVAILABLE FOR ALL CONDITIONS
 (865002) MSFC TWT 834 SHUTTLE LAUNCH T101
 (865006) DATA NOT AVAILABLE FOR ALL CONDITIONS

ORBIN THETA BETA
 0.000 0.000 0.000
 -1.500 0.000 0.000
 -3.000 0.000 0.000

REFERENCE INFORMATION
 SREF 4.8950 88. IN
 LREF 2.6440 IN.
 BREF 3.5250 IN.
 XHRP 3.4900 IN.
 YHRP 0.0000 IN.
 ZHRP 0.1616 IN.
 SCALE 0.0034

EFFECT OF ORBITER INCIDENCE ON LONGITUDINAL CHARACTERISTICS

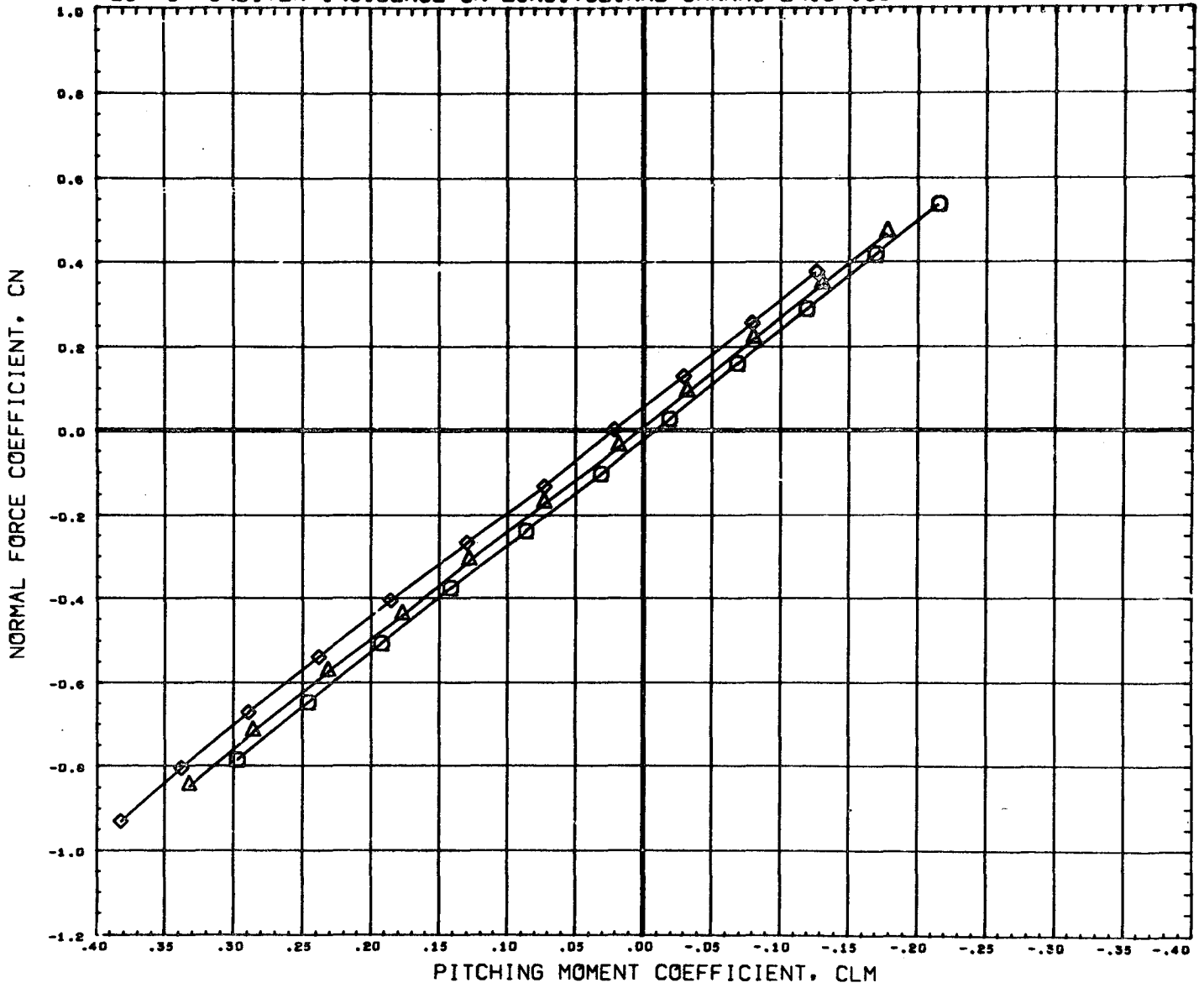

DATA SET SYMBOL	CONFIGURATION DESCRIPTION	ORBIN	THETS	BETA	REFERENCE INFORMATION
(B65009)	MSFC TWT 534 SHUTTLE LAUNCH	T101	0.000	0.000	SREF 4.8950 SQ. IN
(B65002)	MSFC TWT 534 SHUTTLE LAUNCH	T101	-1.500	0.000	LREF 2.6440 IN.
(B65008)	MSFC TWT 534 SHUTTLE LAUNCH	T101	-3.000	0.000	BREF 3.5250 IN.
					XMRP 3.4900 IN.
					YMRP 0.0000 IN.
					ZMRP 0.1616 IN.
					SCALE 0.0034

EFFECT OF ORBITER INCIDENCE ON LONGITUDINAL CHARACTERISTICS

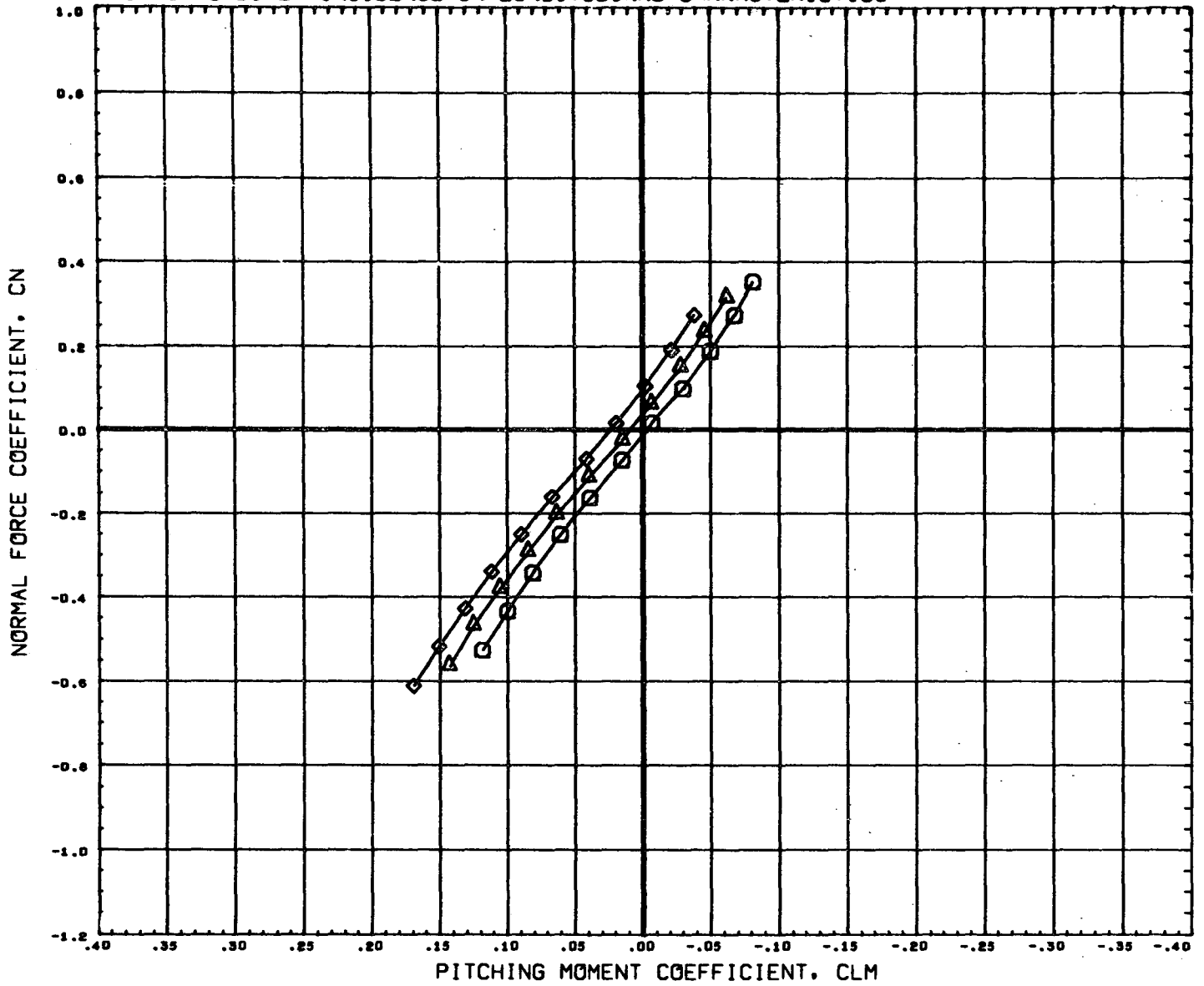

DATA SET SYMBOL	CONFIGURATION DESCRIPTION	ORBIN	THETS	BETA	REFERENCE INFORMATION
(B65009)	MSFC TWT 534 SHUTTLE LAUNCH	T101	0.000	0.000	SREF 4.8950 SQ. IN.
(B65002)	MSFC TWT 534 SHUTTLE LAUNCH	T101	-1.500	0.000	LREF 2.6440 IN.
(B65308)	MSFC TWT 534 SHUTTLE LAUNCH	T101	-3.000	0.000	BREF 3.5250 IN.
					XMRP 3.4900 IN.
					YMRP 0.0000 IN.
					ZMRP 0.1616 IN.
					SCALE 0.0034

MACH 1.97

PAGE 254

EFFECT OF ORBITER INCIDENCE ON LONGITUDINAL CHARACTERISTICS

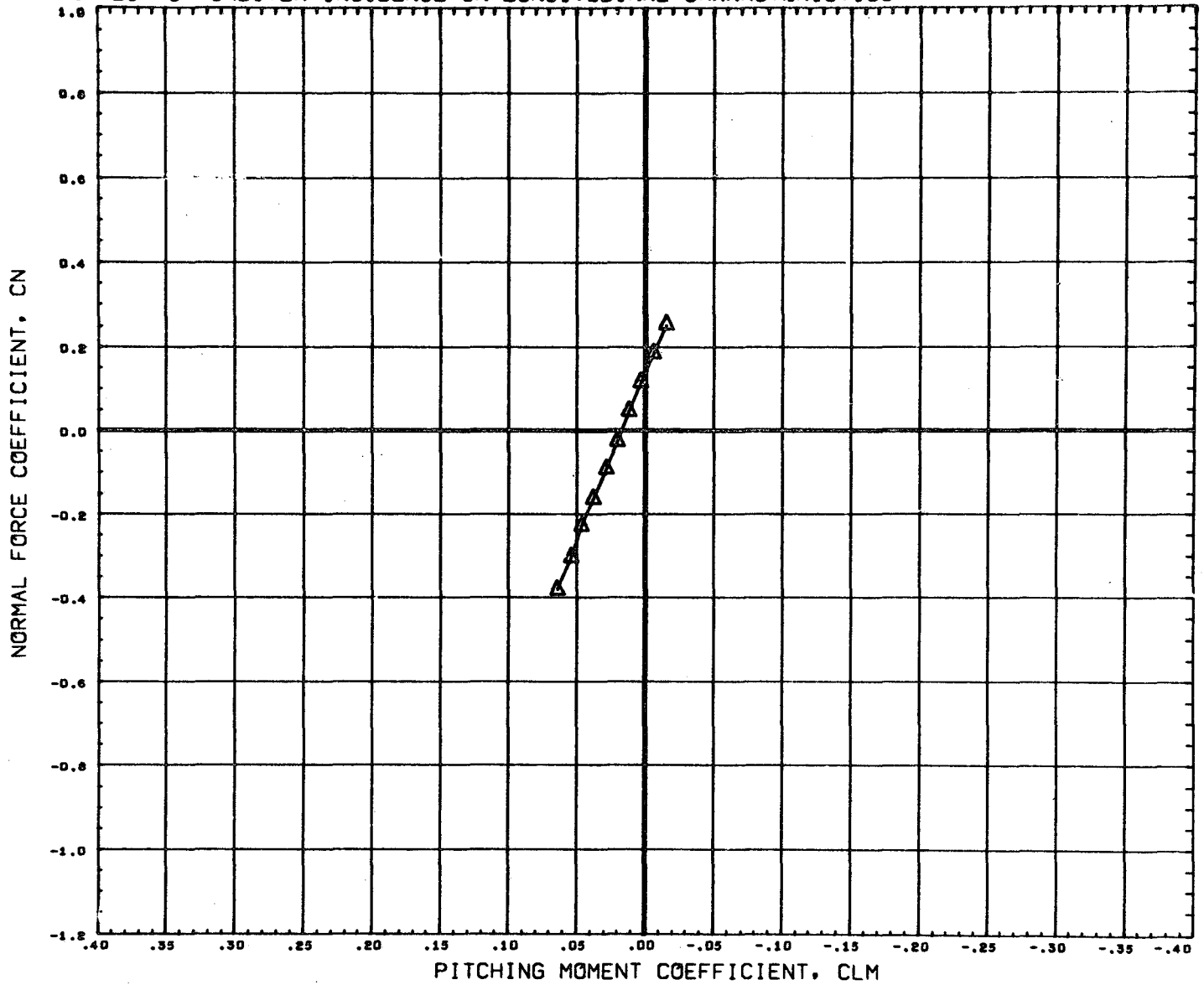

DATA SET SYMBOL	CONFIGURATION DESCRIPTION	ORBIN	THETS	BETA	REFERENCE INFORMATION
(B65009)	DATA NOT AVAILABLE FOR ALL CONDITIONS	0.000		0.000	SREF 4.8950 SQ. IN
(B65002)	MSFC TWT 534 SHUTTLE LAUNCH T101	-1.500		0.000	LREF 2.6440 IN.
(B65808)	DATA NOT AVAILABLE FOR ALL CONDITIONS	-3.000		0.000	BREF 3.5250 IN.
					XMRP 3.4900 IN.
					YMRP 0.0000 IN.
					ZMRP 0.1616 IN.
					SCALE 0.0034

MACH 2.74

EFFECT OF ORBITER INCIDENCE ON LONGITUDINAL CHARACTERISTICS

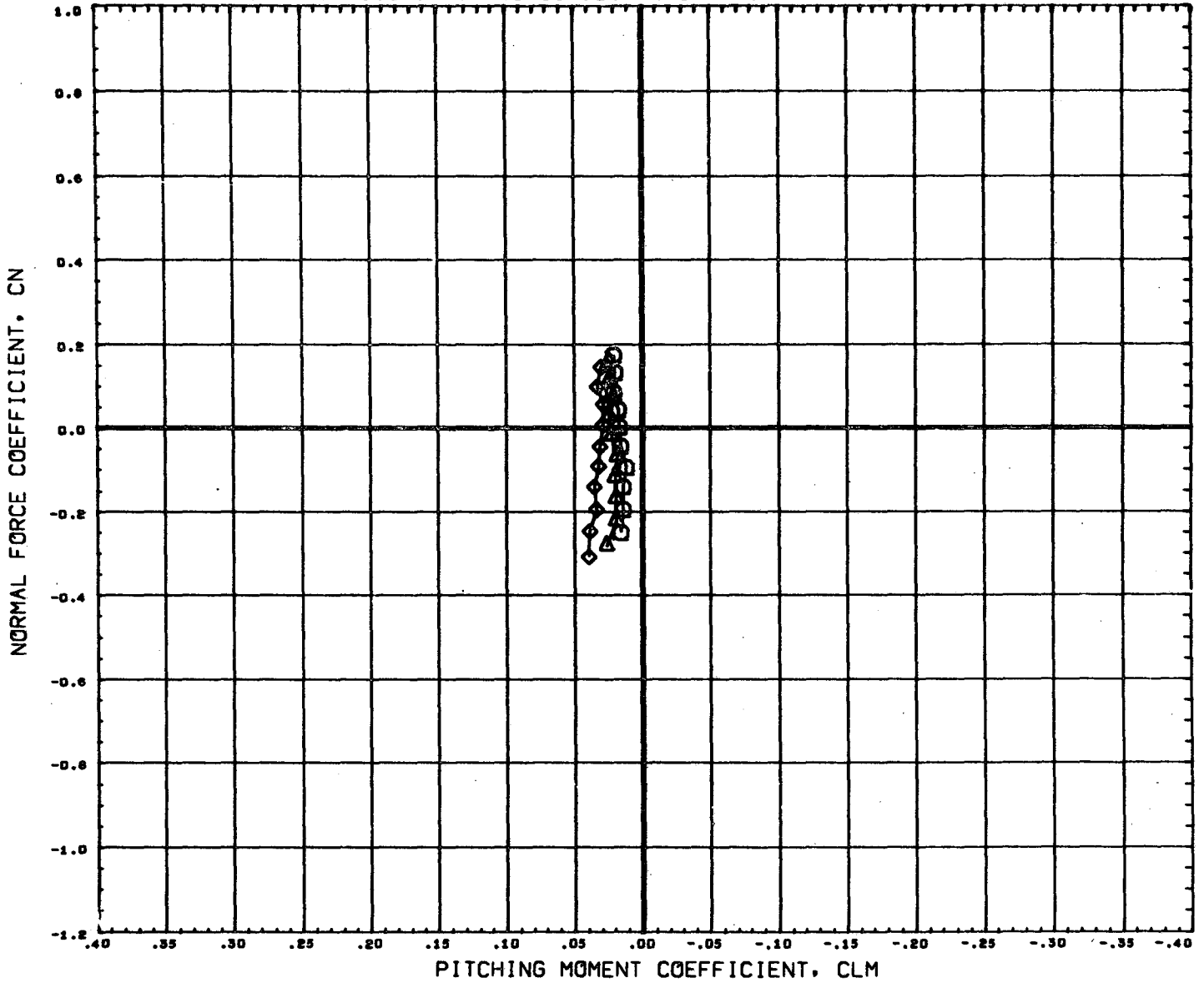

DATA SET SYMBOL	CONFIGURATION DESCRIPTION	T101	ORBIN	THETS	BETA	REFERENCE INFORMATION
(865009)	MSFC TWT 534 SHUTTLE LAUNCH	T101	0.000	0.000	0.000	SREF 4.8950 SQ. IN
(865002)	MSFC TWT 534 SHUTTLE LAUNCH	T101	-1.500	0.000	0.000	LREF 2.6440 IN.
(865008)	MSFC TWT 534 SHUTTLE LAUNCH	T101	-3.000	0.000	0.000	BREF 3.5250 IN.
						XMRP 3.4900 IN.
						YMRP 0.0000 IN.
						ZMRP 0.1616 IN.
						SCALE 0.0034

EFFECT OF SRM CIRCUMFERENTIAL LOCATION ON LONGITUDINAL CHARACTERISTICS

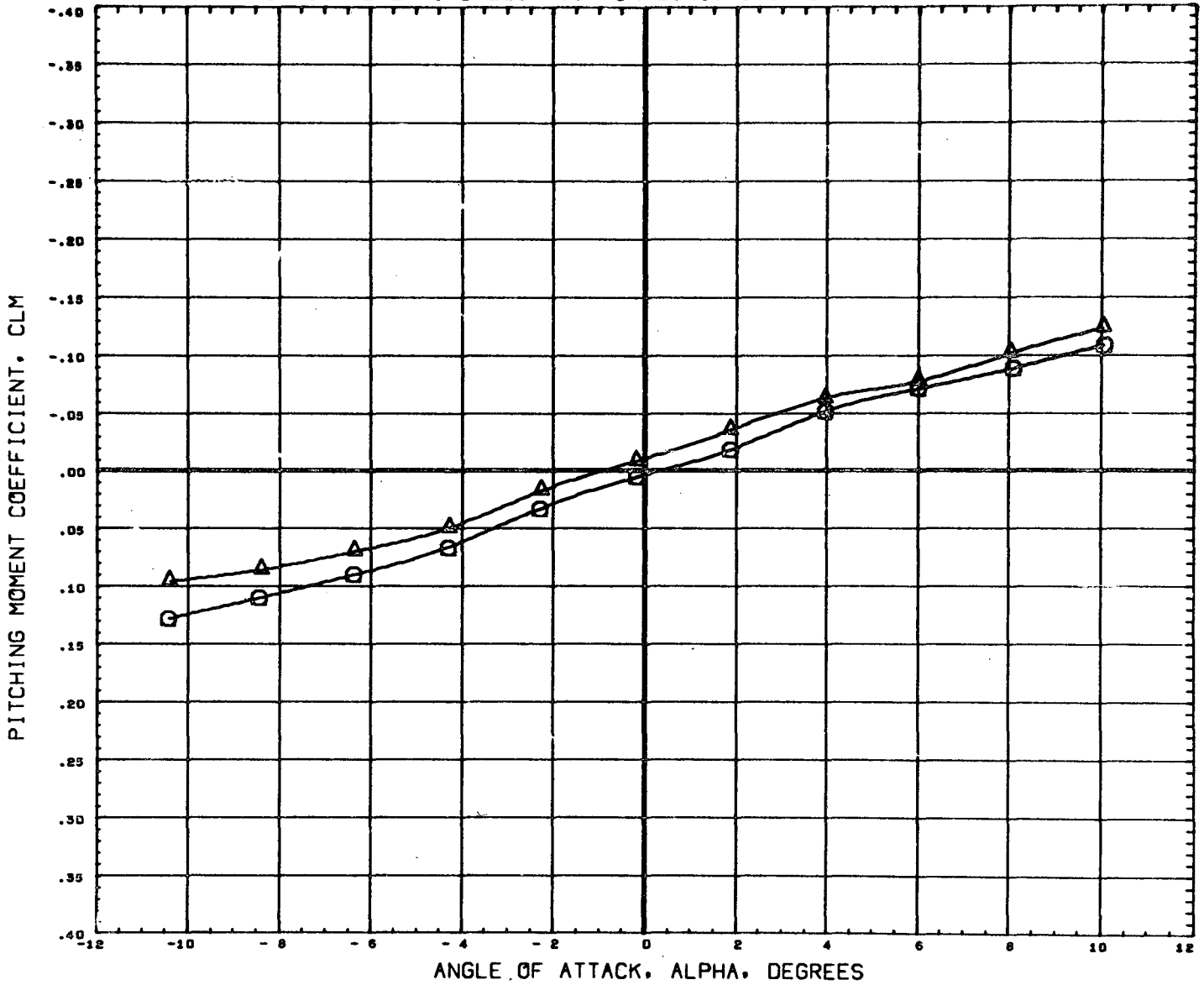

DATA SET SYMBOL	CONFIGURATION DESCRIPTION	ORBIN	THETS	BETA	REFERENCE INFORMATION
(B65010)	MSFC TWT 534 SHUTTLE LAUNCH	-1.500	0.000	0.000	SREF 4.8950 SQ. IN
(B65004)	MSFC TWT 534 SHUTTLE LAUNCH	-1.500	21.000	0.000	LREF 2.6440 IN.
					BREF 3.5250 IN.
					XMRP 3.4900 IN.
					YMRP 0.0000 IN.
					ZMRP 0.1616 IN.
					SCALE 0.0034

MACH .60

EFFECT OF SRM CIRCUMFERENTIAL LOCATION ON LONGITUDINAL CHARACTERISTICS

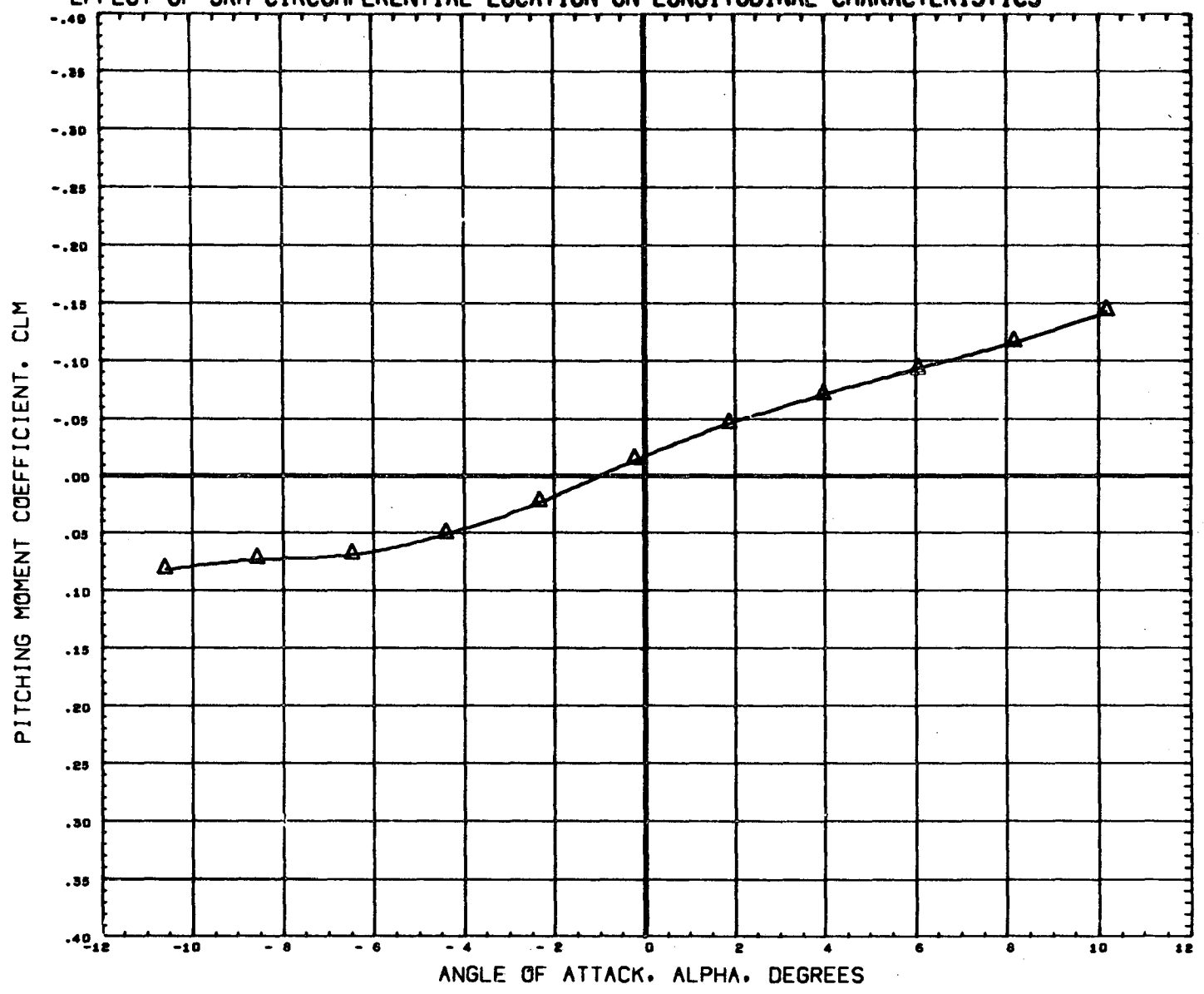

DATA SET SYMBOL CONFIGURATION DESCRIPTION
 (B65010) \square DATA NOT AVAILABLE FOR ALL CONDITIONS
 (B65004) \triangle MSFC TWT 534 SHUTTLE LAUNCH TIC1S1

ORBIN THEYS BETA
 -1.500 0.000 0.000
 -1.500 21.000 0.000

REFERENCE INFORMATION
 SREF 4.8950 SQ. IN
 LREF 2.6440 IN.
 BREF 3.5250 IN.
 XMRP 3.4900 IN.
 YMRP 0.0000 IN.
 ZMRP 0.1616 IN.
 SCALE 0.0034

EFFECT OF SRM CIRCUMFERENTIAL LOCATION ON LONGITUDINAL CHARACTERISTICS

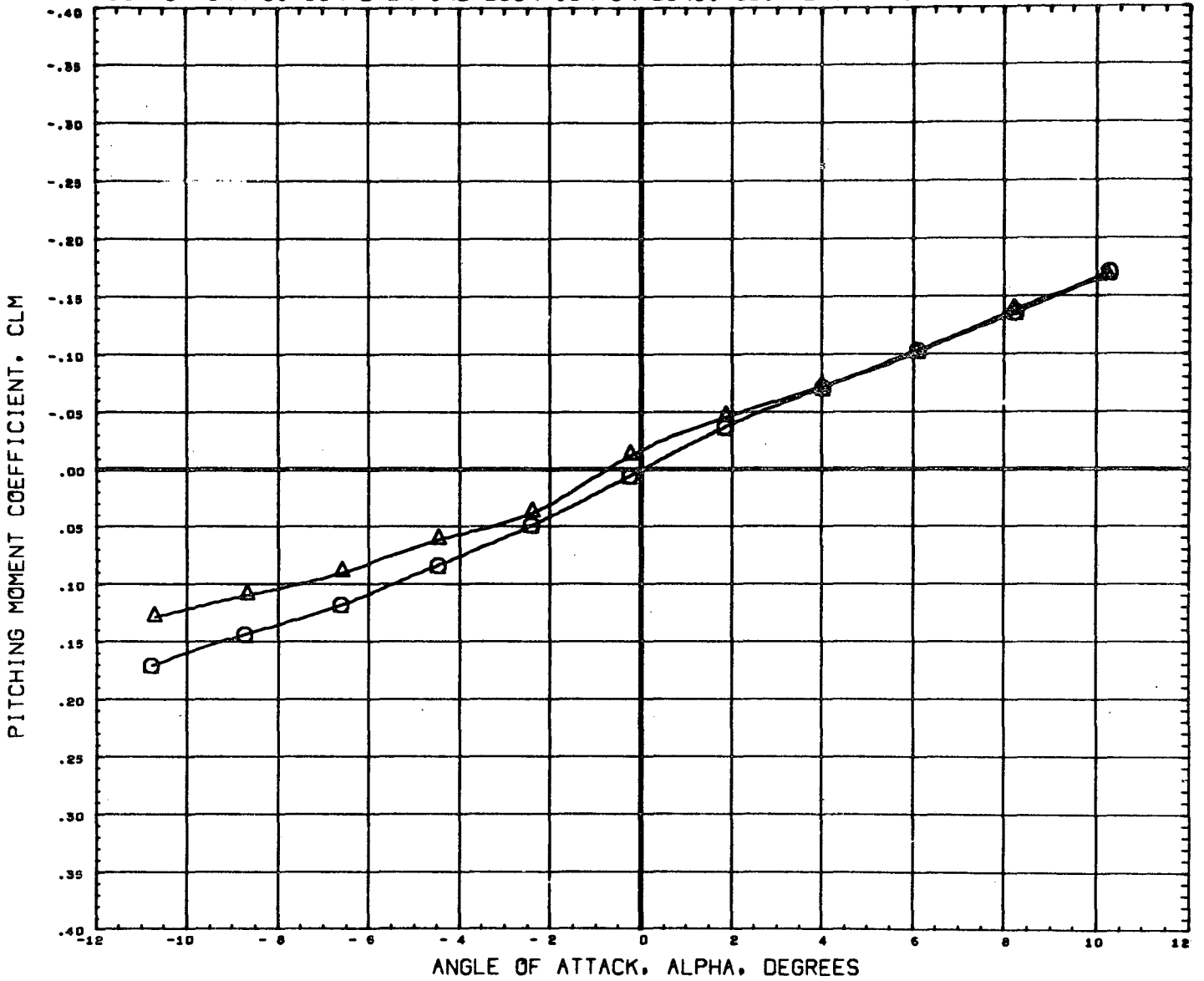

DATA SET SYMBOL	CONFIGURATION DESCRIPTION	ORBIN	THETS	BETA	REFERENCE INFORMATION
(B65010)	MSFC TWT 534 SHUTTLE LAUNCH	-1.500	0.000	0.000	SREF 4.8950 SQ. IN
(B65004)	MSFC TWT 534 SHUTTLE LAUNCH	-1.500	21.000	0.000	LREF 2.6440 IN.
					BREF 3.9250 IN.
					XMRP 3.4900 IN.
					YMRP 0.0000 IN.
					ZMRP 0.1616 IN.
					SCALE 0.0034

MACH .90

EFFECT OF SRM CIRCUMFERENTIAL LOCATION ON LONGITUDINAL CHARACTERISTICS

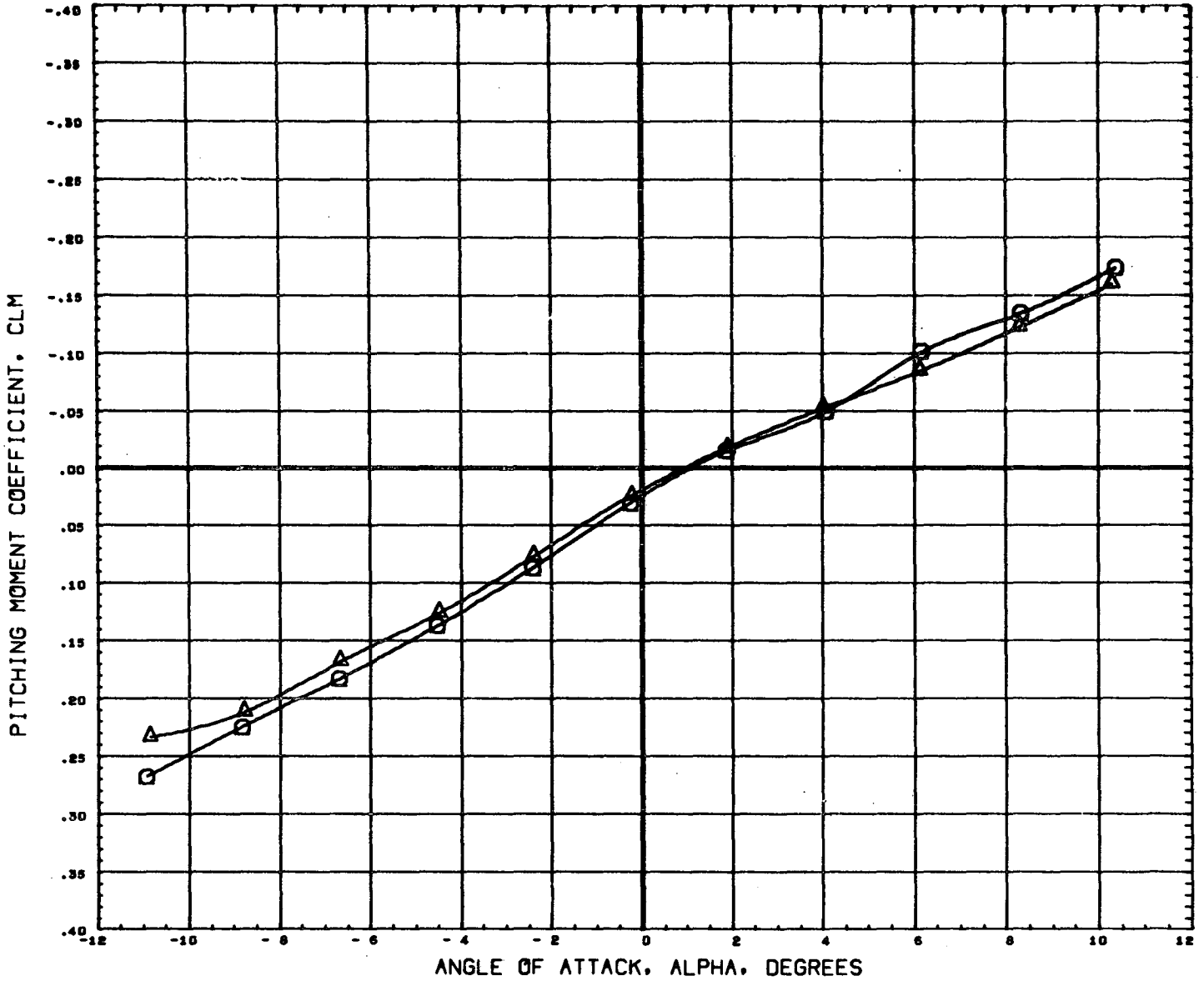

DATA SET SYMBOL	CONFIGURATION DESCRIPTION	ORBIN	THETS	BETA	REFERENCE INFORMATION	
(B65010)	Q NSFC TWT 534 SHUTTLE LAUNCH	T101S1	-1.500	0.005	0.000	SREF 4.8950 sq. IN
(B65004)	Δ NSFC TWT 534 SHUTTLE LAUNCH	T101S1	-1.500	21.000	0.000	LREF 2.6440 IN.
						BREF 3.5250 IN.
						XMRP 3.4900 IN.
						YMRP 0.0000 IN.
						ZMRP 0.1616 IN.
						SCALE 0.0034

EFFECT OF SRM CIRCUMFERENTIAL LOCATION ON LONGITUDINAL CHARACTERISTICS

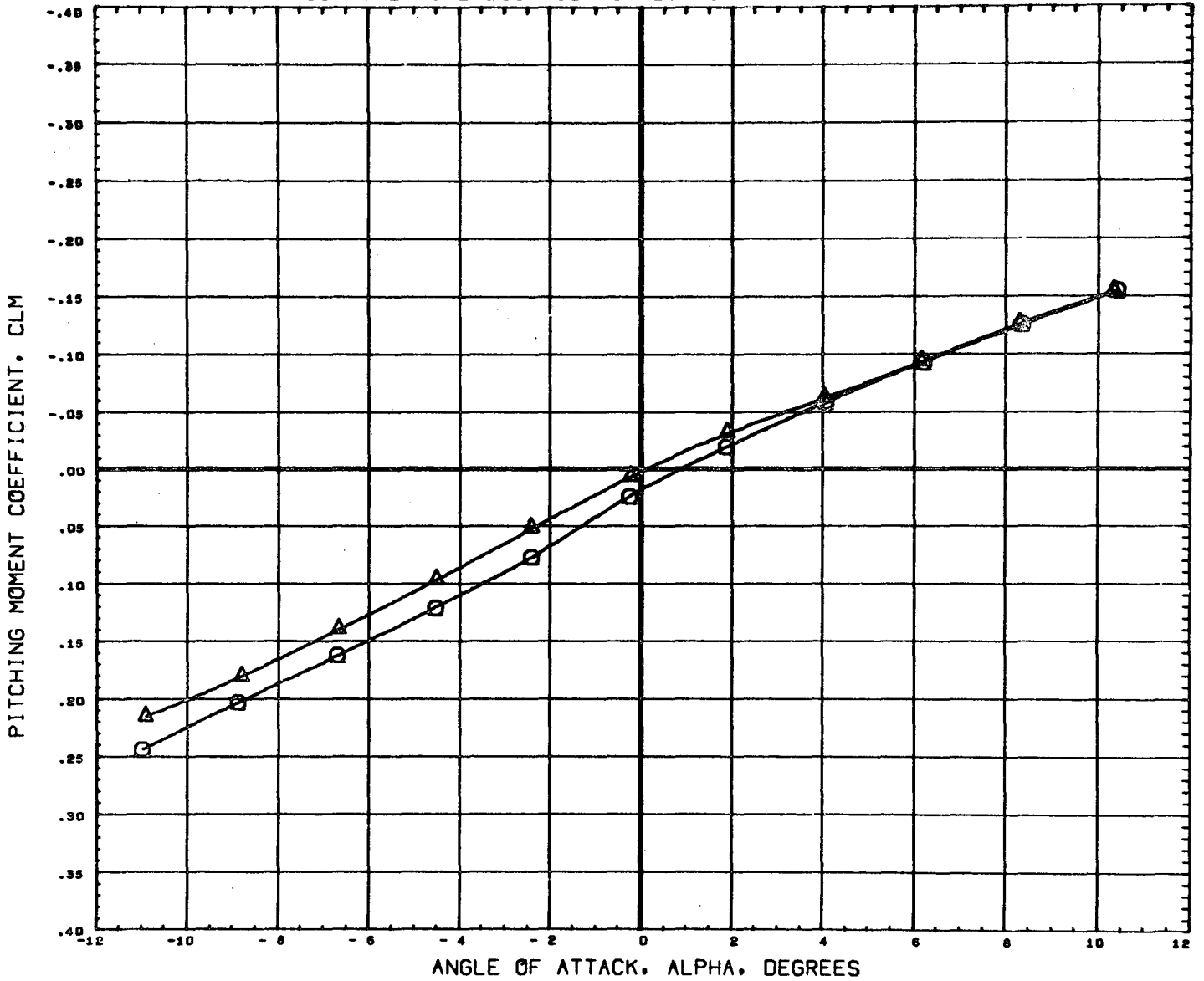

DATA SET SYMBOL	CONFIGURATION DESCRIPTION	ORBIN	THETS	BETA	REFERENCE INFORMATION
(B65010)	MSFC TWT 534 SHUTTLE LAUNCH	T101S1	-1.500	0.000	SREF 4.8950 SQ. IN
(B69004)	MSFC TWT 534 SHUTTLE LAUNCH	T101S1	-1.500	21.000	LREF 2.6440 IN.
					BREF 3.5250 IN.
					XMRP 3.4900 IN.
					YMRP 0.0000 IN.
					ZMRP 0.1616 IN.
					SCALE 0.0034

MACH 1.20

EFFECT OF SRM CIRCUMFERENTIAL LOCATION ON LONGITUDINAL CHARACTERISTICS

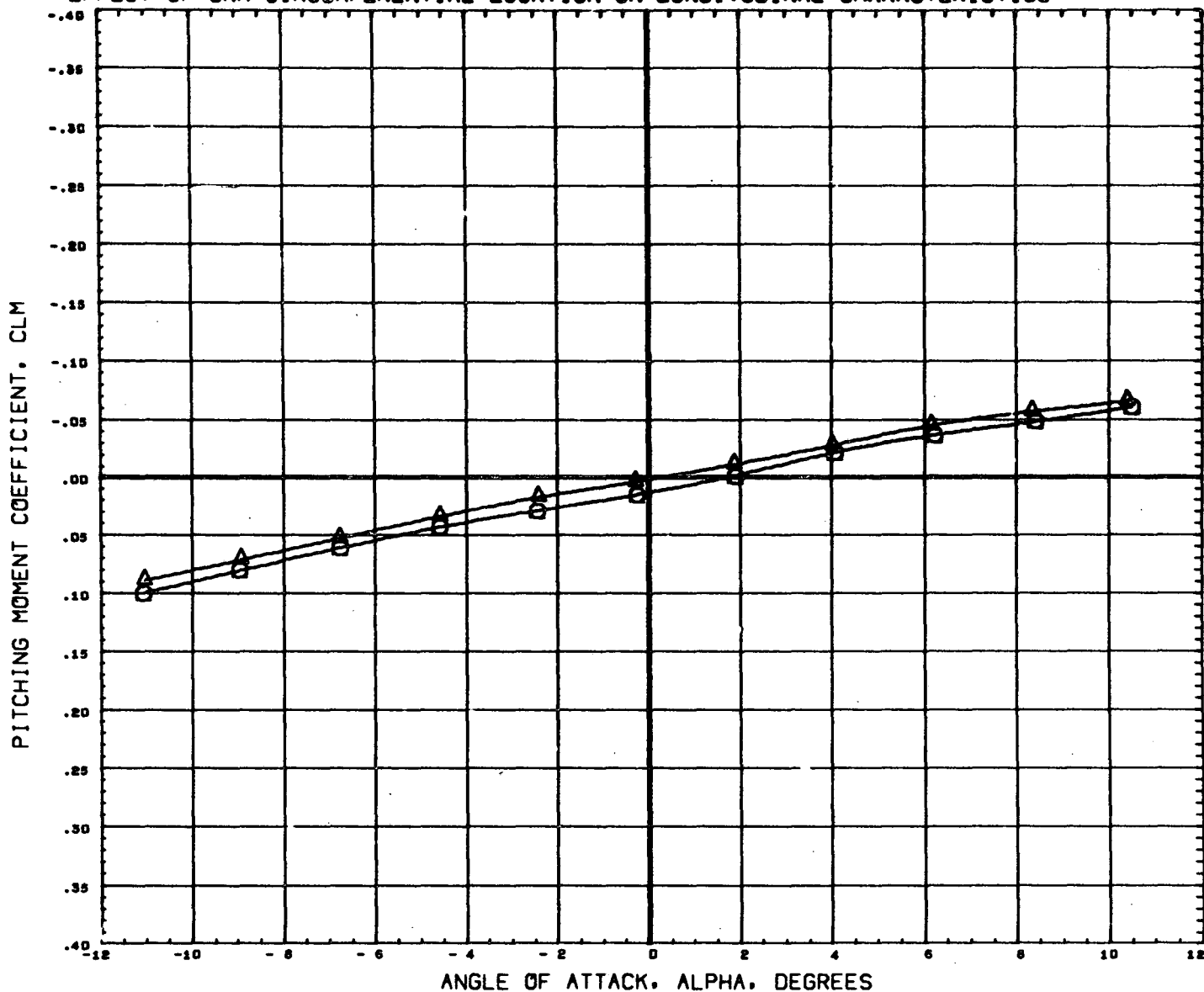

DATA SET SYMBOL	CONFIGURATION DESCRIPTION	ORBIN	THETS	BETA	REFERENCE INFORMATION	
(B65010)	MSFC TWT 534 SHUTTLE LAUNCH	T101S1	-1.500	0.000	SREF	4.8950 SQ. IN
(B65004)	MSFC TWT 534 SHUTTLE LAUNCH	T101S1	-1.500	21.000	LREF	2.6440 IN.
					BREF	3.5250 IN.
					XMRP	3.4900 IN.
					YMRP	0.0000 IN.
					ZMRP	0.1616 IN.
					SCALE	0.0034

MACH 1.97

PAGE 262

EFFECT OF SRM CIRCUMFERENTIAL LOCATION ON LONGITUDINAL CHARACTERISTICS

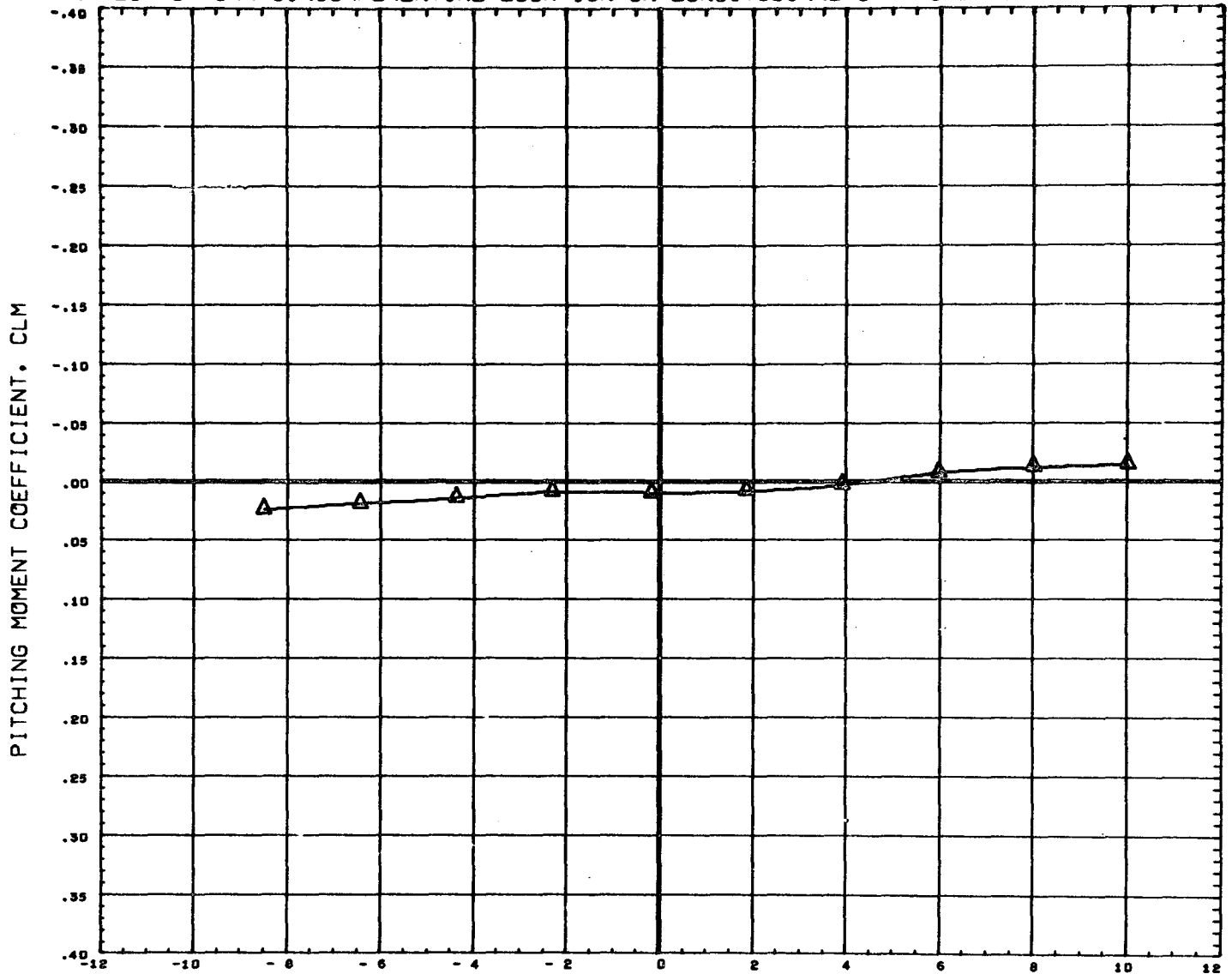

DATA SET SYMBOL CONFIGURATION DESCRIPTION
 (B65010) DATA NOT AVAILABLE FOR ALL CONDITIONS
 (B65004) MSFC TWT 534 SHUTTLE LAUNCH T101S1

ORBIN THETS BETA
 -1.500 0.000 0.000
 -1.500 21.000 0.000

REFERENCE INFORMATION
 SREF 4.8950 SQ. IN.
 LREF 2.6440 IN.
 BREF 3.5250 IN.
 XMRP 3.4900 IN.
 YMRP 0.0000 IN.
 ZMRP 0.1616 IN.
 SCALE 0.0034

MACH 2.74

EFFECT OF SRM CIRCUMFERENTIAL LOCATION ON LONGITUDINAL CHARACTERISTICS

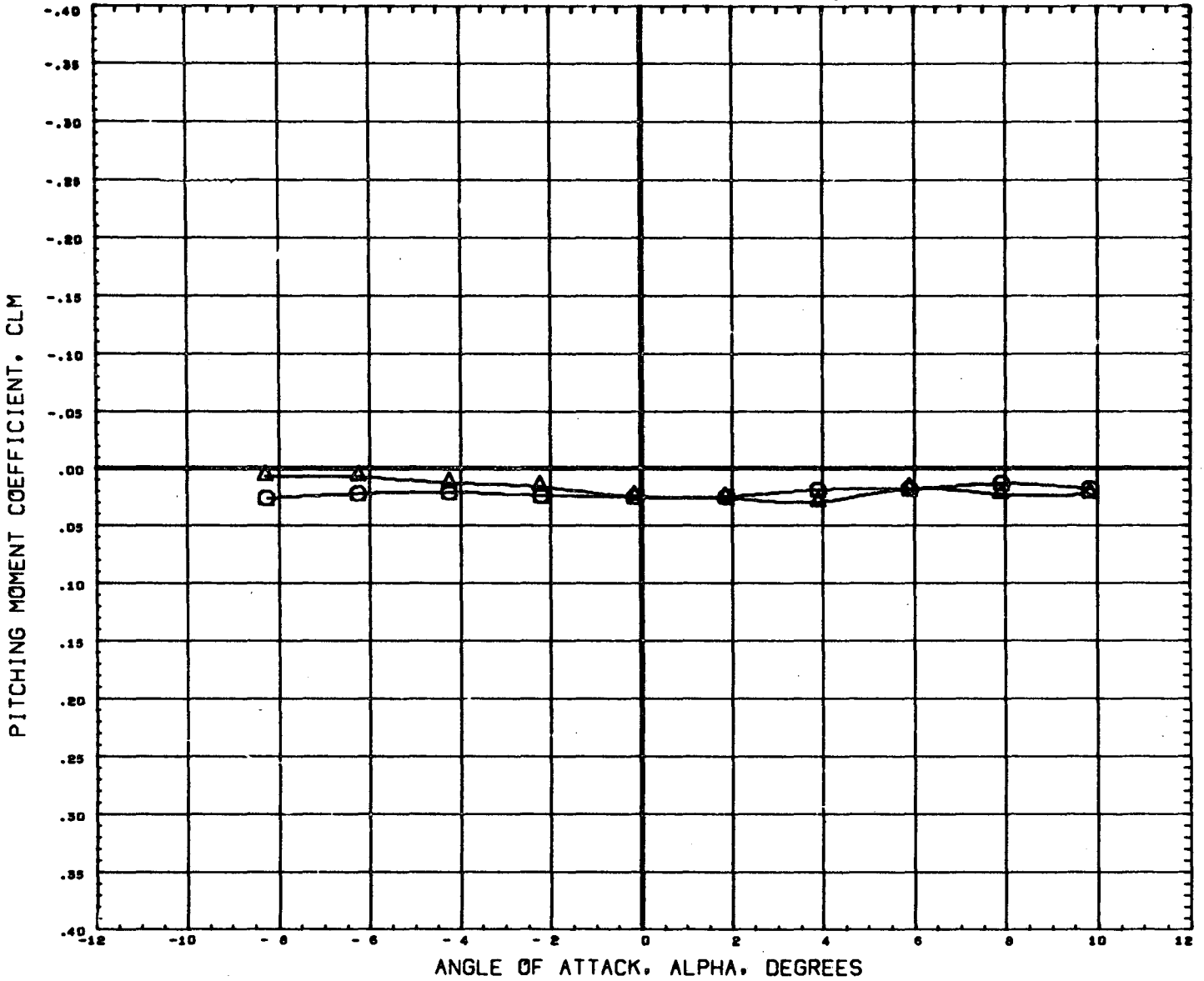

DATA SET SYMBOL	CONFIGURATION DESCRIPTION	ORBIN	THETS	BETA	REFERENCE INFORMATION	
(B65010)	MSFC TWT 534 SHUTTLE LAUNCH	T101S1	-1.500	0.000	SREF	4.8950 SQ. IN
(B65004)	MSFC TWT 534 SHUTTLE LAUNCH	T101S1	-1.500	21.000	LREF	2.6440 IN.
					BREF	3.5250 IN.
					XMRP	3.4900 IN.
					YMRP	0.0000 IN.
					ZMRP	0.1616 IN.
					SCALE	0.0034

MACH 4.96

PAGE 264

EFFECT OF SRM CIRCUMFERENTIAL LOCATION ON LONGITUDINAL CHARACTERISTICS

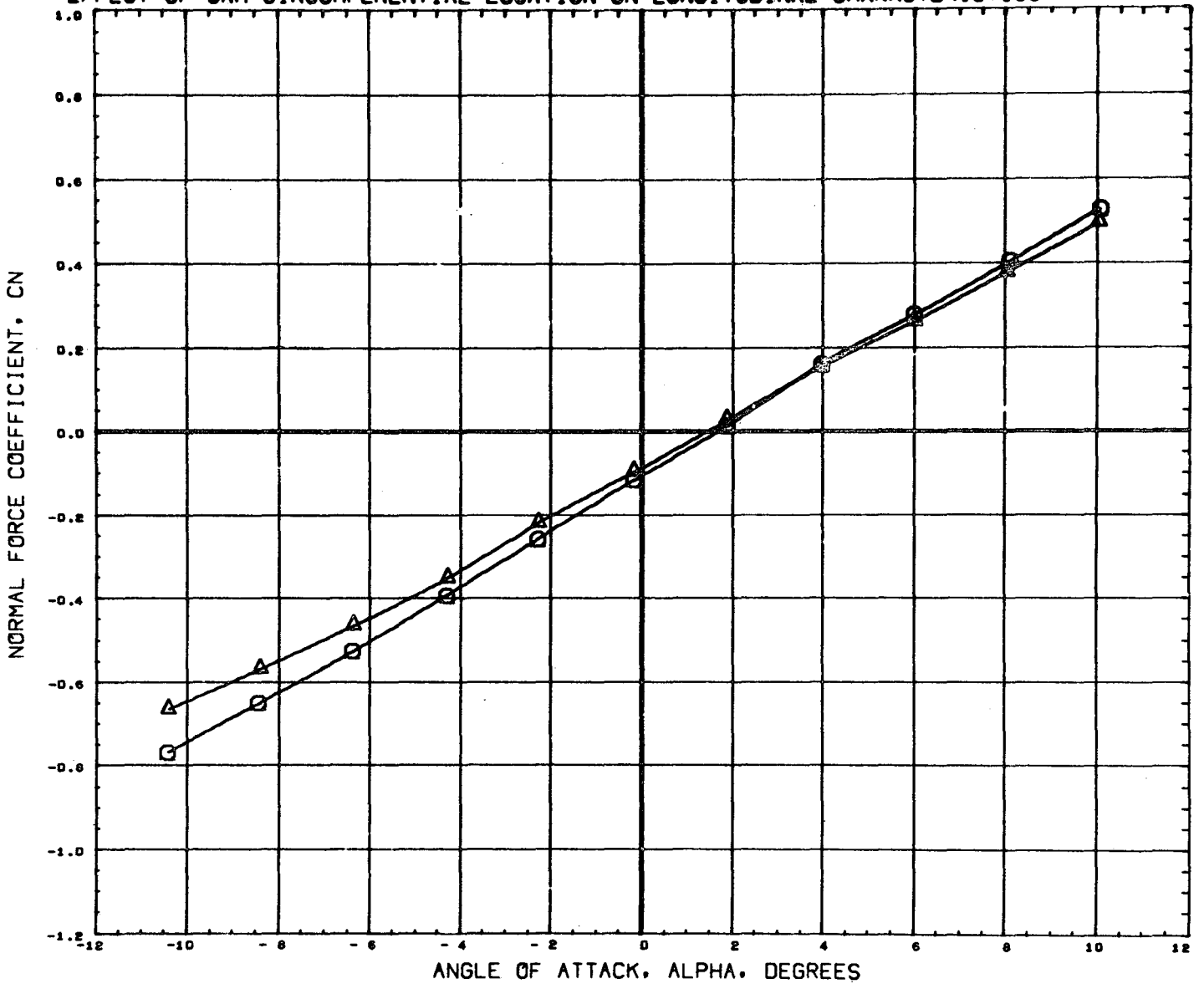

DATA SET SYMBOL	CONFIGURATION DESCRIPTION	ORBIN	THETS	BETA	REFERENCE INFORMATION
(B65D10)	MSFC TWT 534 SHUTTLE LAUNCH	-1.500	0.000	0.000	SREF 4.8950 sq. IN
(B65D04)	MSFC TWT 534 SHUTTLE LAUNCH	-1.500	21.000	0.000	LREF 2.6440 IN.
					BREF 3.5250 IN.
					XMRP 3.4900 IN.
					YMRP 0.0000 IN.
					ZMRP 0.1616 IN.
					SCALE 0.0034

MACH .60

EFFECT OF SRM CIRCUMFERENTIAL LOCATION ON LONGITUDINAL CHARACTERISTICS

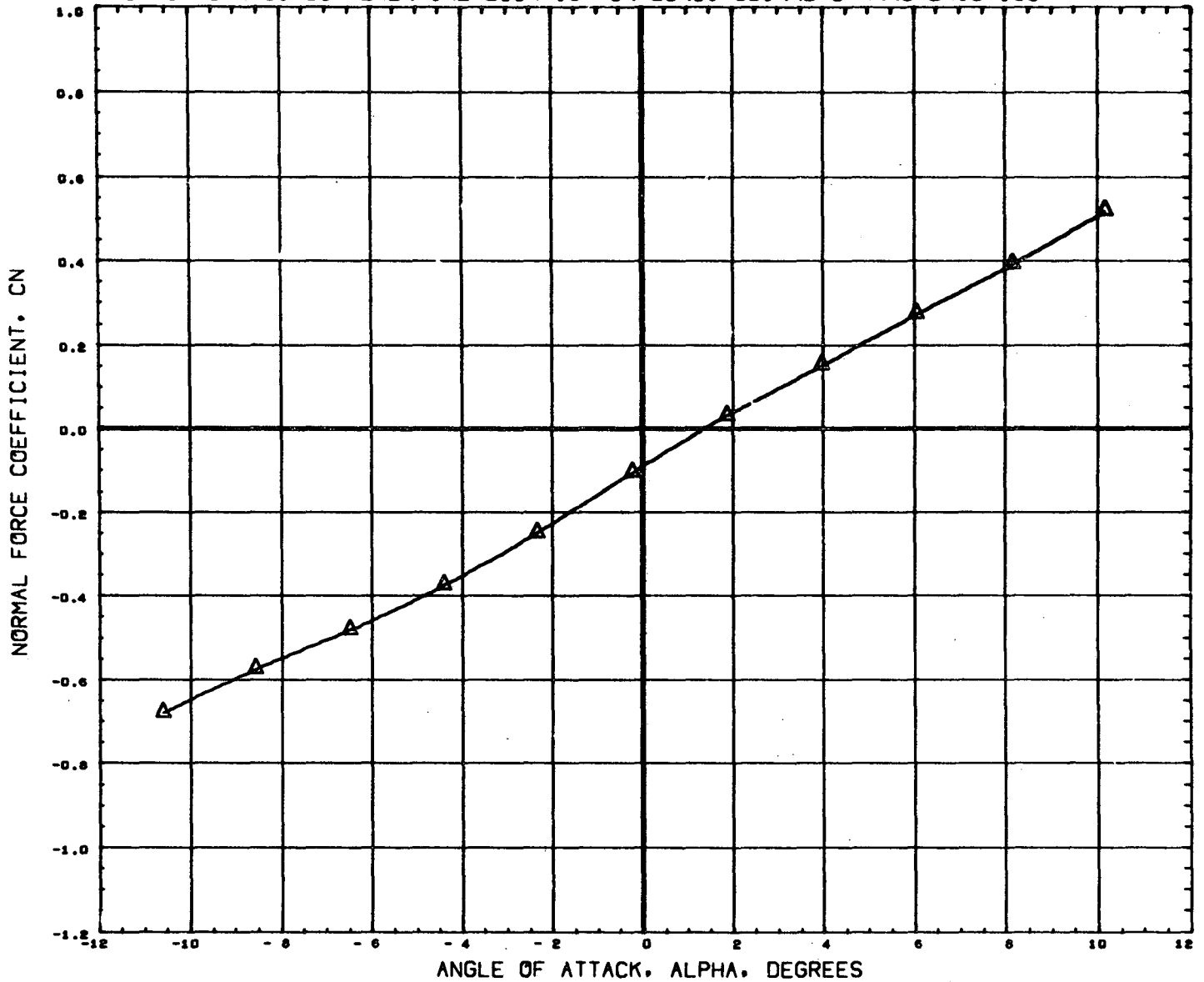

DATA SET SYMBOL CONFIGURATION DESCRIPTION
 (B65010) Q DATA NOT AVAILABLE FOR ALL CONDITIONS
 (B65004) A MSFC TWT 534 SHUTTLE LAUNCH T101S1

ORBIN THETS BETA
 -1.500 0.000 0.000
 -1.500 21.000 0.000

REFERENCE INFORMATION
 SREF 4.8950 SQ. IN
 LREF 2.6440 IN.
 BREF 3.5250 IN.
 XNRP 3.4900 IN.
 YNRP 0.0000 IN.
 ZNRP 0.1616 IN.
 SCALE 0.0034

EFFECT OF SRM CIRCUMFERENTIAL LOCATION ON LONGITUDINAL CHARACTERISTICS

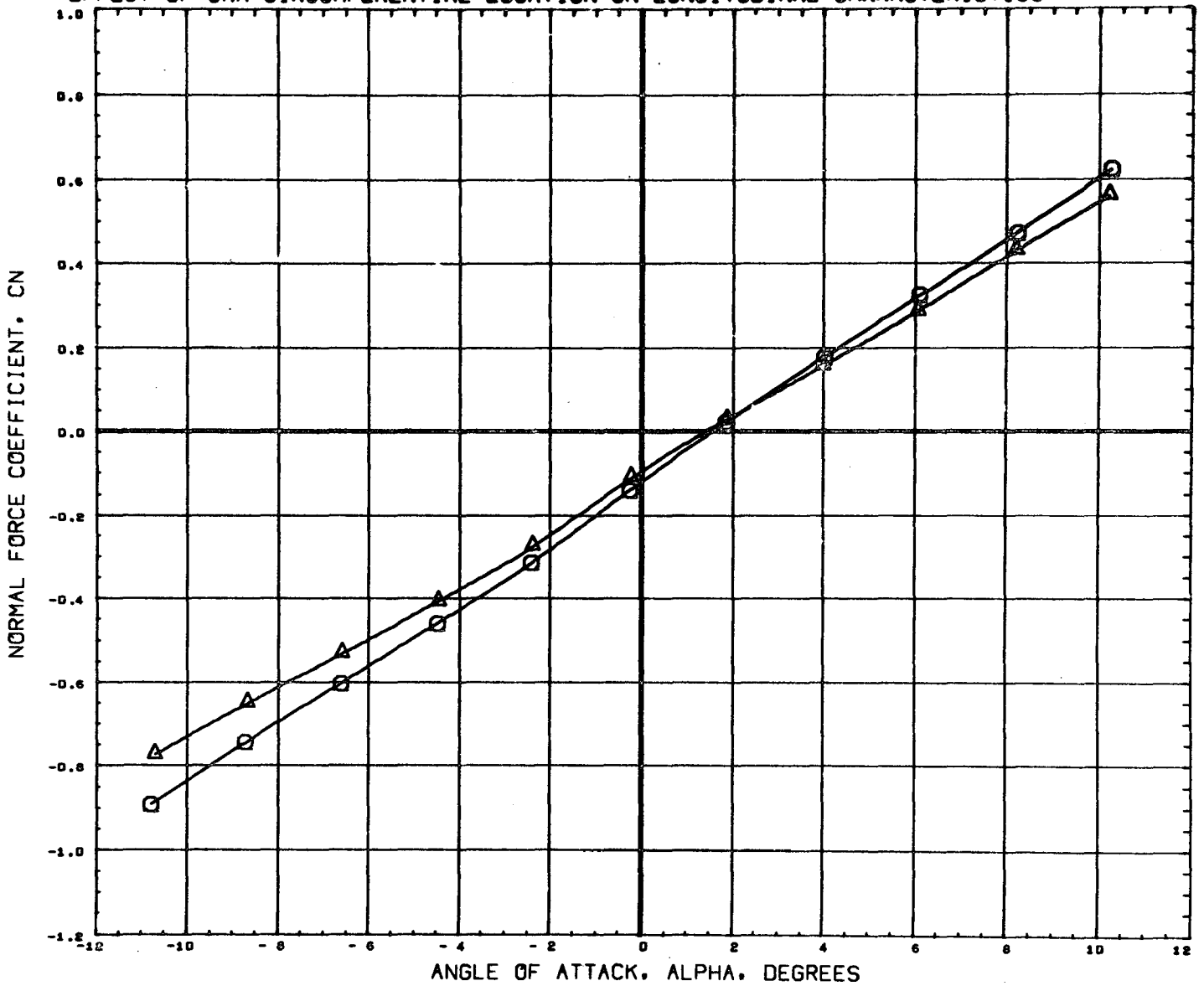

DATA SET SYMBOL	CONFIGURATION DESCRIPTION	ORBIN	THETS	BETA	REFERENCE INFORMATION
(B65010)	MSFC TWT 534 SHUTTLE LAUNCH	T101S1	-1.500	0.000	SREF 4.8950 SQ. IN
(B65004)	MSFC TWT 534 SHUTTLE LAUNCH	T101S1	-1.500	21.000	LREF 2.6440 IN.
					BREF 3.5250 IN.
					XMRP 3.4900 IN.
					YMRP 0.0000 IN.
					ZMRP 0.1616 IN.
					SCALE 0.0034

MACH .90

EFFECT OF SRM CIRCUMFERENTIAL LOCATION ON LONGITUDINAL CHARACTERISTICS

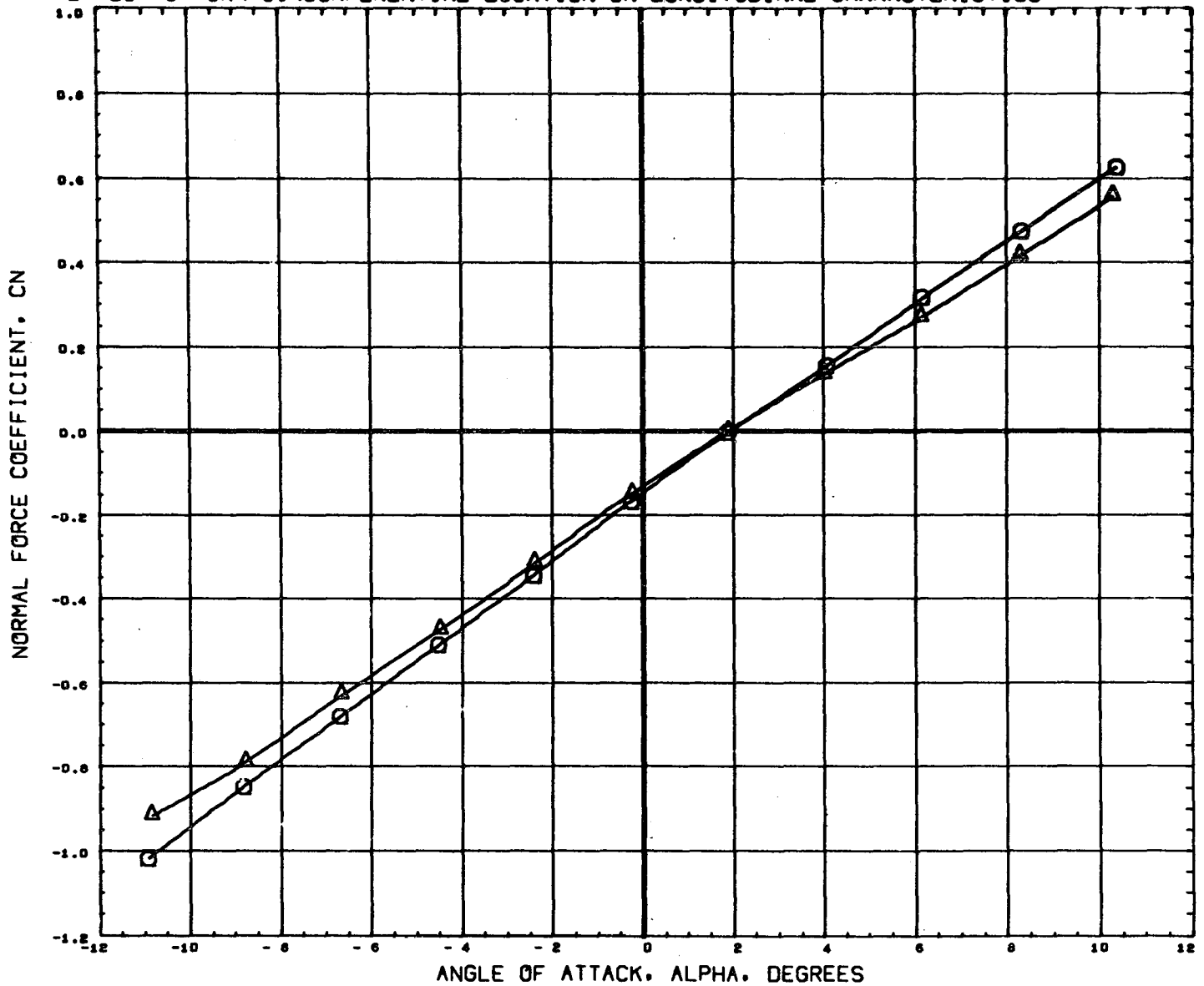

DATA SET SYMBOL	CONFIGURATION DESCRIPTION	ORBIN	THETS	BETA	REFERENCE INFORMATION
(865010)	MSFC TWT 534 SHUTTLE LAUNCH	-1.500	0.000	0.000	SREF 4.8950 SQ. IN
(865004)	MSFC TWT 534 SHUTTLE LAUNCH	-1.500	21.000	0.000	LREF 2.6440 IN.
					BREF 3.5250 IN.
					XMRP 3.4900 IN.
					YMRP 0.0000 IN.
					ZMRP 0.1616 IN.
					SCALE 0.0034

MACH 1.10

EFFECT OF SRM CIRCUMFERENTIAL LOCATION ON LONGITUDINAL CHARACTERISTICS

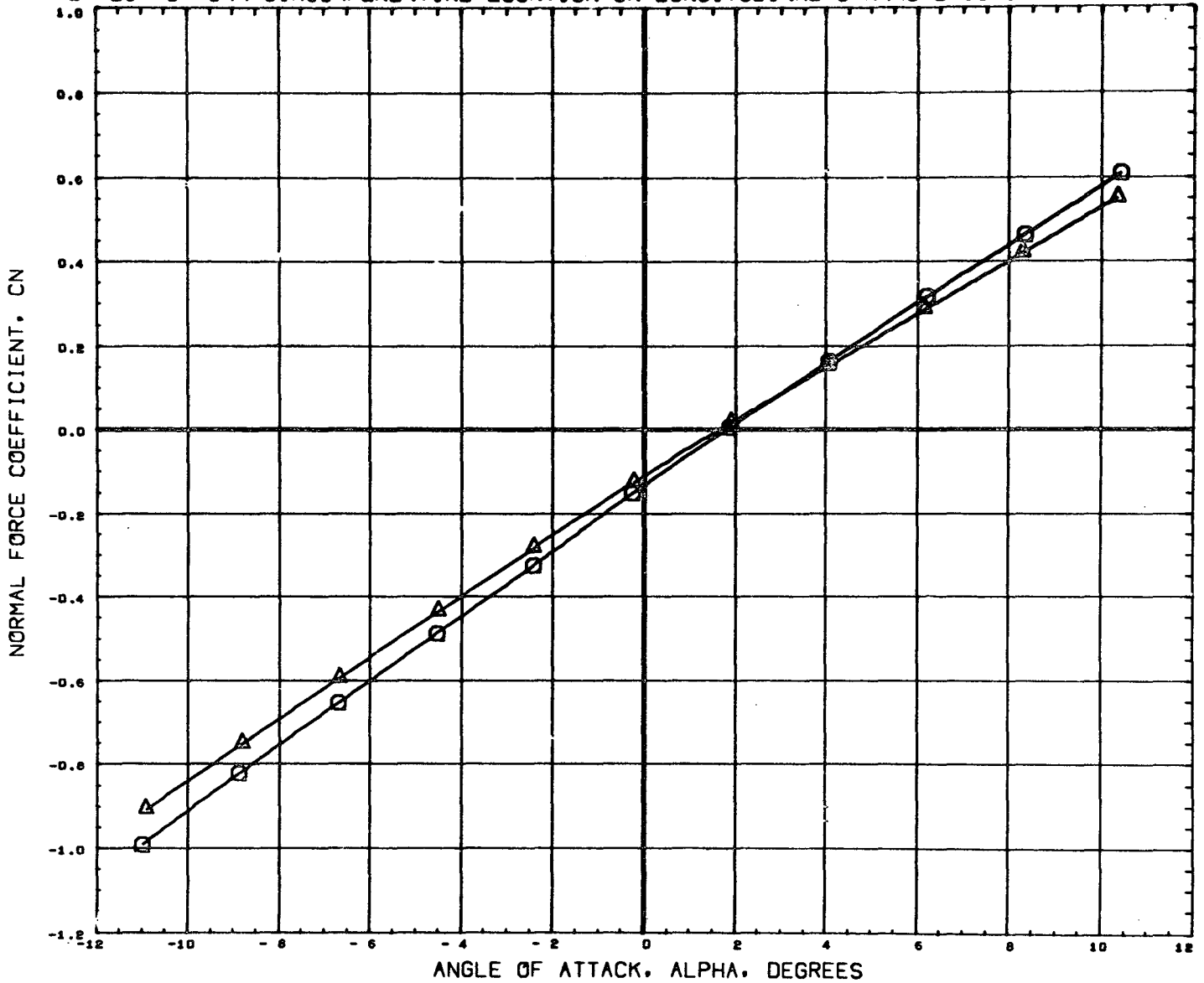

DATA SET SYMBOL	CONFIGURATION DESCRIPTION	ORBIN	THETS	BETA	REFERENCE INFORMATION
(B65010)	MSFC TWT 534 SHUTTLE LAUNCH	T101S1	-1.500	0.000	SREF 4.8950 sq. IN
(B65004)	MSFC TWT 534 SHUTTLE LAUNCH	T101S1	-1.500	21.000	LREF 2.6440 IN.
					BREF 3.5250 IN.
					XMRP 3.4900 IN.
					YMRP 0.0000 IN.
					ZMRP 0.1616 IN.
					SCALE 0.0034

MACH 1.20

EFFECT OF SRM CIRCUMFERENTIAL LOCATION ON LONGITUDINAL CHARACTERISTICS

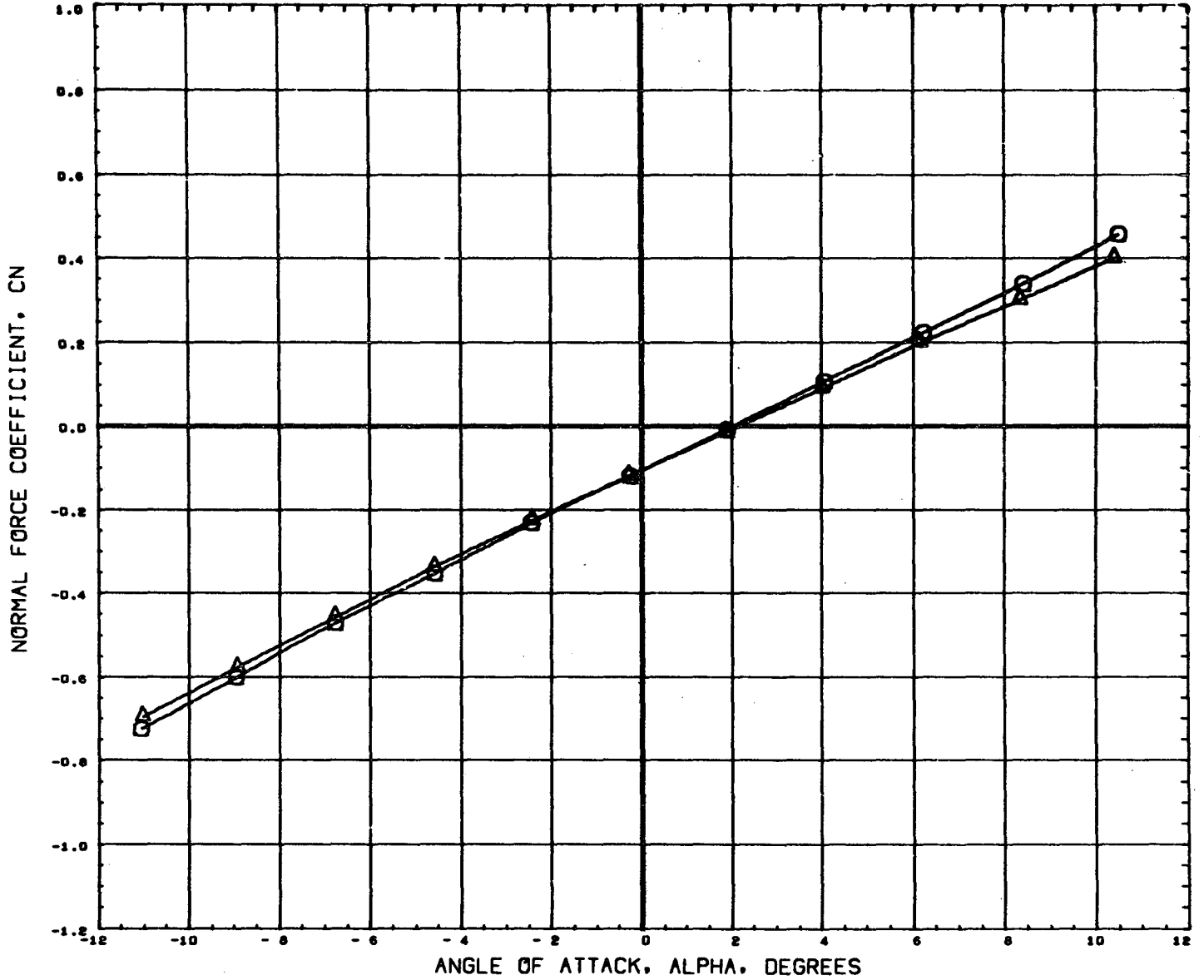

DATA SET SYMBOL	CONFIGURATION DESCRIPTION	ORBIN	THETS	BETA	REFERENCE INFORMATION
(B65010)	MSFC TWT 534 SHUTTLE LAUNCH	T10151	-1.500	0.000	SREF 4.8950 SQ. IN
(B65004)	MSFC TWT 534 SHUTTLE LAUNCH	T10191	-1.500	21.000	LREF 2.6440 IN.
					BREF 3.9250 IN.
					XMRP 3.4900 IN.
					YMRP 0.0000 IN.
					ZMRP 0.1616 IN.
					SCALE 0.0034

MACH 1.97

PAGE 270

EFFECT OF SRM CIRCUMFERENTIAL LOCATION ON LONGITUDINAL CHARACTERISTICS

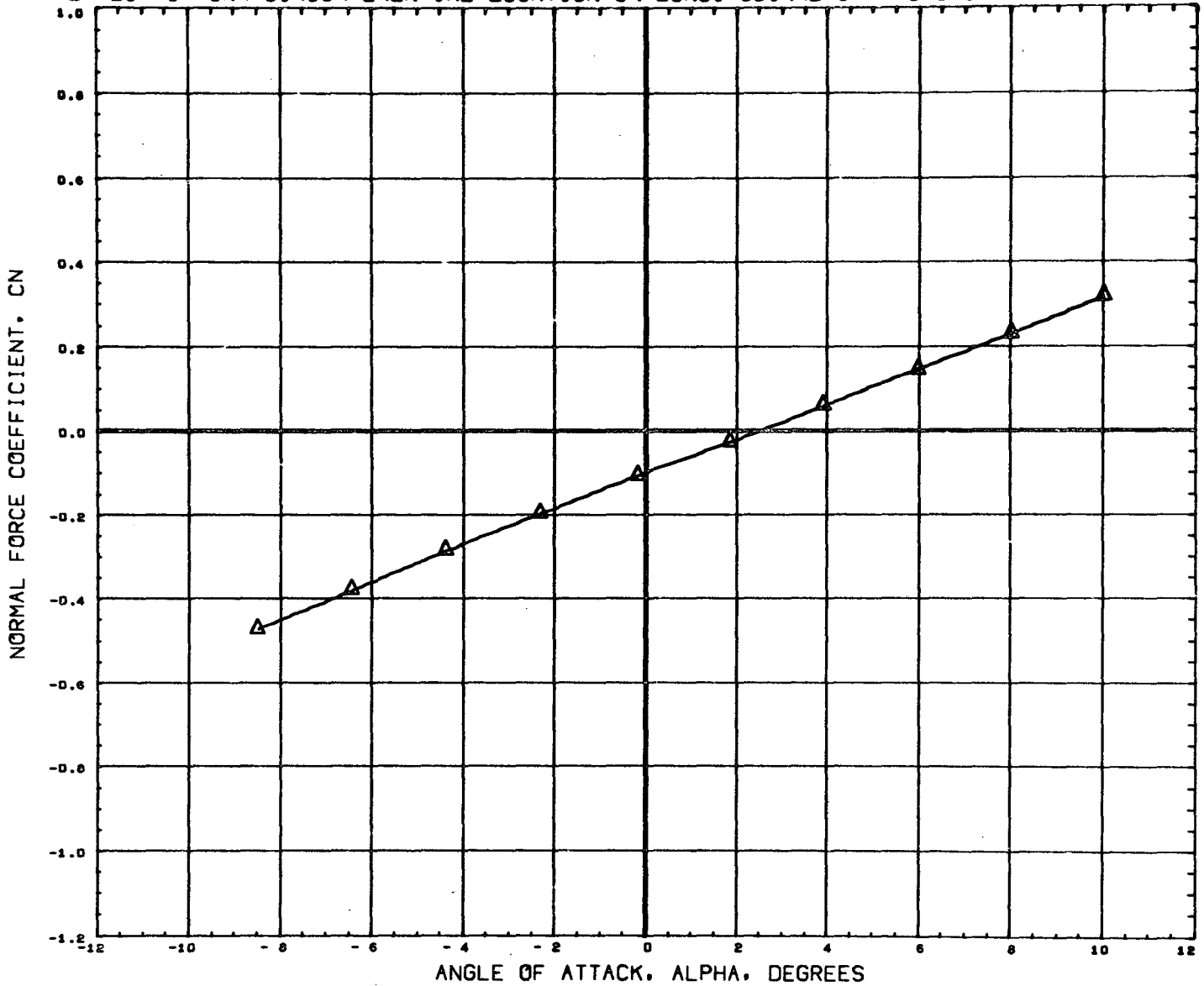

DATA SET SYMBOL CONFIGURATION DESCRIPTION
 (B65010) □ DATA NOT AVAILABLE FOR ALL CONDITIONS
 (B65004) △ MSFC TWT 534 SHUTTLE LAUNCH T10151

ORBIN THETS BETA
 -1.500 0.000 0.000
 -1.500 21.000 0.000

REFERENCE INFORMATION
 SREF 4.8950 SQ. IN.
 LREF 2.6440 IN.
 BREF 3.5250 IN.
 XMRP 3.4900 IN.
 YMRP 0.0000 IN.
 ZMRP 0.1616 IN.
 SCALE 0.0034

MACH 2.74

PAGE 271

EFFECT OF SRM CIRCUMFERENTIAL LOCATION ON LONGITUDINAL CHARACTERISTICS

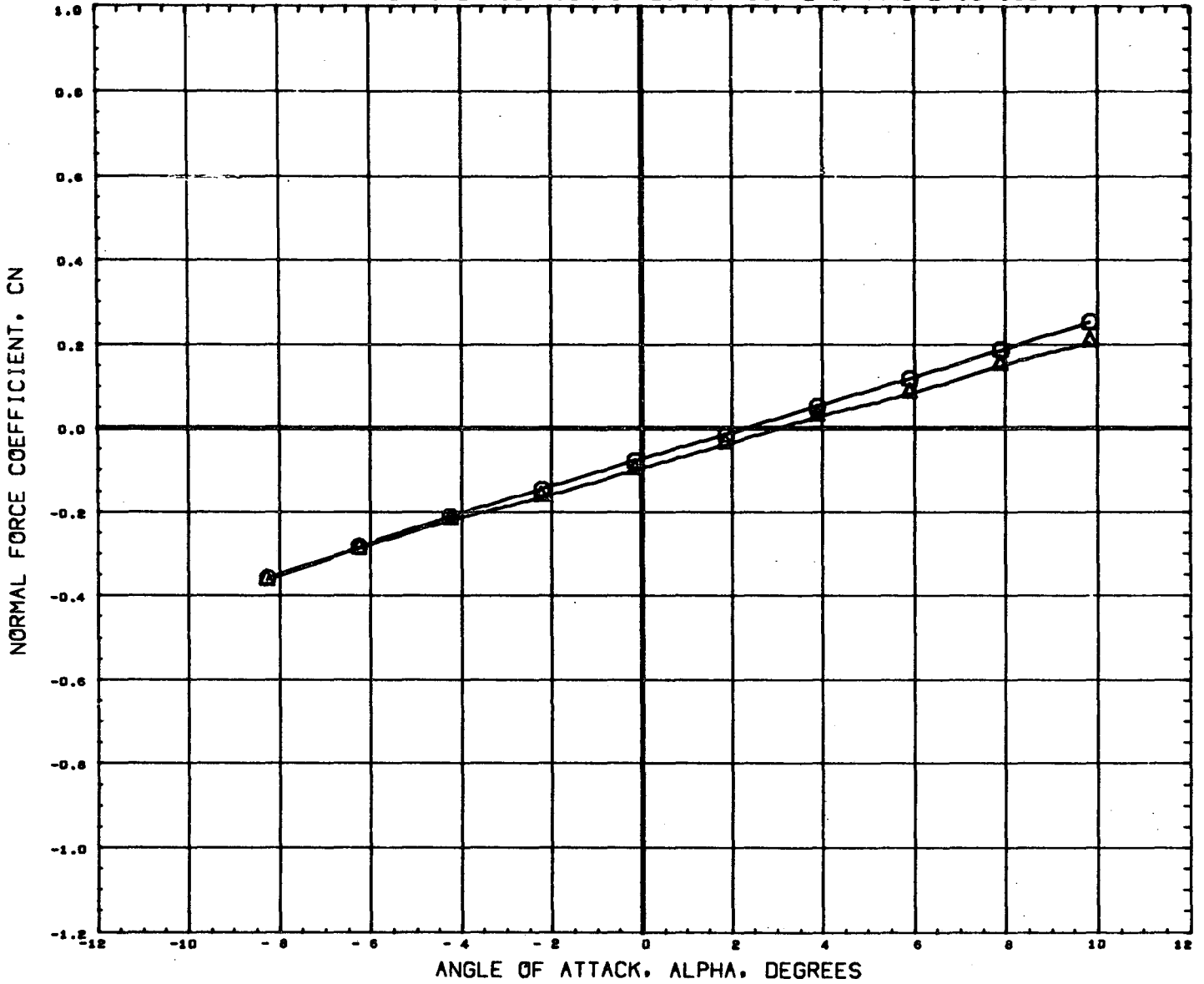

DATA SET SYMBOL	CONFIGURATION DESCRIPTION	ORBIN	THETS	BETA	REFERENCE INFORMATION
(B65010)	MSFC TWT 534 SHUTTLE LAUNCH	-1.500	0.000	0.000	SREF 4.8950 SQ. IN
(B65004)	MSFC TWT 534 SHUTTLE LAUNCH	-1.500	21.000	0.000	LREF 2.6440 IN.
					BREF 3.5250 IN.
					XMRP 3.4900 IN.
					YMRP 0.0000 IN.
					ZMRP 0.1616 IN.
					SCALE 0.0034

MACH 4.96

PAGE 272

EFFECT OF SRM CIRCUMFERENTIAL LOCATION ON LONGITUDINAL CHARACTERISTICS

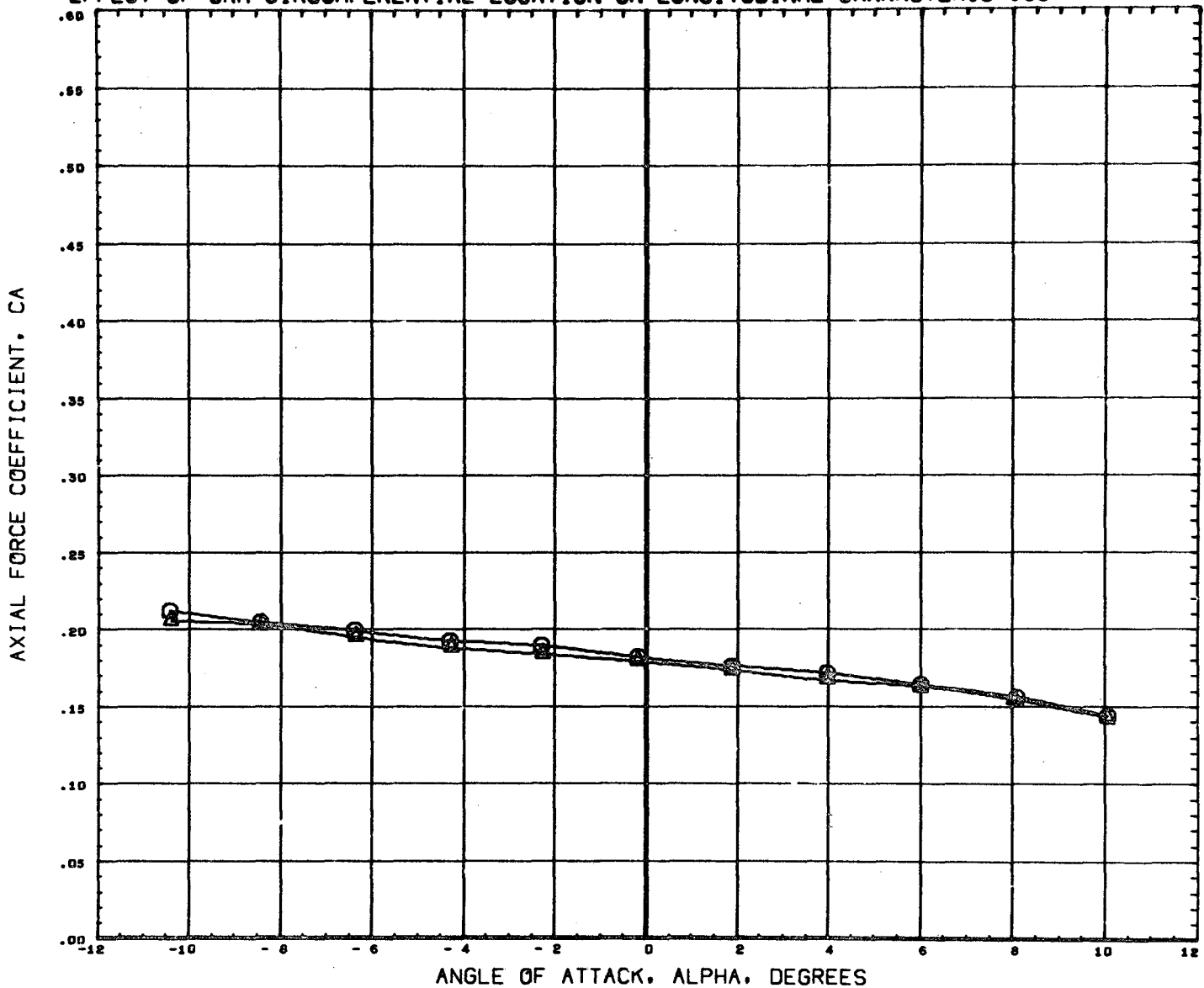

DATA SET SYMBOL	CONFIGURATION DESCRIPTION	ORBIN	THETS	BETA	REFERENCE INFORMATION
(B65010)	MSFC TWT 534 SHUTTLE LAUNCH	-1.500	0.070	0.000	SREF 4.8950 SQ. IN
(B65004)	MSFC TWT 534 SHUTTLE LAUNCH	-1.500	21.000	0.000	LREF 2.6440 IN.
					BREF 3.5250 IN.
					XMRP 3.4900 IN.
					YMRP 0.0000 IN.
					ZMRP 0.1616 IN.
					SCALE 0.0034

MACH .60

EFFECT OF SRM CIRCUMFERENTIAL LOCATION ON LONGITUDINAL CHARACTERISTICS

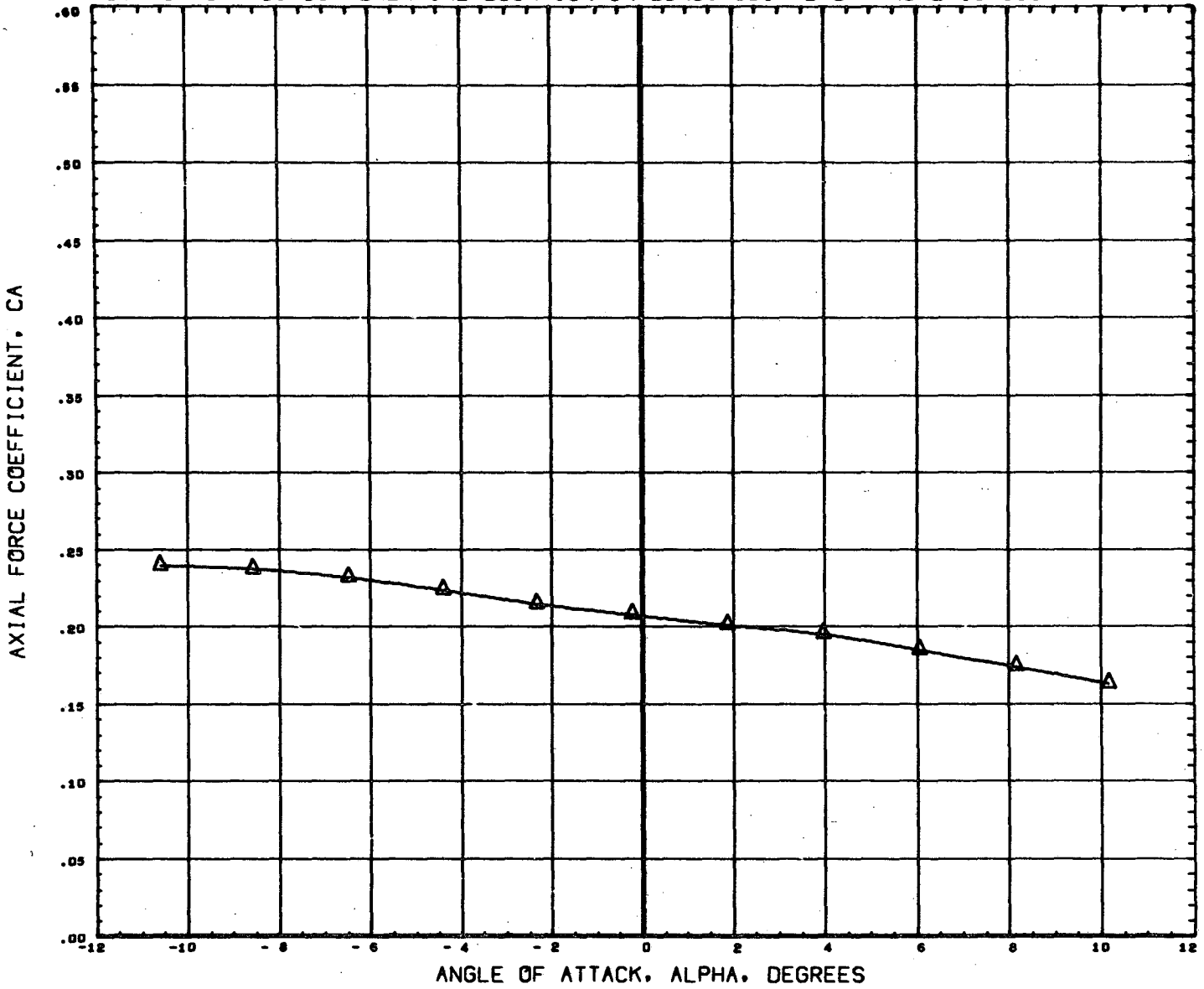

DATA SET SYMBOL CONFIGURATION DESCRIPTION
 (B65010) Ω DATA NOT AVAILABLE FOR ALL CONDITIONS
 (B65004) Δ MSFC TWT 534 SHUTTLE LAUNCH T101S1

ORBIN THETS BETA
 -1.500 0.000 0.000
 -1.500 21.000 0.000

REFERENCE INFORMATION
 SREF 4.8950 Sq. IN
 LREF 2.6440 IN.
 BREF 3.5250 IN.
 XMRP 3.4900 IN.
 YMRP 0.0000 IN.
 ZMRP 0.1616 IN.
 SCALE 0.0034

EFFECT OF SRM CIRCUMFERENTIAL LOCATION ON LONGITUDINAL CHARACTERISTICS

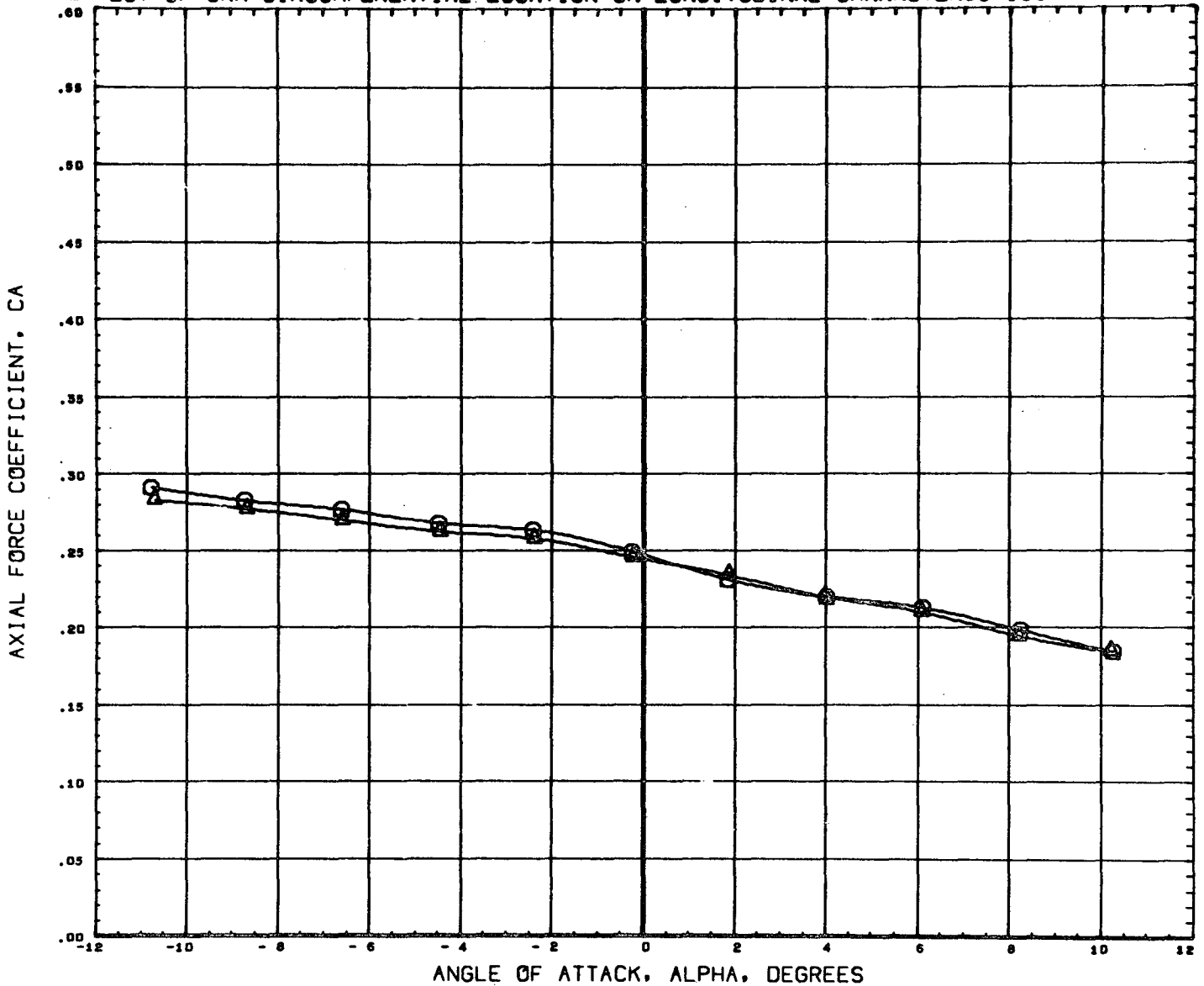

DATA SET SYMBOL	CONFIGURATION DESCRIPTION	ORBIN	THETS	BETA	REFERENCE INFORMATION
(B65010)	MSFC TWT 534 SHUTTLE LAUNCH	-1.500	0.000	0.000	SREF 4.8950 SQ. IN
(B65004)	MSFC TWT 534 SHUTTLE LAUNCH	-1.500	21.000	0.000	LREF 2.6440 IN.
					BREF 3.9250 IN.
					XMRP 3.4900 IN.
					YMRP 0.0000 IN.
					ZMRP 0.1616 IN.
					SCALE 0.0034

MACH .90

EFFECT OF SRM CIRCUMFERENTIAL LOCATION ON LONGITUDINAL CHARACTERISTICS

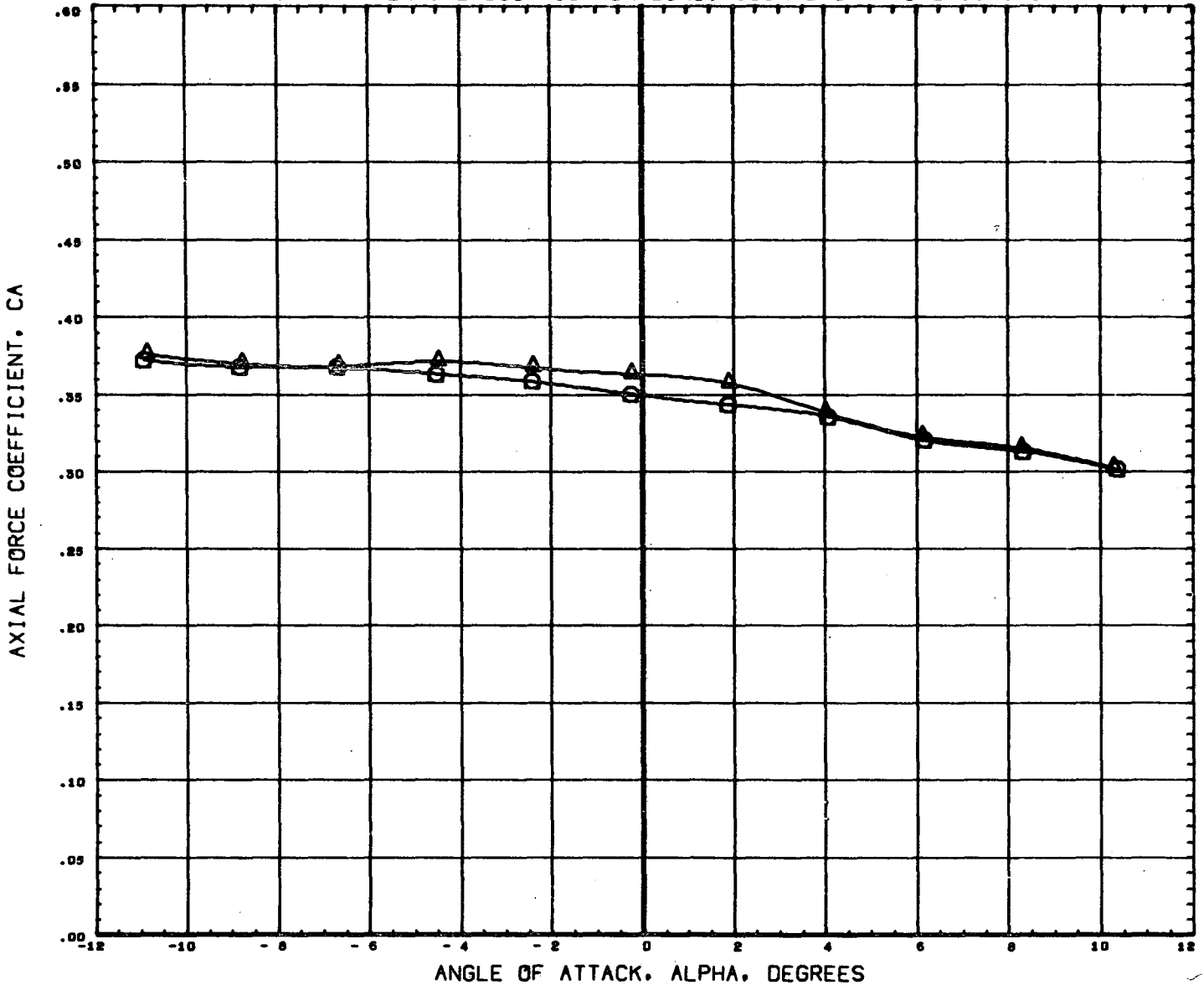

DATA SET SYMBOL	CONFIGURATION DESCRIPTION	ORBIN	THETS	BETA	REFERENCE INFORMATION
(B65010)	MSFC TWT 534 SHUTTLE LAUNCH	T101S1	-1.500	0.000	SREF 4.8950 SQ. IN.
(B65004)	MSFC TWT 534 SHUTTLE LAUNCH	T101S1	-1.500	21.000	LREF 2.6440 IN.
					BREF 3.5250 IN.
					XMRP 3.4900 IN.
					YMRP 0.0000 IN.
					ZMRP 0.1616 IN.
					SCALE 0.0034

EFFECT OF SRM CIRCUMFERENTIAL LOCATION ON LONGITUDINAL CHARACTERISTICS

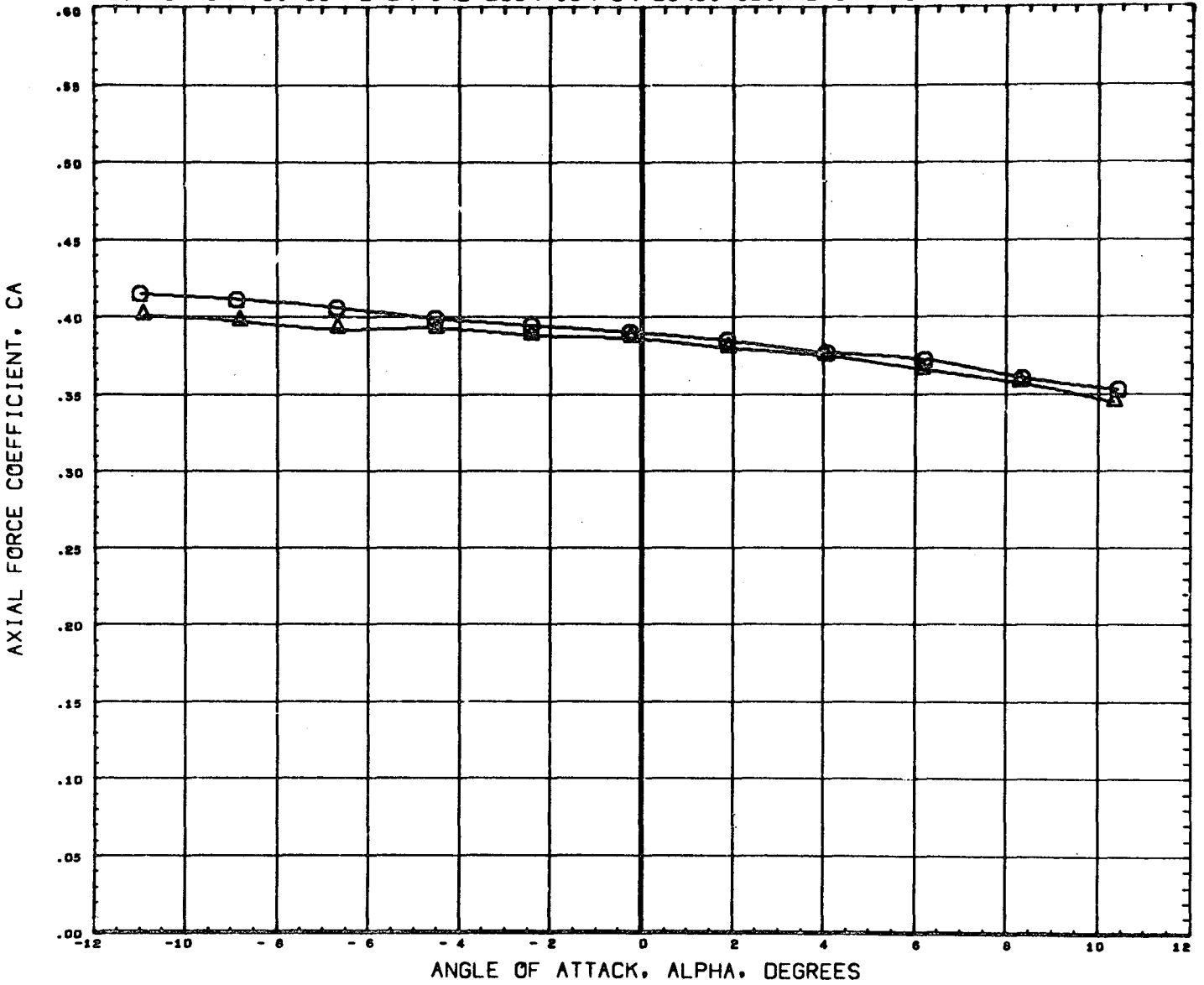

DATA SET SYMBOL	CONFIGURATION DESCRIPTION	ORBIN	THETS	BETA	REFERENCE INFORMATION
(865010)	MSFC TWT 534 SHUTTLE LAUNCH	T101S1	-1.500	0.000	SREF 4.8950 SQ. IN
(865004)	MSFC TWT 534 SHUTTLE LAUNCH	T101S1	-1.500	21.000	LRFF 2.6440 IN.
					BREF 3.5250 IN.
					XMRP 3.4900 IN.
					YMRP 0.0000 IN.
					ZMRP 0.1616 IN.
					SCALE 0.0034

MACH 1.20

EFFECT OF SRM CIRCUMFERENTIAL LOCATION ON LONGITUDINAL CHARACTERISTICS

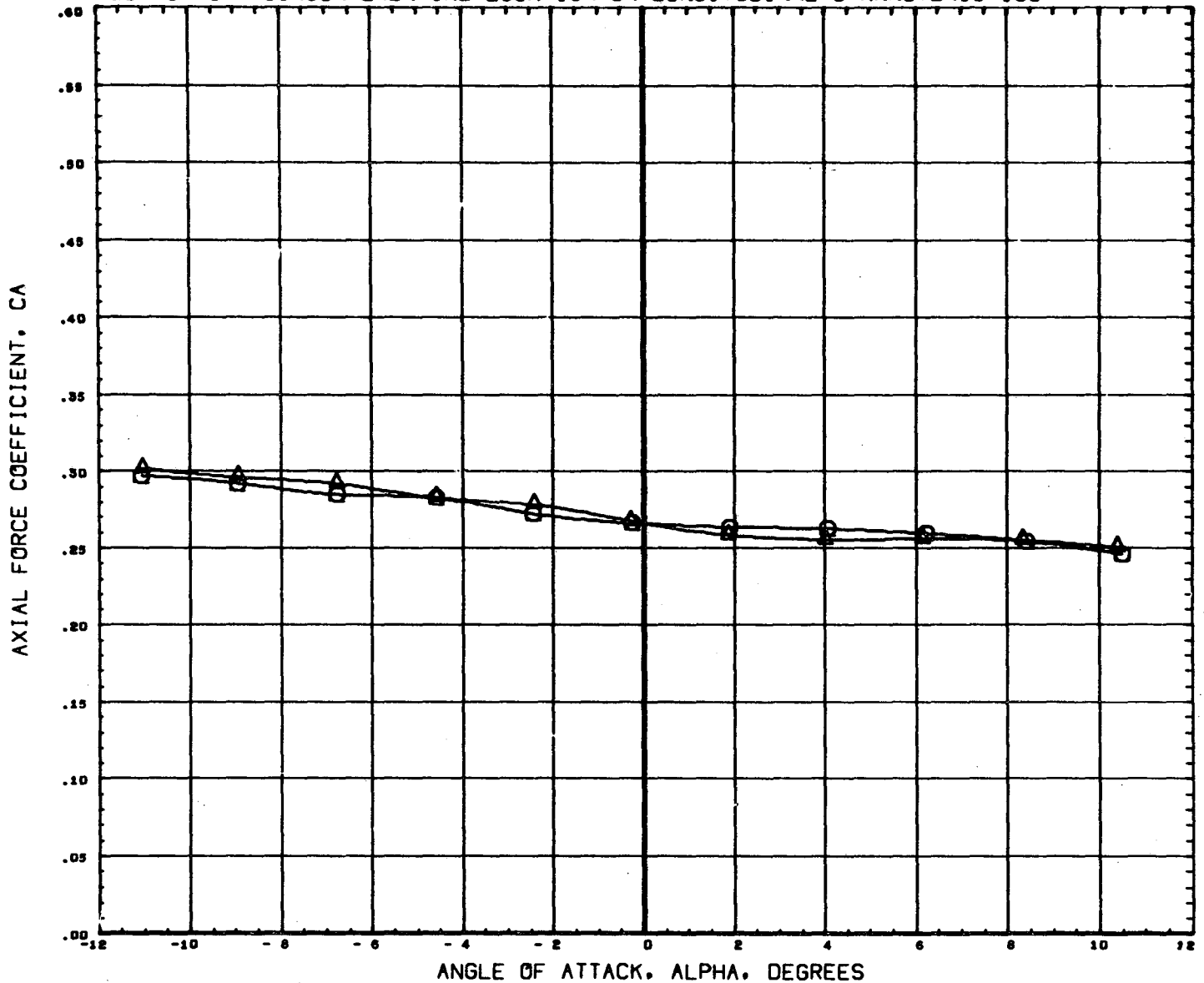

DATA SET SYMBOL	CONFIGURATION DESCRIPTION	ORBIN	THETS	BETA	REFERENCE INFORMATION
(865010)	NSFC TWT 534 SHUTTLE LAUNCH	-1.500	0.000	0.000	SREF 4.8950 30. IN
(865004)	NSFC TWT 534 SHUTTLE LAUNCH	-1.500	21.000	0.000	LREF 2.6440 IN.
					BREF 3.5250 IN.
					XMRP 3.4900 IN.
					YMRP 0.0000 IN.
					ZMRP 0.1616 IN.
					SCALE 0.0034

MACH 1.97

PAGE 278

EFFECT OF SRM CIRCUMFERENTIAL LOCATION ON LONGITUDINAL CHARACTERISTICS

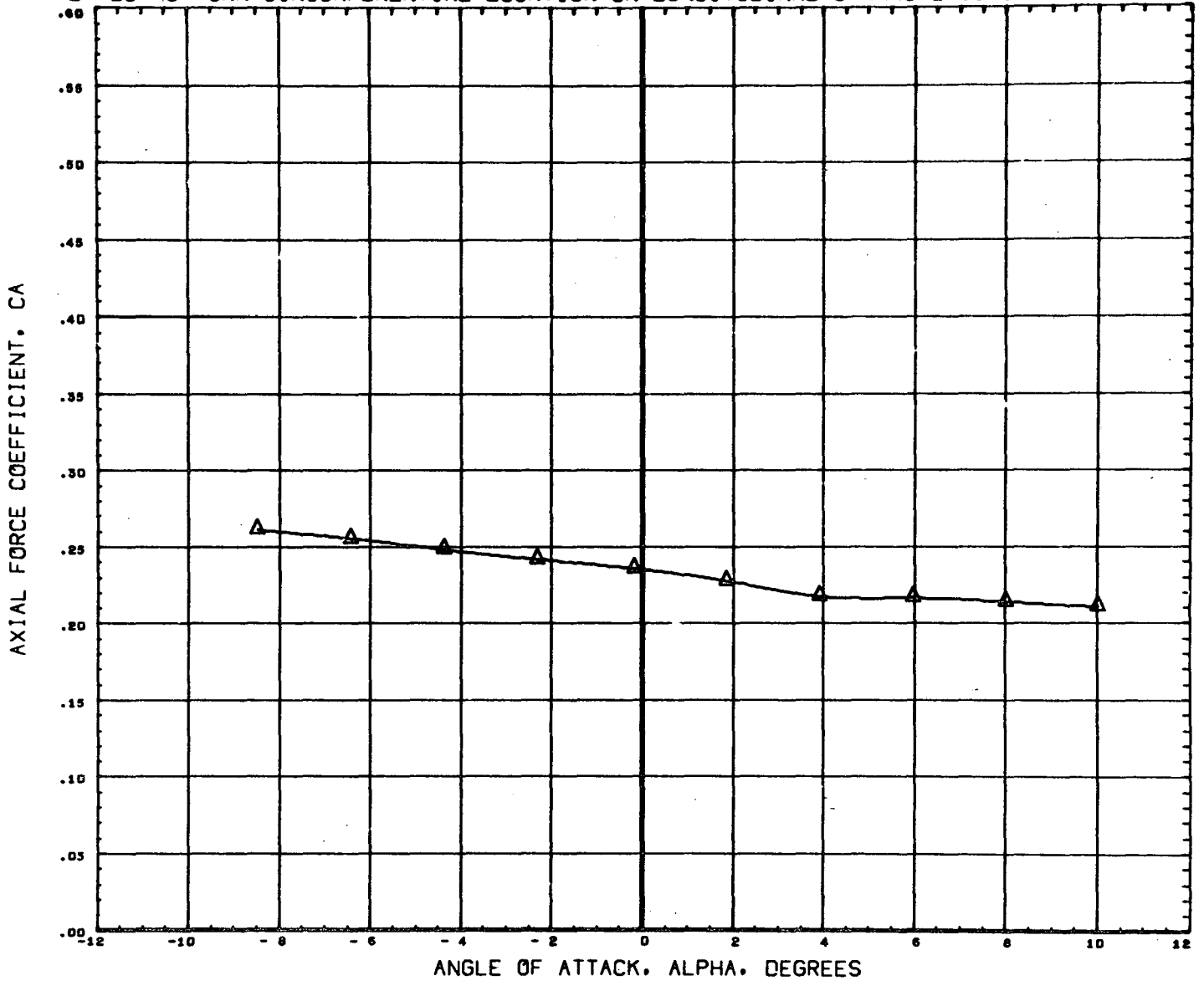

DATA SET SYMBOL	CONFIGURATION DESCRIPTION	ORBIN	THETS	BETA	REFERENCE INFORMATION
(B65010)	DATA NOT AVAILABLE FOR ALL CONDITIONS	-1.500	0.000	0.000	SREF 4.8950 90. IN
(B65004)	MSFC TWT 534 SHUTTLE LAUNCH T101S1	-1.500	21.000	0.000	LREF 2.6440 IN.
					BREF 3.5250 IN.
					XMRP 3.4900 IN.
					YMRP 0.0000 IN.
					ZMRP 0.1616 IN.
					SCALE 0.0034

MACH 2.74

EFFECT OF SRM CIRCUMFERENTIAL LOCATION ON LONGITUDINAL CHARACTERISTICS

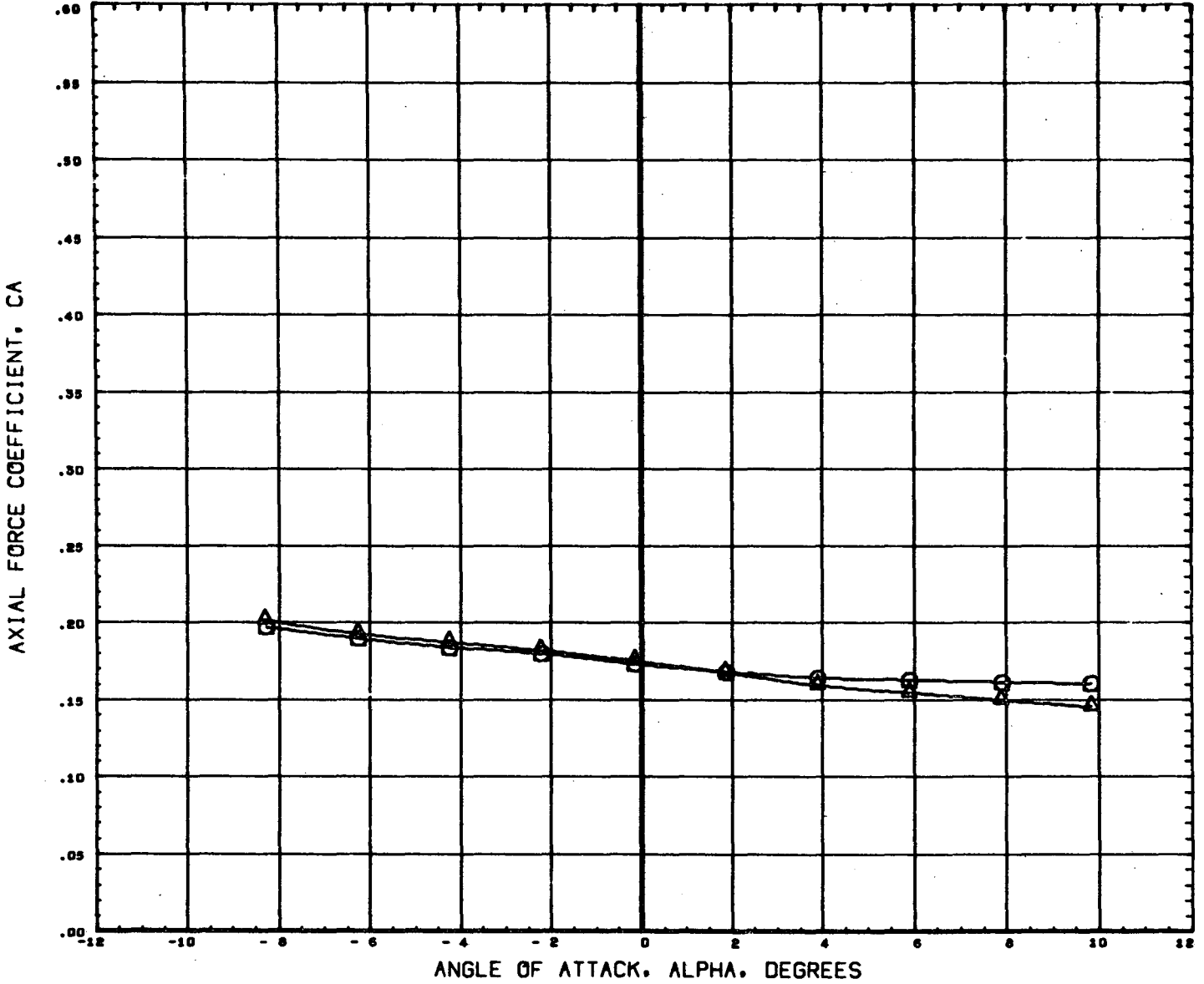

DATA SET SYMBOL	CONFIGURATION DESCRIPTION	ORBIN	THETS	BETA	REFERENCE INFORMATION
(B69010)	NSFC TWT 534 SHUTTLE LAUNCH	-1.500	0.000	0.000	SREF 4.8950 SQ. IN
(B69004)	NSFC TWT 534 SHUTTLE LAUNCH	-1.500	21.000	0.000	LREF 2.6440 IN.
					BREF 3.5250 IN.
					XMRP 3.4900 IN.
					YMRP 0.0000 IN.
					ZMRP 0.1616 IN.
					SCALE 0.0034

MACH 4.96

PAGE 280

EFFECT OF SRM CIRCUMFERENTIAL LOCATION ON LONGITUDINAL CHARACTERISTICS

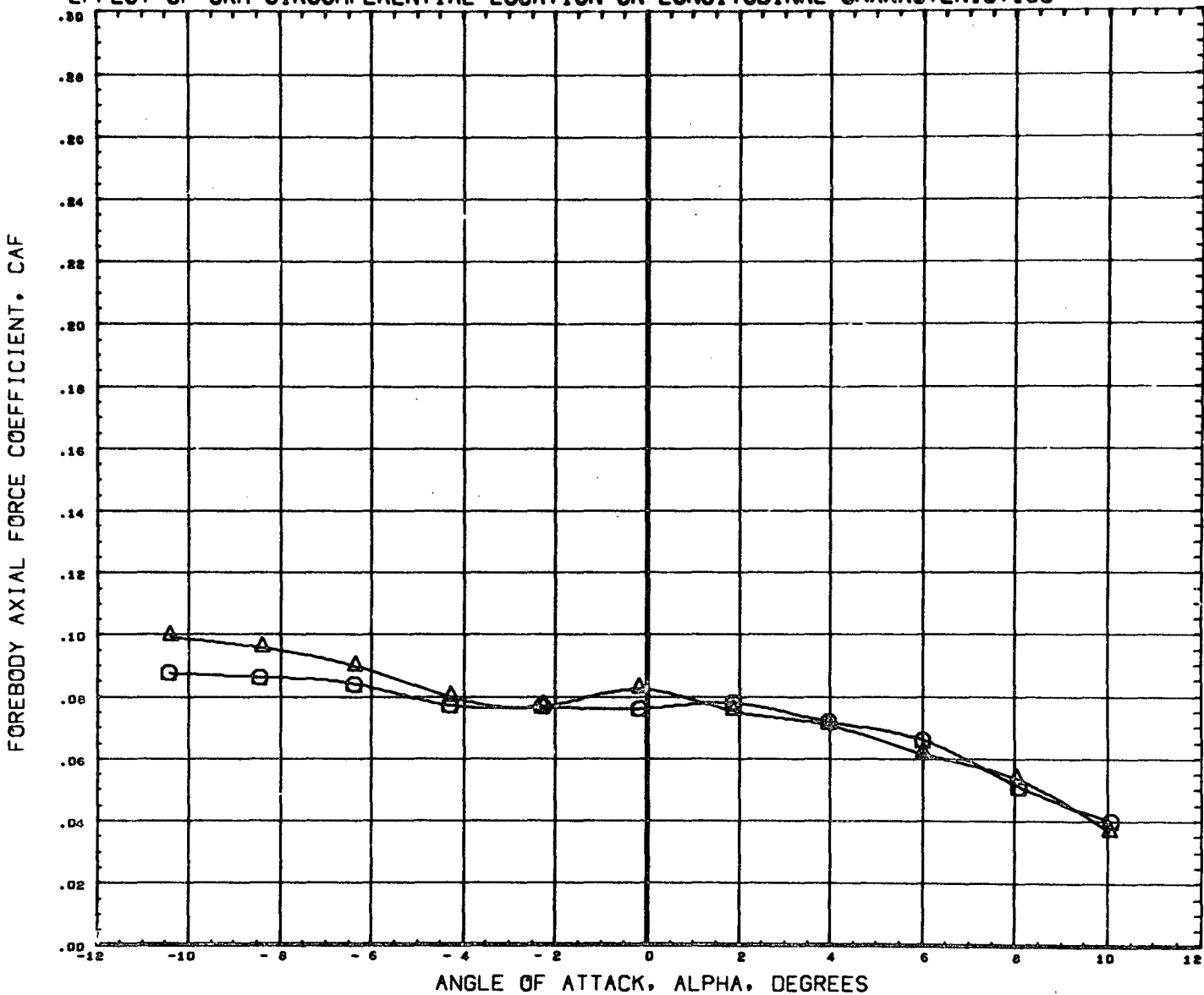

DATA SET SYMBOL	CONFIGURATION DESCRIPTION	ORBIN	THETS	BETA	REFERENCE INFORMATION
(B65010)	MSFC TWT 534 SHUTTLE LAUNCH	-1.500	0.000	0.000	SREF 4.8950 SQ. IN
(B35004)	MSFC TWT 534 SHUTTLE LAUNCH	-1.500	21.000	0.000	LREF 2.6440 IN.
					BREF 3.5250 IN.
					XMRP 3.4900 IN.
					YMRP 0.0000 IN.
					ZMRP 0.1616 IN.
					SCALE 0.0034

MACH .60

EFFECT OF SRM CIRCUMFERENTIAL LOCATION ON LONGITUDINAL CHARACTERISTICS

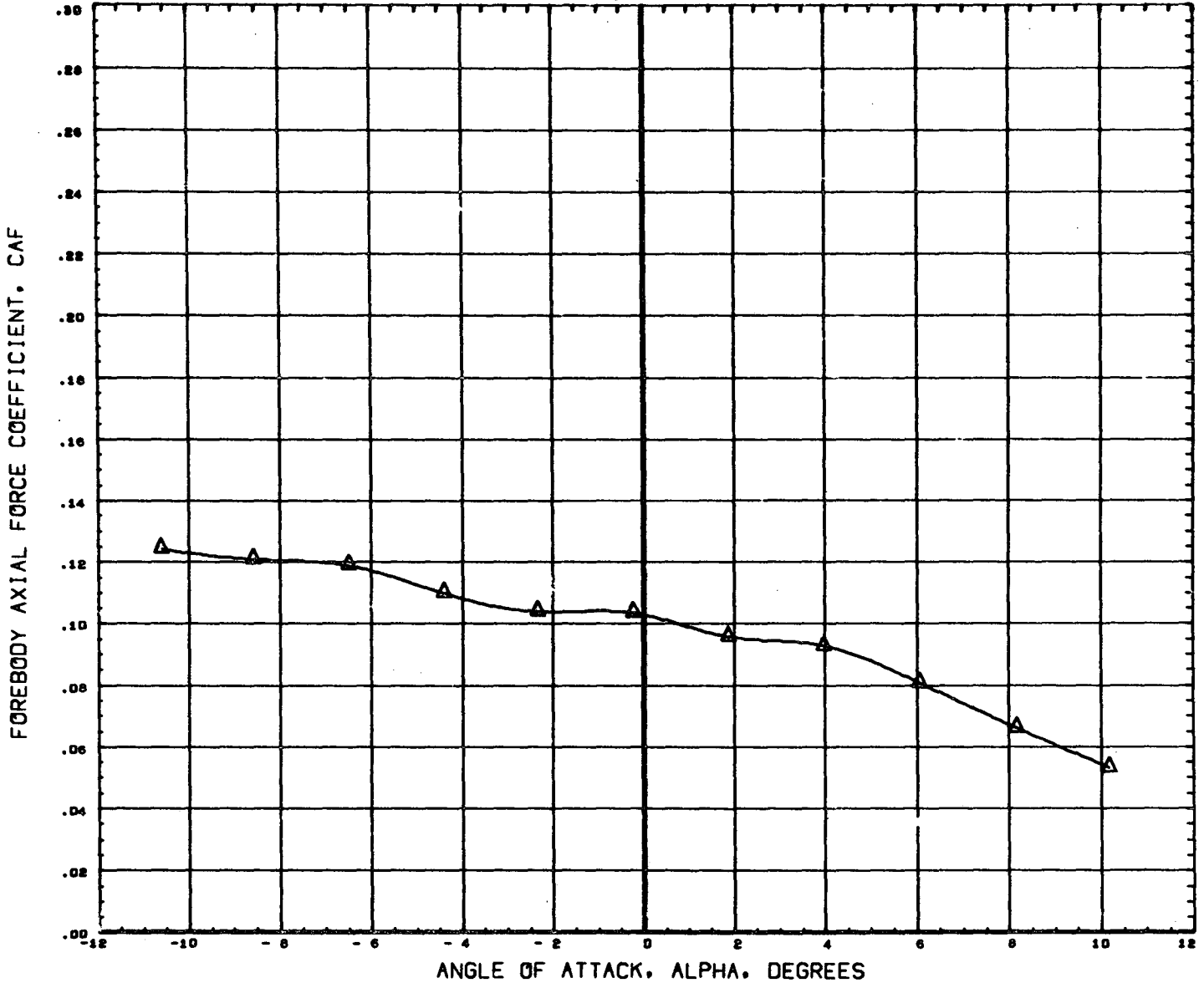

DATA SET SYMBOL CONFIGURATION DESCRIPTION
 (B65010) DATA NOT AVAILABLE FOR ALL CONDITIONS
 (B65004) NSFC TWT 534 SHUTTLE LAUNCH T101S1

ORBIN THETS BETA
 -1.500 0.000 0.000
 -1.500 21.000 0.000

REFERENCE INFORMATION
 SREF 4.8950 SQ. IN
 LREF 2.6440 IN.
 BREF 3.5250 IN.
 XMRP 3.4900 IN.
 YMRP 0.0000 IN.
 ZMRP 0.1616 IN.
 SCALE 0.0034

EFFECT OF SRM CIRCUMFERENTIAL LOCATION ON LONGITUDINAL CHARACTERISTICS

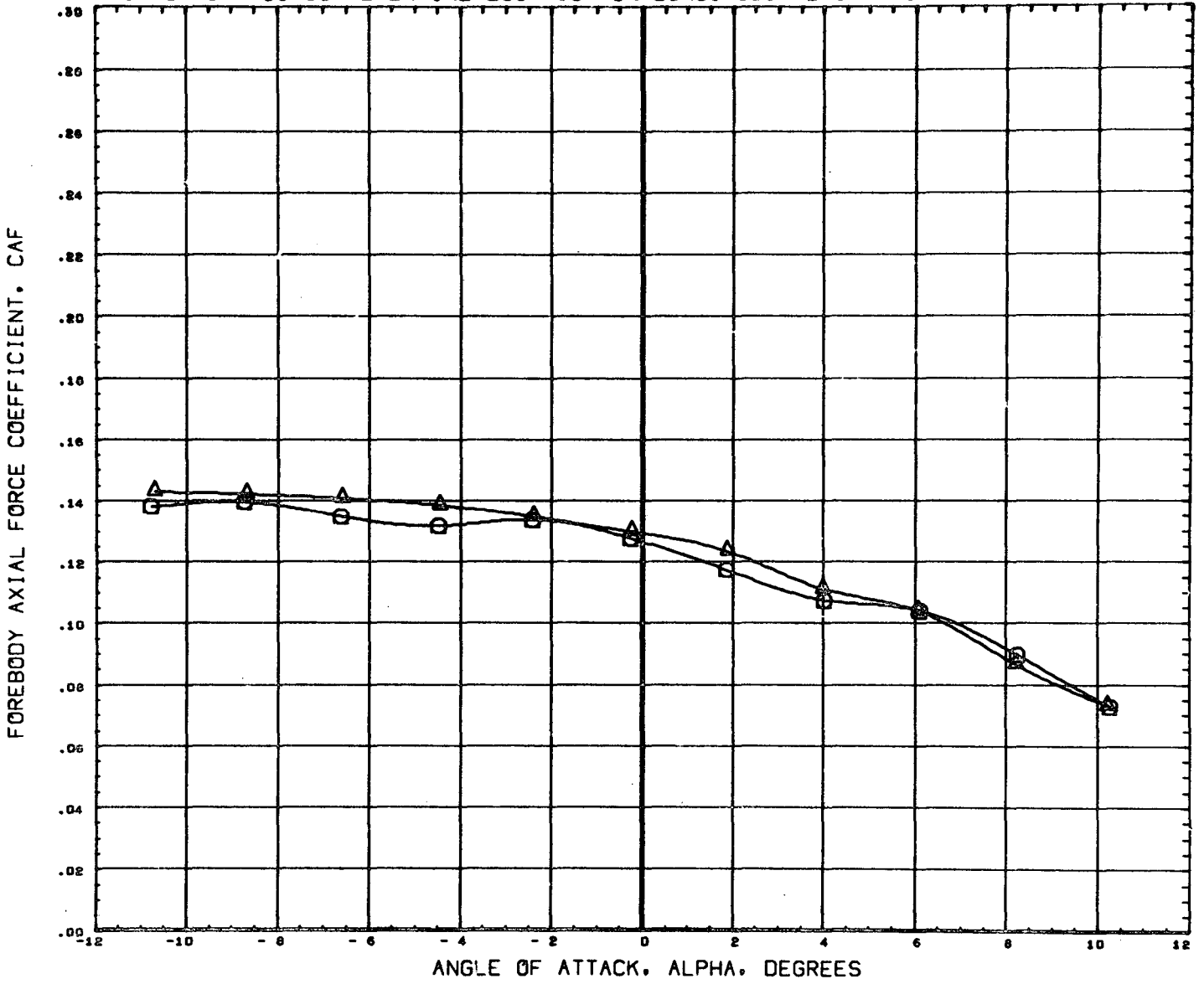

DATA SET SYMBOL	CONFIGURATION DESCRIPTION	ORBIN	THETS	BETA	REFERENCE INFORMATION
(B65010)	MSFC TWT 534 SHUTTLE LAUNCH	T101S1	-1.500	0.000	SREF 4.8950 SQ. IN.
(B55004)	MSFC TWT 534 SHUTTLE LAUNCH	T101S1	-1.500	21.000	LREF 2.6440 IN.
					BREF 3.5250 IN.
					XMRP 3.4900 IN.
					YMRP 0.0000 IN.
					ZMRP 0.1616 IN.
					SCALE 0.0034

MACH .90

EFFECT OF SRM CIRCUMFERENTIAL LOCATION ON LONGITUDINAL CHARACTERISTICS

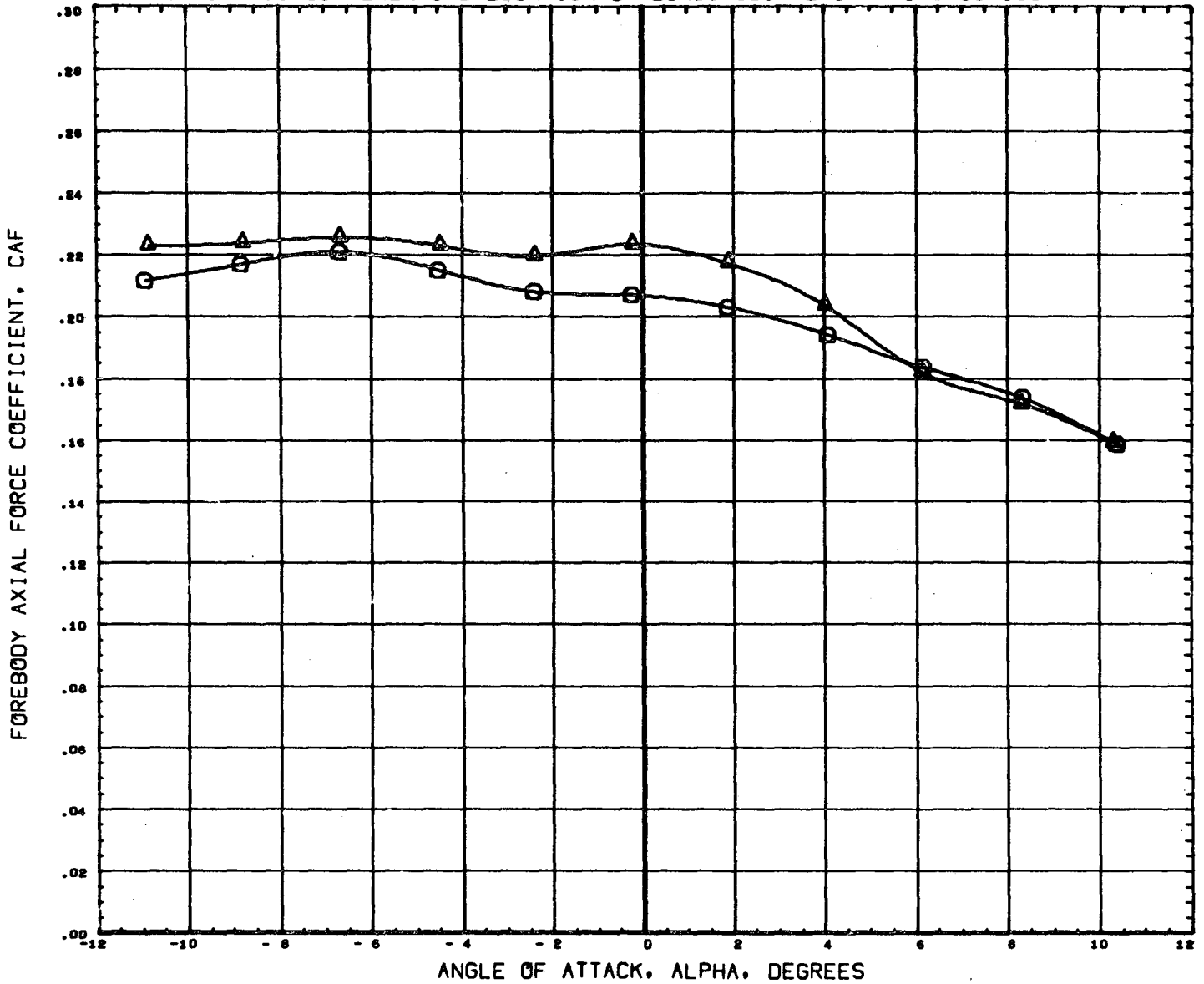

DATA SET SYMBOL	CONFIGURATION DESCRIPTION	ORBIN	THETS	BETA	REFERENCE INFORMATION
(B65010)	MSFC TWT 534 SHUTTLE LAUNCH	T10131	-1.500	0.000	SREF 4.8950 SQ. IN
(B65004)	MSFC TWT 534 SHUTTLE LAUNCH	T10131	-1.500	21.000	LREF 2.6440 IN.
					BREF 3.5250 IN.
					XMRP 3.4900 IN.
					YMRP 0.0000 IN.
					ZMRP 0.1616 IN.
					SCALE 0.0034

EFFECT OF SRM CIRCUMFERENTIAL LOCATION ON LONGITUDINAL CHARACTERISTICS

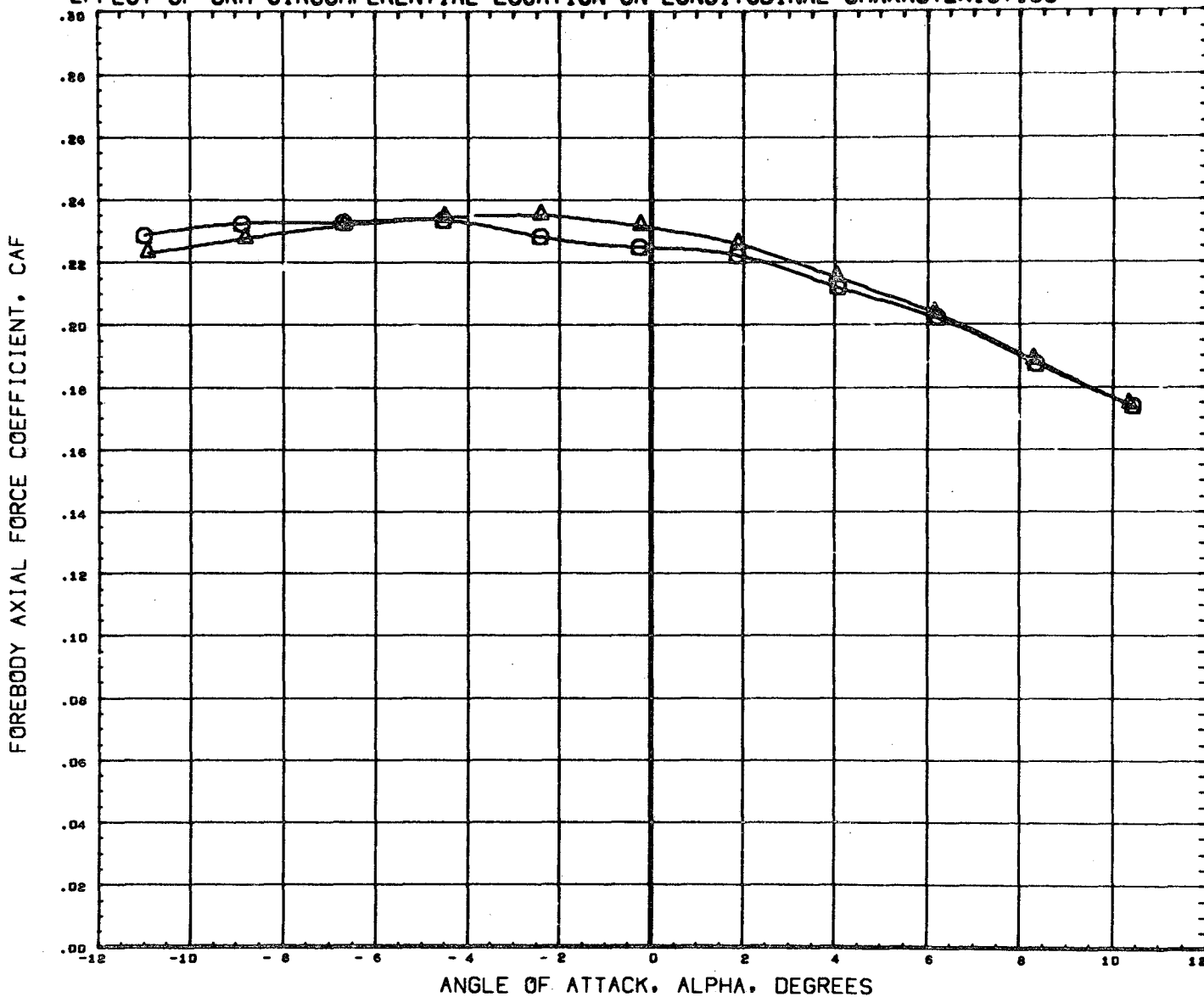

DATA SET SYMBOL	CONFIGURATION DESCRIPTION	ORBIN	THETS	BETA	REFERENCE INFORMATION
(B65010)	MSFC TWT 534 SHUTTLE LAUNCH	T101S1	-1.500	0.000	SREF 4.8950 SQ. IN
(B65004)	MSFC TWT 534 SHUTTLE LAUNCH	T101S1	-1.500	21.000	LREF 2.6440 IN.
					BREF 3.5250 IN.
					XMRP 3.4900 IN.
					YMRP 0.0000 IN.
					ZMRP 0.1616 IN.
					SCALE 0.0034

MACH 1.20

EFFECT OF SRM CIRCUMFERENTIAL LOCATION ON LONGITUDINAL CHARACTERISTICS

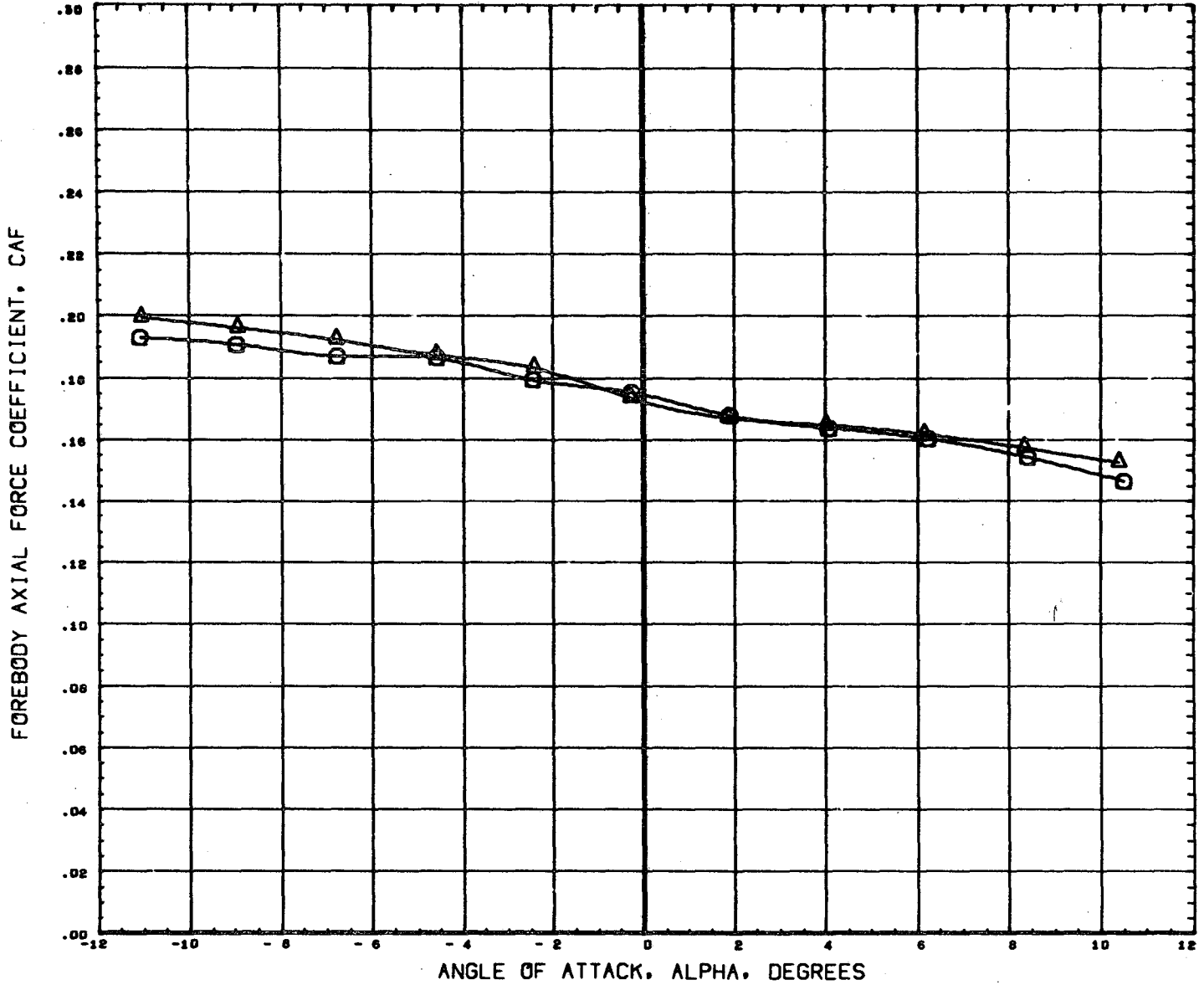

DATA SET SYMBOL	CONFIGURATION DESCRIPTION	ORBIN	THETS	BETA	REFERENCE INFORMATION
(B65010)	NSFC TWT 534 SHUTTLE LAUNCH	T101S1	-1.500	0.000	SREF 4.8950 SQ. IN
(B65004)	NSFC TWT 534 SHUTTLE LAUNCH	T101S1	-1.500	21.000	LREF 2.6440 IN.
					BREF 3.5250 IN.
					XMRP 3.4900 IN.
					YMRP 0.0000 IN.
					ZMRP 0.1616 IN.
					SCALE 0.0034

MACH 1.97

EFFECT OF SRM CIRCUMFERENTIAL LOCATION ON LONGITUDINAL CHARACTERISTICS

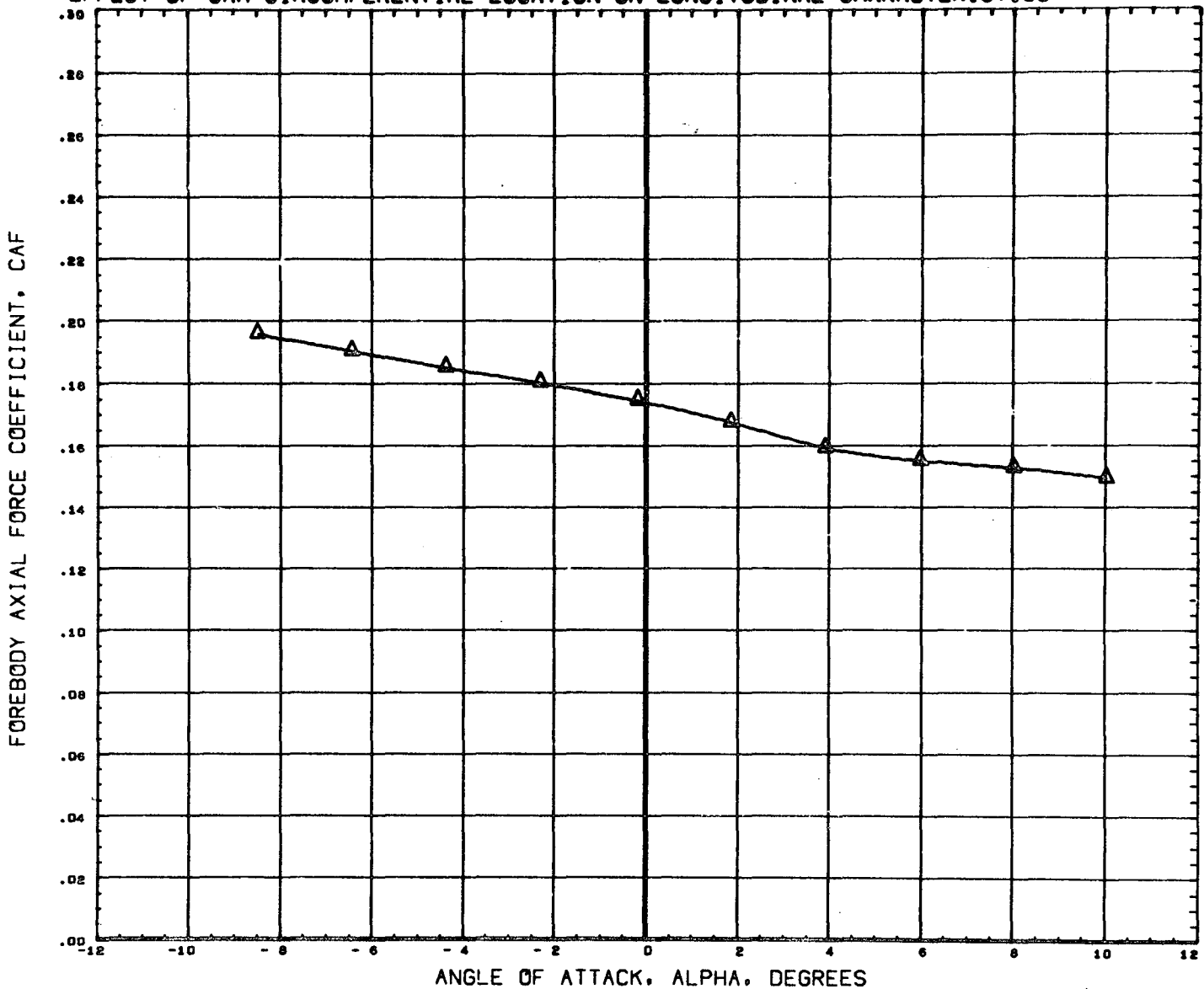

DATA SET SYMBOL CONFIGURATION DESCRIPTION
 (B65010) \emptyset DATA NOT AVAILABLE FOR ALL CONDITIONS
 (B65004) Δ MSFC TWT 534 SHUTTLE LAUNCH T101s1

ORBIN THETS BETA
 -1.500 0.000 0.000
 -1.500 21.000 0.000

REFERENCE INFORMATION
 SREF 4.8950 SQ. IN
 LREF 2.6440 IN.
 BREF 3.5250 IN.
 XMRP 3.4900 IN.
 YMRP 0.0000 IN.
 ZMRP 0.1616 IN.
 SCALE 0.0034

MACH 2.74

EFFECT OF SRM CIRCUMFERENTIAL LOCATION ON LONGITUDINAL CHARACTERISTICS

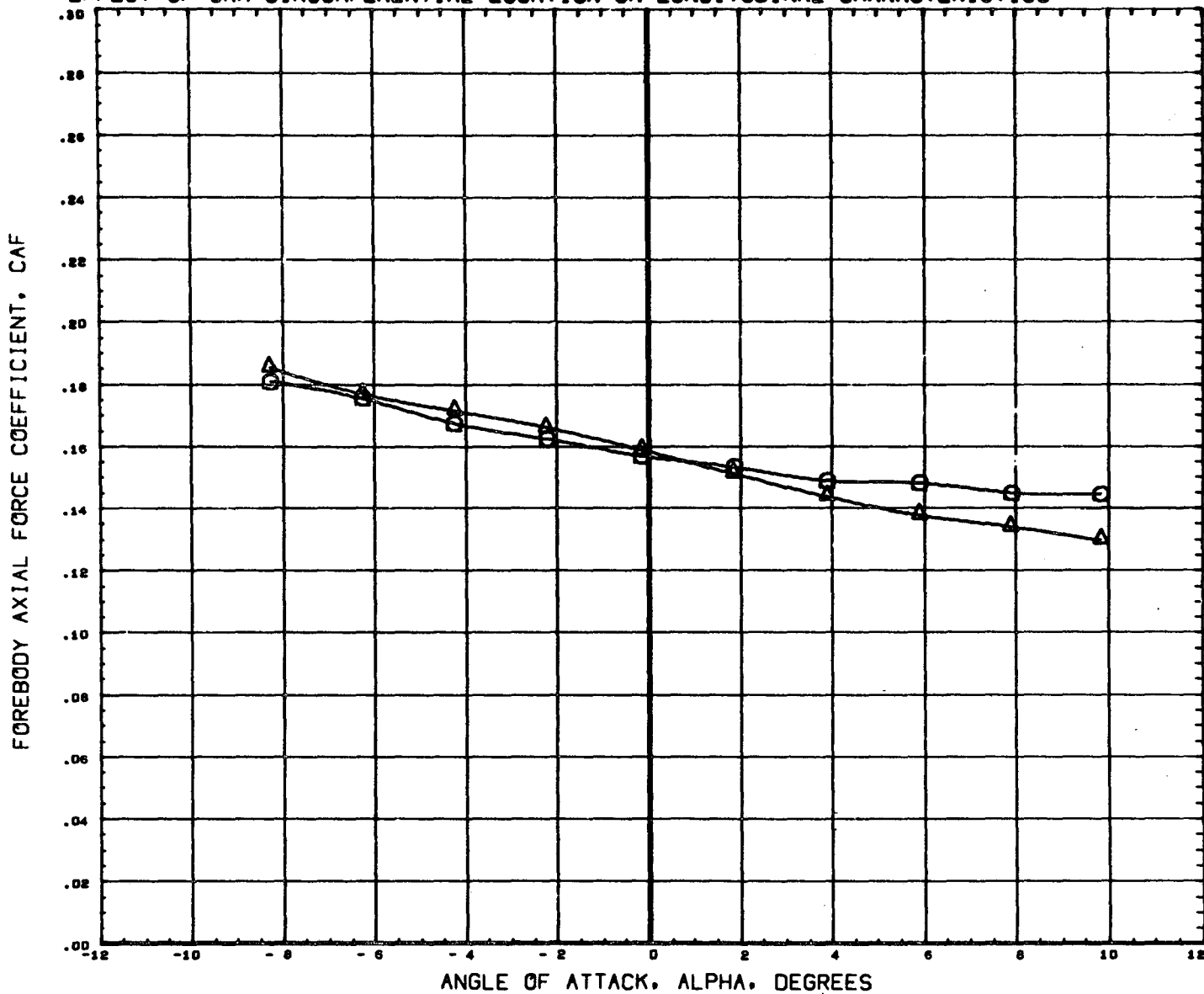

DATA SET SYMBOL	CONFIGURATION DESCRIPTION	ORBIN	THETS	BETA	REFERENCE INFORMATION
(B65010)	MSFC TWT 534 SHUTTLE LAUNCH	-1.500	0.000	0.000	SREF 4.8950 SQ. IN
(B65004)	MSFC TWT 534 SHUTTLE LAUNCH	-1.500	21.000	0.000	LREF 2.6440 IN.
					BREF 3.5250 IN.
					XMRP 3.4900 IN.
					YMRP 0.0000 IN.
					ZMRP 0.1616 IN.
					SCALE 0.0034

MACH 4.96

PAGE 288

EFFECT OF SRM CIRCUMFERENTIAL LOCATION ON LONGITUDINAL CHARACTERISTICS

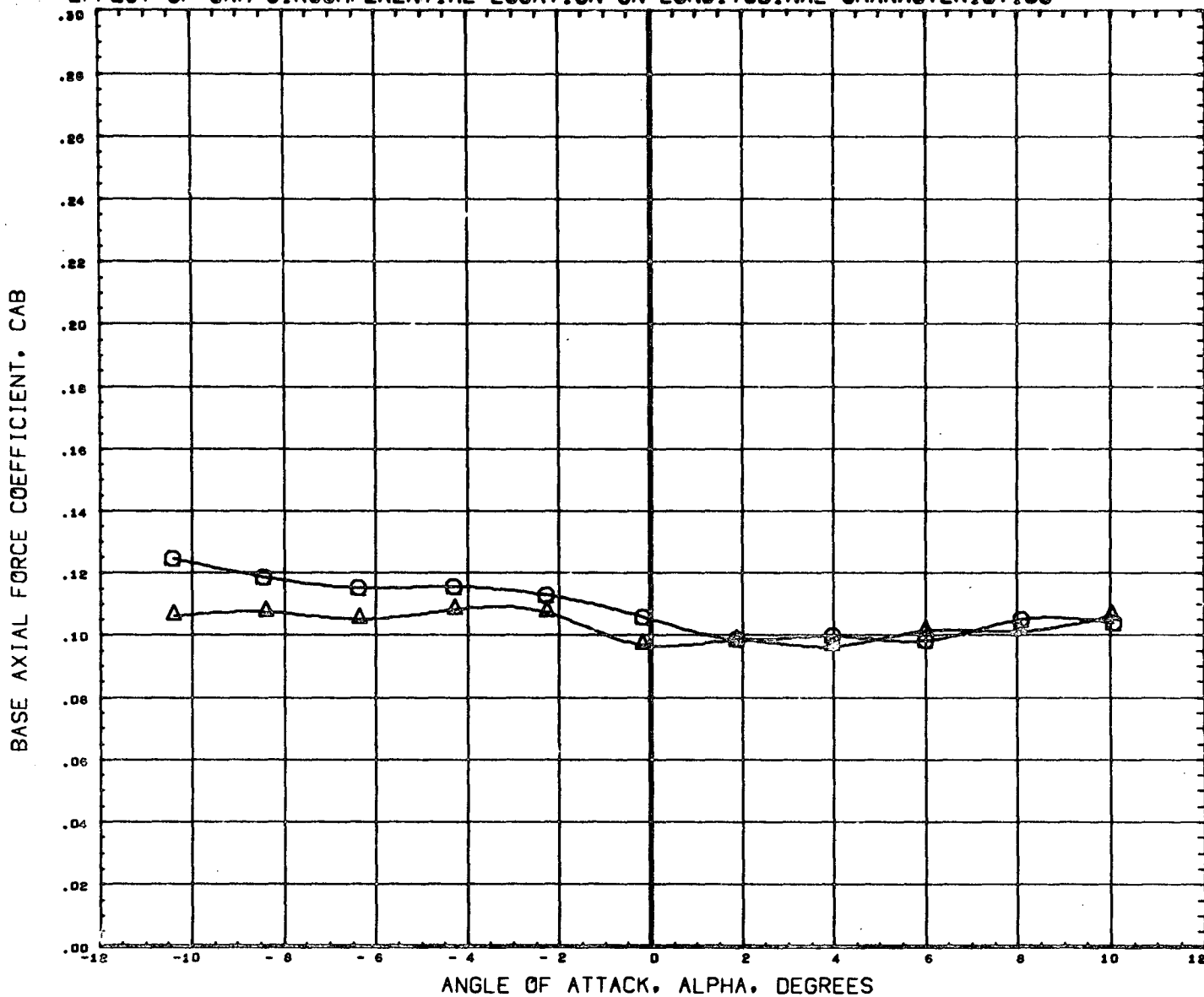

DATA SET SYMBOL	CONFIGURATION DESCRIPTION	ORBIN	THETS	BETA	REFERENCE INFORMATION
(B65010)	MSFC TWT 534 SHUTTLE LAUNCH	T101S1	-1.500	0.000	SREF 4.8950 SQ. IN
(B65004)	MSFC TWT 534 SHUTTLE LAUNCH	T101S1	-1.500	21.000	LREF 2.6440 IN.
					BREF 3.5250 IN.
					XMRP 3.4900 IN.
					YMRP 0.0000 IN.
					ZMRP 0.1616 IN.
					SCALE 0.0034

MACH .60

EFFECT OF SRM CIRCUMFERENTIAL LOCATION ON LONGITUDINAL CHARACTERISTICS

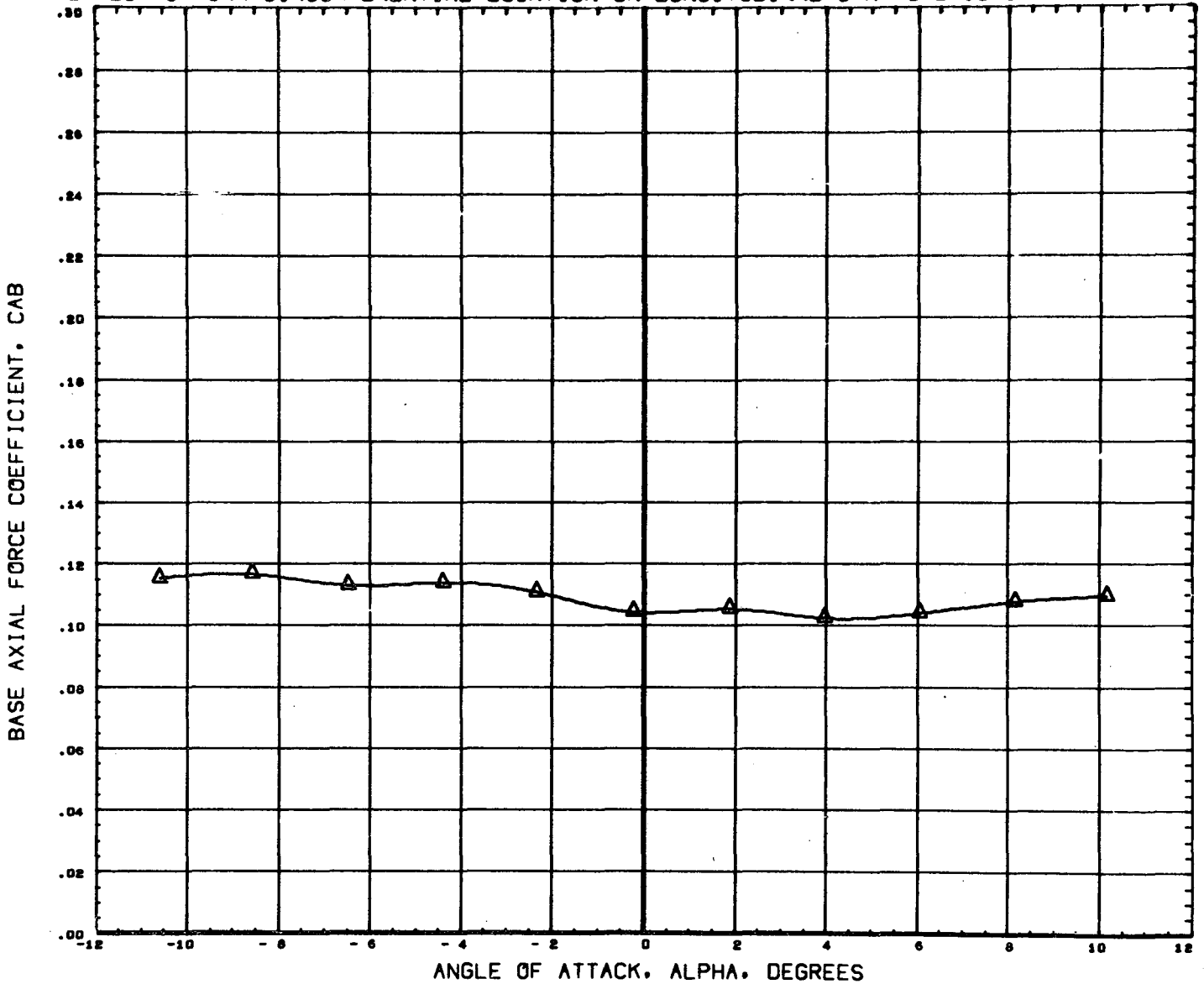

DATA SET SYMBOL CONFIGURATION DESCRIPTION
 (B65010) DATA NOT AVAILABLE FOR ALL CONDITIONS
 (B65004) MSFC TWT 534 SHUTTLE LAUNCH T101S1

ORBIN THETS BETA
 -1.500 0.000 0.000
 -1.500 21.000 0.000

REFERENCE INFORMATION
 SREF 4.8950 SQ. IN
 LREF 2.6440 IN.
 BREF 3.5250 IN.
 XMRP 3.4900 IN.
 YMRP 0.0000 IN.
 ZMRP 0.1616 IN.
 SCALE 0.0034

EFFECT OF SRM CIRCUMFERENTIAL LOCATION ON LONGITUDINAL CHARACTERISTICS

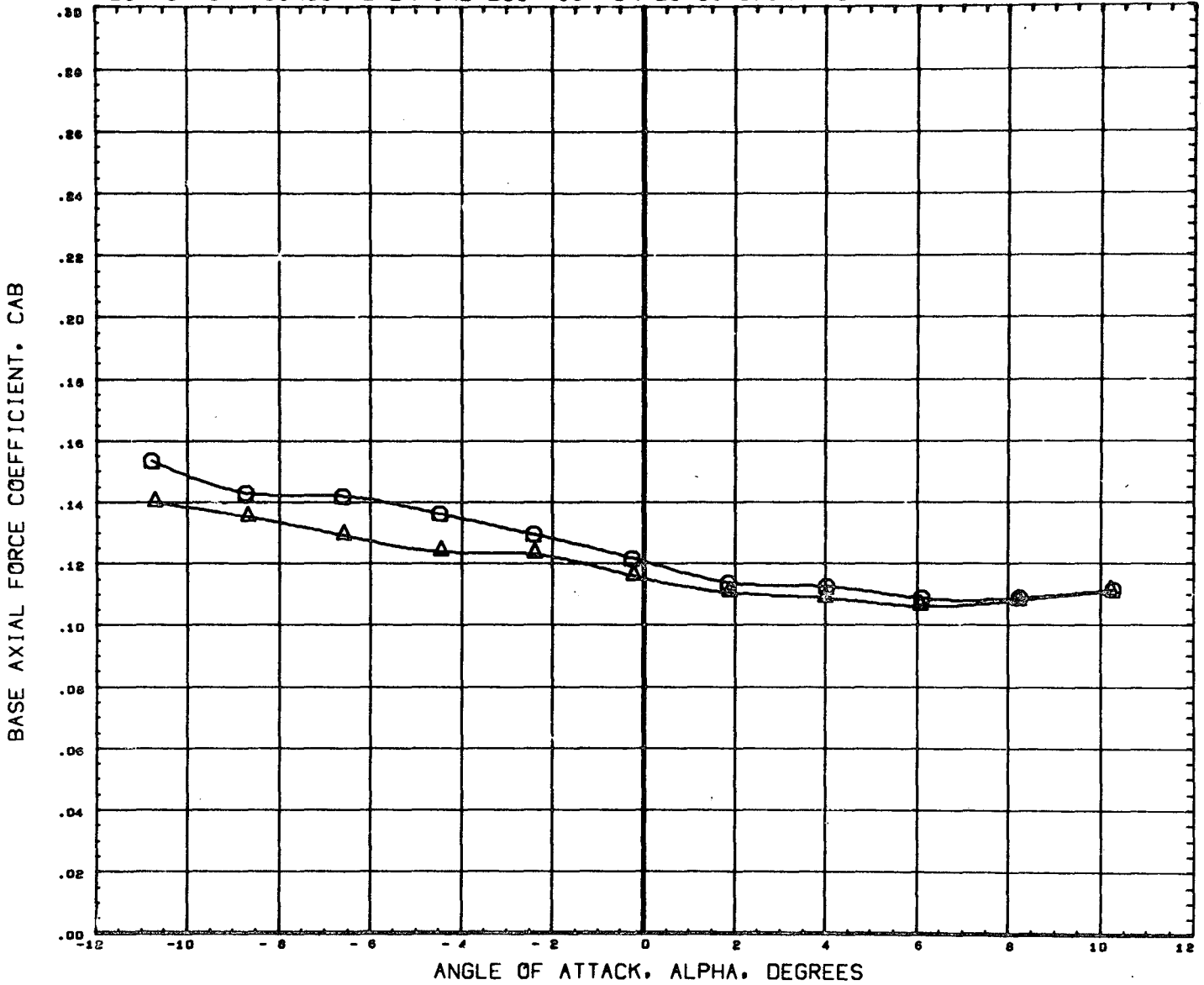

DATA SET SYMBOL	CONFIGURATION DESCRIPTION	ORBIN	THETS	BETA	REFERENCE INFORMATION
(B65D10)	MSFC TWT 534 SHUTTLE LAUNCH	T101S1	-1.500	0.000	SREF 4.8950 sq. IN
(B65D04)	MSFC TWT 534 SHUTTLE LAUNCH	T101S1	-1.500	21.000	LREF 2.6440 IN.
					BREF 3.5250 IN.
					XMRP 3.4900 IN.
					YMRP 0.0000 IN.
					ZMRP 0.1616 IN.
					SCALE 0.0034

MACH .90

EFFECT OF SRM CIRCUMFERENTIAL LOCATION ON LONGITUDINAL CHARACTERISTICS

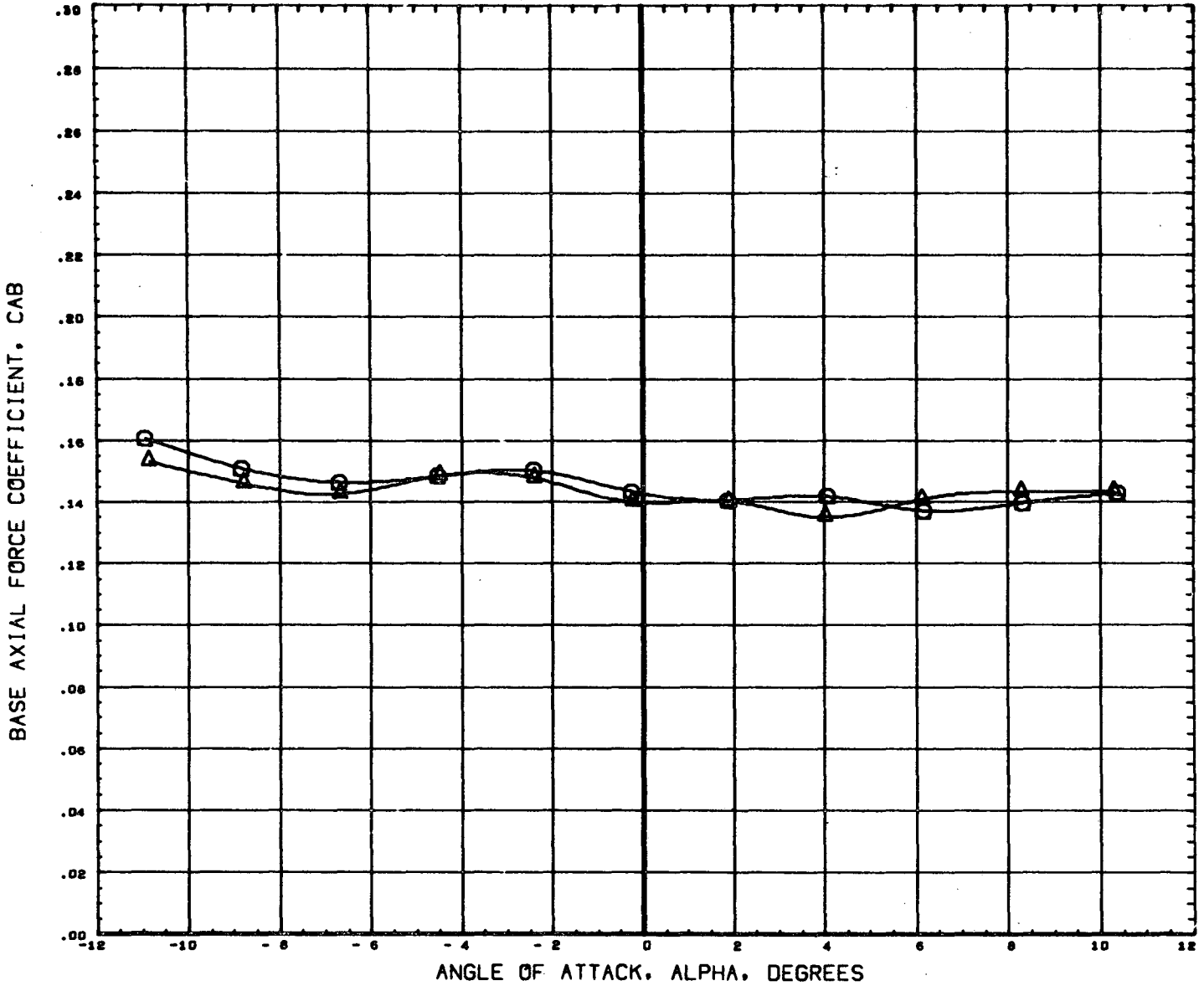

DATA SET SYMBOL	CONFIGURATION DESCRIPTION	ORBIN	THETS	BETA	REFERENCE INFORMATION
(869010)	MSFC TWT 534 SHUTTLE LAUNCH T101S1	-1.500	0.000	0.000	SREF 4.8950 sq. IN
(869004)	MSFC TWT 534 SHUTTLE LAUNCH T101S1	-1.500	21.000	0.000	LREF 2.6440 IN.
					BREF 3.5250 IN.
					XMRP 3.4900 IN.
					YMRP 0.0000 IN.
					ZMRP 0.1616 IN.
					SCALE 0.0034

EFFECT OF SRM CIRCUMFERENTIAL LOCATION ON LONGITUDINAL CHARACTERISTICS

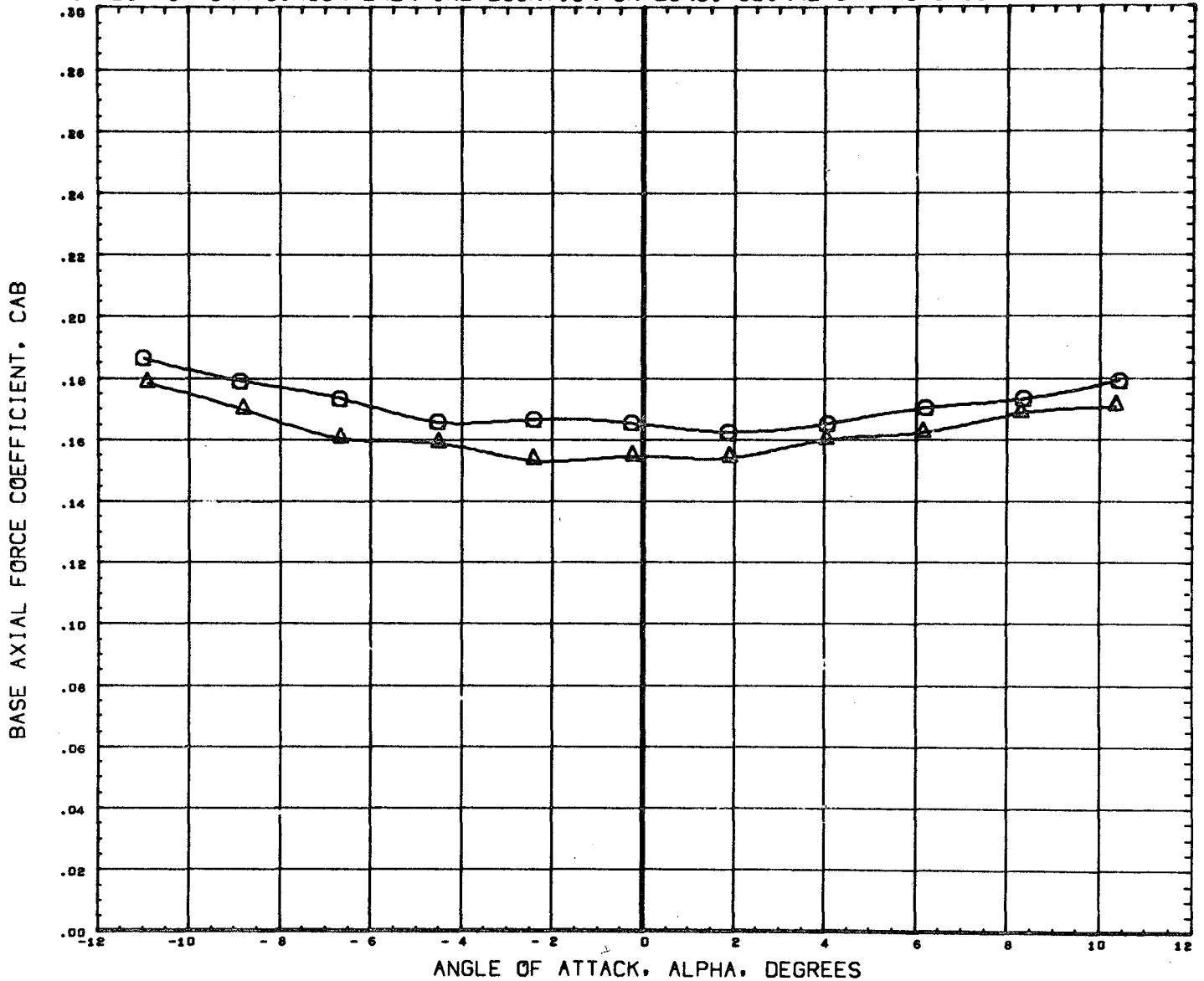

DATA SET SYMBOL	CONFIGURATION DESCRIPTION	ORBIN	THETS	BETA	REFERENCE INFORMATION
(B65010)	MSFC TWT 534 SHUTTLE LAUNCH	T101S1	-1.500	0.000	SREF 4.8950 SQ. IN.
(B65004)	MSFC TWT 534 SHUTTLE LAUNCH	T101S1	-1.500	21.000	LREF 2.6440 IN.
					BREF 3.5250 IN.
					XMRP 3.4900 IN.
					YMRP 0.0000 IN.
					ZMRP 0.1616 IN.
					SCALE 0.0034

MACH 1.20

EFFECT OF SRM CIRCUMFERENTIAL LOCATION ON LONGITUDINAL CHARACTERISTICS

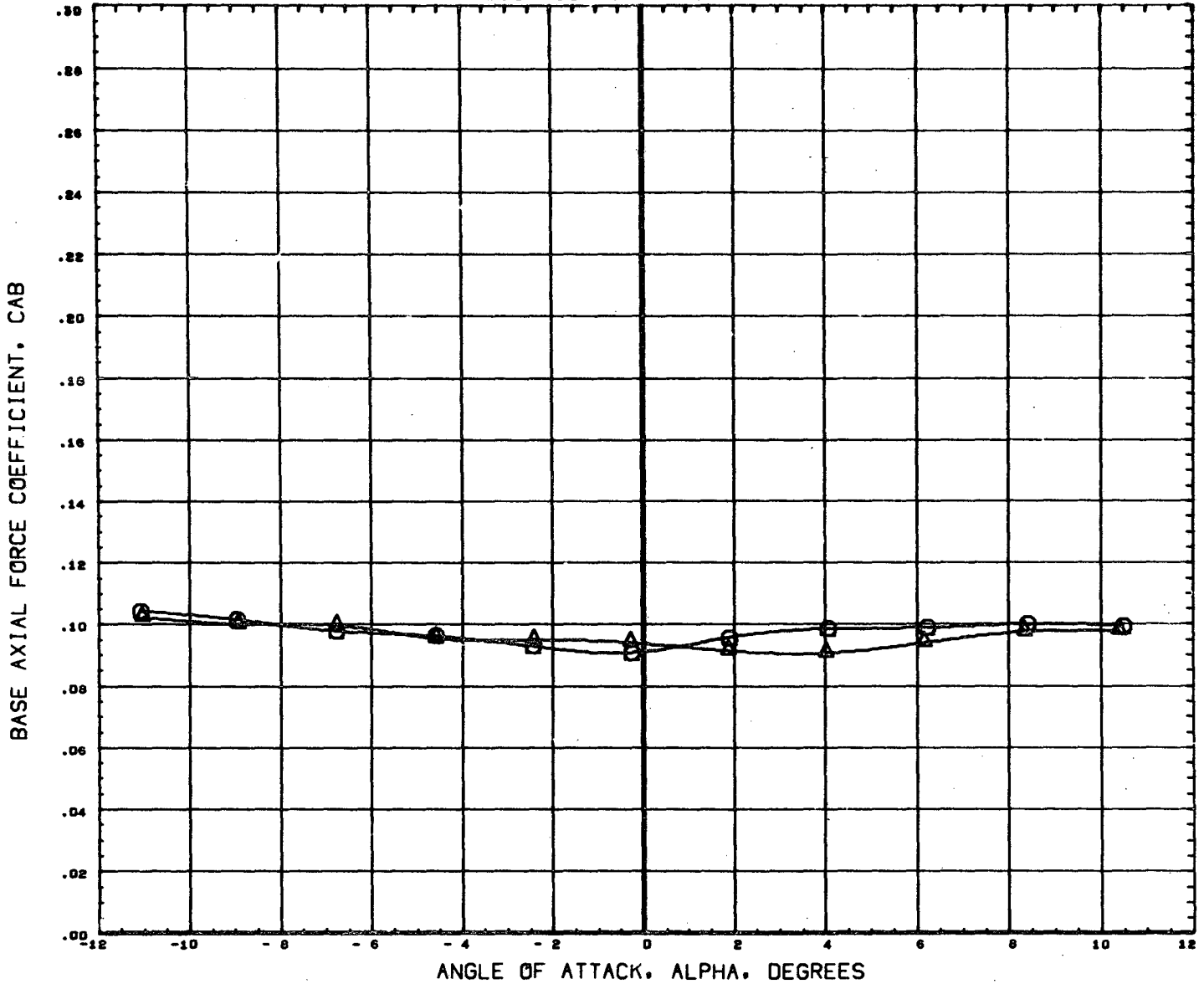

DATA SET SYMBOL	CONFIGURATION DESCRIPTION	T101S1
(865010)	NSFC TWT 534 SHUTTLE LAUNCH	T101S1
(865004)	NSFC TWT 534 SHUTTLE LAUNCH	T101S1

ORBIN	THETS	BETA
-1.500	0.000	0.000
-1.500	21.000	0.000

REFERENCE INFORMATION		
SREF	4.8950	sq. IN
LREF	2.6440	IN.
BREF	3.5250	IN.
XMRP	3.4900	IN.
YMRP	0.0000	IN.
ZMRP	0.1616	IN.
SCALE	0.0034	

EFFECT OF SRM CIRCUMFERENTIAL LOCATION ON LONGITUDINAL CHARACTERISTICS

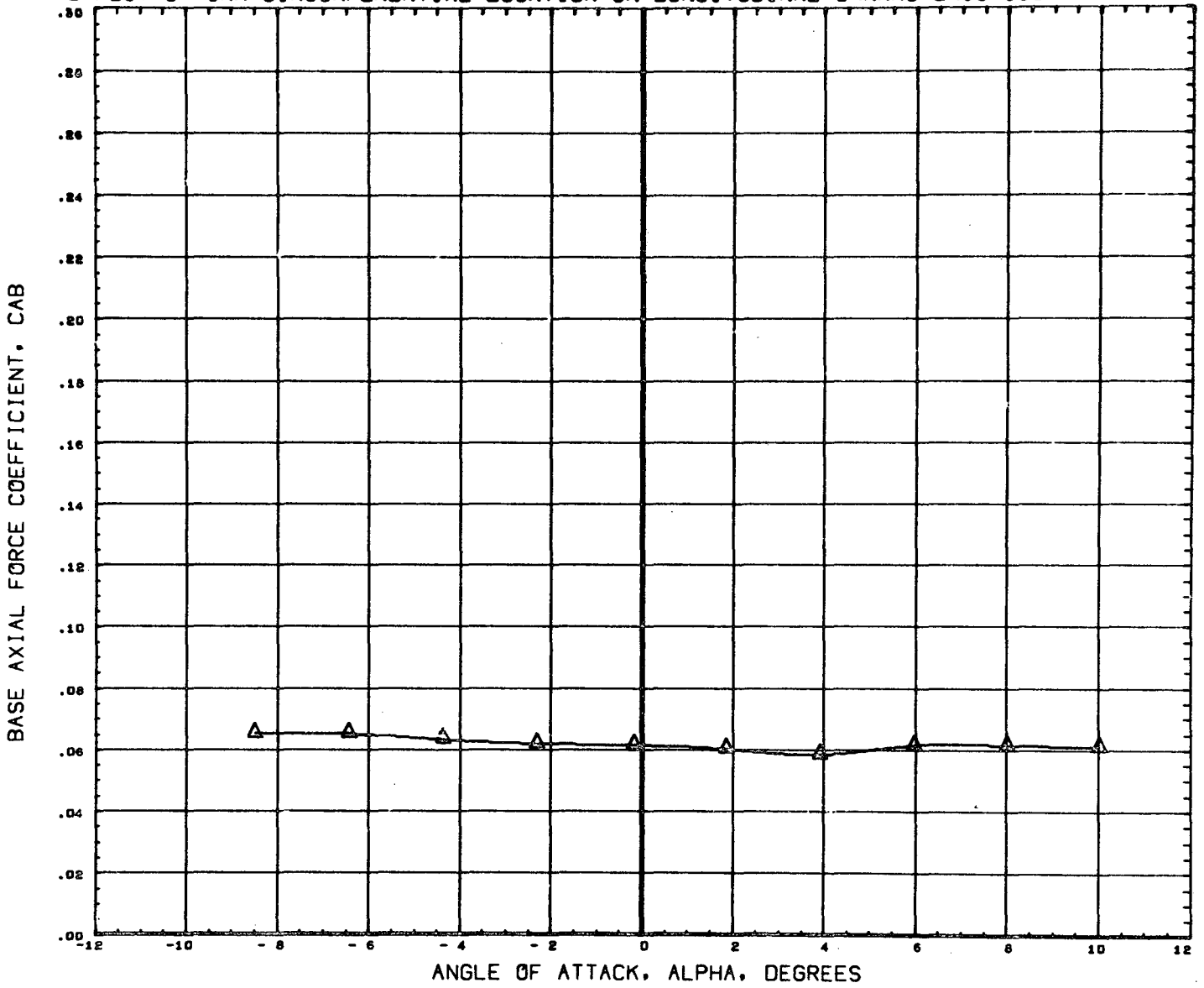

DATA SET SYMBOL	CONFIGURATION DESCRIPTION	ORBIN	THETS	BETA	REFERENCE INFORMATION
(B65010)	DATA NOT AVAILABLE FOR ALL CONDITIONS	-1.500	0.00J	0.000	SREF 4.8950 SQ. IN
(B65004)	MSFC TWT 534 SHUTTLE LAUNCH T101S1	-1.500	21.000	0.000	LREF 2.6440 IN.
					BREF 3.5250 IN.
					XMRP 3.4900 IN.
					YMRP 0.0000 IN.
					ZMRP 0.1616 IN.
					SCALE 0.0034

MACH 2.74

EFFECT OF SRM CIRCUMFERENTIAL LOCATION ON LONGITUDINAL CHARACTERISTICS

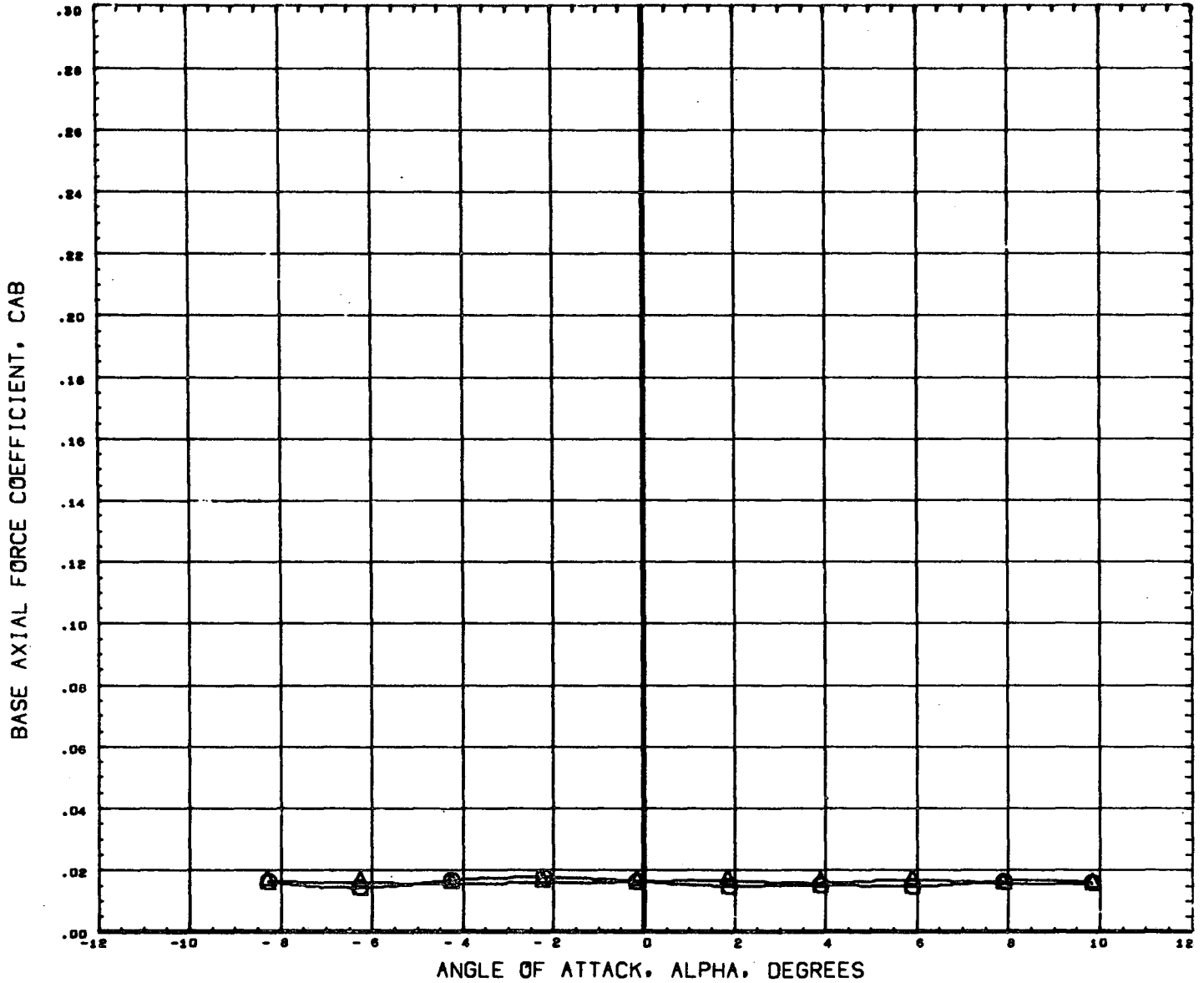

DATA SET SYMBOL	CONFIGURATION DESCRIPTION	ORBIN	THETS	BETA	REFERENCE INFORMATION
(865010)	MSFC TWT 534 SHUTTLE LAUNCH	T1O1S1	-1.500	0.000	SREF 4.8950 90. IN
(865004)	MSFC TWT 534 SHUTTLE LAUNCH	T1O1S1	-1.500	21.000	LREF 2.6440 IN.
					BREF 3.5250 IN.
					XMRP 3.4900 IN.
					YMRP 0.0000 IN.
					ZMRP 0.1616 IN.
					SCALE 0.0034

MACH 4.96

PAGE 296

EFFECT OF SRM CIRCUMFERENTIAL LOCATION ON LONGITUDINAL CHARACTERISTICS

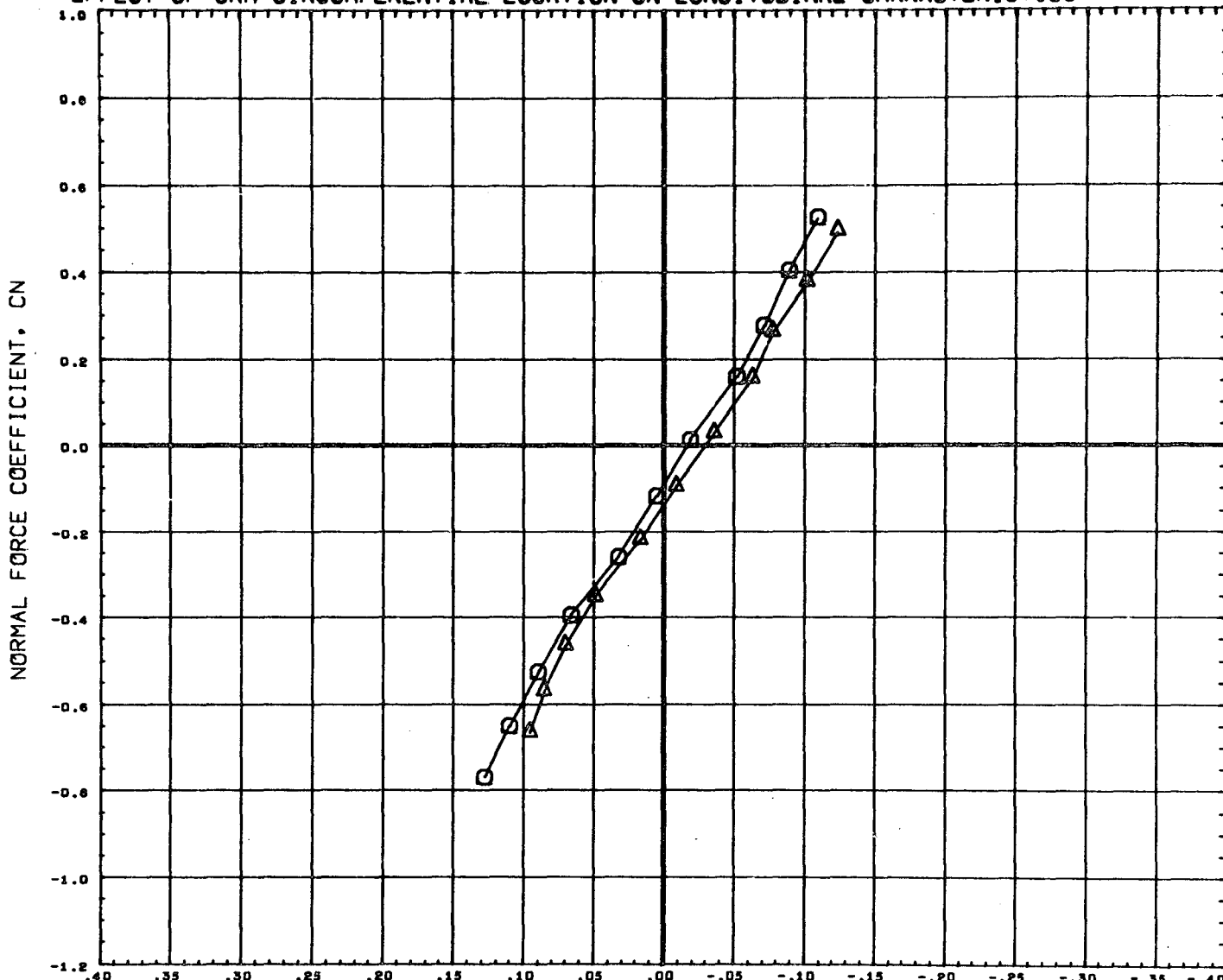

DATA SET SYMBOL	CONFIGURATION DESCRIPTION	ORBIN	THETS	BETA	REFERENCE INFORMATION
(B69010)	MSFC TWT 534 SHUTTLE LAUNCH	-1.500	0.000	0.000	SREF 4.8950 SQ. IN
(B69004)	MSFC TWT 534 SHUTTLE LAUNCH	-1.500	21.000	0.000	LREF 2.6440 IN.
					BREF 3.5250 IN.
					XMRP 3.4900 IN.
					YMRP 0.0000 IN.
					ZMRP 0.1616 IN.
					SCALE 0.0034

MACH .60

EFFECT OF SRM CIRCUMFERENTIAL LOCATION ON LONGITUDINAL CHARACTERISTICS

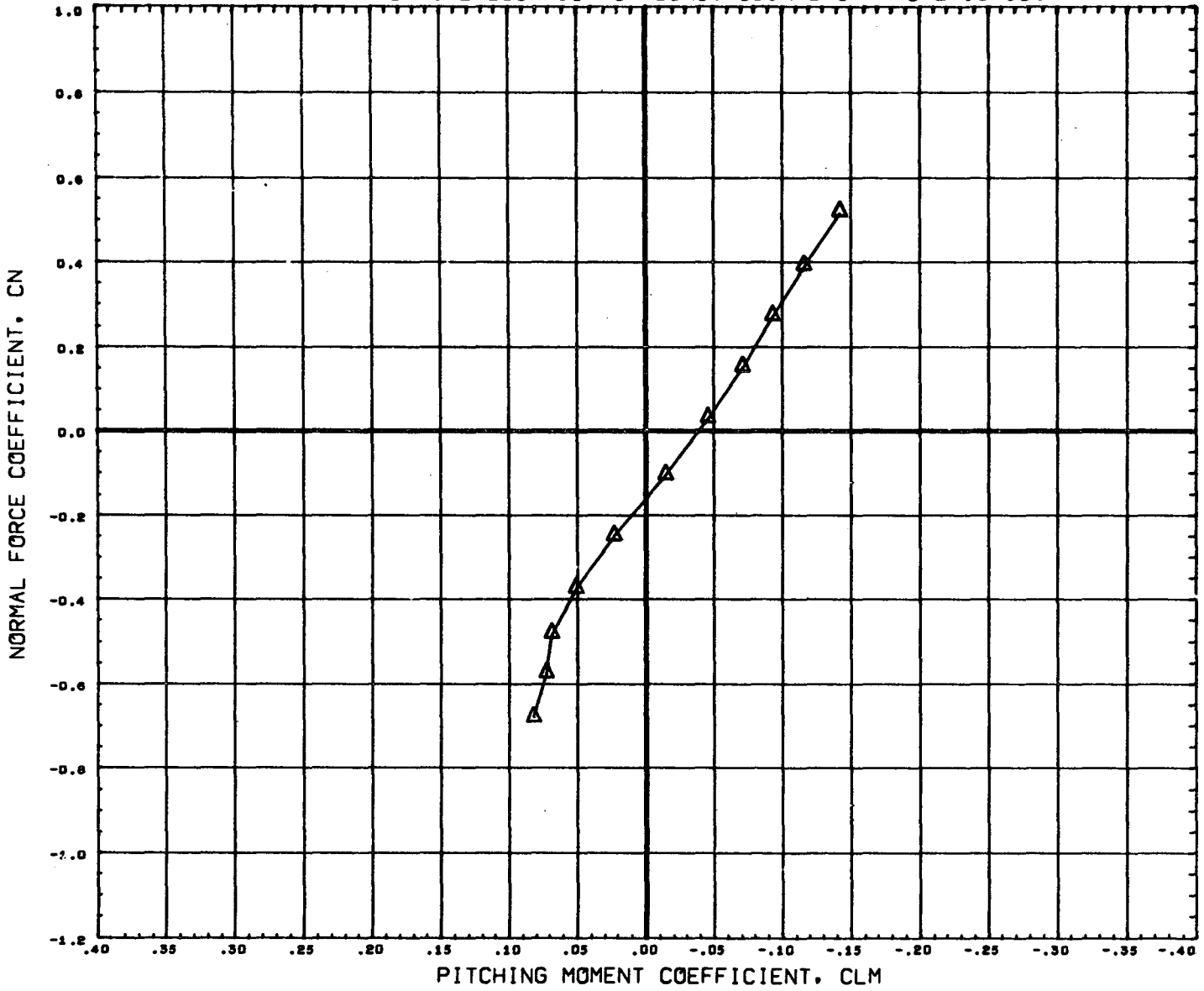

DATA SET SYMBOL CONFIGURATION DESCRIPTION
 (B65010) ○ DATA NOT AVAILABLE FOR ALL CONDITIONS
 (B65004) △ MSFC TWT 534 SHUTTLE LAUNCH T101S1

ORBIN THETS BETA
 -1.500 0.000 0.000
 -1.500 21.000 0.000

REFERENCE INFORMATION
 SREF 4.8950 SQ. IN
 LREF 2.6440 IN.
 BREF 3.5250 IN.
 XMRP 3.4900 IN.
 YMRP 0.0000 IN.
 ZMRP 0.1616 IN.
 SCALE 0.0034

MACH .80

EFFECT OF SRM CIRCUMFERENTIAL LOCATION ON LONGITUDINAL CHARACTERISTICS

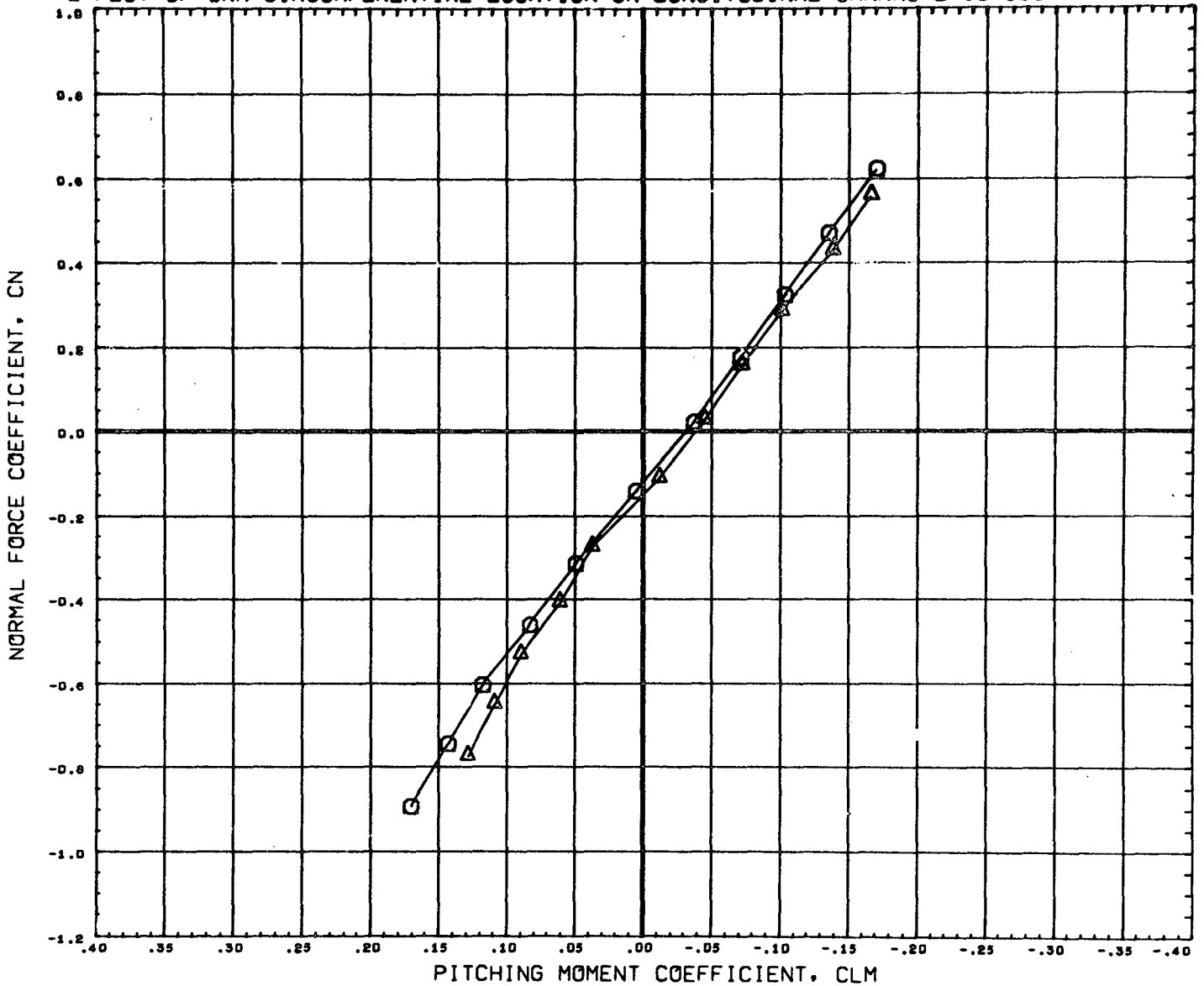

DATA SET SYMBOL	CONFIGURATION DESCRIPTION	ORBIN	THETS	BETA	REFERENCE INFORMATION
(B65010)	MSFC TWT 534 SHUTTLE LAUNCH	-1.500	0.000	0.000	SREF 4.8950 SQ. IN
(B65004)	MSFC TWT 534 SHUTTLE LAUNCH	-1.500	21.000	0.000	LREF 2.6440 IN.
					BREF 3.5250 IN.
					XMRP 3.4900 IN.
					YMRP 0.0000 IN.
					ZMRP 0.1616 IN.
					SCALE 0.0034

MACH .30

EFFECT OF SRM CIRCUMFERENTIAL LOCATION ON LONGITUDINAL CHARACTERISTICS

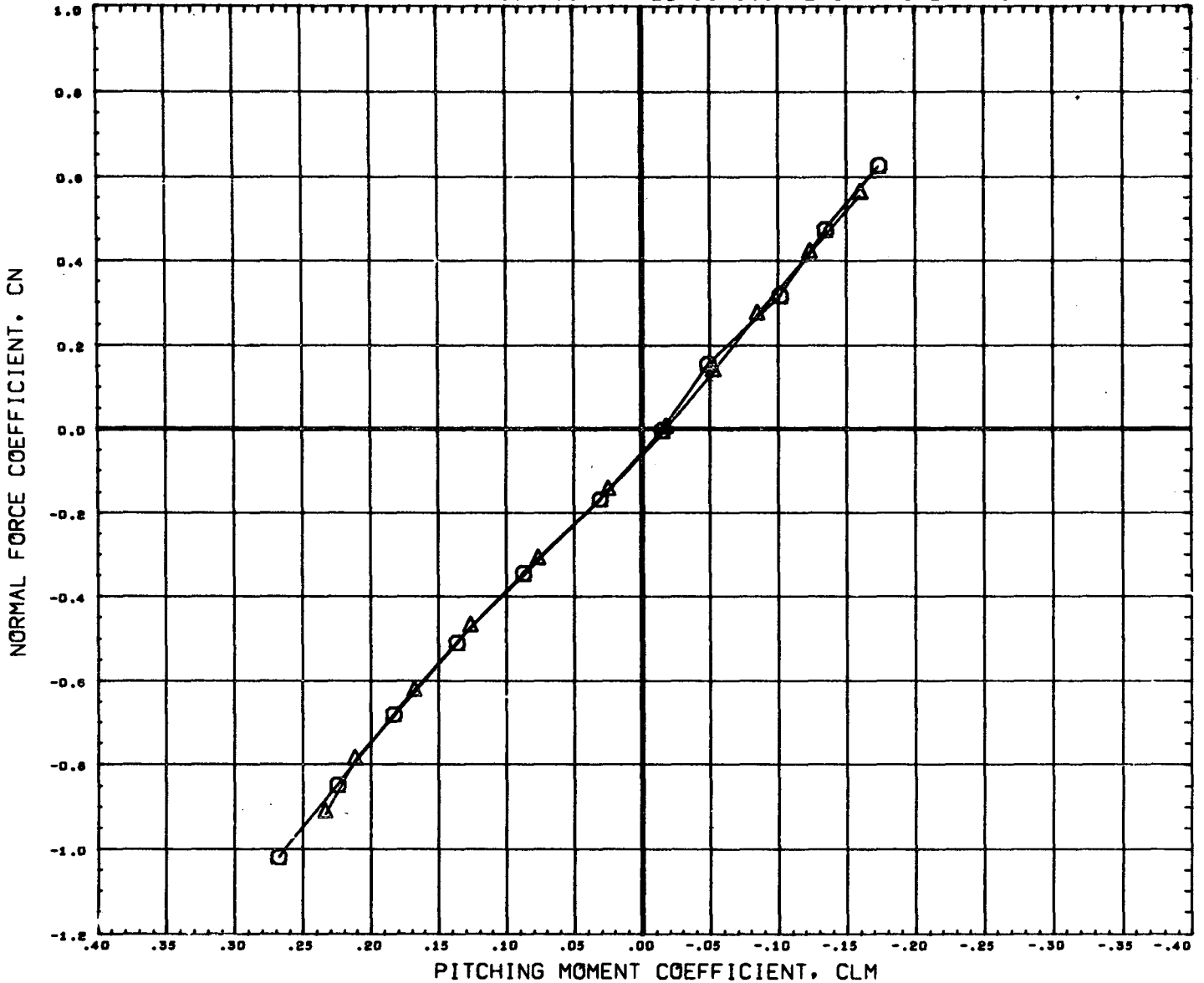

DATA SET SYMBOL	CONFIGURATION DESCRIPTION	ORBIT	THETS	BETA	REFERENCE INFORMATION
(B65010)	MSFC TWT 534 SHUTTLE LAUNCH	T101S1	-1.500	0.000	SREF 4.8950 SQ. IN
(B65004)	MSFC TWT 534 SHUTTLE LAUNCH	T101S1	-1.500	21.000	LREF 2.6440 IN.
					BREF 3.5250 IN.
					XMRP 3.4900 IN.
					YMRP 0.0000 IN.
					ZMRP 0.1616 IN.
					SCALE 0.0034

EFFECT OF SRM CIRCUMFERENTIAL LOCATION ON LONGITUDINAL CHARACTERISTICS

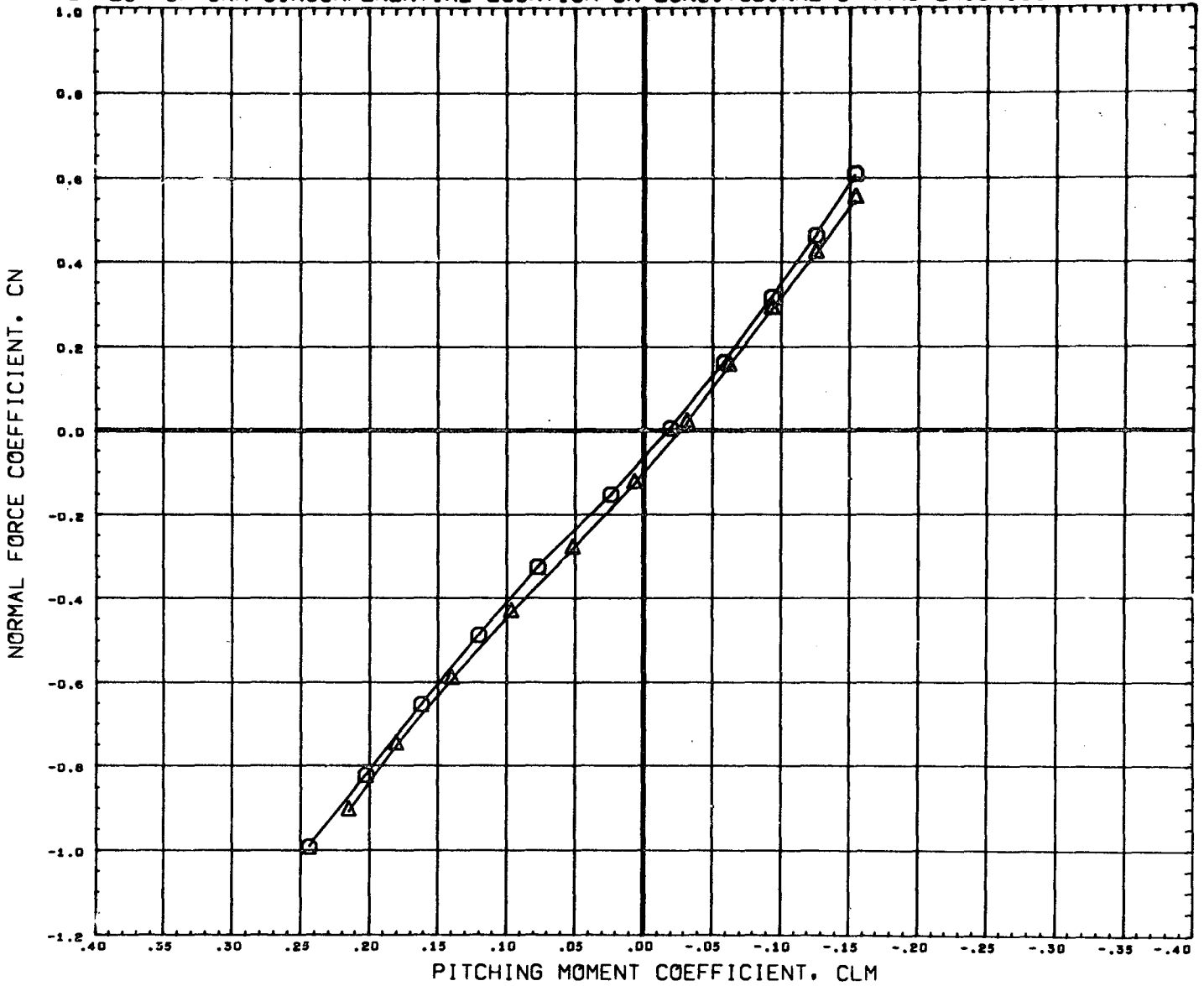

DATA SET SYMBOL	CONFIGURATION DESCRIPTION	ORBIN	THETS	BETA	REFERENCE INFORMATION
(865010)	MSFC TWT 534 SHUTTLE LAUNCH T101S1	-1.500	0.000	0.000	SREF 4.8950 SQ. IN
(865004)	MSFC TWT 534 SHUTTLE LAUNCH T101S1	-1.500	21.000	0.000	LREF 2.6440 IN.
					BREF 3.5250 IN.
					XMRP 3.4900 IN.
					YMRP 0.0000 IN.
					ZMRP 0.1616 IN.
					SCALE 0.0034

MACH 1.20

EFFECT OF SRM CIRCUMFERENTIAL LOCATION ON LONGITUDINAL CHARACTERISTICS

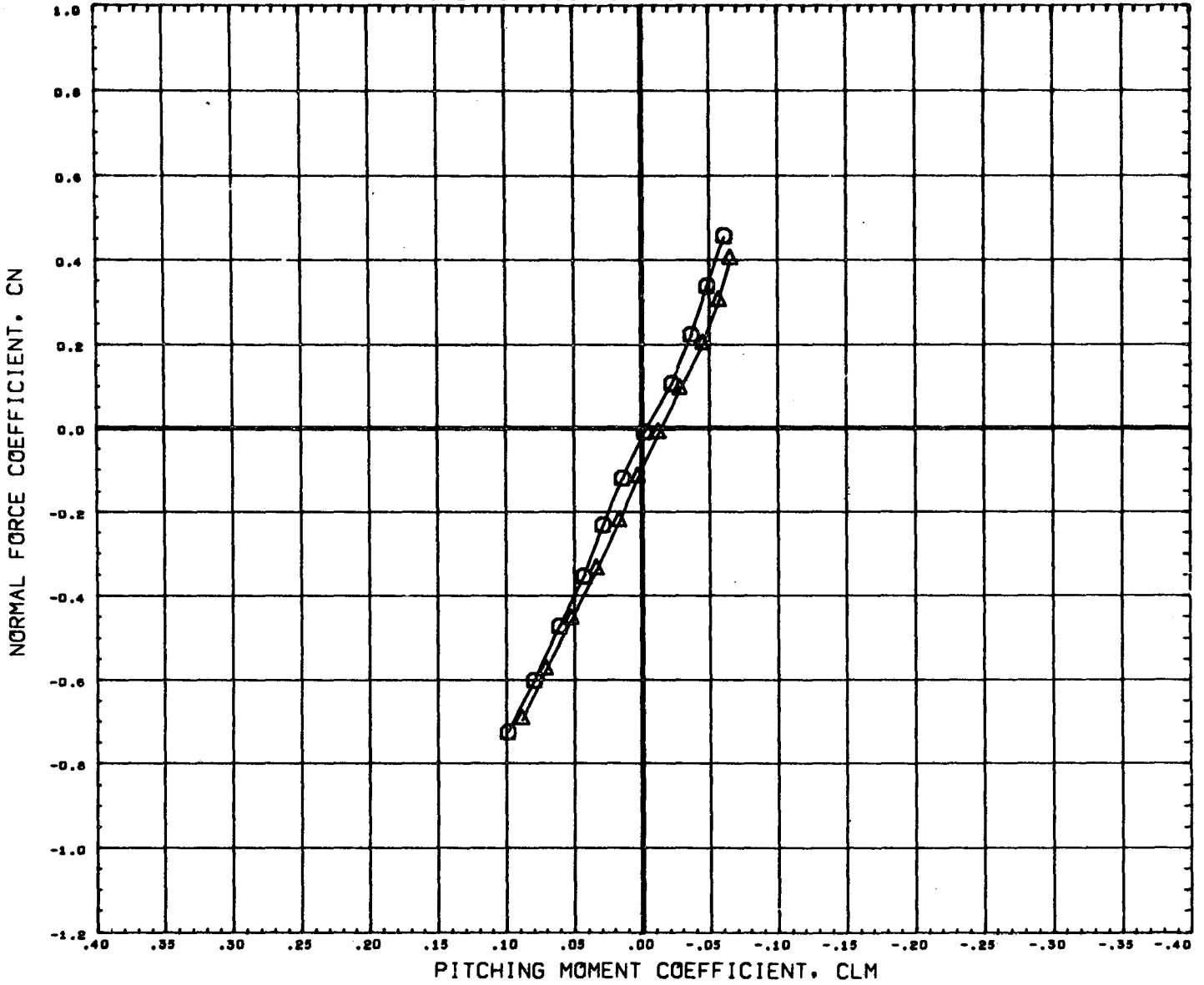

DATA SET SYMBOL	CONFIGURATION DESCRIPTION	ORBIT	THETA	BETA	REFERENCE INFORMATION
(B65010)	MSFC TWT 534 SHUTTLE LAUNCH	T101S1	-1.500	0.000	0.000
(B65004)	MSFC TWT 534 SHUTTLE LAUNCH	T101S1	-1.500	21.000	0.000
					SREF 4.8950 SQ. IN
					LREF 2.6440 IN.
					BREF 3.5250 IN.
					XMRP 3.4900 IN.
					YMRP 0.0000 IN.
					ZMRP 0.1616 IN.
					SCALE 0.0034

MACH 1.97

EFFECT OF SRM CIRCUMFERENTIAL LOCATION ON LONGITUDINAL CHARACTERISTICS

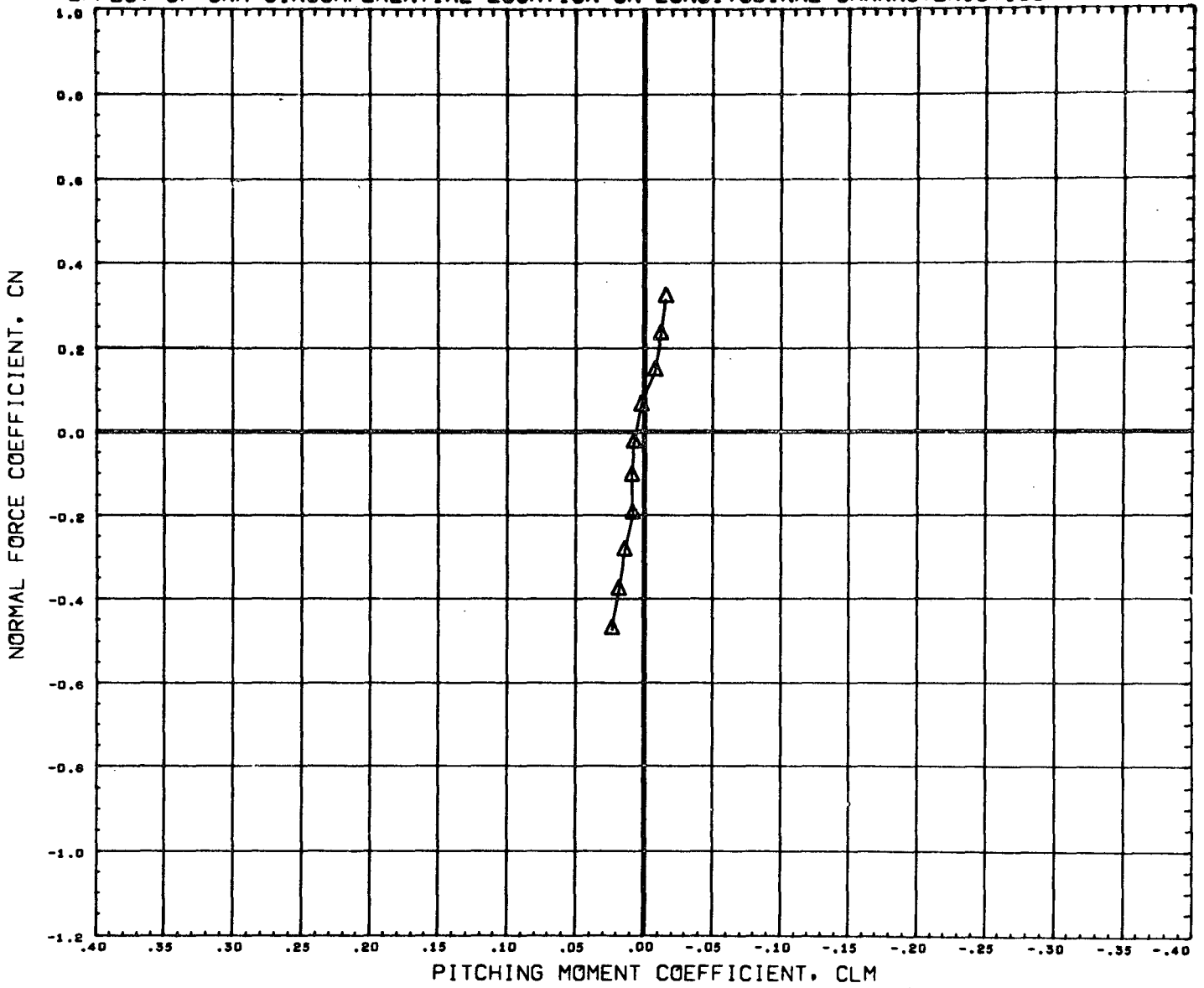

DATA SET SYMBOL CONFIGURATION DESCRIPTION
 (B65010) ○ DATA NOT AVAILABLE FOR ALL CONDITIONS
 (B65004) △ MSFC TWT 534 SHUTTLE LAUNCH T101S1

ORBIN THETS BETA
 -1.500 0.000 0.000
 -1.500 21.000 0.000

REFERENCE INFORMATION
 SREF 4.8950 SQ. IN
 LREF 2.6440 IN.
 BREF 3.5250 IN.
 XMRP 3.4900 IN.
 YMRP 0.0000 IN.
 ZMRP 0.1616 IN.
 SCALE 0.0034

MACH 2.74

PAGE 303

EFFECT OF SRM CIRCUMFERENTIAL LOCATION ON LONGITUDINAL CHARACTERISTICS

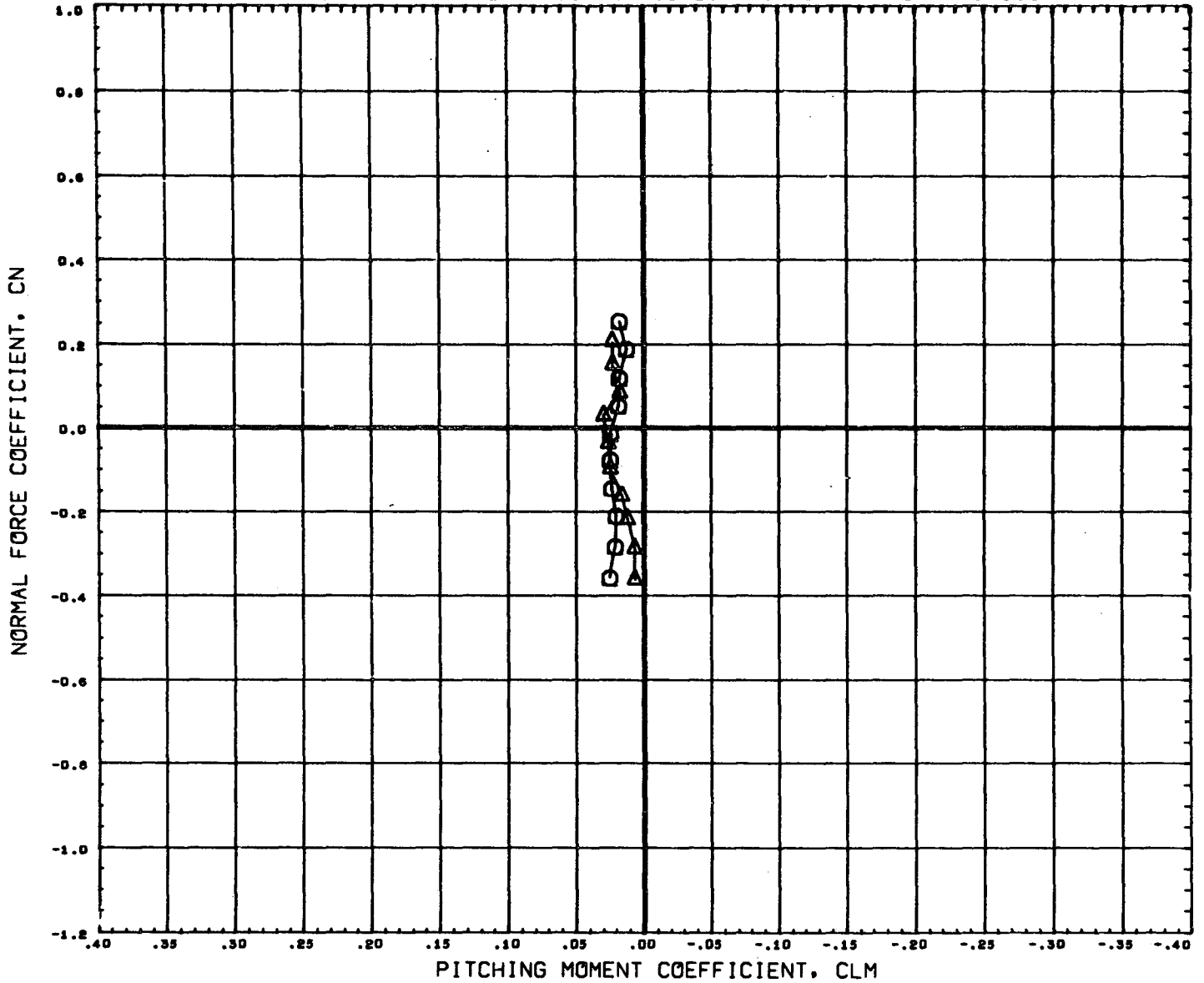

DATA SET SYMBOL	CONFIGURATION DESCRIPTION	ORBIN	THETS	BETA	REFERENCE INFORMATION
(B65010)	MSFC TWT 534 SHUTTLE LAUNCH	T101S1	-1.500	0.000	SREF 4.8950 SQ. IN
(B65004)	MSFC TWT 534 SHUTTLE LAUNCH	T101S1	-1.500	21.000	LREF 2.6440 IN.
					BREF 3.5250 IN.
					XMRP 3.4900 IN.
					YMRP 0.0000 IN.
					ZMRP 0.1616 IN.
					SCALE 0.0034

EFFECT OF SRM CIRCUMFERENTIAL LOCATION ON LATERAL/DIRECTIONAL CHARACTERISTICS

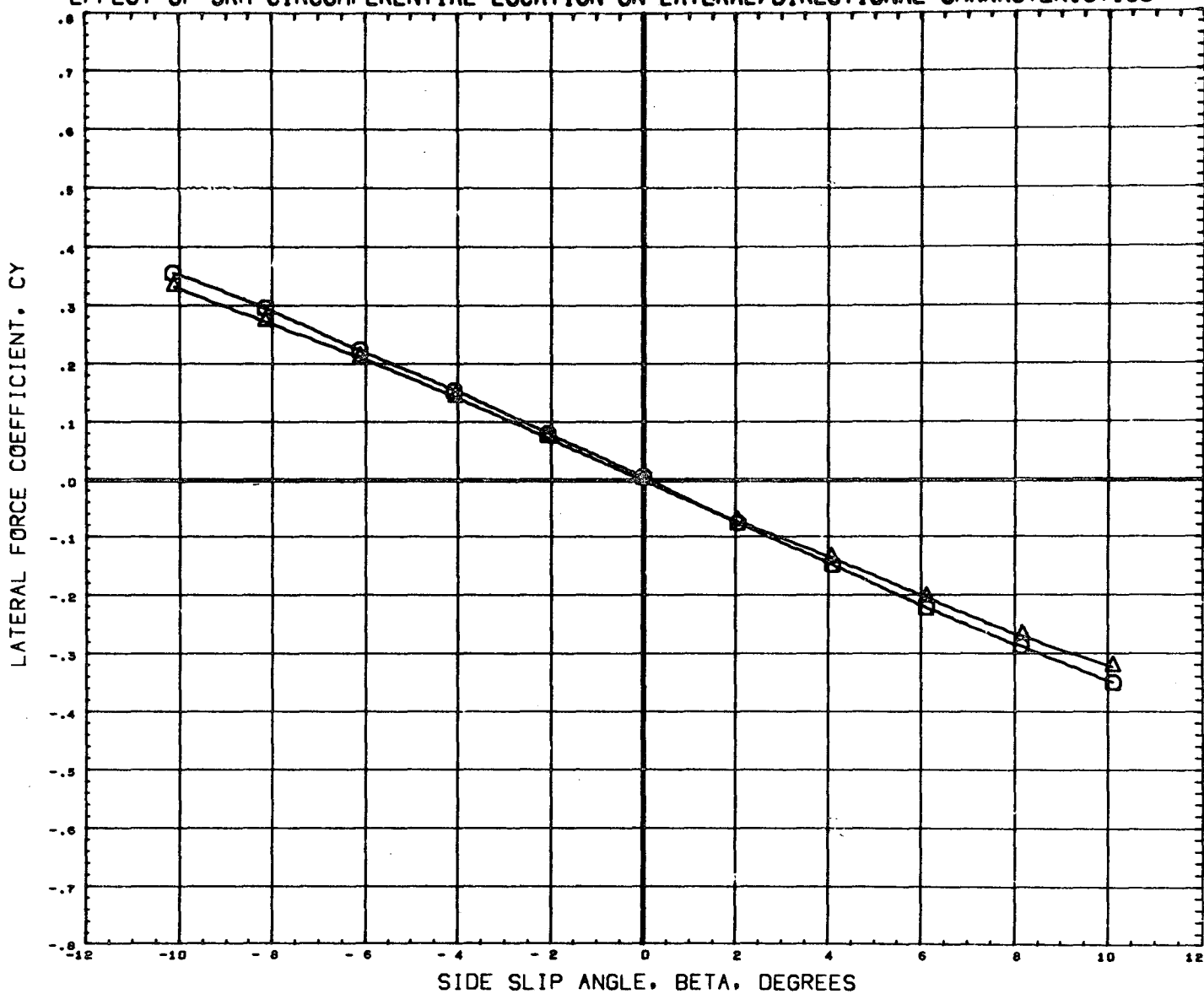

DATA SET SYMBOL	CONFIGURATION DESCRIPTION	ORBIN	THETS	ALPHA	REFERENCE INFORMATION
(B65011) ○	MSFC TWT 534 SHUTTLE LAUNCH	T101S1	-1.500	0.000	SREF 4.8950 SQ. IN
(B65005) △	MSFC TWT 534 SHUTTLE LAUNCH	T101S1	-1.500	21.000	LREF 2.6440 IN.
					BREF 3.5250 IN.
					XMRP 3.4900 IN.
					YMRP 0.0000 IN.
					ZMRP 0.1616 IN.
					SCALE 6.0034

MACH .60

PAGE 305

EFFECT OF SRM CIRCUMFERENTIAL LOCATION ON LATERAL/DIRECTIONAL CHARACTERISTICS

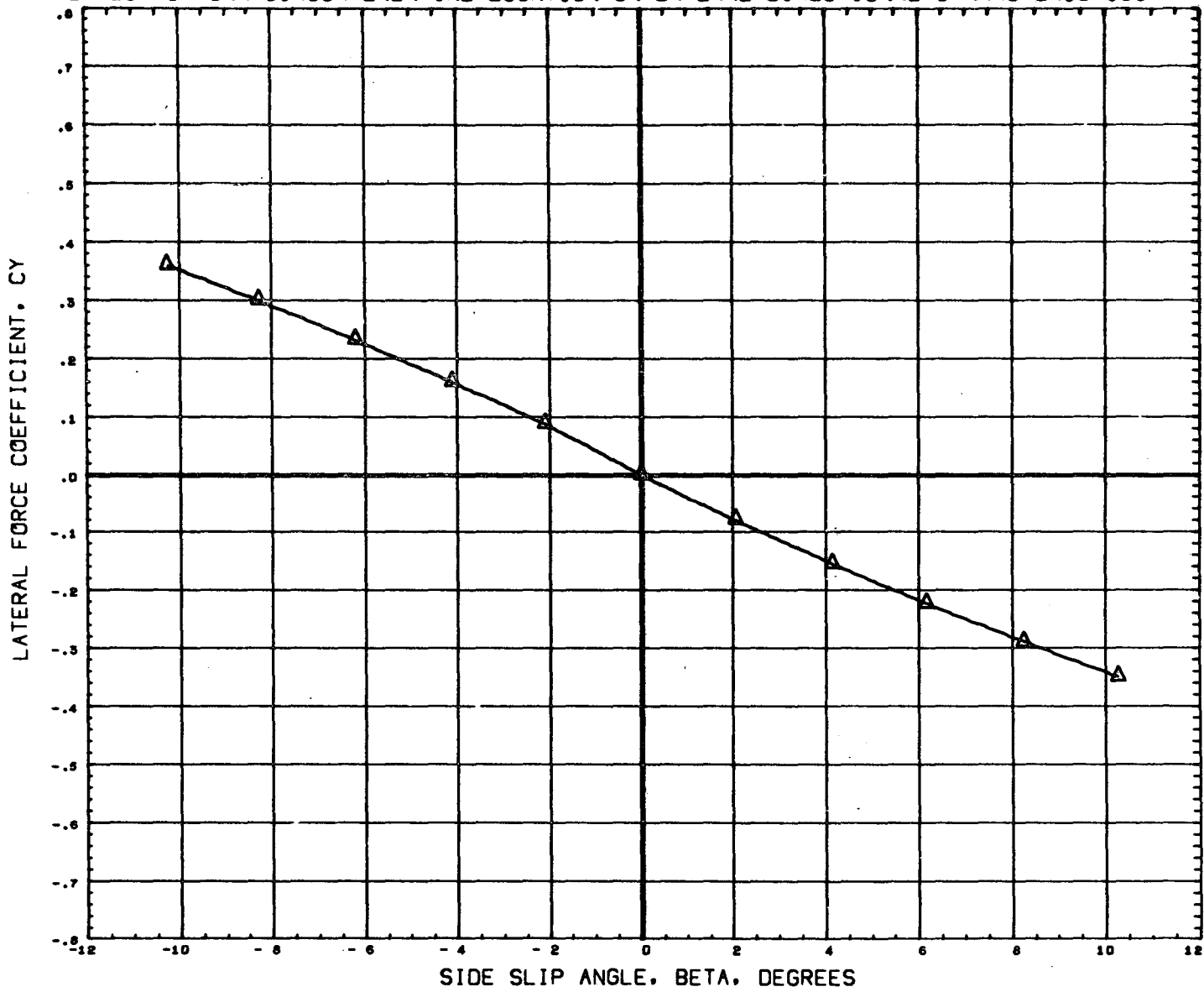

DATA SET SYMBOL CONFIGURATION DESCRIPTION
 (865011) \square DATA NOT AVAILABLE FOR ALL CONDITIONS
 (865005) \triangle MSFC TWT 534 SHUTTLE LAUNCH T101S1

ORBIN THETS ALPHA
 -1.500 0.000 0.000
 -1.500 21.000 0.000

REFERENCE INFORMATION
 SREF 4.8950 SQ. IN
 LREF 2.6440 IN.
 BREF 3.5250 IN.
 XMRP 3.4900 IN.
 YMRP 0.0000 IN.
 ZMRP 0.1616 IN.
 SCALE 0.0034

MACH .80

PAGE 306

EFFECT OF SRM CIRCUMFERENTIAL LOCATION ON LATERAL/DIRECTIONAL CHARACTERISTICS

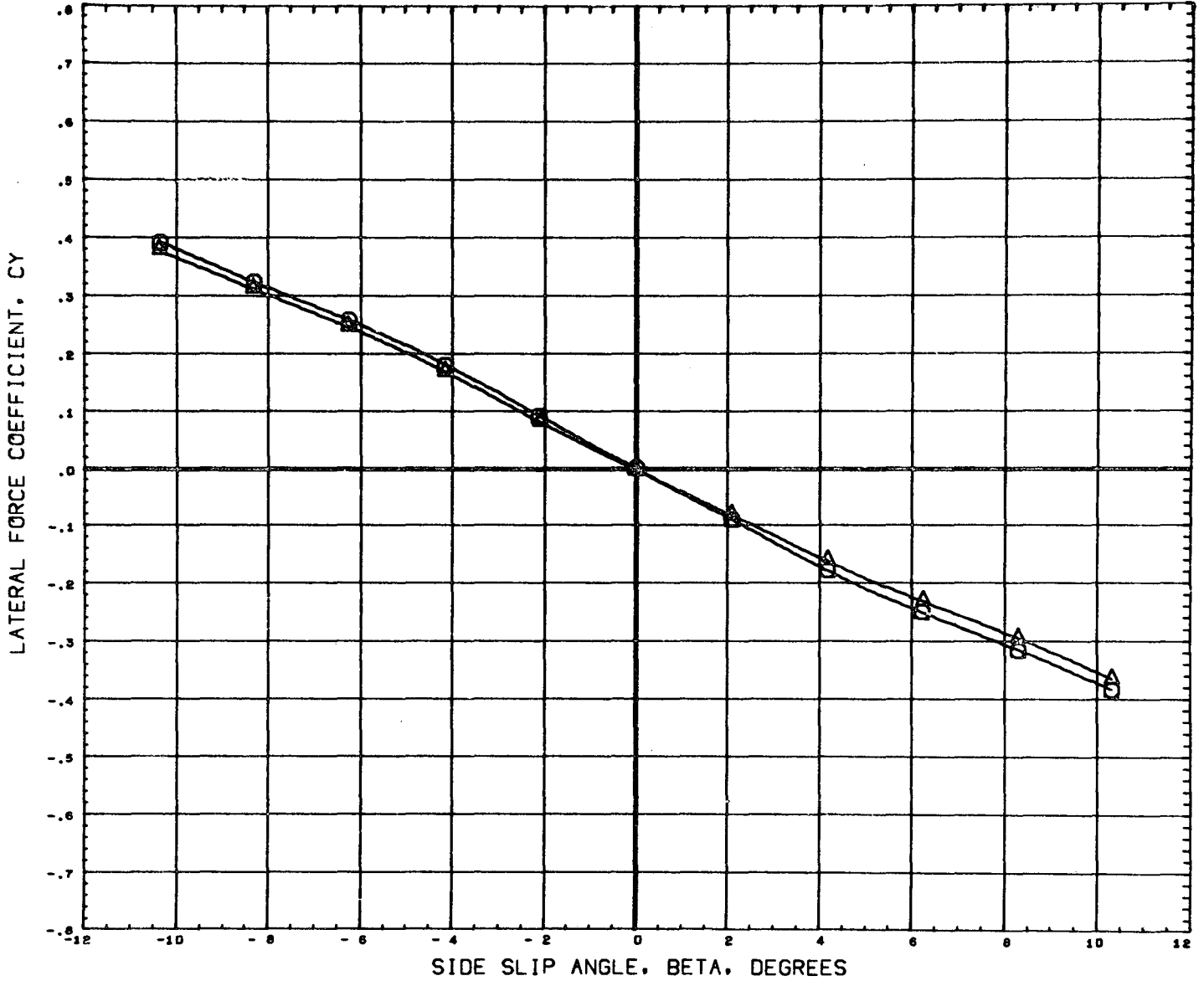

DATA SET SYMBOL	CONFIGURATION DESCRIPTION	ORBIN	THETS	ALPHA	REFERENCE INFORMATION
(B65011)	MSFC TWT 534 SHUTTLE LAUNCH	T101S1	-1.500	0.000	SREF 4.8950 SQ. IN.
(B65005)	MSFC TWT 534 SHUTTLE LAUNCH	T101S1	-1.500	21.000	LREF 2.6440 IN.
					BREF 3.5250 IN.
					XMRP 3.4900 IN.
					YMRP 0.0000 IN.
					ZMRP 0.1616 IN.
					SCALE 0.0034

MACH .90

EFFECT OF SRM CIRCUMFERENTIAL LOCATION ON LATERAL/DIRECTIONAL CHARACTERISTICS

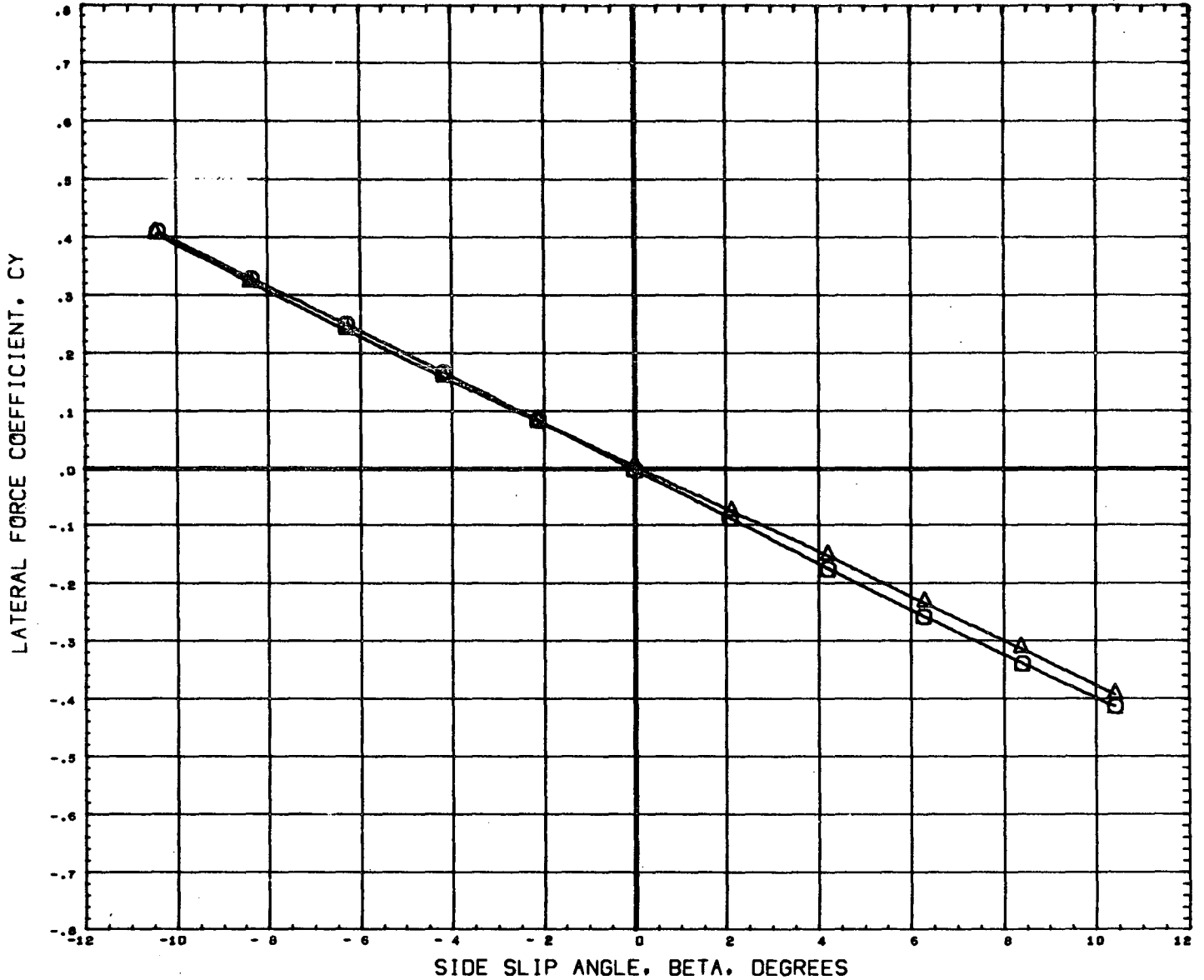

DATA SET SYMBOL	CONFIGURATION DESCRIPTION	ORBIN	THETS	ALPHA	REFERENCE INFORMATION
(B65011)	MSFC TWT 534 SHUTTLE LAUNCH	-1.500	0.000	0.000	SREF 4.8950 SQ. IN
(B65005)	MSFC TWT 534 SHUTTLE LAUNCH	-1.500	21.000	0.000	LREF 2.6440 IN.
					BREF 3.5250 IN.
					XMRP 3.4900 IN.
					YMRP 0.0000 IN.
					ZMRP 0.1616 IN.
					SCALE 0.0034

MACH 1.10

PAGE 308

EFFECT OF SRM CIRCUMFERENTIAL LOCATION ON LATERAL/DIRECTIONAL CHARACTERISTICS

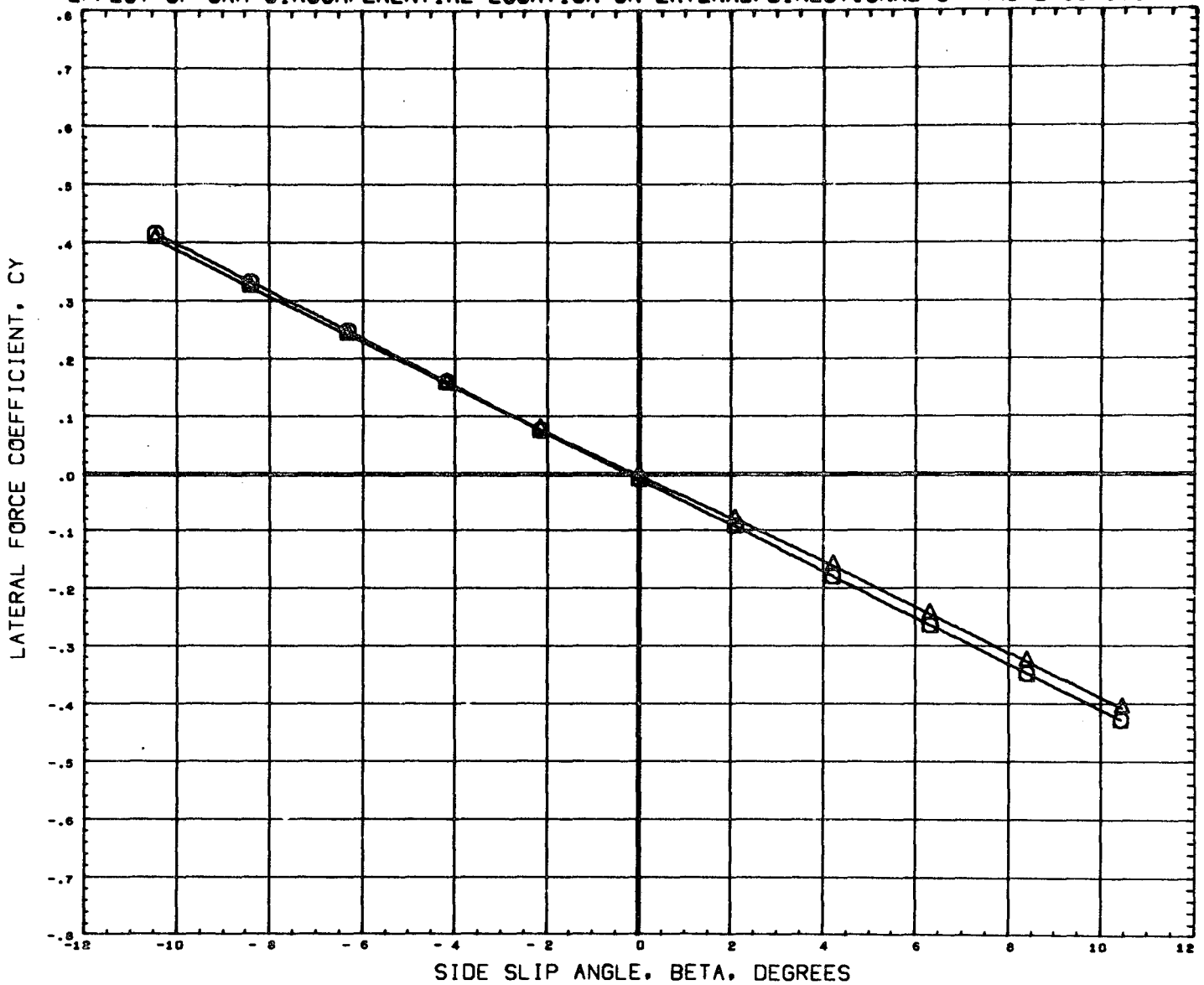

DATA SET SYMBOL	CONFIGURATION DESCRIPTION	ORBIN	THETS	ALPHA	REFERENCE INFORMATION
(B65011)	NSFC TWT 534 SHUTTLE LAUNCH	T101S1	-1.500	0.000	SREF 4.8950 SQ. IN
(B65005)	NSFC TWT 534 SHUTTLE LAUNCH	T101S1	-1.500	21.000	LREF 2.6440 IN.
					BREF 3.5250 IN.
					XMRP 3.4900 IN.
					YMRP 0.0000 IN.
					ZMRP 0.1616 IN.
					SCALE 0.0034

MACH 1.19

EFFECT OF SRM CIRCUMFERENTIAL LOCATION ON LATERAL/DIRECTIONAL CHARACTERISTICS

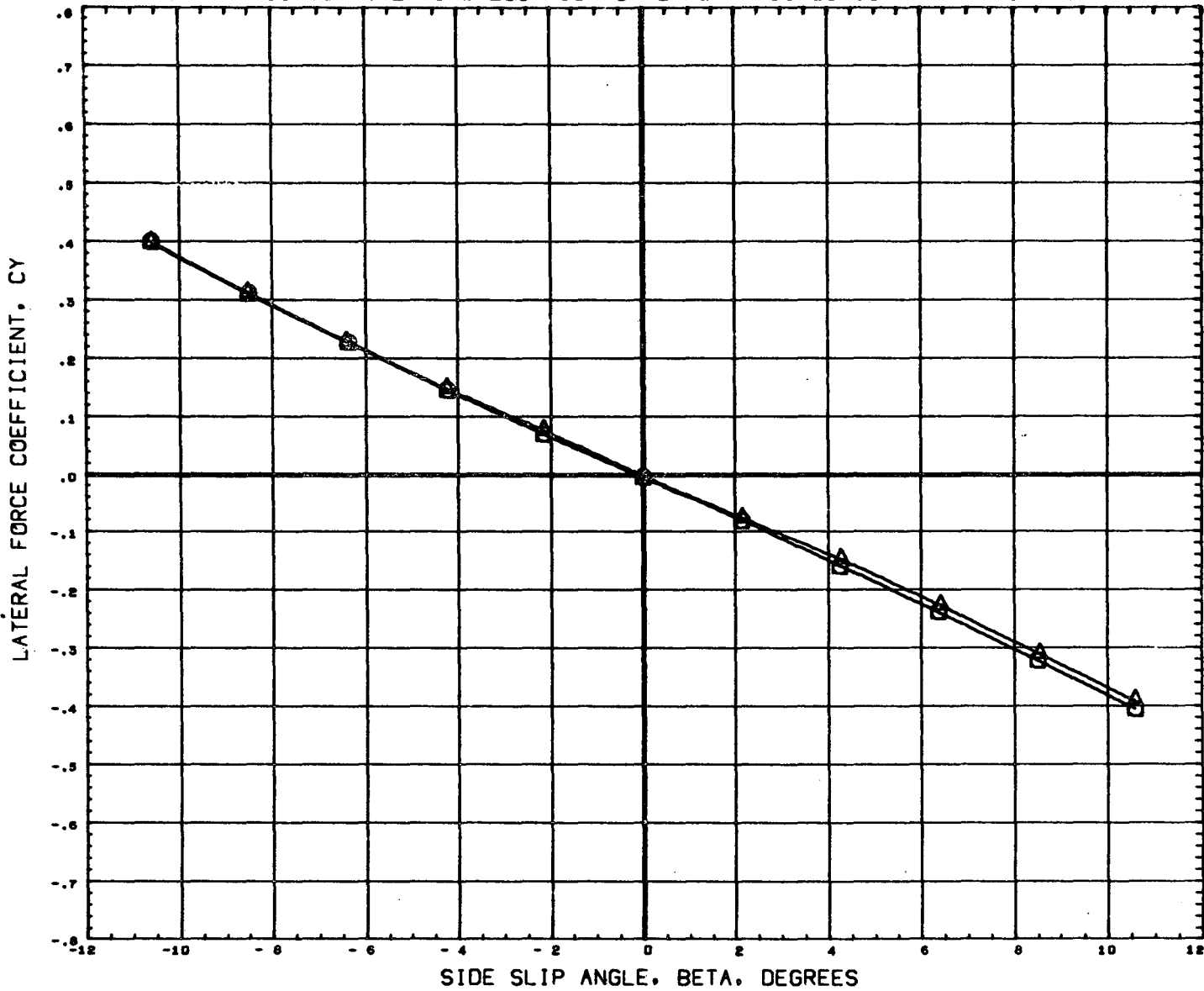

DATA SET SYMBOL	CONFIGURATION DESCRIPTION	ORBIN	THETS	ALPHA	REFERENCE INFORMATION
(B65011)	MSFC TWT 534 SHUTTLE LAUNCH	-1.500	0.000	0.000	SREF 4.8950 SQ. IN
(B65005)	MSFC TWT 534 SHUTTLE LAUNCH	-1.500	21.000	0.000	LREF 2.6440 IN.
					BREF 3.5250 IN.
					XMNP 3.4900 IN.
					YMNP 0.0000 IN.
					ZMNP 0.1616 IN.
					SCALE 0.0034

MACH 1.97

EFFECT OF SRM CIRCUMFERENTIAL LOCATION ON LATERAL/DIRECTIONAL CHARACTERISTICS

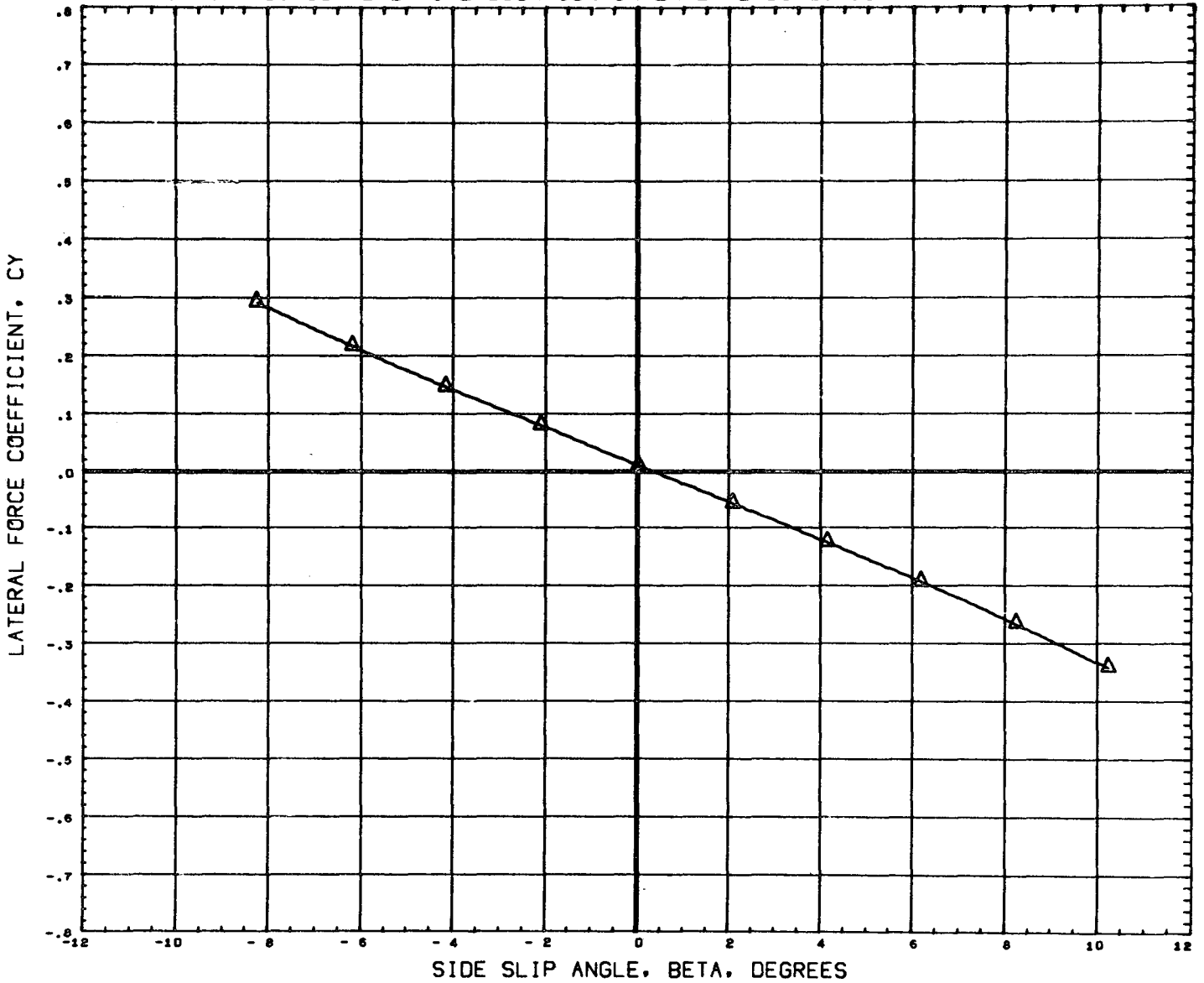

DATA SET SYMBOL CONFIGURATION DESCRIPTION
 (B65011) \square DATA NOT AVAILABLE FOR ALL CONDITIONS
 (B65005) \triangle MSFC TWT 534 SHUTTLE LAUNCH T101S1

ORBIN THETS ALPHA
 -1.500 0.000 0.000
 -1.500 21.000 0.000

REFERENCE INFORMATION
 SREF 4.8950 SQ. IN
 LREF 2.6440 IN.
 BREF 3.5250 IN.
 XMRP 3.4900 IN.
 YMRP 0.0000 IN.
 ZMRP 0.1616 IN.
 SCALE 0.0034

EFFECT OF SRM CIRCUMFERENTIAL LOCATION ON LATERAL/DIRECTIONAL CHARACTERISTICS

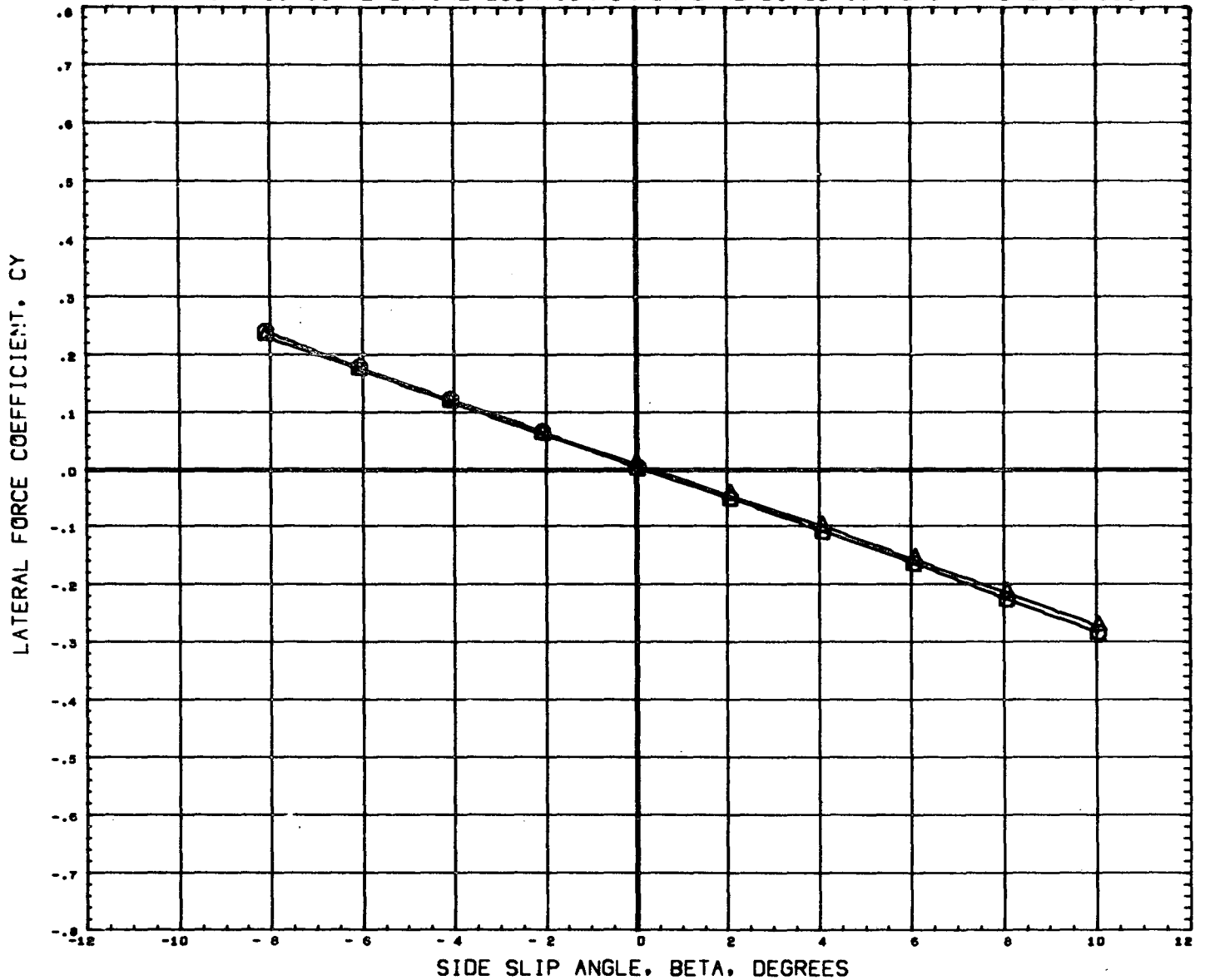

DATA SET SYMBOL	CONFIGURATION DESCRIPTION	ORBIN	THETS	ALPHA	REFERENCE INFORMATION
(B65011)	MSFC TWT 534 SHUTTLE LAUNCH	-1.500	0.000	0.000	SREF 4.8950 90. IN
(B65005)	MSFC TWT 534 SHUTTLE LAUNCH	-1.500	21.000	0.000	LREF 2.6440 IN.
					BREF 3.9250 IN.
					XMRP 3.4900 IN.
					YMRP 0.0000 IN.
					ZMRP 0.1616 IN.
					SCALE 0.0034

MACH 4.96

PAGE 312

EFFECT OF SRM CIRCUMFERENTIAL LOCATION ON LATERAL/DIRECTIONAL CHARACTERISTICS

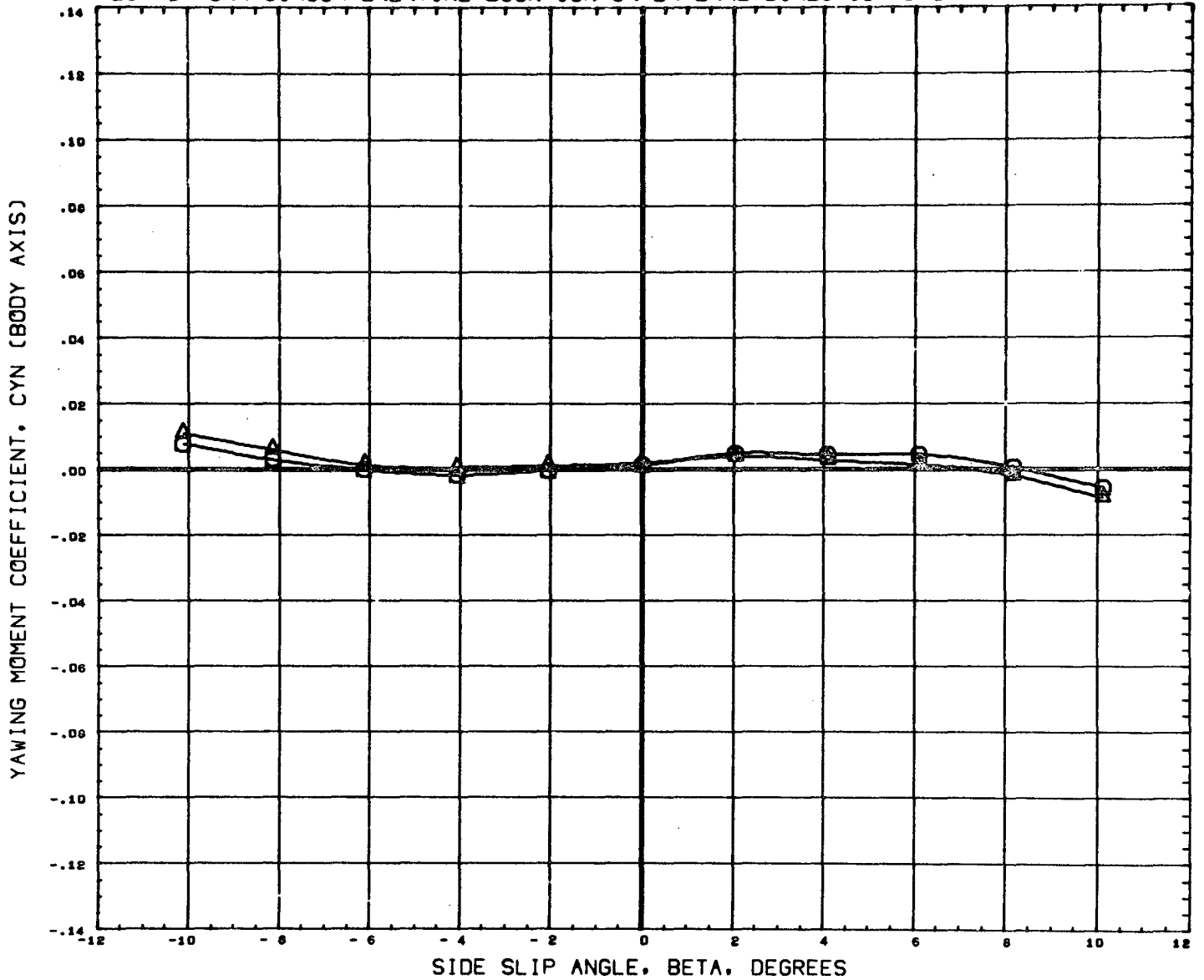

DATA SET SYMBOL	CONFIGURATION DESCRIPTION	ORBIN	THETS	ALPHA	REFERENCE INFORMATION
(B65011)	MSFC TWT 534 SHUTTLE LAUNCH	-1.500	0.000	0.000	SREF 4.8950 SQ. IN.
(B65005)	MSFC TWT 534 SHUTTLE LAUNCH	-1.500	21.000	0.000	LREF 2.6440 IN.
					BREF 3.5250 IN.
					XMRP 3.4900 IN.
					YMRP 0.0000 IN.
					ZMRP 0.1616 IN.
					SCALE 0.0034

MACH .60

EFFECT OF SRM CIRCUMFERENTIAL LOCATION ON LATERAL/DIRECTIONAL CHARACTERISTICS

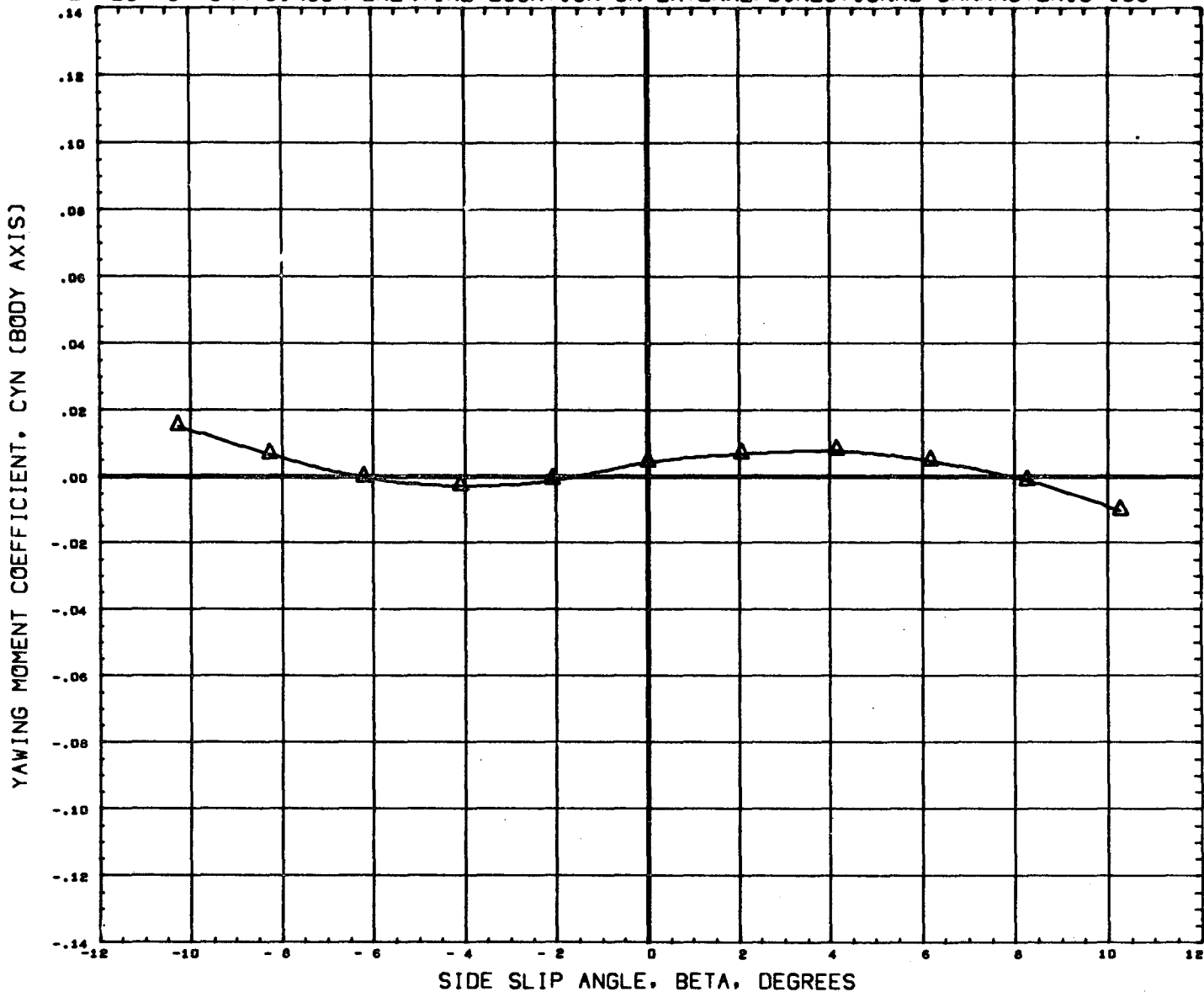

DATA SET SYMBOL CONFIGURATION DESCRIPTION
 (865011) Δ DATA NOT AVAILABLE FOR ALL CONDITIONS
 (865009) Δ NSFC TWT 534 SHUTTLE LAUNCH T101S1

ORBIN THETS ALPHA
 -1.500 0.003 0.000
 -1.500 21.000 0.000

REFERENCE INFORMATION
 SREF 4.8950 99. IN
 LREF 2.6440 IN.
 BREF 3.5250 IN.
 XMRP 3.4900 IN.
 YMRP 0.0000 IN.
 ZMRP 0.1616 IN.
 SCALE 0.0034

MACH .80

PAGE 314

EFFECT OF SRM CIRCUMFERENTIAL LOCATION ON LATERAL/DIRECTIONAL CHARACTERISTICS

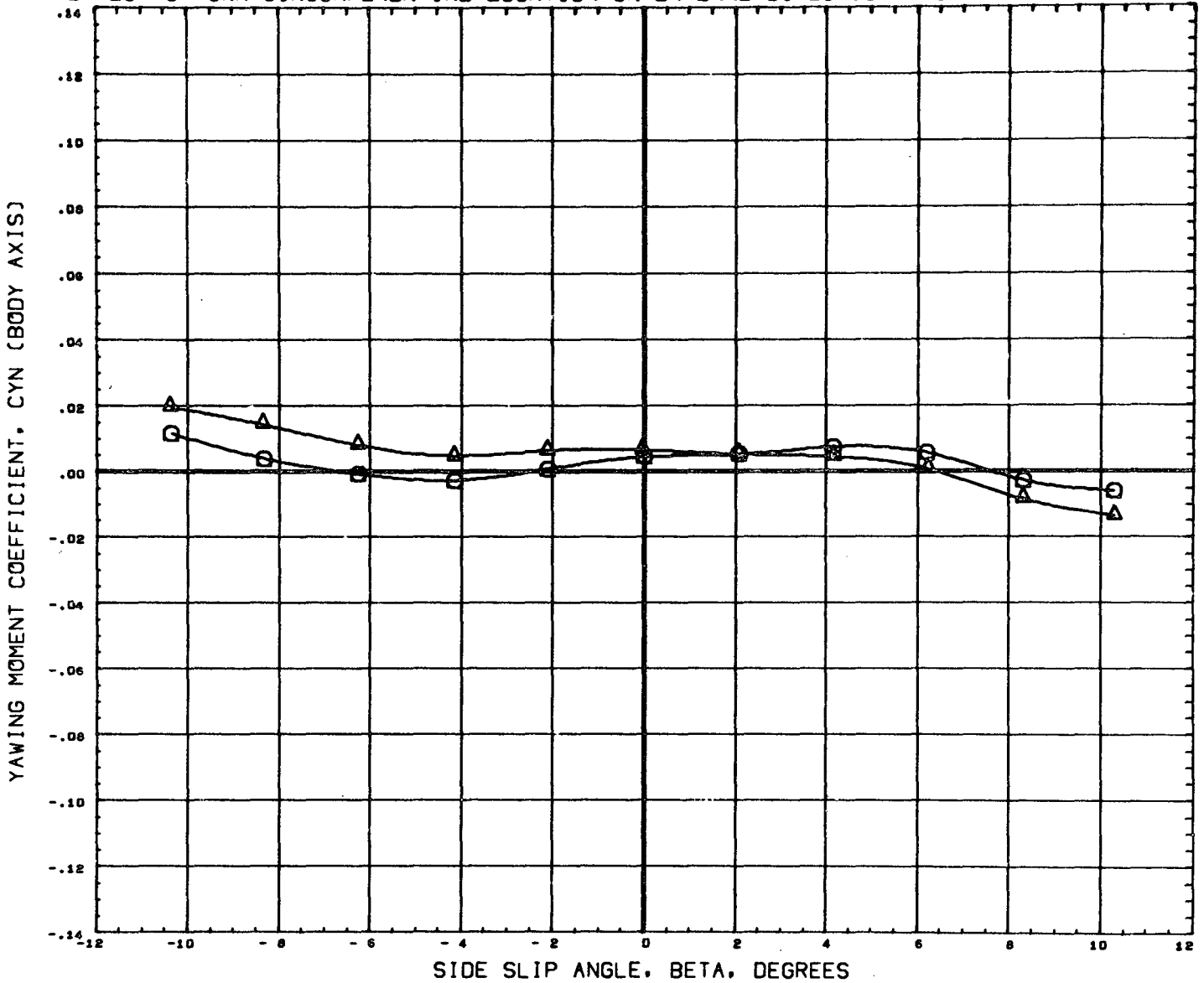

DATA SET SYMBOL	CONFIGURATION DESCRIPTION	ORBIN	THETS	ALPHA	REFERENCE INFORMATION
(B65011)	MSFC TWT 534 SHUTTLE LAUNCH	T101S1	-1.500	0.000	SREF 4.8950 SQ. IN.
(B65005)	MSFC TWT 534 SHUTTLE LAUNCH	T101S1	-1.500	21.000	LREF 2.6440 IN.
					BREF 3.5250 IN.
					XMRP 3.4900 IN.
					YMRP 0.0000 IN.
					ZMRP 0.1616 IN.
					SCALE 0.0034

MACH .90

EFFECT OF SRM CIRCUMFERENTIAL LOCATION ON LATERAL/DIRECTIONAL CHARACTERISTICS

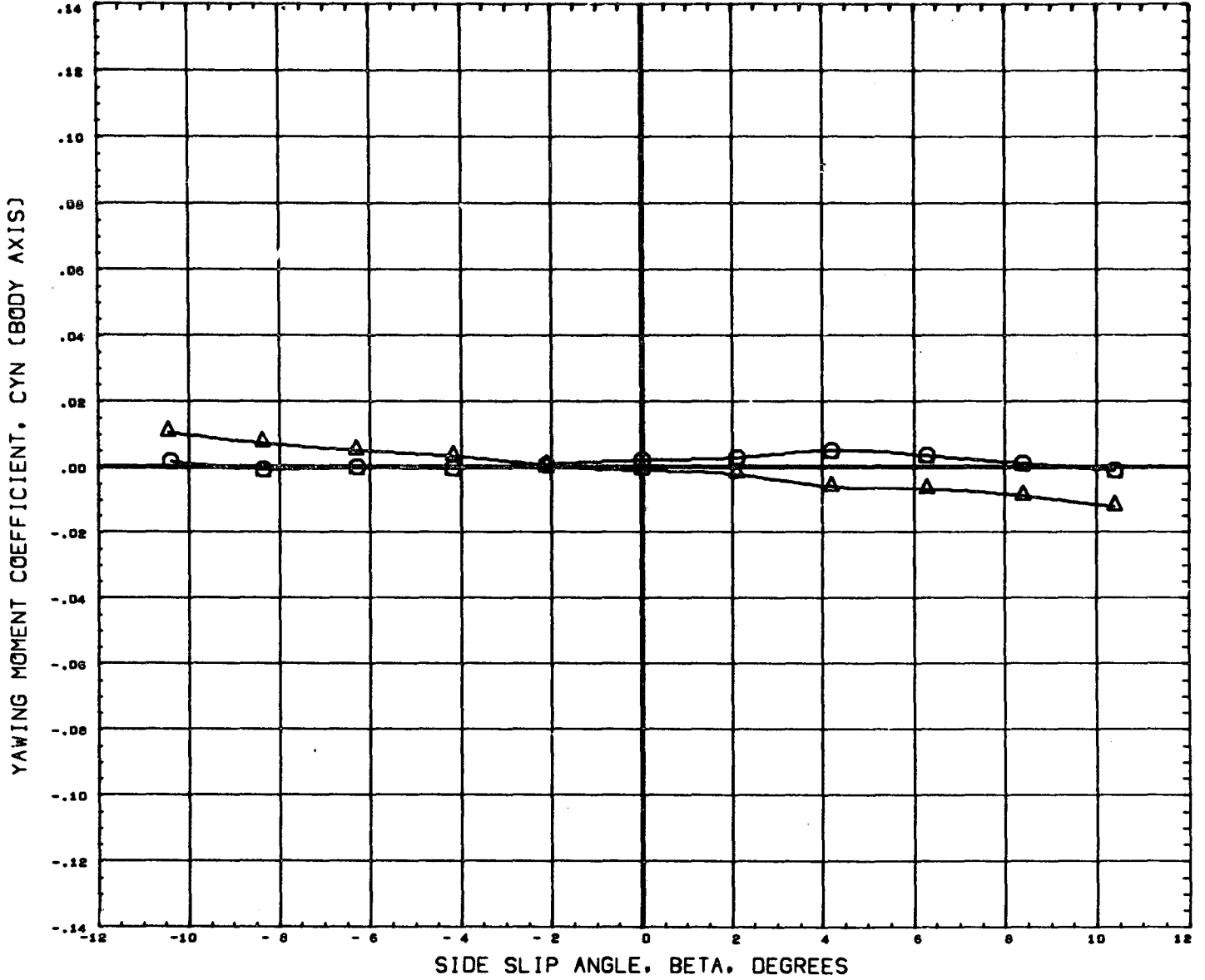

DATA SET SYMBOL	CONFIGURATION DESCRIPTION	ORBIN	THETS	ALPHA	REFERENCE INFORMATION
(B65011)	MSFC TWT 534 SHUTTLE LAUNCH	-1.500	0.000	0.000	SREF 4.0950 SQ. IN
(B65005)	MSFC TWT 534 SHUTTLE LAUNCH	-1.500	21.000	0.000	LREF 2.6440 IN.
					BREF 3.5250 IN.
					XHRP 3.4900 IN.
					YHRP 0.0000 IN.
					ZHRP 0.1616 IN.
					SCALE 0.0034

MACH 1.10

EFFECT OF SRM CIRCUMFERENTIAL LOCATION ON LATERAL/DIRECTIONAL CHARACTERISTICS

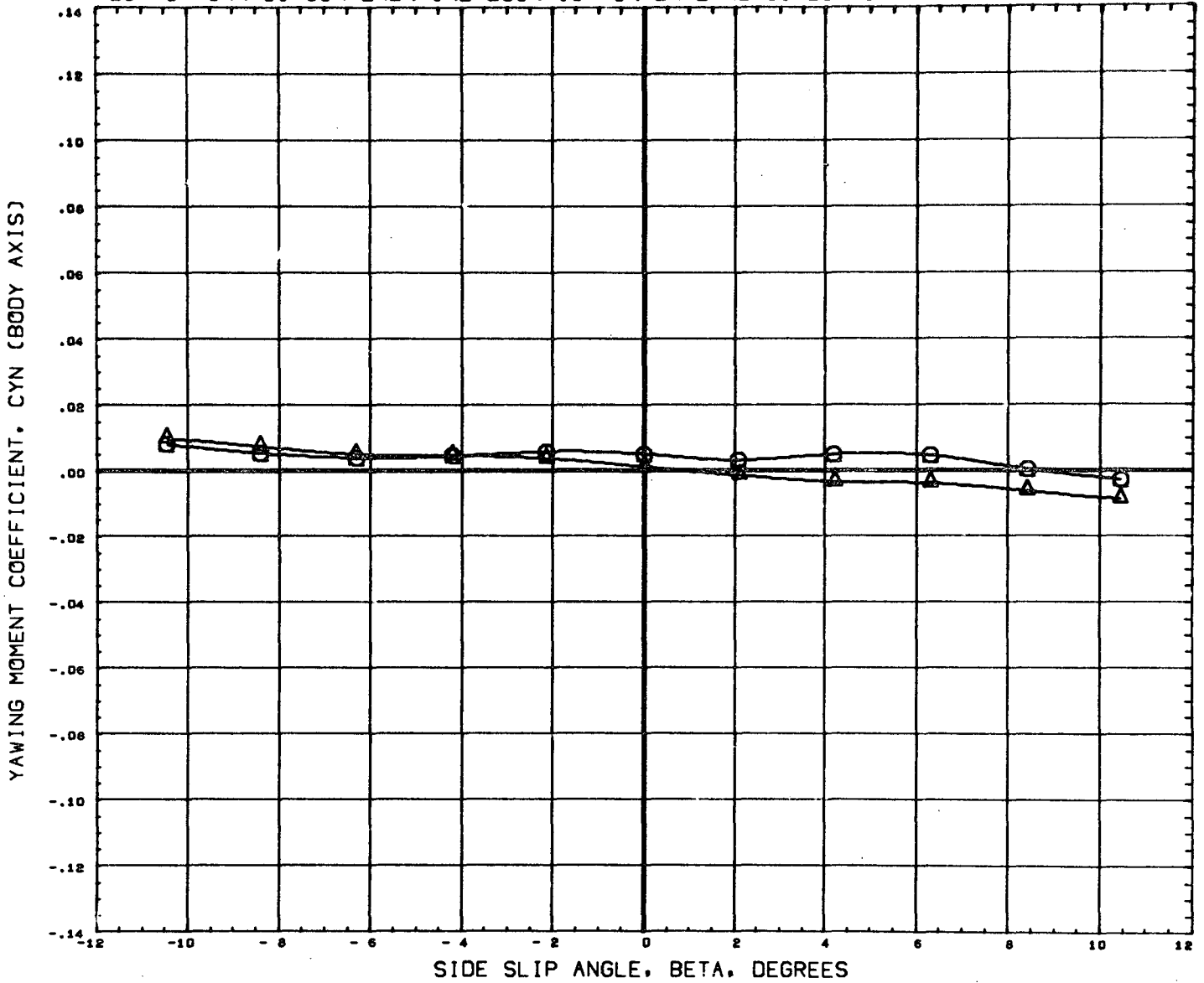

DATA SET SYMBOL	CONFIGURATION DESCRIPTION	ORBIN	THETS	ALPHA	REFERENCE INFORMATION
(B65011)	MSFC TWT 534 SHUTTLE LAUNCH	-1.500	0.000	0.000	SREF 4.8950 SQ. IN
(B65005)	MSFC TWT 534 SHUTTLE LAUNCH	-1.500	21.000	0.000	LREF 2.6440 IN.
					BREF 3.5250 IN.
					XMRP 3.4900 IN.
					YMRP 0.0000 IN.
					ZMRP 0.1616 IN.
					SCALE 0.0034

MACH 1.19

EFFECT OF SRM CIRCUMFERENTIAL LOCATION ON LATERAL/DIRECTIONAL CHARACTERISTICS

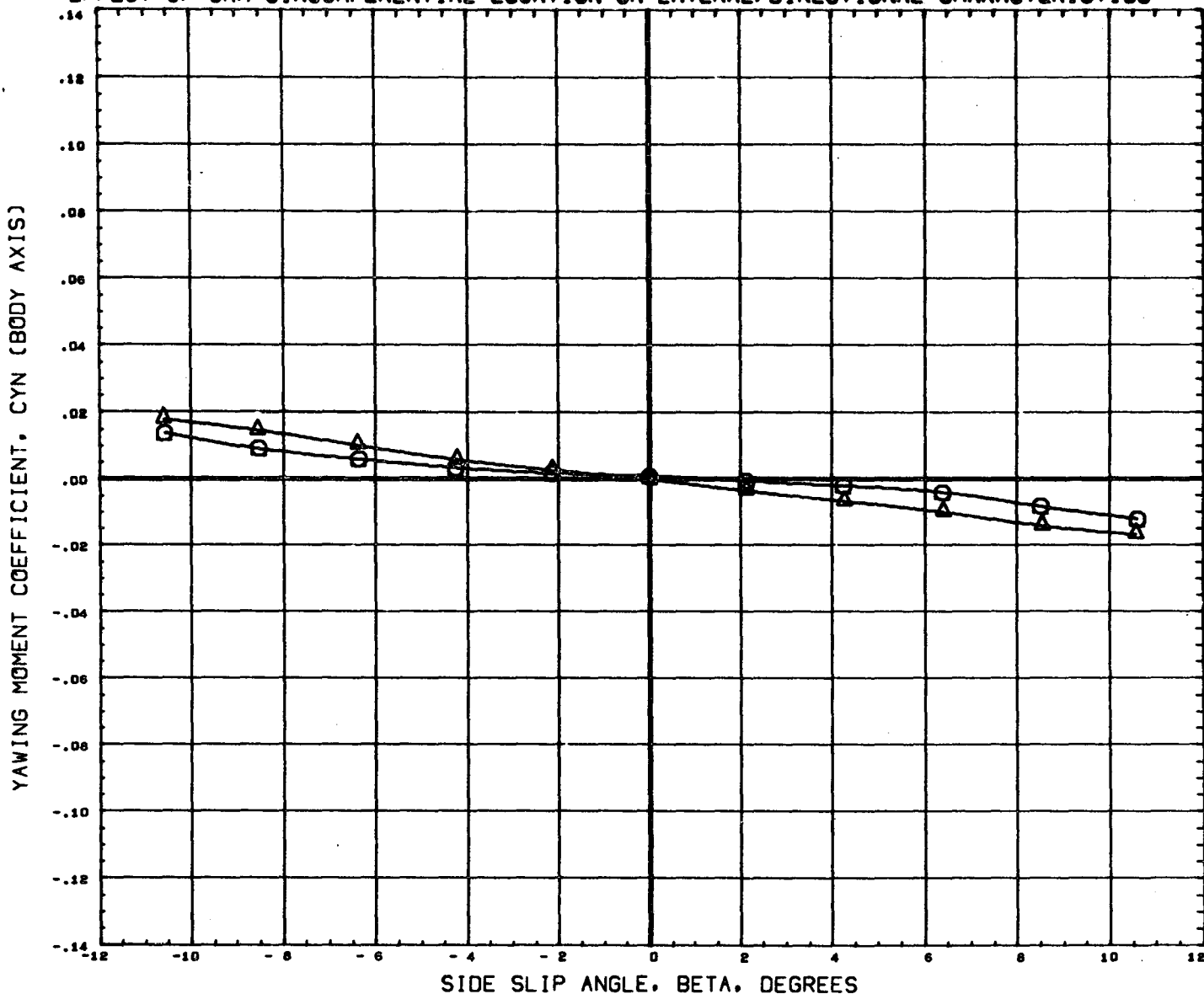

DATA SET SYMBOL	CONFIGURATION DESCRIPTION	ORBIN	THETS	ALPHA	REFERENCE INFORMATION
(B65011)	MSFC TWT 534 SHUTTLE LAUNCH	-1.500	0.000	0.000	SREF 4.8950 SQ. IN
(B65005)	MSFC TWT 534 SHUTTLE LAUNCH	-1.500	21.000	0.000	LREF 2.6440 IN.
					BREF 3.5250 IN.
					XMRP 3.4900 IN.
					YMRP 0.0000 IN.
					ZMRP 0.1616 IN.
					SCALE 0.0034

MACH 1.97

PAGE 318

EFFECT OF SRM CIRCUMFERENTIAL LOCATION ON LATERAL/DIRECTIONAL CHARACTERISTICS

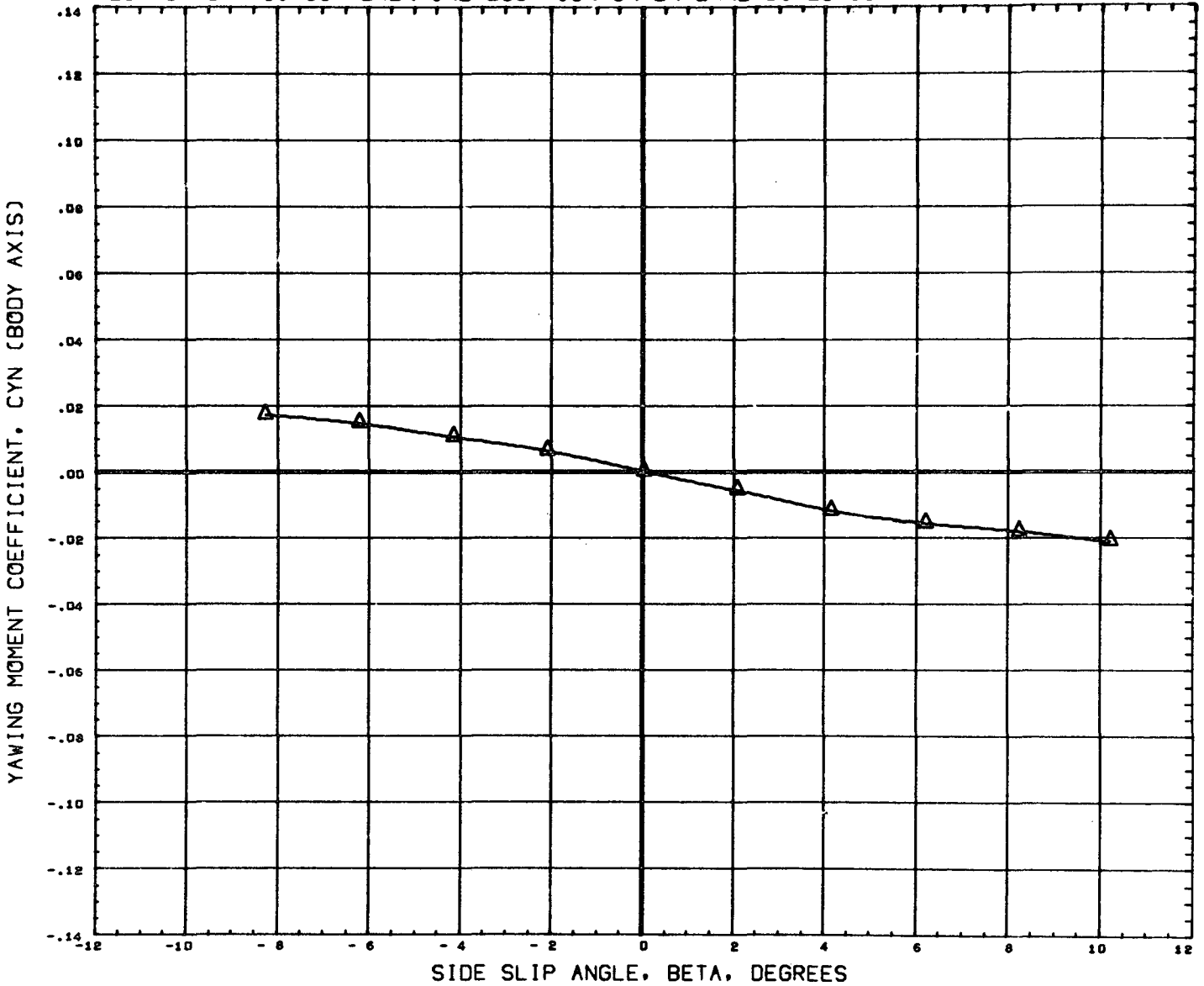

DATA SET SYMBOL	CONFIGURATION DESCRIPTION	ORBIN	THETS	ALPHA	REFERENCE INFORMATION
(B65011)	DATA NOT AVAILABLE FOR ALL CONDITIONS	-1.500	0.000	0.000	SREF 4.8950 SQ. IN
(B65005)	MSFC TWT 534 SHUTTLE LAUNCH T101S1	-1.500	21.000	0.000	LREF 2.6440 IN.
					BREF 3.5250 IN.
					XMRP 3.4900 IN.
					YMRP 0.0000 IN.
					ZMRP 0.1616 IN.
					SCALE 0.0034

MACH 2.74

EFFECT OF SRM CIRCUMFERENTIAL LOCATION ON LATERAL/DIRECTIONAL CHARACTERISTICS

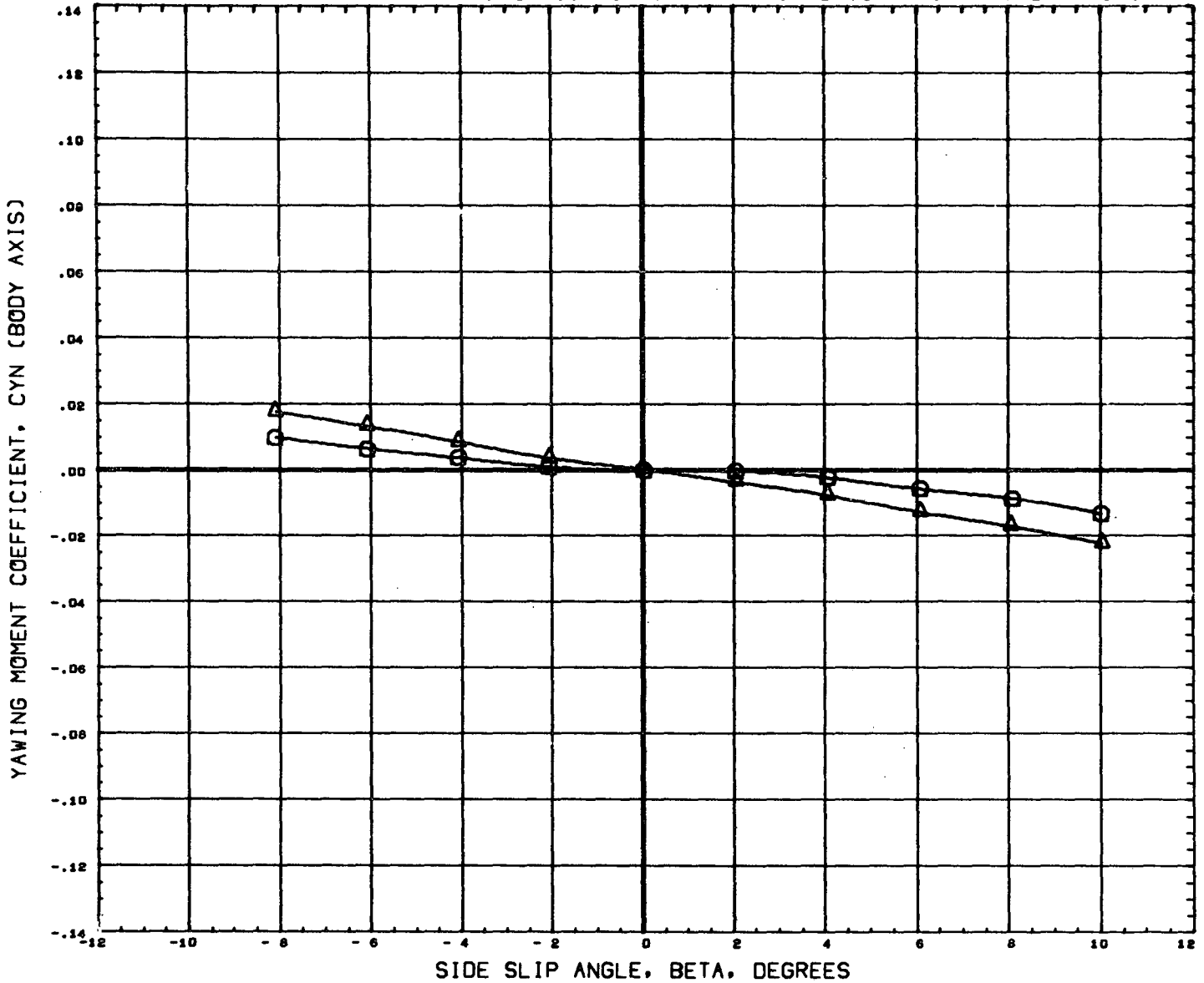

DATA SET SYMBOL	CONFIGURATION DESCRIPTION	ORBIN	THETS	ALPHA	REFERENCE INFORMATION
(B65011)	MSFC TWT 534 SHUTTLE LAUNCH	-1.500	0.000	0.000	SREF 4.8950 99. IN
(B65005)	MSFC TWT 534 SHUTTLE LAUNCH	-1.500	21.000	0.000	LREF 2.6440 IN.
					BREF 3.5250 IN.
					XWRP 3.4900 IN.
					YWRP 0.0000 IN.
					ZWRP 0.1616 IN.
					SCALE 0.0034

MACH 4.96

EFFECT OF SRM CIRCUMFERENTIAL LOCATION ON LATERAL/DIRECTIONAL CHARACTERISTICS

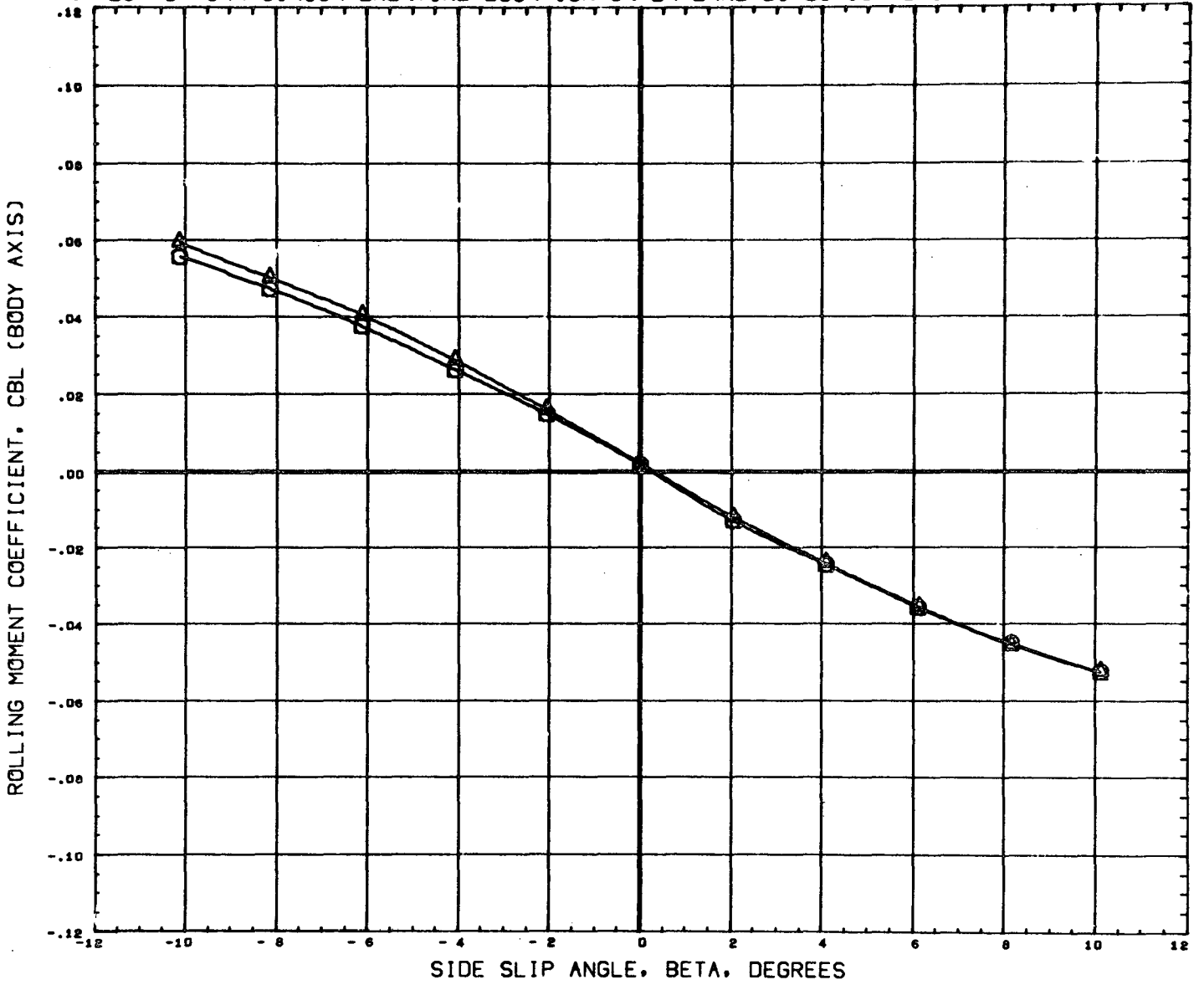

DATA SET SYMBOL	CONFIGURATION DESCRIPTION	ORBIN	THETS	ALPHA	REFERENCE INFORMATION
(B65011)	MSFC TWT 534 SHUTTLE LAUNCH	-1.500	0.000	0.000	SREF 4.8950 sq. IN
(B65005)	MSFC TWT 534 SHUTTLE LAUNCH	-1.500	21.000	0.000	LREF 2.6440 IN.
					BREF 3.5250 IN.
					XMRP 3.4900 IN.
					YMRP 0.0000 IN.
					ZMRP 0.1616 IN.
					SCALE 0.0034

MACH .60

EFFECT OF SRM CIRCUMFERENTIAL LOCATION ON LATERAL/DIRECTIONAL CHARACTERISTICS

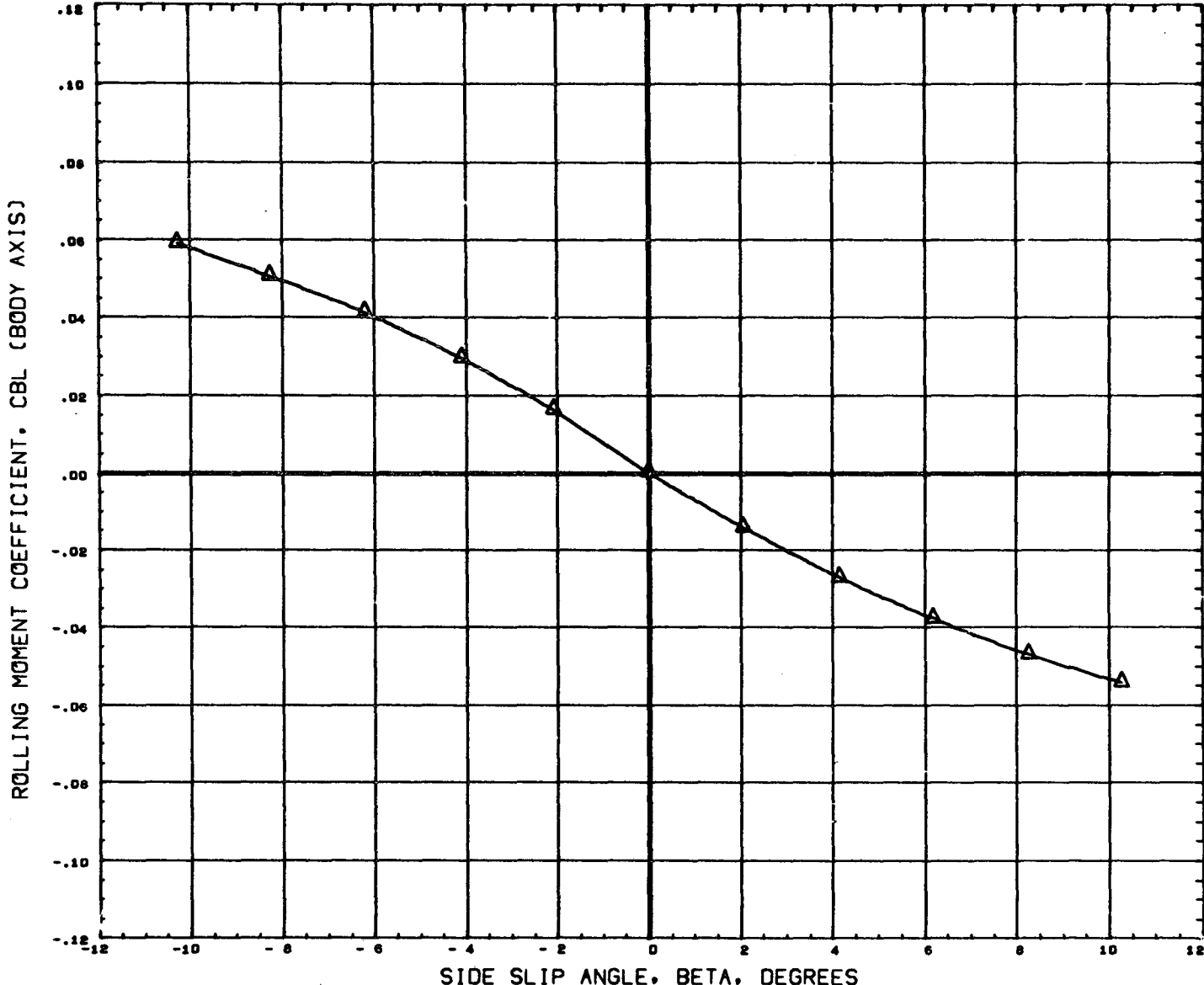

DATA SET SYMBOL CONFIGURATION DESCRIPTION
 (865011) \emptyset DATA NOT AVAILABLE FOR ALL CONDITIONS
 (865005) Δ NSFC TWT 534 SHUTTLE LAUNCH T101S1

ORBIN THETS ALPHA
 -1.500 0.060 0.000
 -1.500 21.000 0.000

REFERENCE INFORMATION
 SREF 4.8950 SQ. IN
 LREF 2.6440 IN.
 BREF 3.5250 IN.
 XMRP 3.4900 IN.
 YMRP 0.0000 IN.
 ZMRP 0.1616 IN.
 SCALE 0.0034

EFFECT OF SRM CIRCUMFERENTIAL LOCATION ON LATERAL/DIRECTIONAL CHARACTERISTICS

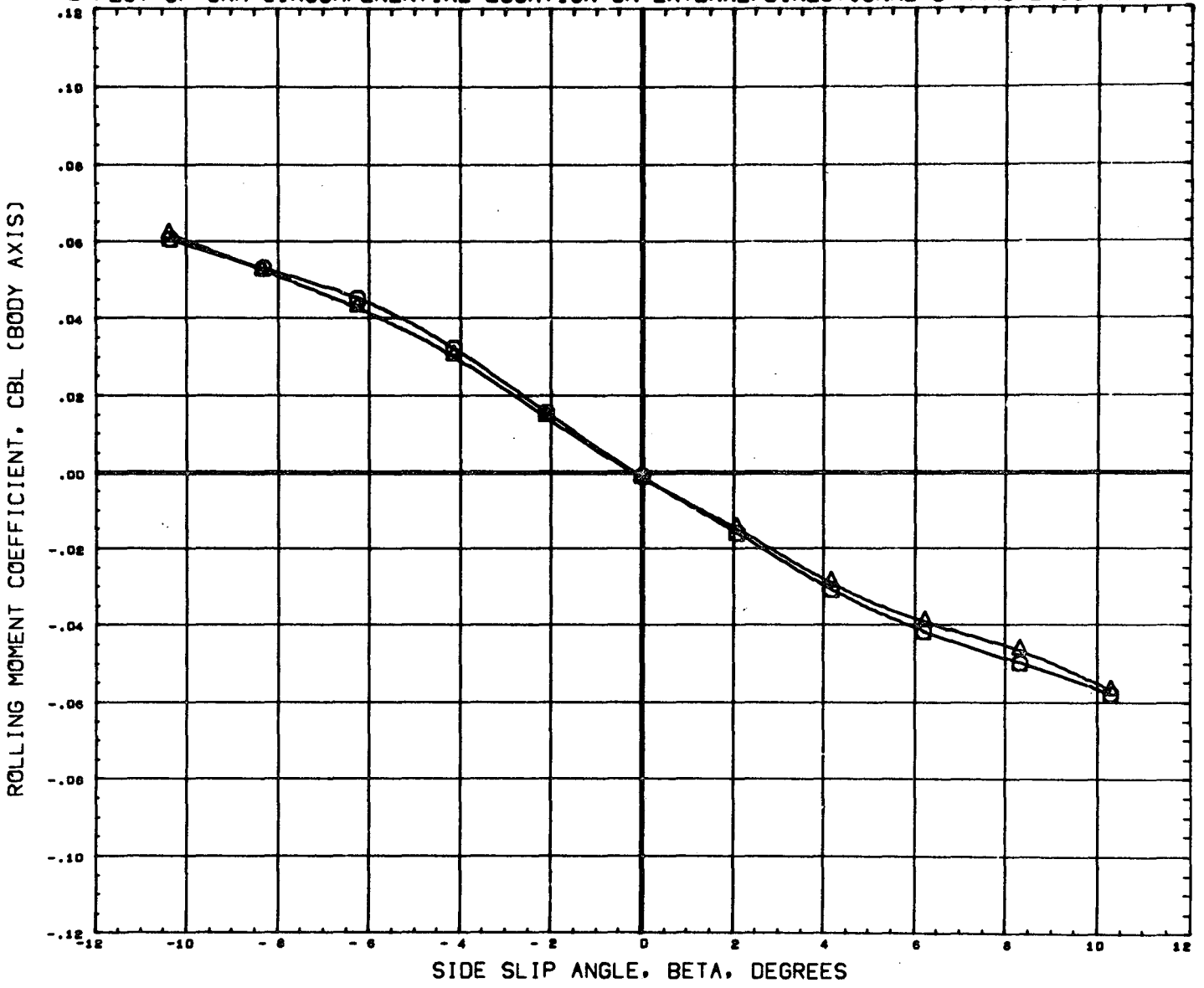

DATA SET SYMBOL	CONFIGURATION DESCRIPTION	ORBIN	THETS	ALPHA	REFERENCE INFORMATION
(B69011)	MSFC TWT 534 SHUTTLE LAUNCH	T101S1	-1.500	0.000	SREF 4.8950 90. IN
(B65005)	MSFC TWT 534 SHUTTLE LAUNCH	T101S1	-1.500	21.000	LREF 2.6440 IN.
					BREF 3.9250 IN.
					XWRP 3.4900 IN.
					YWRP 0.0000 IN.
					ZWRP 0.1616 IN.
					SCALE 0.0034

MACH .90

EFFECT OF SRM CIRCUMFERENTIAL LOCATION ON LATERAL/DIRECTIONAL CHARACTERISTICS

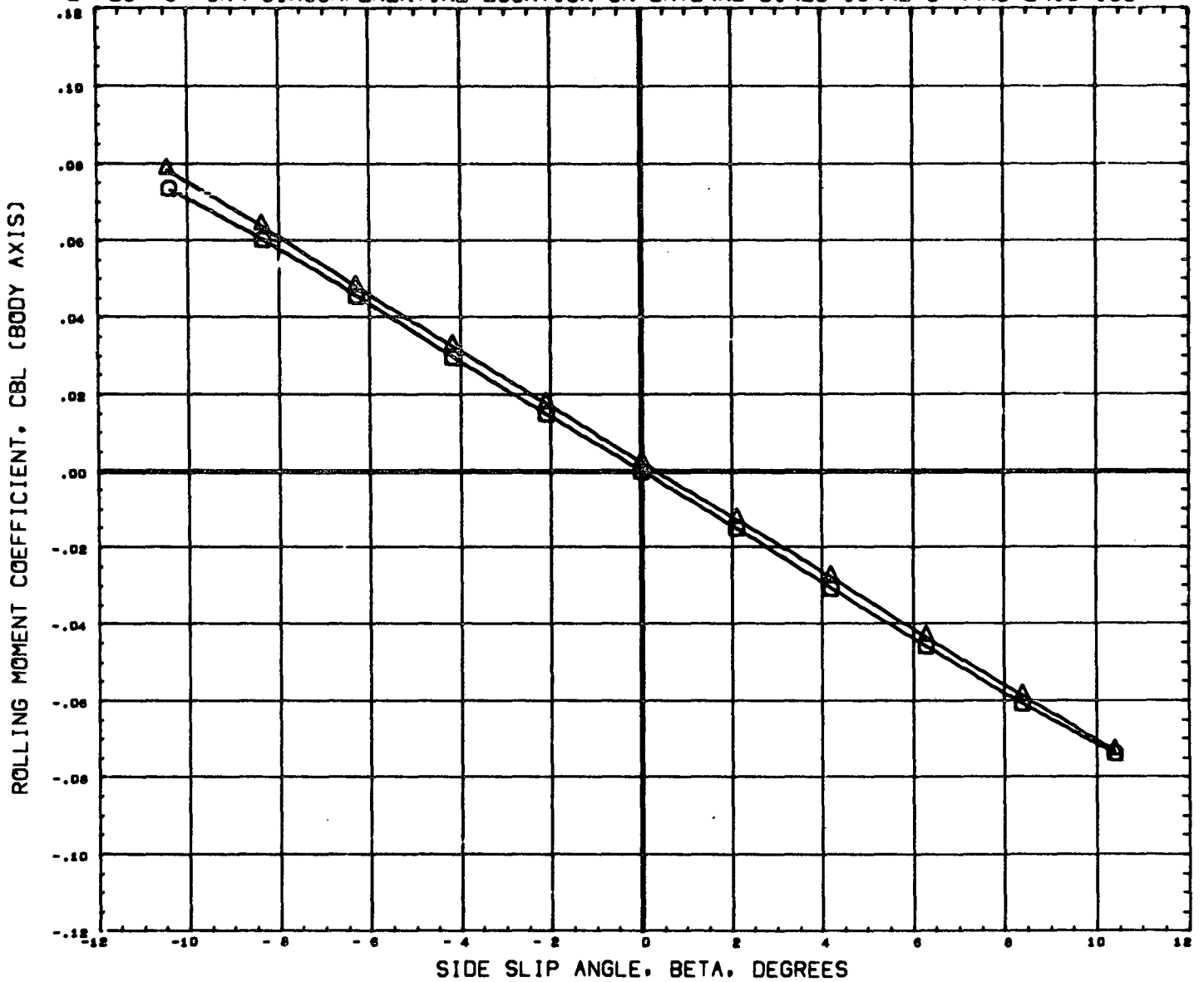

DATA SET SYMBOL	CONFIGURATION DESCRIPTION	ORBIN	THETS	ALPHA	REFERENCE INFORMATION
(865011)	MSFC TWT 534 SHUTTLE LAUNCH	T10181	-1.500	0.000	SREF 4.8950 90. IN
(865009)	MSFC TWT 534 SHUTTLE LAUNCH	T10181	-1.500	21.000	LREF 2.6440 IN.
					BREF 3.5250 IN.
					XNRP 3.4000 IN.
					YNRP 0.0000 IN.
					ZNRP 0.1616 IN.
					SCALE 0.0034

MACH 1.10

EFFECT OF SRM CIRCUMFERENTIAL LOCATION ON LATERAL/DIRECTIONAL CHARACTERISTICS

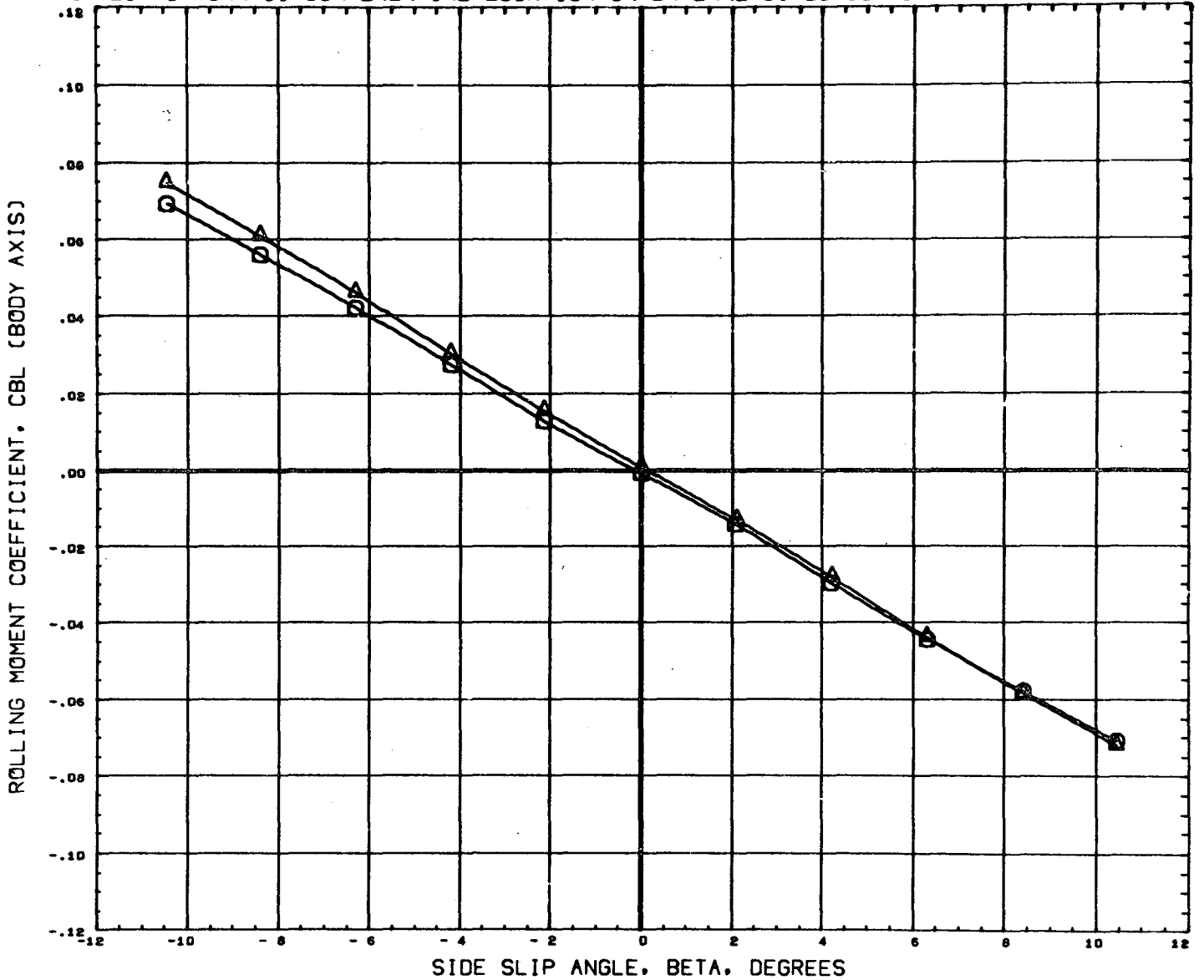

DATA SET SYMBOL	CONFIGURATION DESCRIPTION	ORBIN	THETS	ALPHA	REFERENCE INFORMATION
(865011)	MSFC TWT 534 SHUTTLE LAUNCH	T101S1	-1.500	0.000	SREF 4.8950 SQ. IN
(865005)	MSFC TWT 534 SHUTTLE LAUNCH	T101S1	-1.500	21.000	LREF 2.6440 IN.
					BREF 3.3250 IN.
					XMRP 3.4900 IN.
					YMRP 0.0000 IN.
					ZMRP 0.1616 IN.
					SCALE 0.0034

MACH 1.19

EFFECT OF SRM CIRCUMFERENTIAL LOCATION ON LATERAL/DIRECTIONAL CHARACTERISTICS

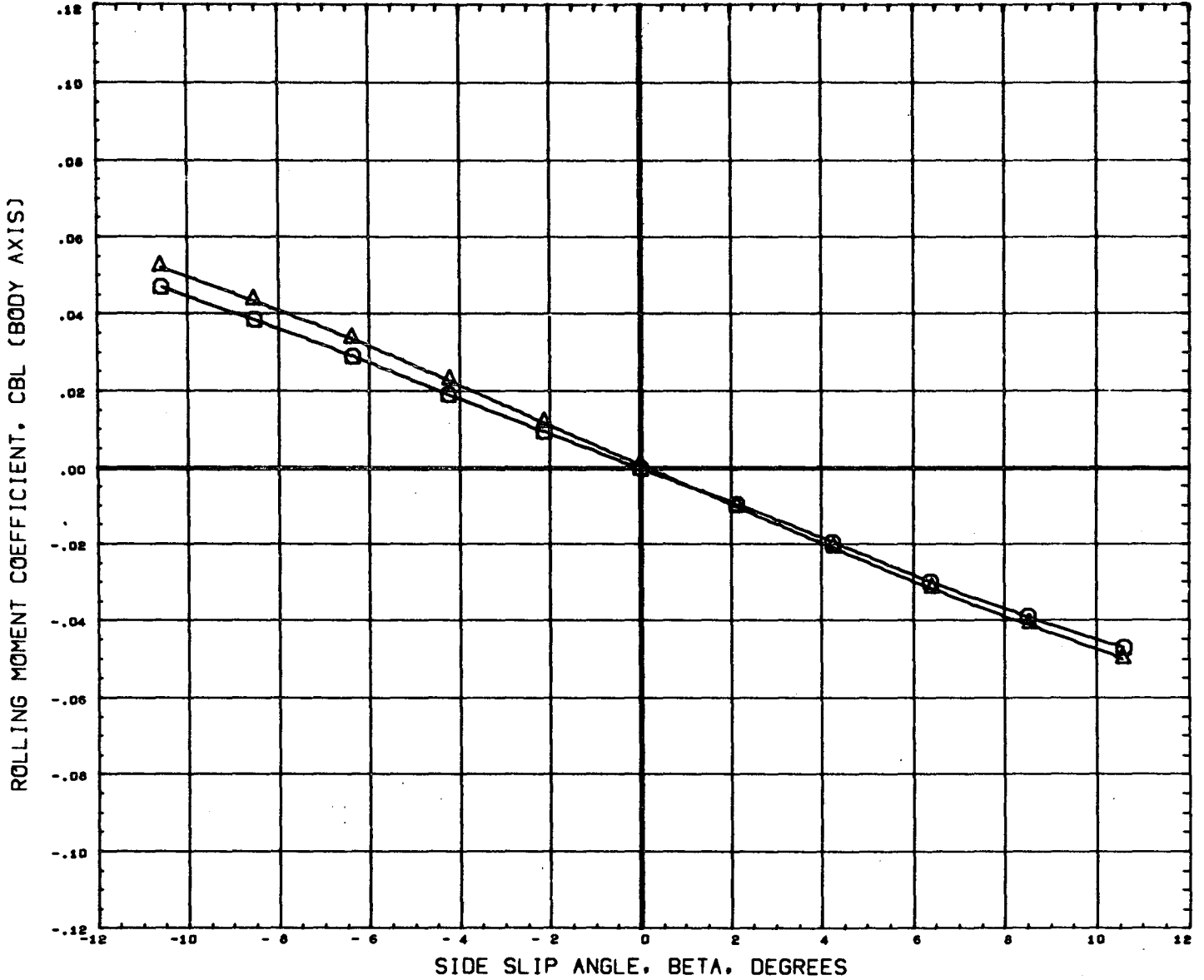

DATA SET SYMBOL	CONFIGURATION DESCRIPTION	ORBIN	THETS	ALPHA
(B65011)	MSFC TWT 534 SHUTTLE LAUNCH	-1.500	0.000	0.000
(B65005)	MSFC TWT 534 SHUTTLE LAUNCH	-1.500	21.000	0.000



REFERENCE INFORMATION	
SREF	4.8950 SQ. IN
LREF	2.6440 IN.
BREF	3.5250 IN.
XMRP	3.4900 IN.
YMRP	0.0000 IN.
ZMRP	0.1616 IN.
SCALE	0.0034

MACH 1.97

PAGE 326

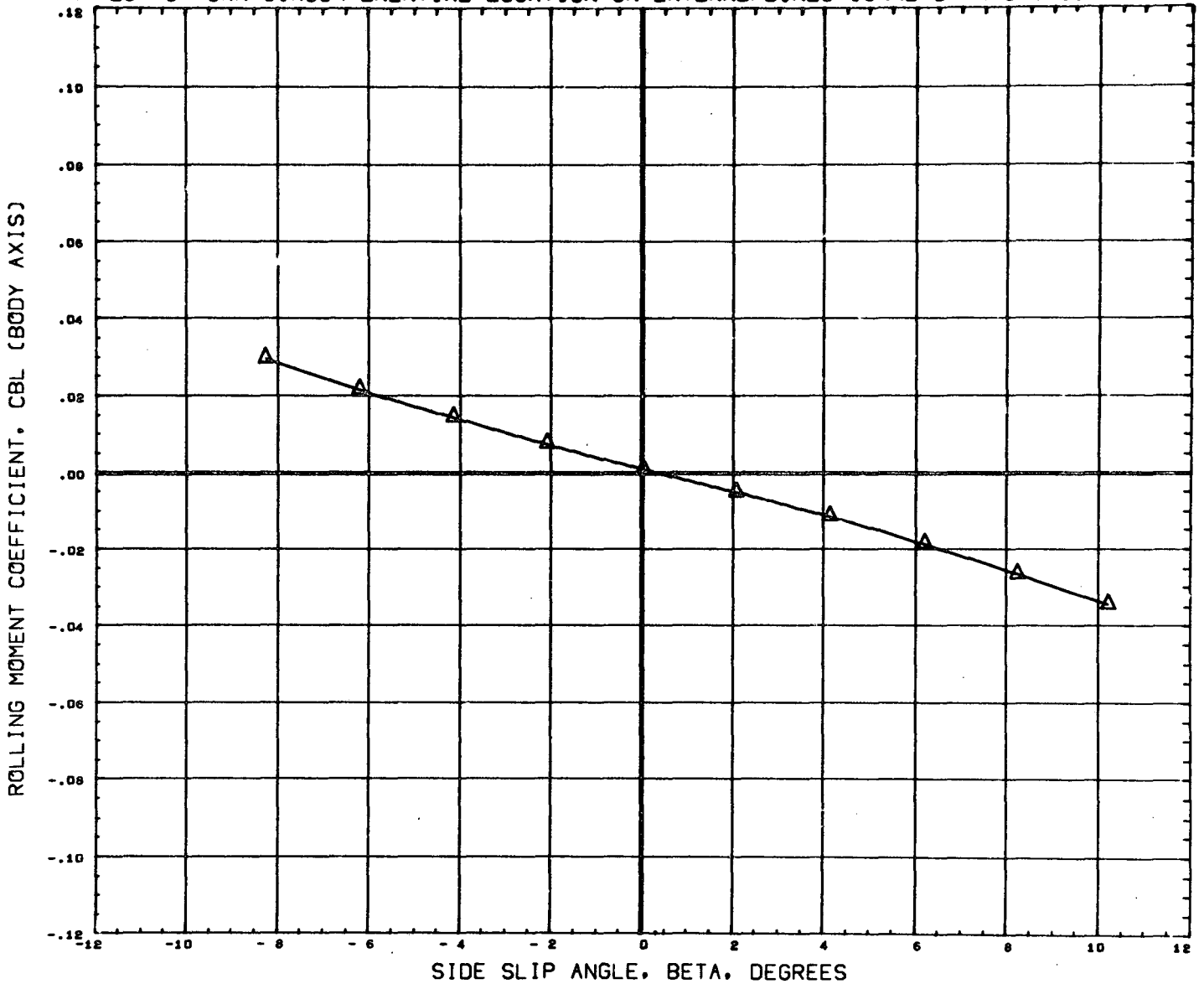
EFFECT OF SRM CIRCUMFERENTIAL LOCATION ON LATERAL/DIRECTIONAL CHARACTERISTICS



DATA SET SYMBOL CONFIGURATION DESCRIPTION
 (B65011)  DATA NOT AVAILABLE FOR ALL CONDITIONS
 (B65005)  MSFC TWT 534 SHUTTLE LAUNCH T101S1

ORBIN THETS ALPHA
 -1.500 0.000 0.000
 -1.500 21.000 0.000

REFERENCE INFORMATION
 SREF 4.8950 SQ. IN
 LREF 2.6440 IN.
 BREF 3.5250 IN.
 XMRP 3.4900 IN.
 YMRP 0.0000 IN.
 ZMRP 0.1616 IN.
 SCALE 0.0034

MACH 2.74

EFFECT OF SRM CIRCUMFERENTIAL LOCATION ON LATERAL/DIRECTIONAL CHARACTERISTICS

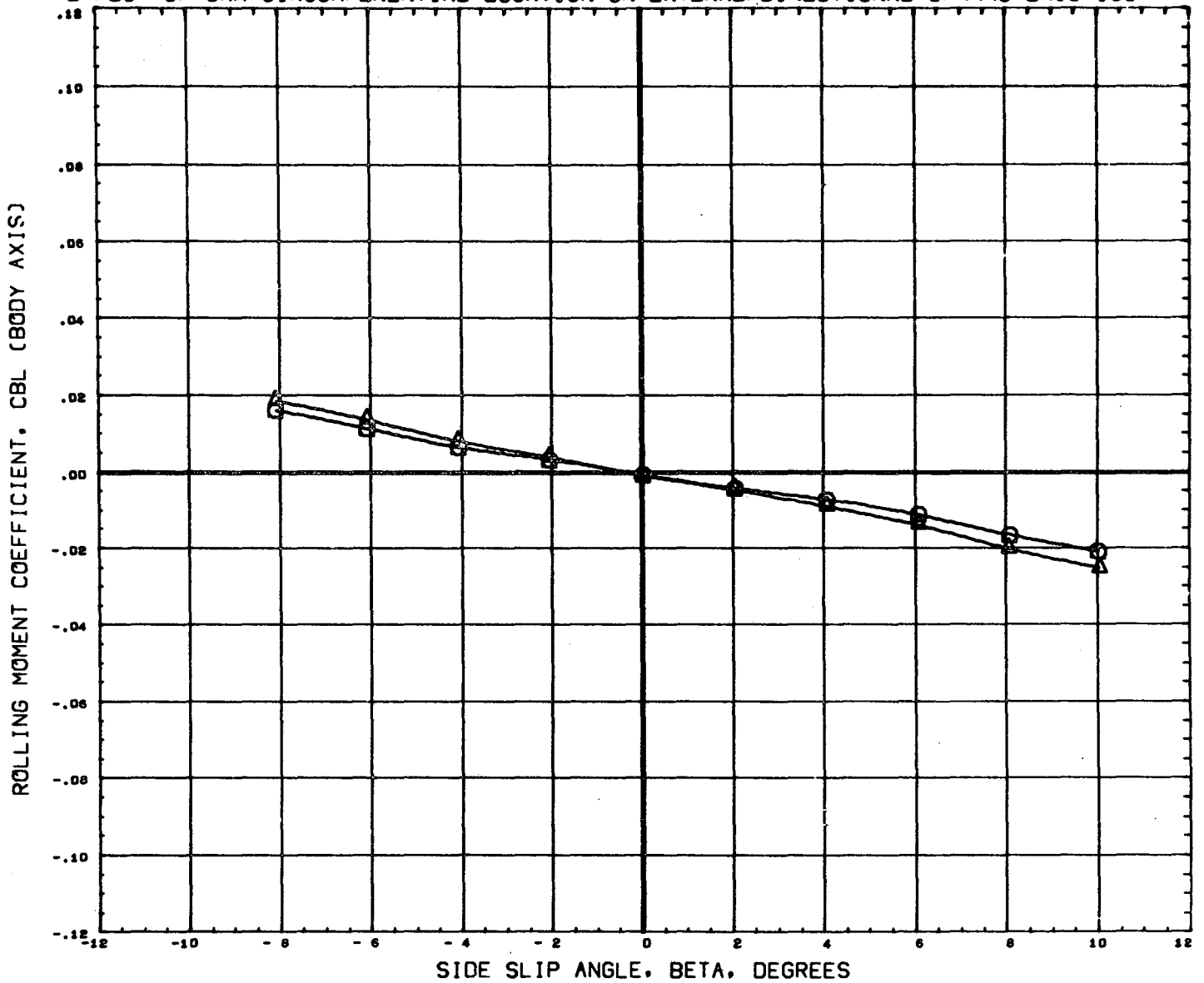

DATA SET SYMBOL	CONFIGURATION DESCRIPTION	ORBIN	THETS	ALPHA	REFERENCE INFORMATION
(B65011)	MSFC TWT 534 SHUTTLE LAUNCH	-1.500	0.000	0.000	SREF 4.8950 SQ. IN
(B65005)	MSFC TWT 534 SHUTTLE LAUNCH	-1.500	21.000	0.000	LREF 2.6440 IN.
					BREF 3.9250 IN.
					XMRP 3.4900 IN.
					YMRP 0.0000 IN.
					ZMRP 0.1616 IN.
					SCALE 0.0034

MACH 4.96

PAGE 328

EFFECT OF SRM CIRCUMFERENTIAL LOCATION ON LATERAL/DIRECTIONAL CHARACTERISTICS

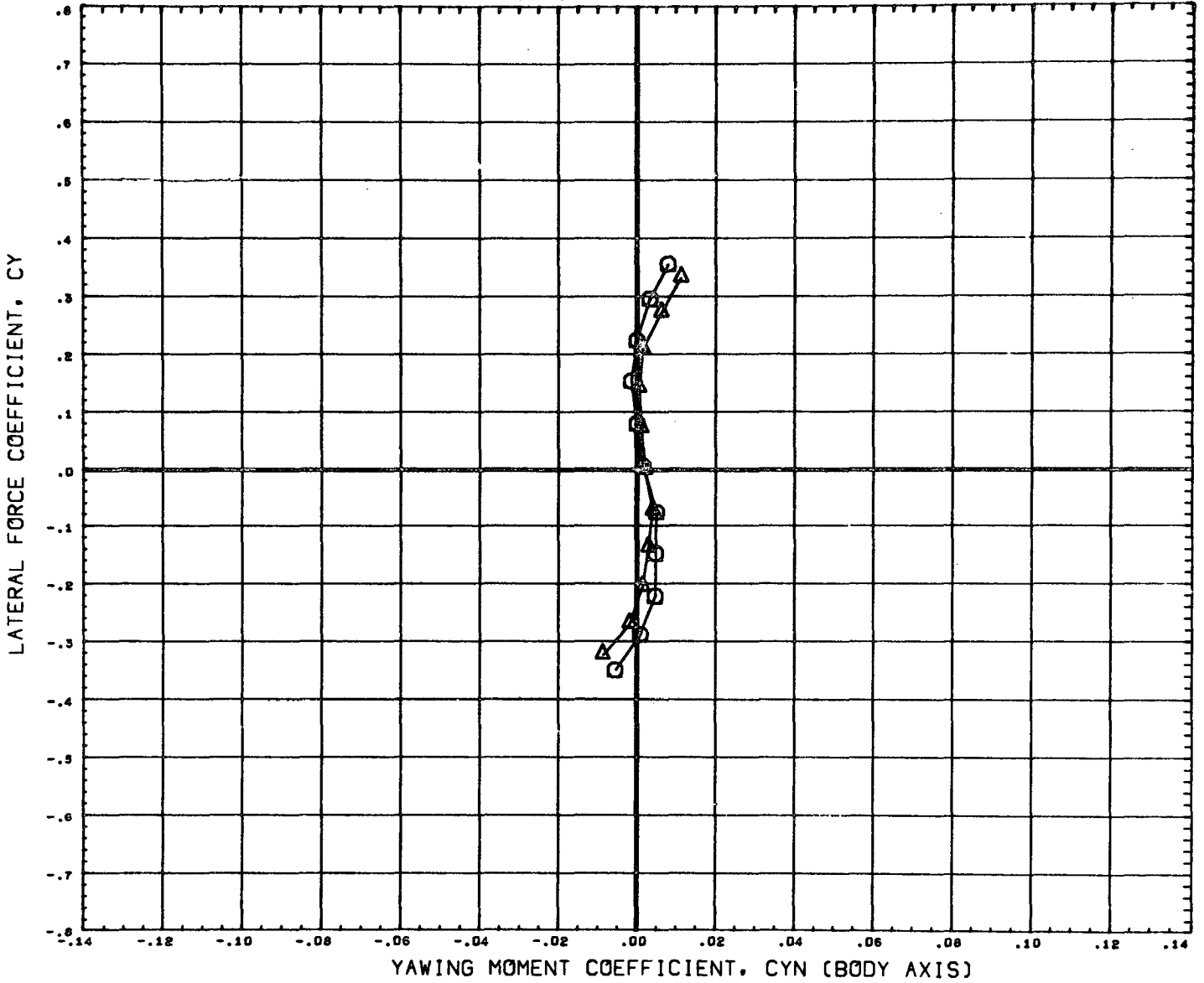

DATA SET SYMBOL	CONFIGURATION DESCRIPTION	ORBIN	THETS	ALPHA	REFERENCE INFORMATION
(B65011)	MSFC TWT 534 SHUTTLE LAUNCH	-1.500	0.000	0.000	SREF 4.8950 SQ. IN
(B65005)	MSFC TWT 534 SHUTTLE LAUNCH	-1.500	21.000	0.000	LREF 2.6440 IN.
					BREF 3.5250 IN.
					XMRP 3.4900 IN.
					YMRP 0.0000 IN.
					ZMRP 0.1616 IN.
					SCALE 0.0034

MACH .60

EFFECT OF SRM CIRCUMFERENTIAL LOCATION ON LATERAL/DIRECTIONAL CHARACTERISTICS

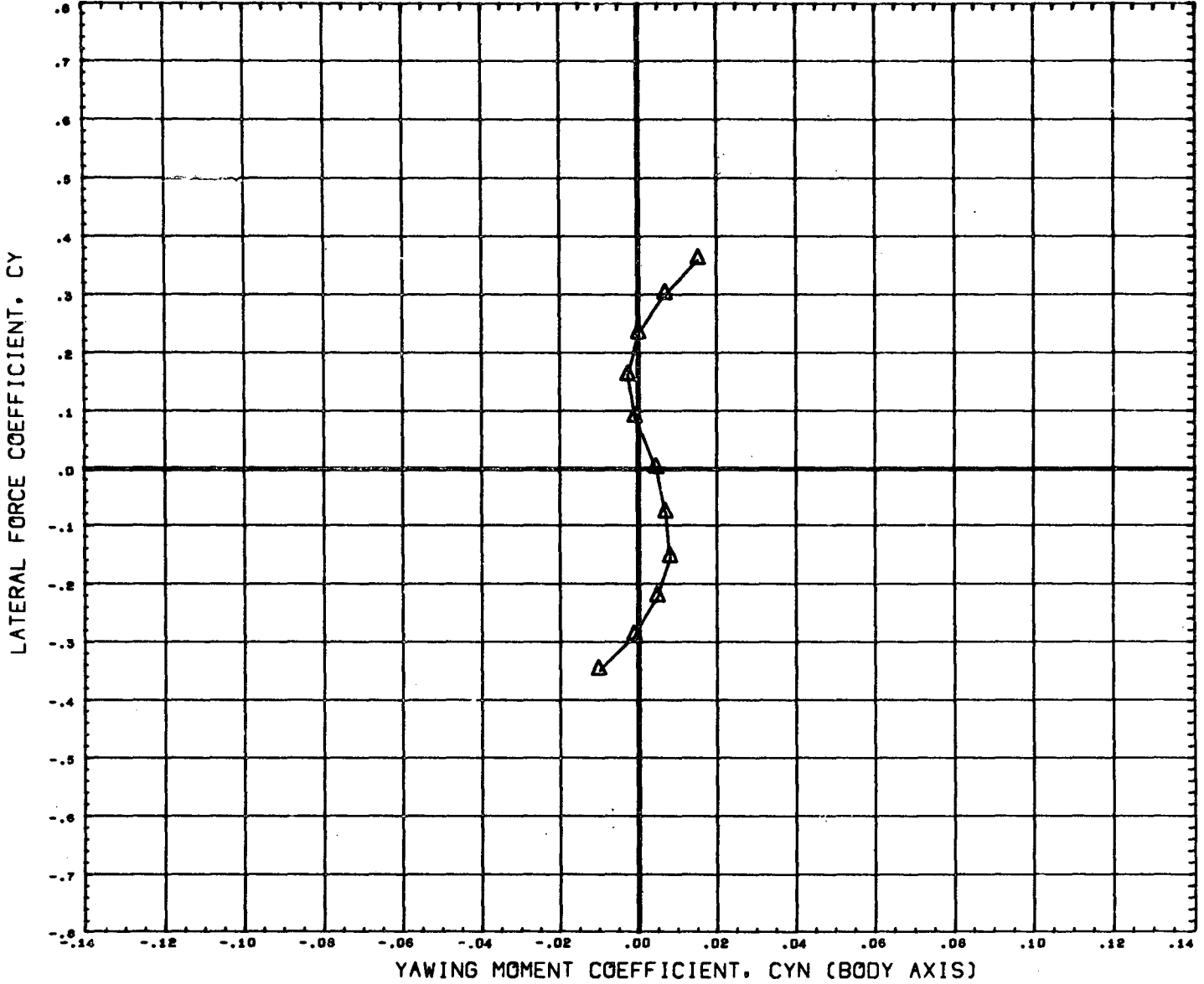

DATA SET SYMBOL	CONFIGURATION DESCRIPTION	ORBIN	THETS	ALPHA	REFERENCE INFORMATION
(B65011)	DATA NOT AVAILABLE FOR ALL CONDITIONS	-1.500	0.000	0.000	SREF 4.8950 39. IN
(B65005)	MSFC TWT 534 SHUTTLE LAUNCH T101S1	-1.500	21.000	0.000	LREF 2.6440 IN.
					BREF 3.5250 IN.
					XMRP 3.4900 IN.
					YMRP 0.0000 IN.
					ZMRP 0.1616 IN.
					SCALE 0.0034

EFFECT OF SRM CIRCUMFERENTIAL LOCATION ON LATERAL/DIRECTIONAL CHARACTERISTICS

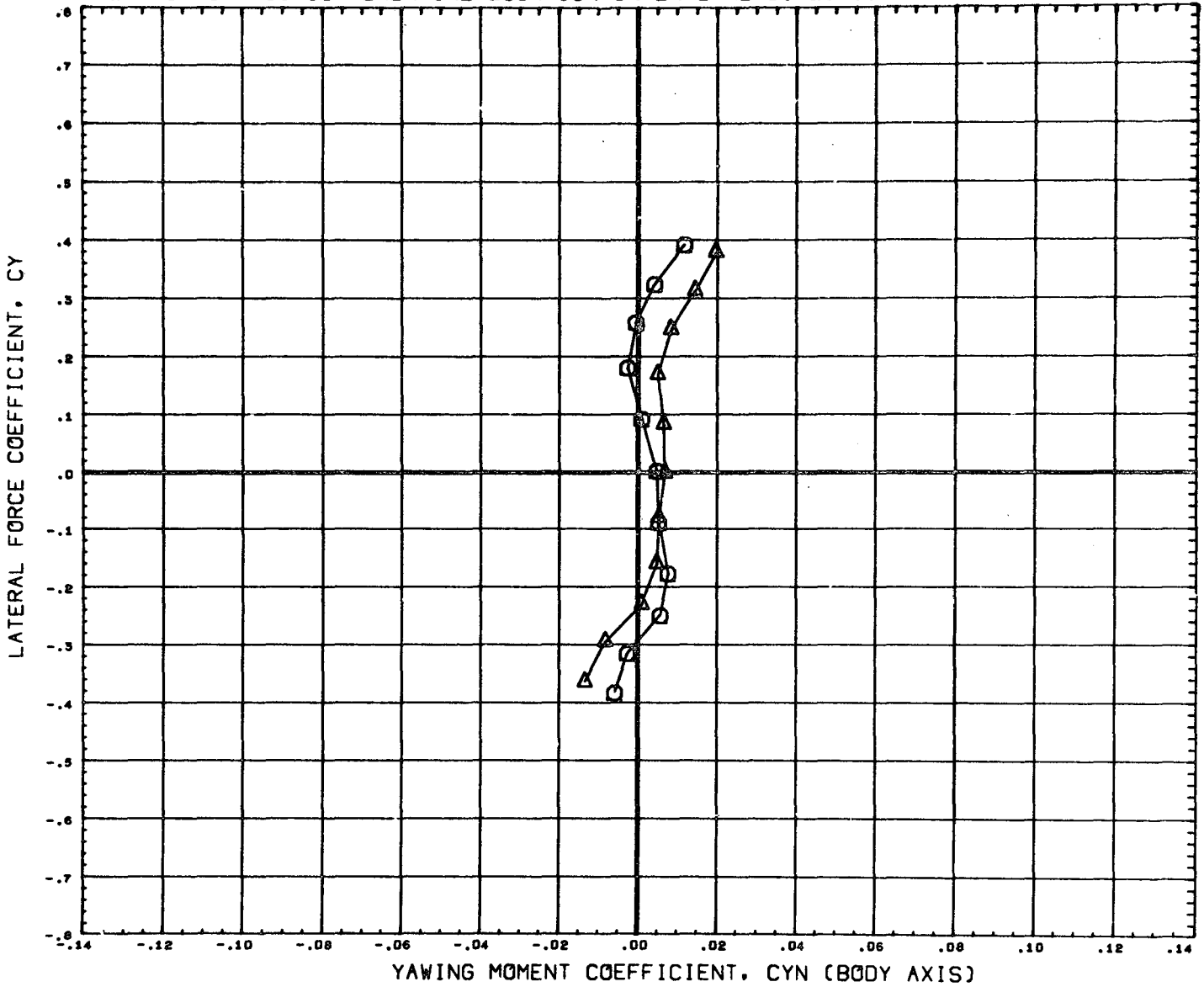

DATA SET SYMBOL	CONFIGURATION DESCRIPTION	ORBIN	THETS	ALPHA	REFERENCE INFORMATION
(B65011)	MSFC TWT 534 SHUTTLE LAUNCH	T101S1	-1.500	0.000	SREF 4.8950 SQ. IN
(B55005)	MSFC TWT 534 SHUTTLE LAUNCH	T101S1	-1.500	21.000	LREF 2.6440 IN.
					BREF 3.5250 IN.
					XMRP 3.4900 IN.
					YMRP 0.0000 IN.
					ZMRP 0.1616 IN.
					SCALE 0.0034

MACH .90

EFFECT OF SRM CIRCUMFERENTIAL LOCATION ON LATERAL/DIRECTIONAL CHARACTERISTICS

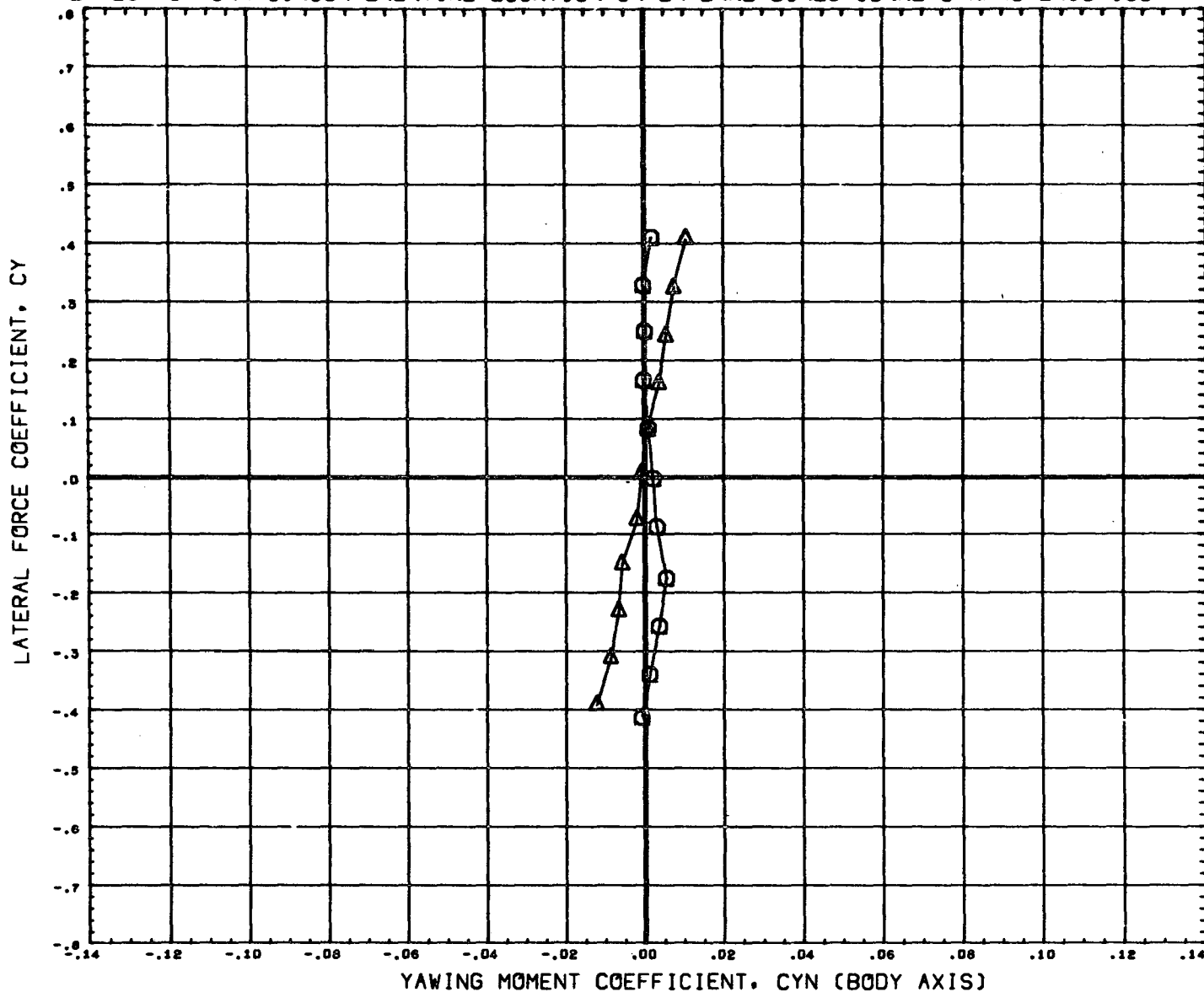

DATA SET SYMBOL	CONFIGURATION DESCRIPTION	ORBIN	THETS	ALPHA	REFERENCE INFORMATION
(865011)	MSFC TWT 534 SHUTTLE LAUNCH	T101S1	-1.500	0.000	SREF 4.8950 SQ. IN
(865005)	MSFC TWT 534 SHUTTLE LAUNCH	T101S1	-1.500	21.000	LREF 2.6440 IN.
					BREF 3.5250 IN.
					XMRP 3.4900 IN.
					YMRP 0.0000 IN.
					ZMRP 0.1616 IN.
					SCALE 0.0034

MACH 1.10

PAGE 332

EFFECT OF SRM CIRCUMFERENTIAL LOCATION ON LATERAL/DIRECTIONAL CHARACTERISTICS

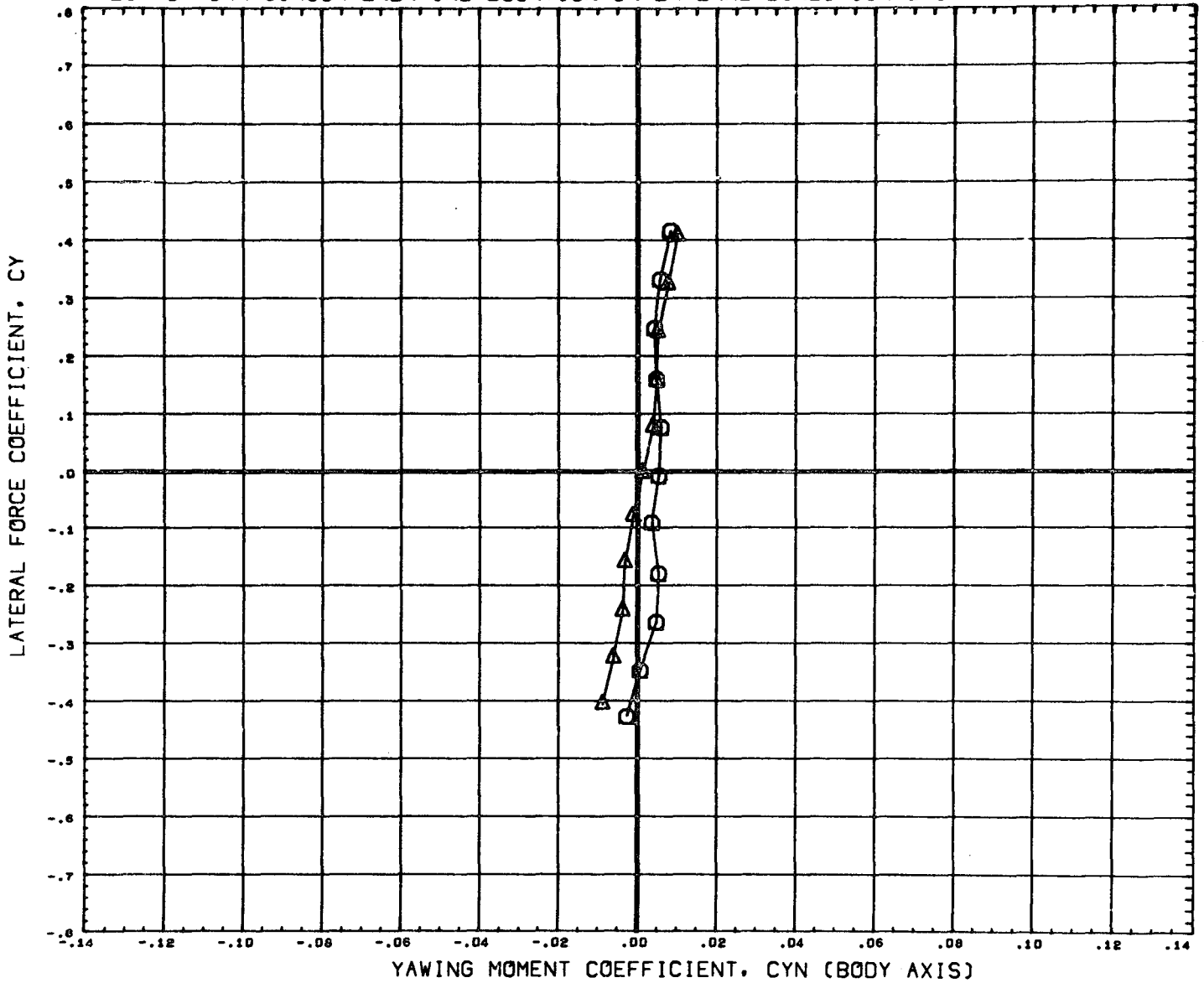

DATA SET SYMBOL	CONFIGURATION DESCRIPTION	ORBIN	THETS	ALPHA	REFERENCE INFORMATION
(B65011)	MSFC TWT 534 SHUTTLE LAUNCH	-1.500	0.000	0.000	SREF 4.8950 SQ. IN
(B65005)	MSFC TWT 534 SHUTTLE LAUNCH	-1.500	21.000	0.000	LREF 2.6440 IN.
					BREF 3.5250 IN.
					XMRP 3.4900 IN.
					YMRP 0.0000 IN.
					ZMRP 0.1616 IN.
					SCALE 0.0034

MACH 1.19

EFFECT OF SRM CIRCUMFERENTIAL LOCATION ON LATERAL/DIRECTIONAL CHARACTERISTICS

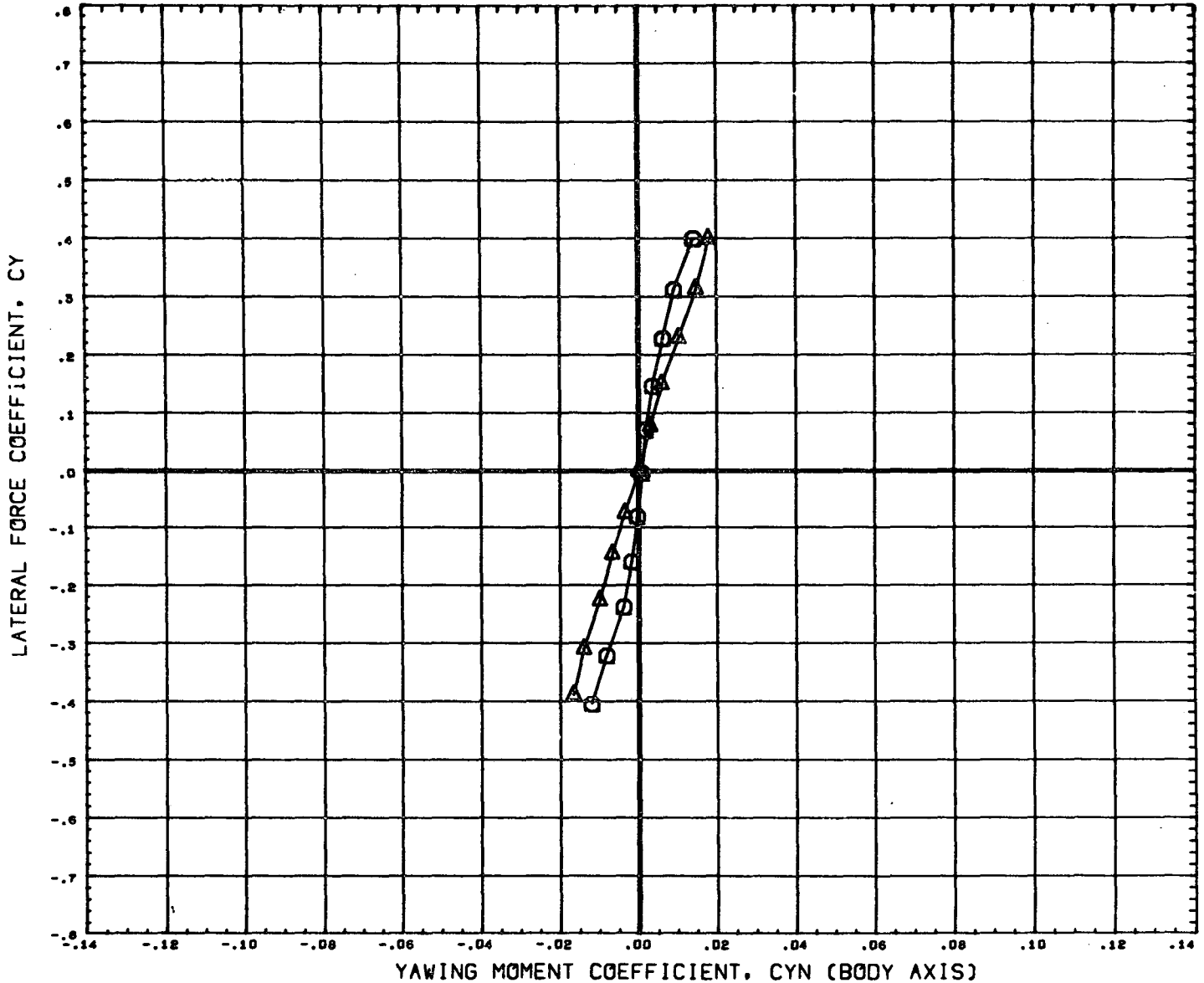

DATA SET SYMBOL	CONFIGURATION DESCRIPTION	ORBIN	THETS	ALPHA	REFERENCE INFORMATION
(B65011)	MSFC TWT 534 SHUTTLE LAUNCH	T101S1	-1.500	0.000	SREF 4.8950 SQ. IN
(B65005)	MSFC TWT 534 SHUTTLE LAUNCH	T101S1	-1.500	21.000	LREF 2.6440 IN.
					BREF 3.5250 IN.
					XMRP 3.4900 IN.
					YMRP 0.0000 IN.
					ZMRP 0.1616 IN.
					SCALE 0.0034

EFFECT OF SRM CIRCUMFERENTIAL LOCATION ON LATERAL/DIRECTIONAL CHARACTERISTICS

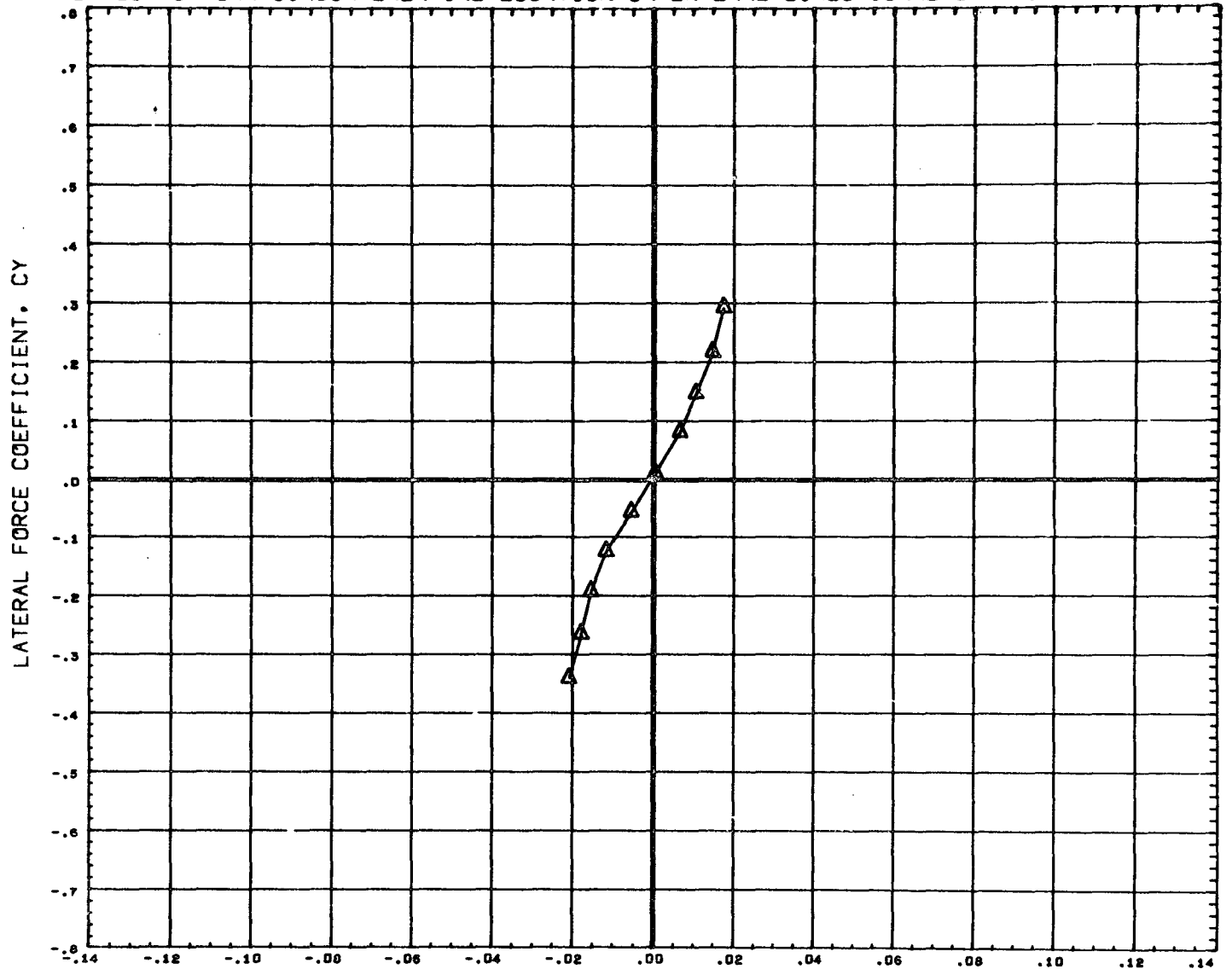

DATA SET SYMBOL	CONFIGURATION DESCRIPTION	ORBIN	THETS	ALPHA	REFERENCE INFORMATION	
(B65011)	DATA NOT AVAILABLE FOR ALL CONDITIONS	-1.500	0.000	0.000	SREF	4.8950 SQ. IN
(B65005)	MSFC TWT 534 SHUTTLE LAUNCH T101S1	-1.500	21.000	0.000	LREF	2.6440 IN.
					BREF	3.5250 IN.
					XMRP	3.4900 IN.
					YMRP	0.0000 IN.
					ZMRP	0.1616 IN.
					SCALE	0.0034

MACH 2.74

EFFECT OF SRM CIRCUMFERENTIAL LOCATION ON LATERAL/DIRECTIONAL CHARACTERISTICS

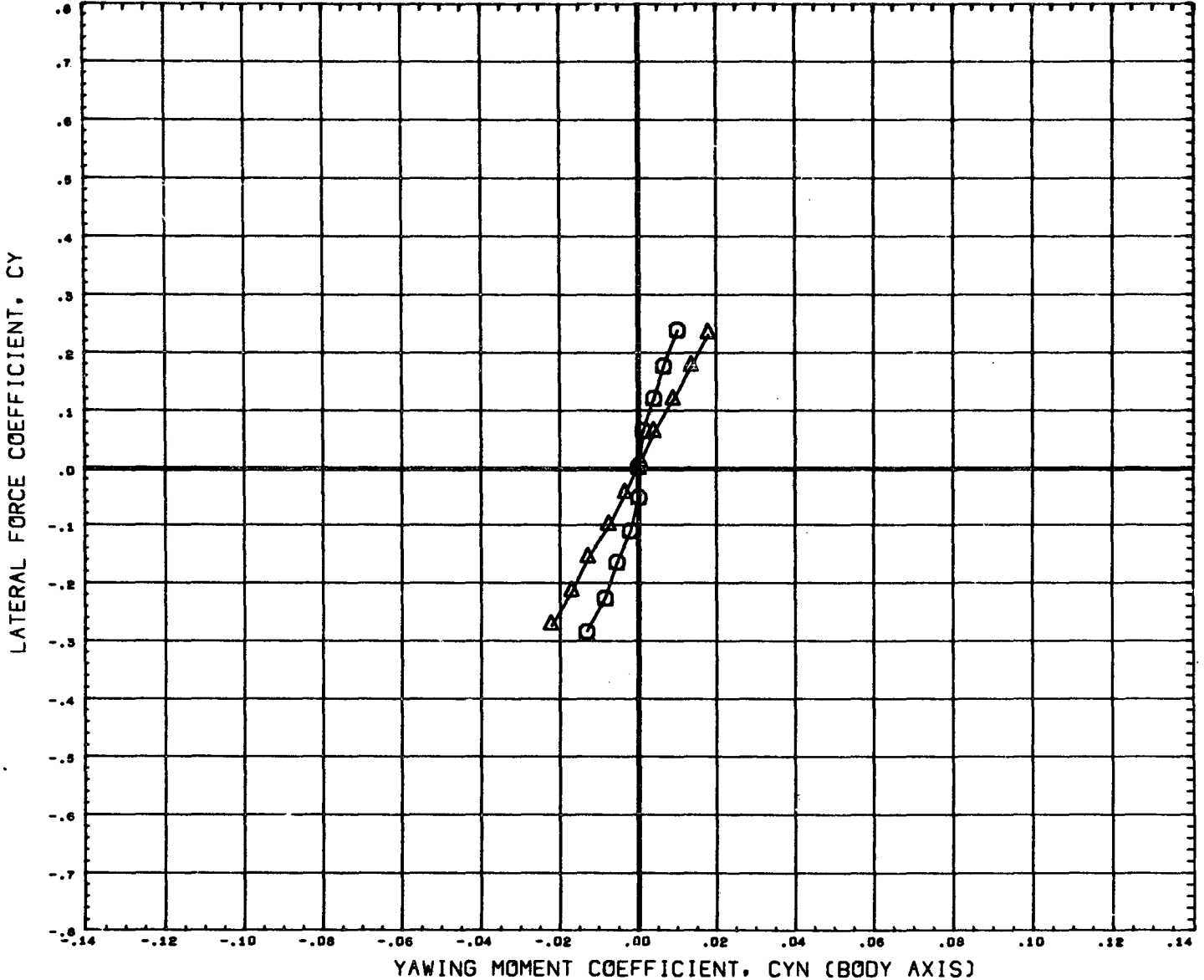

DATA SET SYMBOL	CONFIGURATION DESCRIPTION	ORBIT	THETA	ALPHA	REFERENCE INFORMATION
(B65011)	MSFC TWT 534 SHUTTLE LAUNCH	T101S1	-1.500	0.000	SREF 4.8950 SQ. IN
(B65005)	MSFC TWT 534 SHUTTLE LAUNCH	T101S1	-1.500	21.000	LREF 2.6440 IN.
					BREF 3.5250 IN.
					XMRP 3.4900 IN.
					YMRP 0.0000 IN.
					ZMRP 0.1616 IN.
					SCALE 0.0034

MACH 4.96

EFFECT OF SRM NOSE AND END FAIRINGS ON LONGITUDINAL CHARACTERISTICS

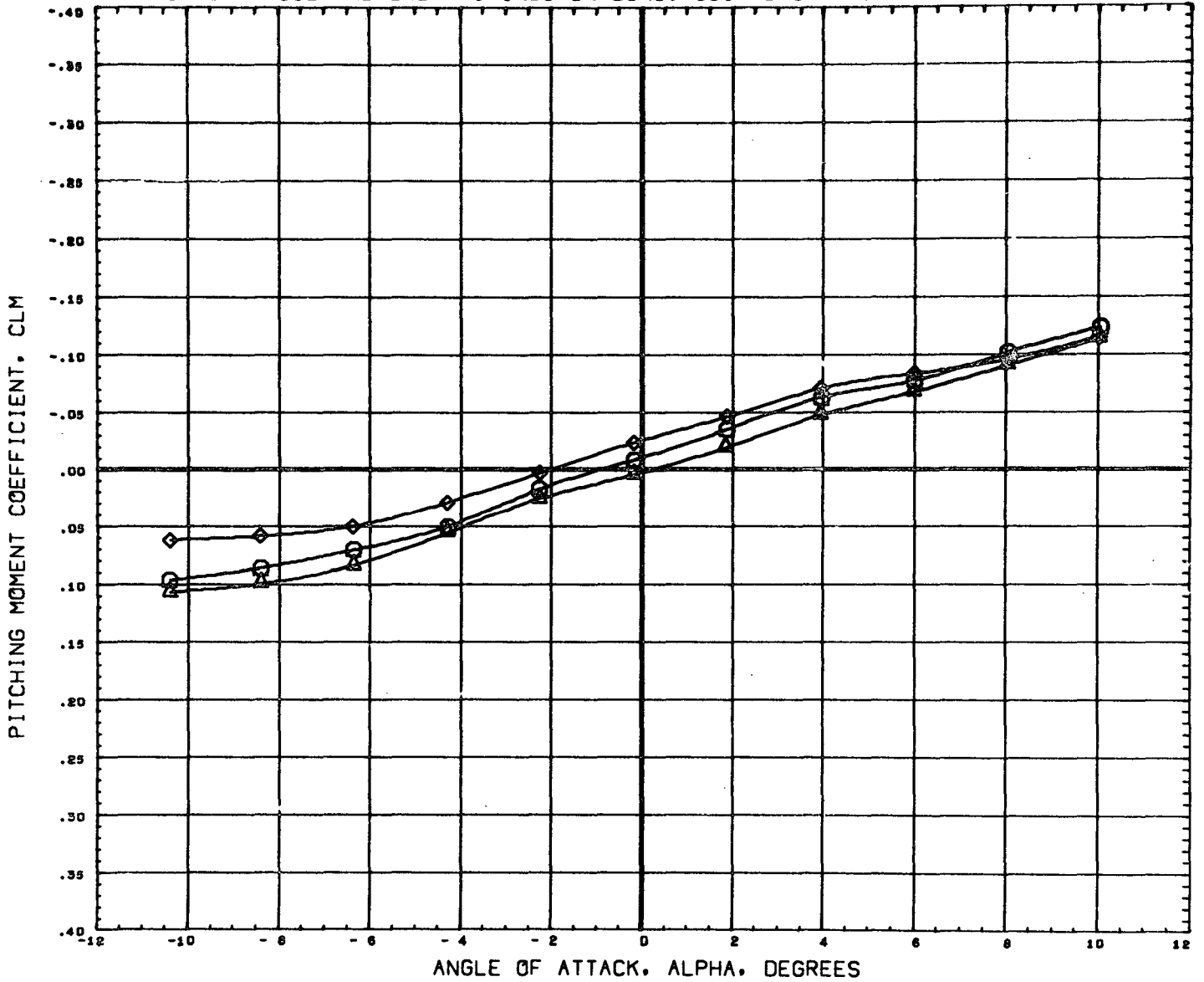

DATA SET SYMBOL	CONFIGURATION DESCRIPTION	T	ORBIN	THETS	BETA	REFERENCE INFORMATION
(B65004)	MSFC TWT 534 SHUTTLE LAUNCH	T101S1	-1.500	21.000	0.000	SREF 4.8950 SQ. IN
(B65017)	MSFC TWT 534 SHUTTLE LAUNCH	T101S2	-1.500	21.000	0.000	LREF 2.6440 IN.
(B65023)	MSFC TWT 534 SHUTTLE LAUNCH	T101S3	-1.500	21.000	0.000	BREF 3.5250 IN.
						XNRP 3.4900 IN.
						YNRP 0.0000 IN.
						ZNRP 0.1616 IN.
						SCALE 0.0034

MACH .60

EFFECT OF SRM NOSE AND END FAIRINGS ON LONGITUDINAL CHARACTERISTICS

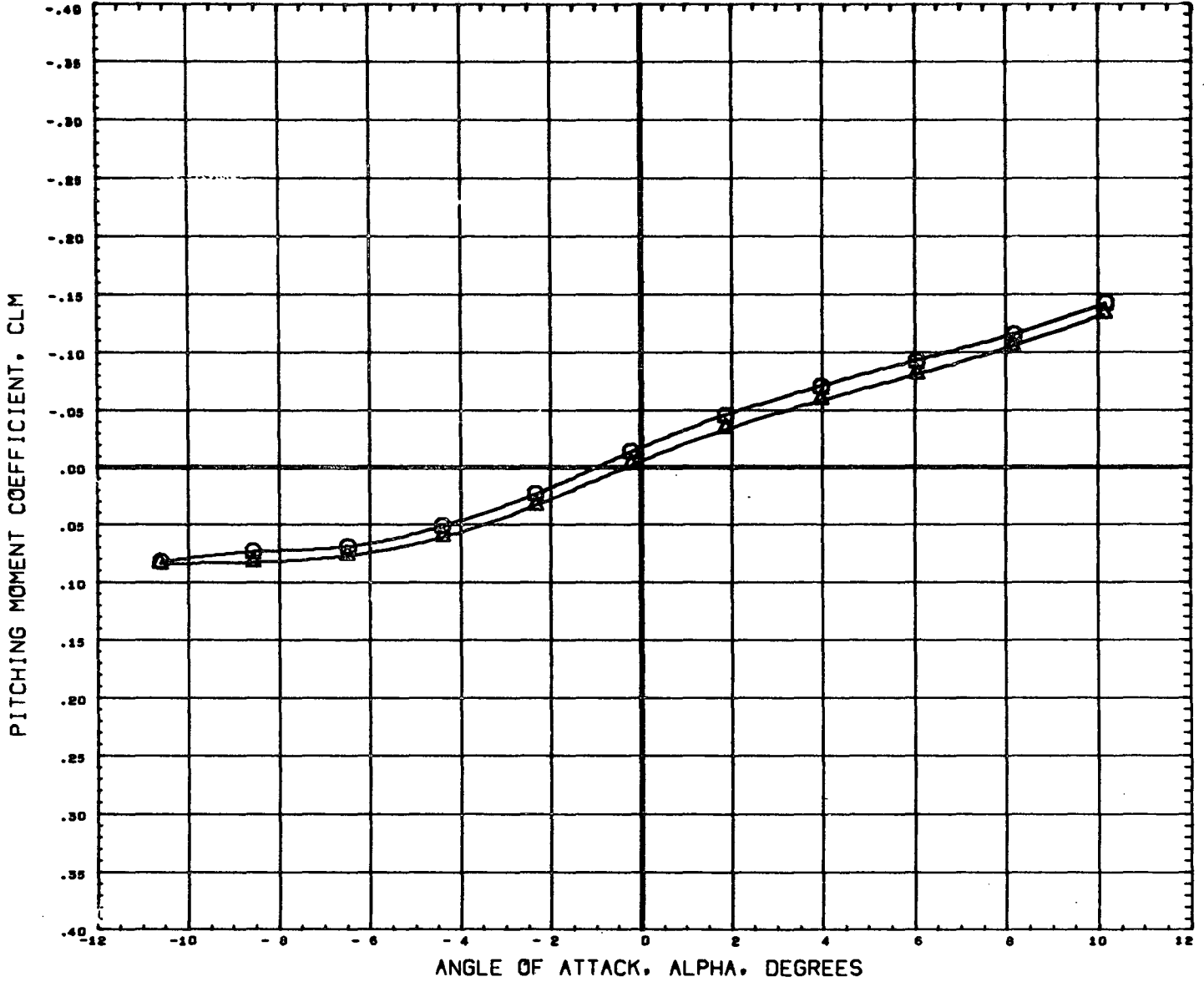

DATA SET SYMBOL	CONFIGURATION DESCRIPTION	ORBIN	THETS	BETA	REFERENCE INFORMATION
(B65004)	MSFC TWT 534 SHUTTLE LAUNCH T10191	-1.500	21.000	0.000	SREF 4.8950 SQ. IN
(B65017)	MSFC TWT 534 SHUTTLE LAUNCH T10192	-1.500	21.000	0.000	LREF 2.6440 IN.
(B65023)	DATA NOT AVAILABLE FOR ALL CONDITIONS	-1.500	21.000	0.000	BREF 3.5250 IN.
					XMRP 3.4900 IN.
					YMRP 0.0000 IN.
					ZMRP 0.1616 IN.
					SCALE 0.0034

MACH .80

EFFECT OF SRM NOSE AND END FAIRINGS ON LONGITUDINAL CHARACTERISTICS

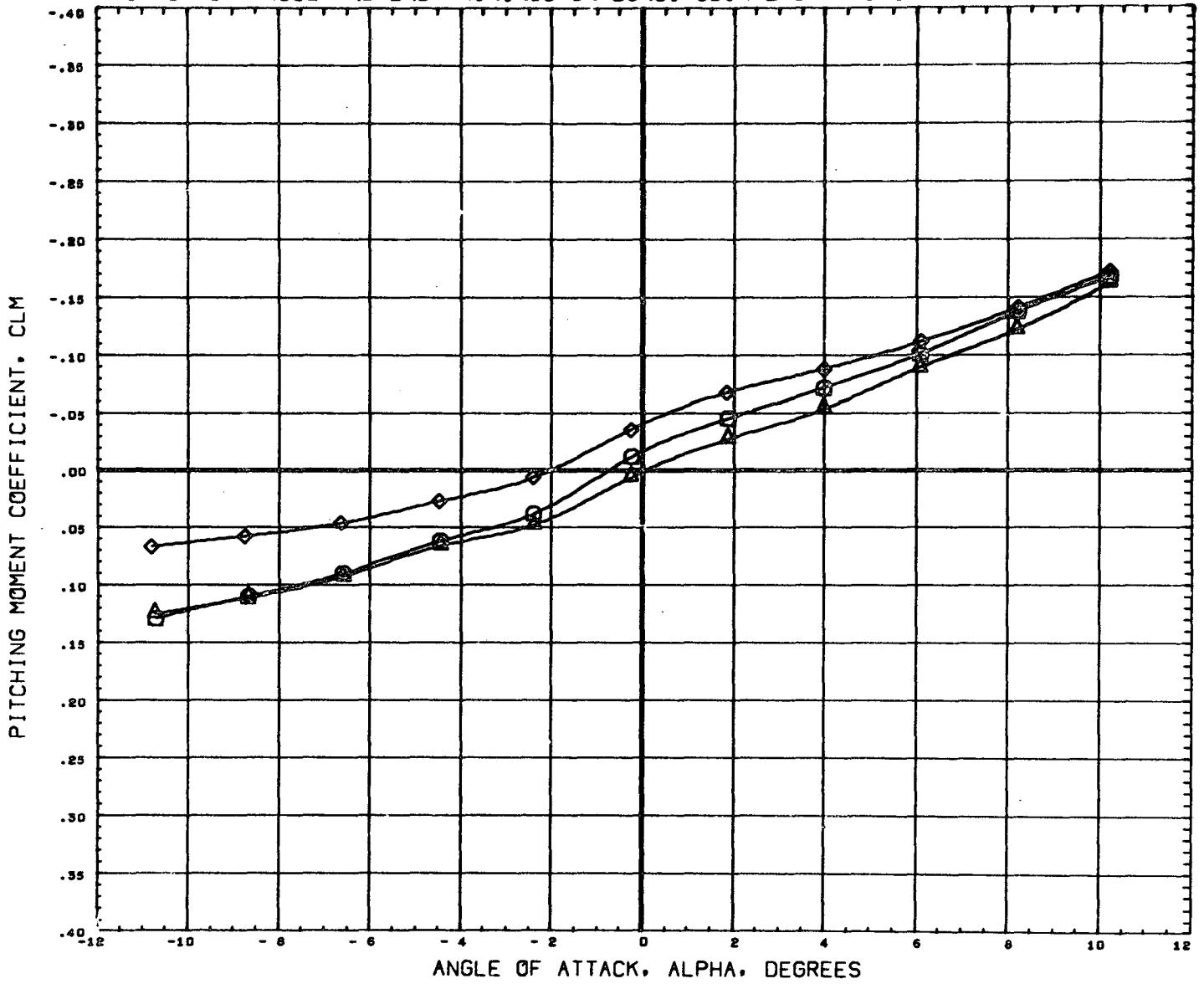

DATA SET SYMBOL	CONFIGURATION DESCRIPTION	ORBIN	THETS	BETA	REFERENCE INFORMATION	
(B65004)	MSFC TWT 534 SHUTTLE LAUNCH	-1.500	21.000	0.000	SREF	4.8950 SQ. IN
(B65017)	MSFC TWT 534 SHUTTLE LAUNCH	-1.500	21.000	0.000	LREF	2.6440 IN.
(B65023)	MSFC TWT 534 SHUTTLE LAUNCH	-1.500	21.000	0.000	BREF	3.5250 IN.
					XMRP	3.4900 IN.
					YMRP	0.0000 IN.
					ZMRP	0.1616 IN.
					SCALE	0.0034

MACH .91

EFFECT OF SRM NOSE AND END FAIRINGS ON LONGITUDINAL CHARACTERISTICS

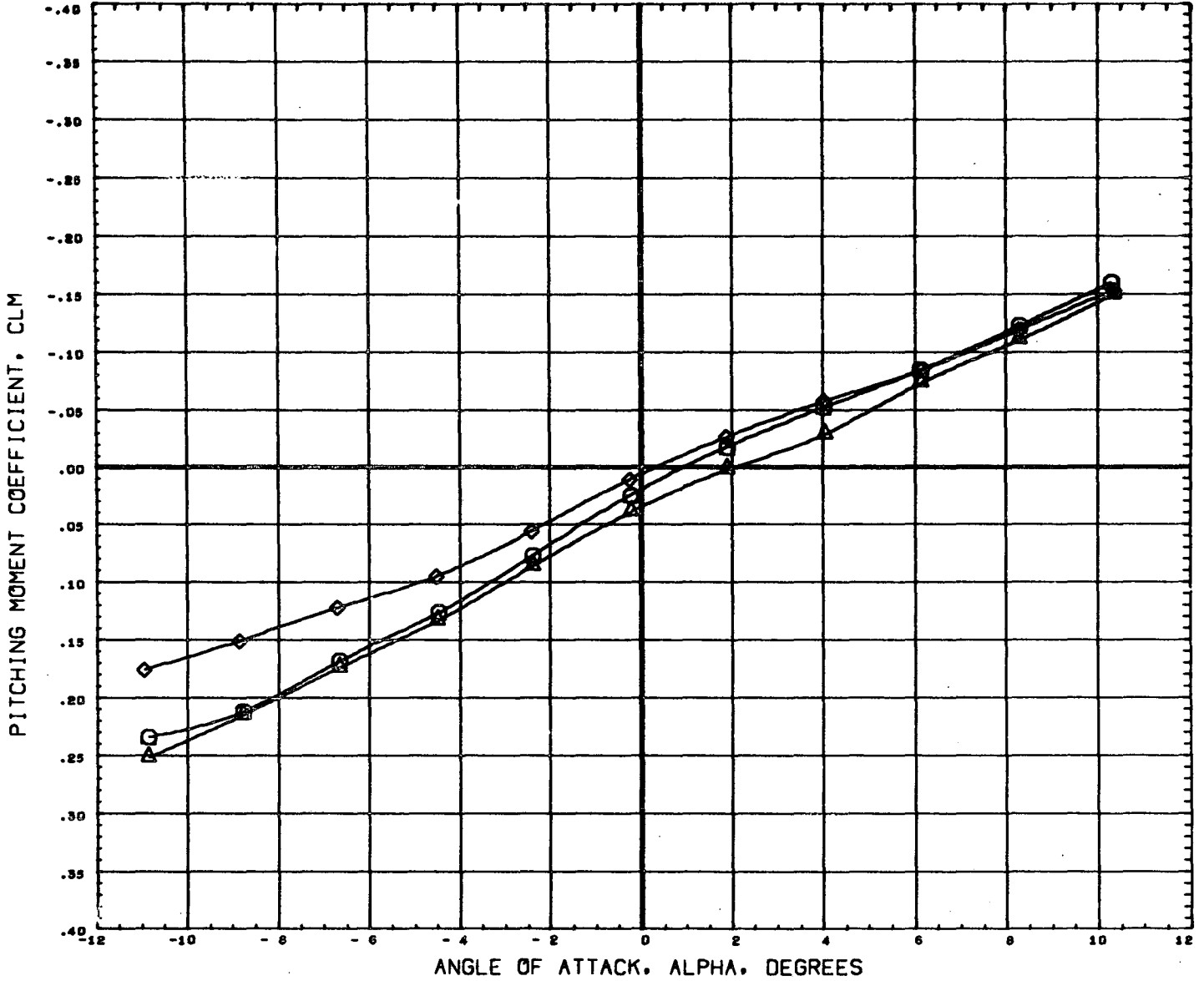

DATA SET SYMBOL	CONFIGURATION DESCRIPTION	ORBIN	THETS	BETA	REFERENCE INFORMATION	
(B65004)	MSFC TWT 534 SHUTTLE LAUNCH	T10181	-1.500	21.000	0.000	SREF 4.8950 SQ. IN
(B65017)	MSFC TWT 534 SHUTTLE LAUNCH	T10182	-1.500	21.000	0.000	LREF 2.6440 IN.
(B65023)	MSFC TWT 534 SHUTTLE LAUNCH	T10183	-1.500	21.000	0.000	BREF 3.5250 IN.
						XMRP 3.4900 IN.
						YMRP 0.0000 IN.
						ZMRP 0.1616 IN.
						SCALE 0.0034

MACH 1.10

PAGE 340

EFFECT OF SRM NOSE AND END FAIRINGS ON LONGITUDINAL CHARACTERISTICS

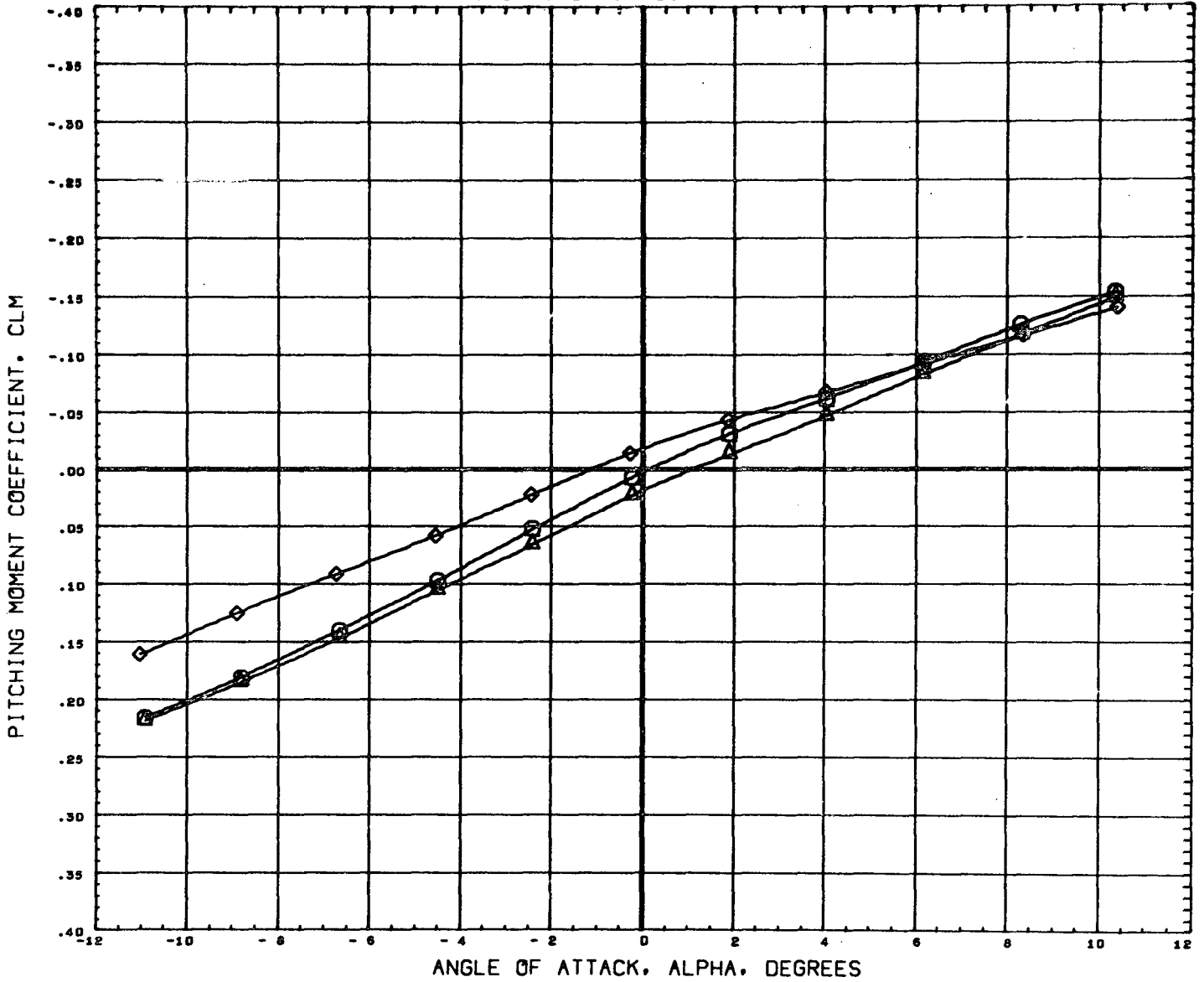

DATA SET SYMBOL	CONFIGURATION DESCRIPTION	ORBIN	THETS	BETA	REFERENCE INFORMATION
(865004) \square	MSFC TWT 534 SHUTTLE LAUNCH T101S1	-1.500	21.000	0.000	SREF 4.8950 Sq. IN
(865017) \circ	MSFC TWT 534 SHUTTLE LAUNCH T101S2	-1.500	21.000	0.000	LREF 2.6440 IN.
(865023) \diamond	MSFC TWT 534 SHUTTLE LAUNCH T101S3	-1.500	21.000	0.000	BREF 3.5250 IN.
					XMRP 3.4900 IN.
					YMRP 0.0000 IN.
					ZMRP 0.1616 IN.
					SCALE 0.0034

MACH 1.20

PAGE 341

EFFECT OF SRM NOSE AND END FAIRINGS ON LONGITUDINAL CHARACTERISTICS

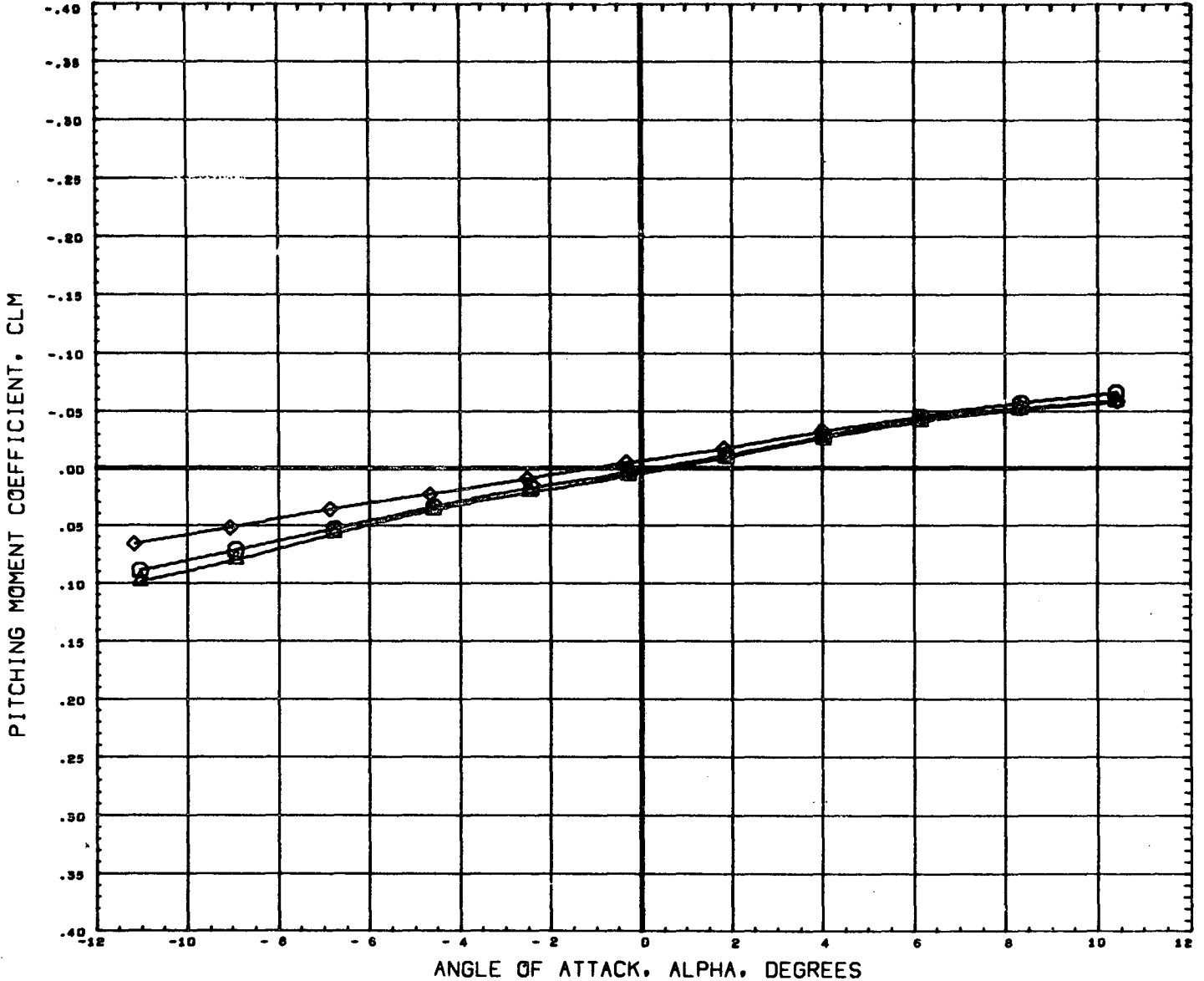

DATA SET SYMBOL	CONFIGURATION DESCRIPTION	ORBIN	THETS	BETA	REFERENCE INFORMATION
(B65004)	NSFC TWT 534 SHUTTLE LAUNCH	-1.500	21.000	0.000	SREF 4.8950 SQ. IN
(B65017)	NSFC TWT 534 SHUTTLE LAUNCH	-1.500	21.000	0.000	LREF 2.6440 IN.
(B65023)	NSFC TWT 534 SHUTTLE LAUNCH	-1.500	21.000	0.000	BREF 3.5250 IN.
					XMRP 3.4900 IN.
					YMRP 0.0000 IN.
					ZMRP 0.1616 IN.
					SCALE 0.0034

MACH 1.97

PAGE 342

EFFECT OF SRM NOSE AND END FAIRINGS ON LONGITUDINAL CHARACTERISTICS

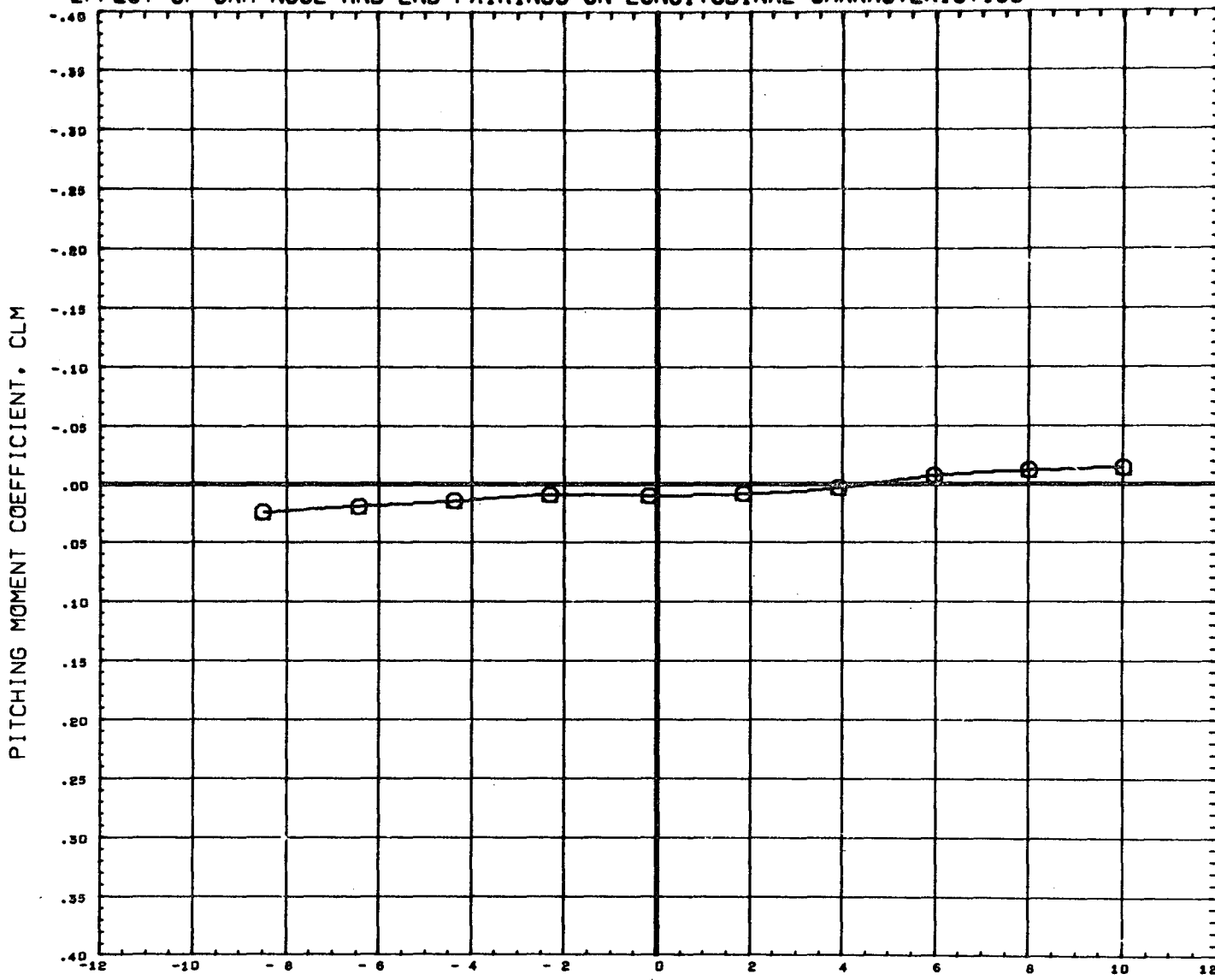

DATA SET SYMBOL	CONFIGURATION DESCRIPTION	ORBIN	THETS	BETA	REFERENCE INFORMATION
(B65004)	MSFC TWT 534 SHUTTLE LAUNCH T10151	-1.500	21.000	0.000	SREF 4.8950 SQ. IN
(B65017)	DATA NOT AVAILABLE FOR ALL CONDITIONS	-1.500	21.000	0.000	LREF 2.6440 IN.
(B65023)	DATA NOT AVAILABLE FOR ALL CONDITIONS	-1.500	21.000	0.000	BREF 3.5250 IN.
					XMRP 3.4900 IN.
					YMRP 0.0000 IN.
					ZMRP 0.1616 IN.
					SCALE 0.0034

MACH 2.74

EFFECT OF SRM NOSE AND END FAIRINGS ON LONGITUDINAL CHARACTERISTICS

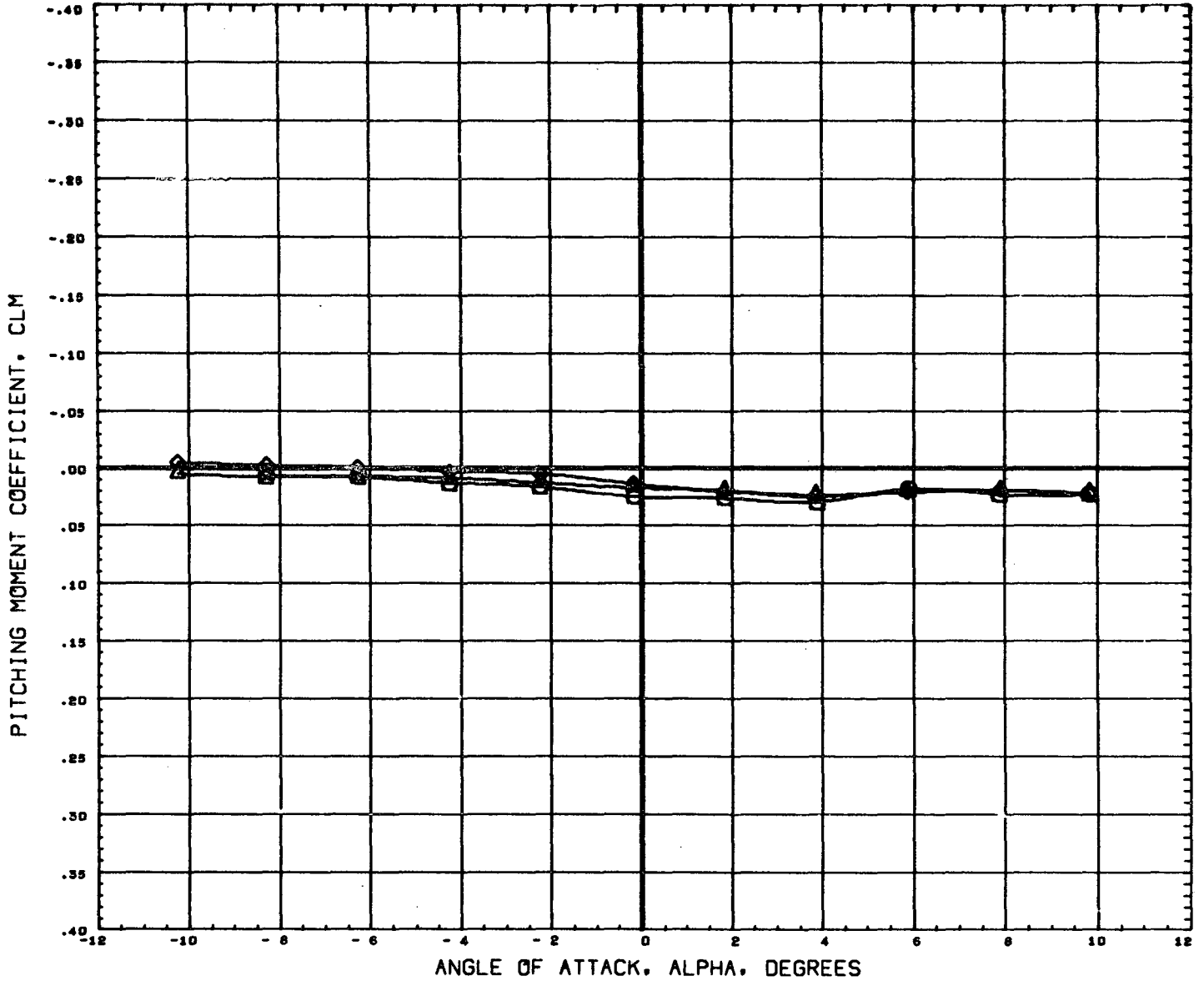

DATA SET SYMBOL	CONFIGURATION DESCRIPTION	ORBIN	THEYS	BETA	REFERENCE INFORMATION	
(B65004)	MSFC TWT 534 SHUTTLE LAUNCH	T101S1	-1.500	21.000	0.000	SREF 4.8950 SQ. IN
(B65017)	MSFC TWT 534 SHUTTLE LAUNCH	T101S2	-1.500	21.000	0.000	LREF 2.6440 IN.
(B65023)	MSFC TWT 534 SHUTTLE LAUNCH	T101S3	-1.500	21.000	0.000	BREF 3.5250 IN.
						XMRP 3.4900 IN.
						YMRP 0.0000 IN.
						ZMRP 0.1616 IN.
						SCALE 0.0034

EFFECT OF SRM NOSE AND END FAIRINGS ON LONGITUDINAL CHARACTERISTICS

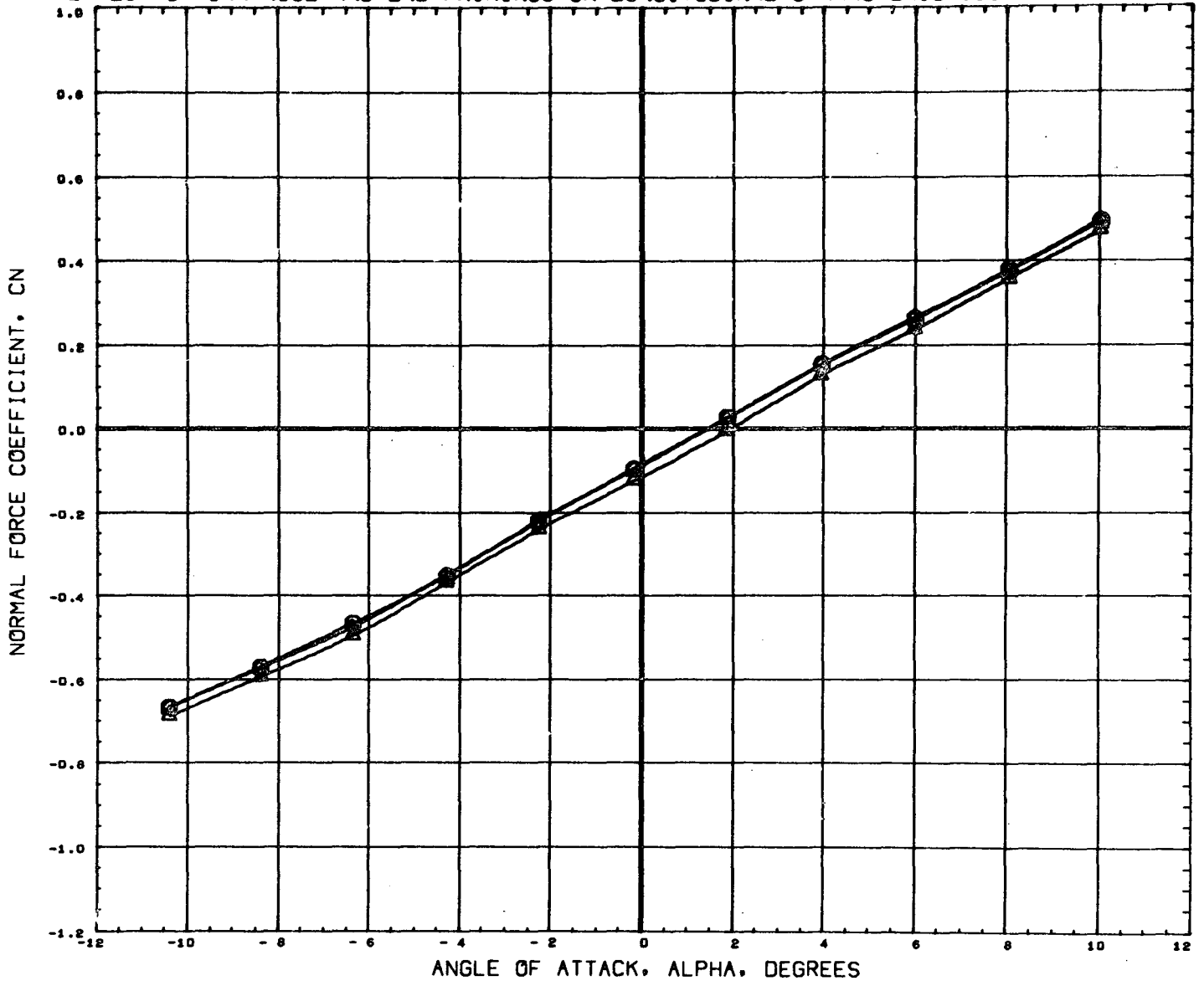

DATA SET SYMBOL	CONFIGURATION DESCRIPTION	ORBIN	THETS	BETA	REFERENCE INFORMATION
(B65004)	NSFC TWT 534 SHUTTLE LAUNCH	-1.500	21.000	0.000	SREF 4.8950 sq. IN
(B65017)	NSFC TWT 534 SHUTTLE LAUNCH	-1.500	21.000	0.000	LREF 2.6440 IN.
(B65023)	NSFC TWT 534 SHUTTLE LAUNCH	-1.500	21.000	0.000	BREF 3.5250 IN.
					XMRP 3.4900 IN.
					YMRP 0.0000 IN.
					ZMRP 0.1616 IN.
					SCALE 0.0034

MACH .60

EFFECT OF SRM NOSE AND END FAIRINGS ON LONGITUDINAL CHARACTERISTICS

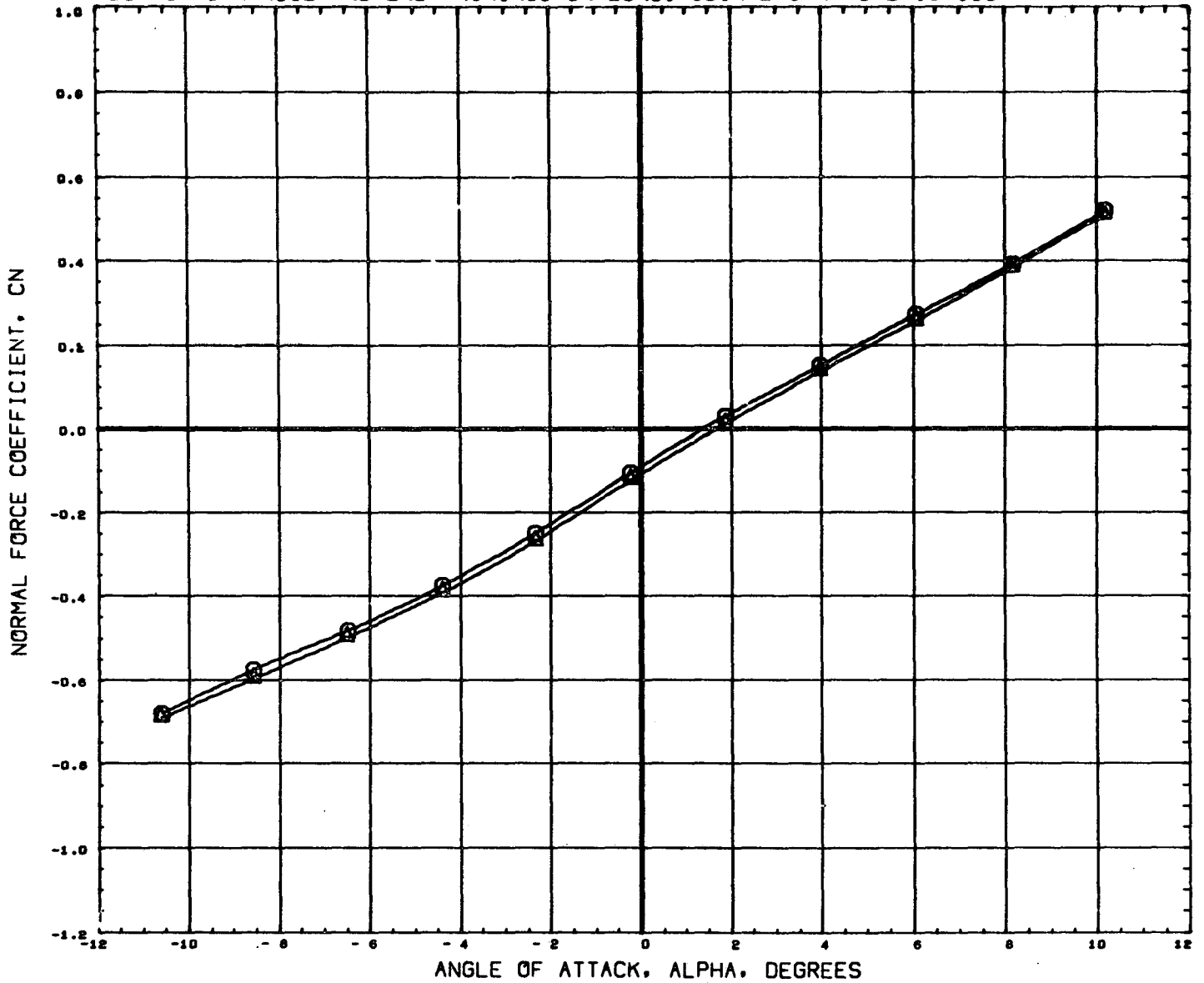

DATA SET SYMBOL	CONFIGURATION DESCRIPTION	ORBIN	THETS	BETA	REFERENCE INFORMATION
(B65004)	MSFC TWT 534 SHUTTLE LAUNCH T101S1	-1.500	21.000	0.000	SREF 4.8950 SQ. IN
(B65017)	MSFC TWT 534 SHUTTLE LAUNCH T101S2	-1.500	21.000	0.000	LREF 2.6440 IN.
(B65023)	DATA NOT AVAILABLE FOR ALL CONDITIONS	-1.500	21.000	0.000	BREF 3.5250 IN.
					XNRP 3.4900 IN.
					YNRP 0.0000 IN.
					ZMRP 0.1616 IN.
					SCALE 0.0034

MACH .80

PAGE 346

EFFECT OF SRM NOSE AND END FAIRINGS ON LONGITUDINAL CHARACTERISTICS

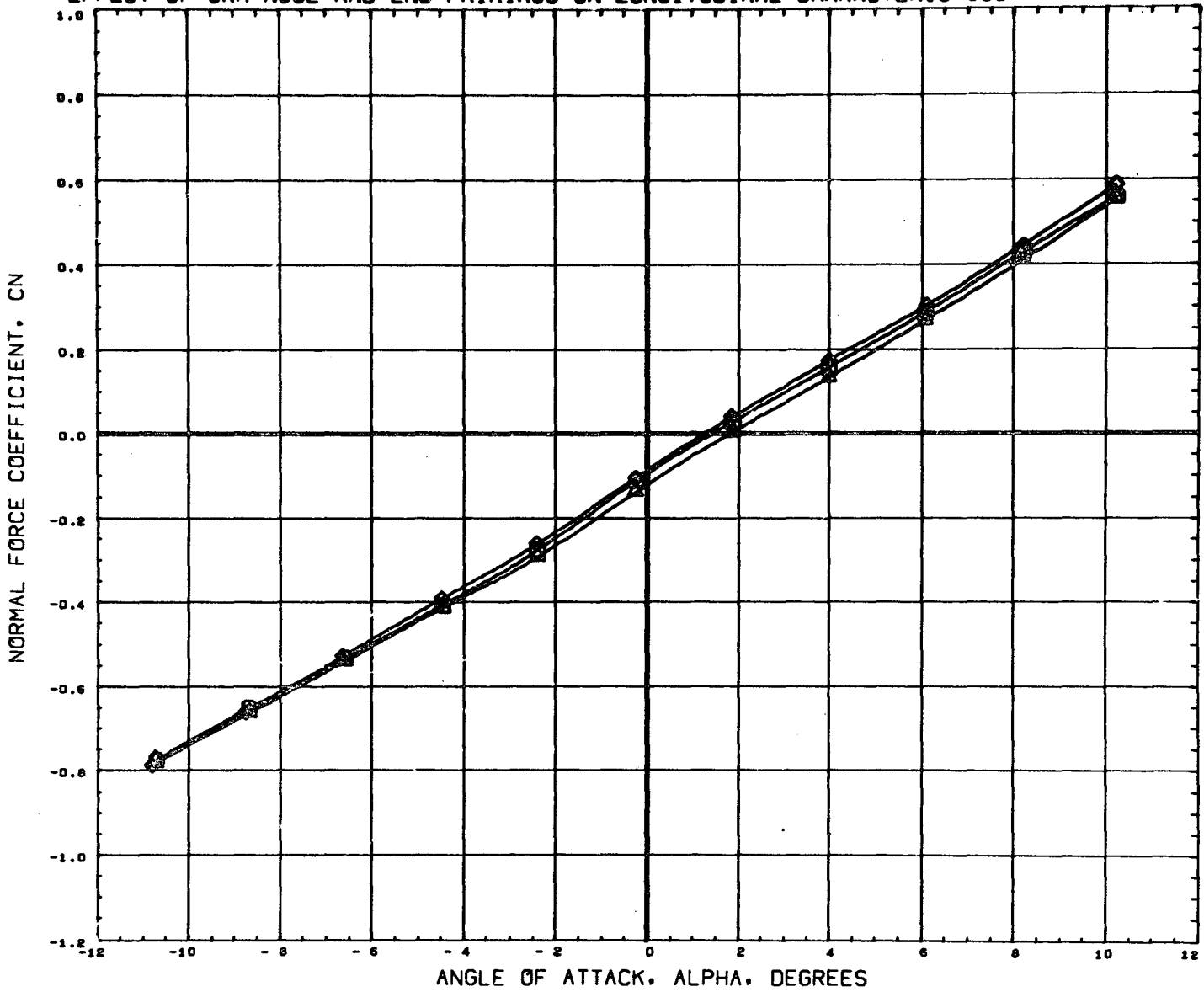

DATA SET SYMBOL	CONFIGURATION DESCRIPTION	ORBIN	THETS	BETA	REFERENCE INFORMATION
(865004)	MSFC TWT 534 SHUTTLE LAUNCH	-1.500	21.000	0.000	SREF 4.8950 SQ. IN
(865017)	MSFC TWT 534 SHUTTLE LAUNCH	-1.500	21.000	0.000	LREF 2.6440 IN.
(865023)	MSFC TWT 534 SHUTTLE LAUNCH	-1.500	21.000	0.000	BREF 3.5250 IN.
					XMRP 3.4900 IN.
					YMRP 0.0000 IN.
					ZMRP 0.1616 IN.
					SCALE 0.0034

MACH .91

EFFECT OF SRM NOSE AND END FAIRINGS ON LONGITUDINAL CHARACTERISTICS

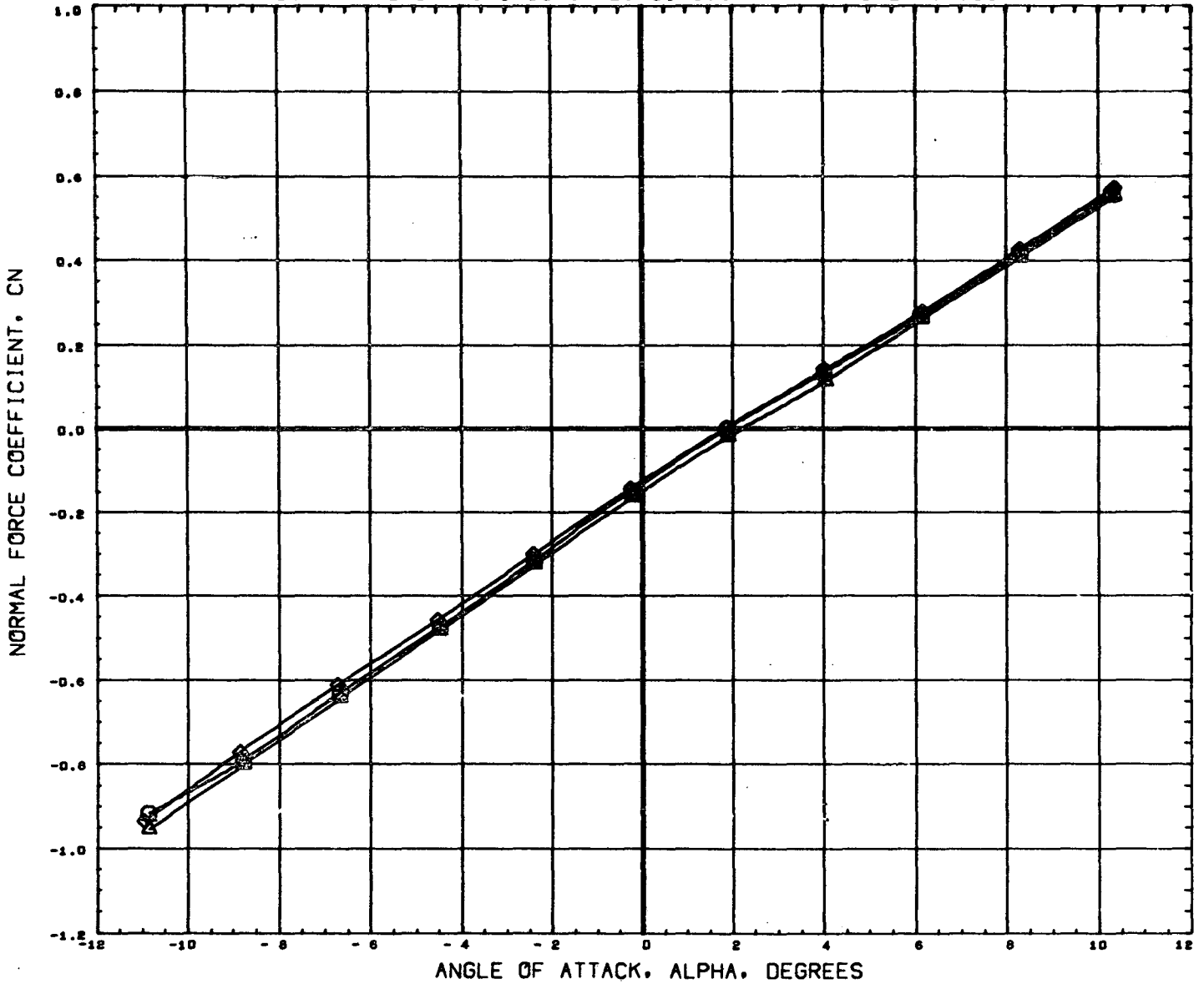

DATA SET SYMBOL	CONFIGURATION DESCRIPTION	ORBIN	THETS	BETA	REFERENCE INFORMATION
(B65004)	MSFC TWT 534 SHUTTLE LAUNCH	-1.500	21.000	0.000	SREF 4.8950 SQ. IN
(B65017)	MSFC TWT 534 SHUTTLE LAUNCH	-1.500	21.000	0.000	LREF 2.6440 IN.
(B65023)	MSFC TWT 534 SHUTTLE LAUNCH	-1.500	21.000	0.000	BREF 3.5250 IN.
					XMRP 3.4900 IN.
					YMRP 0.0000 IN.
					ZMRP 0.1616 IN.
					SCALE 0.0034

EFFECT OF SRM NOSE AND END FAIRINGS ON LONGITUDINAL CHARACTERISTICS

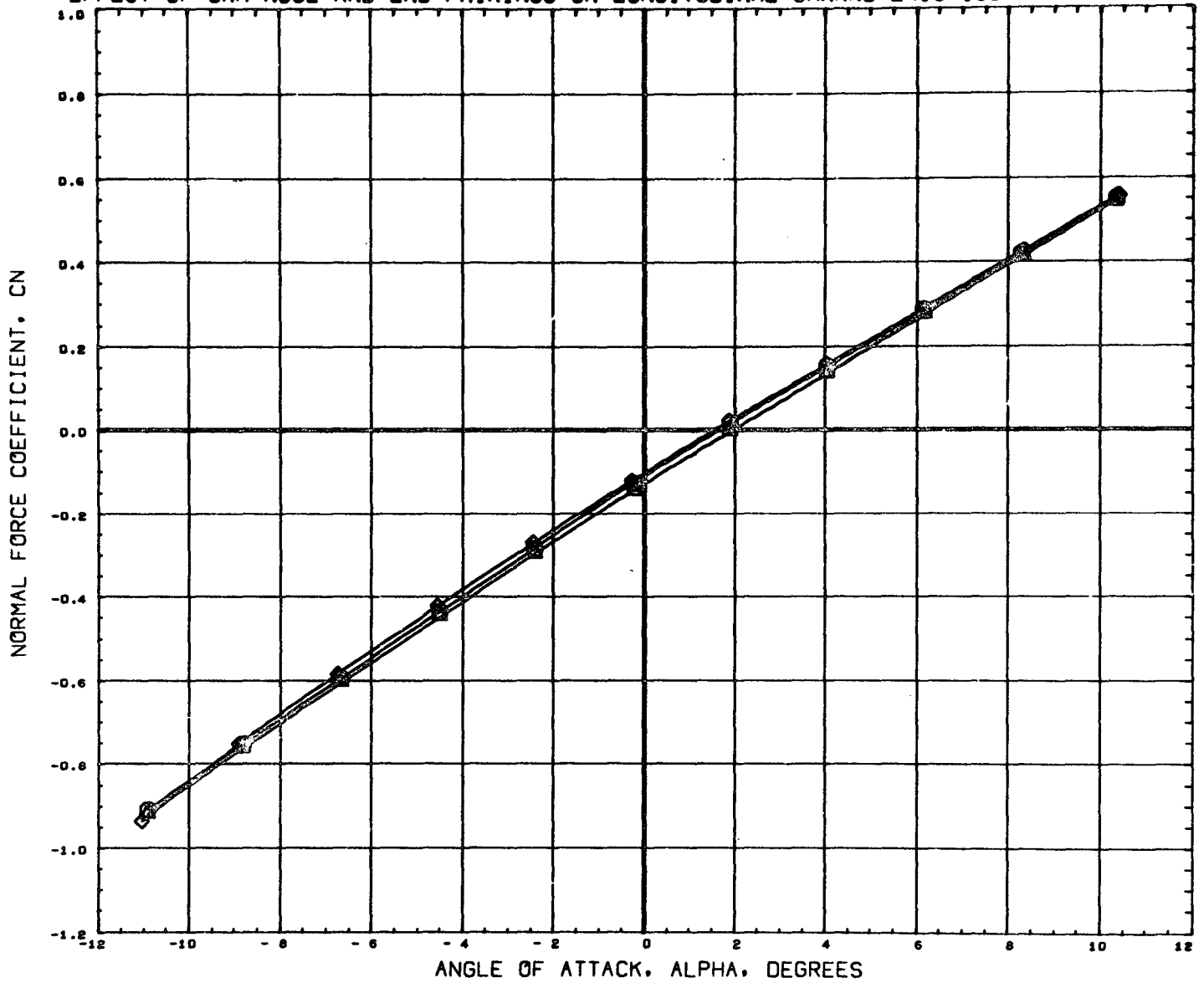

DATA SET SYMBOL	CONFIGURATION DESCRIPTION	ORBIN	THETS	BETA	REFERENCE INFORMATION
(B65004)	MSFC TWT 534 SHUTTLE LAUNCH	-1.500	21.000	0.000	SREF 4.8950 SQ. IN
(B65017)	MSFC TWT 534 SHUTTLE LAUNCH	-1.500	21.000	0.000	LREF 2.6440 IN.
(B65023)	MSFC TWT 534 SHUTTLE LAUNCH	-1.500	21.000	0.000	BREF 3.5250 IN.
					XMRP 3.4900 IN.
					YMRP 0.0000 IN.
					ZMRP 0.1616 IN.
					SCALE 0.0034

MACH 1.20

EFFECT OF SRM NOSE AND END FAIRINGS ON LONGITUDINAL CHARACTERISTICS

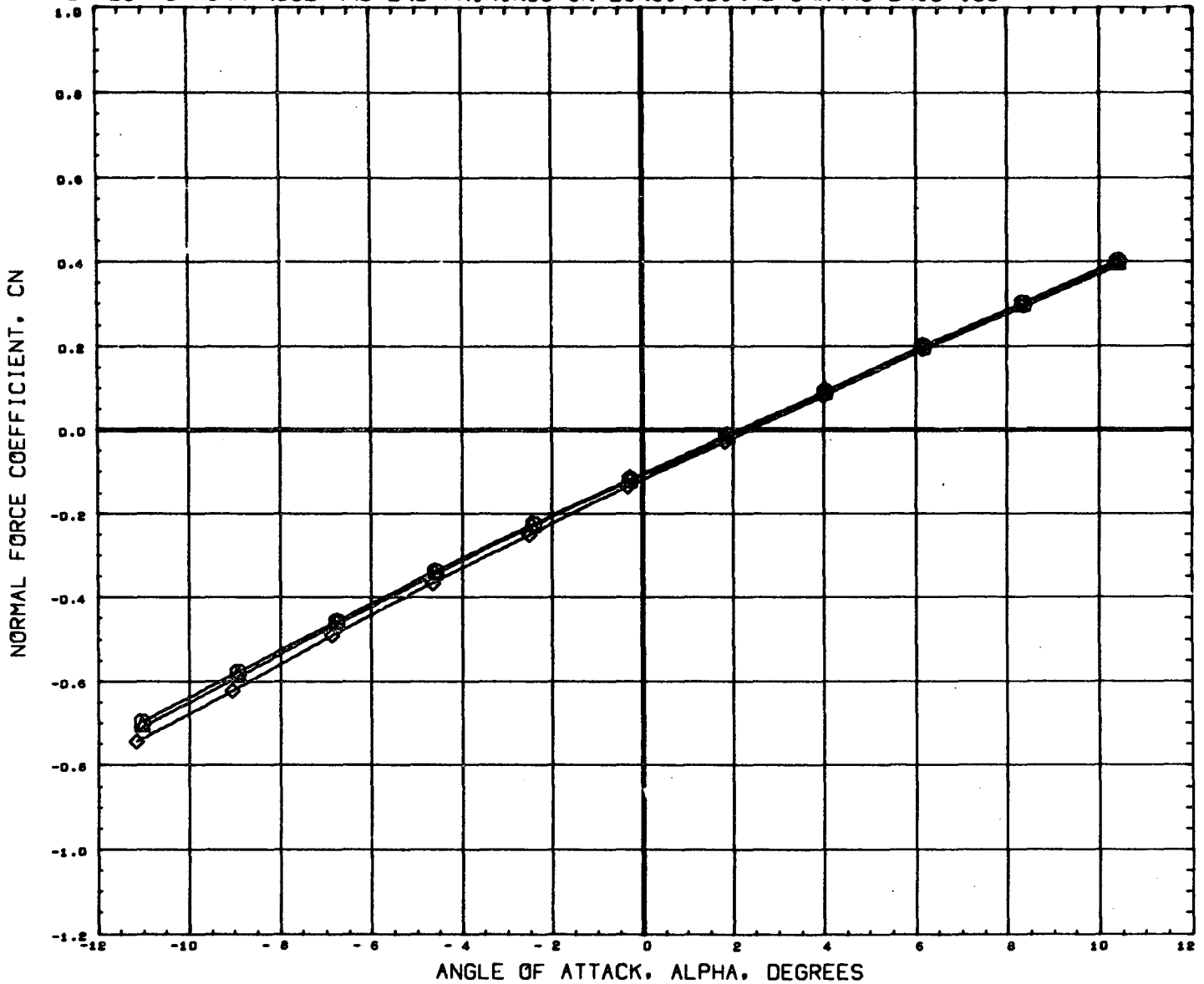

DATA SET SYMBOL	CONFIGURATION DESCRIPTION	ORBIT	THETA	BETA	REFERENCE INFORMATION
(B65004)	MSFC TWT 534 SHUTTLE LAUNCH	-1.500	21.000	0.000	SREF 4.8950 Sq. IN
(B65017)	MSFC TWT 534 SHUTTLE LAUNCH	-1.500	21.000	0.000	LREF 2.6440 IN.
(B65023)	MSFC TWT 534 SHUTTLE LAUNCH	-1.500	21.000	0.000	BREF 3.5250 IN.
					XMRP 3.4900 IN.
					YMRP 0.0000 IN.
					ZMRP 0.1616 IN.
					SCALE 0.0034

EFFECT OF SRM NOSE AND END FAIRINGS ON LONGITUDINAL CHARACTERISTICS

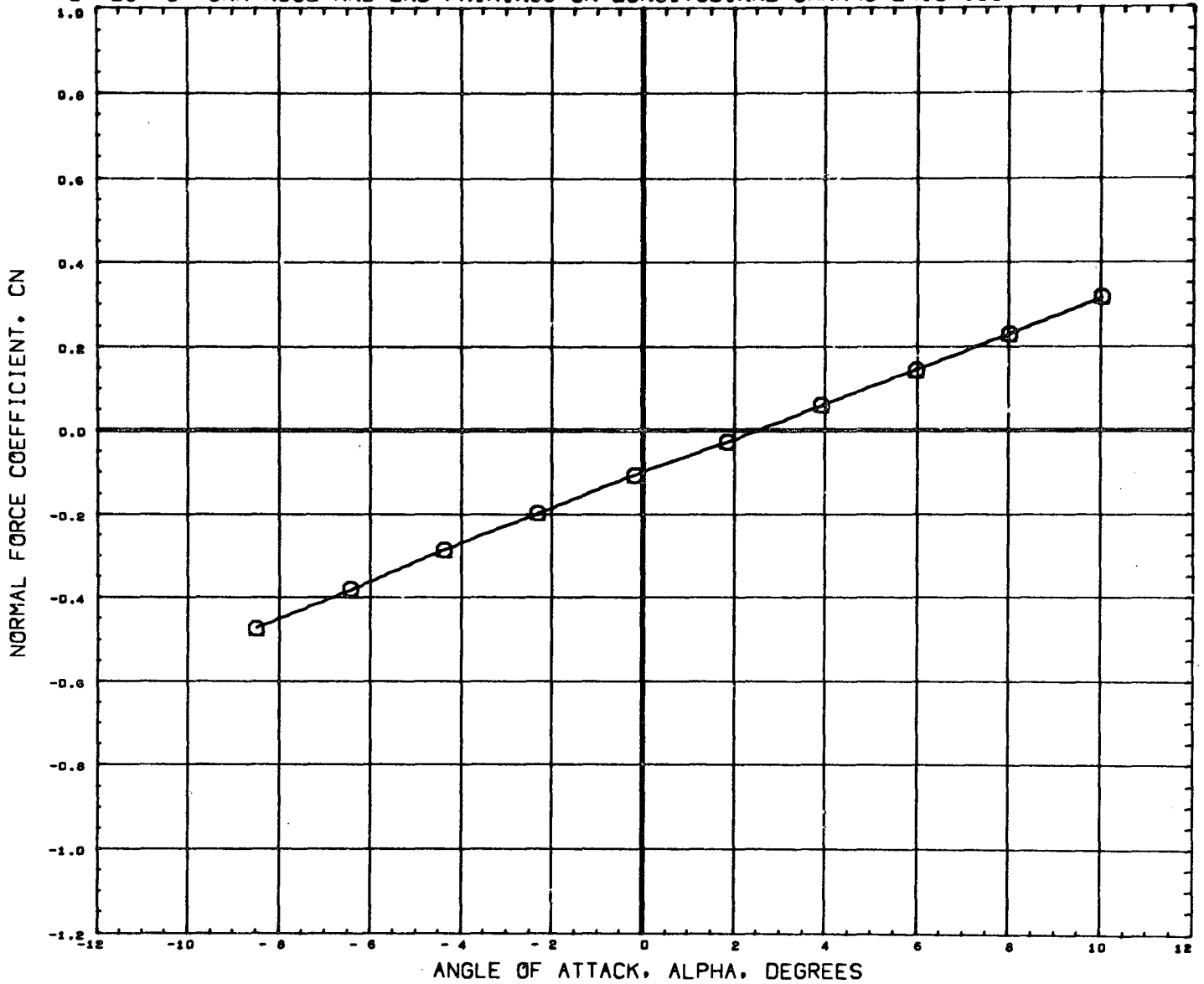

DATA SET SYMBOL	CONFIGURATION DESCRIPTION	ORBIN	THETS	BETA	REFERENCE INFORMATION
(B65004)	MSFC TWT 534 SHUTTLE LAUNCH T101S1	-1.500	21.000	0.000	SREF 4.8950 SQ. IN.
(B65017)	DATA NOT AVAILABLE FOR ALL CONDITIONS	-1.500	21.000	0.000	LREF 2.6440 IN.
(B65023)	DATA NOT AVAILABLE FOR ALL CONDITIONS	-1.500	21.000	0.000	BREF 3.5250 IN.
					XMRP 3.4900 IN.
					YMRP 0.0000 IN.
					ZMRP 0.1616 IN.
					SCALE 0.3034

MACH 2.74

EFFECT OF SRM NOSE AND END FAIRINGS ON LONGITUDINAL CHARACTERISTICS

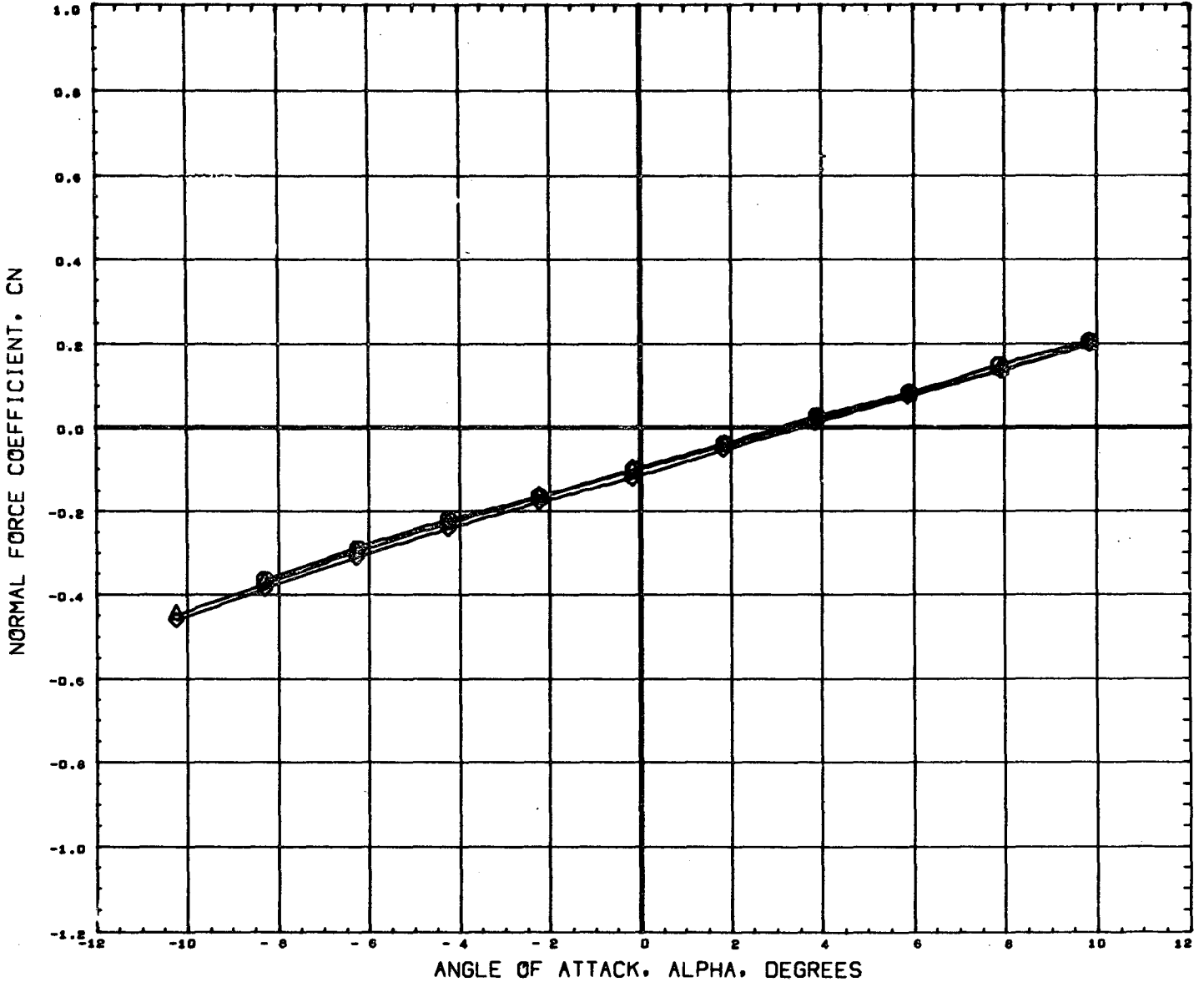

DATA SET SYMBOL	CONFIGURATION DESCRIPTION	ORBIN	THETS	BETA	REFERENCE INFORMATION	
(865004)	MSFC TWT 534 SHUTTLE LAUNCH	T101S1	-1.500	21.000	0.000	SREF 4.8950 90. IN
(865017)	MSFC TWT 534 SHUTTLE LAUNCH	T101S2	-1.500	21.000	0.000	LREF 2.6440 IN.
(865023)	MSFC TWT 534 SHUTTLE LAUNCH	T101S3	-1.500	21.000	0.000	BREF 3.5250 IN.
						XMRP 3.4900 IN.
						YMRP 0.0000 IN.
						ZMRP 0.1616 IN.
						SCALE 0.0034

MACH 4.96

PAGE 352

EFFECT OF SRM NOSE AND END FAIRINGS ON LONGITUDINAL CHARACTERISTICS

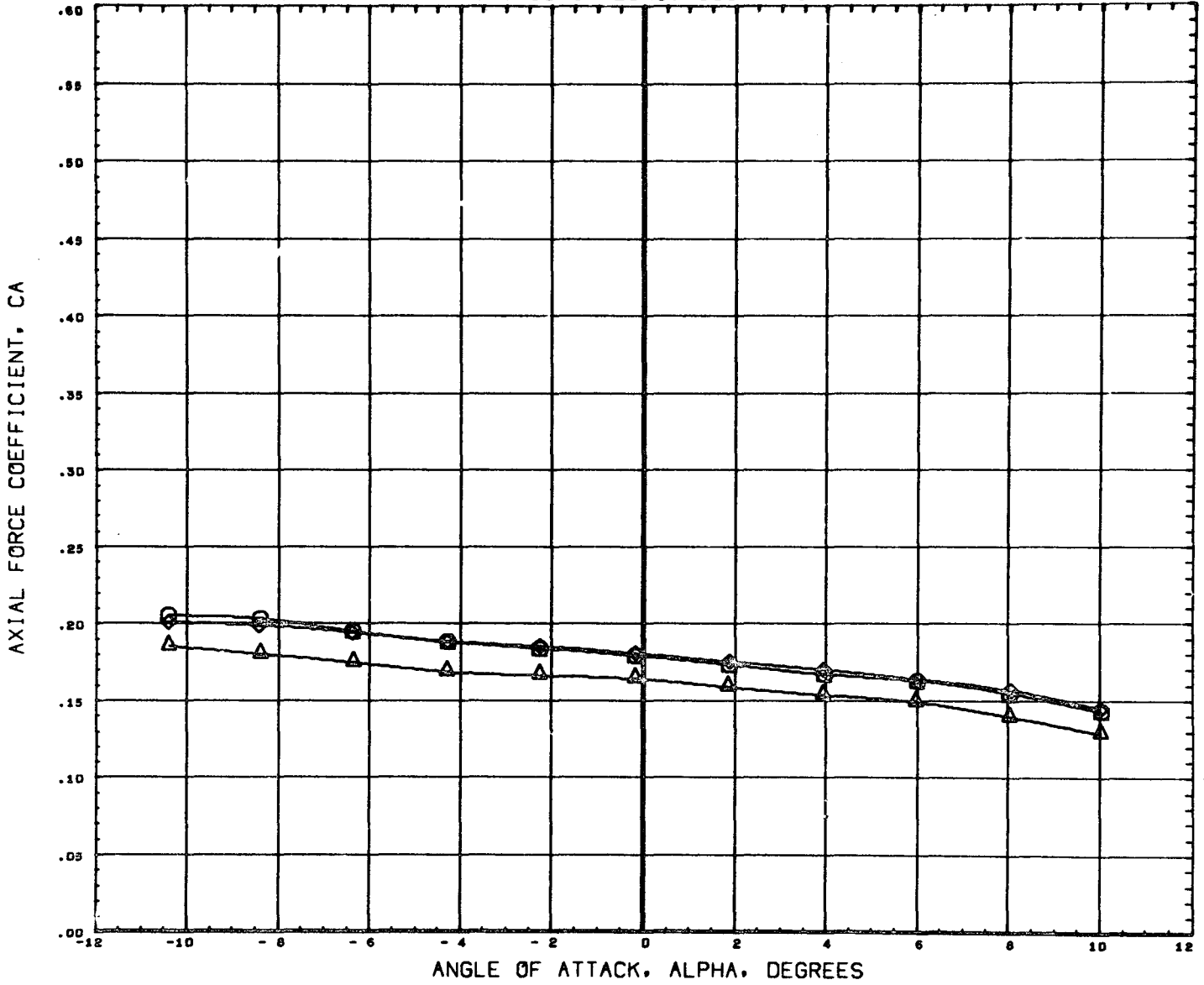

DATA SET SYMBOL	CONFIGURATION DESCRIPTION	ORBIN	THETS	BETA	REFERENCE INFORMATION
(B65004)	MSFC TWT 534 SHUTTLE LAUNCH T101S1	-1.500	21.000	0.000	SREF 4.8950 sq. IN
(B65017)	MSFC TWT 534 SHUTTLE LAUNCH T101S2	-1.500	21.000	0.000	LREF 2.6440 IN.
(B65023)	MSFC TWT 534 SHUTTLE LAUNCH T101S3	-1.500	21.000	0.000	BREF 3.5250 IN.
					XMRP 3.4900 IN.
					YMRP 0.0000 IN.
					ZMRP 0.1616 IN.
					SCALE 0.0034

MACH .60

EFFECT OF SRM NOSE AND END FAIRINGS ON LONGITUDINAL CHARACTERISTICS

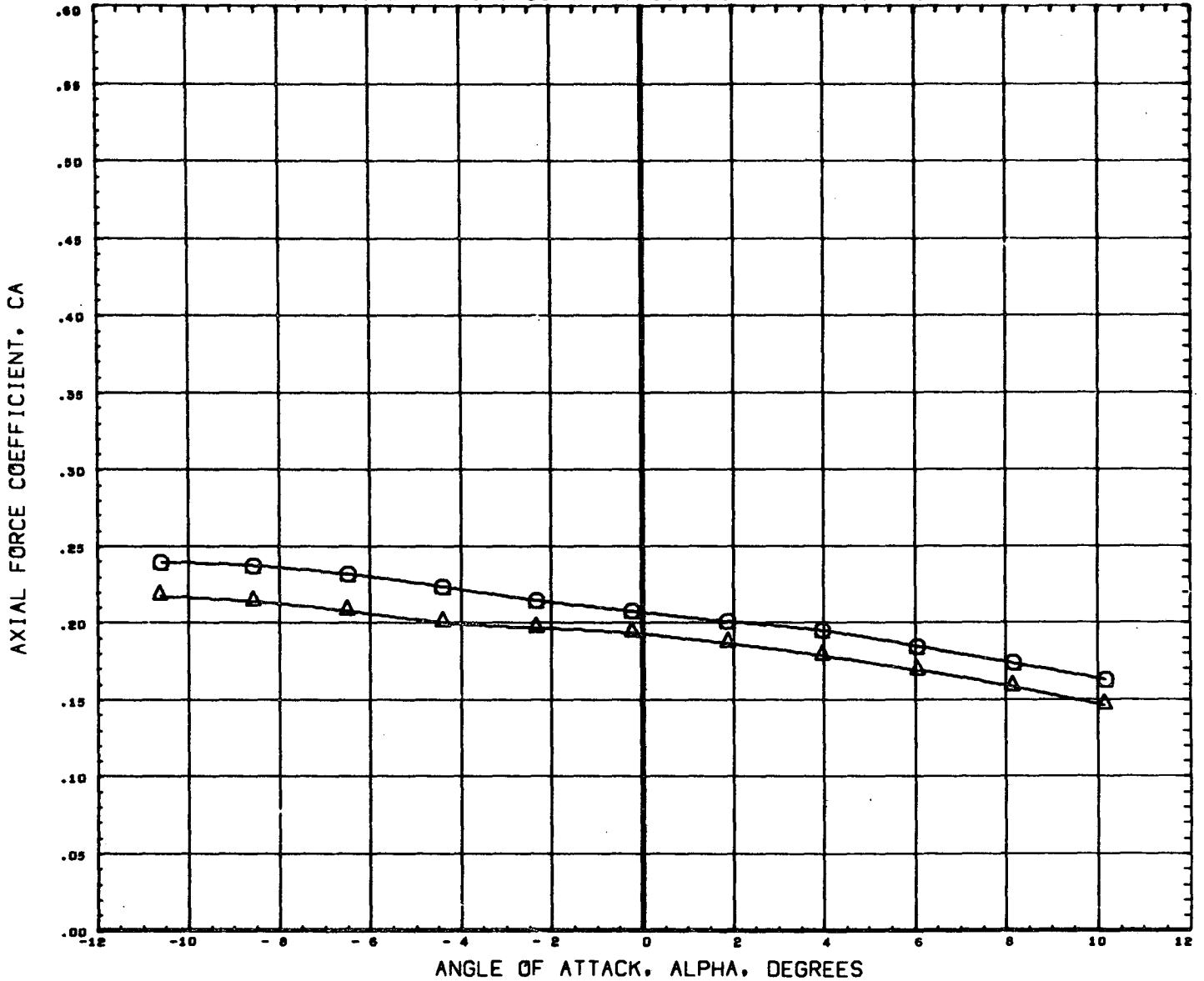

DATA SET SYMBOL	CONFIGURATION DESCRIPTION	ORBIN	THETS	BETA	REFERENCE INFORMATION
(B65004)	MSFC TWT 534 SHUTTLE LAUNCH T101S1	-1.500	21.030	0.000	SREF 4.8950 SQ. IN
(B65017)	MSFC TWT 534 SHUTTLE LAUNCH T101S2	-1.500	21.000	0.000	LREF 2.6440 IN.
(B65023)	DATA NOT AVAILABLE FOR ALL CONDITIONS	-1.500	21.000	0.000	BREF 3.5250 IN.
					XMRP 3.4900 IN.
					YMRP 0.0000 IN.
					ZMRP 0.1616 IN.
					SCALE 0.0034

EFFECT OF SRM NOSE AND END FAIRINGS ON LONGITUDINAL CHARACTERISTICS

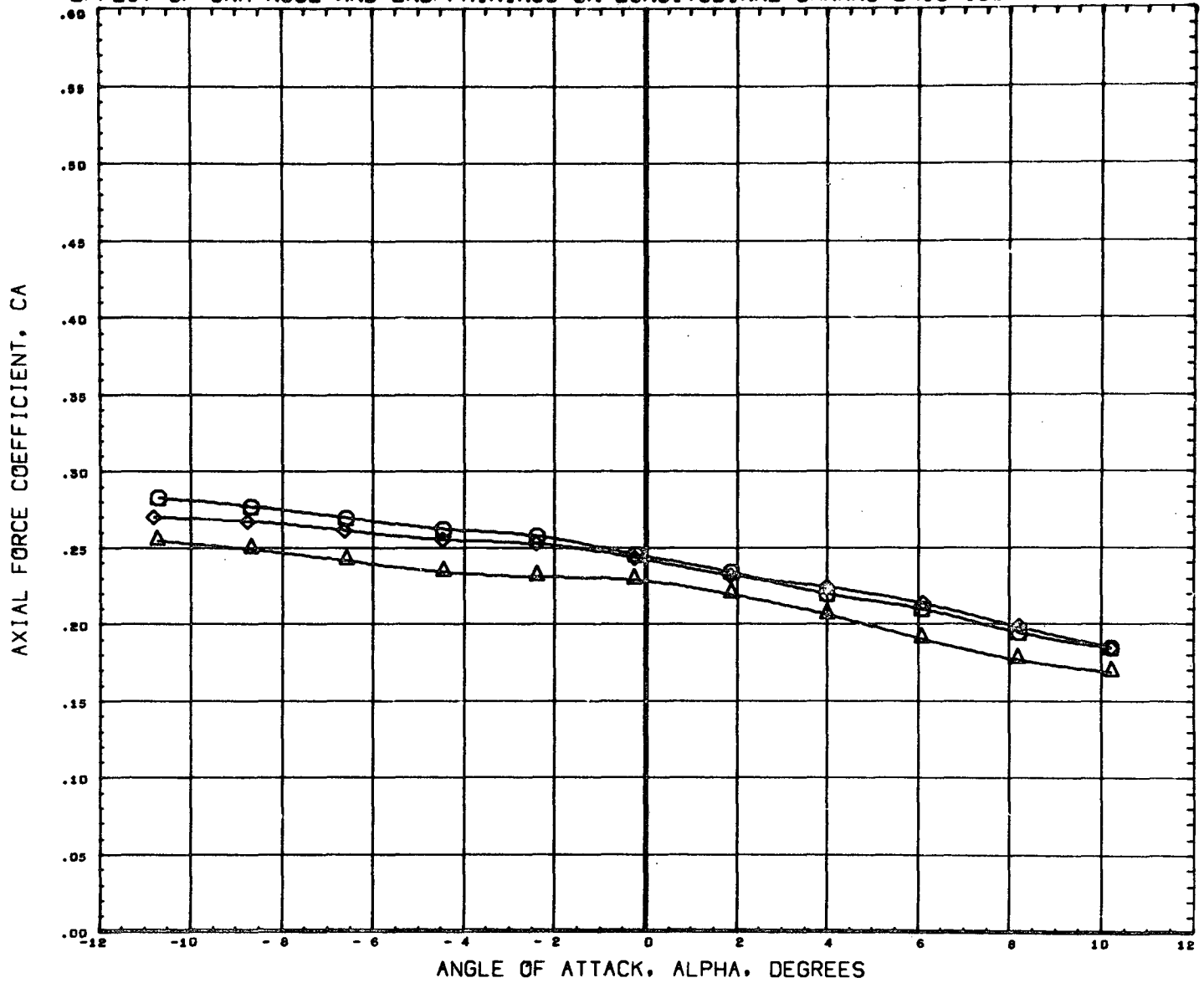

DATA SET SYMBOL	CONFIGURATION DESCRIPTION	ORBIN	THETS	BETA	REFERENCE INFORMATION	
(B65004)	MSFC TWT 534 SHUTTLE LAUNCH	T101S1	-1.500	21.000	0.000	SREF 4.8950 SQ. IN
(B65017)	MSFC TWT 534 SHUTTLE LAUNCH	T101S2	-1.500	21.000	0.000	LREF 2.6440 IN.
(B65023)	MSFC TWT 534 SHUTTLE LAUNCH	T101S3	-1.500	21.000	0.000	BREF 3.5250 IN.
						XMRP 3.4900 IN.
						YMRP 0.0000 IN.
						ZMRP 0.1616 IN.
						SCALE 0.0034

EFFECT OF SRM NOSE AND END FAIRINGS ON LONGITUDINAL CHARACTERISTICS

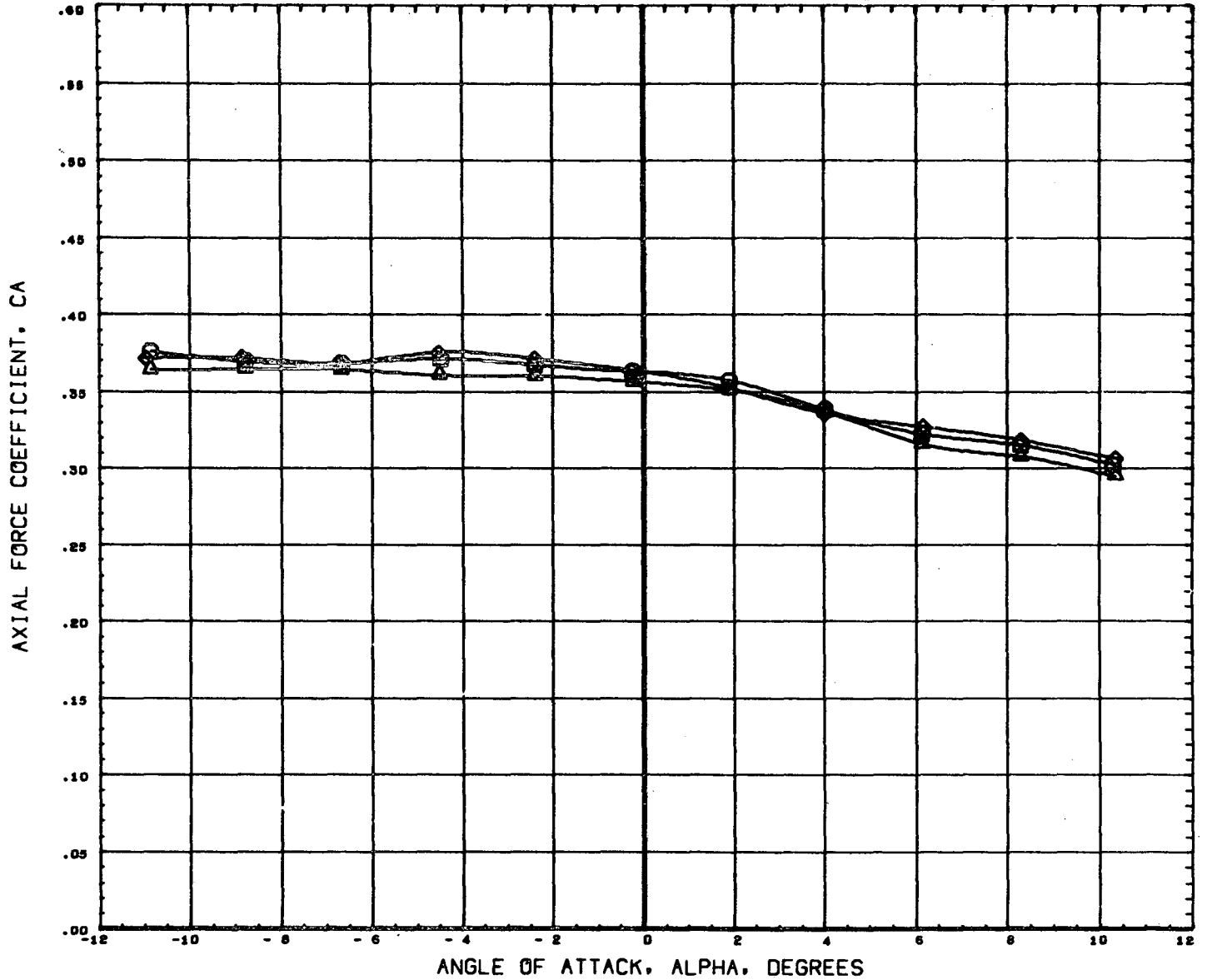

DATA SET SYMBOL	CONFIGURATION DESCRIPTION	ORBIN	THETS	BETA	REFERENCE INFORMATION	
(B65004)	NSFC TWT 534 SHUTTLE LAUNCH	T101S1	-1.500	21.000	0.000	SREF 4.8950 SQ. IN
(B65017)	NSFC TWT 534 SHUTTLE LAUNCH	T101S2	-1.500	21.000	0.000	LREF 2.6440 IN.
(B65023)	NSFC TWT 534 SHUTTLE LAUNCH	T101S3	-1.500	21.000	0.000	BREF 3.5230 IN.
						XHRP 3.4900 IN.
						YHRP 0.0000 IN.
						ZHRP 0.1616 IN.
						SCALE 0.0034

MACH 1.10

PAGE 356

EFFECT OF SRM NOSE AND END FAIRINGS ON LONGITUDINAL CHARACTERISTICS

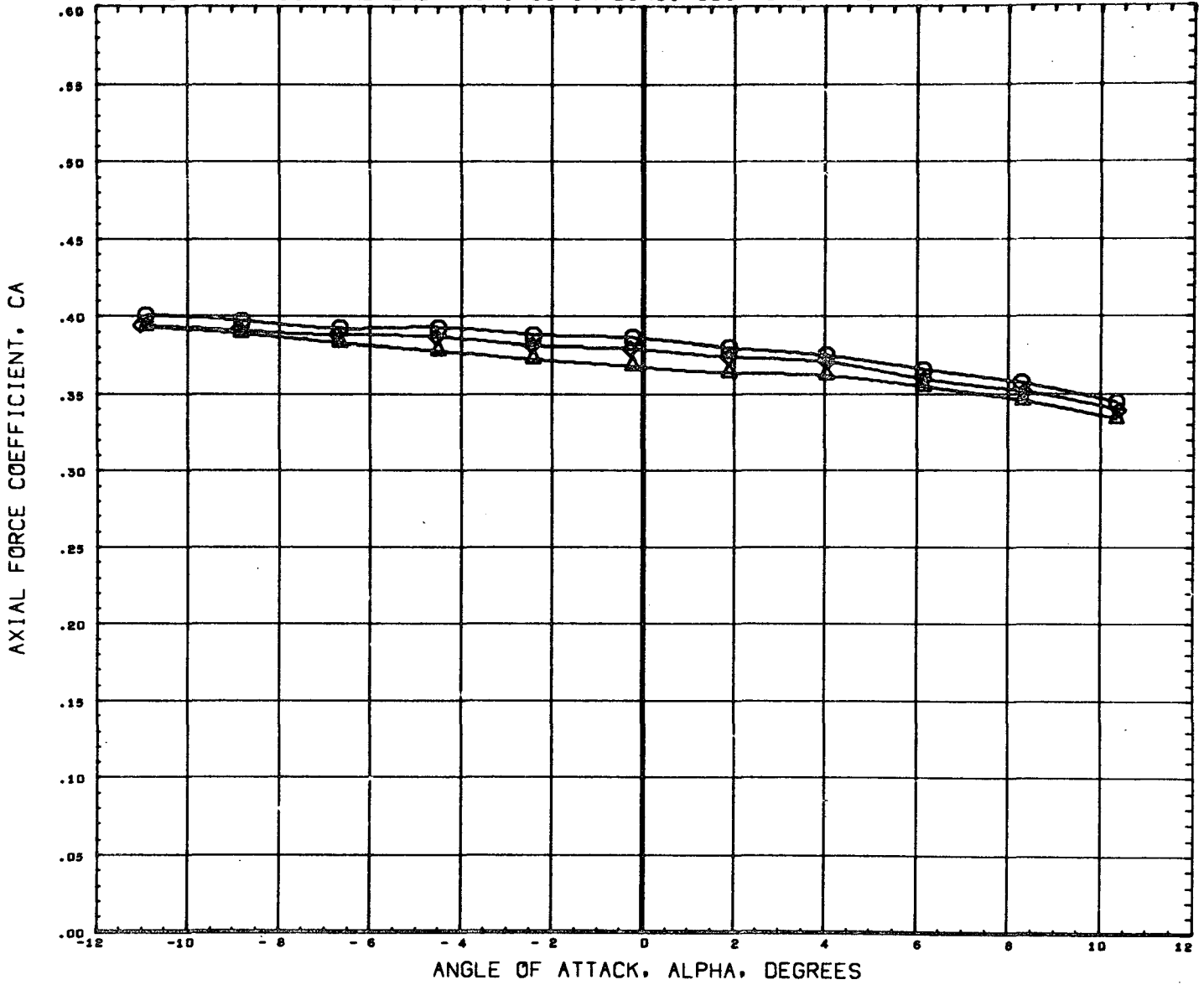

DATA SET SYMBOL	CONFIGURATION DESCRIPTION	ORBIN	THETS	BETA	REFERENCE INFORMATION	
(B65004)	MSFC TWT 534 SHUTTLE LAUNCH	T1O1S1	-1.500	21.000	0.000	SREF 4.8950 SQ. IN
(B65017)	MSFC TWT 534 SHUTTLE LAUNCH	T1O1S2	-1.500	21.000	0.000	LREF 2.6440 IN.
(B65023)	MSFC TWT 534 SHUTTLE LAUNCH	T1O1S3	-1.500	21.000	0.000	BREF 3.5250 IN.
						XMRP 3.4900 IN.
						YMRP 0.0000 IN.
						ZMRP 0.1616 IN.
						SCALE 0.0034

MACH 1.20

EFFECT OF SRM NOSE AND END FAIRINGS ON LONGITUDINAL CHARACTERISTICS

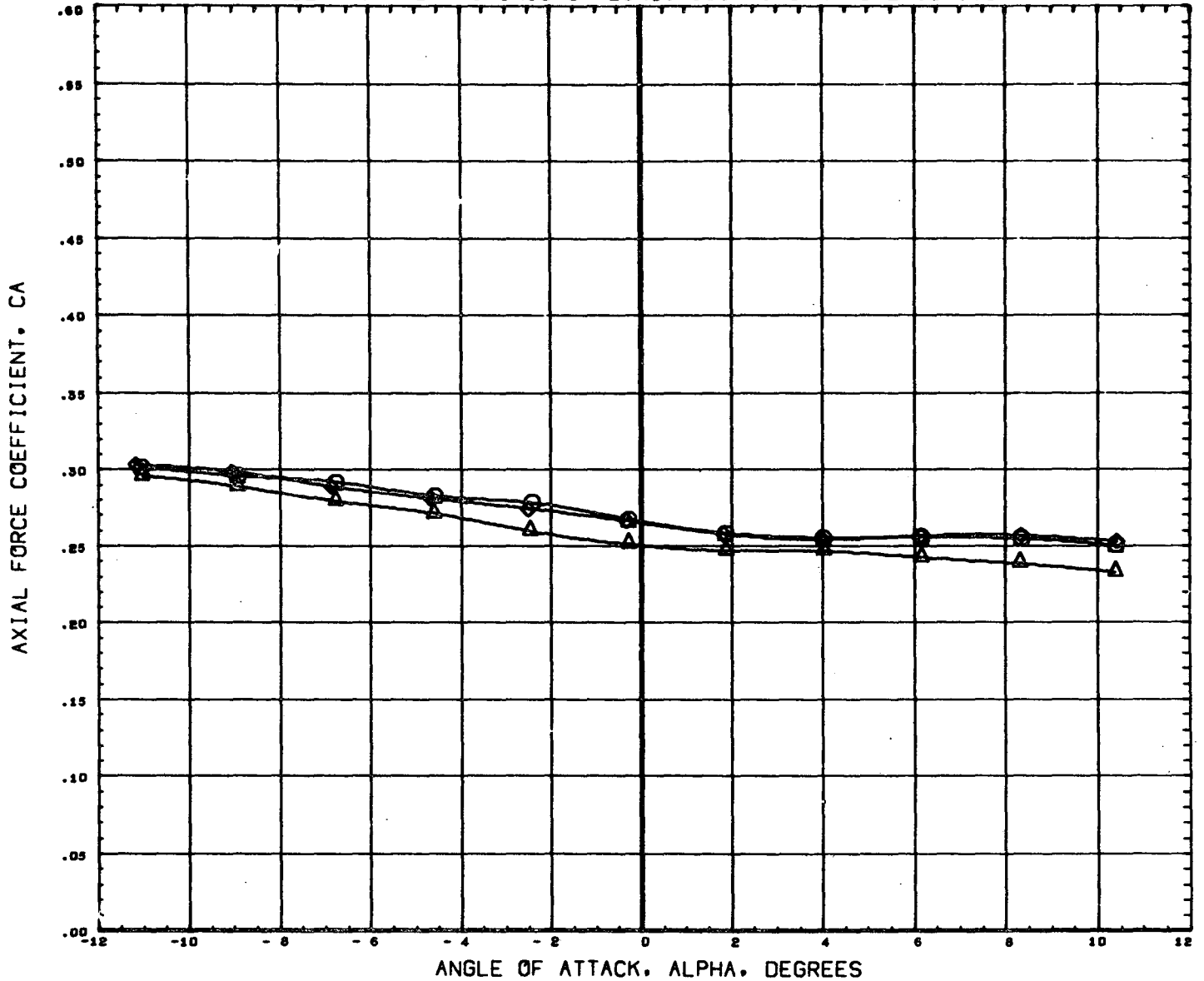

DATA SET SYMBOL	CONFIGURATION DESCRIPTION	ORBIN	THETS	BETA	REFERENCE INFORMATION	
(B65004)	MSFC TWT 534 SHUTTLE LAUNCH	T101S1	-1.500	21.060	0.000	SREF 4.8950 SQ. IN
(B65017)	MSFC TWT 534 SHUTTLE LAUNCH	T101S2	-1.500	21.000	0.000	LREF 2.6440 IN.
(B65023)	MSFC TWT 534 SHUTTLE LAUNCH	T101S3	-1.500	21.000	0.000	BREF 3.5250 IN.
						XMRP 3.4900 IN.
						YMRP 0.0000 IN.
						ZMRP 0.1616 IN.
						SCALE 0.0034

EFFECT OF SRM NOSE AND END FAIRINGS ON LONGITUDINAL CHARACTERISTICS

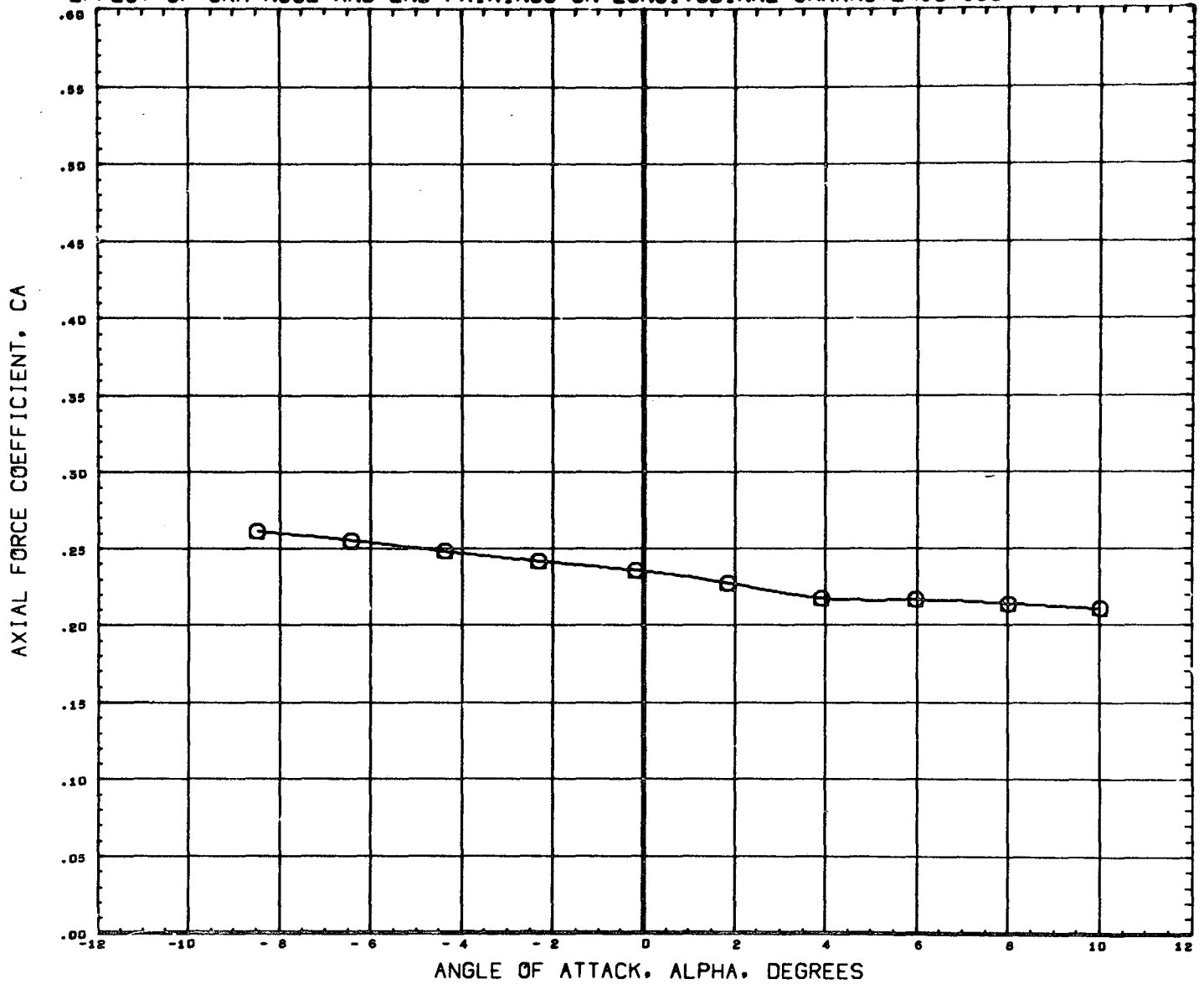

DATA SET SYMBOL	CONFIGURATION DESCRIPTION	ORBIN	THETS	BETA	REFERENCE INFORMATION	
(B65004)	MSFC TWT 534 SHUTTLE LAUNCH T101S1	-1.500	21.000	0.000	SREF	4.8950 SQ. IN
(B65017)	DATA NOT AVAILABLE FOR ALL CONDITIONS	-1.500	21.000	0.000	LREF	2.6440 IN.
(B65023)	DATA NOT AVAILABLE FOR ALL CONDITIONS	-1.500	21.000	0.000	BREF	3.5250 IN.
					XMRP	3.4900 IN.
					YMRP	0.0000 IN.
					ZMRP	0.1616 IN.
					SCALE	0.0034

MACH 2.74

EFFECT OF SRM NOSE AND END FAIRINGS ON LONGITUDINAL CHARACTERISTICS

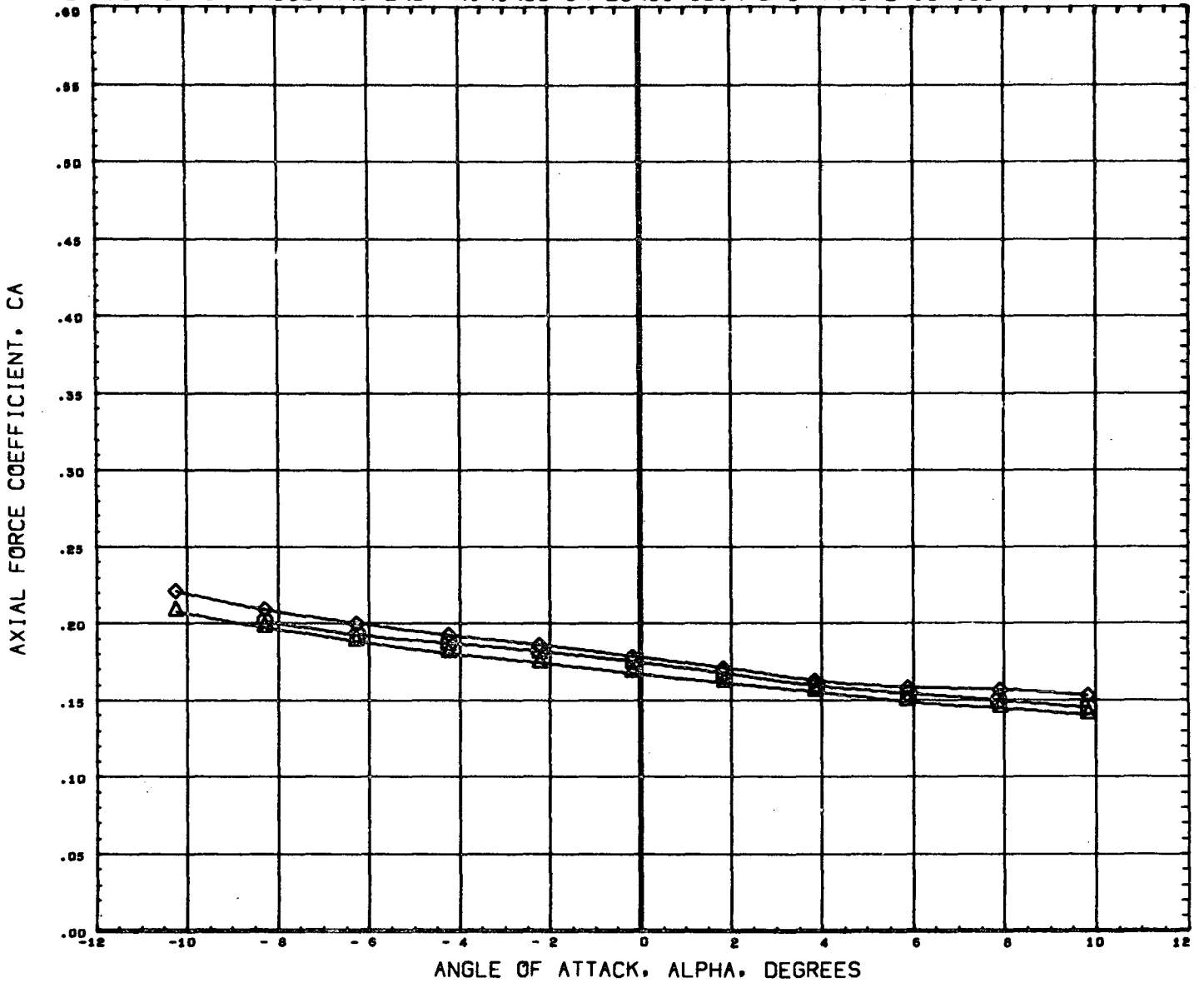

DATA SET SYMBOL	CONFIGURATION DESCRIPTION	ORBIN	THETS	BETA	REFERENCE INFORMATION	
(B65004)	MSFC TWT 534 SHUTTLE LAUNCH	T101S1	-1.500	21.000	0.000	SREF 4.8950 SQ. IN
(B65017)	MSFC TWT 534 SHUTTLE LAUNCH	T101S2	-1.500	21.000	0.000	LREF 2.6440 IN.
(B65023)	MSFC TWT 534 SHUTTLE LAUNCH	T101S3	-1.500	21.000	0.000	BREF 3.5250 IN.
						XMRP 3.4900 IN.
						YMRP 0.0000 IN.
						ZMRP 0.1616 IN.
						SCALE 0.0034

EFFECT OF SRM NOSE AND END FAIRINGS ON LONGITUDINAL CHARACTERISTICS

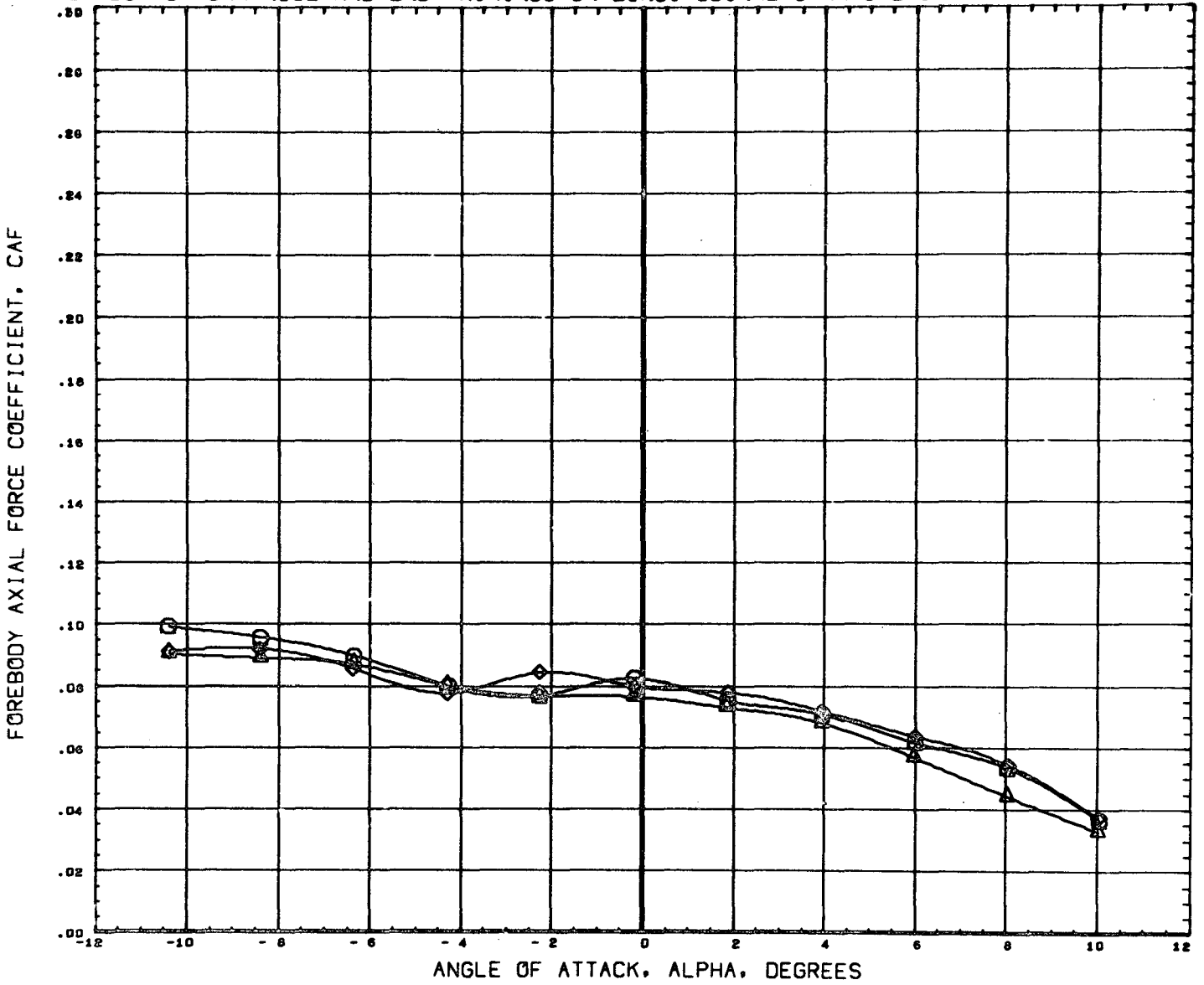

DATA SET SYMBOL	CONFIGURATION DESCRIPTION	ORBIN	THETS	BETA	REFERENCE INFORMATION
(B65004)	MSFC TWT 534 SHUTTLE LAUNCH T101S1	-1.500	21.000	0.000	SREF 4.8950 SQ. IN
(B65017)	MSFC TWT 534 SHUTTLE LAUNCH T101S2	-1.500	21.000	0.000	LREF 2.6440 IN.
(B65023)	MSFC TWT 534 SHUTTLE LAUNCH T101S3	-1.500	21.000	0.000	BREF 3.5250 IN.
					XMRP 3.4900 IN.
					YMRP 0.0000 IN.
					ZMRP 0.1616 IN.
					SCALE 0.0034

MACH .60

EFFECT OF SRM NOSE AND END FAIRINGS ON LONGITUDINAL CHARACTERISTICS

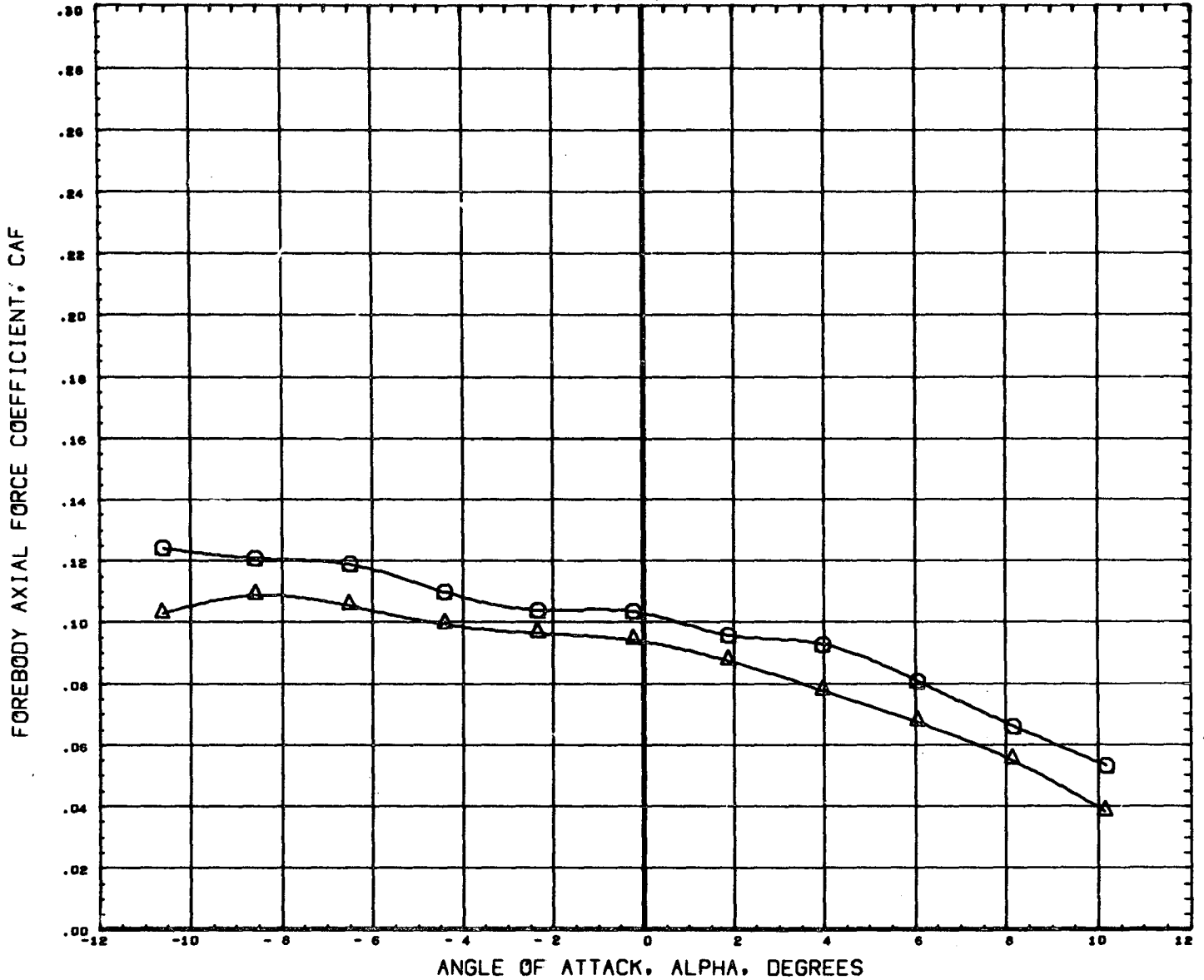

DATA SET SYMBOL	CONFIGURATION DESCRIPTION	ORBIN	THETS	BETA	REFERENCE INFORMATION
(B65004)	MSFC TWT 534 SHUTTLE LAUNCH T101S1	-1.500	21.000	0.000	SREF 4.8950 SQ. IN
(B65017)	MSFC TWT 534 SHUTTLE LAUNCH T101S2	-1.500	21.000	0.000	LREF 2.6440 IN.
(B65023)	DATA NOT AVAILABLE FOR ALL CONDITIONS	-1.500	21.000	0.000	BREF 3.5250 IN.
					XMRP 3.4900 IN.
					YNRP 0.0000 IN.
					ZNRP 0.1616 IN.
					SCALE 0.0034

EFFECT OF SRM NOSE AND END FAIRINGS ON LONGITUDINAL CHARACTERISTICS

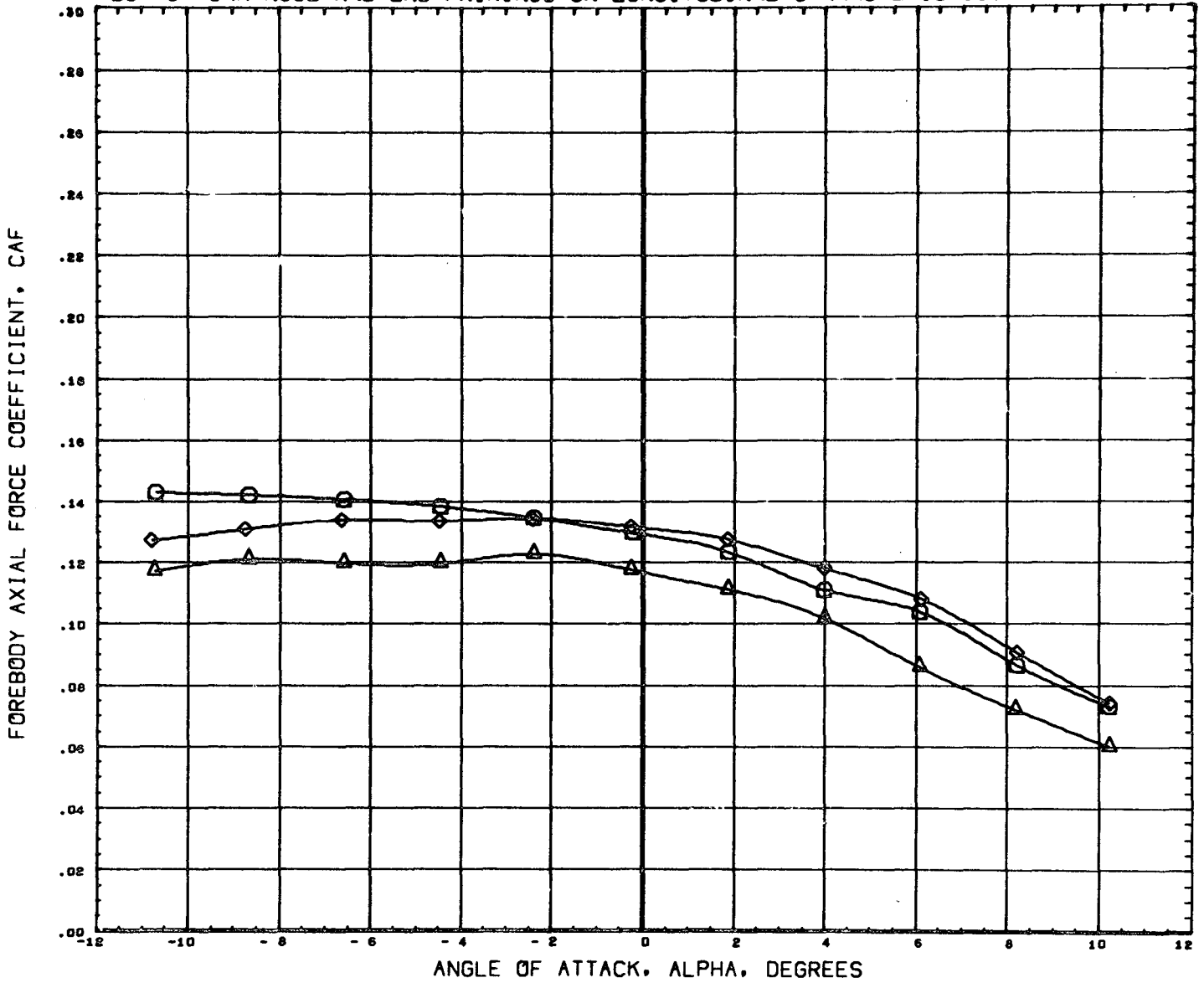

DATA SET SYMBOL	CONFIGURATION DESCRIPTION	ORBIN	THETS	BETA	REFERENCE INFORMATION
(B65004)	MSFC TWT 534 SHUTTLE LAUNCH T101S1	-1.500	21.000	0.000	SREF 4.8950 SQ. IN
(B65017)	MSFC TWT 534 SHUTTLE LAUNCH T101S2	-1.500	21.000	0.000	LREF 2.6440 IN.
(B65023)	MSFC TWT 534 SHUTTLE LAUNCH T101S3	-1.500	21.000	0.000	BREF 3.5250 IN.
					XMNP 3.4900 IN.
					YMNP 0.0000 IN.
					ZMNP 0.1616 IN.
					SCALE 0.0034

MACH .91

EFFECT OF SRM NOSE AND END FAIRINGS ON LONGITUDINAL CHARACTERISTICS

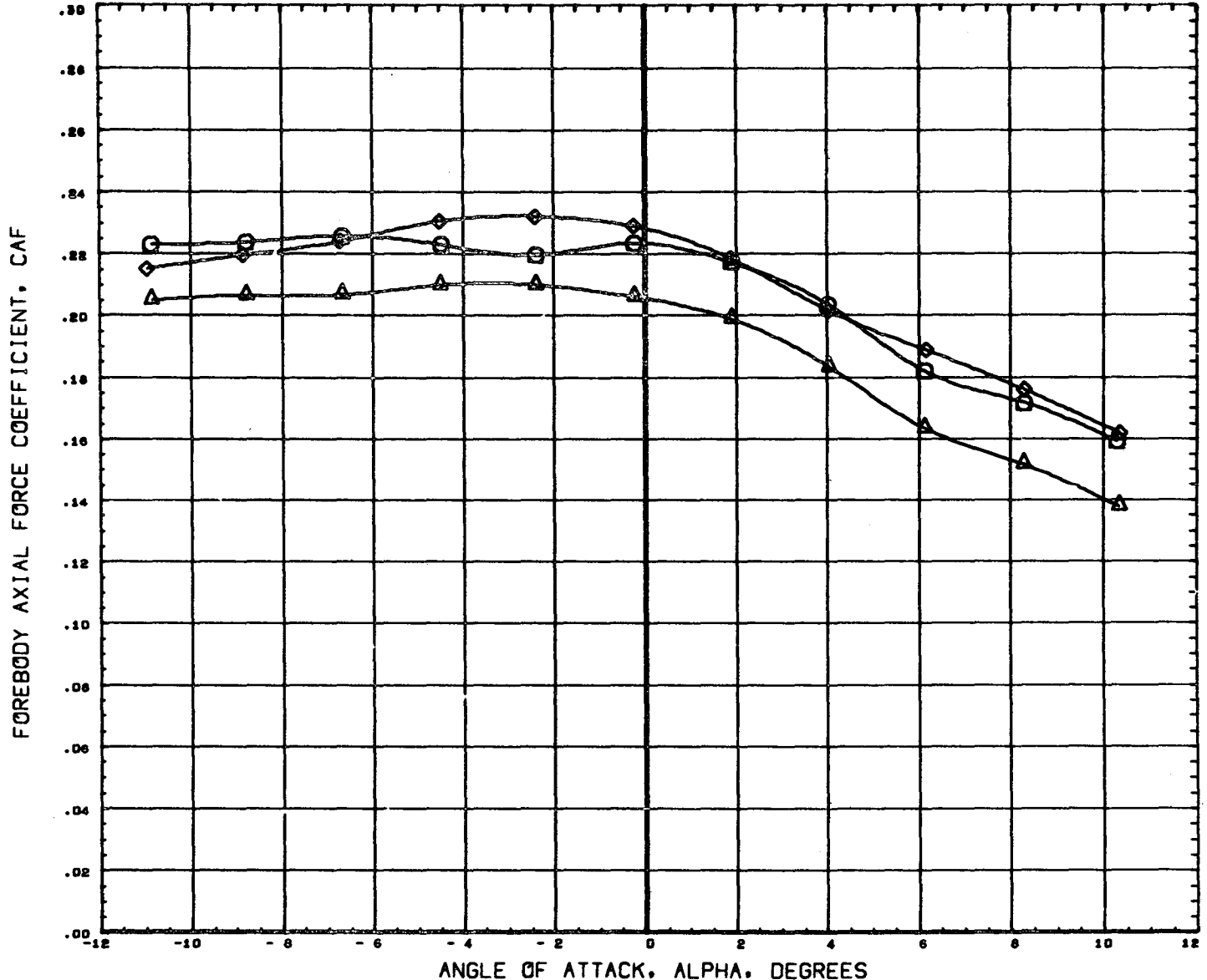

DATA SET SYMBOL	CONFIGURATION DESCRIPTION	ORBIN	THETS	BETA	REFERENCE INFORMATION
(B65004)	MSFC TWT 534 SHUTTLE LAUNCH	-1.500	21.0J0	0.000	SREF 4.8950 SQ. IN
(B65017)	MSFC TWT 534 SHUTTLE LAUNCH	-1.500	21.000	0.000	LREF 2.6440 IN.
(B65023)	MSFC TWT 534 SHUTTLE LAUNCH	-1.500	21.000	0.000	BREF 3.9250 IN.
					XMRP 3.4900 IN.
					YMRP 0.0000 IN.
					ZMRP 0.1616 IN.
					SCALE 0.0034

MACH 1.10

EFFECT OF SRM NOSE AND END FAIRINGS ON LONGITUDINAL CHARACTERISTICS

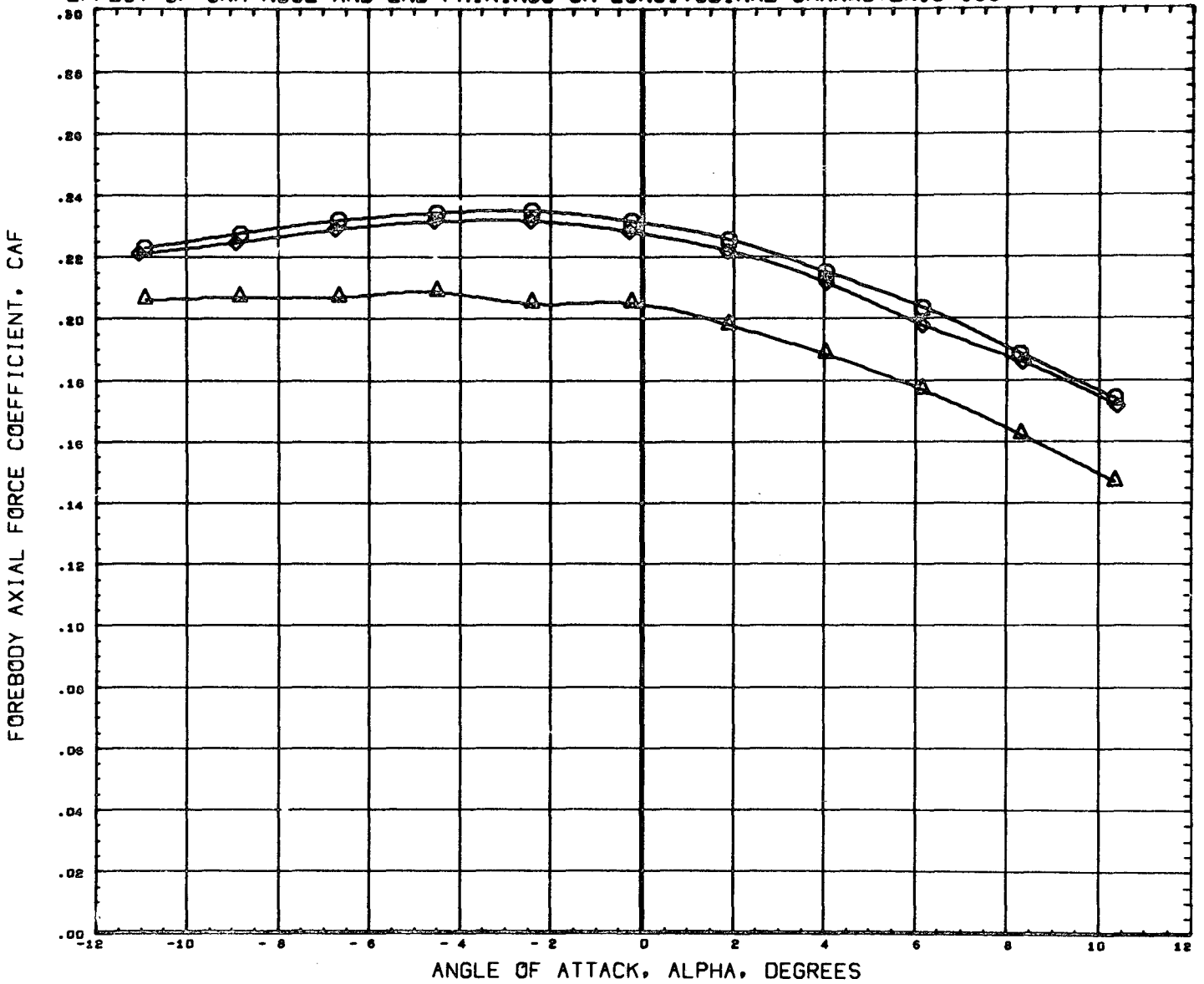

DATA SET SYMBOL	CONFIGURATION DESCRIPTION	T101S1	ORBIN	THETS	BETA	REFERENCE INFORMATION
(B65004)	MSFC TWT 534 SHUTTLE LAUNCH	T101S1	-1.500	21.000	0.000	SREF 4.8950 SQ. IN
(B65017)	MSFC TWT 534 SHUTTLE LAUNCH	T101S2	-1.500	21.000	0.000	LREF 2.6440 IN.
(B65023)	MSFC TWT 534 SHUTTLE LAUNCH	T101S3	-1.500	21.000	0.000	BREF 3.5250 IN.
						XMRP 3.4900 IN.
						YMRP 0.0000 IN.
						ZMRP 0.1616 IN.
						SCALE 0.0034

MACH 1.20

EFFECT OF SRM NOSE AND END FAIRINGS ON LONGITUDINAL CHARACTERISTICS

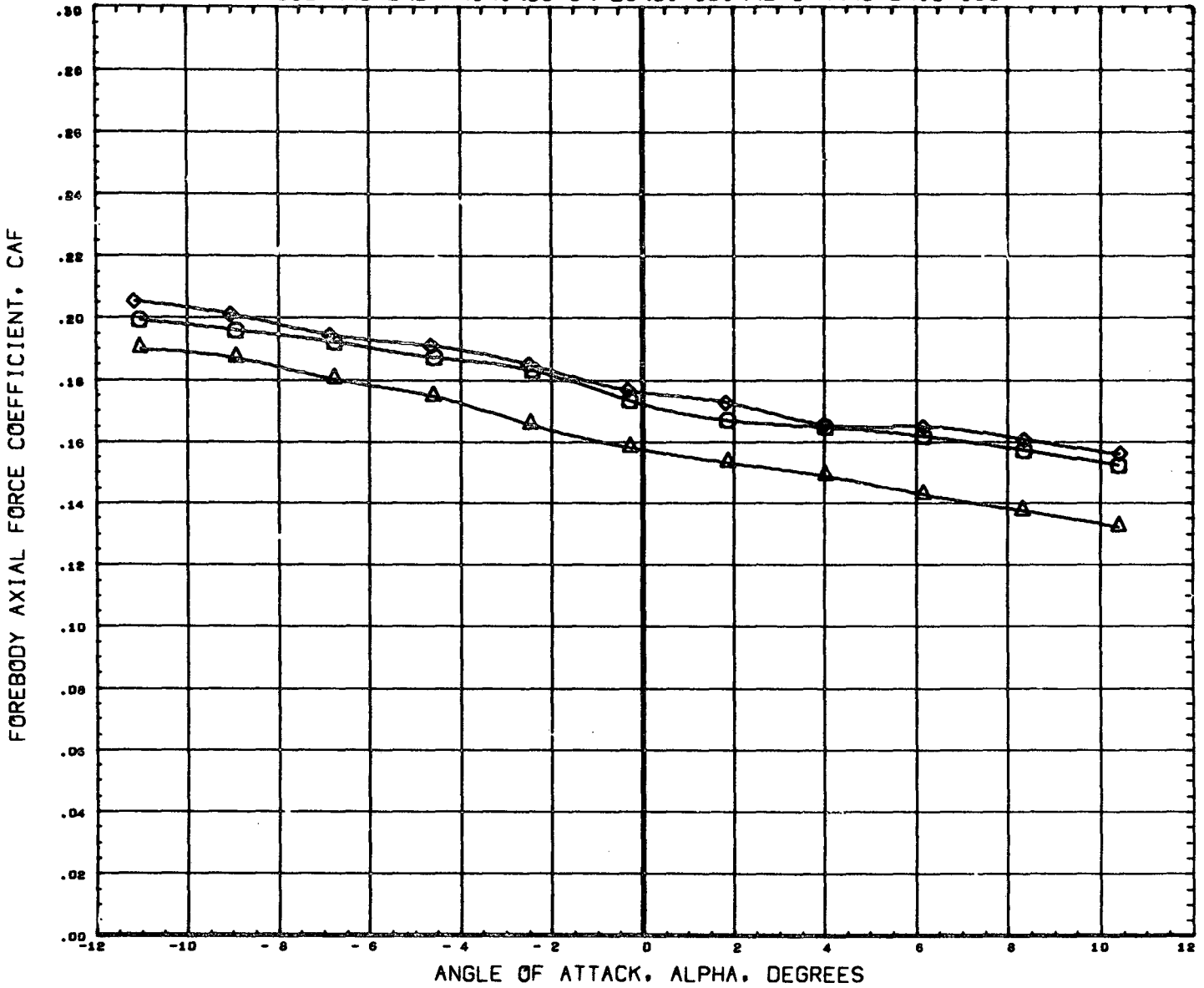

DATA SET SYMBOL	CONFIGURATION DESCRIPTION	ORBIN	THETS	BETA	REFERENCE INFORMATION	
(B65004)	MSFC TWT 534 SHUTTLE LAUNCH	T101S1	-1.500	21.000	0.000	SREF 4.8950 sq. IN
(B65017)	MSFC TWT 534 SHUTTLE LAUNCH	T101S2	-1.500	21.000	0.000	LREF 2.6440 IN.
(B65023)	MSFC TWT 534 SHUTTLE LAUNCH	T101S3	-1.500	21.000	0.000	BREF 3.5250 IN.
						XMRP 3.4900 IN.
						YMRP 0.0000 IN.
						ZMRP 0.1616 IN.
						SCALE 0.0034

EFFECT OF SRM NOSE AND END FAIRINGS ON LONGITUDINAL CHARACTERISTICS

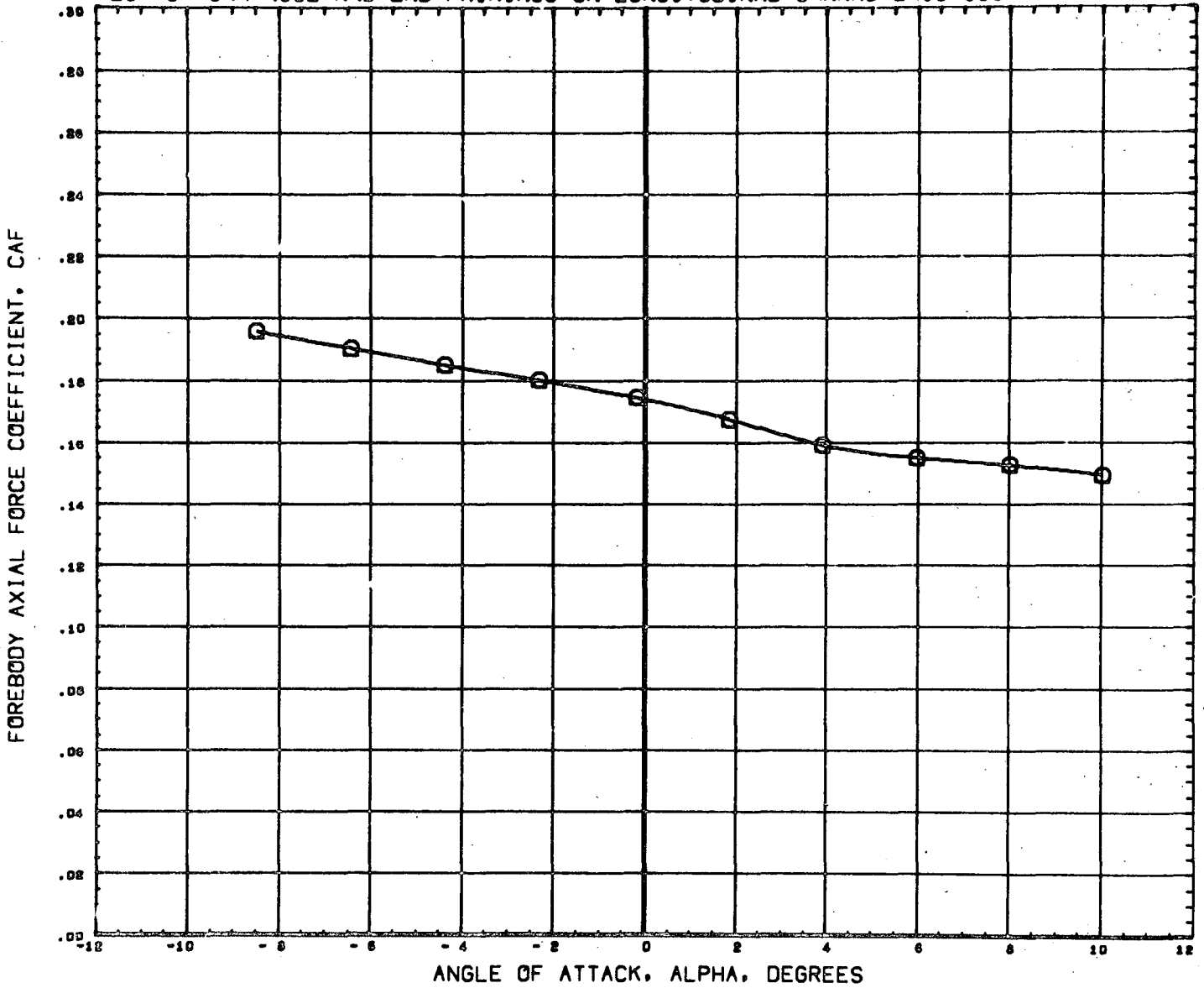

DATA SET SYMBOL	CONFIGURATION DESCRIPTION	ORBIN	THETS	BETA	REFERENCE INFORMATION
(069004)	MSFC TWT 534 SHUTTLE LAUNCH T101S1	-1.500	21.000	0.000	SREF 4.8950 SQ. IN
(069017)	DATA NOT AVAILABLE FOR ALL CONDITIONS	-1.500	21.000	0.000	LREF 2.6440 IN.
(069023)	DATA NOT AVAILABLE FOR ALL CONDITIONS	-1.500	21.000	0.000	BREF 3.9250 IN.
					XMRP 3.4900 IN.
					YMRP 0.0000 IN.
					ZMRP 0.1616 IN.
					SCALE 0.0034

MACH 2.74

EFFECT OF SRM NOSE AND END FAIRINGS ON LONGITUDINAL CHARACTERISTICS

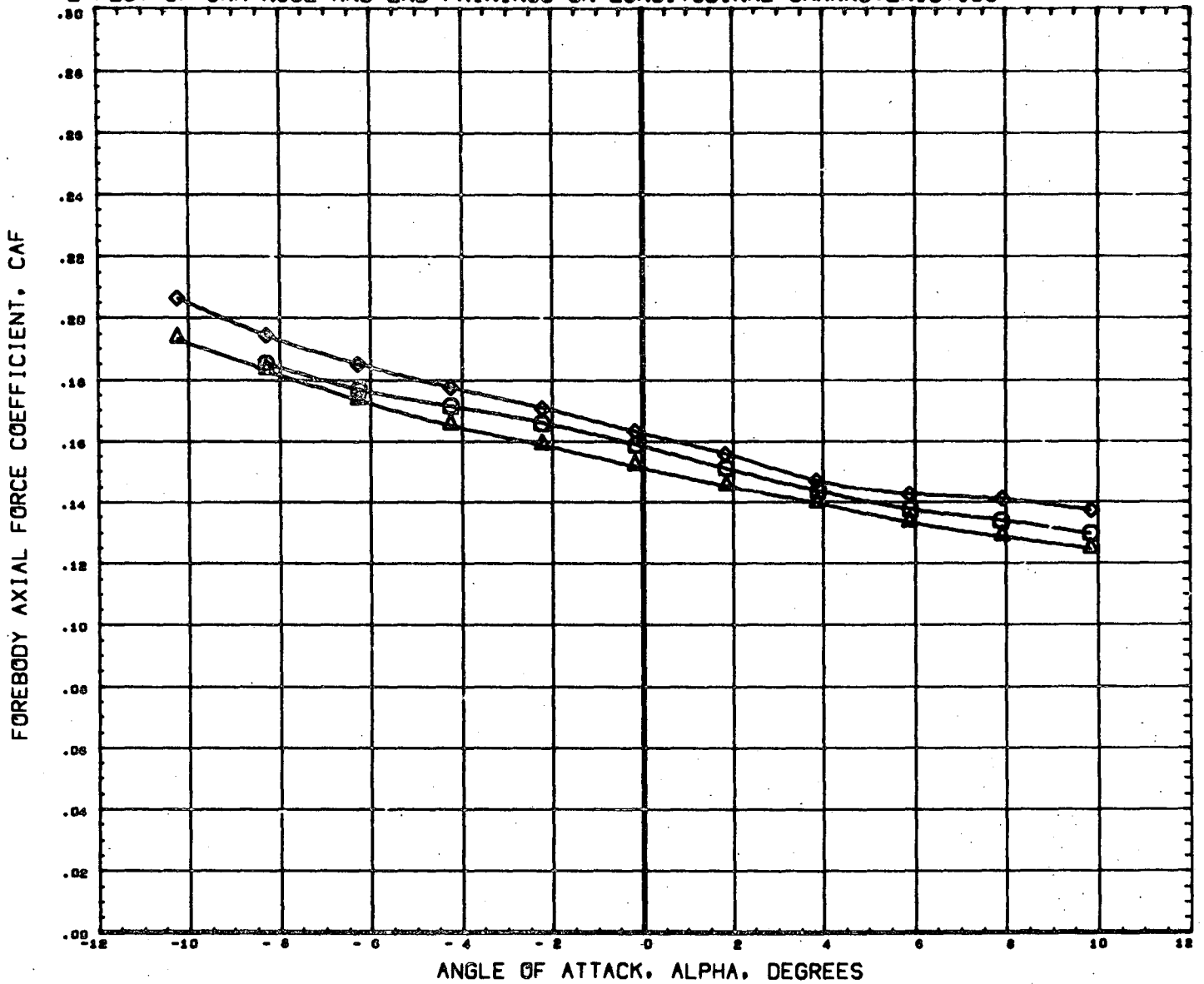

DATA SET SYMBOL	CONFIGURATION DESCRIPTION	ORBIN	THETS	BETA	REFERENCE INFORMATION
(865004)	NSFC TWT 534 SHUTTLE LAUNCH	-1.500	21.000	0.000	SREF 4.8950 SQ. IN
(865017)	NSFC TWT 534 SHUTTLE LAUNCH	-1.500	21.000	0.000	LREF 2.6440 IN.
(865023)	NSFC TWT 534 SHUTTLE LAUNCH	-1.500	21.000	0.000	BREF 3.8250 IN.
					XMRP 3.4900 IN.
					YMRP 0.0000 IN.
					ZMRP 0.1616 IN.
					SCALE 0.0034

EFFECT OF SRM NOSE AND END FAIRINGS ON LONGITUDINAL CHARACTERISTICS

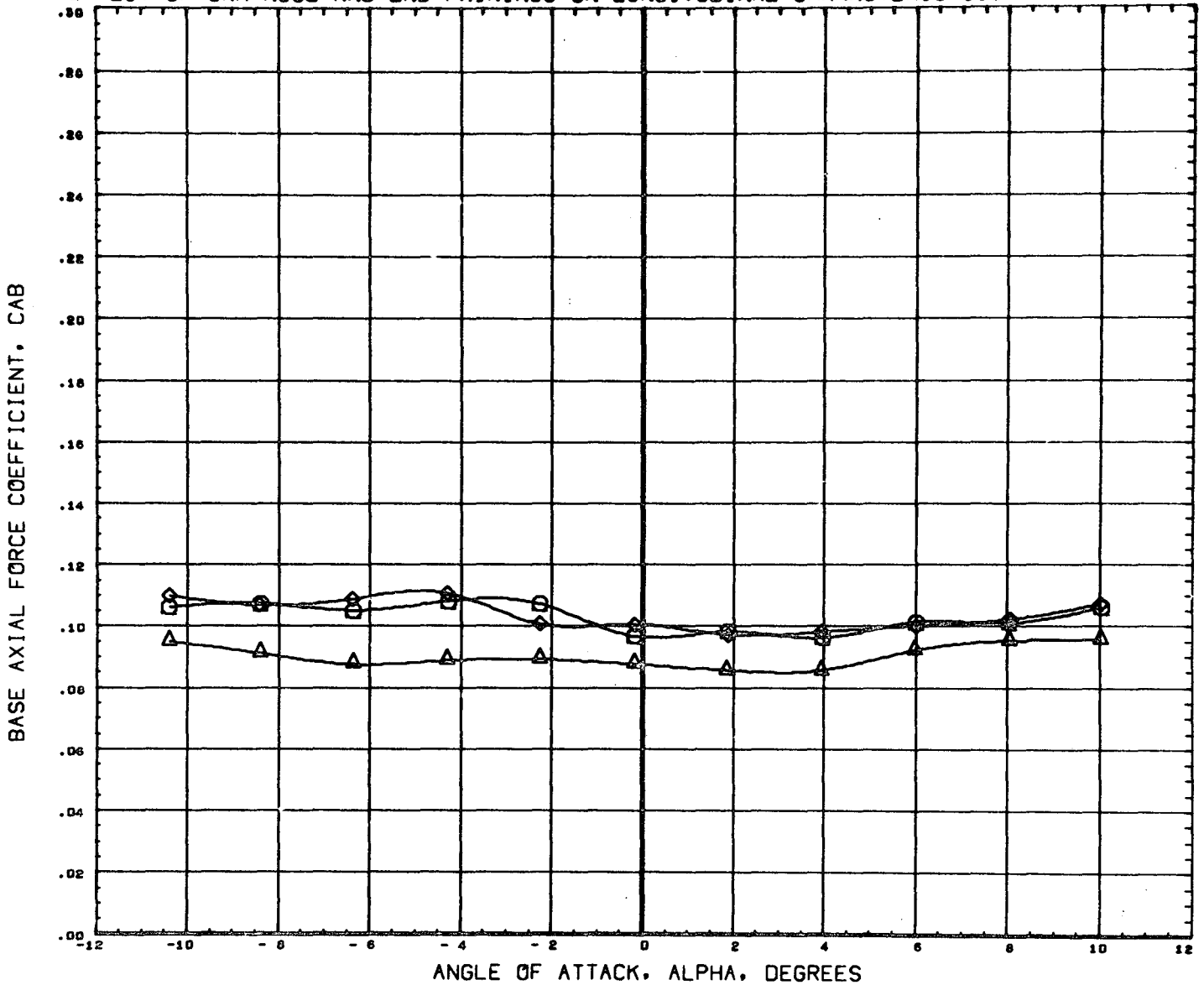

DATA SET SYMBOL	CONFIGURATION DESCRIPTION	ORBIN	THETS	BETA	REFERENCE INFORMATION	
(B65004)	MSFC TWT 534 SHUTTLE LAUNCH	T101S1	-1.500	21.000	0.000	SREF 4.8950 SQ. IN.
(B65017)	MSFC TWT 534 SHUTTLE LAUNCH	T101S2	-1.500	21.000	0.000	LREF 2.6440 IN.
(B65025)	MSFC TWT 534 SHUTTLE LAUNCH	T101S3	-1.500	21.000	0.000	BREF 3.5250 IN.
						XMRP 3.4900 IN.
						YMRP 0.0000 IN.
						ZMRP 0.1616 IN.
						SCALE 0.0034

MACH .60

EFFECT OF SRM NOSE AND END FAIRINGS ON LONGITUDINAL CHARACTERISTICS

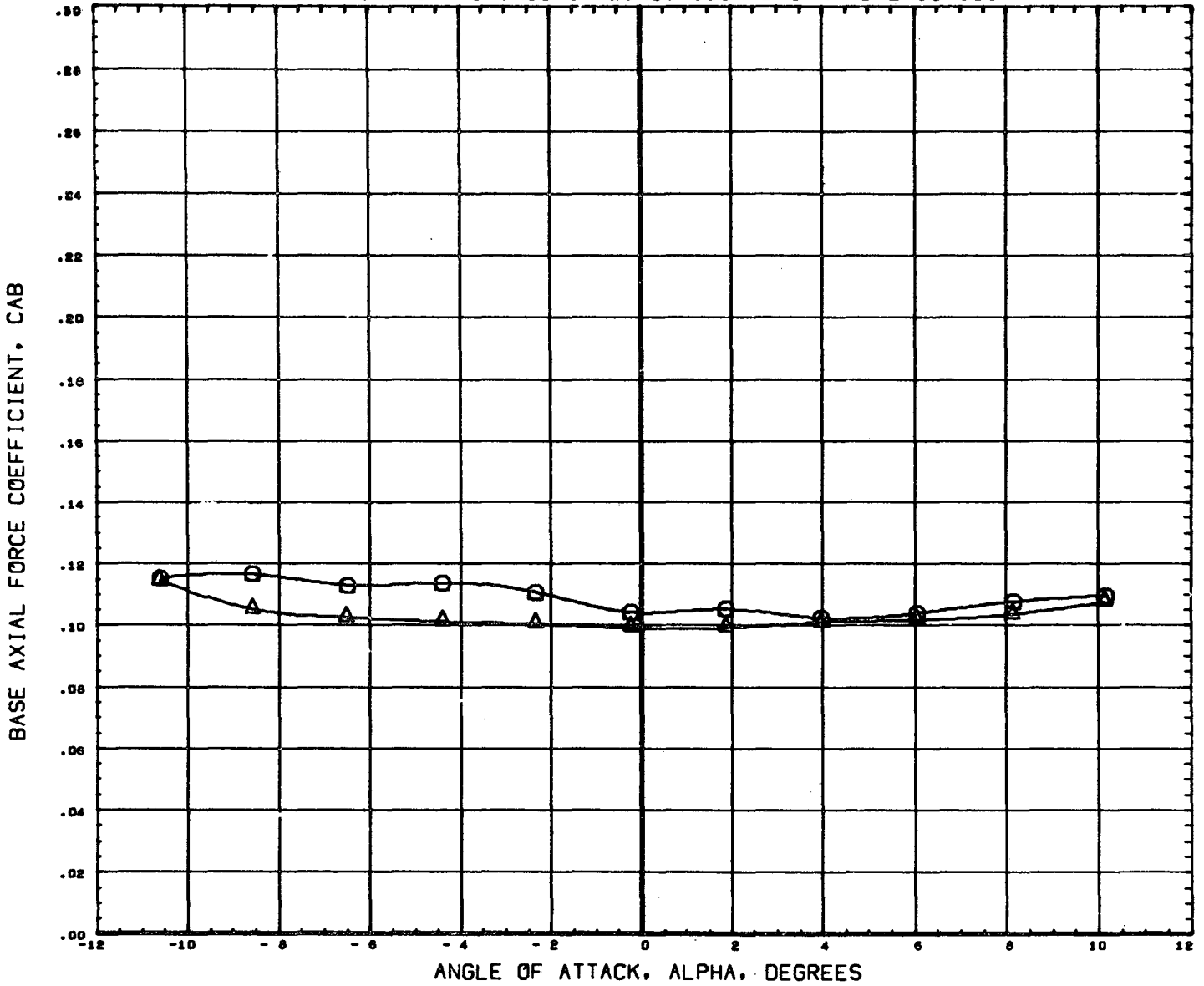

DATA SET SYMBOL	CONFIGURATION DESCRIPTION	ORBIN	THETS	BETA	REFERENCE INFORMATION
(B65004)	MSFC TWT 534 SHUTTLE LAUNCH T101S1	-1.500	21.030	0.000	SREF 4.8950 SQ. IN
(B65017)	MSFC TWT 534 SHUTTLE LAUNCH T101S2	-1.500	21.000	0.000	LREF 2.6440 IN.
(B65023)	DATA NOT AVAILABLE FOR ALL CONDITIONS	-1.500	21.000	0.000	BREF 3.5250 IN.
					XMRP 3.4900 IN.
					YMRP 0.0000 IN.
					ZMRP 0.1616 IN.
					SCALE 0.0034

MACH .80

PAGE 370

EFFECT OF SRM NOSE AND END FAIRINGS ON LONGITUDINAL CHARACTERISTICS

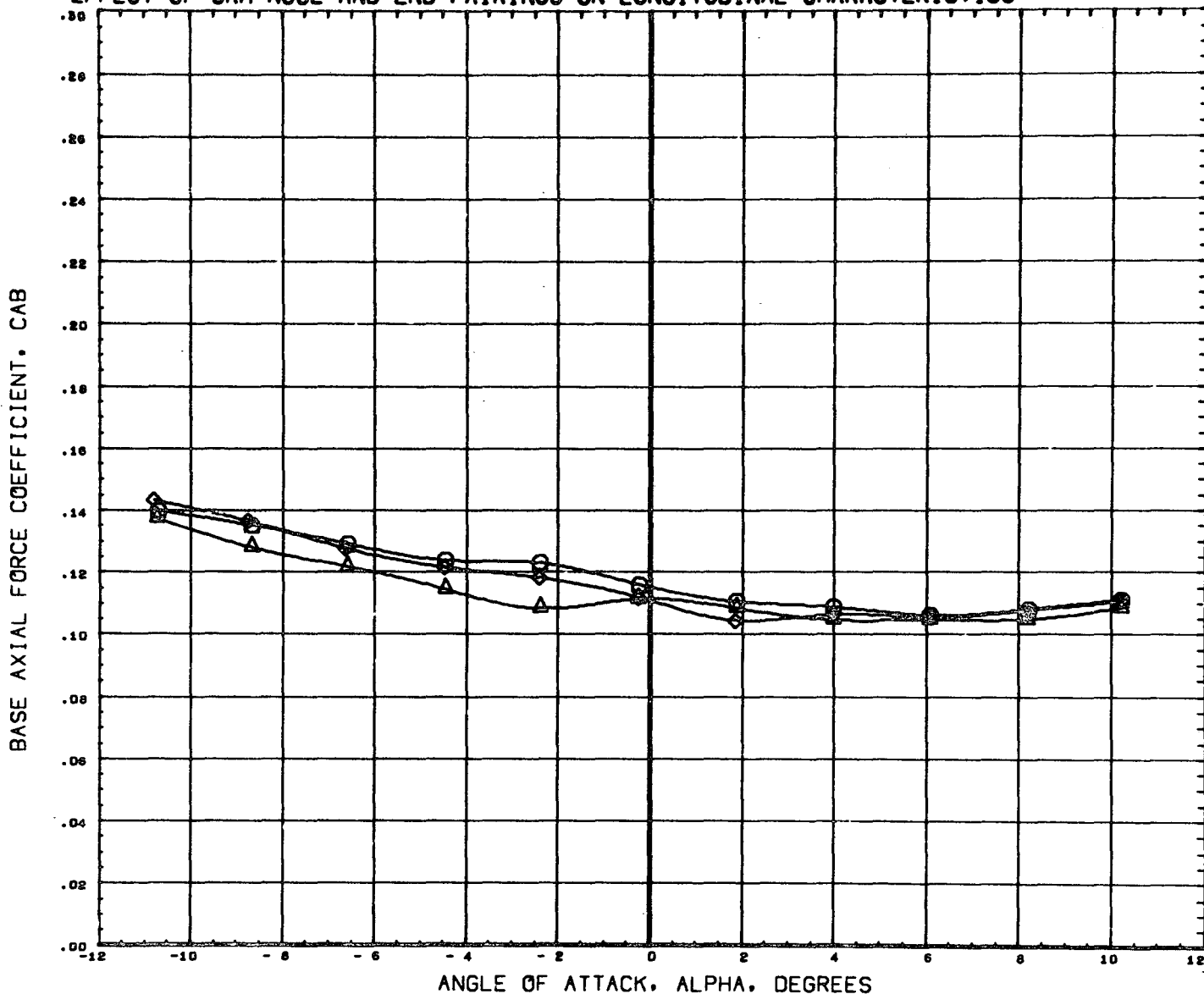

DATA SET SYMBOL	CONFIGURATION DESCRIPTION	ORBIN	THETS	BETA	REFERENCE INFORMATION
(B65004)	MSFC TWT 534 SHUTTLE LAUNCH	-1.500	21.000	0.000	SREF 4.8950 SQ. IN
(B65017)	MSFC TWT 534 SHUTTLE LAUNCH	-1.500	21.000	0.000	LREF 2.6440 IN.
(B65023)	MSFC TWT 534 SHUTTLE LAUNCH	-1.500	21.000	0.000	BREF 3.5250 IN.
					XMRP 3.4900 IN.
					YMRP 0.0000 IN.
					ZMRP 0.1616 IN.
					SCALE 0.0034

MACH .91

EFFECT OF SRM NOSE AND END FAIRINGS ON LONGITUDINAL CHARACTERISTICS

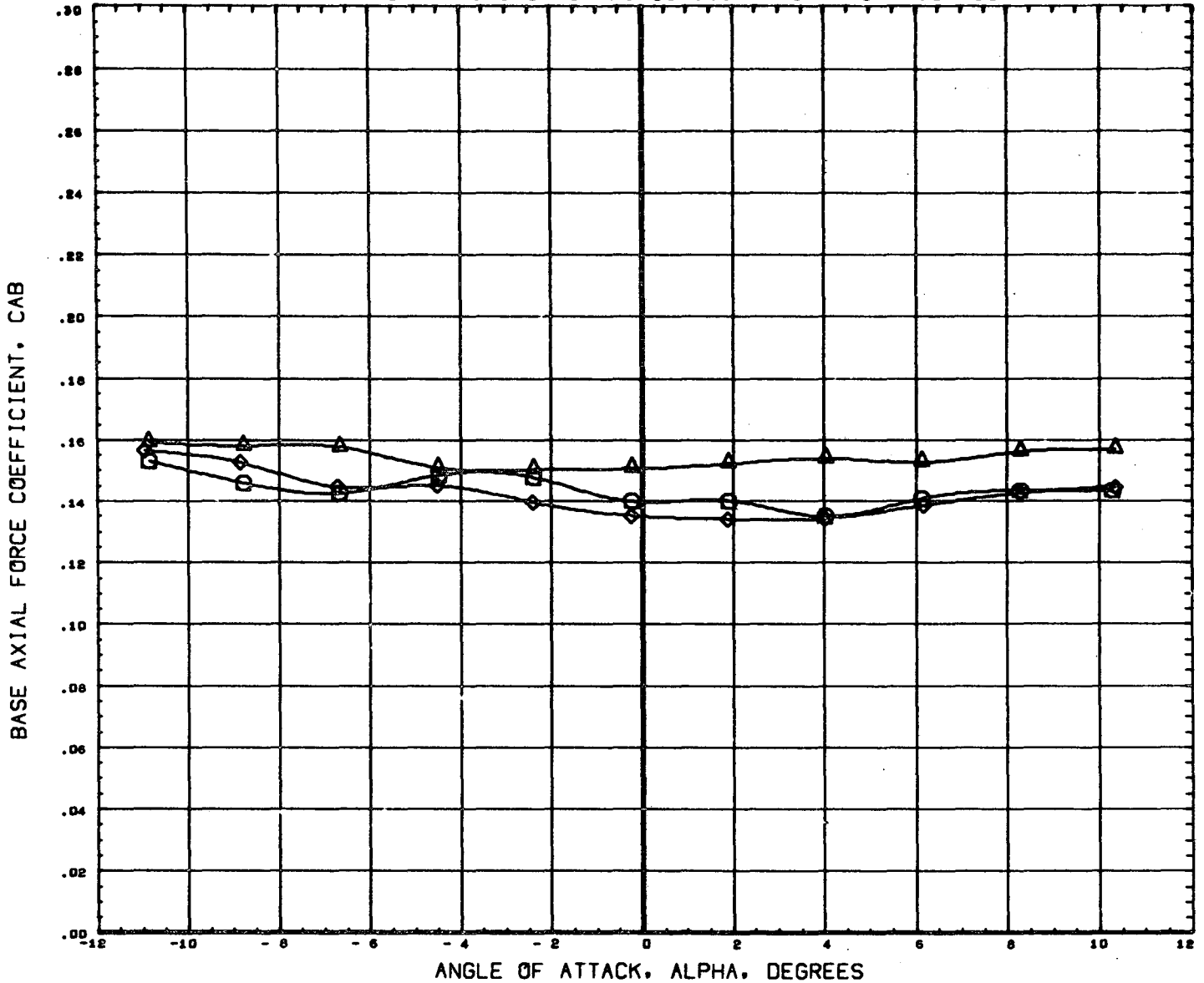

DATA SET SYMBOL	CONFIGURATION DESCRIPTION	ORBIN	THETS	BETA	REFERENCE INFORMATION
(B65004)	MSFC TWT 534 SHUTTLE LAUNCH	-1.500	21.000	0.000	SREF 4.8950 SQ. IN
(B65017)	MSFC TWT 534 SHUTTLE LAUNCH	-1.500	21.000	0.000	LREF 2.6440 IN.
(B65023)	MSFC TWT 534 SHUTTLE LAUNCH	-1.500	21.000	0.000	BREF 3.5250 IN.
					XMRP 3.4900 IN.
					YMRP 0.0000 IN.
					ZMRP 0.1616 IN.
					SCALE 0.0034

MACH 1.10

PAGE 372

EFFECT OF SRM NOSE AND END FAIRINGS ON LONGITUDINAL CHARACTERISTICS

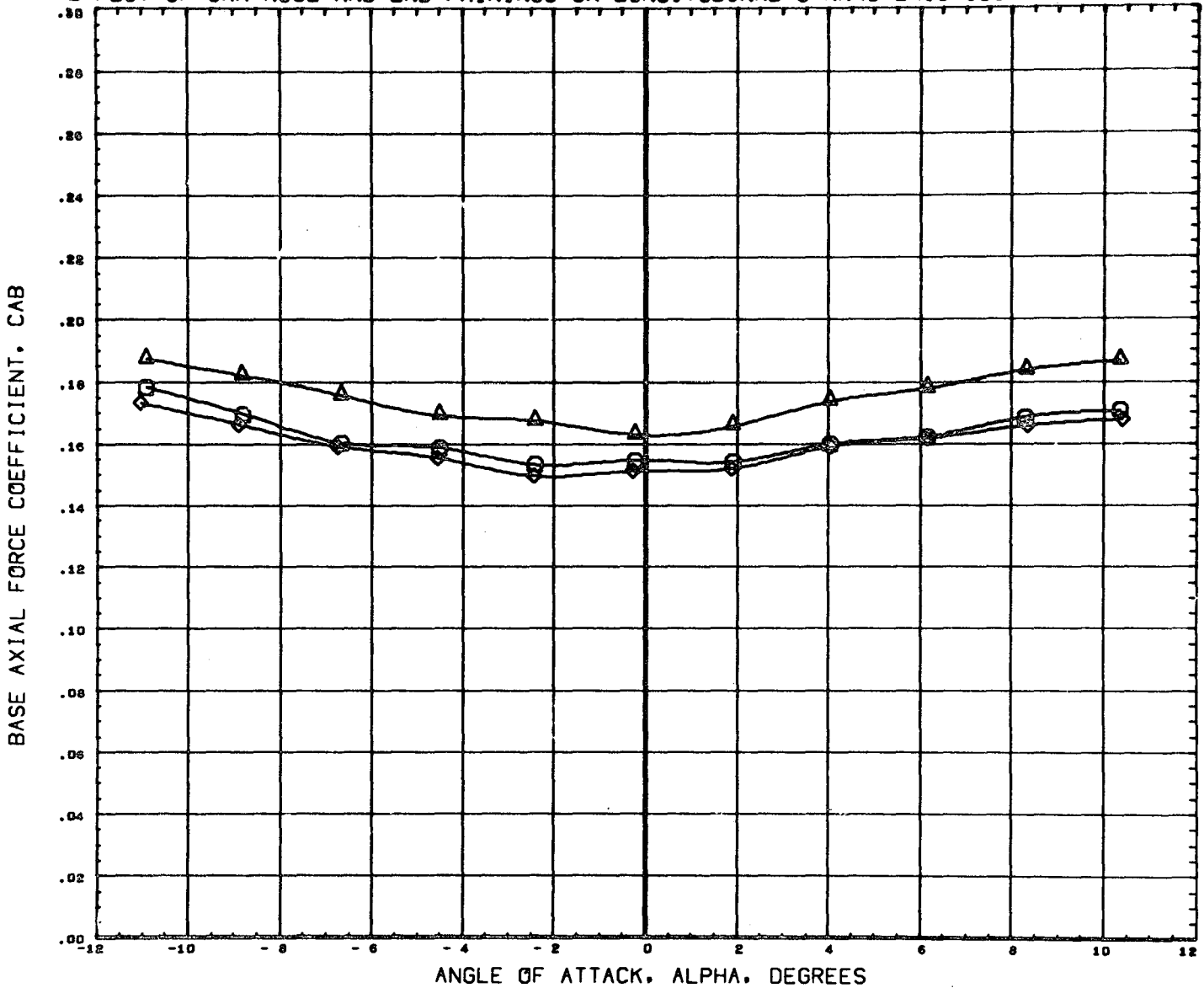

DATA SET SYMBOL	CONFIGURATION DESCRIPTION	ORBIN	THETS	BETA	REFERENCE INFORMATION	
(B65004)	MSFC TWT 534 SHUTTLE LAUNCH	T101S1	-1.500	21.000	0.000	SREF 4.8950 SQ. IN
(B65017)	MSFC TWT 534 SHUTTLE LAUNCH	T101S2	-1.500	21.000	0.000	LREF 2.6440 IN.
(B65023)	MSFC TWT 534 SHUTTLE LAUNCH	T101S3	-1.500	21.000	0.000	BREF 3.5250 IN.
						XMRP 3.4900 IN.
						YMRP 0.0000 IN.
						ZMRP 0.1616 IN.
						SCALE 0.0034

MACH 1.20

EFFECT OF SRM NOSE AND END FAIRINGS ON LONGITUDINAL CHARACTERISTICS

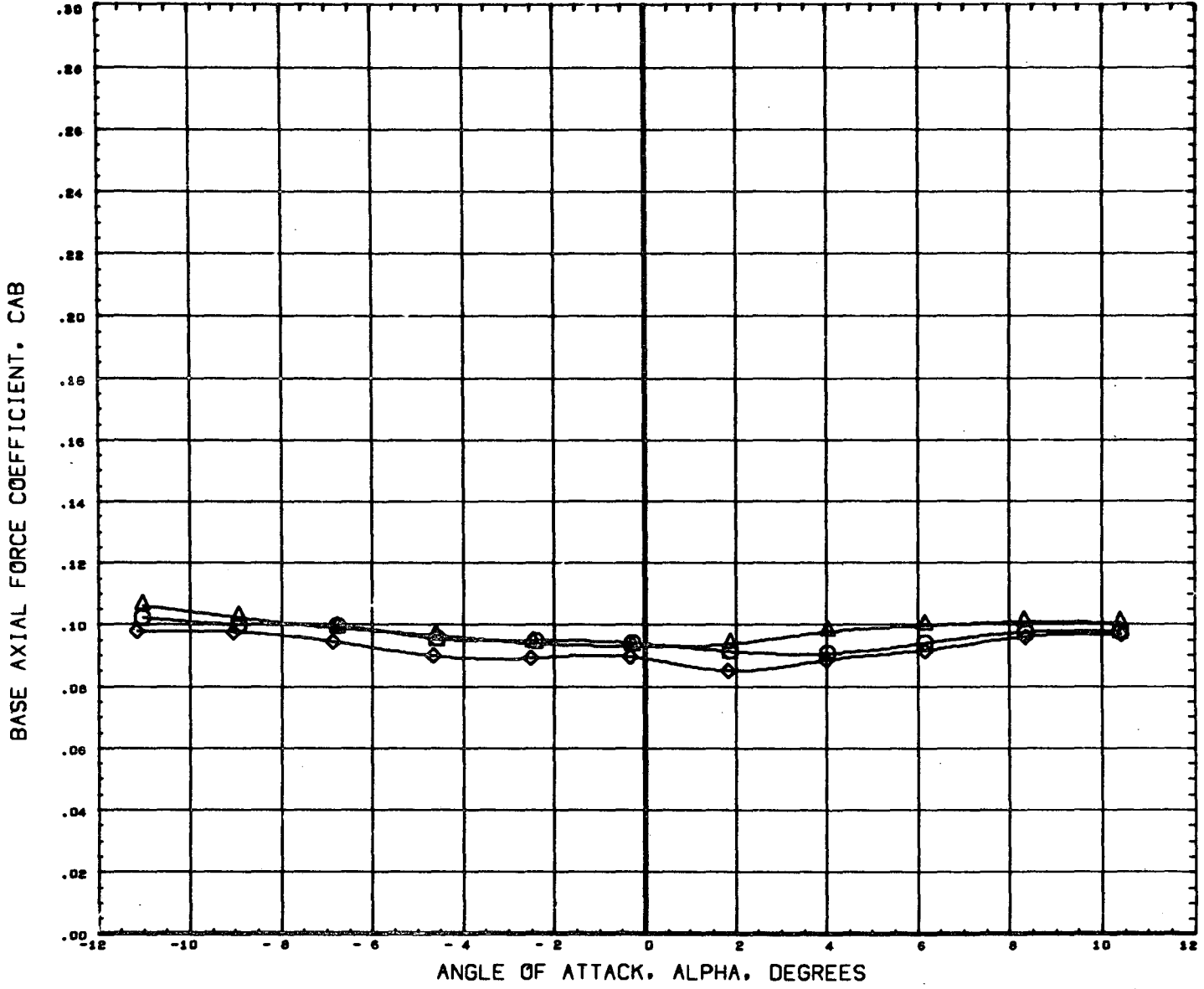

DATA SET SYMBOL	CONFIGURATION DESCRIPTION	ORBIN	THETS	BETA	REFERENCE INFORMATION
(B65004)	MSFC TWT 534 SHUTTLE LAUNCH	-1.500	21.000	0.000	SREF 4.8950 SQ. IN
(B65017)	MSFC TWT 534 SHUTTLE LAUNCH	-1.500	21.000	0.000	LREF 2.6440 IN.
(B65023)	MSFC TWT 534 SHUTTLE LAUNCH	-1.500	21.000	0.000	BREF 3.5250 IN.
					XMRP 3.4900 IN.
					YMRP 0.0000 IN.
					ZMRP 0.1616 IN.
					SCALE 0.0034

MACH 1.97

EFFECT OF SRM NOSE AND END FAIRINGS ON LONGITUDINAL CHARACTERISTICS

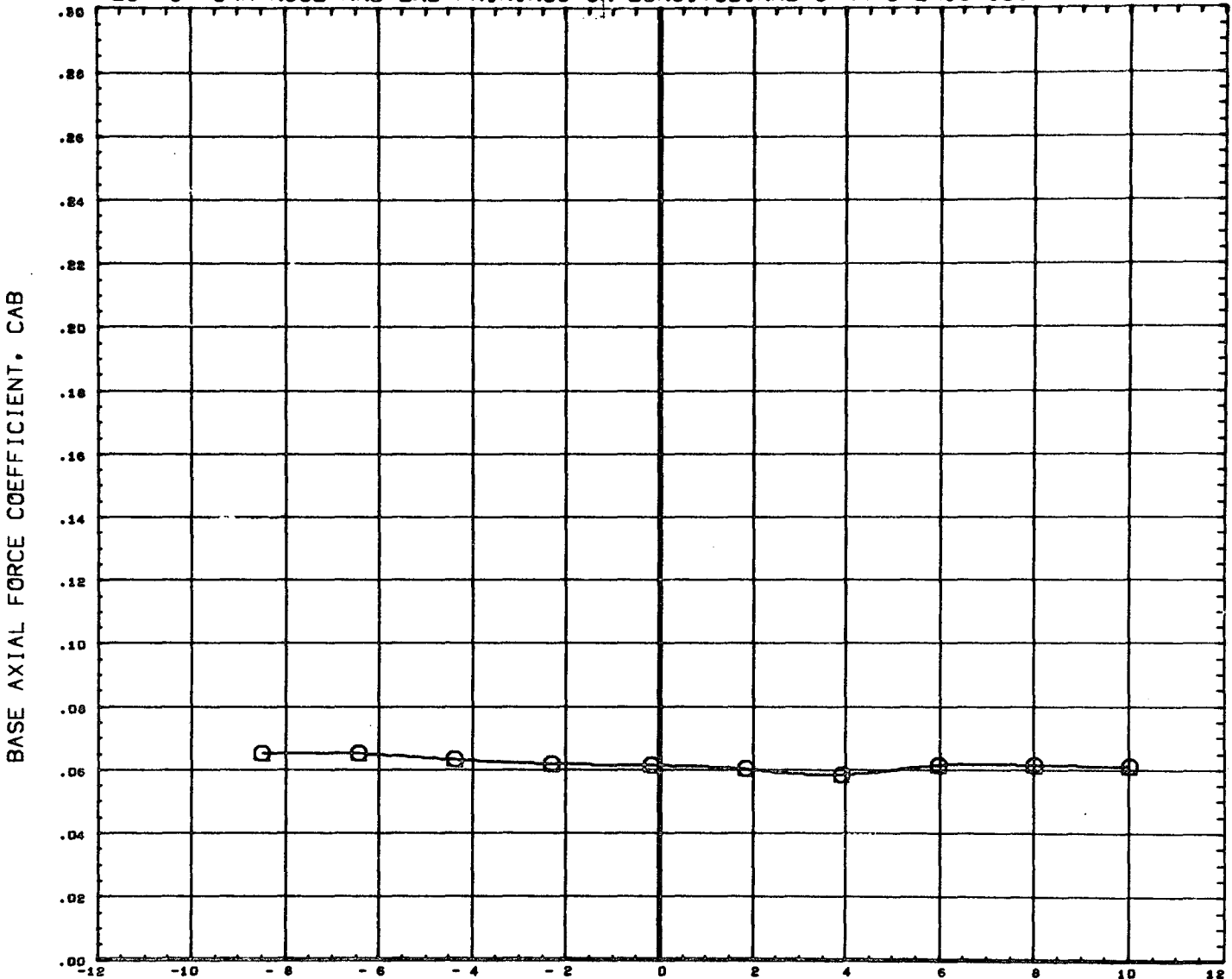

DATA SET SYMBOL	CONFIGURATION DESCRIPTION	ORBIN	THETS	BETA	REFERENCE INFORMATION
(B65004)	MSFC TWT 534 SHUTTLE LAUNCH T101S1	-1.500	21.000	0.000	SREF 4.8950 SQ. IN
(B65017)	DATA NOT AVAILABLE FOR ALL CONDITIONS	-1.500	21.000	0.000	LREF 2.6440 IN.
(B65029)	DATA NOT AVAILABLE FOR ALL CONDITIONS	-1.500	21.000	0.000	BREF 3.5250 IN.
					XHRP 3.4900 IN.
					YHRP 0.0000 IN.
					ZHRP 0.1616 IN.
					SCALE 0.0034

MACH 2.74

EFFECT OF SRM NOSE AND END FAIRINGS ON LONGITUDINAL CHARACTERISTICS

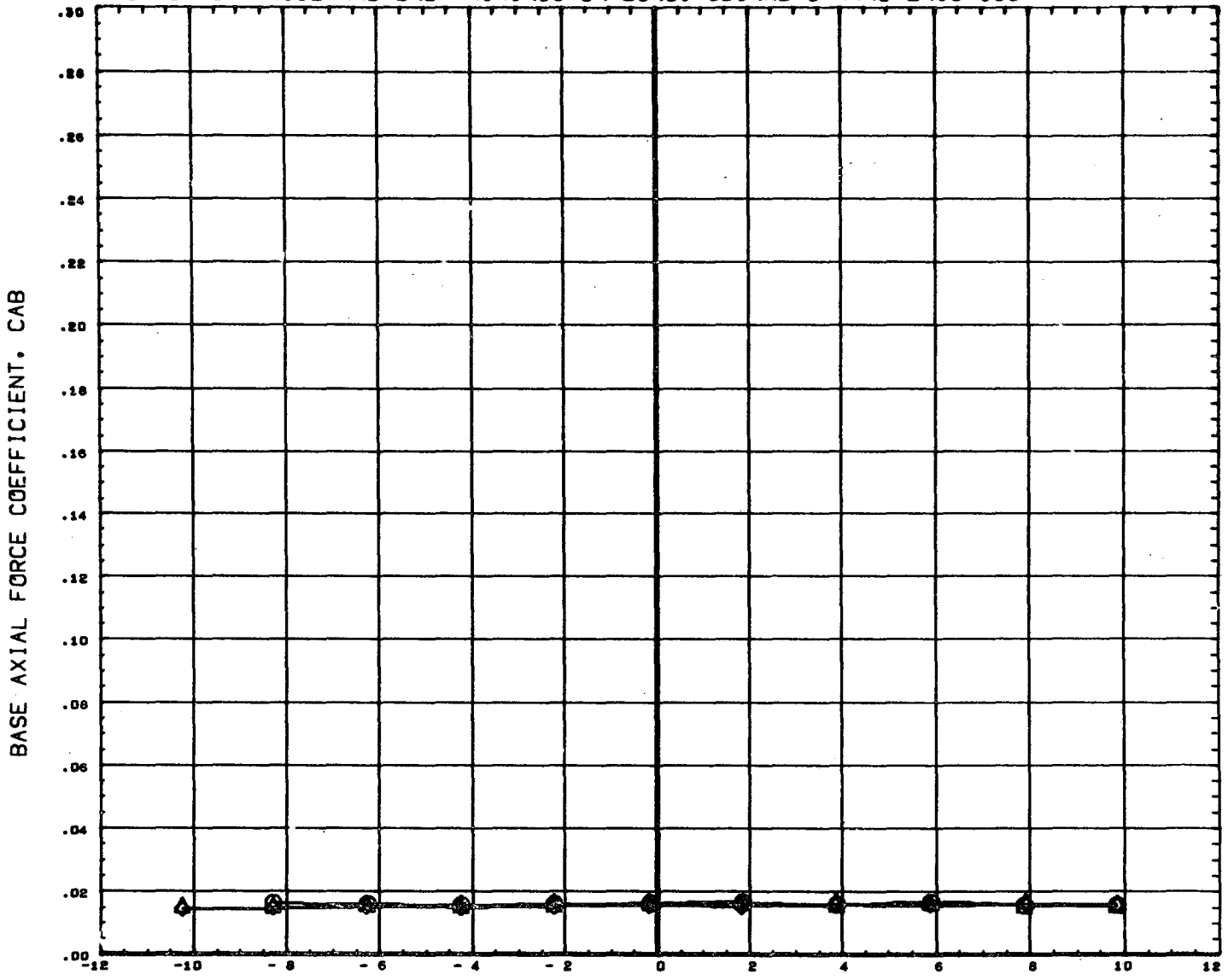

DATA SET SYMBOL	CONFIGURATION DESCRIPTION	ORBIT	THETS	BETA	REFERENCE INFORMATION	
(865004)	MSFC TWT 534 SHUTTLE LAUNCH	T101S1	-1.500	21.000	0.000	SREF 4.8950 SQ. IN
(865017)	MSFC TWT 534 SHUTTLE LAUNCH	T101S2	-1.500	21.000	0.000	LREF 2.6440 IN.
(865023)	MSFC TWT 534 SHUTTLE LAUNCH	T101S3	-1.500	21.000	0.000	BREF 3.5250 IN.
						XMRP 3.4900 IN.
						YMRP 0.0000 IN.
						ZMRP 0.1616 IN.
						SCALE 0.0034

MACH 4.96

PAGE 376

EFFECT OF SRM NOSE AND END FAIRINGS ON LONGITUDINAL CHARACTERISTICS

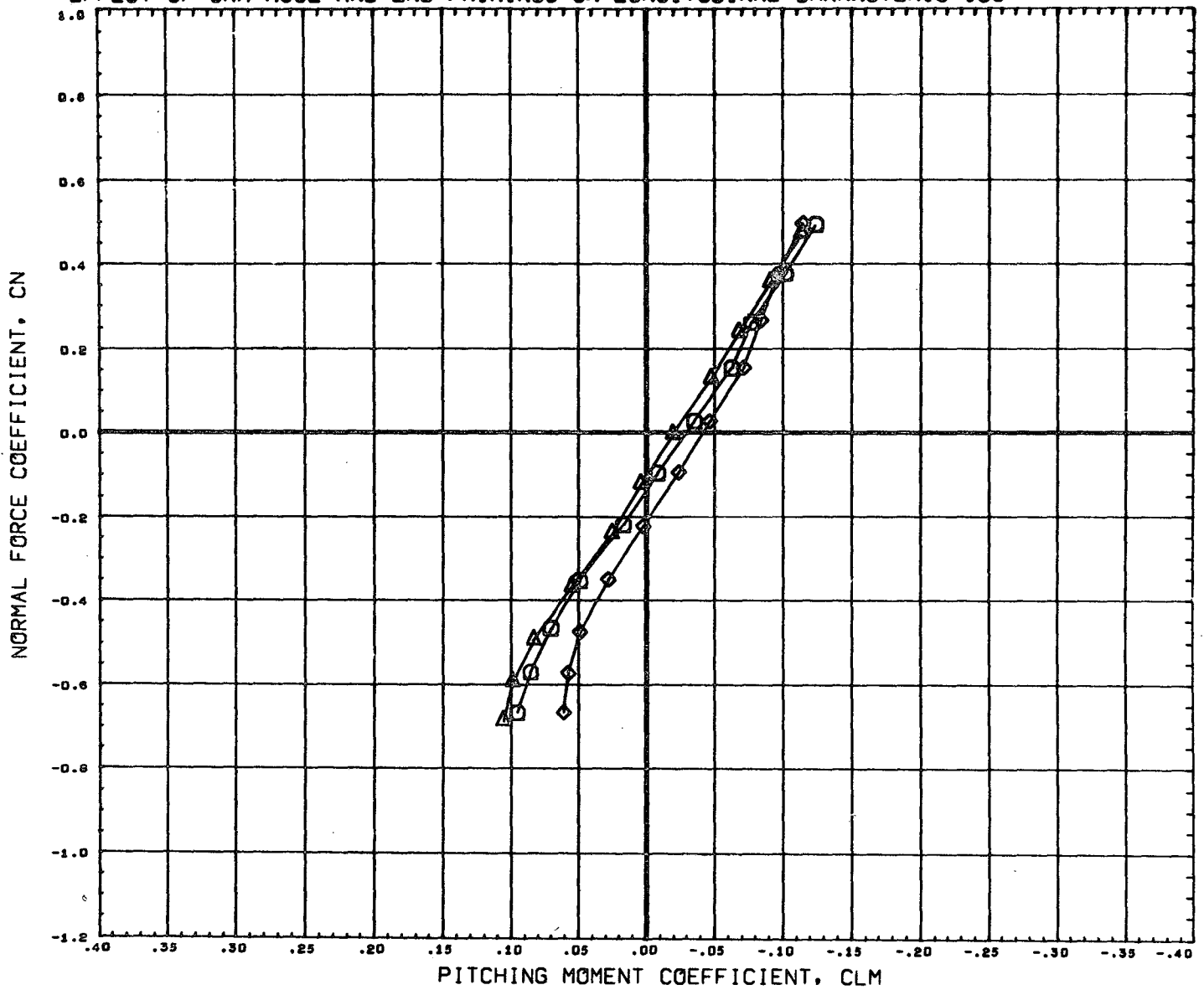

DATA SET SYMBOL	CONFIGURATION DESCRIPTION	ORBIN	THETS	BETA	REFERENCE INFORMATION	
(B65004)	MSFC TWT 534 SHUTTLE LAUNCH	T101S1	-1.500	21.070	0.000	SREF 4.8950 SQ. IN
(B65017)	MSFC TWT 534 SHUTTLE LAUNCH	T101S2	-1.500	21.000	0.000	LREF 2.6440 IN.
(B65023)	MSFC TWT 534 SHUTTLE LAUNCH	T101S3	-1.500	21.000	0.000	BREF 3.5250 IN.
						XMRP 3.4900 IN.
						YMRP 0.0000 IN.
						ZMRP 0.1616 IN.
						SCALE 0.0034

MACH .60

EFFECT OF SRM NOSE AND END FAIRINGS ON LONGITUDINAL CHARACTERISTICS

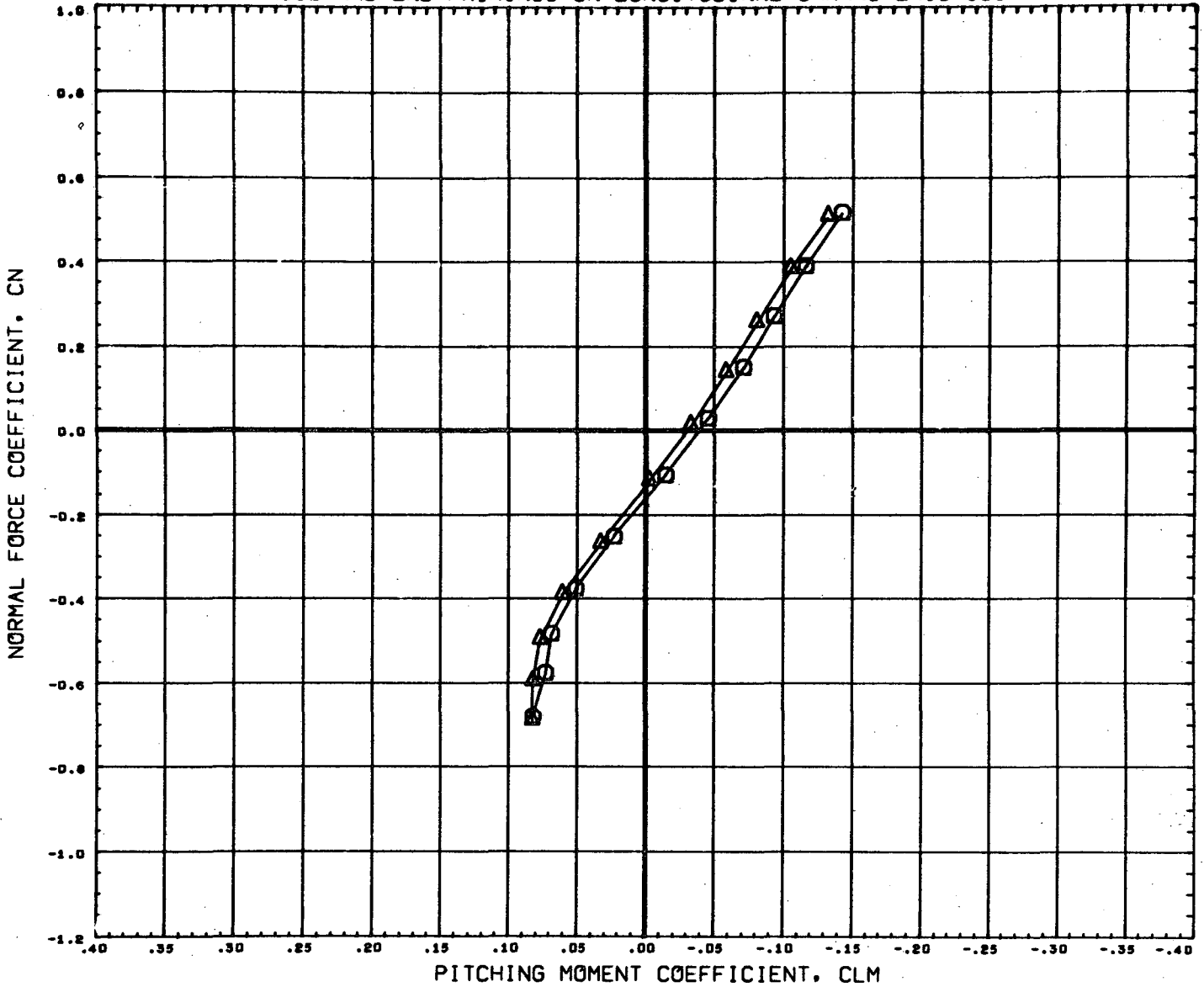

DATA SET SYMBOL	CONFIGURATION DESCRIPTION	ORBIN	THETS	BETA	REFERENCE INFORMATION
(B65004)	MSFC TWT 534 SHUTTLE LAUNCH T101S1	-1.500	21.000	0.000	SREF 4.8950 SQ. IN.
(B65017)	MSFC TWT 534 SHUTTLE LAUNCH T101S2	-1.500	21.000	0.000	LREF 2.6440 IN.
(B65023)	DATA NOT AVAILABLE FOR ALL CONDITIONS	-1.500	21.000	0.000	BREF 3.5250 IN.
					XMRP 3.4900 IN.
					YMRP 0.0000 IN.
					ZMRP 0.1616 IN.
					SCALE 0.0034

EFFECT OF SRM NOSE AND END FAIRINGS ON LONGITUDINAL CHARACTERISTICS

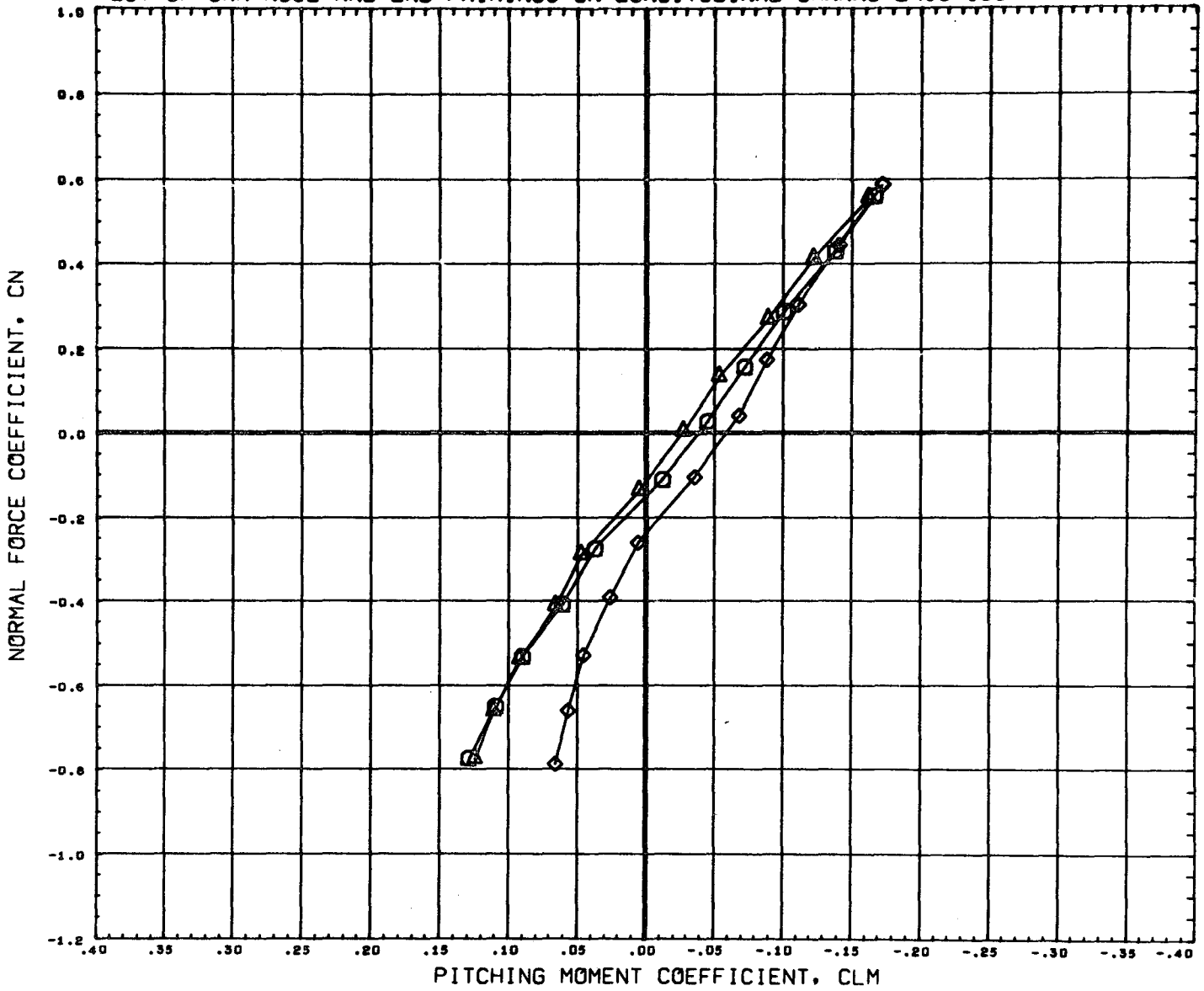

DATA SET SYMBOL	CONFIGURATION DESCRIPTION	ORBIN	THETS	BETA	REFERENCE INFORMATION	
(865004)	MSFC TWT 534 SHUTTLE LAUNCH	T101S1	-1.500	21.000	0.000	SREF 4.8950 sq. IN
(865017)	MSFC TWT 534 SHUTTLE LAUNCH	T101S2	-1.500	21.000	0.000	LREF 2.6440 IN.
(865023)	MSFC TWT 534 SHUTTLE LAUNCH	T101S3	-1.500	21.000	0.000	BREF 3.5250 IN.
						XMRP 3.4900 IN.
						YMRP 0.0000 IN.
						ZMRP 0.1616 IN.
						SCALE 0.0034

MACH .91

EFFECT OF SRM NOSE AND END FAIRINGS ON LONGITUDINAL CHARACTERISTICS

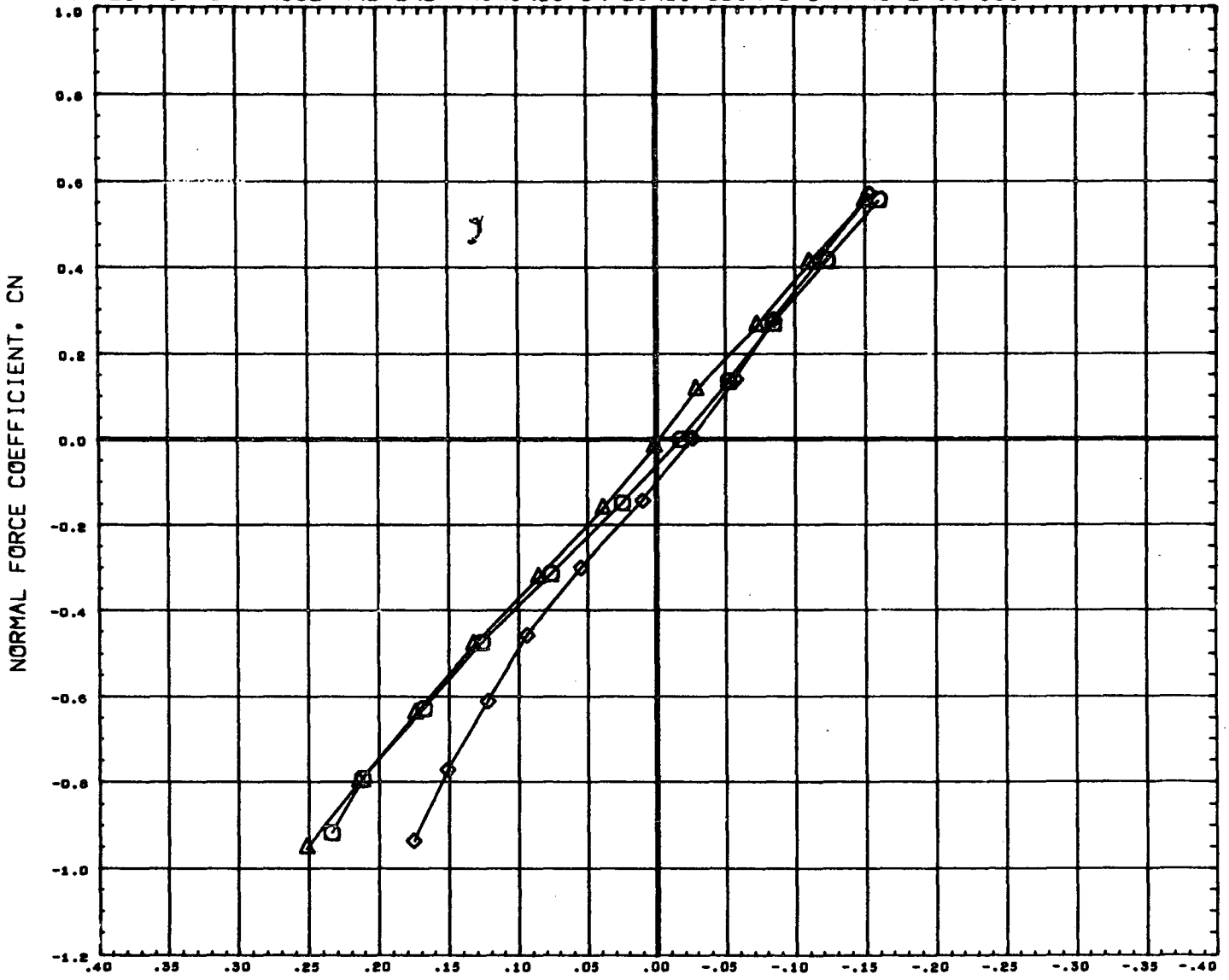

DATA SET SYMBOL	CONFIGURATION DESCRIPTION	ORBIN	THETS	BETA	REFERENCE INFORMATION
(B69004)	MSFC TWT 534 SHUTTLE LAUNCH T101S1	-1.500	21.000	0.000	SREF 4.8950 SQ. IN
(B69017)	MSFC TWT 534 SHUTTLE LAUNCH T101S2	-1.500	21.000	0.000	LREF 2.6440 IN.
(B69023)	MSFC TWT 534 SHUTTLE LAUNCH T101S3	-1.500	21.000	0.000	BREF 3.5250 IN.
					XMRP 3.4900 IN.
					YMRP 0.0000 IN.
					ZMRP 0.1616 IN.
					SCALE 0.0034

EFFECT OF SRM NOSE AND END FAIRINGS ON LONGITUDINAL CHARACTERISTICS

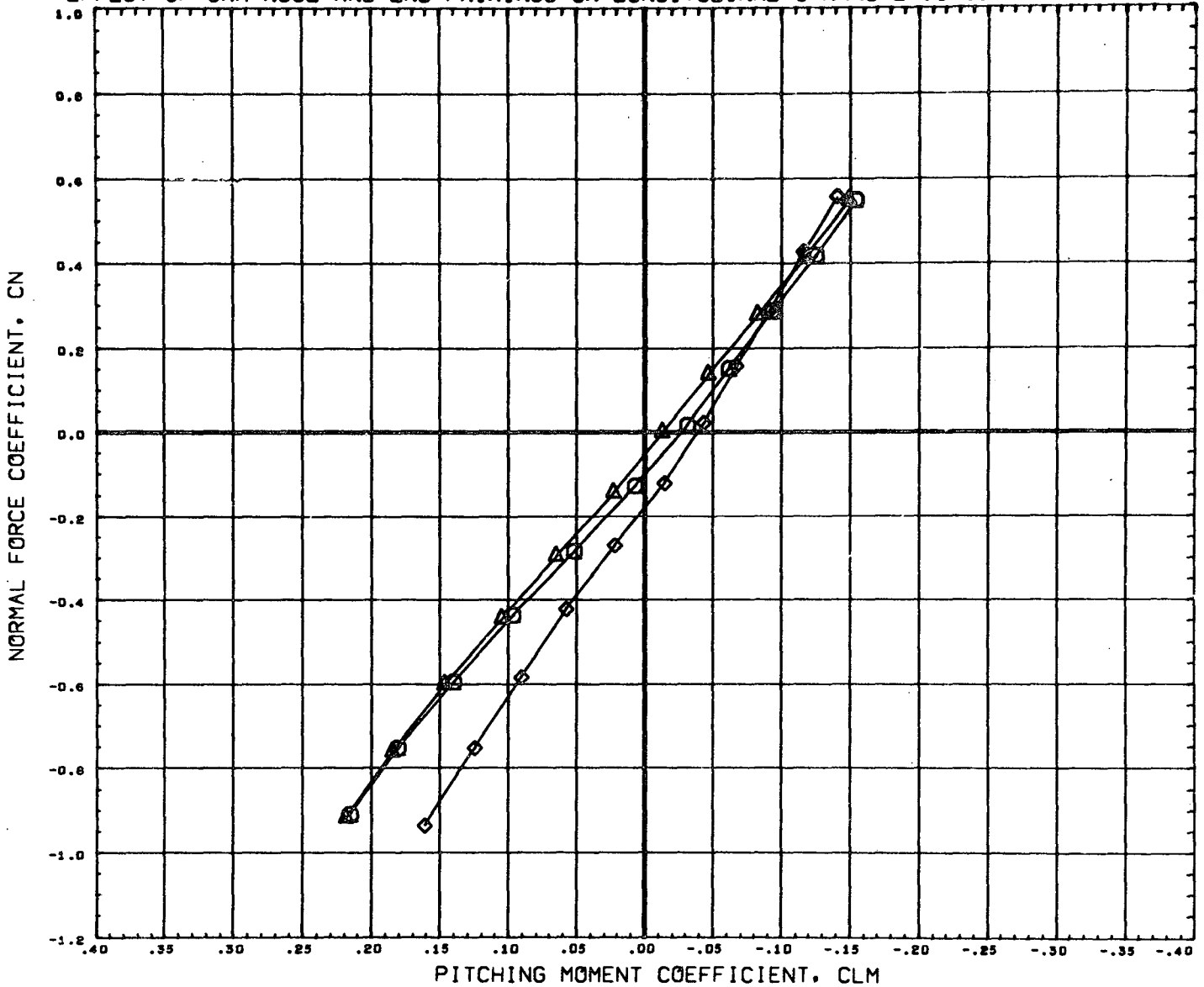

DATA SET SYMBOL	CONFIGURATION DESCRIPTION	ORBIN	THETS	BETA	REFERENCE INFORMATION	
(B65004)	MSFC TWT 534 SHUTTLE LAUNCH	T101S1	-1.500	21.000	0.000	SREF 4.8950 SQ. IN
(B65017)	MSFC TWT 534 SHUTTLE LAUNCH	T101S2	-1.500	21.000	0.000	LREF 2.6440 IN.
(B65023)	MSFC TWT 534 SHUTTLE LAUNCH	T101S3	-1.500	21.000	-0.000	BREF 3.9250 IN.
						XMRP 3.4900 IN.
						YMRP 0.0000 IN.
						ZMRP 0.1616 IN.
						SCALE 0.0034

MACH 1.20

EFFECT OF SRM NOSE AND END FAIRINGS ON LONGITUDINAL CHARACTERISTICS

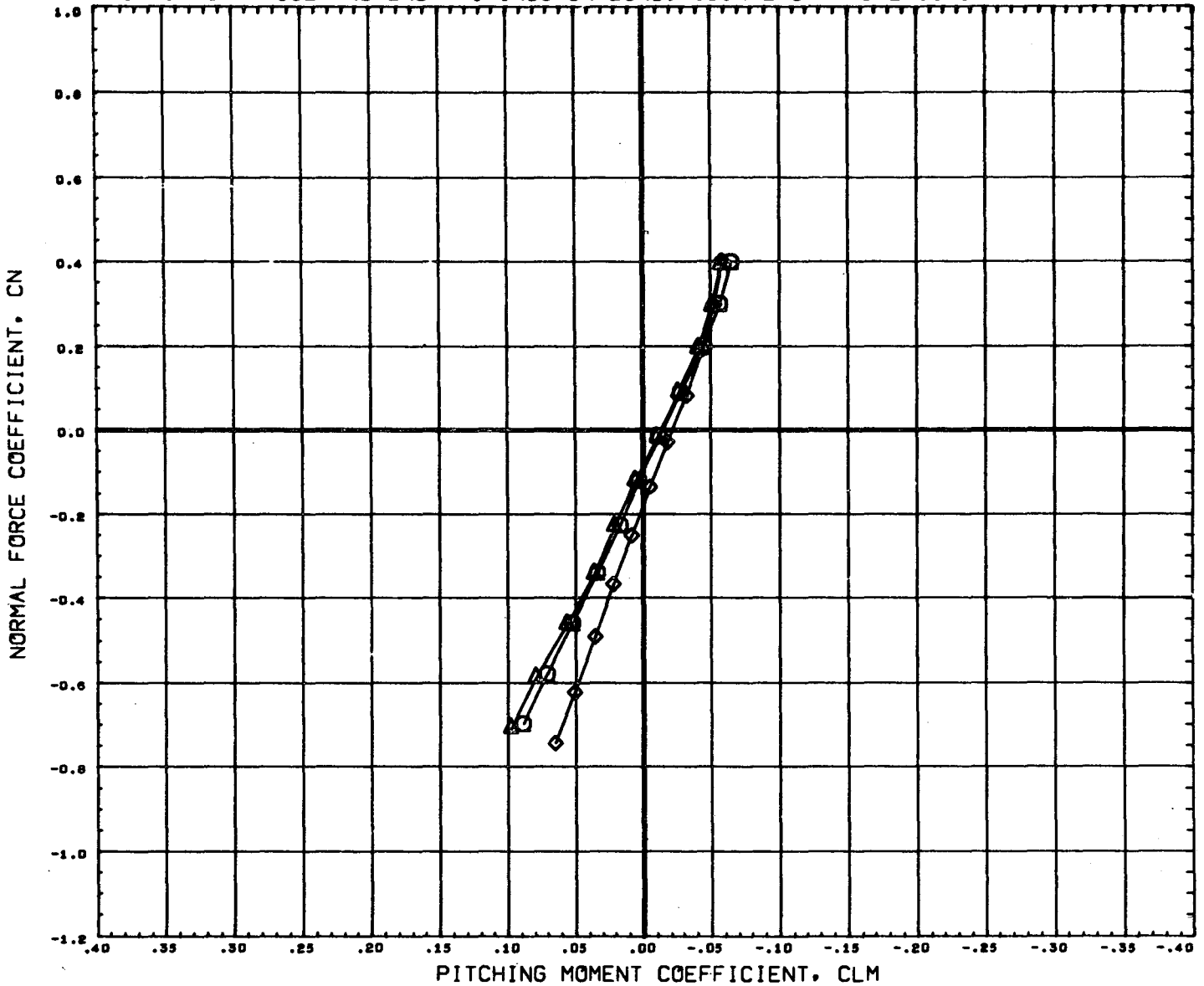

DATA SET SYMBOL	CONFIGURATION DESCRIPTION	ORBIN	THETS	BETA	REFERENCE INFORMATION
(B63004)	MSFC TWT 534 SHUTTLE LAUNCH	-1.500	21.070	0.000	SREF 4.8950 SQ. IN
(B63017)	MSFC TWT 534 SHUTTLE LAUNCH	-1.500	21.000	0.000	LREF 2.6440 IN.
(B63023)	MSFC TWT 534 SHUTTLE LAUNCH	-1.500	21.000	0.000	BREF 3.5250 IN.
					XMRP 3.4900 IN.
					YMRP 0.0000 IN.
					ZMRP 0.1616 IN.
					SCALE 0.0034

MACH 1.97

EFFECT OF SRM NOSE AND END FAIRINGS ON LONGITUDINAL CHARACTERISTICS

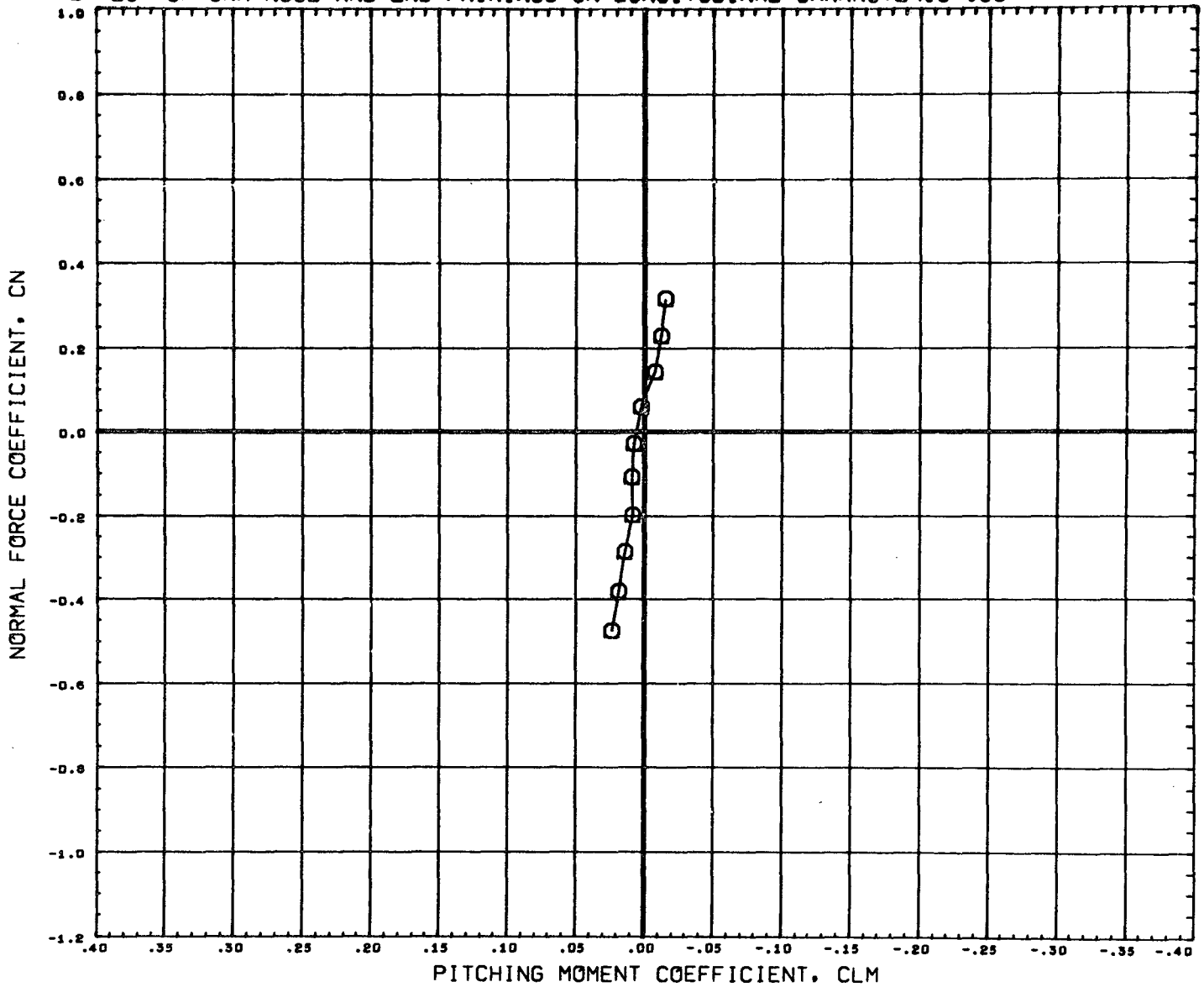

DATA SET SYMBOL	CONFIGURATION DESCRIPTION	ORBIN	THETS	BETA	REFERENCE INFORMATION
(B65004)	MSFC TWT 534 SHUTTLE LAUNCH T101S1	-1.500	21.000	0.000	SREF 4.8950 SQ. IN
(B65017)	DATA NOT AVAILABLE FOR ALL CONDITIONS	-1.500	21.000	0.000	LREF 2.6440 IN.
(B65023)	DATA NOT AVAILABLE FOR ALL CONDITIONS	-1.500	21.000	0.000	BREF 3.5250 IN.
					XMRP 3.4900 IN.
					YMRP 0.0000 IN.
					ZMRP 0.1616 IN.
					SCALE 0.0034

EFFECT OF SRM NOSE AND END FAIRINGS ON LONGITUDINAL CHARACTERISTICS

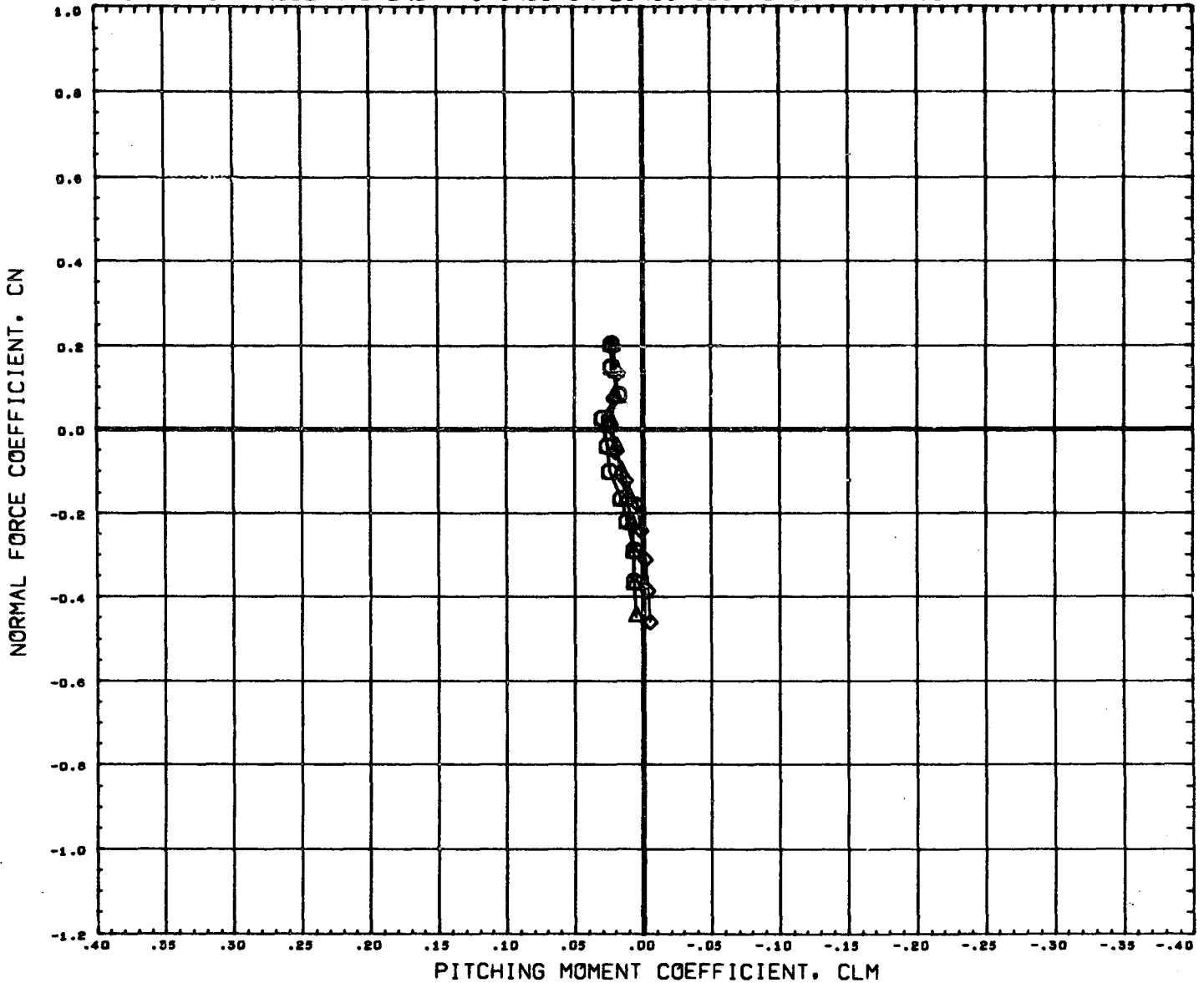

DATA SET SYMBOL	CONFIGURATION DESCRIPTION	ORBIT	THETA	BETA	REFERENCE INFORMATION	
(B65004)	MSFC TWT 534 SHUTTLE LAUNCH	T101S1	-1.500	21.000	0.000	SREF 4.8950 SQ. IN
(B65017)	MSFC TWT 534 SHUTTLE LAUNCH	T101S2	-1.500	21.000	0.000	LREF 2.6440 IN.
(B65023)	MSFC TWT 534 SHUTTLE LAUNCH	T101S3	-1.500	21.000	0.000	BREF 3.5250 IN.
						XMRP 3.4900 IN.
						YMRP 0.0000 IN.
						ZMRP 0.1616 IN.
						SCALE 0.0034

MACH

4.96

PAGE 384

EFFECT OF SRM END FAIRING ON LATERAL/DIRECTIONAL CHARACTERISTICS

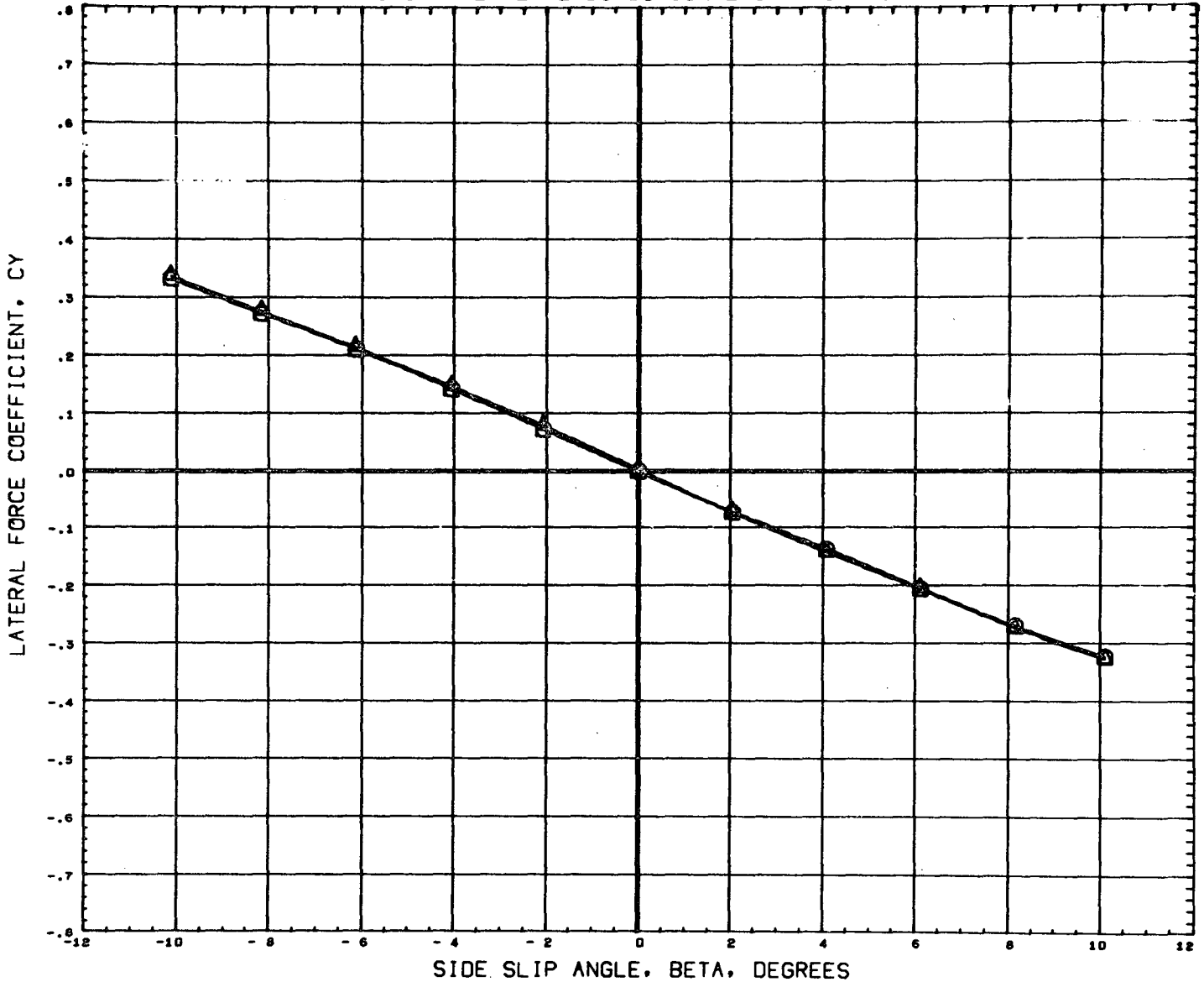

DATA SET SYMBOL	CONFIGURATION DESCRIPTION	ORBIN	THETS	ALPHA	REFERENCE INFORMATION	
(B65005)	MSFC TWT 534 SHUTTLE LAUNCH	T101S1	-1.500	21.00J	0.000	SREF 4.8950 SQ. IN
(B65018)	MSFC TWT 534 SHUTTLE LAUNCH	T101S2	-1.500	21.000	0.000	LREF 2.6440 IN.
						BREF 3.5250 IN.
						XMRP 3.4900 IN.
						YMRP 0.0000 IN.
						ZMRP 0.1616 IN.
						SCALE 0.0034

MACH .60

EFFECT OF SRM END FAIRING ON LATERAL/DIRECTIONAL CHARACTERISTICS

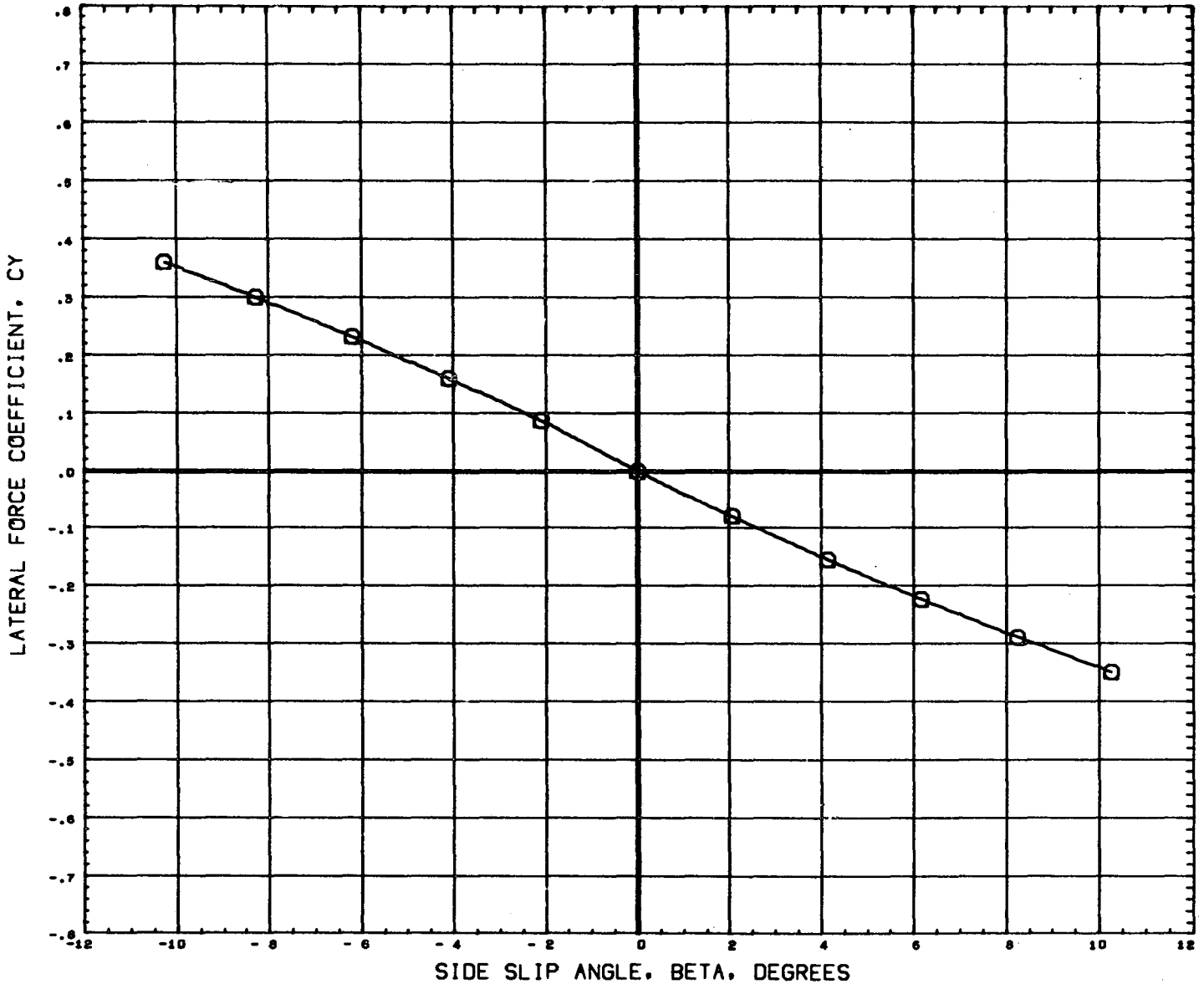

DATA SET SYMBOL CONFIGURATION DESCRIPTION
 (B65005) Δ MSFC TWT 534 SHUTTLE LAUNCH T10191
 (B65018) Δ DATA NOT AVAILABLE FOR ALL CONDITIONS

ORBIN THETS ALPHA
 -1.500 21.000 0.000
 -1.500 21.000 0.000

REFERENCE INFORMATION
 SREF 4.8950 SQ. IN
 LREF 2.6440 IN.
 BREF 3.5250 IN.
 XMRP 3.4900 IN.
 YMRP 0.0000 IN.
 ZMRP 0.1616 IN.
 SCALE 0.0034

EFFECT OF SRM END FAIRING ON LATERAL/DIRECTIONAL CHARACTERISTICS

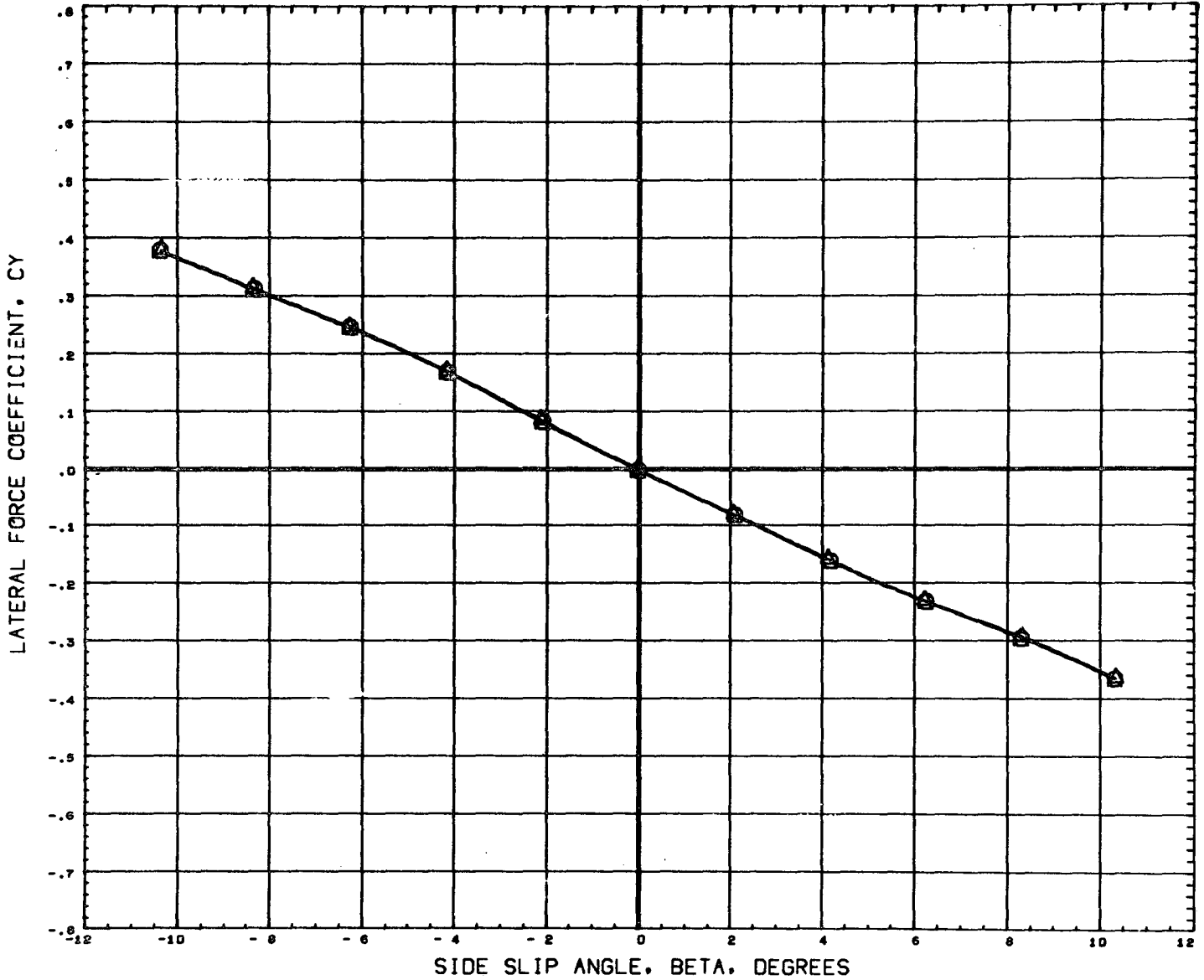

DATA SET SYMBOL	CONFIGURATION DESCRIPTION	ORBIN	THETS	ALPHA	REFERENCE INFORMATION	
(B65005)	MSFC TWT 534 SHUTTLE LAUNCH	T101S1	-1.500	21.000	0.000	SREF 4.8950 SQ. IN
(B65010)	MSFC TWT 534 SHUTTLE LAUNCH	T101S2	-1.500	21.000	0.000	LREF 2.6440 IN.
						BREF 3.5250 IN.
						XNRP 3.4900 IN.
						YNRP 0.0000 IN.
						ZNRP 0.1616 IN.
						SCALE 0.0034

MACH .91

EFFECT OF SRM END FAIRING ON LATERAL/DIRECTIONAL CHARACTERISTICS

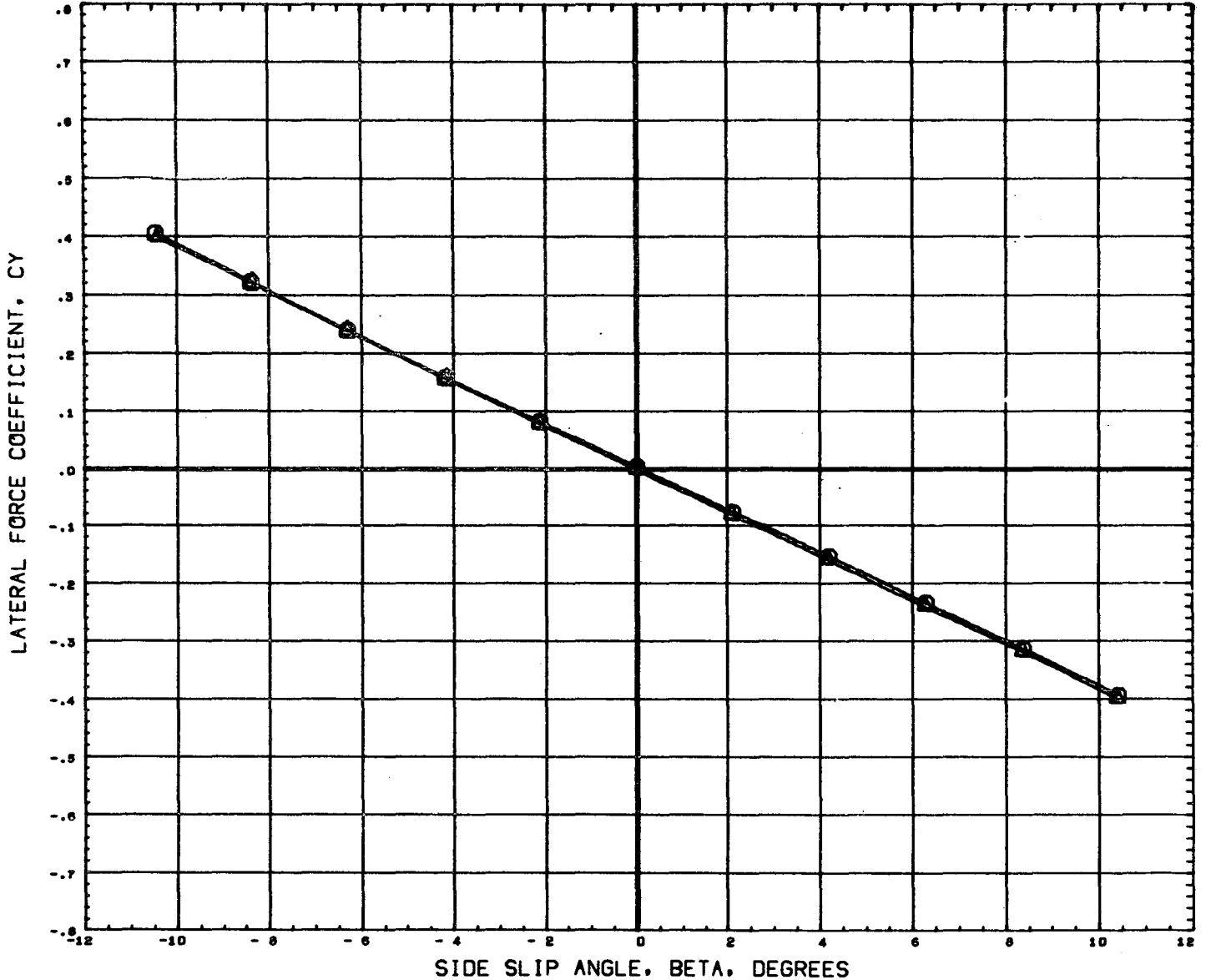

DATA SET SYMBOL	CONFIGURATION DESCRIPTION	ORBIN	THETS	ALPHA	REFERENCE INFORMATION	
(065005)	NSFC TWT 534 SHUTTLE LAUNCH	T101S1	-1.500	21.000	0.000	SREF 4.8950 SQ. IN
(065010)	NSFC TWT 534 SHUTTLE LAUNCH	T101S2	-1.500	21.000	0.000	LREF 2.6440 IN.
						BREF 3.5250 IN.
						XMRP 3.4900 IN.
						YMRP 0.0000 IN.
						ZMRP 0.1616 IN.
						SCALE 0.0034

EFFECT OF SRM END FAIRING ON LATERAL/DIRECTIONAL CHARACTERISTICS

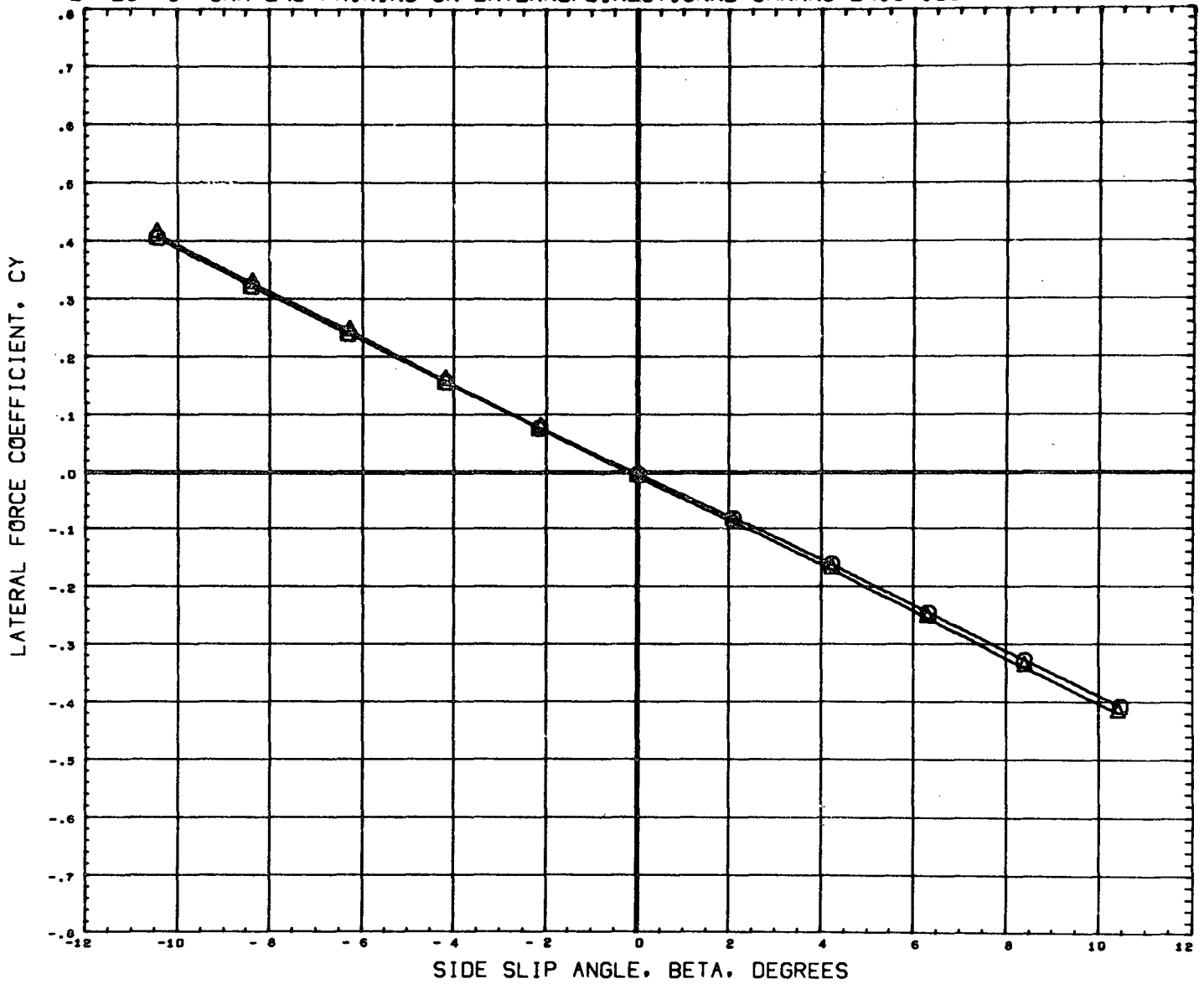

DATA SET SYMBOL	CONFIGURATION DESCRIPTION	ORBIN	THETS	ALPHA	REFERENCE INFORMATION	
(B65005)	MSFC TWT 534 SHUTTLE LAUNCH	T101S1	-1.500	21.000	0.000	SREF 4.8950 SQ. IN
(B65018)	MSFC TWT 534 SHUTTLE LAUNCH	T101S2	-1.500	21.000	0.000	LREF 2.6440 IN.
						BREF 3.5250 IN.
						XMRP 3.4900 IN.
						YMRP 0.0000 IN.
						ZMRP 0.1616 IN.
						SCALE 0.0034

MACH 1.19

EFFECT OF SRM END FAIRING ON LATERAL/DIRECTIONAL CHARACTERISTICS

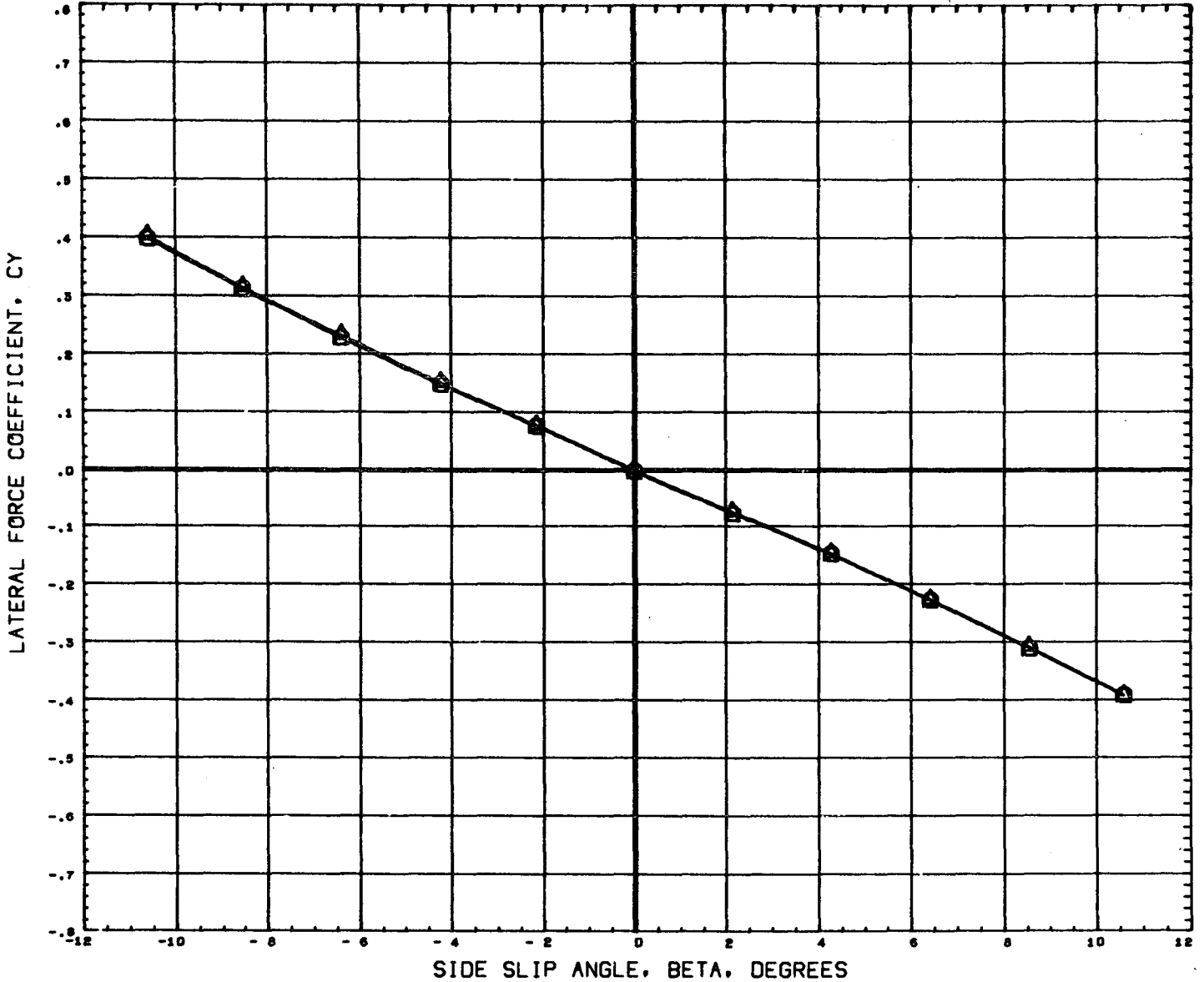

DATA SET SYMBOL CONFIGURATION DESCRIPTION
 (865005) Δ MSFC TWT 534 SHUTTLE LAUNCH T101S1
 (865016) Δ MSFC TWT 534 SHUTTLE LAUNCH T101S2

ORBIN THETS ALPHA
 -1.500 21.000 0.000
 -1.500 21.000 0.000

REFERENCE INFORMATION
 SREF 4.8950 SQ. IN
 LREF 2.6440 IN.
 BREF 3.5250 IN.
 XMRP 3.4900 IN.
 YMRP 0.0000 IN.
 ZMRP 0.1616 IN.
 SCALE 0.0034

EFFECT OF SRM END FAIRING ON LATERAL/DIRECTIONAL CHARACTERISTICS

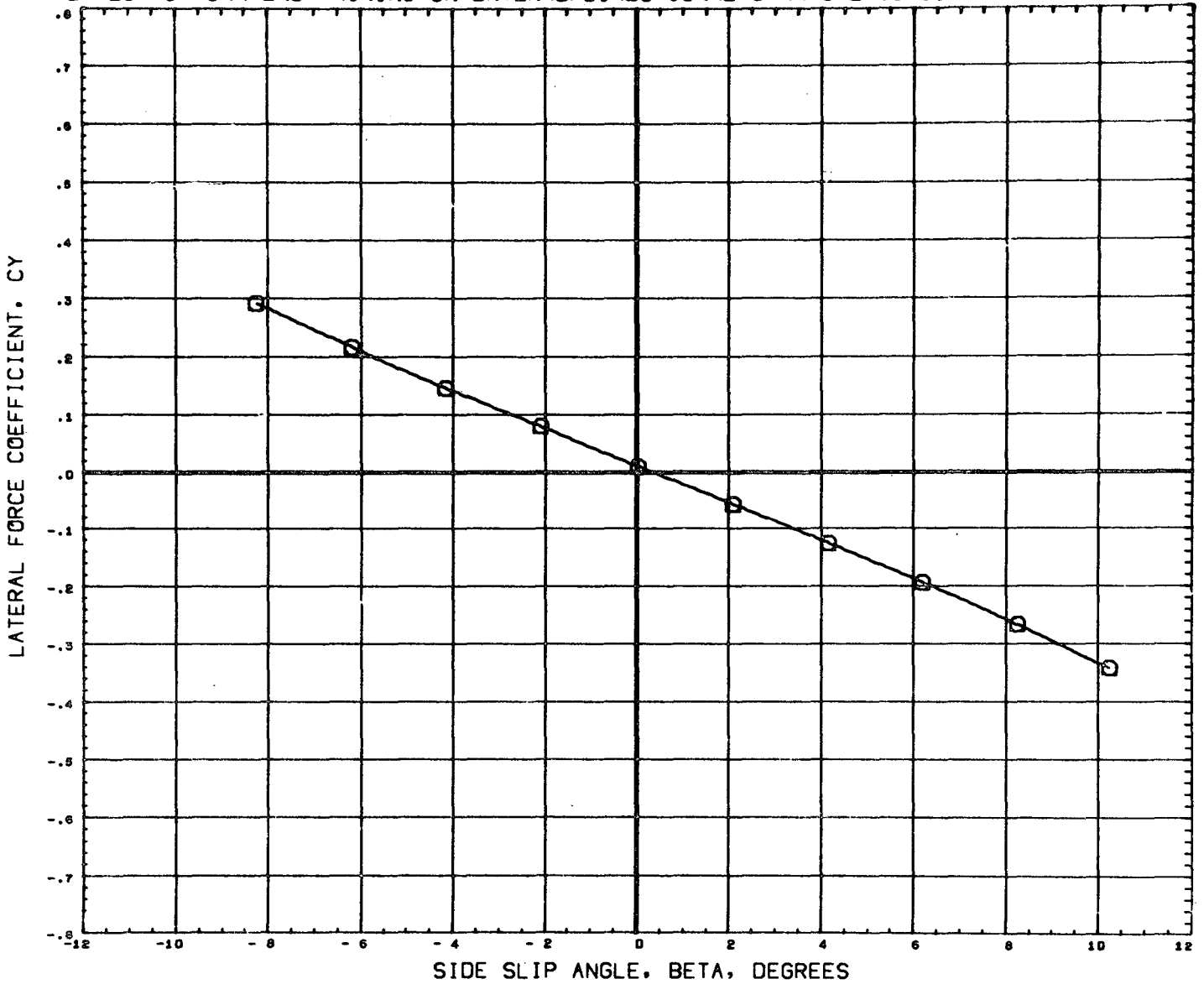

DATA SET SYMBOL CONFIGURATION DESCRIPTION
 (B65005) MSFC TWT 534 SHUTTLE LAUNCH T101S1
 (B65018) DATA NOT AVAILABLE FOR ALL CONDITIONS

ORBIN THETS ALPHA
 -1.500 21.000 0.000
 -1.500 21.000 0.000

REFERENCE INFORMATION
 SREF 4.8950 SQ. IN
 LREF 2.6440 IN.
 BREF 3.5250 IN.
 XMRP 3.4900 IN.
 YMRP 0.0000 IN.
 ZMRP 0.1616 IN.
 SCALE 0.0034

EFFECT OF SRM END FAIRING ON LATERAL/DIRECTIONAL CHARACTERISTICS

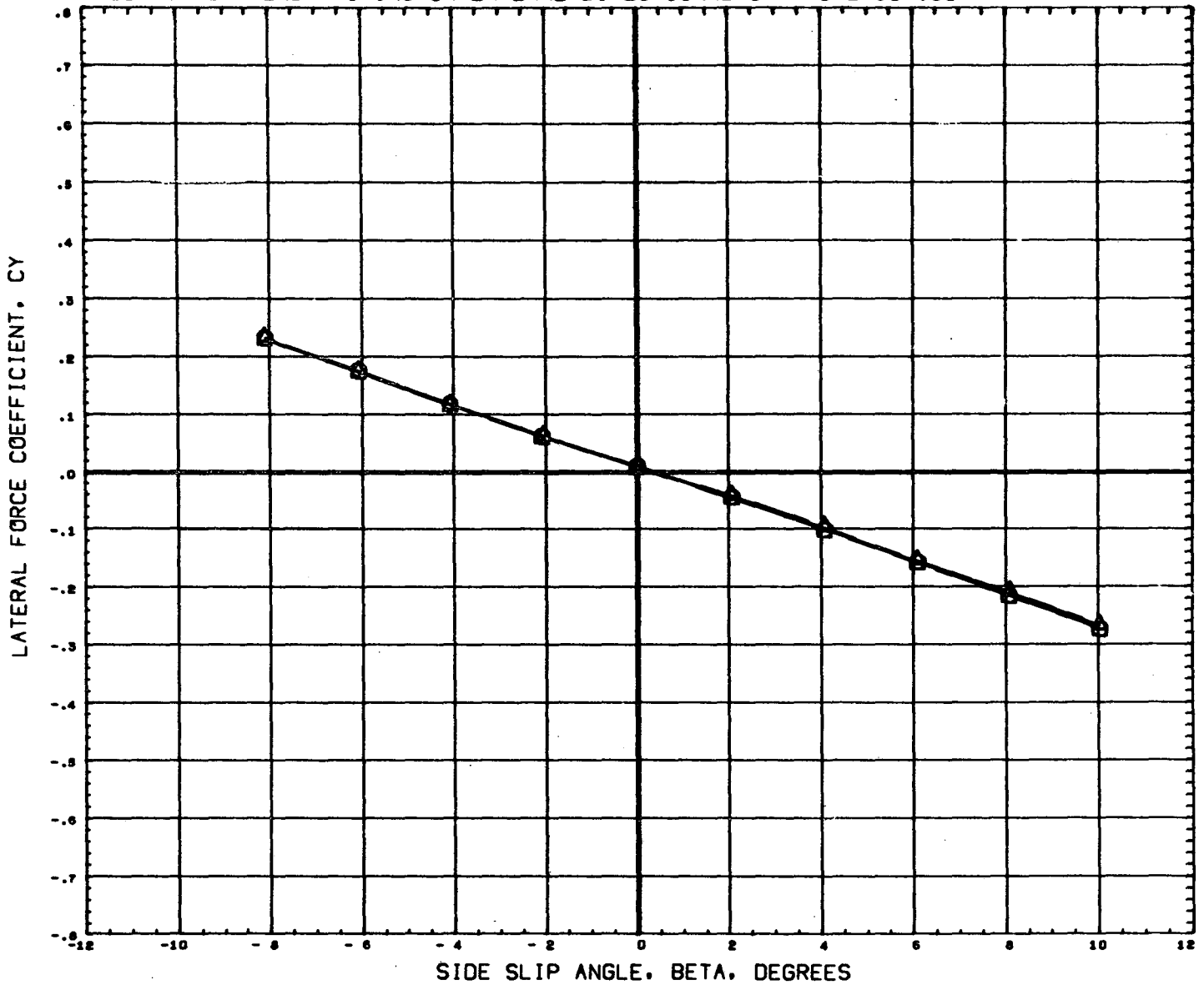

DATA SET SYMBOL	CONFIGURATION DESCRIPTION	ORBIN	THETS	ALPHA	REFERENCE INFORMATION
(B65005)	MSFC TWT 534 SHUTTLE LAUNCH	-1.500	21.000	0.000	SREF 4.8950 99. IN
(B65018)	MSFC TWT 534 SHUTTLE LAUNCH	-1.500	21.000	0.000	LREF 2.6440 IN.
					BREF 3.5250 IN.
					XMRP 3.4900 IN.
					YMRP 0.0000 IN.
					ZMRP 0.1616 IN.
					SCALE 0.0034

MACH 4.96

PAGE 392

EFFECT OF SRM END FAIRING ON LATERAL/DIRECTIONAL CHARACTERISTICS

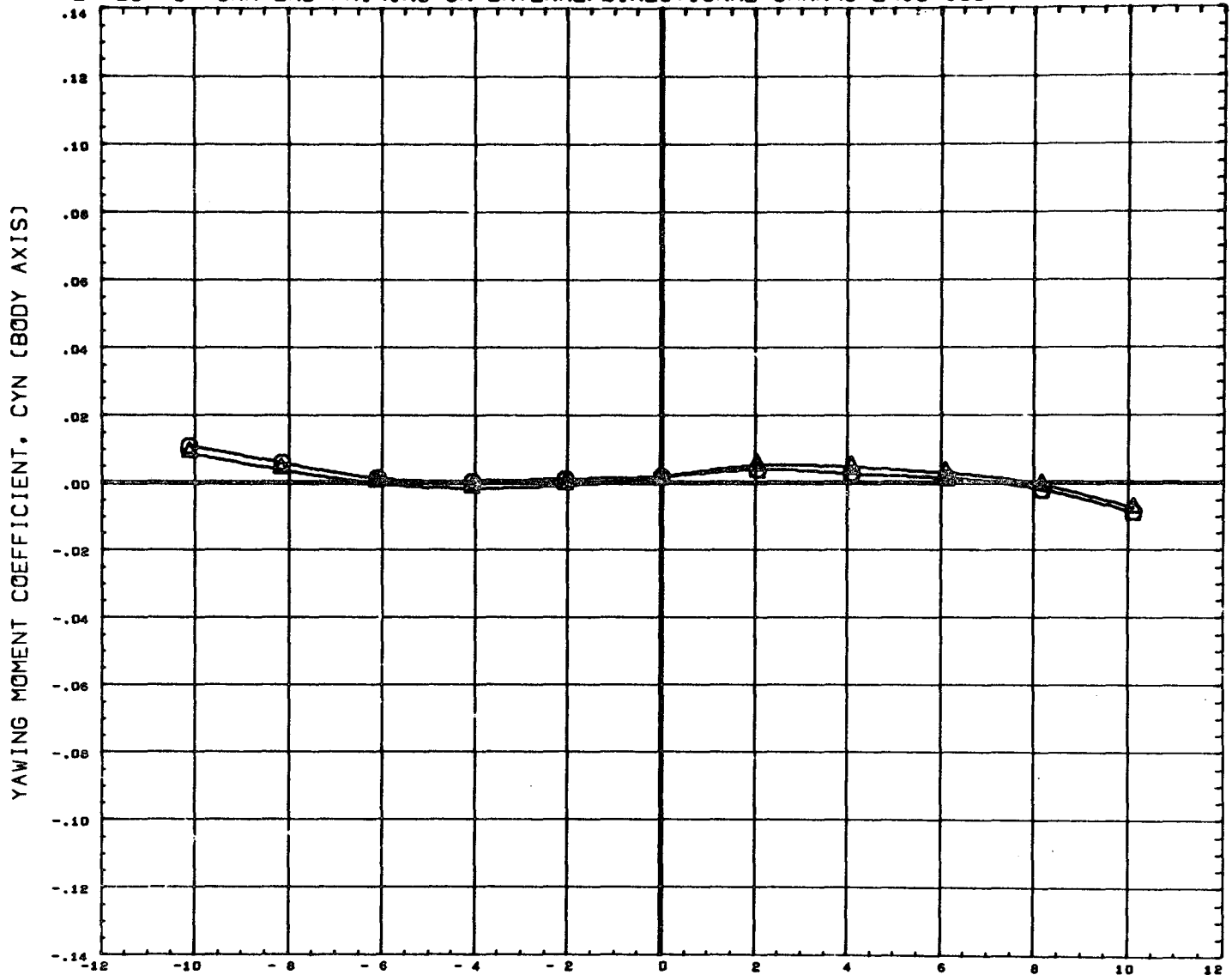

DATA SET SYMBOL	CONFIGURATION DESCRIPTION	ORBIN	THETS	ALPHA	REFERENCE INFORMATION
(B65005)	MSFC TWT 534 SHUTTLE LAUNCH	-1.500	21.000	0.000	SREF 4.8950 SQ. IN
(B65018)	MSFC TWT 534 SHUTTLE LAUNCH	-1.500	21.000	0.000	LREF 2.6440 IN.
					BREF 3.5250 IN.
					XMRP 3.4900 IN.
					YMRP 0.0000 IN.
					ZMRP 0.1616 IN.
					SCALE 0.0034

MACH .60

EFFECT OF SRM END FAIRING ON LATERAL/DIRECTIONAL CHARACTERISTICS

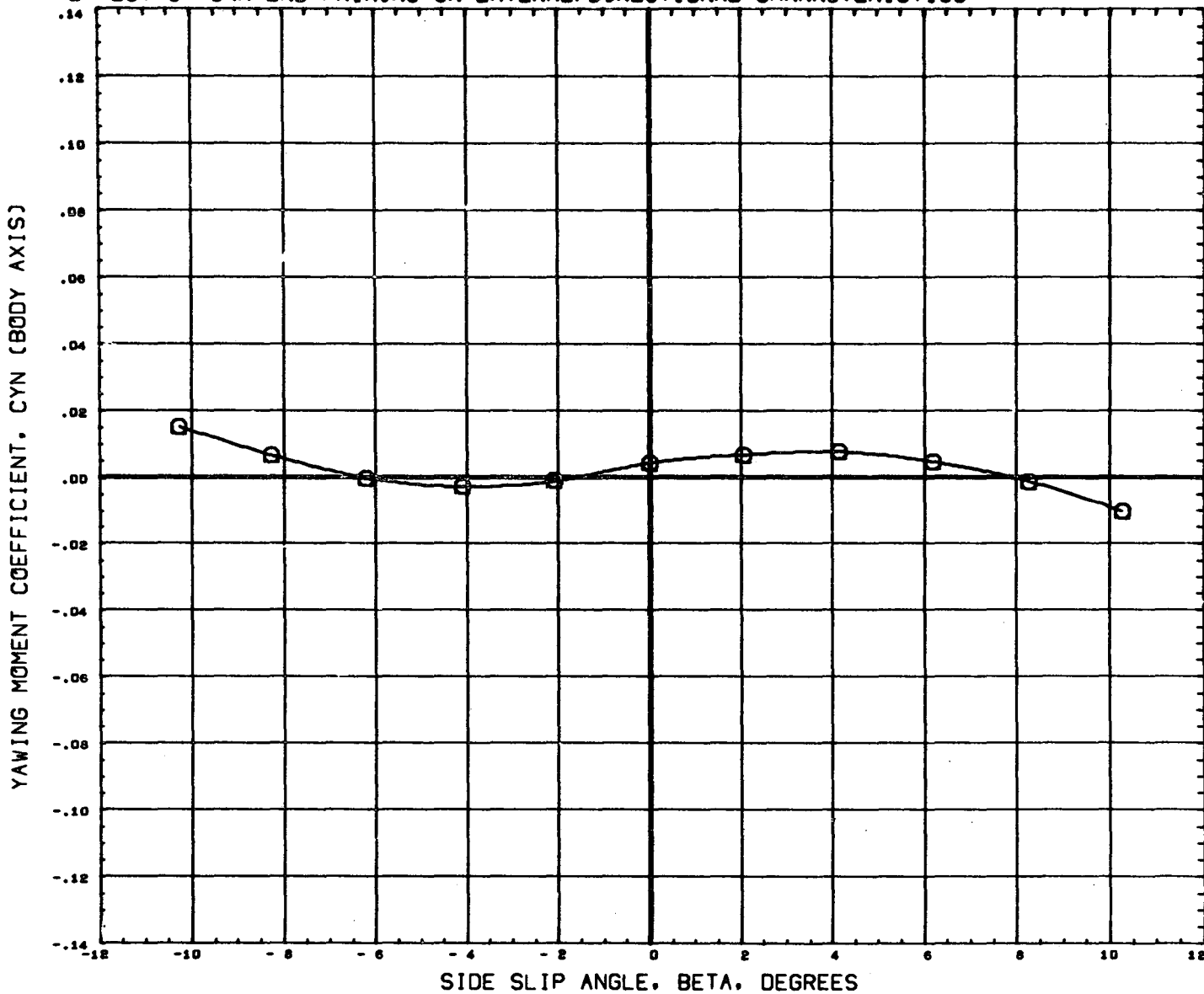

DATA SET SYMBOL CONFIGURATION DESCRIPTION
 (B65005) Δ MSFC TWT 534 SHUTTLE LAUNCH T101S1
 (B65016) Δ DATA NOT AVAILABLE FOR ALL CONDITIONS

ORBIN THETS ALPHA
 -1.500 21.000 0.000
 -1.500 21.000 0.000

REFERENCE INFORMATION
 SREF 4.8950 SQ. IN
 LREF 2.6440 IN.
 BREF 3.5250 IN.
 XMRP 3.4900 IN.
 YMRP 0.0000 IN.
 ZMRP 0.1616 IN.
 SCALE 0.0034

EFFECT OF SRM END FAIRING ON LATERAL/DIRECTIONAL CHARACTERISTICS

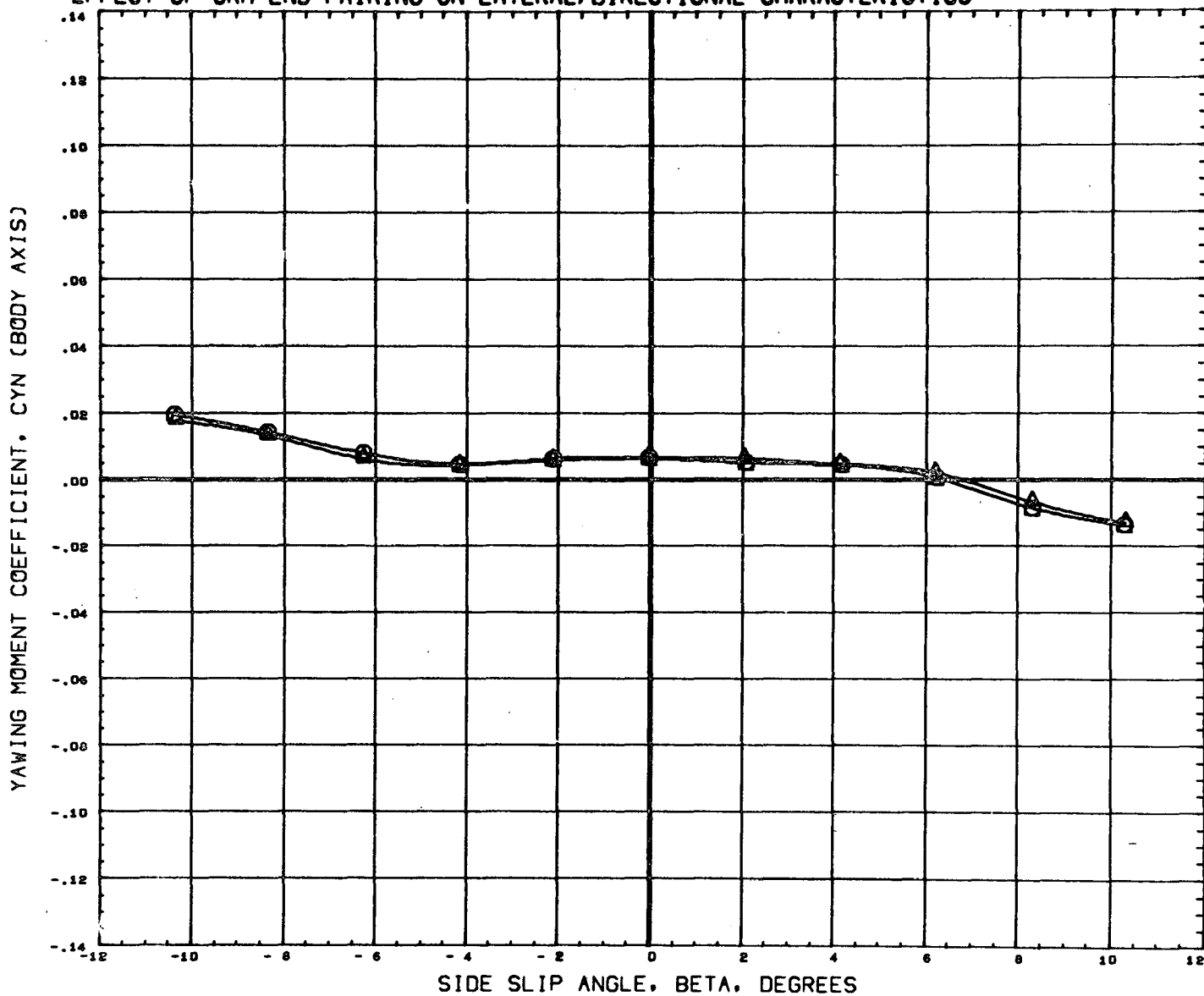

DATA SET SYMBOL	CONFIGURATION DESCRIPTION	ORBIN	THETS	ALPHA	REFERENCE INFORMATION	
(B63005)	MSFC TWT 534 SHUTTLE LAUNCH	T101S1	-1.500	21.000	0.000	SREF 4.8950 sq. IN
(B65018)	MSFC TWT 534 SHUTTLE LAUNCH	T101S2	-1.500	21.000	0.000	LREF 2.6440 IN.
						BREF 3.5250 IN.
						XMRP 3.4900 IN.
						YMRP 0.0000 IN.
						ZMRP 0.1616 IN.
						SCALE 0.0034

MACH .91

EFFECT OF SRM END FAIRING ON LATERAL/DIRECTIONAL CHARACTERISTICS

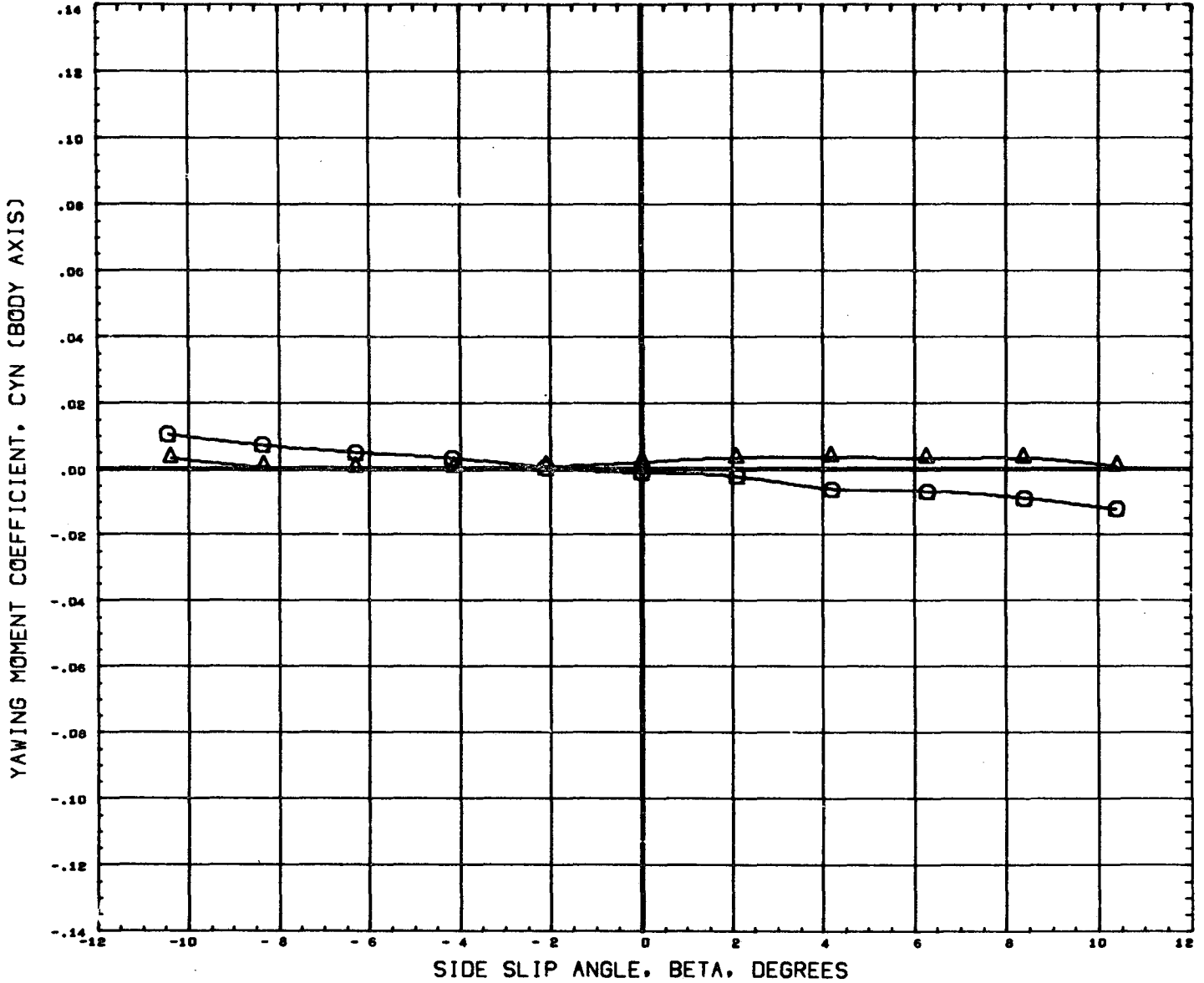

DATA SET SYMBOL	CONFIGURATION DESCRIPTION	ORBIT	THETA	ALPHA	REFERENCE INFORMATION	
(B65005)	MSFC TWT 534 SHUTTLE LAUNCH	T101S1	-1.500	21.000	0.000	SREF 4.8950 SQ. IN
(B65016)	MSFC TWT 534 SHUTTLE LAUNCH	T101S2	-1.500	21.000	0.000	LREF 2.6440 IN.
						BREF 3.5250 IN.
						XMRP 3.4900 IN.
						YMRP 0.0000 IN.
						ZMRP 0.1616 IN.
						SCALE 0.0034

EFFECT OF SRM END FAIRING ON LATERAL/DIRECTIONAL CHARACTERISTICS

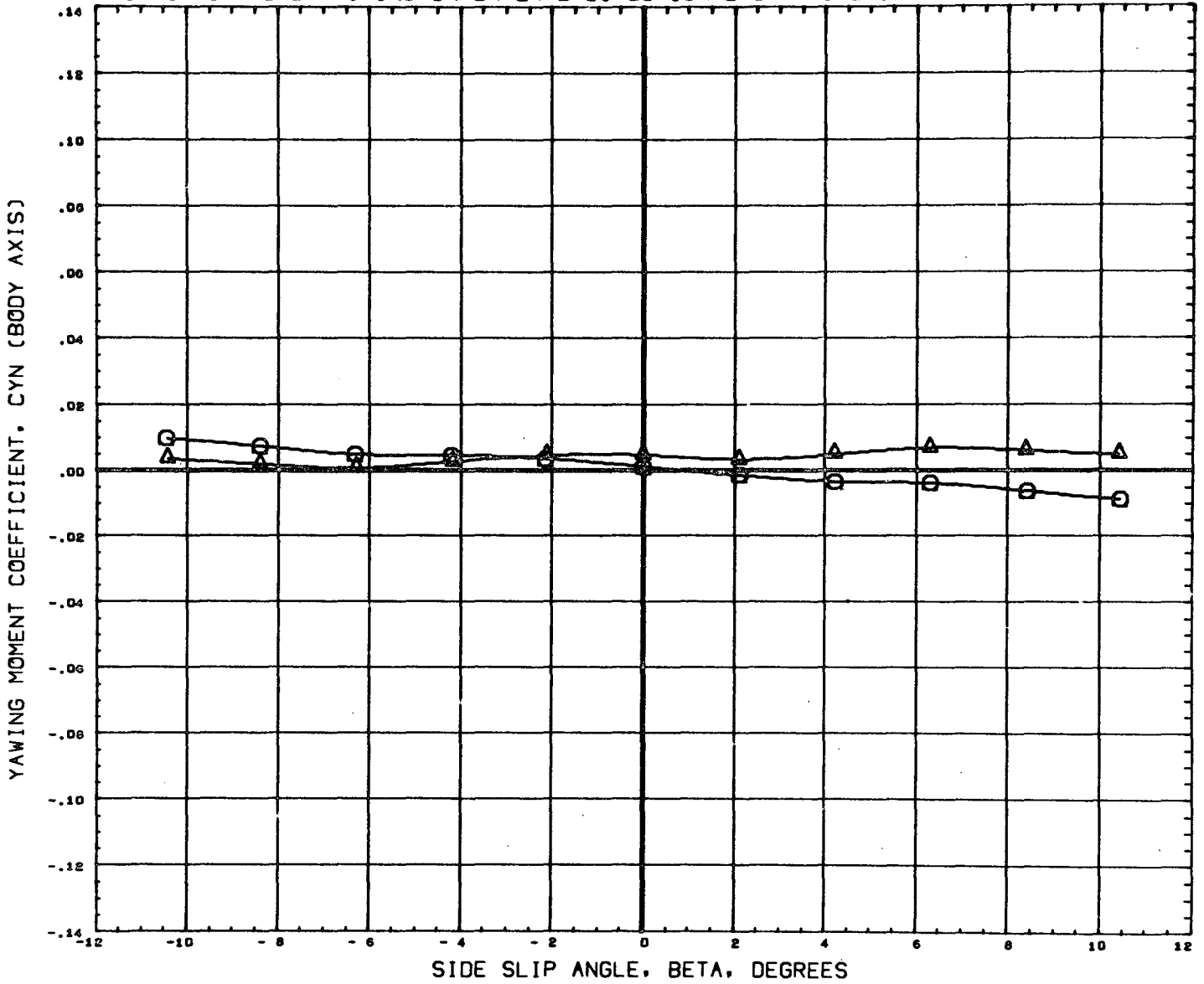

DATA SET SYMBOL CONFIGURATION DESCRIPTION
 (B65005) \bigcirc MSFC TWT 534 SHUTTLE LAUNCH
 (B65018) \triangle MSFC TWT 534 SHUTTLE LAUNCH

T101S1
 T101S2

ORBIN THETS ALPHA
 -1.500 21.000 0.000
 -1.500 21.000 0.000

REFERENCE INFORMATION
 SREF 4.8950 SQ. IN
 LREF 2.6440 IN.
 BREF 3.5250 IN.
 XHRP 3.4900 IN.
 YHRP 0.0000 IN.
 ZHRP 0.1616 IN.
 SCALE 0.0034

EFFECT OF SRM END FAIRING ON LATERAL/DIRECTIONAL CHARACTERISTICS

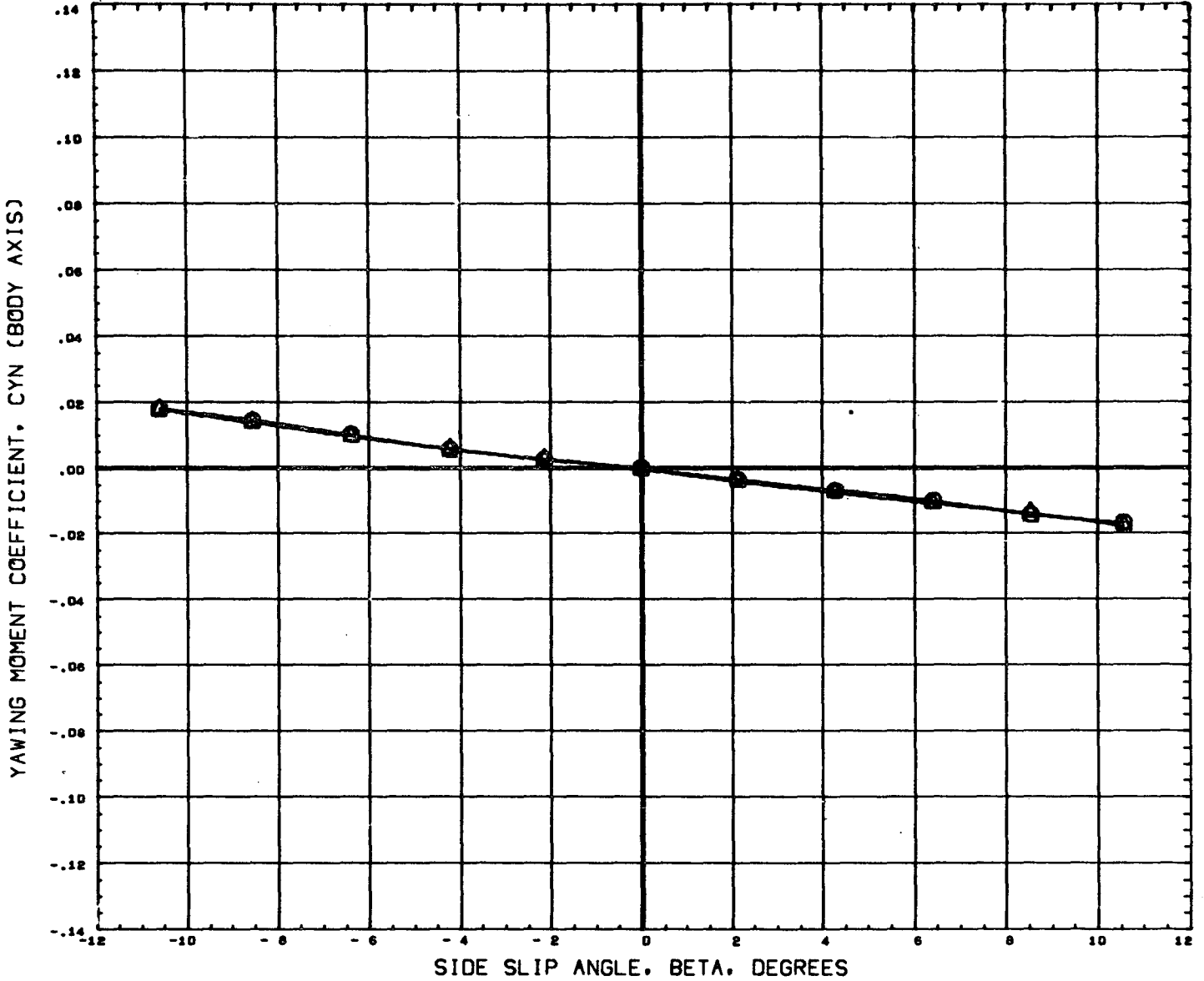

DATA SET SYMBOL	CONFIGURATION DESCRIPTION	ORBIN	TNETS	ALPHA
(B65005)	MSFC TWT 534 SHUTTLE LAUNCH	-1.500	21.000	0.000
(B65018)	MSFC TWT 534 SHUTTLE LAUNCH	-1.500	21.000	0.000

REFERENCE INFORMATION		
SREF	4.8950	90. IN
LREF	2.6440	IN.
BREF	3.5250	IN.
XMRP	3.4900	IN.
YMRP	0.0000	IN.
ZMRP	0.1616	IN.
SCALE	0.0034	

MACH 1.97

EFFECT OF SRM END FAIRING ON LATERAL/DIRECTIONAL CHARACTERISTICS

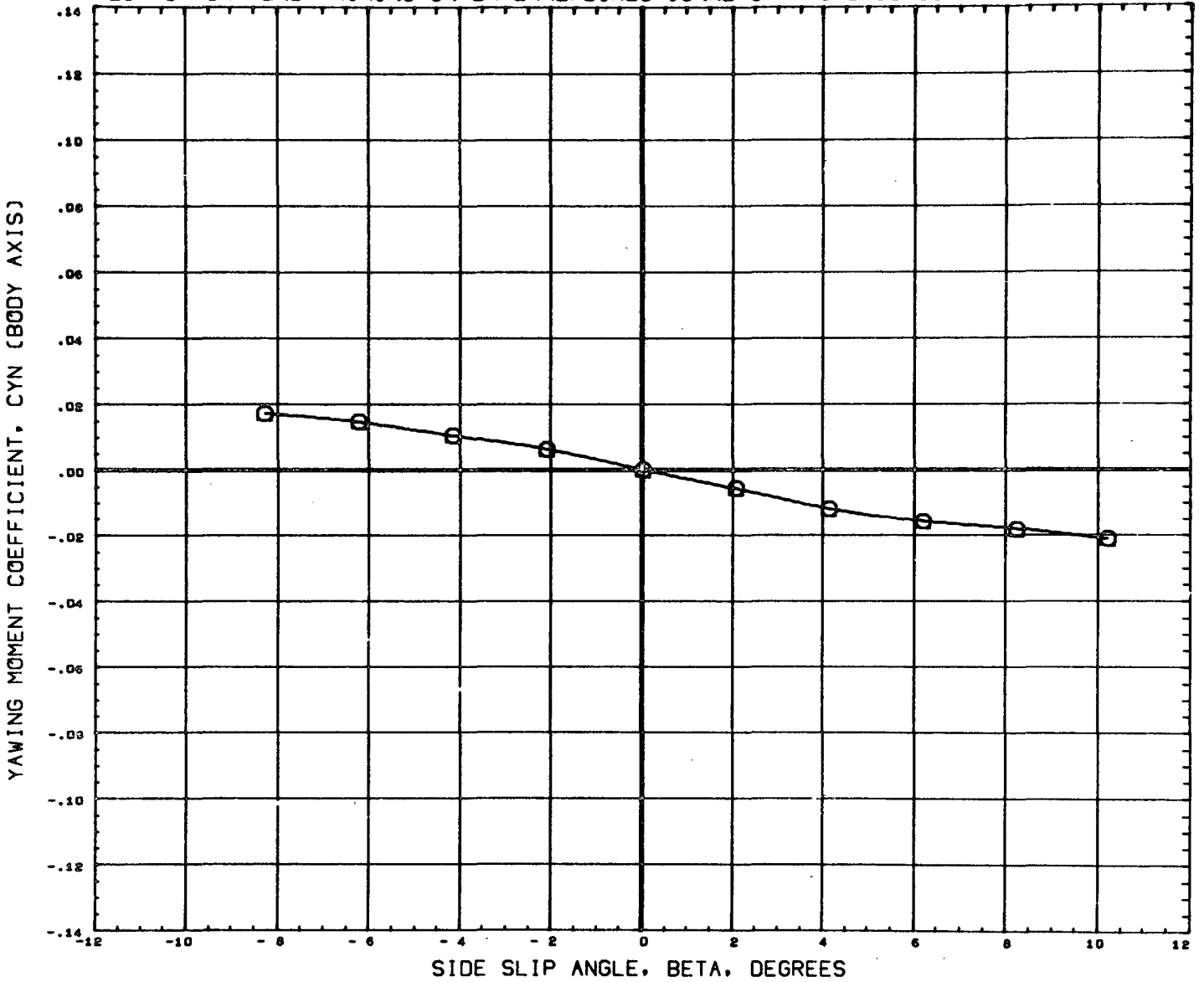

DATA SET SYMBOL CONFIGURATION DESCRIPTION
 (B65005) MSFC TWT 534 SHUTTLE LAUNCH T101S1
 (B65018) DATA NOT AVAILABLE FOR ALL CONDITIONS

ORBIN THETS ALPHA
 -1.500 21.000 0.000
 -1.500 21.000 0.000

REFERENCE INFORMATION
 SREF 4.8950 SQ. IN
 LREF 2.6440 IN.
 BREF 3.5250 IN.
 XMRP 3.4900 IN.
 YMRP 0.0000 IN.
 ZMRP 0.1616 IN.
 SCALE 0.0034

MACH 2.74

PAGE 399

EFFECT OF SRM END FAIRING ON LATERAL/DIRECTIONAL CHARACTERISTICS

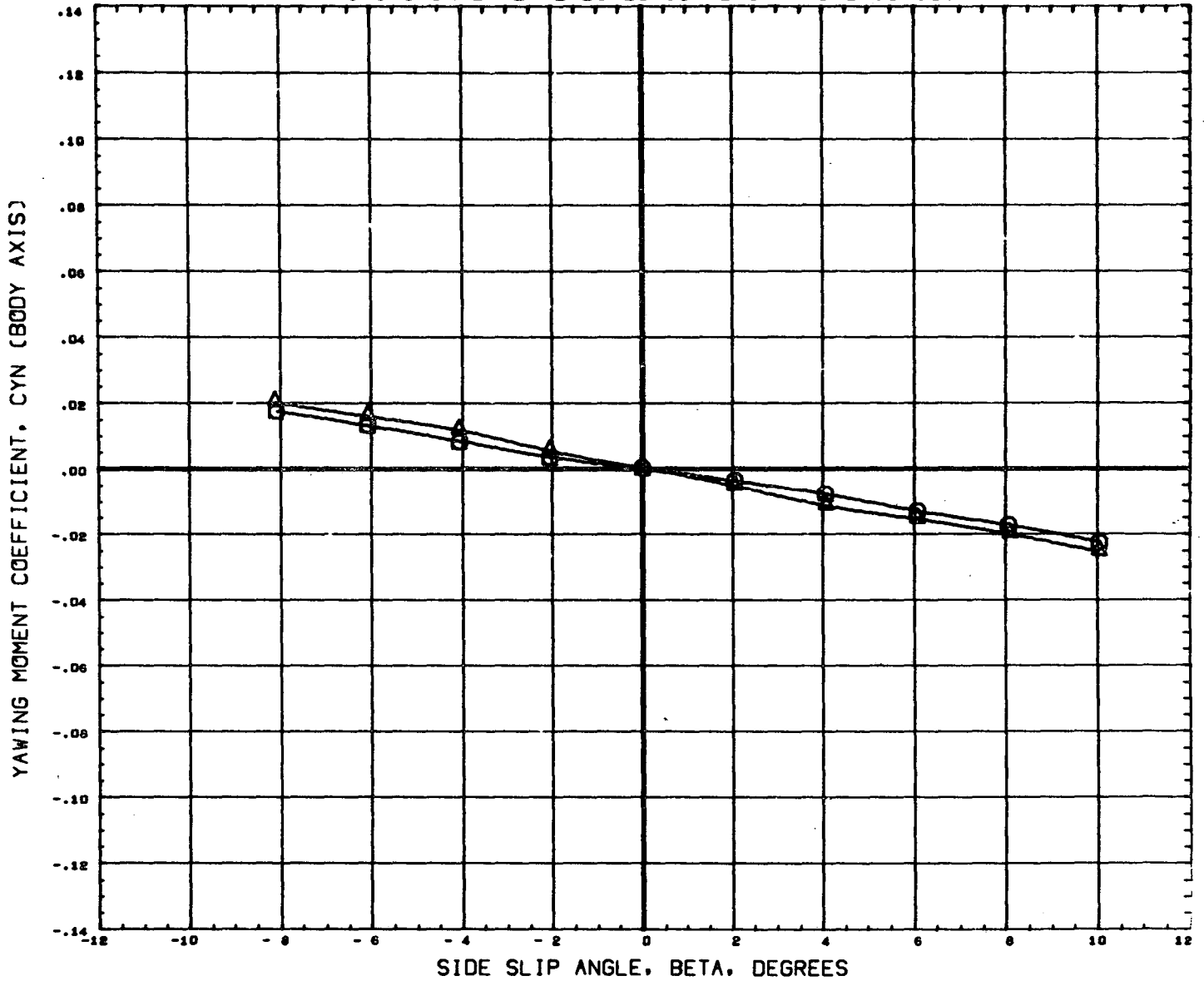

DATA SET SYMBOL	CONFIGURATION DESCRIPTION	ORBIT	THETS	ALPHA	REFERENCE INFORMATION	
(065005)	MSFC TWT 534 SHUTTLE LAUNCH	T101S1	-1.500	21.000	0.000	SREF 4.8950 sq. IN
(065018)	MSFC TWT 534 SHUTTLE LAUNCH	T101S2	-1.500	21.000	0.000	LREF 2.6440 IN.
						BREF 3.5250 IN.
						XMRP 3.4900 IN.
						YMRP 0.0000 IN.
						ZMRP 0.1616 IN.
						SCALE 0.0034

MACH 4.96

PAGE 400

EFFECT OF SRM END FAIRING ON LATERAL/DIRECTIONAL CHARACTERISTICS

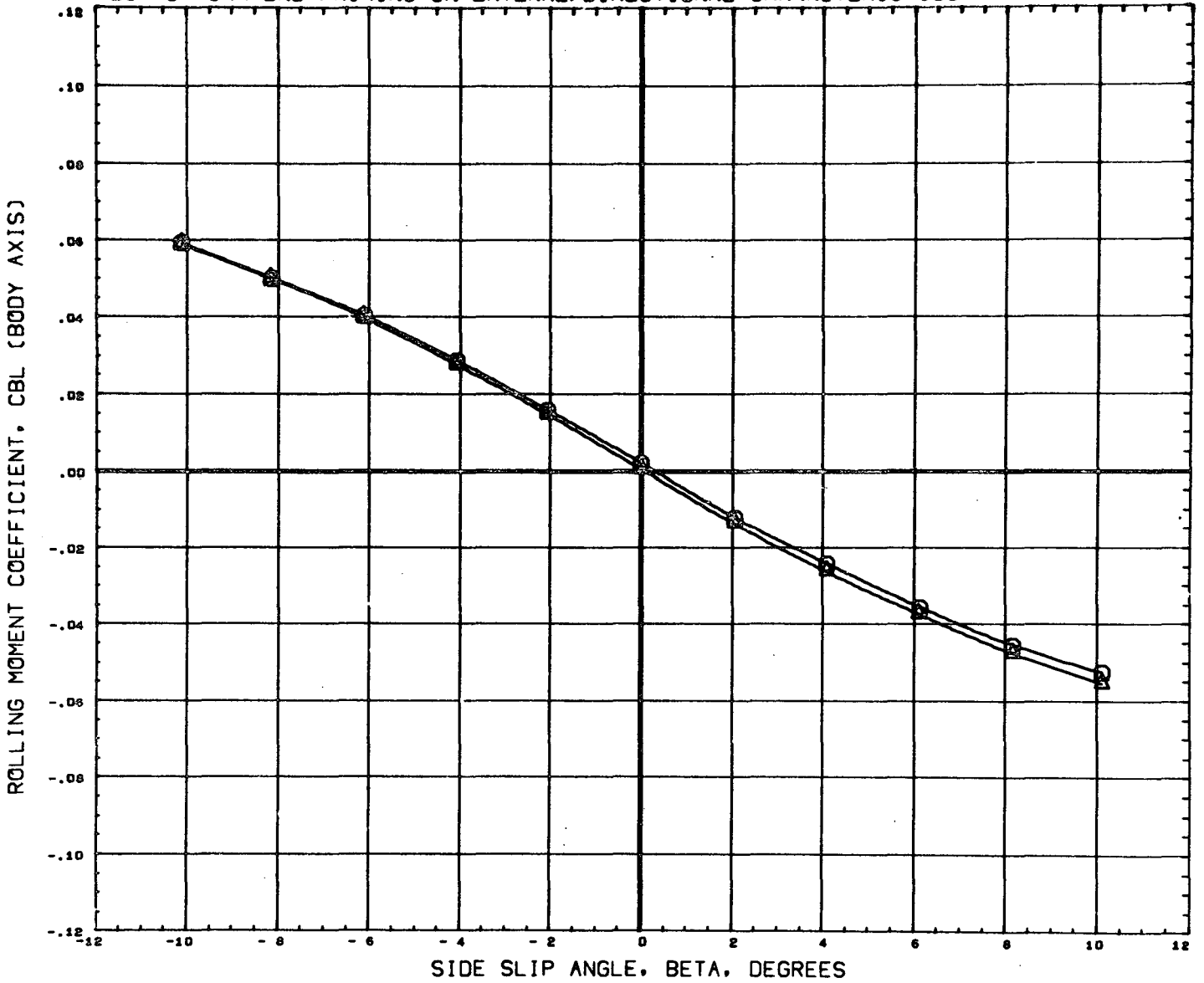

DATA SET SYMBOL	CONFIGURATION DESCRIPTION	ORBIN	THETS	ALPHA	REFERENCE INFORMATION
(B65005)	MSFC TWT 534 SHUTTLE LAUNCH	-1.500	21.000	0.000	SREF 4.8950 SQ. IN
(B65018)	MSFC TWT 534 SHUTTLE LAUNCH	-1.500	21.000	0.000	LREF 2.6440 IN.
					BREF 3.5250 IN.
					XMRP 3.4900 IN.
					YMRP 0.0000 IN.
					ZMRP 0.1616 IN.
					SCALE 0.0034

MACH .60

EFFECT OF SRM END FAIRING ON LATERAL/DIRECTIONAL CHARACTERISTICS

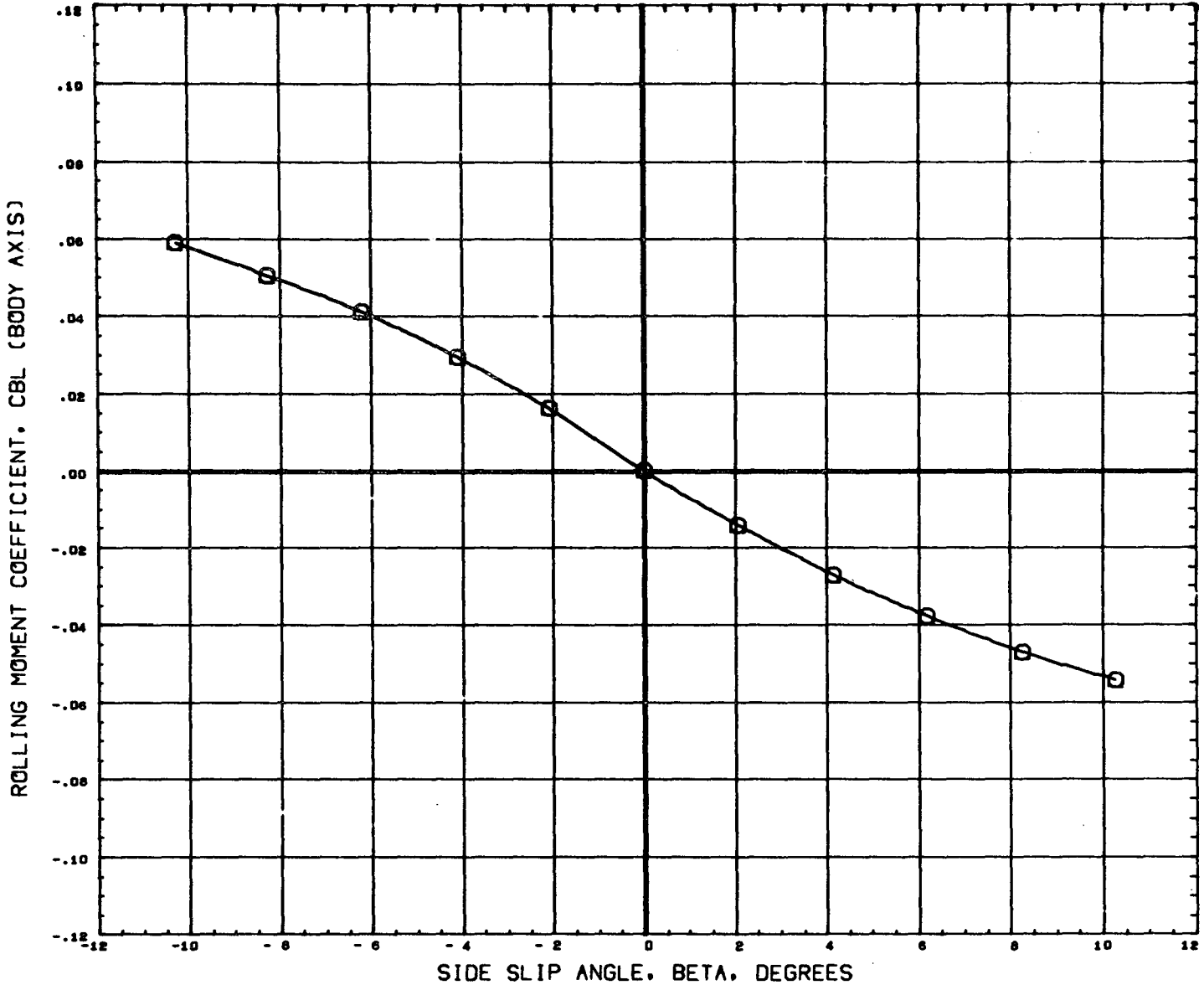

DATA SET SYMBOL CONFIGURATION DESCRIPTION
 (865005) Q MSFC TWT 534 SHUTTLE LAUNCH T10191
 (865018) Δ DATA NOT AVAILABLE FOR ALL CONDITIONS

ORBIN THETS ALPHA
 -1.500 21.000 0.000
 -1.500 21.000 0.000

REFERENCE INFORMATION
 SREF 4.8950 SQ. IN.
 LREF 2.6440 IN.
 BREF 3.5250 IN.
 XMRP 3.4900 IN.
 YMRP 0.0000 IN.
 ZMRP 0.1616 IN.
 SCALE 0.0034

EFFECT OF SRM END FAIRING ON LATERAL/DIRECTIONAL CHARACTERISTICS

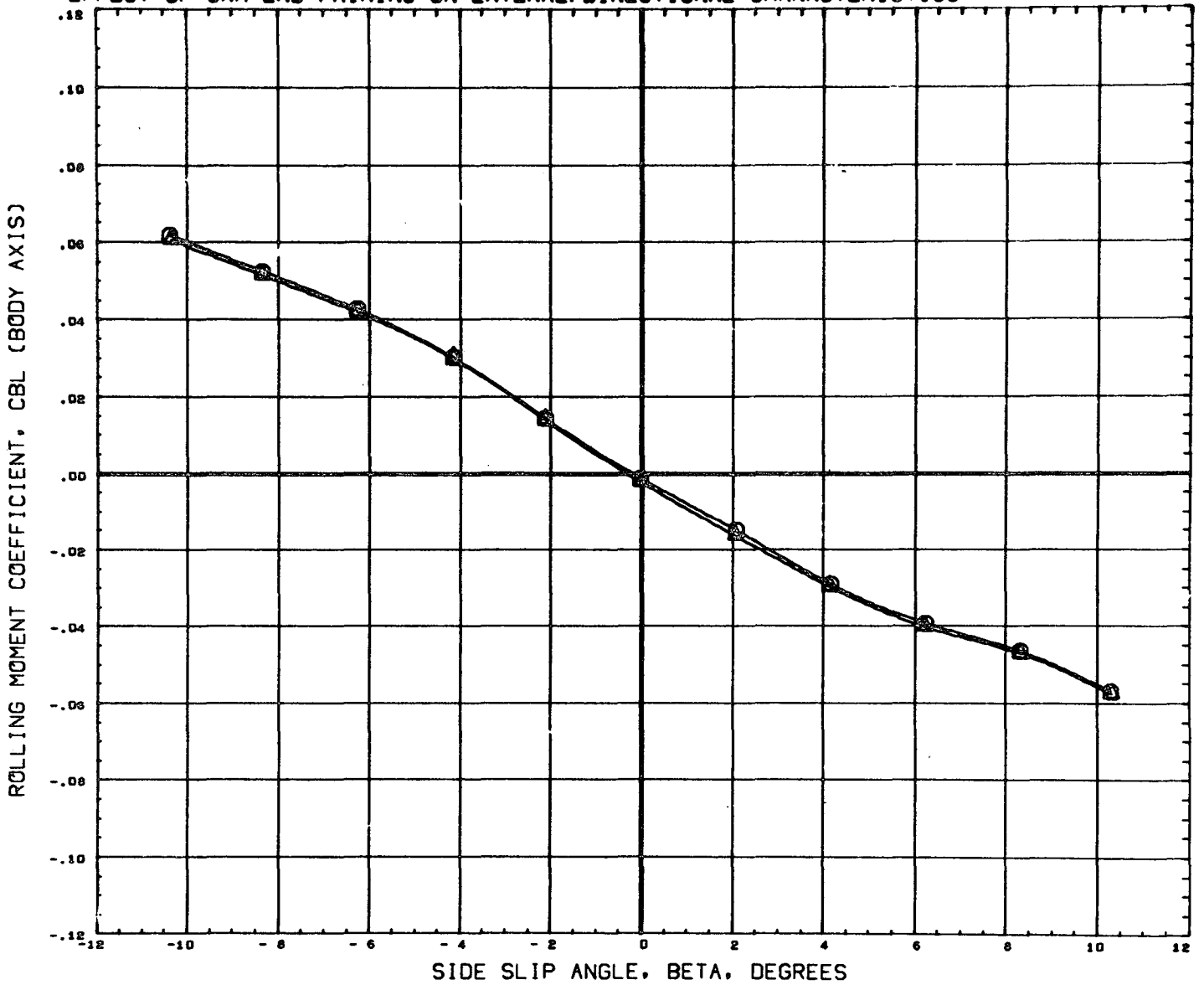

DATA SET SYMBOL	CONFIGURATION DESCRIPTION	ORBIN	THETS	ALPHA	REFERENCE INFORMATION
(B65005)	MSFC TWT 534 SHUTTLE LAUNCH	-1.500	21.000	0.000	SREF 4.8950 SQ. IN
(B65018)	MSFC TWT 534 SHUTTLE LAUNCH	-1.500	21.000	0.000	LREF 2.6440 IN.
					BREF 3.5250 IN.
					XMRP 3.4900 IN.
					YMRP 0.0000 IN.
					ZMRP 0.1616 IN.
					SCALE 0.0034

MACH .91

EFFECT OF SRM END FAIRING ON LATERAL/DIRECTIONAL CHARACTERISTICS

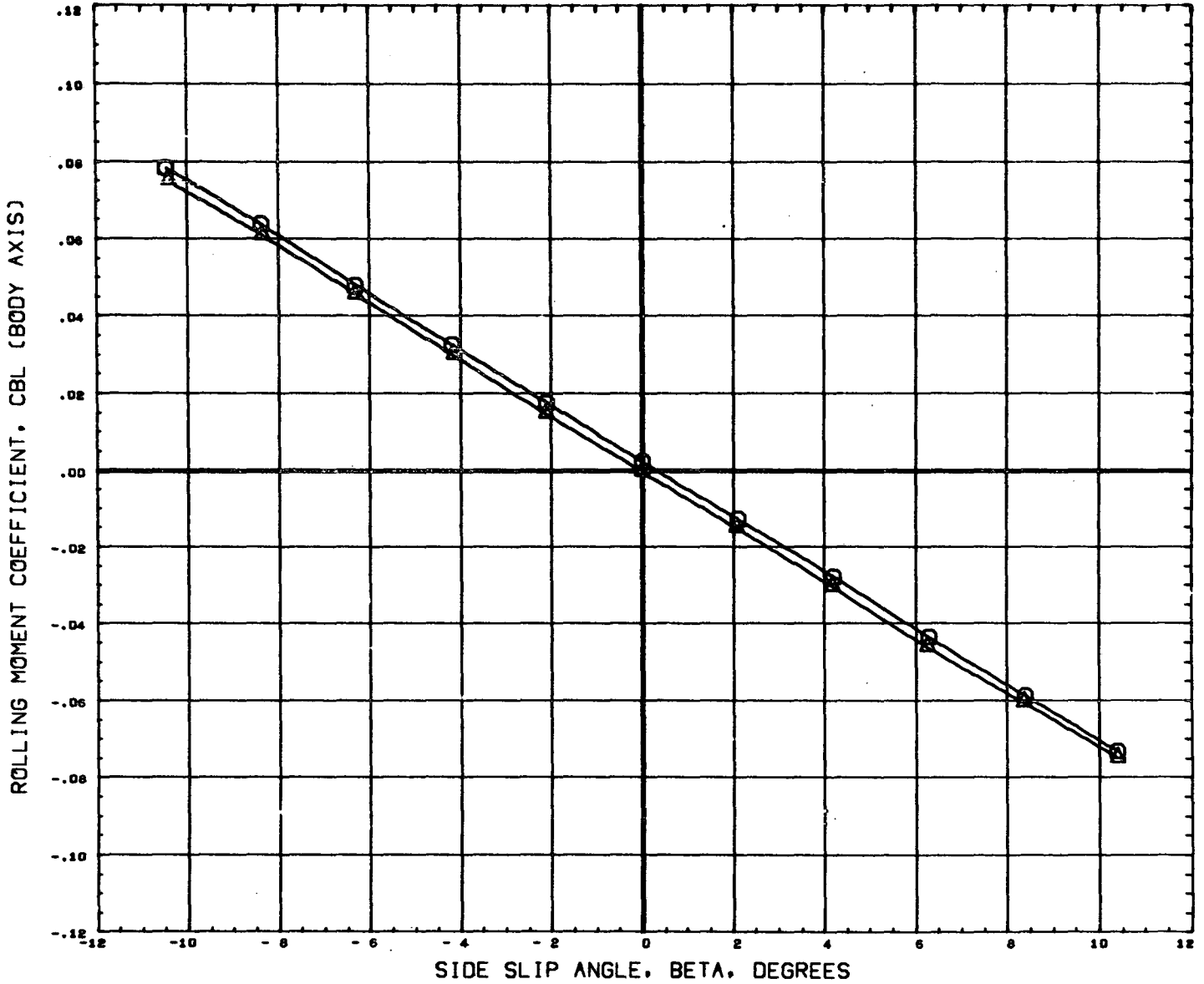

DATA SET SYMBOL	CONFIGURATION DESCRIPTION	ORBIN	THETS	ALPHA	REFERENCE INFORMATION
(B65005)	MSFC TWT 534 SHUTTLE LAUNCH	-1.500	21.000	0.000	SREF 4.8950 SQ. IN
(B65016)	MSFC TWT 534 SHUTTLE LAUNCH	-1.500	21.000	0.000	LREF 2.6440 IN.
					BREF 3.5250 IN.
					XMRP 3.4900 IN.
					YMRP 0.0000 IN.
					ZMRP 0.1616 IN.
					SCALE 0.0034

EFFECT OF SRM END FAIRING ON LATERAL/DIRECTIONAL CHARACTERISTICS

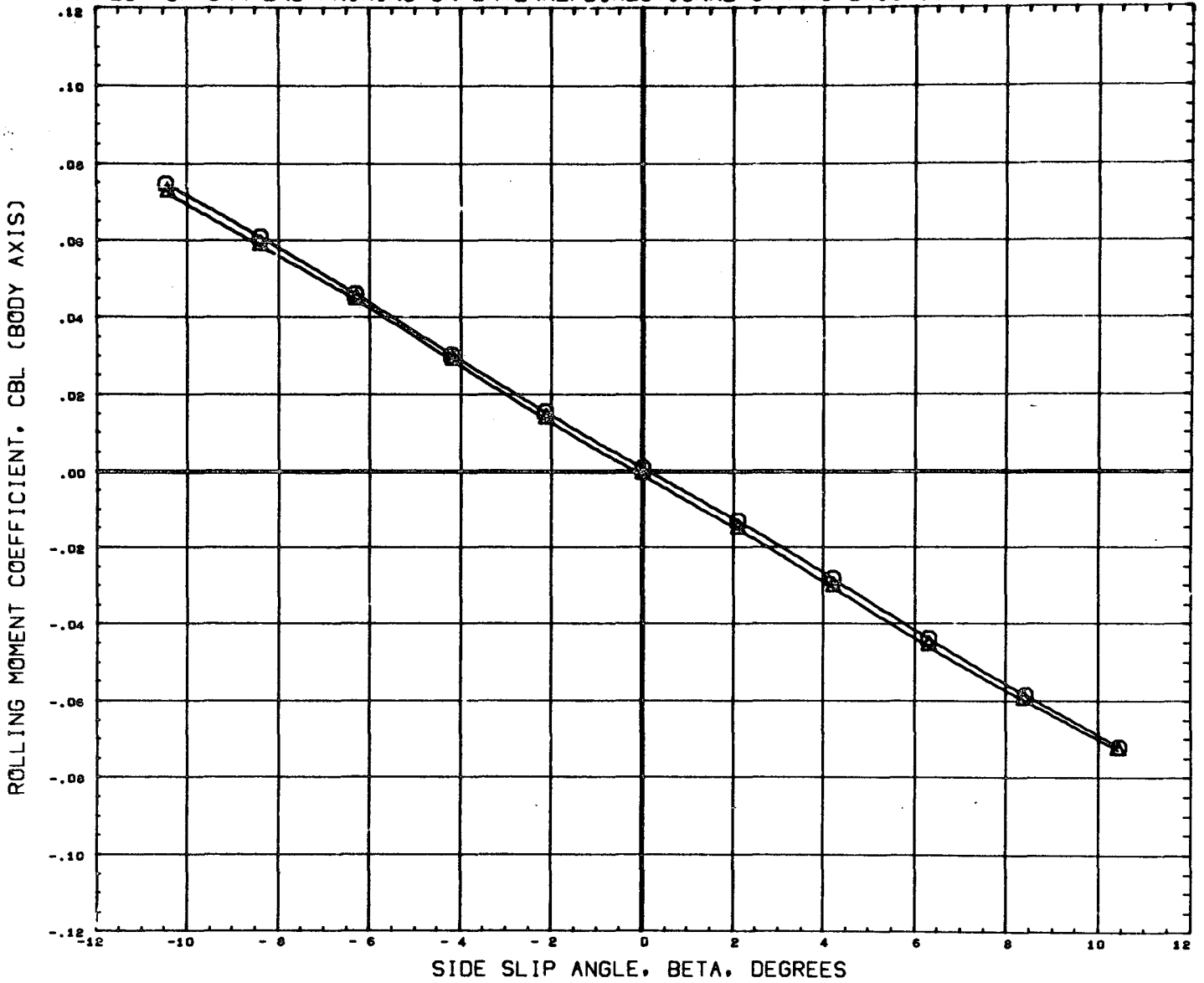

DATA SET SYMBOL	CONFIGURATION DESCRIPTION	ORBIN	THETS	ALPHA	REFERENCE INFORMATION
(B65005)	MSFC TWT 534 SHUTTLE LAUNCH	-1.500	21.000	0.000	SREF 4.8950 sq. IN
(B65018)	MSFC TWT 534 SHUTTLE LAUNCH	-1.500	21.000	0.000	LREF 2.6440 IN.
					BREF 3.3250 IN.
					XWRP 3.4900 IN.
					YWRP 0.0000 IN.
					ZWRP 0.1616 IN.
					SCALE 0.0034

MACH 1.19

EFFECT OF SRM END FAIRING ON LATERAL/DIRECTIONAL CHARACTERISTICS

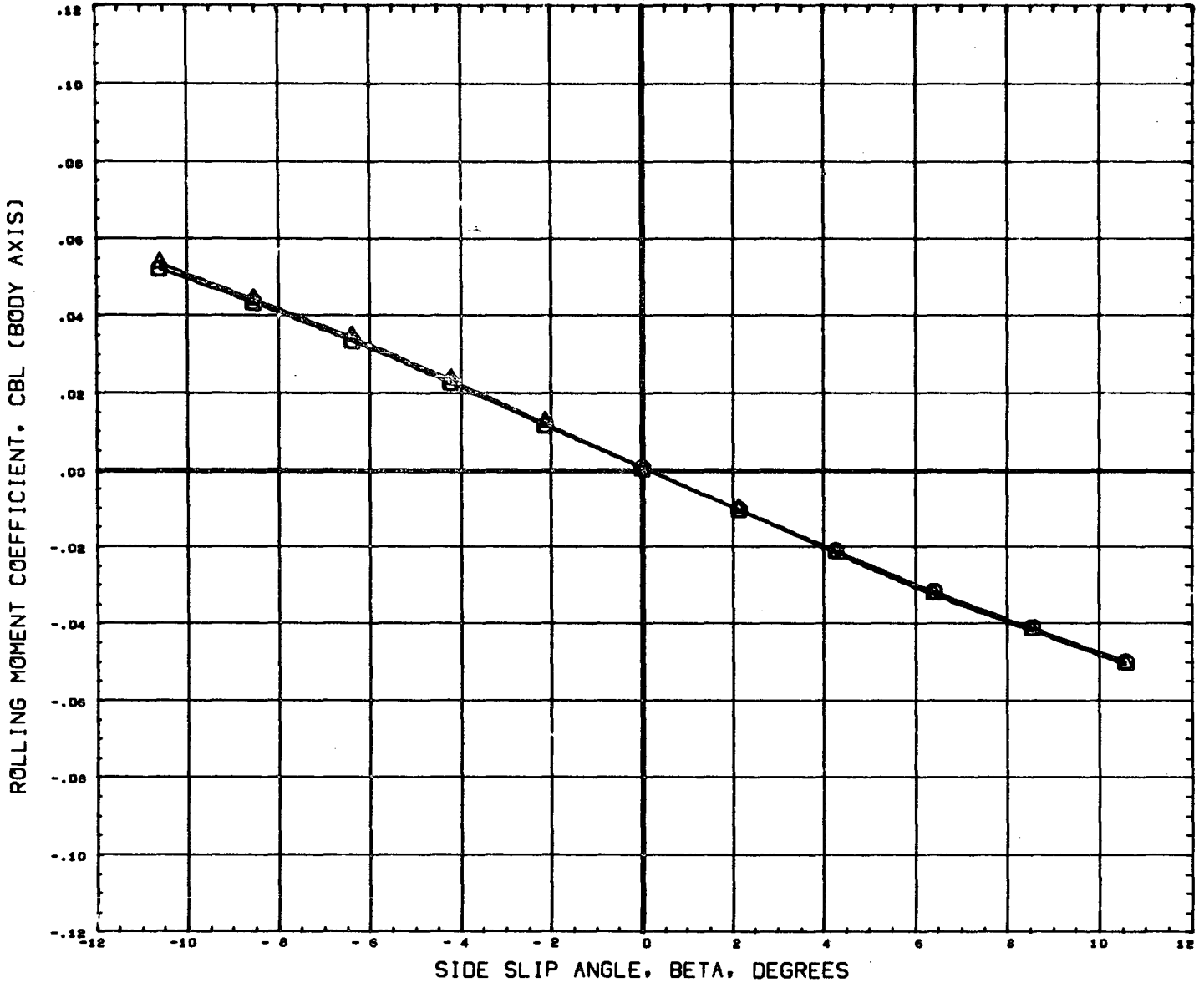

DATA SET SYMBOL	CONFIGURATION DESCRIPTION	ORBIN	THETS	ALPHA	REFERENCE INFORMATION
(B65005)	MSFC TWT 534 SHUTTLE LAUNCH	-1.500	21.000	0.000	SREF 4.8950 90. IN
(B65018)	MSFC TWT 534 SHUTTLE LAUNCH	-1.500	21.000	0.000	LREF 2.6440 IN.
					BREF 3.5250 IN.
					XMRP 3.4900 IN.
					YMRP 0.0000 IN.
					ZMRP 0.1616 IN.
					SCALE 0.0034

MACH 1.97

PAGE 406

EFFECT OF SRM END FAIRING ON LATERAL/DIRECTIONAL CHARACTERISTICS

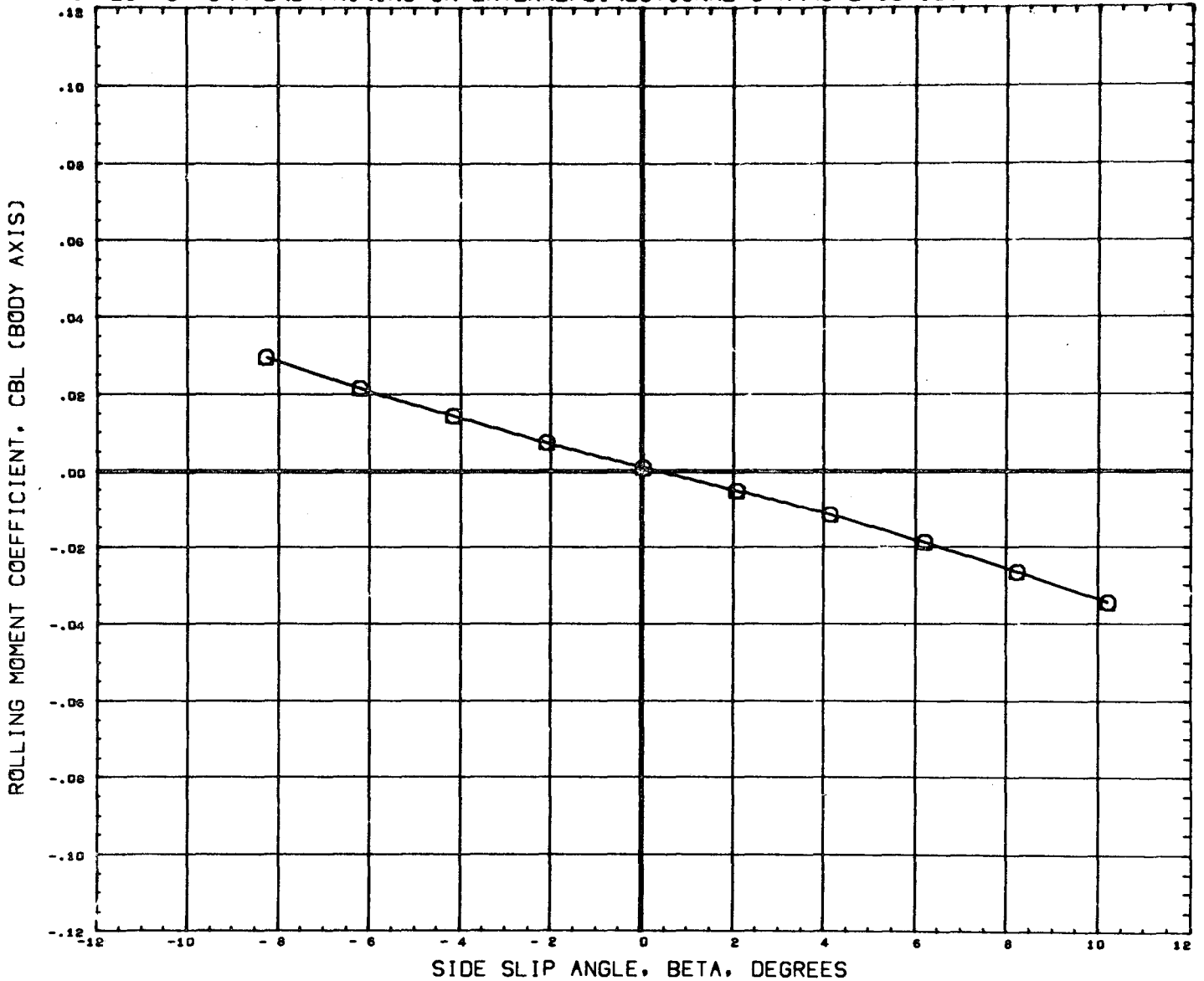

DATA SET SYMBOL CONFIGURATION DESCRIPTION
 (B65005) MSFC TWT 534 SHUTTLE LAUNCH T101S1
 (B65018) DATA NOT AVAILABLE FOR ALL CONDITIONS

ORBIN THETS ALPHA
 -1.500 21.000 0.000
 -1.500 21.000 0.000

REFERENCE INFORMATION
 SREF 4.8950 Sq. IN
 LREF 2.6440 IN.
 BREF 3.5250 IN.
 XMRP 3.4900 IN.
 YMRP 0.0000 IN.
 ZMRP 0.1616 IN.
 SCALE 0.0034

MACH 2.74

PAGE 407

EFFECT OF SRM END FAIRING ON LATERAL/DIRECTIONAL CHARACTERISTICS

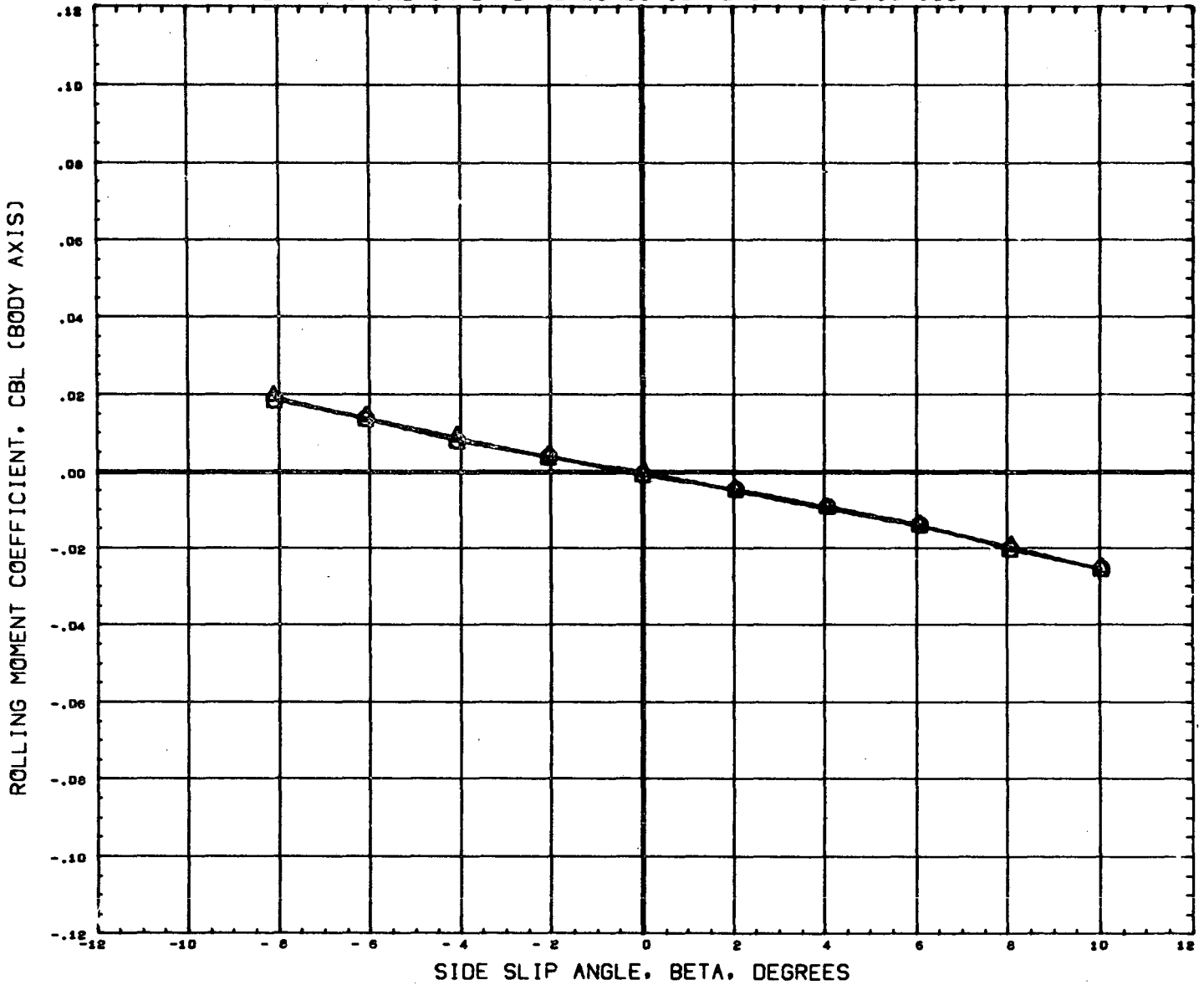

DATA SET SYMBOL	CONFIGURATION DESCRIPTION	ORBIN	THETS	ALPHA	REFERENCE INFORMATION	
(B65005)	MSFC TWT 534 SHUTTLE LAUNCH	-1.500	21.000	0.000	SREF	4.8950 90. IN
(B65018)	MSFC TWT 534 SHUTTLE LAUNCH	-1.500	21.000	0.000	LREF	2.6440 IN.
					BREF	3.5250 IN.
					XWRP	3.4900 IN.
					YWRP	0.0000 IN.
					ZWRP	0.1616 IN.
					SCALE	0.0034

MACH 4.96

PAGE 408

EFFECT OF SRM END FAIRING ON LATERAL/DIRECTIONAL CHARACTERISTICS

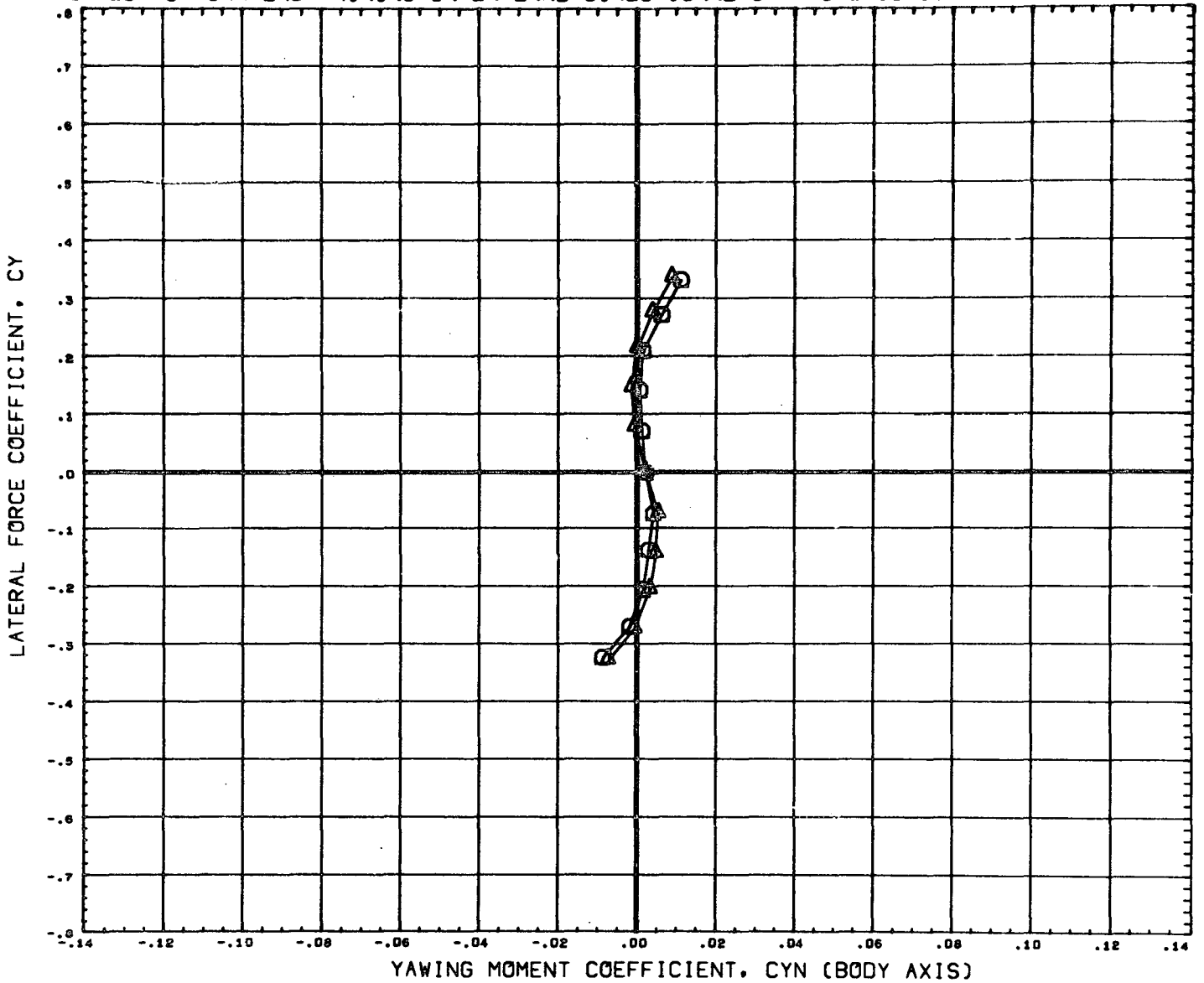

DATA SET SYMBOL	CONFIGURATION DESCRIPTION	ORBIN	THETS	ALPHA	REFERENCE INFORMATION
(B65005)	MSFC TWT 534 SHUTTLE LAUNCH	T101S1	-1.500	21.000	0.000
(B65018)	MSFC TWT 534 SHUTTLE LAUNCH	T101S2	-1.500	21.000	0.000
					SREF 4.8950 SQ. IN
					LREF 2.6440 IN.
					BREF 3.5250 IN.
					XMRP 3.4900 IN.
					YMRP 0.0000 IN.
					ZMRP 0.1616 IN.
					SCALE 0.0034

MACH .60

EFFECT OF SRM END FAIRING ON LATERAL/DIRECTIONAL CHARACTERISTICS

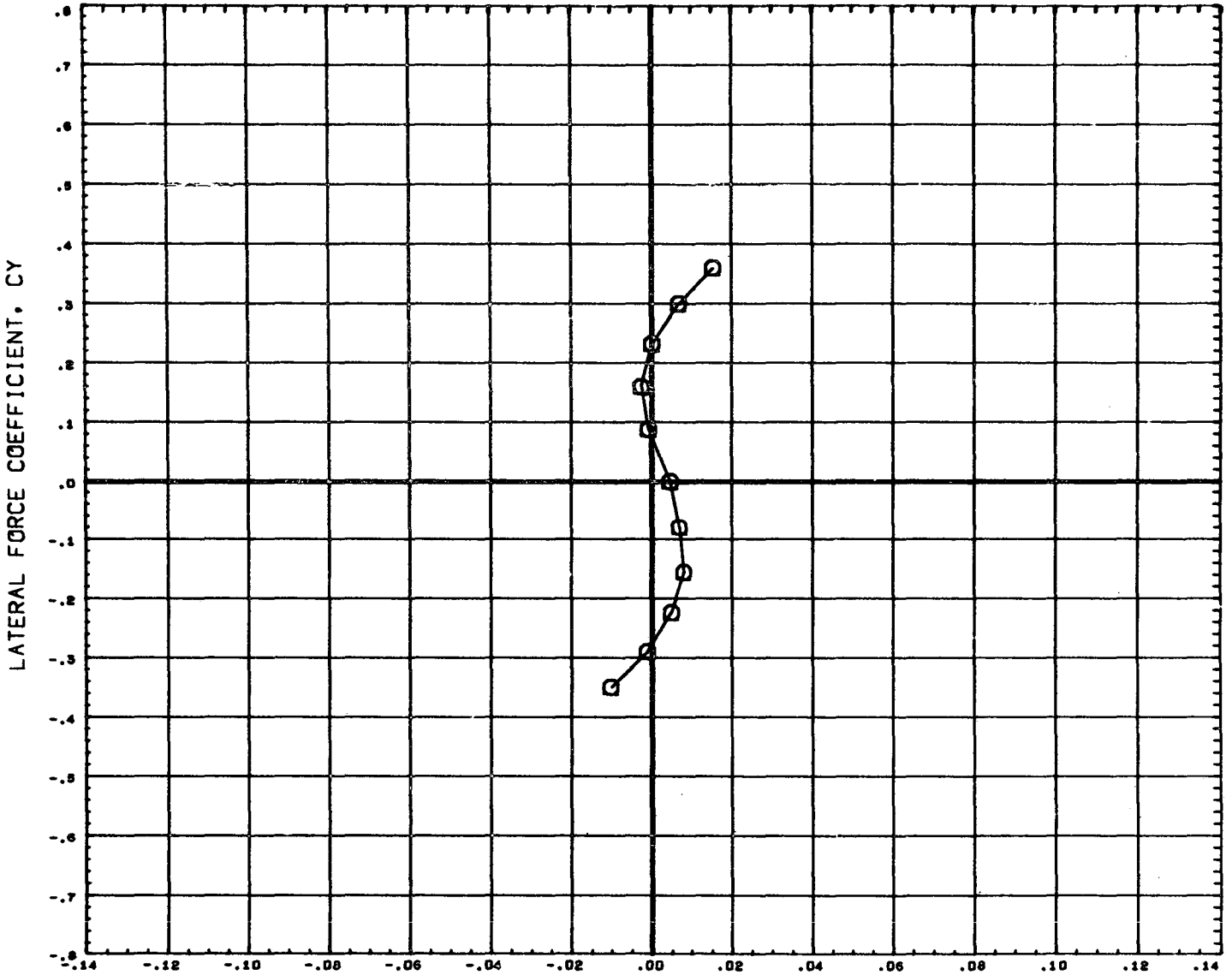

YAWING MOMENT COEFFICIENT, CYN (BODY AXIS)

DATA SET SYMBOL	CONFIGURATION DESCRIPTION	ORBIN	THETS	ALPHA	REFERENCE INFORMATION
(B65005)	MSFC TWT 534 SHUTTLE LAUNCH	-1.500	21.070	0.000	SREF 4.8950 SQ. IN
(B65018)	DATA NOT AVAILABLE FOR ALL CONDITIONS	-1.500	21.000	0.000	LREF 2.6440 IN.
					BREF 3.5250 IN.
					XMRP 3.4900 IN.
					YMRP 0.0000 IN.
					ZMRP 0.1616 IN.
					SCALE 0.0034

MACH .80

EFFECT OF SRM END FAIRING ON LATERAL/DIRECTIONAL CHARACTERISTICS

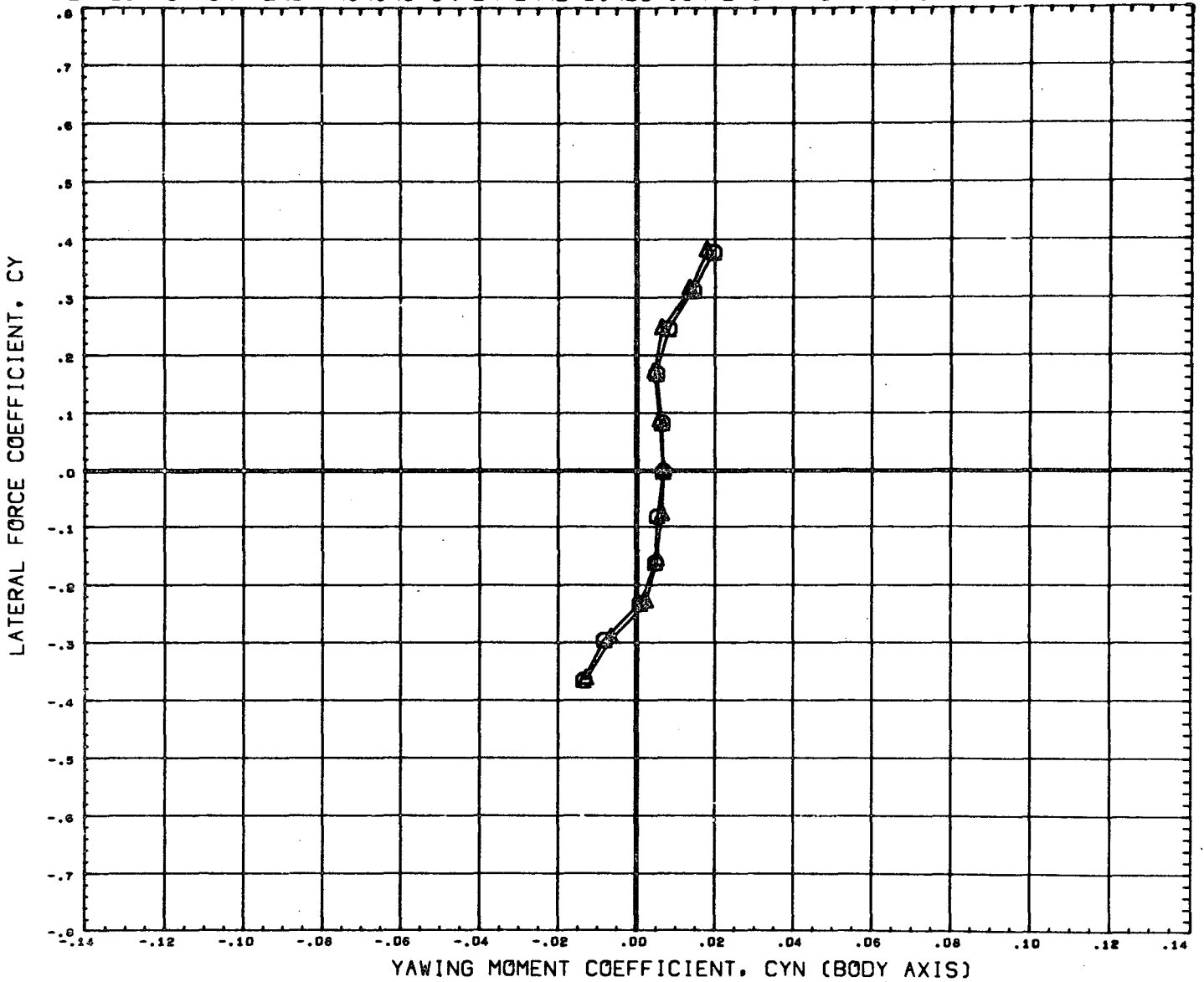

DATA SET SYMBOL	CONFIGURATION DESCRIPTION	ORBIN	THETS	ALPHA	REFERENCE INFORMATION
(B69005)	MSFC TWT 534 SHUTTLE LAUNCH	-1.500	21.000	0.000	SREF 4.8950 SQ. IN
(B65018)	MSFC TWT 534 SHUTTLE LAUNCH	-1.500	21.000	0.000	LREF 2.6440 IN.
					BREF 3.5250 IN.
					XMRP 3.4900 IN.
					YMRP 0.0000 IN.
					ZMRP 0.1616 IN.
					SCALE 0.0034

MACH .91

EFFECT OF SRM END FAIRING ON LATERAL/DIRECTIONAL CHARACTERISTICS

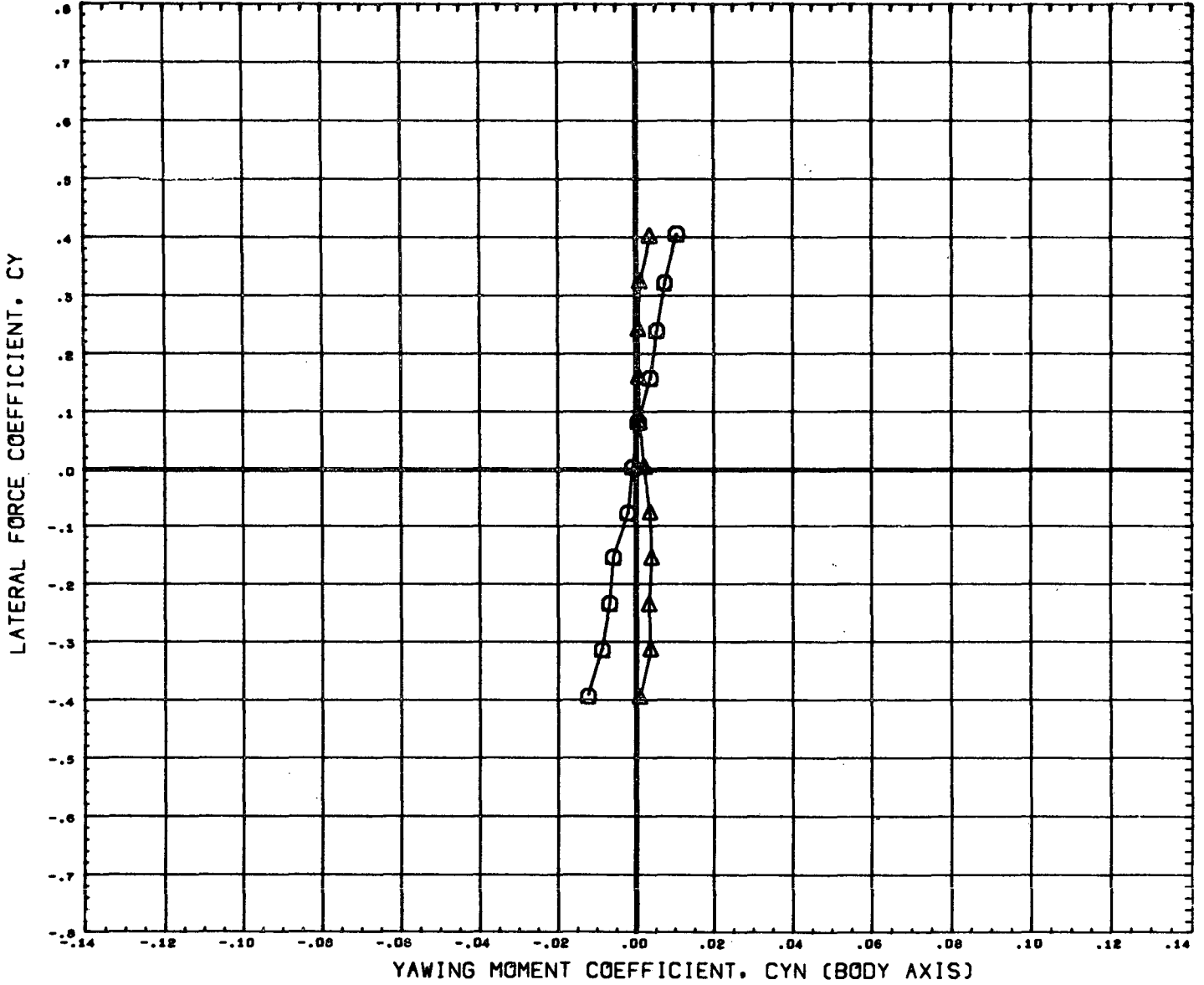

DATA SET SYMBOL	CONFIGURATION DESCRIPTION	ORBIT	THETS	ALPHA	REFERENCE INFORMATION	
(B65005)	MSFC TWT 534 SHUTTLE LAUNCH	T101S1	-1.500	21.000	0.000	SREF 4.8950 SQ. IN
(B65018)	MSFC TWT 534 SHUTTLE LAUNCH	T101S2	-1.500	21.000	0.000	LREF 2.6440 IN.
						BREF 3.5250 IN.
						XMRP 3.4900 IN.
						YMRP 0.0000 IN.
						ZMRP 0.1616 IN.
						SCALE 0.0034

MACH

1.09

PAGE 412

EFFECT OF SRM END FAIRING ON LATERAL/DIRECTIONAL CHARACTERISTICS

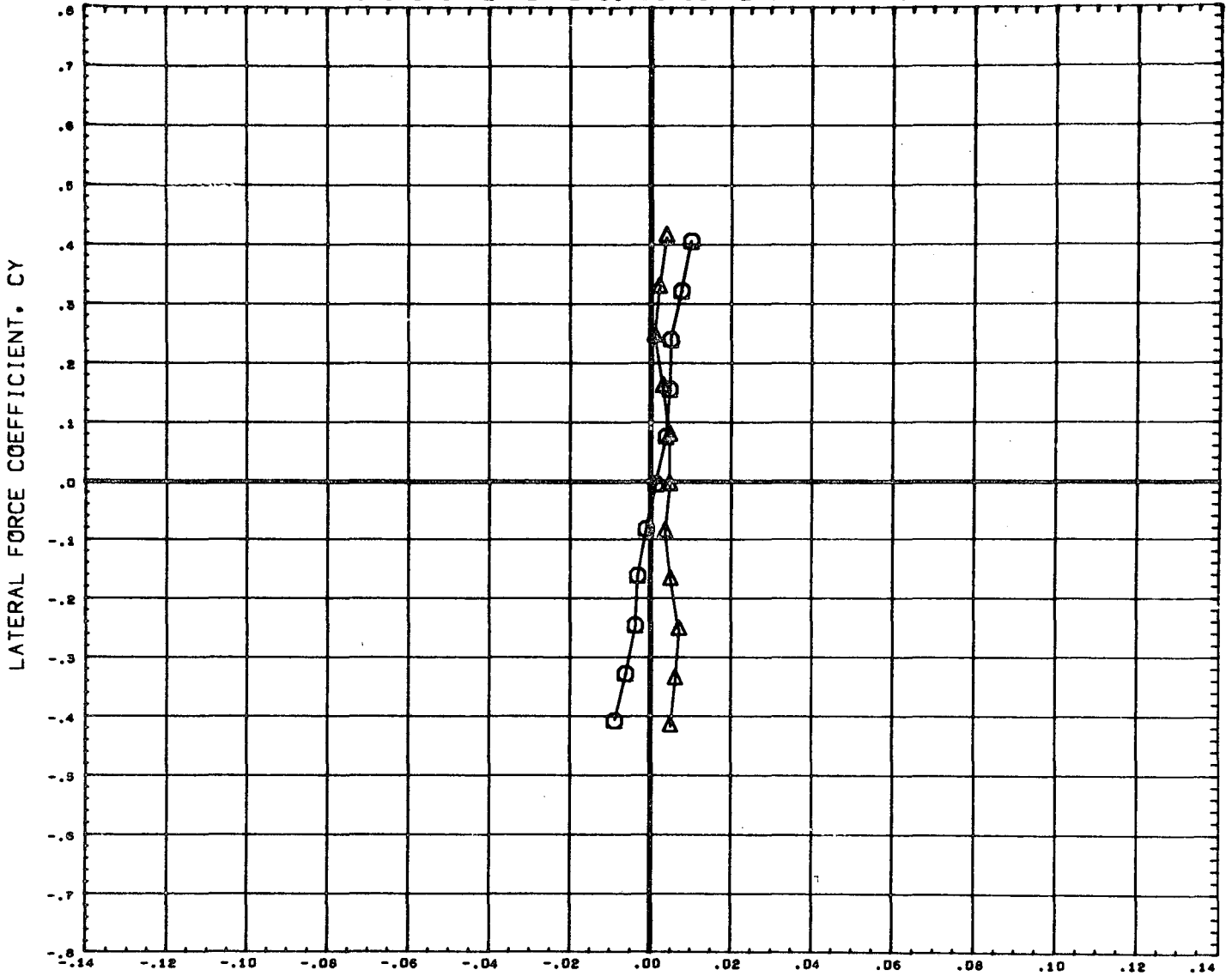

YAWING MOMENT COEFFICIENT, CYN (BODY AXIS)

DATA SET SYMBOL	CONFIGURATION DESCRIPTION	ORBIN	THETS	ALPHA	REFERENCE INFORMATION
(865005)	MSFC TWT 534 SHUTTLE LAUNCH	-1.500	21.000	0.000	SREF 4.8950 SQ. IN
(865018)	MSFC TWT 534 SHUTTLE LAUNCH	-1.500	21.000	0.000	LREF 2.6440 IN.
					BREF 3.5250 IN.
					XMRP 3.4900 IN.
					YMRP 0.0000 IN.
					ZMRP 0.1616 IN.
					SCALE 0.0034

MACH 1.19

PAGE 413

EFFECT OF SRM END FAIRING ON LATERAL/DIRECTIONAL CHARACTERISTICS

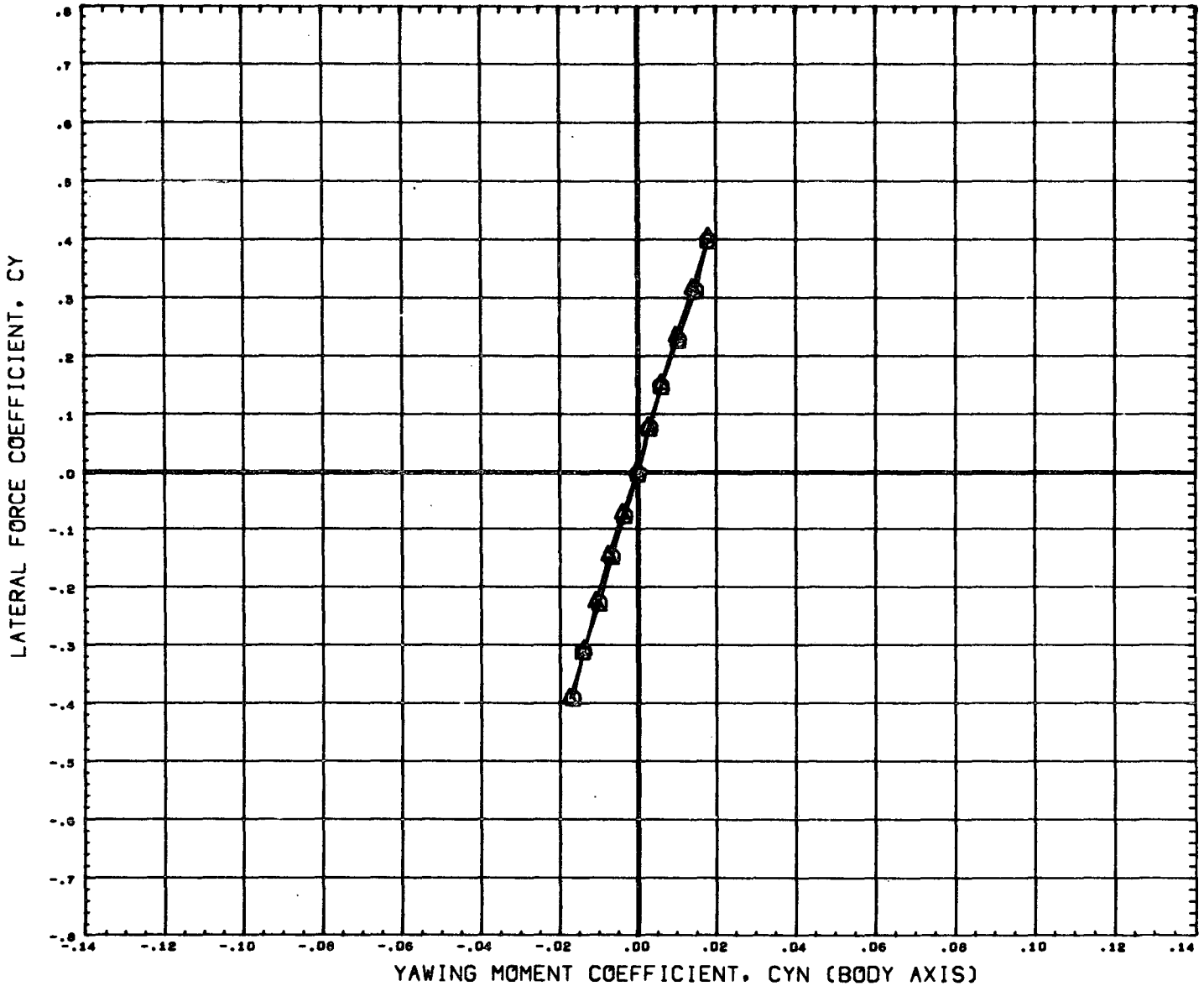

DATA SET SYMBOL	CONFIGURATION DESCRIPTION	ORBIN	THETS	ALPHA	REFERENCE INFORMATION
(B63005)	MSFC TMT 534 SHUTTLE LAUNCH	-1.500	21.000	0.000	SREF 4.8950 SQ. IN
(B65018)	MSFC TMT 534 SHUTTLE LAUNCH	-1.500	21.000	0.000	LREF 2.6440 IN.
					BREF 3.5250 IN.
					XMRP 3.4900 IN.
					YMRP 0.0000 IN.
					ZMRP 0.1616 IN.
					SCALE 0.0034

EFFECT OF SRM END FAIRING ON LATERAL/DIRECTIONAL CHARACTERISTICS

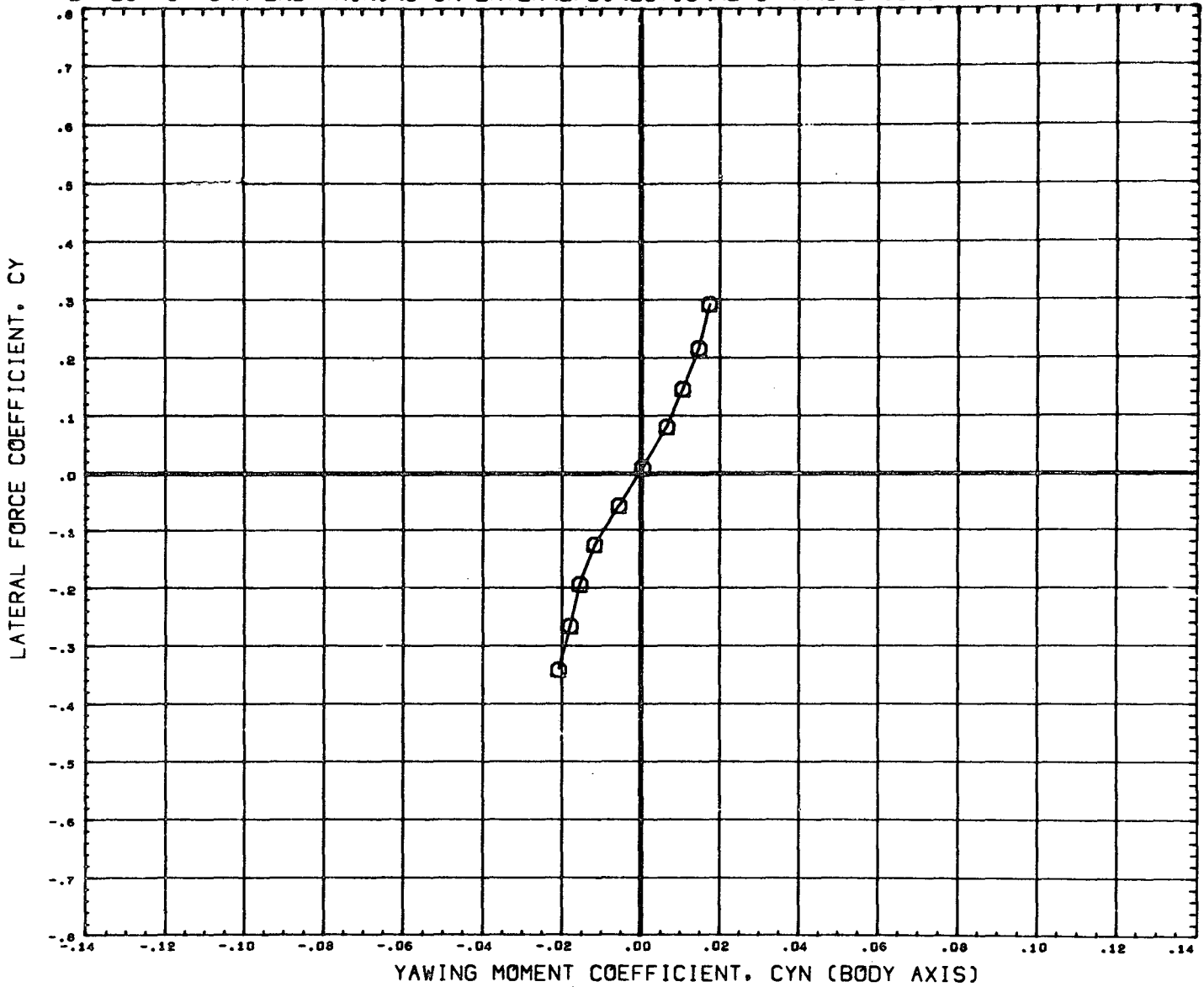

DATA SET SYMBOL CONFIGURATION DESCRIPTION
 (B65005) NSFC TWT 534 SHUTTLE LAUNCH T101S1
 (B65018) DATA NOT AVAILABLE FOR ALL CONDITIONS

ORBIN THETS ALPHA
 -1.500 21.000 0.000
 -1.500 21.000 0.000

REFERENCE INFORMATION
 SREF 4.8950 SQ. IN
 LREF 2.6440 IN.
 BREF 3.5250 IN.
 XMRP 3.4900 IN.
 YMRP 0.0000 IN.
 ZMRP 0.1616 IN.
 SCALE 0.0034

EFFECT OF SRM END FAIRING ON LATERAL/DIRECTIONAL CHARACTERISTICS

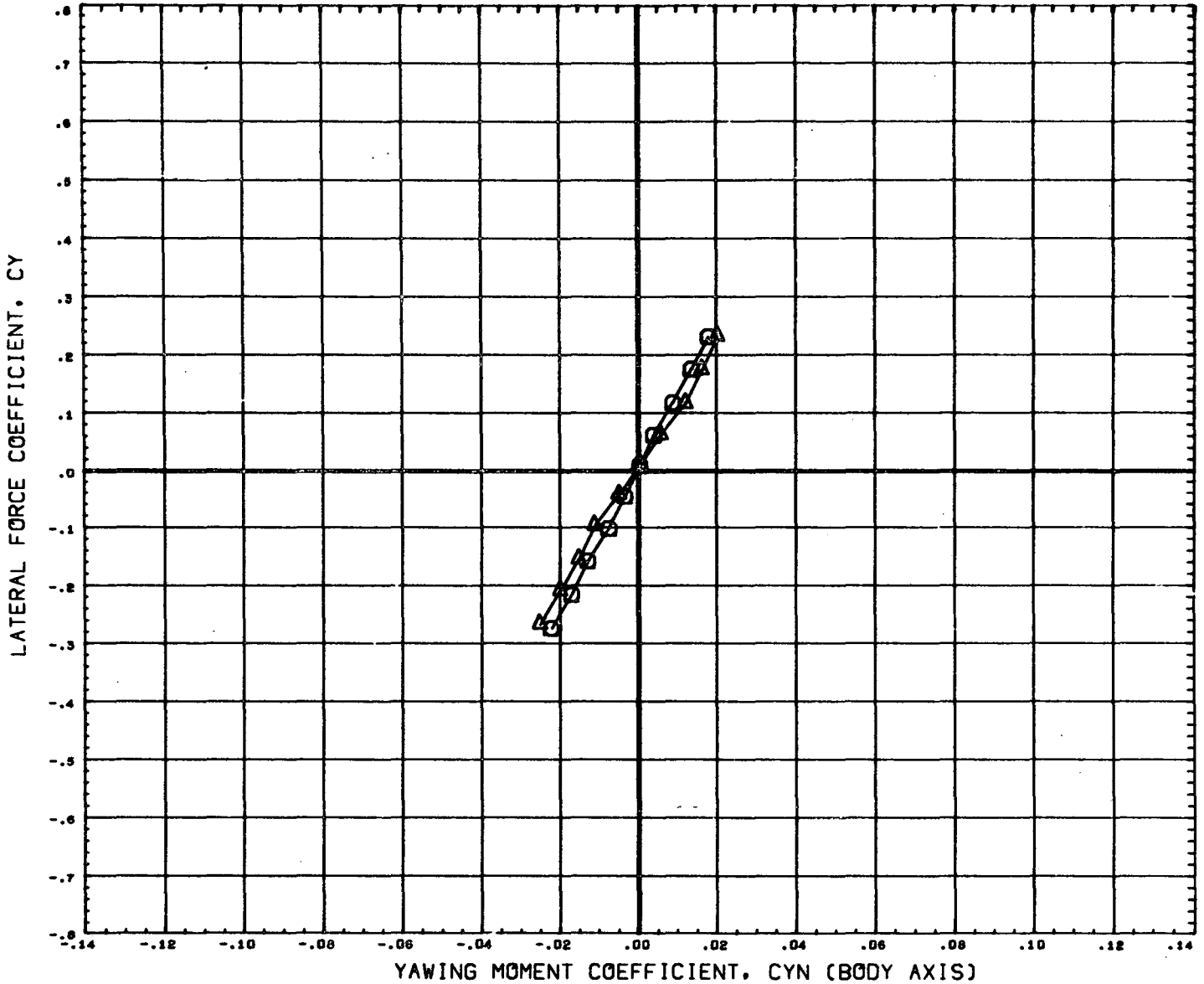

DATA SET SYMBOL	CONFIGURATION DESCRIPTION	ORBIN	THETS	ALPHA	REFERENCE INFORMATION
(B65005)	MSFC TWT 534 SHUTTLE LAUNCH	-1.500	21.000	0.000	SREF 4.6950 99. IN
(B65016)	MSFC TWT 534 SHUTTLE LAUNCH	-1.500	21.000	0.000	LREF 2.6440 IN.
					BREF 3.5250 IN.
					XMRP 3.4900 IN.
					YMRP 0.0000 IN.
					ZMRP 0.1616 IN.
					SCALE 0.0034

MACH

4.96

PAGE 416

EFFECT OF TANK END FAIRING ON LONGITUDINAL CHARACTERISTICS

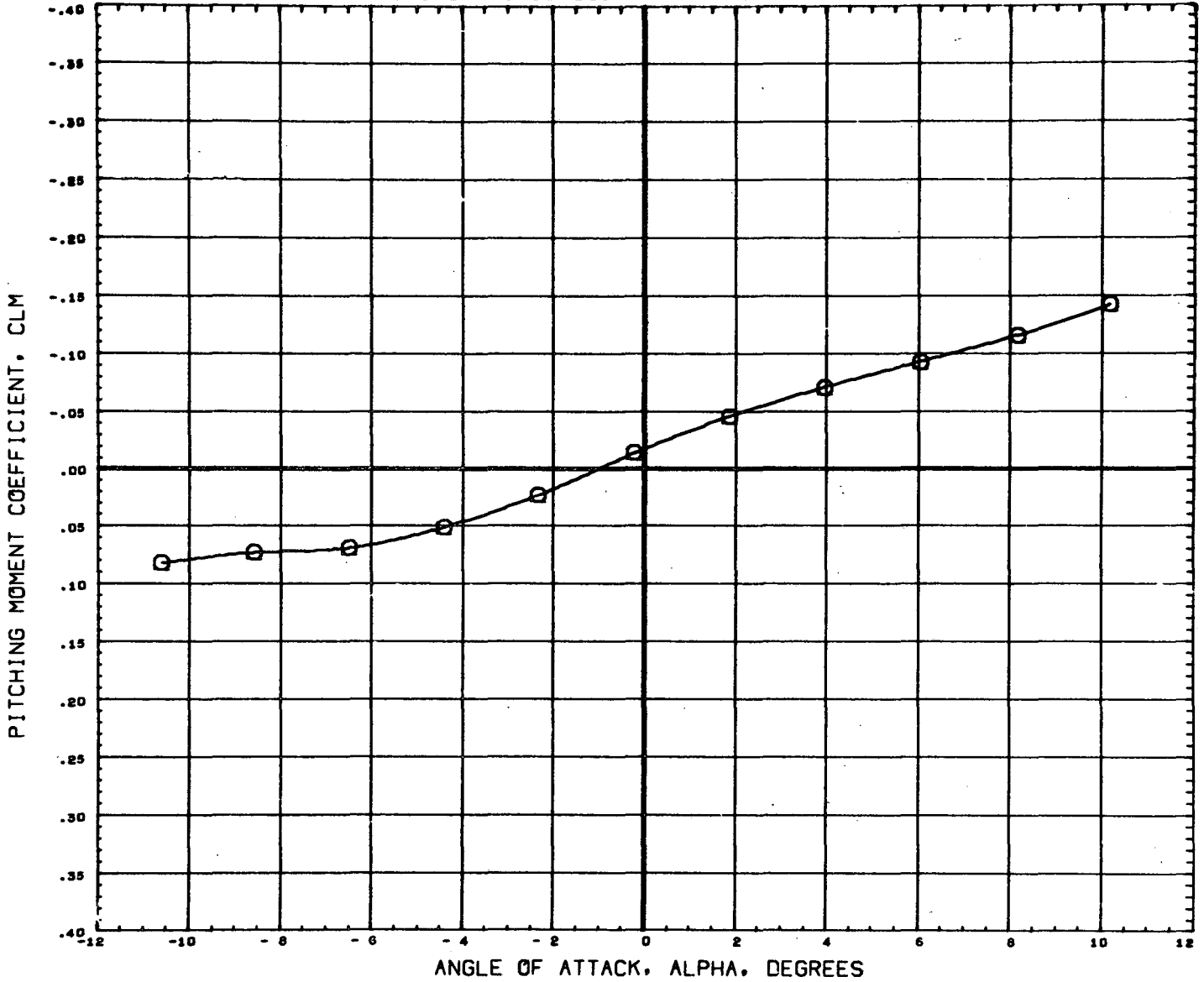

DATA SET SYMBOL CONFIGURATION DESCRIPTION
 (B63004) \square MSFC TWT 534 SHUTTLE LAUNCH T101S1
 (B63024) \triangle DATA NOT AVAILABLE FOR ALL CONDITIONS

ORBIN THETS BETA
 -1.500 21.000 0.000
 -1.500 21.000 0.000

REFERENCE INFORMATION
 SREF 4.8950 SQ. IN
 LREF 2.6440 IN.
 BREF 3.5250 IN.
 XMNP 3.4900 IN.
 YMNP 0.0000 IN.
 ZMRP 0.1616 IN.
 SCALE 0.0034

EFFECT OF TANK END FAIRING ON LONGITUDINAL CHARACTERISTICS

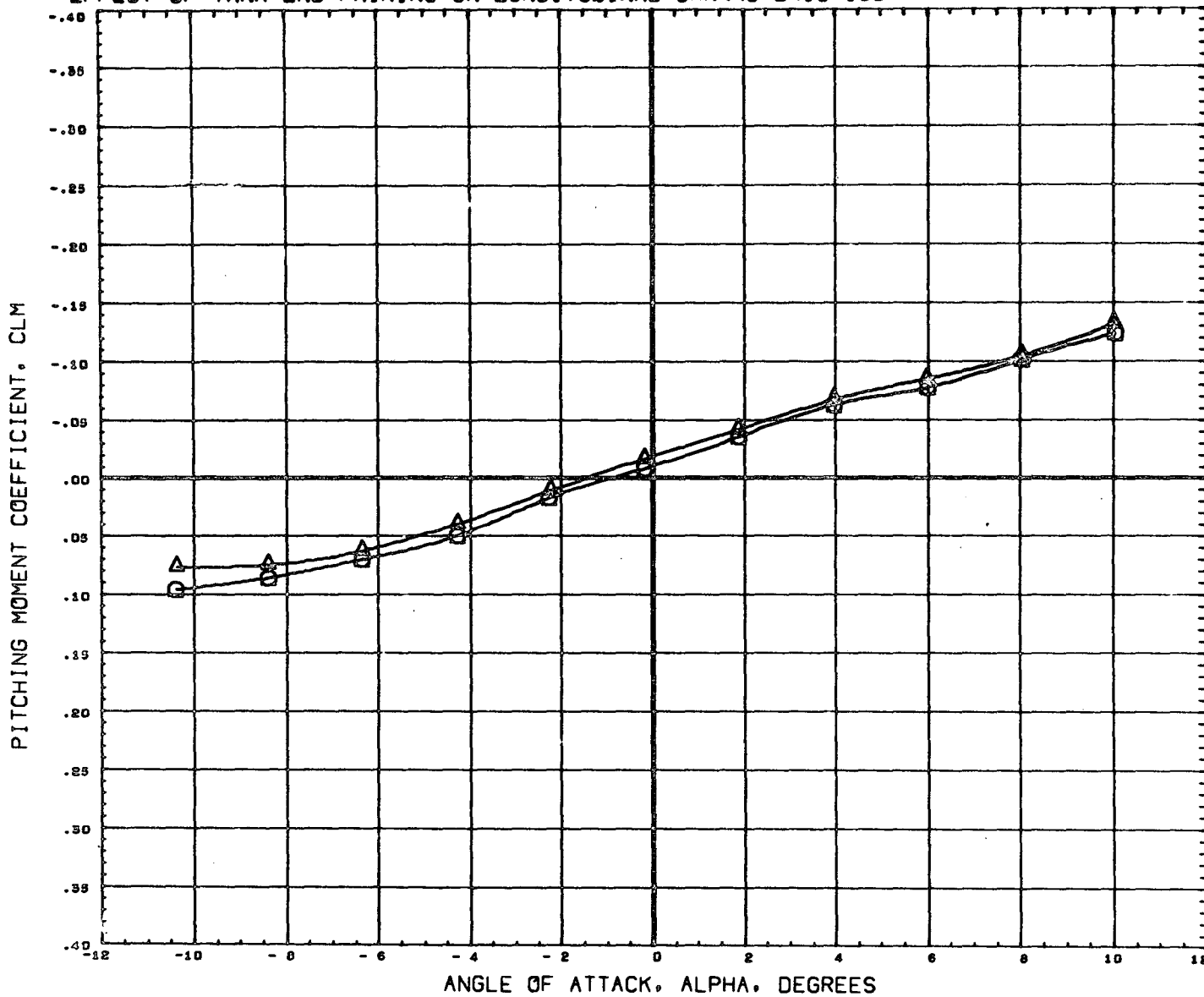

DATA SET SYMBOL	CONFIGURATION DESCRIPTION	ORBIN	THETS	BETA	REFERENCE INFORMATION	
(B65004)	MSFC TWT 534 SHUTTLE LAUNCH	T101S1	-1.500	21.000	0.000	SREF 4.8950 SQ. IN
(B65024)	MSFC TWT 534 SHUTTLE LAUNCH	T301S1	-1.500	21.000	0.000	LREF 2.6440 IN.
						BREF 3.5250 IN.
						XMRP 3.4900 IN.
						YMRP 0.0000 IN.
						ZMRP 0.1616 IN.
						SCALE 0.0034

MACH .60

EFFECT OF TANK END FAIRING ON LONGITUDINAL CHARACTERISTICS

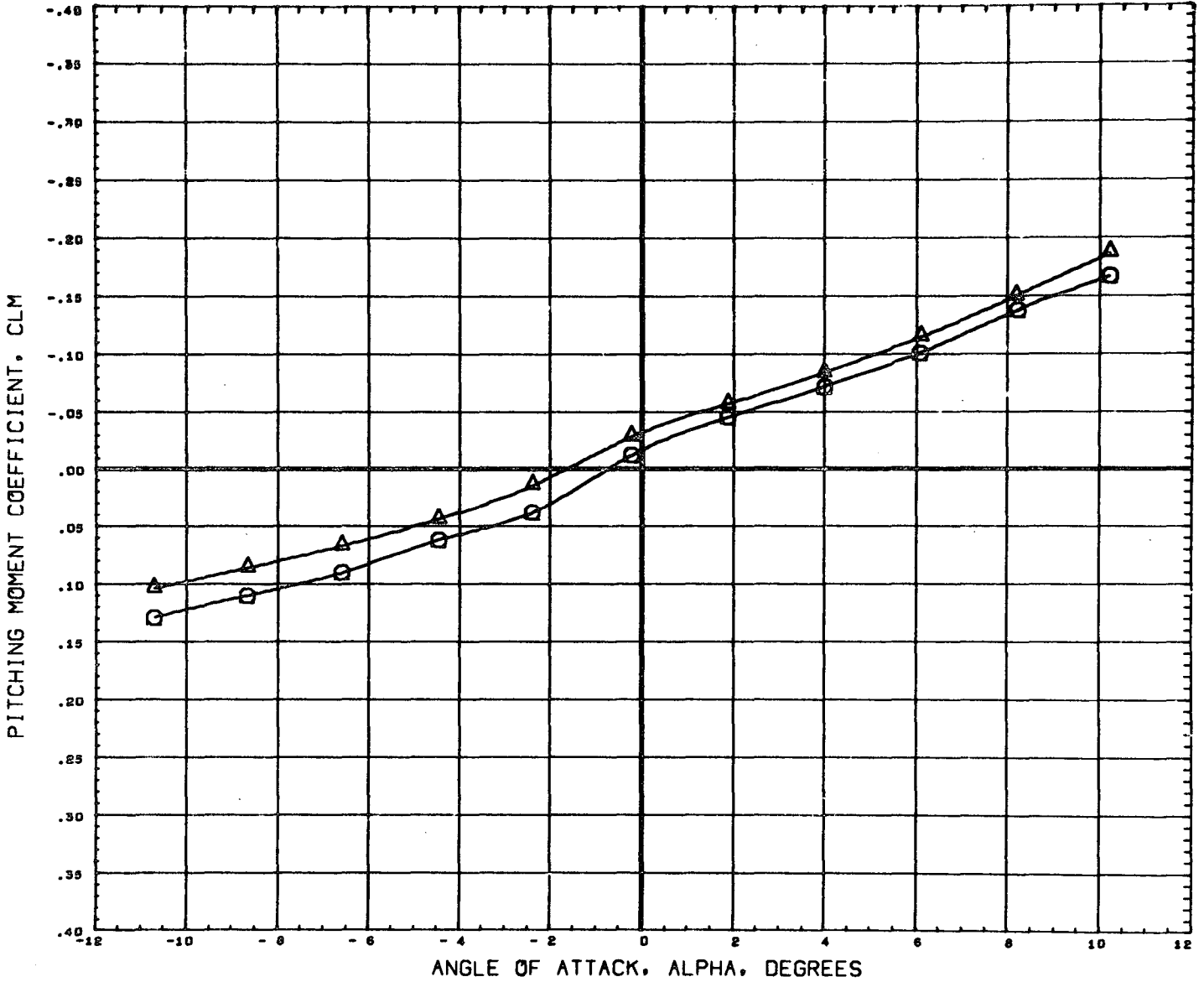

DATA SET SYMBOL	CONFIGURATION DESCRIPTION	ORBIN	THETS	BETA	REFERENCE INFORMATION
(B65004)	MSFC TWT 534 SHUTTLE LAUNCH	-1.500	21.000	0.000	SREF 4.8950 SQ. IN
(B65024)	MSFC TWT 534 SHUTTLE LAUNCH	-1.500	21.000	0.000	LREF 2.6440 IN.
					BREF 3.5250 IN.
					XMRP 3.4900 IN.
					YMRP 0.0000 IN.
					ZMRP 0.1616 IN.
					SCALE 0.0034

MACH .91

EFFECT OF TANK END FAIRING ON LONGITUDINAL CHARACTERISTICS

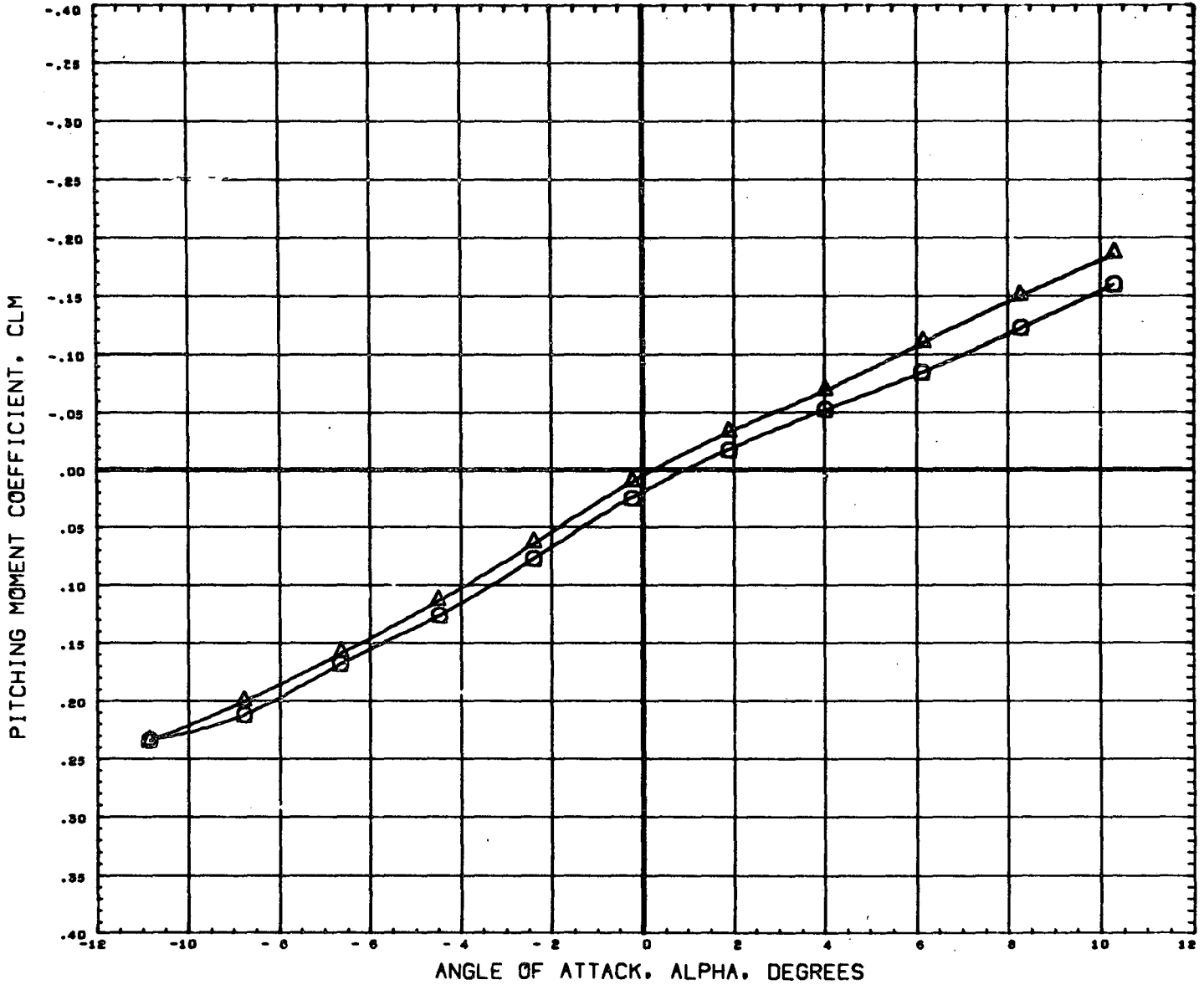

DATA SET SYMBOL	CONFIGURATION DESCRIPTION	ORBIN	THETS	BETA	REFERENCE INFORMATION
(865004)	NSFC TWT 534 SHUTTLE LAUNCH	-1.500	21.000	0.000	SREF 4.8950 SQ. IN
(865024)	NSFC TWT 534 SHUTTLE LAUNCH	-1.500	21.000	0.000	LREF 2.6440 IN.
					BREF 3.5280 IN.
					XMRP 3.4900 IN.
					YMRP 0.0000 IN.
					ZMRP 0.1616 IN.
					SCALE 0.0034

MACH 1.10

EFFECT OF TANK END FAIRING ON LONGITUDINAL CHARACTERISTICS

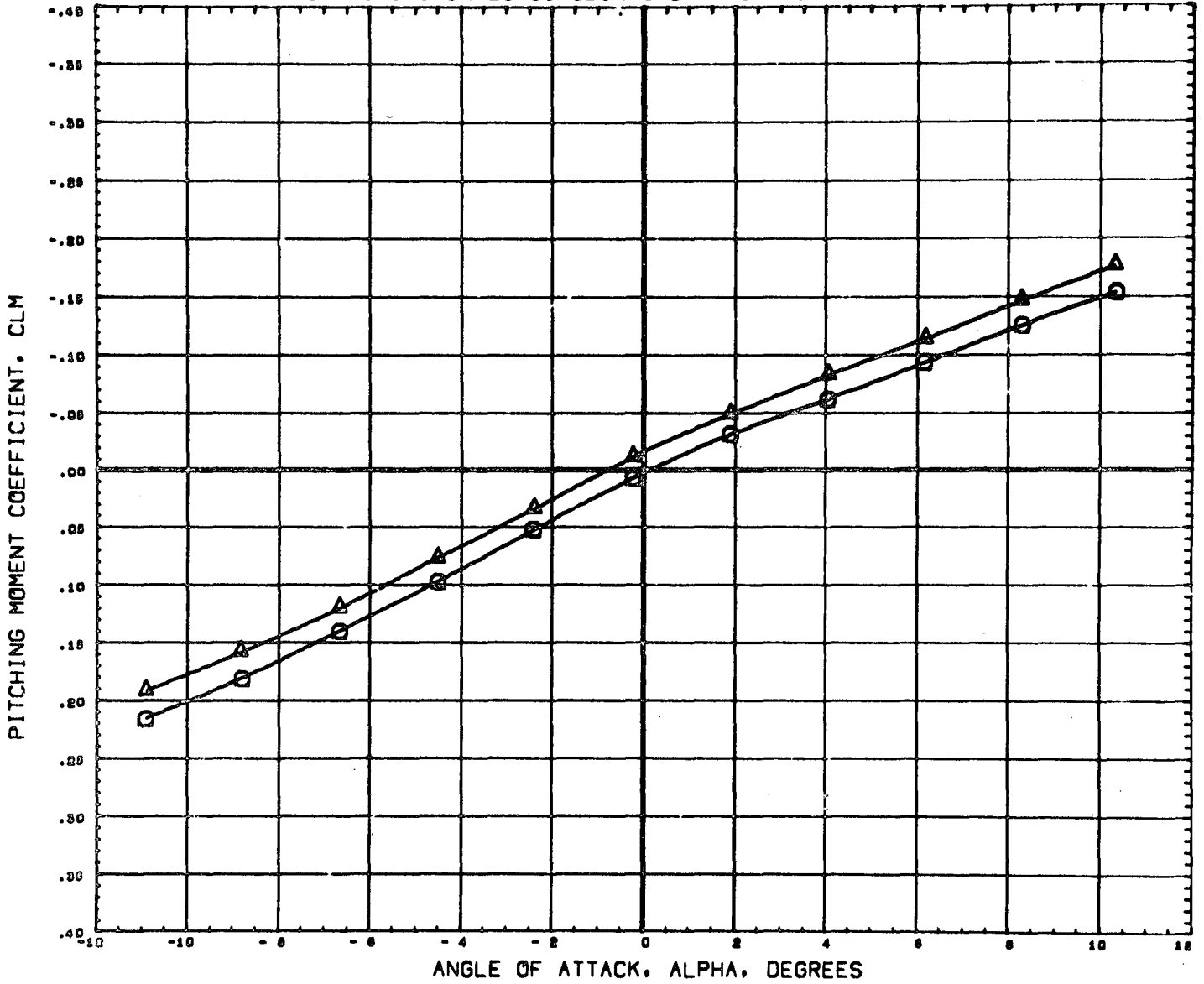

DATA SET SYMBOL	CONFIGURATION DESCRIPTION	ORBIT	THETA	BETA	REFERENCE INFORMATION	
(889004)	MSFC TWT 534 SHUTTLE LAUNCH	T10181	-1.500	21.000	0.000	SREF 4.8950 SQ. IN
(889024)	MSFC TWT 534 SHUTTLE LAUNCH	T30181	-1.500	21.000	0.000	LREF 2.6440 IN.
						BREF 3.5280 IN.
						XMRP 3.4900 IN.
						YMRP 0.0000 IN.
						ZMRP 0.1616 IN.
						SCALE 0.0034

MACH 1.20

EFFECT OF TANK END FAIRING ON LONGITUDINAL CHARACTERISTICS

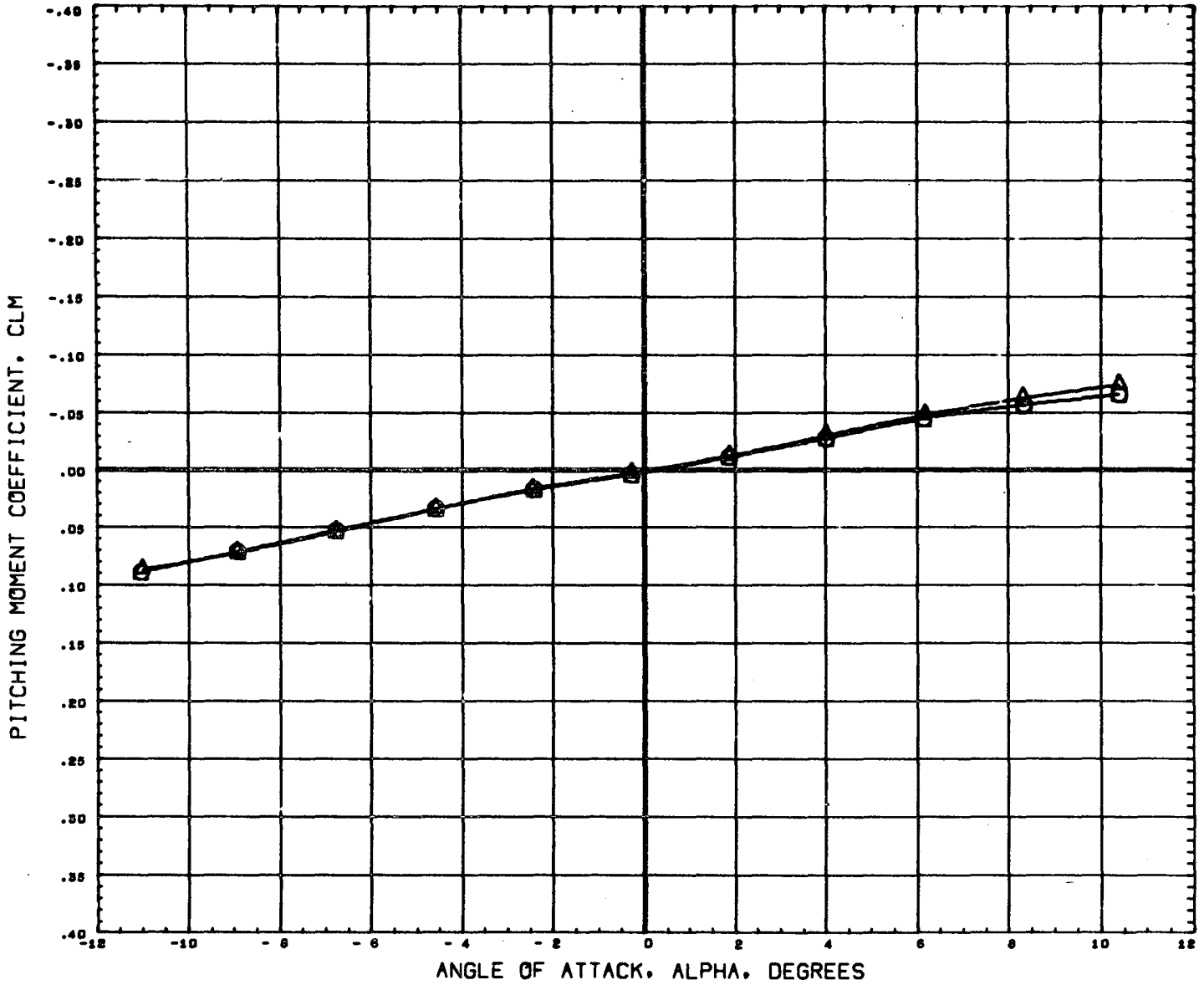

DATA SET SYMBOL	CONFIGURATION DESCRIPTION	ORBIT	THETA	BETA	REFERENCE INFORMATION	
(B65004)	MSFC TWT 534 SHUTTLE LAUNCH	T10191	-1.900	21.000	0.000	SREF 4.8950 SQ. IN
(B65024)	MSFC TWT 534 SHUTTLE LAUNCH	T30191	-1.900	21.000	0.000	LREF 2.6440 IN.
						BREF 3.5250 IN.
						XMRP 3.4900 IN.
						YMRP 0.0000 IN.
						ZMRP 0.1616 IN.
						SCALE 0.0034

MACH 1.97

EFFECT OF TANK END FAIRING ON LONGITUDINAL CHARACTERISTICS

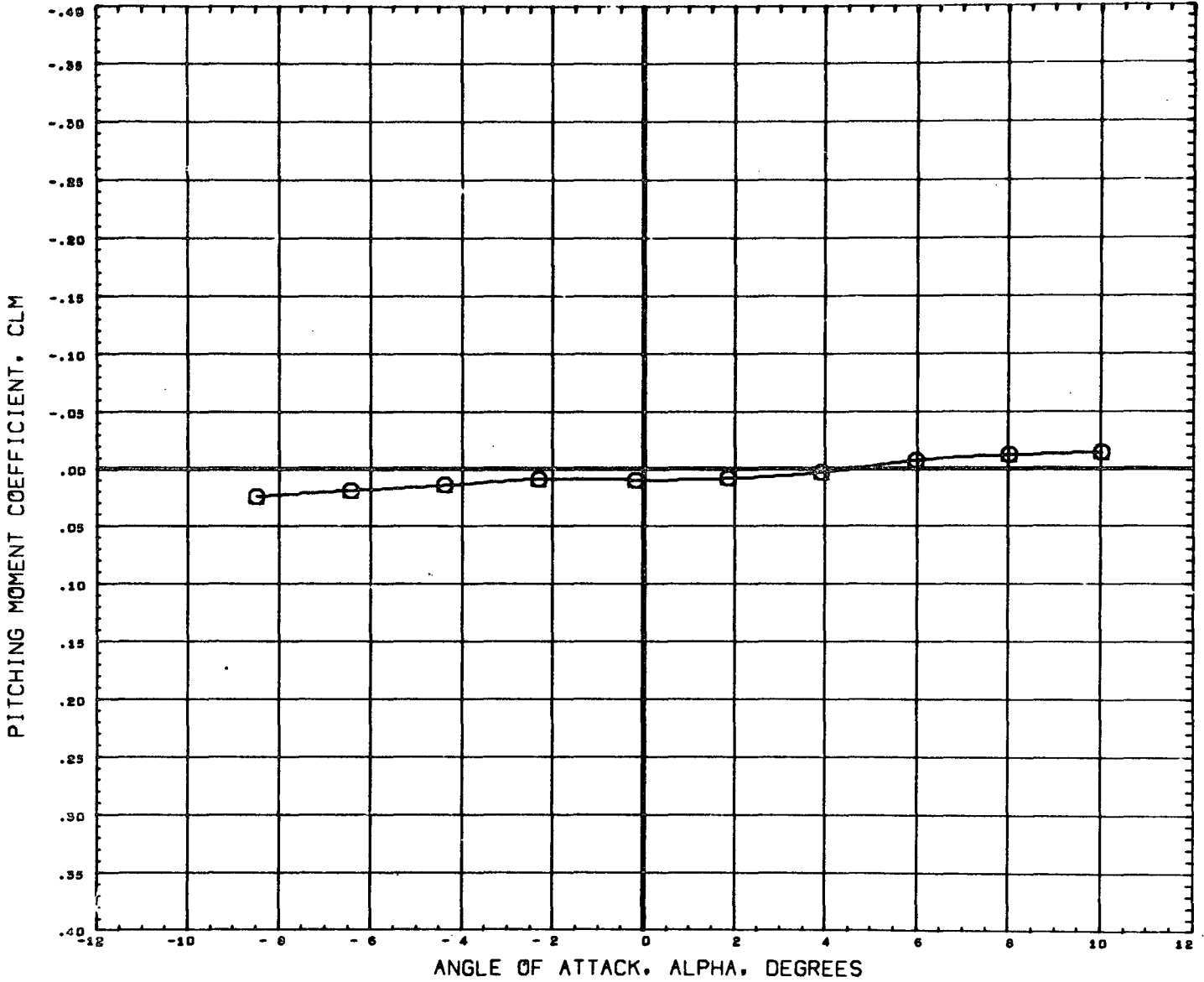

DATA SET SYMBOL CONFIGURATION DESCRIPTION
 (865004) MSFC TWT 534 SHUTTLE LAUNCH T101S1
 (865024) DATA NOT AVAILABLE FOR ALL CONDITIONS

ORBIN THETA BETA
 -1.500 21.000 0.000
 -1.500 21.000 0.000

REFERENCE INFORMATION
 SREF 4.8950 SQ. IN
 LREF 2.6440 IN.
 BREF 3.5250 IN.
 XMRP 3.4900 IN.
 YMRP 0.0000 IN.
 ZMRP 0.1616 IN.
 SCALE 0.0034

EFFECT OF TANK END FAIRING ON LONGITUDINAL CHARACTERISTICS

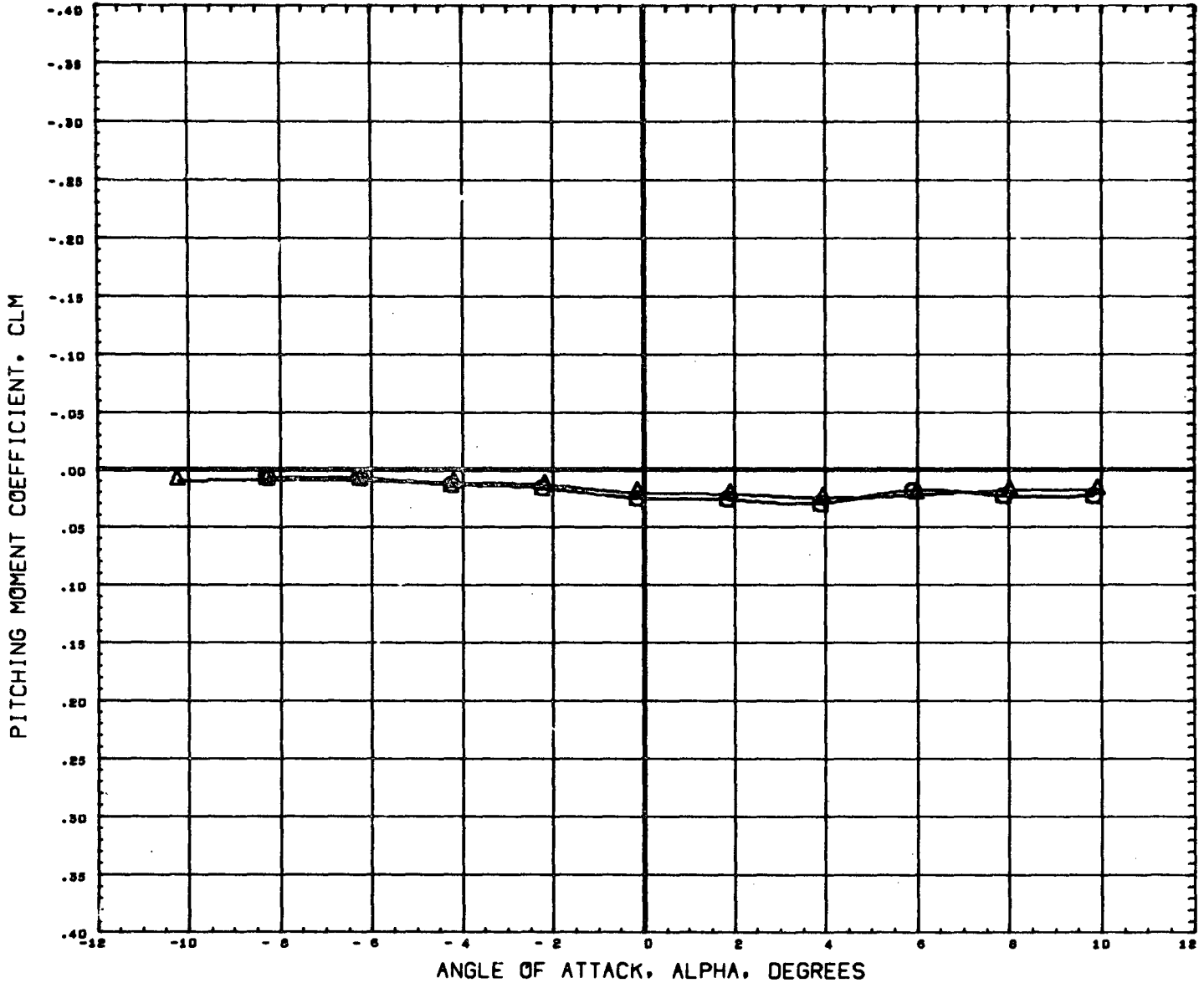

DATA SET SYMBOL	CONFIGURATION DESCRIPTION	ORBIN	THETS	BETA	REFERENCE INFORMATION	
(B65004)	MSFC TWT 534 SHUTTLE LAUNCH	T101S1	-1.500	21.000	0.000	SREF 4.8950 SQ. IN
(B65024)	MSFC TWT 534 SHUTTLE LAUNCH	T301S1	-1.500	21.000	0.000	LREF 2.6440 IN.
						BREF 3.5250 IN.
						XNRP 3.4900 IN.
						YNRP 0.0000 IN.
						ZNRP 0.1616 IN.
						SCALE 0.0034

EFFECT OF TANK END FAIRING ON LONGITUDINAL CHARACTERISTICS

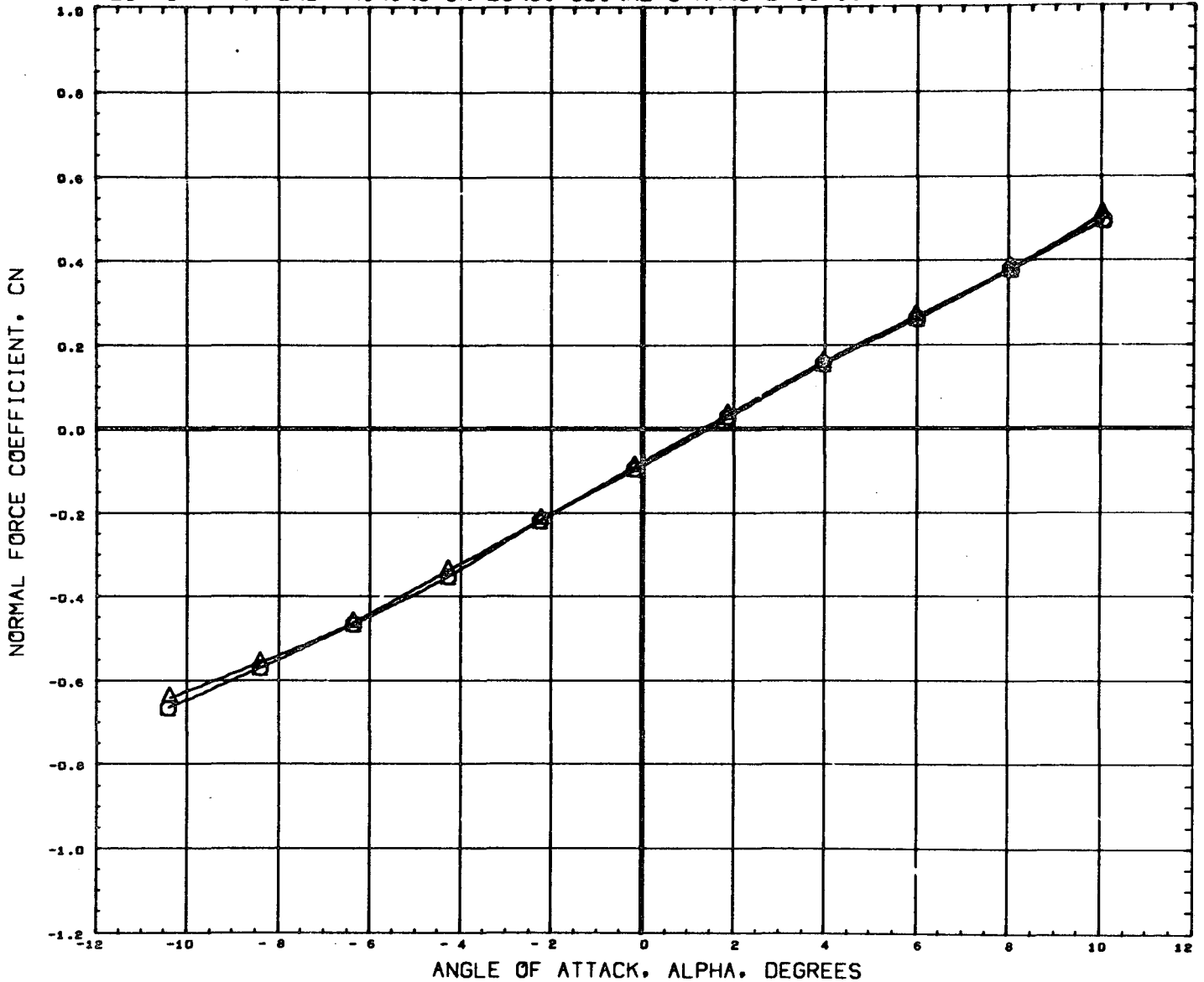

DATA SET SYMBOL	CONFIGURATION DESCRIPTION	ORBIN	THETS	BETA	REFERENCE INFORMATION
(B65004)	MSFC TWT 534 SHUTTLE LAUNCH	-1.500	21.000	0.000	SREF 4.8950 SQ. IN
(B65024)	MSFC TWT 534 SHUTTLE LAUNCH	-1.500	21.000	0.000	LREF 2.6440 IN.
					BREF 3.5250 IN.
					XMRP 3.4900 IN.
					YMRP 0.0000 IN.
					ZMRP 0.1616 IN.
					SCALE 0.0034

MACH .60

EFFECT OF TANK END FAIRING ON LONGITUDINAL CHARACTERISTICS

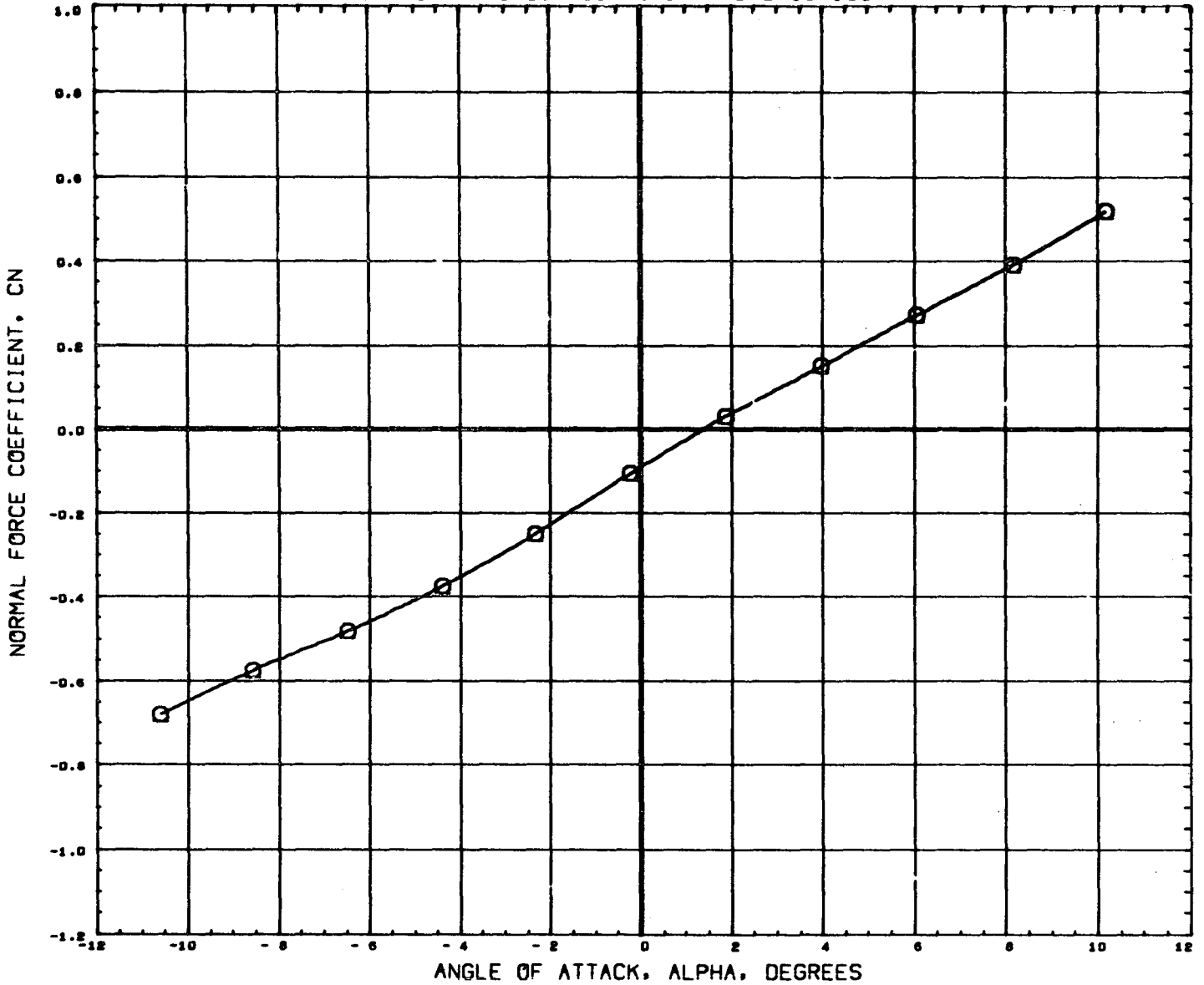

DATA SET SYMBOL CONFIGURATION DESCRIPTION
 (B65004) MSFC TWT 534 SHUTTLE LAUNCH T101S1
 (B65024) DATA NOT AVAILABLE FOR ALL CONDITIONS

ORBIN THETS BETA
 -1.500 21.000 0.000
 -1.500 21.000 0.000

REFERENCE INFORMATION
 SREF 4.8950 SQ. IN
 LREF 2.6440 IN.
 BREF 3.5250 IN.
 XMRP 3.4900 IN.
 YMRP 0.0000 IN.
 ZMRP 0.1616 IN.
 SCALE 0.0034

EFFECT OF TANK END FAIRING ON LONGITUDINAL CHARACTERISTICS

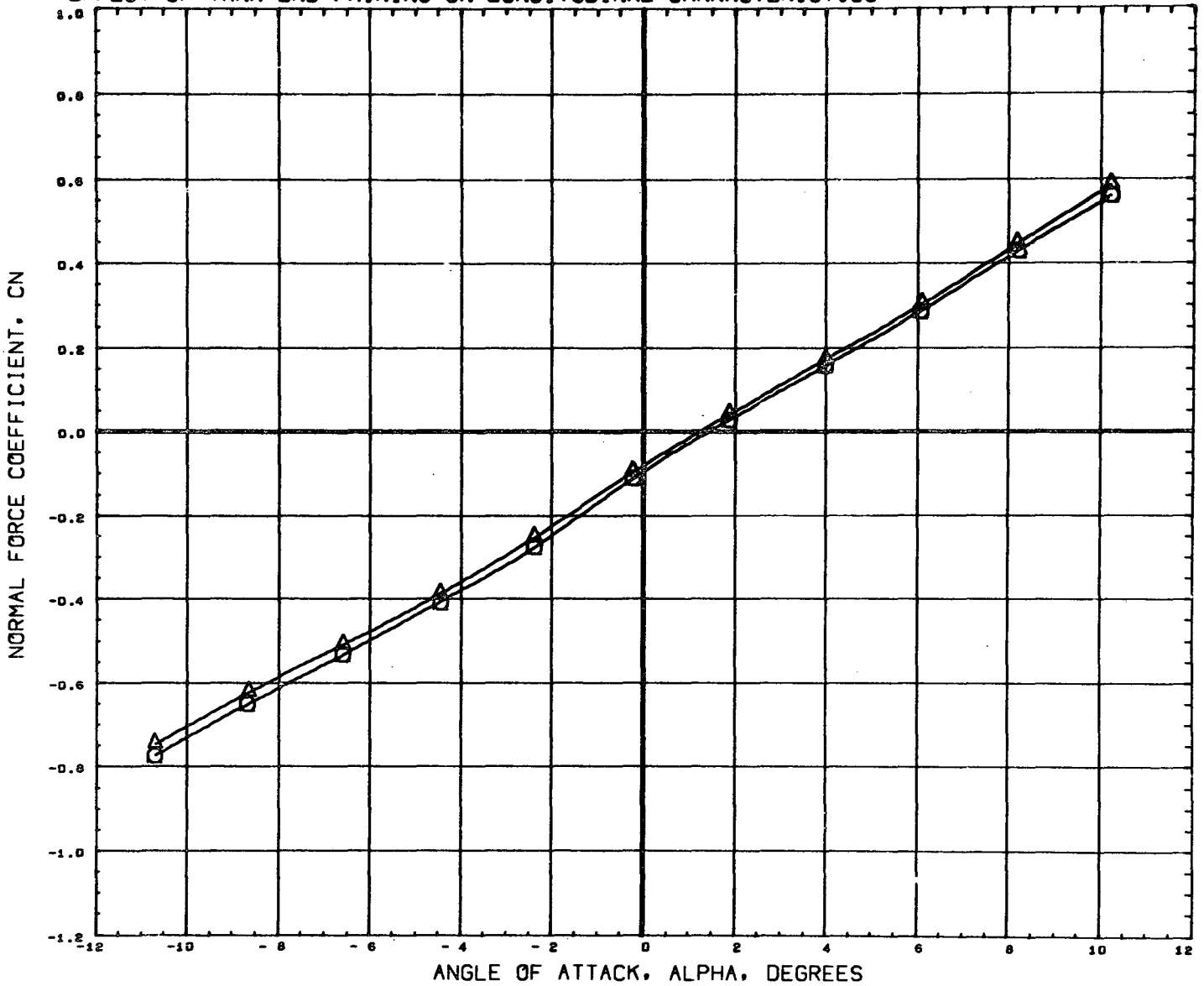

DATA SET SYMBOL	CONFIGURATION DESCRIPTION	ORBIN	THETS	BETA	REFERENCE INFORMATION	
(B65004)	MSFC TWT 534 SHUTTLE LAUNCH	T101S1	-1.500	21.000	0.000	SREF 4.8950 S8. IN
(B65024)	MSFC TWT 534 SHUTTLE LAUNCH	T301S1	-1.500	21.000	0.000	LREF 2.6440 IN.
						BREF 3.5250 IN.
						XMRP 3.4900 IN.
						YMRP 0.0000 IN.
						ZMRP 0.1616 IN.
						SCALE 0.0034

MACH .91

PAGE 427

EFFECT OF TANK END FAIRING ON LONGITUDINAL CHARACTERISTICS

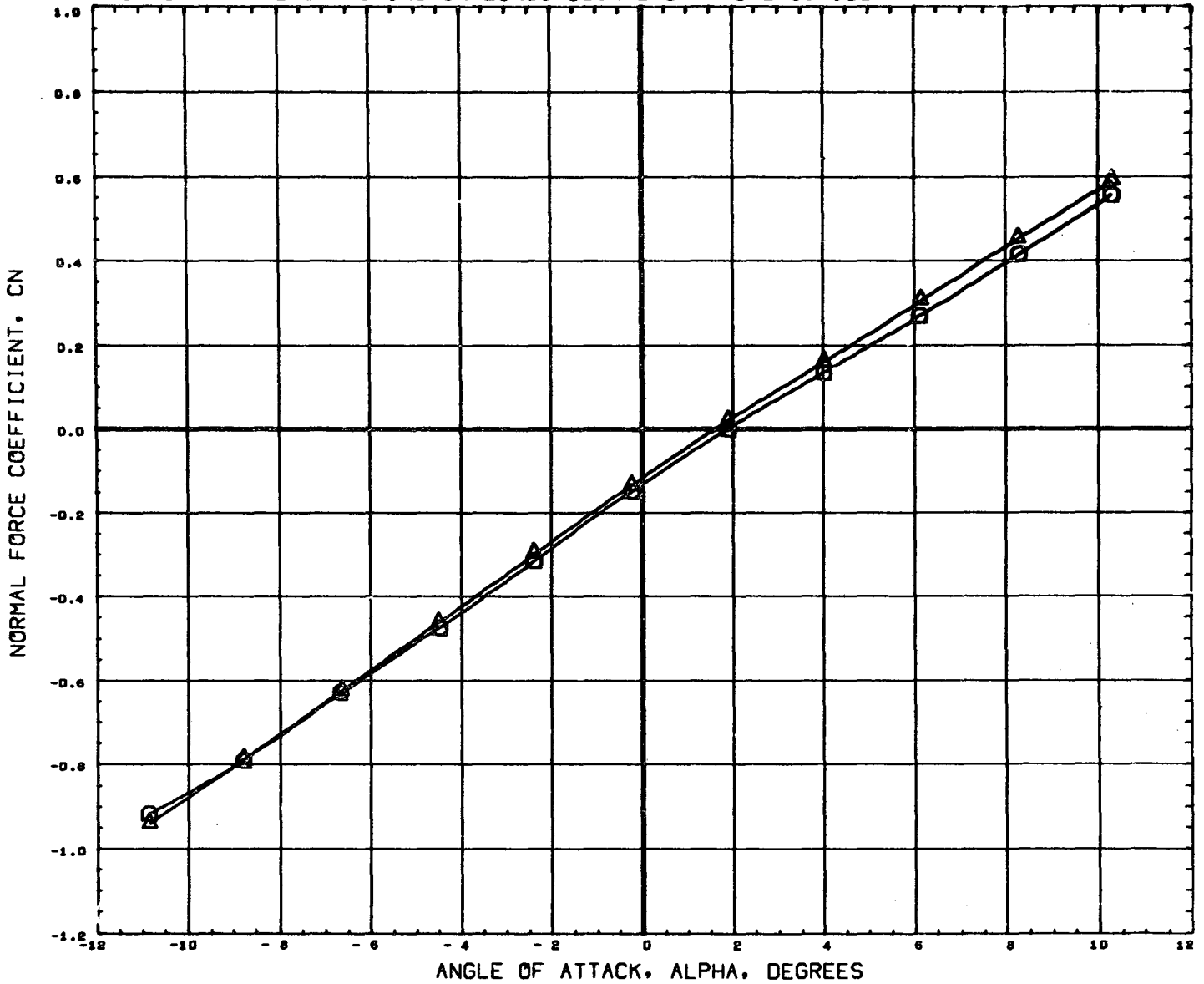

DATA SET SYMBOL	CONFIGURATION DESCRIPTION	ORBIN	THETS	BETA	REFERENCE INFORMATION
(B65004)	MSFC TWT 534 SHUTTLE LAUNCH	-1.500	21.000	0.000	SREF 4.8950 SQ. IN
(B65024)	MSFC TWT 534 SHUTTLE LAUNCH	-1.500	21.000	0.000	LREF 2.6440 IN.
					BREF 3.5250 IN.
					XMRP 3.4900 IN.
					YMRP 0.0000 IN.
					ZMRP 0.1616 IN.
					SCALE 0.0034

EFFECT OF TANK END FAIRING ON LONGITUDINAL CHARACTERISTICS

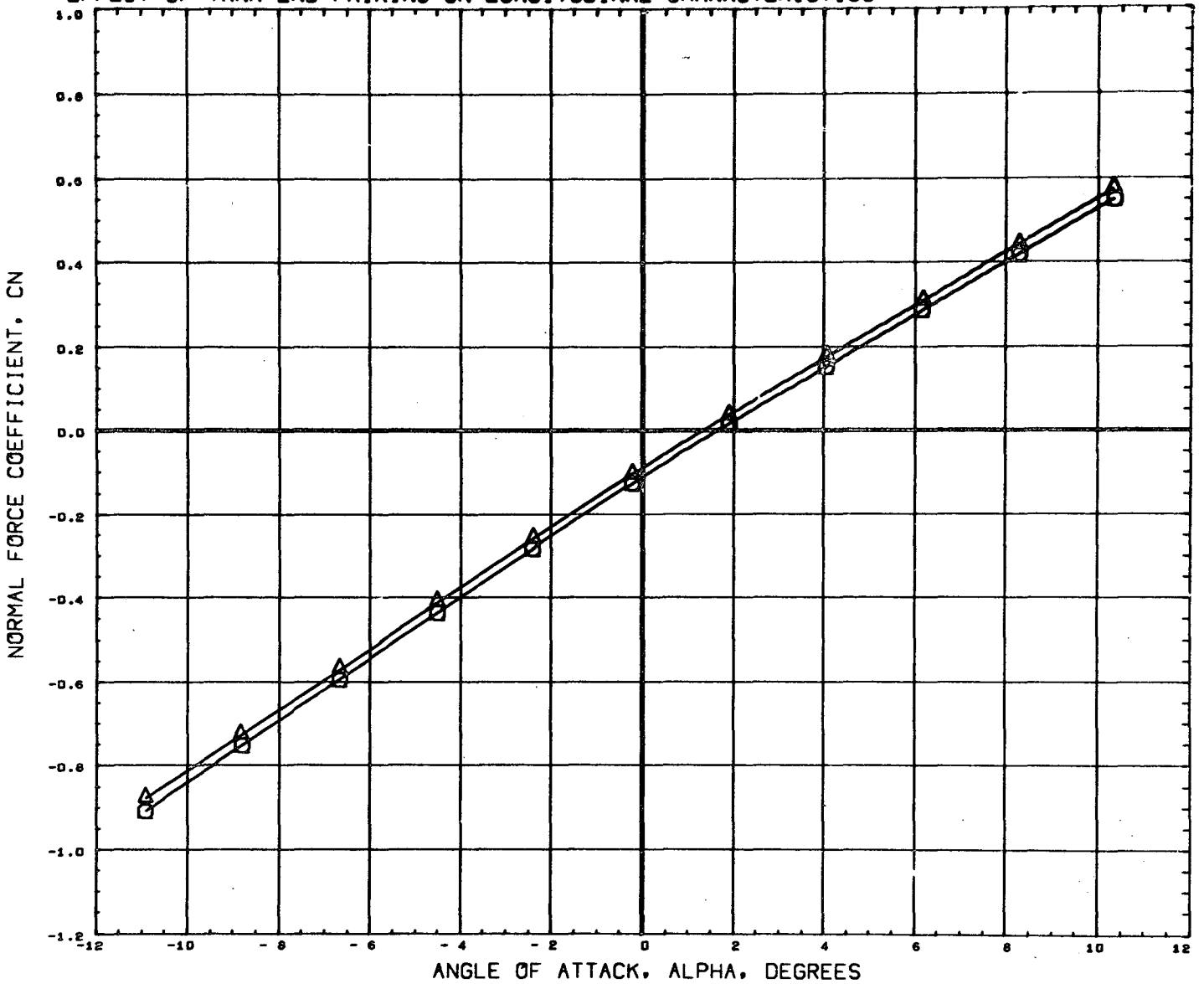

DATA SET SYMBOL	CONFIGURATION DESCRIPTION	ORBIN	THETS	BETA	REFERENCE INFORMATION
(B65004)	MSFC TWT 534 SHUTTLE LAUNCH	-1.500	21.000	0.000	SREF 4.8950 SQ. IN
(B65024)	MSFC TWT 534 SHUTTLE LAUNCH	-1.500	21.000	0.000	LREF 2.6440 IN.
					BREF 3.5250 IN.
					XMRP 3.4900 IN.
					YMRP 0.0000 IN.
					ZMRP 0.1616 IN.
					SCALE 0.0034

MACH 1.20

EFFECT OF TANK END FAIRING ON LONGITUDINAL CHARACTERISTICS

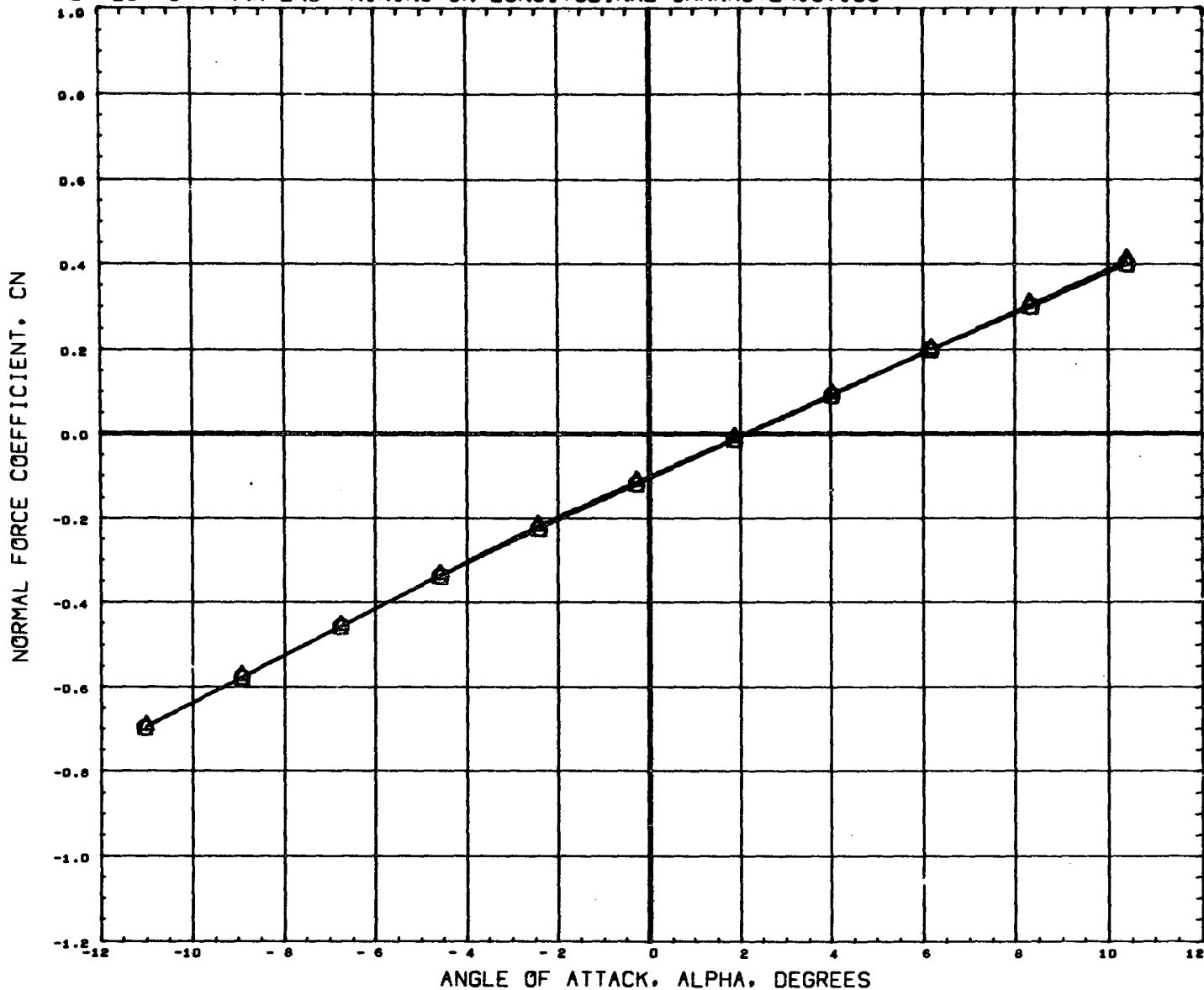

DATA SET SYMBOL	CONFIGURATION DESCRIPTION	ORBIN	THETS	BETA	REFERENCE INFORMATION	
(B65004)	MSFC TWT 534 SHUTTLE LAUNCH	T101S1	-1.500	21.000	0.000	SREF 4.8950 SQ. IN
(B65024)	MSFC TWT 534 SHUTTLE LAUNCH	T301S1	-1.500	21.000	0.000	LREF 2.6440 IN.
						BREF 3.5250 IN.
						XHRP 3.4900 IN.
						YMRP 0.0000 IN.
						ZMRP 0.1616 IN.
						SCALE 0.0034

MACH 1.97

EFFECT OF TANK END FAIRING ON LONGITUDINAL CHARACTERISTICS

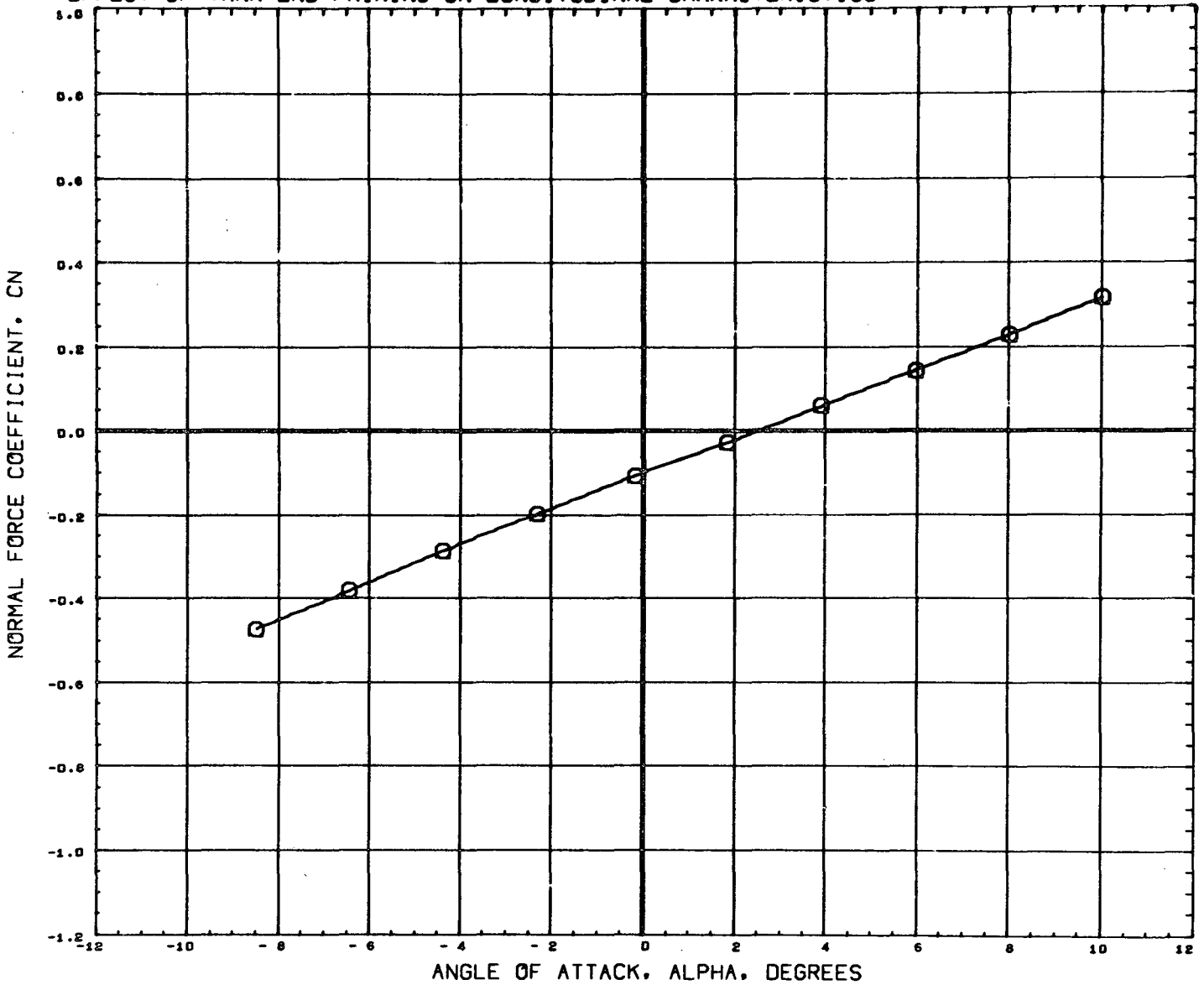

DATA SET SYMBOL CONFIGURATION DESCRIPTION ORBIN THETS BETA
 (B65004) \odot MSFC TWT 534 SHUTTLE LAUNCH T101S1 -1.500 21.00J 0.000
 (B63024) \otimes DATA NOT AVAILABLE FOR ALL CONDITIONS -1.500 21.000 0.000

REFERENCE INFORMATION
 SREF 4.8950 SQ. IN
 LREF 2.6440 IN.
 BREF 3.5250 IN.
 XMRP 3.4900 IN.
 YMRP 0.0000 IN.
 ZMRP 0.1616 IN.
 SCALE 0.0034

MACH 2.74

PAGE 431

EFFECT OF TANK END FAIRING ON LONGITUDINAL CHARACTERISTICS

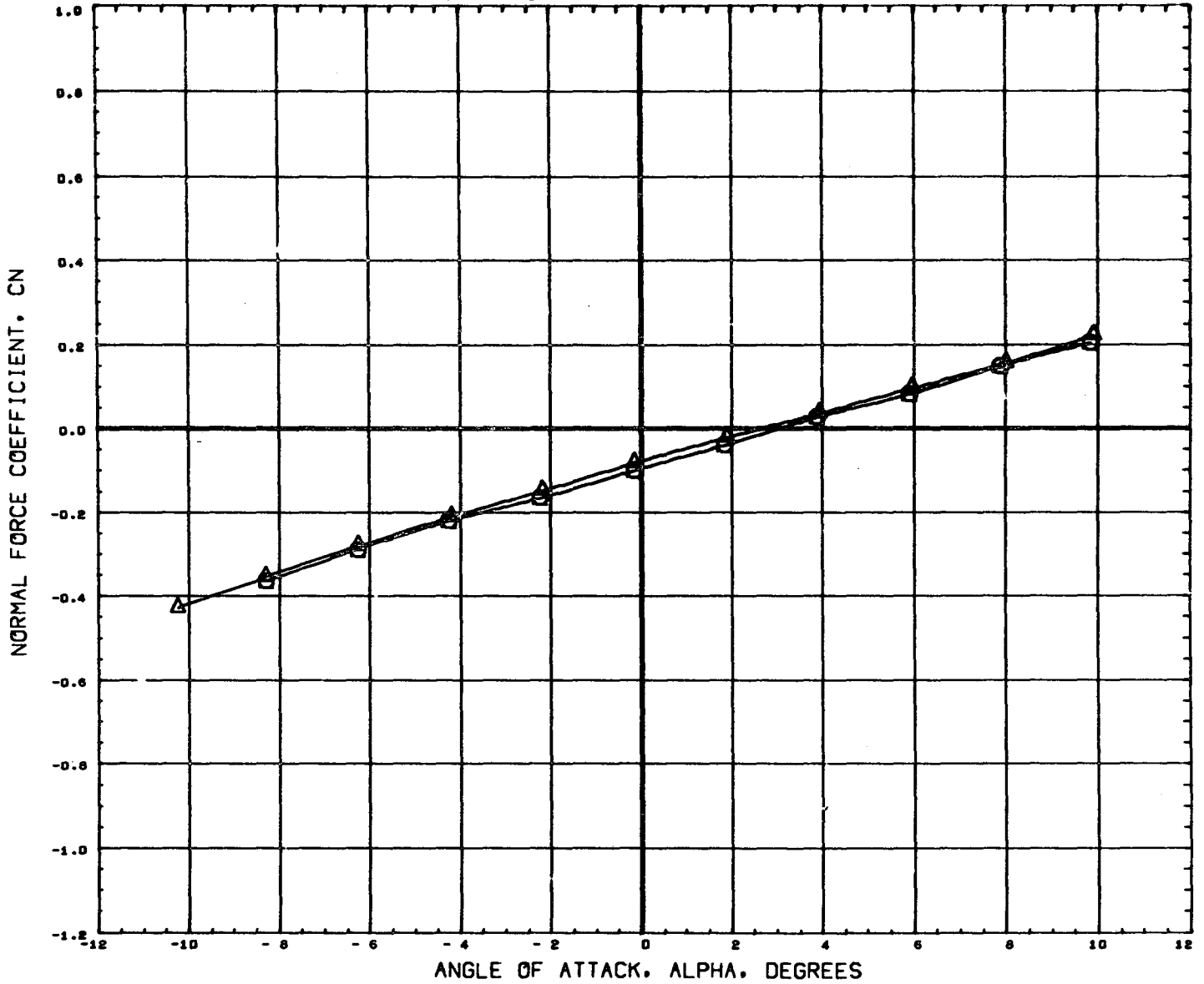

DATA SET SYMBOL	CONFIGURATION DESCRIPTION	ORBIN	THETS	BETA	REFERENCE INFORMATION	
(B65004)	MSFC TWT 534 SHUTTLE LAUNCH	T101S1	-1.500	21.000	0.000	SREF 4.8950 SQ. IN
(B65024)	MSFC TWT 534 SHUTTLE LAUNCH	T301S1	-1.500	21.000	0.000	LREF 2.6440 IN.
						BREF 3.5250 IN.
						XMRP 3.4900 IN.
						YMRP 0.0000 IN.
						ZMRP 0.1616 IN.
						SCALE 0.0034

EFFECT OF TANK END FAIRING ON LONGITUDINAL CHARACTERISTICS

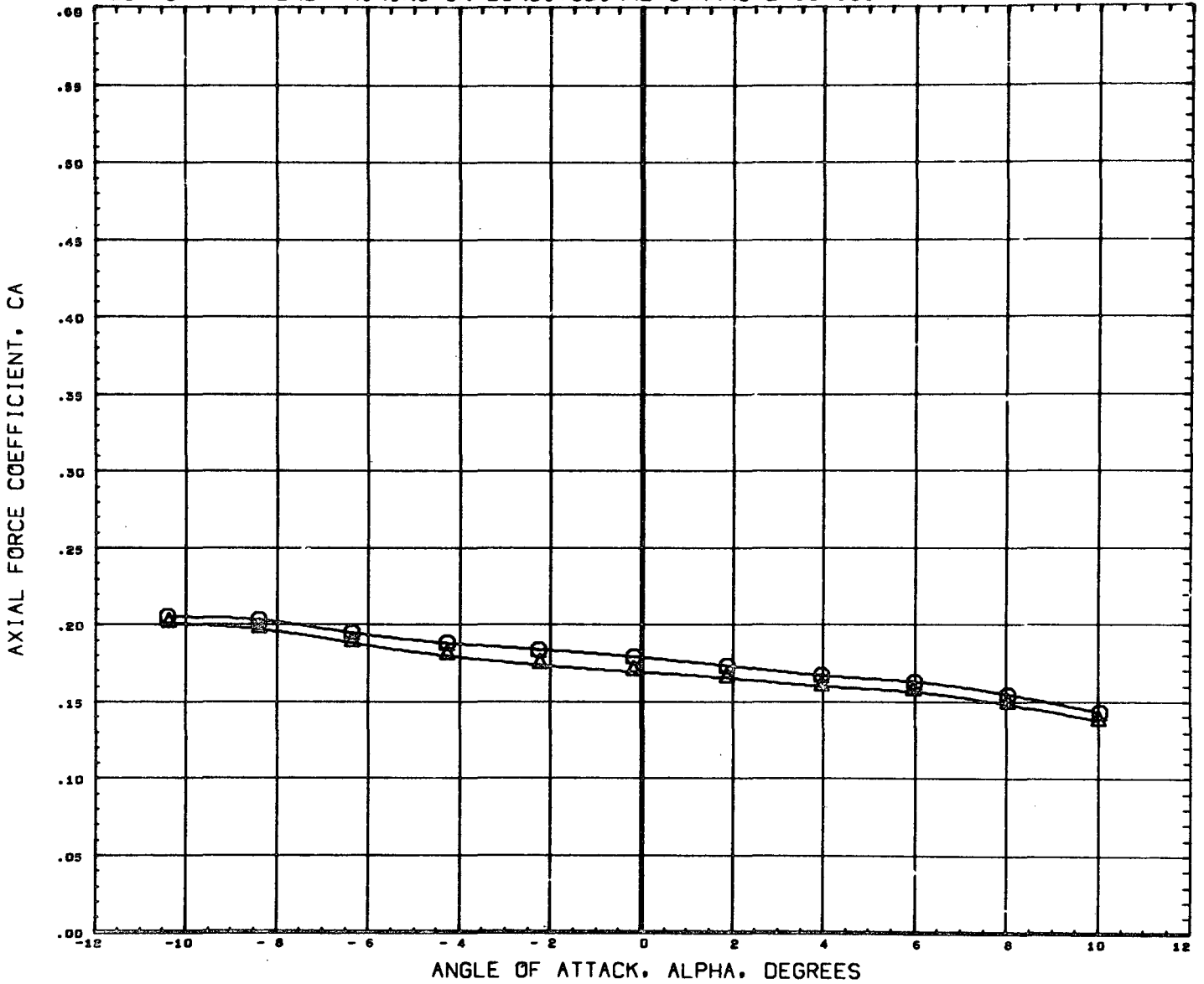

DATA SET SYMBOL	CONFIGURATION DESCRIPTION	ORBIN	THETS	BETA	REFERENCE INFORMATION
(B65004)	MSFC TWT 534 SHUTTLE LAUNCH	-1.500	21.000	0.000	SREF 4.8950 SQ. IN
(B65024)	MSFC TWT 534 SHUTTLE LAUNCH	-1.500	21.000	0.000	LREF 2.6440 IN.
					BREF 3.5250 IN.
					XMRP 3.4900 IN.
					YMRP 0.0000 IN.
					ZMRP 0.1616 IN.
					SCALE 0.0034

MACH .60

EFFECT OF TANK END FAIRING ON LONGITUDINAL CHARACTERISTICS

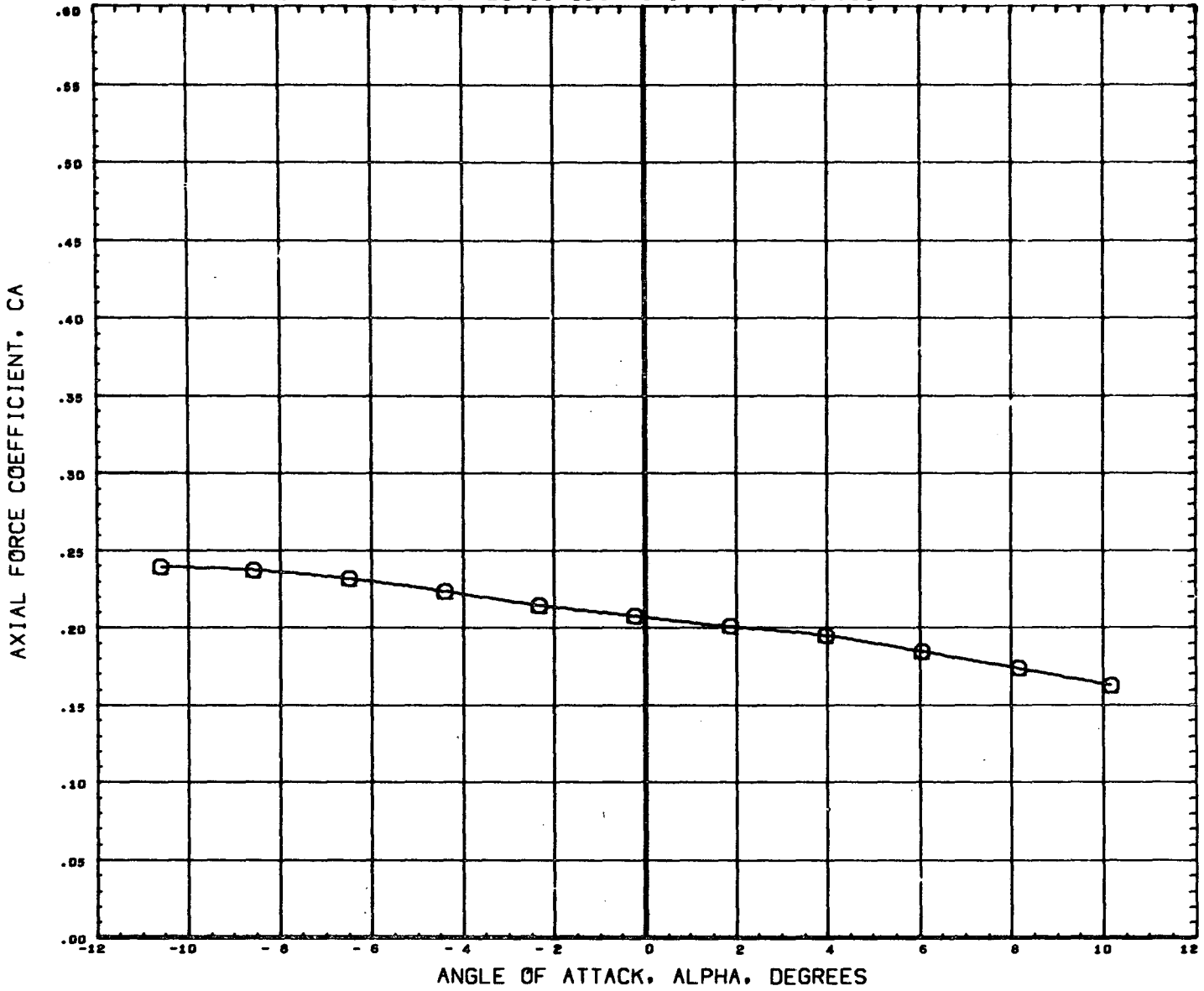

DATA SET SYMBOL CONFIGURATION DESCRIPTION
 (B65004) Q MSFC TWT 534 SHUTTLE LAUNCH T101S1
 (B65024) DATA NOT AVAILABLE FOR ALL CONDITIONS

ORBIN THETS BETA
 -1.500 21.000 0.000
 -1.500 21.000 0.000

REFERENCE INFORMATION
 SREF 4.8950 90. IN
 LREF 2.6440 IN.
 BREF 3.5250 IN.
 XMRP 3.4900 IN.
 YMRP 0.0000 IN.
 ZMRP 0.1616 IN.
 SCALE 0.0034

EFFECT OF TANK END FAIRING ON LONGITUDINAL CHARACTERISTICS

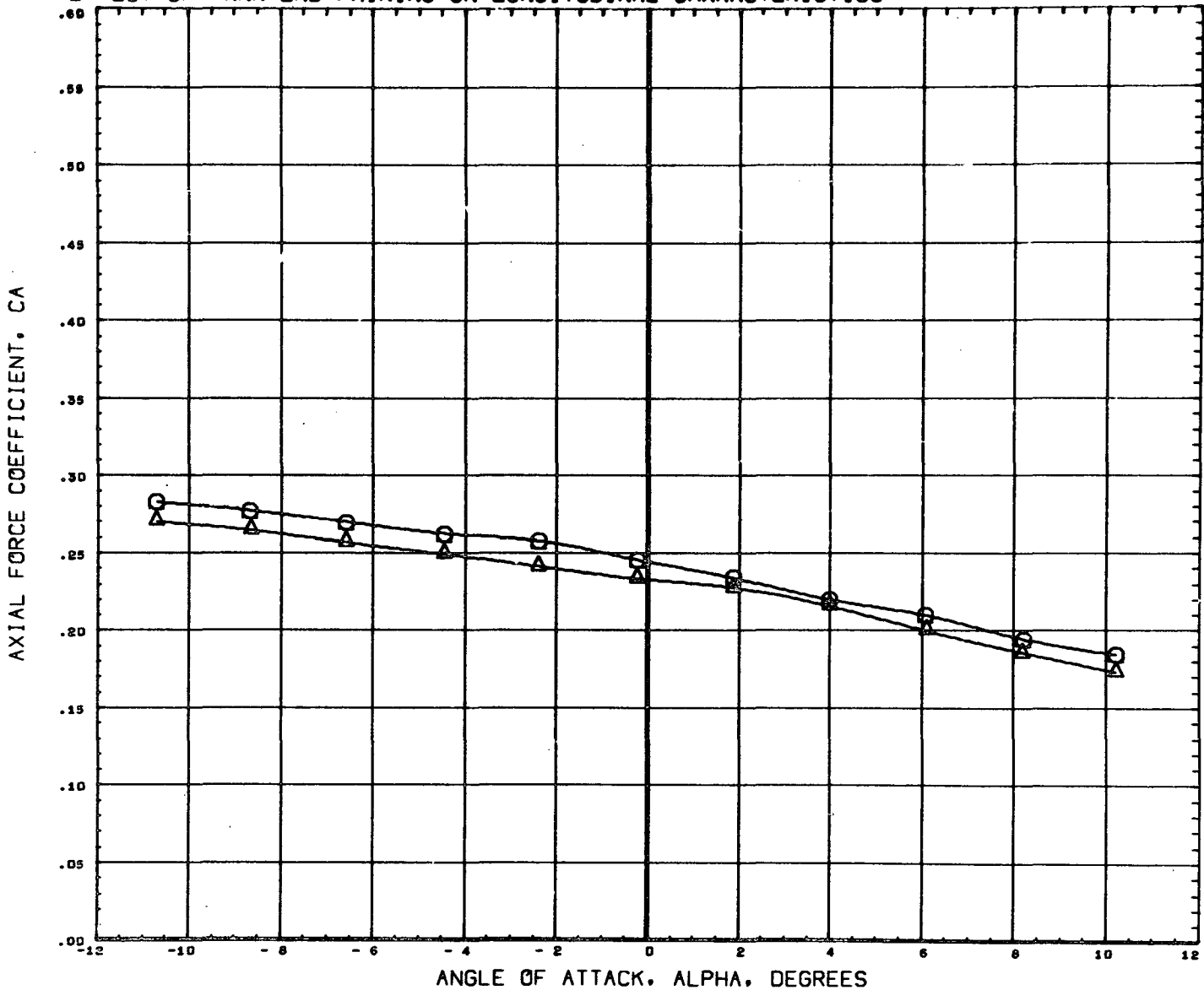

DATA SET SYMBOL	CONFIGURATION DESCRIPTION	ORBIN	THETS	BETA	REFERENCE INFORMATION	
(B65004)	MSFC TWT 534 SHUTTLE LAUNCH	T101S1	-1.500	21.00J	0.000	SREF 4.8950 Sq. IN
(B65024)	MSFC TWT 534 SHUTTLE LAUNCH	T301S1	-1.500	21.000	0.000	LREF 2.6440 IN.
						BREF 3.5250 IN.
						XMRP 3.4900 IN.
						YMRP 0.0000 IN.
						ZMRP 0.1616 IN.
						SCALE 0.0034

MACH .91

PAGE 435

9 ⊕

EFFECT OF TANK END FAIRING ON LONGITUDINAL CHARACTERISTICS

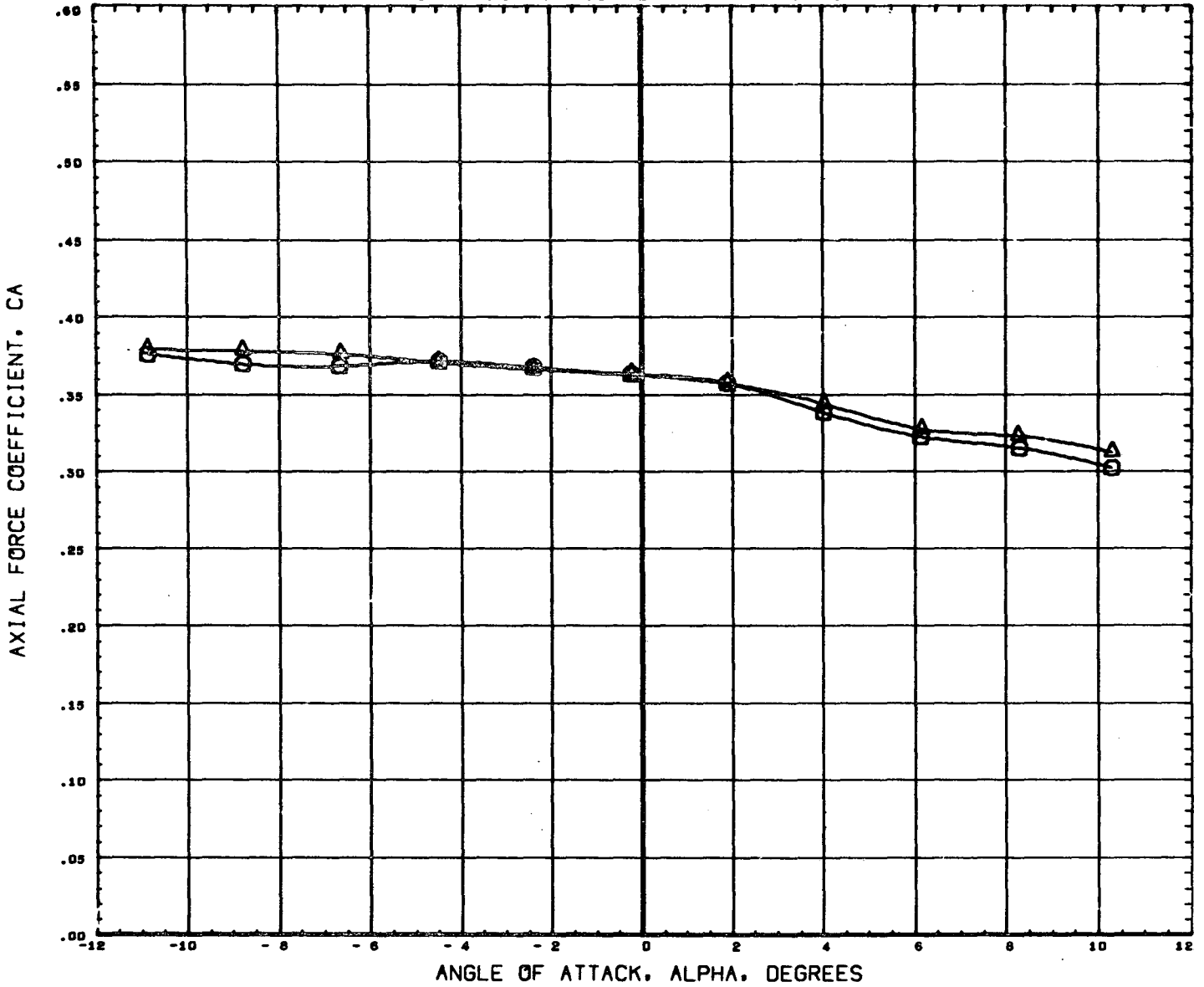

DATA SET SYMBOL	CONFIGURATION DESCRIPTION	ORBIN	THETS	BETA	REFERENCE INFORMATION	
(B65004)	MSFC TWT 534 SHUTTLE LAUNCH	T101S1	-1.500	21.060	0.000	SREF 4.8950 SQ. IN
(B65024)	MSFC TWT 534 SHUTTLE LAUNCH	T301S1	-1.500	21.000	0.000	LREF 2.6440 IN.
						BREF 3.5250 IN.
						XMRP 3.4900 IN.
						YMRP 0.0900 IN.
						ZMRP 0.1616 IN.
						SCALE 0.0034

MACH 1.10

PAGE 436

EFFECT OF TANK END FAIRING ON LONGITUDINAL CHARACTERISTICS

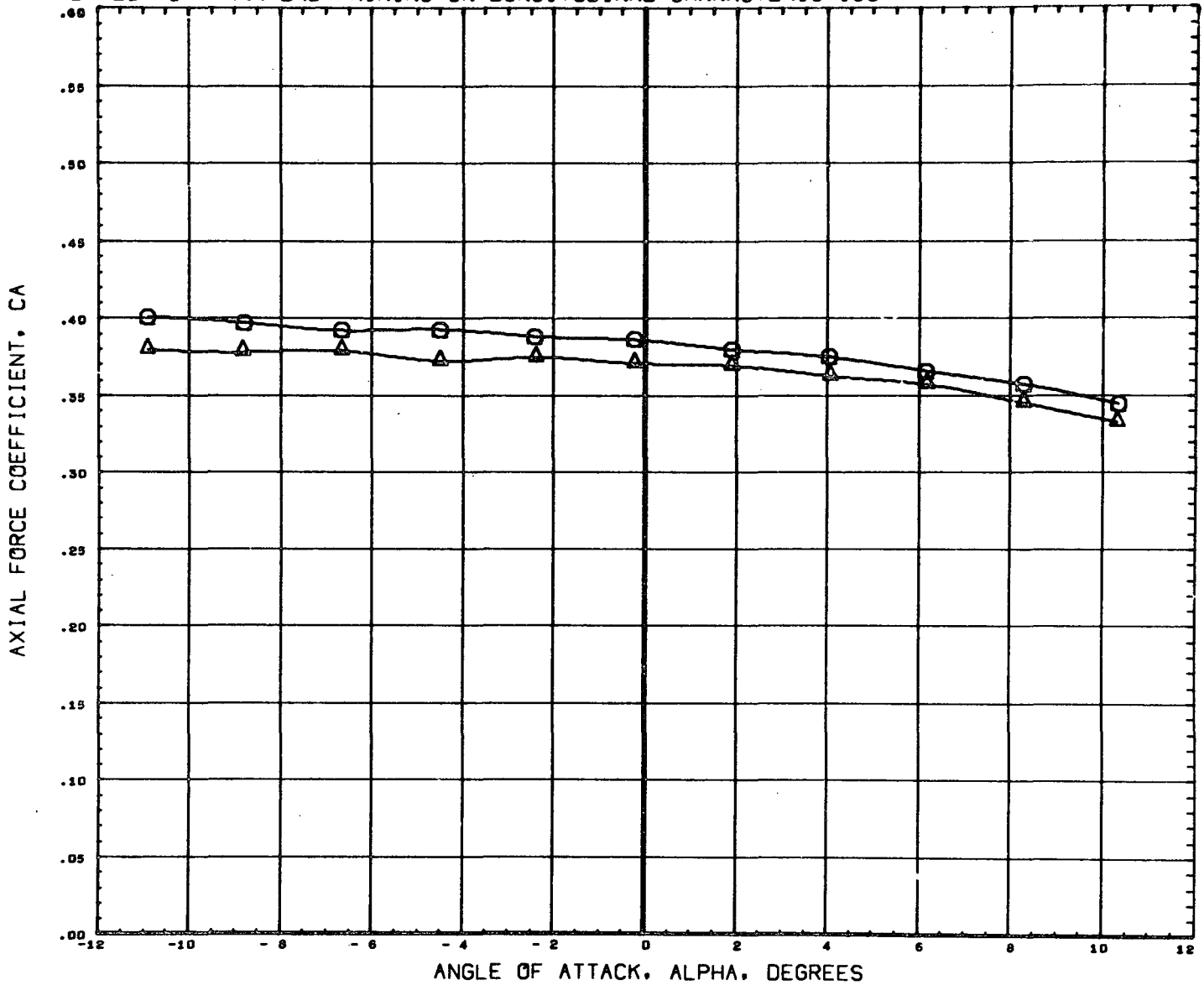

DATA SET SYMBOL	CONFIGURATION DESCRIPTION	ORBIN	THETS	BETA	REFERENCE INFORMATION	
(B65004)	MSFC TWT 534 SHUTTLE LAUNCH	T101S1	-1.500	21.000	0.000	SREF 4.8950 SQ. IN
(B65024)	MSFC TWT 534 SHUTTLE LAUNCH	T301S1	-1.500	21.000	0.000	LREF 2.6440 IN.
						BREF 3.5250 IN.
						XMRP 3.4900 IN.
						YMRP 0.0000 IN.
						ZMRP 0.1616 IN.
						SCALE 0.0034

MACH 1.20

EFFECT OF TANK END FAIRING ON LONGITUDINAL CHARACTERISTICS

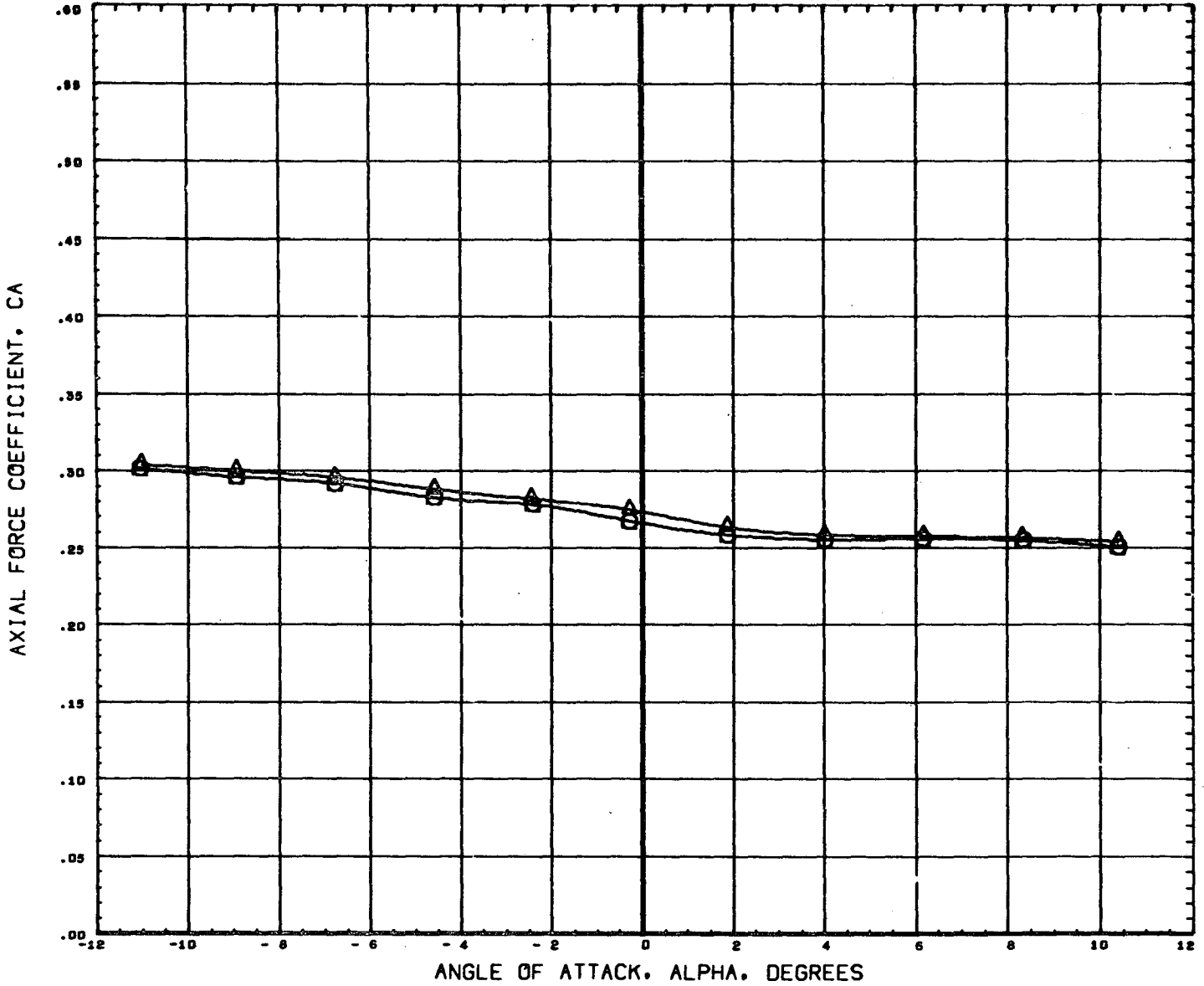

DATA SET SYMBOL	CONFIGURATION DESCRIPTION	ORBIN	THETS	BETA	REFERENCE INFORMATION	
(B65004)	NSFC TWT 534 SHUTTLE LAUNCH	T101S1	-1.500	21.000	0.000	SREF 4.8950 SQ. IN
(B65024)	NSFC TWT 534 SHUTTLE LAUNCH	T301S1	-1.500	21.000	0.000	LREF 2.6440 IN.
						BREF 3.5250 IN.
						XMRP 3.4900 IN.
						YMRP 0.0000 IN.
						ZMRP 0.1616 IN.
						SCALE 0.0034

MACH 1.97

PAGE 438

EFFECT OF TANK END FAIRING ON LONGITUDINAL CHARACTERISTICS

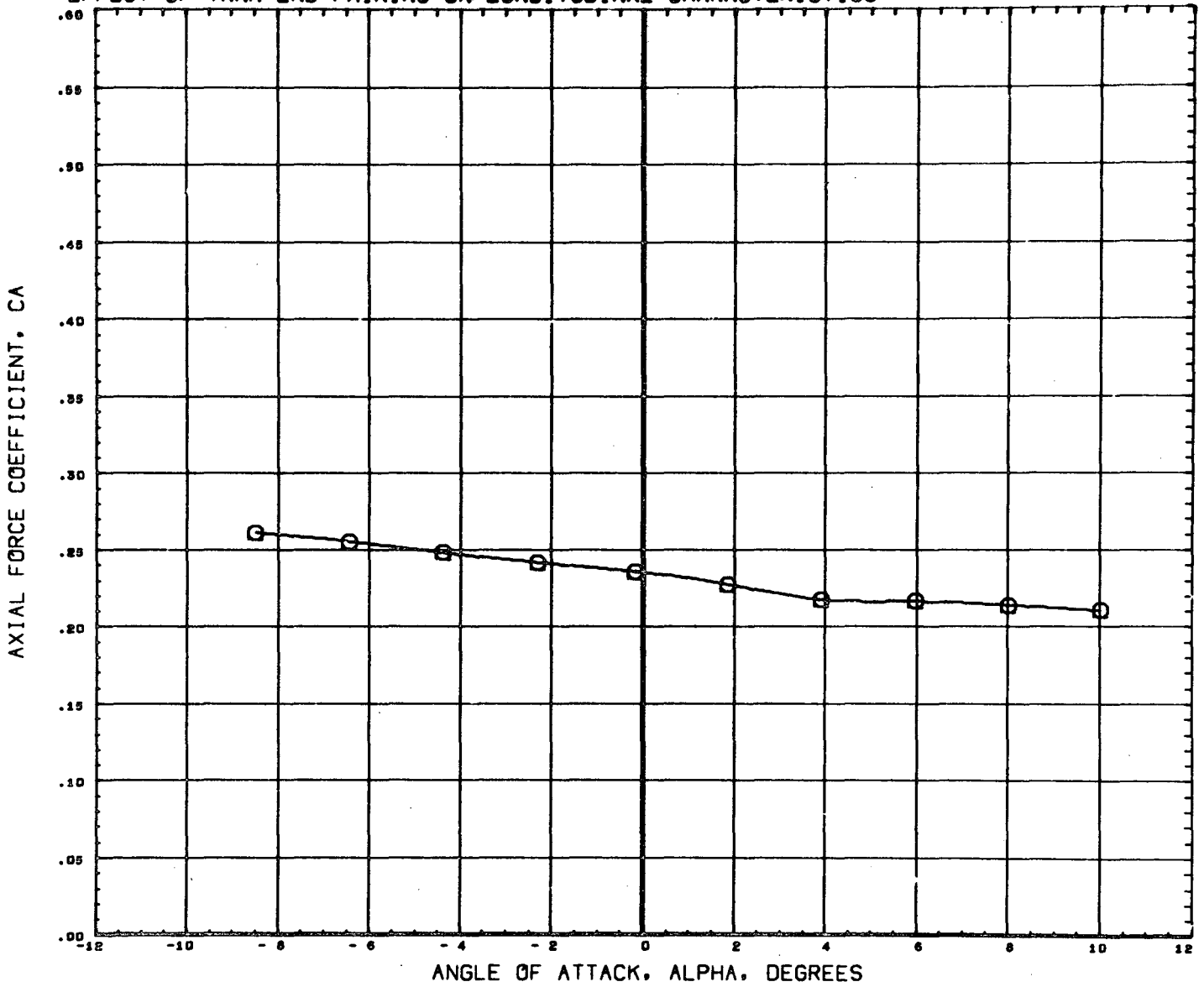

DATA SET SYMBOL CONFIGURATION DESCRIPTION
 (B69004) Ω MSFC TWT 534 SHUTTLE LAUNCH T101S1
 (B69024) Δ DATA NOT AVAILABLE FOR ALL CONDITIONS

ORBIN THETS BETA
 -1.500 21.000 0.000
 -1.500 21.000 0.000

REFERENCE INFORMATION
 SREF 4.8950 SQ. IN
 LREF 2.6440 IN.
 BREF 3.5250 IN.
 XMRP 3.4900 IN.
 YMRP 0.0000 IN.
 ZMRP 0.1616 IN.
 SCALE 0.0034

EFFECT OF TANK END FAIRING ON LONGITUDINAL CHARACTERISTICS

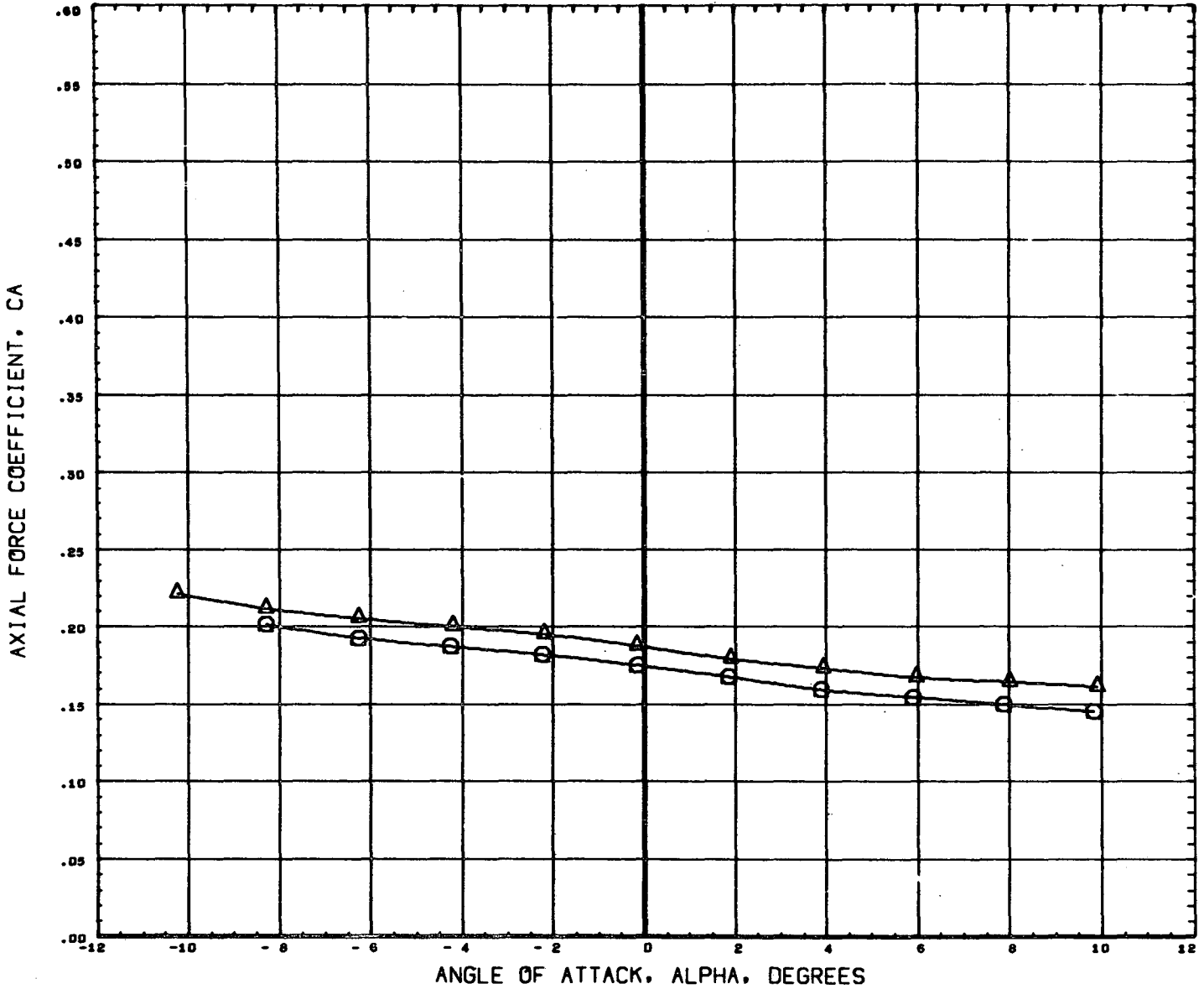

DATA SET SYMBOL	CONFIGURATION DESCRIPTION	ORBIN	THETS	BETA	REFERENCE INFORMATION	
(B65004)	NSFC TWT 534 SHUTTLE LAUNCH	T101S1	-1.500	21.000	0.000	SREF 4.8950 SQ. IN
(B65024)	NSFC TWT 534 SHUTTLE LAUNCH	T301S1	-1.500	21.000	0.000	LREF 2.6440 IN.
						BREF 3.5250 IN.
						XMRP 3.4900 IN.
						YMRP 0.0000 IN.
						ZMRP 0.1616 IN.
						SCALE 0.0034

EFFECT OF TANK END FAIRING ON LONGITUDINAL CHARACTERISTICS

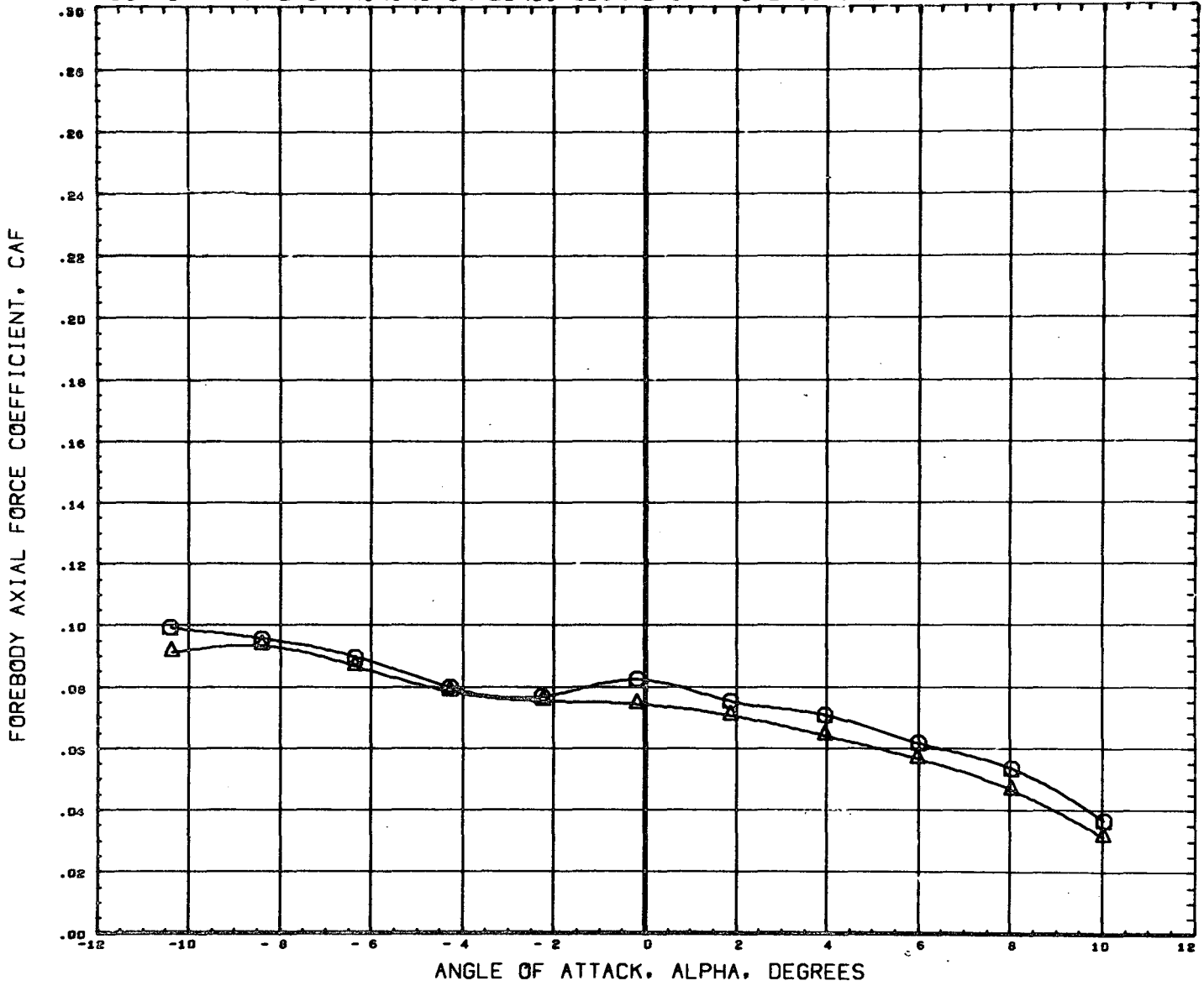

DATA SET SYMBOL	CONFIGURATION DESCRIPTION	ORBIN	THETS	BETA	REFERENCE INFORMATION	
(B65004)	MSFC TWT 534 SHUTTLE LAUNCH	T101S1	-1.500	21.000	0.000	SREF 4.8950 SQ. IN
(B65024)	MSFC TWT 534 SHUTTLE LAUNCH	T301S1	-1.500	21.000	0.000	LREF 2.6440 IN.
						BREF 3.5250 IN.
						XMRP 3.4900 IN.
						YMRP 0.0000 IN.
						ZMRP 0.1616 IN.
						SCALE 0.0034

MACH .60

EFFECT OF TANK END FAIRING ON LONGITUDINAL CHARACTERISTICS

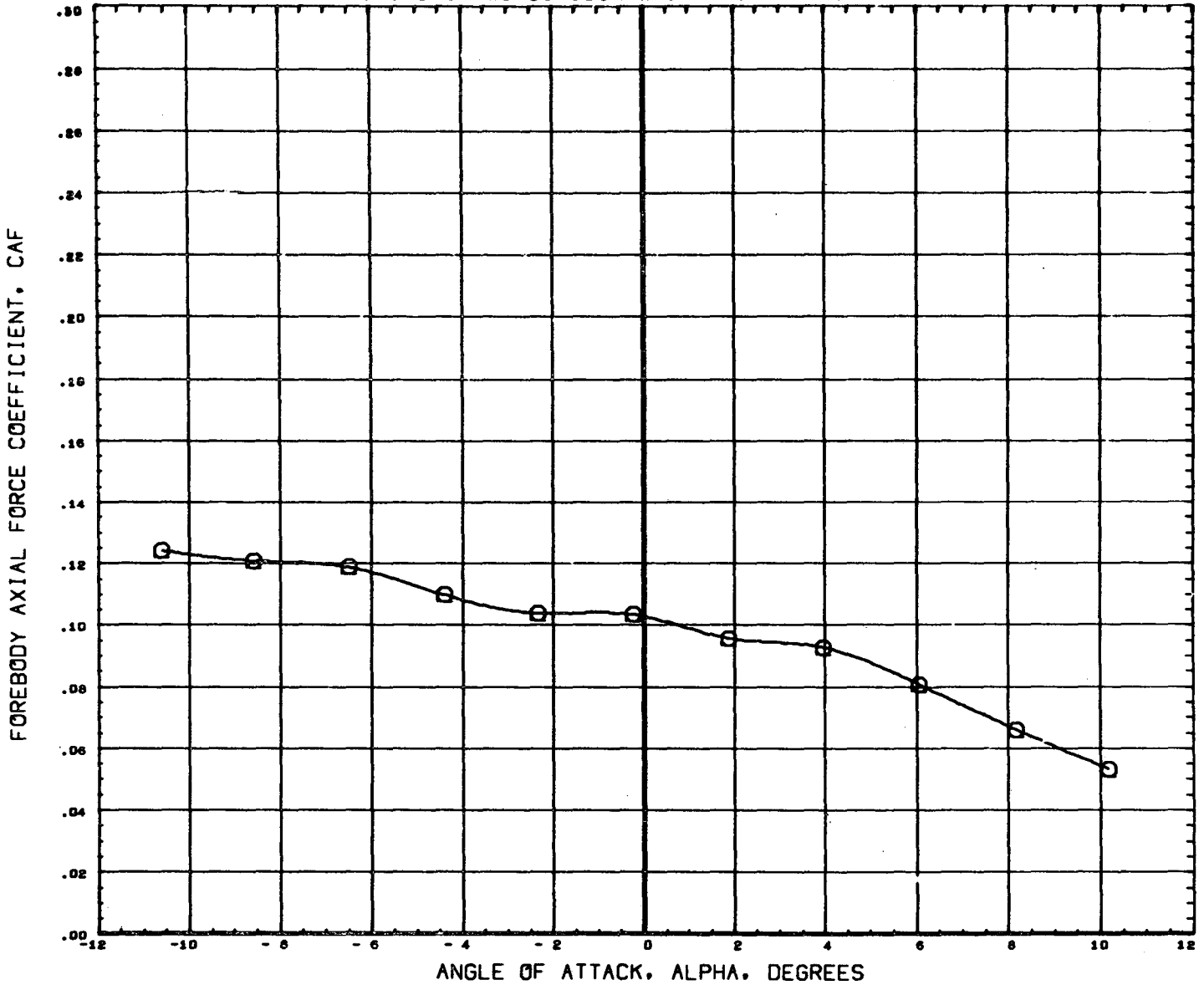

DATA SET SYMBOL CONFIGURATION DESCRIPTION
 (B65004) MSFC TWT 534 SHUTTLE LAUNCH T101S1
 (B65024) DATA NOT AVAILABLE FOR ALL CONDITIONS

ORBIN THETS BETA
 -1.500 21.000 0.000
 -1.500 21.000 0.000

REFERENCE INFORMATION
 SREF 4.8950 Sq. IN
 LREF 2.6440 IN.
 BREF 3.5250 IN.
 XMRP 3.4900 IN.
 YMRP 0.0000 IN.
 ZMRP 0.1616 IN.
 SCALE 0.0034

EFFECT OF TANK END FAIRING ON LONGITUDINAL CHARACTERISTICS

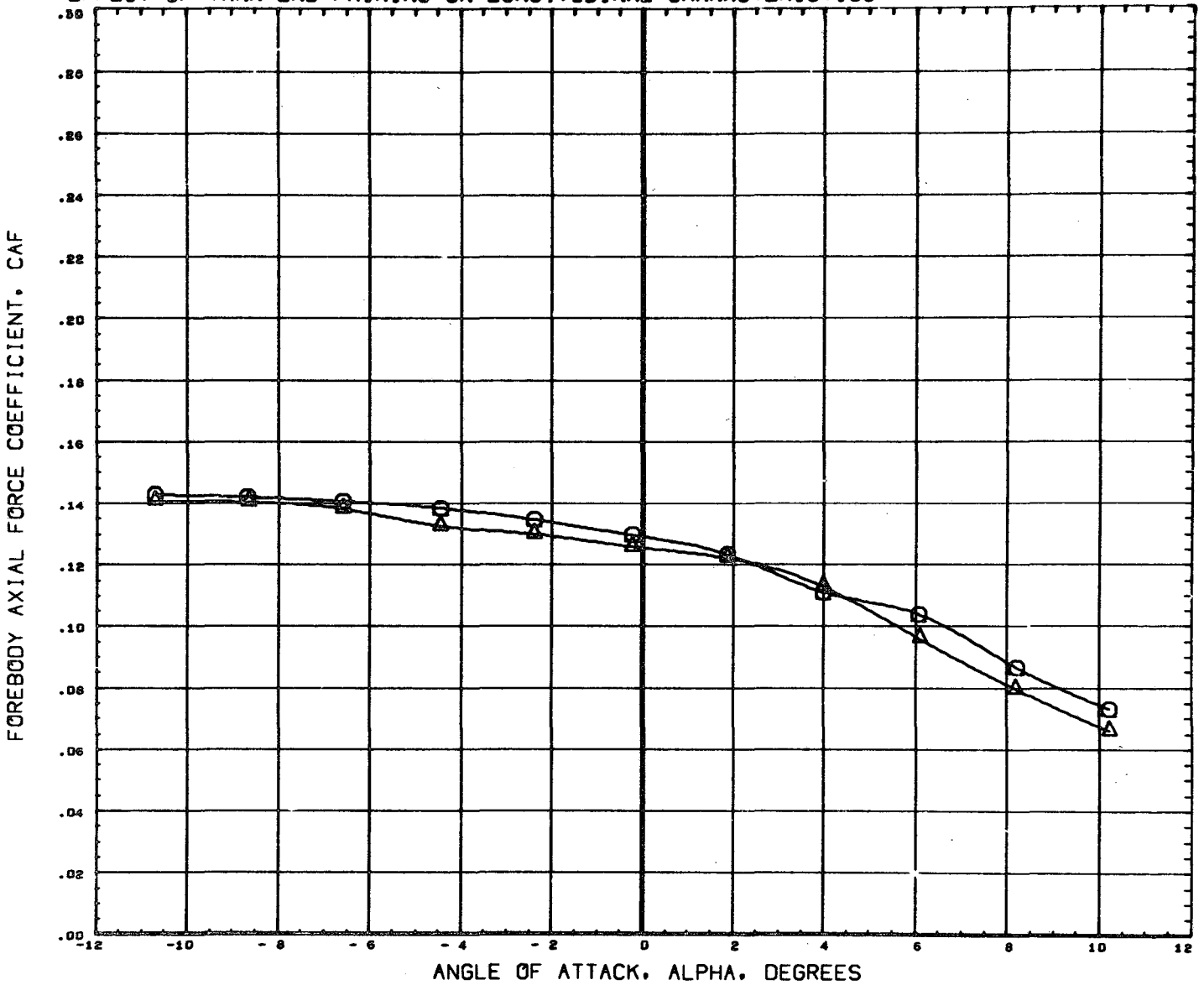

DATA SET SYMBOL	CONFIGURATION DESCRIPTION	ORBIN	THETS	BETA	REFERENCE INFORMATION
(B65004)	MSFC TWT 534 SHUTTLE LAUNCH	-1.500	21.000	0.000	SREF 4.8950 SQ. IN
(B65024)	MSFC TWT 534 SHUTTLE LAUNCH	-1.500	21.000	0.000	LREF 2.6440 IN.
					BREF 3.5250 IN.
					XMRP 3.4900 IN.
					YMRP 0.0000 IN.
					ZMRP 0.1616 IN.
					SCALE 0.0034

MACH .91

EFFECT OF TANK END FAIRING ON LONGITUDINAL CHARACTERISTICS

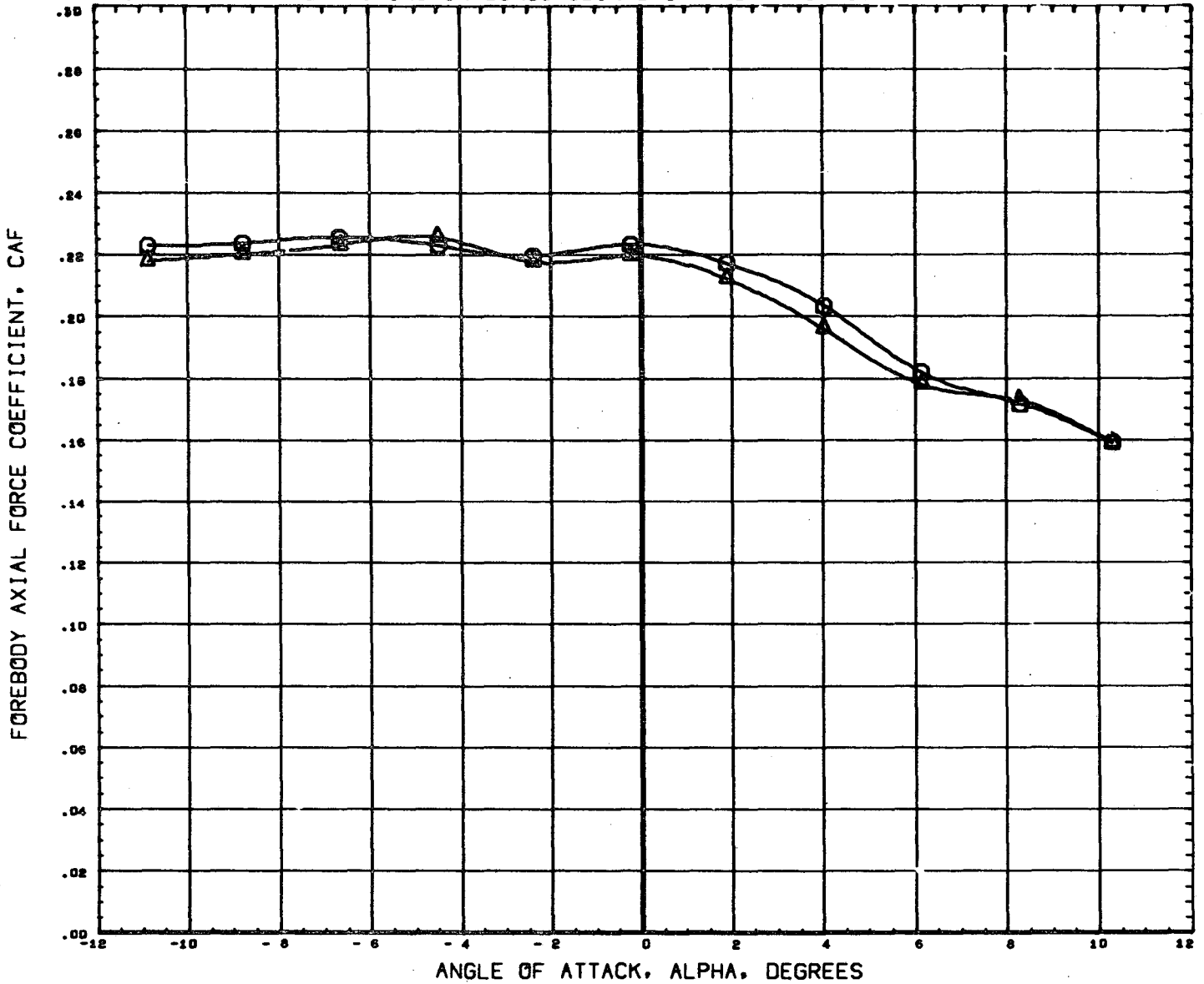

DATA SET SYMBOL	CONFIGURATION DESCRIPTION	ORBIN	THETS	BETA	REFERENCE INFORMATION	
(B65004)	MSFC TWT 534 SHUTTLE LAUNCH	T101S1	-1.500	21.000	0.000	SREF 4.8950 SQ. IN
(B65024)	MSFC TWT 534 SHUTTLE LAUNCH	T301S1	-1.500	21.000	0.000	LREF 2.6440 IN.
						BREF 3.5250 IN.
						XMRP 3.4900 IN.
						YMRP 0.0000 IN.
						ZMRP 0.1616 IN.
						SCALE 0.0034

EFFECT OF TANK END FAIRING ON LONGITUDINAL CHARACTERISTICS

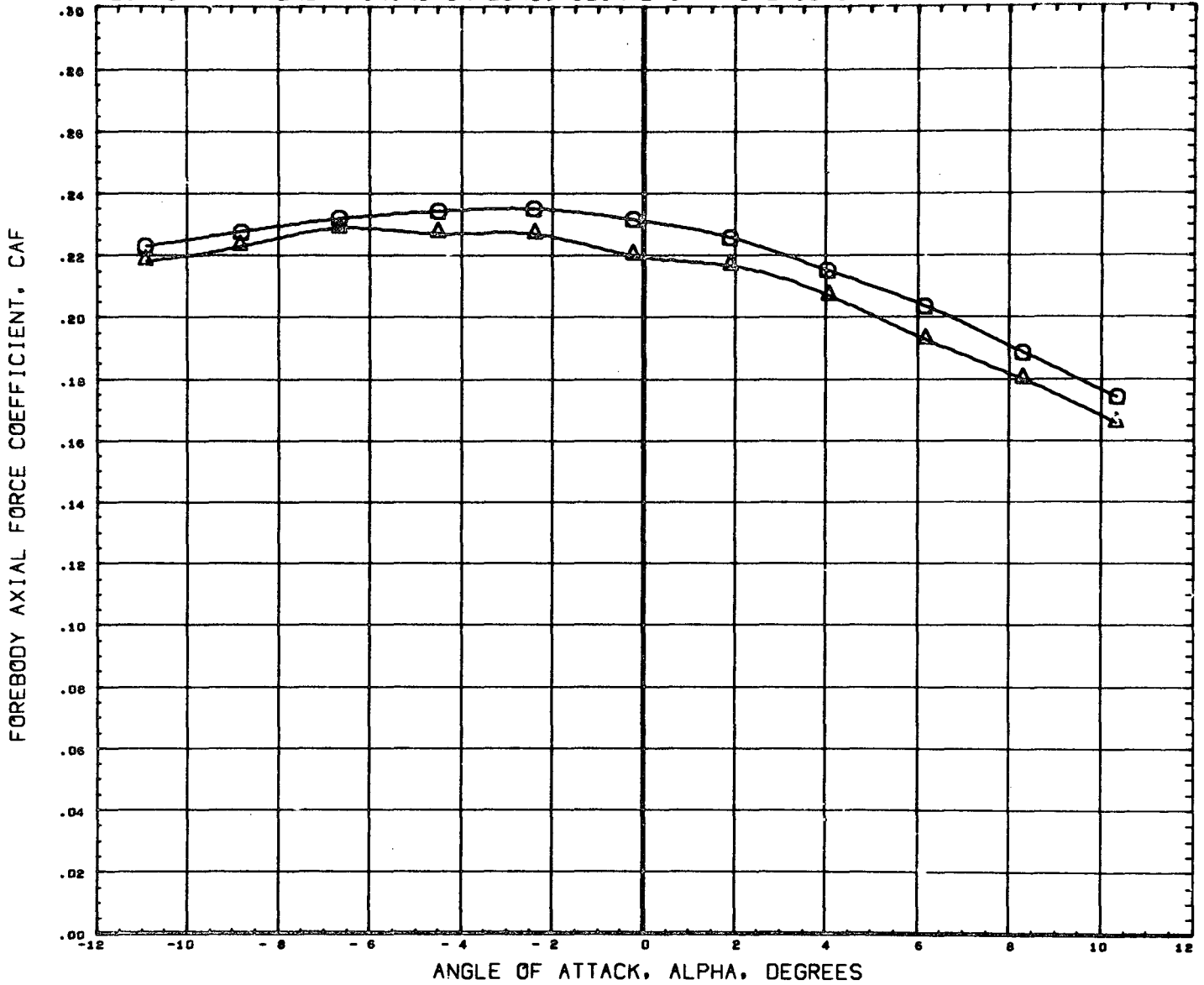

DATA SET SYMBOL CONFIGURATION DESCRIPTION
 (B65004) ○ MSFC TWT 534 SHUTTLE LAUNCH
 (B63024) △ MSFC TWT 534 SHUTTLE LAUNCH

ORBIN THETS BETA
 -1.500 21.000 0.000
 -1.500 21.000 0.000

REFERENCE INFORMATION
 SREF 4.8950 SQ. IN.
 LREF 2.6440 IN.
 BREF 3.5250 IN.
 XMRP 3.4900 IN.
 YMRP 0.0000 IN.
 ZMRP 0.1516 IN.
 SCALE 0.0034

MACH 1.20

PAGE 445

EFFECT OF TANK END FAIRING ON LONGITUDINAL CHARACTERISTICS

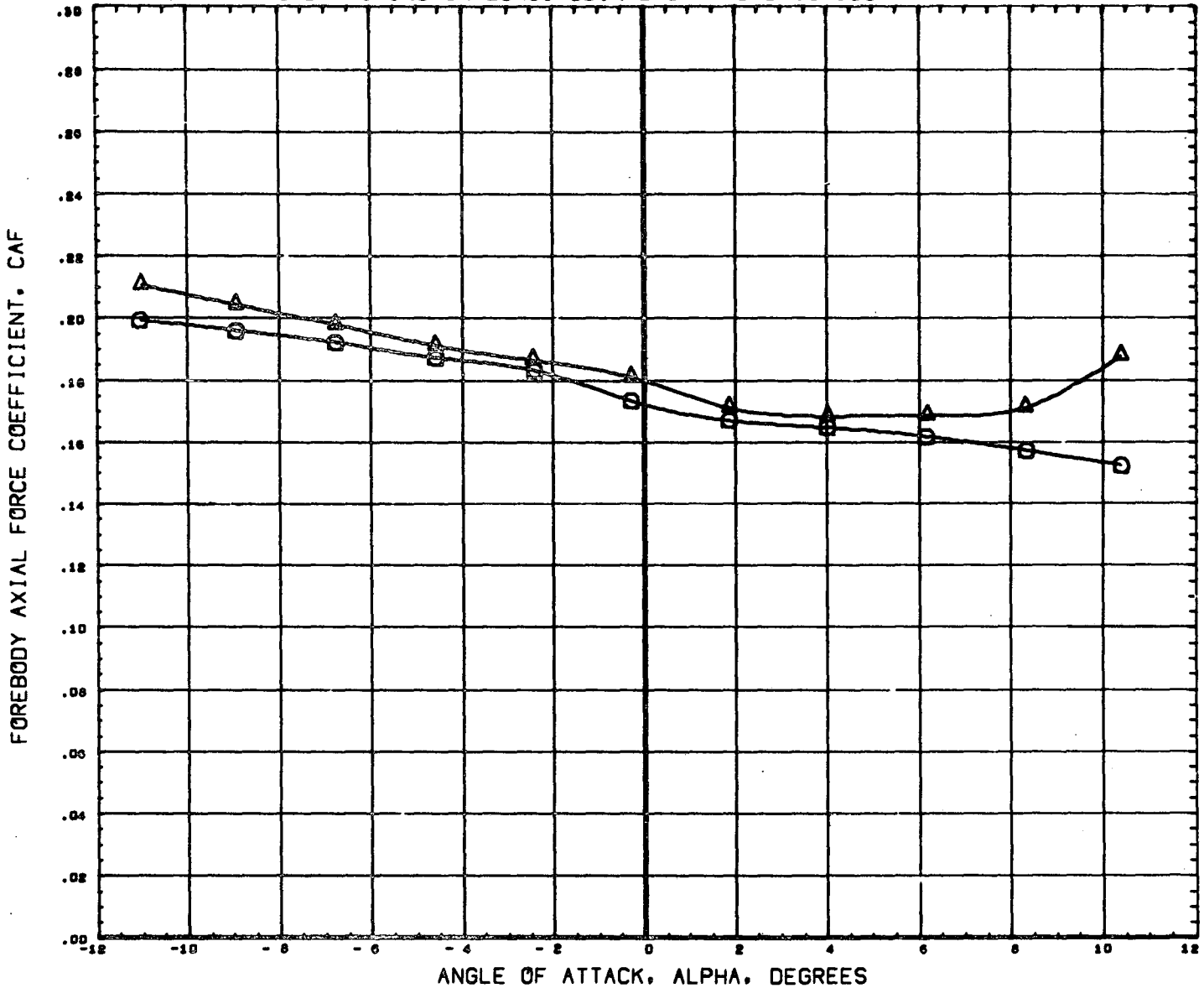

DATA SET SYMBOL	CONFIGURATION DESCRIPTION	ORBIT	THETS	BETA	REFERENCE INFORMATION	
(B65004) ○	MSFC TWT 534 SHUTTLE LAUNCH	T101S1	-1.500	21.000	0.000	SREF 4.8950 SQ. IN
(B65024) △	MSFC TWT 534 SHUTTLE LAUNCH	T301S1	-1.500	21.000	0.000	LREF 2.6440 IN.
						BREF 3.5250 IN.
						XMRP 3.4900 IN.
						YMRP 0.0000 IN.
						ZMRP 0.1616 IN.
						SCALE 0.0034

EFFECT OF TANK END FAIRING ON LONGITUDINAL CHARACTERISTICS

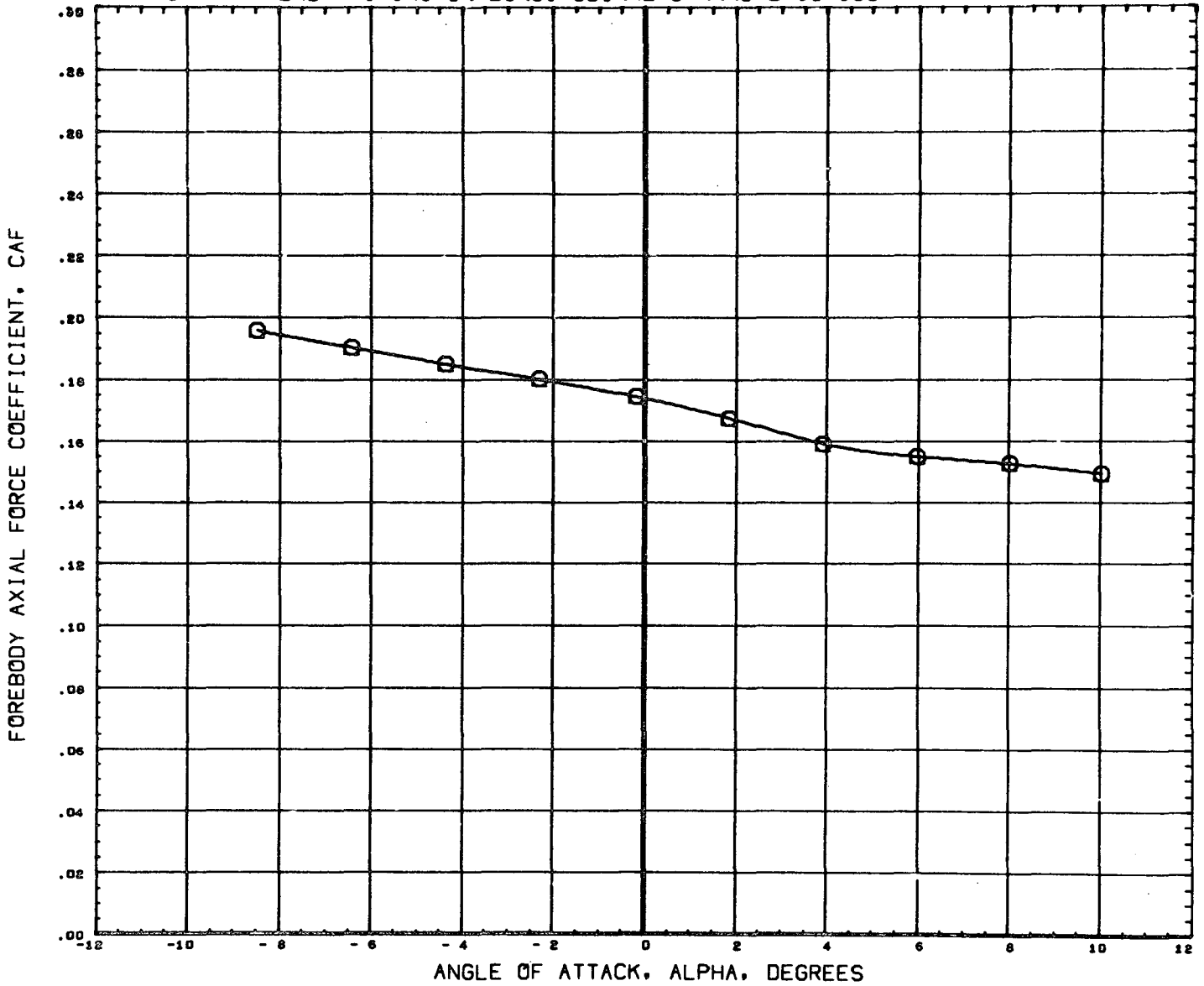

DATA SET SYMBOL CONFIGURATION DESCRIPTION
 (B65004) MSFC TWT 534 SHUTTLE LAUNCH T10191
 (B65024) DATA NOT AVAILABLE FOR ALL CONDITIONS

ORBIN THETS BETA
 -1.500 21.000 0.000
 -1.500 21.000 0.000

REFERENCE INFORMATION
 SREF 4.8950 SQ. IN.
 LREF 2.6440 IN.
 BREF 3.5250 IN.
 XMRP 3.4900 IN.
 YMRP 0.0000 IN.
 ZMRP 0.1616 IN.
 SCALE 0.0034

MACH 2.74

PAGE 447

EFFECT OF TANK END FAIRING ON LONGITUDINAL CHARACTERISTICS

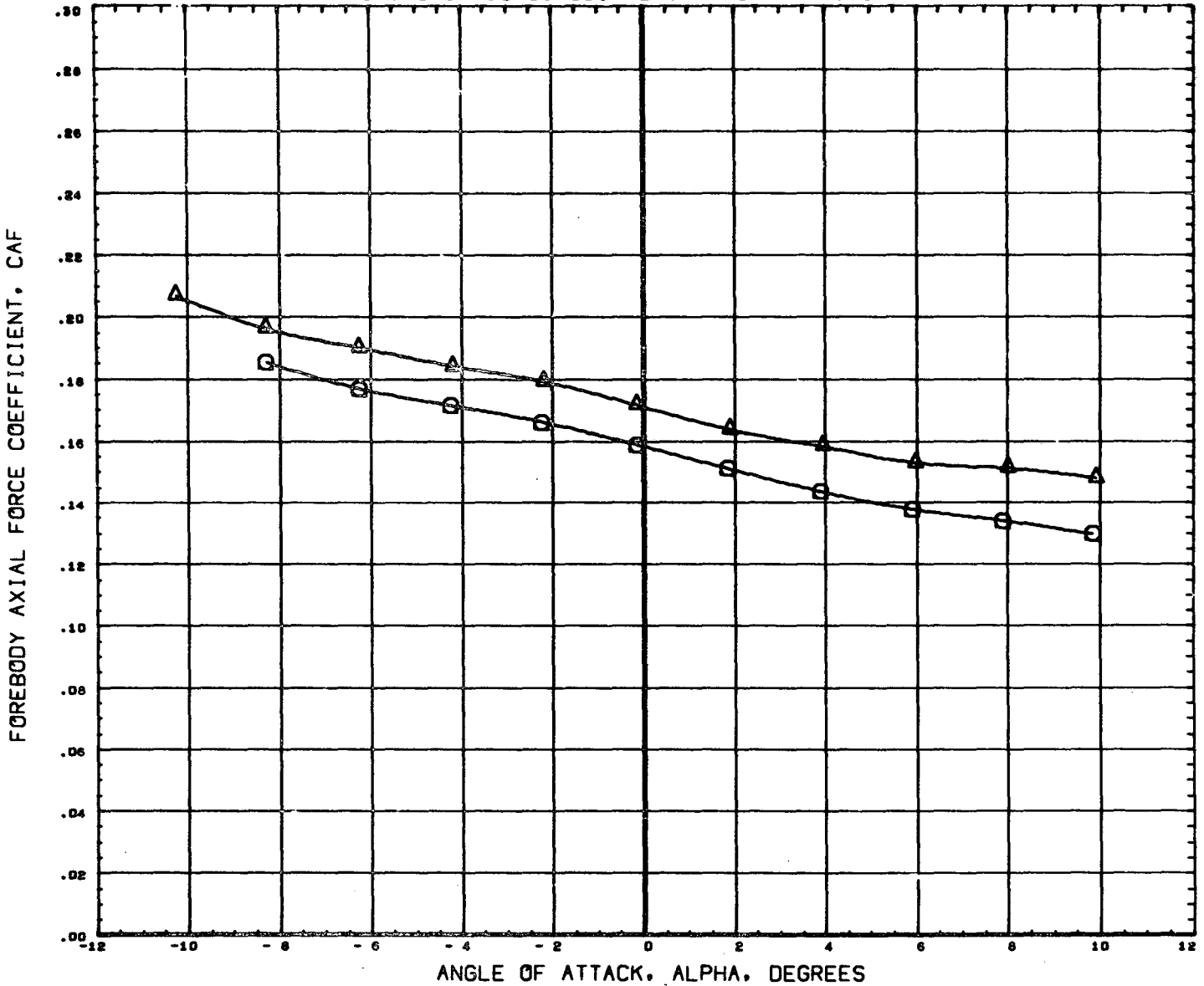

DATA SET SYMBOL	CONFIGURATION DESCRIPTION	ORBIN	THETS	BETA	REFERENCE INFORMATION	
(B65004)	NSFC TWT 534 SHUTTLE LAUNCH	T101S1	-1.500	21.000	0.000	SREF 4.8950 SQ. IN
(B65024)	NSFC TWT 534 SHUTTLE LAUNCH	T301S1	-1.500	21.000	0.000	LREF 2.6440 IN.
						BREF 3.5250 IN.
						XMRP 3.4900 IN.
						YMRP 0.0000 IN.
						ZMRP 0.1616 IN.
						SCALE 0.0034

MACH 4.96

EFFECT OF TANK END FAIRING ON LONGITUDINAL CHARACTERISTICS

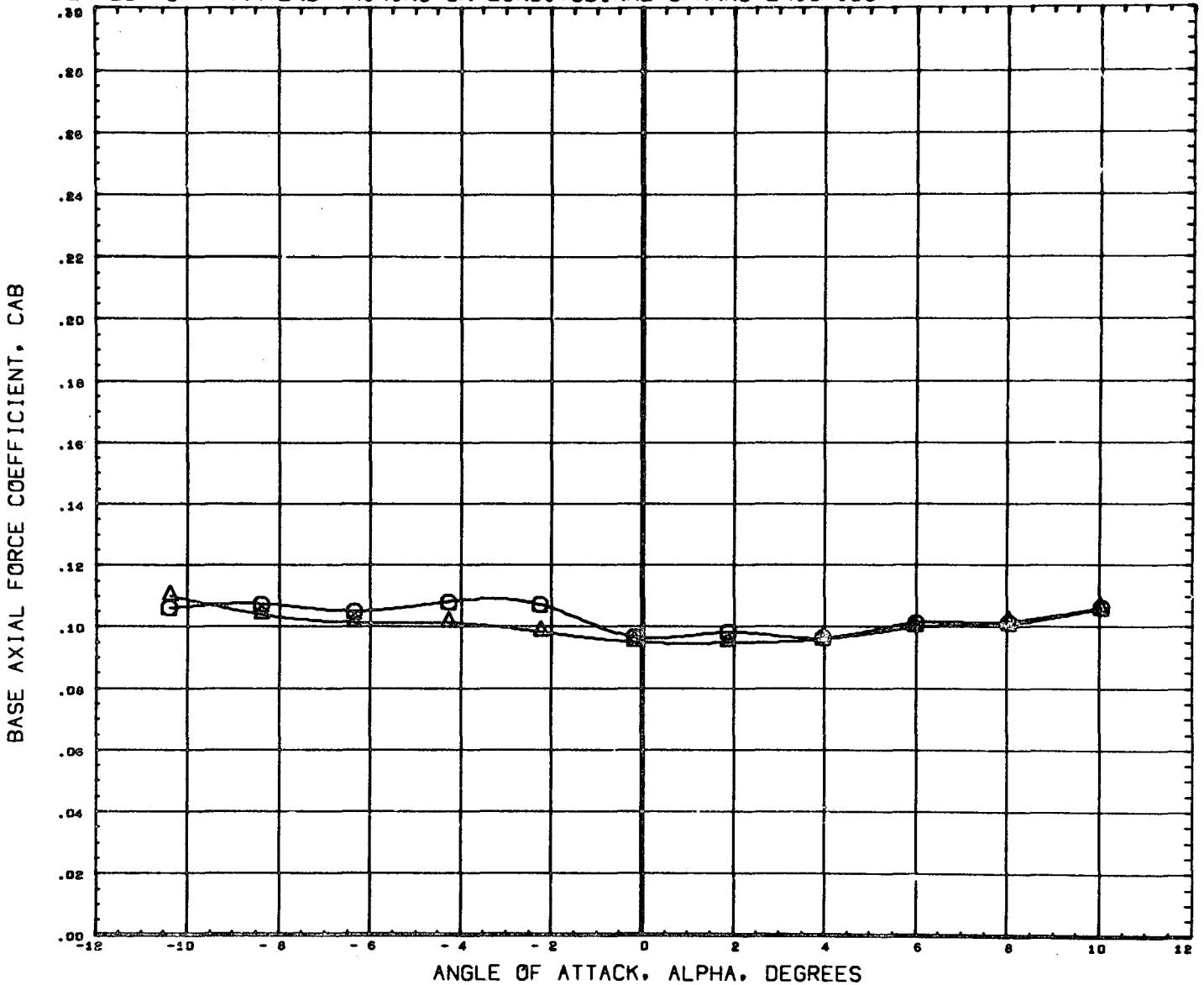

DATA SET SYMBOL	CONFIGURATION DESCRIPTION	ORBIN	THETS	BETA	REFERENCE INFORMATION	
(B65004)	MSFC TWT 534 SHUTTLE LAUNCH	T101S1	-1.500	21.000	0.000	SREF 4.8950 sq. IN
(B65024)	MSFC TWT 534 SHUTTLE LAUNCH	T301S1	-1.500	21.000	0.000	LREF 2.6440 IN.
						BREF 3.5250 IN.
						XMRP 3.4900 IN.
						YMRP 0.0000 IN.
						ZMRP 0.1616 IN.
						SCALE 0.0034

MACH .60

EFFECT OF TANK END FAIRING ON LONGITUDINAL CHARACTERISTICS

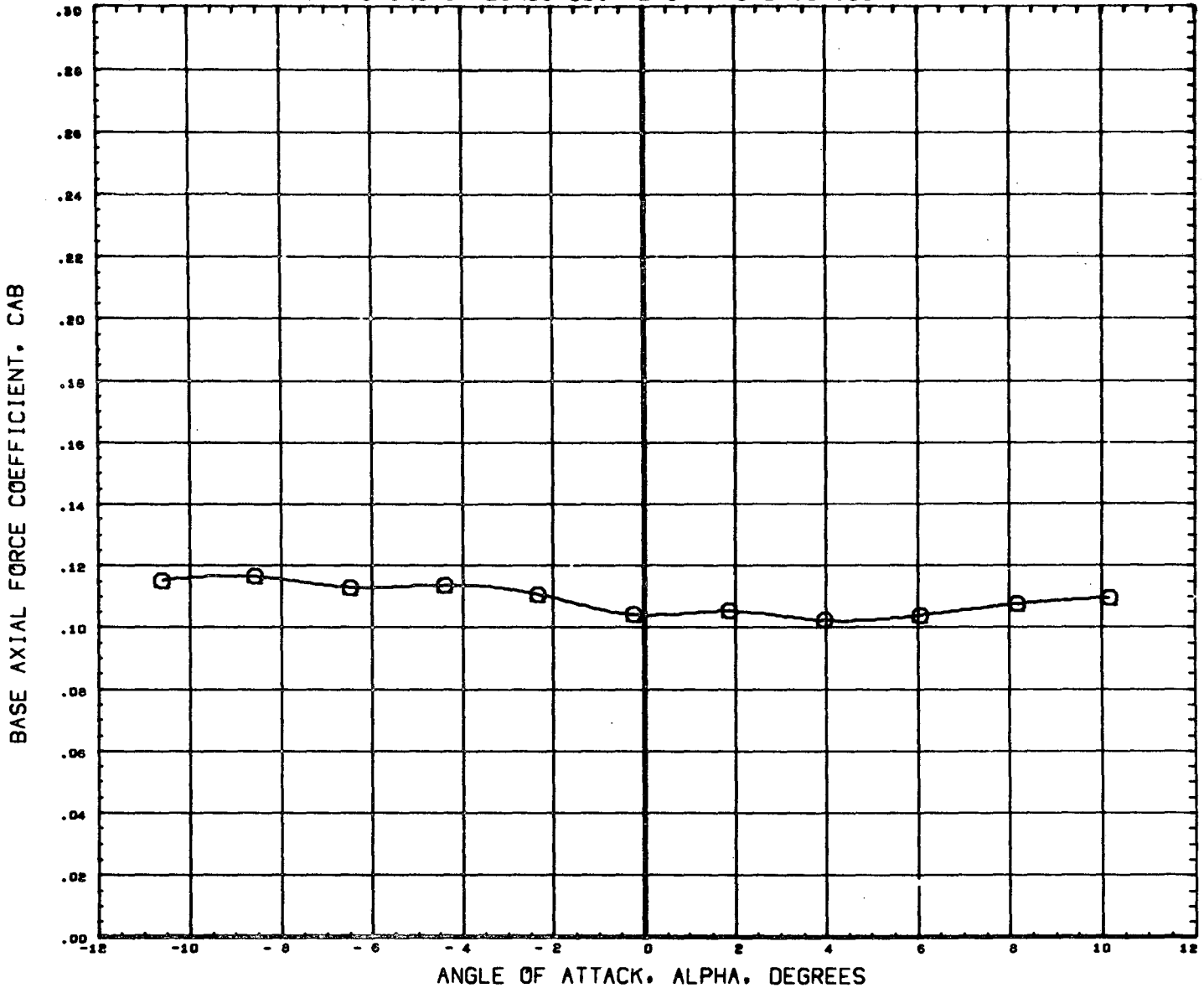

DATA SET SYMBOL (B65004) (B65024)  CONFIGURATION DESCRIPTION MSFC TWT 534 SHUTTLE LAUNCH T101S1 DATA NOT AVAILABLE FOR ALL CONDITIONS

ORBIN	THETS	BETA
-1.500	21.000	0.000
-1.500	21.000	0.000

REFERENCE INFORMATION		
SREF	4.8950	Sq. IN
LREF	2.6440	IN.
BREF	3.5250	IN.
XMRP	3.4900	IN.
YMRP	0.0000	IN.
ZMRP	0.1616	IN.
SCALE	0.0034	

MACH .80

PAGE 450

EFFECT OF TANK END FAIRING ON LONGITUDINAL CHARACTERISTICS

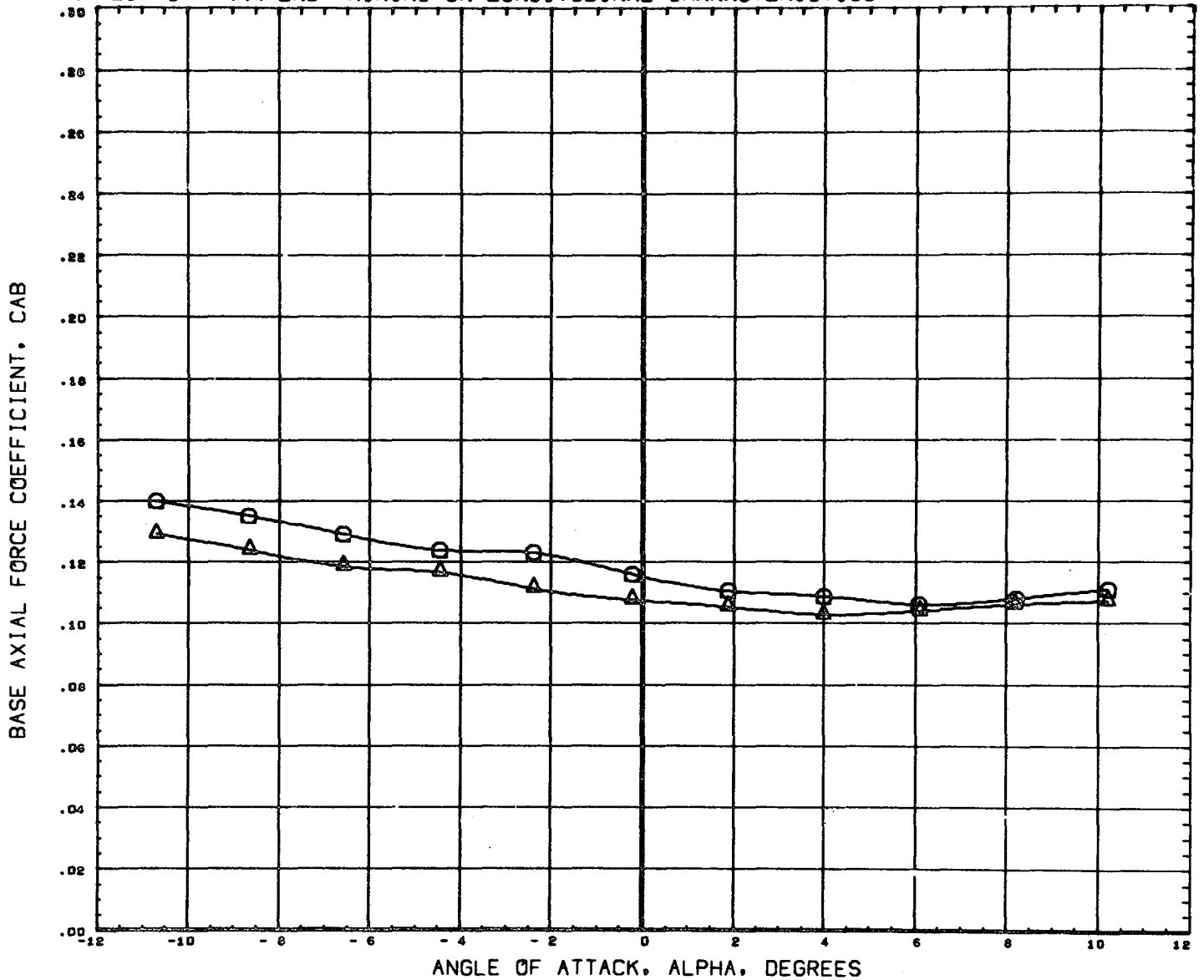

DATA SET SYMBOL	CONFIGURATION DESCRIPTION	ORBIN	THETS	BETA	REFERENCE INFORMATION	
(865004)	MSFC TWT 534 SHUTTLE LAUNCH	T101S1	-1.500	21.000	0.000	SREF 4.8950 SQ. IN
(865024)	MSFC TWT 534 SHUTTLE LAUNCH	T301S1	-1.500	21.000	0.000	LREF 2.6440 IN.
						BREF 3.5250 IN.
						XMRP 3.4900 IN.
						YMRP 0.0000 IN.
						ZMRP 0.1616 IN.
						SCALE 0.0034

MACH .91

EFFECT OF TANK END FAIRING ON LONGITUDINAL CHARACTERISTICS

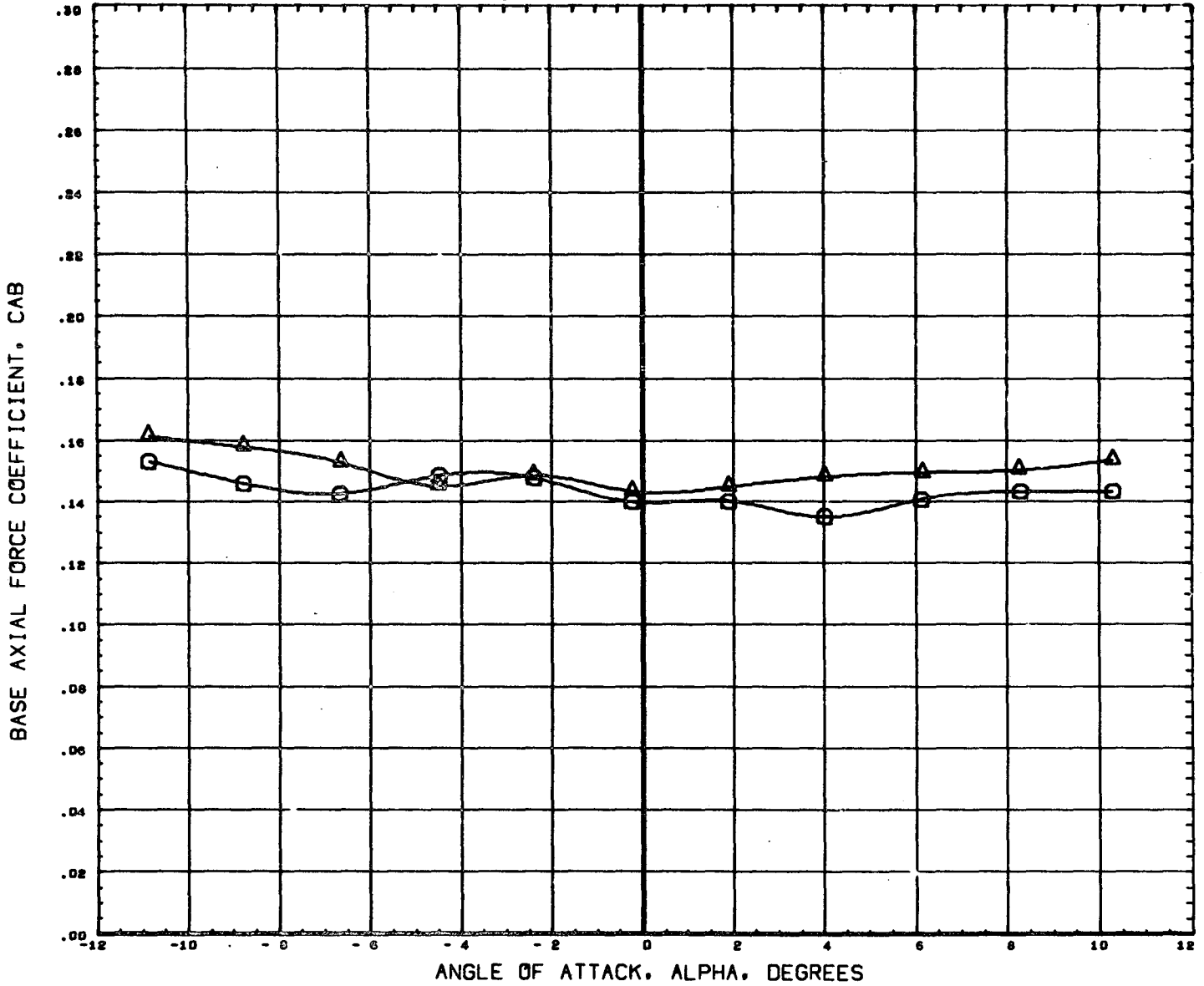

DATA SET SYMBOL	CONFIGURATION DESCRIPTION	ORBIN	THETS	BETA	REFERENCE INFORMATION	
(B65004)	MSFC TWT 534 SHUTTLE LAUNCH	T101S1	-1.500	21.000	0.000	SREF 4.8950 sq. IN
(B65024)	MSFC TWT 534 SHUTTLE LAUNCH	T301S1	-1.500	21.000	0.000	LREF 2.6440 IN.
						BREF 3.5250 IN.
						XMRP 3.4900 IN.
						YMRP 0.0000 IN.
						ZMRP 0.1616 IN.
						SCALE 0.0034

MACH 1.10

EFFECT OF TANK END FAIRING ON LONGITUDINAL CHARACTERISTICS

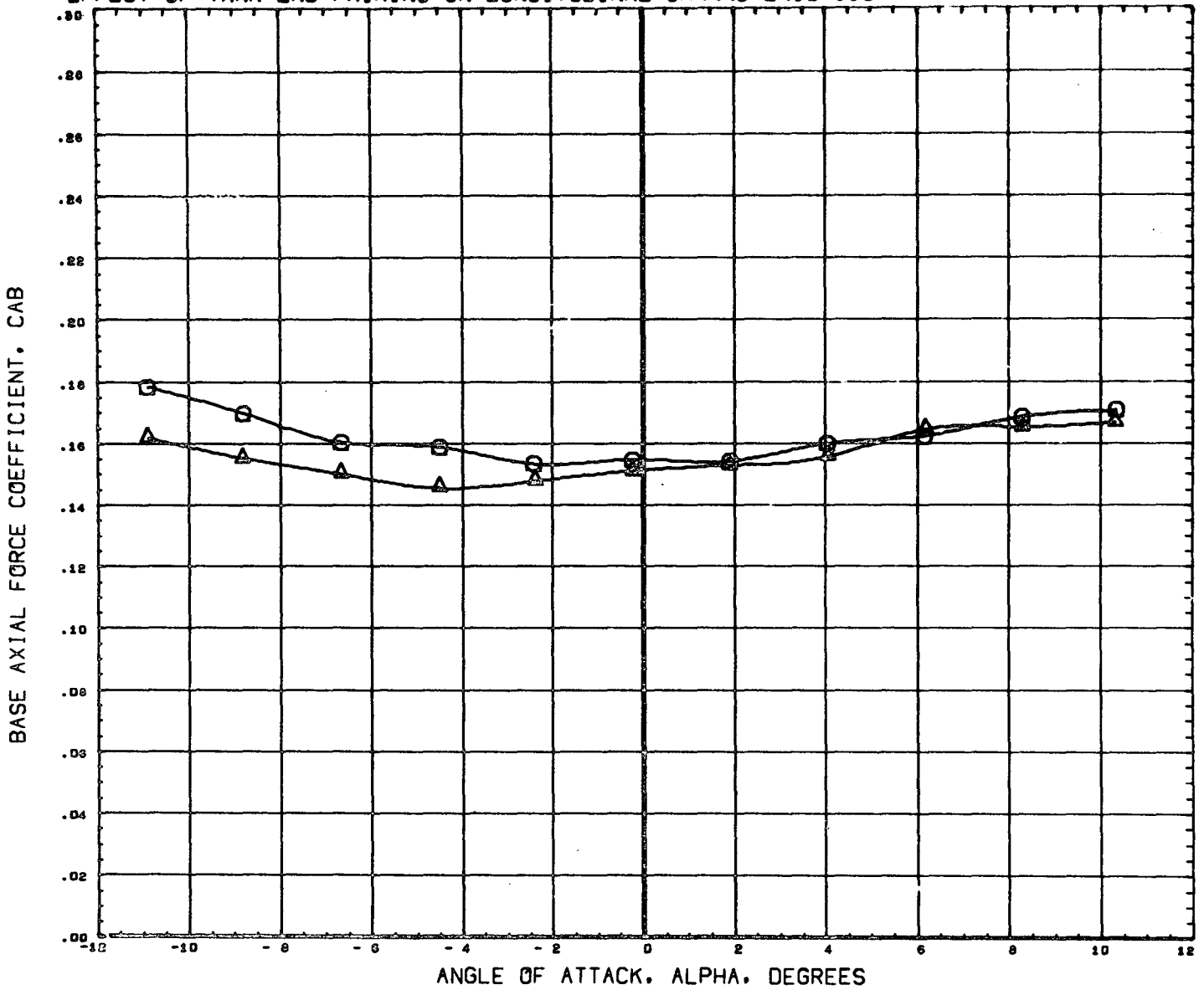

DATA SET SYMBOL	CONFIGURATION DESCRIPTION	ORBIN	THETS	BETA	REFERENCE INFORMATION	
(B65004)	MSFC TWT 534 SHUTTLE LAUNCH	T101S1	-1.500	21.000	0.000	SREF 4.8950 SQ. IN
(B65024)	MSFC TWT 534 SHUTTLE LAUNCH	T301S1	-1.500	21.000	0.000	LREF 2.6440 IN.
						BREF 3.5250 IN.
						XMRP 3.4900 IN.
						YMRP 0.0000 IN.
						ZMRP 0.1616 IN.
						SCALE 0.0034

MACH 1.20

EFFECT OF TANK END FAIRING ON LONGITUDINAL CHARACTERISTICS

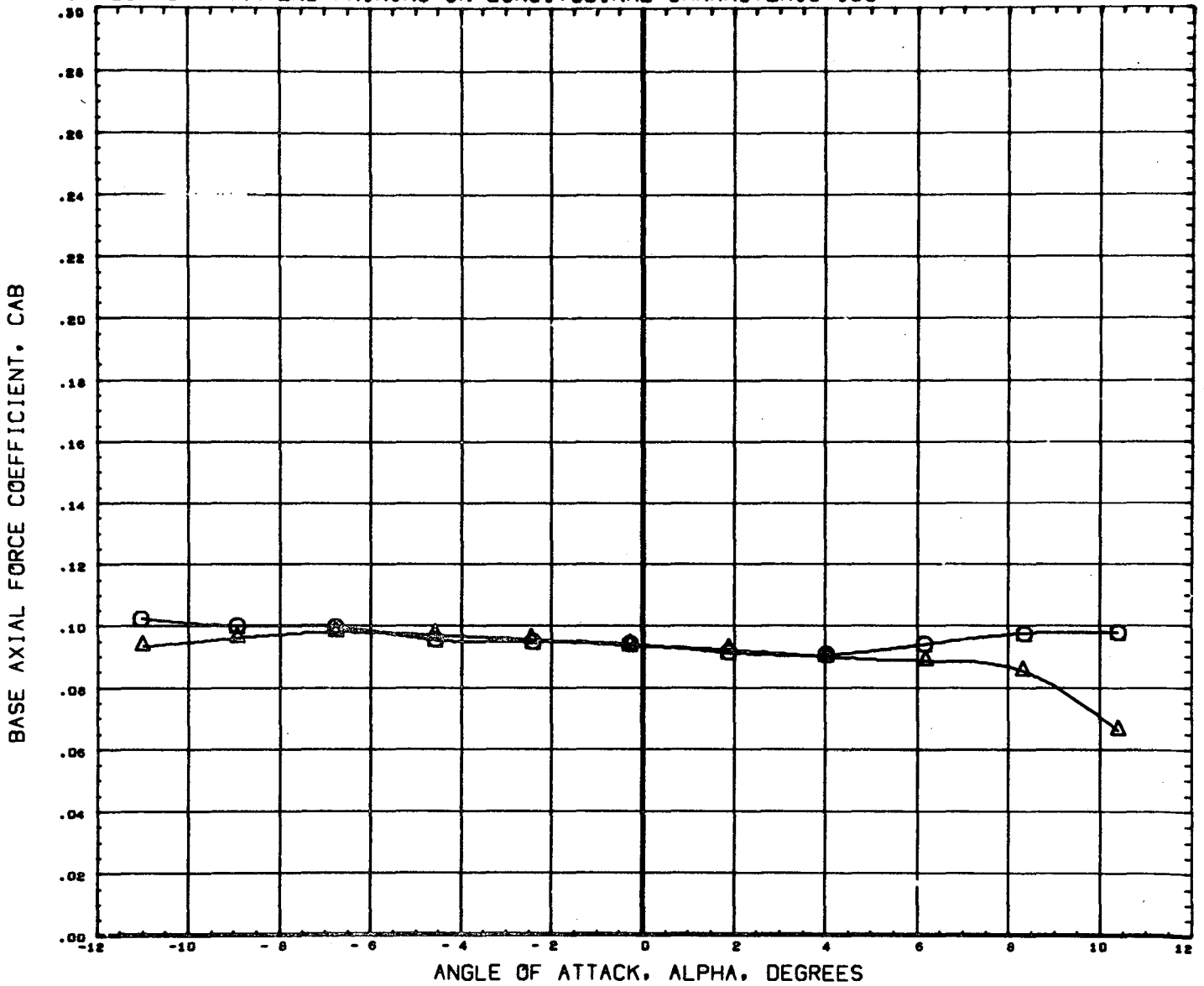

DATA SET SYMBOL	CONFIGURATION DESCRIPTION	T101S1	ORBIN	THETS	BETA	REFERENCE INFORMATION
(B65004)	NSFC TWT 534 SHUTTLE LAUNCH	T101S1	-1.500	21.000	0.000	SREF 4.8950 SQ. IN
(B65024)	NSFC TWT 534 SHUTTLE LAUNCH	T301S1	-1.500	21.000	0.000	LREF 2.6440 IN.
						BREF 3.5250 IN.
						XMRP 3.4900 IN.
						YMRP 0.0000 IN.
						ZMRP 0.1616 IN.
						SCALE 0.0034

EFFECT OF TANK END FAIRING ON LONGITUDINAL CHARACTERISTICS

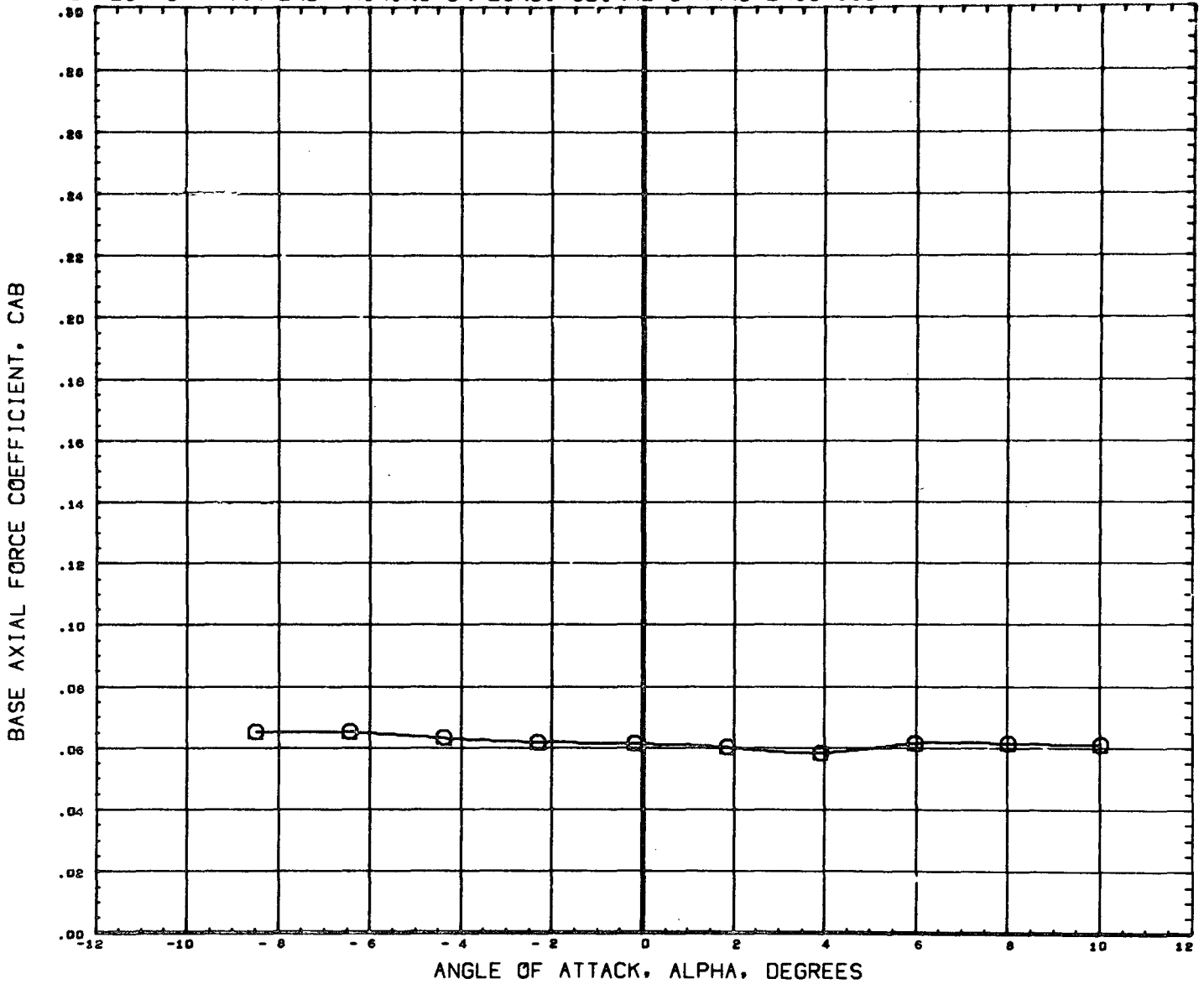

DATA SET SYMBOL CONFIGURATION DESCRIPTION
 (B65004)  MSFC TWT 534 SHUTTLE LAUNCH T101S1
 (B65024)  DATA NOT AVAILABLE FOR ALL CONDITIONS

ORBIN THETS BETA
 -1.500 21.000 0.000
 -1.500 21.000 0.000

REFERENCE INFORMATION
 SREF 4.8950 SQ. IN
 LREF 2.6440 IN.
 BREF 3.5250 IN.
 XMNP 3.4900 IN.
 YMRP 0.0000 IN.
 ZMRP 0.1616 IN.
 SCALE 0.0034

EFFECT OF TANK END FAIRING ON LONGITUDINAL CHARACTERISTICS

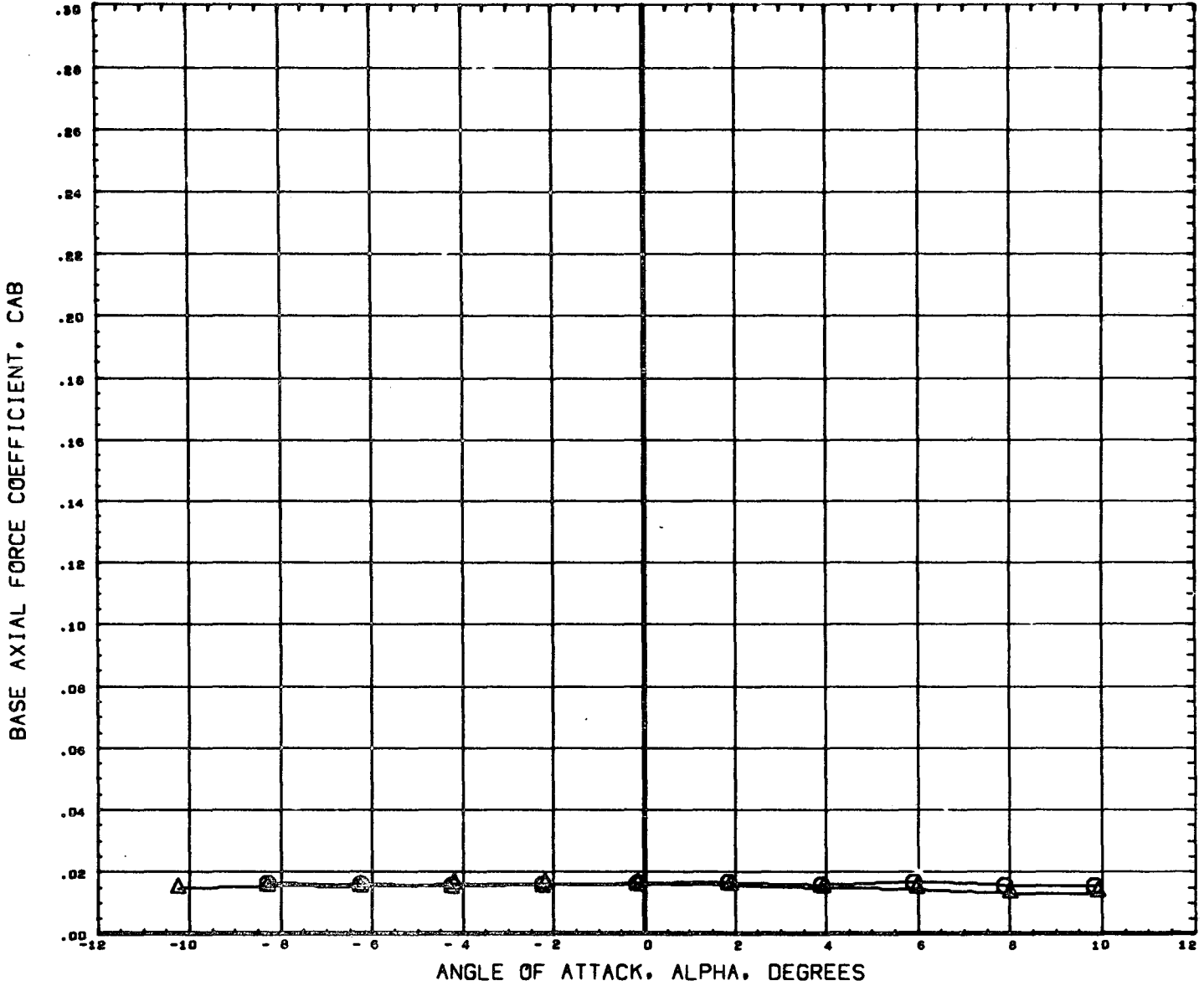

DATA SET SYMBOL	CONFIGURATION DESCRIPTION	ORBIN	THETS	BETA	REFERENCE INFORMATION	
(865004)	MSFC TWT 534 SHUTTLE LAUNCH	T1O1S1	-1.500	21.000	0.000	SREF 4.8950 SQ. IN
(865024)	MSFC TWT 534 SHUTTLE LAUNCH	T3O1S1	-1.500	21.000	0.000	LREF 2.6440 IN.
						BREF 3.5250 IN.
						XMRP 3.4900 IN.
						YMRP 0.0000 IN.
						ZMRP 0.1616 IN.
						SCALE 0.0034

EFFECT OF TANK END FAIRING ON LONGITUDINAL CHARACTERISTICS

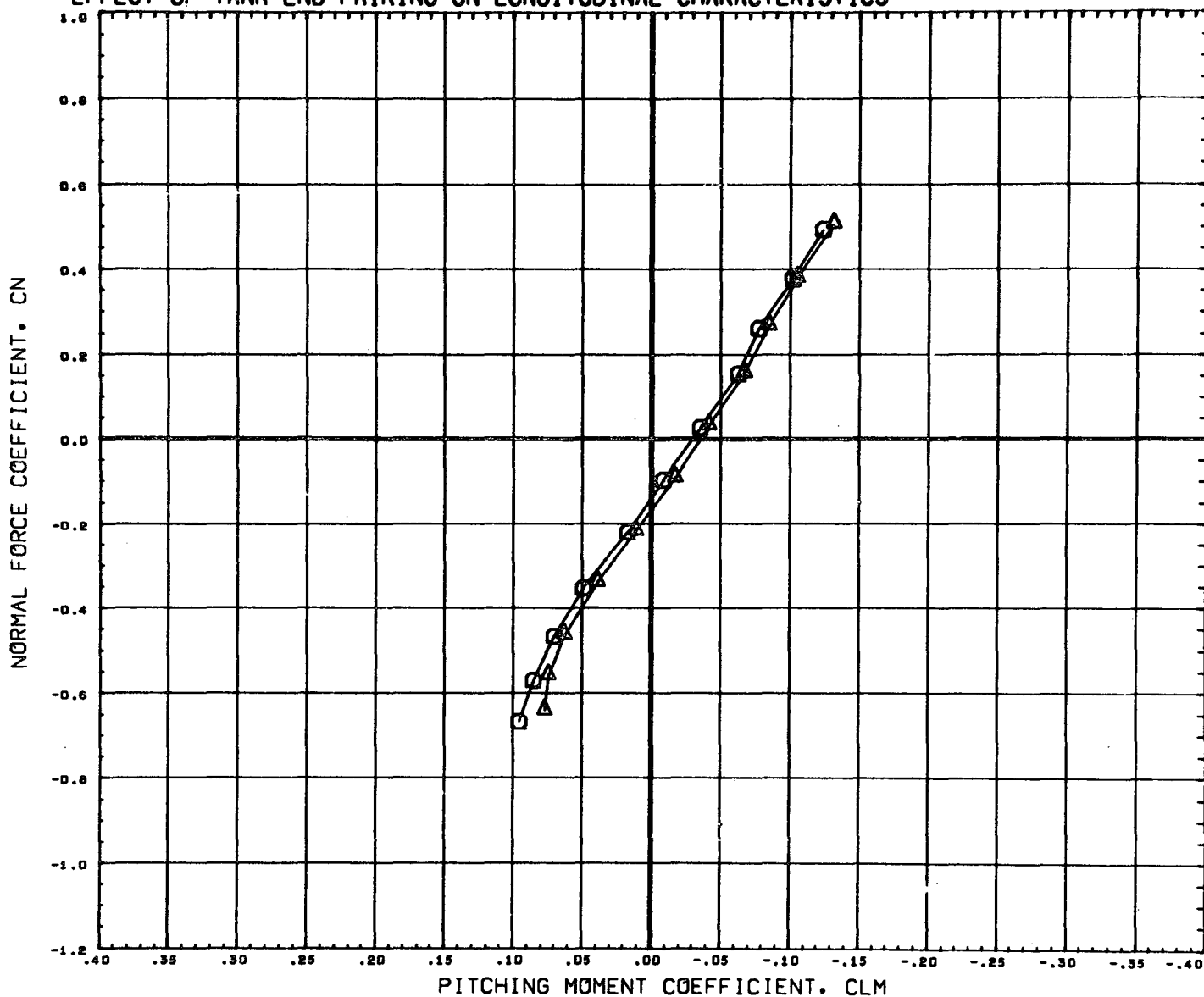

DATA SET SYMBOL	CONFIGURATION DESCRIPTION	ORBIN	THETS	BETA	REFERENCE INFORMATION
(B65004)	MSFC TWT 534 SHUTTLE LAUNCH	T101S1	-1.500	21.000	0.000
(B65024)	MSFC TWT 534 SHUTTLE LAUNCH	T301S1	-1.500	21.000	0.000
					SREF 4.8950 SQ. IN
					LREF 2.6440 IN.
					BREF 3.5250 IN.
					XMRP 3.4900 IN.
					YMRP 0.0000 IN.
					ZMRP 0.1616 IN.
					SCALE 0.0034

MACH .60

EFFECT OF TANK END FAIRING ON LONGITUDINAL CHARACTERISTICS

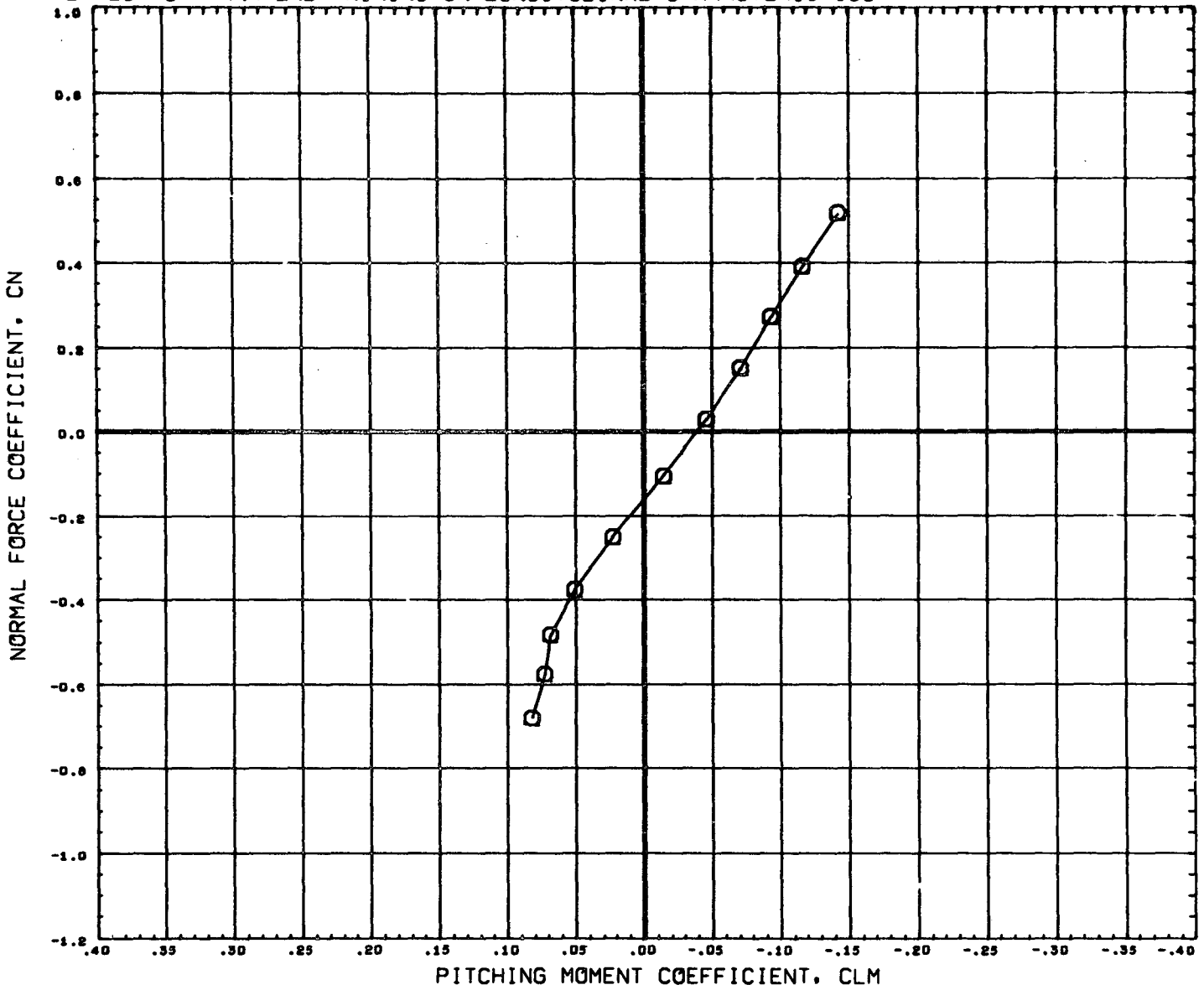

DATA SET SYMBOL (B65004) (B65024)  CONFIGURATION DESCRIPTION MSFC TWT 534 SHUTTLE LAUNCH T101S1 DATA NOT AVAILABLE FOR ALL CONDITIONS

ORBIN THETS BETA
 -1.500 21.000 0.000
 -1.500 21.000 0.000

REFERENCE INFORMATION
 SREF 4.8950 SQ. IN
 LREF 2.6440 IN.
 BREF 3.5250 IN.
 XMRP 3.4900 IN.
 YMRP 0.0000 IN.
 ZMRP 0.1616 IN.
 SCALE 0.6034

EFFECT OF TANK END FAIRING ON LONGITUDINAL CHARACTERISTICS

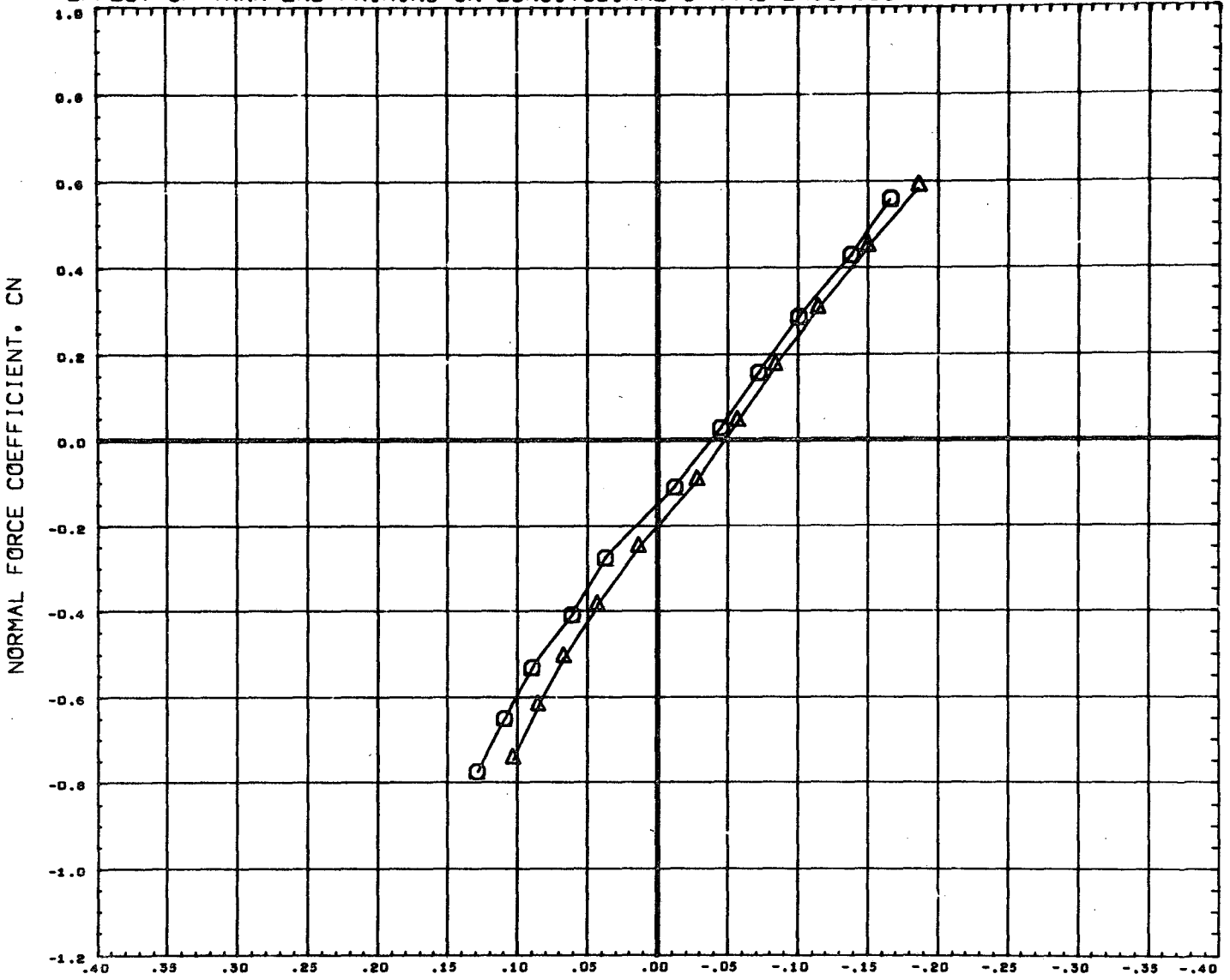

DATA SET SYMBOL	CONFIGURATION DESCRIPTION
(B65004)	MSFC TWT 534 SHUTTLE LAUNCH
(B65024)	MSFC TWT 534 SHUTTLE LAUNCH

T101S1	T301S1
-1.500	-1.500
21.000	21.000
0.000	0.000

ORBIN	THETS	BETA
-1.500	21.000	0.000
-1.500	21.000	0.000

REFERENCE INFORMATION	
SRFF	4.8950 SQ. IN
LREF	2.6440 IN.
BREF	3.5250 IN.
XMRF	3.4900 IN.
YMRF	0.0000 IN.
ZMRF	0.1616 IN.
SCALE	0.0034

EFFECT OF TANK END FAIRING ON LONGITUDINAL CHARACTERISTICS

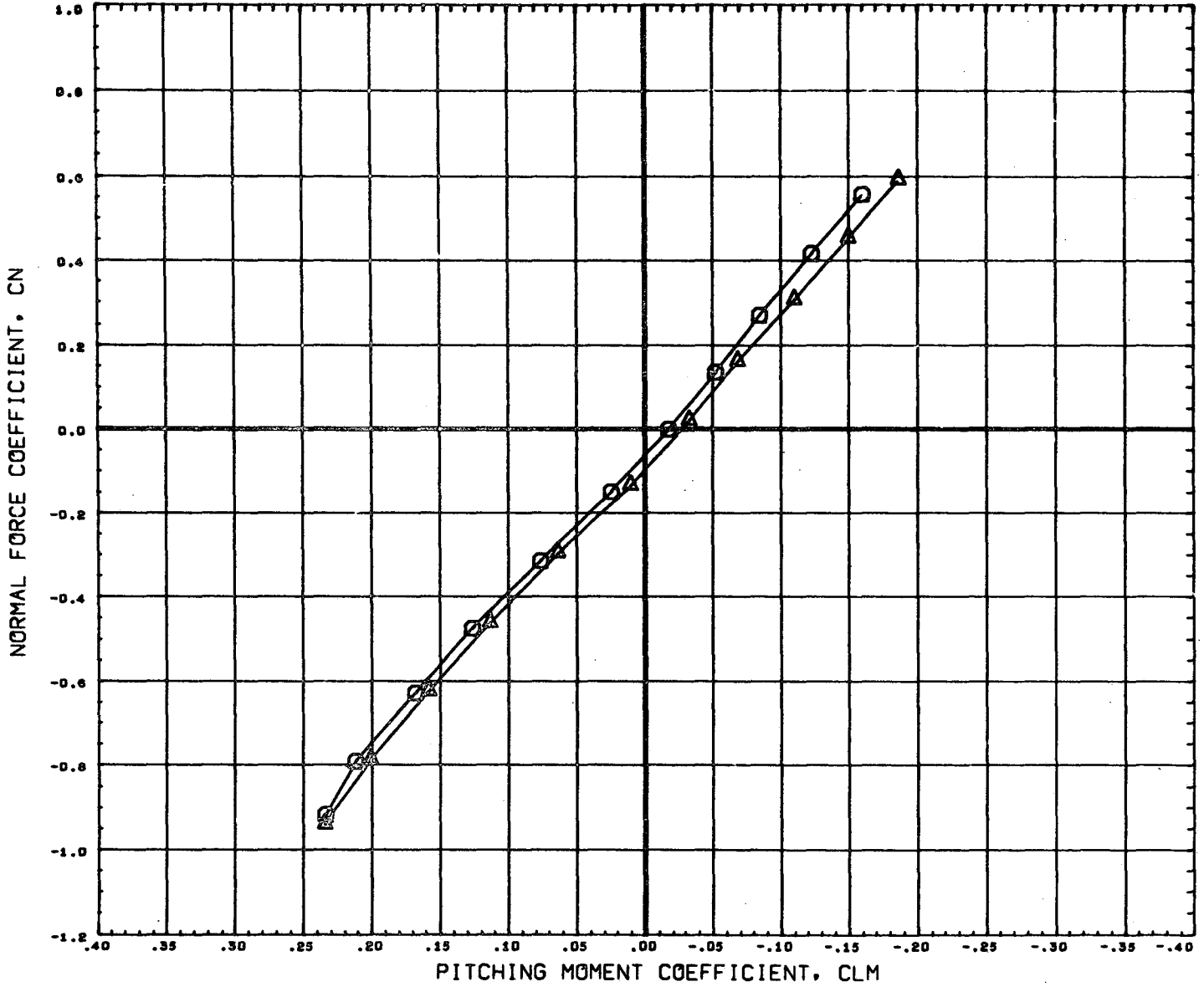

DATA SET SYMBOL	CONFIGURATION DESCRIPTION	ORBIN	THETS	BETA	REFERENCE INFORMATION	
(B65004)	MSFC TWT 534 SHUTTLE LAUNCH	T101S1	-1.500	21.00J	0.000	SREF 4.8950 90. IN
(B65024)	MSFC TWT 534 SHUTTLE LAUNCH	T301S1	-1.500	21.000	0.000	LREF 2.6440 IN.
						BREF 3.5250 IN.
						XMRP 3.4900 IN.
						YMRP 0.0000 IN.
						ZMRP 0.1616 IN.
						SCALE 0.0034

MACH

1.10

EFFECT OF TANK END FAIRING ON LONGITUDINAL CHARACTERISTICS

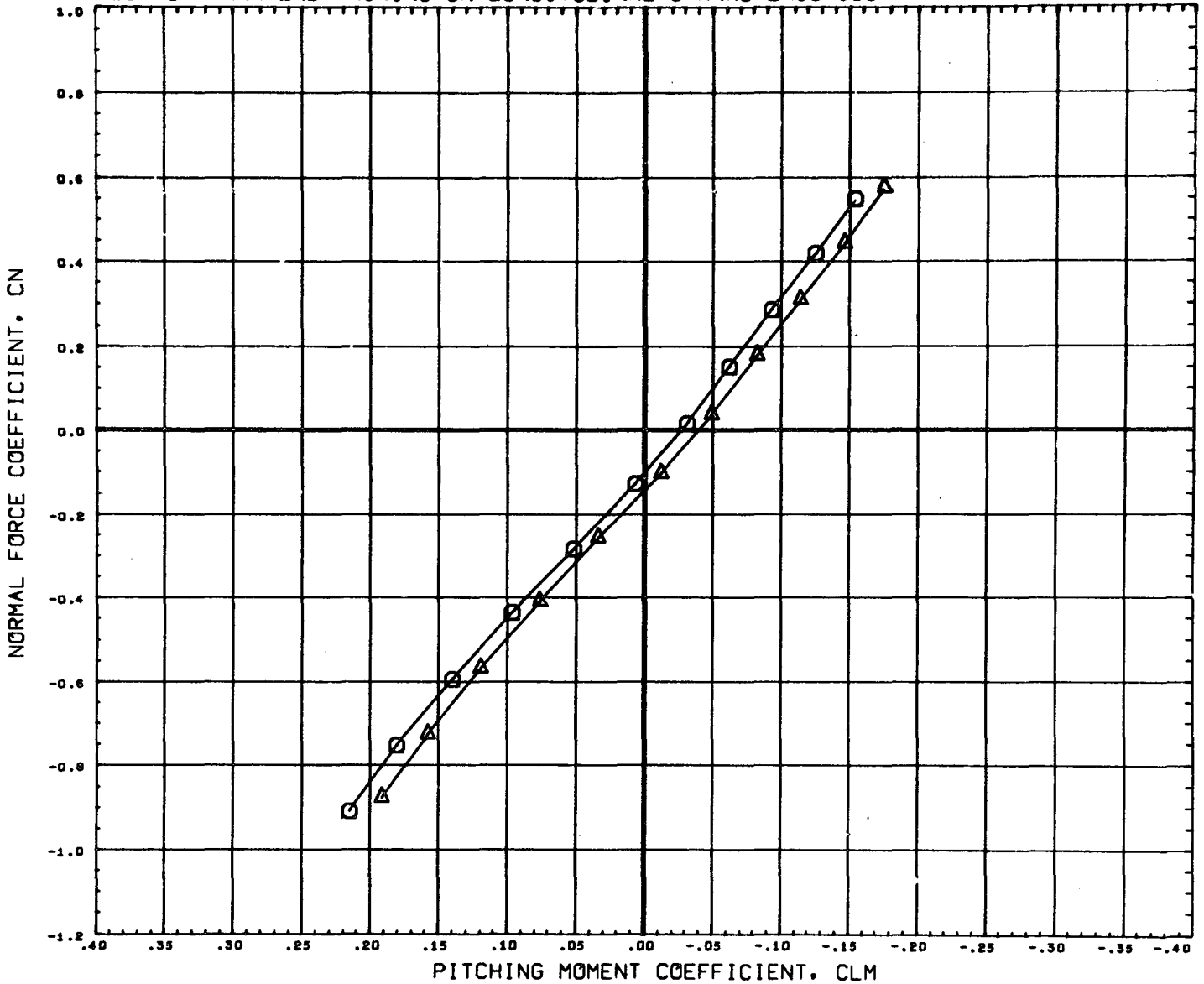

DATA SET SYMBOL	CONFIGURATION DESCRIPTION	ORBIN	THETS	BETA	REFERENCE INFORMATION
(B65004)	MSFC TWT 534 SHUTTLE LAUNCH	-1.500	21.000	0.000	SREF 4.8950 SQ. IN
(B65024)	MSFC TWT 534 SHUTTLE LAUNCH	-1.500	21.000	0.000	LREF 2.6440 IN.
					BREF 3.5250 IN.
					XMRP 3.4900 IN.
					YMRP 0.0000 IN.
					ZMRP 0.1616 IN.
					SCALE 0.0034

MACH 1.20

EFFECT OF TANK END FAIRING ON LONGITUDINAL CHARACTERISTICS

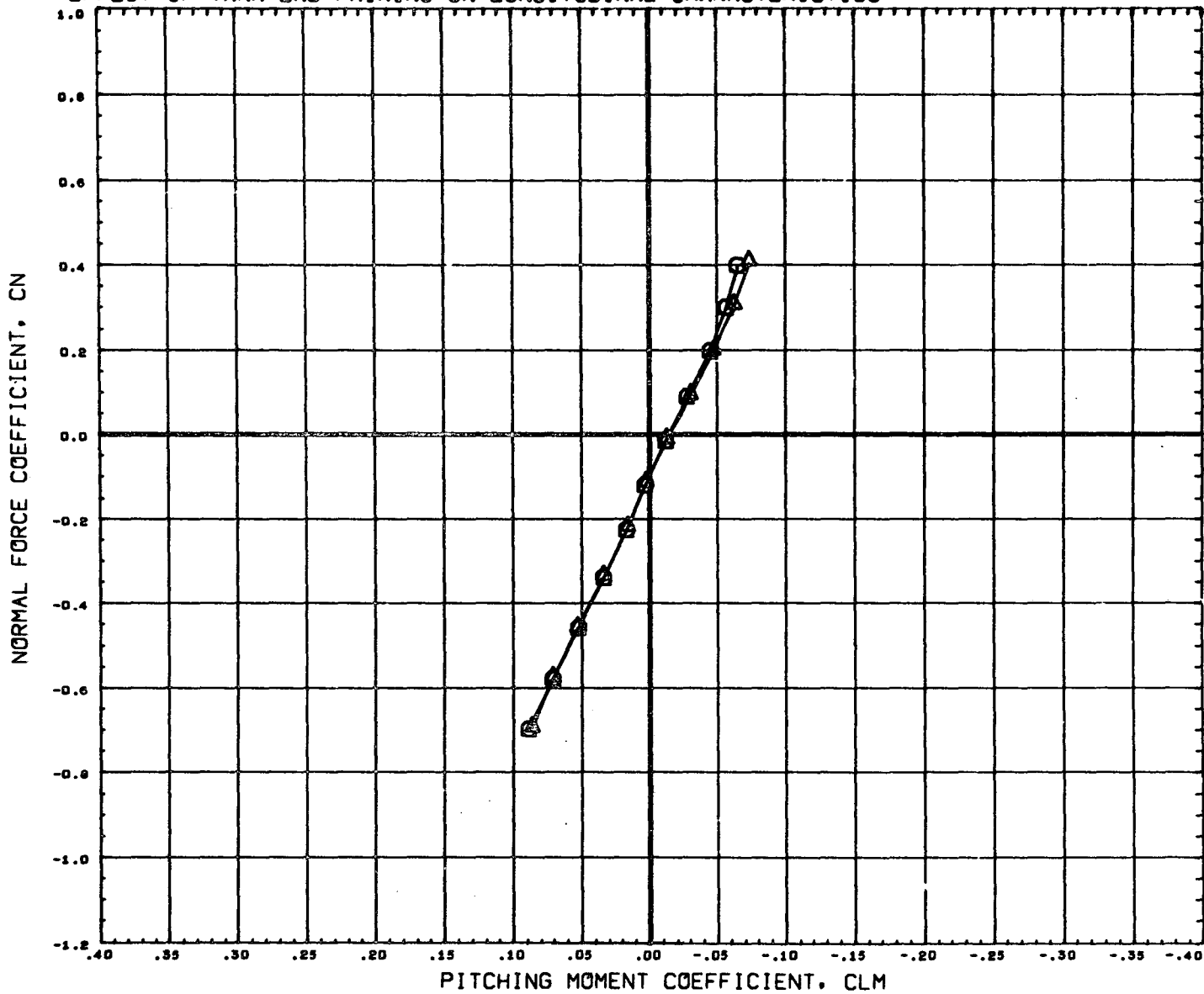

DATA SET SYMBOL	CONFIGURATION DESCRIPTION	ORBIT	THETA	BETA	REFERENCE INFORMATION	
(B65004)	MSFC TWT 534 SHUTTLE LAUNCH	T101S1	-1.500	21.000	0.000	SREF 4.8950 SQ. IN
(B65024)	MSFC TWT 534 SHUTTLE LAUNCH	T301S1	-1.500	21.000	0.000	LREF 2.6440 IN.
						BREF 3.5250 IN.
						XNRP 3.4900 IN.
						YNRP 0.0000 IN.
						ZNRP 0.1616 IN.
						SCALE 0.0034

MACH 1.97

EFFECT OF TANK END FAIRING ON LONGITUDINAL CHARACTERISTICS

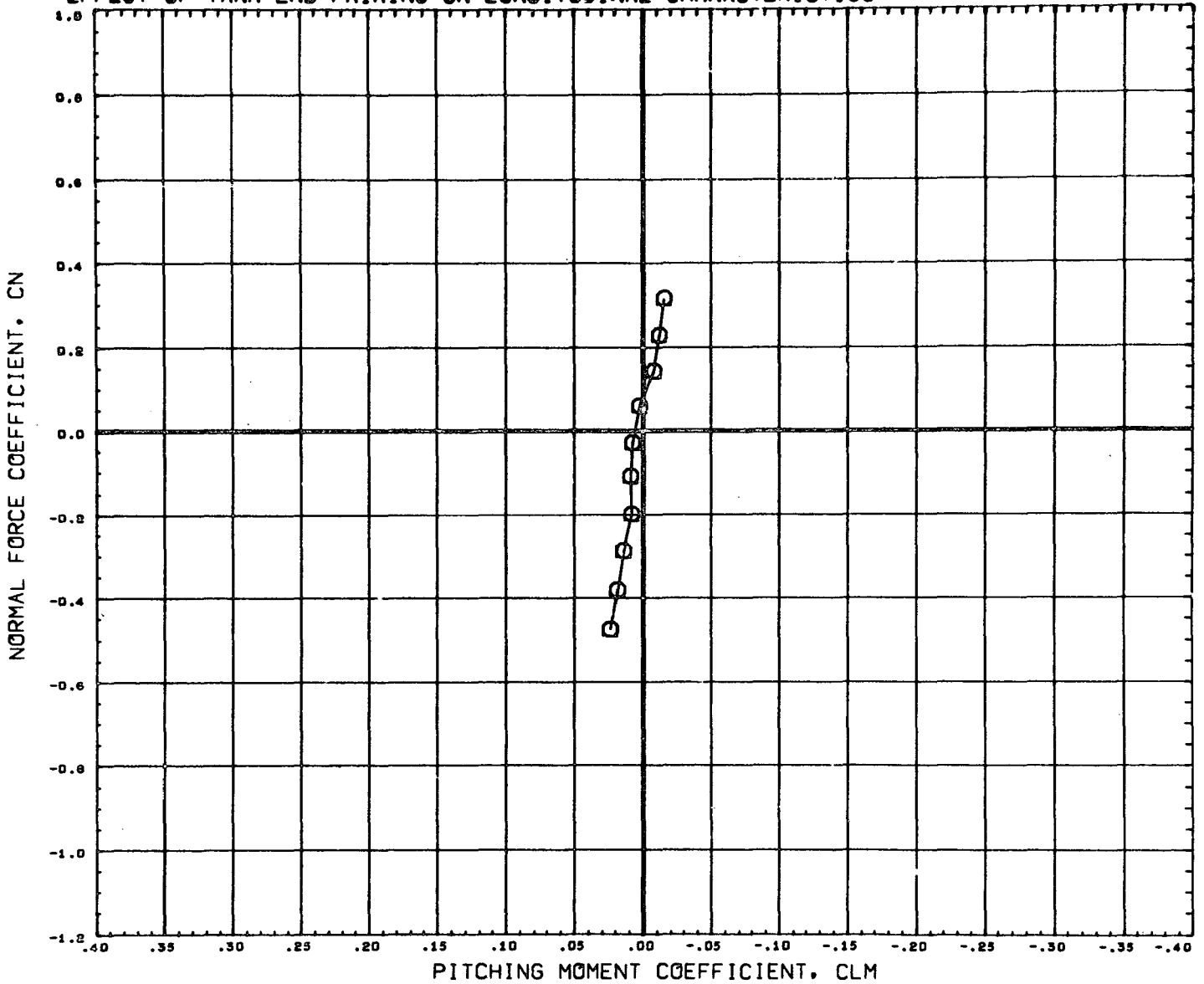

DATA SET SYMBOL	CONFIGURATION DESCRIPTION	ORBIN	THETS	BETA	REFERENCE INFORMATION
(B65004)	MSFC TWT 534 SHUTTLE LAUNCH T101S1	-1.500	21.000	0.000	SREF 4.8950 SQ. IN
(B65024)	DATA NOT AVAILABLE FOR ALL CONDITIONS	-1.500	21.000	0.000	LREF 2.6440 IN.
					BREF 3.5250 IN.
					XMRP 3.4900 IN.
					YMRP 0.0000 IN.
					ZMRP 0.1616 IN.
					SCALE 0.0034

MACH 2.74

PAGE 463

EFFECT OF TANK END FAIRING ON LONGITUDINAL CHARACTERISTICS

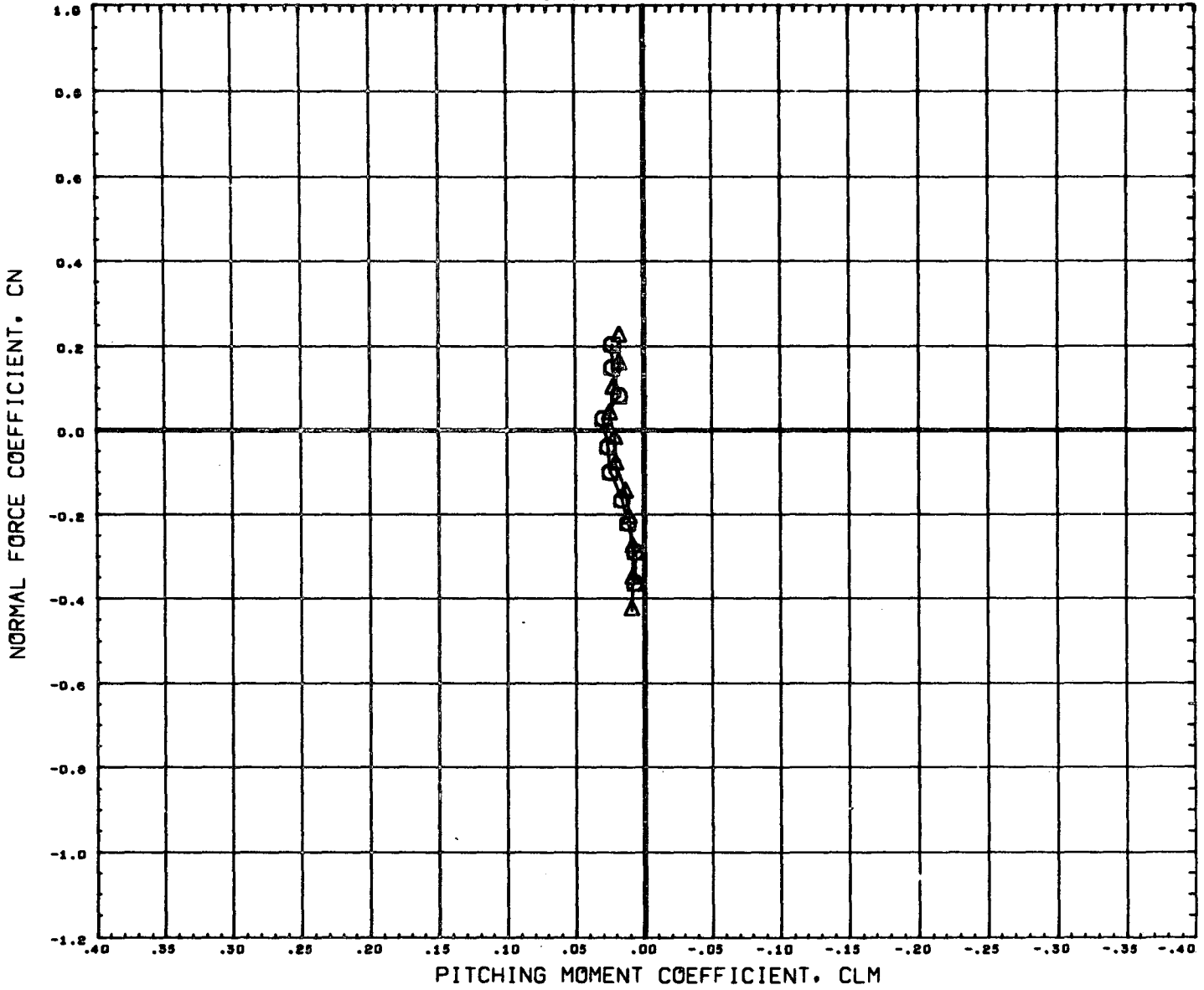

DATA SET SYMBOL	CONFIGURATION DESCRIPTION	ORBIN	THEYS	BETA	REFERENCE INFORMATION	
(B69004)	MSFC TWT 534 SHUTTLE LAUNCH	T101S1	-1.500	21.000	0.000	SREF 4.8950 90. IN
(B69024)	MSFC TWT 534 SHUTTLE LAUNCH	T301S1	-1.500	21.000	0.000	LREF 2.6440 IN.
						BREF 3.5250 IN.
						XMRP 3.4900 IN.
						YMRP 0.0000 IN.
						ZMRP 0.1616 IN.
						SCALE 0.0034

MACH 4.96

PAGE 464

EFFECT OF ANGLE OF ATTACK ON BASELINE CONFIGURATION, LATERAL/DIRECTIONAL CHARACT

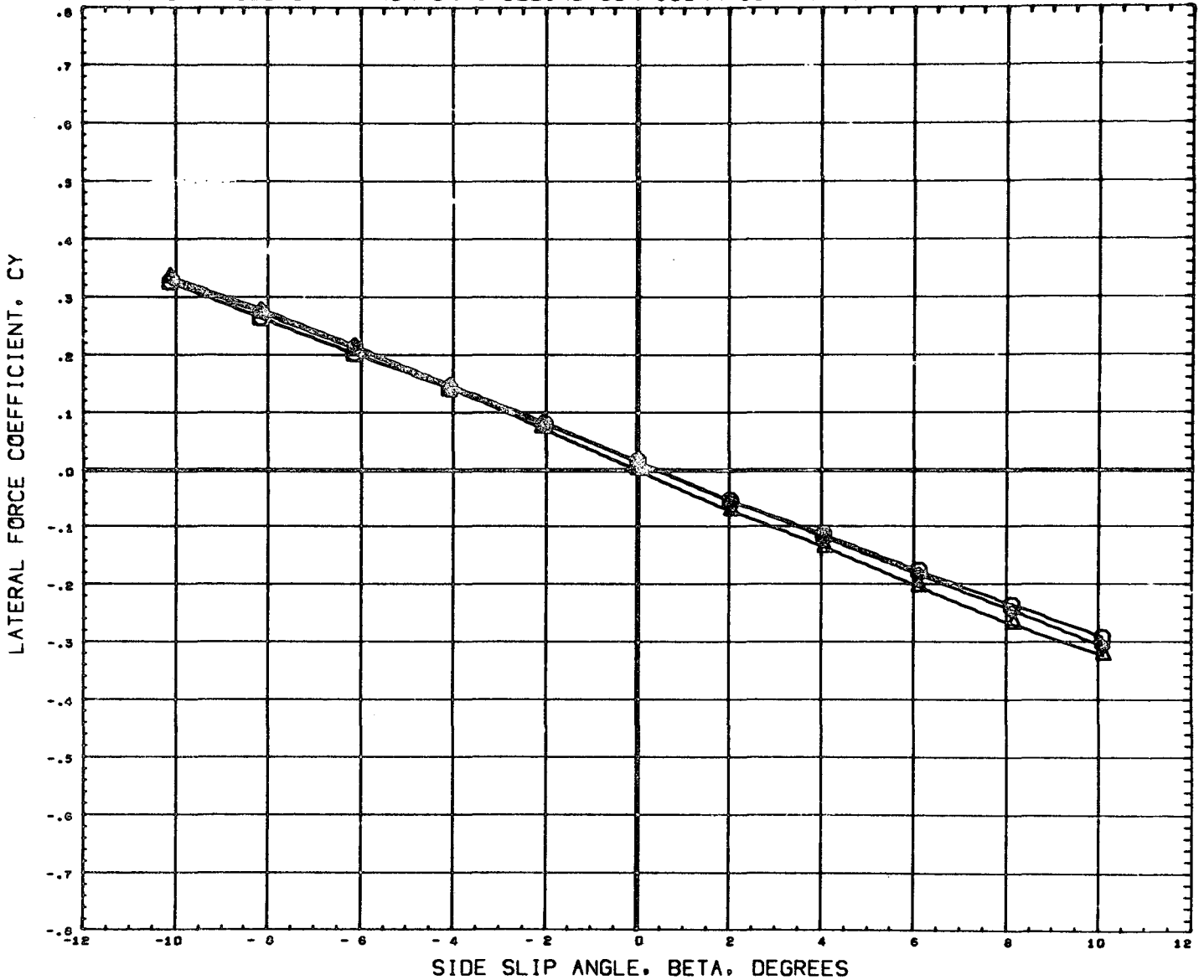

DATA SET SYMBOL	CONFIGURATION DESCRIPTION	ORBIN	THETS	ALPHA	REFERENCE INFORMATION	
(B65007)	MSFC TWT 534 SHUTTLE LAUNCH	T101S1	-1.500	21.000	-6.000	SREF 4.8950 sq. IN
(B65005)	MSFC TWT 534 SHUTTLE LAUNCH	T101S1	-1.500	21.000	0.000	LREF 2.6440 IN.
(B65006)	MSFC TWT 534 SHUTTLE LAUNCH	T101S1	-1.500	21.000	6.000	BREF 3.5250 IN.
						XMRP 3.4900 IN.
						YMRP 0.0000 IN.
						ZMRP 0.1616 IN.
						SCALE 0.0034

MACH .60

EFFECT OF ANGLE OF ATTACK ON BASELINE CONFIGURATION, LATERAL/DIRECTIONAL CHARACT

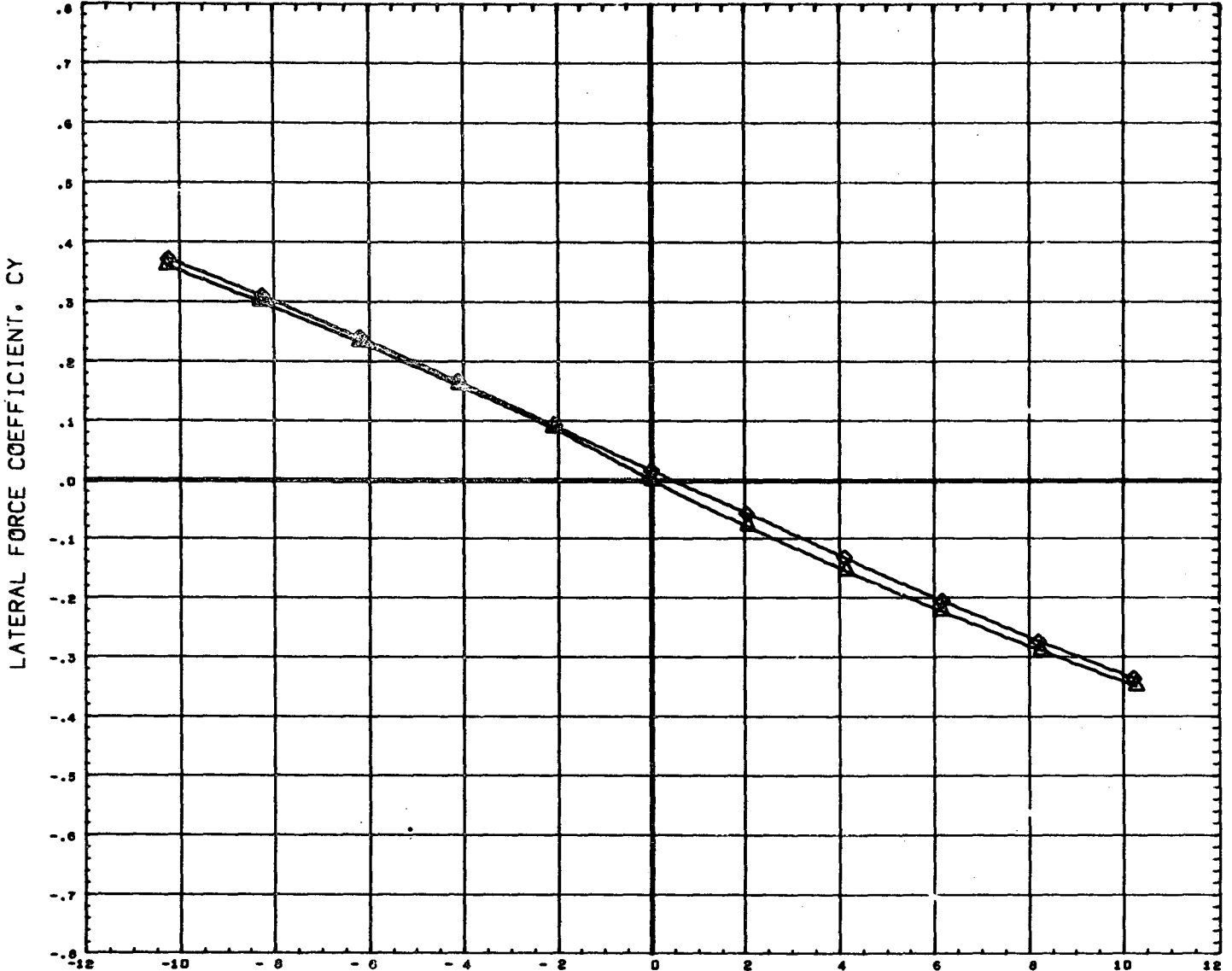

DATA SET SYMBOL	CONFIGURATION DESCRIPTION	ORBIN	THETS	ALPHA	REFERENCE INFORMATION
(865007)	DATA NOT AVAILABLE FOR ALL CONDITIONS	-1.500	21.000	-6.000	SREF 4.8950 SQ. IN
(865005)	NSFC TWT 534 SHUTTLE LAUNCH T101S1	-1.500	21.000	0.000	LREF 2.6440 IN.
(865006)	NSFC TWT 534 SHUTTLE LAUNCH T101S1	-1.500	21.000	6.000	BREF 3.5250 IN.
					XNRP 3.4900 IN.
					YNRP 0.0000 IN.
					ZNRP 0.1616 IN.
					SCALE 0.0034

MACH .80

EFFECT OF ANGLE OF ATTACK ON BASELINE CONFIGURATION, LATERAL/DIRECTIONAL CHARACT

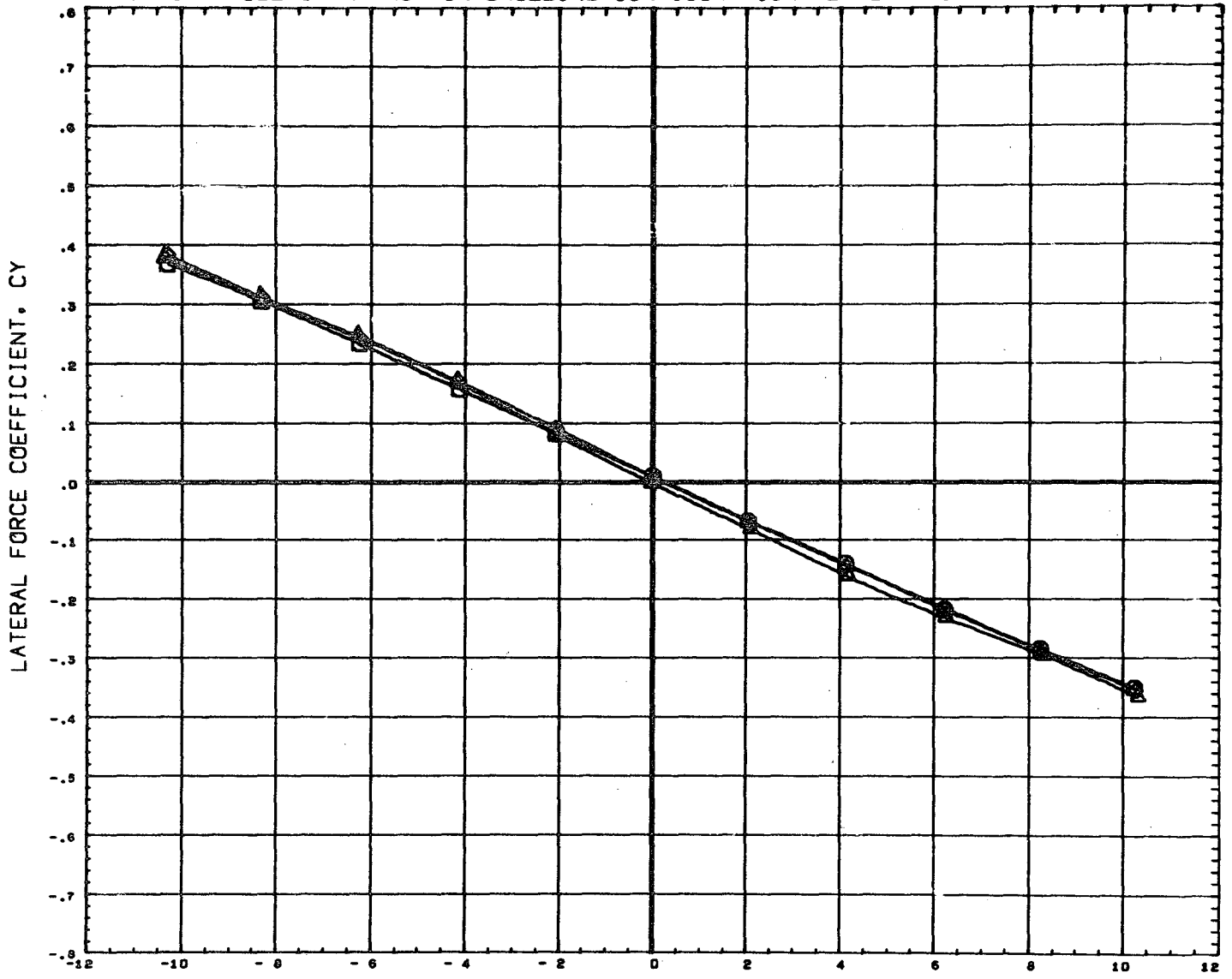

DATA SET SYMBOL	CONFIGURATION DESCRIPTION	T101S1	ORBIN	THETS	ALPHA	REFERENCE INFORMATION
(B65007)	MSFC TWT 534 SHUTTLE LAUNCH	T101S1	-1.500	21.000	-6.000	SREF 4.8950 SQ. IN
(B65005)	MSFC TWT 534 SHUTTLE LAUNCH	T101S1	-1.500	21.000	0.000	LREF 2.6440 IN.
(B65006)	MSFC TWT 534 SHUTTLE LAUNCH	T101S1	-1.500	21.000	6.000	BREF 3.5250 IN.
						XMRRP 3.4900 IN.
						YMRRP 0.0000 IN.
						ZMRRP 0.1616 IN.
						SCALE 0.0034

MACH .90

EFFECT OF ANGLE OF ATTACK ON BASELINE CONFIGURATION, LATERAL/DIRECTIONAL CHARACT

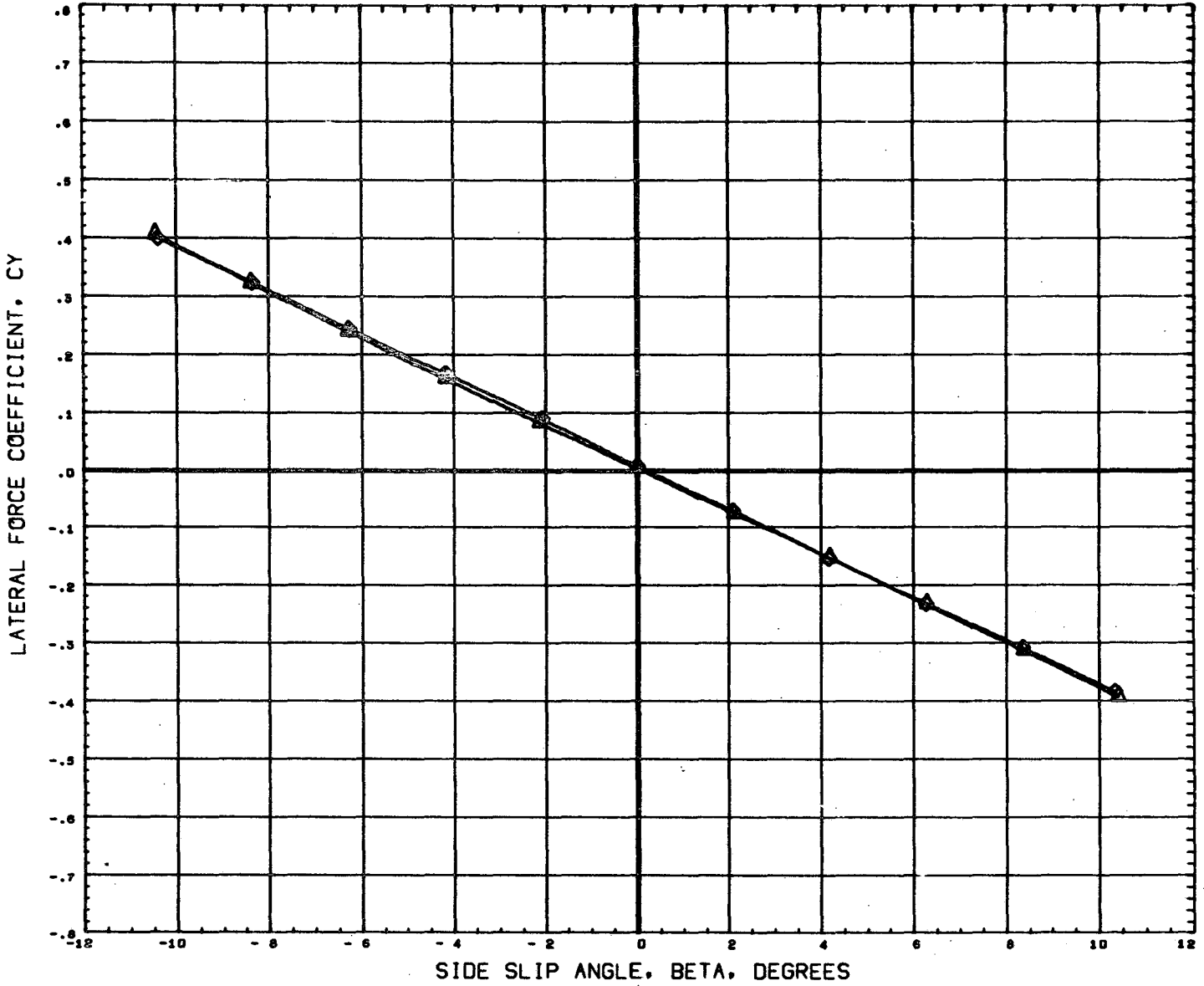

DATA SET SYMBOL	CONFIGURATION DESCRIPTION	ORBIN	THETS	ALPHA	REFERENCE INFORMATION
(865007)	DATA NOT AVAILABLE FOR ALL CONDITIONS	-1.500	21.000	-6.000	SREF 4.8950 SQ. IN
(865005)	MSFC TWT 534 SHUTTLE LAUNCH T101S1	-1.500	21.000	0.000	LREF 2.6440 IN.
(865006)	MSFC TWT 534 SHUTTLE LAUNCH T101S1	-1.500	21.000	6.000	BREF 3.5250 IN.
					XNRP 3.4900 IN.
					YNRP 0.0000 IN.
					ZNRP 0.1616 IN.
					SCALE 0.0034

MACH 1.09

PAGE 468

EFFECT OF ANGLE OF ATTACK ON BASELINE CONFIGURATION, LATERAL/DIRECTIONAL CHARACT

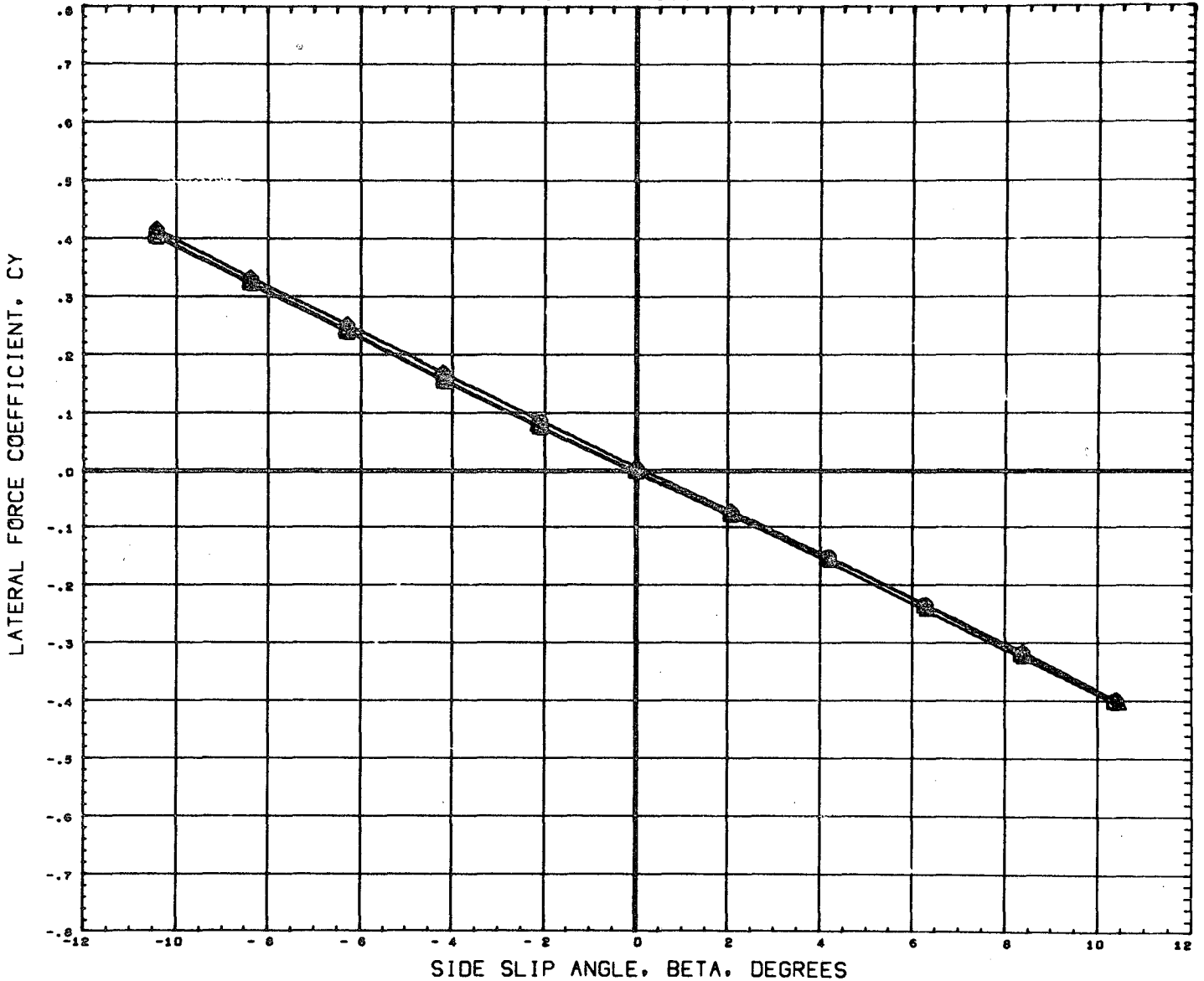

DATA SET SYMBOL	CONFIGURATION DESCRIPTION	T101S1	ORBIN	THETS	ALPHA	REFERENCE INFORMATION
(B65007)	MSFC TWT 534 SHUTTLE LAUNCH	T101S1	-1.500	21.000	-6.000	SREF 4.8950 SQ. IN
(B65005)	MSFC TWT 534 SHUTTLE LAUNCH	T101S1	-1.500	21.000	0.000	LREF 2.6440 IN.
(B65006)	MSFC TWT 534 SHUTTLE LAUNCH	T101S1	-1.500	21.000	6.000	BREF 3.9250 IN.
						XMRP 3.4900 IN.
						YMRP 0.0000 IN.
						ZMRP 0.1616 IN.
						SCALE 0.0034

MACH 1.20

EFFECT OF ANGLE OF ATTACK ON BASELINE CONFIGURATION, LATERAL/DIRECTIONAL CHARACT

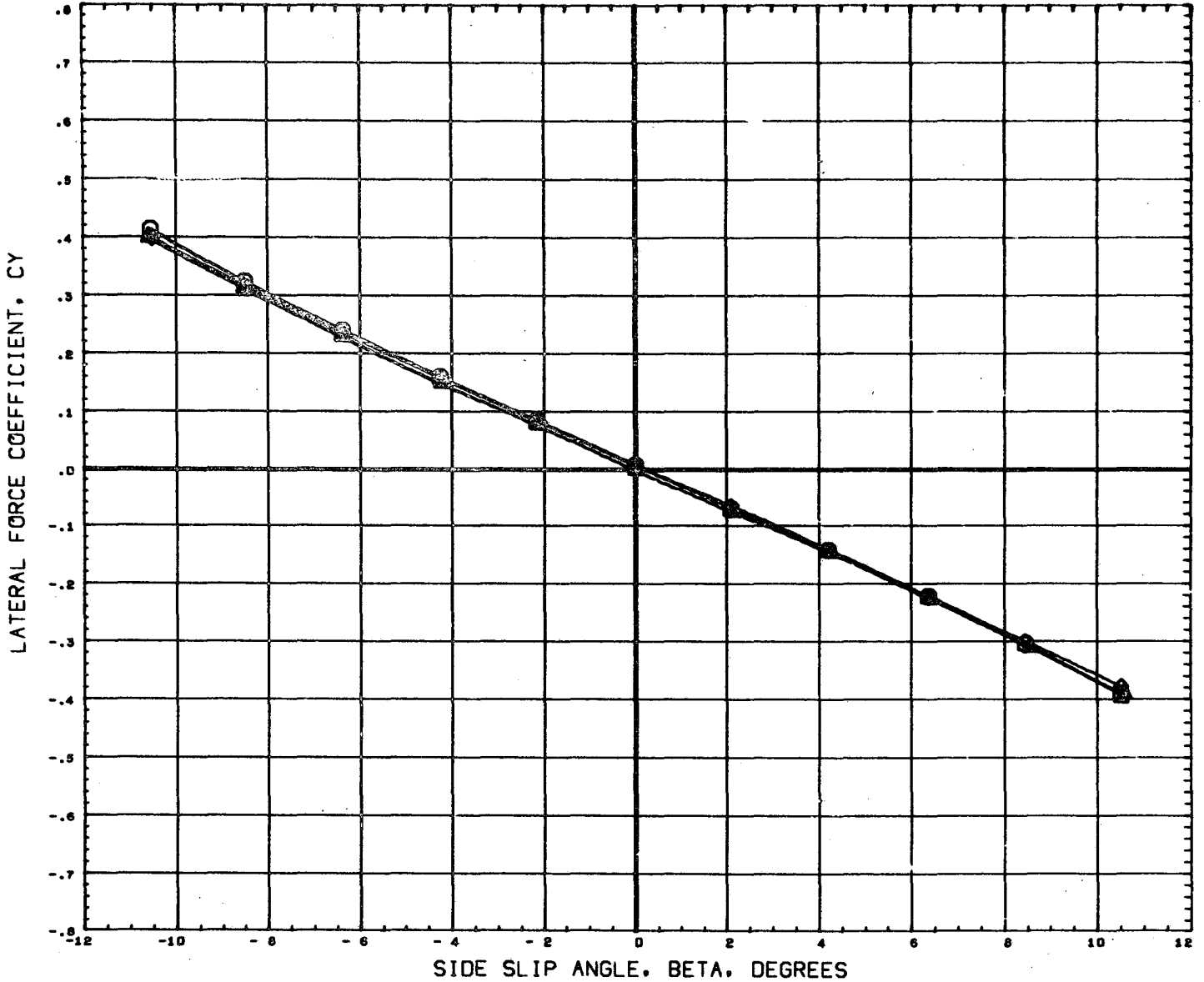

DATA SET SYMBOL	CONFIGURATION DESCRIPTION	ORBIN	THETS	ALPHA	REFERENCE INFORMATION	
(B65007) \circ	MSFC TWT 534 SHUTTLE LAUNCH	T101S1	-1.500	21.000	-6.000	SREF 4.8950 SQ. IN
(B65005) \circ	MSFC TWT 534 SHUTTLE LAUNCH	T101S1	-1.500	21.000	0.000	LREF 2.6440 IN.
(B65006) \diamond	MSFC TWT 534 SHUTTLE LAUNCH	T101S1	-1.500	21.000	6.000	BREF 3.9250 IN.
						XMRP 3.4900 IN.
						YMRP 0.0000 IN.
						ZMRP 0.1616 IN.
						SCALE 0.0034

EFFECT OF ANGLE OF ATTACK ON BASELINE CONFIGURATION. LATERAL/DIRECTIONAL CHARACT

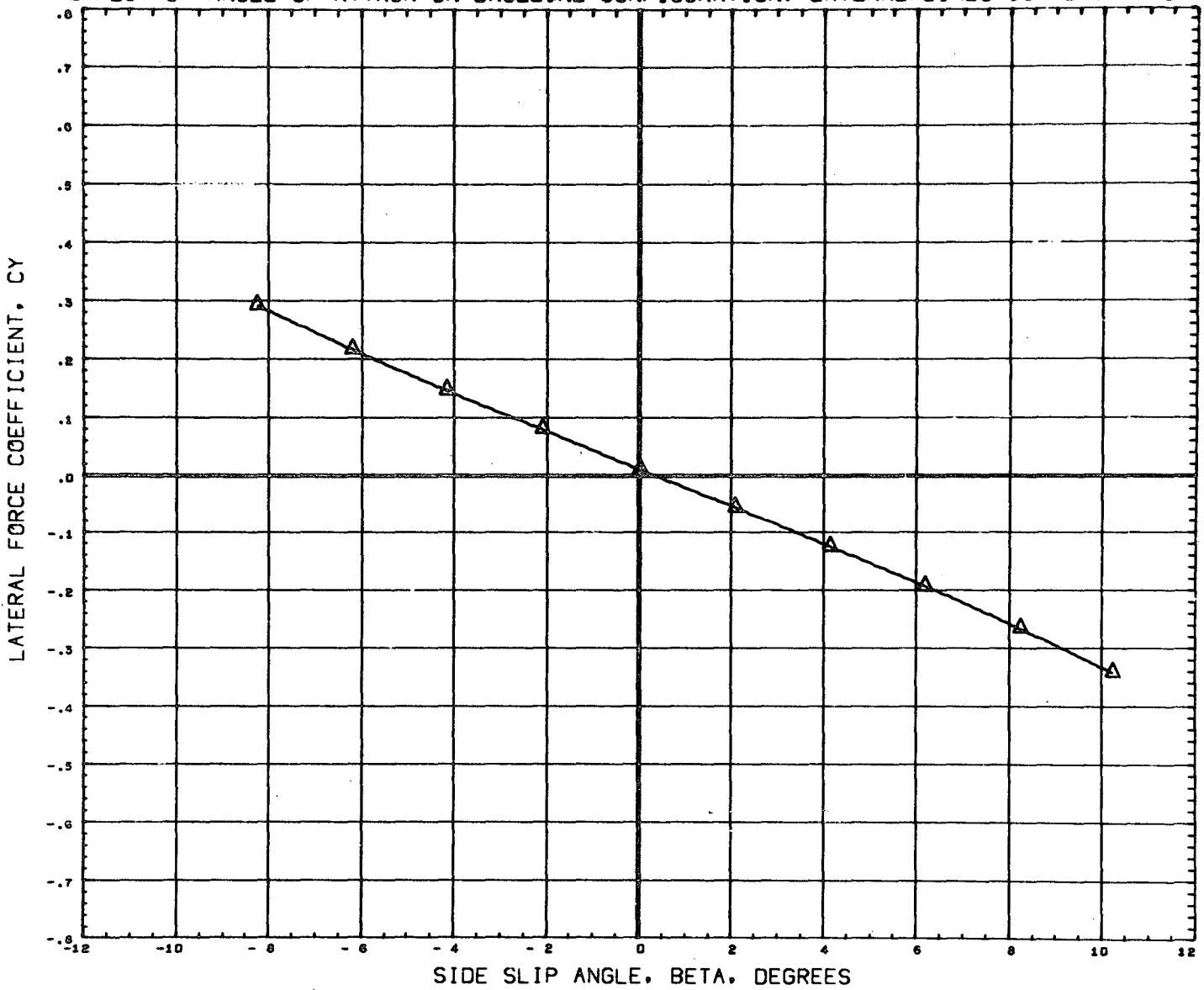

DATA SET SYMBOL	CONFIGURATION DESCRIPTION	ORBIN	THETS	ALPHA	REFERENCE INFORMATION
(865007)	DATA NOT AVAILABLE FOR ALL CONDITIONS	-1.500	21.000	-6.000	SREF 4.8950 SQ. IN
(865005)	MSFC TWT 534 SHUTTLE LAUNCH T101S1	-1.500	21.000	0.000	LREF 2.6440 IN.
(865006)	DATA NOT AVAILABLE FOR ALL CONDITIONS	-1.500	21.000	6.000	BREF 3.5250 IN.
					XMRP 3.4900 IN.
					YMRP 0.0000 IN.
					ZMRP 0.1616 IN.
					SCALE 0.0034

MACH 2.74

EFFECT OF ANGLE OF ATTACK ON BASELINE CONFIGURATION, LATERAL/DIRECTIONAL CHARACT

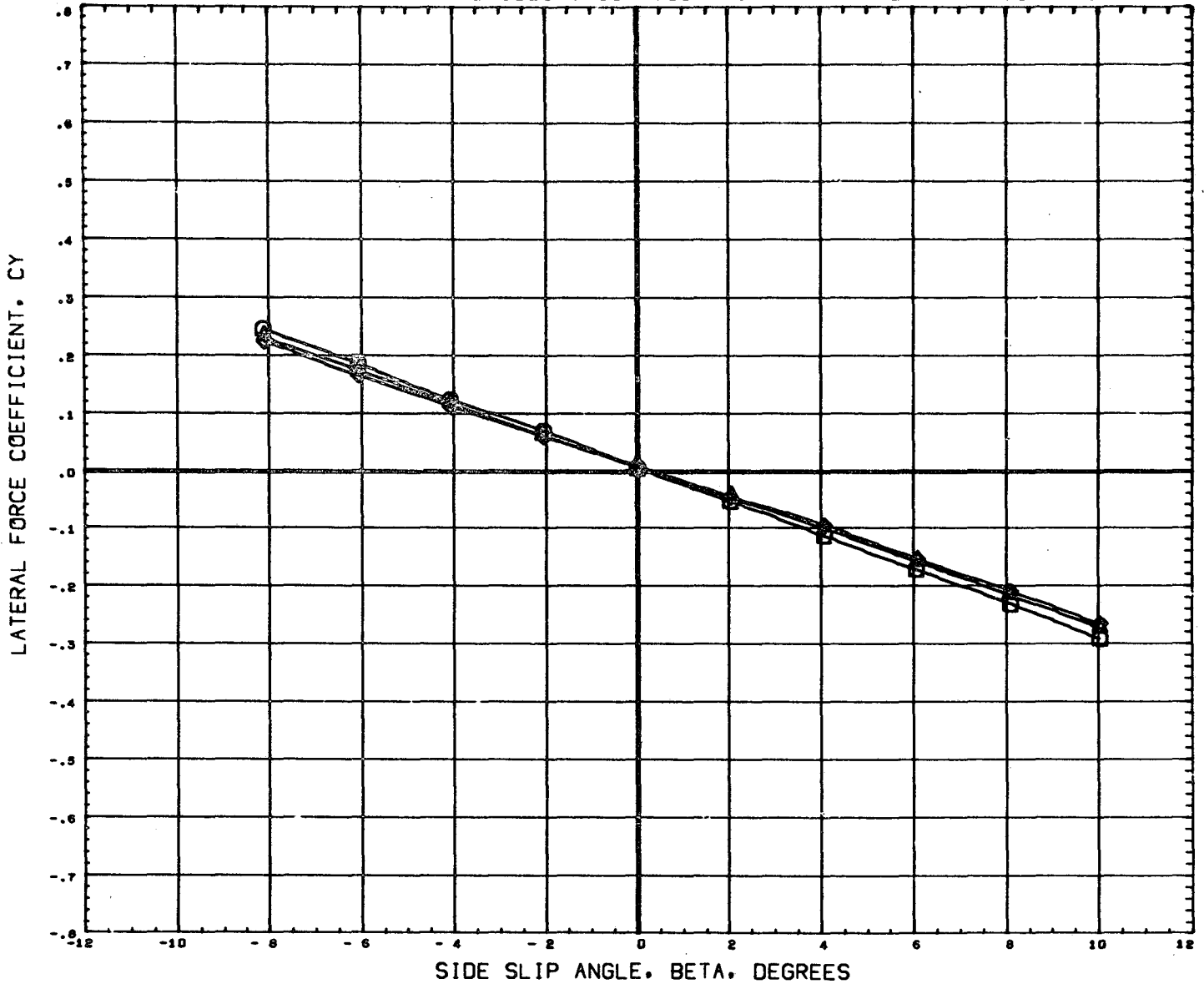

DATA SET SYMBOL	CONFIGURATION DESCRIPTION	ORBIN	THETS	ALPHA	REFERENCE INFORMATION
(B65007)	NSFC TWT 534 SHUTTLE LAUNCH	-1.500	21.000	-6.000	SREF 4.8950 SQ. IN
(B65005)	NSFC TWT 534 SHUTTLE LAUNCH	-1.500	21.000	0.000	LREF 2.6440 IN.
(B65006)	NSFC TWT 534 SHUTTLE LAUNCH	-1.500	21.000	6.000	BREF 3.5250 IN.
					XMRP 3.4900 IN.
					YMRP 0.0000 IN.
					ZMRP 0.1616 IN.
					SCALE 0.0034

MACH 4.96

PAGE 472

EFFECT OF ANGLE OF ATTACK ON BASELINE CONFIGURATION, LATERAL/DIRECTIONAL CHARACT

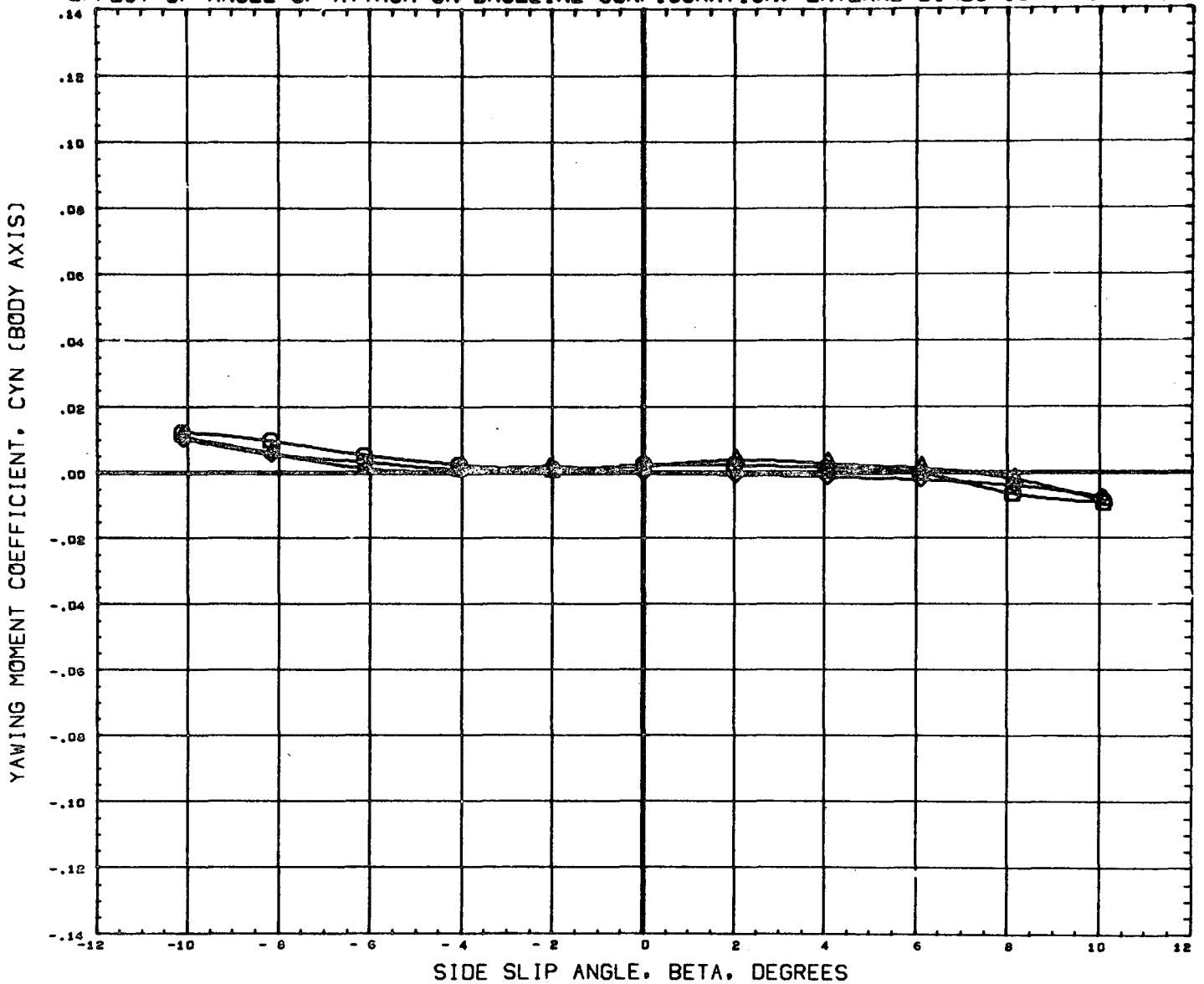

DATA SET SYMBOL	CONFIGURATION DESCRIPTION	ORBIN	THETS	ALPHA	REFERENCE INFORMATION	
(B65007)	MSFC TWT 534 SHUTTLE LAUNCH	T101S1	-1.500	21.000	-6.000	SREF 4.8950 SQ. IN
(B65005)	MSFC TWT 534 SHUTTLE LAUNCH	T101S1	-1.500	21.000	0.000	LREF 2.6440 IN.
(B65006)	MSFC TWT 534 SHUTTLE LAUNCH	T101S1	-1.500	21.000	6.000	BREF 3.5250 IN.
						XMRP 3.4900 IN.
						YMRP 0.0000 IN.
						ZMRP 0.1616 IN.
						SCALE 0.0034

MACH .60

EFFECT OF ANGLE OF ATTACK ON BASELINE CONFIGURATION. LATERAL/DIRECTIONAL CHARACT

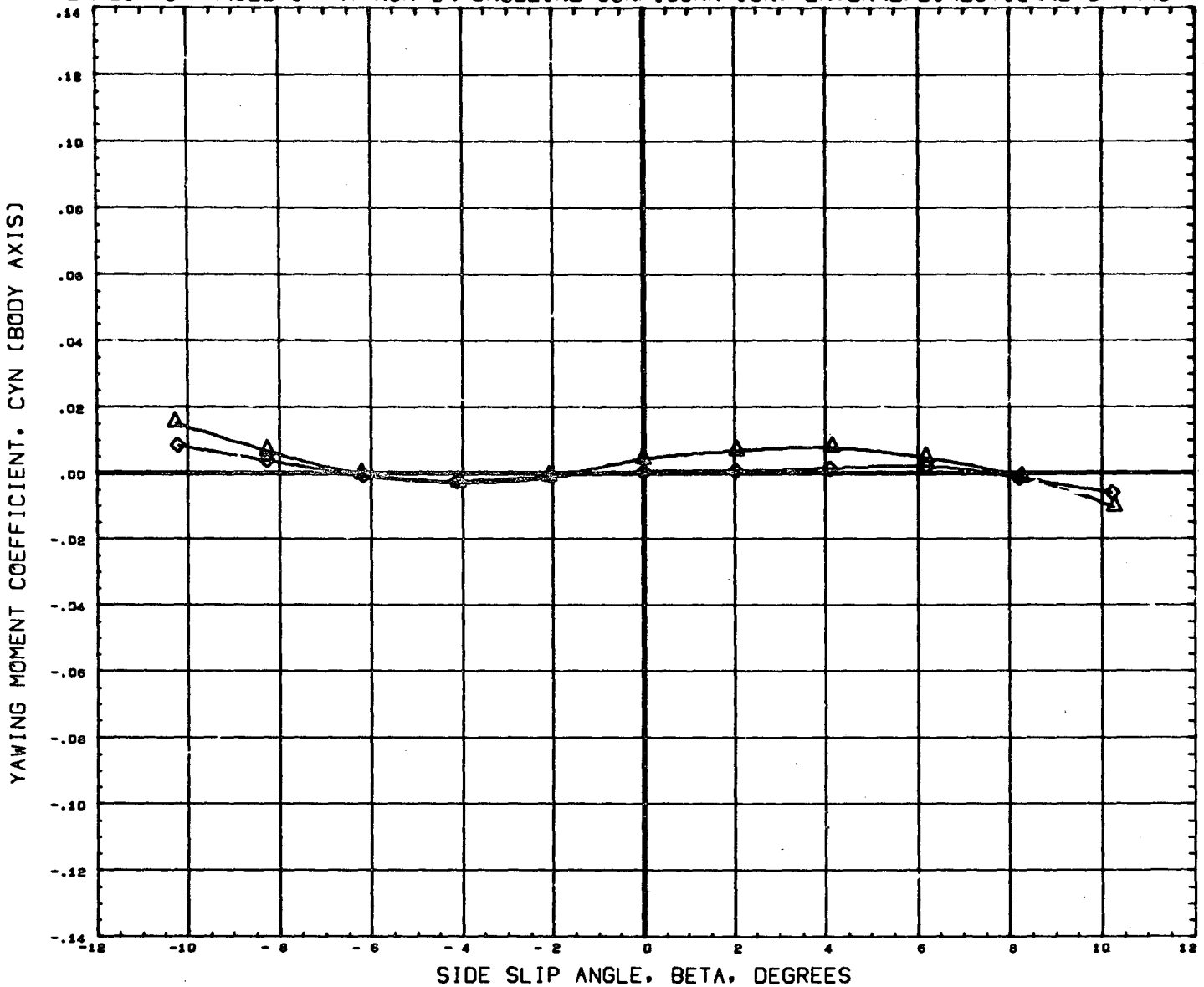

DATA SET SYMBOL	CONFIGURATION DESCRIPTION	ORBIN	THETS	ALPHA	REFERENCE INFORMATION
(B65007)	DATA NOT AVAILABLE FOR ALL CONDITIONS	-1.500	21.000	-6.000	SREF 4.8950 SQ. IN
(B65005)	MSFC TWT 534 SHUTTLE LAUNCH T101S1	-1.500	21.000	0.000	LREF 2.6440 IN.
(B65006)	MSFC TWT 534 SHUTTLE LAUNCH T101S1	-1.500	21.000	6.000	BREF 3.5250 IN.
					XMRP 3.4900 IN.
					YMRP 0.0000 IN.
					ZMRP 0.1616 IN.
					SCALE 0.0034

EFFECT OF ANGLE OF ATTACK ON BASELINE CONFIGURATION, LATERAL/DIRECTIONAL CHARACT

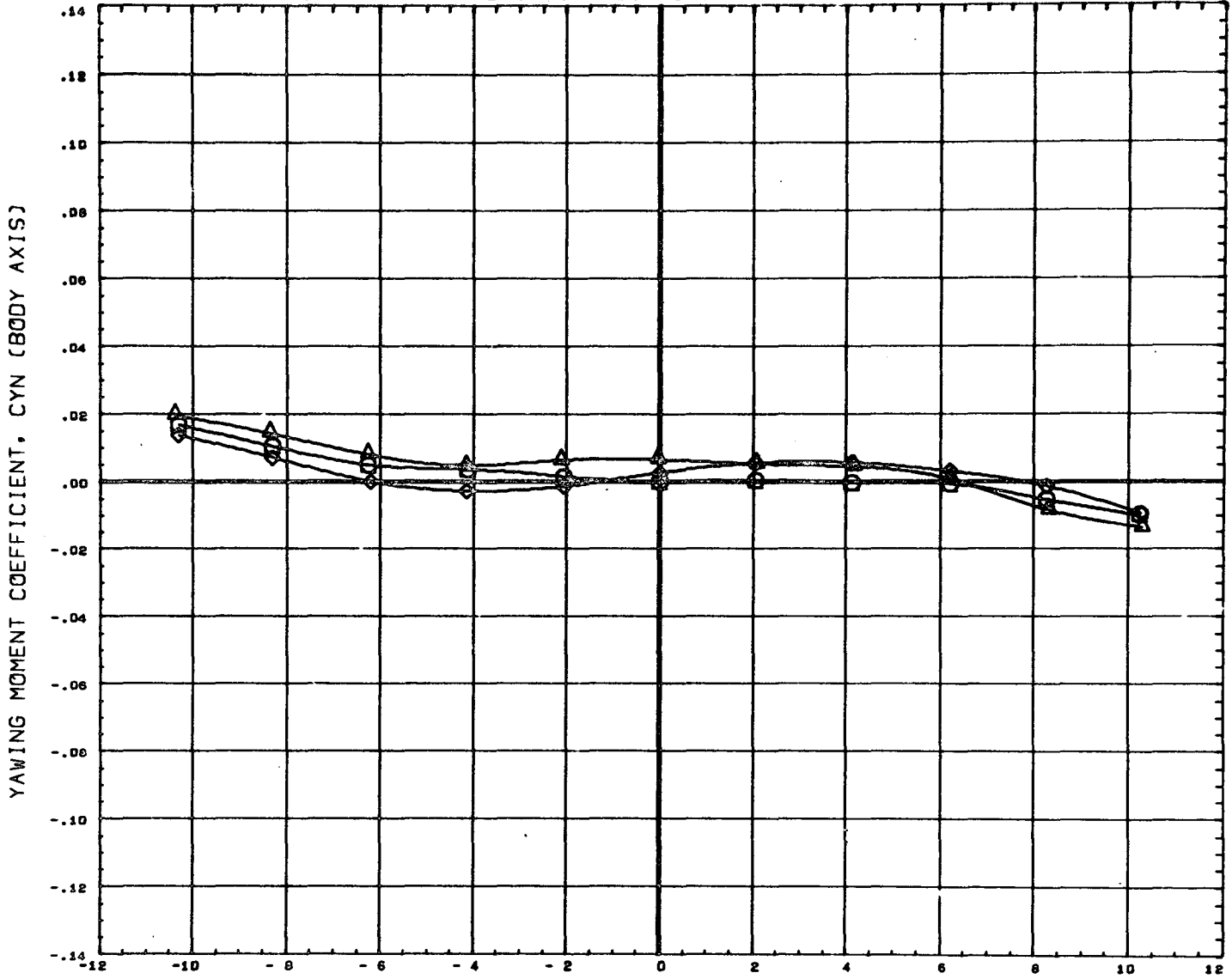

SIDE SLIP ANGLE, BETA, DEGREES

DATA SET SYMBOL	CONFIGURATION DESCRIPTION	T101S1	ORBIN	THETS	ALPHA	REFERENCE INFORMATION
(B65007)	MSFC TWT 534 SHUTTLE LAUNCH	T101S1	-1.500	21.000	-6.000	SREF 4.8950 SQ. IN
(B65005)	MSFC TWT 534 SHUTTLE LAUNCH	T101S1	-1.500	21.000	0.000	LREF 2.6440 IN.
(B65006)	MSFC TWT 534 SHUTTLE LAUNCH	T101S1	-1.500	21.000	6.000	BREF 3.5250 IN.
						XMRP 3.4900 IN.
						YMRP 0.0000 IN.
						ZMRP 0.1616 IN.
						SCALE 0.0034

MACH .90

EFFECT OF ANGLE OF ATTACK ON BASELINE CONFIGURATION, LATERAL/DIRECTIONAL CHARACT

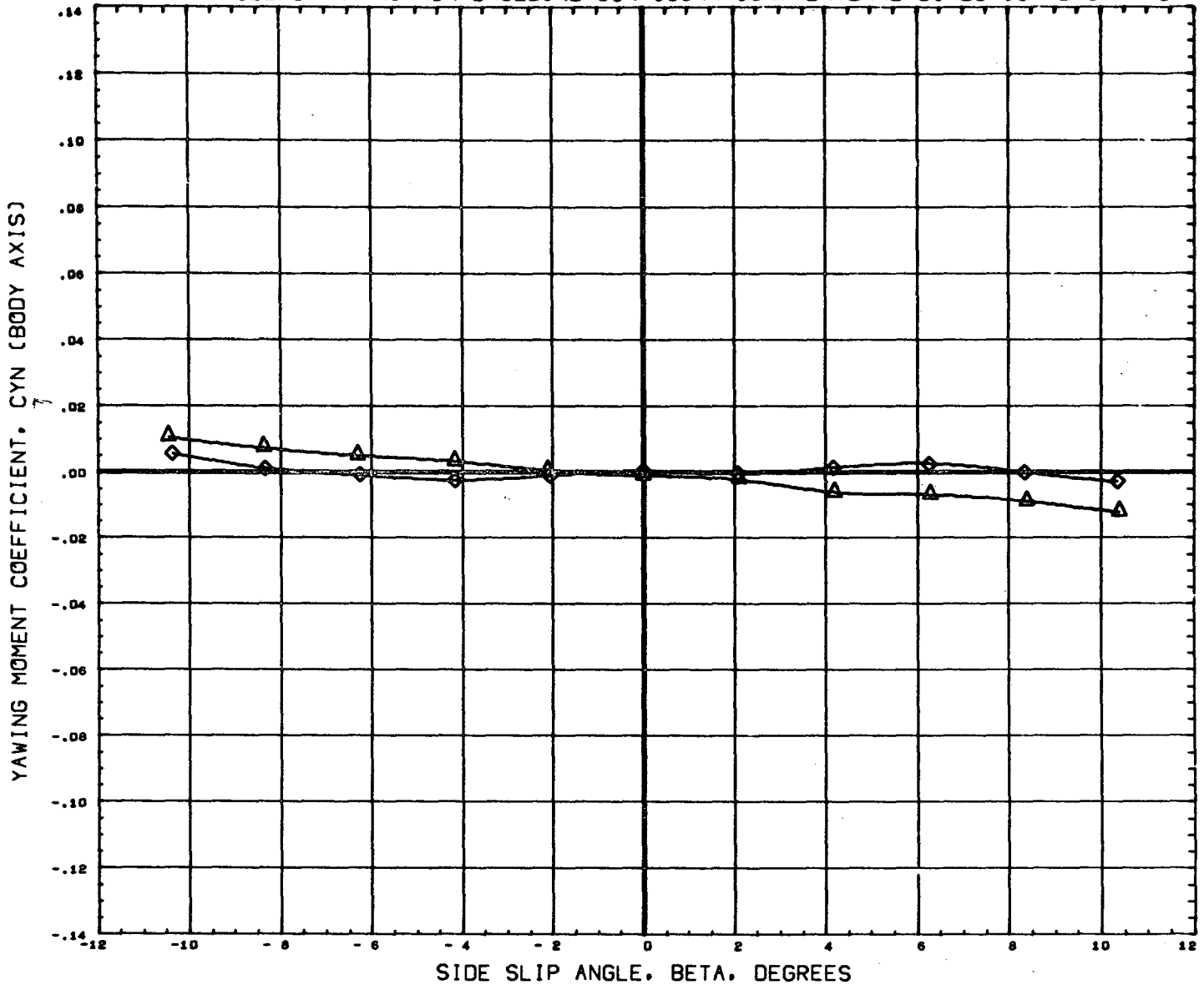

DATA SET SYMBOL	CONFIGURATION DESCRIPTION	ORBIN	THETS	ALPHA	REFERENCE INFORMATION
(B65007)	DATA NOT AVAILABLE FOR ALL CONDITIONS	-1.500	21.000	-6.000	SREF 4.8950 SQ. IN
(B65005)	MSFC TWT 534 SHUTTLE LAUNCH T101S1	-1.500	21.000	0.000	LREF 2.6440 IN.
(B65006)	MSFC TWT 534 SHUTTLE LAUNCH T101S1	-1.500	21.000	6.000	BREF 3.5250 IN.
					XMRP 3.4900 IN.
					YMRP 0.0000 IN.
					ZMRP 0.1616 IN.
					SCALE 0.0034

EFFECT OF ANGLE OF ATTACK ON BASELINE CONFIGURATION, LATERAL/DIRECTIONAL CHARACT

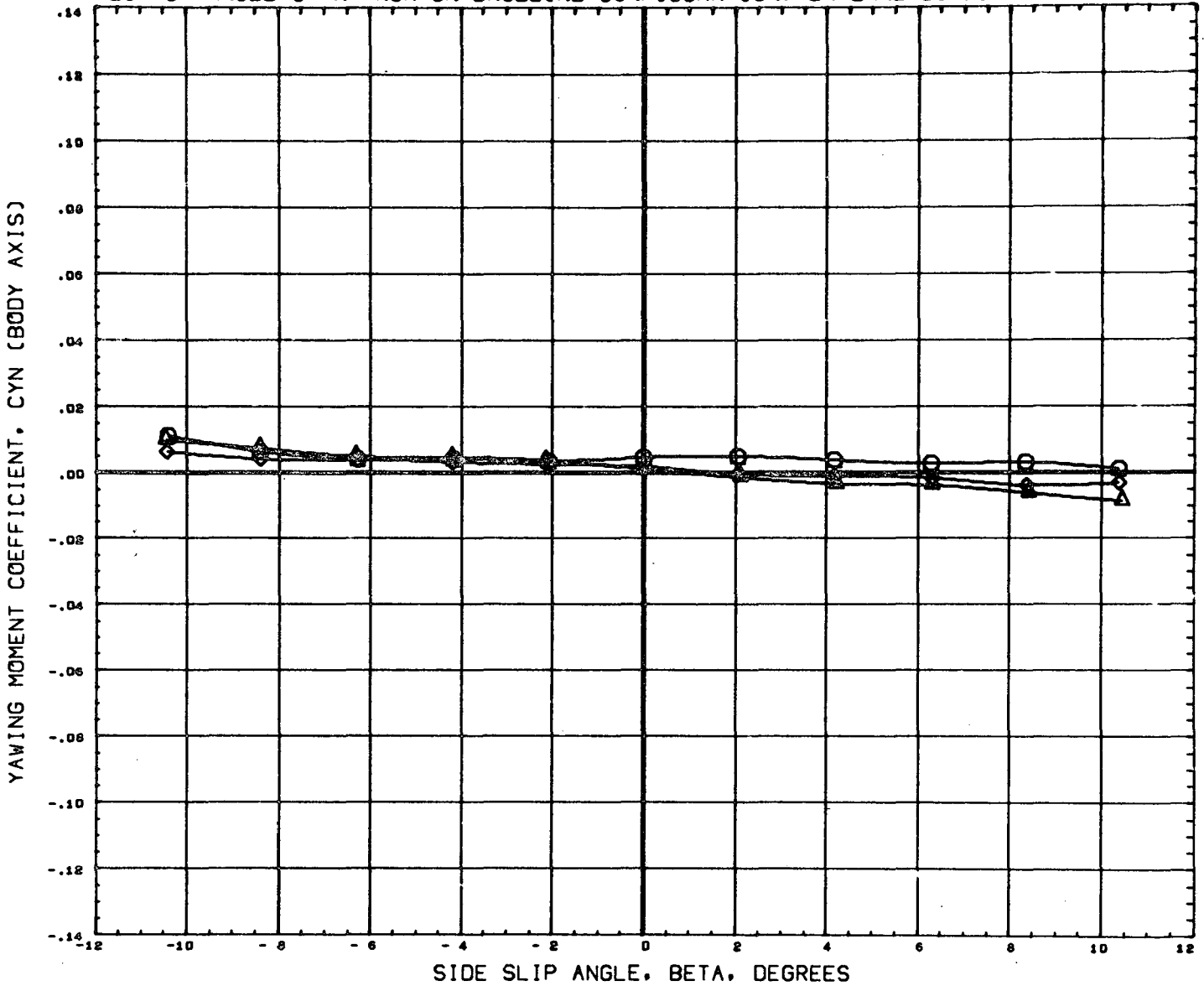

DATA SET SYMBOL	CONFIGURATION DESCRIPTION	ORBIN	THETS	ALPHA	REFERENCE INFORMATION	
(B65007) ○	MSFC TWT 534 SHUTTLE LAUNCH	T101S1	-1.500	21.000	-6.000	SREF 4.8950 sq. IN
(B65005) △	MSFC TWT 534 SHUTTLE LAUNCH	T101S1	-1.500	21.000	0.000	LREF 2.6440 IN.
(B65006) ◇	MSFC TWT 534 SHUTTLE LAUNCH	T101S1	-1.500	21.000	6.000	BREF 3.5250 IN.
					XMRP 3.4900 IN.	
					YMRP 0.0000 IN.	
					ZMRP 0.1616 IN.	
					SCALE 0.0034	

EFFECT OF ANGLE OF ATTACK ON BASELINE CONFIGURATION. LATERAL/DIRECTIONAL CHARACT

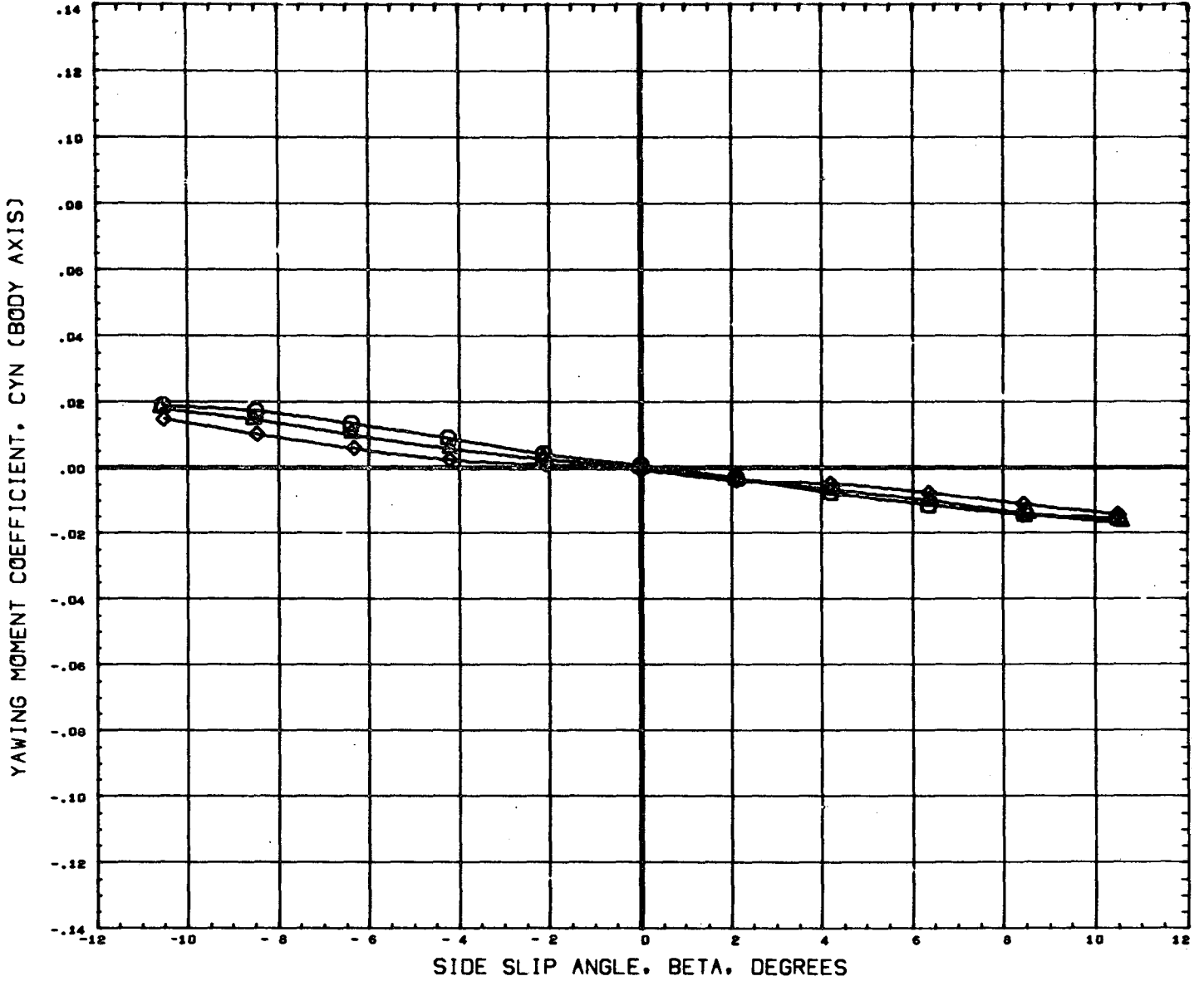

DATA SET SYMBOL	CONFIGURATION DESCRIPTION	ORBIN	THETS	ALPHA	REFERENCE INFORMATION
(B65007) ○	MSFC TWT 534 SHUTTLE LAUNCH T101S1	-1.500	21.000	-6.000	SREF 4.8950 90. IN
(B65005) △	MSFC TWT 534 SHUTTLE LAUNCH T101S1	-1.500	21.000	0.000	LREF 2.6440 IN.
(B65006) ◇	MSFC TWT 534 SHUTTLE LAUNCH T101S1	-1.500	21.000	6.000	BREF 3.5250 IN.
					XMRP 3.4900 IN.
					YMRP 0.0000 IN.
					ZMRP 0.1616 IN.
					SCALE 0.0034

EFFECT OF ANGLE OF ATTACK ON BASELINE CONFIGURATION, LATERAL/DIRECTIONAL CHARACT

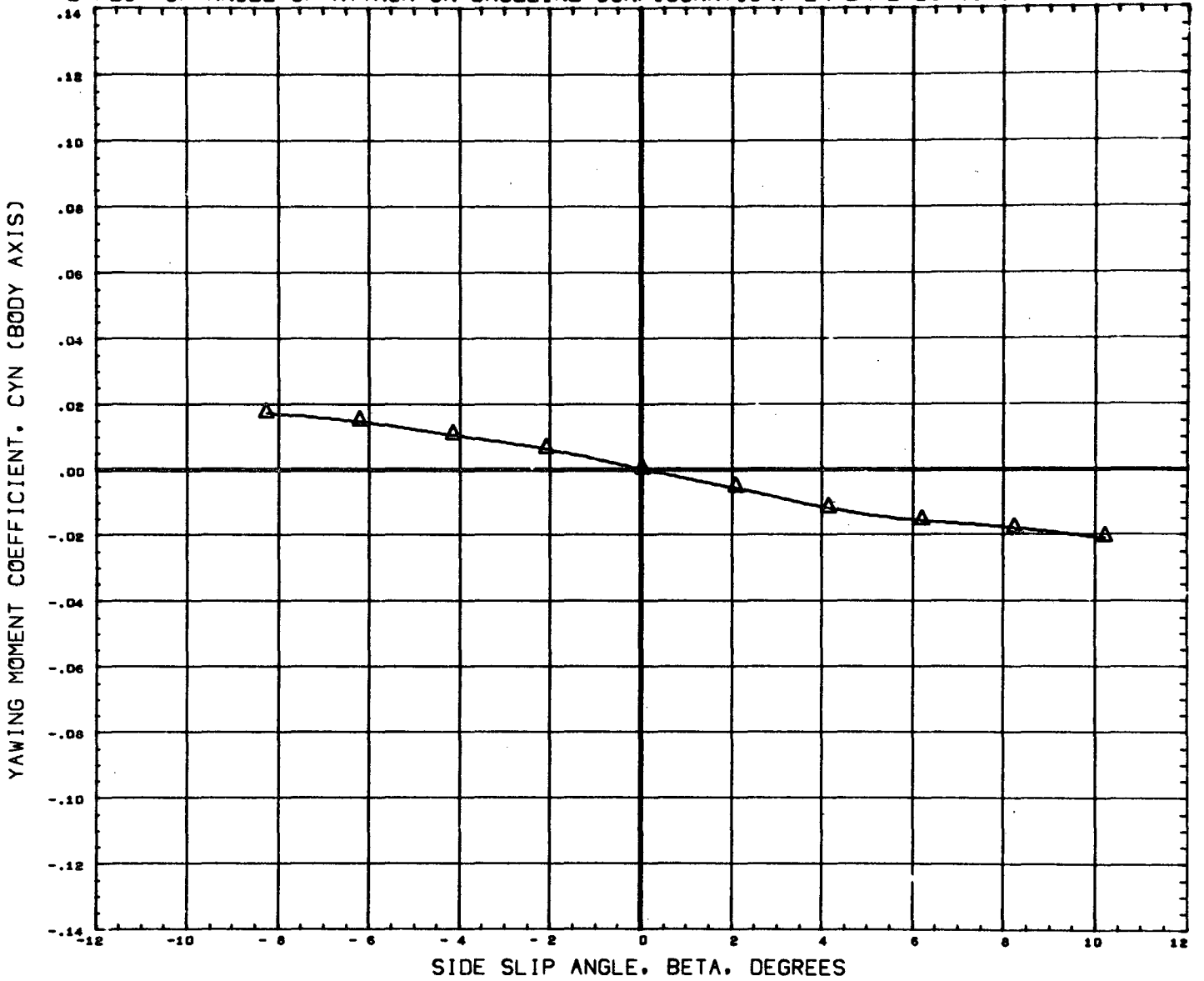

DATA SET SYMBOL CONFIGURATION DESCRIPTION
 (B65007) DATA NOT AVAILABLE FOR ALL CONDITIONS
 (B65005) MSFC TWT 534 SHUTTLE LAUNCH T101S1
 (B65006) DATA NOT AVAILABLE FOR ALL CONDITIONS

ORBIN	THETS	ALPHA
-1.500	21.000	-6.000
-1.500	21.000	0.000
-1.500	21.000	6.000

REFERENCE INFORMATION

SREF	4.8950	SQ. IN
LREF	2.6440	IN.
BREF	3.5250	IN.
XNRP	3.4900	IN.
YNRP	0.0000	IN.
ZNRP	0.1616	IN.
SCALE	0.0034	

MACH 2.74

PAGE 479

EFFECT OF ANGLE OF ATTACK ON BASELINE CONFIGURATION. LATERAL/DIRECTIONAL CHARACT

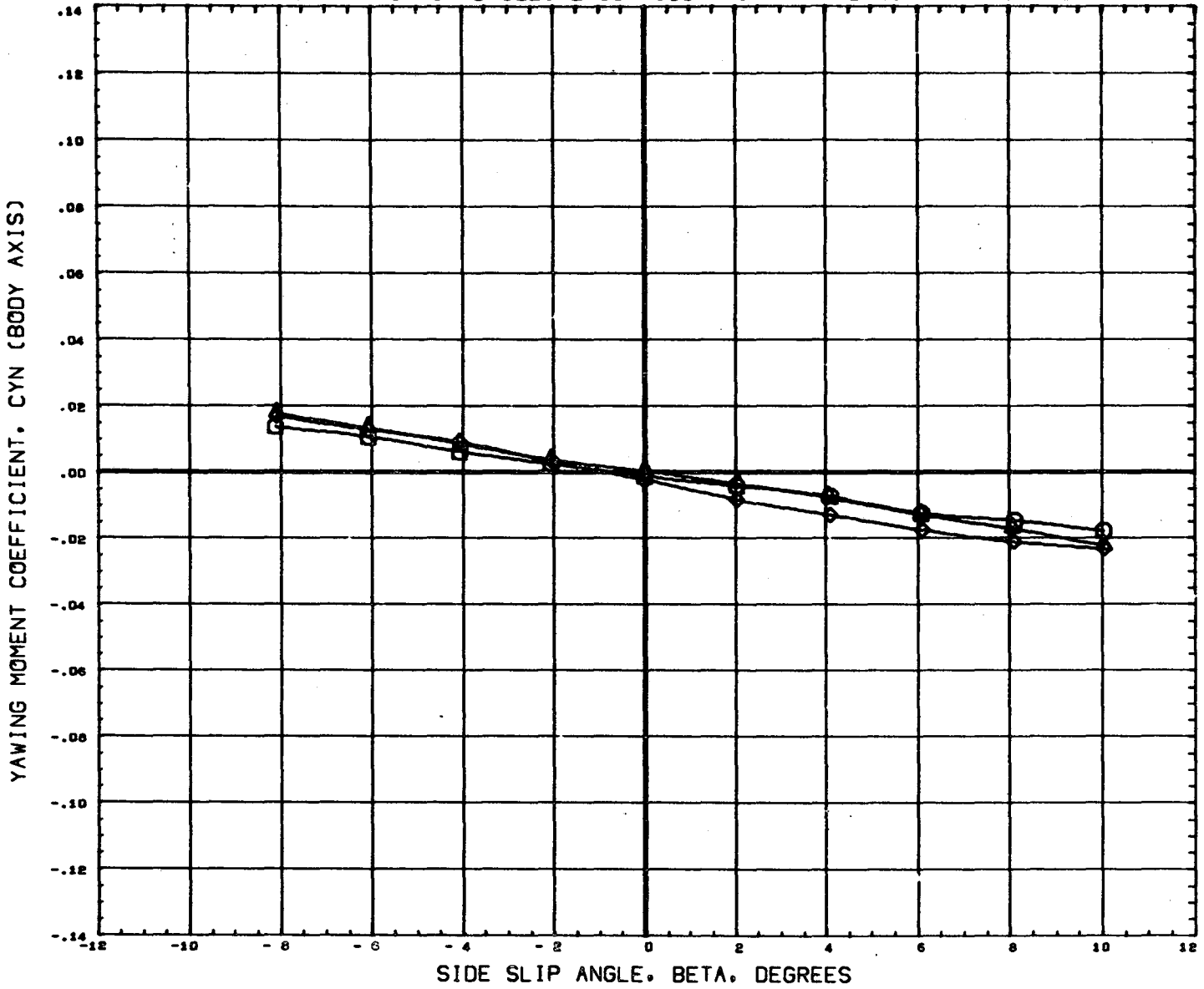

DATA SET SYMBOL	CONFIGURATION DESCRIPTION	ORBIN	THETS	ALPHA	REFERENCE INFORMATION	
(B65007)	MSFC TWT 534 SHUTTLE LAUNCH	T101S1	-1.500	21.00L	-6.000	SREF 4.8950 SQ. IN
(B65005)	MSFC TWT 534 SHUTTLE LAUNCH	T101S1	-1.500	21.000	0.000	LREF 2.6440 IN.
(B65006)	MSFC TWT 534 SHUTTLE LAUNCH	T101S1	-1.500	21.000	6.000	BREF 3.5250 IN.
						XNRP 3.4900 IN.
						YNRP 0.0000 IN.
						ZNRP 0.1616 IN.
						SCALE 0.0034

MACH

4.96

PAGE 480

EFFECT OF ANGLE OF ATTACK ON BASELINE CONFIGURATION, LATERAL/DIRECTIONAL CHARACT

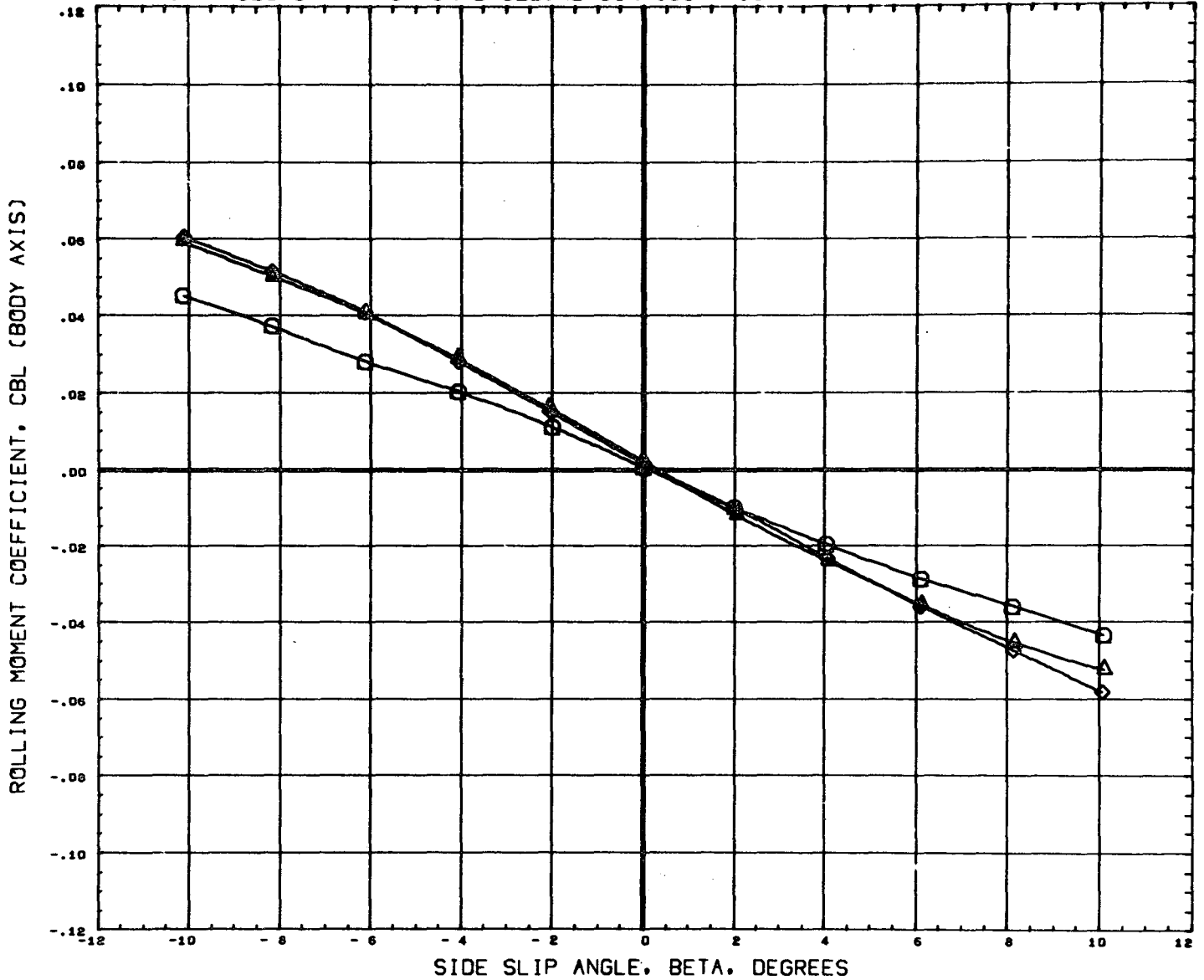

DATA SET SYMBOL	CONFIGURATION DESCRIPTION	ORBIN	THETS	ALPHA	REFERENCE INFORMATION
(B65007) \square	MSFC TWT 534 SHUTTLE LAUNCH T101S1	-1.500	21.000	-6.000	SREF 4.8950 SQ. IN
(B65005) \triangle	MSFC TWT 534 SHUTTLE LAUNCH T101S1	-1.500	21.000	0.000	LREF 2.6440 IN.
(B65006) \diamond	MSFC TWT 534 SHUTTLE LAUNCH T101S1	-1.500	21.000	6.000	BREF 3.5250 IN.
					XMRP 3.4900 IN.
					YMRP 0.0000 IN.
					ZMRP 0.1616 IN.
					SCALE 0.0034

EFFECT OF ANGLE OF ATTACK ON BASELINE CONFIGURATION, LATERAL/DIRECTIONAL CHARACT

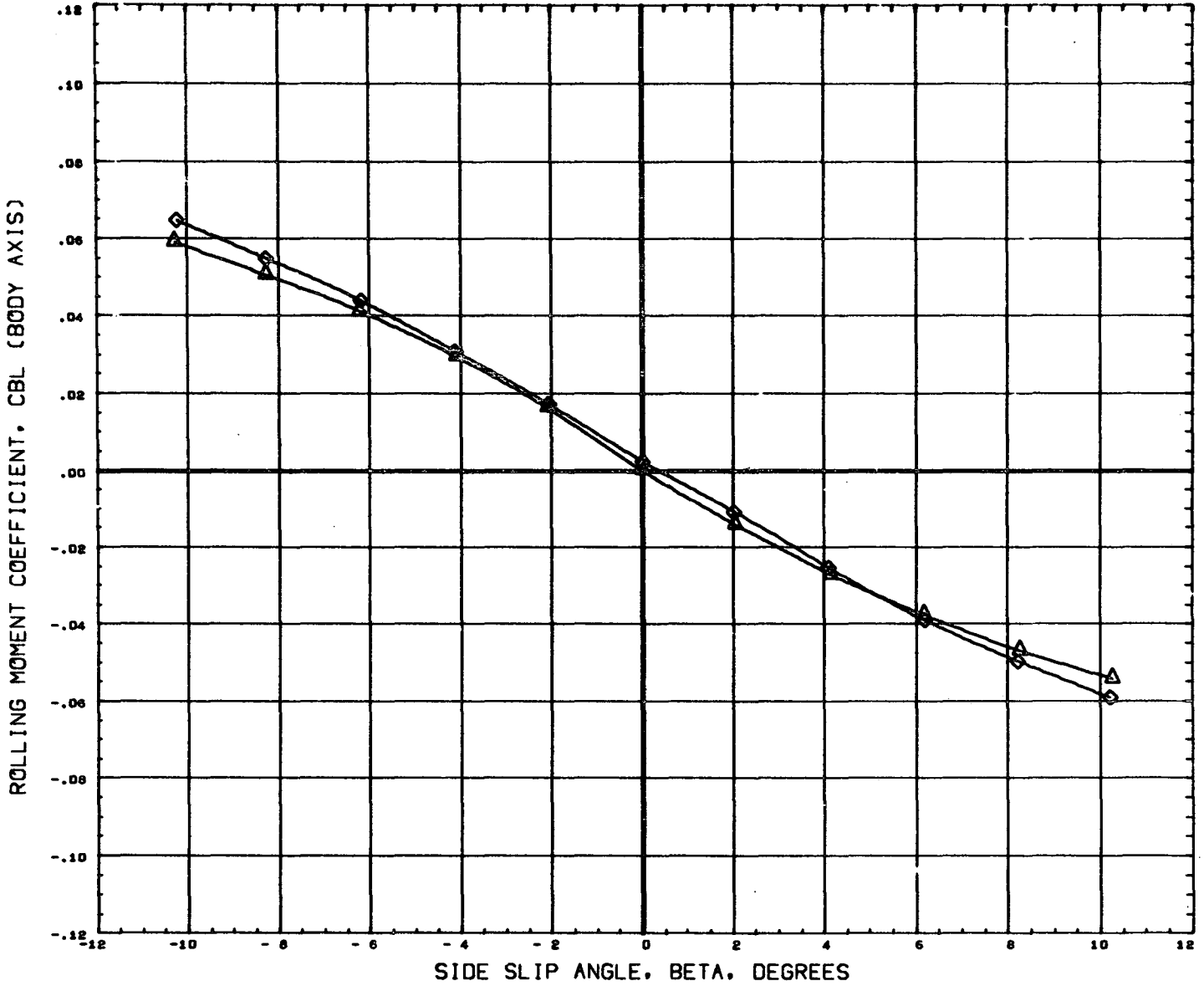

DATA SET SYMBOL	CONFIGURATION DESCRIPTION	ORBIN	THETS	ALPHA	REFERENCE INFORMATION
(B65007)	DATA NOT AVAILABLE FOR ALL CONDITIONS	-1.500	21.000	-6.000	SREF 4.8950 SQ. IN
(B65005)	NSFC TWT 534 SHUTTLE LAUNCH T101S1	-1.500	21.000	0.000	LREF 2.6440 IN.
(B65006)	NSFC TWT 534 SHUTTLE LAUNCH T101S1	-1.500	21.000	6.000	BREF 3.5250 IN.
					XMRP 3.4900 IN.
					YMRP 0.0000 IN.
					ZMRP 0.1616 IN.
					SCALE 0.0034

EFFECT OF ANGLE OF ATTACK ON BASELINE CONFIGURATION, LATERAL/DIRECTIONAL CHARACT

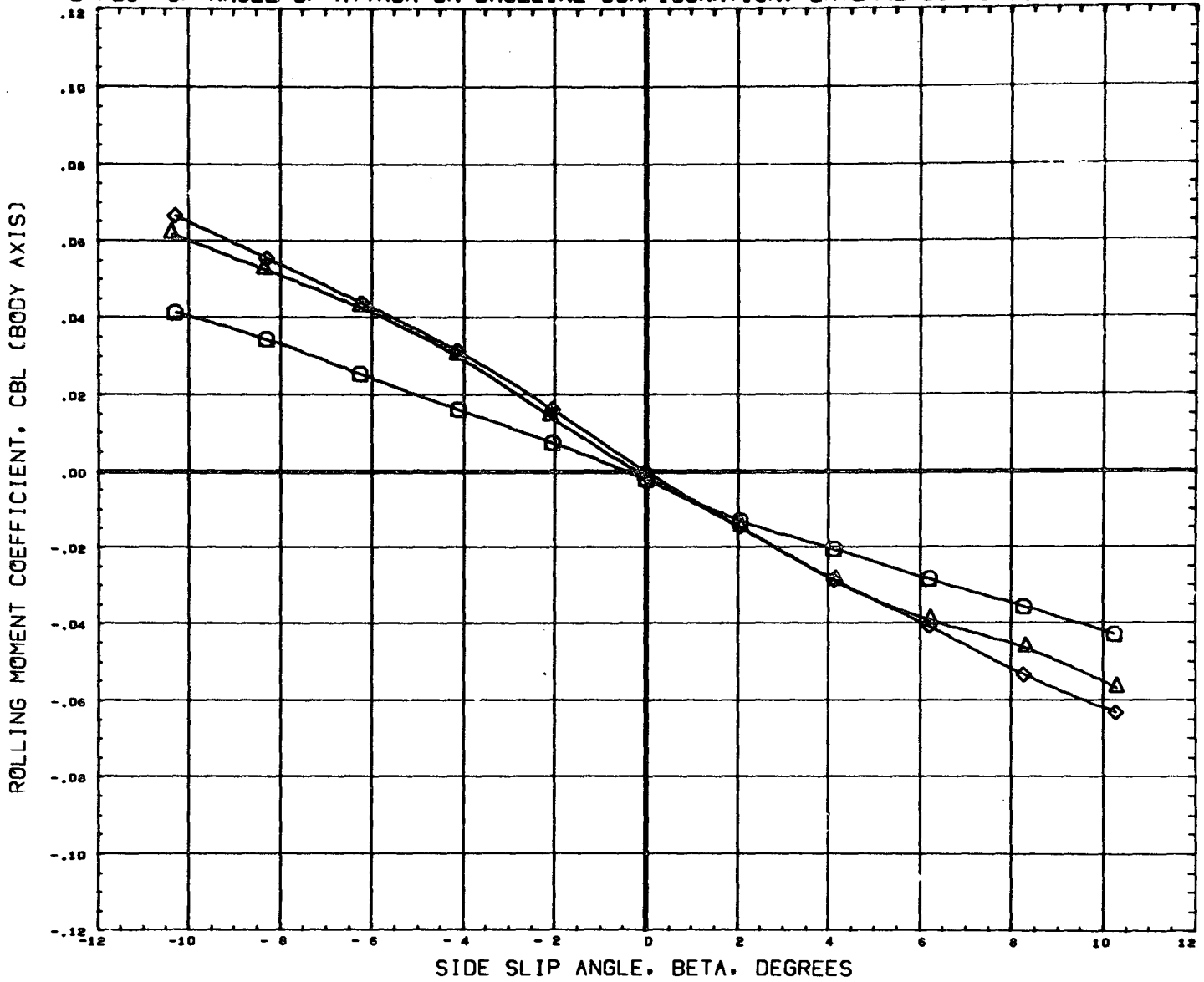

DATA SET SYMBOL	CONFIGURATION DESCRIPTION	T101S1	ORBIN	THETS	ALPHA	REFERENCE INFORMATION	
(B65007)	MSFC TWT 534 SHUTTLE LAUNCH	T101S1	-1.500	21.000	-6.000	SREF	4.8950 SQ. IN
(B65005)	MSFC TWT 534 SHUTTLE LAUNCH	T101S1	-1.500	21.000	0.000	LREF	2.6440 IN.
(B65006)	MSFC TWT 534 SHUTTLE LAUNCH	T101S1	-1.500	21.000	6.000	BREF	3.5250 IN.
						XMRP	3.4900 IN.
						YMRP	0.0000 IN.
						ZMRP	0.1616 IN.
						SCALE	0.6034

MACH .90

EFFECT OF ANGLE OF ATTACK ON BASELINE CONFIGURATION. LATERAL/DIRECTIONAL CHARACT

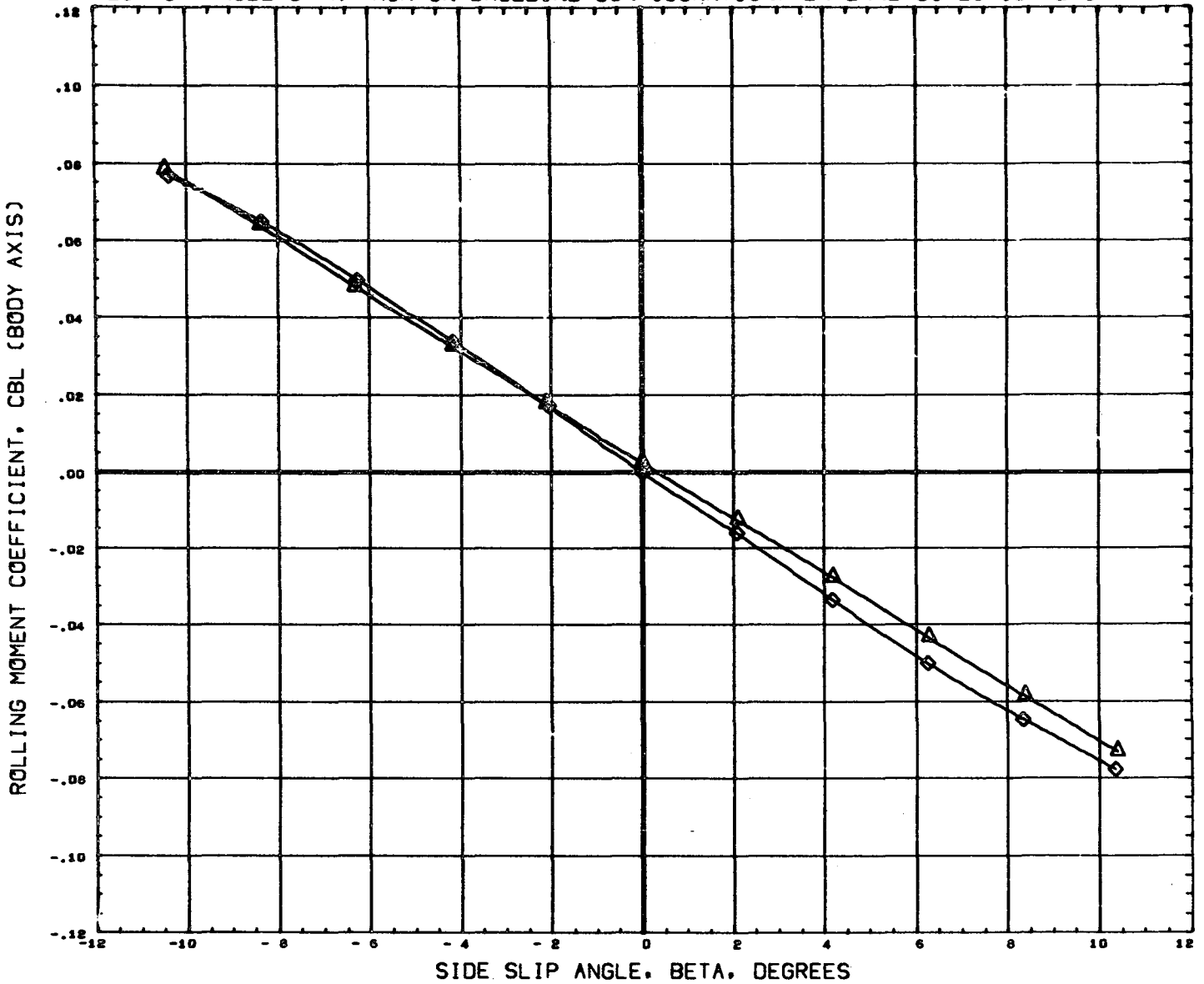

DATA SET SYMBOL	CONFIGURATION DESCRIPTION	ORBIN	THETS	ALPHA	REFERENCE INFORMATION
(B65007)	DATA NOT AVAILABLE FOR ALL CONDITIONS	-1.500	21.000	-6.000	SREF 4.8950 SQ. IN
(B65005)	MSFC TWT 534 SHUTTLE LAUNCH T101S1	-1.500	21.000	0.000	LREF 2.6440 IN.
(B65006)	MSFC TWT 534 SHUTTLE LAUNCH T101S1	-1.500	21.000	6.000	BREF 3.5250 IN.
					YMRP 3.4900 IN.
					YMRP 0.0000 IN.
					ZMRP 0.1616 IN.
					SCALE 0.0034

EFFECT OF ANGLE OF ATTACK ON BASELINE CONFIGURATION. LATERAL/DIRECTIONAL CHARACT

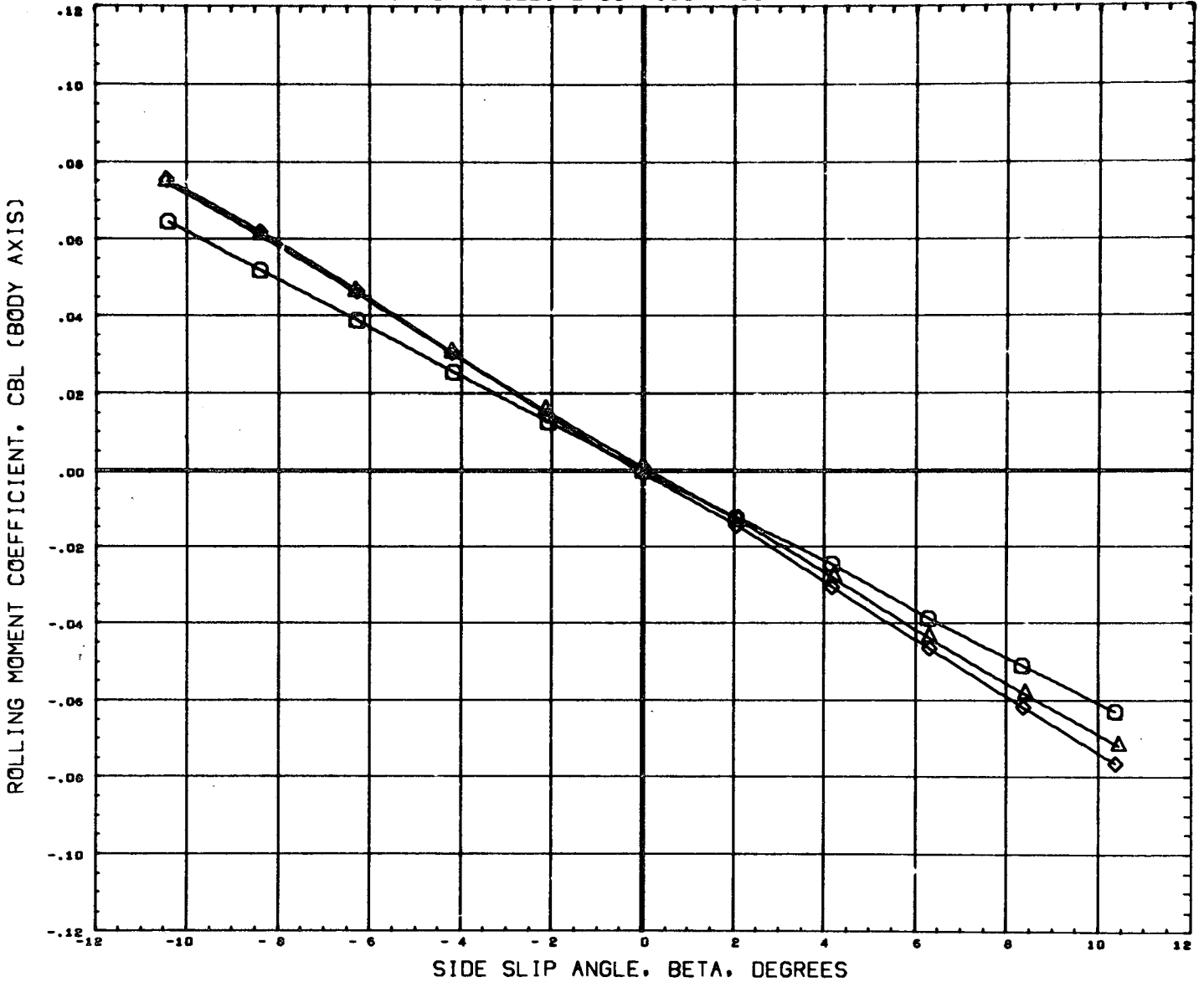

DATA SET SYMBOL	CONFIGURATION DESCRIPTION	ORBIN	THETS	ALPHA	REFERENCE INFORMATION
(B65007) ○	MSFC TWT 534 SHUTTLE LAUNCH T101S1	-1.500	21.000	-6.000	SREF 4.8950 SQ. IN
(B65005) △	MSFC TWT 534 SHUTTLE LAUNCH T101S1	-1.500	21.000	0.000	LREF 2.6440 IN.
(B65006) ◇	MSFC TWT 534 SHUTTLE LAUNCH T101S1	-1.500	21.000	6.000	BREF 3.5250 IN.
					XMRP 3.4900 IN.
					YMRP 0.0000 IN.
					ZMRP 0.1616 IN.
					SCALE 0.0034

EFFECT OF ANGLE OF ATTACK ON BASELINE CONFIGURATION, LATERAL/DIRECTIONAL CHARACT

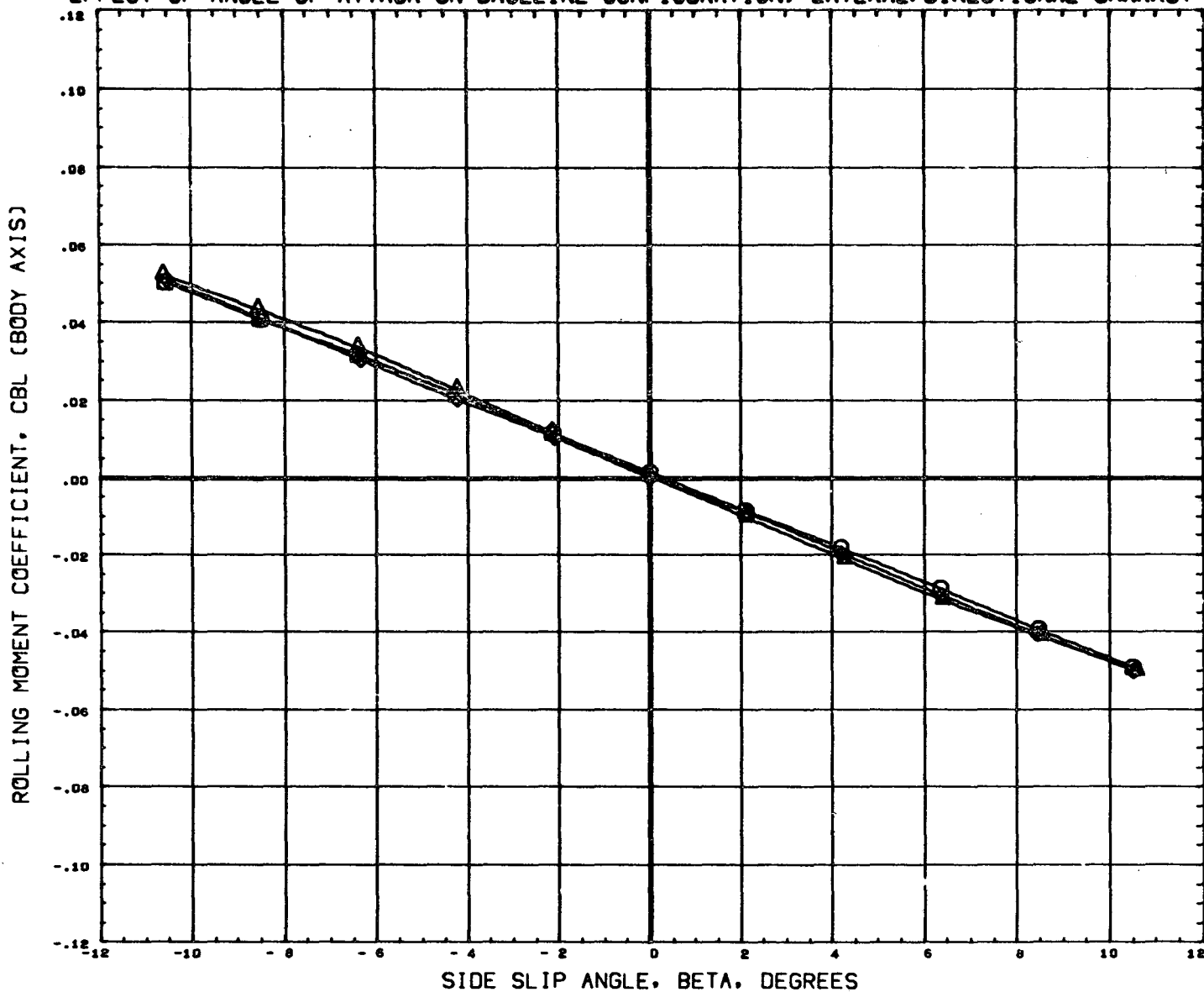

DATA SET SYMBOL	CONFIGURATION DESCRIPTION	ORBIN	THETS	ALPHA
(B65007) ○	MSFC TWT 534 SHUTTLE LAUNCH	-1.500	21.000	-6.000
(B65005) △	MSFC TWT 534 SHUTTLE LAUNCH	-1.500	21.000	0.000
(B65006) ◇	MSFC TWT 534 SHUTTLE LAUNCH	-1.500	21.000	6.000

REFERENCE INFORMATION		
SREF	4.8950	Sq. IN.
LREF	2.6440	IN.
BREF	3.5250	IN.
XMRP	3.4900	IN.
YMRP	0.0000	IN.
ZMRP	0.1616	IN.
SCALE	0.0034	

MACH 1.96

PAGE 486

EFFECT OF ANGLE OF ATTACK ON BASELINE CONFIGURATION, LATERAL/DIRECTIONAL CHARACT

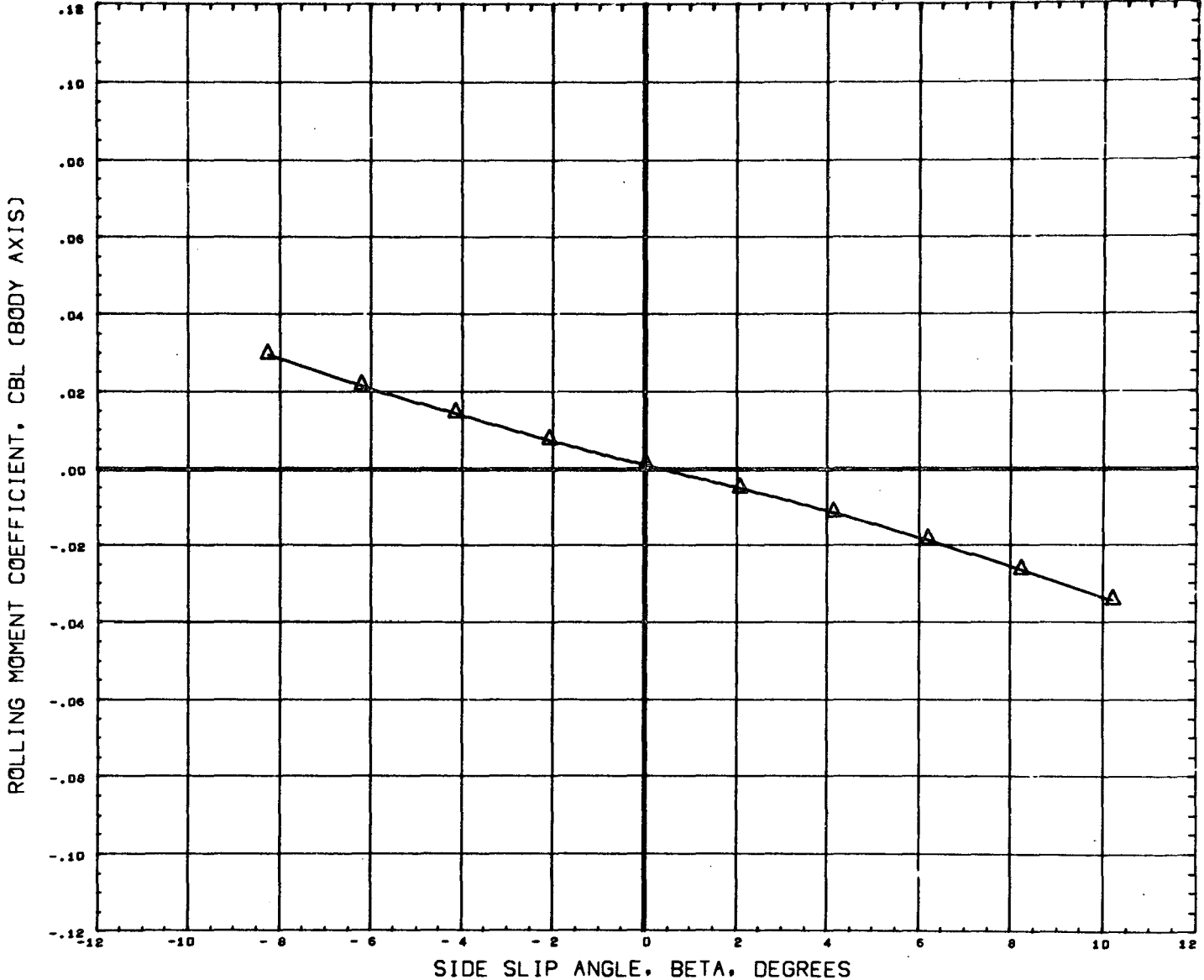

DATA SET SYMBOL	CONFIGURATION DESCRIPTION	ORBIN	THETS	ALPHA	REFERENCE INFORMATION
(B65007)	DATA NOT AVAILABLE FOR ALL CONDITIONS	-1.500	21.000	-6.000	SREF 4.8950 SQ. IN
(B65005)	MSFC TWT 534 SHUTTLE LAUNCH T101S1	-1.500	21.000	0.000	LREF 2.6440 IN.
(B65006)	DATA NOT AVAILABLE FOR ALL CONDITIONS	-1.500	21.000	6.000	BREF 3.5250 IN.
					XMRP 3.4900 IN.
					YMRP 0.0000 IN.
					ZMRP 0.1616 IN.
					SCALE 0.0034

MACH 2.74

EFFECT OF ANGLE OF ATTACK ON BASELINE CONFIGURATION, LATERAL/DIRECTIONAL CHARACT

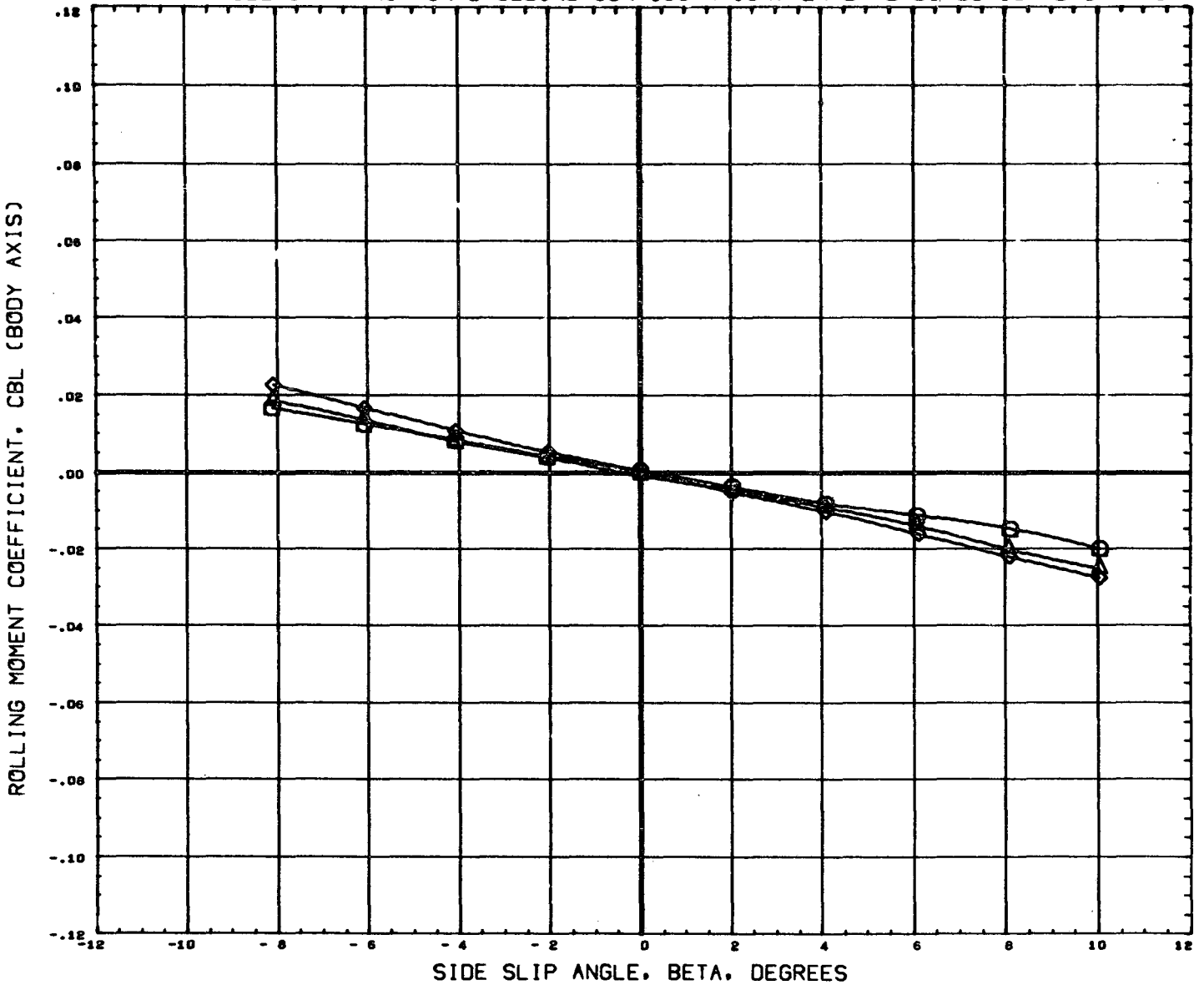

DATA SET SYMBOL	CONFIGURATION DESCRIPTION	ORBIN	THETS	ALPHA	REFERENCE INFORMATION
(865007)	MSFC TWT 534 SHUTTLE LAUNCH	-1.500	21.00J	-6.000	SREF 4.8950 SQ. IN
(865005)	MSFC TWT 534 SHUTTLE LAUNCH	-1.500	21.000	0.000	LREF 2.6440 IN.
(865006)	MSFC TWT 534 SHUTTLE LAUNCH	-1.500	21.000	6.000	BREF 3.5250 IN.
					XMRP 3.4900 IN.
					YMRP 0.0000 IN.
					ZMRP 0.1616 IN.
					SCALE 0.0034

MACH 4.96

PAGE 488

EFFECT OF ANGLE OF ATTACK ON BASELINE CONFIGURATION. LATERAL/DIRECTIONAL CHARACT

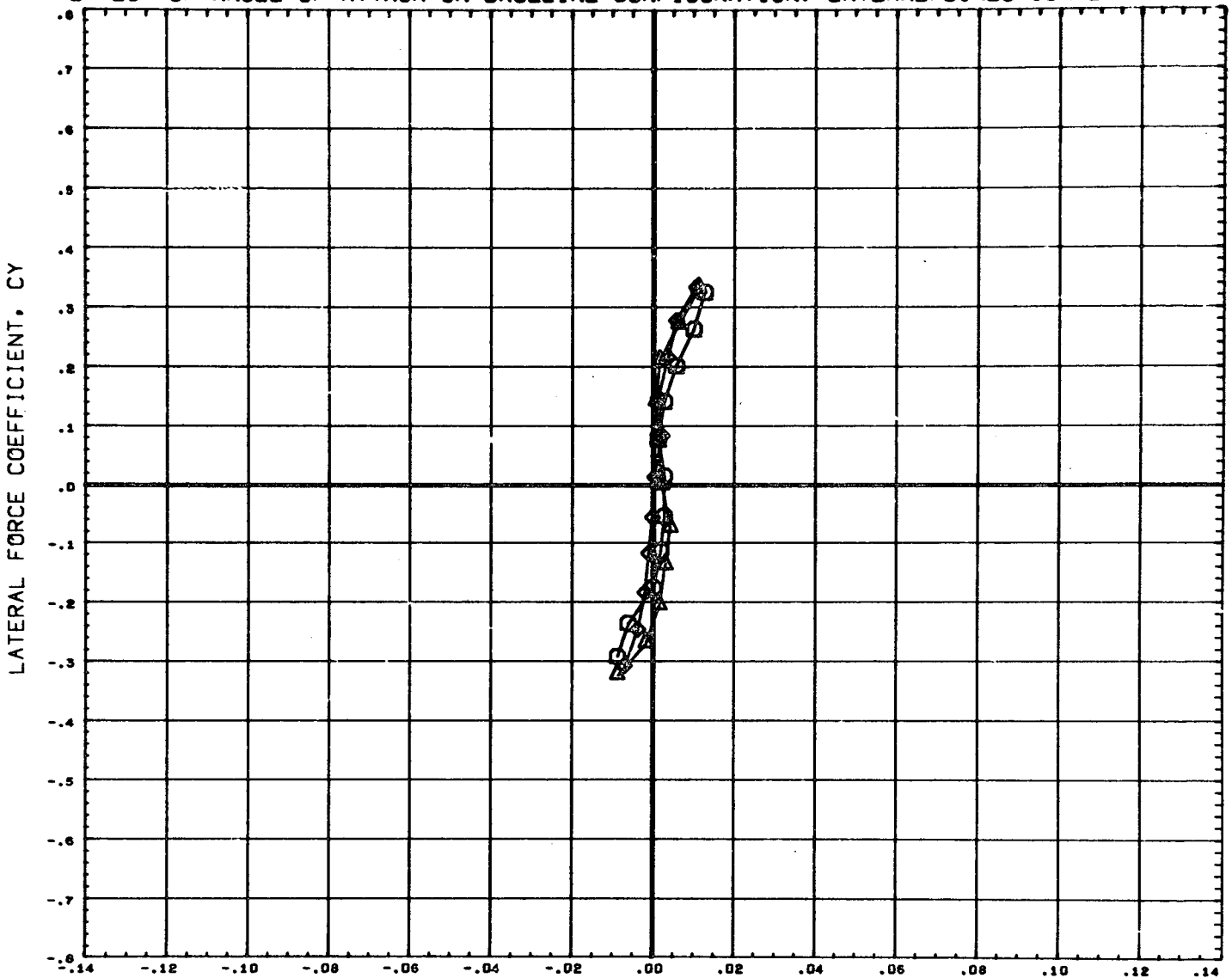

YAWING MOMENT COEFFICIENT, CYN (BODY AXIS)

DATA SET SYMBOL	CONFIGURATION DESCRIPTION	ORBIN	THETS	ALPHA	REFERENCE INFORMATION
(B65007)	MSFC TWT 534 SHUTTLE LAUNCH	-1.500	21.000	-6.000	SREF 4.8950 SQ. IN
(B65005)	MSFC TWT 534 SHUTTLE LAUNCH	-1.500	21.000	0.000	LREF 2.6440 IN.
(B65006)	MSFC TWT 534 SHUTTLE LAUNCH	-1.500	21.000	6.000	BREF 3.5250 IN.
					XMRP 3.4900 IN.
					YMRP 0.0000 IN.
					ZMRP 0.1616 IN.
					SCALE 0.0034

MACH .60

EFFECT OF ANGLE OF ATTACK ON BASELINE CONFIGURATION, LATERAL/DIRECTIONAL CHARACT

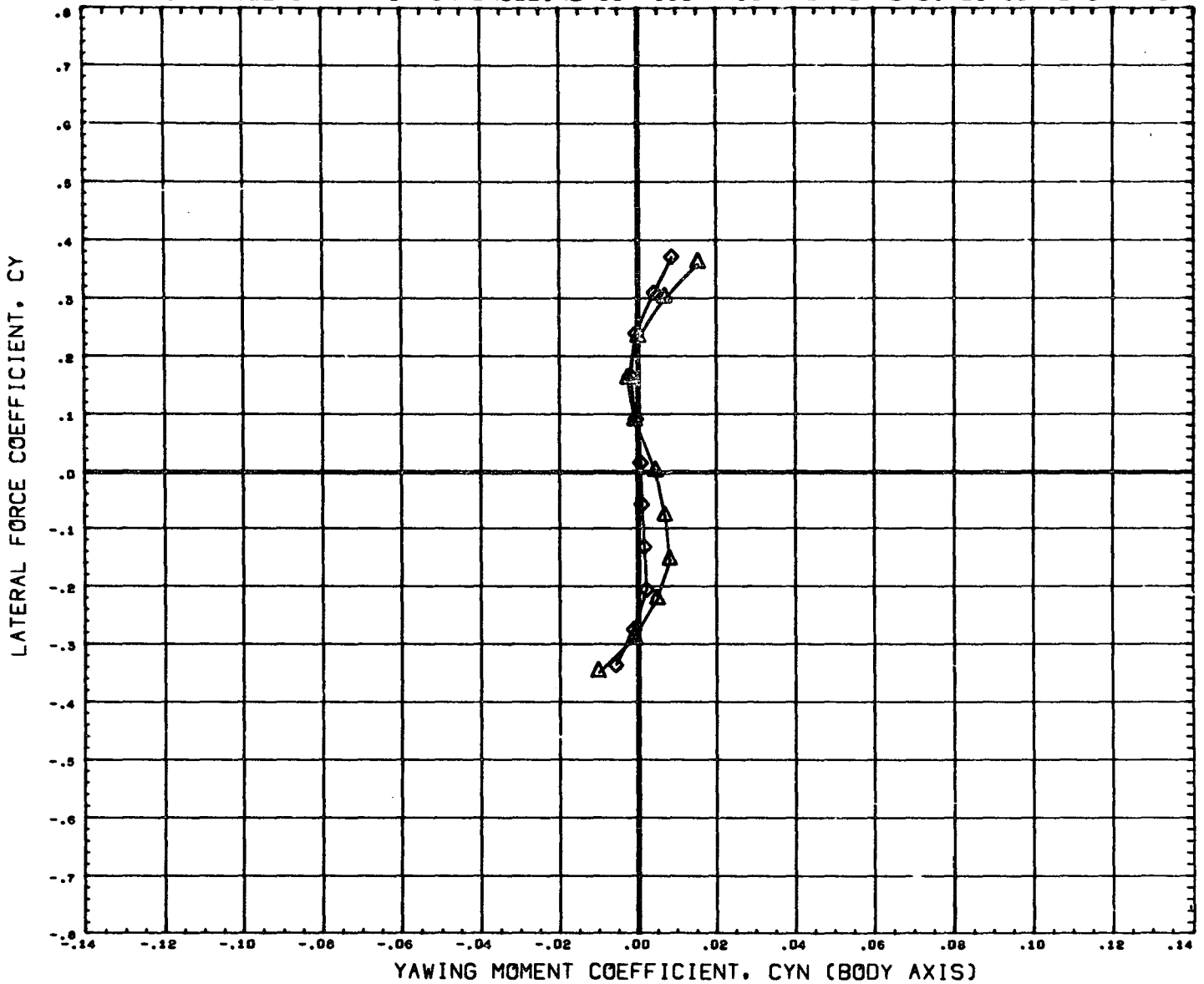

DATA SET SYMBOL	CONFIGURATION DESCRIPTION	ORBIN	THETS	ALPHA	REFERENCE INFORMATION
(865007)	DATA NOT AVAILABLE FOR ALL CONDITIONS	-1.500	21.000	-6.000	SREF 4.8950 SQ. IN
(865005)	MSFC TWT 534 SHUTTLE LAUNCH T101S1	-1.500	21.000	0.000	LREF 2.6440 IN.
(865006)	MSFC TWT 534 SHUTTLE LAUNCH T101S1	-1.500	21.000	6.000	BREF 3.5250 IN.
					XMRP 3.4900 IN.
					YMRP 0.0000 IN.
					ZMRP 0.1616 IN.
					SCALE 0.0034

EFFECT OF ANGLE OF ATTACK ON BASELINE CONFIGURATION. LATERAL/DIRECTIONAL CHARACT

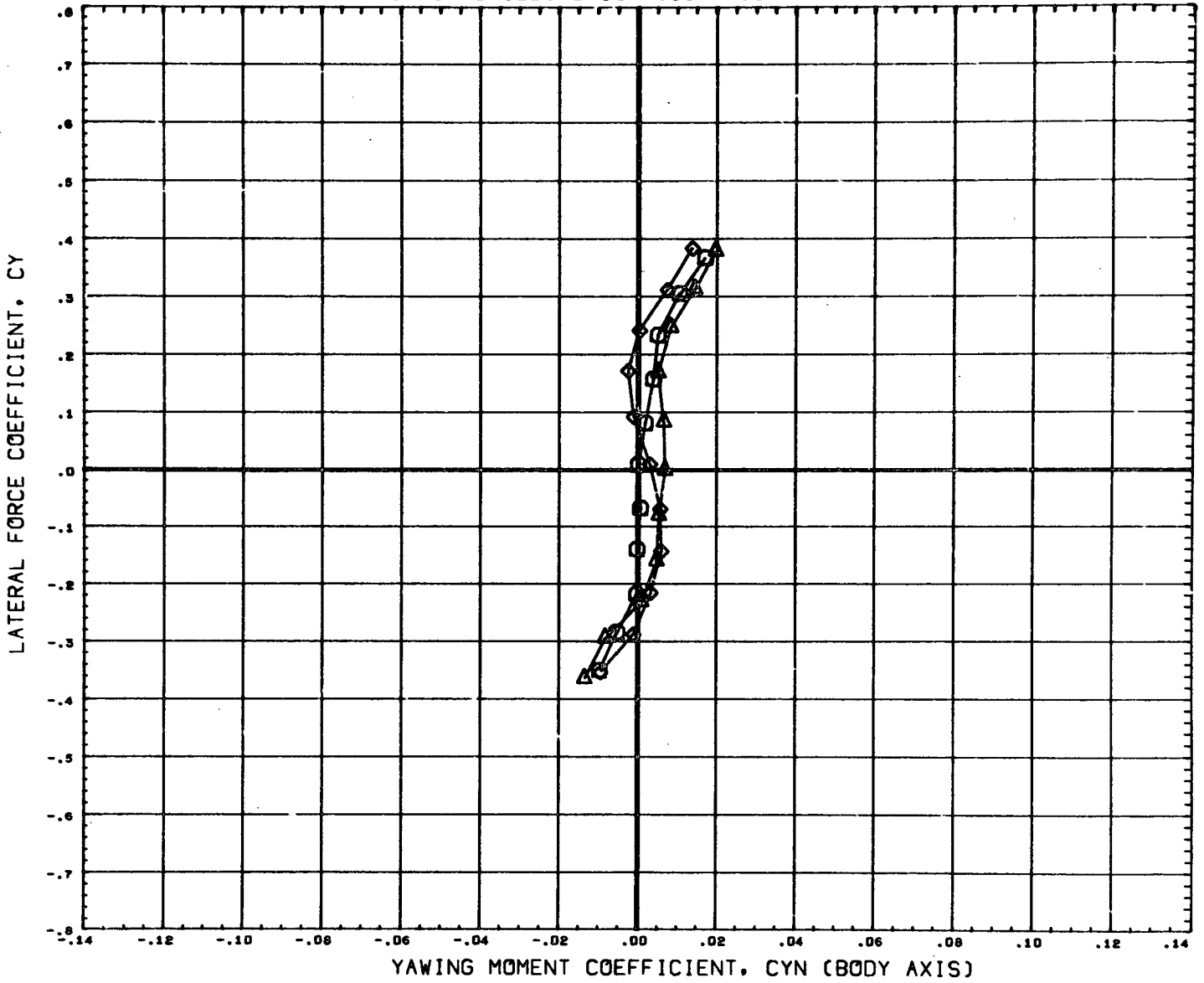

DATA SET SYMBOL	CONFIGURATION DESCRIPTION	ORBIN	THETS	ALPHA	REFERENCE INFORMATION	
(B65007)	MSFC TWT 534 SHUTTLE LAUNCH	T101S1	-1.500	21.000	-6.000	SREF 4.8950 SQ. IN
(B65005)	MSFC TWT 534 SHUTTLE LAUNCH	T101S1	-1.500	21.000	0.000	LREF 2.6440 IN.
(B65006)	MSFC TWT 534 SHUTTLE LAUNCH	T101S1	-1.500	21.000	6.000	BREF 3.5250 IN.
					XMRP 3.4900 IN.	
					YMRP 0.0000 IN.	
					ZMRP 0.1616 IN.	
					SCALE 0.0034	

MACH .90

EFFECT OF ANGLE OF ATTACK ON BASELINE CONFIGURATION, LATERAL/DIRECTIONAL CHARACT

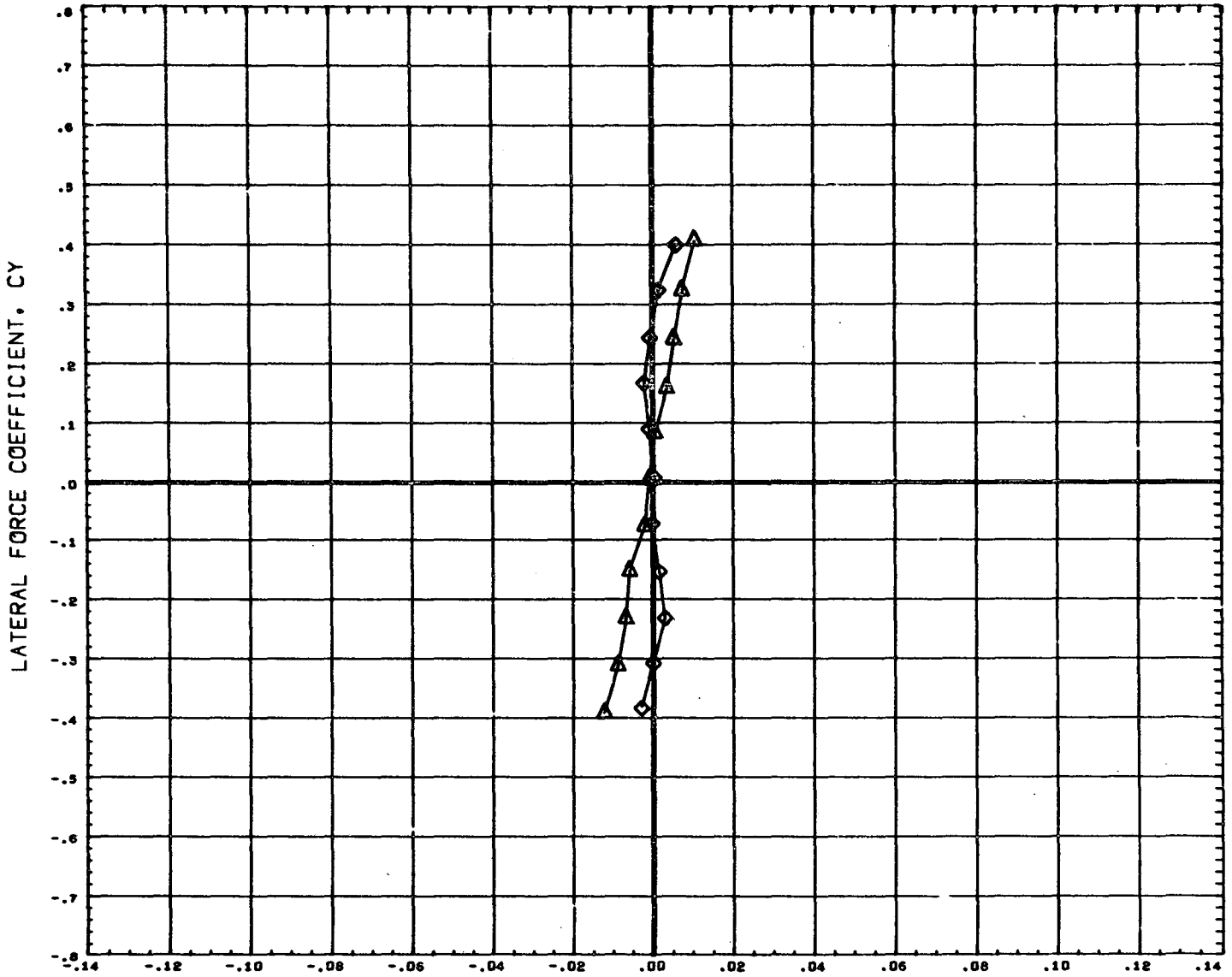

YAWING MOMENT COEFFICIENT, CYN (BODY AXIS)

DATA SET SYMBOL	CONFIGURATION DESCRIPTION	ORBIN	THETS	ALPHA	REFERENCE INFORMATION
(B65007)	DATA NOT AVAILABLE FOR ALL CONDITIONS	-1.500	21.000	-6.000	SREF 4.8950 SQ. IN
(B65005)	MSFC TWT 534 SHUTTLE LAUNCH T101S1	-1.500	21.000	0.000	LREF 2.6440 IN.
(B65006)	MSFC TWT 534 SHUTTLE LAUNCH T101S1	-1.500	21.000	6.000	BREF 3.5250 IN.
					XNRP 3.4900 IN.
					YMRP 0.0000 IN.
					ZMRP 0.1616 IN.
					SCALE 0.0034

MACH 1.09

PAGE 492

EFFECT OF ANGLE OF ATTACK ON BASELINE CONFIGURATION. LATERAL/DIRECTIONAL CHARACT

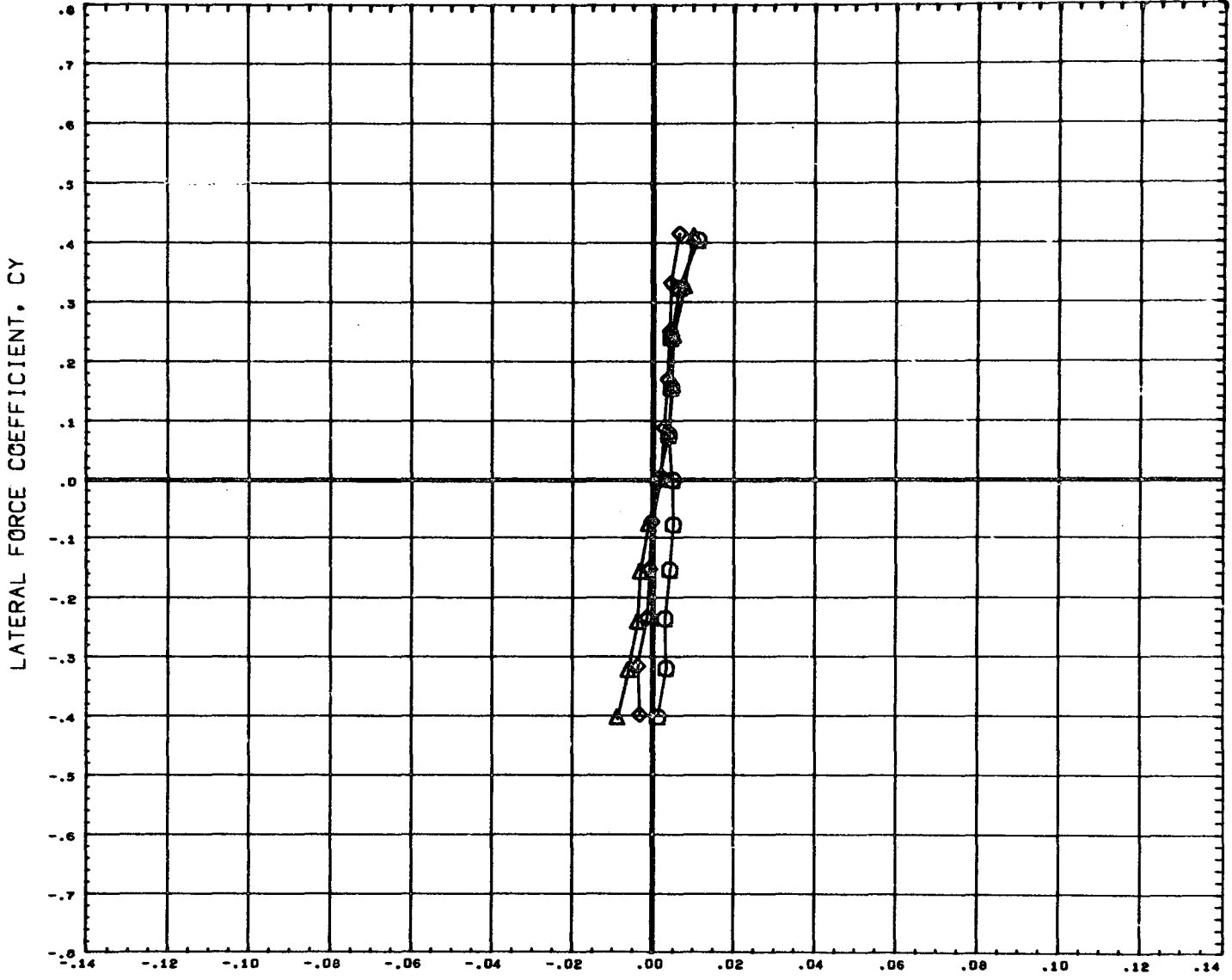

YAWING MOMENT COEFFICIENT, CYN (BODY AXIS)

DATA SET SYMBOL	CONFIGURATION DESCRIPTION	ORBIN	THETS	ALPHA	REFERENCE INFORMATION	
(B65007)	MSFC TWT 534 SHUTTLE LAUNCH	T101S1	-1.500	21.000	-6.000	SREF 4.8950 SQ. IN
(B65005)	MSFC TWT 534 SHUTTLE LAUNCH	T101S1	-1.500	21.000	0.000	LREF 2.6440 IN.
(B65006)	MSFC TWT 534 SHUTTLE LAUNCH	T101S1	-1.500	21.000	6.000	BREF 3.5250 IN.
						XMRP 3.4900 IN.
						YMRP 0.0000 IN.
						ZMRP 0.1616 IN.
						SCALE 0.0034

EFFECT OF ANGLE OF ATTACK ON BASELINE CONFIGURATION. LATERAL/DIRECTIONAL CHARACT

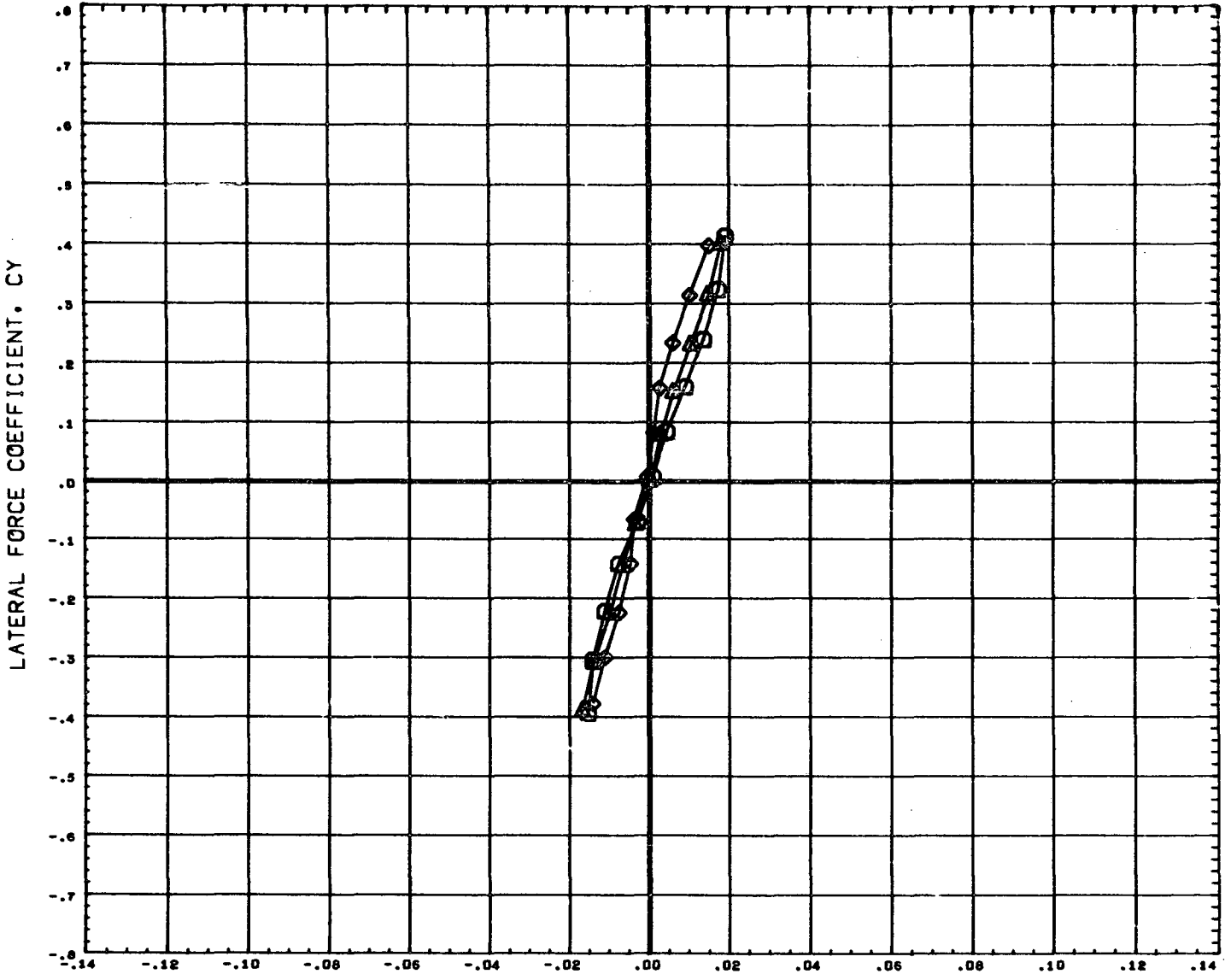

YAWING MOMENT COEFFICIENT, CYN (BODY AXIS)

DATA SET SYMBOL	CONFIGURATION DESCRIPTION	ORBIN	THETS	ALPHA	REFERENCE INFORMATION
(865007) ○	MSFC TWT 534 SHUTTLE LAUNCH T101S1	-1.500	21.000	-6.000	SREF 4.8950 SQ. IN
(865005) △	MSFC TWT 534 SHUTTLE LAUNCH T101S1	-1.500	21.000	0.000	LREF 2.6440 IN.
(865006) ◇	MSFC TWT 534 SHUTTLE LAUNCH T101S1	-1.500	21.000	6.000	BREF 3.5250 IN.
					XMRP 3.4900 IN.
					YMRP 0.0000 IN.
					ZMRP 0.1616 IN.
					SCALE 0.0034

MACH 1.96

PAGE 494

100

EFFECT OF ANGLE OF ATTACK ON BASELINE CONFIGURATION. LATERAL/DIRECTIONAL CHARACT

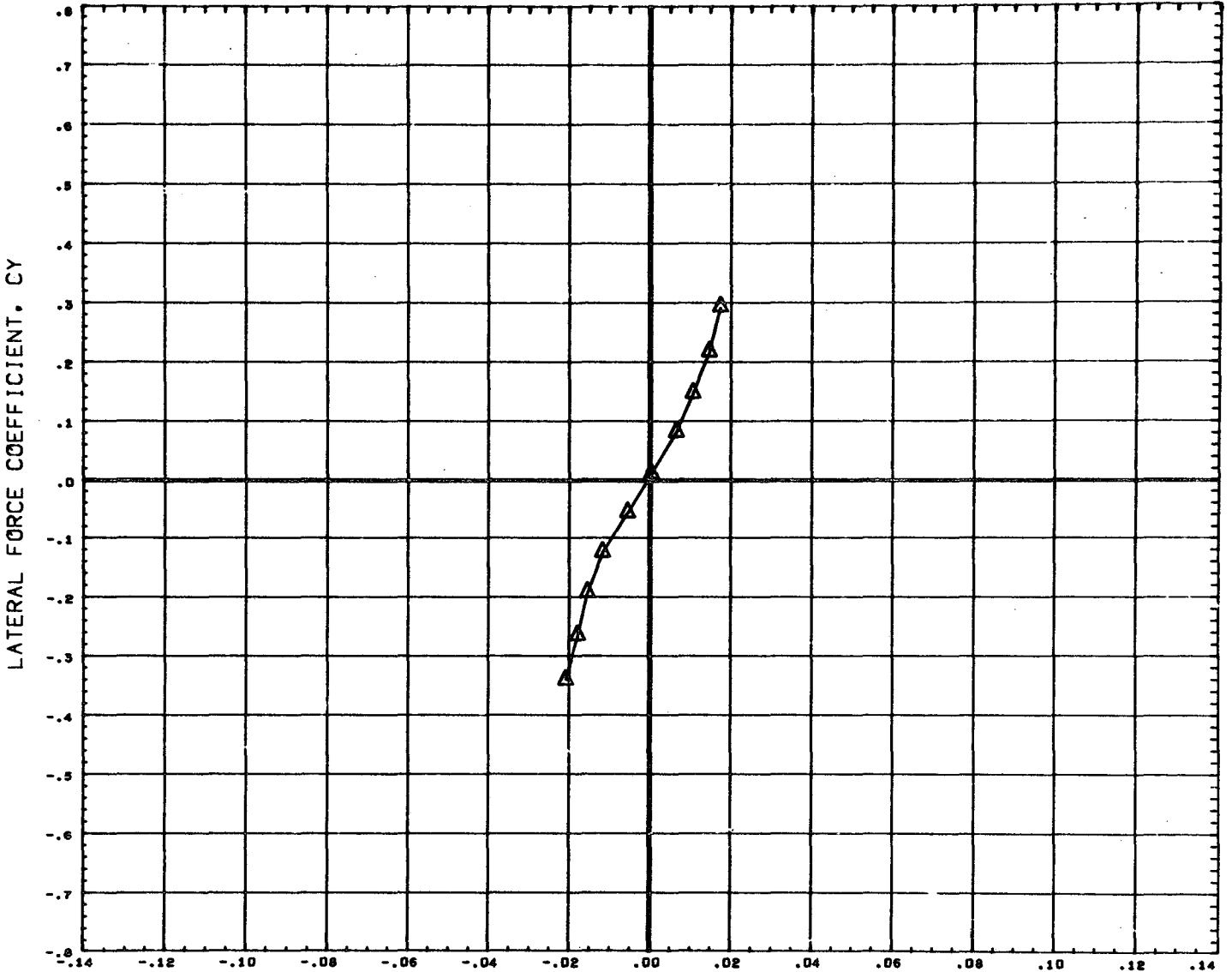

YAWING MOMENT COEFFICIENT, CYN (BODY AXIS)

DATA SET SYMBOL	CONFIGURATION DESCRIPTION	ORBIN	THETS	ALPHA	REFERENCE INFORMATION	
(B65007)	DATA NOT AVAILABLE FOR ALL CONDITIONS	-1.500	21.000	-6.000	SREF	4.8950 SQ. IN
(B65005)	MSFC TWT 534 SHUTTLE LAUNCH T101S1	-1.500	21.000	0.000	LREF	2.6440 IN.
(B65006)	DATA NOT AVAILABLE FOR ALL CONDITIONS	-1.500	21.000	6.000	BREF	3.5250 IN.
					XMRP	3.4900 IN.
					YMRP	0.3000 IN.
					ZMRP	0.1616 IN.
					SCALE	0.0034

EFFECT OF ANGLE OF ATTACK ON BASELINE CONFIGURATION. LATERAL/DIRECTIONAL CHARACT

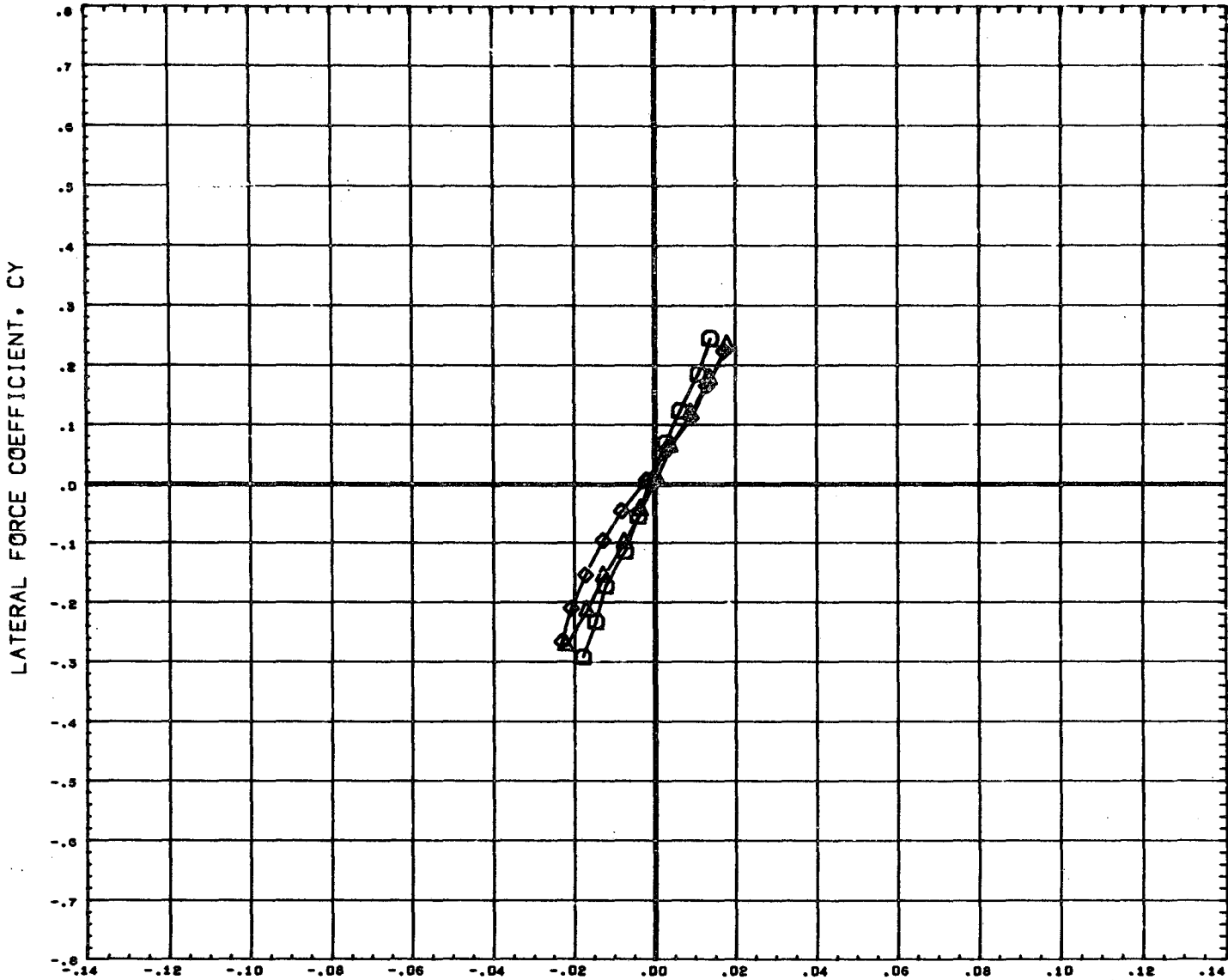

DATA SET SYMBOL	CONFIGURATION DESCRIPTION	T101S1	ORBIN	THETS	ALPHA	REFERENCE INFORMATION
(B65007)	MSFC TWT 534 SHUTTLE LAUNCH	T101S1	-1.500	21.000	-6.000	SREF 4.8950 SQ. IN
(B65005)	MSFC TWT 534 SHUTTLE LAUNCH	T101S1	-1.500	21.000	0.000	LREF 2.6440 IN.
(B65006)	MSFC TWT 534 SHUTTLE LAUNCH	T101S1	-1.500	21.000	6.000	BREF 3.5250 IN.
						XMRP 3.4900 IN.
						YMRP 0.0000 IN.
						ZMRP 0.1616 IN.
						SCALE 0.0034

MACH 4.96

EFFECT OF FIN LOCATION ON LONGITUDINAL CHARACTERISTICS

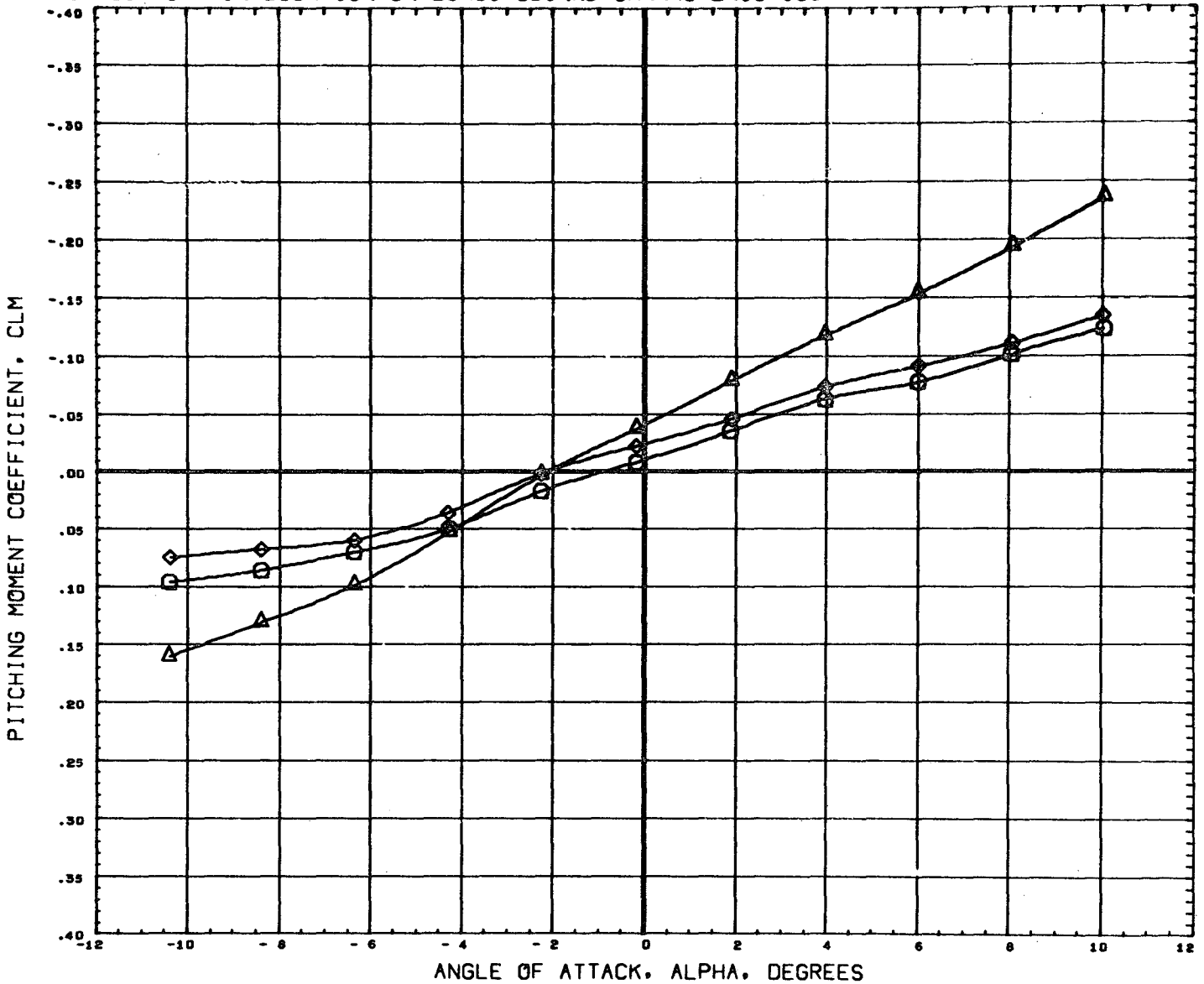

DATA SET SYMBOL	CONFIGURATION DESCRIPTION	ORBIN	THETS	BETA	REFERENCE INFORMATION	
(865004)	MSFC TWT 534 SHUTTLE LAUNCH	T101S1	-1.500	21.000	0.000	SREF 4.8950 SQ. IN
(865012)	MSFC TWT 534 SHUTTLE LAUNCH	T101S1F1	-1.500	21.000	0.000	LREF 2.6440 IN.
(865014)	MSFC TWT 534 SHUTTLE LAUNCH	T101S1F2	-1.500	21.000	0.000	BREF 3.5250 IN.
						XMRP 3.4900 IN.
						YMRP 0.0000 IN.
						ZMRP 0.1616 IN.
						SCALE 0.0034

MACH .60

EFFECT OF FIN LOCATION ON LONGITUDINAL CHARACTERISTICS

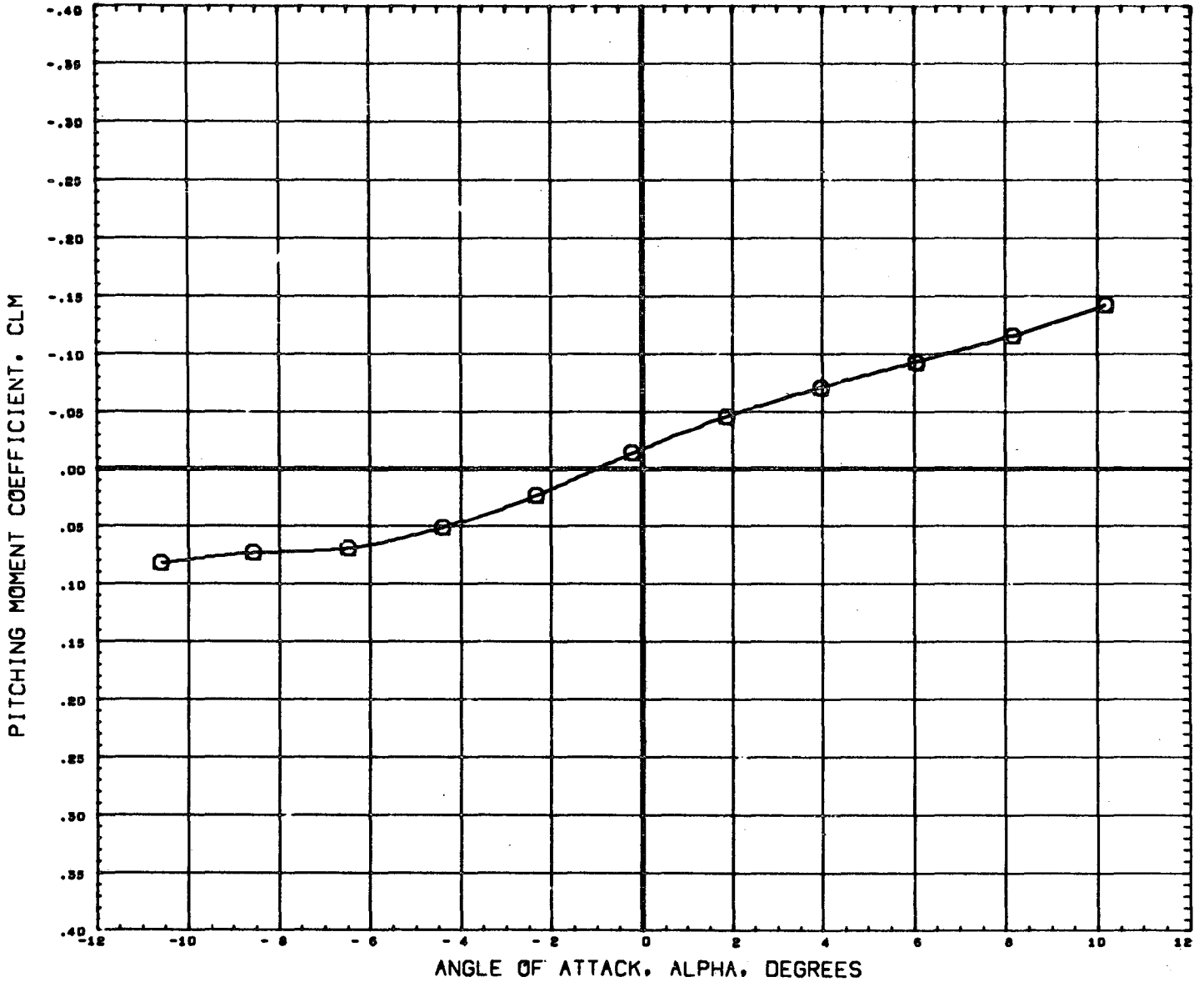

DATA SET SYMBOL	CONFIGURATION DESCRIPTION	ORBIN	THETS	BETA	REFERENCE INFORMATION
(B65004)	MSFC TWT 534 SHUTTLE LAUNCH TSO1S1	-1.500	21.000	0.000	SREF 4.8950 SQ. IN
(B65012)	DATA NOT AVAILABLE FOR ALL CONDITIONS	-1.500	21.000	0.000	LREF 2.6440 IN.
(B65014)	DATA NOT AVAILABLE FOR ALL CONDITIONS	-1.500	21.000	0.000	BREF 3.9250 IN.
					XMRP 3.4900 IN.
					YMRP 0.0000 IN.
					ZMRP 0.1616 IN.
					SCALE 0.0034

MACH .80

PAGE 498

EFFECT OF FIN LOCATION ON LONGITUDINAL CHARACTERISTICS

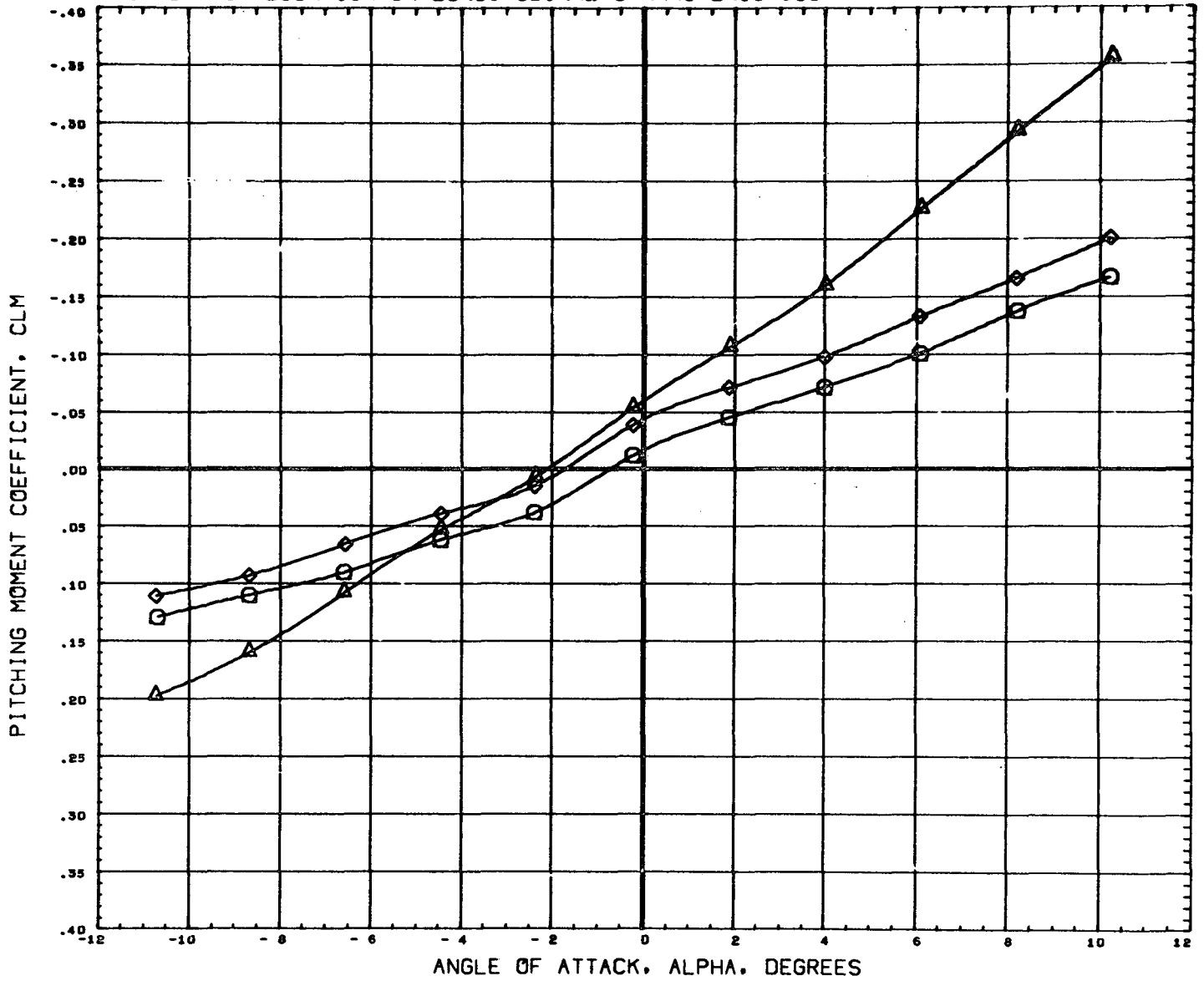

DATA SET SYMBOL	CONFIGURATION DESCRIPTION	ORBIN	THETS	BETA	REFERENCE INFORMATION	
(B65004)	MSFC TWT 534 SHUTTLE LAUNCH	T101S1	-1.500	21.000	0.000	SREF 4.8950 SQ. IN
(B65012)	MSFC TWT 534 SHUTTLE LAUNCH	T101S1F1	-1.500	21.000	0.000	LREF 2.6440 IN.
(B65014)	MSFC TWT 534 SHUTTLE LAUNCH	T101S1F2	-1.500	21.000	0.000	BREF 3.5250 IN.
						XMRP 3.4900 IN.
						YMRP 0.0000 IN.
						ZMRP 0.1616 IN.
						SCALE 0.0034

EFFECT OF FIN LOCATION ON LONGITUDINAL CHARACTERISTICS

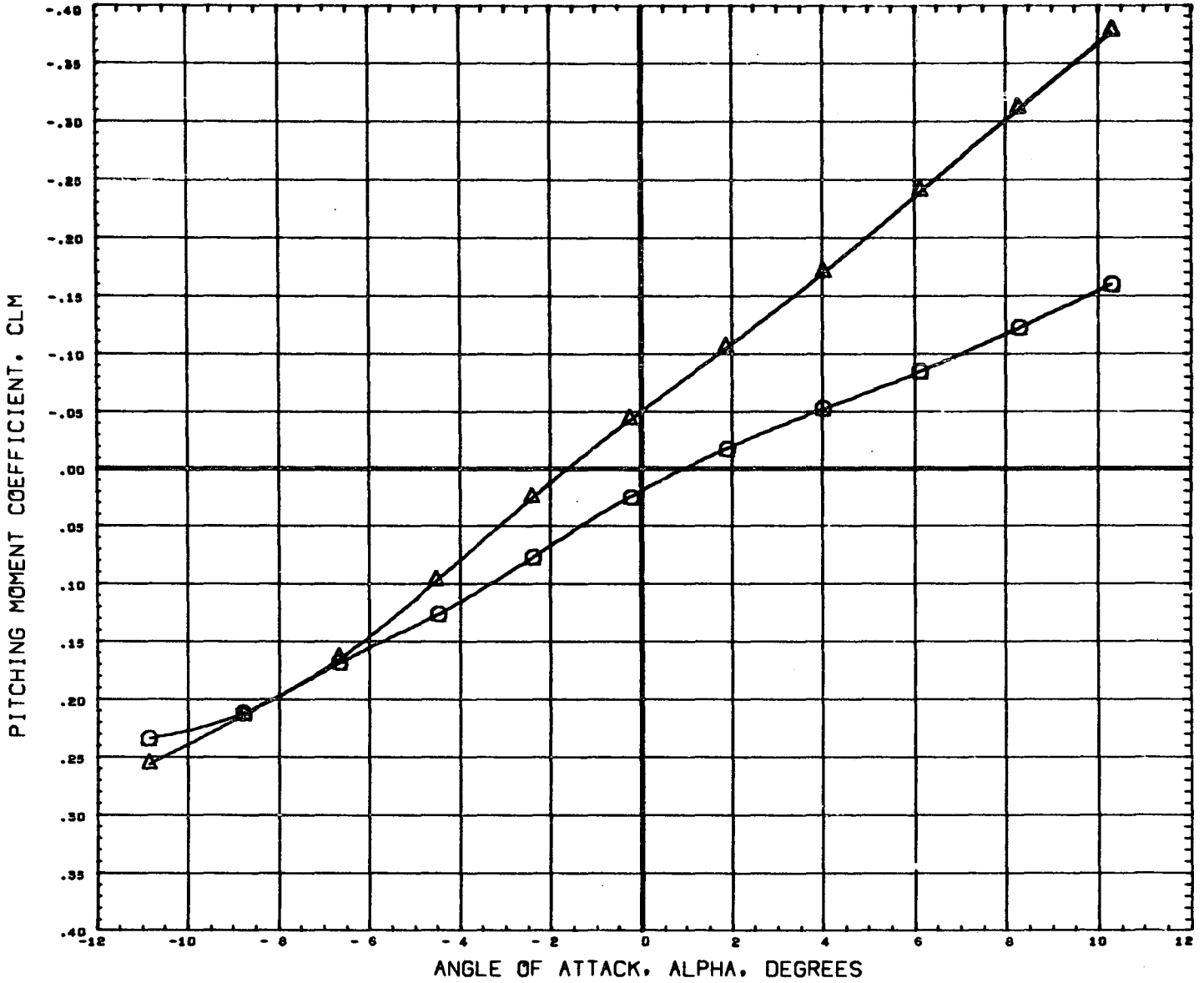

DATA SET SYMBOL	CONFIGURATION DESCRIPTION	ORBIN	THETS	BETA	REFERENCE INFORMATION
(B65004)	MSFC TWT 534 SHUTTLE LAUNCH T101S1	-1.500	21.000	0.000	SREF 4.0950 SQ. IN
(B65012)	MSFC TWT 534 SHUTTLE LAUNCH T101S1F1	-1.500	21.000	0.000	LREF 2.6440 IN.
(B65014)	DATA NOT AVAILABLE FOR ALL CONDITIONS	-1.500	21.000	0.000	BREF 3.5250 IN.
					XNRP 3.4900 IN.
					YNRP 0.0000 IN.
					ZNRP 0.1616 IN.
					SCALE 0.0034

EFFECT OF FIN LOCATION ON LONGITUDINAL CHARACTERISTICS

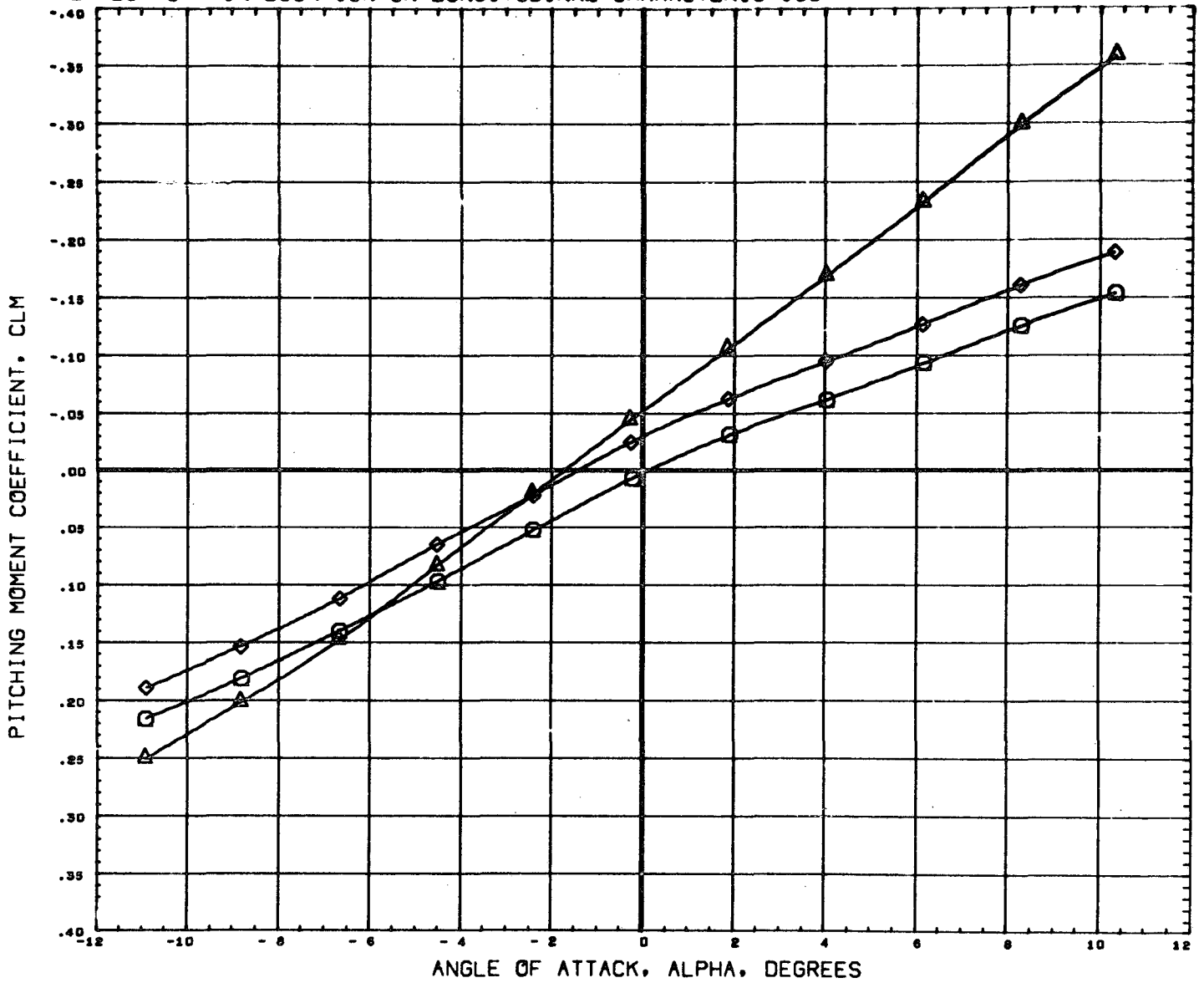

DATA SET SYMBOL	CONFIGURATION DESCRIPTION	ORBIN	THETS	BETA	REFERENCE INFORMATION
(B65004)	MSFC TWT 534 SHUTTLE LAUNCH	-1.500	21.000	0.000	SREF 4.8950 SQ. IN
(B65012)	MSFC TWT 534 SHUTTLE LAUNCH	-1.500	21.000	0.000	LREF 2.6440 IN.
(B65014)	MSFC TWT 534 SHUTTLE LAUNCH	-1.500	21.000	0.000	BREF 3.5250 IN.
					XMRP 3.4900 IN.
					YMRP 0.0000 IN.
					ZMRP 0.1616 IN.
					SCALE 0.0034

MACH 1.20

EFFECT OF FIN LOCATION ON LONGITUDINAL CHARACTERISTICS

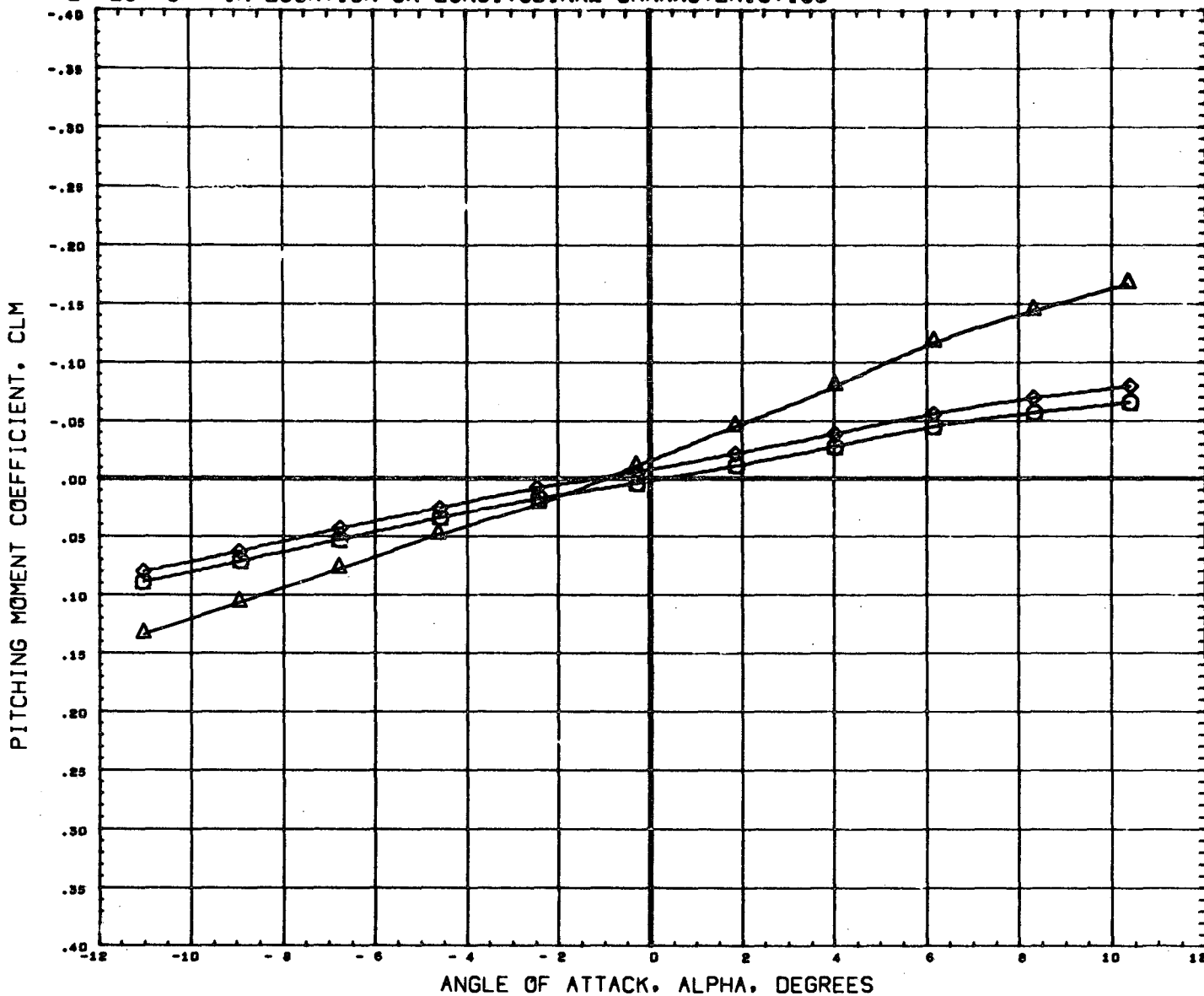

DATA SET SYMBOL	CONFIGURATION DESCRIPTION	ORBIN	THETS	BETA	REFERENCE INFORMATION	
(B65004)	MSFC TWT 534 SHUTTLE LAUNCH	T101S1	-1.500	21.000	0.000	SREF 4.8950 SQ. IN
(B65012)	MSFC TWT 534 SHUTTLE LAUNCH	T101S1F1	-1.500	21.000	0.000	LREF 2.6440 IN.
(B65014)	MSFC TWT 534 SHUTTLE LAUNCH	T101S1F2	-1.500	21.000	0.000	BREF 3.5250 IN.
						XMRP 3.4900 IN.
						YMRP 0.0000 IN.
						ZMRP 0.1616 IN.
						SCALE 0.0034

MACH 1.97

PAGE 502

EFFECT OF FIN LOCATION ON LONGITUDINAL CHARACTERISTICS

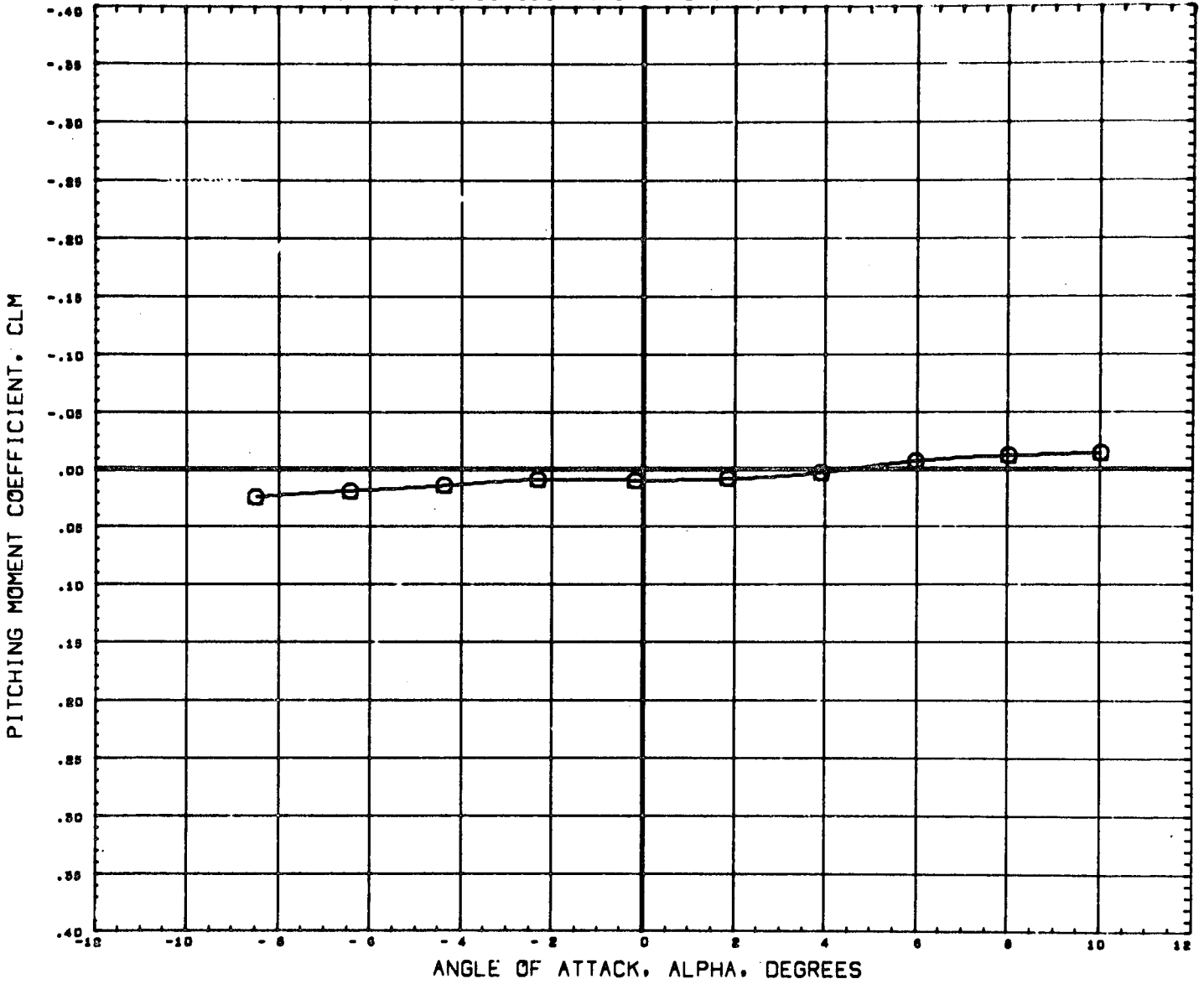

DATA SET SYMBOL	CONFIGURATION DESCRIPTION	ORBIN	THETS	BETA	REFERENCE INFORMATION
(B88004)	MSFC TWT 534 SHUTTLE LAUNCH T101S1	-1.500	21.000	0.000	SREF 4.8950 SQ. IN
(B09012)	DATA NOT AVAILABLE FOR ALL CONDITIONS	-1.500	21.000	0.000	LREF 2.6440 IN.
(B09014)	DATA NOT AVAILABLE FOR ALL CONDITIONS	-1.500	21.000	0.000	BREF 3.5250 IN.
					XMRP 3.4900 IN.
					YMRP 0.0000 IN.
					ZMRP 0.1616 IN.
					SCALE 0.0034

EFFECT OF FIN LOCATION ON LONGITUDINAL CHARACTERISTICS

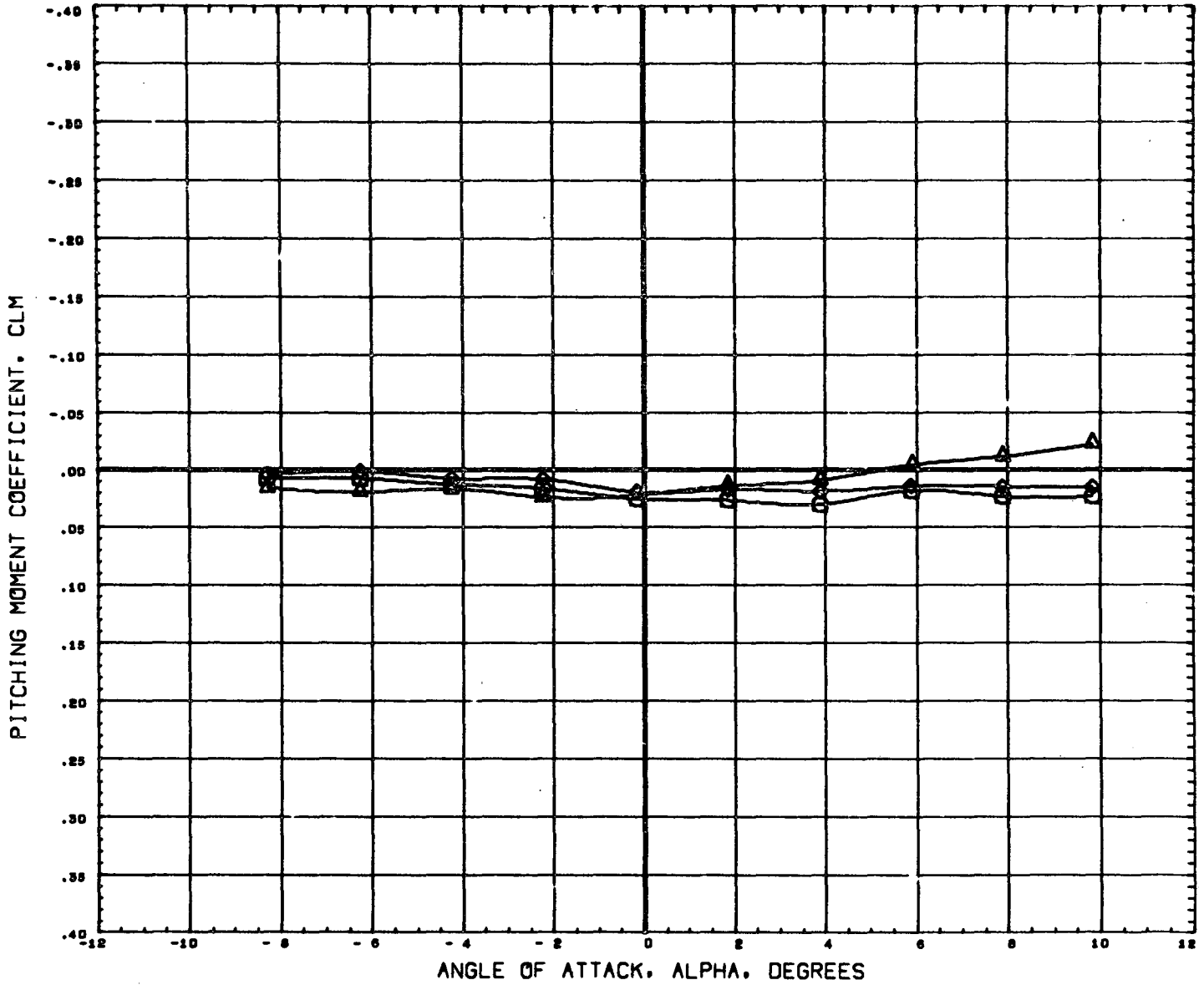

DATA SET SYMBOL	CONFIGURATION DESCRIPTION	ORBIN	THETS	BETA	REFERENCE INFORMATION	
(B65004)	MSFC TWT 534 SHUTTLE LAUNCH	T101S1	-1.500	21.000	0.000	SREF 4.8950 sq. IN
(B65012)	MSFC TWT 534 SHUTTLE LAUNCH	T101S1F1	-1.500	21.000	0.000	LREF 2.6440 IN.
(B65014)	MSFC TWT 534 SHUTTLE LAUNCH	T101S1F2	-1.500	21.000	0.000	BREF 3.5250 IN.
						XMRP 3.4900 IN.
						YMRP 0.0000 IN.
						ZMRP 0.1616 IN.
						SCALE 0.0034

MACH 4.96

EFFECT OF FIN LOCATION ON LONGITUDINAL CHARACTERISTICS

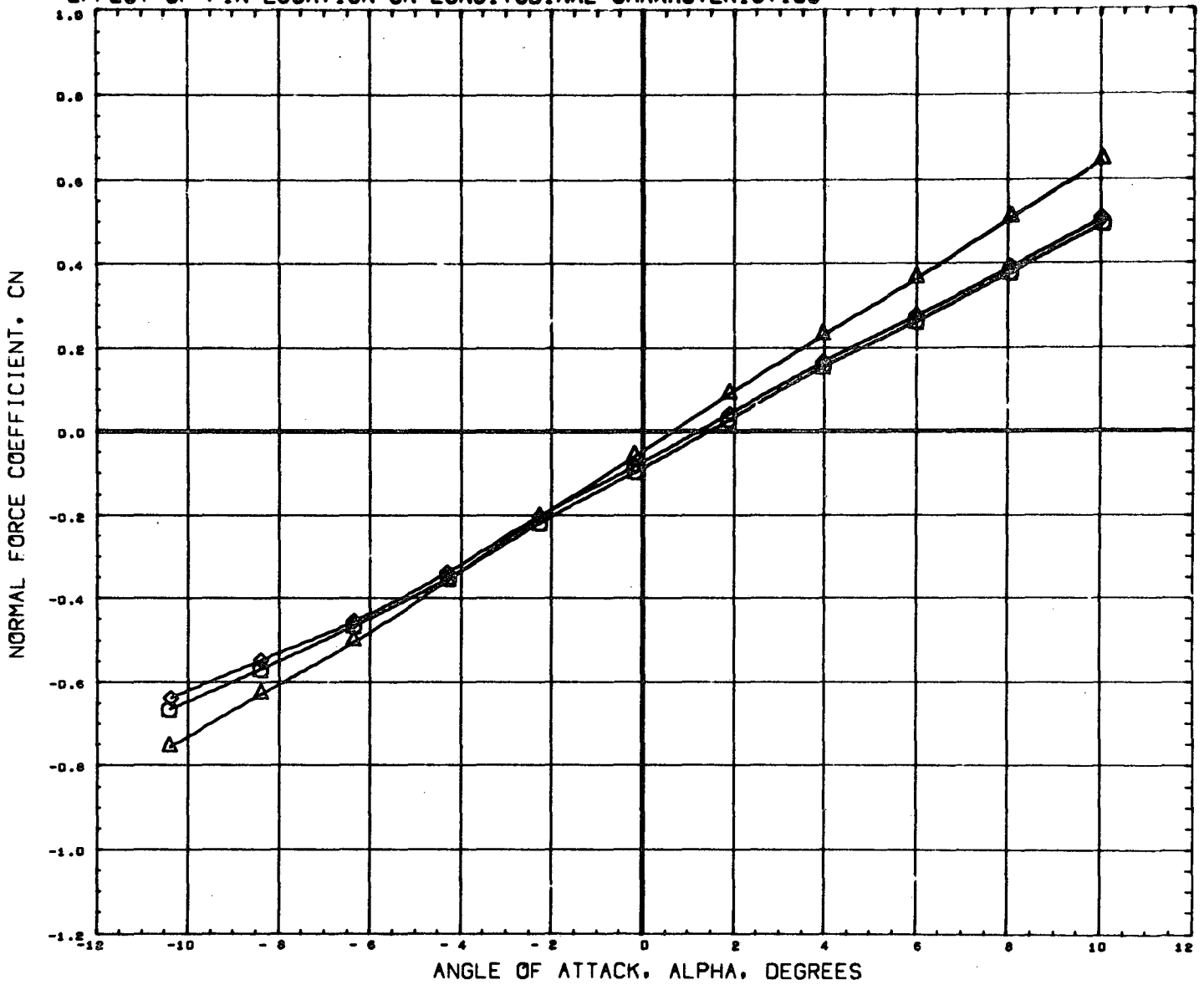

DATA SET SYMBOL	CONFIGURATION DESCRIPTION	ORBIN	THETS	BETA	REFERENCE INFORMATION	
(B69004)	MSFC TWT 934 SHUTTLE LAUNCH	T101S1	-1.500	21.000	0.000	SREF 4.8950 SQ. IN
(B69012)	MSFC TWT 934 SHUTTLE LAUNCH	T101S1F1	-1.500	21.000	0.000	LREF 2.6440 IN.
(B69014)	MSFC TWT 934 SHUTTLE LAUNCH	T101S1F2	-1.500	21.000	0.000	BREF 3.5250 IN.
						XMRP 3.4900 IN.
						YMRP 0.0000 IN.
						ZMRP 0.1616 IN.
						SCALE 0.0034

MACH .60

EFFECT OF FIN LOCATION ON LONGITUDINAL CHARACTERISTICS

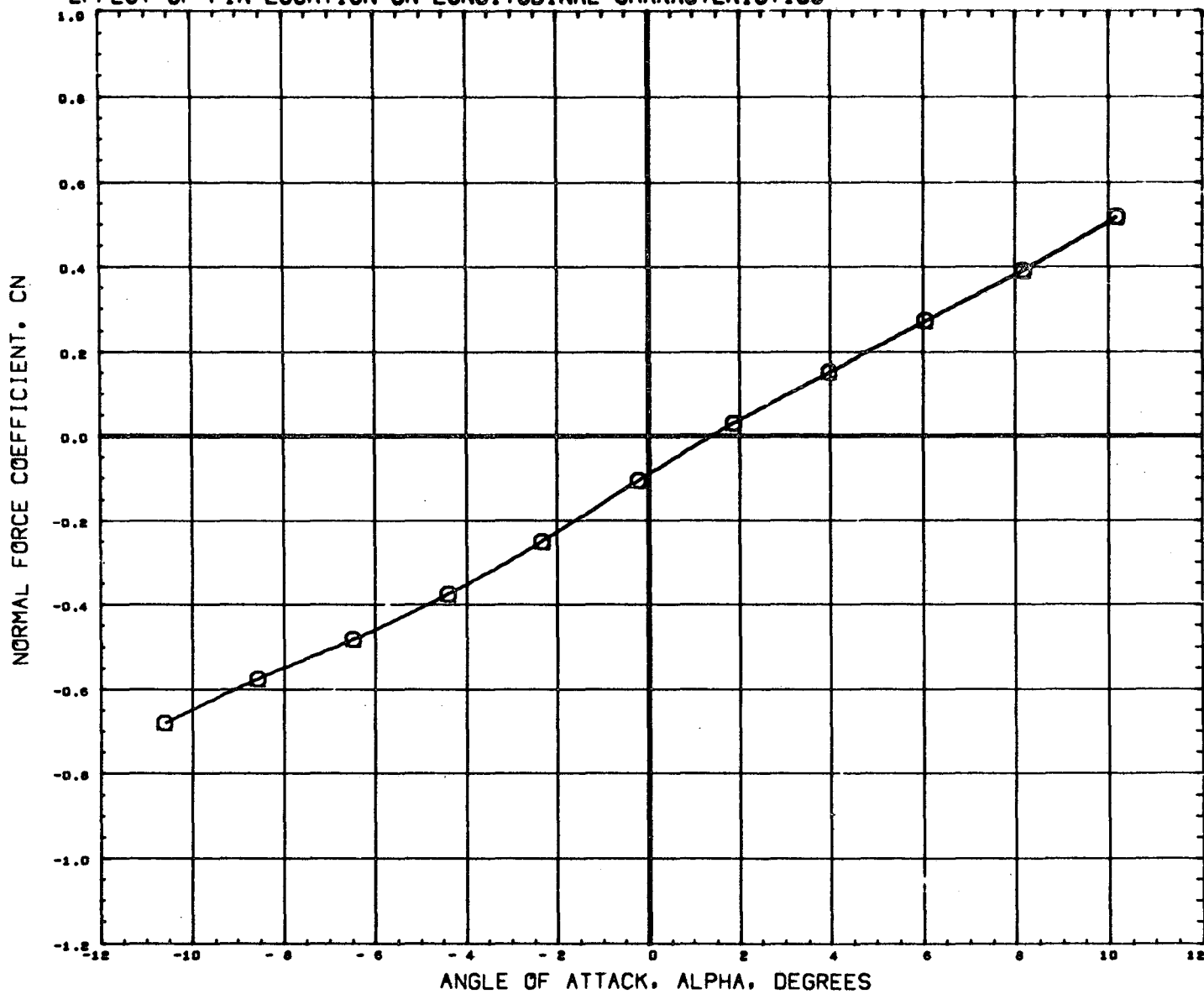

DATA SET SYMBOL	CONFIGURATION DESCRIPTION	ORBIN	THETS	BETA	REFERENCE INFORMATION
(B65004)	MSFC TWT 534 SHUTTLE LAUNCH T101S1	-1.500	21.000	0.300	SREF 4.8950 SQ. IN.
(B65012)	DATA NOT AVAILABLE FOR ALL CONDITIONS	-1.500	21.000	0.000	LREF 2.6440 IN.
(B65014)	DATA NOT AVAILABLE FOR ALL CONDITIONS	-1.500	21.000	0.000	BREF 3.5250 IN.
					YHRP 3.4900 IN.
					YHRP 0.0000 IN.
					ZHRP 0.1616 IN.
					SCALE 0.0034

MACH .80

EFFECT OF FIN LOCATION ON LONGITUDINAL CHARACTERISTICS

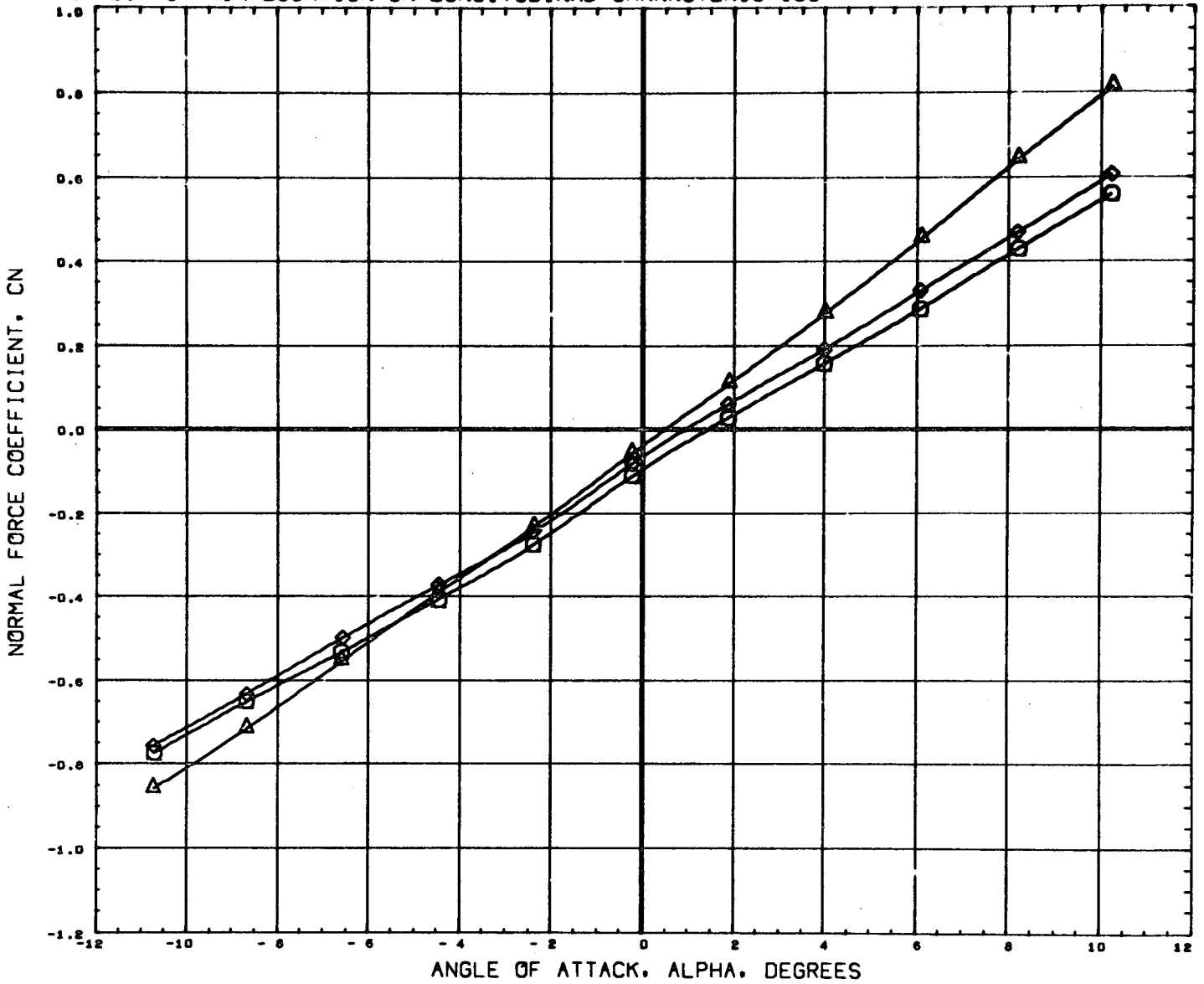

DATA SET SYMBOL	CONFIGURATION DESCRIPTION	ORBIN	THETS	BETA	REFERENCE INFORMATION	
(B65004)	MSFC TWT 534 SHUTTLE LAUNCH	T101S1	-1.500	21.000	0.000	SREF 4.8950 sq. IN
(B65012)	MSFC TWT 534 SHUTTLE LAUNCH	T101S1F1	-1.500	21.000	0.000	LREF 2.6440 IN.
(B65014)	MSFC TWT 534 SHUTTLE LAUNCH	T101S1F2	-1.500	21.000	0.000	BREF 3.5250 IN.
						XMRP 3.4900 IN.
						YMRP 0.0000 IN.
						ZMRP 0.1616 IN.
						SCALE 0.0034

MACH .91

PAGE 507

EFFECT OF FIN LOCATION ON LONGITUDINAL CHARACTERISTICS

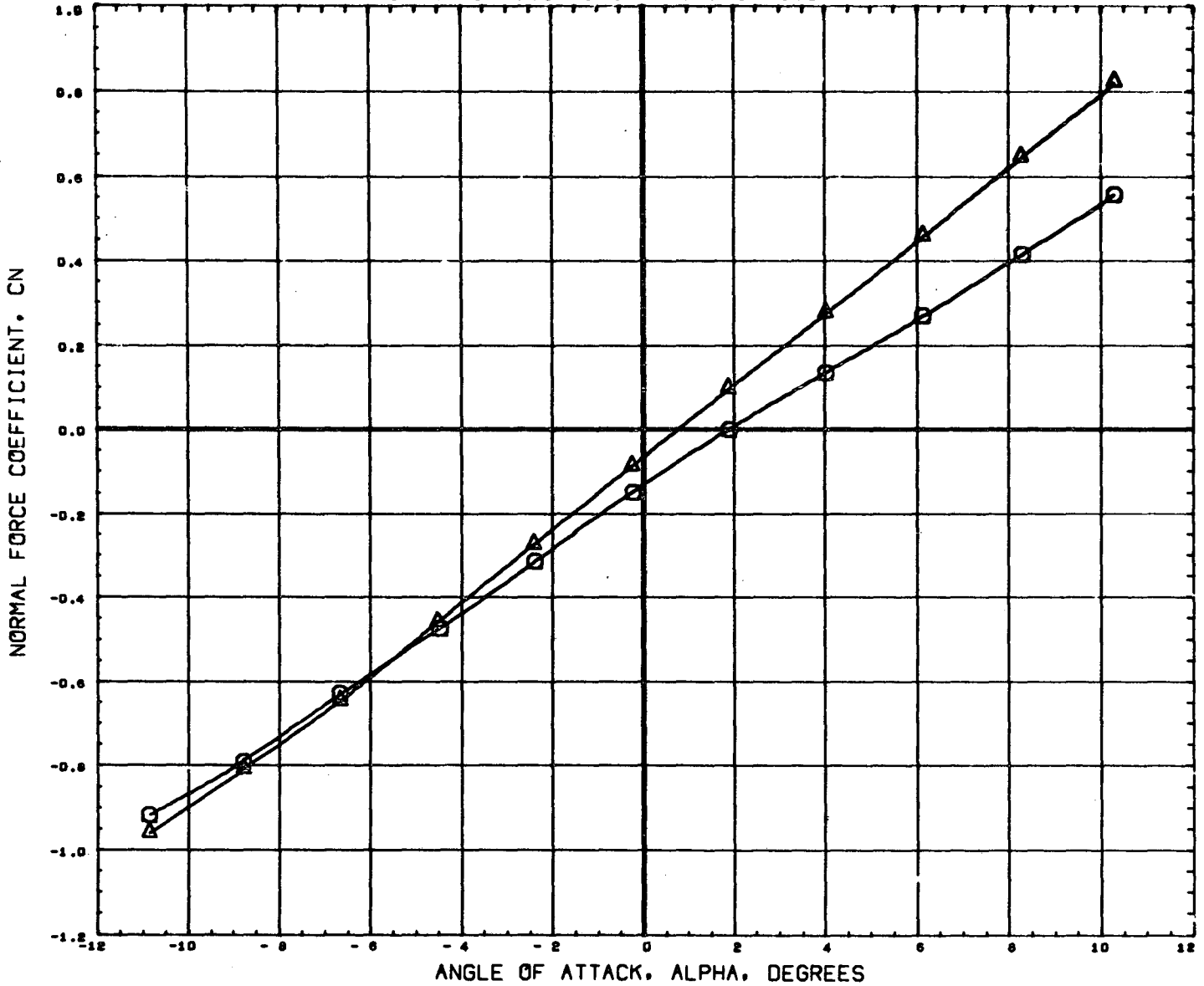

DATA SET SYMBOL	CONFIGURATION DESCRIPTION	ORBIN	THETS	BETA	REFERENCE INFORMATION
(B65004)	MSFC TWT 534 SHUTTLE LAUNCH T1O1S1	-1.500	21.000	0.000	SREF 4.8950 sq. IN
(B65012)	MSFC TWT 534 SHUTTLE LAUNCH T1O1S1F1	-1.500	21.000	0.000	LREF 2.6440 IN.
(B65014)	DATA NOT AVAILABLE FOR ALL CONDITIONS	-1.500	21.000	0.000	BREF 3.9250 IN.
					XMRP 3.4800 IN.
					YMRP 0.0000 IN.
					ZMRP 0.1616 IN.
					SCALE 0.0034

MACH 1.10

EFFECT OF FIN LOCATION ON LONGITUDINAL CHARACTERISTICS

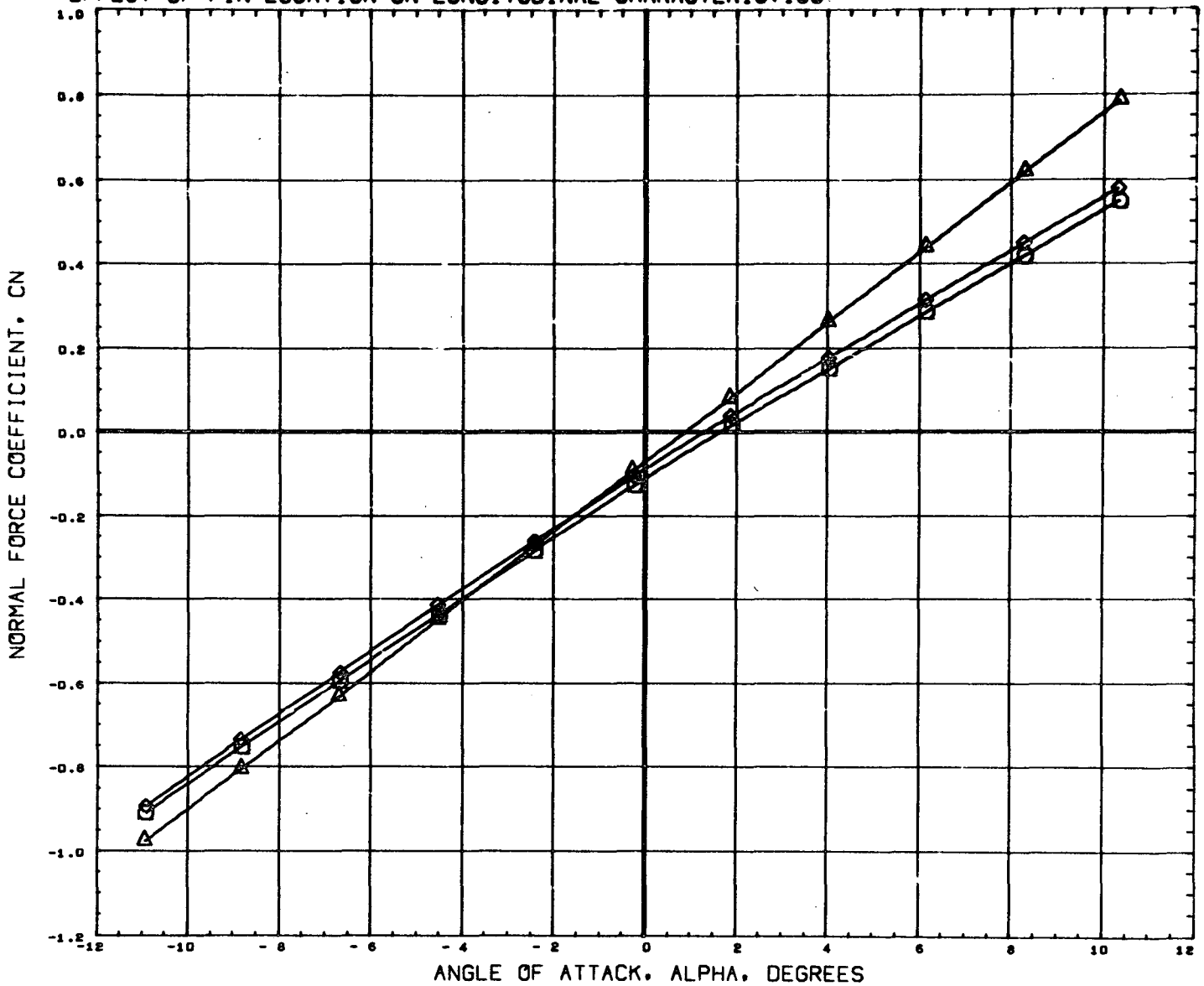

DATA SET SYMBOL	CONFIGURATION DESCRIPTION	ORBIN	THETS	BETA	REFERENCE INFORMATION
(B65004)	MSFC TWT 534 SHUTTLE LAUNCH	-1.500	21.000	0.000	SREF 4.8950 SQ. IN
(B65012)	MSFC TWT 534 SHUTTLE LAUNCH	-1.500	21.000	0.000	LREF 2.6440 IN.
(B65014)	MSFC TWT 534 SHUTTLE LAUNCH	-1.500	21.000	0.000	BREF 3.9250 IN.
					XWRP 3.4900 IN.
					YWRP 0.0000 IN.
					ZWRP 0.1616 IN.
					SCALE 0.0034

MACH 1.20

EFFECT OF FIN LOCATION ON LONGITUDINAL CHARACTERISTICS

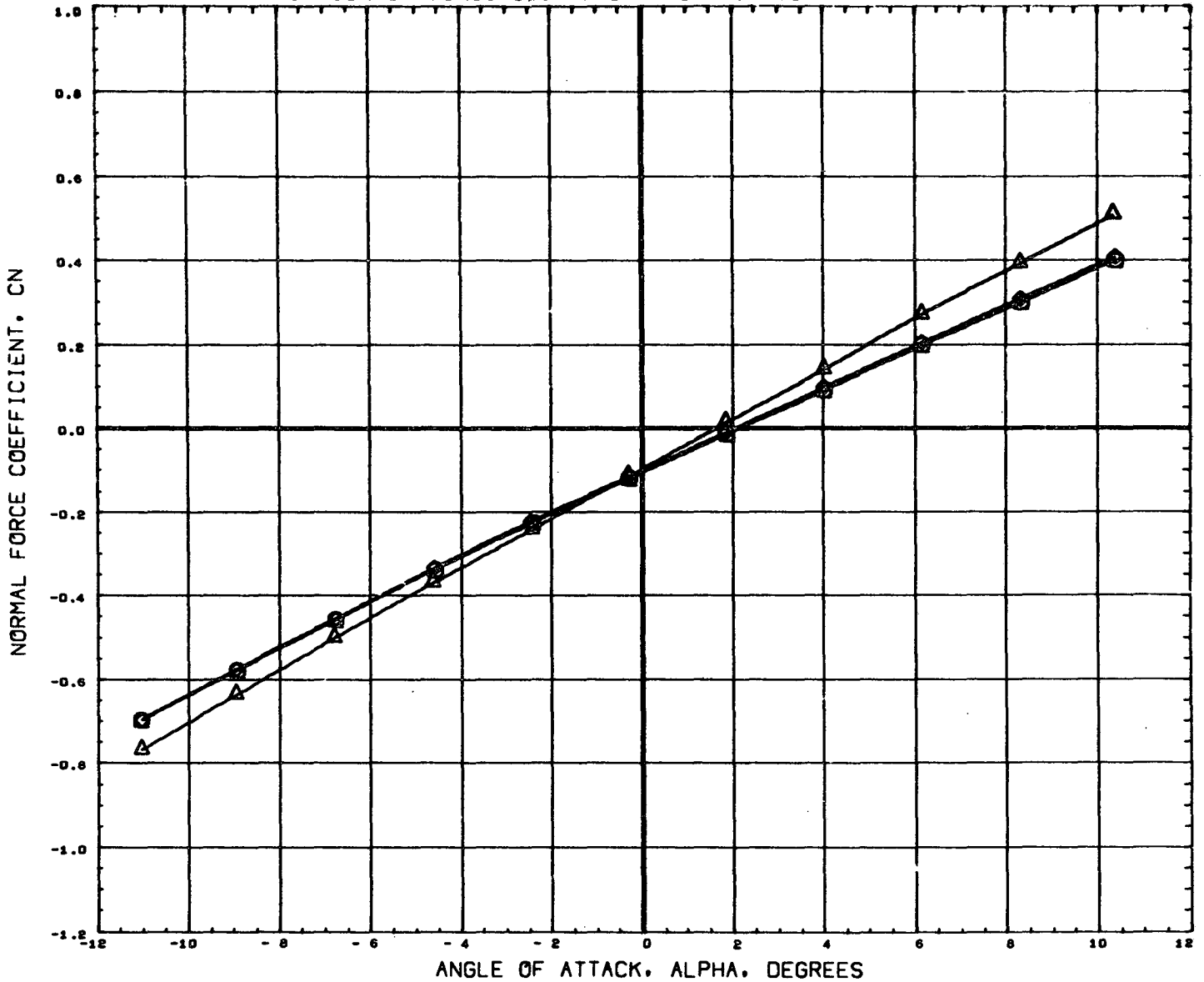

DATA SET SYMBOL	CONFIGURATION DESCRIPTION	ORBIN	THETS	BETA	REFERENCE INFORMATION	
(B65004)	MSFC TWT 534 SHUTTLE LAUNCH	T101S1	-1.500	21.000	0.000	SREF 4.8950 SQ. IN
(B65012)	MSFC TWT 534 SHUTTLE LAUNCH	T101S1F1	-1.500	21.000	0.000	LREF 2.6440 IN.
(B65014)	MSFC TWT 534 SHUTTLE LAUNCH	T101S1F2	-1.500	21.000	0.000	BREF 3.5250 IN.
						XMRP 3.4900 IN.
						YMRP 0.0000 IN.
						ZMRP 0.5616 IN.
						SCALE 0.0034

EFFECT OF FIN LOCATION ON LONGITUDINAL CHARACTERISTICS

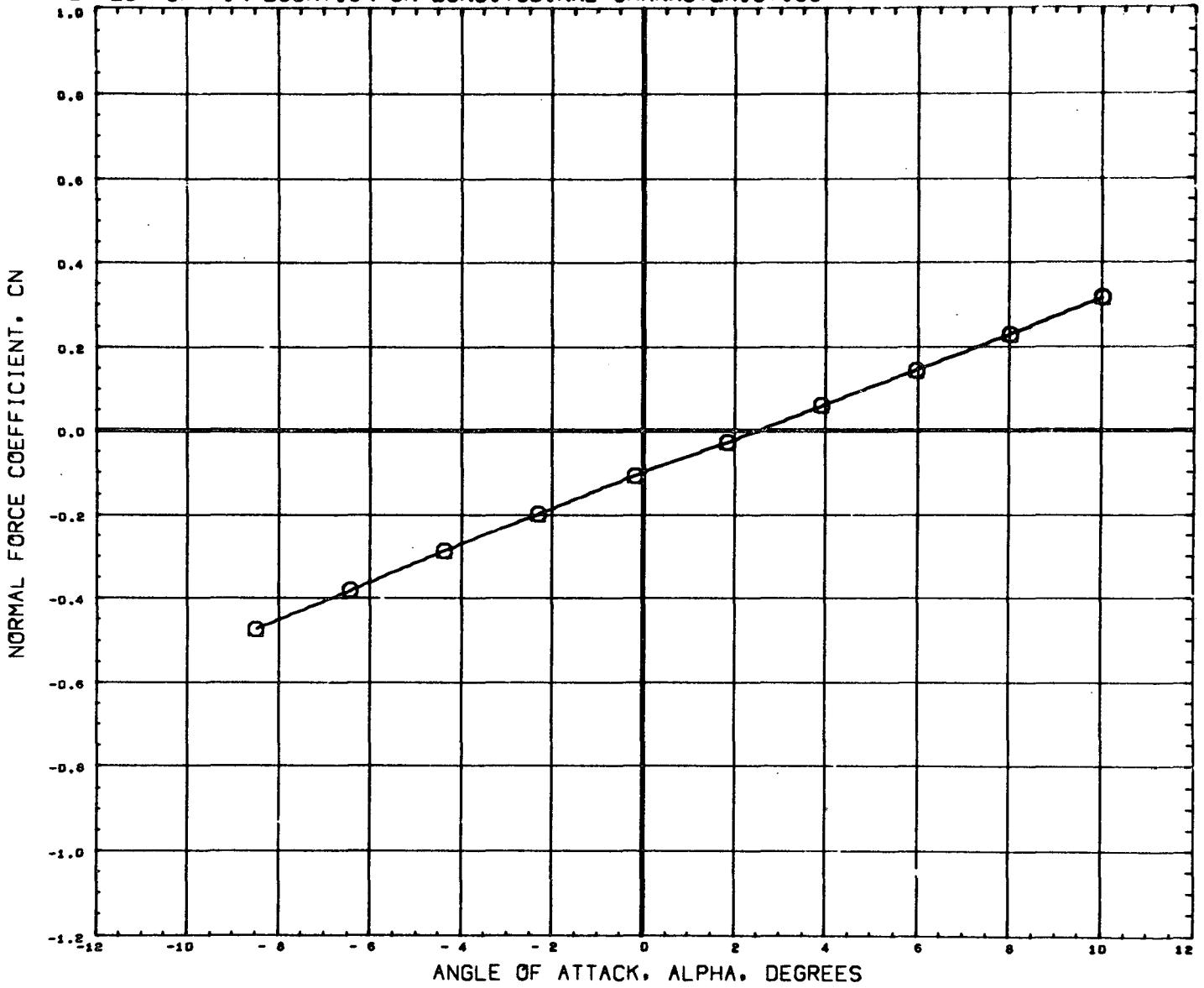

DATA SET SYMBOL	CONFIGURATION DESCRIPTION	ORBIN	THETS	BETA	REFERENCE INFORMATION
(B65004)	MSFC TWT 534 SHUTTLE LAUNCH T101S1	-1.500	21.000	0.000	SREF 4.8950 SQ. IN
(B65012)	DATA NOT AVAILABLE FOR ALL CONDITIONS	-1.500	21.000	0.000	LREF 2.6440 IN.
(B65014)	DATA NOT AVAILABLE FOR ALL CONDITIONS	-1.500	21.000	0.000	BREF 3.5250 IN.
					XMRP 3.4900 IN.
					YMRP 0.0000 IN.
					ZMRP 0.1616 IN.
					SCALE 0.0034

MACH 2.74

EFFECT OF FIN LOCATION ON LONGITUDINAL CHARACTERISTICS

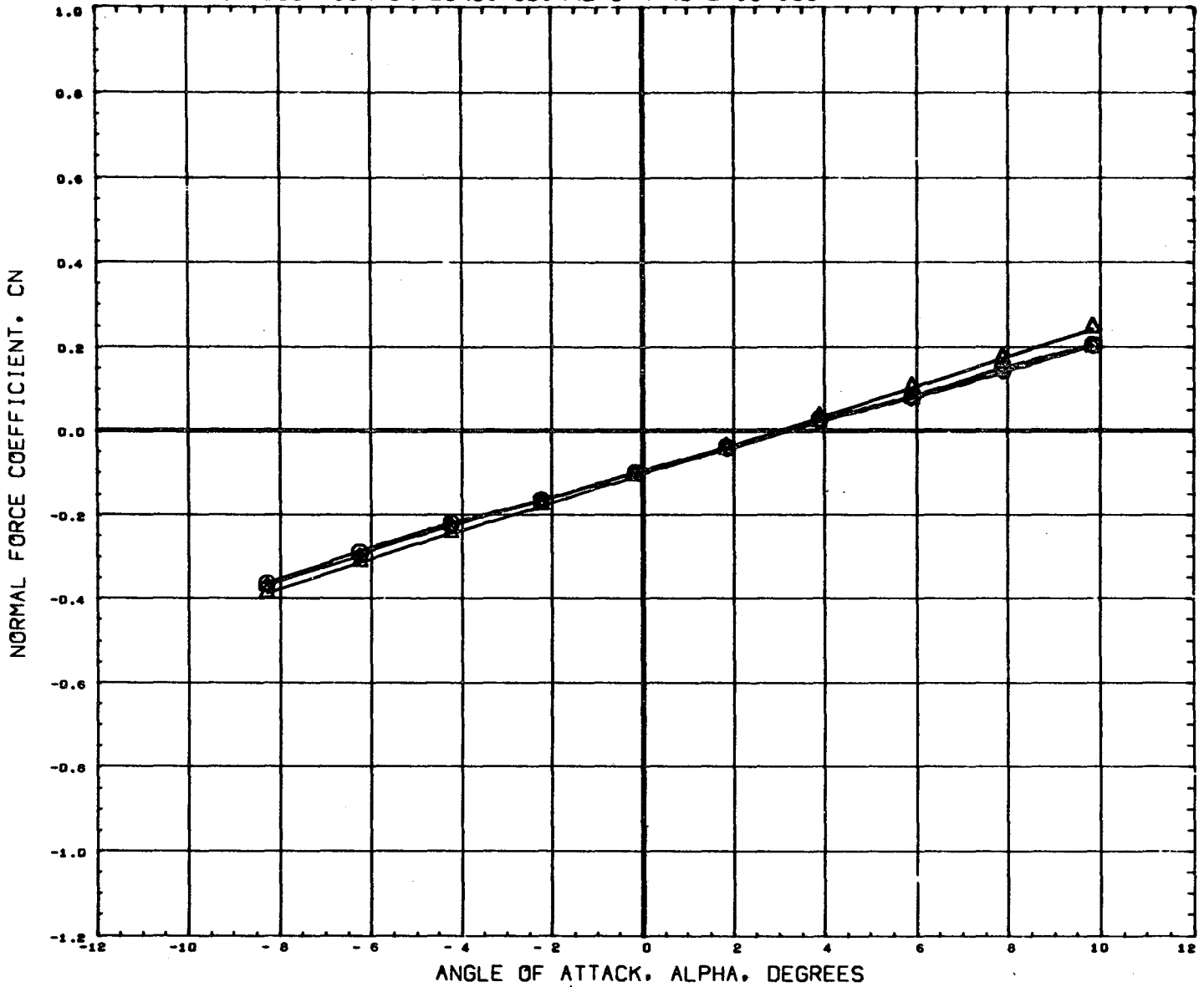

DATA SET SYMBOL	CONFIGURATION DESCRIPTION	ORBIN	THETS	BETA	REFERENCE INFORMATION	
(B65004)	MSFC TWT 534 SHUTTLE LAUNCH	T101S1	-1.500	21.000	0.000	SREF 4.8950 SQ. IN
(B65012)	MSFC TWT 534 SHUTTLE LAUNCH	T101S1F1	-1.500	21.000	0.000	LREF 2.6440 IN.
(B65014)	MSFC TWT 534 SHUTTLE LAUNCH	T101S1F2	-1.500	21.000	0.000	BREF 3.5250 IN.
						XNRP 3.4900 IN.
						YNRP 0.0000 IN.
						ZNRP 0.1616 IN.
						SCALE 0.0034

MACH 4.96

PAGE 512

EFFECT OF FIN LOCATION ON LONGITUDINAL CHARACTERISTICS

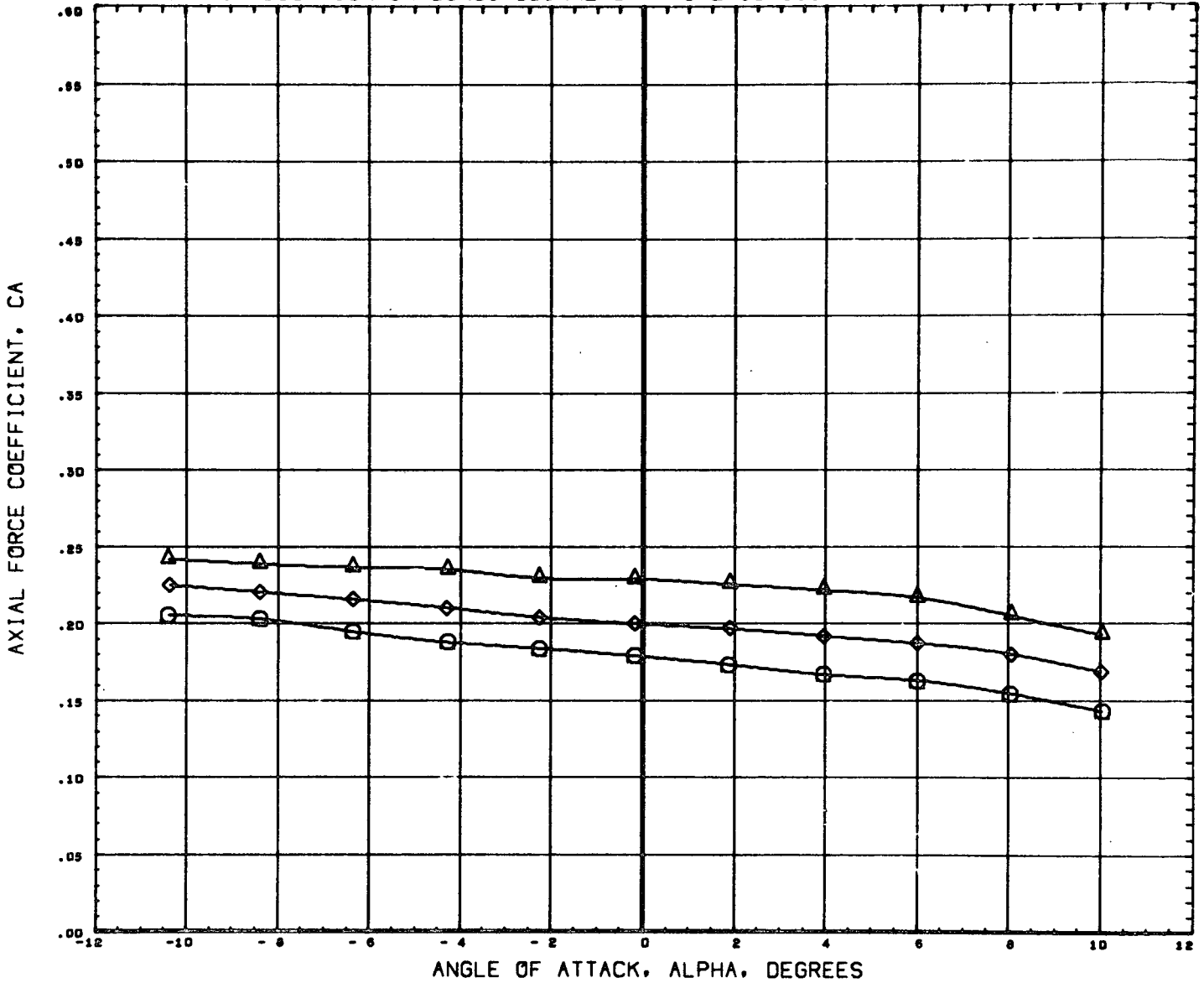

DATA SET SYMBOL	CONFIGURATION DESCRIPTION	ORBIN	THETS	BETA	REFERENCE INFORMATION
(B65004)	MSFC TWT 534 SHUTTLE LAUNCH	-1.500	21.000	0.000	SREF 4.8950 SQ. IN
(B65012)	MSFC TWT 534 SHUTTLE LAUNCH	-1.500	21.000	0.000	LREF 2.6440 IN.
(B65014)	MSFC TWT 534 SHUTTLE LAUNCH	-1.500	21.000	0.000	BREF 3.5250 IN.
					XMRP 3.4900 IN.
					YMRP 0.0000 IN.
					ZMRP 0.1616 IN.
					SCALE 0.0034

MACH .60

EFFECT OF FIN LOCATION ON LONGITUDINAL CHARACTERISTICS

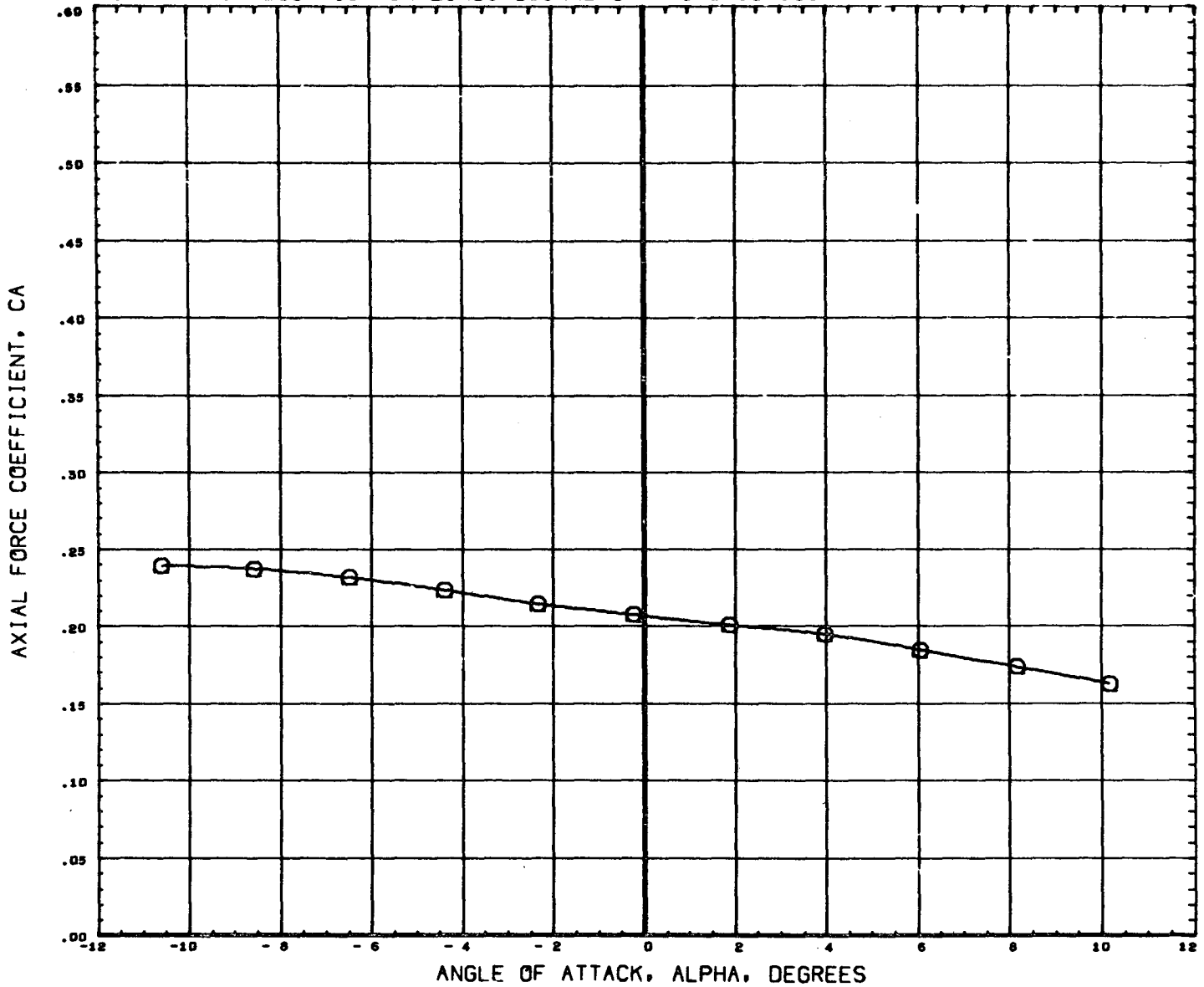

DATA SET SYMBOL	CONFIGURATION DESCRIPTION	ORBIN	THETS	BETA	REFERENCE INFORMATION
(B65004)	MSFC TWT 534 SHUTTLE LAUNCH T:O1S1	-1.500	21.000	0.000	SREF 4.8950 SQ. IN
(B65012)	DATA NOT AVAILABLE FOR ALL CONDITIONS	-1.500	21.000	0.000	LREF 2.6440 IN.
(B65014)	DATA NOT AVAILABLE FOR ALL CONDITIONS	-1.500	21.000	0.000	BREF 3.5250 IN.
					XMRP 3.4900 IN.
					YMRP 0.0000 IN.
					ZMRP 0.1516 IN.
					SCALE 0.0034

MACH .80

EFFECT OF FIN LOCATION ON LONGITUDINAL CHARACTERISTICS

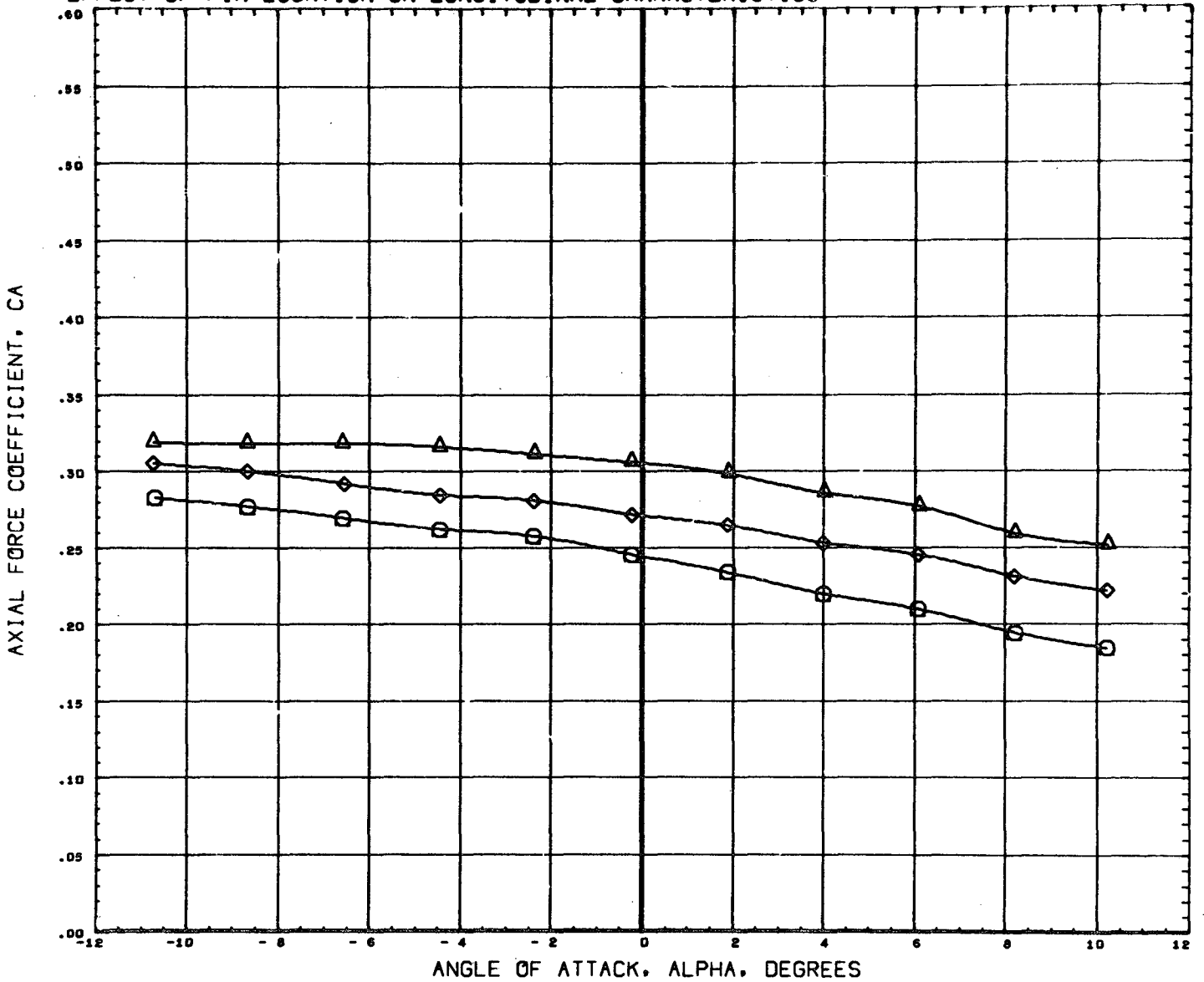

DATA SET SYMBOL	CONFIGURATION DESCRIPTION	ORBIN	THETS	BETA	REFERENCE INFORMATION	
(B65004)	MSFC TWT 534 SHUTTLE LAUNCH	T101S1	-1.500	21.000	0.000	SREF 4.8950 SQ. IN
(B65012)	MSFC TWT 534 SHUTTLE LAUNCH	T101S1F1	-1.500	21.000	0.000	LREF 2.6440 IN.
(B65014)	MSFC TWT 534 SHUTTLE LAUNCH	T101S1F2	-1.500	21.000	0.000	BREF 3.5250 IN.
						XMRP 3.4900 IN.
						YMRP 0.0000 IN.
						ZMRP 0.1616 IN.
						SCALE 0.0034

EFFECT OF FIN LOCATION ON LONGITUDINAL CHARACTERISTICS

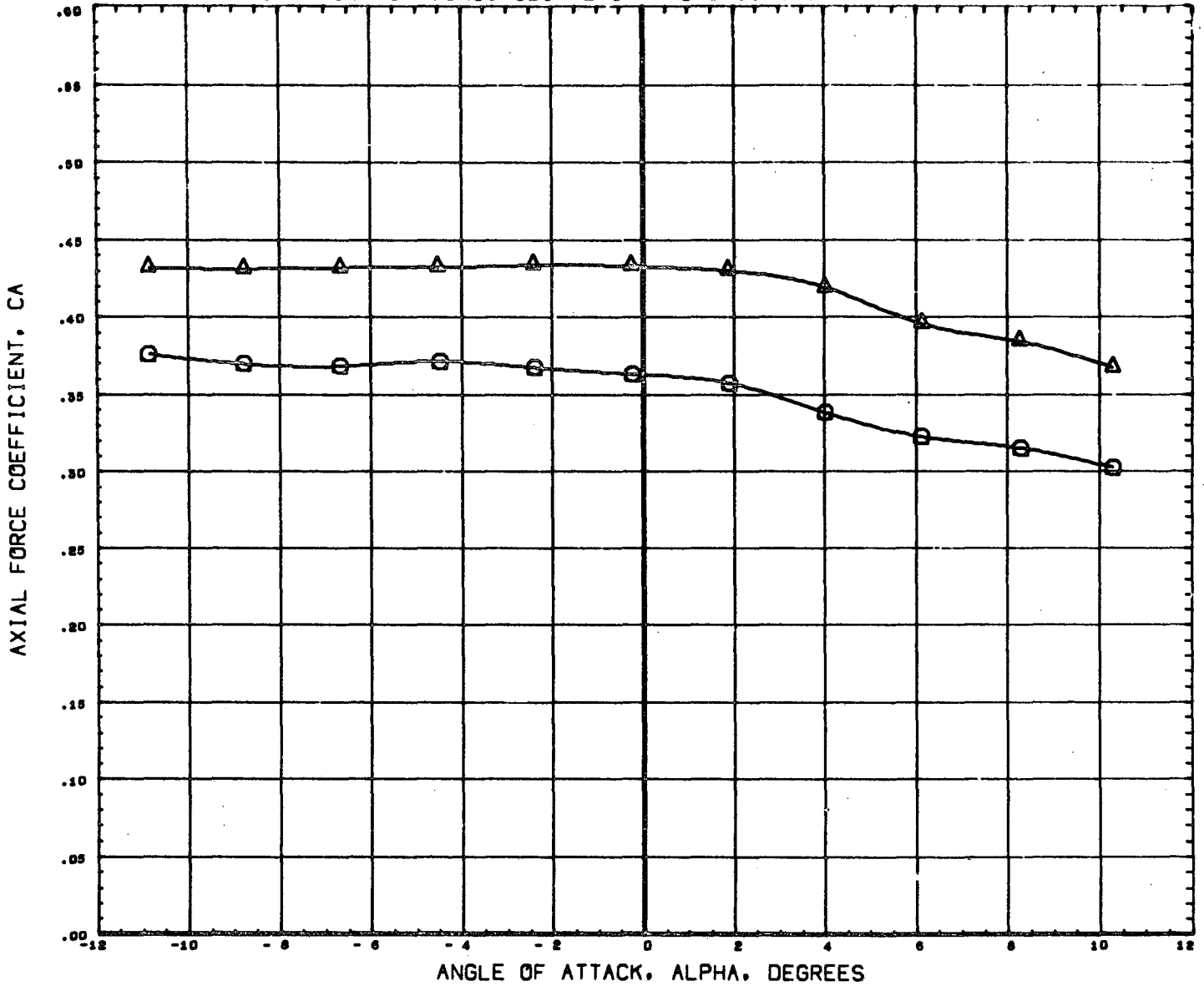

DATA SET SYMBOL	CONFIGURATION DESCRIPTION	ORBIN	THETS	BETA	REFERENCE INFORMATION
(B65004)	MSFC TWT 534 SHUTTLE LAUNCH T101S1	-1.500	21.000	0.000	SREF 4.8950 SQ. IN
(B65012)	MSFC TWT 534 SHUTTLE LAUNCH T101S1F1	-1.500	21.000	0.000	LREF 2.6440 IN.
(B65014)	DATA NOT AVAILABLE FOR ALL CONDITIONS	-1.500	21.000	0.000	BREF 3.9250 IN.
					XNRP 3.4900 IN.
					YNRP 0.0000 IN.
					ZNRP 0.1616 IN.
					SCALE 0.0034

MACH 1.10

EFFECT OF FIN LOCATION ON LONGITUDINAL CHARACTERISTICS

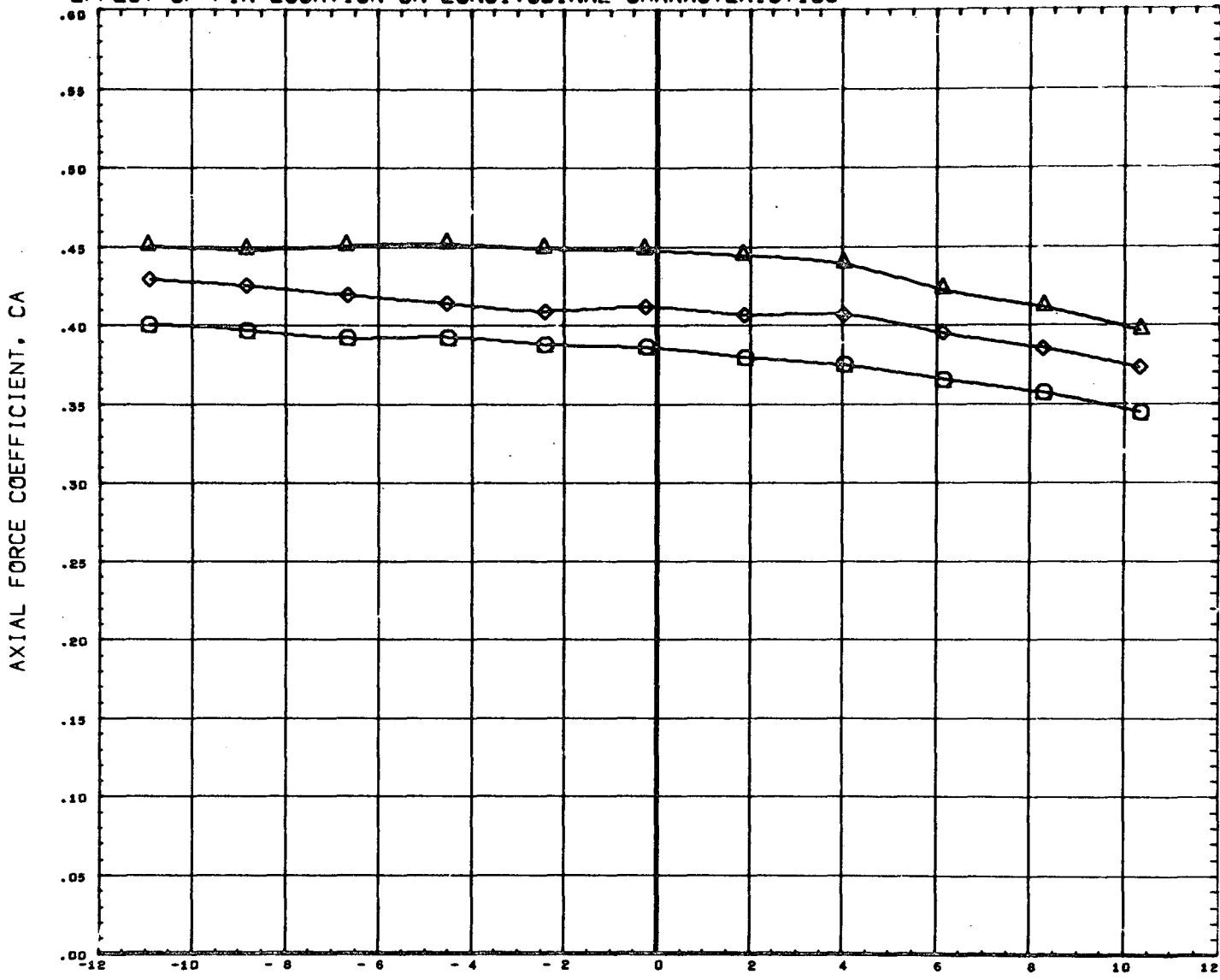

DATA SET SYMBOL	CONFIGURATION DESCRIPTION	ORBIN	THETS	BETA	REFERENCE INFORMATION	
(B65004)	MSFC TWT 534 SHUTTLE LAUNCH	T101S1	-1.500	21.000	0.000	SREF 4.8950 SQ. IN
(B65012)	MSFC TWT 534 SHUTTLE LAUNCH	T101S1F1	-1.500	21.000	0.000	LREF 2.6440 IN.
(B65014)	MSFC TWT 534 SHUTTLE LAUNCH	T101S1F2	-1.500	21.000	0.000	BREF 3.5250 IN.
						XMRP 3.4900 IN.
						YMRP 0.0000 IN.
						ZMRP 0.1616 IN.
						SCALE 0.0034

MACH 1.20

EFFECT OF FIN LOCATION ON LONGITUDINAL CHARACTERISTICS

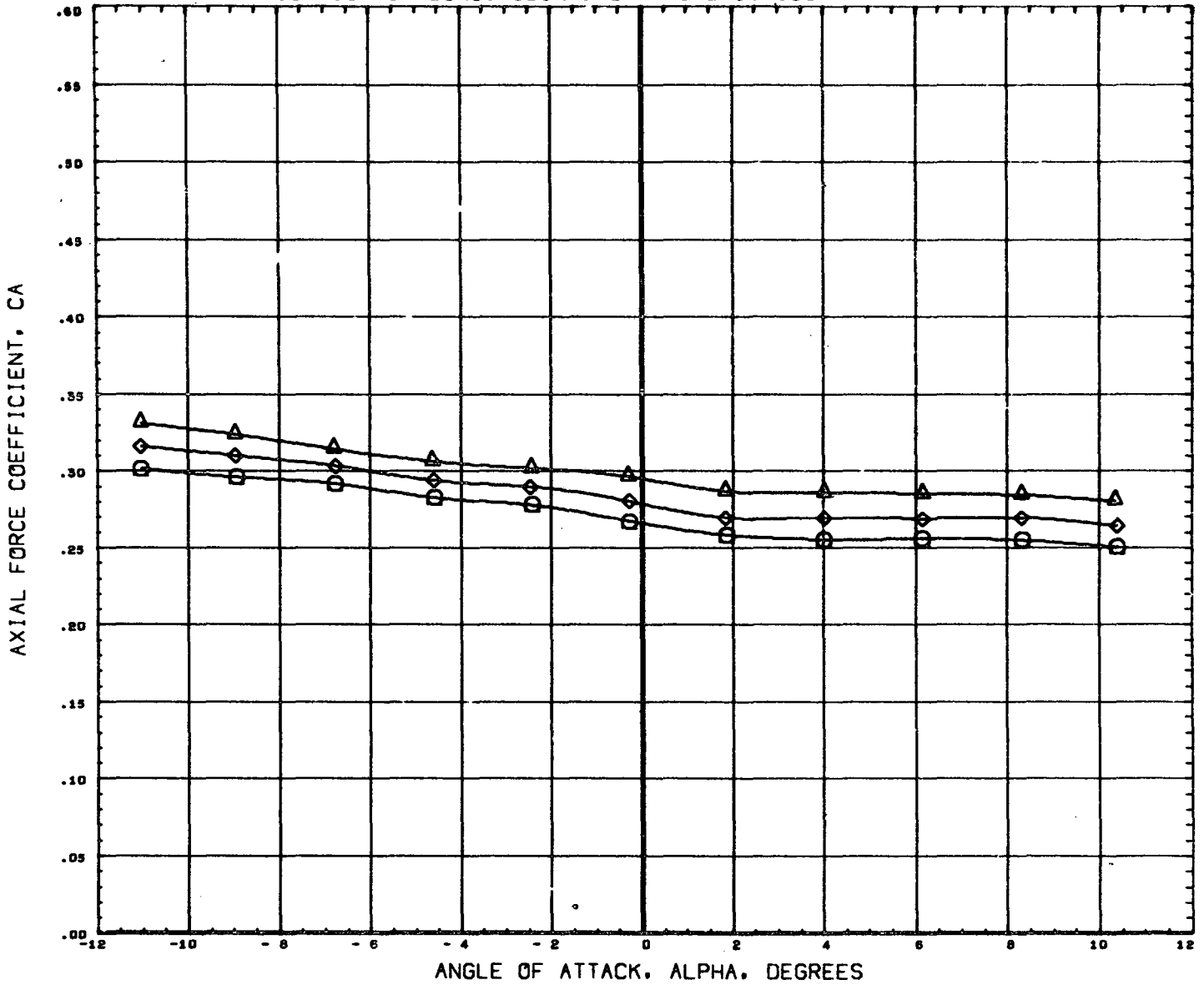

DATA SET SYMBOL	CONFIGURATION DESCRIPTION	ORBIN	THETS	BETA	REFERENCE INFORMATION	
(B65004)	MSFC TWT 534 SHUTTLE LAUNCH	T101S1	-1.500	21.007	0.003	SREF 4.8950 SQ. IN
(B65012)	MSFC TWT 534 SHUTTLE LAUNCH	T101S1F1	-1.500	21.000	0.000	LREF 2.6440 IN.
(B65014)	MSFC TWT 534 SHUTTLE LAUNCH	T101S1F2	-1.500	21.000	0.000	BREF 3.9250 IN.
						XMRP 3.4900 IN.
						YMRP 0.0000 IN.
						ZMRP 0.1616 IN.
						SCALE 0.0034

MACH 1.97

PAGE 518

EFFECT OF FIN LOCATION ON LONGITUDINAL CHARACTERISTICS

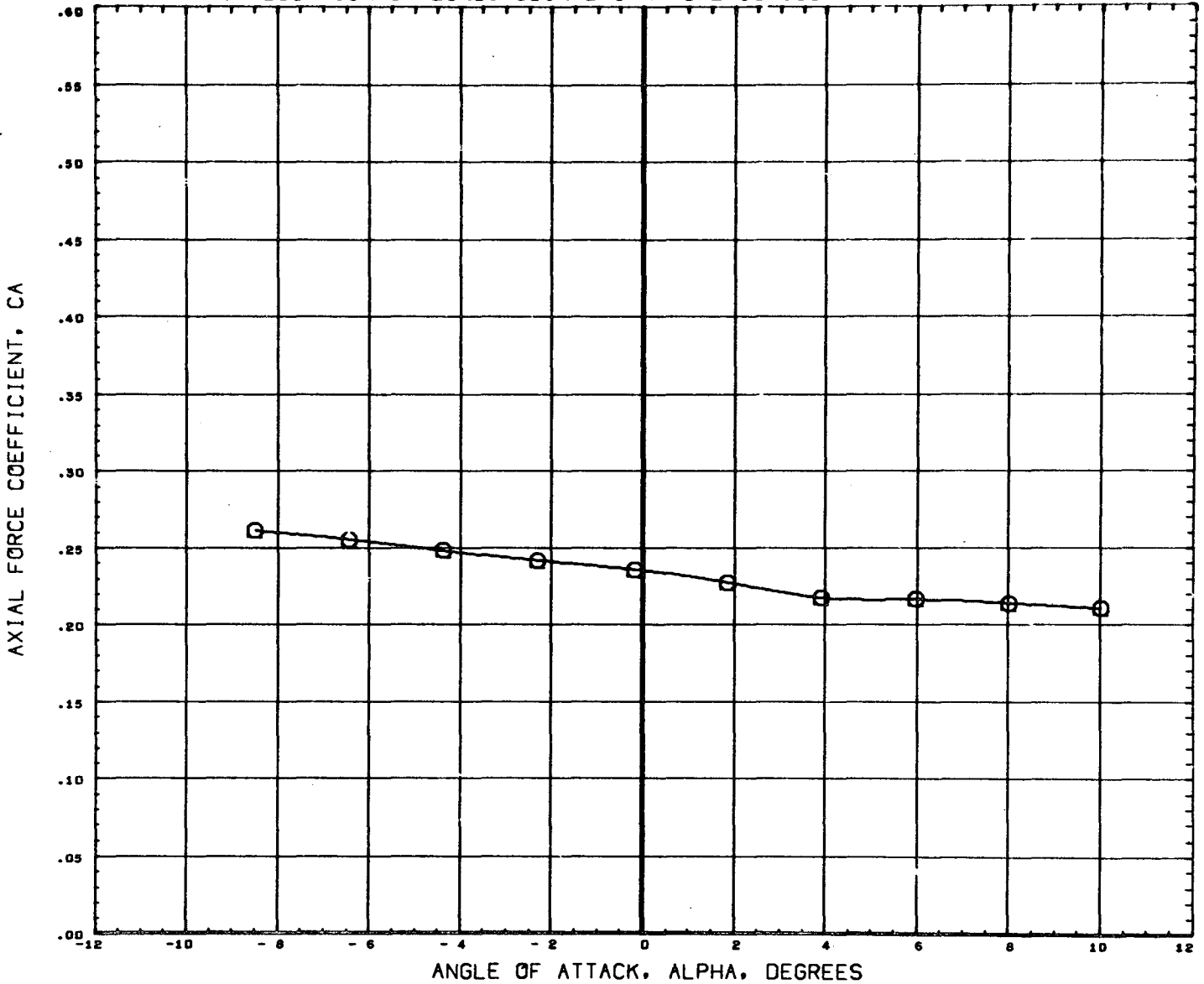

DATA SET SYMBOL	CONFIGURATION DESCRIPTION	ORBIN	THETS	BETA	REFERENCE INFORMATION
(B65004)	MSFC TWT 534 SHUTTLE LAUNCH T101S1	-1.500	21.000	0.000	SREF 4.8950 SQ. IN
(B65012)	DATA NOT AVAILABLE FOR ALL CONDITIONS	-1.500	21.000	0.000	LREF 2.6440 IN.
(B65014)	DATA NOT AVAILABLE FOR ALL CONDITIONS	-1.500	21.000	0.000	BREF 3.5250 IN.
					XMRP 3.4900 IN.
					YMRP 0.0000 IN.
					ZMRP 0.1616 IN.
					SCALE 0.0034

EFFECT OF FIN LOCATION ON LONGITUDINAL CHARACTERISTICS

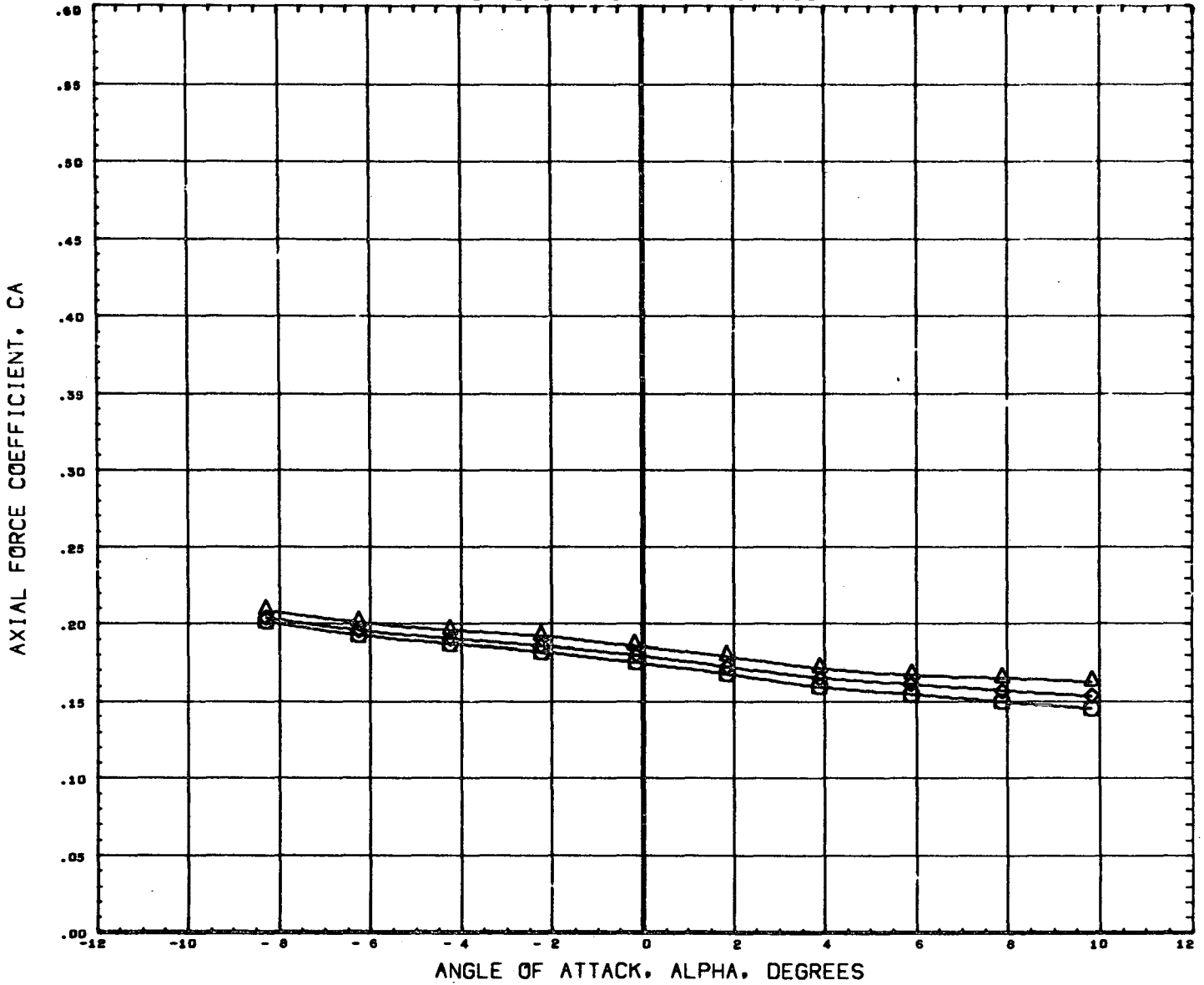

DATA SET SYMBOL	CONFIGURATION DESCRIPTION	ORBIN	THETS	BETA	REFERENCE INFORMATION
(B65004)	MSFC TWT 534 SHUTTLE LAUNCH T101S1	-1.500	21.000	0.000	SREF 4.8950 SQ. IN
(B65012)	MSFC TWT 534 SHUTTLE LAUNCH T101S1F1	-1.500	21.000	0.000	LREF 2.6440 IN.
(B65014)	MSFC TWT 534 SHUTTLE LAUNCH T101S1F2	-1.500	21.000	0.000	BREF 3.5250 IN.
					XNRP 3.4900 IN.
					YNRP 0.0000 IN.
					ZNRP 0.1616 IN.
					SCALE 0.0034

MACH 4.96

PAGE 520

EFFECT OF FIN LOCATION ON LONGITUDINAL CHARACTERISTICS

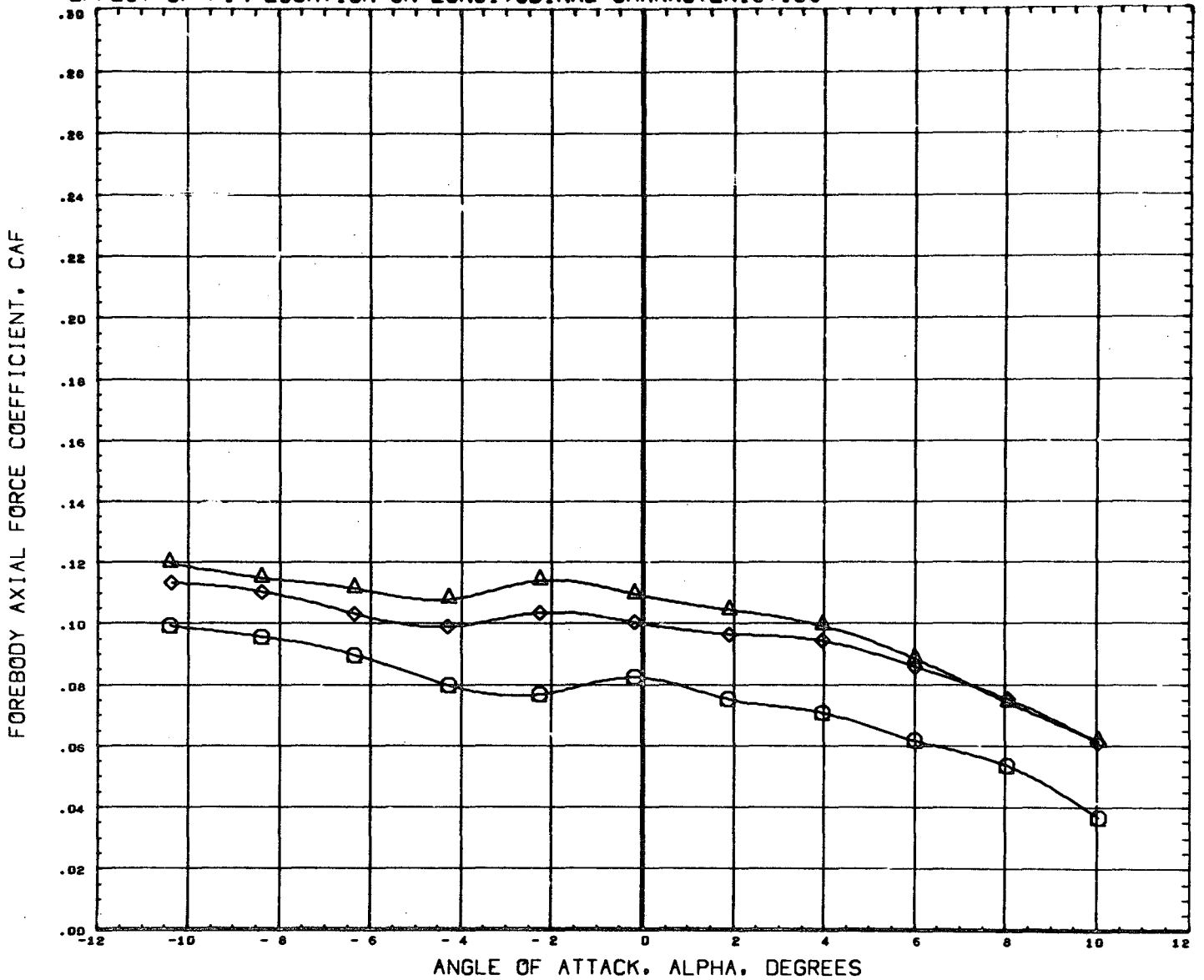

DATA SET SYMBOL	CONFIGURATION DESCRIPTION	ORBIN	THETS	BETA	REFERENCE INFORMATION
(B65004)	MSFC TWT 534 SHUTTLE LAUNCH	-1.500	21.00J	0.000	SREF 4.8950 SQ. IN
(B65012)	MSFC TWT 534 SHUTTLE LAUNCH	-1.500	21.000	0.000	LREF 2.6440 IN.
(B65014)	MSFC TWT 534 SHUTTLE LAUNCH	-1.500	21.000	0.000	BREF 3.9250 IN.
					XMRP 3.4900 IN.
					YMRP 0.0000 IN.
					ZMRP 0.1616 IN.
					SCALE 0.0034

MACH .60

EFFECT OF FIN LOCATION ON LONGITUDINAL CHARACTERISTICS

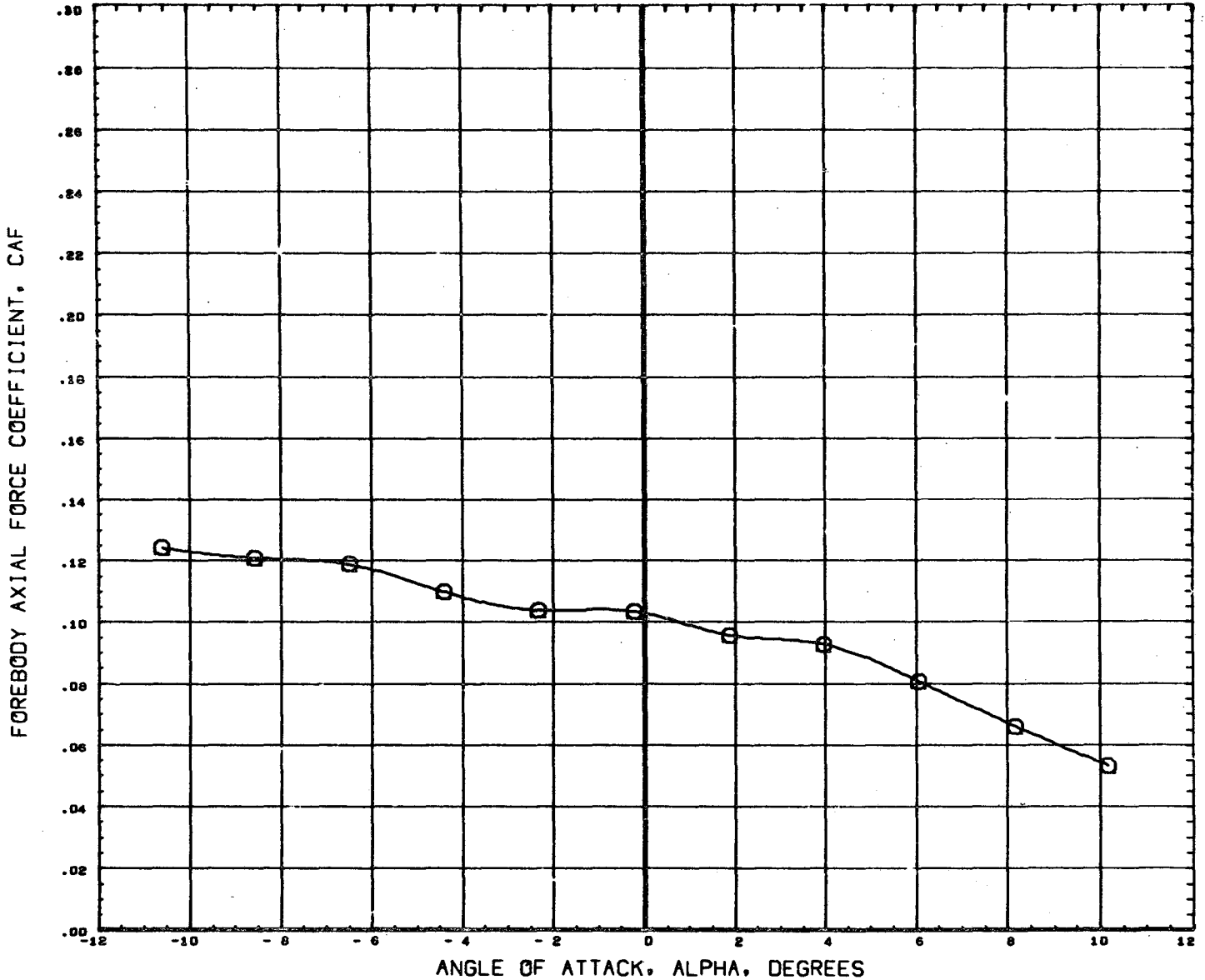

DATA SET SYMBOL	CONFIGURATION DESCRIPTION
(B65004) ○	MSFC TWT 534 SHUTTLE LAUNCH T101S1
(B65012) △	DATA NOT AVAILABLE FOR ALL CONDITIONS
(B65014) ◇	DATA NOT AVAILABLE FOR ALL CONDITIONS

ORBIN	THETS	BETA
-1.500	21.00J	0.000
-1.500	21.00D	0.000
-1.500	21.000	0.000

REFERENCE INFORMATION	
SREF	4.8950 90. IN
LREF	2.6440 IN.
BREF	3.9250 IN.
XMRP	3.4900 IN.
YMRP	0.0000 IN.
ZMRP	0.1616 IN.
SCALE	0.0034

EFFECT OF FIN LOCATION ON LONGITUDINAL CHARACTERISTICS

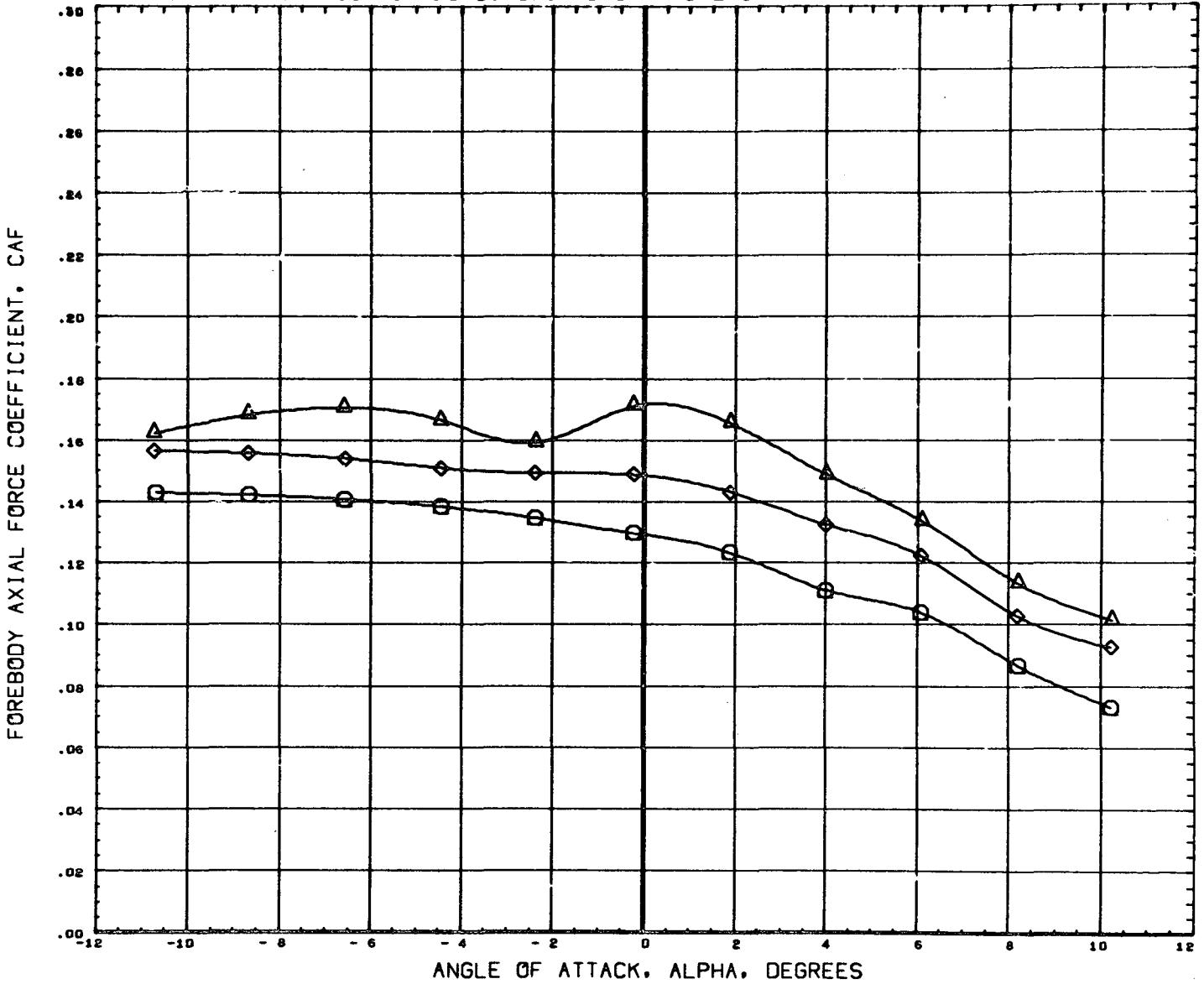

DATA SET SYMBOL	CONFIGURATION DESCRIPTION	ORBIN	THETS	BETA	REFERENCE INFORMATION	
(B65004)	MSFC TWT 534 SHUTTLE LAUNCH	T101S1	-1.500	21.000	0.000	SREF 4.8950 SQ. IN
(B65012)	MSFC TWT 534 SHUTTLE LAUNCH	T101S1F1	-1.500	21.000	0.000	LREF 2.6440 IN.
(B65014)	MSFC TWT 534 SHUTTLE LAUNCH	T101S1F2	-1.500	21.000	0.000	BREF 3.5250 IN.
						YMRP 3.4900 IN.
						YMRP 0.0000 IN.
						ZMRP 0.1616 IN.
						SCALE 0.0034

MACH .91

EFFECT OF FIN LOCATION ON LONGITUDINAL CHARACTERISTICS

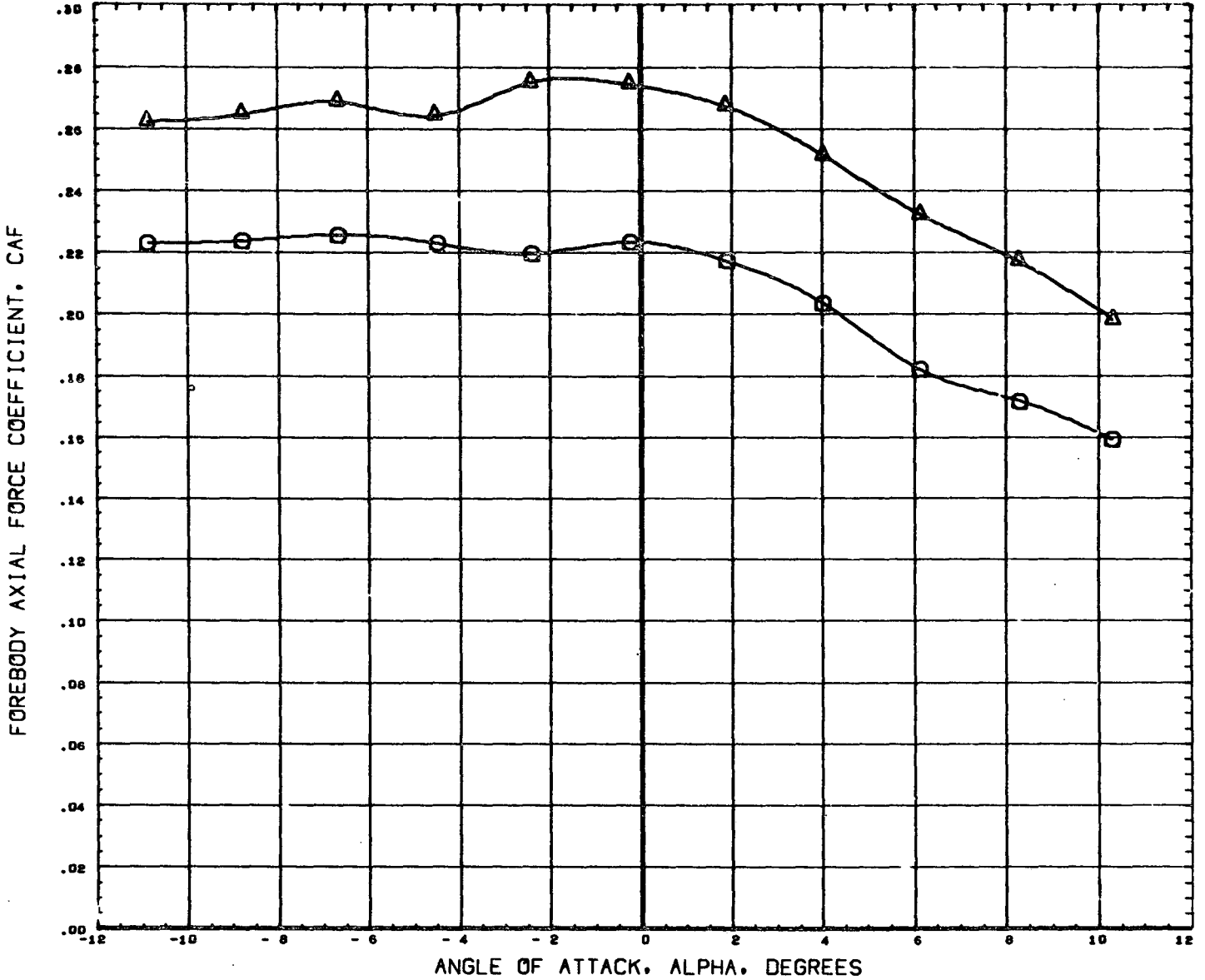

DATA SET SYMBOL	CONFIGURATION DESCRIPTION	ORBIN	THETS	BETA	REFERENCE INFORMATION
(B65004)	MSFC TWT 534 SHUTTLE LAUNCH T101S1	-1.500	21.000	0.000	SREF 4.8950 SQ. IN
(B65012)	MSFC TWT 534 SHUTTLE LAUNCH T101S1F1	-1.500	21.000	0.000	LREF 2.6440 IN.
(B65014)	DATA NOT AVAILABLE FOR ALL CONDITIONS	-1.500	21.000	0.000	BREF 3.5250 IN.
					XMRP 3.4900 IN.
					YMRP 0.0000 IN.
					ZMRP 0.1616 IN.
					SCALE 0.0034

MACH 1.10

EFFECT OF FIN LOCATION ON LONGITUDINAL CHARACTERISTICS

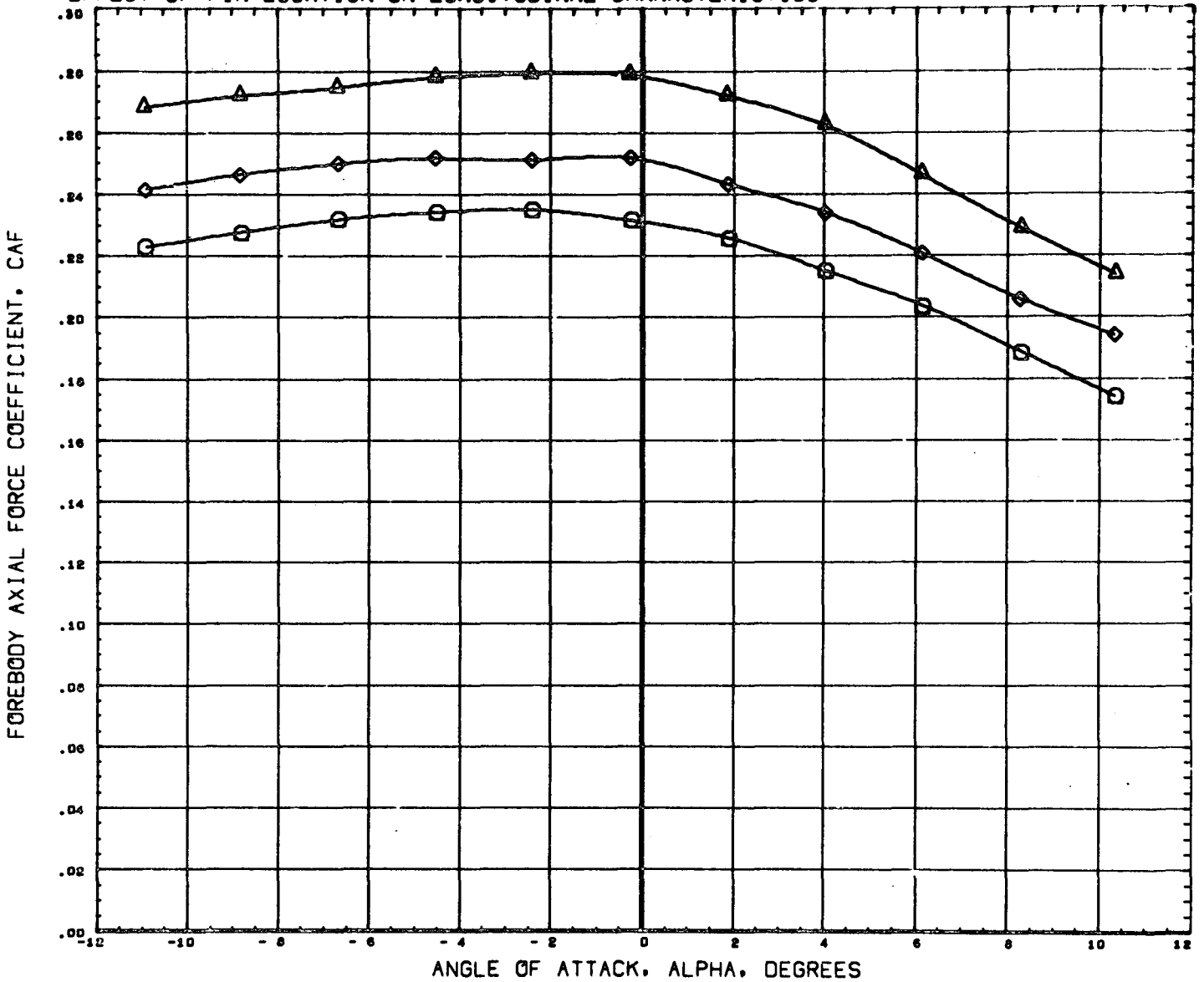

DATA SET SYMBOL	CONFIGURATION DESCRIPTION	ORBIN	THETS	BETA	REFERENCE INFORMATION	
(B650D4)	MSFC TWT 534 SHUTTLE LAUNCH	T101S1	-1.500	21.000	0.000	SREF 4.8950 50. IN
(B650D2)	MSFC TWT 534 SHUTTLE LAUNCH	T101S1F1	-1.500	21.000	0.000	LREF 2.6440 IN.
(B650D14)	MSFC TWT 534 SHUTTLE LAUNCH	T101S1F2	-1.500	21.000	0.000	BREF 3.5250 IN.
						XMRP 3.4900 IN.
						YMRP 0.0000 IN.
						ZMRP 0.1616 IN.
						SCALE 0.0034

MACH 1.20

EFFECT OF FIN LOCATION ON LONGITUDINAL CHARACTERISTICS

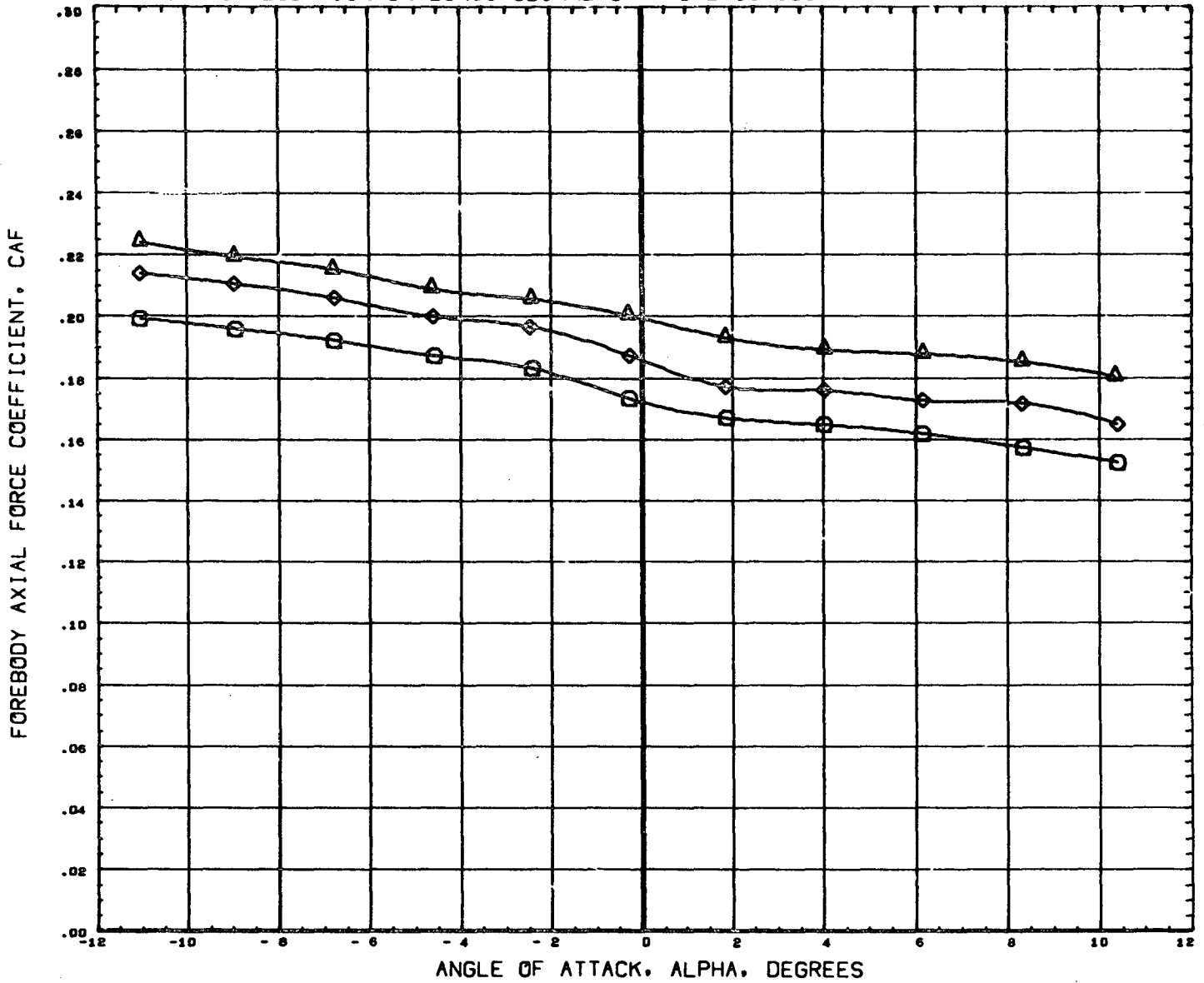

DATA SET SYMBOL	CONFIGURATION DESCRIPTION	ORBIN	THETS	BETA	REFERENCE INFORMATION	
(B65004)	MSFC TWT 534 SHUTTLE LAUNCH	T101S1	-1.500	21.000	0.000	SREF 4.8950 SQ. IN
(B65012)	MSFC TWT 534 SHUTTLE LAUNCH	T101S1F1	-1.500	21.000	0.000	LREF 2.6440 IN.
(B65014)	MSFC TWT 534 SHUTTLE LAUNCH	T101S1F2	-1.500	21.000	0.000	BREF 3.5250 IN.
						XMRP 3.4900 IN.
						YMRP 0.0000 IN.
						ZMRP 0.1616 IN.
						SCALE 0.0034

MACH 1.97

EFFECT OF FIN LOCATION ON LONGITUDINAL CHARACTERISTICS

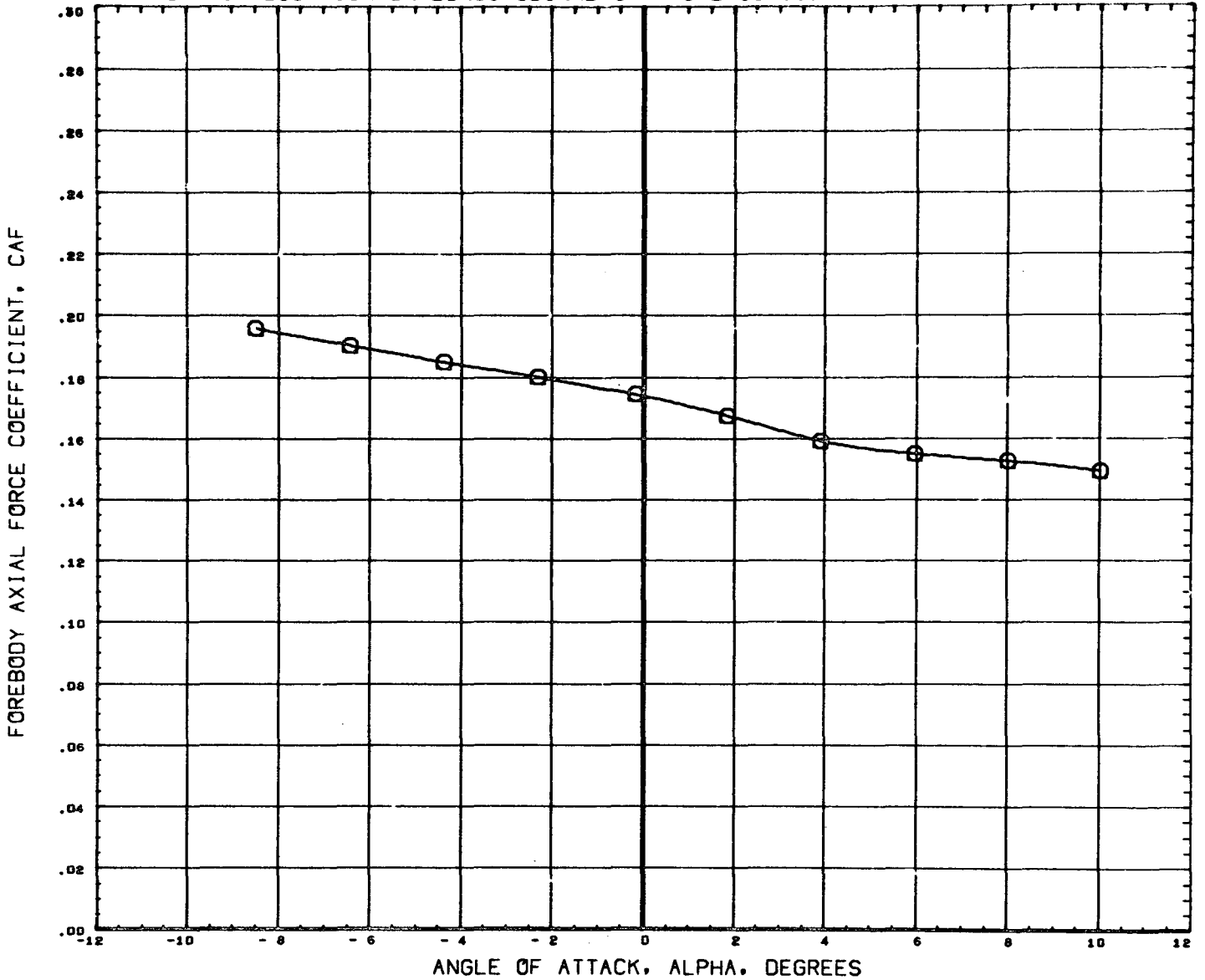

DATA SET SYMBOL	CONFIGURATION DESCRIPTION	ORBIN	THETS	BETA	REFERENCE INFORMATION	
(B65004)	MSFC TWT 534 SHUTTLE LAUNCH T101S1	-1.500	21.000	0.000	SREF	4.8950 SQ. IN
(B65012)	DATA NOT AVAILABLE FOR ALL CONDITIONS	-1.500	21.000	0.000	LREF	2.6440 IN.
(B65014)	DATA NOT AVAILABLE FOR ALL CONDITIONS	-1.500	21.000	0.000	BREF	3.5250 IN.
					XMRP	3.4900 IN.
					YMRP	0.0000 IN.
					ZMRP	0.1616 IN.
					SCALE	0.0034

MACH 2.74

EFFECT OF FIN LOCATION ON LONGITUDINAL CHARACTERISTICS

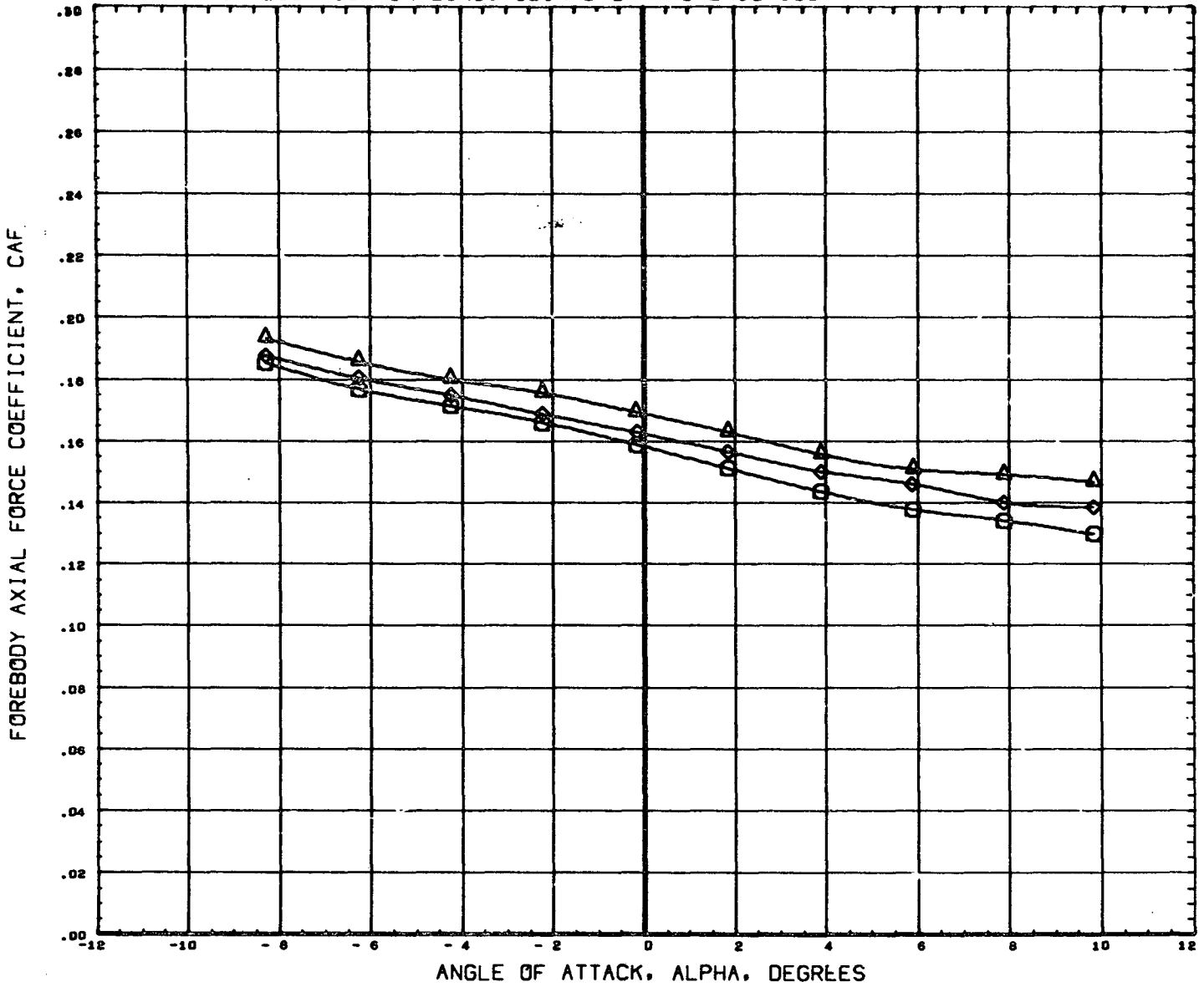

DATA SET SYMBOL	CONFIGURATION DESCRIPTION	ORBIN	THETS	BETA	REFERENCE INFORMATION
(B65004)	MSFC TWT 534 SHUTTLE LAUNCH	-1.500	21.000	0.000	SREF 4.8950 SQ. IN
(B65012)	MSFC TWT 534 SHUTTLE LAUNCH	-1.500	21.000	0.000	LREF 2.6440 IN.
(B65014)	MSFC TWT 534 SHUTTLE LAUNCH	-1.500	21.000	0.000	BREF 3.5250 IN.
					XNRP 3.4900 IN.
					YNRP 0.0000 IN.
					ZNRP 0.1616 IN.
					SCALE 0.0034

MACH 4.96

PAGE 528

EFFECT OF FIN LOCATION ON LONGITUDINAL CHARACTERISTICS

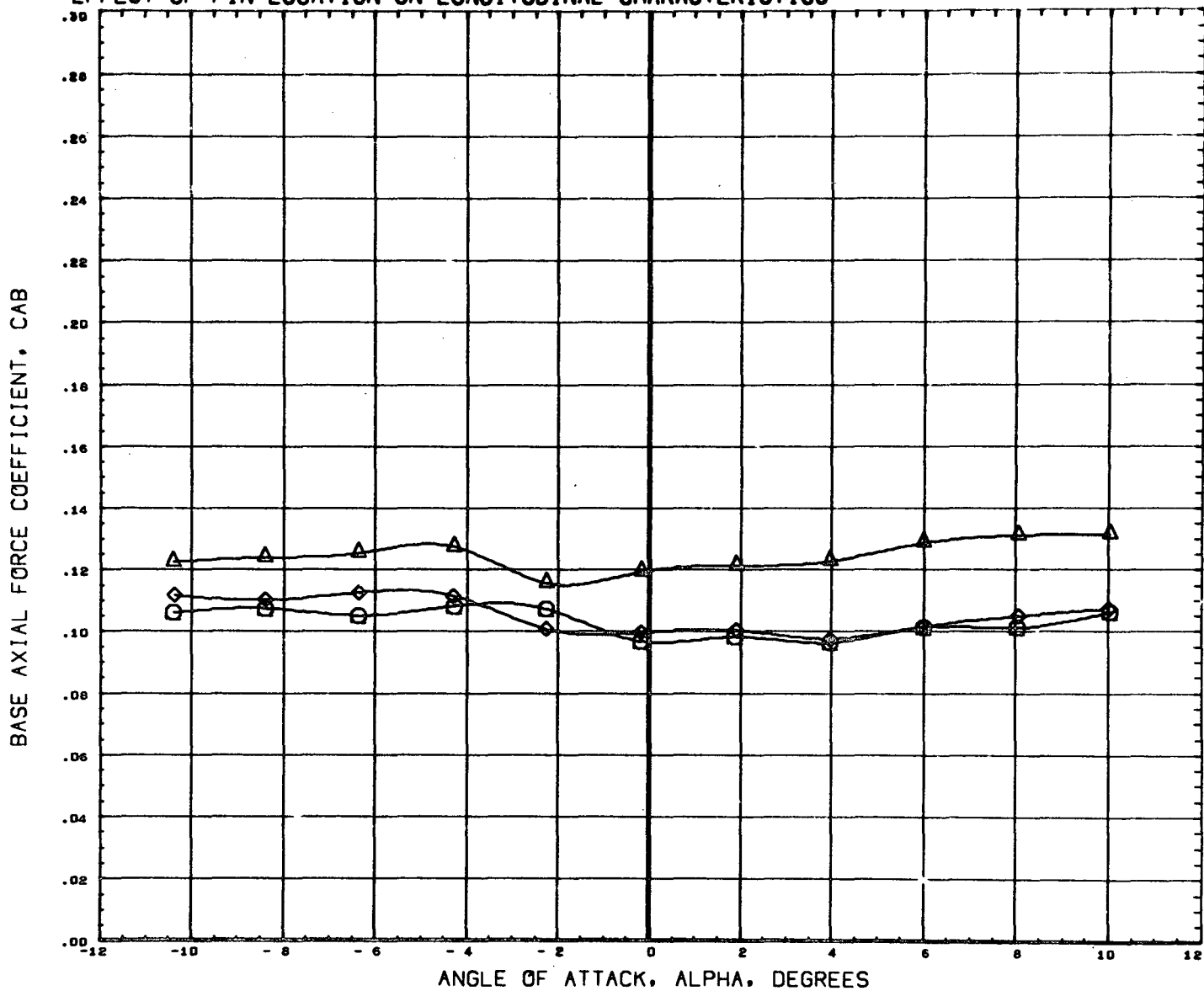

DATA SET SYMBOL	CONFIGURATION DESCRIPTION	ORBIN	THETS	BETA	REFERENCE INFORMATION	
(B65004)	MSFC TWT 534 SHUTTLE LAUNCH	T101S1	-1.500	21.000	0.000	SREF 4.8955 SQ. IN
(B65012)	MSFC TWT 534 SHUTTLE LAUNCH	T101S1F1	-1.500	21.000	0.000	LREF 2.6440 IN.
(B65014)	MSFC TWT 534 SHUTTLE LAUNCH	T101S1F2	-1.500	21.000	0.000	BREF 3.5250 IN.
						XMRP 3.4900 IN.
						YMRP 0.0000 IN.
						ZMRP 0.1616 IN.
						SCALE 0.0034

MACH .60

EFFECT OF FIN LOCATION ON LONGITUDINAL CHARACTERISTICS

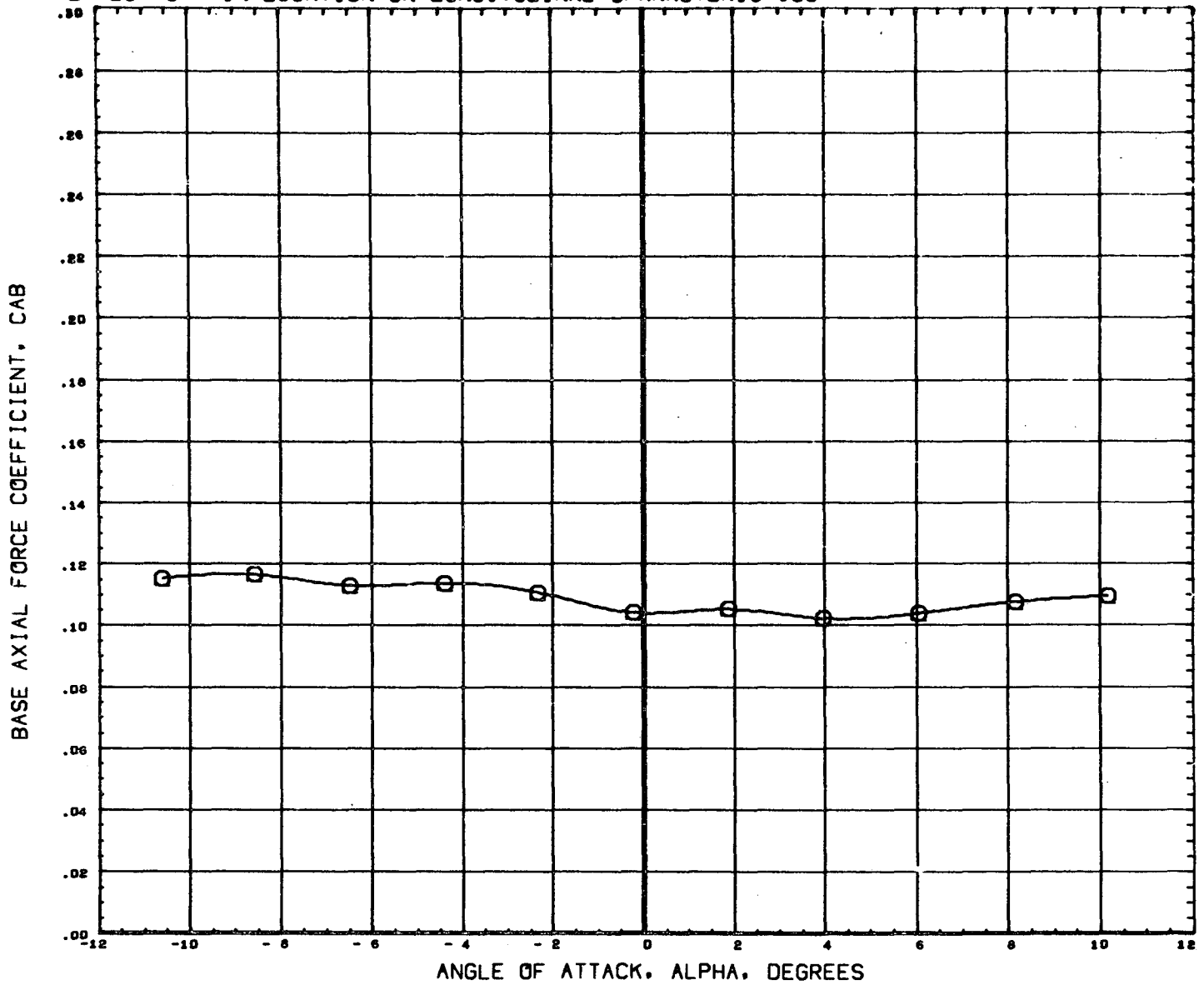

DATA SET SYMBOL	CONFIGURATION DESCRIPTION	ORBIN	THETS	BETA	REFERENCE INFORMATION
(B65004)	MSFC TWT 534 SHUTTLE LAUNCH T101S1	-1.500	21.000	0.000	SREF 4.8950 SQ. IN
(B65012)	DATA NOT AVAILABLE FOR ALL CONDITIONS	-1.500	21.000	0.000	LREF 2.6440 IN.
(B65014)	DATA NOT AVAILABLE FOR ALL CONDITIONS	-1.500	21.000	0.000	BREF 3.5250 IN.
					XMRP 3.4500 IN.
					YMRP 0.0000 IN.
					ZMRP 0.1616 IN.
					SCALE 0.0034

MACH .80

EFFECT OF FIN LOCATION ON LONGITUDINAL CHARACTERISTICS

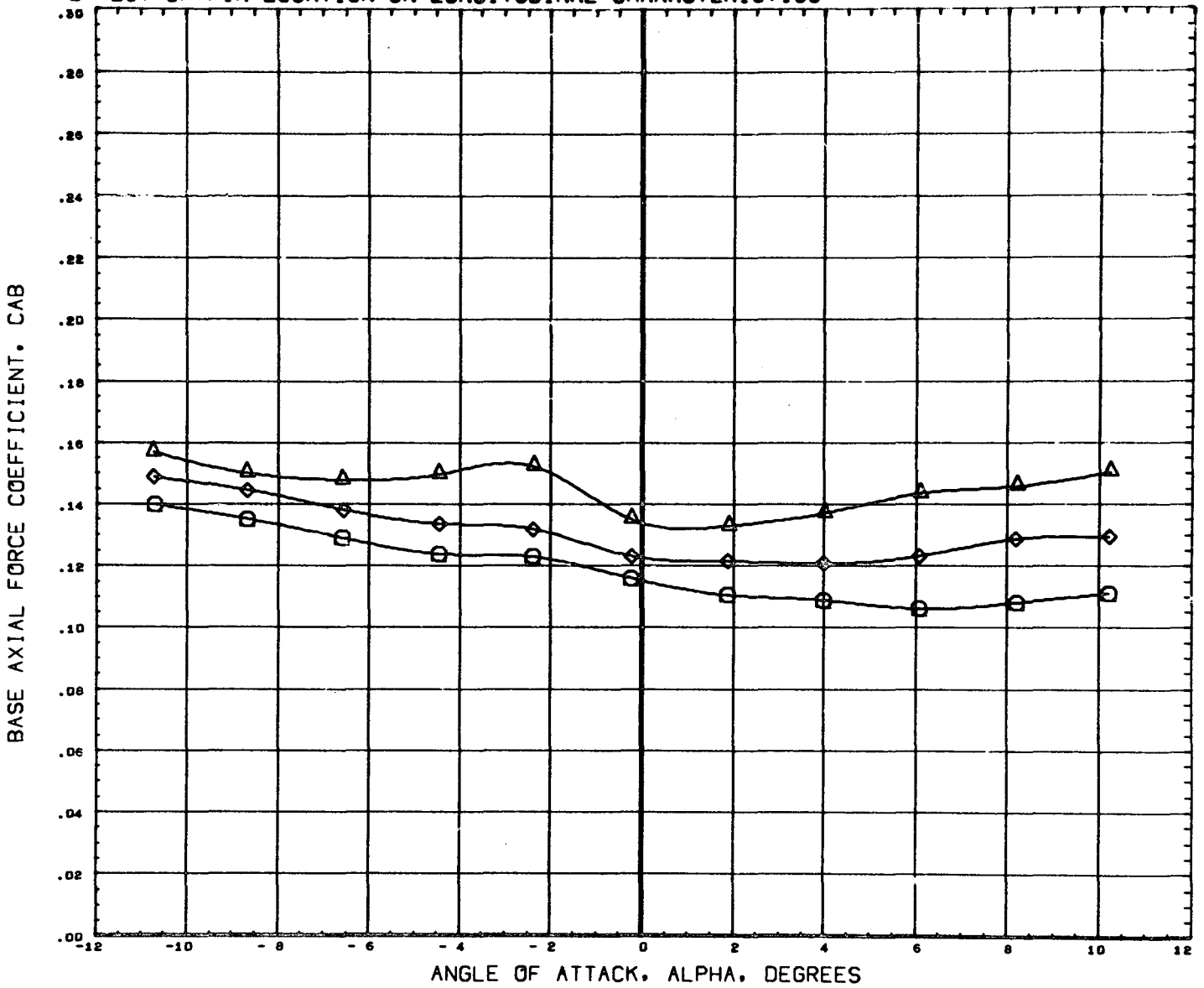

DATA SET SYMBOL	CONFIGURATION DESCRIPTION	ORBIN	THETS	BETA	REFERENCE INFORMATION	
(B65004)	MSFC TWT 534 SHUTTLE LAUNCH	T101S1	-1.500	21.000	0.000	SREF 4.8950 IN.
(B65012)	MSFC TWT 534 SHUTTLE LAUNCH	T101S1F1	-1.500	21.000	0.000	LREF 2.6440 IN.
(B65014)	MSFC TWT 534 SHUTTLE LAUNCH	T101S1F2	-1.500	21.000	0.000	BREF 3.5250 IN.
						XMRP 3.4900 IN.
						YMRP 0.0000 IN.
						ZMRP 0.1616 IN.
						SCALE 0.0034

EFFECT OF FIN LOCATION ON LONGITUDINAL CHARACTERISTICS

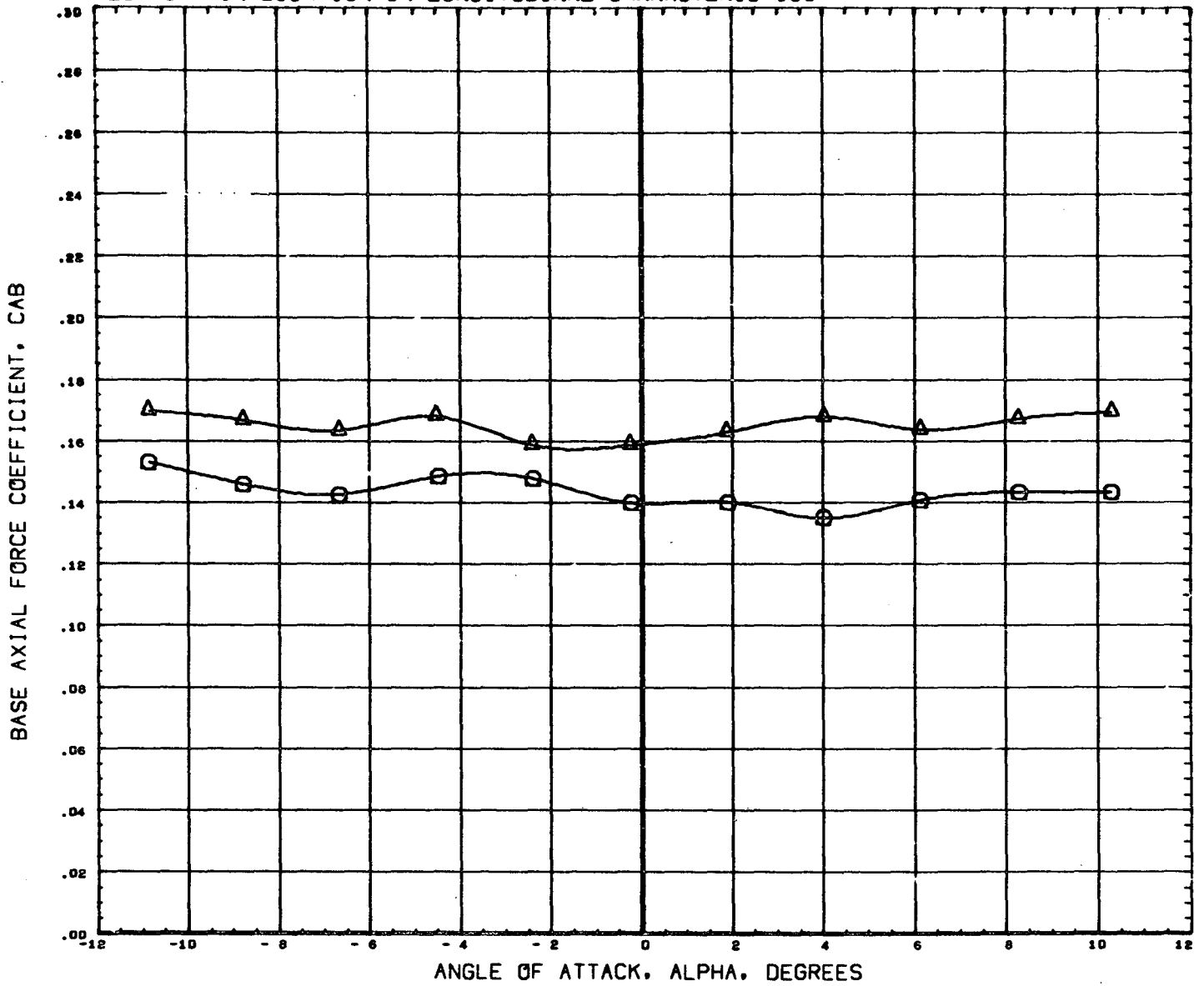

DATA SET SYMBOL	CONFIGURATION DESCRIPTION	ORBIN	THETS	BETA	REFERENCE INFORMATION
(B65004)	MSFC TWT 534 SHUTTLE LAUNCH T101S1	-1.500	21.000	0.000	SREF 4.8950 SQ. IN
(B65012)	MSFC TWT 534 SHUTTLE LAUNCH T101S1F1	-1.500	21.000	0.000	LREF 2.6440 IN.
(B65014)	DATA NOT AVAILABLE FOR ALL CONDITIONS	-1.500	21.000	0.000	BREF 3.5250 IN.
					XMRF 3.4900 IN.
					YMRF 0.0000 IN.
					ZMRF 0.1616 IN.
					SCALE 0.0034

MACH 1.10

EFFECT OF FIN LOCATION ON LONGITUDINAL CHARACTERISTICS

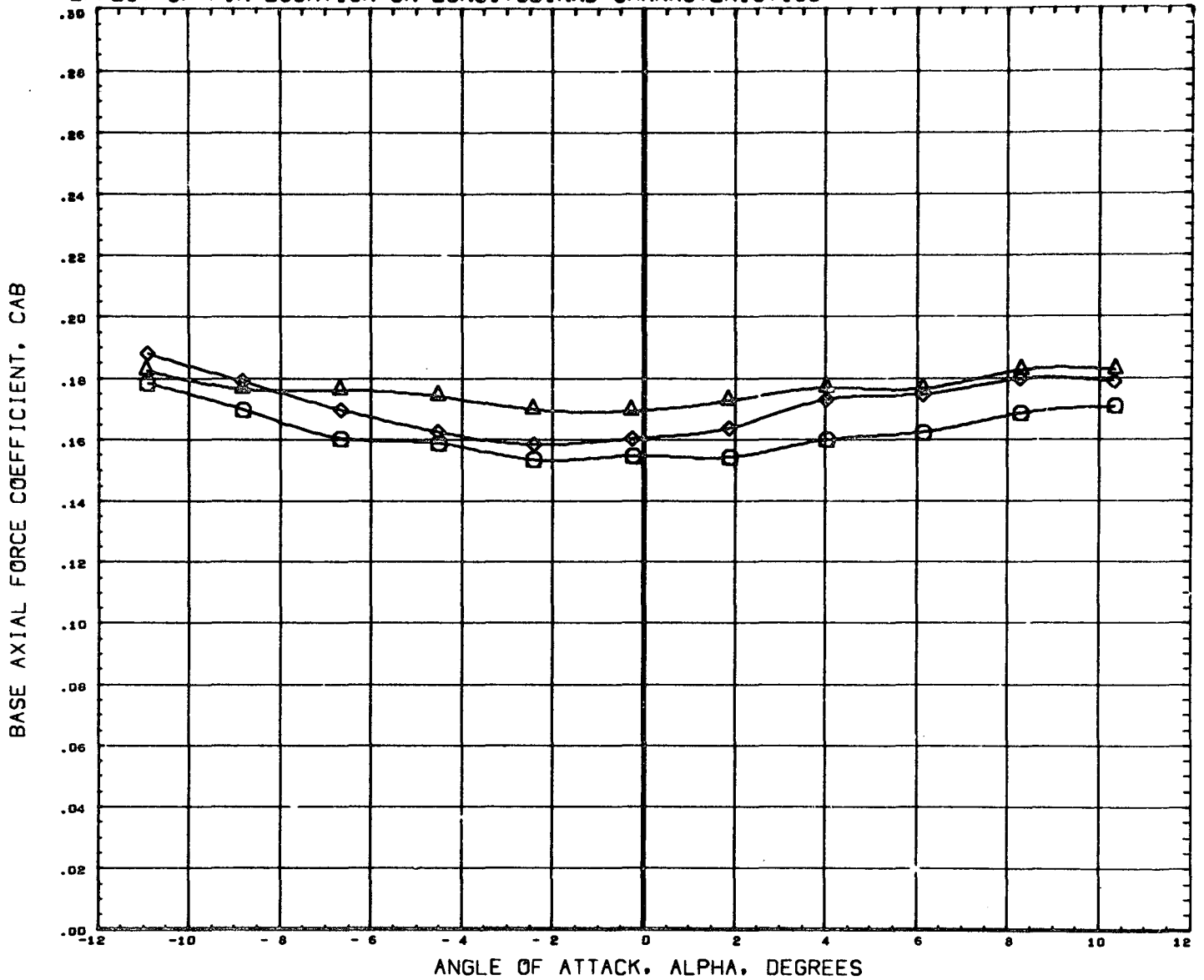

DATA SET SYMBOL	CONFIGURATION DESCRIPTION	T101S1	ORBIN	THETS	BETA	REFERENCE INFORMATION
(B65004)	MSFC TWT 534 SHUTTLE LAUNCH	T101S1	-1.500	21.000	0.000	SREF 4.8950 SQ. IN
(B65012)	MSFC TWT 534 SHUTTLE LAUNCH	T101S1F1	-1.500	21.000	0.000	LREF 2.6440 IN.
(B65014)	MSFC TWT 534 SHUTTLE LAUNCH	T101S1F2	-1.500	21.000	0.000	BREF 3.5250 IN.
						XMRP 3.4900 IN.
						YMRP 0.0000 IN.
						ZMRP 0.1616 IN.
						SCALE 0.0034

MACH 1.20

EFFECT OF FIN LOCATION ON LONGITUDINAL CHARACTERISTICS

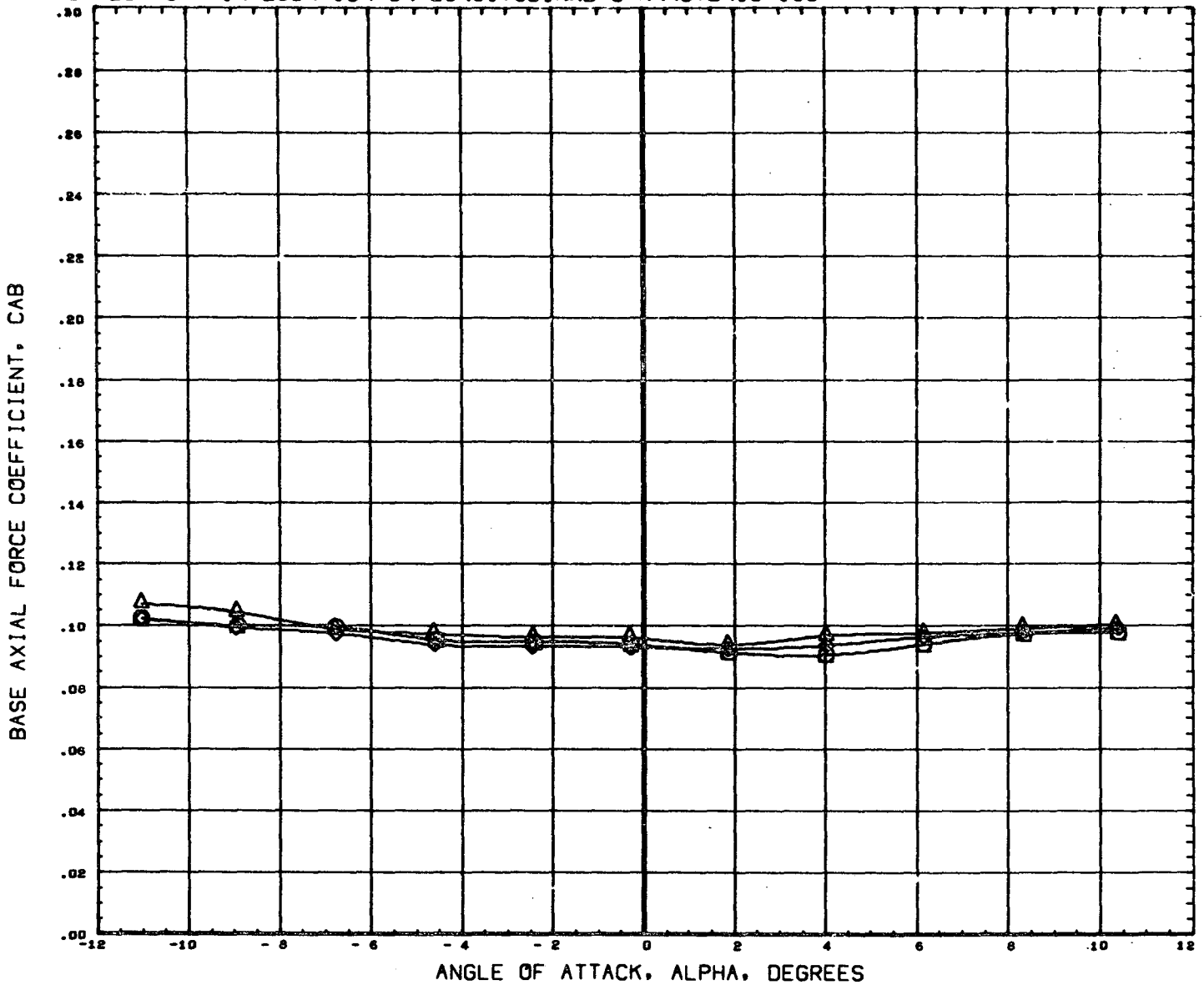

DATA SET SYMBOL	CONFIGURATION DESCRIPTION	ORBIN	THETS	BETA	REFERENCE INFORMATION
(B65004)	MSFC TWT 534 SHUTTLE LAUNCH T101S1	-1.500	21.000	0.000	SREF 4.8950 SQ. IN
(B65012)	MSFC TWT 534 SHUTTLE LAUNCH T101S1F1	-1.500	21.000	0.000	LREF 2.6440 IN.
(B65014)	MSFC TWT 534 SHUTTLE LAUNCH T101S1F2	-1.500	21.000	0.000	BREF 3.5250 IN.
					YHRP 3.4900 IN.
					ZHRP 0.0000 IN.
					ZHRP 0.1616 IN.
					SCALE 0.0034

EFFECT OF FIN LOCATION ON LONGITUDINAL CHARACTERISTICS

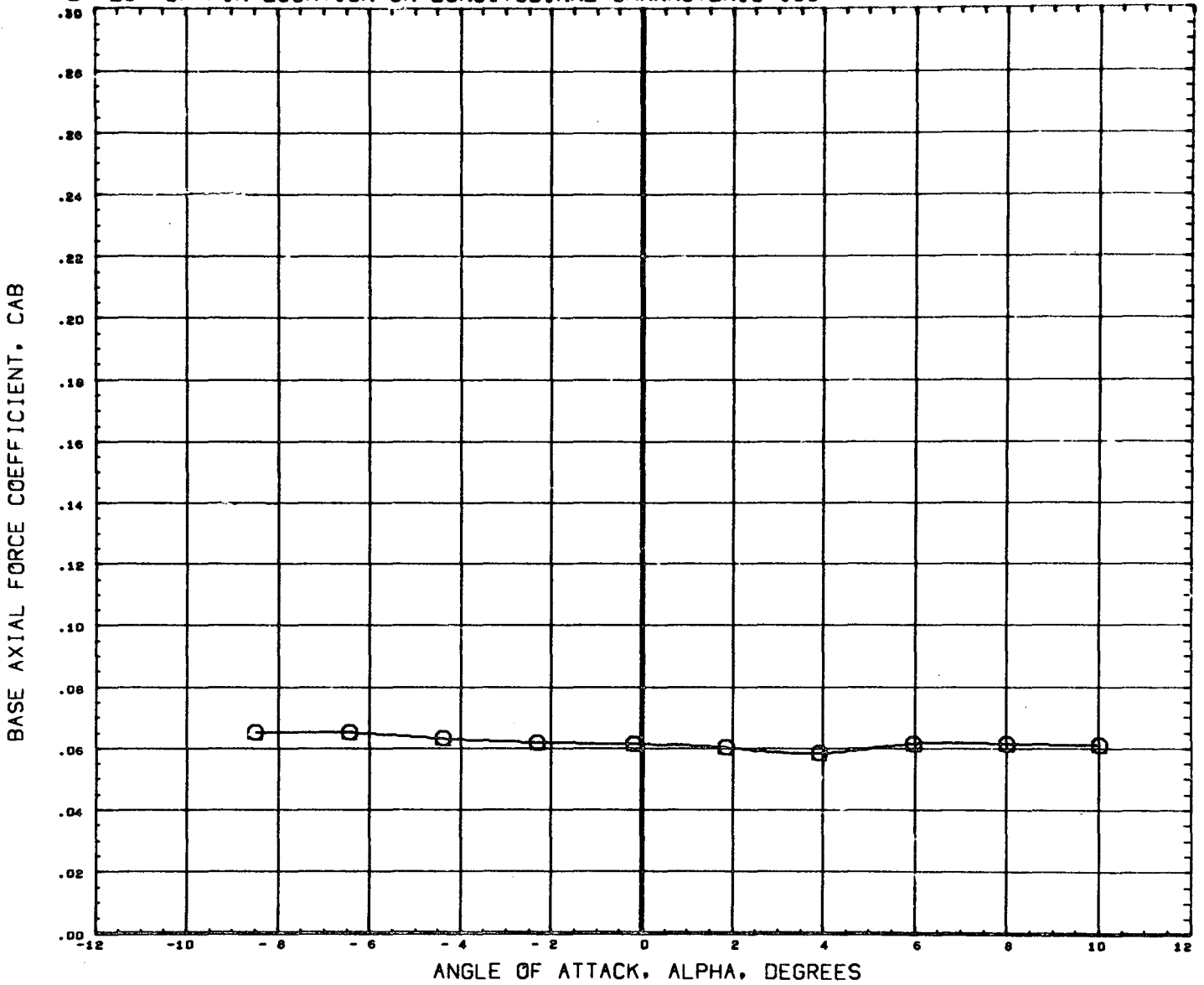

DATA SET SYMBOL	CONFIGURATION DESCRIPTION	ORBIN	THETS	BETA	REFERENCE INFORMATION
(B65004)	MSFC TWT 534 SHUTTLE LAUNCH T101S1	-1.500	21.000	0.000	SREF 4.8950 SQ. IN
(B65012)	DATA NOT AVAILABLE FOR ALL CONDITIONS	-1.500	21.000	0.000	LREF 2.6440 IN.
(B65014)	DATA NOT AVAILABLE FOR ALL CONDITIONS	-1.500	21.000	0.000	BREF 3.5250 IN.
					XMRP 3.4900 IN.
					YMRP 0.0000 IN.
					ZMRP 0.1616 IN.
					SCALE 0.0034

EFFECT OF FIN LOCATION ON LONGITUDINAL CHARACTERISTICS

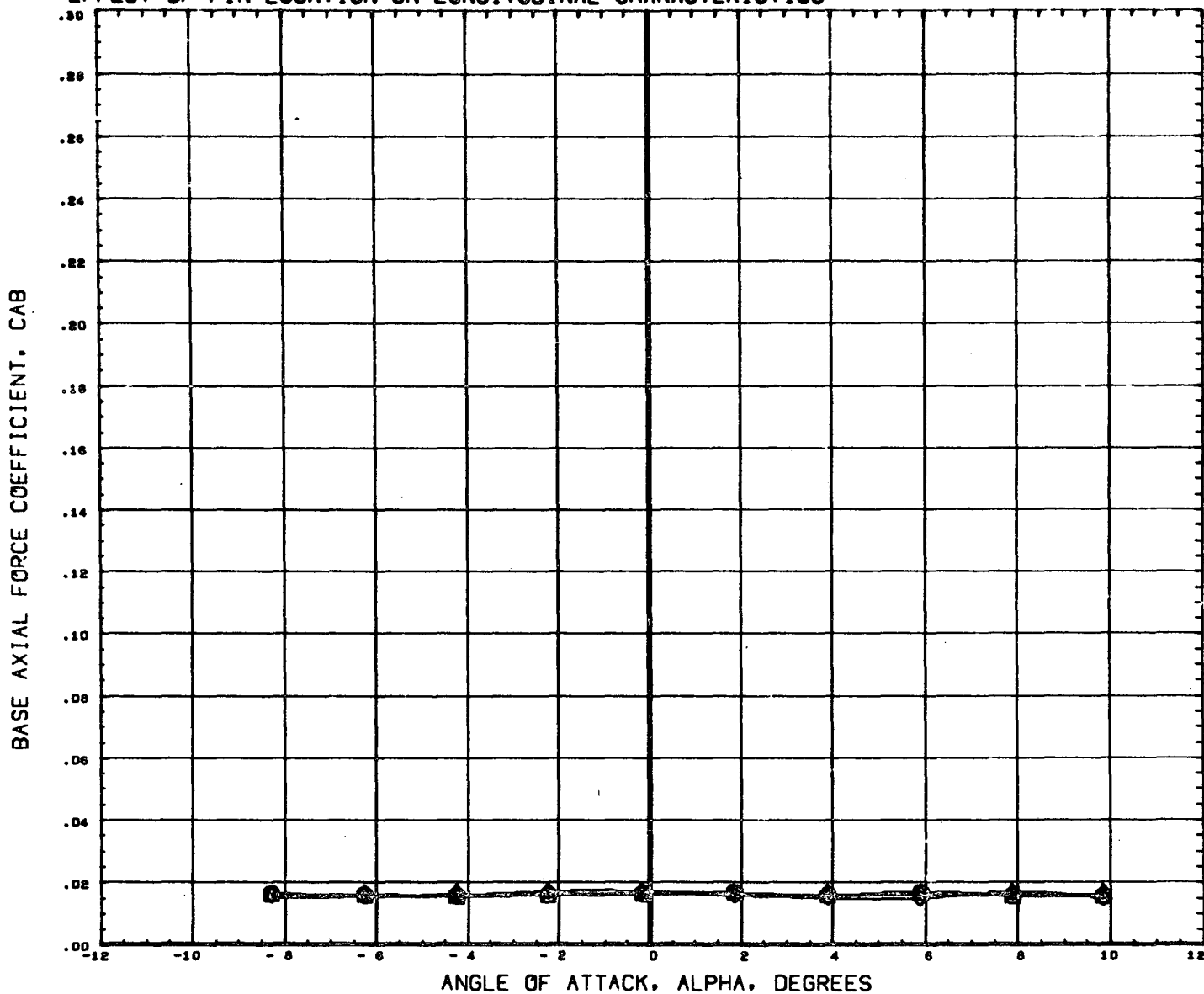

DATA SET SYMBOL	CONFIGURATION DESCRIPTION	ORBIN	THETS	BETA	REFERENCE INFORMATION
(B65004)	MSFC TWT 534 SHUTTLE LAUNCH	-1.500	21.000	0.000	SREF 4.8950 SQ. IN
(B65012)	MSFC TWT 534 SHUTTLE LAUNCH	-1.500	21.000	0.000	LREF 2.6440 IN.
(B65014)	MSFC TWT 534 SHUTTLE LAUNCH	-1.500	21.000	0.000	BREF 3.5250 IN.
					XMRP 3.4900 IN.
					YMRP 0.0000 IN.
					ZMRP 0.1516 IN.
					SCALE 0.0034

MACH 4.96

PAGE 536

EFFECT OF FIN LOCATION ON LONGITUDINAL CHARACTERISTICS

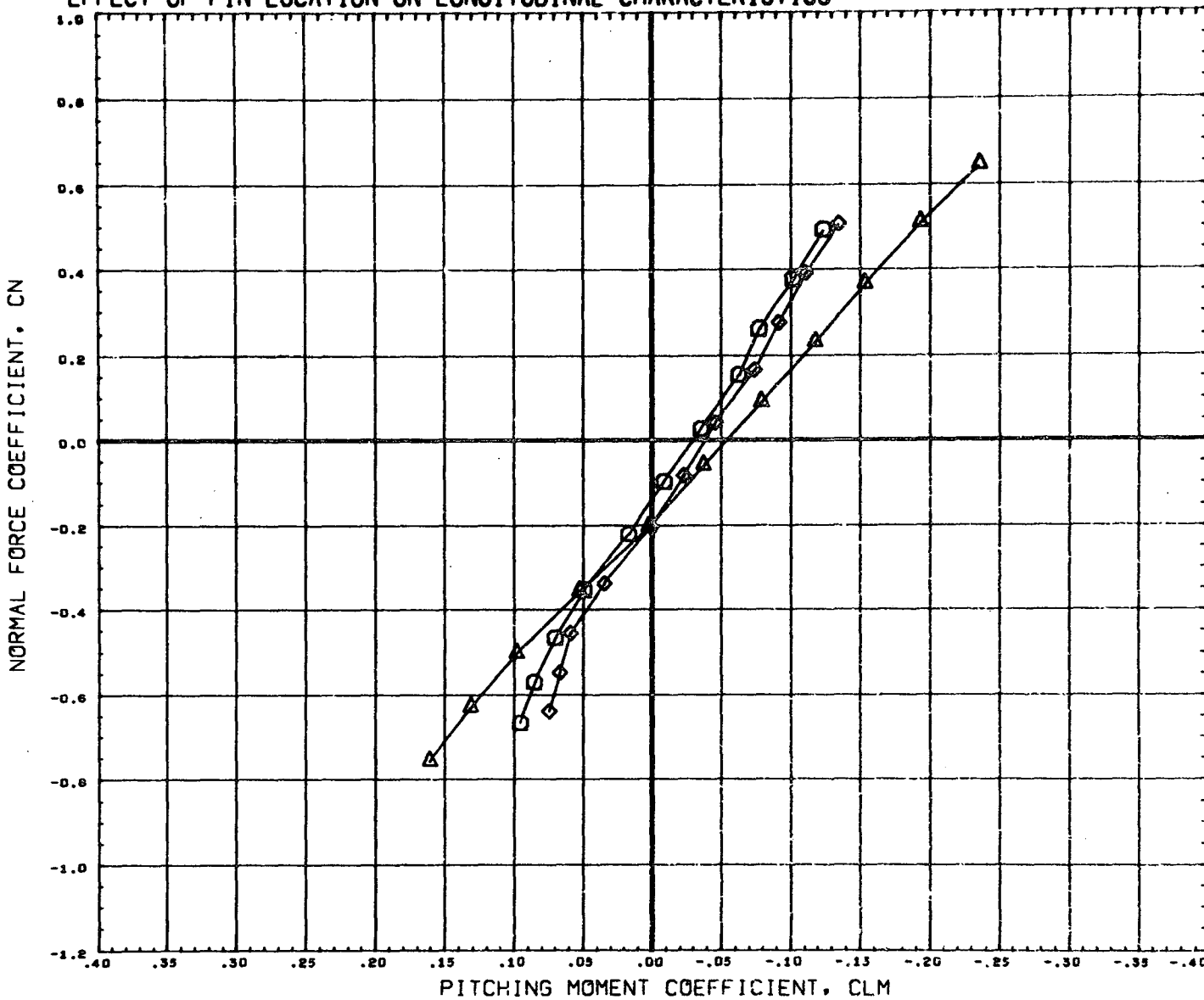

DATA SET SYMBOL	CONFIGURATION DESCRIPTION	ORBIN	THETS	BETA	REFERENCE INFORMATION	
(B65004)	MSFC TWT 534 SHUTTLE LAUNCH	T101S1	-1.500	21.000	0.000	SREF 4.8950 SQ. IN
(B65012)	MSFC TWT 534 SHUTTLE LAUNCH	T101S1F1	-1.500	21.000	0.000	LREF 2.8440 IN.
(B65014)	MSFC TWT 534 SHUTTLE LAUNCH	T101S1F2	-1.500	21.000	0.000	BREF 3.5250 IN.
						XMRP 3.4900 IN.
						YMRP 0.0000 IN.
						ZMRP 0.1616 IN.
						SCALE 0.0034

MACH .60

PAGE 537

EFFECT OF FIN LOCATION ON LONGITUDINAL CHARACTERISTICS

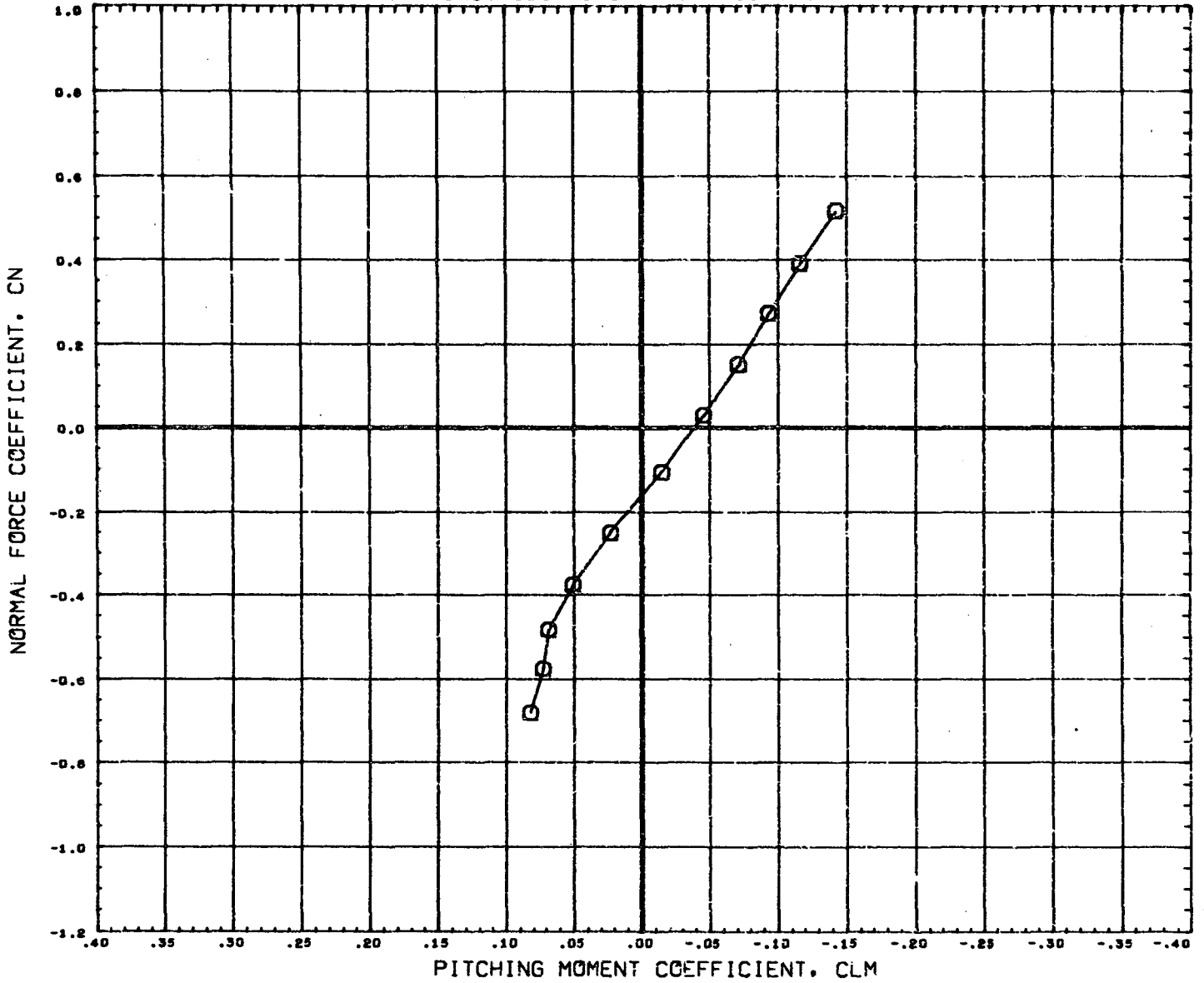

DATA SET SYMBOL	CONFIGURATION DESCRIPTION	ORBIN	THETS	BETA	REFERENCE INFORMATION
(B65004)	MSFC TWT 534 SHUTTLE LAUNCH T101S1	-1.500	21.000	0.000	SREF 4.8950 SQ. IN
(B65012)	DATA NOT AVAILABLE FOR ALL CONDITIONS	-1.500	21.000	0.000	LREF 2.6440 IN.
(B65014)	DATA NOT AVAILABLE FOR ALL CONDITIONS	-1.500	21.000	0.000	BREF 3.5250 IN.
					XMRP 3.4900 IN.
					YMRP 0.0000 IN.
					ZMRP 0.1616 IN.
					SCALE 0.6034

EFFECT OF FIN LOCATION ON LONGITUDINAL CHARACTERISTICS

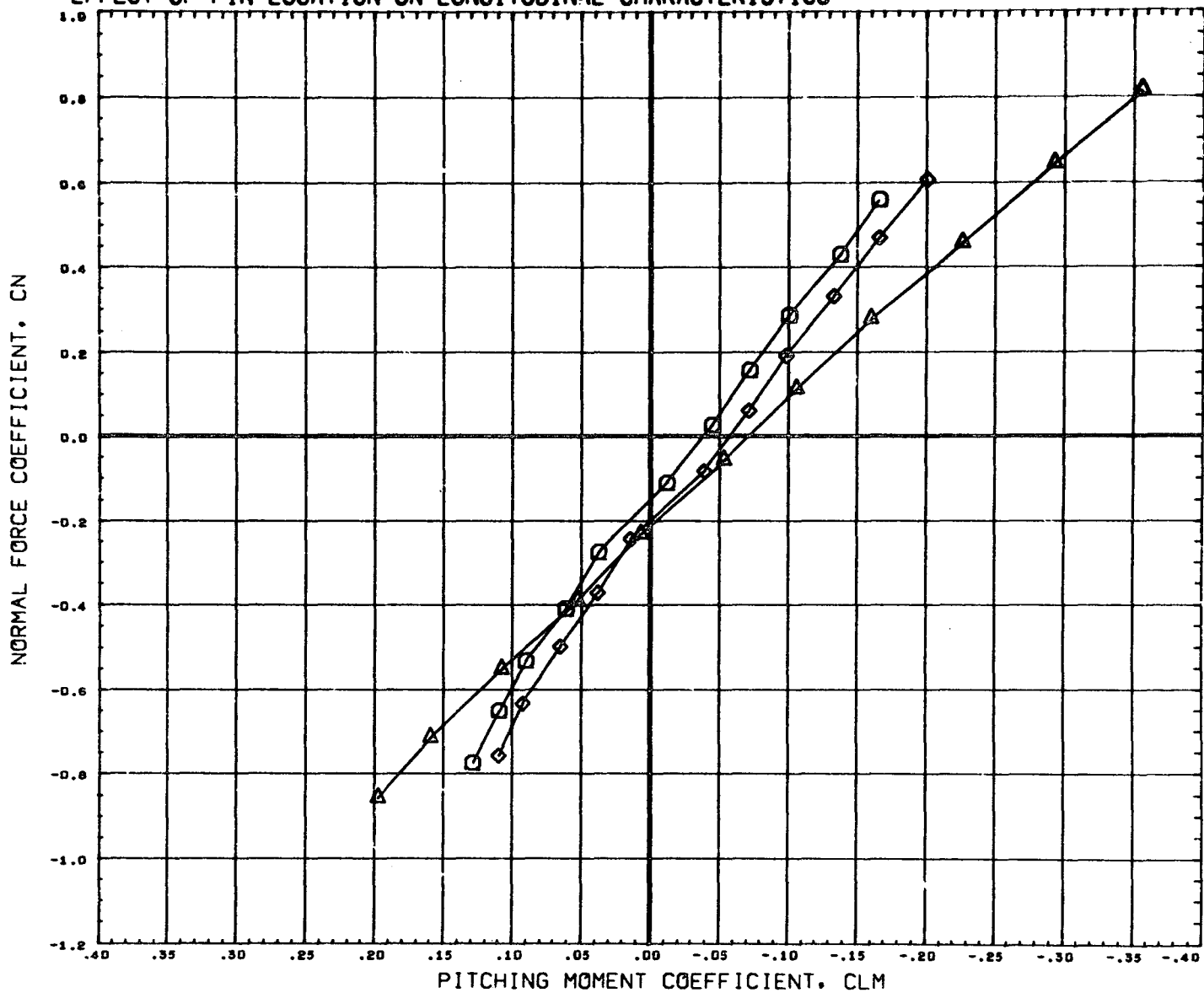

DATA SET SYMBOL	CONFIGURATION DESCRIPTION	ORBIN	THETS	BETA	REFERENCE INFORMATION
(B65004)	MSFC TWT 534 SHUTTLE LAUNCH	-1.500	21.000	0.000	SREF 4.8950 SQ. IN
(B65012)	MSFC TWT 534 SHUTTLE LAUNCH	-1.500	21.000	0.000	LREF 2.6440 IN.
(B65014)	MSFC TWT 534 SHUTTLE LAUNCH	-1.500	21.000	0.000	BREF 3.5250 IN.
					XNRP 3.4900 IN.
					YNRP 0.0000 IN.
					ZMRP 0.1616 IN.
					SCALE 0.0034

EFFECT OF FIN LOCATION ON LONGITUDINAL CHARACTERISTICS

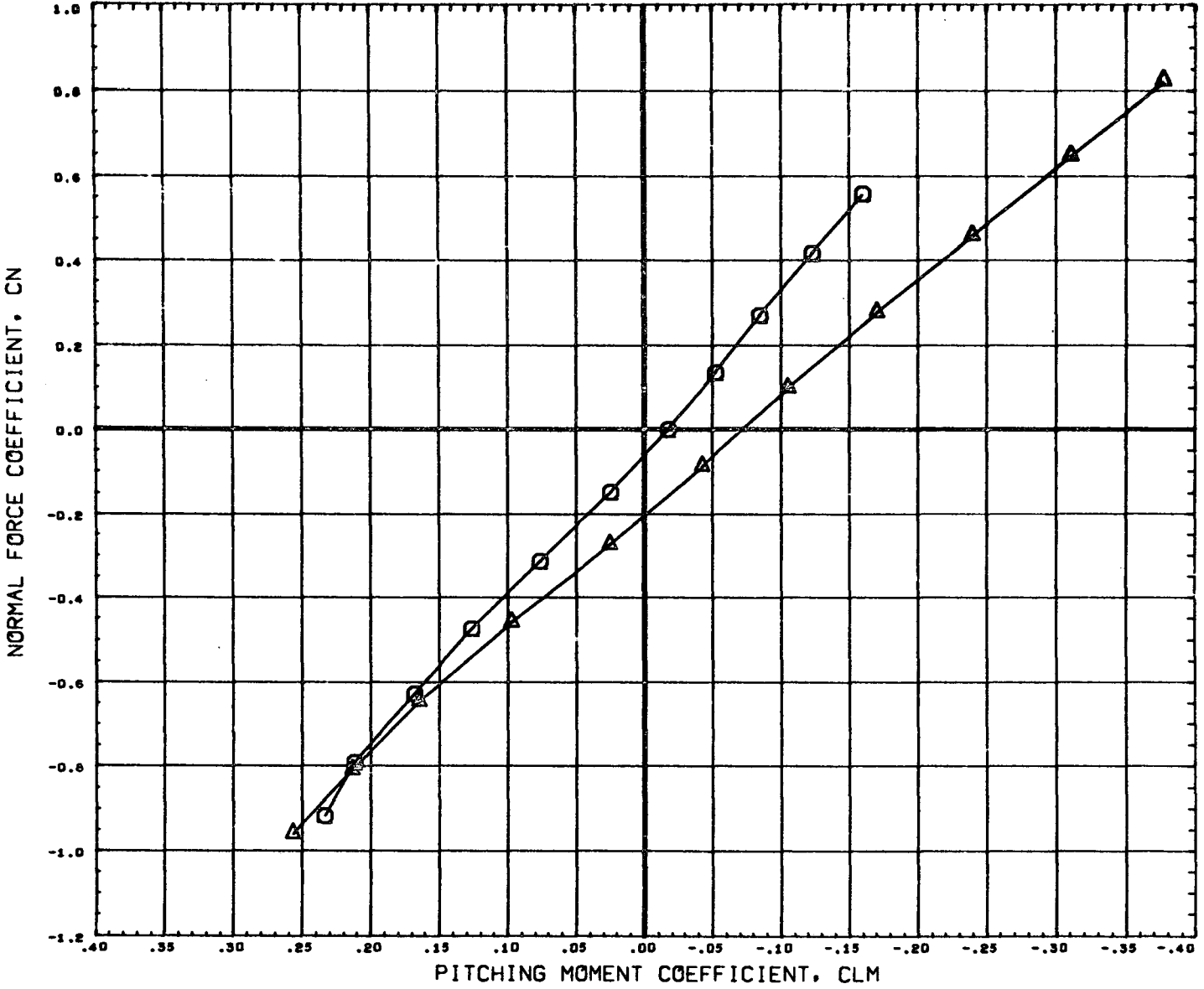

DATA SET SYMBOL	CONFIGURATION DESCRIPTION	ORBIN	THETS	BETA	REFERENCE INFORMATION
(B65004)	MSFC TWT 534 SHUTTLE LAUNCH T101S1	-1.500	21.000	0.000	SREF 4.8950 SQ. IN
(B65012)	MSFC TWT 534 SHUTTLE LAUNCH T101S1F1	-1.500	21.000	0.000	LREF 2.6440 IN.
(B65014)	DATA NOT AVAILABLE FOR ALL CONDITIONS	-1.500	21.000	0.000	BREF 3.5250 IN.
					XMRP 3.4900 IN.
					YMRP 0.0000 IN.
					ZMRP 0.1616 IN.
					SCALE 0.0034

EFFECT OF FIN LOCATION ON LONGITUDINAL CHARACTERISTICS

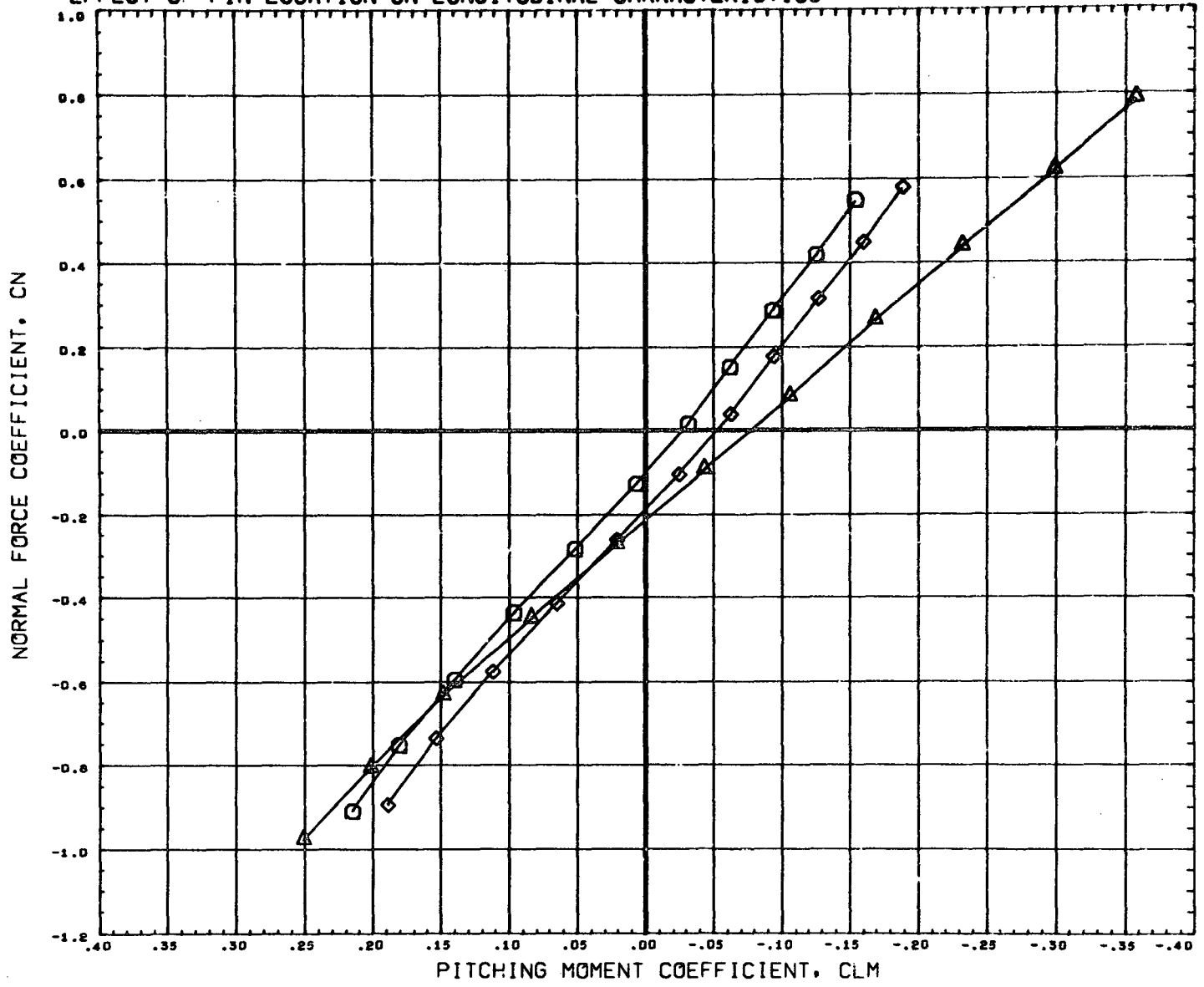

DATA SET SYMBOL	CONFIGURATION DESCRIPTION	ORBIN	THETS	BETA	REFERENCE INFORMATION
(B65004)	MSFC TWT 534 SHUTTLE LAUNCH	-1.500	21.000	0.000	SREF 4.8950 SQ. IN
(B65012)	MSFC TWT 534 SHUTTLE LAUNCH	-1.500	21.000	0.000	LREF 2.6440 IN.
(B65014)	MSFC TWT 534 SHUTTLE LAUNCH	-1.500	21.000	0.000	BREF 3.5250 IN.
					XMRP 3.4900 IN.
					YMRP 0.0000 IN.
					ZMRP 0.1616 IN.
					SCALE 0.0034

MACH 1.20

EFFECT OF FIN LOCATION ON LONGITUDINAL CHARACTERISTICS

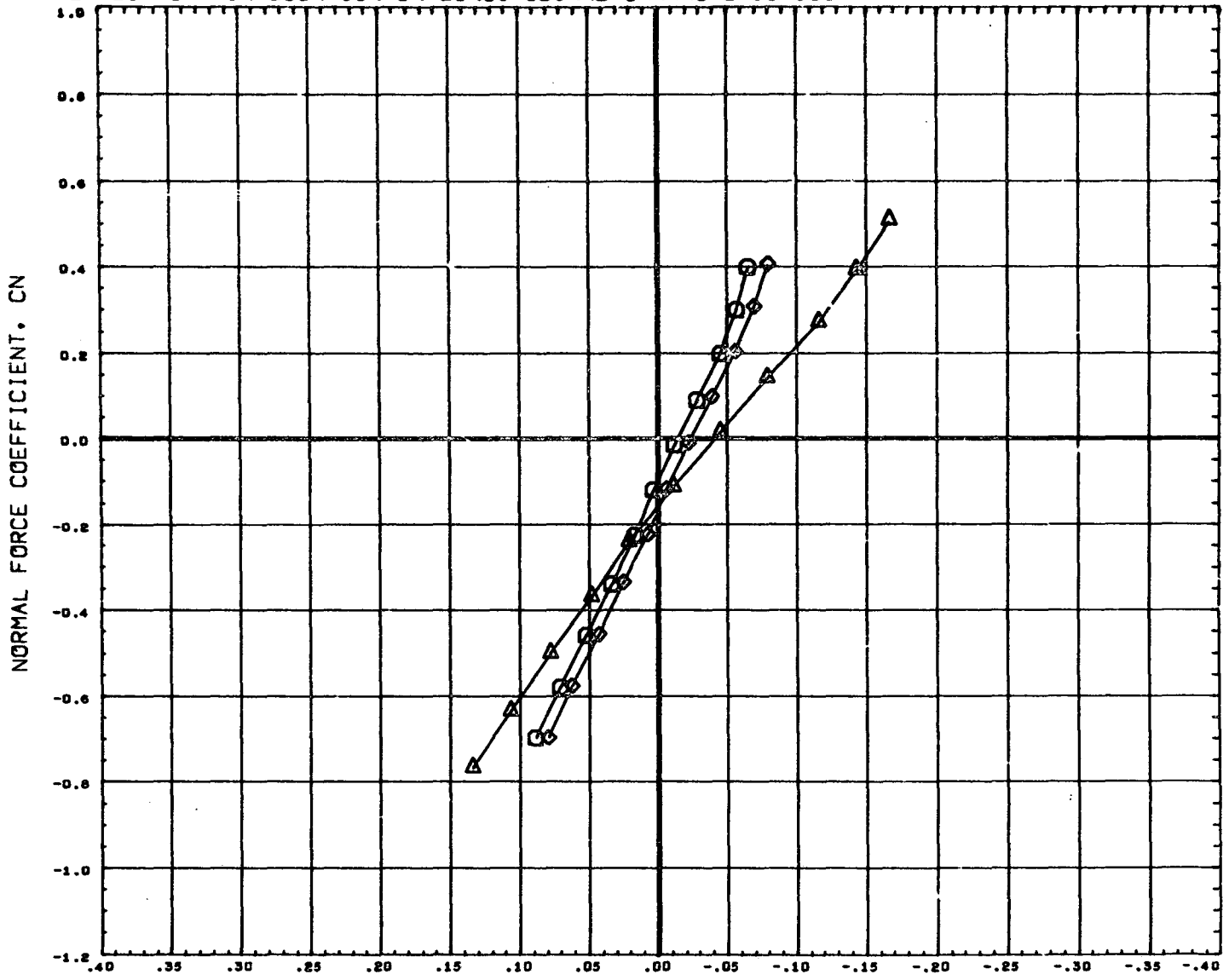

PITCHING MOMENT COEFFICIENT, CLM

DATA SET SYMBOL	CONFIGURATION DESCRIPTION	ORBIN	THETS	BETA	REFERENCE INFORMATION
(B65004)	MSFC TWT 534 SHUTTLE LAUNCH	-1.500	21.000	0.000	SREF 4.8950 SQ. IN
(B65012)	MSFC TWT 534 SHUTTLE LAUNCH	-1.500	21.000	0.000	LREF 2.6440 IN.
(B65014)	MSFC TWT 534 SHUTTLE LAUNCH	-1.500	21.000	0.000	BREF 3.5290 IN.
					XHRP 3.4900 IN.
					YHRP 0.0000 IN.
					ZHRP 0.1616 IN.
					SCALE 0.0034

EFFECT OF FIN LOCATION ON LONGITUDINAL CHARACTERISTICS

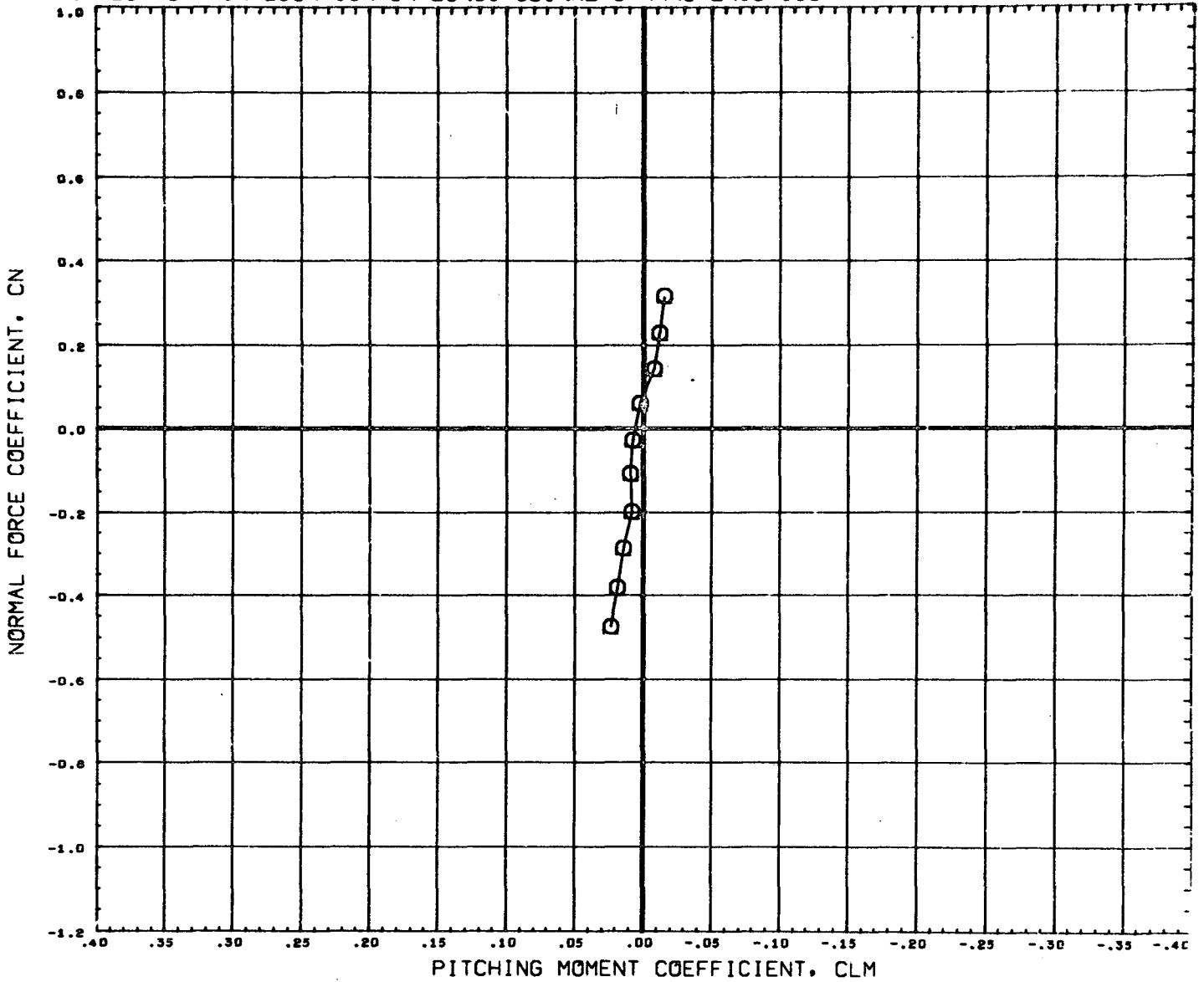

DATA SET SYMBOL	CONFIGURATION DESCRIPTION	ORBIN	THETS	BETA	REFERENCE INFORMATION
(B65004)	MSFC TWT 534 SHUTTLE LAUNCH T101S1	-1.500	21.000	0.000	SREF 4.8950 SQ. IN.
(B65012)	DATA NOT AVAILABLE FOR ALL CONDITIONS	-1.500	21.000	0.000	LREF 2.6440 IN.
(B65014)	DATA NOT AVAILABLE FOR ALL CONDITIONS	-1.500	21.000	0.000	BREF 3.5250 IN.
					XMRP 3.4900 IN.
					YMRP 0.0000 IN.
					ZMRP 0.1616 IN.
					SCALE 0.0034

MACH 2.74

EFFECT OF FIN LOCATION ON LONGITUDINAL CHARACTERISTICS

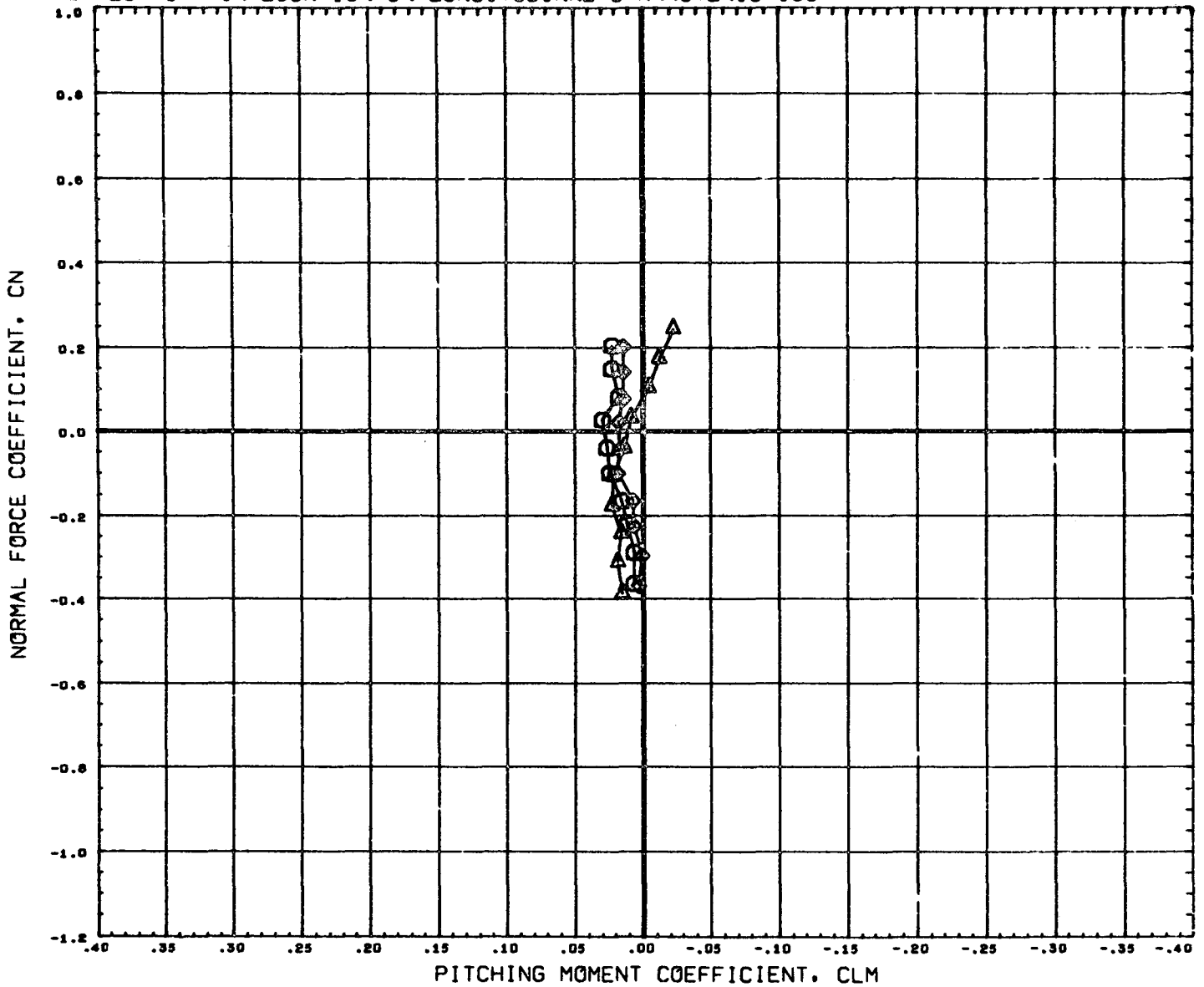

DATA SET SYMBOL	CONFIGURATION DESCRIPTION	T101S1	ORBIN	THETS	BETA	REFERENCE INFORMATION
(B65004)	MSFC TWT 534 SHUTTLE LAUNCH	T101S1	-1.500	21.000	0.000	SREF 4.8950 SQ. IN.
(B65012)	MSFC TWT 534 SHUTTLE LAUNCH	T101S1F1	-1.500	21.000	0.000	LREF 2.6440 IN.
(B65014)	MSFC TWT 534 SHUTTLE LAUNCH	T101S1F2	-1.500	21.000	0.000	BREF 3.5250 IN.
						XMRP 3.4900 IN.
						YMRP 0.0000 IN.
						ZMRP 0.1616 IN.
						SCALE 0.0034

MACH 4.96

PAGE 544

EFFECT OF FIN LOCATION ON LATERAL/DIRECTIONAL CHARACTERISTICS

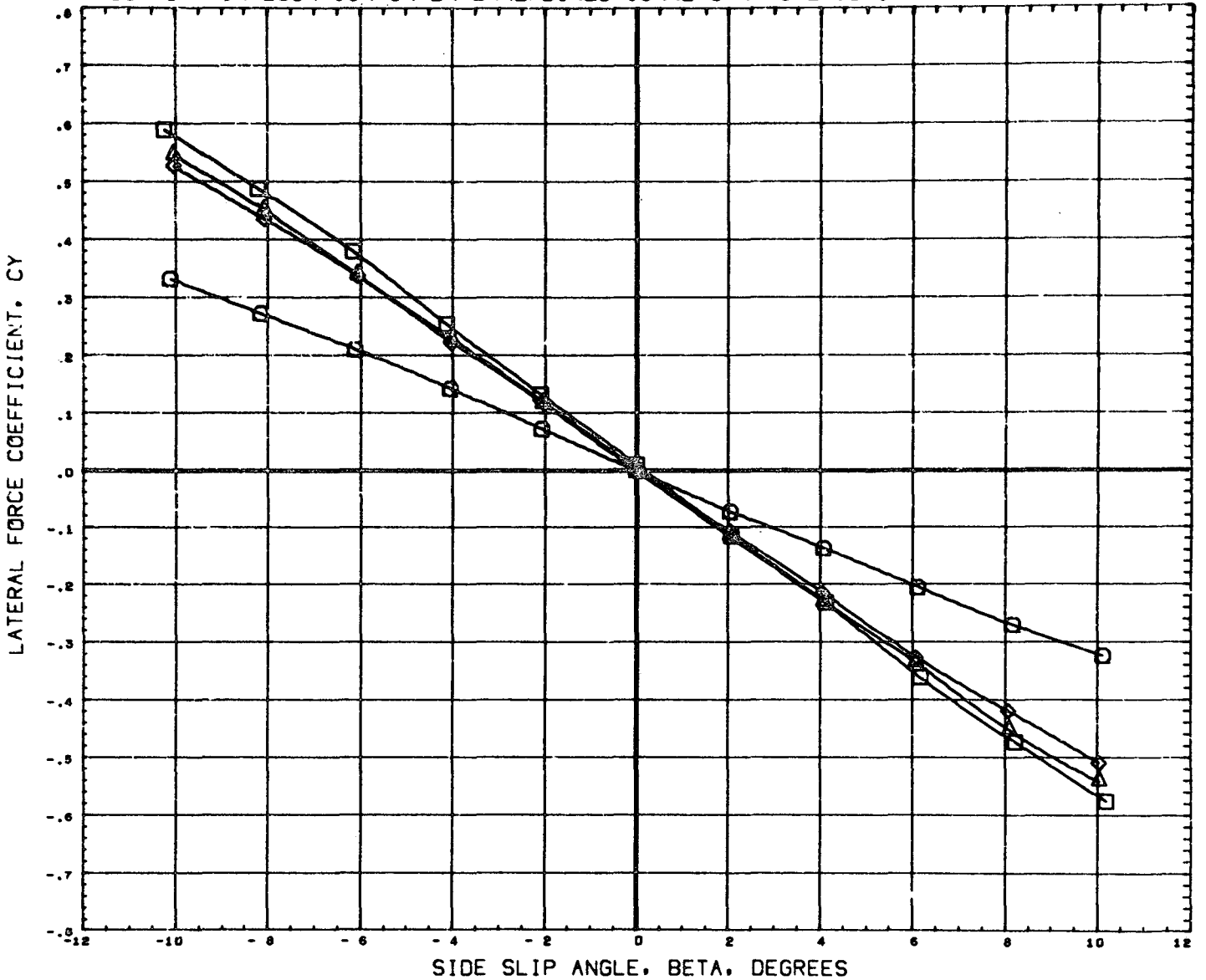

DATA SET SYMBOL	CONFIGURATION DESCRIPTION	ORBIN	THETS	ALPHA	REFERENCE INFORMATION
(B65005)	MSFC TWT 534 SHUTTLE LAUNCH	-1.500	21.000	0.000	SREF 4.8950 SQ. IN
(B65013)	MSFC TWT 534 SHUTTLE LAUNCH	-1.500	21.000	0.000	LREF 2.6440 IN.
(B65015)	MSFC TWT 534 SHUTTLE LAUNCH	-1.500	21.000	0.000	BREF 3.5250 IN.
(B65016)	MSFC TWT 534 SHUTTLE LAUNCH	-1.500	21.000	0.000	XMRP 3.4900 IN.
					YMRP 0.0000 IN.
					ZMRP 0.1616 IN.
					SCALE 0.0034

MACH .60

PAGE 545

EFFECT OF FIN LOCATION ON LATERAL/DIRECTIONAL CHARACTERISTICS

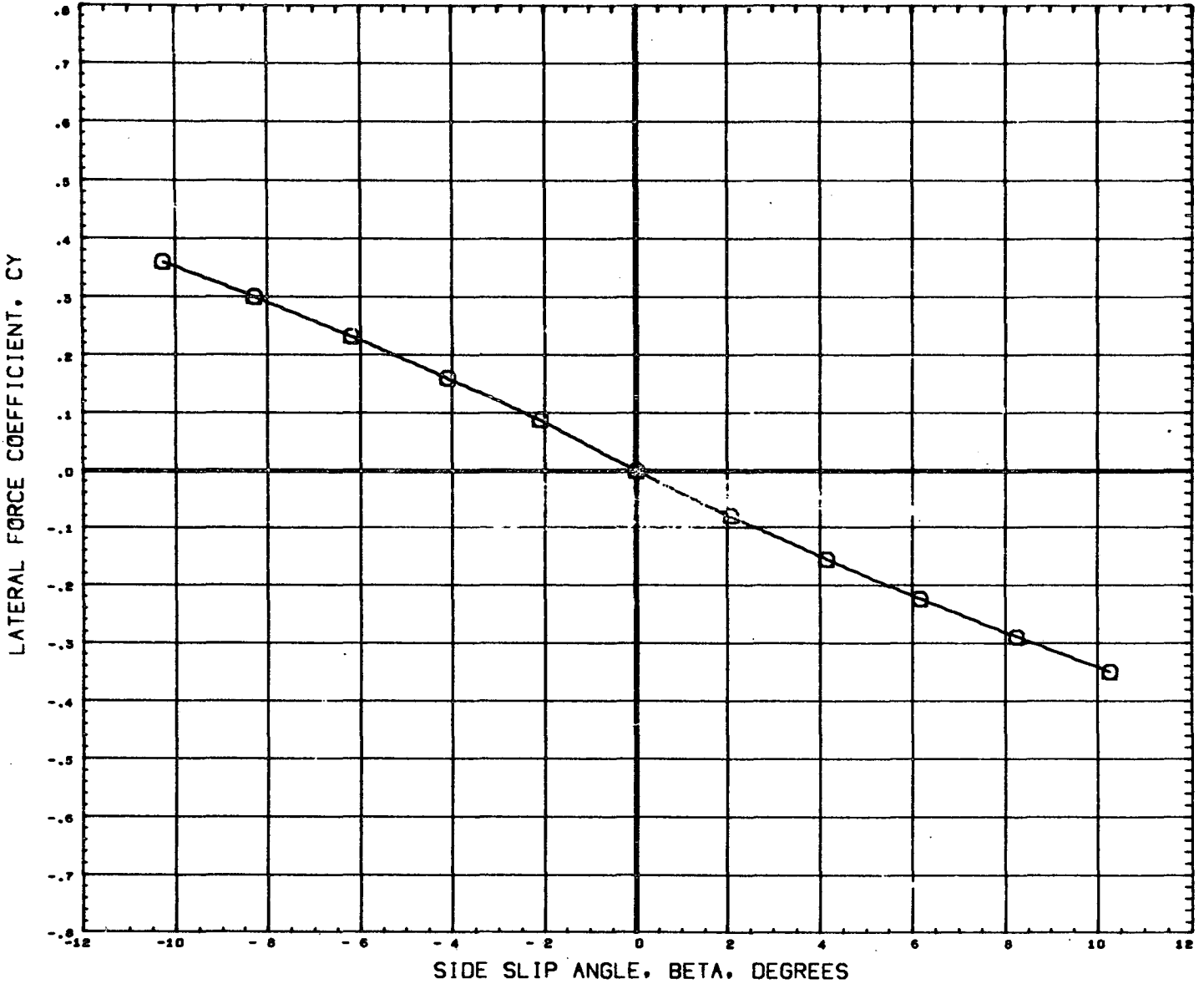

DATA SET SYMBOL	CONFIGURATION DESCRIPTION	ORBIN	THETS	ALPHA	REFERENCE INFORMATION
(B65005)	MSFC TWT 534 SHUTTLE LAUNCH T101S1	-1.500	21.000	0.000	SREF 4.8950 SQ. IN
(B65013)	DATA NOT AVAILABLE FOR ALL CONDITIONS	-1.500	21.000	0.000	LREF 2.6440 IN.
(B65015)	DATA NOT AVAILABLE FOR ALL CONDITIONS	-1.500	21.000	0.000	BREF 3.5250 IN.
(B65016)	DATA NOT AVAILABLE FOR ALL CONDITIONS	-1.500	21.000	0.000	XHRP 3.4900 IN.
					YHRP 0.0000 IN.
					ZHRP 0.1616 IN.
					SCALE 0.0034

MACH .80

EFFECT OF FIN LOCATION ON LATERAL/DIRECTIONAL CHARACTERISTICS

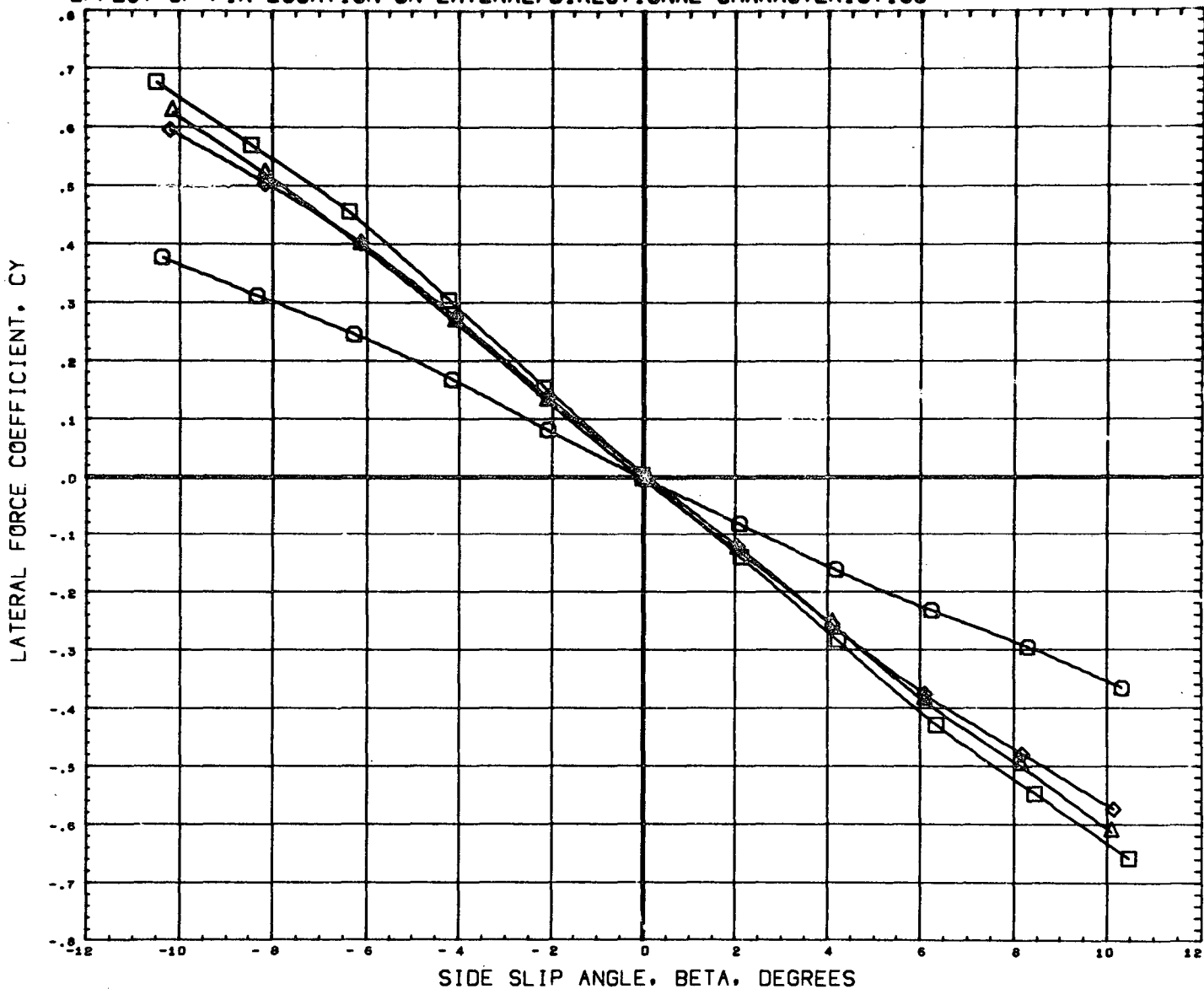

DATA SET SYMBOL	CONFIGURATION DESCRIPTION	ORBIN	THETS	ALPHA	REFERENCE INFORMATION
(B65005)	MSFC TWT 534 SHUTTLE LAUNCH	-1.500	21.000	0.000	SREF 4.8950 sq. IN
(B65013)	MSFC TWT 534 SHUTTLE LAUNCH	-1.500	21.000	0.000	LREF 2.6440 IN.
(B65015)	MSFC TWT 534 SHUTTLE LAUNCH	-1.500	21.000	0.000	BREF 3.5250 IN.
(B65016)	MSFC TWT 534 SHUTTLE LAUNCH	-1.500	21.000	0.000	XNRP 3.4900 IN.
					YNRP 0.0000 IN.
					ZNRP 0.1616 IN.
					SCALE 0.0034

EFFECT OF FIN LOCATION ON LATERAL/DIRECTIONAL CHARACTERISTICS

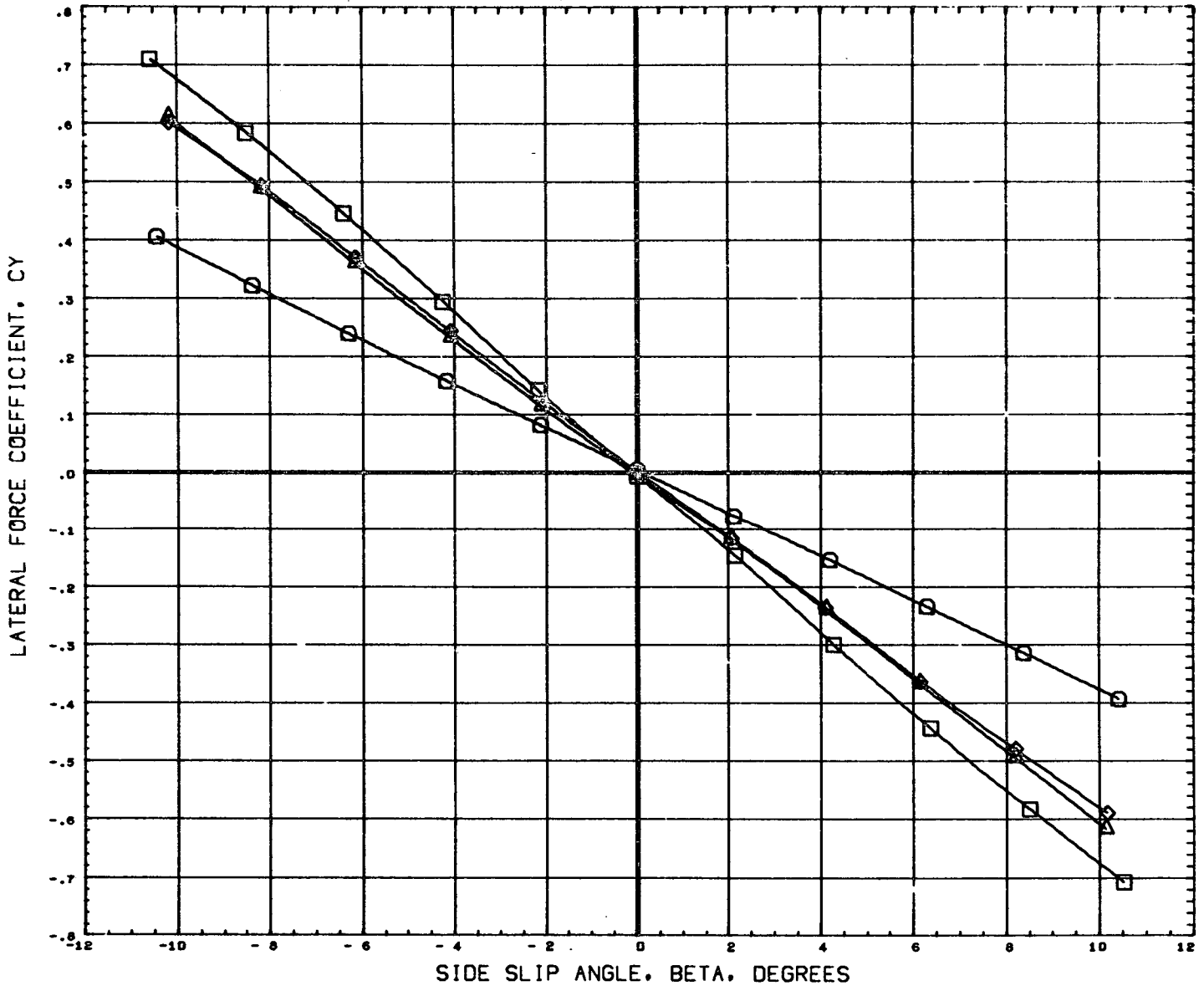

DATA SET SYMBOL	CONFIGURATION DESCRIPTION	ORBIN	THETS	ALPHA	REFERENCE INFORMATION	
(B65005)	MSFC TWT 534 SHUTTLE LAUNCH	T101S1	-1.500	21.000	0.000	SREF 4.8950 SQ. IN
(B65013)	MSFC TWT 534 SHUTTLE LAUNCH	T101S1F1	-1.500	21.000	0.000	LREF 2.6440 IN.
(B65015)	MSFC TWT 534 SHUTTLE LAUNCH	T101S1F2	-1.500	21.000	0.000	BREF 3.5250 IN.
(B65016)	MSFC TWT 534 SHUTTLE LAUNCH	T101S1F3	-1.500	21.000	0.000	XMRP 3.4900 IN.
						YMRP 0.0000 IN.
						ZMRP 0.1616 IN.
						SCALE 0.0034

MACH 1.09

EFFECT OF FIN LOCATION ON LATERAL/DIRECTIONAL CHARACTERISTICS

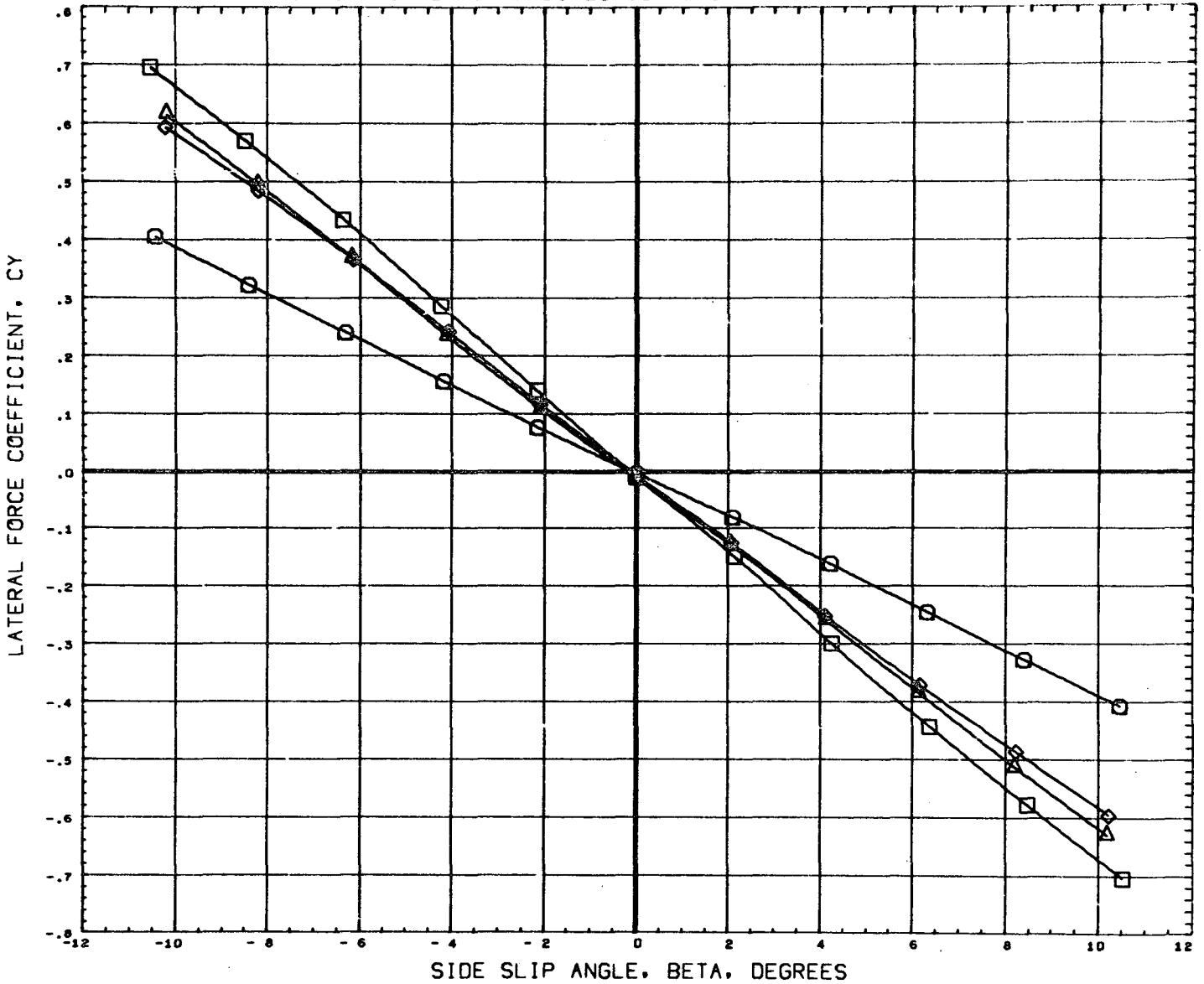

DATA SET SYMBOL	CONFIGURATION DESCRIPTION	ORBIN	THETS	ALPHA	REFERENCE INFORMATION
(B65005)	MSFC TWT 534 SHUTTLE LAUNCH	-1.500	21.000	0.000	SREF 4.8950 SQ. IN
(B65013)	MSFC TWT 534 SHUTTLE LAUNCH	-1.500	21.000	0.000	LREF 2.6440 IN.
(B65015)	MSFC TWT 534 SHUTTLE LAUNCH	-1.500	21.000	0.000	BREF 3.5250 IN.
(B65016)	MSFC TWT 534 SHUTTLE LAUNCH	-1.500	21.000	0.000	XMRP 3.4900 IN.
					YMRP 0.0000 IN.
					ZMRP 0.1616 IN.
					SCALE 0.0034

EFFECT OF FIN LOCATION ON LATERAL/DIRECTIONAL CHARACTERISTICS

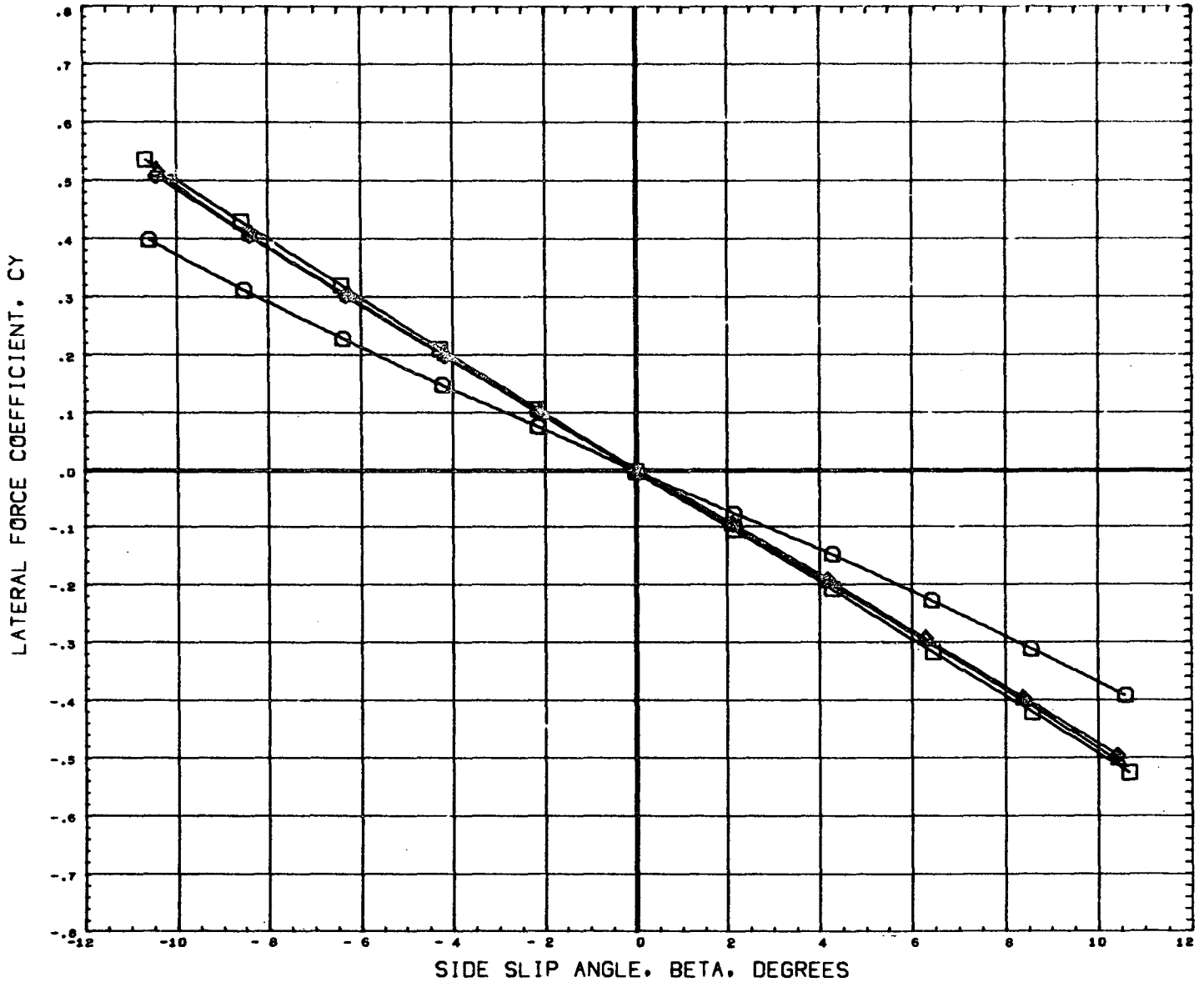

DATA SET SYMBOL	CONFIGURATION DESCRIPTION	ORBIN	THETS	ALPHA	REFERENCE INFORMATION	
(B65005)	MSFC TWT 534 SHUTTLE LAUNCH	T101S1	-1.500	21.000	0.000	SREF 4.8950 SQ. IN
(B65013)	MSFC TWT 534 SHUTTLE LAUNCH	T101S1F1	-1.500	21.000	0.000	LREF 2.6440 IN.
(B65015)	MSFC TWT 534 SHUTTLE LAUNCH	T101S1F2	-1.500	21.000	0.000	BREF 3.5250 IN.
(B65016)	MSFC TWT 534 SHUTTLE LAUNCH	T101S1F3	-1.500	21.000	0.000	XMRP 3.4900 IN.
					YMRP 0.0000 IN.	
					ZMRP 0.1616 IN.	
					SCALE 0.0034	

EFFECT OF FIN LOCATION ON LATERAL/DIRECTIONAL CHARACTERISTICS

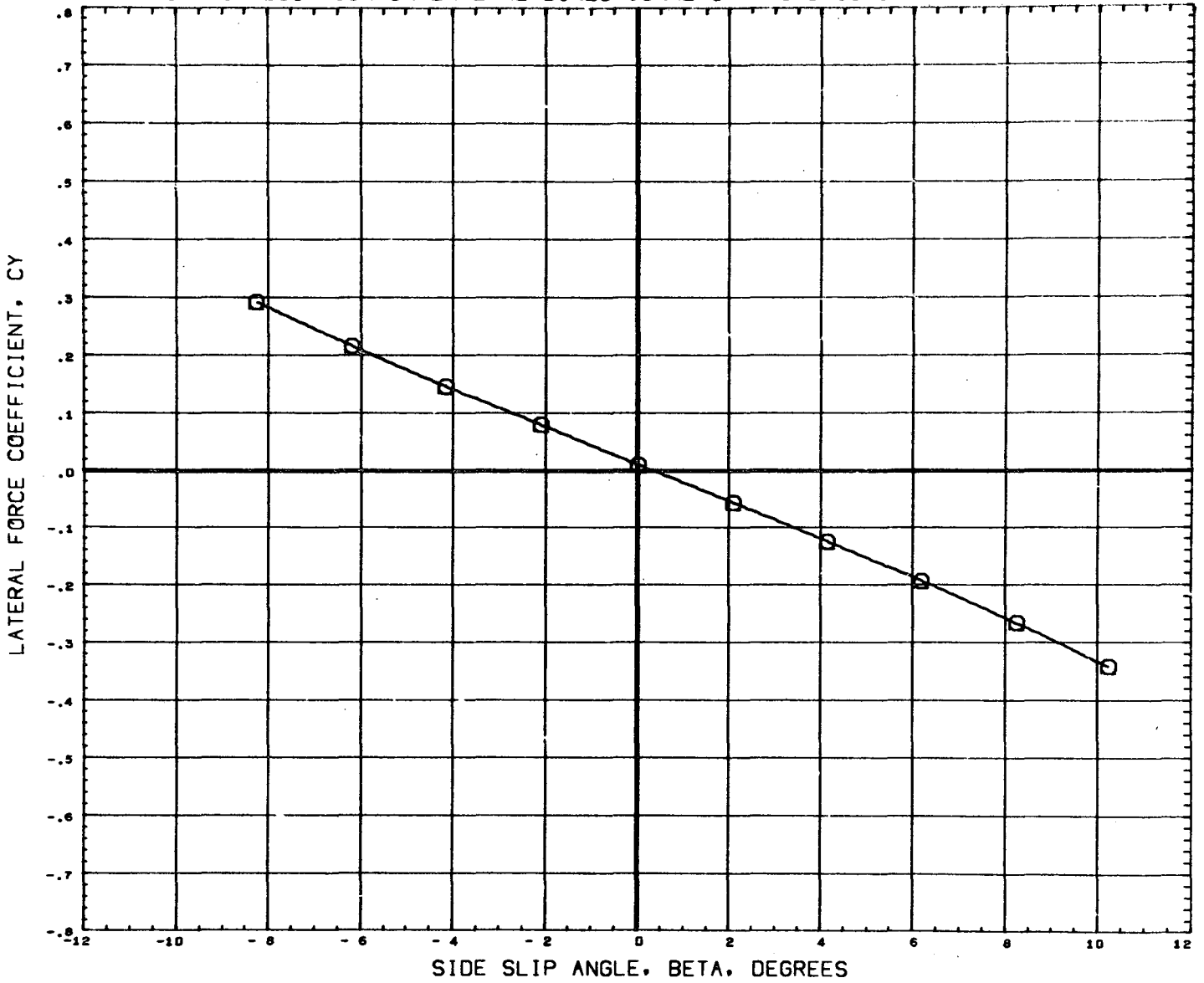

DATA SET SYMBOL	CONFIGURATION DESCRIPTION
(B65005)	MSFC TWT 534 SHUTTLE LAUNCH T101S1
(B65013)	DATA NOT AVAILABLE FOR ALL CONDITIONS
(B65015)	DATA NOT AVAILABLE FOR ALL CONDITIONS
(B65016)	DATA NOT AVAILABLE FOR ALL CONDITIONS

ORBIN	THETS	ALPHA
-1.500	21.000	0.000
-1.500	21.000	0.000
-1.500	21.000	0.000

REFERENCE INFORMATION	
SREF	4.8950 SQ. IN
LREF	2.6440 IN.
BREF	3.5250 IN.
XMRP	3.4900 IN.
YMRP	0.0000 IN.
ZMRP	0.1616 IN.
SCALE	0.0034

MACH 2.74

PAGE 551

EFFECT OF FIN LOCATION ON LATERAL/DIRECTIONAL CHARACTERISTICS

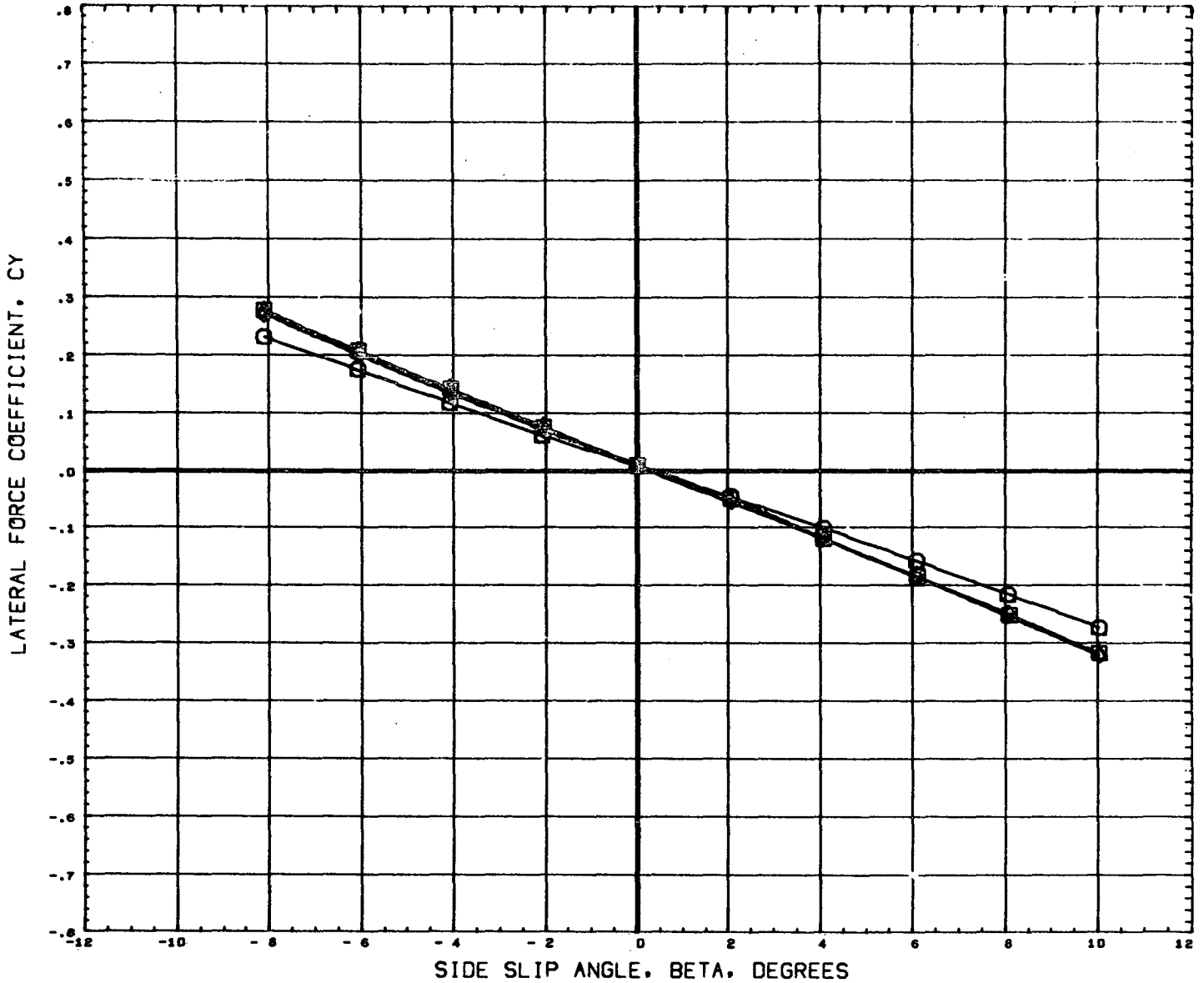

DATA SET SYMBOL	CONFIGURATION DESCRIPTION	ORBIN	THETS	ALPHA	REFERENCE INFORMATION
(B65005)	MSFC TWT 534 SHUTTLE LAUNCH T101S1	-1.500	21.000	0.000	SREF 4.8950 SQ. IN
(B65013)	MSFC TWT 534 SHUTTLE LAUNCH T101S1F1	-1.500	21.000	0.000	LREF 2.6440 IN.
(B65015)	MSFC TWT 534 SHUTTLE LAUNCH T101S1F2	-1.500	21.000	0.000	BREF 3.5250 IN.
(B65016)	MSFC TWT 534 SHUTTLE LAUNCH T101S1F3	-1.500	21.000	0.000	XMRP 3.4900 IN.
					YMRP 0.0000 IN.
					ZMRP 0.1616 IN.
					SCALE 0.0034

MACH 4.96

EFFECT OF FIN LOCATION ON LATERAL/DIRECTIONAL CHARACTERISTICS

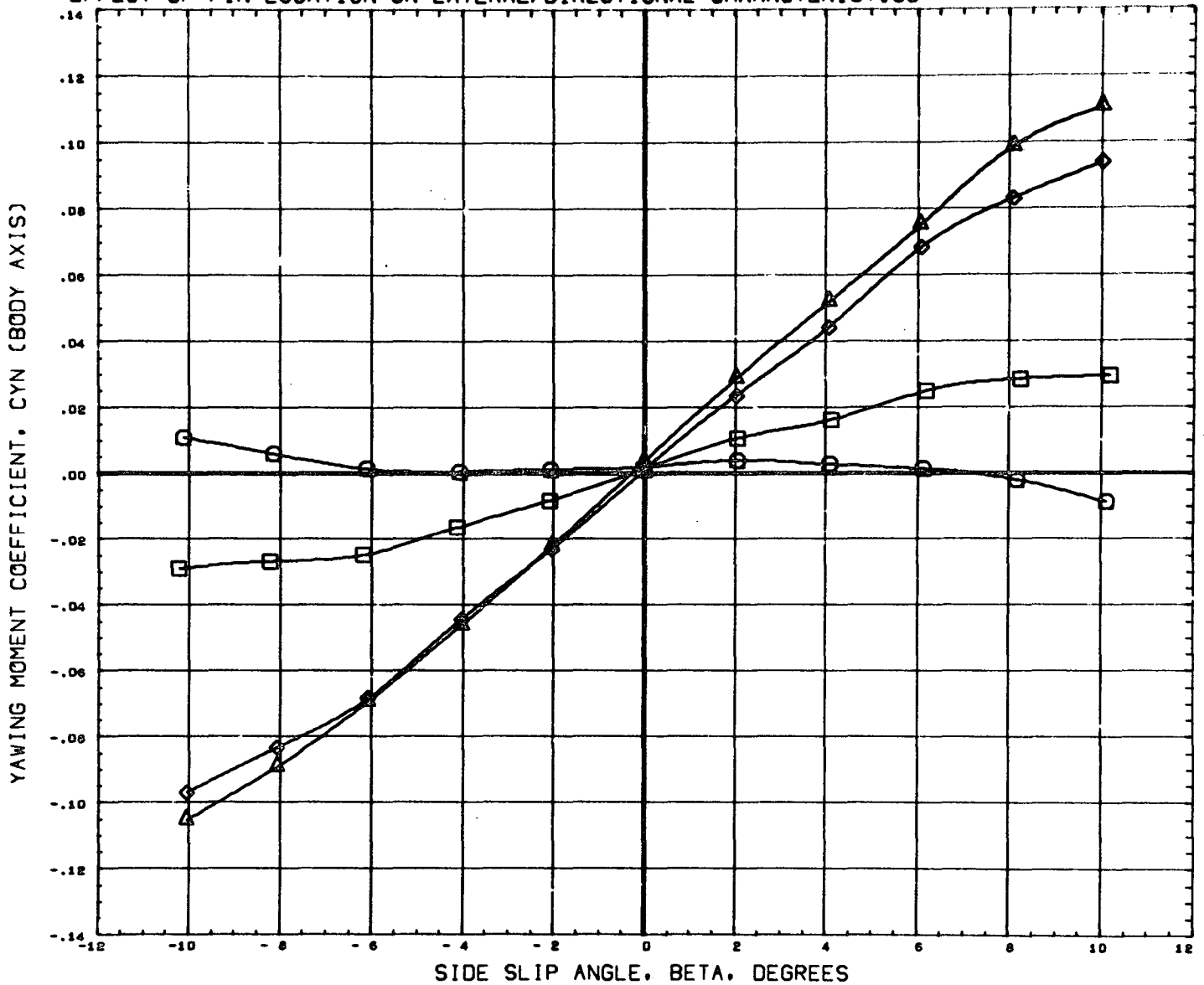

DATA SET SYMBOL	CONFIGURATION DESCRIPTION	ORBIT	THETA	ALPHA	REFERENCE INFORMATION
(B65005)	MSFC TWT 534 SHUTTLE LAUNCH	-1.500	21.000	0.000	SREF 4.8950 SQ. IN
(B65013)	MSFC TWT 534 SHUTTLE LAUNCH	-1.500	21.000	0.000	LREF 2.6440 IN.
(B65015)	MSFC TWT 534 SHUTTLE LAUNCH	-1.500	21.000	0.000	BREF 3.5250 IN.
(B65016)	MSFC TWT 534 SHUTTLE LAUNCH	-1.500	21.000	0.000	XMRP 3.4900 IN.
					YMRP 0.0000 IN.
					ZMRP 0.1616 IN.
					SCALE 0.0034

MACH .60

PAGE 553

11 (4)

EFFECT OF FIN LOCATION ON LATERAL/DIRECTIONAL CHARACTERISTICS

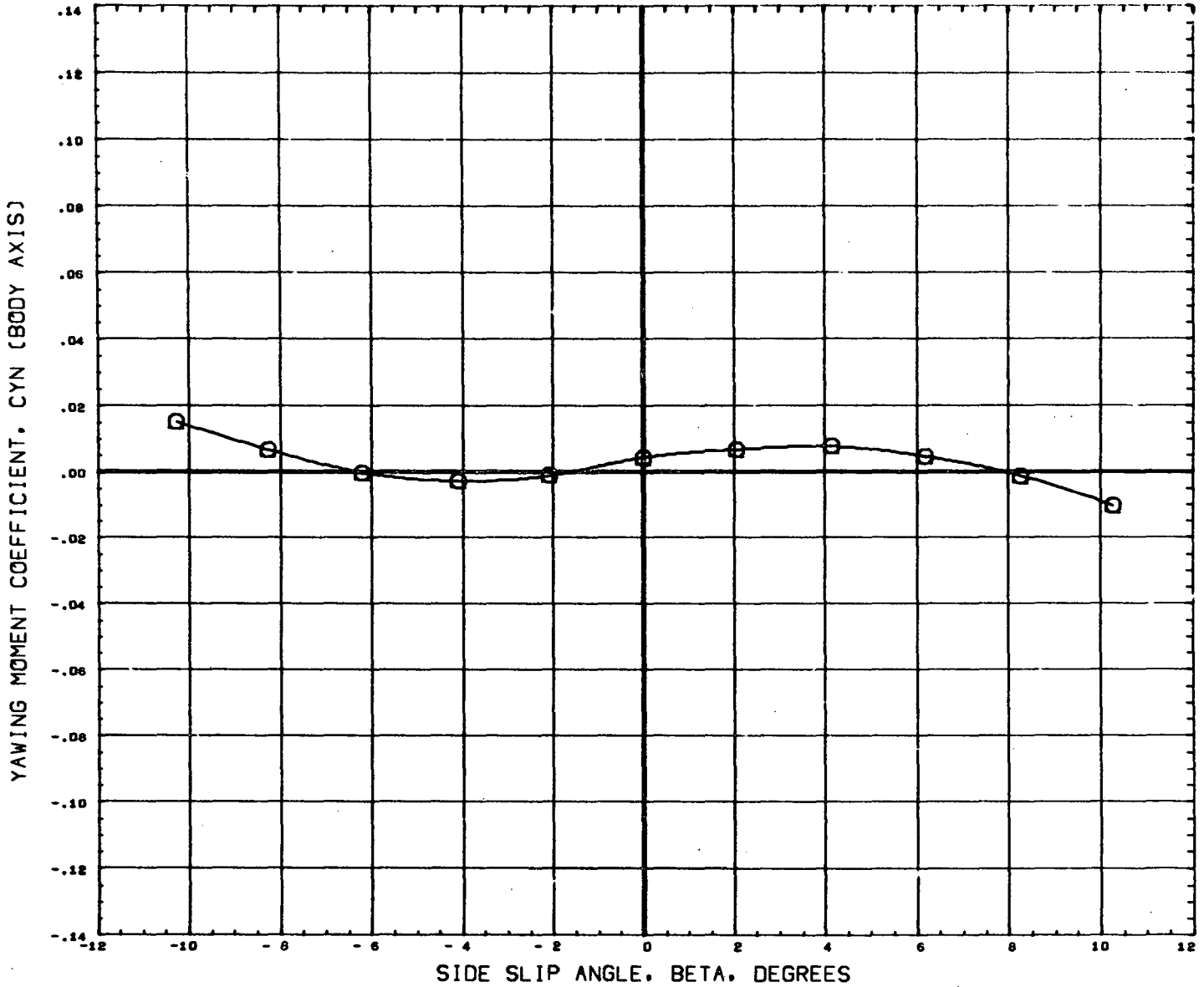

DATA SET SYMBOL	CONFIGURATION DESCRIPTION	ORBIN	THETS	ALPHA	REFERENCE INFORMATION
(B65005)	MSFC TWT 534 SHUTTLE LAUNCH T101S1	-1.500	21.000	0.000	SREF 4.8950 SQ. IN
(B65013)	DATA NOT AVAILABLE FOR ALL CONDITIONS	-1.500	21.000	0.000	LREF 2.6440 IN.
(B65015)	DATA NOT AVAILABLE FOR ALL CONDITIONS	-1.500	21.000	0.000	BREF 3.5250 IN.
(B65016)	DATA NOT AVAILABLE FOR ALL CONDITIONS	-1.500	21.000	0.000	XMRP 3.4900 IN.
					YMRP 0.0000 IN.
					ZMRP 0.1616 IN.
					SCALE 0.0034

MACH .80

EFFECT OF FIN LOCATION ON LATERAL/DIRECTIONAL CHARACTERISTICS

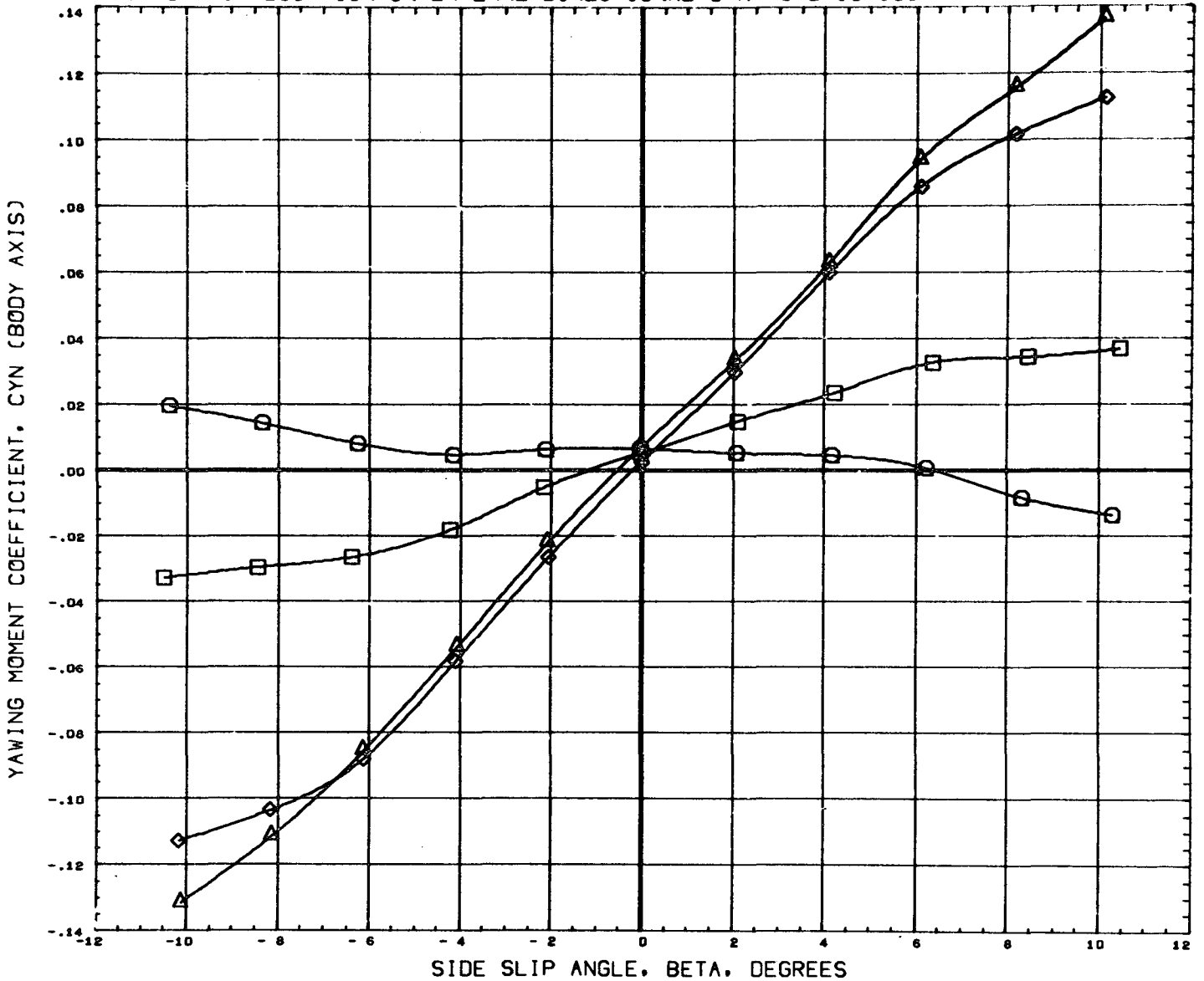

DATA SET SYMBOL	CONFIGURATION DESCRIPTION	ORBIN	THETS	ALPHA	REFERENCE INFORMATION
(B65005)	MSFC TWT 534 SHUTTLE LAUNCH	-1.500	21.000	0.000	SREF 4.8950 sq. IN
(B65013)	MSFC TWT 534 SHUTTLE LAUNCH	-1.500	21.000	0.000	LREF 2.6440 IN.
(B65015)	MSFC TWT 534 SHUTTLE LAUNCH	-1.500	21.000	0.000	BREF 3.5250 IN.
(B65016)	MSFC TWT 534 SHUTTLE LAUNCH	-1.500	21.000	0.000	XMRP 3.4900 IN.
					YMRP 0.0000 IN.
					ZMRP 0.1616 IN.
					SCALE 0.0034

MACH .91

EFFECT OF FIN LOCATION ON LATERAL/DIRECTIONAL CHARACTERISTICS

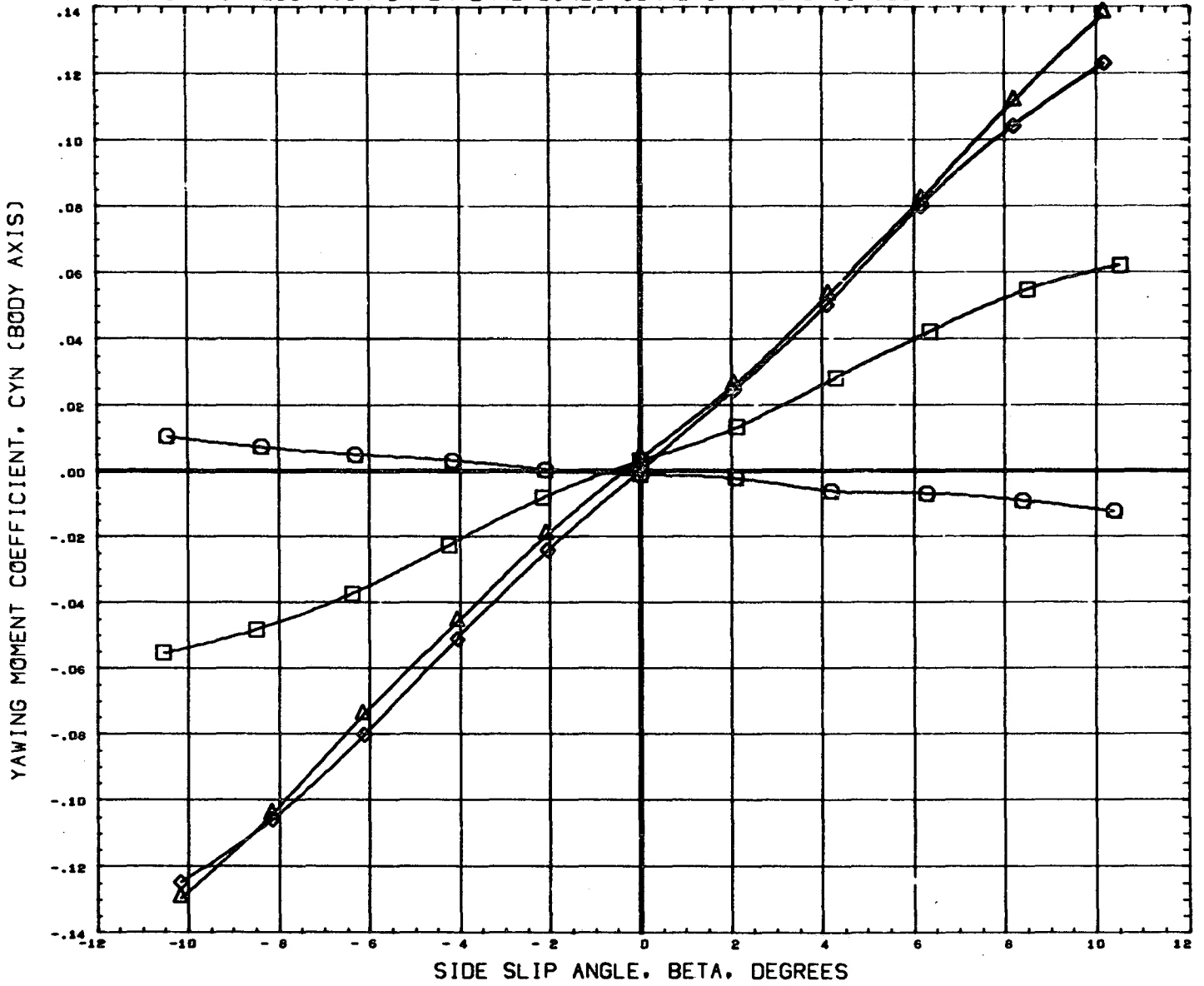

DATA SET SYMBOL	CONFIGURATION DESCRIPTION	T101S1	ORBIN	THETS	ALPHA	REFERENCE INFORMATION
(B65005)	MSFC TWT 534 SHUTTLE LAUNCH	T101S1	-1.500	21.000	0.000	SREF 4.8950 SQ. IN
(B65013)	MSFC TWT 534 SHUTTLE LAUNCH	T101S1F1	-1.500	21.000	0.000	LREF 2.6440 IN.
(B65015)	MSFC TWT 534 SHUTTLE LAUNCH	T101S1F2	-1.500	21.000	0.000	BREF 3.5250 IN.
(B65016)	MSFC TWT 534 SHUTTLE LAUNCH	T101S1F3	-1.500	21.000	0.000	XMRP 3.4900 IN.
						YMRP 0.0000 IN.
						ZMRP 0.1616 IN.
						SCALE 0.0034

MACH 1.09

EFFECT OF FIN LOCATION ON LATERAL/DIRECTIONAL CHARACTERISTICS

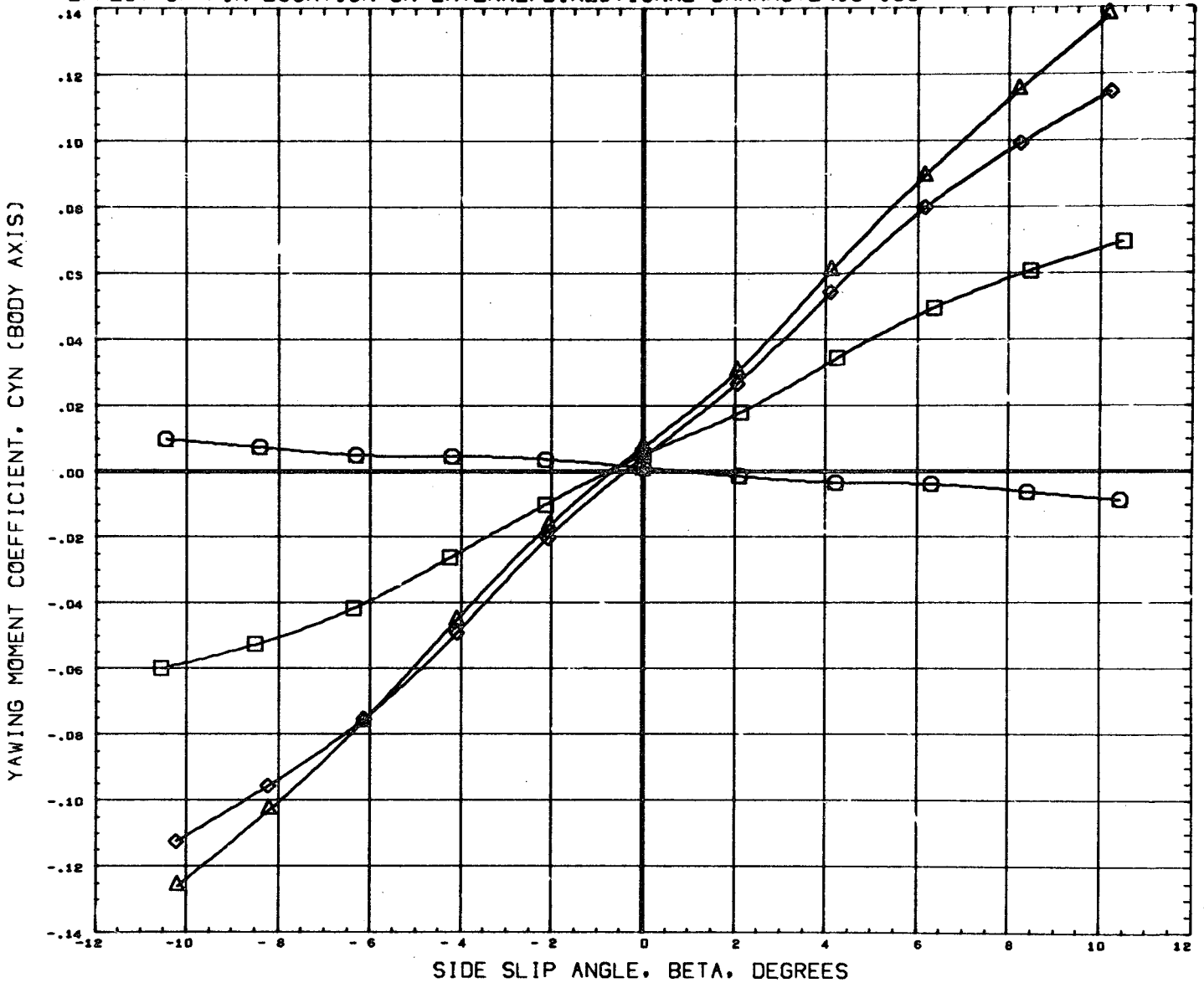

DATA SET SYMBOL	CONFIGURATION DESCRIPTION	ORBIN	THETS	ALPHA	REFERENCE INFORMATION	
(B65005)	MSFC TWT 534 SHUTTLE LAUNCH	-1.500	21.000	0.000	SREF	4.8950 SQ. IN
(B65013)	MSFC TWT 534 SHUTTLE LAUNCH	-1.500	21.000	0.000	LREF	2.6440 IN.
(B65015)	MSFC TWT 534 SHUTTLE LAUNCH	-1.500	21.000	0.000	BREF	3.5250 IN.
(B65016)	MSFC TWT 534 SHUTTLE LAUNCH	-1.500	21.000	0.000	XMRP	3.4900 IN.
					YMRP	0.0000 IN.
					ZMRP	0.1616 IN.
					SCALE	0.0034

EFFECT OF FIN LOCATION ON LATERAL/DIRECTIONAL CHARACTERISTICS

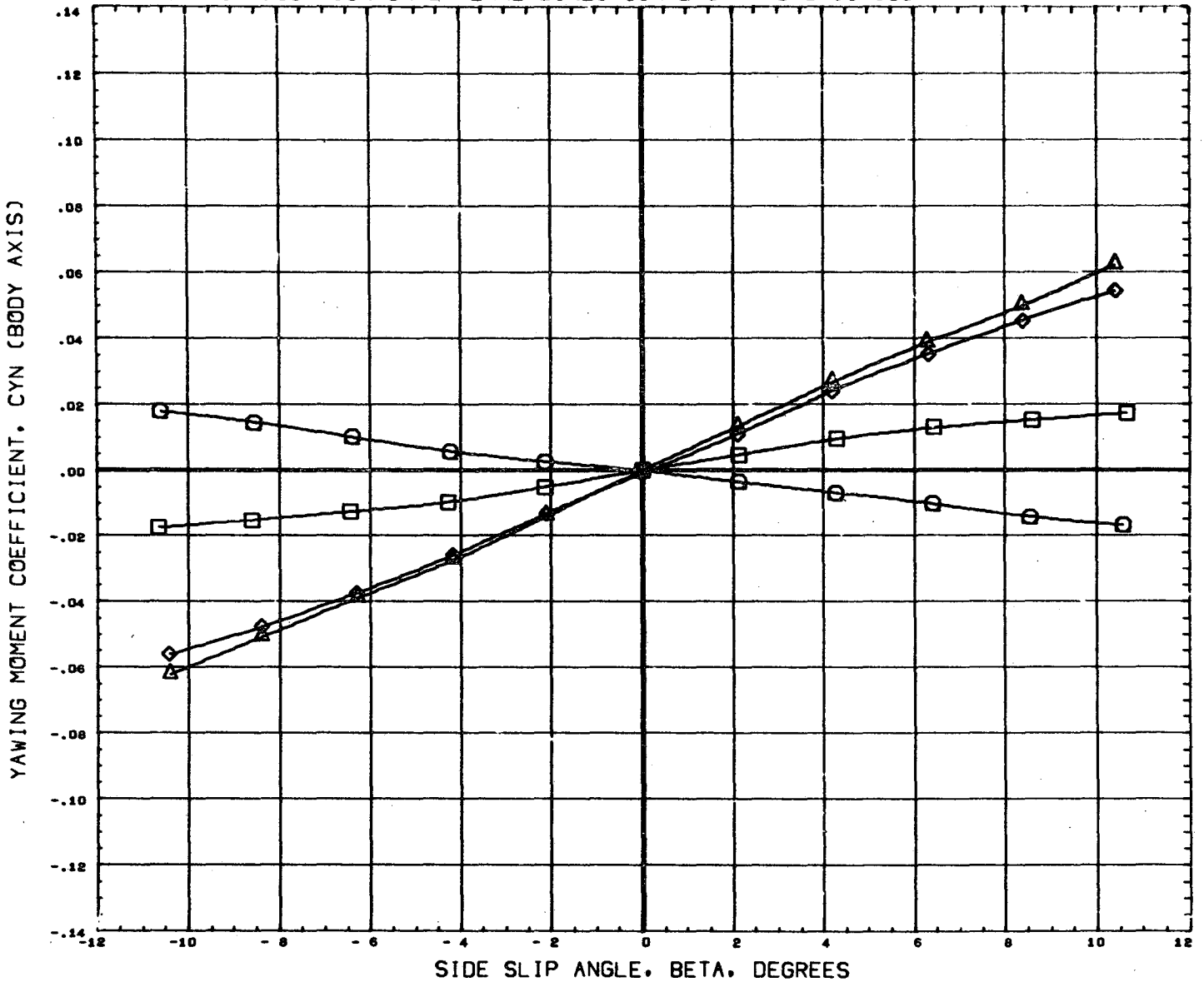

DATA SET SYMBOL	CONFIGURATION DESCRIPTION	ORBIN	THETS	ALPHA	REFERENCE INFORMATION
(B65005)	MSFC TWT 534 SHUTTLE LAUNCH T101S1	-1.500	21.000	0.000	SREF 4.8950 SQ. IN
(B65013)	MSFC TWT 534 SHUTTLE LAUNCH T101S1F1	-1.500	21.000	0.000	LREF 2.6440 IN.
(B65015)	MSFC TWT 534 SHUTTLE LAUNCH T101S1F2	-1.500	21.000	0.000	BREF 3.5250 IN.
(B65016)	MSFC TWT 534 SHUTTLE LAUNCH T101S1F3	-1.500	21.000	0.000	XNRP 3.4900 IN.
					YNRP 0.0000 IN.
					ZNRP 0.1616 IN.
					SCALE 0.0034

EFFECT OF FIN LOCATION ON LATERAL/DIRECTIONAL CHARACTERISTICS

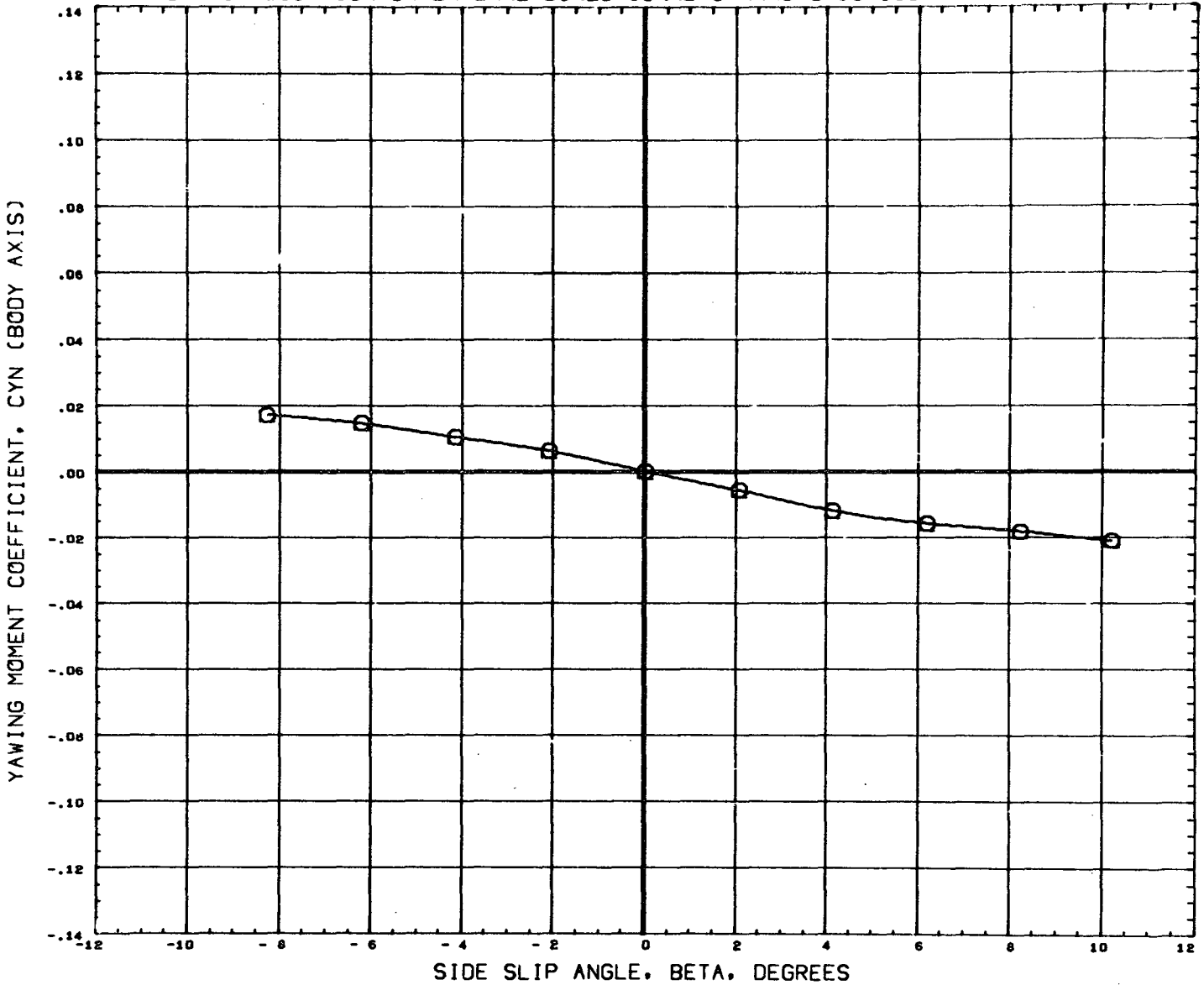

DATA SET SYMBOL	CONFIGURATION DESCRIPTION	ORBIN	THETS	ALPHA	REFERENCE INFORMATION
(B65005)	MSFC TWT 534 SHUTTLE LAUNCH T101S1	-1.500	21.000	0.000	SREF 4.8950 SQ. IN
(B65013)	DATA NOT AVAILABLE FOR ALL CONDITIONS	-1.500	21.000	0.000	LREF 2.6440 IN.
(B65015)	DATA NOT AVAILABLE FOR ALL CONDITIONS	-1.500	21.000	0.000	BREF 3.5250 IN.
(B65016)	DATA NOT AVAILABLE FOR ALL CONDITIONS	-1.500	21.000	0.000	XMRP 3.4900 IN.
					YMRP 0.0000 IN.
					ZMRP 0.1616 IN.
					SCALE 0.0034

MACH 2.74

EFFECT OF FIN LOCATION ON LATERAL/DIRECTIONAL CHARACTERISTICS

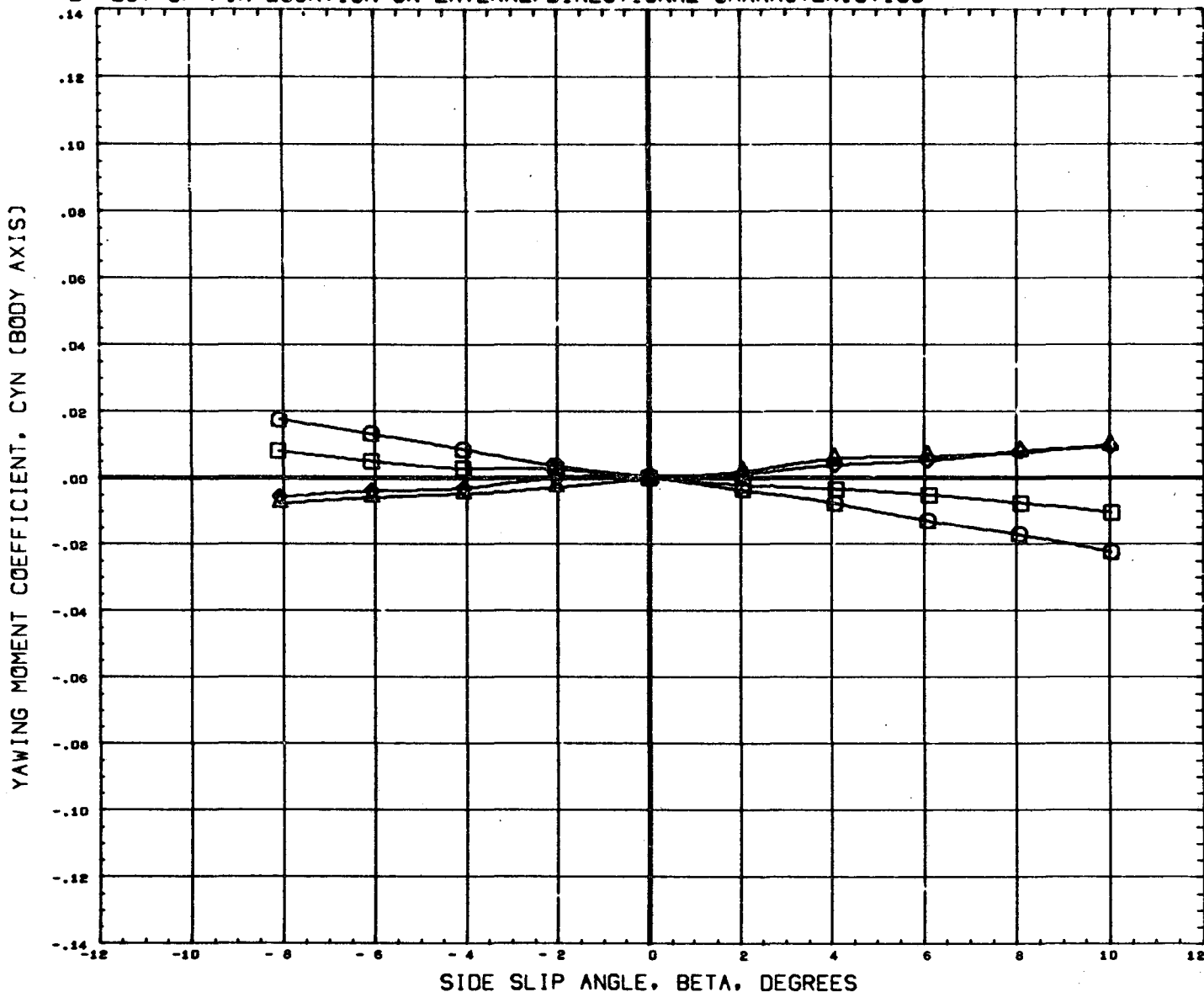

DATA SET SYMBOL	CONFIGURATION DESCRIPTION	ORBIN	THETS	ALPHA	REFERENCE INFORMATION	
(B65005)	MSFC TWT 534 SHUTTLE LAUNCH	T101S1	-1.500	21.000	0.000	SREF 4.8950 SQ. IN
(B65013)	MSFC TWT 534 SHUTTLE LAUNCH	T101S1F1	-1.500	21.000	0.000	LREF 2.6440 IN.
(B65015)	MSFC TWT 534 SHUTTLE LAUNCH	T101S1F2	-1.500	21.000	0.000	BREF 3.5250 IN.
(B65016)	MSFC TWT 534 SHUTTLE LAUNCH	T101S1F3	-1.500	21.000	0.000	XMRP 3.4900 IN.
					YMRP 0.0000 IN.	
					ZMRP 0.1616 IN.	
					SCALE 0.0034	

EFFECT OF FIN LOCATION ON LATERAL/DIRECTIONAL CHARACTERISTICS

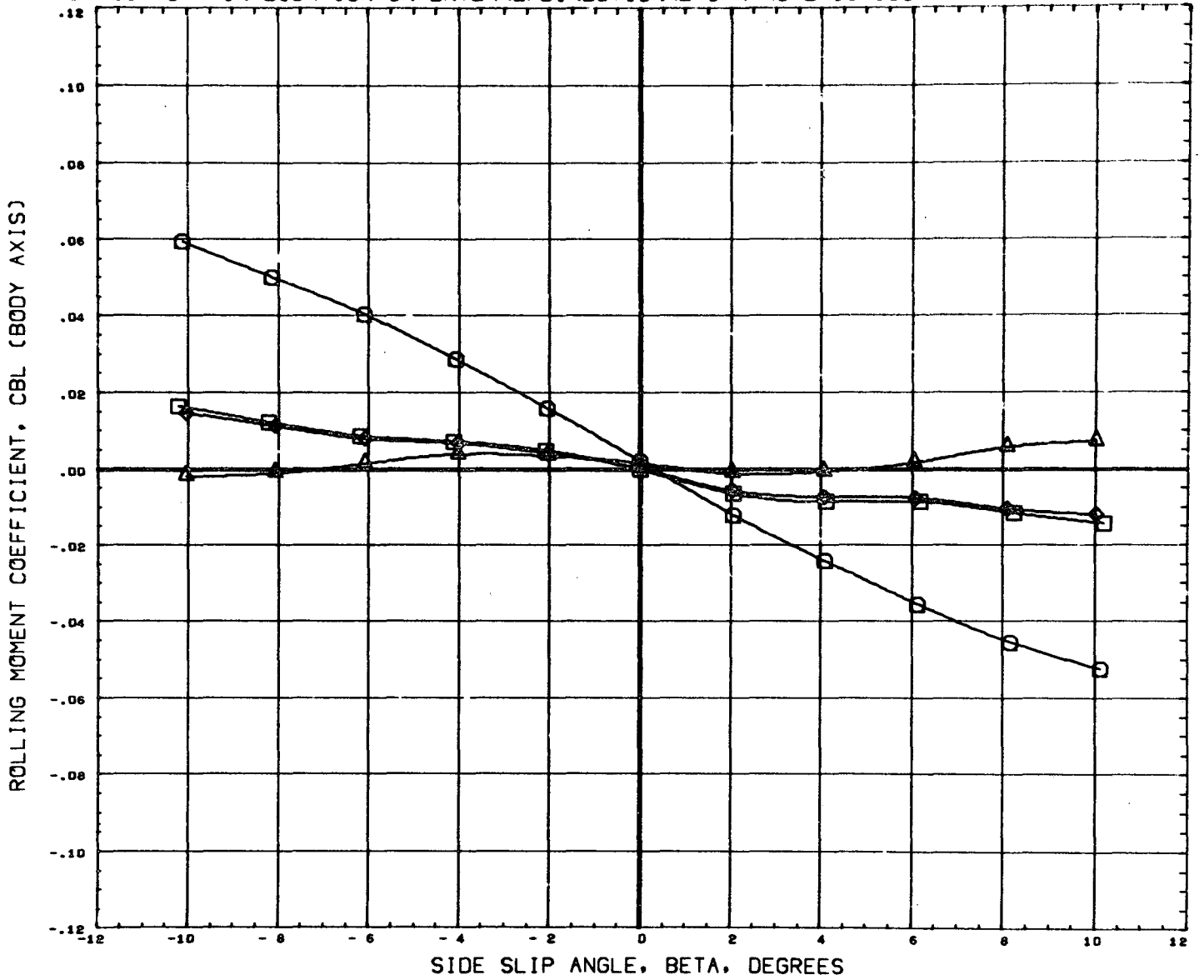

DATA SET SYMBOL	CONFIGURATION DESCRIPTION	ORBIN	THETS	ALPHA
(B65005)	MSFC TWT 534 SHUTTLE LAUNCH	-1.500	21.000	0.000
(B65013)	MSFC TWT 534 SHUTTLE LAUNCH	-1.500	21.000	0.000
(B65015)	MSFC TWT 534 SHUTTLE LAUNCH	-1.500	21.000	0.000
(B65016)	MSFC TWT 534 SHUTTLE LAUNCH	-1.500	21.000	0.000

REFERENCE INFORMATION		
SREF	4.8950	SQ. IN
LREF	2.6440	IN.
BREF	3.5250	IN.
XNRP	3.4900	IN.
YNRP	0.0000	IN.
ZNRP	0.1616	IN.
SCALE	0.0034	

MACH .60

EFFECT OF FIN LOCATION ON LATERAL/DIRECTIONAL CHARACTERISTICS

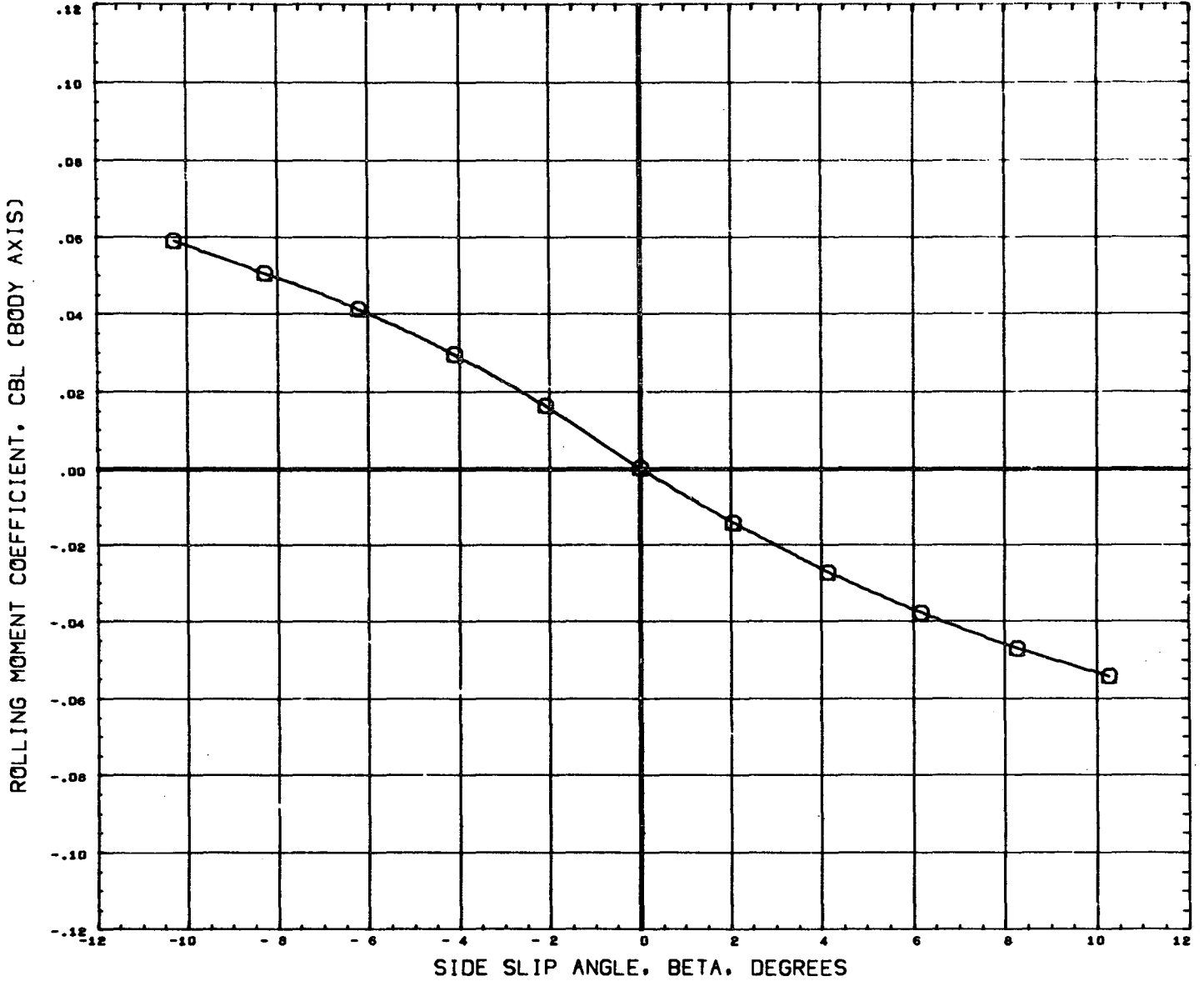

DATA SET SYMBOL	CONFIGURATION DESCRIPTION
(B65005)	MSFC TWT 534 SHUTTLE LAUNCH T101S1
(B65013)	DATA NOT AVAILABLE FOR ALL CONDITIONS
(B65015)	DATA NOT AVAILABLE FOR ALL CONDITIONS
(B65016)	DATA NOT AVAILABLE FOR ALL CONDITIONS

ORBIN	THETS	ALPHA
-1.500	21.000	0.000
-1.500	21.000	0.000
-1.500	21.000	0.000
-1.500	21.000	0.000

REFERENCE INFORMATION		
SREF	4.8950	sq. IN
LREF	2.6440	IN.
BREF	3.5250	IN.
XMRP	3.4900	IN.
YMRP	0.0000	IN.
ZMRP	0.1616	IN.
SCALE	0.0034	

MACH .80

EFFECT OF FIN LOCATION ON LATERAL/DIRECTIONAL CHARACTERISTICS

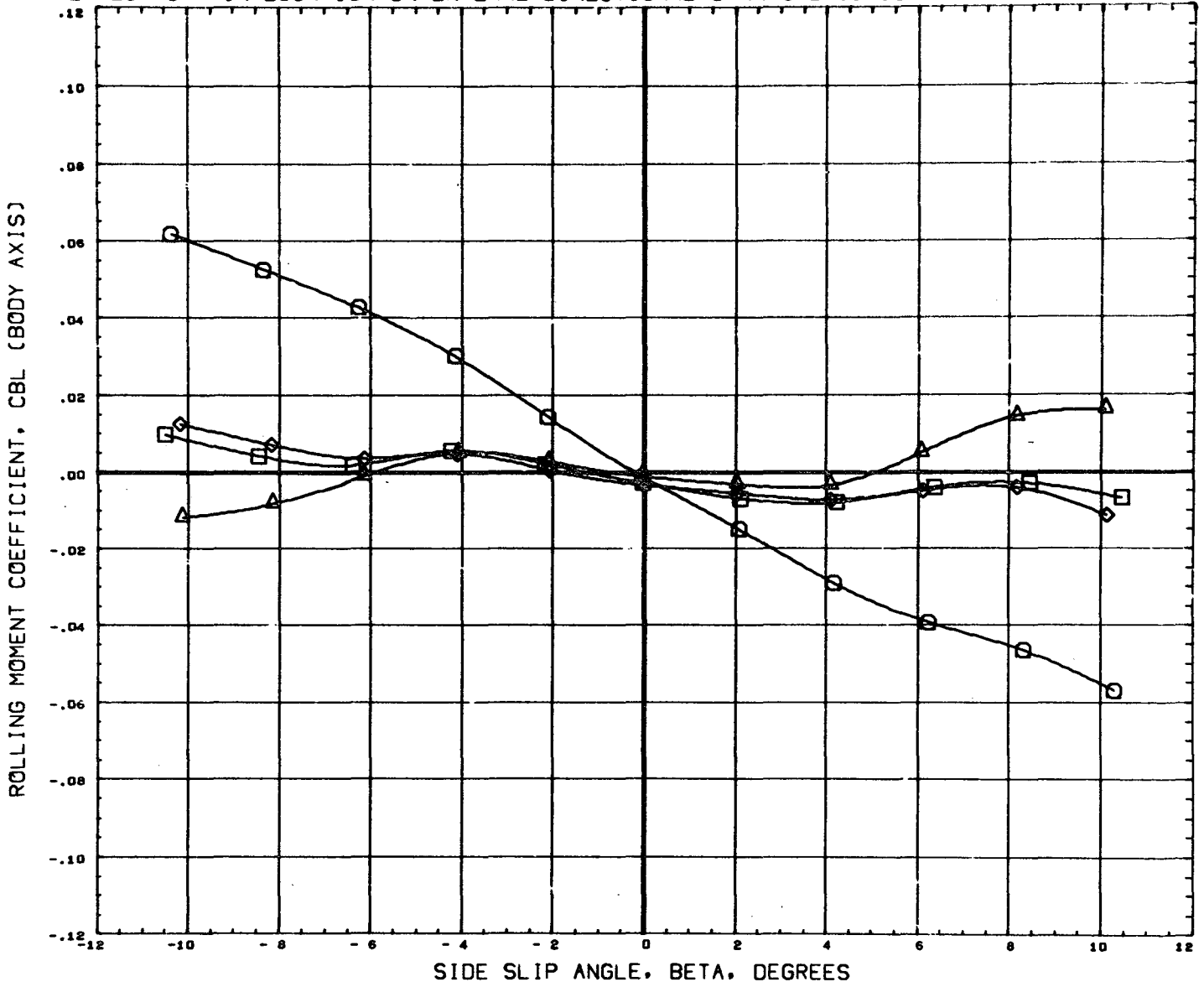

DATA SET SYMBOL	CONFIGURATION DESCRIPTION	ORBIN	THETS	ALPHA	REFERENCE INFORMATION	
(B65005)	MSFC TWT 534 SHUTTLE LAUNCH	T101S1	-1.500	21.000	0.000	SREF 4.8950 SQ. IN
(B65013)	MSFC TWT 534 SHUTTLE LAUNCH	T101S1F1	-1.500	21.000	0.000	LREF 2.6440 IN.
(B65015)	MSFC TWT 534 SHUTTLE LAUNCH	T101S1F2	-1.500	21.000	0.000	BREF 3.5250 IN.
(B65016)	MSFC TWT 534 SHUTTLE LAUNCH	T101S1F3	-1.500	21.000	0.000	XMRP 3.4900 IN.
						YMRP 0.0000 IN.
						ZMRP 0.1616 IN.
						SCALE 0.0034

MACH .91

EFFECT OF FIN LOCATION ON LATERAL/DIRECTIONAL CHARACTERISTICS

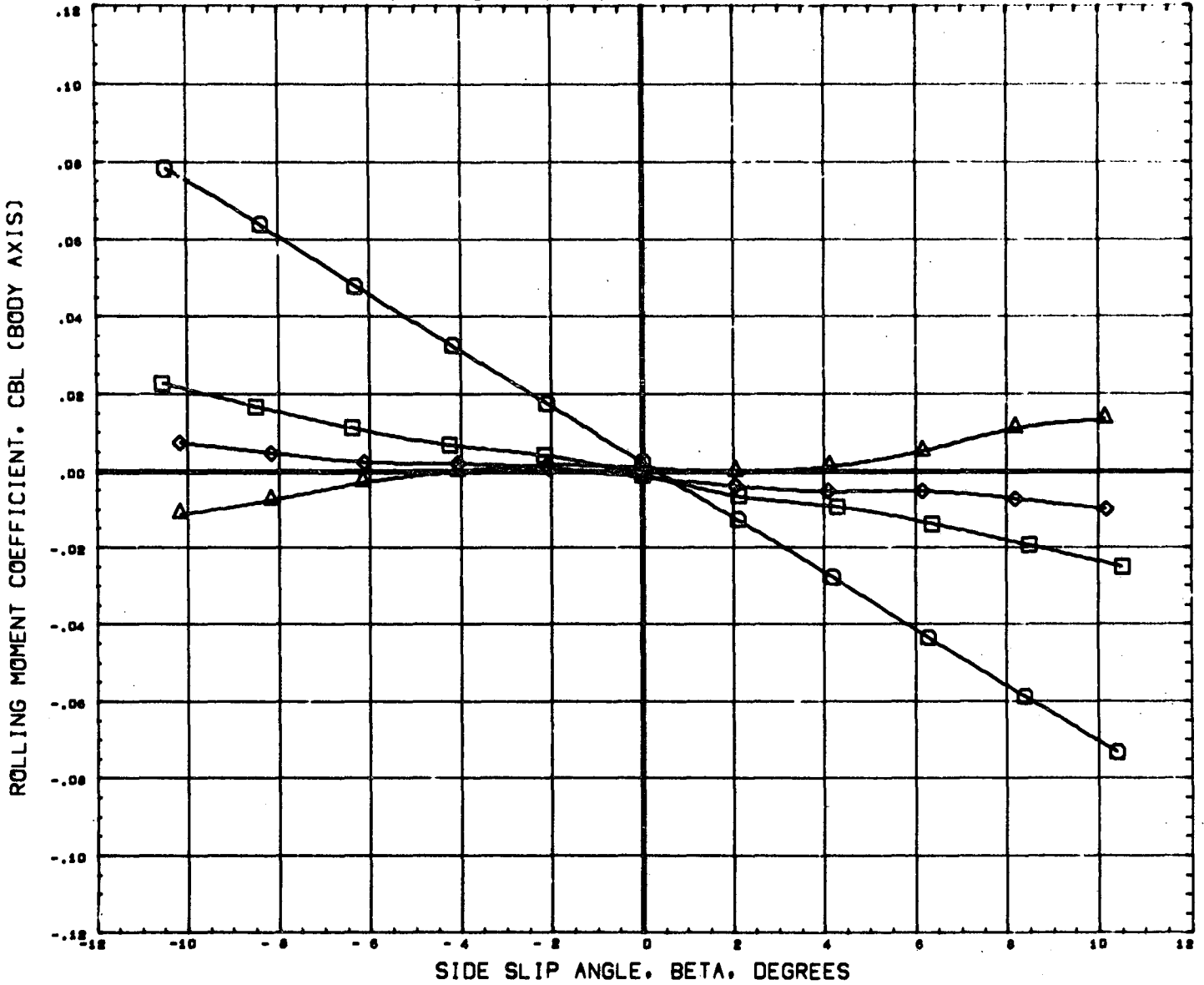

DATA SET SYMBOL	CONFIGURATION DESCRIPTION	ORBIT	THETA	ALPHA	REFERENCE INFORMATION	
(065005)	MSFC TWT 534 SHUTTLE LAUNCH	T10181	-1.500	21.000	0.000	SREF 4.8950 80. IN
(065013)	MSFC TWT 534 SHUTTLE LAUNCH	T10181F1	-1.500	21.000	0.000	LREF 2.6440 IN.
(065015)	MSFC TWT 534 SHUTTLE LAUNCH	T10181F2	-1.500	21.000	0.000	BREF 3.5250 IN.
(065016)	MSFC TWT 534 SHUTTLE LAUNCH	T10181F3	-1.500	21.000	0.000	XMRP 3.4900 IN.
						YMRP 0.0000 IN.
						ZMRP 0.1616 IN.
						SCALE 0.0034

EFFECT OF FIN LOCATION ON LATERAL/DIRECTIONAL CHARACTERISTICS

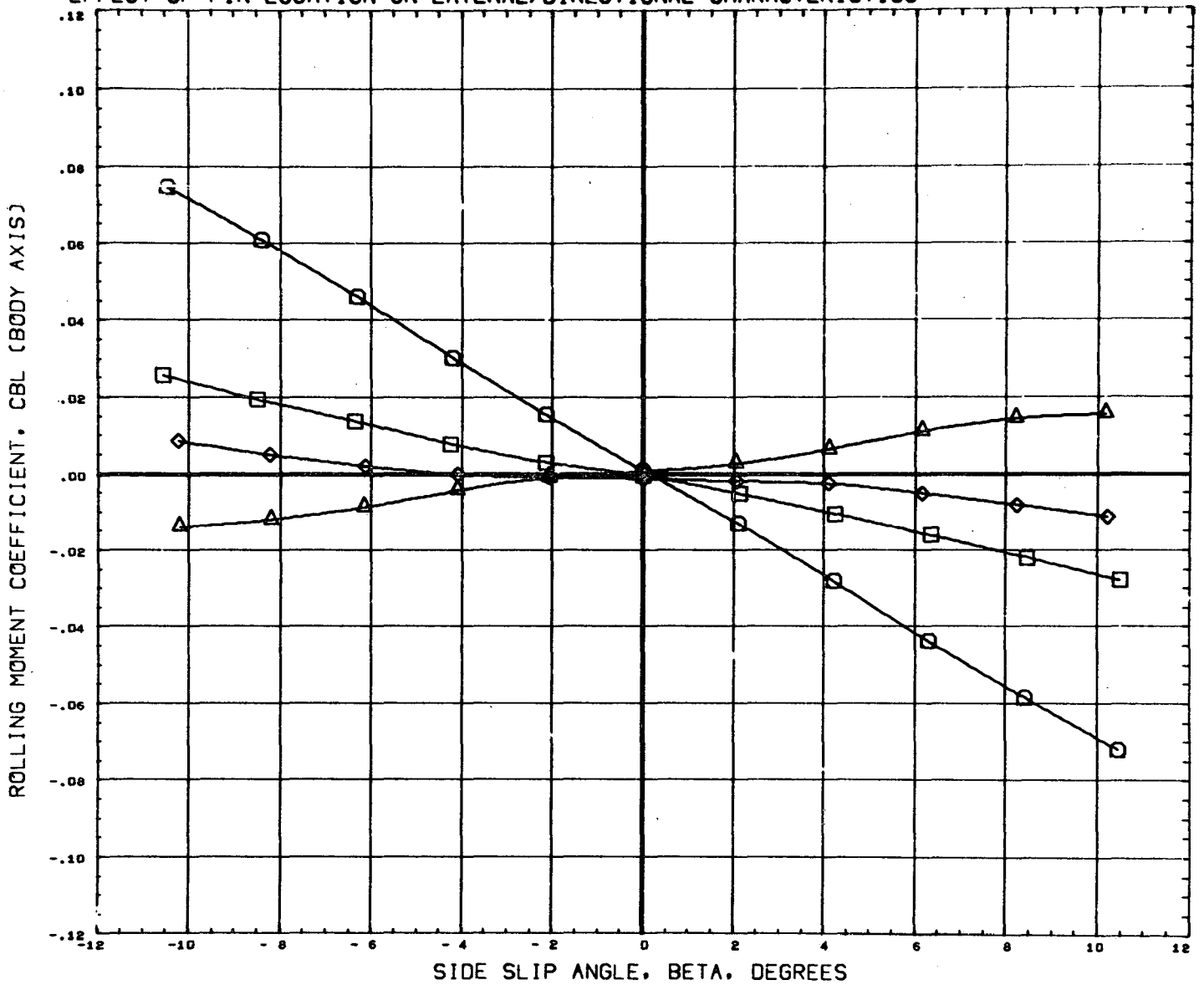

DATA SET SYMBOL	CONFIGURATION DESCRIPTION	ORBIN	THETS	ALPHA	REFERENCE INFORMATION	
(B65005)	MSFC TWT 534 SHUTTLE LAUNCH	T101S1	-1.500	21.000	0.000	SREF 4.6950 SQ. IN
(B65013)	MSFC TWT 534 SHUTTLE LAUNCH	T101S1F1	-1.500	21.000	0.000	LREF 2.6440 IN.
(B65015)	MSFC TWT 534 SHUTTLE LAUNCH	T101S1F2	-1.500	21.000	0.000	BREF 3.5250 IN.
(B65016)	MSFC TWT 534 SHUTTLE LAUNCH	T101S1F3	-1.500	21.000	0.000	XMRP 3.4900 IN.
						YMRP 0.0000 IN.
						ZMRP 0.1616 IN.
						SCALE 0.0034

MACH 1.19

PAGE 565

EFFECT OF FIN LOCATION ON LATERAL/DIRECTIONAL CHARACTERISTICS

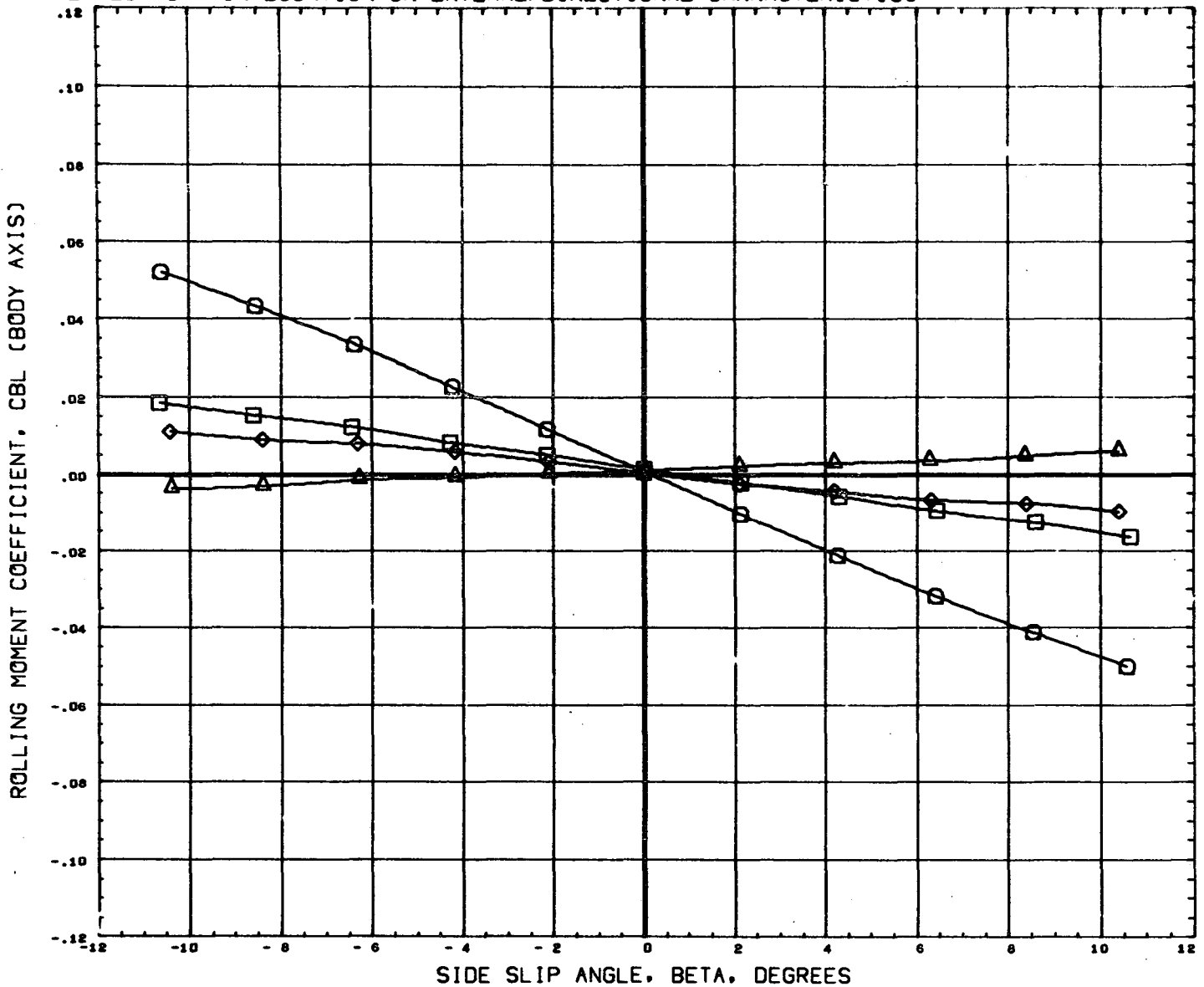

DATA SET SYMBOL	CONFIGURATION DESCRIPTION	ORBIN	THETS	ALPHA	REFERENCE INFORMATION
(865005)	MSFC TWT 534 SHUTTLE LAUNCH T101S1	-1.500	21.000	0.000	SREF 4.8950 SQ. IN
(865013)	MSFC TWT 534 SHUTTLE LAUNCH T101S1F1	-1.500	21.000	0.000	LREF 2.6440 IN.
(865015)	MSFC TWT 534 SHUTTLE LAUNCH T101S1F2	-1.500	21.000	0.000	BREF 3.5250 IN.
(865016)	MSFC TWT 534 SHUTTLE LAUNCH T101S1F3	-1.500	21.000	0.000	XMRP 3.4900 IN.
					YMRP 0.0000 IN.
					ZMRP 0.1616 IN.
					SCALE 0.0034

MACH 1.97

EFFECT OF FIN LOCATION ON LATERAL/DIRECTIONAL CHARACTERISTICS

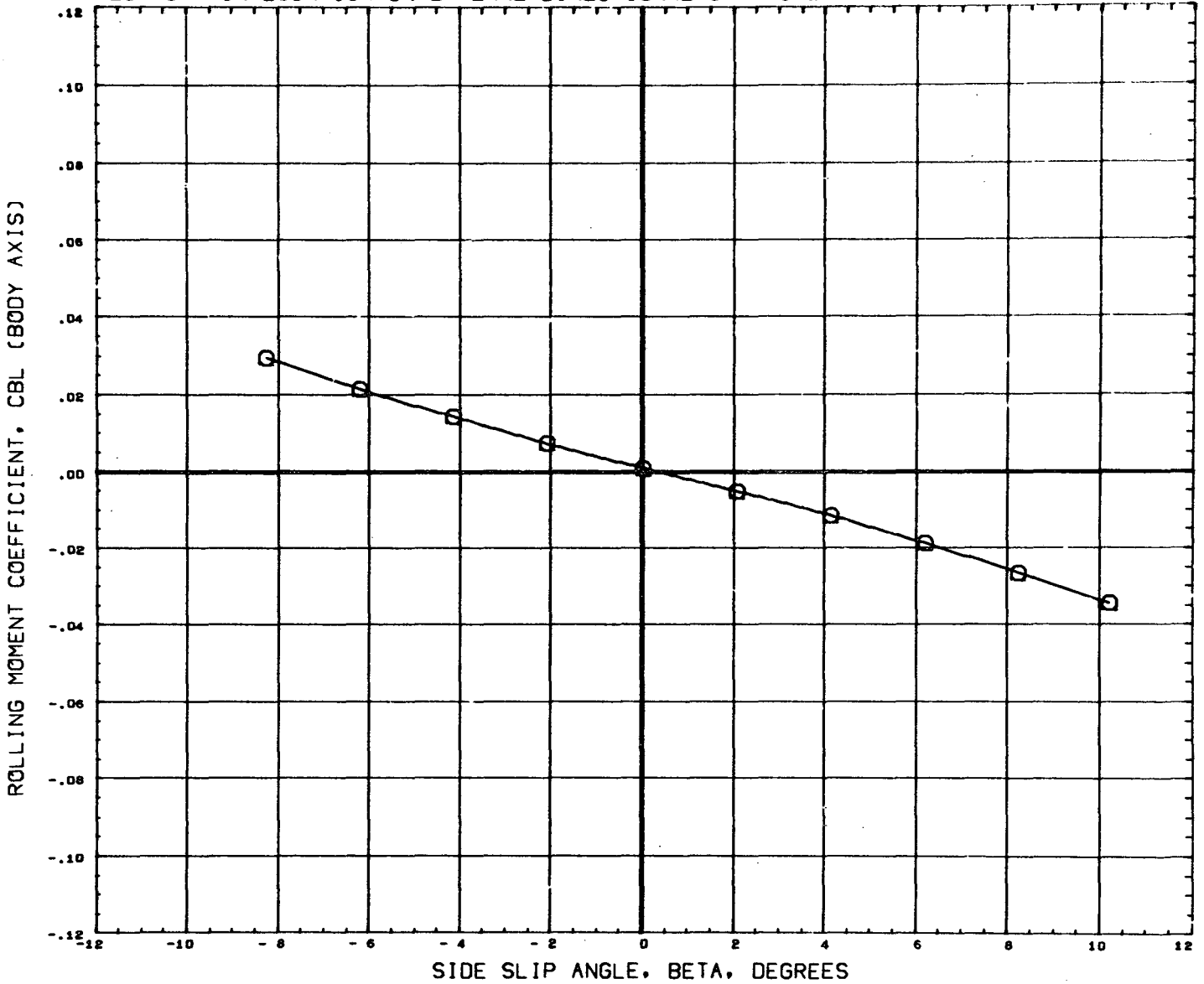

DATA SET SYMBOL	CONFIGURATION DESCRIPTION	ORBIN	THETS	ALPHA	REFERENCE INFORMATION
(B65005)	MSFC TWT 534 SHUTTLE LAUNCH T101S1	-1.500	21.000	0.000	SREF 4.8450 SQ. IN
(B65013)	DATA NOT AVAILABLE FOR ALL CONDITIONS	-1.500	21.000	0.000	LREF 2.6440 IN.
(B65015)	DATA NOT AVAILABLE FOR ALL CONDITIONS	-1.500	21.000	0.000	BREF 3.5250 IN.
(B65016)	DATA NOT AVAILABLE FOR ALL CONDITIONS	-1.500	21.000	0.000	XMRP 3.4900 IN.
					YMRP 0.0000 IN.
					ZMRP 0.1616 IN.
					SCALE 0.0034

MACH 2.74

PAGE 567

EFFECT OF FIN LOCATION ON LATERAL/DIRECTIONAL CHARACTERISTICS

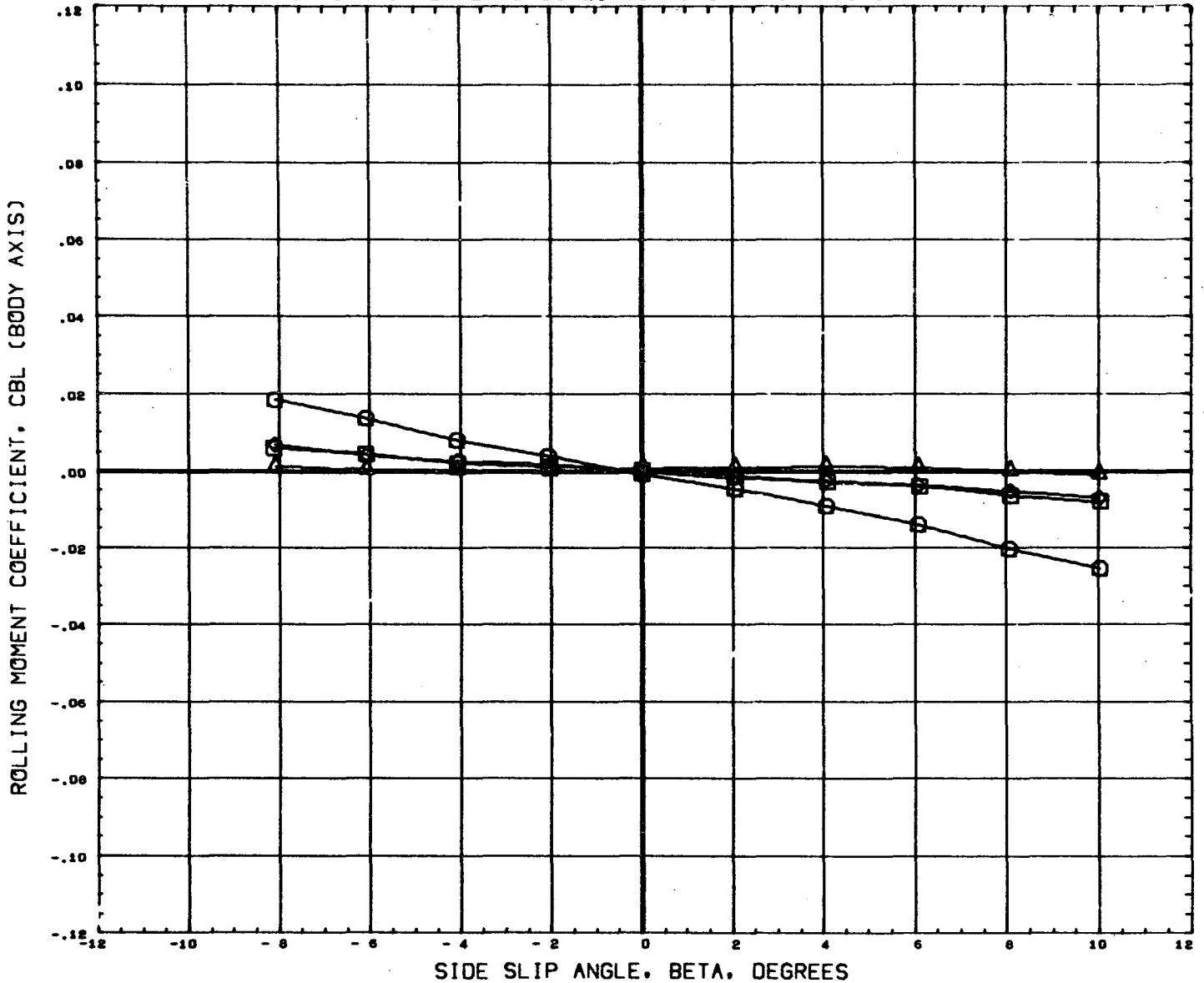

DATA SET SYMBOL	CONFIGURATION DESCRIPTION	ORBIN	THETS	ALPHA	REFERENCE INFORMATION	
(B65005)	MSFC TWT 534 SHUTTLE LAUNCH	T101S1	-1.500	21.000	0.000	SREF 4.8950 SQ. IN
(B65013)	MSFC TWT 534 SHUTTLE LAUNCH	T101S1F1	-1.500	21.000	0.000	LREF 2.6440 IN.
(B65015)	MSFC TWT 534 SHUTTLE LAUNCH	T101S1F2	-1.500	21.000	0.000	BREF 3.5250 IN.
(B65016)	MSFC TWT 534 SHUTTLE LAUNCH	T101S1F3	-1.500	21.000	0.000	XMRP 3.4900 IN.
						YMRP 0.0000 IN.
						ZMRP 0.1616 IN.
						SCALE 0.0034

MACH 4.96

EFFECT OF FIN LOCATION ON LATERAL/DIRECTIONAL CHARACTERISTICS

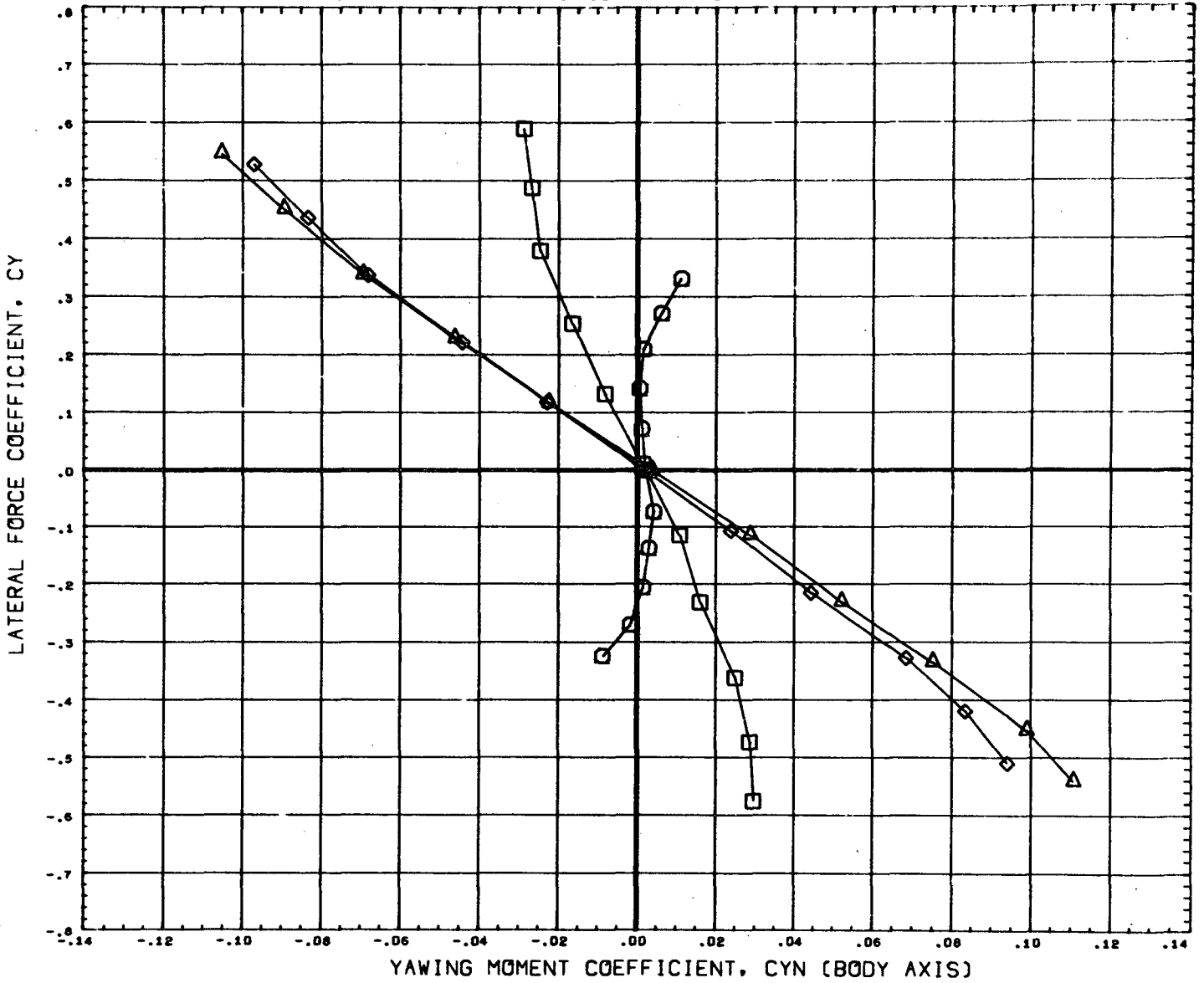

DATA SET SYMBOL	CONFIGURATION DESCRIPTION	ORBIN	THETS	ALPHA	REFERENCE INFORMATION	
(B65005)	MSFC TWT 534 SHUTTLE LAUNCH	T101S1	-1.500	21.000	0.000	SREF 4.8950 SQ. IN
(B65013)	MSFC TWT 534 SHUTTLE LAUNCH	T101S1F1	-1.500	21.000	0.000	LREF 2.6440 IN.
(B65015)	MSFC TWT 534 SHUTTLE LAUNCH	T101S1F2	-1.500	21.000	0.000	BREF 3.5250 IN.
(B65016)	MSFC TWT 534 SHUTTLE LAUNCH	T101S1F3	-1.500	21.000	0.000	XNRP 3.4900 IN.
						YNRP 0.0000 IN.
						ZNRP 0.1616 IN.
						SCALE 0.0034

MACH .60

EFFECT OF FIN LOCATION ON LATERAL/DIRECTIONAL CHARACTERISTICS

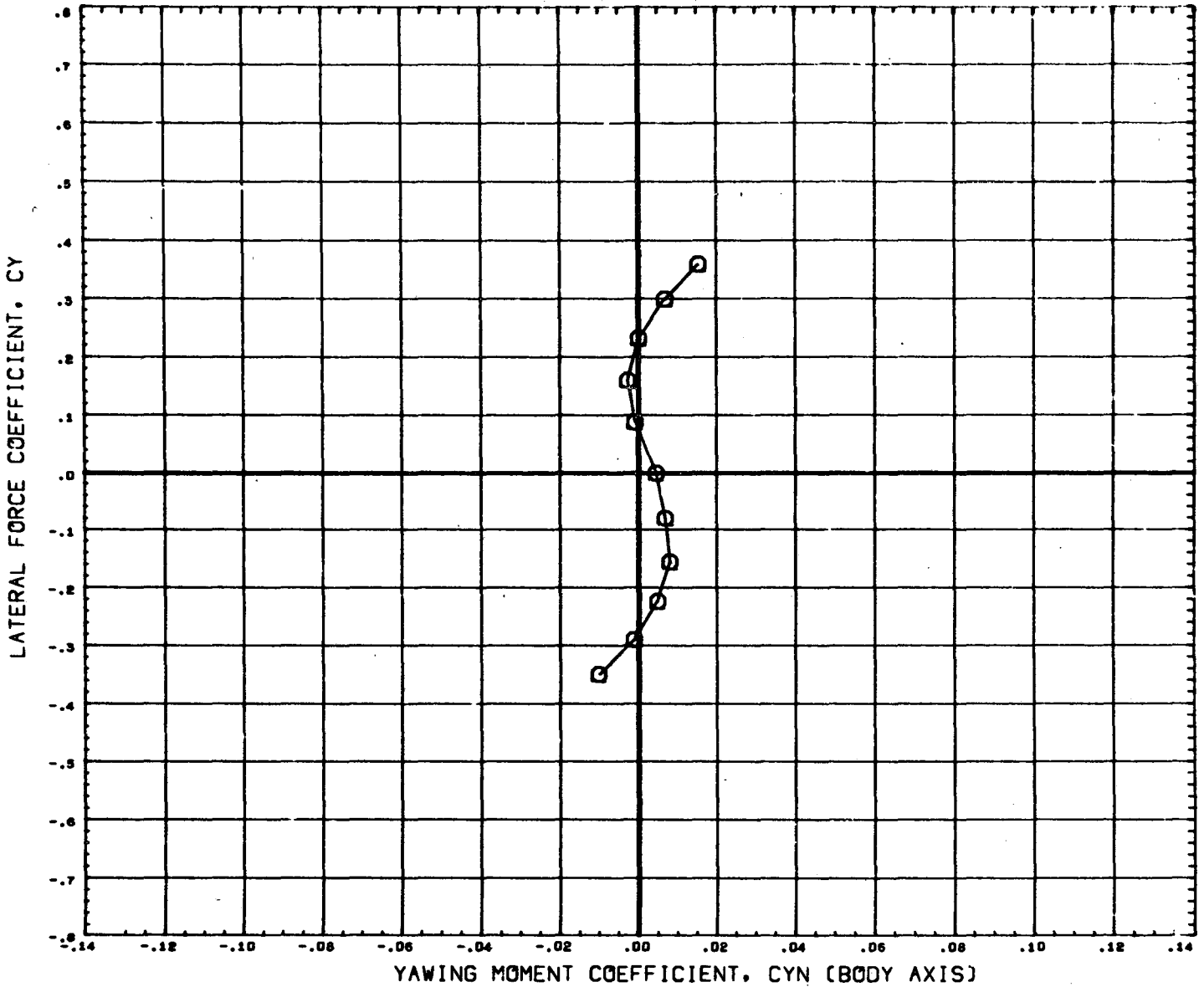

DATA SET SYMBOL	CONFIGURATION DESCRIPTION	ORBIN	THETS	ALPHA	REFERENCE INFORMATION
(865005)	MSFC TWT 534 SHUTTLE LAUNCH T101S1	-1.500	21.000	0.000	SREF 4.8950 SQ. IN
(865013)	DATA NOT AVAILABLE FOR ALL CONDITIONS	-1.500	21.000	0.000	LREF 2.6440 IN.
(865015)	DATA NOT AVAILABLE FOR ALL CONDITIONS	-1.500	21.000	0.000	BREF 3.5250 IN.
(865016)	DATA NOT AVAILABLE FOR ALL CONDITIONS	-1.500	21.000	0.000	XMRP 3.4900 IN.
					YMRP 0.0000 IN.
					ZMRP 0.1616 IN.
					SCALE 0.0034

MACH .80

EFFECT OF FIN LOCATION ON LATERAL/DIRECTIONAL CHARACTERISTICS

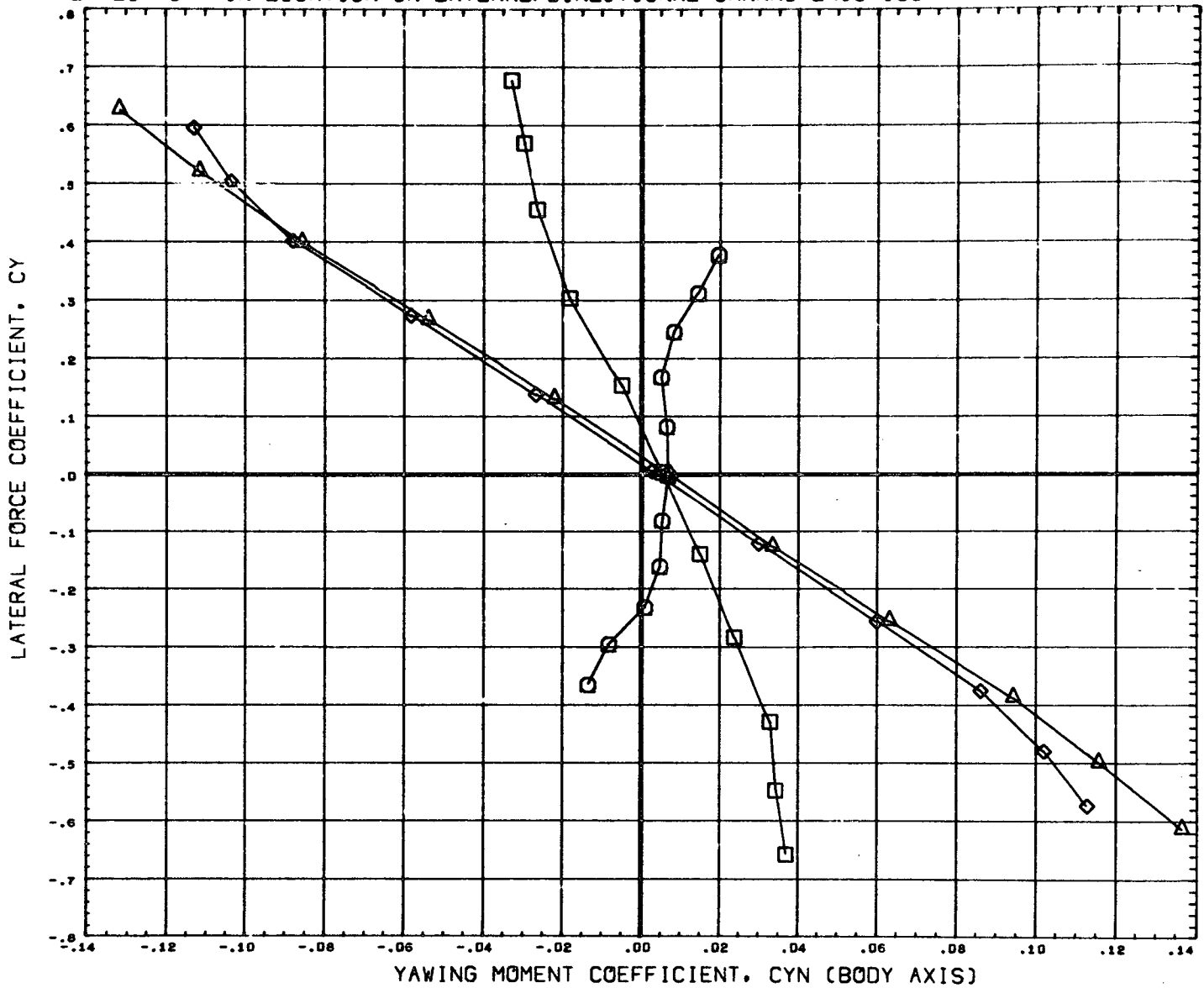

DATA SET SYMBOL	CONFIGURATION DESCRIPTION	ORBIN	THETS	ALPHA	REFERENCE INFORMATION
(B65005)	MSFC TWT 534 SHUTTLE LAUNCH	-1.500	21.000	0.000	SREF 4.8950 SQ. IN
(B65013)	MSFC TWT 534 SHUTTLE LAUNCH	-1.500	21.000	0.000	LREF 2.6440 IN.
(B65015)	MSFC TWT 534 SHUTTLE LAUNCH	-1.500	21.000	0.000	BREF 3.5250 IN.
(B65016)	MSFC TWT 534 SHUTTLE LAUNCH	-1.500	21.000	0.000	XMRP 3.4900 IN.
					YMRP 0.0000 IN.
					ZMRP 0.1616 IN.
					SCALE 0.0034

EFFECT OF FIN LOCATION ON LATERAL/DIRECTIONAL CHARACTERISTICS

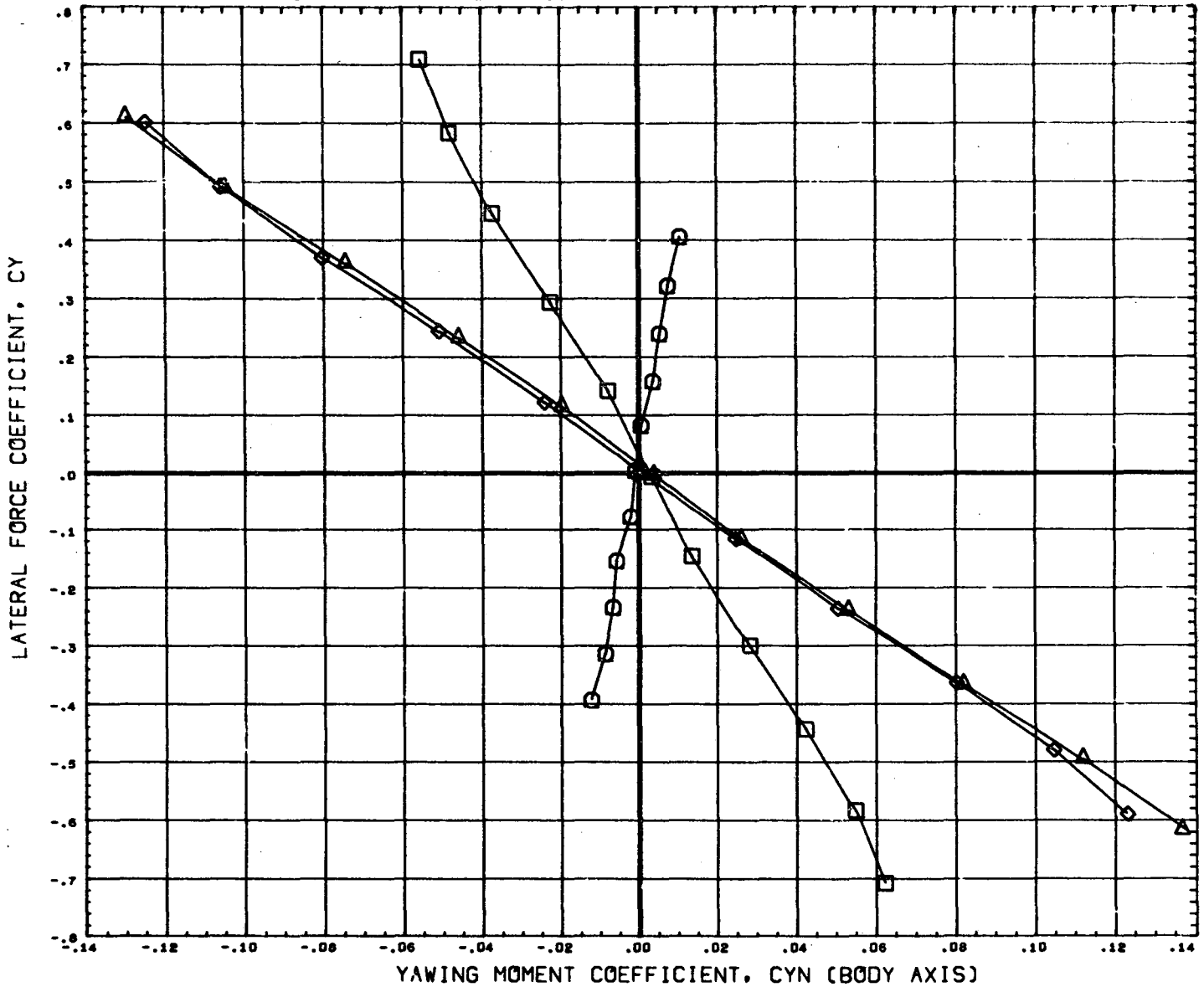

DATA SET SYMBOL	CONFIGURATION DESCRIPTION	ORBIN	THETS	ALPHA	REFERENCE INFORMATION
(B65005)	MSFC TWT 534 SHUTTLE LAUNCH	-1.500	21.000	0.000	SREF 4.8350 SQ. IN
(B65013)	MSFC TWT 534 SHUTTLE LAUNCH	-1.500	21.000	0.000	LREF 2.6440 IN.
(B65015)	MSFC TWT 534 SHUTTLE LAUNCH	-1.500	21.000	0.000	BREF 3.5250 IN.
(B65016)	MSFC TWT 534 SHUTTLE LAUNCH	-1.500	21.000	0.000	XMRP 3.4500 IN.
					YMRP 0.0000 IN.
					ZMRP 0.1616 IN.
					SCALE 0.0034

EFFECT OF FIN LOCATION ON LATERAL/DIRECTIONAL CHARACTERISTICS

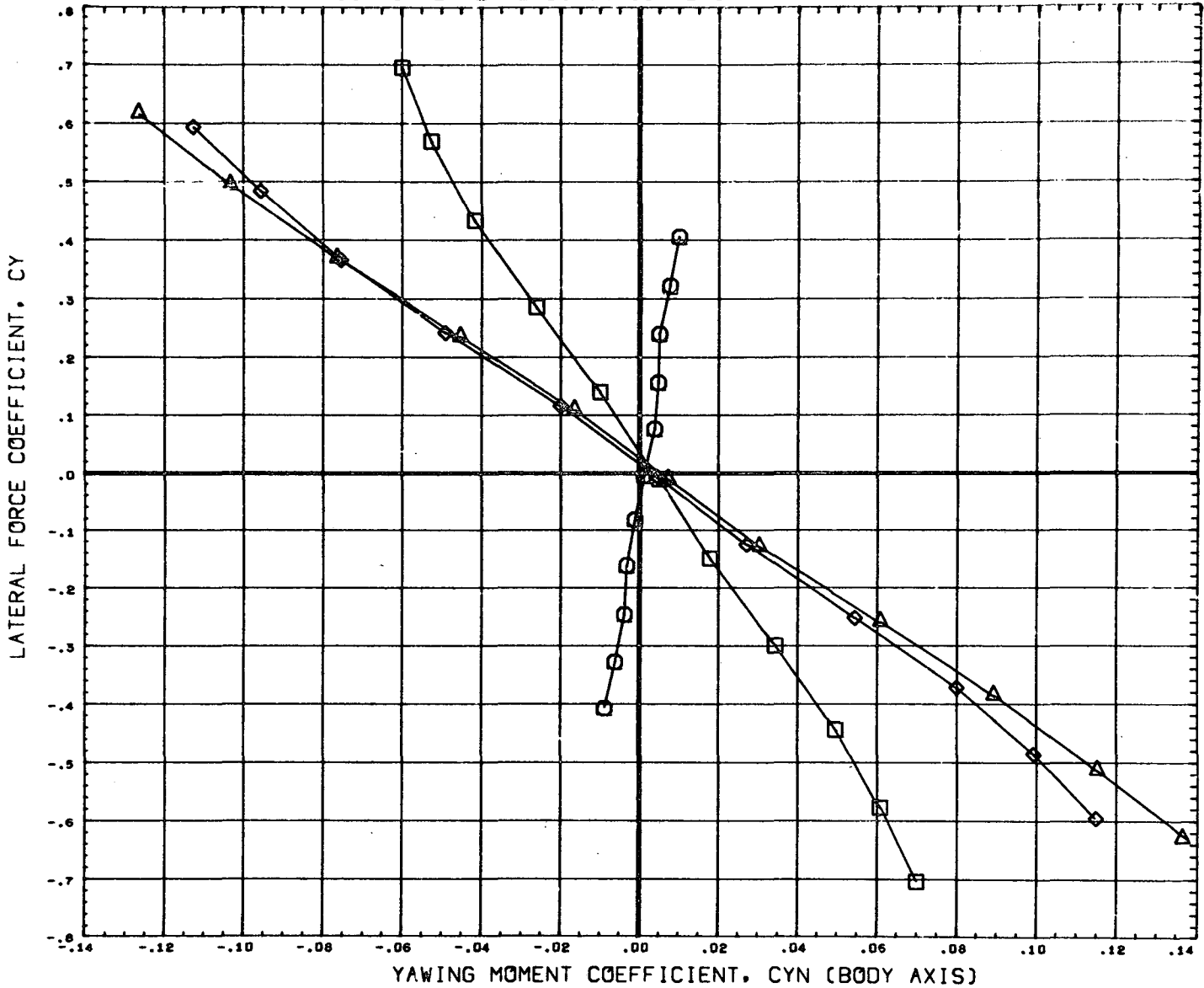

DATA SET SYMBOL	CONFIGURATION DESCRIPTION	ORBIN	THETS	ALPHA	REFERENCE INFORMATION	
(B65005)	MSFC TWT 534 SHUTTLE LAUNCH	T1O1S1	-1.500	21.000	0.000	SREF 4.8950 SQ. IN
(B65013)	MSFC TWT 534 SHUTTLE LAUNCH	T1O1S1F1	-1.500	21.000	0.000	LREF 2.6440 IN.
(B65015)	MSFC TWT 534 SHUTTLE LAUNCH	T1O1S1F2	-1.500	21.000	0.000	BREF 3.5250 IN.
(B65016)	MSFC TWT 534 SHUTTLE LAUNCH	T1O1S1F3	-1.500	21.000	0.000	XMRP 3.4900 IN.
						YMRP 0.0000 IN.
						ZMRP 0.1616 IN.
						SCALE 0.0034

EFFECT OF FIN LOCATION ON LATERAL/DIRECTIONAL CHARACTERISTICS

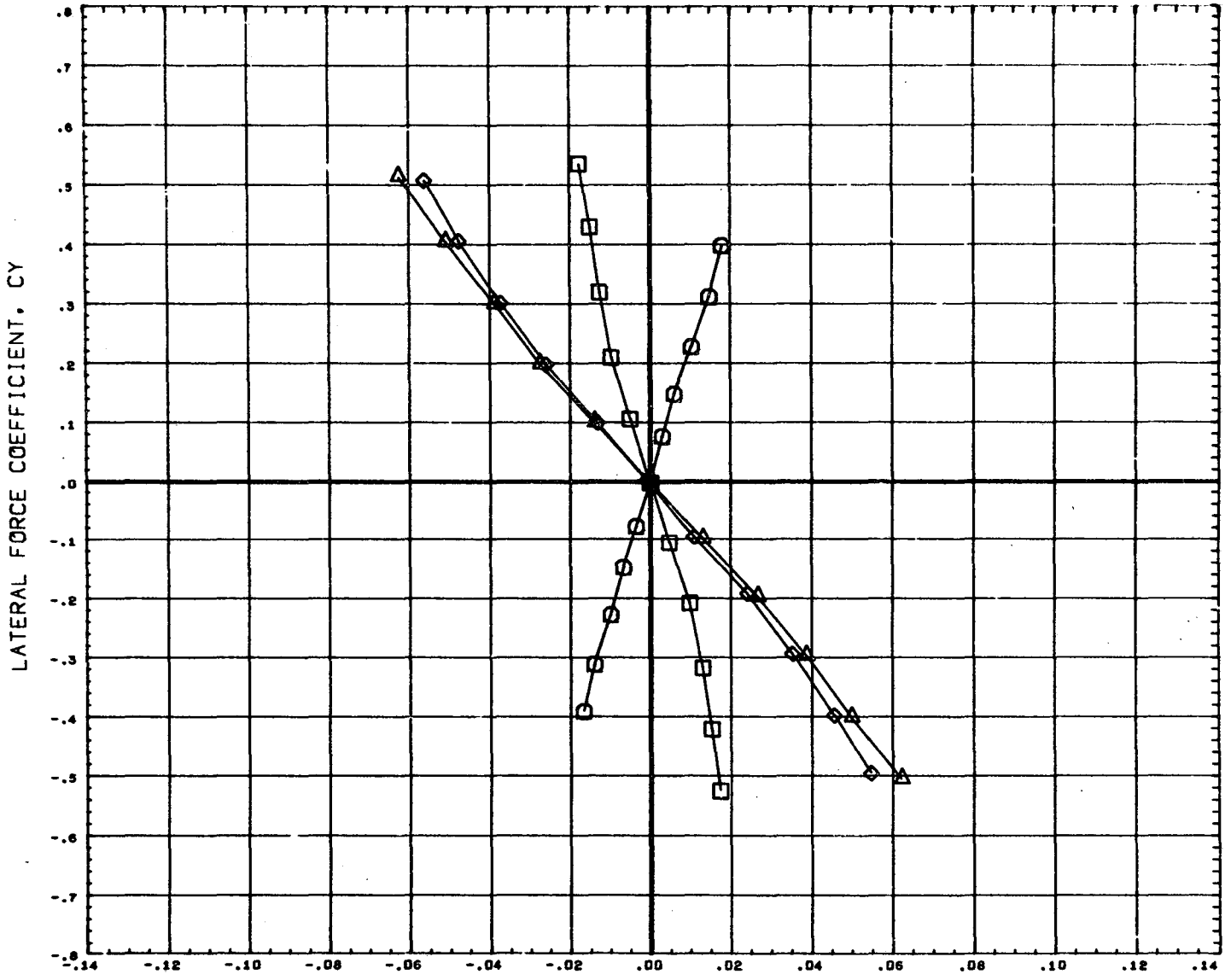

DATA SET SYMBOL	CONFIGURATION DESCRIPTION	ORBIN	THETS	ALPHA	REFERENCE INFORMATION	
(B65005)	MSFC TWT 534 SHUTTLE LAUNCH	T101S1	-1.500	21.000	0.000	SREF 4.8950 SQ. IN
(B65013)	MSFC TWT 534 SHUTTLE LAUNCH	T101S1F1	-1.500	21.000	0.000	LREF 2.6440 IN.
(B65015)	MSFC TWT 534 SHUTTLE LAUNCH	T101S1F2	-1.500	21.000	0.300	BREF 3.5250 IN.
(B65016)	MSFC TWT 534 SHUTTLE LAUNCH	T101S1F3	-1.500	21.000	0.000	XMRP 3.4900 IN.
						YMRP 0.0000 IN.
						ZMRP 0.1616 IN.
						SCALE 0.0034

EFFECT OF FIN LOCATION ON LATERAL/DIRECTIONAL CHARACTERISTICS

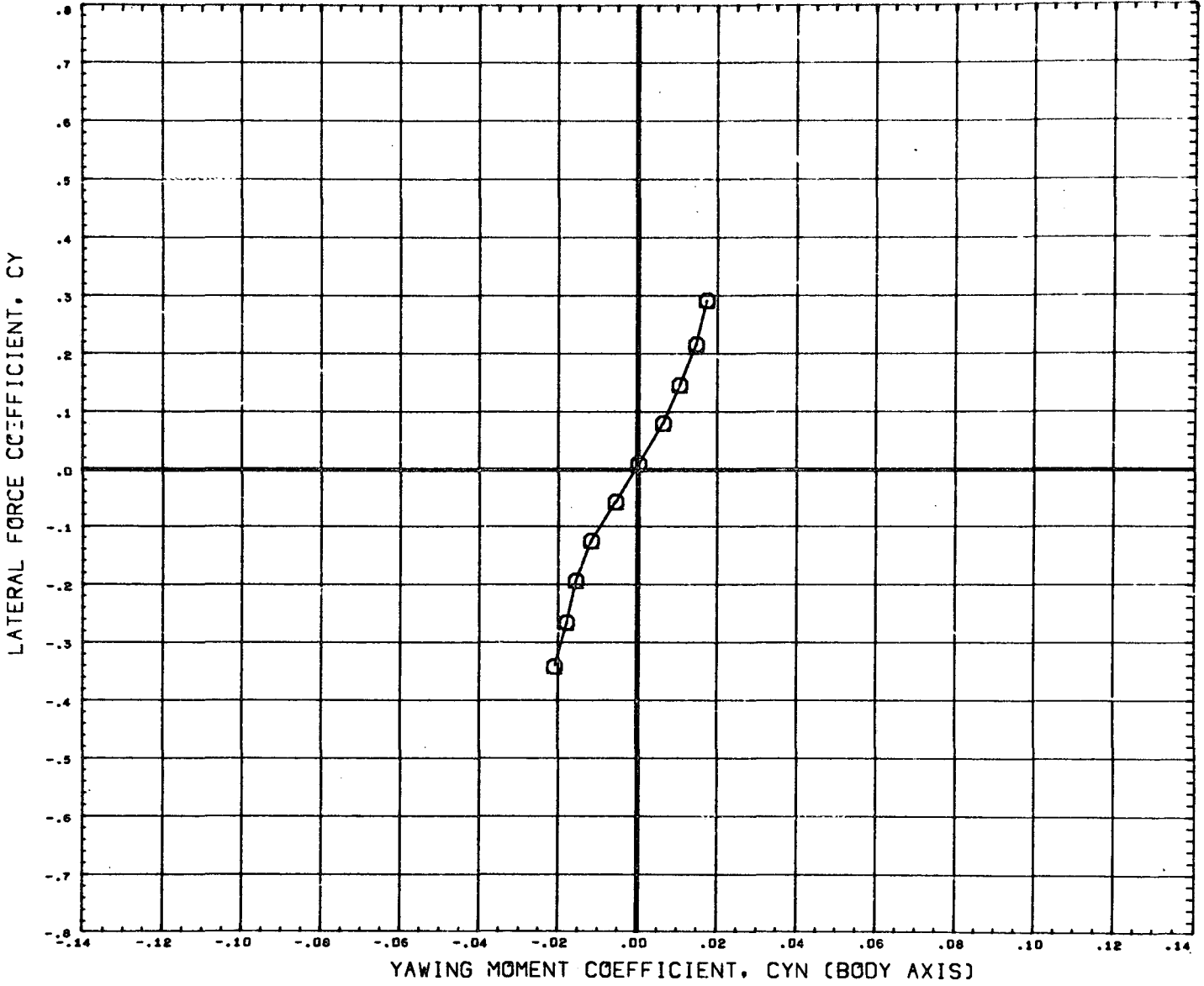

DATA SET SYMBOL	CONFIGURATION DESCRIPTION	ORBIN	THETS	ALPHA	REFERENCE INFORMATION
(B65005)	MSFC TWT 534 SHUTTLE LAUNCH T101S1	-1.500	21.000	0.000	SREF 4.8950 SQ. IN.
(B65013)	DATA NOT AVAILABLE FOR ALL CONDITIONS	-1.500	21.000	0.000	LREF 2.6440 IN.
(B65015)	DATA NOT AVAILABLE FOR ALL CONDITIONS	-1.500	21.000	0.000	BREF 3.5250 IN.
(B65016)	DATA NOT AVAILABLE FOR ALL CONDITIONS	-1.500	21.000	0.000	XMRP 3.4900 IN.
					YMRP 0.0000 IN.
					ZMRP 0.1616 IN.
					SCALE 0.0034

MACH 2.74

EFFECT OF FIN LOCATION ON LATERAL/DIRECTIONAL CHARACTERISTICS

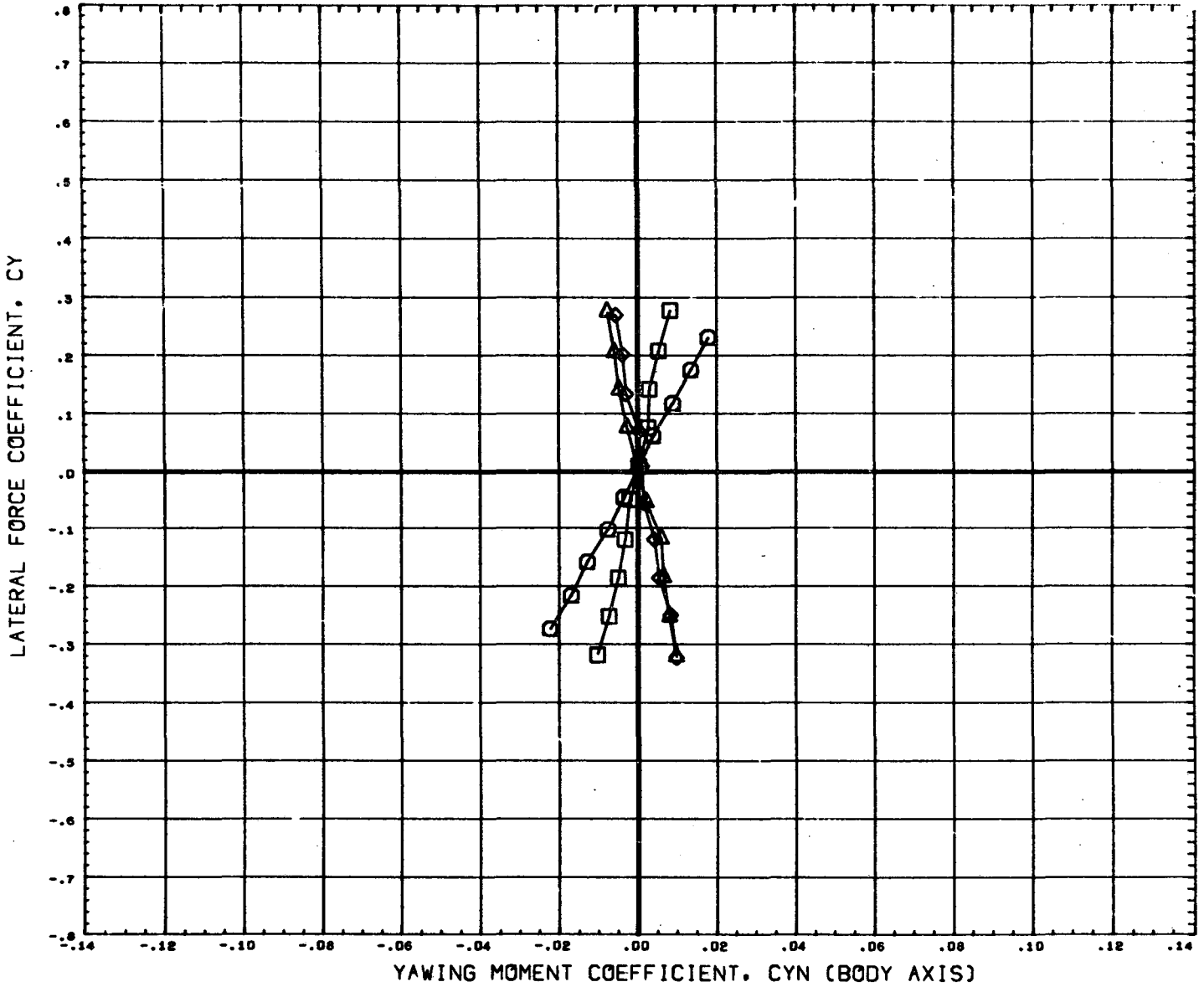

DATA SET SYMBOL	CONFIGURATION DESCRIPTION	ORBIN	THETS	ALPHA	REFERENCE INFORMATION	
(B65005)	MSFC TWT 534 SHUTTLE LAUNCH	T101S1	-1.500	21.000	0.000	SREF 4.8950 SQ. IN
(B65013)	MSFC TWT 534 SHUTTLE LAUNCH	T101S1F1	-1.500	21.000	0.000	LREF 2.6440 IN.
(B65015)	MSFC TWT 534 SHUTTLE LAUNCH	T101S1F2	-1.500	21.000	0.000	BREF 3.5250 IN.
(B65016)	MSFC TWT 534 SHUTTLE LAUNCH	T101S1F3	-1.500	21.000	0.000	XMRP 3.4900 IN.
						YMRP 0.0000 IN.
						ZMRP 0.1616 IN.
						SCALE 0.0034

BASELINE LONGITUDINAL DERIVATIVES AS A FUNCTION OF MACH NUMBER

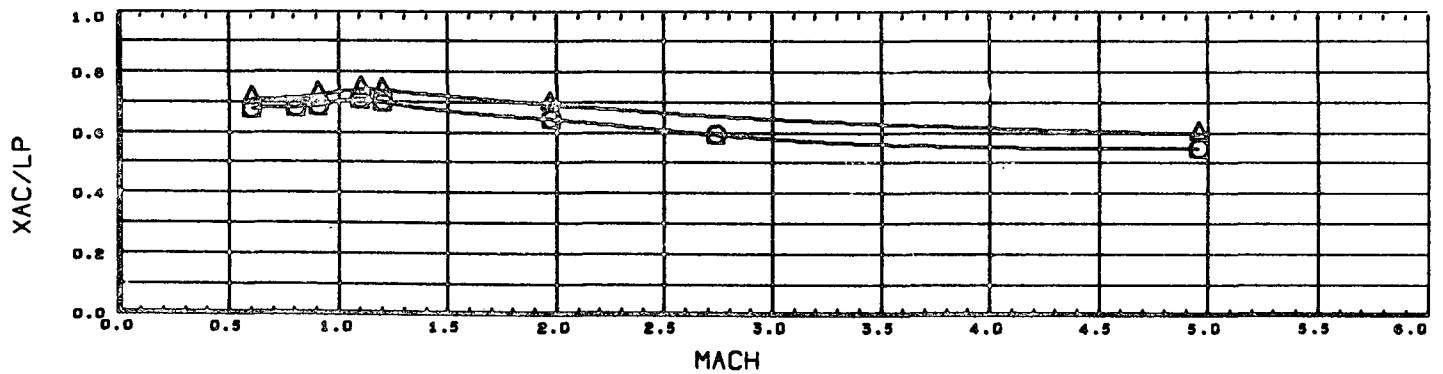
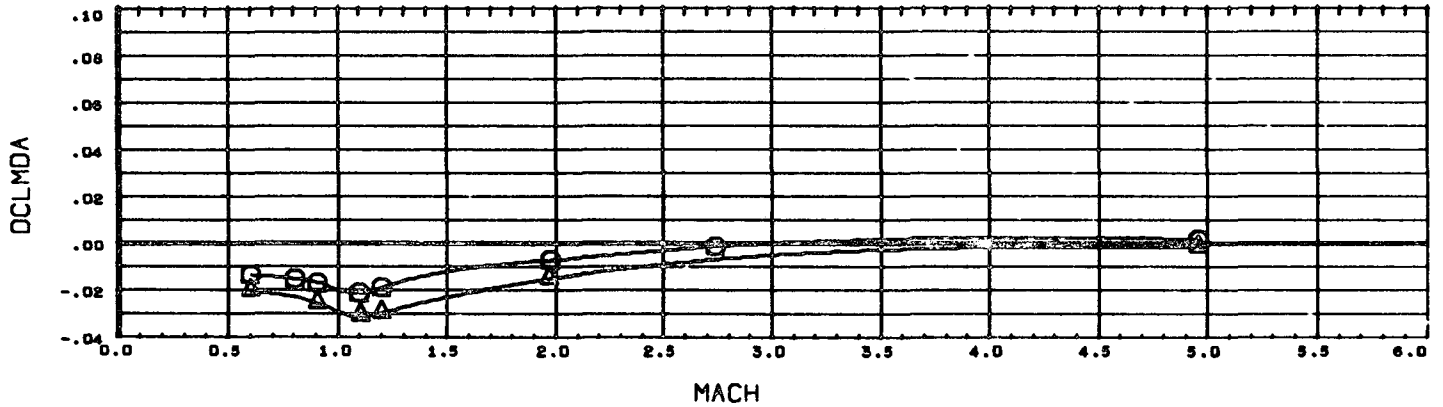
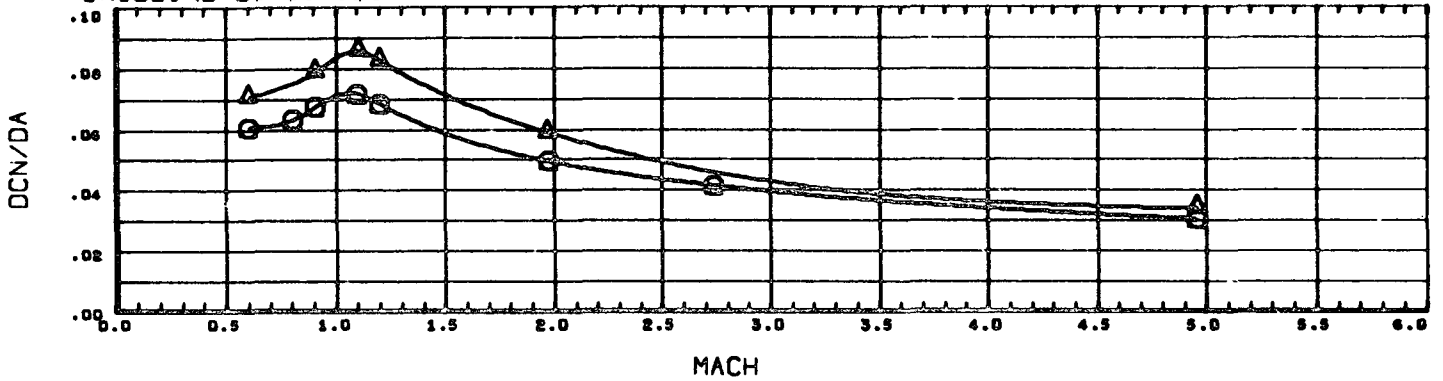

DATA SET SYMBOL	CONFIGURATION DESCRIPTION	ORBIN	THETS	BETA	REFERENCE INFORMATION
(C65004)	MSFC TWT 534 SHUTTLE LAUNCH	-1.500	21.000	0.000	SREF 4.8950 Sq. IN
(C65012)	MSFC TWT 534 SHUTTLE LAUNCH	-1.500	21.000	0.000	LREF 2.6440 IN.
					BREF 3.5250 IN.
					XMRP 3.4900 IN.
					YMRP 0.0000 IN.
					ZMRP 0.1616 IN.
					SCALE 0.0034

BASELINE LONGITUDINAL DERIVATIVES AS A FUNCTION OF MACH NUMBER

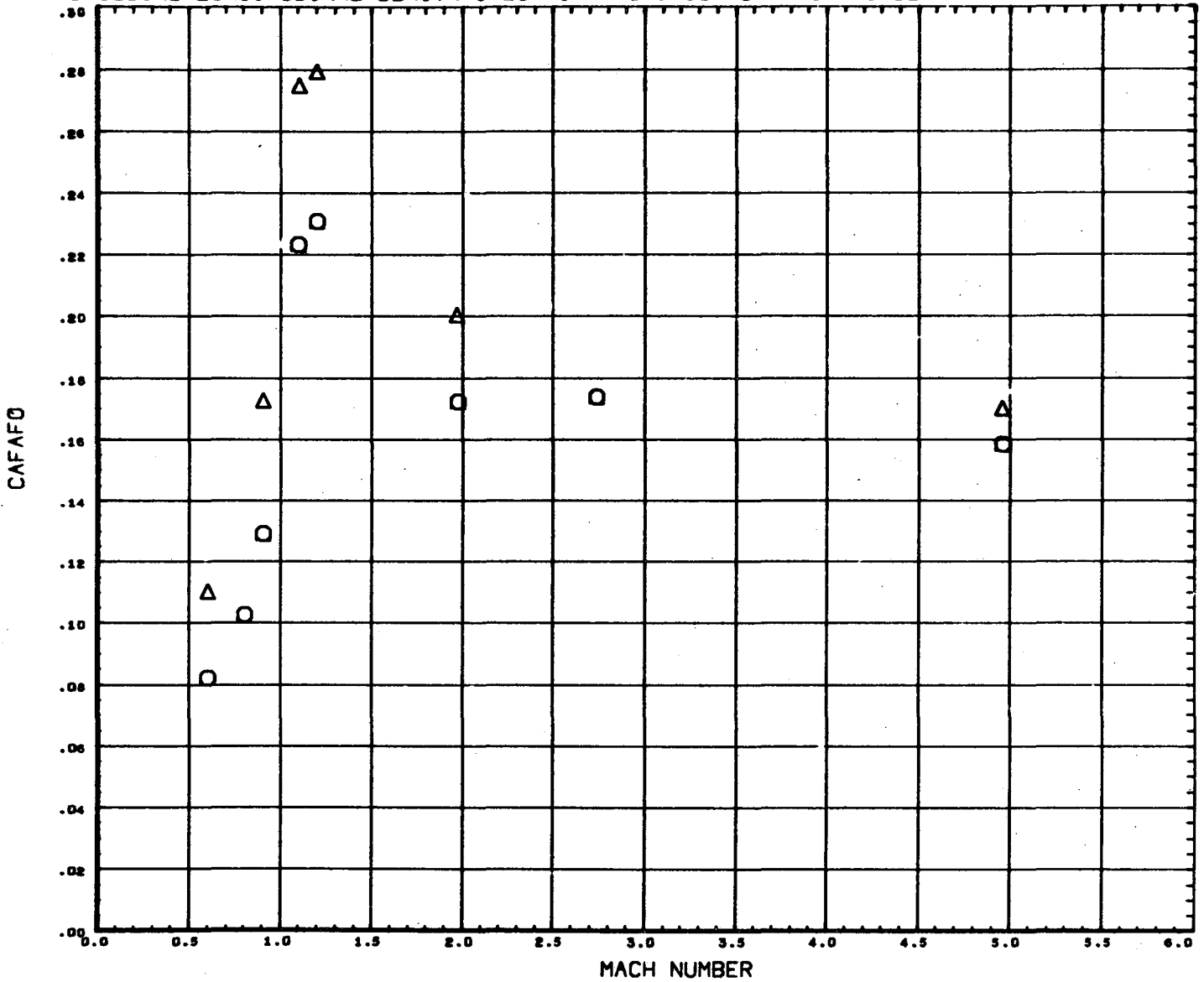

DATA SET SYMBOL	CONFIGURATION DESCRIPTION	ORBIT	THETS	BETA	REFERENCE INFORMATION
(D65004)	MSFC TWT 534 SHUTTLE LAUNCH	-1.500	21.000	0.000	SREF 4.8950 SQ. IN
(D65012)	MSFC TWT 534 SHUTTLE LAUNCH	-1.500	21.000	0.000	LREF 2.6440 IN.
					BREF 3.5250 IN.
					XMRP 3.4900 IN.
					YMRP 0.0000 IN.
					ZMRP 0.1616 IN.
					SCALE 0.0034

BASELINE LATERAL/DIRECTIONAL DERIVATIVES AS A FUNCTION OF MACH NUMBER

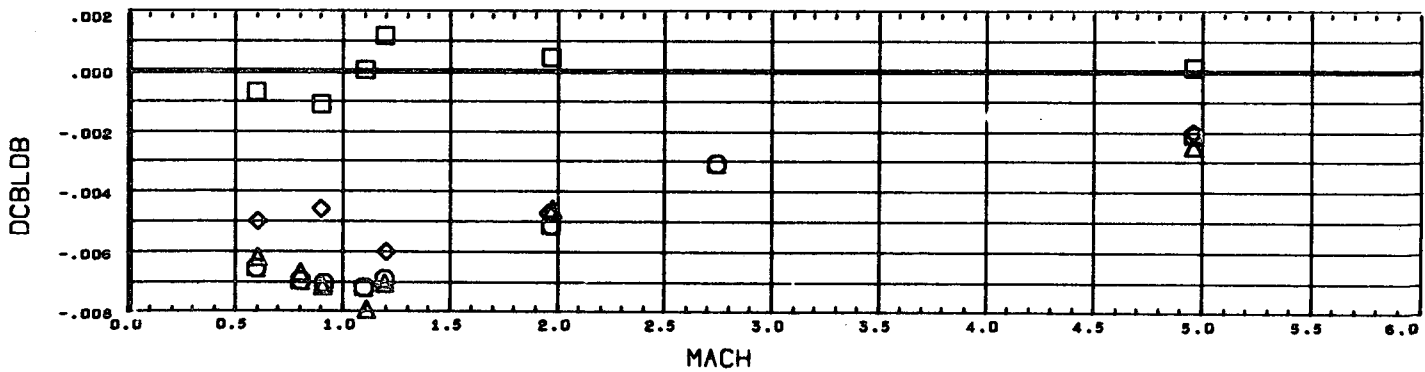
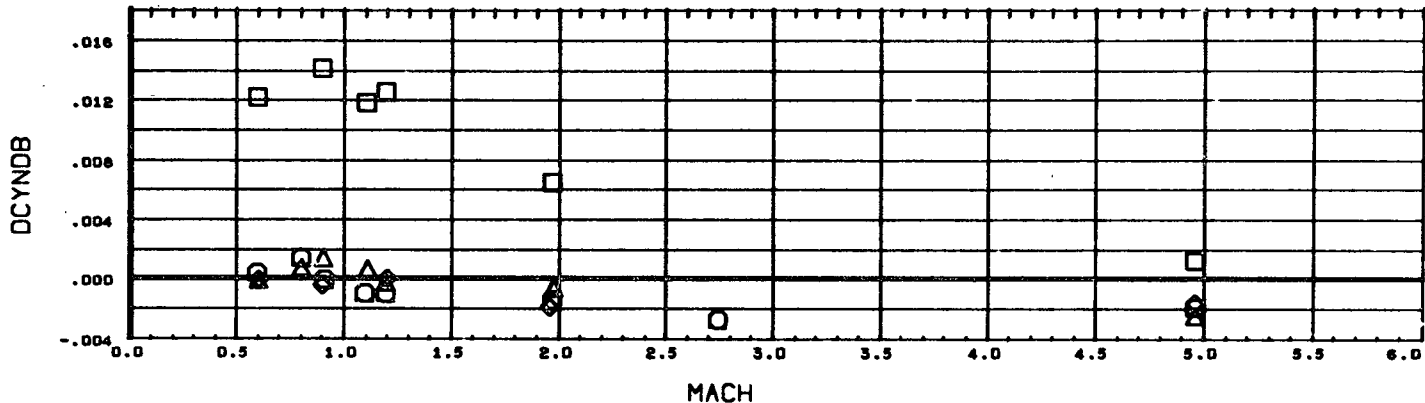
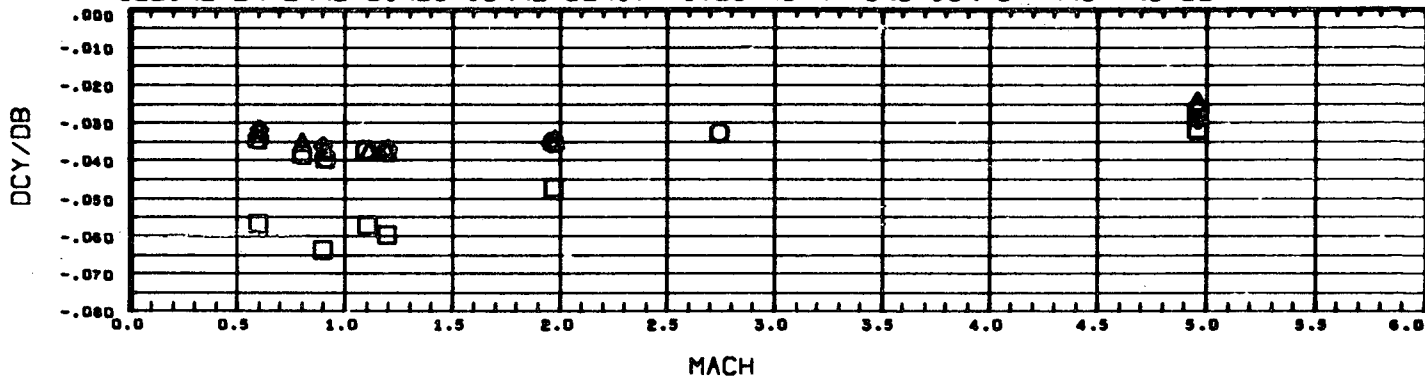

DATA SET SYMBOL	CONFIGURATION DESCRIPTION	ORBIN	THETS	ALPHA	REFERENCE INFORMATION	
(C65005)	MSFC TWT 534 SHUTTLE LAUNCH	T101S1	-1.500	21.000	0.000	SREF 4.8950 SQ. IN
(C65006)	MSFC TWT 534 SHUTTLE LAUNCH	T101S1	-1.500	21.000	6.000	LREF 2.6440 IN.
(C65007)	MSFC TWT 534 SHUTTLE LAUNCH	T101S1	-1.500	21.000	-6.000	BREF 3.5250 IN.
(C65013)	MSFC TWT 534 SHUTTLE LAUNCH	T101S1F1	-1.500	21.000	0.000	XMRP 3.4900 IN.
						YMRP 0.0000 IN.
						ZMRP 0.1616 IN.
						SCALE 0.0034

BASELINE LATERAL/DIRECTIONAL DERIVATIVES AS A FUNCTION OF MACH NUMBER

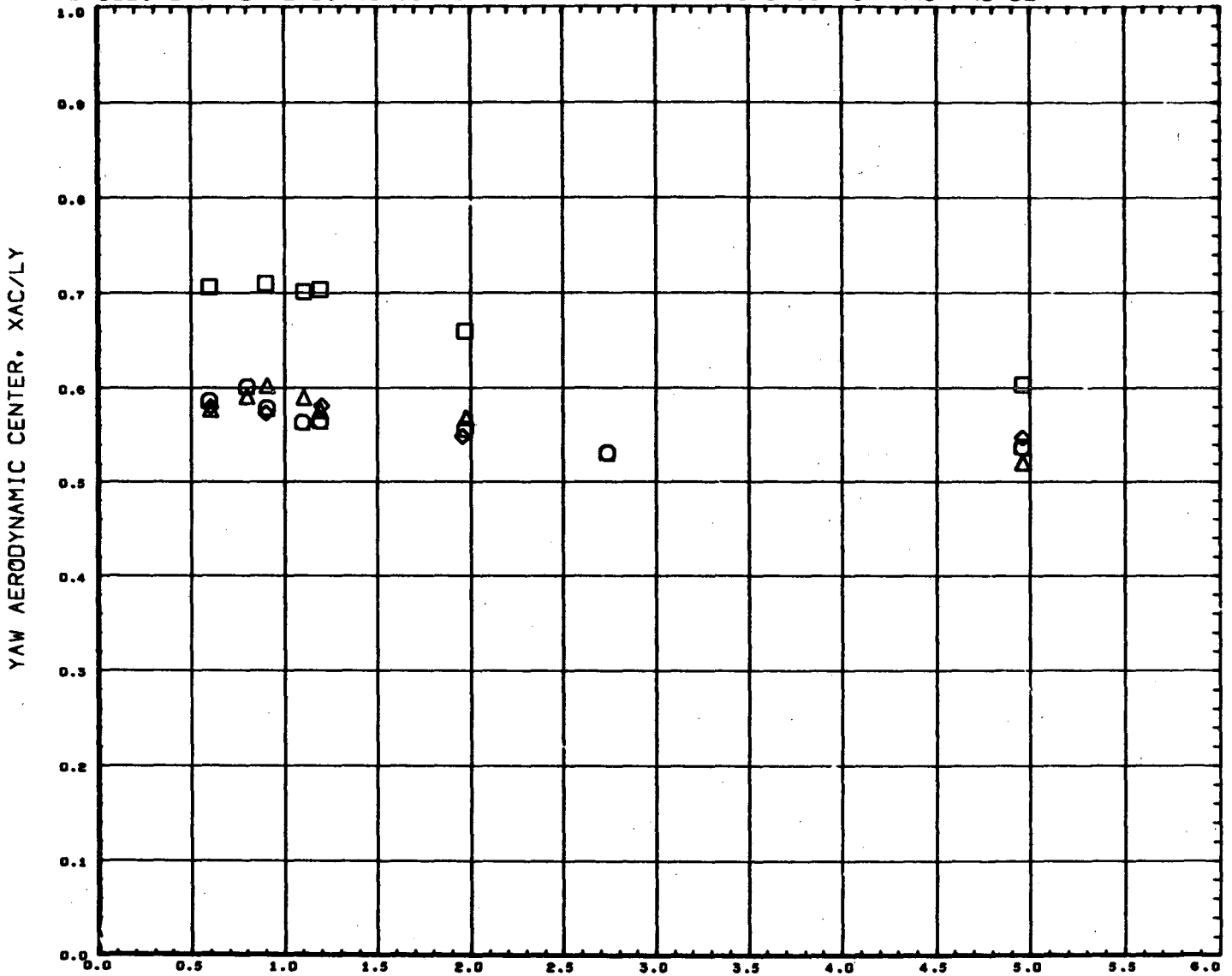

DATA SET SYMBOL	CONFIGURATION DESCRIPTION	ORBIT	THETA	ALPHA	REFERENCE INFORMATION
(C65005)	MSFC TWT 534 SHUTTLE LAUNCH	T10181	-1.500 21.000	0.000	SREF 4.8950 SQ. IN
(C65006)	MSFC TWT 534 SHUTTLE LAUNCH	T10181	-1.500 21.000	6.000	LREF 2.6440 IN.
(C65007)	MSFC TWT 534 SHUTTLE LAUNCH	T10181	-1.500 21.000	-6.000	BREF 3.5250 IN.
(C65013)	MSFC TWT 534 SHUTTLE LAUNCH	T10181F1	-1.500 21.000	0.000	XNRP 3.4900 IN.
					YNRP 0.0000 IN.
					ZNRP 0.1616 IN.
					SCALE 0.0034