

1 up

A Reproduced Copy

OF

N72-22904

Reproduced for NASA

*by the*

**NASA Scientific and Technical Information Facility**

*Ed M. Eichmair*

DRL NO: MSC T-575, LINE ITEM 64 MSC - 02467  
CONTRACT NAS9-9953 SD 71-576

# MODULAR space station

PHASE B EXTENSION  
W72-22904

(NASA-CR-115546) MODULAR SPACE STATION  
PHASE B EXTENSION Quarterly Review E.G.  
Cole, et al (North American Rockwell Corp.)  
4 Nov. 1971 301 p

Unclas  
G3/31 25457

## THIRD QUARTERLY REPORT

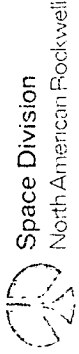

12214 LAKEWOOD BOULEVARD DOWNEY, CALIFORNIA 90241

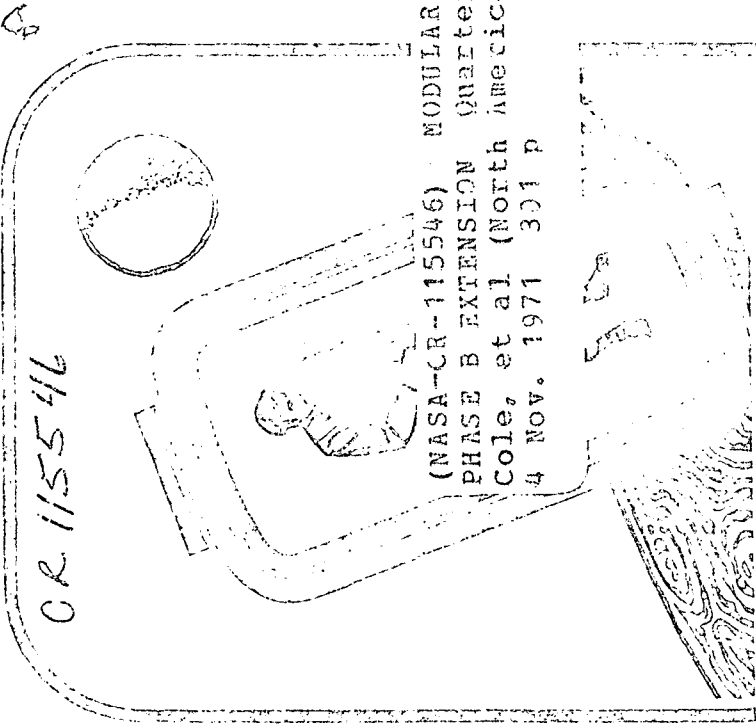

CR 115546

OFFICE OF PRIME RESPONSIBILITY

LA 23

*MT 31*

DRL NO: MSC T-575, LINE ITEM 64  
CONTRACT NAS9-9953

MSC -02467  
SD 71-576

MODULAR SPACE STATION  
PHASE B EXTENSION  
THIRD QUARTERLY REVIEW  
November 4, 1971



Space Division  
North American Rockwell

12214 LAKEWOOD BOULEVARD DOWNEY, CALIFORNIA 90241

TECHNICAL REPORT INDEX/ABSTRACT

PRECEDING PAGE BLANK NOT FILMED

ADDITIONAL REPORT NUMBER	DOCUMENT SECURITY CLASSIFICATION
	UNCLASSIFIED

LIBRARY USE ONLY

TITLE OF DOCUMENT  
 MODULAR SPACE STATION PHASE B EXTENSION  
 THIRD QUARTERLY REPORT

REPORT NUMBER

E.G. COLE, R.A. BERGLUND

ORIGINATING AGENCY AND OTHER SOURCES

SPACE DIVISION  
 NORTH AMERICAN ROCKWELL CORPORATION

DOCUMENT NUMBER

SD71-576

REPORT DATE

4 NOV 71

CONTRACT NUMBER

NAS9-9953

DESCRIPTIVE TERMS

\*MODULAR SPACE STATION, \*PHASE B EXTENSION  
 CONTRACT NAS9-9953

ABSTRACT

THIS DOCUMENT REPRESENTS A COMPILATION OF DATA PRESENTED IN THE  
 MODULAR SPACE STATION PHASE B EXTENSION THIRD QUARTERLY REVIEW,  
 PRESENTED 4 NOVEMBER 1971 AT NASA MANNED SPACECRAFT CENTER,  
 HOUSTON, TEXAS

PRECEDING PAGE BLANK NOT FILMED

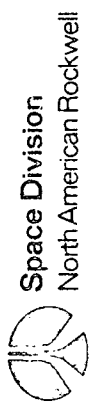

CONTENTS

	Page
SPACE STATION PHASE B SUMMARY . . . . .	1
MODULAR SPACE STATION CONCEPT RECAP . . . . .	21
MODULAR SPACE STATION PRELIMINARY DESIGN . . . . .	51
PRE-MISSION OPERATIONS . . . . .	131
REFERENCE PROGRAMS . . . . .	161
BASELINE PROGRAM COSTS . . . . .	181
SORTIE ANALYSIS . . . . .	201
PROGRAM OPTIONS . . . . .	253
FORECAST FOR THE FUTURE . . . . .	291

# MODUL. SPACE STATION PHASE B EXTENSION

3RD QUARTERLY REVIEW

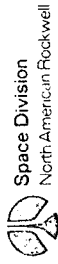
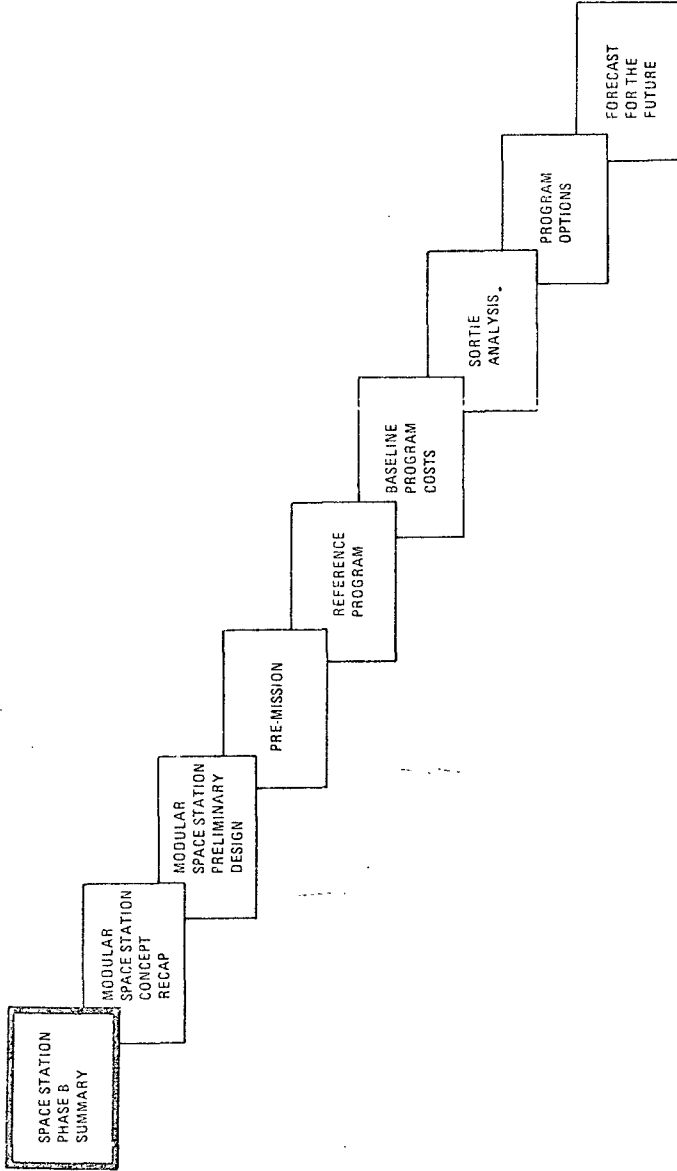



Space Division  
North American Rockwell

#### STUDY PROGRAM EVOLUTION

The initial Phase B definition study of the 33-foot diameter station began in September 1969. The program viewed a large space base becoming operational in the early 1980's. The space station, ready for mission operation in 1975, was a precursor element of the space base. Manned planetary missions were projected for the mid-1980's and both space station and base contributed technology, systems, and modules to these missions.

As the space shuttle program definition progressed, the space station study program changed. In January 1970 the program viewed a large space base in the mid or late 1980's with only a technological relationship to the space station which was to begin operations in 1977. By July of 1970, modular concepts of a space station compatible with space shuttle deliveries were introduced. In March of 1971 the program viewed modular stations in the 1980's preceded by individual shuttle sortie missions.

At this time, November 1971, a number of major program options remain which will be discussed in concluding this presentation.

# STUDY PROGRAM EVOLUTION

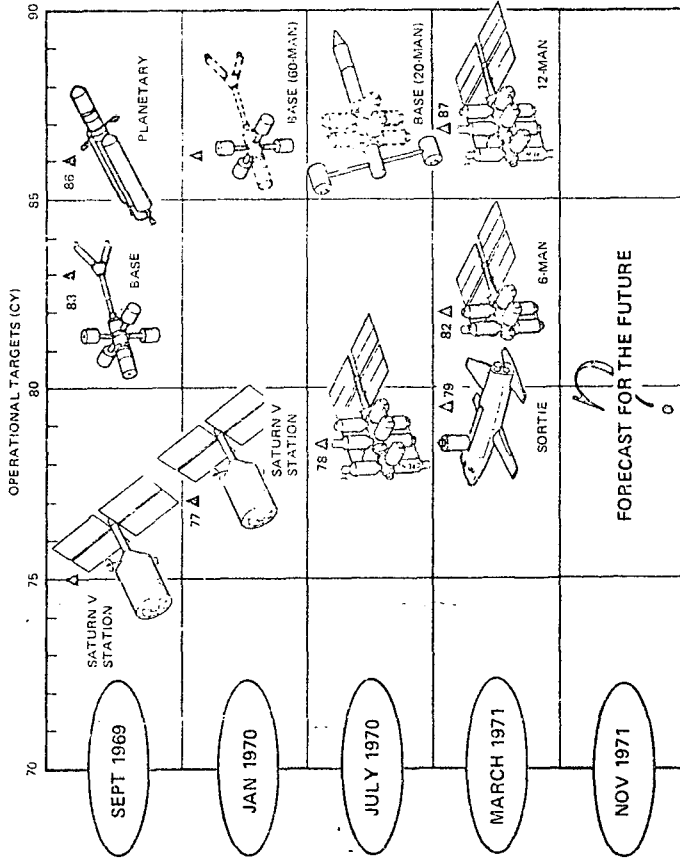





Space Division  
North American Rockwell

#### SOLAR-POWERED STATION

The solar-powered space station was designed as a single self-contained facility with a minimum operating life of 10 years, capable of supporting a crew of 12 for extended periods. The design incorporated a high degree of flexibility and capability to accommodate a multi-disciplinary experiment and applications program. Internal laboratory capability was provided, including experiment airlocks, for general-purpose applications. Subsystem support accommodated operation of special-purpose experiment modules either attached to the station or as free-flying modules.

The solar array/battery system provided ample power for operating the experiments and the station subsystems. Provisions were made in the power boom design for maintenance of turret equipment and for replacement of solar arrays. The subsystems in the large core module were arranged to provide two isolatable volumes with redundant access routes to maintain crew safety.

The station module was launched as a complete operable assembly on a single Saturn launch vehicle. The space shuttle provided logistics support for crew, experiments, and experiment module delivery.

# SOLAR-POWERED STATION

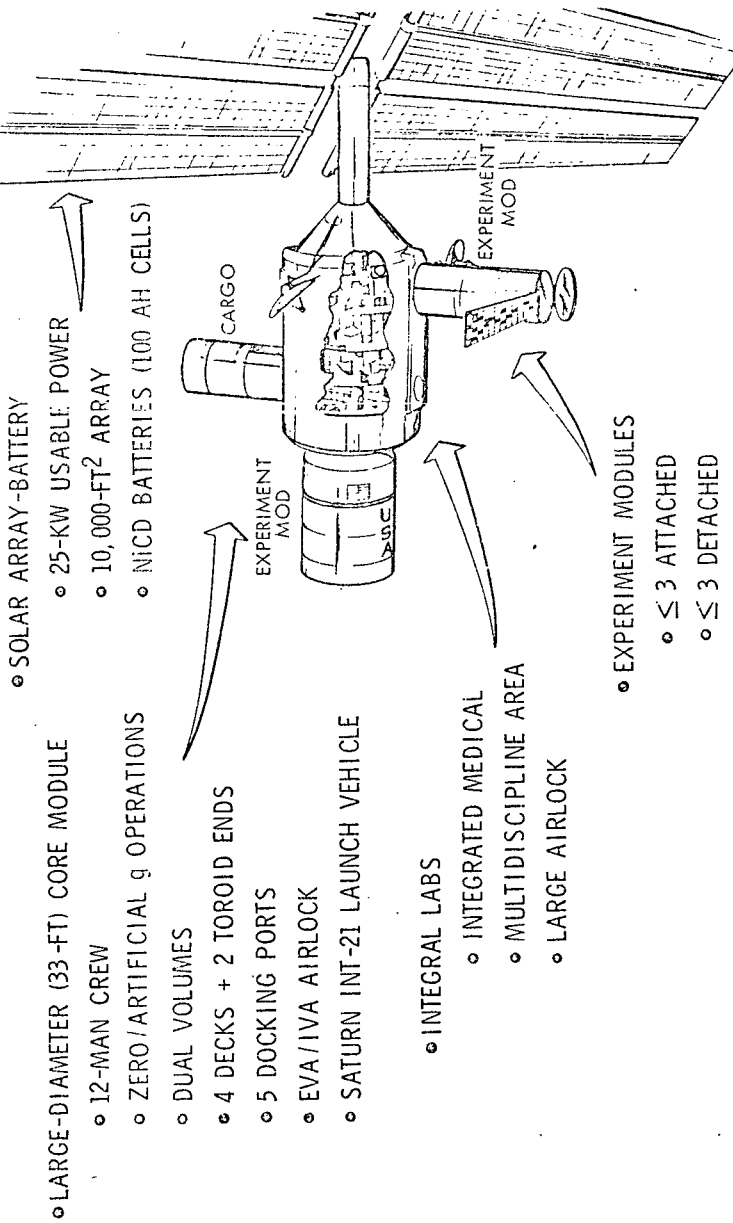

- LARGE-DIAMETER (33-FT) CORE MODULE
- 12-MAN CREW
- ZERO/ARTIFICIAL g OPERATIONS
- DUAL VOLUMES
- 4 DECKS + 2 TOROID ENDS
- 5 DOCKING PORTS
- EVA/IVA AIRLOCK
- SATURN INT-21 LAUNCH VEHICLE

- INTEGRAL LABS
  - INTEGRATED MEDICAL
  - MULTIDISCIPLINE AREA
  - LARGE AIRLOCK

- EXPERIMENT MODULES
  - ≤ 3 ATTACHED
  - ≤ 3 DETACHED



Space Division  
North American Rockwell

#### NUCLEAR POWERED STATION

The nuclear-powered space station design utilized the same large-diameter core module design as the solar-powered station and was designed to the same program requirements. A zirconium hydride (ZrH) reactor was used to generate 126 kilowatts of thermal energy which was converted into electrical energy by gas turbine-driven generators (Brayton conversion cycle).

The reactor and its associated shielding, including a water tank to provide flexibility for augmenting the solid shielding for environmental protection, was packaged into a single module. A large separation distance from the crew was required to obtain feasible shielding weights. The Brayton cycle conversion equipment was packaged in a separate module and was designed for on-orbit maintenance of equipment. The two power modules and the boom attaching them to the core module were delivered by shuttle flights and assembled sequentially to the large-diameter core. A fuel cell secondary power system provided the primary energy during the assembly period.

# NUCLEAR-POWERED STATION

- LARGE-DIAMETER (83-FEET) CORE MODULE
  - 12-MAN, SAME AS SOLAR-POWERED STATION
  - SATURN INT-21 LAUNCH VEHICLE

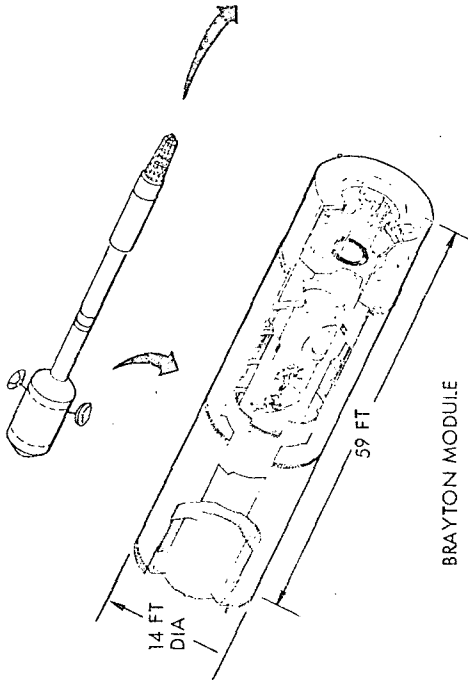

## BRAYTON MODULE

- $\geq 25$ -KW USABLE POWER
- HIGH-EFFICIENCY (25.8%) CONVERSION
- MAINTAINABLE ON ORBIT
- SHUTTLE-DELIVERED

## • REACTOR MODULE

- ZrH REACTOR ~ 126K WT (SNAP 8 REF)
- WATER-AUGMENTED SHIELD
- SHUTTLE-DELIVERED & REPLACED

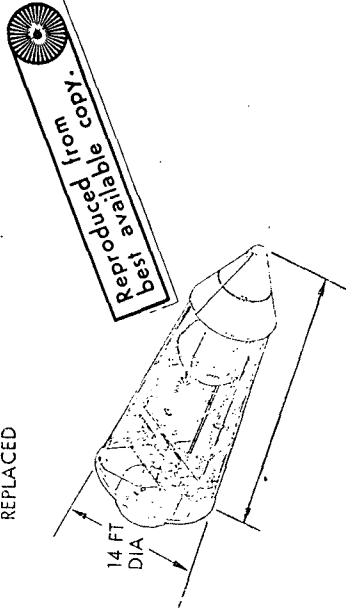

Reproduced from  
Best available copy.



Space Division  
North American Rockwell

#### RADIOISOTOPE-POWERED STATION

The radioisotope-powered space station utilized the same large-diameter core module design as the solar-powered station and was designed to the same program requirements. Plutonium 238 was used as the energy source. The emitted alpha particles and gamma rays were absorbed in the fuel material to produce thermal energy. The plutonium fuel was encapsulated into a number of small units and grouped into a heat source package then installed in an aero shell to protect it from dispersing during atmospheric entry. Two of these heat source reentry vehicle assemblies were used as the power source. Gas turbine-driven generators converted (Brayton cycle) the thermal energy into electrical power.

The complete power system assembly was installed in a boom extending from the large diameter core a sufficient distance to achieve adequate radiation protection. The large core and radioisotope-Brayton power boom were launched on a single Saturn launch vehicle.

# RADIOISOTOPE - POWERED STATION

- LARGE-DIAMETER (33-FT) CORE MODULE
  - \* 12-MAN, SAME AS SOLAR POWERED
  - SINGLE SATURN INT-21 LAUNCH VEHICLE
- RADIOISOTOPE-BRAYTON POWER BOOM
  - EQUIVALENT 25-KW USABLE POWER
  - HIGH-EFFICIENCY CONVERSION
  - WATER-AUGMENTED SHIELD FOR MAINTENANCE
  - ON-ORBIT MAINTENANCE

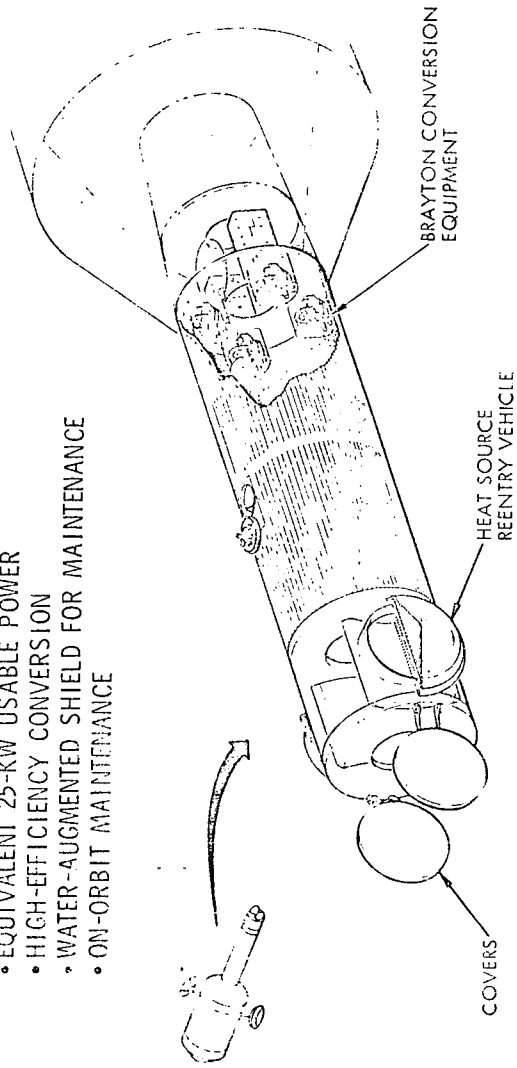



Space Division  
North American Rockwell

#### LARGE CORE MODULAR STATION

A Phase A design analysis was accomplished for a 22-foot-diameter core module station system. The station provided capability for multidisciplinary research and application activities, and the system provided a minimum operating life of 10 years. However, the crew size requirement was different; the 22-foot-diameter core was capable of supporting a crew of six.

The 22-foot-diameter core module contained general-purpose experiment laboratory facilities, crew living quarters, and control centers. The module design was arranged to provide two isolatable volumes with subsystems installed that were directly associated with the internal facilities. A major portion of the subsystem assemblies were installed in replaceable modules that were attached at docking ports. The assemblies were separated into two modules to provide safe, continued operation of either of the dual volumes.

A "Skylab" Saturn launch vehicle delivered the large-core module, power module, and one subsystems module to orbit. The space shuttle delivered the second subsystems module and the initial crew to activate the station.

# LARGE CORE MODULAR STATION

- o LARGE-DIAMETER (22-FT) CORE MODULE
  - o 6-MAN CREW SIZE
  - o INTEGRAL LABS
  - o ATTACHED/DETACHED RAMS
  - o DUAL HABITABLE VOLUMES
- o SOLAR ARRAY-BATTERY POWER
  - o REPLACEABLE POWER BOOM
- o SATURN INT-21 LAUNCH VEHICLE
  - o CORE, POWER, SSM-1\*

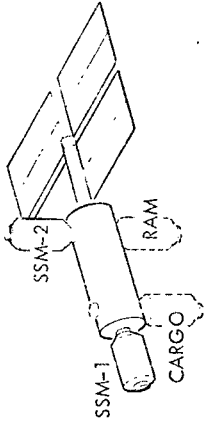

- o SUBSYSTEM MODULES (SSM)
  - o SHUTTLE DELIVERY/REPLACEMENT
  - o REDUNDANCY
- o SSM-1 IN VOL-1
- o SSM-2 IN VOL-2
- o ECLSS & EPS ASSEMBLIES

\*SSM = SUBSYSTEM MODULE







Space Division  
North American Rockwell

#### MODULAR SPACE STATION CONFIGURATION CLASSES

Thirteen configuration alternatives were synthesized during the early portion of the Modular Space Station Phase A study. These alternatives were derived to investigate the issues associated with (1) module clearance, (2) heat rejection and flight mode flexibility, (3) aerodynamic balance, (4) commonality, (5) centralization, (6) dual egress, (7) stiffness, (8) traffic patterns, (9) balanced inertias, and (10) assembly and replacement. The configuration alternatives were arranged into four classes as the initial step in the evaluation process. The Open Class is characterized by a central core with crew and experiment facility modules end-docked. The Closed Class candidates are more difficult for assembly and removal of modules; however, they offer unique safety features in addition to not requiring a central nonreturnable core. The Cluster Class, with closely concentrated mass distribution, minimizes the propellant consumption (for specific flight modes) in addition to affording transverse floor orientation. The Hybrid Class exhibits features of each of the other classes.

# MSS CONFIGURATION CLASSES

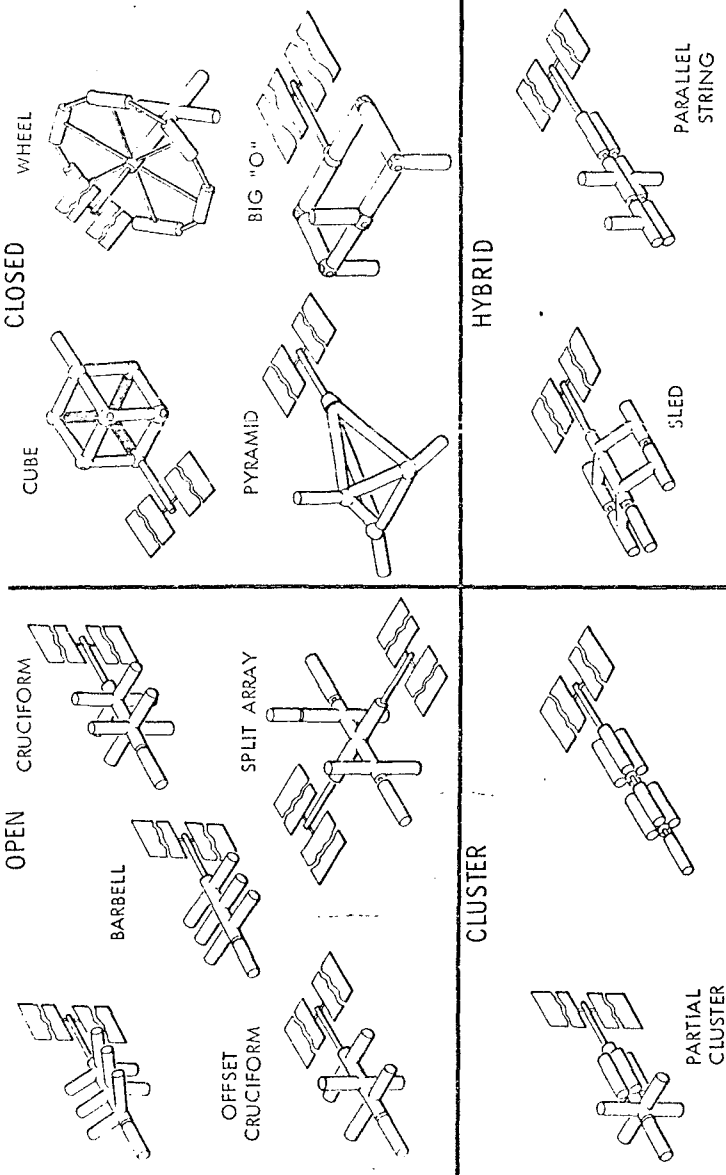



Space Division  
North American Rockwell

#### MODULAR SPACE STATION PHASE A RESULTS

The 13 configurational alternatives were reduced by first making quantitative comparisons within each class and second by a quantitative and qualitative comparison of classes. The Open Class was selected for further study with the specific assembly and removal features of the Closed Class also retained for subsequent comparison before final concept selection. Analysis of the Cluster and Hybrid classes was not pursued as no significant advantage was identified.

Three distinct program options were derived and evaluated in terms of cost and experiment benefits and utility. The four-plateau option affords the lowest peak annual funding with reasonable experiment utility and benefits. The early two-plateau options had the highest achievements; however, they also required a higher peak annual funding.

Analyses of the 1969 Blue Book experiment objectives showed that a crew of eight men could satisfy all objectives within a ten-year program.

# MODULAR SPACE STATION PHASE A RESULTS

## SYSTEM CONFIGURATION

### CONSIDERATIONS

- ASSEMBLY COMPLEXITY
- INITIAL/GROWTH FLEXIBILITY
- FLIGHT MODE SENSITIVITY
- OPERATIONAL COMPLEXITY
- HEAT REJECTION
- SAFETY

### CONCLUSIONS

- OPEN CLASS (BARBELL, CRUCIFORM, TRIMASS) MINIMIZE DESIGN, ASSEMBLY, OPERATIONAL COMPLEXITY
  - REQUIRES SPECIAL-DEVICE APPROACH
  - DUAL SHIRTSLEEVE EGRESS CRITERIA
- CLOSED CLASS PROVIDES DUAL SHIRTSLEEVE EGRESS
  - COMPLEX DESIGN AND ASSEMBLY
  - COMPLEX GROWTH FROM INITIAL
- CLUSTER AND HYBRID CLASSES - NO SIGNIFICANT ADVANCES
  - COMPLEX ASSEMBLY AND BUILDUP

## PROGRAM APPROACH

### ISSUES

- FUNDING REQUIREMENTS
- ACHIEVEMENTS

### CAPABILITY BUILDUP OPTIONS

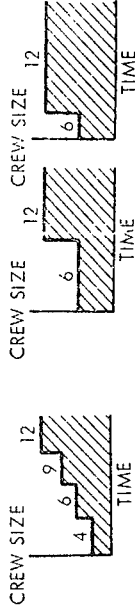

### CONCLUSIONS

- △ LOWEST FUNDING PEAK
- △ REASONABLE ACHIEVEMENTS

- △ HIGHEST FUNDING PEAK
- △ HIGHEST ACHIEVEMENTS



Space Division  
North American Rockwell



Space Division  
North American Rockwell

#### MODULAR SPACE STATION PHASE B STARTING POINT

Both the cruciform and barbell configurational alternatives are members of the Open Class. The cruciform was selected for concept definition during the Phase A study. However, the study pointed out that the same station modules (CQM 1, CQM 2, CCM 1, and CCM 2) could be reconfigured to a barbell with the major configuration change being the core module design. The Phase B study was initiated with the barbell configuration with the added consideration of a manipulator which was not part of the Phase A. The major differences between the concepts (other than core modules) are associated with RAM location and viewing, natural frequency (stiffness), flight mode sensitivities, and reconfigurations for growth. The guidelines required a two-step--six-man initial and 12-man Growth--buildup program with a 5-year life at the six-man Initial level.

# MODULAR SPACE STATION

## PHASE B STARTING POINT

### PHASE A CONFIGURATION RESULTS

#### CRUCIFORM CONCEPT

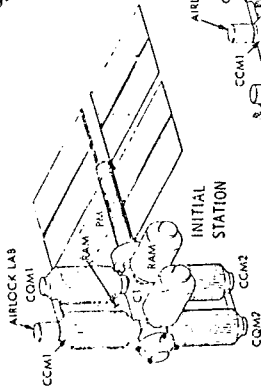

#### BARBELL CONCEPT

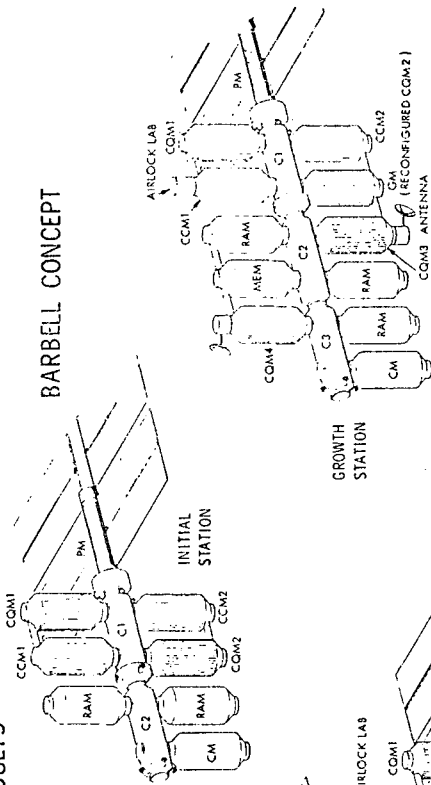

#### PHASE B START

- BARBELL CONFIGURATION WITH MANIPULATOR
- TRADE WITH OTHERS WHERE SIGNIFICANT ISSUES EVOLVE
- TWO-STEP (6, 12) PROGRAM BUILDUP

#### GROWTH STATION

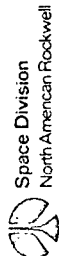
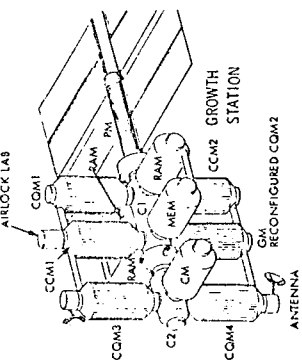



Space Division  
North American Rockwell

#### MSS PHASE B SUMMARY SCHEDULE

During the reporting period the preliminary design and sortie mission analysis tasks were completed. An impact assessment on the resultant effect of shuttle payload length and diameter reductions was completed and documented. An added task, related to synthesis of various program options, was conducted and evaluated in conjunction with the baseline program. The full-scale mockup is on target for a completion of mid-November and a NASA review 8 December 1971. All documentation will be delivered by 17 January 1972.

# MSS PHASE B SUMMARY SCHEDULE

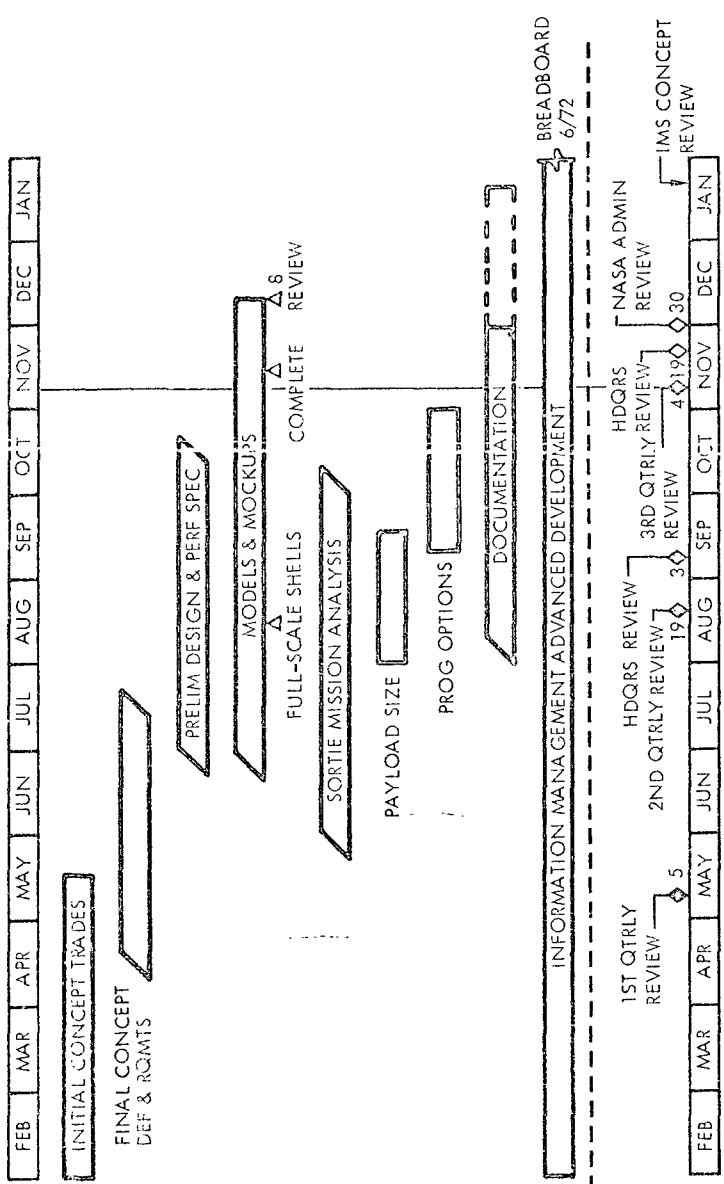

Space Division  
North American Rockwell



PRECEDING PAGE BLANK NOT FILMED  
MODULAR SPACE STATION PHASE B EXTENSION

3RD QUARTERLY REVIEW

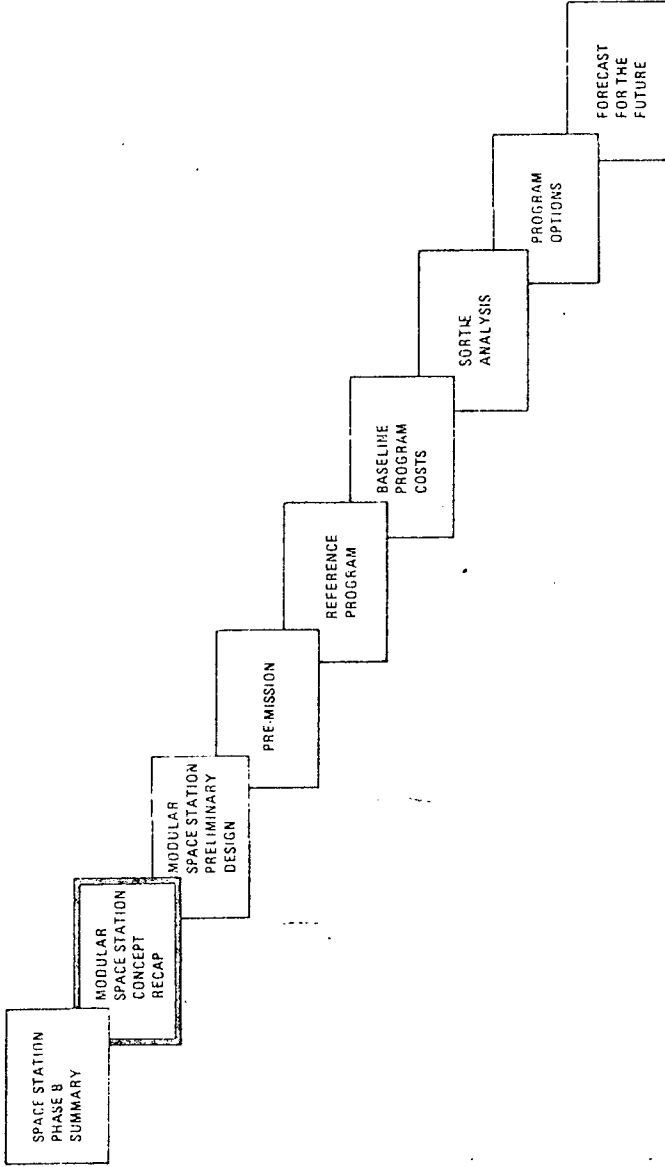



Space Division  
North American Rockwell

#### CONCEPT DEFINITION SUMMARY - STARTING POINT

As denoted, a pure barbell configuration (i.e., all modules in single plane on cores) was utilized as the starting point for trades and analysis for the Phase B MSS definition study. This was done to analyze other configurations as potential solutions to problem areas that may evolve. Sub-system options were evaluated based on cost, operations, maintenance, and buildup considerations to establish the configuration and attendant subsystems which, from an integrated standpoint, would satisfy best the system requirements and, hence, would be used for preliminary design.

# CONCEPT DEFINITION

## STARTING POINT

### CONFIGURATION

- OPTIMIZED FOR GROWTH
- BERTH ONLY
- ALL MODULES IN SINGLE PLANE

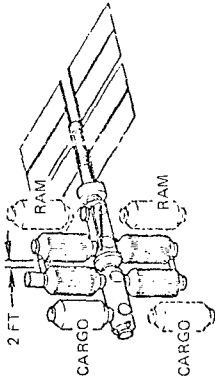

### SECONDARY & EMERGENCY POWER

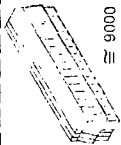

FUEL CELLS



### EPS/RCS/ECLSS GAS STORAGE



CARGO MODULE

CRYO  
O<sub>2</sub>/H<sub>2</sub>/N<sub>2</sub>



POWER BOOM

### THERMAL CONCEPT

CENTRAL OR INDEPENDENT

ACTIVE OR PASSIVE

SINGLE LOOP OR DUAL LOOP

### DPA CONCEPT

FEDERATED

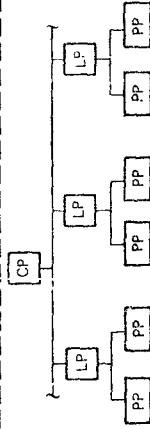

Space Division  
North American Rockwell



Space Division  
North American Rockwell

#### EXPERIMENT CAPABILITY REQUIREMENTS STUDY

This chart summarizes the analyses which led to the present experiment accommodation concept. The general-purpose laboratory (GPL) provides functional support to a variety of experiments. This includes such activities as maintenance, calibration, and data processing and analysis. In addition, it provides utilities and operating volume for all experiments not assigned to a RAM. The GPL analysis identified sufficient commonality among experiment and experiment support functional requirements to effect a significant reduction in equipment redundancy.

Experiments to be performed in the GPL or in RAM's are accomplished in laboratories whose capabilities evolved during the MSS program. In general, more costly experiment provisions were deferred to later phases of the program to reduce early costs. Also, alternative means of accommodation were defined for experiment requirements which would have a major cost impact on the initial MSS.

In addition to the identification and reduction of costly requirements, other experiment analyses influenced preliminary design. For example, to reduce contamination a rule was adopted as a design requirement that extended periods between effluent dumps be provided. Both local vertical and inertial flight mode capabilities for extended durations were required to permit both earth observation and astronomy experiments.

# EXPERIMENT CAPABILITY REQUIREMENTS STUDY

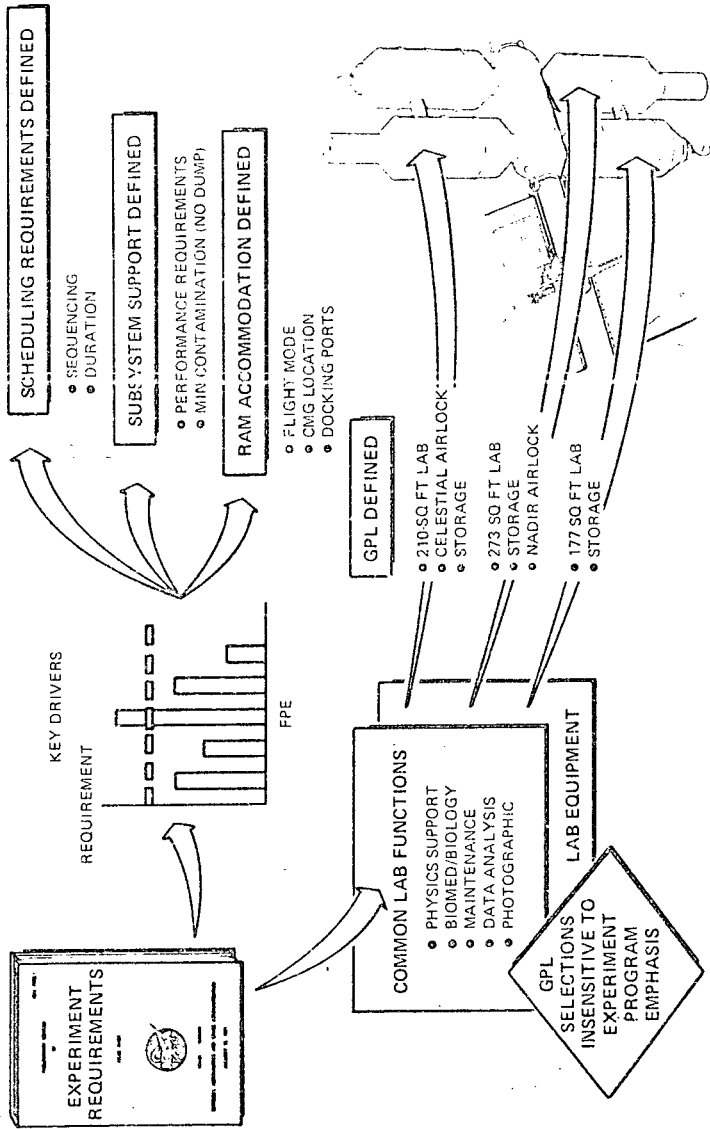



Space Division  
North American Rockwell

#### MAINTENANCE STUDY RESULTS

This chart reflects the results of a major trade study to determine whether maintenance of the MSS could best be satisfied by the removal of a module for ground repair or maximizing the capability for in-flight repair. As noted, module removal imposes severe penalties at the subassembly and lower levels in order to assure that at the module level the mean-time-between-failure (MTBF) is high enough (approximately 5 years) to preclude exceeding available shuttle launches during buildup. These penalties are manifested in the requirement for increases in active and standby redundancy with attendant increases in program costs. While previous data have shown that in-flight maintenance is the desired direction, there are difficult design solutions which must be considered. These are the design of major structural assemblies (seals, primary structures), complex or location-constrained assemblies (insulation panels), and equipment that is hazardous to remove or replace. In addition to the difficulty of design, there is the high probability of EVA being required to support some maintenance activities. The analysis concluded that the system be designed for on-orbit maintenance with a capability being provided for module return as an unscheduled event. Specific design criteria have been established to satisfy these requirements.

# MAINTENANCE STUDY RESULTS

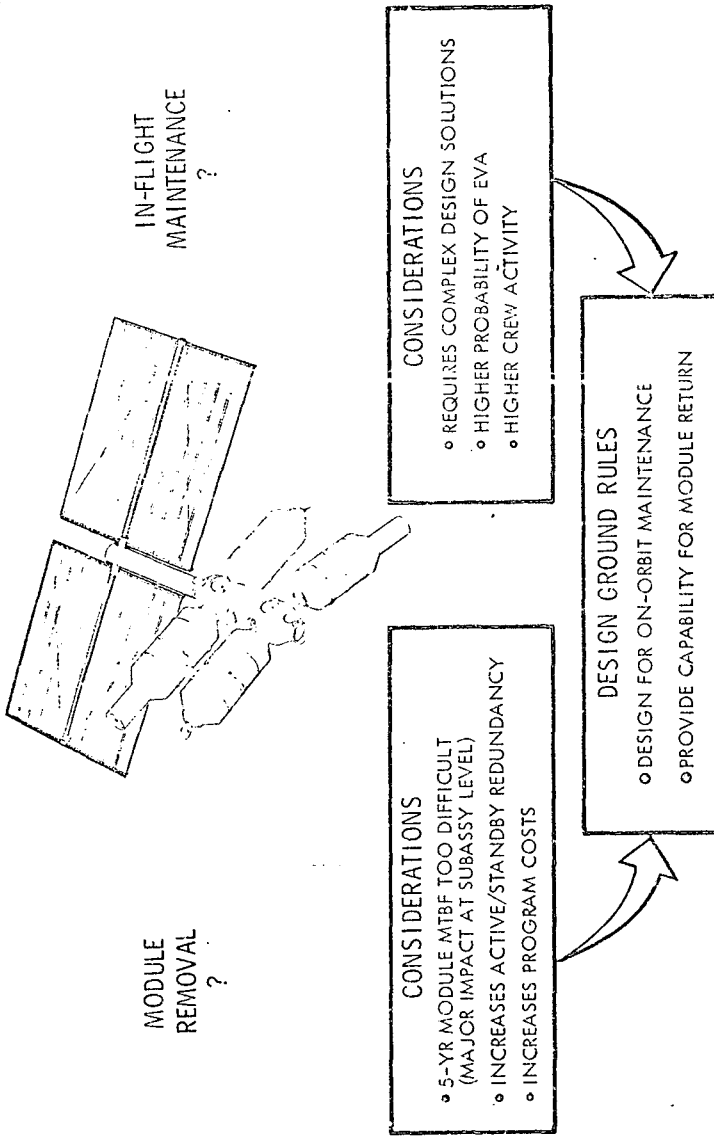

MODULE  
REMOVAL  
?

IN-FLIGHT  
MAINTENANCE  
?

## CONSIDERATIONS

- 5-YR MODULE MTBF TOO DIFFICULT (MAJOR IMPACT AT SUBASSY LEVEL)
- INCREASES ACTIVE/STANDBY REDUNDANCY
- INCREASES PROGRAM COSTS

## CONSIDERATIONS

- REQUIRES COMPLEX DESIGN SOLUTIONS
- HIGHER PROBABILITY OF EVA
- HIGHER CREW ACTIVITY

## DESIGN GROUND RULES

- DESIGN FOR ON-ORBIT MAINTENANCE
- PROVIDE CAPABILITY FOR MODULE RETURN



Space Division

North American Rockwell

#### INTEGRATED SUBSYSTEM TRADE RESULTS

The EPS/RCS/ECLSS integrated concept options were developed by first establishing the candidate options of each individual subsystem. Technical trades eliminated some of the options which could not meet the subsystem MSS guidelines and requirements or which imposed large drivers or influences on MSS configuration or mission operations. A matrix of compatible integrated concept options was constructed from the remaining candidate options. Thirteen major integrated subsystem sets with numerous subsets (a total of 41) were identified.

Independent subsystem trades, such as RCS propellant storage location, EPS energy storage, and ECLSS CO<sub>2</sub> removal were conducted. When the results of these trades were applied to the matrix of 41 integrated subsystem concept options, all but nine were eliminated. The nine remaining concept options were:

1. Three cryo H<sub>2</sub>-O<sub>2</sub> RCS options with closed or open O<sub>2</sub> cycle ECLSS and with NiCd batteries or regenerative fuel cells.
2. Four hydrazine RCS concepts, again with open or closed O<sub>2</sub> cycle ECLSS and with NiCd batteries or regenerative fuel cells.
3. Two H<sub>2</sub>O electrolysis RCS concepts with regenerative fuel cells, and with open or closed O<sub>2</sub> ECLSS.

These nine concepts were costed and compared to make the low-cost subsystem selection.



# INTEGRATED SUBSYSTEM TRADE RESULTS

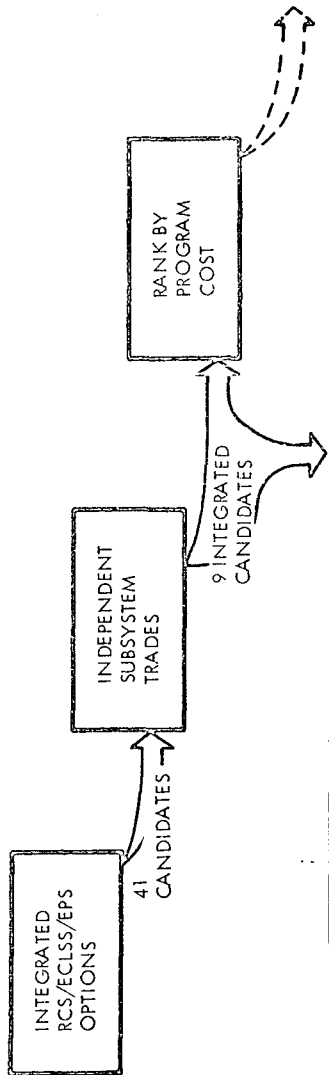

OPTION	RCS	ECLSS	EPS
1-1	CRYO, STA & CM	CLOSED O <sub>2</sub>	NiCd BATTERY
2-2	CRYO O <sub>2</sub> /H <sub>2</sub>	H <sub>2</sub> DEPOLAR.	REGEN FUEL CELL
3-8	CARGO MODULE	OPEN O <sub>2</sub>	NiCd BATTERY
5-3	N <sub>2</sub> F <sub>4</sub>	LiOH	
6-1	CARGO	CLOSED O <sub>2</sub> , H <sub>2</sub> DEP	
6-3	MODULE	N <sub>2</sub> H <sub>4</sub> DISSOCIATION	REGEN
6-4	N <sub>2</sub> H <sub>4</sub> , PACKAGE & RESISTOJET	OPEN O <sub>2</sub>	FUEL
8	WATER	H <sub>2</sub> DEPOLAR.	CELL
11-2	ELECTROLYSIS	CLOSED O <sub>2</sub> H <sub>2</sub> DEP	
		OPEN O <sub>2</sub>	
		H <sub>2</sub> DEPOLAR.	



Space Division  
North American Rockwell

#### INTEGRATED SUBSYSTEM TRADE RESULTS (CONT)

The cost comparison results of the nine options are shown in the bar graph. The shaded areas represent the development cost comparison and the unshaded areas represent the five-year operational costs.

Concepts 11-2 and 8 are the lowest cost concepts with the major difference being the oxygen closure. Concept 8 includes a Sabatier to reduce the CO<sub>2</sub> and recover the O<sub>2</sub>, whereas in Concept 11-2 the CO<sub>2</sub> is vented overboard. The higher venting rates and potential contamination for experiments (13.5 pound/day against 6.6 pounds/day for Concept 8) is a major disadvantage of Concept 11.2. Concept 8 with the closed O<sub>2</sub> ECLSS, which reduces these disadvantages and also maximizes utilization of the ECLSS technology developments, was selected.

# INTEGRATED SUBSYSTEM TRADE RESULTS (CONT)

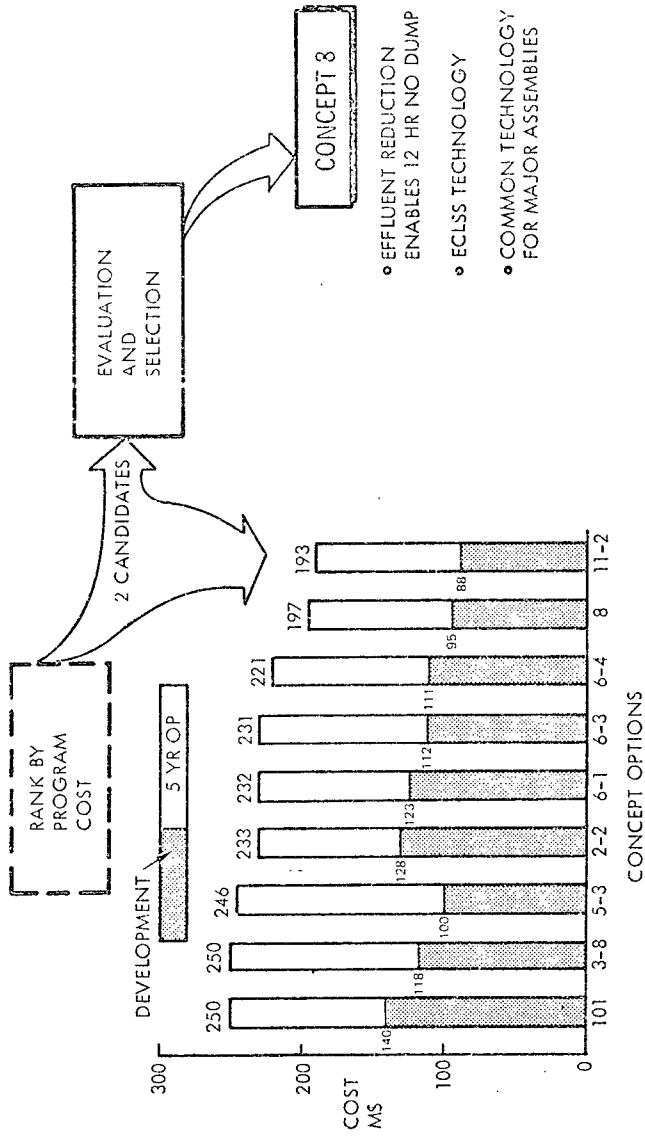

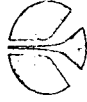

Space Division  
North American Rockwell

#### MANIPULATOR AND BERTH/DOCK TRADE RESULTS

Manipulator studies selected a shuttle-located manipulator in a side and end-berthing mode. Side berthing is dictated by solar array replacement and power module berthing during buildup. Normal RAM operations, cargo resupply operations, and station/core module buildup operations may be accomplished with the shuttle orbiter end-berthed.

Adaptability to a docking mode is retained by maintaining a module spacing of 5 feet and structural provisions for active and passive docking rings.

A berthing baseline is retained and the selection of a berthing or docking mode is a deferrable Phase C option.

# MANIPULATOR & BERTH - DOCK TRADE RESULTS

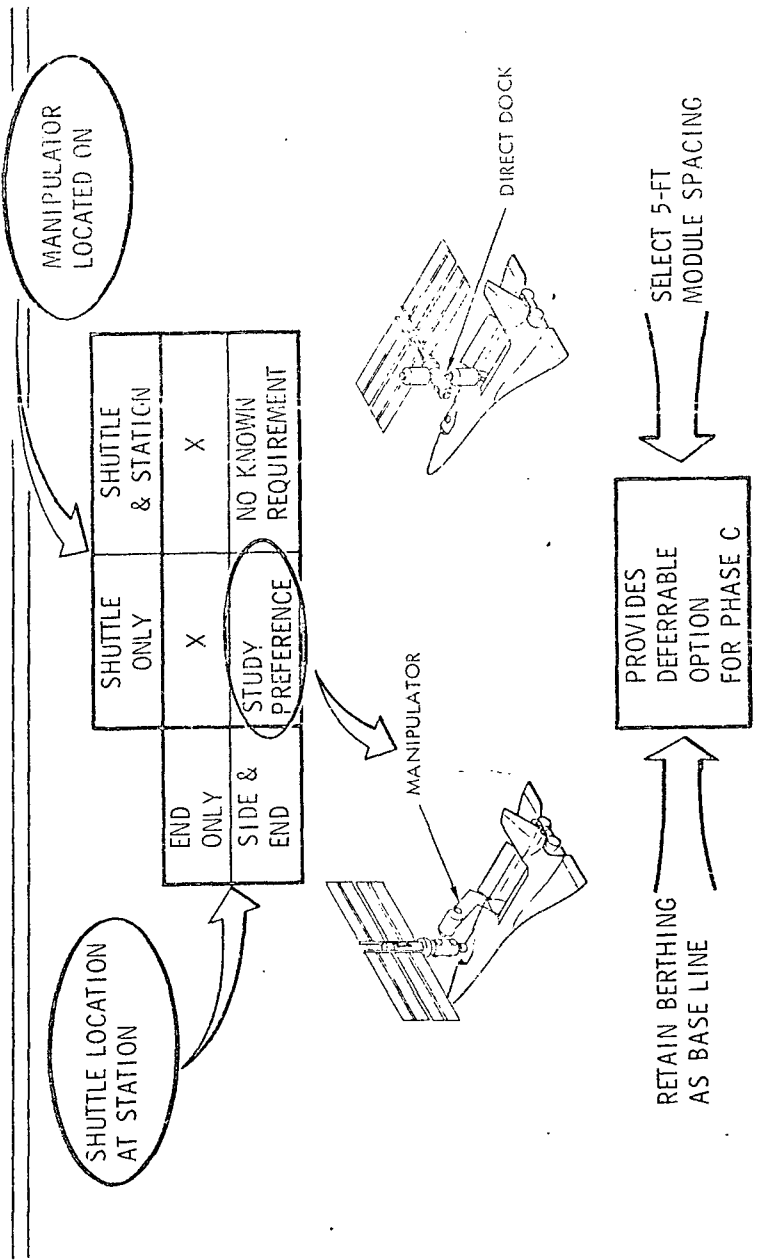



Space Division  
North American Rockwell

#### SAFETY AND FAILURE CRITERIA

Some safety criteria that became major drivers in the station configuration and subsystem trades are identified in this chart.

A primary safety requirement was for a station containing two isolatable volumes with provisions for crew habitability, life support and station controls following the loss of any module or pressurized volume. Safety also dictated the requirement for dual means of egress from all modules; and in the case of inhabited station modules, the requirement included back-up shirtsleeve egress capability to permit rapid escape into the adjacent volume. Alternate airlock capability was required to permit EVA/IVA operations in the event that the normal EVA/IVA airlock should become inoperable.

The failure tolerance criteria became a major driver in establishing subsystem configuration. These were redefined and clarified to relate the criteria to critical functions on a complete station basis. The failure tolerance criteria were further redefined for the buildup period (prior to manning the station) on the basis of capability to perform successful shuttle docking to the portion of the station in orbit and boarding the station shirtsleeve or IVA.

# SAFETY AND FAILURE CRITERIA

**SAFETY:**

- MULTIPLE VOLUMES
- DUAL SHIRTSLEEVE EGRESS
- MINIMUM OF DUAL IVA/EVA ROUTES

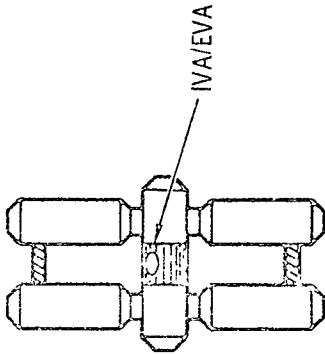

**FAILURE TOLERANCE**

FAILURES	MANNED	BUILDUP (UNMANNED)
1	NOMINAL PERFORMANCE	NOMINAL PERFORMANCE (CAPABLE OF BEING MANNED SHIRTSLEEVE OR IVA)
2	REDUCED CAPABILITY	REDUCED PERFORMANCE (CAPABLE OF BEING MANNED SHIRTSLEEVE OR IVA AT LEAST 96 HR)
3	EMERGENCY - 96-HR (CREW REMOVAL) ABANDON STATION	ABANDON STATION





Space Division  
North American Rockwell

#### INITIAL STATION BUILDUP APPROACH

The initial module to be delivered to orbit preferably has a minimum amount of scar equipment over and above that required for normal operations. In the second quarterly review, it was shown that this objective was best achieved with the core module launched first. This is followed by the power module. These two assembled modules are flown in a gravity gradient mode at minimum (nearly quiescent) power between buildup launches.

A subsequent launch adds the crew/control module. The solar arrays are partially deployed and operated automatically with the now present ISS. The configuration is now flown oriented about the principal axis, and the regenerative segments of the fuel cells are activated. In subsequent sequence, the first lab/ECLSS module, the second lab/ECLSS module, and the second crew/control module are acted at 30 day launch intervals.

Although this chart indicates the numerical sequence of buildup, there are still station module alternate sequence variations that are viable options. An example would be SM-3 before SM-2. This provides a more balanced configuration, but defers the early flexport assembly between SM-1 and SM-2.



# INITIAL STATION BUILDUP APPROACH

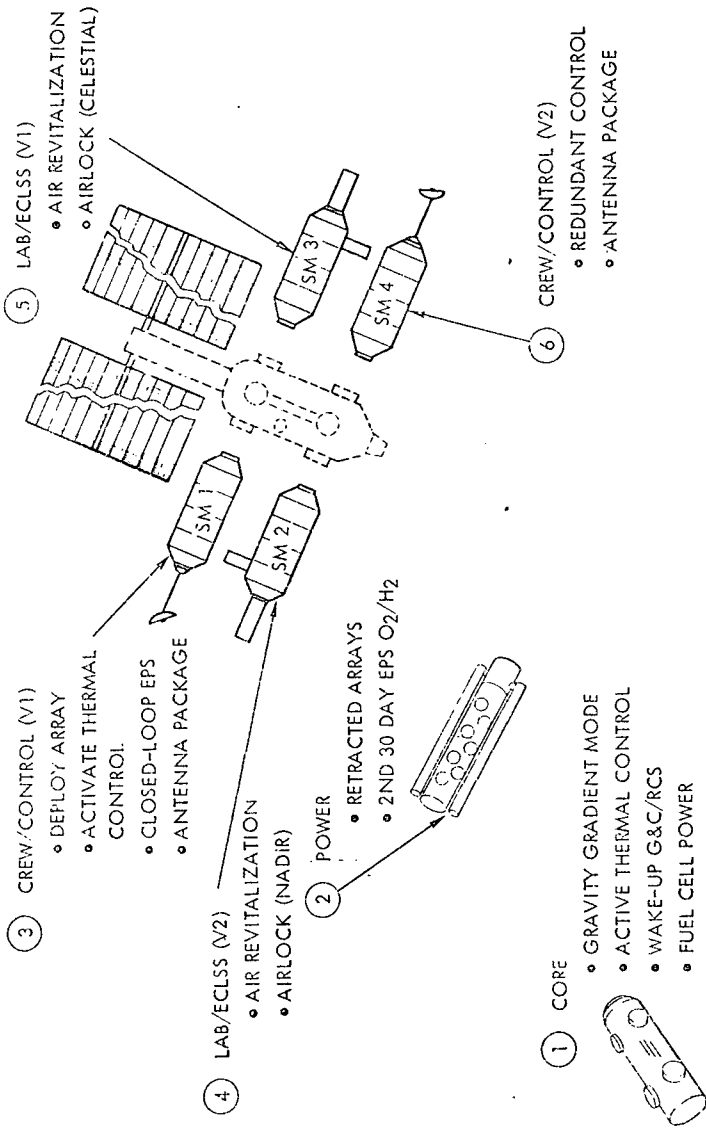



Space Division  
North American Rockwell

#### INITIAL STATION BUILDUP APPROACH. (Cont)

With the addition of a cargo module and the six man crew, the configuration has reached its initial operational capability (IOC).

In addition to the configuration arrangement results shown, two isolatable pressure volumes and dual ingress/egress paths from all station modules (with flexports) and core module are provided. Completely redundant systems provide crew safety and a continuous operation capability which maximizes crew utilization time on-orbit. Station module spacing has been selected (5 feet between modules) to permit direct docking of modules as an alternative to berthing modules with the manipulator. Also, the initial station configuration arrangement allows the best access for later buildup to the growth configuration.



Space Division  
North American Rockwell

#### BUILDUP SEQUENCE--INITIAL MSS

Seven module launches are required to reach the initial operational capability (IOC) of the six-man space station. An initial continuous manning capability exists following the fourth launch. The modular cluster at this point has a minimum of one complete set of subsystems, V<sub>1</sub> and V<sub>2</sub>, and dual egress capability. These modules also include part of the GPL capability.

The sequence of buildup following the first four modules is the second ECS/lab module, the second crew/control module, and the addition of a crew/cargo module. Redundant subsystems and complete general-purpose laboratories are available at this point to begin the program experiment operations.

# INITIAL STATION BUILDUP APPROACH (CONT)

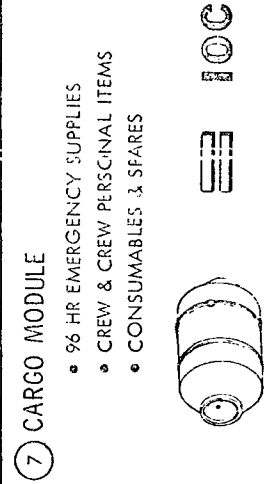

- SIMPLE, LIGHTWEIGHT POWER 300M
- LONG-DURATION UNMANNED CAPABILITY  
(ACTIVATE ONLY BUILDUP ESSENTIAL EQUIPMENT)
- MINIMUM SCAR TO SUBSYSTEMS  
(SEPARATE BUILDUP EQUIPMENT & WIRING)
- EARLY MANNED CAPABILITY  
(AFTER 4TH LAUNCH)

# BUILDUP SEQUENCE-INITIAL MSS

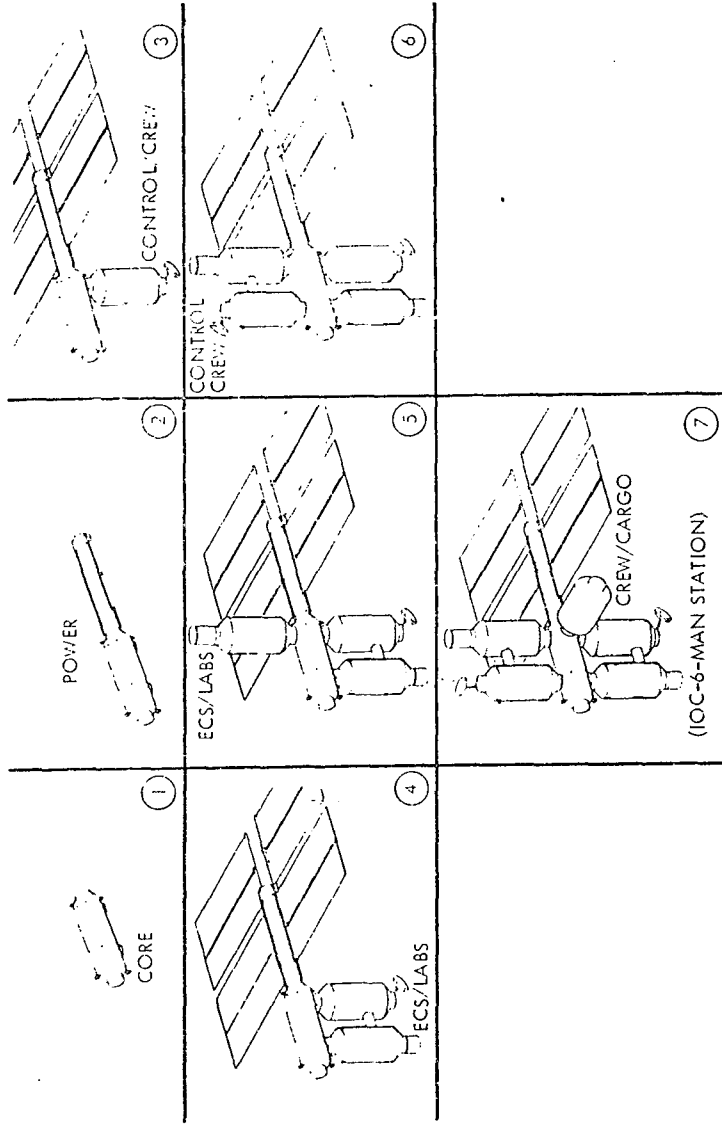



Space Division  
North American Rockwell

### FUNCTIONAL ALLOCATION AND MODULE COMMONALITY

Two basic types of functional station modules evolved during the MSS Phase-B study. Crew and station survival dependent functions were used in developing these module types. Two Type A modules contain identical top deck facilities as follows: (1) crew staterooms, (2) hygiene, and (3) control center. The two Type B modules have identical below-deck air revitalization equipments.

Crew safety considerations forced the duplication of prime functions located in separate pressure volumes. To achieve low cost, commonality of modules was a prime consideration. Through module commonality, manufacturing and checkout are enhanced with associated cost savings realized.

The degree of duplication of prime functions and allocation to station modules was examined from a minimum level (single duplication) to a maximum level (functions duplicated in all station modules). Study results show that single redundant prime functions satisfy crew safety requirements and assure mission continuation at some off-nominal level. The maximum commonality level was rejected because of increased weight (even with resized equipment), space, and equipment utilization.

Final allocation of non-critical functions are made in the preliminary design phase of the study. The functions include galley, dining/recreation, prime and backup medical, and GPL functional areas (photo, data analysis, optical, electrical, mechanical). In allocating the above functions, the following factors were to be considered: Remaining area/volume, shape factors of facilities, traffic patterns, arrangement efficiency (merging facilities, adjacent facilities), experimentation, and weight distribution.

# FUNCTIONAL ALLOCATION AND MODULE COMMONALITY

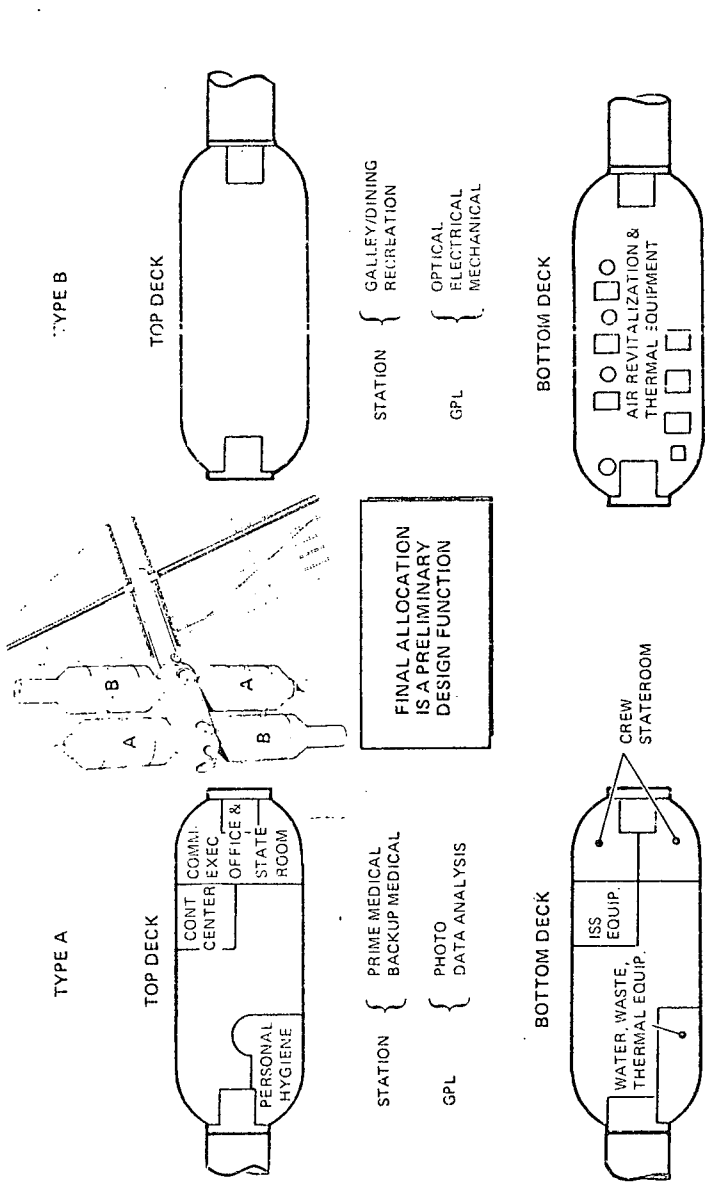



Space Division

North American Rockwell

#### CONCEPT DEFINITION SUMMARY RESULTS

The results of the integrated trades and analysis resulted in the configuration and subsystems selections illustrated. The analysis identified several configuration-dependent issues that were driving the barbell design to a highly complex system. High impulse and momentum exchange requirements were identified for the barbell. The barbell resulted in two core modules for the initial station, resulting in repressurization volume of almost twice that of the cruciform. The selection of regenerative fuel cells, utilizing water electrolysis for reactants, allowed for storage of gasses only and eliminated storage and handling problems attendant to cryogenics. Minimum development, low cost, and relative simplicity led to the thermal concept noted. The re-evaluation of measurement and control requirements during station buildup simplified the DPA by eliminating the need for local processors.



# CONCEPT DEFINITION SUMMARY RESULTS

CONFIGURATION

- OPTIMIZED FOR INITIAL BERTH OR DOCK
- RAMS & CARGO IN HORIZONTAL PLANE

SECONDARY & EMERGENCY POWER

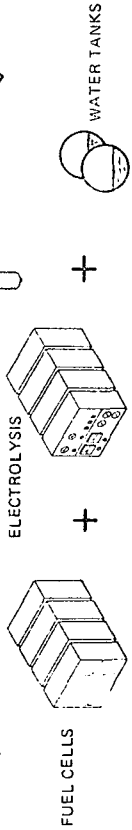

EPS/RCS/ECLSS GAS STORAGE

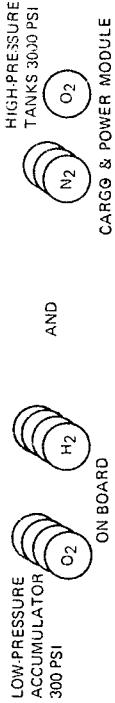

THERMAL CONCEPT

CARGO & POWER MODULE

DPA CONCEPT

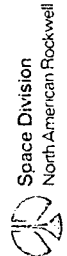
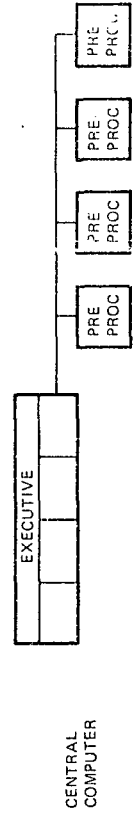



Space Division  
North American Rockwell

#### GROWTH STATION CONCEPT

In order to enhance low development costs for the initial station, the provisions for growth (scars) have been minimized. The two additional station modules utilized for growth have taken maximum advantage of accommodation features developed for the initial station. The ECLSS water management and air revitalization accommodation features from the initial-station, Type B modules and split-level, crew-accommodation features from the Type A modules have been integrated to provide two identical modules necessary for growth operations. Also, a short core module is included to satisfy the additional growth modules (two station plus one additional attached RAM) requirement.

A 10,000 square foot solar array package is included to satisfy growth power needs. This package replaces the 7,000 square foot initial station solar array assembly and retains the power-module boom structure.

As noted, this concept maintains a balanced V1 and V2 to satisfy safety requirements.

# GROW STATION CONCEPT

GOAL: OPTIMIZE FOR INITIAL

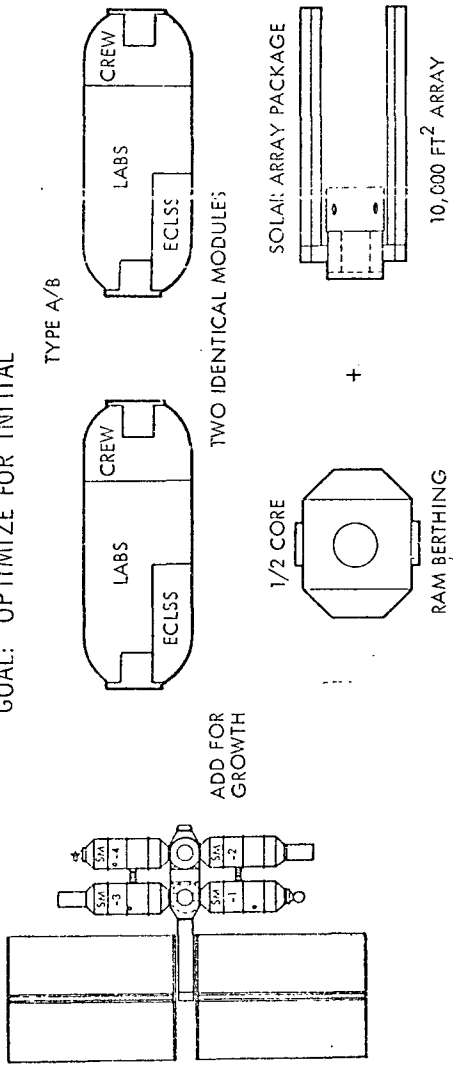

✓ RESULTS IN

- BALANCED V1, V2
  - MINIMUM SCARS IN INITIAL STATION
- OVERSIZED
- EPS - POWER FEEDERS
- ECLSS - THERMAL CONTROL HEADERS

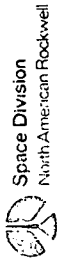



Space Division  
North American Rockwell

#### MAJOR ISSUES FOR PRELIMINARY DESIGN PHASE

The results of trades and analysis leading to preliminary design identified additional issues requiring resolution during the design phase. A means of reducing the launch weight of specific modules below the 20,000-pound design limit requires investigation. This could be accomplished by improved definition of subsystem characteristics and/or re-allocation of assemblies/components to lighter-weight modules or by alternate operational buildup considerations. Solar array replacement, from initial to growth, requires the identification of mechanical and functional interfaces between the solar array assembly and the boom structure and operational considerations for the shuttle transport and installation. Containment of vented gases or other waste products requires understanding in order to minimize contamination of experiment sensors.

# MAJOR ISSUES IN PRELIMINARY DESIGN PHASE

## SYSTEM

- COMPATIBILITY

PERFORMANCE SPEC      DRAWINGS      OPERATIONS

SUBSYSTEM CHARACTERISTICS      WEIGHT STATEMENT      COSTS

- CORE, SM-1, SM-4 OVER 20,000 LB DESIGN GUIDELINE

- LOCATION OF BUILDUP CONSUMABLES

- SOLAR ARRAY REPLACEMENT

## SUBSYSTEM

- EQUIPMENT SIZING & LOCATION

- EFFLUENT CONTAINMENT



# MODULAR SPACE STATION PHASE B EXTENSION

3RD QUARTERLY REVIEW

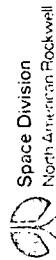
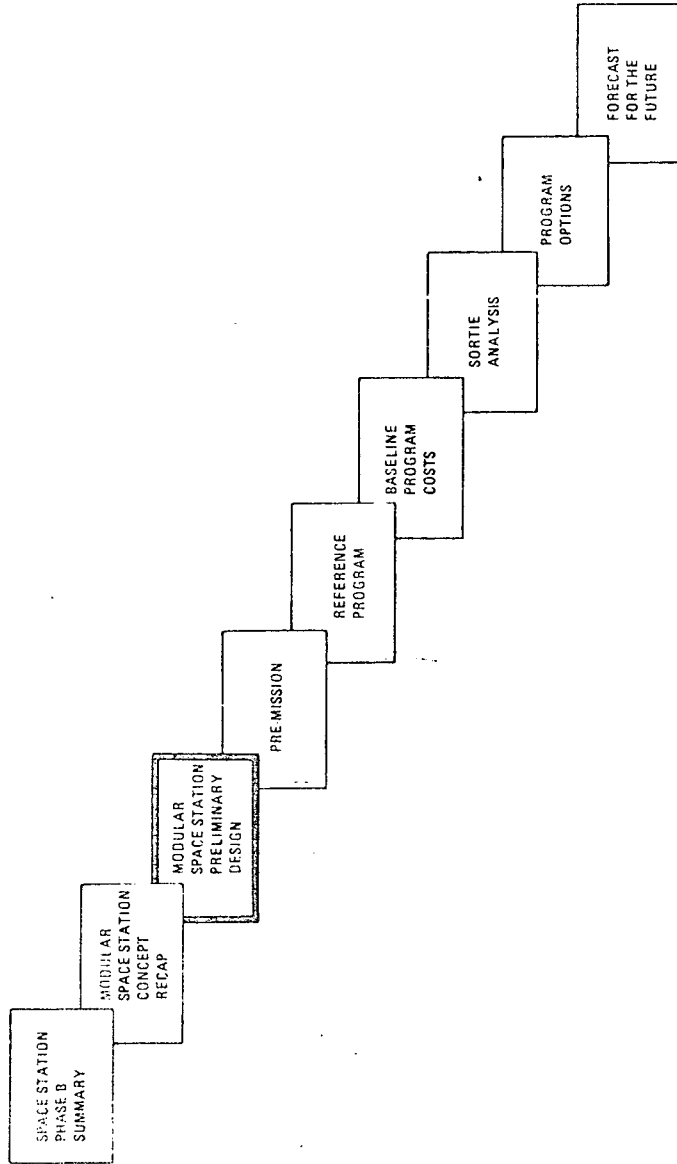



Space Division  
North American Rockwell

#### PRELIMINARY DESIGN CONFIGURATION - INITIAL STATION

The cruciform was selected for the preliminary design configuration, with the RAM's and cargo module located in the Y plane and the station modules in the Z plane. This configuration requires only two special modules (core and power) for the initial station, reduces impulse requirements (propellant usage, gas storage) and momentum exchange level (reduced CMG size and number), and increases stiffness. The location of the station modules was selected for buildup and station operation efficiency.

# PRELIMINARY DESIGN CONFIGURATION INITIAL STATION

• MODULES

- FOUR COMMON STATION MODULES
- TWO SPECIAL MODULES
- ONE CARGO MODULE
- ASSEMBLY/REPLACEMENT
  - MANIPULATOR BERTHING OR DIRECT DOCKING
  - ON-ORBIT REPLACEMENT ANTENNA PACKAGES, EXPERIMENT AIRLOCKS & SOLAR ARRAY

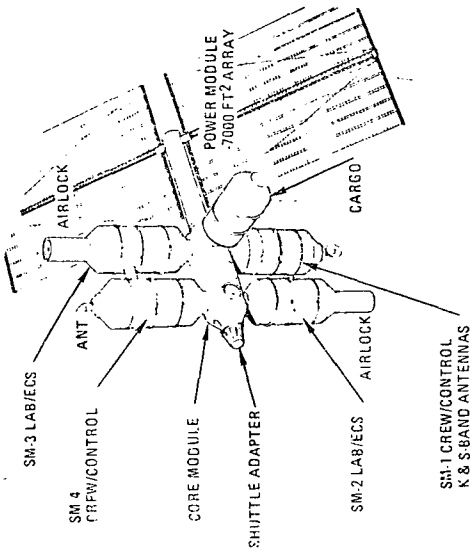

OPERATIONAL CONFIGURATION WITH TWO ATTACHED RAMS

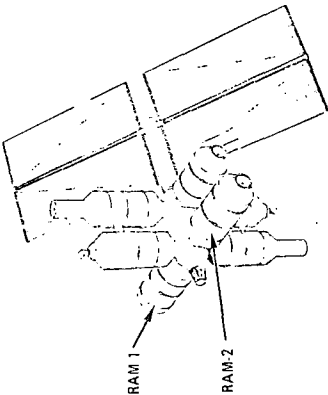

VOLUME ALLOCATION	
• EXPERIMENT ACTIVITY	7649 FT3
• CREW/SUBSYSTEMS	10,648 FT3
• COMMON USAGE	6363 FT3







Space Division  
North American Rockwell

#### INITIAL STATION

The initial station dimensional characteristics are shown on this chart. Dimensions of RAM and cargo elements are potentially the same as those of the station module.

# INITIAL STATION

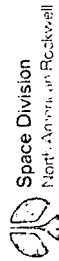
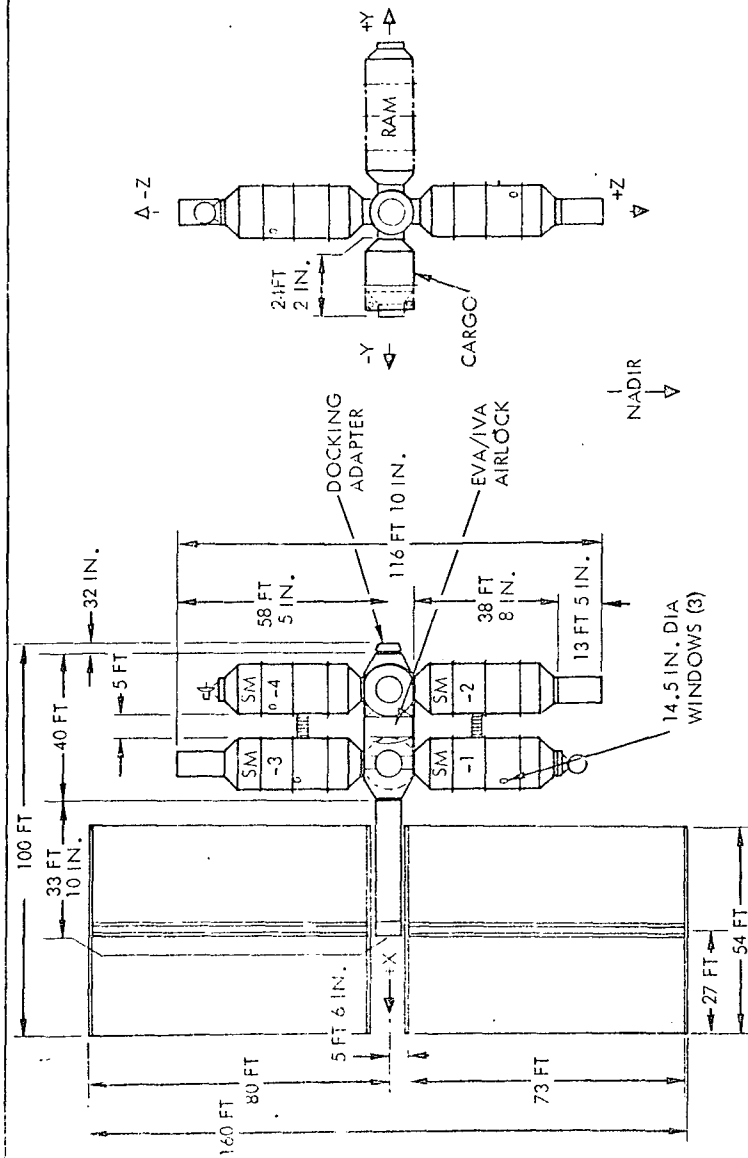



Space Division  
North American Rockwell

#### MSS CONFIGURATION DESIGN FEATURES - SAFETY

Application of safety criteria during the trades and preliminary design resulted in a station configuration with dual habitable volumes, with inhabited station modules connected by means of flexports to adjacent modules to provide alternate shirtsleeve passageways. The combination of flexport and single station module also provided backup airlock capability for IVA between volumes as well as EVA in the case where the normal EVA/IVA airlock might be inoperable.

Subsystem redundancy and installation in the two pressure volumes provided habitability, life support, and station control with any module or volume lost due to depressurization, fire, or presence of hazardous atmosphere.

Additional safety criteria were developed during the study and implemented in the preliminary design. Significant criteria include safety factors of 4.0 for pressure vessels located in inhabited areas, particularly when used as accumulators, and a requirement that all hazardous fluid containers, lines, and components be double contained with provision for venting the intermediate volume to space. The failure tolerance criteria were clarified and related to critical functions on a station-wide basis, both during manned operations and the unmanned buildup period when criticality relates to successful docking with the portion of the station in orbit.

# MSS CONFIGURATION DESIGN FEATURES - SAFETY

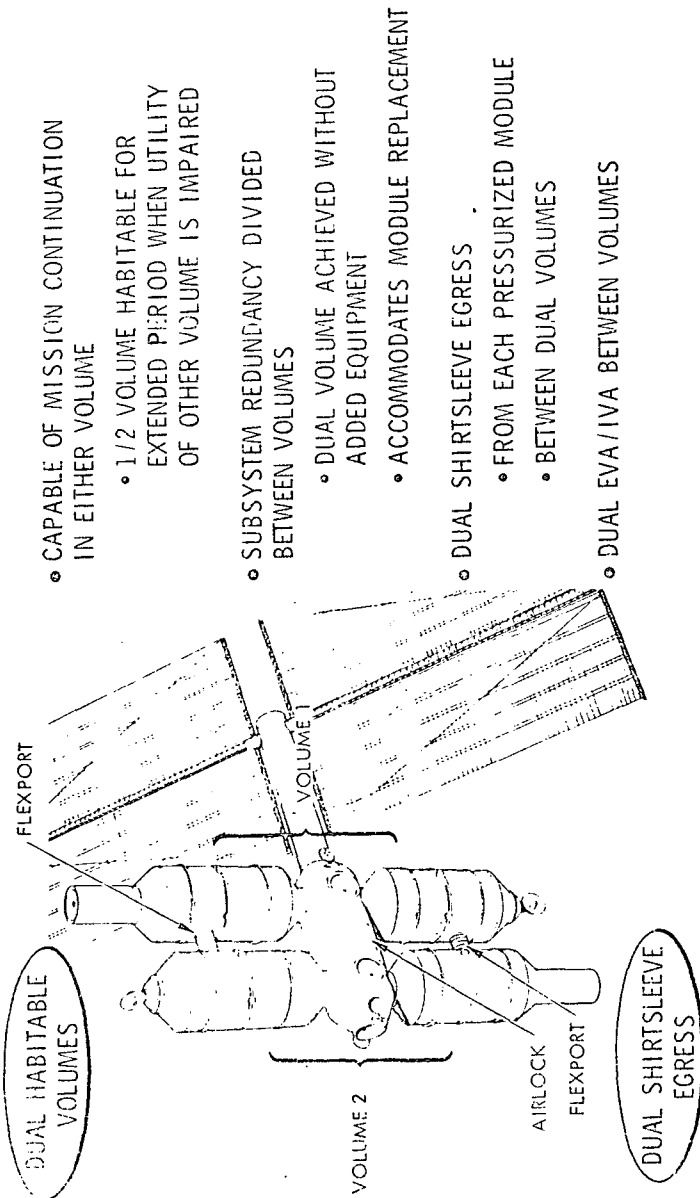

- CAPABLE OF MISSION CONTINUATION IN EITHER VOLUME
  - 1/2 VOLUME HABITABLE FOR EXTENDED PERIOD WHEN UTILITY OF OTHER VOLUME IS IMPAIRED
- SUBSYSTEM REDUNDANCY DIVIDED BETWEEN VOLUMES
  - DUAL VOLUME ACHIEVED WITHOUT ADDED EQUIPMENT
  - ACCOMMODATES MODULE REPLACEMENT
- DUAL SHIRTSLEEVE EGRESS
  - FROM EACH PRESSURIZED MODULE
  - BETWEEN DUAL VOLUMES
- DUAL EVA / IVA BETWEEN VOLUMES



Space Division

North American Rockwell

#### MSS CONFIGURATION DESIGN FEATURES - FLIGHT MODE

The modular space station is capable of maintaining a local vertical hold and an inertial hold flight mode. This provides the basic stable platform mode for earth viewing and solar/stellar viewing instruments, respectively.

The reference flight mode orientation is illustrated on this chart. The X axis is perpendicular to the orbit plane, the Z axis is along the local vertical (down), and the Y axis is opposite to the velocity vector. The flight mode acronym therefore is X-POP, Z-LV, Y-OVV. This mode will be flown at all times except for the short periods or inertial flight for solar/stellar viewing and shuttle approach and berthing/unberthing operations.

The X-POP flight mode is selected based on minimizing solar array shadowing by the station modules, best in-plane ground viewing, best orientation for combined orbit makeup, and control moment gyro desaturation.

# MSS CONFIGURATION DESIGN FEATURES - FLIGHT MODE

## DUAL FLIGHT MODE CAPABILITY

- INERTIAL HOLD
- LOCAL VERTICAL HOLD

- GEOMETRIC AXIS RELATION TO FLIGHT PATH - CONTROLLED, CONSTANT
  - SIMPLIFIES EXPERIMENT EQUIPMENT & COUPLING WITH STATION
  - EXPERIMENT ATTITUDE REFERENCE HELD CONSTANT

## REFERENCE MODE



## VELOCITY DIRECTION ORBITAL PATH

- MINIMUM SOLAR ARRAY SHADOWING
- GOOD EXPERIMENT VIEWING
- GOOD HEAT REJECTION

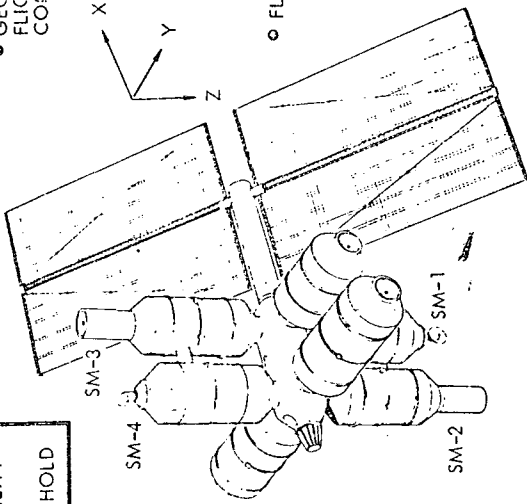

## FLIGHT MODE FLEXIBILITY

- X OR Y PERPENDICULAR TO ORBIT PLANE IN LOCAL VERTICAL HOLD
- EASY, RAPID CONVERSION FROM LOCAL VERTICAL TO INERTIAL MODES





Space Division  
North American Rockwell

#### ASSEMBLY AND BUILDUP APPROACH

All modules will be manufactured, checked out, and launched with complete (wet) subsystems. This approach results in a design which minimizes the impact on station activation for normal subsystem operations.

With all subsystems installed at launch, no internal connection breaks, and fluid lines filled, on-orbit assembly operations are reduced primarily to module-to-module interface connections, verification, and checkout. Other startup operations such as subsystem filling, purging, and recheck are eliminated.

The assembly and buildup approach has been organized to allow only minimum system activation until permanent manning occurs. Only subsystems required to maintain the station in a quiescent mode between launches are activated. Some subsystems are deactivated during quiescent operations (e.g., the reaction control subsystem, most of the ECLS subsystem except for atmosphere and thermal control and internal lighting).

Redundant wakeup receivers provide the communications link from ground or shuttle to the station which has the capability of interrogating subsystem status, turning quiescent systems on and off, and commanding attitude orientation and control, etc.

# ASSEMBLY & BUILDUP APPROACH

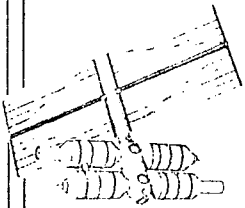

- MODULES MANUFACTURED, CHECKED OUT, & LAUNCHED COMPLETE
- ALL SUBSYSTEMS INSTALLED
- NO INTERNAL CONNECTION BREAKS
- FLUID LINES FILLED

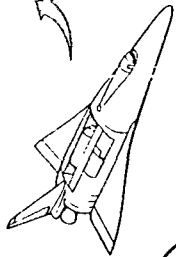

REDUCES ON-ORBIT STARTUP OPERATIONS

- ASSEMBLY TASKS
- COMPLEX FILLING & PURGING
- RE-CHECKOUT

- DESIGN FOR MINIMUM IMPACT ON NORMAL OPERATION SUBSYSTEMS
- LOW-LEVEL SUBSYSTEM ACTIVATION ONLY FUNCTIONS REQUIRED FOR BUILDUP
- UNIQUE BUILDUP EQUIPMENT PACKAGED SEPARATELY

SIMPLIFIED SUBSYSTEM DESIGN

- ELIMINATES UNMANNED OPERATION OF MANNED SUBSYSTEMS
- PROVIDES CAPABILITY TO RETURN TO QUIESCENT MODE



Space Division  
North American Rockwell





Space Division  
North American Rockwell

#### ALTERNATIVE OPERATIONAL MODES

The MSS configuration design is such that it has the capability to operate at either reduced or increased operational levels.

Although station module replacement is not planned, the capability exists for module deactivation, or deactivation and removal with subsequent replacement. Station and limited experiment operations can continue at a reduced level; the worst case operational mode impact is shown on this chart for deactivation/removal of both a crew/control (A) module and an ECLSS/lab (B) module.

The initial modular space station can be operated at increased levels of activity if future studies show this to be practical and feasible for temporary periods. This could be accomplished by adding up to three more crewmen and performing additional experiments or increasing experiment data returns. This operational mode is well within logistics, power, and heat rejection capabilities.

# ALTERNATIVE OPERATIONAL MODES

## REDUCED LEVEL

CONDITION

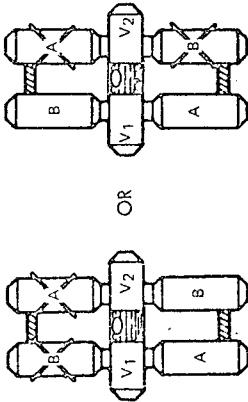

## MODULE DEACTIVATION/REMOVAL

OPERATIONAL MODE

- G&C - NO EFFECT
- RCS - 6-HR ENGINE FIRING INTERVAL
- ISS - SEQUENTIAL CONTRL (STA - EXP - STA ...)
- ECLSS - 4 DAYS TO FIX CO<sub>2</sub> REMOVAL FAILURE BEFORE EMERGENCY
  - DEGRADED HEAT REJECTION }  $\approx 15$  KW
  - DEGRADED POWER LEVEL }
- EPS - EAT RECONSTITUTED FOOD
- CREW - DOUBLE OCCUPANCY
- NO SHOWER

## INCREASED LEVEL

CONDITION

3 ADDED CREWMEN

ADDED EXPERIMENTS

## ADDITIONAL CREW AND EXPERIMENTS

OPERATIONAL MODE

- DOUBLE OCCUPANCY IN 3 STATEROOMS
- INCREASED LOGISTICS FREQUENCY
- 3 KW POWER AVAILABLE
- 3 KW HEAT REJECTION AVAILABLE
- VOLUME AVAILABLE FOR INTEGRAL EXPERIMENTS
- 2 KW ADDED POWER AVAILABLE IN INITIAL PHASE



Space Division  
North American Rockwell



Space Division  
North American Rockwell

#### FINAL FUNCTIONAL ALLOCATION

The station is separated into two basic areas: the normal habitable area (core and station modules) and those areas that are inhabited infrequently (power and cargo modules). All high-pressure gas storage provisions are allocated to the normally uninhabited areas.

The shaded areas of SM-1 and SM-4 are identical (Type A modules) and were established prior to preliminary design. The nonshaded areas represent the noncrew critical functions which are generally not identical. Allocation of these functions is consistent with consideration of remaining area and volume, facility shape factors, arrangement efficiency (merged and adjacent facilities), experimentation utility, traffic patterns, and weight distribution.

SM-2 and SM-3 are primarily dedicated to experiments except for galley/dining provisions. Below-decks allocations for these modules, shown in subsequent charts, have identical subsystem equipment (Type B modules).

# FINAL FUNCTIONAL ALLOCATION

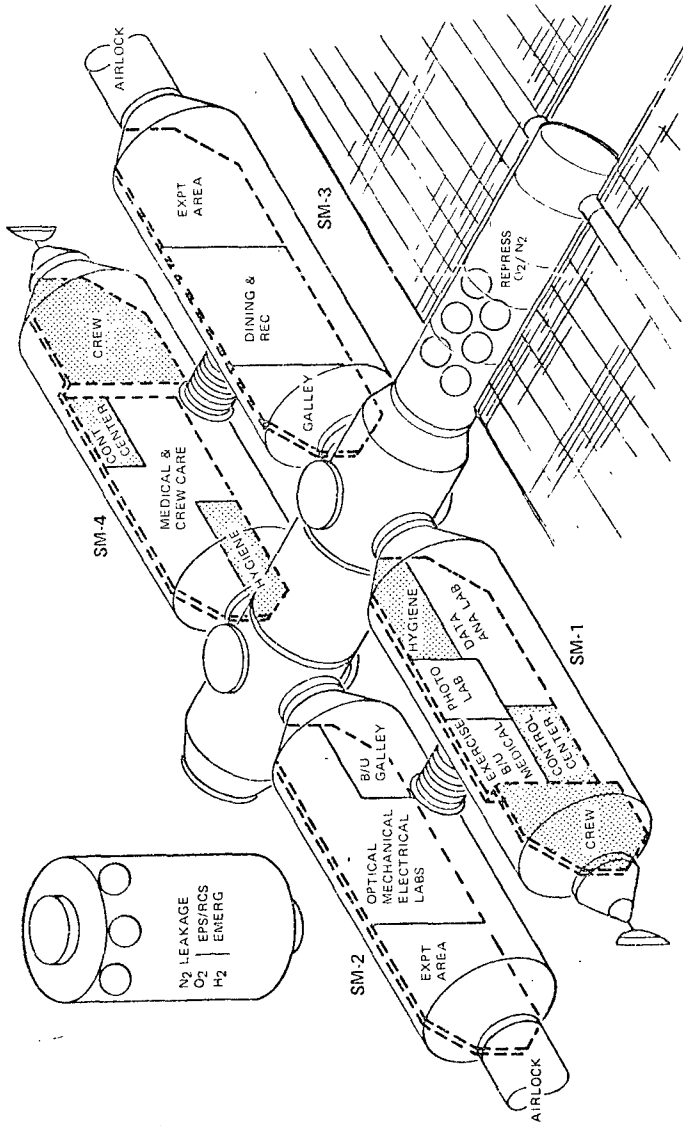



Space Division  
North American Rockwell

#### CORE MODULE

The core module is 40 feet long between berthing interfaces and is 12 foot 8 inches outside diameter. The 15-foot-diameter envelope intersects the edges of the side-berthing ports cluster. Lightweight skin (0.040-inch aluminum) and stringer construction is utilized. The eight side-berthing ports are spaced 20 feet apart, which allows a 5-foot clearance between the station modules. The four side ports are provided with thermal covers. Thermal control of the vertical ports is provided during buildup with special insulation panels.

The installed subsystems are distributed between the V1 and V2 volumes separated by the EVA/IVA airlock. The airlock provides an equivalent floor of approximately 5 feet by 7 feet. All of the hatches open outward from the airlock. The EVA hatch (40-inch-diameter clear opening) is located at a 45-degree angle which provides the maximum clearance between attached modules. The G&C optical reference and CMG's are located adjacent to the RAM berthing ports.

Certain buildup equipment is accommodated such as the antennas, thermal control radiators, RCS propellant, and initial power. All subsystem components are installed with on-orbit shirtsleeve maintenance accommodations including maintenance of the RCS engine assemblies. The utilities routing throughout the module from berthing port to berthing port and end to end of the module are redundant and separated for damage containment and safety.

# CORE MODULE

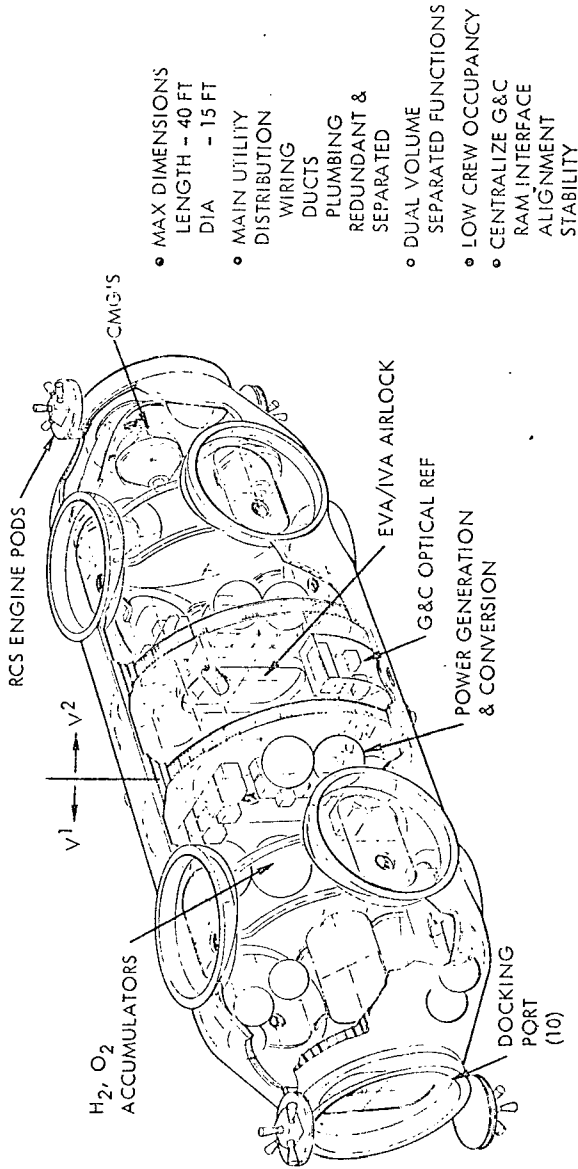

- ALL SUBSYSTEMS ON-ORBIT REPLACEABLE
- MODULE SPACING FOR DIRECT DOCKING OR BERTHING
- FIRST MODULE LAUNCHED - MINIMIZES COMPLEXITY OF POWER MODULE  
- REDUCES BUILDUP SCARS

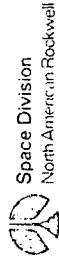



Space Division  
North American Rockwell

#### POWER MODULE

The power module consists of two assemblies, a power boom and a solar array. The solar array assembly consists of the arrays and an orientation drive and power transfer mechanism. Shirtsleeve maintenance of the mechanisms is provided. The solar array assembly is replaceable and utilizes the standard berthing port.

The power boom is 88 inches outside diameter by 27 feet 6 inches long. The 88-inch-diameter boom allows the solar array panels to stow within the 15-foot-diameter shuttle payload envelope. The boom is of monocoque construction utilizing 0.145-inch thick aluminum which increases its stiffness and consequently increases the natural frequency of the total space station assembly. High-pressure gas storage bottles for repressurization are placed in the boom. Shirtsleeve maintenance and replacement is provided even though the module is normally operated unpressurized.

# OWER MODULE

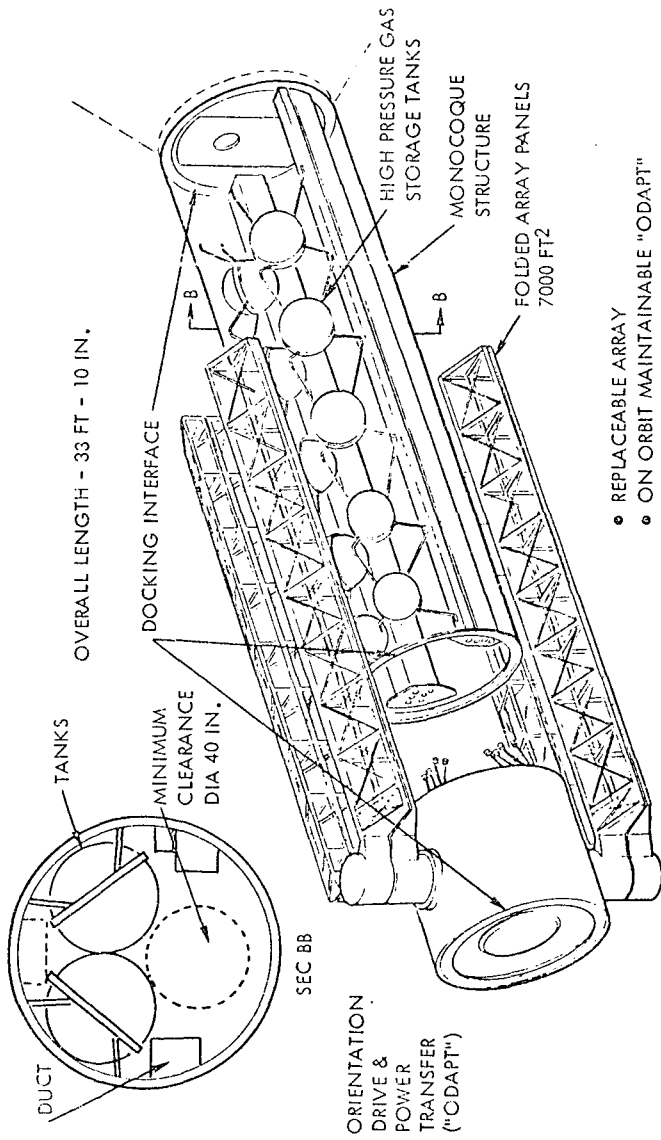

- REPLACEMENT ARRAY
- ON-ORBIT MAINTAINABLE "ODAPT"
- NORMALLY UNPRESSURIZED
- ON-ORBIT REPLACEMENT TANKS & EQUIPMENT





Space Division  
North American Rockwell

#### STATION MODULE FEATURES

All of the modules are 38 feet 8 inches long between berthing interfaces and provide a 13-foot 8-inch clear inside diameter. The external frames and attach points extend to 15 feet. An active berthing port is provided at the core module interface and a passive port at the other end. The interface provisions across the berthing ports are identical. Each module contains four manipulator sockets for shuttle deployment and four shuttle bay attach fittings. Radiators cover the exterior of the cylindrical portion of the modules.

The longitudinal floor provides a single structural component for mounting of equipment both above and below decks, greatly simplifying the manufacturing installation and design details. The longitudinal orientation also simplifies other ground operations of module assembly, checkout, and shuttle installation.

# STATION MODULE FEATURES

## UNIVERSAL STRUCTURE

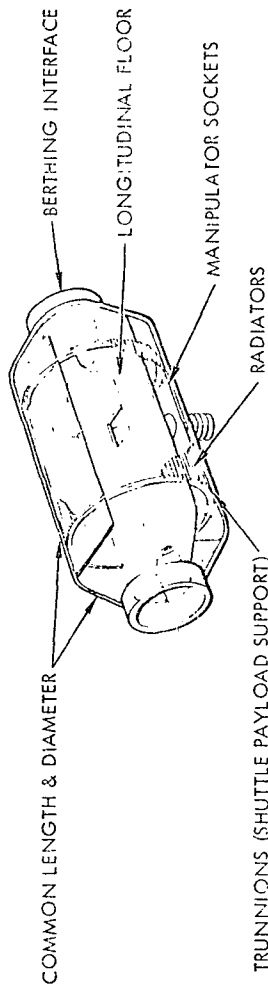

## --- EQUIPMENT MOUNTING --- LONGITUDINAL FLOOR ---

- EQUIPMENT MOUNTING
- ABOVE & BELOW DECK
- LONGITUDINAL FLOOR-SINGLE ORIENTATION DIRECTION
- GROUND ACCESS
- ASSEMBLY
- INSTALLATION
- CHECKOUT
- SHUTTLE LOADING
- REFURBISHMENT

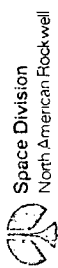
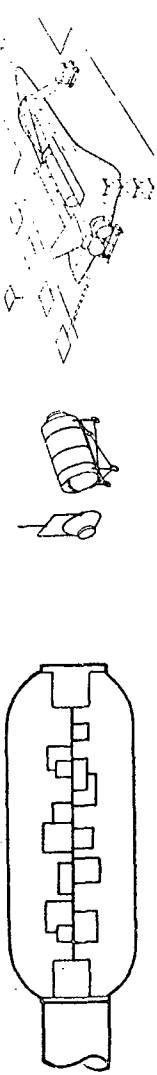



Space Division

North American Rockwell

#### CREW/CONTROL STATION MODULES

The two crew/control modules, SM-1 and SM-4, have common functional allocations and equipment location. Each module performs a similar function in each of the two pressure-isolatable volumes of the station. Where backup functions are provided, they are located in similar areas in the module of the opposite volume.

Both SM-1 and SM-2 contain a commander/executive type stateroom and two crew staterooms in a split-level arrangement. Control centers are located on the upper deck of each module outside the stateroom. The personal hygiene facilities are in similar locations; however, only SM-1 contains a shower. The waste management equipment is located below deck near the personnel hygiene facility to simplify sewage transport and processing.

The area above deck in SM-1 contains the experiment data analysis equipment, including a data analysis control console, a photo-processing lab, and an isotonic exercise area. The exercise areas are also equipped to serve as a backup medical facility. The area above deck in SM-4 contains the primary medical and crew care facilities.

# CREW / CONTROL STATION MODULES

- ACCOMMODATION COMMONALITY
  - STATEROOMS
  - CONTROL CENTERS
  - HYGIENE

SM-1

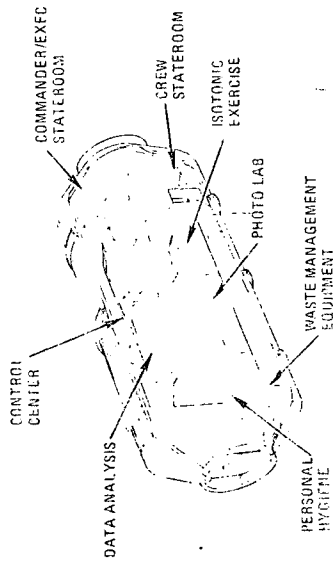

- EQUIPMENT MOUNTING
  - LONGITUDINAL FLOOR-SINGLE ORIENTATION DIRECTION
- COMMON MAINTENANCE & SERVICE ACCESS & TRAFFIC PATTERNS

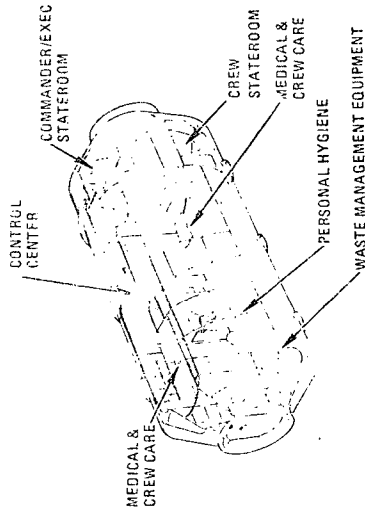

SM-4



Space Division  
North American Rockwell

#### LAB/ECS STATION MODULES

The two Lab/ECS modules, SM-2 and SM-3, are in different isolatable volumes of the station. Where backup functions are provided, they are located in similar areas in the module of the opposite volume.

The lower deck area of station modules SM-2 and -3 contain environmental control subsystem assemblies for air revitalization (CO2 management and atmosphere control). Common installation arrangements provide easy access for maintenance and service. The remaining lower deck area is for storage of station and experiment supplies.

The above-deck area in SM-3 contains the primary galley/diving and recreation areas as well as general-purpose laboratory facilities. The lab capability is designed to support both physics and biomedical experiments. The above-deck area in SM-2 contains primarily general-purpose laboratory installations; however, a small backup galley is installed at the inboard end of the module. GPL equipment and areas for mechanical, electrical, and optical maintenance are provided.

A general-purpose airlock is attached to these lab modules. The one on SM-2 points to nadir on SM-3 to zenith. An experiment operations area and airlock loading access space is provided in each module at the airlock end.

# LAB/SS STATION MODULES

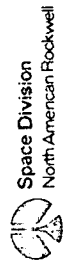
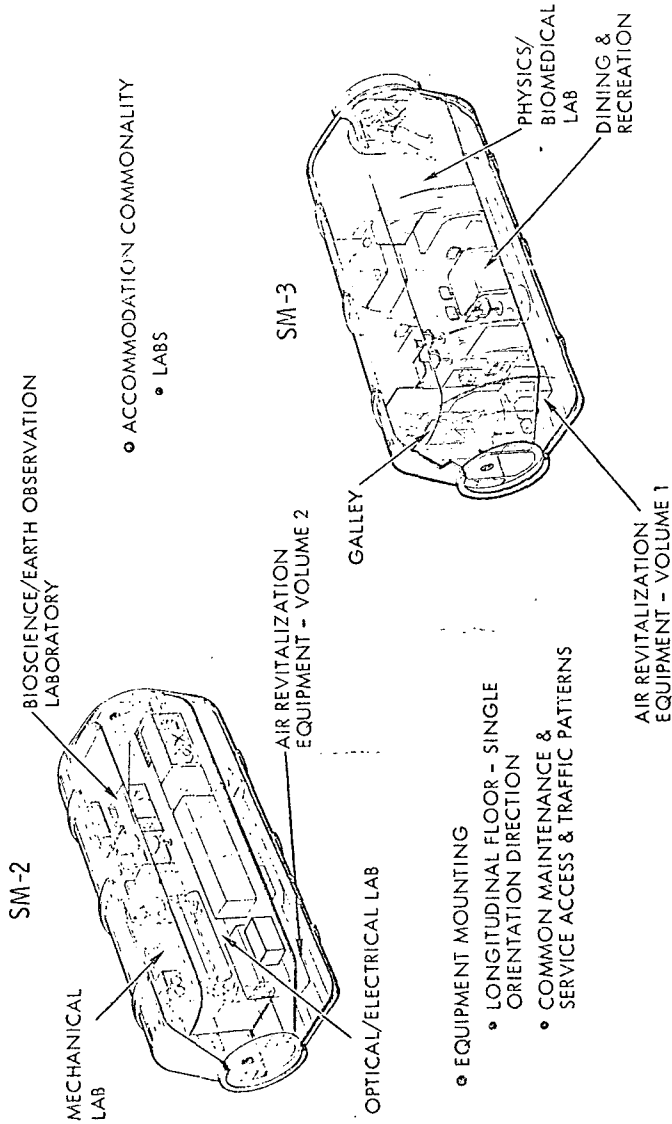



Space Division  
North American Rockwell

#### CARGO MODULE APPROACH

The approach taken to derive a revised cargo module concept compatible with the MSS preliminary design is illustrated on the chart. Key system requirements were examined for the preferred MSS location of required consumables (to meet these requirements). The locations considered included the cargo module, unpressurized power boom, and the pressurized modules. Shown on the chart are the selection/rejection locations and reasons for the various gases and consumable supplies. These considerations then influenced the operational approach selection for the cargo module. These are, briefly: a cargo module will always be present when the station is manned; the cargo module will provide 120-day storage capacity where station capacity is not adequate or onboard station storage presents a higher safety risk (for example, some types of foods or spares, high-pressure gases, and leakage gases); on-orbit crew occupancy times are of short duration, thereby, not requiring a second access/egress route.

# CAT MODULE APPROACH

- SYSTEM REQUIREMENTS**
- 96 HR EMERGENCY SUPPLIES
  - 120 DAY CONSUMABLE CAP.
  - 30 DAY CONSUMABLE RESERVE
  - REPRESS ON STATION FOR MANNED DPS

LOCATION?

CONFIGURATION & DESIGN CONSIDERATIONS		
EMERGENCY SUPPLIES HIGH PRESS GAS	CARGO MODULE	UNPRESS. PWR BOOM
<ul style="list-style-type: none"> <li>• OTHER SUPPLIES</li> <li>• REPRESS GASES</li> <li>• LEAKAGE GASES</li> <li>• CONSUMABLES &amp; RESERVE</li> <li>• WATER</li> <li>• CREW SUPPLIES</li> <li>• SPARES</li> <li>• EXPERIMENT</li> </ul>	<ul style="list-style-type: none"> <li>✓ EMERG EPS SEPARATE FROM PRIMARY</li> <li>X LOGISTICS WT EACH FLIGHT</li> <li>✓ MORE EFFICIENT SUPPLY</li> <li>✓ CONSUMABLE MAKE UP</li> </ul>	<ul style="list-style-type: none"> <li>X SAFETY</li> <li>✓ ACCESSABILITY</li> <li>X SAFETY</li> <li>X SAFETY</li> <li>✓ AVAILABLE STORAGE</li> </ul>
<ul style="list-style-type: none"> <li>✓ SELECTED LOCATION</li> <li>X REJECTED LOCATION</li> </ul>	<ul style="list-style-type: none"> <li>✓ AVAILABILITY</li> <li>X HI WEIGHT OF RESIDUALS FROM LOGISTICS TRANSFER</li> </ul>	<p><b>OPERATIONAL APPROACH</b></p> <ul style="list-style-type: none"> <li>• STAY AT STATION BETWEEN FLIGHTS</li> <li>• 120 DAY STORAGE WHERE STATION CAPACITY NOT ADEQUATE</li> <li>• LIMITED CREW OCCUPANCY (IN ORBIT)</li> </ul>

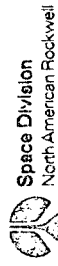





Space Division  
North American Rockwell

#### CARGO MODULE CONCEPT

The cargo module concept utilizes the MSS universal structure except that it is 24 feet in length compared to a station module length of about 39 feet. It is self-sufficient on orbit for six men for 72 hours when in the shuttle cargo bay. Up to 11,800 pounds of cargo can be carried with an up crew load of six passengers. Passengers would occupy the cargo module only during orbital periods, and transfer to the station would be accomplished through the orbiter. One hundred twenty cargo containers, located as shown, provide sufficient dry cargo storage capacity to meet resupply and the 120-day storage capacity requirements. Five 48-inch diameter tanks provide sufficient capacity for all anticipated liquid and gas resupply requirements. Should this requirement ever increase, up to nine tanks can be carried in the annular volume shown.

# CARGO MODULE CONCEPT

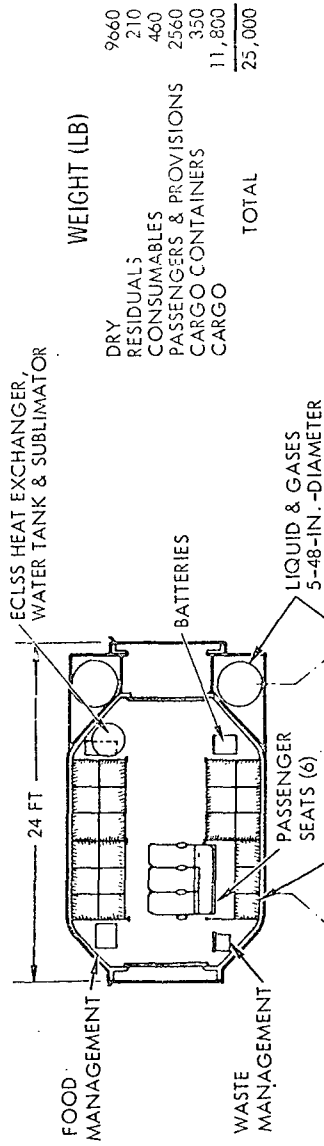

## WEIGHT (LB)

DRY RESIDUALS	9660
CONSUMABLES	210
PASSENGERS & PROVISIONS	460
CARGO CONTAINERS	2560
CARGO	350
<b>TOTAL</b>	<b>11,800</b>
	<b>25,000</b>

## DESIGN FEATURES

- UTILIZES MSS UNIVERSAL MODULE STRUCTURE
- SELF-SUFFICIENT (72 HR) WHEN IN SHUTTLE
- PROVIDES SHUTTLE BERTHING CAPABILITY FOR MSS RESCUE
- EASY CREW AND CARGO UNLOADING
- EASILY CONVERTIBLE TO ALL CARGO
- CREW OCCUPANCY ONLY DURING ORBITAL FLIGHT



Space Division  
North American Rockwell

#### HABITABILITY FEATURES

The habitability designed into the modular space station emphasized comfort, a familiar environment, and special conveniences. All facilities have been designed for male and female crew members.

The phantom sketch of station module 4 illustrates several of the key habitability features. With regard to comfort, ceilings and areas are based on the requirements of 95-percentile crewman extrapolated to the 1981 time period. Privacy is provided. Other areas are left as open as possible to provide a sense of spaciousness to the maximum extent possible. The up-direction from all floors in the space station are in the same direction to minimize the requirement for crewmen to reorient themselves mentally from one module or location to another. In addition to the conveniences listed, cupboards, closets, and other storage areas are designed within the reach capabilities of 5-percentile female crew members.

The emphasis placed on the shaping, sizing, and orientation of interior equipment is intended to provide the crewmen with as large and as familiar an interior environment as possible to assure a favorable crew psychological attitude for long-duration MSS mission stay times (up to 180 days).

# HABITABILITY FEATURES

LIVING AREAS  
◦ COMFORT

- MAXIMUM CEILING HEIGHT & AREA DIMENSIONS
- INDIVIDUAL TEMPERATURE CONTROL
- MAXIMUM PRIVACY
- AWAY FROM NOISE, TRAFFIC
- VARIED FOOD, PREPARATION CAPABILITY

- CONVENIENCES
- STATEROOMS NEAR CONTROL CENTER
- STATEROOMS NEAR PERSONAL HYGIENE
- ENLARGED COMMANDER'S STATEROOM

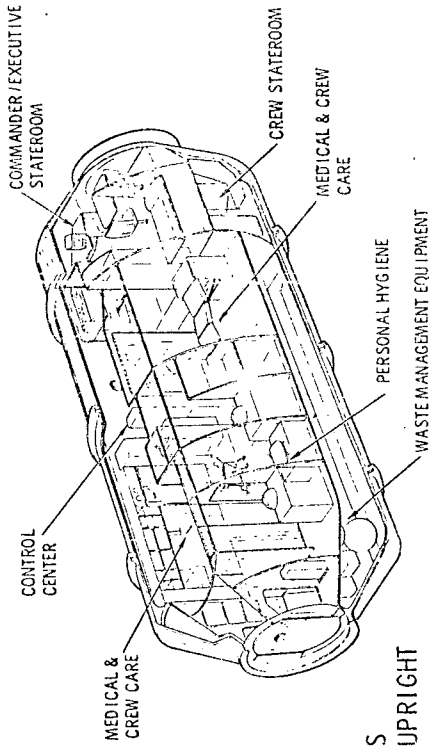

- FAMILIAR ENVIRONMENT
- RECTILINEAR FACILITY SHAPES
- ALL INTERIOR EQUIPMENT IN UPRIGHT ORIENTATION (EARTH-LIKE)
- CONSISTENT ORIENTATION CUE



Space Division  
North American Rockwell



Space Division  
North American Rockwell

#### CREW CARE/EXERCISE FEATURES

Phantom sketches of SM-4 and SM-1 illustrate the location and some of the crew care/exercise primary and backup facilities. The principal functions of these areas are to provide specialized care to injured or ill crewmen, provide the necessary equipment for crew stay time qualification beyond 60 days and up to 180 days, provide equipment to support the life sciences experiments, and provide isotonic equipment for crew conditioning.

The design features of these areas are listed on the chart. Isolation is required for bacteriological control; i.e., forward and backward contamination (in the primary facility only). Sufficient diagnostic and medical care equipment provides the capability needed by the doctor/technician for decision-making in regard to the necessity for an interim shuttle launch to effect evacuation of a seriously injured or ill crewman.

The isotonic or exercise area located in the backup medical area across from the primary control center contains a privacy screen for use by crews of mixed male and female members.

# CREW CARE & EXERCISE FEATURES

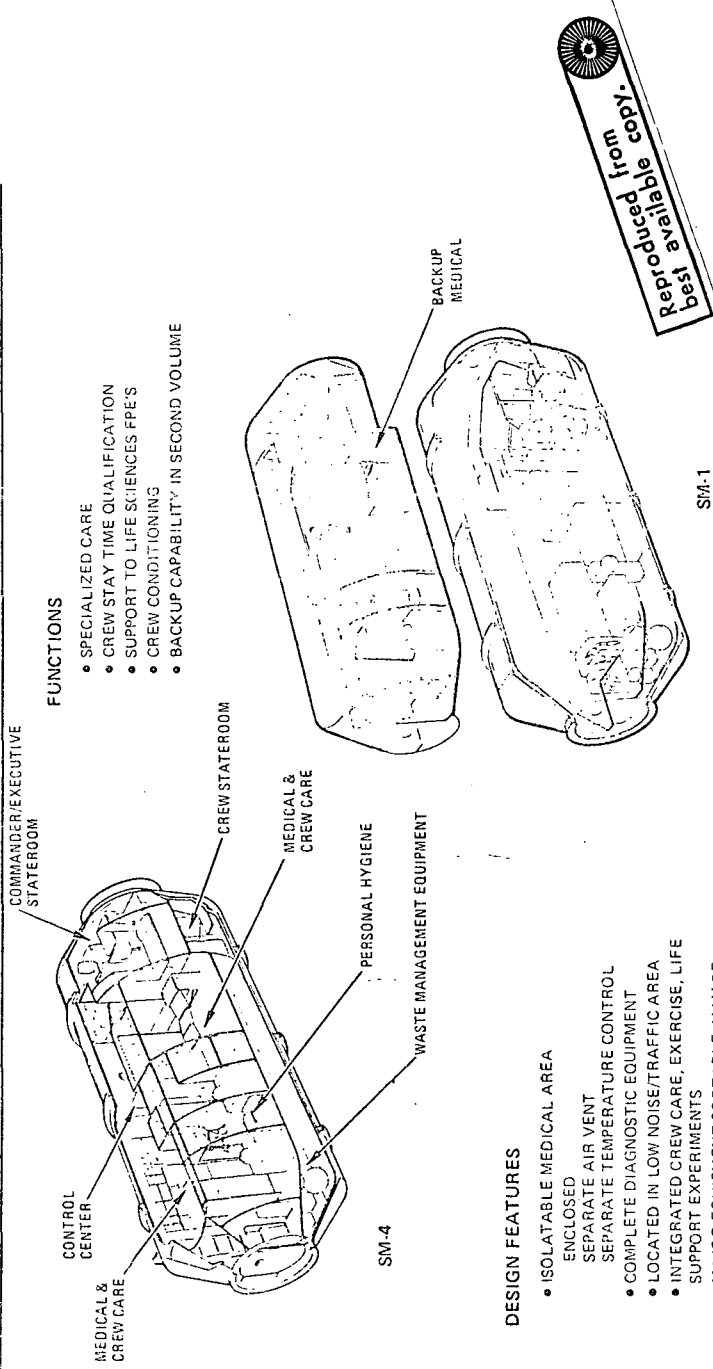

## FUNCTIONS

- SPECIALIZED CARE
- CREW STAY TIME QUALIFICATION
- SUPPORT TO LIFE SCIENCES FPE'S
- CREW CONDITIONING
- BACKUP CAPABILITY IN SECOND VOLUME

## DESIGN FEATURES

- ISOLATABLE MEDICAL AREA
- ENCLOSED SEPARATE AIR VENT
- SEPARATE TEMPERATURE CONTROL
- COMPLETE DIAGNOSTIC EQUIPMENT
- LOCATED IN LOW NOISE/TRAFFIC AREA
- INTEGRATED CREW CARE, EXERCISE, LIFE SUPPORT EXPERIMENTS
- MAJOR EQUIPMENT PORTABLE, MAY BE USED IN BACKUP MEDICAL AREA



Space Division  
North American Rockwell



Space Division  
North American Rockwell

#### EXPERIMENT AIRLOCKS

Two experiment airlocks are provided as part of the GPL configuration to deploy scientific instruments to the space environment from the station pressurized volume. The nadir-pointed airlock is mounted to the end of Station Module 2 and the zenith-pointed airlock is mounted to the end of Station Module 3. The airlocks are mounted to the station modules with the normal station berthing concept that provides mating, sealing, and utilities interfaces. The internal dimensions of the airlocks are 80 inches in diameter by 150 inches in length, providing approximately 436 cubic feet of usable volume. The hatch window in the end of the station module is used for viewing the interior of the airlock from the pressurized volume. A standard window is provided in the hinged outer hatch for viewing EVA operations from within the airlock. The hinged outer door utilizes the station berthing system to lock and seal the airlock and is used to support experiment equipment. Both airlocks are pumped down into the station volume by station equipment and pressurized directly from the station atmosphere. Standard subsystem capabilities and deployment devices are provided for the airlocks.

# EXPERIMENT AIRLOCKS

TYPICAL AIRLOCK ARRANGEMENT  
(EARTH OBSERVATIONS)

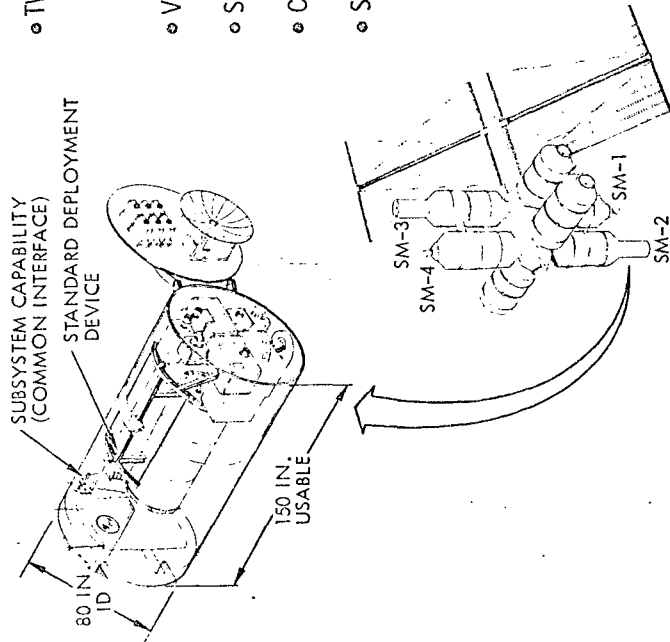

- TWO AIRLOCKS
  - NADIR VIEWING
  - CELESTIAL VIEWING
- VOLUME 436 FT<sup>3</sup> EACH
- STANDARD DEPLOYMENT DEVICE
- COMMON DOCKING INTERFACE (REMOVABLE)
- SUBSYSTEM CAPABILITY
  - ACTIVE THERMAL CONTROL
  - OXYGEN SUPPLY
  - NITROGEN SUPPLY
  - POWER BUS (2)
  - RAPID PRESSURIZATION
  - AIR PROCESS DUCTS
  - DATA
  - CREW SUPPORT





Space Division  
North American Rockwell

#### EXPERIMENT-DEDICATED SERVICES

The services provided for experiments throughout the MSS in Modules 1, 2, and 3 are:

SM-1 - This module accommodates the data analysis laboratory, photographic processing area, laboratory storage areas (below deck) and the experiment control center. The total area allotted to these experiment-dedicated services is 210 square feet. In addition, standard utilities are provided. These include potable water, water-internal coolant, environmental control, and electrical power.

SM-2 - This module is dedicated entirely to the support or performance of experiments plus one of the experiment airlocks. The dedicated area, approximately 273 square feet, contains the maintenance area (i.e., electrical, mechanical, and optical), below-deck equipment storage area, and the experiment nadir airlock, as well as the standard utilities.

SM-3 - The GPL area in this module supports either biomedical equipment or physics equipment but not both simultaneously. In addition, storage area is provided below deck. The same standard station utilities are provided in this module.

# EXPERIMENT DEDICATED SERVICES

- DATA ANALYSIS AREA WITH EQUIPMENT
- PHOTOGRAPHIC PROCESSING AREA WITH EQUIPMENT
- LABORATORY STORAGE AREAS
- EXPERIMENT CONTROL

- MAINTENANCE AREAS WITH EQUIPMENT

- ELECTRICAL
- MECHANICAL
- OPTICAL

- AIRLOCK NADIR
- EXPERIMENT STORAGE

- BIOMEDICAL OR PHYSICS AREA

- AIRLOCK CELESTIAL

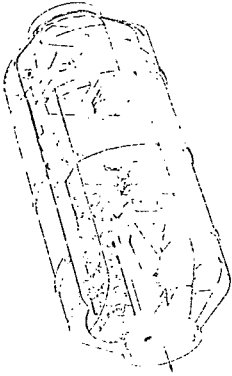

SM-1  
GPL AREA  
~210 FT<sup>2</sup>

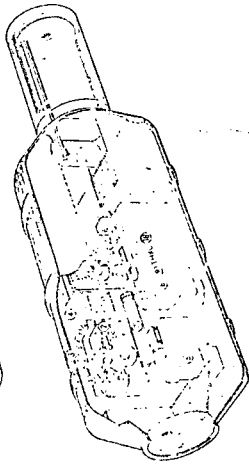

SM-2  
GPL AREA  
~273 FT<sup>2</sup>  
EXP OPS  
164

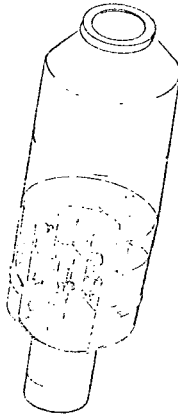

SM-3  
GPL AREA  
~177 FT<sup>2</sup>



Space Division  
North American Rockwell



Space Division  
North American Rockwell

#### EXPERIMENT ACCOMMODATION SUMMARY

The MSS is an on-orbit facility in which space operations and scientific investigations are conducted. As such, the facility must have suitable features for conducting a variety of experiment programs.

The required features were established following an analysis of the NASA Blue Book experiments and their attendant support requirements. The key requirements related to crew time, area, power, data processing, stability (acceleration, pointing) and logistics considerations. Crew time, skills, and area accommodation requirements were primary influences on the number and types of experiments which could be conducted on a time-phased basis. Where these influences were not a constraint, experiment scheduling was analyzed to establish nominal experiment support needs. Where experiment requirements imposed severe penalties to the design of the MSS, alternate means of satisfying the requirements were established. As an example, the earth observation multispectral scanner originally generated an extremely large amount of digital data (50 x 10<sup>6</sup> bps). This was a major impact on the MSS data bus, central processor, and communications equipment. An alternate scheme was derived which converted the output to analog form and handles in a manner similar to a TV signal. This greatly reduced the data handling requirements with no compromise to the experiment.

# EXPERIMENT ACCOMMODATION SUMMARY

## INITIAL STATION

### FLIGHT CHARACTERISTICS

- EARTH REFERENCE ATTITUDE HOLD - LOCAL VERTICAL (GEOMETRIC AXIS)
- INERTIAL ATTITUDE HOLD 12 HR CONTINUOUS - MAX (PRINCIPAL AXIS)
- ANGULAR RATE  $\pm 0.05$  DEG/SEC ( $\pm 0.01$  DEG/SEC UP TO 30 MIN)
- MAX ACCELERATION  $0.01 \text{ g's}$  ( $0.00001 \text{ g's}$  UP TO 2 HR)

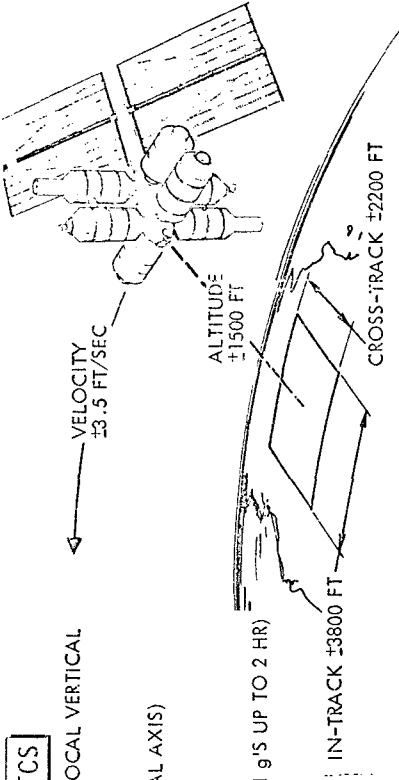

<p>CREW</p> <p>35 MANHOURS/DAY - 6-DAY WORK WK</p>	<p>LOGISTICS RESUPPLY (WEIGHT - 5-YR AVG)</p>
--	---

# EXPERIMENT ACCOMMODATION SUMMARY (CONT)

<p><b>ELECTRICAL POWER</b></p> <p>AVERAGE POWER</p> <ul style="list-style-type: none"> <li>• 7 KW UP TO 1 HOUR IN ANY 24-HOUR PERIOD</li> </ul>	<p><b>COMMUNICATIONS</b></p>
<p><b>ENVIRONMENTAL CONTROL</b></p> <ul style="list-style-type: none"> <li>• TEMPERATURE 65-75 F</li> <li>• PRESSURE 14.7 + 0.5 PSIA</li> <li>• O<sub>2</sub> PP 3.1 + 0.4 PSIA</li> <li>• HUMIDITY 8-12 MM Hg - H<sub>2</sub>O PP</li> <li>• CO<sub>2</sub> PP 3.0 MM Hg NOMINAL</li> </ul> <p><b>SUPPORT</b></p> <ul style="list-style-type: none"> <li>• OXYGEN 1.2 LB/DAY</li> <li>• WATER 35 LB/DAY</li> <li>• WASTE 2.2 LB/DAY</li> <li>• THERMAL 4.5 KW AVE</li> </ul>	<p><b>DATA PROCESSING</b></p> <ul style="list-style-type: none"> <li>• DATA BUS CAPACITY</li> <li>• COMPUTER SPEED (OPERATIONS/SEC) 1,045 X 10<sup>3</sup></li> <li>• OPERATING MEMORY (32 BIT WORDS) 64 X 10<sup>3</sup></li> <li>• MASS MEMORY (32 BIT WORDS) 22 X 10<sup>3</sup></li> </ul>

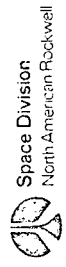



Space Division  
North American Rockwell

#### STRUCTURE AND MECHANICAL SUBSYSTEMS

The station module pressure shell is of monocoque construction utilizing 0.145-inch thick 5052 aluminum alloy. This type of construction and material provides a cost-effective concept insensitive to modifications with long-life characteristics. The three bonded external frames provide the structural payload interface attachment to the shuttle and also provide the manipulator pickup sockets. The external frames provide a clear module interior of 13 feet 8 inches in diameter. An integrated arrangement of radiators, insulation, and pressure shell provides meteoroid and radiation protection and thermal control. Interior arrangement flexibility is provided by utilizing the external ring frames and longitudinal drag longeron. This arrangement will accommodate a longitudinal floor, transverse floors, or no floors.

# STRUCTURE AND MECHANICAL SUBSYSTEM

## STATION MODULE PRELIMINARY DESIGN

LENGTH 38 FT 8 IN.  
14 FT DIA

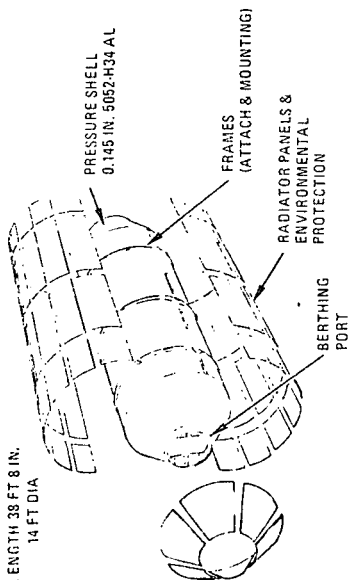

## DESIGN FEATURES

- MONOCOQUE CONSTRUCTION
  - LEAST COST
  - LONG LIFE
  - MODIFICATION SIMPLICITY
  - LEAST COMPLEX MANUFACTURE
- EXTERNAL FRAMES
  - ADHESIVELY BONDED
  - CLEAR INTERIOR
  - LOW COST
- SEGMENTED RADIATOR PANELS
- INTEGRATED ENVIRONMENTAL PROTECTION

## FLEXIBILITY

- LENGTH
- LOADING

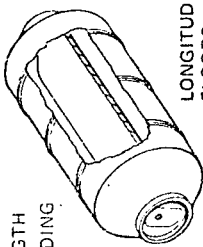

LONGITUDINAL FLOORS

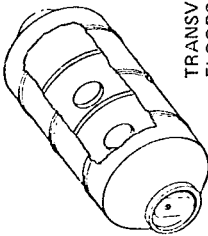

TRANSVERSE FLOORS

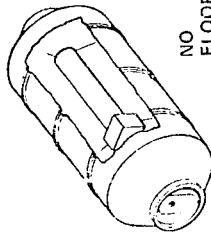

NO FLOORS

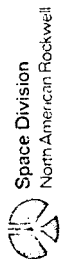

Space Division  
North American Rockwell



Space Division  
North American Rockwell

#### STATION MODULE STRUCTURAL ARRANGEMENT

The module has been designed for low-cost monocoque construction using 0.145-inch 5052 aluminum alloy augmented by an 0.030-inch aluminum meteoroid bumper. Three frames are utilized external to the pressure shell, which accommodate the shuttle attach points and manipulator sockets. Kapton-lined insulation is located inside the meteoroid bumper and acts as a secondary bumper.



# STATION MODULE STRUCTURAL ARRANGEMENT

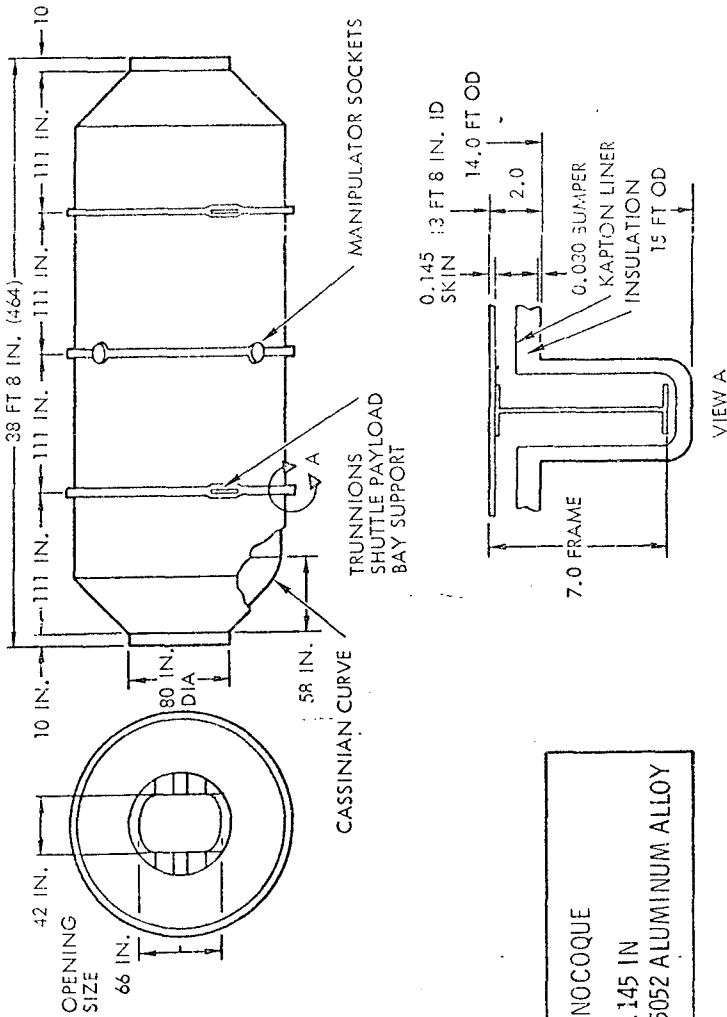

MONOCOQUE  
 .145 IN  
 5052 ALUMINUM ALLOY

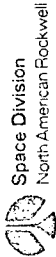



Space Division  
North American Rockwell

#### INTEGRATED SUBSYSTEMS (EPS, ECLSS, RCS)

The EPS will utilize four regenerative fuel cell assemblies, each consisting of one fuel cell, electrolysis unit, H<sub>2</sub> accumulator, O<sub>2</sub> accumulator, and half of a water storage tank. The assembly can receive or supply in an emergency H<sub>2</sub>, O<sub>2</sub>, or water to the ECLSS and RCS.

The ECLSS uses a closed O<sub>2</sub> and water cycle concept consisting of H<sub>2</sub> depolarizer for CO<sub>2</sub> removal, Sabatier for CO<sub>2</sub> reduction, electrolysis for O<sub>2</sub> recovery and for RCS H<sub>2</sub>/O<sub>2</sub> generation, and vapor compression for water reclamation.

The RCS stores H<sub>2</sub>/O<sub>2</sub> gases generated at 300 psia by the ECLSS.

The design integrates the gas generation and gas/water storage functions for all subsystems and maximizes the use of common hardware. The EPS and ECLSS use similar electrolysis units compatible with SSP technology. The EPS energy storage and secondary (emergency) power are supplied by shuttle-developed fuel cells. All subsystems use electrochemical processes based on the H<sub>2</sub> and O<sub>2</sub> chemical reactions, with similar working fluids, hardware, maintenance, checkout, and overall technologies. These features result in the lowest-cost integrated EPS/RCS/ECLSS subsystem. The low cost derives from (1) shared development, (2) reduced hardware through shared redundancy, and (3) reduced logistics through shared contingency consumables. In addition, mission operational flexibility is improved by providing multiple success paths for critical functions (H<sub>2</sub>, O<sub>2</sub> generation) and increased secondary performance through shared capabilities.

# INTEGRATED SUBSYSTEMS (EPS - ECLSS - RCS)

## PRELIMINARY DESIGN

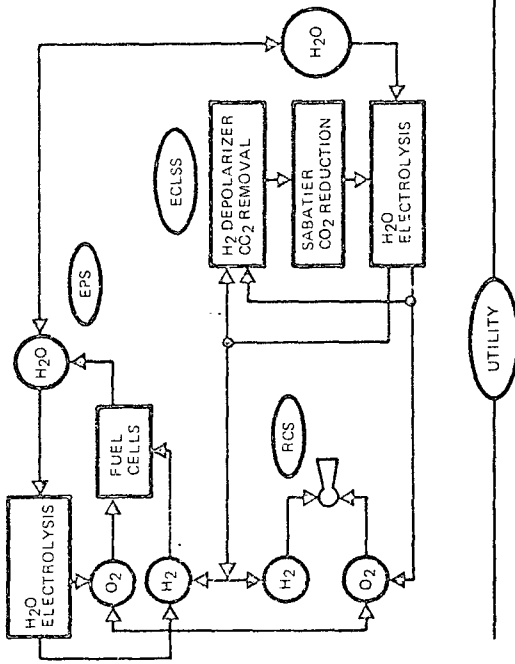

## DESIGN FEATURES

- INTEGRATED FUNCTIONS
- BUILDUP EPS & RCS
  - ENERGY STORAGE & REACTANTS
- NORMAL OPERATIONS ECLSS & RCS
  - AII: REVITALIZATION & REACTANTS
- EMERGENCY EPS, ECLSS, RCS
  - COMMON STORAGE
- HARDWARE COMMONALITY
  - o ELECTROLYSIS ASSEMBLIES
  - o O<sub>2</sub> H<sub>2</sub> ACCUMULATORS
  - o H<sub>2</sub>O STORAGE
  - o VALVES & REGULATORS
- COMMON TECHNOLOGY
  - o WORKING FLUIDS
  - o CHEMICAL PROCESSES
  - o MATERIALS
  - o CHECKOUT
  - o MAINTENANCE

REDUCED COST FOR DEVELOPMENT PLUS 5-YR OPERATION

OPERATIONAL FLEXIBILITY - MULTIPLE SUCCESS PATHS FOR KEY FUNCTIONS  
- SIGNIFICANT SECONDARY PERFORMANCE INCREASE

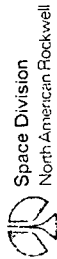



Space Division  
North American Rockwell

#### ELECTRICAL POWER SUBSYSTEM

The EPS design includes the ability to switch power on the array before collected on slip rings. This permits turnoff of power for on-orbit maintenance of turret components and selective switching for power transfer to primary buses and electrolysis units. Switching assists in voltage regulation and helps assure that the converted power is available for station use.

A solar array size of 7000 square feet provides for ample electrical power (19,600 watts 24-hour average) over the five-year life of initial MSS. The array size include a 29.3-percent allowance for degradation in the space environment. Replacement is planned at the end of initial MSS station life.

A standard 120/208 volt ac distribution provides common power characteristics for experiments and permits the EPS to utilize existing technology developed by commercial and military aircraft design, leading to lower cost.

# ELECTRICAL POWER SUBSYSTEM

## PRIMARY POWER DESIGN

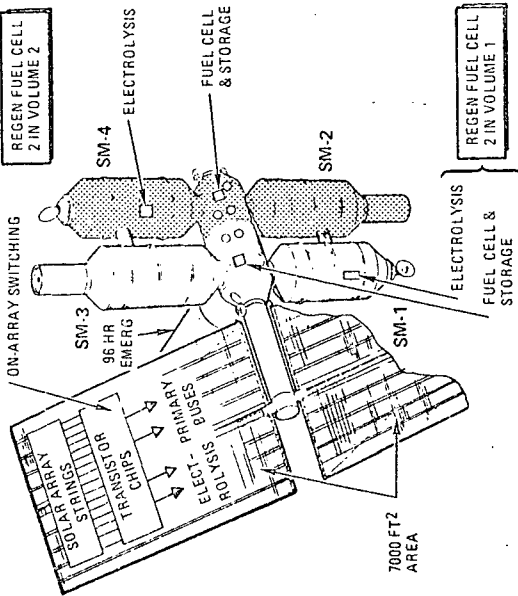

## DESIGN FEATURES

- REPLACEABLE SOLAR ARRAYS
  - MINIMIZE PROGRAM & DEVELOPMENT RISK
- ON-ORBIT MAINTAINABLE TURRET
  - INCREASE ASSEMBLY LIFE
- ON-ARRAY SWITCHING
  - IMPROVED CONTROL & DISTRIBUTION
- ENERGY STORAGE - REGENERATIVE FUEL CELLS
  - INTEGRATED SYSTEMS, LOW COST
  - MULTIPLE FUNCTIONS
    - BUILDUP POWER
    - NORMAL OPERATION ENERGY STORAGE
    - NORMAL OPERATION BACKUP
    - EMERGENCY
- DUAL VOLUME REDUNDANCY
- STANDARD 120/208 VAC
- MINIMUM DEVELOPMENT COST

## UTILITY

- AMPLE POWER 19,600 WATTS CONDITIONED POWER
- HIGH RELIABILITY - MULTIPLE SUCCESS PATHS

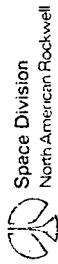

Space Division  
North American Rockwell



Space Division  
North American Rockwell

#### ELECTRICAL POWER SUBSYSTEM (Cont)

Fuel cells and electrolysis are combined in a regenerative energy storage concept to replace large quantities of secondary batteries. The same fuel cells serve multiple purposes to satisfy buildup power and backup and emergency requirements. The fuel cells give the MSS multiple power sources (success paths) to support two isolatable pressure volumes for life support in the event of an emergency.

# ELECTRICAL POWER SUBSYSTEM

## SECONDARY POWER DESIGN

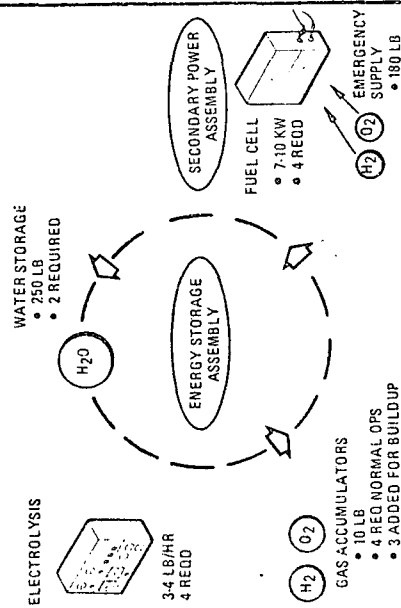

## DESIGN FEATURES

- ELECTROLYSIS ASSEMBLY IDENTICAL TO ECSS ELECTROLYSIS
- COMMON DEVELOPMENT
- ECSS BACKUP O<sub>2</sub> H<sub>2</sub> SOURCE
- FUEL CELL
- SHUTTLE DEVELOPMENT UTILIZED
- EMERGENCY & BUILDUP POWER
- WATER STORAGE FOR BUILDUP
- PRODUCTS
- PROVIDES INTERIM SUPPLY
- ACCUMULATORS FOR POWER PEAKS
- MEASUREMENTS & CONTROL REQUIREMENT REDUCED

## UTILITY

- STATION OPERATING POWER LEVEL CAN BE INCREASED BY LOGISTICS SUPPLY OF REACTANTS
- STATION CAN OPERATE IN ABSENCE OF SOLAR ARRAYS
- INITIAL BUILDUP POWER
- DUAL VOLUME SUPPORT FOR EMERGENCY

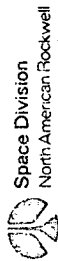

Space Division  
North American Rockwell



Space Division  
North American Rockwell

#### ENVIRONMENTAL CONTROL AND LIFE SUPPORT SUBSYSTEM

The ECLSS is distributed throughout the modular station, with one complete subsystem in each isolatable pressure volume. The repressurization gases are stored in the power boom, with leakage nitrogen, emergency gases ( $H_2, O_2$ ) and other expendibles in the cargo module. The ECLSS thermal control radiators are located on the exterior surface of SM-1 through SM-4. Each module has eight panels, a total of 32. The design margins incorporated allow for loss of two panels without impact on station operation.

The dual installation of full ECLSS capability provides mission continuation in the event of a single volume failure, and online redundancy in the event of ECLSS failure. The dual ECLSS separated subsystem results in placement of interrelated subassemblies such as waste management and water management close together, thereby eliminating intermodule connection of urine lines, in addition to reducing greatly the required coupling distance for tubing, ducts, and wiring.

The overall station design provides inherent safety for loss of critical functions such as oxygen supply,  $CO_2$  removal, and atmospheric temperature control. There is sufficient oxygen in the controlled environment to provide metabolic oxygen requirements without oxygen addition for two weeks before reaching fatal oxygen partial pressure levels. The same can be said of  $CO_2$  for a 4-day period at normal generation rates with no removal. Steady-state cabin air temperatures at maximum load have been estimated at a 95 F with the module heat exchanger out after two failures. Each module contains two heat exchangers sized at half the module load; therefore, a single heat exchanger failure would result in a 75 F cabin at maximum heat load.



# ENVIRONMENTAL CONTROL/LIFE SUPPORT SUBSYSTEM

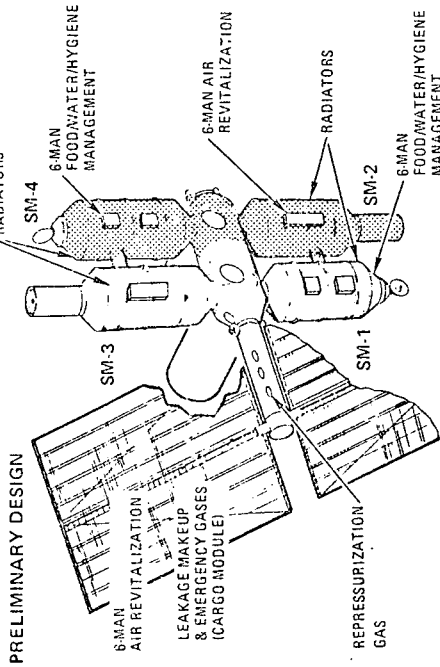

## DESIGN FEATURES

- DUAL HABITABLE VOLUMES
  - SAFE MISSION CONTINUATION
- RADIATOR CAPACITY 35 KW (30 KW REQUIRED)
  - CAN LOSE UP TO 4 OF 32 PANELS
- REDUNDANT & SEPARATED 6-MAN ECLSS ASSEMBLIES
  - MINIMIZED COUPLING OF CREW FACILITIES & ECLSS EQUIPMENT
  - ALLOWS INCREASED FLEXIBILITY FOR HABITABLE ARRANGEMENTS

## UTILITY

- GOOD ENVIRONMENT
  - CLEAN ROOM ATMOSPHERE-ON-BOARD POLLUTION CONTROL
  - SMALL TEMPERATURE VARIATION -65 -75 F
  - FOOD SAME AS EARTH - FROZEN, FRESH, & CANNED
- INHERENT SAFETY
  - LOSE O<sub>2</sub> SUPPLY - OK 2 WEEKS
  - LOSE CO<sub>2</sub> REMOVAL - OK 4 DAYS
  - LOSE AIR TEMP HX - MAX 95° STEADY STATE

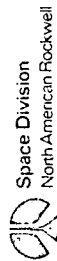



Space Division  
North American Rockwell

#### ENVIRONMENTAL CONTROL AND LIFE SUPPORT SUBSYSTEM (CONT)

The selected ECLSS concept for space station application is the regenerative type with reclamation of oxygen from carbon dioxide and water. The individual processes such as Sabatier, electrolysis, and vapor compression are receiving continual development under current NASA funding.

The important design features of the oxygen recovery approach are the reduction in logistic resupply and reduction in quantity of gases vented overboard which can contaminate the environment to which experiment program sensors are subjected. The electrolysis is a common process in both ECLSS and EPS and the advantages of a single hardware development can be achieved. In addition, the two electrolysis installations provide an additional success path for critical functions in both ECLSS and EPS.

A single vapor compression water recovery concept was selected for all station water recovery.

The vapor compression approach which utilizes the extraction of energy for condensing on one side of a heat transfer surface to cause boiling on the other side results in the important design features of both low energy input and low energy output which is heat rejection. The energy input is the form of compressor power which is very small compared to that required to accomplish boiling of waste water. The single concept has only one development whereas dual concepts, which may show a weight advantage, are more complex and costly to develop.

# ENVIRONMENTAL CONTROL LIFE SUPPORT SUBSYSTEM (CONT)

## RECOVERY PROCESSES

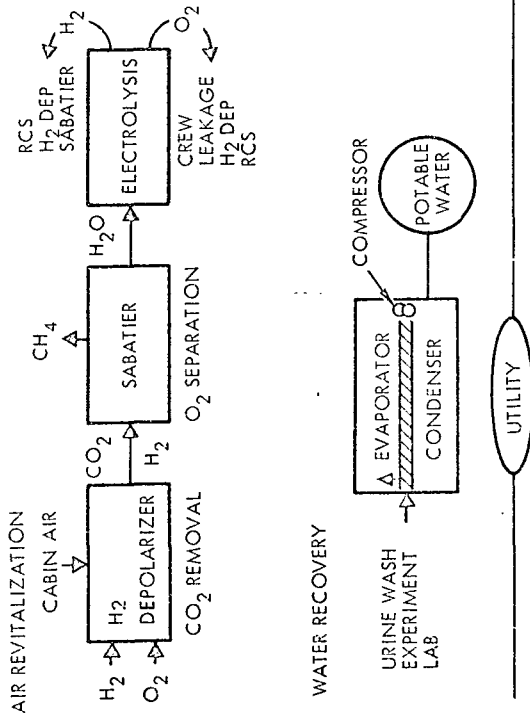

## DESIGN FEATURES

- CLOSED OXYGEN
- LOW LOGISTICS REQD
- MINIMUM CONTAMINATION
- WATER IS O<sub>2</sub> RESUPPLY FORM
- ELECTROLYSIS UP TO 4 LB/HR
- IDENTICAL TO EPS UNIT
- BACKUP TO EPS
- MAINTAINS LOW CO<sub>2</sub> CONCENTRATION
- ≤3 MM Hg CONTINUOUSLY
- VAPOR COMPRESSION
- LOW ENERGY INPUT REQD
- LOW HEAT REJECTION REQD
- SINGLE DEVELOPMENT CONCEPT
- ECLSS TECHNOLOGY
- - REDUCED DEVELOPMENT COST & RISK

- REDUCED INTEGRATED SYSTEMS COST
- REDUCED VENTING CONTAMINATION



Space Division  
North American Rockwell

#### REACTION CONTROL SUBSYSTEM

This chart shows the RCS characteristics, including engines located at each end of the core module on the ZZ axis and the accumulator assemblies which supply the RCS engines with propellants and the ECLSS with oxygen and hydrogen during orbital dark side operations. The RCS engine maintenance concept is presented both in the firing position and the sealed for shirtsleeve maintenance position (dashed configuration).

The design features of the RCS include oxygen/hydrogen propellants derived by water electrolysis, making water the only resupplied consumable which is easily transportable and storable.

The thrusters are independent in that a set of quads at either end of the station can accomplish the RCS functions. The engines operate once every 12 hours to minimize effluent disposal and experiment operations.

Characteristics include the fact that the RCS can adapt to impulse variations by increased frequency of firing and increased electrolysis output.

# REACTION CONTROL SUBSYSTEM

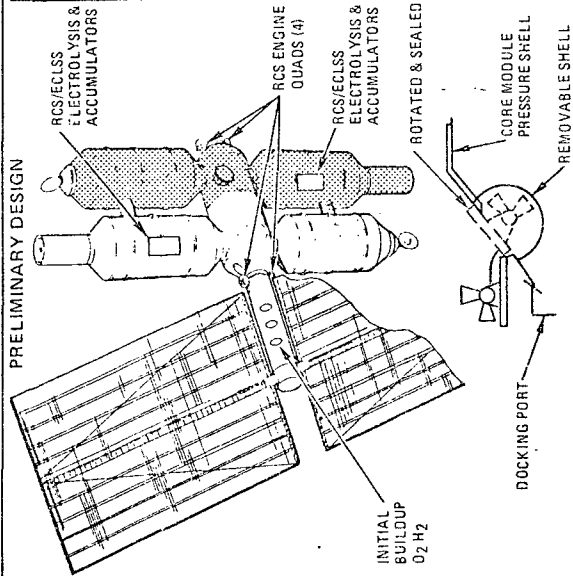

## DESIGN FEATURES

- H<sub>2</sub> O<sub>2</sub> PROPELLANTS
  - WATER ELECTROLYSIS BY ECLSS
  - WATER ONLY CONSUMABLE
  - EPS ELECTROLYSIS ALTERNATIVE
  - GAS STORAGE FOR BUILDUP IN CORE & POWER MODULE
- TWO INDEPENDENT THRUSTER SYSTEMS
  - INCREASED RELIABILITY
- COMBINED ORBIT MAKEUP & MOMENTUM DUMP THRUSTING
  - REDUCES PROPELLANTS
  - THRUSTING ONCE EACH 12 HR
  - REDUCES CONTAMINATION
- SHIRTSLEEVE MAINTENANCE
  - INCREASE SYSTEM LIFE

## UTILITY

- INSENSITIVE TO VARIATIONS IN IMPULSE REQUIREMENTS
- MULTIPLE SUCCESS PATHS FOR MAINTAINING CRITICAL FUNCTIONS

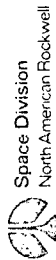



Space Division  
North American Rockwell

#### GUIDANCE AND CONTROL SUBSYSTEM

The G&C concept includes a planar array of three double-gimballed control moment gyros each with an angular momentum of 1100 ft-lb-sec. The gyros are sized for geometric axes, local-level mode operation with a minimum of 12 hours between desaturations. The control moment gyros are desaturated by firing orbit makeup corrections so that they simultaneously torque the vehicle. The CMG system also provides momentum exchange for an orbit-referenced (principal axes) inertial flight mode.

The G&C computation concept includes preprocessors that provide both developmental and operational flexibility. The concept also uses ISS computations where G&C functions are interrelated with other command and control functions.

The station's navigation concept is based on star-horizon measurements. The concept is mechanized to be performed automatically and autonomously. It works independently of ground support, cloud cover, and communication links and uses sensors that are also used for control. Should the shuttle program develop a more accurate navigation concept such as beacon tracking, the station could utilize the system in conjunction with star-horizon measurements to obtain improved performance.

# GUIDANCE & CONTROL SUBSYSTEM

## PRELIMINARY DESIGN

MANUAL ATTITUDE CONTROL

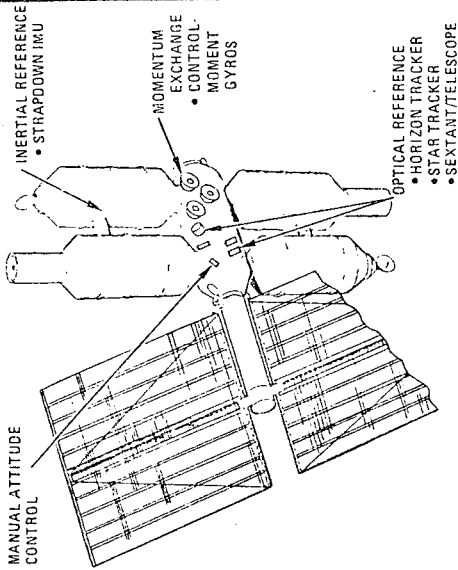

## DESIGN FEATURES

- CMGS, 3 AT 1100 FT LB/SEC EACH
- LOCAL LEVEL FLIGHT MODE WITH GEOMETRIC AXES CONTROLLED X AXIS PERPENDICULAR TO ORBIT PLANE
- OPTIONAL FLIGHT MODE - ORBIT REFERENCED INERTIAL
- MINIMUM OF 12 HR BETWEEN DESATURATIONS
- ORBIT MAKEUP & DESATURATION THRUSTING COMBINED
- COMPUTATION - PREPROCESSORS FOR
  - INERTIAL REFERENCE
  - OPTICAL REFERENCE
  - RCS
  - CMG

## UTILITY

- AUTONOMOUS NAVIGATION - EXPERIMENT REFERENCE INDEPENDENT OF CLOUD COVER OR COMM
- EXPERIMENT POINTING REFERENCE, MIN COMPLEXITY - CONTROLLED GEOMETRIC AXIS FLT MODE
- COMMAND & CONTROL/G&C INTEGRATION, SIMPLE & FLEXIBLE WITH P-PROCESSORS

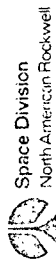



Space Division  
North American Rockwell

#### INFORMATION SUBSYSTEM

The information subsystem is designed with redundant capability to meet the design criteria of the space station. This redundant capability consists of dual control centers, each with a central processor capable of performing the total station subsystem operations. Each control center and central processor has redundancy built within to meet the station failure criteria. One control center is used for station operations while the other control center backs up this function. The backup control center is used for experiment operation during normal operations and is converted to station operations (by software) only during critical periods or those periods when significant onboard checkout is being performed. A quad redundant digital data bus is provided. Dual communications packages are provided, one on SM-1 and one on SM-4. Each package has the ability to transmit and receive on the K, S, and VHF bands.



# INFORMATION SUBSYSTEM

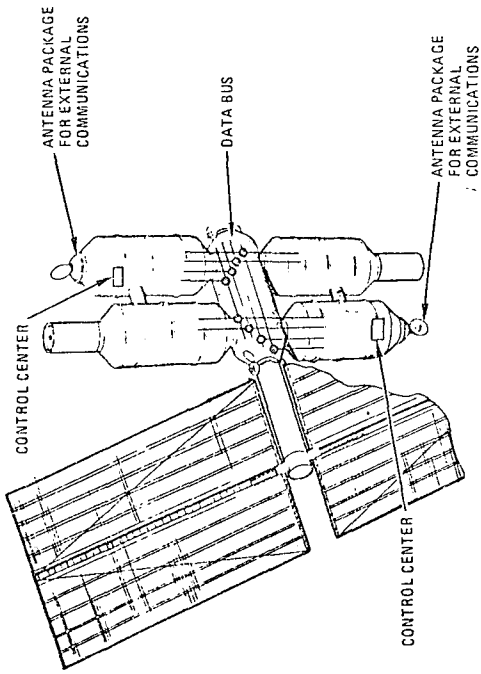

## DESIGN FEATURES

- DUAL CONTROL CENTERS
- DUAL CENTRAL PROCESSORS
- QUAD REDUNDANT DIGITAL BUS
- DUAL COMMUNICATION PACKAGE
  - EACH OF THREE BANDS REDUNDANT

## UTILITY

- SAFETY
- TOTAL STATION CONTROL CAPABILITY FROM EACH PRESSURE VOLUME
- BACKUP COMMAND CONTROL & CENTRAL PROCESSOR USED FOR EXPERIMENTS OPERATIONS DURING NORMAL STATION OPERATIONS

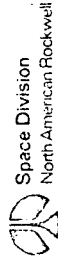



Space Division

North American Rockwell

#### INFORMATION SUBSYSTEM (CONT)

The concept for the external communications package is one which will simplify the equipment, require less component development, and allow greater equipment flexibility. The mixing of the various data sources and the modulation to S band (low power) is accomplished in the control centers and transmitted to the S-band power amplifiers and K-band up-converter (located in the external communications package). The K-band up-converter multiplies the S band to K band and provides the power for antenna radiation in the K-band mounted electronics. The reception of RF information is accomplished the same way with the receivers located at the antennas.

Four separate buses are provided in the station, each having built-in redundancy.

# INFORMATION SUBSYSTEM (CONT)

## EXTERNAL COMMUNICATIONS/INTERNAL BUSES

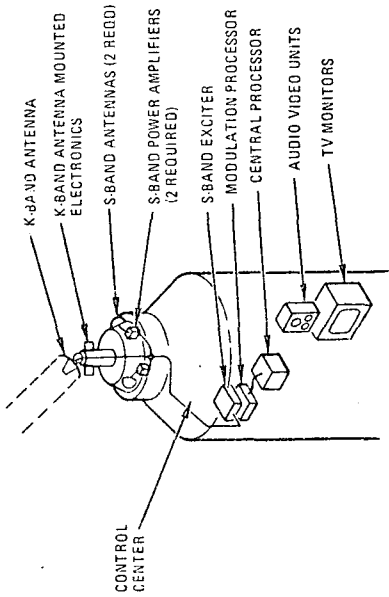

### DESIGN FEATURES

- S-BAND FROM/TO EXCITER/PF. AMPLIFIER
  - NO OUTPUT POWER LOSS
- POWER AMPLIFIERS & PREAMPLIFIERS AT ANTENNAS
- S-BAND TO EACH VOLUME
- BUSES
  - DIGITAL DATA
  - AUDIO/VIDEO
  - PAGING/ENTERTAINMENT
  - TELEMETRY
- REMOVEABLE

### UTILITY

- EXTERNAL COMMUNICATIONS
  - SIMPLIFIES EQUIPMENT
  - FEWER COMPONENTS TO DEVELOP
  - GREATER FLEXIBILITY
- BUSES
  - DIGITAL DATA - QUAD REDUNDANT
  - OTHERS - DUAL REDUNDANT
  - TLM-LOWER DATA RATE ON DIGITAL DATA BUS

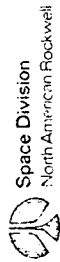

Space Division  
North American Rockwell



Space Division

North American Rockwell

#### SYSTEM WEIGHT

The 20,000-pound design-to weight is comprised of both dry weight and the fluids and gases required to make the modules operational. This design-to-weight includes both airlock and antenna packages as well as the entire GPL furnishings.

Experiment equipment, supplies, and crew logistic items are added to selected modules to provide a fully operational facility when manned. The resultant closeout weight also was held to the 20,000-pound guideline. This closeout weight represents the current module launch weight at this point in the development schedule. The actual weight numbers shown on the chart include all hardware items and the necessary mounting provisions.

Actual shuttle payload weight also must consider certain tariff items due to the buildup operations. In addition, an allowance must be reserved for weight growth that occurs as the program matures from phase B to phase D.

# SYSTEM WEIGHT

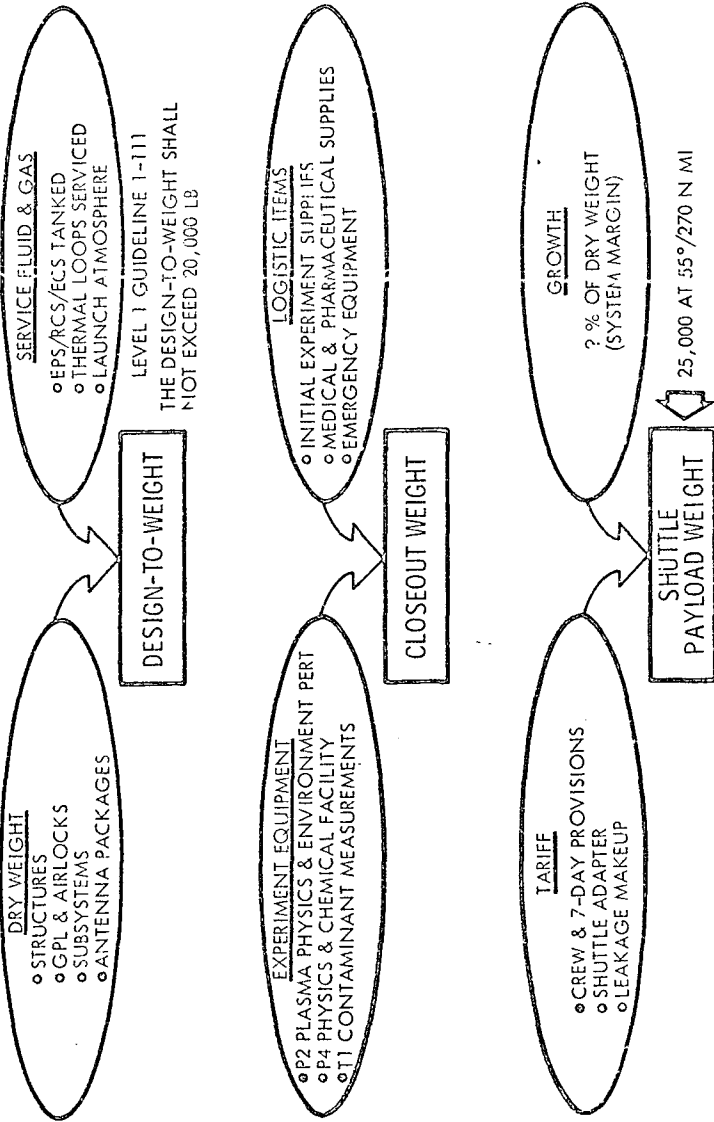



Space Division  
North American Rockwell

#### SYSTEM WEIGHT (CONT)

The subsystem dry weight total of 103,611 pounds is only 491 pounds over the preliminary design start point reported at the second quarterly review. However, at the start of preliminary design the core module and both SM-1 and SM-4 were over a 20,000-pound closeout weight. During preliminary design equipment items were removed from the three overweight modules and redistributed to SM-2 and SM-3. However, the core module was allowed to exceed 20,000 pounds because of its position in the buildup sequence. Being the first module launched, the core module shuttle flight does not require the budgeted rendezvous propellant. This operational offloading is discussed later.





Space Division  
North American Rockwell

#### OPERATIONAL WEIGHT SUMMARY

This chart identifies the weight items that must be added to the dry weight of the previous chart to arrive at a launch weight. The experiment equipment (9.0) and logistic items (10.0) are the only weights that can be transferred to cargo module launches.

Shuttle tariff weights are substantial and their addition leaves a weight growth allowance less than prior single launch station growth margins.



# OPERATIONAL WEIGHT SUMMARY

	CORE	POWER	SM-1	SM-2	SM-3	SM-4	TOTAL
8. SERVICE FLUIDS & GASSES							
REPRESS O2		194					194
LAUNCH ATMOSPHERE	285	381	322	322	322	322	381
ELECTROLYSIS ACCUM. H2O		74					1647
INTERNAL THERMAL LOOP H2O	148		199	50	50	199	100
EXTERNAL THERMAL LOOP F-REON	191		604	223	223	604	740
WATER MANAGEMENT LOOP H2O	5		6	6	6	6	1845
EPS & RCS BUILDUP O2	333	273					29
EPS & RCS BUILDUP H2	42	34					606
TOTAL	1004	956	1131	699	699	1131	5620
9. EXPERIMENT EQUIPMENT							
P-2 PLASMA PHY & ENVIR PORT					1003		1003
P-4 PHYSICS & CHEMICAL FACILITY				807	866		835
T-1 CONTAMINATION MEASUREMENT							807
TOTAL	0	0	0	807	1369		2676
10. LOGISTICS ITEMS							
PORTABLE H2O						400	400
96-HR EMERGENCY LIQH				112	112		224
MED. & PHARM SUPPLIES						110	110
P-2, P-4, T-1 EXP CONSUM				302			302
TOTAL	0	0	0	414	112	510	1036
11. SHUTTLE TARIFF							
2 CREW	400	400	400	400	400	400	400
2 CREW PROVISIONS	300	300	300	300	300	300	300
2 PLSS & 2 PGA	354	354	354	354	354	354	354
PASSENGER PROVISIONS	63	155	190	160	160	166	166
LEAKAGE MAKEUP O2/N2	0	165	180	210	210	210	210
SHUTTLE EPS REACTANTS	50	365	495	383	383	405	405
J TANK WEIGHT	97	425	425	425	425	425	425
MSS SHUTTLE ADAPTER		600					
TOTAL	1264	2764	2344	2232	2232	2260	2260



Space Division  
North America, an Rockwell



Space Division  
North American Rockwell

#### MODULE DRY WEIGHT SUMMARY

The space station dry weight is apportioned to seven functional subsystem groupings. The two-digit codes are the Level 6 major assemblies. Lower-level subassembly quantities and weights are defined in the subsystem characteristics portion of preliminary performance spec (DRL 66, Vol. 1) and preliminary design report (DRL 68, Vol. 4).

Two experiment airlocks and all GPL provisions are included in the structure group (Code 1.5). The two antenna packages are included in the information group (6.3).

The dry weight shown includes mounting and installation provisions as well as standard utilities such as wiring, ducts, and tubing.

The number identification is consistent with the MSS program and project level costing.

# MODULAR DRY WEIGHT SUMMARY

	SUBSYSTEM/MAJOR ASSEM	COFE	POWER	SM-1	SM-2	SM-3	SM-4	TOTAL
1	STRUCTURAL & MECHANICAL	12690	3670	10160	12333	10700	9490	59040
1.1	PRIMARY STRUCTURE	5742	1878	4700	4700	4700	4700	26420
1.2	SECONDARY STRUCTURE	3399	410	3218	3350	3448	3378	17201
1.3	ENVIRONMENTAL SHIELD	1119	582	746	755	746	745	4674
1.4	BERTHING	2430	800	490	450	490	490	5150
1.5	GENERAL PURPOSE LAB FURNISH	0	0	1066	3055	1318	176	5555
2	ENVIRONMENTAL CONTROL/LIFE SUPPORT	1619	849	3690	3310	3415	3420	16303
2.1	GASEOUS STORAGE	42	765	0	11	11	0	820
2.2	CO2 MANAGEMENT	4	0	0	741	741	4	1404
2.3	ATMOSPHERIC CONTROL	780	84	557	876	876	584	3727
2.4	THERMAL CONTROL	681	0	1969	1570	1570	1369	7750
2.5	WATER MANAGEMENT	20	0	638	13	23	638	1342
2.6	WASTE MANAGEMENT	0	0	86	0	79	163	328
2.7	HYGIERNE	0	0	370	17	53	56	506
2.8	SPECIAL LIFE SUPPORT	122	0	38	17	62	38	348
3	ELECTRICAL POWER	3700	7800	1762	545	545	1762	16204
3.1	PRIMARY POWER GEN	0	6676	0	0	0	0	6676
3.2	SECONDARY POWER GEN	0	0	0	0	0	0	0
3.3	ENERGY STORAGE	2449	985	766	0	0	766	4965
3.4	POWER CONDITIONING	379	0	16	16	16	16	442
3.5	DISTRIBUTION CONTROL & WIRING	776	115	834	383	383	834	3325
3.6	LIGHTING	188	24	146	140	146	146	734
4	GUIDANCE & CONTROL	1470	0	0	0	0	0	1470
4.1	INERTIAL REFERENCE	65	0	0	0	0	0	65
4.2	OPTICAL REFERENCE	346	0	0	0	0	0	346
4.3	RCS ELECTRONICS	75	0	0	0	0	0	75
4.4	MOMENTUM EXCHANGE	984	0	0	0	0	0	984
4.5	COMPUTATION	0	0	0	0	0	0	0
5	REACTION CONTROL	180	0	0	153	153	0	486
5.1	PROPELLANT ACCUMULATOR	0	0	0	0	0	0	0
5.2	PROP FEED CONTROLS	60	0	0	75	65	0	190
5.3	ENGINES	120	0	0	0	0	0	120
6	INFORMATION	482	116	2740	134	161	2040	6253
6.1	DATA PROCESSING	171	91	692	64	64	692	1774
6.2	INTERNAL COMMUNICATIONS	189	0	845	0	0	745	1699
6.3	EXTERNAL COMMUNICATIONS	130	21	641	30	57	641	1791
6.4	INTERNAL COMMUNICATIONS	39	0	80	0	0	80	1429
6.5	SOFTWARE	0	0	0	0	0	0	163
7	CREW HABITABILITY	733	125	503	233	1271	900	3855
7.1	PERSONAL EQUIPMENT	0	0	0	0	0	0	0
7.2	GENERAL/EMERG EQUIP	733	125	145	145	145	145	1438
7.3	RECREATION	0	0	230	0	0	230	460
7.4	RECREATION/EXERCISE/CREW CARE	0	0	130	0	0	130	260
7.5	FOOD MANAGEMENT	0	0	0	63	755	0	818
	SUBTOTAL (DRY WEIGHT)	20944	12560	18855	16705	16245	18302	103611

Space Division  
North American Rockwell



101PDS110597



Space Division  
North American Rockwell

#### MSS BUILDUP - FIRST LAUNCH CAPABILITY

The shuttle design reference mission (DRM) baseline configuration has the ability to insert a 20,000-pound target payload weight into orbit, executing various maneuvers and finally deorbiting and landing using 27,730 pounds of OMS + ACPS propellant. Two of the normal on-orbit maneuvers include rendezvous and docking which consume nearly 5,000 pounds of OMS propellant.

The first MSS launch does not require this propellant allowance since the maneuvers are not required. Even though the first launch is inserted at about 274 nautical miles (and allowed to decay to 270 nautical miles over a 3-month period), the propellant weight saved could be converted to payload weight with no increase in launch vehicle weight or change in V performance. It is therefore shown that the first MSS launch could be targeted for up to 29,725 pounds rather than 25,000 pounds.

# MSS BUILDUP FIRST LAUNCH CAPABILITY

- OPERATIONAL ALLOCATION SHUTTLE MANEUVERING PROPELLANT (OMS + ACPS)

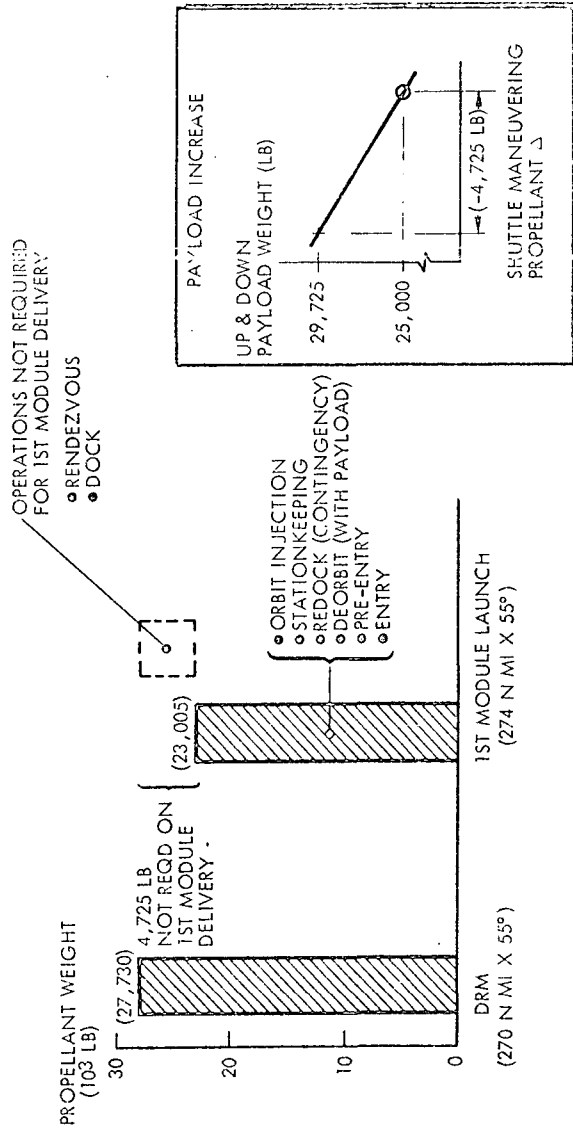



Space Division  
North American Rockwell

#### MOCKUP STATUS - MOCKUP AREA AND EXTERNAL CONFIGURATION

The modular space station mockup is located adjacent to the 33-foot diameter space station mockup at the Seal Beach facility. The MSS mockup contains two of the station modules and a short section of the core module which connects the two station modules.

The modules selected for mockup are (1) a crew/control module, SM-1, and (2) a laboratory/ECS module, SM-2. The SM-1 module contains a commander's stateroom and two crew staterooms, a personal hygiene area, control center, data analysis laboratory, a photo lab, an exercise and backup medical area, and waste management equipment. The SM-2 module contains the ECS air revitalization equipment below deck and a large general-purpose laboratory on the upper deck.

# MOCKUP STATUS

MOCKUP AREA &  
CONFIGURATION  
EXTERIOR



- MODULAR STATION - FOREGROUND
- 33 FT DIA STATION - BACKGROUND

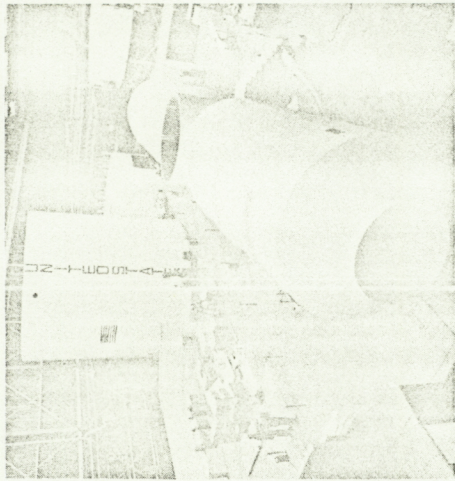

MOCKUP END VIEW

- SM-2 LAB/ECS MODULE  
ENTRANCE



Space Division  
North American Rockwell

MOCKUP STATUS - CREW/CONTROL MODULE-SM-1

The structural shell and secondary structure of the crew/control module, SM-1, has been completed. All of the equipment assemblies have been fabricated and the installation partially completed.

The commander's stateroom and the crew stateroom installations are complete and ready for final decor. Part of the personal hygiene assemblies are installed as well as those for the photo processing lab. The control consoles and data processing assemblies are ready for installation.



# MOCKUP STATUS

CREW/CONTROL MODULE SM-1

COMMANDERS STATEROOM



- CONTROL/COMMUNICATION CONSOLE
- DESK

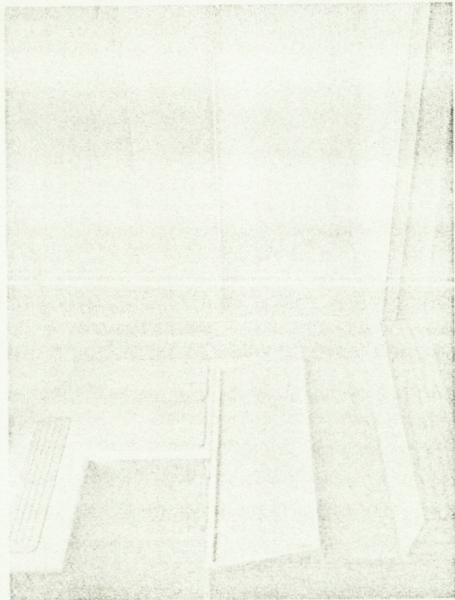
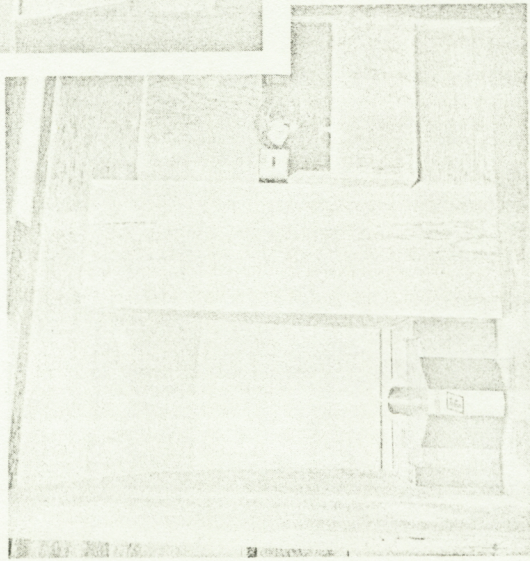

PERSONAL HYGIENE AREA  
(UPPER DECK)



Reproduced from  
best available copy.



Space Division  
North American Rockwell

MOCKUP STATUS - LAB/ECS MODULE - SM-2

The module structural shell, floors, and partitions have been completed and installation of furnishing begun.

All the internal furnishing subassemblies have been fabricated and installations of ECS equipment completed. The lower photograph shows the mounting of these assemblies on one side of the module. The equipment is supported from the load-carrying floor above. Accessibility for installation and in-flight maintenance is clearly visible.

The backup galley, located above deck at one end of the module is partially completed. The secondary structure for the general-purpose laboratory installations, above deck, are also completed. Installation of the GPL equipment is underway.

**MOCKUP STATUS**

LAB/EGS MODULE SM-2

BACKUP GALLEY  
(UPPER DECK)



AIR REVITALIZATION EQUIP  
(LOWER DECK)

# MODULAR SPACE STATION PHASE B EXTENSION

3RD QUARTERLY REVIEW

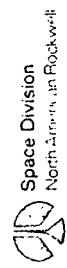
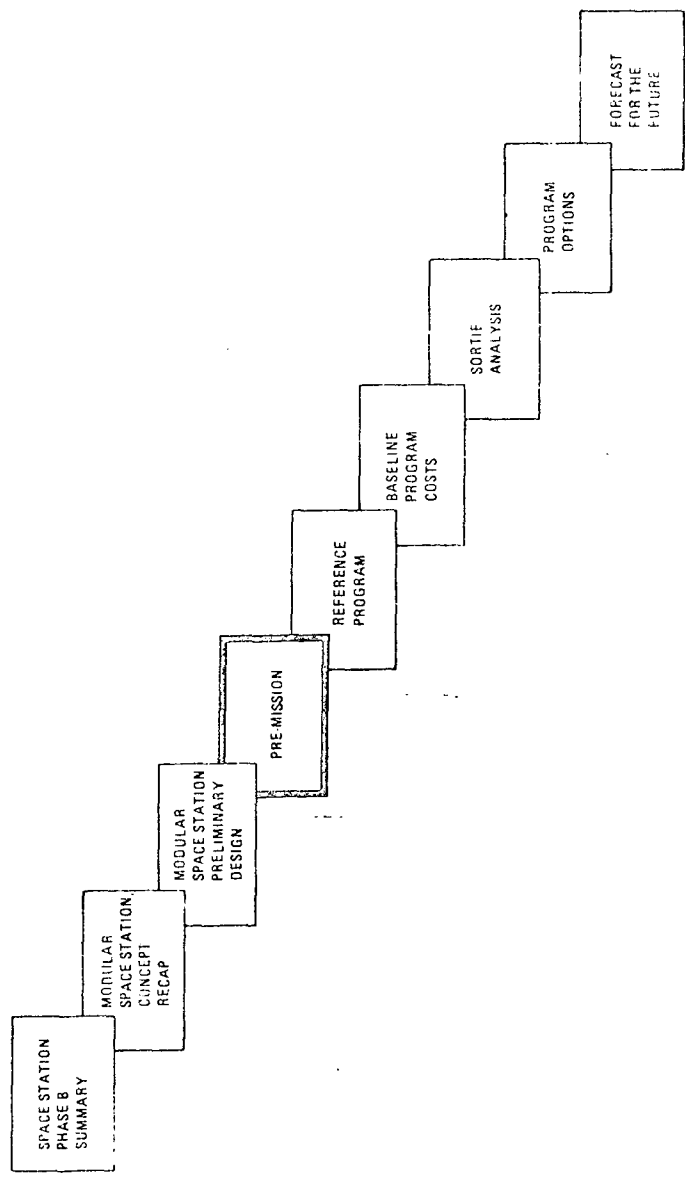



Space Division  
North American Rockwell

#### MAJOR GOALS

Key elements from the ground operations goals are shown on this chart. The reuse of development hardware in other program areas is a cost-saving goal which requires a thorough examination of schedule and phasing alternatives and specific test objectives for each test requirement. The early verification of hardware and software interfaces is essential since the problem areas exposed in that activity are historically time-consuming to resolve and usually quite numerous. The stipulation that qualification be complete prior to flight subsystem installation is designed to minimize the possibility of expensive rework to correct deficiencies exposed in verification testing. The checkout of individual modules with an integrated fixture is to assure that all subsystem interactions are taken into account. The cluster checkout of the four initial flight modules will verify interfaces prior to orbital buildup.

## MAJOR GOALS

---

---

- o REUSE OF DEVELOPMENT HARDWARE
- o EARLY VERIFICATION OF HARDWARE AND SOFTWARE INTERFACES
- o QUALIFICATION COMPLETE PRIOR TO FLIGHT SUBSYSTEM INSTALLATIONS
- o INDIVIDUAL MODULE CHECKOUT WITH INTEGRATED TEST FIXTURE
- o INTEGRATED CHECKOUT OF MODULE CLUSTER PRIOR TO FIRST LAUNCH



Space Division  
North American Rockwell

#### QUALIFICATION SCHEDULE

The qualification schedule is extracted from the program phasing plan to illustrate the relationship between the key qualification test activities and flight article fabrication. Note that the structural and dynamic testing (structural qualification) will be 75-percent complete prior to start of flight article fabrication and 100-percent complete before the first flight article is produced. In the case of the subsystem qualification (CAV operations), the integration will be essentially complete prior to subsystem installation in the flight articles.

# QUALIFICATION SCHEDULE

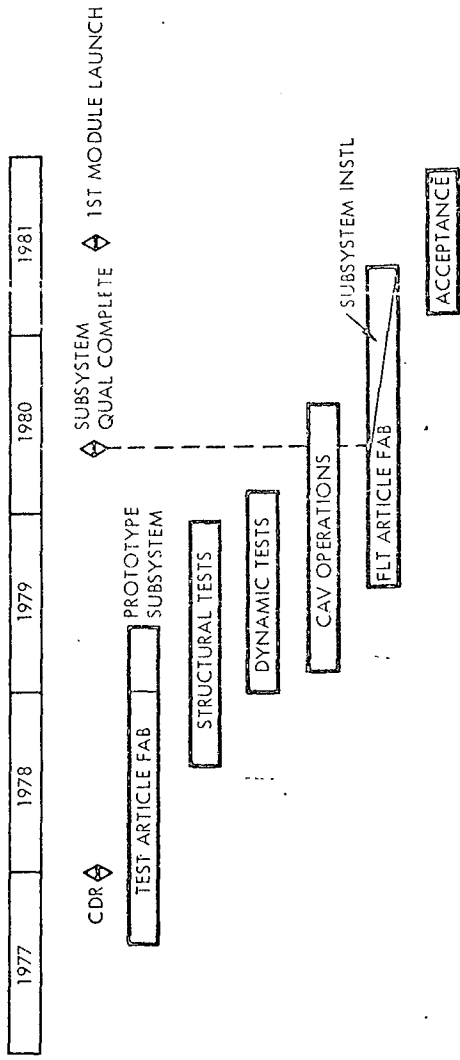





Space Division  
North American Rockwell

#### COMPATIBILITY ASSESSMENT VEHICLE

The compatibility assessment vehicle (CAV) is the primary fixture for physical and functional integration of the space station subsystems and their associated software. This is the first point in the ground operations program that functional, fully configured subsystems and flight-type structures are brought together. The CAV configuration will utilize prototype subsystems permitting an early start on the complex integration tasks. A subsequent update to flight-type subsystems will convert the CAV to an acceptance fixture.

# COMPATIBILITY ASSESSMENT VEHICLE (CAV)

## PURPOSE:

- o SUB SYSTEM INTERFACE/INTERACTIONS
- o SOFTWARE INTEGRATION
- o MAINTENANCE AND OPERATIONS

## CONFIGURATION

- o PHYSICALLY MATED MODULES

CORE  
POWER  
SM-1  
SM-3  
SM-4

- o PROTOTYPE HARDWARE

REFURBISHED WITH FLIGHT-TYPE HARDWARE FOR  
ACCEPTANCE FIXTURE

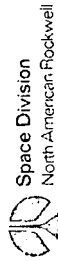

Space Division  
North American Rockwell



Space Division  
North American Rockwell

#### CAV BUILDUP

The buildup of the CAV is programmed to be accomplished over a period of one year starting in April 1979. The various stages in the buildup of hardware also represent the integration levels achieved. The phasing shown permits a logical development of the hardware/software integration process coincident with the reuse of major test articles.

# AV BUILDUP

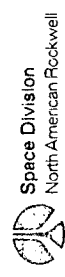
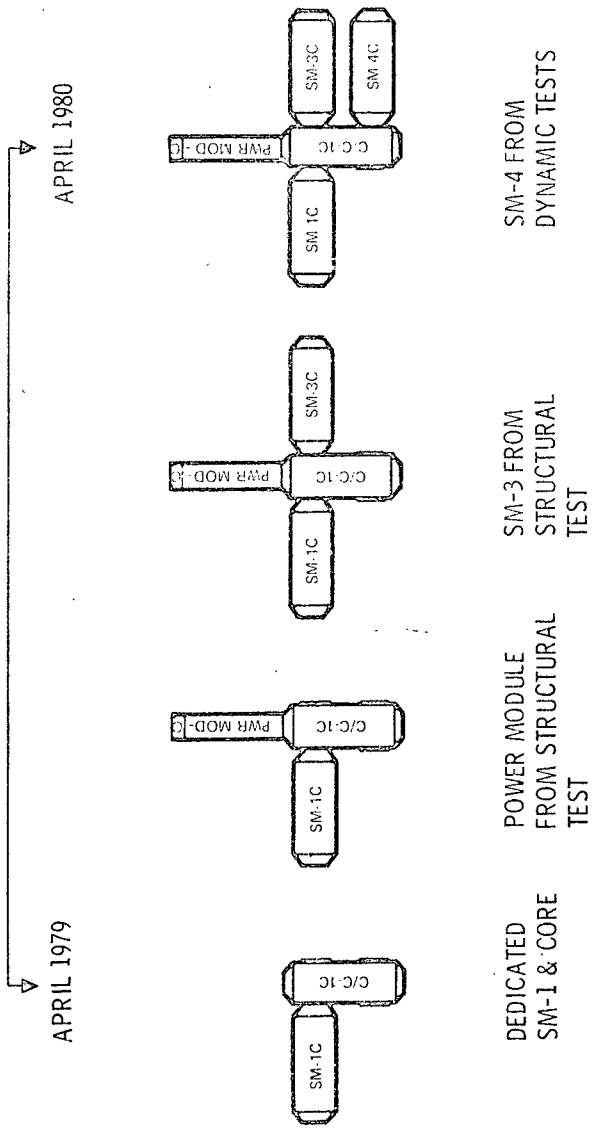



Space Division  
North American Rockwell

#### ACCEPTANCE

Acceptance of the initial station modules is divided into two phases. The first is acceptance at the factory of the four modules providing the basic functions of the station, the core, power, control, and environment. These four modules are physical mated and functionally checked out as an integrated unit to provide confidence that they will perform satisfactorily when built back up in orbit. The second phase is the acceptance of the remaining initial station modules at the launch site.

# ACCEPTANCE

## FACTORY ACCEPTANCE OF MODULE CLUSTER

CORE

POWER

SM-1

SM-3

## INTEGRATED CHECKOUT OF CLUSTER PRIOR TO SHIPMENT

## ACCEPTANCE FIXTURE TO KSC FOR SM-2, SM-4 ACCEPTANCE, AND MISSION SUPPORT

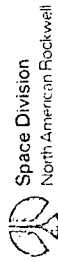

Space Division  
North American Rockwell

- 141 -

101PDS111946



Space Division  
North American Rockwell

#### ACCEPTANCE BUILDUP

This chart illustrates the sequential insertion of flight modules into the acceptance fixture up to the point where the first four modules to be launched are assembled together. As each flight module is added, the corresponding acceptance fixture module is removed and shipped to the launch site to build up the mission support vehicle (MSV).

# ACCEPTANCE BUILDUP

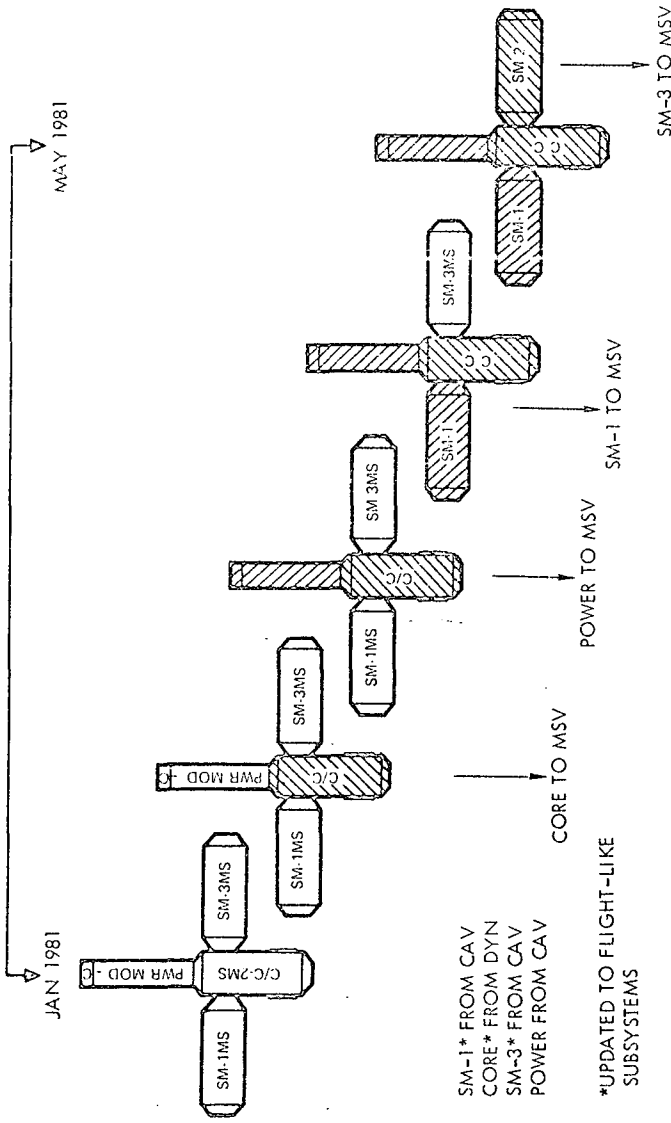

SM-1\* FROM CAV  
 CORE\* FROM DYN  
 SM-3\* FROM CAV  
 POWER FROM CAV

\*UPDATED TO FLIGHT-LIKE  
 SUBSYSTEMS

## FACTORY ACCEPTANCE

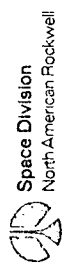

Space Division  
 North American Rockwell





Space Division  
North American Rockwell

#### MISSION SUPPORT VEHICLE FUNCTIONS

The buildup of the mission support vehicle from modules used in the factory acceptance phase is shown in the chart opposite. The NSV is a multipurpose fixture designed to provide support for the orbital operations throughout the life of the space station. Some of the basic functions this set of modules will perform are (1) acceptance of the last three modules comprising the initial station configuration (SM-3, SM-4, and a cargo module), (2) final acceptance of growth station modules, (3) final acceptance of IFRU's, spares, and software revisions, (4) acceptance of RAM's or other experiment hardware having a direct functional interface with the station modules, (5) validation of modifications, and (6) crew familiarization.

# MISSION SUPPORT VEHICLE FUNCTIONS

ACCEPTANCE OF SM-3, SM-4, CARGO MODULES, RAM'S, IFRU'S, SPARES,  
SOFTWARE REVISIONS

CREW FAMILIARIZATION  
MODIFICATION VALIDATION

## MSV BUILDUP

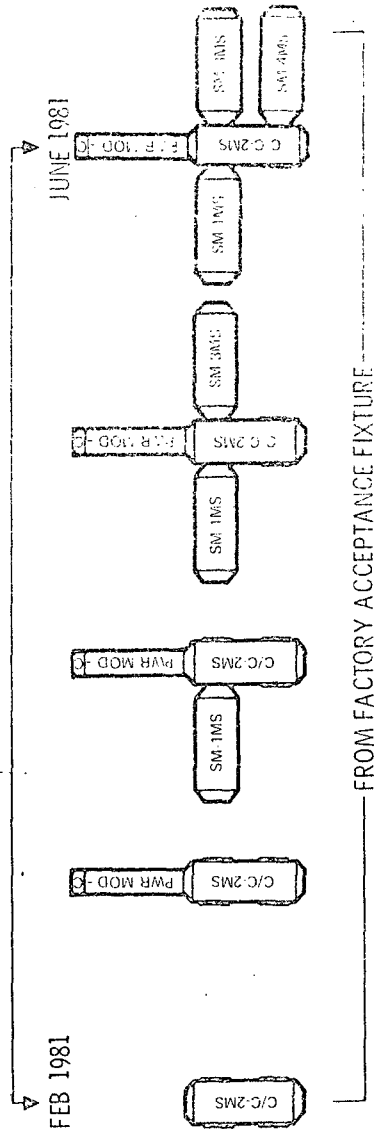



Space Division  
North American Rockwell

#### MSV ACCEPTANCE UTILIZATION

This chart illustrates the use of the MSV at the launch site as an acceptance fixture for the SM-3, SM-4, and cargo modules of the initial station configuration.

# MSV ACCEPTANCE UTILIZATION

JULY 1981 → OCT 1981

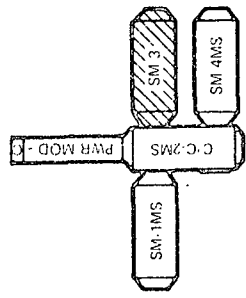

SM-3  
ACCEPTANCE

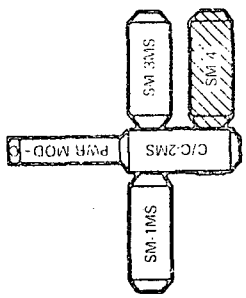

SM-4  
ACCEPTANCE

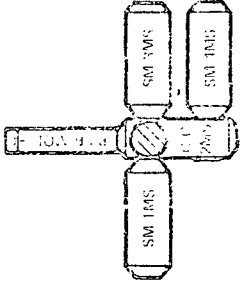

1ST CARGO  
MODULE  
ACCEPTANCE





Space Division  
North American Rockwell

#### MAJOR TEST HARDWARE UTILIZATION

The utilization and flow of major test hardware described in preceding pages is summarized by module, function, and subsystem type. The core module used in structural test and the power module from dynamic tests will consist of structure only when stored.

# MAJOR TEST HARDWARE UTILIZATION & FLOW

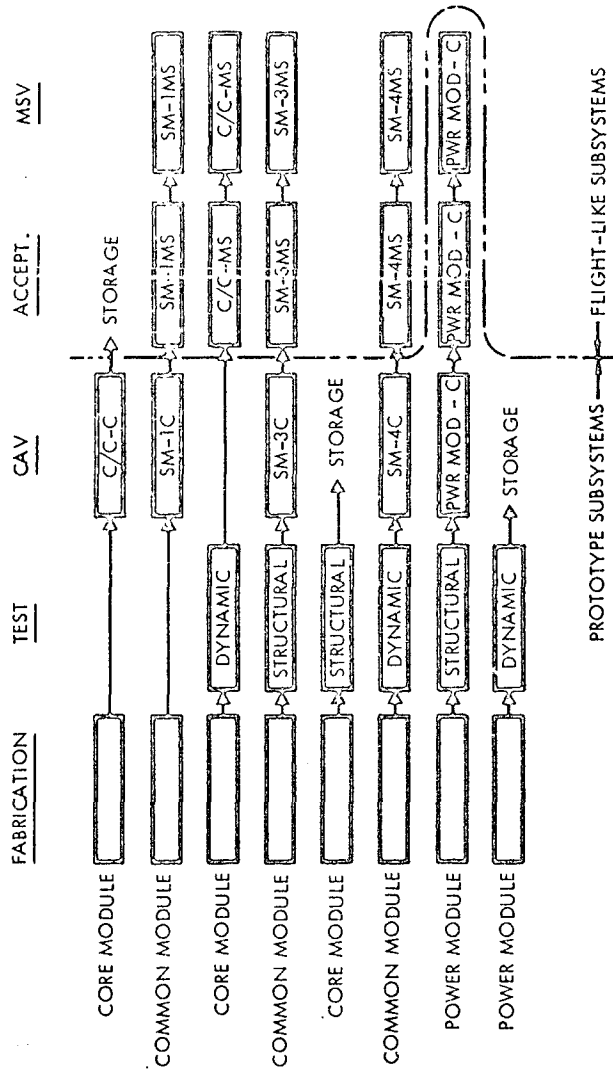



Space Division  
North American Rockwell

#### TEST HARDWARE REQUIREMENTS

The individual subsystem and structure requirements identified on the preceding page are summarized on this chart.

# TEST SOFTWARE REQUIREMENTS

	STRUCT	ISS	RCS	ECS	EPS	G&C	C&H
CORE MODULE	3 PRI	1F	1F	1F	1F	1F	1P
	2 SEC	1P	1P	1P	1P	1P	---
		0.7S	0.7S	0.7S	0.7S	0.7S	---
COMMON MODULE	3 PRI	2.7F	---	3F	1F	---	---
	3 SEC	2.8P	1P	2.4P	3P	---	3P
		0.7S	---	0.7S	---	---	0.7S
POWER MODULE	2 PRI	---	---	---	---	---	---
	1 SEC	1P	---	1P	1P	---	---
		---	---	1S	0.9S	---	---

S = SIMULATED SUBSYSTEM  
P = PROTOTYPE SUBSYSTEM  
F = FLIGHT-TYPE SUBSYSTEM





Space Division  
North American Rockwell

#### MAJOR TEST HARDWARE CONFIGURATION

The structural and subsystem configuration for each of the modules used in the test program is shown on this chart. When more than one subsystem configuration is shown for a given module (such as Common Module 3 which is used in dynamic tests, compatibility assessment, and acceptance), the subsystems are updated to the new configuration between the test sequences. The simulated subsystems used in the dynamic test operations are simulations with respect to mass and c.g. only.

# MAJOR TEST HARDWARE CONFIGURATION

ARTICLE	UTILIZATION																										
	STRUCTURAL TEST						DYNAMIC TEST						COMPATIBILITY ASSESSMENT						ACCEPTANCE AND MSV								
	STR	ISS	RCS	ECS	EPS	G&C	STR	ISS	RCS	ECS	EPS	G&C	STR	ISS	RCS	ECS	EPS	G&C	STR	ISS	RCS	ECS	EPS	G&C			
CORE 1							1**	.75	.75	.75	.75	.75	0	1**	Δ	1P	1P	1P	1P	1P	0	0	1F	1F	1F	1F	1P
CORE 2																											
CORE 3																											
COMMON 1														1**	Δ	1P	0	8PR	1P	0	0	0	1F	0	1P		
COMMON 2														11/2	Δ	8P	1P	8PR	1P	0	0	0	7F	0	1P		
COMMON 3														12/2	Δ	1P	0	8PR	1P	0	0	0	1F	0	1P		
POWER 1							1**	0	0	0	0	0	0	11/2	Δ	1P	0	1PR	0	0	0	0	0	0			
POWER 2							1**	0	0	1S	.95	0	0														

**CODES**

- Δ ENVIRONMENTAL SHIELDING
- \* PRIMARY STRUCTURE
- S SIMULATED SUBSYSTEM
- F FLIGHT TYPE SUBSYSTEM
- P PROTOTYPE SUBSYSTEM
- (1) SECONDARY STRUCTURAL
- (2) BERTHING RING
- R RADIATORS NOT USED FOR HEAT REJECTION
- \*\* PRIMARY SECONDARY BERTHING RING AND GPL FURNISHINGS
- A SOLAR ARRAYS NOT INSTALLED





Space Division  
North American Rockwell

#### STATION MODULE - MANUFACTURING ASSEMBLY SEQUENCE

This chart illustrates the manufacturing assembly sequence for the station module.

The assembly of the station module will consist of joining preformed and preassembled panel segments using longitudinal welds to form the cylinder. The two prefabricated end bulkheads with berthing rings are circumferentially welded to the cylinder completing the basic structure.

After pressure-testing the basic structure, the floors, partitions, and bracketry are installed, followed by subsystem installation.

When the assembly is complete, final in-process checks are performed. The completed module is then sent to the integrated checkout area for final checkout and acceptance. Shipment of the module will be in a horizontal position which is also compatible with the loading of the module into the shuttle.

# STATION MODULE-MANUFACTURING ASSEMBLY SEQUENCE

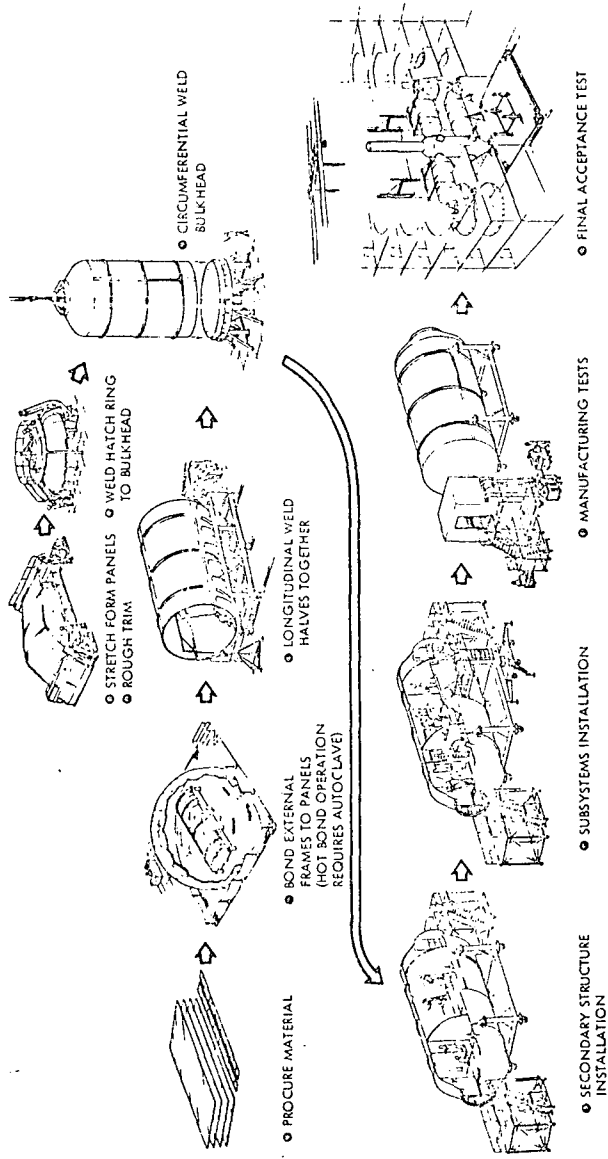



Space Division  
North American Rockwell

#### POWER MODULE - MANUFACTURING ASSEMBLY SEQUENCE

This chart illustrates the manufacturing assembly sequence for the power module.

The assembly of the power module cylinder will consist of joining preformed and preassembled panel segments using longitudinal welds to form the cylinder. The two end berthing rings will be fabricated from forged aluminum rings then joined to cylinder by circumferential welding, completing the basic structure.

After pressure-testing the basic structure, secondary structures and subsystems are installed. Final in-process checks are performed completing the assembly. The completed module is then sent to the integrated checkout area for final checkout and acceptance. Shipment of the module will be in a horizontal position which also is compatible with the loading of the module into the shuttle.

# POWER MODULE-MANUFACTURING ASSEMBLY SEQUENCE

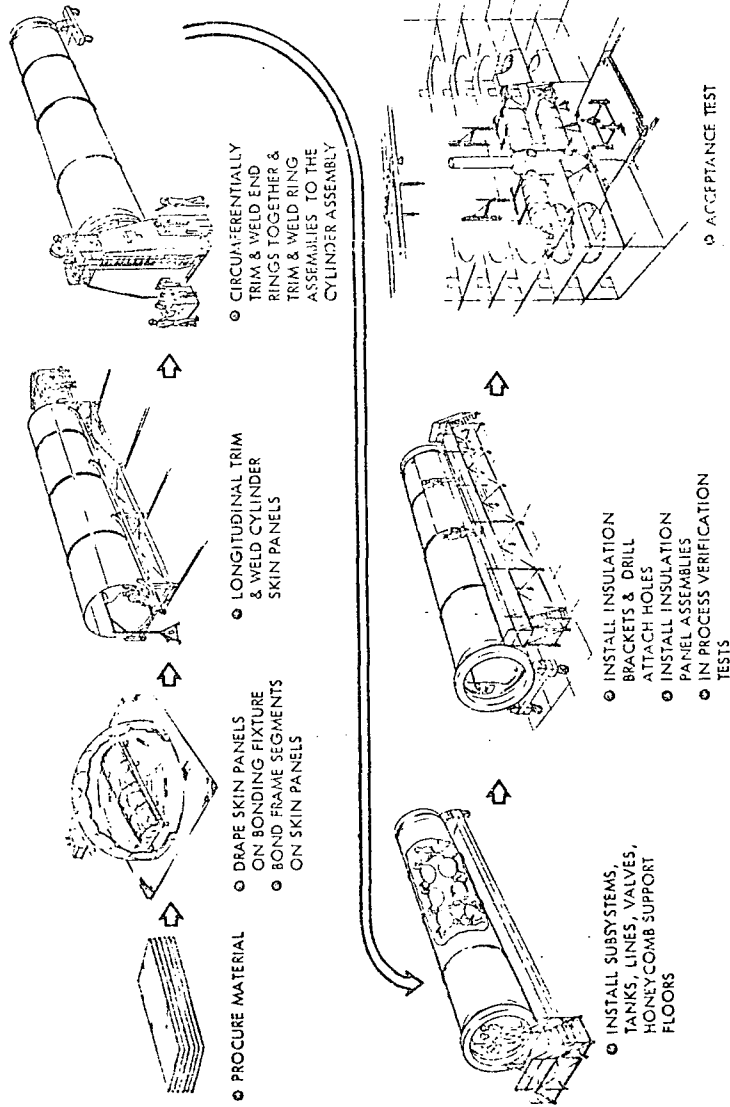



Space Division

North American Rockwell

#### FLIGHT ARTICLE PHASING

The relationships of fabrication, secondary structural installation, subsystem installation, acceptance test, shipment, and launch for the seven modules comprising the initial station are shown on this chart. The portion of the bars labeled "M" is the basic structure fabrication, the crossed portion is a storage period, the solid section is secondary structure installation, and the portions labeled E, S, A are subsystems installation, shipment, and acceptance, respectively. The vertical arrows are the planned launch dates. The factory acceptance of the first four modules followed by field site acceptance of the remaining three is clearly indicated in the reversing of the A and S blocks between SM-2 and SM-3.

# FLIGHT ARTICLE PHASING

FABRICATION, ACCEPTANCE & LAUNCH

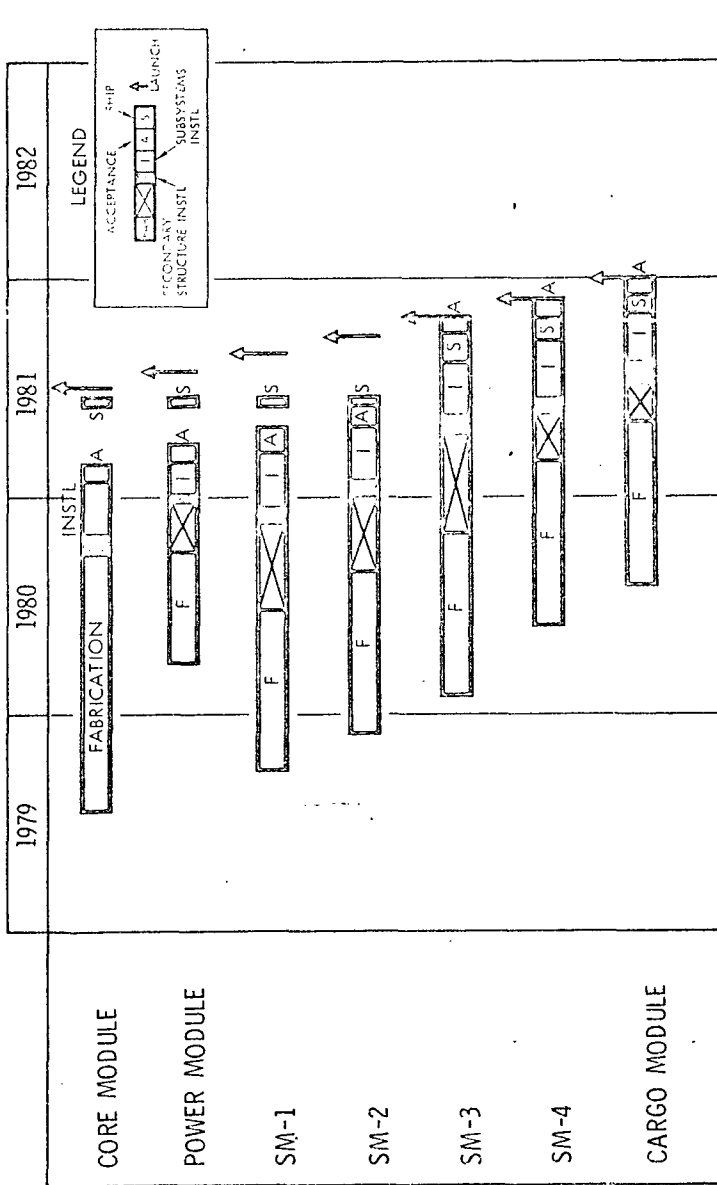



# MODULAR SPACE STATION PHASE B EXTENSION

3RD QUARTERLY REVIEW

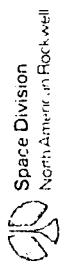
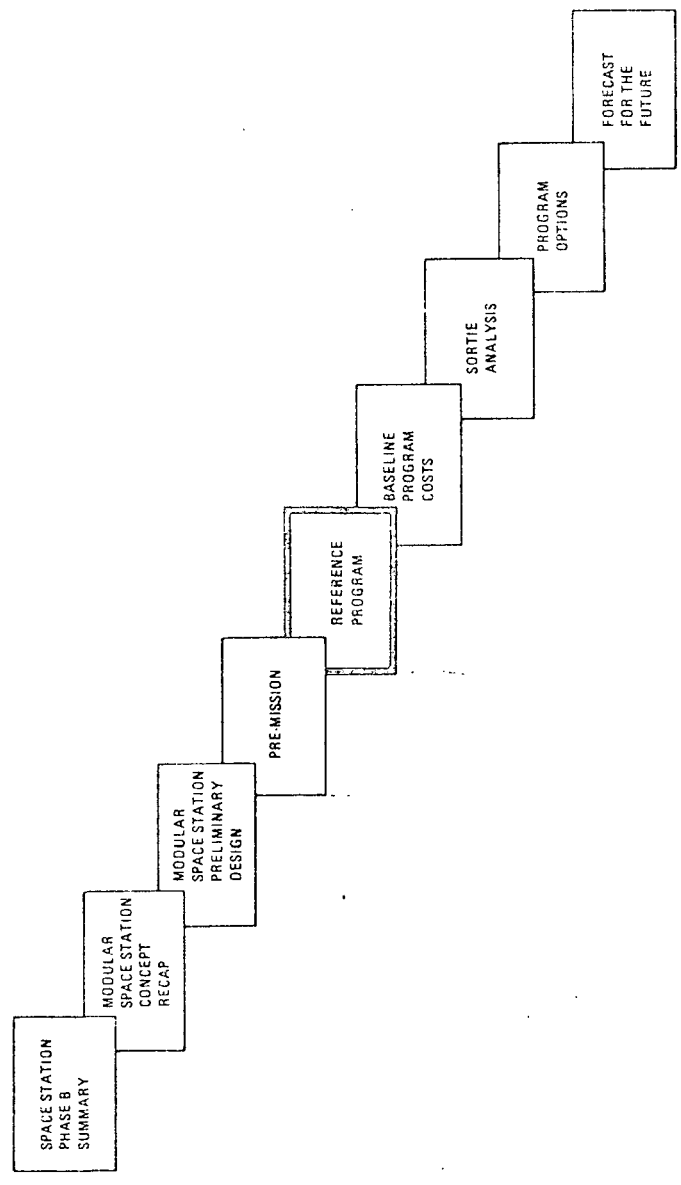



Space Division  
North American Rockwell

#### REFERENCE PROGRAM DEFINITION

The modular space station reference program is defined by the phasing of the basic program elements consisting of the generic experiments, the modular space station, the research and applications modules (RAM), and the earth-orbit shuttle. The experiments in the NASA Blue Book provide a generic set of experiments and the associated experiment equipment, resource requirements, and operational characteristics. The experiments are conducted within the general-purpose laboratory (GPL) of the modular space station or within attached or detached RAM's. The earth-orbit shuttle is required for the delivery of space station modules, RAM's, experiment equipment, station and experiment consumables, etc. The phasing of these elements is determined by the mission sequence plan which provides the basic definition of the modular space station program. Further definition, based on the mission sequence plan, is provided for program costs and the master program phasing.

# REFERENCE PROGRAM DEFINITION

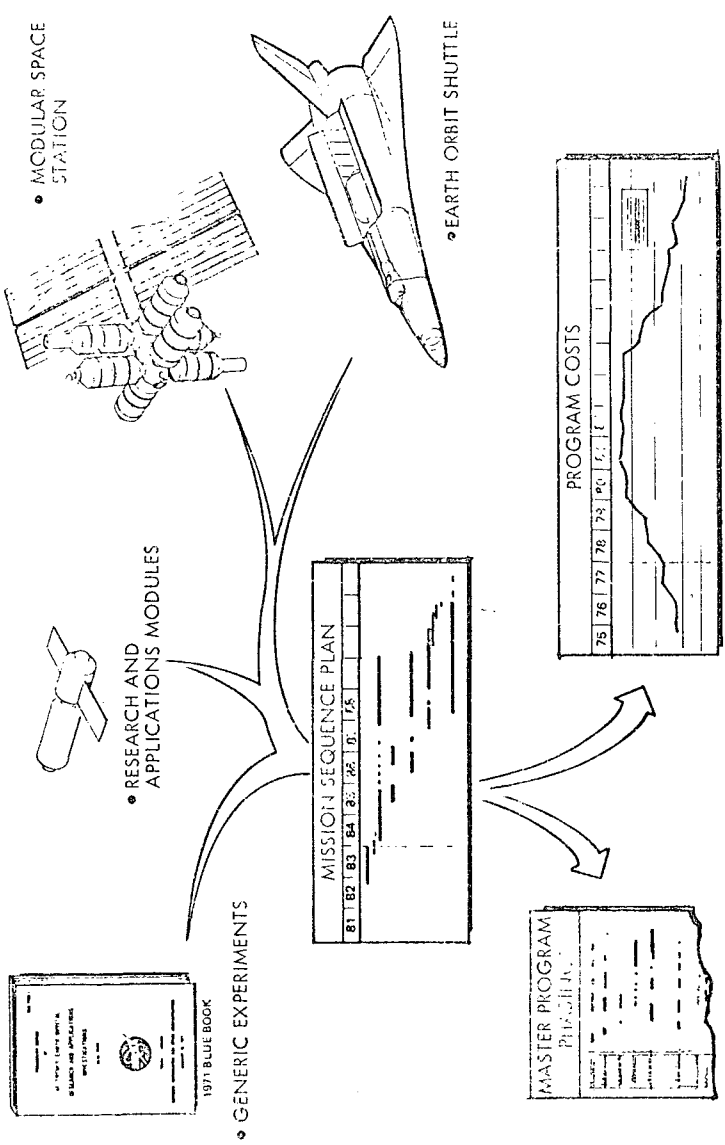



Space Division  
North American Rockwell

#### MISSION SEQUENCE PLAN DEVELOPMENT

The basis of the mission sequence plan is the NASA Blue Book which defines the generic set of experiments to be conducted by the modular space station. An experiment data book was generated which provided an interpretation of the Blue Book and the basis for conducting an experiment drive analysis. An evolutionary program philosophy was developed in which two basic experiment activity levels were identified. The evolutionary program philosophy permits the deferment of experiment costs and the early scheduling of major experiments within each discipline to provide a balanced total program. For each FPE, the operational concept (duration, accommodation mode, and special requirements) and the support requirements (crew, electrical power, data, and logistics) were defined. Utilizing these data, the reference experiment program was established considering FPE interrelationships and constraints and the final mission sequence plan was developed by considering operational factors such as space station buildup, crew rotation, RAM delivery, and logistics resupply.

# MISSION SEQUENCE PLAN DEVELOPMENT

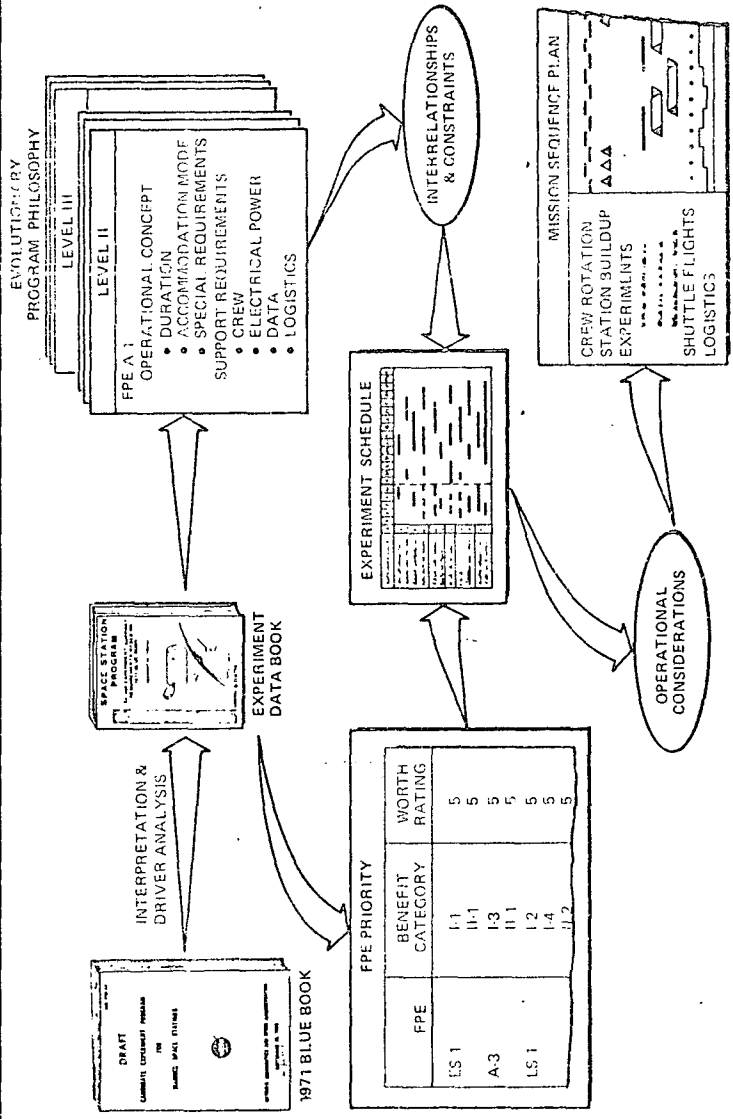

**EXPERIMENT SCHEDULE**

FPE	BENEFIT CATEGORY	WORTH RATING
LS 1	I-1	5
A-3	II-1	5
LS 1	I-3	5
	II-1	5
	I-2	5
	I-4	5
	II-2	5

**MISSION SEQUENCE PLAN**

CREW ROTATION	MISSION SEQUENCE PLAN
STATION BUILDUP	
EXPERIMENTS	
SHUTTLE FLIGHTS	
LOGISTICS	

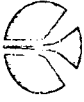

Space Division  
North American Rockwell

#### MISSION SEQUENCE PLAN

The final mission sequence plan is summarized on the following series of charts which present the experiment time phasing, accommodation mode, crew requirements, and logistics requirements. The disciplines are presented in the order in which the FPE's are introduced into the program.

The mission sequence plan as presented was developed assuming each FPE is operated for one cycle at each level of activity (Level II and Level III). In this manner, each FPE is accommodated by the program at the earliest possible date. The resultant total program, including buildup to the initial space station and buildup to the growth space station, requires approximately 16 years to complete.

The mission sequence plan and the associated experiment scheduling is intended to be representative of the operations of the modular space station. It is not intended to represent the experiment program which must be scheduled since the space station has the inherent capability and flexibility to accommodate alternative programs.

PRECEDING PAGE BLANK NOT FILMED

MISSION SEQUENCE PLAN

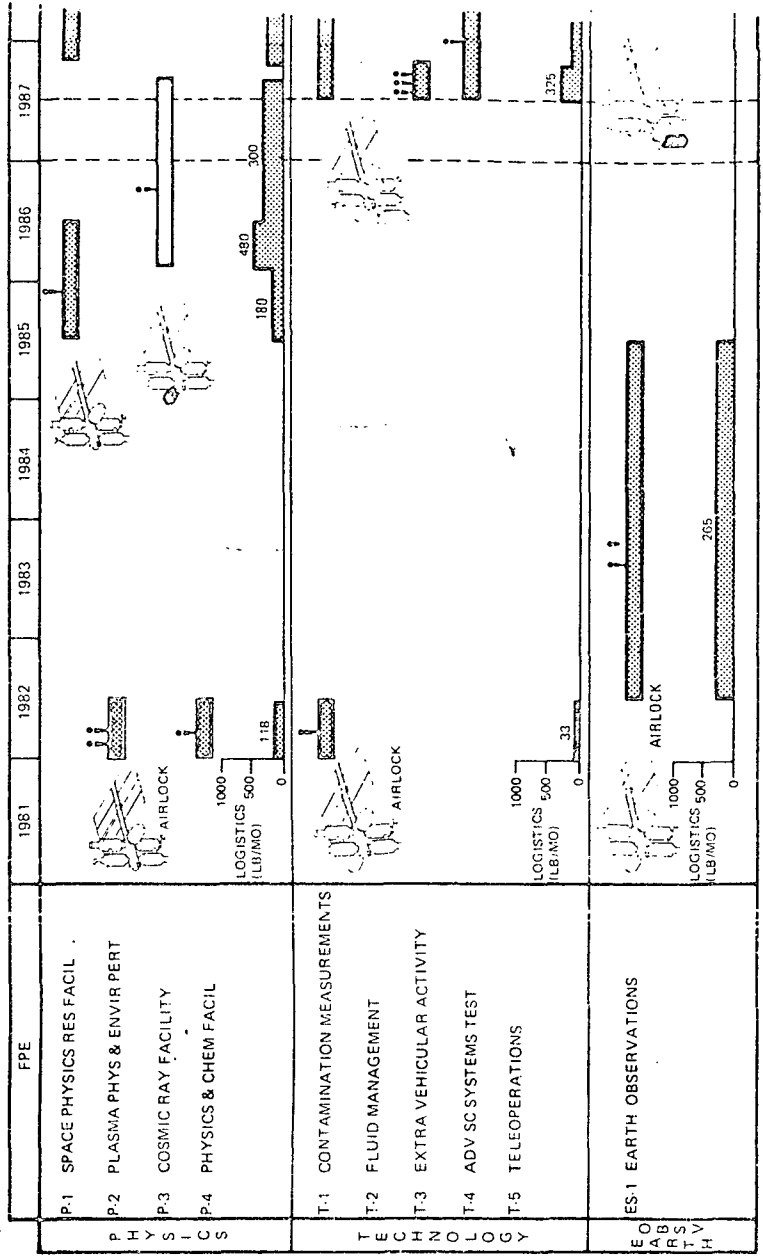

# MISSION SEQUENCE PLAN (CONT)

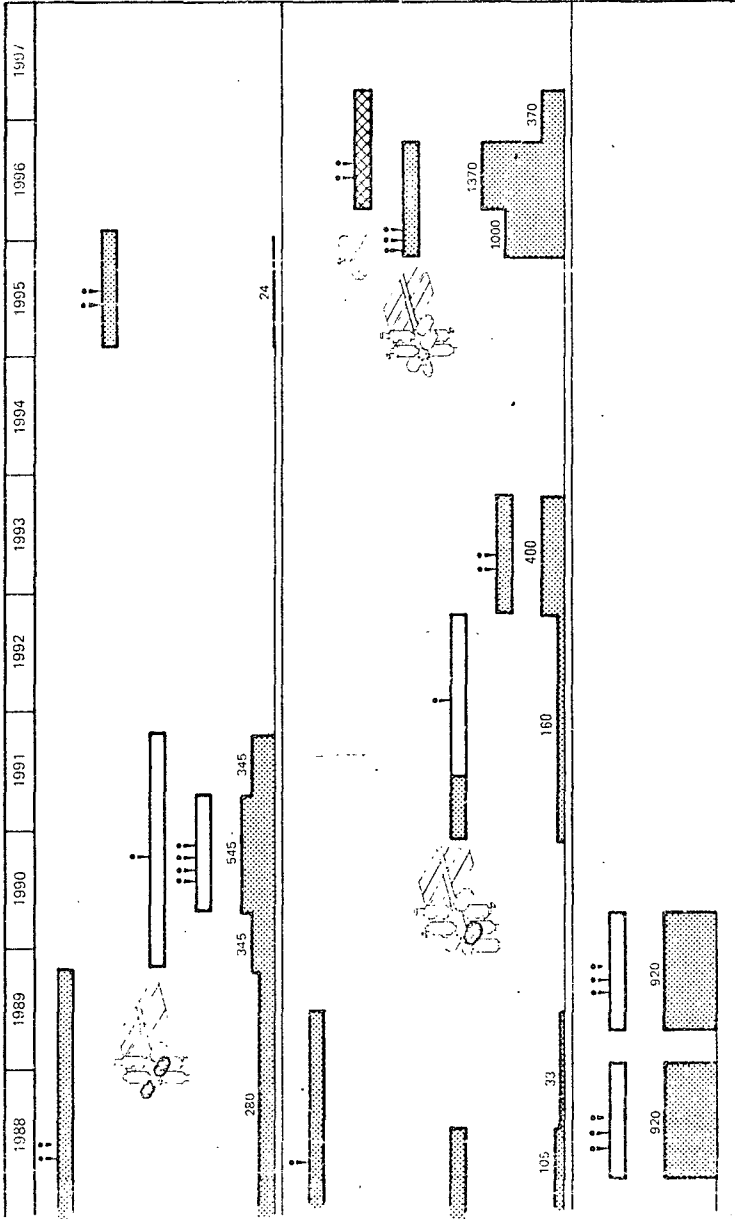

Space Division  
North American Rockwell



# MISSION SEQUENCE PLAN (CONT)

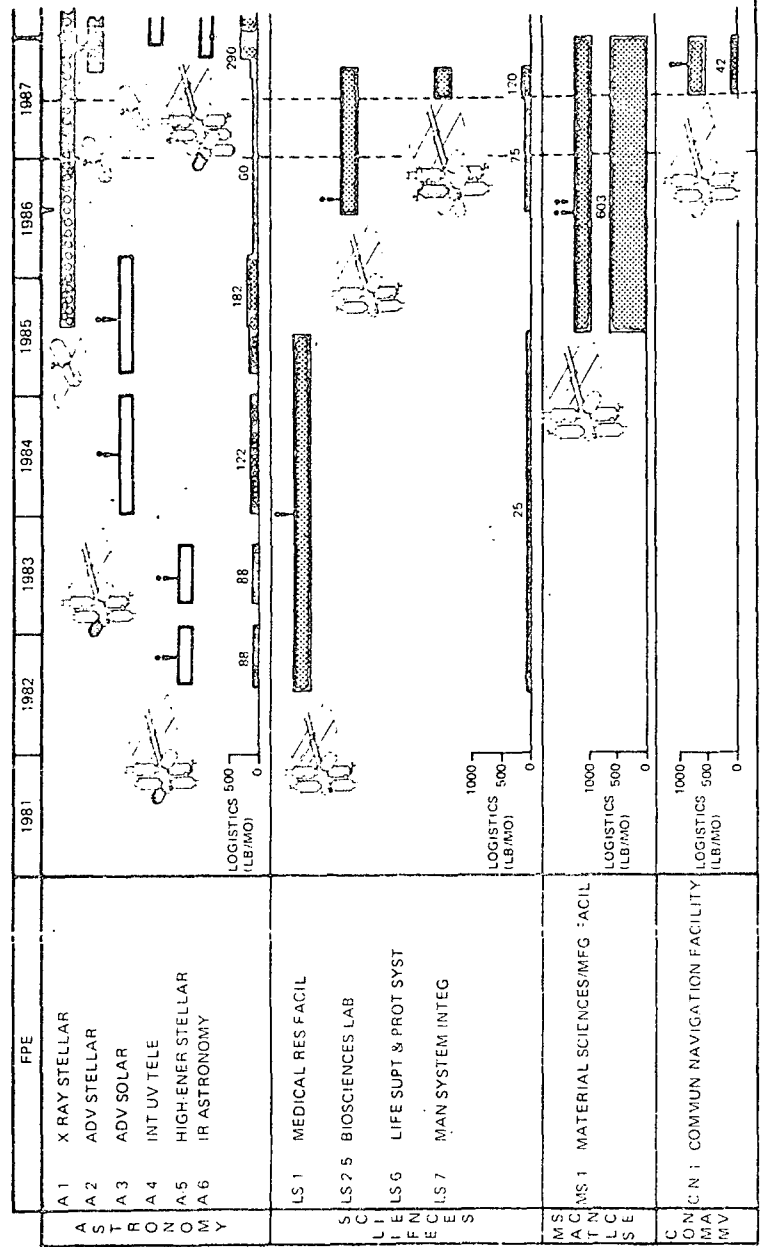

# MISSION SEQUENCE PLAN (CONT)

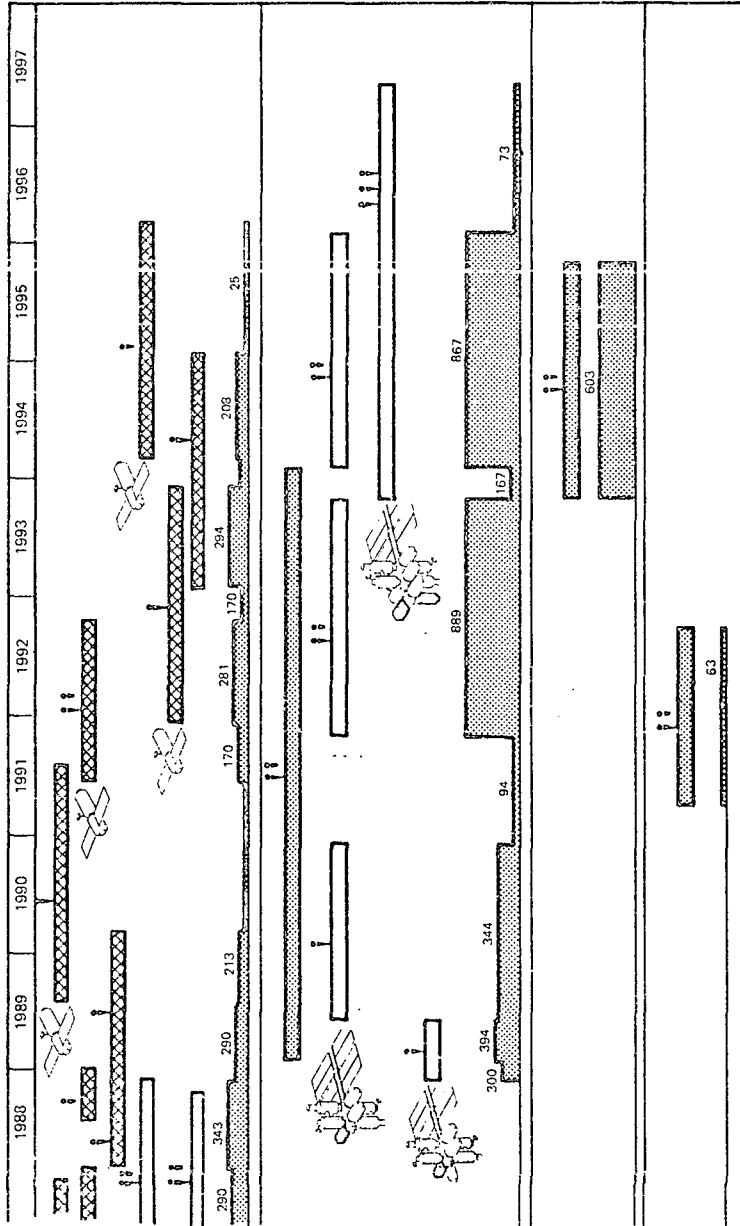



Space Division

North American Rockwell

#### CREW REQUIREMENTS

The crew requirements for station operations and experiment support operations for the initial space station are on the order of 25 man-hours per day. These operations include the routine daily operations of the space station, routine and periodic maintenance, housekeeping, monitoring and control of detached RAM's, etc. The experiment operations are those associated with the daily conduct of the space station experiments. Based on 25 man-hours per day for station operations and experiment support operations and a 10-hour work day, approximately 35 man-hours per day are available for experiment operations for the initial space station.

Twenty-seven crew skills have been identified which are necessary for the conduct of the experiment operations. The phasing of the skill requirements, based on the mission sequence plan, results in a variation in the number of skills required throughout the program.

# CREW REQUIREMENTS

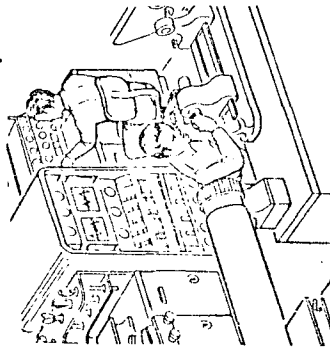
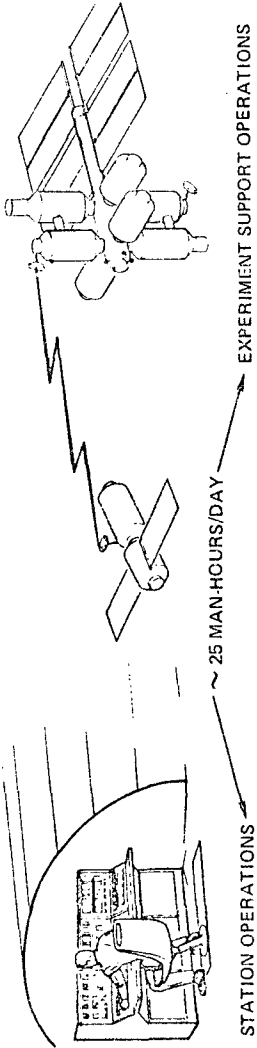

CREW NO	13	49	10	15	17	18	21	22	23	24	25	26	27	28	29	30	31	32	33	34	35	36	37	
DATE REQD	1882	782	1783	785	785	585	885	685	1087	1681	463	788	1058	1887	453	782	1085	490	750	137	437			
SKILL																								
1 BIOLOGICAL TECH																								
2 MICROBIOL TECH																								
3 BIOCHEMIST																								
4 ASTRONAUT/STROPHYS																								

25 AGRONOMIST																								
27 GEOGRAPHER																								
TOTAL NO OF SKILLS	4	9	8	7	8	9	9	11	13	17	11	10	18	19	17	11	11	11	11	11	11	11	11	11
AVERAGE NO OF SKILLS PER CREWMAN	1	1	2	4																				

EXPERIMENT OPERATIONS  
~ 35 MAN-HOURS/DAY

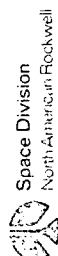

Space Division  
North American in Rockwell



Space Division

North American Rockwell

#### UP-CARGO REQUIREMENTS

The total logistics requirements to support space station operations and the experiment program previously defined are shown on the left. Approximately 1900 pounds per month are required for basic operations of the initial space station and 3600 pounds per month are required for the growth space station. Based on the experiment scheduling previously identified, approximately 1,000 pounds per month are required for operations of the initial space station experiments and 1,800 pounds per month for the growth space station. The experiment logistics requirements shown are an average value of the requirements for consumables and experiment equipment which must be delivered during the operation of the space station.

An additional logistics requirement is imposed by the need for emergency O<sub>2</sub> and N<sub>2</sub> for emergency operations. The resultant cumulative requirements are shown on the right where the lower line represents the cumulative requirements for basic station operations and the upper line represents the total including experiment operations.

# UP CARGO REQUIREMENTS

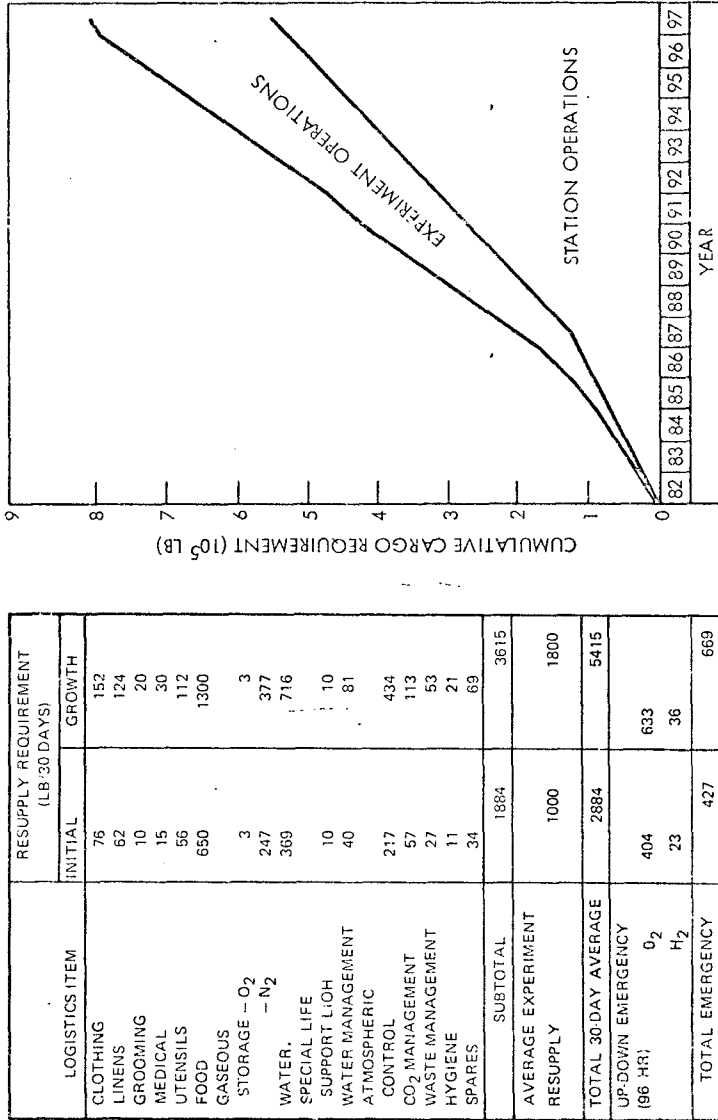

10IPDS111936



Space Division  
North American Rockwell

#### SHUTTLE SUPPORT REQUIREMENTS

The shuttle launch frequency for delivery of crew and cargo is dictated primarily by considerations of crew rotation since these missions occur at a frequency which permits the concurrent delivery of the cargo necessary for the support of the station and experiment operations. The logistics capability for crew and cargo delivery is based on a cargo module capacity of approximately 11,800 pounds per flight for shuttle missions which concurrently deliver up to six crewmen.

In addition to the shuttle missions required for the delivery of the station modules and for crew and cargo delivery, shuttle missions are required for the delivery of RAM's and the support sections necessary for the operation of detached RAM's. For the experiment program previously identified, only two support sections are required to support detached RAM operations. These support sections are periodically returned to earth for refurbishment and redelivered to orbit for further utilization.

# SHUTTLE SUPPORT REQUIREMENTS

SHUTTLE TRANSPORT MISSIONS	YEAR																
	81	82	83	84	85	86	87	88	89	90	91	92	93	94	95	96	97
STATION MODULES																	
CREW/CARGO																	
CARGO																	
RAMS																	
SUPPORT SECTIONS																	

	<b>CARGO MODULE CAPABILITY</b>
	• ~11,800 LB/FLIGHT
	<b>CARGO REQUIREMENTS *</b>
	• INITIAL STATION - 2884 LB/MO
	• GROWTH STATION - 5415 LB/MO
	* EXCLUDES UP-DOWN EMERGENCY CARGO

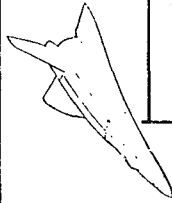

<b>SHUTTLE SUPPORT SUMMARY</b>	
<b>INITIAL STATION</b>	
• STATION MODULES	6
• CREW/CARGO	20
• RAMS	8
• SUPPORT SECTIONS	1
} 35 FLIGHTS (~1/8 WEEKS)	
<b>GROWTH STATION</b>	
• STATION MODULES	4
• CREW & CARGO	54
• RAMS	24
• SUPPORT SECTIONS	17
} 99 FLIGHTS (~1/6 WEEKS)	





Space Division  
North American Rockwell

#### PROGRAM ELEMENTS

The initial space station is provided by the six basic modules consisting of the core module, the power boom, and four station modules. A growth solar array, a short core, and two station modules are added to provide the basic growth space station. In addition to the initial and growth space stations, the experiment equipment necessary to support the experiment program must be provided. Thirteen Level II and 12 Level III experiment equipment groups are accommodated in the GPL which is integral to the space station. Five Level II experiment equipment groups are accommodated in attached RAM's, whereas six groups (FPE's) are attached at Level III. At Level II, two detached RAM's are required and seven detached RAM's are required at Level III. By reconfiguring the Level II attached and detached RAM's, 13 experiment equipment modules will accommodate the experiment program. In addition, three support sections are required to support the identified experiment schedule which includes two operational support sections plus one spare.

To provide the logistic support, three cargo modules are required plus the equivalent of one shuttle dedicated to the space station operations.

# PROGRAM ELEMENTS



## EXPERIMENTS

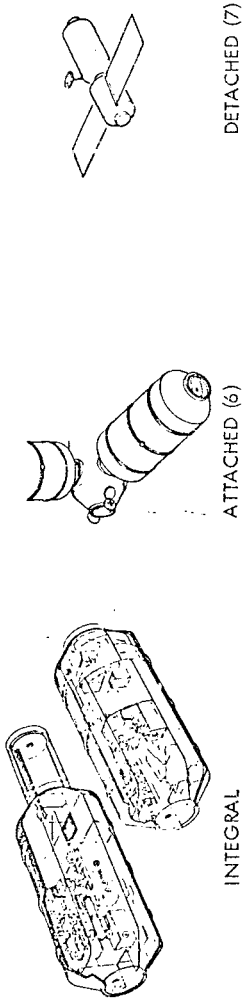

## LOGISTICS

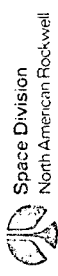
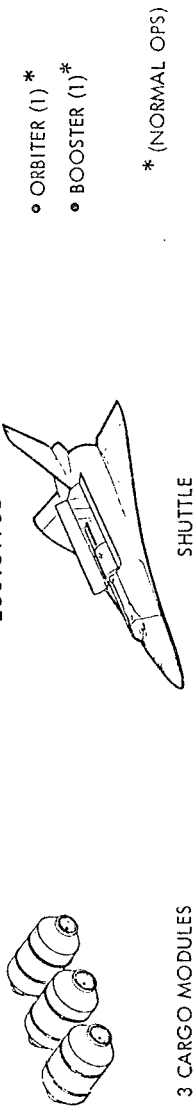

NOT FILMED

# MODULAR SPACE STATION PHASE B EXTENSION

SKD QUARTERLY REVIEW

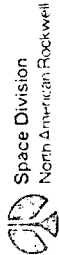
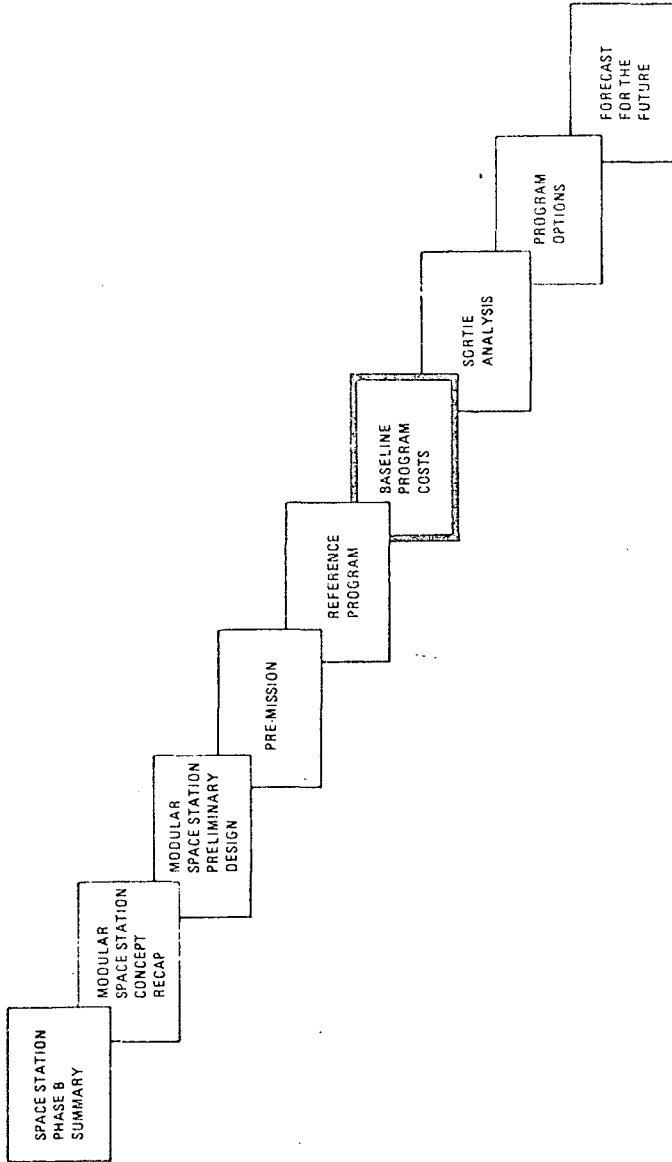



Space Division  
North American Rockwell

#### COST GROUND RULES

The cost and scheduling effort was directed to the areas of overall cost reduction and deferral of costs where possible. With Phase C start in 1975, shuttle technology is assumed to precede station. The general-purpose laboratory is a prime example of eliminating cost redundancies by integration of common FPE requirements into the GPL as part of station-provided functions. The termination of the station program costs at five years of growth operations results in truncating on-going experiment operations and in the elimination of in-process costs for experiments which will not be operational in the specific time frame. To provide a favorable funding profile, development and production of growth station modules, RAM's and experiment equipment are deferred until required by the mission sequence plan. Costs for experiments and RAM's were provided by NASA based on the MSFC cost data base ASR-PD-MP-71-1 dated April 1, 1971 with specific DDf&E and production time spans. Experiment and RAM costs shown in this report are based on NR estimates and interpretation of the MSFC data.

# COST GROUND RULES

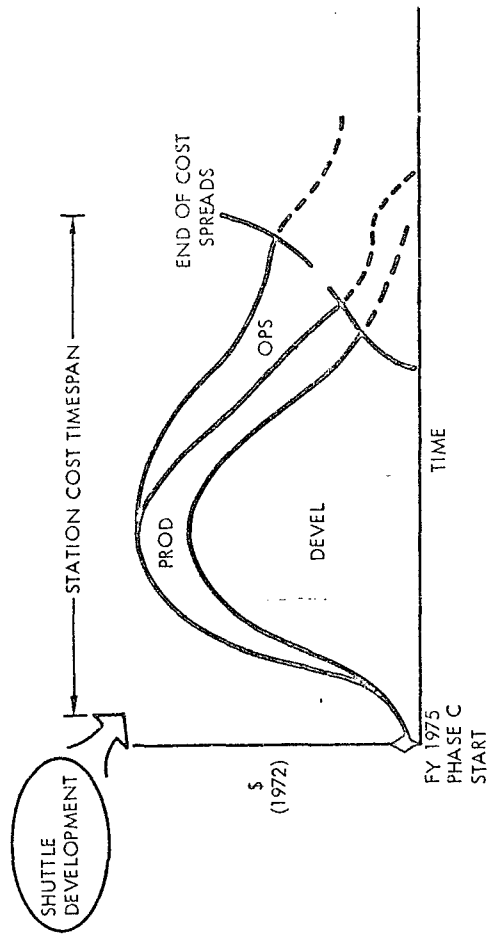

- PRODUCTION APPROACH - INTERRUPTED - GROWTH LATER
- COMMON FPE EQUIPMENT INCLUDED AS PART OF GPL FURNISHINGS
- EXPERIMENT COSTS - NASA GENERATED
- COST EXCLUSIONS:
  - CONTRACTOR FEE
  - NASA IN-HOUSE COSTS
  - SRT COSTS
  - LAUNCH VEHICLE AND FLIGHT COSTS
  - CONSUMABLES



Space Division  
North American Rockwell

#### EXPERIMENT COST PHASING

In developing the mission sequence plan (MSP) for the modular space station the laboratory evolution philosophy was utilized. The MSP employing at least one cycle of each FPE through either the general-purpose laboratory or in an experiment module developed into a schedule that took approximately 15 years (after ISS IOC) to complete. The costing spreads for the study are defined for the period covering design and development of the initial station through five years of growth operations. Utilizing this ground rule the period of experiment cost spreads was defined to include experiment costs related to FPE's that commence their operational period before the fifth year of growth operations. Any in-process costs for experiments or experiment modules that are not operational within the cost period are not included in the MSS program costs.





Space Division

North American Rockwell

#### TYPICAL COST METHODOLOGY

Subsystem technical descriptions and weight estimates for the subassembly hardware (Level 7) are influenced by factors of the developmental status, complexity of the item, and its production and specification status. Quantitative and qualitative estimates were made during the MSS Phase B study of these factors. These inputs when influenced the cost data bank and the existing CER's. The curve on this graph shows how the CER's are affected by variations in development, complexity, and knowhow. The estimates were made both for the selected MSS hardware and for whatever hardware from previous or on-going programs these selections were related to (e.g., shuttle fuel cells were selected, then complexity and knowhow of the MSS was given, and the same factors were estimated for the reference).



# TYPICAL COST METHODOLOGY

KNOW-HOW RANKING	STATE OF THE ART REQUIRES NO MOD	PRODUCTION EXPERIENCE	SPECIFICATION STATUS
1	REQUIRES NO MOD	PRODUCED IN PROD QUAN	SPEC FOR ITEM AS PRODUCED
2	MINOR MOD OF COMMERCIAL OR STD. AEROSPACE ITEM	PRODUCED IN LIMITED QUANTITY	SPEC FOR ITEM AS PRODUCED
3	WITHIN STATE OF THE ART BUT NO COMM. COUNTER. PART EXISTS	PROTOTYPE PRODUCED	SPEC HAS BEEN PREPARED BUT UNDER REVIEW OR REVISION
4	ITEM SLIGHTLY BEYOND CURRENT STATE OF THE ART SOME DEVELOPMENT REQUIRED	EXPERIMENTAL FAB OF SIMILAR ITEM IN PROCESS	WORK ON A SPEC IN EARLY STAGE. ONLY GEN. ROWS IDENTIFIED
5	ITEM SUBSTANTIALLY BEYOND CURRENT STATE OF THE ART. MAJOR DEVELOPMENT REQUIRED	NO PRODUCTION OF ANY KIND	NO WORK ON SPEC. STARTED

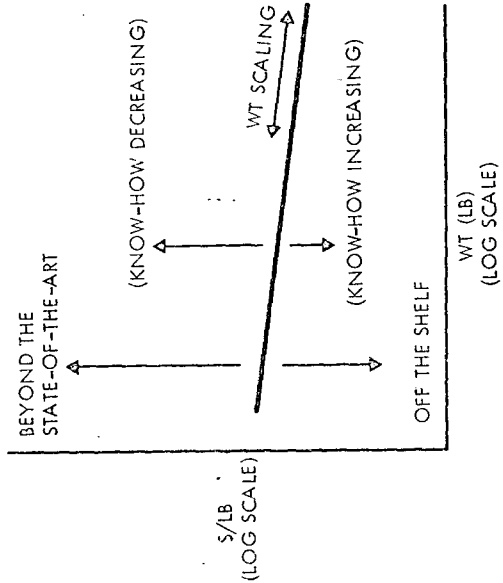



Space Division

North American Rockwell

#### PENETRATION LEVEL FOR COSTING

The technique utilized for MSS subsystem costing was to define down to the assembly Level 6 (and when significant, subassembly Level 7) and provide technical data of comparative hardware and complexity factors and knowhow status. By providing visibility at this lower level of detail, the costing can be done with multiple CER's. Elements of the subsystem that are complex or difficult design problems have separate cost estimates applied than the portions of the design that are relatively simple to design and build (e.g., plumbing, racks, etc.). This method was used in preference to the more gross method of applying an assembly-level CER to the weight and arriving at an estimated cost.

# PENETRATION LEVEL FOR COSTING

SUBASSEMBLY	COMPARATIVE DATA	COMPLEXITY, FACTOR OF COMPARATIVE	KNOWHOW MSS VS COMPARATIVE, FACTOR	RATIONALE
FUEL CELLS	SHUTTLE FUEL CELLS	1.0	< 1 VS 4, 10%	WILL USE COMPONENTS IDENTICAL TO THOSE ON SHUTTLE. ONLY VERY SIMPLE INTEGRATION PROBLEMS ARE UNIQUE TO MSS. SHUTTLE NEEDS DEVELOPMENT ORIENTED TO HIGHER POWER, LONGER LIFETIME, RESTART CAPABILITY, LOWER VOLUME, LOWER FUEL CONSUMPTION, AND LIGHTER WEIGHT/KW THAN APOLLO. HENCE, SOME DEVELOPMENT WORK IS REQUIRED ON SHUTTLE
PLUMBING	APOLLO RCS FEED CONTROL (SAME AS IN RCS COMPARATIVE DATA)	1.0	3 VS 4 FOR 1ST UNIT, 75% < 1 VS 3 FOR 3 REMAINING	THIS REPRESENTS ONLY TUBING HARDWARE AS THE DIFFERENCE BETWEEN THE TWO ARE IDENTICAL. NONE HAVE BEEN

<u>POWER GENERATION LEVELS</u>	<u>WEIGHT (LB)</u>	<u>K/H COMP</u>
FUEL CELLS	202	<div style="display: flex; align-items: center; justify-content: center;"> <div style="border-left: 1px solid black; border-right: 1px solid black; height: 20px; margin: 0 5px;"></div> <div style="margin: 0 5px;">}</div> <div style="margin: 0 5px;">=</div> <div style="margin: 0 5px;">}</div> <div style="margin: 0 5px;">=</div> <div style="margin: 0 5px;">}</div> </div>
PLUMBING	40	
MOUNTINGS AND SUPPORTS	24	
LEVEL 6 WEIGHT	266 LB X-CER (DATA FILE)	TOTAL \$

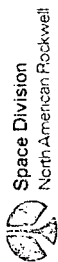



Space Division  
North American Rockwell

#### WORK BREAKDOWN STRUCTURE

The space station earth-orbital program has been defined in terms of the five program elements or projects shown in the work breakdown structure (WBS) at Level 3. These projects are further segregated to identify their principal products (hardware, functions, services) at the system or subsystem levels to the extent permitted by the required degree of study definition. The hardware portion of the MSS project is compatible with the preliminary performance specifications and with the developed mass properties data.

Total program cost and schedule estimates have been prepared based on the WBS and will be reported to the indicated level in the final contract documentation. As noted, cost data for certain WBS elements have been furnished by NASA.

# MODULAR SPACE STATION WORK BREAKDOWN STRUCTURE

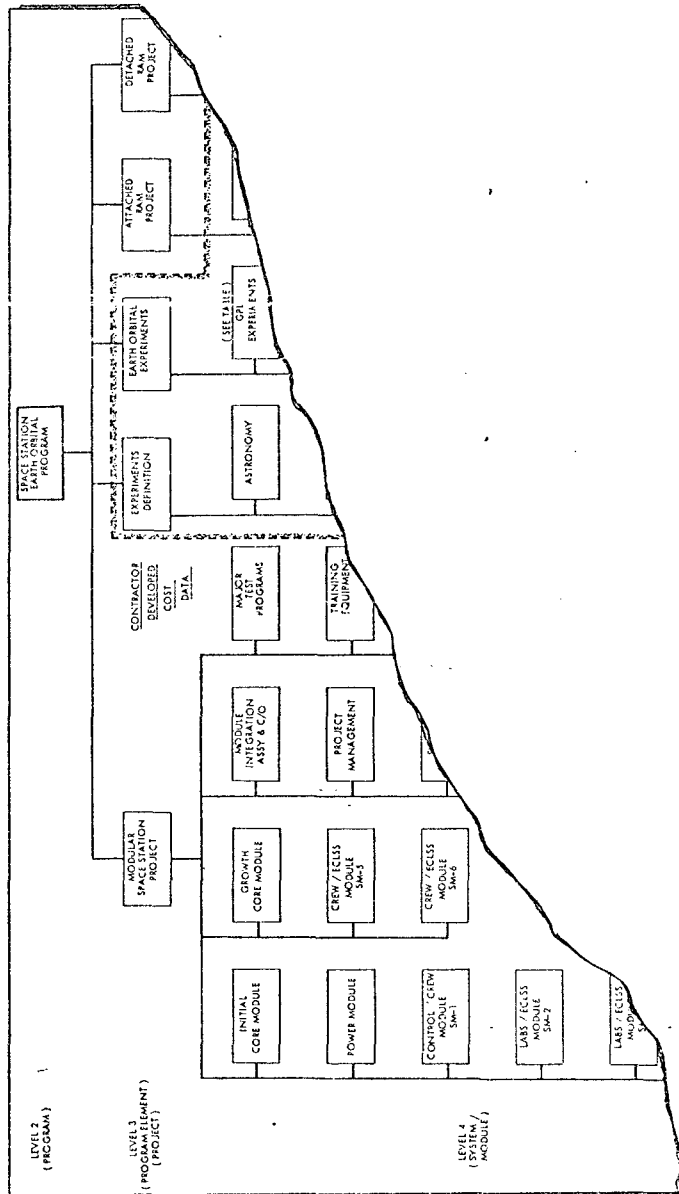



# COST REPRESENTATION FORMAT

PRODUCT COSTS		INITIAL	GROWTH
<ul style="list-style-type: none"> <li>○ SUBSYSTEMS               <ul style="list-style-type: none"> <li>● STRUCTURE &amp; MECHANICAL</li> <li>● EC/LS</li> <li>● EPS</li> <li>● G&amp;C</li> <li>● RCS</li> <li>● ISS</li> <li>● CREW HABITABILITY</li> <li>● SUBS INSTAL, ASSY, &amp; C/O</li> <li>● MODULE REFURBISHMENT</li> </ul> </li> <li>○ PROGRAMMATIC ELEMENTS               <ul style="list-style-type: none"> <li>● MODULE INTEG ASSY &amp; C/O</li> <li>● PROJECT MGMT</li> <li>● SYSTEMS SUPPORT</li> <li>● PREMISSION OPS</li> <li>● MISSION OPS</li> <li>● GPL EXPERIMENT INTEG</li> <li>● MAJOR TEST PROGRAMS</li> <li>● TRAINING EQUIP.</li> <li>● GSE</li> <li>● FACILITIES</li> <li>● SPARES</li> <li>● GFE-GFP &amp; INTEG</li> <li>● EXPERIMENT, INSTAL, ASSY, &amp; C/O</li> </ul> </li> </ul>	<ul style="list-style-type: none"> <li>○ MODULES               <ul style="list-style-type: none"> <li>● INITIAL CORE</li> <li>● POWER</li> <li>● SM-1</li> <li>● SM-2</li> <li>● SM-3</li> <li>● SM-4</li> <li>● CARGO (3)</li> <li>● GROWTH CORE</li> <li>● SM 5</li> <li>● SM-6</li> </ul> </li> </ul>	<ul style="list-style-type: none"> <li>□</li> <li>□</li> <li>□</li> <li>□</li> <li>□</li> <li>□</li> <li>□</li> <li>□</li> <li>□</li> <li>□</li> </ul>	<ul style="list-style-type: none"> <li>---</li> <li>---</li> <li>---</li> <li>---</li> <li>---</li> <li>---</li> <li>---</li> <li>---</li> <li>---</li> <li>---</li> <li>---</li> </ul>
PRODUCT COSTS		<u>XXXX</u>	<u>XXXX</u>
PROGRAMMATIC COSTS		<u>XXXX</u>	<u>XXXX</u>
TOTAL		<u>XXXX</u>	<u>XXXX</u>

MODULE 3 SPACE STATION PROJECT COSTS

WBS ELEMENTS	TOTAL INITIAL STATION			TOTAL GROWTH STATION		
	DDT&E	PRODUCTION	TOTAL	DDT&E	PRODUCTION	TOTAL
PRODUCT COSTS						
STRUCTURES & MECHANISMS	194	22	216	255	35	290
EC/LS	248	32	280	267	70	337
EPS	156	69	225	165	127	292
G&C	61	10	71	61	11	72
RCS	21	3	24	25	4	29
ISS	172	47	219	191	61	252
CREW HABITABILITY	43	6	49	45	8	53
SUBSYST INSTAL & C/O	-	16	16	-	27	27
TOTAL PRODUCT COSTS	895	205	1,100	1,009	343	1,352
PROGRAMMATIC COSTS	561	51	612	586	75	661
TOTAL SS PROJECT COSTS	1,456	256	1,712	1,595	418	2,013

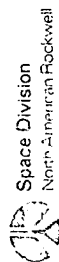

101PDS112101



PRECEDING PAGE BLANK NOT FOLLOWS  
EARTH ORBITAL PROGRAM FUNDING

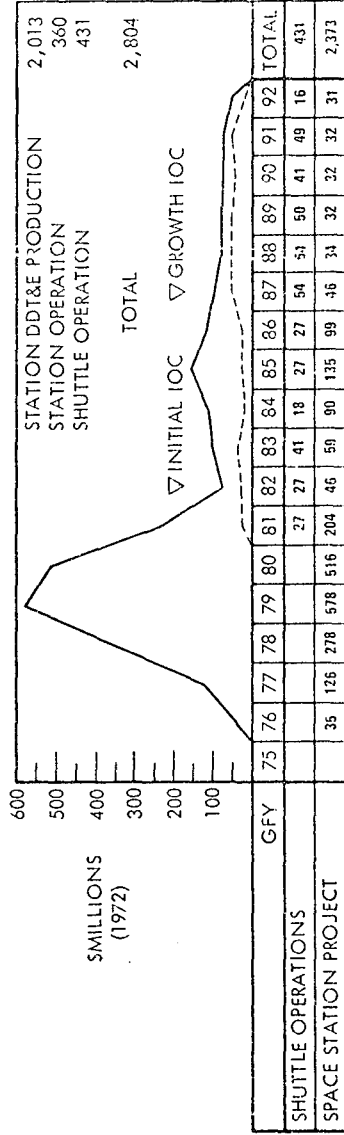
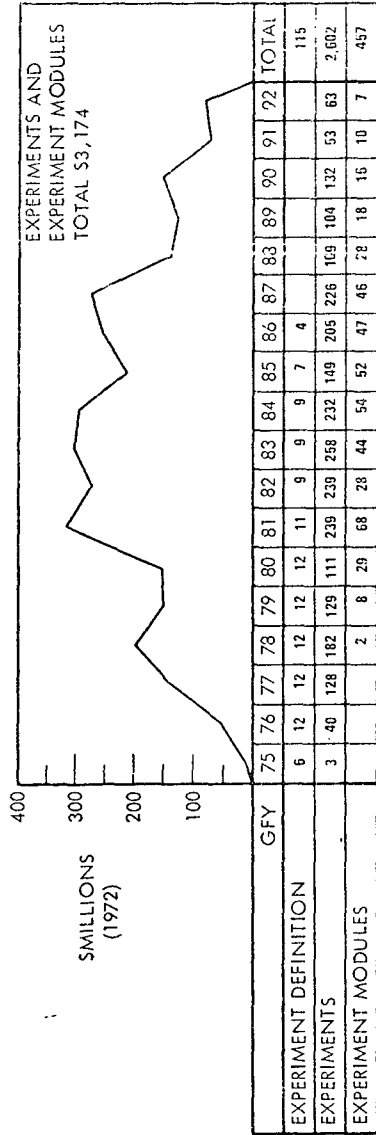

TOTAL EARTH-ORBITAL PROGRAM COSTS

GFY	75	76	77	78	79	80	81	82	83	84	85	86	87	88	89	90	91	92	TOTAL
9	266	474	727	668	548	349	411	403	370	382	372	225	204	221	154	117			5,978

Space Division  
North American Rockwell

101PDS112102

# MODULAR SPACE STATION PHASE B EXTENSION

3RD QUARTERLY REVIEW

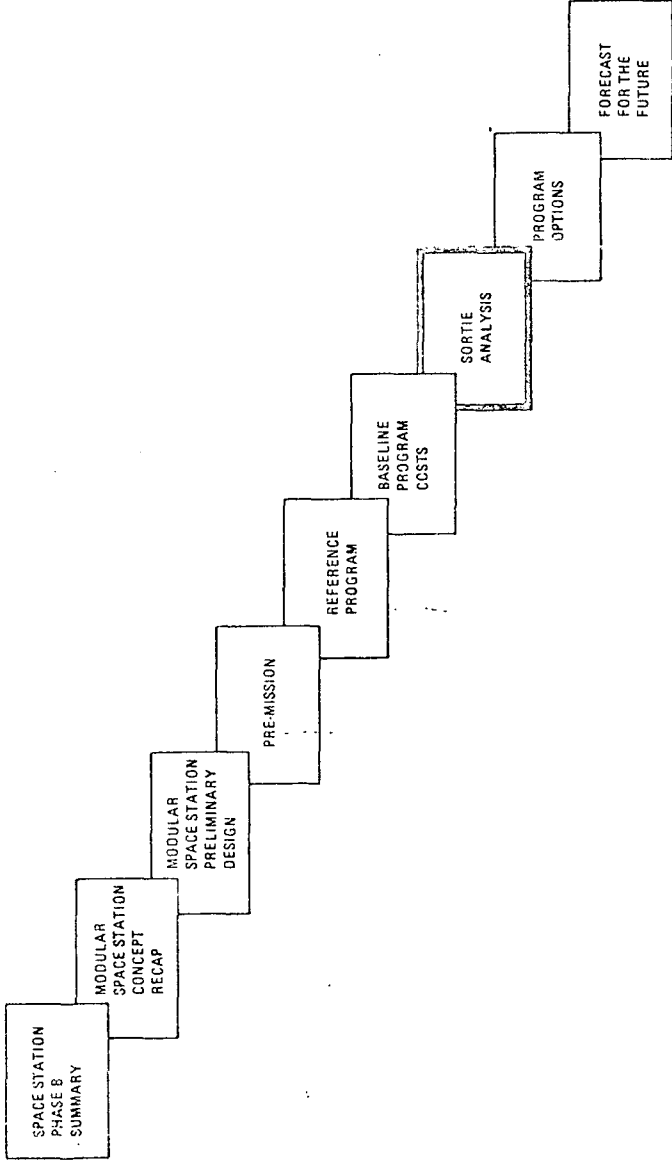



Space Division  
North American Rockwell

#### STUDY OVERVIEW

This chart repeats the overall study objectives of the sortie analysis and indicates which of the five study tasks were reported at the second quarterly review. The remaining tasks in the sortie analysis--the completion of the operational analysis, the subsystem characteristics, the sortie concepts, and the cost and commonality analyses--are presented in the following charts.

It should be noted that the sortie analysis was conducted with the two-stage fully recoverable shuttle as defined by NR's Phase B study as a baseline.

# STUDY OVERVIEW

## OBJECTIVES

- IDENTIFY POTENTIAL PAYLOADS THAT COULD FLY IN THE SORTIE MODE BEFORE STATION IOC
- DETERMINE IF COMMONALITY EXISTS BETWEEN THESE PAYLOADS / SUPPORT SUBSYSTEMS AND STATION MODULES / SUBSYSTEMS.
- 2-STAGE FULLY RECOVERABLE SPACE SHUTTLE

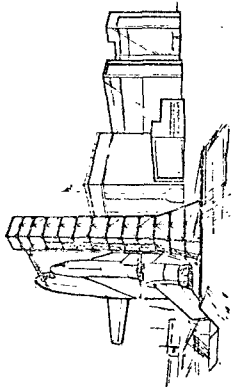

2ND QUARTER REVIEW

## SCHEDULE & TASKS

TASKS	MAY	JUNE	JULY	AUG	SEPT	OCT
EXPERIMENTS DEFINITION	[Bar]					
OPERATIONS ANALYSES		[Bar]				
SUBSYSTEM CHARACTERISTICS			[Bar]			
CONCEPTUAL DESIGNS			[Bar]			
EVALUATION & COST ANALYSES					[Bar]	[Bar]



Space Division  
North American Rockwell



Space Division  
North American Rockwell

#### SELECTED SORTIE PAYLOADS

The second quarterly review presented in August included the identification of our 16 initial sortie payloads arranged in six 7-day missions and ten 30-day missions. Continued analysis of these payloads pointed out several that exceeded the shuttle's payload weight capability for various reasons, thus requiring certain changes.

This chart presents the characteristics of the selected payloads resulting from the changes.

7-Day Missions - Payload 3 deleted the space physics experiment thus reducing the crew requirements from 5 to 2. Payload 4 also deleted the space physics thus allowing the mission to be flown at 55° inclination. Payload 5 satisfies the objectives of the space physics experiment (deleted from Payload 3 and 4) by flying an elliptical orbit of 80 + 100-500 n mi.

30-Day Missions - Payload 4 reduced the mission time from 30 days to 26 days. Payloads 5 and 8 were flown at 28-1/2° inclination as the shuttle cannot obtain a 0 deg inclination. Payloads 6 and 7 were reduced in altitude from 270 to 220 and 250 n mi, respectively. Payload 11 was added making the total number of sortie payloads 17 instead of the original 16.

# SELECTED SORTIE PAYLOADS

## 7-DAY SORTIE MISSION

PAYLOAD NO.	EXPERIMENT PACKAGE	INCL (DEG)	ALT (N MI)	CREW SIZE
1	MATERIALS SCIENCE	28-1/2	200	2
2	PLANT GROWTH CELLS & TISSUES EVA	28-1/2	100	3
3	EARTH OBS ADVANCED S/C SYSTEMS TESTS CONTAMINATION TECHNOLOGY	55	100	2
4	EARTH OBS CONTAMINATION TECHNOLOGY	55	100- 300	3
5	CONTAMINATION TECHNOLOGY SPACE PHYSICS	90	80x100/500	2
6	PLASMA PHYSICS	55	270	2

SELECTED SORTIE PAYLOADS

30-DAY SORTIE MISSIONS

PAYLOAD NO.	EXPERIMENT PACKAGE	INCL (DEG)	ALT (N MI)	CREW SIZE
1	MEDICAL RESEARCH BIO-SCIENCE LIFE SUPPORT MAN SYSTEMS	28-1/2	100	3
2	SPACE PHYSICS PHYSICS & CHEM	28-1/2	200	2
3	FLUID MGMT	28-1/2	300	2
4	EARTH OBS CONTAMINATION TECHNOLOGY	55	100	2
5	X-RAY STELLAR ASTRONOMY	28-1/2	400	2
6	ADVANCED SOLAR ASTRONOMY	SUN SYNCH	220	2
7	INTERMEDIATE U-V TELESCOPE	28-1/2	250	2
8	HIGH ENERGY STELLAR ASTRONOMY	28-1/2	400	2
9	INFRA-RED ASTRONOMY	55	270	2
10	COSMIC RAY PHYSICS	28-1/2	200	2
11	COMMUNICATIONS	55	150	2





Space Division  
North American Rockwell

#### PAYLOAD ACCOMMODATION REQUIREMENTS

An analysis of the experiment accommodation requirements for the 17 sortie payloads revealed those which required airlocks and/or an unpressurized pallet or a pressurized module with manned entry capability.



For the 7-day missions, four payloads require airlocks of pallets while the remaining two need a pressurized module. For those requiring an airlock, considerations were given to using the MSS airlock on the shuttle orbiter's airlock.

For the 30-day missions, all 11 payloads require a pressurized module for extra living accommodations over that provided by the orbiter. In eight cases, a pressurized module also is needed for the experiments while the remaining three utilize a pallet, an airlock, and a combination pallet-airlock.

The following charts define these accommodations in more detail on a payload-to-payload basis.

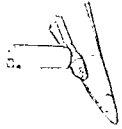
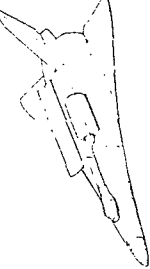

# PAYLOAD ACCOMMODATION REQUIREMENTS

MISSION	REQUIREMENT	ACCOMMODATION
7-DAY MISSIONS (6 PAYLOADS)	PALLET AND AIRLOCK	<ul style="list-style-type: none"> <li>• 4 PAYLOADS</li> </ul>  <p style="margin-left: 40px;">SHUTTLE AIRLOCK</p> <p style="margin-left: 40px;">PALLET</p> <p style="margin-left: 40px;">AIRLOCK MODULE</p>
	PRESSURIZED MODULE	<ul style="list-style-type: none"> <li>• 2 PAYLOADS</li> </ul> 
30-DAY MISSIONS (11 PAYLOADS)	PRESSURIZED MODULE	<ul style="list-style-type: none"> <li>• 11 PAYLOADS</li> </ul> 
	PALLET AND AIRLOCK	<ul style="list-style-type: none"> <li>• 1 AIRLOCK PAYLOAD</li> <li>• 1 PALLET PAYLOAD</li> <li>• 1 COMBO</li> </ul>  <p style="margin-left: 40px;">AIRLOCK MODULE</p>



Space Division  
North American Rockwell

#### MODULE VARIATION

For the two 7-day payloads and on the eleven 30-day payloads, the pressurized module volumes required for indicated payloads are shown expressed in module length (feet). The wide variation in length, from 10 feet to 26 feet, is noted. In summary, seven 10-foot-long modules are needed in addition to one 15-foot, two 18-foot, two 20-foot, and one 26-foot modules.

In order to reduce the number of modules, advantage was made of the weight margins existing between the various payload weights and the shuttle's payload capability. Thus, in all but a few instances, a larger module than actually required could be employed. The overlay indicated the final selection. As may be seen, three of the 30-day payloads require a 10-foot module due to the length of the experiment equipment (45-foot telescope) or an insufficient weight margin to allow a larger module to be utilized. In the remaining payloads, the 20-foot module could be utilized by nine payloads and the 26-foot module for only one payload. Two alternative accommodation modes are suggested to delete the need for the 26-foot module: (1) delete a portion of the experiment equipment, thus reducing its volume requirements, or (2) combine a 10-foot and a 20-foot module, thus accommodating the experiments in the resulting 30-foot module.

# AND SELECTION

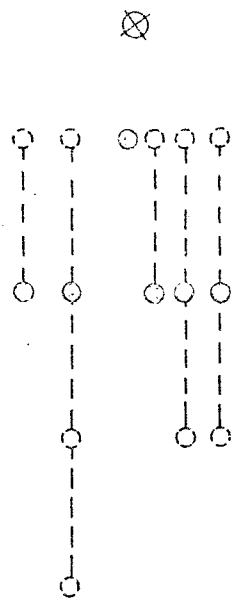

LENGTH LIMITED

WEIGHT LIMITED

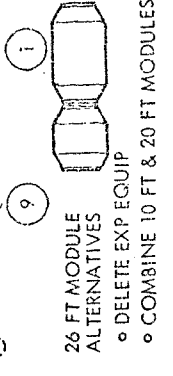
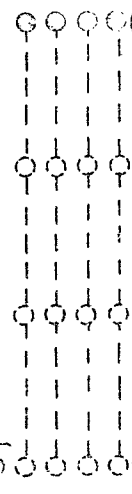

SELECTION CONSIDERATIONS

- COMMONALITY
- WEIGHT MARGIN
- CONSTRAINTS

26 FT MODULE ALTERNATIVES

- DELETE EXP EQUIP
- COMBINE 10 FT & 20 FT MODULES

# MODULE VARIATION

PAYLOAD		MODULE LENGTH (FT)				
NO.	TITLE	10	15	18	20	26
1	EARTH OBSERVATION CONTAMINATION		✓		✓	
2	SPACE PHYSICS CONTAMINATION		✓			
1	LIFE SCIENCE					✓
2	SPACE PHYSICS				✓	
3	FLUID MANAGEMENT			✓		
4	EARTH OBSERVATIONS CONTAMINATION			✓		
5	X-RAY STELLAR	✓				
6	ADVANCED SOLAR	✓				
7	INTERMEDIATE UV	✓				
8	HIGH-ENERGY STELLAR	✓				
9	INFRARED	✓				
10	COSMIC RAY	✓				
11	COMMUNICATIONS	✓				
		(7)	(1)	(2)	(2)	(1)



Space Division  
North American Res. Kwell

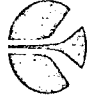

Space Division

North American Rockwell

#### PALLET-AIRLOCK REQUIREMENTS AND MODE SELECTION

A study to utilize common hardware to meet specific payload requirements resulted in the possible use of an MSS-type airlock to serve as either pallet or airlock or both. The MSS airlock is adaptable to these requirements because of its unique capability and versatility. It can serve as a fixed airlock or as a manipulator-maneuvered airlock (to shuttle berthing port) and has an internal capacity for accessible experiment instrumentation of 436 cubic feet. It has various combinations of inflight accessible sensor display areas varying from 35 to 160 square feet. It also has the capability of being used as a pallet for inaccessible (during mission) instruments.

As indicated, the MSS-type airlock could be utilized on seven of the 11 payload missions.

# PALLET-AIRLOCK REQUIREMENTS / MODE SELECTION

7-DAY MISSIONS

PAYLOAD	EXP PKG	PRESS. VOL (FT <sup>3</sup> )	UNPRESS. VOL (FT <sup>3</sup> )
3	EARTH OBS CONTAM S/C SYS	120 9 (+AIRLOCK)	540 (*) 40 (*)
4	EARTH OBS CONTAM	120 9 (+AIRLOCK)	540 (*) 40 (*)
5	PHYSICS CONTAM	9 (+AIRLOCK)	150
6	PLASMA PHYSICS	3	100 + AIRLOCK FOR MAINT./CAL.

30-DAY MISSIONS

PAYLOAD	EXP PKG	PRESS. VOL (FT <sup>3</sup> )	UNPRESS. VOL (FT <sup>3</sup> )
2	SPACE PHYSICS PHYSICS & CHEM	- 15 (+AIRLOCK)	80
3	FLUID MGMT	-	2540 (**)
4	EARTH OBS CONTAM	120 9 (+AIRLOCK)	1040 (*)

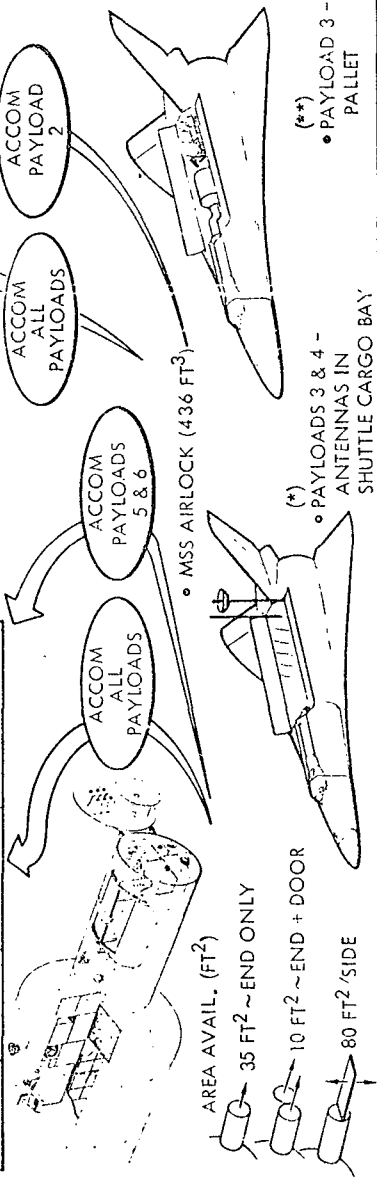

Space Division  
North American Rockwell



Space Division  
North American Rockwell

### SUBSYSTEM APPROACH

This chart depicts the approach taken in selecting characteristics for the major subsystems.

**Electrical Power** - The Phase B shuttle has adequate power generation capability and needs only additional fuel cell reactants to supply power to the payload. Up to 5.2 kw can thus be supplied to the payload with the reactant tankage installed in the payload bay.

**Environmental control** - The shuttle ECLSS is sized for a 2 + 2 crew and as all but two payloads are 2 + 2 crew size, no additional atmosphere processing is needed. For thermal control, however, each payload supplies its own radiator and cooling loop.

**Guidance and Control** - The selected guidance and control approach utilizes the shuttle ACPs for gross pointing and stabilization. For some missions the ACPs is modified to provide a smaller minimum impulse so that the propellant quantity requirements will be reasonable. Supplementary pointing capability is provided by the payload when necessary. Free drift modes are used whenever the experiments are not pointing or stabilization-sensitive.

**Information** - The information subsystem required to support the sortie experiments are provided as an integral part of the sortie payload. This includes the data processing, the command/control/monitoring, and the communications. Exceptions to this independent approach are (1) the voice communications with the crew in the orbiter to the sortie payload, (2) voice communications between the sortie crew and the ground, (3) low data rate information transferred to the ground, and (4) monitoring of the sortie payload during launch.

# SYSTEM APPROACH

UP TO 5.2 KW POWER TO PAYLOAD

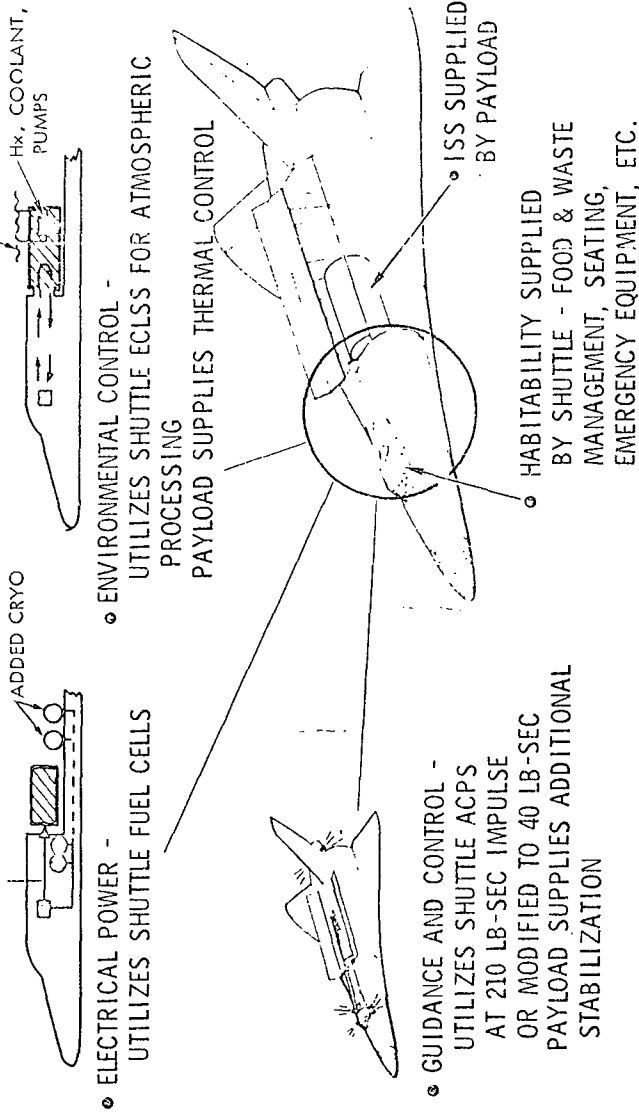





Space Division  
North American Rockwell

#### SUBSYSTEM CHARACTERISTICS

The following charts illustrate the major characteristics of each of the sortie support subsystems.

Information - The analyses of the experiments showed the weight of the ISS required to support each sortie payload. This weight is shown in the chart as a function of the number of payloads. The life sciences and astronomy represented the largest number of payloads in the 1000- through 4000-pound category and the earth observations represented the largest weights. These large weights resulted from the data processing equipment required on the sortie.

Guidance and Control - The ACPS propellant quantity requirements are shown on the diagram. The 1000-pound requirement is typical of the 30-day missions which require continuous stabilization. The 4000-pound requirements is associated with 7-day missions performed without modifying the ACPS to obtain a smaller minimum impulse. As shown on the middle bar graph, approximately half of the missions require the ACPS minimum impulse modification. The last graph shows weight range approximations for the precision pointing equipment required.

# SUBSYSTEMS CHARACTERISTICS

• INFORMATION

- CONTROLS / DISPLAYS
- VIDEO & DIGITAL RECORDERS
- VIDEO & MAGNETIC TAPES
- COMM

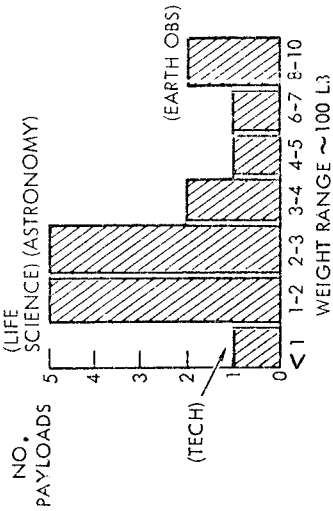
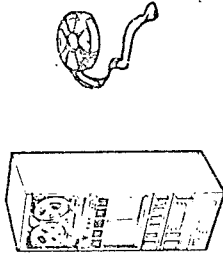

• GUIDANCE/CONTROL

- PROPELLANT
- MINIMUM IMPULSE
- GIMBAL PLATFORM

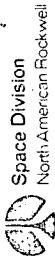
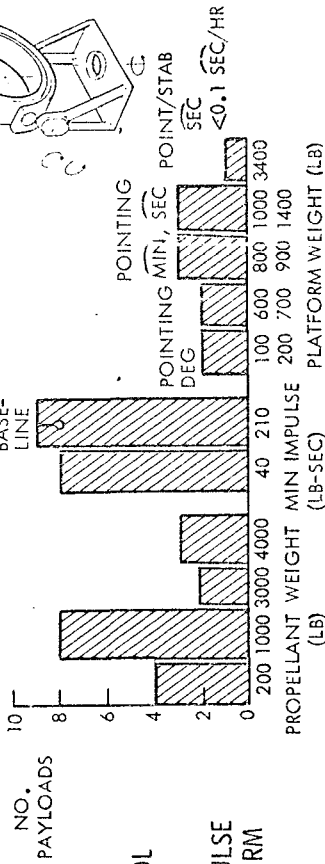



Space Division

North American Rockwell

#### SUBSYSTEMS CHARACTERISTICS (Cont)

Electrical Power - The sortie electrical power will be supplied by excess power from the shuttle fuel cells. The analyses of the sortie payloads indicate the majority of the payloads (12) require average power in the 1-2 kw range, with only three requiring power greater than 2 but less than 5 kw. These power levels are less than the 5.24 kw estimated shuttle capability. The fuel cell reactants would require additional storage beyond the shuttle capability. The second graph defines the number of payloads accommodated versus the number of H<sub>2</sub> + O<sub>2</sub> tanks required.

ECLSS - Also portrayed is the weight to provide various ECLSS sortie functions. This is shown for 7- and 30-day sorties and for 4- or 5-man crews.

The last graph depicts the number of sortie payloads which can be accommodated by various numbers of 70-square-foot radiator panels.

# SUBSYSTEM CHARACTERISTICS (CONT)

## ELECTRICAL POWER

- POWER LEVEL
- CRYO TANKS

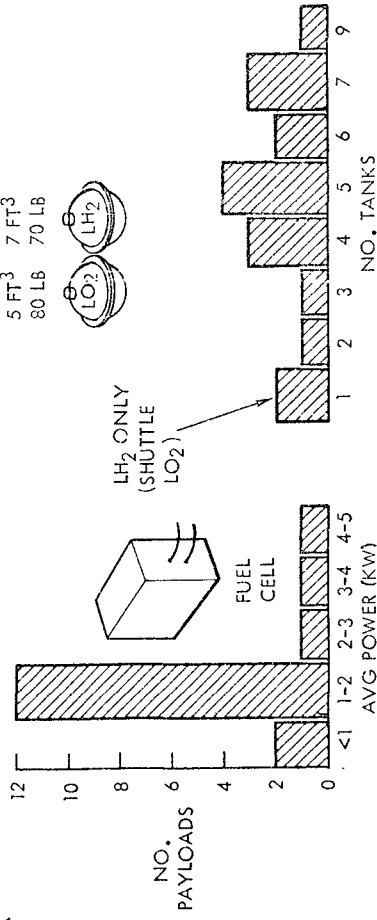

## ENVIRONMENTAL CONTROL

- GAS STORE WEIGHT (100 LB)
- CO2 REMOVAL
- ATMOSPHERE CONTROL
- FOOD/HYGIENE
- RADIATORS

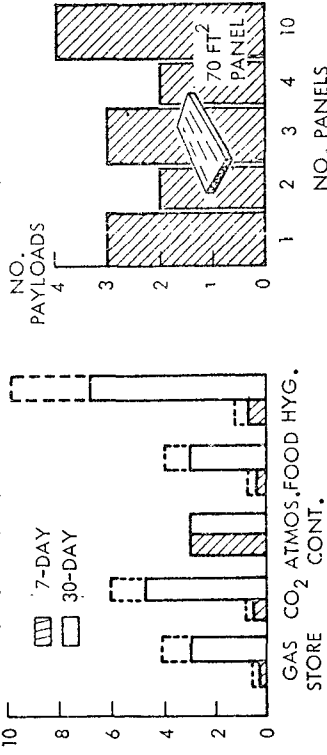

GAS STORE CO2 ATMOS. FOOD HYG. STORE

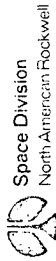



Space Division  
North American Rockwell

EXPERIMENT PAYLOAD/PACKAGE IDENTIFICATION - 7-DAY MISSION

This chart identifies the experiment package within each of the six 7-day sortie payloads and is included to aid the reader in understanding their accommodated modes and support subsystem characteristics shown on the following chart.

# EXPERIMENT PAYLOAD / PACKAGE IDENTIFICATION

## DAY MISSIONS

PAYLOAD	EXPERIMENT PACKAGE	TITLE
1	MS-III	MATERIALS SCIENCE
2	LS3-II LS4-II T3-I	PLANT GROWTH CELLS & TISSUES ASTRONAUT MANEUVERING UNIT
3	ES1-II T4-I T1-I	LAND USE MAPPING ADVANCED SPACECRAFT SYSTEMS TESTS SKY BACKGROUND BRIGHTNESS
4	ES1-III T1-I	AIR & WATER POLLUTION SKY BACKGROUND BRIGHTNESS
5	P1-I T1-I	ATMOSPHERIC/MAGNETOSPHERIC SCIENCES SKY BACKGROUND BRIGHTNESS
6	P2-I P2-II	PLASMA WAKE PLASMA RESONANCES/HARMONICS



Space Division  
North American Rockwell

#### SORTIE CONCEPT MAJOR FEATURES - 7-DAY MISSIONS

This chart indicates the integration of the individual seven-day mission payload characteristics with those of the baseline shuttle. It is divided into two sections: experiment accommodations and subsystem characteristics.

Payloads 1 and 2 require the addition of habitable modules with Payload 2 also requiring EVA capability via the shuttle airlock. Payloads 3 through 6 utilize a MSS-type airlock, while Payload 5 also utilizes the airlock as a deployable pallet for sensor directing.

Under subsystems, the additional crew required is indicated in Column 1. Column 2 lists the data rate characteristic which is supplied entirely by the experiment package. Column 3 lists the power required per payload. These power requirements utilize the shuttle fuel cell power generation capability but the experiment package provides the cryo fuel. This fuel is stored in tanks located in the shuttle bay as part of each experiment package. Column 4 summarizes the experiment stability characteristic. Payloads 1 and 2 fall within the shuttle baseline capability. Payloads 3, 4, and 5 require the addition of stabilized platforms. Payload 6 requires a refinement of the shuttle characteristic to 40 lb-sec ACPS. This would be accomplished by the modification of the shuttle reaction control system.

# SORTIE CONCEPT ● JOR FEATURES - 7-DAY MISSIONS

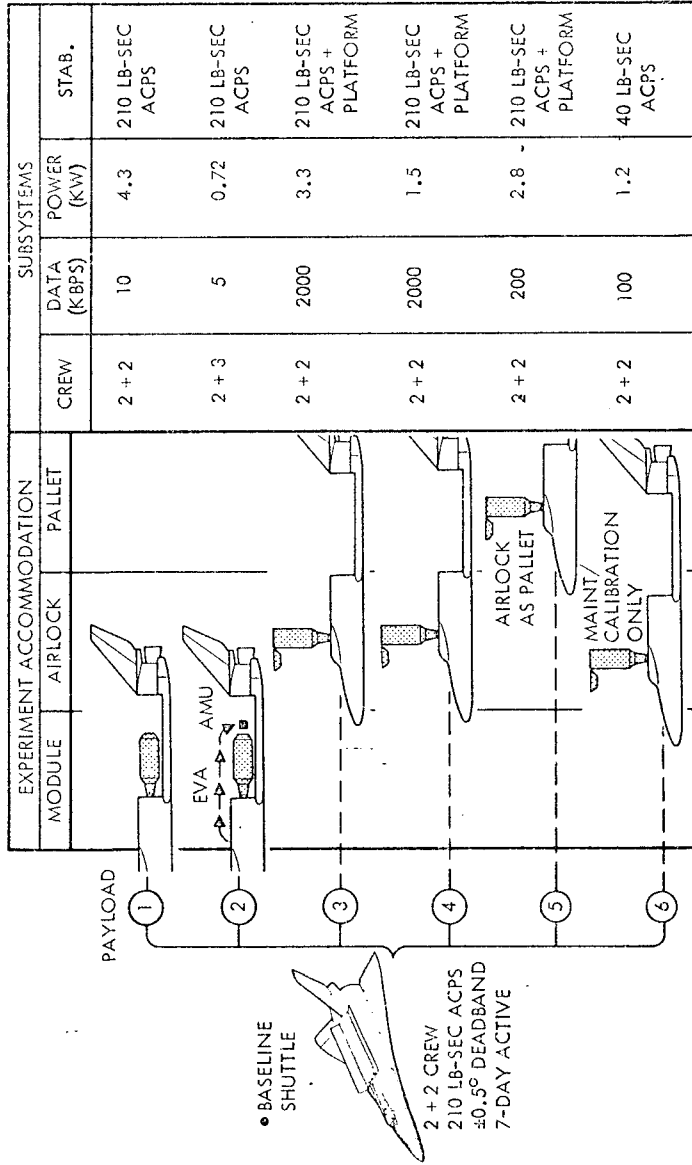

EXPERIMENT ACCOMMODATION		SUBSYSTEMS				
MODULE	AIRLOCK	PALLET	CREW	DATA (KBPS)	POWER (KW)	STAB.
			2 + 2	10	4.3	210 LB-SEC ACPS
	EVA	AMU	2 + 3	5	0.72	210 LB-SEC ACPS
			2 + 2	2000	3.3	210 LB-SEC ACPS + PLATFORM
			2 + 2	2000	1.5	210 LB-SEC ACPS + PLATFORM
		AIRLOCK AS PALLET	2 + 2	200	2.8	210 LB-SEC ACPS + PLATFORM
		MAINT/CALIBRATION ONLY	2 + 2	100	1.2	40 LB-SEC ACPS





Space Division  
North American Rockwell

EXPERIMENT PAYLOAD/PACKAGE IDENTIFICATION - 30-DAY MISSION

This chart identifies the experiment packages within each of the 11 30-day sortie payloads and is included to aid the reader in understanding their accommodation modes and support subsystem characteristics shown on the following chart.

# EXPERIMENT PAYLOAD/PACKAGE IDENTIFICATION

30-DAY MISSIONS

PAYLOAD	EXPERIMENT PACKAGE	TITLE
1	LS1-I LS4-I } LS5-I } LS6-I } LS7-II	BIOMEDICAL RESEARCH ROLE OF GRAVITY IN LIFE PROCESSES LIFE SUPPORT SYSTEMS DEVELOPMENT PERFORMANCE CAPABILITY ASSESSMENT
2	P1-II P4-I	COMETARY PHYSICS MOLECULAR PHYSICS
3	T2-I T2-II T2-III	LIQUID/VAPOR INTERFACE STABILITY BOILING HEAT TRANSFER CAPILLARY STUDIES
4	ES1-I T1-II	METEOROLOGY/ATMOSPHERIC SCIENCES REAL-TIME CONTAMINATION
5	A1-I	HIGH-RESOLUTION X-RAY TELESCOPE
6	A3-I	PHOTOHELIOGRAPH
7	A4-I	NARROW-FIELD UV TELESCOPE
8	A5-I	LOW-ENERGY X-RAY TELESCOPE
9	A6-I	DETECTOR ARRAY SCANNING
10	P3-I	COSMIC RAY NUCLEI CHARGE/ENERGY SPECTRA
11	C/N1-II C/N1-III	MILLIMETER WAVE COMM. SYSTEM/PROPAGATION SURVEILLANCE/SEARCH/RESCUE SYSTEMS

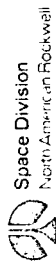



Space Division

North American Rockwell

#### SORTIE CONCEPT MAJOR FEATURES - 30-DAY MISSIONS

This chart indicates the integration of the individual 30-day mission payload characteristics with those of the baseline shuttle. The shuttle characteristics are shown under the sketch of the shuttle at the left side of the chart. The experiment accommodations and subsystems required to conduct the 11 experiments are shown in the chart. The required experiment accommodations are illustrated in the appropriate column. The length of the habitable modules that are required for each payload also is indicated. Payload 1 requires a 26-foot module, while Payloads 2, 3, 4, 8, 9, and 10 utilize a 20-foot module, and payloads 5, 6 and 7 utilize a 10-foot module. The shuttle subsystem characteristics are acceptable to accommodate the experiments except for the stability requirements. Experiment Payloads 2 and 4 through 11 all require a stable platform and Experiments 4 through 11 also require a lower thrust level of the ACP's engines.

# SORTIE CONCEPT MOOR FEATURES - 30-DAY MISSIONS

PAYLOAD	EXPERIMENT ACCOMMODATION		SUBSYSTEMS			
	MODULE	MOD/AIRLOCK MOD/PALLET	CREW	DATA RATE (KBPS)	POWER (KW)	STAB.
1	26 FT	AIRLOCK AS PALLET	2 + 3	28	1.1	210 LB-SEC ACPS
2	20 FT	20 FT	2 + 2	45	1.2	210 LB-SEC ACPS + PLATFORM
3	20 FT	20 FT	2 + 2	5.8	1.7	210-LB-SEC ACPS
4	20 FT	20 FT	2 + 2	40	1.0	40 LB-SEC ACPS + PLATFORM
5	20 FT	TELESCOPES 45 FT	2 + 2	40	1.0	
6	20 FT	40 FT	2 + 2	40	1.1	
7	20 FT	8 FT	2 + 2	40	1.1	
8	20 FT	27 FT	2 + 2	6.4	1.2	
9	20 FT	14 FT	2 + 2	40	1.3	
10	20 FT 25 FT LAB	20 FT	2 + 2	17	1.5	
11	20 FT	20 FT	2 + 2	300	0.75	40 LB-SEC ACPS + PLATFORM

- 2 + 2 CREW
- 210 LB-SEC ACPS
- 40.5° DEADBAND
- 30-DAY ACTIVE

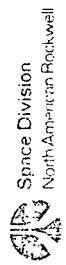



Space Division  
North American Rockwell

#### COMMONALITY ANALYSIS

Commonality analysis was directed to accomplishing two primary objectives: commonality comparison for physical and functional characteristics between sortie and MSS subsystems and module configuration, and commonality comparison between the individual sortie payloads.

# COMMONALITY ANALYSIS

STUDY OBJECTIVE:  
DOES COMMONALITY  
EXIST?

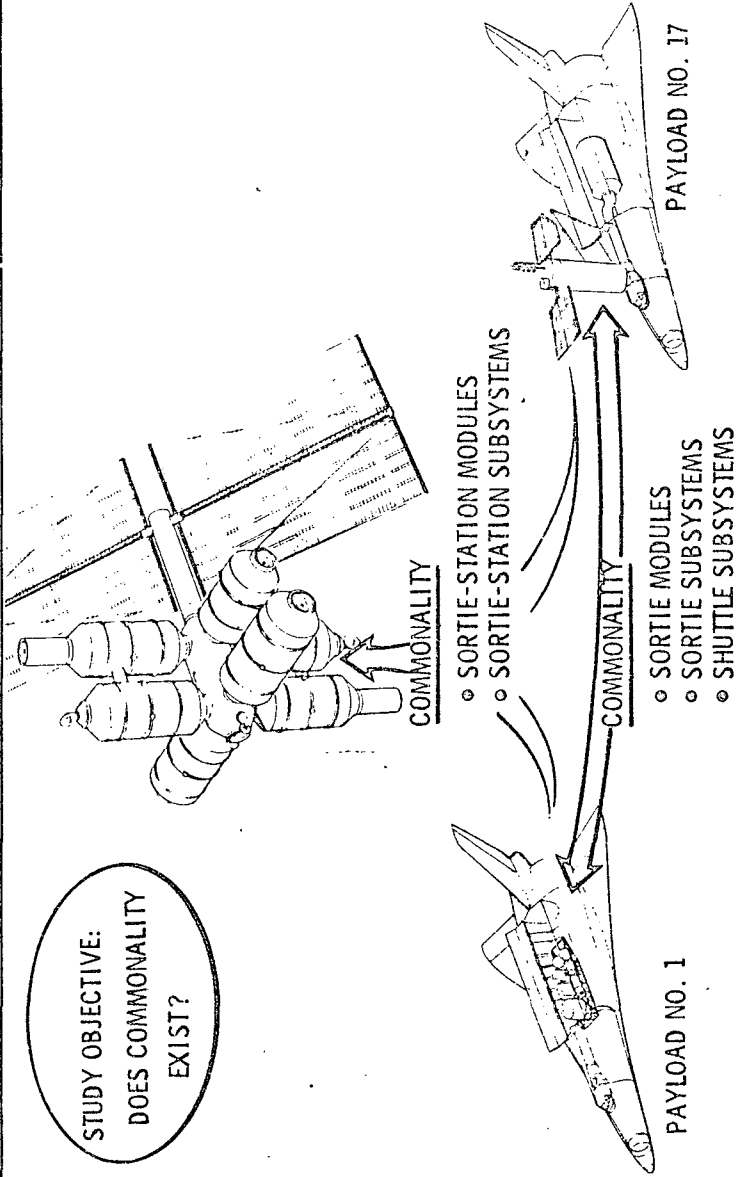



Space Division  
North American Rockwell

#### COMMONALITY RESULTS - STRUCTURE

To achieve commonality for module configuration, the MSS universal structure concept was selected. As a result of the sortie payload analysis, three module configuration lengths would be required. Two module lengths could satisfy these requirements by mating the 10- and 20-foot modules for the third module length. The 20-foot module is a derivative of the MSS cargo module.

The MSS airlock concept will be used where an airlock is required.

# COMMONALTY ANALYSIS RESULTS - STRUCTURE

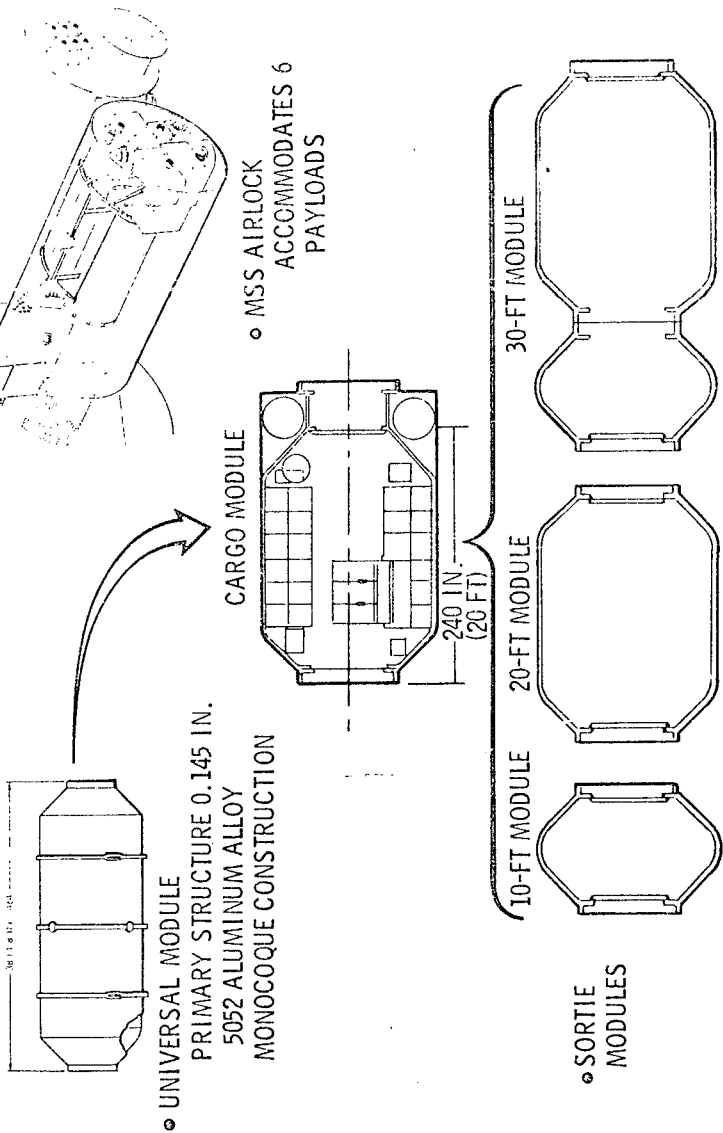



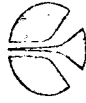

Space Division  
North American Rockwell

#### COMMONALITY RESULTS - SUBSYSTEMS

The results of the subsystem commonality analysis are illustrated by the bar graphs. As an example, the video recorder from the information subsystem has five sortie payloads that have 80-percent commonality, and four have 30-percent commonality to the MSS. Of these sortie payloads, nine have 30-percent and five have 80-percent commonality between themselves. The delta percentage differences exist because of additional equipment or physical characteristics differences.

# COMMONALITY ANALYSIS RESULTS - SUBSYSTEMS

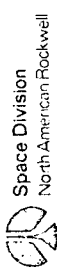
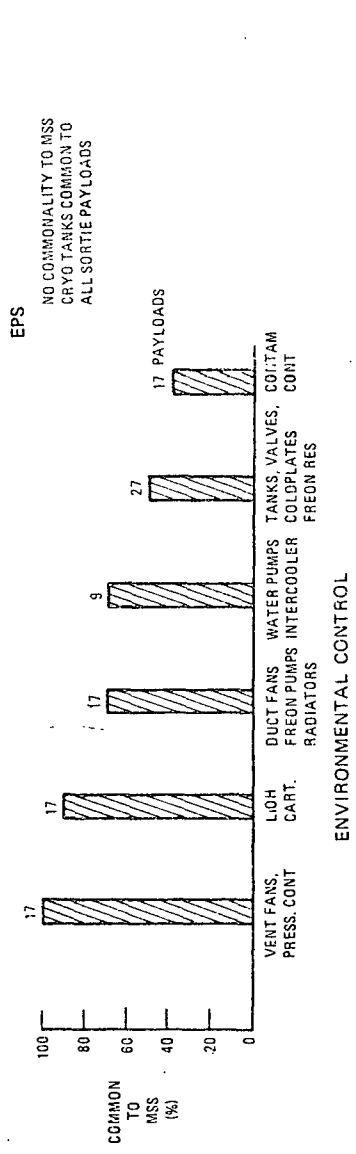
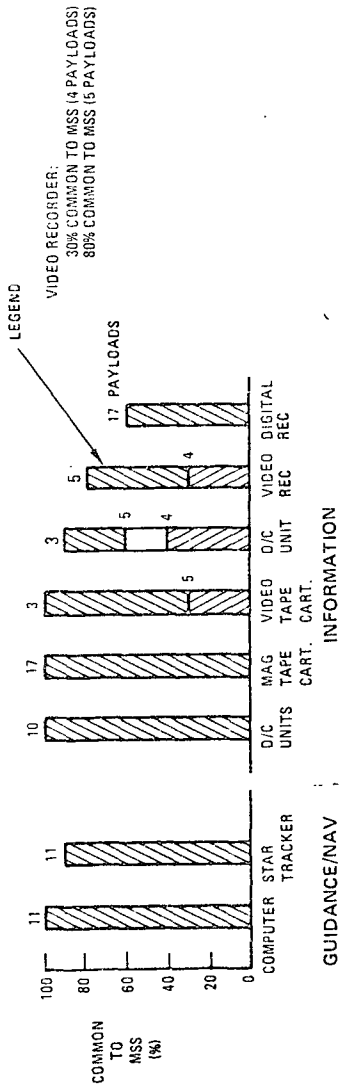



Space Division  
North American Rockwell

#### COST ANALYSIS APPROACH

The cost-analysis approach was accomplished in three steps: (1) determine the development cost, assuming that each individual payload was developed separately; (2) recognizing the commonality between payloads, determine the development cost shared among payloads; and (3) based on commonality percentage to the MSS, determine the dollar benefit to the MSS development.

# CO-ANALYSIS APPROACH

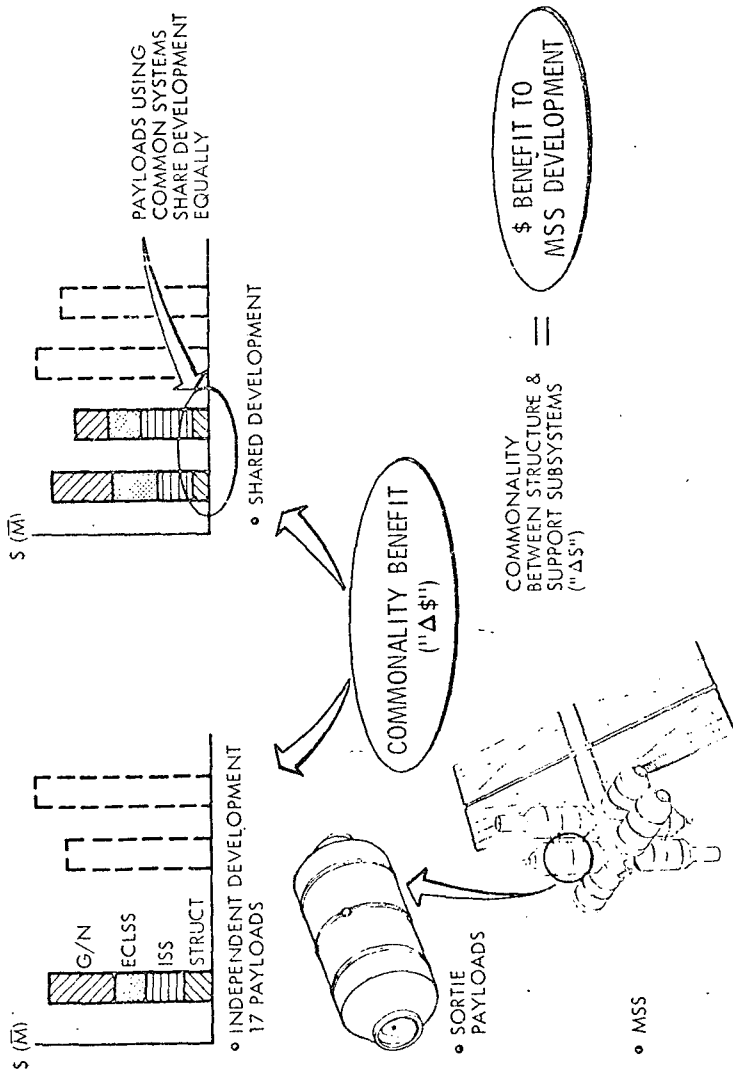



Space Division  
North American Rockwell

#### COST ANALYSIS RESULTS

The cost analysis results show that approximately 60-percent saving is accomplished by sharing cost among payloads. Approximately a 4-percent cost saving can be contributed to the initial MSS development cost. Other tangible savings not expressed in dollar value are identified as shown.

# CO ANALYSIS RESULTS

- 17 SORTIE PAYLOADS
- DEVELOPMENT COSTS ONLY
- 1972 DOLLARS

ITEM	INDEPENDENT DEVELOPMENT (\$)	SHARED DEVELOPMENT (\$)	SAVINGS TO MSS (\$)
STRUCTURE	770	140	28
ECLSS	370	120	27
EPS	120	25	-
G/C	305	235	5
INFORMATION	120	30	10
CREW/HAB.	115	20	7
TOTAL	1,800	570	77

• INTANGIBLE SAVINGS TO MSS

- COMPONENT RELIABILITY DATA
- EXPERIMENT PROCEDURES
- OPERATIONAL EXPERIENCE
- MAINTENANCE PROCEDURES



- o LARGE DEGREE OF COMMONALITY EXISTS BETWEEN SORTIE STRUCTURE/SUBSYSTEMS AND MSS  
\$77M TOWARD MSS DEVELOPMENT
- o ADDITIONAL BENEFITS (E.G., EQUIPMENT RELIABILITY, OPERATIONAL PROCEDURES, ETC.) KNOWN TO EXIST
- o LARGE DEGREE OF COMMONALITY AMONG SORTIE PAYLOADS  
\$1200M VALUE
- o SORTIE MODULES AND MSS CARGO MODULE SIMILAR IN DESIGN AND OPERATION



Space Division  
North American Rockwell

#### SORTIE PAYLOAD REQUIREMENTS AND ACCOMMODATIONS APPROACH

Current studies related to shuttle sortie experiment missions, such as SOAR, RAM, and NR's sortie analysis, have derived their requirements from the 1971 Blue Book for the most part. While the requirements for the accommodations of the various disciplines are the same for each of the studies, the approaches selected for their accommodations are quite different. For example, SOAR defines 36 payloads employing pallet, three different sizes of support modules, and a 'growth' support module. RAM also has 36 payloads, 27 of which are multidisciplined. RAM also uses pallets, an experiment module above (RAM), and a RAM with a support module. NR's sortie analysis defined 31 experiment packages which were assembled into six disciplined payloads and 11 multidisciplined payloads. These are accommodated by pallets, three different size modules and, in some instances, an airlock is required.

In this study, all experiment support was provided by the shuttle augmented in certain areas where necessary.

After reviewing the various ways that are being expounded for accommodating these experiments, the question arises, "Is this the right approach for arriving at the solution?"



# SORTIE PAYLOAD REQUIREMENTS/ ACCOMMODATIONS APPROACH

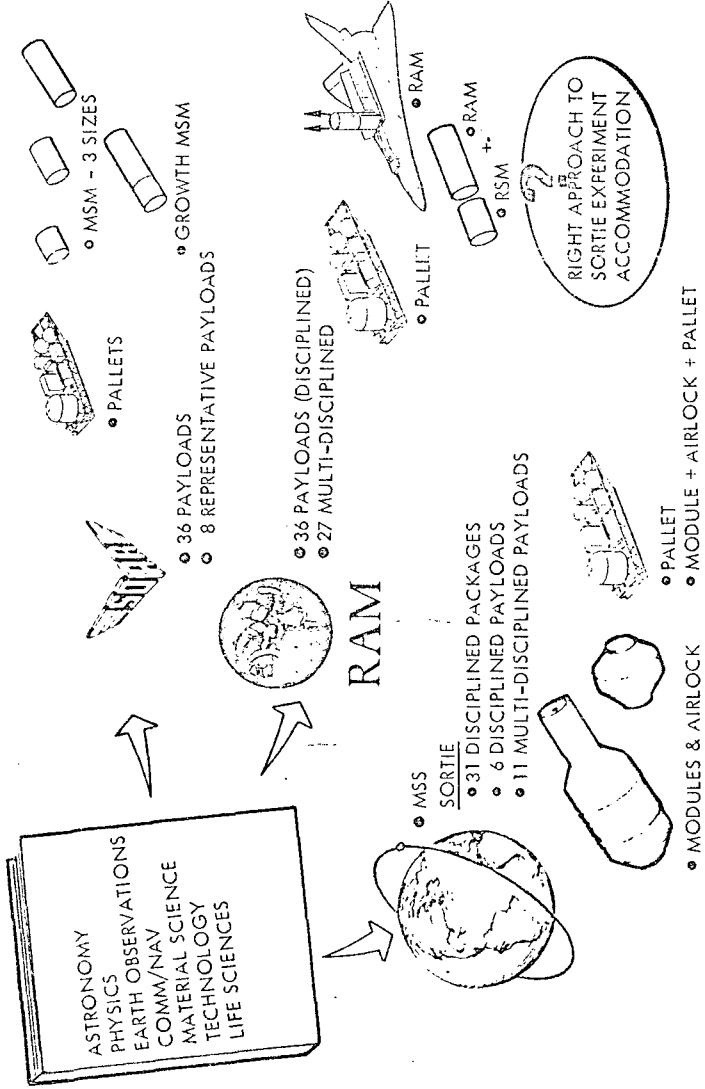



Space Division  
North American Rockwell

#### ALTERNATIVE APPROACHES AND FEATURES

An alternative approach to the accommodation of sortie payloads would be to provide a family of general-purpose laboratories. Each GPL would support a group of related disciplines and would contain, as an integral part of the module, laboratory and experiment equipment. The intent would be to minimize the amount of equipment required from the investigator. The GPL's would be designed so as to exploit the reusability made possible by the shuttle. That is, they would be adaptable to a wide range of missions and users with a minimum of reconfiguration. In addition, use will be made of existing ground- and aircraft-based laboratory equipment (microscopes, cameras, spectrometers, multimeters, etc.) where practical, to minimize costs.

The table on this chart shows two possible approaches for grouping disciplines into GPL's. The first is a "phenomenon-oriented" family which groups disciplines into GPL's according to the particular aspect of the space environment associated with their objective. The second is a "purpose-oriented" family which groups disciplines into GPL's according to the general nature of their objectives.

Based on NR studies to date, the "purpose-oriented" GPL's appear to be the more feasible.

# ALTERNATIVE APPROACHES AND FEATURES

APPROACH NO. 1

APPROACH NO. 2

DISCIPLINE	PHENOMENON-ORIENTED			PURPOSE-ORIENTED		
	EARTH REMOTE SENSING	SPACE REMOTE SENSING	ZERO-GRAVITY, VACUUM	APPLICATION	TECHNOLOGY	SCIENCE
ASTRONOMY		X				X
PHYSICS		X				X
EARTH OBSERVATIONS	X			X		
COMM/NAV	X				X	
MATERIAL SCIENCES			X			
TECHNOLOGY	X	X			X	
LIFE SCIENCES			X	X		

**DESIRABLE FEATURES**

- MULTIPLE MISSIONS
- MULTIPLE USERS
- MINIMUM REQUIREMENT FOR INVESTIGATOR-SUPPLIED EQUIPMENT
- MAXIMUM USE OF "GROUND-TYPE" COMMERCIAL EQUIPMENT

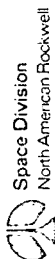



Space Division  
North American Rockwell

### SORTIE LAB PHILOSOPHY

The upper left hand portion of this chart depicts the NR laboratory evolution philosophy applied to general-purpose laboratories. The functional capability of the GPL would evolve from the actual performance of experiments (Level I) to the support of experiments (Level II). This evolving role for the GPL is consistent with an evolving program. In the shuttle sortie period (Level I) when funds are limited and mission durations are short, the emphasis will be on low-cost means of achieving a wide range of experiments, with little or no on-orbit support functions (e.g., data processing, maintenance, calibration, etc.). In the Space Station period (Level II), when a large family of dedicated, discipline-oriented laboratories will be available, the GPL will accommodate the support functions required across all the dedicated labs.

The lower right-hand portion of the chart depicts commonality across a family of Level I GPL's. This family is the "purpose-oriented" one described on the previous chart.

The first level of commonality (structure and subsystems) is common across not only all GPL's in this family but also other program elements such as space station modules. The next level (general-purpose experiment equipment) is that level common across all types of GPL's within the family. The third level (laboratory experiment equipment) is that level common to a substantial number of experiments within the individual GPL's area of interest. The top level is experiment-unique, and this level of equipment would normally be supplied by the investigator.

# SOME LAB PHILOSOPHY

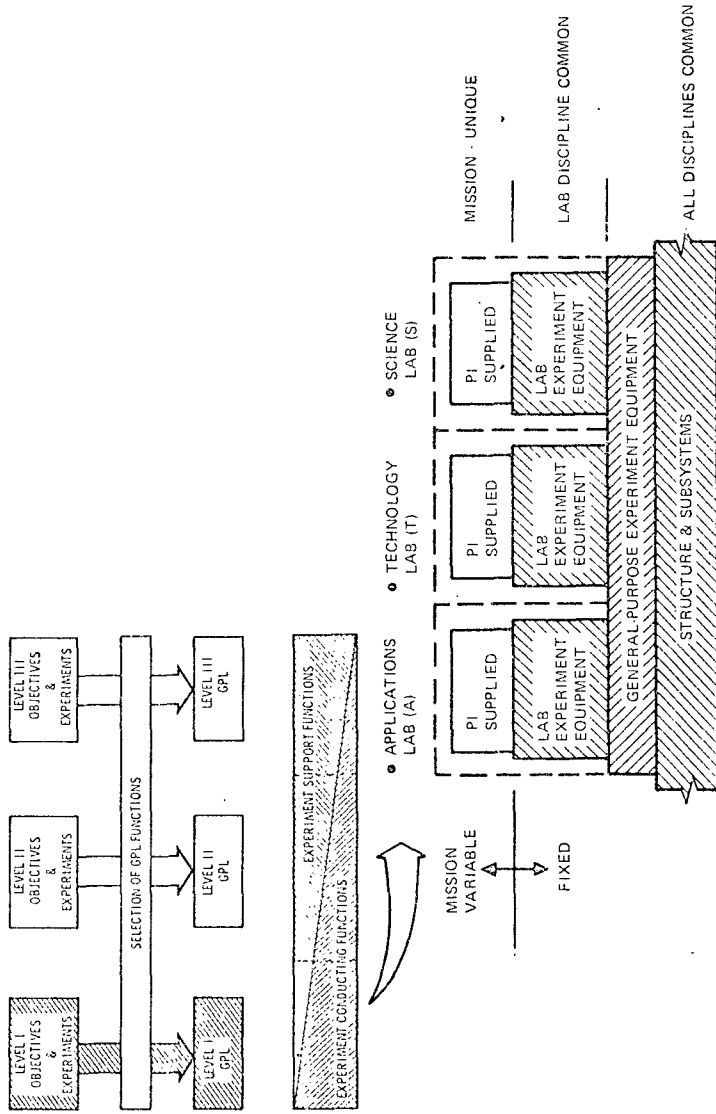



Space Division  
North American Rockwell

#### SORTIE LAB DEFINITION

The philosophy behind the sortie lab expressed on the preceding chart is graphically illustrated here.

First, the structure and support subsystems (i.e., environmental control, electrical power equipment, etc.) is indicated.

Overlay 1 illustrates the addition of the general-purpose lab equipment such as work benches, recorders, control center, etc. Overlay 2 depicts the addition of the lab experiment equipment, in this case, the obvious discipline-oriented equipment such as a resistance furnace for material science experiments, earth observation telescopes, and cameras.

The lab is now complete as for the fixed equipment is concerned. All that is needed beyond this point is the mission-unique equipment supported by the investigator.

C: LAB EXPERIMENTAL EQUIPMENT

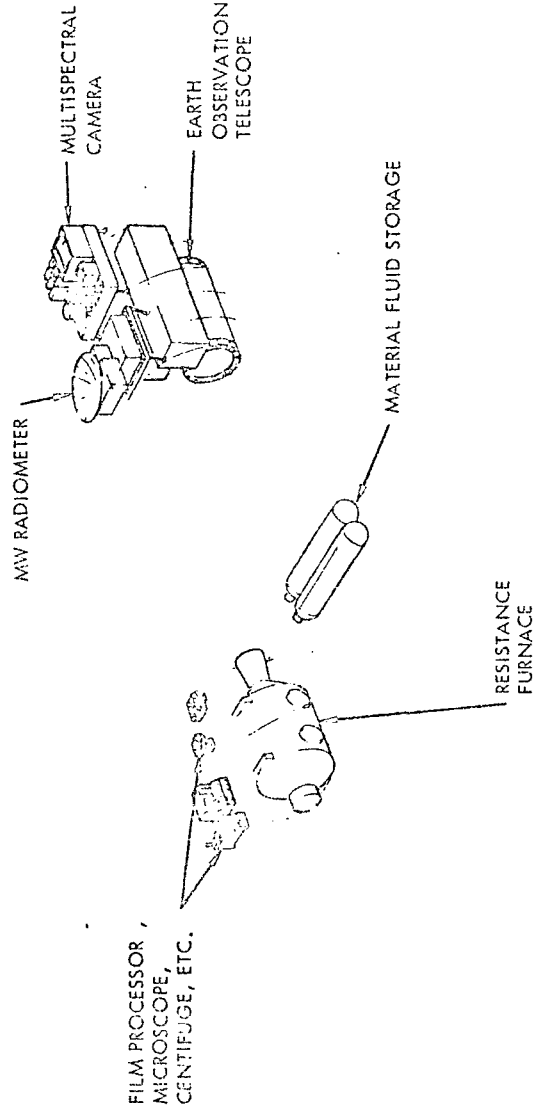

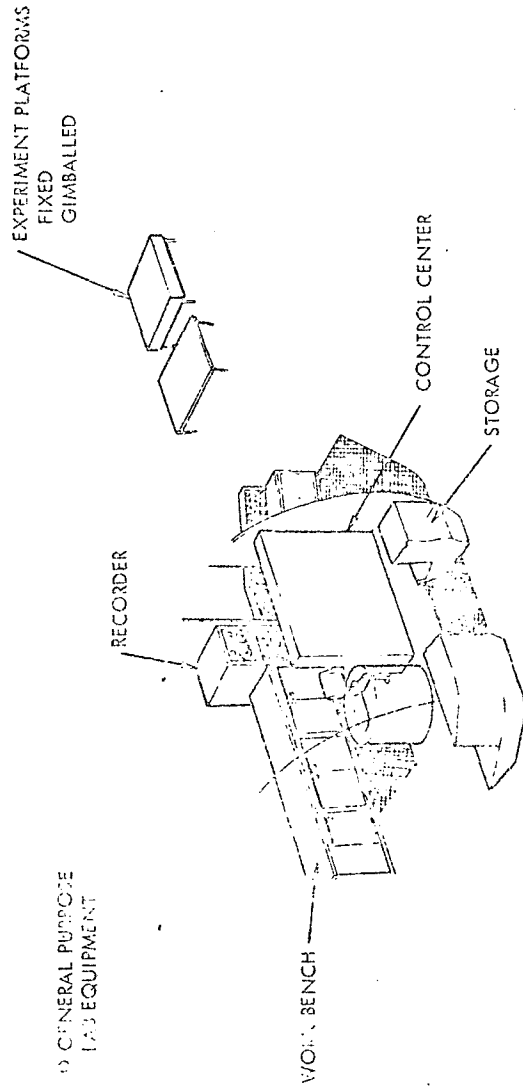



# SORTIE LAB DEFINITION

## o STRUCTURE SUBSYSTEM

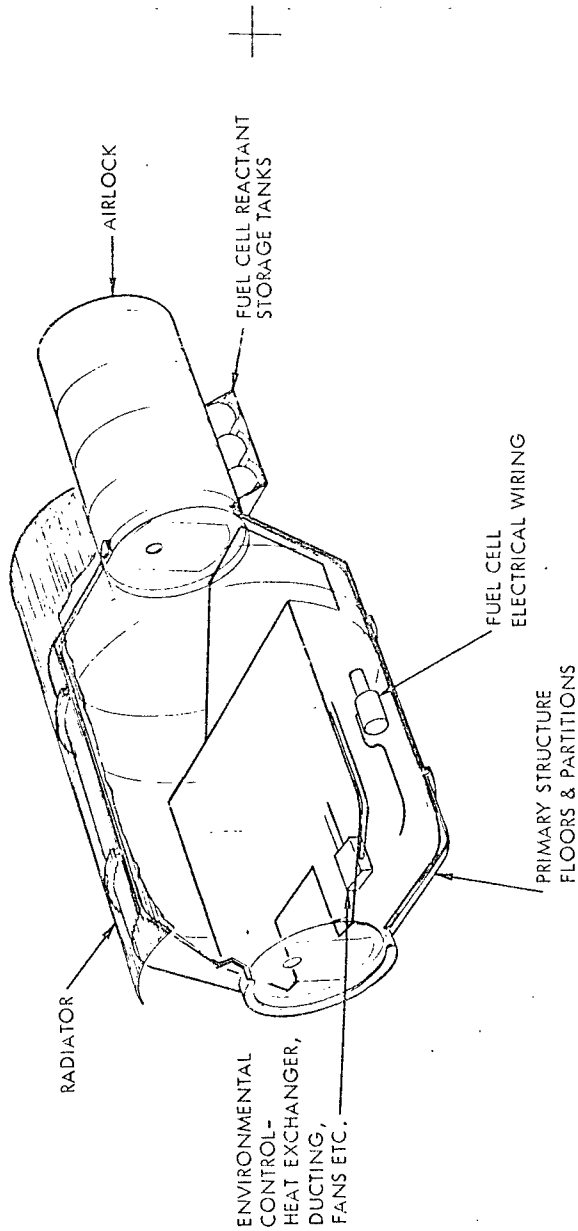



Space Division  
North American Rockwell

#### SORTIE LAB CAPABILITIES

This chart summarizes the major features and capabilities offered by the applications-type sortie lab. The weight of the lab is 20,000 pounds and the curve indicates the weight available for the mission-unique equipment as a function of the shuttle's capability to various orbit altitudes and inclinations. Capabilities with and without the air-breathing engines are shown. Also summarized is the power available for experiments at the various inclinations as limited by the heat rejection capability of the radiator.

# SOAR LAB(A) CAPABILITIES

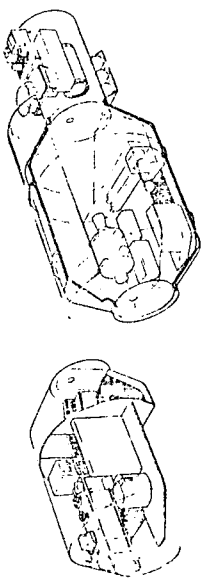

WEIGHT ..... 20,000 LB

- LAB DISCIPLINES:
- EARTH OBS., MATERIAL SCIENCE, LIFE SCIENCE
- EXPERIMENT EQUIPMENT:
- RESISTANCE FURNACE
  - EARTH OBS TELESCOPE
  - MICRO/YAVE SCANNER
  - LOWER BODY NEGATIVE MEASUREMENT
  - CONTROL CENTER, RECORDERS, MICROSCOPES
  - FILM PROCESSOR & CENTRIFUGE
- CREW ACCOMMODATIONS - 2
- ACTIVE THERMAL CONTROL - 250 FT<sup>2</sup> RAD
- ELECTRIC POWER - 7.0 KW FUEL CELL WITH CRYOGENIC STORAGE TANKS
- POWER/THERMAL LIMIT
- 28.5 DEG INCL 2.5 KW
  - 55 DEG INCL 3.0 KW
  - 90 DEG INCL 7.0 KW

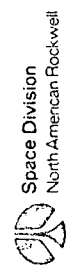
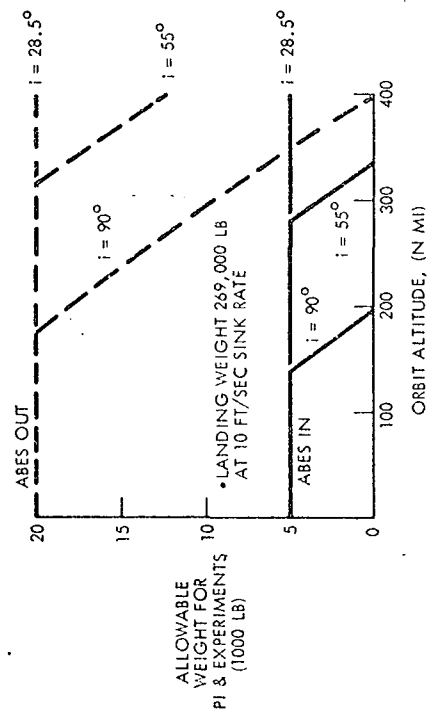

Space Division  
North American Rockwell



Space Division  
North American Rockwell

#### SORTIE LAB CONCEPT

This chart depicts the application lab concept and points out the location of the various pieces of lab equipment. The lab is 20 feet long excluding the 12-1/2-foot airlock. The upper floor is dedicated to the earth observation and life science labs and the lower floor is dedicated to material science. The lab is fixed in the shuttle payload bay with the necessary sensor exposure obtained through the open payload bay doors. For the earth observation telescope, outward looking is obtained by employing a right-angle aperature. The other design features are indicated.

# SCIENCE LAB (A) CONCEPT

EARTH OBS - MAT'L SCIENCE - LIFE SCIENCE

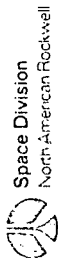
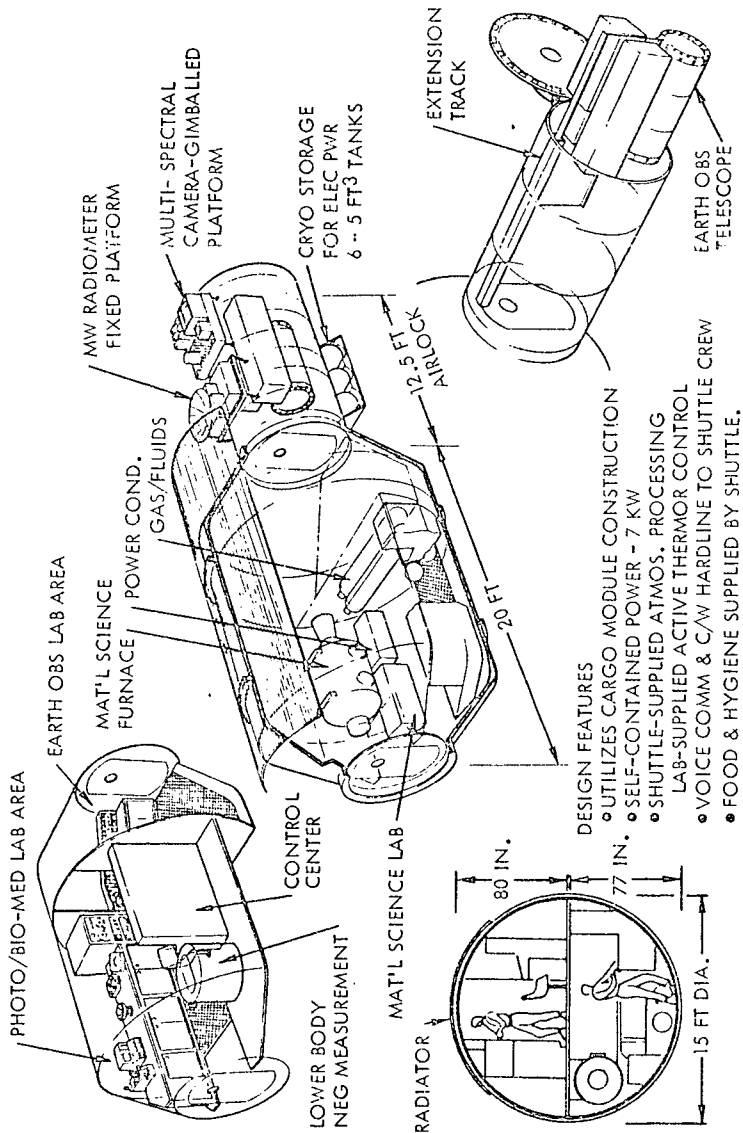

Space Division  
North American Rockwell

# MODULAR SPACE STATION PHASE B EXTENSION

3RD QUARTERLY REVIEW

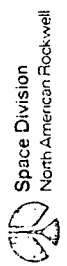
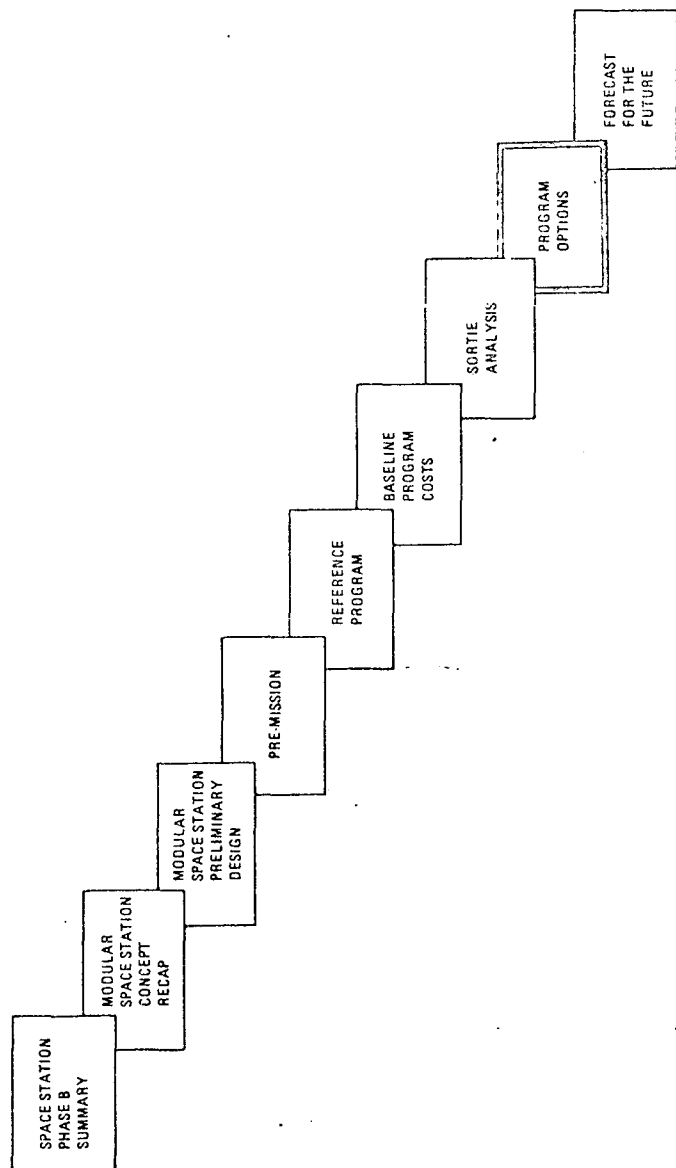



Space Division  
North American Rockwell

#### PROGRAM OPTIONS

A set of program-level alternatives to the MSS Phase B program were investigated. Key differences from study guidelines are as shown. Sets of these alternatives were grouped into eight program options to be compared to a reference program that completes the entire NASA Blue Book of experiments.

# PROGRAM OPTIONS

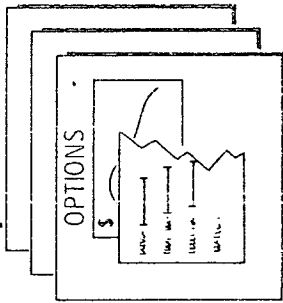
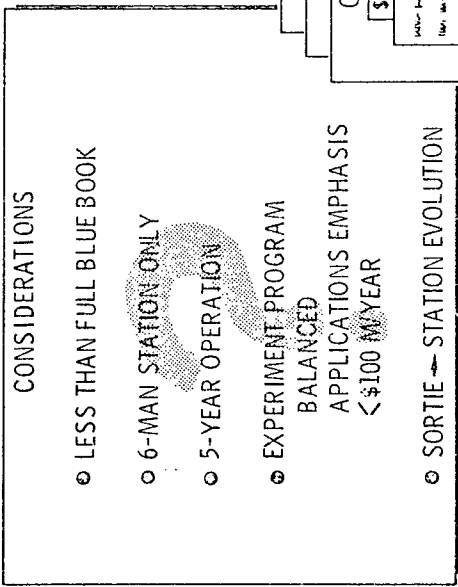
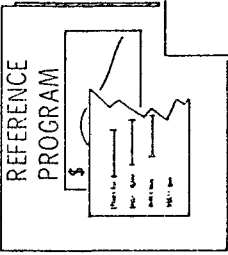





Space Division  
North American Rockwell

#### PROGRAM OPTION GROUND RULES

The basic study ground rules utilized for this study are noted. The shuttle system used in this study was the shuttle model as defined by the initial Phase B study. This is an integral propellant tank orbiter utilizing a reusable booster with a one flight per month launch capability. The NASA '71 Blue Book experiments were used as the basis for the experiment programs which are defined in subsequent charts. The key schedule milestones used as ground rules for program options comparisons are as shown.

# PROGRAM OPTION GROUND RULES

- CURRENT PHASE B MSS DEFINITION UTILIZED

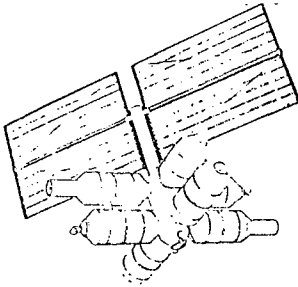

- PHASE B SHUTTLE DEFINITION UTILIZED

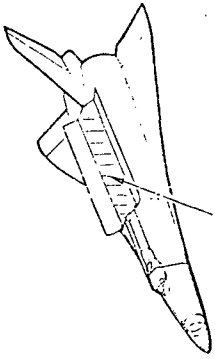

15 FT X 60 FT CARGO BAY  
25,000 LB TO 55 DEG, 270 N MI

- SHUTTLE BOOSTER REUSABLE
- 2 LAUNCH PADS
- 1 FLIGHT/MONTH LAUNCH CAPABILITY
- THREE NASA VEHICLES IN PROGRAM

- INITIAL SPACE STATION (ISS) - 6-MAN
- GROWTH SPACE STATION (GSS) - 12-MAN
- INITIAL SPACE STATION (ISS)<sub>0</sub> - 6-MAN WITH NO GROWTH PROVISIONS

## SCHEDULE

< SHUTTLE >

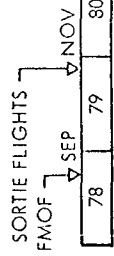

< STATION >

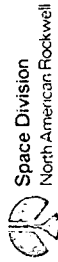



Space Division  
North American Rockwell

#### ALTERNATIVE PROGRAM OPTIONS

This chart defines the nine programs which were used for the program options study. Program 1 (reference) is the MSS Phase B system and includes the initial space station (ISS) at a six-man level and the growth space station (GSS) at the 12-man level. The capability of accomplishing all the NASA Blue Book experiments is provided. The cost reflected for this reference program is the same as the baseline reported for the MSS Phase B study; the key exception is that the baseline allows for 5 years of GSS operation whereas Program 1 extends GSS operations to 10 years.

The remainder of the programs utilize the ISS only with no growth provisions. Programs 2 and 3 utilize a balanced experiment program with different operating durations. Program 4 emphasizes the applications experiments (social and economic benefits) while Program 5 assumes a funding restraint of 100 million dollars per year for experiments. These experiment costs include attached and detached RAM costs and attendant support systems. Programs 6 through 9 utilize the same station programs as Program 2 through 5 with the addition of shuttle-supported sortie experiments for 2-1/2 years preceding the station IOC and also sortie overlap with station operations. Experiment programs (including accomplishments) are defined in subsequent charts.

# ALTERNATE PROGRAM OPTIONS

PROGRAM NO.	PAYLOAD SYSTEM	TYPE OF PROGRAM	OPERATING TIME				
			79	82	87	92	97
1	ISS - GSS	TOTAL NASA BLUE BOOK (15 YR)	SHUTTLE ▲ IOC				
2	(ISS) <sub>0</sub>	<ul style="list-style-type: none"> <li>● REDUCED EXPERIMENT PROGR. (BALANCED)</li> <li>● NO DETACHED RAMS</li> </ul>	ISS 3 YR    GSS 10 YR				
3	(ISS) <sub>0</sub>	<ul style="list-style-type: none"> <li>● REDUCED EXPERIMENT PROGR. (BALANCED)</li> <li>● MAY HAVE DETACHED RAMS</li> </ul>	5 YR				
4	(ISS) <sub>0</sub>	<ul style="list-style-type: none"> <li>● EMPHASIS ON APPLICATIONS (DEFER SCIENCE &amp; TECHNOLOGY)</li> </ul>	10 YR				
5	(ISS) <sub>0</sub>	<ul style="list-style-type: none"> <li>● EXPERIMENTS WITH 5100M YR LIMIT FOR EXPERIMENTS (1.2B TOTAL)</li> </ul>	10 YR				
6	SORTIE MODULES & (ISS) <sub>0</sub>	<ul style="list-style-type: none"> <li>● SAME AS 2</li> </ul>	5 YR				
7		<ul style="list-style-type: none"> <li>● SAME AS 3</li> </ul>	10 YR				
8		<ul style="list-style-type: none"> <li>● SAME AS 4</li> </ul>	10 YR				
9		<ul style="list-style-type: none"> <li>● SAME AS 5</li> </ul>	5 YR				
(ISS) <sub>0</sub> INITIAL STATION LESS GROWTH PROVISIONS			SORTIE MISSIONS				



Space Division  
North American Rockwell

#### BALANCED AND APPLICATIONS PROGRAM DEFINITION

Prior to the identification of the specific experiments to be conducted within any one of the program options, it was necessary to define the meaning of a balanced or an applications program. Alternative definitions of a balanced program are possible, including (1) all disciplines represented, (2) balance between socio-economic benefits and advancement of scientific knowledge, (3) balanced utilization of resources such as crew man-years for experiment operations, years of experiment operations or cost of experiment equipment, and (4) balanced "completion" of the Blue Book experiments.

Of these and other alternatives, the first two were selected; that is, all disciplines are represented and a balance is maintained between socio-economic benefits and advancement in scientific knowledge. In representing all disciplines, the experiment operations within each discipline must be to a level adequate to accomplish key goals within the discipline. An examination using any one of the other alternatives for defining a balanced program resulted in an imbalance among the disciplines. For example, balancing crew time resulted in a disproportionate application of crew man-hours to COMM/NAV when compared with the Blue Book desires for the other disciplines.

The applications programs were developed by scheduling only those FPE's which provide either direct or indirect socio-economic benefits. In this type of program, all disciplines are not necessarily represented.

# BALANCED AND APPLICATIONS PROGRAM DEFINITION

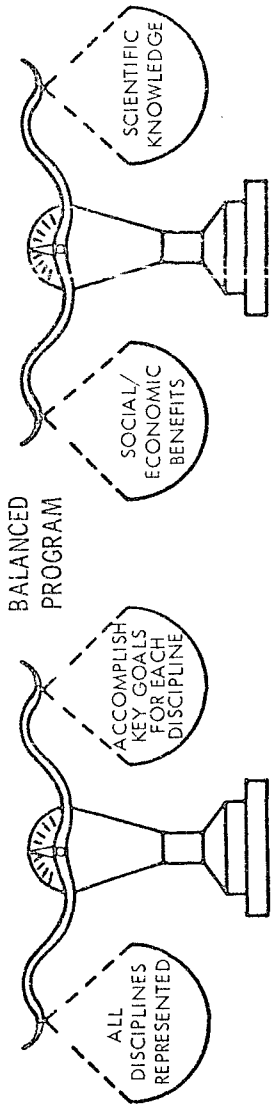

## APPLICATIONS PROGRAM

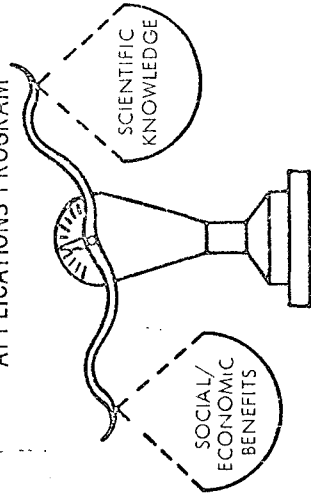

### OTHER MEASURES

- EQUAL CREW TIME (MAN-HOURS)
- EQUAL EXPERIMENT OPERATIONAL PERIOD (YEARS)
- EQUAL DATA (TYPE & QUANTITY)
- EQUAL EXPERIMENT COST

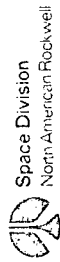



Space Division  
North American Rockwell

#### LABORATORY EVOLUTION PHILOSOPHY

One major feature of the 1971 Blue Book is the introduction of the facility concept. For each FPE, an extensive all-up facility is described which contains experiment equipment capable of accomplishing all stated FPE objectives. NR has defined a series of buildup steps for each FPE facility in the Blue Book. This evolution of experiment capability is a major feature of NR's overall programmatic approach consistent with an evolution of carrier vehicle capability.

Level I is that portion of the total facility which supports experiments of short duration (7 to 30 days). Emphasis is placed on applications and precursor type experiments.

Level II adds equipment associated with long-duration or permanent-type experiments emphasizing a balanced but low-cost program. In general, high-cost research and scientific oriented equipment is deferred to the final level.

Level III consists of the total Blue Book facility.

In the example illustrated, each level is defined not only by the experiments selected but also by accommodation mode. At Level III, this high-energy astronomy FPE is operated as a detached RAM, whereas it is attached at Level II. Note that on the chart only major equipment items are illustrated and, in going to higher levels, only new major items are called out.

# LABORATORY EVOLUTION PHILOSOPHY

(HIGH ENERGY STELLAR ASTRONOMY)

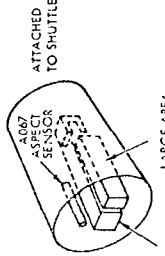
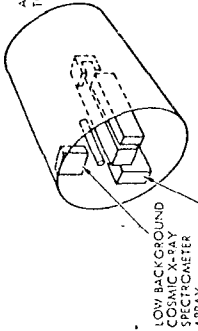
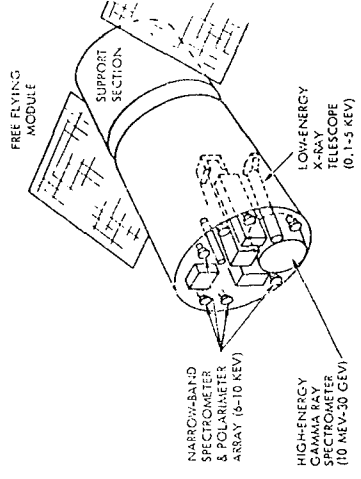
LEVEL I	LEVEL II	LEVEL III
<p>(A-5-1)</p>  <p>EXPERIMENTS 2</p> <p>EQUIPMENT 7</p> <p>MODE ATTACHED TO SHUTTLE</p>	<p>(A-5-11)</p>  <p>EXPERIMENTS 4</p> <p>EQUIPMENT 11</p> <p>MODE ATTACHED MSS</p>	<p>(A-5-111 = FPE A.5)</p>  <p>EXPERIMENTS 7</p> <p>EQUIPMENT 18</p> <p>MODE FREE-FLYING RAM</p>





Space Division  
North American Rockwell

#### TYPICAL ACCOMPLISHMENTS--BALANCED 10-YEAR PROGRAM

A balanced program will produce a variety of information from each of the Blue Book disciplines. At level II astronomy laboratories will concentrate on sky surveys and on selected targets of interest, such as the Crab Nebula, in an effort to understand fundamental processes governing the evolution of the universe. In earth observations, surveys will be made in selected sub-disciplines such as for pollution control or resource inventories. Capability in earth observations would provide only a minimum of real-time data analysis and transmission. In material science, new composite materials containing density gradients will be prepared in pilot plant quantities. In a one-g environment, regions of different density would stratify. In life sciences, a balanced program would include both biomedicine and bioscience. In general, bioscience would be limited to the more easily accommodated call and tissue research rather than more mobile animals or larger plants.

The accomplishment at Level III are essentially the Blue Book objectives except for experiment duration and some decrease in experiment equipment.

# TYPICAL ACCOMPLISHMENTS

ADVANCED 10-YEAR PROGRAM

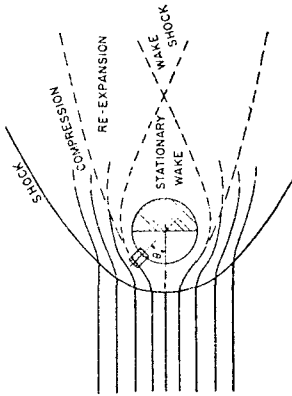

## ASTRONOMY & PHYSICS

- SOLAR-TERRRESTRIAL INTERACTIONS
- HIGH-ENERGY SOURCE MAP

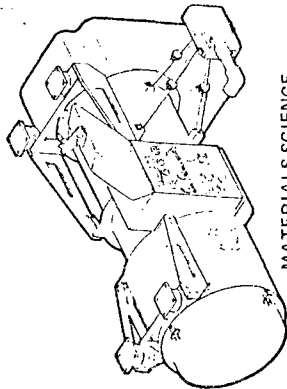

## MATERIALS SCIENCE

- PILOT PLANT OPERATIONS
- NEW GLASSES, SEMICONDUCTORS, COMPOSITE MATERIALS



Space Division  
North American Rockwell

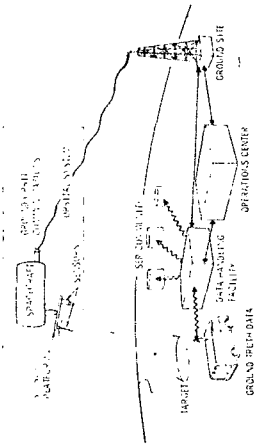

## EARTH OBSERVATIONS

- REAL-TIME DATA DISSEMINATION
- CONTINUOUS RESOURCE MANAGEMENT

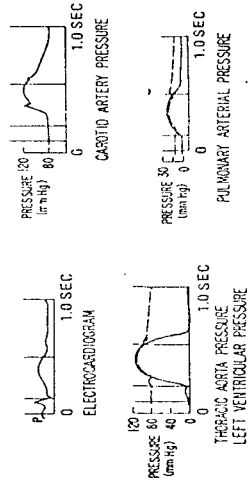

## LIFE SCIENCE

- COMBINED ENVIRONMENTAL EFFECTS ON LARGER MAMMALS
- MAN-SYSTEM INTEGRATION STUDIES



Space Division

North American Rockwell

#### TYPICAL EQUIPMENT, OPTION 3--BALANCED 10-YEAR PROGRAM

The equipment list shown here reflects the variety of operations performed in the so-called balanced program. All disciplines are represented. The list is by no means complete, but is meant to convey the overall scope of the Blue Book experiments accommodated with this program option. On a subsequent chart, an equipment list for another program option is presented. By comparing these lists, the reader can get some feeling for the variation in program emphasis from option to option.

The 10-year duration of this program permits the introduction of several Level III laboratories. This is particularly evident in materials science and life sciences. In earth observations, Level III capability is provided by a more sophisticated accommodation technique (attached RAM) compared with the Level II GPL/airlock mode.

# TYPICAL EQUIPMENT - OPTION 3

## ANCED 10-YEAR PROGRAM

### ASTRONOMY

- 1.5-METER PHOTOHELIOGRAPH
- 0.5-METER X-RAY TELESCOPE
- GAMMA RAY SPECTROMETER
- CORONOGRAPH ASSEMBLY
- 0.25-METER XUV SPECTROHELIOGRAPH
- LARGE AREA X-RAY COUNTER
- GE (L1) GAMMA-RAY DETECTOR

### PHYSICS

- SCANNING GRATING SPECTROMETER
- MAGNETOMETERS
- PARTICLE SENSOR CLUSTER
- LIQUID CERENKOV COUNTER
- TOTAL ABSORPTION DEVICE
- SUPERCONDUCTING MAGNET
- UV TELESCOPE SPECTROMETER
- HIGH-Z SHIELDED (NUCLEI) DETECTOR

### EARTH OBSERVATIONS

- METRIC CAMERA
- MULTISPECTRAL CAMERA
- MULTISPECTRAL SCANNER
- MULTISPECTRAL RADIOMETER
- MICROWAVE SCANNER
- OBSERVATION TELESCOPE

### COMMUNICATIONS/NAVIGATION

- STANDARD TEST EQUIPMENT
- 9-METER ERECTABLE ANTENNA
- RF TRANSMITTERS, RECEIVERS
- OPTICAL TRANSMITTERS, RECEIVERS
- LASER TRACKING SYSTEM
- PLASMA PROBES

### MATERIALS SCIENCE

- ENVIRONMENTAL CHAMBER, PASSIVE
- ENVIRONMENTAL CHAMBER, ACTIVE
- RESISTANCE FURNACE (1800 C)
- DISPERSION CONTROL SYSTEM
- LIQUID METAL SUPPLY SYSTEM
- CRYSTAL PULLER
- ZONE MELTER
- DEPLOYMENT SYSTEMS
- FURNACE, 3200 C OXYGEN

### TECHNOLOGY

- REAL-TIME CONTAMINATION MONITOR
- PHOTOELECTRIC POLARIMETER
- EXPOSURE DEVICES
- LEAK DETECTION SYSTEM
- SOLAR CELL SYSTEM
- ASTRONAUT MANEUVERING UNIT

### LIFE SCIENCES

- METABOLIC ANALYZER (FOR MAN)
- LOWER BODY NEGATIVE PRESSURE DEVICE
- ROTATING LITTER CHAIR
- RAT HOLDING UNIT
- INVERTEBRATE CENTRIFUGE
- IMPACT FORCE DETECTOR
- BODY MASS MEASUREMENT DEVICE
- ELECTROPHYSIOLOGY EQUIPMENT
- HISTOLOGY KIT
- BEHAVIORAL MEASUREMENT UNIT
- PLANT HOLDING UNIT
- EVA MAINTENANCE REPAIR SYSTEM



Space Division  
North American Rockwell



Space Division  
North American Rockwell

TYPICAL ACCOMPLISHMENTS--\$100 M/YEAR PROGRAM

Accomplishments in this program option are similar to the balanced program minus astronomy. In earth observations, real-time capability would not be established. Emphasis in that discipline would be in developmental activities. Limited astronomical observations would be performed in the space physics laboratory with smaller devices than are assigned to the astronomy FPE's.

The materials science discipline benefits from the program funding limits. The additional equipment required for the Level III laboratory in that discipline is relatively inexpensive and will permit the preparation of exotic glasses.

# TYPICAL ACCOMPLISHMENTS

100M/YEAR PROGRAM

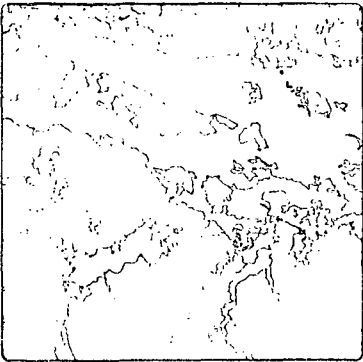

- EARTH OBSERVATIONS**
- SIGNATURE RESEARCH
  - RESOURCE MANAGEMENT
  - SYSTEM DEVELOPMENT

\* NO ASTRONOMY

**MATERIALS SCIENCE**

- PREPARE NEW GLASSES-HIGH REFRACTIVE INDEX
- FEASIBILITY OF MANUFACTURING PROCESS

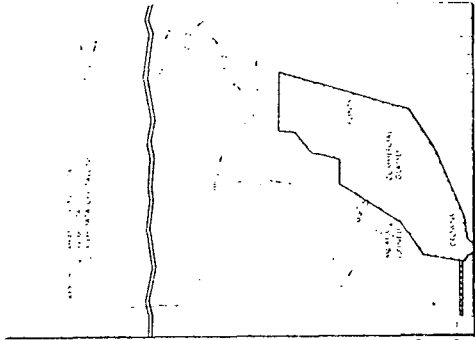

**SPACE PHYSICS RESEARCH**

- SUN'S INFLUENCE ON WEATHER
- STELLAR EVOLUTION-FUSION REACTIONS

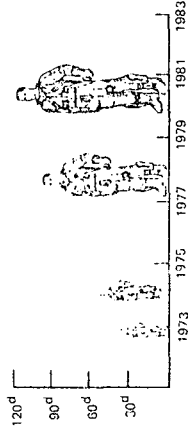

**MEDICAL RESEARCH**

- EXTEND MAN-IN-SPACE CAPABILITY
- DEVELOP EFFECTIVE COUNTERMEASURES TO DECONDITIONING PROCESSES

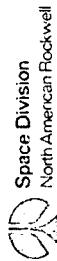

Space Division  
North American Rockwell



Space Division  
North American Rockwell

TYPICAL EQUIPMENT--OPTION 5, \$100 M/YEAR PROGRAM (5 YEARS)

This program is constrained by a \$100 million per year experiments budget. This results in two specific differences when it is compared to other programs. First, no astronomy laboratories are provided, since these are so costly that their inclusion would result in a severely reduced level of effort in all other disciplines. In addition, it becomes desirable to retain laboratories once available rather than initiate new developments.

# TYPICAL EQUIPMENT OPTION 5, \$100 M/YEAR PROGRAM

ASTRONOMY	NONE
PHYSICS	
• SCANNING GRATING SPECTROMETER	• MAGNETOMETER
• UV TELESCOPE SPECTROMETER	
EARTH OBSERVATIONS	
• METRIC CAMERA	• MULTISPECTRAL RADIOMETER
• MULTISPECTRAL CAMERA	• MICROWAVE SCANNER
• MULTISPECTRAL SCANNER	• OBSERVATION TELESCOPE
• OPTICAL RADAR SYSTEM	
COMMUNICATIONS/NAVIGATION	
• 9-METER ERECTABLE ANTENNA	• LASER TRACKING SYSTEM
• OPTICAL TRANSMITTERS/RECEIVERS	• PLASMA PROBES
MATERIALS SCIENCE	
• ENVIRONMENTAL CHAMBERS	• LIQUID METAL SUPPLY SYSTEM
• RESISTANCE FURNACE	• CRYSTAL PULLER
• DISPERSION CONTROL SYSTEM	• ZONE MELTER
TECHNOLOGY	
• REAL-TIME CONTAMINATION MONITOR	• EXPOSURE DEVICES
• PHOTOELECTRIC POLARIMETER	
LIFE SCIENCES	
• METABOLIC ANALYZER (FOR MAN)	• BODY MASS MEASUREMENT DEVICE
• LOWER BODY NEGATIVE PRESSURE DEVICE	• ELECTROPHYSIOLOGY EQUIPMENT



Space Division  
North American Rockwell





Space Division  
North American Rockwell

#### RESOURCE UTILIZATION SUMMARY--BALANCED 10-YEAR PROGRAM

The previous charts have compared two of the programs on the basis of typical experiment equipment and accomplishments. Other means of comparing programs include the relative distribution of crew time for experiment operations, the percent of total experiment time devoted to each discipline, and the relative balance of program emphasis. An examination of the distribution of both the percentage crew time and experiment duration for the balanced 10-year program shows similar results. Approximately 50 percent of these resources are required to support the earth observations and life sciences FPE's. The remaining 50 percent is divided essentially equally between the astronomy, physics, technology and materials sciences FPE's with a relatively small percentage devoted to communication/navigation. The resultant program emphasis is divided approximately equal between socioeconomic benefits and advancement of scientific knowledge with a slightly high percentage emphasis on these FPE's contributing to socio-economic benefits.

# RESOURCE UTILIZATION SUMMARY

BALANCED 10 YEAR PROGRAM

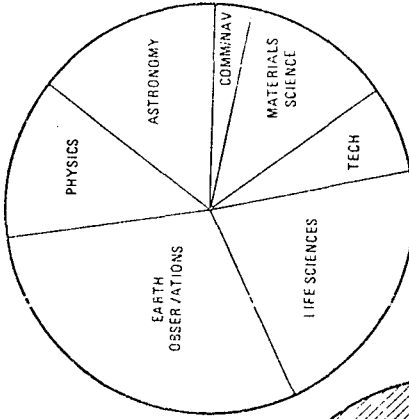
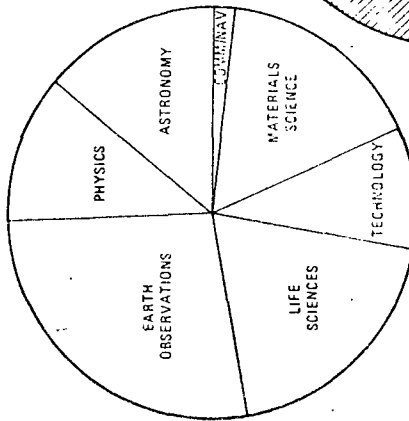

 SOCIO-ECONOMIC  
 SCIENCE

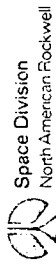
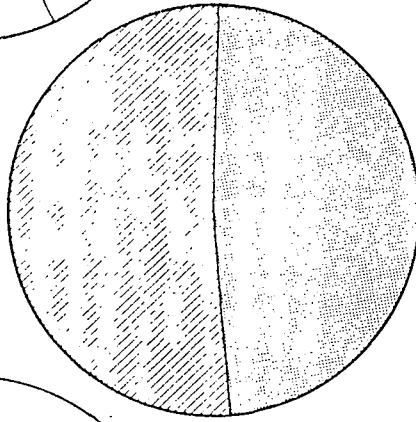



Space Division

North American Rockwell

#### RESOURCE UTILIZATION SUMMARY--\$100 M/YEAR PROGRAM

An examination of the distribution of the percentage crew time and experiment duration also show similar results for the limited-funding 5-year program. In this program, the emphasis was on applications. Therefore, nearly 75 percent of these resources are devoted to FPE's within the earth, observations and materials science disciplines. Of the remaining disciplines within their program option, a relatively high percentage of crew time and experiment duration is devoted to life sciences FPE's. No astronomy FPE's are included in the limited-funding applications emphasis program since the majority of the astronomy FPE's identified in the Blue Book have relatively high costs. The resultant program emphasis is approximately 60 percent on socio-economic benefits and 40 percent on the advancement of scientific knowledge. The relatively high percentage of scientific knowledge emphasis is achieved by incorporating, when possible, these FPE's which have socio-economic benefits and which contribute to advancement in science.

# RESOURCE UTILIZATION SUMMARY (CONT)

100W YEAR PROGRAM

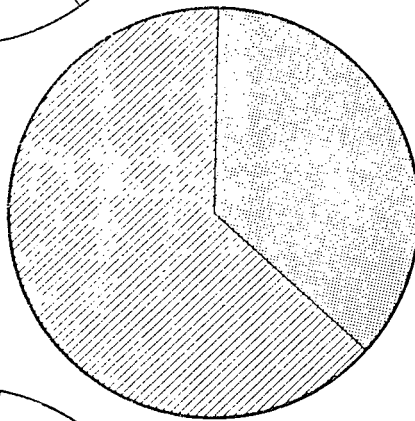
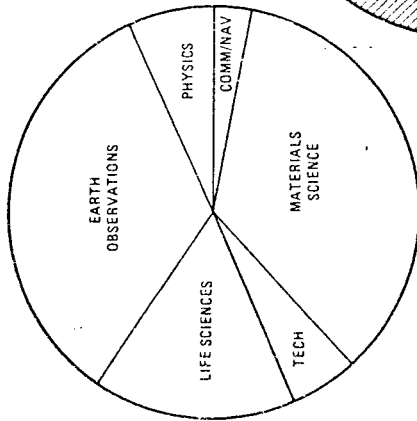
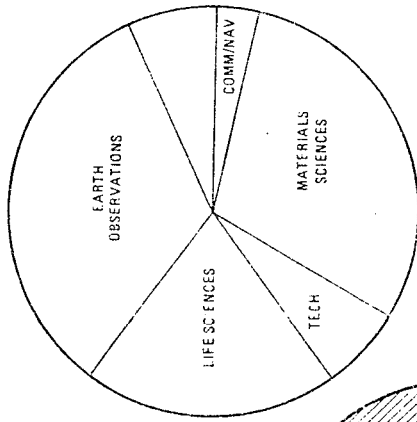

 SOCIO-ECONOMIC  
 SCIENCE

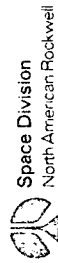



Space Division  
North American Rockwell

#### PROGRAM COMPARISON SUMMARY

The four basic programs have been summarized in terms of the number of experiment disciplines represented, experiment equipment groups, shuttle flights, experiment equipment modules, and support sections. The total experiment crew time and experiment duration also are defined. The first three programs are balanced, therefore, all seven disciplines are represented. Thirteen experiment equipment modules are required for the reference program. For the remaining four program options, the number of experiment equipment modules varies from 1 to 4 depending on program emphasis and duration. The corresponding number of support sections is a maximum of three (including one spare) for the reference program, but only one is required for the balanced 10-year program to support a single detached RAM.

The number of experiment crew hours depends on the program duration and the space crew size. The experiment duration, which represents the sum of the operating periods of all FPE's within the program, also depends on crew size and program duration.

# PROGRAM COMPARISON SUMMARY

PROGRAM OPTION	DISCIPLINES	EXPERIMENT EQUIPMENT GROUPS	SHUTTLE FLIGHTS	EXPERIMENT EQUIPMENT MODULES	FREE FLYER SUPPORT SECTION	EXPERIMENT CREW TIME (MAN YEAR)	EXPERIMENT DURATION (YEAR)
1 REFERENCE	7	51	123	13	3	87.33	70.0
2 BALANCED (5-YEAR)	7	13	31	3	0	16.25	18.08
3 BALANCED (10-YEAR)	7	26	55	4	1	32.48	33.96
4 APPLICATIONS (10-YEAR)	6	15	50	2	0	36.53	28.06
5 LIMITED FUNDING (5-YEAR)	6	8	28	1	0	17.05	15.0



Space Division  
North American Rockwell

#### SHUTTLE PAYLOAD DEFINITION

NR's approach to the definition of shuttle payloads for sortie missions proceeded in the orderly fashion illustrated here. Experiments selected for Level I laboratories were combined into sortie experiment packages by applying criteria such as those shown. These packages were combined into experiment payloads on the basis of additional criteria. For example, contamination experiments are combined with astronomy. Other sortie experiment packages were combined based on similarity of orbit requirements. Then support requirements were determined for the experiment payloads and an accommodation mode defined (e.g., pallet or module). The total set of support structure, subsystems, and experiment payload is the shuttle payload for a sortie mission.

# SHUTTLE PAYLOAD DEFINITION

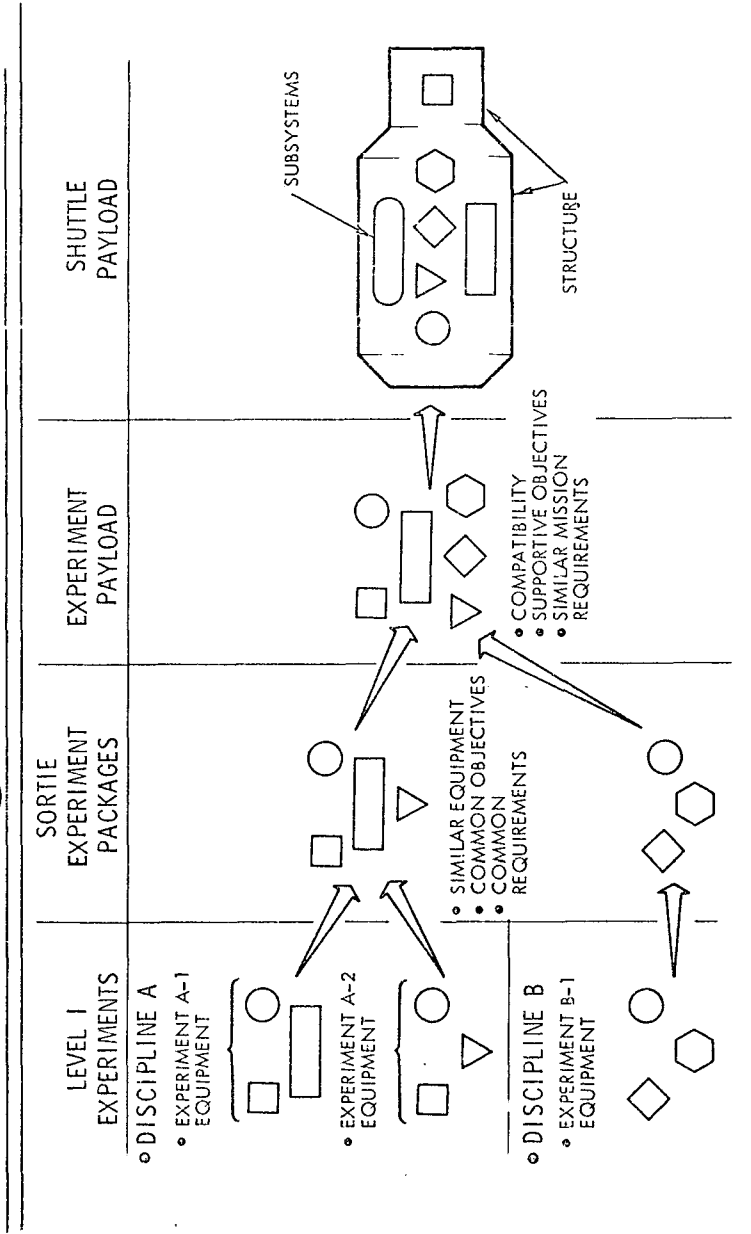





Space Division  
North American Rockwell

#### SORTIE PAYLOADS FOR PROGRAM OPTIONS - 7-DAY MISSIONS

The payloads which are scheduled in the sortie programs are summarized using the payload designators previously identified in the Sortie Analysis section of this briefing. In some cases, the payloads have been modified by reducing the number of experiment packages contained within the payloads. These payloads are identified by the additional letter in the payload numerical designator. One additional payload was identified for the 30-day sortie missions (30-12) which is comparable to payload 7-1, Materials Science. The modification was primarily one of increasing the mission duration for this payload from 7 to 30 days.

For each sortie payload, the sortie payload carrier is identified using the carrier designations previously presented. The program options in which the payloads are scheduled are indicated by the number of flights of each payload. The number of payloads within the program options vary from six for Program Option 9, which is the limited-funding program, to 12 for Program Options 6 and 7, which are both balanced programs. The maximum number of sortie missions for a single payload is 15 for Payload 7-4, which contains earth surveys and technology experiments. In general, the payloads identified with a given program option support the experiments which are subsequently conducted on the space station.

# SORTIE PAYLOADS FOR PROGRAM OPTIONS

## 7-DAY SORTIE MISSIONS

PAYLOAD	EXPERIMENT PACKAGE	TITLE	CARRIER			FLIGHTS				
			10-FT	20-FT	A/L	PALLET	6	7	8	9
7-2A	LS4-II TS-I	CELLS & TISSUES ASTRONAUT MANEUVERING UNIT		✓			3	3	3	
7 7-3A	T4-I	ADVANCED SPACECRAFT SYSTEMS TESTS			✓		2	2	2	
7-4	ES1-III T1-I	AIR & WATER POLLUTION SKY BACKGROUND BRIGHTNESS			✓		14	14	15	14
7-5	P1-I T1-I C/NT-I	ATMOSPHERIC & MAGNETOSPHERIC SCIENCES SKY BACKGROUND BRIGHTNESS TRANSMITTER BREAKDOWN TEST			✓		1	1	1	1



Space Division  
North American Rockwell

SORTIE PAYLOADS FOR PROGRAM OPTIONS - 30-DAY MISSION

The payloads secheduled for the 30-day sortie mission were explained in the discussion on the previous page.

# SORTIE PAYLOADS FOR PROGRAM OPTIONS

## 30 - DAY SORTIE MISSIONS

PAYLOAD	EXPERIMENT PACKAGE	TITLE	CARRIER			FLIGHTS								
			10-FT	20-FT	A/L	PALLET	6	7	8	9				
30-1A	LS1-I	BIOMEDICAL RESEARCH		✓			4							
30-1B	LS1-I	BIOMEDICAL RESEARCH ROLE OF GRAVITY IN LIFE PROCESSES PERFORMANCE CAPABILITY ASSESSMENT	✓						4					
	LS4-I													
	LS5-I													
30-1C	LS7-II	BIOMEDICAL RESEARCH LIFE SUPPORT SYSTEMS DEVELOPMENT PERFORMANCE CAPABILITY ASSESSMENT	✓											
	LS1-I													
	LS6-I													
30-2A	LS7-II	MOLECULAR PHYSICS	✓											
	P4-I													
30-4	EST-I	METEOROLOGY & THE ATMOSPHERIC SCIENCES REAL-TIME CONTAMINATION MEASUREMENTS	✓											
	T1-II													
30-6	A3-I	PHOTOHELIOGRAPH EXPERIMENTS	✓											
30-8	A5-I	LOW-ENERGY X-RAY TELESCOPE EXPERIMENTS		✓										
30-10	P3-I	CHARGE & ENERGY SPECTRA OF COSMIC RAY NUCLEI		✓										
30-11	C/N1-II	MILLIMETER WAVE COMMUNICATION SYSTEM & PROPAGATION DEMONSTRATION SURVEILLANCE & SEARCH & RESCUE SYSTEMS DEMONSTRATION		✓										
	C/N1-III													
30-12	MS-III	MATERIALS SCIENCE		✓										
		UNCOMMITTED PAYLOADS												





Space Division

North American Rockwell

#### TYPICAL SORTIE CONTRIBUTIONS

The program options which include sortie missions are in general identical in content with the corresponding options which do not include sorties. Sorties provide the capability, however, to accomplish selected objectives early in a logical time-phased manner. For example, in earth observational sorties can obtain data on slowly varying phenomena such as natural resource deposits. They can also contribute developmental flights to the earlier establishment of an operational capability with a space station or with satellites. Similarly, in life sciences, techniques to be used on longer duration flights can be evaluated.

There are precursor activities which are desirable to perform in the materials science discipline also. These relate to the behavior of fluids (in particular high-temperature melts) in zero-g, as well as the performance of handling and accident-prevention systems.

With sorties, the orbit flexibility of the shuttle can be exploited. This is particularly appropriate in astronomy, physics, and communications/navigation.

# TYPICAL SORTIE CONTRIBUTIONS

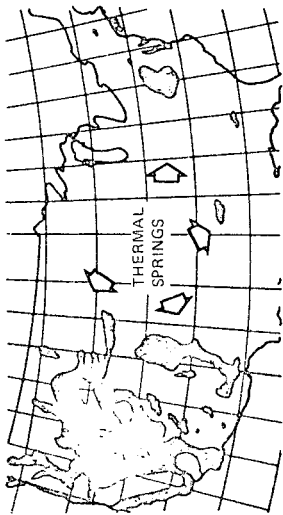

**EARTH OBSERVATIONS**

- RESOURCE SURVEYS
- EARLIER OPERATIONAL STATUS

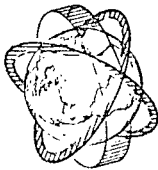

**ASTRONOMY PHYSICS  
COMMUNICATIONS/NAVIGATION**

- EFFECT OF VARYING ORBIT PARAMETERS
- CONCENTRATED OBSERVATIONS OF SELECTED TARGETS

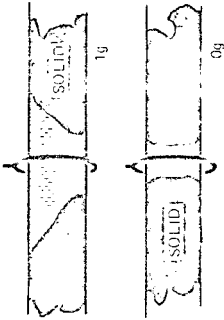

**MATERIALS SCIENCE**

- FLUID BEHAVIOR IN ZERO g
- CRYSTAL GROWTH

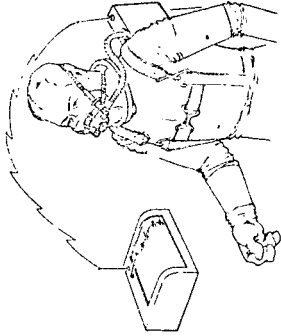

**TECHNOLOGY  
LIFE SCIENCES**

- VERIFICATION OF MEASUREMENT & INSTRUMENTATION TECHNIQUES

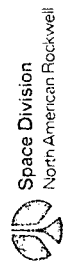

Space Division  
North American Rockwell



Space Division  
North American Rockwell

#### PROGRAM 7 - SORTIE AND EARLY SPACE STATION PHASING

A typical scheduling of the sortie payloads is shown for the balanced program, Program Option 7. The payloads are shown in the order in which they are introduced into the program with the earth surveys and technology (contamination measurement) being introduced first. For purposes of comparison, the initial period of operation of the associated space station experiments also is identified. The space station experiments are identified by the open bars after the first experiment package which contains a related FPE (e.g., earth surveys appears in two experiment payloads but only one bar is shown for the space station following the first earth surveys experiment package, ESL-III). As can be seen, the phasing of the introduction of the sortie experiment payloads generally follows the phasing of the introduction of the experiments into the space station operations. For example, the astronomy FPE's are the last payloads flown on the sortie missions and they are also the last FPE's introduced into the space station experiment program.

# PROGRAM 7 - SCIENCE & EARLY SPACE STATION PHASING

PAY-LOAD	EXPERIMENT PACKAGE	TITLE	YEAR											
			1979	1980	1981	1982	1983	1984	1985	1986				
7-4	ES-III T1-I	AIR & WATER POLLUTION SKY BACKGROUND BRIGHTNESS	▲▲▲▲▲▲▲▲▲▲▲▲▲▲											
30-12	MS-III	MATERIALS SCIENCE	◇◇◇◇◇◇◇◇◇◇											
30-4	FS-I-I	METEOROLOGY & THE ATMOSPHERIC SCIENCES	◇◇◇◇◇◇◇◇◇◇											
30-11	T1-II C/N1-I-I	REAL TIME CONTAMINATION MEASUREMENTS MILLIMETER WAVE COMMUNICATION SYSTEM & PROPAGATION DEMONSTRATION	◇◇◇◇◇◇◇◇◇◇											
7-5	C/N1-III	SURVEILLANCE & SEARCH & RESCUE SYSTEMS DEMONSTRATION		▲										
30-18	P1-I T1-I C/N1-I-I LS1-I LS4-I LS4-I	ATMOSPHERIC & MAGNETOSPHERIC SCIENCES SKY BACKGROUND BRIGHTNESS TRANSMITTER BREAKDOWN TEST BIOMEDICAL RESEARCH ROLE OF GRAVITY IN LIFE PROCESSES		◇◇◇◇										
30-10	LS7-II	PERFORMANCE CAPABILITY ASSESSMENT		◇◇◇◇										
30-2A	P3-I	CHARGE & ENERGY SPECTRA OF COSMIC RAY NUCLEI		◇◇◇◇										
7-2A	P4-I	MOLECULAR PHYSICS		◇◇◇◇										
7-3A	LS4-II	CELLS & TISSUES		▲▲▲										
30-8	T3-I	ASTRONAUT MANEUVERING UNIT		▲▲										
30-6	7-4-I A5-I A3-I	ADVANCED SPACECRAFT SYSTEMS TESTS LOW ENERGY X-RAY TELESCOPE EXPERIMENTS PHOTOHELIOGRAPH EXPERIMENTS		◇◇◇◇										
	LS2 LS3	UNCOMMITTED PAYLOADS ROLE OF GRAVITY IN LIFE PROCESSES		◇◇◇◇										

▲ 7-DAY SORTIE MISSIONS  
◇ 30-DAY SORTIE MISSIONS







Space Division

North American Rockwell

#### PROGRAM COMPARISON SUMMARY WITH SORTIE MISSIONS

The four programs which include shuttle sortie missions are summarized in terms of the number of experiment disciplines represented, experiment equipment groups, shuttle flights, experiment equipment modules, and support sections. Also, the total experiment crew time and experiment duration are defined. The first two programs are balanced programs, therefore, all seven disciplines are represented. The number of shuttle missions required to support the program depends primarily on the program duration varying from 80 for the limited-funding program (Program Option 9) to 131 for the longer duration balanced program (Program Option 7). The number of experiment equipment modules varies from 5 to 12 depending on the program emphasis and duration. Only one support section is required for the long-duration balanced program to support a single detached RAM. The number of experiment crew hours and the duration of experiment operations are increased slightly by the addition of the sortie missions when compared with the corresponding station-only program options.

# PROGRAM COMPARISON SUMMARY

## WITH SORTIE MISSIONS

PROGRAM OPTION	DISCIPLINES	EXPERIMENT EQUIPMENT GROUPS	SHUTTLE FLIGHTS	EXPERIMENT EQUIPMENT MODULES	FREE FLYER SUPPORT SECTION	EXPERIMENT CREW TIME (MAN-YEAR)	EXPERIMENT DURATION (YEAR)
1 REFERENCE	7	51	123	13	3	87.33	70.0
6 SORTIE + BALANCED (2)	7	13 + 13	97	8 + 3	0	19.14	20.79
7 SORTIE + BALANCED (3)	7	15 + 26	131	8 + 4	1	35.45	37.27
8 SORTIE + APPLICATIONS (4)	7	12 + 15	123	5 + 2	0	39.82	31.53
9 SORTIE + LIMITED FUNDING (5)	6	6 + 8	80	4 + 1	0	19.01	16.83

# MODULAR SPACE STATION PHASE B EXTENSION

3RD QUARTERLY REVIEW

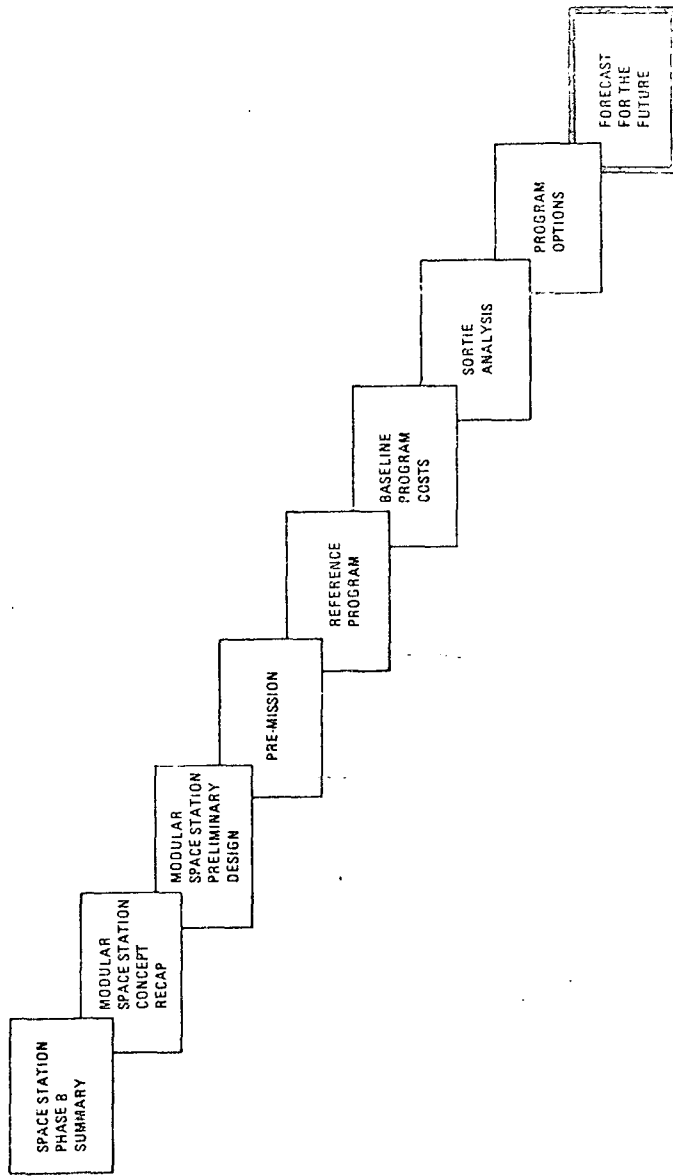



Space Division  
North American Rockwell

### STATION PHASE B LESSONS

Of the many things that were learned during the Phase B studies, several items merit repeating as significant, lasting, and perhaps surprising lessons. It is clear that the primary resource of a space station is crew time and crew skills and the program achievements are proportional to the availability of this resource. All other resources (weight, volume, power, data, etc.) were either relatively easy to obtain or the program could be scheduled to stay within reasonable limits. Related to this is the firm requirement to provide a facility that is basically automatic and trouble-free. Thus the most difficult and least understood technical issue is the integration of functional subsystems with the information management system for instrumentation, control, and computer-assisted checkout.

Station design studies show that the station is fairly insensitive to experiment program details; the aggregate requirements of an applications-oriented experiment program were not significantly different than a science emphasis program. The design studies also showed that the modular station is more complex than the integral, primarily because of the buildup requirement for early modules to initially operate unmanned and to be integrated on-orbit with other modules. The shuttle capability to return modules to the ground for maintenance did not offset this complexity, primarily since onboard maintenance mitigates requirements for proven long life; crew time for replacing equipment is the key factor and this can be engineered and tested on the ground.

Although major attention is given to the development of station subsystems, this is not the main source of programmatic costs. Experiment development and operations are major cost drivers and are much less understood. The key programmatic issue is not sorties versus station; the station has no rival as a clean, stable, continuous facility for those operations where man in-situ contributes and a low cost per man-hour in space is desired. There could be, however, considerable commonality from sorties to station to advanced capability if the program were managed toward that objective.

# STATION PHASE B LESSONS

## RESOURCE UTILIZATION

- CREW (TIME & SKILLS) - MOST LIMITED RESOURCE
- SUBSYSTEM AUTOMATION - TECHNOLOGY ISSUE

## STATION DESIGN

- NOT SENSITIVE TO EXPERIMENT PROGRAM EMPHASIS
- MSS - MOSF COMPLEX - BUILDUP, INTERMODULE INTEGRATION
- SHUTTLE RETURN CAPABILITY - CONTINUED OPERATIONAL COMPLEX - ONBOARD VERSUS GROUND
- EQUIPMENT LIFE - NOT MAIN ISSUES - DESIGN FOR MAINTENANCE

## PROGRAMMATICS

- MAJOR COSTS - EXPERIMENT DEVELOPMENT & OPERATIONS
- SORTIE - NOT SUBSTITUTE FOR STATION; CLEANS, CONTINUOUS STABLE PLATFORM
- PROGRAM EVALUATION NATURAL - SORTIE -- STATION -- ADVANCED CAPABILITIES  
SUBSYSTEMS  
GENERAL-PURPOSE LAB  
COMMONALITY

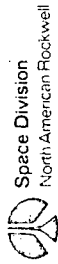

Space Division  
North American Rockwell



Space Division  
North American Rockwell

#### WILL THERE BE A STATION?

The most frequently asked question concerning the nation's space program is, "Will there be a space station?" We think the answer is clearly yes, basically because this is by far the cheapest source of effective man-hours in space and because the benefits of such a facility greatly offset the cost. Of the many disciplines a space station would serve, the world benefits of earth surveys alone could exceed \$100 billion per year.

# WILL THERE BE A STATION?

## YES

## WHY?

- COST-EFFECTIVE EXPERIMENT OPERATING MAN-HOURS IN SPACE

APPROACH	HOURS	\$/MAN-HOUR RATIO
12-MAN STATION (10 YR)	280,800	1
6-MAN STATION (10 YR)	109,200	2
7-DAY SORTIE (10 YR)	20,000	4.5
3-MAN SKYLAB (140 DAYS)	2,352	60.4

## IS IT WORTH IT?

- POTENTIAL YEARLY BENEFITS OR SAVINGS TO

U.S. ~ \$33 BILLION/YR } "EARTH SURVEYS ALONE"  
 WORLD ~ 107 BILLION/YR }

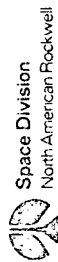



Space Division  
North American Rockwell

#### WILL THERE BE SORTIE MISSIONS?

A fully reusable shuttle works well with manned sortie missions. Deployment and retrieval of automated payloads (particularly in orbits other than near the space station), test and calibration of astronomy payloads, and conducting sortie - compatible experiments are among the viable missions. It is our opinion that a common payload support system design would be the proper approach, and that three or so of these, outfitted as applications, technology, or science "sortie labs" would be an effective, low-cost solution to the requirement for early, beneficial sortie missions.



# WILL THERE BE SORTIE MISSIONS?

YES

WHAT KIND?

PAYLOAD SUPPORT SYSTEM

- MISSION
- A. DEPLOYMENT SERVICE, RETRIEVAL OF AUTOMATED PAYLOADS
  - B. PRELIMINARY TEST & CALIBRATION OF ATTACHED ASTRONOMY PAYLOADS

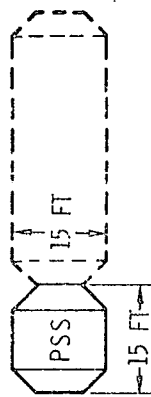

3 - 4 COMMON  
PAYLOAD SUPPORT SYSTEM  
OUTFITTED AS  
PURPOSE - ORIENTED LABS

- C. SORTIE-COMPATIBLE EXPERIMENTS



SORTIE LAB



Space Division  
North American Rockwell



Space Division  
North American Rockwell

#### EARTH-ORBITAL PROGRAM ELEMENTS

Based on the studies just completed, the "Forecast for the Future" is that a common development approach to a space station (either modular or integral) would be the most cost-effective yet flexible system for earth-orbit operations and would complement the development and operation of a reusable shuttle. The inventory would include (1) a module to support automated payload servicing, (2) a set of sortie labs, and (3) the cargo modules, RAM's, and space station modules of a space station program. The development, production, and operation of these would be properly time-phased and related, both to each other and to the shuttle, in a proper manner so as to assure a viable and beneficial space program.

# EARTH-ORBITAL PROGRAM ELEMENTS

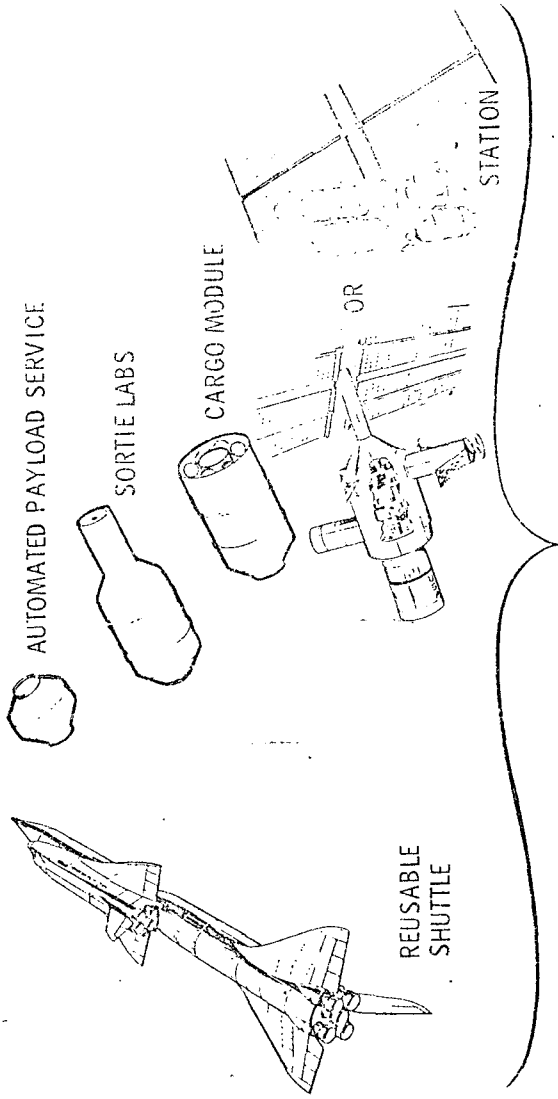

MOST COST-EFFECTIVE FLEXIBLE SYSTEM FOR EARTH-ORBIT OPERATIONS