

N72-26778

NATIONAL AERONAUTICS AND SPACE ADMINISTRATION

Technical Memorandum 33-523

Volume II

*Tracking and Data System Support for the
Mariner Mars 1971 Mission*

*First Trajectory Correction Maneuver
Through Orbit Insertion*

G. P. Textor

L. B. Kelly

M. Kelly

**CASE FILE
COPY**

**JET PROPULSION LABORATORY
CALIFORNIA INSTITUTE OF TECHNOLOGY
PASADENA, CALIFORNIA**

June 15, 1972

NATIONAL AERONAUTICS AND SPACE ADMINISTRATION

Technical Memorandum 33-523

Volume II

*Tracking and Data System Support for the
Mariner Mars 1971 Mission*

*First Trajectory Correction Maneuver
Through Orbit Insertion*

G. P. Textor

L. B. Kelly

M. Kelly

**JET PROPULSION LABORATORY
CALIFORNIA INSTITUTE OF TECHNOLOGY
PASADENA, CALIFORNIA**

June 15, 1972

PREFACE

The work described in this four-part report was performed by the Tracking and Data Acquisition organizations of the Jet Propulsion Laboratory, Air Force Eastern Test Range, Manned Space Flight Network, and the NASA Communications Network of Goddard Space Flight Center. Volume I covers the Tracking and Data System support for the Mariner Mars 1971 Mission from the planning phase through the first trajectory correction maneuver; this volume contains a description of the TDS flight support from the first trajectory correction maneuver through orbit insertion, including TDS support of preorbital training and testing; Volume III will cover TDS flight support of the orbital operations for Mariner Mars 1971; and Volume IV will include TDS flight support of the extended mission.

ACKNOWLEDGMENT

The authors acknowledge the assistance of the NASA Communications Network of the Goddard Space Flight Center and the Deep Space Network of the Jet Propulsion Laboratory in providing tracking and data support. Information regarding the DSN is based on material prepared by the DSN Interface Team for the Mariner Mars 1971 Project, the DSN Operations Staff, and the Monthly DSN Operations Reports. The following persons made significant contributions:

Deep Space Network/Mariner Mars 1971 Interface Team

DSN Operations Representative	P. W. Barnum
DSIF Operations Support	D. W. H. Johnston
Assistant	W. G. Meeks
Assistant	T. W. Howe
GCF Communications	J. W. Capps
Assistant	M. D. Weidner
SFOF Data Systems	L. E. Jennings
SFOF Support	B. M. Hayes
DSN Scheduling	L. R. Stevens
<u>DSN Simulation</u>	E. L. Dunbar
<u>DSN Network Analysis Teams</u>	
Telemetry System	C. W. Harris
Tracking System	R. B. Miller
Command System	W. G. Stinnett
Monitor System	J. E. Allen
<u>DSN Operations Reports for Mariner Mars 1971</u>	R. Santiestevan
<u>DSIF Operations Section</u>	J. Fearey

The authors are indebted to G. M. Truszynski, A. C. Belcher, and M. E. Binkley of the Office of Tracking and Data Acquisition, National Aeronautics and Space Administration, for their support. The authors also wish to thank J. A. Bain of the JPL Tracking and Data Acquisition Documentation Group and D. R. Maple of the JPL Publications Section for their assistance.

CONTENTS

- I. Introduction 1
 - A. Purpose and Scope 1
 - B. Mission Plan 1
 - 1. General 1
 - 2. Mission orbit selection 1
 - C. Science Mission Plan 2
 - D. Project TDS Requirements 2
- II. Tracking and Data System Plan and Configuration 5
 - A. General 5
 - B. DSIF Changes 5
 - C. Data Records 5
 - D. GCF Configuration 5
 - 1. General 5
 - 2. Overall communications network 5
 - 3. Changes precipitated by single spacecraft mission 5
 - E. Wideband Digital Data System Configuration 5
 - 1. General 5
 - 2. Definition of the GCF wideband system 6
 - 3. Configuration of wideband system (data portion) 6
 - 4. Equipment used for the wideband system (data portion) 6
 - 5. Western Union microwave modifications 7
 - 6. Wideband system tests 7
 - F. High-Speed System Interface with University of Colorado at Boulder 7
 - 1. General 7
 - 2. Terminal equipment 7
 - 3. Transmission media 7
- III. Tracking and Data System Flight Support 13
 - A. General 13
 - B. DSN Operations Organization 13
 - 1. DSN operational control 13
 - 2. DSN Operations Control Team functions 13
 - 3. DSN Operations Control Team organization 13
 - 4. DSN/Project Interface Team 13
 - C. Flight Support Pass Chronology 13
 - D. DSN Telemetry System Analysis and Performance 14

CONTENTS (contd)

1.	Residual SNR study	14
2.	Residual data plots	15
3.	Non-real-time telemetry analysis	15
4.	Recalls	15
E.	DSN Tracking System Analysis and Performance	15
1.	First trajectory correction	15
2.	Data quality	15
3.	Real-time operations	15
4.	Predict generation	16
5.	Project interface	17
6.	Master data records	17
7.	Tracking data system performance	17
8.	Mars orbit insertion doppler shift	17
9.	Doppler data problem at DSS 12	17
10.	Pseudoresidual data plots through Pass 317	17
F.	DSN Command System Analysis and Performance	18
1.	Command activity summary	18
2.	System performance	18
3.	New system capabilities	19
IV.	Tracking and Data System Preorbital Testing	194
A.	General	194
B.	Facility Testing	194
1.	DSIF test and training	194
2.	GCF testing	194
3.	SFOF testing	195
C.	Network System Tests	195
1.	General	195
2.	DSN Combined System Test, DSS 12, August 30, 1971	195
3.	DSN Combined System Test, DSS 14, September 1, 1971	196
4.	DSN Combined System Test, DSS 41/62, September 3, 1971	197
5.	DSN Combined System Test, DSS 42/51, September 7, 1971	198
D.	TCP Command Function Ad Hoc Team	198
E.	Project Test Support	200
F.	DSN Simulation System Support	200
	Glossary	205

CONTENTS (contd)

TABLES

1.	Ground communications simulation support	4
2.	Sequence of events, November 13, 1971	20
3.	DSN flight support - cruise Mariner 9 pass chronology	23
4.	Details of pass chronology	24
5.	Discrepancy report (DR) closeout statements for pass chronology	116
6.	DSN telemetry system analysis	145
7.	ODR station recall data, August 1971	146
8.	ODR station recall data, September 1971	146
9.	Three-month summary of command activity	147
10.	360/75 demonstration tests	201
11.	MOS preorbit insertion - tests and training for Mariner Mars 1971 supported by DSN	202
12.	Mandatory TDS/DSN personnel participation requirements - MOS preorbit insertion tests and training	203
13.	Equipment/facilities requirements - MOS preorbit insertion tests and training	204

FIGURES

1.	Configuration for processing μ -ranging	8
2.	TAU ranging subsystem, DSS 12	9
3.	Mariner Mars 1971 cruise and orbital phase operational circuit requirements	10
4.	DSS 14 WBS outbound functional block diagram	11
5.	SFOF communications terminal receiving from DSS 14 WBS functional block diagram	11
6.	DSS 14 receiving WBS functional block diagram	12
7.	ACT (DSC 10) WBS REGEN functional block diagram	12
8.	DSN operations organization	148
9.	DSN Project engineering organization	149
10.	Mariner 9 orbit insertion	150
11.	Residual data plot for DSS 12, June 1971	151
12.	Residual data plot for DSS 14, June 1971	152
13.	Residual data plot for DSS 41, June 1971	153
14.	Residual data plot for DSS 51, June 1971	154
15.	Residual data plot for DSS 62, June 1971	155
16.	Residual data plot for DSS 12, July 1971	156
17.	Residual data plot for DSS 14, July 1971	157
18.	Residual data plot for DSS 41, July 1971	158
19.	Residual data plot for DSS 51, July 1971	159

CONTENTS (contd)

FIGURES
(contd)

20.	Residual data plot for DSS 62, July 1971	160
21.	Residual data plot for DSS 12, August 1971	161
22.	Residual data plot for DSS 14, August 1971	162
23.	Residual data plot for DSS 41, August 1971	163
24.	Residual data plot for DSS 42, August 1971	164
25.	Residual data plot for DSS 51, August 1971	165
26.	Residual data plot for DSS 62, August 1971	166
27.	Residual data plot for DSS 12, September 1971	167
28.	Residual data plot for DSS 14, September 1971	168
29.	Residual data plot for DSS 41, September 1971	169
30.	Residual data plot for DSS 42, September 1971	170
31.	Residual data plot for DSS 51, September 1971	171
32.	Residual data plot for DSS 62, September 1971	172
33.	Residual data plot for DSS 12, October 1971	173
34.	Residual data plot for DSS 14, October 1971	174
35.	Residual data plot for DSS 41, October 1971	175
36.	Residual data plot for DSS 42, October 1971	176
37.	Residual data plot for DSS 51, October 1971	177
38.	Residual data plot for DSS 62, October 1971	178
39.	Residual data plot for DSS 12, November 1971	179
40.	Residual data plot for DSS 14, November 1971	180
41.	Residual data plot for DSS 41, November 1971	181
42.	Residual data plot for DSS 42, November 1971	182
43.	Residual data plot for DSS 51, November 1971	183
44.	Residual data plot for DSS 62, November 1971	184
45.	First trajectory correction pseudoresidual plot	185
46.	Sample 1-second doppler rate at low gain	186
47.	Sample 1-second doppler rate at high gain	187
48.	Doppler residual shift during Mariner orbital insertion	188
49.	DSS 12, average residual plots for November 1 to 14, 1971	189
50.	DSS 14, average residual plots for November 1 to 14, 1971	190
51.	DSS 41, average residual plots for November 1 to 14, 1971	191
52.	DSS 51, average residual plots for November 1 to 14, 1971	192
53.	DSS 62, average residual plots for November 1 to 14, 1971	193

ABSTRACT

This document contains the Deep Space Tracking and Data System activities in support of the Mariner Mars 1971 Project from the first trajectory correction maneuver on June 4, 1971, through cruise and orbit insertion on November 14, 1971. Included are presentations of the changes and updates to the TDS requirements and to the plan and configuration plus detailed information on the TDS flight support performance evaluation and the preorbital testing and training during this report period.

With the loss of Mariner 8 at launch, a few changes to the Mariner Mars 1971 requirements, plan, and configuration were necessitated. Mariner 9 is now assuming the former mission plan of Mariner 8, including the TV mapping cycles and a 12-hr orbital period.

A second trajectory correction maneuver was not required because of the accuracy of the first maneuver. All testing and training for orbital operations were completed satisfactorily and on schedule. The orbit insertion was accomplished with excellent results.

I. INTRODUCTION

A. Purpose and Scope

This report is one volume of a four-part series that summarizes and evaluates the Tracking and Data System (TDS) activities in support of the Mariner Mars 1971 Project (MM'71). Volume I of this series includes the planning phase through first trajectory correction; Volume III completes the period from orbit insertion through the end of the mission; Volume IV will report extended mission activities. This document, Volume II, reports the period from first trajectory correction maneuver through preorbital testing and orbit insertion¹ and is organized as follows:

- (1) Section I: Introduction. Section I describes the purpose, scope, and organization of the report and the MM'71 requirements specific to the reporting period.
- (2) Section II: TDS Plan and Configuration. Section II describes changes in the TDS plan and configuration required when the Mariner 8 spacecraft was lost shortly after launch. Details of the Mariner 8 launch and its subsequent failure are given in Volume I of this series.
- (3) Section III: TDS Flight Support. Section III reports in chronological sequence the actual TDS performance from GMT Day 155 (first trajectory correction maneuver) through GMT Day 318 (orbit insertion).
- (4) Section IV: TDS Preorbital Test and Training. Section IV contains a definition of tests conducted and the results of TDS preorbital test/training activities for MM'71.

B. Mission Plan

1. General. As a result of the loss of the Mariner 8 spacecraft at launch on May 9, 1971, the MM'71 mission required certain changes in the mission plan (see Vol. I, TM 33-523). The Mission B orbital operations plan was cancelled, and Mission A was modified to accommodate both the former Missions A and B into a combined plan for mission orbital operations with the single Mariner 9 spacecraft.

2. Mission orbit selection. The orbit characteristics required for the new combined mission orbital operations plan with the Mariner 9 spacecraft are presented below.

Because of the failure of Mariner 8 during its launch, the MM'71 mission was limited to a single spacecraft from which to gather the maximum amount of science data. This implied a 12-h orbital period for the following reasons: There was only a single 64-m-diameter antenna and 3 h 10 min were required to play back a full tapeload of science data through this antenna. The Goldstone view period was about 9 h long and the data-taking interval about 2 h. This meant that two complete tape recorder loads of data could be returned during a single Goldstone pass with a data-taking interval between. In order to accomplish this as often as possible, a 12-h orbit was required, with the data-taking interval synchronized near the center of the Goldstone view period between the two playbacks.

The science mission required high-resolution, large-area coverage mapping for the reconnaissance objective as well as the coverage of the polar regions and repeated coverage at high sun of

¹The accuracy of the first trajectory correction maneuver was such that a second trajectory correction maneuver planned for this period was cancelled.

several areas on the planet under nearly identical viewing conditions to achieve the variable surface features objective.

The combination of the 12-h orbital period with the 24-h 37-min Mars rotation period meant that every other orbit would retrace its path across the planet except for a 9-deg longitude shift. The 9-deg shift, coupled with the 11 by 14-deg field of view of the wide-angle camera system, allowed contiguous coverage for altitudes above about 1600 km (995 mi). Between 1600 and 1200 km, small sidelap gaps or gores would occur which could be subsequently filled. Below 1200 km, gaps would occur along the track, in front lap, as well as in sidelap and would be extremely difficult to fill in later. Hence, the periapsis altitude was constrained to be above 1200 km.

In order to cover the polar areas, an inclination larger than 65 deg was required. In order for the high sun data taking to occur between ± 30 deg latitude, where the probability of a surface change occurring is highest, except at the polar cap, an inclination lower than 70 deg must be selected. Hence the inclination was selected at 65 deg. Finally, the maximum rotation possible in the line of apsides was required so that apoapsis would be positioned as close to the morning terminator as possible. This allows viewing the planet from the highest altitude in order to acquire near full disc coverage of the planet.

Hence the revised mission orbit requirements were directed toward high resolution and contiguous coverage. The orbital period was nominally 12 h with a periapsis of 1600 km (995 mi). This orbital period synchronized with DSS 14 view periods and allowed for replay of two 3-h loads of tape-recorded science data for every Goldstone pass, or every 24 h. This worked efficiently with the two data passes per day and for the 12-h orbital period. In addition, the combination of the 12-h orbit and the 12-h 37-min Mars rotation period allowed every other orbit to retrace its path across the planet except for a 9-deg longitude shift. The 9-deg shift, coupled with an 11 by 14-deg field of view of the TV subsystem, dictated a 1600-km minimum periapsis altitude (inclination-dependent) in order to get overlapping contiguous coverage. Hence, a 12-h direct orbit between 61 and 67 deg was selected to satisfy sun occultation ΔV and earth occultation requirements. To give optimal lighting conditions for the television experiment, a periapsis near the evening terminator was selected. This orbit resulted in contiguous coverage of the planet with wide-angle TV from approximately -65 to +30 deg latitude. The spacecraft was over the south polar cap for inclinations of greater than 50 deg.

C. Science Mission Plan

The new combined plan for mission orbital operations required that the single Mariner 9 spacecraft handle the entire science program. Otherwise, the science mission plan remained generally the same as that presented in Volume I of this report.

D. Project TDS Requirements

The MM'71 TDS requirements remained the same as those presented in Volume I of this report, with the following changes and additions:

- (1) The time interval for spacecraft orbit insertion (I) was extended from I -2 to I -3 days.
- (2) Tracking requirements on time/distance coverage and sampling rates were changed as follows. (Two-way doppler and S-band ranging were required for activities (a) through (e); two-way doppler and one-way doppler from an open-loop receiver were required for the last activity):
 - (a) First maneuver minus 2 days to first maneuver plus 5 days continuous coverage.
 - (b) Transit cruise. One complete horizon-to-horizon pass every 4 days with two additional 8-h passes per week. No more than 3 consecutive tracks from a single station. Data should be received from the prime DSN sites for the mission in roughly equal amounts.
 - (c) Second maneuver minus 5 days to second maneuver plus 5 days. Continuous coverage. Data should be received from only the prime DSN sites for the mission.
 - (d) Insertion minus 7 days to insertion plus 7 days. Continuous coverage. Data should be received from only DSN sites.
 - (e) Insertion plus 7 days to insertion plus 90 days. 4 h centered at periapsis plus an additional 4-6 h per revolution. Also one horizon-to-horizon pass every 4 days. No more than 3 consecutive tracks from a single station.
 - (f) Insertion to insertion plus 90 days (during each occultation).
- (3) Time constraints for switching between 360/75 computers. In a priority 1 or a priority 2 situation, it is required that the second computer be on line and processing data within 10 min of the request to switch computers. In a priority 3, 4 or 5 situation, it is required that the backup computer be on line and processing data within 30 min after the request is made to switch computers. The requirement is relaxed in the latter case in order to permit an orderly termination of batch jobs which are being processed at the time that the computer switch is requested.

In either case, the level of data processing support which is required after switching computers includes the capability to process, display, and log real-time data and also the capability to run those user programs which run in the real-time job step. It is also highly desirable that, following switchover, the system be able to display the latest available decommutated engineering telemetry data and command status up to the time of switchover. The capability to recall data from the SDR is not required at this time; however,

it should be noted that if operation using the backup computer must continue over a considerable period of time, then the SDR data base must be transferred into the backup computer at a time which is mutually agreeable to DSN and MOS personnel.

- (4) For ground communications simulation support (all phases) see Table 1. (References to two-spacecraft requirements have been deleted.)

Table 1. Ground communications simulation support

Type of Service	Location of Operating Terminals	Bandwidth	Channels	Data Rates	Purpose
1. Simulation Telemetry Data (Long Loop)			Items 1 a, b, c and d below multiplexed and accommodated by single HSD circuit with items 2, 3 and 4, page 600.4 (SIRD).		Training of mission operations personnel.
a) Engineering HSD Telemetry	SFOF to DSN, MSFN, and ETR (through DSS 71 interface) stations supporting Project.	3 kHz	1-FDX (4.8 kbps) each DSN/MSFN/ETR station.	8-1/3 and 33-1/3 bps (1 spacecraft to DSS 71)	Transmit simulation data.
b) Science Low Rate HSD Telemetry	SFOF to DSN stations supporting Project (N/A at DSS 71)	3 kHz	Same as Item a.	50 bps	Transmit simulation data.
c) Science High Rate HSD Telemetry	SFOF to DSN stations supporting Project (N/A at DSS 71)	3 kHz	Same as Item a.	2, 1 kbps (1 spacecraft)	Transmit simulation data.
d) RF Control HSD	SFOF to DSN stations supporting Project (N/A at DSS 71)	3 kHz	1-FDX	8 bps	Simulation coordination and control.
e) Science High Rate	SFOF to DSS 14, CTA 21	48 kHz	1-FDX (50 kbps)	16, 8, 4 kbps	Transmit simulation data.
2. Simulation Telemetry Data (Short Loop)					
a) HSD Telemetry	SFOF Simulation Center to SFOF Communication Terminal	3 kHz	3-FDX (4.8 kbps)	8-1/3, 33-1/3, 50 bps; 2, 1 kbps	Transmit simulation data.
b) Wideband Telemetry	SFOF Simulation Center to SFOF	48 kHz	1-SPX (50 kbps)	16, 8, 4 bps	Transmit simulation data.
3. Simulation Tracking TTY Data	SFOF Simulation Center to SFOF		1-FDX (100 wpm each DSS and RTCS at AFETR)		Transmit simulation tracking data. (SFOF internal only)
4.					
a) Deleted					
b) Voice	SFOF to CTA-21, SAF, and DSS supporting Project		1-FDX each location		Test coordination.

II. TRACKING AND DATA SYSTEM PLAN AND CONFIGURATION

A. General

The Tracking and Data System plan and configuration remained the same as that presented in Volume I (Section III) of this report, except for certain changes made mostly as a result of the loss of the Mariner 8 spacecraft at launch. Essentially, configuration changes were made at the DSN Deep Space Stations (DSS).

B. DSIF Changes

The Deep Space Instrumentation Facility (DSIF) station configurations for MM'71 presented in Volume I were changed as follows:

- (1) Dual Capability. Since only one spacecraft, Mariner 9, achieved successful launch, there was no longer any need for the planned dual spacecraft transmit and receive (downlink and uplink) capability. All lines and configurations relating to dual spacecraft operation were therefore eliminated from the DSN telemetry, tracking, and command systems for all stations.
- (2) DSS 14. At DSS 14, one complete 920 string, including one SSA and one CMA, was eliminated.
- (3) Ranging. During MkIA and τ -ranging, 9-dB uplink carrier suppression was used; 3-dB carrier suppression was used during μ -ranging. Figure 1 shows the configuration for the μ -ranging subsystem interface switching, applicable to DSS 12 only. Figure 2 shows the τ -ranging subsystem applicable to DSS 14 only. The MkIA ranging was used through pass 50 at DSS 12, 41, 51, and 62 from June 4, 1971 through July 19, 1971. The τ -ranging began on pass 6 on June 4, 1971. The μ -ranging began on pass 28 on June 26, 1971.

C. Data Records

The generation, handling, processing, and storage of data records were the same as presented in Volume I (Section III) except for the change in the generation of the master data record (MDR) given below. In an effort to reduce the 360/75 software development task for orbital operations support, the Project accepted the proposal to generate the telemetry MDR on the Project mission and test computer. This decision caused a shift in the Project/DSN interface for MDR generation. Responsibility for producing the MDR now rested with the MM'71 Science Data Handling Team in place of the DSN Telemetry Analysis Group (TAG).

D. GCF Configuration

1. General. This report documents the configuration and support given MM'71 by the GCF from completion of the first trajectory correction maneuver (June 4, 1971) through Mars orbit

insertion (November 14, 1971). An overview of the DSN communications network, together with significant GCF system applications implemented and tested for Project support, is presented in the following subsections.

2. Overall communications network. The communications network shown in Fig. 3 represents the communications circuit quantities, types, and routing to supporting elements of the DSN as well as Project-dependent requirements. Most of the communications circuits shown were furnished by NASA Communications Network (NASCOM); some, however, were provided directly by GCF.

3. Changes precipitated by single spacecraft mission. The Mariner 8 launch failure precipitated only one area of change in GCF equipment: the high speed data assembly (HSDA) at DSS 14 communications equipment subsystem. Preliminary planning revealed that the quantity of user-dependent type code (UDTC) assignments for DSS 14 exceeded the 10-code maximum capability of the HSDA BDXR (block demultiplexer) UDTC selection matrix. The additional UDTC assignments (as compared to assignments for supporting 26-m-diameter antenna stations) were required to adequately support simultaneous dual spacecraft tracking by DSS 14 during orbital operations.

It was necessary to configure both HSDA block demultiplexers (the second was provided for assembly redundancy) in a manner that enabled each to look at the HSD stream inbound to the station. In this manner, it could be determined which station computer would receive appropriately coded HSD blocks. By using this method, up to 20 UDTC's could be examined in collective fashion by the block demultiplexers.

A reexamination of the DSS 14 configuration during orbital operations suggested that it would best benefit the Ground Communications Facility (GCF) to return the overall HSDA configuration at DSS 14 to one functionally similar to that provided at supporting 26-m-diameter antenna stations. Accordingly, the number of UDTC assignments for DSS 14 was revised to the extent that all assignments could be accommodated by one block demultiplexer.

E. Wideband Digital Data System Configuration¹

1. General. The GCF 50-kbps (synchronous) digital data terminals were implemented for real-time transmission of the MM'71 spacecraft high-rate telemetry immediately before Mars orbit insertion and thereafter during orbital operations. Terminals providing this capability were located at DSS 14 and the SFOF Communications Terminal. The transmission path used existing microwave linked between the two locations. The 50-kbps system also served as a precursor for the DSN GCF 1973 configuration, wherein 28.5-kbps data will be returned from DSS 14 and the overseas 64-m-diameter antennas currently being constructed in Australia (DSS 43) and Spain (DSS 63).

¹Hanselman, R., "Wideband Digital Data System Terminal Configuration," in the Deep Space Network, Space Programs Summary 37-66, Vol. II, pp. 107-110. Jet Propulsion Laboratory, Pasadena, Calif., Nov. 30, 1970.

2. Definition of the GCF wideband system. The GCF wideband system (WBS) includes all wide-band equipment and facilities (both analog and digital), such as microwave, closed-circuit television, and telemetry between DSSs. For this report, only that equipment required for the 50-kbps data portion is discussed.

3. Configuration of wideband system (data portion).

a. DSS 14 to SFOF. The DSS 14 wideband terminal is equipped with two independent full-duplex (FDX) digital circuits. The second FDX circuit is a backup to the first. Both FDX circuits are connected full time to the SFOF via two microwave links. The first link is between DSS 14 and the Goldstone Area Communications Terminal (ACT), Deep Space Communications Center (DSC) 10. The second link is between DSC 10 and the SFOF. The Goldstone/SFOF microwave link is actually a system of back-to-back links, five in all, and is a leased service from the Western Union Company.

Switching at DSS 14 allows any of two transmitting sources within the station to time-share, on a block basis, either of the two outbound circuits. This is accomplished by the use of block multiplexers (BMXRs). The BMXR output is in turn fed to an error detection encoder prior to conditioning by the outbound data set. Figure 4 shows the DSS 14 outbound configuration in functional form.

At the SFOF both microwave circuits from DSS 14 are converted back to digital form and are sensed with an error-detection decoder for a dynamic indication of the circuit quality. Switching in the SFOF Communications Terminal allows either circuit to be fed to DSN computers and the mission test computer (MTC) over redundant parallel circuits, isolated with digital line drivers. Figure 5 shows this arrangement in functional block form.

Demultiplexing of 1200-bit blocks takes place in the computers in the SFOF.

b. SFOF to DSS 14. Other than test signals, the SFOF Communications Terminal does not have the capability to transmit wideband data to DSS 14. The DSN Simulation Center (SIMCEN), located in the SFOF, is the only source of outbound (simulation) data to DSS 14 and passes through the SFOF Communications Terminal as a shaped digital signal (baseband). In the SFOF Communications Terminal the baseband signal is patched to either of two send modulator-demodulators (modems) connected to two outbound microwave circuits.

The SIMCEN wideband terminal consists of equipment identical to the prime group of transmitting equipment at DSS 14, with the exception of the modem. This equipment consists of a block multiplexer (BMXR), an encoder, and a data set. Although the SIMCEN has only one source of outbound data (an EMR 6050 computer), a BMXR is used in this terminal to produce filler data to the outbound circuit when the SIMCEN computer is not transmitting. Filler data, in GCF 1200-bit block form, is required to keep the DSS 14 wideband receiving equipment in sync, even though simulation data are not being transmitted.

At DSS 14, the destination for the simulation data is the simulation conversion assembly (SCA) computer. A BDXR is used to feed this computer. The primary function of the BDXR in this application is to prevent filler data, generated by the SIMCEN BMXR, from entering the SCA computer. The receiving equipment at DSS 14 consists of redundant 420 modems, 401 data sets, decoders, and a single BDXR, switchable to either the prime or backup decoders. Figure 6 shows this arrangement in functional block form.

c. Goldstone ACT. The Goldstone ACT (DSC 10), among other functions, serves as a hub for all intrasite GCF microwave links. It is at this station that the Western Union SFOF/Goldstone microwave terminal is located, as well as the GCF microwave link to DSS 14. DSC 10 serves as a regenerative repeater (REGEN) point for both FDX circuits between DSS 14 and the SFOF. Error detection encoders and decoders are not employed in this arrangement. The REGEN assembly consists of back-to-back modem/data set groups interconnected at their digital interface to form a 50-kbps regenerated signal in both directions for both the prime and backup circuits. Figure 7 shows the ACT 50-kbps REGEN in functional form.

4. Equipment used for the wideband system (data portion).

a. Encoder, decoder, BMXR. The error detection encoders, decoders, and BMXRs used in the wideband system are identical to equipment previously developed for and currently in use in the GCF high-speed system. Identical encoders and decoders are also used in some portions of the NASCOM high-speed system.

b. BDXR. The BDXR is equipment designed by JPL for the GCF high-speed system. It is used in the wideband system without modification.

c. Data set and modem. The 401 data set is used to convert the 50-kbps digital signal to a form suitable for transmission over a standard unloaded twisted pair. The signal transmitted to the line is a polar digital signal with the dc component removed. Through filtering in the data set, the line signal is limited to occupy a 2- to 44-kHz spectrum. The 420 modem is used to convert the signal produced by the data set (baseband) to a vestigial sideband (VSB) AM signal that occupies the 60- to 108-kHz spectrum. It is this VSB signal that is placed on a microwave system via a voice multiplex at the group level, replacing 12 standard 4-kHz voice circuits.

Both the data set (TDM 401) and the modem (TDM 420) are standard products of the General Electric Company, modified for cabinet-mount by JPL.

d. Wideband conversion and switching assembly. The encoder, decoder, BMXR, and BDXR operate at the digital interface at a polar 6-Vdc level per EIA specification RS-232C. The data set and user digital interface operate in a neutral current mode over coaxial transmission lines. The wideband conversion and switching assembly (WCSA) was designed by JPL to convert the two logic levels, current and RS-232C. A secondary function of the WCSA provides for switching between the two 50-kbps circuits and switchable parallel drivers to the SFOF computers.

5. Western Union microwave modifications.

For the data portion of the 1971-1972 wideband system, minor modifications were made by Western Union to their General Electric TCS-600 voice multiplex. The modifications included the relocation of 12 channels of 4-kHz voice circuits from group 2 to group 5 and the deletion of a 96-kHz analog circuit which occupied both groups 4 and 5. Thus, two new group-width (48-kHz) FDX circuits were made available in the basic super-group (240-kHz) for the wideband VSB signals. The current allocation of the 50-kbps VSB signals is group 4 (prime) and group 2 (backup).

6. Wideband system tests. Wideband system tests performed relative to system implementation are discussed in Section III.

F. High-Speed System Interface with University of Colorado at Boulder

1. General. The HSS interface at Boulder provided the terminal equipment and media for transfer of spectra-synced ultraviolet (UV) 50-bps orbital science (0420) and engineering (E140) data from the MTC at the SFOF to a PDP 8L/8 computer located at the University of Colorado Laboratory for Atmospheric and Space Physics (LASP) at Boulder. The UV spectrometer experiment principal investigator used the data transmitted to the University to provide quick turnaround analysis of the most interesting UV spectra accumulated during orbital operations.

2. Terminal equipment.

a. SFOF communications terminal. An existing Western Electric 203A data set was used to allow the mission/test computer at the SFOF to transmit the required data. The 203A data set used was identical to other 203A data sets employed by the high-speed data assembly at the SFOF Communications Terminal.

b. University of Colorado terminal. NASA Communications (NASCOM) provided the necessary equipment at the University. The terminal equipment was comprised of a Western Electric 203A data set and a Fredericks Model 600 data test set. Both 203A data sets (at the University and SFOF) employed a data transmission rate of 4.8-kbps (synchronous).

3. Transmission media. Media for transmission consisted of one voice/data 4-wire circuit (used in the data mode) backed up by a second circuit of the same type, usually used in the voice mode. The circuits were arranged at LASP such that the circuit used in the voice mode was associated with a telephone handset and monitor speaker; the circuit used in the data mode was associated with the data terminal equipment. The voice mode circuit was shared by DSN, GCF, and Mission Operations System personnel. Both circuits, leased by NASCOM, were geographically diverse-routed to minimize simultaneous circuit outages.

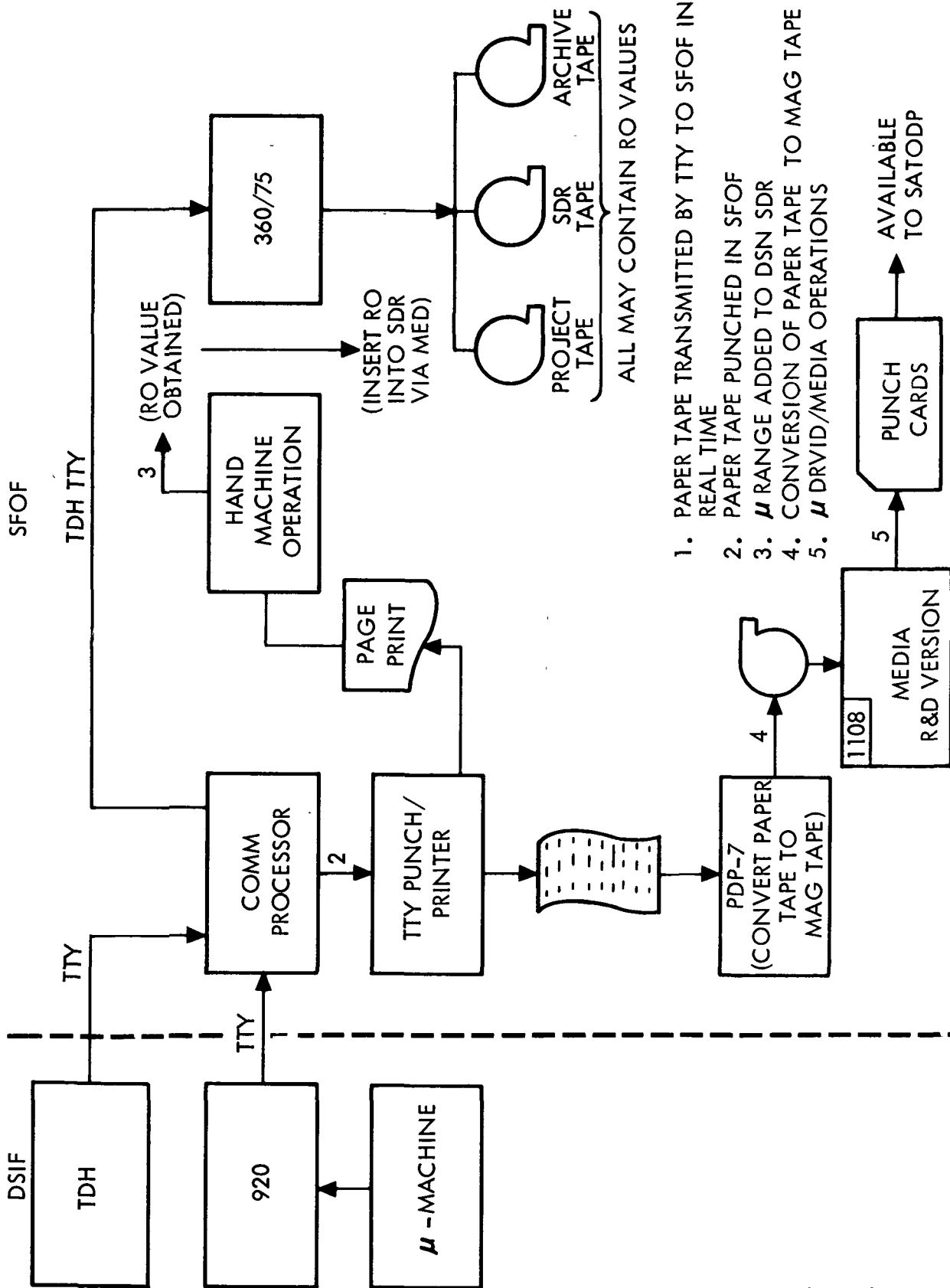

Fig. 1. Configuration for processing μ -ranging

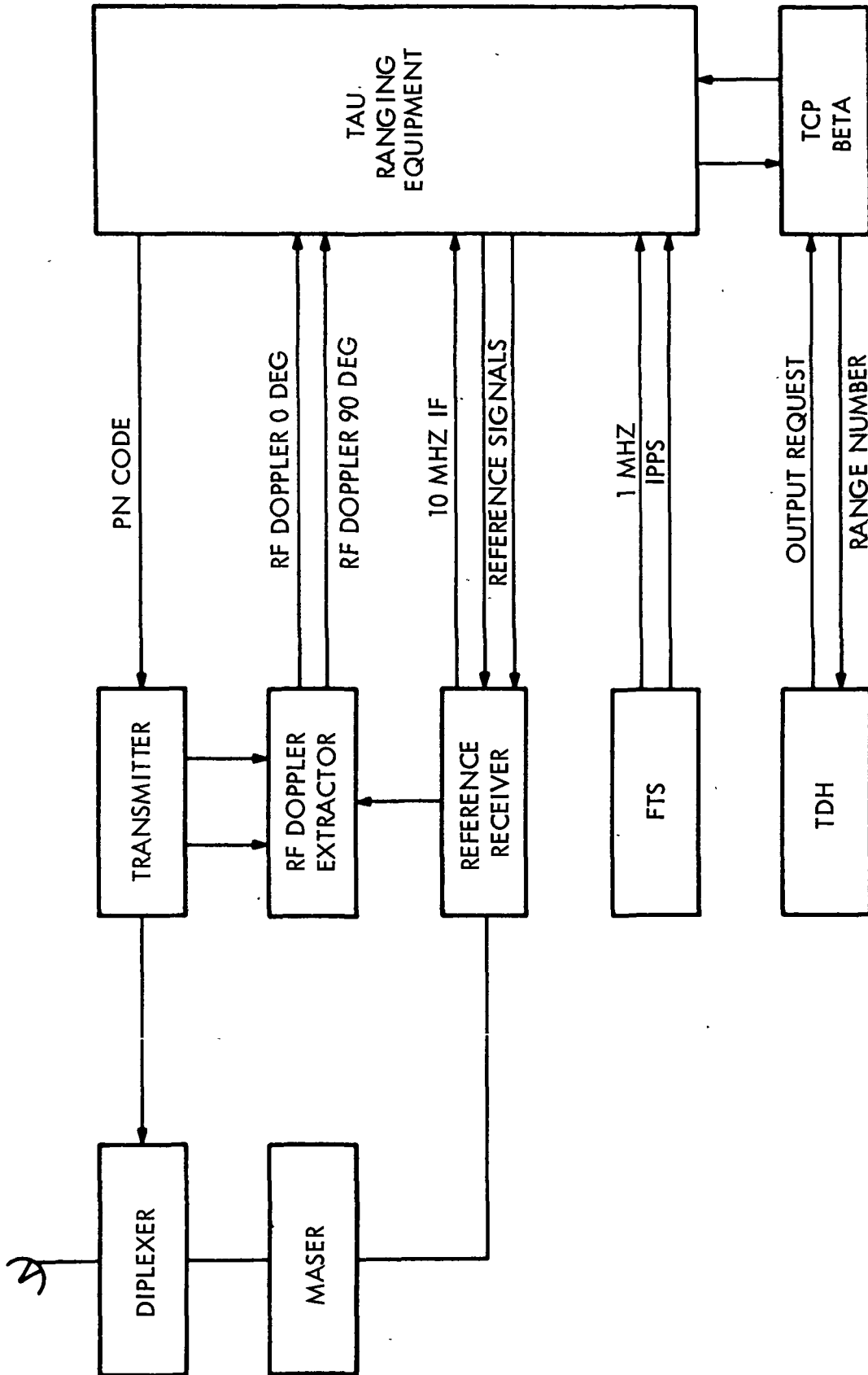

Fig. 2. TAU ranging subsystem, DSS 12

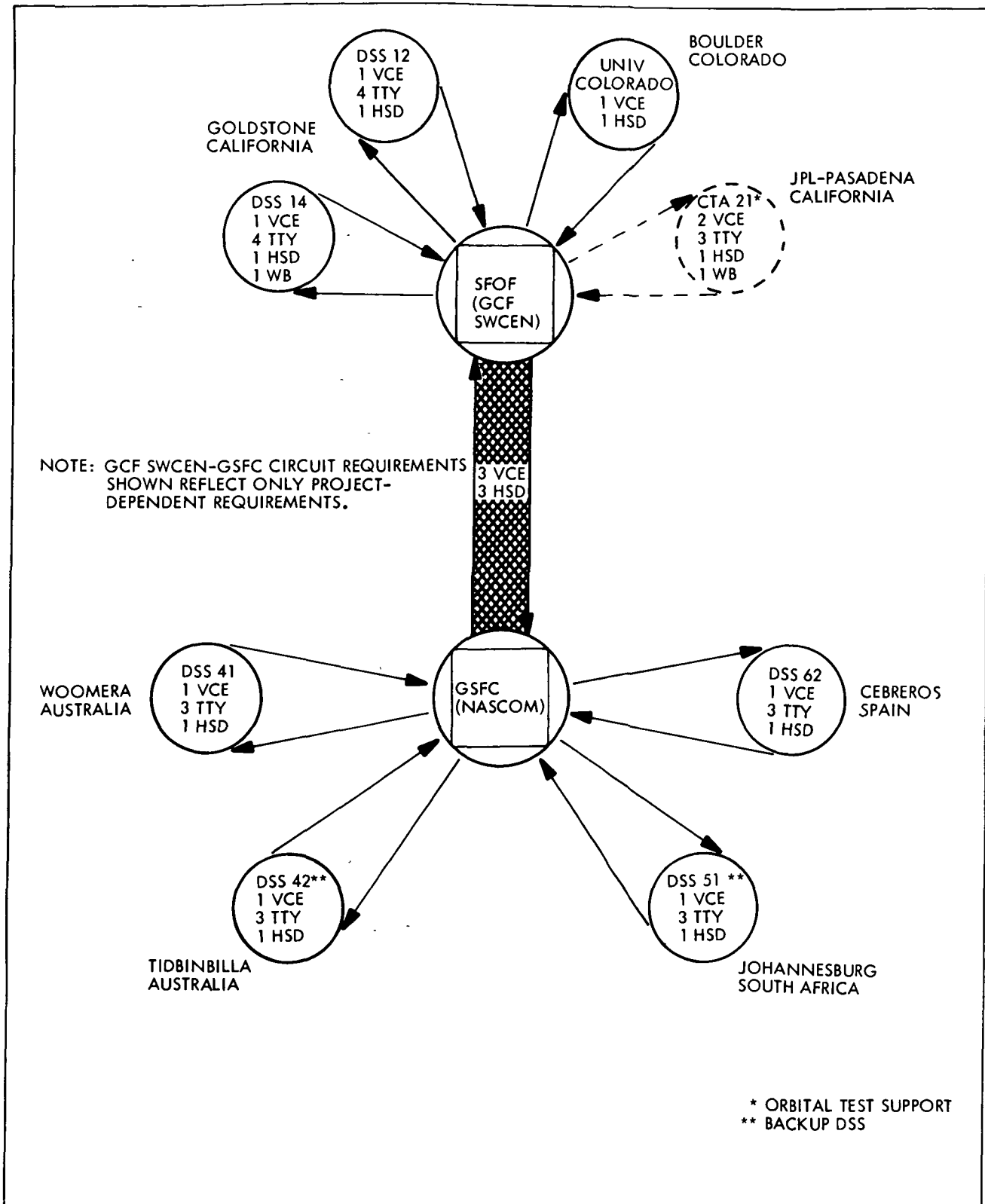

Fig. 3. Mariner Mars 1971 cruise and orbital phase operational circuit requirements

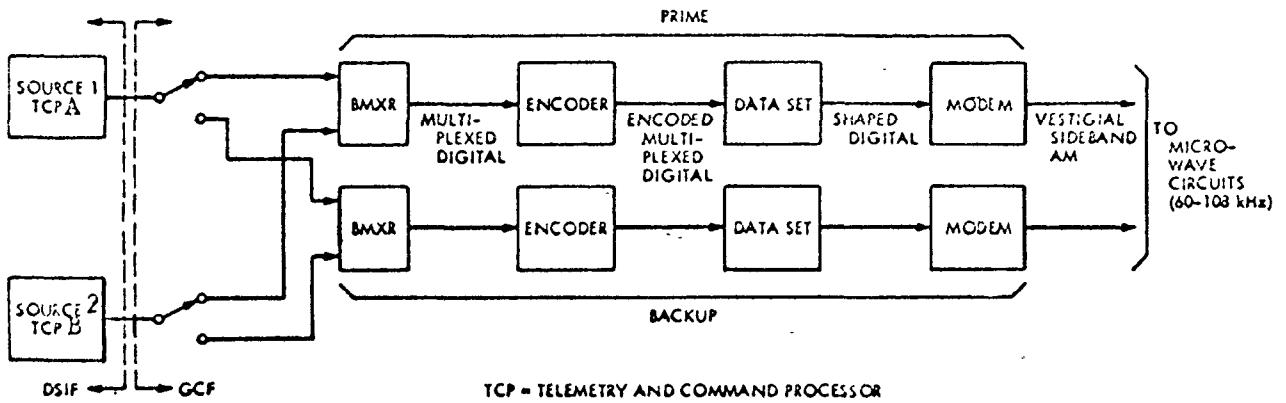

Fig. 4. DSS 14 WBS outbound functional block diagram

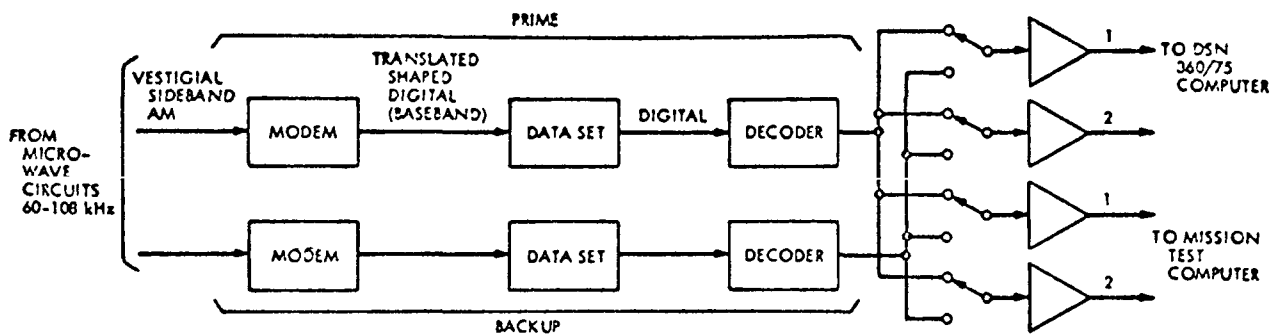

Fig. 5. SFOF communications terminal receiving from DSS 14 WBS functional block diagram

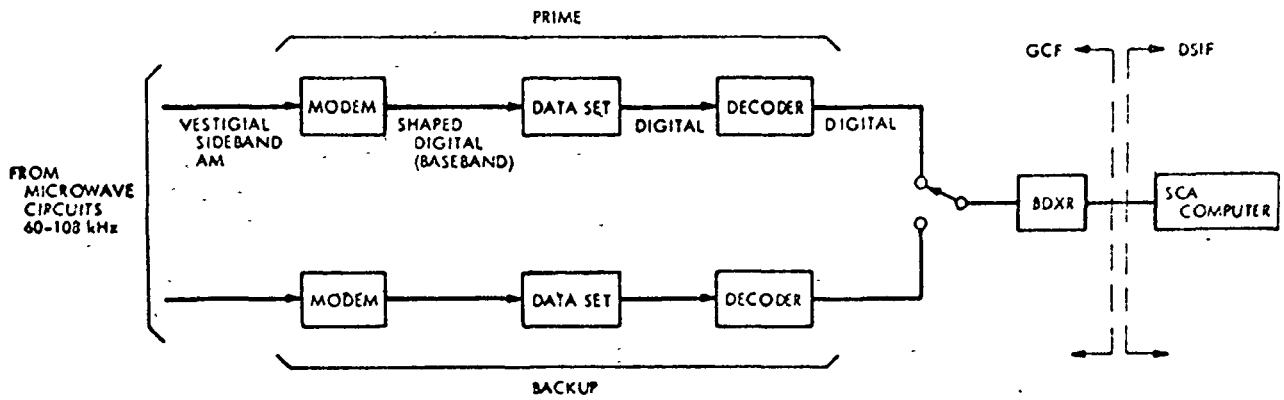

Fig. 6. DSS 14 receiving WBS functional block diagram

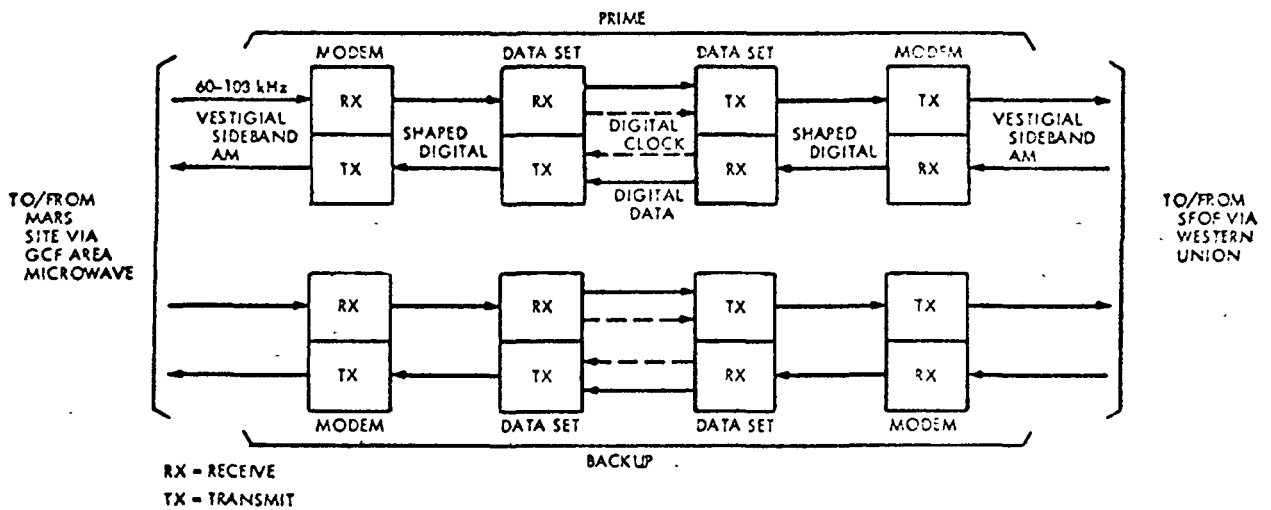

Fig. 7. ACT (DSC 10) WBS REGEN functional block diagram

III. TRACKING AND DATA SYSTEM FLIGHT SUPPORT

A. General

Tracking and Data System flight support information for the period of this report was obtained from the monthly DSN Operations Reports for MM'71. The DSN operations organization is described in paragraph B. Flight support pass chronology data are presented in paragraph C. DSN telemetry, tracking, and command systems analysis performance evaluations are included in paragraph D.

B. DSN Operations Organization

Two separate DSN teams support Project operations. The DSN Operations Control Team (OCT), headed by the DSN Operations Chief (OC), controls and operates the DSN in real-time to support Project flight operations. The DSN/MM'71 Interface Team, headed by the DSN Project Engineer (PE), performs the support planning and evaluation function.

1. DSN operational control. The DSN operational control is provided by the mission-independent DSN operations organization. In the DSN operations organization (Fig. 8), the DSN OC is responsible for the overall direction of DSN operations and specifically responsible for proper operation of the DSN resources committed to the Project. In this operational capacity, the DSN OC acts as the single point of contact between the Project and the DSN.

The DSN OC is delegated the required authority by the DSN Operations Manager for conducting overall direction and control of DSN operations and is responsible to the DSN Operations Manager for effectively exercising this authority in discharging his responsibilities.

2. DSN Operations Control Team functions. The DSN OC directs and controls all committed resources through the DSN OCT. Functional responsibilities of the OCT are described as follows:

- (1) Operate the network to meet the requirements of several flight projects simultaneously.
- (2) Operate the DSN Monitor System.
- (3) Operate the DSN in support of simulation activities.
- (4) Operate the DSN in support of compatibility testing.
- (5) Support maintenance of the operational network.
- (6) Perform real-time (through the seven-day schedule) allocation of resources based on guidelines of the DSN Network Allocation System and the interface organization.
- (7) Respond to the requirements of TDS/Flight Project interface documentation.

- (8) Perform, in real-time, validation of metric and telemetry data delivered to the user.
- (9) Perform, in real-time, analyses of telemetry, tracking, and command operations to ensure that the network has not introduced errors.

3. DSN Operations Control Team organization. The operating positions and organizational responsibilities of the key members of the OCT are described in Volume I.

4. DSN/Project Interface Team. Details of the interface design and operations planning were accomplished by the DSN/MM'71 Interface Design and Interface Operations Team (Interface Team) under the technical guidance and coordination of the DSN/MM'71 PE. The Interface Team consisted of the entire group under the DSN/MM'71 PE shown in Fig. 9, including DSN facility PEs for the SFOF, the GCF, and the DSIF, and PEs and representatives for DSN operations, data processing, simulation, telecommunications, scheduling, and documentation. Meetings were conducted on Thursdays of each week.

The DSN/MM'71 Interface Team maintained responsibility for the integrity of the mission-dependent documentation, and audited DSN performance during operational support of the Project (Fig. 9). In addition, members of the Interface Team were designated as advisors to the DSN OC or Facility Operations Chiefs. In this capacity, they counseled members of the DSN Operations Control Team and provided recommendations as appropriate. Supporting activities of the DSN/Project Interface Team were reported in the monthly DSN Operations Reports for MM'71.

C. Flight Support Pass Chronology

Flight support pass chronology data included in this volume of the Final Report for MM'71 extends from the end of the first trajectory correction maneuver, 2349 GMT, June 4, 1971, Day 155, through cruise and orbit insertion, which ended 0101 GMT, November 14, 1971, Day 318. Orbit insertion began at 2214 GMT, Day 317, November 13, 1971 and lasted 2 h and 47 min.

The Mars Orbit Insertion (MOI) maneuver resulted in the spacecraft orbiting around Mars with the following orbital parameters: orbit period, 12.567 h; periapsis altitude, 1398 km; orbit inclination to equator i , 64.3 deg; apsidal orientation ψ , 139.7 deg. The MOI procedure included the firing of the 1334-N (300-lbf) rocket motor, starting at 0024 GMT on November 14, 1971, for a period of 15 min to slow Mariner 9 down by a change in velocity of 1600 m/s. Details of the procedure are presented in Table 2 and Fig. 10. This was the first time a spacecraft had been placed in orbit around another planet. Mariner 9, joining the natural satellites Phobos and Deimos, became a man-made satellite of Mars.

Flight support for these two periods was excellent. A total of 163 passes (one per day) (509 total tracks) were supported during a period of 5-1/3 months. A total of 2964 commands were transmitted to the spacecraft. Performance of all DSN systems was very good.

The DSN pass chronology activity is summarized in Tables 3, 4, and 5. Only anomalies affecting the prime data source (the station whose telemetry HSD was being processed by the Central Processing System (CPS) or, if the CPS was not supporting, the station that was two-way during track overlaps) are given in the pass chronology on a pass-by-pass or track-by-track basis. Each anomaly is prefaced by a facility or system identifier, such as DSS, GCF, or CPS. Other acronyms used will be found in the Glossary. Anomalies are listed by item number and time of failure and are limited to items that significantly affected project operations during scheduled DSN inflight support (interrupted real-time data flow or caused an actual data loss to the Project for 5 min or longer).

Configuration deviations that restricted the Project from conducting normal or planned operations commensurate with scheduled DSN support were considered significant and will be found in the pass chronology that follows. Configuration codes are not included. Comments listed under deviations or anomalies in the pass chronology were based on real-time observations and indications and did not necessarily reflect non-real-time followup on items requiring further investigation.

All data outages were considered as real-time and recoverable, and data outage times were considered the same as system or equipment down times, unless otherwise indicated.

D. DSN Telemetry System Analysis and Performance

One of the functions of a telemetry system is the generation of predicts for the telemetry signal-to-noise ratio (SNR); therefore, one of the functions of the DSN Telemetry Analysis Group (TAG) is to monitor and record residual SNR values. Since the launch of Mariner 9 on May 30, 1971, the DSN TAG has maintained a record of its residual SNR values, and daily examination of these values revealed two definite patterns in data behavior: (1) a negative displacement of the residuals at DSS 41 and DSS 51 and (2) a gradual negative divergence of the residuals at all DSN stations.

1. Residual SNR study. A study, using linear regression techniques, was initiated in an effort to quantify these phenomena and add a new dimension to the continuing study of spacecraft RF power degradation currently being conducted by the Mariner Mars 1971 Project.

a. Study description. Signal-to-noise ratio in dB was used as the regressor on time (in days). Data for each station pass meridian crossing from Day 167 to Day 306 were used for DSS 12 and DSS 41. Data from Day 260 to Day 306 were used for DSS 62 and DSS 51, since it was felt that the performance at these two stations was more meaningful during this period. The linear regression analysis resulted in the following curve:

$$y = a + bx$$

b. Study results. The results for each station are listed below.

- | | | |
|-------------|-------------------------|--|
| (1) DSS 12: | $y = 0.1114 - 0.0012X$ | coefficient of correlation = -0.090852 |
| | | coefficient of determination = -0.008254 |
| (2) DSS 41: | $y = -0.6003 - 0.0011X$ | coefficient of correlation = -0.107758 |
| | | coefficient of determination = 0.011612 |
| (3) DSS 62: | $y = 0.0920 - 0.0064X$ | coefficient of correlation = -0.224820 |
| | | coefficient of determination = 0.050544 |
| (4) DSS 51: | $y = 0.5611 - 0.0250X$ | coefficient of correlation = -0.477414 |
| | | coefficient of determination = 0.227924 |

c. Conclusion 1. The results showed that the residuals at DSS 41 and DSS 51 are 0.7 dB below those at DSS 12 and DSS 62. It has been pointed out that the stations with the lower values of residual SNRs are both in the southern hemisphere. Could this negative displacement be the result of a TPAP deficiency or of some other unidentified or unconsidered condition?

d. Conclusion 2. The average rate of decrease in SNR using the results from all four stations was 0.0084 dB per day. Perhaps a better number for this divergence would be 0.01 dB per day, the results from both DSS 12 and DSS 41. These two stations have been prime since launch, tracking almost every pass, thus being a more consistent state of calibration, more consistent operationally, and having more data points for analytical use.

It should be observed that the results of this regression analysis for DSS 12 and DSS 41 yielded the same negative slope to three decimal places with almost identical coefficients of correlation and coefficients of determination. This divergence was probably caused by spacecraft RF power degradation, although the above figures are not exactly the same as those published by the MM'71 Project.

e. Summary. The consistent displacement in residuals between stations has resulted in the TAG having to use different limits for these stations in the judgment of station performance, an undesirable situation. Further, as additional spacecraft RF power degradation occurred, these performance criteria tolerances again had to be adjusted. It was suggested that the cause for the displacement discrepancy be identified and incorporated in TPAP (either for MM'71 or in the future) and that the TAG be kept fully informed of the exact degree of spacecraft RF power degradation.

2. Residual data plots. Residual data plots of signal-to-noise levels, uplink (UL) signal levels, and downlink (DL) signal levels for each station tracking Mariner 9 spacecraft during this reporting period are shown in Figs. 11-44. Values plotted were taken at meridian crossing for each pass. The set of plots represents those stations that have actively participated in tracking the Mariner 9 spacecraft during this reporting period. The number of days plotted varies from station to station as a function of individual station tracking schedule. A statistical analysis on absolute data values yielded results detailed in Table 6.

3. Non-real-time telemetry analysis. Non-real-time analysis of telemetry data revealed the following:

DSS 14

- (1) On Pass 121, Day 271, the spacecraft shifted to the 16.2 kbps playback mode from 0107 until 0643. TCP 'A' lost original data record (ODR) write capability but was corrected by reloading TCP.
- (2) On Pass 122, Day 272, TCP had to be reloaded due to a program halt.

DSS 41

- (1) On Pass 116, Day 266, a spacecraft receiver sensitivity test was performed.
- (2) On Pass 120, Day 270, a power failure occurred from 0812 until 0815 because of circuit breaker overload. Data on line at 0852.

DSS 42

- (1) On Pass 94, Day 244, the station switched to TCP 'B' at 1014 because of write errors on TCP 'A' magnetic tape.
- (2) On Pass 113, Day 263, downlink signal strength was 2.2 dB low.

DSS 51

On Pass 100, Day 249, receivers were out of lock from 2007 until 2009 because of an Antenna Pointing Subsystem (APS) problem in declination.

4. Recalls. Recalls from the station ODR (TCP digital log tape) numbered 58 for the month of August (Table 7) and 57 for the month of September (Table 8). These recalls were necessary to fill gaps in the data records being written by the mission test computer (MTC) and the Science Data Team.

The reasons for recalls in September are listed below in descending order of frequency logged:

	Time Logged	
	Aug	Sept
High-speed data line outage	43	50
Assorted equipment failures and system outages	27	14
MTC problem	11	10
TCP problem	-	9

E. DSN Tracking System Analysis and Performance

Overall performance of the NAV/TRAG interface with the DSN and the production of Project data tapes was satisfactory.

1. First trajectory correction. Motor vent and unlatch were uneventful and could be observed in the pseudoresidual listings (a comparison of actual incoming data with tracking predictions). Since the new software did not provide a plotting capability, an effort was made by TRAG to hand-plot pseudoresidual output under a hard copy camera. The pitch and roll turns were plotted but were not visible in the noise of the data. It was discovered after the fact that the turns were visible in the pseudoresidual mean. The first trajectory correction plot showed the successful execution of the burn just a few seconds behind real-time. The plot is shown in Fig. 45.

2. Data quality. Tracking data were of the highest quality seen in any mission to date. The only significant problems were a pass of bad DSS 12 ranging data and several early DSS 51 passes that had excessively high ranging noise. Both problems were isolated to equipment.

Extensive quantity and quality of doppler and ranging data, coupled with new orbit software that can consistently handle both data types, have led to a far more rapid stabilization of NAV orbit determination solutions than on any previous Mariner mission.

3. Real-time operations.

a. June 1971. Many procedures had to be revised with actual mission experience. Software, until the Model 2 cruise, was extremely unreliable and troublesome, yet operations did smooth out much more rapidly than expected. Necessary extensive ranging data analysis training was successfully accomplished.

A major readjustment was made in mid-June when the 360/75 was no longer available for 10 h a day because of development requirements. The necessary revisions to procedures and adjustments to new shift schedules were accomplished in just two days.

There were two minor continuing problems: (1) frequencies errors in the manual inputs to the tracking software and (2) errors associated with the extensive volume of tape handling.

b. July 1971. On July 9, 1971, 360/75 Project support time was limited to 8 h per day. Real-time observation of data was reduced even more because of time spent on recalls and recovery of data for engineering analysis. Incorporation of 360/75 Model 3 format did not allow predicts to be sent for three and four days, making daily transmission necessary. Reduction of data sample rate and elimination of phi factors printout allowed multiday transmission.

c. August 1971. Since no capability to generate right ascensions/declinations predicts on the 360/75 computer existed, when a need developed for this predict type an effort was made to find a usable substitute in the form of a special trajectory run generated by MM'71 project personnel. Listings of this run were reproduced and mailed to all MM'71 stations. The run carried predicts through orbital insertion.

On August 7, 1971, the spacecraft was switched to high power. This caused a large temperature change and associated frequency changes. Project Telcomm (telecommunications) provided a predict of the temperature change, and TRAG produced new predicts with the frequencies biased by the expected change. The high-power switch went smoothly, and the new predicts proved accurate except for a miss estimate of the change in subcarrier frequency, which caused a 5-min delay in SDA lockup for DSS 62 track. The subcarrier predict was in error by 0.5 Hz.

A serious predict problem developed in which angle excursions of up to 0.6 deg occurred in hour angle and declination around 10 deg elevation on some station predicts. The error was traced to a mismatch in tropospheric correction models, which caused interpolation problems. The error was discovered at the time of changeover to Model 3 software and was corrected in Model 3 prior to delivery.

On Model 3 another problem developed where-in all station data showed periods of high noise. The added noise was caused by the software doing erroneous resolver conversions from time-to-fractional count. The problem was a combination of program logic error and the fact that the recalls from the CP (the standard mode of operating since the 360/75 supported operations only 8 h a day) must proceed slower on Model 3 software than they could on Model 2. A temporary solution was to increase the time between each message from the CP to the 360/75.

The combinations of software problems that developed caused all TRAG data processing to fall behind one full week. Project agreed to give up data every other day until the processing caught up, which occurred on August 16.

The Tracking Analysis Group (TRAG) also provided copies of the DSN/MDR in the form of a project tape, which became the celestial mechanics experimenters' MDR (CME/MDR). Analysis activity was still greatly curtailed because of limited 360/75 flight support. The only significant data

problems were phase excursions seen in most DSS 51 passes starting on or about August 25, 1971.

d. September 1971. During September 1971, predicts generation and transmission became exceedingly time-consuming because of computer load. Before the loading became so extensive, predicts for four days were run in 20 to 30 min. Afterwards, predicts for one or two days took up to 2-1/2 h to run.

On September 21, at approximately 1700 GMT, the Mariner 9 spacecraft went to the high-power mode. This increase in signal strength resulted in a decrease of approximately 50% from a standard deviation of about 0.009 to about 0.0045 Hz in two-way doppler noise. On September 23, at 0900 GMT, hydrogen masers (MSFN) were introduced at DSS 12, DSS 41, and DSS 51. This resulted in a reduction by a factor of 3 from a standard deviation of about 0.0045 to about 0.0015 Hz in the two-way doppler noise in the data from these stations.

4. Predict generation. October and November 1971 were taken up with predict problems and activity in anticipation of orbit insertion.

a. Predict problems. On October 17, the 360/75 computer Model 4C was introduced as the on-line real-time operations system. Model 4C contained a revision of the JPL predict program that would speed up the generation of predicts by a factor of 2. First run of predicts produced errors in station view periods, and the on-line operating system was changed back to Model 4B. Corrections were made to the erroneous view period problem, and Model 4C was reinstated.

The following is a list of the predict problems.

- (1) Predicts remained unable to run with Command Generation Program (COMGEN) or sequence of events (SOE).
- (2) Phi factor printout was marginal, depending on the size of the predict run.

b. Predict improvements. The following is a list of predict improvements accomplished:

- (1) Faster run time.
- (2) Increased administration information.
- (3) Angle problem encountered at the delivery of Model 4B, corrected in Model 4C.
- (4) Multiple observables may be requested for a single predict set.
- (5) Med R49 added to the predicts meds, which allows better file management of the predicts phi factor file.
- (6) Open loop receiver predicts (SNYLO) added to the predicts program.

c. Cruise phase. Four sets of predicts, I082, I083, I084, and I085, were used for the mission cruise phase during the month of November 1971. Predict set I082 was generated using a transmitter reference frequency of 22024370 and transponder frequency of 2296107200. Science

instruments were turned on, causing a temperature change in the spacecraft. Predict set I083 was generated with frequency adjustments to account for the temperature change. The new transmitter reference frequency was 2296106350. Predict sets I084 and I085 were generated using the same reference frequencies and were the predict sets in use up to Mariner orbit insertion. The tracking synthesizer frequency (TSF) logic used for the cruise phase predicts was the average XA value over the pass rounded to the nearest 10 Hz.

d. Mariner orbit insertion. Special predict sets, MOI0 through MOI9, and MOIA through MOID, were generated for the mission orbit insertion and were identified by the letter M. Of these sets, MOI2, MOI9, and MOIA were transmitted to the stations for use. Predict sets TRM1, TRM2, and TRM3 were generated and transmitted to the stations for use during the orbit trim maneuver. Pseudoresiduals were computed for all passes.

e. Orbital phase. The orbital phase of the mission required very special predict support. Owing to particular requirements concerning the occultation experiment and to obtain two-way acquisition of the spacecraft in a minimum amount of time after meeting the occultation experiment requirements, the logic of selecting tracking synthesizer frequency and the sequence of events to obtain two-way acquisition were worked out and displayed under the predicts status digital television (DTV) display by the Network Analysis Tracking Group.

f. Summary of predicts. Predicts for November 1971 were generally good, with a few problems that will be listed in Section III-F. Adjustments and biases were made in real-time to account for spacecraft events having effects on the frequencies used by the DSN. A total of 32 predict sets were generated by NAT Track. Out of the 32 predict sets generated, 21 sets were transmitted to and used by the stations. The remaining 11 sets were special cases used by NAT Track to illustrate particular events, such as no burn predicts used to compute pseudoresidual to illustrate the burn, as well as studies of predict accuracy.

5. Project interface.

a. Probe ephemeris tapes received from navigation. NAT Track received a total of 12 probe ephemeris tapes from navigation. Probe ephemeris tapes (PET) were mostly on time, except for two which were late because of physical tape errors. Two tapes were requested aside from the regular PET delivery because of very high raw doppler residuals. PET tapes were good for approximately 24 h during the orbital phase.

b. Processed data passed to navigation for orbit determination. NAT Track delivered a total of 73 project tracking tapes (PTT) to the navigation group during November 1971. The orbital phase of the mission, with its many frequency changes and frequency precision, proved to be quite a task for the NAT Track Analysts as well as for the 360/75 software. Several project tracking tapes (PTT) were passed to navigation containing errors and had to be sent back to NAT Track for rework. Special attention was given to this problem of frequency errors on PTT tapes, and the problem appeared to be resolved; no further problems of this nature were anticipated.

6. Master data records. Master data records stored on master data record (MDR) tapes, were generated with each system data record (SDR) disk deletion. Owing to the increased volume of data received while processing 1-s data, the real-time SDR disk had to be deleted much faster than for normal cruise operations. There were a total of 18 MDR tapes generated, checked, labeled, and turned over to operations Document Control during November 1971.

7. Tracking data system performance. On Day 306 at 16:00:40, with DSS 62 tracking, the downlink signal was lost. At 16:27:21, downlink was acquired at the ground receiver threshold level. After going to low gain antenna and engineering mode, the signal to noise was raised up enough to get readable data. It was confirmed that the spacecraft's Canopus sensor was locked on a different star other than Canopus. The spacecraft was rolled, Canopus reacquired, high-gain antenna reselected, and normal operations were resumed. NAT Track was able to monitor the problem, had the station go to 1- and 10-s sample rate, and displayed near-real-time plots of doppler during this entire period. Figures 46 and 47 show the plots displayed during this period.

8. Mars orbit insertion doppler shift. The descent of Mariner 9 into Martian orbit was planned for a ground observed start time of 00:24:22 GMT, November 14. The burn was planned to last 15 min 39 s and to result in a total doppler shift of -23,290 Hz. The actual tracking data were processed by the pseudoresidual program in near-real-time, and the doppler residuals (actual doppler data/predicted doppler data) were hand-plotted as seen in Fig. 48. At the time of Mars orbit insertion (MOI), the navigation team was concerned that the burn might occur at 80% thrust. If this could have been ascertained concurrently by telemetry and the near-real-time MOI doppler shift plot, it would have resulted in a command being sent to the spacecraft. Thus the plotting of the MOI shift in near-real-time took on added importance as an aid to real-time navigation/spacecraft command decisions.

9. Doppler data problem at DSS 12. Starting on November 7 (Day 311), doppler data from DSS 12 began evidencing a large number (perhaps 30 to 40 per pass) of intermediate-sized (0.01 - 0.10 Hz) blunder points. In fact, a majority of these blunder points were centered closely to ± 0.017 , which would correspond to ± 1 cycle over a 60-s count time. The problem persisted until November 11 (Day 315), when it was discovered that the uplink margin was less than expected when ranging modulation was on. The problem was alleviated by reducing the amount of ranging being performed and reducing ranging suppression.

10. Pseudoresidual data plots through pass 317. The Network Analysis Tracking Group operates a real-time DSN 360/75 pseudoresidual program that monitors tracking prediction quality as well as tracking data quality. To monitor significant events, hand plots are done by the NAT Track analysts and are displayed on the predict status DTV. Figures 49-53 show average residual plots over each station through Pass 317.

F. DSN Command System Analysis and Performance

1. Command activity summary. The present DSN command system in support of MM'71 has proven reliable and efficient. No significant problem occurred to inhibit spacecraft command. In addition to the routine use of the command system, major events occurred during the first month of flight in which the DSN command system played a significant role. Shortly after launch, a command was transmitted to the spacecraft to acquire Canopus. During the first week of flight, commands were transmitted to the spacecraft to perform trajectory correction No. 1. On June 18, 1971, 481 commands were transmitted to the spacecraft to update the onboard computer. These commands were planned to be sent continuously on 30-s centers, and in the early part of the exercise a total of five bit-verify aborts occurred. These were noted as occurring approximately every 21 min, and simple arithmetic quickly tied this to the nominal subcarrier frequency over spacecraft actual frequency, which gives 1/1277, or a coincident periodicity of 21 min 17 s. The commands were then continued with a break of 2 min every 20 min, thus avoiding the problem. The 481 commands were transmitted to the spacecraft in less than 7 hours.

Minimal command activity occurred during July 1971, with the exception of a Central Computer and Sequencer (CC&S) update on 21 July 1971. DC-9 (ranging on) was transmitted on a daily basis, and 80 commands were sent to the spacecraft during the CC&S update.

Command activity was extremely light during August 1971. Cruise mode activity (daily DC-9) was normal during the month except on August 21 (DOY 233) when a CC&S update was accomplished. Three CC-1/2 pairs, a DC-84, and a DC-42 were transmitted. Following is a breakdown of the commands transmitted:

	<u>DSS 41</u>	<u>DSS 51</u>
Commands	5	32
Aborts	0	2

Command activity was light during September 1971, with the exception of Days 270/271 and 273. On Days 270/271, CC&S update No. 4 and ETR playback were accomplished. On Day 273, the TV scan calibration preparation was accomplished. A summary of the command activity by station for September is given below:

Command activity	Station					
	12	14	41	42	51	62
Commands confirmed	173	1	22	3	7	69
Aborts	3	0	0	0	0	0

No command activity was reported for October 1971 since activity was extremely light. However, command activity in support of the orbit of Mariner 9 was significantly increased during November 1971. Table 9 is a summary of the command activity for three months, September through November, 1971, and indicates the tremendous increase in commands transmitted during November 1971.

2. System performance. Problems that occurred in the command system during July did not affect command transmission. Most problems were cured in real-time by either an exchange of equipment or a reload of software in the TCP or 360/75. These problems normally were experienced during the DSN data transfer tests; thus they were cured before Project use.

System performance during August was good; only two problem areas were noted. One was bit verify/aborts, the other the dropping of command loop lock. The bit verify/aborts were caused by a known TCP software deficiency. A fix for this deficiency was developed and incorporated into the next version of the software. The problem of temporary dropping of the command loop lock did not affect Project commanding, as none was scheduled. Momentary dropping of command loop lock was noted at DSS 51 and DSS 62. The command modulator assembly (CMA) is suspected, but the cause remained unknown.

During the CC&S update 4 and ETR playback in September, over 200 commands were transmitted to the spacecraft. Command activity started over DSS 62, continued through DSS 12 track, and terminated over DSS 41 approximately 12 h later. Significant problems were experienced throughout this period which created uncertainty in the SFOF as to what was being transmitted to the spacecraft. The problems were:

- (1) Scrambled displays of command confirmation.

Cause: Bits in HSD blocks were being shifted, cause not known. Problem under investigation.

Effect: Determination of command transmitted could not be made. Erroneous command system alarms were being generated for display in the SFOF.

Solution: None in real-time. Problem under investigation.

- (2) Symbol rate alarms/aborts.

Cause: Insufficient software logic exists within the TCP to accommodate a certain phasing of bit start and the 1-pps clock interrupt. The frequency of this condition is dependent upon the subcarrier frequency being used.

Effect: Command alarms/aborts at a regular interval.

Solution: The DSN could predict when this would occur; thus Project varied its command sequence accordingly. A long-term solution is under investigation.

- (3) Failure to transmit (skip) a timed command.

Cause: Unknown.

Effect: Command sequence was destroyed.

Solution: Project sent priority commands. Cause is under investigation.

- (4) Failure to receive all confirmations of command transmissions.

Cause: Unknown.

Effect: Project unsure if "skip" occurred or actual transmission occurred.

Solution: Voice confirmation requested from station. Cause under investigation.

The Project did complete the command sequence by sending commands in sets of three; a CC-1/2 pair followed by a CC-4. This procedure allowed Project to determine, with reasonable assurance, that commands were being transmitted to the spacecraft correctly and in the right sequence.

The later performance of the command system can best be described by referring to the three-month summary, Table 9. The three command aborts in September occurred just before the update of the TCP software. Since the TCP update, there have been no aborts from a command system anomaly or failure. The four command aborts that occurred during November were caused by operator errors.

Outages of the 360/75 computers account for the majority of percent down time indicated in Table 9 and are not attributed to the command system. Not included in Table 9 are the time periods when command activity was delayed

because of reasons other than the command system not being available. Occasionally, delays were caused by erroneous data displays, loss of data, or operational confusion caused by the erroneous and/or lost data.

3. New system capabilities. New software packages were utilized late in August for the TCP and 360/75 flight support. The new capabilities allow for:

- (1) Ability to display a complete command stack on digital television (DTV).
- (2) Improved command alarm.
- (3) SDR and MDR.
- (4) Correcting deficiencies in old software.

These deficiencies found in the new software packages, however, were corrected before orbit.

The second version (Model 4B) of the 360/75 orbit support software was accepted for flight support on September 24. The command system software changes included only minor modifications which corrected deficiencies noted in the previous version.

In summary, the command system performed extremely well since the update of the TCP software and led to a great increase in operational confidence.

Table 2. Sequence of events, November 13, 1971

Event No.	Name/Description	Earth Received Time (PST)	Initiated By	Remarks
1	<u>Autopilot On</u> Power subsystem switches on power to attitude control (A/C) autopilot	2:14 pm	CC&S command 7E	Early application of power provides ample time for autopilot to warm-up, reach thermal equilibrium & to observe engineering telemetry.
2	<u>Transmit first of four DC-27's</u> To back-up maneuver sequence	2:23 pm	Ground command to CC&S	Other three DC-27's sent on one minute centers.
3	<u>Pitch & Yaw Gyros On</u> Gyros turned on about an hour before they are used to permit warm-up of inertial reference unit	2:44 pm	CC&S commands 5A & 7M1	5A - initiate maneuver sequence in CC&S 7M1 - turn on power to A/C gyros. Roll gyro turned on at 11:13 am.
4	<u>Start Roll Turn</u> Roll jets fire for short time to accelerate S/C to proper roll rate.	3:52 pm	CC&S command 7M4	7M4 to A/C which fires four nitrogen gas roll jets at end of solar panels to turn spacecraft around its roll axis.
5	<u>Switch radio to low-gain antenna (LGA)</u> Switch from high-gain antenna (HGA) to LGA automatically switches on the medium-gain antenna (MGA)	3:53 pm	CC&S commands 2B	Switching to the LGA (hemispherical pattern) and MGA is necessary to maintain communications with the spacecraft (S/C) during critical portions of the orbit insertion maneuver. Both LGA & MGA are coupled & transmit simultaneously.
6	<u>Stop Roll Turn</u> Opposite roll jets fire to decelerate S/C to zero roll rate	3:56 pm	CC&S command 7M4 & 7M3	Working with signals from the gyros, the CC&S commands an end to the roll turn after +43 degrees.
7	<u>Start Yaw Turn</u> Two of four yaw jets on pitch axis solar panels fire for short time to accelerate S/C to proper yaw rate	4:04 pm	CC&S command 7M5	7M5 to A/C which fires two gas jets to turn spacecraft around its yaw axis +125 degrees.
8	<u>Telemetry Blackout</u> Signals from S/C to earth are lost during yaw turn due to location, orientation & radiation patterns of LGA & MGA.	4:06 to 4:13 pm		During yaw turn radio signals, from the LGA, are lost until the MGA pattern begins to intercept the earth.

Table 2 (contd)

Event No.	Name/Description	Earth Received Time (PST)	Initiated By	Remarks
9	<p><u>End Yaw Turn</u> Opposite two yaw jets fire to decelerate S/C to zero yaw rate</p> 	4:16 pm	CC&S command 7M5	<p>Working with signals from the gyros, the CC&S commands an end to the yaw turn after +125 degrees. At this time the rocket motor is pointing in the correct direction for MOI and the MGA is pointing directly at the earth.</p> 
10	<p><u>Start Motor Burn</u> Command to pyrotechnical (pyro) subsystem (S/S) which applies electrical power to main engine valve solenoid.</p>	4:24 pm	CC&S command 8M6	<p>Main engine valve opens, engine ignition occurs upon contact of hypergolic propellants - nitrogen tetroxide (N₂O₄) oxidizer and monomethyl hydrazine (MMH) fuel. Spacecraft weighs 2,193 lb.</p>
11	<p><u>End Motor Burn</u> Pyro S/S halts power to main engine valve which closes.</p>	4:40 pm	CC&S interrupt to pyro	<p>Upon accumulation of 1663 counts (nominal) from accelerometer, CC&S interrupts valve open command to Pyro S/S. 1664 counts should produce $\Delta V=1600$ meters/sec (5240 ft/sec). As backup, CC&S will also send timed shut-off command to Pyro S/S 10 seconds after computed "end motor burn" time. Telemetry of engine ignition, proper ignition time, and engine shutdown at correct number of accelerator counts will indicate a successful retro-firing. Spacecraft will weigh approx. 1242 lb.</p>
12	<p><u>Yaw Unwind</u> Same yaw gas jets as in event no. 9 are fired to accelerate S/C to proper yaw rate & to stop unwind opposite yaw jets fire (event no. 7).</p>	4:41 to 4:56 pm	CC&S commands 7M5 & to stop 7M5	<p>Yaw unwind (-125 degrees) is just opposite of "yaw turn". Yaw & roll unwinds necessary to return to original orientation with solar panels perpendicular to sun's rays, Canopus acquired, and HGA pointing to earth. Telemetry blackout between 4:44 and 4:51.</p>
13	<p><u>Enter Occultation</u> S/C disappears from view behind Mars</p>	4:53 pm	Desired S/C flight path	

Table 2 (contd)

Event No.	Name/Description	Earth Received Time (PST)	Initiated By	Remarks
14	<u>Roll Unwind</u> 	4:57 to 5:01 pm	CC&S commands 7M4 & 7M4 to stop	Roll unwind (-43 degrees) is just opposite of "roll turn".
15	<u>Exit Occultation</u> S/C reappears from behind Mars.	5:22 pm	Desired S/C flight path	Occultation exit time close to predictions will provide confirmation that Mars orbit insertion has been achieved.
16	<u>Switch to High-Gain Antenna</u> Radio transfer from LGA & MGA back to HGA	6:24 pm	CC&S commands 2E	Switch to HGA in preparation orbital operations. Pre-orbit Science 3 data will be played back this evening.
17	<u>Start Playback</u> Last far encounter pictures (POS 3) taken 12 November	7:13 pm	Ground command DC-3	Pictures taken of Mars from 130,000 to 70,000 miles, plus two pictures of Phobos and six of Deimos.

Table 3. DSN flight support-cruise Mariner 9 pass chronology
(first trajectory correction maneuver to orbit insertion,
5-1/2 Mo) June 4, 1971 through November 14, 1971

Mo	Period Days - Passes	DSS	Coverage (Tracks)	Ranging			S/C Cmds Xmtd	Remarks
				IA	μ	τ		
June '71	4 June 1971 to	12	25	21	4	6	510	μ ranging (R&D) started pass 28 τ ranging (R&D) started pass 6 IA ranging each day. All Cmds DSS 41. Overall DSN performance good for all systems with no major problems.
	1 July 1971	14	6					
	Pass 6, through	41	26	26				
	Pass 31, or	51	24	20				
	26 Passes	62	2					
Days 155-181	June Total		83	67	4	6	510	
July '71	1 July 1971 to	12	27		26	5	3	No IA ranging after pass 50, μ ranging for 26 passes this period No τ ranging this period after pass 52 Overall DSN performance good for all systems with no major problems
	1 Aug 1971	14	6					
	Pass 32, through	41	31	15				
	Pass 62	51	19	14				
	31 Passes	62	12	5				
Days 181-212	July Total		95	34	26	5	113	
Aug '71	1 Aug 1971 to	12	23		22	8	30	Only μ & τ ranging this period Light Cmd activity Spacecraft switched to high power on 7 Aug Good overall DSN performance
	1 Sept 1971	14	8					
	Pass 63, through	41	29					
	Pass 93	42	2					
	31 Passes	51	14					
Days 212-243	Aug Total		92		22	8	37	
Sept '71	1 Sept 1971 to	12	26		11		173	Only μ ranging this period Hydrogen masers introduced 23 Sept at DSS 12, 41, & 51 Some Cmd problems; worked out corrections Mod 4B software for 360/75, intro- duced 24 Sept Good overall DSN performance
	1 Oct 1971	14	3					
	Pass 94, through	41	22					
	Pass 123	42	8					
	30 Passes	51	15					
Days 243-273	Sept Total		89		11		275	
Oct '71	1 Oct 1971 to	12	21			2	300	Only τ ranging this period Mod 4C software for 360/75, intro- duced 17 Oct Predict problems with COMGEN & SQF Good overall DSN performance
	1 Nov 1971	14	11					
	Pass 124, through	41	16					
	Pass 154	42	13					
	31 Passes	51	19					
Days 273-304	Oct Total		95			2	626	
Nov '71	1 Nov 1971 to	12	11		6	2	639	Study of SNR residuals reveals negative displacement of values at DSS 41 & DSS 51, plus gradual negative divergence at all DSN stations. Four sets of tracking predicts, I082-5, used for cruise during Nov '71; sets M012, M019, & M01A used for orbit insertion
	14 Nov 1971	14	10					
	Pass 155, through	41	15					
	Pass 168	42	3					
	14 Passes	51	6					
Days 304-318	Nov Total		55		6	2	1403	
5-1/2 mo Grand Total			509	101	69	23	2964	

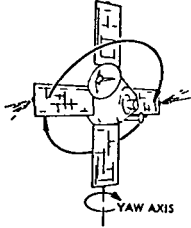
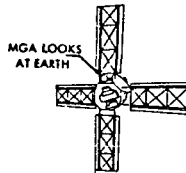
Table 4. Details of Pass Chronology

Pass 6, June 4/5, 1971 (Day 155/156)

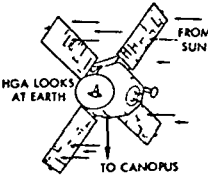
DSS 51 AOS 155/2046; LOS 156/0853; Commands Transmitted - 0; Ranging - No.
Deviations or Anomalies

1. DSS - Ranging subsystem down throughout tracking period. Cause remained under investigation (Ref. open DR 01224).
2. DSS - Station was unable to turn on transmitter for two-way transfer from DSS 41 at 0130. DSS 41 remained two-way and CPS HSD process remained on DSS 41 to DSS 41 LOS. DSS 51 resolved their transmitter problem and obtained two-way lock at 0235. The transmitter problem was caused by a faulty RF switching relay (Ref. DR 01235).
3. CPS - 360/75 down for restart from 0726 to 0731 because of excessive backlog on telemetry processor. 360/75 was restarted again from 0735 to 0738 because of a bad card deck load on previous restart (Ref. DR 1592 and DR 1594).

DSS 12 AOS 156/0803; LOS 156/1632; Commands Transmitted - 0;
Ranging - Mark IA.

Deviations or Anomalies

1. DSS - Station was unable to complete command data transfer test until 0830 because of apparent TCP/DIS interface problem. Cause of problem remained under investigation (Ref. Open DR 01234).

DSS 14 AOS 156/0843; LOS 156/1618; Commands Transmitted - 0;
Ranging - TAU-R & D.

Deviations or Anomalies

None

DSS 41 AOS 156/1321; LOS 157/0154; Commands Transmitted - 1;
Ranging - Mark IA.

Deviations or Anomalies

None

Pass 7, June 5/6, 1971 (Day 156/157)

DSS 51 AOS 156/2045; LOS 157/0849; Commands Transmitted - 0;
Ranging - Limited.

Deviations or Anomalies

1. DSS - Ranging subsystem still considered down (Ref. open DR 01224). Some ranging data were obtained between 2100 and 157/0600; however, ranging residual data showed excessive noise.
-

Table 4 (contd)

Pass 7, June 5/6, 1971 (Day 156/157) (cont'd)

2. GCF - HSDL was erratic both ways from 0242 to 0248. Cause was not determined (Ref. DR 2606).
3. CPS - CDC 3100 went down and required a switch from A to B computer from 0652 to 0700. The problem was apparently caused as a result of a scheduled 360/75 computer switch (B to A) that took place at 0648 (Ref. DR 1597).
4. CPS - 360/75 down for reload from 0711 to 0735 because of I/O errors (unable to control tape banks and would not respond to restart). Cause was apparently a program fault (Ref. DR 1596).
5. CPS - 360/75 down for restart with a disk-pack change from 0841 to 0850 because of Mission Support Area (MSA) disk-pack errors (Ref. DR 1598).

DSS 12 AOS 157/0801; LOS 157/1626; Commands Transmitted - 0;
Ranging - Mark IA.

Deviations or Anomalies

1. CPS - 360/75 formatted data outputs stopped from 0914 to 0924; cause unknown. Formatted data outputs resumed automatically.
2. CPS - 360/75 down for restart with dump from 0945 to 0948 because of formatted data output halt (Ref. DR 1599).
3. CPS - 360/75 down for restart from 0957 to 1000 because of formatted data output halt (Ref. DR 1600).
4. CPS - 360/75 down for reload from 1423 to 1431 because of telemetry process backlog caused by predict generation run (Ref. DR 1603).

DSS 41 AOS 157/1333; LOS 158/0157; Commands Transmitted - 3;
Ranging - Mark IA.

Deviations or Anomalies

1. CPS - 360/75 down for reload from 1850 to 1858 because of system control I/O lockout (Ref. DR 1604).

Pass 8, June 6/7, 1971 (Day 157/158)

DSS 51 AOS 157/2040; LOS 158/0847; Commands Transmitted - 0; Ranging - No.

Deviations or Anomalies

1. DSS - Ranging subsystem still down throughout tracking period (Ref. open DR 01224).
-

Table 4 (contd)

Pass 8, June 6/7, 1971 (Day 157/158) (cont'd)

DSS 12 AOS 158/0748; LOS 158/1622; Commands Transmitted - 0;
Ranging - Mark IA.

Deviations or Anomalies

1. CPS - 360/75 down for restart with dump from 1016 to 1021 because of disk errors (Ref. DR 1607).
2. GCF - JPL CP down requiring a CP switch (B to A) from 1513 to 1526 because of a faulty circuit card connection in CP-B (Ref. DR 2609).

DSS 41 AOS 158/1453; LOS 158/2250; Commands Transmitted - 1;
Ranging - Mark IA.

Deviations or Anomalies

1. CPS - 360/75 down for restart from 1651 to 1658 because of inability to perform predicts generation run (Ref. DR 1606).

Pass 9, June 7/8, 1971 (Day 158/159)

DSS 51 AOS 158/2122; LOS 159/0845; Commands Transmitted - 0; Ranging - No.

Deviations or Anomalies

1. DSS - Ranging subsystem still down throughout tracking period (Ref. Open DR 01224).
2. DSS - Station lost command loop lock from 2257 to 2306 because of momentary accidental trip-off of transmitter beam voltage by operator (Ref. DR 01239).

DSS 12 AOS 159/0742; LOS 159/1619; Commands Transmitted - 0;
Ranging - Mark IA.

Deviations or Anomalies

1. CPS - CDC 3100 down from 1100 to 1448 because of sync timing problem caused by a bad data disk (Ref. DR 1613).
2. CPS - 360/75 down for restart from 1105 to 1110 because of time-outs received as a result of the CDC 3100 problem (Ref. Item 1 above).
3. CPS - 360/75 down for reload from 1132 to 1146 because of I/O lock-out and formatted data output halt (Ref. Item 2 above).
4. CPS - 360/75 down for reload from 1200 to 1216 because of continuing CDC 3100 problem.

DSS 14 AOS 159/0828; LOS 159/1600; Commands Transmitted - 0;
Ranging - TAU-R & D.

Deviations or Anomalies

1. CPS - 360/75 down for switch (A to B) from 1305 to 1313 as a result of continuing efforts to resolve CDC 3100 interface problem.

Table 4 (contd)

Pass 9, June 7/8, 1971 (Day 158/159)(cont'd)

DSS 41 AOS 159/1430; LOS 160/0146; Commands Transmitted - 1
Ranging - Mark IA.

Deviations or Anomalies

1. GCF - Goddard Space Flight Center (GSFC) CP down for 2/3 recovery from 1804 to 1816 because of system fault (Ref. DR 2617 and DR 2618).
2. CPS - 360/75 down for reload with software version 27.2 from 2253 to 2305 for trial run (done with DSN-OC/Project approval).
3. CPS - 360/75 down for reload from 2330 to 2338 because of an incorrect card deck load at 2253 (Ref. Item 2 above).

Pass 10, June 9, 1971 (Day 160)

DSS 51 AOS 160/0048; LOS 160/0838; Commands Transmitted - 0;
Ranging - Mark IA.

Deviations or Anomalies

NOTE

Ranging subsystem, functioning satisfactorily as of this track however, is not officially declared green pending outcome of Periodic Confidence Test.

DSS 12 AOS 160/0746; LOS 160/1616; Commands Transmitted - 0;
Ranging - Mark IA.

Deviations or Anomalies

1. CPS - 360/75 down for reload with software version 26.7 Mod II from 1329 to 1340. Trial run on software version 27.2 (initiated on day 160/2253) was terminated because of indications of software errors.
2. CPS - 360/75 down for reload from 1526 to 1541 because of I/O lockout and telemetry process backloging (Ref. DR 1619).

DSS 41 AOS 160/1430; LOS 160/2217; Commands Transmitted - 1;
Ranging - Mark IA.

Deviations or Anomalies

1. CPS - Central Document Control (CDC) 3100 down from 1541 to 1614 because of a defective data disk driver caused by circuit card failure (Ref. DR 1620).
 2. CPS - CDC 3100 down from 2105 to 2129 and from 2147 to 2225 because of a defective circuit card in the CIC subassembly (Ref. DR 1623).
-

Table 4 (contd)

Pass 10, June 9, 1971 (Day 160) (cont'd)

3. CPS - 360/75 down for reload from 2118 to 2129 because of I/O lockouts stimulated by CDC 3100 interface problem indicated above (Ref. Item 2, and same DR).
4. CMD - S/C commanding was executed in backup manual mode because of inability to verify test command transmissions in remote mode. Cause of problem was not determined in real time (Ref. DR 0419).

Pass 11, June 9/10, 1971 (Day 160/161)

DSS 51 AOS 160/2058; LOS 161/0834; Commands Transmitted - 0;
Ranging - Mark IA.

Deviations or Anomalies

NOTE

Ranging subsystem officially declared green
as of this track.

1. GCF - Unable to activate HSDL until 2200 because of excessive line error rate. Actual cause of problem was not determined because, while attempting to trace cause, the problem cleared itself (Ref. DR 2632). Backup low-speed teletype (TTY) circuits operable during HSDL outage. CPS HSD process remained on DSS 41 until 2209.
2. CPS - 360/75 down for reload from 2216 to 2225 because of I/O lockout caused by CDC 3100 interface problem (Ref. Item 2, DSS 41 Pass 10 and same DR).
3. CPS - 360/75 down for reloads from 0403 to 0414, 0418 to 0424, and 0427 to 0439 because of I/O lockouts, apparently caused by a software problem related to the Tracking System segment of Program Version 27.2 Model II (Ref. DR 1625).

DSS 12 AOS 161/0740; LOS 161/1400; Commands Transmitted - 0;
Ranging - Mark IA.

Deviations or Anomalies

1. CPS - 360/75 down for reload from 1020 to 1033 because of disk errors and loss of CDC 3100 interface (Ref. DR 1627).

DSS 41 AOS 161/1258; LOS 162/0136; Commands Transmitted - 1;
Ranging - Mark IA.

Deviations or Anomalies

1. CPS - 360/75 A and B down from 1714 to 1845 because of a common I/O interface problem; neither 360/75 computer could be activated with the JPLOS real-time system (Ref. DR 1631).
-

Table 4 (contd)

Pass 12, June 11, 1971 (Day 162)

DSS 51 AOS 162/0057; LOS 162/0830; Commands Transmitted - 0;
Ranging - Mark IA.

Deviations or Anomalies

None

DSS 12 AOS 162/0731; LOS 162/1608; Commands Transmitted - 0;
Ranging - Mark IA.

Deviations or Anomalies

None

DSS 41 AOS 162/1437; LOS 162/2200; Commands Transmitted - 1;
Ranging - Mark IA.

Deviations or Anomalies

1. DSS - Transmitter down from 1922 to 1946 because of low heat-exchanger coolant flow. Coolant flow was increased and no further problems were encountered (Ref. DR 01251).
2. CPS - 360/75 down for reloads from 2106 to 2211 because of telemetry process backlog, CDC 3100 output halt, and I/O lockout, apparently caused by an I/O device failure (Ref. DR 1637).

Pass 13, June 11/12, 1971 (Day 162/163)

DSS 51 AOS 162/2057; LOS 163/0827; Commands Transmitted - 0;
Ranging - Mark IA.

Deviations or Anomalies

1. CPS - No HSD process until 2211 because of 360/75 down for reloads from 2106 to 2211 (Ref. Pass 12, DSS 41, Item 2). Lowspeed TTY telemetry data was satisfactory during computer down time.

DSS 12 AOS 163/0726; LOS 163/1604; Commands Transmitted - 0;
Ranging - Mark IA.

Deviations or Anomalies

None

DSS 14 AOS 163/0835; LOS 163/1552; Commands Transmitted - 0;
Ranging - TAU-R & D.

Deviations or Anomalies

1. DSS - Transmitter down from 1257 to 1310 because of transmitting tube coolant flow blockage (Ref. DR 01254).
-

Table 4 (cont'd)

Pass 13, June 11/12, 1971 (Day 162/163) (cont'd)

DSS 41 AOS 163/1456; LOS 163/2100; Commands Transmitted - 1;
Ranging - Mark IA.

Deviations or Anomalies

None

Pass 14, June 12/13, 1971 (Day 163/164)

DSS 51 AOS 163/2019; LOS 164/0823; Commands Transmitted - 0;
Ranging - Mark IA.

Deviations or Anomalies

1. CPS - 360/75 support was delayed approximately 10 minutes (following release from scheduled development time at 0200) because of problems in loading the computer for flight support caused by a defective disk-pack (Ref. DR 1639).

DSS 12 AOS 164/0723; LOS 164/1600; Commands Transmitted - 0;
Ranging - Mark IA.

Deviations or Anomalies

None

DSS 41 AOS 164/1444; LOS 164/0123; Commands Transmitted - 1;
Ranging - Mark IA.

Deviations or Anomalies

None

Pass 15, June 14, 1971 (Day 165)

DSS 51 AOS 165/0058; LOS 165/0819; Commands Transmitted - 0;
Ranging - Mark IA.

Deviations or Anomalies

None

DSS 12 AOS 165/0720; LOS 165/1530; Commands Transmitted - 0;
Ranging - Mark IA.

Deviations or Anomalies

None

Table 4 (contd)

Pass 15, June 14, 1971 (Day 165) (cont'd)

DSS 41 AOS 165/1403; LOS 164/0100; Commands Transmitted 3;
Ranging - Mark IA.

Deviations or Anomalies

None

Pass 16, June 15, 1971 (Day 166)

DSS 51 AOS 166/0001; LOS 166/0811; Commands Transmitted - 0;
Ranging - Mark IA.

Deviations or Anomalies

1. DSS - Ranging data lost from 0253 to 0349 because of ranging program halt (Ref. DR 01259).

DSS 12 AOS 166/0715; LOS 166/1530; Commands Transmitted - 0;
Ranging - Mark IA.

Deviations or Anomalies

None

DSS 14 AOS 166/0757; LOS 166/1530; Commands Transmitted - 0;
Ranging - TAU-R & D.

Deviations or Anomalies

1. CPS - 360/75 down for reload from 1228 to 1233 because of I/O lockout apparently caused by line printer failures. Also no CDC 3100 interface from 1221 to 1233 because of same problem (Ref. DR 1648).

DSS 41 AOS 166/1357; LOS 166/2230; Commands Transmitted - 1;
Ranging - Mark IA.

Deviations or Anomalies

1. GCF - HSDL down from 1757 to 1802 because of line failure between Canberra and GSFC NASCOM (Ref. DR 2667).

Pass 17, June 15/16, 1971 (Day 166/167)

DSS 51 AOS 166/2116; LOS 167/0806; Commands Transmitted - 0;
Ranging - Mark IA.

Deviations or Anomalies

None

Table 4 (contd)

Pass 17, June 15/16, 1971 (Day 166/167) (cont'd)

DSS 12 AOS 167/0710; LOS 167/1400; Commands Transmitted - 0;
Ranging - Mark IA.

Deviations or Anomalies

None

DSS 41 AOS 167/1233; LOS 168/0100; Commands Transmitted - 1;
Ranging - Mark IA.

Deviations or Anomalies

1. GCF - HSDL down from 1406 to 1415 because of line failure between Canberra and GSFC NASCOM (Ref. DR 2675).

Pass 18, June 16/17, 1971 (Day 167/168)

DSS 51 AOS 167/2330; LOS 168/0802; Commands Transmitted - 0;
Ranging - Mark IA.

Deviations or Anomalies

None

DSS 12 AOS 168/0706; LOS 168/1530; Commands Transmitted - 0;
Ranging - Mark IA.

Deviations or Anomalies

None

DSS 41 AOS 168/1358; LOS 168/2100; Commands Transmitted - 1;
Ranging - Mark IA.

Deviations or Anomalies

1. CPS - 360/75 down for restart with dump from 1820 to 1825 because of suspected problems with the Tracking Data Processor (TDP) portion of program (Ref. DR 1662).

Pass 19, June 17/18, 1971 (Day 168/169)

DSS 51 AOS 168/1959; LOS 169/0800; Commands Transmitted - 0;
Ranging - Mark IA.

Deviations or Anomalies

None

DSS 12 AOS 169/0702; LOS 169/1330; Commands Transmitted - 0;
Ranging - Mark IA.

Deviations or Anomalies

1. GCF/CPS - Lost HSD clock sync between SFOF communications and CPS interface, intermittently from 1105 to 1139. Cause was not determined because problem cleared itself while being checked.

Table 4 (contd)

Pass 19, June 17/18, 1971 (Day 168/169) (cont'd)

DSS 41 AOS 169/1217; LOS 170/0100; Commands Transmitted 481;
Ranging - Mark IA.

Deviations or Anomalies

1. DSS - Five command aborts were experienced during commanding sequence. A CC-1 aborted at 1850, CC-1 at 1911, CC-2 at 1932, CC-1 at 2022, and a CC-1 at 2043. Commands aborted on bit 01 verify. The cause was apparently related to a TCP software problem (Ref. DR 1263).

Pass 20, June 18/19, 1971 (Day 169/170)

DSS 51 AOS 169/2339; LOS 170/0755; Commands Transmitted - 0;
Ranging - Mark IA.

Deviations or Anomalies

1. CPS - 360/75 down for restart with dump from 0048 to 0057 because of telemetry process backlog and I/O lockout apparently caused by computer core fragmentation caused by excessive real-time job process requests (SOE transmission and command generation jobs running simultaneously). Ref. DR 1673.)
2. CPS - 360/75 down for restart with dump from 0124 to 0130 because of I/O lockout and telemetry process backlog, apparently caused by an incorrect I/O entry (Ref. DR 0180).

DSS 14 AOS 170/0801; LOS 170/1520; Commands Transmitted - 0;
Ranging - TAU-R & D.

Deviations or Anomalies

1. CPS - 360/75 down for reload with disk-pack change from 1353 to 1406 because of disk-drive failure (Ref. DR 1674).

DS 41 AOS 170/1424; LOS 170/2100; Commands Transmitted - 1;
Ranging - Mark IA.

Deviations or Anomalies

None

Pass 21, June 19/20, 1971 (Day 170/171)

DSS 51 AOS 170/1951; LOS 171/0748; Commands Transmitted - 0;
Ranging - Mark IA.

Deviations or Anomalies

None

Table 4 (contd)

Pass 21, June 19/20, 1971 (Day 170/171) (cont'd)

DSS 12 AOS 171/0654; LOS 171/1333; Commands Transmitted - 0;
Ranging - Mark IA.

Deviations or Anomalies

None

DSS 41 AOS 171/1209; LOS 171/2400; Commands Transmitted - 1;
Ranging - Mark IA.

Deviations or Anomalies

1. CPS - 360/75 down for restart with dump from 2020 to 2025 because of formatted telemetry data output halt caused by a disk-pack error (Ref. DR 1680).

Pass 22, June 20/21, 1971 (Day 171/172)

DSS 51 AOS 171/2215; LOS 172/0748; Commands Transmitted - 0;
Ranging - Mark IA.

Deviations or Anomalies

1. GCF - JPL CP down from 0002 to 0019 because of online system faults that eventually required a CP switch from B to A (Ref. DR 2711).

DSS 12 AOS 172/0648; LOS 172/1521; Commands Transmitted - 0;
Ranging - Mark IA.

Deviations or Anomalies

None

DSS 41 AOS 172/1348; LOS 172/2042; Commands Transmitted - 1;
Ranging - Mark IA.

Deviations or Anomalies

1. GCF - JPL CP down from 1858 to 1910 because of online system fault. Several recoveries and finally a CP switch (A to B) were performed to restore system (Ref. DR 2723).
 2. GCF - HSDL down from 1928 to 1936 because of line interrupt between Canberra and GSFC NASCOM (Ref DR 2724).
-

Table 4 (contd)

Pass 23, June 21/22, 1971 (Day 172/173)

DSS 51 AOS 172/1942; LOS 178/0740; Commands Transmitted - 0;
Ranging - Mark IA.

Deviations or Anomalies

1. GCF - HSDL down from 2309 to 2328 because of line failures between the DSS and JPL (Ref. DR 2729).

DSS 12 AOS 173/0643; LOS 173/1516; Commands Transmitted - 0;
Ranging - Mark IA.

Deviations or Anomalies

None

DSS 14 AOS 173/0812; LOS 173/1500; Commands Transmitted - 0;
Ranging - TAU-R & D.

Deviations or Anomalies

1. DSS - TCP was reloaded from 1131 to 1137 in an attempt to correct erroneous downlink AGC (signal level) readings. Reload did not correct and problem remained through EOT (Ref. DR 0183).

DSS 41 AOS 173/1336; LOS 173/2400; Commands Transmitted - 1;
Ranging - Mark IA.

Deviations or Anomalies

1. GCF - HSDL down from 1658 to 1706 because of line failure between JPL and GSFC NASCOM (Ref. DR 2740).

Pass 24, June 22/23, 1971 (Day 173/174)

DSS 51 AOS 173/2235; LOS 174/0737; Commands Transmitted - 0;
Ranging - Mark IA.

Deviations or Anomalies

None

DSS 12 AOS 174/0639; LOS 174/1300; Commands Transmitted - 0;
Ranging - Mark IA.

Deviations or Anomalies

1. DSS - Transmitter down from 0850 to 0907 because of focus magnet under current interlock trip. Interlock was reset and no further problems were experienced (Ref. DR 1269).
-

Table 4 (contd)

Pass 24, June 22/23/ 1971 (Day 173/174) (cont'd)

2. GCF - Upon return of 360/75 computer support at 1130 (360/75 was scheduled for development from 0201 to 1130) no HSD was received from station. HSD was restored at 1143. Problem was apparently a defective HSDL patch at DSS 12 communications terminal (Ref. DR 1270).

DSS 41 AOS 174/1159; LOS 175/0037; Commands Transmitted - 1;
Ranging - Mark IA.

Deviations or Anomalies

1. CPS - 360/75 down for restart with dump from 1606 to 1617 because of I/O lockout and telemetry process backlogging. Problem was apparently caused by I/O unit check alarms. Actual cause was not determined in real time (Ref. DR 1695).

Pass 25, June 23/24, 1971 (Day 174/175)

DSS 51 AOS 174/2330; LOS 175/0732; Commands Transmitted - 0;
Ranging - Mark IA.

Deviations or Anomalies

None

DSS 12 AOS 175/0634; LOS 175/1502; Commands Transmitted - 0;
Ranging - Mark IA.

Deviations or Anomalies

1. DSS - Transmitter tripped off at 0730 because of klystron collector coolant flow interrupt. Antenna was taken to zenith to reset transmitter interlock from 0738 to 0805 (receiver back in lock). Approximately 27 minutes of telemetry, TDH, and ranging data were lost (Ref. DR 1272).

DSS 41 AOS 175/1324; LOS 175/2100; Commands Transmitted - 1;
Ranging - Mark IA.

Deviations or Anomalies

1. CPS - 360/75 down for restart from 2037 to 2042 because of telemetry process backlogging caused by core fragmentation (Ref. DR 1644).
-

Table 4 (contd)

Pass 26, June 24/25, 1971 (Day 175/176)

DSS 51 AOS 175/1939/ LOS 176/0724; Commands Transmitted - 0;
Ranging - Mark IA.

Deviations or Anomalies

1. CPS - 360/75 would not accept TDH data for processing for entire support period (2046 to 0203). Cause was not determined in real time and was not specifically identified as a CPS problem (Ref. DR 0192).

DSS 12 AOS 176/0629; LOS 176/1500; Commands Transmitted - 0;
Ranging - Mark IA.

Deviations or Anomalies

None

DSS 41 AOS 176/1352; LOS 177/0026; Commands Transmitted - 1;
Ranging - Mark IA.

Deviations or Anomalies

1. CPS - CDC 3100 output halted from 1908 to 1953 because of core drive power supply failure (Ref. DR 1709).

Pass 27, June 25/26, 1971 (Day 176/177)

DSS 62 AOS 176/2339; LOS 177/0719; Commands Transmitted - 0; Ranging - No.

Deviations or Anomalies

1. DSS - Station was unable to lock ranging receiver throughout entire track. The problem was attributed to a very low elevation angle throughout the track (never above 18 degrees) resulting in poor SNR and also the fact that the spacecraft-to-Earth distance is approaching threshold of the Mark IA ranging system. (To be investigated further per DR 1276.)
2. CPS - At 0122, 360/75 telemetry processing jumped from 13 minutes backlog to real time with no action taken by the CPS. Cause was not determined.
3. DSS - Station was off track from 0241 to 0316 because of "E" buss power failure caused by circuit breaker trip-off. Reason for circuit breaker trip-off was not determined in real time (Ref. DR 01277). Approximately 35 minutes of telemetry and TDH data were lost.

DSS 12 AOS 177/0625; LOS 177/1430; Commands Transmitted - 0;
Ranging - Mark IA.

Deviations or Anomalies

None

Table 4 (contd)

Pass 27, June 25/26, 1971 (Day 176/177) (cont'd)

DSS 41 AOS 177/1320; LOS 177/2300; Commands Transmitted - 1;
Ranging - Mark IA.

Deviations or Anomalies

1. CPS - 360/75 down for restart with dump from 2023 to 2031 because of telemetry process backlogging caused by core fragmentation (Ref. open DR 1644).

Pass 28, June 26/27, 1971 (Day 177/178)

DSS 51 AOS 177/2145; LOS 178/0718; Commands Transmitted - 0;
Ranging - Mark IA.

Deviations or Anomalies

None

DSS 12 AOS 178/0620; LOS 178/1430; Commands Transmitted - 0;
Ranging - μ -R&D.

Deviations or Anomalies

NOTE

Station equipped with and started using the
 μ -R & D Planetary Ranging System as of
this pass.

DSS 41 AOS 178/1320; LOS 178/2300; Commands Transmitted - 1;
Ranging - Mark IA.

Deviations or Anomalies

1. CPS - 360/75 down for reload from 1352 to 1358 because of I/O lockout (Ref. DR 1714).
2. CPS - 360/75 down for reload from 1745 to 1754 because of a machine check causing the real-time job (flight support) function to be deleted (Ref. DR 1716).

Pass 29, June 27/28, 1971 (Day 178/179)

DSS 51 AOS 178/2133; LOS 179/0710; Commands Transmitted - 0;
Ranging - Mark IA.

Deviations or Anomalies

NOTE

GSFC NASCOM performed scheduled CP
switch from 0006 to 0019.

Table 4 (contd)

Pass 29, June 27/28, 1971 (Day 178/179) (cont'd)

DSS 12 AOS 179/0616; LOS 179/1236; Commands Transmitted - 0;
Ranging - μ -R & D.

Deviations or Anomalies

None

DSS 41 AOS 179/1137; LOS 180/0013; Commands Transmitted - 1;
Ranging - Mark IA.

Deviations or Anomalies

1. GCF - HSDL down from 1527 to 1529 and from 1531 to 1535 apparently caused by performing unauthorized maintenance at Canberra NASCOM switching center (Ref. DR 2774 and DR 2775).
2. CPS - 360/75 down for reload and MSD disk-pack change from 1643 to 1650 because of inability to write tracking system tapes (Ref. DR 1717 and DR 1719).
3. CPS - 360/75 down for reload and RTOSA disk-pack change from 1800 to 1809 (same problem as Item 2). (Ref. DR 1721 and DR 1717.)

Pass 30, June 28/29, 1971 (Day 179/180)

DSS 62 AOS 179/2313; LOS 180/0704; Commands Transmitted - 0; Ranging - No.

Deviations or Anomalies

1. DSS - Station was unable to obtain ranging receiver lock throughout entire pass. Cause remained under investigation following EOT (Ref. DR 01281, also see Pass 27, DSS 62, Item 1).

DSS 12 AOS 180/0610; LOS 180/1441; Commands Transmitted - 0;
Ranging - μ -R & D.

Deviations or Anomalies

1. CPS - 360/75 down for reload and dump from 1409 to 1418 because of I/O lockout. Cause was not determined in real time (Ref. DR 1726).

DSS 41 AOS 180/1330; LOS 180/2005; Commands Transmitted - 1;
Ranging - Mark IA.

Deviations or Anomalies

None

Table 4 (contd)

Pass 31, June 29/30, 1971 (Day 180/181)

DSS 51 AOS 180/1906; LOS 181/0700; Commands Transmitted - 0;
Ranging - Mark IA.

Deviations or Anomalies

NOTE

GSFC NASCOM down for scheduled CP switch
from 0002 to 0008.

1. GCF - All TTY data stopped from 0038 to 0045 because of Madrid NASCOM CP fault (Ref. DR 2794).
2. CPS - 360/75 down for reload from 2157 to 2229 because of inability to access disk-storage areas for utility job functions (Ref. DR 1728).

DSS 12 AOS 181/0605; LOS 181/1436; Commands Transmitted - 0;
Ranging - μ R&D

Deviations or Anomalies

1. CPS - CDC 3100 outputs halted at 1324. 360/75 down for reload from 1327 to 1332 because of halt on real-time job function apparently caused by time out alarms from the CDC 3100 problem; however, the CDC 3100 output resumed normally following the 360/75 reload. Actual cause of problem was not determined in real time (Ref. DR 1732).

DSS 41 AOS 181/1329; LOS 181/2000; Commands Transmitted - 1;
Ranging - Mark IA.

Deviations or Anomalies

1. CPS - 360/75 down for reload from 1437 to 1448 because of halt on HSD logging (Ref. DR 1733).

NOTE

360/75 was released from flight support (with DSN OC and Project concurrence) at 1908 through EOT, for 360/75 log tape data recalls in an attempt to discover the cause of problem indicated under Item 1 above.

Pass 32, June 30/July 1, 1971 (Day 181/182)

DSS 51 AOS 181/1859; LOS 182/0655; Commands Transmitted - 0;
Ranging - Mark IA.

Deviations or Anomalies

1. CPS - 360/75 down for reload from 2149 to 2200 because of system control I/O lockout. Cause was not determined in real time (Ref. DR 1736).

Table 4 (contd)

Pass 32, June 30/July 1, 1971 (Day 181/182) (cont'd).

2. GCF - HSDL down from 2204 to 2212 because of carrier failure between GSFC NASCOM and JPL (Ref. DR 2802).

DSS 12 AOS 182/0601; LOS 182/1431; Commands Transmitted - 0;
Ranging - μ -R & D.

Deviations or Anomalies

None

DSS 14 AOS 182/0755; LOS 182/1422; Commands Transmitted - 0;
Ranging - TAU-R & D.

Deviations or Anomalies

None

DSS 41 AOS 182/1319; LOS 182/2358; Commands Transmitted - 1;
Ranging - Mark IA.

Deviations or Anomalies

1. CPS - 360/75 down for reload from 1643 to 1649 because Network Analysis Team (NAT) command I/O was not able to access the system to load configuration tables. Cause of problem was not determined in real time (Ref. DR 1706).

Pass 33, July 1/2, 1971 (Day 182/183)

DSS 51 AOS 182/1853; LOS 183/0650; Commands Transmitted - 0;
Ranging - Mark IA.

Deviations or Anomalies

1. DSS - Station was unable to perform ranging until 2300. The problem was apparently caused by a drift in the ranging correlation circuitry (Ref. DR 01287). (A two-station ranging test with DSS 41 Pass 32 was unsuccessful as a result of this problem.)

DSS 12 AOS 183/0555; LOS 183/1426; Commands Transmitted - 0;
Ranging - μ -R & D.

Deviations or Anomalies

None

DSS 41 AOS 183/1323; LOS 183/2353; Commands Transmitted - 1;
Ranging - Mark IA.

Deviations or Anomalies

1. CPS - 360/75 and CDC 3100 were down numerous times between 1535 and 1955 because of a 360/75 CDC 3100 interface problem caused by a failure in the CDC 3100 disk control unit (Ref. DR 1743). Approximately 55 minutes of real-time telemetry data process and display were lost.

Table 4 (contd)

Pass 34, July 2/3, 1971 (Day 183/184)

DSS 51 AOS 183/1855; LOS 184/0645; Commands Transmitted - 0;
Ranging - Mark IA.

Deviations or Anomalies

1. GCF - All TTY circuits down from 2122 to 2127 because of Madrid NASCOM CP fault that required a CP switch (Ref. DR 2814).

DSS 12 AOS 184/0550; LOS 184/1421; Commands Transmitted - 0;
Ranging - μ -R & D.

Deviations or Anomalies

None

DSS 41 AOS 184/1229; LOS 184/1945; Commands Transmitted - 1;
Ranging - Mark IA.

Deviations or Anomalies

1. GCF - HSDL down from 1402 to 1408 because of line failure between Canberra and GSFC NASCOM (Ref. DR 2820).
2. CMD - Unable to interrogate or instruct the DSS/TCP command functions in remote mode, from 1620 to 1638. The problem cleared following a manual instruction to the TCP command function to Idle 2 mode. Cause of problem was not determined in real time (Ref. DR 0210).

Pass 35, July 3/4, 1971 (Day 184/185)

DSS 51 AOS 184/1854; LOS 185/0640; Commands Transmitted - 0;
Ranging - Mark IA.

Deviations or Anomalies

1. TRK - Predicts not available because of procedural error. AOS and two-way transfer were delayed (Ref. DR 0211).

DSS 14 AOS 185/0636; LOS 185/1406; Commands Transmitted - 0;
Ranging - TAU-R & D.

Deviations or Anomalies

1. TRK - Predicts not available because of procedural error. AOS was delayed 8 minutes (Ref. DR 0212).
 2. CPS - 360/75 down for restart from 1120 to 1129 because of I/O lockout (Ref. DR 1745).
 3. DSS - Range data suspect throughout the pass. Station transferred early when transmitter drive fell off (Ref. DR 1290).
-

Table 4 (contd)

Pass 35, July 3/4, 1971 (Day 184/185) (cont'd)

DSS 41 AOS 185/1105; LOS 185/2343; Commands Transmitted - 1;
Ranging - Mark IA.

Deviations or Anomalies

1. CPS - 360/75 down from 1435 to 1450 because of power loss on main frame (Ref. DR 1746).

Pass 36, July 4/5, 1971 (Day 185/186)

DSS 62 AOS 185/2244; LOS 186/0633; Commands Transmitted - 0;
Ranging Mark IA.

Deviations or Anomalies

1. CPS - 360/75 down for restart from 2340 to 2345 because of heavy backlog (Ref. DR 1641).
2. DSS - Ranging code was not acquired throughout the pass (Ref. DR 1281).

DSS 12 AOS 186/0543; LOS 186/1411; Commands Transmitted - 0;
Ranging - μ -R & D.

Deviations or Anomalies

None

DSS 41 AOS 186/1240; LOS 186/2338; Commands Transmitted - 1;
Ranging - Mark IA.

Deviations or Anomalies

1. DSS - Station unable to acquire good ranging data throughout the pass (Ref. DR 1274).

Pass 37, July 5/6, 1971 (Day 186/187)

DSS 62 AOS 186/2238; LOS 187/0628; Commands Transmitted - 0;
Ranging - Mark IA.

Deviations or Anomalies

None

DSS 12 AOS 187/0536; LOS 187/1156; Commands Transmitted - 0;
Ranging - μ -R & D.

Deviations or Anomalies

None

Table 4 (contd)

Pass 37, July 5/6, 1971 (Day 186/187) (cont'd)

DSS 41 AOS 187/1059; LOS 187/2333; Commands Transmitted - 1;
Ranging - Mark IA.

Deviations or Anomalies

1. CPS - 360/75 down from 1725 to 1741 to replace 1052 I/O keyboard (Ref. DR 1755). 360/75 down from 1851 to 1902 to replace 1052 I/O keyboard (Ref. DR 1744).

Pass 38, July 6/7, 1971 (Day 187/188)

DSS 62 AOS 187/2236; LOS 188/0623; Commands Transmitted - 0;
Ranging - Mark IA.

Deviations or Anomalies

1. CPS - CDC 3100 down from 0028 to 0103, cause unknown (Ref. DR 1759). 360/75 down from 0035 to 0058, cause unknown (Ref. DR 1759).

DSS 12 AOS 188/0531; LOS 188/1402; Commands Transmitted - 0;
Ranging - μ -R & D.

Deviations or Anomalies

None

DSS 41 AOS 188/1243; LOS 188/1923; Commands Transmitted - 1;
Ranging - Mark IA.

Deviations or Anomalies

1. CPS - 360/75 down from 1338 to 1408, when all 06 devices were locked out. A string exchange was performed (Ref. DR 1762).
2. DSS - Maser-1 vapor pressure varied, causing D/L AGC errors of about 2.5 db (Ref. DR 1293).

Pass 39, July 7/8, 1971 (Day 188/189)

DSS 51 AOS 188/1823; LOS 189/0619; Commands Transmitted - 0;
Ranging - Mark IA.

Deviations or Anomalies

1. CPS - 360/75 down from 2341 to 2348 for restart because of heavy backlog (Ref. DR 1766).
-

Table 4 (contd)

Pass 39, July 7/8, 1971 (Day 188/189) (cont'd)

DSS 12 AOS 189/0526; LOS 189/1356; Commands Transmitted - 0;
Ranging - μ -R & D.

Deviations or Anomalies

None

DSS 41 AOS 189/1247; LOS 189/2323; Commands Transmitted - 1;
Ranging - Mark IA.

Deviations or Anomalies

1. CPS - Cable exchange on CDC 3100 caused 360/75 problems. 360/75 taken down for Internal Program Load (IPL) from 1947 to 1959 (Ref. DR 1769).
2. DSS - A special ranging test was performed between DSS 41 and DSS 51 with two-way transfers at 1925, 2205, and 2225.

Pass 40, July 8/9, 1971 (Day 189/190)

DSS 51 AOS 189/1818; LOS 190/0614; Commands Transmitted - 0;
Ranging - Mark IA.

Deviations or Anomalies

1. CPS - CDC 3100 down from 0344 to 0350 because of power supply failure on channels 41-60 (Ref. DR 1772). 360/75 down for IPL from 0353 to 0402, because of I/O lockout (Ref. DR 1774). CDC 3100 down for reload from 0406 to 0413, because of recurring power supply problems (Ref. DR 1775). CDC 3100 string exchange from 0413 to 0502, because of continuing power supply problems (Ref. DR 1776).

DSS 14 AOS 190/0609; LOS 190/1341; Commands Transmitted - 0;
Ranging - TAU-R & D.

Deviations or Anomalies

- i. DSS - TCP AGC output was in error throughout the pass (Ref. DR 0216). SNR was about 4 db low throughout the pass (Ref. DR 0217).

DSS 41 AOS 190/1229; LOS 190/1913; Commands Transmitted - 1;
Ranging - Mark IA.

Deviations or Anomalies

None

Table 4 (contd)

Pass 41, July 9/10, 1971 (Day 190/191)

DSS 51 AOS 190/1813; LOS 191/0611; Commands Transmitted - 0;
Ranging - Mark IA.

Deviations or Anomalies

1. CPS - 360/75 down for IPL from 2345 to 2350, because of core fragmentation (Ref. DR 1641).

DSS 12 AOS 191/0515; LOS 191/1345; Commands Transmitted - 0;
Ranging - μ -R & D.

Deviations or Anomalies

None

DSS 41 AOS 191/1211; LOS 191/1908; Commands Transmitted - 1;
Ranging - Mark IA.

Deviations or Anomalies

1. DSS - Transmitter tripped off from 1743 to 1755 by open cabinet door (Ref. DR 1295).

Pass 42, July 10/11, 1971 (Day 191/192)

DSS 51 AOS 191/1808; LOS 192/0604; Commands Transmitted - 0;
Ranging - Mark IA.

Deviations or Anomalies

1. CPS - CDC 3100 down from 0001 to 0009, because of system failure (Ref. DR 1784).

DSS 12 AOS 192/0510; LOS 192/1340; Commands Transmitted - 0;
Ranging - μ -R & D.

Deviations or Anomalies

None

DSS 41 AOS 192/1210; LOS 192/1902; Commands Transmitted - 1;
Ranging - Mark IA.

Deviations or Anomalies

None

Table 4 (contd)

Pass 43, July 11/12, 1971 (Day 192/193)

DSS 51 AOS 192/1804; LOS 193/0559; Commands Transmitted - 0;
Ranging - Mark IA.

Deviations or Anomalies

1. CPS - 360/75 down for IPL from 2135 to 2147 because of 2260 lock-out (Ref. DR 1788). CDC 3100 down from 2148 to 2154. Problem associated with 360/75 IPL above (Ref. DR 1789).

DSS 12 AOS 193/0508; LOS 193/1335; Commands Transmitted - 0;
Ranging - μ -R & D.

Deviations or Anomalies

1. CPS - 360/75 down from 1231 to 1237 for IPL. Unable to access tape drives (Ref. DR 1192).

DSS 41 AOS 193/1221; LOS 193/1857; Commands Transmitted - 1;
Ranging - Mark IA.

Deviations or Anomalies

1. CPS - 360/75 down from 1709 to 1723 because of disk error. IPL required (Ref. DR 1794).
2. DSS - Ranging attempts unsuccessful.

Pass 44, July 12/13, 1971 (Day 193/194)

DSS 51 AOS 193/1757; LOS 194/0554; Commands Transmitted - 0;
Ranging - Mark IA.

Deviations or Anomalies

None

DSS 12 AOS 194/0500; LOS 194/1330; Commands Transmitted - 0;
Ranging - μ -R & D.

Deviations or Anomalies

None

DSS 41 AOS 194/1204; LOS 194/2257; Commands Transmitted - 1;
Ranging - Mark IA.

Deviations or Anomalies

None

Table 4 (contd)

Pass 45, July 13/14, 1971 (Day 194/195)

DSS 62 AOS 194/2158; LOS 195/0547; Commands Transmitted - 0;
Ranging - Mark IA.

Deviations or Anomalies

1. CPS - 360/75 down from 0026 to 0038 because of core fragmentation (Ref. DR 1797).
2. DSS - Two-way transfer dropped because of late transmitter turn on (Ref. DR 1299). Receiver out of lock from 2223.50 to 2225.18 and from 2226.33 to 2227.07 because operator had wrong bandwidth setting while tuning (Ref. DR 1300).

DSS 12 AOS 195/0455; LOS 195/1110; Commands Transmitted - 0;
Ranging - μ -R & D.

Deviations or Anomalies

None

DSS 41 AOS 195/1012; LOS 195/2252; Commands Transmitted - 1;
Ranging - Mark IA.

Deviations or Anomalies

1. DSS - No ranging data.
2. CPS - 360/75 down from 1742 to 1758 because of disk error. IPL required (Ref. DR 1798).

Pass 46, July 14/15, 1971 (Day 195/196)

DSS 62 AOS 195/2151; LOS 196/0542; Commands Transmitted - 0;
Ranging - Mark IA.

Deviations or Anomalies

1. CPS - 360/75 A down at 2210 because of LCS logic error. 360/75 B up for flight support at 2239 (Ref. DR 1799).

DSS 14 AOS 196/0532; LOS 196/1310; Commands Transmitted - 0;
Ranging - TAU-R & D.

Deviations or Anomalies

None

DSS 41 AOS 196/1143; LOS 196/1842; Commands Transmitted - 1;
Ranging - Mark IA.

Deviations or Anomalies

None

Table 4 (contd)

Pass 47, July 15/16, 1971 (Day 196/197)

DSS 51 AOS 196/1742; LOS 197/0538; Commands Transmitted - 0;
Ranging - Mark IA.

Deviations or Anomalies

1. CPS - 360/75 released for unscheduled tape drive installation from 2157 to 2314. CDC 3100 down from 0034 to 0042, cause unknown (Ref. DR 1807). 360/75 down from 0105 to 0114 because of I/O lock-out. IPL required (Ref. DR 1808).

DSS 12 AOS 197/0444; LOS 197/1315; Commands Transmitted - 0;
Ranging - μ -R & D.

Deviations or Anomalies

None

DSS 41 AOS 197/1151; LOS 197/1837; Commands Transmitted - 1;
Ranging - N/A.

Deviations or Anomalies

1. DSS - Station released from further Mark IA ranging attempts.

Pass 48, July 16/17, 1971 (Day 197/198)

DSS 51 AOS 197/1737; LOS 198/0534; Commands Transmitted - 0;
Ranging - Mark IA.

Deviations or Anomalies

1. DSS - Station unable to lock up on ranging code.

DSS 12 AOS 198/0439; LOS 198/1310; Commands Transmitted - 0;
Ranging - μ -R & D.

Deviations or Anomalies

None

DSS 41 AOS 198/1132; LOS 198/1831; Commands Transmitted - 1;
Ranging - N/A.

Deviations or Anomalies

None

Table 4 (contd)

Pass 49, July 17/18, 1971 (Day 198/199)

DSS 51 AOS 198/1733; LOS 199/0528; Commands Transmitted - 0;
Ranging - Mark IA.

Deviations or Anomalies

1. DSS - Station unable to acquire ranging code.

DSS 12 AOS 199/0433; LOS 199/1305; Commands Transmitted - 0;
Ranging - μ -R & D.

Deviations or Anomalies

1. CPS - 360/75 down from 1220 to 1301 because of bad MSA pack and lockout of 480 devices (Ref. DR 1814).

DSS 41 AOS 199/1128; LOS 199/1826; Commands Transmitted - 1;
Ranging - N/A.

Deviations or Anomalies

1. CPS - 360/75 string exchange initiated because of inability to access any 480 devices. All five mission packs restored because of SRF errors. System was up and down numerous times from 1310 to 1732 (Ref. DRs 1814-1815).

Pass 50, July 18/19, 1971 (Day 199/200)

DSS 51 AOS 199/1725; LOS 200/0523; Commands Transmitted - 0;
Ranging - Mark IA.

Deviations or Anomalies

1. DSS - Station unable to acquire ranging code. Released from further ranging attempts.
2. CPS - 360/75 down from 2354 to 0107 because of 1052 I/O lockout. Attempted string exchange unsuccessful (Ref. DR 1816).

DSS 12 AOS 200/0428; LOS 200/1300; Commands Transmitted - 0;
Ranging - μ -R & D.

Deviations or Anomalies

1. CPS - 360/75 down from 1219 to 1228 to force R dump (Ref. DR 1818).

DSS 41 AOS 200/114; LOS 200/2226; Commands Transmitted - 1;
Ranging - N/A.

Deviations or Anomalies

None

Table 4 (contd)

Pass 51, July 19/20, 1971 (Day 200/201)

DSS 62 AOS 200/2126; LOS 201/0521; Commands Transmitted - 0;
Ranging - N/A.

Deviations or Anomalies

None

DSS 12 AOS 201/0431; LOS 201/1255; Commands Transmitted - 0;
Ranging - μ -R & D.

Deviations or Anomalies

None

DSS 41 AOS 201/1130; LOS 201/2221; Commands Transmitted - 1;
Ranging - N/A.

Deviations or Anomalies

None

Pass 52, July 20/21, 1971 (Day 201/202)

DSS 62 AOS 201/2120; LOS 202/0515; Commands Transmitted - 0;
Ranging - N/A.

Deviations or Anomalies

None

DSS 14 AOS 202/0501; LOS 202/1241; Commands Transmitted - 0;
Ranging - TAU-R & D.

Deviations or Anomalies

None

DSS 41 AOS 202/1120; LOS 202/2140; Commands Transmitted - 81;
Ranging - N/A.

Deviations or Anomalies

1. DSS - Antenna stopped moving in hour angle (HA) with no warning when prelimit cam slipped. Thirty-five minutes of scheduled track were lost (Ref. DR 1307).
-

Table 4 (contd)

Pass 53, July 21/22, 1971 (Day 202/203)

DSS 51 AOS 202/2118; LOS 203/0507; Commands Transmitted - 0;
Ranging - N/A.

Deviations or Anomalies

None

DSS 12 AOS 203/0412; LOS 203/1245; Commands Transmitted - 0;
Ranging - μ -R & D.

Deviations or Anomalies

1. DSS - Transmitter tripped off at 0733 because of focus magnet under-current. Back on at 0740 (Ref. DR 1309).

DSS 41 AOS 203/1144; LOS 203/1806; Commands Transmitted - 1;
Ranging - N/A.

Deviations or Anomalies

None

Pass 54, July 22/23, 1971 (Day 203/204)

DSS 51 AOS 203/1712; LOS 204/0503; Commands Transmitted - 0;
Ranging - N/A.

Deviations or Anomalies

1. CPS - 360/75 down from 2325 to 2339. Cause unknown (Ref. DR 1832).

DSS 12 AOS 204/0414; LOS 204/1240; Commands Transmitted - 0;
Ranging - μ -R & D.

Deviations or Anomalies

1. DSS - TCP program failed at 0719. Reloaded and back on line at 0723 (Ref. DR 1311).

DSS 41 AOS 204/1109; LOS 204/1801; Commands Transmitted - 1;
Ranging - N/A.

Deviations or Anomalies

1. SFOF - Power panel 2BC shorted out at 1519, resulting in power loss to 360/75 peripherals, on line CP and miscellaneous TTY machines. Power restored at 1529 (Ref. DR 544).
 2. GCF - CP back up at 1626 after several recoveries and a fresh system load (Ref. DR 2954).
 3. CPS - 360/75 back on line at 1623.
-

Table 4 (contd)

Pass 55, July 23/24, 1971 (Day 204/205)

DSS 51 AOS 204/1701; LOS 205/0457; Commands Transmitted - 0;
Ranging - N/A.

Deviations or Anomalies

1. CPS - 360/75 down for IPL from 2313 to 2319 because of I/O lockout (Ref. DR 1836).

DSS 12 AOS 205/0402; LOS 205/1235; Commands Transmitted - 0;
Ranging - μ -R & D.

Deviations or Anomalies

None

DSS 41 AOS 205/1102; LOS 205/1756; Commands Transmitted - 0;
Ranging - N/A.

Deviations or Anomalies

1. CPS - 360/75 down from 1303 to 1311 because of 3100 interface problems (Ref. DR 1818). 360/75 down from 1330 to 1336. IPL required (Ref. open DR 1818).
2. SFOF - Power failure from 1522 to 1554 caused loss of lights, TTY machines, and TV monitors (Ref. DR 548).

NOTE: The on-line 360/75 and 3100 were taken down at 1528 because of the power failure. A 360 system exchange was performed and the 360/75 was on line at 1615.

Pass 56, July 24/25, 1971 (Day 205/206)

DSS 51 AOS 205/1657; LOS 206/0452; Commands Transmitted - 0;
Ranging - N/A.

Deviations or Anomalies

None

DSS 12 AOS 206/0357; LOS 206/1230; Commands Transmitted - 3;
Ranging - N/A.

Deviations or Anomalies

None

DSS 14 AOS 206/0440; LOS 206/1223; Commands Transmitted - 0;
Ranging - N/A.

Deviations or Anomalies

None

NOTE: Spectrum Analysis Test

Table 4 (contd)

Pass 56, July 24/25, 1971 (Day 205/206) (cont'd)

DSS 41 AOS 206/1117; LOS 206/1751; Commands Transmitted - 1;
Ranging - N/A.

Deviations or Anomalies

1. CPS -360/75 down from 1546 to 1557 because of I/O lockout. IPL required (Ref. DR 1840).

Pass 57, July 25/26, 1971 (Day 206/207)

DSS 51 AOS 206/1651; LOS 207/0447; Commands Transmitted - 0;
Ranging - N/A.

Deviations or Anomalies

1. CPS - CDC 3100 down from 2032 to 2123 because of burned out disk on DTV driver (Ref. DR 1841). 360/75 locked out from 2055 to 2107 because of 3100 problem. System brought up minus DTV (Ref. DR 1842). 360/75 down from 2130 to 2149 because of I/O lockout (Ref. DR 1840).

DSS 12 AOS 207/0351; LOS 208/1226; Commands Transmitted - 0;
Ranging - μ -R & D.

Deviations or Anomalies

None

DSS 41 AOS 207/1121; LOS 207/2151; Commands Transmitted - 1;
Ranging - N/A.

Deviations or Anomalies

None

Pass 58, July 26/27, 1971 (Day 207/208)

DSS 62 AOS 207/2048; LOS 208/0443; Commands Transmitted - 0;
Ranging - N/A.

Deviations or Anomalies

None

DSS 12 AOS 208/0346; LOS 208/1221; Commands Transmitted - 0;
Ranging - μ -R & D.

Deviations or Anomalies

None

Table 4 (contd)

Pass 58, July 26/27, 1971 (Day 207/208) (cont'd)

DSS 41 AOS 208/1119; LOS 208/2146; Commands Transmitted - 1;
Ranging - N/A.

Deviations or Anomalies

1. CPS - 360/75 down from 1806 to 1818 because of I/O lockout (Ref. DR 1848).

Pass 59, July 27/28, 1971 (Day 208/209)

DSS 62 AOS 208/2045; LOS 209/0438; Commands Transmitted - 0;
Ranging - N/A.

Deviations or Anomalies

1. DSS - Transmitter power fluctuated between 9.3 kw and 10 kw (Ref. DR 1319). Transmitter tripped off from 0055 to 0058 because of arc detector and heat exchanger alarms (Ref. DR 1320).

DSS 12 AOS 209/0348; LOS 209/1216; Commands Transmitted - 0;
Ranging - μ -R & D.

Deviations or Anomalies

None

DSS 41 AOS 209/1111; LOS 209/2141; Commands Transmitted - 1;
Ranging - N/A.

Deviations or Anomalies

None

Pass 60, July 28/29, 1971 (Day 209/210)

DSS 62 AOS 209/2039; LOS 210/0432; Commands Transmitted - 0;
Ranging - N/A.

Deviations or Anomalies

None

DSS 12 AOS 210/0336; LOS 210/0959; Commands Transmitted - 0;
Ranging - μ -R & D.

Deviations or Anomalies

None

Table 4 (contd)

Pass 60, July 28/29, 1971 (Day 209/210) (cont'd)

DSS 41 AOS 210/0858; LOS 210/2136; Commands Transmitted - 1;
Ranging - N/A.

Deviations or Anomalies

None

Pass 61, July 29/30, 1971 (Day 210/211)

DSS 62 AOS 210/2033; LOS 211/0429; Commands Transmitted - 0;
Ranging - N/A.

Deviations or Anomalies

None

DSS 12 AOS 211/0330; LOS 211/0954; Commands Transmitted - 0;
Ranging - μ -R & D.

Deviations or Anomalies

None

DSS 41 AOS 211/0854; LOS 211/2131; Commands Transmitted - 1;
Ranging - N/A.

Deviations or Anomalies

None

Pass 62, July 30/31, 1971 (Day 211/212)

DSS 62 AOS 211/2028; LOS 212/0425; Commands Transmitted - 0;
Ranging - N/A.

Deviations or Anomalies

None

DSS 12 AOS 212/0325; LOS 212/1203; Commands Transmitted - 0;
Ranging - μ -R & D.

Deviations or Anomalies

None

Table 4 (contd)

Pass 62, July 30/31, 1971 (Day 211/212) (cont'd)

DSS 41 AOS 212/1052; LOS 212/2126; Commands Transmitted - 1;
Ranging - N/A.

Deviations or Anomalies

None

Pass 63, July 31/Aug 1, 1971 (Day 212/213)

DSS 62 AOS 212/2022; LOS 213/0424; Commands Transmitted - 0;
Ranging - N/A.

Deviations or Anomalies

Station transmitter turned off instead of command modulator due to operator error at 0045.

DSS 12 AOS 213/0323; LOS 213/1201; Commands Transmitted - 0;
Ranging - μ -R & D.

Deviations or Anomalies

None

DSS 41 AOS 213/1032; LOS 213/1716; Commands Transmitted - 0;
Ranging - N/A.

Deviations or Anomalies

None

Pass 64, Aug 1/2, 1971 (Day 213/214)

DSS 51 AOS 213/1616; LOS 214/0416; Commands Transmitted - 1;
Ranging - N/A.

Deviations or Anomalies

None

DSS 12 AOS 214/0319; LOS 214/1154; Commands Transmitted - 0;
Ranging - μ -R & D.

Deviations or Anomalies

None

DSS 41 AOS 214/1047; LOS 214/1712; Commands Transmitted - 0;
Ranging - N/A.

Deviations or Anomalies

None

Table 4 (contd)

Pass 65, Aug 2/3, 1971 (Day 214/215)

DSS 51 AOS 214/1612; LOS 215/0408; Commands Transmitted - 1;
Ranging - N/A.

Deviations or Anomalies

1. GCF - HSDL down from 1855 to 1914 (Ref. DR-3029).
2. CPS - 360/75 down from 0022 due to system multiplexer hangup until released at 0045 (Ref. DR-1880).

DSS 12 AOS 215/0311; LOS 215/1150; Commands Transmitted - 0;
Ranging - μ -R & D.

Deviations or Anomalies

None

DSS 41 AOS 215/1043; LOS 215/2112; Commands Transmitted - 1;
Ranging - N/A.

Deviations or Anomalies

None

Pass 66, Aug 3/4, 1971 (Day 215/216)

DSS 62 AOS 215/2011; LOS 216/0408; Commands Transmitted - 0;
Ranging - N/A.

Deviations or Anomalies

None

DSS 12 AOS 216/0305; LOS 216/1145; Commands Transmitted - 0;
Ranging - μ -R & D.

Deviations or Anomalies

Station suffered power loss on "U" buss due to generator failure from 0340 to 0347 (Ref. DR-1327).

DSS 41 AOS 216/1037; LOS 216/2102; Commands Transmitted - 1;
Ranging - N/A.

Deviations or Anomalies

None

Table 4 (contd)

Pass 67, Aug 4/5, 1971 (Day 216/217)

DSS 62 AOS 216/2004; LOS 217/0406; Commands Transmitted - 0;
Ranging - N/A.

Deviations or Anomalies

CPS - 360/75 down to force "R" dump from 2240 to 2251. Initial
program load required (Ref. DR-1886).

DSS 12 AOS 217/0259; LOS 217/1141; Commands Transmitted - 0;
Ranging - μ -R & D.

Deviations or Anomalies

None

DSS 41 AOS 217/1037; LOS 217/2057; Commands Transmitted 1;
Ranging - N/A.

Deviations or Anomalies

None

Pass 68, Aug 5/6, 1971 (Day 217/218)

DSS 62 AOS 217/1957; LOS 218/0402; Commands Transmitted - 0;
Ranging - N/A.

Deviations or Anomalies

None

DSS 14 AOS 218/0337; LOS 218/1129; Commands Transmitted - 0;
Ranging - TAU-R & D.

Deviations or Anomalies

None

DSS 41 AOS 218/1022; LOS 218/2058; Commands Transmitted - 1;
Ranging - N/A.

Deviations or Anomalies

None

Table 4 (contd)

Pass 69, Aug 6/7, 1971 (Day 218/219)

DSS 62 AOS 218/1953; LOS 219/0358; Commands Transmitted - 0;
Ranging - N/A.

Deviations or Anomalies

None

DSS 12 AOS 219/0250; LOS 219/1133; Commands Transmitted - 0;
Ranging - μ -R & D.

Deviations or Anomalies

None

DSS 41 AOS 219/0817; LOS 219/2055; Commands Transmitted - 1;
Ranging - N/A.

Deviations or Anomalies

CPS - 360/75 down from 1634 to 1656 for initial program loading due
to backloging and I/O lockout.

Pass 70, Aug 7/8, 1971 (Day 219/220)

DSS 51 AOS 219/1555; LOS 220/0346; Commands Transmitted - 0;
Ranging - N/A

Deviations or Anomalies

None

DSS 12 AOS 220/0246; LOS 220/0912; Commands Transmitted - 0;
Ranging - μ -R & D.

Deviations or Anomalies

None

DSS 41 AOS 220/0810; LOS 220/2049; Commands Transmitted - 1;
Ranging - N/A.

Deviations or Anomalies

None

Table 4 (contd)

Pass 71, Aug 8/9, 1971 (Day 220/221)

DSS 51 AOS 220/1949; LOS 221/0331; Commands Transmitted - 0;
Ranging - N/A.

Deviations or Anomalies

None

DSS 12 AOS 221/0240; LOS 221/0907; Commands Transmitted - 0;
Ranging - μ -R & D.

Deviations or Anomalies

Station transmitter tripped off from 0720 to 0734 (Ref. DR-1334).

DSS 41 AOS 221/0807; LOS 221/2045; Commands Transmitted - 1;
Ranging - N/A.

Deviations or Anomalies

CPS - 360/75 down from 1819 to 1826 (Ref. DR-1798). At 1938,
360/75 was loaded with Model III.

Pass 72, Aug 9/10, 1971 (Day 221/222)

DSS 62 AOS 221/1939; LOS 222/0335; Commands Transmitted - 0;
Ranging - N/A.

Deviations or Anomalies

None

DSS 12 AOS 222/0236; LOS 222/1121; Commands Transmitted - 0;
Ranging - μ -R & D.

Deviations or Anomalies

None

DSS 41 AOS 222/1016; LOS 222/2033; Commands Transmitted - 1;
Ranging - N/A.

Deviations or Anomalies

CPS - 360/75 down from 1812 to 1817 due to backlogging (Ref.
DR-1900).

Table 4 (contd)

Pass 73, Aug 10/11, 1971 (Day 222/223)

DSS 62 AOS 222/1935; LOS 223/0340; Commands Transmitted - 0;
Ranging - N/A.

Deviations or Anomalies

None

DSS 14 AOS 223/1004; LOS 223/1102; Commands Transmitted - 0;
Ranging - TAU-R & D.

Deviations or Anomalies

None

DSS 41 AOS 223/1004; LOS 223/2036; Commands Transmitted - 1;
Ranging - N/A.

Deviations or Anomalies

None

Pass 74, Aug 11/12, 1971 (Day 223/224)

DSS 62 AOS 223/1932; LOS 224/0337; Commands Transmitted - 0;
Ranging - N/A.

Deviations or Anomalies

None

DSS 12 AOS 224/0233; LOS 224/1113; Commands Transmitted - 0;
Ranging - μ -R & D.

Deviations or Anomalies

None

DSS 41 AOS 224/1005; LOS 224/2023; Commands Transmitted - 1;
Ranging - N/A.

Deviations or Anomalies

CPS - 360/75 down from 1644 to 1649 due to backloging (Ref.
DR-1913).

Table 4 (contd)

Pass 75, Aug 12/13, 1971 (Day 224/225)

DSS 62 AOS 224/1925; LOS 225/0332; Commands Transmitted - 0;
Ranging - N/A.

Deviations or Anomalies

None

DSS 12 AOS 225/0223; LOS 225/1110; Commands Transmitted - 0;
Ranging - μ -R & D.

Deviations or Anomalies

None

DSS 41 AOS 225/0952; LOS 225/1622; Commands Transmitted - 0;
Ranging - N/A.

Deviations or Anomalies

From 1510 to 1542 transmitter power fluctuated between 9 and 10 kw.
Cause unknown (Ref. DR-1346).

Pass 76, Aug 13/14, 1971 (Day 225/226)

DSS 51 AOS 225/1524; LOS 226/0320; Commands Transmitted - 1;
Ranging - N/A.

Deviations or Anomalies

1. GCF - HSDL down from 2001 to 2014 (Ref. DR-3110).
2. GCF - TTY circuits down from 0150 to 0210 (Ref. DR-3115).

DSS 12 AOS 226/0216; LOS 226/1106; Commands Transmitted - 0;
Ranging - μ -R & D.

Deviations or Anomalies

None

DSS 14 AOS 226/0258; LOS 226/1056; Commands Transmitted - 0
Ranging - TAU-R & D.

Deviations or Anomalies

None

DSS 41 AOS 226/1002; LOS 226/1620; Commands Transmitted - 0;
Ranging - N/A.

Deviations or Anomalies

None

Table 4 (contd)

Pass 77, Aug 14/15, 1971 (Day 226/227)

DSS 51 AOS 226/1559; LOS 227/0315; Commands Transmitted - 1;
Ranging - N/A.

Deviations or Anomalies

AOS was 41 minutes late due to suspect predict set (Ref. DR-1347).

DSS 12 AOS 227/0212; LOS 227/1102; Commands Transmitted - 0;
Ranging - μ -R & D.

Deviations or Anomalies

None

DSS 41 AOS 227/0948; LOS 227/2010; Commands Transmitted - 1;
Ranging - N/A.

Deviations or Anomalies

None

Pass 78, Aug 15/16, 1971 (Day 227/228)

DSS 62 AOS 227/1928; LOS 228/0321; Commands Transmitted - 0;
Ranging - N/A.

Deviations or Anomalies

None

DSS 12 AOS 228/0212; LOS 228/1058; Commands Transmitted - 0;
Ranging - μ -R & D.

Deviations or Anomalies

None

DSS 41 AOS 228/0952; LOS 228/2015; Commands Transmitted - 1;
Ranging - N/A.

Deviations or Anomalies

None

Table 4 (contd)

Pass 79, Aug 16/17, 1971 (Day 228/229)

DSS 62 AOS 228/1906; LOS 229/0318; Commands Transmitted - 0;
Ranging - N/A.

Deviations or Anomalies

None

DSS 12 AOS 229/0324; LOS 229/1055; Commands Transmitted - 0;
Ranging - μ -R & D.

Deviations or Anomalies

None

DSS 41 AOS 229/0733; LOS 229/2012; Commands Transmitted - 1;
Ranging - N/A.

Deviations or Anomalies

GCF - TTY circuits out from 1716 to 1740 due to Goddard CP problem
(Ref. DR-3134).

Pass 80, Aug 17/18, 1971 (Day 229/230)

DSS 51 AOS 229/1506; LOS 230/0258; Commands Transmitted - 0;
Ranging - N/A.

Deviations or Anomalies

None

DSS 12 AOS 230/0202; LOS 230/1051; Commands Transmitted - 0;
Ranging - μ -R & D.

Deviations or Anomalies

None

DSS 41 AOS 230/0951; LOS 230/2008; Commands Transmitted - 1;
Ranging - N/A.

Deviations or Anomalies

None

Table 4 (contd)

Pass 81, Aug 18/19, 1971 (Day 230/231)

DSS 51 AOS 230/1504; LOS 231/0259; Commands Transmitted - 0;
Ranging - N/A.

Deviations or Anomalies

CPS - 360/75 down from 1845 to 1853 due to I/O lockout (Ref. DR-1940), and from 2318 to 2326 due to DTV problem (Ref. DR-1941).

DSS 12 AOS 231/0158; LOS 231/0825; Commands Transmitted - 0;
Ranging - μ -R & D.

Deviations or Anomalies

None

DSS 41 AOS 231/0724; LOS 231/2003; Commands Transmitted - 1;
Ranging - N/A.

Deviations or Anomalies

CPS - 360/75 down from 1817 to 1826 due to backlog. Initial program loading required (Ref. DR-1744).

Pass 82, Aug 19/20, 1971 (Day 231/232)

DSS 62 AOS 231/1903; LOS 232/0307; Commands Transmitted - 0;
Ranging - N/A.

Deviations or Anomalies

None

DSS 14 AOS 232/0232; LOS 232/1035; Commands Transmitted - 0;
Ranging - TAU-R & D.

Deviations or Anomalies

1. CPS - 360/75 down from 0242 to 0302 due to backlog. Initial program loading required (Ref. DR-1941).
2. Station transmitter tripped off from 0624 to 0629 and from 0837 to 0911 due to heat exchanger interlock (Ref. DR-1359).

DSS 41 AOS 232/0934; LOS 232/1948; Commands Transmitted - 1;
Ranging - N/A.

Deviations or Anomalies

CPS - 360/75 down from 1803 to 1817 due to MSB pack (Ref. DR-1956).

Table 4 (contd)

Pass 83, Aug 20/21, 1971 (Day 232/233)

DSS 62 AOS 232/1849; LOS 233/0303; Commands Transmitted - 0;
Ranging - N/A.

Deviations or Anomalies

Station transmitter tripped off from 2102 to 2112 due to heat exchanger problem (Ref. DR-1361).

DSS 41 AOS 233/0717; LOS 233/1900; Commands Transmitted - 8;
Ranging - N/A.

Deviations or Anomalies

CPS - 360/75 down from 1556 to 1606 and from 1745 to 1750 due to tracking SDR tape problem (Ref. DR-1925).

Pass 84, Aug 21/22, 1971 (Day 233/234)

DSS 51 AOS 233/1455; LOS 234/0247; Commands Transmitted - 1;
Ranging - N/A.

Deviations or Anomalies

CPS - 360/75 down from 2320 to 2339 due to I/O lockout (Ref. DR-1876).

DSS 12 AOS 234/0145; LOS 234/0814; Commands Transmitted - 0;
Ranging - μ -R & D.

Deviations or Anomalies

Bad TDH VCO printout from 0141 to 0253 (Ref. DR-1363).

DSS 41 AOS 234/0713; LOS 234/1953; Commands Transmitted - 1;
Ranging - N/A.

Deviations or Anomalies

GCF - All TTY circuits out from 1927 to 1935 due to Goddard CP problem (Ref. DR-3167).

Table 4 (contd)

Pass 85, Aug 22/23, 1971 (Day 234/235)

DSS 51 AOS 234/1848; LOS 235/0236; Commands Transmitted - 0;
Ranging - N/A.

Deviations or Anomalies

None

DSS 12 AOS 235/0455; LOS 235/1035; Commands Transmitted - 0;
Ranging - μ -R & D.

Deviations or Anomalies

None

DSS 42 AOS 235/0900; LOS 235/1920; Commands Transmitted - 0;
Ranging - N/A.

Deviations or Anomalies

1. CPS - 360/75 down from 1753 to 1758 due to faulty tape unit (Ref. DR-1969).
2. CPS - 260/75 down from 1813 to 1820 due to excessive backlog (Ref. DR-1970).
3. Receiver out-of-lock from 1905 to 1911 due to receiver hitch (Ref. DR-01365).

Pass 86, Aug 23/24, 1971 (Day 235/236)

DSS 62 AOS 235/1836; LOS 236/0232; Commands Transmitted - 1;
Ranging - N/A.

Deviations or Anomalies

None

DSS 12 AOS 236/0138; LOS 236/1032; Commands Transmitted - 0;
Ranging - μ -R & D.

Deviations or Anomalies

None

DSS 42 AOS 236/0852; LOS 236/1916; Commands Transmitted - 0;
Ranging - N/A.

Deviations or Anomalies

1. CPS - 360/75 down from 1551 to 1605 due to excessive backlog (Ref. DR-1976).
 2. Command subsystem was RED throughout entire pass.
-

Table 4 (contd)

Pass 87, Aug 24/25, 1971 (Day 236/237)

DSS 62 AOS 236/1833; LOS 237/0228; Commands Transmitted - 0;
Ranging - N/A.

Deviations or Anomalies:

None

DSS 14 AOS 237/0218; LOS 237/1017; Commands Transmitted - 0;
Ranging - TAU-R & D.

Deviations or Anomalies

VCO field in TDH data was out of tolerance intermittently throughout most of pass (Ref. DR-0248).

DSS 41 AOS 237/0702; LOS 237/1941; Commands Transmitted - 1;
Ranging - N/A.

Deviations or Anomalies

1. Current overload alarm tripped transmitter off at 1203. Two-way mode regained at 1235 (Ref. DR-01367).
2. CPS - 360/75 down from 1517 to 1527 due to I/O lockouts (Ref. DR-1990) and from 1535 to 1607 due to failure of 1443 printer (Ref. DR-1990).

Pass 88, Aug 25/26, 1971 (Day 237/238)

DSS 62 AOS 237/1840; LOS 238/0249; Commands Transmitted - 0;
Ranging - N/A.

Deviations or Anomalies

None

DSS 14 AOS 238/0218; LOS 238/1017; Commands Transmitted - 0;
Ranging - TAU.

Deviations or Anomalies

None

DSS 41 AOS 238/0914; LOS 238/1531; Commands Transmitted - 0;
Ranging - N/A.

Deviations or Anomalies

None

Table 4 (contd)

Pass 89, Aug 26/27, 1971 (Day 238/239)

DSS 51 AOS 238/1433; LOS 239/0232; Commands Transmitted - 0;
Ranging - TAU.

Deviations or Anomalies

CPS - 360/75 down from 238/1925 to 238/1933 and again from 239/0111 to 239/0123 due to heavy backlog and 2260 devices being locked out on both occasions (Ref. DR-1997).

DSS 14 AOS 239/0200; LOS 239/1014; Commands Transmitted - 0;
Ranging - TAU.

Deviations or Anomalies

None

DSS 41 AOS 239/0910; LOS 239/1933; Commands Transmitted - 1;
Ranging - N/A.

Deviations or Anomalies

None

Pass 90, Aug 27/28, 1971 (Day 239/240)

DSS 51 AOS 239/1832; LOS 240/0215; Commands Transmitted - 0;
Ranging - N/A.

Deviations or Anomalies

None

DSS 12 AOS 240/0116; LOS 240/1019; Commands Transmitted - 0;
Ranging - μ -R & D.

Deviations or Anomalies

None

DSS 41 AOS 240/1007; LOS 240/1524; Commands Transmitted - 0;
Ranging - N/A.

Deviations or Anomalies

Repair of high-voltage relay in transmitter cause 48 minute delay in AOS (Ref. DR-01374).

Table 4 (contd)

Pass 91, Aug 28/29, 1971 (Day 240/241)

DSS 51 AOS 240/1424; LOS 241/0211; Commands Transmitted - 1;
Ranging - N/A.

Deviations or Anomalies

1. CPS - 360/75 support interrupted from 2116 to 2141 to load Model 4 System Program for on-line flight support checkout* and from 2335 to 2347 due to I/O lockouts.
2. From 241/0036 throughout remainder of pass, CPS - 360/75 support was terminated*

DSS 12 AOS 241/0155; LOS 241/1016; Commands Transmitted - 0;
Ranging - N/A.

Deviations or Anomalies

Station 44 minutes late in AOS due to transmitter problem and was in one-way tracking mode throughout entire pass (Ref. DR-01375).

DSS 41 AOS 241/0911; LOS 241/1926; Commands Transmitted - 1;
Ranging - N/A.

Deviations or Anomalies

None

Pass 92, Aug 29/30, 1971 (Day 241/242)

DSS 51 AOS 241/1815; LOS 242/0207; Commands Transmitted - 0;
Ranging - N/A.

Deviations or Anomalies

1. Average value of SNR was 1.3 db below that predicted for this pass (Ref. DR-0256).
2. CPS - 360/75 down from 1929 to 2009 due to problem in SOE generation (Ref. DR-2007).
3. CPS - 360/75 down from 2014 to 2020 due to Model 3 tape being read into Model 2 system (Ref. DR-2008).

DSS 12 AOS 242/0109; LOS 242/0900; Commands Transmitted - 0;
Ranging - μ -R & D.

Deviations or Anomalies

None

*with Project concurrence

Table 4 (contd)

Pass 92, Aug 29/30, 1971 (Day 241/242) (cont'd)

DSS 41 AOS 242/0756; LOS 242/1907; Commands Transmitted - 1;
Ranging - N/A.

Deviations or Anomalies

GCF - High-speed data interrupted from 1632 to 1642. Cause unknown (Ref. DR-3238).

Pass 93, Aug 30/31, 1971 (Day 242/243)

DSS 62 AOS 242/1820; LOS 243/0223; Commands Transmitted - 0;
Ranging - N/A.

Deviations or Anomalies

1. CPS - 360/75 down from 1955 to 2004 due to 1052 lockout probably caused SOE run (Ref. DR-1876).
2. CPS - 360/75 down from 2032 to 2056 due to select lock on disc module (Ref. DR-2013).

DSS 14 AOS 243/0145; LOS 243/1001; Commands Transmitted - 0;
Ranging - TAU.

Deviations or Anomalies

None

DSS 41 AOS 243/0858; LOS 243/1919; Commands Transmitted - 1;
Ranging - N/A.

Deviations or Anomalies

CPS - 360/75 down from 1724 to 1732 due to Printer lockout (Ref. DR-2016).

Pass 94, Aug 31/Sept 1, 1971 (Day 243/244)

DSS 62 AOS 243/1805; LOS 244/0234; Commands Transmitted - 0;
Ranging - N/A.

Deviations or Anomalies

CPS - 360/75 down from 0103 to 0117 due to abnormal ending (Ref. DR-2017). Restart required.

Table 4 (contd)

Pass 94, Aug 31/Sept 1, 1971 (Day 243/244) (cont'd)

DSS 12 AOS 244/0125; LOS 244/1008; Commands Transmitted - 0;
Ranging - μ .

Deviations or Anomalies

None

DSS 42 AOS 244/0841; LOS 244/1510; Commands Transmitted - 0;
Ranging - N/A.

Deviations or Anomalies

None

Pass 95, Sept 1/Sept 2, 1971 (Day 244/245)

DSS 51 AOS 244/1411; LOS 245/0208; Commands Transmitted - 1;
Ranging - N/A.

Deviations or Anomalies

None

DSS 12 AOS 245/0108; LOS 245/0734; Commands Transmitted - 0;
Ranging - μ .

Deviations or Anomalies

None

DSS 42 AOS 245/0634; LOS 245/1842; Commands Transmitted - 1;
Ranging - N/A.

Deviations or Anomalies

TWM No. 1 tripped off uplink outage from 1650 until 1700 while reconfiguring to TWM No. 2 (Ref. DR-1384).

Pass 96, Sept 2/3, 1971 (Day 245/246)

DSS 51 AOS 245/1810; LOS 246/0205; Commands Transmitted - 0;
Ranging - N/A.

Deviations or Anomalies

1. CPS - 360/75 down from 1757 until 1822 to abnormal ending of real time spool. Restart required (Ref. DR-1876).
 2. CPS - 360/75 down from 1834 until 1845 due to standard recovery failure.
-

Table 4 (contd)

Pass 96, Sept 2/3, 1971 (Day 245/246) (cont'd)

DSS 12 AOS 246/0105; LOS 246/0634; Commands Transmitted - 0;
Ranging - μ .

Deviations or Anomalies

None

DSS 42 AOS 246/0600; LOS 246/1845; Commands Transmitted - 0;
Ranging - N/A.

Deviations or Anomalies

None

Pass 97, Sept 3/4, 1971 (Day 246/247)

DSS 62 AOS 246/1758; LOS 247/0222; Commands Transmitted - 1;
Ranging - N/A.

Deviations or Anomalies

1. CPS - 360/75 down from 2026 until 2042 because MEDs could not be entered. Restart required (Ref. DR-2048).
2. CPS - 360/75 down from 2122 until 2211 due to bad Comgen run. Restart required (Ref. DR-2048).
3. CPS - 360/75 down from 2215 until 2231 due to 2260 lockout (Ref. DR-2048).
4. CPS -360/75 down from 2254 until 2310 due to 2260 lockout (Ref. DR-2048).

DSS 12 AOS 247/0120; LOS 247/1000; Commands Transmitted - 0;
Ranging - μ .

Deviations or Anomalies

None

DSS 41 AOS 247/0851; LOS 247/1500; Commands Transmitted - 0;
Ranging - N/A.

Deviations or Anomalies

None

Pass 98, Sept 4/5, 1971 (Day 247/248)

DSS 51 AOS 247/1407; LOS 248/0158; Commands Transmitted - 1;
Ranging - N/A.

Deviations or Anomalies

1. CPS - 360/75 down from 1820 until 1835 due to Pseudo-Resid program abnormal ending. Bad disc discovered when attempting to bring system back up. IPL required (Ref. DR-2053).
2. CPS - 360/75 down from 2047 until 2058 due to damaged disc drive. Restart required (Ref. DR-2056).
3. Lost receiver lock from 0043 until 0053 because antenna drove off spacecraft (Ref. DR-1389).

DSS 12 AOS 248/0050; LOS 248/0725; Commands Transmitted - 0;
Ranging - μ .

Deviations or Anomalies

None

DSS 41 AOS 248/0624; LOS 248/1457; Commands Transmitted - 0;
Ranging - N/A.

Deviations or Anomalies

None

Pass 99, Sept 5/6, 1971 (Day 248/249)

DSS 51 AOS 248/1357; LOS 249/0155; Commands Transmitted - 1;
Ranging - N/A.

Deviations or Anomalies

CPS - 360/75 down from 1500 until 0100 because of timing problem
(Ref. DR-2059).

DSS 12 AOS 249/0053; LOS 249/0954; Commands Transmitted - 0;
Ranging - μ .

Deviations or Anomalies

None

DSS 42 AOS 249/0849; LOS 249/1835; Commands Transmitted - 1;
Ranging - N/A.

Deviations or Anomalies

None

Table 4 (contd)

Pass 100, Sept 6/7, 1971 (Day 249/250)

DSS 51 AOS 249/1728; LOS 250/0136; Commands Transmitted - 0;
Ranging - N/A.

Deviations or Anomalies

1. CPS - 360/75 down from 1907 until 1920 due to bad TLM format request. IPL required (Ref. DR-2062).
2. CPS - 360/75 down from 2033 until 2111 due to hardware problems. Switched to backup (Ref. DR-2063).
3. CPS - 360/75 down from 2217 until 2227 due to all 2260s locked out. Restart required (Ref. DR-2064).

DSS 12 AOS 250/0041; LOS 250/0954; Commands Transmitted - 0;
Ranging - μ .

Deviations or Anomalies

None

DSS 41 AOS 250/0833; LOS 250/1857; Commands Transmitted - 1;
Ranging - N/A.

Deviations or Anomalies

CPS - 360/75 down from 1729 until 1745 due to backlog problem caused by SOE program (Ref. DR-2068).

Pass 101, Sept 7/8, 1971 (Day 250/251)

DSS 62 AOS 250/1757; LOS 251/0213; Commands Transmitted - 0;
Ranging - N/A.

Deviations or Anomalies

1. CPS - 360/75 down from 1933 until 2040 due to invalid DTV data. Took system down for restart at 2016 after discovering bad Gould 4800 hard copies (Ref. DR-2069).
 2. CPS - 360/75 down from 2251 until 2259 due to heavy backlog on TLM processor (Ref. DR-2070).
 3. CPS - 360/75 down from 2326 until 2338 due to 1052 lockout. Restart required (Ref. DR-2070).
 4. CPS - 360/75 down from 2342 until 0048 due to no DTV output. At 2347 real time spool began abnormal ending. System back on line after IPL (Ref. DR-2070).
-

Table 4 (contd)

Pass 101, Sept 7/8, 1971 (Day 250/251) (cont'd)

DSS 41 AOS 251/0616; LOS 251/1834; Commands Transmitted - 1;
Ranging - N/A.

Deviations or Anomalies

1. CPS - 360/75 down from 1222 until 1252 due to 2260 lockout. IPL required (Ref. DR-2071).
2. CPS - 360/75 down from 1808 until 1824 due to 1052 lockout. IPL required (Ref. DR-2071).

Pass 102, Sept 8/9, 1971 (Day 251/252)

DSS 62 AOS 251/1739; LOS 252/0211; Commands Transmitted - 0;
Ranging - N/A.

Deviations or Anomalies

1. CPS - High speed data outage from 2013 until 2024 due to faulty synchronizer. Switched to alternate (Ref. DR-2072).
2. GCF - High speed data outage from 0154 to 0205 due to station power failure (Ref. DR-3316).

DSS 12 AOS 252/0109; LOS 252/0949; Commands Transmitted - 0;
Ranging - μ .

Deviations or Anomalies

CPS - 360/75 down from 0535 until 0601 due to 1052 lockout. IPL required (Ref. DR-2071).

DSS 41 AOS 252/0837; LOS 252/1850; Commands Transmitted - 1;
Ranging - N/A.

Deviations or Anomalies

CPS - 360/75 down from 1813 until 1831 due to background jobs inhibiting real-time job step. IPL required (Ref. DR-2078).

Pass 103, Sept 9/10, 1971 (Day 252/253)

DSS 62 AOS 252/1750; LOS 253/0200; Commands Transmitted - 0;
Ranging - N/A.

Deviations or Anomalies

None

Table 4 (contd)

Pass 103, Sept 9/10, 1971 (Day 252/253) (cont'd)

DSS 12 AOS 253/0115; LOS 253/0709; Commands Transmitted - 0;
Ranging - μ .

Deviations or Anomalies

CPS - 360/75 down from 0250 until 0337 because DTV format stopped updating and 2260 lockout. Cancelled real-time data because of abnormal endings. IPL required (Ref. DR-2045).

DSS 41 AOS 253/0611; LOS 253/1442; Commands Transmitted - 0;
Ranging - N/A.

Deviations or Anomalies

None

Pass 104, Sept 10/11, 1971 (Day 253/254)

DSS 51 AOS 253/1343; LOS 254/0139; Commands Transmitted - 1;
Ranging - N/A.

Deviations or Anomalies

1. CPS - 360/75 down from 1954 until 2005 due to 1052 lockout. IPL required (Ref. DR-2071).
2. CPS - 360/75 down from 0013 until 0057 due to 1052 lockout. IPL required (Ref. DR-2068).
3. Receiver No. 1 and No. 2 doppler extractor gave wrong D2 and D3 readings. Replaced faulty frequency shifter (Ref. DR-1394).

DSS 12 AOS 254/0039; LOS 254/0706; Commands Transmitted - 0;
Ranging - μ .

Deviations or Anomalies

1. CPS - 360/75 down from 0039 until 0057 due to 1052 lockout. IPL required (Ref. DR-2068).
2. Station TCP down from 0219 until 0243 (Ref. DR-1368).
3. Station transmitter out from 0419 until 0435 (Ref. DR-1403).
4. Station Phase IV TCP-AGC voltage readout varied from 0228 until 0706 (Ref. DR-1396).

DSS 41 AOS 254/0606; LOS 254/1844; Commands Transmitted - 1;
Ranging - N/A.

Deviations or Anomalies

CPS - 360/75 down from 1759 until LOS at 1844 due to DTV update problems. IPL required (Ref. DR-2086).

Table 4 (contd)

Pass 105, Sept 11/12, 1971 (Day 254/255)

DSS 62 AOS 254/1744; LOS 255/0118; Commands Transmitted - 0;
Ranging - N/A.

Deviations or Anomalies

1. CPS - 360/75 down from 1759 until 1908 and from 1912 until 1926 due to DTV problems (Ref. DR-2086).
2. CPS - 360/75 down from 2017 until 2038 because unable to access card reader (Ref. DR-2086).

DSS 12 AOS 255/0032; LOS 255/0940; Commands Transmitted - 0;
Ranging - μ .

Deviations or Anomalies

None

DSS 41 AOS 255/0839; LOS 255/1841; Commands Transmitted - 1;
Ranging - N/A.

Deviations or Anomalies

None

Pass 106, Sept 12/13, 1971 (Day 255/256)

DSS 51 AOS 255/1738; LOS 256/0134; Commands Transmitted - 0;
Ranging - N/A.

Deviations or Anomalies

Station indicated error of 0.2 degree in HA and DEC angles
(Ref. TFR-50340).

DSS 12 AOS 256/0030; LOS 256/0700; Commands Transmitted - 0;
Ranging - N/A.

Deviations or Anomalies

None

DSS 42 AOS 256/0600; LOS 256/1806; Commands Transmitted - 1;
Ranging - N/A.

Deviations or Anomalies

None

Table 4 (contd)

Pass 107, Sept 13/14, 1971 (Day 256/257)

DSS 51 AOS 256/1658; LOS 257/0131; Commands Transmitted - 1;
Ranging - N/A.

Deviations or Anomalies

None

DSS 12 AOS 257/0031; LOS 257/0555; Commands Transmitted - 0;
Ranging - N/A.

Deviations or Anomalies

None

DSS 42 AOS 257/0506; LOS 257/1802; Commands Transmitted - 1;
Ranging - N/A.

Deviations or Anomalies

None

Pass 108, Sept 14/15, 1971 (Day 257/258)

DSS 51 AOS 257/1719; LOS 257/2316; Commands Transmitted - 0;
Ranging - N/A.

Deviations or Anomalies

1. CPS - 360/75 down from 1915 until 1924 due to Comgen run. IPL required (Ref. DR-2105).
2. CPS - 360/75 down from 2041 until 2046 due to I/Os locked out. Restart required (Ref. DR-2106).
3. Station had early LOS (2316 instead of 0128) due to failure of servo power supply.

DSS 12 AOS 258/0012; LOS 258/0654; Commands Transmitted - 0;
Ranging - N/A.

Deviations or Anomalies

1. CPS - 360/75 down from 0406 until 0422 due to heavy backlog (Ref. DR-2068).
2. CPS - 360/75 down from 0452 until 0504 due to 2260 lockout (Ref. DR-2068).

DSS 41 AOS 258/0554; LOS 258/1427; Commands Transmitted - 0;
Ranging - N/A.

Deviations or Anomalies

None.

Table 4 (contd)

Pass 109, Sept 15/16, 1971 (Day 258/259)

DSS 51 AOS 258/1332; LOS 259/0125; Commands Transmitted - 1;
Ranging - N/A.

Deviations or Anomalies

CPS - 360/75 down for restart due to DTV format problems (Ref. DR-2112).

DSS 12 AOS 259/0026; LOS 259/0651; Commands Transmitted - 0;
Ranging - N/A.

Deviations or Anomalies

None

DSS 41 AOS 259/0551; LOS 259/1831; Commands Transmitted - 1;
Ranging - N/A.

Deviations or Anomalies

None

Pass 110, Sept 16/17, 1971 (Day 259/260)

DSS 51 AOS 259/1729; LOS 260/0100; Commands Transmitted - 0;
Ranging - N/A.

Deviations or Anomalies

CPS - 360/75 down from 2026 until 2033 and again from 2139 until 2150 due to core problems (Ref. DR-2086).

DSS 12 AOS 260/0005; LOS 260/0929; Commands Transmitted - 0;
Ranging - N/A.

Deviations or Anomalies

None

DSS 41 AOS 260/0831; LOS 260/1804; Commands Transmitted - 1;
Ranging - N/A.

Deviations or Anomalies

1. GCF - Low speed data lost from 1337 until 1348. Suspected cause is Canberra CP (Ref. DR-3377).
 2. CPS - 360/75 down from 1702 until 1718 due to abnormal endings (Ref. DR-2119).
-

Table 4 (contd)

Pass 111, Sept 17/18, 1971 (Day 260/261)

DSS 62 AOS 260/1706; LOS 261/0144; Commands Transmitted - 0;
Ranging - N/A.

Deviations or Anomalies

1. CPS - 360/75 down from 1706 until 1718 due to abnormal endings (Ref. DR-2119).
2. CPS - 360/75 down from 2014 until 2028 due to backlog (Ref. DR-2086).
3. CPS - 360/75 down from 2217 until 2238 due to SOE problems (Ref. DR-2124).

DSS 41 AOS 261/0544; LOS 261/1824; Commands Transmitted - 1;
Ranging - N/A.

Deviations or Anomalies

None

Pass 112, Sept 18/19, 1971 (Day 261/262)

DSS 62 AOS 261/1724; LOS 262/0147; Commands Transmitted - 0;
Ranging - N/A.

Deviations or Anomalies

Station transmitter down from 2110 until 2115 due to beam volt alarm (Ref. DR-1408).

DSS 12 AOS 262/0101; LOS 262/0643; Commands Transmitted - 0;
Ranging - N/A.

Deviations or Anomalies

None

DSS 41 AOS 262/0541; LOS 262/1416; Commands Transmitted - 0;
Ranging - N/A.

Deviations or Anomalies

None

Table 4 (contd)

Pass 113, Sept 19/20, 1971 (Day 262/263)

DSS 51 AOS 262/1316; LOS 263/0051; Commands Transmitted - 0;
Ranging - N/A.

Deviations or Anomalies

1. Telemetry SNR average was -2.5 dB below predicts for pass. No appreciable improvement with change of data stream (Ref. DR-0280).
2. CPS - 360/75 down from 1922 until 1928, 2041 until 2044, and from 2051 until 2101 due to heavy backlog. Restart required each time (Ref. DR-2126 and DR-2128).

DSS 12 AOS 262/2354; LOS 263/0922; Commands Transmitted - 0;
Ranging - N/A.

Deviations or Anomalies

None

DSS 42 AOS 263/0810; LOS 263/1742; Commands Transmitted - 0;
Ranging - N/A.

Deviations or Anomalies

None

Pass 114, Sept 20/21, 1971 (Day 263/264)

DSS 62 AOS 263/1653; LOS 264/0143; Commands Transmitted - 1;
Ranging - N/A.

Deviations or Anomalies

1. CPS - 360/75 down from 1857 until 1922 due to heavy backlog and 2260s and 1052s locked out. IPL required (Ref. DR-2131).
2. CPS - 360/75 down from 2217 until 2223 due to abnormal ending of disc pack (Ref. DR-2132).

DSS 12 AOS 264/0043; LOS 264/0548; Commands Transmitted - 0;
Ranging - N/A.

Deviations or Anomalies

None

DSS 42 AOS 264/0452; LOS 264/1740; Commands Transmitted - 0;
Ranging - N/A.

Deviations or Anomalies

1. Station late for AOS due to mismatch in TCP (Ref. DR-1410).
2. GCF - Lost low speed data from 0557 until 0603 due to Canberra line problem.

Table 4 (contd)

Pass 114, Sept 20/21, 1971 (Day 263/264) (cont'd)

3. Station unable to access TCP Alpha computer due to loss of I/O console. Changed to TCP 'B' computer at 1527 (Ref. DR-1382).

Pass 115, Sept 21/22, 1971 (Day 264/265)

DSS 62 AOS 264/1653; LOS 265/0120; Commands Transmitted - 1;
Ranging - N/A.

Deviations or Anomalies

1. CPS - 360/75 down from 1855 until 1913 due to 2260 lockout. Restart required (Ref. DR-2136).
2. CPS - 360/75 down from 2048 until 2108 due to 1052 console lockout (Ref. DR-2137).

DSS 12 AOS 265/0100; LOS 265/0652; Commands Transmitted - 0;
Ranging - N/A.

Deviations or Anomalies

None

DSS 41 AOS 265/0535; LOS 265/1407; Commands Transmitted - 0;
Ranging - N/A.

Deviations or Anomalies

1. CPS - 360/75 down from 0607 until 0619. IPL required.
2. CPS - 360/75 down from 0850 until 0857 due to 2260 lockout (Ref. DR-2128).
3. CPS - 360/75 down from 1249 until 1307. Restart required (Ref. DR-2131).

Pass 116, Sept 22/23, 1971 (Day 265/266)

DSS 51 AOS 265/1307; LOS 266/0107; Commands Transmitted - 1;
Ranging - N/A.

Deviations or Anomalies

1. CPS - 360/75 down from 1249 until 1307 for restart (Ref. DR-2131).
 2. CPS - 360/75 down from 1615 until 1624 and from 1719 until 1729 due to bad Comgen run. Restart required (Ref. DR-2142).
 3. CPS - 360/75 down from 1644 until 1710. Unable to accept commands. IPL required (Ref. DR-2143).
 4. CPS - 360/75 down due to heavy backlog (Ref. DR-2142).
-

Table 4 (contd)

Pass 116, Sept 22/23, 1971 (Day 265/266) (cont'd)

DSS 12 AOS 266/0015; LOS 266/0632; Commands Transmitted - 0;
Ranging - N/A.

Deviations or Anomalies

None

DSS 41 AOS 266/0531; LOS 266/1811; Commands Transmitted - 0;
Ranging - N/A.

Deviations or Anomalies

1. CPS - 360/75 operator locked out of 1052 console from 1248 until 1309.
2. CPS - 360/75 down from 1430 until 1439 due to 2260 and 1052s being locked out of system. IPL required (Ref. DR-2137).

Pass 117, Sept 23/24, 1971 (Day 266/267)

DSS 62 AOS 266/1712; LOS 267/0038; Commands Transmitted - 0;
Ranging - N/A.

Deviations or Anomalies

1. CPS - 360/75 down during following times for unknown causes (Ref. DR-2150):
 - (a) 1759 until 1829
 - (b) 1848 until 1919
 - (c) 1931 until 2021
 - (d) 2057 until 2126
 - (e) 2134 until 2203
 - (f) 2204 until 2225
2. Station TDH punch No. 2 failed due to heavy matrix jam (Ref. DR-1417).
3. CPS - 360/75 down from 1736 until 1757 due to DTV format 106 problems (Ref. DR-2149).
4. CPS - 3100 down from 2240 until 2254 due to unknown causes.

DSS 12 AOS 266/2340; LOS 267/0914; Commands Transmitted - 0;
Ranging - N/A.

Deviations or Anomalies

None

Table 4 (contd)

Pass 117, Sept 23/24, 1971 (Day 266/267) (cont'd)

DSS 41 AOS 267/0811; LOS 267/1738; Commands Transmitted - 0;
Ranging - N/A.

Deviations or Anomalies

1. CPS - 360/75 down during following times:
 - (a) 0850 until 0930
 - (b) 1128 until 1134
 - (c) 1251 until 1432No DRs written.
2. CPS - 360/75 down from 1547 to 1600 due to switching software versions.

Pass 118, Sept 24/25, 1971 (Day 267/268)

DSS 62 AOS 267/1640; LOS 268/0134; Commands Transmitted - 0;
Ranging - N/A.

Deviations or Anomalies

1. CPS - 360/75 down during following times due to system recovery failures (Ref. DR-2155):
 - (a) 1914 until 1919
 - (b) 1921 until 1930
 - (c) 1933 until 1944
 - (d) 2157 until 2248
2. CPS - 360/75 down from 2104 until 2124 due to unknown cause (Ref. DR-2150).

DSS 14 AOS 268/0014; LOS 268/0901; Commands Transmitted - 1;
Ranging - N/A.

Deviations or Anomalies

1. Station lost TCP tape data from 0108 until 0121. Reloaded program (Ref. DR-1421).
2. Station lost TDH data from 0600 until 1615. Both punches were stopped for trouble shooting on approval from TRACK (Ref. DR-1422).

DSS 41 AOS 268/0754; LOS 268/1805; Commands Transmitted - 0;
Ranging - N/A.

Deviations or Anomalies

None

Table 4 (contd)

Pass 119, Sept 25/26, 1971 (Day 268/269)

DSS 51 AOS 268/1705; LOS 269/0032; Commands Transmitted - 0;
Ranging - N/A.

Deviations or Anomalies

1. CPS - 360/75 down from 1819 until 1832 due to unknown cause. IPL required (Ref. DR-2160).
2. CPS - 360/75 down from 2239 to 2308 due to poor telemetry processing. IPL required (Ref. DR-2161).

DSS 12 AOS 268/2333; LOS 269/0910; Commands Transmitted - 0;
Ranging - N/A.

Deviations or Anomalies

None

DSS 41 AOS 269/0802; LOS 268/1357; Commands Transmitted - 0;
Ranging - N/A.

Deviations or Anomalies

None

Pass 120, Sept 26/27, 1971 (Day 269/270)

DSS 51 AOS 269/1301; LOS 270/0055; Commands Transmitted - 0;
Ranging - N/A.

Deviations or Anomalies

Station had dec angle pointing error (Ref. DR-1425) and transmitter down from 2314 until LOS due to power supply failure (Ref. DR-1426).

DSS 12 AOS 269/2330; LOS 270/0621; Commands Transmitted - 0;
Ranging - N/A.

Deviations or Anomalies

Station had early AOS due to transmitter problem at DSS 51.

DSS 41 AOS 270/0520; LOS 270/1727; Commands Transmitted;
Ranging - N/A.

Deviations or Anomalies

Station lost all data from 0812 until 0852 due to power failure (Ref. DR-1427).

Table 4 (contd)

Pass 121, Sept 27/28, 1971 (Day 270/271)

DSS 62 AOS 270/1631; LOS 271/0026; Commands Transmitted - 33;
Ranging - N/A.

Deviations or Anomalies

Garbled command confirmation messages received. Cause unknown (Ref. DR-018).

DSS 12 AOS 270/2327; LOS 271/0906; Commands Transmitted - 173;
Ranging - N/A.

Deviations or Anomalies

1. CPS - 360/75 down from 0038 until 0047 due to core fragmentation. Restart required.
2. CPS - 360/75 down from 0809 until 0827 due to abnormal endings. Real-time jobs cancelled. IPL required (Ref. DR-2169).

DSS 14 AOS 271/0015; LOS 271/0855; Commands Transmitted - 0;
Ranging - N/A.

Deviations or Anomalies

Tape stoppage at station from 0116 until 0126. Reload required (Ref. DR-1428).

DSS 41 AOS 271/0857; LOS 271/1724; Commands Transmitted - 14;
Ranging - N/A.

Deviations or Anomalies

1. CPS - 360/75 down from 1035 until 1054. IPL required (Ref. DR-2170).
2. CPS - 360/75 down from 1138 until 1142. NAT TRACK tried to write SDR and tape drive hung up. Real-time job cancelled. Restart required (Ref. DR-2171).

Pass 122, Sept 28/29, 1971 (Day 271/272)

DSS 62 AOS 271/1625; LOS 272/0015; Commands Transmitted - 0;
Ranging - N/A.

Deviations or Anomalies

CPS - 360/75 down from 1718 until 1732 due to unknown cause (Ref. DR-2175).

DSS 12 AOS 271/2321; LOS 272/0902; Commands Transmitted - 0;
Ranging - N/A.

Deviations or Anomalies

None

Table 4 (contd)

Pass 122, Sept 28/29, 1971 (Day 271/272) (cont'd)

DSS 14 AOS 272/0001; LOS 272/0845; Commands Transmitted - 0;
Ranging - N/A.

Deviations or Anomalies

None

DSS 41 AOS 272/0748; LOS 272/1720; Commands Transmitted - 0;
Ranging - N/A.

Deviations or Anomalies

1. CPS - 360/75 down from 1515 until 1523 due to predict problems. Real-time job cancelled (Ref. DR-2179).
2. CPS - 360/75 down from 1712 until LOS due to heavy backlog. IPL required (Ref. DR-2181).
3. CPS - 360/75 down due to TCP core fragmentation. No DR written.

Pass 123, Sept 29/30, 1971 (Day 272/273)

DSS 62 AOS 272/1620; LOS 273/0019; Commands Transmitted - 0;
Ranging - N/A.

Deviations or Anomalies

1. CPS - 360/75 down from 1942 until 1954 and from 1958 until 2006 due to heavy backlog. Switched disc packs. IPL required (Ref. DR-2181).
2. CPS - 360/75 down from 2246 until 2301 due to 2260s locked out (Ref. DR-2182).

DSS 41 AOS 273/0752; LOS 273/1717; Commands Transmitted - 0;
Ranging - N/A.

Deviations or Anomalies

CPS - 360/75 down from 1611 until 1616, 1649 until 1705, 1712 until 1721 due to bad loads. IPL required each time (Ref. DR-2186).

Pass 124, Sept 30/Oct 1, 1971 (Day 273/274)

Configuration Codes: DSIF - L000/B000/D000/G000; GCF - S40L/S40B/S40D/S40G; SFOF - T012.

DSS 62 AOS 273/1627; LOS 274/0123; Commands Transmitted 32; Ranging N/A.

Deviations or Anomalies

1. CPS - 360/75 down from 1649 to 1705 for disc pack change.
 2. CPS - 360/75 down from 1712 to 1721 for bad system load. IPL required (Ref. DR-2186).
-

Table 4 (contd)

Pass 124, Sept 30/Oct 1, 1971 (Day 273/274) (cont' d)

DSS 12 AOS 273/2318; LOS 274/0905; Commands Transmitted 17; Ranging N/A.

Deviations or Anomalies

1. CPS - 360/75 down from 0729 to 0743 due to 1052s and 2260s locked out. IPL required (Ref. DR-2191).
2. DSS - TCP "A" telemetry data lost from 0225 to 0238 due to program failure during computer entry for bit synch lock indicator threshold change (Ref. DR-1435).

DSS 14 AOS 274/0001; LOS 274/0035; Commands Transmitted 0; Ranging N/A.

Deviations or Anomalies

Short track due to schedule commitments by Track Chief.

DSS 42 AOS 274/0819; LOS 274/1315; Commands Transmitted 0; Ranging N/A.

Deviations or Anomalies

1. DSS - Loss of 2 way until 0906. No explanation (Ref. DR-1436).
2. DSS - No science data (50 BPS) due to SSA. Cause under investigation (Ref. DR-1437).

Pass 125, Oct 1/2, 1971 (Day 274/275)

DSS 51 AOS 274/1244; LOS 274/1714; Commands Transmitted 0; Ranging N/A.

Deviations or Anomalies

None

DSS 62 AOS 274/1616; LOS 275/0121; Commands Transmitted 39; Ranging N/A.

Deviations or Anomalies

1. CPS - 360/75 down from 1857 to 1902 due to problems with predicts. IPL required (Ref. DR-2196).

DSS 12 AOS 274/2315; LOS 275/0902; Commands Transmitted 26; Ranging N/A.

Deviations or Anomalies

1. CPS - 360/75 down 0246 to 0259, due to backlog. IPL required with disc pack swap (Ref. DR-2197).
 2. CPS - 3100 down due to procedural outage. (No DR).
 3. CPS - 360/75 down 0727 to 0732 for restart due to backlog (Ref. DR-2198).
-

Table 4 (contd)

Pass 125, Oct 1/2, 1971 (Day 274/275) (cont' d)

DSS 14 AOS 274/2353; LOS 275/0848; Commands Transmitted 0; Ranging N/A.

Deviations or Anomalies

1. CPS - 360/75 down 0249 to 0259. IPL required (Ref. DR-2199).
2. CPS - 3100 down (No DR).

Pass 126, Oct 2/3, 1971 (Day 275/276)

Configuration Codes: DSIF - J000/D000/G000; GCF - S40J/S40D/S40G;
SFOF - T012

DSS 51 AOS 275/1242; LOS 276/0040; Commands Transmitted 33; Ranging N/A.

Deviations or Anomalies

1. CPS - 360/75 down 0007 to 0014 due to 1052 consoles locked out. IPL required (Ref. DR-2159).

DSS 14 AOS 275/0130; LOS 276/0846; Commands Transmitted 0; Ranging Tau.

Deviations or Anomalies

None

DSS 42 AOS 276/0713; LOS 276/1346; Commands Transmitted 0; Ranging N/A.

Deviations or Anomalies

None

Pass 127, Oct 3/4, 1971 (Day 276/277)

DSS 51 AOS 276/1239; LOS 277/0037; Commands Transmitted 1; Ranging N/A.

Deviations or Anomalies

None

DSS 12 AOS 276/2325; LOS 277/0856; Commands Transmitted 0; Ranging N/A.

Deviations or Anomalies

None

DSS 41 AOS 277/0503; LOS 277/1743; Commands Transmitted 0; Ranging N/A.

Deviations or Anomalies

1. CPS - 360/75 down from 1559 to 1613 for restart. Forced "R" dump. Cause unknown (Ref. DR-2208).

Table 4 (contd)

Pass 128, Oct 4/5, 1971 (Day 277/278)

DSS 51 AOS 277/1640; LOS 278/0035; Commands Transmitted 0; Ranging N/A.

Deviations or Anomalies

1. CPS - 360/75 down from 1848 to 1936 due to 1052 lockouts. Possible cause: Comgen run. IPL required (Ref. DR-2209).
2. CPS - 360/75 down 1954 to 2012 and 2034 to 2046 due to 1052 lockout. IPL required (Ref. DR-2209 and 2210).
3. GCF - HSDL outage 1938 to 1944 between DSS 51 and Ascension Island. Cause unknown (Ref. DR-3511).

DSS 12 AOS 277/2335; LOS 278/0518; Commands Transmitted 0; Ranging N/A.

Deviations or Anomalies

None

DSS 42 AOS 278/0427; LOS 278/1703; Commands Transmitted 0; Ranging N/A.

Deviations or Anomalies

None

Pass 129, Oct 5/6, 1971 (Day 278/279)

DSS 62 AOS 278/1558; LOS 279/0040; Commands Transmitted 0; Ranging N/A.

Deviations or Anomalies

1. CPS - 360/75 down from 1624 to 1630 due to core allocation problem. IPL required (Ref. DR-2215).
2. CPS - 360/75 down from 1646 to 1652 due to reallocation of 2260s and 2501s after operations power failure. IPL required (Ref. DR-640).
3. CPS - 360/75 down from 1943 to 1952 due to backlog caused by 2k bit from CTA 21. IPL required. No DR issued.

DSS 14 AOS 278/2339; LOS 279/0540; Commands Transmitted 18; Ranging Tau.

Deviations or Anomalies

1. CPS - 360/75 down 0500 to 0505 for restart (Ref. DR-2159).
2. CPS - 360/75 down 0536 to 0550 for IPL (Ref. DR-2156).

DSS 42 AOS 279/0726; LOS 279/1659; Commands Transmitted 0; Ranging N/A.

Deviations or Anomalies

None

Table 4 (contd)

Pass 130, Oct 6/7, 1971 (Day 279/280)

DSS 62 AOS 279/1557; LOS 279/2358; Commands Transmitted 0; Ranging N/A.

Deviations or Anomalies

1. CPS - 360/75 down from 2348 to LOS (2358) due to telemetry processing problems. No DR.

DSS 12 AOS 279/2300; LOS 280/0500; Commands Transmitted 11; Ranging N/A.

Deviations or Anomalies

1. DSS - Bit error alarms on commands from 0127 to 0500 (Ref. DR-01458 and 01459).

DSS 41 AOS 280/0453; LOS 280/1735; Commands Transmitted 0; Ranging N/A.

Deviations or Anomalies

None

Pass 131, Oct 7/8, 1971 (Day 280/281)

DSS 62 AOS 280/1633; LOS 280/2355; Commands Transmitted 30; Ranging N/A.

Deviations or Anomalies

1. DSS - TCP program did not react when 50 BPS science data was initiated (Ref. DR-1462).

DSS 12 AOS 280/2557; LOS 281/0849; Commands Transmitted 237; Ranging N/A.

Deviations or Anomalies

None

DSS 41 AOS 281/0732; LOS 281/1734; Commands Transmitted 173; Ranging N/A.

Deviations or Anomalies

1. DSS - Switched from TCP Alpha to TCP Beta at 1014 because of command problem.
 2. CPS - 360/75 down from 1354 to 1415. IPL required (Ref. DR-2230).
 3. DSS - Switched back to TCP Alpha.
-

Table-4 (contd)

Pass 132, Oct 8/9, 1971 (Day 281/282)

DSS 62 AOS 281/1631; LOS 281/2355; Commands Transmitted 34; Ranging N/A.

Deviations or Anomalies

1. GCF - CP down 2235 to 2242. Project's enabled message 204-3 not accepted by TCP 62B. (Ref. DR-029).

DSS 12 AOS 281/2255; LOS 282/0847; Commands Transmitted 34; Ranging N/A.

Deviations or Anomalies

1. CPS - 360/75 down from 0012 to 0024 due to abends. 1052 lockout of console. Real time cancelled. IPL required (Ref. DR-2156).

DSS 14 AOS 281/2337; LOS 282/0827; Commands Transmitted 0; Ranging N/A.

Deviations or Anomalies

None

DSS 41 AOS 282/0452; LOS 282/1731; Commands Transmitted 0; Ranging N/A.

Deviations or Anomalies

None

Pass 133, Oct 9/10, 1971 (Day 282/283)

DSS 51 AOS 282/1632; LOS 282/2350; Commands Transmitted 26; Ranging N/A.

Deviations or Anomalies

None

DSS 12 AOS 282/2253; LOS 283/0830; Commands Transmitted 0; Ranging N/A.

Deviations or Anomalies

None

DSS 41 AOS 283/0741; LOS 283/1322; Commands Transmitted 0; Ranging N/A.

Deviations or Anomalies

None

Table 4 (contd)

Pass 134, Oct 10/11, 1971 (Day 283/284)

DSS 51 AOS 283/1222; LOS 283/2347; Commands Transmitted 1; Ranging N/A.

Deviations or Anomalies

1. CPS - 360/75 down 1543 to 1622 due to power failure (Ref. DR-2242).

DSS 12 AOS 283/2251; LOS 284/0830; Commands Transmitted 0; Ranging N/A.

Deviations or Anomalies

None

DSS 41 AOS 284/0730; LOS 284/1700; Commands Transmitted 0; Ranging N/A.

Deviations or Anomalies

None

Pass 135, Oct 11/12, 1971 (Day 284/285)

DSS 51 AOS 284/1600; LOS 285/0018; Commands Transmitted 0; Ranging N/A.

Deviations or Anomalies

1. CPS - 360/75 down 1643 to 1707 due to CP interface problems (No DR).

DSS 42 AOS 285/0406; LOS 285/1317; Commands Transmitted 0; Ranging N/A.

Deviations or Anomalies

None

Pass 136, Oct 12/13, 1971 (Day 285/286)

DSS 51 AOS 285/1217; LOS 286/0016; Commands Transmitted 0; Ranging N/A.

Deviations or Anomalies

1. CPS - 360/75 down from 1642 to 1653 due to inability to process telemetry data. Restart. (Ref. DR-2253).
2. DSS - TDH tape broken from 1257 to 1301. Loss of 1 minute samples. (No DR).

DSS 12 AOS 286/0238; LOS 286/0800; Commands Transmitted 0; Ranging N/A.

Deviations or Anomalies

Unscheduled track.

Table 4 (contd)

Pass 136, Oct 12/13, 1971 (Day 285/286) (cont' d)

DSS 42 AOS 286/0700; LOS 286/1315; Commands Transmitted 0; Ranging N/A.

Deviations or Anomalies

1. DSS - Late acquisition due to magtape problems on TCP B and locked out of I/O devices on TCP A (Ref. DR-1478).
2. DSS - CMA Alpha declared red. Lost cmd capability. (Ref. DR-1479 and 1428).

Pass 137, Oct 13/14, 1971 (Day 286/287)

DSS 51 AOS 286/1214; LOS 287/0014; Commands Transmitted 0; Ranging N/A.

Deviations or Anomalies

1. CPS - 360/75 down from 1230 to 1242 and 1250 to 1256 due to amps run and 1052 lockout (Ref. DR-2156).
2. CPS - 360/75 down from 1321 to 1326. Cause of outage unknown. (Ref. DR-2258).
3. GCF - HSDL down from 1349 to 1356.
4. CPS - 360/75 down from 1445 to 1503 because of 6050 problems (Ref. DR-2156).

DSS 42 AOS 287/0401; LOS 287/1313; Commands Transmitted 0; Ranging N/A.

Deviations or Anomalies

None

Pass 138, Oct 14/15, 1971 (Day 287/288)

DSS 51 AOS 287/1213; LOS 287/1603; Commands Transmitted 0; Ranging N/A.

Deviations or Anomalies

None

DSS 62 AOS 287/1546; LOS 287/2250; Commands Transmitted 0; Ranging N/A.

Deviations or Anomalies

1. CPS - 360/75 down from 1646 to 1704. Restart and "R" dump (Ref. DR-2264).
 2. CPS - 360/75 down from 1753 to 1800 and 1813 to 1820 (Ref. DR-2264).
 3. CPS - 360/75 down from 1913 to 1930. "R" dump and IPL required (Ref. DR-2264).
-

Table 4 (contd)

Pass 138, Oct 14/15, 1971 (Day 287/288) (cont'd)

DSS 51 AOS 287/2220; LOS 288/0012; Commands Transmitted 0; Ranging N/A.

Deviations or Anomalies

None

Pass 139, Oct 15/16, 1971 (Day 288/289)

Configuration Codes: DSIF - J000/G000; GCF - S40J/S40G; SFOF - T012

DSS 51 AOS 288/1228; LOS 289/0009; Commands Transmitted 0; Ranging N/A.

Deviations or Anomalies

1. CPS - 360/75 down from 1337 to 1345 due to unknown cause. IPL required (Ref. DR-2156).
2. CPS - 360/75 down from 1540 to 1547. Scheduled disc pack change.

DSS 42 AOS 289/0359; LOS 289/1310; Commands Transmitted 0; Ranging N/A.

Deviations or Anomalies

None

Pass 140, Oct 16/17, 1971 (Day 289/290)

DSS 51 AOS 289/1208; LOS 290/0007; Commands Transmitted 1; Ranging N/A.

Deviations or Anomalies

1. GCF - HSDL down from 1658 to 1711. Released to Goddard. (Ref. DR-3653).

DSS 14 AOS 289/2307; LOS 290/0540; Commands Transmitted 0; Ranging N/A.

Deviations or Anomalies

1. CPS - 360/75 down from 0326 to 0340. Suspected cause was predicts run. IPL required (Ref. DR-2273).

DSS 42 AOS 290/0356; LOS 290/1308; Commands Transmitted 0; Ranging N/A.

Deviations or Anomalies

None

DSS 41 AOS 290/0433; LOS 290/1712; Commands Transmitted 1; Ranging N/A.

Deviations or Anomalies

1. CPS - 360/75 down from 1206 to 1219. "R" dump and IPL required (Ref. DR-6623).
 2. CPS - 360/75 down from 1405 to 1430. IPL required. (No DR).
-

Table 4 (contd)

Pass 141, Oct 17/18, 1971 (Day 290/291)

DSS 51 AOS 290/1610; LOS 291/0004; Commands Transmitted 0; Ranging N/A.

Deviations or Anomalies

None

DSS 12 AOS 290/2304; LOS 291/0643; Commands Transmitted 0; Ranging N/A.

Deviations or Anomalies

None

DSS 42 AOS 291/0547; LOS 291/1625; Commands Transmitted 0; Ranging N/A.

Deviations or Anomalies

1. DSS - CMD alarm 0400 (Ref. DR-1488).

Pass 142, Oct 18/19, 1971 (Day 291/292)

DSS 62 AOS 291/1524; LOS 292/0052; Commands Transmitted 1; Ranging N/A.

Deviations or Anomalies

1. CPS - 360/75 down from 2209 to 2216. Clean up and restore MSD packs. Restart.

DSS 12 AOS 291/2352; LOS 292/0451; Commands Transmitted 0; Ranging N/A.

Deviations or Anomalies

1. CPS - 360/75 down from 0202 to 0214. IPL required (Ref. DR-2156).

DSS 12 AOS 292/0540; LOS 292/0655; Commands Transmitted 0; Ranging N/A.

Deviations or Anomalies

None

DSS 42 AOS 292/0352; LOS 292/1621; Commands Transmitted 0; Ranging N/A.

Deviations or Anomalies

1. DSS - CMD out of lock intermittently from 0733 to 0758 on CMA Alpha. Modulation switched off (Ref. DR-1493).
-

Table 4 (contd)

Pass 143, Oct 19/20, 1971 (Day 292/293)

DSS 51 AOS 292/1504; LOS 293/0000; Commands Transmitted 1; Ranging N/A.

Deviations or Anomalies

1. CPS - 360/75 down from 1637 to 1703 due to rewrites on disc. "R" dump went 3/4 of the way before being locked out. IPL required (Ref. DR-2284).

DSS 14 AOS 292/2258; LOS 293/0817; Commands Transmitted 0; Ranging N/A.

Deviations or Anomalies

None

DSS 41 AOS 293/0649; LOS 293/1705; Commands Transmitted 0; Ranging N/A.

Deviations or Anomalies

1. CPS - 360/75 down from 0756 to 0805 due to predicts tape manipulation (Ref. DR-2288).

Pass 144, Oct 20/21, 1971 (Day 293/294)

DSS 62 AOS 293/1605; LOS 294/0017; Commands Transmitted 1; Ranging N/A.

Deviations or Anomalies

1. CPS - 360/75 down from 2240 to 2300. MSD pack accessing problems. Restart (Ref. DR-2292).

DSS 12 AOS 293/2345; LOS 294/0829; Commands Transmitted 0; Ranging N/A.

Deviations or Anomalies

None

DSS 42 AOS 294/0716; LOS 294/1616; Commands Transmitted 0; Ranging N/A.

Deviations or Anomalies

1. DSS - Command high speed data block reject TCP-A from 0809 to 1053 (Ref. DR-1496).

Pass 145, Oct 21/22, 1971 (Day 294/295)

DSS 51 AOS 294/1502; LOS 294/2357; Commands Transmitted 1; Ranging N/A.

Deviations or Anomalies

None

Table 4 (contd)

Pass 145, Oct 21/22, 1971 (Day 294/295) (cont' d)

DSS 12 AOS 295/0200; LOS 295/0425; Commands Transmitted 0; Ranging N/A.

Deviations or Anomalies

None

DSS 41 AOS 295/0419; LOS 295/1607; Commands Transmitted 0; Ranging N/A.

Deviations or Anomalies

1. CPS - 360/75 down from 0452 to 0459 and 0548 to 0600 (Ref. DR-2302).

Pass 146, Oct 22/23, 1971 (Day 295/296)

DSS 62 AOS 295/1509; LOS 296/0046; Commands Transmitted 1; Ranging N/A.

Deviations or Anomalies

1. CPS - 360/75 down from 1656 to 1703 due to stoppage of formatted telemetry output. Cancelled real time (Ref. DR-2302).

DSS 12 AOS 295/2215; LOS 296/0826; Commands Transmitted 0; Ranging N/A.

Deviations or Anomalies

None

DSS 41 AOS 296/0700; LOS 296/1659; Commands Transmitted 0; Ranging N/A.

Deviations or Anomalies

1. DSS - High doppler noise starting at 0840 causing erratic data. Station switched to RCVR 2 but did not eliminate problem (Ref. DR-0294).

Pass 147, Oct 23/24, 1971 (Day 296/297)

DSS 51 AOS 296/1555; LOS 296/2346; Commands Transmitted 1; Ranging N/A.

Deviations or Anomalies

None

DSS 12 AOS 296/2235; LOS 297/0810; Commands Transmitted 0; Ranging N/A.

Deviations or Anomalies

None

DSS 41 AOS 297/0700; LOS 297/1659; Commands Transmitted 0; Ranging N/A.

Deviations or Anomalies

None

Table 4 (contd)

Pass 148, Oct 24/25, 1971 (Day 297/298)

DSS 51 AOS 297/1150; LOS 297/2344; Commands Transmitted 1; Ranging N/A.

Deviations or Anomalies

None

DSS 14 AOS 297/2248; LOS 298/0809; Commands Transmitted 0; Ranging N/A.

Deviations or Anomalies

None

DSS 42 AOS 298/0655; LOS 298/1600; Commands Transmitted 0; Ranging N/A.

Deviations or Anomalies

1. CPS - 360/75 down 0855 to 0908. Lost talk capability to tape units. Cancel R/T and dump. Restart. System didn't accept log tape. IPL required (Ref. DR-2316).
2. DSS - SNR cyclic from 1054 to 1126. Reconfigure TCP patch panel per DSS 41 and reloaded TCP. TCP dropping lock. (Ref. DR-1503).

Pass 149, Oct 25/26, 1971 (Day 298/299)

DSS 62 AOS 298/1459; LOS 298/2341; Commands Transmitted 3; Ranging N/A.

Deviations or Anomalies

None

DSS 14 AOS 298/2241; LOS 299/0808; Commands Transmitted 0; Ranging N/A.

Deviations or Anomalies

None

DSS 41 AOS 299/0647; LOS 299/1555; Commands Transmitted 0; Ranging N/A.

Deviations or Anomalies

None

Pass 150, Oct 26/27, 1971 (Day 299/300)

DSS 62 AOS 299/1459; LOS 299/2338; Commands Transmitted 1; Ranging N/A.

Deviations or Anomalies

None

Table 4 (contd)

Pass 150, Oct 26/27, 1971 (Day 299/300) (cont'd)

DSS 14 AOS 299/2238; LOS 300/0806; Commands Transmitted 0; Ranging N/A.

Deviations or Anomalies

1. CPS - 360/75 down 0025 to 0101 and 0508 to 0516. Telemetry process out and 1052s locked out of system. IPL required (Ref. DR-2323).

DSS 41 AOS 300/0703; LOS 300/1550; Commands Transmitted 0; Ranging N/A.

Deviations or Anomalies

None

Pass 151, Oct 27/28, 1971 (Day 300/301)

DSS 62 AOS 300/1454; LOS 300/2300; Commands Transmitted 1; Ranging N/A.

Deviations or Anomalies

1. CPS - 360/75 down from 1936 to 1942. Restart (Ref. DR-2330).

DSS 12 AOS 300/2203; LOS 301/0819; Commands Transmitted 0; Ranging N/A.

Deviations or Anomalies

None

DSS 41 AOS 301/0438; LOS 301/1549; Commands Transmitted 0; Ranging N/A.

Deviations or Anomalies

None

Pass 152, Oct 28/29, 1971 (Day 301/302)

DSS 62 AOS 301/1451; LOS 301/2257; Commands Transmitted 1; Ranging N/A.

Deviations or Anomalies

None

DSS 12 AOS 301/2221; LOS 302/0818; Commands Transmitted 0; Ranging N/A.

Deviations or Anomalies

1. CPS - 360/75 down from 0027 to 0034, due to 1052's locked out. Restart. (Ref. DR-2323).
 2. GCF - Incoming HSD dropped from 0138 to 0205. (No DR).
 3. CPS - 360/75 down 0404 to 0416 to correct lockout on all I/O devices. (Ref. DR-2342).
-

Table 4 (contd)

Pass 152, Oct 28/29, 1971 (Day 301/302) (cont' d)

4. CPS - 360/75 down 0514 to 0522 (Ref. DR-2342).

5. CPS - 360/75 down 0752 to 0758. CMD anomalies. Restart. (No DR).

DSS 41 AOS 302/0433; LOS 302/1545; Commands Transmitted 0; Ranging N/A.

Deviations or Anomalies

1. CPS - 360/75 down 0752 to 0758. Command system anomalies.
(No DR).

Pass 153, Oct 29/30, 1971 (Day 302/303)

DSS 62 AOS 302/1456; LOS 302/2254; Commands Transmitted 1; Ranging N/A.

Deviations or Anomalies

None

DSS 12 AOS 302/2158; LOS 303/0817; Commands Transmitted 0; Ranging N/A.

Deviations or Anomalies

1. CPS - 360/75 down. IPL required. (Ref. DR-2349).

2. CPS - 360/75 down. Restart. (No DR).

DSS 41 AOS 303/0425; LOS 303/1644; Commands Transmitted 0; Ranging N/A.

Deviations or Anomalies

1. CPS - 360/75 down 0907 to 0917. Error on disk pack. IPL required
(Ref. DR-2151).

2. CPS - 360/75 down 0944 to 0950. Core lockout. (Ref. DR-2152).

Pass 154, Oct 30/31, 1971 (Day 303/304)

DSS 51 AOS 303/1535; LOS 303/2336; Commands Transmitted 1; Ranging N/A.

Deviations or Anomalies

None

DSS 14 AOS 303/2227; LOS 304/0800; Commands Transmitted 0; Ranging N/A.

Deviations or Anomalies

None

Table 4 (contd)

Pass 154, Oct 30/31, 1971 (Day 303/304) (cont'd)

DSS 41 AOS 304/0425; LOS 304/1644; Commands Transmitted 0; Ranging N/A.

Deviations or Anomalies

1. CPS - 360/75 down 0645 to 0653 for restart.
2. CPS - 360/75 down 0907 to 0917. Error on disk pack. IPL required. (Ref. DR-2151).
3. CPS - 360/75 down 0944 to 0950. Core lockout (Ref. DR-2152).

Pass 155, Oct 31/Nov 1, 1971 (Day 304/305)

DSS 51 AOS 304/1142; LOS 304/2334; Commands Transmitted 1; W/O Ranging.

Deviations or Anomalies

None

DSS 41 AOS 305/0714; LOS 305/1538; Commands Transmitted 0; W/O Ranging.

Deviations or Anomalies

1. 1412Z - 1419Z, H/S data link down Canberra, data loss, DR-3797.
Corrective action: Restored CKT HTWN GSFC/ACSW Day 305, 1419Z.

Pass 156, Nov 1/2, 1971 (Day 305/306)

DSS 62 AOS 305/1430; LOS 305/2247; Commands Transmitted 12; W/O Ranging.

Deviations or Anomalies

None

DSS 12 AOS 305/2149; LOS 306/0813; Commands Transmitted 416; Mu Ranging.

Deviations or Anomalies

1. 0800Z, Nat Tlm wrote DRT-24 due to D/L residuals exceeding allowable tolerance of 1.0 DB.
Corrective action:

DSS 41 AOS 306/0713; LOS 306/1535; Commands Transmitted 0; Ranging N/A.

Deviations or Anomalies

None

Table 4 (contd)

Pass 157, Nov 2/3, 1971 (Day 306/307)

DSS 62 AOS 306/1435; LOS 307/0032; Commands Transmitted 25; Ranging N/A.

Deviations or Anomalies

1. 1645Z - 1653Z, 360/75 down. CANX R/T job with dump - warm restart (Ref. DR-2368).
Corrective action:

DSS 51 AOS 306/1821; LOS 306/2105; Commands Transmitted 0; W/O Ranging.

Deviations or Anomalies

1. Station called up for emergency support due to S/C problems AOS 1821Z data line to 1901Z. Station released.
2. No NAT CMD support. No data taken. Brought up for emergency operations as B/O to DSS 62 - HS lines bad. No NAT CMD activity.

DSS 12 AOS 306/2149; LOS 307/0811; Commands Transmitted 124; Mu Ranging.

Deviations or Anomalies

1. 0010Z, station had input attenuator set too high on SDA 1. Request for change of setting failed to get results. DRs T-25 and 151Z refers.
Corrective action:
2. 0231 - 0232Z, prime BDA out of lock, lost W/B data. (Ref. DR-T-26).
Corrective action:

DSS 14 AOS 306/2217; LOS 307/0653; Commands Transmitted N/R; Ranging N/A.

Deviations or Anomalies

1. DSS 14 DIS Red, no monitor data.

DSS 14 AOS 307/0711; LOS 307/1635; Commands Transmitted 0; Ranging N/A.

Deviations or Anomalies

1. TFR 41/DIS/A58619, DIS KSR at SMC not spacing after code character.
2. TFR 41/SERVO/A58620, antenna ran off when slave mode selected.

Pass 158, Nov 3/4, 1971 (Day 307/308)

DSS 62 AOS 307/1535; LOS 307/2241; Commands Transmitted 1; Ranging N/A.

Deviations or Anomalies

1. 1854Z - 1921Z, 306/75 down, switch to B string, R dump, cold IPL (Ref. DR-2375).
Corrective action:
-

Table 4 (contd)

Pass 158, Nov 3/4, 1971 (Day 307/308) (cont'd)

DSS 12 AOS 307/2143; LOS 308/0550; Commands Transmitted 7; Mu Ranging.

Deviations or Anomalies

None

DSS 14 AOS 308/2315; LOS 309/0754; Commands Transmitted 0; Tau Ranging.

Deviations or Anomalies

1. 0019Z - 0025Z, 360/75 down for R/T system swap from A to B.
2. 0114Z - 0139Z, 3100 down due to bad tape drive, console 360/75 not to drive 3100 on interface (Ref. DR-2378).
Corrective action:
3. 0126 - 0139Z, 360/75 down; restart required to clear 360/75/3100 interface problem (Ref. DR-2378).
Corrective action:
4. 0205Z - 0228Z, 360/75 down due to hardware problem (Ref. DR-2379).
Corrective action:
5. 0405Z, HSD down due to TCP operator typed in DIN 2, causing H/S outage; this was done without permission (Ref. DR-1519).
Corrective action:

Pass 159, Nov 4/5, 1971 (Day 308/309)

DSS 12 AOS 308/2143; LOS 309/0809; Commands Transmitted 0; Mu Ranging.

Deviations or Anomalies

1. 0029Z - 0037Z, 360/75 down, because of tape handling problems; restart required (Ref. DR-2286).
Corrective action:
 2. 0053Z - 0100Z, TCP alpha down due to computer fault, reload required (Ref. DR-1521).
Corrective action:
 3. 2139Z - 2217Z no eng. tlm processing on TCP alpha, bad digital phase shifter (Ref. DR-1520 and TFR-A59437).
Corrective action:
-

Table 4 (contd)

Pass 159, Nov 4/5, 1971 (Day 308/309) (cont'd)

DSS 41 AOS 309/0710; LOS 309/1600; Commands Transmitted 0; W/O Ranging.

Deviations or Anomalies

1. 1002Z - 1011Z, 360/75 down due to 2260s locked out, R & IPL required (Ref. DR-2258).
Corrective action:
2. 1250Z - 1313Z 360/75 down, 2260 locked out, swapped to A string due to CPH hardware failure (Ref. DR-2258).
Corrective action:

Pass 160, Nov 5/6, 1971 (Day 309/310)

DSS 41 AOS 310/0349; LOS 310/1600; Commands Transmitted 0; W/O Ranging.

Deviations or Anomalies

1. AOS-0621Z, 3100 down, rebased to ensure smooth SOE run for project, no DTV formats entered at request of Computer Chief; interface problems between 360/75A and 3100.
2. 0313Z - 0330Z, 360/75A down, 2260s locked out, peripheral equipment problems, IPL (Ref. DR-2393).
Corrective action:
3. 0607Z - 0621Z, 360/75 down, string swap mode A to B to clear system.
4. 0912Z - 0915Z, 360/75 down, R/T job started (Ref. DR-2393).
Corrective action:

DSS 51 AOS 310/1500; LOS 310/1700; Commands Transmitted 74; Ranging N/A.

Deviations or Anomalies

1. Post track report 1 SCA 8.3 bps eng. SDA locks, but no TCP lock; under investigation (Ref. DR-1525).
Corrective action:
 2. DR-1527 applies to 0 on rigorous following of JPL Document 610-83, Rev. B, in connection with precommand transmission procedure and abort/stop commanding procedures.
 3. OVT MOI Trim Test.
-

Table 4 (contd)

Pass 160, Nov 5/6, 1971 (Day 309/310) (cont'd)

DSS 51 AOS 310/1709; LOS 310/2234; Commands Transmitted 1; Ranging N/A.

Deviations or Anomalies

1. 1800Z - 1803Z, 360/75 down for string swap B to A.
2. 2025Z - 2037Z and 2043Z - 2101Z, 360/75 down, warm IPL required (Ref. DR-2393).

Corrective action:

3. 2102Z - 2124Z, 360/75 down, 2260s locked out, restart and pack swap (Ref. DR-2393).

Corrective action:

DSS 41 AOS 311/0808; LOS 311/0958; Commands Transmitted 3; Ranging N/A.

Deviations or Anomalies

1. LOS scheduled block time, DSN OVT/MM9 S/C 75 track.
2. CMD abort due CCM/5 manual type in per ACE-1.
3. OVT MOI Trim Test.

Pass 161, Nov 6/7, 1971 (Day 310/311).

DSS 62 AOS 310/1500; LOS 310/1730; Commands Transmitted 0; W/O Ranging.

Deviations or Anomalies

None

DSS 12 AOS 310/2136; LOS 311/0200; Commands Transmitted 0; Mu Ranging.

Deviations or Anomalies

1. Scheduled LOS of 0806Z is station block time, reconfigured to support DSN OVT Test.
2. 2346Z - 0004Z, 3100 down, interface problems with 360/75 (Ref. DR-2393).

Corrective action:

3. 0012Z - 0015Z, 3100 down, interface problems with 360/75 (Ref. DR-2393).

Corrective action:

4. 0018Z - 0041Z, 360/75 B down, 2260s locked out, swap to A system TEM (Ref. DR-2393).

Corrective action:

Table 4 (contd)

Pass 161, Nov 6/7, 1971 (Day 310/311) (cont'd)

5. 0047Z - 0050Z, 3100 down, interface problems with 360/75 (Ref. DR-2393).

Corrective action:

6. 0052Z - 0114Z, 360/75 down, swap to B system with A packs (Ref. DR-2393).

Corrective action:

DSS 14 AOS 310/2207; LOS 311/0709; Commands Transmitted 3; W/O Ranging.

Deviations or Anomalies

1. 2304Z, switched to S/C CGA. LOS at 0054Z AOS 0129Z.
2. 2346Z - 0004Z, 3100 down, interface problems with 360/75.
3. 0012Z - 0015Z, 3100 down, interface problems with 360/75.
4. 0018Z - 0041Z, 360/75 down, 2260s locked out, swap to A system.
5. 0047Z - 0050Z, 3100 down, interface problems with 360/75.
6. 0052Z - 0114Z, 360/75A down, swap to B system with A packs.
7. 0245Z, TCP-DIS interface taken down for playbacks.
8. OVT MOI Trim Test.

DSS 12 AOS 311/0223; LOS 311/0806; Commands Transmitted 5; Ranging N/A.

Deviations or Anomalies

1. AOS scheduled is station block time for MM9 S/C 75/DSN OVT Tracks.
2. 0739Z - 0744Z, 360/75 down, swap from B to A system.
3. DSN OVT MOI Test.

DSS 42 AOS 311/0320; LOS 311/1036; Commands Transmitted 0; Ranging N/A.

Deviations or Anomalies

1. SSA SNR 5.2 DB from predicts (Ref. DR-T-30 initiated).
Corrective action:

2. LOS scheduled block time MM9 S/C 75/DSN OVT Tracks.

DSS 41 AOS 311/1008; LOS 311/1600; Commands Transmitted 0; Ranging N/A.

Deviations or Anomalies

1. AOS scheduled block time for DSN OVT/MM9 S/C 75 Track, station unable to lock TCP B on science-data, switched to TCP A 1046Z (Ref. DR-1529).

Corrective action:

Table 4 (contd)

Pass 161, Nov 6/7, 1971 (Day 310/311) (cont'd)

DSS 42 AOS 311/1110; LOS 311/1200; Commands Transmitted 0; Ranging N/A.

Deviations or Anomalies

1. AOS schedule is station block time for MM9 S/C 75/DSN OVT Track.

Pass 162, Nov 7/8, 1971 (Day 311/312).

DSS 51 AOS 311/1500; LOS 311/2304; Commands Transmitted 1; Ranging N/A.

Deviations or Anomalies

1. 1712Z - 1722Z, 360/75 down for cold IPL (Ref. DR-2392).
Corrective action:
2. 1727Z-1758Z, 360/75 down (Ref. DR-2398).
Corrective action:
3. 2025Z - 2116Z, 360/75 down, B string considered "red".
4. 1801Z, LOS 360/75 A considered red.
5. Post Track Rpt, Maser 1 started to warm up, changed to Maser 2; Maser 1 operational 2015Z, TFR A52433 (Ref. DR-1531).
Corrective action:

DSS 14 AOS 311/2204; LOS 312/0748; Commands Transmitted 0; Tau ranging.

Deviations or Anomalies

1. 0002Z, no DTV updates, interface problem between 360/75 and 3100.
 2. 0317Z, received permission to enter DTV meds.
 3. 0348Z-0354Z, 360/75 B down, swap to A system in order to prepare it for encounter.
 4. 0530Z - 0542Z, 3100 down interface problems (Ref. DR-2393).
 5. 0706Z - 0712Z, 360/75 down, utility programs won't work, IPL (Ref. DR-2393).
Corrective action:
 6. TCP SNR SAT, discovered station was 3 sec behind WWV entire pass (Ref. DR-1532).
Corrective action:
 7. SDA 1+2 glitched (Ref. DR-1533).
Corrective action:
-

Table 4 (contd)

Pass 162, Nov 7/8, 1971 (Day 311/312) (cont'd)

DSS 12 AOS 312/0648; LOS 312/1600; Commands Transmitted 0; Ranging N/A.

Deviations or Anomalies

1. 0759Z - 0803Z 3100 down, interface problems with 360/75 (Ref. DR-2393).
Corrective action:
2. 0916Z - 0920Z 360 down (Ref. DR-2393).
Corrective action:
3. 0941Z - 0946Z 360/75 down, cancelled RIT job with dump, restart (Ref. DR-2393).
Corrective action:
4. 1201Z-1222Z, 360/75 down, swapped to B system (Ref. DR-2393).
Corrective action:
5. 1346Z-1355Z, 3100 down (Ref. DR-2393).
Corrective action:

Pass 163, Nov 8/9 (Day 312/313).

DSS 62 AOS 312/1512; LOS 313/0001; Commands Transmitted 58; Ranging N/A.

Deviations or Anomalies

None

DSS 12 AOS 312/2130; LOS 313/0803; Commands Transmitted 23; Ranging N/A.

Deviations or Anomalies

1. 0018Z - 0021Z, 3100 down, interface problems, restart (Ref. DR-2393).
Corrective action:
2. 0207Z - 0216Z, 360/75 down, 1052s locked out, IPL (Ref. DR-2393).
Corrective action:

DSS 14 AOS 312/2217; LOS 313/0747; Commands Transmitted 0; Ranging N/A.

Deviations or Anomalies

1. Ref. DR T-31 on residuals SNR and D/L.
Corrective action:
-

Table 4 (contd)

Pass 163, Nov 8/9 (Day 312/313) (cont'd)

DSS 41 AOS 313/0659; LOS 313/1600; Commands Transmitted 3; Ranging N/A.

Deviations or Anomalies

1. 0821Z - 0827Z, 360/75 down, restart (Ref. DR-2415).
Corrective action:
2. 1343Z - 1349Z, 360/75 down, re IPL due to core problem and Cmd SDR (Ref. DR-2417).
Corrective action:

Pass 164, Nov 9/10 (Day 313/314).

DSS 62 AOS 313/1504; LOS 314/0001; Commands Transmitted 2; Ranging N/A.

Deviations or Anomalies

1. Ref. DR C-034, DTA transfer test delayed AOS due to bad TCP load.
Corrective action:
2. 1614Z - 1656Z, 360/75 down, R. dump and restart, cold IPL required A (Ref. DR-2418).
Corrective action:
3. 1901Z - 1921Z, 360/75 (Ref. DR-2418).
Corrective action:
4. 2102Z - 2130Z, 360/75 down (Ref. DR-2418).
Corrective action:

DSS 12 AOS 313/2127; LOS 314/0605; Commands Transmitted 26; Ranging N/A.

Deviations or Anomalies

1. Excessive doppler noise during lost part of pass, causing early termination of Track.

DSS 14 AOS 313/2158; LOS 314/0713; Commands Transmitted 0; Ranging N/A.

Deviations or Anomalies

1. No TCP interface, three-way Track; released early by Track Chief from Track.
 2. TCP B high-density recorder down (Ref. DR-1536).
Corrective action:
-

Table 4 (contd)

Pass 164, Nov 9/10 (Day 313/314) (cont'd)

DSS 41 AOS 314/0534; LOS 314/1600; Commands Transmitted 377; W/O Ranging.

Deviations or Anomalies

1. 0924Z - 0939Z, 360/75 down.

Pass 165, Nov 10/11 (Day 314/315)

DSS 62 AOS 314/1500; LOS 314/2359; Commands Transmitted 53; W/O Ranging.

Deviations or Anomalies

1. 1852Z - 1853Z, 360/75 down for string swap B to A.

DSS 12 AOS 314/2124; LOS 315/0802; Commands Transmitted 1; Mu Ranging.

Deviations or Anomalies

1. 0132Z - 0145Z, 360/75 down to swap from version 11.4 to 11.3.
2. 0210Z - 0224Z, 360/75 down due to 2260s locked out; restart (Ref. DR-401-10).
Corrective action:

DSS 14 AOS 314/2156; LOS 315/0744; Commands Transmitted 7; W/O Ranging.

Deviations or Anomalies

1. DIS red.

DSS 41 AOS 315/0653; LOS 315/1600; Commands Transmitted 15; Ranging N/A.

Deviations or Anomalies

None

DSS 62 AOS 315/1500; LOS 315/2359; Commands Transmitted 27; Ranging N/A.

Deviations or Anomalies

1. 2007Z - 2008Z TCP A log unit B started running fast forward at same time I/O message of tape data lost, TCP B log unit on line to record ODR, suspected software problem (Ref. DR-1538).
Corrective action:
2. TCP-A-2 SNR actual 4.4 DB, predict 3.5 DB, +0.9 DB difference.

Pass 166, Nov 11/12 (Day 315/316)

DSS 41 AOS 316/0704; LOS 316/1600; Commands Transmitted 18; W/O Ranging.

Deviations or Anomalies

None

Table 4 (contd)

Pass 166, Nov 11/12 (Day 315/316) (cont'd)

DSS 14 AOS 315/2214; LOS 316/0743; Commands Transmitted 0; Ranging N/A.

Deviations or Anomalies

1. DIS red.
2. P/B/16.2 KBPS at 2317Z, 8 KBPS at 0238Z.

Pass 167, Nov 12/13 (Day 316/317)

DSS 62 AOS 316/1500; LOS 316/2327; Commands Transmitted 27; Ranging N/A.

Deviations or Anomalies

1. DR C 047, DSS 62, a verification and erroneous alarm problem.
Corrective action:
2. 1704Z station swapped to TCP B due to Command System problem
(Ref. DR-C-047).
Corrective action:

3. 2144Z - 2153Z, 360/75 down, cancelled R/T job with dump, restart.

4. TCP-B-2 SNR actual 18.6 DB, predict 18.8, difference 0.2 db.

DSS 12 AOS 316/2119; LOS 317/0758; Commands Transmitted 11; Mu Ranging.

Deviations or Anomalies

1. 2030Z - 2043Z, 360/75 down, string swap B to A.
2. 2144Z - 2153Z, 360/75 down, cancelled R/T job with dump, restart.
3. 0753Z - 0758Z, 360/75 down for string swap from A to B.

DSS 41 AOS 317/0640; LOS 317/1547; Commands Transmitted 16; W/O Ranging.

Deviations or Anomalies

None

Pass 168, Nov 13/14 (Day 317/318).

DSS 62 AOS 317/1509; LOS 318/0015; Commands Transmitted 13; Ranging N/A.

Deviations or Anomalies

1. 1718Z - 1726Z, 360/75 DC, cancelled R/T job with dump, warm IPL
(Ref. DR-2434).
Corrective action:
 2. 1729Z, TCB B reloaded, swapped to A.
-

Table 4 (contd)

Pass 168, Nov 13/14 (Day 317/318) (cont'd)

3. 1736Z - 1742Z, 360/75 down, cold IPL (Ref. DR-2434).
Corrective action:
4. 1749Z - 1756Z, 360/75 down, not processing tracking data, swapped disc packs, restart (Ref. DR-2434).
Corrective action:
5. 1813Z - 1815Z, TCP A down, swap data to TCP B.

DSS 51 AOS 317/1603; LOS 317/2126; Commands Transmitted 0; Ranging N/A.

Deviations or Anomalies:

1. 1617Z DIS and TCP reloaded at AOS.
2. 1718Z - 1726Z, 360/75 down, cancelled R/T job with dump, warm IPL (Ref. DR-2434).
Corrective action:
3. 1736Z - 1742Z, 360/75 down, cold IPL (Ref. DR-2434).
Corrective action:
4. 1749Z - 1756Z, 360/75 down, not processing tracking data (Ref. DR-2434).
Corrective action:

DSS 12 AOS 317/2118; LOS 318/0758; Commands Transmitted 26; No Ranging.

Deviations or Anomalies

1. 2159Z, DIS reloaded.

DSS 14 AOS 317/2147; LOS 318/0659; Commands Transmitted 2; Ranging N/A.

Deviations or Anomalies

1. 2124Z - 2136Z, unable to get into Command system, reload of TCP A unsuccessful, switched to TCP B (Ref. DR-1546 and T-FR-56049).
Corrective action:
2. DIS log tape problems, no enabled, no monitor data.

DSS 12 AOS 318/0334; LOS 318/1611; Commands Transmitted 25; Ranging N/A.

Deviations or Anomalies

1. 0739Z - 0743Z, DIS reloaded (no DR).
 2. 0254Z, recall response data blocks hanging up at station, reload of Command portion of TCP (Ref. DR-C-048).
Corrective action:
-

Table 5. Discrepancy report (DR) closeout statements for pass chronology

Pass 6, June 4/5

DSS 51

DR-01224: Aligned subsystems and modified SM 10.

DR-01235: Replaced module A107.

DR-1592/94: Fix in cruise version; data backlog; operator error; reentered check.

DSS 12

DR-01234: ECO 71-001A, B, C and D; D correction.

Pass 7, June 5/6

DSS 51

DR-01224: Aligned subsystems and modified SM 10.

DR-2606: Cleared while checking.

DR-1597: Replaced logic card.

DR-1596: Lost power on 002.

DR-1598: Restored backup pack, RFO UNK.

DSS 12

DR-1599: Fix in cruise version.

DR-1600: Fix in cruise version.

DR-1603: Fix in cruise version.

DSS 41

DR-1604: Fix in cruise version.

Pass 8, June 6/7

DSS 51

DR-01224: See Pass 6, DSS 51.

DSS 12

DR-1607: Drive is being used; no trouble found.

DR-2609: No trouble found after test.

DSS 41

DR-1606: IBM repaired; damaged M53 pack.

Table 5 (contd)

Pass 9, June 7/8

DSS 51

DR-01224: See Pass 6, DSS 51.

DR-01239: Switched on beam voltage; transmitter up.

DSS 12

DR-1613: Replaced disc motor, system B, CH 21-40.

DSS 41

DR-2617/18: Recovery.

Pass 10, June 9

DSS 12

DR-1619: Insufficient information.

DSS 41

DR-1620: Replaced "C" card in DTV system 2.

DR-1623: Replaced logic card.

DR-0419: Insufficient information.

Pass 11, June 9/10

DSS 51

DR-2632: Unable to make good on any circuit; no trouble found.

DR-1625: Correction in future models.

DSS 12

DR-1627: Change real-time spool, DI card.

DSS 41

DR-1631: Cleared I/O units, cold start.

Pass 12, June 11

DSS 41

DR-01251: Coolant flow interlock reset.

DR-1637: Insufficient information.

Table 5 (contd)

Pass 13, June 11/12

DSS 14

DR-01254: Bled system, restored water flow.

Pass 14, June 12/13

DSS 51

DR-1639: No corrective action, system functioned properly.

Pass 16, June 15

DSS 51

DR-01259: Operator error; personnel advised.

DSS 14

DR-1648: Ran system diagnosis; no trouble found.

DSS 41

DR-2667: Line swaps; data set swapped out.

Pass 17, June 15/16

DSS 41

DR-2675: Made good on alternate circuit; noisy circuit.

Pass 18, June 16/17

DSS 41

DR-1662: Reprogrammed CP at GSFC.

Pass 19, June 17/18

DSS 41

DR-1263: Temporary fix based on operation workaround; to be corrected in phase 4B omega S/W, applicable by August 1, 1971.

Table 5 (contd)

Pass 20, June 18/19

DSS 51

DR-1673: Corrected on JPLOS 2.7.177.

Pass 21, June 19/20

DSS 41

DR-1680: Repaired heads on MSA3 pack.

Pass 22, June 20/21

DSS 51

DR-2711: No trouble found.

Pass 23, June 21/22

DSS 51

DR-2729: Line swap, JPL/GSFC.

DR-2740: Made good on GDA-58490.

Pass 24, June 22/23

DSS 12

DR-1270: Personnel coordination problem; interfaces clarified.

DSS 41

DR-1695: Insufficient information; need dump.

Pass 25, June 23/24

DSS 12

DR-1272: Replaced STAKON connector.

DSS 41

DR-1644: Model 3 fix; TCP S/W fix needed.

Table 5 (contd)

Pass 26, June 24/25

DSS 51

DR-0192: Expect fix on E623 in Model 3.

DSS 41

DR-1709: Rezeroed and adjusted drive power.

Pass 27, June 25/26

DSS 62

DR-1276: No trouble found.

DR-01277: Power restored, RFO UNK.

DSS 41

DR-1644: Model 3 fix, TCP S/W fix needed.

Pass 28, June 26/27

DSS 41

DR-1714: Insufficient information; need R dump.

DR-1716: Insufficient information; need R dump.

Pass 29, June 27/28

DSS 41

DR-2774/75: Unauthorized maintenance at Canberra; problem resolved.

DR-1719: Corrected in version 7.137.

DR-1721/17: Insufficient information to solve.

Pass 30, June 28/29

DSS 62

DR-01281: No trouble found.

DSS 12

DR-1726: Procedure error; personnel advised.

Table 5 (contd)

Pass 31, June 29/30

DSS 41

DR-1733: No trouble found, RFO UNK.

Pass 32, June 30/July 1

DSS 51

DR-1736: Bad address in appendage table.

DR-2802: Made good on GDA-58667; RFO, no trouble found.

Pass 33, July 1/2

DSS 51

DR-01287: Action UNK (DR-1282).

Pass 34, July 2/3

DSS 51

DR-2814: System swap; RFO UNK.

DSS 41

DR-2820: Line swap between GSFC/Canberra.

DR-0210: Insufficient information.

Pass 35, July 3/4

DSS 14

DR-0212: No trouble found.

DR-1745: Investigating problem; RFO UNK.

DR-1290: Replace exciter buffer amplifier.

DSS 41

DR-1746: No trouble found; reset CB, power down/back up.

Table 5 (contd)

Pass 36, July 4/5

DSS 41

DR-1274: No trouble found.

Pass 38, July 6/7

DSS 41

DR-1293: Removed drive unit; changed crosshead.

Pass 39, July 7/8

DSS 41

DR-1769: 2870 interface noisy; maintenance error.

Pass 40, July 8/9

DSS 51

DR-1776: Replaced servo motor and lamp; no trouble found RFO UNK; replaced parts in pressure pad mechanism.

DSS 14

DR-0217: Operator error; tape written on 9 track; operations chief and communications chief advised.

Pass 41, July 9/10

DSS 41

DR-1295: Operator error; personnel instructed.

Pass 42, July 10/11

DSS 51

DR-1784: Manual restart; RFO UNK.

Table 5 (contd)

Pass 43, July 11/12

DSS 51

DR-1789: Correction in JPLOS 139 Mod 3; no trouble found RFO UNK.

DSS 12

DR-1192: TCP S/W anomaly, corrected for phase 4.

DSS 41

DR-1794: Improved RCVY SCR 407.

Pass 45, July 13/14

DSS 62

DR-1797: Corrected on JPLOS 3.0 system.

DR-1300: Exciter operator error, ref. T1300; operator error, investigating transfer procedures.

DSS 41

DR-1798: Insufficient information to solve.

DSS 62

DR-1799: Replaced SLT card.

Pass 47, July 15/16

DSS 51

DR-1808: No trouble found; insufficient information.

Pass 49, July 17/18

DSS 12

DR-1814: No trouble found.

DSS 41

DR-1814/15: No trouble found; invalid for CPS; time hack is put on TDH at stations; reported to DSIF chief.

Table 5 (contd)

Pass 50, July 18/19

DSS 51

DR-1816: Restored system packs, RFO UNK.

DSS 12

DR-1818: Insufficient information.

Pass 52, July 20/21

DSS 41

DR-1307: Repaired chain link and limit mechanism.

Pass 53, July 21/22

DSS 12

DR-1309: Repaired broken wire in magnet.

Pass 54, July 22/23

DSS 12

DR-1311: Operator error; additional training completed.

DSS 41

DR-544: Cleared system and restored power.

DR-2954: Short on power distribution bar caused UPS system to take dip.

Pass 55, July 23/24

DSS 51

DR-1836: Insufficient information; need dump.

DSS 41

DR-1818: Insufficient information.

DR-548: Replace transformer.

Table 5 (contd)

Pass 56, July 24/25

DSS 41

DR-1840: Pointer to res. subpool 253, 254, 255 overlaid; cause not yet determined from available information.

Pass 57, July 25/26

DSS 51

DR-1840: See Pass 56, above.

Pass 58, July 26/27

DSS 41

DR-1848: S/W problem; under investigation.

Pass 59, July 27/28

DSS 62

DR-1320: Microwave switch failure.

Pass 65, Aug 2/3

DSS 51

DR-3029: Forced retrain again between Canary and ACN; on best line available with DSS 51.

DR-1880: Replace SLT in 2870.

Pass 66, Aug 3/4

DSS 12

DR-1327: U buss switched to backup generator.

Pass 67, Aug 4/5

DSS 62

DR-1886: S/W problem with COMGEN; fixed in real-time, JPLOS 3.0.

Table 5 (contd)

Pass 71, Aug 8/9

DSS 12

DR-1334: Personnel advised.

DSS 41

DR-1798: No action possible; insufficient information available.

Pass 72, Aug 9/10

DSS 41

DR-1900: Modified GM control, GC control update.

Pass 74, Aug 11/12

DSS 41

DR-1913: Insufficient information.

Pass 75, Aug 12/13

DSS 41

DR-1346: Replaced coaxial switch; calibrated panel.

Pass 76, Aug 13/14

DSS 51

DR-3110: Circuit made good between GSFC/ACN/CY2.

DR-3115: No trouble found.

Pass 77, Aug 14/15

DSS 51

DR-1347: Operator error calculating acquisition frequency.

Table 5 (contd)

Pass 79, Aug 16/17

DSS 41

DR-3134: CP fresh load.

Pass 81, Aug 18/19

DSS 51

DR-1941: IGC 210 correction; insufficient information.

DSS 41

DR-1744: Replaced 1052.

Pass 82, Aug 19/20

DSS 14

DR-1941: Insufficient information.

DSS 41

DR-1956: Adjusted detent, Mod J.

Pass 83, Aug 20/21

DSS 62

DR-1361: Cleaned HX relay contacts; checked ground insulation of AC lines; ascertained proper operation of HX alarm interlocks.

DSS 41

DR-1925: Insufficient information.

Pass 84, Aug 21/22

DSS 51

DR-1876: Insufficient information.

DSS 12

DR-1363: Adjust trigger level of counter.

DSS 41

DR-3167: Referred for CP maintenance at GSFC.

Table 5 (contd)

Pass 85, Aug 22/23

DSS 42

DR-1969: TD OCC lost on interrupt UNK.

DR-1970: Limit of 500 lines placed on all net TRK display required in Mod 6.

DR-01365: Operator tuning error; personnel instructed.

Pass 86, Aug 23/24

DSS 42

DR-1976: DDP sent UI; action UNK.

Pass 87, Aug 24/25

DSS 14

DR-0248: COMGEN/RTOS problems; dumps to aid; problem does not occur with JPLOS 3.0 system.

DSS 41

DR-1990: Insufficient information.

Pass 89, Aug 26/27

DSS 51

DR-1997: Corrected on JPLOS 3.0.228.

DSS 41

DR-01374: Dirty relay K31 HV power supply.

Pass 91, Aug 28/29

DSS 12

DR-01375: Replace broken wire klystron CAB.

Table 5 (contd)

Pass 92, Aug 29/30

DSS 51

DR-0256: System restart.

DR-2007: Adjusted CCRF voltage.

DR-2008: Incompatibility between Mod 2 and 3 S/W. Permanent fix in Mod 4. Workaround memo forthcoming.

DSS 41

DR-3238: Carrier failure on west coast; location unknown per GSFC data link.

Pass 93, Aug 30/31

DSS 62

DR-1876: Insufficient information.

DR-2013: Pack involved with head crashes on 3 modules; the pack will not be used.

DSS 41

DR-2016: Insufficient information; need R dump.

Pass 94, Aug 31/Sept 1

DSS 62

DR-2017: Procedure error; wrong station entered.

Pass 95, Sept 1/Sept 2

DSS 42

DR-1384: Switched to Maser 2; fixed maser.

Pass 96, Sept 2/3

DSS 51

DR-1876: Appears to be hardware problem; will need computer time and dumps to correct difficulty.

Table 5 (contd)

Pass 97, Sept 3/4

DSS 62

DR-2048: S/W problem; ref. DDR 5677.

DR-2048: See above.

DR-2048: See above.

DR-2048: See above.

Pass 98, Sept 4/5

DSS 51

DR-2053: Replaced detent assembly.

DR-2056: Repaired detent assembly on Mod B.

DR-1389: Procedure error; new SOP needed.

Pass 99, Sept 5/6

DSS 51

DR-2059: User change stop time, DT routes.

Pass 100, Sept 6/7

DSS 51

DR-2062: Ref. SCR-673, SRF problem.

DR-2063: Replaced SLT at 01A-B1F4-2075.

DR-2064: S/W to dev, RFO UNK.

DSS 41

DR-2068: Operator error; personnel advised.

Pass 101, Sept 7/8

DSS 62

DR-2069: Replaced line receiver in DIB.

DR-2070: RX abends on RT spool; 3100 problem.

DR-2070: See above.

DR-2070: See above.

Table 5 (contd)

Pass 101, Sept 7/8 (cont'd)

DSS 41

DR-2071: S/W correction on JPLOS 3.0.259.

DR-2071: See above.

Pass 102, Sept 8/9

DSS 62

DR-2072: Replaced card FC 30/DC 30.

DR-3316: Restored; WB failure in Spain.

DSS 12

DR-2071: S/W correction on JPLOS 3.0.259.

DSS 41

DR-2078: SCISM, abends CTRT CMO1, 2 TDTV 50.

Pass 103, Sept 9/10

DSS 12

DR-2045: Auto R dump caused by SRF error. SVCLIB not core redundant (see SCR 673).

Pass 104, Sept 10/11

DSS 51

DR-2071: S/W correction on 3.0.259.

DR-2068: Operator error; personnel advised; SRF problem.

DR-1394: Replaced frequency shifter.

DSS 12

DR-2068: Operator error; advised personnel; SRF problem.

DR-1368: Problem was corrected by reloading the TCP.

DR-1403: Tripped off; lost 2-way lock.

DR-1396: Reloaded TCP.

DSS 41

DR-2086: S/W problem to dev.

Table 5.(contd)

Pass 105, Sept 11/12

DSS 62

DR-2086: S/W problem to dev.

DR-2086: See above.

Pass 108, Sept 14/15

DSS 51

DR-2105: Insufficient information; need dump.

DR-2106: Insufficient information; need dump.

DSS 12

DR-2068: Operator error; advised; SRF problem.

DR-2068: See above.

Pass 110, Sept 16/17

DSS 51

DR-2086: S/W problem to dev.

DSS 41

DR-3377: Cleared while checking.

DR-2119: Adjusted sync.

Pass 111, Sept 17/18

DSS 62

DR-2119: Adjusted sync.

DR-2086: S/W problem to dev.

DR-2124: Insufficient information; bad dump tape.

Pass 112, Sept 18/19

DSS 62

DR-1408: Tripped off; arc detector alarm.

Table 5 (contd)

Pass 113, Sept 19/20

DSS 51

DR-2126/28: Cleaned relay; insufficient information; need dump.

Pass 114, Sept 20/21

DSS 62

DR-2131: Abends on DTV.

DR-2132: Replaced defective detent assembly.

DSS 42

DR-1410: TCP patchboard error; documentation in error.

DR-1382: I/O problems; lost RT data.

Pass 115, Sept 21/22

DSS 62

DR-2136: Corrected on 3.0.259 and 3.0.265.

DR-2137: R/T ops lost; 1052's consoles.

DSS 41

DR-2128: Insufficient information; need dump.

DR-2131: Abends on DTV.

Pass 116, Sept 22/23

DSS 51

DR-2131: Abends on DTV.

DR-2142: S/W fix on JPLOS 3.0.259 system.

DR-2143: Operator error; instructed.

DR-2142: See above.

DSS 41

DR-2137: RT ops lost; 1052's consoles.

Table 5 (contd)

Pass 117, Sept 23/24

DSS 62

DR-2150: Processing telemetry data; system hung.

DR-1417: Replaced punch.

DR-2149: S/W under dev.

Pass 118, Sept 24/25

DSS 62

DR-2155: S/W under dev.

DR-2150: Processing telemetry data; system hung.

DSS 14

DR-1421: Tape data lost on TCPA.

DR-1422: Replaced PC 143, CM 117-67 board.

Pass 119, Sept 25/26

DSS 51

DR-2160: Programmer error; personnel advised.

DR-2161: Unable to process telemetry data.

Pass 120, Sept 26/27

DSS 41

DR-1427: Reset circuit breaker; supporting generator up.

Pass 121, Sept 27/28

DSS 62

DR-018: Problem is to be fixed in Phase 4B.

DSS 12

DR-2169: Core lockout caused by MDR interface; under investigation and repair; fix provided.

DSS 14

DR-1428: Lost tape write capability.

Table 5 (contd)

Pass 121, Sept 27/28 (cont'd)

DSS 41

DR-2170: Replaced typewriter.

DR-2171: Investigation being pursued. Problem with interface between RT tape and tasks making use of capability.

Pass 122, Sept 28/29

DSS 62

DR-2175: RT predix, receiving DOA on tasks.

DSS 41

DR-2179: Predix run; unable to request tape.

DR-2181: Test update submitted.

Pass 123, Sept 29/30

DSS 62

DR-2181: Test update submitted.

DR-2182: Corrected in 3.0.286.

DSS 41

DR-2186: Insufficient information; dump lost.

Pass 124, Sept 30/Oct 1

DSS 62

DR-2186: Insufficient information; dump lost.

DSS 12

DR-2191: Checking S/W (Ref. IOM 915.33/547).

DR-1435: DOI-5026, op. phase 4; no telemetry data.

DSS 42

DR-1436: Operator error; advised.

DR-1437: Operator error; inexperienced operator.

Table 5 (contd)

Pass 125, Oct 1/2

DSS 62

DR-2196: Investigating software.

DSS 12

DR-2197: Insufficient information; dump lost.

DR-2198: Replaced with spare.

DSS 14

DR-2199: New 1416 running stiff; lubricated new cartridge.

Pass 126, Oct 2/3

DSS 51

DR-2159: Replaced SMS card in 2821.

Pass 127, Oct 3/4

DSS 41

DR-2208: Corrected with text deck.

Pass 128, Oct 4/5

DSS 51

DR-2209: Locked out of both 1052's.

DR-2209/10: See above; also, replaced type ball, RFO ops. error.

DR-3511: Swapped lines between DSS 51 and ACN per GSFC D/L.

Pass 129, Oct 5/6

DSS 62

DR-2215: Investigating software.

DR-2156: Replaced SMS card in 2821.

Table 5 (contd)

Pass 130, Oct 6/7

DSS 12

DR-01458/59: Phase 4B bit rate error alarms; unable to initialize phase 4B.

Pass 131, Oct 7/8

DSS 62

DR-1462: Procedure error; personnel advised.

DSS 41

DR-2230: Locked out of 2260's and 1052's.

Pass 132, Oct 8/9

DSS 62

DR-029: Spurious interrupts problem; installed extra humidifiers in mid Nov '71; no further problems.

DR-2156: R dump output lost and tape scratched before could be reprinted; abends E37.

Pass 134, Oct 10/11

DSS 51

DR-2242: Replaced +3-V power supply.

Pass 136, Oct 12/13

DSS 51

DR-2253: Corrected on JPLOS 3.0.286.

DSS 42

DR-1478: Changed cards in W buffer.

DR-1479/28: Replaced power supply, CMD synth.; lost tape write capability, no recurrence.

Table 5 (contd)

Pass 137, Oct 13/14

DSS 51

- DR-2156: Unable to write to RT spool.
- DR-2258: Corrected on JPLOS 3.0.286.
- DR-2156: See above.

Pass 138, Oct 14/15

DSS 62

- DR-2264: Corrected on JPLOS 3.0.286.
- DR-2264: See above.

Pass 139, Oct 15/16

DSS 51

- DR-2156: Unable to write to RT spool.

Pass 140, Oct 16/17

DSS 51

- DR-3653: No trouble found.

DSS 14

- DR-2273: Replaced cards, RFO UNK.

DSS 41

- DR-6623: Corrected on JPLOS 3.0.286.

Pass 141, Oct 17/18

DSS 42

- DR-1488: Incorrect TCP I/O entry.

Pass 142, Oct 18/19

DSS 12

- DR-2156: Unable to write to RT spool.
-

Table 5 (contd)

Pass 142, Oct 18/19 (cont'd)

DSS 42

DR-1493: Command loop dropped lock.

Pass 143, Oct 19/20

DSS 51

DR-2284: DGA DG4 abends, 2260's lockout.

DSS 41

DR-2288: Investigating software.

Pass 144, Oct 20/21

DSS 62

DR-2292: SCR 407 correction.

DSS 42

DR-1496: Rx alarm 4200 000.

Pass 145, Oct 21/22

DSS 41

DR-2302: TLM processing hung; prox halted.

Pass 146, Oct 22/23

DSS 62

DR-2302: TLM processing hung; prox halted.

Pass 148, Oct 24/25

DSS 42

DR-2316: System not recognizing tape units.

DR-1503: SNR cycling from 22 dB to 0 dB.

Table 5 (contd)

Pass 150, Oct 26/27

DSS 14

DR-2323: Locked out of 1052's; abends.

Pass 151, Oct 27/28

DSS 12

DR-2330: I/O error 233 (MSD).

Pass 152, Oct 28/29

DSS 12

DR-2323: Locked out of 1052's; abends.

DR-2342: Abends on GTSLOMOP; system down.

Pass 153, Oct 29/30

DSS 12

DR-2349: Insufficient information; need dump.

DSS 41

DR-2151: Replaced broken spring; cleaned and adjusted.

Pass 154, Oct 30/31

DSS 41

DR-2151: Replaced broken spring; cleaned; adjusted.

DR-2152: No trouble found.

Pass 155, Oct 31 / Nov 1

DSS 41

DR-3797: Restored CKT HTWN GSFC/ACSW

Table 5 (contd)

Pass 157, Nov 2/3

DSS 62

DR-2368: PCA-5423 submitted.

DSS 12

DR-T-25 and 151Z: Modex index changed to zero.

DR-T-26: BDA may have slipped a cycle; problem has not recurred.

Pass 158, Nov 3/4

DSS 62

DR-2375: S/W fix available, hardware pending.

DSS 14

DR-2378: S/W fix available; hardware pending.

DR-2378: S/W fix available; hardware pending.

DR-2379: Replaced core array.

DR-1519: Typing error; operator advised.

Pass 159, Nov 4/5

DSS 12

DR-2286: Replaced carriage drive assembly.

DR-1521: Reloaded program; RFO UNK.

DR-1520 and TFR-A59437: Replaced digital phase shifter.

DSS 41

DR-2258: Corrected on JPLOS 3.0.286.

DR-2258: See above.

Pass 160, Nov 5/6

DSS 41

DR-2393: S/W fix available; hardware pending.

DR-2393: See above.

DSS 51

DR-1525: Operator error; operator advised.

Table 5 (contd)

Pass 160, Nov 5/6 (cont'd)

DSS 51 (cont'd)

DR-2393: S/W fix available, hardware pending.

DR-2393: See above.

Pass 161, Nov 6/7

DSS 12

DR-2393: S/W fix available; hardware pending.

DR-2393: See above.

DR-2393: See above.

DR-2393: S/W fix available; hardware pending.

DR-2393: See above.

DSS 42

DR-T-30: Faulty synthesizer in SDA2 repaired; VCO readjusted.

DSS 41

DR-1529: Switched to TCPA; operator advised.

Pass 162, Nov 7/8

DSS 51

DR-2392: S/W error in operating system; system hung on channel 0 of 360/75; DTV stopped, locked out of 1052's; forced R dump.

DR-2398: Adjusted ribbon tracking.

DR-1531: Switched to MASER 2; adjust flow.

DSS 14

DR-2393: S/W fix available, hardware pending.

DR-2393: S/W fix available, hardware pending.

DR-1532: Reset clocks; DSS chiefs advised.

DR-1533: Replaced cable, W-37.

DSS 12

DR-2393: S/W fix available; hardware pending.

DR-2393: See above.

DR-2393: See above.

Table 5 (contd)

Pass 162, Nov 7/8 (cont'd)

DSS 12 (cont'd)

DR-2393: See above.

DR-2393: See above.

Pass 163, Nov 8/9

DSS 12

DR-2393: S/W fix available, hardware pending.

DR-2393: See above.

DSS 14

DR-T-31: Performed SDA alignment which corrected the low SNR problem; receiver recalibrated; new AGC curve loaded into DIS/TCP.

DSS 41

DR-2415: PCA 5422 submitted for fix.

DR-2417: Insufficient information; no logout.

Pass 164, Nov 9/10

DSS 62

DR-2418: Insufficient information; no logout.

DR-2418: See above.

DR-2418: See above.

DSS 14

DR-1536: Unable to control HDR.

Pass 165, Nov 10/11

DSS 12

DR-401-10: Reconnected power cable.

DSS 62

DR-1538: Replaced and adjusted on/off thyratrons.

Table 5 (contd)

Pass 167, Nov 12/13

DSS 62

DR-C-047: Installed extra humidifiers middle of November 1971; no further problems.

DR-C-047: See above.

Pass 168, Nov 13/14

DSS 62

DR-2434: Insufficient information.

DR-2434: Insufficient information.

DR-2434: See above.

DSS 51

DR-2434: Insufficient information.

DR-2434: See above.

DR-2434: See above.

DSS 14

DR-1546 and T-FR-56049: Would not accept CMD data.

DSS 12

DR-C-048: High-speed I/O hang-up problem. Solution pending review by DSIF of DR-1569; SFOF PX HSD steady invalids.

Table 6. DSN Telemetry System analysis

Month	No. Readings	Arith Mean	Variance (DB)	Std Dev	Percent of observations		Remarks
					Within 1 dB	Within 0.3 dB	
Jun SNR Signal DL Level UL	42	0.4583	----	0.3784		Value most often observed: dB <0.29 <0.3 <0.46	
	46	0.6087	----	0.5240			
	46	0.6880	----	0.7014			
Jul SNR Signal DL Level UL	99	0.7253	0.3999	0.6323	78.79	23.23	
	99	0.6162	0.2769	0.5262	71.72	31.31	
	99	0.5152	0.2055	0.4534	90.91	31.31	
Aug SNR Signal DL Level UL	93	0.6032	0.2301	0.4797	79.5	27.96	August figures show improvement over July
	93	0.6140	0.2351	0.4849	81.85	25.81	
	92	0.6880	0.5066	0.7117	78.2	26.09	
Sep SNR Signal DL Level UL	82	0.5378	0.1836	0.4285	86.59	25.61	Quartile Value (DB) 1st Median 3rd 0.2 0.5 0.8 0.2 0.4 0.8 0.2 0.5 0.7
	83	0.5181	0.1788	0.4229	80.72	38.55	
	82	0.5598	0.3116	0.5582	86.59	32.93	
Oct SNR Signal DL Level UL	76	0.9921	0.5143	0.7172	55.26	17.11	Statistical Mode, ^a Decile (DB) 0.8 to 0.9 ^b 0.1 to 0.2 0.4 to 0.5
	72	0.4583	0.1529	0.3910	87.50	37.50	
	76	0.5100	0.1267	0.3560	87.14	27.14	
Nov SNR Signal DL Level UP	104	0.5519	0.2002	0.4474	80.77	34.62	0.1 to 0.2 0.4 to 0.5 0.1 to 0.2
	106	0.5264	0.1536	0.3919	81.13	26.42	
	76	0.3671	0.1273	0.3568	93.42	46.05	

^a Most often observed value of residuals.

^b Values are relatively high because of poor performance at DSS 62. Cause was investigated.

Table 7. ODR station recall data, August 1971

DSS	View periods	Recalls		Data time	
		Yes	No	Hours	Minutes
51	13	9	4	12	5
41	29	26	3	12	51
42	1	1	0	0	31
12	23	2	21	1	18
14	5	3	2	2	19
62	18	17	1	5	1
Totals	89	58	31	34	5

Table 8. ODR station recall data, September 1971

DSS	View periods	Recalls		Data time	
		Yes	No	Hours	Minutes
51	12	9	3	13	30
12	25	11	14	5	10
14	3	1	2	1	31
41	20	19	1	12	1
42	8	8	0	4	37
62	12	9	3	5	48
Totals	80	57	23	42	37

Table 9. Three-month summary of command activity

Command activity	Station						
	12	14	41	42	51	62	Total
September							
Commands confirmed	173	1	22	3	7	69	275
Aborts	3	0	0	0	0	0	3
Percent down ^a	3.1	6.1	2.5	2.2	3.4	8.2	—
October							
Commands confirmed	300	18	191	0	68	49	626
Aborts	0	0	0	0	0	0	0
Percent down ^a	3.1	2.8	2.2	2.5	2.7	3.4	—
November ^b							
Commands confirmed	1,377	27	1,079	—	2	3,279	5,764
Aborts	4	0	0	—	0	0	4
Percent down ^a	3.1	3.8	4.3	—	6.6	4.6	—
^a Includes 360/75 and HSDL outages. ^b Command activity shown for entire month.							

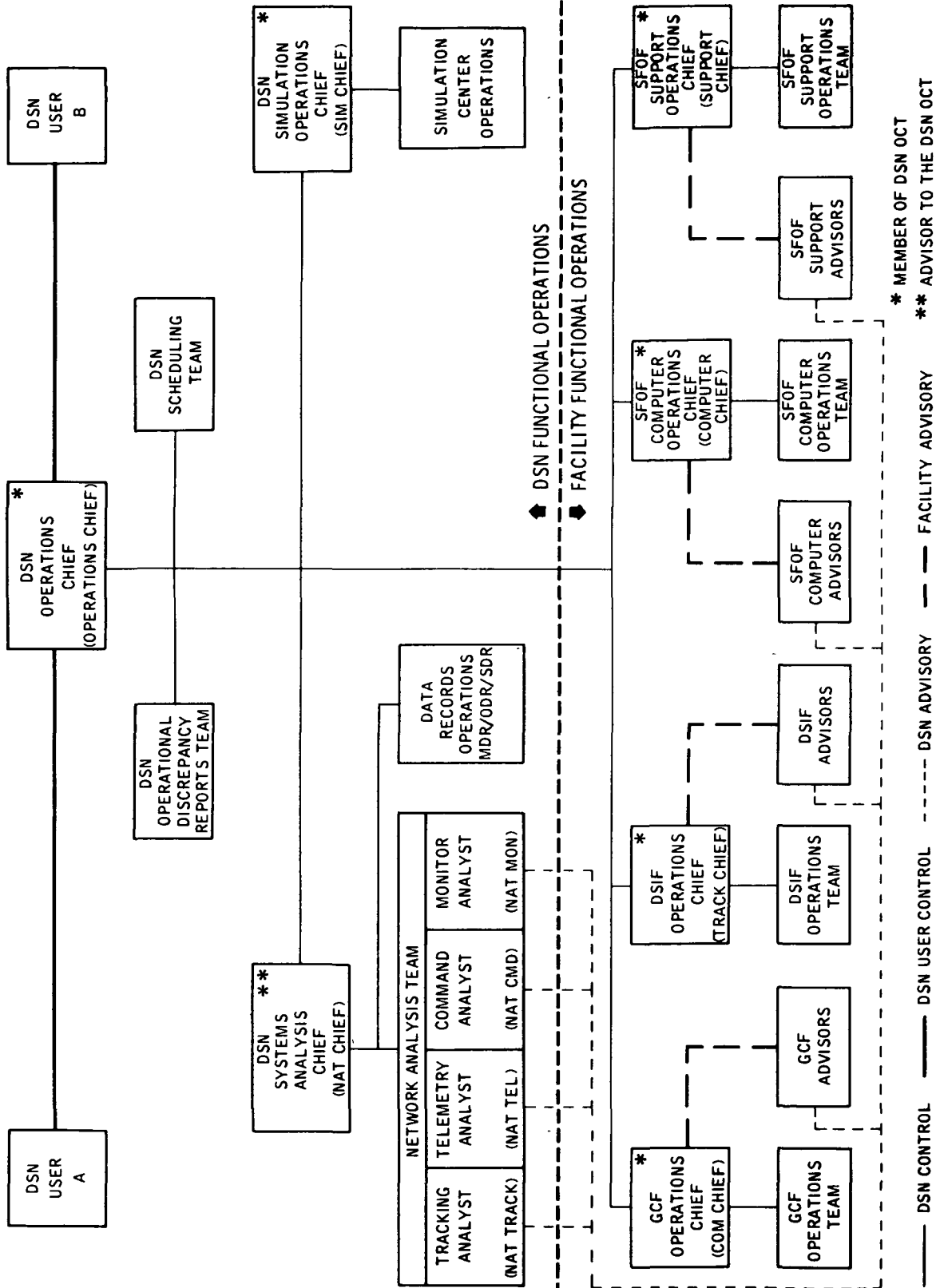

Fig. 8. DSN operations organization

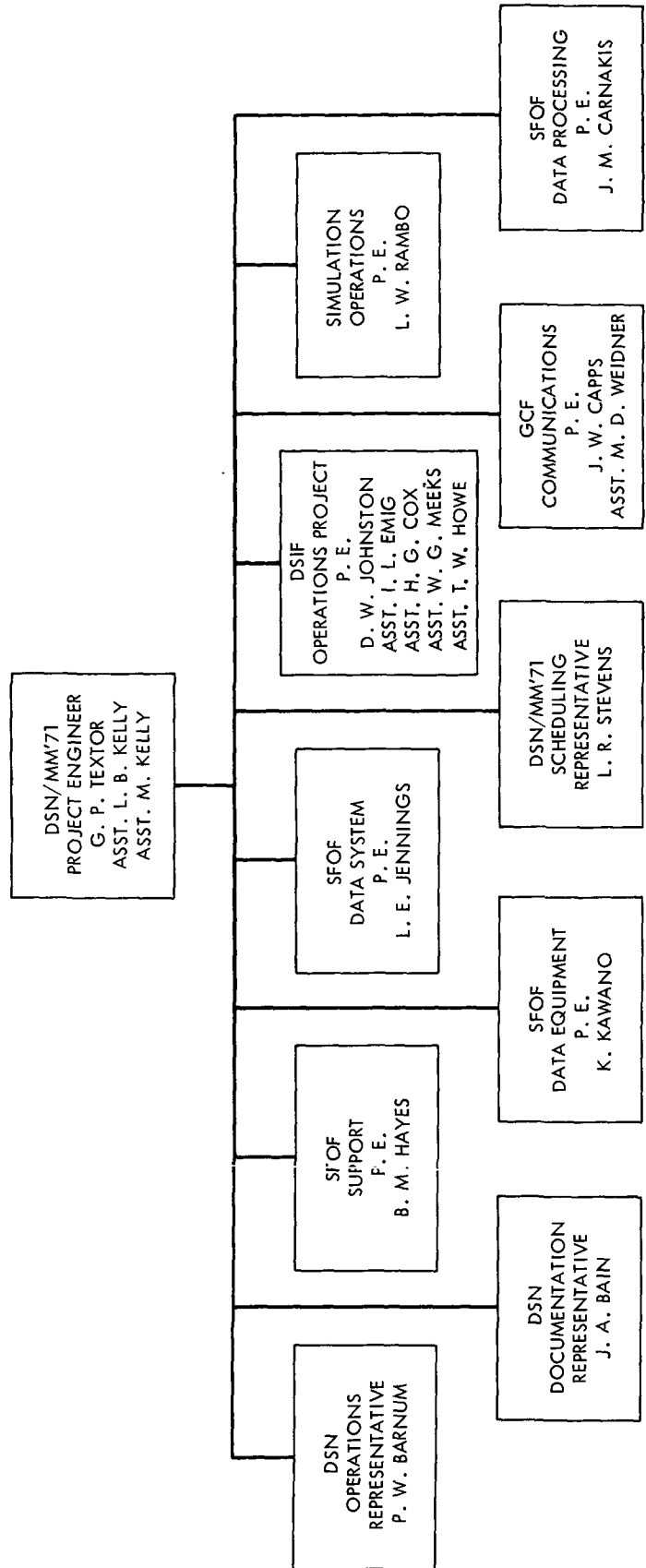
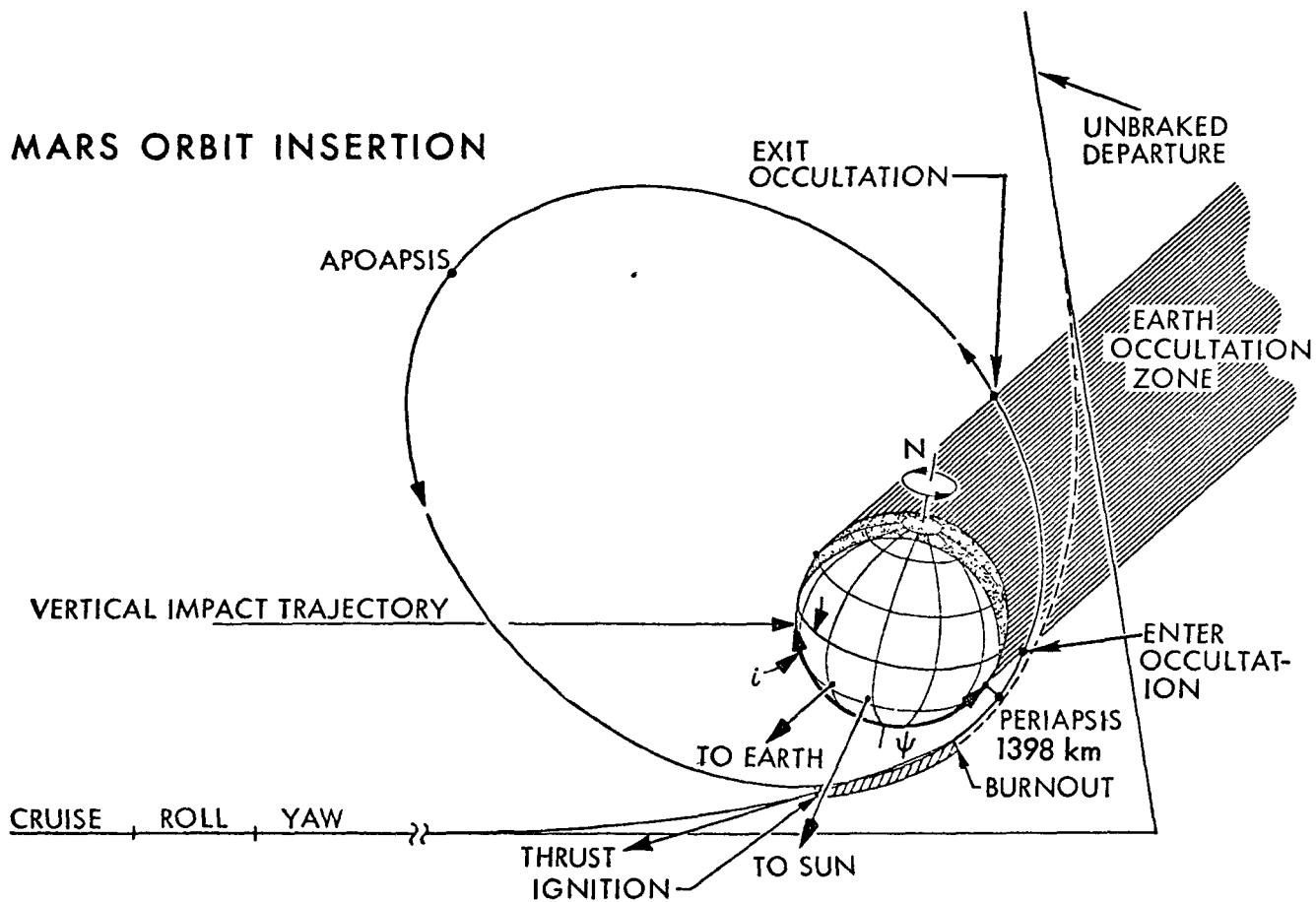

Fig. 9. DSN Project engineering organization



ψ = ORBIT INCLINATION TO EQUATOR 64.3 deg ORBITAL PERIOD = 12.567 h
 i = APSIDAL ORIENTATION 139.7 deg

Fig. 10. Mariner 9 orbit insertion

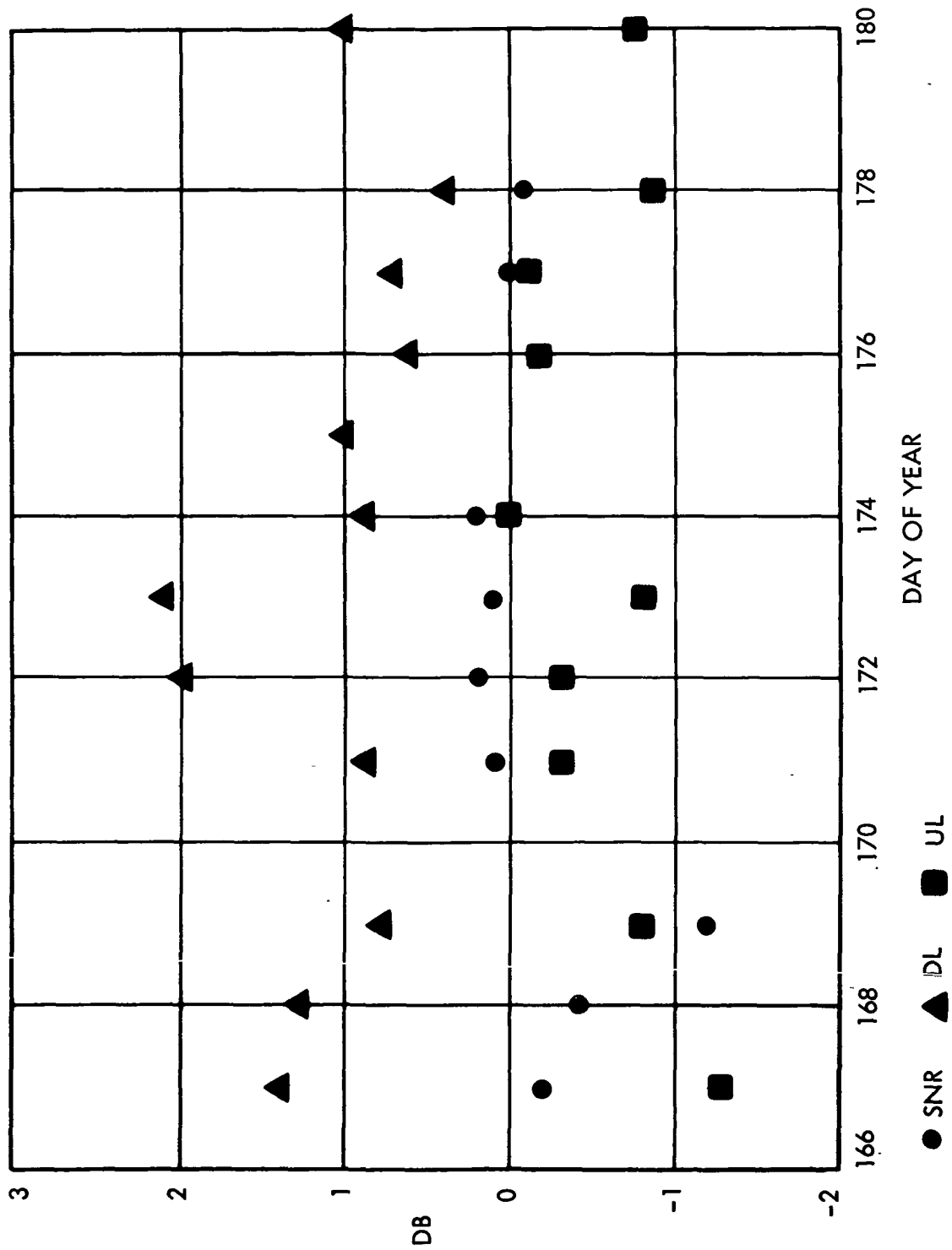

Fig. 11. Residual data plot for DSS 12, June 1971

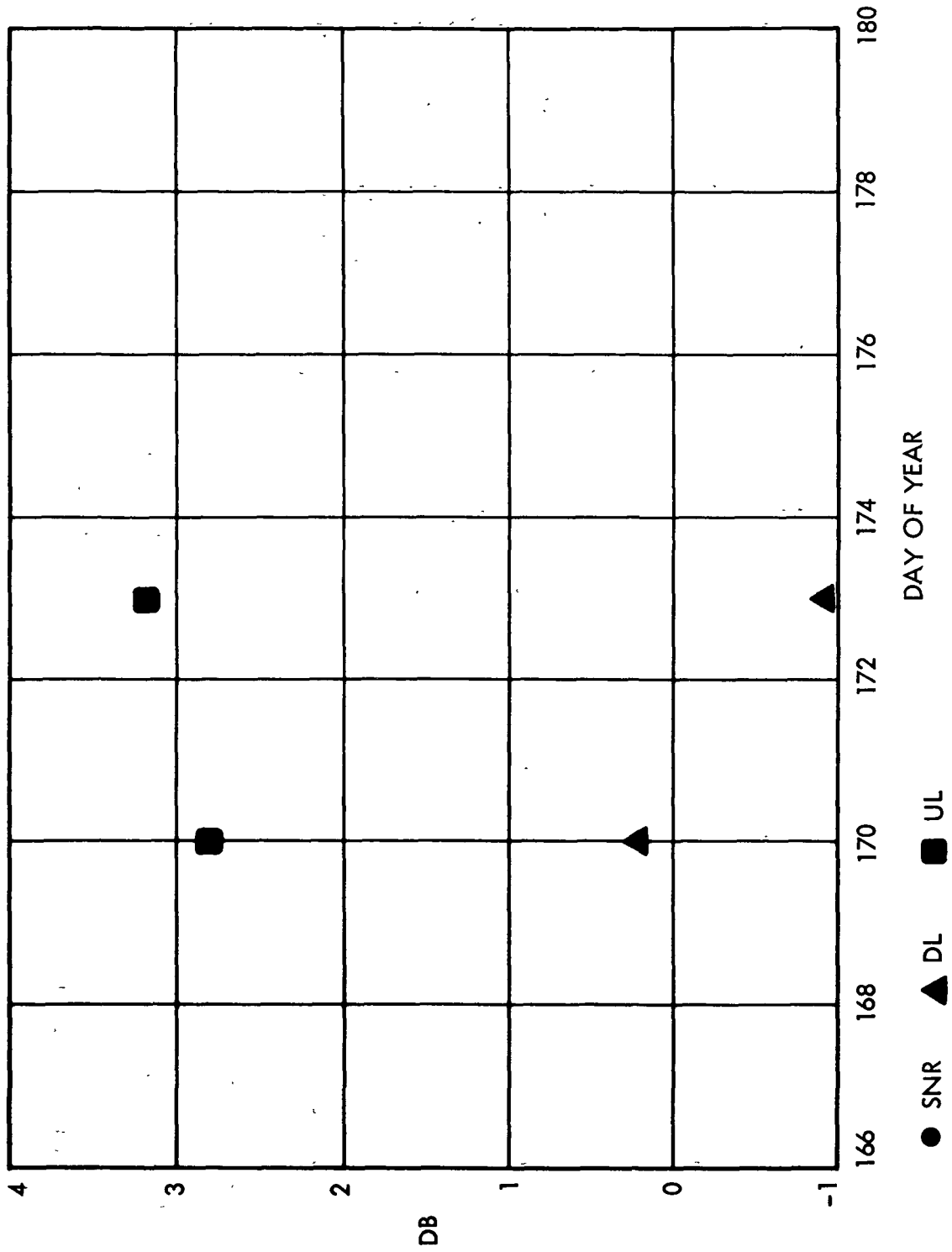

Fig 12. Residual data plot for DSS 14, June 1971

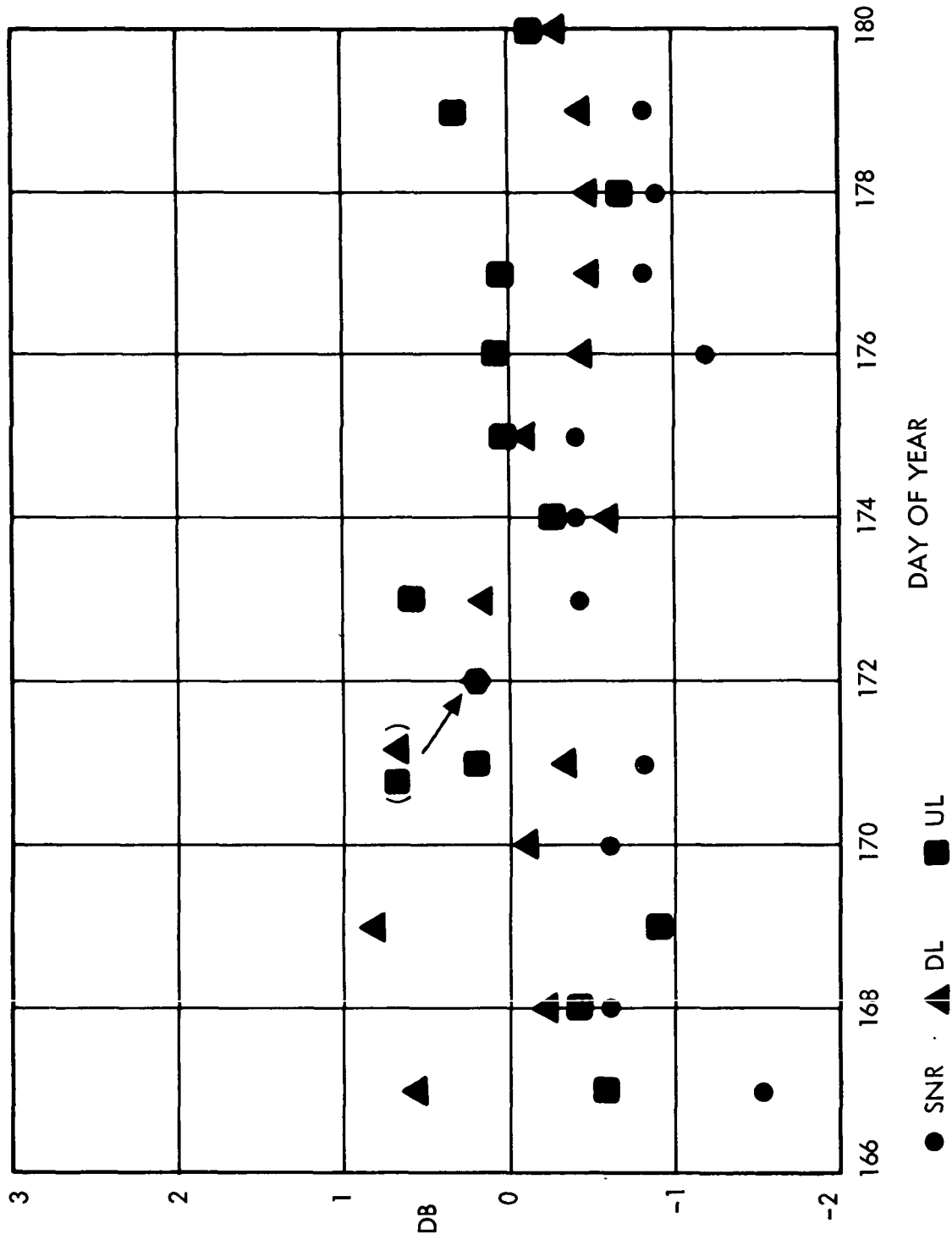

Fig. 13. Residual data plot for DSS 41, June 1971

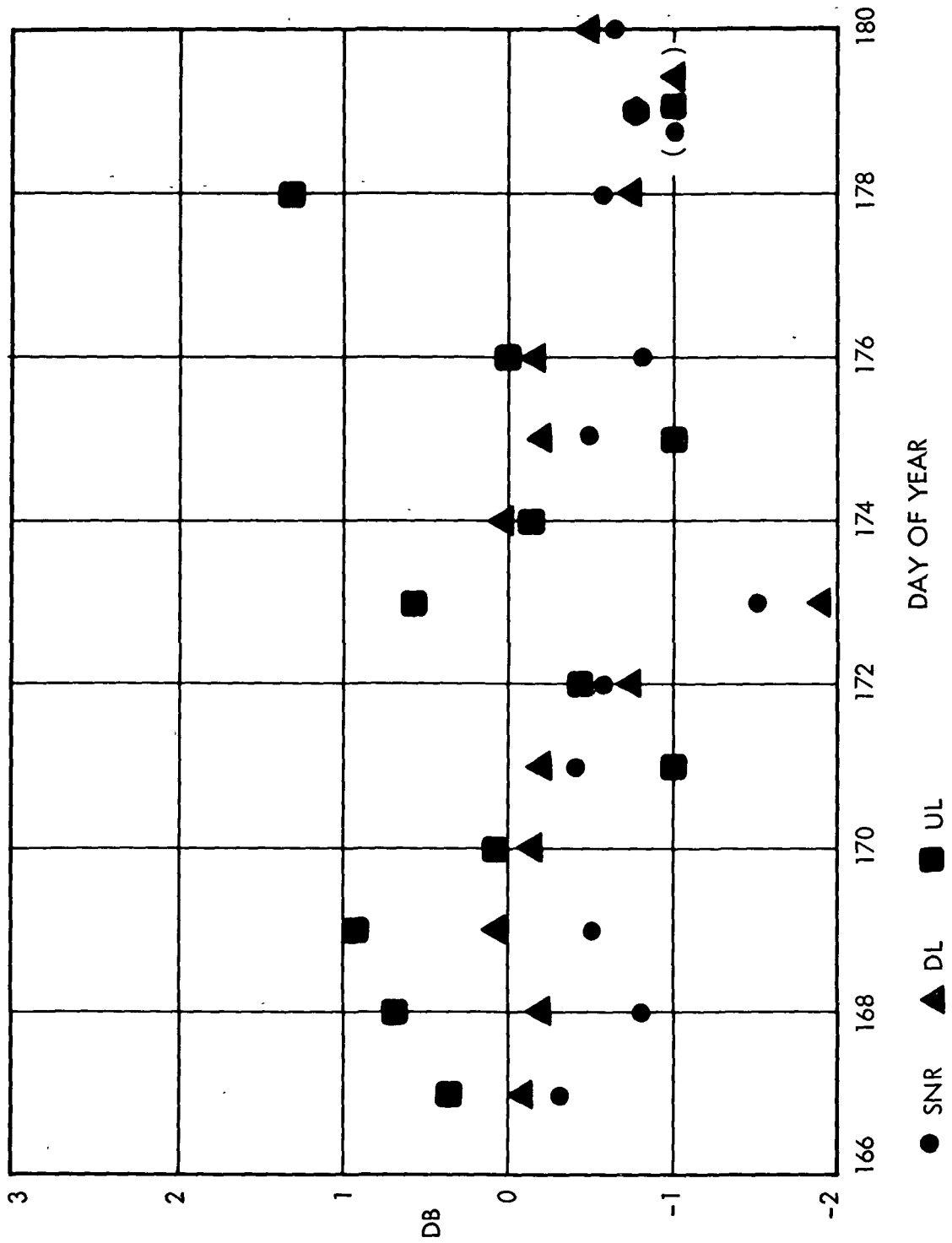

Fig. 14. Residual data plot for DSS 51, June 1971

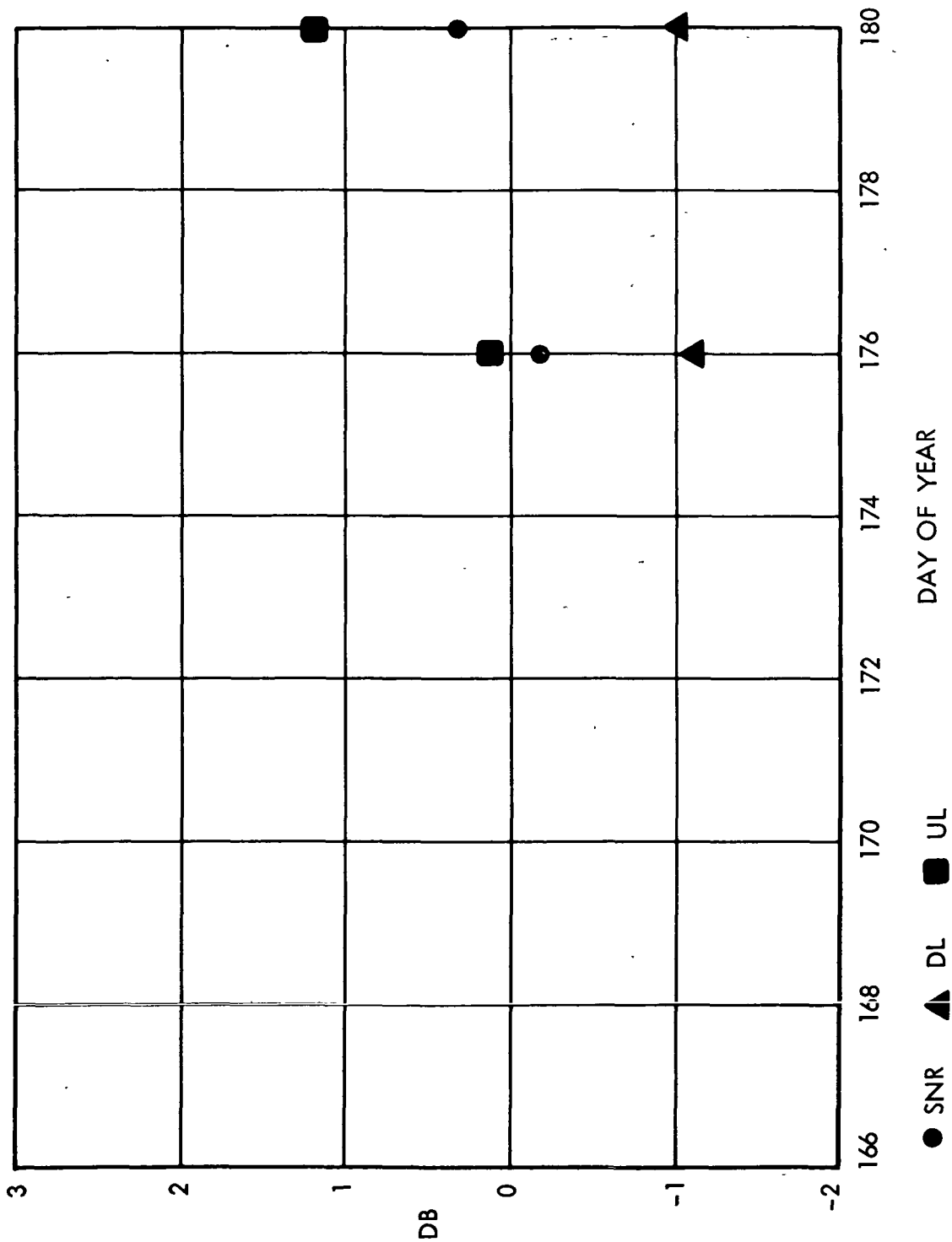

Fig. 15. Residual data plot for DSS 62, June 1971

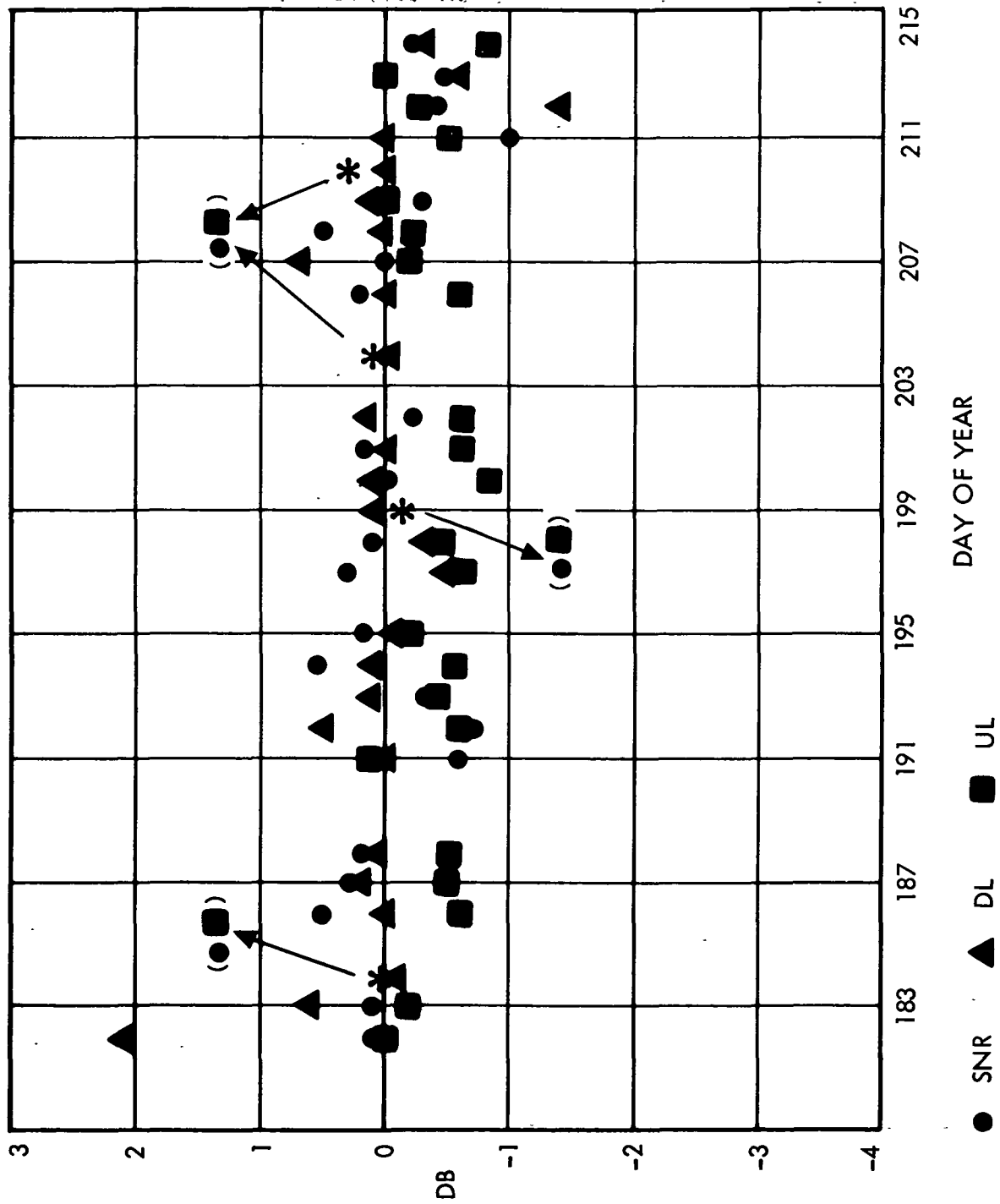

Fig. 16. Residual data plot for DSS 12, July 1971

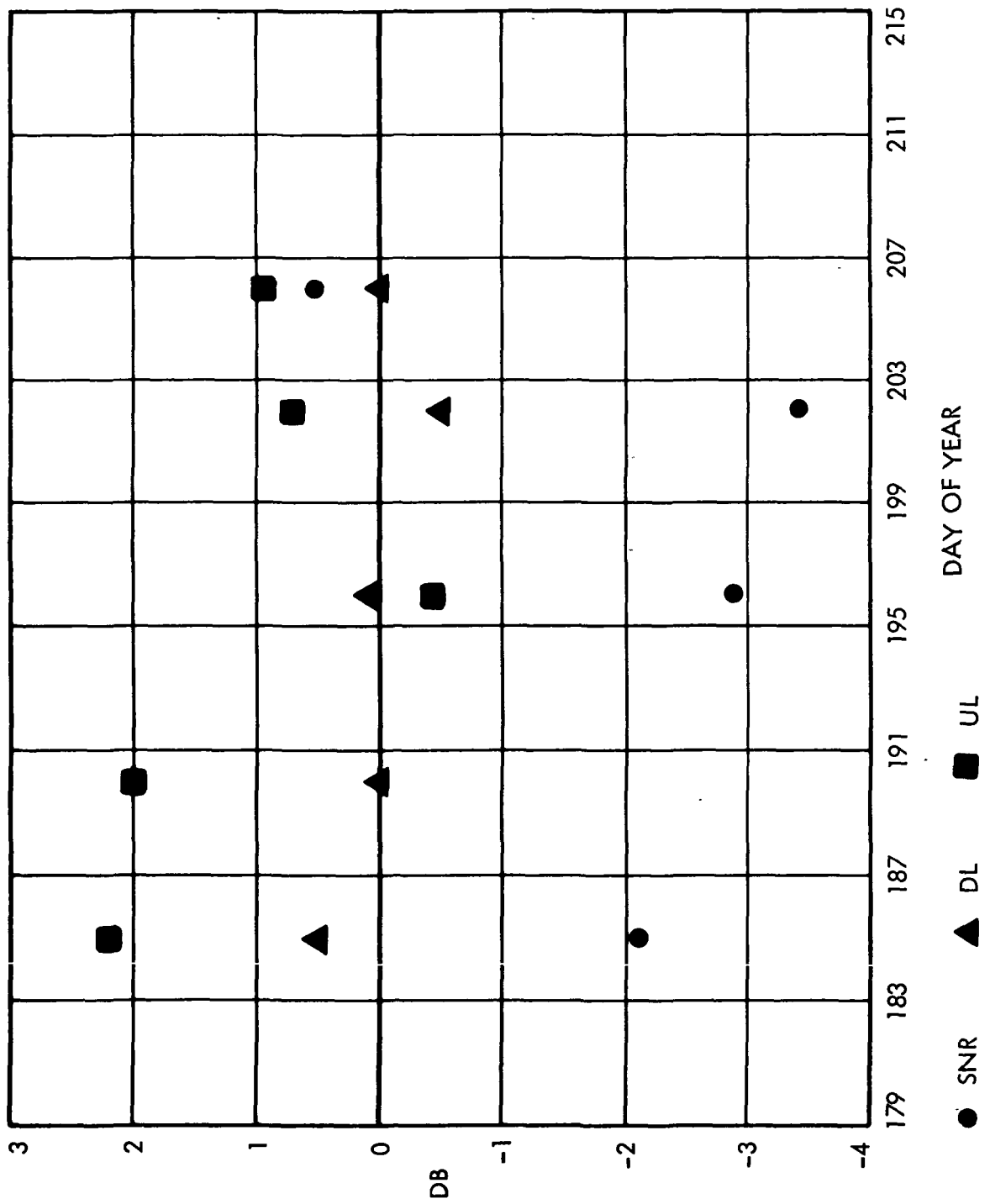

Fig. 17. Residual data plot for DSS 14, July 1971

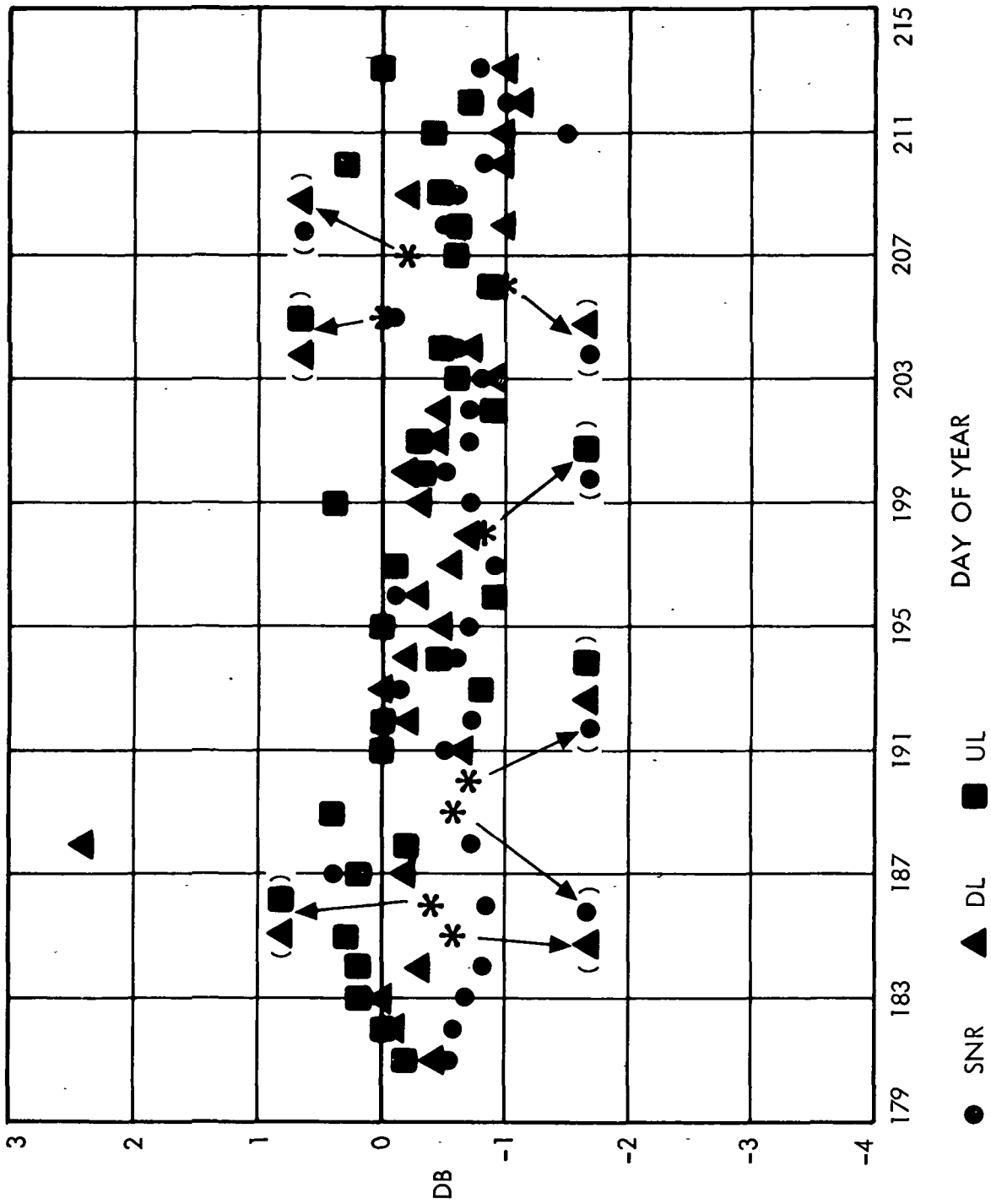

Fig. 18. Residual data plot for DSS 41, July 1971

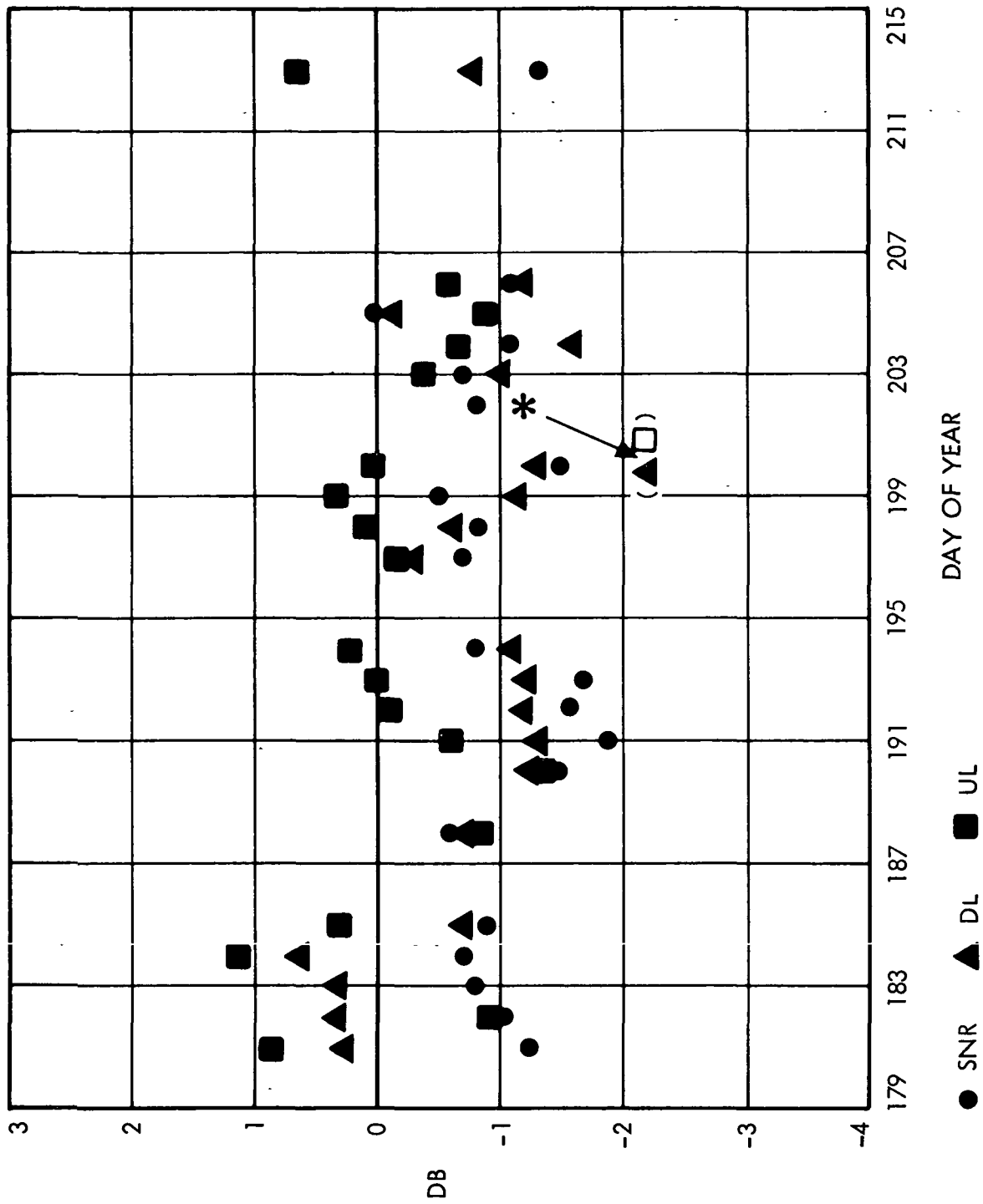

Fig. 19. Residual data plot for DSS 51, July 1971

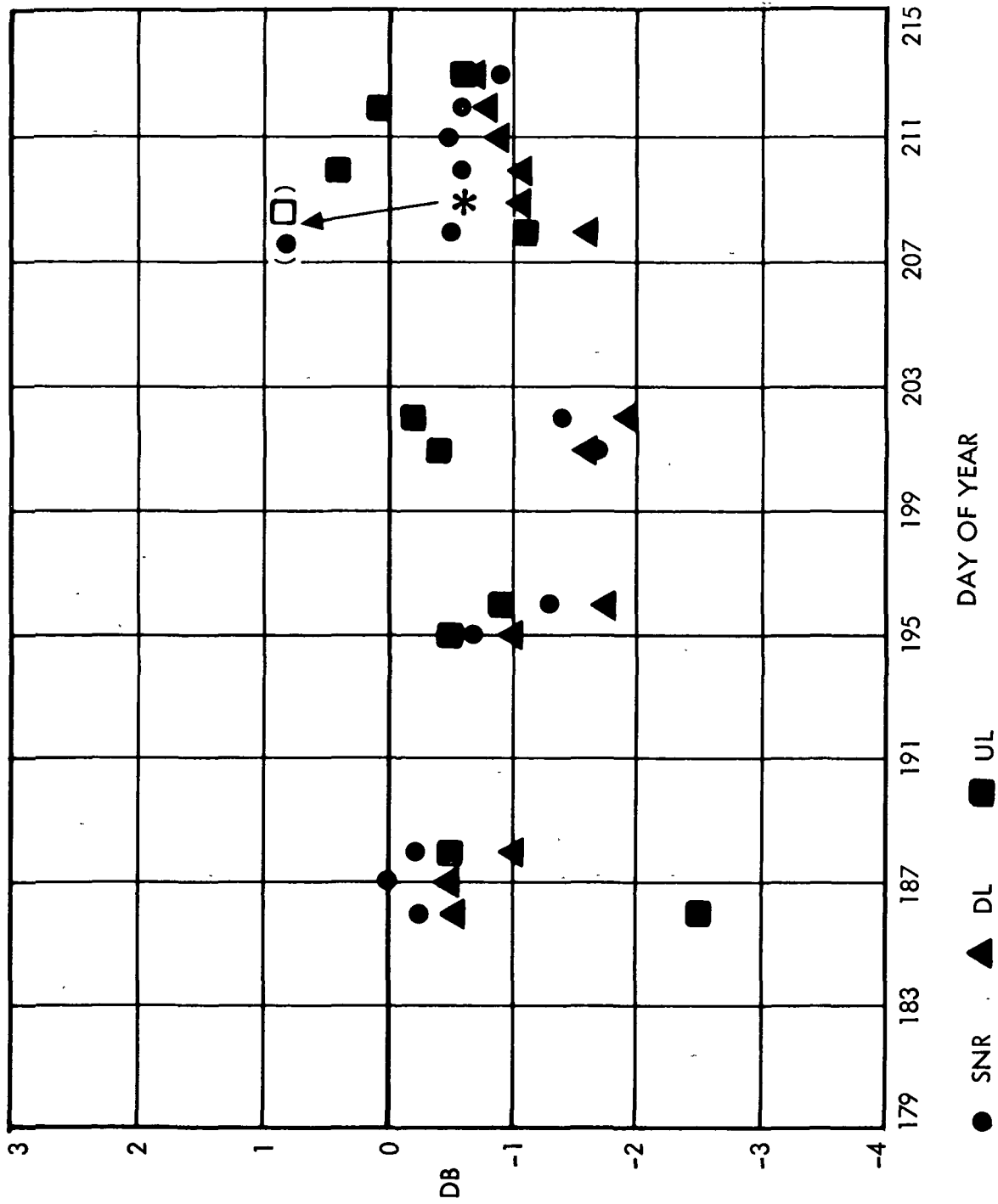

Fig. 20. Residual data plot for DSS 62, July 1971

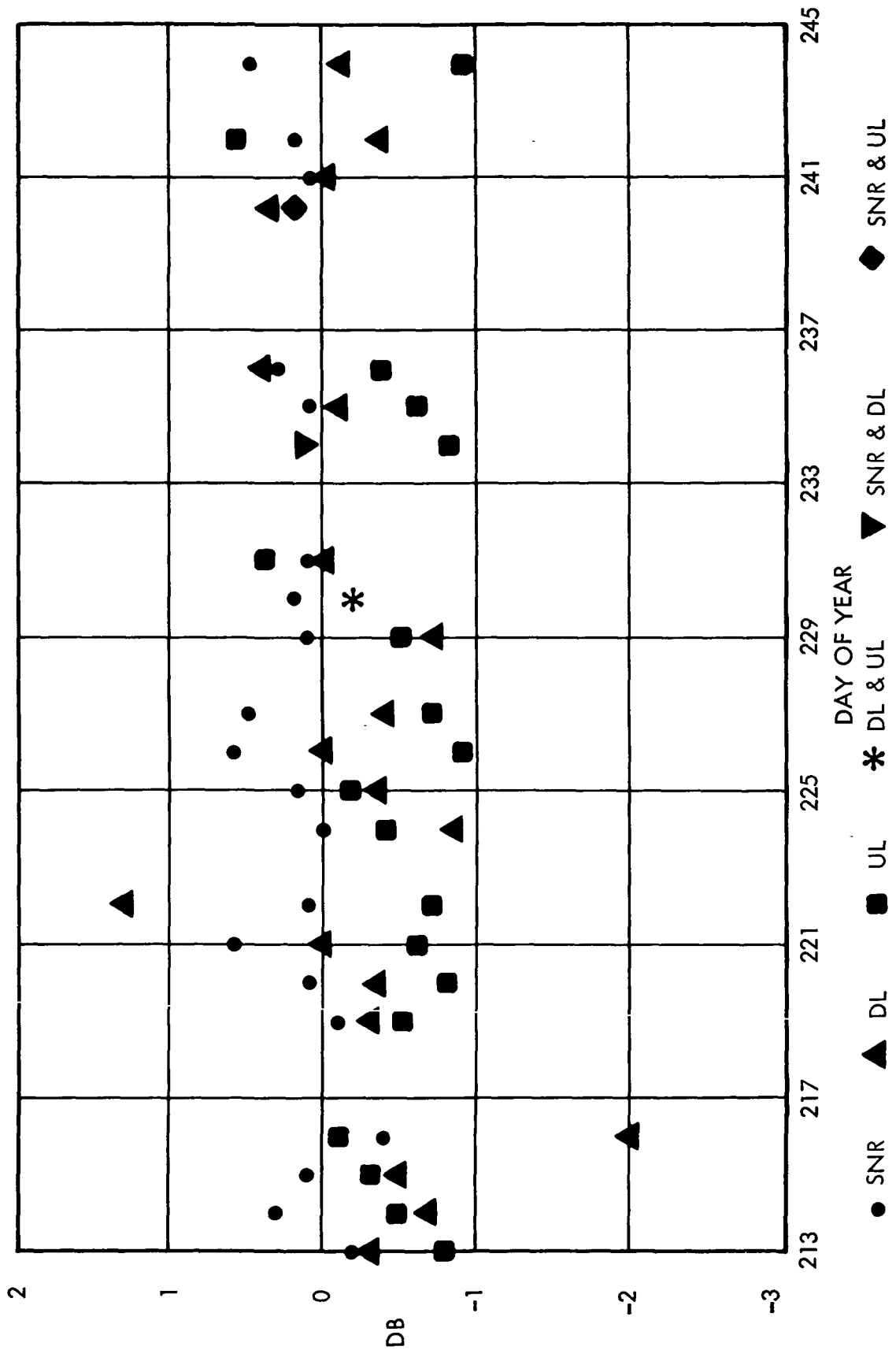

Fig. 21. Residual data plot for DSS 12, August 1971

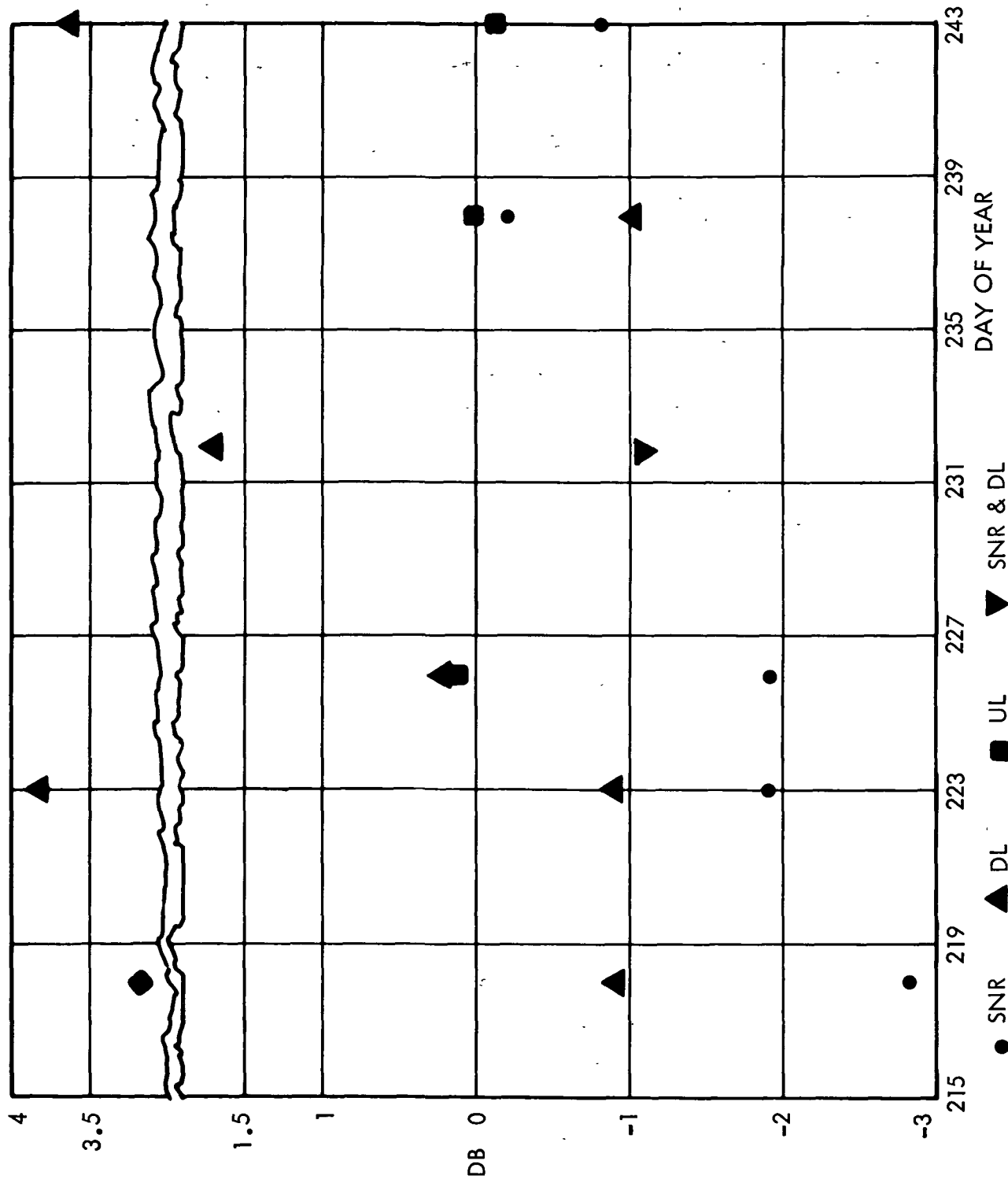

Fig. 22. Residual data plot for DSS 14, August 1971

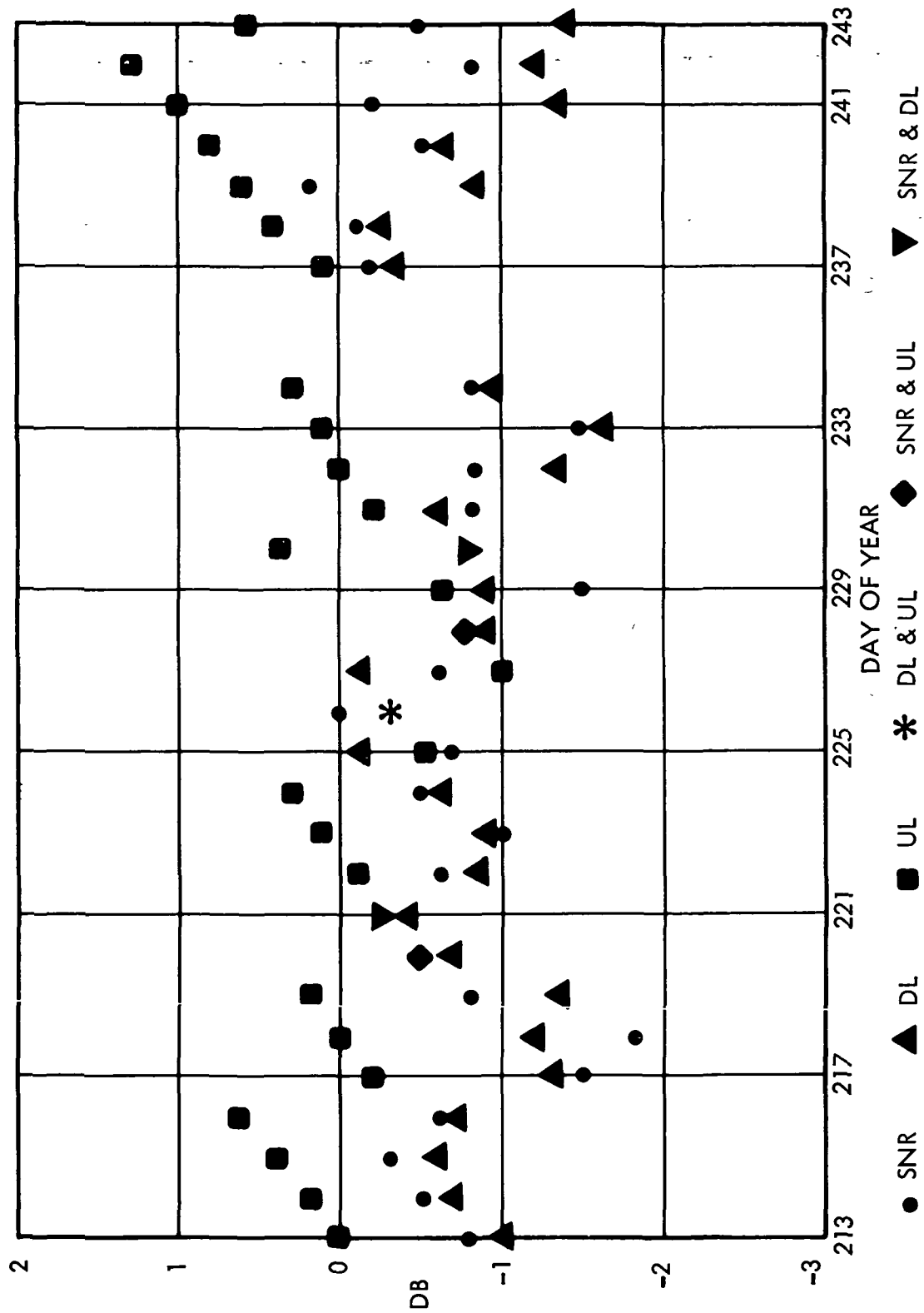

Fig. 23. Residual data plot for DSS 41, August 1971

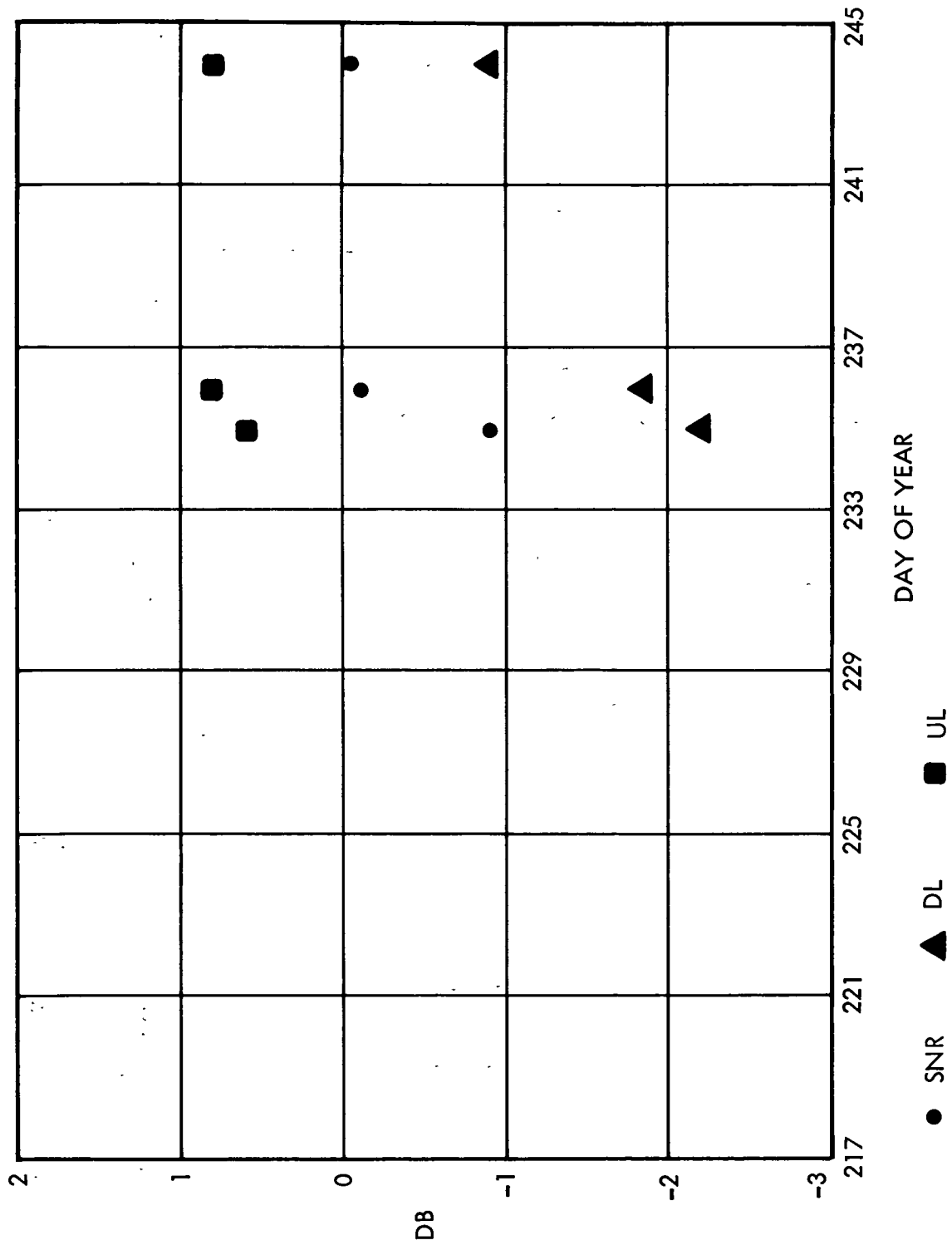

Fig. 24. Residual data plot for DSS 42, August 1971

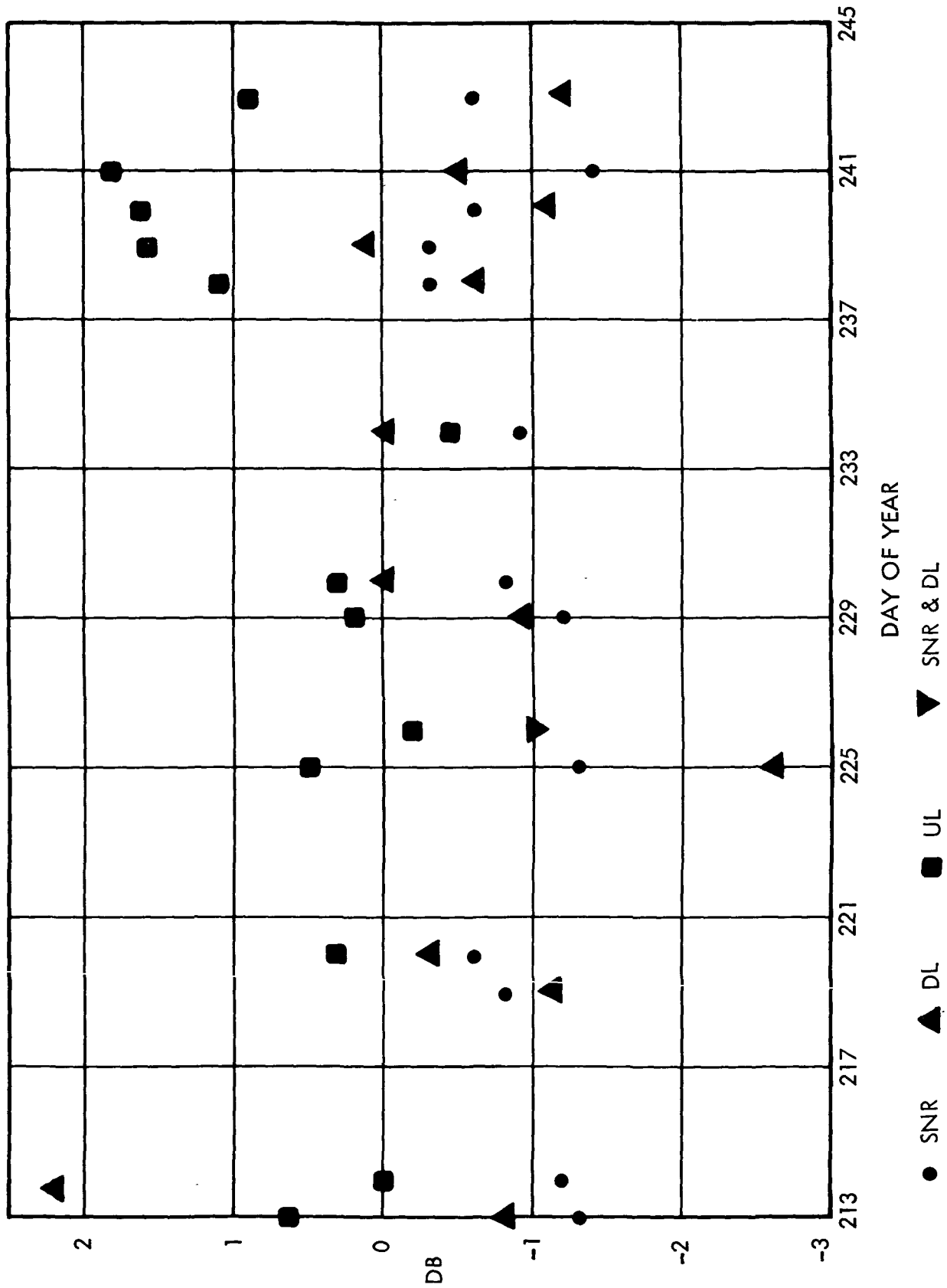

Fig. 25. Residual data plot for DSS 51, August 1971

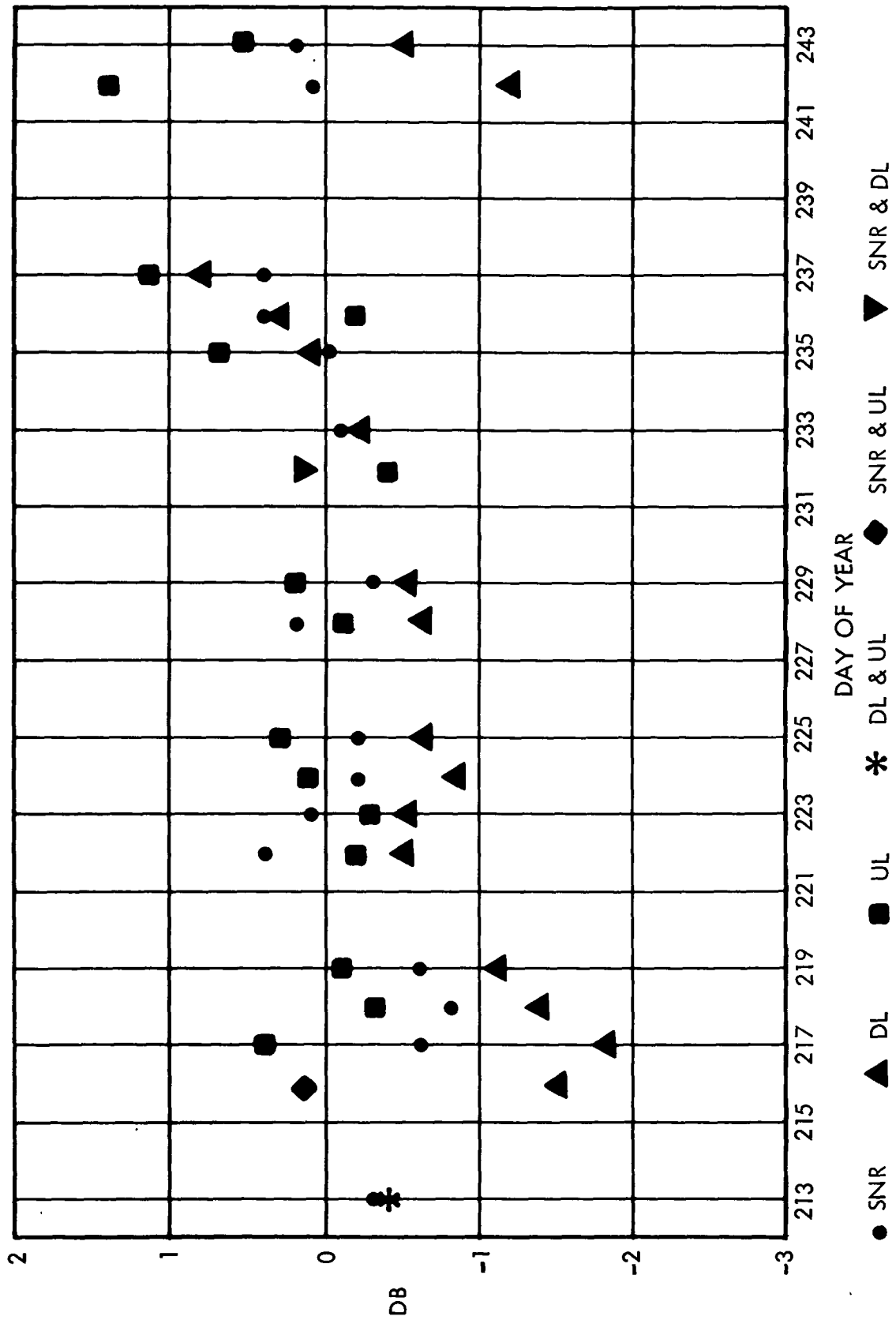

Fig. 26. Residual data plot for DSS 62, August 1971

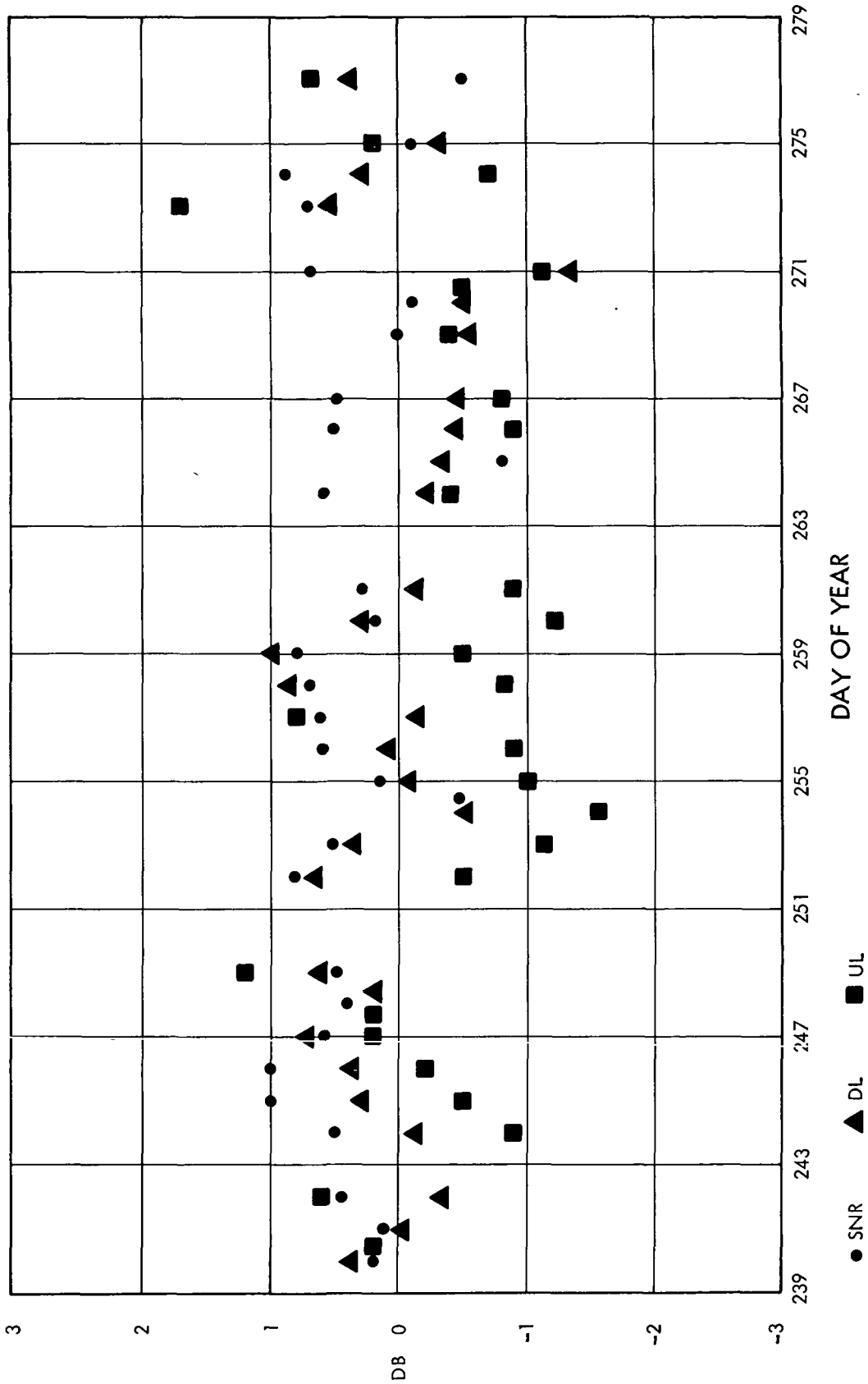

Fig. 27. Residual data plot for DSS 12, September 1971

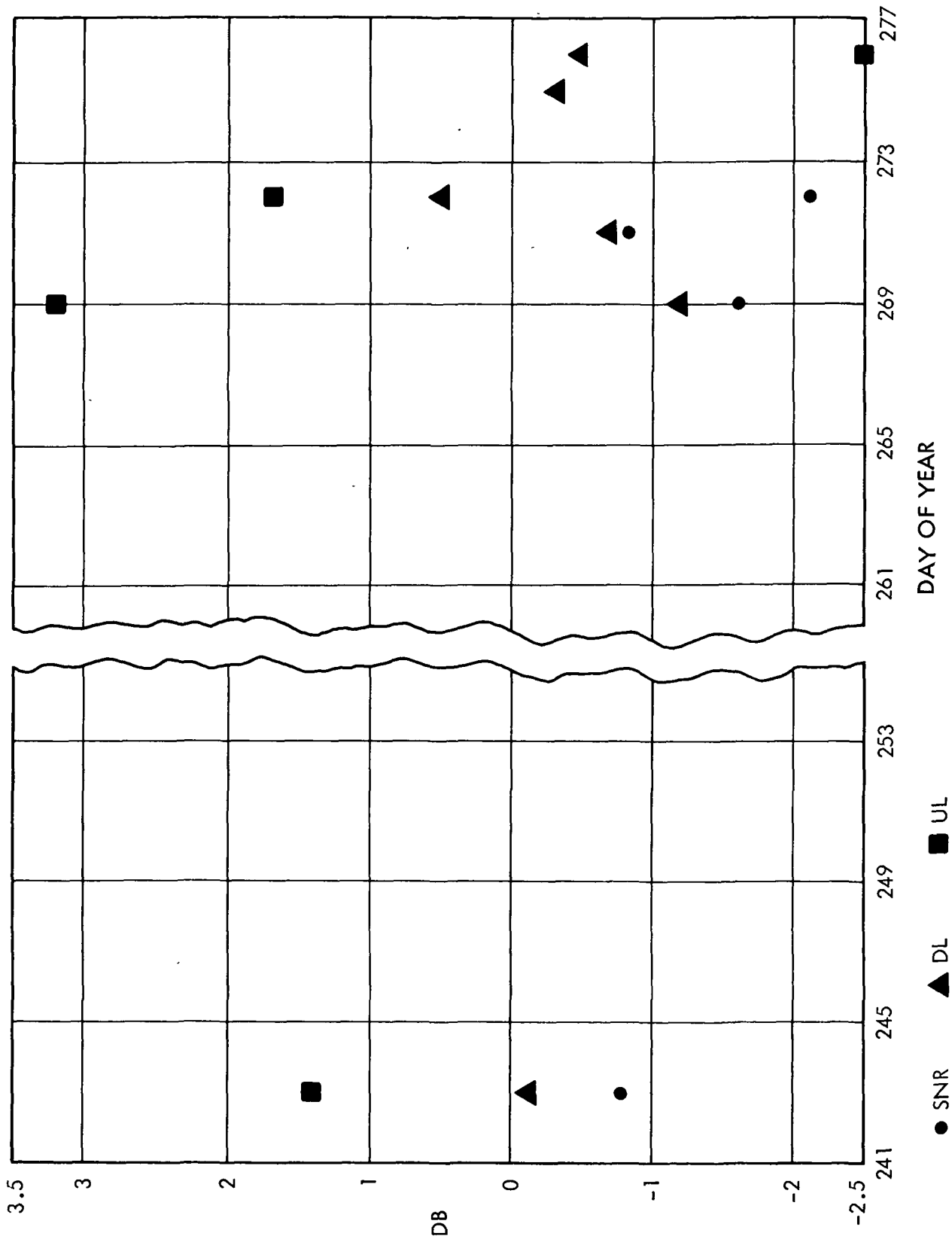

Fig. 28. Residual data plot for DSS 14, September 1971

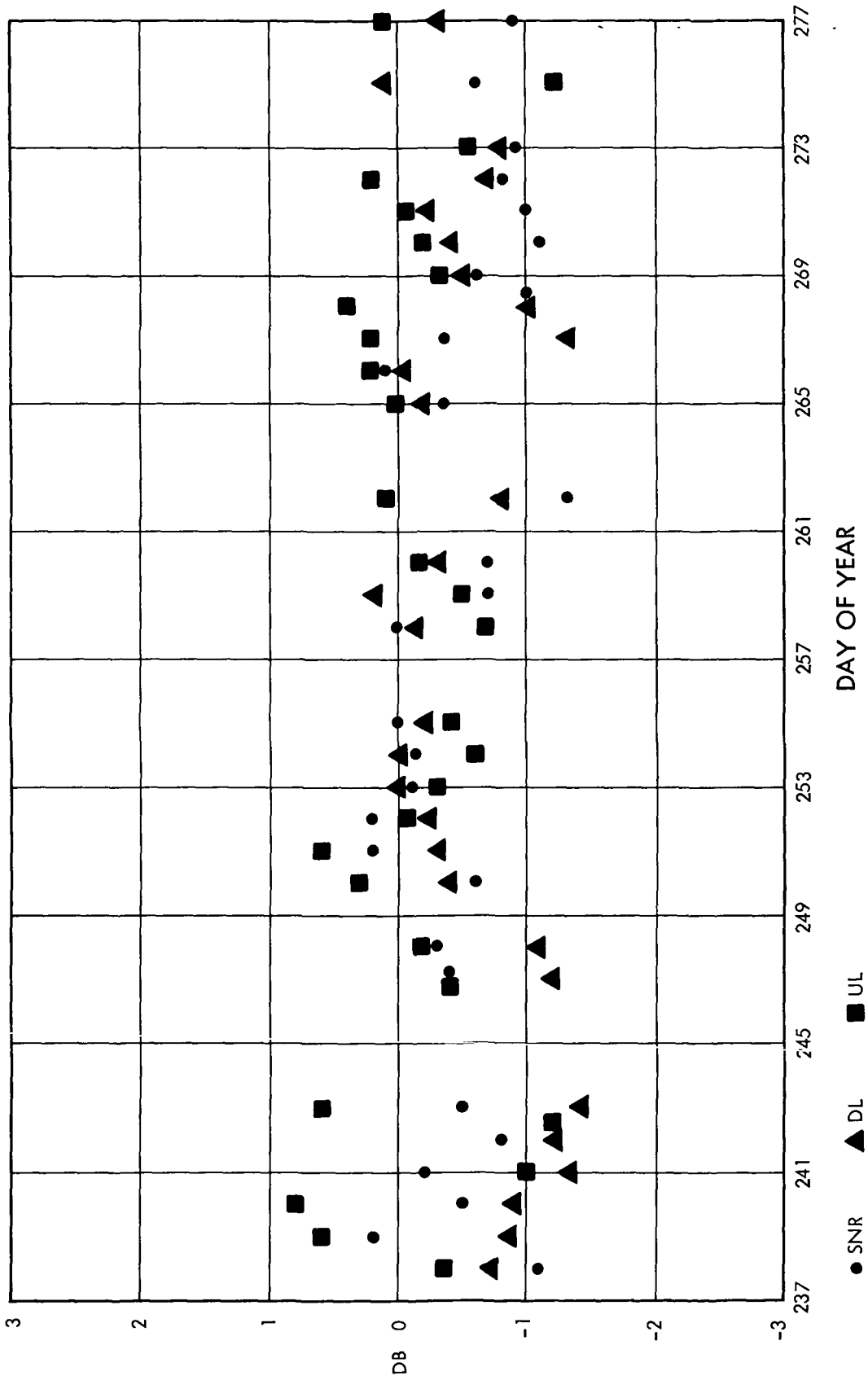

Fig. 29. Residual data plot for DSS 41, September 1971

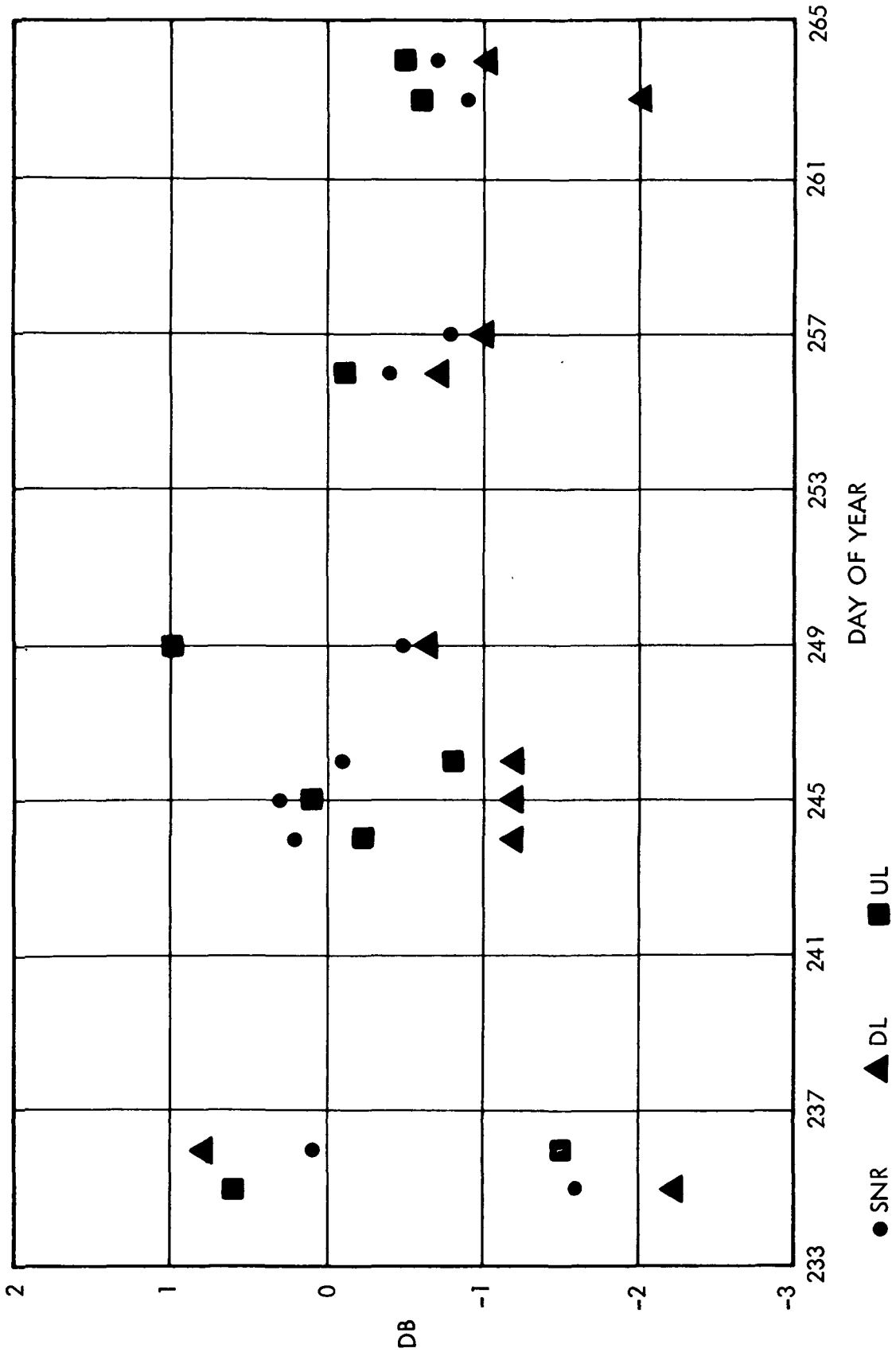

Fig. 30. Residual data plot for DSS 42, September 1971

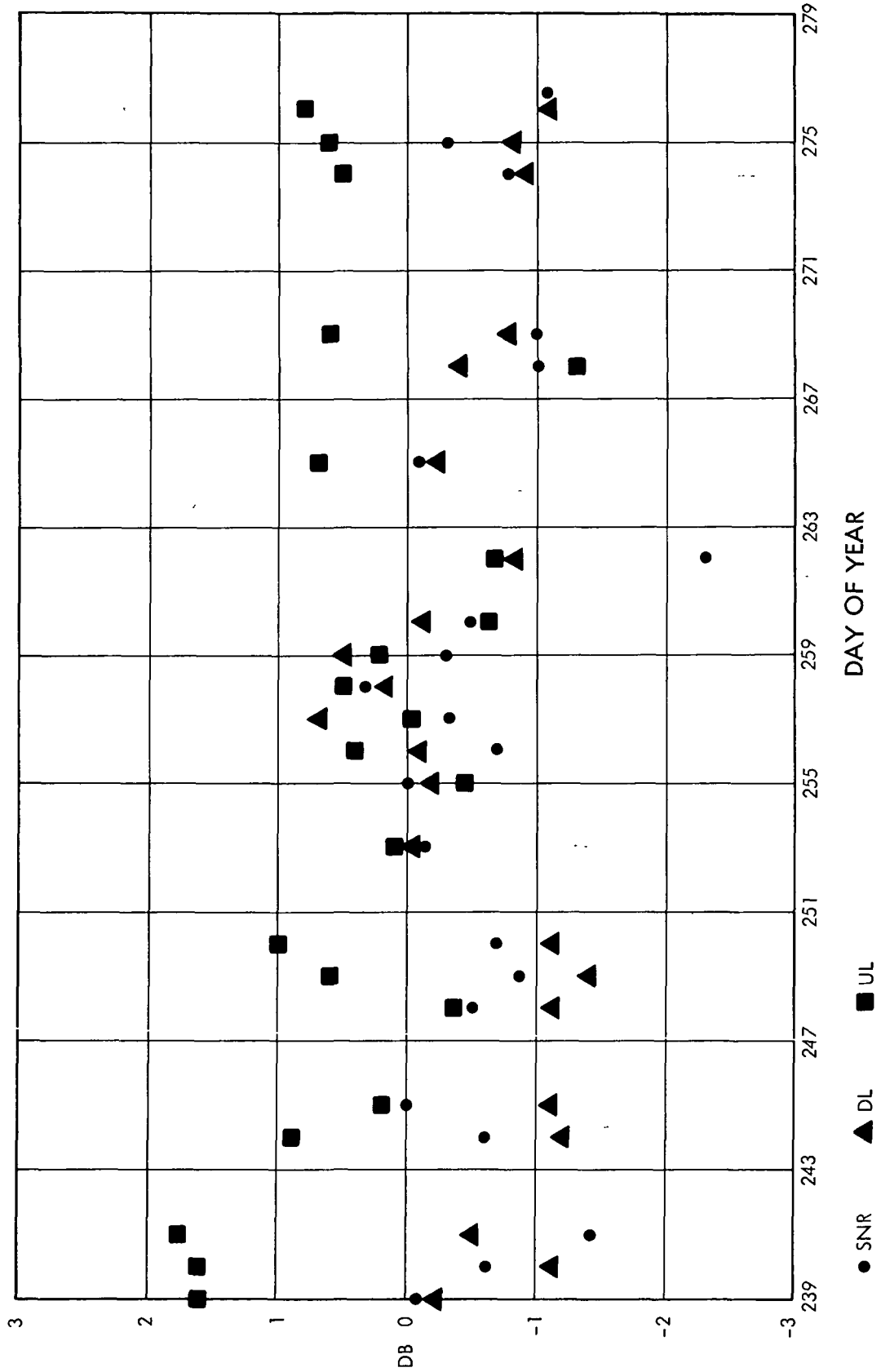

Fig. 31. Residual data plot for DSS 51, September 1971

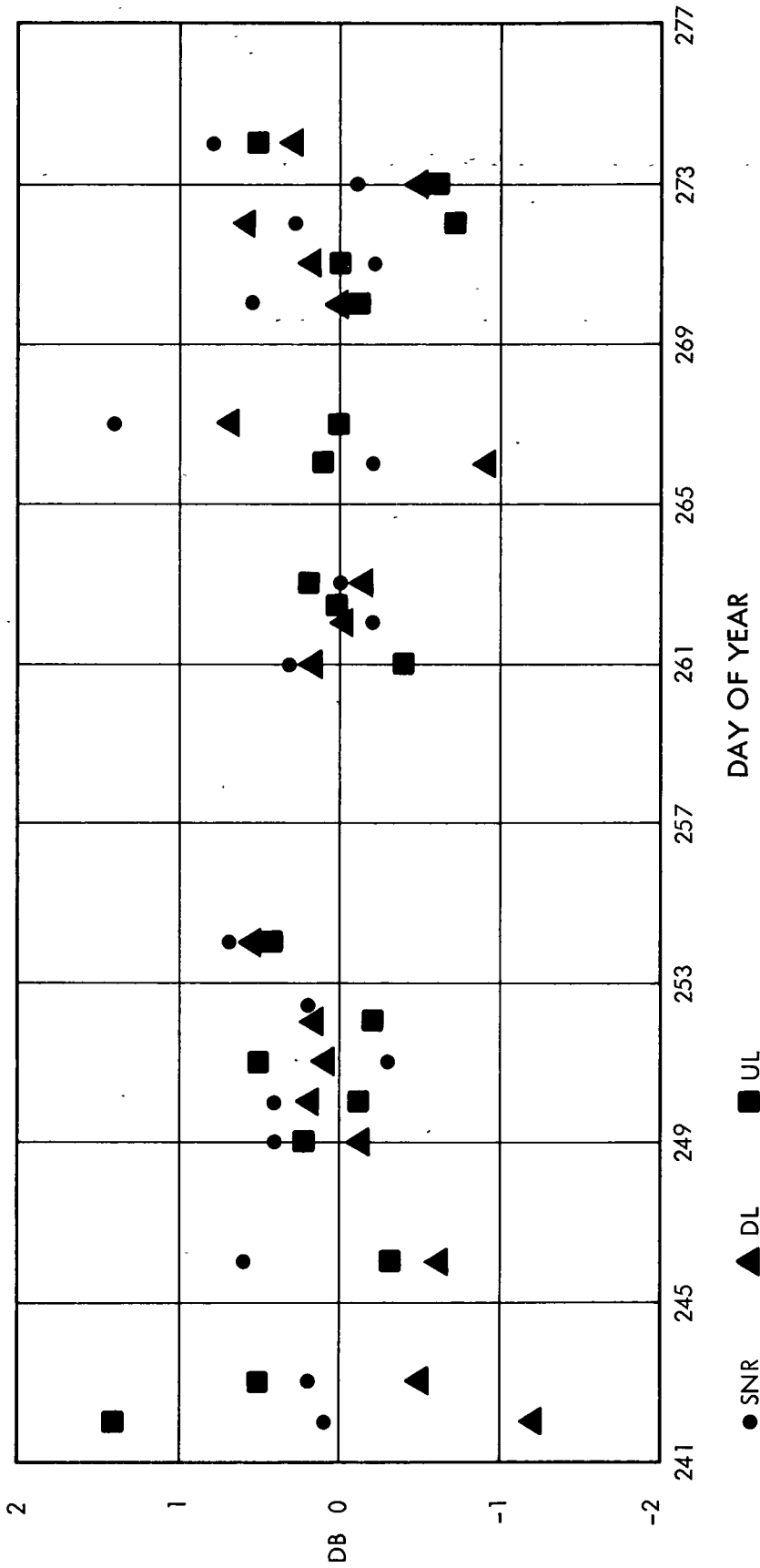

Fig. 32. Residual data plot for DSS 62, September 1971

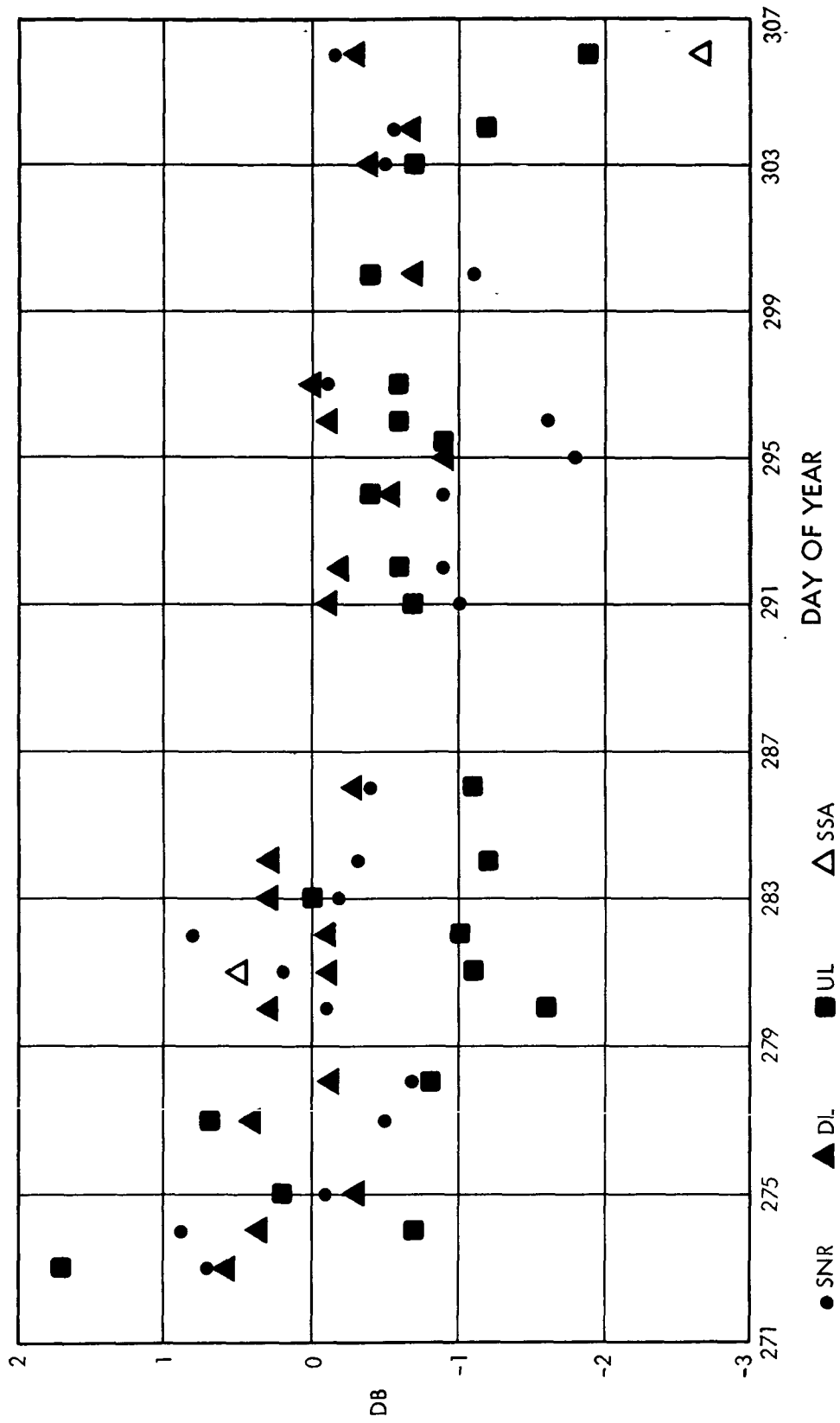

Fig. 33. Residual data plot for DSS 12, October 1971

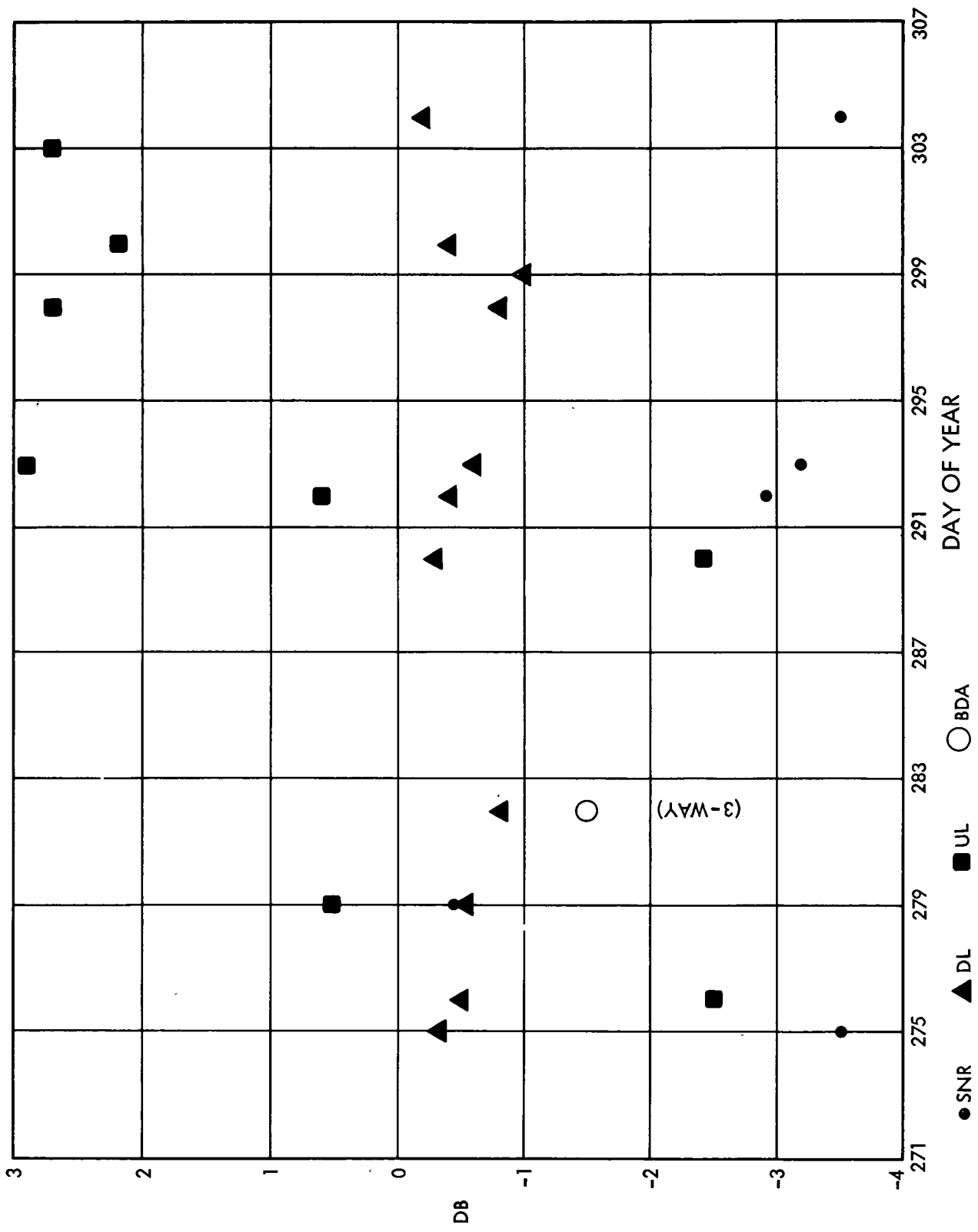

Fig. 34. Residual data plot for DSS 14, October 1971

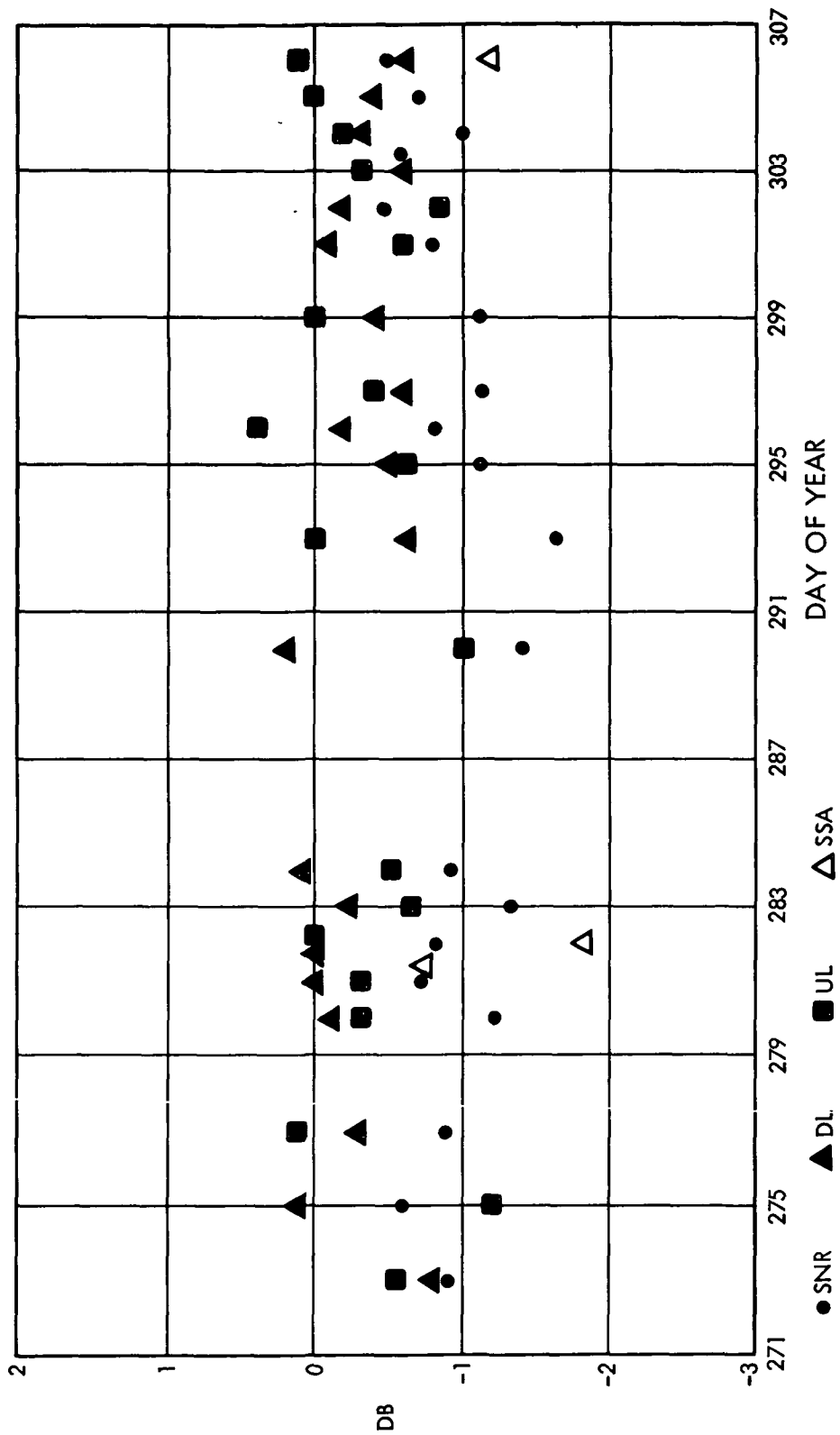

Fig. 35. Residual data plot for DSS 41, October 1971

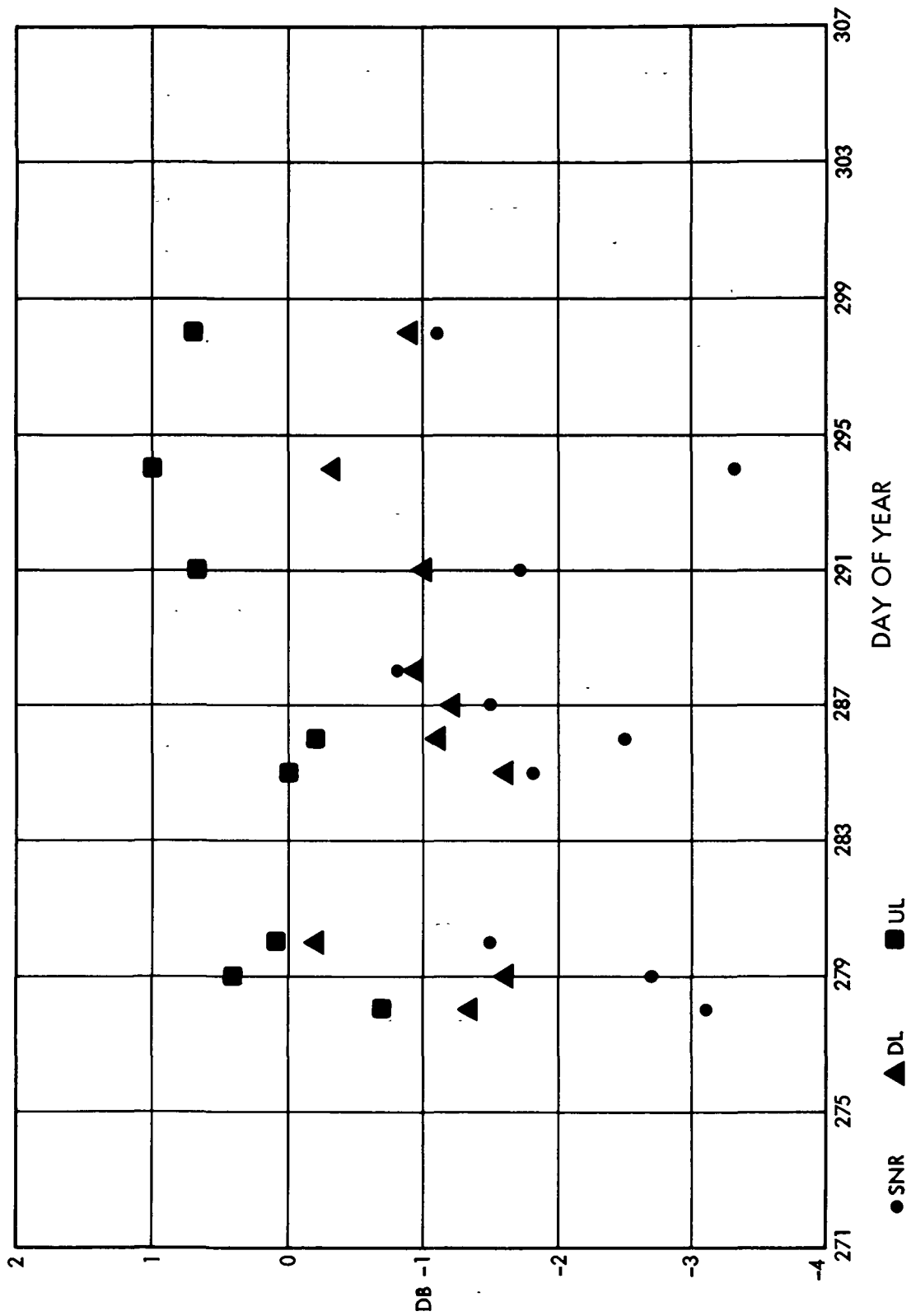

Fig. 36. Residual data plot for DSS 42, October 1971

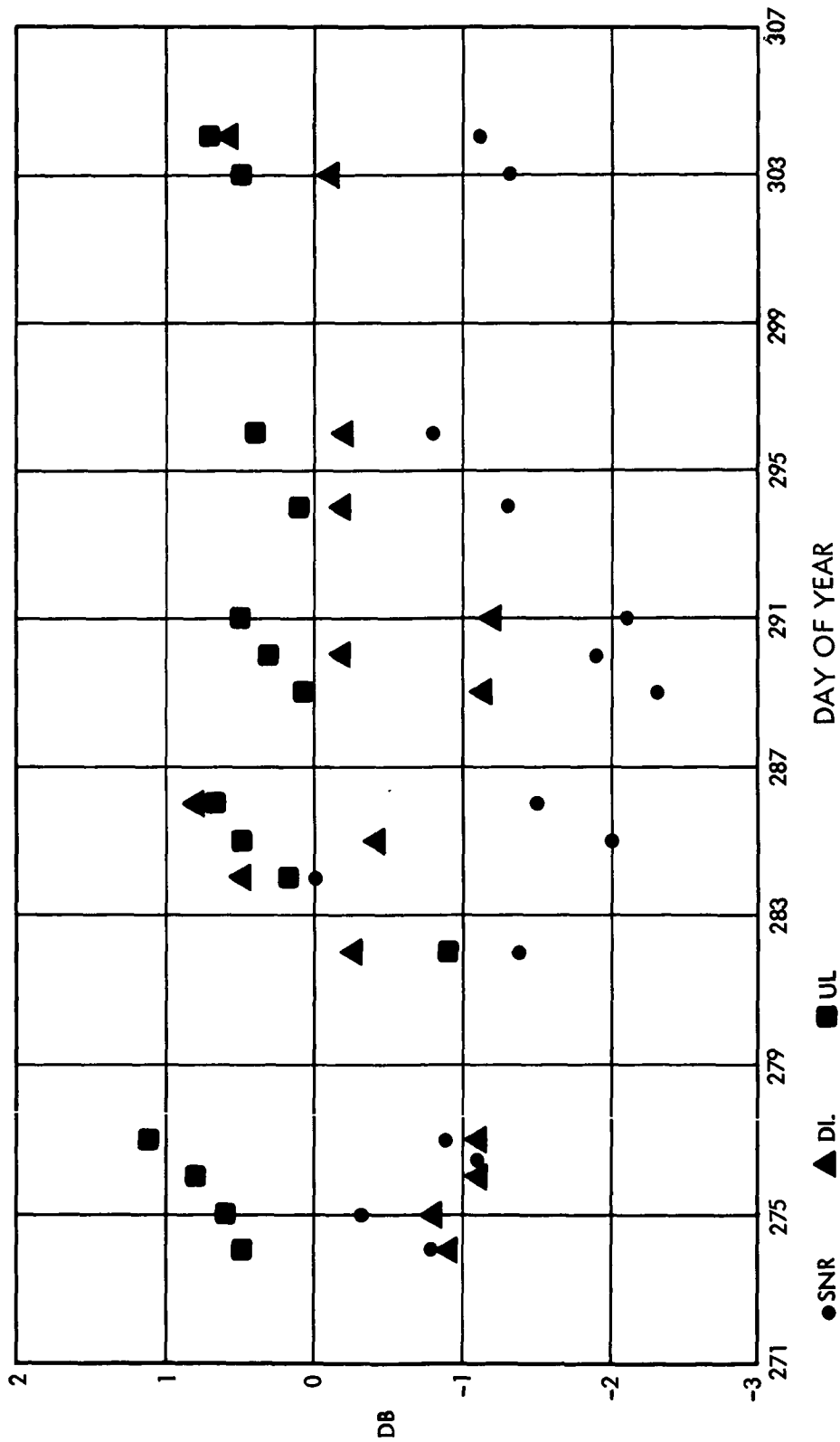

Fig. 37. Residual data plot for DSS 51, October 1971

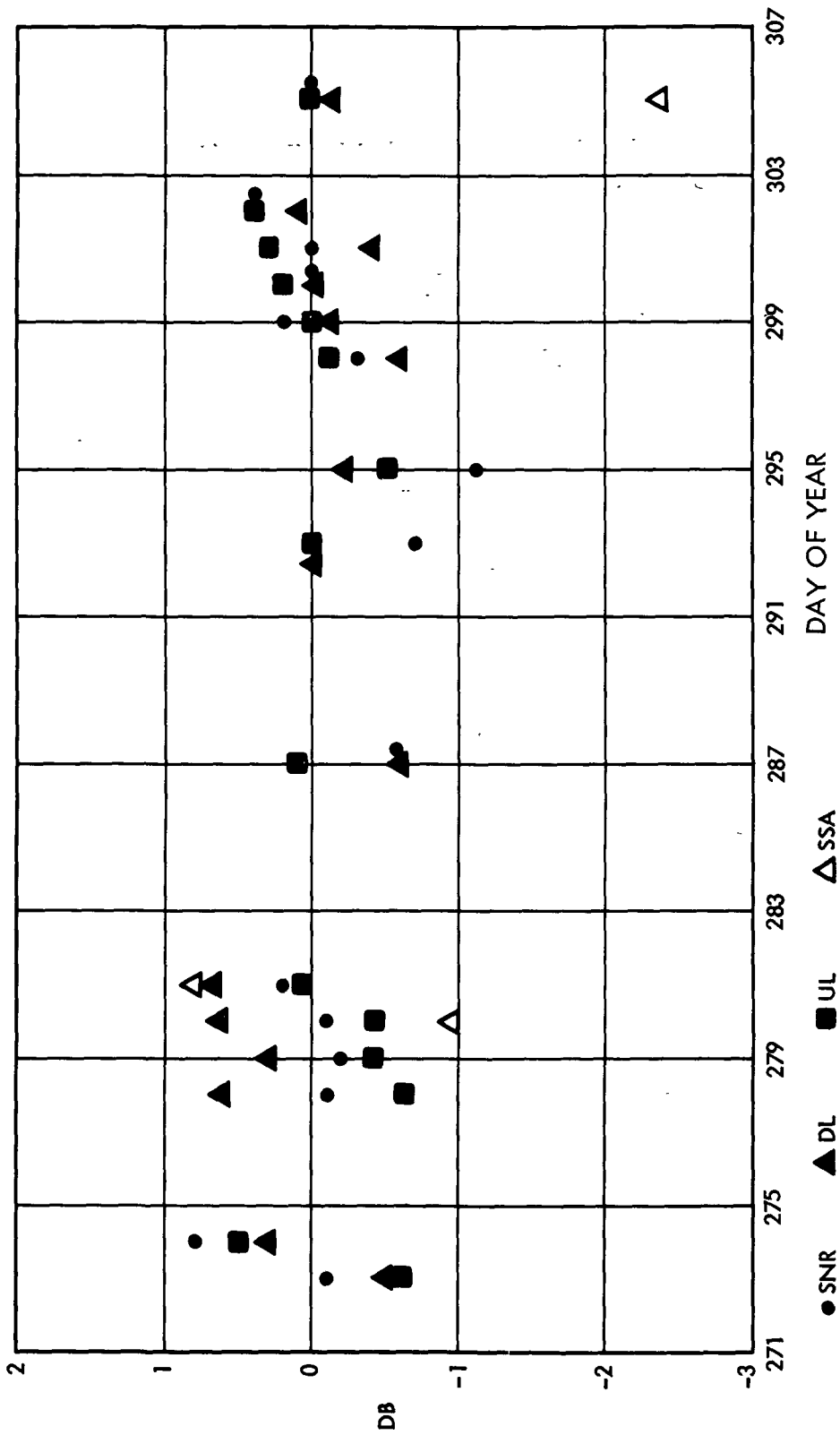

Fig. 38. Residual data plot for DSS 62, October 1971

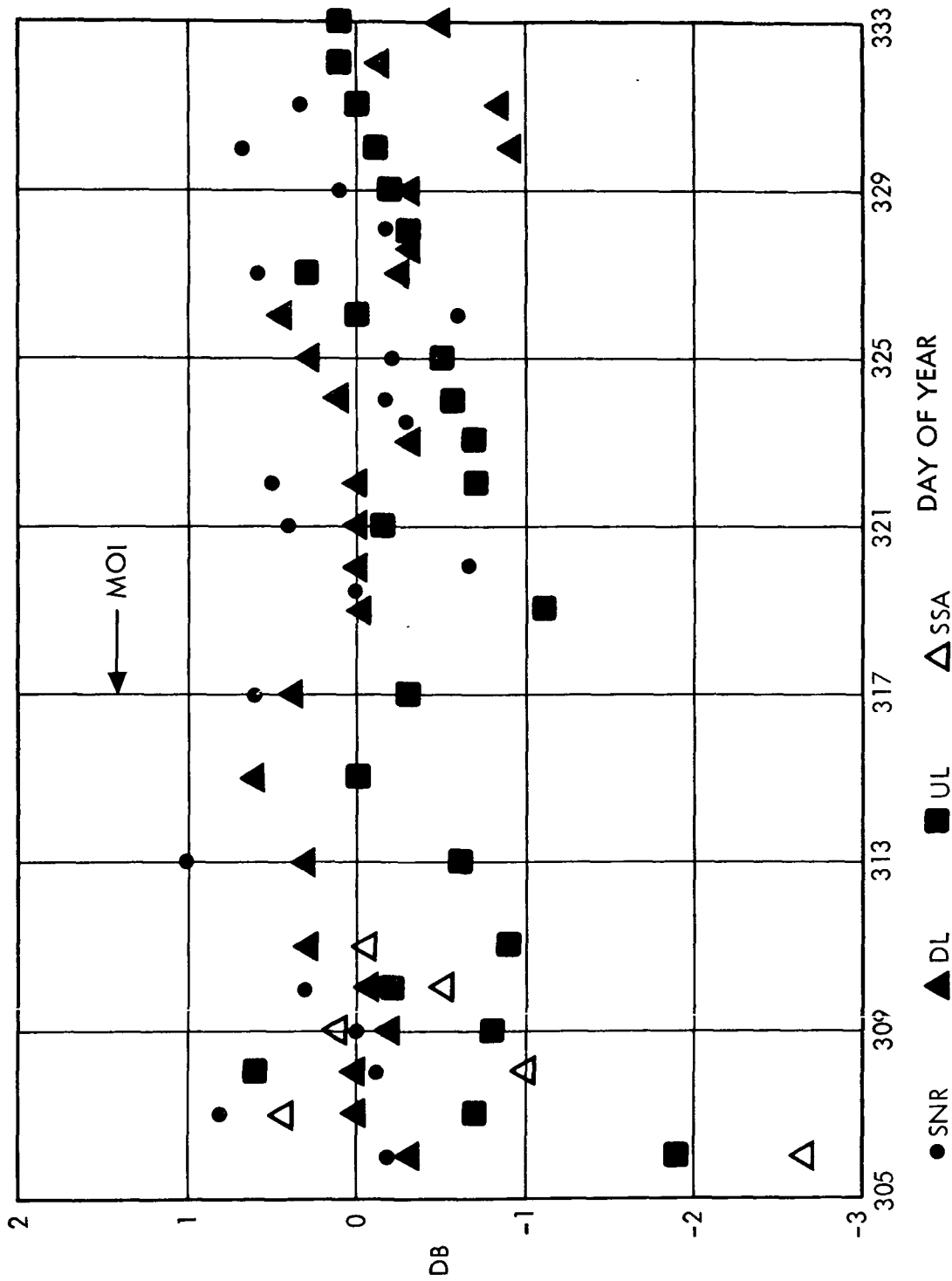

Fig. 39. Residual data plot for DSS 12, November 1971

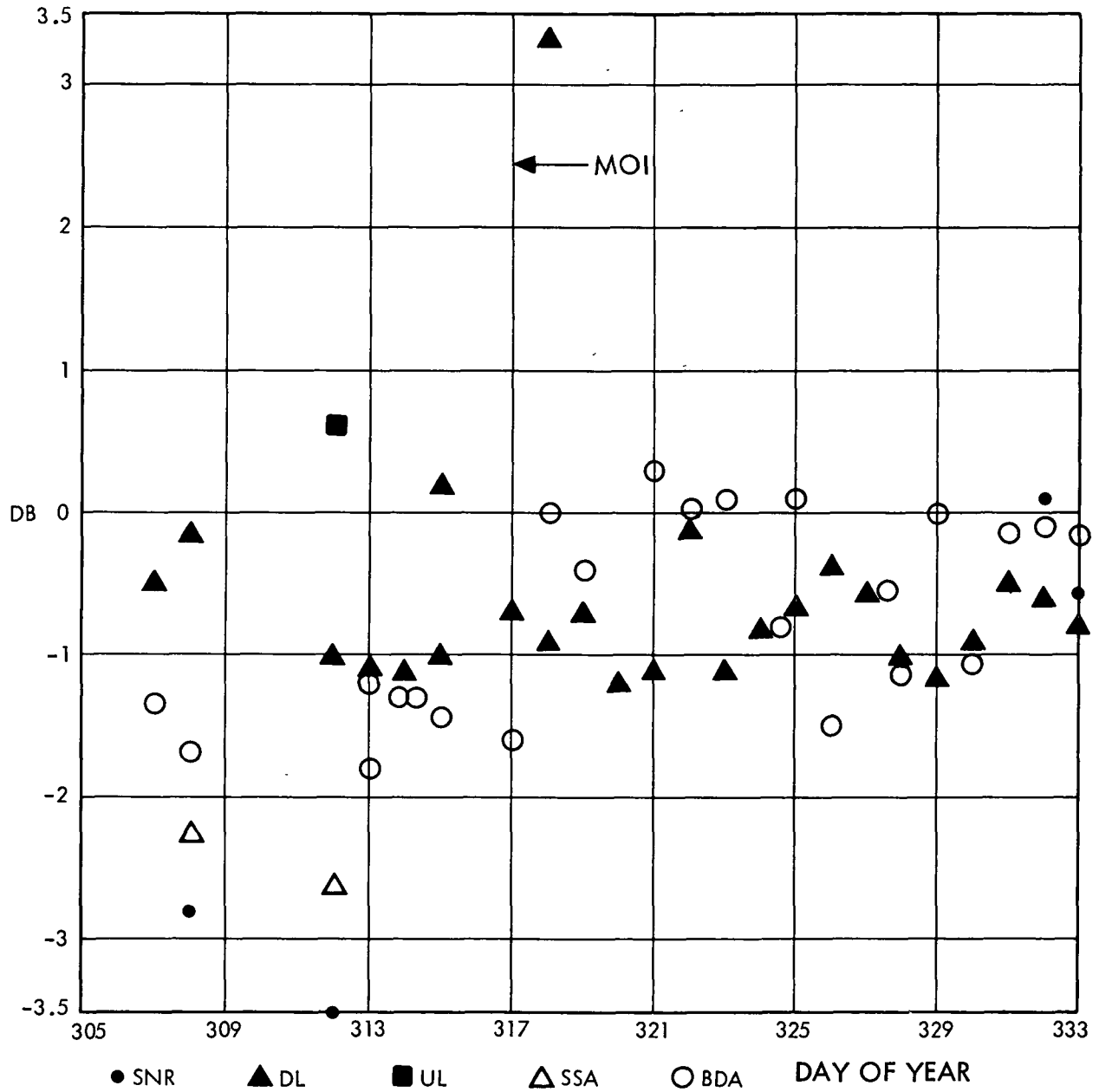

Fig. 40. Residual data plot for DSS 14, November 1971

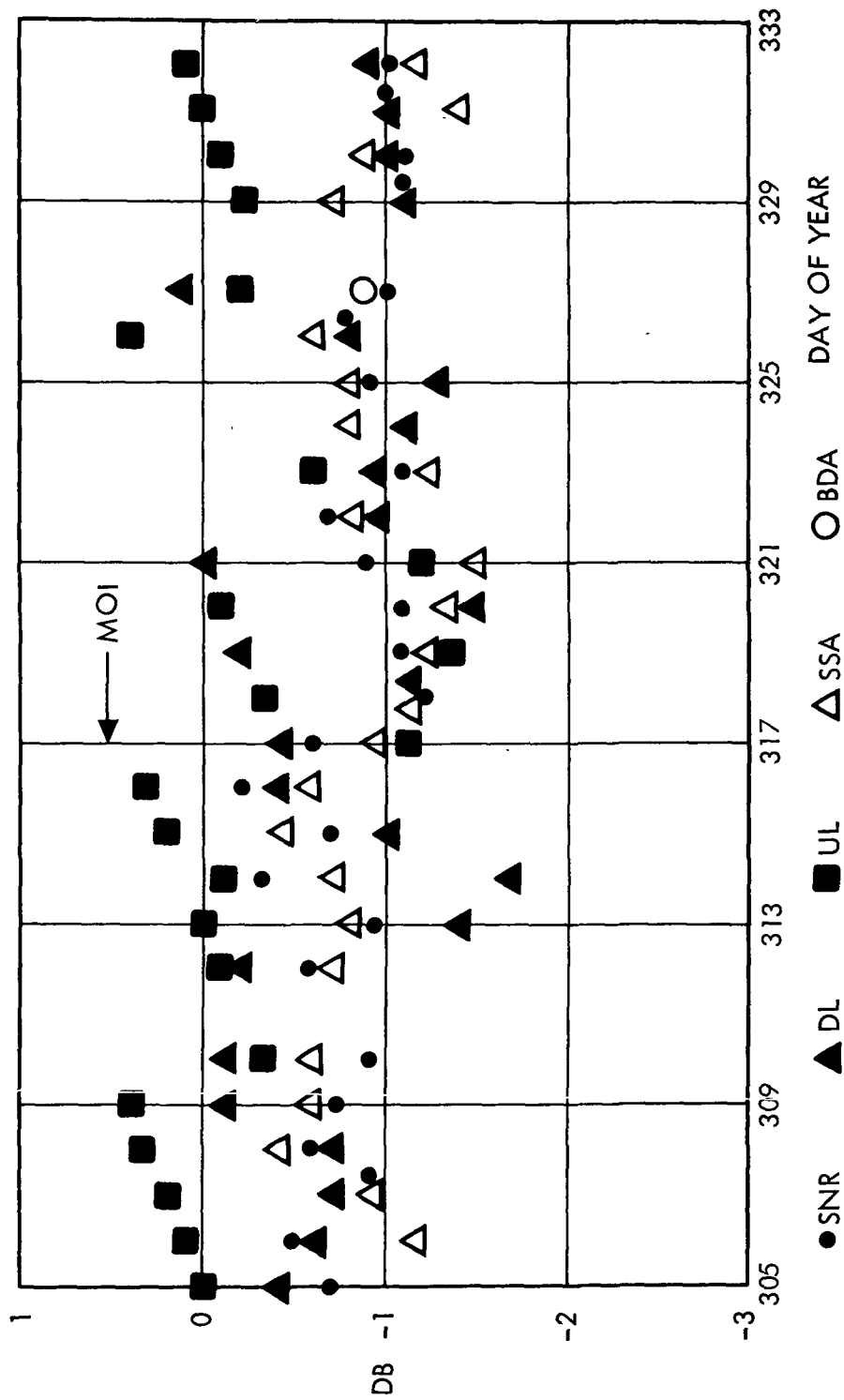

Fig. 41. Residual data plot for DSS 41, November 1971

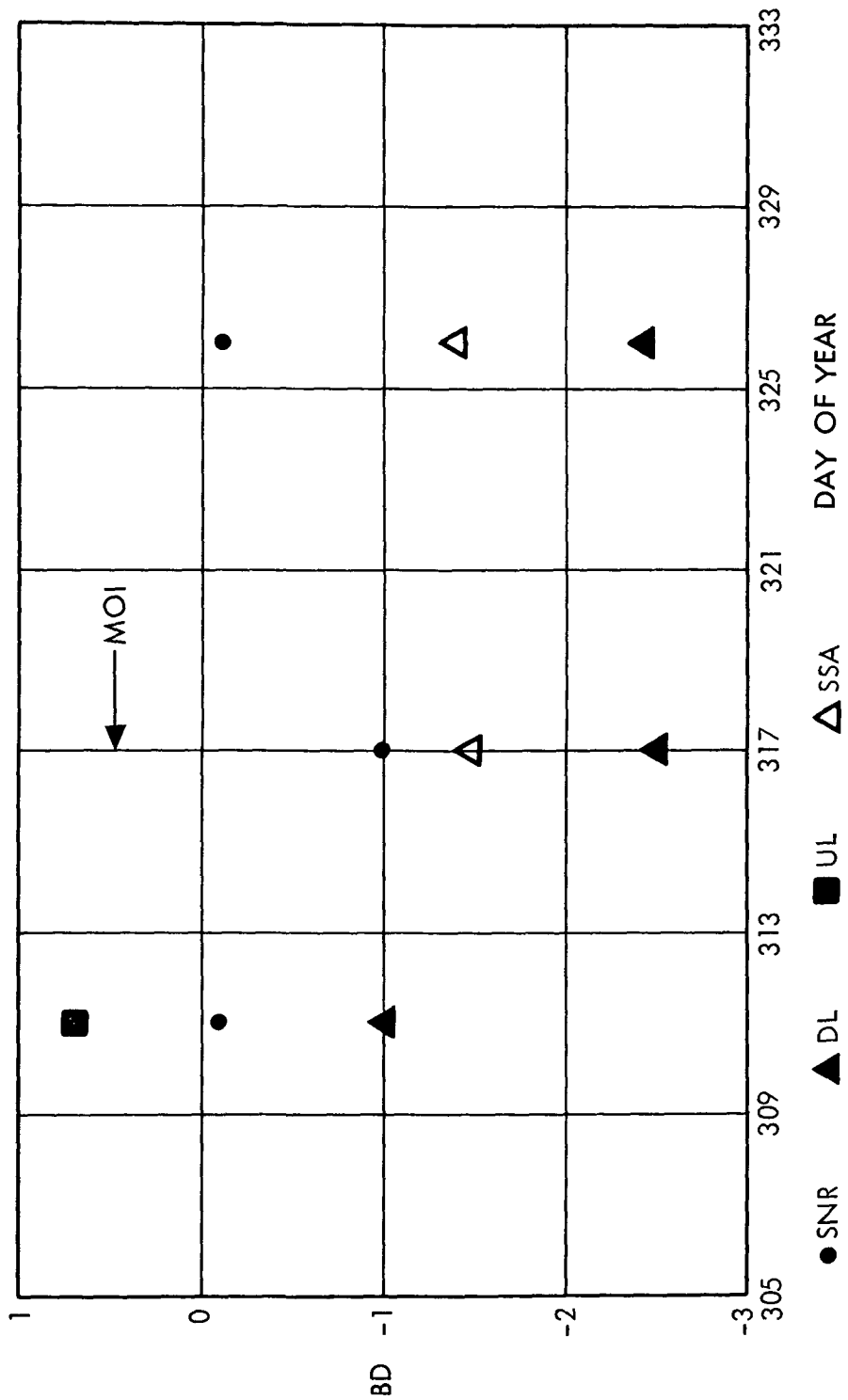

Fig. 42. Residual data plot for DSS 42, November 1971

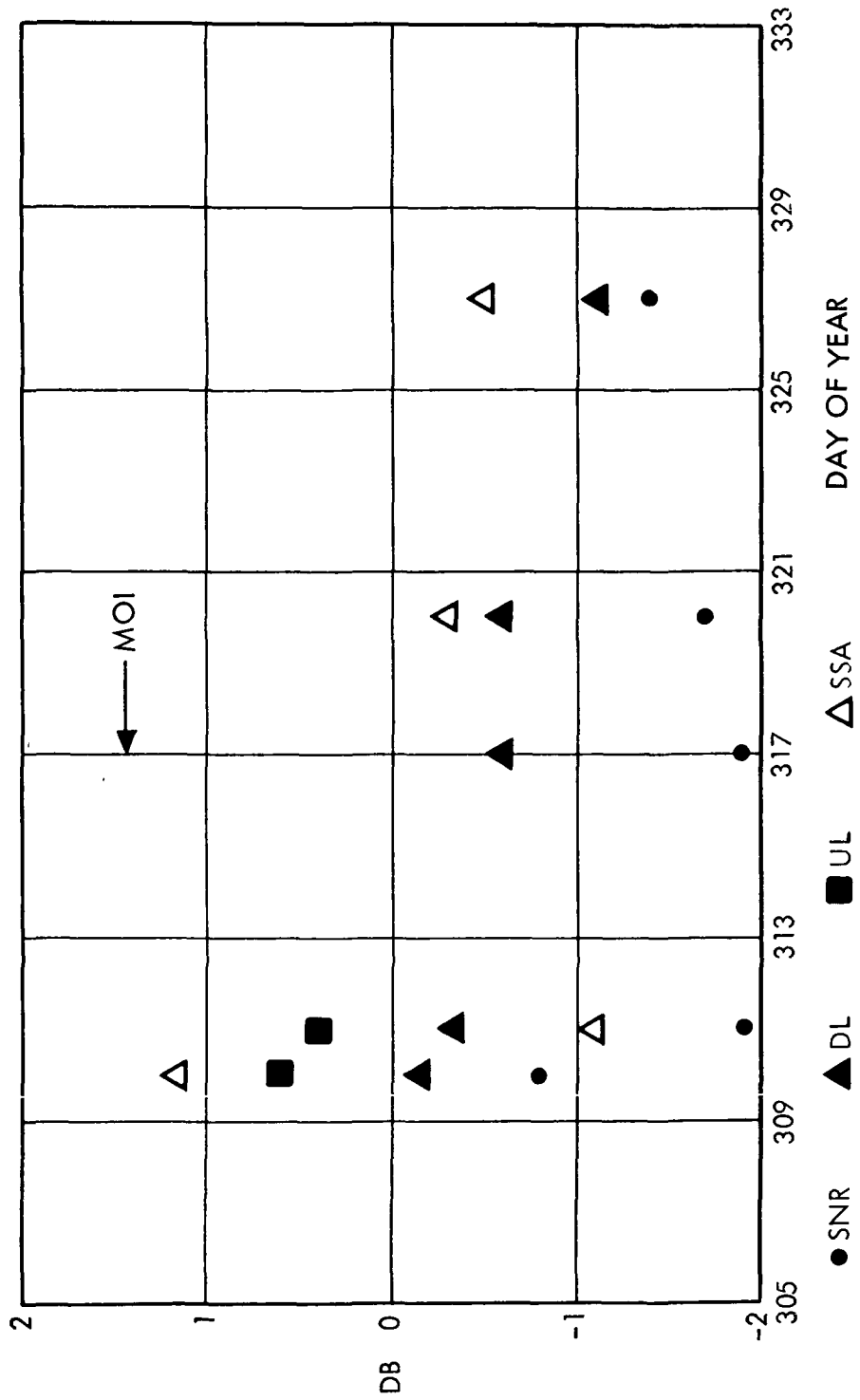

Fig. 43. Residual data plot for DSS 51, November 1971

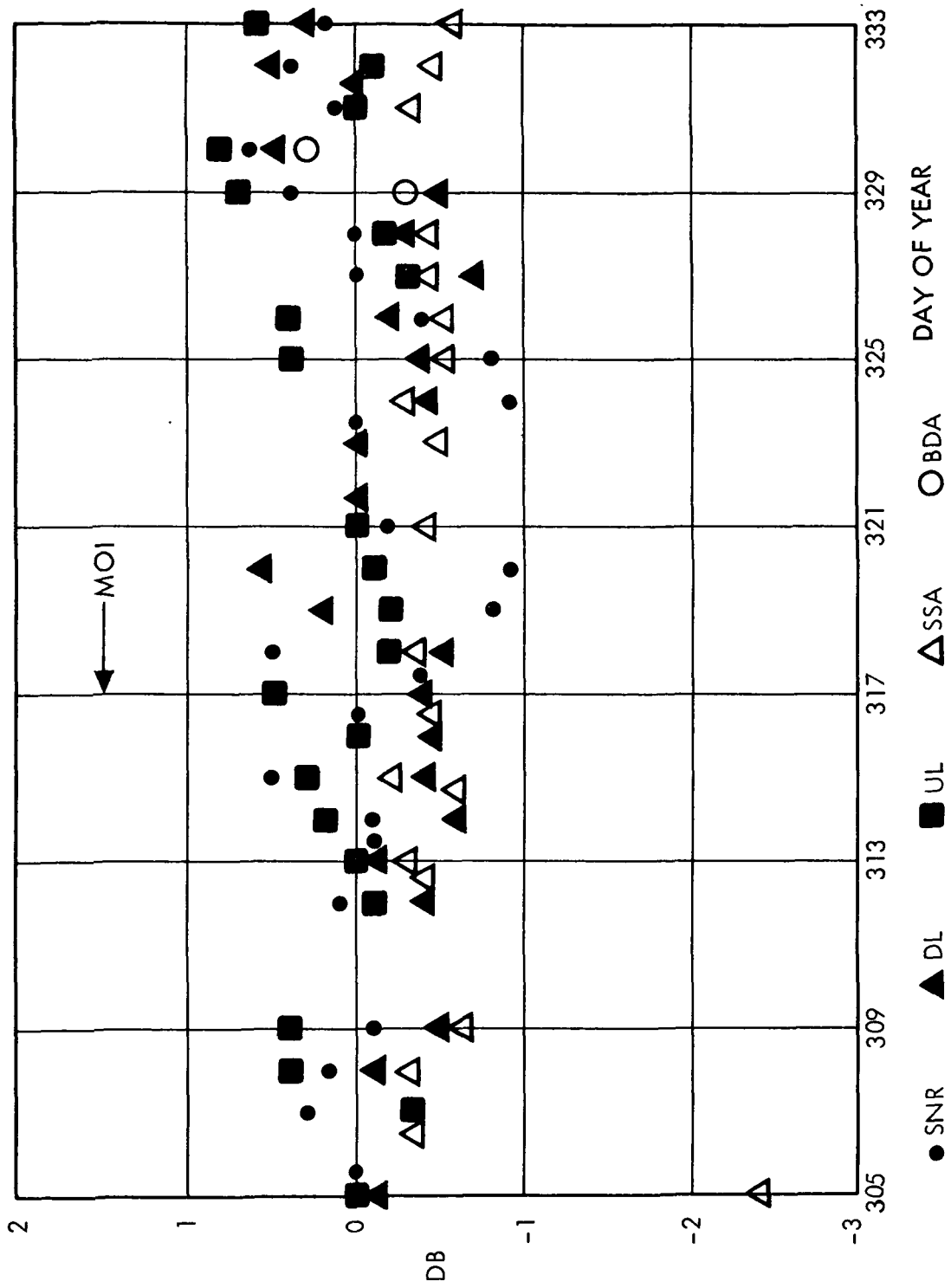

Fig. 44. Residual data plot for DSS 62, November 1971

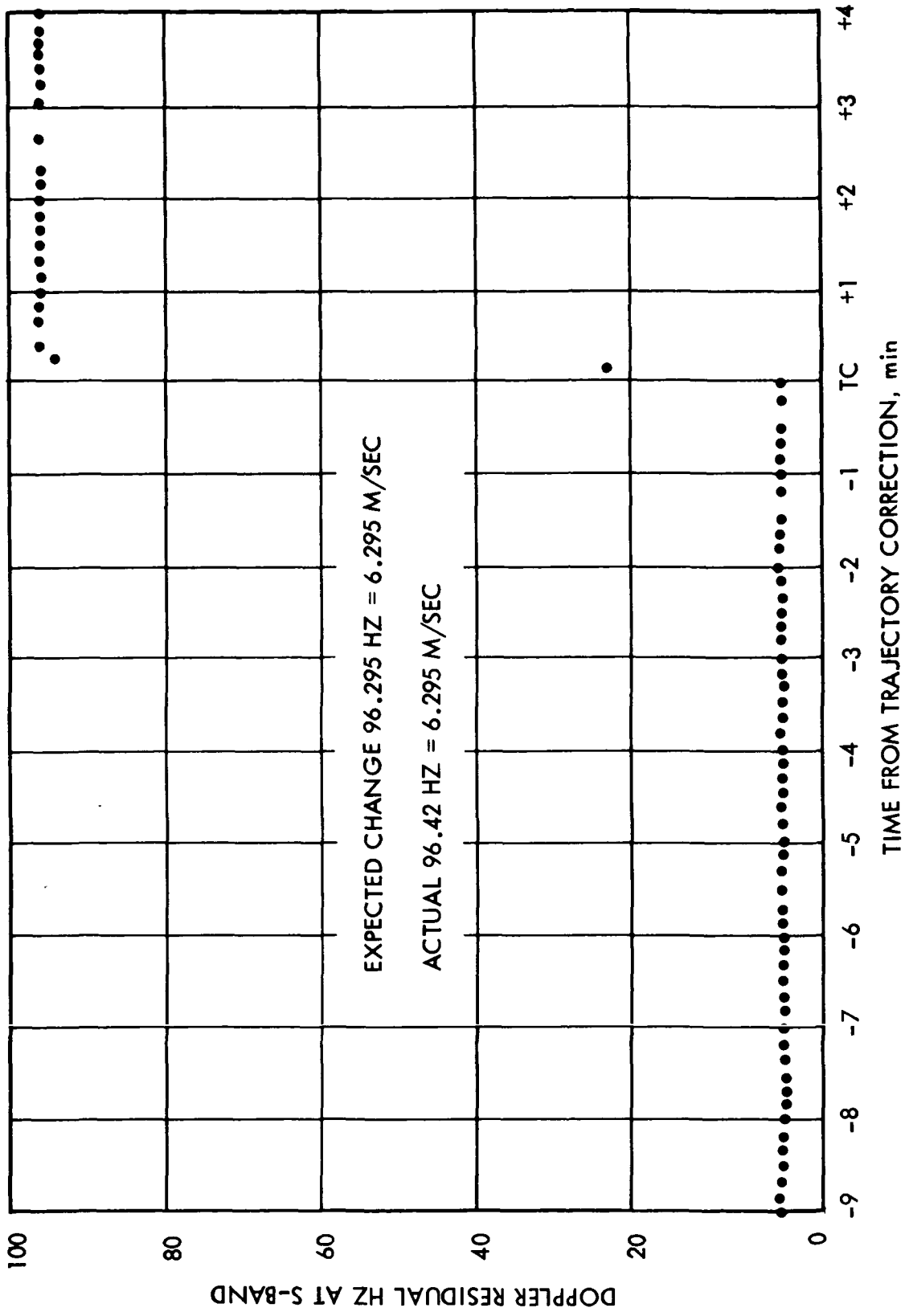

Fig. 45. First trajectory correction pseudoresidual plot

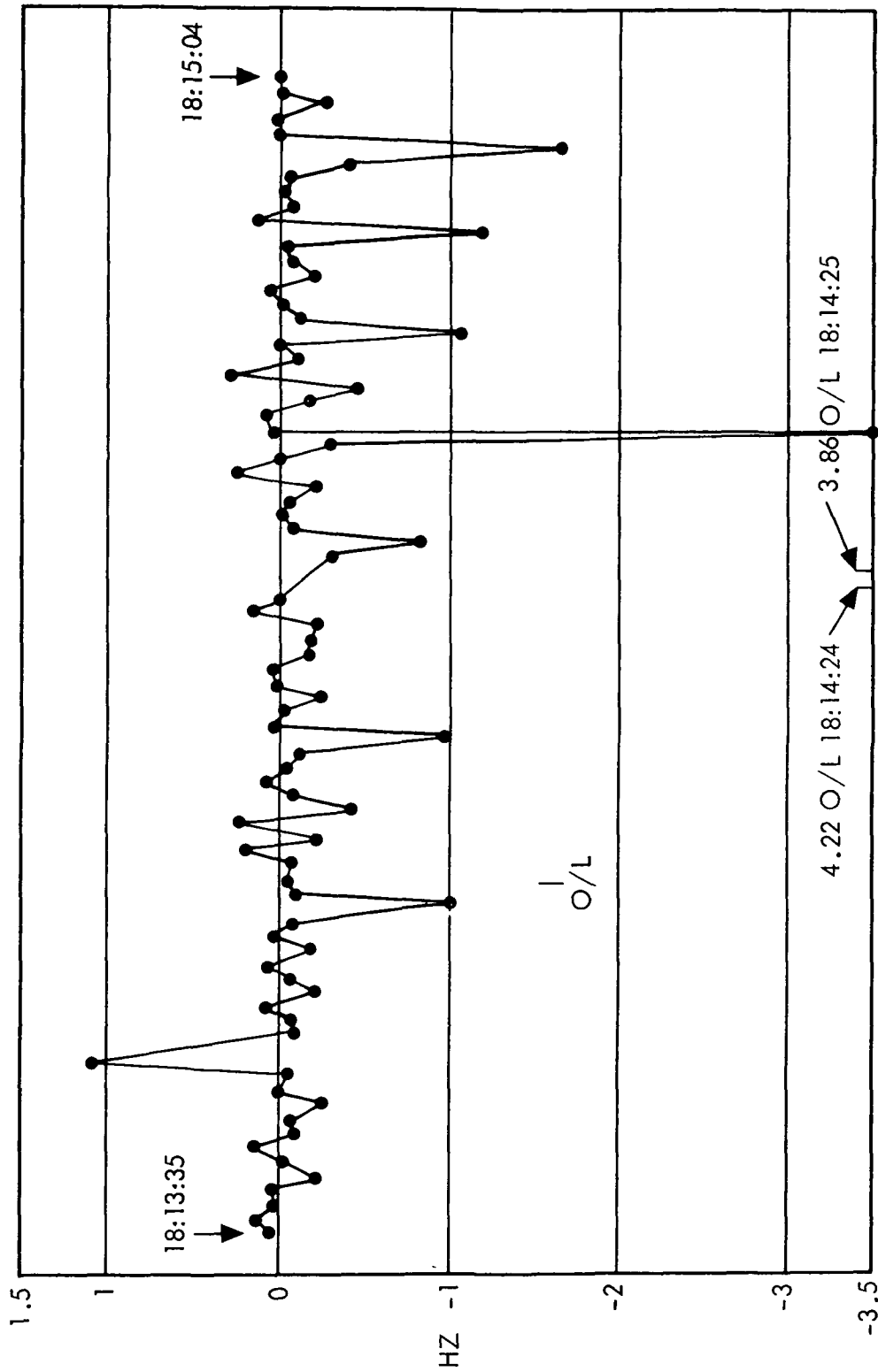

Fig. 46. Sample 1-second doppler rate at low gain

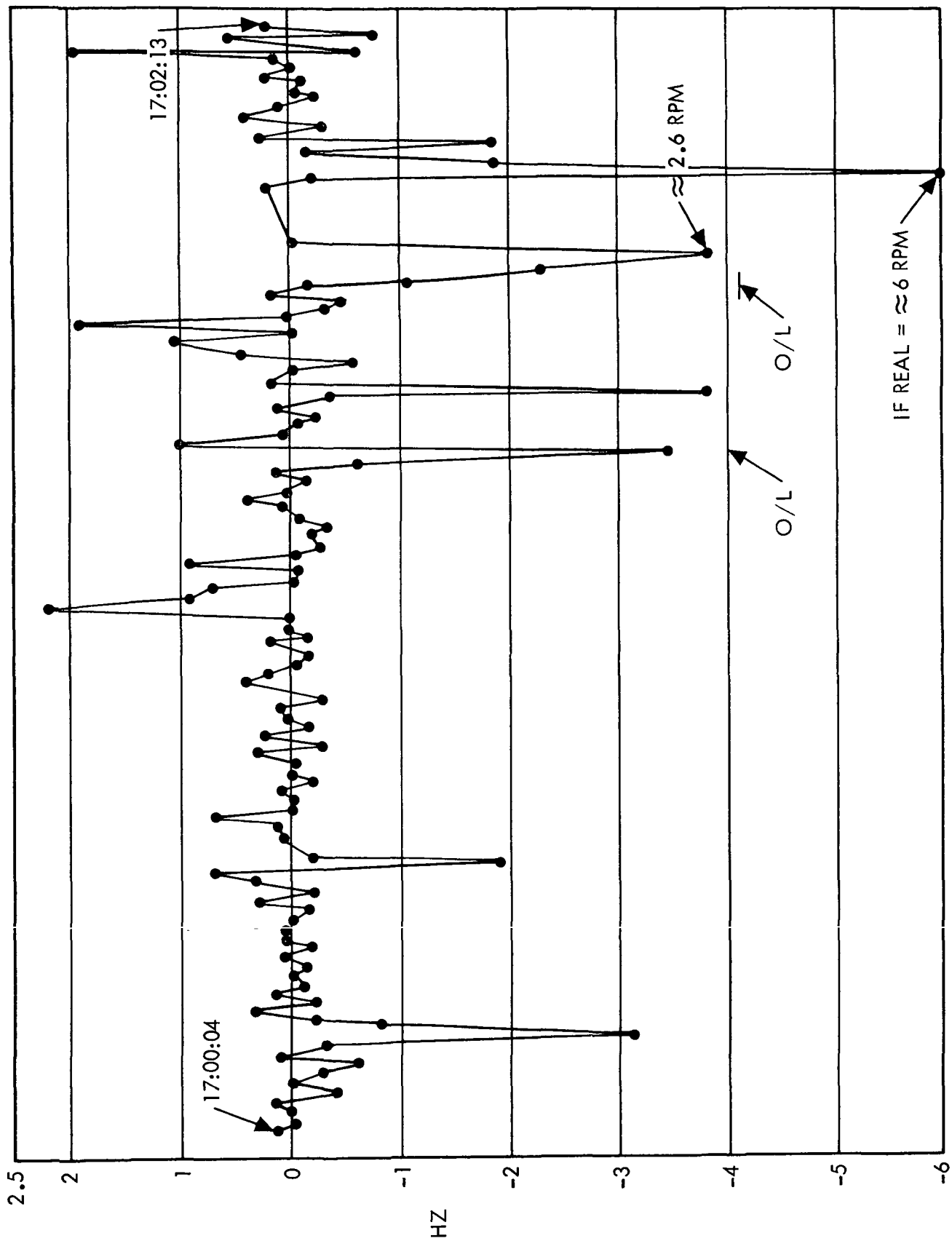

Fig. 47. Sample 1 - second doppler rate at high gain

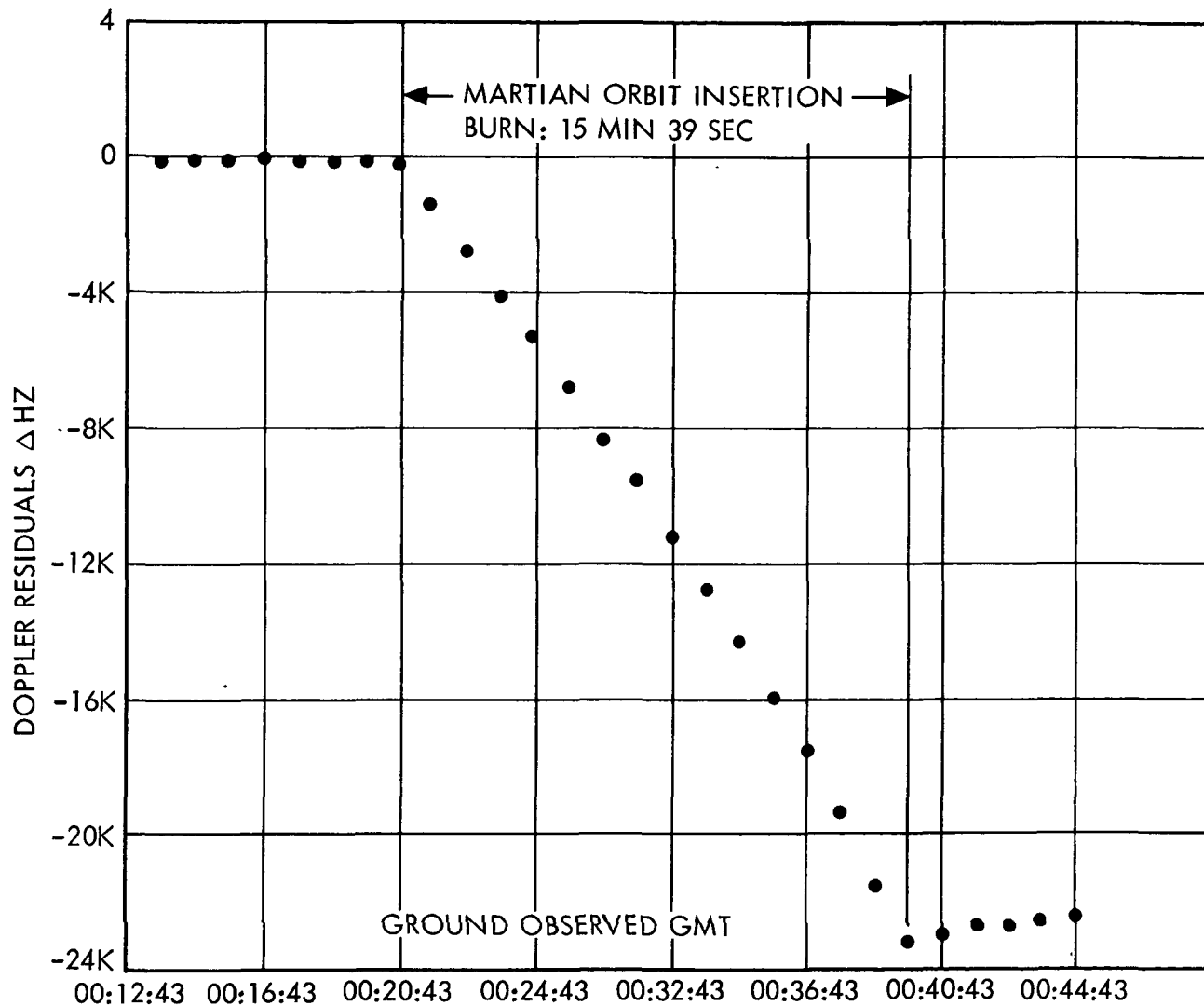
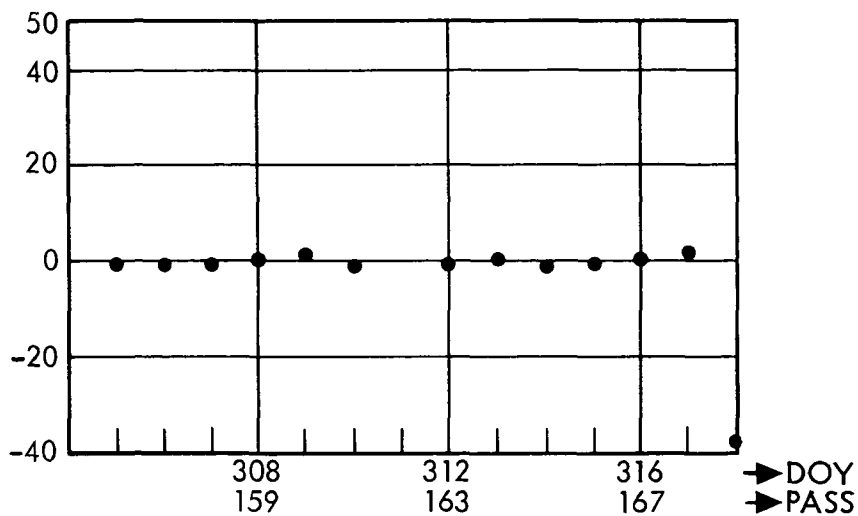
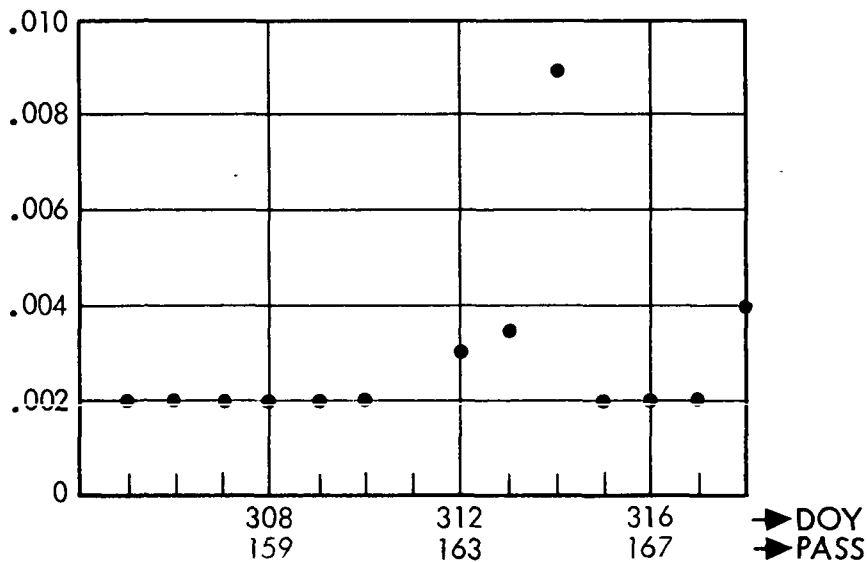

Fig. 48. Doppler residual shift during Mariner orbital insertion



RESIDUAL PLOTS OF AVERAGE DOPPLER RESID PER PASS



RESIDUAL PLOTS OF AVERAGE DOPPLER NOISE PER PASS

Fig. 49. DSS 12, average residual plots for November 1 to 14, 1971

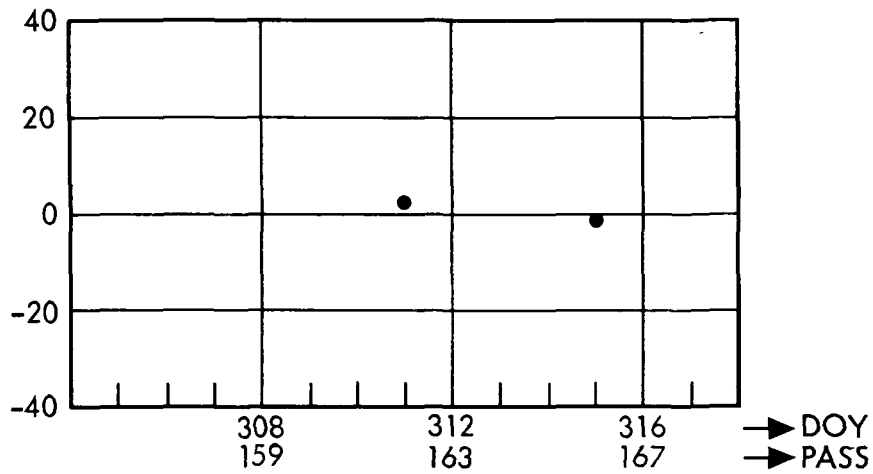

RESIDUAL PLOTS OF AVERAGE DOPPLER RESID PER PASS

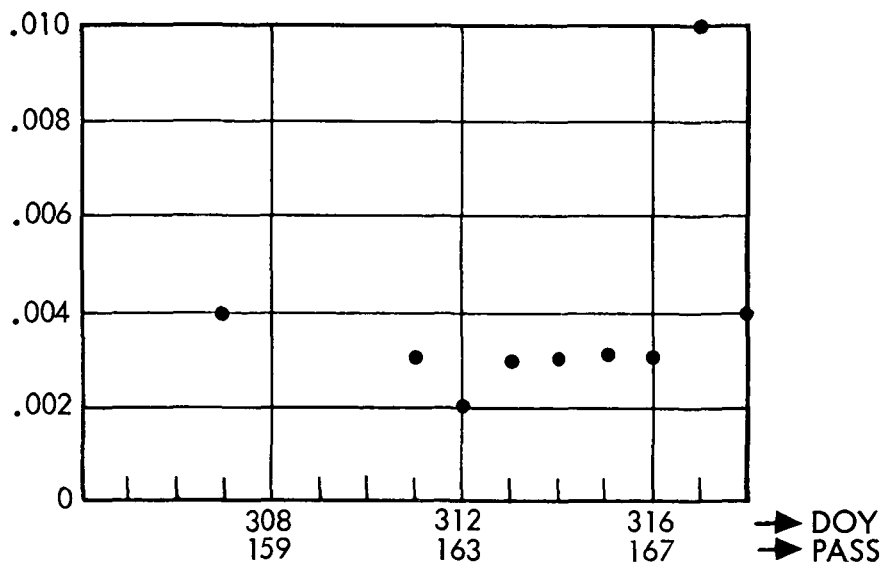

RESIDUAL PLOTS OF AVERAGE DOPPLER NOISE PER PASS

Fig. 50. DSS 14, average residual plots for November 1 to 14, 1971

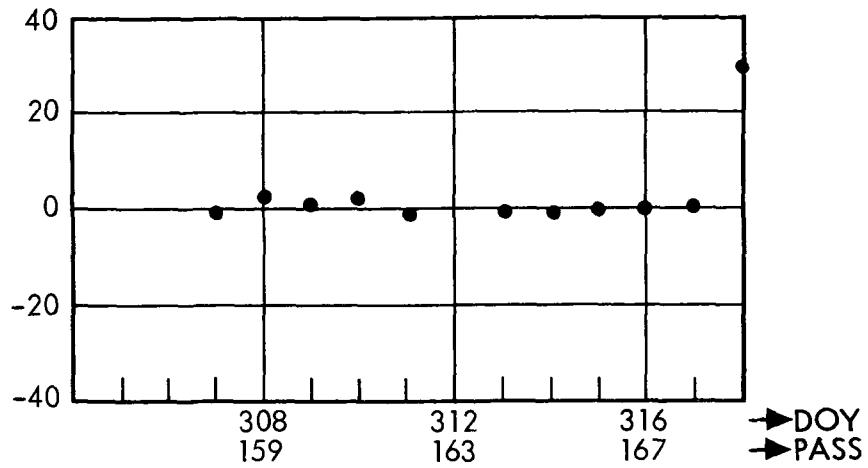

RESIDUAL PLOTS OF AVERAGE DOPPLER RESID PER PASS

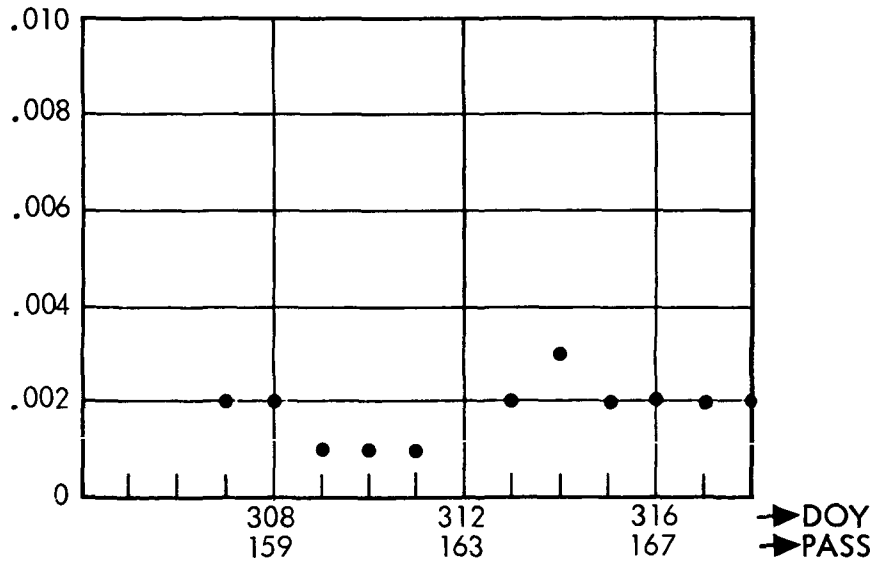

RESIDUAL PLOTS OF AVERAGE DOPPLER NOISE PER PASS

Fig. 51. DSS 41, average residual plots for November 1 to 14, 1971

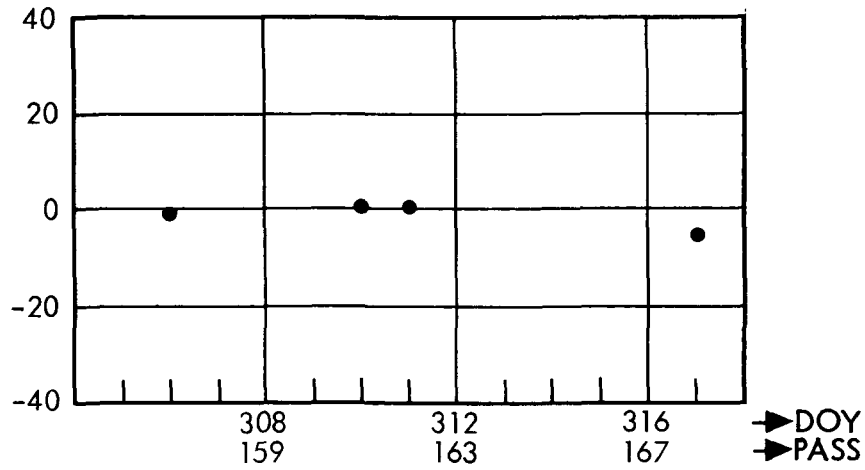

RESIDUAL PLOTS OF AVERAGE DOPPLER RESID PER PASS

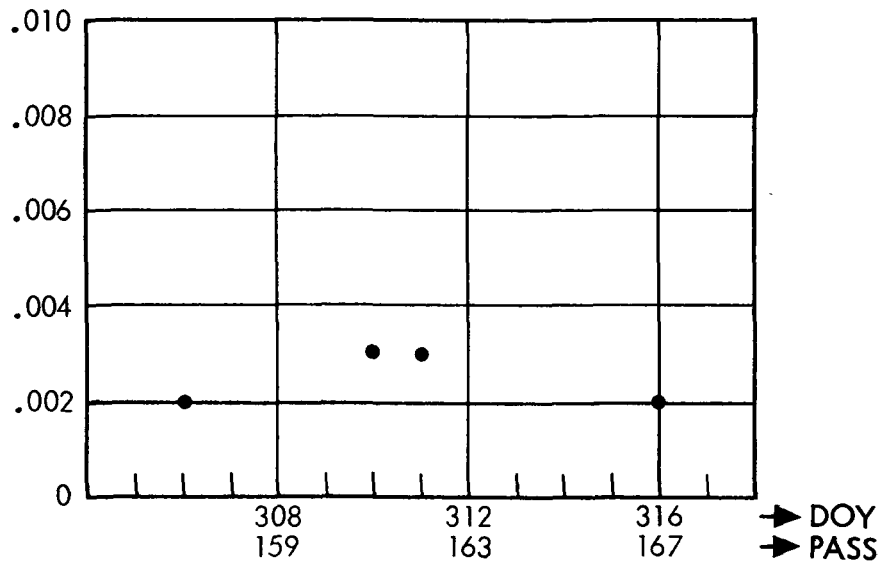

RESIDUAL PLOTS OF AVERAGE DOPPLER NOISE PER PASS

Fig. 52. DSS 51, average residual plots for November 1 to 14, 1971

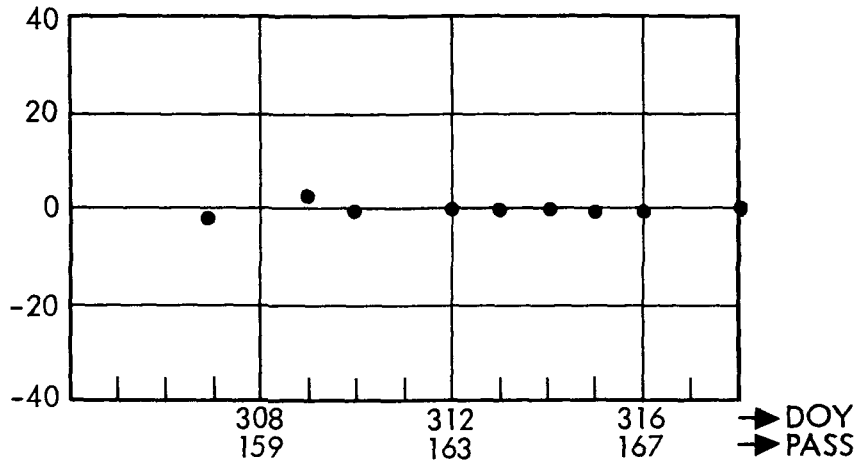

RESIDUAL PLOTS OF AVERAGE DOPPLER RESID PER PASS

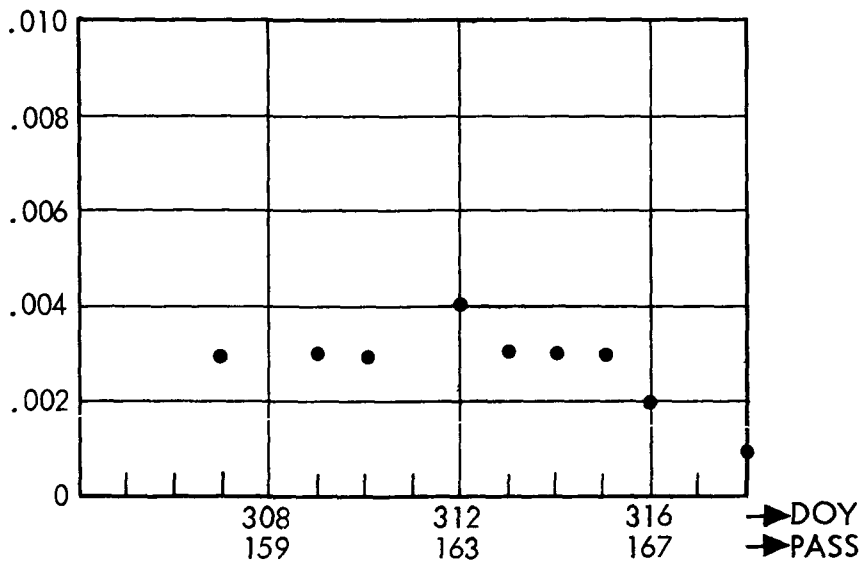

RESIDUAL PLOTS OF AVERAGE DOPPLER NOISE PER PASS

Fig. 53. DSS 62, average residual plots for November 1 to 14, 1971

IV. TRACKING AND DATA SYSTEM PREORBITAL TESTING

A. General

In preparation for MM'71 orbital operations, the TDS conducted a series of tests to verify the new ground system capabilities and to train the operations personnel for orbital activities. The test series consisted of facility tests and network system tests. In addition, the TDS supported all Project training tests and two joint MM'71/TDS Operational Readiness Tests (ORT). Details of the preorbital testing are presented below.

B. Facility Testing

1. DSIF test and training.

a. June. Following the trajectory correction maneuver, only DSS 14 remained unqualified for MM'71 cruise-mode operations. Two DSIF ORTs were conducted with DSS 14 during June 1971. The first was on the 27th, with the major objective of exercising MM'71 cruise procedures. The objective was not met as the station was unfamiliar with MM'71 operational procedures. The second ORT on the following day proved more successful; nearly all test objectives were met. However, it was felt that DSS 14 needed further training.

b. July. During July, heavy concentration was placed on fully qualifying DSS 14 for cruise-mode support. The DSIF Operations Support PE (OPSPE) office conducted three on-site training tests at Goldstone to familiarize all shifts with operations procedures for cruise support and to answer questions during critiques. The three sessions were very productive, and questions and problems were resolved in real-time. In addition, internal station training was continued throughout the month. On July 28, a DSIF ORT with DSS 14 met all test objectives. The following day, DSS 14 was declared fully qualified for MM'71 cruise support.

c. August. During August, 13 DSIF orbit-phase ORTs were conducted. Stations 12, 41, 42, 51, and 62 had two tests each, and Station 14 had three tests. These ORTs differed from previously run ORTs in that orbit procedures and high science bit rates were used. Each test was 5 h in duration, with all engineering and science data exercised and a simulated occultation taking place midway through the test.

All DSIF ORTs during August were conducted with Phase-3 TCP operational software. Results of the first test with DSS 14 indicated a lack of familiarity by station personnel with newly developed orbital procedures.

d. September. As of September 7, 1971, DSS 12, 51, and 62 had been fully qualified for orbital operations, and more ORTs were being planned for DSS 14, 41, and 42. DSS 41 was qualified on September 10.

After three unsuccessful DSIF ORTs and an unsuccessful DSN Combined Systems test with DSS 14, it was clear that additional training would be needed for DSS 14 personnel. The DSN PE requested and obtained extra training time. DSS 14

was released from tracking commitments for about two weeks to concentrate on training. On-site training was conducted on September 7, 8, and 9; a DSIF OPSPE acted as test conductor. At the same time, GCF on-site training was conducted with emphasis on HSD/WB circuit activation alignment. The SFOF/GCF Operations Section aided in this on-site GCF training.

All stations were fully qualified for orbital operations by September 20, the start of MOS training. Additional DSIF special command testing is discussed in paragraph D below.

2. GCF testing. Testing of the GCF that relates only to orbital-phase mission support is documented in this volume of the Final Report, although certain GCF configurations were implemented and tested before launch.

a. Wideband system tests series. A series of wideband system tests were conducted beginning in November 1970 and concluding in January 1971. Test objectives were designed to measure system performance, verify operational procedures, and compare measured system performance with the requirements of the GCF functional design for 1971-1972. The tests were conducted in the following order:

- | | |
|-------------------|---|
| (1) Nov. 3, 1970 | CTA 21 to SFOF ACTS |
| (2) Nov. 4, 1970 | SIMCEN to SFOF ACTS and 360/75 MTC |
| (3) Nov. 12, 1970 | SIMCEN to CTA 21 and CTA 21 to SFOF ACTS |
| (4) Dec. 29, 1970 | SIMCEN to DSS 14 and DSS 14 to SFOF communications Terminal |
| (5) Jan. 7, 1971 | DSS 14 to SFOF ACTS |
| (6) Jan. 14, 1971 | DSS 14 to SFOF ACTS |

In each test, minor deficiencies were noted, such as errors in jackfield labels and procedural deficiencies. The regeneration assembly in the Goldstone Deep Space Communications (DSC) 10 Area Communications Terminal Subsystem (ACTS) experienced some noise problems that prevented simultaneous FDX regeneration. This problem, as well as others, was eliminated by the end of January 1971.

b. Test results. In each test, it was determined the system either met or surpassed the requirements of the GCF functional design for 1971-1972.

The tests between DSS 14 and SFOF ACTS demonstrated repeatedly that extremely good error rates can be achieved on both the prime and backup microwave links. Further, operational experience has since revealed that the wideband system is not the sole contributing factor when sporadic occurrences of substandard error rates are observed. Detailed investigation centered about such instances revealed that deterioration in the rigid timing interface between the station HSD-WBD I/O equipment

and the wideband terminal is the primary cause. It was determined that the station TCP could not properly respond to HSD-WBD I/O equipment interrupts when the high-rate telemetry processing program was not operating in a discrete software environment. As a result, bit slippage was introduced into the wideband system, and the effect was seen as apparent data block errors. Once the wideband system returned to a quiescent state, i. e., DSS 14 BMXR outputting filler data, data block errors would simply disappear as the system became block-synchronous with itself once again.

Procedural modifications accomplished subsequent to identification of the cause of the problem required that the station TCP be initialized in only the high-rate telemetry mode, thus obviating the effects when other programs (such as command program) were initialized.

c. High-speed system mission-dependent interface tests series. The majority of mission-dependent interfaces with the high-speed system were tested and reported on in Volume I of this report. However, high-speed transmission capability from the mission test computer (MTC) to the University of Colorado at Boulder was tested subsequently and will be reported on here.

Two tests were conducted in July 1971. Test objectives centered about engineering validation as well as operational acceptance. Tests were conducted as follows:

- (1) July 27, 1971 Bit error rate test from the University to SFOF ACTS and from SFOF ACTS to the University.
- (2) July 29, 1971 Digital interface testing between MTC and SFOF ACTS.

d. Test results. Both tests were considered acceptable. The bit error rate from SFOF ACTS to the University was 1 in 116470, while from the University to the SFOF ACTS it was 1 in 551490. (The acceptable GCF standard for a circuit of this type is 1 in 50000.)

Of all the digital interface signals measured between MTC and SFOF ACTS, it was found that the "send data" signal contained approximately 6% distortion. The standard GCF interface required that distortion be no more than 3%. This interface with the HSS was, however, nonstandard and the 6% distortion figure was quoted as questionable rather than unacceptable. Notably, the digital interface did not experience degraded performance.

Operational procedures were validated in each test and were found to be acceptable in both cases. The total interface was declared fully operable shortly thereafter, early August 1971.

e. Operational Verification Testing. Two GCF OVTs were conducted with DSS 42 on June 15 and 17, 1971. Both tests produced excellent results; it was therefore decided that additional GCF OVTs with DSS 42 would not be necessary. Remaining DSSs comprising the prime 26-m-diameter antenna net were not tested either, owing to the fact that the GCF configuration supporting

the 26-m-diameter antenna net remained unchanged for orbital operations.

DSS 14 was subjected to a strenuous series of GCF OVTs before DSN and MOS pre-Mars orbit insertion tests. The GCF OVTs were designed to reveal deficiencies insofar as wideband system procedures were concerned. Indeed, many procedural modifications were implemented; in general, the modifications improved operational visibility into the system as a whole and ensured timely response to indications of degraded performance.

3. SFOF testing. SFOF orbital training was done in conjunction with DSIF OVTs. SFOF personnel supported all DSIF, DSN, and MOS tests. In addition, special facility tests to demonstrate new 360/75 software capabilities were performed as shown in Table 10.

C. Network System Tests

1. General. DSN Combined System Tests were conducted with each DSS supporting MM'71 in order to verify end-to-end data flow using the Model 4 Version 6.10 360/75 software at the SFOF and the Phase 4 TCP software at the Deep Space Stations. The tests were designed to minimize the effect on flight operations support while still providing an adequate check of the new software capabilities. To this end, test time was curtailed when possible, and some tests were run in parallel. These tests constitute the formal network testing of the Model 4/Phase 4 capabilities. Subsequent testing of new versions of the software was done on a facility level with informal joint testing performed during the software development. The network system tests performed on Model 4/Phase 4 are discussed below.

2. DSN Combined System Test, DSS 12, August 30, 1971. For the most part, test results were adequate. There was only one 360/75 failure, which necessitated an initial program load (IPL). There were minor problems with the data patterns used during the simulation conversion assembly (SCA) stand alone mode for 2 kbps/1 kbps data rates. It was found that the patterns expected were not consistent with the SCA input parameters. Problems encountered are detailed, by systems, in the paragraphs that follow.

a. Telemetry System. Both engineering and science (33-1/3 and 0420) data were processed in the 360/75. Lack of documentation on new MED entries for 0420 science data caused problems in completing test requirements for science data. The engineering data processing was satisfactory.

High-rate telemetry data one and two kbps were received, dumped, and logged by the 360/75. No attempt was made to process these data. This first Combined System Test was not conclusive in that it served more to familiarize and train individuals in the operation of the system.

b. Command System. Configuration table recall response messages were displayed which were not requested. This occurred several times during the test, always two seconds after an enable or disable verify message was received. The tables contained erroneous data. Some monitor formats displayed erroneous data or had missing data.

Destructive overlays of linear formats on Command Analysis Group (CAG) DTV channels resulted in multiple separator lines (as many as seven occurred at one time) and partial separator lines between segments of data. The problems seem to occur when the Project called up the same displays in the CMD operations area.

A number of bit rate error alarms were received. Two commands were aborted for BIT/SYM rate error. Suppression for continuous alarms did not work. A configuration table display had all parameters filled with number signs (#). After tables were reentered into the 360, the display was correct.

A stack recall response display indicated ERROR after the command number for two commands in a block. The command message display, prior to sending to the station, indicated the proper commands (both were CC-4). Both commands confirmed properly. Confirm messages were not received at the SFOF for several commands which were transmitted. The station did see the confirms. A T command in stack with a time = 00:00:00 did not confirm. Alarm message elapsed T CMD was received. All other commands in the same block (all T commands on 1-min centers) transmitted properly.

Owing to lack of test time, the ODR playback program was not used.

c. Monitor and Operations Control System. SOEGEN was run and successfully transmitted at four blocks/s. Predicts were successfully transmitted at one block/s.

d. Tracking System. Pseudoresiduals processing was initiated for both data streams and displayed on both DTV and TTY. MED R-34 was exercised to disable and enable specified streams.

Phi-factors and predicts were run for Mariner 9 for a period of one day at all committed stations.

Station 62 data for the period preceding the test period were recalled and a system data record (SDR) written with the recalled and real-time data. Predicts were transmitted via both TTY and HSD. The option to display Pass Summary, Transmitter Record, TROG Records, and Tracking Data was displayed. The options of MED R-33 and R-39 were exercised. It was determined, after a time, that the values entered as changes were not displayed until after the next data point was processed.

MED R-82, MFP Status, and MED R-88, Project Tape display were exercised. A DR was generated on the R-88 in that the data requested were not completely generated and displayed. It was also discovered that a run cannot be terminated once started and that display by time is not possible.

A Project tape was written, but, since the 1108 was not up, an ODR run was not attempted. The R-49 MED to delete phi-factor files was exercised and found to be satisfactory.

3. DSN Combined System Test, DSS 14, September 1, 1971. The 360/75 did not duplicate

the excellent service provided during the test with DSS 12 on August 30, 1971. The system was down approximately 10 times during this 8 h support period.

DSS 14 had not completed the Phase 4 integration tests. It was found that TCP Alpha was not compatible with Phase 4 at all. Thus the test had to be run entirely on TCP Beta. DSIF configuration limitations require either high-rate data or command/engineering/50-bit science on a single string at one time. With only one string available, all data rates/modes had to be run sequentially.

There were minor communications problems at the beginning of the test. The HSDL and WBL were not ready at test start.

Problems encountered are detailed, by systems, in the paragraphs that follow.

a. Telemetry System. Many problems occurred with the 360/75 faulting and having to be reloaded. When the 360 was up, data would process for both engineering 33-1/3 and science 0420. Adequate assistance was provided by trained recon and Project personnel. This allowed a larger area of testing to be accomplished on the TCPs.

The automatic data stream select feature was exercised and found to function. One major drawback existed with the auto select feature, however. If one station's view period expired, and the other station's SNR was below the minimum level, the station would not process until the minimum SNR value was changed.

Analysis Programs, COMGEN, and SOEG were allowed to run while processing with spacecraft 75 and test case 35 with no effects on the system. On two occasions, telemetry data ceased to output. MED entries were accepted and printed on a line printer. Data appeared after 10 min on the first occasion and on the second the 360 was reloaded.

b. Command System. A T command in stack failed to transmit for no apparent reason. A stack recall showed the stack contained two blocks of enabled T commands on 30-s centers and one block of nonenabled P commands. All of the T commands except one transmitted properly. Alarm message elapsed T CMD was generated,

A T command with time = 00:00:00 would not transmit. T commands with the following times were entered:

Current	DOY 00:00:00 TCP rejected; TCMD exceeds maximum time of execution.
Upcoming	DOY 00:00:00 TCP accepted, did not transmit.
Upcoming	DOY 00:00:00 TCP accepted, transmitted.

Alarms HSD block rejected by TCP and Request to E/D command not to stack were received for a legal disable message. A stack recall prior to the disable message showed blocks 114, 115, 116 and commands 117-1, 117-2 in stack. All were nonenabled P commands. A disable message

for 114, 115, and 116 resulted in the alarms mentioned. A stack recall showed only commands 117-1 and 117-2 remained in stack. A disable message for these was accepted, and the commands were disabled.

Confirm messages were still missing for some commands that had been transmitted. Bit rate alarms and aborts still occurred. Unrequested configuration tables continued to be received.

c. Monitor and Operations Control System. The DSS 14 DIS was declared "red" at test start. During the course of the test, the DIS was declared a "best efforts green." Attempts to transmit predicts and SOE by HSDL were unsuccessful.

d. Tracking System. The data package for this test was simulated radio metric data, generated by the 6050 for a Mariner orbit case and previously transmitted to the CP. The test was considered satisfactory, in spite of the system down periods, in that the processing options exercised performed normally. The time to accomplish some tasks was extended due to the system problems.

The simulated radio metric data were recalled from the CP and the pseudoresidual program was exercised with this data base. Recalling data with no time delay intervals between messages tends to cause the pseudoresidual program to skip and/or duplicate data points. The same data were recalled a second time, with a delay between messages, and the problem of skipping data points was greatly improved. Predicts were again generated and made available for transmission to the station.

4. DSN Combined System Test, DSS 41/62, September 3, 1971. The first 3 hours of the test were used in trying to bring the 360/75 up to a state of reasonable stability. This was never really accomplished during the course of this test. The five mission packs and RTOS-A pack were restored before there was any semblance of a system.

DSS 41 and DSS 62 both provided excellent support under the circumstances. Even with the limited test time (due to 360/75 down times), both stations were checked out satisfactorily to be considered ready to support live tracks with Phase 4.

There were no startling new problems encountered during this test. The problems were, for the most part, duplications of problems experienced during previous tests. Problems encountered are detailed, by system, in the paragraphs that follow.

a. Telemetry System. During this test, all engineering and science formats were tested. Outside of format problems already documented by the facility test, only Format 753 had a problem. Format 753 is the DSS station ID change and summary format. The 753 output only the data for the new station and no summary for the old station.

The 360/75 faulted when SIMCEN entered DTV formats in error. SIMCEN entered formats 204 and 308 instead of 604 and 608. This was tried from area 12 (Recon), but the MED entries were not accepted and the 360 did not fault.

Special processing features of the 360 were tried for the R-7938 data. This has a serious impact on the engineering TCP in its entirety, which could not be used in that condition.

Analysis programs and COMGEN were run in real-time while engineering and science data were being processed with no effect on the system.

In summary, E140 data looked good through all three tests. Minor backlogging was experienced during recall, and interference with the E140 data was experienced while R-7938 data was being processed. No attempt was made to process the 16.2- or 8-kbps HRT data during the test period because of problems with DSS 14 wideband transmission problems. The 0420 data looked good on all three tests.

b. Command System. At DSS 62 two recall response messages were displayed for each request. At DSS 41 a stack recall request resulted in a stack recall response plus a list of erroneous alarms. This occurred during normal command activity. At DSS 41 no confirm message was received for two commands. The station verified that the commands transmitted.

A file stopped because the interlock code had not been entered. When the code was entered, it was accepted by the 360; however, the file did not restart. It was necessary to disconnect and reconnect the file and then reenter the interlock code.

At DSS 62 HSD blocks to the station never verified on the first attempt. Configuration table response messages, which were not requested, were still being received. Two confirm messages for one command were displayed on DTV and TTY at the SFOF. The station saw only one confirm. Bit rate alarms and aborts still occurred.

c. Monitor and Operations Control. The output router was successfully exercised with both stations.

d. Tracking System. The data package used for this test was radio metric data generated by the SIMCEN. Generally, the test was considered successful as far as the Tracking System was concerned. The 360/75 processor software version M3A4 V06.10 and the 6050 TRKSIM program were used during the test. The 360/75 processor was down six times during the test period for various reasons.

This was the first time the TRKSIM program was run in the 6050 with the telemetry program. Data were to start at 0800 GMT, but difficulties were encountered in getting the radio metric data started, and at 1045 GMT the program was declared "red." After a down time ending at approximately 1249 GMT, the TRKSIM program was started; then telemetry data was output. The system functioned properly under these circumstances. Radio metric data continued until 1508 GMT.

Pseudoresidual processing was initiated for the data stream and displayed on TTY. Although radio metric data were queued when the 360/75 processor was down, recall was required to obtain pseudoresiduals, for the queue would clear when the 360/75 system came up before the pseudoresidual display processing could be initiated.

Phi-factors and predicts for Mariner 9 were generated and made available for transmission to the station. A Project tape was written and the tape number provided for 1108 processing.

5. DSN Combined System Test, DSS 42/51, September 7, 1971. As in the last two DSN tests, the 360/75 support was somewhat less than acceptable. There were approximately eight 360/75 down times during the test. DSS 51 supported the first three hours of the test with Phase 3 instead of Phase 4, thus making that test time invalid. Both DSS 42 and DSS 51 are considered "green" for flight support with Phase 4. Problems encountered are detailed, by system, in the paragraphs that follow.

a. Telemetry System. No new problems were encountered during this test. All problems have been documented in previous DSN Combined Systems test reports.

b. Command System. Confirm messages were not displayed at the SFOF for some commands which were transmitted. During this test it was determined that the SDR did not contain these confirms; they were displayed at the station.

A C-13, DISP MED entry sent commands to the station rather than just displaying them. The problem was repeatable. A C-13, DISP MED entry followed by a stack recall request caused an enable message for a fictitious command block (usually 227-0) to be sent to the station. The problem was repeatable. A DTV destructive overlay problem appeared to be caused by alarm message Format 106. This format was deleted from DTV Channel 47 and put on Channel 48 (with FMTS 108, 128, and 129). The overlay problem switched from Channel 47 to Channel 48.

At DSS 42 A bit error rate (BER) alarm message was generated for a command while it was clocking out (on bit 4), but it did not abort. Bit rate alarm and abort limits were the same. After a BIT/SYM rate abort, the CMA apparently stayed in the abort mode. Format 10 was not available to verify this because there was no DIS at the station; however, a configuration message to change to Idle 2 was rejected by the TCP for reason CMA ACTIVE. A recall showed the CMA in Idle 2, but Enabled P commands in stack were not transmitting. A TCP reload restored proper operation. A DR was written.

Two abort messages from DSS 42 displayed for the same command. Several commands, which were in stack and properly enabled, did not transmit. Bit rate alarms and aborts still occurred.

c. Monitor and Operations Control. The output router was successfully exercised with DSS 51. DSS 42 has no GSDS DIS.

d. Tracking System. The data package for this test was simulated radio metric data generated by the 6050 for the Mariner cruise situation, compatible with the current day and real-time spacecraft 75 metric data. The 360/75 processor and the 6050 TRKSIM program were used during the test.

The test was considered satisfactory in that the processing option exercised performed

normally. Problems were encountered by the 6050, so after obtaining approximately 1 h of 20-s data, the 6050 requirement was deleted and real-time spacecraft 75 data used. The problem of starting the TRKSIM program with telemetry has apparently been solved and performance was satisfactory.

A Project tape was written and pseudoresiduals displayed on TTY for the simulated radio metric data. Predicts were generated and made available for transmission to the stations. Spacecraft 75 radio metric data were processed in real-time and recalled, as required, to complete SDR requirements. Numerous options were exercised without problems.

D. TCP Command Function Ad Hoc Team

To resolve the numerous command problems noted in the DSN Combined System Tests, a major update to the Phase 4 TCP program was necessary. Because of the late delivery date planned for the updated version, designated Phase 4B, and because some command problems still were not resolved, the TCP command function was placed on the problem list on September 27, 1971.

During the week of September 27 to October 4, Phase 4B formal acceptance testing was completed at CTA 21, and software was shipped to all prime stations in support of MM'71 for integration testing. Phase 4B was used at DSS 14 on October 1 to process high-rate telemetry only, with no problems encountered.

On October 6, a TWX was sent by the MM'71 Operations PE which authorized use of Phase 4B by DSS 12 and 14 for live tracking, tests or training.

During the week of October 4 to 11, three cases of anomalous command activity were experienced. A CC&S update by DSS 12 was scrubbed on October 6 because of spurious symbol rate alarms. On October 8, during the DSS 12 pass, a triplet of priority coded commands (CC) was transmitted in an incorrect order. During the DSS 41 pass on the same day, a priority command remained in stack and could not be transmitted nor disabled. At this time a TWX from the DSIF Project Engineer (PE) to all stations changed the DSS configuration to one TCP dedicated to command and one TCP dedicated to telemetry.

On October 8, a TCP Command Function Ad Hoc Team (Tiger Team) was established. The objectives of the team were to understand, in detail, the command functioning of the TCP Hardware/Phase 4B Software System, to investigate the anomalies it exhibited, and to design and qualify necessary changes to a reliable operational configuration for MM'71 orbital operations, based on the existing hardware/software configuration.

The team was composed of three groups: an Empirical Timing Study Group, a Coding Review Group, and a Real-Time Operations Support Group. Personnel assigned to each group were as follows:

Team Chief, R. Stevens

Deputy, J. Fearey

JPL Technical Memorandum 33-523, Vol. II

Empirical Timing Study Group

C. W. Johnson (leader)
J. Wilcher (Command System engineer)
G. Osborn (timing study)
R. Murray (timing study)

Coding Review Group

P. Poulson (leader)
I. Urban (EXEC)
J. Adem (CMD)
J. White (SFOF CMD)
S. Friesma (TCP CDE)

Real-Time Operations Support Group

R. Chafin (leader)
M. Pancino (Ops. S/W)
R. Riggs (CMD Ops.)
B. Falin (Sys COE)

The task of the Empirical Timing Study Group was to instrument the TCP/Phase 4B program in order to derive internal timing data that would lead to understanding the program execution sequence and thereby indicate the source of observed anomalies. The task of the Coding Review Group was to analyze and chart the grammatical and timing structure to the CMD/TLM/EXEC software and to recommend diagnostic and debugging tools to be used during team testing. The Real-Time Operations Support Group provided technical support to the ongoing mission activities.

One TCD string was made available at CTA 21, two shifts per day, to be used as a troubleshooting tool. Over the weekend of October 9-10, 1971, heavy testing was accomplished at CTA 21. The Empirical Team developed a patch to solve a timing anomaly. Work continued on developing a HSD block patch and a histogram patch. The Coding Review Team analyzed the timing and priority structure. The Operations Control Team, using DSS 51, configured a single string for command only and encountered no problems.

On October 11, a TWX was sent to alert stations as to Phase 4B usage authorization. Phase 4A, as modified by ECO 71-220, was to be used by all stations in support of MM'71 with the exception of DSS 12 and 14. DSS 12 was to use Phase 4B for telemetry and command. DSS 14 would use Phase 4B for telemetry only. The Operations Support Group continued monitoring real-time operations of MM'71.

During the MM'71 Operational Demonstration Test (ODT) conducted on the 12th, Phase 4B was used to send 50 commands with no problems observed. The commands were sent in blocks of threes as timed commands. A backup team was established on October 13 to provide a fallback system in the unexpected case that the team working on the present MM'71 Command System was unable to solve the problems in that system. The backup team devised a simplified command system program. The backup team consisted of:

M. Easterling (leader)
N. A. Burow
R. R. Green
G. A. Morris

Consultants to the team were:

W. C. Allen	CMA
R. M. Goldstein	Software design
W. G. Stinnett	Formats and monitor interfaces
R. C. Tausworthe	System design
J. H. White	SFOF interface
J. K. Woo	CMA

Two problems were identified by the team on October 13. The first problem caused a new command to be loaded into the command register before the previous command had been completed. The second problem caused timed commands to be skipped during high activity on the HSD processor.

On October 14, J. Manis was added to the TCP Command Function Tiger Team in C. Johnson's group. His function was to validate station hardware configuration, including ECOs related to the team's work.

On October 14, patches were incorporated to correct the two problems identified on the 13th. Tests conducted at CTA 21 using these patches proved quite successful.

On October 15, testing of the patched version of Phase 4B, now called Phase 4B Omega, continued at CTA 21. A total of 1059 priority commands were sent in the fault forcing mode with no anomalies observed. A total of 3524 timed commands were sent in the fault-forcing mode with similar results.

On October 16, ECO 71.229 was issued to allow the command modulator assembly (CMA) command bit stream to be recorded on the CEC recorder. This allowed an analog recording of command bits to facilitate analysis efforts of anomalies. Acceptance and confidence testing continued at DSS 12 and CTA 21, with no command anomalies in the testing to date. Testing time was lost at CTA 21 for 16 h because of a power failure. Plans were introduced to run Phase 4B Omega tests with each of the MM'71 prime stations. The tests were to be 4 h long and would include a 3-h CC&S update plus 1 h of other command tests.

On October 17, during acceptance testing at DSS 12, an anomaly occurred which was connected with the patch for the timed command fix. A patch was developed, and DSS 12 continued testing with this new patch. This new anomaly did not invalidate the previous successful soak testing.

On October 18, tests were continued at DSS 12 and 41 and CTA 21. Two problems occurred. The first was an isolated anomaly occurring at DSS 12 only. The second occurred at all three stations. The first problem was that the block number of a CMD in Block 42 reappeared in Block 46 with the same time and CMD structure at CMD 1 of Block 46 except that it was not enabled. All CMDs of Block 42 had been enabled, transmitted, and

confirmed. The second problem was spurious: CMD alarms on outgoing data blocks and TCP rejects on incoming data blocks. The problem appeared to be connected to the HSD input/output and was placed under investigation.

On October 20, a TWX was sent to all stations authorizing the use of the patched version of Phase 4B software, now known as Phase 4B Omega 1, for the ORT starting with DSS 41 on Day 293. The program was not to be used for live spacecraft support.

On October 21, a TWX was sent, DTG 21/1431Z, which described six patches to Omega 1 and also listed seven problems and the fixes for them.

On October 22, W. Frey, K. Kimball, and W. Scott were added to the TCP Command Function Tiger Team. Frey and Kimball were assigned to the group under C. Johnson; their function was to investigate station HSD I/O buffer equipment. Scott was assigned to support Stevens/Fearey in the evaluation of risks/confidence in use of CMD configuration for spacecraft CC&S servicing during orbital operations.

Equipment failure during the ORT caused the remainder of the ORT to be postponed; however, enough confidence had been gained to authorize Phase 4B Omega 1 for use by the net in support of all MM'71 activities including live tracking support.

During the week of October 25 to November 1, a 4-h Command Test was scheduled to develop confidence in the Omega 1 software before the orbit phase of the MM'71 mission. The tests were conducted with each of the DSIF stations in support of MM'71. The test consisted of 3 h of timed commands and 1 h of priority commands, while 2 and 33-1/3 kbps data were being processed. Troubleshooting of the HSD I/O buffer continued, with problems identified and isolated and corrections made. ECOs were implemented and incorporated. The backup command team continued design and development of a minimum command-only program.

On October 26, during a test, an abort occurred at DSS 12 with erroneous and different times of abort displayed at the station RO and the SFOF 360. During the week of November 1-8, 1971, ECOs were incorporated to correct the TCP I/O buffer problem. The problem, which occurred at DSS 12 on October 26, could not be explained after six days of intensive effort. The problem may have been caused by a momentary power failure at the station at the time of the event, or by minor equipment failures which occurred in the first few

days following the event. The backup command team under M. Easterling was released.

On October 29, the following people were released from the TCP Command Function Ad Hoc Team and C. Johnson's group: J. Wilcher, J. Manis, and R. Murray. S. Friesma and J. Adem were released from P. Poulson's group. On November 10, 1971, the Ad Hoc Tiger Team was dissolved and the TCP command function removed from the problem list with the concurrence of D. Schneiderman, MM'71 Project Manager.

E. Project Test Support

The DSN supported 13 Project Orbital Training Tests for a total of 372 h. The test schedule is shown in Table 11. The TDS/DSN personnel supporting MOS preorbit insertion test and training are shown in Table 12. Facilities required for the tests are shown in Table 13.

F. DSN Simulation System Support

From launch through orbit insertion, the DSN Simulation System supported 314 h of Mission Operations (MOS) testing. An additional 837 h were used in support of Mk III 360/75 development testing and 200 h in support of DSN test and training.

MOS testing placed the severest load on the Simulation System and, as before launch, the test periods were characterized by many data interruptions caused by 6050 and 1108 hardware and software failures. The software failures and 1108/6050 compatibility problems were sequentially eliminated, and Simulation System reliability improved to the point that only one or two data outages were experienced in the later tests.

Heavy demands on the Simulation System for testing to support all users were satisfied at the expense of programmed preventive maintenance on the simulation computer. This computer failed with a major hardware problem during the final phases of MOS testing that required several days to restore computer service. The MOS elected to finish testing with the PTM and uncovered a problem which would not otherwise have been recognized.

Tracking data and SCA performance were adequate during the tests, in general, surpassing the performance of the rest of the Simulation System. SIMCEN operations under heavy load were, as usual, hectic, but the personnel performance was equal to the task and admirable under the conditions imposed. Had voice communications with the DSS SCA operators been available during Mariner testing, SCA/6050 problems would have been solved much quicker and would have enhanced those tests.

Table 10. CPS 360/75 demonstration tests

Date, 1971	Model	Test version	JPL operating system
September 3	4	6.10	3.0.228
September 22	4	10.8	3.0.259
October 15	4	10.8	3.0.286
October 20	4	11.3	3.0.286

Table 11. MOS preorbit insertion - tests and training for Mariner Mars 1971 supported by the DSN

Number	Test	Date, 1971	Total hours	Remarks
1	MO: Data Flow Test 1	8/26	10	
2	MO: Data Flow Test 2	9/2	10	Software problems; rerun 9/9/71
3	MO/TDS: MOI maneuver	9/8	24	SIM problems; rerun 9/14/71
4	MO: Data Flow Test 2A	9/9	10	See 2 above
5	Rerun MOI maneuver	9/14	24	See 3 above
6	PTM second MC Test	9/16	8	
7	MO/TDS: OTT MARS TV Cal. II	9/17	8	
8	ODT: MOI maneuver, CC&S update	9/22-24	55	PTM used as data source from 1600 - 0100 GMT daily
9	MO: Data Flow Test 4	10/3	16	
10	MO/TDS: MARS orbit trim	10/4-6	48	
11	ODT: orbit trim and orbit operations	10/11-16	123	
12	ORT: MOI maneuver and Sub. Ops	10/21	17	Major SIM failure; terminated
13	Rerun ORT	10/28-29	19	PTM used as data source from 1500 - 0100 GMT
			372	

Table 12. Mandatory TDS/DSN personnel participation requirements –
MOS preorbit insertion tests and training

Activity	TDS, DSN		
	Project Engineering Team ^a	Operations Control Team	Simulation Team
Navigation Team orbit training			X
Spacecraft Team orbit training			X
Science Data Team orbit training			X
Command Team orbit training		X	X
MO: Data Flow Test 1			X
MO: Data Flow Test 2	X	X	X
MO/TDS: MOI Maneuver Training Test	X	X	X
MO/TDS: Data Flow Test 3	X	X	X
MO/TDS: Mars Orbit Trim Training Test	X	X	X
MO/TDS: Mars TV Calibration II Test	X	X	X
MO/TDS: Data Flow Test 4	X	X	X
ODT: MOI maneuver and CC&S update	X	X	X
ODT: orbit operations	X	X	X
ODT: MOI maneuver and trim	X	X	X
ORT: MOI maneuver and subsequent operations	X	X	X

^a Participation in operational exercises required only as normal for the represented mission phase.

Table 13. Equipment/facilities requirements - MOS preorbit insertion tests and training

	Navigation Team orbit training	Spacecraft Team orbit training	Science Data Team orbit training	Command Team orbit training	MO: Data Flow Test 1	MO: Data Flow Test 2	MO/TDS: MOI Maneuver Training Test	MO/TDS: Data Flow Test 3	MO/TDS: Mars Orbit Trim Training Test	MO/TDS: Mars TV Calibration II Test	MO/TDS: Data Flow Test 4	ODT: MOI maneuver and CC&S update	ODT: orbit operations	ODT: MOI maneuver and trim	ORT: MOI maneuver and subsequent operations
<u>SFOF</u>															
MSA	X	X	X	X	X	X	X	X	X	X	X	X	X	X	X
360/75	X	X	X	X	X	X	X	X	X	X	X	X	X	X	X
360/75 ^a															
1108	X	X	X	X	X	X	X	X	X	X	X	X	X	X	X
MTC			X	X	X	X	X	X	X	X	X	X	X	X	X
MTVS			X	X	X	X	X	X	X	X	X	X	X	X	X
Simulation Center	X	X	X	X	X	X	X	X	X	X	X	X	X	X	X
<u>GCF</u>															
TVSA	X	X	X	X	X	X	X	X	X	X	X	X	X	X	X
Voice/HSD/TTY/WB Communications															
SFOF internal	X	X	X	X	X	X	X	X	X	X	X	X	X	X	X
SFOF external															
<u>DSIF</u>															
DSS 12								X	X	X	X	X	X	X	X
DSS 14							X	X	X	X	X	X	X	X	X
DSS 41								X	X	X	X	X	X	X	X
DSS 62								X	X	X	X	X	X	X	X

^a Alerted only for typical mission backup support:

- (1) Support in case of prime computer failure.
- (2) Support during critical mission periods.

GLOSSARY

abends	abnormal endings	GSDS	Goldstone duplicate standard
ACN	Ascension Island	HDR	high density recorder
ACT	Area Communications Terminal	HRT	high-rate telemetry
ACTS	Area Communications Terminal Subsystem	HSD	high-speed data
APS	Antenna Pointing Subsystem	HSDA	high-speed data assembly
BDXR	block demultiplexer	HSS	high-speed system
BER	bit error rate	I/O	input/output
BMXR	block multiplexer	IPL	initial program load
CAG	Command Analysis Group	JPLOS	JPL Operational System
CC	coded commands	LASP	Laboratory for Atmospheric and Space Physics (University of Colorado)
CDE	Cognizant Development Engineer	MDR	master data record
CEC	Consolidated Electrodynamics Corp.	MED	manual entry device
CMA	command modulator assembly	MFP	multiple primary feed
CMD	command	MkIA	mark IA ranging
CME	celestial mechanics experimenters	MO	mission oriented
CMO	Chief of Mission Operations	MOI	Mars orbit insertion
COE	Cognizant Operations Engineer	MOS	Mission Operations
COMGEN	Command Generation Program	MSA	Mission Support Area
CP	computer processor/communications processor	MSFN	Manned Space Flight Network
CPS	Central Processing System	MSG	message
CTA-21	Compatibility Test Area, JPL	MTC	mission test computer
CYI	Grand Canary Island (Spain)	MTS	mobile tracking station
DEV/dev	development	MTVS	Mission Test and Video System
DIS	Digital Instrumentation Subsystem	NAT	Network Analysis Team
DL	downlink	NAV	navigation
DOY	day of year	OC	Operations Chief
DR	discrepancy report	OCC	Operations Control Chief
DSC	Deep Space Communications Center	OCT	Operations Control Team
DTV	digital television	ODR	original data record
ECO	engineering change order	ODT	Operational Demonstration Test
EIA	Electronic Industries Assn.	OPSE	Operations Support Project Engineer
EXEC	Executive software assembly	ORT	Operational Readiness Test
FDX	full duplex	PE	Project Engineer
FTS	Federal Telecommunications System	PET	probe ephemeris tapes
GCF	Ground Communications Facility	PN	pseudonoise

GLOSSARY (contd)

PTM	proof test model	TDH	Tracking Data Handling Subsystem
PTT	project tracking tapes	TDS	Tracking and Data System
REGEN	regenerative repeater	Telcomm	Telecommunications
RFO	radio frequency oscillator	TRAG	Tracking Analysis Group
RO	receive only/read only	TRKSIM	tracking simulation
RTOS-A	Real-Time Operating System	TSF	tracking synthesizer frequency
SCA	simulation conversion assembly	TTY	teletype
SDR	system data record	TVSA	television assembly
SIMCEN	Simulation Center	UDTC	user-dependent type code
SOE	sequence of events	UL	uplink
SOEG	sequence of events generation	UNK	unknown
SOP	standard operating procedure	VSB	vestigial sideband
S/W	software	WB	wideband
T	elapsed time from launch; T = 0 at launch L	WBS	wideband system
TAG	Telemetry Analysis Group	WCSA	wideband conversion and switching assembly
TCP	telemetry and command processor	XA	ground transmitter VCO frequency setting