

# COSIE: The Coronal Spectrographic Imager in the EUV



And the COSIE Team  
[PI: Leon Golub | DPI: Ed DeLuca]

# COSIE – What is it?

COSIE is a solar-observing instrument (currently proposed for mounting onto the ISS) which obtains **wide field images of the corona and full Sun spectral images with high sensitivity and rapid cadence**. The primary purpose of the instrument is to constrain the global field topology and to track coronal mass ejections **from the disk through the inner heliosphere**.

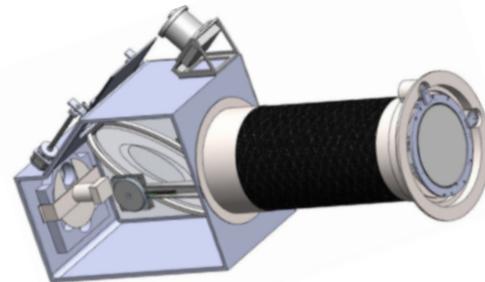
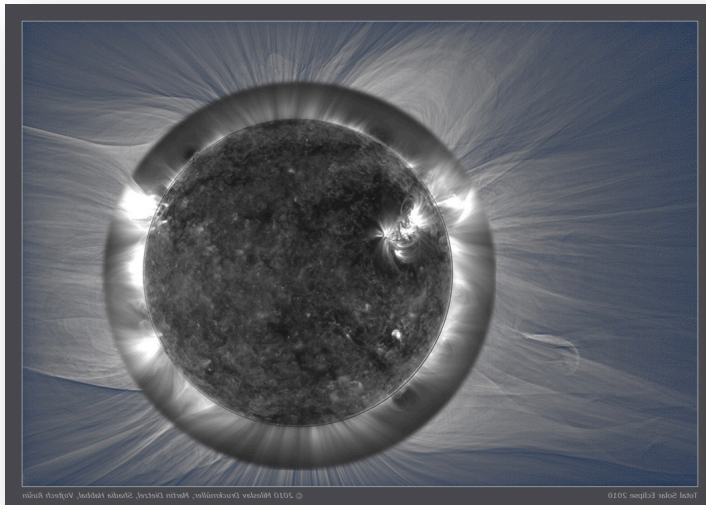
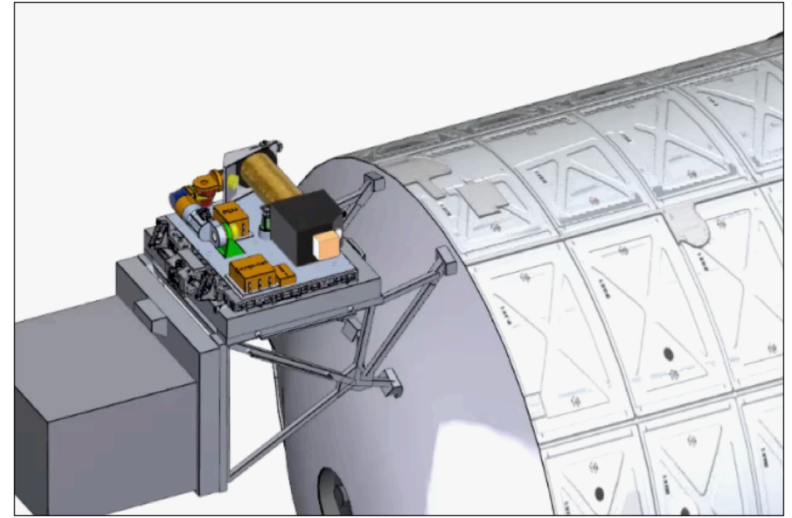

# COSIE – The Whys.

**Why COSIE?** COSIE's **1000x increase in sensitivity** and improved spatio-temporal coverage compared to available coronal EUV instrumentation will answer major outstanding questions of solar wind origin, and lead to improved forecasting of geo-effective CMEs.

**Why now?** Space weather forecasting is a high-priority national issue, and developing the **next generation of forecasting models** requires observations that fill the gap between the disk and the outer corona.

**Why ISS?** The ISS provides a low cost **unique observing platform**. It offers high data rates and ample power. The orbital day/night cycles do not compromise COSIE science, as nearly all departing CMEs will be detected.

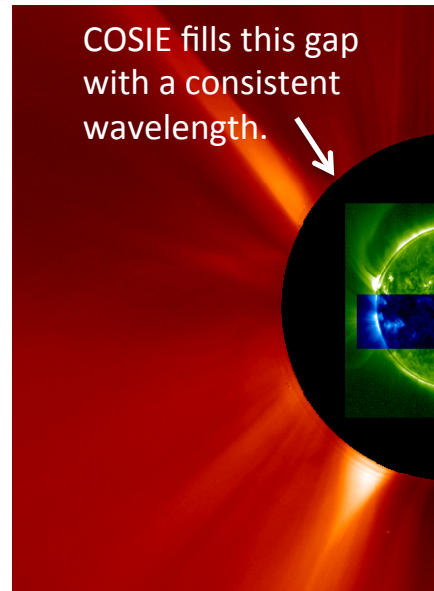

COSIE fills this gap with a consistent wavelength.

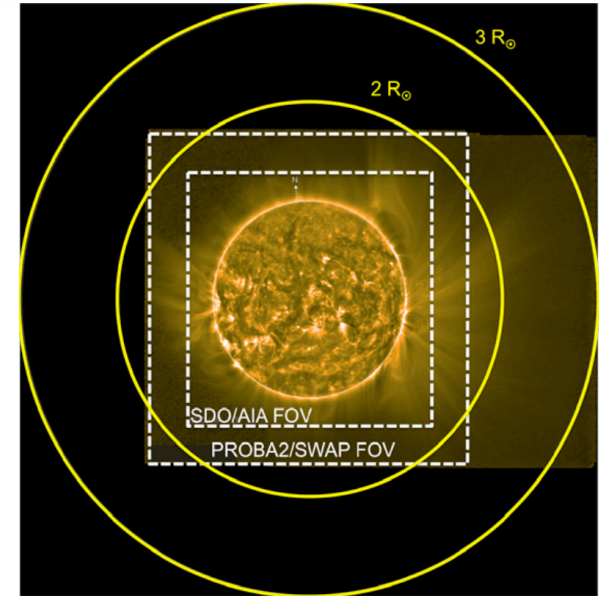

Density from Fe XIII Line Ratio  
203.795 + 203.826 / 202.044 Å

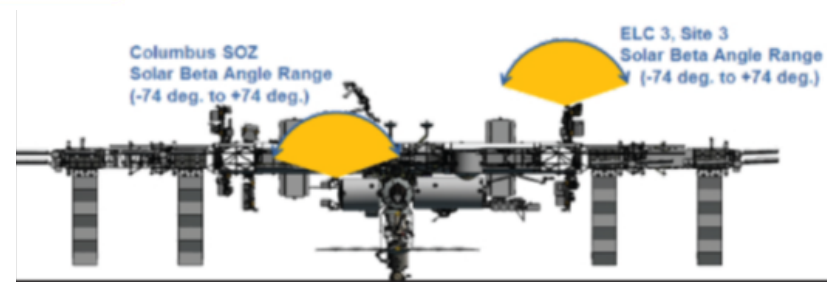
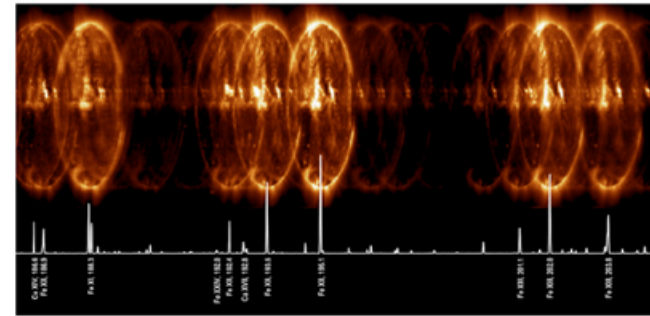
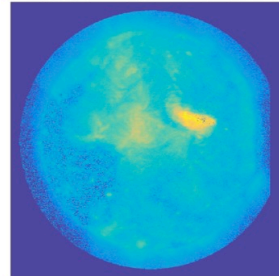

# COSIE – Why ISS?

- ✓ Fills in the **altitude, observation time, and funding gap** between sounding rocket and explorer class payloads.
- ✓ Creates a **new platform** for developing technology and evaluating **innovative observations** to provide **improved space weather services**.

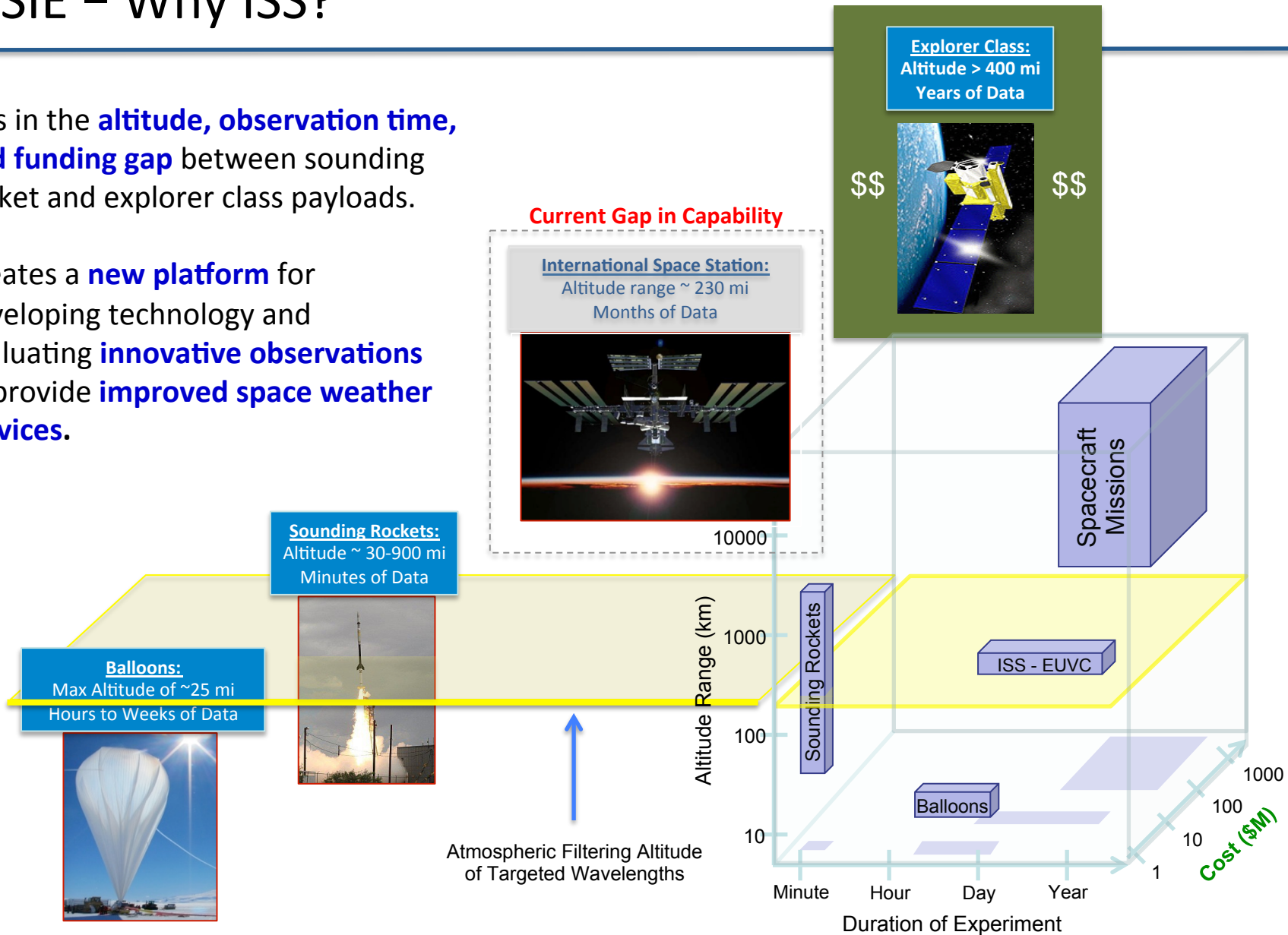

# COSIE – The EUV Corona

COSIE is made possible and scientifically attractive because the corona is observed to be **greatly extended** in the EUV.

- The fall-off goes as  $n_e$  rather than  $n_e^2$ .
- EUV structures are highly dynamic and magnetically variable.
- Dynamic events observed at all position angles around the limb.

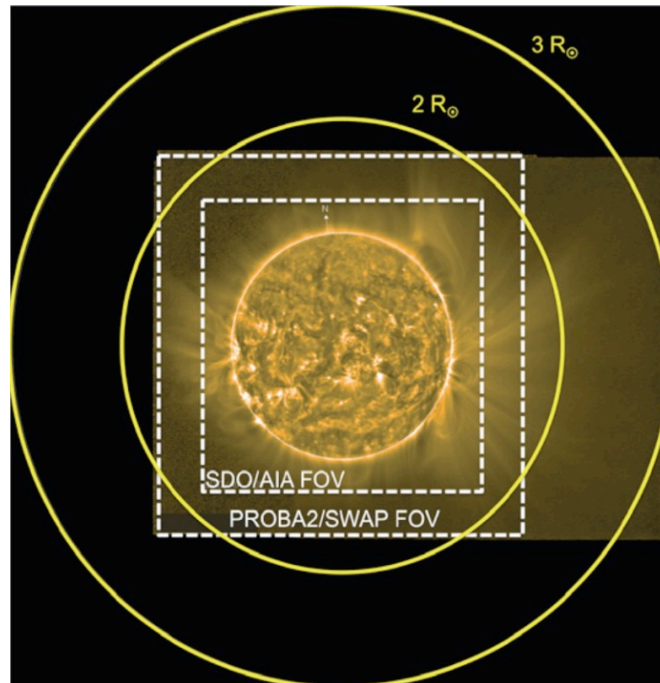

SWAP 174 mosaic. EUV streamer emission visible beyond  $2 R_{\odot}$ . COSIE FOV is  $3.3 R_{\odot}$  square.

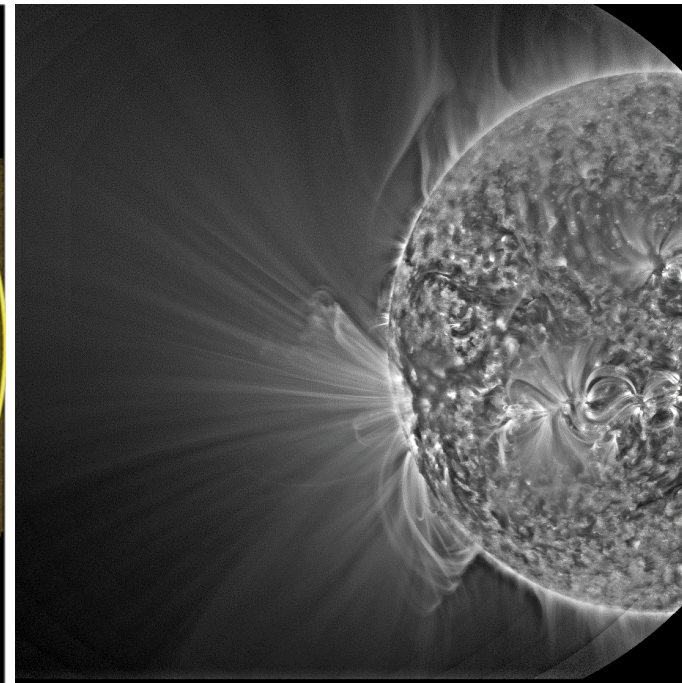

AIA off-point mosaic from 2014 Nov 12.

# COSIE – Characterizing the Transition Corona

Coronagraphs are a necessary tool for monitoring spaceweather. The only one in operation observes in white light, does not see the disk or the eruption source regions, and is 20+ years old (but we still love it!).

- An EUV coronagraph is a new capability for an ‘old’ idea, which will open a new look on the structure of the extended corona where dynamic transitions occur that affect the interplanetary environment.
- Emission from the low corona is dominated – largely but not entirely – by magnetically closed regions, while the outer corona has a mostly radial structure.
- Between the chromosphere-corona transition region and the nominal source surface at  $\sim 2.5$  solar radii there is another transition region.

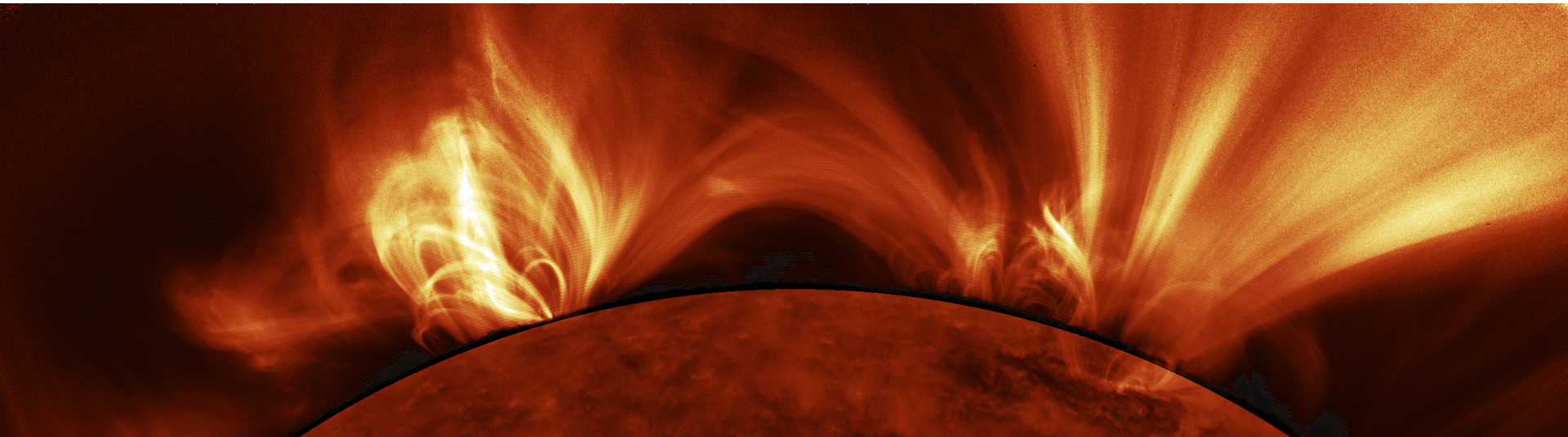

# COSIE – Characterizing the Transition Corona

The transition corona (“TC”) is a dynamic portion of the atmosphere where the plasma  $\beta$  changes from low ( $\beta \ll 1$ ) back to high ( $\beta > 1$ ), the inverse of the lower transition region.

The TC determines where and how the corona transitions from closed structures to open ones, allowing solar wind and energetic particles to escape. Large FOV mosaics have, until now, required  $\sim 1$  hour and dozens of images to generate. COSIE will obtain such images in  $\sim 30$  seconds.

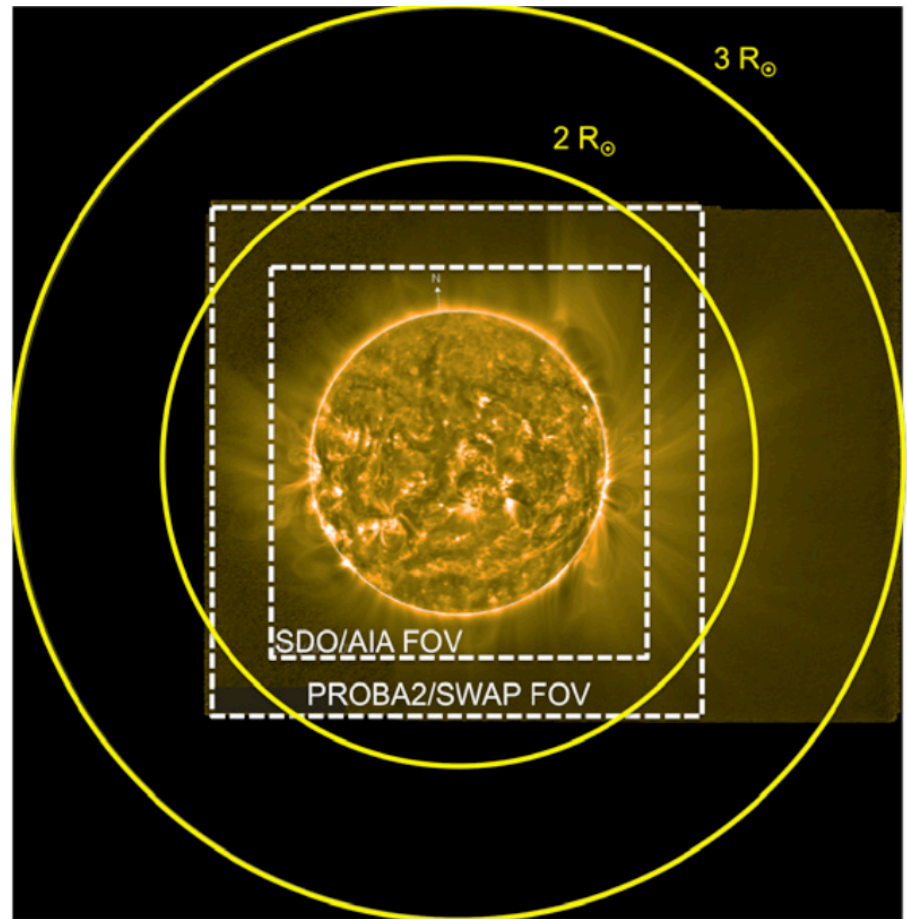

# COSIE – Two Instruments

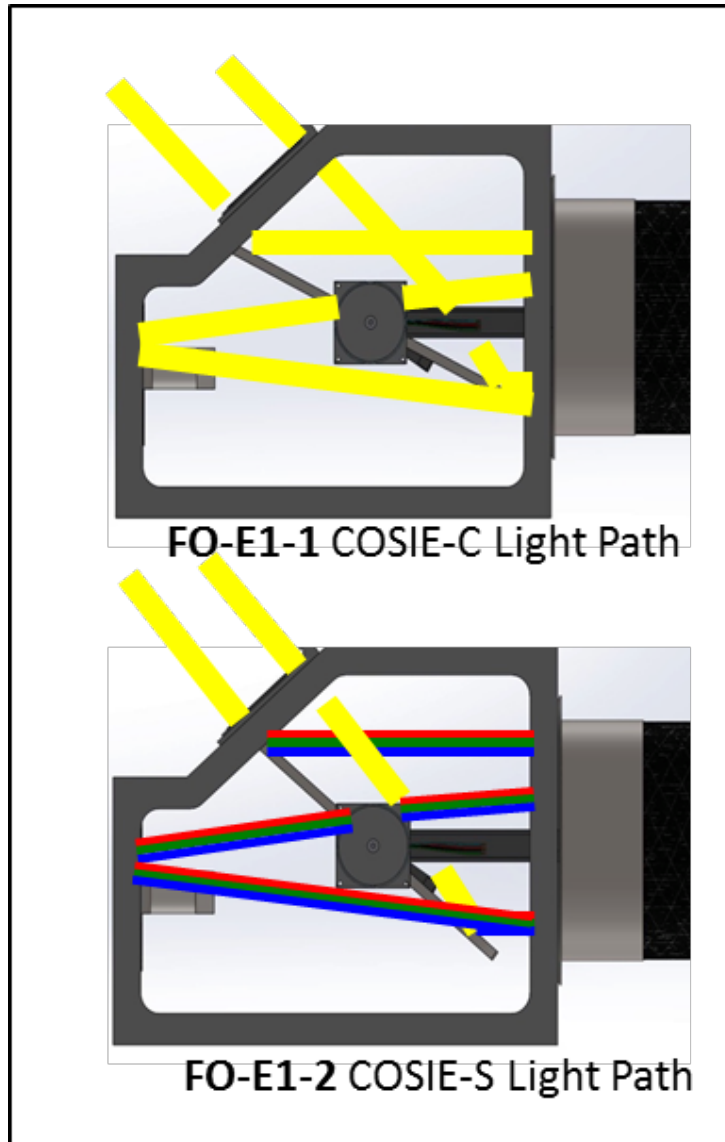

## COSIE-C

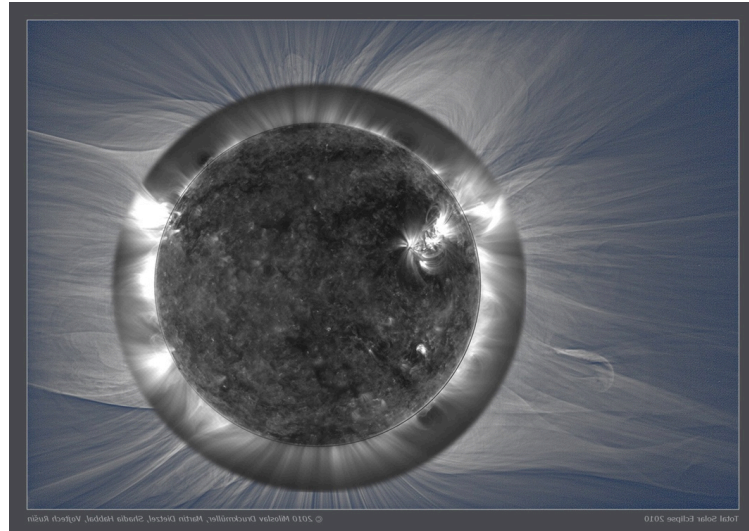

## COSIE-S

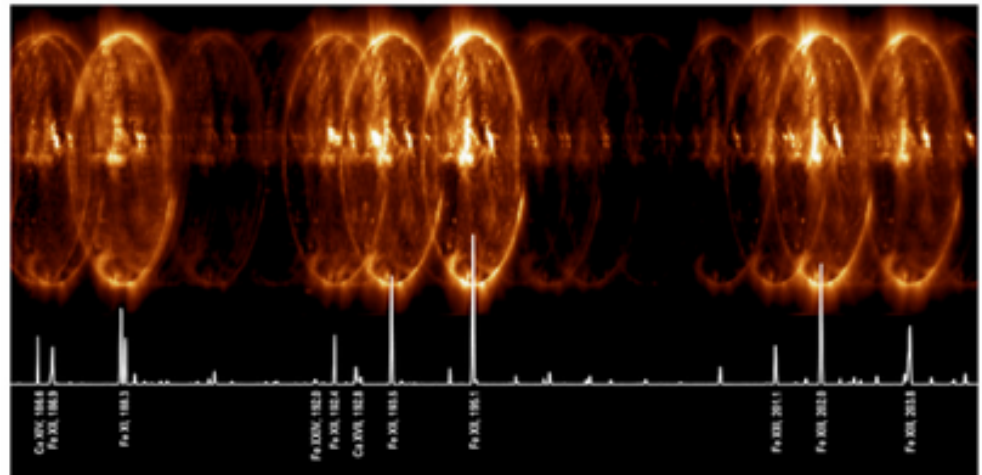



# COSIE-C – Large-Scale EUV Diagnostics

## Spaceweather events and magnetic connectivity are tracked through the Sun's corona with COSIE-C:

- Disk/Coronal brightness varies by a small factor in the EUV (vs.  $10^6$  in white light).
- EUV coronagraphs allow for simultaneous visibility of the source region and the propagating disturbance.

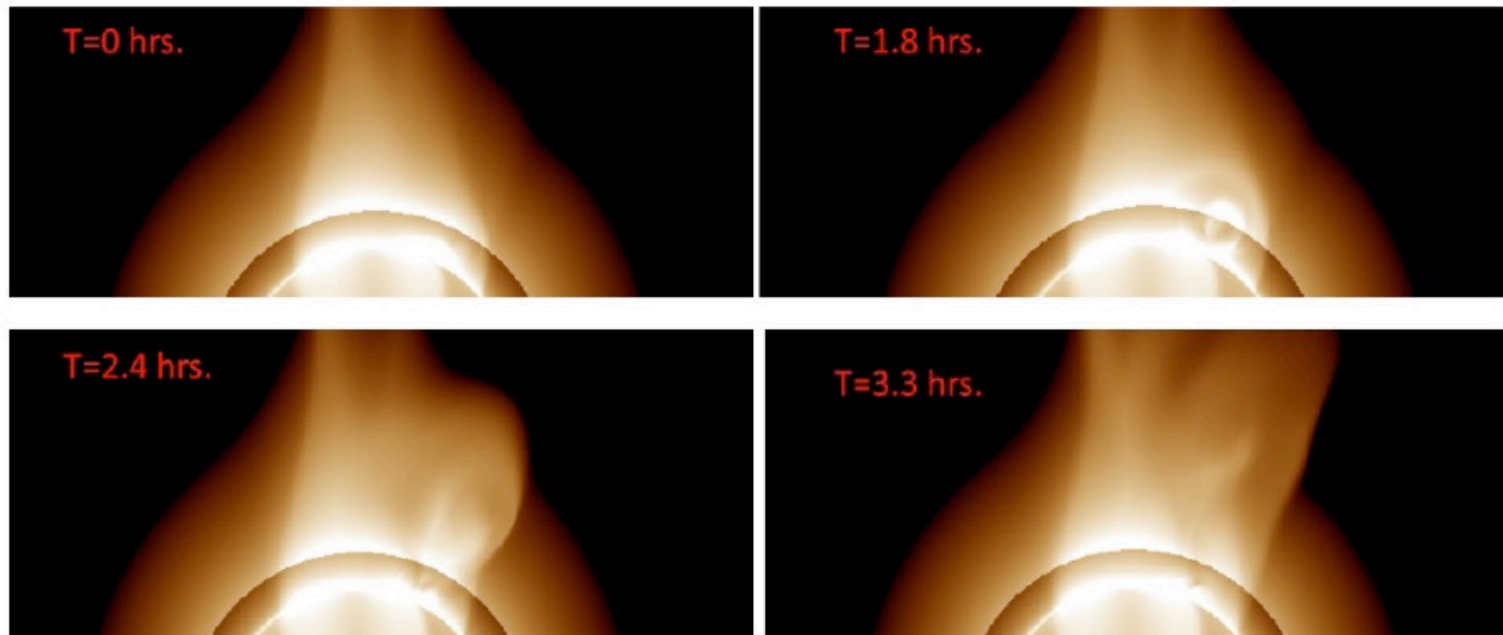

PSI 3D CME model

# COSIE-C – Constraining PFSS Models

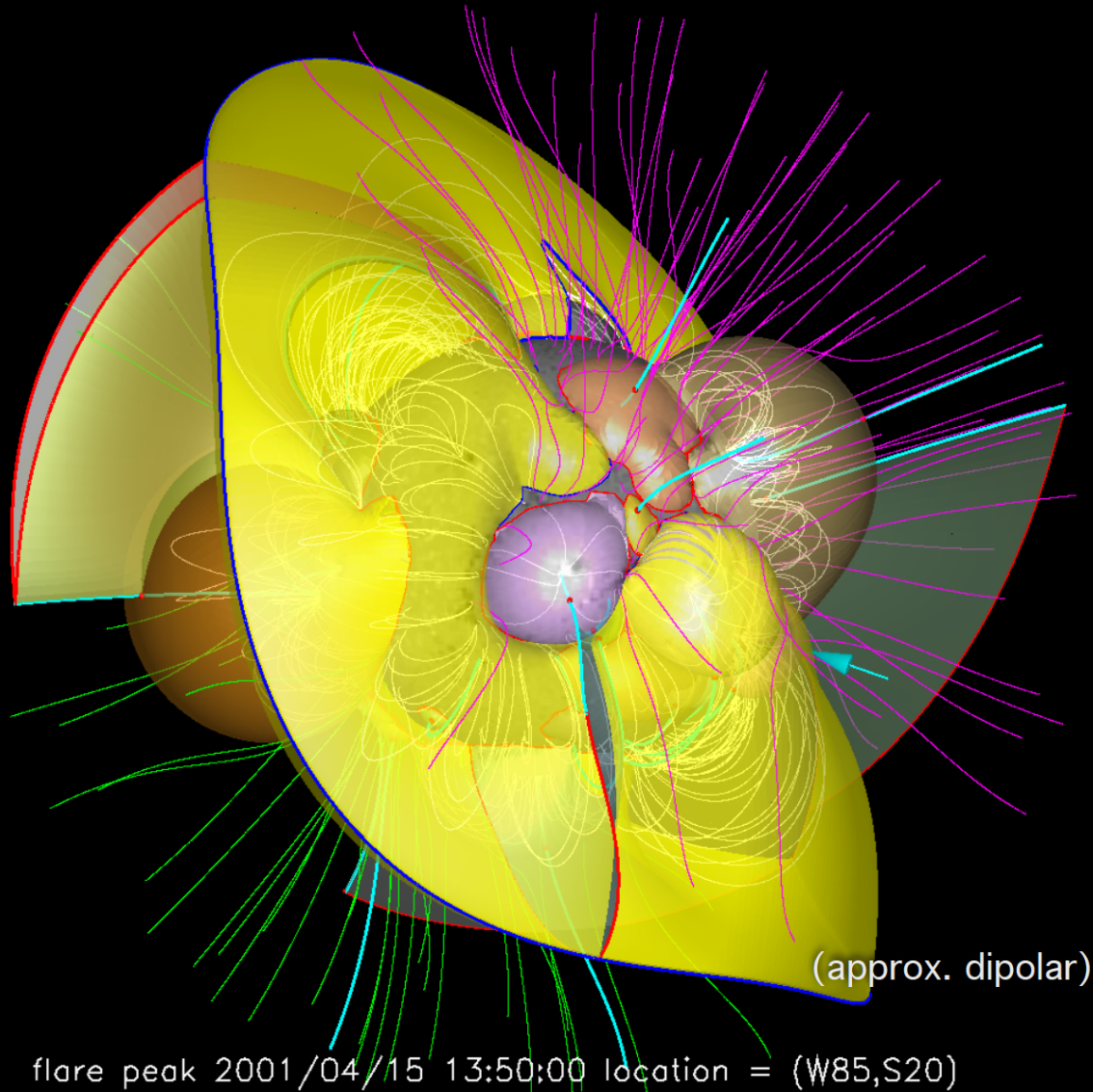

Topological modeling using a potential field source surface (PFSS) model constrained by photospheric magnetic field measurements, low coronal observations, and Large Angle Spectrometric Coronagraph (LASCO) C2 images.

COSIE observations between 1.3 and 2.5  $R_{\odot}$  will allow us to improve these models (DeRosa 2016; Masson et al. 2014).

# COSIE-S – Full-disk Overlapping Spectral Diagnostics

**Slitless spectrograph (COSIE-S) that disperses the full solar image along a spectrum (compressed in 1 direction).**

Additional scientific capability and value with overlap-o-gram over 186—205 Å range:

- COSIE spectra based on EIS observations of AR core loop (Del Zanna 2013).
- Direct response to CMEs.

**COSIE-S images will be converted to spectral radiance cubes.**

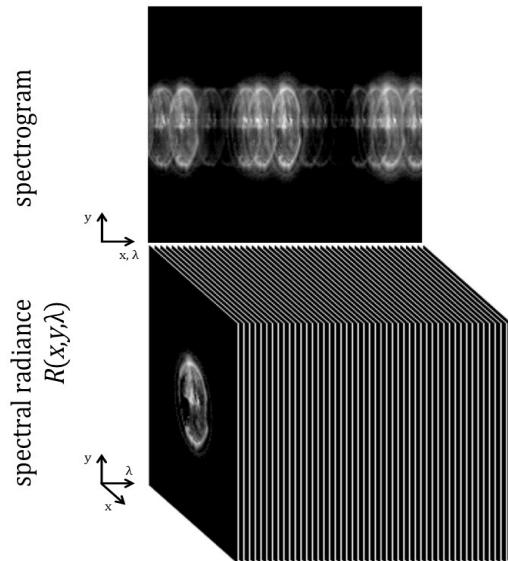

**Density from Fe XIII Line Ratio  
203.795 + 203.826 / 202.044 Å**

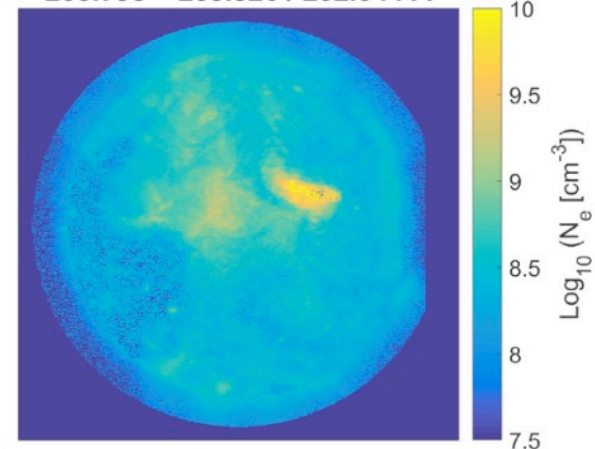

**Near-real time full Sun  
coronal density maps.**

# COSIE-S – Full-disk Overlapping Spectral Diagnostics

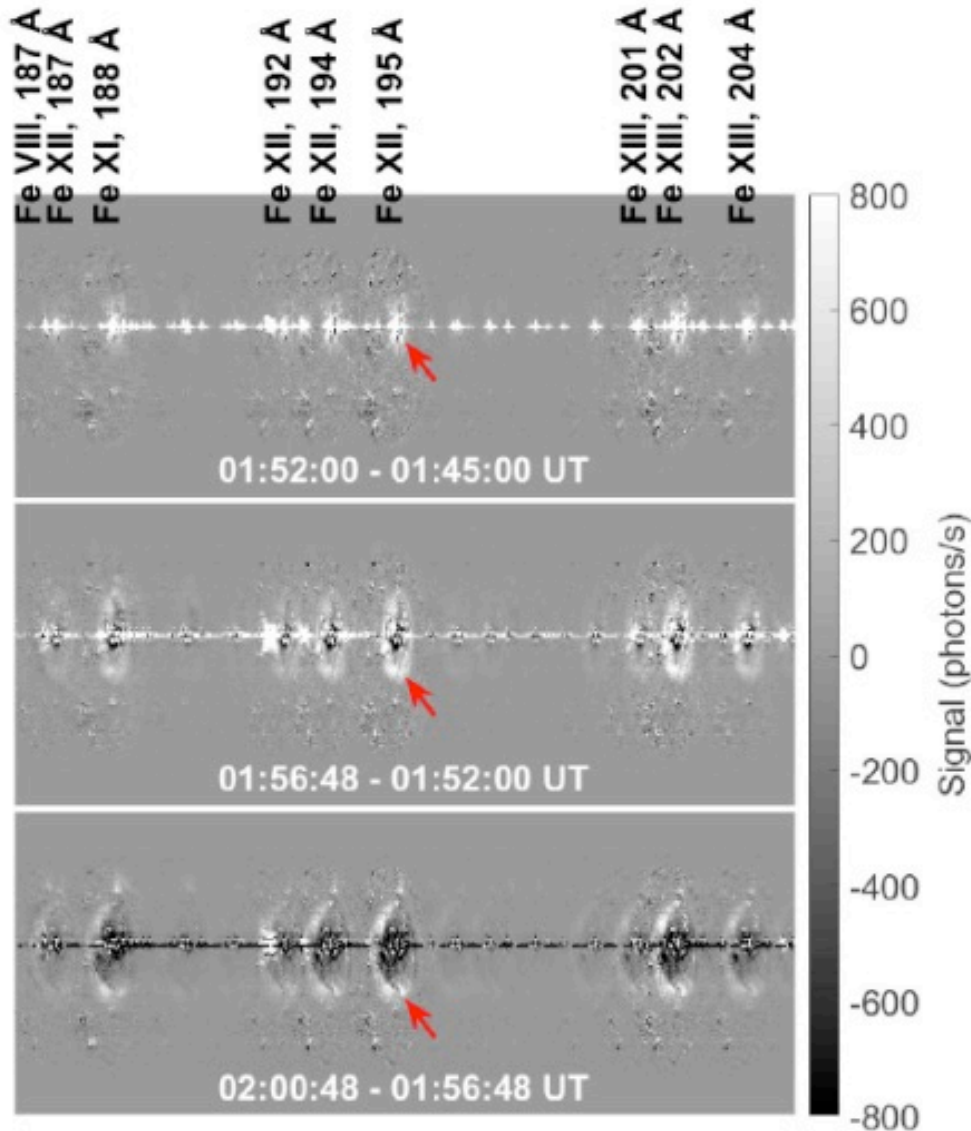

Modeled COSIE-S observation of an EUV wave from the 2011-Feb-15 X-class flare and CME (Vanninathan et al. 2105). *Flare* is seen as a bright or dark line across the middle of each image. The *wave* moves outward from the flare site, as shown by red arrow in the 195 Å image.

# COSIE – Capturing Events on the ISS

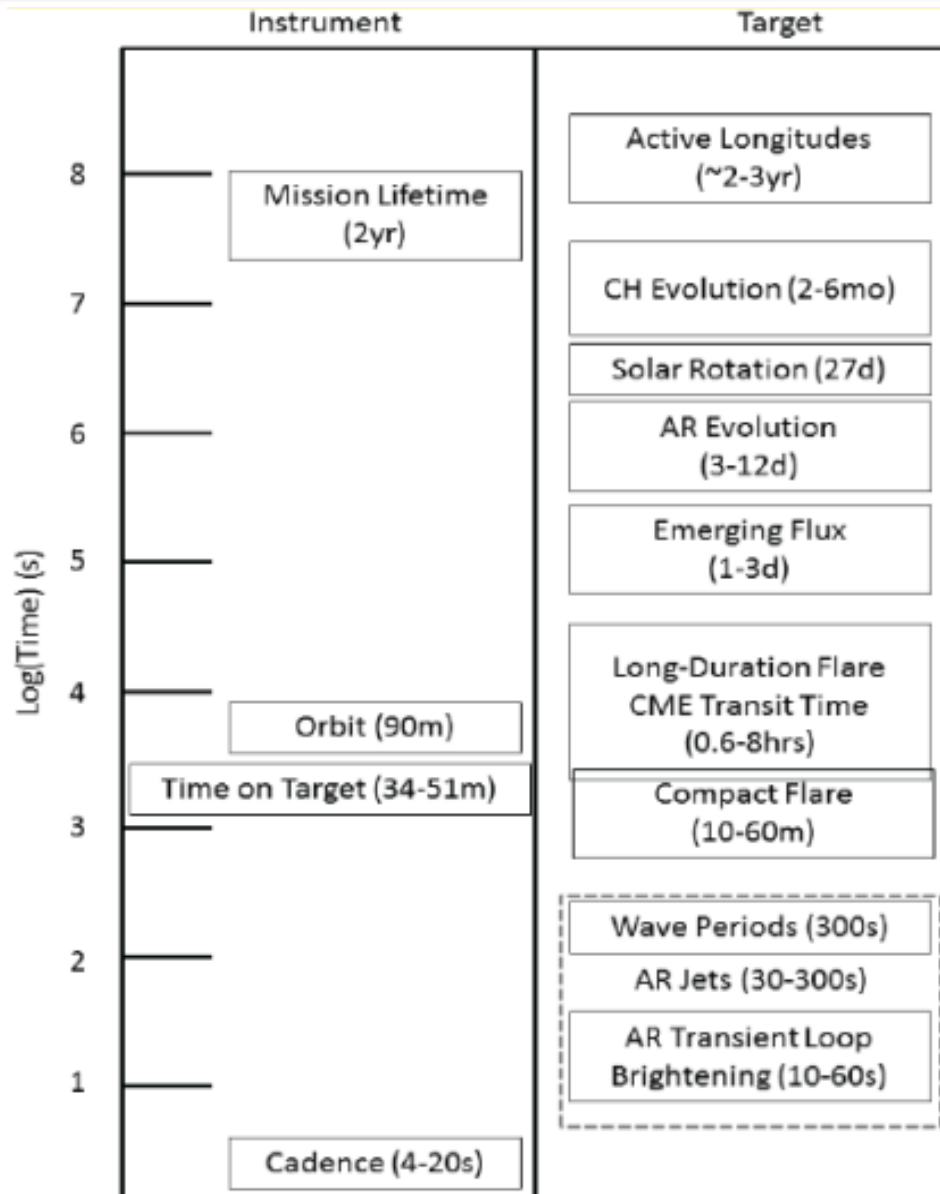

A comparison of timescales for COSIE (left) and Solar Events.

Well observed over multiple orbits

Well observed in a single orbit

# COSIE – CME Detection Percentages

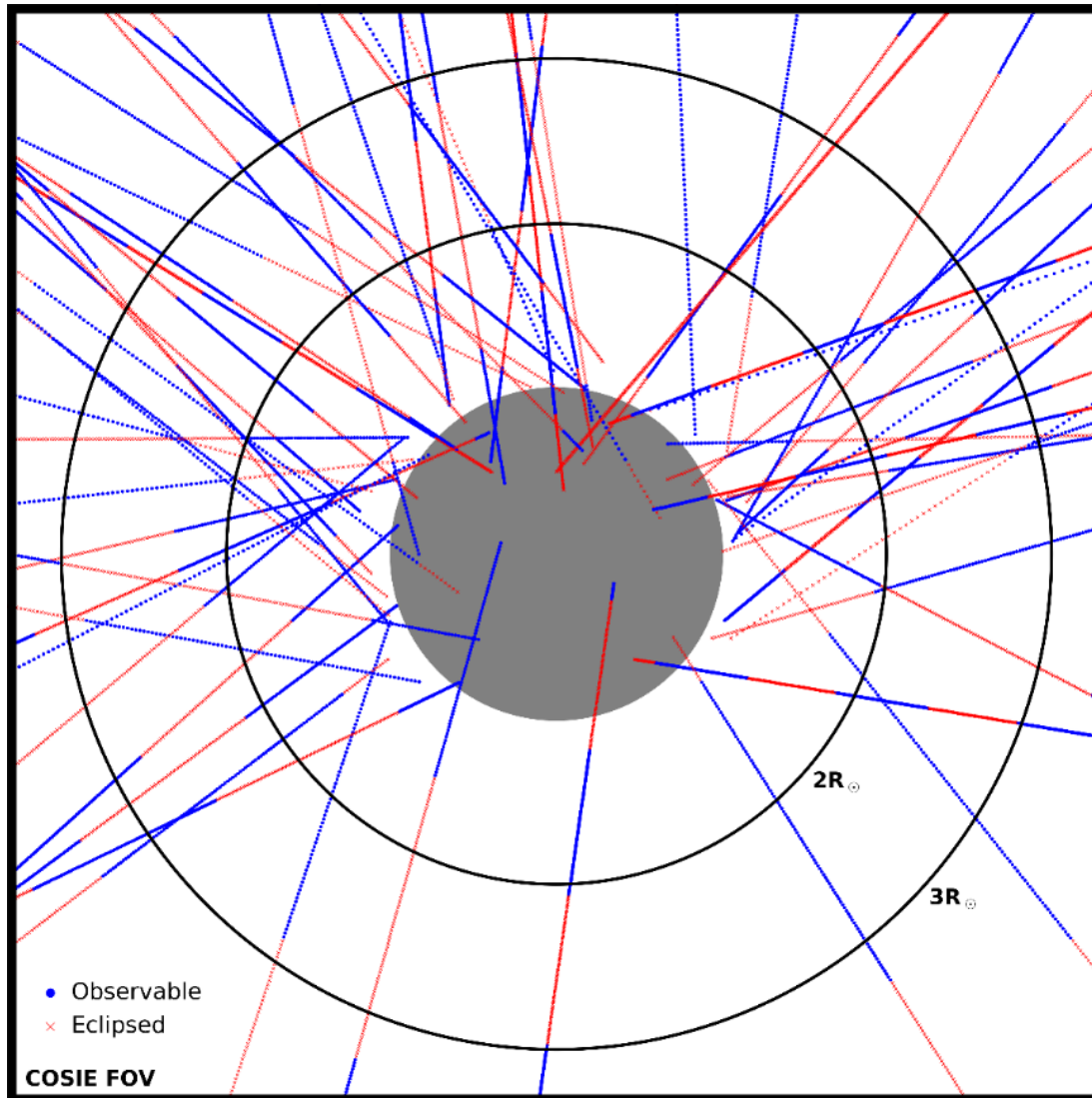

Dots show COSIE measurements made 30 seconds apart.

COSIE will measure at least one velocity point for 97% of all events (CY 2011 data set).

CMEs taken from SAO filament eruption catalog:  
<http://aia.cfa.harvard.edu/filament/> and CATus

# COSIE – Summary of Goals

---

1. Determine the magnetic connectivity between the lower and outer corona where the transition between open and closed magnetic fields occur.
2. Characterize the magnetic topology and dynamic evolution of slow solar wind sources.
3. Trace the early evolution of coronal mass ejections and prominences as they propagate into the interplanetary medium and create space weather.

## **Beyond ISS...**

ISS is an outstanding platform for utilizing this type of instrumentation, but it is not the only option.

COSIE is a relatively compact instrument **suitable for providing full-disk, wide field context for hot plasmas in the corona to any complementary Explorer size mission.**

---

*Thanks*

---

