

Fluid Studies on the International Space Station

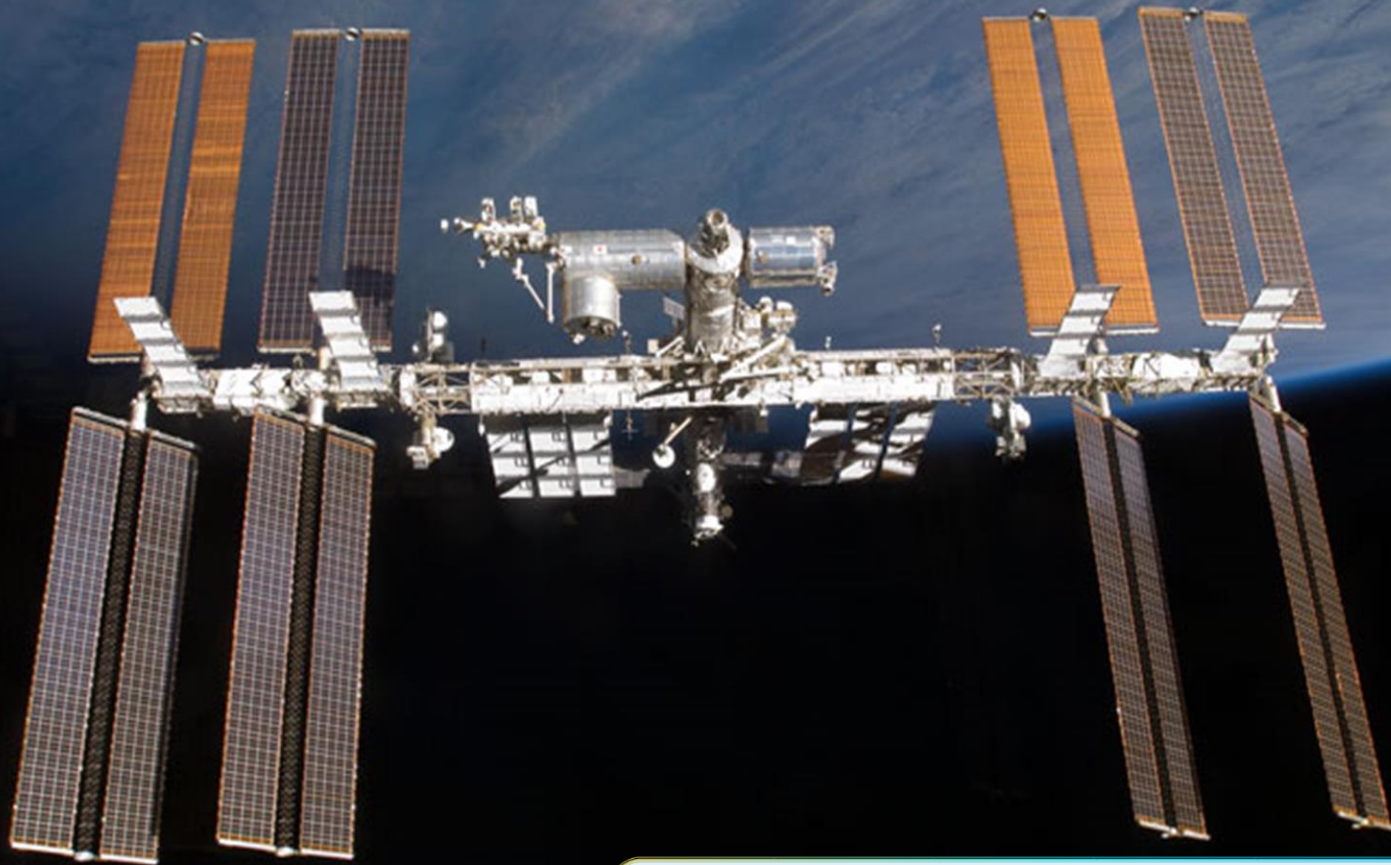

Brian J. Motil

NASA Glenn Research Center, Cleveland, OH



Glenn Research Center's Role in Gravity-Dependent Research in Space

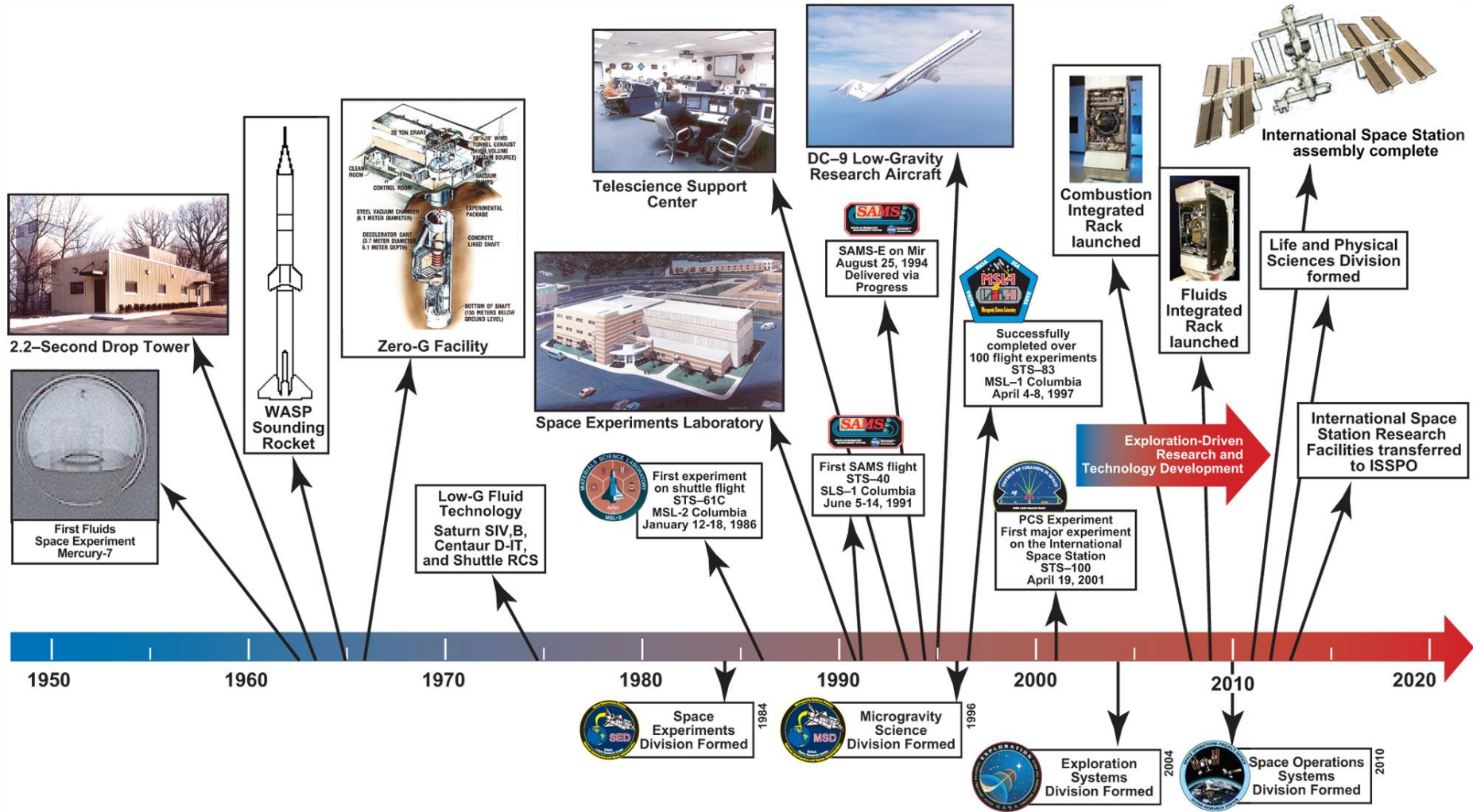
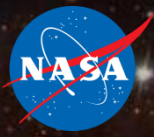

Why Study Fluids in Space?

To enable space exploration.

- Two-phase flow systems for heat transfer and life support.
- Long term propellant storage.
- Excavation, material handling and *in-situ* resource utilization.

“When the influence of gravity on fluid behavior is diminished or removed, other forces, otherwise of small significance, can assume paramount roles.”

- NRC Report to NASA, 2003

To advance science.

- Model “atomic” systems at an observable scale (colloids).
- Study self assembly and crystallization – advance knowledge of phase transitions.
- Study fluid systems near critical points.

To enable technologies on earth.

- Reveal effective rheological properties of non-Newtonian fluids and suspensions.
- Stabilization of foams.
- Understand the aging of gels and late collapse (P&G) – increasing product shelf life.
- Can gain critical insights into strongly non-linear systems (multiphase & interfacial problems) where gravity constitutes a significant perturbation or instability or complicates the interpretation of experimental results.

Macroscopic consequences of gravity on fluids include:

- *Stratification of different densities.*
- *Hydrostatic pressure gradient.*
- *Sedimentation (when particles are freely suspended).*
- *Buoyancy-driven convection.*
- *Drainage of liquid films.*



Fluid Physics and Complex Fluids Today

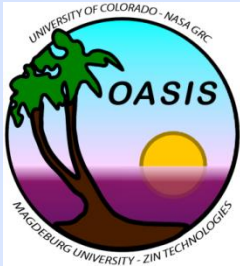

Fluid Physics

- Two-phase flow
- Phase separation
- Boiling, condensation
- Capillary and interfacial phenomena

Complex Fluids

- Colloids
- Liquid crystals
- Foams
- Granular flows

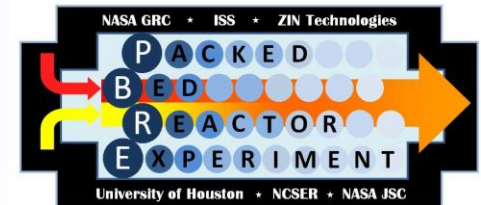
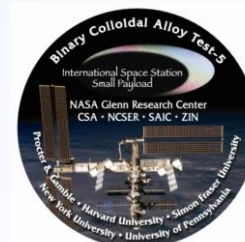

Guiding Research for Fluid Physics

- The overarching goal in fluids is to develop a sufficient database for future spacecraft designers such that they can select the optimum fluid system in the relevant environment (partial or 0-g).
- Database will establish the basis (closure laws) for CFD models.
- Models/design guidelines then become the basis for technology development.
- External teams (FluidsLAB) were formed in 2014 to focus on near-term/ISS research, giving special consideration (when possible) to using existing hardware with minor modifications.

“Calculations of gas-liquid flows on earth are not done using “exact” equations but rely rather heavily on empirical models. Hence, prediction of behavior in space is not a matter of turning off the gravity term in the calculations.”

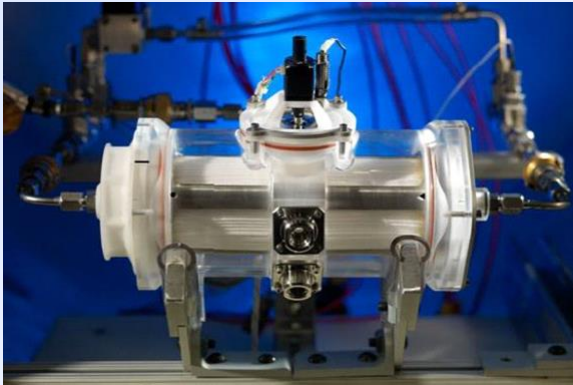

Spacesuit Water Membrane Evaporator (SWME)



Cryogen Tank



ECLSS Water Recovery Rack



FluidsLAB Priorities

Multiphase Systems

Without heat transfer

Adiabatic Two-Phase Flows

- #1: Flow Regimes
- #2: Instability Phenomena
- #3: Bubble and Droplet Dynamics

Capillary Flow and Interfacial Phenomena

- #1: Multi-User, Multi-Geometry Capillary Science and Technology Facility
- #2: Imperfect Wetting Phenomena – Science and Applications
- #3: Global Equilibrium in Non-Symmetric/Symmetric Geometries for Liquid Management

With heat transfer

Boiling and Condensation

- #1: Flow Boiling – Critical Heat Flux and Flow Instabilities.
- #2: Flow Condensation in Channels.
- #3: Microgravity Issues Relevant to Two Phase Systems

Cryogenic Storage and Handling

- #1: Large scale cryogen storage tank demo.
- #2: Active Tank Pressure control & Noncondensable Effects.
- #3: Boiling, Turbulence, Impulse Accelerations, Tank Chillover & Pressurant Injection
- #4: Phase Management & Control

Separate reports (4) published in International Journal of Transport Phenomena - IJTP Volume 14, Number 2 (2015)

Adiabatic Two-Phase Flow - Applications

2011 Decadal: "... multiphase systems and thermal transport processes are enabling for proposed human exploration by NASA."



Temperature and Humidity Control for Advanced Plant Habitat

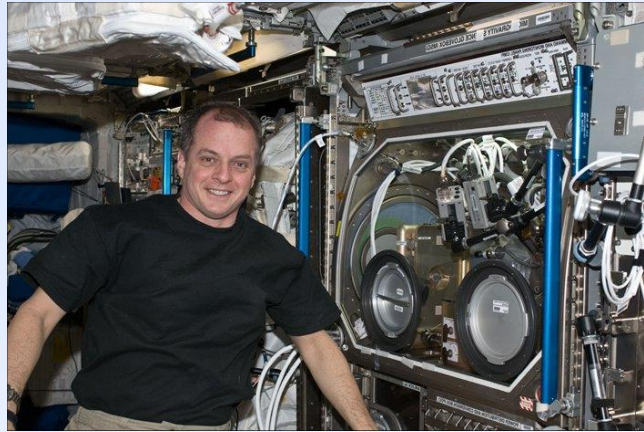

Astronaut T. J. Creamer in front of IVGEN experiment: In-Situ generation of IV-grade fluid



Clogged Rotary Separator on STS 32

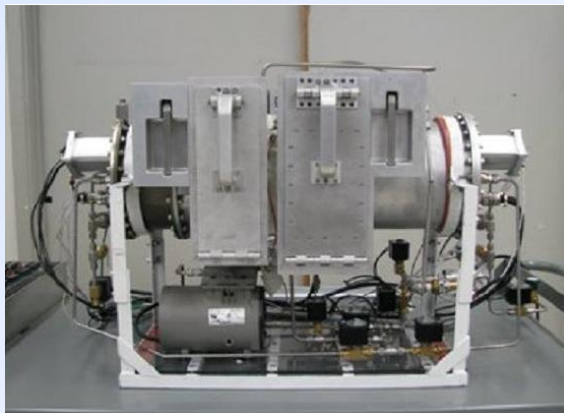

Prototype For Heat Melt Compactor Which Squeezes Trash And Recovers Water



ISS Water Recovery System



Extravehicular Mobility Unit (EMU) With Water in Helmet During Post-EVA 23 Screening Test

Adiabatic Two Phase Flow

PI: Dr. Brian Motil, NASA GRC

Co-I: Prof. Vemuri Balakotaiah, U. of Houston

Packed Bed Reactor Experiment (PBRE) - 2016 (on-going)

- Investigating the role and effects of gravity on gas-liquid flow through porous media which is a critical component in life-support; thermal control devices; and fuel cells.
- Validate and improve design and operational guidelines for gas-liquid reactors in partial and microgravity conditions.
- Preliminary models predict significantly improved reaction rates in 0-g.
- Models developed from early 0-g aircraft tests led to the successful operation of **IntraVenous fluid GENeration (IVGEN)** in 2010 providing the ability to generate IV fluid from *in situ* resources on the ISS.
- Provides test fixture to test future two-phase flow components.

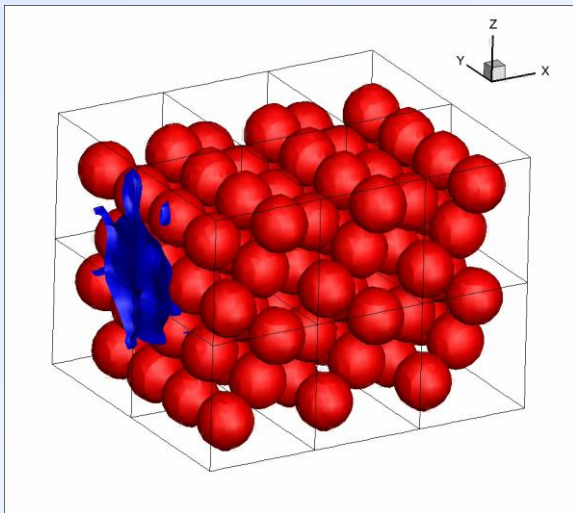

Pulse Flow CFD Model (Prof. Y. Lian)

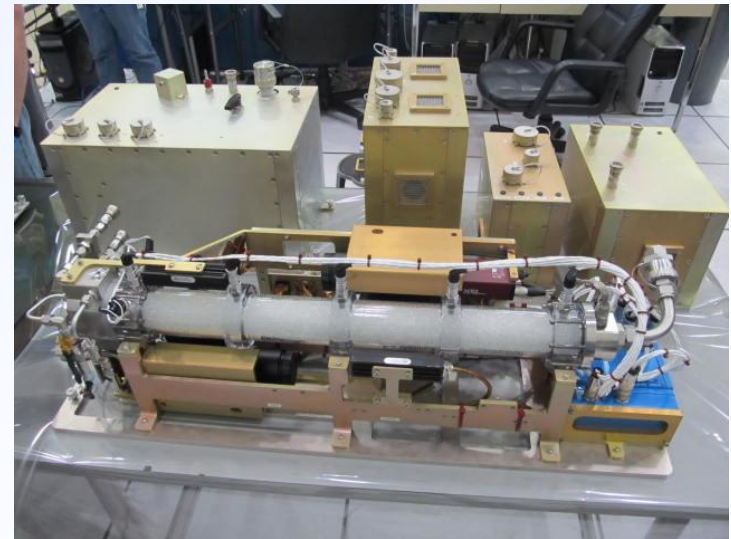

PBRE Flight Hardware

Adiabatic Two Phase Flow

US Co-I: Prof. Alexander Yarin, University of Chicago

ESA PI: Prof. Cameron Tropea, Institute of Fluid Mechanics and Aerodynamics (SLA) Technische Universität Darmstadt

Dynamics of Liquid Film/ Complex Wall Interaction (DOLFIN II) - 2019

- ESA led experiment to develop continuum models to describe interactions between spreading fluids and chemically and/or morphologically complex surfaces in 0-g.
- Ability to manipulate surface flows in microgravity is a key to thermal management solutions in space exploration.
- US PI (Yarin) will perform experiments on spray cooling over specially patterned surfaces.
- Recently developed numerical model to detail physical mechanisms of pool-boiling.
- Boiling curves measured on nano-textured surfaces revealed heat fluxes 2-7 times higher than those on the bare surfaces, also increasing the CHF.
- Polymer nanofiber mats significantly increase heat transfer in pool boiling in channel flows (this part was conducted together with the group of the Technical University of Darmstadt, Germany).

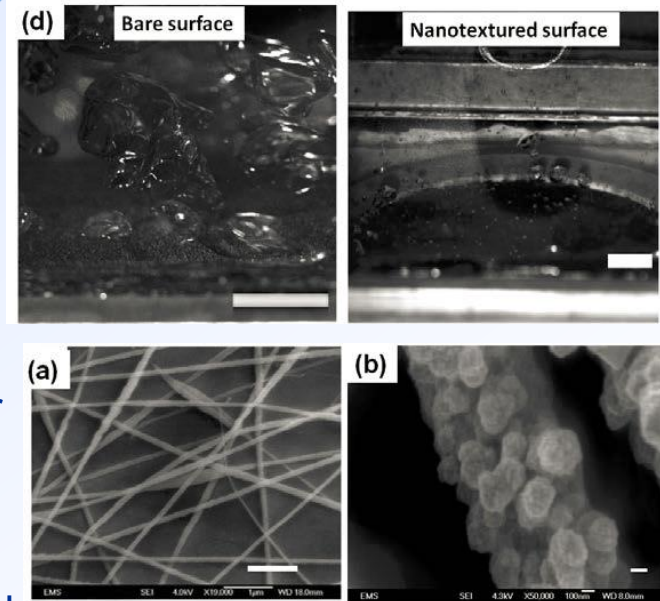

Nanofibers (a) are plated with copper (b) to form a mat that greatly alters nucleation patterns leading to much higher heat flux (d)

Gas-Liquid Separation Devices



Pumped Separator for PBRE

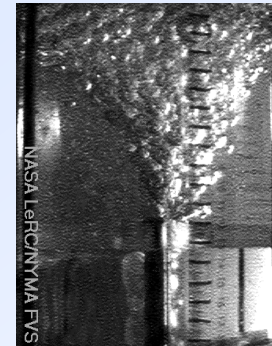

Reduced Gravity
Bubble Vortex

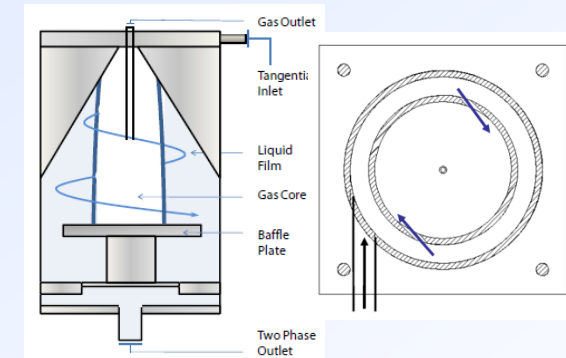

Cyclonic Concepts

PI: Dr. Georges Chahine and Xiongjun Wu, DynaFlow, Inc.
PI: Prof. Yasuhiro Kamotani, Case Western Reserve University
Co-I: Prof. Jaikrishnan Kadambi, Case Western Reserve University

Two-Phase Flow Separator Experiment (TPFSE) – 2021

- Two PI Teams will share common test hardware to study different aspects.
- Experiments will determine separator performance at extreme gas/liquid mixtures and flow rates.
- Determine separator stability envelope to startup, shutdown and liquid slugging conditions.
- TPFSE facility can accommodate additional experimental test sections of future investigators.
- Advanced separation technology is critical to high reliability, audibly quiet, and low power gas-liquid systems for use in astronaut life support, fluid degassing, and power generation.

Capillary Flow and Interfacial Phenomena - Applications

When asked to name one of the biggest challenges to living in space, Astronaut Suni Williams replied that it is removing and dealing with bubbles in fluids systems.

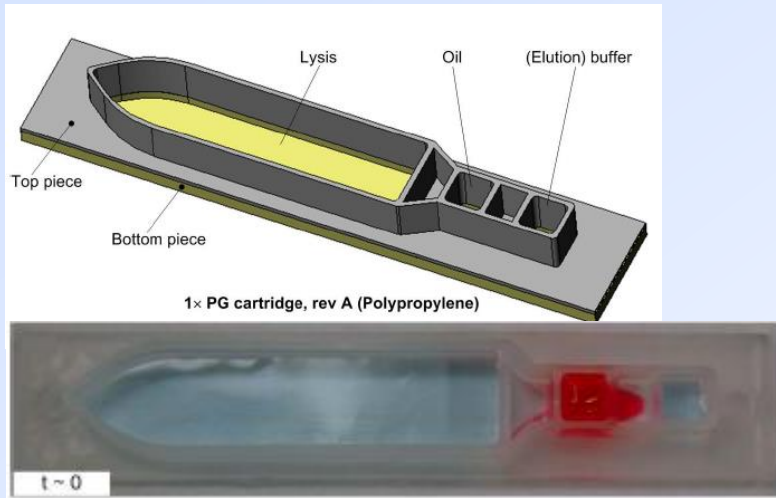

A fluid cartridge to detect infectious diseases developed through collaboration with NASA PI (CFE)



The evolution of the "coffee cup" designed for partially wetting teas and coffees in microgravity

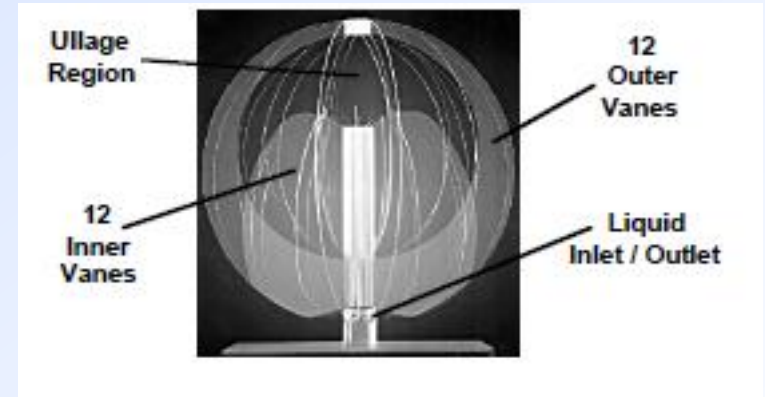

Vented Tank Resupply Experiment (VTRE) Vane Type Propellant Management Device (PMD)

Chato, David, and Timothy Martin. "Vented Tank Resupply Experiment – Flight Test Results." NASA Technical Memorandum 107498 (1997).

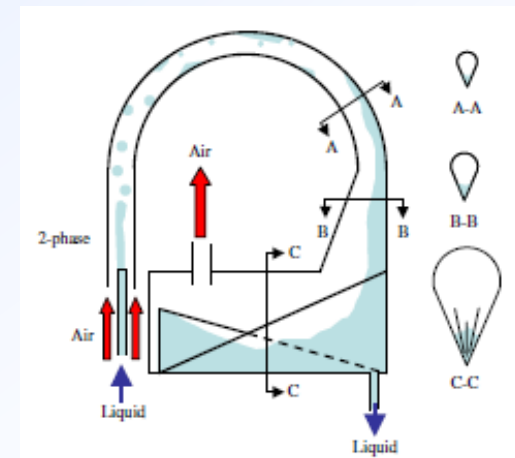

A diagram of the device for urine collection or other gas/liquid separations in low or zero gravity conditions

E.A. Thomas, M.M. Weislogel, D.M. Klaus, Design Considerations for Sustainable Spacecraft Water Management Systems, *Adv. Space Res.*, Vol. 46, pp. 761-767, 2010

Capillary and Interfacial Phenomena

The Capillary Flow Experiment (CFE 1&2) -2004 - 2014

- Series of handheld vessels with various test chamber geometries to investigate the behavior of capillary flow phenomena in wicking structures such as interior corners and small gaps created by a vane and the test chamber wall.
- The working fluid is silicone oil of various viscosities, depending on the individual unit geometry.
- The results of CFE have applications in propellant management for fluid storage tanks, thermal control systems, and advanced life support systems for spacecraft.
- Critical wetting vane angles have been determined to within 0.5 degrees for Vane Gap 1 and 2 experiments.
- A bulk shift phenomena has been characterized that has implications for tank designs.



Astronaut Karen Nyberg adjusting the liquid volume during a CFE-2 Interior Corner Flow 9 (ICF9) experiment on ISS (June 15, 2013)



45° vane angle in earth gravity.



45° vane angle in microgravity.

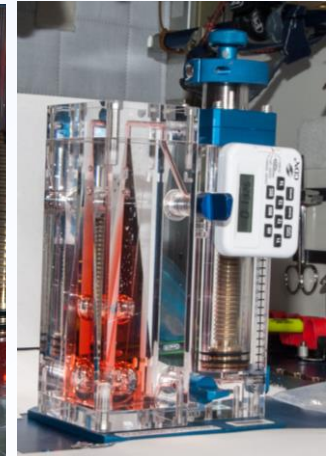
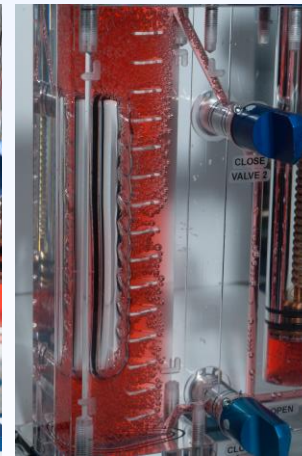

Interior Corner Flow Modules (ICF3, ICF 8 and ICF9)

Capillary and Interfacial Phenomena

The Capillary Channel Flow (CCF) Experiment 2011–2014

- Led by the German Space Agency (DLR) with a US/NASA Co-Investigator.
- Study of open channel capillary flow in microgravity.
 - The cross section of the flow path is partly confined by free surfaces.
- Experiment has led to high fidelity models that accurately predict maximum flow rates for an open capillary channel
- Research is critical to on-orbit fuel transfers and in space propulsion systems that utilize capillary vanes.
 - Current design of spacecraft fuel tanks rely on additional reservoirs (higher mass) to prevent the ingestion of gas into the engines during firing.

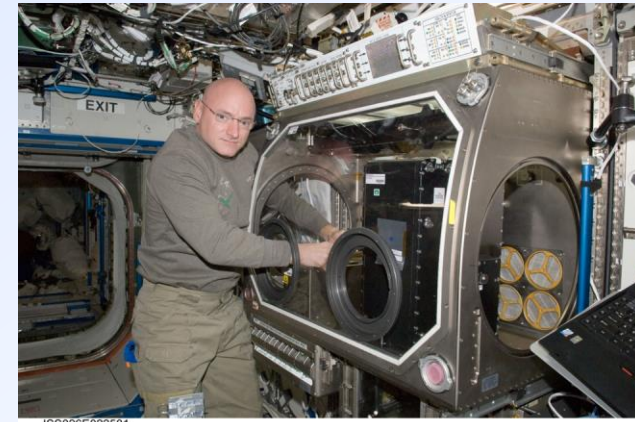

Astronaut Scott Kelly installing CCF in MSG in Dec 2010.

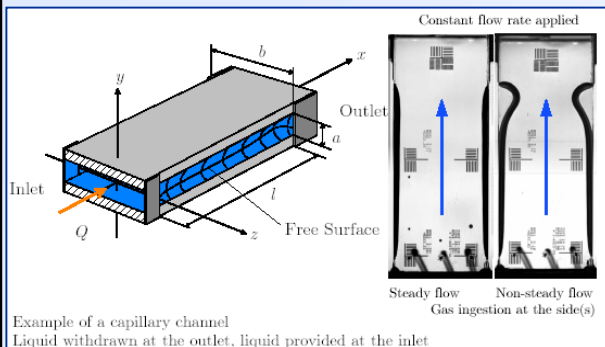

Example of a capillary channel
Liquid withdrawn at the outlet, liquid provided at the inlet

Capillary Channel Flow Test Unit 1
(flat plate and groove geometries)

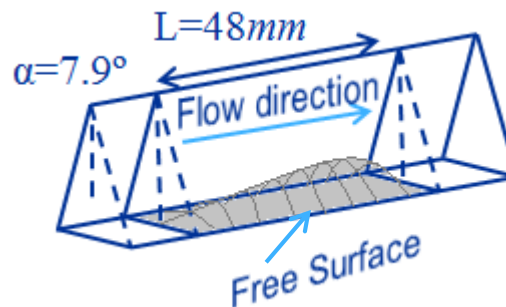

Capillary Channel Flow Test Unit 2
(interior corner (wedge) geometry)

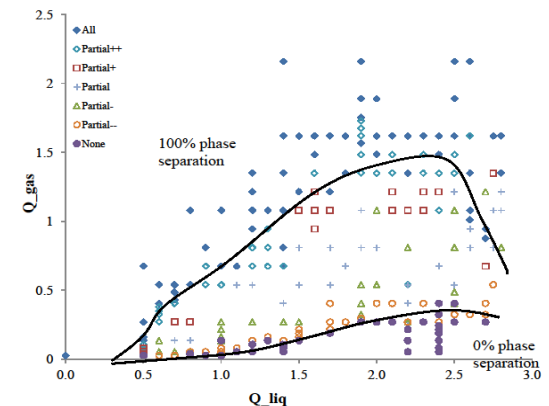

Gas-Liquid Phase Separation
Flow Regime Map

PI: Prof. Michael Dreyer, ZARM

US Co-I: Prof. Mark Weislogel, Portland State University

Boiling and Condensation - Applications

PURDUE
UNIVERSITY

Customer Technology Applications



Vapor
Compression
Heat Pump for
Future Space
Vehicles
Planetary Bases

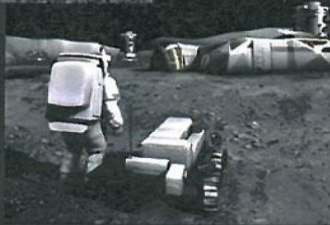

Thermodynamic Vent
System (TVS) for
Cryogenic Liquid
Storage

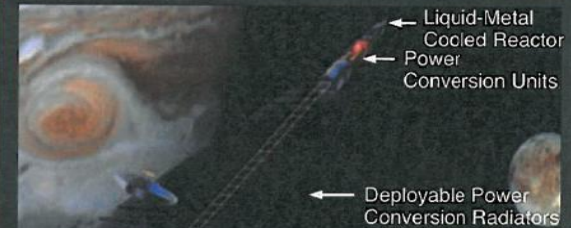
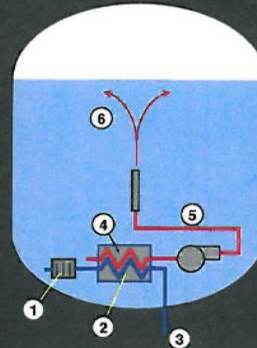

Project Prometheus:
Developing means to efficiently
power advanced spacecraft for
Solar System exploration

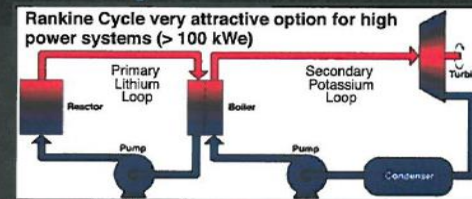

Thermal Control Systems and
Advanced Life Support Systems

- Thermal Control System (TCS) to control temperature and humidity
- Refrigerator/freezer components
- Advanced water recovery systems

**Nuclear
Fusion:**
High power/
long duration
missions

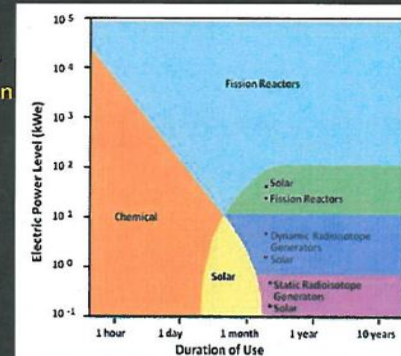

2011 Decadal: “Research literature, unfortunately, contains only very limited data on pool boiling in reduced gravity. Thus, available correlations and models are unable to provide reliable data on nucleate boiling and critical heat flux in reduced gravity.”

Boiling and Condensation

Constrained Vapor Bubble (CVB) Experiment – 2009 & 2013

- Prototype for a wickless heat pipe in microgravity – based on corner flows.
- Used pure Pentane as operating fluid for first set of experiments.
- Provided fundamental transport data including the overall stability, flow characteristics, average heat transfer coefficient in the evaporator, and heat conductance as a function of heat flow rate and vapor volume.
- Interferometry technique obtained direct measurements of fluid curvature and thickness.
- Visualized film stability and shape of dry out regions with a microscope in detail never obtained before in microgravity.
- CVB-2 (2013) extended data to a *binary mixture* rather than a pure fluid (Pentane – Isohexane).
- Discovered a new limit for heat pipe operation: Marangoni or Flooding limit.
 - First performance limitation is flooding, not dryout of the heater end.
 - Wickless designs can pump more than enough liquid to the heater end.
- Flooding limitation can be broken by the addition of a second, liquid, component. This may be the origin of reported enhancements using mixtures.
- Unexpected phenomena were observed and enhanced in microgravity including meniscus oscillations, autophobic droplet formation, and controlled single bubble nucleation phenomena (a hybrid pool/flow boiling experiment not accessible in 1-g environments).

PI: Prof. Joel L. Plawsky, Rensselaer Polytechnic Institute

Co-I: Prof. Peter C. Wayner, Jr., Rensselaer Polytechnic Institute

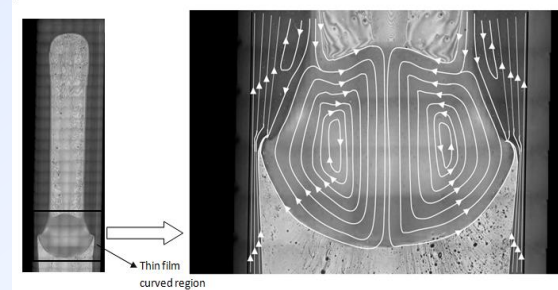

Marangoni limit and flooding of heater end with flow streamlines.

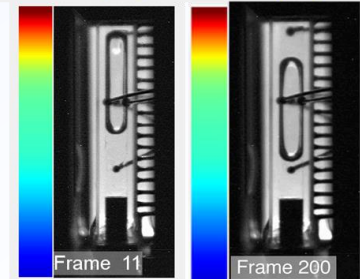
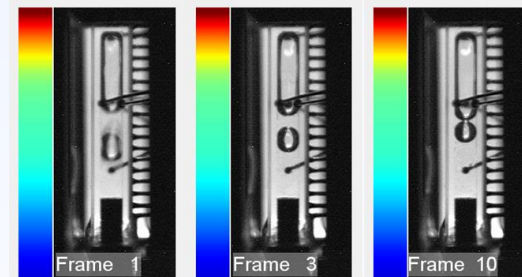

Unexpected Explosive Nucleation in 0-g.

Boiling and Condensation

PI: Prof. Jungho Kim, University of Maryland

PI: Prof. Vijay K. Dhir, UCLA

Boiling eXperiment Facility (BXF) – 2011

- BXF included two separate pool boiling investigations:
 - **Microheater Array Boiling Experiment (MABE)**
 - **Nucleate Pool Boiling Experiment (NPBX).**
- Advanced understanding of local boiling heat transfer mechanisms & critical heat flux in microgravity for nucleate and transition pool boiling.
- Detailed measurements of bubble growth, detachment and subsequent motion of single and merged (larger) bubbles.
- Developed a criteria for Boiling Transition
 - Buoyancy Dominated Regime (BDB)
 - Heat transfer by bubble growth and departure
 - Heat flux increases with gravity
 - Surface Tension Dominated Regime (SDB)
 - Dominated by the presence of a non-departing primary bubble
 - Effect of residual gravity is very small
 - Transition Criteria based on Capillary Length



Paulo Nespoli installing BXF in MSG.

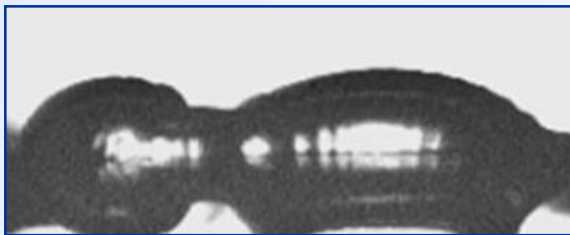

(Left) Coalescence of vapor bubbles on NPBX wafer.

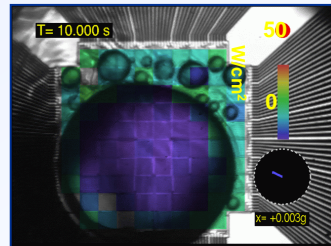

(Right) Subcooled nucleate boiling in μg . The MABE microheater array is colorized with actual heat flux data.

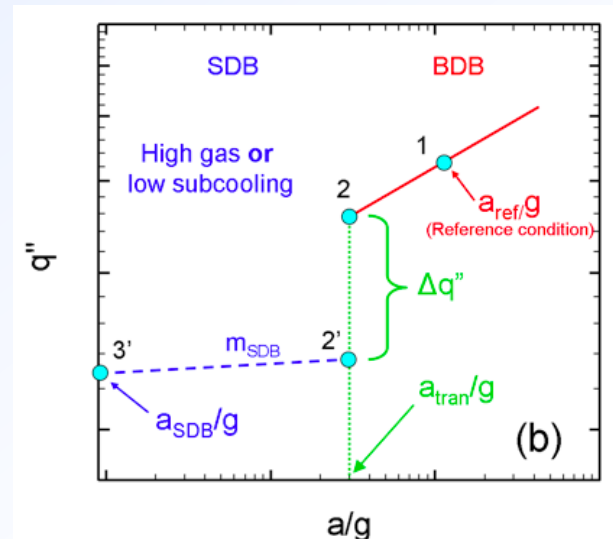

Transition of boiling Heat Flux as a function of acceleration.

Boiling and Condensation

Flow Boiling and Condensation Experiment (FBCE) – 2019

- Will develop mechanistic models for microgravity flow boiling Critical Heat Flux (CHF) and dimensionless criteria to predict the minimum flow velocities required to ensure gravity-independent CHF along with boiling heat transfer coefficients and pressure data correlations.
- Will develop mechanistic model for microgravity annular condensation and dimensionless criteria to predict minimum flow velocity required to ensure gravity-independent annular condensation; also develop correlations for other condensation regimes in microgravity.
- Recently completed an axisymmetric 2-D computational model developed to predict variations of void fraction, condensation heat transfer coefficient, wall temperature and temperature profile across the liquid film.

PI: Prof. Issam Mudawar, Purdue University
Co-I: Dr. Mojib Hasan, NASA GRC

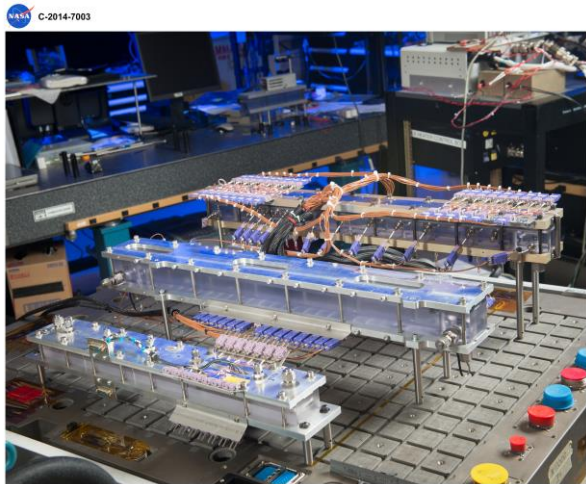

National Aeronautics and Space Administration
Glenn Research Center at Lewis Field

FBCE Test Module

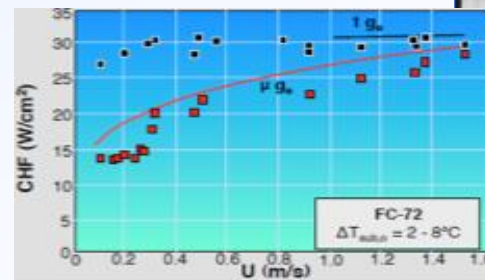
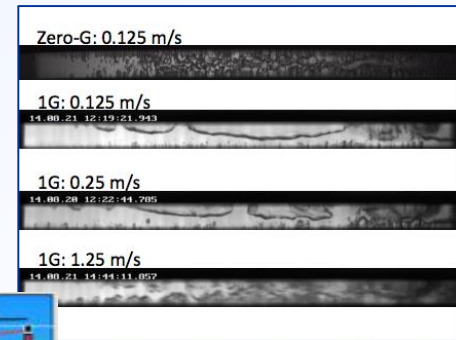

Critical Heat Flux (CHF) data and model predictions for microgravity and Earth gravity for flow boiling.

Boiling and Condensation

PI: Prof. Jungho Kim, University of Maryland

ESA PI: Catherine Colin, Institut de Mécanique des Fluides de Toulouse

Multiphase Flow and Heat Transfer Experiment (MFHT) - 2019

- Will develop models that incorporate two-phase flow regimes and fluid conditions to predict local heat transfer coefficients from subcooled nucleate boiling through critical heat flux (CHF) and dryout.
- Will obtain local measurements of the wall heat transfer coefficient with high temporal and spatial resolution using an infrared video (IR) camera and/or quantum dots.
- ESA to provide carrier and facility: (Fluid Science Laboratory (FSL) Thermal Platform
- ESA will build and develop flight hardware/insert.
- NASA will design, build and test prototype insert.

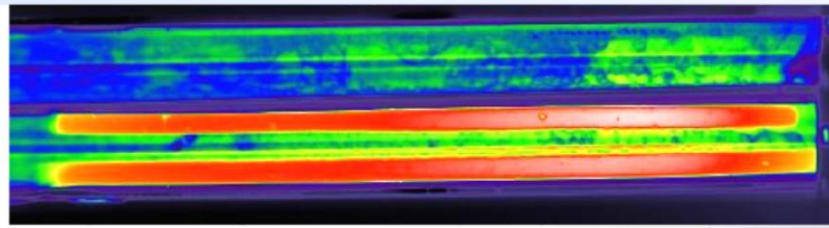

Heat transfer map using IR camera technique

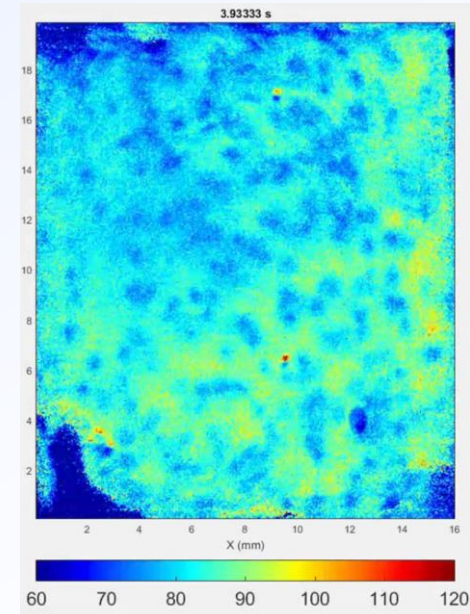

Snapshot of pool boiling data using quantum dots to measure temperature

Boiling and Condensation

Electro-Hydrodynamic Device (EHD) – 2021

- Uses a dielectric fluid to electrically drive liquid to the heated area – forcing the bubbles away from the nucleation sites.
- Will develop fundamental understanding and physical models to characterize the effects of gravity on the interaction of electric and flow fields in the presence of phase change.
- Will characterize electrowetting effect on boiling and CHF in the absence of gravity.
- Micro-scale devices have extremely high heat fluxes due to the small heat transfer surface area.
- Provides a robust, non-mechanical, lightweight, low-noise and low-vibration device.

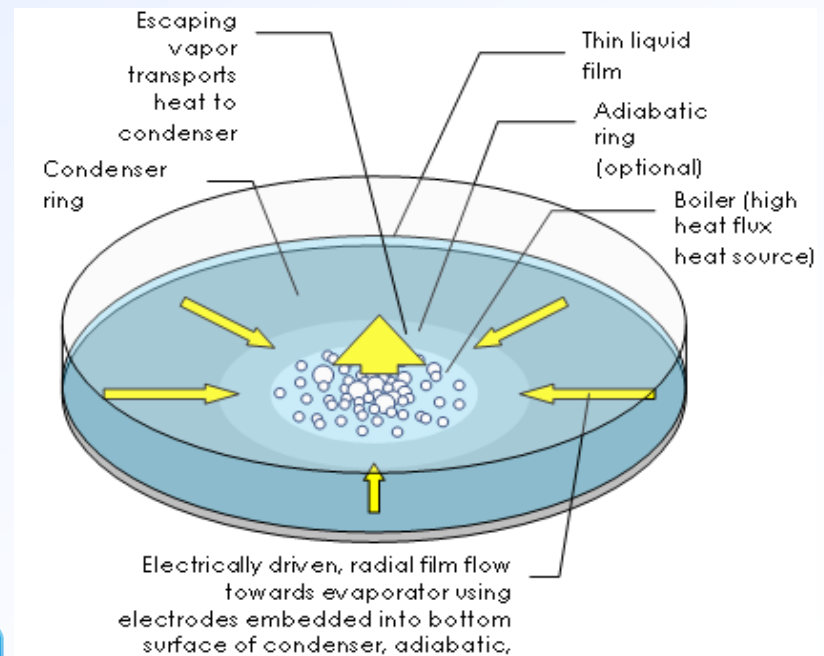
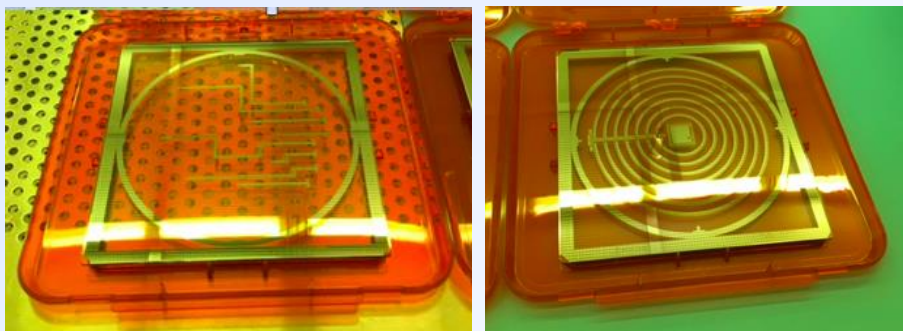

PI: Prof. Jamal Seyed-Yagoobi, Worcester Polytechnic Institute
Co-I: Jeffrey Didion, NASA GSFC

Cryogenic Storage & Handling - Applications

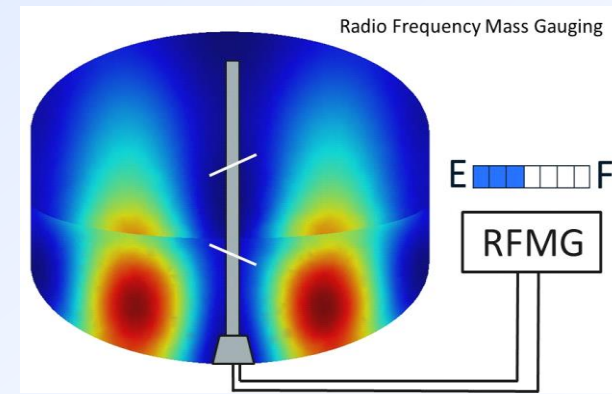
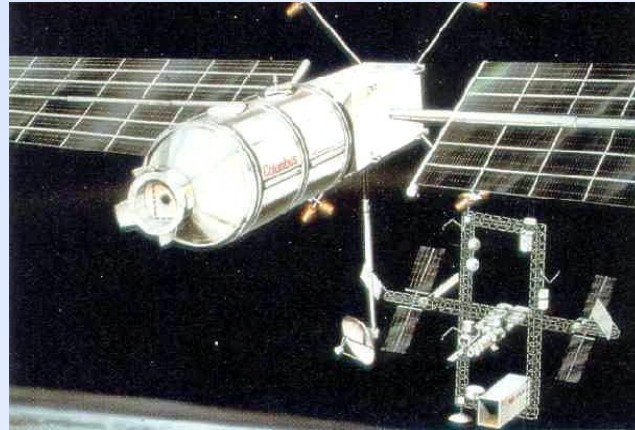
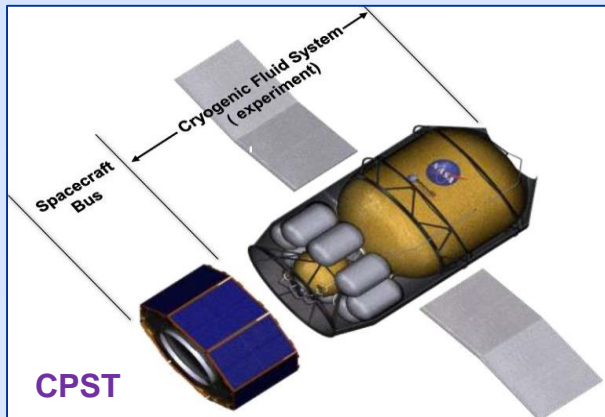

Cryogenic Propellant Storage & Transfer

ESA Columbus Free Flyer

Radio-frequency Mass Gauging

“The data obtained from these highly controlled and instrumented experiments in the microgravity environment will be critical for validating models that will be used to design integrated low- and zero-boil-off cryogenic fluid storage and utilization concepts for a wide range of missions.”

**Jeffrey Sheehy,
Senior Technical Officer, STMD**

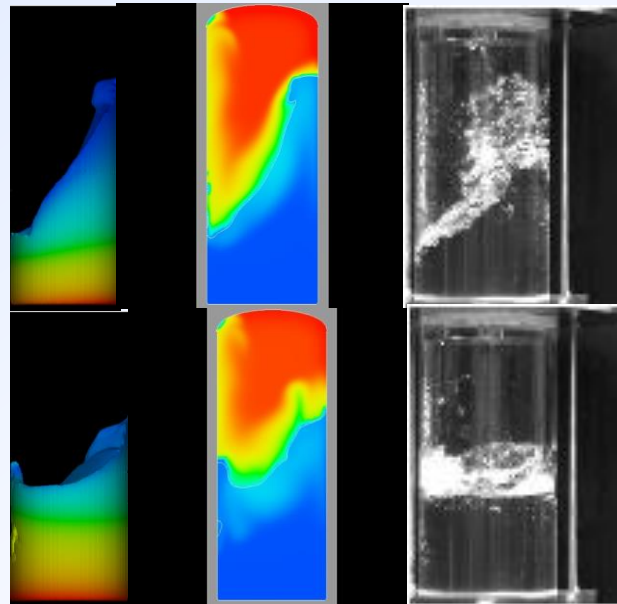

Capturing Liquid Slosh Dynamics

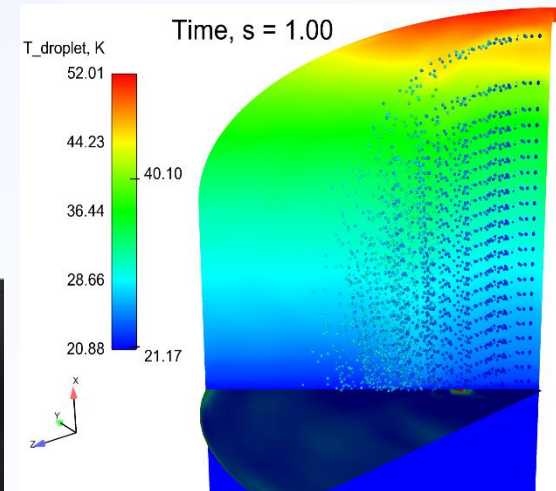

Model Validation: Tank Spray Droplet Pressure Control

Cryogenic Storage & Handling

Zero Boil-Off Tank Experiment (ZBOT) - 2016

- Will study storage tank pressurization & pressure reduction through fluid mixing in microgravity (ZBOT-1).
- Add the effects of non-condensable gasses (ZBOT-2). The presence of non-condensables produces barriers to the transport of vapor to and from the interface creating gradients of the gaseous concentrations along the interface may give rise to Marangoni convection. This changes the pressurization and pressure reduction rates.
- ZBOT-3 will characterize tank thermal destratification and pressure reduction through active cooling schemes for: (i) sub-cooled jet mixing (ii) droplet spray-bar mixing; and (iii) broad area cooling with intermittent mixing.
- ZBOT provides an instrumented test section with controllable BCs; velocimetry; and flow visualization.

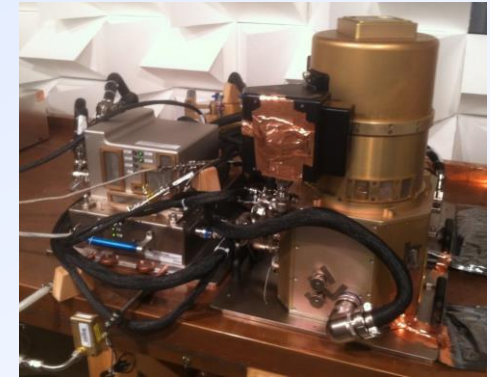

ZBOT EU

Effect of Noncondensable on Flow and Temperature Fields during Jet cooling Pressure Control

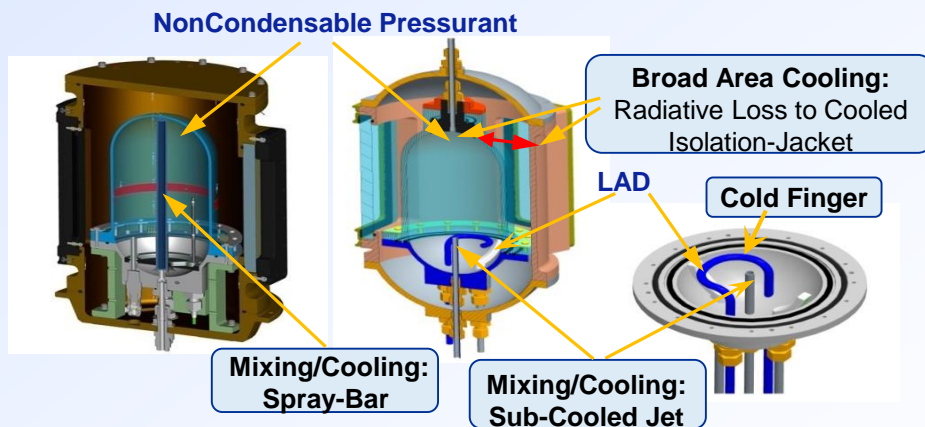
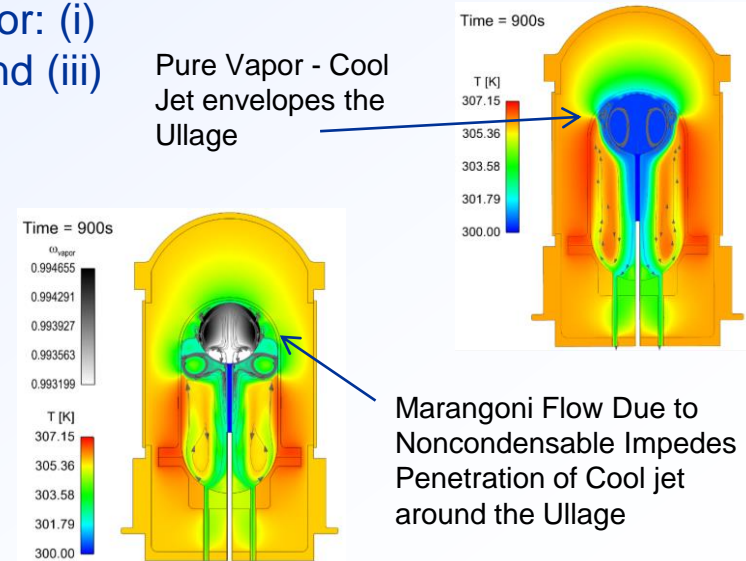

PI: Dr. Mohammad Kassemi, NCSER
Co-I: Dr. David Chato, NASA, GRC

Complex Fluids

- Colloids
- Liquid crystals
- Foams
- Granular flows

“The coffee ring effect is very common in everyday experience,” Yunker said. “To avoid it, scientists have gone to great lengths designing paints and inks that **produce an even coating** upon evaporation. We found that the effect can be eliminated **simply by changing the shape of the particle.**”

Peter J. Yunker, Tim Still, Matthew A. Lohr & A. G. Yodh, Nature 476, 308–311 (18 August 2011).

http://penn.museum/events-calendar/details/599-penn-science-cafe-the-coffee-ring-effect.html?utm_source=twitter&utm_medium=tweet&utm_campaign=socialmedia

Colloids

In microgravity, you can...

- Gain insight into many diverse fields (phase transitions, nucleation and growth of crystals, glass formation, etc.
- Understand processes that guide phase separation rates to guide product stabilizer design for extending product shelf life (P&G).
- See and control how structures form – colloidal engineering.
- Study self-replication, develop nano-pumps (nano-bots).
- Create lock-and-key reactions – building blocks for colloidal self-assembly.
- Eliminate sedimentation to study the unmasked effects of other forces.

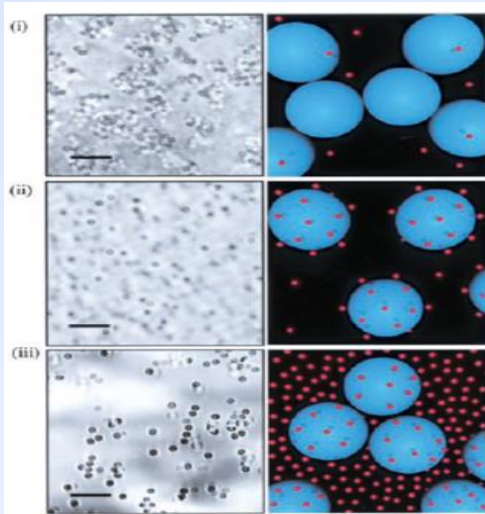

Nanoparticle Haloing
concentration effects
(ACE-H-2)

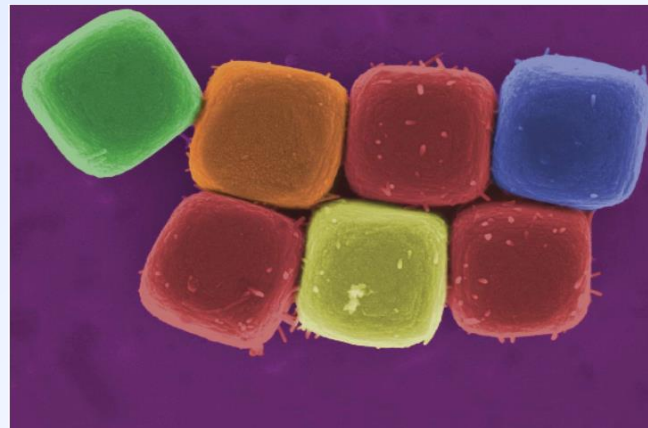

Controlling materials: The role of
shape and depletant size on structure
2-D to 3-D when in 0-g (ACE-M-3)

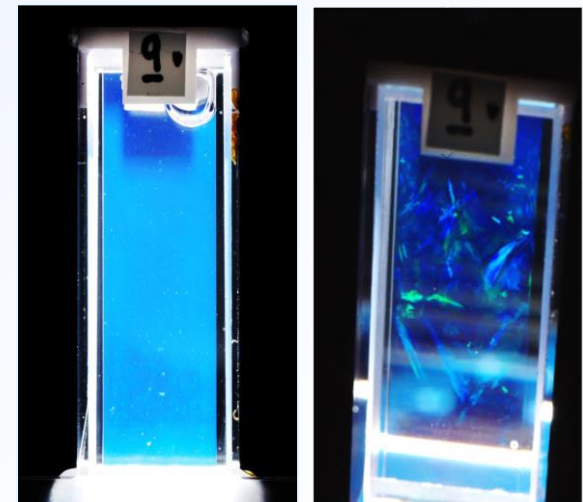

1-g
Seeded growth (BCAT)

0-g
Seeded growth (BCAT)



PIs: Paul Chaikin (NYU, US), David Weitz (Harvard, US), Arjun Yodh (U. Penn, US); Matthew Lynch (P&G); Roberto Piazza, Stefano Buzzaccaro / Luca Cipelletti (U. Milano, Italy / U. Montpellier, France); Peter Schall, Gerard Wegdam / Marco Potenza (U. Amsterdam, Netherlands / U. Milano, Italy); Chang-Soo Lee (CNU, S. Korea); Boris Khusid (NJIT); David Marr (CO-Mines); Ali Mohraz (UCI); Stuart Williams (EPSCoR, U. of Louisville, US).

Advanced Colloids Experiment (ACE) – 2012 thru 2018

- Series of 15 space experiments to observe colloidal suspensions and processes for long time scales that are not available on Earth due to sedimentation and jamming. Additional 3 for ACE-E are pending.
- Processes include: phase separation, gelation, disorder-order transition, self-assembly, self-replication, crystal formation, colloidal engineering, competition (crystals / phase separation). ACE is the microscopic realization of the previous macroscopic paradigm changing microgravity experiments on Mir, STS, and ISS work (e.g., CDOT, CGEL, PHASE, PSC, BCAT).
- New specialty cells under development will enable control and ultimately manipulation of these processes (ACE-H – Heated sample, ACE-T – Temperature controlled sample, ACE-E – Electric field).

Evolution of NASA Colloids Program:

Macroscopic

↳
Microscopic

↳
Microscopic with Controlled Processes

↳
Microscopic while Manipulating Processes

Liquid Crystals



Concept of lighter windowless commercial aircraft with interactive displays ~10 yrs



Test of SPACE X LCD display control



Flexible Transparent Display

Future LC technologies:

- Flexible Transparent Displays
- Super High Definition Screens
- Holographic Cellular Phones
- Computer display that can provide a texture to feel to the touch

Liquid Crystals

(OASIS)

Observation and Analysis of Smectic Islands in Space (OASIS) - 2015

- Studied the interfacial and hydrodynamic behavior of freely suspended liquid crystals.
- Specifically the basic 2D hydrodynamics/fluid physics, probe droplet/island diffusion, hydrodynamic interactions, and droplet/island coalescence.
- Has application for ferroelectric liquid crystal micro-displays and very high speed electro-optic devices.
- Modules include: 1) freely suspended bubble film formation; 2) pico liter droplet injection; 3) external E field perturbation; and 4) dynamic bubble oscillations.
- Recently completed 0-g aircraft tests (ESA) - testing a bubble inflation system in microgravity as well Pressure Quenching and Pulsation; Thermocapillary; Inkjet Droplet Device; Air Jets; and E-Field.

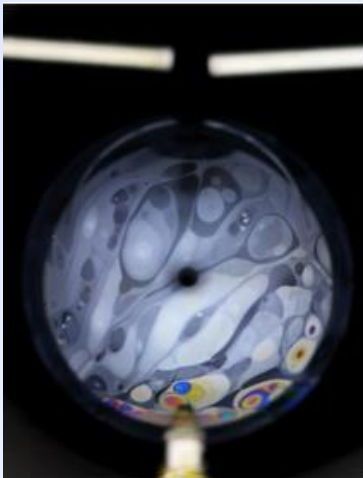

Aircraft Flight showing liquid crystal bubble and islands

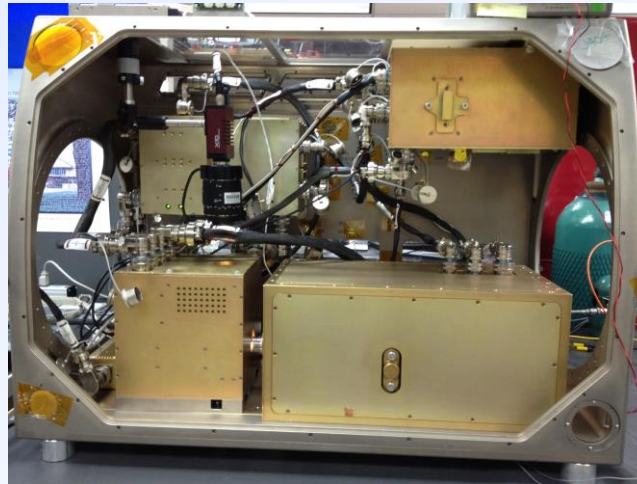

OASIS flight hardware in MSG

PI: Prof. Noel Clark,
University of Colorado, Boulder

Liquid Crystals

Liquid Crystal of Nanoplates (LCN) - 2020

- Will investigate the dynamics of phase transitions of discotic colloids in microgravity environment to better understand the structures/properties of colloidal disks.
- Novel colloidal self-assembly structures including the chiral nematics, smectics, the twist grain boundary phase, and the equilibrium gel or empty liquid state, contribute to develop the frontier of complex fluids and soft matter.
- The understanding of the structure and properties of colloidal disks are important to soil science and space exploration (e.g., Mars), to the fundamental investigation of discotic liquid crystals, as well as various industries, including oil recovery, the delivery of pharmaceuticals, nutrition and cosmetics.
- LCN will utilize majority of OASIS flight hardware in the MSG. Design modifications are needed to current Optics Assembly and Bubble Chamber Enclosure. Up to 5 interchangeable crystal growing modules with built including Electric Field, Temperature gradient, and Temperature control.

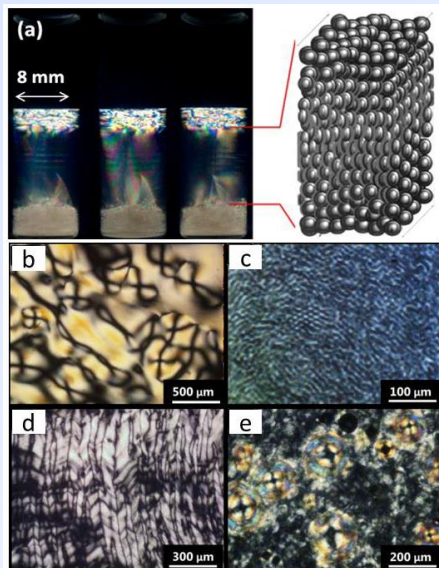

(a) Monolayer suspension under cross polarized light viewed from different angles.

PI: Prof. Zhengdong Cheng, Texas A&M

Collaborators: Dr. Efim I Kats, Landau Institute of Theoretical Physics, Russian Academy of Sciences.
Dr. Vladimir Dolganov, Institute of Solid State Physics Russian Academy of Sciences.

Prof. Yuri Martínez-Ratón, Universidad Carlos III de Madrid, Leganés, Madrid, Spain.

Prof. Enrique Velasco, Universidad Autónoma de Madrid, Madrid, Spain.

Images of thin layers of the liquid crystal phases between a pair of cross polarizers (b) typical Schlieren pattern for N, (c) the square grid pattern for TGB, (d) the zigzag texture for Sc^* , (e) focal conic pattern for S.

Foams

ESA funded: **Foam Optics And Mechanics (FOAM) - 2018**

- ESA will develop all hardware and use the Fluids Science Lab (FSL).
- Studies to develop materials (foams) with more a desirable rheology and better stability.
- Microgravity eliminates draining.
- On board rheometry and light scattering techniques will provide the rheology and coarsening in terms of microscopic structure and dynamics.
- US PI will study issues related to the FOAM C (Foam Coarsening) experiment and assisting the development of a spectroscopic system for the FOAM optical hardware system.

PI: Prof. Douglas Durian, Univ. of Pennsylvania

PAST YEAR:

- O'Soft-Matter Dynamics' (ESA built) hardware nearing completion for both foam and granular cells by end of 2017 (available for ops mid of 2018).

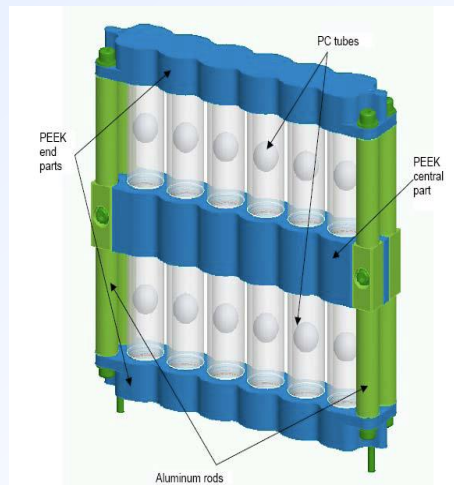

FOAM Stability Test cells

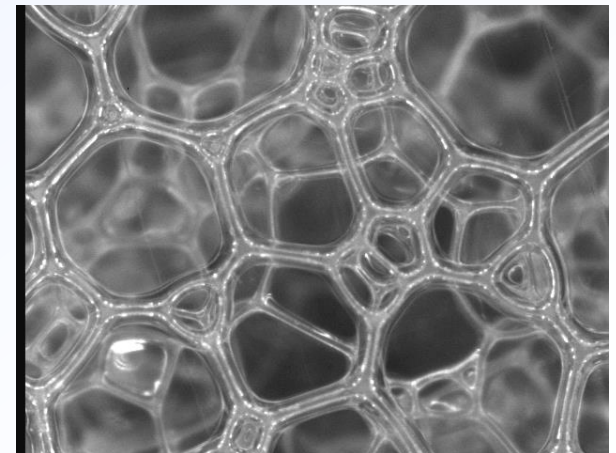

Foams

ESA funded: **Particle Stabilised Emulsions and Foams (PASTA) - 2018**

- Will study foams and emulsions forming and stabilizing.
- Collaborative research effort of all PIs from 14 institutions from 10 countries, multiple flight experiments of “PASTA” using existing hardware.
- US PI will participate in LIFT (Liquid Film Tensiometer) under development by Italian Space Agency for to study the single bubble interface laden with particles or polymers.
- Microgravity conditions facilitate mechanistic determination of foam destabilization by elimination of drainage. Additionally sedimentation is also attenuated, which allows decoupling of the adsorption of monomeric and aggregated particles.
- Goal is to tune the stabilizing or destabilizing action of a particle/surfactant system, depending on the demands of a respective application.

PAST YEAR:

- Liquid Film Tensiometer (LIFT) Experiment Scientific Requirements (July 13, 2015) at Max Planck Institute for Colloids and Interfaces in Potsdam, Germany

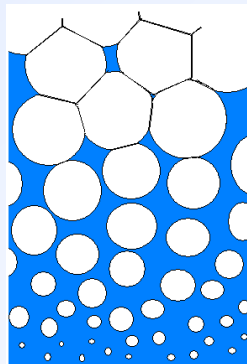

Inhomogeneity in a foam or emulsion due to drainage in normal gravity

PI: Prof. James Ferri, Lafayette College,
ESA PI, Team Coordinator: Dr. Reinhard Miller, Max Planck Institute of Colloids and Interfaces & 14 P.Is (Germany, France, Italy, U.K., Switzerland, Russian Federation, Canada, Spain, Greece)

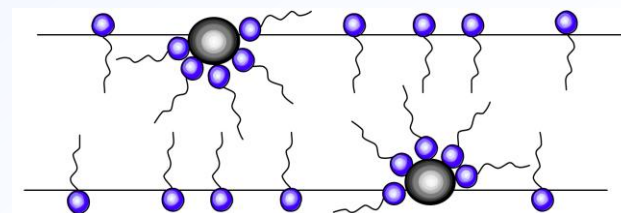

Liquid film stabilized by a particle-surfactant mixture. Film is stable only if the respective adsorption layers exist.

Granular Flows

ESA funded: **Compaction and Sound in Granular Matter (COMPGRAN) - 2020**

- Will quantify the fundamental nature of jamming transition of granular materials in random close packing. Need μG to suppress sedimentation.
- Will measure the transmission of sound during the various packing contact configurations.
- Need to collect empirical data on non-gravitational forces in granular flows.
- Develop and test optics and analysis tools for experiments using sound measurements and 3D stress-birefringence visualization. This more broadly enables advanced instrumentation for many granular physics experiments.
- A general 'Soft Matter' machine/apparatus will be available by the end of 2017, and is scheduled to be on the ISS by mid-2018.
- Granular sound propagation apparatus should be complete by 2019 and a 3D birefringence apparatus should be complete by 2020.

PI: Prof. Robert P. Behringer, Duke University
ESA PIs: Matthias Sperl (DE), Eric Clement (FR),
Stefan Luding (NL), Matthias Schroeter (DE)

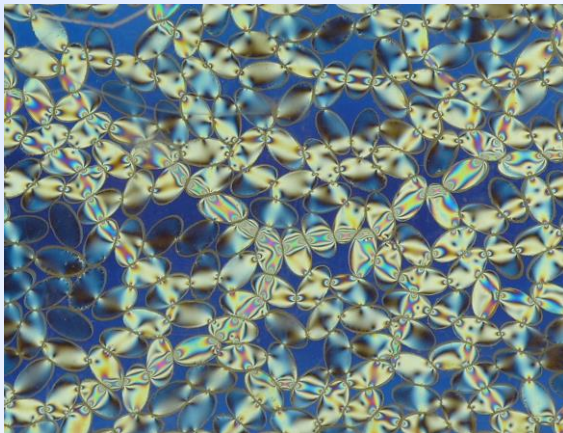

Photoelastic image of ellipses.

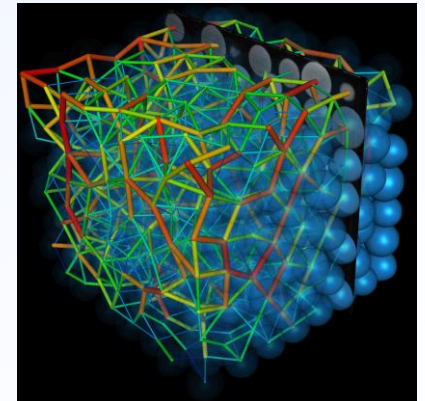

A fully reconstructed sample of particles, showing the boundaries of the particles (transparent blue), a single slice image (black and grey) and the contact forces between particles and the outer wall.

GRC ISS Physical Sciences Research

TSC



User Labs



Zero-Gravity Drop Tower



MSG



CIR



FIR

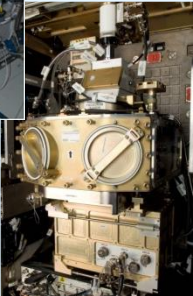

LMM



2.2-Second Drop Tower



Zero-G Aircraft

On-Orbit Research Capabilities

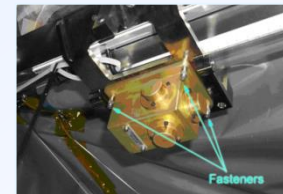

SAMS

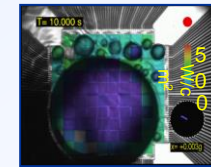

Pool Boiling

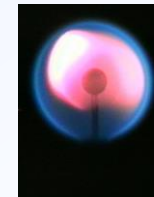

Flame Design

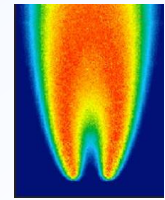

CLD Flame

SAME Ops



CVB Ops



InSPACE Ops



DAFT Ops



CFE Ops

Operations



SHERE Ops



FLEX Ops

CSLM Samples

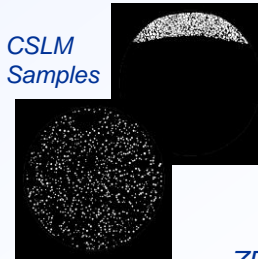

ZBOT Tank

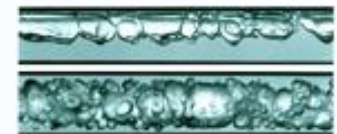
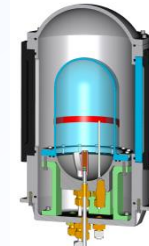

Two-Phase Flow Science

Thank you – questions?