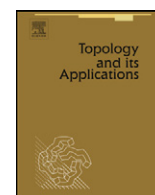

Contents lists available at [SciVerse ScienceDirect](http://SciVerse.ScienceDirect.com)

Topology and its Applications

www.elsevier.com/locate/topol

On Minc's sheltered middle path

 Dušan Repovš^a, Witold Rosicki^b, Žiga Virk^c, Andreas Zastrow^{b,*}
^a Faculty of Education and Faculty of Mathematics and Physics, University of Ljubljana, P.O. Box 2964, Ljubljana 1001, Slovenia

^b Institute of Mathematics, University of Gdansk, ul. Wita Stwosza 57, 80-952 Gdańsk, Poland

^c Faculty of Mathematics and Physics, University of Ljubljana, Jadranska 19, Ljubljana 1000, Slovenia

ARTICLE INFO

Article history:

Received 13 January 2011

Received in revised form 17 April 2012

Accepted 17 April 2012

MSC:

primary 54D05, 54C05

secondary 54C50

Keywords:

Sheltered middle path

Helly type theorem

Topologist's sine curve

Winding number

ABSTRACT

This paper shows that a construction, which was introduced by Piotr Minc in connection with a problem that came from Helly type theorems and that allows to replace three PL-arcs with a “sheltered middle path”, can in the case of general (non-PL) paths result in the topologist's sine curve.

© 2012 Elsevier B.V. All rights reserved.

1. Introduction: Motivation via Helly type theorems and the three-colored sphere-problem

1.1. Motivation

Helly's two-page theorem [7] from 1923 (cf. Theorem 1.3), which was originally a theorem from geometry about intersections of convex bodies, has given rise to many generalizations and variations (see [3,4,15] for survey articles, and [5,6] for more recent papers not cited in them). Among them are topological Helly type theorems (cf. Remark 1.4) which are analogously structured implications where Helly's original condition “convex” is in the assumptions and in the conclusions replaced by appropriate topological conditions. In two dimensions Helly's theorem implies, that if in a family of convex sets each three intersect, then the entire family has a nonempty intersection. The first one to prove topological Helly's theorems was Helly himself in [8]. While his proof in general uses Vietoris homology, Helly in §2 of [8] also considers the two-dimensional case separately (rather as a motivation, than as the initial step for some induction) and works with simply connected sets. A fairly natural picture that one has of an intersection of three sets in the plane (cf. Fig. a) compared to an analogous picture for four sets must have lead to the question, whether one can imagine three simply connected sets really intersecting with connected intersections in such a different way than pictured in Fig. a. In 1956 Molnár asserted (quoted below as 1.5) a statement in this sense as a “known theorem”. One year later, in a paper [13] that only appeared in Hungarian, he used this assertion as a starting point of an induction to prove a theorem that attempts to generalize Helly's theorem for two dimensions so that he reduces the assumption “simply connected” for the triple-intersections to “nonempty”. He calls this theorem a “two-dimensional Helly theorem”, while later it got referred to as “Molnár's theorem” (e.g. [2]) or

* Corresponding author.

E-mail addresses: dusan.repovs@guest.arnes.si (D. Repovš), wrosicki@mat.ug.edu.pl (W. Rosicki), zigavirk@gmail.com (Ž. Virk), zastrow@mat.ug.edu.pl (A. Zastrow).

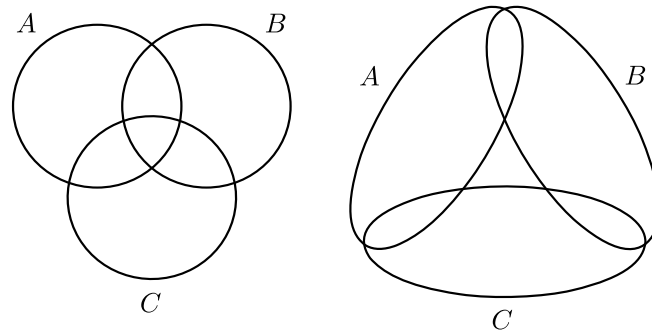

Fig. a. The left figure is the classical Venn-diagram of three intersecting sets. The left and right figures together correspond to what one is tempted to believe to be the only possibilities for three simply connected sets in the plane to intersect with connected pairwise intersections, and this image explains Molnár's assertion 1.5. However cf. 1.6.

Helly–Molnár theorem (e.g. [1, Rem. 18 from §4.3]). It was stated in this form (without the additions “path-connected”) in [3, §4.11], and also quoted in the Introduction of [2]. However, in this form it was disproved in [10, §5] together with Thm. 1 of [2].

Apparently the first one to note that there was a problem with these theorems was Bogatyĭ in [1]. While his paper is mainly written to close a gap in the proof of the topological Helly theorem for singular homology theory, he also considers many related statements. Molnár's footnote has also attracted his attention: Apparently he does not believe that it is true as stated by Molnár, but he conjectures only (Hyp. 2 in §4.3 in [1]) that the analogous version where “connected” is replaced by “path-connected” is true, and he proves this conjecture only in the special case of Peano continua (it appears as Cor. 4.2 on page 397, where “function” in this context has the very special meaning explained in the paragraph after the end of the proof of Prop. 1 on page 367, but this statement is best phrased in the pen-penultimate sentence of the abstract). Another weakened version of Bogatyĭ's conjecture, where one does not need the assumption of local pathwise connectivity, and instead replaces the condition “connected” by “pathwise connected” in the assumption, but not in the conclusion, was proved by Karimov and Repovš [9], and this result was strengthened independently in the papers by Tymchatyn and Valov [14, Prop. 1.2] and Minc [11, Cor. 1.2], by proving the full conjecture of Bogatyĭ. In his proof of this version of Molnár's footnote, Minc proposes the construction of a “sheltered middle path”.

At the same time while Minc was working on his paper we have for some time been building on the hypothesis stated as Question 1.2 below.

Although [14] and Minc's results solve the problem of Molnár's footnote, we are treating the three-colored sphere-problem as a problem which is of interest on its own. The method of a sheltered middle path solves the three-colored sphere-problem in the case when the three bi-colored meridians are mapped into the plane without double points. It is not difficult to see (and it is explained in the paper below, see Lemma 2.4), that Minc's method extends to the case where the images of the three bi-colored meridians have only finitely many intersections and self-intersections. However, the goal of this paper is to demonstrate that Minc's method of a sheltered middle path apparently cannot solve the three-colored sphere-problem in general.

The main result. *There exists a continuous map of the three-colored sphere into the plane such that the sheltered middle path does not give a topological path but only a topologist's sine curve.*

1.2. Question (*The three-colored sphere-problem*). *In brief:* If three symmetric regions between the north and the south pole of a 2-sphere S^2 are colored by different colors and this sphere is in an arbitrary continuous way mapped into \mathbb{R}^2 , must there always exist a path between the images of the north and of the south pole, each of whose points has preimages of all three colors?

More precisely stated, this is the following question:

Consider a two-dimensional sphere S^2 and let N and S denote its north and south pole, respectively. Connect N and S by three different meridians (paths) thus subdividing S^2 into three different subsets X_1 , X_2 and X_3 bounded by the chosen meridians. We think of these subsets as closed, i.e., each of the three meridians belongs to two of these subsets and $X_1 \cap X_2 \cap X_3 = \{N, S\}$. Given an arbitrary continuous map $f : S^2 \rightarrow \mathbb{R}^2$, the points $f(N)$ and $f(S)$ lie in $f(X_1) \cap f(X_2) \cap f(X_3)$. Is there always a path between $f(N)$ and $f(S)$ which is contained in $f(X_1) \cap f(X_2) \cap f(X_3)$?

1.3. Theorem (*Helly's original theorem*). ([7]) *Suppose that X_1, X_2, \dots, X_n is a finite collection of convex subsets of \mathbb{R}^d , where $n > d$. If the intersection of every $d + 1$ of these sets is nonempty, then the entire collection has a nonempty intersection: $\bigcap_{j=1}^n X_j \neq \emptyset$.*

1.4. Remark. “Topological Helly theorems” are statements, where the convexity-assumptions for the sets X_i are replaced by corresponding topological assumptions (e.g. acyclicity with respect to some homology theory), and they usually assert similar assertions for the overall intersection.

1.5. Molnár’s assertion from 1956 [12]

(The parentheses “(pathwise)” do not appear in Molnár’s text.) If A, B and C are three simply connected sets in the plane and all three pairwise intersections are nonempty and (pathwise) connected, and if the intersection of all three sets is nonempty, then it is (pathwise) connected.

1.6. Proven and disproven versions of Molnár’s assertion

	Condition for intersections $A \cap B, A \cap C$ and $B \cap C$	Conclusion for $A \cap B \cap C$	Status of assertion
(a)	connected	simply connected	disproved in [10]
(b)	path-connected	simply connected	conjectured in [1]
(c)	connected (for locally path-connected A, B & C)	locally path-connected and simply connected	proved in [1]
(d)	path-connected	connected	proved in [9]
(e)	path-connected	path-connected	proved in [11]
(f)	path-connected	simply connected	proved in [14]

Note that the discrepancy in the second column between the statement of 1.5 and all lines apart from (e) can easily be explained: If a subset of the plane has non-trivial π_1 , this is also unveiled by a simple closed non-nullhomotopic curve. If such a curve can be found in the intersection of three simply connected sets, the interior of this curve must have belonged to each of the sets and thus to the intersection, contradicting the assumption that the curve was non-nullhomotopic. Thus the non-trivial claim of the conclusion in lines (b)–(d) & (f) is the triviality of π_0 (i.e. that the space is path-connected), not that of π_1 .

1.7. How a solution of the three-colored sphere-problem implies Molnár’s assertion in the version (b) & (d)–(f)

Let P and Q be any two points in $A \cap B \cap C$. Since $A \cap B, B \cap C$ and $A \cap C$ are path-connected we obtain three paths connecting P with Q , one in each of the intersections. The assumed simple connectivity of A, B and C implies that each two of these three paths are relatively homotopic. Hence we can define a map on a three-colored sphere as described in Question 1.2 by the following rules:

- ▷ the three paths from the intersection of two of the three sets give the maps of the three bi-colored meridians;
- ▷ the three homotopies are used to define the maps on the three one-colored regions.

Since the definitions on the boundaries of one-colored regions coincide we obtain a continuous map of the entire sphere. The definition is consistent with the coloring in the sense that each color is entirely mapped into one of the sets A or B or C . Thus the existence of a three-colored path between the image of the north and the image of the south pole (which get mapped to P and Q) implies that this path lies in $A \cap B \cap C$. Consequently, P and Q belong to the same path-component of $A \cap B \cap C$.

1.8. Definition. Let $f: S^1 \rightarrow \mathbb{R}^2$ denote a loop in the plane and suppose $x \notin f(S^1)$. Given any point $y \in S^1$ define α_y as the positively oriented circular loop with center at x and basepoint at $f(y)$. The “winding number” of the point x with respect to the loop f is the integer k such that $[f] = [\alpha_y]^k \in \pi_1(\mathbb{R}^2 - \{x\}, f(y))$. It turns out that the definition is independent of the choice of point y .

Note that if x has a nonzero winding number with respect to the loop f then every nullhomotopy of f contains x in its image.

1.9. Remark. The winding number is a well-known tool which appears in many areas of mathematics. In the case of a reasonably well-behaved loop (i.e., a loop allowing the construction below) it can be computed in the following way. Choose any differentiable arc $p: [0, \infty) \rightarrow \mathbb{R}^2$ satisfying the following conditions:

- (a) $p(0) = x, |p'(t)| \neq 0 \forall t$, and p diverges to infinity, i.e., $\lim_{t \rightarrow \infty} d(x, p(t)) = \infty$;
- (b) p has finitely many intersections with loop f , none of which is a self-intersection of f ;
- (c) every intersection of p and f is transversal, i.e., the loop f is locally differentiable at every intersection and the corresponding tangent vectors p' and f' are linearly independent at every intersection. The signature of the intersection is defined to be $+1$ if the oriented angle between p' and f' is between 0 and π . If the oriented angle between p' and f' is between π and 2π the signature of the intersection is -1 .

If such an arc can be found then the winding number of x with respect to f can be computed as the sum of the signatures of all intersections between the loop f and the arc p .

2. The tame case: The construction of a three-colored path as a sheltered middle path in the PL-case

An analysis of Minc's papers shows that in his combinatorial proofs in Section 2 he was actually working with a stronger version of sheltered than what he defined on the first page of his paper. In the sequel we shall call the definition from the beginning of his paper "*weakly sheltered*", the definition that he was actually using "*strongly sheltered*", and an intermediate version that would suffice to prove the three-colored sphere-problem we shall call just "*sheltered*". Our counterexample from Section 3 will also be for this version of shelteredness.

Given paths $a, b: [0, 1] \rightarrow \mathbb{R}^2$ the inverse path of a will be denoted by $a^-(t) := a(1 - t)$; the concatenation of paths a and b that satisfy $a(1) = b(0)$ will be denoted by $a * b$. If a and b are paths with $a(0) = b(0)$ and $a(1) = b(1)$, then the loop determined by paths a & b is $a^- * b$ or $b^- * a$. Such a loop is determined up to an orientation.

2.1. Definition. Let $a, b, c: [0, 1] \rightarrow \mathbb{R}^2$ be paths from A to B , where $A \neq B$ are points in the plane. A point in the union of their traces is called:

- (a) "*weakly sheltered*", if it lies either on at least two of the three traces, or on just one of the traces, but in the bounded component with respect to the union of the remaining two traces;
- (b) "*sheltered*", if it lies either on at least two of three traces, or on just one of the traces, but has nonzero winding number with respect to the loop determined by the remaining two paths;
- (c) "*strongly sheltered*", if it lies either on at least two of three traces, or on just one of the traces, but has an odd winding number with respect to the loop determined by the remaining two paths.

The loop determined by two paths is unique up to orientation which does not affect the properties of having even, odd or nonzero winding number.

2.2. Lemma. Let a, b and c be three PL-paths in the plane from A to B which have only general position intersections and self-intersections.

- (a) If P is an intersection of two different paths then exactly two of the four incoming segments at P are strongly sheltered. Furthermore, the two strongly sheltered segments are not contained in the same path.
- (b) If P is a self-intersection of one of the paths then either none or all four of the incoming segments at P are strongly sheltered.
- (c) If P is either A or B , then either one or all three of the three incoming segments at P are strongly sheltered.

Proof. All three claims are proved using the winding number analysis of Remark 1.9, hence the paths used in the proof satisfy appropriate conditions required in that remark. Note that the traces of the three PL-paths define a graph whose vertices are induced by the PL-structure of paths and by their intersection. It is easy to see that the strong shelteredness is an invariant of open edges (segments) of such a graph.

- (a) Two points on different incoming segments of the same path can be connected by a differentiable arc which transversely intersects the second path of the intersection exactly once, hence changing the parity of the appropriate winding numbers of original points. Consequently, exactly one of the two incoming segments of each path is strongly sheltered.
- (b) Two points on the different incoming segments of the path can be connected by a differentiable arc which does not intersect the remaining two paths, hence the winding number on all segments is the same.
- (c) Choose points A', B' and C' on the incoming segments of a, b and c . Connect points A' and C' by a differentiable arc r which has exactly one intersection with path b . We can assume that the intersection is transverse and it occurs at point B' . Choose an arc p so that:
 - (i) p starts at C' ;
 - (ii) the concatenation of paths r and p satisfies the conditions of Remark 1.9;
 - (iii) p intersects paths a, b and c at α, β and γ many intersections respectively, all of which are transversal.
 The parity of the winding numbers of points C', B' and A' determining strong shelteredness is the same as the parity of $\alpha - \beta, \gamma - \alpha + 1$ and $\beta - \gamma + 2$, respectively. This follows from Remark 1.9 using the path p combined with appropriate segments of r when necessary. Hence the sum of the winding numbers in question is odd, implying that either one or three of the winding numbers are odd. Consequently, either one or three of the incoming segments at P are strongly sheltered. \square

2.3. Lemma. (Also observed in [11], cf. Prop. 2.6.) Let a, b and c be any three PL-arcs in the plane from A to B which have only general position intersections. Then there exists a strongly sheltered path from A to B within the sum of traces of paths a, b and c .

Proof. Transverse intersection between two different paths is the only type of intersection phenomenon that can occur. Thus the union of traces, when treated as a graph, has (with the exceptions of the points A and B) only vertices of valency four coming from the intersections of our paths. Lemma 2.2(a) implies that from the four incoming edges for each of these vertices exactly two of them are strongly sheltered and that the sheltered path switches between the two intersecting paths at the vertex. Furthermore, either one or three of the incoming edges are strongly sheltered at A and B . Thus one can trace a strongly sheltered path starting at A . Such path either ends at B or comes back to A . In the latter case a third edge from A is also strongly sheltered. A strongly sheltered path starting at such vertex A can only end at B . \square

2.4. Lemma. *Let a, b and c be any three PL-paths in the plane from A to B which have only general position intersections and self-intersections. Then there exists a strongly sheltered path from A to B within the sum of traces of a, b & c .*

Proof. In difference to Lemma 2.3 we now have the additional situation that a path can intersect itself. Lemma 2.2(b) implies that either all four or none of incoming edges of such self-intersection are strongly sheltered. Thus the subgraph of strongly sheltered edges is a graph which has only vertices of even valency with vertices A and B being the only exceptions by having an odd valency. Similarly as in Lemma 2.3 we can find a strongly sheltered path from A to B . \square

2.5. How a sheltered middle path might solve the three-colored sphere-problem

Given a map $f : S^2 \rightarrow \mathbb{R}^2$ where S^2 is three-colored as in Question 1.2, the images of the three bi-colored meridians are paths that run from $P := f(N)$ to $Q := f(S)$. We claim that the points that are sheltered in the sense of Definition 2.1(b) contain all three colors. Such sheltered points fall into two categories.

- (a) The points which lie on the images of at least two meridians. These points obviously have all three colors.
- (b) The points which lie on the image of one meridian and have a nonzero winding number with respect to the other two meridians. Choose any such point x . The containment in the image of one meridian implies the presence of the appropriate two colors at x . Considering the third color, note that the image of the correspondingly colored region on the sphere induces a nullhomotopy of the loop obtained as a concatenation of the other two meridians. Since x has a nonzero winding number with respect to the other two meridians any such nullhomotopy contains x in its image (see Definition 1.8) hence x also has the third color.

We conclude that all sheltered points have all three colors. Consequently, wherever the sheltered middle path comes out as an honest path it is a three-colored path in the sense of Question 1.2 and solves the three-colored sphere-problem in that case.

3. The general case: An example where the sheltered middle path of three non-PL-paths results in a topologist's sine curve

In this section we present an example of how three paths in the plane, connecting the same pair of distinct points, can be placed in such a way that the points that are sheltered by them in the sense of Definition 2.1(b) yield a topologist's sine curve but not a genuine path. The construction is sketched in Fig. b. It is a plane drawing which pictures the union of the traces of our three paths. The construction requires an infinite iteration, hence only the first finitely many steps can be drawn. Since the definitions near the regions where our sheltered middle path (the path in bold on the diagram) turns around (near the left and right boundary of our diagram) need to be different from the region in between, the first few steps that we could draw hardly unveil the construction principle.

Most of this section is devoted to a description of our example. Since the paths are relatively complicated we shall describe the individual oriented sections of their traces (3.1–3.10). Afterwards we shall assemble these traces in a continuous path (3.12–3.14) and eventually compute the appropriate winding numbers (3.15–3.16) which will confirm that the sheltered path is indeed the bold path of Fig. b. We shall begin by assigning phrases to some of the elements of our construction and the diagram that will be needed for a complete description.

3.1. Notations used in Fig. b

- ▷ P, Q and T are three points in the plane.
- ▷ $[T, Q]$ denotes the straight line segment between these points, as it is marked in Fig. b. It will be also called “the straight line segment” or the “central line”. Within a topologist's sine curve to be defined in this section it will serve as the accumulation line.
- ▷ a, b and c are the names of our three paths. When they show up in the figure, they are to be understood in this way, that the corresponding segment belongs to our path a, b or c respectively. Since the paths are highly self-intersecting and intersecting each other along the straight line segment, their definition can hardly be understood from these labels, but will be explained in 3.13, 3.14.
- ▷ “ x ” and “ y ” indicate areas where Fig. b is not drawn correctly for the reasons of scale. Appropriate areas should be changed according to the corresponding subfigure of Fig. c.

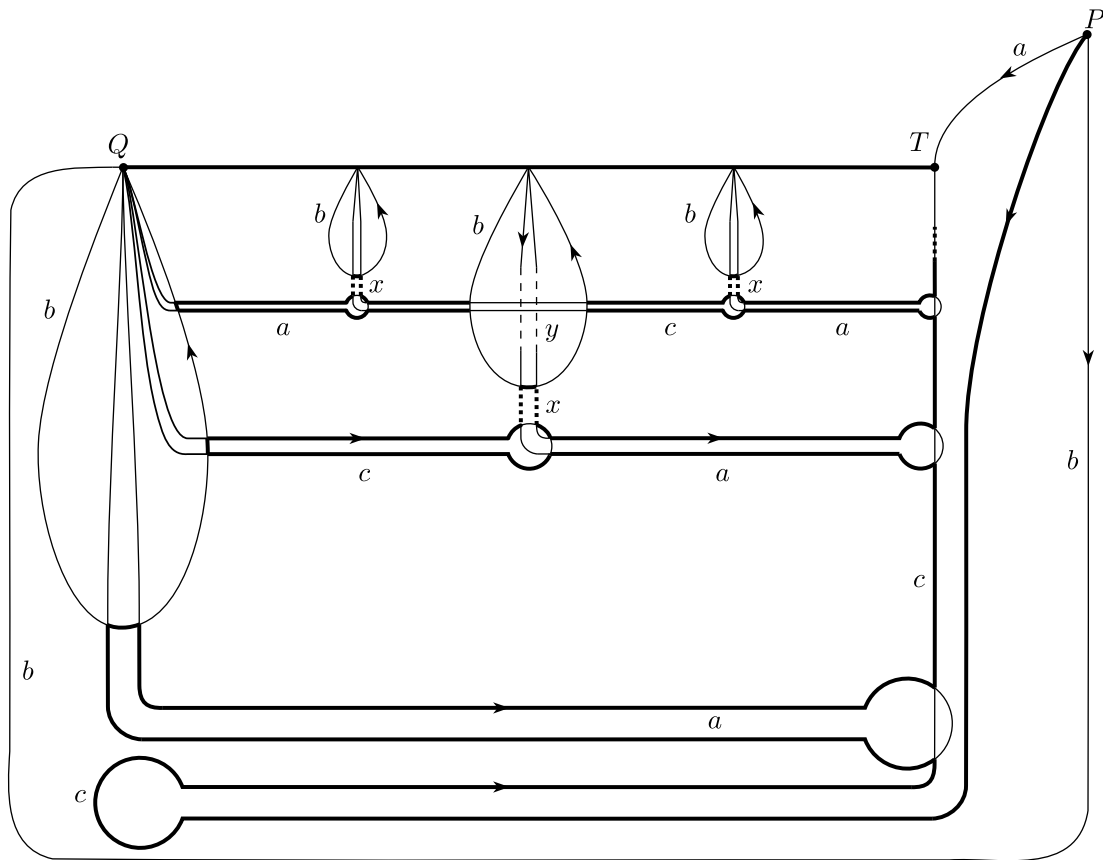

Fig. b. This figure shows that three continuous paths in the plane can intersect so that the sheltered middle path is a topologist's sine curve. The construction is naturally a fractal-like iteration, and only the very few first steps can be pictured. The construction principle is explained in 3.1–3.10.

3.2. Remark. It is easy to verify by counting the winding number that the bold line from Fig. b is the sheltered path according to Definition 2.1(b). More explanation will follow in 3.15.

Furthermore, we shall explain below that the construction principle can be iterated infinitely many times by squeezing in smaller and smaller loops. When the same intersection patterns as those shown in these first steps are used, the line in bold will continue to return forward and backward from the left boundary-near region of the figure to right one. The result will be a topologist's sine curve converging to the straight line segment (cf. Remark 3.8).

3.3. Definition of various kinds of loops

Some parts of our paths *a*, *b* and *c* will be called “loops”. According to their geometric shape we shall distinguish between “straight loops” and “turning loops”. The turning loops are then again distinguished into “standard turning” and “non-standard turning”. We decided to call the kind which is more often used in the diagram “standard turning”, and the other kind “non-standard turning”. Fig. c explains which of the names is assigned to which kind of loop. The loops which have the geometric shape of the drop will be called “straight”, the other ones “turning”. All straight loops will be labeled “*b*” and all standard-turning loops will be labeled either by “*a*” or by “*c*”. The starting and ending point of each such loop-path is called the “vertex”. All vertices are on the central line. Considering turning loops we shall be also talking about the “vertical part” and the “horizontal part”. Between the vertical and the horizontal part there is the “turning region”, and opposite to the vertex there is “the turning-around disk”.

3.4. The biggest elements of the diagram

Looking closer at Fig. b there is no loop turning in the non-standard way therein. The only part of the diagram which looks approximately like this is actually not a loop, because it is not a closed curve. It is rather a curve which connects two nearby different points *P* and *T* in a very indirect way. This line is labeled “*c*” and will henceforth be called “the open loop”. It is one of the exceptions that do not go into the fractal-like iteration. The other exception is the leftmost *b*-loop.

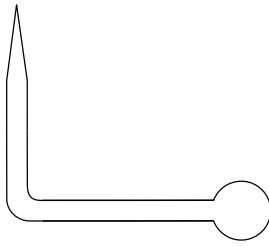

A standard turning loop

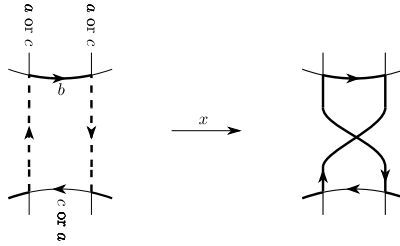

“x” indicates that two vertical strands should actually cross each other

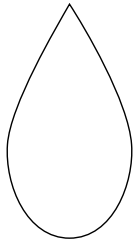

A straight loop

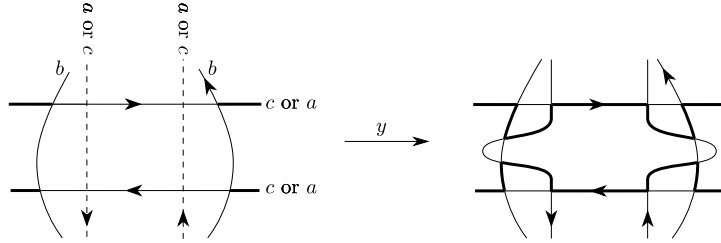

“y” indicates that a crossing of a pair of vertical and a pair of horizontal strands is to be replaced by a “clover-crossing”.

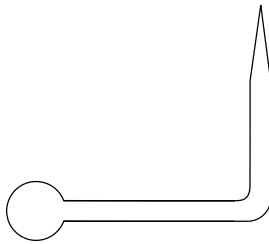

A non-standard turning loop

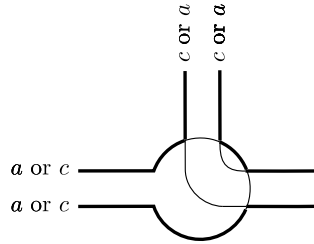

Here an arrangement of two standard turning loops is shown that we call “hooked”

Fig. c. Supporting diagrams for Fig. b.

All other straight- and standard-turning loops are in principle already a part of the fractal-like iteration. In particular, the standard-turning loops are put into “generations”. The biggest standard-turning loop in the drawing is labeled by a . It has its vertex at the point Q . Similarly as for the other standard-turning loops of the fractal-like iteration, most of the vertical part of this loop falls into the inner region of a straight loop. (Actually, all other loops with vertex at Q have their entire vertical part within the inner region of the leftmost straight loop.) For this single loop of first generation the horizontal part is almost as long as the central line and the turning-around disk intersects with one of the strands of the vertical part of the single open loop.

3.5. The elements of the second generation of the diagram

There are two standard-turning loops of the second generation in Fig. b, each approximately half the size of the single standard-turning loop of the first generation. The size comparison relates to their horizontal as well as their vertical parts although the horizontal size may become smaller with respect to the vertical size in later generations. The one on the right hand side is intersecting with the open loop in a similar way as the single standard-turning loop of the first generation. This fact will hold for every generation: the rightmost standard-turning loop of every generation is always intersecting at its turning-around disk with the left vertical strand of the open loop. The left standard-turning loop of the second generation is intersecting with the leftmost b -loop. It has its vertical part inside the leftmost b -loop in such a way that inside the b -loop there is no intersection with the vertical part of the single standard-turning loop of the first generation. This fact will hold for every generation: the leftmost standard-turning loop will always have its vertical part in the leftmost b -loop, not intersecting the vertical parts of the turning loops of the prior generations.

All other b -loops have another pattern of intersection of their turning loops in the interior. The b -loop at the middle of the central line covering the vertical part of the right hand turning loop of the second generation is the only b -loop which shows a bit of the general behavior in the course of the fractal-like iteration. Considering this general behavior: each vertical part of a turning loop of a new generation is in a similar way placed in the interior of a straight b -loop. “Similar way” means that the intersection of the vertical part of the turning loop with the line of the b -loop is above the turning region, but still below the level where all horizontal parts of the loops of the forthcoming generations intersect this arrangement of the vertical part of a turning loop. Each b -loop partially contains the vertical part of exactly one turning loop. It should also be mentioned, that all those loops of forthcoming generations, which by their general placement do not intersect with the open loop, are in a similar way as the left turning loop of the second generation “hooked” to the next loop of the same generation on the right. The phrase “hooked” is explained in Fig. c. Recall that our construction is a plane arrangement, thus “hooked” just means that the turning part of one of the turning loop is placed in the interior of the turning-around disk of another turning loop, and that the natural intersections occur in this pattern.

3.6. On the meaning of y -regions

In the middle of the b -loop that is placed in the center of the segment $[Q, T]$ there is a letter “ y ” which, similarly as “ x ”, acknowledges that the given diagram Fig. b is actually incorrectly drawn for reasons of scale. Fig. c explains how the diagram should have been drawn. The rule is as follows and it applies to all situations where the horizontal parts of turning loops of higher generations intersect the vertical parts of a turning loop of a prior generation. It always happens in the interior of a b -loop where an intersection of two parallel horizontal and two parallel vertical strands occur. Such intersection situation is to be replaced by a “clover figure”, as shown in Fig. c. Note that with the exception of the leftmost straight loop all other straight loops have only two vertical strands inside. The letter y places a clover figure, which means that wherever the horizontal strands of loops of higher generations cross the arrangement of a b -loop and vertical strands of an a - or c -loop inside, the (in general) vertical strands turn between the two parallel intersecting horizontal strands outside, intersect the strands of the surrounding b -loop, but then turn around again and come back into the interior of the b -loop, and go again into a vertical position before they intersect the second of the two parallel horizontal intersecting strands. Although there is only one letter y in the current figure, the clover figure will appear infinitely many times to the two a -strands in the middle b -loop on their way going upwards because there will be infinitely many new generations of loops between the (currently last drawn) turning loops of the third generation, and the line $[Q, T]$. Such clover figures will always be placed inside all b -loops granting them infinitely many clover figures, except inside the leftmost one which, as we mentioned before, is an exception.

The role of the clover figure is to prevent the sheltered path from reaching the central line $[Q, T]$ via the vertical strands of the standard-turning loops as that would prevent the sheltered path from being a topologist’s sine curve with limit line $[Q, T]$.

3.7. The elements of the third generation of the diagram

We have already discussed how the middle one of the three turning loops of the third generation intersects the middle straight loop. Actually, we have discussed all other aspects of the three pictured turning loops of this generation. To complete the description of the iteration from the aspect of how the diagram looks we will briefly describe how the straight and turning loops of the higher generation are put inside this figure.

As already mentioned, with the exception of the leftmost b -loop the vertical parts of turning loops are never placed inside existing b -loops. They are always located at new places between the existing vertical parts of the loops of the prior generation. Each of them receives its own b -loop to cover 80% of the vertical part. When putting a new generation of turning loops into the figure, there may be more than one standard-turning loop with its vertical part placed between the existing vertical parts of loops of prior generation. Each new generation is placed in such a way that the horizontal parts together are hooked and give a through connection between the vertical part which sits in the leftmost exceptional b -loop, and the left line of the vertical part of the open c -loop at the right hand side.

Naturally, with increasing generation index the loops have to become small. The vertical parts of the turning loops become small because the horizontal parts are placed higher with every new generation. The horizontal parts of the turning loops are becoming smaller by the demand of placing at least one of them between the vertical parts of the existing b -loops for each new generation. This causes the lengths of the horizontal parts of the loops of each new generation to have essentially half the lengths with respect to the loops of the preceding generation. Word “essentially” suggests that there is an uncertainty of factor 2 in the length-calculation. This factor of the turning loops depends on whether the horizontal part has or has not to cross the vertical part of a loop of the prior generation according to the requirements below. However, since we make sure that within each new generation each turning loop crosses at most one loop of a prior generation, these factors 2 do not accumulate. There will be at most one such factor 2 and it does not prevent the lengths of the horizontal parts from tending to zero either. Whether we shall place one or two new turning loops of the new generation between the existing turning loops and whether these loops will be labeled by a or by c , has to be arranged so that the following rules are kept:

- ▷ The loops of a new generation which intersect the vertical part of a turning loop and the surrounding b -loop of a prior generation have to have a different label than the strands of the loop of the old generation that are inside the b -loops in the vertical position, i.e., inside a b -loop only c and a are allowed to intersect but not a with a or c with c .
- ▷ The rightmost turning loop of each new generation (the one intersecting the open c -loop) has to be “of type a ”, i.e., has to have the label “ a ”.
- ▷ Every two loops which are hooked have to be of different type.

3.8. Remark 3.2 continued

Based on these demands it should be clear that the construction can be continued to infinity maintaining these demands and adding smaller and smaller loops to our diagram. Observe that each new generation of turning loops requires a new generation of b -loops, each covering approximately 80% of the vertical part of a turning loop of the new generation. The only exception is the leftmost loop of each new generation, which goes always into the leftmost old b -loop of the first generation. The situation for the first three generations is drawn in Fig. b.

3.9. Definition of the orientation of loops

We now clarify how the orientation of loops as suggested in Fig. b coincides with the orientation of the segment of the corresponding path a , b or c that traverses this loop as a part of its trace. The straight line should not be regarded as oriented since it is in both directions run through by our paths. For this reason the calculation of the winding numbers will avoid it. However, all other elements of our figure are in the trace of one (or at most two at the intersections) of our paths. Hence they should be regarded as oriented which is indicated by our Fig. b. To repeat the rules and to clarify the conventions for the parts of the iteration that could not have been drawn, we summarize them within the following list:

- ▷ The three lines that are emanating from the point P are oriented away from the point P . This automatically implies that the open c -loop is clockwise oriented.
- ▷ All straight loops (i.e., all b -loops) are anticlockwise oriented.
- ▷ All turning loops (i.e., all a -loops and all c -loops) are in principle clockwise oriented. However, the presence of x -regions effects such orientation which is explained in 3.10.

3.10. On the meaning of x -regions

“ x ” (similarly to “ y ”) means that the drawing of Fig. b is not correctly drawn but needs to be changed. Such letter is to be added to every (in its generation not leftmost) standard-turning loop in the lower part of the vertical section where the loop is already above the turning-around disk to which it is hooked, and still below the intersection of the straight b -loop which is supposed to cover 80% of its vertical part. Letter x in principle means that in this part the two vertical strands of our loop are not (as they are pictured in the current drawing) parallel but actually cross each other. A consequence of this crossing is that the orientation of the loop can be only clockwise in the horizontal part, the turning region, and the turning-around disk, but in the majority of the vertical part (due to this crossing) the orientation will naturally be anticlockwise. Therefore the orientation is not contradictory as it might appear at first sight when looking at Fig. b.

3.11. A note on continuity

Recall (cf. the introductory paragraph of this section) that Fig. b together with the explanations given in the preceding paragraphs on how to iterate its construction was set up to be part of a definition of three paths a , b and c in the plane with the following properties:

- ▷ each of the three paths connects points P and Q ;
- ▷ the three paths induce the bold path of Fig. b as a sheltered middle path (according to Definition 2.1(b)) which is a topologist’s sine curve.

The description of Fig. b and the principle according to which the iteration of the construction should be continued is by now complete. We proceed with an explanation on how the continuous paths a , b and c can be defined so that they traverse infinitely many corresponding loops. A concatenation of countably many paths of appropriate diameters can be performed in various ways. The following lemma is adapted to our situation.

3.12. Lemma on infinite concatenation of paths. Suppose $\alpha: [0, 1] \rightarrow \mathbb{R}^2$ is an arc between points A and B , $\{x_i\}_{i \in \mathbb{N}}$ is a dense subset of $\alpha((0, 1))$ and $\{\alpha_i: [0, 1] \rightarrow \mathbb{R}^2\}_{i \in \mathbb{N}}$ is a collection of loops based at x_i such that the sets $\alpha([0, 1])$, $\alpha_1((0, 1))$, $\alpha_2((0, 1))$, ... are pairwise disjoint and such that $\lim_{i \rightarrow \infty} \text{diam}(\alpha_i([0, 1])) = 0$. Then there exists a path $\beta: [0, 1] \rightarrow \mathbb{R}^2$ from A to B with

$$\beta([0, 1]) \subset \alpha([0, 1]) \cup \bigcup_{i \in \mathbb{N}} \alpha_i((0, 1)),$$

such that β traverses each loop α_i exactly once (preserving the orientation of α_i), i.e.,

- ▷ for each $i \in \mathbb{N}$ there exists $(a_i, b_i) \subset (0, 1)$ so that $\beta(a_i + (b_i - a_i) \cdot t) = \alpha_i(t)$, $\forall t \in (0, 1)$;
- ▷ for each $i \in \mathbb{N}$ and every $x \in \alpha_i((0, 1))$ the preimage $\beta^{-1}(\{x\})$ is exactly one point.

Proof. Path β will be obtained as a limit path of a uniformly convergent sequence of paths $\beta_n: [0, 1] \rightarrow \mathbb{R}^2$. The iterative construction of paths β_n will imitate the construction of the standard ternary Cantor set C , which is obtained by inductively removing the middle thirds of the intervals. Accordingly we denote by C_n an appropriate inductive step of the construction of C so that $\bigcap_{n=0}^{\infty} C_n = C$, i.e., $C_0 = [0, 1]$, $C_1 = [0, 1/3] \cup [2/3, 1]$, \dots

Path β_1 is obtained from path α by inserting loop α_1 in the appropriate spot. We divide the interval $[0, 1]$ into three equal parts and define:

$$\beta_1(t) := \begin{cases} \alpha(3 \cdot t \cdot x_i), & t \in [0, \frac{1}{3}], \\ \alpha_1(3 \cdot (t - \frac{1}{3})), & t \in [\frac{1}{3}, \frac{2}{3}], \\ \alpha(3 \cdot (t - \frac{2}{3}) \cdot (1 - x_i) + x_i), & t \in [\frac{2}{3}, 1]. \end{cases}$$

In other words, $\beta_1|_{[0, 1/3]}$ is the reparameterized path $\alpha|_{[0, x_1]}$, $\beta_1|_{[2/3, 1]}$ is the reparameterized path $\alpha|_{[x_1, 1]}$ and $\beta_1|_{[1/3, 2/3]}$ is the reparameterized loop α_1 . Consequently $(a_1, b_1) = (1/3, 2/3)$ and $\beta_1|_{C_1}$ essentially represents loop α , i.e. the concatenation of $\beta_1|_{[0, 1/3]}$ and $\beta_1|_{[1/3, 2/3]}$ is the reparameterized path α .

In a similar way we can define β_2 as a path obtained from β_1 by inserting loops α_2 and α_3 in the appropriate spot so that $(a_2, b_2) = (1/9, 2/9)$ and $(a_3, b_3) = (7/9, 8/9)$. Note that the properties of paths α_i are preserved under every permutation of indices i , hence we can assume that $0 < x_2 < x_1 < x_3 < 1$. Furthermore, $\beta_2|_{C_2}$ essentially represents the loop α in a similar way as $\beta_1|_{C_1}$ essentially represents loop α .

We proceed by induction. By redefining β_n on C_n so that the middle thirds of the intervals are mapped by ever smaller loops α_i and the remainder (which essentially represents path α) is reparameterized, we obtain β_{n+1} . Note that the sequence $(\beta_i)_i$ is uniformly convergent as diameters of $\alpha_i([0, 1])$ as well as diameters of components of C_i tend to 0. Hence we obtain a continuous path β satisfying the required conditions. \square

3.13. Interpretation of Lemma 3.12

Consider the notation of Lemma 3.12. Note that the map $\beta|_{[0, 1] - C}$ essentially consists of loops α_i and $\beta|_C$ represents the path α , i.e., there exists a surjection $g: C \rightarrow [0, 1]$ so that $\beta = \alpha \circ g$. The behavior of a path β when constructed in this way is described by the following statement: “Path β moves on a Cantor set over a line segment $\alpha([0, 1])$ and performs excursions $\alpha_i([0, 1])$ on all intervals not belonging to the Cantor set”.

3.14. Definition of paths a , b and c

The definition of the paths a , b and c is based on the construction principle explained in 3.12. All three of them start at P and end at Q .

Definition of the path a :

- ▷ starts at P ;
- ▷ runs over the short curve to T ;
- ▷ moves over the straight line segment on a Cantor set to while taking excursions on all the correspondingly marked a -loops not belonging to the Cantor set.

Definition of the path b :

- ▷ starts at P ;
- ▷ runs over the accordingly marked long curve directly to the point Q ;
- ▷ moves on a Cantor set over the central line to the point T while taking excursions over all b -loops on the intervals that do not belong to this Cantor set;
- ▷ runs straight without further excursions back from T to Q .

Definition of the path c :

- ▷ starts at P ;
- ▷ runs over the single open non-standard-turning loop to T ;
- ▷ moves on a Cantor set over the central line to the point Q taking excursions over all c -loops on the intervals that do not belong to the Cantor set.

Thus we have defined continuous paths containing all the correspondingly marked loops and other segments of Fig. b and all infinitely many loops that were to be added according to the iteration described in 3.4–3.10.

3.15. Comments on the resulting sheltered path

We already mentioned that the sheltered path is highlighted by boldness in Fig. b. At the critical, most details requiring phases, the information about boldness should be taken from the corresponding subfigures of Fig. c. This in particular affects the hooked regions where everything is becoming very small and the regions where the corrections via letters x and y are implemented. The shelteredness in all the above mentioned regions behaves analogously and can be computed by a procedure described in Remark 1.9.

With the exception of the central line all parts of the diagram are tame. Outside the central line each of the drawn loops is only once traversed by one segment of the path whose label it carries. The visible intersection points are the only double points. Furthermore, there will be no additional insertions below the three generations of loops that we have drawn.

In order to verify that the sheltered path has been correctly marked we use the criterion of Remark 1.9. Given any point on a bolded section choose an arc according to Remark 1.9. In fact we can choose a straight line segment transversely intersecting the pictured path-system and avoiding the central line. Given such arc the intersection numbers and consequently the winding numbers can be obtained. Note that we have defined the appropriate winding numbers up to a factor -1 .

3.16. Conclusion for the resulting sheltered path

The following list describes the resulting sheltered path which starts at P .

- ▷ The path runs from P through the open c -loop until its intersection with the turning-around disk of the single standard-turning loop of the first generation. This section has winding number 1 with respect to the other two paths by Remark 1.9.
- ▷ The second part runs forward and backward over the horizontal parts of the single standard-turning loop of the first generation labeled by a , turning around at the straight loop labeled b . The appropriate winding number of this section is 1. In particular, the winding number with respect to b and c is 1 on the contained part of the standard-turning loop labeled a . Similarly, the winding number with respect to a and c is 1 on the contained part of the straight loop labeled b . All other paths approaching the intersections in question have winding number 0.
- ▷ The path switches between the rightmost standard-turning loops of the first and the second generation along the path labeled c , connecting their turning-around regions. The corresponding winding number is 1.
- ▷ The path continues along the two hooked horizontal parts of the loops of the second generation and reaches the turning-around region of the rightmost standard-turning loop. In particular, it runs forward and backward along the horizontal parts, turning around at the straight loop labeled b , switching between the loops of the second generation and making a small excursion in the x -region according to Fig. c. The corresponding winding numbers are 1 whose calculation should also include the information of Fig. c.
- ▷ The path continues to switch to the rightmost standard-turning loop of the next generation and to run forward and backwards on the hooked horizontal parts of the turning loops of every generation. Small diversions occur in the hooking-regions and in the clover-crossings wherever the vertical parts of our turning loops have to be crossed.

Since the running backward and forward always occurs between the left vertical segment of the open c -loop on the right hand side of the picture and the right strand of the leftmost b -loop on the left hand side of the picture, the obtained path is a topologist's sine curve accumulating to the straight line.

Acknowledgements

This research was supported by the Polish–Slovenian grants BI-PL 2008-2009-010 and 2010-2011-001, the first and the third authors by the ARRS program P1-0292-0101 and project J1-2057-0101 and the second and the fourth authors by the MNiSW grant N200100831/0524. We thank the referee for comments and suggestions.

References

- [1] S.A. Bogatyĭ, The topological Helly theorem, *Fundam. Prikl. Mat.* 8 (2002) 365–405 (in Russian).
- [2] Marilyn Breen, A Helly-type theorem for intersections of compact connected sets in the plane, *Geom. Dedicata* 71 (2) (1998) 111–117.
- [3] L. Danzer, B. Grünbaum, V. Klee, Helly's theorem and its relatives, in: Victor L. Klee (Ed.), *Convexity*, in: *Proc. Sympos. Pure Math.*, vol. VII, Amer. Math. Soc., Providence, RI, USA, 1963, pp. 101–180.
- [4] Jürgen Eckhoff, Helly, Radon, and Carathéodory type theorems, in: P.M. Gruber, J.M. Wills (Eds.), *Handbook of Convex Geometry*, vol. A, North-Holland Publishing Co., Amsterdam, 1993, pp. 389–448.
- [5] Benson Farb, Group actions and Helly's theorem, *Adv. Math.* 222 (5) (2009) 1574–1588.
- [6] Gunnar Fløystad, The colorful Helly theorem and colorful resolutions of ideals, *J. Pure Appl. Algebra* 215 (6) (2011) 1255–1262.
- [7] Eduard Helly, Über Mengen konvexer Körper mit gemeinschaftlichen Punkten, *Jahresberichte der Deutschen Math.-Ver.* 32 (1923) 175–176.
- [8] Eduard Helly, Über Systeme von abgeschlossenen Mengen mit gemeinschaftlichen Punkten, *Monatsh. Math. Phys.* 37 (1930) 281–302.

- [9] U.H. Karimov, D. Repovš, On topological Helly theorem, *Topology Appl.* 153 (10) (2006) 1614–1621.
- [10] U.H. Karimov, D. Repovš, M. Željko, On the unions and intersections of simple connected planar sets, *Monatsh. Math.* 145 (3) (2005) 239–245.
- [11] Piotr Minc, Choosing a sheltered middle path, *Topology Appl.* 153 (10) (2006) 1622–1629.
- [12] József Molnár, Über eine Verallgemeinerung auf die Kugelfläche eines topologischen Satzes von Helly, *Acta Math. Acad. Sci. Hugar.* 7 (1956) 107–108.
- [13] József Molnár, Über den zweidimensionalen topologischen Satz von Helly, *Mat. Lapok* 8 (1957) 108–114 (in Hungarian).
- [14] E.D. Tymchatyn, V. Valov, On intersection of simply connected sets in the plane, *Glas. Mat. Ser. III* 41 (1) (2006) 159–163.
- [15] Rephael Wenger, Helly-type theorems and geometric transversals, in: Jacob E. Goodman, Joseph O'Rourke (Eds.), *Handbook of Discrete and Computational Geometry*, in: CRC Press Ser. Discrete Math. Appl., CRC Press, Boca Raton, FL, USA, 1997, pp. 63–82.