



9th International Conference on Photonic Technologies - LANE 2016

Innovative laser sources operating around 2 μm

D. Kracht^{a,*}, H. Sayinc^a, S. Yilmaz^{a,b}, M. Wysmolek^a, K. Hausmann^a, C. Ottenhues^a,
D. Wandt^a, A. Wienke^a, J. Neumann^a

^aLaser Zentrum Hannover e.V., Hollerithallee 8, 30419 Hannover, Germany

^bDepartment of Physics, Bilkent University, Ankara, 06800, Turkey

- Invited Paper -

Abstract

We report on a variety of continuous wave and pulsed laser sources based on Thulium- and Holmium-doped materials, emitting in the spectral range around 2 μm . This includes continuous wave Thulium-doped fiber lasers which have been realized based on the beam combining technique by using tapered fused bundles and truly single mode WDM cascades, respectively. A pulsed laser source emitting nano- or picosecond pulses has been developed in a master oscillator power amplifier (MOPA) configuration, which consists of a gain-switched diode operating at a wavelength of 1.95 μm , followed by Thulium-doped fiber-based pre- and main amplifiers. Furthermore, we present a femtosecond regenerative amplifier system using Thulium:YAP and Holmium:YAG crystals with emission wavelengths around 1.95 μm and 2.1 μm , respectively. Output energies of more than 700 μJ have been generated with both systems.

© 2016 Published by Elsevier B.V. This is an open access article under the CC BY-NC-ND license (<http://creativecommons.org/licenses/by-nc-nd/4.0/>).

Peer-review under responsibility of the Bayerisches Laserzentrum GmbH

Keywords: All-fiber combining; Pulsed fiber amplifiers; Regenerative amplifiers; Thulium and Holmium doped solid state lasers

1. Introduction

In recent years, there has been great interest in the development of Thulium and Holmium based laser and amplifier systems operating in the wavelength range between 1900 and 2150 nm. This is mainly attributed to the large application potential of those systems in a variety of application fields, e.g. medicine, research, defense and

* Corresponding author. Tel.: +49-511-2788-113 ; fax: +49-511-2788-100 .

E-mail address: d.kracht@lzh.de

industry, as such systems cover continuous wave (cw) as well as pulsed laser operation in nanosecond (ns), picosecond (ps) and femtosecond (fs) pulse regimes. In medicine, continuous and pulsed emitting Thulium-doped fiber lasers (TDFL) are among others used for urology, pneumology and otorhinolaryngology [1]. In photonics research, ps and fs-pulsed Thulium and Holmium-doped lasers are powerful tools used as pump sources for nonlinear frequency conversion in the 3 – 10 μm range [2,3] or high harmonic generation [4]. Typical industrial applications of ps- and fs-lasers operating around a wavelength of 2 μm are material processing and micromachining of plastics, polymers and semiconductors [5].

This high potential stimulates massive research on such laser sources. The main efforts in the development of TDFL are attributed to the direction of fiber integration, increased output power and brightness. A double-clad continuous wave (cw) emitting TDFL was demonstrated first in 1998 [6]. The ability to dope Thulium in high concentrations was realized by the inclusion of Aluminum dopants to reduce clustering and enhance the desirable cross relaxation process in thulium fiber lasers. With a new understanding on doping fused silica with Thulium ions and the increase in available diode power, starting in 1998, the output power and efficiency of double clad, TDFL have both steadily risen. An output power of 85 W was achieved from Tm doped silica fiber laser operating at 2040 nm diode pumping at 793 nm with 56 % efficiency [7]. The high power Thulium laser was reported by S. Jiang et. al. and they reached 104 W by using highly doped germanate glass fibre with relatively high efficiency (68%) [8]. Significant power level of 600 W was reached by G. Goodno et. al. with a TDFL [9]. Besides scaling the output power of individual lasers, spectral and spatial power combination is a promising perspective to overcome fundamental nonlinear and thermal limitations of individual laser systems to enable output power scaling. The goal of beam combining is not only to increase the power, but to preserve the beam quality for applications in which high intensity is required on a target.

In addition to cw-lasers, pulsed laser sources at 2 μm have a high application potential as mentioned above and corresponding high-power nanosecond and picosecond pulses can be efficiently generated in Tm- or Ho-doped fiber amplifiers, seeded by a gain-switched laser-diode operating around 2 μm . Within this master oscillator power amplifier scheme (MOPA) the low-power laser diode is determining repetition rate and pulse duration of the laser system and the subsequent fiber amplifier stages generate pulse energies at μJ level [10]. These systems can be assembled in all-fiber configurations, which are versatile, alignment-free and cost-effective light sources.

Until now, only few high energy, ultrashort pulse laser systems have been reported in the 2 μm wavelength region. Although up to 120 μJ pulse energy with a pulse duration of 540 fs was demonstrated by a thulium-doped large-pitch fiber chirped-pulse-amplification (CPA) system [11], a further increase of pulse energy is limited due to a thermal degradation of the beam profile induced by the propagation in air [12]. Therefore, regenerative amplifiers (RA) with Tm- or Ho-doped bulk materials have gained an increased interest recently, which are most attractive approaches for the generation of high energy ultrafast laser pulses in the wavelength range around 2 μm .

This contribution is organized as follows. In Section 2.1, all-fiber combining of continuous wave Thulium doped fiber lasers is described. Tapered fused fiber bundles as well as wavelength division multiplexers were employed for incoherent beam combination in single and multimode fibers.

Section 2.2 describes an approach for the realization of ps and ns-pulsed laser sources around a wavelength of 2 μm with the master oscillator power amplifier concept. It is shown that pulses with high energy at flexible repetition rates, relevant for a variety of applications, can be provided with a single all-fiber setup. The output pulse characteristics of such a fiber laser system are mainly determined by the seed source.

In Section 2.3, the experimental lay-out of the developed ultrashort-pulse regenerative amplifier systems using Tm- and Ho-doped materials will be presented first. After that, experimental results with a Tm-based RA operating in the wavelength range around 1.95 μm will be described. Afterwards the corresponding properties of a Ho-based RA with an emission around 2.1 μm will be reported. Both systems generated pulse energies of more than 700 μJ and pulse durations of 400 fs in case of Tm:YAP and 800 fs with Ho:YAG crystals, respectively.

2. Experimental results

2.1. High power continuous wave emitting Thulium doped fiber laser sources realized by all-fiber beam combining

Beam combining in fibers can be performed by bundeling and tapering the delivery fibers down to a diameter fitting to a fiber which is capable of guiding light with the resulting NA [13]. A second strategy for beam combining is using a cascade of specially designed wavelength division multiplexers (CWDM) [14, 15]. Both methods have advantages and drawbacks. A tapered fiber bundle offers the possibility to combine signals propagating in fiber cores supporting higher order transversal modes and therefore higher power compared to single mode fibers and it is independent of the exact source wavelength. A drawback of this method is that a critical splice joint between the bundle and the target fiber is necessary. This splice joint naturally causes optical loss which can lead to a critical temperature elevation due to absorption of signal radiation in the fiber coating, resulting in catastrophic damage of the fiber. In contrast, the cascaded WDM concept enables an efficient fiber setup with simple splices between single-mode fibers. Drawbacks of this method are the wavelength dependence and the necessary channel spacing between individual WDMs, which can differ between 10 to 20 nm according to the manufacturing parameters.

2.1.1. Beam combining by tapered fused fiber bundles

In this section experimental results on beam combining with tapered fused fiber bundles are presented. The developed fiber combiners had three input fibers with a NA of 0.13 and a core and cladding diameter of 50 and 125 μm , respectively. Fig. 1 shows a typical cross section of tapered and cleaved input fiber bundles. The cleaved end facet of the bundles was spliced to a multi-mode beam delivery fiber with a NA of 0.22 and core and cladding diameters of 105 and 125 μm either by flame or utilizing a conventional splicer.

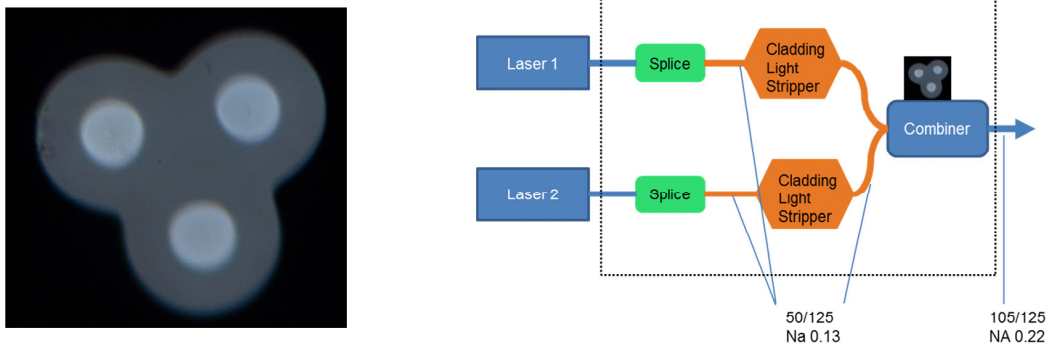

Fig. 1. Photograph of the end facet of a fiber bundle (left) and scheme of the beam combiner consisting of three signal delivery fibers (50/125, NA = 0.13) spliced to a multimode fiber (105/125, NA 0.22) (right side).

Bundles were manufactured with different taper ratios and degrees of fusion and were spliced to the identical target fiber. The splice joint of the combiner was placed in an aluminum housing to prevent contamination by dust particles. The transmission of the combined channels was measured at a signal wavelength of 1950 nm. The highest achieved transmission per channel was 83% for a bundle taper ratio of 2. At this taper ratio, the NA of the tapered individual signal fibers fits to the NA of the target fiber. Higher taper ratios resulted in losses due to a NA mismatch. Combination of TDFLs was tested with the setup depicted in Fig. 1 (right). Delivery fibers of two TDFL emitting at a wavelength of 1950 nm were spliced to input fibers of in-house developed cladding light strippers which are ensuring that no signal light is coupled to the cladding of the combiner input fibers [16]. The cladding light strippers also consisted of a fiber with a core and cladding diameter of 50 and 125 μm and had the same NA like the combiner input fibers. Despite the losses of about 17%, per port, the bundle was capable of handling output power in the range of several tens of W. These initial results are very promising and tests with up to three TDFL sources with

output power at the hundred W level will be conducted in the next step. Besides experiments with tapered fiber bundles for power combining in a multimode target fiber, we investigated power combining by employing a cascade of WDMs. These investigations are presented in the next section.

2.1.2. Beam combining by truly single-mode WDM cascades

In order to perform cascaded combining with WDMs, the only way to reach high efficiency is using laser sources which provide signals from a truly single-mode fiber. We developed four continuous wave all-fiber TDFL oscillators at different wavelengths. The setup is shown in Fig. 2 (left) for an oscillator emitting at a wavelength of 2030 nm. The pump diode had a wavelength of 793 nm. An output power of up to 60 W was provided from the delivery fiber of the laser diode which had a core diameter of 105 μm and a NA of 0.22. A pump combiner was used optionally to enable pump coupling of more than one laser diode. The pump combiner was connected to a high reflection Fiber Bragg grating (HR-FBG). The pump power was completely transmitted through the HR-FBG, which was spliced to the Tm-doped fiber with the same core and cladding diameters. The Tm-doped fiber had a length of 5 meters with peak absorption of 3 dB/m at a wavelength of 793 nm. The length of the active fiber was optimized with respect to maximum attainable signal power. A low reflection FBG (LR-FBG) acted as 10% outcoupler. The same architecture was used for each of the four TDFL at the wavelengths 1920, 1950, 1997 and 2030 nm. The combining scheme for these TDFL foresaw a combination into two subgroups with the in-house-made wavelength division multiplexers WDM1 (1996/2030 nm) and WDM2 (1920/1949 nm). These subgroups were then multiplexed with the third in-house developed multiplexer WDM3. All WDMs were fabricated from SM2000 as well as from SMF28 fibers.

The overall transmission of WDM1 and WDM2 for the coupled seed sources was 94 and 99 %, while a spectral combination efficiency of 82 % and 91 % were reached, respectively. The experimental result for WDM3 is shown on the right side of Fig. 2. The total power from the idler and the output port of WDM3 was 45 W. At the output port of WDM3 a power of up to 38 W was measured, which results in a combining efficiency of 82 % for WDM3. Thus, the overall efficiency for the WDM cascade has a value of 70 %.

In summary truly single-mode power coupling was demonstrated employing four TDFLs operating at slightly different wavelengths and a cascade of single-mode WDMs. The presented cascading concept offers maximum efficiency for largest possible separation of the wavelength groups and smallest possible separation of wavelengths within respective groups. Therefore, scaling up this configuration to even higher power can be achieved by increasing the power per channel and increasing the number of channels which is related with the number of WDMs being used in the cascade design. Improvements on power scaling by adding channels can be achieved by using a smaller spectral separation which is limited by the manufacturing parameters of WDMs. At the same time, the number of individual channels can be increased which is also related with largest possible separation of the wavelength groups inside the Tm-gain bandwidth of more than 100 nm around 1900 nm. Hence, a further scaling by additional and more powerful channels appears to be feasible in a straightforward manner.

The developed source can also be applied as pump source for Holmium (Ho) doped fiber amplifiers, as demonstrated earlier for Ytterbium doped fibers [16]. The concentration of the whole combined power to the small core diameter of just 10 μm enables core pumping of a Ho-doped fiber and therefore efficient amplification even in very short pieces of active fiber (~ 1 m) depending on the concentration of dopants.

The results presented in this section are showing ways to scale the output power of cw Tm-doped fiber laser sources by all-fiber beam combining. While combining with CWDM is a promising perspective for truly single-mode fiber lasers, the tapered fused fiber bundle approach represents a perspective for combining state of the art few- and multi-mode fiber lasers to reach higher power levels than currently commercially available.

Besides scaling the cw output power of a system, depending on the application, the pulsed operation mode might be preferred to achieve high peak power. A concept for the realization of nano- and picosecond pulsed sources in the wavelength region around 2 μm is presented in the next section.

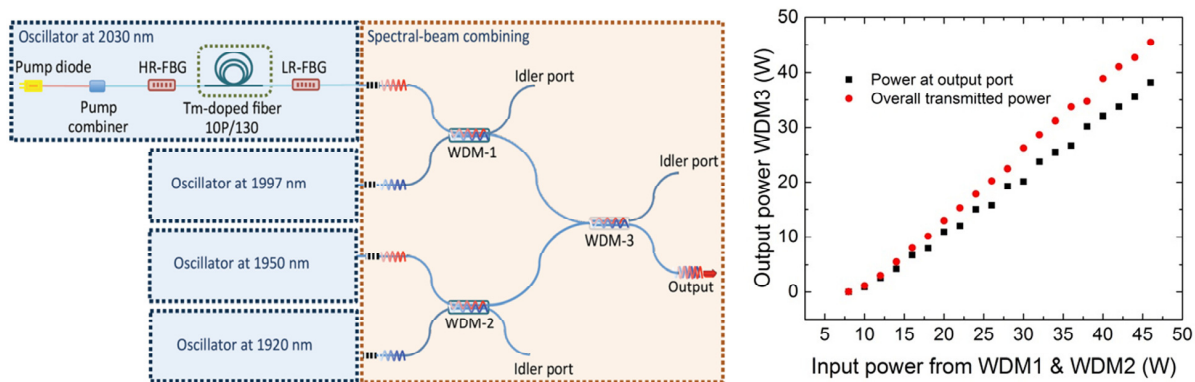

Fig. 2. One of the continuous-wave fiber oscillator setups for spectral-beam combining and the schematic diagram of the spectral beam combining setup (left). HR-FBG: High reflection fiber-Bragg grating, LR-FBG: Low reflection fiber-Bragg grating, WDM: Wavelength-division multiplexer (WDM1 for combination of 1996 & 2030 nm, WDM2 for combination of 1920 & 1949 nm). Combined output power from WDM3 plotted versus the input power from WDM1 & WDM2 (right).

2.2. Nano- and picosecond pulsed Thulium doped fiber laser sources realized in a MOPA setup

A nano- or picosecond pulsed laser source can be realized with a master oscillator power amplifier (MOPA) configuration, which consists of a seed source, pre- and main amplifiers [17]. In this configuration the main operation characteristics (pulse duration, pulse shape, wavelength, repetition frequency) are determined by the seed source, while the amplifiers only serve for single pass energy scaling. As flexible seed source, typically laser diodes are used which can provide pulses with durations in the ps or ns regime. The pre- and main amplifiers consist of a pump source, a WDM or pump combiner, a Tm-doped fiber and a cladding light stripper removing residual pump light.

An all-fiber MOPA configuration for the amplification of pulses around a wavelength of 1950 nm is shown in Fig. 3 on the left side. The seed module provides optical pulses with a variable pulse duration between 10 and hundreds of ns and repetition frequencies between a few kHz and tens of MHz. A first core pumped pre-amplifier consisting of a WDM and a Tm-doped fiber scales the average power of the seed-laser from the μW regime to several mW. A circulator and a FBG are acting as a noise reduction unit since the amplified spontaneous emission noise of the amplifier is transmitted through the FBG, while the signal is reflected. The pre-amplifier is followed by two counter pumped double clad main amplifiers which consecutively scale the average power from mW to hundreds of mW and finally to the level of several W of output power. While the active fiber of the pre-amplifier had a single cladding with a core diameter of 9 μm , the subsequent double-clad Tm-doped fibers had core diameters of 12 and 25 μm and clad diameters of 128 and 250 μm . Therefore, the pre-amplifier was core pumped by an Erbium doped fiber laser with an output power of 3 W. In contrast, both main amplifiers were cladding pumped with a fiber coupled laser diode emitting an output power of 35 W at a wavelength of 793 nm. The output fiber end facet was angle cleaved to avoid backreflections.

The output power of the system is plotted versus the input pump power of the last amplifier stage at the right side of Fig. 3 for different pulse durations. An average power of 10 W was obtained for a pulse duration of 100 ns. At a repetition rate of 10 kHz this corresponds to a pulse energy of 1 mJ. The high degree of flexibility of the presented setup results from its suitability for amplification of ps as well as ns seed pulses. The seed pulse parameters can be varied to achieve the desired output pulse parameters at the fiber output end of the system.

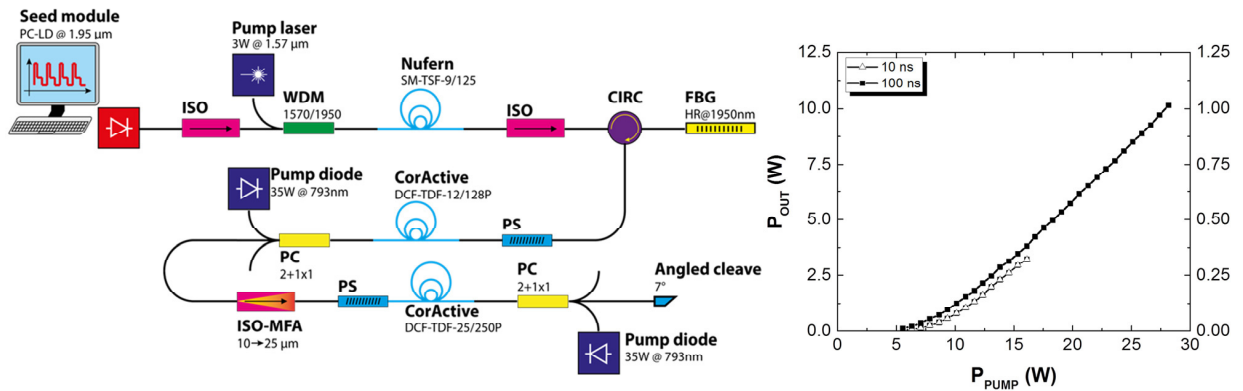

Fig. 3. All-fiber MOPA setup for the generation and amplification of ns and ps pulses around a wavelength of 1950 nm (left) and output power plotted versus pump power of the last amplifier stage for the case of ns seed pulses (right).

We demonstrate the flexibility of the setup by just changing the seed source and amplification of pulses generated by a gain switched laser diode emitting at a central wavelength of 1950 nm. A typical optical spectrum of the pulses after propagating through the pre-amplifier stage and the noise reduction unit are shown in Fig. 4 on the left side. A measurement of the temporal pulse profile was performed employing an ultrafast photo diode and a broadband oscilloscope (>40 GHz). The temporal pulse profile measured after pre-amplification is shown on the right side of Fig. 4 and indicates a full width at half maximum of 110 ps. After propagation through the whole amplifier chain, an output power of more than 10 W was achieved at repetition rates between 2.5 and 40 MHz, as depicted in Fig. 5 (left). The right side of Fig. 5 indicates that at a maximum output pulse energy of 4 μJ, the spectral width at an intensity level of -3 dB was still below 5 nm despite the occurrence of nonlinear effects like Raman scattering and self phase modulation. At highest output pulse energy, the temporal profile was nearly unchanged.

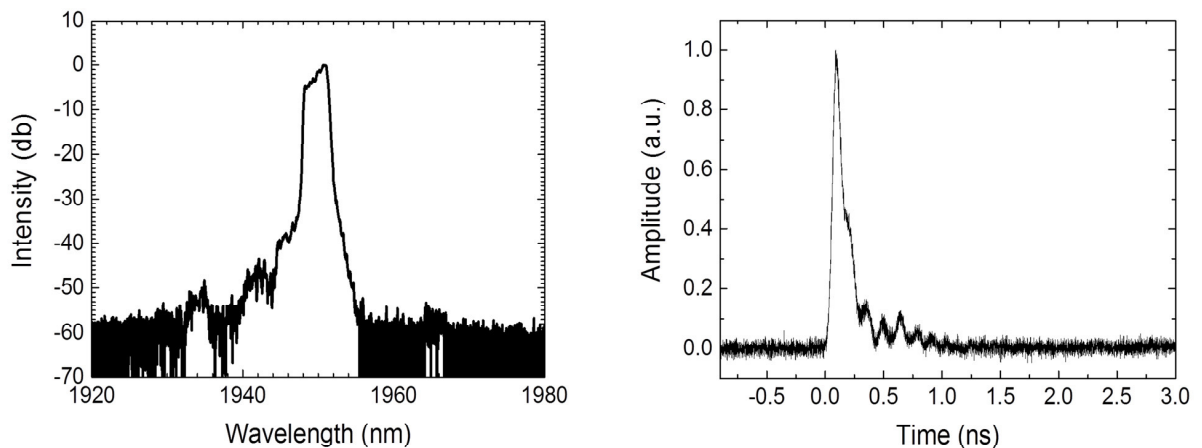

Fig. 4. Spectrum of the ps-pulses after propagating through the pre-amplifier and the noise reduction unit (left) and corresponding temporal pulse profile indicating a FWHM of 110 ps (right).

In summary, a pulsed laser source with an emission wavelength around 1950 nm was developed, which provided a very flexible operation parameter range with respect to the pulse duration and repetition frequency. Such a source

can be used in a manifold of applications like machining of organic material with a high accuracy or as a pump for frequency conversion processes.

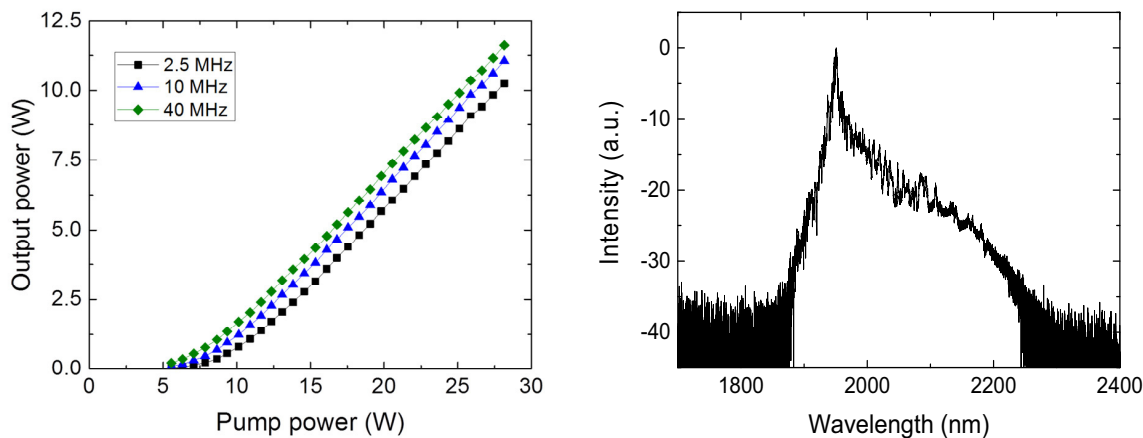

Fig. 5. Average output power versus pump power of the third amplifier stage (left) and output spectrum at a maximum pulse energy of 4 μJ , a pulse duration of 100 ps and 2.5 MHz (right).

2.3 Regenerative amplifiers (RA) for the generation of femtosecond pulses with high energy

In this section, we demonstrate ultrafast RA-systems operating at 1.9 μm and 2.1 μm with output energies of hundreds of μJ by using Tm-doped YAP and Ho-doped YAG crystals, respectively. The setup of the Tm-based amplifier, depicted in Fig. 6, consists of an ultrashort pulse seed oscillator, pulse stretcher and preamplifier, the RA cavity, and a grating compressor. The passively mode-locked fiber oscillator, which is comparable to the one described in [18], emits pulses with an energy of 145 pJ and a duration of 120 fs. A polarization maintaining (PM) passive fiber (100 m of PM1950) is used to stretch the fs-oscillator pulses to 90 ps pulse duration. These negatively stretched pulses are amplified in a following single-stage double-cladding pumped Tm-doped PM-fiber amplifier up to 50 nJ pulse energy. The resulting seed pulses have a central wavelength of 1940 nm, a full width at half maximum (FWHM) of the power spectrum of 21.7 nm and could still be compressed to 250 fs pulse duration. A Pockels cell (PC) consisting of two rubidium titanyl phosphate (RTP) crystals picks the pulses to 1 kHz repetition rate before they are injected into the RA cavity. Furthermore, a telescope is introduced into the seed beam path to ensure a good mode matching between seed beam and resonator mode, resulting in a high seeding efficiency. A thin film polarizer (TFP) and a Faraday rotator (FR) separate the amplified pulses from the seed pulses.

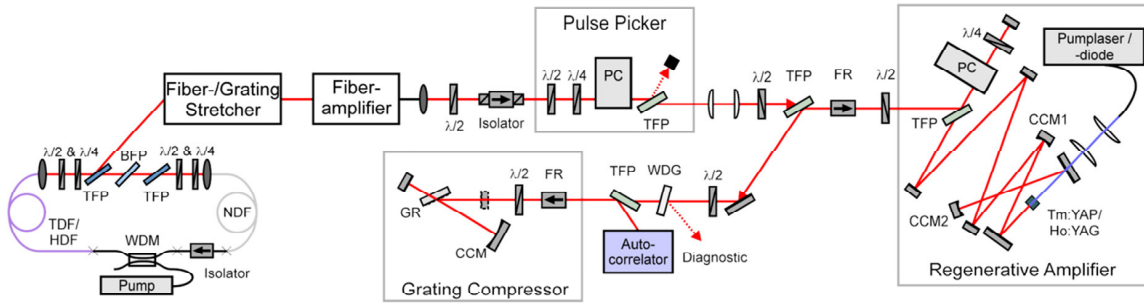

Fig. 6. Experimental setup of the complete amplifier system. PC: Pockels cell, TFP: thin film polarizer, FR: Faraday rotator, CCM1: concave mirror with 600 mm ROC, CCM2: Concave mirror with 300 mm ROC, WDG: Wedge, GR: Grating.

The RA consists of a 2.2 m long, standing wave three mirror cavity with two concave and one plane end mirror. The concave mirrors are placed 35.4 cm (CCM1) and 29.5 cm (CCM2) apart from the crystal. A second RTP PC is used in combination with a TFP and a quarter wave plate (QWP) as an optical switch. The resonator mode diameters are 320 μm inside the laser crystal ($5 \times 5 \text{ mm}^2$ aperture) and 1.7 mm inside the PC, which has an aperture of 3.2 mm. The 4 mm long Tm:YAP crystal is cut for c-axis orientation and has a doping concentration of 4 at. %. It is wrapped in indium foil and placed in a copper mount, which is electrically cooled down to 17°C. The pump diode is a multi-mode fiber-coupled laser diode (LD) with 35 W output power at a central wavelength of 793 nm. The output fiber of the pump diode has a core diameter of 105 μm and a numerical aperture of 0.22. At this pump wavelength, 60 % of the pump light is absorbed inside the crystal. The collimated pump light is focused with a 100 mm lens into the Tm:YAP crystal through one of the dichroic end mirrors, which is located close to the crystal, producing a pump spot diameter of 500 μm . The RA cavity is enclosed to purge the cavity with inert gas (argon, nitrogen etc). After amplification, the pulses are compressed with a Martinez-type compressor [10], which consists of a single gold coated grating (600 grooves per mm, Blaze angle: 34 degree), one concave mirror (ROC = 1000 mm) and two plane mirrors. The compressor efficiency of 50 % is mainly limited by the grating efficiency and the Faraday rotator.

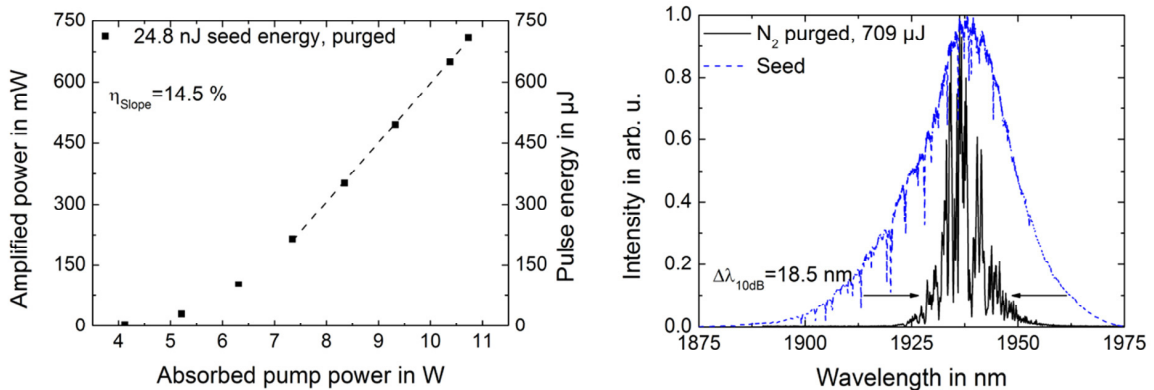

Fig. 7. Output power/pulse energy versus absorbed pump power (left); power spectrum of Tm:YAP RA (right).

The pulse energy versus absorbed pump power at a repetition rate of 1 kHz is shown in Fig. 7. (left). After 34 round trips within the RA cavity, a maximum output energy of 700 μJ has been achieved. The only limiting factor is the damage threshold of the active crystal at a power density of 2.0-2.2 J/cm^2 . Fig. 7. (right) shows the optical spectrum of Tm:YAP at 709 μJ output energy as black curve after regenerative amplification (blue dashed: seed pulses). The spectrum is strongly structured, particularly by atmospheric absorptions at this wavelength which are

partly compensated by purging the RA cavity with nitrogen. Therefore, the spectrum width is 18.5 nm at -10 dB level.

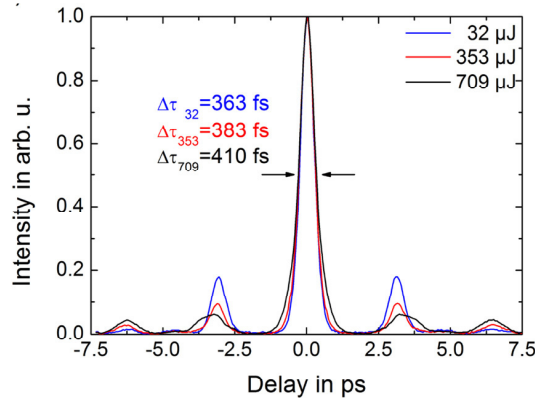

Fig. 8. Autocorrelation trace at different pulse energies of the Tm:YAP regenerative amplifier.

In Fig. 8 the autocorrelation (AC) trace of the compressed output pulses of the Tm:YAP RA is shown. After purging, a long ps-pedestal generated by atmospheric absorptions vanishes nearly completely. The pulses can be compressed to a pulse duration of 410 fs at maximum output power of 709 μJ. A satellite pulse with a relative peak intensity of 6.2 % in a temporal distance of 3.2 ps remains. The generation of the satellite pulse can be attributed at least partly to a technical imperfection of the Pockels cell. Nonetheless, around 76 % of energy is confined in the main peak.

The lay-out of the corresponding Ho-based amplifier is similar to the above described Tm:YAP set-up but with some minor modifications. The Tm-doped fibers of the seed oscillator and pre-amplifier have been replaced by a Holmium-doped fiber resulting in an emission band centered at 2100 nm with a bandwidth of 15.5 nm and in pulse durations of 463 fs directly out of the oscillator. The fiber stretcher is substituted by a bulk grating configuration and the Tm:YAP crystal is exchanged by a Ho:YAG crystal. Additionally, this crystal has been pumped by a cw Tm-fiber laser operating at a wavelength of 1910 nm with an average power of up to 10 W.

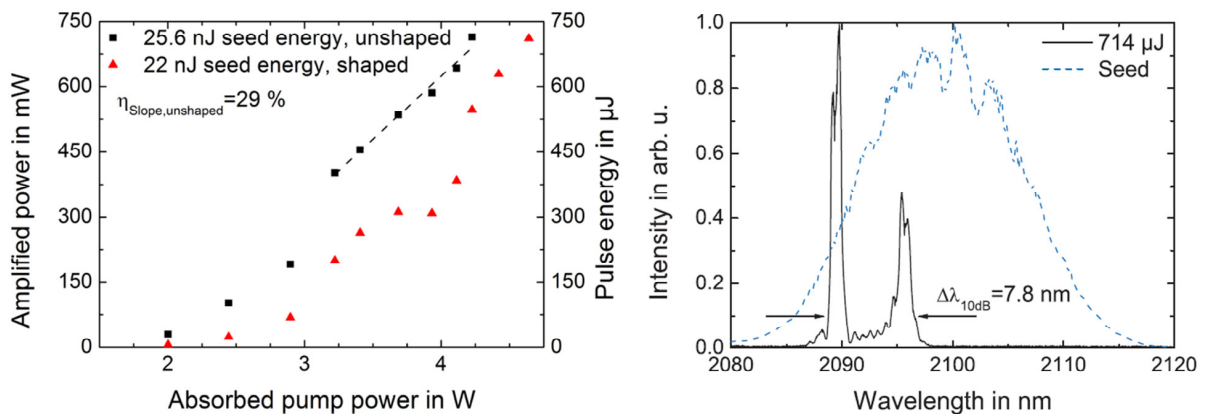

Fig. 9. Output power/pulse energy versus absorbed pump power (left); power spectrum of Ho:YAG RA (right).

The output power/pulse energy versus pump power of the Ho:YAG RA is shown in Fig. 9. (left). After 10 roundtrips and at 4.5 W absorbed pump power a maximum pulse energy of 714 μJ at a repetition rate of 1 kHz was achieved. This energy was again limited by the damage threshold of the crystal which was found at a comparable power density as in the case of Tm:YAP. The pulses were amplified with an efficiency of 29 %.

The emission spectrum of the Ho:YAG RA at an output energy of 711 μJ in combination with the corresponding seed spectrum (blue dashed) is shown in Fig. 9. (right). The amplified spectrum shows a strong deformation of the Gaussian-shaped seed spectrum. Mainly visible in the spectrum are two peaks centered at 2090 nm and 2096 nm with a combined width of 7.8 nm at -10 dB, which are attributed to the emission cross section structure of Ho:YAG. In order to precompensate for the strong spectral evolution into these two peaks, the seed spectrum is hard-cut filtered inside the grating stretcher by the use of two pins. The resulting seed spectrum is shown in Fig. 10 as blue dashed curve with two dips at the main emission peaks of Ho:YAG. Due to the precompensation, the main peaks are suppressed to generate a broader optical spectrum (10.5 nm at -10 dB) around 2093 nm.

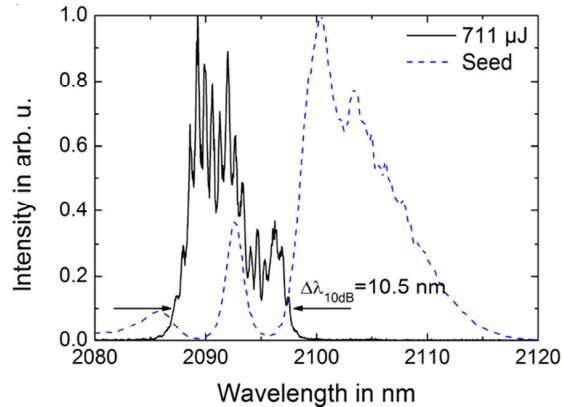

Fig. 10. Power spectrum of Ho:YAG RA recorded with shaped seed spectrum.

The compressed AC trace of the unshaped Ho:YAG pulses is depicted in Fig. 11. (left), whereas Fig. 11. (right) shows the trace of the shaped pulses in which no satellite pulses are visible. The advantage of the aforementioned spectral shaping is clearly visible, because the multi-pulse like structure of the AC trace in the unshaped case vanishes and a smooth AC trace in the shaped case appears with a compressed pulse duration of 1.19 ps at an energy of 711 μJ . Anyway, no satellite pulse nor a broadband ps-pedestal occurs in this wavelength region. The pulse duration is nearly a factor of 3 larger than for Tm:YAP, which results in a 2.34 times lower peak power. Obviously, the narrow gain spectrum of Ho:YAG is responsible for the longer compressed pulse duration of Ho:YAG. On the other hand, no atmospheric absorption take place at 2.1 μm , therefore purging as in the case of Tm:YAP is not necessary.

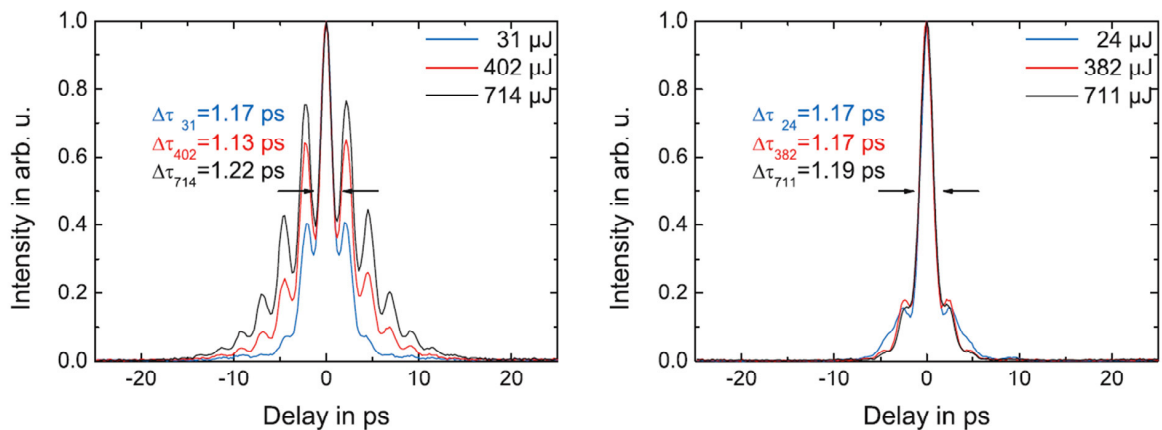

Fig. 11. Autocorrelation traces at different output energies in the unshaped case (left) and in the shaped case (right).

3. Conclusion

In conclusion we presented innovative laser sources operating around a wavelength of 2 μm . In the case of continuous wave lasers, we investigated techniques for incoherent power combination to open power scaling perspectives. Ps- and ns-pulsed sources were realized in a single-pass all-fiber amplifier configuration and investigated. Finally, regenerative amplifiers as candidates for the generation of fs-pulses with a high energy per pulse are investigated. Owing to the variety of output parameters, e.g. average power, pulse duration, energy and repetition rate, a multitude of applications can be addressed by these light sources. Therefore, these laser systems cannot only be applied for the already mentioned purposes, but offer and promise a high impact in future photonics research and applications. This will be in particular still accelerated considering their industrialisation potential.

Acknowledgement

The authors thank Associate Professor Ömer Ilday for collaboration on high power cw laser sources, the manufacturer of the GSLD (PicoQuant) for providing it and the company LISA Laser Products OHG for collaboration on continuous wave and pulsed sources.

This work has been funded by the German Federal Ministry of Education and Research (BMBF) under contract 13N12079 “NEXUS”, 13N12619 “SUMER” and by the Ministry of Economic Affairs and energy (BMWi) under contract 03SX376A “FUTURIA”.

References

- [1] <http://www.lisalaser.de/Lisa/index.php/medical/medical-professionals/anwendungsgebiete.html>
- [2] D. Sanchez, M. Hemmer, M. Baudisch, S. L. Cousin, K. Zawilski, P. Schunemann, V. Smirnov, H. Hoogland, R. Holzwarth, O. Chalus, C. Simon-Boisson, and J. Biegert, “Broadband 7 μm OPCPA pumped by a 2 μm picosecond Ho:YLF CPA system,” in CLEO: 2015, OSA Technical Digest (online) (Optical Society of America, 2015), paper SW4O.5.
- [3] N. Leindecker, A. Marandi, R. L. Byer, K. L. Vodopyanov, J. Jiang, I. Hartl, M. Fermann, and P. G. Schunemann, “Octave-spanning ultrafast OPO with 2.6–6.1 μm instantaneous bandwidth pumped by femtosecond Tm-fiberlaser,” *Opt. Express* 20 (2012).
- [4] K.-H. Hong, C.-J. Lai, J. P. Siqueira, P. Krogen, J. Moses, C.-L. Chang, G. J. Stein, L. E. Zapata, and F. X. Kärtner, “Multi-mJ, kHz, 2.1 μm optical parametric chirped-pulse amplifier and high-flux soft x-ray high-harmonic generation,” *Opt. Lett.* 39 (2014).
- [5] K. Scholle, S. Lamrini, P. Koopmann, and P. Fuhrberg, “2 μm laser sources and their possible applications,” in *Frontiers in Guided Wave Optics and Optoelectronics*, B. Pal, ed. (InTech, 2010).
- [6] S.D. Jackson, T.A. King “High power diode cladding pumped Tm doped silica fibre laser” *Optics Letters*, Volume 23 (1998).
- [7] G. Frith, D.G. Lancaster, S.D. Jackson “85 W Tm doped silica fibre laser” *Electronics Letters*, Volume 41 (2005).
- [8] J.F. Wu, Z. Yao, J. Zong, S.B. Jiang “Highly efficient high power thulium doped germinate glass fibre laser” *Optics Letters*, Volume 32 (2007).
- [9] G.D. Goodno, L.D. Book, J.E. Rothenberg, “Low phase noise single frequency, single mode 608 W thulium fibre amplifier” *Optics Letters*, Volume 34 (2009).
- [10] A. M. Heidt, Z. Li, J. Sahu, P. C. Shardlow, M. Becker, M. Rothhardt, M. Ibsen, R. Phelan, B. Kelly, S. U. Alam, and D. J. Richardson, “100 kW peak power picosecond thulium-doped fiber amplifier system seeded by a gain-switched diode laser at 2 μm ,” *Opt. Lett.* 38 (2013).
- [11] F. Stutzki, C. Gaida, M. Gebhardt, F. Jansen, C. Jauregui, J. Limpert, and A. Tünnermann, “Tm-based fiber-laser system with more than 200 MW peak power,” *Opt. Lett.* 40 (2015).
- [12] M. Gebhardt, C. Gaida, F. Stutzki, S. Hädrich, C. Jauregui, J. Limpert, and A. Tünnermann, “Impact of atmospheric molecular absorption on the temporal and spatial evolution of ultra-short optical pulses,” *Opt. Express* 23 (2015).
- [13] D. Noordegraaf, D. M. Maack, W. M. P. Skovgaard, J. Johansen, F. Becker, S. Belke, M. Blomqvist, J. ; Lægsgaard, “All-fiber 7x1 signal combiner for incoherent laser beam combining,” *Proc. of SPIE Vol. 7914, 79142L-1* (2011).
- [14] Wirth, C., Schmidt, O., Tsybin, I., Schreiber, T., Eberhardt, R., Limpert, J., Tünnermann, A., Ludewigt, K., Gowin, M., Have, E. T. and Jung, M. “High average power spectral beam combining of four fiber amplifiers to 8.2 kW,” *Opt. Lett.* 36 (2011).
- [15] G. Pelegrina-Bonilla, K. Hausmann, H. Tünnermann, P. Wessels, H. Sayinc, U. Morgner, J. Neumann, D. Kracht, „Analysis of the Coupling Mechanism in Asymmetric Fused Fiber Couplers,” *Journal of Lightwave Technology* 13 (2014).

- [16] Theeg, T., Ottenhues, C., Sayinc, H., Neumann, J. and Kracht, D., "158 W Core-pumped single frequency amplifier at kHz linewidth using a standard Ytterbium-doped single mode fiber," *Photonics West 2015*, 9344-6, (2015).
- [17] Lei Li, Bin Zhang, Ke Yin, Linyong Yang, and Jing Hou, "1 mJ nanosecond all-fiber thulium-doped fiber laser at 2.05 μm ," *Opt. Express* 23 (2015).
- [18] A. Wienke, F. Haxsen, D. Wandt, U. Morgner, J. Neumann, and D. Kracht, "Ultrafast, stretched-pulse thulium-doped fiber laser with a fiber-based dispersion management," *Opt. Lett.* 37 (2012).