

Blanket/first wall challenges and required R&D on the pathway to DEMO



Mohamed Abdou*, Neil B. Morley, Sergey Smolentsev, Alice Ying, Siegfried Malang¹, Arthur Rowcliffe¹, Mike Ulrickson¹

University of California Los Angeles, Los Angeles, CA 90095, USA

ARTICLE INFO

Article history:

Received 11 December 2014
Received in revised form 30 June 2015
Accepted 20 July 2015
Available online 2 September 2015

Keywords:

Blanket
First wall
Fusion nuclear technology
Tritium self-sufficiency
MHD
Ceramic breeders
Liquid metals
DCLL
Materials
Fusion nuclear science facility
Heat transfer
Mass transfer
Fusion technology

ABSTRACT

The breeding blanket with integrated first wall (FW) is the key nuclear component for power extraction, tritium fuel sustainability, and radiation shielding in fusion reactors. The ITER device will address plasma burn physics and plasma support technology, but it does not have a breeding blanket. Current activities to develop “roadmaps” for realizing fusion power recognize the blanket/FW as one of the principal remaining challenges. Therefore, a central element of the current planning activities is focused on the question: what are the research and major facilities required to develop the blanket/FW to a level which enables the design, construction and successful operation of a fusion DEMO? The principal challenges in the development of the blanket/FW are: (1) the Fusion Nuclear Environment – a multiple-field environment (neutrons, heat/particle fluxes, magnetic field, etc.) with high magnitudes and steep gradients and transients; (2) Nuclear Heating in a large volume with sharp gradients – the nuclear heating drives most blanket phenomena, but accurate simulation of this nuclear heating can be done only in a DT-plasma based facility; and (3) Complex Configuration with blanket/first wall/divertor inside the vacuum vessel – the consequence is low fault tolerance and long repair/replacement time.

These blanket/FW development challenges result in critical consequences: (a) non-fusion facilities (laboratory experiments) need to be substantial to simulate multiple fields/multiple effects and must be accompanied by extensive modeling; (b) results from non-fusion facilities will be limited and will not fully resolve key technical issues. A DT-plasma based fusion nuclear science facility (FNSF) is required to perform “multiple effects” and “integrated” experiments in the fusion nuclear environment; and (c) the Reliability/Availability/Maintainability/Inspectability (RAMI) of fusion nuclear components is a major challenge and is one of the primary reasons why the blanket/FW will pace fusion development toward a DEMO.

This paper summarizes the top technical issues and elucidates the primary challenges in developing the blanket/first wall and identifies the key R&D needs in non-fusion and fusion facilities on the path to DEMO.

Published by Elsevier B.V. This is an open access article under the CC BY-NC-ND license (<http://creativecommons.org/licenses/by-nc-nd/4.0/>).

Contents

1. Introduction	3
2. DEMO definition and primary world blanket concepts	4
2.1. Definition of DEMO	4
2.2. Brief summary of world blanket concepts	5
2.2.1. Liquid metal blanket concepts	5
2.2.2. Solid breeder blanket concepts	8
2.2.3. Other concepts	9

* Corresponding author.

E-mail address: abdou@fusion.ucla.edu (M. Abdou).

¹ Independent consultants.

3.	Key technical issues	9
3.1.	Tritium self-sufficiency	9
3.2.	MHD thermofluid and fluid materials interactions	11
3.3.	Selective issues of ceramic breeder blanket with neutron multiplier	13
3.3.1.	Thermal-physical properties: effective thermal conductivity and interface conductance of pebble beds	13
3.3.2.	Tritium release, inventory, and control (solid breeder)	15
3.3.3.	Material interactions and thermomechanics	15
3.4.	Reliability/Availability/Maintainability/Inspectability (RAMI)	16
3.5.	Other materials interactions and responses	18
3.5.1.	PbLi corrosion	18
3.5.2.	SiC flow channel inserts	19
3.5.3.	Tritium permeation membranes and tritium barrier materials for PbLi blankets	20
3.5.4.	Fabrication of structural and functional materials	21
4.	Challenges in developing blankets and implications for the R&D pathway	22
4.1.	The fusion nuclear environment	22
4.2.	Volumetric nuclear heating	24
4.3.	Complex configuration with blanket <i>inside</i> the vacuum vessel	26
5.	Science-based framework for R&D	26
6.	R&D in non-fusion facilities	28
6.1.	Basic and separate effects R&D	29
6.1.1.	Tritium extraction R&D in PbLi blankets	29
6.1.2.	Solid breeder thermomechanics R&D	30
6.1.3.	Fabrication R&D for RAFM steels	31
6.2.	Multiple-Effects/Multiple Interactions R&D	31
6.2.1.	Blanket mockup thermomechanical/thermofluid/MHD testing and laboratory facilities	31
6.2.2.	In-pile blanket unit cell experiments	33
6.3.	Partially integrated experiments in H/D phase FNSF and ITER	34
7.	R&D in fusion facilities	34
7.1.	Stages of R&D in fusion facilities	35
7.2.	FNSF mission and major design features and parameters	35
7.3.	FNSF strategy for design and testing of materials and blankets	38
7.3.1.	Base breeding blanket	38
7.3.2.	Base blanket and testing ports	38
7.4.	FNSF operating phases (stages) strategy	39
8.	Concluding remarks	39
	Acknowledgments	40
	References	40

1. Introduction

A fusion power reactor system consists of (1) burning plasma, (2) plasma support system (magnets, plasma heating and current drive, plasma fueling), (3) fusion nuclear core, and (4) balance of plant. The fusion nuclear core, also called the plasma chamber, consists of (a) the blanket with integrated first wall (FW), (b) divertor, (c) elements of plasma heating, fueling, and vacuum pumping ducts penetrating the blanket/FW, (d) radiation shield, and (e) vacuum vessel. The blanket is the key nuclear component that achieves two of the three principal functions of a fusion power system: power extraction at high temperature and tritium breeding to ensure tritium self-sufficiency. The ITER device will address plasma burn physics and plasma support technology, but it does not have a power-reactor relevant blanket (no tritium breeding, low temperature, and non-relevant materials). ITER provides three ports for testing six blanket modules. Although the test blanket modules (TBM) program in ITER is very important it has a very limited scope. Therefore, current activities to develop “roadmaps” for realizing fusion power recognize the blanket/FW as one of the principal remaining challenges.

This paper focuses on the blanket for a Fusion Energy Demonstration Reactor, commonly called DEMO. In particular, the paper is focused on the question: what are the research and major facilities required to develop the blanket/FW to a level which enables the design, construction and successful operation of a fusion DEMO? It should be noted here that the first wall will always be integrated with the blanket in any fusion power system (this is a conclusion of

many studies that we will not repeat here, see for example [1–3]). Therefore, whenever we use the word “blanket,” we mean blanket with integrated first wall. Sometimes we use the term “blanket/FW” at points in the paper to especially reinforce this integrated nature.

Some notes are useful here to help the reader in studying through this long paper and also in consulting related references. The topic of blanket is a key part of the broader topic of Fusion Nuclear Science and Technology (FNST) [3]. FNST is defined as the science, engineering, technology and materials for the fusion nuclear components that generate, control and utilize neutrons, energetic particles & tritium. The primary fusion nuclear components are the “in-vessel” components which represent the “core” of a fusion reactor immediately surrounding the plasma and are inside the vacuum vessel: (1) blanket with integrated first wall, (2) plasma facing components, which include the divertor, and those elements of plasma heating, current drive, and fueling systems which penetrate the blanket/FWFW and are exposed to the plasma, (3) bulk radiation shield, and (4) the vacuum vessel. Other components of FNST which are also affected by the fusion nuclear environment are: (a) Tritium Fuel Cycle, (b) Instrumentation & Control Systems, (c) Remote Maintenance Components, and (d) the primary Heat Transport & Power Conversion Systems. The importance of FNST, particularly the blanket was recognized from the early days of fusion energy research in the early 1970s. Many design studies were carried out in the 1970s in the US and from the 1980s until now in US, EU, Russia, and Japan. More recently in the past several years blanket studies have been carried out in China, S. Korea, and India. Early in the 1980s, it was recognized in the US that the FNST,

particularly the blanket is complex and its development requires detailed investigation. The US carried out a pioneering study called FINESSE² [4–12]. This was a major study which identified and characterized the issues, and the requirements for experiments and non-fusion and fusion facilities for all FNST. The study involved experts from the aerospace and fission industry, experts on technology development, and strong participation by Japan and EU. In addition to FINESSE, the US carried out in the early 1980s the first world DEMO study [13–16], which provided the top-level performance goals of FNST components used in FINESSE for technical planning. The US also carried out in the early 1980s a Blanket Comparison and Selection Study (BCSS) [1,2] which narrowed the design options for blankets based on technical criteria. EU carried out a BCSS-type study [17] in the 1990s. EU, Japan, and Russia also carried out DEMO studies [17–19] in the past 20 years. Europe carried out power plant conceptual studies from 2002 to 2007 [20]. These studies evaluated 5 models for commercial fusion power plants based on 5 different blanket concepts: Water-cooled Lead-Lithium (WCLL), Helium-cooled Pebble Beds (HCPB), Helium-cooled Lead-Lithium (HCLL), Dual-coolant Lead-Lithium (DCLL), and Self-cooled Lead-Lithium with SiC-composite as structural material. The first four are also the candidate blanket concepts for the EU DEMO Plant studies that were initiated in 2014 [21,22].

One of the most important results of FINESSE was identifying the need for a plasma-based facility in which fusion nuclear components can be tested in the fusion nuclear environment. The facility was called Volumetric Neutron Source, VNS, and later called Component Test Facility, CTF, and more recently called Fusion Nuclear Science Facility (FNSF). An important international study was carried out in 1994–1996 under the auspices of IEA to study the FNST issues and needs particularly for FNSF-type facility [3].

Looking at FNST, particularly the blanket, studies of the past 40 years, it is clear that extensive Technical Planning Studies were carried out to identify issues as well as define modeling, experiments and facilities required for blanket R&D. Major R&D Tasks were defined, and far-sighted Roadmaps were identified. The major problem is that funds did not come and the well-thought-out R&D plans of the 1980s and early 1990s were not fully implemented. While the blanket program broadened to other countries (e.g. China, Korea, and India), which is positive, the major blanket programs have been seriously limited in funding, and hence in R&D capabilities. The authors of this paper are concerned that blanket researchers, many are new and young, may think that just continuation of current programs is sufficient to develop blankets for DEMO. Therefore a primary objective of this paper is to illuminate the many extensive and challenging blanket R&D tasks still required on the path to DEMO, with emphasis on the near- to mid-term.

Some important notes about the objectives and scope of this paper are in order. There are two principal objectives of this paper. The first is to explain the major technical challenges in developing the blanket/FW and the second is to define the R&D required on the pathway to DEMO in terms of major technical features and capabilities of models and experimental facilities. In this paper we are not spending much time to explain the technical issues of each blanket concept. Rather, we are focused much more on analysis of the technical challenges created by the complex fusion nuclear environment and the multiple functions of the blanket/FW that make it very difficult to define modeling activities and laboratory facilities to adequately investigate and resolve the blanket/FW issues. In other words, our analysis of the technical challenges helps define the major “drivers” of the R&D. We utilize the results of this analysis

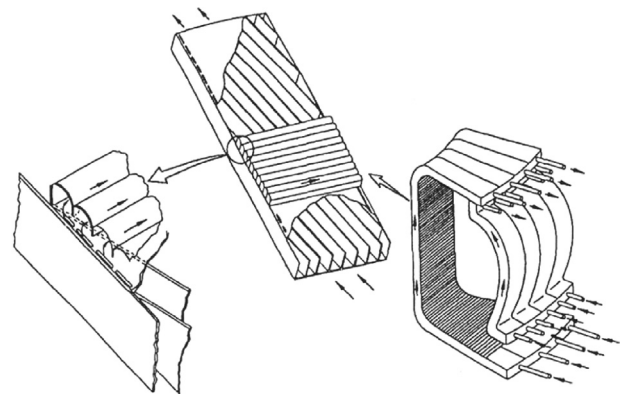

Fig. 1. Self-cooled lithium/vanadium blanket (poloidal/toroidal flow) [2].

to derive important technical requirements on R&D facilities and modeling development. We then define a scientific framework for the development of the blanket/FW that consists of modeling and a sequence of laboratory facilities and plasma-based facility.

This paper does not attempt to cover certain topics. For example: (1) the scope of the paper does not include survey or comparison of blanket concepts or designs. Some designs for the Solid Breeder and Liquid Metal classes of concepts are briefly presented as an aid in identifying and quantifying the technical issues and R&D challenges, (2) the scope of this paper does not include detailing the history of blanket development. Only quick and brief statements were made earlier in this introduction about major national and international activities that had direct impact on planning the R&D for DEMO and are related to the scope of this paper, and (3) the scope of this paper does not include describing previous R&D or ongoing research activities. These can be found in the large volume of literature in scholarly journals and proceedings of numerous international conferences.

Section 2 briefly summarizes the DEMO definition and the current primary world blanket/FW concepts for this device. Section 3 describes the key technical issues of the blanket. The challenges in developing blankets and the implications for the R&D pathway are addressed in Section 4. A Science-Based Framework for fusion nuclear technology R&D is discussed in Section 5 and key R&D needs in non-fusion facilities are described in Section 6. Finally, required R&D in integrated plasma-based fusion facilities are described in Section 7, followed by final concluding remarks in Section 8.

2. DEMO definition and primary world blanket concepts

In this section we briefly define the “DEMO” as commonly understood in the world fusion program. We also highlight the principal features of liquid and solid breeder blanket concepts currently being pursued worldwide.

2.1. Definition of DEMO

World fusion programs have defined the successful construction and operation of a Fusion Demonstration Power Plant (DEMO) as the last step before commercialization of fusion – i.e. DEMO must provide energy producers with the confidence to invest in commercial fusion. It is anticipated that several such fusion demonstration devices will be built around the world. The first world study of fusion DEMO [13–16] investigated the goal of the DEMO and developed a consensus among utilities, industry, and fusion researchers on a set of objectives. A US panel [23] on plans for DEMO further refined these objectives. EU, Japan, Russia and other countries also examined the objectives of DEMO (see for example [17–22,24]). There are variations in Plans of World Fusion Programs as to when

² See also for other FINESSE papers and reports (all can be found on the web site <http://www.fusion.ucla.edu/>).

Table 1
Top level goals for the fusion DEMO.

Demonstrate tritium self-sufficiency and a closed tritium fuel cycle
Demonstrate simultaneous power extraction at high temperature and efficient tritium extraction and control
Demonstrate attractive safety and environmental impact: <ul style="list-style-type: none"> • No evacuation plan required • Only low-level radioactive waste • No disturbance of the public's day-to-day activities • No worker risk or exposure higher than other power plants
Demonstrate acceptable Reliability/Maintainability/Availability/Inspectability (RAMI): <ul style="list-style-type: none"> • Remote maintenance of fusion core with acceptable repair/replacement time • Routine operation with minimum number of unscheduled shutdowns per year • Ultimately achieve an availability >50% and extrapolate to commercially practical levels
Demonstrate potential for economic competitiveness

DEMO will be built and also as to the goals and requirements for the early phase of DEMO operation. But there is agreement that DEMO must ultimately demonstrate the commercial practicality of fusion power. There is also agreement on the top level goals for DEMO summarized in Table 1.

2.2. Brief summary of world blanket concepts

Many blanket concepts have been proposed worldwide over the past 40 years using different combinations of materials and principles of operation. Here we will highlight only the key blanket concepts currently being pursued in the major fusion programs. These can be classified as: (a) liquid metal concepts, (b) ceramic breeder concepts, and (c) other concepts such as molten salts.

2.2.1. Liquid metal blanket concepts

Lithium-containing liquid metals (LMs), are used for breeding materials in blanket applications with pure lithium (Li) and the eutectic lead-lithium alloy (PbLi), as the primary candidates. In “self-cooled” concepts, the same LM is used as both breeder and coolant. In “separately-cooled” concepts, another liquid or gas, e.g. helium or water, is used as the coolant while the LM is slowly circulated only for tritium extraction external to the fusion reactor core. Such LMs can provide sufficient tritium breeding ratio and have high thermal conductivity ($\sim 10^1$ W/mK) and low viscosity ($\sim 10^{-7}$ m²/s) that make them very favorable for heat removal. PbLi is considered by many researchers as a more attractive breeder/coolant option than pure Li due to its lower chemical reactivity with water, air and concrete, but PbLi is more corrosive and has higher density and more undesirable activation products. During recent decades, a handful of LM blanket concepts were proposed and intensively studied worldwide, including self-cooled, separately-cooled and dual-coolant blankets. Each LM blanket concept has its own advantages with regard to its thermal efficiency, design simplicity, cost and safety, and each also has specific feasibility issues. A significant advantage of LM blankets over the solid breeder designs is potentially higher power density and much reduced susceptibility to radiation damage. All LM blanket concepts have, however, feasibility issues associated with magnetohydrodynamic (MHD) interactions between the flowing high electrical conductivity LM ($\sim 10^6$ S/m) and a strong plasma-confining magnetic field. An important MHD issue is the high MHD pressure drop in the blanket module caused by the electric currents induced in the flowing liquid and the associated strong flow-opposing electromagnetic Lorentz force. Historically *self-cooled* blanket concepts were the first to be considered. Self-cooled concepts have potential for simplifying the blanket design significantly. But studies found that the high velocity needed to cool the first wall resulted

in untenable MHD effects such as large pressure drop. The high magnetohydrodynamic (MHD) pressure drop required at high flow rates resulted in pressure stresses exceeding the allowable structural material limits. Electric insulators for the first wall region (e.g. coatings) have not been successfully developed. To solve the MHD problem the *separately-cooled* blankets were proposed, where the LM serves only as a breeder material while all the surface and volumetric heat is removed by a coolant like water or helium (He) gas. The separately-cooled blanket concept suffers from low coolant exit temperature dictated by the maximum allowable temperature of the structural material. Also, the concept still suffers from some MHD effects due to magnetic field transients and the need to circulate the liquid metal for tritium recovery. A combination of both ideas led to proposing the *dual-coolant* blanket concept, where the surface heat flux on the first wall is removed by a He coolant, while the liquid metal is used for “self-cooling” in the breeder zone. Typical examples that illustrate these three LM blanket concepts are briefly described below.

2.2.1.1. Self-cooled liquid metal blankets. One of the examples of the self-cooled class of blankets is the US self-cooled lithium blanket with the vanadium alloy as the structural material [1,2]. Although this concept was ranked highest by the Blanket Comparison and Selection Study (BCSS) in the US [2], its further development was suspended due to low tolerance of insulating coatings to cracks and other insulation defects that are likely to occur and give rise to unacceptably high MHD pressure drop [25,26]. Mainly because of this reason, almost no considerations are given to this concept nowadays. In this design (Fig. 1), a toroidal–poloidal configuration is maintained to minimize the MHD pressure drop and to provide high heat flux removal capabilities at the same time. The design is composed of slightly slanted poloidal manifolds and relatively small toroidal channels. The toroidal channels are exposed to both the surface heat flux and volumetric nuclear heating. The poloidal manifold is protected by the toroidal channels both thermally from the surface heat flux and structurally from radiation damage. A large cross-sectional area is maintained for the poloidal manifold to keep the velocity low to reduce the MHD pressure drop. Although the toroidal flows do not create significant MHD pressure drops, large pressure losses occur when the liquid changes its direction from toroidal to poloidal. As a result, the overall pressure drop may exceed the nominal pressure drop limit of 2 MPa. As a means of reducing the MHD pressure drop, thin insulating coatings were proposed but, as mentioned above, their ability to tolerate small defects in the insulation is still questionable.

There were other self-cooled blankets using PbLi as breeder/coolant and SiC composites as structural materials, for example the TAURO concept in France [27], the Model D in the EUPPCS [20], and the ARIES-AT concept in the US [28]. These concepts have not been further pursued because the successful development of SiC as structural material in the fusion nuclear environment is not likely prior to the first generation of fusion power plants.

2.2.1.2. Separately-cooled liquid-metal blankets. An example of the separately-cooled blanket concept is a helium-cooled lead-lithium (HCLL) blanket. In the EU, the HCLL blanket is considered as a possible design option for applications in fusion power reactors. This concept relies on available structural materials and fabrication techniques. That is why it was chosen as the European reference design for a LM blanket to be tested in ITER [29]. In the HCLL, PbLi serves exclusively as a breeder material while the entire thermal power released in the blanket is removed by a helium cooling system. Therefore, from a thermal point of view, there is no LM flow required for heat transfer. Only a weak flow is needed for a slow (0.1–1 mm/s) circulation of the breeder toward the external

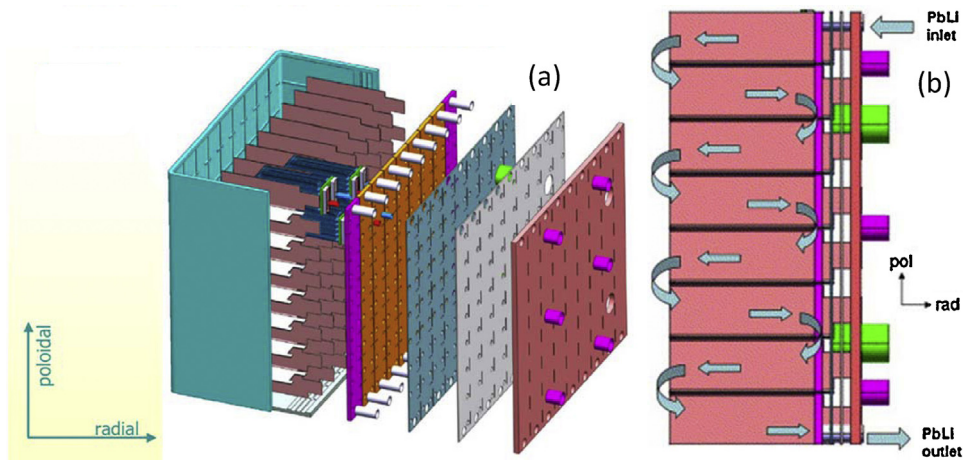

Fig. 2. EU HCLL blanket: (a) general view, (b) PbLi flow path [29].

ancillary system for tritium extraction and LM purification. A sketch of the HCLL blanket is shown in Fig. 2.

The HCLL blanket module is subdivided by a helium cooled stiffening grid into an array of rectangular breeder units (BUs). Each of them is supplied with a number of cooling plates for efficient heat removal. Since the liquid-metal velocity in BUs is very small, the interaction of the electrically conducting PbLi with the plasma-confining magnetic field is weak and MHD pressure drop in BUs is not an issue. However, in a blanket module, as foreseen for ITER and for a DEMO reactor, a number of BUs is combined in columns and fed by a single system of pipes and manifolds. In these components, velocities may reach considerable values, so that MHD effects become important and cannot be ignored any longer [30]. Tritium permeation from PbLi into He flows is a serious safety issue for the HCLL blanket. Thus, it has to be ensured that all BUs have the same PbLi mass flow rates and no stagnant flow regions are formed to avoid high tritium losses into the He streams.

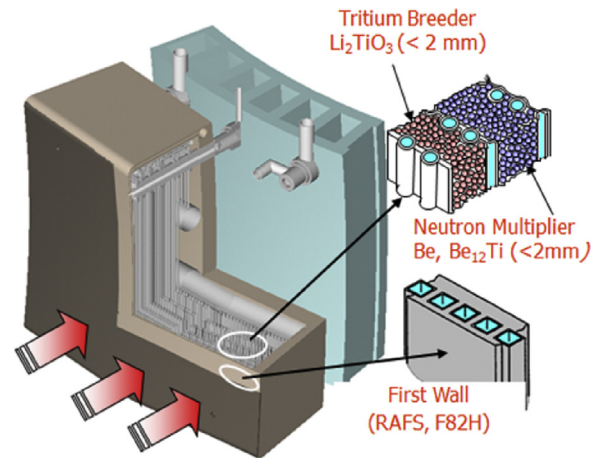

Fig. 4. Water cooled ceramic breeder blanket concept proposed by Japan [38].

2.2.1.3. Dual-coolant lead-lithium blanket. The dual-coolant lead-lithium (DCLL) blanket concept promises a solution toward a high-temperature, high-efficiency blanket while using temperature-limited reduced-activation ferritic-martensitic (RAFMs) steel as structural material [31]. In this concept, a high-temperature PbLi alloy flows slowly (velocity ~ 10 cm/s) in large poloidal rectangular ducts (duct size ~ 20 cm) to remove the volumetric heat and produce tritium, while the pressurized He (typically to 8 MPa) is used to remove the surface heat flux and to cool the ferritic first

wall and other blanket structures to $<550^\circ\text{C}$. A few millimeter thick low-conductivity flow channel insert (FCI) is used for electrical and thermal insulation (Fig. 4). Electrical insulation is needed because of MHD effects even at low liquid metal flow velocity. Thermal insulation is needed to thermally insulate the high-temperature self-cooled PbLi (which operates at $\sim 550\text{--}700^\circ\text{C}$ depending on the variant of the design) and the lower operating temperature of

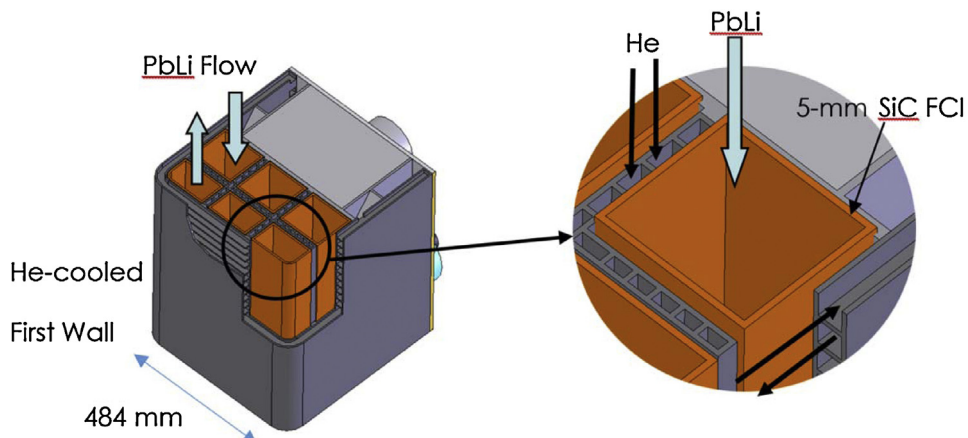

Fig. 3. Sketch of a DCLL blanket design, including a poloidal duct with SiC FCI and He and PbLi flows.

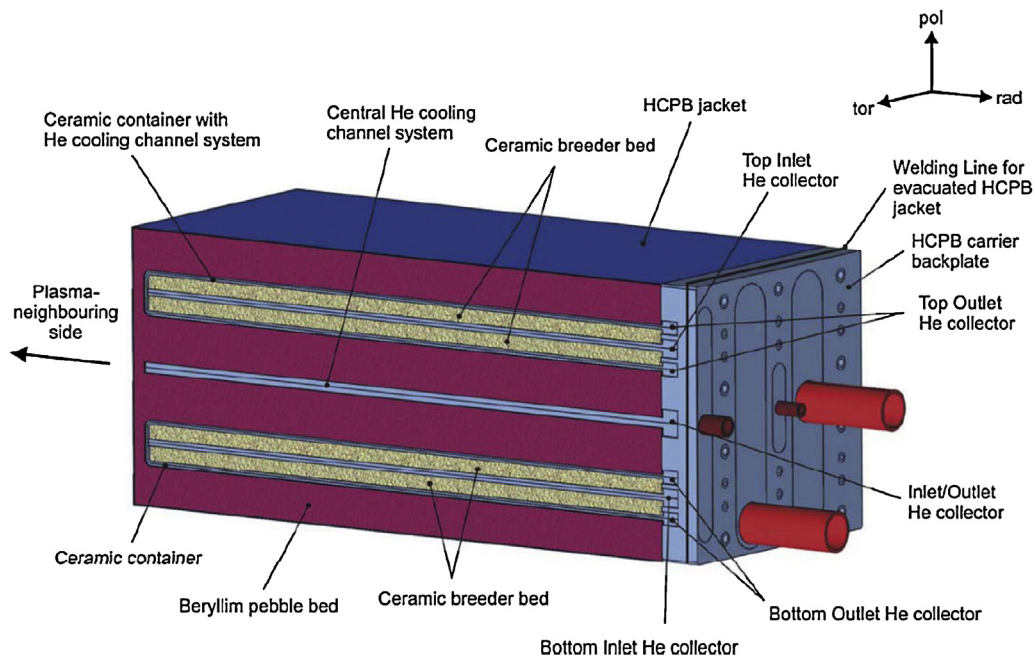
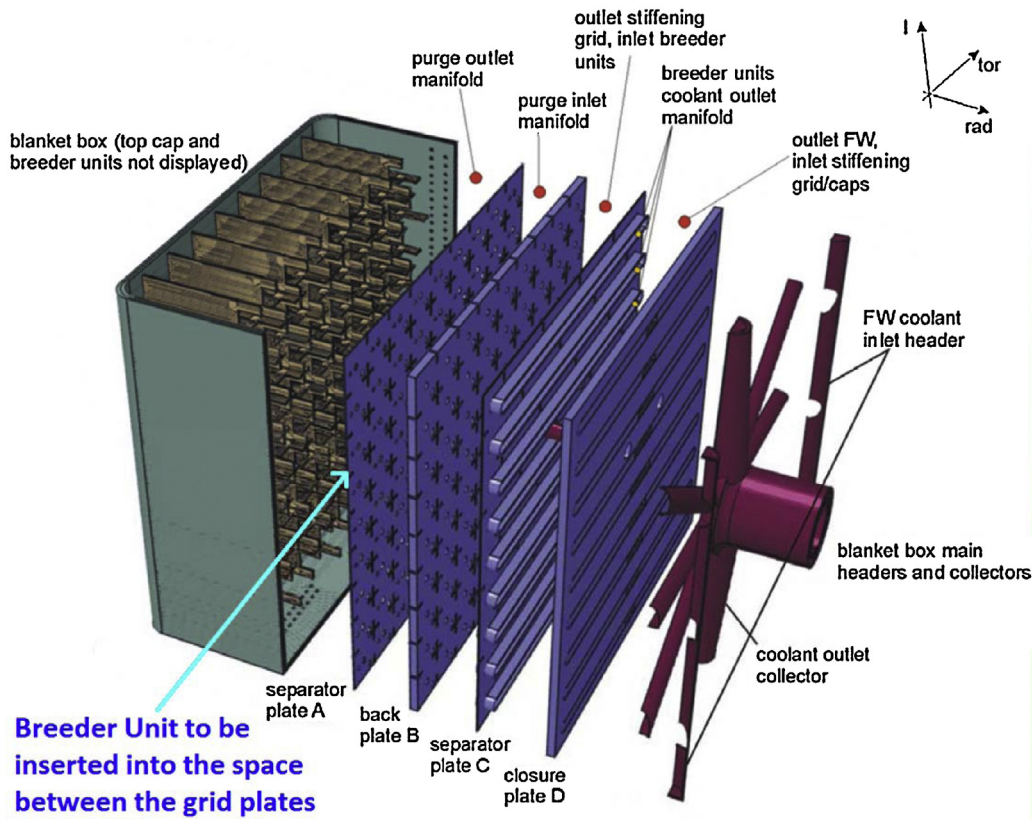

Fig. 5. Helium cooled ceramic breeder pebble bed blanket concept proposed by EU [39].

ferritic steel (which is kept $<550^{\circ}\text{C}$ because of radiation damage considerations).

Several variants of the DCLL blanket have been considered in Europe [32], US [33] and China [34]. Historically, the first DCLL blanket, known as a low-temperature (LT) DCLL blanket [35], relies on qualified materials and existing fabrication technologies that can be used to manufacture a sandwich-type (e.g., ferritic steel-alumina-ferritic steel) FCI as a means for electrical insulation. The

low activation ferritic steel in the sandwich FCI is the same as the structural material and hence its database and confidence in performance is good. The irradiation behavior of Alumina is still being evaluated (Fig. 3).

In the next-step high-temperature (HT) DCLL blanket, the ferritic steel first wall and blanket structure is still kept $<550^{\circ}\text{C}$ by the use of helium cooling, but PbLi operates at much higher temperature. An FCI made of silicon carbide (SiC), either composite or

foam, is proposed as a means for electrical and also thermal insulation to provide acceptable MHD pressure drops and to achieve high PbLi exit temperature of $\sim 700^\circ\text{C}$ (i.e. $\sim 200^\circ\text{C}$ higher than the maximum allowable temperature at the PbLi/RAFM interface and 150°C higher than the maximum allowable first wall temperature) and, ultimately, to provide high thermal efficiency of about 45% (as opposed to about 470°C and 34% in the LT concept). However, relatively low thermal conductivity of ferritic steels may limit the design window with regard to potential increase in neutron wall loading. Utilization of a high-temperature BRAYTON power conversion cycle is proposed to avoid the potential of PbLi-water interaction in the Rankine power conversion system [36]. In practice, utilization of SiC as a functional blanket material requires substantial R&D efforts in both qualification of its thermo-physical/thermo-mechanical responses to neutron irradiation and high temperature, and development of fabrication technologies for manufacturing complex shape FCIs. It also requires detailed studies of fluid materials (PbLi-SiC/RAFM steel) interactions in the presence of a strong (4–12 T) magnetic field and volumetric heating. Such studies are underway in the US and worldwide as described in [37] and also summarized in this article in the subsequent sections.

2.2.2. Solid breeder blanket concepts

A typical solid breeder design consists of a number of breeder units placed in alternating fashion with a beryllium multiplier layer inserted in between with the configuration optimized for a better tritium breeding performance and heat removal. The breeder unit with ceramic breeders in the form of pebbles contained between parallel cooling plates operates at a temperature window based on considerations for enhancing tritium release and avoiding thermal and radiation-induced sintering. Helium is the primary choice as a coolant in most of the world ceramic breeder blankets concepts. Japan proposes using pressurized water or supercritical water for ceramic breeder blankets. The Japanese layered pebble bed type ceramic breeding blanket with water cooling is shown in Fig. 4 [38]. Water-cooled blankets in DEMO fusion reactors have been proposed because of the existing expertise in power generation using water coolants in BWR or PWR. The crucial issues in using water coolant in ceramic breeder blankets are: (a) potential for water-beryllium interaction, (b) temperature of structure becomes too low for ferritic steels that require minimum operating temperature above 350°C to avoid embrittlement, and (c) typical power plant efficiency in PWR is $<35\%$. It should be noted that the primary blanket concepts we address in this paper for both liquid metal and ceramic breeder blankets do not include water cooling. Hence, no detailed analysis of the issues, problems, and merits of water cooling is provided in this paper.

In the layer configuration with the ceramic breeder, cooling plates and beryllium multiplier in parallel to the first wall, there is the flexibility of varying breeder zone thicknesses and compositions in different zones to allow for the exponential decrease in heat generation in the radial direction while maintaining the solid breeder at an acceptable temperature. In the column or edge-on configuration, where both beryllium and breeder beds are placed perpendicular to the FW facing the plasma region, the coolant manifold is located at the back having an advantage of locating the welds away from the high irradiation zone. The HCPB design by EU [39], as shown in Fig. 5, using helium gas as a coolant can be classified as the edge-on configuration. With the aim to reduce the amount of beryllium multiplier in the blankets, neutron reflector materials such as graphite pebbles are being considered, which results in the HCCR (helium-cooled ceramic breeder graphite reflector) concept as proposed by Korea [40]. In all design configurations, the breeding zones are housed behind a reduced activation ferritic steel (RAFS) U-shaped FW, the two remaining sides being closed by cooled cap/side plates, forming a structural box. In the EU's

design, the structural box is further strengthened by radial-toroidal stiffening grid plates welded into the box.

In EU's design, helium coolant passes the major blanket parts in series: the First pass is through the U-shape First Wall/side walls, the Second pass includes 75% of helium to the stiffening grid plates and 25% to the caps running in parallel, and the Third passes are over breeder units cooling plates. The manifolding between these passes is contained within the back wall's three manifolding spaces between back plate and closure plate. In all designs, tritium generated in the ceramic pebble bed is removed by a dedicated low pressure helium purge gas stream connected to the tritium extraction system.

A ceramic breeder blanket as it is proposed for DEMO requires a neutron multiplier such as Beryllium (Be) to ensure sufficient tritium breeding to meet the tritium fuel self-sufficiency goal for fusion reactors. Be has been known to swell under neutron irradiation due to the internal production of helium and tritium. Irradiation induced volumetric swelling can be as high as 16% at an irradiated temperature of 650°C [41], the desired operational temperature to permit tritium release and decrease tritium inventory. Such a significant amount of volume increase can pose threats to the neighboring ceramic breeders by imposing additional external compressive load to the ceramic breeder pebble beds, which might worsen the dimensional stability of ceramic breeder pebbles. Thus, from the point of view of ceramic breeder/Be material system thermomechanics, this high swelling phenomenon is undesired. In contrary, it is desired to operate at higher temperatures in order to reduce tritium inventory. A solution to this issue is the use of intermetallic beryllium such as Be_{12}Ti , which has a higher melting temperature, a lower chemical reactivity with water, a lower swelling as compared to the pure beryllium, and a lower tritium retention [42]. Upon the successful development of plasma-assisted sintered beryllide rod [43] for use in the rotating electrode method for titanium beryllide pebble production, titanium beryllide is a promising potential replacement to pure Be as a neutron multiplier for ceramic breeder blankets for DEMO. It has already been shown in recent irradiation data from HIDOBE-1 and HIDOBE-2 [44] that helium production that at high temperature such as 750°C titanium beryllide has significantly less volumetric swelling of 12% as compared to about 22% of the pure Be at 30% of the DEMO End-of-Life [41].

One possibility to enhance tritium breeding and overcome the low power density capability resulting from the low thermal conductivity of ceramic breeders is to mix the neutron multiplier with the ceramic breeder. This possibility is not feasible with Be, but appears more practical with Be_{12}Ti because of its high operating temperature capabilities and more resistance to oxidation.

The material form of ceramic breeder and beryllium can be either pebble beds as we showed above or can be in block forms. The sintered block form was considered for ceramic breeder and beryllium and adopted in solid breeder blanket designs in the 1970s and 1980s, for example in ANL-DEMO [45], BCSS [1], ITER CDA [46]. Analysis and experiments on block (including cellular) form showed: (1) interface thermal conductance between the block and the structural wall is a serious problem because of potentially large temperature drop across the gap at the interface and difficulties in predictability and control and (2) thermal stress cracking reduces effective thermal conductivity and leads to physical integrity concerns [47]. Therefore, the pebble bed form was later considered as superior to the block form. Ceramic breeder spheres have several advantages for fusion blankets including: (1) simpler assembly of breeder into regions of complex geometry without needing many uniquely shaped parts; (2) uniform, stable pore network for purge-gas transport; and (3) no thermal stress cracking because the thermal gradient across each sphere is small [48]. These advantages have led to adopting pebble bed configurations in recent solid

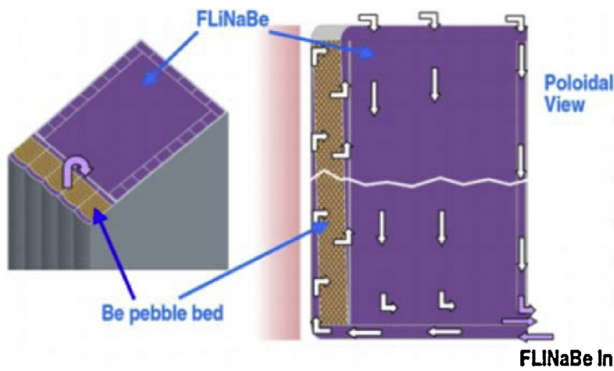

Fig. 6. View of a self-cooled molten salt blanket [51].

breeder blanket designs and developments as seen for example in ITER TBMs [49] and DEMO [50] designs. This paper only addresses R&D issues associated with the pebble bed configurations; however this does not exclude considerations of more advanced block forms of materials if such material development is shown to have merits.

It should be noted that practically all He-cooled blankets suffer from an important issue. The large number of very small coolant channels (typically 4 mm by 4 mm) in the large number of coolant plates causes high pressure drop (impact on net efficiency) and is a challenge for obtaining high reliability.

2.2.3. Other concepts

In the recent past in the US [51] and even currently in other countries, especially Japan [52], there is an interest in the use of lithium containing molten salts as a breeder material and coolant. The main motivation for this is the low electrical conductivity of molten salts when compared to liquid metals, which eliminates MHD pressure drop and flow control concerns, leading to low operating pressures. Typical salts, such as combinations of F-Li-Be and F-Li-Na-Be, also are relatively inert in contact with water and air. The main disadvantages include high viscosity and high melting point and therefore small operating temperature window given the upper limit on current structural steels. Molten salts also have questionable breeding requiring the addition of extra Be, and corrosion concerns during irradiation where highly aggressive free fluorine is liberated. Both self-cooled and dual coolant blanket concepts have been developed, and example of a self-cooled design is shown in Fig. 6.

Another recent blanket concept advanced by India, and being pursued jointly for test blanket development for ITER by India and Russia [53] is the combined use of PbLi as a coolant and solid ceramic breeder. The goals of such a combination are to achieve high breeding without the use of hazardous Be present in most ceramic breeder blanket concepts, and the ability to control online breeding rates by adjusting the Li6 concentration in the flowing PbLi. The disadvantages are that the concept inherits the feasibility issues of both ceramic breeder and liquid metal designs including MHD and tritium control and release issues. The complexity of the system is also increased by the use of both types of breeder. The design of the Indian TBM shown in Fig. 7 is a dual coolant type concept with helium cooling the FW and box structure.

3. Key technical issues

This section highlights the key technical issues for blanket and associated tritium systems. The intention here is not to provide a detailed description of all technical issues. Rather it is intended to highlight only the key feasibility and attractiveness issues that substantially influence the required R&D.

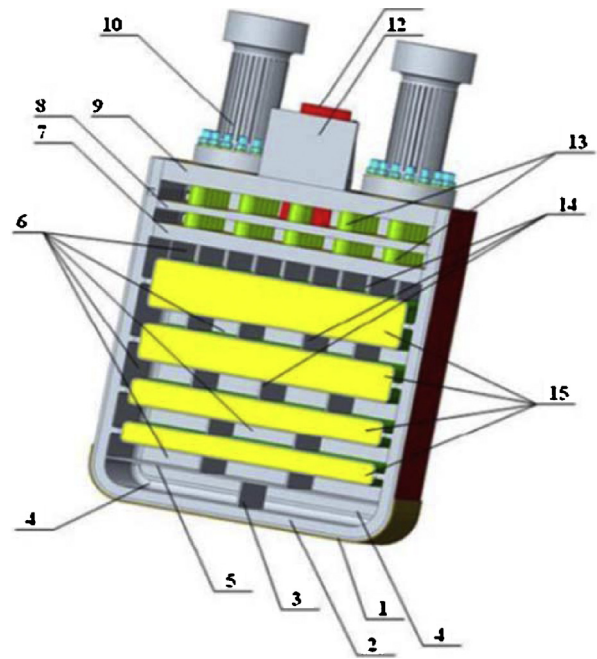

Fig. 7. Indian PbLi ceramic breeder TBM cutaway view. 1. Be-armor; 2. FW; 3. Inter-duct partition of eutectic downward flowing zone; 4. Ducts of eutectic downward flowing zone; 5. Partition of eutectic flowing zones; 6. Ducts of eutectic upward flowing zone; 7. Partition of eutectic upward flowing zone and inlet header of He-coolant; 8. Partition of He-coolant headers; 9. Back plate of TBM casing; 10. Flexible support; 11. Outlet branch-pipe of He-coolant; 12. Shear key; 13. Stiffness ribs of He-coolant headers; 14. Inter-duct partition of eutectic upward flowing zone; 15. Canisters with ceramic breeder [53].

3.1. Tritium self-sufficiency

Tritium is a dominant consideration in the development and operation of D-T fusion plants. It must be generated in sufficient quantities and extracted efficiently to ensure tritium self-sufficiency. Because tritium is a safety and biological hazard, its transport and permeation must be controlled.

The tritium self-sufficiency condition can be stated as:

$$TBR_a > TBR_r$$

where TBR_a is the achievable tritium breeding ratio and TBR_r is the required tritium breeding ratio. Both are complex functions of plasma physics, materials, and technology choices and operating parameters. This critical topic has been addressed in several publications, e.g. [54–57].

The required TBR must exceed unity by a margin to

- (1) Compensate for losses and radioactive decay (5.47% per year) of tritium between production and use.
- (2) Supply tritium inventory for start-up of other reactors (for a specified doubling time).
- (3) Provide a “reserve” storage inventory necessary for continued reactor operation under certain conditions (e.g. a failure in a tritium processing line).

To accurately determine the required TBR, Abdou et al. [54,55,57] developed a dynamic model to calculate time-dependent tritium flow rates and inventories and required TBR. Because tritium decays in a relatively short time (half life is 12.3 years), it is essential to accurately calculate the time-dependent tritium inventories and flow rates throughout the system. Fig. 8 shows a simplified schematic of the tritium fuel cycle. The main subsystems with significant tritium inventories are plasma exhaust and

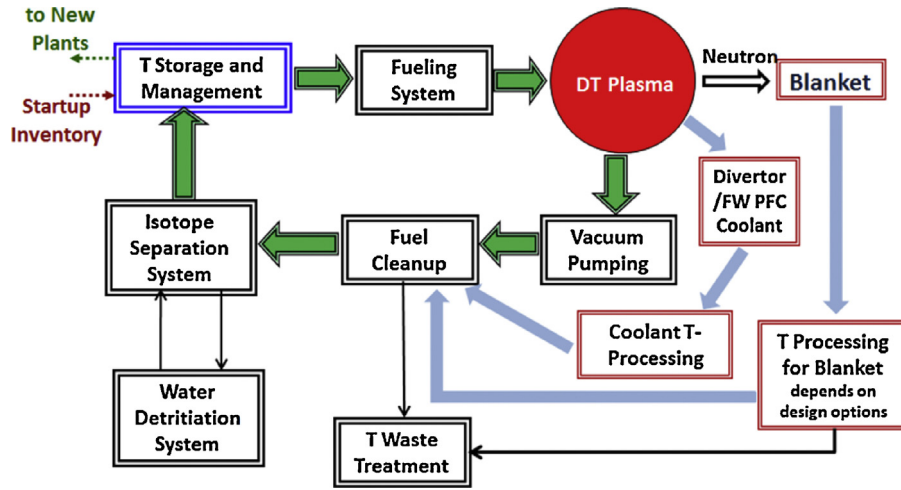

Fig. 8. Simplified schematic of the tritium fuel cycle.

Table 2
Key parameters affecting tritium inventories, and hence, required TBR.

1. Tritium burnup fraction in the plasma (f_b)
2. Fueling efficiency (η_f) fraction of injected fuel that enters the plasma
3. Time(s) required for tritium processing of various tritium-containing streams (e.g. plasma exhaust, tritium-extraction fluids from the blanket), t_p
4. “Reserve Time”, i.e. period of tritium supply kept in “reserve” storage to keep plasma and plant operational in case of any malfunction in a part of any tritium processing system (q is fraction failed)
5. Parameters and conditions that lead to significant “trapped” inventories in reactor components (e.g. in divertor, FW, blanket)
6. Inefficiencies (fraction of T not usefully recoverable) in various tritium processing schemes, ε
7. Doubling time for fusion power plants (time to accumulate surplus tritium inventory sufficient to start another power plant)

vacuum pumping, first wall (FW), blanket, plasma-facing components (PFC), fuel clean-up, isotope separation, fueling, and storage. Prior studies (e.g. [54–57]) have shown that the required TBR depends on many physics and technology parameters of the fusion system. Table 2 shows the key parameters affecting tritium inventories, and hence, the required TBR.

Note that large tritium inventories present two problems: an increase in the required TBR to account for radioactive decay and an increase in the safety risks associated with mobilization and storage. A special issue is the “startup tritium inventory,” also called “initial inventory,” which is the inventory that must be supplied to a fusion plant at the beginning of its operation. The startup inventory is necessary because there is a time lag between tritium production and use and because of the initial build-up of tritium inventories in various components. However, a large “startup inventory” represents a problem since there is no practical external source of tritium, and the cost of producing it in fission reactors or accelerators is prohibitive. Fig. 9 shows that the “startup” (initial) tritium inventory depends strongly on the tritium burnup fraction in the plasma, tritium fueling efficiency, and tritium processing time, t_p , in the plasma exhaust system (time to go through the vacuum pumping, impurity separation, Isotope Separation System (ISS), fuel fabrication and injection). Low burnup fraction, low fueling efficiency, and long t_p result in unacceptably large tritium inventory.

Fig. 10 shows the required TBR as a function of the product of the burnup fraction and fueling efficiency. The results are shown for various values of the tritium processing times. For burnup fraction \times fueling efficiency of $>3\%$ and processing time of 6 h, the required TBR is ~ 1.04 . But for burnup fraction \times fueling efficiency significantly $<1\%$, the required TBR increases rapidly for

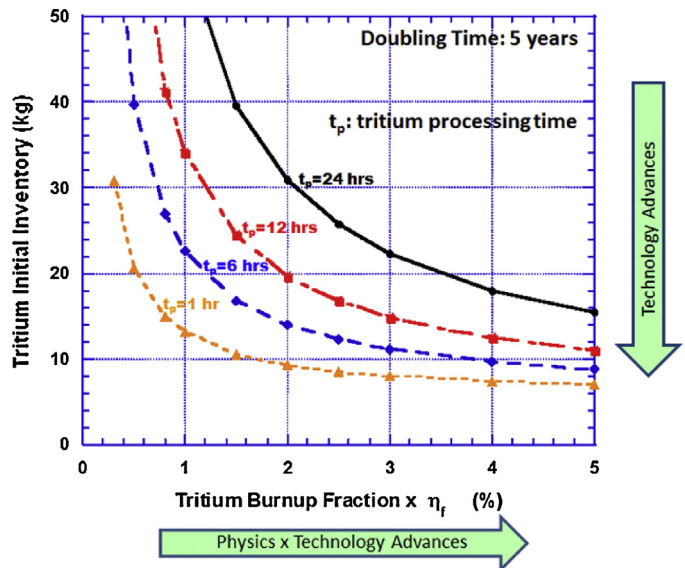

Fig. 9. Variation of startup (initial) tritium inventory with the product of tritium burnup fraction and fueling efficiency, for various values of the tritium processing times. Results are shown for doubling time of 5 years and the following reference values: fusion power = 3000 MW, reserve time for outage times the fraction of tritium plant failing = 0.25 day, inefficiency, $\varepsilon = 0.01\%$, blanket mean residence time = 10 days.

lower burnup fraction and depends strongly on the processing time and increases from 1.05 for burnup fraction \times fueling efficiency of $\sim 1\%$ and fast processing time of 1 h to values >1.2 for burnup fraction \times fueling efficiency of $<0.3\%$ and processing time >6 h. Note that these numbers were derived for continuous operation of the power plant. If the plant availability factor is low and/or the plasma is highly pulsed with short pulse length, the required TBR will increase because of radioactive decay of tritium during the plant and plasma downtimes.

It is informative to briefly state the current state-of-the-art of these key parameters. The most difficult and most uncertain parameter to assess is the burnup fraction [57,58]. This parameter relates to the probability that a tritium atom injected into the plasma will undergo a D-T fusion reaction before it escapes from the plasma. Reactor studies in the past assumed very extensive recycling from the plasma edge, which leads to relatively high burnup fraction. But recent results show the ineffectiveness of gas fueling [59] and cast doubt on the validity of high edge recycling. In this case, the

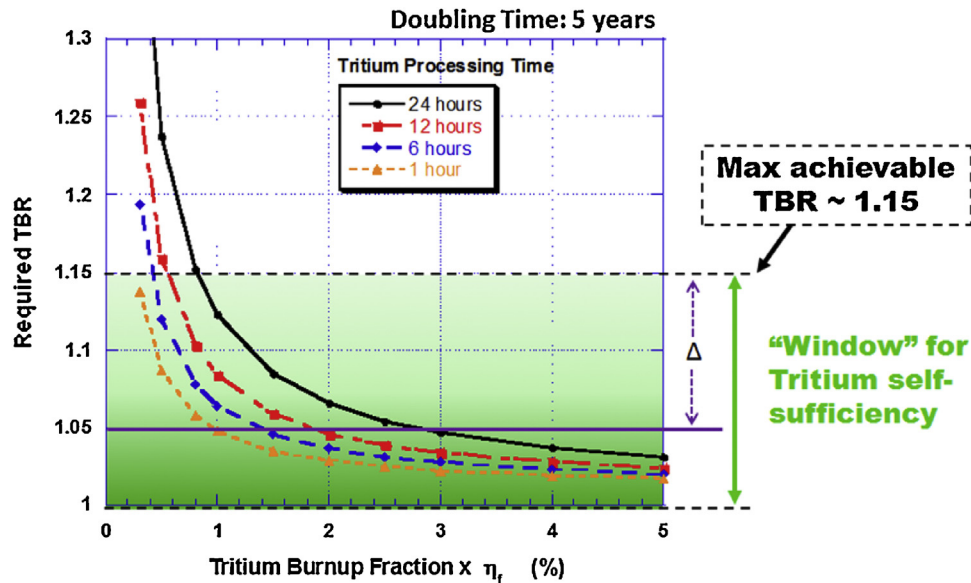

Fig. 10. Variation of required TBR with the product of the tritium burnup fraction and fueling efficiency, as well as the tritium processing time in the plasma exhaust. Reference parameters are the same as those for Fig. 9. Δ is the “uncertainty” in predicting the maximum achievable TBR.

burnup fraction is very low and is predicted for ITER conditions to be in the range of 0.3–0.5% [58]. Results on fueling studies in current plasma experiments show [59,60] that the fueling efficiency is $\sim 5\%$ for gas puffing, 50% for pellet fueling on the low magnetic field side, and 90% for pellet fueling on the high-magnetic field side. The tritium processing time, t_p , in the plasma exhaust system is a function of the technology of the tritium processing system. In 1986, the Tritium Test Assembly (TSTA) [61] demonstrated a processing time of 24 h. However, ITER is advancing the technology of tritium processing [62] and is aiming to reduce the processing time to as short as one hour.

To determine the “window” for achieving tritium self-sufficiency requires addressing the question of the achievable TBR, i.e. the actual TBR that can be produced in a practical blanket system. The achievable TBR is obviously a function of material and design choices for the blanket and FW. But the achievable TBR also depends on other plasma chamber components, e.g. divertor, and on the physics requirements and operating conditions such as the presence of stabilizing shells and conducting coils for plasma control and attaining advanced plasma physics modes and the size and materials used in plasma fueling, heating, current drive and plasma exhaust components that share space with the blanket/FW. The achievable TBR also depends on the confinement scheme, primarily due to the impact on breeding blanket coverage and possible limitation on blanket thickness. For example, in a small aspect ratio tokamak such as the Spherical Torus there is practically no or little space on the inboard region to add a thick blanket for breeding and the TBR is smaller than that obtainable in tokamaks with standard aspect ratio of ~ 3 . Calculation of the achievable TBR must be based on a detailed 3D model that accounts for all materials, configurations, and heterogeneity details in the most complete engineering description of the blanket.

There are uncertainties in calculating the achievable details. These uncertainties are due to: (1) uncertainties in system definition (e.g. precise thickness of first wall to handle all steady state and transient heat loads from plasma particles and radiation), (2) uncertainties in modeling (e.g. modeling all heterogeneity and geometric details of the materials and configuration), and (3) uncertainties in nuclear data and codes.

Abdou et al. [54] investigated the sources of these uncertainties and methods to quantify them, and also proposed a sophisticated

“statistical” approach to estimate the range of “total uncertainties” in calculating the achievable TBR when all the effects of different uncertainties are combined. Reference [56] quantified the different uncertainties in more recent designs, codes, and data and estimated the achievable TBR. Based on this prior work, the best estimate of the achievable TBR for the most detailed blanket system designs available is 1.15. There is uncertainty of $\sim 10\%$ between integral experiments and calculations [56,63] that cannot be resolved until we build and operate a practical blanket system.

In Fig. 10, the achievable TBR line of 1.15 is shown. Also shown is the line of 1.05 to account for an uncertainty, Δ , of $\sim 10\%$ as illustrated in the figure. The window for tritium self-sufficiency is the region colored “green” in which the required TBR is less than the achievable TBR. From a statistical uncertainty analysis viewpoint, the probability of achieving tritium self-sufficiency is higher for lower values of required TBR.

The importance of the above analysis is to drive recommendations for physics and technology R&D. Example of key goals for R&D should be to achieve: T burnup fraction (f_b) \times fueling efficiency (η_f) $\gtrsim 5\%$ (not less than 2%) and T processing time (in plasma exhaust/fueling cycle) < 6 h.

3.2. MHD thermofluid and fluid materials interactions

In spite of their attractiveness, liquid-metal blankets have several feasibility issues associated with the nature of lithium-containing liquids. The key issues are related to:

- high chemical reactivity;
- strong interaction of the flowing breeder/coolant with the plasma-confining magnetic field resulting in magnetohydrodynamic (MHD) effects;
- tritium transport, including tritium permeation, extraction and control;
- corrosion, transport of activated corrosion products and their deposition in the cold section of the liquid breeder loop.

All these processes are in fact interrelated, primarily due to a strong impact of the magnetic field on the velocity distribution in the flowing liquid.

The MHD effects appear when an electrically conducting fluid moves through the strong magnetic field used to confine the plasma [64]. Such a flow induces an electromagnetic Lorentz force that dominates over inertial and viscous forces by 4–5 orders of magnitude and creates strong drag resulting in MHD pressure drop in all blanket flows, including poloidal, radial and toroidal ducts, manifolds, turns, expansions, contractions, etc. The MHD effects affecting flow distribution and stability as well as the coupled heat and mass transfer have a profound impact on the blanket performance, operation and safety, which can be either positive or negative depending on the specific issue. In fact, MHD and heat/mass transfer considerations (hereinafter called “MHD thermofluid and fluid materials interaction”) are primary drivers of any liquid-metal (LM) blanket design. A better understanding and prediction of MHD and other coupled effects during normal blanket operation and off-normal conditions is necessary to resolve the critical issues and improve the performance of LM blanket systems.

For last decades, LM blankets were designed using simplified models based on limited experimental data, starting from a slug-flow approximation, followed by a more advanced “core flow” approach [65]. The associated R&D studies were mostly focusing on prediction of the MHD pressure drop in typical blanket configurations. Among common concerns of LM blankets, reduction of MHD pressure drop still remains one of the most important issues, stimulating new ideas and efforts on decoupling the electrically conducting wall from the fluid. However, there are many important considerations beyond the MHD pressure drop predictions that have not been uncovered yet. Therefore current studies [30] are focusing more on the detailed structure of MHD flows, including various 3D and unsteady effects associated with buoyancy-driven convection, flow instability, and MHD turbulence (Fig. 11). These complex MHD processes can affect transport properties of MHD flows in a drastic way and have a profound impact on blanket performance. In spite of significant success in advancing our knowledge of blanket flows over the last two decades, the MHD thermofluid and fluid materials interaction phenomena in blanket-relevant conditions are not fully understood yet. For example, mass transport in liquid-metal blankets (e.g. in DCLL or HCLL

blankets), including tritium permeation into helium streams and corrosion/deposition processes, is closely coupled with MHD flows and heat transfer, requiring much better knowledge of MHD flows compared to relatively simple pressure drop predictions.

The MHD flows of conducting fluids under blanket conditions, particularly the velocity field and the induced electric current distribution, are rigorously described with the set of Navier–Stokes and Maxwell equations. However, in order to address transport processes in the flowing breeder/coolant, such as tritium transport/permeation and corrosion/redeposition, the MHD equations need to be coupled to the equations for heat and mass transport that describe temperature and concentration fields. The governing MHD equations are often written in the *inductionless approximation*, i.e. the magnetic field is considered as given, without being affected by the fluid flow (see, e.g., [64] for details). In particular, the momentum equation takes the following form

$$\rho \left[\frac{\partial \mathbf{v}}{\partial t} + (\mathbf{v} \cdot \nabla) \mathbf{v} \right] = -\nabla p + \rho \nu \nabla^2 \mathbf{v} + \mathbf{j} \times \mathbf{B} + \mathbf{f}. \quad (1)$$

Here, \mathbf{v} , \mathbf{B} , \mathbf{j} , p , and t are the fluid velocity, applied magnetic field, electric current density, pressure, and time, whereas ρ denotes the density, ν the kinematic viscosity, and σ the electrical conductivity of the liquid metal. Frequently, variables in Eq. (1) are expressed in dimensionless form by using characteristic scales: U_0 for velocity, B_0 for magnetic field, and L as a length scale. In such a formulation, the balance of momentum is fully characterized by two dimensionless groups. One is the Hartmann number $Ha = LB_0 \sqrt{\sigma/\nu\rho}$, the square of which represents the ratio of electromagnetic to viscous forces. The other is the hydrodynamic Reynolds number $Re = (U_0 L)/\nu$, which measures the ratio of inertial to viscous forces. Their combinations, such as the *interaction parameter* or *Stuart number* $N = Ha^2/Re$ and the parameter $R = Re/Ha$ are also used in various studies to characterize inertial effects, including the onset of MHD instabilities, turbulence, and the impact of inertia on MHD pressure drop. The term \mathbf{f} on the right-hand side of the momentum equation denotes a volumetric force different from the electromagnetic one, which typically represents the gravitational force. For applications in fusion with variations of the fluid density due to strong temperature gradients, \mathbf{f} stands for the buoyant force. The contribution of buoyancy with respect to viscous forces is described by the *Grashof number* $Gr = g\beta\Delta T L^3/\nu^2$, where β is the volumetric thermal expansion coefficient, g is acceleration of gravity, and ΔT is a characteristic temperature difference in the fluid.

Table 3 summarizes characteristic values of these dimensionless parameters for the DCLL, HCLL and self-cooled blankets. In the calculations of these parameters, the magnetic field B_0 in the inboard region is 10 T and that at the outboard is 4 T. The other parameters are the following. The average neutron wall load (NWL) for DCLL DEMO is 2.13 MW/m² and 0.78 MW/m² for ITER TBM. Characteristic duct dimensions L , a half of the toroidal duct width, is 0.1 m for DCLL (ITER TBM, DEMO OB, DEMO IB) and 0.07 m for HCLL (ITER TBM). Flow velocities in a blanket duct are: 4 cm/s for DCLL (ITER TBM), 7 cm/s for DCLL (DEMO OB), 15 cm/s for DCLL (DEMO IB) and 1 mm/s for HCLL (ITER TBM). For the Li/V self-cooled blanket we use $B_0 = 10$ T, $U_0 = 0.5$ m/s and $L = 0.05$ m, heat load typical to a generic DEMO reactor (average neutron wall load 2 MW/m²), and physical properties of lithium at 450 °C.

Usually, the main goal of MHD thermofluid studies is to reproduce, via modeling or experiments, field characteristics of the flowing breeder/coolant (velocity, pressure, electric potential, temperature, tritium concentration and concentration of corrosion products) and then to use obtained data to construct dimensionless correlations as suggested by the similarity theory: $P = f(Ha, Re, N, R, Gr, \dots)$. Here, P is a dimensionless integral characteristics of a specific blanket component, for example, pressure

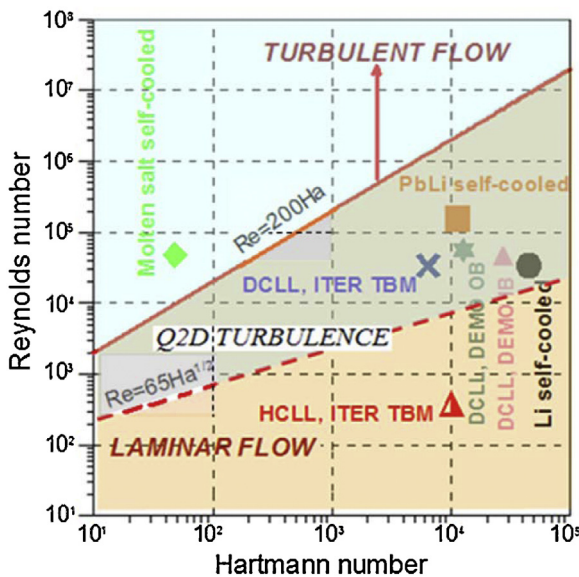

Fig. 11. Hartmann–Reynolds number diagram can be used to predict flow regimes in liquid-breeder blankets. In the lower, middle and upper areas on the diagram, blanket flows are expected to be laminar, Q2D turbulent and 3D turbulent, correspondingly. Shown in the figure are the values for including HCLL (ITER TBM), DCLL (ITER TBM and DEMO), Li/V self-cooled, PbLi self-cooled and molten salt self-cooled blankets [66].

Table 3

Characteristic values of the dimensionless MHD flow parameters for LM blanket concepts under different conditions.

	DCLL	DCLL	DCLL	HCLL	Li/V Self-cooled
Machine	ITER TBM	DEMO	DEMO	ITER TBM	DEMO
Location	Outboard	Outboard	Inboard	Outboard	Inboard
B_0 , T	4	4	10	4	10
L , m	0.1	0.1	0.1	0.07	0.05
U_0 , m/s	0.04	0.07	0.15	0.001	0.5
NWL, MW/m ² (average)	0.78	2.13	1.33	0.78	2.0
Ha	6.5×10^3	1.2×10^4	3.0×10^4	1.1×10^4	4.5×10^4
Re	3.0×10^4	6.0×10^4	1.2×10^5	670	3.2×10^4
N	1.4×10^3	2.4×10^3	7.5×10^3	1.8×10^5	6.0×10^4
R	4.6	5.0	4.0	0.06	0.7
Gr	7.0×10^9	2.0×10^{12}	1.6×10^{12}	1.0×10^9	6.0×10^8
Reference	[67]	[67]	[68]	[29]	–

drop coefficient λ , Nusselt number Nu (dimensionless heat transfer coefficient) or Sherwood number Sh (dimensionless mass transfer coefficient). In the same way, scaling laws can be constructed to predict important transitions in MHD flows, such as laminar-turbulent transitions [69] or transitions from 3D to quasi-two-dimensional (Q2D) MHD flows. A review of MHD studies for liquid-metal blankets performed in the US and worldwide in the recent past and a complete reference list can be found in [30]. As examples of more current studies we can refer to experimental investigations of MHD pressure drop reduction in PbLi flows using MaPLE facility at University of California, Los Angeles [70] as well as theoretical studies of MHD instabilities and Q2D turbulence [71], mixed-convection flows [72], tritium transport [73] and MHD flow induced corrosion in the RAFM-PbLi system [74]. Fig. 12 illustrates key physical phenomena in a DCLL blanket [30].

Due to their importance for blanket applications, MHD thermofluid and fluid materials interaction is an active research area which offers many challenges to researchers. The R&D performed worldwide includes modeling and experimental studies using new computational MHD codes, such as HIMAG (US) [75], MTC (China) [76], or modified commercial and open-source codes such as MHD Fluent (India) [77], OpenFoam (EU) [78,79], and MHD CFX (Korea) [80]. Application of these codes to blanket problems is still limited to relatively low flow parameters or/and single effects. Further efforts are required to extend computations to multiple effects (e.g. coupling between MHD and heat & mass transfer) at higher values of the flow parameters: $Ha, Re \sim 10^4, Gr \sim 10^{12}$. Experimental studies are also progressing using either “surrogate” room-temperature (NaK, InGaSn, Hg) or “real” hot-temperature liquid metals (PbLi). There are a few MHD facilities in the world that utilize PbLi as a work fluid: in the US [70], Latvia [81], Japan [82], China [83] and Korea [84]. Some of them address problems specific to lead-lithium blankets, including corrosion of RAFM steels in the flowing PbLi and interfacial phenomena between PbLi and silicon carbide. Similar to modeling, present experimental capabilities need to be extended to achieve higher magnetic fields (up to 4–8 T) to reproduce outboard blanket and approach inboard blanket fields, and a larger work space, and to simulate somehow volumetric heating. There is no partially-integrated blanket facility of this type in the world. Bringing together these conditions especially for DCLL blanket systems is an essential step to understand blanket thermofluid behavior prior to fully integrated testing.

3.3. Selective issues of ceramic breeder blanket with neutron multiplier

Solid breeder blankets, using lithium ceramic as a breeder, are one of the main candidate concepts for fusion reactors, and a considerable part of the worldwide R&D efforts have been dedicated to this type of blanket. The ceramic breeder material is as important as the structure material, and directly involves energy and tritium

transport, both of which are critical to the functions of the blanket. Presently, the lithium ceramics of interest are lithium orthosilicate Li_4SiO_4 and lithium metatitanate Li_2TiO_3 . The use of lithium ceramics in the form of pebble beds has been considered in many blanket designs. The main issues associated with ceramic breeder blankets discussed here are:

1. Thermal-Physical Properties of Pebble Beds: Effective Thermal Conductivity and Interface conductance.
2. Tritium Release, Inventory, and Control.
3. Material Interaction and Thermomechanics.
4. Impact of high fluence irradiation on the behavior of pebble beds (e.g. irradiation-induced cracking or sintering of ceramic breeder and beryllium multiplier pebbles).

Note that an extensive overview on ceramic breeder materials was recently given in [85].

Maintaining the breeder temperature within its design window is crucial for adequate tritium release. Proper temperature analysis requires careful characterization of thermal properties of the pebble beds. In order to study the heat transfer in the blanket, the effective thermal conductivity and other thermomechanical properties of the lithium ceramics pebble beds and the thermal conductance of its interface with the structure have to be well characterized. Further, the temperature gradient and radiation effects in the breeder section can cause differential stresses which may lead to cracking/sintering of breeder pebbles, which impact thermal and tritium release performances. The tritium release characteristics also depend on the state of the interconnected pores and the size of the grain of the breeder material. A database, modeling, and R&D of these affected properties are required for the blanket design and performance prediction. In addition, solid breeder fusion blankets generally use beryllium-helium pebble beds for neutron multiplication to ensure sufficient tritium breeding. Thus, the prediction of the thermal and tritium behavior in ceramic breeder blankets also requires understanding of thermal-physical-mechanical properties, tritium transport, and retention in the beryllium material within the fusion environment.

3.3.1. Thermal-physical properties: effective thermal conductivity and interface conductance of pebble beds

The effective thermal conductivity of a pebble bed is mainly determined by its packing characteristics, packing density and solid and gas thermal conductivity (as a function of temperature). The contact pressure between the pebbles and plates also has important impact. Thermal conductivity of a solid material such as ceramic depends on its internal porosity. The existence of the containing wall leads to a lower packing density near the wall region and thus a reduced heat conduction due to low thermal conductivity of gas. A general practice in characterizing thermal properties for a packed pebble bed is to use an effective thermal conductivity for

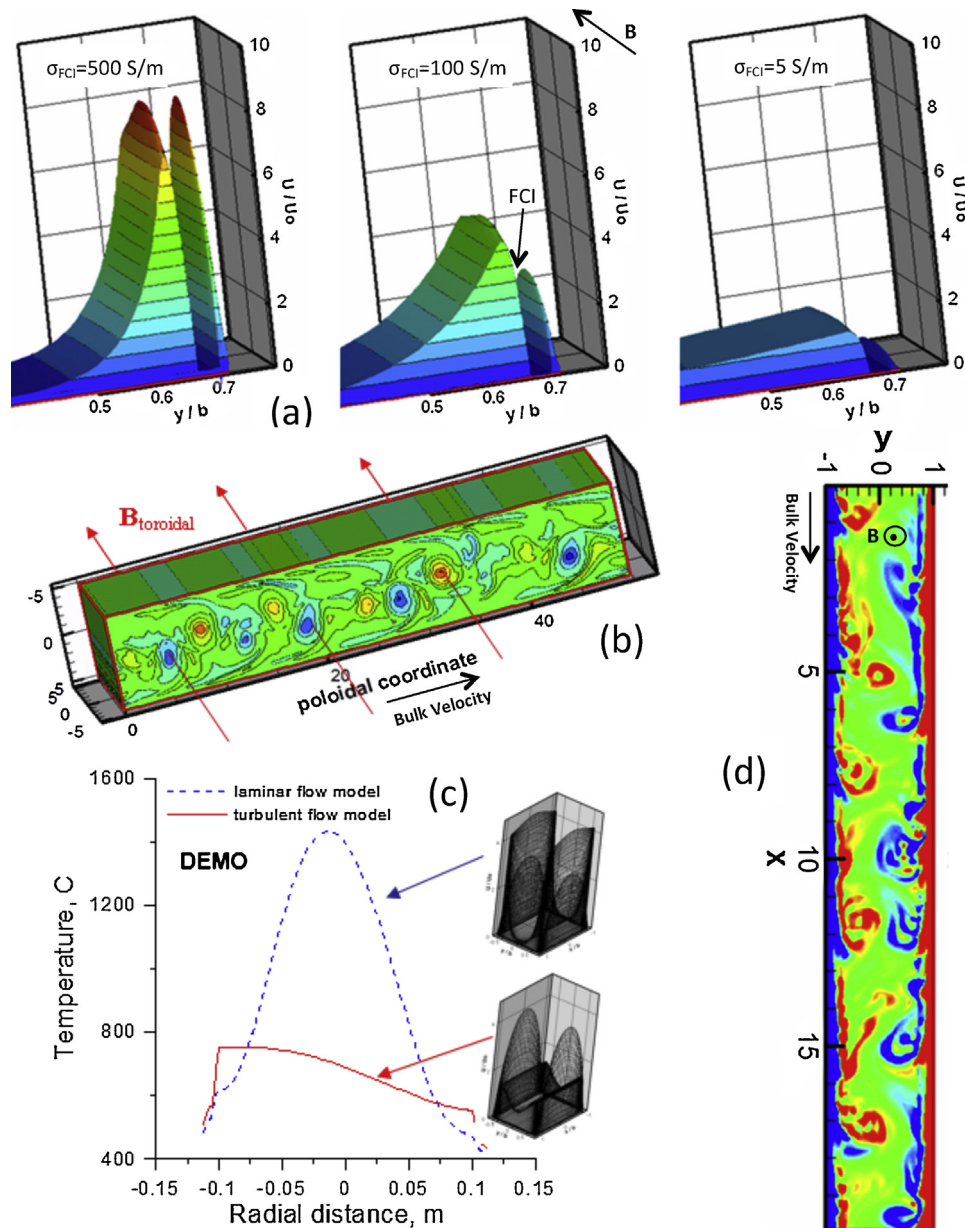

Fig. 12. Key physical phenomena in poloidal flows of DCLL blanket based on recent computational studies [30]: (a) FCI electrical conductivity dependence of high-velocity PbLi jet formation near the FCI and in gap region between the FCI and RAFM wall parallel to the magnetic field (b) vorticity structures of quasi-two-dimensional turbulence aligned with the toroidal magnetic field in a poloidally flowing DCLL channel, (c) effect of laminar or turbulent flow regime on the temperature distribution in a DCLL front channel, (d) vorticity resulting from instability and transition to MHD turbulence of an MHD M-shaped velocity profile inside an electrically insulated FCI/wall.

the bulk region and attribute the wall effect on thermal transport to an interface conductance. The low purge gas velocity and the wall-channeling effect have not increased both thermal properties significantly, and most experimental characterizations of these two properties were performed with stagnant gas.

Packing characteristics, such as pebble/pebble contact area, can be altered during operations, and thus the volumetric strain of the pebble bed has been used to account for this effect, assuming that the packing state is not disturbed too much [86,87]. Compared to uncompressed beryllium pebble beds, the conductivity increased by a factor of about 5 for bed deformations of about 1% [86]. For ceramic breeder pebble beds, the conductivity increase with increasing deformation is expected to be much smaller compared to beryllium pebble beds because of the smaller conductivity ratio of pebble material to gas atmosphere. For a Li_4SiO_4 -He pebble bed, the conductivity increased by about 4% for bed deformations

of about 1% [87]. The fact that the effective thermal conductivity depends on the volumetric compressive strain, predicting thermal behavior of the pebble bed during the operation, requires the knowledge of the stress-strain state of the pebble bed.

Under a well-defined configuration, modeling of interface conductance is achieved by incorporating the combined effects of radiation heat transfer, pebble-solid conduction, and solid-gas heat transfer. However, in the event of a gap formation at the interface between pebble bed and containing wall due to pebble breakages or a containing wall deflection, the interface conductance can only be analyzed by coupling with pebble bed thermomechanics analysis. These multiple effect phenomena require better understanding of the bed's thermomechanical interactions and are not yet well characterized. Considering the uncertainty in the behavior of the pebble beds under irradiation as well as the differential thermal expansion between the pebble beds and the blanket box made of

RAFM steels, it may be necessary to design for a certain elasticity between the blanket box and cooling plates to ensure a certain contact pressure between the cooling plates and the pebble beds over the lifetime of the blanket.

The thermal performance of the ceramic breeder blanket is constrained by a relatively low thermal conductivity and a narrow operating temperature window associated with breeders. Within current knowledge of the allowable breeder temperature design window, the ceramic breeder blanket can be potentially designed to a neutron wall load of about 2.5 MW/m^2 . The breeder upper temperature limits depend on many processes such as sintering, creep, phase change, vapor phase transport, and remain to be defined as R&D continues. The lower temperature limit is dictated by tritium diffusion. The design margin for a solid breeder blanket can be enhanced if the effective thermal conductivity can be increased. A possible method to achieve a higher effective thermal conductivity is by using a mixed bed of Be_{12}Ti and ceramic breeder pebbles.

3.3.2. Tritium release, inventory, and control (solid breeder)

Tritium recovery and control requires understanding the transport and retention of tritium within the breeder and multiplier. Tritium generated from neutron capture is first transported to the grain boundary by diffusion of atomic tritium within the grains. Tritium then diffuses along the grain boundary paths between adjacent grains to the solid/gas interface. At the grain, solid/gas interface various processes take place, involving dissociative adsorption of gas species present in the pores unto the surface, adsorption of atomic tritium from the solid, surface recombination reactions and associative desorption of tritium-bearing species to the pore. Further, the tritium-bearing species are transported through the interconnected pores and enters the flow of the purge gas. Fig. 13 shows a schematic of the involved tritium transport mechanisms [88]. Knowledge of tritium diffusivity, solubility and adsorption properties is then essential in order to calculate the tritium inventory, a very important parameter with regard to D-T fusion reactor safety.

Experimental results indicate that the addition of H_2 reduces the tritium inventory and enhances recovery through the combined effects of isotope exchange and oxygen activity reduction. By hydrogen addition to the purge gas, surface adsorption can be reduced involving isotope exchange with hydrogen, isotope exchange with water present at the surface and desorption of tritium predominantly in molecular forms of HTO or HT. The form of tritium released can significantly impact tritium inventory within the breeder, permeation across the cladding, and extraction from the breeder purge gas stream.

Maintaining open porosity in any solid breeder throughout its irradiation period is important to ensure good tritium release characteristics. The closed porosity provides another means to build up inventory in the material. In the latest irradiation experiment from the EXOTIC series, EXOTIC-9/1 [89], tritium release measurements and the analysis of the tritium residence time showed that tritium release in the new batch of the high density Li_2TiO_3 pebbles (93.0% TD) is rather slow [89] compared to the ceramics irradiated in the EXOTIC-8 irradiation campaign [90]. The tritium residence time measured at 773 K in the EXOTIC-9/1 experiment was $\sim 30 \text{ h}$, while the same characteristic measured on the Li_2TiO_3 pebbles obtained from CEA and ENEA in the EXOTIC-8 campaign was 1.3 and 5.2 h, respectively. Other uncertainties of how porosity distribution may change with operation and affect tritium release including radiation or thermal-induced sintering, grain growth, pore closure, purge channel redistribution, and breeder cracking are yet to be characterized.

Tritium concentration, partial pressure and permeation from the breeder unit to the helium coolant depend on helium purge

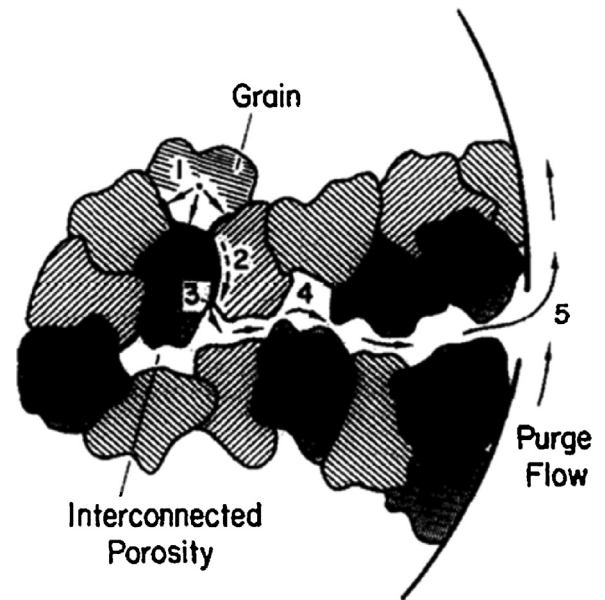

Fig. 13. Schematic diagram showing tritium transport mechanisms in single ceramic breeder pebble: (1) Intragranular diffusion, (2) Grain boundary diffusion, (3) Surface adsorption/desorption, (4) Pore diffusion, (5) Purge flow convection [88].

gas velocity. However, analysis shows no apparent benefit on tritium permeation reduction due to the wall jet velocity profile until the average purge gas velocity reaches about 10 cm/s [91]. Tritium permeation at the low purge gas velocity is still a concern although the isotope swamping effect may help lessen this problem.

Tritium and helium can be produced in beryllium as a result of neutron-induced transmutations. The out-of-pile temperature programmed desorption (TPD) tritium release measurements for the samples from HIDOBE-1 and HIDOBE-2 [44] have shown that tritium retention in Be is about 100% at irradiated temperatures below 525°C [41,92,93], while titanium beryllides show only 30–50% of tritium retention at 425°C and virtually no retention at higher temperatures [41]. This result of low tritium retention in beryllide seems very encouraging as the data has shown swelling can be a concern at high temperatures.

3.3.3. Material interactions and thermomechanics

Packed ceramic pebbles are an attractive solid breeder option because they undergo reduced cracking compared to sintered material forms, due to the low thermal stress and small temperature gradient within individual pebbles. However, stresses still arise from the differing rates of thermal expansion of the structure and the pebbles and from irradiation swelling. These stresses may endanger the safety of blanket operation if breeder pebbles breakage or sinter deteriorates the mechanical integrity of the packed bed and jeopardizes heat and tritium removal. The mechanical integrity of packed ceramic breeder pebbles is a complex function, depending both on operating conditions (irradiation, temperature magnitude and gradient, evolution of the packing arrangement, etc.), and the properties of the breeder pebble material (open porosity, microstructure, grain size, etc.). Although considerable progress has been made in characterizing the basic properties of thermomechanical interactions and responses, and in developing models for simulating them [94–97], the dimensional stability of packed ceramic breeder pebbles over the lifetime is still a concern [94].

This dimensional stability can become even more complex if the neighboring element of Be (or beryllide) is taken into consideration due to its swelling under irradiation. The available irradiation data

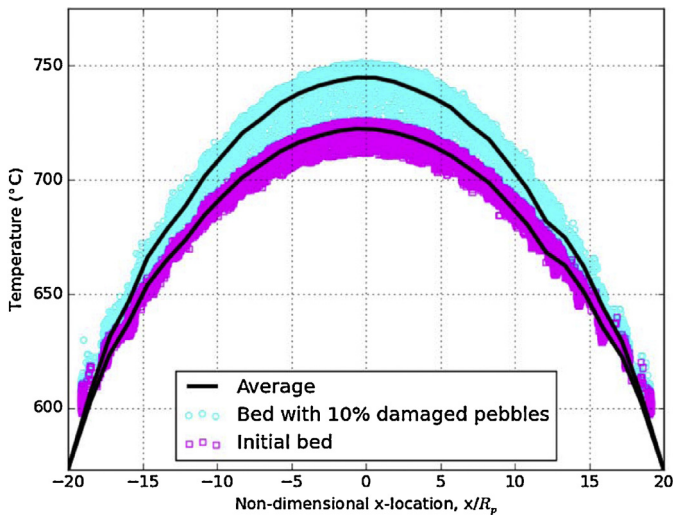

Fig. 14. Example CFD coupled with DEM simulations show the effect of pebbles damaged on bed temperature distribution [101].

has shown swelling is less a concern for beryllide [41,44], this may lessen the thermomechanical interaction between ceramic breeder and beryllide pebble beds by the cooling plate. Nevertheless, as the operational temperatures for titanium beryllide in DEMO as well as the blanket designs become more clearly defined, the combined effects of irradiation-induced volumetric swelling and thermal and irradiation creep on the thermomechanical interactions with the ceramic breeder, cooling plate structure, and neutron multiplier still needs to be studied. Particularly, the consequences of this interaction on both breeder operating temperatures and tritium release and retention must not endanger blanket functions.

A mechanically stable pebble bed with a high packing factor is desired. However, achieving high and homogenous packing for typical blanket geometry can be challenging [98,99]. This requires that blanket relevant pebble filling procedures be developed with attentions given to irregular configurations, and shallow regions/corners. During the operations, the deformation and cracking of pebbles due to the breeder/structural mechanical interactions result in rearrangement of packing structure and pebble/pebble force network. This leads to a temperature distribution that is hard to model and/or predict based on macroscopic thermal conductivity measurements of typical experiments. The lack of predictability of the temperature distribution can be a major safety issue. In an attempt to assess the manner of pebble relocations and packing rearrangement when pebble cracking failure occurs, a discrete element method (DEM) model is being developed [100]. This DEM modeling employs a transient algorithm to dynamically capture ensemble rearrangements due to particle breakage, thermal expansion, or external loading aiming at determining the subsequent effects of pebble failures on thermomechanical properties of the bed as a whole. The DEM model of the pebbles is coupled to a volume-averaged model of helium to capture the influence of the purge gas on heat transport in the entire bed. In Fig. 14, we see how the temperature across the pebble bed increases in response to crushing of 10% of the pebbles. The increased temperature corresponds to a 22% decrease in effective thermal conductivity. The maximum temperature in the bed with crushed pebbles increased by 4.0% as compared to the well-packed bed [101]. Note that in this investigation, the pessimistic limit of pebble crushing was assumed, e.g. the crushed pebble is completely removed from the system. In reality, the broken pebble may only crack into large chunks that continue to act as pathways for thermal transport. The results facilitate our further understanding of blanket performance under

reactor conditions and should be used as a guide toward the limits at which pebble failure becomes unacceptable.

The DEM models consider the microscopic, inter-particle contacts between pebbles and then extrapolate bulk properties of the whole pebble bed from the analysis of interactions at these particle interfaces. Other numerical models approach the pebble bed thermomechanics and material interactions from a continuum medium perspective utilizing the finite element method (FEM) to recreate the macroscopic, effective phenomena of pebble bed thermomechanics by assuming phenomenological relationships on homogeneous volumes representing the pebble beds. The continuum modeling approach using FEM and empirically-derived material constitutive equations is capable of characterizing the stresses/inelastic deformations and subsequent bed/wall separation to which a breeder pebble bed unit may be subject while interacting with other elements in a breeder system as shown in Fig. 15, in which an analysis was performed for a breeder unit based on a layer configuration design under ITER pulsed operations [102]. The FEM thermomechanical analysis shows the breeder bed will undergo time-dependent stress, inelastic deformation and separation during a cooling down period. In this particular design using Li_4SiO_4 pebble bed mechanical properties showed a gap separation of 19 mm at the end of ITER dwell time during the 1st cycle of operation.

Benchmarking efforts for FEM models have only recently begun [94]. Two most developed models, from KIT and ENEA, have had their results compared to experimental data and have thus far shown promise. However, benchmarking efforts are incomplete and inconsistencies between two models must still be explained (e.g. gap or no gap formation). Under-developments in the DEM model are the predictive capabilities for pebble failure. Pebble failure predictive models require much experimental data on the crush loads of single pebbles under various temperature environments as well as in fatigue cycles; data which is, at present, missing in the community.

Since pebble beds differ from continuous media in their packing state evolutions (and associated evolutions in thermomechanical properties), it is important to learn if the breeder unit will continue to function in accord with the original design goals under all complex operating conditions. A continued effort to validate current continuum FEM models though both out-of-pile and in-pile experiments is still necessary. Experiments should also be conducted to assess the manner of pebble relocations and packing rearrangement when pebble cracking occurs. Furthermore, there may be merits to perform crush load tests for irradiated pebbles at operating temperature ranges. Only with a full understanding of all these aspects can we ensure ceramic breeders will function as intended in the fusion operational phase spaces.

3.4. Reliability/Availability/Maintainability/Inspectability (RAMI)

Reliability/Availability/Maintainability/Inspectability (RAMI) is a serious issue for fusion, particularly for fusion nuclear, or “in-vessel,” components. Device availability is reduced by two types of outages: scheduled outages and unscheduled outages. Scheduled outages are planned as part of design, operation, and maintenance; for example, replacement of the blanket/FW at the end of its predicted life. Such scheduled outages are manageable because much of the planned maintenance can be scheduled simultaneously. In particular, any power plant is normally scheduled for annual routine shutdown, typically 1–2 months, to perform maintenance operations on the heat exchangers, turbines, and other balance-of-plant components. Almost all scheduled outages for replacement or maintenance of the reactor components such as the blanket can be planned to be performed during the routine annual shutdown. In contrast, unscheduled outages are due to random failures that occur

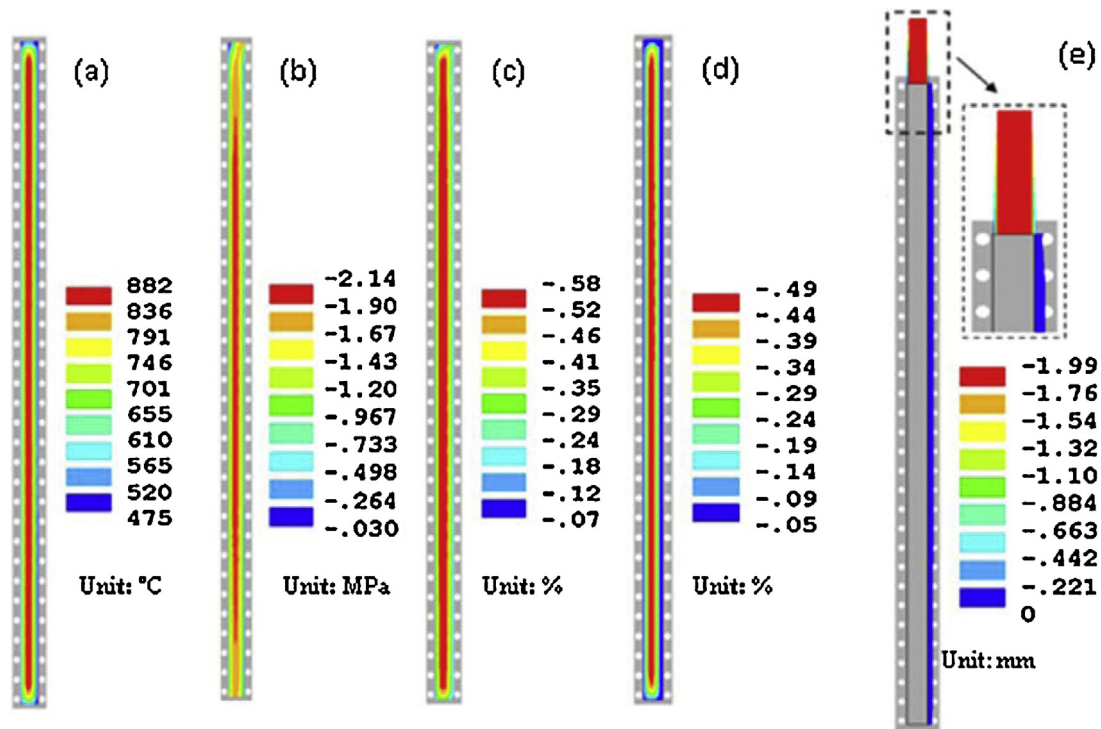

Fig. 15. Breeder unit FEM thermomechanical analysis for a layer configuration (a) temperature, (b) poloidal stress, (c) poloidal plastic strain, and (d) poloidal creep strain at the end of burn time, (e) the gap distance at the end of dwell time [102].

Table 4

Results of availability allocation model for DEMO components with an overall DEMO availability goal of ~50%. (Assuming 0.19 as the fraction of a year for regular (scheduled) maintenance, the overall availability is $0.81 \times 0.615 \approx 0.5$.)

Component	Number	Failure rate, h ⁻¹	MTBF, years	MTTR for Major failure, h	MTTR for Minor failure, h	Fraction of failures that are major	Outage risk	Component availability
Toroidal coils	16	5×10^{-6}	23	10 ⁴	240	0.1	0.098	0.91
Poloidal coils	8	5×10^{-6}	23	5×10^3	240	0.1	0.025	0.97
Magnet supplies	4	1×10^{-4}	1.14	72	10	0.1	0.007	0.99
Cryogenics	2	2×10^{-4}	0.57	300	24	0.1	0.022	0.978
Blanket	100	1×10^{-5}	11.4	800	100	0.05	0.135	0.881
Divertor	32	2×10^{-5}	5.7	500	200	0.1	0.147	0.871
Htg/CD	4	2×10^{-4}	0.57	500	20	0.3	0.131	0.884
Fueling	1	3×10^{-5}	3.8	72	–	1.0	0.002	0.998
Tritium system	1	1×10^{-4}	1.14	180	24	0.1	0.005	0.995
Vacuum	3	5×10^{-5}	2.28	72	6	0.1	0.002	0.998
Conventional equipment-instrumentation, cooling, turbines, electrical plant –							0.05	0.952
Total system							0.624	0.615

at random times, thus requiring unplanned shutdown and reducing availability. Random failures occur in any engineering system. Reliability growth R&D programs are essential to reduce random failures, but they cannot eliminate them in a practical system. Our analysis here will focus on this serious issue of unscheduled outages.

A fusion device has many major components, and therefore the availability required for each component is very high. Availability is defined as:

$$\text{Availability} = \frac{\text{MTBF}}{\text{MTBF} + \text{MTTR}} \quad (2)$$

where MTBF is the mean time between failures, and MTTR is the mean time to repair or replace.

RAMI for the blanket, divertor, and other “in-vessel” components is particularly challenging because they are located *inside* the vacuum vessel which results in the following consequences:

- Many failures (e.g. coolant leak) require immediate shutdown (low fault tolerance and no redundancy possible lead to short MTBF)
- Repair/replacement takes long time (longer MTTR)
- Shorter MTBF and longer MTTR result in lower availability

The RAMI issue has not yet received the high priority it deserves in the fusion program. But some studies (e.g. [3,11,103–109]) investigated the issue in sufficient depth to allow quantifying goals and issues.

Table 4 shows the results of combining the methods and analysis of references [103,3]. The results show that DEMO availability of 50% requires:

- Blanket Availability ~88% (and Divertor Availability of ~87%)
- Blanket MTBF >11 years
- MTTR <2 weeks

As we will show in Section 4.3, these goals required to achieve high availability are very challenging because they require orders of magnitude extrapolation from the state-of-the-art in other technologies as fission reactors.

An overall conclusion from RAMI analysis is that performance, design margin, and failure modes/rates should now be the focus of FNST R&D, not a long dpa lifetime. Therefore:

1. Setting goals for MTBF/MTR is more important now than dpa goals for lifetime of materials. Maximizing MTBF and minimizing MTR is a more important goal for the development of a fusion power plant than an extension of the allowable dpa for the structural material.
2. Current R&D should focus on:
 - a. Scientific understanding of multiple effects, performance, and failures, so that functions, requirements and safety margins can be achieved and designs simplified and improved.
 - b. Subcomponent tests in non-nuclear tests and wherever possible in fission reactors.
3. Extensive “Reliability Growth” testing is required in FNSF.
4. Reliability of components and systems must be a primary emphasis in fusion power plant design. Reliability starts with a suitable design; for example, the number of welds and joints in the blanket/FW is an indication of reliability since failures tend to occur more often at welds and joints.

3.5. Other materials interactions and responses

The fusion nuclear environment is an extremely hostile one for the materials used for blanket/FW components. Continuous exposure to plasma heat and particle fluxes, chemically aggressive coolants, time-varying thermal and mechanical stresses and of course intense bombardment by high energy neutron irradiation represents an unprecedented combination of loads that drive strong changes and interactions in materials. While it is often the atomic displacement and helium damage in reduced activation ferritic steels that dominate the discussion of material issues for fusion, there are many other material requirements and issues affecting both structural and functional materials that have a more near term feasibility impact on fusion in-vessel systems. This section describes a sample of issues for RAFM structural steels other than displacement damage, as well as SiC use as flow channel insert. Ceramic breeder and Be multiplier material issues related to thermomechanical responses and tritium have been described previously in this section.

3.5.1. PbLi corrosion

Use of PbLi and RAFM steels, such as F82H, EUROFER or CLAM, in blanket applications requires a much better understanding of material compatibility related to physical/chemical interactions in the 450–550 °C temperature range. In steel/PbLi systems, the associated corrosion phenomenon is known as a “liquid metal attack”. For almost three decades of experimental and theoretical studies of corrosion of structural blanket materials (see, e.g. [110–114]) various deterioration mechanisms related to the liquid metal attack were revealed. These include: dissolution of the main steel constituents, formation of intermetallic compounds, penetration of liquid metal along grain boundaries and leaching of particular steel constituents. In the case of RAFM/PbLi, it is widely believed that uniform dissolution of iron and chromium in the flowing PbLi is the key corrosion mechanism. This is different from the nickel-rich austenitic steels where leaching of high-solubility nickel results in formation of a porous layer at the interface. However, the current scientific understanding of corrosion of RAFM steel at high temperatures relevant for fusion is established only for relatively simple material systems, where impact of several key

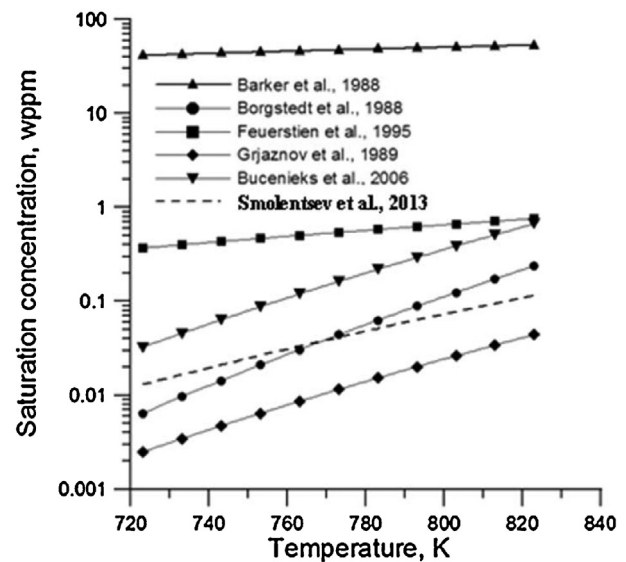

Fig. 16. Available correlations for saturation concentration of iron in PbLi as a function of temperature demonstrate scattering of several orders of magnitude.

features of RAFM/PbLi corrosion are often missing. There are many unknowns, such as: effects of the imposed magnetic field, liquid metal embrittlement and stress corrosion, multi-material corrosion and irradiation effects. Even available data and correlations on the saturation concentration of iron in PbLi exhibit scattering of several orders of magnitude and require further evaluation (see Fig. 16).

The impact of corrosion includes deterioration of the mechanical integrity of the blanket structure due to the wall thinning, as well as serious concerns associated with the transport of corrosion products throughout the liquid metal loop. When transported by flowing PbLi, the activated corrosion products can precipitate in the colder sections of the loop, e.g. in a heat exchanger. This may lead to considerable safety problems, particularly if deposition of corrosion products results in localized regions of high concentration of activated materials. Plugging the loop by precipitated corrosion products in the cold section is another concern. Such an event has been reported in many experimental studies. At present, it is generally accepted that deposition processes in the cooler parts of the loop are more critical to the safe blanket operation than reduction of strength by the wall thinning in the hotter parts.

Present PbLi blanket designs limit the maximum wall thinning caused by corrosion to 20 $\mu\text{m}/\text{yr}$, which corresponds to the maximum wall temperature at the interface with the liquid metal in the hot leg of about 470 °C. However, the experimental data on the mass loss for ferritic/martensitic steels in the flowing PbLi vary over a wide range, predicting possible wall thinning at temperatures higher than 450 °C from 5 $\mu\text{m}/\text{yr}$ to values up to a few hundred $\mu\text{m}/\text{yr}$ [81].

The observed variations in the experimental data on RAFM/PbLi corrosion point to a strong influence of the interface temperature and, what is also important, of the flow itself, including flow development effects, and especially turbulence, buoyancy and MHD phenomena. Although the influence of the temperature on corrosion processes is described well with a kind of exponential Arrhenius law, the flow effects are poorly understood. The existing experimental data are in fact not sufficient to explain the strong variations in the corrosion rate, first of all due to uncertainties related to different flow conditions in the experiments. Moreover, these experimental data are mostly limited to purely hydrodynamic flows and thus cannot be used to predict corrosion processes and transport of

corrosion products in a real blanket system, where the flowing PbLi is severely affected by a strong plasma confining magnetic field.

A general discussion of possible effects of a magnetic field on corrosion and deposition in PbLi is given in [115]. The main effect of the magnetic field on corrosion processes seems to be due to changes in the velocity profile, mostly due to steeper velocity gradients in the near-wall region and associated changes in the temperature distribution in the flow and at the material interface with the solid metal. Only a few experimental [81,116–118] and theoretical [74,119,120] studies have been performed in the presence of a magnetic field, predicting significant, up to several times, increase in the wall mass loss if a magnetic field is applied. These results still need to be explained and/or reexamined. Another important consideration that may further affect present corrosion notion for PbLi-based blankets is the presence of SiC or other functional materials in the material system, which may further alter the corrosion chemistry. These all necessitate further experimental and modeling efforts, including development and testing of phenomenological models and boundary conditions followed by new numerical codes and multi-parameter computations.

Corrosion and corrosion product transport phenomena hence are very strong limitations on current blanket systems where the desire to achieve high coolant temperature is in conflict with the need to operate the system with acceptable corrosion behavior. It is a fallacy to consider the development of high temperature structural materials without considering that the main temperature limitation may in fact be due to corrosion behavior.

3.5.2. SiC flow channel inserts

While SiC/SiC composites are considered as a possible structural materials for advanced fusion energy blanket concepts such as the self-cooled lead-lithium (SCLL) system, SiC based materials also have a nearer term application as a thermal and electrical insulator in the form of flow channel inserts (FCI) in PbLi based blanket systems such as the DCLL concept (Fig. 3). The FCI is a loose fitting insert placed into the flow channel whose role is to prevent MHD electric current from, and nuclear heat deposited in, the main PbLi flow from reaching the highly conducting structural walls. This has the dual benefit of controlling MHD pressure drop and allowing the internal PbLi flow to be hotter than the compatibility limit of the RAFM steel structure. The SiC material must maintain its thermo-physical and mechanical properties within design limits over the lifetime of the blanket. Research and development on SiC/SiC composite materials has made substantial progress over the past 10 years or so and an overview discussion can be found in references [121–123]. Based on these works, it is apparent that several key feasibility issues remain to be resolved before extended performance in the fusion environment can be predicted with sufficient confidence.

A primary requirement for the flow channel insert is an adequately low electrical and thermal conductivity in the through-thickness orientation of the wall and maintenance of these properties throughout the operational lifetime exposure to the fusion neutron environment. Design requirements for electrical conductivity for flow channel inserts in the DCLL blanket concept lie in the range of 1–10 S/m whereas typical un-irradiated through-thickness conduction for several SiC/SiC materials varies from ~2 to 3 S/m at ~400 °C and converging to values of ~20 S/m at ~1000 °C. The contributions from the various microstructural features to the mechanism of electrical conduction in 2D woven-fabric SiC/SiC composites with a conductive pyrolytic carbon (PyC) interphase have been identified. These findings include (a) through-thickness conduction within the stacked fabric layers by the interphase bypass network at relatively low temperatures, (b) over-coating and/or internal layers of semiconducting SiC add serial resistors to the through-thickness circuit, (c) in-plane conduction is governed

by conduction through axial interphases at relatively low temperatures, and (d) conduction through SiC constituents dominates at high temperatures.

Neutron irradiation influences the composite electrical conductivity since the semiconducting properties of SiC become governed by radiation defects induced by neutron irradiation, resulting in a steeper temperature dependence of electrical conductivity in the temperature range of interest. The electrical conductivity of the PyC interphase is relatively insensitive to irradiation and may decrease or increase, depending on its starting microstructure. Fission neutron data up ~8 dpa indicate that the through-thickness electrical conductivity of the 2D SiC/SiC with thin PyC interphase material will likely be of the order of ~10 S/m in the typical operating temperature range for FCLs [124]. However, nuclear transmutations in the fusion neutron environment produce significantly higher concentrations of solid elements which have the potential to modify the electronic properties of SiC since it is an impurity semiconductor. Recent calculations for the production rates of potentially deleterious elements are Mg (10–45), Be (5–18), Al (3–14), and P (0.2–1.5) appm/dpa [125]. The impact of the solid transmutant population on electrical conductivity in a neutron irradiation environment is presently unknown and thus constitutes a significant feasibility issue. In addressing this issue useful information could be provided initially via ion implantations and atomistic simulations. Strategies for electrical conductivity by tailoring interphase structure and configuration are feasible and require further study, and approaches to mitigating the electronic effects of solid transmutants need to be evaluated.

The thermal conductivity of SiC/SiC composite materials is not strongly temperature dependent although significant differences in behavior of the various types of composite currently under development are to be expected depending upon their detailed microstructure and impurity contents [126]. In general, design requirements for effective flow channel insert performance are in the range 1–5 W/mK. Fission neutron irradiation induces an order of magnitude decrease in the room temperature thermal conductivity of SiC and also a steeper temperature dependency. Model-based predictions indicate that the thermal conductivity of neutron irradiated 2D Si/SiC composites should be in the <5 W/mK at 200 °C increasing to ~15 W/mK at ~800 °C [124]. Achieving lower thermal conductivities therefore remains a significant issue. The current SiC/SiC materials have a 2D fiber weave that provides hoop strength to the FCI and allows the insert to be relatively thin while retaining good structural properties. The fact that fibers are not oriented through the thickness of the FCI helps reduce the electrical and thermal conductivities in this direction by elimination of fiber conduction paths. In addition, high conductivity carbon interphase coatings on the fibers are replaced with a SiC interphase to help further reduce electrical and thermal conductivities.

Internal porosity can also be introduced to help lower conductivity, and a SiC foam-based material [127] is also being considered for FCI applications. The concept is to utilize a core of low-density SiC foam to achieve low thermal and electrical conductivity; in addition, internal void regions allow thin SiC foam ligaments to move and thus accommodate swelling and control overall thermal and differential swelling stress. This concept does not require the use of expensive high quality fibers and is expected to be more cost effective than composite material. These foam cores are sealed at all surfaces with a layer of CVD SiC and possibly infiltrated with an additional closed cell aerogel foam material to help prevent any PbLi ingress through flaws or cracks. Proving that PbLi ingress can be avoided over long periods of operation is a difficult challenge for foam based materials. Several experiments reported in [37] with a foam-based mockup with additional aerogel filler exposed to high temperature PbLi and overpressure demonstrated no or small

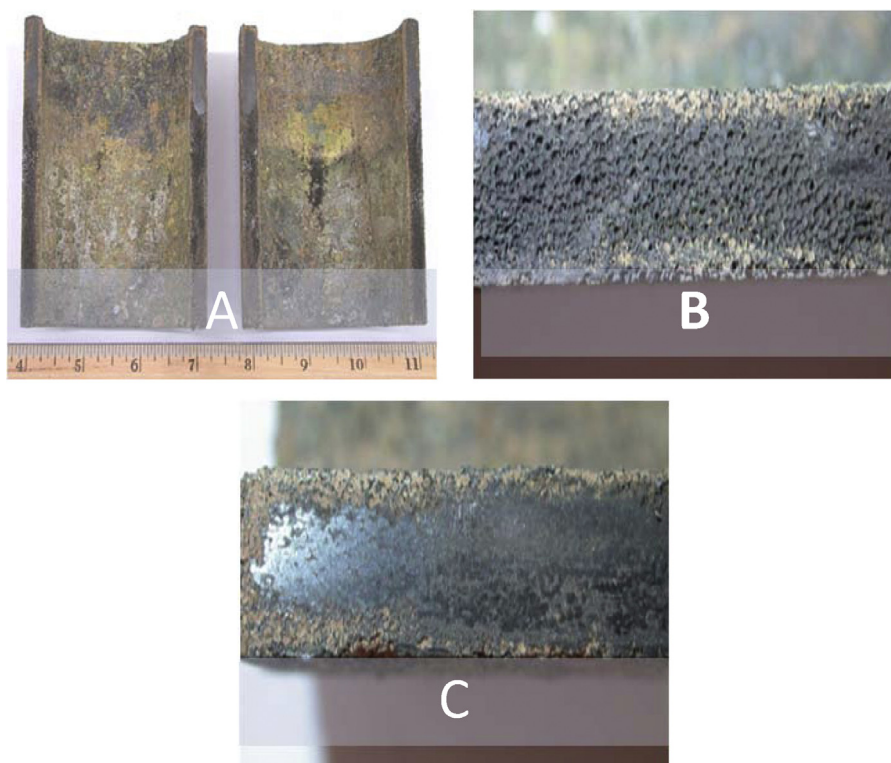

Fig. 17. SiC foam FCI with aerogel injected into pores, but no CVD SiC overlayer pictured here after exposure to static bath of PbLi with applied temperature gradient. (A) The sectioned FCI, (B) close up of one end with no PbLi infiltration, and (C) close up of other end where PbLi infiltration occurred [37].

ingress. However, in one of the experiments shown in Fig. 17 one end of the mockup demonstrated no PbLi ingress while the other end experienced significant ingress.

The long-term impact of the generation of large concentrations of H and He via nuclear transmutation in the fusion neutron spectrum presents a challenging feasibility issue; recent calculations [125] indicate production rates of 50–180 appm/dpa for He and 20–70 appm/dpa for H. Ion irradiation studies have demonstrated that He generation enhances swelling both at intermediate and high (>1000 °C) temperatures [123] suggesting that there is a potential for He-driven swelling in the FCI operating regime and raises the possibility that through-thickness swelling gradients could generate stresses approaching the fracture stress [128]. There is a strong likelihood that irradiation creep would relieve these stresses to some extent but currently there is insufficient understanding regarding the interaction of irradiation creep and swelling in SiC and SiC/SiC composites to make any credible predictions in this regard. The impact of very large concentrations of transmutation-generated He on the microstructure, dimensional stability and mechanical behavior of SiC/SiC composite materials is unlikely to be adequately understood until the availability of a suitable fusion neutron source capable of simultaneously generating the displacement damage and H and He concentrations and thus remains a long-term critical issue.

Other areas of continuing R&D include joining technology, corrosion in PbLi, neutron irradiation-induced mechanical property degradation, cyclic fatigue, and hermeticity against permeation of liquid coolants. The successful development of SiC/SiC composite structural materials for fusion energy systems will require continuing efforts in these technology areas which need to be under-pinned by continuing expansion of the understanding of the physical mechanisms of property degradation and the development of constitutive theories for physical, thermal, mechanical and fracture behavior.

3.5.3. Tritium permeation membranes and tritium barrier materials for PbLi blankets

Tritium permeation and trapping in the blanket structure and associated piping constitutes a major feasibility issue that must be resolved to enable the development of successful fusion blanket systems for next step machines beyond ITER [129]. The continuous and efficient removal of tritium from He and liquid PbLi coolant streams to meet allowable tritium inventories and permeation safety limits are of overarching concern. The materials requirements are particularly challenging since high permeability materials are required to permit efficient extraction from both flowing PbLi and He streams whereas in other areas of the plant, high temperature tritium barrier materials are required to maintain allowable safety levels in the plant.

One of the most significant advantages of the DCLL blanket concept is that the relatively high PbLi circulation rate ensures a relatively low increase in the tritium concentration during one pass through the blanket. In combination with a high efficiency tritium extraction system capable of extracting tritium down to a tritium partial pressure of ~0.1 ppb, the DCLL concept has the potential to avoid any problems with tritium permeation into the He coolant or into the environment. Of the various concepts under consideration for tritium extraction, the vacuum permeator [130,131] in particular has the potential to achieve very high efficiency extraction. The device consists of long thin tubes that act as permeation membranes or “windows” between turbulent PbLi flow on one side and an actively pumped vacuum environment on the other side. There are strong material interface issues and requirements associated with the membrane material for the high temperature DCLL.

Because of their good corrosion resistance in liquid metals, high temperature performance capability and high hydrogen permeability, the Group V metals, and Nb in particular as well as Ta, represent the most promising basis for a membrane structure material. However, the database on PbLi corrosion for Nb and Nb alloys

is very limited and corrosion measurements under the flow conditions anticipated in the permeator tubing have not been made. However, of far greater concern is the susceptibility of Nb-based materials to reactions with interstitial impurities and in particular, the absorption of oxygen from the vacuum side of the permeator presents a difficult issue. The thermodynamics of the oxidation reactions ensures that the Nb will continually getter oxygen from the vacuum unless extremely low oxygen partial pressures of oxygen can be achieved and maintained throughout the lifetime of the component. For example for an operating temperature of 700 °C, oxygen partial pressures would need to be of the order of the order 10^{-10} to 10^{-11} torr to prevent oxygen ingress. For a typical vacuum system level of $\sim 10^{-6}$ torr it is estimated that the equilibrium oxygen concentration in Nb at 600 °C is ~ 600 wppm [132], which is sufficient to significantly affect mechanical behavior. The absorption of oxygen leads to an increase in yield stress accompanied by a reduction in ductility and an increase in the ductile-brittle transition temperature. Based on bend-test transition temperature measurements, oxygen concentrations of 2000–3000 wppm are sufficient to induce brittle behavior at room temperature [133]. Calculations based on the kinetics of oxygen pick-up indicate that for a 3 mm wall-thickness Nb tube operating at 700 °C, oxygen concentrations in this range would be achieved in ~ 1 year of operation in a vacuum with an oxygen partial pressure of $\sim 10^{-8}$ torr [134]. These concentrations are well below the terminal solubility limits for oxygen in Nb in the 650–700 °C operating regime of a vacuum permeator and since protective oxide scale formation does not occur at the relevant temperature and oxygen partial pressures, the terminal solubility concentration will inevitably be reached at some point in the lifetime of the component. This situation would be reached rapidly in the event of a significant vacuum leak.

One possible approach to mitigation of this issue is the alloying of Nb with the reactive metals such as Zr, Ti and Hf. These elements have substantially greater negative free energies of formation of oxides than Nb. Consequently, for alloys of Nb with these reactive elements, internal oxidation occurs with the formation of various oxide precipitates resulting in possible increases in the tolerable absorbed oxygen concentration. Numerous alloys containing various combinations and concentrations of the reactive elements have been investigated for high temperature structural applications primarily in aerospace [133]. However further investigation of alloying possibilities and microstructural control specific to the needs of fusion technology needs to be pursued with the goal of significantly increasing toleration to oxygen absorption.

The development of protective multi-layered coatings to provide an oxygen barrier is likely to be counterproductive because of the potential reduction in the tritium mass transfer coefficient through the Nb wall. However in many other areas of the total system for the DCLL (e.g. the heat exchanger), or in PbLi blanket concepts like the HCLL with slow flowing PbLi, the development of effective tritium barriers may be required. System wide permeation analysis of the HCLL concept [135] shows the tradeoffs between various characteristics of PbLi and He cooling circuits, with dependence on PbLi flowrate and tritium permeation barrier efficiency shown in Fig. 18. Such analyses are used to set requirements for barrier efficiency.

In Europe, early development work on coatings concentrated mainly on alumina/FeAl coatings for RAFM steels [136]. The most successful process was the Hot-Dip Aluminizing Process, where permeation reduction factors (PRF) of ~ 100 were achieved. None of these coating fared well after thermal cycling, or irradiation exposure on complex shapes. More recent research efforts are also testing sandwich coatings of Er_2O_3 or Al_2O_3 together with W as anti-permeation and corrosion barriers. Such coating development has met with only mixed success to date in rather idealized

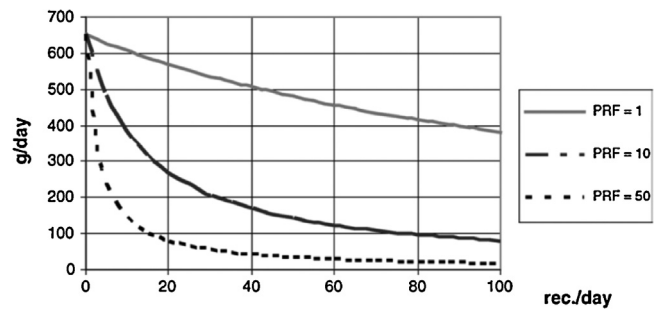

Fig. 18. Tritium permeation losses from HCLL as a function of number of PbLi volume recycle rate [135].

conditions. It is far from assured that a permeation barrier coating will ever be practical given the large complex surfaces, strong thermal gradients, contact with high temperature PbLi, and if used in situ the presence of significant neutron and secondary charged particle irradiation over the required lifetime of the blanket components.

3.5.4. Fabrication of structural and functional materials

All of the materials that comprise the blanket/FW system, both structural (e.g. RAFM steels) and functional (SiC/SiC composite or SiC foam for FCIs, ceramic breeders, liquid PbLi, neutron multipliers, FW armor) will require the establishment of industrial-scale technologies for production and fabrication which attain the highest levels of reproducibility and impurity control. These fabrication techniques are needed even in the near term to produce a supply of relevant and characterized material for blanket/FW research in experimental mockups. It is beyond the scope of this paper to cover the full diversity of materials issues surrounding all of these materials and the discussion will focus on the fabrication issues involved with the RAFM steels which are the basic blanket structural material under development world-wide. Some discussion of the fabrication issues for the SiC/SiC flow channel inserts is included in Section 3.5.2.

3.5.4.1. Impurity control. During the past 10 years or so, full commercialization of the RAFM steels has been realized via the production of 5–10 ton quantities by manufacturers in the EU, Japan, and China. Smaller commercial heats have also been produced in Korea, China and Russia. Procedures have been established for reliable and consistent production of a full range of product forms, the development of a range of joining technologies and the compilation of comprehensive mechanical properties databases. The control of residual impurities such as S, P, As, Sn, etc. which are known to give rise to embrittlement problems both during fabrication and in-service, have been reduced to satisfactory levels via advanced melting procedures. In the case of the Eurofer RAFM steel, a code-qualified properties database has been established and entry into the RCC-MRx code as a new structural material has been partially approved [137].

The major feasibility issue related to impurity control that remains to be addressed is the control of those elements which directly affect the waste disposal classification of the large quantities of material which will be exposed to the highest levels of neutron dose in the fusion environment. Analysis of some 18 impurity elements characteristic of large heats of various RAFM steels produced by current commercial technology demonstrated that the activation requirements for shallow land burial following a 20 MWy/m² lifetime and a 100 years cooling could not be met [138]. However, analysis of small heats of RAFM steels prepared from carefully selected high purity stock demonstrated that impurity concentrations can be sufficiently reduced to meet the criteria for

shallow land burial. The feasibility of attaining such impurity concentrations on a commercial production scale via stringent control of raw materials and further refinements to processing technology remains to be demonstrated.

3.5.4.2. Blanket fabrication/assembly technologies. A variety of blanket fabrication and assembly technologies are under development in the EU, Japan, China, Korea and India with a focus on the deployment of test blanket modules (TBMs) in ITER [139]. The basic design of the HCLL, DCLL, and HCCB (see Section 2.2) employ similar basic structural elements namely, (a) a U-shaped first wall with cap plates and (b) horizontal and vertical stiffening grids defining an array of internal cells for the breeder units.

The range of concepts currently being evaluated for the construction of the U-shaped first wall includes, (a) two-step HIPing of symmetrically grooved plates, (b) insertion of round tubes between plates with machined square grooves and HIPing to conform the tubes to the shape of the grooves, (c) closure of machined grooves via EB welding thin cover sheets followed by HIPing a thick-walled cover plate, (d) HIPing rectangular tubes sandwiched between cover plates, (e) fitting rounded square section tubes into conforming grooved cover plates followed by HIPing. Assembly of the stiffening grid and attachment to the first wall unit also requires the deployment of a range of joining technologies including narrow gap TIG welding, laser welding, EB welding and metal inert gas/laser hybrid welding [140,141].

In addition to meeting the required specifications on dimensional tolerances and flaw populations, these fabrication procedures must meet the microstructural specifications which have been selected to produce the levels of strength, fracture toughness, creep and fatigue resistance required to ensure adequate structural integrity throughout the D-T testing phase of ITER. Although fabrication technologies have been advanced to the stage of constructing one-third size TBM mock-ups of T91 and Eurofer [140], there are several feasibility issues related to fabrication that have to be resolved before proceeding to full-scale TBM manufacture as follows;

- (a) Achieving the dimensional accuracy in the cooling channels necessary to achieve maximum cooling efficiency; control of residual stresses and distortions during welding and post-weld heat treatment (PWHT).
- (b) Increasing accessibility for welding and inspection via design modifications.
- (c) Development of effective and reliable inspection procedures for characterization of flaw populations in welded and bonded joints.
- (d) Ensuring that post-weld heat treatments (PWHTs) produce the correct start-of-life microstructure for all welded and bonded joints.

3.5.4.3. Alternative fabrication technologies. To progress beyond the deployment of TBMs, further advances in fabrication technologies will be needed for the development and testing of the large-scale blanket systems required for a next-step machine such as FNSF. There is risk and uncertainty into how well these technologies scale up from ITER TBMs having module sizes on the order of one meter to various reactor blanket designs that may use sector like modules with larger dimensions. It will be important to introduce an awareness of fabrication and joining issues into the blanket design process with a view to minimizing complexity and easing assembly issues, minimizing the number of weldments, and positioning welds and bonded joints away from regions of maximum temperature, temperature gradient and neutron dose. A major systems reliability issue is that the current fabrication

options being pursued result in blanket structures which contain a high volume fraction of bonded and welded interfaces; this implies a high probability of leaks and potential failures which in turn implies a low MTBF (see Section 3.4). In considering these fabrication-related issues, the 2012 US-FESAC report on materials science and technology research [129] recommended that the potential application of alternative fabrication technologies to the construction of breeding blanket modules should be evaluated. One such technique is near net shaped fully dense casting that has been explored for austenitic steels for ITER by the US [142], and has been suggested for ferritic steels as part of the US TBM effort [143]. Additionally, in many industries over the past 10–15 years there has been an extraordinary growth in the development of advanced manufacturing techniques to enable near-net shape fabrication of intricate geometries via techniques such as electron beam, ion beam and laser-assisted deposition. Application of these techniques is enabling the production of weld-free components at significantly lower cost compared to techniques based primarily on machining and welding. For example in the aerospace industry, General Electric are planning to produce some 25,000 jet engine nozzles per year utilizing additive manufacturing technology while eliminating the need for some 24 welds per unit [144]. It is not known at this point in time whether or not an additive manufacturing technique could be utilized to produce blanket components based on a RAFM steel composition which could be subsequently transformed by heat treatment to produce the required mechanical properties and radiation damage tolerance. On the other hand it is possible that more advanced materials such as the nanostructured oxygen dispersion strengthened (ODS) ferritic steels could be more compatible with additive manufacturing and yield materials with the desired combination of mechanical properties, radiation damage tolerance and corrosion resistance.

4. Challenges in developing blankets and implications for the R&D pathway

There are numerous challenges in the development of Fusion Nuclear Technology/blanket/FW. In particular, there are principal challenges that have huge impacts on both the complexity of the technical issues and the development pathway, including the requirements on non-fusion and fusion R&D facilities. These challenges are:

- *The Fusion Nuclear Environment:* Multiple field environment (neutrons, heat/particle fluxes, magnetic field, etc.) with high magnitude and steep gradients
- *Nuclear heating* in a large volume with steep gradients
- *Complex configuration* with FW/blanket/Divertor inside the vacuum vessel

4.1. The fusion nuclear environment

The fusion nuclear environment is complex and unique. As shown in Table 5, it has multiple fields: neutrons, surface- and bulk-heating, particle fluxes, spatially and temporally varying magnetic fields with steep gradients, and mechanical and electromagnetic forces resulting from both normal and off-normal plasma operating conditions. The neutrons produce tritium and volumetric heating, cause radiation damage, and produce radioactive products and decay heat; all with strong spatial dependence.

A very important characteristic of the multi-component fields of the fusion nuclear environment is the presence of strong “gradients” in these various fields and resultant loads and responses. Fig. 19 shows representative examples of the steep gradients in the

Table 5
Characteristics of the fusion environment and effects on blankets.

Neutrons (flux, spectrum, gradients, pulses) - Bulk Heating - Radiation Effects - Tritium Production - Activation and Decay Heat
Heat Sources (thermal gradients, pulses) - Bulk (neutrons) - Surface (particles, radiation)
Particle/Debris Fluxes (energy, density, gradients)
Magnetic Fields (3-components, gradients) - Steady and Time-Varying Field
Mechanical Forces - Normal (steady, cyclic) and Off-Normal (pulsed)
Inertial Forces / Gravity
Blanket: Multiple functions, materials, and many interfaces in highly constrained space in vacuum
Combined Loads, Multiple Environmental Effects - Thermal-chemical-mechanical-electrical-magnetic-nuclear interactions and synergistic effects - Interactions among physical elements of components

volumetric nuclear heating, toroidal and poloidal magnetic fields, tritium production, and radiation damage indicators (He and H production and dpa).

The multi-component fields of the fusion nuclear environment will be experienced by the blanket/FW system which itself has multiple functions (breeding, heat extraction, etc.), materials (breeding and structural materials, neutron multiplier, coolants, thermal and electric insulators, etc.) and many interfaces among materials and physical elements of the blanket (e.g. liquid metal/structure, breeder/structure/coolant, insulator/structure/coolant interfaces).

The combined loads and multiple environmental effects experienced by the complex blanket/FW system will drive yet undiscovered new phenomena. These phenomena are caused by synergistic thermal-chemical-mechanical-electrical-magnetic-nuclear interactions and synergistic effects, as well as interactions among the physical elements of components. It is well known from many scientific fields, including plasma physics, that “gradients” drive new phenomena which are often the most difficult to understand and predict. Therefore, the presence of steep gradients in the fusion nuclear environment such as those in Fig. 19 are a critically important feature of the test environment and will be an important contributor to the emergence of new phenomena that are yet to be discovered.

In the next subsection we will show an example of combining the effects of 2 environmental loads, the magnetic field and gravity, and the gradients in nuclear heating on MHD flows in

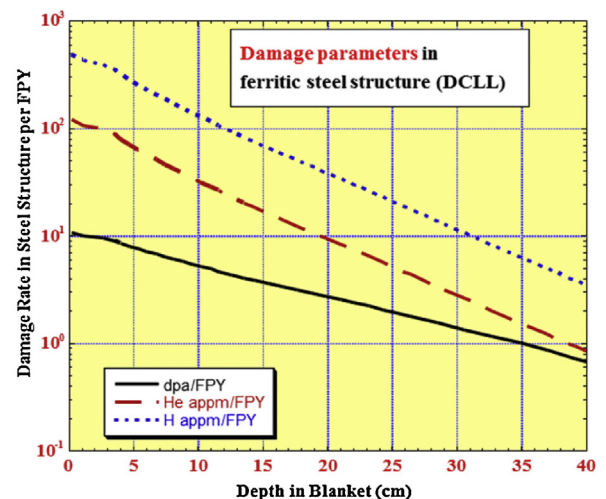
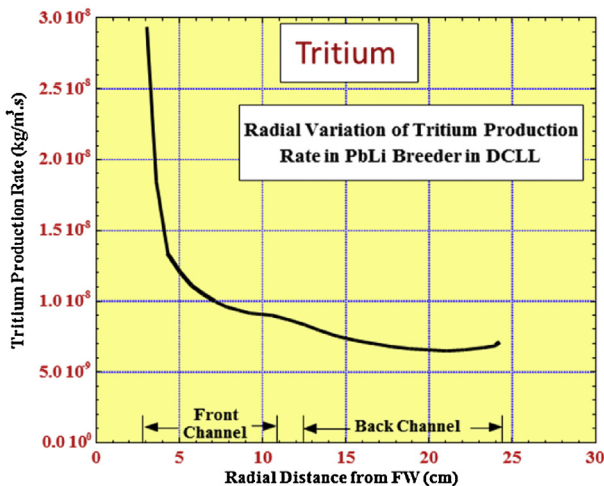
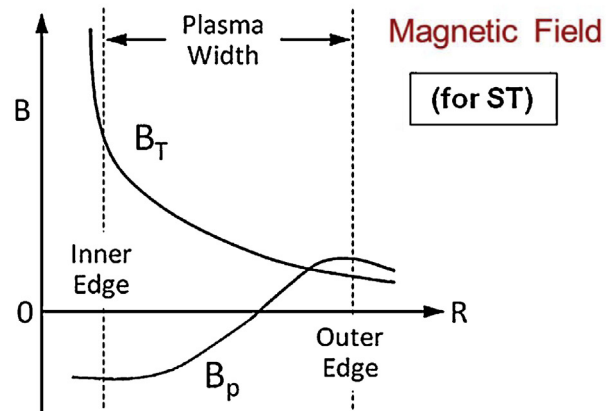
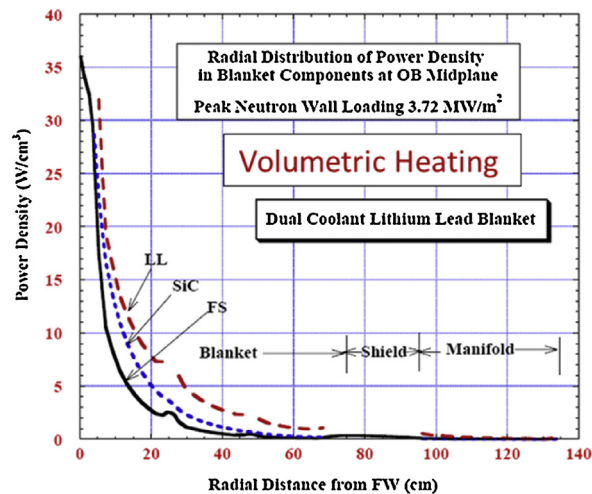

Fig. 19. Representative examples of the strong gradients in the multi-component fields and responses of the fusion nuclear environment. These gradients play a major role in the behavior of fusion nuclear components.

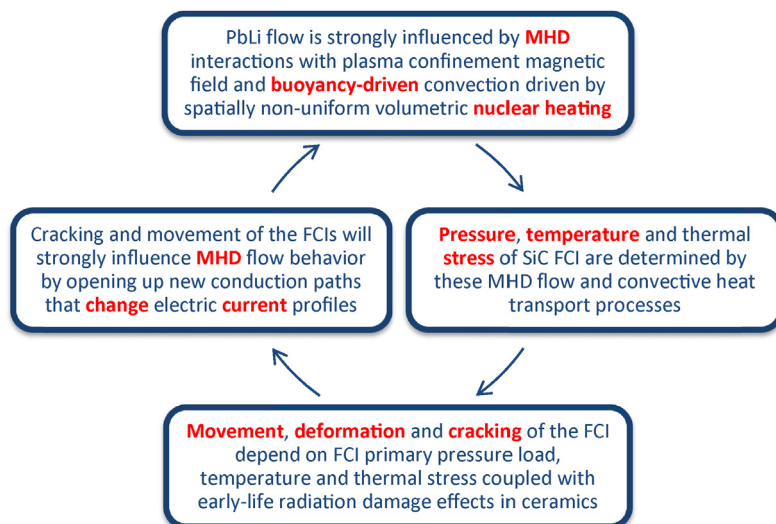

Fig. 20. Example of importance of exploring multiple effects/multiple interactions phenomena in the complex fusion nuclear environment. Interactions between MHD flow and FCI behavior are highly coupled. Similar coupled phenomena occur in tritium permeation, corrosion, ceramic breeder thermomechanics, and other blanket and material systems behavior.

the blanket. This combination results in “mixed convection” and “flow reversal” in a case that was shown to be stable laminar flow under the effect of only the magnetic field without considering gravity or the nuclear heating response. Fig. 20 shows another example of the complex interactions between the MHD flow and FCI behavior when the combined effects of the fusion environmental conditions and material-fluid interactions are considered. The illustration in Fig. 20 shows the importance of exploring multiple effects/multiple-interactions and coupled phenomena in both modeling and experiments. The fusion nuclear environment with the many interactive and synergistic effects discussed above can be completely simulated only in a DT plasma-based device. It cannot be fully simulated in non-fusion facilities such as laboratory facilities, fission reactors, and accelerator based neutron sources. Therefore, a Fusion Nuclear Science Facility (FNSF) is required prior to DEMO. The FNSF is discussed in more detail in Section 7, but its principal objective is to enable experiments and obtain fundamental data on the behavior of fusion nuclear components. However, prior to FNSF, we must perform an extensive R&D program using numerical modeling and experiments in non-fusion facilities that advance the understanding and design maturity of blanket/FW components to the maximum practical degree. This R&D, discussed in detail in Section 6, will improve performance, reliability, and safety of an FNSF, and thus save time and costs associated with operating this relatively expensive DT fusion facility. The required laboratory experiments must have substantial capabilities to simulate multiple effects.

4.2. Volumetric nuclear heating

The inability to adequately simulate volumetric nuclear heating and its gradients in laboratory experiments represents a serious challenge in the development of the blanket/FW. There must be worldwide attention to this challenge and methods and capabilities must be explored and the consequences must be evaluated and included as a primary consideration in the R&D pathway to DEMO.

Simulating volumetric nuclear heating in a large volume with gradients is necessary to reproduce prototypic temperature and temperature gradients. Most material properties and phenomena are temperature dependent. In addition, temperature gradients play a key role in determining material responses in different elements of the blanket, e.g. thermal stress gradient. The combination

of the gradients of neutron flux and temperature determine the gradient in material “swelling,” i.e. differential swelling. It is important to remember that gradients, such as stress gradients and differential swelling, have more impact than uniform responses on the behavior of components and on failure modes and rates.

Simulating the gradients in the volumetric nuclear heating is essential to discovering new phenomena. One example is from reference [37] and mentioned in Section 3. It is found through modeling and analytical studies for liquid metal blankets that accounting for the gradients in nuclear heating results in complex “mixed convection” MHD flows with buoyancy forces playing a key role in MHD heat, mass, and momentum transfer (Fig. 21). In fact, the combined effects of the presence of a magnetic field and buoyancy effects caused by the presence of volumetric nuclear heating with gradients are so large that they can result in flow reversal in the “downward flow” channel in the DCLL as analyzed in Fig. 22. These combined effects result in substantial changes in the velocity field, e.g. in formation of potentially unstable velocity profiles with inflection points.

Simulating the volumetric nuclear heating magnitude and gradients in a large volume requires a strong neutron field which can be achieved only in a D-T plasma-based device. But we must carefully investigate and be creative in developing methods to create approximate volumetric heating and approximate gradients in laboratory facilities such as liquid metal MHD flow and ceramic breeder thermomechanics facilities. Resistive heaters have the flaw of being only in “discrete” spatial locations and of altering the behavior in regions where they are embedded. Surface heating can give reasonable values of the magnitude but may result in complete distortion and reversal of the gradients of the volumetric nuclear heating and the resultant temperatures. The possibility of using rf waves for heating ceramic breeder mockups in the laboratory may be feasible but needs to be carefully evaluated. “Induction heating” is another method that should be explored for heating in ceramic breeders as well as liquid metals. The utilization of a gamma-ray source that emits sufficiently energetic photons, e.g. 2 MeV, to produce volumetric heating with gradient is yet another possibility that should be explored. This will complicate the operation of laboratory facilities but there will be no residual radioactivity after shutdown. If accurate simulation of the volumetric heating and its gradients in laboratory facilities proves impossible, a plausible alternative is to attempt to simulate at least the temperature with approximate

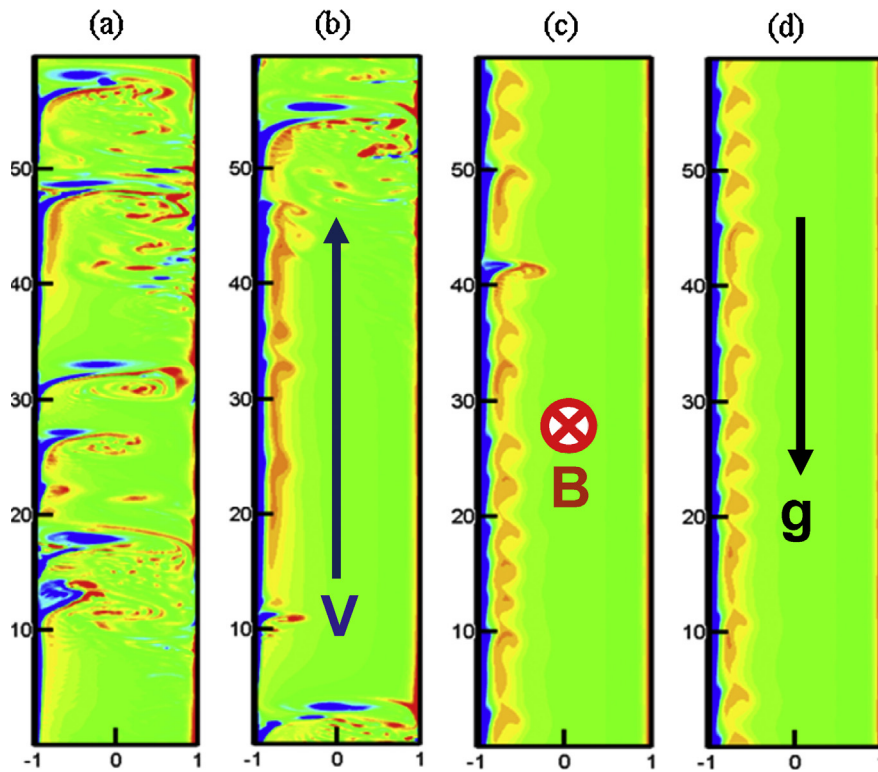

Fig. 21. Gradients in nuclear heating and temperature cause buoyancy forces playing a key role. Shown is the turbulent vorticity field in the resultant “mixed-convection” flow at $Re = 5000$ and $Gr = 10^8$ computed in [72]. Strong turbulence: (a) $Ha = 50$, and (b) $Ha = 60$. Weak turbulence: (c) $Ha = 100$, and (d) $Ha = 120$.

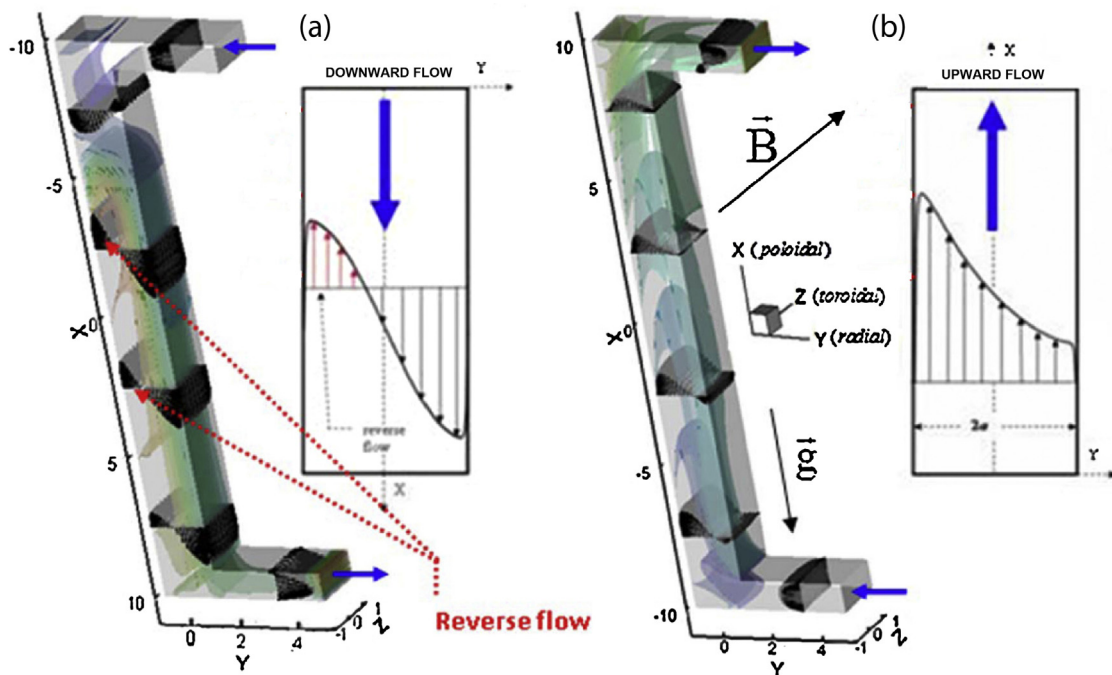

Fig. 22. The combined effects of magnetic field and buoyancy forces caused by the presence of volumetric nuclear heating with gradients are so large that may cause “flow reversals” in DCLL ducts: (a) formation of flow reversal zones near the “hot” wall in downward flows, where buoyancy forces oppose the flow; (b) in upward flows, buoyancy forces are in the main flow direction causing local flow overspeed [67,71].

representation of the temperature gradients in order to capture the strong dependence of most phenomena on temperature. For example, a clever design of a combination of surface heaters and heat sinks may result in good representation of the temperature profile. There are widely available technologies for producing surface

heating. The heat sink can be affected by surface cooling. Such approach will result in linear temperature profile rather than the more complex non-linear actual temperature profile, but if the gradients direction is correct with good approximate representation of the rate of temperature drop per unit length, one would expect

that important information about multiple effect phenomena can be obtained in laboratory experiments.

Small mockups of the blanket can be tested in fission reactors. While neutrons in fission reactors can produce reasonably representative values of the magnitude of the nuclear heating, they cannot simulate gradients—actually they result in “reversed gradients.” This is because neutrons in this case represent a “surface source” which will diffuse from outside the mockup to the inside rather than being distributed as in fusion. Also the predominantly low energy neutrons in fission will be quickly absorbed in Li in layers in the outer layer of the mockup. Another limitation is the small volume available for testing in a fission reactor, limiting the mockup size to a cylindrical assembly with ~5–10 cm diameter. However, fission reactors can and must be utilized to investigate issues such as “in-situ” tritium release in ceramic breeders and neutron effects on structural and functional materials.

Accelerator-based neutron sources are not suitable for producing significant volumetric heating in blanket mockups. Note that, a D-T accelerator-based neutron source that produces 5×10^{12} neutrons per second results only in $\sim 1 \mu\text{K}$ temperature rise in a blanket mockup. So the neutron source strength of currently available accelerator-based neutron sources is too low to produce sufficient simulation of volumetric nuclear heating to produce temperatures and gradients suitable for blanket experiments.

It is clear from the above that non-neutron laboratory test stands must be the primary vehicle, prior to FNSF, for carrying out tests that combine the magnetic field and volumetric heating with gradients. The necessity of volumetric heating and gradients is to reproduce the temperature and temperature gradients. The possibility of producing the temperature gradients through the use of surface heating and clever changes in the LM flow path in the magnetic field region should also be explored although this might require expensive large-volume magnets.

4.3. Complex configuration with blanket inside the vacuum vessel

The most consequential decision made in the 1970s in fusion reactor designs was to locate the vacuum vessel outside the blanket. This decision was necessary to enable the vacuum vessel to be robust and not exposed to the substantial surface and volumetric heating and radiation damage in the first wall region. But the location of the blanket/FW/Divertor *inside* the vacuum vessel has major consequences:

- (a) many failures (e.g. coolant leak) require immediate shutdown, this means low fault tolerance, and hence short MTBF
- (b) repair/replacement takes a long time, and hence long MTTR.

Short MTBF and long MTTR mean that attaining high device “availability” is a challenge (see Section 3.4). Characterization of this challenge can be quantified. In Section 3.4 we indicated that achieving DEMO availability of ~50% requires blanket availability of 87%, MTBF >11 years, and MTTR <2 weeks. The question is then: what are the likely achievable MTBF and MTTR with current tokamak and blanket concepts? This question was addressed in [3]. There is currently no data on failures rates, modes, and effects for blankets in the fusion nuclear environment. Extrapolation from operating fission reactor experience using unit failure rates for pipes, joints, etc. of fission fuel rods to the fusion first wall indicates that the MTBF in the FW is likely to be as short as hours to days. This estimate assumes that there are no additional failures due to the harsh fusion nuclear environment. This is compared to required MTBF of >11 years required in DEMO. There are many reasons why the failure rate in the FW is expected to be higher and the MTBF is expected to be shorter than in fission reactor core. All the fusion energy produced in the plasma must pass through the first

wall and divertor, and in order to keep the surface heat and neutron fluxes manageable, the first wall surface must be large with long coolant pipes and joints.

The Fusion program has not yet built any fusion facility with a prototypical fusion nuclear environment, and therefore precise estimates of MTTR are not possible. However, approximate estimates are possible based on detailed analysis of remote maintenance operations performed for ITER [145]. Such estimates predict MTTR for replacement of the blanket/FW to be ~3–4 months. This is compared to required MTTR <2 weeks in DEMO. Primary reasons for such long predicted MTTR of 3–4 months are the complex configuration and the location of the blanket/FW inside the vacuum vessel, which necessitate many long maintenance operations – all with remote maintenance in the radioactive nuclear environment. It is worth noting that in current operating fission reactors, an entire fuel bundle can be replaced in 2 days.

Note that availability is determined by both MTBF and MTTR as shown in Eq. (2). So, there is a tradeoff between MTBF and MTTR to achieve the same availability. But the above analysis shows that there is a huge discrepancy between “required” goals and what is most likely to be achievable. This is one of the top challenges for fusion development.

This challenge has a major impact on planning R&D and on defining the goals and designs of facilities in any roadmap to DEMO. We will address this in Section 5 through Section 7.

5. Science-based framework for R&D

In this section we describe a science-based framework for fusion nuclear science and technology (FNST) R&D, which involves modeling and experiments in non-fusion and fusion facilities. This framework was initially developed in the FINESSE study [4,5] and utilized and evolved over many years, and we have found it to be a very effective basis to plan a credible pathway toward DEMO. Several planning studies in the US have accepted and utilized this framework (see for example references [129,131,146]).

We have further evolved and refined this framework and developed associated quantitative parameters to measure progress. The framework is illustrated in Fig. 23 and can be briefly summarized as follows. The ultimate goal of current fusion research and development is to produce verified and validated predictive capability in the form of design codes and databases that can be utilized to design and predict the performance of DEMO and power plants. This requires theory and modeling efforts, accompanied by a substantial program of experiments. These experiments progress from basic and separate effects to multiple interactions/multiple effects experiments, and then to the more complex categories of partially integrated experiments, and integrated experiments and finally component tests. These categories are defined in some more detail in Table 6.

Multiple-effect/multiple interaction experiments cover a wide range of two, three, or more environmental conditions and two or more physical elements. Facilities become obviously more complex and more expensive, and accompanying modeling becomes more advanced as we proceed from separate to multiple effect/multiple interactions experiments. In partially integrated tests, the full prototypical subcomponent (e.g. blanket module) is tested with all environmental conditions except neutrons. Integrated experiments provide for testing a blanket module in the integrated fusion nuclear environment. Component tests provide for testing the full blanket with module-to-module interactions.

Note that while the sequence of experiments in Fig. 23 indicates loose “chronological order,” some overlap and feedback will and should occur. For example, some separate effects experiments can continue in parallel with multiple effects experiments, and some of

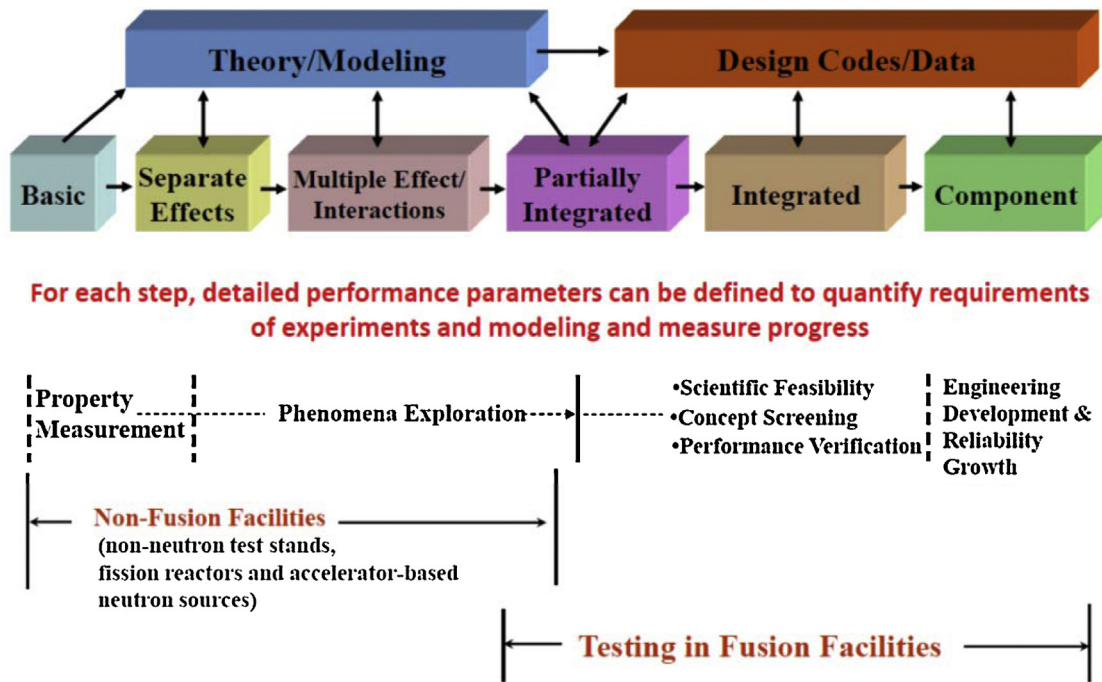

Fig. 23. Science-based framework for FNST R&D, which involves modeling & experiments in non-fusion and fusion facilities.

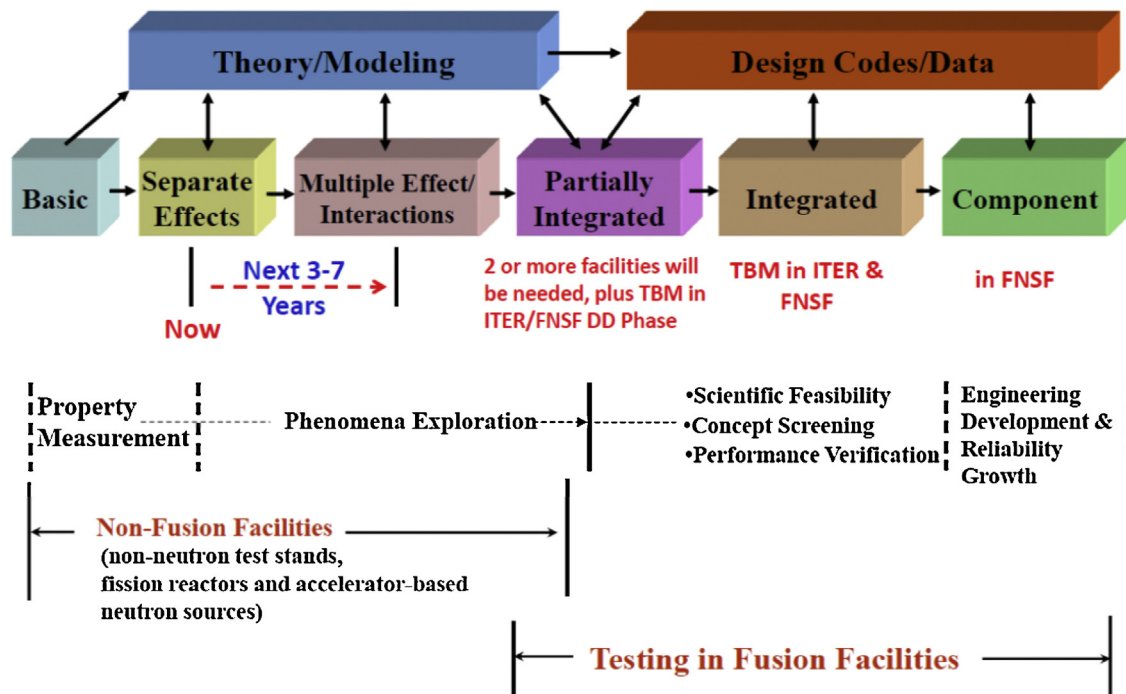

Fig. 24. Science-based framework shows that the world blanket programs are now in “separate effects” stage. The world needs to move to “multiple effects/multiple interactions” to discover new phenomena and enable future integrated tests in ITER TBM and FNSF.

both can continue in parallel to integrated experiments, especially as new phenomena discoveries may require additional clarifying or supporting research at the separate or multiple effect level.

Based on analysis presented in Section 4, integrated experiments and component tests can be performed only in DT plasma-based devices with the full fusion nuclear environment. Partially integrated tests can be performed in elaborate laboratory

facilities. The initial hydrogen and DD phase of DT fusion facilities, e.g. ITER and FNSF, provide excellent conditions for partially integrated tests.

The purpose of separate and multiple-effect experiments is phenomena exploration. These can be performed in laboratory experiments with some specialized tests in fission reactors and DT accelerator-based neutron sources. One critical point that must be

Table 6
Categories for FNST/blanket R&D experiments shown in the science-based R&D framework in Figs. 23 and 24.

Basic experiments
Basic or intrinsic property data
Single material specimen
Examples: thermal conductivity and neutron absorption cross section
Single-effect experiments
Explore a single effect, a single phenomenon, or the interaction of a limited number of phenomena to develop understanding and models
Generally a single environmental condition and a clean geometry
Examples: (a) pellet-in-a-can test of the thermal stress/creep interaction between solid breeder and clad, (b) electromagnetic response of bonded materials to a transient magnetic field, and (c) Tritium production rate in a heterogeneous assembly of materials exposed to a point neutron source
Multiple-effect/multiple-interaction experiments
Explores multiple environmental conditions and multiple interactions among physical elements to develop understanding and prediction capabilities
Includes identifying unknown interactions and directly measuring specific global parameters that cannot be calculated
Two or more environmental conditions and more realistic geometry
Example: testing of an internally cooled first-wall section under a steady surface heat load and a time-dependent magnetic field
Partially integrated experiments
Partial integration test information but without some important environmental conditions to permit large cost savings
All key physical elements of the component and not necessarily full scale
Example: liquid-metal blanket test facility without neutrons if insulators are not required. (For concepts requiring insulators, tests without neutrons are limited to multiple effect.)
Integrated experiments
Concept verification and identification of unknowns
All key environmental conditions and physical elements, although often not full scale
Example: blanket module test in a fusion test device
Component test
Design verification and reliability data
Full-size component under prototypical operating conditions
Examples: (a) an isolated blanket module with its own cooling system in a fusion test reactor and (b) a complete integrated blanket in an experimental power reactor

stressed is that some single and multiple effects, such as volumetric heating, temperature and their gradients, cannot be adequately simulated in non-fusion facilities (see discussion in Section 4). Therefore, some important phenomena will not be observed prior to testing in the DT fusion facilities. This implies that the first stage of testing in the fusion nuclear environment, e.g. in FNSF, must be planned for scientific exploration and discovery (not validation) as we will discuss in Section 7.

For each step in Fig. 23 (e.g. multiple interaction experiment for any given technical area), detailed performance parameters can be defined to measure progress. For example, for MHD fluid flow dynamics, we can utilize parameters such as Ha , Gr , and Re numbers, length scales and aspect ratios, etc., to define goals and measure progress. It is important that such set of parameters are supplemented by measures such as the ability to simulate volumetric heating and temperatures and their gradients.

We can use this science-based R&D framework of Fig. 23 to indicate where we are today in blanket research and where we need to go next as we illustrate in Fig. 24. Blanket R&D worldwide for many technical areas (e.g. MHD fluid flow dynamics, MHD mass transport, tritium permeation, ceramic breeder thermomechanics, structural material response) are now mostly in the “separate effects” experiments stage. To make substantial progress on blanket R&D, the world programs need to move rapidly to multiple effect/multiple interactions facilities and experiments.

An example is MHD experiments. Currently, PbLi is used in the presence of a magnetic field to investigate the single effect of a magnetic field on MHD fluid flow. The world programs need to

move quickly to the next step of adding surface and volumetric heating with multiple-channel test articles to better understand for example the impact of MHD mixed convection discussed in Section 4.2 and other effects.

This science-based framework will serve as a basis for the analysis in the following two sections: Section 6 on R&D in non-fusion facilities and Section 7 on R&D in plasma-based fusion facilities.

6. R&D in non-fusion facilities

Blanket design concepts and their scientific and engineering issues have already been described in some detail in Sections 2 and 3. R&D in non-fusion facilities is necessary to advance from the present state of knowledge to the degree needed to initiate, execute and understand effective testing in the fusion nuclear environment. The science-based framework presented in Section 5 classifies required near and medium term R&D into *Basic* and *Separate Effects*, and then *Multiple-Effect/Multiple-Interaction* to *Partially Integrated* R&D in dedicated test facilities. This blanket/FW R&D in non-fusion facilities includes a coordinated program of experiments, phenomenological and computational modeling, and simulation and analysis for design and concept improvement.

Laboratory experiments are expensive and time consuming to build and operate, but essential to develop and verify models and as a tool to uncover new synergistic phenomena resulting from the complex loads and conditions in the fusion environment. A number of laboratory scale research facilities and capabilities are required that can partially simulate the heating, magnetic field, temperature and temperature gradients and other conditions relevant to blanket operation, including:

- *Liquid metal flow loops*: Several PbLi flow facilities will be needed for MHD, heat transfer, chemistry control, and corrosion/mass transport studies. Test facilities specifically focused on blanket MHD and heat transfer will need magnetic field and heating systems
- *Tritium extraction and permeation test facilities*: Several facilities will be needed for testing tritium behavior in PbLi and ceramic breeder mockups and unit cells under in-vessel blanket conditions, as well as tritium permeation and extraction in ancillary components of the blanket system
- *Heat flux/thermomechanical loading test facilities*: Ceramic breeder materials, packed beds and multi-layer unit cells as well as blanket/FW structure will require thermomechanical testing in simulated fusion conditions. Heating, mechanical loading, and helium coolant loops will be required as part of these facilities to provide prototypic cooling to ceramic breeder unit cells and blanket/FW structure mockups
- Ultimately, a number of significant multiple effect facilities will be needed that bring together magnetic field, heating, gravity, and high temperature PbLi flow or CB unit cells for testing mockups approaching full scale in size and geometric complexity

Worldwide and especially in the US, few of these facilities currently exist and will need to be constructed. In addition to the test facilities themselves, a significant expansion of instrumentation options is necessary to acquire quantitative in situ data (e.g. in contact with PbLi) from complex test articles at high temperature without disturbing the phenomena under investigation. Laboratory test environments present the opportunity for more complete instrumentation that will likely be feasible in later experiments in the fusion environment. Measurements of flow velocity, strain, pressure, voltage, temperature, tritium/impurity concentration, etc. are all required for validating models and understanding phenomena. These measurement capabilities need to be vigorously

developed in the near term, with an eye toward possible deployment in the fusion environment as well.

Phenomenological and computational modeling are also essential, as models and simulation codes are needed to explain and interpret experiments and then to extrapolate experimental results beyond the limited conditions of a small number of experiments to the conditions of fusion environment tests and ultimately to DEMO. A key focus of the modeling effort should be to develop time varying predictive capabilities for blanket temperature, mass transport and mechanical response of the blankets components and systems. But modeling of the blanket/FW is very challenging because of unknown synergistic phenomena stemming from the multiple loads and multiple fields experienced by the complex, multi-scale, multiple material blanket/FW component and its ancillary systems. The experiments described above are a tool discovering these synergistic phenomena that can't simply be predicted by synthesizing separate effects so that they can be included and validated in models and design codes going forward.

R&D activities should be kept generic and scientifically based in order to be relevant to broadest number of blanket concepts and design variations, and to encourage understanding, innovation and improvement of designs. In this way, simulation and analysis using the models and experimental database described above can be used to incorporate what is learned from separate and multiple effects R&D efforts into practical blanket system designs. Blanket designs will be improved from the perspective of performance, safety margin, and accident consequences.

In Table 7 and in the following subsections, examples of important R&D areas are discussed in more detail. They are based upon lead lithium based breeder blankets, specifically the Dual Coolant Lead Lithium (DCLL) blanket system, and Helium Cooled Ceramic Breeder (HCCB) based blanket systems. Both blanket families use RAFM steels as the structural material which is cooled by helium, and so have issues and R&D tasks in common related to the structural thermomechanics, fabrication, cooling and some tritium transport and permeation issues. But the DCLL an HCCB have markedly different feasibility issues and R&D when it comes to the material interactions of the breeder, multiplier, and other functional materials; and the use of flowing PbLi as a coolant in the DCLL.

6.1. Basic and separate effects R&D

As described in Section 5, Basic Experiments includes R&D such as the measurement of thermophysical properties of material samples; and Separate Effects R&D explores a single effect, a single phenomenon, or the interaction of a limited number of phenomena with a single environmental condition to develop better understanding, models and predictive capability. While blanket R&D has been advancing and progress has been made in many areas, because of new designs, new understanding, new blanket concepts and new materials and fabrication methods, there remain Basic and Separate Effects research and theory and modeling development required in a number of key areas. For the DCLL these include PbLi eutectic stability, physical chemistry and tritium behavior; SiC FCI fabrication, thermomechanical and cracking characteristics and compatibility with PbLi; and solubility of RAFM steel constituents and impurities in PbLi. For the HCCB new fabrication techniques for ceramic breeder pebble or porous block, and the introduction of new multiplier materials such as Be₁₂Ti, require continued characterization of thermomechanical properties and strength of materials feeding into constitutive model development. Both DCLL and HCCB use RAFM steels as the structural material and Helium as the first wall and structure coolant. R&D to further develop fabrication technologies for current generation RAFM steels is essential to enable construction of representative RAFM steel test articles for Separate

Table 7

Near term R&D areas for dual coolant lead lithium (DCLL) and He cooled ceramic breeder (HCCB) blanket systems (e.g. [37,94,129–131,143]).

Main thrust areas	R&D tasks
PbLi-based blanket flow, heat transfer, and transport processes	<ul style="list-style-type: none"> • Long term behavior of prototype FCIs including movement, cracking, wetting and LM infiltration at prototypic temperatures, pressures and magnetic fields • Impact of 3D flow elements on pressure drop, e.g. gaps and overlap regions between adjacent FCIs • Flow distribution between parallel channels with/without FCIs for pressure drop control • Onset and stability of buoyancy driven secondary flows driven by internal heating with strong spatial gradients • Stability of shear flows inside FCIs with low electrical conductivity • Impact of these unsteady flows on heat and mass transport in large poloidal flow channels and thin gap regions • PbLi corrosion/redeposition under prototypic multi-material and MHD conditions • PbLi impurity, corrosion and transmutation product control methodologies
PbLi blanket tritium extraction, control and processing	<ul style="list-style-type: none"> • Consistent blanket tritium control strategy for PbLi/He systems • Tritium extraction from PbLi with high efficiency at low tritium partial pressure and high PbLi temperature • High temperature He coolant tritium cleanup methodology • Tritium accountancy and permeation control methodologies • Tritium and He bubble formation and dynamics in PbLi under neutron irradiation
Thermomechanical response of helium cooled blanket/FW structures	<ul style="list-style-type: none"> • Heat transfer phenomena and thermomechanical response of large area structures cooled by helium (typical FW heat loads) • Heat transfer phenomena and thermomechanical response of internal cooling plates and internal blanket ribs • Testing of blanket/FW integral mockups with heat loads
Ceramic breeder and beryllium pebble thermomechanics and tritium release	<ul style="list-style-type: none"> • Characterization of ceramic breeder and Be multiplier material stress, strain, creep and deformation behavior under thermo-mechanical conditions • Filling and packing of CB and Be pebble beds in blanket components • Mechanisms and impact of pebble cracking on packing rearrangement and heat transfer • Stability of ceramic breeder and Be multiplier thermomechanical and tritium release properties under neutron irradiation to high burnup
Structural and functional material fabrication and property characterization	<ul style="list-style-type: none"> • Fabrication of RAFM steels for blanket mockups • Fabrication of CB, Be, Beryllide pebble or porous block materials • Manufacturing processes for PbLi breeder • High temperature SiC for flow channel inserts compatible with pressurized PbLi • High temperature heat exchanger tubes, and tritium extraction membranes compatible with PbLi • High temperature permeation barriers compatible with PbLi • Degradation of RAFM steel and SiC properties with irradiation

Effect and later Multiple-Effect experiments for blanket/FW development. Several specific examples of the associated R&D needs are highlighted below.

6.1.1. Tritium extraction R&D in PbLi blankets

For the DCLL concept in particular there is a significant benefit gained from developing a high efficiency tritium extraction

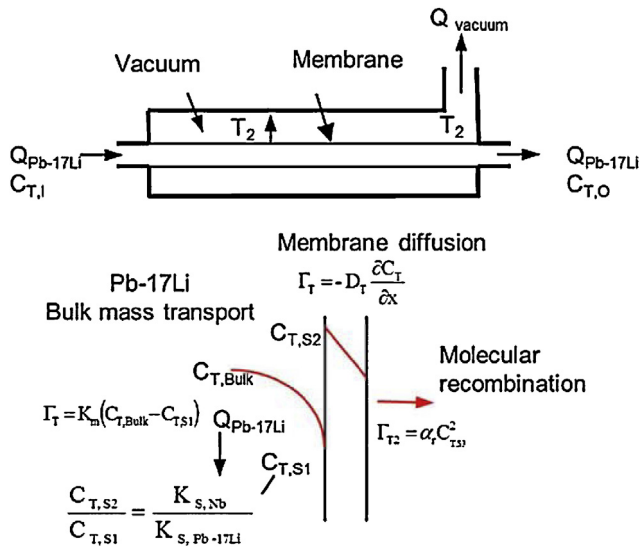

Fig. 25. Single tube vacuum permeator for tritium removal, and tritium concentration and flux model [147].

technology [130]. This benefit stems from (a) the relatively high flow velocity that limits the tritium increase per PbLi pass through the blanket to be quite low and (b) the presence of a SiC FCI that may serve as a tritium permeation barrier due to very low diffusion of tritium in silicon carbide [73]. If the tritium concentration at the blanket inlet can also be kept low, by means of a high efficiency tritium extraction system, then the tritium concentration and thus partial pressure and resultant tritium permeation in the entire PbLi circulating loop can be kept very low, reducing tritium permeation into undesirable areas such as the reactor building or secondary coolants to the required limit of 1 g/yr cited in safety studies. The vacuum permeator as shown in Fig. 25 is one tritium extraction method that might meet this need [130,131,147]. In this device, the liquid metal flows through thin walled tube bundles housed in a vacuum chamber and the tritium diffuses through the LM boundary layer and the tube wall, and is then extracted by vacuum pumping. While conceptually promising, this concept has not been tested for PbLi even at the lab scale. The key R&D activities include development of compatible tube materials, possibly Ta, Nb, V, or Zr alloys, understanding the tritium diffusion rates through turbulent PbLi boundary layers, and the impact and control of impurities on both the PbLi and vacuum sides that might degrade the permeation behavior or the tube mechanical integrity. All of these tasks are challenging in themselves, suggesting a need for a single tube proof of principle testing of this concept to assess its feasibility and validate process models.

For the HCLL blanket, the tritium extraction method can be different from that for DCLL because of the low PbLi circulation rate and thus correspondingly high increase of tritium concentration at the blanket exit. These HCLL conditions will likely require permeation barriers, as described in Section 3.5, to control otherwise intolerably high tritium permeation losses. The main candidates for such coatings are:

- Alumina or aluminides applied either by hot dipping of the steel into an aluminum pool, by powder pack cementation, or by plasma spraying
- Erbium oxide layers possibly with over-layers of tungsten as protective anti-permeation and corrosion barriers

Continued R&D is required to establish effective permeation barriers that control permeation losses over the long term and under non-steady and non-isothermal PbLi conditions. These are essential

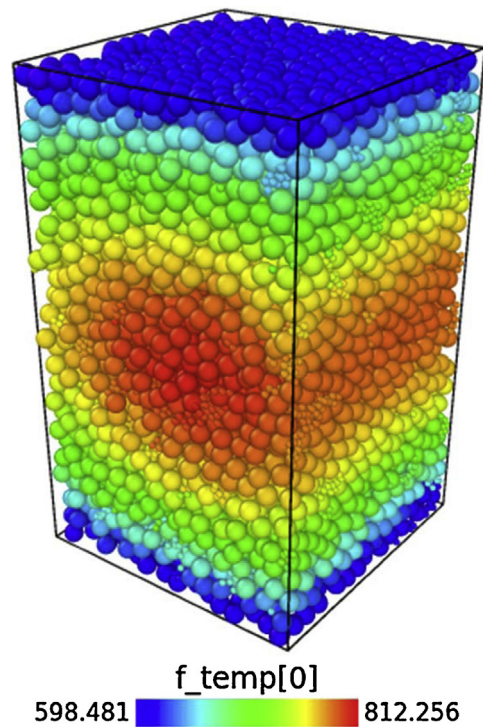

Fig. 26. Coupled discrete element with CFD simulation of a ceramic breeder bed showing resultant temperature profiles after 3% of pebbles crushed and simulated uniform nuclear heating (temperature in °C) [148].

separate effects tests needed prior to testing barrier coating effectiveness in a flowing system or their longevity under neutron irradiation.

6.1.2. Solid breeder thermomechanics R&D

As described in Section 3.3, solid breeder blanket concepts are typically based on the use of granular pebble beds of lithium ceramics and beryllium packed between structural plates with embedded internal helium cooling channels. Initial packing of these pebble beds into blanket modules can be a challenge given many fabrication constraints and module size and weight. During reactor operation, the bed will undergo thermal expansion relative to cooled structure due to higher expansion coefficient, temperature, and irradiation swelling of the beds—causing significant stresses, deformation and breakage. Particle breakage and deformation can endanger safe blanket operation, particularly if heat transfer and tritium removal significantly deteriorate due to loss of good contact with heat sinks (helium cooled blanket structures) or sealing off of porosity needed for tritium release. Consequently, the determination of these stresses and their resultant impact on breeder blanket performance and material specifications is an important focus of the ceramic breeder R&D.

Separate Effects research on non-linear elastic and partially irreversible deformation due to compaction and creep are key phenomena in need of specific R&D [94]. The application of classical continuum model to simulate a prototypical blanket pebble bed operation is difficult, requiring constitutive equations obtained from experimental data as well as extensions to the model to account for granular bed rearrangement. Complementary approaches using discrete elements (see Fig. 26) can be used to model the particle bed as a collection of rigid particles interacting via Mindlin-Hertz-type contact interactions, i.e. a non-linear spring-dashpot response for normal contact between particles a Coulomb friction coefficient for shear interactions.

Improving the material database that feeds these models requires better detailed measurements of candidate material properties, microstructures and surface morphology as well as better knowledge of the sizes of particles, non-uniformities and asymmetries in conditions, and loading histories as experienced by particles, etc. Packed bed thermomechanics experiments with better simulated heating and mechanical loading and geometric effects must continue to provide better understanding and quantification of phenomena for modeling improvements, building toward full small scale unit cell tests including prototypic structure, He coolant, ceramic breeder and neutron multiplier materials.

6.1.3. Fabrication R&D for RAFM steels

Current knowledge of irradiation damage in ferritic/martensitic structural steels such as F82H and EUROFER is deemed sufficient to make these materials candidates for fusion environment testing. Thus test sections and mockups for blanket system experiments like those described in Table 7 need to be fabricated from these candidate structural materials in the near term, and require the development of RAFM steel fabrication technologies and material interactions database. Given that the short MTBF/long MTTR issue will be the most serious challenge in fusion development from beginning to end (see Section 3.4), R&D testing of mockups and prototypes in simulated fusion environment that can help uncover performance issues and failure modes and effects should be the main focus on blanket R&D and not long dpa lifetime. The results of blanket/FW R&D in non-fusion facilities (and later in integrated fusion environment testing) will likely lead to significant changes in blanket and first wall design concepts and in structural and functional material requirements going forward.

In parallel with fabrication and materials interactions R&D, irradiation damage and helium production effects can continue to be studied by making maximum use of existing fission reactor capabilities. For example, methods to amplify He production via isotopically tailored iron [149] appear to be a promising option for fundamental studies on the mechanisms of helium-induced property degradation and the development of microstructural strategies to control the nano-scale distribution of transmuted helium.

6.2. Multiple-Effects/Multiple Interactions R&D

Multiple-Effect/Multiple Interaction to Partially Integrated R&D are intended to uncover a range of unknown synergetic effects that come from bringing together the elements of the unique fusion environment (volumetric heating, surface heating, surface particle loading, magnetic field, gravity, neutron irradiation, etc.) with the operation of high temperature, complex configuration, prototypic material blanket/FW component mockups and modules. This stage of R&D is designed to:

- discover new phenomena that will arise due to multiple fields/multiple interactions
- attempt to understand the likely true behavior (currently unknown) of materials, fluids, and subcomponents of the blanket/FW in the fusion nuclear environment
- calibrate results of experimentally observed “**synergistic**” effects against a “**synthesis**” of separate effect experiments and modeling
- provide a failure modes, effects and rates database for blanket/FW designs for fusion environment testing and DEMO

The knowledge and data is vital for validating modeling developed in the separate effects stage and to begin to establish the database for blanket safety and reliability, including failure modes, effects, and rates. Performing partially integrated testing is an essential link between laboratory scale experiments and full fusion

environment testing, where failures must be avoided and limited access and complex conditions can make interpreting experimental results difficult.

To address this research need, a number of significant testing facilities are required where combinations of fusion conditions are simulated to the greatest practical degree, and where complex components can be accommodated and fully instrumented to best understand their performance and failures during short to long operation cycles. These are rather expensive facilities with significant capabilities that do not often appear in fusion development roadmaps. Two main areas and associated experiments are described here with particular focus on the blanket/FW performance. Other facilities at this stage may still be needed in other areas, for instance for the development of reactor scale remote handling and high speed, high availability plasma exhaust processing.

6.2.1. Blanket mockup thermomechanical/thermofluid/MHD testing and laboratory facilities

Blanket/FW components and their associated heat transport and tritium processing loops are complex, multifunction systems that have many materials, joints, and interfaces and must function reliably under difficult environmental conditions. For liquid metal blankets, the flow of liquid metal breeder/coolant has a strong influence on (a) the ultimate operating temperature and pressure, and thus thermal-mechanical stresses; and (b) the mass transport in particular on tritium transport and corrosion processes. As stressed in Section 3.2, high MHD pressure drop is just the first of several serious MHD issues that must be addressed by R&D in the development of liquid breeder blankets:

- $\mathbf{J} \times \mathbf{B}$ forces in bulk flow that typically oppose the motion, leading to high MHD-induced drag and pressure losses, possibly requiring driving pressures that exceed the stress limits of the materials
- $\mathbf{J} \times \mathbf{B}$ forces in boundary layers or near insulation imperfections that can drive high velocity jets several times faster or even reversed in direction when compared to the mean flow
- Strong energy dissipation via Joule heating competing with turbulence production in internal shear layers leading to transitional and new turbulence phenomena like quasi-two-dimensional turbulence
- Global flow reorganization controlling flow distribution between parallel channels fed from a common manifold
- MHD drag and instabilities near regions of strong magnetic field gradients and geometrical or electrical conductivity variations
- Interactions of MHD effects with buoyancy effects resulting from gradients in fusion nuclear heating and temperature gradients that drive convection cells and modify thermal transport in ways similar to turbulence

These phenomena are driven by magnetic and thermal interactions that can exceed typical hydrodynamic viscous and inertial forces by many orders of magnitude (see Table 3), differ greatly from the intuitive behavior of ordinary hydrodynamic flows, and thus require specialized test facilities. MHD behavior will also involve interactions of the flow and electric currents with solid material components such as flow channel inserts and structural walls, requiring test facilities that can accommodate complex configuration mockups that reproduce these current paths.

Experiments will be required at sufficient magnetic field, flowrate, and channel size to reach typical Hartmann and Reynolds numbers of prototypic fusion blankets shown in Fig. 11. But simply increasing magnetic field alone without considering the effects of heating leading to buoyancy forces (Grashof number) will result in mistaken conclusions as to the flow stability and heat and mass transport of the system. Fig. 27 gives an indication of the operating

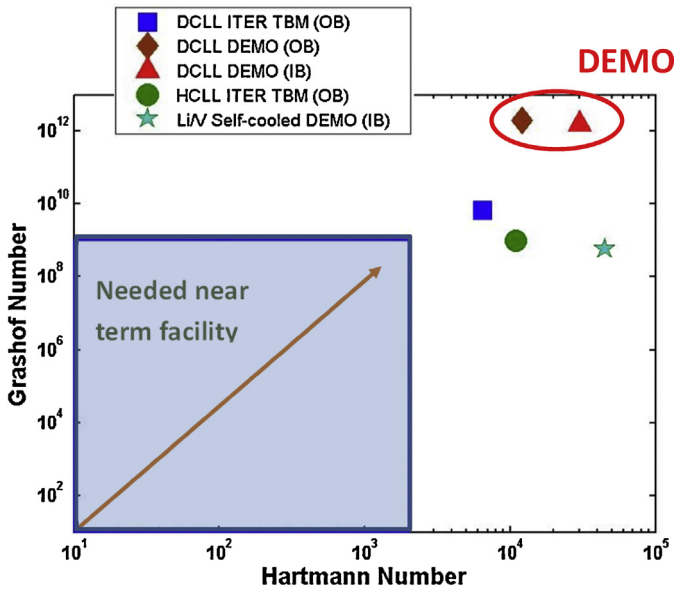

Fig. 27. Grashof/Hartmann space for needed near term experimental facilities compared to that required for various LM blanket designs in ITER TBM and DEMO.

point of typical blanket systems from the perspective of Ha and Gr, and shows the challenge to build facilities that can reach this parameter space.

We envision the need for a series of test facilities where blanket/FW components and supporting coolant systems can be tested under combined thermomechanical/electromagnetic loading conditions, moving toward more prototypical parameters, larger and more complex test articles, and building toward longer periods of operation and PbLi exposure. (Note: while focus here is on liquid metal blankets these facilities and their heating sources and helium coolant loops could be used for testing ceramic breeder blanket systems unit cells and modules as well.)

6.2.1.1. Limited multiple-effect LM MHD mixed convection experiments. Limited multiple-effect experiments on the interaction of pressure driven flow with magnetic and buoyancy forces should be a near-term goal and will require a facility that includes heat sources and sinks that can reproduce blanket temperature gradients and Grashof number, as noted in Fig. 27. One possibility is to upgrade the aforementioned MaPLE facility [70] by the addition of flexible heat sources and a system to modify magnet gap orientation in order to simulate buoyancy effects at different inclinations of the flow channels to the field and to gravity. Experiments should focus on understanding the combination of parameters that define the stability regime as a function of magnetic field and temperature gradient conditions, and to quantify the impact of the stability regime on the transport and pressure drop behavior.

6.2.1.2. Multiple effects/multiple interactions blanket facility. This intermediate facility will explore more reactor relevant conditions such as stronger magnetic field beyond 2 T, larger magnetic volume and more prototypical field gradients, simulated surface and volumetric heating and gradients, all with flexible orientation with respect to gravity. The key goal of experiments will be to simulate thermomechanical and thermofluid-MHD behavior of smaller scale unit cells and later nearer-to-full-scale blanket module mockups in a test environment that includes:

- Reactor relevant FW heat flux and transients and simulated volumetric heating
- Reactor relevant magnetic field strength and gradients

Table 8

Example parameters of a multiple-effect/multiple-interactions blanket/FW test facility for thermomechanical/thermofluid experiments.

Parameter	Max/typical value	Note
Module Size	1–2 m	Accommodate any size test articles up to near ITER-TBM and full size modules
PbLi Flow Loop	500 kg/s 2 MPa, 500 °C	Typical coolant/flowrates/pressures
He Flow Loop	5 kg/s 8 MPa, 500 °C	Typical coolant/flowrates/pressures
FW Heat Flux	1 MW/m ² (4 MW)	Ion/neutral beam or radiant (not affected by field)
Volumetric Heating	3 MW/m ² (12 MW)	Equivalent NWL, Simulated in some way (heaters)
Gravity	Variable	Flexible orientation w.r.t. gravity
Magnetic Field	5 T	Poloidal/Toroidal, 1/R, temporal variations
Mechanical Forces	10 MPa	Pressure; also vibration, impulse loads
Hydrogen load	H/D, 1000 Pa	To simulate tritium transport and hydrogen chemistry
Exposure time	Short to 5000 h	Cover short, prompt responses up to long term exposures

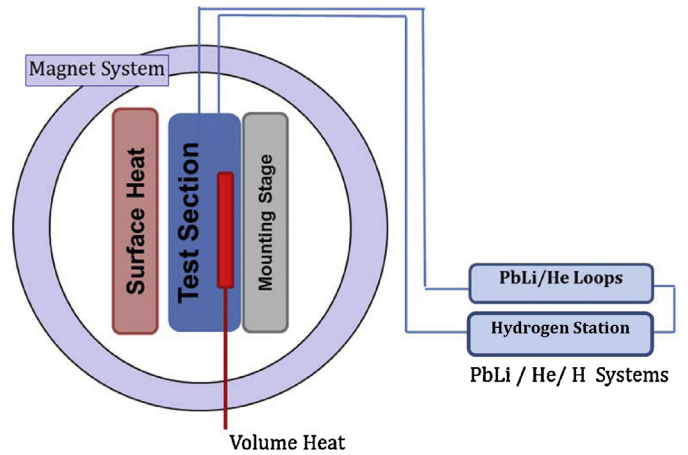

Fig. 28. Simple pictorial diagram of blanket mockup thermomechanical/thermofluid test facility.

- Prototypic operating temperatures and temperature gradients
- Prototypic mechanical loads: weight, pressure, vibration, impulses
- Prototypic coolant flow, pressure and temperature
- Hydrogen/deuterium loading
- Complex configurations and prototypic materials

Table 8 and Fig. 28 show possible parameters and simplified graphical representation for this intermediate Multiple Effects/Multiple Interactions Blanket Facility. The facility should be designed to accommodate aggressive testing and “testing to failure” experiments so that first contributions to the mockup and component reliability growth and failure modes and effects database can be made in a significant way. This facility should additionally be thought of as a systems test facility, including not only the test articles and test environment, but also the ancillary heat and hydrogen transport and control systems that will likely be considered safety grade components in later fusion environment testing.

6.2.1.3. Partially integrated blanket facility. The role of this significant facility is to bring together all simulated conditions affecting thermofluid/thermomechanical blanket/FW performance to the maximal practical degree prior to FNSF. For example, a full toroidal and poloidal magnetic field simulation that can accommodate near full size test articles mounted in multiple poloidal orientations with respect to the field and to gravity. The experimental mission is to perform full beginning of life testing of complete blanket designs and ancillary systems so that any “infant mortality” effects can be discovered and eliminated prior to fusion environment testing. Both the test articles and ancillary systems can be considered prototypes of those to be deployed in FNSF.

Each of these multiple-effect to partially integrated thermomechanical/thermofluid test facilities will be a significant, expensive and challenging facility to design, construct and operate. The loading conditions should be available in steady state for long term experiment operations, which means the power consumption can be significant, especially depending on the type of magnetic field system and heating systems employed. Significant instrumentation is required for operational control and for quantitative data collection for comparison against simulations. In addition, longer term processes such as corrosion, transport and deposition would also be quantifiably measured with concentration measurements and witness plate samples.

The introduction of volumetric heat in a prototypic way is a difficult challenge for a test facility (see discussion in Section 4.2) given that heaters embedded in the LM flow, in the FCI, or on the walls or flow channel inserts are likely to change the flow or material interaction behavior. Using RF induction heating on highly conducting liquid metals will have a limited skin depth and can also disturb the flow (such devices are used to actually stir liquid metals in the metal processing industries). Using gamma-ray sources as a way to introduce true volumetric heating may not be able to provide the large amount of power needed. Careful study is needed to determine the best way to simulate volumetric heating for each particular experimental mockup and goal. Similarly, reactor like magnetic fields approaching the field strengths of a reactor inboard and with temporal and spatial variations will be expensive to recreate. Finally, hydrogen transport and permeation can also be investigated in these facilities in an integrated fashion, requiring careful consideration of hydrogen control and measurement. It is conceivable that at a later stage of operation, that trace tritium could also be introduced into the system for studying more integrated effects of tritium transport and inventory behavior. In this case, the facilities would have to be designed with this in mind from the beginning, which would add to the complexity and cost. Given these questions, a serious study of the capabilities and trade-offs by facility and magnet designers and costing professionals, together with blanket R&D subject matter experts, is a necessary first step to any conceptual design.

6.2.2. In-pile blanket unit cell experiments

It is well known that neutron irradiation will impact the properties and behavior of materials used in blanket components. The often described evolution and degradation of structural materials is just one aspect, but the behavior of functional materials and the influence of irradiation on blanket processes are also important from the perspective of breeding blanket design, operation, performance, and material requirements. In particular, unit cell experiments where a breeding cell is mocked-up in a fission reactor or other neutron source will be an important tool to uncover synergistic effects resulting from functional materials property evolution and degradation, production of transmutation products, and changes in transport processes, coolant chemistry and tritium extraction.

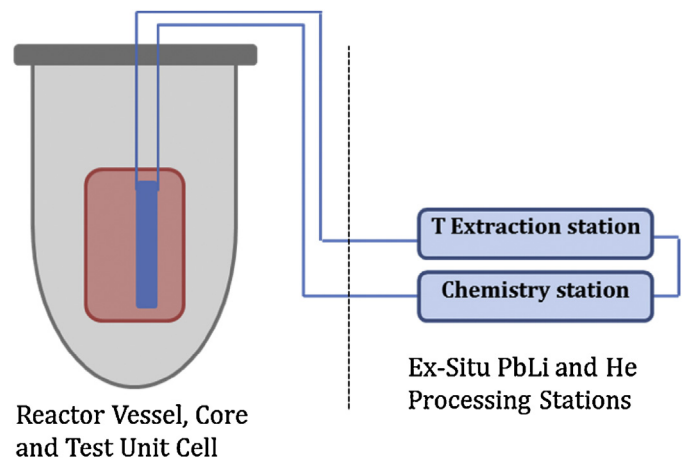

Fig. 29. Simple layout of in-reactor experimental unit cell coupled to ex situ processing and tritium extraction and chemistry control experimental stations.

6.2.2.1. PbLi breeder in-pile unit cell experiments. Important differences can exist between tritium transport and extraction experiments where tritium is loaded into the PbLi stream by diffusion as opposed to being produced there via an energetic reaction with a neutron. Bred tritium is produced simultaneously with insoluble helium that can potentially form micro-bubbles that may in turn act as trap sites for tritium near bubble surfaces. In such a case there may be an enhanced solubility for tritium that leads to different permeation and tritium extraction behavior. Similarly, permeation of tritium in general may be altered due to secondary gamma rays and charged particles altering surface dissociation and recombination processes, possibly leading to an enhanced permeation when compared to rates measured without irradiation. Bred tritium is also quite energetic (Q value is 4.78 MeV for $\text{Li6}(n,\alpha)\text{T}$ reaction) and tritium and helium bred near surfaces of SiC flow channel inserts or structural walls (possibly with a permeation or corrosion coating) will implant and damage those surfaces. The combination of these and other yet unanticipated synergistic effects need to be investigated through experiments in neutron irradiation facilities prior to integrated fusion environment testing.

Such experiments would have to be carefully planned and evaluated for the appropriate scope and required neutron source. What is currently envisioned at this conceptual stage (pictured in Fig. 29), is a unit breeder cell in a large 12.5 cm diameter flux trap typical of the Advanced Test Reactor at the Idaho National Lab. The unit cell experiment would consist of concentric tubes of steel and SiC filled with PbLi coupled to a flowing PbLi loop and helium loops carrying coolant and breeder out of the reactor. The external loops would have stations for PbLi chemistry control and monitoring, and prototypic tritium extraction testing. Measurements of tritium production, permeation, helium bubbles formation and their impact on tritium transport and extraction over long operation times will be a key feature of this work. Thermomechanical and neutronics simulations could also be partially validated against in-pile PbLi unit cell experiments.

Such external loops using sodium, gas, or high temperature pressurized water have been considered in the past at ATR and other irradiation facilities. The utilization of small gas loops for thermal barrier control and sample transport are routine on existing experiments (see Fig. 30). Techniques to vary the spectrum with neutron absorbers and control temperature with gas buffers are routinely employed. The integration of PbLi and He loops that supply coolant for and extract tritium from the in-pile unit cell that connect to the ex situ chemistry control and tritium extraction experimental stations will require significant design and safety efforts and resources. The entire experiment must meet stringent

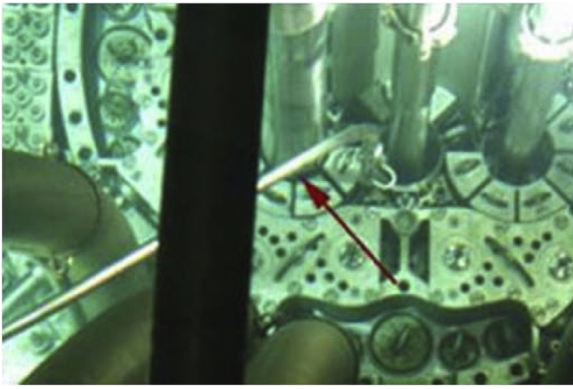

Fig. 30. Tube for ATR hydraulic sample shuttle entering reactor core.

nuclear safety criteria, but can serve as a way to further train fusion scientists for nuclear environment testing and provide invaluable safety experience for subsequent fusion environment testing.

6.2.2.2. Ceramic breeder pebble bed in-pile unit cell experiments. In-pile ceramic breeder unit cell experiments designed to study the effect of neutron irradiation on the thermo-mechanical behavior and tritium release of a ceramic breeder/multiplier pebble beds are an important multiple effects tool to assess the response of new blanket materials, designs, and fabrication and assembly routes. Such experiments have been performed in the past for ceramic breeder blankets, especially in the EU, where for example a small-scale mock-up of a HCPB TBM was tested with a ceramic breeder pebble bed sandwiched between two beryllium pebble beds. In addition to thermomechanical behavior, tritium generated inside the ceramic breeder pebble is released to the purge gas through multiple transport mechanisms, including bulk diffusion, dissolution, desorption and adsorption at the surfaces, chemical or irradiation induced trapping, and pore diffusion, that need study in the more integrated irradiation environment. These in-pile ceramic breeder/multiplier unit cell experiments need to continue to quantify ceramic breeder material thermomechanics and tritium release and inventory characteristics as a function of different materials and different operating conditions. Especially in regards to tritium, out-of-pile laboratory experiments in which a breeder sample is loaded with tritium through exposure to neutron irradiation followed by out-of-pile tritium desorption through stepwise iso-thermal or ramp annealing tests in laboratory set-ups can be used to study beginning of life conditions. But full in-pile unit cell experiments with tritium purge gas flow and on-line monitoring of transient tritium release during temperature, purge gas composition, purge flow rate and tritium generation rate transients are essential to qualify ceramic breeder materials and models closer to breeding blanket conditions, including long time operation, irradiation damage, effect on transport, and lithium burn-up. The same facility/capabilities described for PbLi unit cell experiments can be utilized for these partially integrated ceramic breeder tests as well, where interactions in the unit cell pebble bed assembly can be studied together with coupled He coolant flow and purge flow processing ex situ for effective tritium recovery development.

6.3. Partially integrated experiments in H/D phase FNSF and ITER

Partially integrated experiments by definition include all fusion environmental conditions except neutrons together with prototypical blanket/FW components and ancillary transport systems. Prior to D/T operations, both ITER and FNSF will have significant and lengthy plasma performance and systems integration testing

using H/D fuel to slowly bring the machine up to its full operating conditions in terms of plasma current, temperature, density and duration. During this phase of operations, the blanket/FW should also be fully installed and functional for several reasons. Firstly, physics operations need to be developed and optimized with the presence of the blanket/FW that can interact with plasma via electromagnetic coupling of the ferritic steel and highly conducting PbLi, and via plasma wall interactions with the high temperature FW. Secondly, this time serves also as a unique opportunity to test aspects of the in-vessel components (blanket/FW, divertor, plasma fueling and heating systems, etc.) in a partially integrated environment that includes all loads except neutron irradiation and volumetric nuclear heating. The operation, control and reliability of in-vessel components and their heat and tritium transport systems given these normal and transient plasma conditions will themselves have to be developed, improved and decisively demonstrated during the pre-nuclear phase. For blanket/FW systems, this is especially important from the perspective of operations with the following prototypic reactor conditions:

- Magnetic fields, gradients and transients (especially from plasma current fluctuations and disruptions)
- Plasma heating, particle loading and transients at the FW
- Integration and support of multiple modules within the vacuum vessel
- Integration of ancillary coolant and tritium systems with the tokamak systems
- Trace tritium production and transport

Finally, during this phase of testing both the steady and transient surface heat loads on blanket/FW components can be better quantified. For example, there still appears to be significant uncertainty on the radiation and particle loads expected at the first wall. Design studies to date (e.g. [150]) assume a uniform distribution of heat and particles at the FW (uniform $\sim 0.5 \text{ MW/m}^2$). However, extensive analysis of many complex considerations such as ELMs, module size, and accuracy of fabrication for the design of the ITER FW resulted in a prediction of increased peak heat flux by a factor of 2–3 in some areas. The ITER FW has since been shaped in a way to concentrate larger heat fluxes (localized $\sim 4.7 \text{ MW/m}^2$) on specially designed limiter-like surfaces primarily due to the presence of plasma flowing along field lines [151,152]. Understanding the normal and transient heating and electromagnetic conditions and blanket/FW response in ITER and FNSF prior to nuclear operations are important partially integrated physics/technology R&D that will strongly impact the decision to proceed to nuclear operations, and impact the designs, requirements and expected reliability of the blanket/FW for DEMO.

7. R&D in fusion facilities

R&D consisting of modeling and experiments in non-fusion facilities (laboratory experiments, fission reactors and DT accelerator-based neutron sources) as discussed in Section 6 plays a crucial role and is an essential step forward. However, as shown earlier in this paper, none of the FNST/blanket/FW top technical issues can be resolved prior to testing in the fusion nuclear environment. This section summarizes the stages of the fusion environment testing and the requirements on the fusion facilities to perform such a mission, the objectives and major features of FNSF, and the Material and Blanket strategy for construction of and development in FNSF.

Table 9
Stages of fusion nuclear science and technology/blanket/FW testing in fusion facilities.

Stage 0: Exploratory R&D	– Understand issues through basic modeling and experiments
Stage I: Scientific Feasibility and Discovery	– Discover and Understand new phenomena – Establish scientific feasibility of basic functions (e.g. tritium breeding/extraction/control) under prompt responses (e.g. temperature, stress, flow distribution) and under the impact of rapid property changes in early life
Stage II: Engineering Feasibility and Performance Verification & Validation	– Establish engineering feasibility: satisfy basic functions & performance, up to 10 to 20% of MTBF and 10 to 20% of lifetime – Show Maintainability with MTBF > MTTR – Validate models, codes, and data
Stage III: Engineering Development and Reliability Growth	– Investigate RAMI: Failure modes, effects, and rates and mean time to replace/fix components and reliability growth. – Show MTBF >> MTTR – Verify design and predict availability of components in DEMO

7.1. Stages of R&D in fusion facilities

The stages of FNST R&D, which are dominated by blanket/FW considerations, can be classified into the stages summarized in Table 9. The classification is in analogy with other technologies and was used extensively in technically-based planning studies, e.g. FINESSE [4–6]. Such classification is almost always used in external high-level review panels of new technology development. Stage 0 is Exploratory or Preparatory R&D, which is performed in non-fusion facilities such as those described in Section 6. The objectives of this stage are to understand issues through basic modeling and experiments. The other three stages in the fusion nuclear environment are:

- Stage I: Scientific Feasibility and Discovery
- Stage II: Engineering Feasibility and Performance Verification and Validation
- Stage III: Engineering Development and Reliability Growth

As discussed earlier in Section 4, non-fusion facilities cannot adequately simulate the integrated fusion nuclear environment (see Table 5) and cannot adequately simulate fundamental effects such as volumetric nuclear heating and resulting temperature, tritium production, etc., and their gradients. Therefore, there will be many new phenomena yet to be discovered from experiments in the fusion nuclear environment. Therefore, Stage I for establishing Scientific Feasibility and Discovery requires testing in plasma-based DT fusion facility capable of simulating the fusion nuclear environment and accommodating meaningfully sized mockups and test modules. The objectives of Stage I are: (1) Discover and Understand new phenomena and (2) Establish scientific feasibility of basic functions (e.g. tritium breeding/extraction/control) under prompt responses (e.g. temperature, stress, flow distribution) and under the impact of rapid property changes in early life.

The goal of Stage II is to establish Engineering Feasibility and Performance Verification and Validation. The objectives of Stage II are: (a) establish engineering feasibility, which is defined as: satisfy basic functions and performance, up to 10–20% of MTBF and 10–20% of lifetime, (b) demonstrate Maintainability with MTBF > MTTR, and (c) validate models, codes, and data. The goal of Stage III is

Engineering Development and Reliability Growth with the specific objectives: (1) to investigate RAMI: failure modes, effects, and rates and mean time to replace/fix components and reliability growth, (2) show MTBF >> MTTR (the ultimate goal for power reactor is MTBF > 43 MTTR), and (3) verify design and predict availability of components in DEMO.

A more detailed description of these three stages of testing in fusion facilities are given in Table 10 where a summary is shown for each stage of the key objectives of the experiments. The Table also quantifies for each stage the requirements on the parameters of the fusion facility in which these experiments are performed such as the neutron wall load, the integrated wall load (also called energy fluence), plasma mode of operation and continuous operating time (COT), which is periods of continuous operation of the device necessary to complete certain experimental campaigns for particular technical issues. Also shown for each stage, is the size for test articles and the total testing area at the first wall to perform the required experiments. All these requirements in Table 10 were derived from detailed studies [5,6,10,11] that investigated the issues, the required experiments and developed and applied engineering scaling laws to enable extrapolation of the results from experiments to future DEMO and power reactors.

7.2. FNSF mission and major design features and parameters

The next DT fusion facility that provides the real fusion nuclear environment in which the stages of fusion nuclear testing described above can be performed in order to test and qualify the blanket/FW and other fusion nuclear components prior to construction of DEMO is called Fusion Nuclear Science Facility (FNSF) [3]. The idea of FNSF was first proposed in the US in the 1980s [4,11] and was further studied and evolved in an IEA international study [3]. More detailed considerations of the design of FNSF were evaluated in [153–156]. All these studies developed and evolved a specific vision for FNSF which we will discuss first followed by brief description of a modified vision of FNSF recently advocated by some researchers. In the original vision of FNSF, which the authors still fully support, FNSF is a small size, low fusion power DT plasma-based device in which Fusion Nuclear Science and Technology (FNST) experiments can be performed and tritium self-sufficiency can be demonstrated in the relevant fusion environment:

1. at the smallest possible scale, cost, and risk, and
2. with practical strategy for solving the tritium consumption and supply issues for FNST development.

In magnetic fusion configuration, small-size, low fusion power can be obtained in a low-Q (driven) plasma device, with normal conducting copper magnets.

Note that since FNSF will be the first facility in which FNST/blanket/FW is tested in the fusion environment, FNSF first phase will focus on Stage I, i.e. on “Scientific Feasibility and Discovery” – it cannot be for “validation”. Note also that RAMI considerations predict that in the first stages of the first FNSF, failure rates are expected to be high and availability low even given the entire preparatory R&D performed in Stage 0. Analysis shows that FNSF should be low fusion power, small size device [3–6,10,11] for the following reasons:

- To reduce risks associated with external T supply and internal breeding shortfall
- To reduce initial capital and operating costs (note blanket/FW/Divertor will fail and get replaced many times)

Given the FNST key requirement of 1–2 MW/m² neutron wall load on 10–30 m² test area a cost/risk/benefit analysis for tokamaks

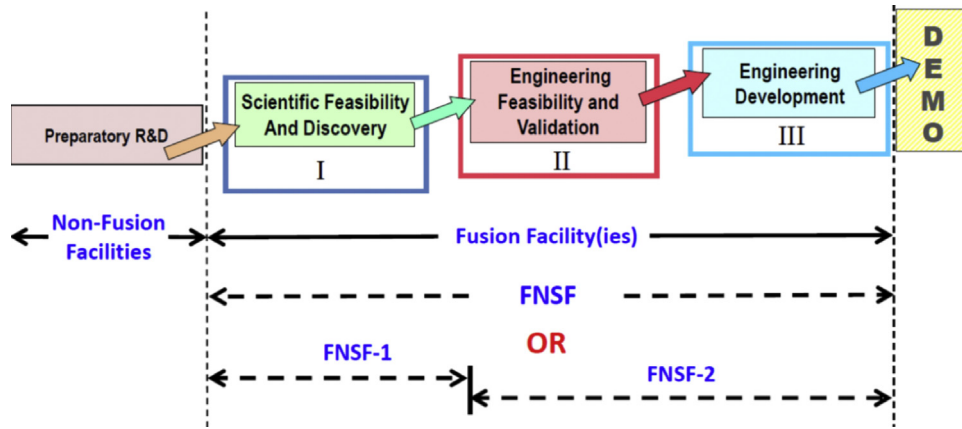

Fig. 31. Summary illustration of the science-based pathway to DEMO. Roadmapping must account for unexpected FNST challenges in current FNST and plasma confinement concepts.

leads to the conclusion that FNSF fusion power should be <150 MW [3]. The two options considered for tokamak are the standard aspect ratio (A typically about 3) tokamak [153–155] and the very small aspect ratio (A ~ 1.3) tokamak normally called Spherical Torus (ST) [156]. For a tokamak (standard A & ST) this leads to recommendation of:

- Low Q plasma (2–3) – and encourage minimum extrapolation in physics from current physics experiments such as JET
- Normal conducting TF coil (to reduce inboard B/S thickness, also configuration flexibility to enhance maintainability e.g. demountable coils)
- The use of the H/D Phase of FNSF for extensive partially integrated testing without neutrons prior to the DT Phase

FNSF should be built as soon as possible because testing and development of the blanket and other FNST components will take very long time, at least 20 years, in order to fulfill the stages shown in Table 10 with the required fluences. FNSF should be operational in parallel to ITER to enhance the probability that DEMO construction can begin not long after completion of ITER. A detailed cost estimate of FNSF has not yet been made. However, very rough estimate of the cost based on the studies in [153,154,155] is in the range of 3–4 billion dollars for standard aspect ratio tokamak. This is plausible since the size of FNSF considered in these studies is less than 20% of ITER and expensive superconducting magnets are not used. The cost of FNSF based on ST is likely smaller because of the much smaller size. However, the ST concept has some technological challenges, such as the large heat and radiation loads on the central solenoid, that must be resolved [156].

Table 10 Stages in fusion nuclear science technology/blanket/FW testing in fusion facilities.

Scientific Feasibility and Discovery	Engineering Feasibility & Performance Verification and Validation	Engineering Development & Reliability Growth	DEMO
Stage I	Stage II	Stage III	
0.1 – 0.3 MW·y/m ²	1 - 3 MW·y/m ²	> 4 - 6 MW·y/m ²	
≥ 0.5 MW/m ² , burn > 200 s	1-2 MW/m ² steady state or long burn COT ~ 1-2 weeks	1-2 MW/m ² steady state or long burn CO T ~ 1-2 weeks	
Sub-Modules/Modules	Modules (10-20 m ²)	Modules/Sectors (20-30 m ²)	
<ul style="list-style-type: none"> • Initial exploration of coupled phenomena in a fusion environment • Uncover unexpected synergistic effects, Calibrate non-fusion tests • Impact of rapid property changes and materials interactions in early life • Integrated environmental data for model improvement and simulation benchmarking • Develop experimental techniques and test instrumentation • Screen and narrow the many material combinations, design choices, and blanket design concepts 	<ul style="list-style-type: none"> • Uncover unexpected synergistic effects coupled to radiation interactions in materials, interfaces, and configurations • Verify performance beyond beginning of life and until changes in properties become small (changes are substantial up to ~ 1-2 MW·y/m²) • Initial data on failure modes & effects • Establish engineering feasibility of blankets (satisfy basic functions & performance, up to 10 to 20 % of lifetime) • Select 2 or 3 concepts for further development 	<ul style="list-style-type: none"> • Identify limiting failure modes and effects based on full environment coupled interactions • Failure rate data: Develop a data base sufficient to predict mean-time-between-failure with confidence • Iterative design / test / fail / analyze / improve programs aimed at reliability growth and safety • Obtain data to predict mean-time-to-replace (MTTR) for both planned outage and random failure • Develop a database to predict overall availability of FNT components in DEMO (10-20 m²) 	

The ITER Parties plan to test 6 blanket modules representing 6 blanket concepts in ITER. The key limitation of blanket testing in ITER is that the fluence is limited to $\sim 0.1\text{--}0.3\text{ MW}\cdot\text{y}/\text{m}^2$. Therefore, ITER is suitable to do a part of Stage I of FNST development (see Table 10) in DT fusion facilities, but FNSF is still required to perform Stages II and III in addition to all parts of Stage I. Another serious shortcoming of blanket module tests in ITER is the limitations on replacing failed TBMs. As discussed earlier frequent failures are expected when TBM is exposed to the fusion nuclear environment, particularly in Stage I. These failures should be utilized to learn failure modes, change the design, and test an improved test module. Unfortunately, ITER design and operation plans do not permit replacement of test blanket modules more than 2–3 times during the entire DT operation phase. Therefore, it is not clear how much of Stage I testing objectives can be achieved in ITER.

Even with FNSF parallel to ITER, it is still prudent to utilize ITER for testing full blanket modules as planned in the ITER TBM program in addition to testing in FNSF because:

- a. No extra cost for facility
 - ITER has substantial “capital investments” in infrastructure for TBM testing that are already paid for by all parties
 - Facility “operating cost” is free for TBM
- b. Big saving on R&D costs because of international collaboration
 - All the R&D for each ITER TBM concept will be needed for FNSF or any other DT facility
 - ITER will test 6 blanket concepts; each is led by one Party which performs the R&D for one concept. By sharing the test results among the ITER Parties, the costs and benefits of developing and testing 6 blanket concepts, the world will save considerable money and efforts in exploring a large number of blanket concepts. This is critical since no one knows which blanket will prove feasible and attractive.
- c. TBM testing in ITER complements FNSF. Since FNSF has to be small size with highly driven plasma the magnetic field configuration (magnitude and gradient) will not be exactly prototypical of DEMO. ITER TBM tests can serve a useful function of benchmarking the FNSF results in the more prototypical magnetic environment of ITER.

Another key question is whether one FNSF can do all the 3 stages of FNST development. Fig. 31 illustrates in summary form the key elements of the science-based pathway for FNST/blanket development. A Science-Based pathway planning must account for unexpected challenges in current FNST and plasma confinement concepts. A key question for such pathway planning is whether one FNSF will be sufficient. The current state of the scientific knowledge compels us to admit that today we do not know whether one facility will be sufficient to show scientific feasibility, engineering feasibility, and carry out engineering development sufficient to proceed to DEMO, OR if we will need two or more consecutive facilities. We will not know until we build one!! Only the laws of nature will tell us regardless of how creative or diligent we are. We may even find that we must change “direction” (e.g. need to invent new confinement scheme in which the challenge in RAMI issues present in current plasma configurations are ameliorated). The idea of multiple FNSFs in parallel in several countries should be encouraged to increase probability of timely progress. It should also be noted that each country will need a relatively large tritium inventory to provide the initial “startup” inventory for its own DEMO. Since such large amounts of tritium are extremely difficult and expensive to obtain from fission reactors, FNSF in each country can be designed in its later stages of development to accumulate enough extra tritium to supply the initial startup inventory for its DEMO.

Recently, China launched a major study to explore options for the design of FNSF-type facility, called CFETR (China Fusion

Engineering Test Reactor) [157–161]. CFETR is a tokamak with standard aspect ratio. One option considered for CFETR is superconducting magnets (the other is water-cooled copper magnet). With the Superconducting magnet option, the device is designed with major radius $\sim 5.7\text{ m}$, and minor radius $\sim 1.6\text{ m}$, elongation ~ 1.8 , with toroidal magnetic field at the plasma center of 5 T. The advocates of the superconducting magnet option worry about the large resistive power in the normal conducting magnets. The issue with superconducting magnets is the need for larger blanket/shield thickness on the inboard, which leads to a large size device which has the problems we indicated earlier in this section. There are other problems with large-size FNSF. For example with the expected low MTBF, frequent replacement of blanket/FW on large first wall area ($\sim 600\text{ m}^2$) is very expensive and will lead to accumulation of large inventory of radioactive waste. In addition, there is a problem in selecting the fusion power. Such a large size device, of the approximate size of ITER, can produce relatively large power, up to 1000 MW. This provides a neutron wall load of $\sim 1\text{--}1.5\text{ MW}/\text{m}^2$, which is consistent with the FNST testing requirements we defined earlier. But with such a large size, large power device the capital and operating costs of this type of facility will be large. Also with such large fusion power, the tritium consumption will be large and there is risk in finding an external supply to provide the initial tritium inventory and any short fall from internal breeding. On the other hand, if the fusion power is kept relatively small (50–200 MW as stated in [157,159]) in this large device, the neutron wall load will be substantially lower than what is needed for FNST testing.

Some questions have been raised recently [162,163] on the required degree of similarity between FNSF design/configuration and DEMO. Some researchers advocate that FNSF should be as close as possible to DEMO in order to minimize the gap between FNSF and DEMO. Based on the analysis provided in this paper, we can provide some insights into answering this question. The major issue in fusion development now is that we do not know how the fusion nuclear components will behave in the fusion nuclear environment and that testing and qualifying these components is likely to require long time. As mentioned earlier, we do not even know if one FNSF will be sufficient. Therefore, our concern should be how to build a practical FNSF with minimum extrapolation of the current state-of-the-art of physics and technology. The focus in FNSF should be on the “in-vessel components” because the nuclear components inside the vacuum vessel represent the major part missing from ITER and current plasma devices. Components outside the vacuum vessel, e.g. superconducting magnets are already tested in ITER at an almost the same DEMO scale. An approach that attempts to make the FNSF close to a DEMO will have much larger size than needed for the FNST testing mission and will have much larger capital and operating costs. It will very likely be extremely risky because it ignores the fact that we do not know how the fusion nuclear components will behave and the prediction of high failure rates, and hence no credible prediction of the device availability can be made.

Another approach is to skip FNSF and proceed to DEMO after ITER as in the EU Roadmap [24]. The motivation for this approach is to shorten the time for development and commercialization of fusion power. This paper has provided much analysis for why FNSF is needed prior to DEMO. Any major DT device which will be built going forward in which the fusion nuclear components are exposed to the fusion nuclear environment for the first time will serve the function of FNSF regardless of name DEMO or FNSF. Therefore, in approaches like EU that skip FNSF, the first stage of the DEMO will serve as FNSF. The EU DEMO is envisioned to be large size ($R=6\text{--}9\text{ m}$) and large fusion power (1000–2000 MW) [24]. This means that fusion nuclear components will be tested for the first time in the fusion nuclear environment in large size; large fusion

power device for which we discussed earlier involves high costs and large risks.

7.3. FNSF strategy for design and testing of materials and blankets

The primary mission of FNSF as defined earlier in this paper and in the earlier comprehensive studies since the 1980s is to provide the prototypical fusion nuclear environment in which the fusion nuclear components and materials (blanket/FW and PFC) can be tested and developed. But since FNSF is itself a fusion nuclear device that must have blanket and PFC components, key questions arise as to what materials and blankets can be used for the “base” in-vessel components of FNSF and what type of qualification is required prior to their construction in FNSF. These questions have been studied recently (see [164]) and important conclusions were reached. Here, we briefly highlight the key points necessary to illuminate the technical answers to such questions.

7.3.1. Base breeding blanket

Regarding the “base” blanket in FNSF, the key conclusion is that a breeding blanket should be installed as the “base” blanket on FNSF from the beginning. The main reasons for this conclusion are:

1. Need to breed tritium

A successful ITER will exhaust most of the world supply of tritium. One FNSF with a fusion power of 100 MW will consume 5.56 kg per full power year. This is about five to ten times more than the tritium production rate from a specifically designed fission reactor. Therefore, FNSF must breed its own tritium from the beginning. Note that the lack of sufficient external tritium supply is a major issue for the start-up of the DEMO. A typical DEMO with 2000 MW fusion power, modest tritium burn fraction in the plasma, and moderate tritium recycling time (see Section 3.1) will require a start-up inventory of ~10 kg. Considering the current situation where each of several countries plans to build its own DEMO, a compelling question is: Where will the start-up tritium inventories for all these DEMOs come from? Therefore, we recommend that FNSF base breeding blanket be designed with an adequate tritium breeding capability to: (a) supply most or all of its consumption, and if possible; (b) accumulate excess (at least in its later stages of operation) tritium sufficient to provide the tritium inventory required for startup of DEMO.

2. Switching from non-breeding to breeding blanket involves complexity and long downtime, especially if coolant changes from water to Helium, and will involve recalibrating plasma control scenarios if conductivity, permeability and inductances change significantly (e.g. change to liquid metal blankets and/or austenitic to martensitic steels).
3. There is no non-breeding blanket for which there is more confidence than a breeding blanket—all involve risks, all will require development. Materials and technologies that are developed for other applications will have different behavior in the fusion environment and will require R&D prior to utilization in FNSF. Stainless steel is not suitable for blanket/FW because of limitations on wall loading capability, temperature, and radiation damage. Ferritic steel system even without breeding will have risks when utilized in the fusion environment for the first time [109]. At least for a breeding blanket that employs fusion prototypic materials this R&D will not be wasted.
4. Using base breeding blanket will provide very important information essential to “reliability growth”. This makes full utilization of the “expensive” neutrons.
5. A significant amount of surface area will be required for testing anyway. Note that ~10–20 m² of testing area is required per

concept. Two concepts need 20–40 m² which is almost most of the net surface area available on the outboard of FNSF [3].

7.3.2. Base blanket and testing ports

From the above discussion, we conclude that FNSF should be designed with a base breeding blanket selected from among the most promising candidates for DEMO. FNSF should also be designed with separate test ports for testing blanket modules and submodules and materials. The primary concepts for DEMO should be used for both “testing ports” and “base” breeding blanket in FNSF but operate under different parameters as discussed below. Budget limitations will preclude almost any country, e.g. US, from testing many concepts because the cost of R&D, design and analysis, and mockup testing for any given concept to qualify a test module for testing in FNSF is large (>\$80 million). Screening of many concepts is better done by international collaboration by the 7 international partners of ITER.

Both “port-based” and “base” blankets will have “testing missions” in FNSF:

- a. Base blankets will operate longer in a more conservative mode (run initially at reduced parameters/performance) and will provide information on longer term effects. They may not be highly instrumented but will have operating flow, temperature, pressure conditions monitored and can be examined post-exposure in hot cells.
- b. Port-based blankets are more highly instrumented, specialized for experimental missions, and are operated near their high performance levels in the highest neutron wall load zones; the purpose of making them port based is so they are more readily replaceable in case of failure or to accommodate a new experimental test.

Now let us focus on the question of the “structural material” for the base and test blankets in FNSF and propose a technically-based practical strategy. It should be noted that RAFM steels are the reference structural material selected for DEMO in all world fusion programs. RAFM steels are used for all TBMs in ITER. Therefore, RAFM steel should be the structural material for both the “base” and “testing” breeding blankets on FNSF. RAFM steels irradiation database from fission reactors extend to ~80 dpa, but it generally lacks helium except for some limited simulation of helium in some experiments. Material experts agree that there is confidence in He data in fusion typical neutron spectrum up to at least 100 appm He (~10 dpa). But many material experts state confidence that RAFM (e.g. EUROFER) will work well up to at least 300 appm He (~30 dpa) at irradiation temperature >350 °C.

Recall here from Section 3.4 that the major challenge in developing fusion nuclear components is the low MTBF and long MTTR. With MTBF predicted to be hours to days and MTTR of 3–4 months, the early phases of the next DT fusion device such as FNSF will have low device availability and accumulation of dpa will be very slow. Therefore, the central question is not what the dpa life for RAFM steel in the FNSF fusion nuclear environment will be. The much more fundamental and central questions are: (1) how to design blanket/FW so that failure rates are reduced and recovery time from failure is not too long; and (2) how to increase MTBF and shorten MTTR over time through careful engineering-science-based testing strategy on FNSF that includes making use of “reliability growth” principles well developed in other technologies (e.g. aerospace industry).

7.4. FNSF operating phases (stages) strategy

Based on many considerations some of which are discussed above, we propose the following strategy for FNSF for testing and development of breeding blankets, materials, PFC, and vacuum vessel. FNSF must be planned for “phases” or “stages” of operation. Also, FNSF must be run initially in a HH/DD phase prior to operation with DT plasmas. The role of the HH/DD phase is to verify performance of all in-vessel components (divertor/PFC, blanket/FW) without significant neutrons. The “Day 1” design for FNSF Phase 1 should be based on the following approach:

1. The vacuum vessel (VV) will be constructed from proven materials and technology and will operate in low radiation dose environment. Similar to ITER, it should be part of the primary safety boundary.
2. All components inside the VV are considered “experimental”. Given that FNSF will be the first DT device in which the blanket/FW experience the full fusion nuclear environment, there is no credible approach to provide “fully qualified” blanket for construction in the first phase of FNSF. All in-vessel components should be expected to experience high failure rates and require frequent replacement of failed modules. Understanding failure modes, rates, effects, and component maintainability is a crucial FNSF mission.
3. The structural material will be RAFM steel operating $>350^{\circ}\text{C}$. The design of in-vessel components for the Day 1 design should be for 10 dpa, which is an acceptable projection.
4. The “base” breeding blanket will operate at conservative parameters. For example, the minimum and maximum operating temperatures in a ceramic breeder should be significantly higher than the diffusion limits for large tritium inventory and substantially below temperatures where sintering and other undesirable phenomena occur. As mentioned earlier the “Day 1” Design should be based on only 10 dpa, which is an acceptable projection.
5. Blanket test modules in testing “ports” should be more highly instrumented, specialized for experimental missions, operated near their high performance levels, and be more readily replaceable than the base blanket components. A special test module should be included to test thousands of materials specimens at different conditions.

For FNSF Phase 2 operation and subsequent operational phases, upgraded blanket and PFC design should be planned and a “bootstrap approach” should be utilized. The fundamental approach is to “extrapolate by a factor of 2” which is standard in fission and other technology/science development. Therefore, the results of Phase 1, which is for 10 dpa, should be extrapolated to 20 dpa in Phase 2, and 40 dpa in Phase 3, etc.

It must be clearly recognized that the results from testing and operation of blankets and other material systems in FNSF will be conclusive. These will be the results of operation of actual components in the real, full fusion nuclear environment. There will be no uncertainty in spectrum, or other environmental effects. The response of materials and components will be prototypical response that includes all elements of the fusion nuclear environment and materials interactions including gradients, joints, temperature, and stress.

The strategy outlined above addresses well the challenges of developing fusion nuclear components and deals effectively with the very complex issue of the lack of adequate integrated test facilities for developing FNST except in a DT plasma-based facility, which must itself be made of the same materials and components to be tested.

8. Concluding remarks

The fusion nuclear environment is complex and unique with multiple fields and strong gradients. The nuclear components exposed to this environment have multiple functions, materials, and interfaces. The combined loads and multiple environmental effects experienced by the complex blanket/FW system will result in yet undiscovered new phenomena. We have shown in this paper that the blanket behavior in the fusion nuclear environment cannot be predicted by synthesizing results from modeling and experiments on separate effects. Designs and predictions of performance based on “separate effect” models and experiments will often not work and can lead to erroneous conclusions. Therefore, models and experiments must simulate the simultaneous presence of multiple environmental conditions and multiple material interactions in the blanket. The primary challenges in simulating the blanket are listed below.

1. It is impossible to simulate the full fusion nuclear environment (multiple field environment with neutrons, heat/particle fluxes, magnetic field, etc., all with high magnitudes and steep gradients) in non-fusion facilities (laboratory experiments, fission reactors, accelerator-based neutron sources).
2. There are currently no good methods to simulate the bulk nuclear heating in large volume with steep gradients in laboratory facilities. Without simulating the volumetric heating, it is not possible to adequately simulate the temperature profile – a very serious limitation since most blanket phenomena are temperature dependent and many are driven by temperature gradients. Therefore, there needs to be extensive research to develop such methods.
3. The complex mock up configuration of the blanket with prototypic size and scale is not possible in fission reactors or accelerator-based neutron sources. This indicates the necessity of large blanket laboratory facilities in which volumetric nuclear heating and magnetic field and their gradients are adequately simulated.

Therefore, new blanket laboratory facilities should be planned to have such significant capabilities. We presented examples of multiple effect/multiple interaction facilities for liquid metal MHD thermofluid and material interaction experiments and for ceramic breeder thermomechanics. There is a range of multiple effect/multiple interaction facilities starting with simulations of groups of environmental conditions with limited-size test articles and extending to a partially integrated facility in which all environmental conditions except neutrons are simulated with full size blanket mock ups. The cost for such facilities will be relatively substantial – about 20–50 million dollars for the examples we presented and much higher for partially integrated facilities. These facilities and research programs will still be much less expensive than the many big and expensive plasma devices constructed over the past 30 years and are necessary prior to the much more expensive testing in the full fusion nuclear environment.

Some key issues will still not be fully resolved prior to performing blanket experiments in the full fusion nuclear environment, which can be realized only in a DT plasma-based facility. Therefore, a Fusion Nuclear Science Facility (FNSF) in which the blanket and other nuclear components are tested and qualified is needed prior to construction of DEMO. The ITER TBM program is important because of the capabilities provided in ITER and the savings on R&D realized through international collaboration. However, the usefulness of the TBM results will be limited to providing results on only the prompt response to the fusion nuclear environment due to the short irradiation time.

Additionally, developing practical fusion energy presents unique Reliability/Availability/Maintainability/Inspectability (RAMI) challenges. For fusion nuclear components, the difference between “expected” and “required” is huge for both MTBF and MTTR – leading us to speculate that RAMI may be the deciding factor in choosing a plasma confinement configuration (e.g. tokamak vs. open systems) and in selecting specific technologies. RAMI could ultimately be the “Achilles Heel” for fusion. Therefore, understanding performance, extending design margin and determining failure modes and rates should now be a key focus of FNST R&D and must be an explicit part of a blanket/FW R&D program in general, and the FNSF mission, design and operation in particular.

FNSF should be constructed and operated parallel to ITER. FNSF should ideally be a small size, low power DT, driven plasma device in which the in-vessel components (blanket/FW, PFC) and their materials experience prototypical fusion nuclear environment. A small size, low fusion power FNSF is recommended to (1) reduce risks associated with external tritium supply and internal breeding shortfall and (2) reduce initial capital and operating costs (note blanket/FW/divertor will fail and get replaced many times). A blanket and material development strategy in FNSF is proposed that includes: (1) a “base” breeding blanket from the beginning initially operated at reduced parameters and performance and (2) “port-based” blankets in which test blanket modules are highly instrumented, operated near their high performance levels, and are more readily replaceable. Both the “base” blanket and “port-based” modules have testing missions and are based on leading DEMO blanket candidate designs and are fabricated from prototypical materials. The question of “structural material” development is important and must be approached from a “component-based”, not an “abstract stand-alone” approach. Many performance parameters of blanket/FW/divertor determine the objectives and strategy of material development. Reliable knowledge of the behavior of materials must be derived from tests of actual submodules/modules/components operating in the fusion nuclear environment. We propose a material development strategy where in an FNSF first phase, the “Day 1” blanket is fabricated from the best candidate RAFM and operated to 100 appm He (10 dpa), which is an acceptable projection. Using “bootstrap approach”, the results from Phase 1 are extrapolated by a factor of 2, which corresponds to 200 appm He (20 dpa). The results of tests in FNSF will be conclusive with “real environment” and “real” components.

While over the past three decades there has been substantial progress on understanding and resolving many of the FNST technical issues discussed in this paper, there are critical issues for which there has been little or no progress because of the significance of the scientific and engineering challenges, the difficulties in simulating the complex blankets in the multi-field fusion nuclear environment in non-fusion facilities, and the limited resources allocated for FNST R&D. The many challenges illuminated in this paper clearly suggest that the most demanding phase of fusion development still lies ahead. It is the development of Fusion Nuclear Science and Technology that will be the “time-controlling” step for demonstrating the practicality of fusion and its entry into the energy market. Therefore, we suggest that the world fusion program must immediately launch an aggressive FNST R&D program if fusion energy is to be realized in the 21st century. Such a program must include: (1) extensive modeling of important phenomena and multiple synergistic effects utilizing advances in high performance computing, (2) the construction and utilization of new major laboratory facilities with extensive capabilities to simulate multiple effects/multiple interactions, (3) enhancing the TBM Program in ITER to include a strong R&D program to enable successful construction and operation of TBMs that can effectively measure key prompt responses, and (4) the construction and operation of a Fusion Nuclear Science Facility (FNSF) dedicated to FNST at the

module and component level beyond infant mortality in the fusion environment.

Acknowledgments

This work was supported by the US Department of Energy Office of Fusion Energy Science. We gratefully acknowledge the work of many scientists and engineers who contributed over many years to fusion technology, fusion nuclear science and technology, blankets, plasma-facing components, and materials who advanced the subjects addressed in this paper. Particular thanks are due to Ms. Emily Hoffmann who provided version management for this manuscript, and to Mr. Arnaud Larousse who reviewed the manuscript and assisted with some graphics.

References

- [1] M. Abdou, et al., Blanket Comparison and Selection Study, ANL/FPP/83-1, Argonne National Laboratory, 1983.
- [2] D.L. Smith, C. Baker, D. Sze, G. Morgan, M. Abdou, S. Piet, S. Schultz, R. Moir, J. Gordon, Overview of the blanket comparison and selection study, *Fusion Technol.* 8 (1985) 10–113.
- [3] M. Abdou, S. Berk, A. Ying, M. Peng, S. Malang, E. Proust, et al., Results of an international study on a high-volume plasma-based neutron source for fusion blanket development, *Fusion Technol.* 29 (1996) 1–57.
- [4] M. Abdou, P. Gierszewski, M.S. Tillack, K. Taghavi, K. Taghavi, et al., A study of the issues and experiments for fusion nuclear technology, *Fusion Technol.* 8 (1985) 2595–2645.
- [5] M. Abdou, P. Gierszewski, M. Tillack, J. Groover, R. Puigh, et al., Technical requirements of experiments and facilities for fusion nuclear technology, *Fusion Technol.* 10 (1986) 1065–1078.
- [6] M. Abdou, P. Gierszewski, M. Tillack, M. Nakagawa, J. Reimann, et al., Technical issues and requirements of experiments and facilities for fusion nuclear technology, *Nucl. Fusion* 27 (4) (1987) 619–688.
- [7] M. Tillack, D. Sze, M. Abdou, Required momentum, heat, and mass transport experiments for liquid metal blankets, *Fusion Technol.* 10 (1986) 1088–1096.
- [8] P. Gierszewski, M. Abdou, R. Puigh, Fission reactor experiments for solid breeder blankets, *Fusion Technol.* 10 (1986) 1097–1101.
- [9] M. Abdou, et al., Modeling, analysis and experiments for fusion nuclear technology, *Fusion Eng. Des.* 6 (1988) 3–64.
- [10] M. Abdou, P. Gierszewski, M. Tillack, D. Sze, J. Bartlit, et al., Technical Issues and Requirements of Experiments and Facilities for Fusion Nuclear Technology,” (FINESSE Phase I Report), Rep. PPG-909, UCLA-ENG-85-39, Univ. of California, Los Angeles, 1985.
- [11] M. Abdou, D. Berwald, M. Billone, J. Davis, G. Deis, et al., FINESSE: A Study of the Issues, Experiments and Facilities for Fusion Nuclear Technology Research and Development (Interim Report), Rep. PPG-821, UCLA-ENG-84-30, Univ. of California, Los Angeles, 1984.
- [12] M. Abdou, M. Tillack, R. Raffray, et al., Modelling, Analysis and Experiments for Fusion Nuclear Technology, Rep PPG-102.1, UCLA-ENG-86-44, Univ. of California, Los Angeles, 1987.
- [13] M. Abdou, C. Baker, J. Brooks, et al., A demonstration Tokamak power plant study (DEMO), Rep. ANL/FPP-82-1, Argonne National Laboratory, 1982.
- [14] M. Abdou, C. Baker, J. Brooks, et al., DEMO Tokamak Power Plant Study Interim Report, ANL/FPP-TM-154, 1982.
- [15] M. Abdou, C. Baker, J. Brooks, D. Ebst, R. Mattas, D. Smith, Recent Progress in Design Studies for Tokamak Demonstration and Commercial Power Plants, IAEA-TC-392/15, 1983.
- [16] M. Abdou, et al., Demonstration Tokamak power plant, in: *Fusion Technol.: Proceedings of the Twelfth Symp. on Fusion Technol.*, 1982.
- [17] S. Malang, M. Dalle Donne, L. Anzidei, L. Giancarli, E. Proust, European blanket development for a DEMO reactor, in: *Proc. 11th Topl. Mtg. Technology of Fusion Energy*, New Orleans, LA, 1994.
- [18] Y. Seki, Fusion reactor design and technology programme in Japan, in: *Proc. Technical Committee Mtg. and Workshop on Fusion Reactor Design and Technology*, International Atomic Energy Agency, Los Angeles, CA, 1993.
- [19] Y. Sokolov, DEMO concept definition in Russia, in: *Proc. Technical Committee Mtg. and Workshop on Fusion Reactor Design and Technology*, International Atomic Energy Agency, Los Angeles, CA, 1993.
- [20] D. Maisonnier, D. Campbell, I. Cook, et al., Power plant conceptual studies in Europe, *Nucl. Fusion* 47 (2007) 1524–1532.
- [21] G. Federici, et al., The technology pathway towards a demonstration fusion reactor, in: *21st Topical Meeting on the Technology of Fusion Energy (TOFE)*, 2014, Anaheim, CA.
- [22] L. Boccaccini, et al., EU blanket design and R&D for DEMO, 2014, See second EU-US workshop at <http://www.fusion.ucla.edu/>
- [23] R. Goldston, M. Abdou, C. Baker, et al., A plan for the development of fusion energy, *J. Fusion Energy* 21 (2) (2003) 61–111.

- [24] G. Federici, et al., Overview of EU DEMO design and R&D activities, *Fusion Eng. Des.* 89 (2014) 882–889.
- [25] A. Ying, A. Gaizer, The effects of imperfect insulating coatings on MHD and heat transfer in rectangular ducts, *Fusion Eng. Des.* 27 (1995) 634–641.
- [26] A. Gaizer, M. Abdou, Effects of imperfect insulating coatings on the flow partitioning between parallel channels in self-cooled liquid metal blankets, *Fusion Technol.* 30 (1996) 1005–1010.
- [27] H. Gouffier, G. Aiello, M. Futterer, L. Giancarli, A. Li-Puma, Y. Poitevin, J. Szczepanski, Progress on the TAURO blanket system, *Fusion Eng. Des.* 61–62 (2002) 461–470.
- [28] F. Najmabadi, The ARIES Team, Advanced technology fusion power plant, *Fusion Eng. Des.* 80 (2006) 3–23.
- [29] G. Rampal, A. Li Puma, Y. Poitevin, E. Rigal, J. Szczepanski, C. Boudot, HCLL TBM for ITER-design studies, *Fusion Eng. Des.* 75–79 (2005) 917–922.
- [30] S. Smolentsev, R. Moreau, L. Buehler, C. Mistrangelo, MHD thermofluid issues of liquid-metal blankets: phenomena and advances, *Fusion Eng. Des.* 85 (2010) 1196–1205.
- [31] S. Malang, M. Tillack, C. Wong, N. Morley, S. Smolentsev, Development of the lead lithium (DCLL) blanket concept, *Fusion Sci. Technol.* 60 (2011) 249–256.
- [32] R. Norajitra, L. Buehler, A. Buenaventura, E. Diegele, U. Fischer, S. Gordeev, E. Hutter, R. Krueßmann, S. Malang, A. Orden, J. Reimann, G. Vieider, D. Ward, F. Wasastjerna, Conceptual Design of the Dual-Coolant Blanket, Kernforschungszentrum Karlsruhe GmbH, Karlsruhe, FZKA, 2003.
- [33] N. Morley, Y. Katoh, S. Malang, B. Pint, A. Raffray, S. Sharafat, S. Smolentsev, G. Youngblood, Recent research and development for the dual-coolant blanket concept in the US, *Fusion Eng. Des.* 83 (2008) 920–927.
- [34] Y. Wu, the FDS Team, Design status and development strategy of China liquid lithium-lead blankets and related material technology, *J. Nucl. Mater.* 367–370 (2007) 1410–1415.
- [35] S. Malang, K. Schleisiek (Eds.), *Dual Coolant Blanket Concept*, Kernforschungszentrum Karlsruhe, KfK 5424, Karlsruhe, 1994.
- [36] M. Tillack, P. Humrickhouse, S. Malang, A. Rowcliffe, The use of water in a fusion power core, *Fusion Eng. Des.* 91 (2015) 52–59.
- [37] S. Smolentsev, N. Morley, M. Abdou, S. Malang, Towards DCLL blanket. Status and critical R&D needs prior to fusion environment testing, *Fusion Eng. Des.* (2015) (in press).
- [38] M. Enoeda, et al., Design and technology development of solid breeder blanket cooled by supercritical water in Japan, *Nucl. Fusion* 43 (2003) 1837–1844.
- [39] S. Hermesmeier, et al., Revision of the EU Helium cooled pebble bed blanket for DEMO, in: *Symposium on the 20th IEEE/NPSS, Fusion Engineering*, 2003.
- [40] S. Cho, et al., Overview of helium cooled ceramic reflector test blanket module development in Korea, *Fusion Eng. Des.* 88 (6–8) (2013) 621–625.
- [41] S. van Til, A.V. Fedorov, M.P. Stijkel, M. Nakamichi, M. Zmitko, Post irradiation characterization of BeTi grades after high temperature irradiation up to 3000 appm He production in HIDOBE-01, presented at 28th Symposium on Fusion Technology, 2015, San Sebastian, Spain.
- [42] H. Kawamura, H. Takahashi, N. Yoshida, Y. Mishima, et al., Present status of beryllide R&D as neutron multiplier, *J. Nucl. Mater.* 329–333 (2004) 112–118.
- [43] M. Nakamichi, J.-H. Kim, K. Yonehara, Novel granulation process of beryllide as advanced neutron multipliers, *Fusion Eng. Des.* 88 (2013) 611–615.
- [44] S. van Til, J. Hegeman, H. Cobussen, M. Stijkel, Evolution of beryllium pebbles (HIDOBE) in long term, high flux irradiation in the high flux reactor, *Fusion Eng. Des.* 86 (2011) 2258–2261.
- [45] M. Abdou, et al., A Demonstration Tokamak power plant study, ANL/FPP-82-1, September 1982.
- [46] ITER Blanket, Shield and Materials Data Base, ITER Documentation Series No. 29, IAEA, 1991.
- [47] H. Kwast, R. Conrad, E. May, S. Casadio, N. Roux, H. Werle, The behavior of ceramic breeder materials with respect to tritium release and pellet/pebble mechanical integrity, *J. Nucl. Mater.* 212–215 (1994) 1010–1014.
- [48] P. Gierszewski, J. Sullivan, Ceramic sphere-pac breeder design for fusion blankets, *Fusion Eng. Des.* 17 (1991) 95–105.
- [49] L. Giancarli, M. Abdou, D. Campbell, V. Chuyanov, M. Ahn, M. Enoeda, C. Pan, Y. Poitevin, E. Rajendra Kumar, I. Ricapito, Y. Strebkov, S. Suzuki, P. Wong, M. Zmitko, Overview of the ITER TBM program, *Fusion Eng. Des.* 87 (2012) 395–402.
- [50] P. Di Maio, P. Arena, L. Boccaccini, G. Bongiovi, D. Carloni, P. Chiovaro, R. Giannusso, S. Kecskes, G. Vella, On the numerical assessment of the thermo-mechanical performances of the DEMO Helium-Cooled Pebble Bed breeding blanket module, *Fusion Eng. Des.* 89 (2014) 1411–1416.
- [51] C. Wong, S. Malang, M. Sawan, S. Smolentsev, S. Majumdar, B. Merrill, D. Sze, N. Morley, S. Sharafat, M. Dagher, P. Peterson, H. Zhao, S. Zinkle, M. Abdou, M. Youssef, Assessment of first wall and blanket options with the use of liquid breeder, *Fusion Sci. Technol.* 47 (2005) 502–509.
- [52] A. Sagara, T. Tanaka, H. Hashizume, T. Kunugi, S. Fukada, A. Shimizu, Innovated liquid blanket design activities in Japan, *Fusion Sci. Technol.* 47 (2005) 524–529.
- [53] A. Leshukov, V. Kapyshev, I. Kartashev, V. Kovalenko, A. Razmerov, M. Sviridenko, Y. Strebkov, I. Kirillov, D. Obukhov, I. Vitkovskiy, D. Pertsev, Design development and analytical assessment of LLCB TBM in Russian Federation during 2012–2013, *Fusion Eng. Des.* 89 (7–8) (2014) 1232–1240.
- [54] M. Abdou, et al., Deuterium-tritium fuel self-sufficiency in fusion reactors, *Fusion Technol.* 9 (1986) 250–285.
- [55] W. Kuan, M. Abdou, A new approach for assessing the required tritium breeding ratio and startup inventory in future fusion reactors, *Fusion Technol.* 35 (1999) 309–353.
- [56] M. Sawan, M. Abdou, Physics and technology conditions for attaining tritium self-sufficiency for the DT fuel cycle, *Fusion Eng. Des.* 81 (2006) 1131–1144.
- [57] M. Abdou, H. Liu, A. Ying, Plasma physics and technology R&D requirements to attain tritium self-sufficiency and reduce tritium inventories in fusion systems, *Fusion Eng. Des.* (2015) (submitted for publication).
- [58] M. Abdou, Blanket Technology, Fuel Cycle and Tritium Self Sufficiency, 27–28 June 2011, Available at: <http://www.fusion.ucla.edu/abdou/abdou%20presentations/2011/JASON%20Presentation%20San%20Diego%206-28-11.pdf>
- [59] L. Baylor, et al., Comparison of fueling efficiency from different fueling locations on DIII-D, *J. Nucl. Mater.* 313–316 (2003) 530–533.
- [60] L. Baylor, et al., Pellet fuelling and control of burning plasmas in ITER, *Nucl. Fusion* 47 (2006) 443.
- [61] J. Anderson, et al., Experience of TSTA milestone runs with 100 grams-level of tritium, *Fusion Sci. Technol.* 14 (1988) 438–443.
- [62] M. Gluga, et al., Exploration and assessment of design windows for a Tokamak-based volumetric neutron source, *Fusion Eng. Des.* 31 (1996) 323–332.
- [63] M. Abdou, et al., Japan atomic energy research institute/united states integral neutronics experiments and analyses for tritium breeding, nuclear heating, and induced radioactivity, *Fusion Technol.* 28 (1995) 5–38.
- [64] R. Moreau, *Magnetohydrodynamics*, Kluwer, 1990.
- [65] U. Mueller, L. Buehler, *Magnetofluidynamics in Channels and Containers*, Springer, 2001.
- [66] S. Smolentsev, S. Badia, R. Bhattacharyay, L. Bühler, L. Chen, Q. Huang, H.-G. Jin, D. Krasnov, D.-W. Lee, E. Mas de les Valls, C. Mistrangelo, R. Munipalli, M.-J. Ni, D. Pashkevich, A. Patel, G. Pulugundla, P. Satyamurthy, A. Snegirev, V. Sviridov, P. Swain, T. Zhou, et al., An approach to verification and validation of MHD codes for fusion applications, *Fusion Eng. Des.* (2015), <http://dx.doi.org/10.1016/j.fusengdes.2014.04.049> (in press).
- [67] S. Smolentsev, R. Moreau, M. Abdou, Characterization of key magnetohydrodynamic phenomena in PbLi flows for the US DCLL blanket, *Fusion Eng. Des.* (2008) 771–783.
- [68] S. Smolentsev, C. Wong, S. Malang, M. Dagher, M. Abdou, MHD considerations for the DCLL inboard blanket and access ducts, *Fusion Eng. Des.* 85 (2010) 1007–1011.
- [69] S. Smolentsev, N. Vetcha, M. Abdou, Effect of a magnetic field on stability and transitions in liquid breeder flows in a blanket, *Fusion Eng. Des.* 88 (2013) 607–610.
- [70] S. Smolentsev, F. Li, N. Morley, Y. Ueki, M. Abdou, T. Sketchley, Construction and initial operation of MHD PbLi facility at UCLA, *Fusion Eng. Des.* 88 (2013) 317–326.
- [71] S. Smolentsev, N. Vetcha, R. Moreau, Study of instabilities and transitions for a family of quasi-two-dimensional magnetohydrodynamic flows based on a parametric model, *Phys. Fluids* 24 (2012) 024101.
- [72] N. Vetcha, S. Smolentsev, M. Abdou, R. Moreau, Study of instabilities and quasi-two-dimensional turbulence in volumetrically heated MHD flows in a vertical rectangular duct, *Phys. Fluids* 25 (2013) 024102.
- [73] M. Pattison, S. Smolentsev, R. Munipalli, M. Abdou, Tritium transport in poloidal flows of a DCLL blanket, *Fusion Sci. Technol.* 60 (2011) 809–813.
- [74] S. Smolentsev, S. Saeidi, S. Malang, M. Abdou, Numerical study of corrosion of ferritic/martensitic steels in the flowing PbLi with and without a magnetic field, *J. Nucl. Mater.* 432 (2013) 294–304.
- [75] S. Smolentsev, N. Morley, M. Abdou, R. Munipalli, R. Moreau, Current approaches to modeling MHD flows in the dual coolant lead lithium blanket, *Magnetohydrodynamics* 42 (2006) 225–236.
- [76] H. Wang, Y. Wu, Simulation of liquid metal LiPb fluid MHD effects in the DFL test blanket module for ITER, *Chin. J. Nucl. Sci. Eng.* 26 (2006) 173–177.
- [77] ANSYS FLUENT 12.0, *Magnetohydrodynamics (MHD) Module Manual*, ANSYS, Inc., 2009.
- [78] C. Mistrangelo, L. Buehler, Development of a numerical tool to simulate magnetohydrodynamic interactions of liquid metals with strong applied magnetic fields, *Fusion Sci. Technol.* 60 (2011) 798–803.
- [79] E. Mas de les Valls, L. Batet, V. de Medina, J. Fradera, A. Sedano, Modeling of integrated effect of volumetric heating and magnetic field on tritium transport in a U-bend flow as applied to HCLL blanket concept, *Fusion Eng. Des.* 86 (2011) 341–356.
- [80] S. Kim, M. Kim, D. Lee, C. Choi, Code validation and development for MHD analysis of liquid metal flow in Korean TBM, *Fusion Eng. Des.* 87 (2012) 951–955.
- [81] L. Buceniek, R. Krishbergs, E. Platacis, G. Lipsbergs, A. Shishko, A. Zik, F. Muktepavela, Investigation of corrosion phenomena in EUROFER steel in Pb-17Li stationary flow exposed to a magnetic field, *Magnetohydrodynamics* 42 (2006) 237–251.
- [82] A. Sagara, T. Tanaka, J. Yagi, M. Takahashi, K. Miura, T. Yokomine, S. Fukada, S. Ishiyama, First operation of the Flinak/LiPb twin loop Orosh²-1-2 with a 3T

- SC magnet for R&D of liquid blanket for fusion reactor, *Fusion Sci. Technol.* 82 (2015).
- [83] R. Lu, H. Chen, T. Zhou, Z. Yang, F.D.S. Team, Magnetohydrodynamic experimental design and analysis for Chinese liquid metal LiPb experimental loop DRAGON-IV, *Chin. J. Nucl. Sci. Eng.* 29 (2009) 76–80.
- [84] J. Yoon, D. Lee, Y. Bae, S. Kim, K. Jung, S. Cho, Development of an experimental facility for a liquid breeder in Korea, *Fusion Eng. Des.* 86 (2011) 2212–2215.
- [85] J. Van der Laan, A. Fedorov, S. van Til, J. Riemann, Ceramic breeder materials, in: R.J.M. Konings (Ed.), *Comprehensive Nuclear Materials*, vol. 4, Elsevier, Amsterdam, 2012, pp. 463–510.
- [86] J. Reimann, G. Piazza, H. Harsch, Thermal conductivity of compressed beryllium pebble beds, *Fusion Eng. Des.* 81 (2006) 449–454.
- [87] J. Reimann, S. Hermsmeyer, Thermal conductivity of compressed ceramic breeder pebble beds, *Fusion Eng. Des.* 61–62 (2002) 345–351.
- [88] G. Federici, A. Raffray, M. Abdou, MISTRAL: a comprehensive model for tritium transport in lithium-base ceramics. Part I: Theory and description of model capabilities, *J. Nucl. Mater.* 173 (1990) 185–213.
- [89] M. Peeters, A. Magielsen, M. Stijkel, J. van der Laan, In-pile tritium release behaviour of lithiummetatitanate produced by extrusion–spheroidisation–sintering process in EXOTIC-9/1 in the high flux reactor, *Petten, Fusion Eng. Des.* 82 (2007) 2318–2325.
- [90] S. Casadio, J. van der Laan, C. Alvani, A. Magielsen, M. Stijkel, Tritium release kinetics from Li₂TiO₃ pebbles as prepared by soft-wet-chemistry, *J. Nucl. Mater.* 329–333 (2004) 1252–1255.
- [91] W. Guo, A. Ying, M. Ni, A. Abdou, Influence of 2D and 3D convection–diffusion flow on tritium permeation in helium cooled solid breeder blanket units, *Fusion Eng. Des.* 81 (2006) 1465–1470.
- [92] S. van Til, A. Fedorov, M. Stijkel, H. Cobussen, R. Mutnuru, P. Idsert, M. Zmitko, Tritium release from beryllium pebbles after high temperature irradiation up to 3000 appm He in the HIDOBE-01 experiment, *J. Nucl. Mater.* 442 (2013) S478–S482.
- [93] V. Chakin, R. Rolli, A. Moeslang, M. Klimentov, et al., Tritium release and retention properties of highly neutron-irradiated beryllium pebbles from HIDOBE-01 experiment, *J. Nucl. Mater.* 442 (2013) S483–S489.
- [94] A. Ying, J. Reimann, L. Boccaccini, M. Enoeda, M. Kamlah, R. Knitter, Y. Gan, J. van der Laan, L. Magielsen, P. Di Maio, G. Dell’Orco, R. Annabattula, J. van Lew, H. Tanigawa, S. van Til, Status of ceramic breeder pebble bed thermo-mechanics R&D and impact on breeder material mechanical strength, *Fusion Eng. Des.* 87 (2012) 1130–1137.
- [95] J. Riemann, L. Boccaccini, M. Enoeda, A. Ying, Thermomechanics of solid breeder and Be pebble bed materials, *Fusion Eng. Des.* 61–62 (2002) 319–331.
- [96] Y. Gan, M. Kamlah, Identification of material parameters of a thermo-mechanical model for pebble beds in fusion blankets, *Fusion Eng. Des.* 82 (2007) 189–206.
- [97] Z. An, A. Ying, M. Abdou, Numerical characterization of thermo-mechanical performance of breeder pebble beds, *J. Nucl. Mater.* 367–370 (Part B) (2007) 1393–1397.
- [98] J. Riemann, A. Abou-Sena, R. Nippen, P. Tafforeau, Pebble bed packing in prismatic containers, *Fusion Eng. Des.* 88 (2013) 2343–2347.
- [99] J. Riemann, E. Brun, C. Ferrero, J. Vicente, Pebble bed structures in the vicinity of concave and convex walls, *Fusion Eng. Des.* (2015), <http://dx.doi.org/10.1016/j.fusengdes.2015.05.026> (in press).
- [100] J. van Lew, A. Ying, M. Abdou, A discrete element method study on the evolution of thermomechanics of a pebble bed experiencing pebble failure, *Fusion Eng. Des.* 89 (2014) 1151–1157.
- [101] J.T. Van Lew, A. Ying, M. Abdou, Coupling discrete element models of ceramic breeder pebble beds to thermofluid models of helium purge gas using volume-averaged Navier-Stokes and the Lattice-Boltzmann method, *Fusion Sci. Technol.* 68 (2) (2015), <http://dx.doi.org/10.13182/FST14-937>, Technical Paper, Proceedings of TOFE-2014.
- [102] C. Zhang, A. Ying, M. Abdou, FEM modeling of pebble beds/structural wall separation, *Fusion Sci. Technol.* (2015), <http://dx.doi.org/10.13182/FST14-935>, Technical Paper, Proceedings of TOFE-2014.
- [103] J. Sheffield, R. Dory, S. Cohn, J. Delene, L. Parsly, D. Ashby, W. Reiersen, Cost assessment of a generic magnetic fusion reactor, *Fusion Technol.* 9 (2) (1986) 199–249.
- [104] A. Ying, M. Abdou, Application of reliability analysis method to fusion component testing, *Fusion Eng. Des.* 27 (1995) 191–197.
- [105] R. Buende, Reliability, availability, and quality assurance considerations for fusion components, *Fusion Eng. Des.* 29 (1995) 262–285.
- [106] R. Brown, M. Porton, The development of a methodology to allocate RAMI Requirements to DEMO, in: SOFE, San Francisco, 2013.
- [107] D. Van Houtte, K. Okayama, F. Sagot, RAMI approach for ITER, *Fusion Eng. Des.* 85 (2010) 1220–1224.
- [108] T. Pinna, G. Cambi, S. Ciattaglia, et al., Collection and analysis of data related to fusion machines (JET and TLK) operating experience on component failure, *Fusion Eng. Des.* 75–79 (2015) 1199–1203.
- [109] “Workshop on FNSF and ITER TBM, FNSF meeting at UCLA,” August 2008. [Online]. Available at: <http://www.fusion.ucla.edu/FNST/>
- [110] P. Tortorelli, J. DeVan, Corrosion of ferrous alloys exposed to thermally convective Pb-17 at% Li, *J. Nucl. Mater.* 141–143 (1986) 592–598.
- [111] H. Borgstedt, M. Grundmann, The influence of liquid Pb-17Li eutectic on the mechanical properties of structural materials, *Fusion Eng. Des.* 6 (1988) 155–158.
- [112] J. Sannier, M. Broc, T. Flament, A. Terlain, Corrosion of austenitic and martensitic stainless steels in flowing Pb17Li alloy, *Fusion Eng. Des.* 14 (1991) 299–307.
- [113] J. Konys, W. Krauss, Z. Voss, O. Wedemeyer, Corrosion behavior of EUROFER steel in flowing eutectic Pb–17Li alloy, *J. Nucl. Mater.* 329–333 (2004) 1379–1383.
- [114] S. Malang, D. Smith, Modeling of liquid metal corrosion/deposition in a fusion reactor blanket, ANL/FPP/TM-192, April 1984.
- [115] F. Barbier, A. Alemany, S. Martemianov, On the influence of a high magnetic field on the corrosion and deposition processes in the liquid Pb-17Li alloy, *Fusion Eng. Des.* 43 (1988) 199–208.
- [116] A. Terlain, T. Dufrenoy, Influence of a magnetic field on the corrosion of austenitic and martensitic steels by semi-stagnant Pb17Li, *J. Nucl. Mater.* 212–215 (1994) 1504–1508.
- [117] R. Krishbergs, E. Ligere, F. Muktepavela, E. Platacis, A. Shishko, A. Zik, Experimental studies of the strong magnetic field action on the corrosion of RAFM steels in Pb17Li melt flows, *Magnetohydrodynamics* 45 (2009) 289–296.
- [118] E. Platacis, A. Ziks, A. Poznjak, F. Muktepavela, A. Shishko, A. Sarada, P. Chakraborty, K. Sanjay, M. Vrushank, R. Fotedar, E. Rajendra, A. Suri, Corrosion phenomena of FMS (P-91) steel in Pb-Li in magnetic field, in: 8th Int. Pamir Conf. on Fundamental and Applied MHD, Borgo, Corsica, France, 2011.
- [119] C. Mistrangelo, MHD and corrosion analysis of dual coolant PbLi blanket modules for ARIES-CS, in: FZKA 7311, Forschungszentrum Karlsruhe, 2007.
- [120] R. Moreau, Y. Bréchet, L. Maniguet, Eurofer corrosion by the flow of the eutectic alloy Pb-Li in the presence of a strong magnetic field, *Fusion Eng. Des.* 86 (2011) 106–120.
- [121] T. Nozawa, et al., Recent advances and issues in development in silicon carbide composites for fusion applications, *J. Nucl. Mater.* 386–388 (2009) 622–627.
- [122] L. Snead, et al., Silicon carbide composites as fusion power reactor structural material, *J. Nucl. Mater.* 417 (2011) 330–339.
- [123] Y. Katoh, et al., Current status and recent research achievements in SiC/SiC composites, *J. Nucl. Mater.* 455 (2014) 387–397.
- [124] Y. Katoh, et al., DC electrical conductivity of silicon carbide ceramics and composites for flow channel insert applications, *J. Nucl. Mater.* 386–388 (2009) 639–642.
- [125] M. Sawan, et al., Transmutation of silicon carbide in fusion nuclear environment, *J. Nucl. Mater.* 442 (2013) S370–S375.
- [126] Y. Katoh, et al., Thermophysical and mechanical properties of near-stoichiometric fiber CVI SiC/SiC composites after neutron irradiation at elevated temperatures, *J. Nucl. Mater.* 403 (2010) 48–61.
- [127] S. Sharafat, A. Aoyama, N. Morley, S. Smolentsev, Y. Katoh, B. Williams, N. Ghoniem, Development Status of a SiC-Foam based flow channel insert for a US-ITER DCLL TBM, *Fusion Sci. Technol.* 56 (2009) 883.
- [128] Y. Katoh, L. Snead, T. Nozawa, N. Morley, W. Windes, Advanced radiation-resistant ceramic composites, *Adv. Sci. Technol.* 45 (2006) 1915–1924.
- [129] S. Zinkle, Materials Science and Technology Research Opportunities Now and in the ITER Era: A Focused Vision on Compelling Fusion Nuclear Science,” FESAC Report, 2012.
- [130] S. Malang, A. Raffray, N. Morley, An example pathway to a fusion power plant system based on lead-lithium breeder: comparison of the dual-coolant lead lithium (DCLL) blanket with the helium-cooled lead-lithium (HCLL) concept as initial step, *Fusion Eng. Des.* 84 (2009) 2145–2157.
- [131] C. Kessel, Fusion Nuclear Science Pathways Assessment, Princeton Plasma Physics Report PPPL-4736, 2012.
- [132] L.J. Pionke, J. Davis, Technical Assessment of Nb alloys Database for Fusion Reactor Applications, INIS Report no. COO 4247-2, August 1979.
- [133] C. English, The physical, mechanical and irradiation behavior of Nb and Nb-based alloys, in: Proc. Int. Symp. Niobium ‘81, San Francisco November 8–11, 1981, pp. 239–325.
- [134] R. Kurtz, Use of refractory metal alloys in permeator and heat exchanger applications in DCLL Pb-Li breeding blankets, in: 12th Int. Conf. on Fusion Reactor Materials, Santa Barbara CA, December 5th, 2005.
- [135] W. Farabolini, et al., Tritium control modelling for a helium cooled lithium–lead blanket of a fusion power reactor, *Fusion Eng. Des.* 81 (2006) 753–762.
- [136] I. Ricapito, A. Ciampichetti, G. Benamati, Tritium management in the HCLL-DEMO blanket, ENEA Report, 2004.
- [137] A. Tavassoli, et al., Current status and recent research achievements in ferritic/martensitic steels, *J. Nucl. Mater.* 455 (2014) 269–276.
- [138] R. Klueh, et al., Impurity effects on reduced-activation ferritic steels developed for fusion applications, *J. Nucl. Mater.* 280 (2000) 353–359.
- [139] L. Giancarli, et al., Breeding blanket modules testing in ITER: an international program on the way to DEMO, *Fusion Eng. Des.* 81 (2006) 393–405.
- [140] Q. Huang, et al., Recent progress of R&D activities on reduced activation ferritic/martensitic steels, *J. Nucl. Mater.* 442 (2013) S2–S8.

- [141] P. Aubert, et al., Review of candidate welding processes of RAFM steels for ITER test blanket modules and DEMO, *J. Nucl. Mater.* 417 (2011) 43–50.
- [142] J. Busby, Development of high performance cast stainless steels for ITER shield module applications, *J. Nucl. Mater.* 417 (2011) 866–869.
- [143] M. Abdou, et al., US ITER Test Blanket Module (TBM Program), Volume 1: Technical Plan and Cost Estimate Summary, UCLA-FNT-216, 2006, Available at: <http://www.fusion.ucla.edu/ITER-TBM/documents/TBM.Planning.and.Costing.Report.4-16-2007.pdf>
- [144] M. LaMonica, Additive Manufacturing, *MIT Technology Review*, 23 April 2013.
- [145] "ITER," [Online]. Available at: <http://www.iter.org/>
- [146] R. Hazeltine, et al., Research Needs for Magnetic Fusion Energy Sciences; Report of the Research Needs Workshop (ReNeW), DOE OFES, 2009.
- [147] B. Merrill, C. Wong, L. Cadwallader, M. Abdou, N. Morley, Normal operation and maintenance safety lessons from the ITER US PbLi test blanket module program for a US FNSF and DEMO, *Fusion Eng. Des.* 89 (2014) 1989–1994.
- [148] J. Van Lew, A. Ying, M. Abdou, Influence of pebble crushing, breeding zone orientation, and purge gas on temperatures in solid breeders, in: ISFNT-12, Jeju Island, S. Korea, 2015.
- [149] H. Liu, M. Abdou, L. Greenwood, ^{55}Fe effect on enhancing ferritic steel He/dpa ratio in fission reactor irradiations to simulate fusion conditions, *Fusion Eng. Des.* 88 (11) (2014) 2860–2864.
- [150] M. Tillack, X. Wang, S. Malang, F. Najmabadi, ARIES team, ARIES-ACT1 power core engineering, *Fusion Sci. Technol.* 64 (3) (2012) 427–434.
- [151] A. Ying, H. Zhang, J. Garde, M. Ulrickson, Structural analysis for EHF hypervapotron twin fingers and beryllium tile size study, *Fusion Sci. Technol.* 64 (2) (2013) 309–314.
- [152] R. Mitteau, P. Strangeby, C. Lowry, M. Merola, Heat loads and shape design of the ITER first wall, *Fusion Eng. Des.* 85 (2010) 2049–2053.
- [153] S. Ho, M. Abdou, Exploration and assessment of design windows for a Tokamak-based volumetric neutron source, *Fusion Eng. Des.* 31 (1996) 323–332.
- [154] V. Chan, R. Stambaugh, et al., A fusion development facility on the critical path to fusion energy, *Nucl. Fusion* 51 (2011).
- [155] A. Garofalo, et al., A fusion nuclear science facility for a fast-track path to DEMO, *Fusion Eng. Des.* 89 (2014) 876–881.
- [156] Y. Peng, et al., Fusion nuclear science facility (FNSF) before upgrade to component test facility (CTF), *Fusion Sci. Technol.* 60 (2011).
- [157] Y. Wan, et al., Design and strategy for CFETR, in: *Proc. IEEE 25th Symp. Fusion Engineering (SOFE)*, San Francisco, 2013.
- [158] B. Wan, et al., Physics design of CFETR: determination of the device engineering parameters, *IEEE Trans. Plasma Sci.* 42 (2014) 495–502.
- [159] Y. Song, et al., Concept design of CFETR Tokamak machine, *IEEE Trans. Plasma Sci.* 42 (2014) 502.
- [160] J. Zheng, et al., Concept design of hybrid superconducting magnet for CFETR Tokamak reactor, in: *IEEE 25th Symposium on Fusion Engineering*, San Francisco, 2013.
- [161] V. Chan, Evaluation of CFETR as a fusion nuclear science facility using multiple system codes, *Nucl. Fusion* 5 (2015).
- [162] Y. Wan, et al., Present status of CFETR, in: *IAEA Third Demo Workshop*, Hefei, China, 2014 May.
- [163] "IAEA DEMO Programme Workshops," [Online]. Available at: <http://advprojects.pppl.gov/Roadmapping/IAEADEMO/index.asp>; <http://advprojects.pppl.gov/ROADMAPPING/IAEA2/DEMO2.index.asp>
- [164] M. Abdou, et al., Fusion Nuclear Science Facility (FNSF) Issues and Strategy for Material and Blanket Development (in press).