



PUBLISHED FOR SISSA BY SPRINGER

RECEIVED: May 31, 2015

ACCEPTED: July 14, 2015

PUBLISHED: August 7, 2015

Seiberg-Witten for Spin(n) with spinors

Oscar Chacaltana,^a Jacques Distler^b and Anderson Trimm^b

^a*ICTP South American Institute for Fundamental Research,
Instituto de Física Teórica, Universidade Estadual Paulista,
01140-070 São Paulo, SP, Brazil*

^b*Theory Group and Texas Cosmology Center,
Department of Physics, University of Texas at Austin,
Austin, TX 78712, U.S.A.*

E-mail: chacaltana@ift.unesp.br, distler@golem.ph.utexas.edu,
atrimm@physics.utexas.edu

ABSTRACT: $\mathcal{N} = 2$ supersymmetric Spin(n) gauge theory admits hypermultiplets in spinor representations of the gauge group, compatible with $\beta \leq 0$, for $n \leq 14$. The theories with $\beta < 0$ can be obtained as mass-deformations of the $\beta = 0$ theories, so it is of greatest interest to construct the $\beta = 0$ theories. In previous works, we discussed the $n \leq 8$ theories. Here, we turn to the $9 \leq n \leq 14$ cases. By compactifying the $D_N(2,0)$ theory on a 4-punctured sphere, we find Seiberg-Witten solutions to almost all of the remaining cases. There are five theories, however, which do not seem to admit a realization from six dimensions.

KEYWORDS: Supersymmetry and Duality, Supersymmetric gauge theory, Extended Supersymmetry, Duality in Gauge Field Theories

ARXIV EPRINT: [1404.3736](https://arxiv.org/abs/1404.3736)

Contents

1	Introduction	1
2	Seiberg-Witten geometry	1
2.1	Seiberg-Witten curve	1
2.2	Calabi-Yau geometry	2
2.3	Dependence on the gauge coupling	3
3	$\text{Spin}(2N) + (2N - 2)(V)$ and $\text{Spin}(2N - 1) + (2N - 3)(V)$	4
4	$\text{Spin}(9)$ and $\text{Spin}(10)$ gauge theories	5
4.1	$\text{Spin}(9)$	5
4.1.1	$\text{Spin}(9) + 1(16) + 5(9)$	5
4.1.2	$\text{Spin}(9) + 2(16) + 3(9)$	6
4.1.3	$\text{Spin}(9) + 3(16) + 1(9)$	6
4.2	$\text{Spin}(10)$	7
4.2.1	$\text{Spin}(10) + 1(16) + 6(10)$	7
4.2.2	$\text{Spin}(10) + 2(16) + 4(10)$	8
4.2.3	$\text{Spin}(10) + 3(16) + 2(10)$	9
4.2.4	$\text{Spin}(10) + 4(16)$	10
5	$\text{Spin}(11)$ and $\text{Spin}(12)$ gauge theories	11
5.1	$\text{Spin}(11)$	11
5.1.1	$\text{Spin}(11) + \frac{1}{2}(32) + 7(11)$	11
5.1.2	$\text{Spin}(11) + 1(32) + 5(11)$	12
5.1.3	$\text{Spin}(11) + \frac{3}{2}(32) + 3(11)$	13
5.1.4	$\text{Spin}(11) + 2(32) + 1(11)$	14
5.2	$\text{Spin}(12)$	14
5.2.1	$\text{Spin}(12) + \frac{1}{2}(32) + 8(12)$	14
5.2.2	$\text{Spin}(12) + 1(32) + 6(12)$	16
5.2.3	$\text{Spin}(12) + \frac{1}{2}(32) + \frac{1}{2}(32') + 6(12)$	16
5.2.4	$\text{Spin}(12) + \frac{3}{2}(32) + 4(12)$	17
5.2.5	$\text{Spin}(12) + 1(32) + \frac{1}{2}(32') + 4(12)$	19
5.2.6	$\text{Spin}(12) + 2(32) + 2(12)$	20
5.2.7	$\text{Spin}(12) + \frac{3}{2}(32) + \frac{1}{2}(32') + 2(12)$	21
5.2.8	$\text{Spin}(12) + 1(32) + 1(32') + 2(12)$	22
5.2.9	More Spinors	23
6	$\text{Spin}(13)$ and $\text{Spin}(14)$ gauge theories	23
6.1	$\text{Spin}(13) + \frac{1}{2}(64) + 7(13)$	23
6.2	More spinors	25
7	Higher N?	25

1 Introduction

$\mathcal{N} = 2$ supersymmetric $\text{Spin}(n)$ gauge theory, with $n - 2$ hypermultiplets in the vector representation, is superconformal for any $n > 2$, and the Seiberg-Witten solutions are known from the mid 1990's [1, 2]. Replacing some number of vectors by hypermultiplets in spinor representations is only possible for sufficiently low n . The corresponding Seiberg-Witten solutions do not seem to be known.¹ For $\text{Spin}(5) \simeq \text{Sp}(2)$ and $\text{Spin}(6) \simeq \text{SU}(4)$, the solutions were presented in [5, 6]. The solutions to $\text{Spin}(7)$, $\text{Spin}(8)$ appeared in our previous papers [7, 8] (see [9] for an alternative formulation). As a further application of [7, 8], we will discuss $\text{Spin}(n)$ gauge theories for $n = 9, 10, \dots, 14$, with matter content such that $\beta = 0$. These are all of the remaining cases where one can have matter in the spinor representation. For $n > 14$, only matter in the vector representation is compatible with $\beta \leq 0$.

These 4D gauge theories can be obtained by compactifying [10, 11] a 6D (2,0) theory of type D_N on a 4-punctured sphere, where the punctures are labeled by nilpotent orbits in \mathfrak{d}_N (or in \mathfrak{c}_{N-1} for twisted-sector punctures) [7, 8, 12–14]. When the 4-punctured sphere degenerates into a pair of 3-punctured spheres (“fixtures”), connected by a long thin cylinder, the gauge theory description is weakly-coupled. Fixtures with only hypermultiplets in the vector representation are, necessarily, twisted. With at least one (half-)hypermultiplet in the spinor representation, we can find an untwisted fixture and — wherever possible — we prefer to work in the untwisted theory.

From these realizations as 4-punctured spheres, we construct the corresponding Seiberg-Witten geometries, and discuss the strong-coupling S-dual realizations [15] of the gauge theories.

2 Seiberg-Witten geometry

2.1 Seiberg-Witten curve

In the D_N theory, the Seiberg-Witten curve, $\Sigma \subset \text{tot}(K_C)$, is the spectral curve (in the vector representation) for D_N . In other words, it can be written as the locus

$$0 = \lambda^{2N} + \phi_2(z)\lambda^{2N-2} + \phi_4(z)\lambda^{2N-4} + \dots + \phi_{2N-2}(z)\lambda^2 + \tilde{\phi}(z)^2 \tag{2.1}$$

where the Seiberg-Witten differential, $\lambda = ydz$, is the tautological 1-form on K_C . Σ is a branched cover of C , of rather high genus. But it admits an obvious involution $\iota: \lambda \rightarrow -\lambda$. The quotient by this involution is a curve \tilde{C} , also a branched cover of C . One finds² that

¹The solutions (with arbitrary masses for the vector and spinor hypermultiplets) of the asymptotically-free theories for $n = 8, 10, 12$ were constructed in [3]. The status of Seiberg-Witten solutions, to *various* $\mathcal{N} = 2$ supersymmetric gauge theories, was recently reviewed in [4].

²For many purposes, it's convenient to replace Σ by the compact curve

$$0 = \lambda^{2N} + \phi_2(z)\lambda^{2N-2}\mu^2 + \phi_4(z)\lambda^{2N-4}\mu^4 + \dots + \phi_{2N-2}(z)\lambda^2\mu^{2N-2} + \tilde{\phi}(z)^2\mu^{2N}$$

in $\text{tot}(P(K_C \oplus \mathcal{O}))$. Away from the punctures, $\mu \neq 0$ and we can scale it to 1. At the punctures, $\mu = 0$, and the SW curve has interesting ramification over the punctures. The A_{N-1} case [16, 17] is explained in detail in [18]. The generalization to D_N has a few subtleties, which we won't attempt to explicate here.

$g(\Sigma) - g(\tilde{C}) = N$. The SW solution is obtained by computing the periods of λ over the cycles which are anti-invariant under ι . Said differently, the fibers of the Hitchin integrable system are the Prym variety for $\Sigma \rightarrow \tilde{C}$.

For the $\text{Spin}(2N)$ gauge theories considered below, the above description is completely adequate, as $\tilde{\phi}(z)$ is nowhere-vanishing on C . For the $\text{Spin}(2N - 1)$ gauge theories, $\tilde{\phi}(z)$ vanishes identically. So Σ is reducible

$$0 = \lambda^2(\lambda^{2N-2} + \phi_2(z)\lambda^{2N-4} + \phi_4(z)\lambda^{2N-6} + \dots + \phi_{2N-2}(z)).$$

Let Σ_0 be the component

$$0 = \lambda^{2N-2} + \phi_2(z)\lambda^{2N-4} + \phi_4(z)\lambda^{2N-6} + \dots + \phi_{2N-2}(z).$$

As before, Σ_0 admits an involution $\iota: \lambda \rightarrow -\lambda$, with quotient $\tilde{C}_0 = \Sigma_0/\iota$, and the SW solution, for the $\text{Spin}(2N - 1)$ gauge theory, is given by the periods of λ on the anti-invariant cycles. There is one subtlety which did not occur in the previous case: $\phi_{2N-2}(z)$ typically does have zeroes on C , which means that Σ_0 is slightly singular. It has ordinary double-points over the zeroes of $\phi_{2N-2}(z)$. As in Hitchin's original paper [19], we actually work over the resolutions,³ $\hat{\Sigma}_0 \rightarrow \tilde{C}_0$, whose Prym variety has the desired dimension, $g(\hat{\Sigma}_0) - g(\tilde{C}_0) = N - 1$.

2.2 Calabi-Yau geometry

An alternative formulation [20, 21], more directly related to the Type-IIB description of these 4D theories is as follows. Consider a family of noncompact Calabi-Yau 3-folds, $X_{\vec{u}}$, realized as the hypersurface

$$0 = w^2 + yx^2 - y^{N-1} - \phi_2(z)y^{N-2} - \phi_4(z)y^{N-3} - \dots - \phi_{2N-2}(z) - 2\tilde{\phi}(z)x$$

in the total space of the bundle $V = (K_C^{(N-1)} \oplus K_C^{(N-2)} \oplus K_C^2) \rightarrow C$. Here, \vec{u} are the Coulomb branch parameters, on which the $\phi_k(z)$ depend, and

$$w = \tilde{w}(dz)^{N-1}, \quad x = \tilde{x}(dz)^{N-2}, \quad y = \tilde{y}(dz)^2$$

are the tautological differentials on V . The $g_s \rightarrow 0$ limit of Type IIB on $\mathbb{R}^{3,1} \times X_{\vec{u}}$ is the 4D $\mathcal{N} = 2$ field theory (decoupled from the bulk gravity).

$X_{\vec{u}}$ has a collection of 3-cycles of the form of an S^2 in the fiber over a curve on C . The Seiberg-Witten solutions to the $\text{Spin}(2N)$ theories below are constructed from the periods of the holomorphic 3-form,

$$\Omega = \frac{d\tilde{x} \wedge d\tilde{y} \wedge dz}{\tilde{w}}$$

over a (rational) symplectic basis of these 3-cycles. For the $\text{Spin}(2N - 1)$ theories, $\tilde{\phi}(z) \equiv 0$, and $X_{\vec{u}}$ has an involution $\iota: (w, x) \rightarrow (-w, -x)$, under which Ω is invariant. ι acts by exchanging two of the S^2 s in the fiber (fixing the rest). Integrating Ω over the invariant cycles yields the $2(N - 1)$ periods which comprise the solution for the $\text{Spin}(2N - 1)$ theories.

³In the D_4 theory, there are examples of $\text{Spin}(8)$ gauge theory, with matter in the $n_s(8_s) + n_c(8_c) + (6 - n_s - n_c)(8_v)$, where $\tilde{\phi}(z)$ has isolated zeroes on C . Over those points, Σ has ordinary double points and, similarly, we work on the resolution, $\hat{\Sigma}$.

2.3 Dependence on the gauge coupling

The Seiberg-Witten solutions to the $\beta = 0$ gauge theories, which are our focus, have elaborate (but holomorphic) dependence [22] on the complexified gauge coupling

$$\tau = \frac{\theta}{\pi} + \frac{8\pi i}{g^2}.$$

In particular, *any* such theory, which can be realized by compactifying the (2,0) theory on a 4-punctured sphere, *automatically* has a symmetry under $\Gamma(2) \subset \text{PSL}(2, \mathbb{Z})$, generated by

$$T^2 : \tau \mapsto \tau + 2, \quad ST^2S : \tau \mapsto \frac{\tau}{1 - 2\tau}.$$

That is, the dependence on the gauge coupling is through the function

$$\begin{aligned} f(\tau) &\equiv -\frac{\theta_2^4(0, \tau)}{\theta_4^4(0, \tau)} \\ &= -\left(16q^{1/2} + 128q + 704q^{3/2} + \dots\right) \end{aligned}$$

where $q = e^{2\pi i\tau}$.

In the untwisted theory, $f(\tau)$ is simply identified with the cross-ratio of the 4-punctured sphere:

$$f(\tau) = x \equiv \frac{z_{13}z_{24}}{z_{14}z_{23}}. \tag{2.2}$$

The limit $x \rightarrow 0$ is the usual weak-coupling limit. $x \rightarrow 1$ and $x \rightarrow \infty$ are limits which admit an alternative (physically-distinct) S-dual description as a weakly coupled gauge theory.

When the punctures at z_1 and z_2 are identical, then the theory has a larger symmetry under $\Gamma_0(2) \supset \Gamma(2)$, where the extra generator acts on the x -plane as

$$S : x \mapsto \frac{1}{x}.$$

The theories, below, with two (one full and one minimal) twisted punctures and two untwisted punctures, have a similar story, except that the relation between $f(\tau)$ (which parametrizes the gauge theory moduli space) and the cross-ratio is more complicated. The gauge theory moduli space is a branched double-cover [8] of the moduli space of the 4-punctured sphere, $\mathcal{M}_{0,4}$. Instead of (2.2),

$$w^2 = x \equiv \frac{z_{13}z_{24}}{z_{14}z_{23}} \tag{2.3}$$

and the gauge coupling

$$f(\tau) = \frac{w - 1}{w + 1}. \tag{2.4}$$

In particular, this means that $x \rightarrow 0$ corresponds to $f(\tau) \rightarrow -1$ (i.e. $\tau \rightarrow i$), which is an *interior* point of the gauge theory moduli space and intrinsically strongly coupled. As in our previous works on the twisted sector [6, 8], we denote these peculiar degenerations as involving a ‘‘gauge theory fixture.’’ The other degeneration limits have more prosaic

interpretations. The limit $f(\tau) \rightarrow 1$ projects to $x \rightarrow \infty$ and the limits $f(\tau) \rightarrow 0$ and $f(\tau) \rightarrow \infty$ (which have isomorphic physics) both project to $x \rightarrow 1$.

In presenting the solutions, below, we write the dependence on the positions of the four punctures in a manifestly $\text{PSL}(2, \mathbb{C})$ -invariant form. For calculational purposes, it is invariably easier to fix the $\text{PSL}(2, \mathbb{C})$ symmetry by setting $(z_1, z_2, z_3, z_4) = (0, \infty, x, 1)$.

3 $\text{Spin}(2N) + (2N - 2)(V)$ and $\text{Spin}(2N - 1) + (2N - 3)(V)$

Just as $\text{Spin}(2N)$ gauge theory with $2(N - 1)$ fundamentals is realized as the compactification of the D_N theory with four \mathbb{Z}_2 -twisted punctures

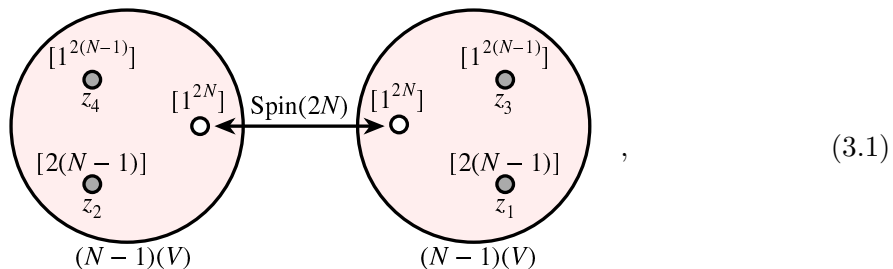

there is a universal realization of $\text{Spin}(2N - 1)$ with $2N - 3$ fundamentals plus $(N - 1)$ free hypermultiplets as a four-punctured sphere in the (twisted) D_N theory

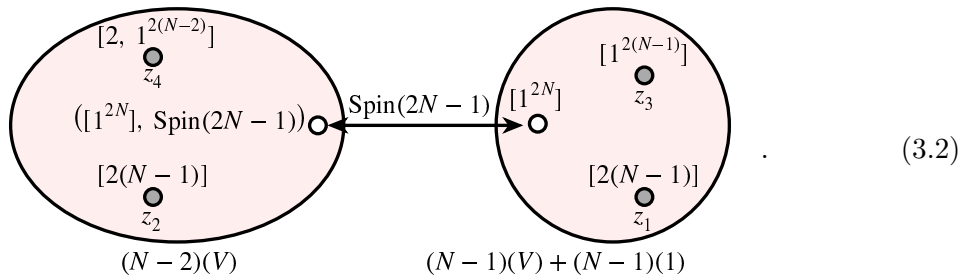

The Seiberg-Witten curve corresponding to (3.1) takes the form of (2.1) where the invariant k -differentials are

$$\phi_{2k}(z) = \frac{u_{2k} z_{14} z_{23} z_{34}^{2(k-1)} (dz)^{2k}}{(z - z_1)(z - z_2)(z - z_3)^{2k-1}(z - z_4)^{2k-1}}$$

$$\tilde{\phi}(z) = \frac{\tilde{u} z_{14}^{1/2} z_{23}^{1/2} z_{34}^{N-1} (dz)^N}{(z - z_1)^{1/2}(z - z_2)^{1/2}(z - z_3)^{(2N-1)/2}(z - z_4)^{(2N-1)/2}}.$$

The Seiberg-Witten curve for (3.2) takes the same form, but with $\tilde{\phi} \equiv 0$.

This pattern will repeat, in many of the examples below. The $\text{Spin}(2N - 1)$ theory, with the same number of hypermultiplets in the spinor, but one fewer in the vector representation, is obtained by replacing the puncture at z_4 , with one where the last box in the Young diagram is shifted to a new row. Physically, this corresponds to using one of the vector hypermultiplets to Higgs $\text{Spin}(2N) \rightarrow \text{Spin}(2N - 1)$. The “surprise” is that integrating out the massive modes has such a simple effect on the Coulomb branch geometry.

The strong-coupling dual of (3.2) is an $SU(2)$ gauging of the $Sp(2N-3)_{2N-1} \times SU(2)_8$ SCFT, with $N-1$ additional free hypermultiplets

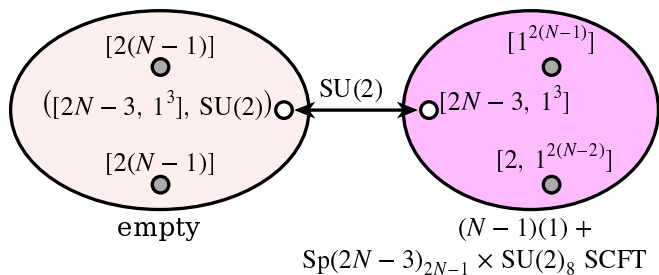

These theories have vanishing β -function for any N .

Including hypermultiplets in spinor representations will follow a similar pattern, where we will realize $Spin(2N-1)$ and $Spin(2N)$ gauge theories as 4-punctured spheres in the D_N theory. The Seiberg-Witten curve for each of these theories takes the form (2.1). We list the invariant k -differentials for each theory below.

As we saw above, the solutions for $Spin(2N-1)$ is obtained from the corresponding $Spin(2N)$ theory (i.e, the theory with the same number of spinors (ignoring their chirality, for N even) and one more vector) by setting $\tilde{u} = 0$.

4 Spin(9) and Spin(10) gauge theories

All of the following arise in the D_5 theory, possibly with \mathbb{Z}_2 -twisted punctures.

4.1 Spin(9)

4.1.1 Spin(9) + 1(16) + 5(9)

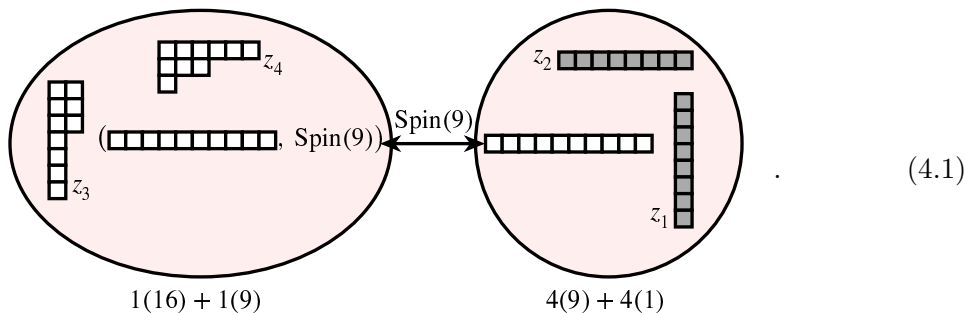

The other degeneration limits yield a gauge theory fixture

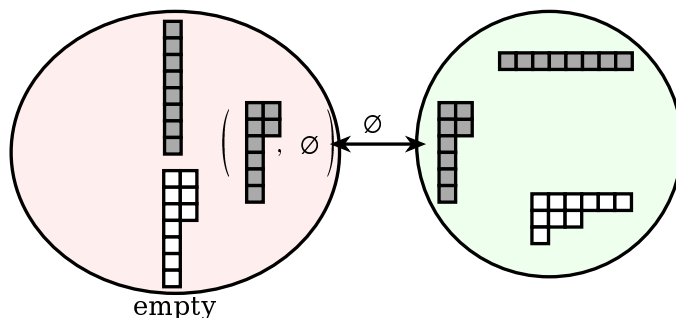

and an $Sp(2)$ gauging of the $Sp(7)_9$ SCFT + $\frac{3}{2}(4) + 4(1)$

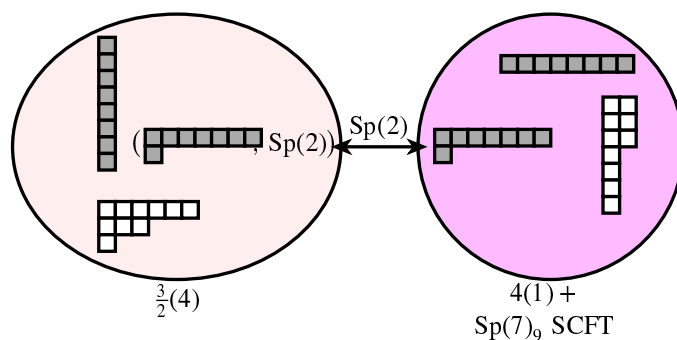

4.1.2 $Spin(9) + 2(16) + 3(9)$

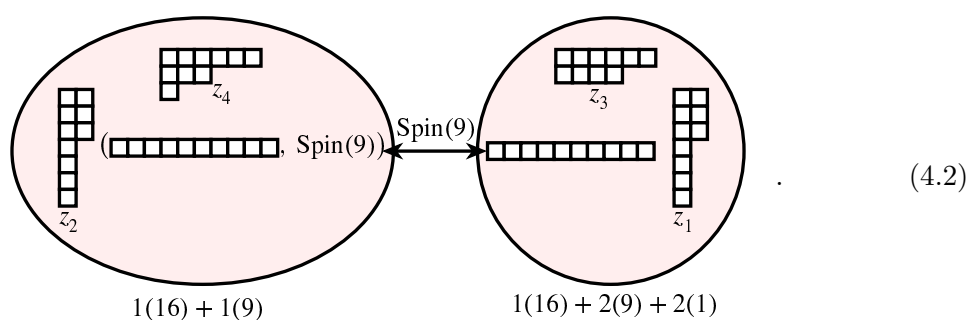

The S-dual theory is an $SU(2)$ gauging of the $Sp(3)_{16} \times Sp(2)_9 \times SU(2)_7$ SCFT + $\frac{1}{2}(2) + 2(1)$

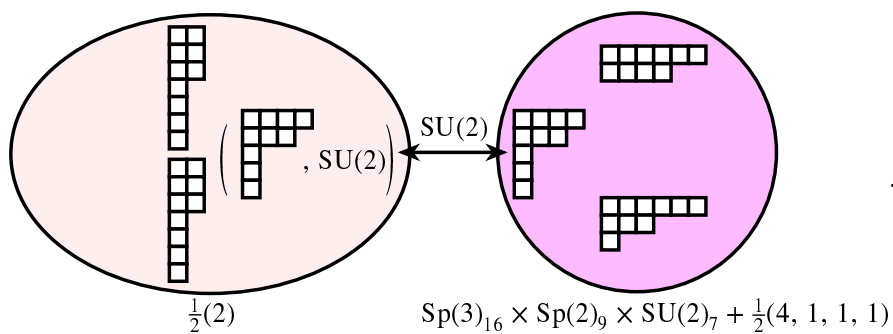

4.1.3 $Spin(9) + 3(16) + 1(9)$

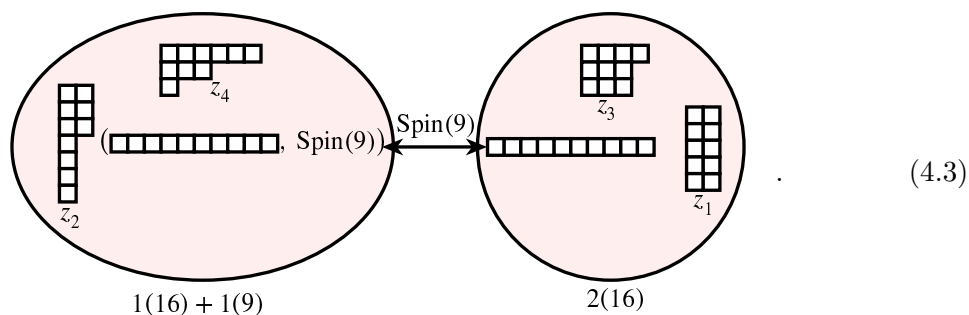

The S-dual theories are an $SU(2)$ gauging of the $Sp(3)_{16} \times SU(2)_8 \times SU(2)_9$ SCFT

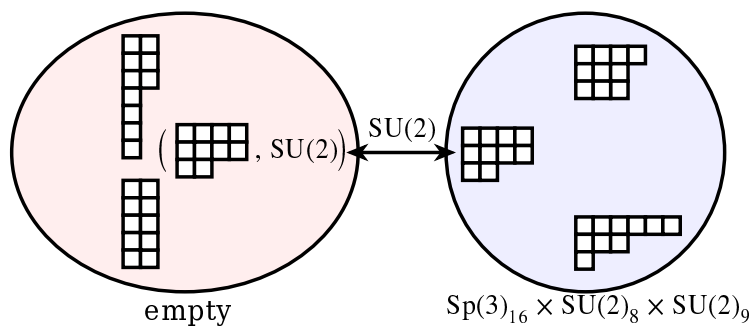

and a G_2 gauging of the $(E_7)_{16} \times SU(2)_9$ SCFT⁴

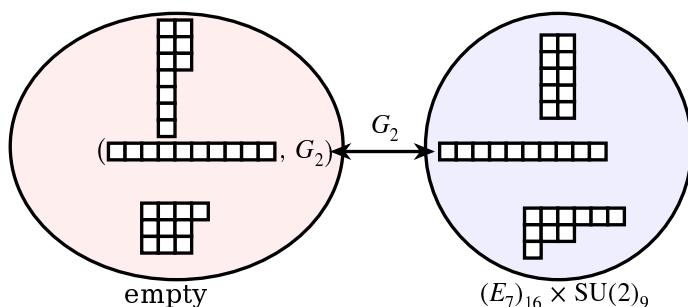

4.2 Spin(10)

4.2.1 Spin(10) + 1(16) + 6(10)

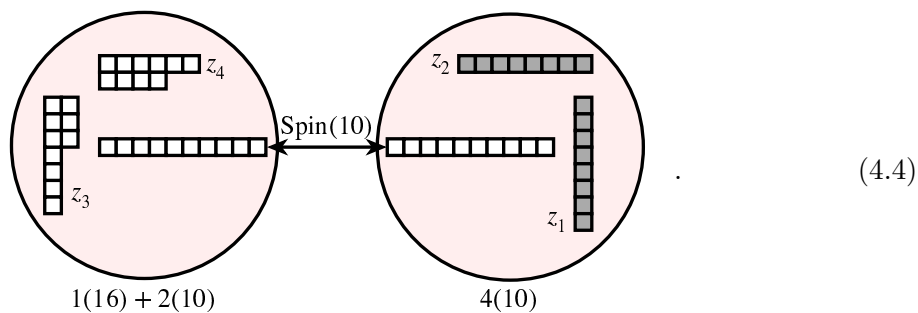

The other degenerations involve a gauge theory fixture

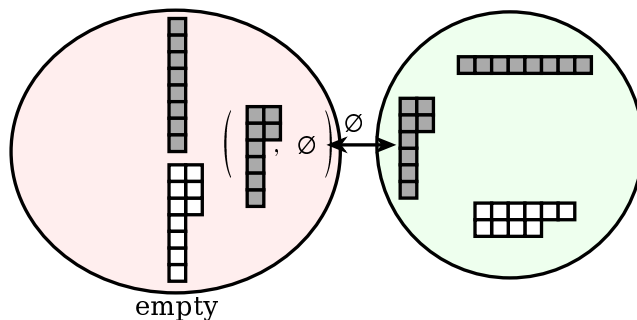

⁴This interacting fixture is another realization of the $(E_7)_{8n} \times SU(2)_{(n-1)(4n+1)}$ SCFT, which arises on the world volume of n D3-branes probing a III^* singularity in F-theory (see [23–25] and section 5.3 of [26]).

and an $Sp(2)$ gauging of the $Sp(8)_{10}$ SCFT + $1(4)$

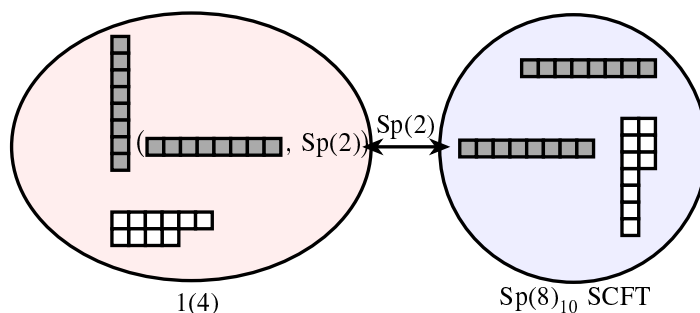

The invariant k -differentials for (4.4) are given by

$$\begin{aligned}
 \phi_2(z) &= \frac{u_2 z_{13} z_{24} (dz)^2}{(z - z_1)(z - z_2)(z - z_3)(z - z_4)} \\
 \phi_4(z) &= \frac{[u_4 (z - z_3) z_{24} - \frac{1}{4} u_2^2 (z - z_2) z_{34}] z_{13} z_{24}^2 (dz)^4}{(z - z_1)(z - z_2)^3 (z - z_3)^2 (z - z_4)^3} \\
 \phi_6(z) &= \frac{u_6 z_{13} z_{23} z_{24}^4 (dz)^6}{(z - z_1)(z - z_2)^5 (z - z_3)^2 (z - z_4)^4} \\
 \phi_8(z) &= \frac{u_8 z_{13} z_{23} z_{24}^6 (dz)^8}{(z - z_1)(z - z_2)^7 (z - z_3)^2 (z - z_4)^6} \\
 \tilde{\phi}(z) &= \frac{\tilde{u} z_{13}^{1/2} z_{23}^{1/2} z_{24}^4 (dz)^5}{(z - z_1)^{1/2} (z - z_2)^{9/2} (z - z_3)(z - z_4)^4}.
 \end{aligned} \tag{4.5}$$

The gauge theory moduli space is a branched double-cover of $\mathcal{M}_{0,4}$ and the gauge couplings are given by (2.4).

The invariant k -differentials for (4.1) are as above, but with $\tilde{\phi} \equiv 0$.

4.2.2 Spin(10) + 2(16) + 4(10)

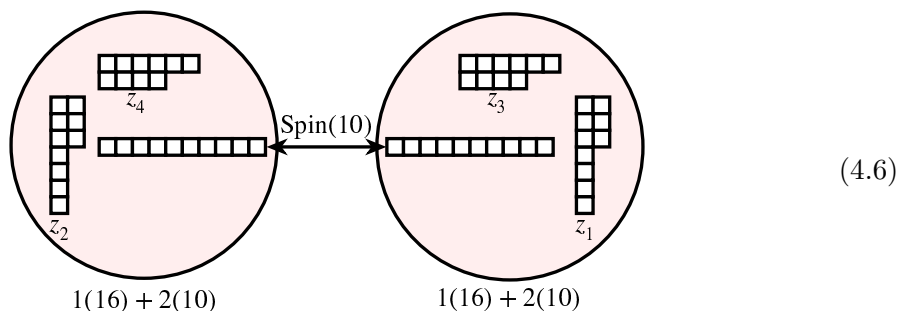

The S-dual is an $SU(2)$ gauging of the $Sp(4)_{10} \times SU(2)_{16} \times SU(2)_7 \times U(1)$ SCFT + $\frac{1}{2}(2)$

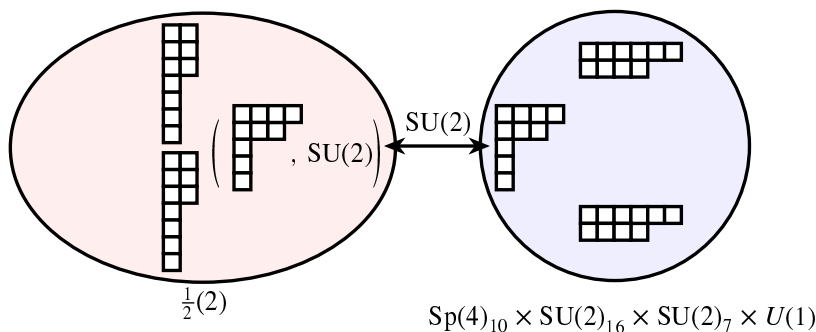

The invariant k -differentials for (4.6) are given by

$$\begin{aligned}
 \phi_2(z) &= \frac{u_2 z_{12} z_{34} (dz)^2}{(z-z_1)(z-z_2)(z-z_3)(z-z_4)} \\
 \phi_4(z) &= \frac{[u_4 (z-z_1)(z-z_2)z_{34} + \frac{1}{4}u_2^2 ((z-z_2)(z-z_3)z_{14} - (z-z_1)(z-z_4)z_{23})] z_{12} z_{34}^2 (dz)^4}{(z-z_1)^2 (z-z_2)^2 (z-z_3)^3 (z-z_4)^3} \\
 \phi_6(z) &= \frac{u_6 z_{12}^2 z_{34}^4 (dz)^6}{(z-z_1)^2 (z-z_2)^2 (z-z_3)^4 (z-z_4)^4} \\
 \phi_8(z) &= \frac{u_8 z_{12}^2 z_{34}^6 (dz)^8}{(z-z_1)^2 (z-z_2)^2 (z-z_3)^6 (z-z_4)^6} \\
 \tilde{\phi}(z) &= \frac{\tilde{u} z_{12} z_{34}^4 (dz)^5}{(z-z_1)(z-z_2)(z-z_3)^4 (z-z_4)^4}.
 \end{aligned} \tag{4.7}$$

The k -differentials for (4.2) are as above, but with $\tilde{\phi} \equiv 0$.

Since we are in the untwisted theory, the gauge theory moduli space is $\mathcal{M}_{0,4}$ (or more precisely, in this case, its \mathbb{Z}_2 quotient), and the gauge coupling is given by (2.2).

4.2.3 Spin(10) + 3(16) + 2(10)

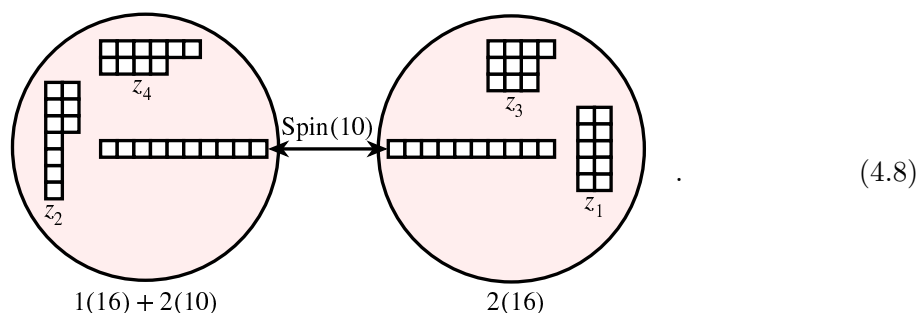

The S-dual theories are an $SU(2)$ gauging of the $SU(3)_{32} \times Sp(2)_{10} \times SU(2)_8 \times U(1)$ SCFT

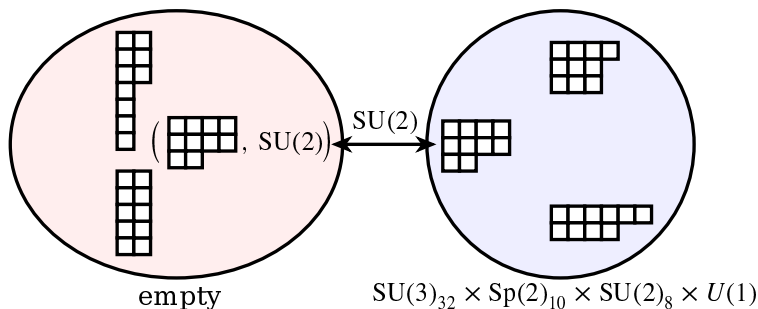

and a G_2 gauging of the $(E_6)_{16} \times Sp(2)_{10} \times U(1)$ SCFT

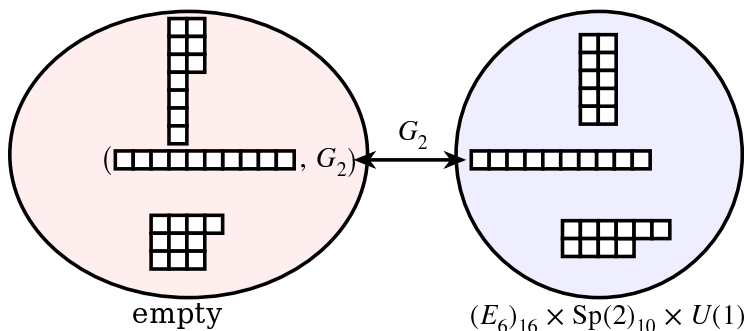

The invariant k -differentials for (4.8) are given by

$$\begin{aligned}
 \phi_2(z) &= \frac{u_2 z_{12} z_{34} (dz)^2}{(z - z_1)(z - z_2)(z - z_3)(z - z_4)} \\
 \phi_4(z) &= \frac{[u_4 (z - z_2) z_{14} + \frac{1}{4} u_2^2 (z - z_4) z_{12}] z_{12} z_{34}^2 (dz)^4}{(z - z_1)^2 (z - z_2)^2 (z - z_3)^2 (z - z_4)^3} \\
 \phi_6(z) &= \frac{[u_6 (z - z_1) z_{34} + \frac{1}{2} u_2 u_4 (z - z_4) z_{13}] z_{12}^2 z_{34}^3 (dz)^6}{(z - z_1)^3 (z - z_2)^2 (z - z_3)^4 (z - z_4)^4} \\
 \phi_8(z) &= \frac{[u_8 (z - z_1) z_{34} + \frac{1}{4} u_4^2 (z - z_4) z_{13}] z_{14} z_{12}^2 z_{34}^4 (dz)^8}{(z - z_1)^4 (z - z_2)^2 (z - z_3)^5 (z - z_4)^6} \\
 \tilde{\phi}(z) &= \frac{\tilde{u} z_{14} z_{12} z_{34}^3 (dz)^5}{(z - z_1)^2 (z - z_2)(z - z_3)^3 (z - z_4)^4}.
 \end{aligned} \tag{4.9}$$

The k -differentials for (4.3) are as above, but with $\tilde{\phi} \equiv 0$.

4.2.4 Spin(10) + 4(16)

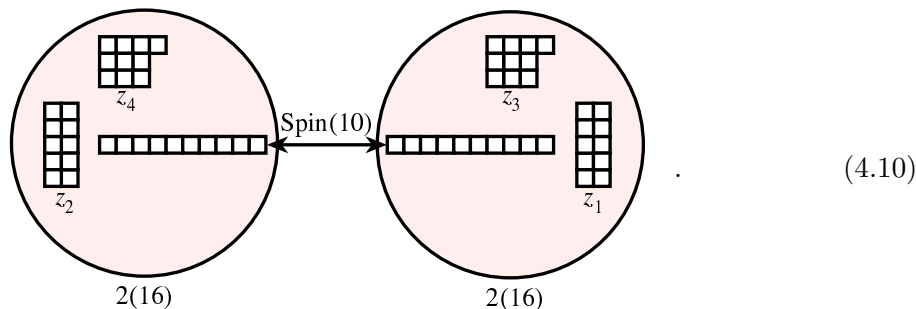

The S-dual theory is an $Sp(2)$ gauging of the $SU(4)_{32} \times Sp(2)_{10}$ SCFT + 1(4)

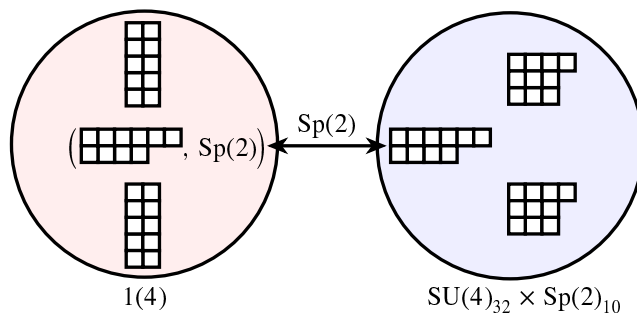

For this theory, the k -differentials characterizing the Seiberg-Witten curve are

$$\begin{aligned}
 \phi_2(z) &= \frac{u_2 z_{12} z_{34} (dz)^2}{(z - z_1)(z - z_2)(z - z_3)(z - z_4)} \\
 \phi_4(z) &= \frac{u_4 z_{12}^2 z_{34}^2 (dz)^4}{(z - z_1)^2 (z - z_2)^2 (z - z_3)^2 (z - z_4)^2} \\
 \phi_6(z) &= \frac{[u_6 (z - z_1)(z - z_2)z_{34} - \frac{1}{2}u_2 (u_4 - \frac{1}{4}u_2^2) ((z - z_1)(z - z_3)z_{24} - (z - z_2)(z - z_4)z_{13})] z_{12}^2 z_{34}^3 (dz)^6}{(z - z_1)^3 (z - z_2)^3 (z - z_3)^4 (z - z_4)^4} \\
 \phi_8(z) &= \frac{[u_8 (z - z_1)(z - z_2)z_{34} - \frac{1}{4}(u_4 - \frac{1}{4}u_2^2)^2 ((z - z_1)(z - z_3)z_{24} - (z - z_2)(z - z_4)z_{13})] z_{12}^3 z_{34}^4 (dz)^8}{(z - z_1)^4 (z - z_2)^4 (z - z_3)^5 (z - z_4)^5} \\
 \tilde{\phi}(z) &= \frac{\tilde{u} z_{12}^2 z_{34}^3 (dz)^5}{(z - z_1)^2 (z - z_2)^2 (z - z_3)^3 (z - z_4)^3}.
 \end{aligned} \tag{4.11}$$

In this case, there are no hypermultiplets in the vector, which one could use to Higgs $Spin(10) \rightarrow Spin(9)$. Equivalently, it's not possible to move the last box, in the Young diagram at z_4 , to a new row while keeping it a D-partition. So there is no corresponding $Spin(9)$ gauge theory.

5 Spin(11) and Spin(12) gauge theories

These arise in the compactification of the D_6 theory, possibly with \mathbb{Z}_2 -twisted punctures.

5.1 Spin(11)

5.1.1 Spin(11) + $\frac{1}{2}(32)$ + 7(11)

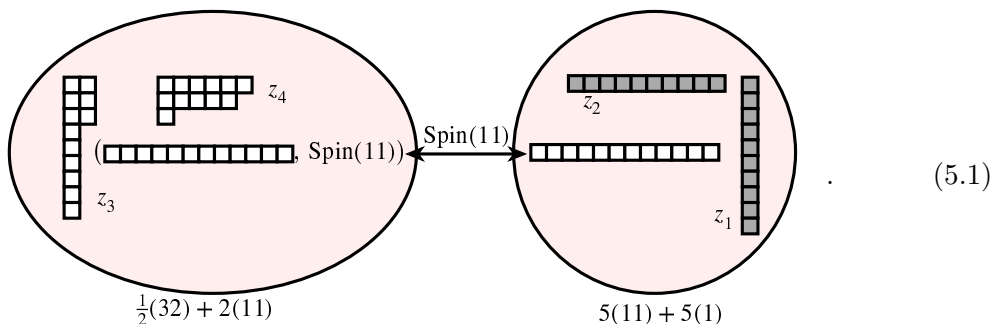

The other degenerations involve a gauge theory fixture

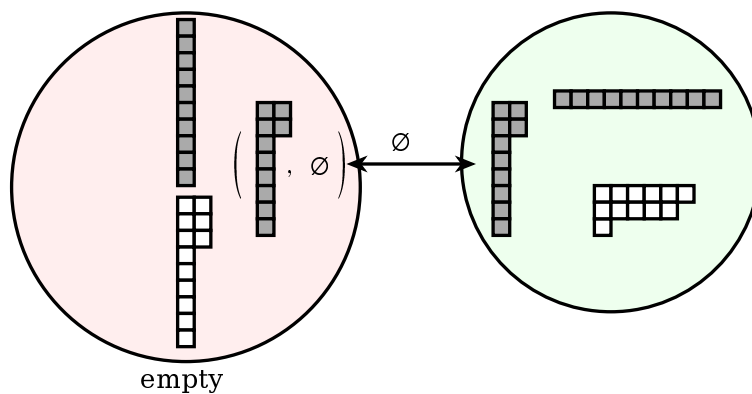

and an $Sp(2)$ gauging of the $Sp(9)_{11}$ SCFT + $\frac{1}{2}(4) + 5(1)$

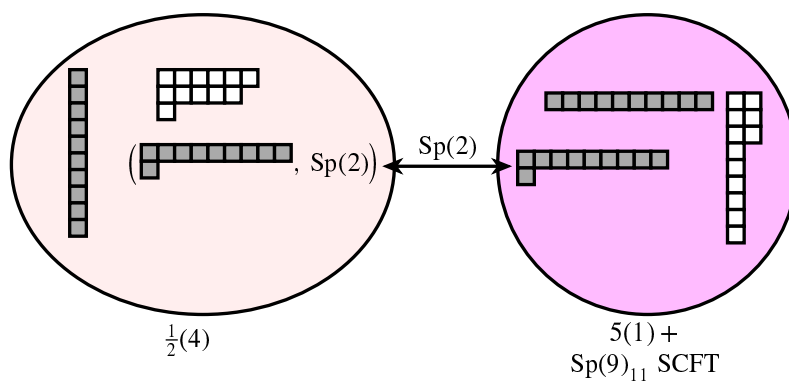

5.1.2 Spin(11) + 1(32) + 5(11)

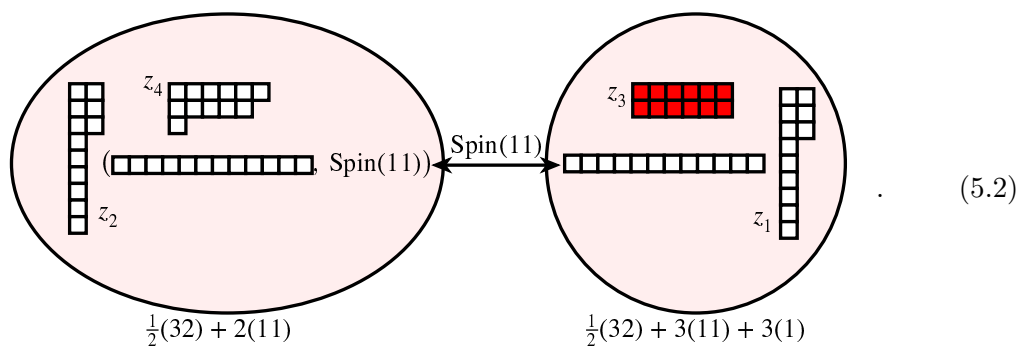

The S-dual theory is an $SU(2)$ gauging of the $Sp(5)_{11} \times SU(2)_7 \times U(1)$ SCFT $+\frac{1}{2}(2) + 3(1)$,

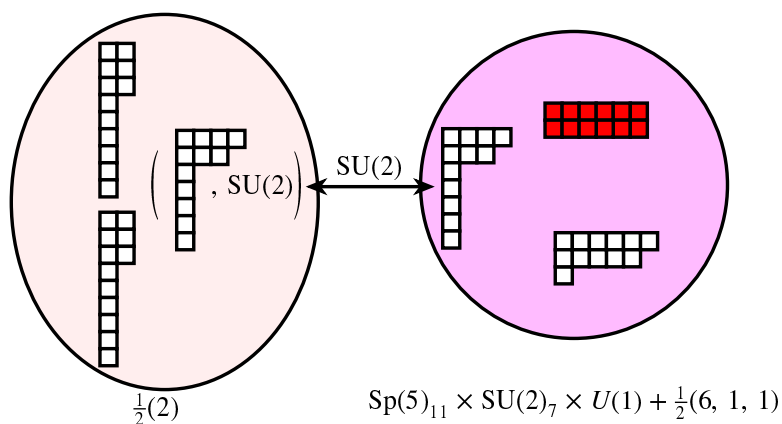

5.1.3 Spin(11) + 3/2(32) + 3(11)

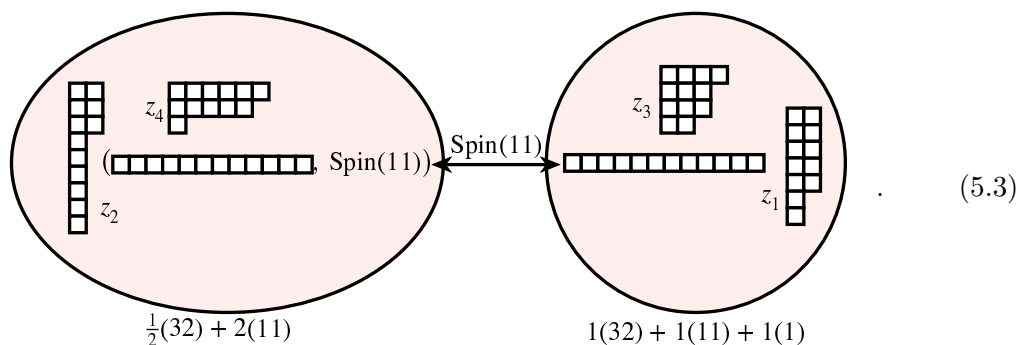

The S-dual theories are an $SU(2)$ gauging of the $Sp(3)_{11} \times SU(2)_8 \times SU(2)_{128}$ SCFT $+1(1)$

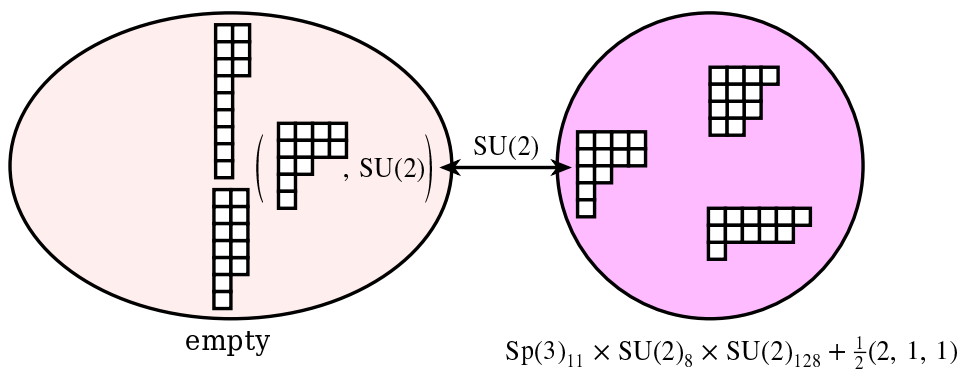

and a G_2 gauging⁵ of the $Sp(3)_{11} \times (F_4)_{16}$ SCFT + 1(1)

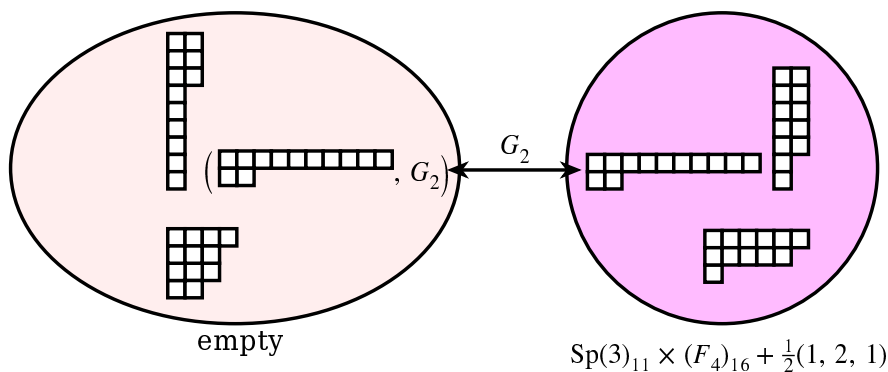

5.1.4 Spin(11) + 2(32) + 1(11)

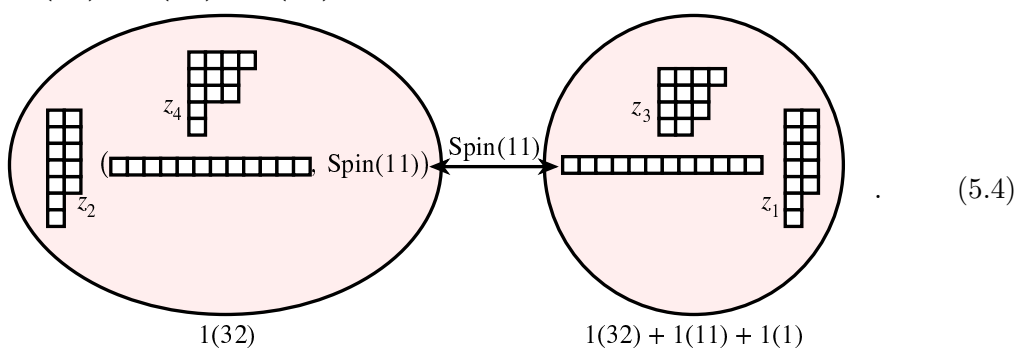

The S-dual theory is an $Sp(2)$ gauging of the $Sp(3)_{11} \times SU(2)_{32}^2$ SCFT + $\frac{1}{2}(4)$ + 1(1)

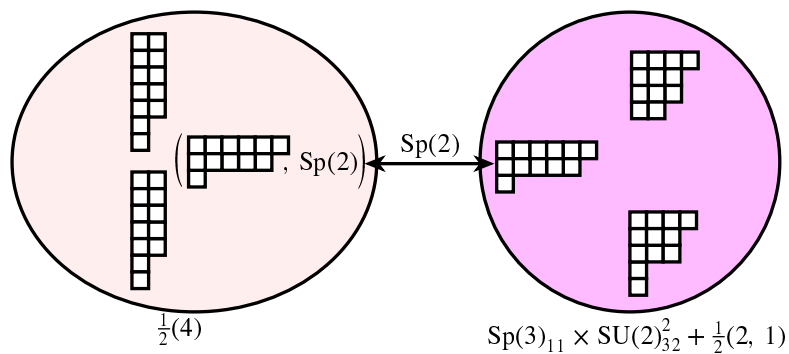

5.2 Spin(12)

5.2.1 Spin(12) + 1/2(32) + 8(12)

⁵Note that, here, we use the Lie algebra embedding, $(f_4)_k \supset (\mathfrak{g}_2)_k \times \mathfrak{su}(2)_{8k}$.

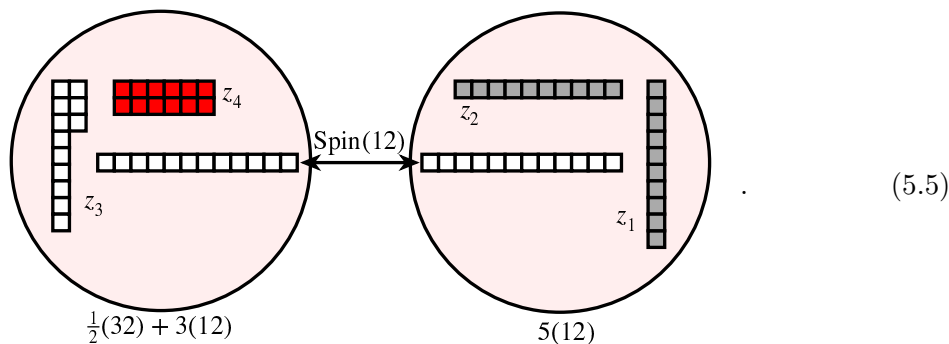

The other degenerations involve an gauge theory fixture

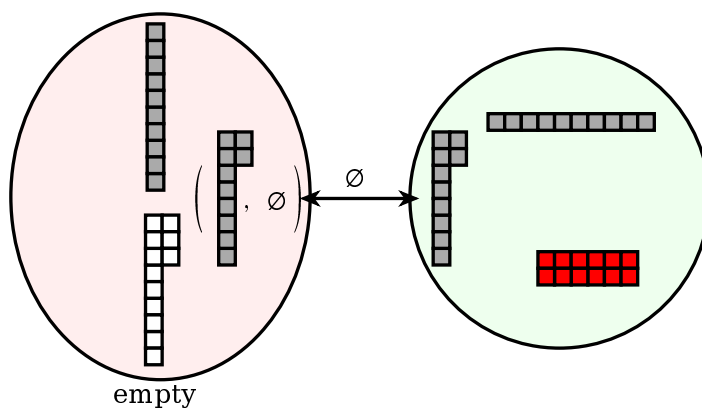

and an $Sp(2)$ gauging of the $Sp(10)_{12}$ SCFT

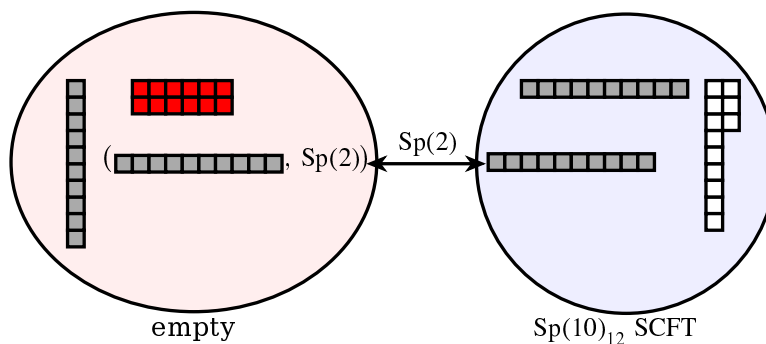

The invariant k -differentials for (5.5) are given by

$$\begin{aligned}
 \phi_2(z) &= \frac{u_2 z_{13} z_{24} (dz)^2}{(z - z_1)(z - z_2)(z - z_3)(z - z_4)} \\
 \phi_4(z) &= \frac{[u_4 (z - z_3) z_{24} - \frac{1}{4} u_2^2 (z - z_2) z_{34}] z_{13} z_{24}^2 (dz)^4}{(z - z_1)(z - z_2)^3 (z - z_3)^2 (z - z_4)^3} \\
 \phi_6(z) &= \frac{[u_6 (z - z_4) z_{13} + 2\tilde{u} (z - z_3) z_{14}] z_{23} z_{24}^4 (dz)^6}{(z - z_1)(z - z_2)^5 (z - z_3)^2 (z - z_4)^5} \\
 \phi_8(z) &= \frac{u_8 z_{13} z_{23} z_{24}^6 (dz)^8}{(z - z_1)(z - z_2)^7 (z - z_3)^2 (z - z_4)^6}
 \end{aligned}
 \tag{5.6}$$

$$\phi_{10}(z) = \frac{u_{10} z_{13} z_{23} z_{24}^8 (dz)^{10}}{(z - z_1)(z - z_2)^9 (z - z_3)^2 (z - z_4)^8}$$

$$\tilde{\phi}(z) = \frac{\tilde{u} z_{14}^{1/2} z_{24}^{9/2} z_{23} (dz)^6}{(z - z_1)^{1/2} (z - z_2)^{11/2} (z - z_3)(z - z_4)^5}.$$

For (5.1), they are as above, but with $\tilde{u} \equiv 0$.

5.2.2 Spin(12) + 1(32) + 6(12)

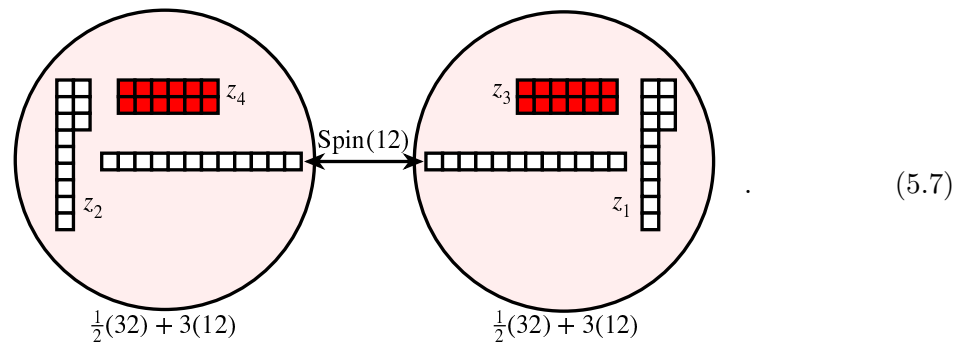

The S-dual theory is an SU(2) gauging of the $Sp(6)_{12} \times SU(2)_7 \times U(1)$ SCFT + $\frac{1}{2}(2)$

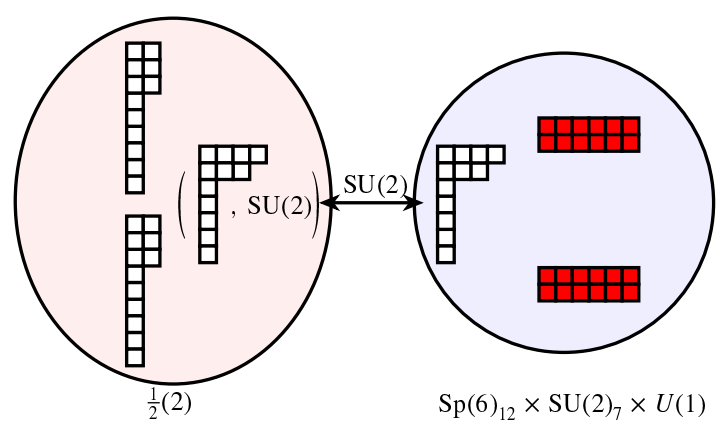

5.2.3 Spin(12) + 1/2(32) + 1/2(32') + 6(12)

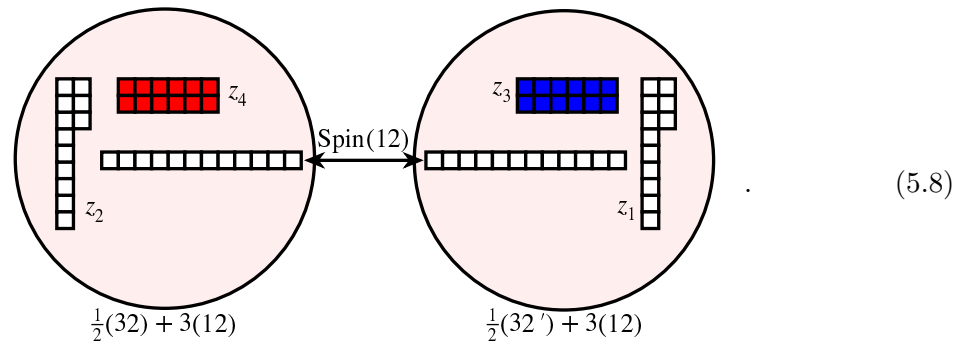

The S-dual is an $SU(2)$ gauging of the $Sp(6)_{12} \times SU(2)_7$ SCFT + $\frac{1}{2}(2)$

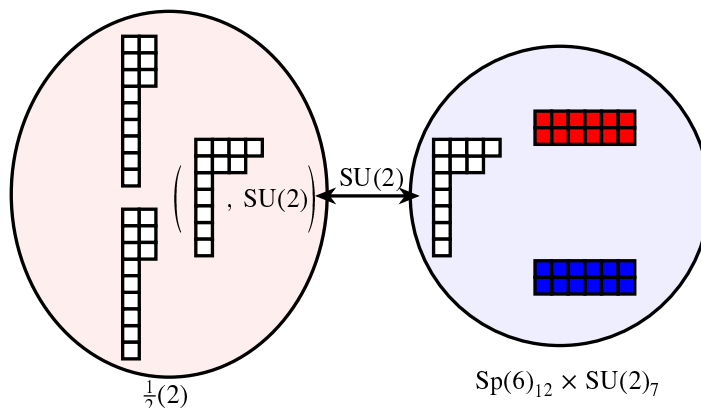

The invariant k -differentials for (5.7) and (5.8) are

$$\begin{aligned}
 \phi_2(z) &= \frac{u_2 z_{12} z_{34} (dz)^2}{(z-z_1)(z-z_2)(z-z_3)(z-z_4)} \\
 \phi_4(z) &= \frac{[u_4 (z-z_1)(z-z_2)z_{34} + \frac{1}{4}u_2^2 ((z-z_2)(z-z_3)z_{14} - (z-z_1)(z-z_4)z_{23})] z_{12} z_{34}^2 (dz)^4}{(z-z_1)^2 (z-z_2)^2 (z-z_3)^3 (z-z_4)^3} \\
 \phi_6(z) &= \frac{[u_6 (z-z_3)(z-z_4)z_{12} + 2\tilde{u}((z-z_1)(z-z_4)z_{23} \mp (z-z_2)(z-z_3)z_{14})] z_{12} z_{34}^4 (dz)^6}{(z-z_1)^2 (z-z_2)^2 (z-z_3)^5 (z-z_4)^5} \\
 \phi_8(z) &= \frac{u_8 z_{12}^2 z_{34}^6 (dz)^8}{(z-z_1)^2 (z-z_2)^2 (z-z_3)^6 (z-z_4)^6} \\
 \phi_{10}(z) &= \frac{u_{10} z_{12}^2 z_{34}^8 (dz)^{10}}{(z-z_1)^2 (z-z_2)^2 (z-z_3)^8 (z-z_4)^8} \\
 \tilde{\phi}(z) &= \frac{\tilde{u} z_{12} z_{34}^5 (dz)^6}{(z-z_1)(z-z_2)(z-z_3)^5 (z-z_4)^5}.
 \end{aligned} \tag{5.9}$$

where the upper/lower sign in the expression for ϕ_6 is for (5.7)/(5.8), respectively. The invariant k -differentials for (5.2) are as above, but with $\tilde{u} \equiv 0$.

5.2.4 Spin(12) + $\frac{3}{2}(32)$ + 4(12)

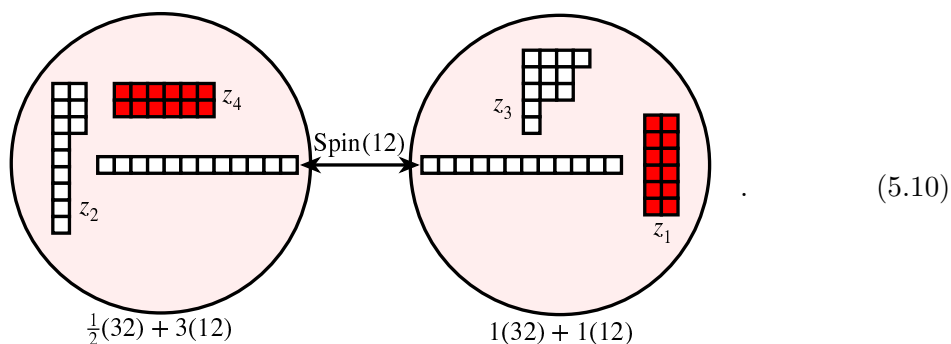

The S-dual theories are an $SU(2)$ gauging of the $Sp(4)_{12} \times SU(2)_8 \times SU(2)_{128}$ SCFT

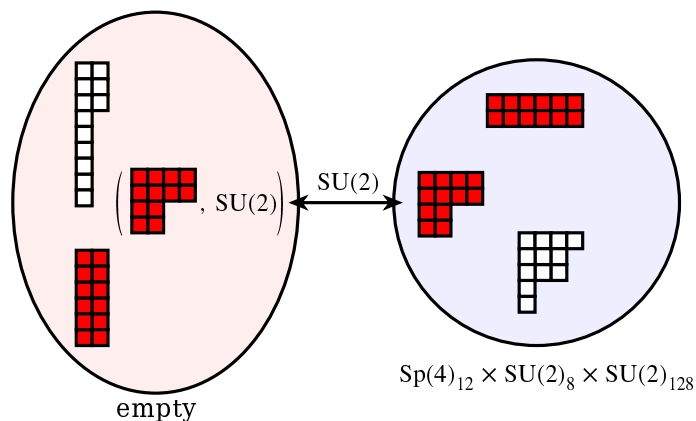

and a G_2 gauging of the $(F_4)_{16} \times Sp(4)_{12}$ SCFT

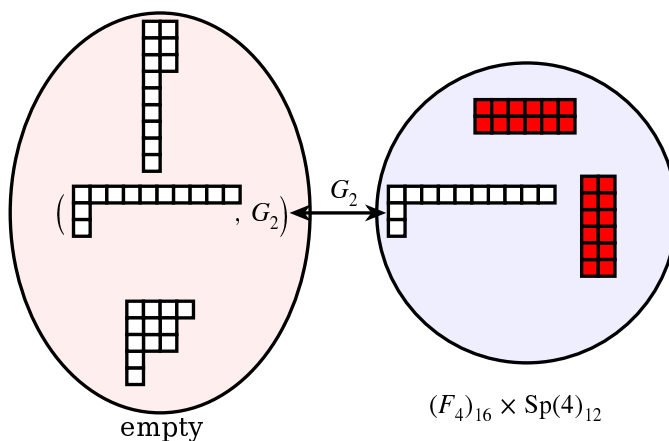

The invariant k -differentials for (5.10) are given by

$$\begin{aligned}
 \phi_2(z) &= \frac{u_2 z_{12} z_{34} (dz)^2}{(z-z_1)(z-z_2)(z-z_3)(z-z_4)} \\
 \phi_4(z) &= \frac{[u_4(z-z_2)z_{14} + \frac{1}{4}u_2^2(z-z_4)z_{12}]z_{12}z_{34}^2(dz)^4}{(z-z_1)^2(z-z_2)^2(z-z_3)^2(z-z_4)^3} \\
 \phi_6(z) &= \frac{[u_6(z-z_1)(z-z_4)z_{23} - 2\tilde{u}(z-z_1)(z-z_2)z_{34} + (2\tilde{u} + \frac{1}{4}u_2u_4)(z-z_3)(z-z_4)z_{12}]z_{12}z_{14}z_{34}^3(dz)^6}{(z-z_1)^3(z-z_2)^2(z-z_3)^4(z-z_4)^5} \\
 \phi_8(z) &= \frac{[u_8(z-z_1)z_{34} + (\frac{1}{4}u_4^2 + \tilde{u}u_2)(z-z_4)z_{13}]z_{14}z_{12}^2z_{34}^4(dz)^8}{(z-z_1)^4(z-z_2)^2(z-z_3)^5(z-z_4)^6} \\
 \phi_{10}(z) &= \frac{[u_{10}(z-z_1)z_{34} + \tilde{u}u_4(z-z_4)z_{13}]z_{12}^2z_{14}^2z_{34}^5(dz)^{10}}{(z-z_1)^5(z-z_2)^2(z-z_3)^6(z-z_4)^8} \\
 \tilde{\phi}(z) &= \frac{\tilde{u}z_{12}z_{14}^2z_{34}^3(dz)^6}{(z-z_1)^3(z-z_2)(z-z_3)^3(z-z_4)^5}.
 \end{aligned} \tag{5.11}$$

For (5.3), they are as above, but with $\tilde{u} \equiv 0$.

5.2.5 Spin(12) + 1(32) + 1/2(32') + 4(12)

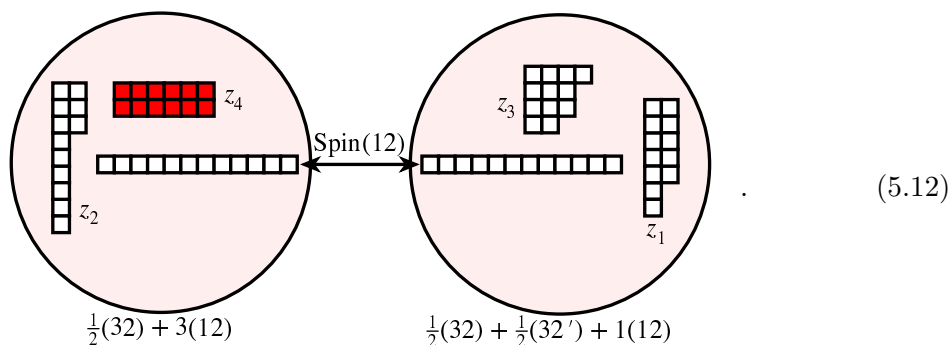

The S-dual theories are an SU(2) gauging of the Sp(4)₁₂ × SU(2)₈ × U(1) SCFT

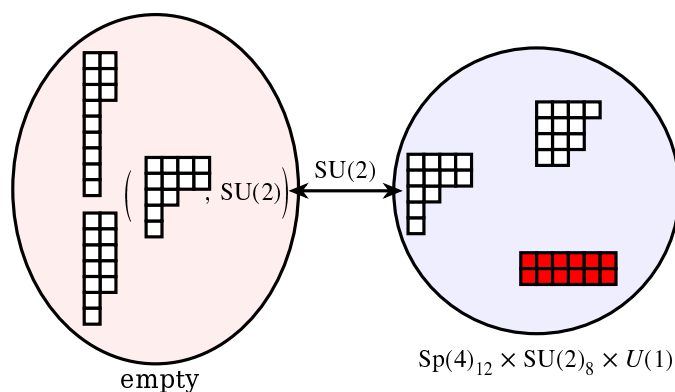

and a G₂ gauging of the Sp(4)₁₂ × Spin(9)₁₆ SCFT

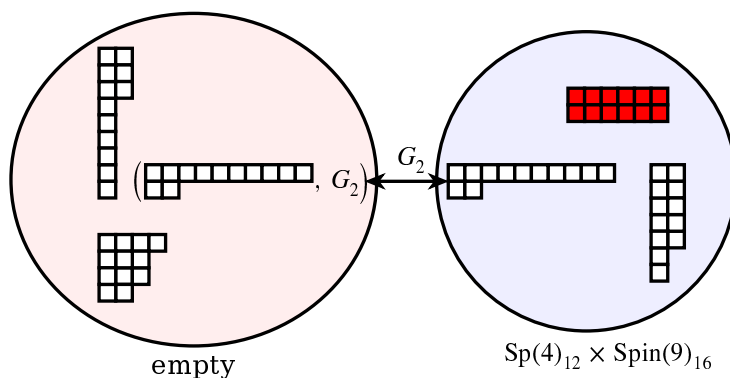

The invariant *k*-differentials for (5.12) are given by

$$\begin{aligned}
 \phi_2(z) &= \frac{u_2 z_{12} z_{34} (dz)^2}{(z - z_1)(z - z_2)(z - z_3)(z - z_4)} \\
 \phi_4(z) &= \frac{[u_4 (z - z_2) z_{14} + \frac{1}{4} u_2^2 (z - z_4) z_{12}] z_{12} z_{34}^2 (dz)^4}{(z - z_1)^2 (z - z_2)^2 (z - z_3)^2 (z - z_4)^3} \\
 \phi_6(z) &= \frac{[u_6 (z - z_1)(z - z_4) z_{23} - 2\tilde{u} (z - z_1)(z - z_2) z_{34} + \frac{1}{4} u_2 u_4 (z - z_3)(z - z_4) z_{12}] z_{12} z_{14} z_{34}^3 (dz)^6}{(z - z_1)^3 (z - z_2)^2 (z - z_3)^4 (z - z_4)^5} \\
 \phi_8(z) &= \frac{[u_8 (z - z_1) z_{34} + \frac{1}{4} u_4^2 (z - z_4) z_{13}] z_{14} z_{12}^2 z_{34}^4 (dz)^8}{(z - z_1)^4 (z - z_2)^2 (z - z_3)^5 (z - z_4)^6}
 \end{aligned}
 \tag{5.13}$$

$$\phi_{10}(z) = \frac{u_{10}z_{12}^2z_{14}^2z_{34}^6(dz)^{10}}{(z-z_1)^4(z-z_2)^2(z-z_3)^6(z-z_4)^8}$$

$$\tilde{\phi}(z) = \frac{\tilde{u}z_{12}z_{14}z_{34}^4(dz)^6}{(z-z_1)^2(z-z_2)(z-z_3)^4(z-z_4)^5}$$

For (5.3), they are as above, but with $\tilde{u} \equiv 0$ (note that (5.13) and (5.11) become equal at $\tilde{u} = 0$).

5.2.6 Spin(12) + 2(32) + 2(12)

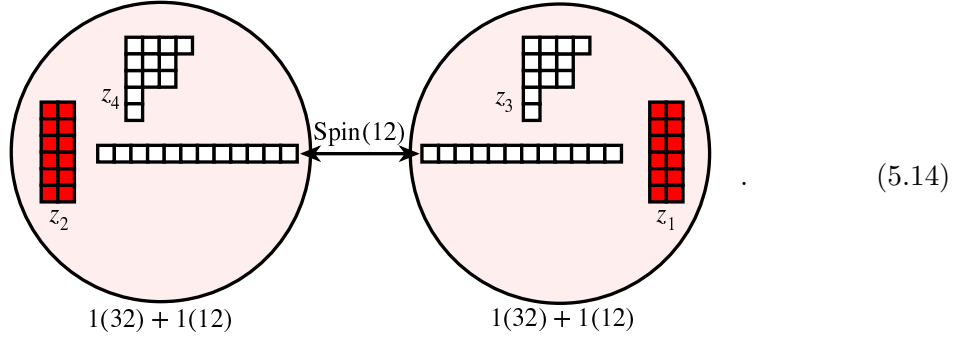

The S-dual theory is an Sp(3) gauging of the Sp(3)₁₁ × SU(2)₃₂ SCFT + 5/2(6)

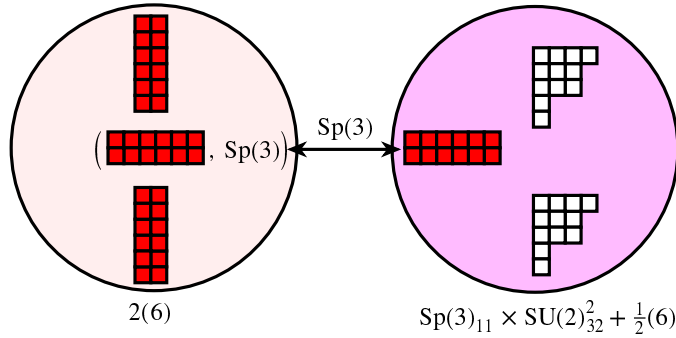

The invariant k -differentials for (5.14) are given by

$$\phi_2(z) = \frac{u_2z_{12}z_{34}(dz)^2}{(z-z_1)(z-z_2)(z-z_3)(z-z_4)}$$

$$\phi_4(z) = \frac{u_4z_{12}^2z_{34}^2(dz)^4}{(z-z_1)^2(z-z_2)^2(z-z_3)^2(z-z_4)^2}$$

$$\phi_6(z) = \frac{[u_6(z-z_1)(z-z_2)z_{34} - (2\tilde{u} + \frac{1}{2}u_2(u_4 - \frac{1}{4}u_2^2))(z-z_1)(z-z_4)z_{23}]}{(z-z_1)^3(z-z_2)^3(z-z_3)^4(z-z_4)^4} + \frac{(2\tilde{u} + \frac{1}{2}u_2(u_4 - \frac{1}{4}u_2^2))(z-z_2)(z-z_3)z_{14}]z_{12}^2z_{34}^3(dz)^6}{(z-z_1)^3(z-z_2)^3(z-z_3)^4(z-z_4)^4}$$

$$\phi_8(z) = \frac{[u_8(z-z_1)(z-z_2)z_{34} - (\frac{1}{4}(u_4 - \frac{1}{4}u_2^2)^2 + \tilde{u}u_2)(z-z_1)(z-z_4)z_{23}]}{(z-z_1)^4(z-z_2)^4(z-z_3)^5(z-z_4)^5} + \frac{(\frac{1}{4}(u_4 - \frac{1}{4}u_2^2)^2 + \tilde{u}u_2)(z-z_2)(z-z_3)z_{14}]z_{12}^3z_{34}^4(dz)^8}{(z-z_1)^4(z-z_2)^4(z-z_3)^5(z-z_4)^5}$$

$$\phi_{10}(z) = \frac{[u_{10}(z-z_1)(z-z_2)z_{34} - \tilde{u}(u_4 - \frac{1}{4}u_2^2)(z-z_1)(z-z_4)z_{23}]}{(z-z_1)^5(z-z_2)^5(z-z_3)^6(z-z_4)^6} + \frac{\tilde{u}(u_4 - \frac{1}{4}u_2^2)(z-z_2)(z-z_3)z_{14}z_{12}^4z_{34}^5(dz)^{10}}{(z-z_1)^5(z-z_2)^5(z-z_3)^6(z-z_4)^6}$$

$$\tilde{\phi}(z) = \frac{\tilde{u}z_{12}^3z_{34}^3(dz)^6}{(z-z_1)^3(z-z_2)^3(z-z_3)^3(z-z_4)^3}$$

5.2.7 Spin(12) + $\frac{3}{2}(32)$ + $\frac{1}{2}(32')$ + 2(12)

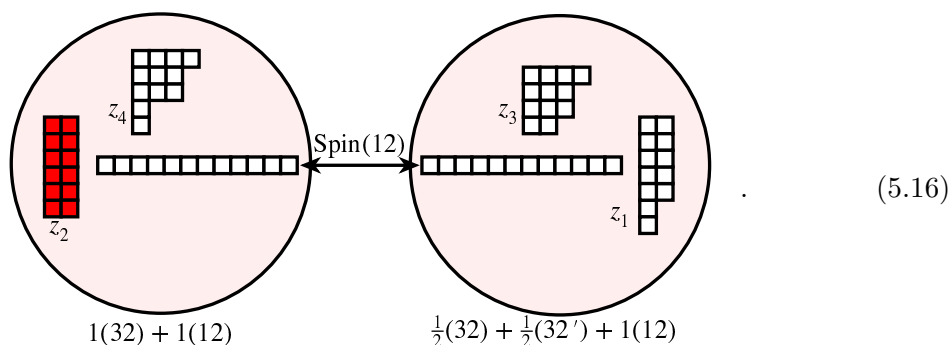

The S-dual theories are an Sp(2) gauging of the Sp(4)₁₂ × SU(2)₁₂₈ SCFT

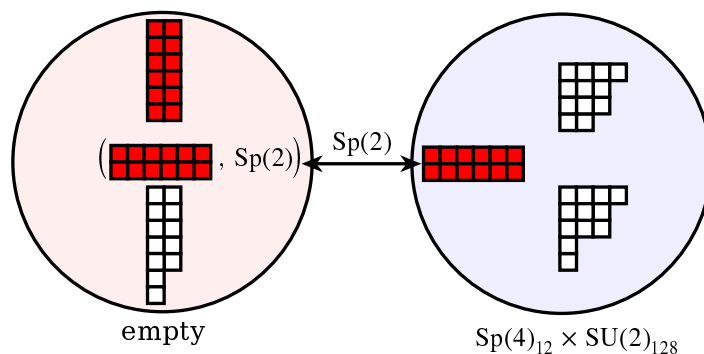

and a Spin(11) gauging of the (E₈)₁₂ SCFT + $\frac{3}{2}(32)$

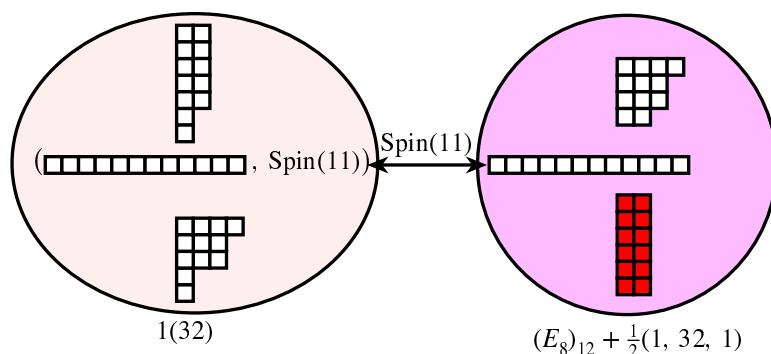

The invariant k -differentials for (5.16) are given by

$$\begin{aligned}
 \phi_2(z) &= \frac{u_2 z_{12} z_{34} (dz)^2}{(z - z_1)(z - z_2)(z - z_3)(z - z_4)} \\
 \phi_4(z) &= \frac{u_4 z_{12}^2 z_{34}^2 (dz)^4}{(z - z_1)^2 (z - z_2)^2 (z - z_3)^2 (z - z_4)^2} \\
 \phi_6(z) &= \frac{[u_6 (z - z_1)(z - z_2) z_{34} + (2\tilde{u} - \frac{1}{2}u_2(u_4 - \frac{1}{4}u_2^2))(z - z_1)(z - z_4) z_{23}]}{(z - z_1)^3 (z - z_2)^3 (z - z_3)^4 (z - z_4)^4} \\
 &\quad + \frac{1}{2}u_2(u_4 - \frac{1}{4}u_2^2)(z - z_2)(z - z_3) z_{14}] z_{12}^2 z_{34}^3 (dz)^6 \\
 \phi_8(z) &= \frac{[u_8 (z - z_1)(z - z_2) z_{34} - (\frac{1}{4}(u_4 - \frac{1}{4}u_2^2)^2 - \tilde{u}u_2)(z - z_1)(z - z_4) z_{23}]}{(z - z_1)^4 (z - z_2)^4 (z - z_3)^5 (z - z_4)^5} \\
 &\quad + \frac{1}{4}(u_4 - \frac{1}{4}u_2^2)^2 (z - z_2)(z - z_3) z_{14}] z_{12}^3 z_{34}^4 (dz)^8 \\
 \phi_{10}(z) &= \frac{[u_{10} (z - z_2) z_{34} + \tilde{u}(u_4 - \frac{1}{4}u_2^2)(z - z_4) z_{23}] z_{12}^4 z_{34}^5 (dz)^{10}}{(z - z_1)^4 (z - z_2)^5 (z - z_3)^6 (z - z_4)^6} \\
 \tilde{\phi}(z) &= \frac{\tilde{u} z_{23} z_{12}^2 z_{34}^3 (dz)^6}{(z - z_1)^2 (z - z_2)^3 (z - z_3)^4 (z - z_4)^3}.
 \end{aligned} \tag{5.17}$$

5.2.8 Spin(12) + 1(32) + 1(32') + 2(12)

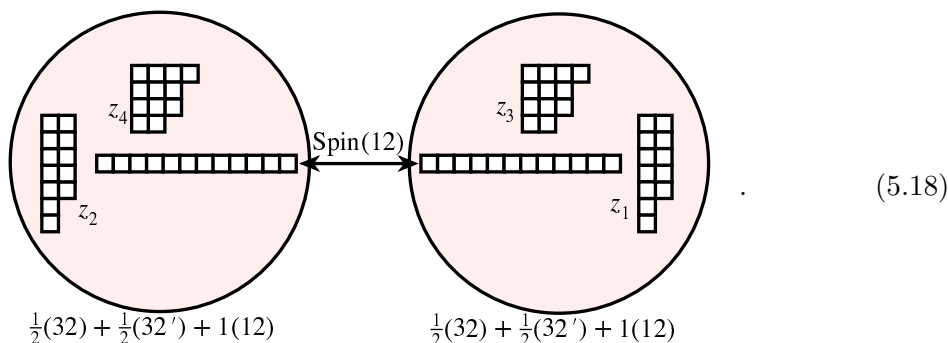

The S-dual theory is an Sp(2) gauging of the Sp(2)₁₂ × Sp(2)₁₁ × U(1)² SCFT + 1/2(4)

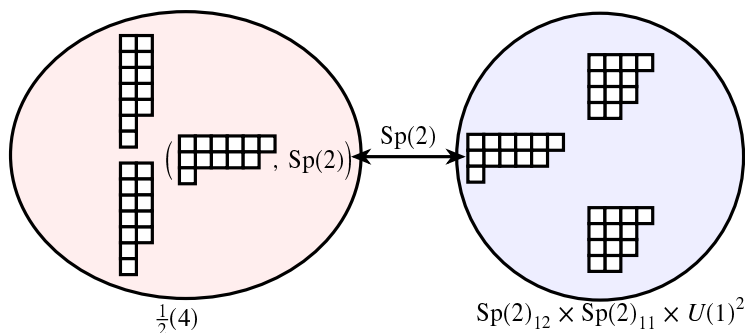

The invariant k -differentials for (5.18) are given by

$$\begin{aligned}
 \phi_2(z) &= \frac{u_2 z_{12} z_{34} (dz)^2}{(z-z_1)(z-z_2)(z-z_3)(z-z_4)} \\
 \phi_4(z) &= \frac{u_4 z_{12}^2 z_{34}^2 (dz)^4}{(z-z_1)^2(z-z_2)^2(z-z_3)^2(z-z_4)^2} \\
 \phi_6(z) &= \frac{[u_6(z-z_1)(z-z_2)z_{34} - \frac{1}{2}u_2(u_4 - \frac{1}{4}u_2^2)((z-z_1)(z-z_3)z_{24} - (z-z_2)(z-z_4)z_{13})] z_{12}^2 z_{34}^3 (dz)^6}{(z-z_1)^3(z-z_2)^3(z-z_3)^4(z-z_4)^4} \\
 \phi_8(z) &= \frac{[u_8(z-z_1)(z-z_2)z_{34} - \frac{1}{4}(u_4 - \frac{1}{4}u_2^2)^2((z-z_1)(z-z_3)z_{24} - (z-z_2)(z-z_4)z_{13})] z_{12}^3 z_{34}^4 (dz)^8}{(z-z_1)^4(z-z_2)^4(z-z_3)^5(z-z_4)^5} \\
 \phi_{10}(z) &= \frac{u_{10} z_{12}^4 z_{34}^6 (dz)^{10}}{(z-z_1)^4(z-z_2)^4(z-z_3)^6(z-z_4)^6} \\
 \tilde{\phi}(z) &= \frac{\tilde{u} z_{12}^2 z_{34}^4 (dz)^6}{(z-z_1)^2(z-z_2)^2(z-z_3)^4(z-z_4)^4}.
 \end{aligned} \tag{5.19}$$

For (5.4), they are as above, but with $\tilde{u} \equiv 0$. As before, (5.15), (5.17) and (5.19) become identical when you set $\tilde{u} = 0$.

5.2.9 More Spinors

We cannot obtain

- $\text{Spin}(12) + \frac{5}{2}(32)$
- $\text{Spin}(12) + 2(32) + \frac{1}{2}(32')$
- $\text{Spin}(12) + \frac{3}{2}(32) + 1(32')$

from compactifying the D_6 theory.

6 Spin(13) and Spin(14) gauge theories

Here, we work in the D_7 theory.

6.1 Spin(13) + $\frac{1}{2}(64) + 7(13)$

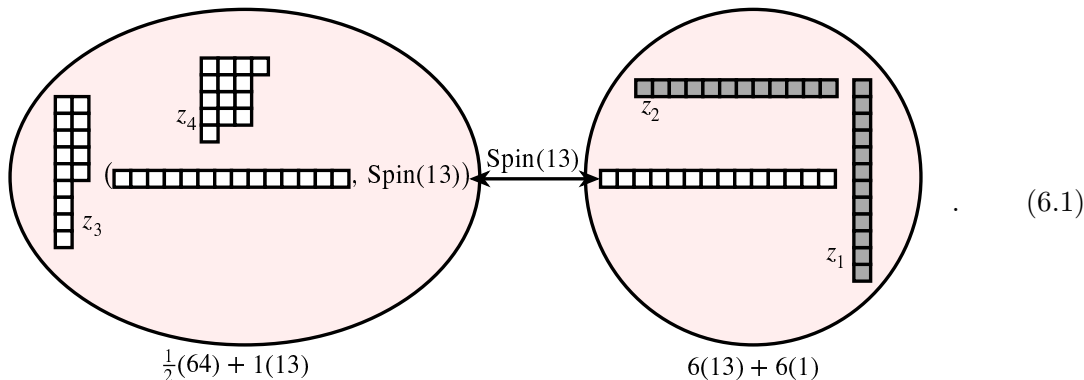

Over the other degenerations, we have a gauge theory fixture

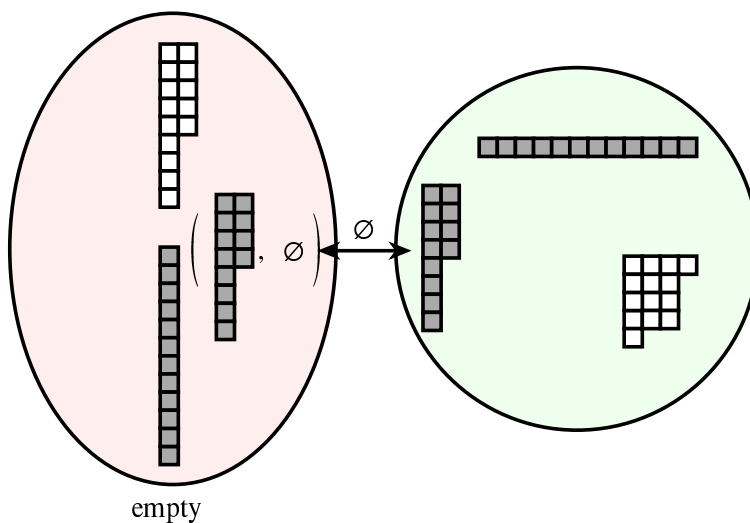

and an $SU(2)$ gauging of the $Sp(7)_{13} \times SU(2)_7$ SCFT + $\frac{1}{2}(2) + 6(1)$

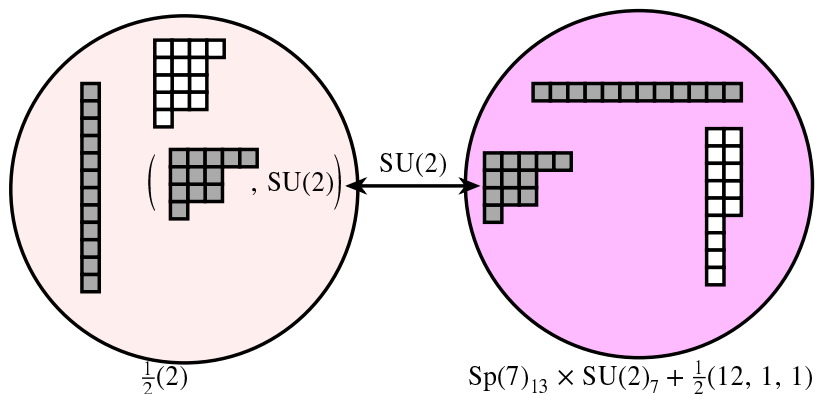

The invariant k -differentials for (6.1) are given by

$$\begin{aligned}
 \phi_2(z) &= \frac{u_2 z_{13} z_{24} (dz)^2}{(z - z_1)(z - z_2)(z - z_3)(z - z_4)} \\
 \phi_4(z) &= \frac{u_4 z_{13} z_{23} z_{24}^2 (dz)^4}{(z - z_1)(z - z_2)^3 (z - z_3)^2 (z - z_4)^2} \\
 \phi_6(z) &= \frac{[u_6 (z - z_3) z_{12} - \frac{1}{2} u_2 (u_4 - \frac{1}{4} u_2^2) (z - z_2) z_{13}] z_{23} z_{34} z_{24}^3 (dz)^6}{(z - z_1)(z - z_2)^5 (z - z_3)^3 (z - z_4)^4} \\
 \phi_8(z) &= \frac{[u_8 (z - z_3) z_{12} - \frac{1}{4} (u_4 - \frac{1}{4} u_2^2)^2 (z - z_2) z_{13}] z_{34} z_{23}^2 z_{24}^4 (dz)^8}{(z - z_1)(z - z_2)^7 (z - z_3)^4 (z - z_4)^5} \\
 \phi_{10}(z) &= \frac{u_{10} z_{13} z_{24} z_{23}^3 z_{24}^5 (dz)^{10}}{(z - z_1)(z - z_2)^9 (z - z_3)^4 (z - z_4)^6} \\
 \phi_{12}(z) &= \frac{u_{12} z_{13} z_{24} z_{23}^3 z_{24}^7 (dz)^{12}}{(z - z_1)(z - z_2)^{11} (z - z_3)^4 (z - z_4)^8}
 \end{aligned} \tag{6.2}$$

and

$$\tilde{\phi}(z) = 0.$$

6.2 More spinors

We cannot obtain

- $\text{Spin}(13) + 1(64) + 3(13)$
- $\text{Spin}(14) + 1(64) + 4(14)$

from compactifying the D_7 theory.

7 Higher N ?

For the “missing” theories of section 5.2.9 and section 6.2, we might hope to find realizations in the higher D_N or A_{2N-1} theories. It is easy to see that is no help. The key realization is that we need a candidate free-field fixture, consisting of three regular punctures. One of these punctures must be a full puncture.

In the D_N theory, the full puncture, $[1^{2N}]$, has a $\text{Spin}(2N)_{4(N-1)}$ flavour symmetry. The free fields transform as some representation of $\text{Spin}(2N)$ which reproduce the level $k = 4(N-1)$. If the representation should *happen* to decompose correctly under a $\text{Spin}(12)$ (*mutatis mutandis* for a $\text{Spin}(13)$ or $\text{Spin}(14)$) subgroup, then we would have a chance to build a realization of one of our missing gauge theories.

- For the $\text{Spin}(12)$ theories of section 5.2.9, we could note that the 64 of $\text{Spin}(14)$ decomposes as $1(32) + 1(32')$. But getting the right level would require a puncture with level $k = 32$, whereas the full puncture of the D_7 theory has only $k = 24$.
- For the $\text{Spin}(13)$ and $\text{Spin}(14)$ theories of section 6.2, going to higher D_N could only produce the 64 with multiplicity > 1 , which also does not help.

In the twisted sector of the A_{2N-1} theory, the full puncture has $\text{Spin}(2N+1)_{2(2N-1)}$ flavour symmetry.

- For the $\text{Spin}(12)$ theories of section 5.2.9, we need k to be a multiple of 8, so none of these are satisfactory.
- For the $\text{Spin}(13)$ and $\text{Spin}(14)$ theories of section 6.2, we need k to be a multiple of 4, which also does not work.

What about the exceptional (2,0) theories? E_7 and E_8 contain our desired gauge groups as subgroups. But neither the 56 of E_7 , nor the 248 of E_8 decompose correctly to provide candidate free field fixtures with one full puncture (and two other regular punctures).

So it appears that the missing theories of section 5.2.9 and section 6.2, are not realizable as compactifications of the (2,0) theory.

Acknowledgments

We would like to thank D. Ben-Zvi, S. Katz, G. Moore, D. Morrison, A. Neitzke, R. Plesser and Y. Tachikawa for helpful discussions. J. D. and O. C. would like to thank the Aspen Center for Physics (supported, in part, by the National Science Foundation under Grant PHY-1066293) for their hospitality when this work was initiated. O. C. would further like to thank the Simons Foundation for partial support in Aspen. The work of J. D. and A. T. was supported in part by the National Science Foundation under Grant PHY-1316033. The work of O. C. was supported in part by the INCT-Matemática and the ICTP-SAIFR in Brazil through a Capes postdoctoral fellowship.

Open Access. This article is distributed under the terms of the Creative Commons Attribution License ([CC-BY 4.0](https://creativecommons.org/licenses/by/4.0/)), which permits any use, distribution and reproduction in any medium, provided the original author(s) and source are credited.

References

- [1] P.C. Argyres and A.D. Shapere, *The vacuum structure of $N = 2$ superQCD with classical gauge groups*, *Nucl. Phys. B* **461** (1996) 437 [[hep-th/9509175](#)] [[INSPIRE](#)].
- [2] A. Hanany, *On the quantum moduli space of vacua $N = 2$ supersymmetric gauge theories*, *Nucl. Phys. B* **466** (1996) 85 [[hep-th/9509176](#)] [[INSPIRE](#)].
- [3] S. Terashima and S.-K. Yang, *Seiberg-Witten geometry with various matter contents*, *Nucl. Phys. B* **537** (1999) 344 [[hep-th/9808022](#)] [[INSPIRE](#)].
- [4] L. Bhardwaj and Y. Tachikawa, *Classification of 4d $N = 2$ gauge theories*, *JHEP* **12** (2013) 100 [[arXiv:1309.5160](#)] [[INSPIRE](#)].
- [5] O. Chacaltana and J. Distler, *Tinkertoys for Gaiotto Duality*, *JHEP* **11** (2010) 099 [[arXiv:1008.5203](#)] [[INSPIRE](#)].
- [6] O. Chacaltana, J. Distler and Y. Tachikawa, *Gaiotto duality for the twisted A_{2N-1} series*, *JHEP* **05** (2015) 075 [[arXiv:1212.3952](#)] [[INSPIRE](#)].
- [7] O. Chacaltana and J. Distler, *Tinkertoys for the D_N series*, *JHEP* **02** (2013) 110 [[arXiv:1106.5410](#)] [[INSPIRE](#)].
- [8] O. Chacaltana, J. Distler and A. Trimm, *Tinkertoys for the Twisted D-Series*, *JHEP* **04** (2015) 173 [[arXiv:1309.2299](#)] [[INSPIRE](#)].
- [9] Y. Tachikawa and S. Terashima, *Seiberg-Witten Geometries Revisited*, *JHEP* **09** (2011) 010 [[arXiv:1108.2315](#)] [[INSPIRE](#)].
- [10] D. Gaiotto, *$\mathcal{N} = 2$ dualities*, *JHEP* **08** (2012) 034 [[arXiv:0904.2715](#)] [[INSPIRE](#)].
- [11] D. Gaiotto, G.W. Moore and A. Neitzke, *Wall-crossing, Hitchin Systems and the WKB Approximation*, [arXiv:0907.3987](#) [[INSPIRE](#)].
- [12] Y. Tachikawa, *Six-dimensional D_N theory and four-dimensional SO - USp quivers*, *JHEP* **07** (2009) 067 [[arXiv:0905.4074](#)] [[INSPIRE](#)].
- [13] Y. Tachikawa, *$\mathcal{N} = 2$ S-duality via Outer-automorphism Twists*, *J. Phys. A* **44** (2011) 182001 [[arXiv:1009.0339](#)] [[INSPIRE](#)].

- [14] O. Chacaltana, J. Distler and Y. Tachikawa, *Nilpotent orbits and codimension-two defects of 6d $N = (2, 0)$ theories*, *Int. J. Mod. Phys. A* **28** (2013) 1340006 [[arXiv:1203.2930](#)] [[INSPIRE](#)].
- [15] P.C. Argyres and N. Seiberg, *S-duality in $\mathcal{N} = 2$ supersymmetric gauge theories*, *JHEP* **12** (2007) 088 [[arXiv:0711.0054](#)] [[INSPIRE](#)].
- [16] V.B. Mehta and C.S. Seshadri, *Moduli of vector bundles on curves with parabolic structures*, *Math. Ann.* **248** (1980) 205.
- [17] C.T. Simpson, *Harmonic bundles on noncompact curves*, *J. Amer. Math. Soc.* **3** (1990) 713.
- [18] W.-y. Chuang, D.-E. Diaconescu, R. Donagi and T. Pantev, *Parabolic refined invariants and Macdonald polynomials*, *Commun. Math. Phys.* **335** (2015) 1323 [[arXiv:1311.3624](#)] [[INSPIRE](#)].
- [19] N. Hitchin, *Stable bundles and integrable systems*, *Duke Math. J.* **54** (1987) 91.
- [20] A. Klemm, W. Lerche, P. Mayr, C. Vafa and N.P. Warner, *Selfdual strings and $N = 2$ supersymmetric field theory*, *Nucl. Phys. B* **477** (1996) 746 [[hep-th/9604034](#)] [[INSPIRE](#)].
- [21] D.-E. Diaconescu, R. Donagi and T. Pantev, *Intermediate Jacobians and ADE Hitchin Systems*, [hep-th/0607159](#) [[INSPIRE](#)].
- [22] N. Seiberg and E. Witten, *Monopoles, duality and chiral symmetry breaking in $N = 2$ supersymmetric QCD*, *Nucl. Phys. B* **431** (1994) 484 [[hep-th/9408099](#)] [[INSPIRE](#)].
- [23] K. Dasgupta and S. Mukhi, *F theory at constant coupling*, *Phys. Lett. B* **385** (1996) 125 [[hep-th/9606044](#)] [[INSPIRE](#)].
- [24] T. Banks, M.R. Douglas and N. Seiberg, *Probing F-theory with branes*, *Phys. Lett. B* **387** (1996) 278 [[hep-th/9605199](#)] [[INSPIRE](#)].
- [25] O. Aharony and Y. Tachikawa, *A holographic computation of the central charges of $D = 4$, $N = 2$ SCFTs*, *JHEP* **01** (2008) 037 [[arXiv:0711.4532](#)] [[INSPIRE](#)].
- [26] O. Chacaltana, J. Distler and A. Trimm, *Tinkertoys for the E_6 theory*, [arXiv:1403.4604](#) [[INSPIRE](#)].