

Disease mitigation and pathogenic control in German  
and common wasps, *Vespula germanica* and *V. vulgaris*  
(Hymenoptera:Vespidae)

By

Stephen John Harcourt

A thesis completed in partial fulfilment of  
the requirements for the degree of

DOCTOR OF PHILOSOPHY

at

Lincoln University  
Canterbury, New Zealand

2002



*Vespula vulgaris* nest being examined during the colony hygiene experiment (see Chapter Six).

## ABSTRACT

*Vespula germanica* (F.) (German wasp) and *V. vulgaris* (L.) (common wasp) are major pests in New Zealand. They damage crops, have a significant impact on the biodiversity of native ecosystems and present a significant health hazard by stinging people and animals. Efforts to control them, both chemically and biologically, have not been as effective as initially hoped. This research contributes to a larger programme studying the potential of entomopathogenic microbes for the control of German and common wasps in New Zealand. This study has demonstrated the potential and limitations which exist for control of wasps using microbial pathogens. Effective pathogens were identified and disease transmission quantified in bioassays. Behavioural and physiological adaptations of wasps were investigated as resistance mechanisms to disease.

Three species of fungi (*Beauveria bassiana*, *Aspergillus flavus* and *Metarhizium anisopliae*) were identified as having potential to kill workers and larvae and severely disrupt the colony. In laboratory trials, fungi and bacteria were readily transmitted between workers and larvae and among workers. Workers and larvae, individually, possess few resistance mechanisms capable of suppressing a mass infection of pathogenic fungi. No tested bacteria were pathogenic to adult wasps.

Although *B. bassiana* was extremely pathogenic in bioassays, behavioural adaptations of wasp workers and larvae restricted proliferation of fungi in a healthy nest. Anomalies in behaviour when removing sporulating or infectious cadavers indicate a 'window-of-opportunity' for the dissemination of disease if the fungus could achieve maturity. However, getting sufficient inoculum into the nest and achieving widespread sporulation to establish an epizootic will be a significant challenge.

All of the bacteria tested were susceptible to antibiotics in larval saliva, and therefore not significantly pathogenic to wasps. Significant inhibitory effects of venom against *A. flavus* were identified, but no evidence of its use in the nest could be found.

A more cryptic and infectious disease, such as a bacterium or microsporidian, holds the greatest potential for future control efforts. It is apparent that, in order to establish an infection capable of developing into an epizootic in wasp nests, a microbe needs to be gradually invasive, readily transmitted, a prolific replicator, cryptic and have little impact on host behaviour leading up to maturation. Limitations to the current use of pathogens for wasp control may be overcome by strain selection and development of delivery systems. Pathogens have the potential to complement and enhance existing biological control programmes, but much research is needed to realise this potential.

*Key words:* *Vespula vulgaris*, *Vespula germanica*, *Beauveria bassiana*, *Aspergillus flavus*, *Serratia marcescens*, fungus, bacteria, bioassay, entomopathogen, mortality, venom, larval saliva, hygienic behaviour, necrophoria, necrophagia, trophallaxis.

## ACKNOWLEDGEMENTS

Firstly, I would like to acknowledge the sacrifice my family have made to allow me the luxury of working on this thesis. It goes without saying that I could not have taken on such a project without their backing, but it has been difficult for you all. Mac, Ben and Cameron, in time, will not remember the hardships they have endured, but Nikki will probably never forget. For your understanding, I am grateful.

I would like to thank my supervisors, Bruce Chapman and Dr. Eric Scott from Lincoln University and Dr. Richard Harris from Landcare Research for their guidance and encouragement throughout this research project. I would also like to thank the many science and support staff at Landcare Research (Lincoln and Nelson) and AgResearch who were a constant source of encouragement and enthusiasm concerning my research, especially Peter Read, Anne Rose, Dr. Travis Glare, Tracy Nelson, Dr. Trevor Jackson. Special mention must go to Dr. Barry Donovan who was an enduring source of inspiration about wasp research and provided me with innovative discussion to keep me on my scientific toes.

Many thanks to the Applied Entomology and Pathology team (weeds and pests), my hosts at Landcare Research. Lindsay, Hugh, Lynley, Pauline, Helen, Jeremy, Tom (and Vanessa) you have been excellent colleagues and friends. I would also like to recognise the contribution made by staff from Crop and Food Research for the casual employment which made the difference financially, but particularly Dr. David Teulon and Marlon Stufkens and Damien Coup for being supportive of my research and for the great working environment and lasting friendships.

For financial support and facilities I must thank the executive of Landcare Research, the trustees of the Frank Sydenham Trust and Lincoln University who made this research possible.

Lastly I would like to thank Christophe Placet for his assistance with the contents of Appendix Three. A small, but informative, section of work that I was able to draw upon for much of my discussion.

# TABLE OF CONTENTS

ABSTRACT.....	III
ACKNOWLEDGEMENTS .....	IV
TABLE OF CONTENTS .....	V
LIST OF FIGURES .....	VIII
LIST OF TABLES .....	XII
LIST OF SYMBOLS AND ABBREVIATIONS.....	XIV

## *Chapter One*

### General Introduction

Background.....	1
Vespid wasps in New Zealand .....	2
Micro-organisms in biological control.....	7
Study goals and objectives.....	15

## *Chapter Two*

### Adult Bioassays: Susceptibility of wasps to generalist entomopathogens

Introduction .....	16
Materials and methods.....	18
Results .....	22
Discussion.....	25

## *Chapter Three*

### Transfer of pathogens between nestmates

Introduction .....	29
Materials and Methods.....	30
Results .....	32
Discussion.....	34

## *Chapter Four*

### Anti-microbial properties of wasp exocrine secretions, venom and larval saliva

Introduction .....	39
Preliminary experiments: Growth plate assays	
Introduction .....	42
Materials and methods.....	43
Results .....	44
Discussion.....	47

Fungicidal properties of venom: Germination assays	
Introduction .....	51
Method and Materials .....	51
Results .....	53
Discussion.....	57
Anti-bacterial properties of larval saliva: Liquid media assays	
Introduction .....	61
Materials and methods .....	63
Results .....	66
Discussion.....	69
<i>Chapter Five</i>	
Field trial of <i>Beauveria bassiana</i> for wasp control	
Introduction .....	74
Methods and Materials.....	74
Results .....	77
Discussion.....	81
<i>Chapter Six</i>	
The role of hygienic behaviour in suppression of fungal epizootics	
Introduction .....	85
Physical intervention experiments: horizontal nest box experiments	
Materials and methods .....	88
Results .....	90
Discussion.....	93
Colony hygiene experiments: field nest box	
Materials and Methods.....	95
Results .....	98
Discussion.....	104
Removal of displaced larvae: Vertical nest experiments	
Materials and Methods.....	108
Results .....	113
Discussion.....	119
<i>Chapter Seven</i>	
General Discussion	
Review of goals and objectives.....	124
Disease resistance mechanisms .....	130
Implications for biological control.....	133

General References .....	138
--------------------------	-----

*Appendix One*

Miscellaneous data.....	138
-------------------------	-----

*Appendix Two*

Environmental conditions within the nest

Introduction .....	140
Methods and materials .....	140
Results .....	141
Discussion.....	144

*Appendix Three*

Maturation and sporulation time for *B. bassiana* in *Vespula* larvae

Introduction .....	147
Methods and materials .....	147
Results .....	148
Discussion.....	150

## LIST OF FIGURES

- Figure 1.1: Lifecycle of *Vespula* wasps in New Zealand. Note some *V. germanica* colonies survive the winter and develop into very large nests in their second season. .... 3
- Figure 1.2: *Vespula vulgaris* workers killed by the entomopathogenic fungi *Beauveria bassiana* (A) and *Aspergillus flavus* (B). *A. flavus* is commonly found in wasp nests whereas *B. bassiana* is rarely found in the nest but is occasionally isolated from cadavers found away from the nest. .... 13
- Figure 1.3: Nest design features significant in pathogen control within *Vespula* nests (Stylised image adapted from Spradbery 1973). .... 14
- Figure 4.1: The inhibitory effect of *Vespula* venom on the growth of pathogenic fungi and bacteria. Inhibition of pathogen growth normalised to control ( $\pm$  standard error). See Appendix One, Table 8.1 for mean data and significance values. (\*\*\*) significantly different at the 0.1 % level). .... 46
- Figure 4.2: The inhibitory effect of *Vespula* larval saliva on the growth of pathogenic bacteria and fungi. Inhibition of pathogen growth normalised to control ( $\pm$  standard error). See Appendix One, Table 8.2 for mean data and significance values. (\*\*\*) significantly different at the 0.1 % level). .... 46
- Figure 4.3: In vitro germination of *Aspergillus flavus* spores without (A) and with (B) *Vespula vulgaris* venom sac constituents. .... 54
- Figure 4.4: Inhibition of *in vitro* *Aspergillus flavus* germination by exocrine secretions of *Vespula vulgaris* after 20 hours. See Appendix One, Table 8.3 for mean data and significance values. (\*\*\*) significantly different at the 0.1% level). .... 55
- Figure 4.5: Inhibition of *in vitro* *Beauveria bassiana* germination by exocrine secretions of *Vespula vulgaris* after 20 hours. See Appendix One, Table 8.3 for mean data and significance values. (\*\*\*) significantly different at the 0.1% level). .... 55
- Figure 4.6: Number of CFUs in a dilution series of *Aspergillus flavus* after 20 hours of *in vitro* incubation with exocrine secretions of *Vespula vulgaris*. Nnumber of colony forming units (CFUs) developing on PDA 24 hours after plating. .... 56



- Figure 4.7: Experimental layout of the microtiter plates to test the anti-bacterial properties of larval saliva. Plate 1 contains the saliva (saliva and bacteria) and positive control (streptomycin sulphate and bacteria) treatments and plate 2 contains the negative control (saliva only) and the control (bacteria only) treatment. .... 65
- Figure 4.8: The effect of *Vespula* larval saliva on the change in optical density of pathogen suspensions compared with streptomycin sulphate (positive control) over a 20 hour incubation period. Pathogen only (control) and saliva only (negative control) provide baseline measurements. Results comprise the mean increase in optical density (OD Units). .... 67
- Figure 4.9: Dilution series of treatment suspensions showing the lethal or inhibitory nature of the effect of *Vespula* larval saliva on pathogen proliferation (20 hours incubation at 30°C). Concentration % indicates the percent volume of original test suspension in the dilution. .... 68
- Figure 5.1: Internally inoculated *Vespula germanica* nest with the involucrum removed from one side. Five ml of *Beauveria bassiana* (F180) inoculum was sprayed between the layers through this opening. The involucrum and soil was replaced after inoculation. . 76
- Figure 5.2: Sample of comb extracted from a *Vespula vulgaris* nest 16 days after internal spray inoculation with *Beauveria bassiana* (F180). Arrows indicate the fruiting bodies (conidia) of the fungus growing on dead larvae (lower) and adults (upper). Fungal sporulation was also present on the bodies of the pupae (capped). .... 78
- Figure 5.3: The percent composition (alive and dead) of larvae in the treatment (*Beauveria bassiana*) and control nests 16 days after inoculation. .... 79
- Figure 5.4: The percent composition (alive and dead) of the pupae in the treatment (*Beauveria bassiana*) and control nests 16 days after inoculation. .... 79
- Figure 5.5: The traffic rate (number of wasps entering or leaving a nest) of nests before (day 0) and after (day 16) treatment in the *Beauveria bassiana* field evaluation trial. The period of the experiment was 16 days at which point the nests were excavated and analysed. 80

Figure 6.1: Design of the horizontal observation nest box. Comb is laid flat within the nest chamber and the rotating stand allows easy access to the underside of the comb. Perspex sheets slide out for cleaning while a cover keeps the nest secure, minimising disruption to the colony.....	89
Figure 6.2: Time (Mean $\pm$ SE) to removal of <i>Vespula germanica</i> larvae and pupae following physical disruption. (I) = side stabbed (V) = top stabbed (***) significantly different from the control at the 0.1% level). .....	91
Figure 6.3: Cumulative removal of <i>Vespula germanica</i> pupae over time, by workers, following physical disruption. An observation was made after one hour (0.042 days) to record the immediate reaction of workers (n=40).....	92
Figure 6.4: Cumulative removal of <i>Vespula germanica</i> larvae over time, by workers, following physical disruption. An observation was made after one hour (0.042 days) to record the immediate reaction of workers (n=40). (S) = side stabbed, (T) = top stabbed. ....	92
Figure 6.5: The nest box design used in the colony hygiene experiments. The intact nest is suspended from the horizontal rods which are run through the nest at collection. The rods rest against the lower surface of a middle layer of comb. Note the arrow to indicate the direction of rotation when opening the box and the perspex entrance trap to inhibit the removal of juvenile wasps. Inset: experimental nest (30x30x30 cm).....	97
Figure 6.6: Rows of larvae treated with <i>Beauveria bassiana</i> in the colony hygiene experiment. Selected larvae were distinguish by removing the adjacent larvae and pupae. Red vivid marker pen was also used to colour the caps of pupae not in the experiment and further demarcate the test individuals. All intervention was replicated in the controls. ....	101
Figure 6.7: Fate of <i>Vespula vulgaris</i> larvae treated with <i>Beauveria bassiana</i> (F180) in observation colonies and patterns of juvenile removal. Discrete data were compiled daily, from all nests, as a percent of total treatments.....	103
Figure 6.8: Fate of <i>Vespula vulgaris</i> larvae treated with water (control) in observation colonies and patterns of juvenile removal. Discrete data were compiled daily, from all nests, as a percent of total treatments.....	103

Figure 6.9: Vertical observation nest used in the removal of displaced larvae experiment. Note the treatment aperture for inserting the larvae into the chamber and the adjustable shelf to allow the nest to expand.....	109
Figure 6.10: Healthy larva (left) and larva killed by <i>Beauveria bassiana</i> infection (right). Approximately four days after larvae turn purple and become mummified the fungus erupts through the cuticle and sporulates.....	111
Figure 6.11: Mean time to contact and removal of displaced <i>Vespula vulgaris</i> larvae. *** significant at the 0.1% confidence limit (P<0.0001). .....	114
Figure 6.12: The behavioural response of <i>Vespula vulgaris</i> workers to infected and healthy displaced larvae in the nest. Observations relate to the treatments i, iv, v and vi of the protocols for recording necrophoric and necrophagic behaviour outlined in the methods and materials. ....	115
Figure 6.13: Necrophoric behaviour by a <i>Vespula germanica</i> worker removing the dismembered thorax and upper abdomen of a nestmate. Necrophoria is a fundamental mechanism in the maintenance of hygiene in the nest. ....	118
Figure 6.14: Encapsulation of old or infected cells isolates disease from the rest of the colony. Encapsulation is common on older comb late in the season and is often found over areas of comb with infected larvae or pupae. It is also commonly found covering empty cells from which the occupants have been removed. ....	121

## LIST OF TABLES

Table 2.1: Isolates of fungi and bacteria tested in bioassays against <i>Vespula vulgaris</i> and <i>V. germanica</i> . Only <i>Beauveria bassiana</i> and <i>Aspergillus flavus</i> strains were isolated from wasps, whereas the others are generalist insect pathogens. Strains are maintained in constant conditions (-18°C) in the AgResearch pathology laboratory, Lincoln. .	19
Table 2.2: Mean life expectancy (MLE) data for treatment and control adult wasps when dipped into suspensions of (mean $\pm$ SE). (P > Chi-square at the 95% level of significance).....	23
Table 2.3: Mean life expectancy (MLE) data for treatment and control adult wasps treated with bacteria in the oral bioassays (mean $\pm$ SE). (P> Chi-square at the 95% level of significance).....	24
Table 2.4: Mean life expectancy (MLE) data comparing the application techniques for treatment and control adult wasps in fungal bioassays (mean $\pm$ SE). (P > Chi-square at the 95% level of significance).....	25
Table 3.1: Mean life expectancy and percent emergence of non-inoculated workers and larvae (respectively) resulting from the transfer of <i>Beauveria bassiana</i> (F180) from infected individuals. Mean $\pm$ SE. * different from control at 95% level of significance. .	34
Table 4.1: The inhibitory effect of <i>Vespula</i> body parts on the growth of <i>Aspergillus flavus</i> (F202). Mean inhibition diameter (mm $\pm$ standard error) of pathogen growth and control. .	44
Table 6.1: Development and removal time for <i>Vespula vulgaris</i> individuals in the colony hygiene experiment. Larval and pupal blocks represent the mean time for the expression of each variable. The rows headed emergent pupae represent data for those individuals which completed pupation and emerged as adults.....	102
Table 6.2: The percentage of <i>Vespula vulgaris</i> larvae and pupae removed, pupated and emerged in the colony hygiene experiment.....	102

## LIST OF SYMBOLS AND ABBREVIATIONS

∅	.....	Diameter
~	.....	Approximately
°C	.....	Degrees Celsius
RH	.....	Relative humidity
%	.....	Percent
<i>P</i>	.....	Probability of significance
ml	.....	Millilitre
μl	.....	Microlitre
μm	.....	Micrometre
± SE	.....	Plus or minus standard error
>	.....	Greater than
<	.....	Less than
<i>n</i>	.....	Sample size (number)
MLE	.....	Mean life expectancy
Var.	.....	Variety
PDA	.....	Potato dextrose agar
JC	.....	Joussier and Catroux agar
CFU	.....	Colony forming unit
NZST	.....	New Zealand Standard Time
GMT	.....	Greenwich Mean Time
NJ	.....	New Jersey
<i>et al.</i>	.....	<i>L. et alii</i> (and others)
e.g.	.....	<i>L. exempli gratia</i> (for example)
i.e.	.....	<i>L. id est</i> (that is)
a.m.	.....	<i>L. ante meridiem</i> (before noon)
p.m.	.....	<i>L. post meridiem</i> (after noon)
ANOVA	.....	Analysis of variance
a.i.	.....	Active ingredient
***	.....	99.9 % confidence level (P = 0.0001)
**	.....	99 % confidence level (P = 0.001)
*	.....	95% confidence level (P = 0.05)

# Chapter One

## General Introduction

### Background

**Historical:** The earliest historical records document that wasps were considered pests by all but the ancient Egyptians, who revered wasps as they did many insect species. The 5th Century BC Greek play-write, Aristophan (445-385 BC), wrote a comical satire (*Wasps*, 422 BC) on the politics of his native Athens. In it he ridiculed his enemies by representing their supporters on stage as wasps. The wasps were armed with stings with which to torment people who disagreed with them. Later, the Greek philosopher Aristotle (384-322 BC) made the first comprehensive documentation of wasp biology and behaviour. Roman authors also described wasps, but none in as much detail as Gaius Plinius Secundus (Pliny the Elder, 23-79 AD). His 37-volume *Historia Naturalis* (Natural History) described many aspects of wasp behaviour. The Bible also holds many references to wasps, which in all cases are depicted as vermin capable of driving people from their homes.

Though the nuisance-status of wasps to humans has long been understood, it was only with the recent spread of wasps into virgin habitats that the threat to ecosystem biodiversity has been recognised. The relatively recent incursion of wasps into the vespidae-free regions of the world, including New Zealand, poses a severe threat to the stability of many diverse ecosystems. Some ecosystems in particular (e.g., South Island beech forest, New Zealand) support high numbers of exotic wasps (Sandlant and Moller 1989, Thomas *et al.* 1990) and have had no historical association with such a large, mobile and extremely voracious arthropod predator.

## Vespid wasps in New Zealand

**Life history:** The life cycle of German and common wasps is similar in most aspects except some German wasp colonies over-winter in temperate climates (Ratnieks 1996), (see **Error! Reference source not found.**). In spring a fertile queen emerges from hibernation and begins constructing a nest from macerated wood fibres (Thomas 1960). The queen tends the first brood of workers who then relieve the queen of foraging, nest maintenance, larval care and defence duties (Spradberry 1965). By mid summer, the nest is well established and producing large numbers of workers. Drones emerge in early autumn along with a new generation of infertile queens (Jeanne 1982). Drones and queens depart the nest on mating flights which complete the life cycle. By winter, the nests of most wasps are deserted, but a few German wasp colonies survive the winter and develop into very large colonies in the following summer (Donovan *et al.* 1992). In the common wasp, the sole survivors are the new generation of fertilised queens. They begin new colonies, having survived a winter hibernation sheltered from the weather (Akre and MacDonald 1986).

**The problem:** Vespid wasps are major pests in New Zealand. They are a public nuisance, have economic impact and have severely modified some forest ecosystems (Toft and Beggs 1995, Barr *et al.* 1996, Toft and Rees 1998, Beggs and Rees 1999). New Zealand has now been colonised by two predatory social wasp species, *Vespula vulgaris* (L.) (common wasp) and *V. germanica* (F.) (German wasp). *Vespula germanica* was accidentally introduced through Hamilton airport during the 1940s (Thomas 1960). This wasp readily established and spread throughout the North Island within six years, reaching Canterbury in 1954 (Star/Sun newspaper 1954). The South Island beech forest provided a largely untapped food resource in the form of honey dew from native scales (*Ultracoelostoma brittini* Morales and *U. assimile* (Maskell)) on the beech trees (Moller *et al.* 1991). In these areas, wasp numbers built up rapidly and soon became a dominant feature of the ecosystem (Thomas *et al.* 1990). In the early 1980s, *V. vulgaris* also became established. In the years that followed, populations flourished all over New Zealand and before long it displaced *V. germanica* as the dominant species (Clapperton *et al.* 1994).

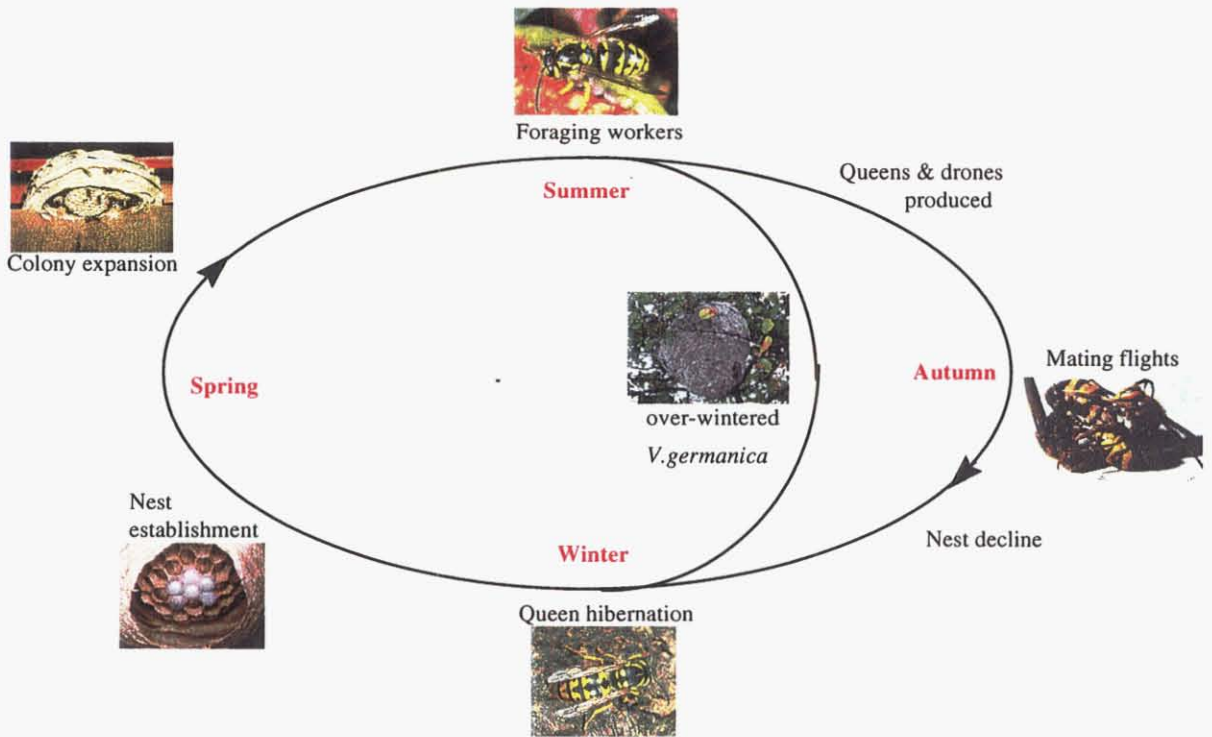

Figure 1.1: Life cycle of *Vespa* wasps in New Zealand. Note some *V. germanica* colonies survive the winter and develop into very large nests in their second season.



In urban areas, wasps forage on a wide variety of food and household rubbish, but it is on their natural prey that they have the greatest impact. Arthropods constitute a large proportion of wasp diet, from small moths and flies up to large spiders and grasshoppers (Harris 1991, Barr *et al.* 1996). Honeydew, when available, also makes up a large part of their diet and they will often be seen in association with large infestations of aphids, scales, psyllids and other sucking insects. The consumption of honeydew from native scales, in particular, may have far reaching effects on the beech forest ecosystem (Beggs and Wilson 1991). Nectivorous birds, such as bellbird (*Anthornis melanura* (Sparrman)) and tui (*Prosthemadera novaeseelandiae* (Gmelin)), supplement their diet with and, in some cases, depend on the regular supply of honeydew (Thomas *et al.* 1990). In the height of summer, wasp numbers often reach epidemic proportions leading to a scarcity of the usually abundant honeydew (Moller *et al.* 1991, Beggs 1999). Many native insects also feed on honeydew, which puts them in direct competition with wasps. The extent to which these animals depend on honeydew has not been clearly established, but observations suggest that honeydew plays a major role in this ecosystem (Moller and Tilly 1989).

Wasp predation of forest invertebrates not only impacts on the success of this group, but also depletes the food supply for insectivorous birds and bats (e.g., fantail *Rhipidura fuliginosa* (Sparrman) and the short-tailed bat *Mystacina tuberculata* (Gray) (Toft and Beggs 1995, Barr *et al.* 1996)). Wasps are very effective insect predators (Barr *et al.* 1996, Beggs 1999, Beggs and Rees 1999), which could result in birds being forced to seek prey in the leaf litter (thereby exposing them to ground-dwelling predatory mammals).

Wasps can cause disruption to public use of natural areas and represent a public health issue due to mass attacks and hypersensitivity (Dymock *et al.* 1994), as well as hindering the practices of many primary industries (Walton and Reid 1976, Clapperton *et al.* 1989). Wasps have been documented as causing major problems for beekeepers by attacking hives for honey and larvae and depleting natural nectar supplies (Clapperton *et al.* 1989). Honey bees and bumble bees are also susceptible to attack by wasps while foraging and are displaced from food sources when competing with high wasp populations (Thomson 1989, Markwell *et al.* 1993). Wasps can cause severe damage, on occasion destroying hives and even whole apiaries (Walton and Reid 1976).

Wasps are also a major pest in the horticulture industry, especially for viticulturists (Anon. 1990). Wasp damage not only marks the fruit for local sales, but creates an opening through which pathogens can enter and destroy the utility of the fruit for wine production. Hazards to workers are also a minor concern for growers (The Press 1995). The most common complaint against wasps is public nuisance. Wasps have found human-made structures most suitable as nest sites, which must then be destroyed and removed at great cost to property owners and councils (Horton *et al.* 1997).

**Natural control factors:** In their native Europe, vespoid wasps have several invertebrate predator and parasitoid enemies (e.g., *Sphexophaga vesparum* (Curtis), Edwards 1980; *Bareogonialis canadensis* (Harrington), Carmean *et al.* 1981; *Vespula austriaca* (Panzer), Reed *et al.* 1979; *Pheromermis pachysoma*, Poinar 1981). Harsh winters and short summers (shorter nesting season) limit the development of large nests and high wasp populations (Brian 1965). Other factors such as failure to hibernate, mate or establish nests accounts for most of the natural population control (Spradbery 1973). Edwards (1980) estimated that cumulative losses account for over 99% of queens before workers are produced. Consequently, German and common wasps never reach the epidemic proportion, seen in some areas of New Zealand, in their native habitat.

The establishment of *V. germanica*, and *V. vulgaris*, in New Zealand is attributed to the accidental importation of a few hibernating queens (Thomas 1960, Donovan 1984). Few, if any, natural enemies were introduced with them. There is no evidence that any specific pathogens were imported with the original or subsequent populations. In the absence of natural predators, parasites, and pathogens, and in an apparently ideal environment, wasp populations have flourished. Both species spread rapidly throughout New Zealand (Clapperton *et al.* 1994). Where *V. germanica* and *V. vulgaris* were present together, populations were initially elevated (Sandlant and Moller 1989), before *V. germanica* was displaced by *V. vulgaris* in beech forest (Harris 1992). The current populations of each species fluctuate annually (Clapperton *et al.* 1994, Beggs *et al.* 1996) but may have reached an equilibrium restricted by the carrying capacity of the environment (Barlow *et al.* 1996).

**Current control measures:** Intensive nest search and kill tactics have some impact on localised populations, but need to be regular due to the wide dispersal of queens. For example, camping ground staff in the Nelson Lakes District in the South Island of New Zealand, have employed this strategy with some success (J. Spence 1997, pers. comm.). Early chemical control strategies were limited to the use of a few common insecticides (e.g., carbaryl, pirimiphos-methyl, lindane) applied directly to the nest or in wasp-specific baits (Spurr 1991, 1993). More recently, effective insecticides (finitron, sulfuramid and fipronil) have been developed along with wasp specific baits for targeted application in natural ecosystems (Spurr 1993, Spurr and Elliot 1996, Spurr 1997). A recent Department of Conservation project (Mainland Island) demonstrated that wasp eradication can be achieved with a large scale (300 ha) baiting operation using fipronil (R. Harris 1999, pers. comm.). However, the size of the area cleared of wasps is limited by the cost of such an operation.

The first attempt (in New Zealand) to control wasps on a large scale using biological control began in 1979 with the importation and successful establishment of the ichneumonid parasitoid *Sphecophaga vesparum vesparum* (Curtis) (Donovan and Read 1997). This parasitoid is a natural enemy of *Vespula* spp. in Europe. *Sphecophaga vesparum* has now established in Canterbury and the north-west of the South Island. Ecological modelling estimates that in these areas up to a 10-20% reduction of wasp populations could be achieved (Barlow *et al.* 1996) and that the parasitoid population may still be increasing (Barlow *et al.* 1998). Subsequently, *S. v. burra* (Cresson) has been recently released in several areas of the South Island, and an Israeli strain of *Sphecophaga* has also been imported as a control agent (B.J. Donovan 1999, pers. comm.). Despite these efforts, wasps continue to pose a major threat to the public and the environment. Estimates, based on data from wasp exclusion and predation trials, indicate that a reduction of over 95% of the current wasp population is necessary to adequately protect the integrity of the beech forest ecosystem (Toft and Rees 1998, Beggs and Rees 1999).

**Problems with control measures:** Control of wasps by biological and conventional chemical techniques has had only limited success (Beggs *et al.* 1996, 1998). The scale of the infestation of wasps in South Island beech forests limits the efficacy of widespread poison baiting. Further, the use of chemical insecticides may kill non-target species and have implications for

the abundance and diversity of organisms in the community. Baiting with insecticides can be ineffective early in the season as low worker numbers reduces bait uptake (Beggs *et al.* 1998).

*Sphexophaga* parasitoids have the potential to spread throughout the inaccessible forest areas, but the colony defences against arthropod invaders can be very effective (Akre and MacDonald 1986). To suppress wasp populations on an annual basis, colonies must be severely weakened or destroyed before queen production gets under way, or predation and parasitism must be directed at the queen brood or adults (Spradbery 1973).

## Micro-organisms in biological control

**Experiences with microbial control:** There has been pressure from many groups for the development of alternative forms of pest control to replace chemical pesticides. The justification for these demands include pest resistance, residues in food, environmental hazards, human health concerns, and escalating costs of pesticide development (Moore and Prior 1993). Entomopathogenic microbes can play an important role in the natural regulation of insect populations (Weiser 1969, Mesquita *et al.* 1997). Natural epizootics do occur in insect populations and have been reported for *Metarhizium anisopliae* in leafcutting ant, *Atta sexdens* L., nests (Allen and Buren 1974), for *Cordyceps unilateralis* in *Atta cephalotes* L. (Andrade 1980). Epizootics are considered common in *Apis mellefera* L. (Veen *et al.* 1994) and some Lepidoptera species (Bowers *et al.* 1993) and pose a significant problem for apiarists and conservationist alike. The augmentation of natural pathogen populations, or the introduction of exotic pathogens, to induce such epizootics, is the basis for most microbial control programmes (Stimac *et al.* 1990, Milner *et al.* 1998).

Pathogens have been successfully used as inundative and classical biological control agents against a range of insects (Tanada and Kaya 1993, Milner and Staples 1996). Inundative measures have been employed to control mosquito larvae using *Beauveria tenella* in Australia (Pinnock *et al.* 1973); *Melolontha melolontha* (L.) with *Beauveria brongniartii* (Keller 1992); swarming locusts in South Africa using *Metarhizium anisopliae* (Müller and Price 1997); and a range of lepidopteran pests using strains of *Bacillus thuringiensis*, worldwide (Boucias and Pendland 1998).

Social insects are susceptible to attack by pathogens, despite having life habits adapted for limiting disease. Honey bees, in particular, are prone to attack by a number of fungi, bacteria and viruses (Palmer-Jones 1964, Bailey and Ball 1991). This susceptibility of social insects to disease, although often very slight, can be exploited to develop successful biological control agents. Pathogen-based control programmes are under development for fire ants (*Solenopsis invicta* Buren) using *B. bassiana* in the south east USA (Stimac *et al.* 1990) and termites using *M. anisopliae* in Australia (Milner 1994). Further, it has been observed that the combination of multiple biological control agents can have synergistic effects on the host population (Agra Gothama *et al.* 1995, Poncet *et al.* 1995, Mesquita *et al.* 1997, Bauer *et al.* 1998, Brousseau and Charpentier 1998, Delgado and James 1999). The action of the parasitoid *S. vesparum*, combined with other vertebrate or invertebrate control agents, could induce such an effect, enhancing the potential impact beyond current expectations.

**Advantages and limitations of pathogens:** The use of pathogens to control wasps has potential to supplement the existing biological control. In most situations, an effective pathogen could have the advantage over a pesticide when low levels of the agent enter the pest population, because a disease can spread and result in an epizootic (Harris *et al.* 2000). The proliferation and spread of a disease depends on many factors including the density of the host population, the level of interaction between individuals, and the suitability of the disease to environmental conditions, which can be enhanced through product formulation (Moore and Prior 1993). With targeted strain selection, specificity to a pest species can be achieved, or formulation of a combination of agents can target control of a pest complex (Charnley 1991).

Carruthers *et al.* (1993) presented arguments to validate the use of exotic arthropods and pathogens in classical biological control of native and exotic pests. They claim that this approach to pest management has resulted in control of many important pest species, and has been associated with few, if any, serious environmental problems. Conversely, it has been suggested that the use of native pathogens in an inundative or a classical biological control system carries less risk of harmful side-effects on the environment than exotic strains (Lockwood *et al.* 1993). Lockwood *et al.* (1993) postulated that the host range of many exotic organisms are essentially unknown (given the quality and quantity of available data), so ecological safety assurances are unfounded. Furthermore, Lockwood *et al.* (1993) pointed to

existing data showing that native biological control agents are as or more effective in population regulation than the exotic agents. Given the value of unique ecosystems (such as South Island beech forest) and the rigorous demands of regulatory considerations, prudence dictates that native strains should be considered ahead of exotics, where no clear advantage exists for the latter.

In agricultural systems, the speed of kill by a control agent has been a primary concern. Most pathogens do not effect rapid kill on the scale of most chemical insecticides. This is less of an issue for wasp control because the aim of control is not to prevent short-term crop loss, but to prevent the seasonal depletion of honeydew and the invertebrate fauna, and curtail the production of reproductives (queens and males) that affect future seasons. By contrast, advanced insecticide formulations could be developed with rapid knockdown for domestic use. In many instances, a delay between uptake of inoculum and death is advantageous. For some pathogens, that lag of two-three days allows more time for the dissemination of the pathogen among the host population. Once established within the population, a high degree of multiplication would be advantageous to achieve effective spread. Destruction of the reproductive potential of pest populations is the aim of many control strategies (Febvay *et al.* 1988) and is likely to be a key factor in wasp control (Spradbery 1973).

Host specificity is often promoted as an advantage of microbial control agents, but when no host-specific strains are known, 'generalist' pathogens are often tested first (Moore and Prior 1993). A lack of host specificity can be a problem in natural ecosystems, due to the risk of non-target effects. For wasps, this may be overcome by using relatively specific baits to limit exposure to non-target organisms (e.g., bee-safe sugars and protein baits).

Adverse environmental conditions, such as low humidity and high temperatures, can be detrimental, especially to fungi and nematodes (Potter 1965, Moore and Prior 1993). Improvements in formulation may broaden the tolerance of fungi to environmental factors. Genetic improvements and modifications to application practices can lessen the influence of environmental conditions on fungal spores or other infectious units (e.g., bacterium, nematode) (Keller 1992). One major limitation of bacterial control agents is the relatively short field life of the inoculum. Though fungal spores can be delivered in a stable state (spores), bacteria do not survive extended periods of dehydration. The rapid proliferation of

bacteria in a nutrient rich medium also limits the effective life of bacteria in baits. Cost effective production and storage of microbial insecticides continues to be a limitation to the implementation of this technology (Moore and Prior 1993).

A major advantage of microbial pathogens is the ability of the disease agent to cycle in the pest population and contribute to long-term suppression. For social insects, this potential is limited by the co-ordinated defence of the host against disease dissemination (Akre *et al.* 1976, Edwards 1980). Diseased individuals may be easily detected and removed from the nest before a secondary infection can develop. Hygienic behaviour, such as necrophoria and necrophagia, have been noted in many wasp behavioural studies (Archer 1972, Greene *et al.* 1976, Akre *et al.* 1982). However, this behaviour may also cause spread of the disease through contact with body parts of infected individuals (especially if infected with bacteria, virus or microsporidian). In the case of fungi (e.g. *B. bassiana*), the cadaver must go undetected for up to a week before secondary infection can occur, due to the delay between maturity and sporulation. After fungal infection, highly susceptible insect hosts often die rapidly (<24 h). This results in the proliferation of saprophytic species on the cadaver, before the pathogenic fungus reaches maturity. In this event, the septic host may not be infectious to nest-mates. The defence mechanisms of colonies need to be overcome and appropriate delivery systems developed for pathogens to be used successfully as control agents (Harris *et al.* 2000).

***Pathogens associated with wasps:*** Wasp adults and larvae are constantly exposed to contamination by a wide range of potential pathogens brought in on the food collected by foragers. Ratnieks *et al.* (1996) posed the question “Are yellowjackets really free of diseases or does their apparent good health merely reflect a lack of study?”. A number of studies and reviews have been conducted on the pathogen flora associated with wasps (e.g., Gambino and Thomas 1988, Fouillaud and Morel 1995, Rose *et al.* 1999). Common associates include the fungal genera *Aspergillus*, *Beauveria*, *Penicillium* and *Paecilomyces* and the bacterial genera *Bacillus* and *Serratia*. Fungi of the genus *Cordyceps* are often documented in association with wasps (Hywel-Jones 1995), but are relatively rare compared with the almost ubiquitous occurrence of the pathogenic aspergilli. Some viruses (e.g., cricket paralysis virus, Kashmir bee virus) and an unidentified microsporidian have been isolated from wasps in New Zealand, but their pathogenicity has not been determined (Glare *et al.* 1993). Documented evidence of colony failure resulting from pathogen attack is rare. Weiser (1969) described the death of

colonies of tropical polistine wasps resulting from infections of the fungus *Cordyceps sphecocephala* (Klotzsch). For local vespids, it is rare to find a wasp nest or individual that has died for any reason other than seasonal decline or ageing (R.J. Harris 1998, pers. comm.). In most cases, the pathogenic microbes associated with vespid colonies gain ascendancy only during the autumn decline of the colony (Gambino 1988). The most common invading species include the entomopathogenic fungi *Aspergillus flavus* and *Beauveria bassiana* (Figure 1.2), (Gambino and Thomas 1988, Gambino 1988, Fouillaud and Morel 1995, Glare *et al.* 1996, Rose *et al.* 1999).

The widespread occurrence of pathogenic organisms in wasp nests and the lack of evidence of their impact on healthy colonies suggests that colony members may actively modify the environment to restrict pathogen proliferation. If adults are removed from comb (in field or lab nests), larvae are soon overwhelmed by the fungal and bacterial infection (S.J. Harcourt, pers. obs.). Quite how wasps maintain a healthy nest environment in the presence of fungal and bacterial pathogens is not fully understood. Selective removal of contaminants and microclimate maintenance must certainly contribute.

**Pathogen-wasp interactions:** Epizootics are rare in social insects but, once established, can have devastating effects on the host population (Allen and Buren 1974, Andrade 1980, Samson *et al.* 1981). Micro-organism invasion is more difficult to defend against than macro-organisms (Gambino 1988). Wasps have evolved a suite of subtle behavioural and biochemical mechanisms that prevent the introduction and spread of disease (Gambino 1988). Life-habit adaptations of *Vespula* wasps, contributing to pathogen regulation in the nest, are summarised in Figure 1.3.

Internal insect defence mechanisms are also a primary factor in the limitation of disease in a colony. Among the physiological mechanisms that maintain this internal integrity (homeostasis), the nervous, endocrine and immune systems play a decisive role (Gliński and Jaroz 1995a). Animals defend themselves against invasion and colonisation by foreign organisms with immune mechanisms and, although insects lack the complexity of the vertebrate immune system, they have developed alternative defence mechanisms that protect them well against infections (Gliński and Jaroz 1995b). Pathogens adapt to these defences and develop mechanisms to counter insect immunity (Boucias and Pendland 1998).



The defence mechanisms of particular interest in this study are behavioural responses and physiological secretions. These include: grooming to remove spores (Dustmann 1993), antimicrobial substances in saliva (Gambino 1993), venom spraying (Jouvenaz *et al.* 1972), sealing of cells in the nest (Spivak and Gilliam 1993), physical avoidance of pathogens (Oi and Pereira 1993) and the removal of sick or dead individuals (Siebeneicher *et al.* 1992).

The physical and biochemical defences combined with the behavioural adaptations must form a formidable barrier to disease. There is a constant struggle between host and pathogen which usually results in a dynamic equilibrium; where by, some disease is constantly present but at low (enzootic) levels, rarely gaining ascendancy because of the behavioural responses of the host to infection (Evans 1989). The balance may be lost after a disturbance in the ecosystem or at very high host population densities, promoting dramatic oscillation of diseases in insect populations. This appears to be a weakness in the defence system of all social insects that could be exploited in biological control systems. The key to overcoming these defences in wasps is to stimulate conditions that result in the pathogen gaining ascendancy. A key question is, 'what would it take to tip the balance in a wasp colony and could the effects of an imbalance trigger a 'snowball' effect, resulting in the development of an epizootic?' Finding the answers to these fundamental questions is the aim of the research presented in this thesis.

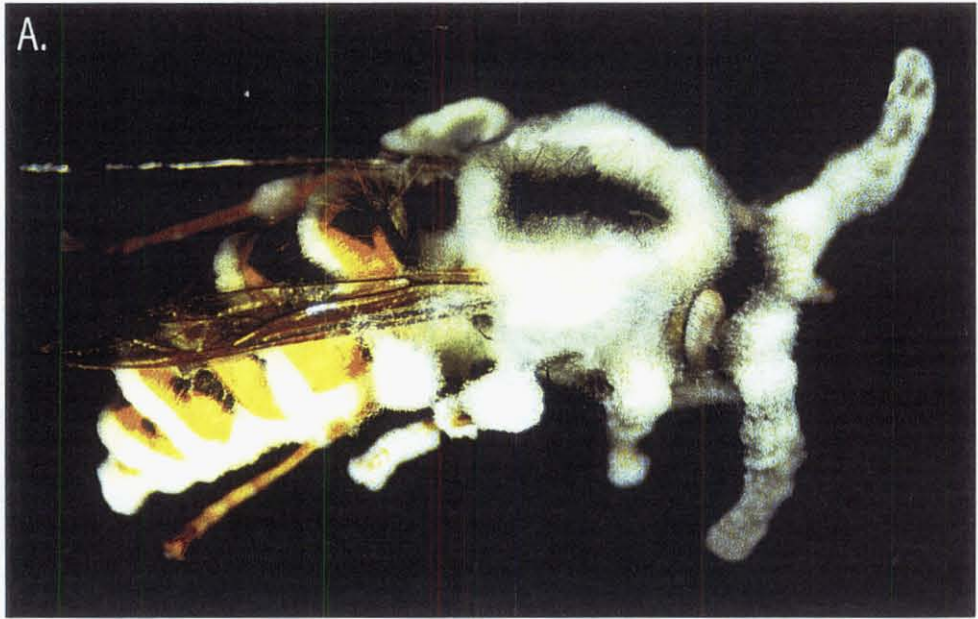

Figure 1.2: *Vespula vulgaris* workers killed by the entomopathogenic fungi *Beauveria bassiana* (A) and *Aspergillus flavus* (B). *A. flavus* is commonly found in wasp nests whereas *B. bassiana* is rarely found in the nest but is occasionally isolated from cadavers found away from the nest.

Figure 1.3: Nest design features significant in pathogen control within the *Vespula* nest (stylised image adapted from Spradbery 1973).

**Abandoned comb:** the oldest layers of comb are abandoned and often encapsulated with paper as the nest grows.

**Involucrum:** multi-layered envelope surrounds the comb forming a second barrier and insulation for the nest.

**Nest cavity:** gap between the nest and the substrate acts as a barrier to soil borne pathogens and moisture.

**Basal entrance:** allows waste and dead nestmates to fall out of the nest which accumulate on the base of the cavity.

**Single season nests:** nest sites are usually inhabited for a single season reducing vertical transmission of disease.

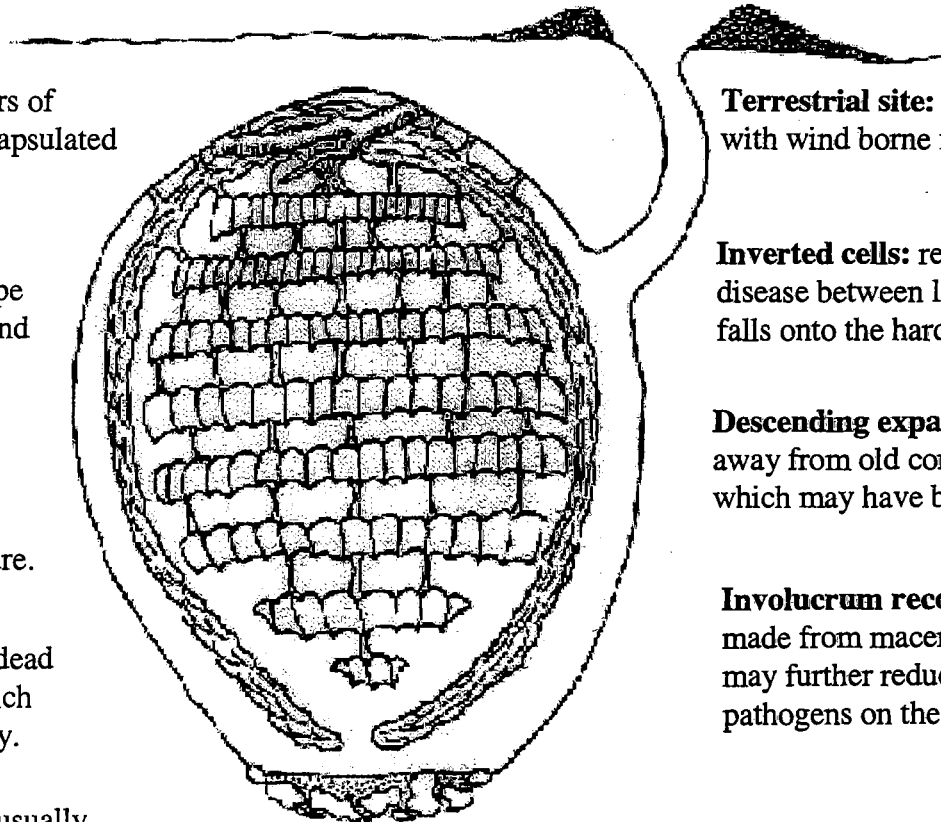

**Terrestrial site:** cuts down contact with wind borne fungal spores.

**Inverted cells:** reduces the transmission of disease between larvae. Infected material falls onto the hard upper surface of the comb.

**Descending expansion:** ensures movement away from old comb and the pathogens which may have built up in these areas.

**Involucrum reconstituted:** new comb is made from macerated envelope which may further reduce the survival of pathogens on the foraged material.

## Study goals and objectives

The primary goal of this study was to identify the key processes and interactions between wasps and their pathogens. The investigation was conducted on two levels:

1. Using individual wasps and portions of nest comb, the colony structure was broken down to determine how individual wasps respond to pathogen contamination in the absence of social stimuli. This involved:

- pathogen bioassays and disease transfer bioassays;
- tracking the movement and survival of pathogens within the nest, between adults and larvae;
- the identification of naturally occurring antibiotic and fungicidal agents produced by adults and larvae.

2. The hypotheses developed when experimenting with individual workers, were tested in active nests, where the interaction of colony members and the influence of the social structure on disease resistance was analysed. Nests were manipulated and the resulting behaviour was observed. This entailed:

- field testing a pathogenic fungus identified in bioassay experiments;
- collecting data on the frequency and precision of hygienic behaviour;
- determining the behavioural adaptations of individual wasps and the colonies unit, to the presence of disease within active nests;
- an investigation into the nest environment and its suitability for the growth of pathogens (nest temperature and humidity).

This research contributes to a larger programme studying the potential of entomopathogenic microbes for the control of German and common wasps in New Zealand. Information gained will contribute to the development of control strategies for vespidae wasps inhabiting beech forests and urban areas.

# Chapter Two

## Adult Bioassays: Susceptibility of wasps to generalist entomopathogens

### Introduction

The role of micro-organisms in population regulation has been demonstrated for many insects (e.g. Edwards 1988, Villaini *et al.* 1992, Lockwood *et al.* 1993), but their potential as a biological control agent is yet to be realised (Milner and Staples 1996, Price *et al.* 1997). Some of these associations are being exploited in attempts to develop microbe-based control programmes for termites, ants and locusts (Stimac *et al.* 1990, Milner and Staples 1996, Müller and Price 1997). The search for novel pathogens is the focus of much research and may provide a useful addition to current control strategies for many pests.

A broad range of micro-organisms are commonly found associated with wasps and wasp colonies (Gambino and Thomas 1988, Rose *et al.* 1999). Some have been shown to be pathogenic by Koch's postulates (Last *et al.* 1984), but none has been recorded as causing major disruption to colony life. Pathogens have infrequently been tested as potential biological control agents for wasps (Gambino *et al.* 1992, Gambino *et al.* 1994, Glare *et al.* 1996, Harcourt *et al.* 1998, J.P. Spradbery 1998, pers. comm.) and none has yet resulted in the development of an effective control tool. Much work is needed to isolate strains with the right combination of attributes to survive in wasp nests. Extension of the list of known pathogens is critical to these efforts.

Gambino (1988) orally assayed three strains of *Bacillus thuringiensis* and the nematode *Neoaplectana carpocapsae* against *Vespula pensylvanica* (Saussure) larvae. The bacterial strains showed toxicity, but at concentrations higher than were practical for field use. *N. carpocapsae* was highly pathogenic to both workers and larvae<sup>1</sup>. This lower concentration threshold was

---

<sup>1</sup> Three nematodes per wasp adult or larvae was pathogenic (Gambino 1988)

appropriate for field usage, but the humidity requirements, for secondary infection of nematodes (approaching 100%), make them an unsuitable candidate for biological control of wasps. The bacterium *Streptomyces avermitilis* was pathogenic to *V. maculifrons* (Buysson) larvae in assays (Parrish and Roberts 1984). Glare *et al.* (1996) demonstrated the toxicity of the facultative pathogen *Aspergillus flavus* against *Vespula* spp. Although demonstrating the potential of inundative pathogens as control agents for wasps, *A. flavus* was not adopted for use because it was believed to produce carcinogenic aflatoxins (Glare *et al.* 1996). Kashmir bee virus and cricket paralysis virus are also toxic to *V. germanica* when injected (P. Wigley 1998, pers. comm., Rose *et al.* 1999) but were not considered a possibility for inundative control because of host specificity problems. Rose *et al.* (1999) summarised the literature regarding micro-organisms isolated from *Vespula*, *Vespa*, and *Dolichovespula* wasps including 50 fungal, 12 bacterial, 5-7 nematode, 4 protozoan, and 2 viral species. Fungi belonging to the genera *Aspergillus*, *Paecilomyces*, *Metarhizium*, *Beauveria*; the bacteria *Serratia marcescens* and *Bacillus thuringiensis*, and nematodes *Heterorhabditis bacteriophora*, *Steinernema* (= *Neoaplectana*) sp., *S. feltiae*, *S. carpocapsae* and *Pheromermis vesparum* have been confirmed through bioassay as Vespinae pathogens (Rose *et al.* 1999).

Bioassays are useful indicators of pathogenicity and mode of action of a pathogen. To be effective in a screening programme for biological control agents, assays must be quick and relatively coarse. Data generated in an efficient screening programme are often imprecise and usually target one indicator of toxicity (death). Relatively low number of replicates (but sufficient to determine significant variation with reasonable accuracy), high concentrations, and many test strains make extrapolation of data beyond virulence an approximation. Detailed analysis of the pathogenicity and activity is not necessary until a smaller number of potential candidates for biological control has been isolated. The assays presented here are part of a wider screening programme of biological control agents for *V. germanica* and *V. vulgaris*.

The bioassays were performed according to the principles of Koch's postulates to establish the pathogenicity of microbial agents. That is, the microbial agent must reproduce when inoculated into a healthy individual, be present in all cases of diseased in experimental hosts, be isolated

from those diseased individuals and grown in culture from that isolate. The aim of this work was to: (i) determine the susceptibility of wasps to generalist entomopathogenic fungi and bacteria through laboratory bioassays of wasp workers and (ii) compare different methods of inoculation to assess the potential of fungi and bacteria as inundative control agents for wasps.

## Materials and methods

*Selection of pathogens:* Bioassays were conducted using a range of potential wasp pathogens. Some isolates were collected from wasps or wasp nest material. However, most were generalist pathogens, extracted from other unrelated insects or the soil, which had shown potential in bioassays on Coleopteran or Lepidopteran pests (T.R. Glare 1998, pers comm.). Most strains were chosen for their high virulence, unique action or environmental tolerance. The fungal isolates tested included three strains of *Metarhizium anisopliae* (F16, F142, F204), five strains of *Beauveria bassiana* (F180, F225, F226, F233, F234), and one strain each of *Aspergillus flavus* (F202) and *Cladosporium* spp. (F34). The bacteria tested included four strains of *Serratia marcescens* (363, 457, 458, 486), and one strain each of *S. entomophila* (154), and *Enterobacter* spp. (K). One microsporidian was also tested (*Varimorpha mesnili*) (Table 2.1).

Bacterial and fungal samples were removed from cold storage (-18°C) and cultured on an appropriate nutrient agar medium (JC's agar for fungi and Lauria Bertani agar for bacteria, Sambrook *et al.* 1989<sup>2</sup>) at 20-25°C. Conidia and bacterial cells were scraped from the agar and placed into liquid media. The solutions were prepared using phosphate buffer (for bacteria) and 0.05% Triton X-100 in sterile tap water (for fungi). Spore suspension concentrations between  $1 \times 10^7$  and  $1 \times 10^9$  CFU/ml (CFU=colony forming units) were produced and checked with a haemocytometer and an appropriate dilution series was plated on potato dextrose agar (PDA,

---

<sup>2</sup> Fungi were plated on an adapted JC medium (4% D-glucose, 1% neopeptone (DIFCO), 1.5% agar, 0.0125% cyclohexamide, 0.035% streptomycin, and 0.05% tetracycline essentially Veen's selective agar base + streptomycin and tetracycline in a stock solution, as in Joussier and Catroux 1976), at a concentration between  $1 \times 10^7$  and  $1 \times 10^9$  spores/ml.

GIBCO, Paisley, Scotland). The suspensions were kept in cool dark storage for no more than 24 hours (usually only two hours) before initiation of the experiment.

Table 2.1: Isolates of fungi and bacteria tested in bioassays against *Vespula vulgaris* and *V. germanica*. Only *Beauveria bassiana* and *Aspergillus flavus* strains were isolated from wasps, whereas the others are generalist insect pathogens. Strains are stored in constant conditions (-18°C) in the AgResearch pathology laboratory, Lincoln.

Organism	Genus / species	Strain #	Origin
Fungi	<i>Beauveria bassiana</i>	F225	Hamilton ex. <i>Vespula germanica</i>
		F226	Matamata ex. <i>V. germanica</i>
		F233	Mt Thomas ex. wasps (species unknown)
		F234	Mt Hutt ex. wasps (species unknown)
		F180	Chatham Island soil
	<i>Metarhizium anisopliae</i>	F16	Nelson ex. grass grub, <i>Costelytra zealandica</i>
		F142	Gordonton (N.I.) soil
		F204	Canterbury ex. grass grub
	<i>Aspergillus flavus</i>	F202	Lincoln ex. <i>V. vulgaris</i> larvae
<i>Cladosporium</i> spp.	F34	Nelson ex. <i>Scolypopa australis</i>	
Microsporidium	<i>Vairimorpha mesnili</i>	Vm	North Island ex. leafroller (species unknown)
Bacterium	<i>Serratia entomophila</i>	154	Canterbury ex. grass grub
		363	Lincoln soil, ex. <i>Paropsis</i> spp.
		486	Taranaki soil
		392	Lincoln soil
	<i>Serratia ficaria</i>	457	Bordeaux (Fr.) soil, Pasture collection
		458	Grihont (Fr.) ex. calimyrna fig
	<i>Enterobacter</i> spp.	K	Confidential, patent pending

**Bioassay design:** Assays were conducted between December 1996 and March 1997 using nests of *V. germanica* and *V. vulgaris* collected from Lincoln and Christchurch, New Zealand. The generalised design of all the bioassays was the same in all aspects except for the treatment method. All adult bioassay experiments comprised three replicates of 10 wasps per treatment. Comb with a large number of pupae was cleared of wasps and set aside 24 hours before the experiment was to start to ensure all workers used were no older than 24 hours. Workers were selected from a massed sample of wasps and randomly assigned to treatments. Workers were placed in Petri dishes in groups of 10 ready for treatment. To facilitate ease of handling, wasps were cooled for 30 minutes at 7°C before treatment.

The bioassays involved four experimental procedures: dipping, spraying, spore dusting and oral bioassays, which were compared to assess mode of activity of the pathogen. Dipping bioassays



were conducted on wasps with all the fungi listed in Table 2.1 while the bacteria and microsporidian in Table 2.1 were tested in oral bioassays only. Further spraying, dusting and oral bioassays were conducted, for one isolate of *B. bassiana* (F180) and one isolate of *M. anisopliae* (F142), and compared to assess mode of activity and application techniques. All adult bioassays were conducted over a four month period during the summer of 1996/97. Continuity of the experiments over this period was maintained by selecting apparently healthy, newly emerged adults and conducting the assays to standardised method in a controlled environment.

**Dip bioassay:** Using forceps, workers were carefully placed into a suspension of the pathogen and fully submerged, three times, for 1 second. Based on visual inspection, three dips were necessary to achieve spore adhesion over the entire body. Control group wasps were similarly dipped into a 0.05% v/v Triton X-100 in sterile tap water. *Botrytis cinerea* suspensions (at  $10^7$  spores/ml) were also used as a control in these experiments. Individual wasps were placed directly into separate Petri dishes.

**Spray bioassay:** This bioassay was performed using a sub-sample of the fungal strains that showed high toxicity in the dip bioassays. The procedure could mimic the dose volume and distribution expected if such a product were used in the field. Groups of 10 wasps were placed into a spray column (diameter 110 mm; height, 290 mm) covered by a gauze mesh (2 x 1 mm). One hundred  $\mu$ l of fungal conidia suspension was sprayed with a 'Paasche' single action air-brush running on compressed air. Microscope slides and PDA plates were sprayed and assessed to confirm spore density and viability (results not presented). The workers were then transferred to individual Petri dishes. Control group wasps were sprayed with a 0.05% v/v Triton X-100 and sterilised tap water solution.

**Dust bioassay:** Conidial suspensions (1 ml @  $>1 \times 10^7$  cfu/ml) were plated on to Petri dishes containing JC's agar and incubated at 30° C (50% RH) until sporulation occurred across the whole surface. Wasps were then rolled individually in the sporulating cultures for 10 seconds. A visual coating of spores was evident after treatment. Each agar plate was used to dust 10 wasps

from each treatment. Control group wasps were dusted using a non-pathogenic plant fungus, *Botrytis cinerea*, obtained from kiwifruit *Actinidia deliciosa* (Chev).

**Oral bioassay:** Wasps were fed 10  $\mu$ l of a 50/50 (v/v) suspension of conidia or bacteria mixed with 30% sugar syrup in a sterile water solution. Each wasp was fed individually in a Petri dish and the consumption of the entire dose was observed. If workers did not feed immediately, they were moved to the droplet using forceps, which induced them to feed. Control solutions consisted of a 10  $\mu$ l drop of 50/50 (v/v) Triton X-100 and 30% sugar syrup in sterile water. One isolate of *B. bassiana* (F180) and one isolate of *M. anisopliae* (F142) were tested in all four assays to compare the application techniques. Dipping assays were also conducted on the full range of fungi, as listed previously, to compare isolates. Bacteria were tested only in the oral assay because of the particular mode of action of these pathogens.

**Post treatment conditions:** Once treated, the subjects were placed into separate Petri dishes. A small piece of damp filter paper was added to the Petri dishes containing fungal treatments to simulate nest conditions (high humidity) and aid spore germination. The dishes were kept at 30° C (50% RH) in constant darkness until all wasps were dead or a clear difference between treatment and control was evident. Wasps were fed 30% sucrose and sterile tap water and checked daily for mortality.

Results were recorded as the number of individuals dead per day for the duration of the experiment. These values were normalised against the control by doing a transformation<sup>3</sup> and plotted as percentage mortality over time to identify any trends. Analysis involved using SAS (Anon. 1989) to determine mean longevity (LIFEREG) and probability of significance (LIFETEST) for individuals in each treatment. Survival, or time-mortality data, such as these, are often characterised by the presence of right-censored observations due either to withdrawal of individuals or termination of the experiment (Anon. 1989). In such cases, the life time is known only to exceed the given value. These survival data are as important as the mortality data and

---

<sup>3</sup> Transformation -  $\%MLE_{Norm.} = (MLE^{treat.}/MLE_{cont.}) \times 100$ , MLE = mean life expectancy.

cannot be ignored. The analysis methodology chosen accounts for both the censored and non-censored observations.

The LIFETEST procedure fits non-parametric models to failure time data which may be right-censored. This analysis was used to compute rank tests for association of the response variable with other variables. Because the rank tests are pooled over the strata, it was necessary to run pair-wise comparisons for each treatment against the control. The LIFETEST procedure uses the Kaplan-Meier method to compute estimates of the survival distribution function (SDF). This function describes the life times of the population by calculating the probability that an experimental unit will survive longer than any chosen time. The resulting survival curves were compared to determine whether the two data sets could have arisen from similar survival functions.

The LIFEREG procedure fits a parametric model to failure time data that may be right, left or interval-censored. The model for the response variable consists of a linear effect composed of the covariables together with a random disturbance term (Anon. 1989). The disturbance term chosen fits an exponential or Weibull distribution to the model. The exponential distribution was assumed in most situations because it fitted the expected results more closely. The parameters are estimated by maximum likelihood using a Newton-Raphson algorithm. The standard error estimates are computed from the inverse of the observed information matrix. This model is equivalent to accelerated failure time models when the logarithms of the response is the variable being modelled. These models assume that the effect of independent variables on survival time distribution is multiplicative on that time.

## Results

Assessment of microscope slide and agar plate cultures inoculated before the spray assays confirmed the concentration of inoculum at  $10^7$  viable conidia/ml. Absolute individual dose rates were not calculated as this was not the focus or the intended design of these assays.

**Fungi:** Except for *Cladosporium* spp. (F34) and *M. anisopliae* (F204), there was a significant reduction in adult longevity for all fungi tested in the dipping bioassays ( $P < 0.05$ , see Table 2.1). All *B. bassiana*, *A. flavus* and two *M. anisopliae* (F16, F142) isolates exhibited a rapid kill. *A. flavus* killed most quickly but was not significantly different from the fastest *B. bassiana* isolate (F225,  $P=0.1558$ ). However, mean life expectancy of workers treated with *A. flavus* was significantly lower than all other *B. bassiana* isolates ( $P<0.0012$ , Table 2.2). The F16 isolate of *M. anisopliae* was the only other pathogen to achieve a similar killing speed as *A. flavus* (mean  $2.16 \pm 0.25$  days,  $P=0.1748$ ).

Table 2.2: Mean life expectancy (MLE) data for treatment and control adult wasps when dipped into fungal suspensions (mean  $\pm$  SE). ( $P >$  Chi-square at the 95% level of significance).

Species	Isolate	MLE treatment (days)	MLE control (days)	% MLE (T) of Control	P > Chi-square
<i>Cladosporium</i> sp.	F34	26.1 $\pm$ 1.0	17.7 $\pm$ 3.9	147.4 $\pm$ 5.8	0.1850
<i>M. anisopliae</i>	F16	2.2 $\pm$ 0.3	17.7 $\pm$ 4.0	12.2 $\pm$ 1.4	0.0031
	F142	2.7 $\pm$ 0.3	19.5 $\pm$ 2.9	13.7 $\pm$ 1.6	0.0001
	F204	19.4 $\pm$ 1.1	17.7 $\pm$ 4.0	109.5 $\pm$ 5.9	0.6579
<i>A. flavus</i>	F202	1.4 $\pm$ 0.1	19.5 $\pm$ 2.9	7.4 $\pm$ 0.6	0.0001
<i>B. bassiana</i>	F180	3.4 $\pm$ 0.4	18.6 $\pm$ 3.4	18.6 $\pm$ 2.1	0.0062
	F225	2.2 $\pm$ 0.3	17.7 $\pm$ 4.0	12.2 $\pm$ 1.4	0.0010
	F226	5.9 $\pm$ 0.6	17.7 $\pm$ 4.0	33.3 $\pm$ 3.2	0.0136
	F233	2.5 $\pm$ 0.3	17.7 $\pm$ 4.0	13.9 $\pm$ 1.6	0.0013
	F234	5.4 $\pm$ 0.5	17.7 $\pm$ 4.0	30.4 $\pm$ 3.0	0.0065

**Bacteria and microsporidian:** No bacterial isolate significantly reduced the longevity of workers compared with the controls (Table 2.3). There was more variability in the longevity of treated workers in bacterial assays compared with the fungi as indicated by the standard error. This is because the consistently rapid mortality in the fungal treatments tended to lump mortality, whereas in the controls mortality was spread over a longer period.

The *Serratia marcescens* strain (486) achieved a 20% reduction in longevity compared with the control. However, this difference was not statistically significant ( $P > 0.05$ ). The high level of control mortality in the *S. ficaria* (457) treatment indicates (unidentified) errors in experimental set-up but repetition was not considered due to time restraints and the lack of effect from this and other *Serratia* species in larval and adult bioassays. *Varimorpha mesnili* caused no significant reduction in longevity when inoculated orally. *V. mesnili* was not inoculated externally due to its predominant intestinal action in most host species.

Table 2.3: Mean life expectancy (MLE) data for treatment and control adult wasps treated with pathogens in oral bioassays (mean  $\pm$  SE). ( $P >$  Chi-square at the 95% level of significance).

Species	Isolate	MLE Treatment (days)	MLE Control (days)	% MLE (T) of Control	P > Chi-square
<i>Vairimorpha mesnili</i>	Vm	18.6 $\pm$ 0.9	18.9 $\pm$ 2.3	96.8 $\pm$ 4.9	0.5290
<i>Enterobacter</i> sp.	K	17.2 $\pm$ 2.6	15.0 $\pm$ 2.6	114.4 $\pm$ 16.9	0.1021
<i>Serratia entomophila</i>	154	30.0 $\pm$ 0.2	11.1 $\pm$ 0.9	270.2 $\pm$ 0.6	0.3948
<i>S. ficaria</i>	457	3.3 $\pm$ 0.6	4.1 $\pm$ 1.0	79.3 $\pm$ 0.02	0.3537
	458	19.6 $\pm$ 0.3	15.0 $\pm$ 2.6	130.7 $\pm$ 2.1	0.1652
<i>S. marcescens</i>	486	17.2 $\pm$ 0.9	22.1 $\pm$ 2.9	77.8 $\pm$ 4.07	0.3150
	392	25.8 $\pm$ 1.3	22.1 $\pm$ 2.9	116.9 $\pm$ 6.01	0.3976

**Application method:** *B. bassiana* (F180) and *M. anisopliae* (F142) significantly reduced longevity compared with the controls irrespective of inoculation technique ( $P < 0.05$ , Table 2.4). Mortality was significantly greater in the dipping assays and progressively lower in the dusting, spray and oral assays respectively (Table 2.4). The effect of *B. bassiana* (F180) and *M. anisopliae* (F142) was not significantly different in each of the methods (oral  $P = 0.2473$ , spray  $P = 0.0925$ , dust  $P = 0.1800$ , dip  $P = 0.1769$ ).

Table 2.4: Mean life expectancy (MLE) data comparing the application techniques for treatment and control adult wasps in fungal bioassays (mean  $\pm$  SE). (P > Chi-square at the 95% level of significance).

Species	Treatment	MLE Treatment (days)	MLE Control (days)	% MLE (T) of Control	Pr > Chi-square
<i>M. anisopliae</i> (F142)	Dip	2.7 $\pm$ 0.3	19.5 $\pm$ 2.9	13.7 $\pm$ 1.6	0.0001
	Dust	4.0 $\pm$ 0.4	14.1 $\pm$ 2.4	28.2 $\pm$ 3.1	0.0001
	Spray	6.3 $\pm$ 0.5	14.3 $\pm$ 0.6	46.8 $\pm$ 3.6	0.0067
	Oral	8.5 $\pm$ 0.7	22.1 $\pm$ 2.9	38.4 $\pm$ 3.1	0.0006
<i>B. bassiana</i> (F180)	Dip	3.4 $\pm$ 0.4	18.6 $\pm$ 3.4	18.6 $\pm$ 2.1	0.0062
	Dust	3.4 $\pm$ 0.4	14.1 $\pm$ 2.4	23.9 $\pm$ 2.7	0.0001
	Spray	6.7 $\pm$ 0.5	15.4 $\pm$ 0.5	41.1 $\pm$ 3.3	0.0001
	Oral	11.6 $\pm$ 0.8	22.1 $\pm$ 2.9	52.5 $\pm$ 3.5	0.0137

## Discussion

Most of the fungi tested showed significant levels of pathogenicity, but the bacteria and microsporidian were not pathogenic to adult wasps. Concurrent assays showed the same fungi were effective pathogens of wasp larvae (Harris *et al.* 2000) and the bacteria were similarly ineffective. Only two of the fungi tested failed to significantly reduce longevity. *Cladosporium* sp. (F34) is relatively specific to *Scolytopa australis* (Walker) in New Zealand (Cumber 1966), while *M. anisopliae* (F204) is a low temperature active strain which may not readily germinate at 29°C, but is pathogenic to *Costelytra zealandica* (White) (T. R. Glare, unpubl. data).

The bacteria assayed were isolated from a variety of insect pests and are usually obligate pathogens of those hosts (see Table 2.1). The lack of pathogenicity against wasp adults and larvae may be related to the presence of antibiotics in larval labial gland (saliva) secretions (Gambino 1993). The susceptibility of these bacteria to larval saliva is tested in Chapter Four where the implications of these assay results are further discussed.

A prominent effect on wasps inoculated with virulent fungi was the rapid death of most individuals. Others, surviving the initial period after exposure, often remained alive for as long as

the control individuals. This was particularly common when testing the most effective bacterial agents (457 and 486) and least effective fungal pathogens (F226 and F234). This effect may be caused by some individuals receiving a sub-lethal dose, due to low virulence or grooming away the conidia before infection occurred. This can significantly alter the estimated mean life expectancy and LJFEREG analysis is particularly sensitive to such outliers (Anon. 1989).

Application technique significantly influenced the virulence of fungi. The dipping bioassay was designed as a maximum challenge technique to identify potentially useful pathogens. The concentrations used were very high compared to expected field rates, but were necessary to detect even the slightest pathogenic effect of a microbial agent. The dusting assays were designed to assess the effect of dry conidia on adult wasps. This has important implications for the transfer of conidia and is discussed in Chapter Three. The spray and oral assays attempted to more closely represent how exposure to pathogens might occur in the field. Both had the effect of reducing the dose and activity of the pathogens, though some still showed high pathogenicity despite the reduced dose. Two factors need to be considered when interpreting the application technique data: actual dose (number of spores on treated wasps) and spore adhesion.

Actual dose rates were not calculated for each procedure because dose dependant effects were not being tested. However, the dip and dust treatments by their nature delivered a very high dose and is reflected in rapid death in these treatments. However, the actual dose in the oral treatment was very low (spores contacting the mouth parts during feeding), but still resulted in a high level of mortality ( $38.4 \pm 3.1\%$ ) in the *M. anisopliae* treatment. It is concluded that treatments delivering large actual doses overwhelm the subject rapidly, whereas, in treatments delivering lower actual dose rates, longevity is extended but frequently death still results. Application technique has an influence on dose rate and should, therefore, be considered in field applications. A high dose rate (concentration and volume) may result in widespread mortality but induce a rapid colony response while low dose rates may induce a chronic infection that is less readily detected by the colony. Conversely, rapid infection from a high dose may overwhelm the colony defences while low dose rates may be easily picked up and eliminated by everyday nest cleansing behaviour.

Such questions should be tested during large scale field testing and related to strain and species selection experiments.

Spore adhesion is crucial for the successful germination and penetration of the fungus on insect cuticle. Surface tension of the liquid in the suspensions ensures adhesion until it evaporates. The dry conidial preparations were also very effective, which indicates that adhesion may not be a limiting factor (for effective kill) when spore concentrations are high. The critical mass of wasp and spore and the static electricity differentials between them ensures adhesion of even small doses of dry inoculum.

Environmental conditions are crucial to the effectiveness of many entomopathogenic fungi (Milner *et al.* 1997, Jacques and Christian 2000). It appears that humidity was not a limiting factor in these experiments due to humidity augmentation in the method. Adult inoculation by dipping and spraying probably increased humidity sufficiently in the containers and on the wasp cuticle for spore germination and infection to readily occur. However, dusting with dry spores was as effective, suggesting surface humidity was adequate when damp filter paper was present in Petri dish bioassays. High humidity is essential for these fungi to germinate and sporulate (T.R. Glare 1998, pers. comm.). Humidity within wasp nests can be consistently high (>80% RH, see Appendix Two) and it is likely that the micro-climate at the insect cuticle would create a higher humidity. Given the environmental constraints of most pathogenic fungi, it is unlikely that nest humidity would limit spore germination (see Appendix Two), but sporulation, which occurs in humidity over 95% (Christian 1998), may be affected for most fungal pathogens. The death of the host reduces the humid (transpiration induced) cuticular micro-climate. This may explain the occurrence (in *in situ* treated nests) of cadavers supporting mature *B. bassiana* infections, but not sporulation, when normal fungal developmental patterns dictate that spores should have formed (R. J. Harris, unpubl. data). Sporulation of the fungus is critical for secondary infection to occur. As a biological control agent, an effect on only a single cohort, equates the role of a pathogen to that of a low-dose chemical insecticide.



All the pathogenic fungi screened (except the low temperature active strain) are effective at temperatures of about 30°C and tolerate 5°C fluctuations (T.R. Glare 1999, pers. comm.). The temperature inside a wasp nest has often been reported to be around 30°C (Hummer 1932 (in Spradbery 1973); Ishay and Litinetsky, 1996). However, nest temperature fluctuates with diurnal and seasonal cycles and is susceptible to extreme weather patterns. A wide temperature tolerance in a pathogenic fungus is advantageous but not critical as long as the nest temperature range falls within the fungus' threshold long enough to allow infection and sporulation to occur on a regular basis. Spores are very tolerant to temperature extremes and hyphae are partially insulated within the host.

The high spore concentrations used to achieve infection in the bioassays was not a reflection of low virulence of the fungi, but the necessity to ensure a result where pathogenicity exists. Wasps may be more susceptible to some fungal strains than others and screening a wide range of isolates may therefore identify some that are more effective at lower concentrations. There was no evidence, in these preliminary investigations, that isolates originating from wasps were more virulent than novel isolates. This may reflect an opportunistic rather than co-evolved origin of insect-fungal associations.

Bioassays are useful indicators of pathogenicity but are only the first stage in the development of microbial biological control. Kermarrec and Mauleon (1975) found some fungi effective against worker leaf-cutter ants isolated in bioassays were less effective against individuals within the colony. They concluded that a level of coordinated activity against infection could limit the development of disease. Indications are that wasps also possess some powerful tools for disease prevention (see Chapter Six). The results of these bioassays confirm that individual wasps are susceptible to entomopathogenic fungi. However, the defence mechanisms of colonies need to be overcome and appropriate delivery systems developed for fungi to be used successfully as control agents. Furthermore, these bioassays demonstrate a need to overcome the defence mechanisms of colonies using appropriate delivery systems if the potential for fungi as control agents is to be realised.

# Chapter Three

## Transfer of pathogens between nestmates

### Introduction

Dissemination of infectious material between hosts and within populations is the key to successful transmission of disease and the establishment of epizootics within social insect colonies (Harcourt *et al.* 1998). The mode of transmission and mechanisms evolved to limit it are varied and complex (Pereira and Stimac 1992). Understanding the interactions between hosts and pathogens is vital for the successful establishment of a microbial control agent (Hajek and St Leger 1994). Though the role of individual workers in disease transmission has been discussed (Thomas 1960, Edwards 1980, Gambino 1988), it has not been quantitatively demonstrated.

Spread of disease within wasp nests may be limited by hygienic behaviour (Akre *et al.* 1976), the presence of antimicrobial substances (Gambino 1993), and the existence of annual colony cycles (Jeanne 1982). However, the occurrence of high population densities (Veal *et al.* 1992), frequent interaction between nestmates (Gambino 1988) and persistence of high temperatures and humidity within the nest (Spradbery 1973), favour the transmission and proliferation of disease. The paucity of documented epizootics in field wasp colonies suggests that the natural balance falls in favour of the wasps. Archer (1972), Akre *et al.* (1976), and Edwards (1980), suggest that maintenance of healthy wasp colonies is due to the existence of behavioural adaptations, and a coordinated colony response to the presence of disease-causing organisms.

Two processes of disease transmission are of interest for achieving microbial control: the primary dissemination of the pathogenic inoculum, and the spread of secondary infection from the resulting septic or moribund hosts. The latter form of disease transmission is discussed in relation to hygienic behaviour in Chapter Seven and is partly dependent on the level of primary

dissemination. Widespread dissemination of the primary inoculum is vital to the establishment of an epizootic and is the stage at which the infection is most easily eliminated by the host. Preliminary observations suggest that groups of workers were less susceptible to low dose external treatments of *A. flavus* (in bioassays) than similarly treated lone workers (S.J. Harcourt unpubl. data). Furthermore, the longevity of *A. flavus* inoculated wasps in groups was not significantly different from lone and grouped control workers (S.J. Harcourt unpubl. data). The hypothesis that wasps possess behavioural and/or physiological adaptations which limit the transmission of pathogens between nest-mates was proposed.

The aim of this chapter was to address the need to qualitatively evaluate the role of individual workers in disease transmission. To meet this objective, the transfer of pathogens between workers, and between workers and larvae, was monitored to determine whether the dissemination of pathogens was limited by the wasps at the point of primary infection. Different methods of inoculation were compared to assess the potential of fungi and bacteria as inundative wasp control agents.

## Materials and Methods

The transfer of fungal spores was investigated using *B. bassiana* (strain F180). Strain F180 was chosen because it was effective in larval (Harris *et al.* 2000) and adult bioassays (Chapter Two) and had the advantage of being easy to culture and to re-isolate. Experiments were conducted over four months. Practicalities (wasp availability, time constraints, preparation time and results assessment) prevented the completion of all assays in one experiment, however, consistency of method ensured comparability between experiments. In each experiment, inoculated individuals were placed with non-inoculated individuals that were monitored daily for mortality. Bioassays were performed according to the principles of Koch's postulates (outlined in Chapter Two). Non-inoculated individuals were incubated at 44% RH for the duration of each experiment. *Vespula germanica* and *V. vulgaris* wasps were used (depending on availability), but each experimental chamber comprised wasps of one species acquired from the same colony. Between nest variation was a concern but was not easily controlled due to the extended period of experimentation and the

availability of nests. Transfer of inoculum (*B. bassiana* @  $1 \times 10^7$  spores/ml) between three groups was investigated as follows:

**Adult-adult transfer:** Three replicates consisting of a single inoculated and four non-inoculated newly emerged workers were placed into a 300 ml ventilated plastic pot. The treated individual was either fed, dipped, sprayed or dusted using identical methods to the adult bioassay (Chapter Two), and marked on the thorax for identification with 'Twink' correction fluid (Mitchell and Dean Ltd, Auckland). Control replicates were similarly set up with the omission of pathogenic inoculum. Wasps were fed with 30% sucrose solution, and the fate of both the inoculated and non-inoculated workers was recorded daily.

**Adult-larvae transfer:** In three replicated experiments five inoculated workers were placed into a 300 ml ventilated plastic pot containing a small section of comb. The comb was cleared of all but 15 apparently healthy fifth instar larvae. The workers were either fed, dipped, sprayed or dusted as before and placed into the plastic pots. After 72 h workers were removed. Five larvae were also removed, then macerated and incubated on JC agar to determine the presence/absence of F180. Mortality and pupation of the remaining 10 larvae were recorded daily. Control larva and adult replicates were similarly set up with the omission of pathogenic inoculum. At the conclusion of the experiment, emergent workers and dead pupae were placed on damp filter paper to encourage conidial development and record the presence of strain F180.

**Larvae-adult transfer:** Three replicates of 15 apparently healthy fifth instar larvae were either orally dosed, sprayed, or dusted. Orally dosed larvae individually received one 10  $\mu$ l aliquot of a 50:50 solution of spore suspension : 30% sugar syrup in sterile water. Spray treatments (100  $\mu$ l) were applied directly to wasp comb containing the larvae using the spray tower as described in Chapter Two. Dry spores were applied using a small artist's brush to lightly coat the larvae with spores obtained from F180 colonies cultured on PDA. Comb containing treated larvae was placed into a ventilated plastic container and maintained at 30°C, 50% RH for the duration of the experiment (up to 30 days). Five newly-emerged, non-inoculated workers were added to the container after four hours. Workers were removed after 24 hours, and maintained and fed

individually in humidity-augmented (~50%RH) Petri dishes and monitored until death. Control workers and larvae were similarly treated, with the omission of pathogenic inoculum, and maintained for the duration of the experiment. Cadavers were plated onto JC agar, and incubated at 30°C until sporulation occurred, to establish the presence of strain F180.

The transfer of bacteria was also investigated. However, since no pathogenic strains had been identified (see Chapter Two), only the presence or absence of the inoculum was studied. The bacterium *Serratia marcescens* (isolate 363) was used as an assay organism because it is not commonly isolated from wasps and was visually identifiable by its red colour. The use of *S. marcescens* provides a model system for tracking the transmission of bacteria between wasps and workers and will be valuable if pathogenic bacterial strains are discovered. The application and experimental techniques were as outlined for the fungi but the non-inoculated individuals were macerated and incubated on PDA to determine the level of transmission.

Transfer assay data were recorded as presence-absence, or mortality data. The mortality data for larvae and adults were analysed using the same LIFEREG and LIFETEST formulae (Anon. 1989) as in the adult bioassay (Chapter Two). Adult-larva transfer data are presented as the percent emergence of non-inoculated larvae after pupation.

## Results

**Adult-adult:** For dipped and dusted adults at a 1:4 ratio of exposed to unexposed workers, the unexposed wasps died at a rate that did not differ significantly from those directly exposed to the fungus ( $P>0.05$ ). As expected from Chapter Two, dipped and dust inoculated workers had significantly reduced longevity compared with the controls ( $P<0.05$ ). The longevity of non-inoculated adults was significantly less than the controls in the dipping and dusting treatments ( $P=0.001$ ). Significant levels of mortality was recorded for the inoculated individuals in both the oral and spray treatments ( $P<0.001$ ). However, the transfer of spores from oral-inoculated and spray-inoculated workers failed to induce a significant reduction in longevity of non-inoculated

workers. Spores were recovered from over 90% of the non-inoculated individuals in all treatments.

**Larvae-adult:** The presence of treated larvae significantly reduced the longevity of non-inoculated adults added to the comb (oral  $P=0.0235$ , sprayed  $P=0.0042$ , dusted  $P<0.0001$ ) and F180 was recovered from all the workers. Oral inoculation of larvae resulted in the largest reduction in mean longevity for the non-inoculated workers. The oral transfer assays from larvae to adults resulted in a significant reduction in larval survival compared with the control. Larvae died rapidly after treatment, but did not support sporulation while the workers were in contact with them. In all treatments, mean longevity of treated workers was significantly less than control workers (Table 3.1). Viable infections were recovered from emerging adults inoculated before pupation.

**Adult-larvae:** Inoculated workers died rapidly in all treatments (rarely surviving > 48 hours). Larvae removed after 72 hours had F180 spores present. Significant reductions in the number of the remaining larvae emerging were recorded for dipping ( $P=0.0123$ ) and dusting ( $P=0.0017$ ) inoculation methods, but not for the spray ( $P=0.1769$ ) or oral inoculation ( $P=0.0681$ ). Those pupae that did not emerge after exposure to the adults that had received spray treatment were covered in sporulating F180, whereas those pupae that did not emerge in the controls showed no obvious sign of pathogen infection. In F180 treatments where some of the untreated larvae completed development, viable spores were recovered from newly emerged adults (oral 71%, spray 19%).

*Serratia marcescens* (strain 363) was readily transferred between adults and between adults and larvae from both dipping and oral applications. Adult-larval transmission resulted in the recovery of strain 363 in 48.5% of the non-inoculated larvae in the dipping assay and 40% in the oral assay. The adult-adult assay resulted in infection of 93.33% of the non-inoculated workers in the dipping assay and 76.32% in the oral assay. Infection of 84% of the non-inoculated adults in the larvae-adult assay was achieved. The dipping assay was not practical with larvae.

Table 3.1: Mean life expectancy and percent emergence of non-inoculated workers and larvae (respectively) resulting from the transfer of *Beauveria bassiana* (F180) from inoculated individuals. Mean  $\pm$  SE. \* different from control at 95% level of significance.

Transfer	Treatment	Application Method			
		Dipped	Dust	Spray	Oral
<i>Adult longevity (days)</i>					
Adult-adult	F180	7.6 $\pm$ 0.2*	4.1 $\pm$ 0.2*	18.8 $\pm$ 1.0	13.5 $\pm$ 2.2
	Control	24.9 $\pm$ 3.0	8.7 $\pm$ 0.9	19.7 $\pm$ 0.8	12.7 $\pm$ 1.9
Larvae-adult	F180	-	5.5 $\pm$ 0.1*	5.3 $\pm$ 0.6*	3.5 $\pm$ 0.4*
	Control	-	16.6 $\pm$ 1.4	9.5 $\pm$ 1.3	13.9 $\pm$ 3.6
<i>Larval emergence (%)</i>					
Adult-larvae	F180	0 $\pm$ 0*	0 $\pm$ 0*	48.2 $\pm$ 5.3	15.6 $\pm$ 8.7
	Control	22.2 $\pm$ 9.1	43.9 $\pm$ 5.2	60.7 $\pm$ 6.8	14.4 $\pm$ 7.8

## Discussion

The bioassays conducted here confirm that viable spores are readily passed between workers, and between workers and larvae. This rapid transfer of spores would be crucial for the success of a potential pathogen control agent. Sufficient spores were transferred to cause mortality of the recipient individual, be it adult or larva.

**Concentration:** The *B. bassiana* dose given to the carrier was sufficient to kill quickly even in the oral treatment. The volume of inoculum transferred to the recipient individual must be greatly reduced compared with the primary host. However, the effective dose to non-inoculated individuals in the dipping transfer assay (adult-adult) resulted in a similar level of mortality to that seen in the adult bioassay. This indicates that the concentration and/or the volume (i.e., dose) of inoculum in the adult bioassay for F180 was far in excess of the lethal dose.

**Trophallaxis:** The reduced longevity observed in the adult-larval interactions, compared with the adult-adult interactions and the control, was significant ( $P < 0.05$ ). This may be due to the fastidious nature of food exchange between adults, unlike the interactions between adults and larvae (more liquid contamination of the mouth parts). It could also be an artefact of greater

interaction between larvae and adults than between adults. Trophallaxis is obviously the major dispersal mechanism for imbibed inoculum between adults and larvae, but may also increase (through increased interaction) the transmission of pathogens from the surface inoculations (dust, spray and dip). It is important to note that the larval spray treatment resulted in large quantities of inoculum on the comb substrata. This inoculum would have contributed to the transmission to adults.

The insignificant reduction in longevity for the oral and spray treatments for the adult-larval assay (Table 3.1) may reflect the nature of the interactions between the two life stages. All workers tested were newly emerged and would therefore rely on larvae for sustenance (Spradbery 1973). The interactions between larvae and newly emerged adults involves a one way passage of saliva. This restricts transmission of the inoculum from adult to larvae. In the field, foragers would bring prey to the larvae and therefore the interactions would be more bi-directional and contamination would possibly be more widespread.

High levels of personal grooming (compared with control workers) by adults after imbibing inoculum was evident in all oral inoculations. Wasps, like most insects are well adapted for grooming the oral appendages and the lack of lethal effects resulting from transfer in the oral adult-adult assay may reflect this. Fastidious grooming may remove a large proportion of the spores from the mouthparts of an orally-inoculated worker, but not sufficient to prevent infection. Significant reduction in worker longevity in the oral inoculations of the adult bioassays (see Chapter Two) supports this supposition. Grooming behaviour combined with low volumes of inoculum must result in less available inoculum for transmission and therefore lower levels of mortality in the non-inoculated individuals.

**Humidity:** The non-inoculated individuals were incubated at approximately 44% RH for the duration of the experiment. It has been suggested that this is not optimal for the germination and sporulation of *Beauveria bassiana* spores (T.R. Glare 1999, pers. comm.). Certainly, greater toxicity was achieved in the adult and larval bioassays by increasing the humidity during germination (Chapter Two). Dipping wasps invariably increased the moisture levels in the



experimental chamber, which would have increased the humidity and resulted in higher levels of viable spore germination. Small pieces of damp filter paper were added to the Petri dishes when workers were separated from the groups (within 72 hours). Transferred spores may not have germinated immediately but once in the Petri dish the infection process could begin. This demonstrates one of the advantages of fungal pathogens. In the right conditions, fungi can remain viable for months or even years (Boucias and Pendland 1998). Viable spores can endure environmental suppression, then germinate within hours when the appropriate conditions occur (Boucias and Pendland 1998).

**Spore adhesion:** The three treatment techniques delivered the dose in different forms. The dipped wasps were saturated with spore suspension. Once dry, many spores would fall or be knocked from the carrier's body. The sprayed individuals received a thin even coat of spores, which would adhere to the wasp's body, and fewer spores are available to disseminate. In the oral treatment, however, the majority of the inoculum was imbibed (possibly ineffective) and only a small proportion of spores remain externally. However, germination of *B. bassiana* spores in the crop of ants has been reported (Siebeneicher *et al.* 1992). The carrier may still die rapidly but transmission would not be widespread. A dry spore inoculation is a promising method for future research as it allows more transmission through contact and from spores falling from the body. This is demonstrated by the 100% infection and mortality of larvae in the dusted adult-larval assay. *Metarhizium anisopliae* is already used in bait stations in dry spore formulations, for the biological control of cockroaches (Biopath) and termites (Bioblast) (EcoScience Corporation, East Brunswick, NJ). However, the indoor environment is vastly different from native beech forests of the South Island and trials are needed to test the efficacy of this application method. *M. anisopliae* and *B. bassiana* spores are quite different in size, which may have a bearing on the dispersal and transmission of inoculum.

The transfer of bacteria from adults to larvae and vice versa resulted in viable bacterial contamination in the recipient group. The bacteria used to trace the movement of cells were from the genus *Serratia*, which did not show any toxicity towards wasp adults or larvae (see Chapter Two). Transfer of viable *S. marcescens* (363) cells between adult wasps has been demonstrated

and it is known not to effect the longevity of the hosts (Chapter Two). The transmission of bacteria was also demonstrated between adults and larvae. For control purposes, it is advantageous that bacteria are readily transmitted in a viable state among nest mates. The identification of a pathogenic bacterial strain would be useful if this high level of transmission is achievable in an active nest. It is also interesting to note that *S. marcescens* was easily isolated from larvae despite indications that it is highly susceptible to antibiotics contained in larval saliva (Chapter Four).

The method of applying a pathogen may influence the transfer between nest-mates. Exchange of food from larvae to adults (trophallaxis) resulted in the transfer of lethal doses. A dry spore inoculum may facilitate greater transmission through contact as well as more spores falling from the body and transferring to other individuals. The results presented here demonstrate the potential for transfer of lethal doses of pathogenic fungi between nest-mates in an artificial environment. The extrapolation of these findings into a colony environment enhances the perceived potential of microbial control agents for wasps. In practice, many other factors contribute to the containment of disease and the establishment of an epizootic in an active colony may be very difficult to achieve.

# Chapter Four

## Anti-microbial properties of wasp exocrine secretions, venom and larval saliva

### Introduction

In earlier Chapters, the ubiquitous presence of disease in most insect populations has been discussed. Though infection and the occurrence of epizootics are often cyclic, they can have devastating effects on the host population when established (Allen and Buren' 1974, Andrade 1980, Samson *et al.* 1981). Contagious diseases affect many insects and those that live close together are especially susceptible to infection from transmitted disease. In particular, those organised into highly integrated societies are most at risk due to the regularity of interaction. This has been demonstrated in Chapter Three. In social insects, this susceptibility is compounded by the close genetic relationship of all individuals, which makes their colonies particularly vulnerable to epidemics (Veal *et al.* 1992). Therefore, social insects appear to be extremely vulnerable to attack from micro-organisms. Despite this, social wasps are remarkably unaffected by the multitude of potentially pathogenic micro-organisms within their environments. A key question is: how do social wasps defend themselves against proliferation of pathogenic micro-organisms?

Individual adult wasps and larvae may succumb to disease. However, few studies have investigated possible pathogenic organisms or the colony defences against them. Among the physiological defence mechanisms, the cellular and humoral defence mechanisms of the nervous, endocrine and immune systems play a decisive role in insect defence against microbial antagonists (Gliñshi and Jarosz 1995b). This area has been extensively studied for many insects (including social species) and there are several good reviews (e.g., Boucias and Latgé 1988, Hajek and St Leger 1994, Gliñshi and Jarosz 1995a). However, laboratory bioassays have shown that humoral defence is not the key to this apparent resistance to attack

by fungi (see Chapter Two). As insects lack the complexity of the vertebrate immune system, alternative defence mechanisms have evolved that protect them against infections (Gliński and Jarosz 1995b).

There have been reports that insects produce extra-cellular antimicrobial substances, most of which are non-specific, broad spectrum defence mechanisms (Blum *et al.* 1958, Sannasi and Sundara Rajulu 1967, Orbin and Vander Meer 1985, Beattie *et al.* 1986, Cherrett 1986, Kaaya 1989, Veal *et al.* 1992, Oi and Pereira 1993). This is especially true in the case of social insects and particularly the eusocial Hymenoptera. Many ants, wasps and bees incorporate antibiotics and fungicides into their venom, saliva and propolis (Schildknecht 1971, Gambino 1988, Tomlinson and Williams 1985). Literature on *Vespula* venom primarily deals with its allergenic and toxic properties while larval saliva has been revealed to have antibiotic properties (Gambino 1993). It is this type of defence that will be discussed in this chapter, focusing on factors that may limit the growth and proliferation of pathogenic micro-organisms in the nest environment.

**Nest hygiene in eusocial insects:** Though diverse in many ways, there are also many instances of functional homology among social insects, especially with regard to colony defence and hygiene. Termites, *Odontotermes gurdaspurensis* Holmgren (Sannasi and Sundara Rajulu 1967), *Microtermes bellicosus* (Smeathman) (Batra and Batra 1966), *Termes redemanni* (Wasmann) (Sannasi and Sundara Rajulu 1967); ants, *Atta sexdens* L. (Schildknecht 1971), *Myrmecia nigriscapa* Roger (Beattie *et al.* 1985), *Solenopsis invicta* Buren (Orbin and Vander Meer 1985, Storey *et al.* 1991); and bees, *Apis mellifera* (L.) (Gliński and Jarosz 1995a) are some examples of eusocial Hymenoptera that use anti-microbial substances to maintain healthy colonies.

**Wasps:** The Vespoidea (true wasps) and particularly the Vespidae have developed an array of characteristics that enable them to resist the progression of disease. Foremost of these is their dedication to the maintenance of nest hygiene. This is achieved by fastidious cleaning behaviour aided, for many species, by a chemical milieu every bit as complex as that seen in their more distant aculeate relatives the Formicoidea (ants) and Apoidea (bees). Apart from behavioural and physiological adaptations, the Vespidae have undergone an evolutionary transformation resulting in a life habit ideally suited to a colonial existence in temperate and

sub-tropical habitats. The success of these strategies is exemplified by the lack of evidence of pathogens in most *Vespula* nests excavated and the absence of published accounts of nests succumbing to pathogen attack. Moreover, it has proved difficult to initiate an epizootic in *Vespula* nests at the peak of the season (R.J. Harris, unpublished data<sup>1</sup>).

Contrary to the popular perception that healthy wasp nests are relatively pathogen free, we now know that nests contain a great variety of micro-organisms (Gambino and Thomas 1988, Glare *et al.* 1996), some of which are pathogenic. It was hypothesised that the reason nests are not overwhelmed by these pathogens is due to some biochemical suppressants produced by the wasps. The spectrum of activity and the toxicity of the proposed chemical suppressants will have significant ramifications on the selection of pathogens for the biological control of wasps. The aim of the research in this chapter was to investigate the antibiotic and fungicidal properties of venom and larval saliva as possible mechanisms for the suppression of pathogen attack within wasp nests. The chapter is presented in three sections that address the stages of the investigation into the properties of venom and larval saliva:

- preliminary anti-microbial experiments: growth plate assays;
- anti-fungal properties of venom: germination assays; and
- anti-bacterial properties of larval saliva: liquid media assays.

---

<sup>1</sup> Field trials conducted subsequent to the experiments presented in Chapter Four. These experiments were conducted on large nests at the height of the season with limited impact of the fungus on colony vigour.

## Preliminary experiments: Growth plate assays

### Introduction

***Aspergillus flavus*:** The genus *Aspergillus* exists mainly as a ubiquitous saprophytic mould (Boucias and Pentland 1998). A number of species, such as *A. flavus*, are entomopathogenic and, occasionally, saprophytic on plant material. *A. flavus* is one of the most common fungi found in association with many social insects, e.g., termites, *Odontotermes latericius* (Haviland) (Sellschop 1965), *Termes redemanni* (Sannasi and Sundara Rajulu 1967), *Reticulitermes flavipes* (Kollar) and *R. virginicus* (Banks) (Beal and Kais 1962); ants, *Atta capiguara* Goncalves and *A. vollenweideri* (Forel) (Cherrett 1989); bees, *Apis mellifera* (Gliñshi and Jarosz 1995b); wasps, *Vespula vulgaris* and *V. germanica* (Glare *et al.* 1996, Rose *et al.* 1999), *V. pennsylvanica* (Gambino 1988), *Polistes hebraeus* (F.) (Fouillaud and Morel 1995). It is both saprophytic and pathogenic on these insects as well as being a commensal, living in the soil or in the nest substrate. All the termites, bees and wasps and possibly the ants mentioned above, plus many other insects, are susceptible to attack by this fungus. In most, it results in rapid death in laboratory bioassays (Beal and Kais 1962, Sannasi and Sundara Rajulu 1967, Sands 1969, Fouillaud and Morel 1995, Gliñshi and Jarosz 1995b, Harris *et al.* in press). However, it is not attributed with significant population regulation in eusocial Hymenoptera, nor has it been utilised in an effective pathogen-based biological control strategy against this group.

***Vespula - Aspergillus flavus* complex:** *A. flavus* grows and sporulates on untended nest paper of *Vespula* and requires micro-climatic conditions equivalent to those found in the nest chamber of an active colony to germinate (Appendix Two). Spores of this fungus are common in wasp nests and, in laboratory bioassays, *A. flavus* kills *Vespula* adults (see Chapter Two) and larvae (Harris *et al.* 2000) as effectively as *B. bassiana*. However, no wasp colonies have been seen to fail as a direct result of this fungus and, even late in the season during colony decline, its impact seems limited. The interaction between *Vespula* and *A. flavus* has not been studied in any detail and no analogous occurrences are evident among other Vespoidea. It is not known whether wasps are able to detect and remove individual spores. Even if they were

able to do so, it would be impossible to remove all spores of *A. flavus* from the many undulations and irregularities of the nests, not to mention those built into the paper envelope and carton. The physical removal of fungal hyphae and spores would be a labour-intensive task. There is, however, an available labour force for such a task and its importance to colony success is indisputable.

It has been suggested that wasps must possess some antimicrobial substance that is used to sanitise the nest environment (Akre and MacDonald 1986, Gambino 1993, Glare *et al.* 1996). Growth plate assays were used to give a fast and simple indication of the source of any antimicrobial substance in wasp colonies. The primary question was: does any portion of a wasp's body, or its exudates, inhibit microbial growth when applied to the inoculated growth media?

## Materials and methods

Cultures of the bacteria *Bacillus thuringiensis*, var. *israelensis* (Bti), var. *san diego* (Btsd), var. *beubeu* (Btb), *Serratia entomophila* (isolate 154), *S. marcescens* (isolates 363, 457, and 458) *Entobacter* sp. (isolate K) and the fungi *B. bassiana* (isolates F180, F233, and F234) and *A. flavus* (isolate F202) were used as bioassay organisms. The method for preparing pathogen suspensions was described in Chapter Two. Venom was collected by dissecting venom sacs from freshly killed mature *Vespula germanica* workers. Saliva was solicited by initiating a trophallactic regurgitation from late instar *Vespula* larvae. Venom sacs and larval saliva were inoculated, unrefined, on to the fungal growth soon after extraction. Wasp body sections (head, abdomen and thorax) were macerated separately to a watery paste by adding one ml of distilled water to 10 body sections.

Lauria-Bertani (LB) (Sambrook *et al.* 1989) and Joussier-Catroux (JC), (Joussier and Catroux 1976) agar plates (LB for bacteria and JC for fungi), were inoculated with 100 µl of the bioassay organisms at  $1 \times 10^7$  CFU/ml, covering the surface evenly using a glass spreader. Plates were allowed to dry for several hours, in sterile conditions at room temperature. Each Petri dish was divided in two and 15 treatment arenas (Ø5 mm) drawn on each side. Using a micro-pipette, 5 µl of the treatment suspensions were dispensed into the arenas on one side of each dish (this created a drop of pure saliva approximately 8 mm diameter on the plate

surface). For the venom treatment, one venom sac was placed into each arena. Fifteen equivalent aliquots of distilled water (+ 0.01% Triton X-100) were applied to the control side of each dish. The macerated preparations were similarly applied. The antibiotic, streptomycin sulphate (Agrimycin®17 @ 100 mg/ml), and the fungicide dodine (Malprex @ 600 ppm) were used as a positive control to indicate the upper level of inhibition. Five replicate dishes for each treatment were sealed with parafilm and kept at 30°C and ~54% RH for two weeks. Dishes were checked for any sign of growth inhibition around the arenas at 24 hour intervals. The diameter of inhibition of microbial growth surrounding the treatment area was recorded and analysed using a one-way ANOVA. A one-way analysis was chosen as a simple test for significance between the means of the two replicated samples in each experiment (test and control).

## Results

The macerated body sections resulted in no significant ( $P>0.05$ ) inhibition of any fungi (Table 4.1).

Table 4.1: The inhibitory effect of *Vespula* body parts on the growth of *Aspergillus flavus* (F202). Mean inhibition diameter (mm  $\pm$  standard error) of pathogen growth and control.

	Test	Control	<i>P</i> -value
Head	0.4 $\pm$ 2.0	0.2 $\pm$ 0.1	0.5336
Thorax	1.3 $\pm$ 7.0	0.5 $\pm$ 0.1	0.1734
Abdomen	0.6 $\pm$ 4.1	0.0 $\pm$ 0.0	0.3963

The venom sacs restricted the growth of *A. flavus* compared with the water control, with an average diameter of 8.1  $\pm$  0.8 mm ( $P<0.0001$ ) (Figure 4.1). This was approximately half the effect seen for the positive control, dodine (15.6  $\pm$  2.1 mm), which was significantly different from the water control ( $P<0.0001$ ) and the venom sac treatment ( $P=0.0002$ ). The F180 strain of *B. bassiana* was also inhibited, with an average diameter 3.3  $\pm$  0.7 mm ( $P=0.0001$ ). The two other strains of *B. bassiana* gave no significant inhibition ( $P>0.8500$ ). No bacterium was significantly inhibited by the venom sac treatment (Appendix One, Table 8.1).



Larval saliva significantly inhibited the growth of all the *Bacillus* isolates (mean diameter  $9.8 \pm 0.9$  mm,  $P < 0.0001$ ) and one strain of *S. marcescens* (363) (mean diameter  $6.6 \pm 0.7$  mm,  $P < 0.0001$ ), (Figure 4.2). *B. bassiana* growth was not significantly inhibited compared with the water control, but a narrow inhibition perimeter was detected compared with other uninhibited pathogens (mean diameter  $4.1 \pm 1.3$  mm,  $P = 0.0586$ ). The positive control antibiotic, streptomycin sulphate, greatly restricted the growth of Bti (mean diameter  $42.4 \pm 1.1$  mm,  $P < 0.0001$ ), resulting in an area of inhibition three times the average diameter of inhibition resulting from larval saliva. Bti was most sensitive to saliva, followed by Btsd and Btb (see Appendix One, Table 8.2).

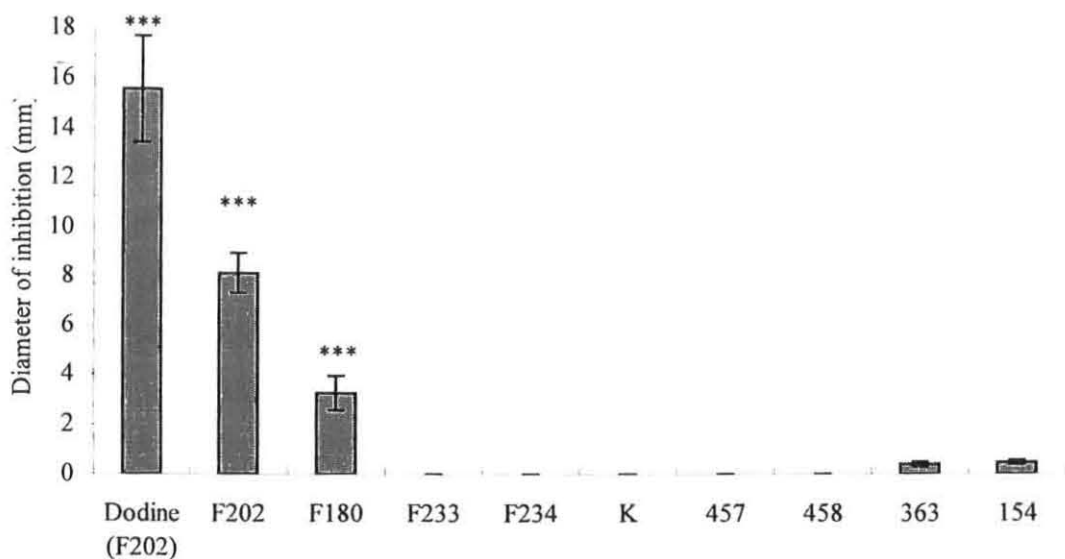

Figure 4.1: The inhibitory effect of *Vespula* venom on the growth of pathogenic fungi and bacteria. Inhibition of pathogen growth normalised to control ( $\pm$  standard error). See Appendix One, Table 8.1 for mean data and significance values. (\*\*\*) significantly different at the 0.1 % level).

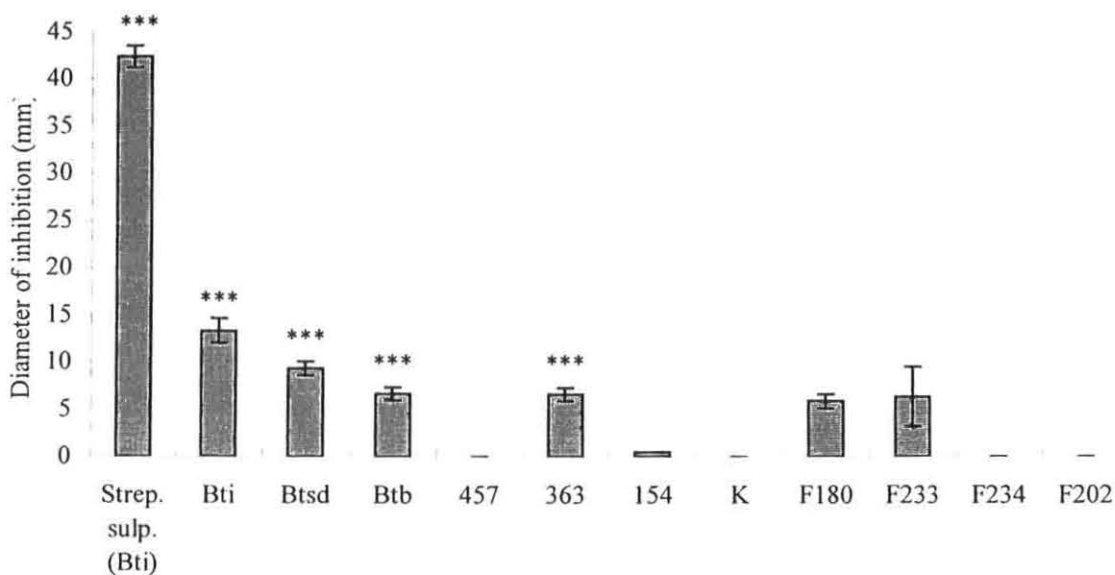

Figure 4.2: The inhibitory effect of *Vespula* larval saliva on the growth of pathogenic bacteria and fungi. Inhibition of pathogen growth normalised to control ( $\pm$  standard error). See Appendix One, Table 8.2 for mean data and significance values. (\*\*\*) significantly different at the 0.1 % level).

## Discussion

The thorax was considered unlikely to reveal any anti-microbial activity because it is primarily a mass of flight muscles containing relatively few glands or excretory organs. The head was tested to examine any effect of glands such as the salivary and hypopharyngeal glands. It was not possible to induce the production of saliva from adults without it being contaminated with regurgitated crop contents. Detailed investigation of one component of the abdomen (venom) was considered a more likely source of fungicidal activity than the investigation of the many glands of the head and thorax. This line of research was therefore followed first.

There were significant effects from the venom sac treatments on fungi, therefore abdomen treatments might be expected to induce inhibition of the same fungi. However, there was considerable variation in the response to dissected venom sacs so the lack of fungal inhibition in this treatment is not unexpected. It may be due to the dilution of any component with anti-microbial properties.

Streptomycin sulphate is a powerful broad-spectrum antibiotic from the aminoglycosides group. The concentration used in this experiment was equivalent to the highest recommended dose for common phyto-pathogenic bacteria and resulted in a very high level of inhibition of all *Bacillus* species. Gambino's (1993) results for the *kurstaki* strain of Bt were supported by results for all three Bt strains tested. Bti was most sensitive followed by Btsd and Btb. The larval saliva was applied unrefined. Saliva is primarily composed of sugars and the components with antibiotic activity are likely to be a very small proportion. The relatively high level of inhibition in the tests with *Bacillus* spp. and *Serratia* spp. indicates that the antibiotic substance in larval saliva is very strong. The higher viscosity of saliva compared with streptomycin may reduce the diameter of inhibition, by limiting diffusion through the substrate.

The F180 strain of *B. bassiana* was also affected by the saliva but the inhibition area was comparatively small and not statistically significant. This result may be influenced by the methodology as the germination results in the next section indicate. The spores of *Beauveria* ( $\text{\O} \sim 2 \mu\text{m}$ ) are much smaller than those of *Aspergillus* ( $\text{\O} \sim 5 \mu\text{m}$ ) and are, therefore, more

prone to any wash effect (spores forced to the perimeter of the inoculation drip by water surface tension) experienced at inoculation. Wash effects are minimised by inoculating the fungus first and allowing time for the conidia to adhere to the agar surface through drying. However, the extremely small size of *B. bassiana* spores results in some wash by capillary action alone.

There was no obvious effect of venom on bacteria, but there was a small amount of inhibition of *B. bassiana* (F180) growth. It appears that this fungus may be simply responding to changes in the growth medium. It is important to recognise that this most likely indicates sensitivity of the fungus to nutrient composition rather than the effectiveness of the venom constituents. *A. flavus* (F202) growth was significantly inhibited by the presence of venom sacs.

These results confirm that adult venom and larval saliva are likely sources of anti-microbial substances in the colony. It is probable that the strength of the activity depends on concentration. It will be necessary to conduct further experiments on venom and saliva in a pure form extracted immediately before application. Larval saliva has broad spectrum antibiotic properties which affect some of the major groups of entomopathogenic bacteria. Adult venom shows fungistatic properties, but seems to be very narrow in its activity range. It is not clear from these experiments whether either of these materials is inhibitory or lethal<sup>2</sup> to the microbes in question. Gambino (1993) indicated larval saliva was lethal against Btk. The growth plate experiments indicated there was potential in this line of research and further experiments were designed.

Further evidence that venom can disrupt the normal growth processes of *A. flavus* was gained when the presence of some unusual growths were observed in the inoculation arena. When venom sacs were inoculated on to plates of *A. flavus*, an area of inhibited growth formed around the inoculation point. When incubated for 10 days (see Methods), several beige coloured masses (diameter 0.5-1.0 mm) began to appear in the centre of the inoculation arena. These growths were round and brittle when crushed. They were most likely sclerotia (Durrell 1965). Sclerotia are stress-induced survival bodies that develop from hyphal growth when

conditions are not suitable for completion of the normal life cycle of a fungus (Ainsworth and Bisby 1961, see sclerotium). Adverse conditions, such as those experienced within the inoculation arena, may well initiate such a reaction. Microscopic investigation of a cross section of these sclerotia revealed little of the structure or composition. When crushed and smeared for investigation with a compound microscope, the growths were a mass of constricted hyphae encapsulated by a sclerotised outer shell (characteristic of sclerotia).

Several sclerotia were washed in a series of distilled water baths to remove any contamination from the surrounding sporulating growth. The clean material was crushed, dehydrated and plated on to PDA (GIBCO, Paisley, Scotland). Within one week, the plates were covered with a thriving mass of sporulating *A. flavus*. It appears that *A. flavus* has evolved an effective endurance state that permits its survival when conditions are not ideal. With the return of favourable environmental conditions rapid proliferation and infection would occur. This fits with the observation that *A. flavus* is present in active nests, but not damaging. However, when adults are removed this fungus proliferates and infects larvae and pupae.

Durrell (1965) investigated the paper of *Vespula* nests and found the chewed fibres to be interlaced with fungal hyphae. Further, he described finding very small fungal sclerotia after dissolving the plant fibre with sulphuric acid ( $H_2SO_4$ ) (leaving the chitinous, dark-pigmented sclerotia). Agar plating of the wasp paper resulted in fungal growth. The most conspicuous species was *Aureobasidium pullulans* (de Bary). The sclerotia and very dark hyphae in the paper appeared to be of this fungus. Several other fungi were identified and all were known or suspected to have cellulolytic activity. Durrell speculated that the function of the fungi was to strengthen the paper given the warm moist environment of the nest. It was noted that most of the fungi were cellulolytic in their activity, which would seem to contradict their proposed purpose. It is more likely that the presence of these fungi is unavoidable given the source of the material used in the production of the nest paper (decaying wood fibre). There is probably a struggle occurring between the wasps and the fungi for survival where the fungi attempt to grow and sporulate in the paper (followed by infection of wasps and larvae for *Aspergillus*) and the wasps are constantly restricting this process through physical and biochemical

---

<sup>2</sup> Inhibitory effect - a temporary suppression of pathogen proliferation without causing death. Lethal effect - the death of pathogenic cells without the possibility of recovery.

intervention. These interventions are likely to include the constant re-constitution of nest paper, grooming and possibly the maintenance of an unfavourable nest chemistry. The paper production process would be a convenient point at which wasps could limit pathogens either physically or chemically, and the regular reconstitution of carton and comb is likely to be responsible for some level of restriction of disease. These factors will be investigated further in subsequent chapters.

## Fungicidal properties of venom: Germination assays

### Introduction

The results of the growth plate assays indicated that the growth of *A. flavus* (F202) and *B. bassiana* (F180) were affected in some way by the presence of venom sacs on the growth media. Due to the design of the growth plate assays, it was not possible to determine whether the inhibition was acting on the germination of spores, the growth of the mycelium or the production of conidia. The following *in-vitro* experiments attempt to isolate the action and give a quantitative measure of the effect of venom on spore germination. The aim of the germination assay was to determine whether wasp venom has properties capable of inhibiting the germination of fungal spores. The following hypothesis was proposed: that exocrine secretion (venom) from the venom gland of *Vespula vulgaris* can inhibit the *in vitro* germination of *A. flavus* and *B. bassiana*.

### Method and Materials

*A. flavus* (F202) and *B. bassiana* (F180) spore suspensions (in 0.05% Triton X-100 surfactant) were prepared at concentrations of  $1 \times 10^5$  spores/ml. From these two base suspensions, an emulsion was produced using 50% JC nutrient broth and 50% spore suspension. Kanomycin sulphate (100 mg/ml) was added (5% of the base suspension) to eliminate bacterial infections resulting from the introduction of the test material. Nine columns (8 wells per column) of a sterile 96 well microtiter plate were loaded with 100  $\mu$ l of the base suspension (five with *A. flavus* and four with *B. bassiana*). The treatments were added to the wells containing the base and spore solution. Each column constituted the eight replicates for each treatment.

The treatments were:

- |   |         |
|---|---------|
| 1). five venom sacs;  | Af + Bb |
| 2). five $\mu\text{l}$ of un-refined larval saliva;                                 | Af + Bb |
| 3). five $\mu\text{l}$ fungicide (Bravo, 500 g/kg aziprotryne);                     | Af + Bb |
| 4). five $\mu\text{g}$ of adult gut (added to the <i>A. flavus</i> treatment only); | Af only |
| 5). five $\mu\text{l}$ sterile tap water.   | Af + Bb |

The sterile water was the neutral control and the adult gut was a control for the venom sacs, which are similarly dissected from the haemolymph and therefore contain various substances which may confound the results. Saliva was added to the test because it appeared to increase the growth of *A. flavus* in some treatments of the preliminary experiments. The plates were incubated in darkness at 30°C for 20 hours.

After incubation, the microtiter plate was placed into a refrigerator (4°C) and the spores were counted immediately. Each suspension was mixed thoroughly and 10  $\mu\text{l}$  was loaded into a haemocytometer to determine the number of germinated and ungerminated spores. The germ tubes are clearly visible under a compound microscope at 400x magnification (Figure 4.3). The counts were done as rapidly as possible (within 2 hours) and in a methodical order (one sample from each treatment counted in groups of eight, and in sequential order for each group) to avoid subsequent germination confounding the results. This experiment was replicated three times and five counts were made from each replicate. The proportion of germinated spores out of the total number of spores was calculated for each replicate and an ANOVA performed on pooled, log transformed<sup>3</sup>, data to identify significant treatment effects. Mean percentage germination ( $\pm$  S.E.) is presented graphically (Figure 4.4 and Figure 4.5). A dilution series of the excess solution was run for each treatment to confirm the counts and determine the inhibitory or lethal nature of the activity. This consisted of a four sequential 10% dilutions of the test suspension which were plated out to count colony formation and therefore number of viable spores.

---

<sup>3</sup> Log transformations were necessary to convert percentage data into a form suitable for ANOVA analysis.



## Results

Germination of *A. flavus* in the control treatment averaged approximately 60%, which reflects the short time of incubation and common viability levels (Figure 4.4). The dissected gut material and the saliva treatment did not restrict the germination of *A. flavus*, resulting in normal growth similar to the control ( $P=0.9969$ ). Only 17% of the spores in the venom sac treatment germinated, significantly less than the control ( $P<0.0001$ ). No germination was evident in the positive control (fungicide) treatment.

In assays for *B. bassiana*, the controls showed a low level of germination ( $18.91 \pm 2.81\%$ ) (Figure 4.5). It is important to note that the counts were made after 20 hours to restrict vegetative growth that causes clumping and hampers counting. This short incubation may not have been sufficient to produce the ultimate level of germination possible. *B. bassiana* is also slower to germinate than *A. flavus* (T.R. Glare 1999, pers. comm.). Saliva did not inhibit the germination of this fungus ( $P=0.6018$ ) and the venom sac treatment significantly increased the level of germination ( $P=0.0004$ ). No germination was evident in the positive control (fungicide) treatment.

A dilution series was performed to determine whether the effect of the venom was inhibitory or lethal. Results indicated that the effect was inhibitory (Figure 4.6). However, it is interesting to note that the undiluted (100%) concentration resulted in no growth indicating that the effect of the venom was strong enough to restrict growth on fresh media. It was only after dilution of the venom treatment that some germination and growth was seen. However, the higher dilutions (1, 0.1, 0.01) limit the available spores and disguises the evidence of the removal of the inhibitory effect. A lesser effect of inhibition was also seen for the fungicide. Given the extremely low number of colonies in the fungicide dilutions, it is possible that many of the spores were also killed in the incubation.

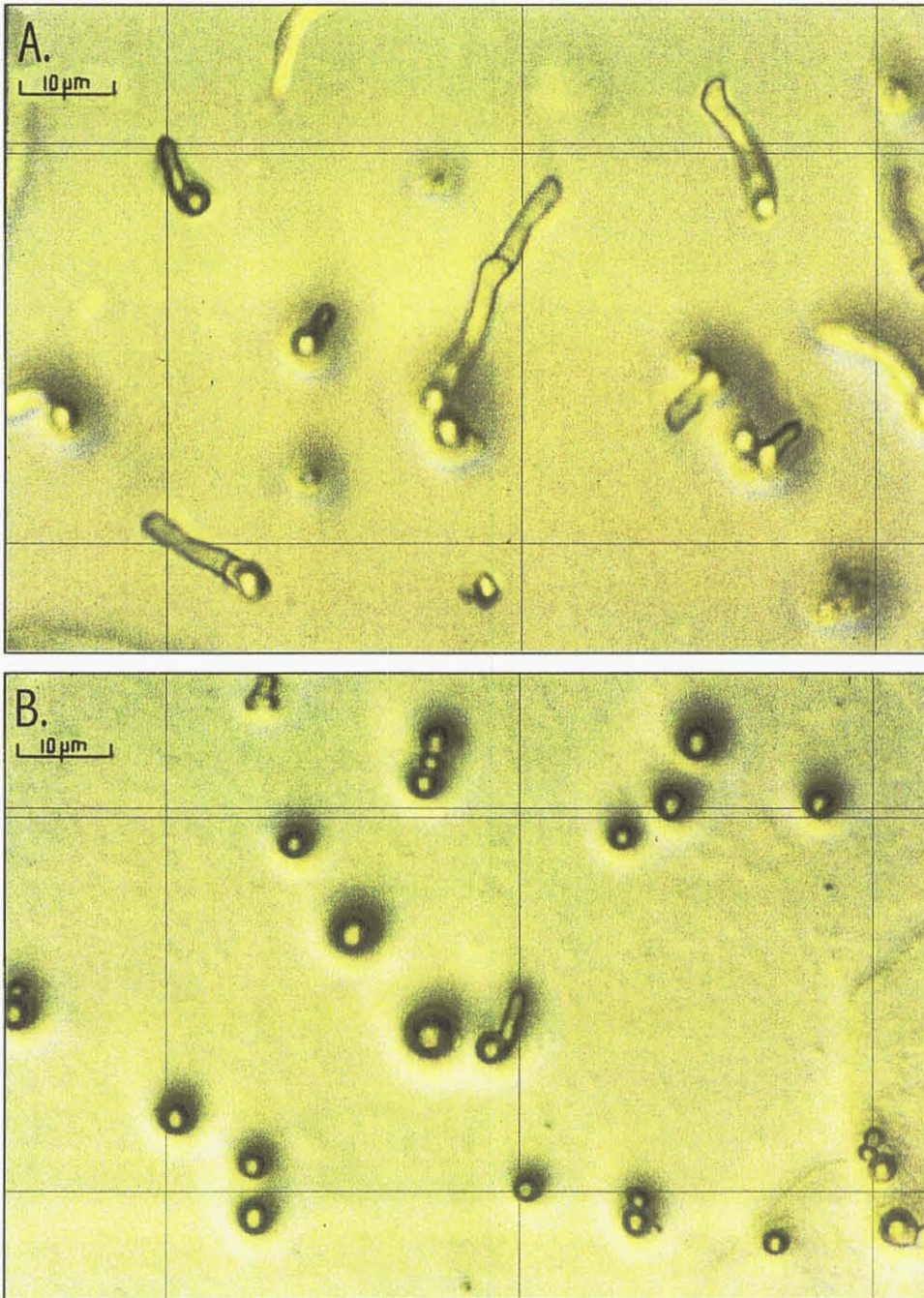

Figure 4.3: In vitro germination of *Aspergillus flavus* spores without (A) and with (B) *Vespa vulgaris* venom sac constituents.

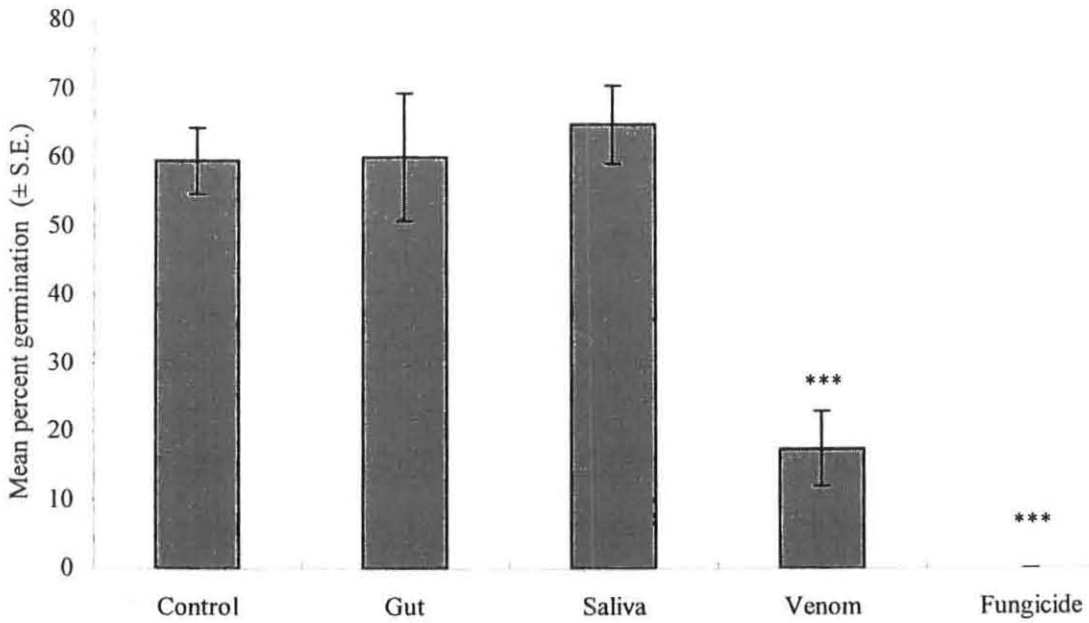

Figure 4.4: Inhibition of *in vitro* *Aspergillus flavus* germination by exocrine secretions of *Vespula vulgaris* after 20 hours. See Appendix One, Table 8.3 for mean data and significance values. (\*\*\*) significantly different at the 0.1% level).

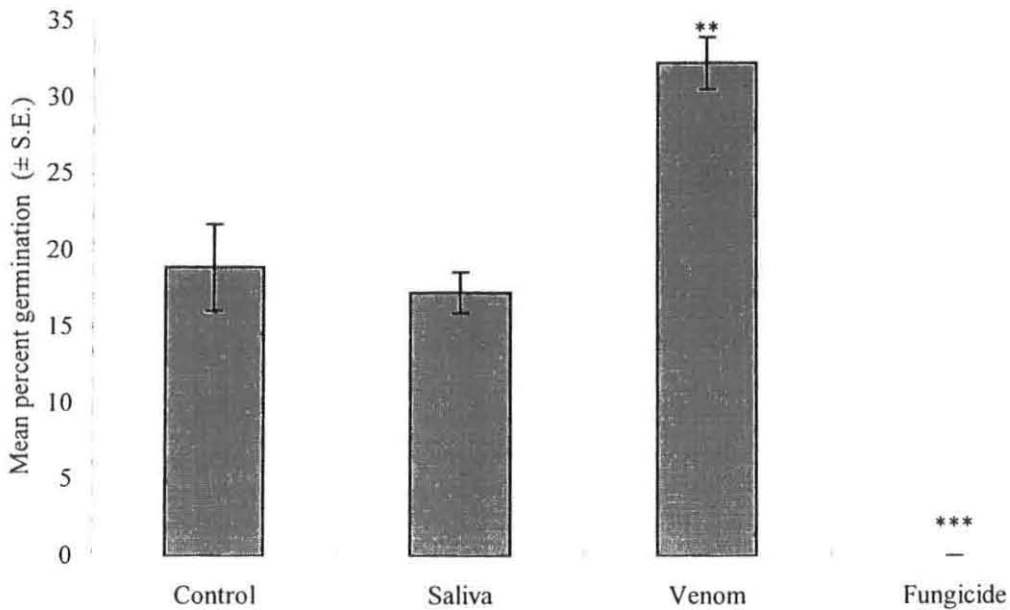

Figure 4.5: Inhibition of *in vitro* *Beauveria bassiana* germination by exocrine secretions of *Vespula vulgaris* after 20 hours. See Appendix One, Table 8.3 for mean data and significance values. (\*\*\*) significantly different at the 0.1% level).

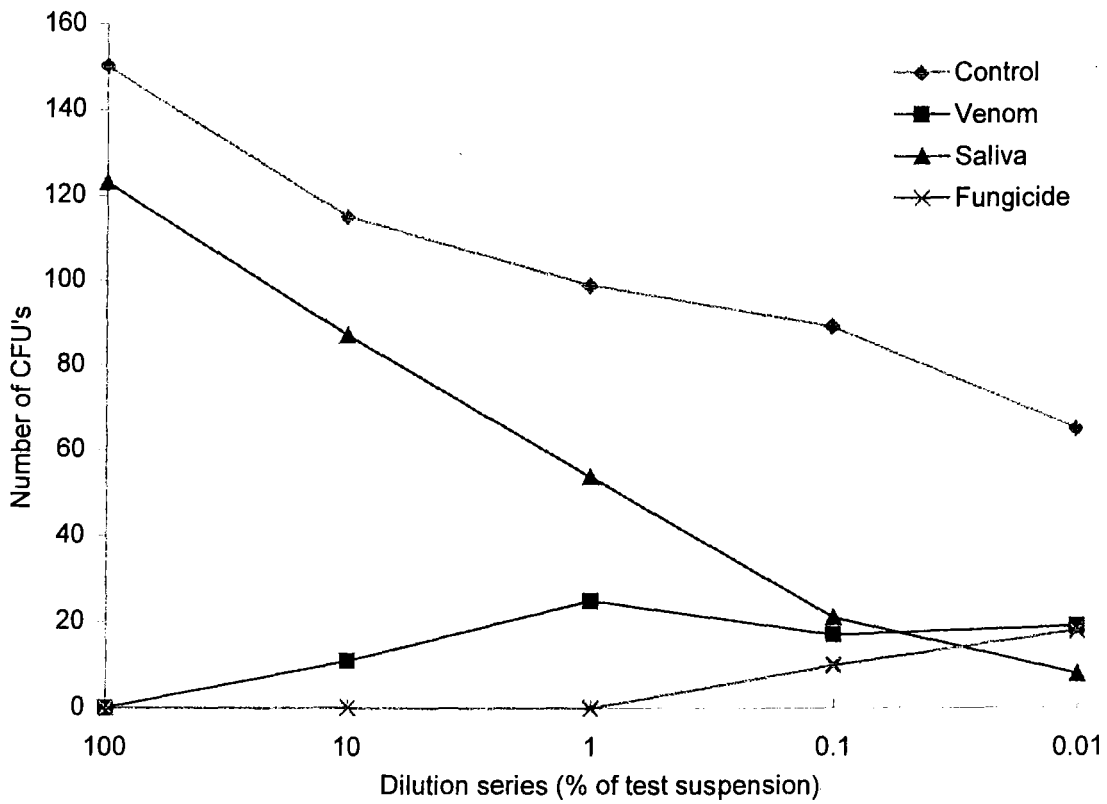

Figure 4.6: Number of CFUs in a dilution series of *Aspergillus flavus* after 20 hours of *in vitro* incubation with exocrine secretions of *Vespula vulgaris*. Number of colony forming units (CFUs) developing on PDA 24 hours after plating.

## Discussion

A key question was: how do wasps restrict the impact of *A. flavus* and other pathogens in the nest? The germination assays reinforced the results from the plate assays, that venom has an inhibitory effect on the germination of *A. flavus*. The effect of saliva on *B. bassiana* seen in the plate assay was most likely an artefact of the method (as described on page 50).

*B. bassiana* was not susceptible to *Vespula* venom in these trials, but is susceptible to the venom alkaloids of the imported fire ant, *Solenopsis invicta* Buren (Storey *et al.* 1991). However, it appears to be relatively tolerant of other alkaloids because it has an enhanced detoxification system to degrade them (Costa and Gaugler 1989). *B. bassiana* is a dimorphic fungus and so has the ability to change growth habits between mycelial and hyphal bodies (yeast-like cells), dependent on environmental factors (Storey *et al.* 1991). Hyphal bodies apparently result from pattern alteration of cell wall synthesis, which leads to fungal cell budding instead of germ tube elongation. Storey *et al.* (1991) showed that the hyphal body stage of this fungus can be induced after 48 hours by the addition of an antagonist, specifically venom alkaloids, to the liquid medium. This suggests that the effect of the venom alkaloids on the fungus is restricted to conidial germination. Very low numbers of hyphal bodies were noted in *B. bassiana* treated with venom, indicating that there may be a subtle effect that is negated by the fungus.

The use of venom for sanitary purposes could involve spraying from the gaster, a behaviour associated with some ants and a few social wasps (Saslavsky *et al.* 1973, Greene *et al.* 1976, Orbin and Vander Meer 1985, Jeanne and Keeping 1995). Sanitation could be efficiently achieved through the airborne dispersal of some inhibitory chemical. Observation colonies set up during this research to monitor workers, revealed no behaviour that could be identified as spraying venom in association with fungi. A constant seepage of venom from the sting apparatus, which is dragged on the nest substratum, is an alternative mechanism for distribution of venom. The presence of fungistatic airborne volatiles, which may or may not originate from the venom gland, is another possible method of fungus control. The van der Vecht organ (see Spradbery 1973) may also be implicated in the dispersal of volatile fungistatic substances. Examination of its structure suggests that the function may be to

produce and disperse pheromones or volatile chemicals. The antero-ventral position on the abdomen is ideally suited to laying down chemical inhibitors during a worker's daily movements over the comb. Norepinephrine has been found in the nest envelop of *Vespula (Paravespula) germanica* (Lecomte *et al.* 1976) and *P. (V.) vulgaris* (Bourdon *et al.* 1975), which Akre and MacDonald (1986) suggested may serve as a protection against microbial invaders. The origin of this chemical is unknown but it could be linked to the van der Vecht organ.

If venom is used by wasps for fungal control, it would be inoculated in regular low volume, high concentration, applications. Such applications would most likely inhibit germination but would not necessarily result in spore death. This is consistent with ecological and experimental observations of *Aspergillus* in wasp nests (see Chapter One), and would explain the rapid proliferation of *A. flavus* when workers are removed from a nest (Glare *et al.* 1996).

The presence of sclerite bodies in the venom assays on *A. flavus* indicates some adaptive strategy on the part of the fungus. Similarly, wasps would appear to have evolved a strategy to suppress *A. flavus*, given that nests are commonly saturated with pathogenic *A. flavus* spores without any apparent evidence of them affecting the health of the colony. The stability and ubiquity of this complex indicates an historical association between host and pathogen.

Bactericidal and fungicidal effects have been demonstrated from a range of ant species (*Solenopsis*, Blum *et al.* 1958, Story *et al.* 1991; *Dolichoderinae*, Paven 1958; *Formica*, Sauerländer 1961). Maschwitz and Kloft (1971) questioned the biological significance of these effects, saying they might be secondary effects of a general toxic action of the venom against living cells. This possibility has not been discounted and until evidence is found to indicate active dispersal of venom within the nest then few conclusions can be drawn.

Another hydroxyl group acid, 5-hydroxytryptamine, is a major component of wasp and hornet venom (Spradbery 1973, Edwards 1980). The major components of fungicultural secretions from the metathoracic glands of attine ants are  $\beta$ -hydroxydecanoic acid (myrmicacin) and phenylacetic acid, both of which are known to show antibiotic activity (Schildknecht and Koob 1970). Whether there are any similarities in the activity of these chemicals is unknown. Myrmicacin has received much attention because bees secrete a homologue with similar

properties (Cherrett 1986). Powell (1984) discovered that myrmicacin, a potent member of a homologous series of 'myrmic acids', reversibly inhibited germination and production of spores in fungi such as *Aspergillus* and *Penicillium*. Its potency, against these common contaminants of attine fungus-gardens, was governed by acidity and it was effective at very low concentrations. This helps explain the observation by Schildknecht and Koob (1971) that the fungus gardens of attines were quickly overrun by contaminant fungi soon after the ants were removed. Parallel observations have been made in wasp nests (P.E.C. Reid 1998, pers. comm.).

Schmidt and Blum (1979) suggested that the chemistry of yellow jacket venom indicates that it functions primarily as a defensive weapon against vertebrate predators. Ants use their stings for defence, prey capture, pheromone dispersal and fungal inhibition (Wilson 1971, Bradshaw and Howse 1984, Orbin and Van der Meer 1985). Although defence is the primary role for venom, it may have other functions. *V. vulgaris* uses its sting to subdue large prey such as cicadas and mantids (S.J. Harcourt pers. obs.). Furthermore, the venom gland in *Vespula squamosa* also contains aggregation pheromones (Landolt and Heath 1987). Alarm pheromones have also been reported for *V. vulgaris* and *V. germanica* (Maschwitz 1964a, 1966), presumably associated with the sting (Edwards 1980). Cole *et al.* (1975) found evidence that common social insect alarm pheromones inhibited radial growth of fungi in plate assays.

The distribution mechanism for such a chemical inhibitor is also available in the form of a sting spray apparatus (Maschwitz and Kloft 1971). In the Vespidae, the muscles of the venom reservoir provide the force that injects venom into the victim ('spray sting type') (Jeanne and Keeping 1995). Venom ejection in wasps is therefore independent of the stinging movement so can be executed at will. Bees and most ants have the 'pump sting type' of venom injection in which the action of the lancets during stinging itself pumps venom into the wound (Maschwitz and Kloft 1971). This ability in wasps has been adapted and used as a defensive behaviour by the Neotropical wasp *Parachartergus colobopterus* (Lichtenstein) (Hymenoptera: Vespidae: Polistinae). This wasp sprays an atomised mist of venom at intruders from the outer surface of the nest (Jeanne and Keeping 1995). Venom spraying by *Parachartergus fraternus* (Gribodo) (Richards 1978, Hermann *et al.* 1993), *Parachartergus aztecus* Willink (Hermann *et al.* 1993), *V. germanica* and *V. vulgaris* (Maschwitz 1964b) has

been recorded, but is suggested to be a result of stinging attempts. Venom spraying has also been reported for *Dolichovespula arenaria* (F.) (Greene *et al.* 1976) and *Vespa orientalis* (F.) (Saslavsky *et al.* 1973). The majority of research on social wasp defence has been restricted to a few easily managed species. It is therefore plausible that the tenet that all social wasps use venom in defence of their colonies almost certainly conceals considerable detail about how the sting is actually used. Further investigation is therefore warranted.

The enclosed nature of *Vespula* nests and the abundance of workers throughout the chamber provide an opportunity to distribute small volumes of highly concentrated exocrine exudates throughout the nest. The constant discharge of these materials ensures wide coverage and accounts for the short effective life of such chemicals. Venom may be used in this way as may other glandular excretions. The production and airborne dispersal of a volatile, fungistatic compound (possibly from the venom gland) would achieve the fungicidal requirements of wasps in this environment, and be consistent with observations of *A. flavus* suppression in the nest. Evidence has been presented for the existence of such a substance in the venom and the effects on the nest environment. However, no evidence exists for the presence of a suitable dispersal mechanism.

There is no conclusive evidence that venom or saliva are used for sterilisation of the nest, but the regularity of trophallactic exchanges between nest-mates and larvae must ensure extensive distribution of saliva throughout the population. The evolution of hymenopteran venoms and sting morphology is characterised by functional parsimony, which is perhaps the key to the success of this group. Social wasps are a very successful group of insects and it is likely that they have evolved a mélange of pheromones and chemical cocktails every bit as complex as those of ants.



# Anti-bacterial properties of larval saliva: Liquid media assays

## Introduction

**Role of trophallaxis:** The exchange of liquids among members of the same colony (trophallaxis) plays a key role in the social organisation of most species of social insect. The term trophallaxis was coined by the famed American entomologist W.M. Wheeler (1910), who proposed the word to describe this reciprocal food exchange in wasps and ants (Spradbery 1973). He later developed his concept of the insect society being a 'super-organism' where the exchange of food involved the transmission of necessary social stimuli. Akre and MacDonald (1986) speculated that this constant contact and exchange of food, in addition to its obvious function, probably plays a large role in maintaining a colony odour. What Akre and MacDonald (1986) were alluding to is probably more accurately described as a social bond or communal identity. This evolutionary acquisition of trophallaxis for societal conjugation has enabled hornets, for example, to maintain a social colony in the absence of a single founding queen (Abe *et al.* 1991). It is one of many social stimuli that colony members frequently encounter (Wilson 1971).

In *Vespula*, the interactions between adults and larvae and among the workers provide the foundations for social life. These interactions are essentially trophic, involving the constant exchange of food and saliva among colony members. It is one of the primary activities observed inside wasp nests (Spradbery 1973; Edwards 1980; Akre *et al.* 1982).

**The role of larval saliva in trophallaxis:** When approached or stimulated by an adult, larvae secrete a drop of liquid from an enlarged salivary gland. Weyrauch (1937) proposed that larval regurgitation has a role in the regulation of nest temperature and humidity, and may also be used by adults to soften earth for excavation. It may also serve an excretory function for larvae by getting rid of excess water (Brain and Brain 1952, Wilson 1971) and as an aid to the intake and digestion of the relatively dry food (Spradbery 1965).

Within wasp nests, there is a high frequency of trophallactic exchanges between adults. Trophallactic exchanges occur between all workers, usually involving the exchange of larval saliva as well as the passing of food from foragers to brood tenders (Spradbery 1973). These exchanges are the mechanism for the distribution of larval saliva and are likely the key to the development of a specific colony odour (Spradbery 1973; Edwards 1980; Matsuura and Yamane 1984).

In chemical studies, Maschwitz (1966) confirmed that the larval saliva was both attractive and nutritive. It contains on average 9% trehalose and glucose, which is approximately four-fold higher than the concentration in larval haemolymph. Amino acids and proteins are also present in saliva but at only 20 percent of the level found in haemolymph. Uric acid and ammonia also occur but in small amounts (Maschwitz 1966). Montagner (1963) and Maschwitz (1966) considered the larval secretions to represent a colony food reserve. Ikan *et al.* (1968) and Ishay and Ikan (1969) discovered that larvae of *Vespa orientalis* are the only colony members capable of converting proteins to carbohydrates. The inability of adult wasps to engage in gluconeogenesis is unusual among insects. This is significant because it shows that larvae can also exhibit altruistic behaviour towards adults and thus they contribute to the homeostatic machinery of the colony (Wilson 1971). It is likely that larvae play an indispensable role as stock foods similar to honey and pollen in honey bee (Abe *et al.* 1991). These are not necessarily the only functions of trophallaxis and it is likely that no single function is the exclusive purpose. It is possible all functions are served by the trophallactic exchanges.

Larval saliva may also function in the maintenance of nest hygiene. The presence of antibiotics in the paper brood cells of wasps is a strong indication that attacks by pathogenic micro-organisms pose a serious threat to colony survival (Spradbery 1973). Juvenile stages of many insects are particularly susceptible to disease, so it is likely that disease constitutes a significant problem for colonial larval stages among social Hymenoptera. Beattie *et al.* (1986) claimed that brood cells that incorporate antibiotics are the very fabric of bee and wasp nests. The analogous process among ants appears to be the secretion of antibiotics from the metapleural glands (Beattie *et al.* 1986). Gambino (1993) first published experimental evidence of antibiotics in the brood chamber of *Vespula* wasps by demonstrating that saliva, the trophallactic regurgitations of wasp larvae, possessed antibiotic properties. Treatment

concentrations of approximately six percent saliva suppressed *Bacillus thuringiensis* var. *kurstaki* (Btk) growth in plate bioassays. Further, heat and protease treatments did not diminish the effect. The effect of the saliva was lethal (bactericidal) rather than inhibitory (bacteriostatic) against Btk (Gambino 1993). Bt is only one of many pathogenic microorganisms to which wasp colonies could potentially be exposed. The antibiotic effects of saliva may be equally broad.

The aim of the research in this section was to establish a baseline by corroborating Gambino's (1993) results for *Bacillus* and determine the range of pathogens affected by antibiotics present in larval saliva. It was hypothesised that larval saliva from *V. vulgaris* contained a broad spectrum antibiotic capable of inhibiting *in vitro* growth of bacteria from various pathogenic genera.

## Materials and methods

**Liquid media assay:** Light absorption analysis was used to determine the level of bacterial cell proliferation in microtiter wells filled with nutrient broth and treated with saliva at several concentrations. Nests of *V. vulgaris* were collected from in and near Christchurch, New Zealand. Comb containing larvae was stored overnight in an incubator at 10°C. Larval saliva was elicited by stimulating the back of the head with a gentle touch to induce regurgitation of salivary gland secretion that was collected in a pipette. Saliva was assayed within one hour of collection.

The bacteria *Bacillus thuringiensis israelensis* (Bti), *Serratia entomophila* (154), *S. marcescens* (363, 457) and *Enterobacter* sp. (K) were used as bioassay organisms. Bacterial cell suspensions (in phosphate buffer) at concentrations of  $1 \times 10^5$  CFU/ml were prepared.

Two 96-well microtiter plates were demarcated as in Figure 4.7. Fifteen microlitres of LB nutrient broth were added to all wells. On plate One, wells A2 to H2 were inoculated with 15 µl of *S. marcescens* (457) suspension, as were A3 to H3, with 154, and so on through 363, K, and Bti. Columns 7 to 11 were similarly inoculated. Saliva was added at 70, 30, 15, 7.5, 2.5, 1, 0.1 and 0.001 % of the base solution, in a descending order, for columns 2-6. Streptomycin

sulphate (100 mg/ml) was similarly added to columns 7-11 at the same concentrations. On plate Two, 15 µl of distilled water (and 0.01% Triton X-100 surfactant) was added to wells A3 to H5. These wells contained the negative control (saliva only) to determine the presence of any contaminating microbes in the saliva or that were picked up during saliva collection. Saliva was added to these wells at the same concentrations as on plate One in three replicates corresponding to columns 3, 4 and 5. Columns 7-11 were control treatments so were inoculated with 15 µl of bacteria, one strain per column.

Once all wells were loaded, the optical density (absorbency) of each well was measured in an ELISA microplate analyser (Biorad model 450) reading at a wavelength of 655 nm. Both plates were incubated in darkness at 30°C. After 20 hours, the microtiter plate was removed from incubation and analysed again.

A four stage dilution series was run to confirm the analysis output and determine the inhibitory or lethal nature of the reaction. Solutions from the 2.5% concentration were used in the dilution series following the microplate analysis. The 2.5% concentration was used because it showed a high level of inhibition without being too high to conceal a drop in inhibitory activity through the dilutions. The dilutions, and therefore the active ingredient (saliva or streptomycin sulphate), should reveal an increase in bacterial proliferation if the active ingredient is inhibitory, or no increases in proliferation if the effect is lethal.

The experiment was replicated three times for saliva, streptomycin, no bacteria and control treatments. The volume of cellular division and therefore bacterial growth was calculated for each replicate by subtracting the initial plate absorbency reading from the second reading. The difference between the light absorbency at the two readings, corresponds to the level of bacterial growth or inhibition. An ANOVA was performed to determine any significant difference in growth between each treatment and the control. Results are presented graphically as the mean increase in optical density (measured in optical density units, ODUs) with standard errors.



## Results

All bacterial strains treated with saliva were significantly inhibited (Figure 4.8). *S. marcescens* strain (363) was the most sensitive to saliva and *S. ficaria* (457) and *Entobacter* sp. (K) the least. Inhibition by saliva was significantly lower ( $P < 0.05$ ) than the antibiotic treatment in the positive control.

There was some bacterial contamination in the 154, Bti and K strains evident from the negative control (saliva only). This was suppressed by the saliva at concentrations greater than one percent, suggesting it is only at very low concentrations of saliva (<1%) that this background contamination is evident (due to the sensitivity of the contaminants to the saliva). The significance of this contamination to the treatments and the experiment as a whole is minimal because it is expressed only at low saliva concentrations and in isolated treatments.

Significant bacterial growth in the positive control (streptomycin sulphate) treatments was evident only at levels below one percent and, for most, below 0.1 percent concentrations. *S. entomophila* (154) was less susceptible to streptomycin sulphate, exhibiting some growth at concentrations over one percent.

Growth in the controls (bacteria only) was consistently high, and similar for all strains ( $P = 0.1024$ ) with a mean ( $\pm$ SE) of  $0.46 \pm 0.03$  ODU's increased absorbency. This indicates that the experimental set-up was consistently precise.

The dilution series showed that saliva generally had a strongly lethal effect on the growth and division of most of the bacteria (i.e., dilution of the suppressing agent and the addition of new nutrient, did not result in increased growth of the pathogen). However, there was one exception; strain 363 plated out in a pure form had a significant number of viable cells ( $>600$  CFU/100 $\mu$ l). By the third dilution (0.1%), there was no significant growth (Figure 4.9c). Because there was no growth in the saliva treatment for this bacterium above one percent, the effect of the saliva may be inhibitory. The difference between pure strain 363 and the control is simply a function of the reduced growth in the saliva treatment during the 20 hours of the

a. *Serratia ficaria* (457)

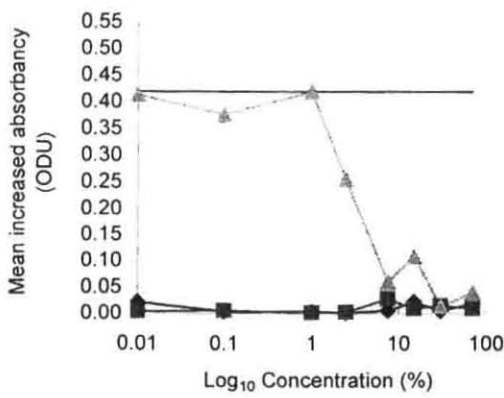

b. *Serratia entomophila* (154)

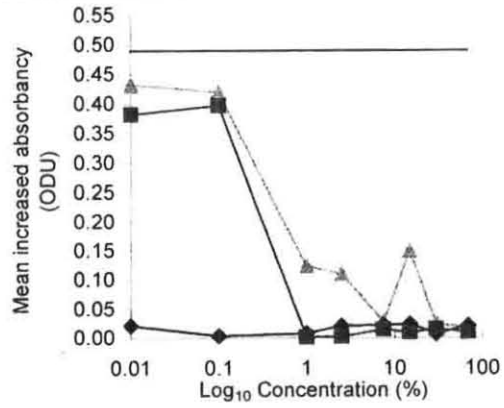

c. *Serratia marcescens* (363)

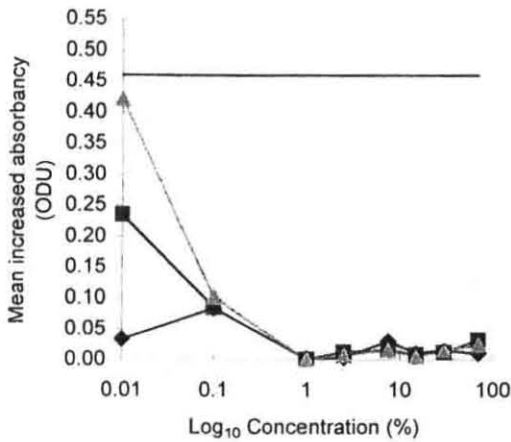

d. *Enterobacter* sp. (K)

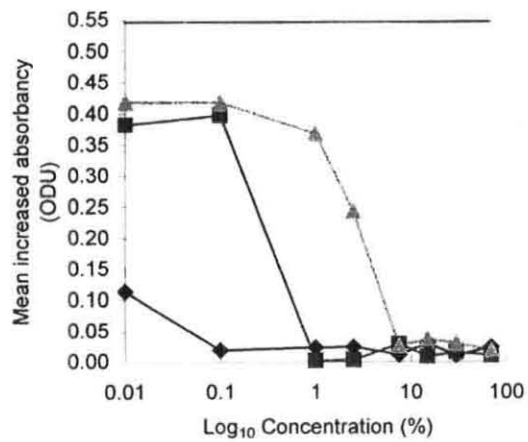

e. *Bacillus thuringiensis israelensis* (Bti).

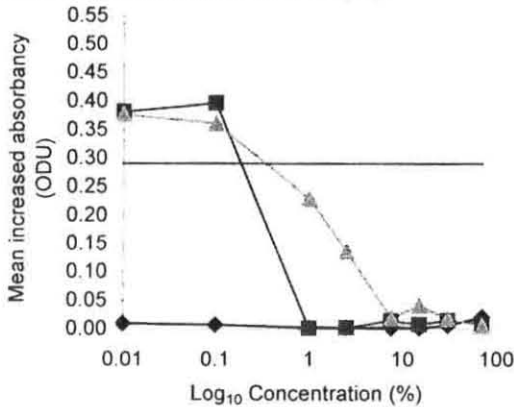

◆ Positive control

■ Negative control

▲ Saliva test

— Control

Figure 4.8: The effect of *Vespa* larval saliva on the change in optical density of pathogen suspensions compared with streptomycin sulphate (positive control) over a 20 hour incubation period. Pathogen only (control) and saliva only (negative control) provide baseline measurements. Results comprise the mean increase in optical density (OD Units).

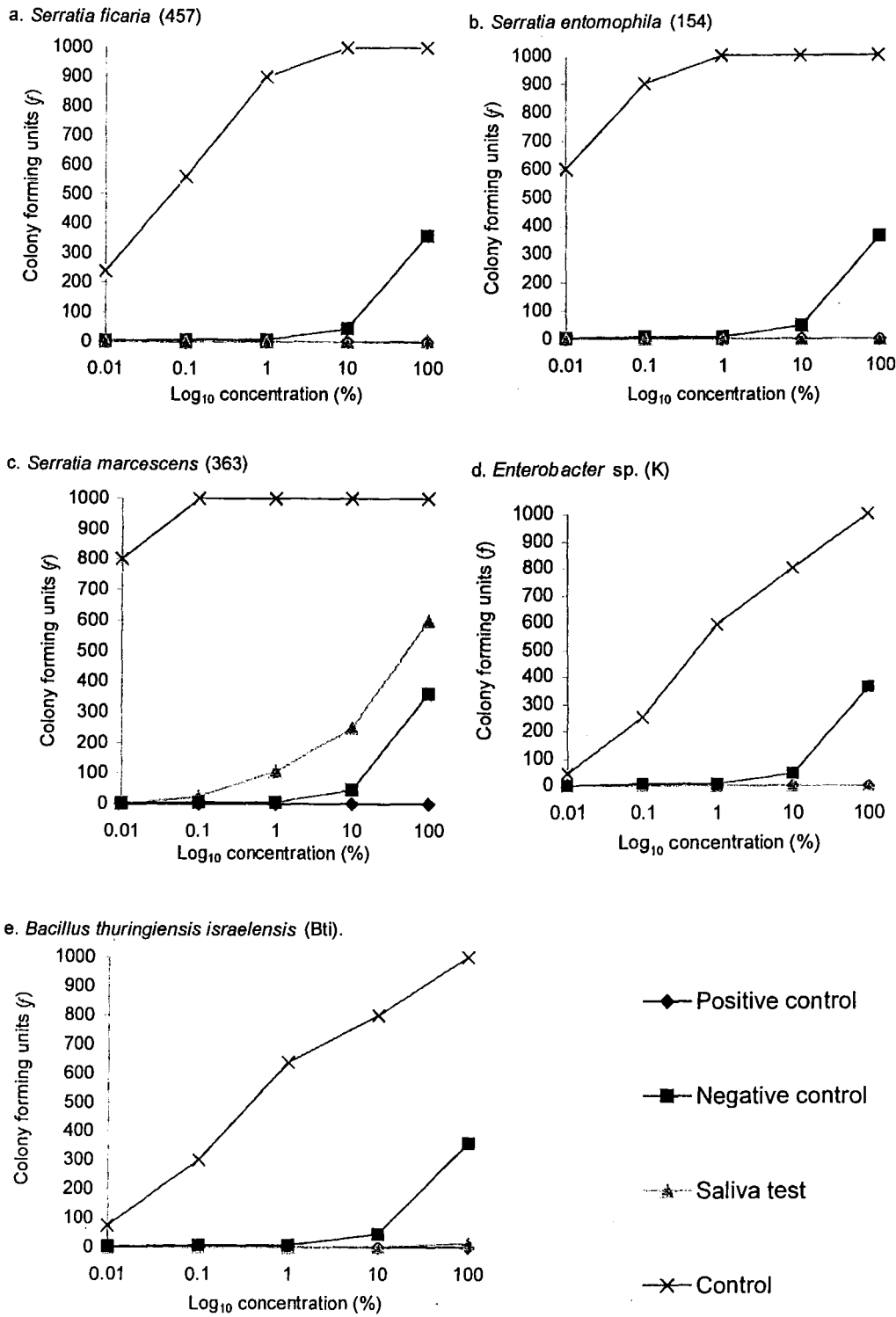

Figure 4.9: Dilution series of treatment suspensions showing the lethal or inhibitory nature of the effect of *Vespula* larval saliva on pathogen proliferation (20 hours incubation at 30°C). Concentration % indicates the percent volume of original test suspension in the dilution.



experiment. Six hundred colony forming units (CFU) in the 363 treatment is the equivalent of  $6 \times 10^3$  cells/ml (close to the starting concentration), while the control with  $1 \times 10^4$  CFU, shows significant proliferation of the bacterium during incubation. This suggests that once the inhibition effect of saliva is removed from the 363 treatment, by plating on a fresh medium, this bacterium can recover and proliferate.

## Discussion

It is possible that the secretions from the salivary gland of wasp larvae have multiple functions. Trophallaxis acts to spread the nutrient load evenly throughout the colony and would likewise spread disease organisms, possibly to the detriment of the colony. However, it is possible that the dissemination, and therefore dilution, of disease agents brought into the nest could be advantageous. It is evident from this research that the concentration of larval saliva (and/or pathogen) is crucial when considering a lethal dose. Therefore, even if the volumes (or relative concentration exposed to infected material) of antibiotics are limited on an individual basis, they would certainly be overwhelming against any small infection if disseminated throughout the colony.

A low level of bacterial contamination in the saliva treatments was unavoidable. The process of pipetting saliva from the mouth parts of larvae for unrefined inoculation into the broth solution almost guarantees this. Centrifuging or using a solvent to extract the active ingredients of the saliva could have minimised contamination. However, a result from those techniques would have little relevance to the survival of a microbial agent in a nest. These bacterial contaminants are, however, suppressed at saliva concentrations above one percent.

Streptomycin sulphate has a very strong antibiotic action that resulted in little or no growth of any bacteria even at the lowest concentrations. The concentration of streptomycin used in these experiments was 0.6 g/l (@170 g/kg A.I. = 0.0035 % A.I.). Larval saliva contains very high levels of carbohydrates and amino acids, but the composition or concentration of the antibiotic substance is unknown. It is likely to be a small proportion of the extracted saliva. If

so, the similarity between saliva and streptomycin in some assays (e.g., strain 363 >0.1%) indicates strong antibiosis in the active ingredient from saliva.

It is clear that saliva contains a strong antibiotic substance with a broad spectrum of activity against the bacteria tested. One of the major reported functions of trophallaxis, and therefore its evolutionary significance, is the distribution of chemicals for the purpose of social bonding and communication (Wilson 1971). All the major theories regarding trophallaxis were formulated long before the discovery of an antibiotic in larval saliva, and since this discovery there has been little consideration of its significance to the evolution of food exchange in vespid wasps. It may be argued that, in order to evolve a gregarious habit, in a temperate environment (with the resulting limitations as outlined in the introduction), it was necessary to develop a range of antimicrobial substances and, subsequently, the mechanism to distribute them throughout the nest.

The reinforcement of social bonding and additional communication may be derived from this need, and have enhanced the success of the social species. Such adaptations would have been necessary for the evolution from solitary proto-hymenopteran (Edwards' 'pro-vespid', 1980) to the advanced eusocial wasps. This expansion into a colonial habit resulted in large colonies capable of producing many thousands of reproductives, thereby increasing the 'genetic fitness' of sterile workers to a level otherwise unattainable. It would have been necessary for the early precursors of social wasps to develop some form of trophallaxis at an early stage for, without it, a colonial lifestyle would be compromised. Hygienic behaviour and the design of the nest contribute to the limitation of disease, but the sheer abundance of trophallactic exchanges and the strength of the antibiotic in saliva indicate that this is a primary line of defence against disease.

The presence of a broad spectrum antibiotic in the saliva of larvae necessitates reconsideration of the role of larvae in the colony. Although, in the strict sense, this regurgitation of salivary gland secretions is an altruistic behaviour (Wilson 1971), there are many first hand benefits to the larvae which characterise this as an egotistic adaptation. From a genetic standpoint, the production and distribution of antibiotics by larvae improves that individual's "inclusive fitness" by contributing to the health of the colony and thereby supporting the production of more reproductives, which carry the genetic load into future generations. By promoting the

survival of siblings (both adult and larvae), which contribute directly to the rearing of that individual by foraging for food or defending the colony, larvae again reap the benefits of their output.

***Significance of antibiosis to the bioassay results:*** It is evident that most of the bacterial pathogens tested in larval bioassays on *Vespula* (Harris *et al.* in press) were susceptible to the antibiotic in larval saliva at very low concentrations (<7 %). In oral bioassays, bacteria were inoculated in a 5 µl drop, which could be diluted by at least 50% given that larvae regularly exude a droplet of saliva of similar volume. It is therefore not surprising that no positive results were obtained using bacteria. The adult bioassays, however, warrant further consideration. The bacteria tested on adults also revealed no significant lethal effect (Chapter Two). The reason for this may be that the bacteria simply are not lethal to adult wasps or that the wasps had imbibed larval saliva before the test. The adults tested were collected from comb after emerging from pupation in the previous 20 hours. The comb invariably contained a number of larvae from which the adults feed during the first few hours after emergence. This could have supplied the adults with enough saliva to counter any bacteria imbibed in the bioassay trial. Because bacteria work effectively as pathogens only when imbibed, this may be a major confounding factor in the results. The significance of the effect of the saliva secretions on the range of bacteria being tested was not known at the time of the bioassays so was not incorporated into the experimental procedure.

***Significance of antibiosis to biological control:*** If the antibiotics in saliva limited the pathogenicity of a bacterium in the bioassays, then it would be of little use in the field, regardless of whether the bacterium can kill adults in the absence of larval secretions. It would be of benefit to run screening assays such as those used here on a wider range of bacteria to determine if any groups are resistant to the antibiotic.

The presence of saliva antibiotics has to be considered in the selection of a pathogen for use as a biological control agent. The possibility of selecting for or producing resistant strains of bacteria to create a pathogen that can survive long enough to infect the haemolymph of the larvae before being killed by saliva should be considered.

Ongoing work aims to investigate the presence of symbiotic bacteria in the larval gut (T.R. Glare 1999, pers. comm.). Such bacteria could have some level of resistance to the antibiotic compounds in the saliva and may therefore offer benefits for future biological control efforts.

# Chapter Five

## Field trial of *Beauveria bassiana* for wasp control

### Introduction

A field experiment was conducted to identify the problems involved with the use of microbial insecticides against wasps. *B. bassiana* has been isolated from wasp nests in New Zealand (Rose *et al.*1999) and is often found in late season (autumn) nests during their decline. As wasp nests are usually subterranean, contact with soil-borne pathogens such as *B. bassiana* would not be uncommon. Results from laboratory bioassays indicate that one isolate of *B. bassiana*, (F180), had potential as a microbial insecticide (R.J. Harris 1999, pers. comm.). It is, therefore, surprising that there are no documented examples of this or any other common soil borne pathogen significantly affecting wasp colonies.

The primary aim of this study was to test the capability of *B. bassiana* to infect and reduce German and common wasps in the field. External and internal nest inoculation methods were also investigated. High dose inoculations, applied directly into the nest, were used to break down any colony defence behaviour in an attempt to induce an epizootic.

### Methods and Materials

*Beauveria bassiana* isolate F180 is held in the AgResearch insect pathogen culture collection at Lincoln. The fungus was cultured and maintained for sporulation on PDA at 20-22°C and subcultured approximately every two weeks. Spore suspensions of  $1 \times 10^8$  spores/ml were prepared by scraping conidia from the plates, suspending in 0.01% Triton X-100 in sterile water, and checked using a haemocytometer. Suspensions were kept at 4°C for a maximum of 48 hours before inoculation. The control treatment consisted of 0.01% Triton X-100 in sterile water.

On the 17 April 1997, a field site was selected at Little River, Banks Peninsula, near Christchurch. This experiment was conducted late in the season so that prerequisite laboratory experiments could be completed first. Six active nests (five *Vespula vulgaris* and one *V. germanica*) within a one hectare area were chosen (only six were found in this location). Traffic counts (the number of foragers entering or exiting per minute, see Malham *et al.* 1991) were made before inoculation and 16 days after inoculation.

Two control nests (one *V. vulgaris*, one *V. germanica*) were sprayed internally with 5 ml of 0.01% Triton X-100 in sterile water. Three treatment nests were similarly sprayed internally (internal inoculation) with the F180 suspension. For external inoculations, foragers milling at the entrance of the remaining nest were sprayed with 10 ml of the F180 suspension. In all treatments, the spray apparatus used was a 'Paasche' single action air-brush on a compressed oxygen aerosol which produced a fine mist spray.

Nests that were to be internally inoculated were carefully excavated to expose one side from which the involucre (nest envelope) was removed (Figure 5.1) to allow access to all layers. Approximately 70% of one side of the nest was exposed for inoculation. Five ml of *B. bassiana* spore suspension was sprayed throughout the nest at which point the outer surface was saturated. The involucre was carefully replaced and the cavity refilled leaving a small entrance tunnel.

The nest to be externally inoculated was disturbed by beating the ground around the entrance, to encourage foragers and guard wasps to leave the nest. The entrance was then sealed off for five minutes to allow a build-up of returning foragers. When a large number of wasps (at least 100) were milling around the entrance they were sprayed with 10 ml of F180 spore suspension, before being allowed to re-enter the nest cavity.

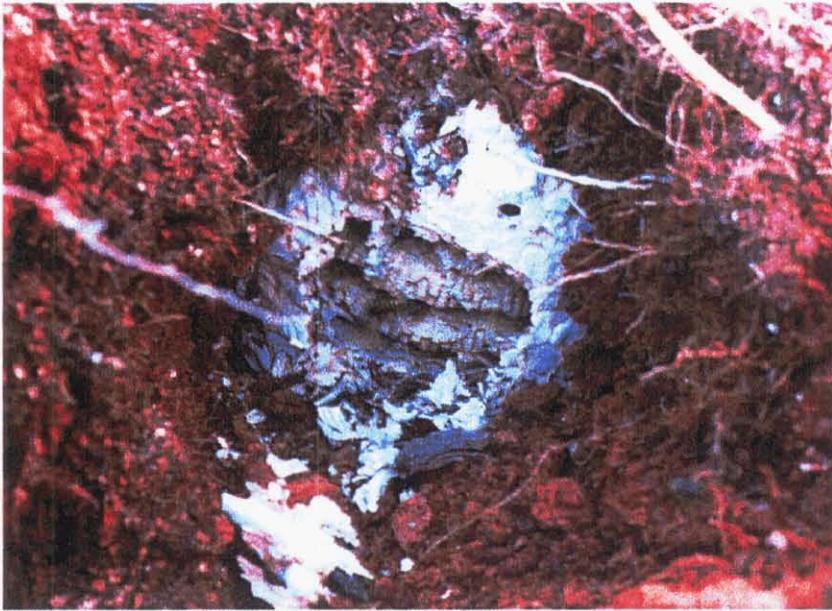

Figure 5.1: Internally inoculated *Vespula germanica* nest with the involucrum removed from one side. Five ml of *Beauveria bassiana* (F180) inoculum was sprayed between the layers through this opening. The involucrum and soil was replaced after inoculation.

After 16 days all nests were recovered as intact as possible, bagged separately and returned to the laboratory. Levels of mortality, infection and sporulation for larvae and pupae were recorded by counting all visually infected (with F180), septic and live individuals. Adult wasps were not collected but those found in the nest during dissection were visually checked for signs of disease.

## Results

After 16 days, traffic rates of the internally-treated nests dropped by 79% ( $25 \pm 5$  before inoculation down to  $5.3 \pm 2.4$  per minute after inoculation), the externally treated nest by 59% (41 down to 17), while the traffic rate of the one control nest dropped by 32% (22 down to 15) (see Figure 5.5). The second control nest (*V. germanica*) was lost due to natural flooding because of its low lying position. There was no evidence that any of the other nests were affected by flooding.

Dissection of the recovered nests treated internally with F180 revealed extensive larval death (Figure 5.3). Eighty four percent (total larvae 659) of the larvae were dead, of which 76% showed symptoms of infection by *B. bassiana* and 24% died from unknown causes. Six percent (total larvae 701) larval mortality was recorded in the control nest, but there was no evidence of larval infection by *B. bassiana* or any other fungal pathogen in the larvae killed by an unknown cause. The external inoculation resulted in less *B. bassiana* infection in the larvae (9% of 572 larvae). A further 20% of the larvae in this treatment died from unknown causes.

High levels of F180 infection were found in pupae from all the internally inoculated nests (76% of a total 262 pupae), whereas external treatment of nests with F180 spore suspension resulted in only 6% (total pupae 146) mortality (Figure 5.4). One pupa (total pupae 88) in the control exhibited symptoms of *Beauveria* infection.





Figure 5.2: Sample of comb extracted from a *Vespula vulgaris* nest 16 days after internal spray inoculation with *Beauveria bassiana* (F180). Arrows indicate the fruiting bodies (conidia) of the fungus growing on dead larvae (lower) and adults (upper). Fungal sporulation was also present on the bodies of the pupae (capped).

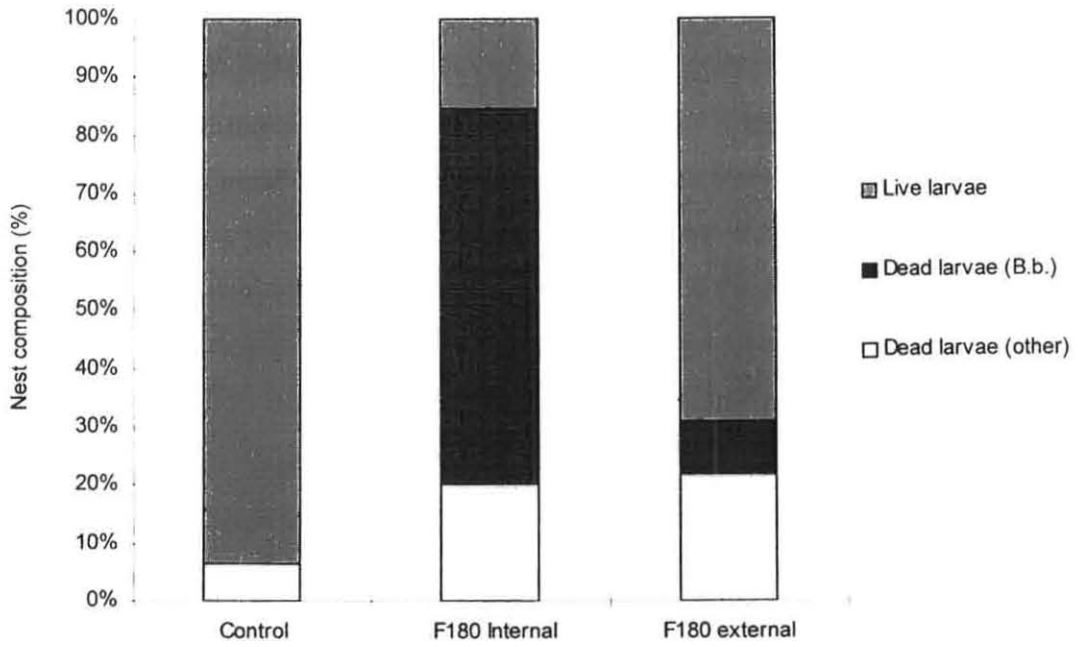

Figure 5.3: The percent composition (alive and dead) of larvae in the treatment (*Beauveria bassiana*) and control nests 16 days after inoculation.

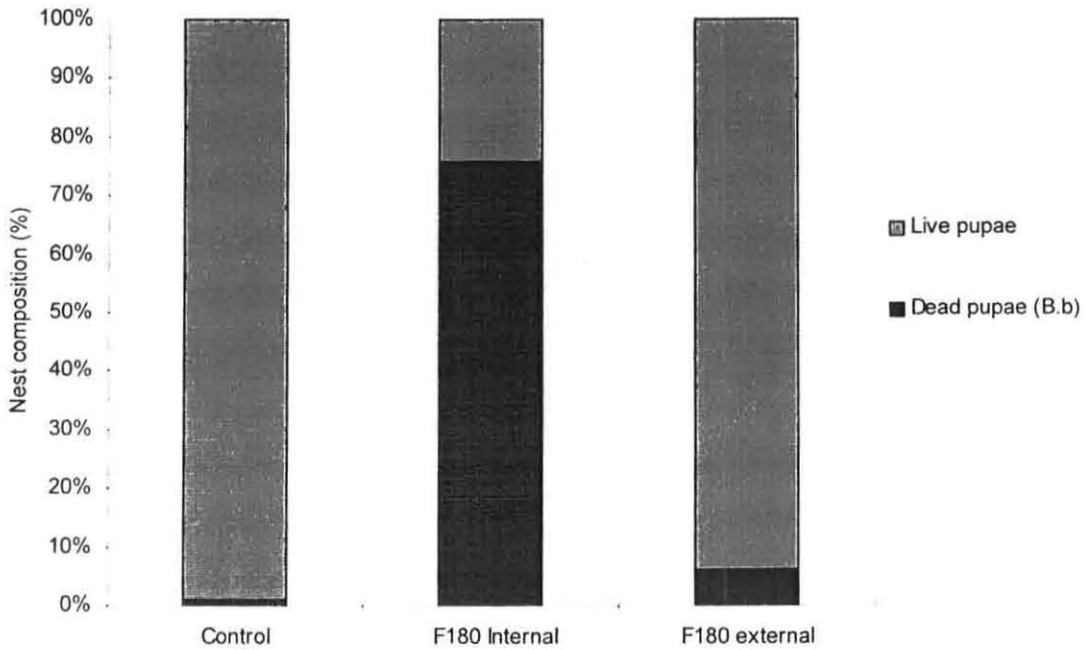

Figure 5.4: The percent composition (alive and dead) of the pupae in the treatment (*Beauveria bassiana*) and control nests 16 days after inoculation.

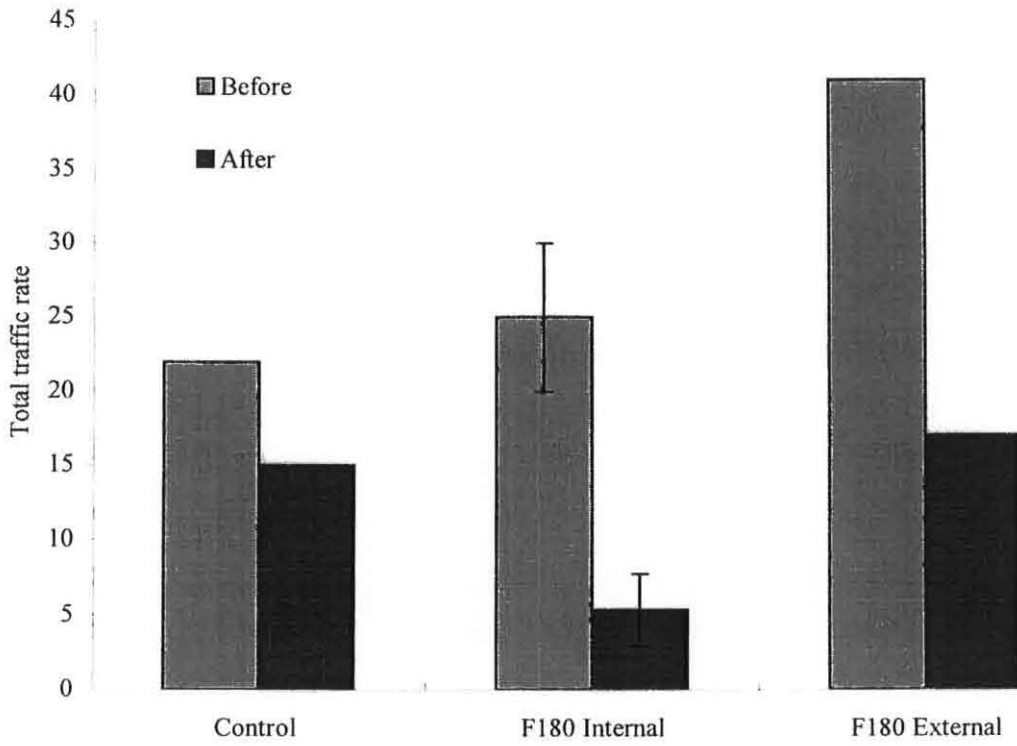

Figure 5.5: The traffic rate (number of wasps entering or leaving a nest) of nests before (day 0) and after (day 16) treatment in the *Beauveria bassiana* field evaluation trial. The period of the experiment was 16 days at which point the nests were excavated and analysed.

Sporulation of *B. bassiana* occurred extensively on both larvae and pupae from several layers of the internally-treated nests (see Figure 5.2). Similarly, in the externally-treated nest, cadavers of larvae and pupae supported heavy sporulation of *B. bassiana*. Where infection was widespread it tended to be patchy within and between layers of the nest.

Adult wasps were also susceptible to *B. bassiana*. About 100 workers and new-season queens were found dead (usually as sporulating cadavers) in each of the internally-treated nests. Five adults supporting sporulation were also found in the externally treated nest. Other workers were found dead in the nest but, because there was no evidence of *B. bassiana*, they were not characterised as infected. Many of these adults had been incorporated into the structure of the nest with paper. No dead adults were infected with *B. bassiana* in the control nest.

## Discussion

This is the first time a fungus has been tested in the field as a microbial insecticide against wasps. Similar techniques have been tested, with some success, for the control of fire ants with *B. bassiana* (Stimac *et al.* 1990) and termites with *M. anisopliae* (Milner and Staples 1996).

To successfully destroy a wasp nest using a pathogen-based spray it is necessary, once a pathogenic strain has been isolated, to overcome behavioural, physical and environmental barriers. The field trials conducted here demonstrate that the internal inoculation of a liquid inoculum effectively overcame the physical barriers (i.e., transmission to the nest and penetration through the involucrum). Further, the environmental barriers were modified by briefly increasing the humidity within the nest (if only for a few hours).

Once established in the nest, the behavioural barriers, however, could influence the success of the pathogen once it is established in the nest. Factors such as the removal of infected or dead nest-mates and the encapsulation (sealing off) of areas of infected comb could limit the spread of the disease. The externally-treated nest had a higher

traffic rate throughout the experiment than the internally-treated nests. Therefore the externally-treated nest may have had the capability (worker force) to overcome the infection to some extent and thereby obscure the actual impact of the fungi seen at the dissection. However, the presence of sporulating cadavers indicated a level of infection beyond the capacity of the colony to control which, given time, may have developed into an epizootic.

The infection caused by the external inoculation demonstrates the successful transmission of viable conidia between nest-mates (horizontal transmission). The incidence of infected larvae was patchy but was spread throughout the layers of the nest indicating that point source infections were often spread to nearby larvae. It is unknown whether these small infections were being isolated by worker activity or were the beginning of an epizootic. This would depend on the virulence and reproductive capability of the fungus, the behavioural response of the wasps, and on the environmental conditions within the nest.

The results of the control indicate that wasp colonies do begin to decline naturally in autumn. During decline, fewer workers are produced in favour of reproductives (males and females). This suggests colonies are less able to maintain nest hygiene and fight infection. However, at this study site the nests were vigorous and the traffic rate decline of the control nest was far less than that of nests exposed to other treatments. The normal appearance of the control nest was consistent with an interpretation that the impact of the fungus was a significant factor in the decline of the treated nests.

Wasps have been known to exhibit colony drift similar to that seen in honey bees (Akre *et al.* 1976). This, combined with the closeness (~30m) of the study nests, may explain the occurrence of a single *B. bassiana* infected pupa and some of the unexplained deaths in the control nest. It is also possible that this is a natural infection which is occasionally found in the field.

The presence of dead workers within the internally treated nests suggests that the infection could have some direct impact on the workforce. Many new-season queens

were also dead in these nests. It is likely that many other adults either died outside the nests or that removal of adult cadavers from within the nests had occurred before dissection. The adult cadavers were erupting with conidia and represent another potential source of inoculum for horizontal transmission.

Infected pupae often supported sporulation within capped cells, which prevents spore dispersal and therefore represent a population sink for the fungus. Unless such pupae are uncapped or removed, then the infection is unlikely to be passed on from this source. As it may take longer for workers to detect disease within capped cells, the fungus has a greater chance of sporulating before removal occurs. The process of removal would then promote disease transmission to the individual removing the cadaver and to those it contacts following the extraction.

Larvae characterised as having died of unknown causes may have died as a result of *Beauveria* infection or some other cause. These larvae were typically mushy possibly indicating an infection that caused rapid death of the host before fungal maturity (preventing sporulation and re-infection). A number of these individuals would also have died as a result of naturally occurring pathogenic disease or injury. This phenomenon was also seen in the control.

Many workers were directly sprayed in the inoculation process and it is likely that the majority of these would have died within a few days (Chapter Two). It is unknown whether the founding queen was killed in the treated nests. If a founding queen was infected and killed early in the season, the ensuing breakdown in the social structure (Spradbery 1991) could enhance the spread of disease and development of an epizootic.

This experiment, although limited by low replication, demonstrates that infections can be established within late season nests by inoculating the foragers externally and these diseased individuals can remain in the nest long enough to become infectious. Fungal sporulation from cadavers was common and may provide a source of re-infection to subsequent generations (vertical transfer). A key issue in the development of microbial control agents is whether small infections persist and go on

to establish epizootics. Vertical transmission of disease is a significant factor in the successful control of wasp colonies using *B. bassiana* as a microbial agent.

The colony response to disease may vary at different times of the season and experiments on mid-season colonies are needed to accurately quantify the type and frequency of behavioural intervention. Research is presented in Chapter Six that follows the fate of small infections to determine the level of this intervention by the colony. Information on the necessary infection rate to establish an epizootic in an active nest will be crucial in determining methods for exploiting this fungus for use in a wasp control programme. Invasive techniques such as internal spraying, although not practical for wasp control, can cause large infections which have the potential to limit traffic rates and the reproductive output of the colony. In addition to the contributions made by this study, research into methods for exploiting these fungi in wasp control strategies is continuing at Landcare Research, Nelson (R.J. Harris).

# Chapter Six

## The role of hygienic behaviour in suppression of fungal epizootics

### Introduction

Infection and transmission of secondary infection of wasp larvae and pupae is key to the success of a microbial control agent. The duration of infection in the nest is crucial to the establishment of an epizootic (widespread infection or epidemic). Sporulation of fungi is also vital to achieve secondary infection and to improve the chance of an epizootic developing.

Pathogenic organisms are regularly found in wasp nests (Gambino and Thomas 1988, Fouillaud and Morel 1995, Glare *et al.* 1996). They are usually identified from a few diseased individuals. However, they rarely establish an epizootic (only one has been documented<sup>1</sup>). It has been suggested that the majority of small infections are either removed or suppressed by workers (Archer 1972, Glare *et al.* 1996), but there is a need for replicated experiments to quantify the processes involved.

In the field experiment discussed in Chapter Five, evidence of colony members acting to counteract the spread of *B. bassiana* was presented (Harcourt *et al.* 1998, R.J. Harris unpublished data). In subsequent tests on mid-season nests, it was difficult to recover *B. bassiana* from treated nests, let alone induce an epizootic (R.J. Harris unpublished data). The inoculum was taken up by foragers and the traffic rates were reduced slightly in some treatments, but dissection of the nest revealed very little visual evidence of an infection. When an infection was found, it was in the early stages of development (purple infected cadavers but no sporulation). This indicated that the primary infection was killing a cohort of workers and larvae, but adults emerging from the pupal



stage augmented recovery of the colony through behavioural intervention. It was hypothesised that hygienic behaviours were primary factors in the maintenance of disease-free colonies.

Hygienic behaviours of social insects are the primary line of defence against pathogenic micro-organisms and have been attributed as the limiting factor in many pathogen-based biological control programmes (e.g., leafcutter ant, *Acromyrmex octospinosus* Reich - Kermarrec and Mauleon 1975; red imported fire ant, *Solenopsis invicta* - Oi and Pereira 1993; termites, *Coptotermes acinaciformis* Froggatt - Milner and Staples 1996). In some instances, fungi, highly pathogenic in laboratory bioassays, have been completely ineffective as biological control agents (or microbial insecticides) in the field. This is due primarily to the co-ordinated behaviour of the target species against infection and the development of disease (Cherrett 1986, Pereira and Stimac 1992).

A range of hygienic behaviour has been reported for social wasps (Wilson 1971, Spradbery 1973, Edwards 1980). Necrophoria (removal of the dead) and necrophagia (consumption of the dead) are common behaviours in *Vespula* colonies (Spradbery 1973, Akre *et al.* 1976, Archer 1981). Archer (1972) conducted extensive experiments on the behaviour of *Vespula* workers in healthy observation colonies. Workers removed apparently healthy and diseased larvae from cells, consuming or disposing of them. Although extensive, this work provided no quantitative measurement of the reasons for removal of larvae or the worker's recognition of larval health status. Diseased and healthy larvae, which either dropped out or were pulled from their cells, were frequently cut up and fed to other larvae (Akre *et al.* 1976). Removal and cannibalistic behaviour increases during colony decline (Akre *et al.* 1976, Archer 1981) and primary sanitation activities decrease markedly (Spradbery 1973, Akre *et al.* 1976). This decline usually coincides with a surge in the level of pathogenic infections (Gambino and Thomas 1988) and may be related to the weakening or death of the queen.

Workers remove cadavers or isolate them in unused areas of the nest (Spradbery 1973). This is

---

1 *Nosema* sp. infection of a wasp colony in NSW, Australia. Current testing is underway to determine the biology and potential of this disease for wasp control (R.J. Milner 1998, pers. comm.).

often achieved by incorporating cadavers, faeces or debris into the nest envelope or papering over cells (encapsulation). This habit seals off infected cadavers, decomposing faecal and prey material, which can be a source of disease (Spradbery 1973, Akre *et al.* 1976).

Ritualised self-grooming and grooming of nest-mates is common and ensures a high level of individual hygiene among workers (Wilson 1971, Akre *et al.* 1976). However, it is unclear whether this is a routine habitual act or a response to the presence of foreign material. Further, it is unknown whether grooming removes individual spores or just macro-particles.

The aim of the research in this chapter was to determine the response of workers to the presence of selected pathogens introduced to the nest. Three experiments were conducted using three different artificial nest designs that allowed a slightly different method of observation of the various hygienic behaviours. The three designs were:

- (1) physical intervention experiments - horizontal nest chamber to target the reaction of workers to interference;
- (2) colony hygiene experiments - field nest box experiments to record the colony response to a localised infection; and
- (3) worker hygiene experiment - vertical observation nests to examine the efficiency of removal of displaced larvae.

Together, these experiments provide the first comprehensive account of the behavioural defence mechanisms of *Vespula* and allow the limitations of fungal pathogens in biological control systems to be discussed.

## Physical intervention experiments: horizontal nest box experiments

The physical intervention experiments involved the development of an observation nest chamber to investigate the reaction of workers to interference with larvae and pupae. The aim was to determine the level of awareness of workers to the well-being of juveniles and study their response to physical disruption.

### Materials and methods

An observation chamber was adapted from that of Archer (1972). This involved the dissection of an active *V. vulgaris* nest and placing layers of comb horizontally within a narrow chamber (Figure 6.1). Workers were allowed to return to the nest and were left *in situ* for three days at the collection site, before moving the nest to the laboratory. This period was crucial for the stability of the colony and allowed the capture of the majority of the foragers. The queen was identified and placed into the chamber. To move the nest the entrance hole was plugged after dark, when the foragers were inside. The nest was then taken to the laboratory and an entrance tunnel to the outside was created for the foragers. Inoculation or manipulation of larvae and pupae was achieved with little disruption to the colony by drilling holes ( $\varnothing$  3 mm) in the perspex below the point of interest. Physical intervention treatments were administered through these holes using slender pipettes and probes.

A preliminary experiment was carried out to establish characteristic behaviour in a healthy, artificially housed colony. Three larval and four pupal treatments were selected ( $n=40$ , 20 replicates per nest, two nests) and tested against 20 healthy individuals. Third - fourth instar larvae and freshly capped pupae were selected, in an even spread, from a uniform section of comb.

***The treatments were:***

- (i) pupae uncapped - pupal cap fully removed;
- (ii) pupae stabbed - pupae stabbed vertically through the centre of the cell;
- (iii) pupal cap holed - hole made in the cap to mimic that in the stabbed treatment;
- (iv) pupal control - pupae untouched;
- (v) larvae stabbed (side) - larvae stabbed laterally below the surface;
- (vi) larvae stabbed (top) - larvae stabbed vertically through the body; and
- (vii) larval control - larvae untouched.

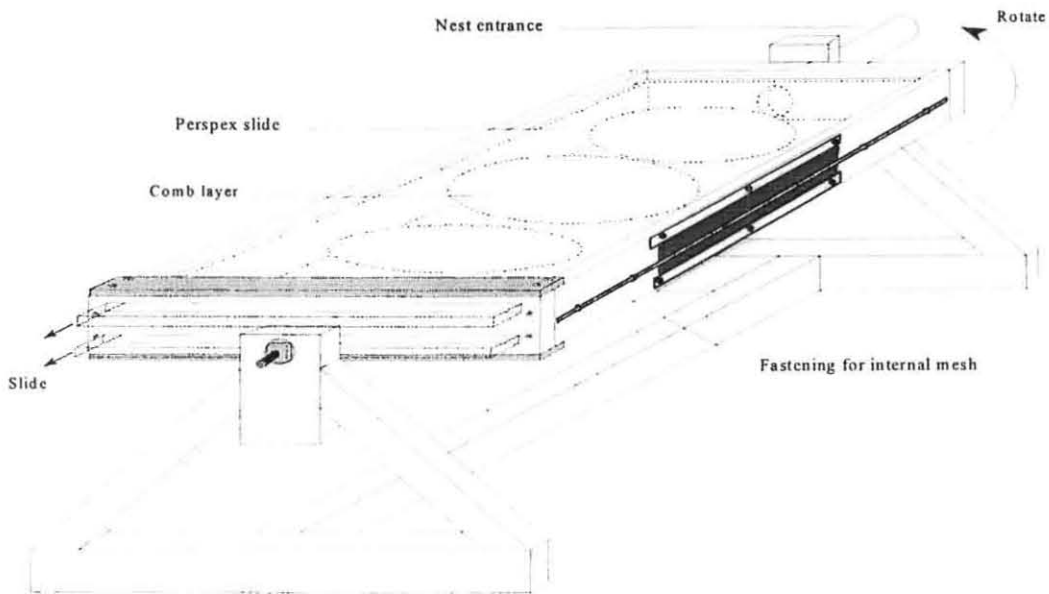

Figure 6.1: Design of the horizontal observation nest box. Comb is laid flat within the nest chamber and the rotating stand allows easy access to the underside of the comb. Perspex sheets slide out for cleaning while a cover keeps the nest secure, minimising disruption to the colony.

Larvae were stabbed with a probe, either vertically through the centre of the body or the probe was inserted half the length of the cell between the larva and the cell wall before being turned in to puncture the larval cuticle. This wound, although lethal, was concealed from the workers (by entering from the neighbouring cell) and the immediate appearance of the test larvae was not obviously changed to the human eye. Twenty untouched third and fourth instar larvae comprised the control. The pupal treatments involved uncapping pupae, stabbing pupae through the cap leaving it intact (except for a small hole), and creating a puncture hole in the cap without harming the pupa within. Twenty recently capped pupae were left untouched in the control.

Removal of treated larvae or pupae and any evidence of intervention (chewing or uncapping) of these individuals was noted one hour after treatment and again every 24 hours for six days. A one-way ANOVA was used to determine the probability of the differences between the treatments and controls being significant and to compare differences between the intervention treatments. Where not all replicates were removed, the data were treated as censored and analysed using SAS (Chapter One) to reveal mean removal times.

## Results

Uncapped pupae were removed fastest and at the highest frequency; 35 ( $\pm 0.9$ ) of the uncapped pupae were removed within the first hour and 55 ( $\pm 0.9$ ) in the first 24 hours; no removal of control pupae occurred in the first 24 hours. The mean time to removal ( $2.39 \pm 0.42$  days) was significantly lower ( $P < 0.0001$ ) in the uncapped treatment than the untouched control ( $6.68 \pm 0.19$  days). Fewer of the stabbed pupae and holed pupae were removed in the first 24 hours (Figure 6.3). However, stabbed pupae were detected and removed more rapidly later in the week. Only two control pupae were removed over the duration of the experiment.

The mean time for removal of stabbed and holed pupae was  $3.75 \pm 0.19$  days and  $5.50 \pm 0.19$  days respectively. Both reaction times were significantly faster than the control ( $P < 0.0001$  and  $P = 0.0061$ ). The mean time for removal of uncapped pupae ( $2.39 \pm 0.42$  days) was significantly

shorter ( $P=0.0142$ ) than for stabbed pupae ( $3.75 \pm 0.35$  days), as was that for stabbed over holed pupae ( $5.50 \pm 0.37$  days,  $P=0.0009$ ) (Figure 6.2). A low level of pupal cap chewing was seen in pupal intervention treatments. In the stabbed pupal treatment, this chewing was usually followed by the removal of the pupa. However, in the control and holed treatment cells that were chewed, pupae were more often left to emergence.

The mean times to removal of top stabbed ( $4.80 \pm 0.42$  days) and side stabbed larvae ( $3.90 \pm 0.42$  days) were not significantly different ( $P=0.1329$ ) (Figure 6.2). However, they were significantly ( $P<0.0001$ ) quicker than the control ( $6.80 \pm 0.13$  days). Stabbed larvae, top ( $P=0.0635$ ) and side ( $P=0.8161$ ), were not removed significantly faster than stabbed pupae. Larval and pupal controls were removed at very low levels (two larvae, three pupae) that were not significantly different from each other ( $P=0.5163$ ) (see Figure 6.3 and Figure 6.4).

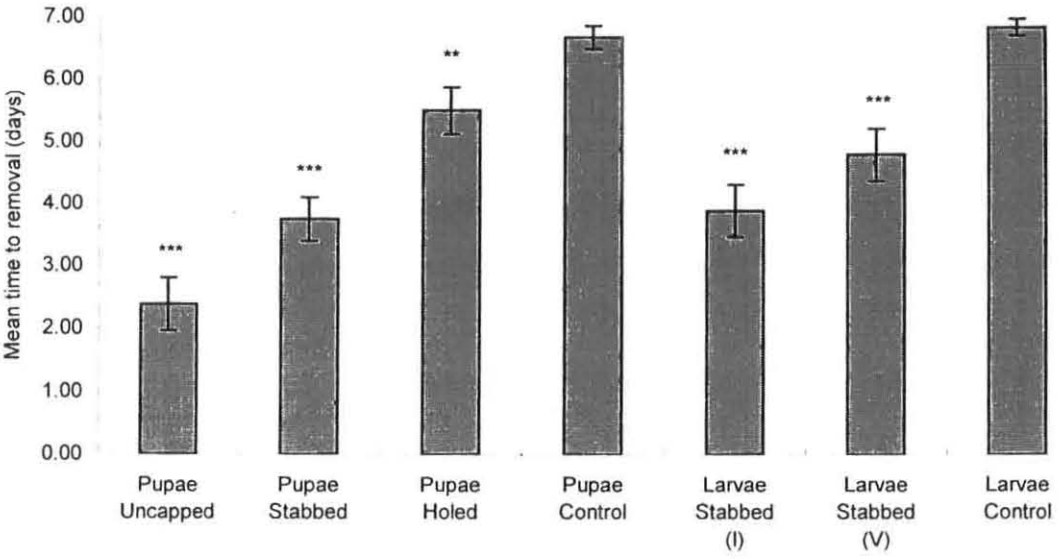

Figure 6.2: Time (Mean  $\pm$  SE) to removal of *Vespsula germanica* larvae and pupae following physical disruption. (l) = side stabbed (v) = top stabbed (\*\*\*) significantly different from the control at the 0.1% level).

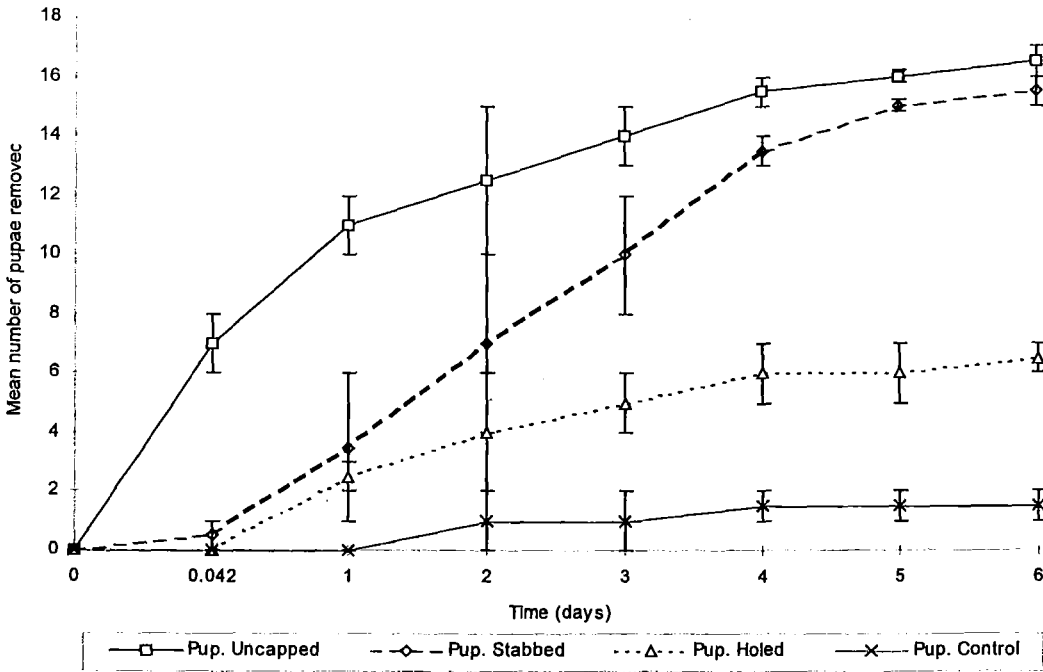

Figure 6.3: Cumulative removal of *Vespula germanica* pupae over time, by workers, following physical disruption. An observation was made after one hour (0.042 days) to record the immediate reaction of workers (n=40).

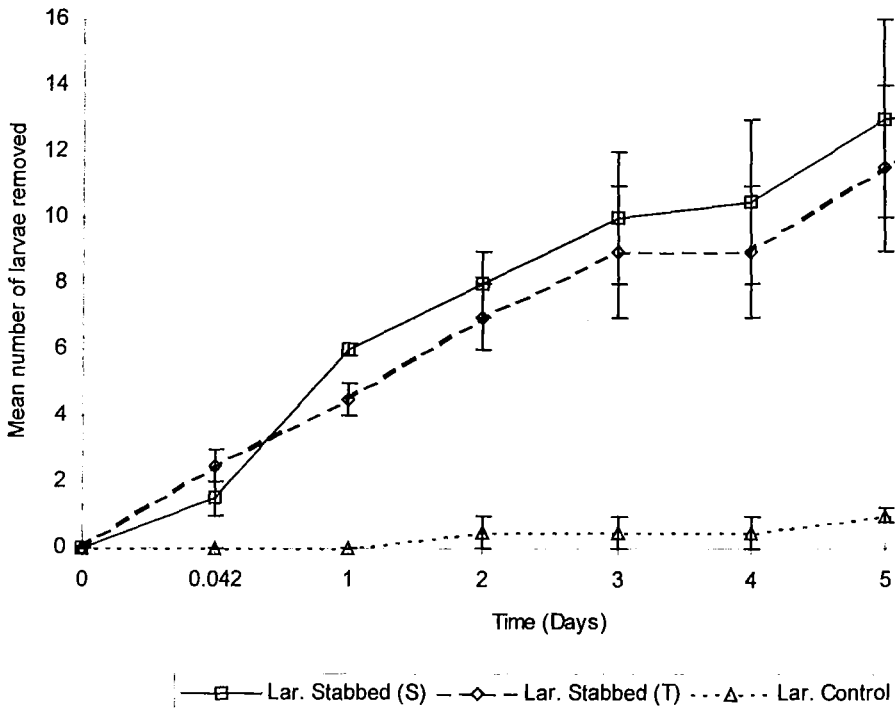

Figure 6.4: Cumulative removal of *Vespula germanica* larvae over time, by workers, following physical disruption. An observation was made after one hour (0.042 days) to record the immediate reaction of workers (n=40). (S) = side stabbed, (T) = top stabbed.

## Discussion

Workers showed a range of behavioural responses to the physical disturbance of the nest environment. Damage to a pupal cap resulted in a low level response, occasionally resulting in the removal of the pupa. If the pupa was injured or the cap removed, the pupa was usually removed by the workers. The responsibility for removing a sick or disrupted pupa or larva often passes between several workers before the task was accomplished (Balduf 1954, Akre *et al.* 1976). Workers encountering an uncapped pupa may assume the responsibility of finishing the removal task. The reason for task sharing is not fully understood. It appears to expose multiple workers to possible infection if removing a potentially diseased nest-mate. It may be that short exposures limit chances for infection. It appears to be a common trait among Vespidae that the readiness of individuals to contribute or sacrifice themselves exposes them to seemingly unnecessary risks. While extremely effective against low volume, sporadic infections, the behaviour may not be effective against the regular exposure to high volumes of disease in an augmented control programme. This may be the one major shortcoming in their defensive repertoire that could be exploited with microbial control agents.

The removal of stabbed larvae began slowly, taking three days to remove  $\approx 50\%$  in both intervention treatments. The apparent lack of distinction, by workers, between the two puncture sites may indicate how workers determine larval death. There was no obvious visual evidence (to the human eye) of the side inflicted wound at the opening of the cell while the top wound was obvious and always resulted in the discharge of a small droplet of haemolymph. Workers were seen imbibing this liquid in the first few hours of the experiment. The side stabbed treatment larvae often discharged a droplet of liquid (saliva or crop contents) upon treatment, which was also observed being eagerly imbibed by workers. The availability of liquid discharge could be one mechanism by which the workers determine the health of the larvae. These small amounts of discharge may have delayed the determination of death for 24 hours or more. Without such an explanation, it might be expected that the top stabbed larvae would be detected and removed more rapidly than the stabbed pupae, which had more cryptic injuries.



Low rates of removal of stabbed and holed pupae, compared with the uncapped pupae, on the first day indicates that workers do not identify pupae with disturbed caps as being necessary to remove. Workers were observed investigating the punctures in the cap of many pupal cells during this time but all left without removing the pupae. Results indicate that workers do not identify the majority of mortality in the stabbed treatment for two days. If the pupal cap conceals the fate of pupae for a short time, pupae may therefore act as a repository for disease agents. This could allow some disease to reach a re-infective stage (sporulation) before it is removed. This hypothesis is tested and discussed further in the following section (nest box experiments).

The rotating horizontal observation chamber proved very useful for collecting replicated data on specific treatments. The use of clear perspex on both sides of the comb gave a high level of visibility and allowed easy access to larvae and pupae through the treatment apertures. Building the nest box on a pivoting frame ensured quick, non-invasive observations with little discomfort to the observer. One drawback of this set-up was the relatively short time available for making observations, because the colony does not flourish in this artificial setting. Archer (1972) indicated that a shortcoming of this type of experimental nest is that the conclusions may be applied only with caution to the organisation of colonies in the field. For this reason it was decided to design a more natural observation nest box to facilitate the observation of behavioural reactions to pathogens.

## Colony hygiene experiments: field nest box

It was hypothesised that ‘a high level of removal and disposal of diseased material is a primary factor in the maintenance of colony hygiene’. The aim of this experiment was to record a colony’s response to a localised infection of *B. bassiana* in an active nest by determining the time taken for workers to detect and remove juveniles infected with *B. bassiana* (F180).

### Materials and Methods

**Nest box design:** It was necessary to develop a new nest box for these experiments. The design had to be: cheap and easy to construct; allow for simple collection procedures (reducing disruption to the colony); allow nests to be held in a natural state (vertical layering); allow for quick observations (reducing daily disruption during the experiment); and be portable (for transport to the collection site and back to the laboratory). A nest chamber with a hinged base was designed and constructed (Figure 6.5) so the nest was suspended from pins running horizontally through the chamber. The nest boxes were 30 x 30 x 30 cm and constructed from 12 mm untreated plywood.

**Nest collection:** *V. vulgaris* and *V. germanica* nests were collected from Christchurch. Nests were carefully excavated without breaking the involucrum or dislodging layers of comb and lowered into the nest box until almost touching the bottom. Pins were run through the nest into the opposite wall (Figure 6.5). The nest was suspended on the pins inserted below a central layer of comb. The top of the box was replaced and screwed down in preparation for transportation. The cavity left by the nest was cleared of wasps as far as was possible and refilled with soil. The box was then placed on the flattened surface<sup>2</sup> directly above the old nest sight. The entrance hole in the box was left unplugged and foragers began entering within a few minutes. If possible, the box

---

<sup>2</sup> The flattened surface is crucial to the success of extraction. Dirt was also built up around the base of the box to stop workers burrowing in under the box. This happened on one occasion and resulted in the loss of large numbers of the worker force upon removal.

was left at the nest site for three days. However, a shorter period was occasionally dictated by the property owner. After three days, the colony was foraging from the nest box. To transfer the nest box to the trial site at Lincoln, a rubber bung was placed into the entrance hole after dark (2130 h, NZST January-March<sup>3</sup>), capturing all but a few guard wasps on the outer walls. Nests were kept closed until early the following morning when the bung was removed at the new site.

**Research site:** All colonies were allowed to settle at the study site for at least two weeks before any experiments were conducted. Several nests declined and were discarded. The remainder appeared to be flourishing and were used for the experiments. The research site on the Canterbury Agricultural Research Centre campus was situated in an abandoned orchard with large walnut trees and many flowering shelter trees. The site was sunny, warm and sheltered from prevailing weather. There was an abundance of arthropod prey and plant food (nectar and pollen) and a nearby apiary supplemented foragers with discarded bee cadavers (S.J. Harcourt pers. obs.).

**Experimental set-up:** Experiments were carried out between January and March 1999. Once 10 healthy nests were assembled and settled on the ground at the research site, they were prepared for the experiment. The screws were removed from the non-hinged side of the base and the top was lifted back to expose the bottom layer of comb and involucrum on a vertical plane. The involucrum was carefully removed to uncover the bottom layer of comb. If there was insufficient brood in the bottom layer (new comb not yet oviposited in), it was also removed to gain access to a large section of healthy comb. If the nests were large enough, two rows of 10 healthy late instar larvae were selected from a cross-section of the comb. On small nests or nests with few late instar larvae, a single row of 10 larvae was selected. The position of the larvae was established by either removing the adjacent larvae or by marking pupal caps with a permanent ink pen (Figure 6.6). Using a fine paint brush, the treatment larvae were inoculated with a lethal dose<sup>4</sup> of *B. bassiana* spore suspension (F180 @  $1 \times 10^7$  spores/ml). Control larvae were similarly inoculated with a sterile solution of 0.05% Triton X-100 and water.

---

<sup>3</sup> NZST - New Zealand Summer time (11 hours ahead of GMT), January - March (mid - late summer).

<sup>4</sup> Treatment of larvae in the larvae to adult transfer experiments (see Chapter Three) showed that a 5  $\mu$ l dose was sufficient to achieve rapid kill of larvae. The effective dose administered in the nest box experiments could not be applied exactly but was consistently in excess of 5  $\mu$ l.

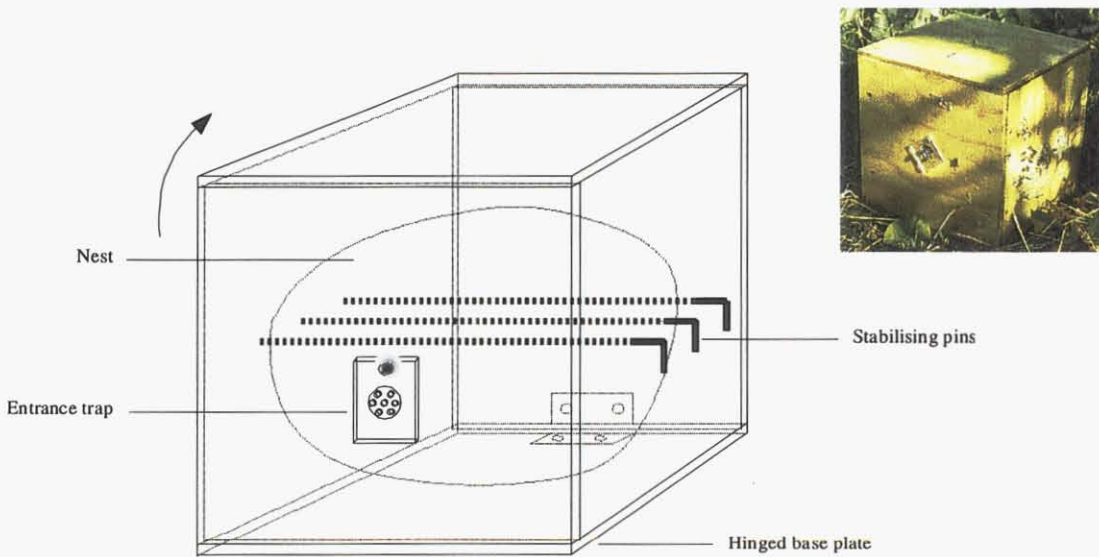

Figure 6.5: The nest box design used in the colony hygiene experiments. The intact nest is suspended from the horizontal rods which are run through the nest at collection. The rods rest against the lower surface of a middle layer of comb. Note the arrow to indicate the direction of rotation when opening the box and the perspex entrance trap to inhibit the removal of juvenile wasps. Inset: experimental nest (30x30x30 cm)

The fate of larvae was recorded daily (by opening the base of each box) until all had either been removed or emerged. Data collected included: larval removal, visible infection, pupation, uncapped pupa, pupal removal and emergence. Any subsequent transfer of infection to untreated larvae was noted and their fate monitored. This experiment was replicated three times using five treatment and five control nests in each. In all, 21 rows of 10 larvae (n=210,) were treated with *B. bassiana* and 18 rows of 10 larvae (n=180) were treated in the control. The treatment population consisted of six nests with 20 larvae and nine nests with 10 larvae, while controls consisted of three nests with 20 larvae and 12 nests with 10 larvae. Analysis of variance was used to detect differences between treatment and control nests. Data from three 'atypical colonies' were discarded after the experiment on the basis that their inclusion would confound the results (see Discussion). Results are presented graphically to illustrate the whole nest's reaction to the infection (i.e., the life-stage composition of the test groups through time).

A trapping device was designed and placed over the entrance to the nest boxes. This consisted of a small perspex plate with seven, 6 mm diameter holes, drilled in the entrance for forager access. The trap was designed to restrict workers removing large debris from the nest. The larvae and pupae being removed were consequently dropped to the base of the nest where they could be inspected daily and counted.

## Results

**Infection:** Infection was identified when larvae or pupae developed a purple body colour, as is characteristic of *B. bassiana* infections. This colour change in the cadaver is an indication that infection has occurred, but the initial infection would have occurred three or four days earlier (Appendix Three).

In total, 210 larvae were treated with *B. bassiana* between the three replicated experiments. Of these, only 21 individuals (14 larvae and 7 pupae) showed visual signs of infection. Infection of untreated larvae was apparent on two occasions in pathogen-treated nests. In treated nests,

infection was apparent from day three to six (mean  $5.00 \pm 0.26$ ) days. When infection became visible (purple body colour), the infected individual was usually removed within the next 24 hours (mean  $6.10 \pm 0.24$  days from inoculation). Only one larva with visible signs of infection was recorded in its cell on consecutive days.

No infected larval or pupal cadavers supported sporulation in the cell. Ten infected cadavers dumped by wasps on the base of the nest box supported sporulation after three days (10 days after inoculation). Some of these cadavers were removed soon after sporulation of the fungus. These were probably consumed or dismembered by workers, because intact removal was almost impossible given the size of the cadaver. One cell was encapsulated after the infected larva was removed. It remained sealed for the duration of the experiment while the surrounding cells were cleaned and built up or chewed back several times. Infection was not seen in the control nests.

**Atypical colonies:** One treatment and two control colonies declined sharply in vigour during the experiment. The decline and death of these colonies was atypical compared with other control and *B. bassiana* treated colonies. These colonies were removed from the data set on the basis that behaviour leading up to the decline was not representative of a healthy functioning colony. The queen was not seen in two of the nests during the decline and none was found in the subsequent dissection of the moribund nests. In the other control nest, the queen died (or was killed) at an early stage of the decline. Within 24 hours, there was an obvious increase in removal of juveniles followed by an increase in worker oviposition. The surviving workers appeared to tend these new brood with some vigour and were seen leaving the nest to forage regularly. Three weeks later the colony consisted of males that rapidly dispersed. Although the death of the queen limits the success of the colony, the effect of this behaviour is that the surviving workers maximise their personal 'genetic fitness' through the production of male reproductives. There was also no obvious outbreak of infection in the declining *B. bassiana* treated nests. The rapid removal of larvae and pupae associated with colony decline appeared to augment nest sanitation.

**Trap catch:** Over the 23 days of the experiments, the mean daily trap catch of larvae and pupae was significantly higher in the *B. bassiana* treatment ( $10.2 \pm 2.3$ ) than in the control ( $4.80 \pm 0.78$ ),

P=0.0325). The trap counts from the *B. bassiana* treatments revealed a peak after seven days, which coincided with a reduction in pupal numbers and the peak of visual infection (Figure 6.7). There was a similar small peak in the number of larvae and pupae in the control traps on day six but on average, there was a low but constant level of larval removal in the controls.

**Larvae:** Of the 210 larvae inoculated with *B. bassiana*, only 53% pupated successfully, whereas 83% of the 180 control larvae pupated. The remainder of the larvae in both the *B. bassiana* treatment (47%) and control (17%) were removed or dropped from their cell. There was no significant difference in the time to disappearance of these larvae (mean  $4.80 \pm 0.27$  days for *B. bassiana* and  $5.30 \pm 0.86$  days for control; (P=0.5186), (Table 6.1).

**Pupae:** Infected larvae that entered pupation were still removed by workers despite being concealed beneath the pupal cap. Overall, larvae pupated earlier in the *B. bassiana* treatment ( $3.08 \pm 0.24$  days) than in the control ( $5.02 \pm 0.55$  days) (P=0.0019), (Table 6.1). Levels of pupation were comparable between treatment and control groups for the first couple of days (10% on day one and 20% on day two) (Figure 6.8). However, the cumulative total of pupae in the *B. bassiana* treatment began to decline after four days as the removal of infected pupae and larvae increased (Figure 6.7). The mean time for removal of pupae was  $5.35 \pm 0.20$  days in the *B. bassiana* treatment and  $8.50 \pm 0.66$  days in the control (P<0.0001), reflecting the rapid removal of infected pupae. Of all larvae treated with *B. bassiana*, 96% were removed as larvae or pupae compared with 40% for the control (P=0.0096), (Table 6.2). The remaining 3.8% in the *B. bassiana* treatment and 60% in the control emerged successfully.

**Emergence:** For larvae that developed through to adults, the developmental time (*B. bassiana*  $13.38 \pm 0.68$  days, control  $15.27 \pm 0.26$  days, P=0.0549) and the onset of pupation (*B. bassiana*  $4.13 \pm 0.58$  days and control  $4.60 \pm 0.27$  days, P=0.6382) was similar between treatment and control (see Table 6.2). Likewise, the pupal period, for those individuals that completed the transformation to adults was not significantly different (*B. bassiana*  $9.25 \pm 0.59$  days and control  $10.65 \pm 0.28$  days, P=0.1186).

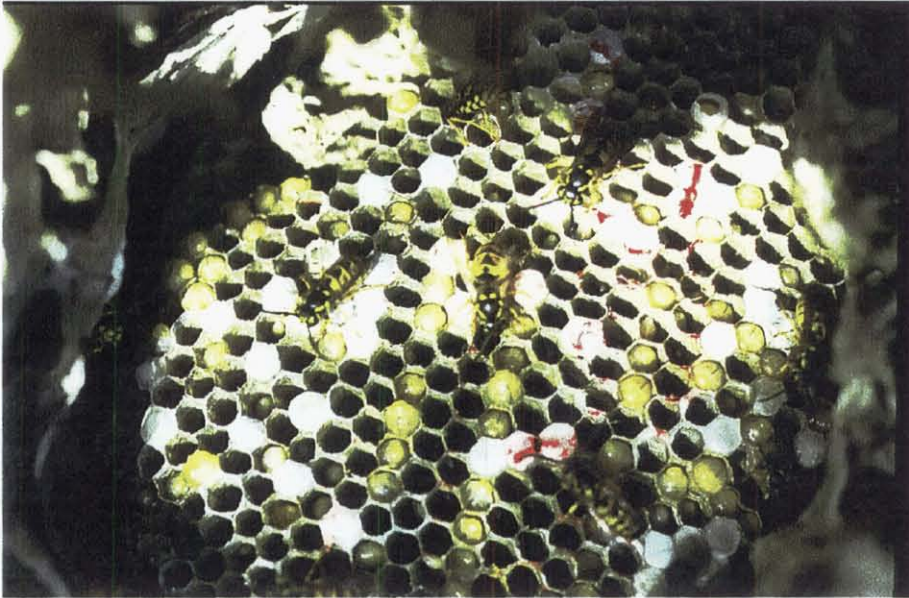

Figure 6.6: Rows of larvae treated with *Beauveria bassiana* in the colony hygiene experiment. Selected larvae were distinguish by removing the adjacent larvae and pupae. Red vivid marker pen was also used to colour the caps of pupae not in the experiment and further demarcate the test individuals. All intervention was replicated in the controls.



Table 6.1: Development and removal time for *Vespula vulgaris* individuals in the colony hygiene experiment. Larval and pupal blocks represent the mean time for the expression of each variable. The rows headed emergent pupae represent data for those individuals which completed pupation and emerged as adults.

	<i>B. bassiana</i> (F180)		Control		P-value
	(n = 210)		(n = 180)		
	Mean ± S.E.	<i>n</i>	Mean ± S.E.	<i>n</i>	
<b>Larvae</b>					
Removal time	4.83 ± 0.27	99	5.33 ± 0.86	30	0.5186
<b>Pupae</b>					
Pupation time	3.08 ± 0.24	111	5.02 ± 0.55	150	0.0019
Removal time	5.35 ± 0.20	103	8.50 ± 0.66	42	< 0.0001
<b>Emergent pupae</b>					
Pupation time	4.13 ± 0.58	8	4.60 ± 0.27	108	0.6382
Emergence time	13.38 ± 0.68	8	15.27 ± 0.26	108	0.0549
Time in pupation	9.25 ± 0.59	8	10.65 ± 0.28	108	0.1186

Table 6.2: The percentage of *Vespula vulgaris* larvae and pupae removed, pupated and emerged in the colony hygiene experiment.

Treatments	<i>n</i>	% Removed as larvae	% pupated	% removed as pupae	Emerged successfully
<i>B. bassiana</i>	210	47.0	52.9	49.0	3.8
Control	180	17.0	83.3	23.0	60.0

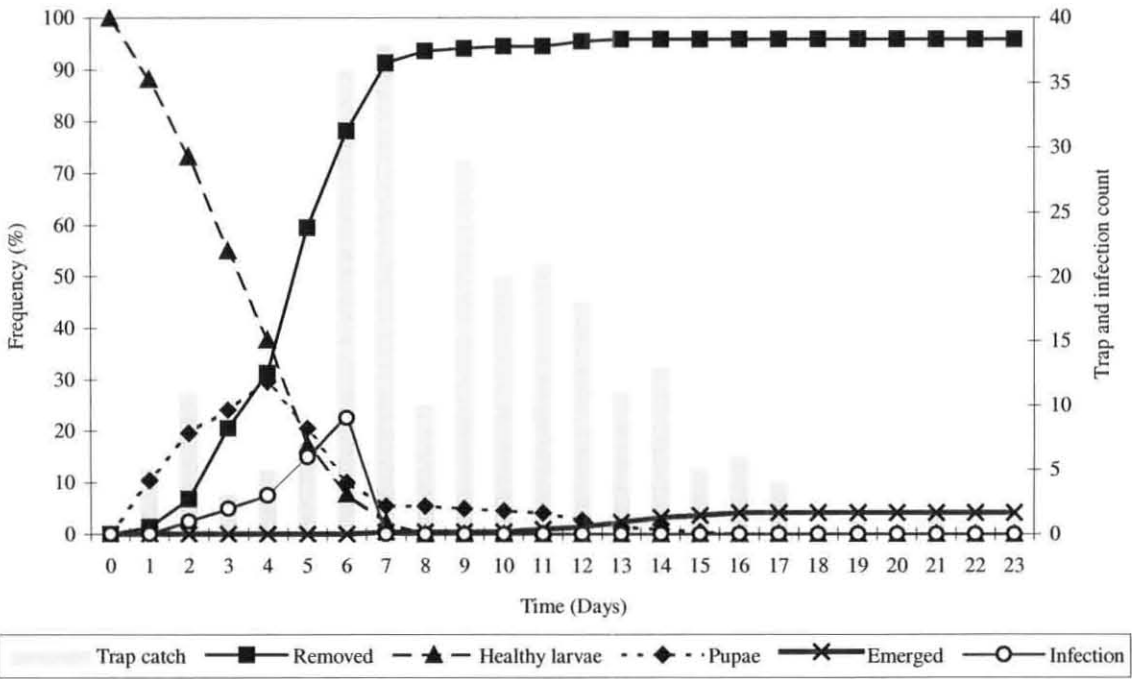

Figure 6.7: Fate of *Vespa vulgaris* larvae treated with *Beauveria bassiana* (F180) in observation colonies and patterns of juvenile removal. Discrete data were compiled daily, from all nests, as a percent of total treatments.

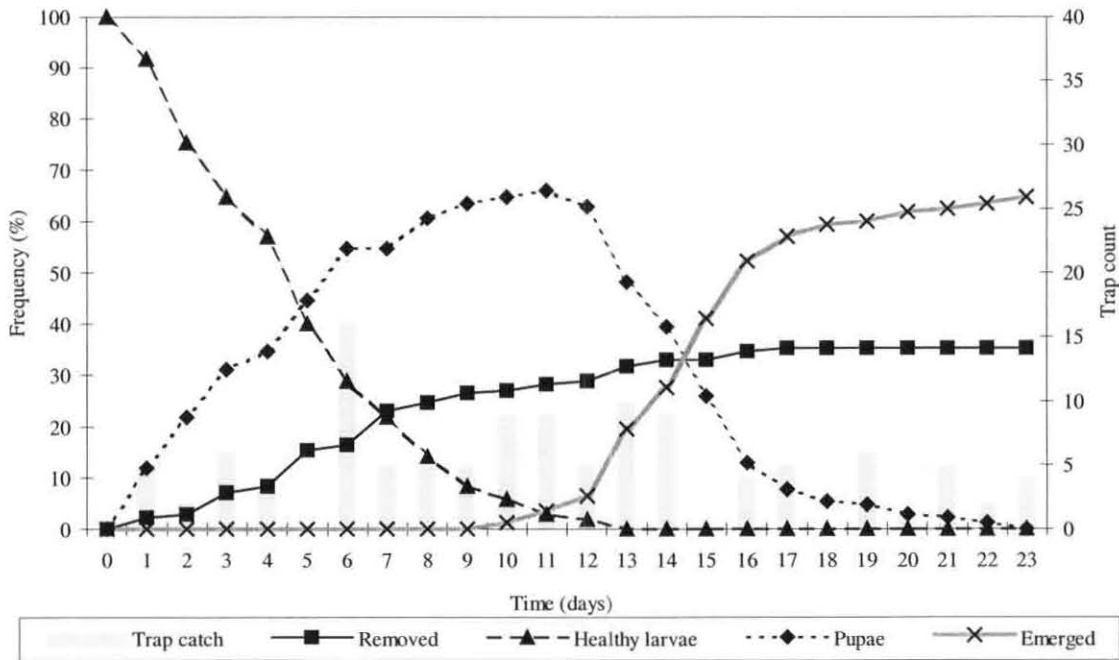

Figure 6.8: Fate of *Vespa vulgaris* larvae treated with water (control) in observation colonies and patterns of juvenile removal. Discrete data were compiled daily, from all nests, as a percent of total treatments.

## Discussion

**Box design:** The new nest box design was very successful in creating stable colonies that were easily managed. By evening of the collection day the colony had usually settled into the new chamber as evidenced by a steady flow of foragers at the entrance. The transfer of the colony to the trial site caused little disruption apart from the expected short-term disorientation seen in the behaviour of the first foragers to emerge from the box. Access to the comb was quick and resulted only in a small disruption to the colony, which abated within five minutes of the intrusion. Control colonies showed no obvious adverse effects from the daily opening of the nest box and the involucrum removed for comb inspection was rapidly replaced overnight. Most colonies grew while in the nest box. This growth rate and the traffic rate were useful indicators of colony well-being and were considered before removing several nests from the experiment. The establishment of a stable colony was a priority before initiating the experiments.

Other researchers have experimented with observation nest boxes with varying results. Most of these attempts at rearing laboratory colonies have involved rearing from founding queens through to colonies (Vetter and Visscher 1995, Leathwick 1997). Archer (1972) developed a single layer nest box (outlined in the horizontal nest box experiments) where the nest was fragmented, resulting in limited longevity of the colony. Akre *et al.* (1976) developed a nest box to hold a vertical, multi-layered, nest. These nests were placed into the box at a very early developmental stage and still there was a limit to the establishment of colonies. Large nests are more readily found and seem to be less sensitive to disruption during the transition to the nest box.

**Pupation:** These data indicate that larvae entered pupation earlier in the *B. bassiana* treatment than in the control. However, the mean time to pupation is confounded by the absence of the larvae that would have pupated had they not been removed (17% of the control larvae and 47% of the *B. bassiana* treated larvae were removed before pupation). The removal of these larvae artificially skews the normal distribution of pupation time towards zero. Further, pupation times for those *B. bassiana* treatment individuals that completed successful pupation (i.e., were not affected by the fungus) were not significantly different from the control.

**Infection:** The low number of individuals that showed visual signs of infection combined with the high number of larvae and pupae removed relative to the control, indicate a high level of worker awareness of juvenile health. The awareness of the condition of the pupae is particularly relevant to biological control efforts. The removal of these cadavers, after sporulation has occurred, is a key to vertical transmission of disease. In the field trial (Chapter Four), where very high doses were used, *B. bassiana* treatment nests contained many pupal cadavers supporting sporulation. The chance of the fungus sporulating in a pupal cadaver is very low in healthy nests with this volume of infection. Workers removed the infected individuals before the fungus began to sporulate. Evidence from other field trials indicated that the physical removal of infected material and nestmates is a large component of wasp pathogen defence (Harcourt *et al.* 1998, R.J. Harris, unpublished data). However, a large dose to the nest might kill many workers and reduce the colony's ability to clean up the infection (as in the field trial, Chapter Four). This would allow the infection to proliferate during the resulting shortage of nest-tending workers. In the field trial (Chapter Four), workers in the F180 treated nests had not been able to suppress the disease and cadavers supporting sporulation were widespread. Recovery of nest hygiene and stability, in this situation, is very unlikely.

**Sensory information (larvae):** The dose (concentration and volume) administered was adequate to kill larvae (see Chapter Two) and it appears that most individuals (96%) in the F180 treatment were sufficiently affected to induce a removal response by the workers. Spradbery (1973) hypothesised that wasps make use of both physical and chemical information to detect sick or dead larvae. Sensory information available to workers is limited to olfactory, auditory, tactile and taste (given the lack of light in a terrestrial nest). The physical and chemical characteristics of many insects change dramatically when infected with disease (e.g. microbes *Trypanosoma cruzi* and *Trypanosoma rangeli* and their interactions with hemolymph components of *Rhodnius prolixus*, Mello *et al.* 1995). All the sensory stimuli listed above would likely be affected by disease and, therefore, promote detection by workers. When infected with *B. bassiana*, moribund larvae begin to harden and become pale purple. As death approaches, the response to stimulation by workers diminishes (S.J. Harcourt pers. obs.) and, soon after death, body temperature begins to

decline. Death occurs when the fungus overwhelms the vital organs, erupting through the cuticle to sporulate within about eight days (see Appendix Three, Table 10.1). Given the regularity and intimate nature of contact between workers and larvae, it is likely that infected cadavers would be rapidly detected. It follows that modification of larval behaviour and physiology could occur at an early stage of infection and detection of such cues would be a suitable mechanism for initiating removal.

**Sensory information (pupae):** Diseased pupae were also detected rapidly, despite being insulated within the puparia. A large number of *B. bassiana* treated larvae successfully pupated. Some developed symptoms of infection (purple coloration), which were visible (in daylight) through the pupal cap. These pupae were all removed within 24 hours of the appearance of infection. Others, however, showed no visual sign of infection, but were likewise removed. The pupa has no known audible output and the pupal cap, although porous, restricts physical contact. In the absence of taste, visual, tactile and auditory signals, it is concluded that olfactory information must be used to detect *B. bassiana* infection. It is likely that wasps possess a hierarchy of sensory response mechanisms for the detection of disease upon which they can rely in the absence of one or other of the necessary stimuli. The phenomenon of hierarchical response is seen in many Hymenoptera and is exemplified by the navigation of honey bees (von Frisch 1967). It allows flexibility in the face of adversity, which is reflected in the success of the eusocial Hymenoptera.

**Behavioural resistance:** Common theories on disease resistance in insects centre around a co-evolutionary race between a pathogen and the host immune system (Tooby 1982, Rice 1983). The immune system is constantly adapting to cope with a plethora of disease organisms, gaining a level of resistance from each encounter. Hygienic behaviour, on the other hand, acts to remove the pathogen from the nest and thereby reduces the chance of the pathogen adapting to the genotypes of the host (Spivac and Gilliam 1993). Hygienic behaviour is a major factor contributing to a lack of disease in wasp colonies (Akre *et al.* 1976, Gambino 1988, Glare *et al.* 1996). Most discussion has focused on containment of the disease, by physical removal or isolation, and rarely considered the implications of restricting the adaptive success of the pathogen. Given time and exposure, chance mutations will occur that may enhance the

pathogenicity of a micro-organism to its host. The constant removal of infected material exposes individual workers to the risk of infection but limits the development of genetic and physiological adaptations in the disease organism. This may help explain why wasps have so few successful microbial natural enemies (Rose *et al.* 1999) and why colonies, under natural conditions, almost never fail as a result of disease.

***Implications for biological control:*** Wasp hygienic behaviour reduces the effectiveness of microbial control agents. One redeeming feature of microbial agents in classical biological control systems is that very small volumes of inoculum can have a significant impact through the proliferation of the microbe. This research shows that wasp behaviour may negate this advantage and indicates that even large doses may not have the impact that would be expected in the absence of co-ordinated hygienic defence. A limitation of fungi is the length of time between death of the host and sporulation (the infective stage). For *B. bassiana* (at 30°C) this can be up to eight days (see Appendix Three, Table 10.1). Sporulation is also dependent on humidity, which although high in wasp nests (see Appendix Two) can vary greatly. The effective surface humidity on a larval cadaver, particularly a cadaver within a capped cell, may be too low to allow sporulation (T.R. Glare 1998, pers. comm.). A bacterial agent may be less easily detected by workers because it builds up slowly and can constantly re-infect. However, they are susceptible to antibiotics (Chapter Five) and none is known that is pathogenic to wasps (Chapter Two). It is unknown whether any microsporidian is susceptible to larval antibiotics, but slow-working chronic diseases such as a microsporidian seem to be an effective method of limiting the impact of this defensive behaviour. The search for a pathogenic strain of a chronic disease should be a priority.

The colony hygiene experiment revealed a high level of removal of infected larvae and a consistently low level of apparently healthy larval removal. Due to the design of the experiment, the fate of these larvae once out of their cell was not immediately obvious. A nest was needed that simulated natural conditions and allowed full observation of the interior.

## Removal of displaced larvae: Vertical nest experiments

Previous experiments showed wasps efficiently remove diseased larvae and pupae before they become infectious. Given the efficiency of this response, I hypothesised that the worker removal of displaced larvae would be rapid, efficient and limit unnecessary risk of contamination. The aim of this experiment was to determine the response of workers to displaced larvae at different stages of infection with *B. bassiana* (F180). This was achieved by timing removal and observing the behaviour of workers when presented with displaced larvae dropped into the nest.

### Materials and Methods

It was necessary to develop an observation chamber that incorporated the intrinsic design of a natural nest with the need to observe behaviour. The vertical observation nest design achieved these criteria by retaining the vertical striation (comb layers) while reducing the width of the chamber thus making observations possible throughout the nest (Figure 6.9). *V. vulgaris* nests were collected and monitored as in the colony hygiene experiment and colony stability was similarly established through observations over time. Food supplements (30% sucrose solution and honey) were given to boost the colony leading up to experiments and to ensure that observed behaviour was not an artefact of a food shortage.

A range of treatment subjects was placed into the nest between the last two layers (representing a naturally displaced larva). The treatments were as follows:

- (i) live, healthy larvae (control);
- (ii) live, *B. bassiana*-inoculated larvae (20 hours incubated);
- (iii) frozen larvae (healthy larvae, frozen, then thawed);
- (iv) dead, *B. bassiana*-infected larvae (purple, non-sporulating); and
- (v) dead, *B. bassiana*-infected larvae (sporulating fungus).

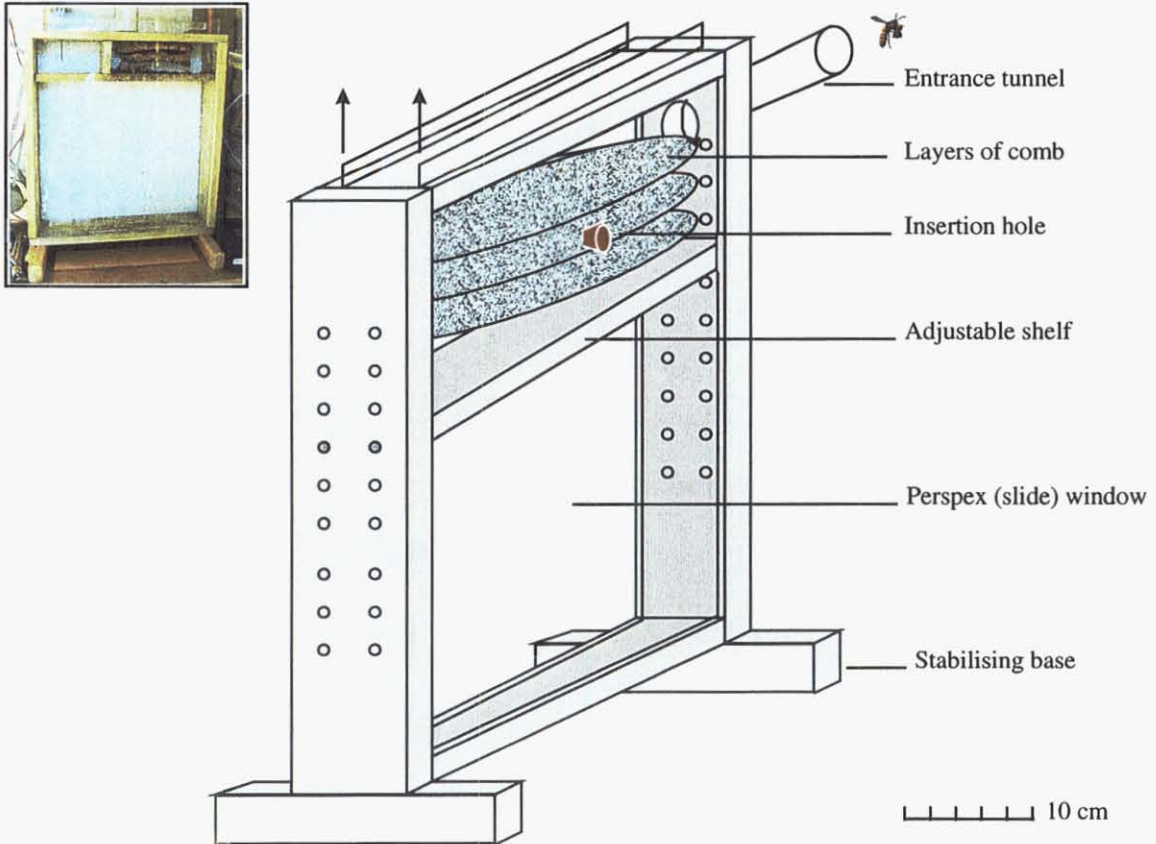

Figure 6.9 Vertical observation nest used in the removal of displaced larvae experiment. Note the treatment aperture for inserting the larvae into the chamber and the adjustable shelf to allow the nest to expand.



**Larval preparation:** Treatment larvae were taken from the experimental nests at collection. Larvae for treatment (iii) were frozen immediately whereas those for treatments (iv) and (v) were inoculated and incubated as outlined in Chapter Two. Once these larvae showed visual signs of infection (purple, see Figure 6.10), they were removed from their cells. Half were refrigerated and the rest were placed into high humidity Petri dishes (sealed with damp filter paper) to induce sporulation. Larvae for treatments (i) and (ii) were stored at 7°C until 20 hours before the experiment, when half were inoculated (dipped in spore suspension) with F180 and the rest were kept warm. All larvae inserted into the nest were first removed from their cells and brought up to nest temperature (30°C, Appendix Two).

**The tests:** A small hole (10 mm diameter) was drilled into the perspex front of the nest chamber and covered with a tab of parcel tape. Larvae were passed through the hole using fine forceps and placed on the upper surface of the bottom layer of comb. Worker response was determined by recording the time taken for larvae (infected and not infected) to be detected and removed by workers. The wasp's behaviour exhibited in the process of removal or consumption was also noted. Observations of grooming behaviour were made to determine whether this behaviour increased in the presence of pathogens.

First, 20 large (fourth-fifth instar) and small (second-third instar) living larvae were tested to compare the response of workers to small and large larvae. This treatment was tested first in order to get an estimate of time for removal and allow size selections that would not unnecessarily slow the collection of data. The larvae chosen for this experiment (second and third instar) were all of a similar size. Second and third instar larvae were also chosen because they were abundant and one adult wasp could carry these larvae easily. Twenty larvae were then tested for each treatment (i)-(v) and tests were replicated in time (2 experiments on different colonies). Treatments were tested between 1000 and 1600 h daily until each experiment was complete. Infected and sporulating treatments were tested last to avoid pathogen transfer confounding the results.

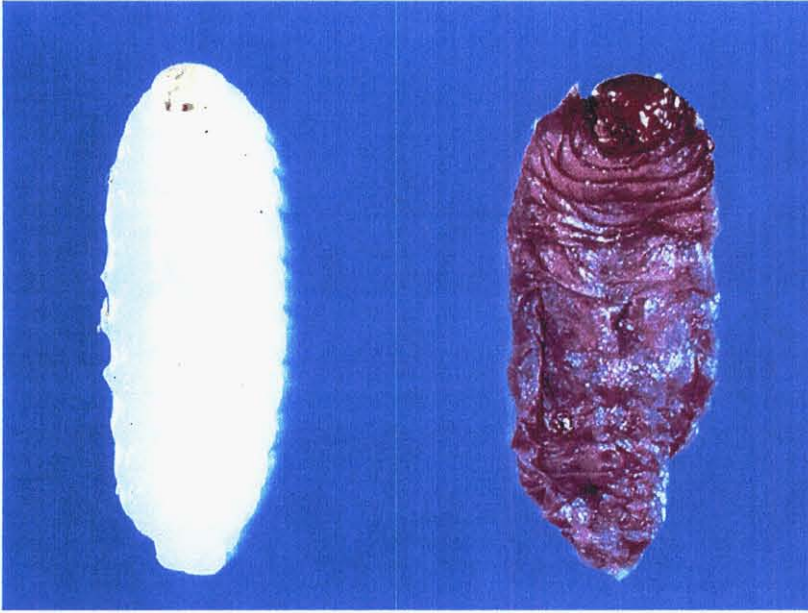

Figure 6.10: Healthy larva (left) and larva killed by *Beauveria bassiana* infection (right). Approximately four days after larvae turn purple and become mummified the fungus erupts through the cuticle and sporulates.

A set of 11 protocols was established for recording hygienic behaviour towards displaced larvae (based on Visscher 1983). Typical interactions of adult wasps with individual cadavers were categorised as follows:

- (i) Encounter larva, touch with antennae;
- (ii) Exploration of larva, touch with antennae and mouthparts;
- (iii) Movement of the larva from discovery point;
- (iv) Chew or feed from the larva;
- (v) Dissection of the larva;
- (vi) Removal of a section of the larva from the nest;
- (vii) Removal of whole larva from the nest;
- (viii) Consumption of larva;
- (ix) Abandon larva inside the nest;
- (x) Larva passed between workers; and
- (xi) Grooming during or after contact with larva.

Observations were made by watching individual larvae placed in the nest and recording the presence or absence of any category of behaviour exhibited towards that larva until it was removed from the nest. The time of first contact and time to removal (from the nest) of each larva was also recorded to measure the speed of detection and removal of displaced larvae. Tests were conducted over several days with a small number of the replicates from each treatment tested each day and the pathogen treatments tested on the latter days. This was necessary to control against daily differences in behaviour (due to temperature, humidity, barometric pressure, etc.), because of the time involved in each replicate. Temporal data are presented as mean time to contact and removal of larvae from the nest. Behavioural responses are plotted as a normalised frequency (%) of expression, of each behaviour category, for the five treatments. Data were analysed using a replicated ANOVA to test for variation within treatments and in time.

## Results

**Contact and removal times:** Large and small larvae were detected by workers at approximately the same time after insertion into the nest (small  $1.17 \pm 0.29$  min., large  $1.15 \pm 0.11$  min.,  $P=0.9502$ ). However, removal from the nest (either by consumption or dumping) of large larvae was much slower than removal of small larvae (small  $6.44 \pm 0.42$  min., large  $104.58 \pm 12.19$  min.,  $P<0.0001$ ).

There was no significant difference between the contact or removal times for the live larval treatments ( $P=0.7671$  removal,  $P=0.2269$  contact) (Figure 6.11). Further, disease-free larval cadavers were not removed significantly faster than the live larvae ( $P=0.9082$  live healthy,  $P=0.9030$  live infected). However, first contact by workers was significantly delayed in this treatment compared with both the live treatments and the other dead treatments ( $P=0.0073$  dead sporulating,  $P=0.0039$  dead infected,  $P=0.0072$  live healthy,  $P=0.0122$  live infected). Larval cadavers supporting sporulation were detected and removed significantly faster than the frozen larval cadavers ( $P=0.0349$  removal,  $P=0.0073$  contact), but time to removal from first contact was not significantly different ( $P=0.1244$ ) from the control (live healthy larvae). Infected larval cadavers were detected (mean  $5 \pm 0.1$  sec,  $P=0.0003$ ) and removed (mean  $119 \pm 52$  sec,  $P=0.0039$ ) the faster than all other treatments.

Generally, infected cadavers were detected earlier than controls and their removal was more rapid than the cadavers supporting sporulation or the controls. Live larvae were detected very quickly but removal was much slower than infected cadavers (Figure 6.11).

**Behavioural observations:** Three behavioural traits were observed in all replicates and treatments. All larvae were rapidly detected by workers (i), all larvae were moved from the insertion point by workers (iii) and grooming (xi) was always performed either during or after contact with larvae.

Other behavioural categories differed between treatments (Figure 6.12). Exploration of the larvae (or cadavers) (ii) were variable between the treatments and involved repetitive touching with the antennae and mouthparts. Infected cadavers (55%), live infected larvae (35%) and cadavers supporting sporulation (25%) were most commonly investigated. Frozen cadavers (15%) and live healthy larvae (10%) were rarely investigated for more than a few seconds.

Chewing and feeding by the adults on larvae were not easily distinguished from each other so were pooled into one category (iv). Infected cadavers (40%) and frozen cadavers (25%) were chewed most frequently whereas live healthy (15%), infected larvae (10%) and cadavers supporting sporulation (15%) were infrequently chewed or fed from.

Live healthy larvae were never dissected (v) but infected cadavers were commonly (35%) dissected into two or more sections. Very few live infected larvae (10%), frozen cadavers (15%) or cadavers supporting sporulation (15%) were dissected. If dissected, the sections were usually dropped to the base of the nest or consumed by workers.

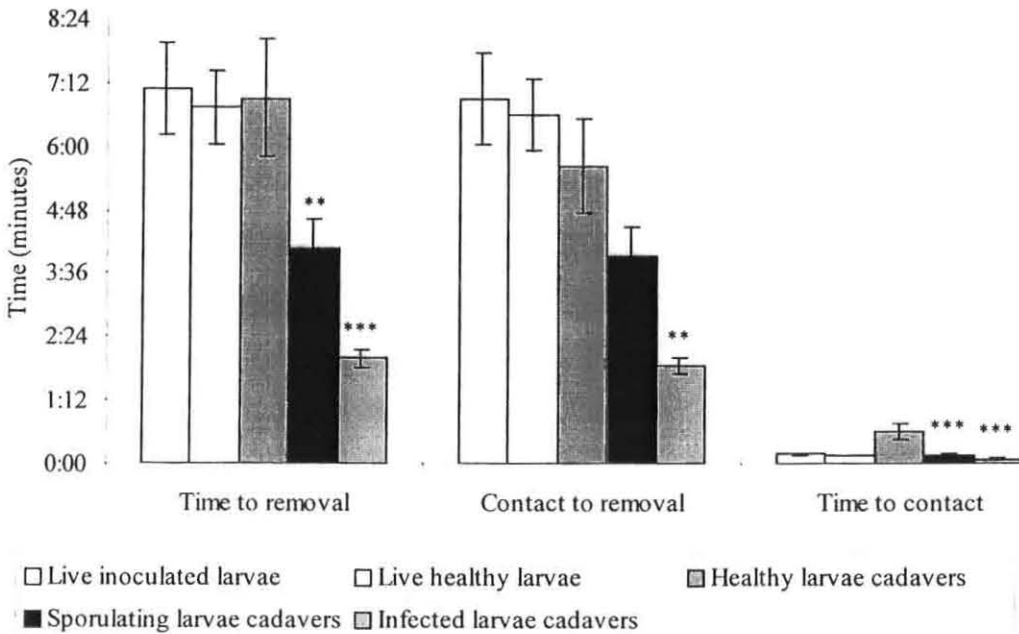

Figure 6.11: Mean time to contact and removal of displaced *Vespsula vulgaris* larvae. \*\*\* significant at the 0.1% confidence limit ( $P < 0.0001$ ).

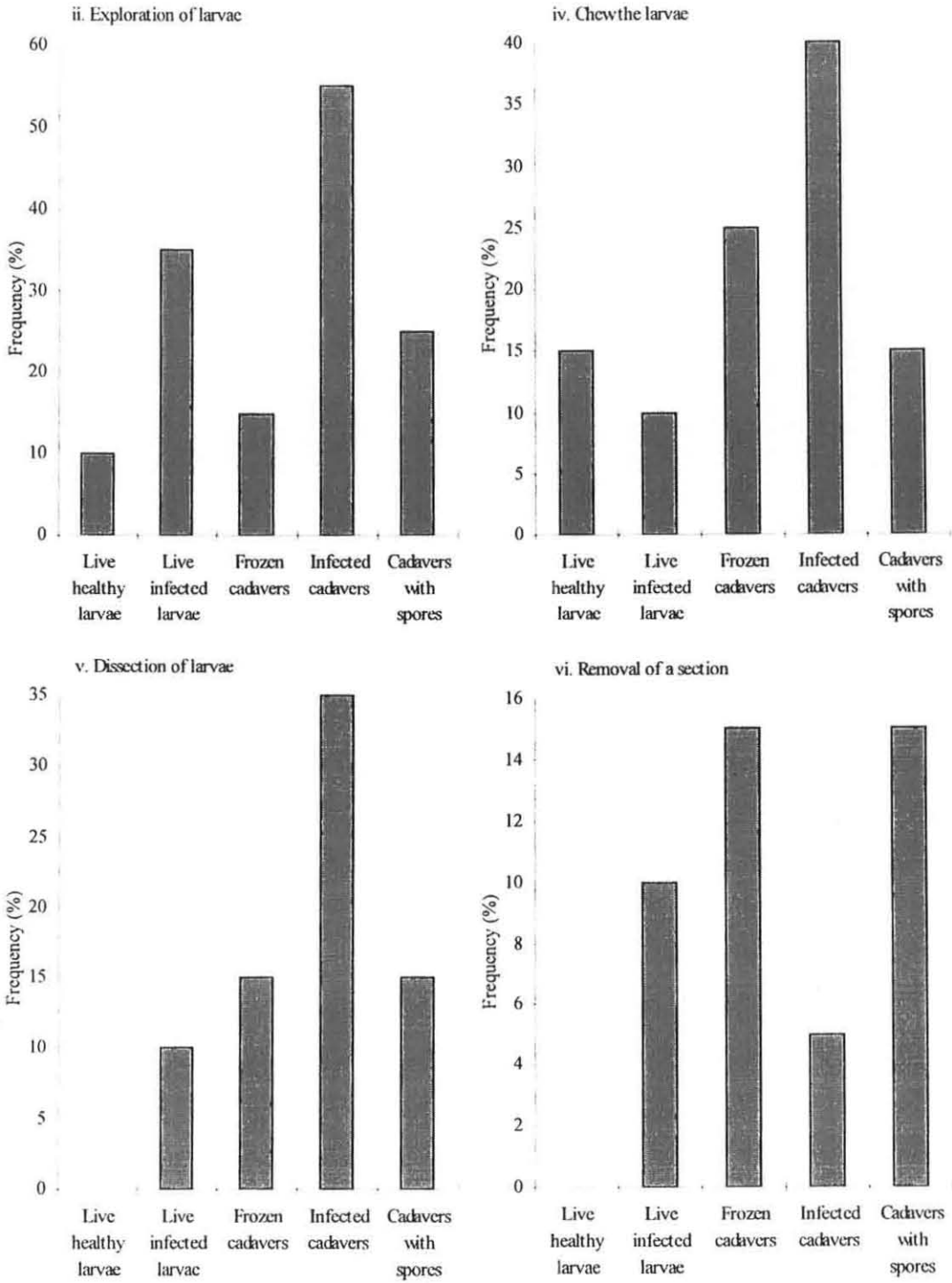

Figure 6.12: The behavioural response of *Vespula vulgaris* workers to infected and healthy displaced larvae in the nest. Observations relate to the treatments i, iv, v and vi of the protocols for recording necrophoric and necrophagic behaviour outlined in the methods and materials.

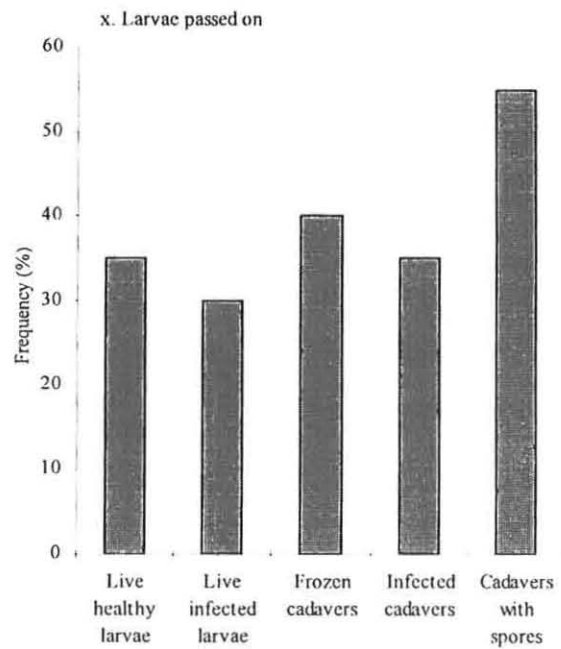
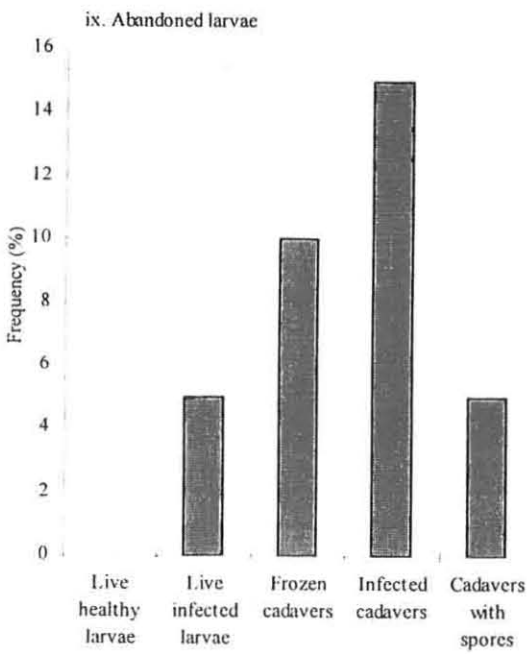
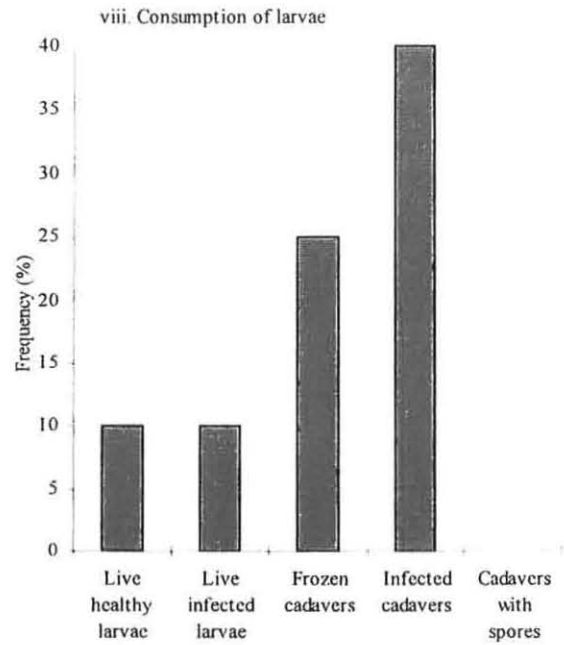
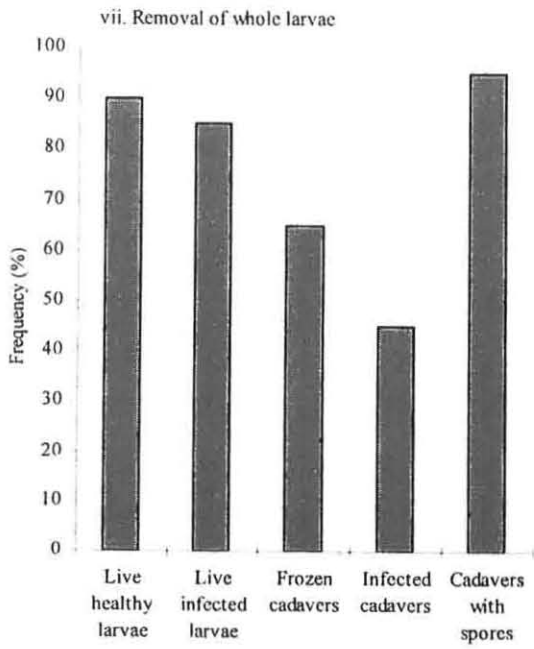

Figure 6.12: (Continued): The behavioural response of *Vespula vulgaris* workers to infected and healthy displaced larvae in the nest. Observations relate to treatments vii, viii, ix and x of the protocol for recording necrophoric and necrophagic behaviour outlined in the methods and materials.

There was very little removal of parts of larval bodies from any of the treatments (<15%). More commonly, larvae were removed intact. The cadavers supporting sporulation were nearly always removed intact (95%) but were frequently carried throughout the nest in what appeared to be a random search for the exit. The live larval treatments were also frequently removed whole (healthy = 90%, infected = 85%), though the dissection of frozen cadavers and the infected cadavers reduced this statistic (45% and 65% respectively).

Consumption (necrophagia) of larvae was most common on cadavers showing visual signs of infection (40%). Many frozen cadavers (25%) were also consumed, but this behaviour was rare in the other treatments. In all treatments, workers appeared to claim the displaced larvae and went to great lengths to keep them. However, other workers would pursue the wasp with the cadaver and were persistent in their efforts to take possession of the corpse. The transfer of possession occurred on many occasions in all of the treatments and was especially high when the cadaver supported sporulation (55%).

Displaced larvae were infrequently abandoned in the nest (<15%). This occurred most often when the larva was dropped into an inaccessible crevice or fell into the debris at the base of the chamber. The workers that dropped these larvae often spent 30-60 seconds searching for the body and would, on occasion, return, apparently to continue the search.

The removal of large larvae was much slower and usually involved either dissection and/or consumption. The immediate reaction of workers was delayed, but once detected, several workers began to work vigorously to drag the larva towards the exit. The lack of co-ordinated direction often resulted in the failure of these efforts and after several minutes the workers resorted to dissecting the larvae. This process took up to three hours but was usually achieved and the sections were consumed or removed from the nest. Many workers left larvae during dissection. Most returned and continued the dissection but occasionally a worker would abandon the larva. The workers also fed parts of the displaced larva to other larvae in their cells.





Figure 6.13: Necrophoric behaviour by a *Vespula germanica* worker removing the dismembered thorax and upper abdomen of a nestmate. Necrophoria is a fundamental mechanism in the maintenance of hygiene in the nest.

## Discussion

The vertical observation nest was a more effective design (than the horizontal nest design) for creating an environment where behaviour was similar to the natural situation. The observational qualities of the design were exceptional. Worker movements and behaviour could be monitored in most areas of the nest. The chamber was designed to represent a possible nest site (e.g., a cavity in a roof space, wall or shed, which although completely artificial, are frequently chosen by wasps as nest sites). However, the nest chamber is an artificial environment that was not chosen by the queen, and there is no way of knowing how it affects the behaviour of workers. Colonies were allowed to establish in the chamber before the experiments began and, if there was any doubt about the stability (normal colony function) of the colony, then nests were discarded. If the results are as close as possible to being representative of normal colony function, they may be used to forecast the likely response of workers to infected larvae in the field.

Detection of displaced larvae by workers is rapid and is followed by vigorous attempts to remove the body. However, the behaviour exhibited during removal of infectious cadavers does not appear to be rapid or efficient. Spore-covered larvae were carried throughout the colony for up to eight minutes before being ejected from the nest. Workers appeared to be disorientated or were unaware of the exit location. Nests were established on site for at least a week before the experiments were conducted in which time foragers and workers became familiar with their surroundings<sup>5</sup>. Workers responsible for removal of debris from the nest are newly emerged (Spradbery 1973) and therefore may be naïve about the location of the exit. However, this was not tested. Regardless of the reason, this behaviour is potentially detrimental to the hygiene of the colony. Spores from *B. bassiana* drop from the host at the slightest touch or vibration. The jostling scramble through the nest and the regular engagements as other workers try to wrestle the morsel free, inevitably disperses infectious spores. This apparent lack of adaptive strategy to cope with a spore-covered cadaver can be explained when results of the previous section are considered; all infected larvae and pupae were removed from the nest long before sporulation was

---

<sup>5</sup> Nests were also settling into the chamber while at the collection site for several days. The exit hole was obvious as it radiated light into the nest and foragers were competent in their search for the exit within a few hours of capture.

due to occur. This meticulous cleanliness means that wasps very rarely have to dispose of cadavers supporting sporulation. It is also possible that the efficiency of this hygienic behaviour enables wasps to cope with the widespread distribution of pathogenic fungal spore. If sporulation occurs, then another strategy may be employed to isolate the infection. In some field-collected nests where sporulating fungi have been found, the affected cells have been papered over (encapsulated) in an effort to isolate the disease (S.J. Harcourt, pers. obs.), (Figure 6.14).

Infected larval cadavers were detected and removed from the nest faster than any other treatment. The texture and consistency of these larvae was unlike any other treatment. The larvae were the consistency of cheddar cheese and had a characteristic purple colour (Figure 6.10). It is evident from the observations that workers were particularly aware of the difference between infected and normal, healthy larvae. Fifty-five percent of these larvae were investigated at some length before the worker began the task of dissecting or removing the cadaver. Peculiarly, more of these larvae were dissected and consumed than any other treatment. This appears to be disadvantageous to the colony because many *Beauveria* species can infect the host in the vegetative stage and are particularly successful (among fungi) within the digestive tract. Akre *et al.* (1976) remarked that workers avoid dark patches when dissecting displaced larvae. However, these are most likely septic bacterial infections, which have little nutritive value and are specifically transferred by ingestion. There is likely to be nutritional value in a moribund (purple) larva and recycling of waste and the dead is common wasp behaviour.

The lack of difference in the response (contact and removal) time to the two live treatments indicates that workers treat recently infected and healthy larvae the same way. This does not imply that they do not detect difference between them. Observations showed more exploration of infected larvae. Similarly, frozen cadavers were not removed any faster than live larvae. However, first contact by workers was significantly slower in this treatment and there were marked differences in the behaviour exhibited towards the frozen cadavers (e.g., number chewing



Figure 6.14: Encapsulation of old or infected cells isolates disease from the rest of the colony. Encapsulation is common on older comb late in the season and is often found over areas of comb with infected larvae or pupae. It is also commonly found covering empty cells from which the occupants have been removed.

and consuming larvae). This, combined with results from the colony hygiene experiment, indicates that the level of awareness of infection in larvae is acute. Removal behaviour is most likely triggered by behavioural and sensory changes to the larvae and not solely the occurrence of germ tube penetration of the host cuticle.

In all treatments, the inserted larva was frequently passed between workers before it was ejected or consumed. Workers tended to defend displaced larvae against pilfering by other workers. Despite their efforts, many were lost. Although some of these larvae were subsequently consumed, the great majority were removed from the nest. The energetic defence of these larvae may be related to the nutritive value of the flesh, but it is more likely an expression of instinctive hygienic behaviour.

By far the most striking impression of wasp behaviour within the nest is the frequency of social and personal grooming among workers. Worker encounters with larvae inserted into the nest were always succeeded by and often punctuated by short periods of personal grooming. The frequency and duration of the grooming behaviour increased in the presence of fungal spores. Extended periods of grooming were also noted in the bioassay preparation where workers were dusted with spores of *B. bassiana*. Although it is likely that wasps cannot see individual spores on their bodies, they can detect the presence of dirt, dust and debris on their body hairs, which is the likely stimulus for grooming (Spradbery 1973). Furthermore, wasps have been observed grooming as a displacement activity induced by stress or apparent confusion (Evans 1982). Personal grooming is a routine habitual act, which is magnified in response to the presence of foreign material or stress factors. Grooming is especially prevalent when workers manipulate particulate debris such as fungal spores.

In summary, displaced infected larvae were removed from the nest more rapidly than healthy larvae. The removal of infected larvae exposes individual workers to the risk of infection while limiting the impact on the whole colony. However, the time taken and the apparent irregular removal of the infectious material amplifies the risk to both the individual and the colony. These

discrepancies in the behavioural defence repertoire of wasps are the key to vertical transmission of disease, which is fundamental to the success or failure of a microbial control agent.

# Chapter Seven

## General Discussion

### Review of goals and objectives

The primary goal of this study was to develop an understanding of the processes and interactions between wasps and their pathogens. This has been achieved through detailed investigation of wasp behaviour and biology in both controlled laboratory and field trials. The two broad areas of research allowed the isolation of individual and colony defence mechanisms and enabled an assessment of the role each played in disease resistance.

Individual workers and larvae possess few resistance mechanisms capable of suppressing a mass infection of pathogenic fungi such as was inoculated in the bioassays and transfer bioassays. Mechanical and physiological barriers (cuticle, peritrophic membranes, etc.); cellular immune responses (phagocytosis, encapsulation, nodule formation, lysozyme and lectin activity, etc.); and induced antibacterial immune proteins, all play a part in the defensive chemistry of insects. Pathogens, by definition, are capable of overcoming these immune responses and causing disease in the host. Workers also exhibit individual behavioural responses to the presence of disease agents that involved extensive grooming of the body and appendages. This was also not sufficient to prevent the development of disease from most of the fungal pathogens tested.

Although fungi, such as *B. bassiana*, were highly pathogenic in bioassays, their effectiveness as a biological agent in active wasp colonies was shown to be limited by the colony response. The colony response to *B. bassiana* infection was swift and comprehensive. Removal and encapsulation of infected larvae and pupae resulted in the disposal of all infectious material before sporulation could occur. This study confirms that the collective behaviour of the colony is

the primary line of defence against disease and individual hygiene reduces the hazard involved with dealing with such infections.

**Adult bioassays:** The aim of the adult bioassays was to establish a list of pathogens (fungi and bacteria) which had potential as biological control agents for wasps. The objectives were to conduct bioassays using several different inoculation techniques to determine pathogenicity, speed of toxic action and give an indication of mode of action. It was concluded that strains of the fungal pathogens *B. bassiana*, *M. anisopliae* and *A. flavus* are capable of rapid kill of adult wasps in bioassays.

**Transfer bioassays:** The specific objective of the transfer bioassays was to track movement and survival of pathogens between adults and larvae. Both bacteria (*S. marcescens*) and fungi (*B. bassiana*) were readily transmitted between adults, from adults to larvae and vice versa. Lethal doses of *B. bassiana* were achieved for the transmission on all levels. The level of individual hygienic behaviour was not sufficient to eliminate the presence of small doses of fungi or bacteria in a bioassay environment.

**Field Experiment:** The aim of the field experiment was to test the efficacy of inundative inoculation of *B. bassiana* in an active free-foraging nest. The direct inoculation of *B. bassiana* (Isolate F180) resulted in the establishment of minor epizootics in active nests of *V. vulgaris*. Inoculation of foragers also resulted in small infections in the nest, showing the potential for bait application of microbial agents. Conclusions drawn from these trials were limited because of the low level of replication and the timing of the experiment (late season). Further trials are being conducted to replicate these results and adapt the inoculation methods for use in an inundative biological control programme (R.J. Harris, Landcare Research, Nelson).

**Anti-microbial properties of exocrine secretions:** The aim of these experiments was to investigate the antibiotic and fungicidal properties of venom and larval saliva as it relates to the suppression of pathogen attack within wasp nests.



**Anti-fungal properties of venom:** The hypothesis that 'the exocrine secretion (venom) from the venom gland, or one of its constituents, can inhibit the *in vitro* growth and germination was not rejected for *Aspergillus flavus*, but was rejected for *Beauveria bassiana*. However, further investigation at a molecular level is needed to determine whether the effect seen for *A. flavus* is fungicidal or biocidal. It was concluded that wasp colonies possess products which may be used for both a broad spectrum and targeted antiseptic cleaning of the nest environment. Some pathogens were not affected by the treatments indicating a degree of selectivity of the active ingredients.

**Anti-bacterial properties of larval saliva:** The aim of this research was to corroborate Gambino's results for *Bacillus* and determine the range of pathogens affected by the antibiotics present in larval saliva. The hypothesis that 'larval saliva from *V. vulgaris* contained broad spectrum antibiotics capable of inhibiting *in vitro* growth of pathogenic bacteria from various key groups' was supported. Saliva has a strongly lethal effect on the growth and division of most of the bacteria tested. It is evident from this research that the concentration of larval saliva is crucial when considering a lethal dose. Such an antibiotic will have significant implication for the selection of a bacterial biological control agent. The identification of the antibiotic substance could be useful for selection or development of resistant strains of bacteria.

**Hygienic behaviour:** The aim of the hygienic behaviour experiments was to determine the behavioural adaptations of individual wasps and the colony unit, to the presence of disease within active nests. The question was asked: How do wasps limit the infection and spread of the fungus *Beauveria bassiana* once in the nest? Results indicate a rapid intervention by workers to eliminate the infection upon discovery. It is concluded that there is a high level of awareness of the health of larvae and the readiness of workers to remove larvae seems to protect the colony from the development of epizootics. Further, it is concluded that personal grooming is a routine habitual act which is magnified in response to the presence of foreign material or stress factors. Grooming behaviour, combined with the constant removal of debris from the nest, forms an integral part of the 'hygienic' behaviour of social wasps.

**Methodological critique:** The major shortcomings of the adult (Chapter Two) and transfer bioassays (Chapter Three) were the minimal replication used and not conducting *V. vulgaris* and *V. germanica* assays separately. The low number of replicates in each assay was necessary to complete the tests against the range of microbes selected for screening, but could have been extended to 20 individuals. The decision to use both species in these assays was made very early and was made on the assumption that there would be no specific variation in susceptibility to these pathogens. This assumption was made on the advice of a number of scientists and after much literature investigation. In hindsight, it would have been clearer and more appropriate to conduct bioassays for each species. The availability of wasps of each species over an extended period was also a contributing factor and would have made the species-specific assays very time consuming (at least two seasons).

One further shortcoming of these experiments was the failure to assess the effective dose of individuals in each of the assays and between the assay methods. The lack of dose information limited the comparisons that could be drawn between experimental techniques, despite clear differences in effective dose rates. The assessment of dose rate should have been made and could have been achieved by washing a sub-sample of workers, post treatment, and counting spores present after dosing. This step was left out due to an alternative focus on future field inoculation, where inoculum concentration is controlled and effective dose is dependant on exposure. The goal and purpose of these experiments were thus confused, and limits inferences that can be drawn from these results.

The experiments on antimicrobial properties of exocrine secretions of wasps (Chapter Four) was a large and difficult piece of research. It involved a very high level of precision and was, by necessity, conducted on a micro scale. One problem inherent in working with very low volumes of liquid is the accurate mixing of experimental concentrations. A number of very fine micro-pipettes were used, but when mixing concentrations of 0.01% (v/v) in a stock solution of 30 $\mu$ l, some level of error is unavoidable. This error was minimised by consistency of procedure between treatments and ensured that comparisons between treatments were valid.

The standard technique for a plate assay is to randomise the allocation of treatments within a plate. This was not done because the number of components added to each well and the number of treatments used was very high. Time was also critical in the 20 hour assay and randomisation would have confounded the experiment by extending the 4 hour set up time further. It was decided that random allocation would add confusion, and therefore error, to the set up procedure. The risk of plate effects was minimised by standardising the incubation environment (dark at even temperatures) and allocating treatments in an ascending descending order.

The use of venom sacs instead of pure venom was a major limitation to the *A. flavus* germination experiments. An attempt was made to extract venom from wasps, but this proved very difficult. Mechanised apparatus is used for the commercial extraction of venom but attempts to borrow or buy such apparatus were not successful due to commercial sensitivity of the technology. Consideration was given to purchasing venom (used for desensitisation therapy) but the cost was not justifiable. Controls (lower intestinal tract) were used for the inclusion of venom sacs in these treatments but this introduced an inconsistent source of bacterial contamination and were not reliable as a control. The heat treatment of venom sacs (assuming this inactivated venom) or inclusion of muscular tissue from the haemolymph would have constituted a more reliable control.

The field trial (Chapter Five) was limited by the lack of replication and the late-season timing of the experiment. However, it was intended as a preliminary investigation of the response of field colonies to fungal pathogens. Much of the direction and focus of the following experiments on colony behaviour (and subsequent thrust of the Landcare Research pathogenic wasp control programme) was derived from the few insights and ideas gained in this experiment. The low level of replication was influenced by the decision to work on nests within a small area to minimise environmental factors confounding the results. In hindsight, it would have been better to incorporate nests from other locations (with controls) to create a statistically more robust experiment that would be less affected by environmental differences. The drowning of one control nest was unfortunate, but unavoidable. The low lying nest should have been selected as a treatment and perhaps the externally treated nest should have been included as an internal

treatment to bolster numbers. However, some significant insights were gained from having this external treatment and overall the objectives of the experiment were achieved.

The hygienic behaviour experiments (Chapter Six) were an attempt to replicate field conditions within a controlled environment in order to present known challenges and observe responses. The normality (closeness to natural nests) of the colonies in nest chambers (vertical, horizontal and box) was a concern addressed prior to initiating these experiments. Some atypical behaviour was observed, especially in the horizontal nest chamber where colonies began to decline soon after establishment (5-10 days). The vertical and box colonies appeared more normal and once established some developed through to the end of the season (producing reproductive males and queens). Despite these efforts to mimic normal colony conditions, these are still artificial conditions and must therefore be regarded as such in the interpretation of results.

The discarding of three nests from the colony hygiene experiment was deemed necessary due to colony decline for reasons unrelated to the experimental treatments. The inclusion of data from these colonies would have artificially obscured the behavioural trends. Discarding these data would have been a simpler decision to make if supporting evidence, such as traffic rates, were collected to corroborate the natural decline and challenge the link to the application of inocula.

Statistical analysis of Chapters Four and Six could be improved by applying more appropriate models to the data. For example, the saliva test plate data was replicated within plates and over time yet there is no analysis of group effects (i.e., data was pooled). Further, there is some variation in this data set and it appears to be skewed. This may violate the assumptions of ANOVA. A non-parametric test would have been more appropriate for these data. The analysis of variance for colony nest experiments were also not ideal. The replication of nests within and between experiments should have been fitted as a factor in the analysis. An assumption was made that the nests were largely uniform in their response to pathogens and that the extreme atypical colonies were not representative of the norm or the range. An analysis should have at least been done to confirm this.

An enhancement of the whole research programme may have been to make some effort to isolate microbes from wasps with a view to finding effective pathogens for use in augmentative control systems. This was decided against because it did not fit the research objectives, which were centred on investigating the behavioural and physiological adaptations of wasps. Despite this, and given the general lack of pathogenicity of the bacteria and microsporidian tested, six months work isolating as many microbes from geographically scattered populations may have paid great dividends, particularly when isolation of a non-fungal pathogens for wasps seems, from this research, to be the most likely source of successful wasp control.

### Disease resistance mechanisms

Exposure to disease in wasp colonies is potentially high. The prevalence of subterranean nests brings wasps into contact with a plethora of potentially pathogenic microorganisms in the soil. Pathogens are likely to be brought into the nest with prey and building material and disseminated throughout the nest by worker movements and through the process of trophallaxis. The nest environment is warm, humid and crowded and interaction between nest-mates is frequent. These factors combine to present a formidable challenge to the healthy existence of wasp colonies, and may have promoted the evolution of pathogen resistance mechanisms. Adaptations to these constraints can be categorised in two groups: individual response, and colony response.

***Individual response:*** Life cycle adaptations are effective against the long term build-up of disease, but wasps must also cope with the everyday occurrence of disease organisms coming into the nest with food, water and nest building materials. These small volumes of contaminants must be dealt with by other means, to prevent expansion of the disease within the colony. This defence relies on the use of antimicrobial substances and behavioural intervention.

Larval saliva is one identified source of antibiotic activity in wasp nests; there are likely to be others. Saliva has a broad range of activity and is highly toxic to many bacteria at very low concentrations. The process of trophallaxis not only has an impact on the dissemination of disease

but also distributes the antibiotics in larval saliva. The dissemination of disease has the effect of diluting the infectious material but with every new trophallactic exchange the volume and concentration of antibiotic saliva is replenished. Workers carry only a small volume (~2  $\mu$ l) of macerated food to the larvae and, in turn, larvae regurgitate up to 5  $\mu$ l of saliva in a single trophallactic exchange. After several exchanges, the concentration of saliva acting on any contaminant in the food would be very high, far in excess of the lowest effective concentrations in the *in vitro* assays. Trophallaxis could be as much a mechanism for the dispersal and dilution of disease, as some form of social bonding activity.

Bioassays have been used to establish that the individual components (workers and larvae) of a wasp colony are extremely susceptible to generalist pathogenic fungi. The same fungi applied at high volumes in the field caused a widespread epizootic that debilitated the colony. However, when smaller doses were applied in the colony hygiene experiments, the infection was eliminated and no epizootic developed. From the interpretation of the colony hygiene and larval displacement experiments it is evident that infected larvae are rapidly detected and removed from their cells. Larvae found out of their cells were also quickly removed from the nest and many larvae incidentally infected through disease dissemination were also removed. The response of the colony to the presence of disease was comprehensive and rigorous. The readiness of workers to destroy immatures for the greater good of the colony is their greatest defence against disease. The co-ordination of effort to remove large numbers of larvae and pupae and the efficiency of this removal indicates a highly integrated society and gives credence to concept of the social insect colony being a super-organism existing as an integration of many equally contributing parts (Wilson 1971).

**Colony response:** Densely populated nests create efficiencies in the nurturing process and allow a large but partially expendable, workforce due to a high reproductive output. Large colonies, however, mean warm, humid conditions and continuous interactions between workers and larvae. Such conditions are ideal for the proliferation of many disease causing organisms. However, wasps have evolved a life history ideally suited to the maintenance of hygiene in this environment. Ventrally opening cells, ventral extension of comb (away from old comb), limited

use of individual cells, insulating involucrum, and the nest cavity partition all contribute to colony hygiene. The use of paper for nest construction reduces the humidity of the nest environment and therefore restricts the cycling of fungal infections.

The annual cycling of colonies sets wasps apart from many social insects. The completion of production of reproductives and the collapse of the colony, within part of a year, limits the build-up of disease within the colony. Honey bee colonies, for example, can occupy the same site for many years and consequently there are several very effective pathogens, which, if allowed to build up, can be devastating to bee colonies (e.g., stone brood, chalk brood, American foulbrood, sac brood, Kashmir bee virus (Palmer-Jones 1964, Dustmann 1993)).

The seasonality of the wasp life cycle restricts the build-up of disease over several seasons. The pathogenic nematode *Pheromermis pachysoma* (Linstow) illustrates this point. *P. pachysoma* is an obligate pathogen of Vespidae (Gambino 1988). At the end of the season, new queens and males leave the nest to mate, some of them carrying *P. pachysoma* cysts. The males die shortly after and a very large proportion of the queens do not establish viable nests. In order to avoid this extreme bottle neck that would limit the long term viability of the pathogen, *P. pachysoma* has evolved an alternative life cycle (Poinar *et al.* 1976). Mature nematodes escape from foragers when they settle near water and lay eggs in the water. Juvenile nematodes are ingested by aquatic insects and become encysted in the muscle tissue. When the aquatic insect is captured and fed to wasp larvae in the following season the nematode life cycle is complete. The evolution of such a complex life cycle is testament to the effectiveness of the wasp habit of shedding the microbial contaminants that inevitably build up in a colony. Any queen carrying pathogens from the previous season is also less likely to survive the winter or establish a nest and enhances the effect of this bottle neck.

## Implications for biological control

**Fungal agents:** Pathogens have been identified that may have the potential to be used for the biological control of German and common wasps. Three of the four genera of fungi tested were pathogenic by Koch's postulates and lethal doses of fungi were readily passed between workers and larvae in laboratory experiments. The transfer of viable infections into nests through the contamination of foragers can initiate small infections. The spread of these infections within the nest is limited by a number of factors and conforms, in some part, to Anderson and May's (1981) model for pathogen proliferation in a host population. In this, and other models (e.g., Dwyer 1994), key emphasis is placed on the density of host and pathogen populations, the reproductive ability (speed and magnitude) of the host and pathogen, and the rate of disease induced mortality in the host population. The delay between infection and sporulation of the fungus and the capacity of workers to detect the infection both acted to limit the proliferation of disease and allowed the colony to overcome the infection.

The proliferation of pathogens within a colony is obviously vital to the success of a control agent, but horizontal transfer (spread) within the population is also a significant factor. Wasps have been seen to isolate disease (encapsulation and removal), which directly interferes with the rate of disease spread. Models such as Dwyer's (1992) 'spatial spread of pathogens' are of little value in wasp populations where uniformity of spread is not likely due to intervening social behaviour. Dwyer (1992) refers to a 'travelling wave' of disease passing through a uniform population of solitary insects. In order to apply such models to the spread of disease agents in wasp populations factors such as necrophoric, necrophagic and other hygienic behaviour must be quantified and incorporated into the model. Larger direct inoculations into the nest overwhelmed colonies and infections developed into the early stages of an epizootic, however, small inoculations were quickly overcome. This suggests that application of a modified version of Dwyer's (1992) model (including parameters for hygienic behaviour) would extrapolate to extinction of the pathogen and continual growth of the host population. If fungi are to have any potential as inundative control agents for wasps, large quantities of inoculum must enter the nest, or strains must be identified that are not detected as readily as *B. bassiana* (F180).



**Future research on fungi:** The testing of low humidity tolerance of fungi should be a priority for selection of fungi for biological control. Thorough investigation of nest humidity should be conducted on both *V. germanica* and *V. vulgaris* to establish the parameters in which a biological control agent must work. Testing to determine the effect of micro-climate on the larval body and cadaver needs to be conducted to ascertain the lower humidity constraints. This could be done by accurately establishing the humidity requirements of a fungus *in situ*, and then assessing fungal sporulation at several experimental nest humidities covering the range. If sporulation were achieved at low environmental humidity, then it would eliminate humidity as an explanation for the recent field trial failures and research could be focused on overcoming behavioural mechanisms of resistance.

**Bacterial agents:** No bacteria tested showed significant pathogenicity against wasps. The bacteria tested were all susceptible to the antibiotics in larval saliva. However, this may not be the primary reason for the lack of pathogenicity. Bacteria are not limited by the humidity constraints that affect most fungi (Milner and Staples 1996, Fargues and Luz 1999). Early detection of infections by workers is also less likely to restrict a bacterial disease because they tend to be more contagious in the early stages of infection, due to the presence of infective units in the living host (Radek and Fabel 1999).

**Future research on bacteria and other non-fungi:** Non-fungal pathogens have many similarities in their potential and limitations for the biological control of wasps. The behavioural research presented in this thesis and experiences with chronic disease organisms, such as nematodes (Poinar 1972), indicates that the more cryptic and chronic disease symptoms, typical of many bacteria and microsporidia, would be useful in a biological control system for wasps. Chronic infections build up slowly in the population, and infected hosts can survive for long periods (Sanchez-Peña *et al.* 1993). Infectious units (microsporidia spores or bacteria and virus cells) build up in the living host and can be transmitted before or shortly after death (Radek and Fabel 1999). The search for bacterial, protozoan, microsporidian and viral pathogens should be a priority. The antibiotic effects of larval saliva on bacteria is a limitation for their use as biological control agents. The development of strains with resistance (either through genetic engineering or

marker assisted selection) to the antibiotics in larval saliva may enhance the potential of some agents. The use of bacteria (or other non-fungal micro-organisms) in combination with fungal agents has the potential to enhance current initiatives (Glare 1994). Common pathogenic bacteria may have a greater impact in combination with a fungus if the fungus sufficiently disrupts the organisation of the colony long enough for the bacterial infection to establish.

Research is needed to develop stable formulations, specifically for the delivery of bacterial control agents, to prolong the infectious life of bait in the field. Research by Spurr (1995) indicated that wasp attraction and consumption of protein baits is high, but varies throughout the season. Baits need to be safe from native and beneficial organisms, such as honey bees, and a bee-safe sugar bait is being developed for this purpose at Landcare Research. To some extent, the specificity of the microbial disease agent offers the greatest protection to non-target organisms and careful host range testing is a prerequisite for registration and release of biological control agents in New Zealand.

***In summary:*** Pathogenic fungi have been identified that will kill individual workers, larvae and severely disrupt the colony. This study confirms that the existence of behavioural and physiological adaptations of wasp workers and larvae that severely restrict the proliferation of these fungi in normal healthy nests. The patterns in behaviour exhibited when removing sporulating or infectious cadavers indicate a possible 'window of opportunity' for the dissemination of disease if a fungus could achieve maturity within the nest. Identification and delivery of a social destabilising agent with the inoculum could alter the behavioural intervention allowing fungal pathogens to mature. An example of this involves the use of sub-lethal doses of imidacloprid against termites (Boucias *et al.* 1996). Exposure to this chemical inhibits normal behaviour allowing the termites to be overcome by a variety of lethal micro-organisms such as *Metarhizium anisopliae* (Bayer Corporation Ltd, unpublished data) However, getting sufficient inoculum into the nest and achieving widespread sporulation to establish an epizootic will be a significant challenge. The incidence of colony drift (worker movement between nests) in *Vespula* (see Akre *et al.* 1976) has important implications for the spread of disease agents throughout a population. If low levels of drift occur in the beech forest ecosystem, then the high density of

nests would ensure rapid dispersal of disease organisms. The search for pathogens adapted to wasp defences and the development of delivery systems are paramount to the success of a microbial control strategy. A more cryptic and infectious disease, such as a bacterium or microsporidian, holds the greatest potential for future control efforts. It is apparent that, in order to establish an infection capable of developing into an epizootic in wasp nests, a microbe needs to be: gradually invasive, readily transmitted, a prolific replicator, cryptic and have little impact on host behaviour leading up to maturation.

Hygienic behaviour, physiological adaptations, chemical inhibitors and a life habit suited to the maintenance of hygiene, constitutes a formidable barrier to the insurgence of disease into wasp nests. Pathogens stand little chance of survival in a healthy nest and it is not surprising that wasp colonies rarely succumb to disease. This research contributes to a larger programme studying the potential of entomopathogenic microbes for the control of German and common wasps in New Zealand. Information gained in this research has already been used to develop strategies for further study into the microbial control of wasps. Parallel research is being conducted (Landcare Research, Nelson<sup>1</sup> and AgResearch, Lincoln<sup>2</sup>) on the application and infection rates of field-inoculated fungi (*B. bassiana*) and delivery systems (e.g., wet and dry bait formulations), for targeted application of inoculum.

This thesis has demonstrated some of the limitations which exist for control of wasps using microbial insecticides as biological control agents. There are limitations to the current use of pathogens for wasp control, however, strain selection and development of delivery systems will overcome many of these. This has been an investigation into the intricate functions of social behaviour in one of the most highly adapted insect groups. The many questions raised by this research reflects the extreme complexity and consummate evolution of the social life habit of wasps.

---

<sup>1</sup> Landcare Research Ltd. Private Bag 6, Nelson, New Zealand.

<sup>2</sup> New Zealand Pastoral Agriculture Research Institute Ltd, P.O. Box 60, Lincoln, New Zealand.

## References

- Abe, T., Tanaka, Y., Miyazaki, H., and Kawasaki, Y.Y. (1991) Comparative study of the composition of hornet larval saliva; Its effect on behaviour and role of trophallaxis. *Comparative Biochemistry and Physiology* 99C (1/2):79-84.
- Ainsworth, G.C. and Bisby, G.R. (1961) *Dictionary of the Fungi* (fifth edition). Commonwealth Mycological Institute, Kew, Surrey, U.K. 547 pp.
- Agra Gothama, A. A., Sikorowski, P. P., Lawrence, G. W. (1995) Interactive effects of *Steinernema carpocapsae* and *Spodoptera exigua* nuclear polyhedrosis virus on *Spodoptera exigua* larvae. *Journal of Invertebrate Pathology* 66: 3, 270-276.
- Akre, R.D. and MacDonald, J.F. (1986) Biology, economic importance and control of yellow jackets. Pp. 353-412 in: S.B. Vinson (ed.) *Economic Impact and Control of Social Insects*. Praeger Publishers, New York.
- Akre, R.D., Garnett, W.B., MacDonald, J.F., Greene, A. and Landolt, P. (1976) Behaviour and colony development of *Vespula pennsylvanica* and *V. atropilosa* (Hymenoptera: Vespidae). *Journal of the Kansas Entomological Society* 49 (1): 63-84.
- Akre, R.D., Reed, H.C. and Landolt, P.J. (1982) Nesting biology and behaviour of the blackjacket, *Vespula consobrina* (Hymenoptera: Vespidae). *Journal of the Kansas Entomological Society* 55: 373-405.
- Allen, G.E. and Buren, W.F. (1974) Microsporidian and fungal diseases of *Solenopsis invicta* Buren in Brazil. *Journal of the New York Entomological Society* 82: 125-130.
- Anderson, R.M. and May, R.M. (1981) Population biology of infectious diseases. *Nature* 280: 361-362.
- Andrade, C.F.S. de (1980) Natural epizootic caused by *Cordyceps unilateralis* (Hypocreales: Euascomycetes) in adults of *Camponotus* sp. in the region of Manaus, Amazonas, Brazil. *Acta Amaz.* 10: 671-678.
- Anon. (1989). ASAS/STAT<sup>7</sup> Users Guide, Version 6, Edition 4, Volume 2. SAS Institute Inc., Cary, NC.
- Anon. (1990) European wasp. Agriculture Protection Board of Western Australia Infonote :13/90, AGDEX 614.
- Archer, M.E. (1972) The importance of worker behaviour in the colony organisation of the social wasps, *Vespula vulgaris* (L.) and *V. germanica* (F.) (Vespidae: Hymenoptera). *Insectes Sociaux* 19 (2): 227-242.
- Archer, M.E. (1981) Successful and unsuccessful development of colonies of *Vespula vulgaris* (Linn.) (Hymenoptera: Vespidae). *Ecological Entomology* 6: 1-10.
- Bailey, L. and Ball, B. (1991) *Honeybee Pathology*. 2nd ed. Academic Press, New York / London.
- Balduf, W.V. (1954) Observations on the white-faced wasp *Dolichovespula maculata* (Linn.) (Vespidae: Hymenoptera). *Annals of the Entomological Society of America* 47: 445-458.
- Barlow N.D., Moller, H. and Beggs, J.R. (1996) A model for the effect of *Sphecophaga vesparum vesparum* as a biological control agent of the common wasp in New Zealand. *Journal of Applied Ecology* 33: 31-44.
- Barlow, N.D., Beggs, J.R. and Moller, H. (1998) Spread of the wasp parasitoid *Sphecophaga vesparum vesparum* following its release in New Zealand. *New Zealand Journal of Ecology* 22 (2): 205-208.
- Barr, K., Moller, H., Christmas, E., Lyver, P. and Beggs, J. (1996). Impacts of introduced common wasps (*Vespula vulgaris*) on experimentally placed mealworms in a New Zealand beech forest. *Oecologia* 105: 266-270

- Batra, L.R. and Batra, S.W.T. (1966) Fungus growing termites of tropical India and associated fungi. *Journal of the Kansas Entomological Society* 39 (4): 725-738.
- Bauer, L.S., Miller, D.L., Joseph, V. (1998) Interactions between a *Nosema* sp. (Microspora: Nosematidae) and nuclear polyhedrosis virus infecting the gypsy moth, *Lymantria dispar* (Lepidoptera: Lymantriidae). *Journal of Invertebrate Pathology* 72: 2, 147-153.
- Beal, R.H. and Kais, A.G. (1962) Apparent infection of subterranean termites with *Aspergillus flavus* Link. *Journal of Insect Pathology* 4: 488-489.
- Beattie, A.J., Turnbull, C.L., Hough, T., Jobson, S. and Knox, R.B. (1985) The vulnerability of pollen and fungal spores to ant secretions: evidence of some evolutionary implications. *American Journal of Botany* 72: 606-614.
- Beattie, A.J., Turnbull, C.L., Hough, T. and Knox, R.B. (1986) A possible function for the metapleural gland of ants (Hymenoptera: Formicidae). *Annals of the Entomological Society of America* 79 (3): 448-450.
- Beggs, J.R. (1999) The ecological impact and control of introduced social wasps (*Vespula* spp.) in *Nothofagus* forest. PhD Thesis, University of Otago.
- Beggs, J.R. and Rees, J.S. (1999) Restructuring of Lepidoptera communities by introduced *Vespula* wasps in a New Zealand beech forest. *Oecologia* 119 (4): 565-571.
- Beggs, J.R. and Wilson, P.R. (1991) The kaka (*Nestor meridionalis*), a New Zealand parrot endangered by introduced wasps and mammals. *Biological conservation* 56: 23-38.
- Beggs, J.R., Harris, R.J., Read, P.E.C. (1996) Invasion success of the wasp parasitoid *Sphecophaga vesparum vesparum* (Curtis) in New Zealand. *New Zealand Journal of Zoology* 23: 1-9.
- Beggs, J. R., Toft, R. J., Malham, J. P., Rees, J., Tilley, J. A. V., Moller, H. and Alspach, P. (1998) The difficulty of reducing introduced wasp (*Vespula vulgaris*) populations for conservation gains. *New Zealand Journal of Ecology* 22: 55-63.
- Blum, M.S., Walker, J.R., Callahan, P.S. and Novark, A.F. (1958) Chemical, insecticidal and antibiotic properties of fire ant venom. *Science* 128: 306-307.
- Boucias, D. and Latge, J.P. (1988) Fungal elicitors of the invertebrate cell defence system. in Drouhet, E., Cole, G.T., de Repentigny, L. and Latge, J.P. (eds.), *Fungal Antigens*. Plenum Publishing Co., U.S.A.
- Boucias, D.G. and Pendland, J.C. (1998) *Principles of Insect Pathology*. Kluwer Academic Publishers, Boston, MA, 568 pp.
- Boucias, C. S., Storey, G. and Pendland, J. C. (1996) The effects of imidacloprid on the termite *Reticulitermes flavipes* and its interaction with the mycopathogen *Beauveria bassiana*. *Pflanzenschutz-Nachrichten Bayer* 49: 103-144.
- Bourdon, V., Lecomte, J., Leclercq, M. and Leclercq, J. (1975) Presence de noradrenaline conjuguée dans l'enveloppe du nid de *Vespula vulgaris*, *Bulletin de la Societe Royale des Sciences de Liège* 44: 474-476.
- Bowers, R., Begon, M. and Hodgkinson, D. (1993). Host-pathogen population cycles in forest insects: Lessons from simple models reconsidered. *Oikos* 67, 529-538.
- Bradshaw, J.W.S. and Howse, P.E. (1984) Semiochemicals of ants. Pp. 429-473, in: W.J. Bell and R.T. Cardé (eds). *Chemical Ecology of Insects*. Sinauer Association, Sunderland, M.A.
- Brian, M.V. (1965) *Social Insect Populations*. Academic Press, London. 135 pp.
- Brian, M.V. and Brain, A.D. (1952) The wasp *Vespula sylvestris* Scopoli: feeding, foraging and colony development. *Transactions of the Royal Entomological Society of London* 103 (1): 1-26.

- Brousseau, C., Charpentier G. (1998) Effects of *Bacillus thuringiensis* and Destruxins (*Metarhizium anisopliae* Mycotoxins) combinations on spruce budworm (Lepidoptera: Tortricidae). *Journal of Invertebrate Pathology* 72 (3): 262-268.
- Carmean, D., Akre, R.D., Zack, R.S. and Reed, H.C. (1981) Notes on the yellowjacket parasite *Bareogonialis canadensis* (Hymenoptera: Trigonaliidae). *Entomological News* 92 (1): 23-26.
- Charnley, A.K., (1991) Microbial pathogens and insect pest control. *Letters in Applied Microbiology* 12 (5): 149-157.
- Carruthers, I.R., Onsager, J.A. and Lockwood, J.A. (1993) Perspective on the use of exotic natural enemies of biological control of pest grasshoppers (Orthoptera: Acrididae). *Environmental Entomology* 22 (5): 885-903.
- Cherrett, J.M. (1986) The biology, physiology and ecology of leaf-cutter ants. Pp.155-192 in: S.B. Vinson (ed.) *Economic Impact and Control of Social Insects*, Praeger, NY. 192pp.
- Christian, L. (1998) Factors affecting conidial production of *Beauveria bassiana* from fungus-killed cadavers of *Rhodnius prolixus*. *Journal of Invertebrate Pathology* 72 (2): 97-103.
- Clapperton, B. K., Alspach, P. A., Moller, H. and Matheson, A. G. (1989) The impact of common and German wasps (Hymenoptera: Vespidae) on the New Zealand beekeeping industry. *New Zealand Journal of Zoology* 16 (3): 325-332.
- Clapperton, B.K., Tilley, J.A.V., Beggs, J.R. and Moller, H. (1994) Changes in the distribution and proportions of *Vespula vulgaris* (L.) and *V. germanica* (Fab.) (Hymenoptera: Vespidae) between 1987 and 1990-91 in New Zealand. *New Zealand Journal of Zoology* 21: 295-303.
- Cole, L.K., Blum, M.S. and Roncadori, R.W. (1975) Antifungal properties of the insect alarm pheromones, citral, 2-heptanone and 4-methyl-3-heptanone. *Mycologia* 67: 701-708.
- Costa, S.D. and Gaugler, R.R. (1989) Sensitivity of *Beauveria bassiana* to solanine and tomatine: Plant defensive chemicals inhibit an insect pathogen. *Journal of Chemical Ecology* 15: 697-706.
- Cumber, R. A. (1966) Factors influencing population levels of *Scolypopa australis* Walker (Hemiptera-Homoptera: Ricaniidae) in New Zealand. *New Zealand Journal of Science* 9: 336-356.
- Delgado, F.X., James, H. (1999) Field assessment of *Beauveria bassiana* (Balsamo) Vuillemin and potential synergism with Diflubenzuron for control of savanna grasshopper complex (Orthoptera) in Mali. *Journal of Invertebrate Pathology* 73: 1, 34-39.
- Donovan, B.J. (1984) Occurrence of common wasp *Vespula vulgaris* (L.) (Hymenoptera: Vespidae) in New Zealand. *New Zealand Journal of Zoology* 11: 417-427.
- Donovan, B.J. and Read, P.E.C. (1997) Attempted biological control of social wasps, *Vespula* spp. (Hymenoptera: Vespidae) with *Sphécophaga vesparum* (Curtis) (Hymenoptera: Ichneumonidae) in New Zealand. *New Zealand Journal of Zoology* 14: 329-335.
- Donovan, B. J., Howie, A. M. E., Schroeder, N. C., Wallace, A. R., Read, P. E. C. (1992) Comparative characteristics of nests of *Vespula germanica* (F.) and *Vespula vulgaris* (L.) (Hymenoptera: Vespinae) from Christchurch City. *New Zealand Journal of Zoology* 19: 1-2, 61-71.
- Durrell, L.W. (1965) Fungi in paper wasp nests. *American Midland Naturalist* 73 (2): 501-503.
- Dustmann, J.H. (1993) Natural defence mechanisms of a honey bee colony against diseases and parasites. *American Bee Journal* June: 431-434.
- Dwyer, G. (1992) On the spatial spread of insect pathogens. *Ecology* 73 (2) : 479-494.

- Dwyer, G. (1994) Density dependence and spatial structure in the dynamics of insect pathogens. *The American Naturalist* 143 (4) : 533-562.
- Dymock, J.J., Forgie, S.A. and Ameratunga, R. (1994) A survey of wasp sting injuries in urban Auckland from December to April in 1991/2 and 1992/3. *New Zealand Medical Journal* 107: 32-33.
- Edwards, R. (1980) *Social Wasps: their Biology and Control*. Rentokil, Sussex, England, 398 pp.
- Edwards, T.L. (1988). The ecology of the spruce shoot aphid, *Cinara pilicornis* (Homoptera: Aphididae). Thesis, University of Ulster, UK, 181 pp.
- Evans, H.C. (1982) Entomogenous fungi in tropical forest ecosystems: an appraisal. *Ecological Entomology* 7: 47-60.
- Evans, H.C. (1989) Mycopathogens of insect epigeal and aerial habitats, Pp. 205-237 in: N. Wilding, N.M. Collins, P.M. Hammond and J.F. Webber (eds) *Insect-Fungus Interactions*, 14th Symposium of the Royal Society of London. Academic Press, London, 344 pp.
- Fargues, J. and Luz, C. (2000) Effects of Fluctuating moisture and temperature regimes on the infection potential of *Beauveria bassiana* for *Rhodnius prolixus*. *Journal of Invertebrate Pathology* 75 (3): 202-211.
- Febvay, G., Hostachy, B., Rahbe, Y. and Kermarrec, A. (1988). Principles of a new control strategy against the leaf-cutting ant, *Acromyrmex octospinosus* Reich, in Guadeloupe. *Bulletin Agronomique Petit Bourg* 7: 10-15.
- Fouillaud, M. and Morel, G. (1995) Fungi associated with nests of the paper wasp *Polistes hebraeus* (Hymenoptera: Vespidae) on la Reunion Island. *Environmental Entomology* 24 (2): 298-305.
- Gambino, P.V. (1988) *Interactions between yellowjackets and insect pathogens*. PhD Thesis, University of California, Berkeley, U.S.A.
- Gambino, P.V. (1993) Antibiotic activity of larval saliva of *Vespula* wasps. *Journal of Invertebrate Pathology* 61: 110.
- Gambino, P. (1994) Susceptibility of the Western yellowjacket *Vespula pennsylvanica* to three species of entomogenous nematodes. *IRCS Medical Science: Microbiology, Parasitology and Infectious Diseases* 12: 3-4.
- Gambino, P.V. and Thomas, G. M. (1988) Fungi associated with two *Vespula* (Hymenoptera: Vespidae) species in the eastern San Francisco Bay area. *Pan Pacific Entomologist* 64 (2): 107-113.
- Gambino, P., Pierluisi, G.J. and Poinar, G.O. Jr. (1992) Field test of the nematode *Steinernema feltiae* (Nematoda: Steinernematidae) against yellowjacket colonies (Hymenoptera: Vespidae). *Entomophaga* 37: 107-114.
- Glare, T.R. (1994). Stage-dependent synergism using *Metarhizium anisopliae* and *Serratia entomophila* against *Costelytra zealandica*. *Biocontrol Science and Technology* 4: 321-329.
- Glare, T.R., O'Callaghan, M. and Wigley, P.J. (1993) Check-list of naturally occurring entomopathogenic microbes and nematodes in New Zealand. *New Zealand Journal of Zoology* 20: 95-120.
- Glare, T.R., Harris, R.J. and Donovan, B.J. (1996) *Aspergillus flavus* as a pathogen of wasps, *Vespula* spp., in New Zealand. *New Zealand Journal of Zoology* 23: 339-344.
- Gliñshi, Z. and Jarosz, J. (1995a) Cellular and humoral defences in honey bees. *Bee World* 76 (4): 195-205.
- Gliñshi, Z. and Jarosz, J. (1995b) Mechanical and biochemical defences of honey bees. *Bee World* 76 (3): 110-118.

- Greene, A., Akre, R.D. and Landolt, P.J. (1976) The aerial yellow-jacket, *Dolichovespula arenaria* (Fab.): Nesting biology, reproductive production, and behaviour (Hymenoptera: Vespidae). *Melandria* 26: 1-34.
- Hajek, A.E. and St Leger, R.J. (1994) Interactions between fungal pathogens and insect hosts. *Annual Review of Entomology* 39: 293-233.
- Harcourt S.J., Harris R.J., Rose E.A.F., Glare T.R. and Nelson T.L. (1998) The potential of *Beauveria bassiana* for the control of common and German wasps (*Vespula vulgaris* L. and *V. germanica* F.) in New Zealand. *Proceedings of the 4th International Workshop on Microbial Control of Soil Dwelling Pests*, 159-164.
- Harris, R.J. (1991) Diet of the wasps *Vespula vulgaris* and *V. germanica* in honeydew beech forest of the South Island, New Zealand. *New Zealand Journal of Zoology* 18 (2): 159-169.
- Harris, R.J. (1992) *Competition between the introduced wasps Vespula germanica and V. vulgaris in honey dew beech forest, north-western South Island, New Zealand*. Ph.D. thesis, University of Canterbury, Christchurch, New Zealand, 145 pp.
- Harris, R.J., Harcourt, S.J., Rose, E.A.F. Glare, T.R. and Nelson, T.J. (2000) Susceptibility of *Vespula vulgaris* and *V. germanica* (Hymenoptera: Vespidae) to generalist entomopathogenic fungi and their potential for wasp control. *Journal of Invertebrate Pathology* 75: 251-258.
- Hermann, H.R., Blum, M.S. and Fales, H.M. (1993) Venom spraying by a tropical polistine wasp (Hymenoptera: Vespidae: Polistinae). *Sociobiology* 23: 95-99.
- Horton, D. L., Ellis, H.C., All, J.N., Dutcher, J. D. (1997) Summary of losses from insect damage and costs of control in Georgia - 1997. The University of Georgia, Department of Entomology, College of Agricultural and Environmental Sciences, Athens, GA, USA.
- Hywel-Jones, N. (1995) *Cordyceps sphecocephala* and a *Hymenostilbe* sp. infecting wasps and bees in Thailand. *Mycological Research* 99 (2): 154-158.
- Ikan, R., Bergmann, E.D., Ishay, J. and Gitter, S. (1968) Proteolytic enzyme activity in the various colony members of the oriental hornet, *Vespa orientalis* F. *Life Sciences* 7(18): 929-934.
- Ishay, J. and Ikan, R. (1969) Glucooneogenesis in the oriental hornet *Vespa orientalis* F. *Ecology* 49 (1): 169-171.
- Ishay, J. S. and Litinetsky, L. (1996) Thermoelectric current of hornet cuticle- morphological and electrical changes induced by temperature and light. *Physiological Chemistry and Physics and Medical NMR* 28: 55-67.
- Ishay, J. S. and Ruttner, F. (1971) Thermoregulation in Hornissennest. *Zeitschrift für vergleichende Physiologie* 72: 423-434.
- Jacques, F. and Christian, L. (2000) Effects of fluctuating moisture and temperature regimes on the infection potential of *Beauveria bassiana* for *Rhodnius prolixus*. *Journal of Invertebrate Pathology* 75 (3): 202-211.
- Jeanne, R.L. (1982) Predation, defence and colony size and cycle in the social wasps. *Proceedings of the IX Congress of the International Union for the Study of Social Insects*: 280-284.
- Jeanne, R.L. and Keeping, M.G. (1995) Venom spraying in *Parachartergus colobopterus*: A novel defensive behaviour in a social wasp (Hymenoptera: Vespidae). *Journal of Insect Behaviour* 8 (4 ): 433-442.
- Joussier, D. and Catroux, G. (1976) Mise au point d'un milieu de culture pour le denombrement de *Beauveria tenella* dans les sols. *Entomophaga* 21: 223-225.



- Jouvenaz, D.P., Blum, M.S. and MacConnell, J.G. (1972) Antibacterial activity of venom alkaloids from the imported fire ant, *Solenopsis invicta* Buren. *Antimicrobial Agents in Chemotherapy* 2: 91-293.
- Kaaya, G.P. (1989) Assessment of antibiotic potential of insect antibacterial factors. *Insect Science and its Applications* 10: 341-346.
- Keller, S. (1992) The *Beauveria-Melolontha* project: experiences with regard to locusts and grasshopper control. Pp. 279-286 in: Lomer, C.J., and Prior, C. (eds) *Biological Control of Locusts and Grasshoppers*. CAB International, Wallingford, UK.
- Kermarrec, A. and Mauleon, H. (1975) Quelques aspects de la pathogénie d'*Entomophthora coronata* Cost. Kervork. Pour la fourmi-manioc de la Guadeloupe: *Acromyrmex octospinosus* (Attini). *Annual Parasitologist* 50: 351-360.
- Landolt, P.J. and Heath, R.R. (1987) Alarm pheromone behaviour of *Vespula squamosa* (Hymenoptera: Vespidae) *Florida Entomologist* 70 (2): 222-225.
- Last, F.T., Fowler, D. and Freer-Smith, P.H. (1984) Koch's postulates and air pollution. *Forstwissenschaftliches Centralblatt* 103 (1): 28-48
- Leathwick, D. M. (1997) Growth and development of queen colonies of *Vespula germanica* and *V. vulgaris*. *New Zealand Journal of Zoology* 24 (1): 17-23.
- Lecomte, J., Bourdon, V., Damas, J., Leclercq, M., and Leclercq, J. (1976) Presence de noradrenaline conjuguée dans les parois du nid de *Vespula germanica*. *Bulletin de la Societe Royale des Sciences de Liège* 170: 212-215.
- Lockwood, J.A., Carruthers, R.I. and Onsager, J.A. (1993). Benefits and costs of controlling rangeland grasshoppers (Orthoptera: Acrididae) with exotic organisms: search for a null hypothesis and regulatory compromise. *Environmental Entomology* 22 (5): 904-914.
- Malham, J.P., Rees, J.S., Alspach, P.A., Beggs, J.R., Moller, H. (1991). Traffic rate as an index of colony size in *Vespula* wasps. *New Zealand Journal of Zoology* 18 (2): 105-109.
- Markwell, T.J., Kelly, D. and Duncan, K.W. (1993) Competition between honey bees (*Apis mellifera*) and wasps (*Vespula* spp.) in honeydew beech (*Nothofagus solandri* var. *solandri*) forest. *New Zealand Journal of Ecology* 17 (2): 85-93.
- Maschwitz, U.W. (1964a) Alarm substances and alarm behaviour in social Hymenoptera. *Nature* 204: 324-327.
- Maschwitz, U.W. (1964b) Gefahrenalarmstoffe und Gefahrenalarmierung bei sozialen Hymenopteren. *Zeitschrift für vergleichende Physiologie* 47: 596-655.
- Maschwitz, U.W. (1966) Alarm substances and alarm behaviour in social insects. *Vitamins and hormones* 24: 267-290.
- Maschwitz, U.W.J. and Kloft, W. (1971) Morphology and function of the venom apparatus of insects - Bees, wasps, ants and caterpillars in: W. Bücherl and E.E. Buckley (eds) *Venomous animals and their venoms*. Academic Press, New York, 537pp.
- Matsuura, M. and Yamane, S. (1984) *Biology of the Vespine Wasps*. Springer-verlag, New York. 323 pp.
- Mello, C. B., Garcia, E. S., Ratcliffe, N. A., Azambuja, P. (1995) *Trypanosoma cruzi* and *Trypanosoma rangeli*: Interplay with hemolymph components of *Rhodnius prolixus*. *Journal of Invertebrate Pathology* 65 (3): 261-268.

- Mesquita, A.L.M., Lacey, L.A. and Leclant, F. (1997) Individual and combined effects of the fungus, *Paecilomyces fumosoroseus* and parasitoid, *Aphelinus asychis* Walker (Hymenoptera: Aphelinidae) on confined populations of Russian wheat aphid, *Diuraphis noxia* (Mordvilko) (Homoptera: Aphididae) under field conditions. *Journal of Applied Entomology* 121: 155-163.
- Milner, R.J. (1994) Future prospects for fungal biopesticides. Proceedings of the first Brisbane Symposium. Biopesticides: Opportunities for Australian Industry: 28-34.
- Milner, R.J. and Staples, J.A. (1996) Biological control of termites: Results and experiences within a CSIRO project in Australia. *Biocontrol Science and Technology* 6: 3-9.
- Milner, R.J., Staples, J.A. and Lutton, G.G. (1997) The effect of humidity on germination and infection of termites by the hyphomycete, *Metarhizium anisopliae*. *Journal of Invertebrate Pathology* 69: 64-69.
- Milner, R.J., Staples, J.A., Hartley, T.R., Lutton, G.G., Driver, F. and Watson, J.A.L. (1998). Occurrence of *Metarhizium anisopliae* in nests and feeding sites of Australian termites. *Mycological Research* 102, 216-220.
- Moller, H. and Tilly, J.A.V. (1989) Beech honeydew: seasonal variation and use by wasps, honey bees, and other insects. *New Zealand Journal of Zoology* 16 (3): 289-302.
- Moller, H., Tilley, J.A.V., Thomas, B.W. and Gaze, P.D. (1991) Effect of introduced social wasps on the standing crop of honeydew in New Zealand beech forests. *New Zealand Journal of Zoology* 18 (2): 171-179.
- Montagner, H. (1963) Étude préliminaire des relations entre les adultes et le couvain chez les guêpes sociales du genre *Vespa*, au moyen d'un radio-isotope. *Insectes Sociaux* 10 (2): 153-165.
- Moore, D. and Prior C. (1993) The potential of mycoinsecticides. *Biocontrol News and Information* 14(2): 31-40.
- Müller, E. and Price, R. (1997) Biological warfare against the red locust. *Plant Protection News* 50: 13-15.
- Oi, D. H. and Pereira, R. M. (1993) Ant behaviour and microbial pathogens (Hymenoptera: Formicidae). *Symposium: Insect Behavioural Ecology* 76 (1): 63-74.
- Orbin, M.S. and Vander Meer, R.K. (1985) Gaster flagging by fire ants (*Solenopsis* spp.): Functional significance of venom dispersal behaviour. *Journal of Chemical Ecology* 11 (12): 1757-1768.
- Palmer-Jones, T. (1964) Diseases of honey bees in New Zealand. *New Zealand Entomologist* 3 (3): 41-44.
- Parrish, M.D. and Roberts, R.B. (1984) Toxicity of avermectin B1 to larval yellowjackets, *Vespula maculifrons* (Hymenoptera: Vespidae). *Journal of Economic Entomology* 77: 769-772.
- Paven, M. (1958) Significato chemico e biologico di alcuni veeni di insetti. *Tipografia Artigianelli* 24: 1-75.
- Pereira, R.M. and Stimac, J.L. (1992) Transmission of *Beauveria bassiana* within nests of *Solenopsis invicta* (Hymenoptera: Formicidae) in the laboratory. *Environmental Entomology* 21 (6): 1427-1432.
- Pinnock, D.E., Garcia, R. and Cubbin, M.C. (1973) *Beauveria tenella* as a control agent for mosquito larvae. *Journal of Invertebrate Pathology* 22: 143-147.
- Poinar, G.O. Jr. (1981) Distribution of *Pheromermis pachysoma* (Mermithidae) determined by paratenic invertebrate hosts. *Journal of Nematology* 13 (3): 421-424.
- Poinar, G.O. Jr., Lane, R.S. and Thomas, G.M. (1976) Biology and redescription of *Pheromermis pachysoma* (V. Linstow) (Nematoda: Mermithidae), a parasite of yellowjackets (Hymenoptera: Vespidae). *Nematologica* 22: 360-370.

- Poncet, S., Delécluse, A., Klier, A. and Rapoport, G. (1995) Evaluation of synergistic interactions among the CryIVA, CryIVB, and CryIVD toxic components of *B. thuringiensis* subsp. *israelensis* crystals. *Journal of Invertebrate Pathology* 66: 2, 131-135.
- Potter, N.B. (1964) A study of the common wasp, *Vespula vulgaris* L., with special reference to the foraging behaviour. Ph.D Dissertation, University of Bristol, England. 75 pp.
- Price, R.E. Bateman, R.P. Brown, H.D. Butler, E.T. and Muller, E.J. (1997). Aerial spray trials against brown locust (*Locustana pardalina*, Walker) nymphs in South Africa using oil-based formulations of *Metarhizium flavoviride*. *Crop Protection* 16 (4): 345-351.
- Radek, R. and Fabel, P. (2000) A New Entomopoxvirus from a Cockroach: Light and Electron Microscopy. *Journal of invertebrate Pathology* 75 (1): 19-27.
- Ratnieks, F. L. W., Vetter, R.S. and Visscher, P. K. 1996. A polygynous overwintered nest of *Vespula pennsylvanica* from southern California. *Insectes Sociaux* 43 (4): 401-410.
- Reed, H.C., Akre, R.D. and Garnett, W.B.(1979) A North American host of the yellowjacket social parasite *Vespula austriaca* (Panzer) (Hymenoptera: Vespidae). *Entomological News* 90 (2): 110-113
- Rice, W.R. (1983) Parent-offspring pathogen transmission: a selective agent promoting sexual reproduction. *American Naturalist* 121: 187-203.
- Richards, O.W. (1978) *The Social Wasps of the Americas; Excluding the Vespinae*. British Museum (Natural History), London.
- Rose, E.A.F., Harris, R.J. and Glare, T.R. (1999) Possible pathogens of social wasps (Hymenoptera: Vespidae) and their potential as biological control agents. *New Zealand Journal of Zoology* 26: 179-190.
- Sambrook, J., Fritsch, E.F. and Maniatis, T. (1989) *Molecular Cloning: a Laboratory Manual*. 2<sup>nd</sup> ed. Cold Spring Harbour Laboratory Press, Cold Spring Harbour, U.S.A. 1546 pp.
- Samson, R.A., Evans, H.C. and Van de Klashorts, G. (1981) Notes on entomogenous fungi from Ghana: the genera *Stillbella* and *Polycephalomyces*. *Proceedings of Nederlandse akademie van wetenschappen* 84: 289-301.
- Sanchez-Peña, S.R., Buschinger, A., Humber, R.A. (1993) *Myrmicinosporidium durum*, an enigmatic fungal parasite of ants. *Journal of Invertebrate Pathology* 61 (1) 90-96.
- Sandlant, G.R. and Moller, H. (1989) Abundance of German and common wasps (Hymenoptera: Vespidae) in honeydew beech forests of New Zealand in 1987. *New Zealand Journal of Zoology* 16: 33-343.
- Sands, W.A. (1969) The association of termites and fungi. Pp. 495-524. in: K. Krishna and F.M. Weesner (eds), *Biology of Termites* Vol. 1, Academic press, NY.
- Sannasi, A. and Sundara Rajulu, G. (1967) Occurrence of antimicrobial substances in the exudate of physogastric queen termite, *Termes redemanni* Wasmann. *Current Science* 16: 436-437.
- Saslavsky, H., Ishay, J. and Ikan, R. (1973) Alarm substances as toxicants in the oriental hornet colony. *Life Science* 12: 135-144.
- Sauerländer, S. (1961) Das Gift von *Formica polyctena* Forst. als ein möglicher Schutzmechanismus dieses Insekts gegen Mikroorganismen. *Naturwissenschaften* 48: 629.
- Schildknecht, H. (1971) Evolutionary peaks in the defensive chemistry of insects. *Endeavour* 30: 136-141.
- Schildknecht, H. and Koob, K. (1970) Plant bioregulators in the methoracic glands of Myrmicine ants. *Angewandte Chemistry institute* 9: 173.

- Schildknecht, H. and Koob, K. (1971) Myrmicacin, the first insect herbicide. *Angewandte Chemistry Institute* 10: 124-125.
- Schmidt, J.O. and Blum, M.S. (1979) Toxicity of *Vespula maculata* venom. *Toxicon* 17: 645-648.
- Sellschop, J.P.F. (1965) Field observations on conditions conducive to the contamination of groundnuts with the mould *Aspergillus flavus*. *South African Medical Journal* (Supplementary to *S.A. Journal of Nutrition*) 26: 774-776.
- Siebeneicher, S.R., Vinson, S.B. and Kenerley, C.M. (1992) Infection of the red imported fire ant with *Beauveria bassiana* through various routes of exposure. *Journal of Invertebrate Pathology* 59: 280-285.
- Spivac, M. and Gilliam, M. (1993) Facultative expression of hygienic behaviour of honey bees in relation to disease resistance. *Journal of Apicultural Research* 32 (3/4):147-157.
- Spradbery, J.P. (1965) Social organisation of wasp communities. *Symposium of the Zoological Society of London* 14: 61-96.
- Spradbery, J.P. (1973) *Wasps: An Account of the Biology and Natural History of Social and Solitary Wasps*. Sedgwick and Jackson Ltd., London, 408 p.
- Spradbery, J. P. (1991) An orphaned colony of the European wasp *Vespula germanica* (F.) (Hymenoptera: Vespidae) in Australia resulting from repeated usurpation. *New Zealand Journal of Zoology* 18 (2): 101-103.
- Spurr, E.B. (1991) Reduction of wasp (Hymenoptera: Vespidae) populations by poison-baiting; Experimental use of sodium monofluoroacetate (1080) in canned sardine. *New Zealand Journal of Zoology* 18: 215-222.
- Spurr, E.B. (1993) The effectiveness of sulfluramid in sardine bait for control of wasps (Hymenoptera: Vespidae). *Proceedings of the 46<sup>th</sup> New Zealand Plant Protection Conference*: 307-312.
- Spurr, E.B. (1995) Protein bait preferences of wasps (*Vespula vulgaris* and *V. germanica*) at Mt Thomas, Canterbury, New Zealand. *New Zealand Journal of Zoology* 22: 281-289.
- Spurr, E.B. (1997) Freeze-dried bait for wasp control. *Proceedings of the New Zealand Beekeepers Conference* 50: 401-404.
- Spurr, E.B. and Elliot, G. (1996) User trial for Finitron wasp bait. *The New Zealand Beekeeper* 3: 18-20.
- Stimac, J. L., Pereira, R. M., Alves, S. B. and Wood, L. A. (1990). Field evaluation of a Brazilian strain of *Beauveria bassiana* for control of the red imported fire ant, *Solenopsis invicta*, in Florida. Proceedings and abstracts of the 5th international colloquium on invertebrate pathology and microbial control, Adelaide, Australia, August, 337 pp.
- Storey, G.K., Vander Meer, R.K., Boucias, D.G. and McCoy, C.W. (1991) Effect of fire ant (*Solenopsis invicta*) venom alkaloids on the in vitro germination and development of selected entomogenous fungi. *Journal of Invertebrate Pathology* 58: 88-95.
- Tanada, Y. and Kaya, H. K. (1993) *Insect pathology*. Academic Press, New York.
- The Press (Christchurch) 18 July 1995 Scientists still trying to perfect biological control of wasps, By David Gee.
- Toft, R.J. and Beggs, J.R. (1995) Seasonality of crane flies (Diptera: Tipulidae) in South Island beech forest in relation to the abundance of *Vespula* wasps (Hymenoptera: Vespidae). *New Zealand Entomologist* 18: 37-43.
- Toft, R.J. and Rees, J.S. (1998) Reducing predation of orb-web spiders by controlling common wasps (*Vespula vulgaris*) in a New Zealand beech forest. *Ecological Entomology* 23: 90-95.

- Tomlinson, J. T. and Williams, S. C. (1985) Antibiotic properties of honey produced by the domestic honey bee *Apis mellifera* (Hymenoptera: Apidae). *Pan Pacific Entomologist* 61 (4): 346-347.
- Thomas, C.R. (1960) The European wasp (*Vespula germanica* Fab.) in New Zealand. Department of Scientific and Industrial Research Information Series 27: 74 pp.
- Thomas, C.D., Moller, H., Plunkett, G.M. and Harris, R.J. (1990) The prevalence of introduced *Vespula vulgaris* wasps in a New Zealand beech forest community. *New Zealand Journal of Ecology* 13 (1): 63-72.
- Thomson, J.D. (1989) Reversal of apparent feeding preferences of bumble bees by aggression from *Vespula* wasps. *Canadian Journal of Zoology* 67: 2588-2591.
- Tooby, J. (1982) Pathogens, Polymorphism and the evolution of sex. *Journal of Theoretical Biology* 97: 557-576.
- Veal, D.A., Trimble, J.E. and Beattie, A.J. (1992) Antimicrobial properties of secretions from the metapleural glands of *Myrmecia gulosa* (the Australian bull ant). *Journal of Applied Bacteriology* 72: 188-194.
- Veen, J. W. v., Arce, A. H. and Ortiz, M. A. (1994). Apiculture: strategies for correct hive management. *Proceedings of the third national beekeeping congress*, 6-8, Heredia, Costa Rica.
- Vetter, R. S. and Visscher, P. K. (1995) Laboratory rearing of western yellowjackets (Hymenoptera: Vespidae) through a foundress-to-gyne colony cycle. *Annals of the Entomological Society of America* 88 (6): 791-799.
- Villaini, M.G., Nyrop S.R. and Kruger, J.P. (1992). A case study of the impact of the soil environment on insect-pathogen interactions: Scarabs in turfgrass, Pp. 111-126 in: T.A. Jackson and T.R. Glaré (eds.), *Use of Pathogens in Scarab Pest Management*. Intercept, Andover, 303 pp.
- Visscher, P.K. (1983) The honey bee way of death: necrophoric behaviour in *Apis mellifera* colonies. *Animal Behaviour* 31: 1070-1076.
- von Frisch, K. (1967) *The Dance Language and Orientation of Bees*. Harvard University Press, Cambridge, MA.
- Walton, G.M. and Reid, G.M. (1976) The 1975 New Zealand European wasp survey. *The New Zealand Beekeeper* 38: 26-30.
- Weiser, J. (1969) *An Atlas of Insect Diseases*. Irish University Press, Shannon, Ireland.
- Weyrauch, W.K. (1937) Wie entsteht ein Wespennest 5 Teil. experimentelle analyse des verhaltens von *Vespa germanica* F. und *Vespa vulgaris* L. beim bauen mit erde. *Zoologische Jahrbücher* (Systematik, Ökologie und Geographie der Tiere) 69: 215-240.
- Wheeler, W.M. (1910) *Ants: their Structure, Development, and Behaviour*. Columbia University Press, New York, 663 pp.
- Wilson, E.O. (1971) *The Insect Societies*. Harvard University Press. Massachusetts, USA, 548 pp.

# Appendix One

## Miscellaneous data

Table 8.1: The inhibitory effect of *Vespula* venom on the growth of pathogenic bacteria and fungi. Mean diameter of inhibition zone of pathogen growth resulting from inoculation of venom or distilled water (control), (measured in mm  $\pm$  standard error).

	Pathogen	Venom	Control	<i>P</i> -value
<i>Serratia marcescens</i>	363	0.4 $\pm$ 0.1	0.5 $\pm$ 0.1	0.8550
	457	0.0 $\pm$ 0.0	0.0 $\pm$ 0.0	1.0000
	458	0.0 $\pm$ 0.0	0.0 $\pm$ 0.0	1.0000
<i>Serratia entomophila</i>	154	0.5 $\pm$ 0.1	0.5 $\pm$ 0.1	1.0000
<i>Entobacter</i> sp.	K	0.0 $\pm$ 0.0	0.0 $\pm$ 0.0	1.0000
<i>Beauveria bassiana</i>	F180	3.3 $\pm$ 0.7	0.0 $\pm$ 0.0	0.0001
	F233	0.0 $\pm$ 0.0	0.0 $\pm$ 0.0	1.0000
	F234	0.0 $\pm$ 0.0	0.0 $\pm$ 0.0	1.0000
<i>Aspergillus flavus</i>	F202	8.1 $\pm$ 0.8	0.0 $\pm$ 0.0	0.0000
Positive control	F202	15.6 $\pm$ 2.1	0.0 $\pm$ 0.0	0.0000

Table 8.2: The inhibitory effect of *Vespula* larval saliva on the growth of pathogenic bacteria and fungi. Mean diameter of inhibition zone of pathogen growth resulting from inoculation of larval saliva or distilled water (control), (measured in mm  $\pm$  standard error).

	Pathogen	Saliva	Control	P-value
Positive control	<i>Bti</i>	42.6 $\pm$ 1.1	0.0 $\pm$ 0.0	0.0000
<i>Bacillus thuringiensis</i>	<i>Bti</i>	13.3 $\pm$ 1.3	0.0 $\pm$ 0.0	0.0000
	<i>Btsd</i>	9.3 $\pm$ 0.7	0.0 $\pm$ 0.0	0.0000
	<i>Btb</i>	6.7 $\pm$ 0.7	0.0 $\pm$ 0.0	0.0000
<i>Serratia marcescens</i>	363	6.6 $\pm$ 0.7	0.0 $\pm$ 0.0	0.0000
	457	0.0 $\pm$ 0.0	0.0 $\pm$ 0.0	1.0000
<i>Serratia entomophila</i>	154	0.5 $\pm$ 0.0	0.0 $\pm$ 0.0	0.7246
<i>Entobacter</i> sp.	K	0.0 $\pm$ 0.0	0.0 $\pm$ 0.0	1.0000
<i>Beauveria bassiana</i>	F180	5.9 $\pm$ 0.8	0.5 $\pm$ 0.1	0.0000
	F233	6.3 $\pm$ 3.2	0.0 $\pm$ 0.0	0.1172
	F234	0.0 $\pm$ 0.0	0.0 $\pm$ 0.0	1.0000
<i>Aspergillus flavus</i>	F202	0.0 $\pm$ 0.0	0.0 $\pm$ 0.0	1.0000

Table 8.3: Inhibition of in vitro *Aspergillus flavus* (F202) germination by exocrine secretions of *Vespula vulgaris*. Percent germination calculated from the proportion of conidia with germ tubes against those without, after 20 hours.

	Treatment	Mean percent germination ( $\pm$ SE)	P-value
<i>Aspergillus flavus</i>	Control	59.5 $\pm$ 4.8	
	Gut	60.1 $\pm$ 9.3	0.9930
	Saliva	64.8 $\pm$ 5.7	0.9969
	Venom	17.4 $\pm$ 5.5	0.0000
	Fungicide	0.0 $\pm$ 0.0	0.0000
<i>Beauveria bassiana</i>	Control	18.9 $\pm$ 2.8	
	Saliva	17.3 $\pm$ 1.3	0.6018
	Venom	32.2 $\pm$ 1.7	0.0004
	Fungicide	0.0 $\pm$ 0.0	0.0000

# Appendix Two

## Environmental conditions within the nest

### Introduction

Many fungi require specific environmental requirements to achieve germination and sporulation. High humidity (>95%) is usually necessary to induce this response and warm temperatures will promote rapid development (Milner *et al.* 1997). Apart from strain 204 (*Metarhizium anisopliae*), the pathogenic fungi used in the adult bioassays develop optimally at temperatures of  $25 \pm 5^{\circ}\text{C}$  (survival range 15-35°C, temperate fungi) and at relative humidities (RH) above 95% (T.R. Glare 1999, pers. comm.). Studies have revealed European colonies of *V. vulgaris* maintain the temperature in the nest steady at 30°C (Ishay and Ruttner 1971). Spradbery (1973) indicated involucrum thickness, adult movement and grouping are the primary mechanism for manipulating nest temperature. Relative humidity has not been recorded previously. Here relative humidity and temperature data were recorded to establish the influence nest climate might have on the infection and development of a pathogenic fungi.

### Methods and materials

One large, over wintering, aerial *V. germanica* and five average-sized, subterranean, *V. vulgaris* nests were examined. Nests were carefully excavated from the side and probes were inserted into the interior. Soil surrounding subterranean nests was replaced and data were recorded after 30 minutes, allowing the colony time to resume normal behaviour. Internal temperature and humidity were recorded from the centre of the nest and ambient data were recorded in full shade, 30 cm from the entrance, using a 'Grants' data logger. The *V. vulgaris* nests were monitored for two, two hour



intervals between 1200 and 1400 hours on fine days between 14 and 20°C. The *V. germanica* nest was monitored for three consecutive days during early autumn (mid March).

## Results

Temperature in wasp nests is constant and stable. The two hour record of daytime temperature in *V. vulgaris* nests revealed a mean temperature of 30°C, approximately 15°C higher than ambient. The individual nest records show that the coolest nest (28°C ± 0.03) was recorded during the highest ambient temperature (19°C ± 0.05). Compared with the other nests (internal 31°C ± 0.24, ambient 15.5°C ± 1.12), it is evident that the body heat generated by the colony contributes to the maintenance of temperature.

Temperature regulation in the *V. germanica* nest was consistent with the 30°C for *V. vulgaris*. Recorded later in the season and over several days meant lower ambient temperatures and showed the extent of temperature maintenance in a large aerial nest. Ambient temperatures of 8°C on the second night of surveillance did not reduce the nest temperature below 30°C. Ambient temperature on the first night of surveillance dropped as low as 4.5°C while the nest temperature dropped only to 27°C.

Daytime relative humidity in the smaller *V. vulgaris* nests was consistently high at 20% above ambient. Despite being subterranean, internal humidity was influenced by fluctuations in ambient humidity. Relative humidity in the large *V. germanica* nest was maintained at around 64% (range 39%) while the ambient humidity fluctuated extensively around 81% (range 72%).

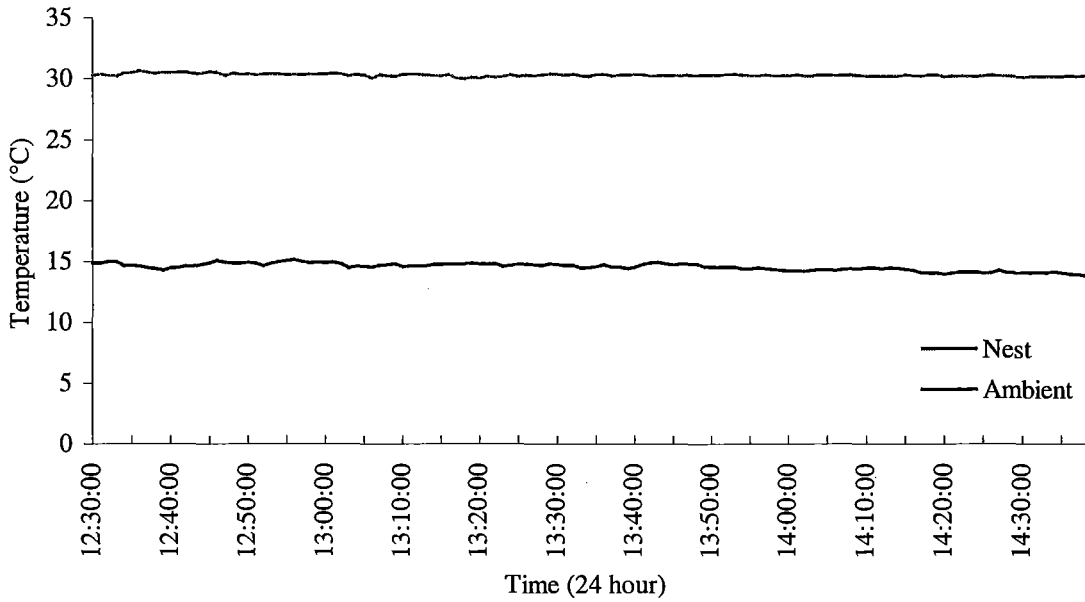

Figure 9.1: Mean temperature data from the two hour observations of *Vespula vulgaris* nests showing significant maintenance of internal nest temperature but little fluctuation in either the ambient or the nest temperature.

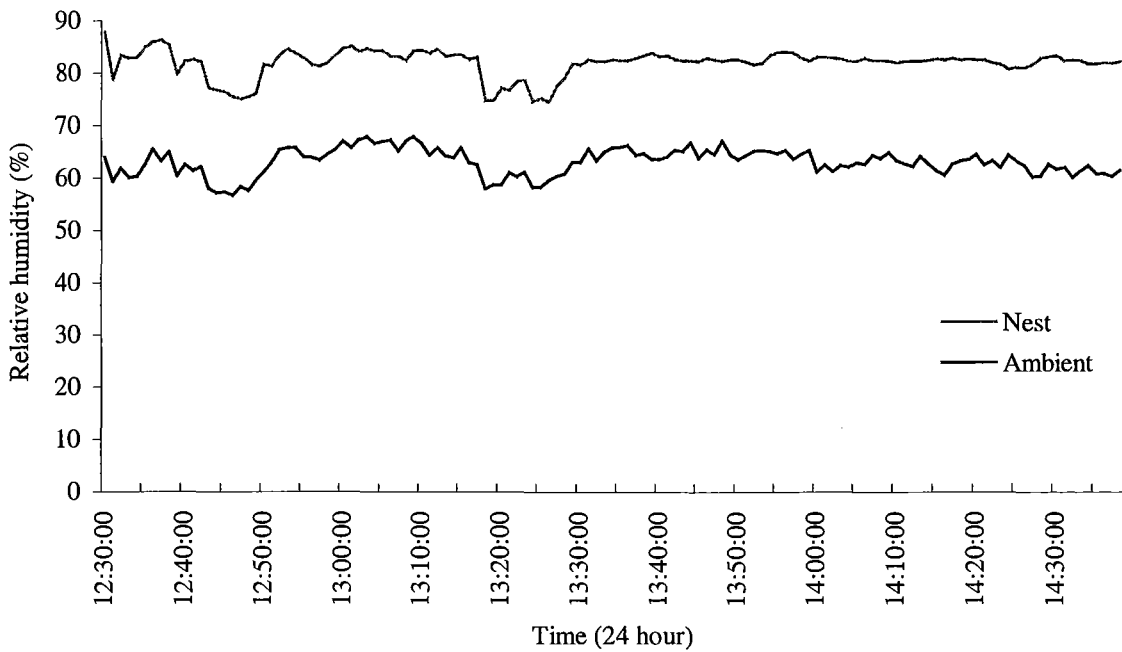

Figure 9.2: Mean humidity data from the two hour observations of *Vespula vulgaris* nests showing a higher internal humidity and fluctuations parallel to the ambient humidity.

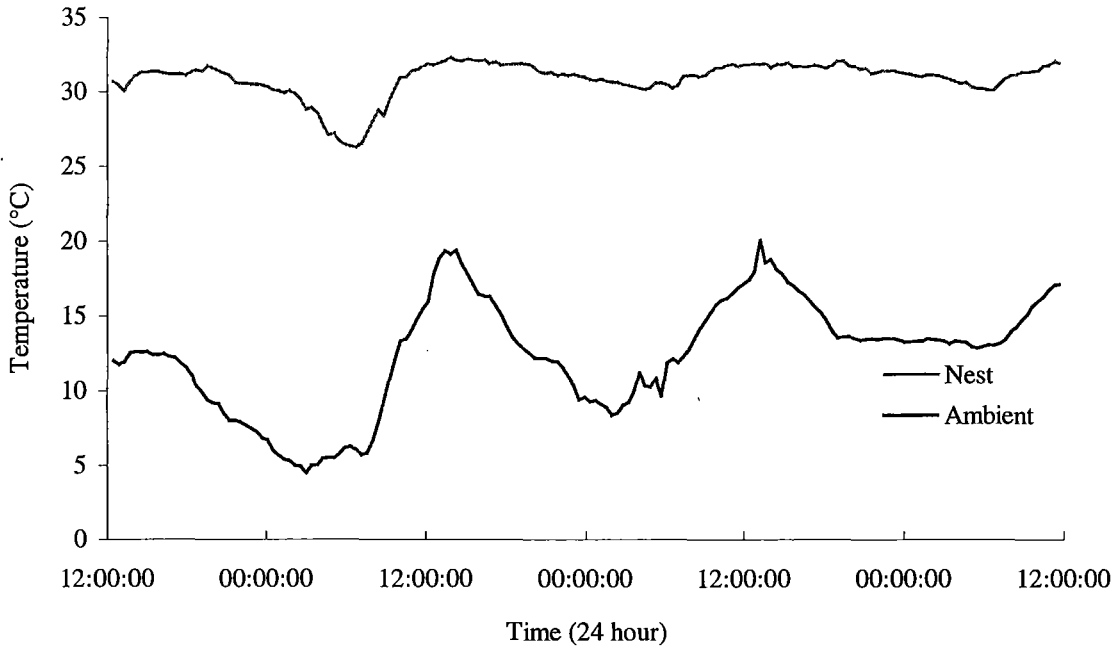

Figure 9.3: A three day record of temperature in a large, over wintering, *Vespula germanica* colony in a nest box.

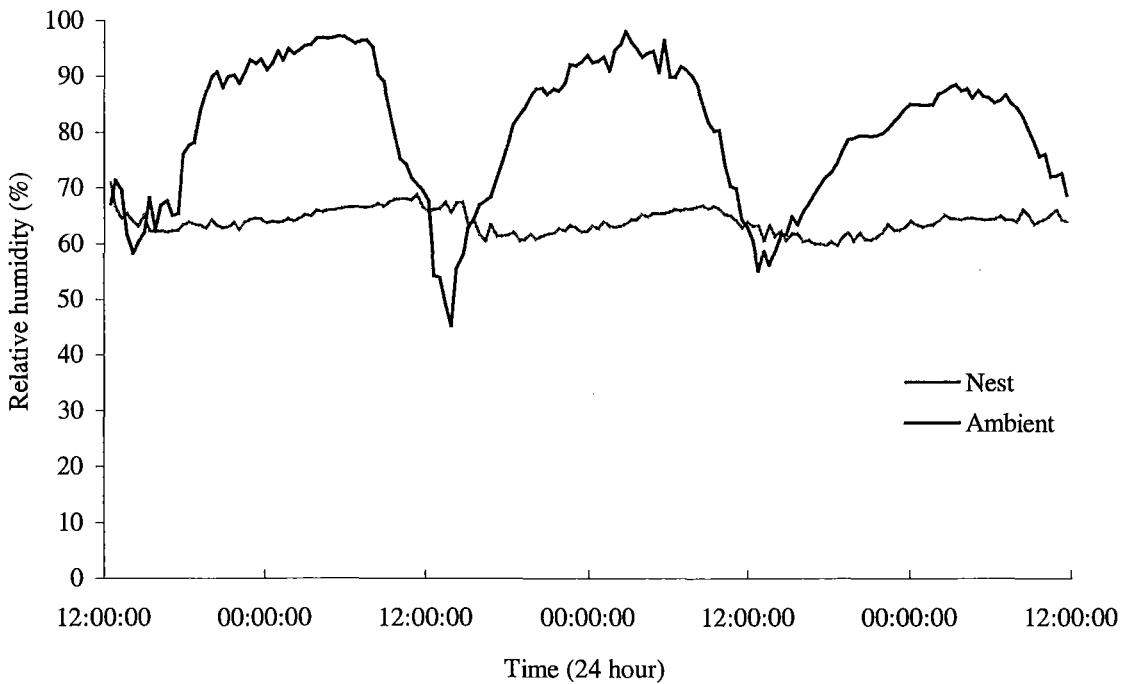

Figure 9.4: A three day record of relative humidity in a large, over wintering, *Vespula germanica* colony in a nest box.

Table 9.1: Temperature and humidity data from the 2 hour observations of *V. vulgaris* nests.

Parameter		Mean $\pm$ SE	Range
Temperature	Nest	30.30 $\pm$ 0.26	29.99 - 30.62
	Ambient	14.61 $\pm$ 0.54	13.85 - 15.37
Relative humidity	Nest	82.18 $\pm$ 0.24	74.64 - 87.72
	Ambient	63.17 $\pm$ 0.22	56.74 - 67.92

Table 9.2: Temperature and humidity data from the 3 day observations of the *V. germanica* nest.

Parameter		Mean $\pm$ SE	Range
Temperature	Nest	30.88 $\pm$ 0.02	25.82 - 32.23
	Ambient	12.39 $\pm$ 0.06	4.50 - 20.99
Relative humidity	Nest	64.03 $\pm$ 0.04	35.71 - 74.72
	Ambient	80.56 $\pm$ 0.19	26.34 - 98.13

## Discussion

The thermoregulation of the colony environment (particularly the cooling) is an active process in response to ambient fluctuations. On hot days, wasps in the nest boxes used in Chapter Six, were seen fanning on mass for most of the day and the chamber was saturated with transpired moisture. The behaviour was so widespread that traffic rates were down compared with normal and must have had an impact on the frequency of hygienic behaviour. The presence of moisture on the chamber walls indicated humidity was approaching 100%, ideal conditions for the outbreak of disease.

The large *V. germanica* nest had many layers of involucrum and a significant biomass which assisted in the maintenance of the internal temperature. However, the colony was in an artificial chamber which offered less insulation than a subterranean nest. Spradbery (1973) suggested that movement of adults and larvae, and the aggregation of workers on brood comb are the primary mechanisms of heat generation. The 22.5°C differential between internal and ambient temperatures on a cold night

represents a significant energy output by a colony with a biomass of no more than 3 kg. It is very likely that this level of output is not sustainable long term and may be a factor in the rarity of over-wintering *V. germanica* colonies.

Akre *et al.* (1976) indicated that many aspects of basic biology are similar within the genus *Vespula* and the temperature recorded is equivalent in both species. Therefore, the discrepancies in nest humidity may be related to the physical differences rather than some species difference. This discrepancy in humidity between *V. vulgaris* and *V. germanica* indicates that the individual characteristics of a nest control the level of humidity and the ability of the colony to maintain that level. The large *V. germanica* nest with more insulation was better insulated against air moisture and temperature.

Nest climate data from daytime measurements of the *V. vulgaris* nests indicate that temperature is within the range necessary for germination and sporulation to occur given the parameters of the fungi life cycle (see Chapter One). However, relative humidity was not optimal for germination or sporulation of fungi. Field tests have demonstrated that sporulation does not always occur on cadaver supporting mature fungal infections (R.J. Harris unpubl. data). Although most infected larvae appear to have been removed by workers, a small number of infected cadavers were present but not supporting sporulation. The reason for this lack of sporulation was most likely insufficient humidity as the nests were particularly dry (R.J. Harris, pers. comm.). Mature infections can persist for long periods in dry conditions. However, the likelihood of being removed from by workers (see Chapter Six) allows little latitude for delay of sporulation if re-infection is to occur. Such climatic extremes may not be a major factor in the beech forest where a fungal control agent would be most used. The vast majority of wasp nests in this environment are small *V. vulgaris* colonies, which appear to fit the humidity criteria better. Although nest humidity appears unsuitable for rapid fungus proliferation, the cuticular microclimate of larvae, pupae and workers may be suitable for germination of spores. The cuticular microclimate of mummified cadavers is not known but it would more closely conform to the ambient climate, so could severely restrict sporulation and therefore horizontal transfer of disease.

Humidity and temperature are key factors in the survival and proliferation of fungal pathogens. The isolation of low humidity tolerant strains should be a priority for further research.

# Appendix Three

## Maturation and sporulation time for *B. bassiana* in *Vespula* larvae

### Introduction

The early identification of disease and rapid intervention are of primary importance to the maintenance of colony hygiene. Field trials revealed a significant level of removal of larvae before visible signs of *B. bassiana* infection were noticed. Sporulation from the infected cadaver occurred only after removal (on the base of the chamber). Tactile and olfactory cues were the most likely means of identification of the diseased larvae by workers. How long before infection was visually evident (purple colour) the larvae were removed, has been difficult to determine. No data existed on the maturation and sporulation time of *B. bassiana* in wasp larvae. The aim of this work was to determine the timing of maturity and sporulation of *B. bassiana* infections in wasp larvae. The reason for this was to cross reference with the appearance of infection and removal behaviour in nest box experiments.

### Methods and materials

Six hundred healthy third and fourth instar larvae were spray inoculated with *B. bassiana* at  $10^7$  spores/ml (see Chapter Two). Larvae were incubated at 30°C (>90% RH) for the duration of the experiment. Larvae were monitored daily for visible signs of infection. Infected larvae were removed from the comb daily and placed into a sealed Petri dish labelled with the date of removal. Cadavers supporting sporulation were removed from these Petri dishes and the date was also noted.

## Results

The time for visual signs of infection and sporulation to appear is presented in Figure 10.1. It takes approximately four days for *B. bassiana* to mature within *V. germanica* larvae, with a further four days to sporulation in laboratory conditions (Table 10.1). The time for *B. bassiana* to sporulate in this experiment was negatively correlated with the time for visual symptoms to appear in the larvae. That is, the earlier a larva turned purple (or succumbed to the disease) the longer it would take for the fungus to reach sporulation. Analysis of variance revealed a significant difference ( $P=0.0373$ ) between the time to sporulation of the larvae showing infection on day one and five. A negative linear regression was fitted with a correlation coefficient of  $-0.32$ . This indicates a weak but significant correlation.

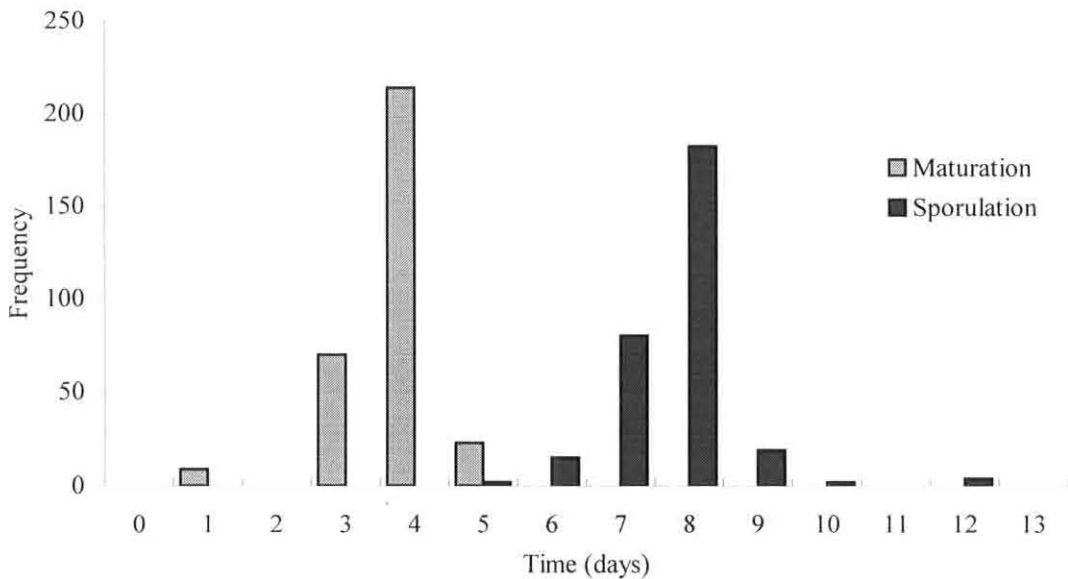

Figure 10.1: Time to visual signs of infection (maturation) and sporulation of the fungi in *Vespula germanica* larvae infected with *Beauveria bassiana*.



Table 10.1: The mean time to see visual signs of infection and sporulation in *Vespula germanica* larvae infected with *Beauveria bassiana*.

Stage	Mean $\pm$ SE (days)
<i>Maturation</i>	3.8 $\pm$ 0.04
<i>Sporulation</i>	7.6 $\pm$ 0.08

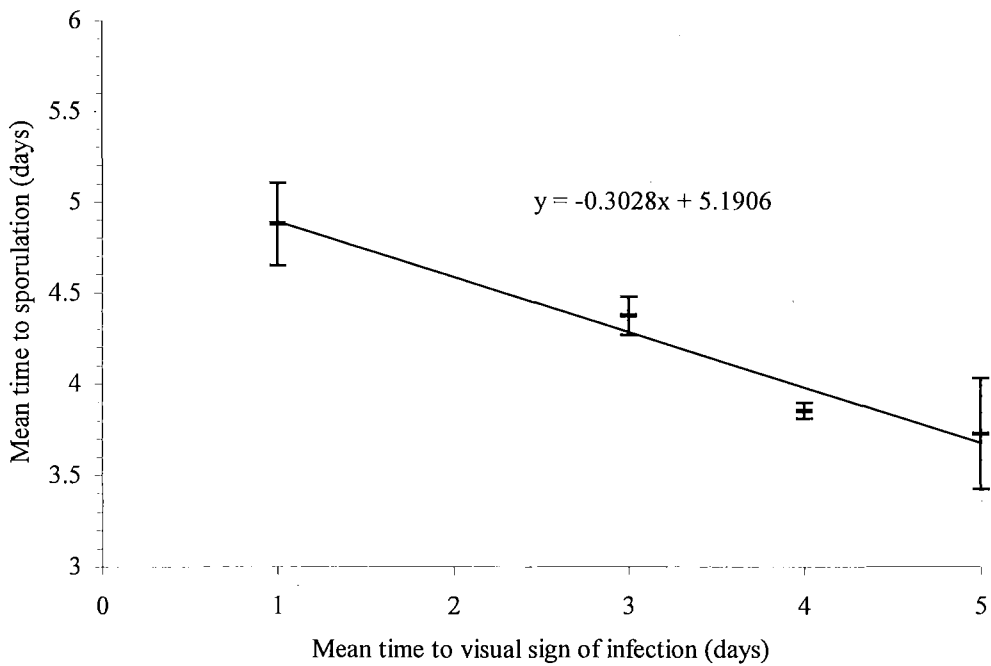

Figure 10.2: The relationship between time to maturity and sporulation of the fungus *Beauveria bassiana* in larvae of *Vespula germanica*. The line fitted indicates a significant negative correlation coefficient of -0.32.

## Discussion

The comparison with the few cadavers infected and supporting sporulation in the colony hygiene experiment (Chapter Six), indicates that there is a slight lag in the timing of these events nests compared with the laboratory. Fluctuations in nest temperature may explain this. However, data in Appendix Two indicate that normal summer temperatures would not have a significant impact on the internal nest temperature.

It is more likely that the earliest infection to appear was easily detected in the pristine nest and rapidly removed, while over time the process of detection of disease became confounded by the dissemination of inoculum. The relatively few infected larvae and the long delay for infection to occur in the colony hygiene experiments supports this.

The negative correlation between time to infection and time to sporulation of *B. bassiana* is most likely due to the lack of maturity of the fungus in hosts that die prematurely. This means the fungus must compete with saprophytic bacteria and fungi before it can sporulate. Some larvae removed from the comb were septic and still supported sporulation. In healthy larvae the immune system fights the saprophytic diseases while the pathogen reaches maturity at which point most of the host resources are tapped by the fungus and other diseases have little to consume. This ability to elude the host's immune system determines to a large extent the pathogenicity of a disease. Septic larvae have also been collected from field inoculation trials with *B. bassiana* so may represent not only a mortality record but also a potential re-infection site. Septic larvae are very difficult to remove from cells and could therefore be a factor in disease cycling.

The generation time of fungal pathogens can be a significant limitation to the success of fungi as biological control agents. This is particularly pertinent to social insects such as wasps that exhibit effective behavioural resistance to fungi. The mean time to sporulation (re-infection) of *B. bassiana* is approximately eight days, (up to 10 in the field), but the mean time to removal of *B. bassiana* infected larvae is approximately

five days. The generation time of *B. bassiana* in wasp larvae is too long to achieve re-infection before removal by workers. Larger volumes of inoculum may increase the chances of overwhelming the colony. However, one of the potential advantages of microbial control is small doses entering a colony can develop into an epizootic.

## **PUBLICATIONS ARISING FROM THIS THESIS (TO DATE):**

Most of the data from the bioassay chapter (Chapter One) has been published in the Journal of Invertebrate Pathology.

Harris, R.J., Harcourt, S.J., Rose, E.A.F. Glare, T.R. and Nelson, T.J. (2000) Susceptibility of *Vespula vulgaris* and *V. germanica* (Hymenoptera: Vespidae) to generalist entomopathogenic fungi and their potential for wasp control. *Journal of Invertebrate Pathology* 75: 251-258.

The field trial data (Chapter Four) has been presented and published at an international microbial control workshop.

Harcourt S.J., Harris R.J., Rose E.A.F., Glare T.R. and Nelson T.L. (1998) The potential of *Beauveria bassiana* for the control of common and German wasps (*Vespula vulgaris* L. and *V. germanica* F.) in New Zealand. *Proceedings of the 4th International Workshop on Microbial Control of Soil Dwelling Pests*, 159-164.

Data from Chapter Five and Six are currently being drafted for publication. The expected submission date is June 2002.

Steve Harcourt 30/4/2001