

572524
p. 26



N63 23511

CODE-1
NASA CR 52070.

26p.

MEASUREMENTS OF LIQUID DAMPING PROVIDED
BY RING BAFFLES IN CYLINDRICAL TANKS

BY

LUIS R. GARZA AND H. NORMAN ABRAMSON

TECHNICAL REPORT NO. 5
CONTRACT NO. NAS8-1555
SwRI PROJECT NO. 6-1072-2

PREPARED FOR

NATIONAL AERONAUTICS AND SPACE ADMINISTRATION
GEORGE C. MARSHALL SPACE FLIGHT CENTER
HUNTSVILLE, ALABAMA

OTS PRICE

XEROX \$ ~~266.00~~
MICROFILM \$ ~~578.00~~

1 APRIL 1963

SOUTHWEST RESEARCH INSTITUTE
SAN ANTONIO, TEXAS

8136009

SOUTHWEST RESEARCH INSTITUTE
8500 Culebra Road, San Antonio 6, Texas

MEASUREMENTS OF LIQUID DAMPING PROVIDED BY
RING BAFFLES IN CYLINDRICAL TANKS *

by

Luis R. Garza and H. Norman Abramson *Apr. 1, 1963* *3 refs*

NASA * Technical Report No. 5
Contract No. NAS8-1555;
SwRI Project No. 6-1072-2) ~~6-1072-2~~

(NASA CR - 52070)
OTS:(cov)

Prepared for

National Aeronautics and Space Administration
George C. Marshall Space Flight Center
Huntsville, Alabama

1 April 1963

APPROVED:



H. Norman Abramson, Director
Department of Mechanical Sciences

ABSTRACT

23511

Measured data on the damping effectiveness of flat ring baffles in partially filled cylindrical tanks is presented in considerable detail. Particular emphasis is placed on the effects of baffle perforation.

LIST OF SYMBOLS

a	Longitudinal acceleration of tank
d	Cylindrical tank diameter
d_s	Distance from top of baffle to liquid surface
D	Baffle spacing
h	Liquid depth to bottom of tank
R	Cylindrical tank radius
W	Baffle width
X_o	Tank excitation amplitude in translation
ω_n	Liquid natural circular frequency
$\omega^2 d/a$	Dimensionless frequency parameter
γ_s	Damping ratio
ξ_w	Liquid slosh height, double amplitudes

LIST OF ILLUSTRATIONS

1. Details of baffle support arrangements and tank configuration.
2. Effect of % perforation on liquid resonant frequencies as a function of baffle depth.
3. Effect of perforation hole size on liquid resonant frequencies as a function of baffle depth.
4. Effects of double rings as a function of baffle depth.
5. Comparison of theory and experiment for damping provided by a flat solid ring baffle as a function of baffle depth.
6. Interaction between a flat solid ring baffle and the liquid free surface at shallow liquid depth.
7. Effect of excitation amplitude on damping effectiveness of a solid flat ring baffle as a function of baffle depth.
8. Effect of perforation hole size on damping effectiveness as a function of baffle depth.
9. Effect of % perforation on damping effectiveness as a function of baffle depth.
10. Table I: Liquid Resonant Frequency
11. Table II: Ring Damping

INTRODUCTION

Because of the relatively large lateral forces which can be developed by liquid sloshing in a bare-wall cylindrical tank, it is evident that some means must be provided for reducing liquid motion in the propellant tanks of large rocket boosters. The liquid resonant frequencies must likewise be carefully controlled to avoid dynamic coupling with structural components and with the rocket's control system. It is desirable therefore to select a damping system that is capable of satisfying both requirements, if possible. For a given tank the first mode liquid resonant frequency can be substantially altered and its motion damped by means of either tank compartmentation or ring baffling of various types; either baffle system satisfies the double requirement to some extent.

The present paper presents the results of an experimental investigation of the effectiveness of ring-baffle systems by comparing the effects of several different types of ring baffles in a partially filled cylindrical tank undergoing forced vibration. Experimental resonant frequencies and damping values are obtained for each of several flat ring baffles in a cylindrical tank at various depths below the liquid free surface. In essence, the present study may be regarded as a rather detailed and exhaustive investigation of the effectiveness of

flat ring baffles, in extension of the preliminary data given in Reference 1. Particular emphasis is placed on the effects of baffle perforation.*

The experimental equipment and procedures utilized in the present work are similar to those employed in Reference 2. The tank used is a rigid-wall cylindrical tank supported by four dynamometers. The ring baffles investigated were of relatively thin stock varying from 0.018" to 0.030" in thickness, the width to radius ratio being held fixed at $W/R = 0.157$.** These baffles were secured to the tank by four 1/8" x 3/4" steel strips that were attached at points 90° apart around the outer edge of the ring, and were supported through angle iron brackets bolted to the upper flange of the tank, as shown in Figure 1. Because the baffle was supported in four places only, the outer edge of the ring was turned down, giving the ring an L type cross section which stiffened the ring considerably, but had little effect on damping characteristics. Several baffle materials were used, varying from solid sheet to perforated sheet stock having 0.079" hole perforations with 30% of the area removed. All tests were conducted for three amplitudes of translation excitation and for several baffle depths below the liquid free surface.

* A similar investigation on the effectiveness of vertical wall baffles in compartmented tanks is now in progress.

** The effects of baffle width are rather well delineated in Reference 1.

LIQUID RESONANT FREQUENCIES

For a cylindrical tank containing a single ring baffle, the liquid resonant frequencies are dependent upon the ring baffle area and upon its location, d_s/R , below the liquid free surface. Shown in Figures 2 and 3 are plots of the first mode liquid natural frequencies, presented in terms of the dimensionless parameter $\omega^2 d/a$, versus the ring baffle depth d_s/R for various single ring baffles, where the overall liquid depth is held fixed at $h/d = 1.0$.

It is noted that for single ring baffles having a width to radius ratio of $W/R = 0.157$, the liquid resonant frequency exhibits a maximum value when the baffle is located at the liquid free surface ($d_s/R = 0$), and decreases to a minimum value near a baffle depth of $d_s/R = 0.10$. At ring depths greater than $d_s/R = 0.10$, the liquid resonant frequencies increase with d_s/R , gradually approaching the first liquid resonant frequency for a bare-wall cylindrical tank. Also, for baffle depths greater than about $d_s/R = 0.06$, it may be observed that for perforated baffles with 0.079" diameter holes, the frequency increases as the percentage perforated area is increased; for a given percentage perforated area, the frequency also increases with perforation hole size. Because of the rather significant effects of excitation amplitude, measurements were made for various values ranging from $0.00184 \leq X_0/d \leq 0.00823$, and then all data presented in terms of RMS values.

It may sometimes be desirable to use the highest possible resonant frequency which can be maintained with a given baffle system. In order to maintain the effect of raising the natural frequency by use of ring baffles, as mentioned above, the axial spacing between each of a series of ring baffles must be less than $d_s/R \approx 0.08$. This effect is displayed in Figure 4, which shows the frequency $\omega^2 d/a$ versus the baffle depth d_s/R for a cylindrical tank containing two ring baffles. Because the ring baffles can be placed at any position along the tank wall, the baffles can be set for maximum frequency at the critical spacing.

Resonant frequencies are given in Table I for all of the various tests conducted.

LIQUID DAMPING

Solid Rings

The initial phase of this investigation was directed toward comparing experimental values of the damping ratio γ_s , with values calculated from Miles' equation (Reference 3). The experimental values of γ_s presented in this paper were obtained from the resonance peaks of experimental force response curves. The theoretical values of γ_s were calculated from Miles' equation using liquid surface amplitudes, ξ_w , measured at the tank wall.

Figure 5 presents a comparison of experimental and theoretical damping for a solid ring baffle having a width to radius ratio of $W/R = 0.157$. The experimental and theoretical damping values show close agreement for baffle locations well below the liquid free surface. For ring baffle depths less than $d_s/R = 0.125$, however, the experimental values are considerably greater than those predicted by Miles' equation, except for the case where the ring baffle is located at the free surface ($d_s/R = 0$). Figure 6 shows the complex shape of the free liquid surface typical of ring depths from $d_s/R = 0$ to $d_s/R = 0.125$, thus confirming the discrepancy which exists between the values of damping obtained experimentally for this range of d_s/R , and those obtained by the theory, which assumes a smooth shape for the free surface.

Figure 7 shows the results of damping tests using solid rings conducted for the three excitation amplitudes $X_0/d = 0.00184$, 0.00417 , and 0.00833 . These curves emphasize the necessity of accounting for excitation amplitude when describing the damping produced by a ring baffle system. For comparison of the damping derived from single ring baffles, a root mean square (RMS) average curve is included in Figure 7, as previously displayed in Figures 2 and 3. This curve therefore typifies the damping derived from a solid flat ring baffle.

Perforated Ring Baffles

The damping effectiveness of perforated ring baffles is largely dependent upon the perforation hole size and the percentage area removed by perforation. Figure 8 shows a comparison of the damping ratios versus depth d_s/R for various single ring baffles having a fixed width ($W/R = 0.157$), and using the RMS average values obtained for excitation amplitudes ranging from $X_0/d = 0.00187$ to $X_0/d = 0.00833$. For this comparison, the percentage area removed from the perforated baffles was held fixed at 30%, and three perforation hole sizes (0.020", 0.040", and 0.079") were used to demonstrate the effect of hole size on damping. Although the damping produced by the perforated ring baffles is consistently lower than that produced by the solid ring, it is interesting to note how the damping effectiveness is improved as the perforation hole size is decreased.

Figure 9 shows the variation of damping with depth for perforated ring baffles, where the perforation hole size was held fixed at 0.079" diameter and the percentage perforation area was varied between 8% and 30%. Also included in Figure 9, for comparative purposes, are the damping results for a solid ring and the results for a perforated ring having 23% area removed with 0.020" holes. It is interesting to note that the damping increases abruptly with decreasing perforation area for percentage perforation areas less than 16%. It is also interesting to note the close correlation between the damping produced by the small hole (0.020") 23% perforated area ring baffle, and the large hole (0.079") 8% perforated area ring baffle.

Tabulated damping values for each of the various tests performed are presented in Table II.

Multiple Ring Baffles

A series of annular ring baffles can be used in a tank to provide a high degree of damping for all liquid levels, from completely full to completely empty. The minimum damping to be provided by such a system of multiple ring baffles is controlled by proper spacing of the baffles. To establish the proper spacing of the baffles, tests were conducted with a set of two ring baffles, where one is located above, and the other below, the liquid surface. Typical results are presented in Figure 4.

The test data indicates that, for an excitation amplitude of $X_0/d = 0.00417$, the baffle above the liquid is effective only when its distance from the liquid free surface is less than $|d_s/R| = 0.125$, and that the submerged baffle is effective from $d_s/R = 0$ to $d_s/R = 0.375$. From these tests the baffle spacing corresponding to some minimum acceptable damping γ_{\min} for a series of ring baffles can be determined. The spacing necessary to maintain the minimum acceptable damping is the depth of the submerged baffle corresponding to γ_{\min} plus the additional $d_s/R = 0.125$ for which the upper baffle is still effective.

CONCLUSIONS

From the results presented in this paper, it may be concluded that a series of ring baffles can be used efficiently to damp liquid motion throughout the depth of a cylindrical tank. Perforated material having relatively small diameter perforation holes can be effectively used for ring baffles, reducing the ring baffle area by as much as 23% with no appreciable loss in damping effectiveness. Such reduction in baffle area may be effectively used for additional baffles thus increasing the minimum damping ratio value with no appreciable increase in baffle weight.

For a cylindrical tank containing a set of ring baffles, the liquid natural frequencies are somewhat dependent on both the ring width and the ring baffle spacing. The first liquid resonant frequency increases over that of a bare wall tank only for baffle positions in the immediate vicinity of the liquid surface, and decreases below that of a bare wall tank for more deeply submerged ring baffles.

For a vehicle in which the first liquid resonant frequency is not critically coupled with the control system, ring baffle damping is therefore probably the most efficient means of introducing liquid damping into the propellant tanks. If, however, the liquid resonant frequencies are critical and must be shifted by rather significant amounts, other baffle systems should be considered.

REFERENCES

1. Silveira, M. A., Stephens, D. G., and Leonard, H. W., "An Experimental Investigation of the Damping of Liquid Oscillations in Cylindrical Tanks with Various Baffles", NASA Tech. Note. D-715, May 1961.
2. Abramson, H. N., and Ransleben, G. E., Jr., "Simulation of Fuel Sloshing Characteristics in Missile Tanks by Use of Small Models", ARS Journal, 30, pp. 603-612, July 1960.
3. Miles, J. W., "Ring Damping of Free Surface Oscillations in a Circular Tank", Journal of Applied Mechanics, 25, 2 pp. 274-276, June 1958.

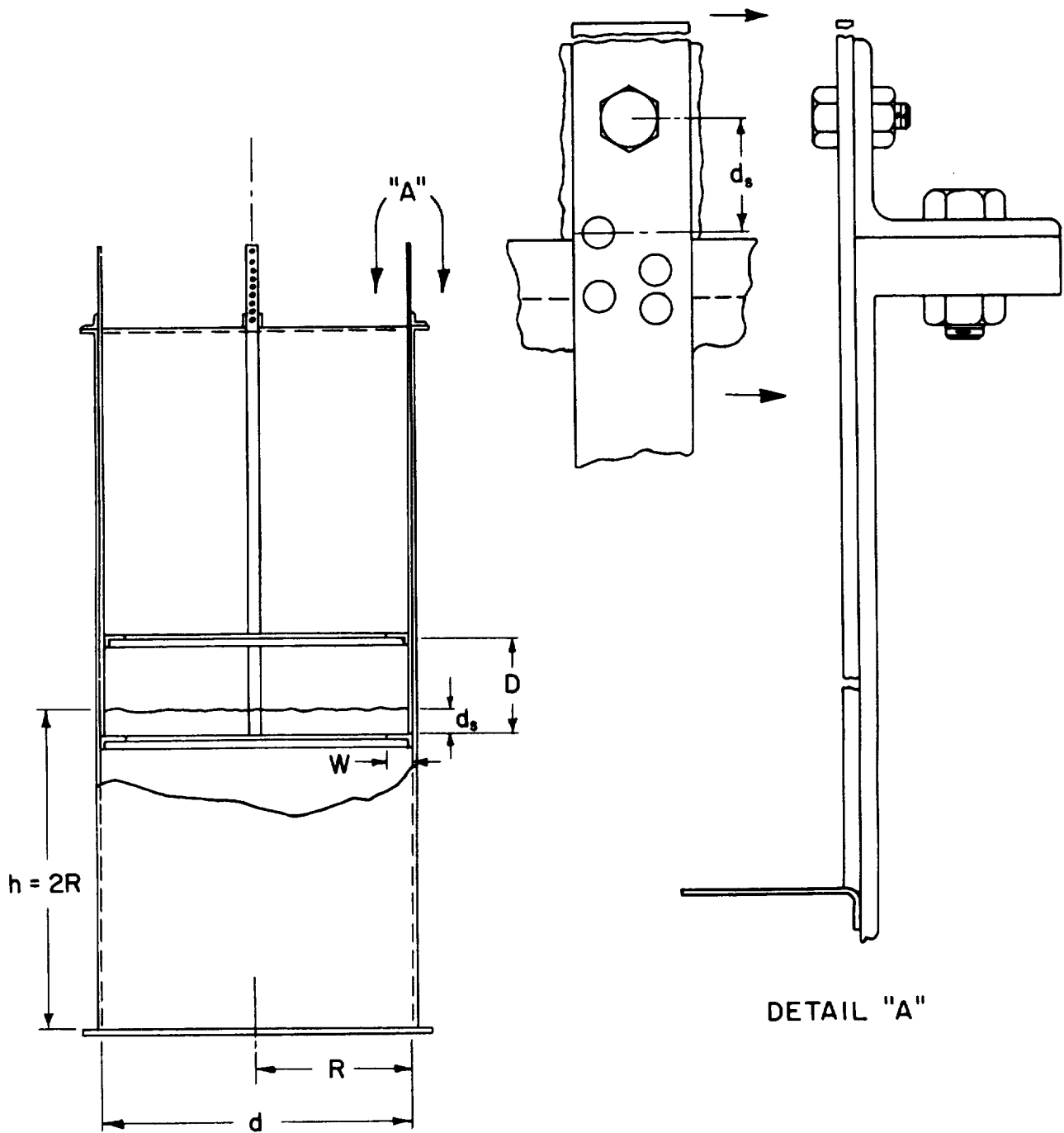

FIGURE I. DETAILS OF BAFFLE SUPPORT ARRANGEMENTS AND TANK CONFIGURATION

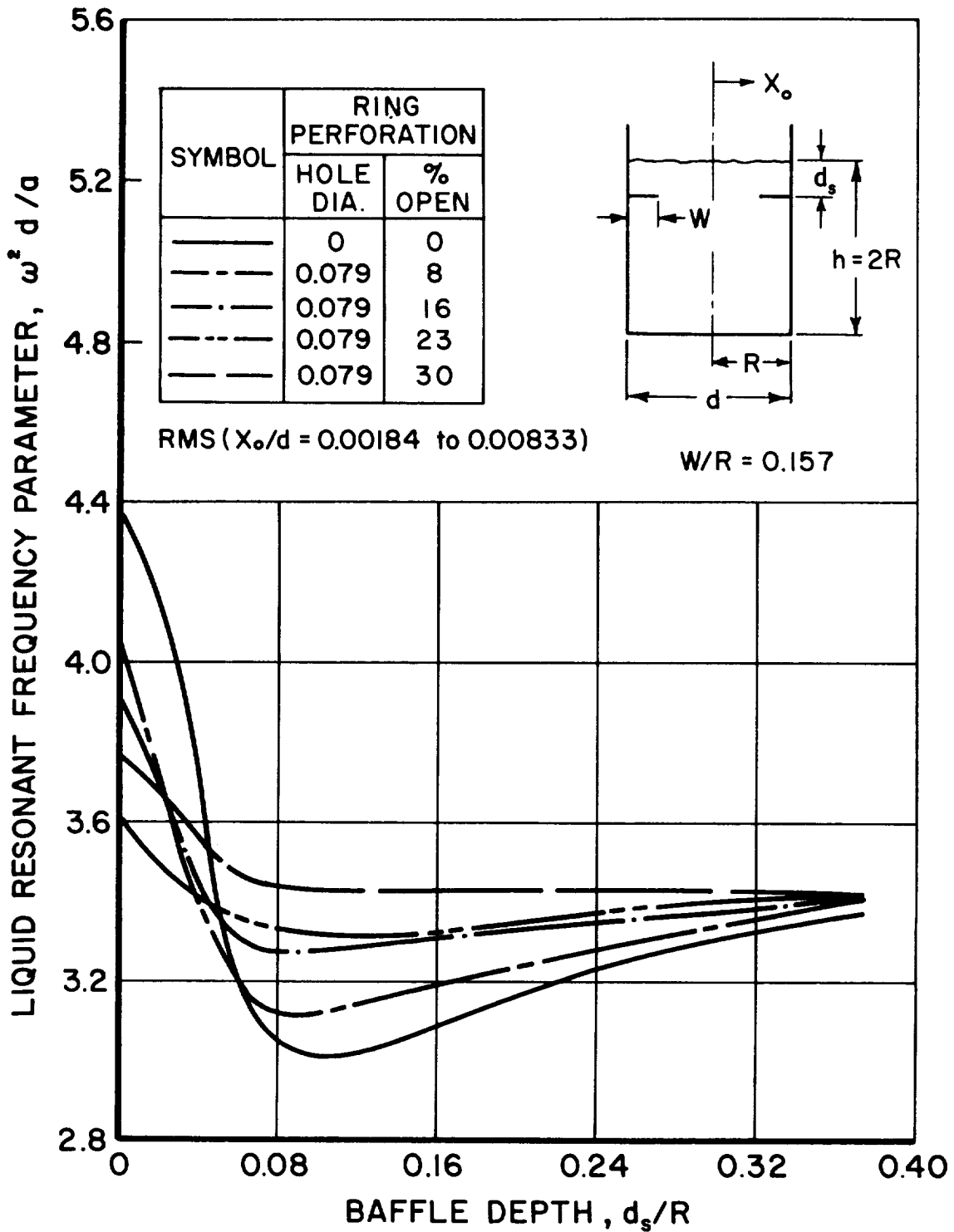

FIGURE 2. EFFECT OF % PERFORATION ON LIQUID RESONANT FREQUENCIES AS A FUNCTION OF BAFFLE DEPTH

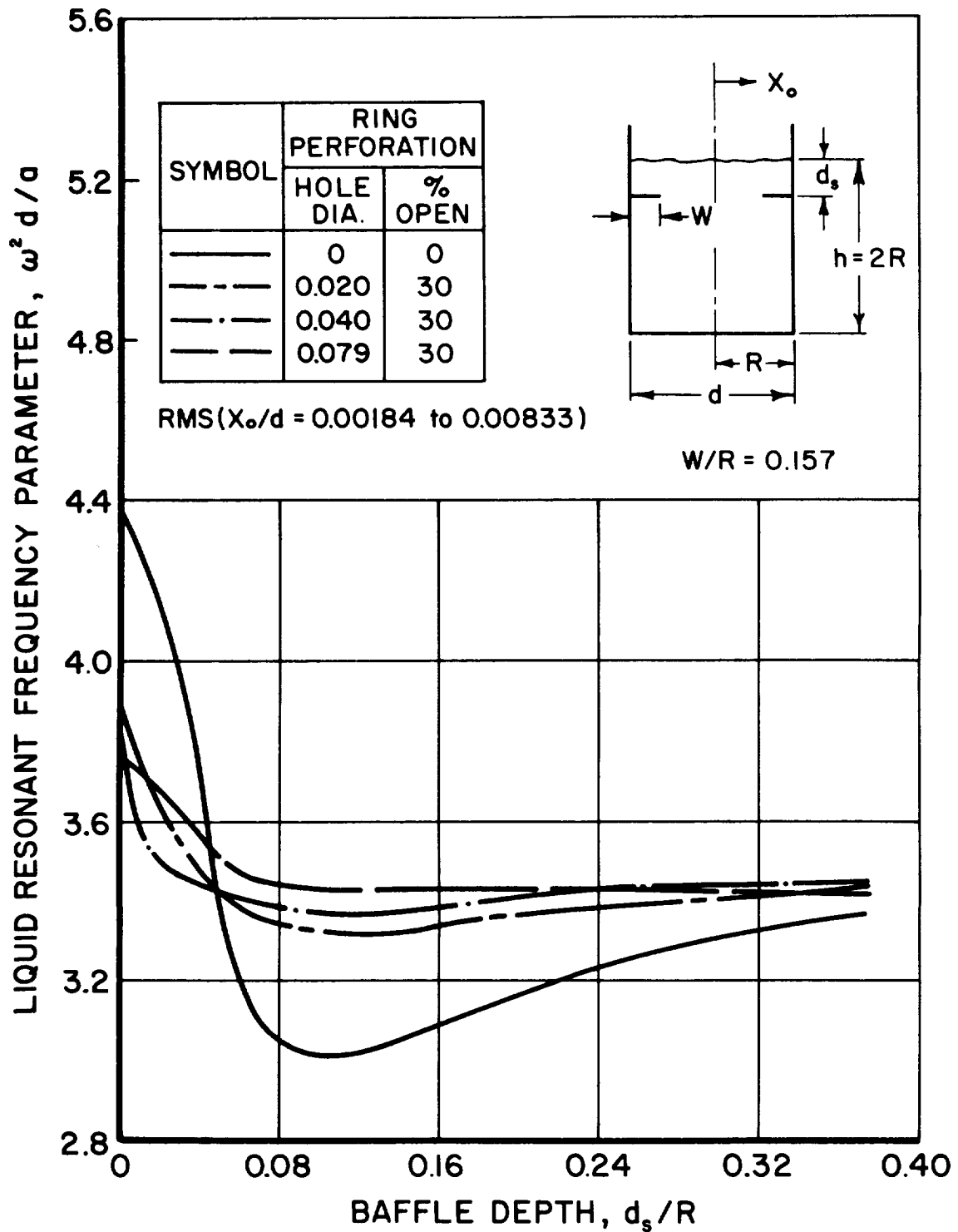

FIGURE 3. EFFECT OF PERFORATION HOLE SIZE ON LIQUID RESONANT FREQUENCIES AS A FUNCTION OF BAFFLE DEPTH

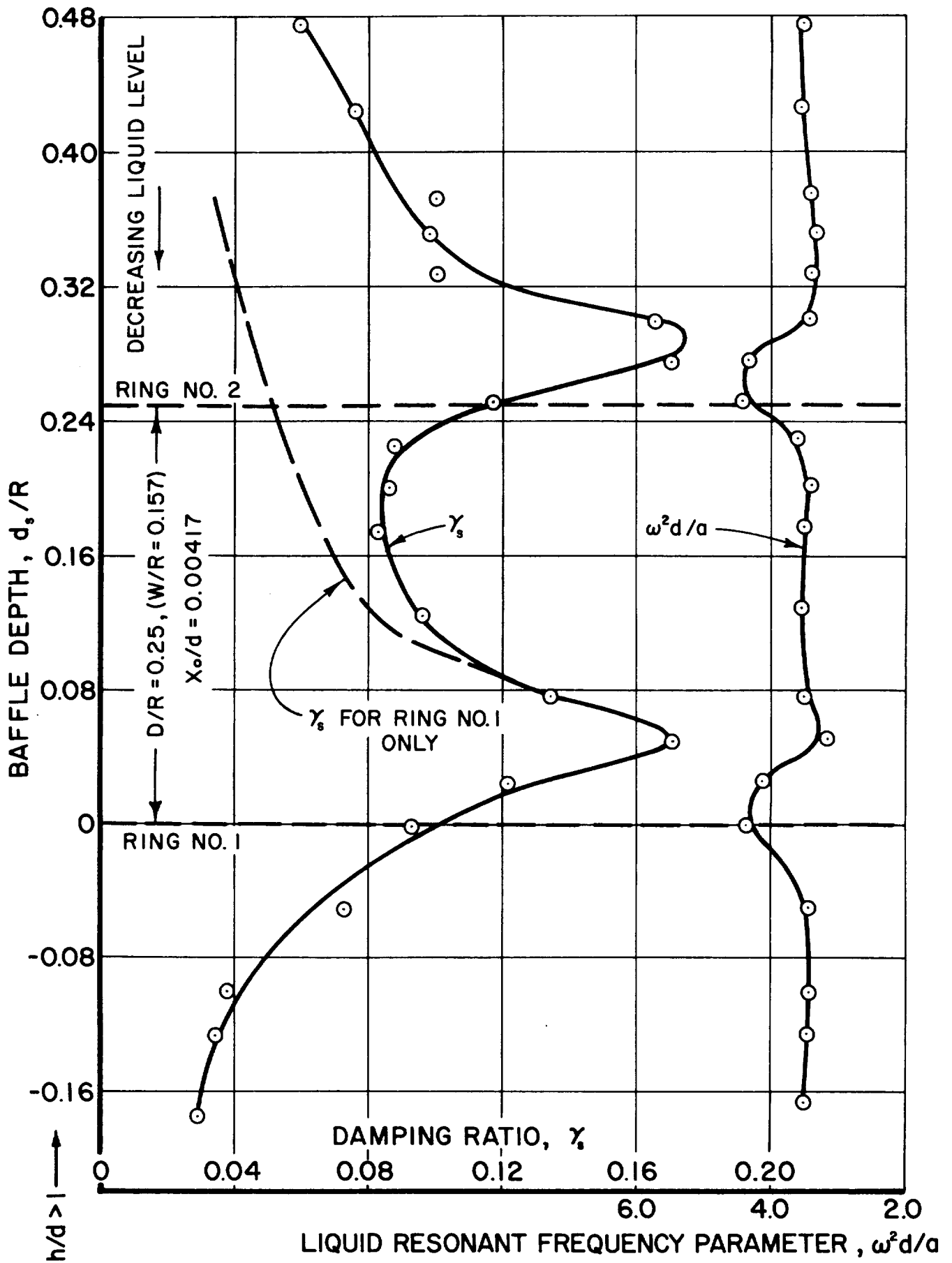

FIGURE 4. EFFECTS OF DOUBLE RINGS AS A FUNCTION OF BAFFLE DEPTH

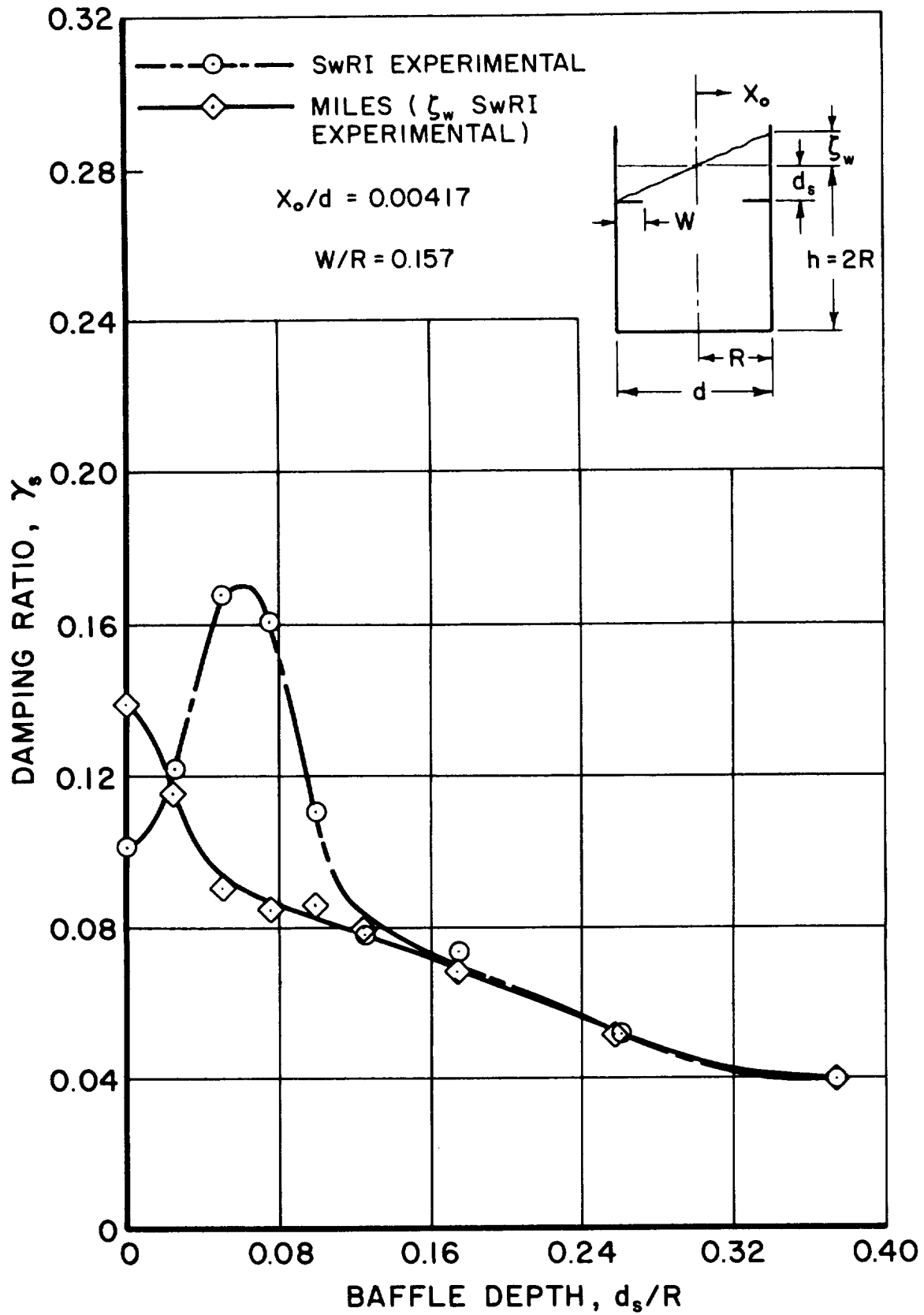

FIGURE 5. COMPARISON OF THEORY AND EXPERIMENT FOR DAMPING PROVIDED BY A FLAT SOLID RING BAFFLE AS A FUNCTION OF BAFFLE DEPTH

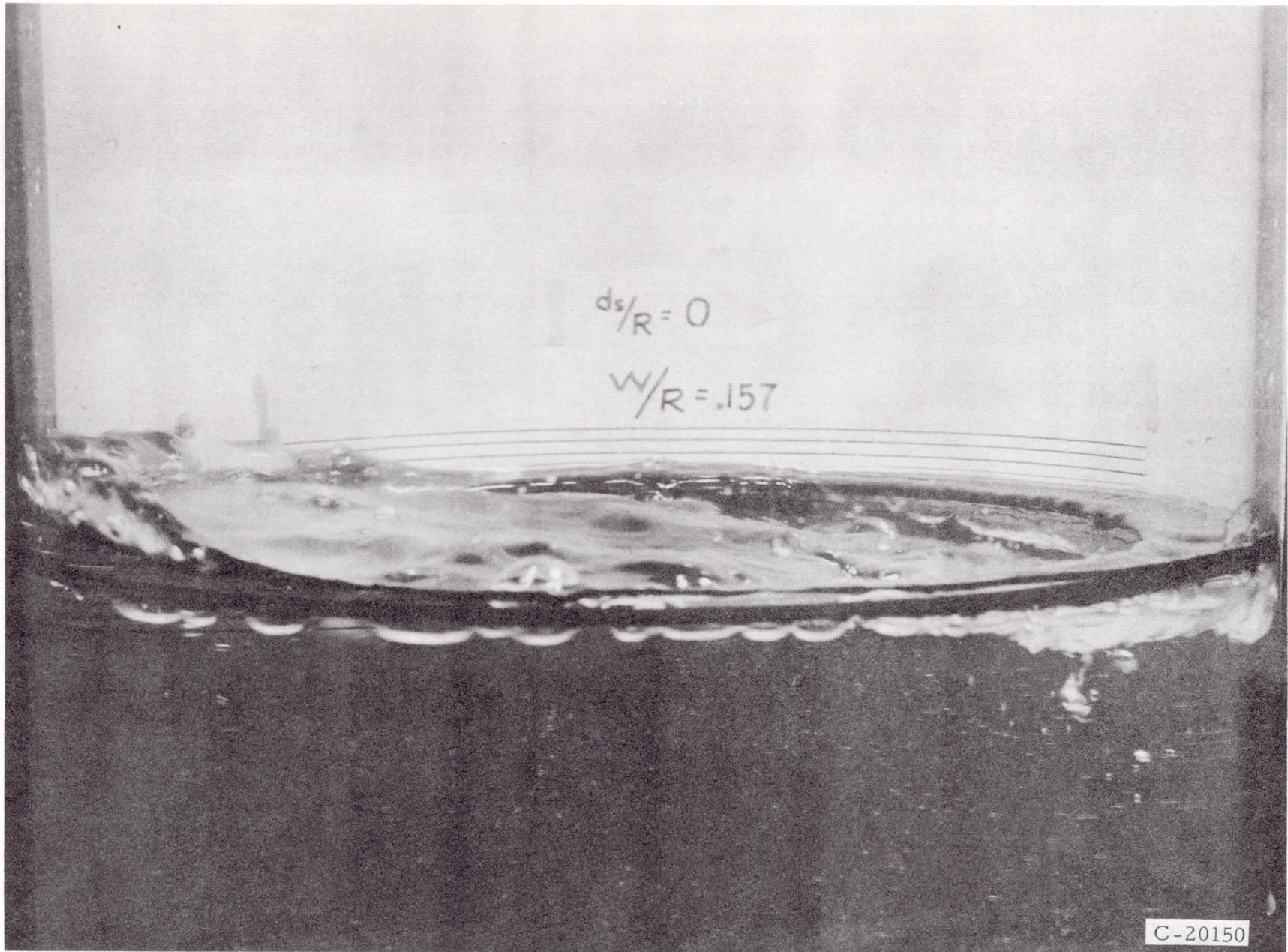

FIGURE 6. INTERACTION BETWEEN A FLAT SOLID RING BAFFLE AND THE LIQUID FREE SURFACE AT SHALLOW LIQUID DEPTH

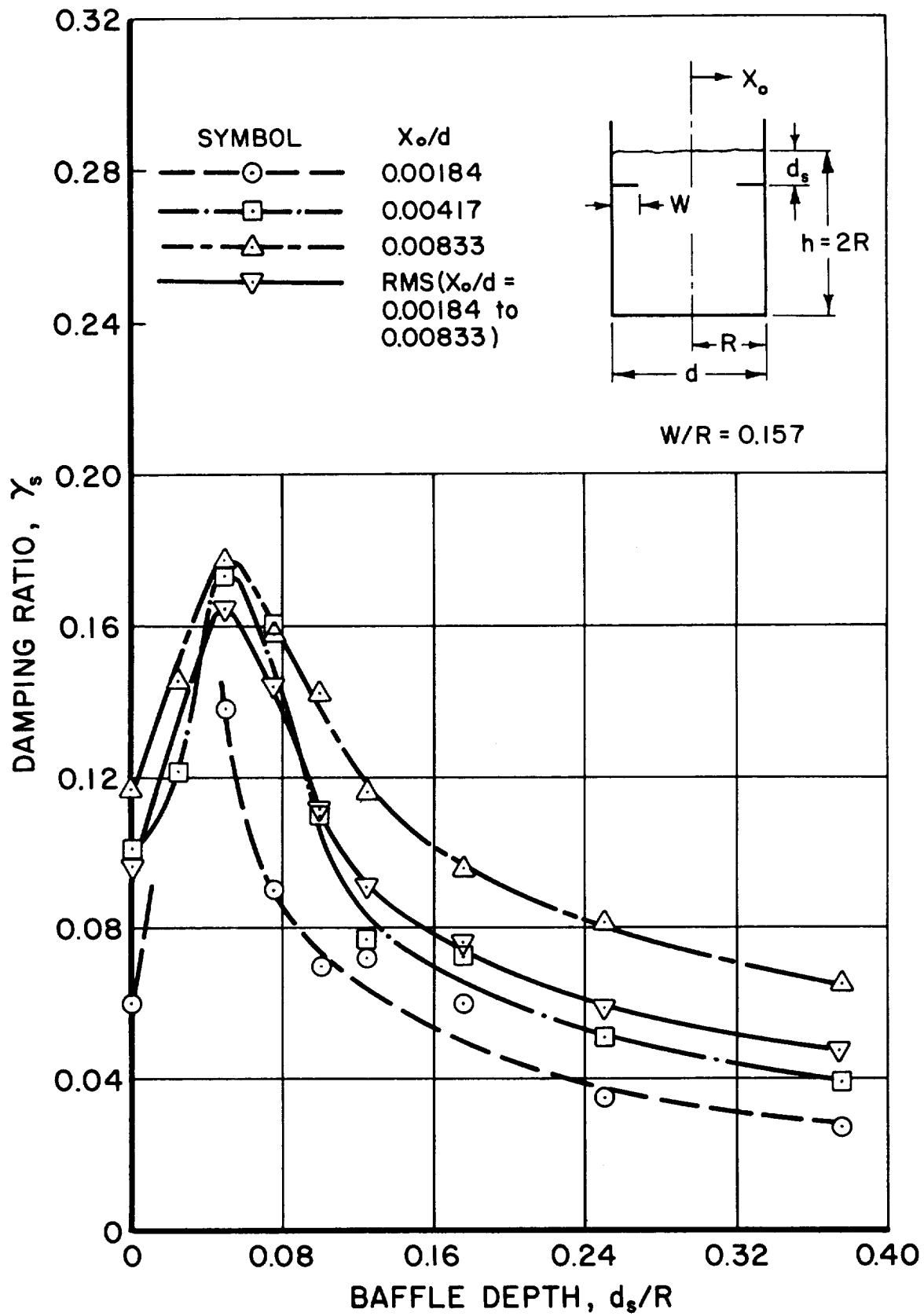

FIGURE 7. EFFECT OF EXCITATION AMPLITUDE ON DAMPING EFFECTIVENESS OF A SOLID FLAT RING BAFFLE AS A FUNCTION OF BAFFLE DEPTH

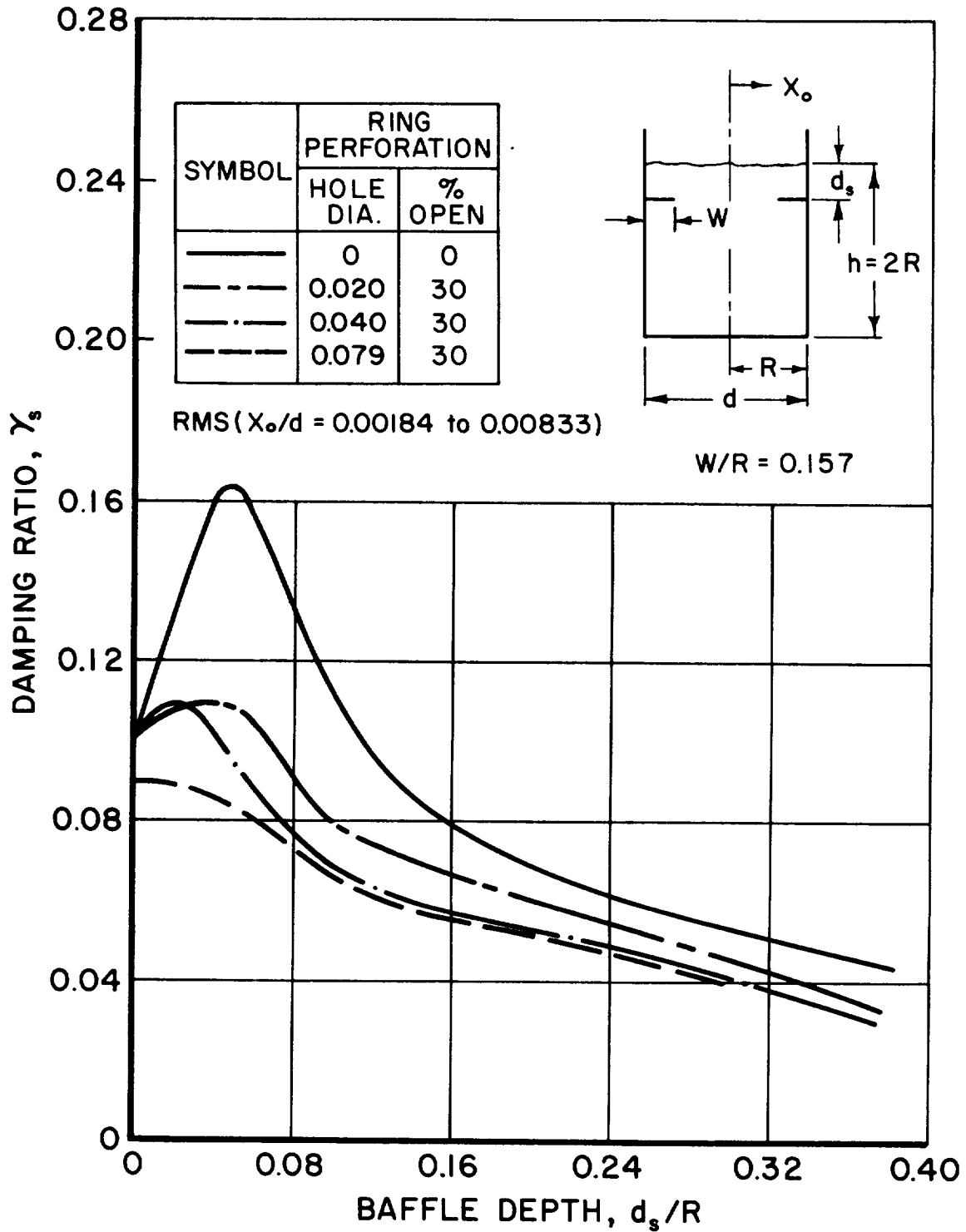

FIGURE 8. EFFECT OF PERFORATION HOLE SIZE ON DAMPING EFFECTIVENESS AS A FUNCTION OF BAFFLE DEPTH

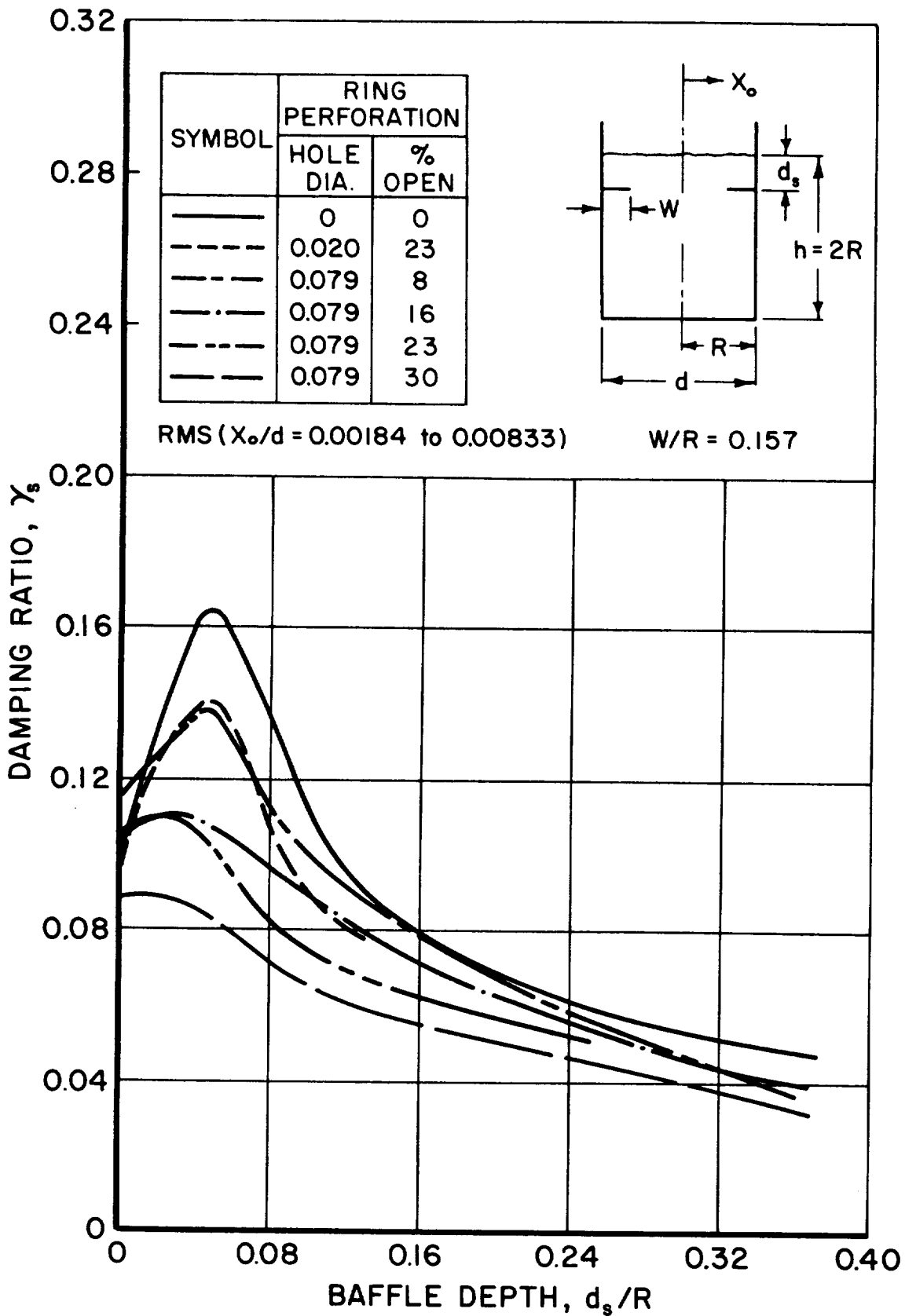

FIGURE 9. EFFECT OF % PERFORATION ON DAMPING EFFECTIVENESS AS A FUNCTION OF BAFFLE DEPTH

TABLE I

LIQUID RESONANT FREQUENCY

$W/R = 0.157$

% W Open	0	8%	16%	23%	30%	23%	30%	30%
Hole Diameter (in.)	0	0.079	0.079	0.079	0.079	0.040	0.040	0.020
Ring Depth d_s/R		$\omega^2 d/a$		$(X_0/d = 0.00184)$				
0	4.68	4.40	4.25	3.57	4.1	4.11	4.14	4.33
.025	4.19	3.19	3.47	3.30	3.88	3.20	3.43	3.26
.050	2.92	3.17	3.31	3.34	3.52	3.36	3.34	3.22
.075	3.01	2.90	3.27	3.32	3.47	3.26	3.34	3.32
.100	3.06	2.96	3.31	3.35	3.51	3.32	3.41	3.34
.125	2.97	3.19	3.40	3.36	3.49	3.31	3.43	3.35
.175	3.18	3.24	3.35	3.32	3.54	3.38	3.47	3.41
.250	3.40	3.36	3.40	3.45	3.56	3.52	3.54	3.42
.375	3.48	3.49	3.54	3.58	3.57	3.52	3.56	3.54
.450	3.47	3.54	3.62	3.58	3.58	3.59	3.62	3.54
		$\omega^2 d/a$		$(X_0/d = 0.00417)$				
0	4.43	3.84	3.76	3.73	3.65	3.81	4.16	3.87
.025	4.27	3.64	3.79	3.62	3.62	3.60	3.54	3.90
.050	3.71	3.29	3.40	3.54	3.50	3.44	3.66	3.55
.075	2.99	3.14	3.28	3.32	3.46	3.26	3.45	3.31
.100	2.94	3.15	3.28	3.35	3.45	3.28	3.38	3.30
.125	3.09	3.20	3.22	3.35	3.45	3.26	3.40	3.31
.175	3.09	3.24	3.26	3.38	3.51	3.26	3.45	3.34
.250	3.18	3.34	3.38	3.43	3.49	3.39	3.45	3.40
.375	3.33	3.46	3.40	3.43	3.42	3.52	3.45	3.44
		$\omega^2 d/a$		$(X_0/d = 0.00833)$				
0	3.96	3.84	3.73	3.54	3.52	3.58	3.28	3.49
.025	3.77	3.77	3.75	3.49	3.50	3.54	3.41	3.54
.050	3.58	3.58	3.51	3.49	3.47	3.47	3.40	3.49
.075	3.18	3.24	3.28	3.40	3.40	3.40	3.41	3.40
.100	2.97	3.22	3.28	3.31	3.38	3.24	3.34	3.36
.125	3.00	3.06	3.32	3.24	3.31	3.28	3.30	3.28
.175	3.07	3.13	3.28	3.31	3.31	3.28	3.30	3.32
.250	3.16	3.28	3.28	3.31	3.28	3.22	3.32	3.32
.375	3.30	3.32	3.31		3.24	3.30	3.36	3.32

TABLE 11

RING DAMPING

$W/R = 0.157$

% W Open	0	8%	16%	23%	30%	23%	30%	30%
Hole Diameter (in.)	0	0.079	0.079	0.079	0.079	0.040	0.040	0.020
Ring Depth d_s/R		Damping Ratio,		$X_0/d = 0.00184$				
0	.060	.087	.084	.108	.087	.091	.110	.103
.025	.210	.132	.084	.106	.087	.114	.112	.116
.050	.137	.147	.071	.073	.055	.086	.086	.103
.075	.090	.1145	.070	.065	.050	.072	.082	.084
.100	.070	.0885	.069	.059	.045	.046	.050	.057
.125	.073	.067	.056	.049	.045	.059	.045	.053
.175	.060	.054	.056	.045	.040	.054	.033	.049
.250	.035	.040	.035	.047	.031	.032	.032	.042
.375	.027	.025	.026	.021	.022	.023	.022	.029
.450	.025	.022			.017	.023	.015	.023
		Damping Ratio,		$X_0/d = 0.00417$				
0	.101	.127	.101	.098	.082	.094	.102	.086
.025	.121	.126	.122	.108	.093	.110	.114	.109
.050	.173	.134	.119	.112	.089	.109	.106	.103
.075	.160	.112	.108	.084	.077	.104	.077	.089
.100	.110	.091	.090	.075	.064	.085	.068	.085
.125	.077	.102	.077	.064	.047	.077	.064	.078
.175	.072	.070	.072	.061	.050	.066	.054	.070
.250	.051	.061	.051	.049	.047	.051	.049	.055
.375	.039	.044	.038	.035	.040	.039	.032	.037
		Damping Ratio,		$X_0/d = 0.00833$				
0	.117	.122	.121	.111	.095	.110	.091	.114
.025	.146	.126	.124	.117	.087	.122	.106	.112
.050	.177	.134	.124	.109	.098	.126	.098	.118
.075	.158	.123	.114	.099	.084	.104	.086	.120
.100	.142	.115	.102	.093	.082	.093	.072	.093
.125	.116	.106	.093	.088	.078	.093	.082	.088
.175	.096	.096	.081	.078	.072	.079	.074	.072
.250	.082	.066	.067	.061	.057	.067	.058	.058
.375	.066	.048	.046		.026	.046	.038	.042