

NASA TECHNICAL NOTE



NASA TN D-2996

e.1

NASA TN D-2996



LOCATED FOR THE
AFM (V710.2)
KIRTLAND AFB, NM

FLIGHT PARAMETERS AND VEHICLE PERFORMANCE FOR PROJECT FIRE FLIGHT 1, LAUNCHED APRIL 14, 1964

by William I. Scallion and John H. Lewis, Jr.

Langley Research Center

Langley Station, Hampton, Va.

NATIONAL AERONAUTICS AND SPACE ADMINISTRATION • WASHINGTON, D.C.





FLIGHT PARAMETERS AND
VEHICLE PERFORMANCE FOR PROJECT FIRE FLIGHT 1,
LAUNCHED APRIL 14, 1964

By William I. Scallion and John H. Lewis, Jr.

Langley Research Center
Langley Station, Hampton, Va.

NATIONAL AERONAUTICS AND SPACE ADMINISTRATION

For sale by the Clearinghouse for Federal Scientific and Technical Information
Springfield, Virginia 22151 - Price \$3.00

FLIGHT PARAMETERS AND
VEHICLE PERFORMANCE FOR PROJECT FIRE FLIGHT 1,
LAUNCHED APRIL 14, 1964

By William I. Scallion and John H. Lewis, Jr.
Langley Research Center

SUMMARY

Project Fire has been undertaken by the National Aeronautics and Space Administration to investigate the heating environment of vehicles entering the earth's atmosphere at velocities slightly higher than return velocities from a lunar mission. This project was accomplished by using an Atlas D launch vehicle in conjunction with an Antares II-A5 solid-propellant rocket motor which successfully placed a blunt-nosed reentry vehicle into the desired reentry environment. Sufficient data were obtained from the supporting systems to define closely the overall trajectory and the characteristics of the atmosphere through which the experiment was conducted.

INTRODUCTION

The primary purpose of this flight reentry experiment is to determine the hot-gas radiance and the total-heat-transfer rates on a blunt-nosed body of fairly large scale. The resulting data are intended to provide anchor points for comparison with results obtained from ground facilities and theoretical prediction methods.

The first Project Fire flight was launched at 21:42:25.536 Greenwich mean time on April 14, 1964, from Cape Kennedy, Florida. The flight terminated with the impact of the experimental payload into the Atlantic Ocean near Ascension Island.

The purpose of this paper is to document the experimental conditions as defined by the reentry trajectory and to describe the unique portions of the space vehicle.

MISSION AND VEHICLE DESCRIPTION

Flight Objectives

The major objective of the space vehicle was to place the reentry package in an atmospheric entry environment with a velocity of 37 000 feet per second or greater and at an entry angle of -15° . The magnitude of velocity was chosen as representative of that of return velocities from missions to the moon and the near planets. The entry angle was selected as a compromise between the values needed to enhance gas radiation levels and those which would insure the survival of the reentry package and its state-of-the-art instrumentation. The desired altitude for attainment of the selected reentry trajectory parameters was 400 000 feet. This altitude was designated as the beginning of the reentry experiment.

The space vehicle was launched from Cape Kennedy along the Eastern Test Range (ETR) to permit reentry into the Ascension Island area. A photograph of the space vehicle at lift-off is shown in figure 1. The area of reentry was arranged so that radar tracking, data-acquisition, and optical instrumentation on Ascension Island could be utilized. Launch of the space vehicle was timed to insure that complete darkness would prevail along the reentry flight path during the experimental period.

Space Vehicle Components

The Project Fire space vehicle is shown in figure 2. It consists of a powered spacecraft, composed of a velocity package and a reentry package, mounted atop an Atlas D launch vehicle. The spacecraft also includes an aerodynamic shroud which protects the velocity package and the reentry package from aerodynamic heating during ascent through the atmosphere.

Launch vehicle.- The Atlas D launch vehicle used to boost the spacecraft into a ballistic trajectory was basically the same as that which has been used in numerous space-flight programs. It was modified slightly to satisfy specialized Project Fire mission requirements. The modifications affected only the timing of flight events and electrical signals crossing the Atlas-spacecraft interface. Major Atlas systems were not modified. Since the Atlas has been so widely used as a launch vehicle, a detailed description of its systems and their operation has been excluded from this report.

Spacecraft.- A cutaway view and an exploded view of the spacecraft, in addition to a sketch of the aerodynamic shroud, are presented in figure 3. A complete weight breakdown of the spacecraft is given in table I.

Velocity package: The velocity-package system was designed specifically for Project Fire and components developed by the Scout program were utilized. The system provides the propulsive power to increase the velocity of the reentry package from that imparted by the launch vehicle to the desired experimental velocity. In addition, it provides spacecraft attitude control during coasting

and reentry-stage acceleration phases of the flight. The physical characteristics of the velocity package, together with some pertinent dimensions, are given in table II.

The velocity-package system consists of a radio-frequency-transparent aerodynamic shroud, an Antares II-A5 solid-propellant rocket motor, and a shell structure which provides structural support for the Antares II-A5 and the necessary equipment for spacecraft stability and control. The shell structure consists of two concentric walls. A metal shelf located between the outer and inner wall sections provides mounting space for the major part of the velocity-package equipment. This equipment includes primarily an attitude control system for maintaining stability and vehicle orientation during the coast phase of the flight and a telemetry system for transmitting flight data. Three small solid-propellant motors are mounted on the shell to provide a spin rate, prior to ignition, of the Antares II-A5, sufficient to maintain attitude control during Antares burning. Adapters provide structural and electrical interfaces between the launch vehicle, velocity package, and reentry package.

The velocity-package telemetry consists of a 16-channel PAM/FM/FM system with 15 continuous channels and 1 commutated data channel. The telemetry system provides monitoring capabilities for the velocity package during the pre-launch check-out and flight data from lift-off until separation of the velocity-package shell from the reentry stage. The telemetry measurements include system temperatures and pressures, flight events, attitude-control-system outputs, and reaction-control-motor performance. The transmitter output is approximately 4 watts on a frequency of 244.3 megacycles.

A block diagram of the velocity-package stabilization and control system as adapted from the Scout system for Project Fire is shown in figure 4. The system is designed to:

- (a) Provide control to capture the spacecraft at separation, orient it to and stabilize it at the reference attitude established by the launch vehicle.
- (b) Perform a pitch maneuver through a predetermined angle to reorient the spacecraft to the prescribed reentry attitude.
- (c) Stabilize the spacecraft at the reentry attitude during the coast phase of flight.

In addition to the stabilization and control system, a timer was provided for initiation and termination of the pitch maneuver, initiation of reentry-package timers, separation of the velocity-package shell, and ignition of the Antares II-A5 rocket motor.

The Antares II-A5 rocket motor consists of a solid-propellant grain cast into a case reinforced with glass fiber. Its physical characteristics are given in reference 1.

Reentry package: The reentry package, which is the experimental portion of the Project Fire vehicle and which contains the primary-data gathering system, is shown in figure 5. The physical characteristics and pertinent

dimensions of the reentry package are given in table III. The package consists of a blunt forebody and a conical afterbody. The forebody consists of a six-layer arrangement of beryllium calorimeters alternated with phenolic-asbestos heat-protection shields, all of which are instrumented with thermocouples. Additionally, the forebody is equipped with one spectral and two total radiometers. The spectral radiometer and one total radiometer are located at the center of the forebody heat shield to provide spectral and total radiation measurements at the stagnation point, and the other total radiometer is located in an offset position on the forebody.

The conical afterbody is instrumented with temperature sensors and a total radiometer. The telemetry system is an FM/FM system utilizing two transmitters. The seven continuous and four commutated channels are transmitted in real, or actual, time by one transmitter and in delayed time from the tape recorder on the other transmitter. In the event of failure of the delayed-time transmitter, the tape-recorded data are automatically switched to the real-time transmitter; thus, a redundant method of obtaining the primary experimental data is assured.

The antenna for the telemetry transmitter is embedded in an indentation around the circumference of the afterbody and is covered with a heat-protection material. A C-band beacon is provided to assist in radar tracking. Prior to reentry-package separation, the beacon feeds an antenna mounted on the reentry-package adapter and, after separation, feeds an antenna on the apex of the reentry-package afterbody.

Sequence of Events

The Project Fire mission profile showing the major sequence of events required to meet the flight objectives is shown in figure 6. The mission profile essentially consists of using a launch vehicle to loft the reentry vehicle into a ballistic trajectory and then adding a final velocity increment just prior to reentry by igniting a solid-propellant rocket motor.

Since the sequence of events for the Project Fire mission was primarily serial in nature, whereby activation of events was dependent on events that have preceded it, careful analysis was required in order to provide backup activation functions and to identify problem areas such as overlapping of events. A description of the method used in this analysis is presented in the appendix.

The Atlas D launch vehicle provided the necessary energy to place the spacecraft on a coast trajectory that would intercept a predetermined point in space in the Ascension Island area. This predetermined point was that at which the Antares II-A5 solid-propellant rocket motor would be ignited. During the boost phase of the flight, the space vehicle was guided by a radio command system consisting of a ground-based computer, ground radar equipment, and airborne transponders and decoder. The radar data supplied to the computer were transformed into position and velocity vectors by a set of guidance equations programmed in the computer. The guidance equations computed the required pitch and yaw steering rates and the times for initiating discrete events necessary to satisfy the target-point conditions.

After separation from the launch vehicle, the Atlas retrorockets were fired, and the spacecraft was oriented to the inertial attitude required for reentry. This attitude was maintained throughout the coast period. During the descending portion of the coast trajectory at an altitude of about 1 000 000 feet, the velocity-package timer ignited three spin rockets in order to spin stabilize the reentry stage and reentry package. The reentry stage was spring separated from the velocity-package shell, and the Antares II-A5 rocket motor was ignited to provide a velocity increment of about 17 000 feet per second. Separation of the reentry package from the reentry stage is accomplished by timer activation of an explosive nut connecting the two components. Activation of the explosive nut allows a coil spring to impart a relative velocity of approximately 5 feet per second between the reentry package and spent reentry stage. The attitude of the spent motor was disturbed by a small rocket motor mounted on the adapter in order to increase the aerodynamic drag and thus enhance the separation of the motor from the reentry package. During the experimental period of the reentry, the data were recorded on a continuous-loop tape recorder and were subsequently played back and transmitted continuously by telemetry after emergence from VHF blackout until impact. No recovery of the reentry package was planned.

DESCRIPTION OF FLIGHT AND VEHICLE PERFORMANCE

The Project Fire space vehicle was launched from Cape Kennedy, Florida, on April 14, 1964, at 21:42:25.536 Greenwich mean time. The flight consisted of four phases: the boost phase which ended with spacecraft separation from the launch vehicle, the coast phase which ended with Antares II-A5 ignition, the reentry-stage acceleration phase which ended with Antares II-A5 burnout, and the separation and reentry phase.

Boost and Coast Phases

The boost and coast phases of flight, from lift-off to ignition of the Antares II-A5 rocket motor, followed very nearly as was planned. A measure of the launch-vehicle performance can be obtained from figure 7, which presents data obtained from the ETR tracking facilities. Figure 7(a) presents altitude as a function of elapsed time and ground range from the launch site. Relative velocity and flight-path angle as a function of elapsed time are presented in figure 7(b). Figure 7 graphically indicates that the launch vehicle and its guidance system provided a near nominal ascent and coast trajectory.

All launch-vehicle events occurred within allowable limits of their expected times. The aerodynamic shroud separation was very smooth. Small disturbances were noted when the shroud separation bolts were fired, but these disturbances were expected and were quickly damped out. The spacecraft was separated smoothly from the launch vehicle and with a very small angular disturbance. The maximum angular rates imparted to the spacecraft were approximately 0.6 degree per second left in yaw, 1.0 degree per second clockwise in roll, and 0.5 degree per second up in pitch. These rates were well within the expected limits.

Accuracy of the initial attitude reference of the spacecraft as provided by the launch vehicle, the attitude following the spacecraft pitch maneuver, and the coast stabilization attitude was not individually determinable; however, trajectory-parameter errors at the 400 000-foot reentry injection point were within the expected dispersion bounds, indicating small initial misalignment of the reference, accurate programming of the pitch maneuver, and small amounts of system drifts during coast.

Satisfactory performance of the spin motor resulted in an initial spin rate of 161 revolutions per minute as compared with a predicted rate of 169 ± 12 revolutions per minute. Since the roll-rate gyro located in the reentry package was inoperative, the achieved spin rate was determined by examination of signal-strength records from a trihelix-telemetry-antenna system located on Ascension Island. This determination was possible because the reentry-package telemetry-antenna pattern was such that the signal received at the ground station would be modulated as a result of the package spinning.

Following spin stabilization, the velocity-package shell was cleanly separated from the reentry stage. Within the limitations of the reentry-package instrumentation, no coning motion could be detected.

Reentry-Stage Acceleration Phase

The performance of the Antares II-A5 solid-propellant rocket motor was completely satisfactory. The flight data indicated that the actual performance closely approximated that which was expected and that the velocity increment imparted to the reentry package provided a reentry velocity which satisfied mission requirements.

Radar tracking information and onboard acceleration measurements were utilized to evaluate the Antares II-A5 performance. The onboard acceleration measurements were made by accelerometers mounted in the reentry package. An accelerometer capable of measuring forces from 0g to 45g was mounted along the longitudinal (roll) axis, and three accelerometers capable of measuring forces from -6g to 6g were mounted along the longitudinal (roll), transverse (pitch), and normal (yaw) axes. Data from these accelerometers were obtained by telemetry through a commutated channel in the reentry-package telemetry system which provided 10 data points per second for the longitudinal accelerometer (-6g to 6g) and 20 data points per second for the transverse and normal accelerometers. Radar tracking information was obtained from the radar units on Ascension Island: the FPS-16, the TPQ-18, and the Nike-Zeus Target Tracking Radar (TTR).

Figure 7(c) presents the variation of velocity with time during the reentry-stage acceleration phase. This figure is a comparison of the expected velocity variation with that obtained by reducing the data obtained by the FPS-16 radar and onboard accelerometer measurements. As can be seen from the figure, the FPS-16 radar data agree very closely with that which was expected. The onboard accelerometer data indicate a velocity of about 450 feet per second lower than that which was expected. Due to the accelerometer measurement

capabilities and the data-transmission-system accuracy, an error of 2 percent is possible between the actual acceleration and that which is recorded at the telemetry receiving station. This 2-percent error in the accelerometer data would result in a velocity error of about 950 feet per second. It was concluded that the radar data would most accurately reflect the actual conditions during the flight, and since the data provided by the FPS-16 radar was the best available, they were used to determine the performance of the Antares II-A5.

The results of the Antares II-A5 performance as evaluated from flight data (ref. 2) are shown in figures 8(a) and 8(b), which present the variation with elapsed time from motor ignition of thrust and weight flow rate, respectively. Total impulse of the rocket motor was 719 931.6 pound-seconds, as compared with an expected value of 726 922.6 pound-seconds for this particular motor. The consumed-weight average specific impulse was determined to be 276.17 pounds of thrust per pound of mass per second. It should be noted that the residual thrust shown after 33 seconds (fig. 8(a)) is an estimate and does not necessarily represent the actual residual thrust, since the data-gathering devices were not sufficiently sensitive to define the performance in this region.

Separation and Reentry Phase

Following burnout of the Antares II-A5, separation of the reentry package from the spent Antares motor and adapter was established by telemetry as having occurred at a flight elapsed time of 1640.46 seconds. The spin rate at this time was determined by telemetry-signal-strength measurements to be 174 rpm, an increase of 13 rpm over that prior to ignition. As indicated by the onboard yaw rate gyro, a small deviation in attitude occurred at separation. The pitch rate gyro was determined to be inoperative; however, since the two orthogonally mounted gyros would be expected to experience the same body rates, the yaw-rate oscillation frequency and amplitude were used in conjunction with the spin frequency and preflight reentry-package inertias to determine a coning half-angle of about 1° . The indicated yaw-rate frequency and amplitude were maintained until telemetry blackout occurred at 1653.9 seconds. The C-band radar blackout occurred at 1660.2 seconds. The experimental data were recorded on a continuous tape during telemetry blackout and were replayed by way of telemetry after emergence from blackout. A sample of the telemetry record obtained after emergence from blackout is shown in figure 9. (The reason for the poor quality of the record is discussed subsequently.) As shown in this figure, an abrupt change in yaw rate occurred at 1665.94 seconds. This abrupt change is shown more clearly in figure 10, which presents the variation of yaw rate with time as obtained from the telemetry record. This disturbance lasted for about 0.06 second, after which the yaw-rate data reversed again, with a resulting rate that went off scale alternately in both directions. The large cyclic variations in yaw rate continued for the remainder of the reentry-data period. Additionally, the effects of the disturbance on the total radiometer data can be seen in figure 9 by the cyclic variation in the radiometer outputs after an elapsed time of 1665.94 seconds. The disturbance was also manifested in the accelerometer data shown in figure 11. This figure shows the variation of longitudinal, normal, and lateral accelerations with time as obtained from

accelerometers (measuring forces from 6g to -6g) mounted in these planes. Since these data were commutated and not continuous, the acceleration values at the instant of the disturbance were not obtained. All these data indicate that the body attitudes resulting from the disturbance were probably relatively large.

The magnitude of the disturbance cannot be explained by mass unbalance or aerodynamic forces associated with unsymmetrical melting of the first beryllium calorimeter layer; however, the possibility of a collision or near collision exists between the reentry package and the spent reentry stage. A collision could occur if the reentry stage were not sufficiently translated laterally from the reentry-package wake, or if the reentry stage were sufficiently translated laterally but not given a large enough coning motion to insure ever increasing displacement along the flight path due to aerodynamic drag. However, the fact that none of the numerous sensors and antennas distributed over the reentry package was affected at the time the sudden body motions occurred tends to argue against an actual collision.

In an effort to determine what actually happened, a study of the available flight information, along with a wind-tunnel investigation, was conducted. The first question to be answered was whether the reentry-stage-adapter tumble rocket had fired as planned. No telemetry existed on this portion of the vehicle; therefore, the firing of the tumble rocket could not be monitored directly by a discrete signal. Since telemetry recording of this event was not possible, a 16-mm film of the reentry recorded at the TTR was analyzed. The first event observed in this film was a small flare which occurred at an indicated 1644.4 seconds and which lasted approximately 1.3 seconds.

The time of the preceding events as generated by the separation timers did occur as expected, and, since the tumble-rocket firing signal was a function of the same timer, it should also have occurred as expected. Therefore, it was reasoned that the observed flare was the firing at the tumble rocket and that the film timing was in error.

The next step was to estimate the separation between the reentry package and spent reentry stage. The film showed two distinct objects at 1655 seconds (this time is based on the starting time of the film); the objects were identified as the reentry package and the spent reentry stage. Inasmuch as the film had a 1-mil angular scale imprinted on it and since its timing was established by the tumble-rocket firing, the film was used in conjunction with the TTR data to estimate the separation distance between the two objects. These estimated distances are necessarily assumed to lie along the flight path. Prints of four frames of this film are shown in figure 12.

The longitudinal separation distance thus deduced is plotted in figure 13 as a function of flight elapsed time, along with the results of the preflight calculations. As can be seen in this figure, the film data indicate that the separation distance increased to a maximum of about 356 feet at 1661.5 seconds and thereafter decreased continuously. An extension of this curve would show that the longitudinal separation closed to zero at an elapsed time of about 1666 seconds. Since the lateral separation at this time is unknown, it can

only be concluded that there was either a collision or near collision between the reentry package and the spent reentry stage.

Subsequent wind-tunnel tests were conducted to determine the effects of shock interference between the reentry package and the reentry stage in close proximity. These tests were made at a Mach number of 4.63 with the bodies separated laterally by a distance up to 4 reentry-package diameters. The results showed a definite abrupt change in the reentry-package pitching moment and normal force when the bow shock from the reentry stage impinged on the edge of the blunt face of the reentry package. A sample photograph of the shock pattern and a plot of reentry-package pitching-moment and normal-force coefficients against longitudinal distance are shown in figures 14 and 15, respectively. Although rigorous proof is lacking, extrapolation of these data from the Mach number of the wind-tunnel tests to the flight Mach number of 38 at the time in question indicates that an impulse of the necessary magnitude could be developed for lateral distances between flight paths as large as approximately 200 feet.

The reentry package emerged from telemetry blackout at an elapsed time of 1686.8 seconds. Deterioration in the telemetry signal from the system used for transmission of the playback data from the tape recorder resulted in numerous dropouts in the data. The dropouts are graphically shown in figure 9. It was established that this failure occurred at velocity-package spin-up at an elapsed time of 1574.31 seconds. The cause of the failure was not definitely established; however, it could have been caused by a broken coaxial connector in the delayed-time antenna. At 1851.5 seconds a switch transferred the taped data to the real-time transmitter, and the last portion of one playback of the recorded data was obtained from this system prior to loss of the signal. Although dropouts occurred during operation of the delayed-time transmitter, a considerable amount of data was obtained by combining the results of several playbacks.

The time of emergence from C-band blackout was not established because of acquisition difficulties. The C-band beacon was acquired at a later time, and track was maintained almost to the horizon; however, the data indicated much interference due to noise. The impact time provided by the Eastern Test Range was 1965.7 seconds.

A comparison of actual times for the flight events with those that were expected is presented in table IV. The table includes the major spacecraft events from launch to reentry-package impact. All launch-vehicle events from lift-off to spacecraft separation occurred within allowable limits of their expected times.

Except for the disturbance which caused large body motions during the experimental period and the intermittent dropouts in data from the delayed-time telemetry transmitter, the Project Fire flight objectives as originally planned were successfully accomplished, and valuable reentry heating data were obtained within the required environmental conditions.

REENTRY TRAJECTORY

The reentry trajectory was established by utilizing several sources of flight data, since no single data source completely covered the reentry phase of flight. The individual data sources that were used, and the method employed to define the reentry trajectory are described in the following paragraphs.

Sources of Data

The primary research data were gathered by the reentry-package onboard instrumentation and were telemetered to the ground stations. A vast amount of electronic and optical equipment was necessary to insure receipt of the data, tracking of the reentry package, and establishing of the occurrence of events. A résumé of the most useful sources and the data acquired from each source is given in the following paragraphs, and the geographical locations are shown on a map of Ascension Island in figure 16.

Radar.- The Ascension Island FPS-16 radar maintained valid beacon tracking during the flight elapsed time from 1178 to 1797 seconds, except for the blackout period between 1660 and 1717 seconds.

Data were obtained by the TPQ-18 radar on Ascension Island which also tracked the beacon for the period from 1178 seconds to the beginning of blackout. The TPQ-18 radar did not track the reentry package after its emergence from blackout.

The TTR, which was operating in the wake-scan tracking mode, tracked the reentry package for 67 seconds, starting at the flight elapsed time of 1600 seconds.

Optics.- Photographs of the reentry package against the star background were obtained by ballistic cameras located near the TTR site and near the telemetry-receiver (TLM-18) site. These photographs provided position information for the time period from 1666 to 1716 seconds. The motion-picture camera on the TTR provided 266 frames of usable 16-mm black-and-white film.

Atmospheric soundings.- In order that the properties of the atmosphere through which the reentry took place might be determined, Nike-Apache sounding rockets carrying pitot-static-tube payloads were launched from Ascension Island by Goddard Space Flight Center 4 and 12 hours after impact of the reentry package. The launches, along with standard radiosonde and Arcas soundings, provided accurate information on the variation of the density, pressure, and temperature with altitude from ground level to an altitude of approximately 325 000 feet.

Derivation of Reentry Trajectory

Since the reentry package was not continuously tracked by radar because of the blackout phenomenon or sufficiently tracked by ballistic cameras during

the major part of the experimental period, the complete reentry trajectory was derived by computer simulation utilizing the last good radar data prior to blackout as the initial conditions. Selection of the initial conditions was based on comparisons of data from the various radar sources.

Comparison of trajectory parameters derived from radar tracking data.- Comparisons of the trajectory parameters as obtained from the FPS-16, the TPQ-18, and the TTR are shown in figure 17. Figure 17(a) shows that the reentry ground tracks as obtained from the FPS-16 radar and the TTR compare closely. Figure 17(b) shows the variation of altitude with time obtained from the TTR and the FPS-16 and TPQ-18 radars. As can be seen from this figure, data obtained from the FPS-16 and TPQ-18 radars nearly coincide, and the TTR data show a small consistent difference in altitude, at any given time, of about 5000 feet less. The variation of relative velocity and flight-path angle with time obtained from the three radars is shown in figure 17(c). The velocity data obtained from the FPS-16 and TPQ-18 radars agree very closely up to about 1638 seconds but, subsequently, show increased scatter. The TTR velocity data are widely scattered throughout the time period shown; however, this scatter might be expected since this radar was operating without the use of the reentry-package beacon.

In general, the data from all three radars are in reasonable agreement as to position, and two show agreement in velocity and are within the bounds of scatter of the third. The largest disagreement shown among the radars is in flight-path angle, although there is unanimous agreement that the flight-path angle was shallower than the nominal -15° at the point (400 000-foot altitude) which defines the start of the reentry.

Selection of initial conditions.- The initial conditions for the extension of the trajectory by computer simulation were chosen at an elapsed time of 1638 seconds, which was at the latest time for which smooth velocity data were available. The FPS-16 and TPQ-18 data agreed closely in position and velocity, and either set of data would provide satisfactory values to be used as initial conditions. The primary tracker for this flight was the FPS-16 radar and, although the TPQ-18 data were good, the facility was not considered by the ETR personnel to be fully operational. For these reasons, the values selected for the initial conditions were obtained from the FPS-16 data.

The initial trajectory parameters chosen for the extension of the trajectory by computer simulation were altitude, 490 517 feet; velocity, 37 897 feet per second; flight-path angle, -15.05° ; flight-path azimuth, 122.48° . In order that publication of this paper be expedited, the initial conditions were utilized in a three-degree-of-freedom particle-trajectory program, rather than a six-degree-of-freedom program, even though considerable body motions did exist during the reentry. The effects of the body motions were accounted for by varying the drag coefficient to correspond to the average angle of attack at a given time. The average angles of attack were obtained from six-degree-of-freedom analysis of the body-motion data. The reentry-area atmosphere was simulated by using U.S. Standard Atmosphere, 1962 (ref. 3). Figure 18 shows a comparison between the results of the atmospheric soundings obtained at Ascension Island subsequent to the flight and the U.S. Standard

Atmosphere. At most altitudes the survey data agree closely with reference 3, and the effect of neglecting the larger differences in density (fig. 18(b)) on the overall trajectory is very small.

Presentation of reentry trajectory parameters.- The results of the computer simulation of the reentry trajectory are presented in figure 19. The reentry ground track, along with a portion of the FPS-16 data, is shown in figure 19(a); included is the impact point as computed at the ETR from FPS-16 data obtained subsequent to emergence from C-band blackout. (The impact point obtained from the simulation fell within the area enclosed by the circular data symbol labeled "impact" in fig. 19(a) which indicates the impact point obtained from the ETR.) The variation of altitude, velocity, and flight-path angle with elapsed time is shown in figure 19(b).

A plot of the reentry trail as obtained from a ballistic-camera photograph is compared in figure 20 with that which was computed from the simulation. The camera data and the computed values of right ascension and declination show very good agreement.

In the areas where they could be compared, the computed reentry trajectory parameters show good agreement with the actual flight data. The computer simulation results, therefore, are considered to represent adequately the actual reentry trajectory and experimental environment encountered by the Project Fire reentry package. The results of the simulation of the Project Fire reentry trajectory are presented in table V for 0.50-second increments, beginning at the elapsed time of 1638.00 seconds. The trajectory and environmental parameters presented are:

- Geodetic latitude (negative south of the equator)
- Longitude (negative west of Greenwich)
- Altitude
- Earth relative velocity
- Flight-path angle relative to the local geodetic horizon
(negative below the horizon)
- Flight-path heading measured clockwise from true north
- Acceleration (negative slowing down)
- Dynamic pressure
- Mach number
- Reynolds number per foot
- Static pressure
- Mass density

CONCLUDING REMARKS

The overall system performance of the first Project Fire space vehicle resulted in successful injection of the reentry package into the prescribed reentry trajectory. The vehicle performance was nearly nominal, and the sequence of events occurred as planned.

A deterioration of the playback telemetry system resulted in numerous dropouts in the received data, but much of the data could be recovered by combining the results of several playbacks.

Abrupt large reentry-package motions were experienced during the reentry. These body motions were assumed to have been caused by shock interference from the passing reentry stage.

Sufficient data were obtained to permit an accurate definition of the reentry trajectory and to document the atmospheric environment, as defined by sounding measurements, through which the experiment was conducted.

Langley Research Center,
National Aeronautics and Space Administration,
Langley Station, Hampton, Va., June 3, 1965.

APPENDIX

ANALYSIS OF SEQUENCE OF EVENTS

Analysis of the sequence of events for Project Fire was conducted by utilizing a logic diagram to study the interrelationship between the various functions which occur during the flight. Figure 21 presents a simplified version of this diagram. The functions tabulated on the left of this diagram are arranged from top to bottom in the order in which they would occur in flight. The events are sequenced from left to right at the times they would nominally occur, with each event represented by a vertical line connecting one or more causes and one or more affected functions. For example, function c (velocity-package timer) is activated by a (guidance equations) at a nominal time of 294.8 seconds, providing event b (ignition interlock) has been previously activated.

Wherever possible, critical functions were provided with backup signals or redundant circuits for portions of the signal paths that were most likely to fail. Where backup signals were based on time, dispersion studies were examined to insure that primary signals would not be compromised.

REFERENCES

1. Skurzynski, E. J.; Morash, Richard; and Pritt, Harold: Ballistic Data Summary Report for Rocket Motor X259. ABL/I-21 (Contract NOrd 16640), Allegany Ballistics Lab., Hercules Powder Co.(Cumberland, Md.), June 1962.
2. SLV Test Evaluation and Guidance Software Groups: Project Fire Integrated Post Flight Evaluation Report. Flight No. 1. NASA CR 57017, 1964.
3. Anon.: U.S. Standard Atmosphere, 1962. NASA, U.S. Air Force, and U.S. Weather Bur., Dec. 1962.

TABLE I.- FINAL SPACECRAFT WEIGHTS, INCLUDING VELOCITY-PACKAGE ADAPTER,
FOR PROJECT FIRE FLIGHT 1

	Weight, lb
Spacecraft weight at lift-off	4393.89
Less aerodynamic shroud	<u>-294.93</u>
	4098.96
Less velocity-package adapter and clamp	<u>-238.90</u>
	3860.06
Less velocity-package shell and dynamic balance weights	<u>-789.03</u>
Weight at ignition of Antares II-A5	3071.03
Less propellant consumed	<u>-2607.00</u>
Weight at burnout	464.03
Less motor adapter and balance weights	<u>-27.03</u>
	437.00
Less inert motor	<u>-200.00</u>
	237.00
Less reentry-package adapter and balance weights	<u>-53.40</u>
Weight of reentry package at reentry	183.60

TABLE II.- PHYSICAL CHARACTERISTICS OF VELOCITY PACKAGE

AND REENTRY STAGE

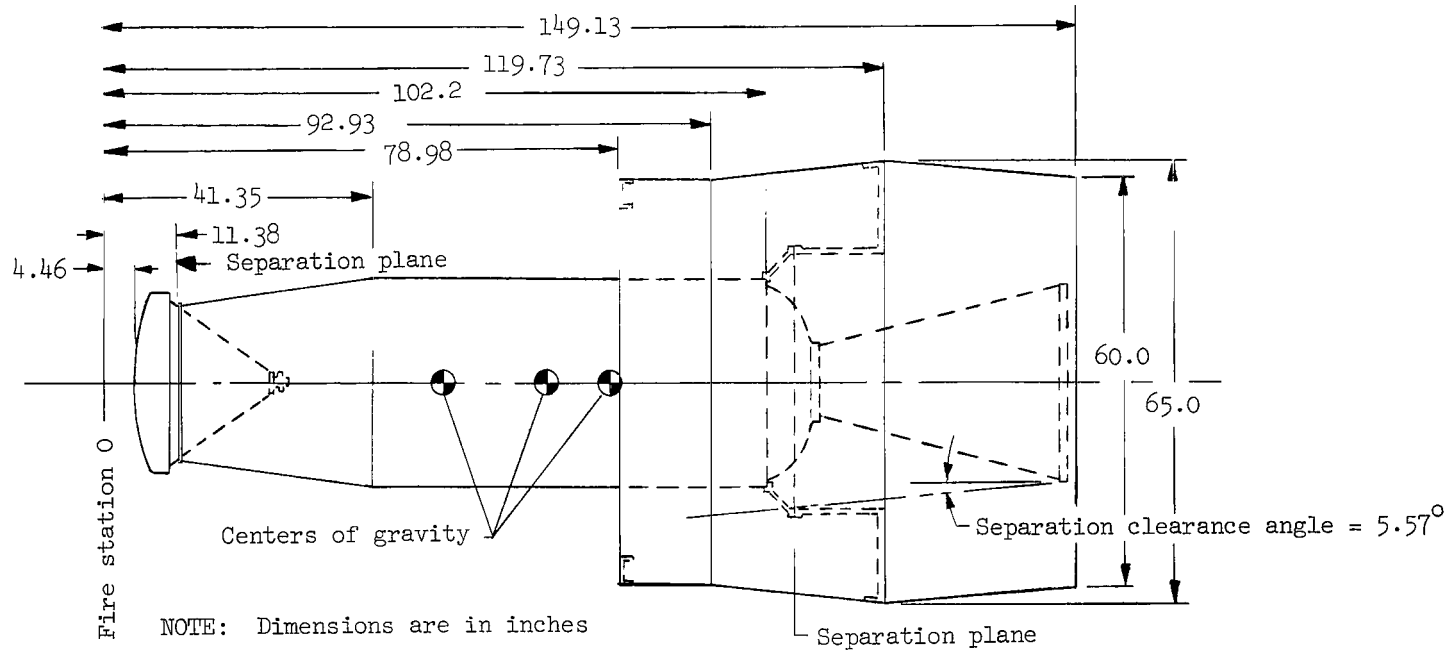

Configuration	Weight, lb	Center of gravity measured from Fire station 0, in.	Moment of inertia, slug-ft ²		
			Roll	Pitch	Yaw
Velocity-package coast configuration	3860.06	78.14	193.05	930.76	929.16
Reentry stage at ignition (velocity-package shell jettisoned)	3071.03	68.39	68.35	511.78	512.08
Reentry stage at burnout	464.03	52.497	10.3	231.7	231.9

TABLE III.- PHYSICAL CHARACTERISTICS OF REENTRY PACKAGE

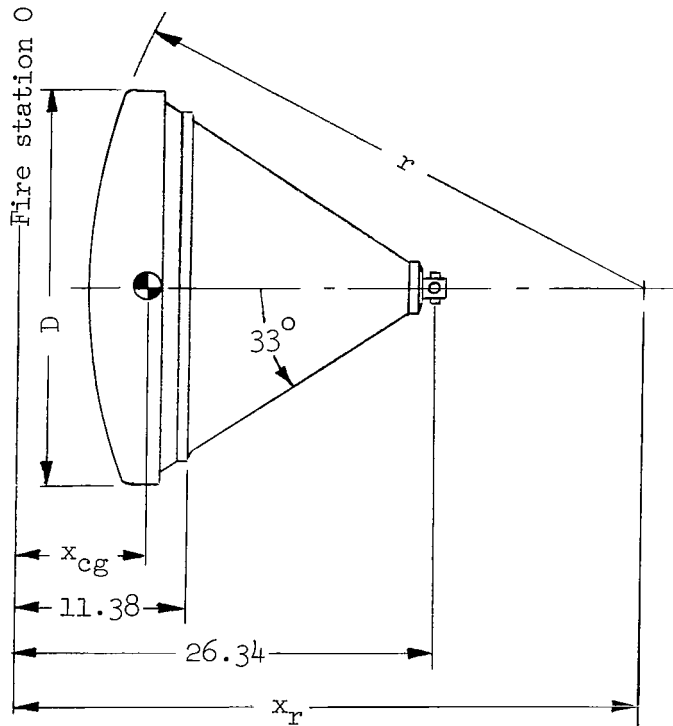

NOTE: Dimensions are in inches

Configuration	Weight, lb	x_{cg} , in.	Moment of inertia, slug-ft ²			Dimension, in.		
			Roll	Pitch	Yaw	D	r	x_r
Complete reentry package	183.6	11.06	2.48	1.98	1.96	26.46	36.80	41.26
Less first calorimeter	176.1	11.27	2.31	1.86	1.83	25.63	36.56	41.26
Less first phenolic layer	160.4	11.71	1.96	1.61	1.58	24.80	31.70	36.90
Less second calorimeter	151.9	11.99	1.78	1.47	1.44	23.90	31.46	36.90
Less second phenolic layer	138.7	12.40	1.50	1.27	1.25	23.11	27.64	33.54
Less third calorimeter	134.2	12.60	1.43	1.21	1.19	22.69	27.40	33.54

TABLE IV.- SEQUENCE OF EVENTS FOR
PROJECT FIRE FLIGHT 1

Event (inflight sequences)	Time, sec	
	Expected	Actual
Enable velocity-package ignition interlock (signal transmission)	129.9	128.0
Start velocity-package timer (signal transmission)	294.81	295.38
Jettison velocity-package shroud (signal transmission)	295.5	298.0
Uncage velocity-package gyros (signal transmission)	302.8	306.0
Separate spacecraft (signal transmission)	308.3	311.5
Start velocity-package pitch program	319.31	319.88
End velocity-package pitch program	420.84	421.39
Start reentry-package separation timers	1567.2	1567.57
Fire spin rockets	1573.95	1574.31
Ignite Antares II-A5 delay squib	1573.95	1574.31
Separate velocity-package shell	1576.95	1577.32
Ignite Antares II-A5	1580.2	1580.31
Burnout of Antares II-A5 (main thrust termination)	1613.18	1613.13
Separate reentry package	1640.2	1640.46
Arrival at 400 000-foot altitude	1644.95	1647.36
Ignite tumble rocket	1646.2	1646.46*
Begin telemetry blackout	1655.4	1653.9
Begin C-band radar blackout		1660.2
Start reentry timer (10g deceleration)	1666.0	1666.6
Eject first heat shield (signal)	1669.0	1669.6
Eject second heat shield (signal)	1676.0	1676.6
End telemetry blackout	1682.0	1686.8
Disable record and erase head	1688.65	1689.0
Activate failover switch		1851.5
Reentry-package impact	1970.5	1965.7

*Obtained by adding nominal time delay of 6 seconds from reentry-package separation. (Both events are activated by same timer.)

TABLE V.- PROJECT FIRE FLIGHT 1 REENTRY TRAJECTORY PARAMETERS

Notes: Numbers are given in pairs for the two quantities indicated in the column headings.

Each tabulated value in the column "Atmospheric density" is listed as a decimal followed by a whole number which indicates the power of ten by which the decimal is to be multiplied.

TABLE V.- PROJECT FIRE FLIGHT I REENTRY TRAJECTORY PARAMETERS

Elapsed time, sec	Geodetic latitude, deg	Longitude, deg	Altitude, ft	Earth relative velocity, fps	Earth relative flight-path angle, deg	Earth relative heading angle, deg
	Acceleration, g units	Dynamic pressure, psf	Mach number	Reynolds number per foot	Atmospheric pressure, psf	Atmospheric density, slugs/cu ft
1638.00	-7.7881 -0.0001	-16.5650 0.003	490517.0 42.37	37897.00 0.17	-15.0501 0.00	122.4842 0.36590372E-11
1638.50	-7.8145 -0.0001	-16.5233 0.003	485601.2 42.37	37900.97 0.19	-15.0199 0.00	122.4774 0.39806683E-11
1639.00	-7.8410 -0.0001	-16.4816 0.003	480695.0 42.38	37904.93 0.21	-14.9897 0.00	122.4706 0.43420245E-11
1639.50	-7.8675 -0.0001	-16.4398 0.003	475797.0 42.38	37908.89 0.24	-14.9595 0.00	122.4637 0.47496504E-11
1640.00	-7.8940 -0.0001	-16.3981 0.004	470909.0 42.38	37912.85 0.27	-14.9293 0.00	122.4569 0.52111536E-11
1640.50	-7.9205 -0.0001	-16.3563 0.004	466030.2 42.39	37916.79 0.30	-14.8991 0.00	122.4500 0.57359804E-11
1641.00	-7.9470 -0.0001	-16.3144 0.005	461160.5 42.39	37920.74 0.34	-14.8688 0.00	122.4431 0.63356072E-11
1641.50	-7.9735 -0.0002	-16.2726 0.005	456300.0 42.40	37924.67 0.38	-14.8386 0.00	122.4362 0.70240624E-11
1642.00	-8.0000 -0.0002	-16.2307 0.006	451447.5 42.40	37928.60 0.44	-14.8083 0.00	122.4292 0.78189494E-11
1642.50	-8.0265 -0.0002	-16.1888 0.006	446606.0 42.41	37932.52 0.50	-14.7780 0.00	122.4223 0.87414584E-11
1643.00	-8.0531 -0.0002	-16.1469 0.007	441772.2 42.41	37936.44 0.58	-14.7478 0.00	122.4153 0.98195218E-11
1643.50	-8.0796 -0.0002	-16.1050 0.008	436948.2 42.42	37940.35 0.68	-14.7174 0.00	122.4083 0.11087471E-10
1644.00	-8.1061 -0.0003	-16.0630 0.009	432133.2 42.42	37944.25 0.79	-14.6871 0.00	122.4012 0.12590121E-10
1644.50	-8.1327 -0.0003	-16.0210 0.010	427327.7 42.42	37948.15 0.93	-14.6568 0.00	122.3941 0.14385317E-10
1645.00	-8.1593 -0.0004	-15.9790 0.012	422531.0 42.43	37952.04 1.11	-14.6265 0.00	122.3871 0.16549744E-10
1645.50	-8.1858 -0.0004	-15.9369 0.014	417744.7 42.43	37955.92 1.33	-14.5961 0.00	122.3799 0.19184445E-10

TABLE V. - PROJECT FIRE FLIGHT I REENTRY TRAJECTORY PARAMETERS - Continued

Elapsed time, sec	Geodetic latitude, deg	Longitude, deg	Altitude, ft	Earth relative velocity, fps	Earth relative flight-path angle, deg	Earth relative heading angle, deg
	Acceleration, g units	Dynamic pressure, psf	Mach number	Reynolds number per foot	Atmospheric pressure, psf	Atmospheric density, slugs/cu ft
1646.00	-8.2124 -0.0005	-15.8949 0.016	412966.7 42.44	37959.79 1.62	-14.5657 0.00	122.3728 0.22428890E-10
1646.50	-8.2390 -0.0006	-15.8528 0.019	408198.0 42.44	37963.66 2.00	-14.5354 0.00	122.3657 0.26473343E-10
1647.00	-8.2656 -0.0007	-15.8106 0.023	403438.0 42.45	37967.52 2.50	-14.5050 0.00	122.3585 0.31586855E-10
1647.50	-8.2922 -0.0009	-15.7685 0.028	398688.0 42.45	37971.37 3.17	-14.4746 0.00	122.3513 0.38154057E-10
1648.00	-8.3188 -0.0011	-15.7263 0.034	393947.0 42.45	37975.21 4.10	-14.4442 0.00	122.3440 0.46745452E-10
1648.50	-8.3454 -0.0013	-15.6841 0.040	389215.7 42.46	37979.05 5.04	-14.4137 0.00	122.3368 0.55786888E-10
1649.00	-8.3720 -0.0015	-15.6419 0.048	384493.0 42.46	37982.87 6.23	-14.3833 0.00	122.3295 0.66916137E-10
1649.50	-8.3986 -0.0018	-15.5996 0.058	379780.7 42.47	37986.68 7.77	-14.3529 0.00	122.3222 0.80884626E-10
1650.00	-8.4253 -0.0022	-15.5573 0.071	375077.0 42.47	37990.48 9.79	-14.3224 0.00	122.3149 0.98599520E-10
1650.50	-8.4519 -0.0027	-15.5150 0.088	370383.2 42.48	37994.27 12.48	-14.2919 0.00	122.3075 0.12130401E-09
1651.00	-8.4786 -0.0034	-15.4727 0.109	365697.5 42.48	37998.04 16.12	-14.2615 0.00	122.3002 0.15076592E-09
1651.50	-8.5052 -0.0043	-15.4303 0.137	361021.5 42.48	38001.79 21.10	-14.2310 0.00	122.2928 0.18948896E-09
1652.00	-8.5319 -0.0053	-15.3880 0.169	356355.7 42.49	38005.53 26.61	-14.2005 0.00	122.2854 0.23397861E-09
1652.50	-8.5585 -0.0065	-15.3456 0.210	351698.5 42.49	38009.23 33.73	-14.1699 0.00	122.2779 0.29033437E-09
1653.00	-8.5852 -0.0082	-15.3031 0.262	347050.5 42.50	38012.91 43.06	-14.1394 0.00	122.2704 0.36240958E-09
1653.50	-8.6119 -0.0103	-15.2607 0.329	342412.5 42.50	38016.55 55.36	-14.1089 0.00	122.2630 0.45521106E-09

TABLE V. - PROJECT FIRE FLIGHT I REENTRY TRAJECTORY PARAMETERS - Continued

Elapsed time, sec	Geodetic latitude, deg	Longitude, deg	Altitude, ft	Earth relative velocity, fps	Earth relative flight-path angle, deg	Earth relative heading angle, deg
	Acceleration, g units	Dynamic pressure, psf	Mach number	Reynolds number per foot	Atmospheric pressure, psf	Atmospheric density, slugs/cu ft
1654.00	-8.6386 -0.0130	-15.2182 0.416	337784.0 42.50	38020.15 71.73	-14.0783 0.00	122.2554 0.57558542E-09
1654.50	-8.6653 -0.0165	-15.1757 0.530	333163.7 42.51	38023.69 93.71	-14.0478 0.00	122.2479 0.73298600E-09
1655.00	-8.6920 -0.0212	-15.1331 0.680	328554.2 42.51	38027.15 123.47	-14.0172 0.00	122.2403 0.94038673E-09
1655.50	-8.7187 -0.0270	-15.0906 0.868	323953.2 42.52	38030.53 160.34	-13.9866 0.00	122.2327 0.11999375E-08
1656.00	-8.7454 -0.0346	-15.0480 1.111	319362.0 42.52	38033.80 208.75	-13.9560 0.00	122.2251 0.15360425E-08
1656.50	-8.7721 -0.0445	-15.0054 1.429	314780.5 42.52	38036.91 273.23	-13.9254 0.00	122.2175 0.19756133E-08
1657.00	-8.7988 -0.0576	-14.9628 1.848	310208.5 42.53	38039.84 359.59	-13.8948 0.00	122.2098 0.25535364E-08
1657.50	-8.8255 -0.0748	-14.9201 2.401	305646.0 42.53	38042.52 475.95	-13.8642 0.00	122.2022 0.33175049E-08
1658.00	-8.8523 -0.0977	-14.8774 3.136	301093.0 42.53	38044.87 633.70	-13.8335 0.00	122.1945 0.43331642E-08
1658.50	-8.8790 -0.1284	-14.8347 4.119	296549.0 42.90	38046.79 848.94	-13.8029 0.00	122.1867 0.56916033E-08
1659.00	-8.9058 -0.1666	-14.7920 5.345	292015.7 43.04	38048.14 1107.57	-13.7722 0.00	122.1790 0.73836582E-08
1659.50	-8.9325 -0.2147	-14.7492 6.888	287490.7 43.04	38048.80 1427.48	-13.7416 0.01	122.1712 0.95162124E-08
1660.00	-8.9593 -0.2765	-14.7064 8.873	282977.7 43.04	38048.58 1838.71	-13.7109 0.01	122.1634 0.12257766E-07
1660.50	-8.9860 -0.3560	-14.6636 11.424	278473.2 43.04	38047.22 2367.48	-13.6802 0.01	122.1556 0.15783319E-07
1661.00	-9.0128 -0.4581	-14.6208 14.700	273979.5 43.04	38044.39 3046.67	-13.6496 0.01	122.1477 0.20312810E-07
1661.50	-9.0395 -0.5892	-14.5780 18.906	269495.7 43.03	38039.70 3918.73	-13.6189 0.01	122.1398 0.26130299E-07

TABLE V. - PROJECT FIRE FLIGHT I REENTRY TRAJECTORY PARAMETERS - Continued

Elapsed time, sec	Geodetic latitude, deg	Longitude, deg	Altitude, ft	Earth relative velocity, fps	Earth relative flight-path angle, deg	Earth relative heading angle, deg
	Acceleration, g units	Dynamic pressure, psf	Mach number	Reynolds number per foot	Atmospheric pressure, psf	Atmospheric density, slugs/cu ft
1662.00	-9.6663 -C.7573	-14.5352 24.300	265022.0 43.02	38032.60 5037.80	-13.5883 0.02	122.1319 0.33598589E-07
1662.50	-9.0930 -C.9601	-14.4923 30.808	260559.7 42.75	38022.47 6319.84	-13.5576 0.02	122.1240 0.42619888E-07
1663.00	-9.1158 -1.1897	-14.4494 38.177	256109.0 42.13	38008.90 7641.61	-13.5270 0.03	122.1161 0.52852643E-07
1663.50	-9.1465 -1.4646	-14.4066 46.997	251669.7 41.53	37991.27 9188.24	-13.4964 0.04	122.1081 0.65122963E-07
1664.00	-9.1732 -1.7915	-14.3637 57.489	247242.5 40.95	37968.81 10989.05	-13.4658 0.05	122.1002 0.79755401E-07
1664.50	-9.2000 -2.1782	-14.3208 69.896	242828.0 40.39	37940.61 13075.70	-13.4353 0.06	122.0922 0.97112139E-07
1665.00	-9.2266 -2.1558	-14.2780 84.487	238427.5 39.84	37906.93 15482.49	-13.4048 0.08	122.0841 0.11759370E-06
1665.50	-9.2533 -2.6027	-14.2351 101.586	234040.7 39.32	37872.38 18249.41	-13.3744 0.09	122.0761 0.14165132E-06
1666.00	-9.2800 -3.1254	-14.1923 121.489	229668.0 38.81	37830.04 21414.20	-13.3441 0.12	122.0680 0.16978269E-06
1666.50	-9.3066 -3.7333	-14.1496 144.531	225309.7 38.30	37778.61 25018.83	-13.3138 0.14	122.0600 0.20253498E-06
1667.00	-9.3332 -4.4363	-14.1068 171.061	220967.5 37.81	37716.64 29106.35	-13.2837 0.17	122.0519 0.24049959E-06
1667.50	-9.3597 -5.2450	-14.0641 201.428	216643.5 37.32	37642.53 33720.27	-13.2537 0.21	122.0438 0.28431038E-06
1668.00	-9.3862 -6.1700	-14.0215 235.999	212338.2 36.83	37554.47 38906.68	-13.2238 0.25	122.0357 0.33467009E-06
1668.50	-9.4126 -7.2217	-13.9790 275.124	208053.5 36.34	37450.53 44710.49	-13.1941 0.30	122.0276 0.39232228E-06
1669.00	-9.4389 -8.4104	-13.9366 319.142	203790.5 35.85	37328.57 51176.59	-13.1647 0.35	122.0195 0.45806967E-06
1669.50	-9.4652 -9.8058	-13.8943 370.618	199553.0 35.47	37186.06 58985.40	-13.1355 0.42	122.0114 0.53603920E-06

TABLE V. - PROJECT FIRE FLIGHT I REENTRY TRAJECTORY PARAMETERS - Continued

Elapsed time, sec	Geodetic latitude, deg	Longitude, deg	Altitude, ft	Earth relative velocity, fps	Earth relative flight-path angle, deg	Earth relative heading angle, deg
	Acceleration, g units	Dynamic pressure, psf	Mach number	Reynolds number per foot	Atmospheric pressure, psf	Atmospheric density, slugs/cu ft
167C.00	-9.4913 -11.4333	-13.8522 430.441	195341.2 35.13	37C19.07 68273.23	-13.1066 0.50	122.0033 0.62819167E-06
167C.50	-9.5174 -13.2763	-13.8102 497.864	191158.5 34.78	36824.19 78771.58	-13.0780 0.59	121.9952 0.73430144E-06
1671.00	-9.5432 -15.3480	-13.7685 573.293	187009.2 34.40	36597.82 90575.06	-13.0499 0.69	121.9871 0.85604405E-06
1671.50	-9.5689 -17.6581	-13.7270 657.019	182897.0 33.99	36336.22 103773.75	-13.0222 0.81	121.9791 0.99524076E-06
1672.00	-9.5944 -20.2139	-13.6859 749.198	178823.7 33.56	36035.47 118452.67	-12.9951 0.95	121.9711 0.11538939E-05
1672.50	-9.6197 -23.0141	-13.6451 849.690	174794.5 33.09	35691.63 134670.00	-12.9686 1.11	121.9631 0.13340058E-05
1673.00	-9.6448 -26.1183	-13.6046 960.606	170815.5 32.62	35300.65 153184.92	-12.9429 1.29	121.9551 0.15417353E-05
1673.50	-9.6695 -29.6574	-13.5647 1086.593	166890.5 32.21	34855.94 175486.39	-12.9180 1.50	121.9473 0.17887235E-05
1674.00	-9.6939 -33.4755	-13.5252 1221.789	163025.0 31.75	34352.00 200215.39	-12.8941 1.73	121.9395 0.20707226E-05
1674.50	-9.7179 -37.6735	-13.4864 1364.590	159226.5 31.22	33783.56 227378.99	-12.8713 2.00	121.9317 0.23912304E-05
1675.00	-9.7415 -42.0792	-13.4482 1512.715	155501.7 30.63	33145.83 256910.41	-12.8498 2.30	121.9241 0.27537809E-05
1675.50	-9.7646 -46.9759	-13.4108 1682.421	151857.7 30.14	32433.41 294537.84	-12.8297 2.65	121.9166 0.31987435E-05
1676.00	-9.7872 -52.0479	-13.3742 1857.126	148303.0 29.57	31640.54 336252.98	-12.8112 3.03	121.9092 0.37100835E-05
1676.50	-9.8092 -57.3606	-13.3386 2031.530	144844.5 28.91	30764.00 381652.54	-12.7946 3.47	121.9020 0.42930651E-05
1677.00	-9.8306 -62.5712	-13.3040 2199.750	141492.5 28.16	29802.58 430290.54	-12.7801 3.96	121.8949 0.49533128E-05
1677.50	-9.8513 -67.2585	-13.2705 2355.878	138255.0 27.32	28761.26 481574.71	-12.7679 4.51	121.8880 0.56959599E-05

TABLE V. - PROJECT FIRE FLIGHT I REENTRY TRAJECTORY PARAMETERS - Continued

Elapsed time, sec	Geodetic latitude, deg	Longitude, deg	Altitude, ft	Earth relative velocity, fps	Earth relative flight-path angle, deg	Earth relative heading angle, deg
	Acceleration, g units	Dynamic pressure, psf	Mach number	Reynolds number per foot	Atmospheric pressure, psf	Atmospheric density, slugs/cu ft
1678.00	-9.8712 -71.4644	-13.2382 2494.043	135138.5 26.40	27648.17 534741.34	-12.7583 5.11	121.8813 0.65253128E-05
1678.50	-9.8902 -75.2698	-13.2073 2607.815	132151.0 25.40	26470.42 588716.62	-12.7515 5.78	121.8748 0.74436390E-05
1679.00	-9.9085 -78.2520	-13.1777 2691.703	129297.7 24.33	25237.84 642295.72	-12.7479 6.50	121.8685 0.84518681E-05
1679.50	-9.9258 -80.2892	-13.1496 2742.050	126582.7 23.21	23964.77 694237.62	-12.7477 7.27	121.8625 0.95490190E-05
1680.00	-9.9423 -81.3015	-13.1229 2756.858	124010.2 22.05	22667.12 743251.66	-12.7512 8.10	121.8567 0.10731285E-04
1680.50	-9.9578 -81.2723	-13.0977 2736.459	121580.7 20.87	21361.55 788216.85	-12.7587 8.98	121.8511 0.11993706E-04
1681.00	-9.9724 -80.2540	-13.0740 2683.279	119292.2 19.68	20064.53 828238.29	-12.7705 9.90	121.8458 0.13330228E-04
1681.50	-9.9861 -78.3361	-13.0517 2600.965	117144.2 18.50	18791.31 862538.33	-12.7868 10.85	121.8408 0.14731619E-04
1682.00	-9.9989 -75.6561	-13.0309 2494.670	115132.0 17.35	17555.26 890724.51	-12.8080 11.84	121.8360 0.16189312E-04
1682.50	-10.0108 -72.1392	-13.0115 2370.531	113250.7 16.23	16369.35 912734.96	-12.8342 12.86	121.8314 0.17693449E-04
1683.00	-10.0220 -68.2402	-12.9934 2234.729	111493.5 15.16	15243.32 928817.00	-12.8659 13.89	121.8270 0.19235159E-04
1683.50	-10.0323 -64.1089	-12.9766 2092.271	109853.7 14.15	14182.10 939252.55	-12.9031 14.93	121.8229 0.20804957E-04
1684.00	-10.0420 -59.8771	-12.9609 1947.547	108324.0 13.19	13188.29 944489.37	-12.9463 15.99	121.8190 0.22394466E-04
1684.50	-10.0509 -55.6581	-12.9463 1804.185	106896.5 12.30	12262.64 945077.88	-12.9956 17.04	121.8152 0.23996254E-04
1685.00	-10.0593 -51.5361	-12.9328 1664.901	105564.2 11.47	11404.18 941572.45	-13.0514 18.09	121.8116 0.25602964E-04
1685.50	-10.0670 -47.2968	-12.9202 1527.948	104319.2 10.68	10613.17 929869.38	-13.1139 19.14	121.8082 0.27129914E-04

TABLE V. - PROJECT FIRE FLIGHT I REENTRY TRAJECTORY PARAMETERS - Continued

Elapsed time, sec	Geodetic latitude, deg	Longitude, deg	Altitude, ft	Earth relative velocity, fps	Earth relative flight-path angle, deg	Earth relative heading angle, deg
	Acceleration, g units	Dynamic pressure, psf	Mach number	Reynolds number per foot	Atmospheric pressure, psf	Atmospheric density, slugs/cu ft
1686.00	-10.0742	-12.9084	103153.2	9888.19	-13.1833	121.8049
	-43.3442	1400.262	9.96	915808.25	20.17	0.28642178E-04
1686.50	-10.0809	-12.8975	102063.2	9223.35	-13.2600	121.8018
	-39.8105	1281.773	9.30	899813.33	21.19	0.30134445E-04
1687.00	-10.0872	-12.8873	101035.0	8613.22	-13.3441	121.7987
	-36.5465	1172.745	8.69	882588.38	22.20	0.31615670E-04
1687.50	-10.0931	-12.8778	100074.5	8054.45	-13.4359	121.7958
	-33.4256	1072.599	8.13	864132.55	23.19	0.33067082E-04
1688.00	-10.0985	-12.8689	99163.0	7543.52	-13.5357	121.7930
	-30.5977	981.833	7.62	845430.78	24.18	0.34507971E-04
1688.50	-10.1037	-12.8605	98305.5	7076.07	-13.6437	121.7903
	-28.0267	899.335	7.15	826332.74	25.14	0.35922606E-04
1689.00	-10.1085	-12.8527	97492.5	6647.99	-13.7602	121.7877
	-25.6994	824.672	6.72	807246.45	26.09	0.37319046E-04
1689.50	-10.1130	-12.8453	96724.0	6255.59	-13.8853	121.7851
	-23.5914	757.027	6.33	788183.08	27.02	0.38690497E-04
1690.00	-10.1173	-12.8384	95992.7	5895.48	-14.0194	121.7826
	-21.6864	695.894	5.97	769413.20	27.93	0.40043711E-04
1690.50	-10.1213	-12.8318	95293.5	5564.55	-14.1626	121.7802
	-19.9665	640.703	5.63	751101.98	28.84	0.41383367E-04
1691.00	-10.1251	-12.8257	94629.2	5260.00	-14.3152	121.7779
	-18.4078	590.686	5.33	733101.07	29.73	0.42698736E-04
1691.50	-10.1287	-12.8198	93991.5	4979.34	-14.4775	121.7755
	-16.9994	545.491	5.05	715677.01	30.61	0.44002219E-04
1692.00	-10.1320	-12.8143	93385.5	4720.32	-14.6495	121.7733
	-15.7200	504.437	4.78	698601.80	31.48	0.45278791E-04
1692.50	-10.1353	-12.8091	92798.7	4480.90	-14.8316	121.7711
	-14.5639	467.339	4.54	682250.45	32.34	0.46551204E-04
1693.00	-10.1383	-12.8041	92235.7	4259.28	-15.0239	121.7689
	-13.5138	433.643	4.32	666416.87	33.18	0.47806755E-04
1693.50	-10.1412	-12.7994	91695.5	4053.82	-15.2267	121.7667
	-12.5584	402.985	4.11	651082.78	34.02	0.49044403E-04

TABLE V. - PROJECT FIRE FLIGHT I REENTRY TRAJECTORY PARAMETERS - Continued

Elapsed time, sec	Geodetic latitude, deg	Longitude, deg	Altitude, ft	Earth relative velocity, fps	Earth relative flight-path angle, deg	Earth relative heading angle, deg
	Acceleration, g units	Dynamic pressure, psf	Mach number	Reynolds number per foot	Atmospheric pressure, psf	Atmospheric density, slugs/cu ft
1694.00	-10.1440 -11.6917	-12.7949 375.173	91170.0 3.92	3863.08 636451.69	-15.4401 34.85	121.7646 0.50279979E-04
1694.50	-10.1466 -10.9009	-12.7906 349.799	90664.2 3.74	3685.73 622311.80	-15.6644 35.67	121.7625 0.51499397E-04
1695.00	-10.1491 -10.1781	-12.7865 326.606	90177.5 3.58	3520.58 608637.69	-15.8997 36.48	121.7605 0.52701800E-04
1695.50	-10.1515 -9.5207	-12.7826 305.510	89699.7 3.42	3366.61 595681.73	-16.1462 37.29	121.7584 0.53910124E-04
1696.00	-10.1538 -8.9184	-12.7789 286.183	89237.5 3.28	3222.82 583196.74	-16.4041 38.10	121.7564 0.55106433E-04
1696.50	-10.1559 -8.3661	-12.7754 268.459	88789.5 3.14	3088.38 571179.11	-16.6735 38.89	121.7544 0.56291943E-04
1697.00	-10.1580 -7.8596	-12.7719 252.205	88353.0 3.01	2962.53 559666.70	-16.9546 39.68	121.7524 0.57472349E-04
1697.50	-10.1600 -7.3951	-12.7687 237.300	87925.2 2.89	2844.56 548691.78	-17.2475 40.48	121.7504 0.58653822E-04
1698.00	-10.1620 -6.9673	-12.7655 223.572	87509.0 2.78	2733.84 538138.91	-17.5524 41.26	121.7485 0.59827603E-04
1698.50	-10.1638 -6.5737	-12.7625 210.943	87100.5 2.68	2629.80 528072.27	-17.8693 42.05	121.7465 0.61003057E-04
1699.00	-10.1656 -6.2109	-12.7596 199.303	86700.0 2.58	2531.93 518450.83	-18.1985 42.84	121.7446 0.62178580E-04
1699.50	-10.1673 -5.8753	-12.7569 188.531	86310.0 2.48	2439.76 509180.30	-18.5400 43.62	121.7426 0.63345754E-04
1700.00	-10.1689 -5.5661	-12.7542 178.610	85923.0 2.40	2352.88 500417.03	-18.8939 44.41	121.7407 0.64526285E-04
1700.50	-10.1705 -5.2792	-12.7516 169.405	85545.2 2.31	2270.88 491975.98	-19.2603 45.19	121.7388 0.65700449E-04
1701.00	-10.1720 -5.0132	-12.7491 160.868	85174.7 2.24	2193.42 483882.25	-19.6392 45.98	121.7368 0.66873463E-04
1701.50	-10.1735 -4.7663	-12.7468 152.946	84810.2 2.16	2120.19 476141.13	-20.0308 46.76	121.7349 0.68048561E-04

TABLE V. - PROJECT FIRE FLIGHT I REENTRY TRAJECTORY PARAMETERS - Continued

Elapsed time, sec	Geodetic latitude, deg	Longitude, deg	Altitude, ft	Earth relative velocity, fps	Earth relative flight-path angle, deg	Earth relative heading angle, deg
	Acceleration, g units	Dynamic pressure, psf	Mach number	Reynolds number per foot	Atmospheric pressure, psf	Atmospheric density, slugs/cu ft
17C2.00	-10.1749 -4.5377	-12.7444 145.608	84448.2 2.09	2050.88 468809.36	-20.4350 47.55	121.7330 0.69236700E-04
17C2.50	-10.1762 -4.3244	-12.7422 138.764	84094.5 2.03	1985.23 461732.48	-20.8519 48.34	121.7310 0.70418417E-04
17C3.00	-10.1776 -4.1262	-12.7401 132.406	83743.5 1.96	1922.99 455015.83	-21.2816 49.14	121.7291 0.71611433E-04
17C3.50	-10.1788 -3.9422	-12.7380 126.501	83393.7 1.90	1863.95 448671.80	-21.7239 49.94	121.7271 0.72820957E-04
17C4.00	-10.1801 -3.7654	-12.7360 120.956	83054.5 1.85	1807.89 442478.86	-22.1789 50.74	121.7252 0.74014320E-04
17C4.50	-10.1813 -3.6094	-12.7341 115.821	82711.7 1.79	1754.62 436725.64	-22.6467 51.56	121.7232 0.75240473E-04
17C5.00	-10.1824 -3.4552	-12.7322 111.003	82376.0 1.74	1703.96 431167.09	-23.1270 52.37	121.7212 0.76461862E-04
17C5.50	-10.1835 -3.3188	-12.7304 106.498	82043.7 1.69	1655.78 425867.43	-23.6200 53.19	121.7192 0.77690633E-04
17C6.00	-10.1846 -3.1878	-12.7286 102.292	81712.5 1.64	1609.90 420862.73	-24.1254 54.01	121.7172 0.78935965E-04
17C6.50	-10.1856 -3.0645	-12.7269 98.337	81387.2 1.60	1566.19 416036.87	-24.6432 54.84	121.7152 0.80178809E-04
17C7.00	-10.1866 -2.9498	-12.7252 94.656	81059.0 1.56	1524.53 411561.86	-25.1733 55.69	121.7132 0.81453523E-04
17C7.50	-10.1876 -2.8418	-12.7236 91.189	80736.5 1.52	1484.79 407247.75	-25.7155 56.53	121.7111 0.82726282E-04
17C8.00	-10.1886 -2.7405	-12.7221 87.940	80415.2 1.48	1446.88 403175.61	-26.2697 57.39	121.7091 0.84014460E-04
17C8.50	-10.1895 -2.6452	-12.7206 84.882	80097.7 1.44	1410.68 399286.27	-26.8357 58.25	121.7070 0.85307936E-04
17C9.00	-10.1904 -2.5562	-12.7191 82.025	79778.2 1.41	1376.11 395683.28	-27.4134 59.12	121.7049 0.86630318E-04
17C9.50	-10.1913 -2.4722	-12.7177 79.330	79463.0 1.37	1343.08 392234.93	-28.0024 60.00	121.7028 0.87955792E-04

TABLE V. - PROJECT FIRE FLIGHT I REENTRY TRAJECTORY PARAMETERS - Continued

Elapsed time, sec	Geodetic latitude, deg	Longitude, deg	Altitude, ft	Earth relative velocity, fps	Earth relative flight-path angle, deg	Earth relative heading angle, deg
	Acceleration, g units	Dynamic pressure, psf	Mach number	Reynolds number per foot	Atmospheric pressure, psf	Atmospheric density, slugs/cu ft
1710.00	-10.1921 -2.3931	-12.7163 76.791	79150.5 1.34	1311.50 388962.66	-28.6027 60.89	121.7006 0.89290317E-04
1710.50	-10.1929 -2.3191	-12.7150 74.417	78835.2 1.31	1281.30 385964.37	-29.2138 61.79	121.6985 0.90657756E-04
1711.00	-10.1937 -2.2493	-12.7137 72.176	78523.5 1.28	1252.40 383113.19	-29.8356 62.70	121.6963 0.92031258E-04
1711.50	-10.1945 -2.1836	-12.7124 70.068	78212.5 1.25	1224.75 380455.22	-30.4678 63.62	121.6941 0.93422789E-04
1712.00	-10.1952 -2.1220	-12.7112 68.091	77900.0 1.23	1198.28 378024.77	-31.1100 64.56	121.6918 0.94842868E-04
1712.50	-10.1960 -2.0635	-12.7100 66.217	77592.5 1.20	1172.93 375695.29	-31.7619 65.50	121.6896 0.96262038E-04
1713.00	-10.1967 -2.0088	-12.7088 64.460	77282.7 1.18	1148.64 373596.24	-32.4232 66.46	121.6873 0.97713632E-04
1713.50	-10.1974 -1.9568	-12.7077 62.791	76978.7 1.15	1125.37 371575.09	-33.0934 67.41	121.6850 0.99160248E-04
1714.00	-10.1980 -1.9083	-12.7066 61.234	76669.7 1.13	1103.05 369823.33	-33.7723 68.40	121.6826 0.10065328E-03
1714.50	-10.1987 -1.8624	-12.7056 59.764	76362.5 1.11	1081.66 368212.52	-34.4593 69.40	121.6802 0.10216085E-03
1715.00	-10.1993 -1.8190	-12.7045 58.370	76058.7 1.09	1061.15 366707.36	-35.1541 70.39	121.6778 0.10367414E-03
1715.50	-10.1999 -1.7784	-12.7035 57.067	75751.7 1.07	1041.46 365425.86	-35.8563 71.42	121.6754 0.10522708E-03
1716.00	-10.2005 -1.7398	-12.7025 55.828	75449.5 1.05	1022.58 364219.02	-36.5653 72.44	121.6729 0.10677942E-03
1716.50	-10.2011 -1.7037	-12.7016 54.671	75143.5 1.03	1004.45 363236.88	-37.2807 73.49	121.6704 0.10837505E-03
1717.00	-10.2017 -1.6699	-12.7006 53.584	74836.7 1.01	987.05 362421.13	-38.0021 74.56	121.6678 0.1099926E-03
1717.50	-10.2023 -1.6373	-12.6997 52.541	74538.2 1.00	970.34 361606.36	-38.7288 75.62	121.6652 0.11160392E-03

TABLE V. - PROJECT FIRE FLIGHT I REENTRY TRAJECTORY PARAMETERS - Continued

Elapsed time, sec	Geodetic latitude, deg	Longitude, deg	Altitude, ft	Earth relative velocity, fps	Earth relative flight-path angle, deg	Earth relative heading angle, deg
	Acceleration, g units	Dynamic pressure, psf	Mach number	Reynolds number per foot	Atmospheric pressure, psf	Atmospheric density, slugs/cu ft
1718.00	-10.2028 -1.6074	-12.6989 51.580	74231.2 0.98	954.29 361091.77	-39.4606 76.72	121.6625 0.11327938E-03
1718.50	-10.2033 -1.5787	-12.6980 50.659	73931.0 0.96	938.87 360599.25	-40.1968 77.82	121.6599 0.11494317E-03
1719.00	-10.2038 -1.5521	-12.6972 49.805	73626.0 0.95	924.05 360332.15	-40.9368 78.94	121.6572 0.11665899E-03
1719.50	-10.2043 -1.5270	-12.6963 49.001	73321.7 0.93	909.80 360188.45	-41.6803 80.09	121.6544 0.11839698E-03
1720.00	-10.2048 -1.5033	-12.6956 48.239	73020.0 0.92	896.10 360134.34	-42.4267 81.24	121.6516 0.12014698E-03
1720.50	-10.2053 -1.4808	-12.6948 47.518	72720.7 0.91	882.93 360167.51	-43.1754 82.39	121.6487 0.12190884E-03
1721.00	-10.2057 -1.4600	-12.6940 46.851	72416.7 0.89	870.25 360415.15	-43.9260 83.59	121.6458 0.12372592E-03
1721.50	-10.2062 -1.4403	-12.6933 46.218	72116.5 0.88	858.05 360721.98	-44.6778 84.78	121.6428 0.12554801E-03
1722.00	-10.2066 -1.4220	-12.6926 45.631	71813.0 0.87	846.31 361211.64	-45.4304 86.01	121.6398 0.12741794E-03
1722.50	-10.2070 -1.4045	-12.6919 45.070	71515.0 0.86	835.00 361723.55	-46.1833 87.23	121.6367 0.12928190E-03
1723.00	-10.2074 -1.3884	-12.6912 44.554	71212.5 0.85	824.11 362436.11	-46.9359 88.49	121.6336 0.13120278E-03
1723.50	-10.2078 -1.3733	-12.6906 44.069	70911.0 0.84	813.61 363246.78	-47.6877 89.76	121.6304 0.13314659E-03
1724.00	-10.2082 -1.3593	-12.6899 43.619	70608.2 0.83	803.49 364194.45	-48.4383 91.06	121.6272 0.13512833E-03
1724.50	-10.2086 -1.3459	-12.6893 43.188	70311.0 0.82	793.73 365154.31	-49.1871 92.35	121.6239 0.13710357E-03
1725.00	-10.2090 -1.3337	-12.6887 42.796	70008.5 0.81	784.30 366319.15	-49.9336 93.69	121.6205 0.13914431E-03
1725.50	-10.2093 -1.3221	-12.6881 42.423	69710.0 0.80	775.21 367518.31	-50.6775 95.03	121.6171 0.14118880E-03

TABLE V. - PROJECT FIRE FLIGHT I REENTRY TRAJECTORY PARAMETERS - Continued

Elapsed time, sec	Geodetic latitude, deg	Longitude, deg	Altitude, ft	Earth relative velocity, fps	Earth relative flight-path angle, deg	Earth relative heading angle, deg
	Acceleration, g units	Dynamic pressure, psf	Mach number	Reynolds number per foot	Atmospheric pressure, psf	Atmospheric density, slugs/cu ft
1726.00	-10.2097 -1.3112	-12.6876 42.076	69412.0 0.79	766.42 368812.60	-51.4182 96.38	121.6136 0.14326076E-03
1726.50	-10.2100 -1.3013	-12.6870 41.758	69111.2 0.78	757.93 370261.16	-52.1553 97.77	121.6100 0.14538356E-03
1727.00	-10.2104 -1.2921	-12.6865 41.462	68811.7 0.77	749.72 371786.81	-52.8884 99.17	121.6064 0.14752977E-03
1727.50	-10.2107 -1.2835	-12.6859 41.185	68513.5 0.76	741.78 373387.25	-53.6170 100.59	121.6027 0.14969948E-03
1728.00	-10.2110 -1.2756	-12.6854 40.934	68212.7 0.76	734.09 375130.99	-54.3408 102.04	121.5989 0.15192072E-03
1728.50	-10.2113 -1.2682	-12.6849 40.697	67915.0 0.75	726.64 376911.68	-55.0594 103.49	121.5951 0.15415324E-03
1729.00	-10.2116 -1.2615	-12.6844 40.479	67617.0 0.74	719.42 378788.62	-55.7724 104.97	121.5911 0.15642149E-03
1729.50	-10.2119 -1.2551	-12.6840 40.276	67320.5 0.74	712.41 380725.81	-56.4796 106.47	121.5871 0.15871248E-03
1730.00	-10.2122 -1.2492	-12.6835 40.085	67026.5 0.73	705.61 382702.28	-57.1804 107.97	121.5830 0.16101837E-03
1730.50	-10.2124 -1.2439	-12.6831 39.915	66729.7 0.72	699.01 384816.91	-57.8747 109.51	121.5788 0.16338074E-03
1731.00	-10.2127 -1.2392	-12.6826 39.764	66431.2 0.72	692.59 387047.47	-58.5622 111.08	121.5745 0.16579308E-03
1731.50	-10.2129 -1.2347	-12.6822 39.621	66135.7 0.71	686.35 389300.32	-59.2426 112.66	121.5702 0.16821741E-03
1732.00	-10.2132 -1.2306	-12.6818 39.488	65842.0 0.70	680.27 391598.51	-59.9156 114.25	121.5657 0.17066364E-03
1732.50	-10.2134 -1.2263	-12.6814 39.352	65549.2 0.70	674.35 393675.52	-60.5810 115.86	121.5611 0.17307100E-03
1733.00	-10.2137 -1.2226	-12.6810 39.231	65254.0 0.69	668.59 395855.10	-61.2386 117.50	121.5565 0.17552898E-03
1733.50	-10.2139 -1.2191	-12.6806 39.119	64960.7 0.68	662.97 398066.87	-61.8881 119.16	121.5518 0.17800491E-03

TABLE V. - PROJECT FIRE FLIGHT I REENTRY TRAJECTORY PARAMETERS - Continued

Elapsed time, sec	Geodetic latitude, deg	Longitude, deg	Altitude, ft	Earth relative velocity, fps	Earth relative flight-path angle, deg	Earth relative heading angle, deg
	Acceleration, g units	Dynamic pressure, psf	Mach number	Reynolds number per foot	Atmospheric pressure, psf	Atmospheric density, slugs/cu ft
1734.00	-10.2141 -1.2158	-12.6803 39.013	64670.5 0.68	657.50 400290.44	-62.5294 120.82	121.5469 0.18048998E-03
1734.50	-10.2143 -1.2129	-12.6799 38.921	64378.0 0.67	652.15 402623.13	-63.1623 122.52	121.5419 0.18302947E-03
1735.00	-10.2145 -1.2102	-12.6796 38.834	64088.7 0.67	646.93 404957.40	-63.7866 124.23	121.5368 0.18557595E-03
1735.50	-10.2147 -1.2077	-12.6792 38.752	63801.0 0.66	641.83 407323.62	-64.4022 125.95	121.5316 0.18814448E-03
1736.00	-10.2149 -1.2056	-12.6789 38.687	63509.2 0.66	636.84 409827.57	-65.0090 127.71	121.5263 0.19078506E-03
1736.50	-10.2151 -1.2037	-12.6786 38.626	63219.7 0.65	631.95 412346.44	-65.6069 129.49	121.5209 0.19344199E-03
1737.00	-10.2153 -1.2018	-12.6783 38.566	62934.2 0.65	627.16 414841.21	-66.1957 131.27	121.5153 0.19609851E-03
1737.50	-10.2155 -1.2003	-12.6780 38.515	62647.0 0.64	622.46 417425.08	-66.7754 133.09	121.5095 0.19880822E-03
1738.00	-10.2157 -1.1988	-12.6777 38.468	62361.5 0.64	617.86 420025.49	-67.3459 134.91	121.5037 0.20153859E-03
1738.50	-10.2158 -1.1975	-12.6775 38.427	62076.5 0.63	613.33 422666.71	-67.9071 136.76	121.4977 0.20430166E-03
1739.00	-10.2160 -1.1963	-12.6772 38.388	61793.0 0.63	608.89 425325.49	-68.4591 138.63	121.4916 0.20708783E-03
1739.50	-10.2162 -1.1952	-12.6769 38.354	61510.2 0.62	604.52 428016.57	-69.0017 140.51	121.4853 0.20990455E-03
1740.00	-10.2163 -1.1943	-12.6767 38.323	61228.5 0.62	600.22 430731.87	-69.5350 142.42	121.4789 0.21274950E-03
1740.50	-10.2165 -1.1933	-12.6764 38.293	60948.5 0.62	595.98 433454.60	-70.0589 144.34	121.4723 0.21561505E-03
1741.00	-10.2166 -1.1926	-12.6762 38.269	60667.7 0.61	591.81 436234.87	-70.5735 146.29	121.4655 0.21852715E-03
1741.50	-10.2167 -1.1917	-12.6760 38.239	60392.2 0.61	587.70 438945.86	-71.0788 148.22	121.4586 0.22142304E-03

TABLE V. - PROJECT FIRE FLIGHT I REENTRY TRAJECTORY PARAMETERS - Continued

Elapsed time, sec	Geodetic latitude, deg	Longitude, deg	Altitude, ft	Earth relative velocity, fps	Earth relative flight-path angle, deg	Earth relative heading angle, deg
	Acceleration, g units	Dynamic pressure, psf	Mach number	Reynolds number per foot	Atmospheric pressure, psf	Atmospheric density, slugs/cu ft
1742.00	-10.2169 -1.1911	-12.6757 38.220	60113.0 0.60	583.65 441775.39	-71.5747 150.21	121.4515 0.22439764E-03
1742.50	-10.2170 -1.1904	-12.6755 38.199	59837.2 0.60	579.65 444569.28	-72.0613 152.21	121.4443 0.22737420E-03
1743.00	-10.2171 -1.1898	-12.6753 38.180	59561.7 0.59	575.71 447394.55	-72.5386 154.22	121.4369 0.23038763E-03
1743.50	-10.2173 -1.1893	-12.6751 38.163	59286.5 0.59	571.81 450250.37	-73.0067 156.27	121.4292 0.23343825E-03
1744.00	-10.2174 -1.1886	-12.6749 38.139	59017.0 0.59	567.96 453016.76	-73.4657 158.29	121.4213 0.23646437E-03
1744.50	-10.2175 -1.1881	-12.6747 38.125	58743.5 0.58	564.16 455903.26	-73.9154 160.38	121.4132 0.23957559E-03
1745.00	-10.2176 -1.1875	-12.6745 38.107	58474.0 0.58	560.40 458736.08	-74.3561 162.45	121.4050 0.24268142E-03
1745.50	-10.2177 -1.1871	-12.6744 38.091	58203.7 0.58	556.68 461615.78	-74.7879 164.57	121.3965 0.24583641E-03
1746.00	-10.2178 -1.1866	-12.6742 38.075	57935.0 0.57	553.00 464493.22	-75.2106 166.69	121.3877 0.24901465E-03
1746.50	-10.2179 -1.1859	-12.6740 38.054	57670.7 0.57	549.36 467301.98	-75.6245 168.81	121.3787 0.25217983E-03
1747.00	-10.2180 -1.1855	-12.6739 38.040	57403.0 0.56	545.76 470217.56	-76.0297 170.99	121.3695 0.25542802E-03
1747.50	-10.2181 -1.1848	-12.6737 38.018	57140.7 0.56	542.19 473037.33	-76.4261 173.14	121.3601 0.25865014E-03
1748.00	-10.2182 -1.1842	-12.6736 37.999	56878.0 0.56	538.66 475898.19	-76.8139 175.33	121.3504 0.26191927E-03
1748.50	-10.2183 -1.1836	-12.6734 37.980	56615.7 0.55	535.17 478774.10	-77.1932 177.54	121.3405 0.26522344E-03
1749.00	-10.2183 -1.1830	-12.6733 37.963	56354.0 0.55	531.70 481665.94	-77.5641 179.78	121.3302 0.26856298E-03
1749.50	-10.2184 -1.1822	-12.6732 37.936	56097.7 0.55	528.28 484458.00	-77.9266 182.00	121.3197 0.27187312E-03

TABLE V.- PROJECT FIRE FLIGHT I REENTRY TRAJECTORY PARAMETERS - Continued

Elapsed time, sec	Geodetic latitude, deg	Longitude, deg	Altitude, ft	Earth relative velocity, fps	Earth relative flight-path angle, deg	Earth relative heading angle, deg
	Acceleration, g units	Dynamic pressure, psf	Mach number	Reynolds number per foot	Atmospheric pressure, psf	Atmospheric density, slugs/cu ft
175C.0C	-10.2185	-12.6730	55837.0	524.88	-78.2809	121.3088
	-1.1817	37.920	0.54	487379.89	184.28	0.27528340E-03
175C.5C	-10.2186	-12.6729	55579.7	521.51	-78.6271	121.2976
	-1.1810	37.898	0.54	490246.38	186.56	0.27868986E-03
1751.CC	-10.2187	-12.6728	55326.5	518.18	-78.9652	121.2861
	-1.1802	37.871	0.54	493045.61	188.83	0.28208464E-03
1751.5C	-10.2187	-12.6727	55072.0	514.87	-79.2954	121.2743
	-1.1795	37.847	0.53	495899.86	191.14	0.28553790E-03
1752.CC	-10.2188	-12.6726	54820.7	511.60	-79.6178	121.2622
	-1.1786	37.819	0.53	498701.41	193.45	0.28898863E-03
1752.5C	-10.2189	-12.6725	54568.7	508.36	-79.9325	121.2496
	-1.1778	37.794	0.53	501546.09	195.80	0.29249164E-03
1753.CC	-10.2189	-12.6724	54321.5	505.14	-80.2395	121.2367
	-1.1768	37.761	0.52	504300.34	198.13	0.29596995E-03
1753.5C	-10.2190	-12.6723	54073.5	501.96	-80.5391	121.2235
	-1.1758	37.731	0.52	507098.21	200.49	0.29950045E-03
1754.CC	-10.2190	-12.6722	53824.7	498.80	-80.8313	121.2099
	-1.1750	37.704	0.52	509938.83	202.89	0.30308404E-03
1754.5C	-10.2191	-12.6721	53580.5	495.67	-81.1163	121.1957
	-1.1739	37.670	0.51	512695.43	205.27	0.30664461E-03
1755.CC	-10.2191	-12.6720	53336.0	492.57	-81.3941	121.1812
	-1.1729	37.638	0.51	515482.04	207.69	0.31025077E-03
1755.5C	-10.2192	-12.6719	53092.0	489.50	-81.6648	121.1663
	-1.1719	37.606	0.51	518280.46	210.12	0.31389192E-03
1756.CC	-10.2192	-12.6718	52850.0	486.46	-81.9286	121.1510
	-1.1709	37.573	0.50	521054.57	212.57	0.31754553E-03
1756.5C	-10.2193	-12.6717	52613.5	483.45	-82.1856	121.1349
	-1.1696	37.531	0.50	523717.05	214.99	0.32115728E-03
1757.CC	-10.2193	-12.6717	52371.7	480.46	-82.4360	121.1186
	-1.1686	37.499	0.50	526534.13	217.49	0.32489177E-03
1757.5C	-10.2194	-12.6716	52135.7	477.50	-82.6797	121.1015
	-1.1674	37.459	0.49	529231.37	219.96	0.32857936E-03

TABLE V. - PROJECT FIRE FLIGHT I REENTRY TRAJECTORY PARAMETERS - Continued

Elapsed time, sec	Geodetic latitude, deg	Longitude, deg	Altitude, ft	Earth relative velocity, fps	Earth relative flight-path angle, deg	Earth relative heading angle, deg
	Acceleration, g units	Dynamic pressure, psf	Mach number	Reynolds number per foot	Atmospheric pressure, psf	Atmospheric density, slugs/cu ft
1758.00	-10.2194 -1.1663	-12.6715 37.424	51898.0 0.49	474.57 531997.74	-82.9170 222.47	121.0843 0.33233672E-03
1758.5C	-10.2195 -1.1649	-12.6714 37.382	51665.2 0.49	471.67 534662.52	-83.1479 224.96	121.0662 0.33605681E-03
1755.CC	-10.2195 -1.1639	-12.6714 37.348	51428.5 0.48	468.79 537455.06	-83.3726 227.52	121.0476 0.33988360E-03
1759.50	-10.2195 -1.1624	-12.6713 37.300	51200.5 0.48	465.95 540047.26	-83.5912 230.02	121.0284 0.34361019E-03
176C.CC	-10.2196 -1.1612	-12.6713 37.263	50967.5 0.48	463.13 542795.07	-83.8038 232.60	121.0085 0.34746085E-03
176C.50	-10.2196 -1.1599	-12.6712 37.221	50738.2 0.48	460.33 545470.36	-84.0105 235.16	120.9883 0.35129173E-03
1761.00	-10.2196 -1.1587	-12.6711 37.182	50508.2 0.47	457.57 548190.36	-84.2114 237.76	120.9671 0.35517766E-03
1761.50	-10.2197 -1.1572	-12.6711 37.134	50284.0 0.47	454.83 550786.52	-84.4067 240.33	120.9453 0.35900792E-03
1762.00	-10.2197 -1.1560	-12.6710 37.095	50056.0 0.47	452.12 553507.69	-84.5964 242.96	120.9226 0.36294468E-03
1762.50	-10.2197 -1.1545	-12.6710 37.047	49834.0 0.46	449.43 556094.31	-84.7807 245.55	120.8994 0.36681934E-03
1763.00	-10.2198 -1.1532	-12.6709 37.006	49609.2 0.46	446.78 558782.32	-84.9596 248.21	120.8751 0.37078430E-03
1763.50	-10.2198 -1.1520	-12.6709 36.966	49385.0 0.46	444.15 561483.22	-85.1334 250.89	120.8502 0.37478322E-03
1764.00	-10.2198 -1.1504	-12.6708 36.914	49168.5 0.46	441.54 564001.66	-85.3021 253.50	120.8246 0.37868489E-03
1764.50	-10.2198 -1.1490	-12.6708 36.871	48948.2 0.45	438.97 566648.65	-85.4657 256.18	120.7978 0.38269597E-03
1765.00	-10.2199 -1.1478	-12.6708 36.832	48726.7 0.45	436.41 569356.20	-85.6246 258.91	120.7706 0.38677268E-03
1765.50	-10.2199 -1.1463	-12.6707 36.783	48512.0 0.45	433.89 571907.02	-85.7786 261.58	120.7421 0.39076675E-03

TABLE V. - PROJECT FIRE FLIGHT I REENTRY TRAJECTORY PARAMETERS - Continued

Elapsed time, sec	Geodetic latitude, deg	Longitude, deg	Altitude, ft	Earth relative velocity, fps	Earth relative flight-path angle, deg	Earth relative heading angle, deg
	Acceleration, g units	Dynamic pressure, psf	Mach number	Reynolds number per foot	Atmospheric pressure, psf	Atmospheric density, slugs/cu ft
1766.00	-10.2199 -1.1449	-12.6707 36.740	48294.7 0.45	431.39 574553.59	-85.9279 264.32	120.7126 0.39484937E-03
1766.50	-10.2199 -1.1435	-12.6706 36.693	48081.0 0.44	428.92 577131.15	-86.0727 267.03	120.6819 0.39890791E-03
1767.00	-10.2200 -1.1419	-12.6706 36.644	47870.2 0.44	426.47 579656.16	-86.2130 269.74	120.6499 0.40295044E-03
1767.50	-10.2200 -1.1407	-12.6706 36.603	47655.5 0.44	424.05 582318.18	-86.3490 272.53	120.6178 0.40711189E-03
1768.00	-10.2200 -1.1392	-12.6706 36.555	47446.0 0.44	421.65 584860.28	-86.4808 275.27	120.5836 0.41121309E-03
1768.50	-10.2200 -1.1379	-12.6705 36.514	47233.7 0.43	419.28 587508.50	-86.6083 278.08	120.5487 0.41541037E-03
1769.00	-10.2200 -1.1365	-12.6705 36.469	47025.2 0.43	416.94 590078.16	-86.7319 280.87	120.5123 0.41957530E-03
1769.50	-10.2200 -1.1351	-12.6705 36.425	46817.0 0.43	414.62 592668.73	-86.8515 283.68	120.4743 0.42377695E-03
1770.00	-10.2201 -1.1337	-12.6704 36.379	46611.2 0.43	412.32 595217.26	-86.9673 286.49	120.4360 0.42796959E-03
1770.50	-10.2201 -1.1322	-12.6704 36.331	46407.7 0.42	410.05 597730.85	-87.0792 289.29	120.3948 0.43215730E-03
1771.00	-10.2201 -1.1308	-12.6704 36.286	46204.0 0.42	407.80 600277.71	-87.1876 292.13	120.3532 0.43639123E-03
1771.50	-10.2201 -1.1296	-12.6704 36.248	45997.5 0.42	405.58 602934.06	-87.2924 295.03	120.3096 0.44072476E-03
1772.00	-10.2201 -1.1281	-12.6703 36.199	45798.2 0.42	403.38 605407.38	-87.3937 297.85	120.2644 0.44494703E-03
1772.50	-10.2201 -1.1268	-12.6703 36.157	45596.5 0.41	401.20 607982.73	-87.4916 300.74	120.2174 0.44926354E-03
1773.00	-10.2201 -1.1254	-12.6703 36.112	45397.7 0.41	399.05 610499.73	-87.5862 303.62	120.1697 0.45355692E-03
1773.50	-10.2202 -1.1242	-12.6703 36.074	45196.2 0.41	396.92 613125.95	-87.6777 306.56	120.1192 0.45795164E-03

TABLE V. - PROJECT FIRE FLIGHT I REENTRY TRAJECTORY PARAMETERS - Continued

Elapsed time, sec	Geodetic latitude, deg	Longitude, deg	Altitude, ft	Earth relative velocity, fps	Earth relative flight-path angle, deg	Earth relative heading angle, deg
	Acceleration, g units	Dynamic pressure, psf	Mach number	Reynolds number per foot	Atmospheric pressure, psf	Atmospheric density, slugs/cu ft
1774.00	-10.2202	-12.6703	45002.2	394.81	-87.7660	120.0673
	-1.1226	36.025	0.41	615559.32	309.42	0.46222308E-03
1774.50	-10.2202	-12.6702	44800.7	392.73	-87.8513	120.0136
	-1.1216	35.991	0.41	618242.80	312.42	0.46670201E-03
1775.00	-10.2202	-12.6702	44609.7	390.66	-87.9337	119.9566
	-1.1200	35.940	0.40	620642.16	315.29	0.47098762E-03
1775.50	-10.2202	-12.6702	44413.7	388.62	-88.0131	119.8990
	-1.1188	35.901	0.40	623219.65	318.26	0.47542643E-03
1776.00	-10.2202	-12.6702	44217.7	386.60	-88.0898	119.8386
	-1.1176	35.864	0.40	625824.38	321.26	0.47990713E-03
1776.50	-10.2202	-12.6702	44026.7	384.61	-88.1638	119.7755
	-1.1163	35.820	0.40	628309.20	324.21	0.48431429E-03
1777.00	-10.2202	-12.6702	43833.7	382.63	-88.2352	119.7102
	-1.1151	35.782	0.40	630881.40	327.22	0.48880876E-03
1777.50	-10.2202	-12.6701	43646.2	380.68	-88.3040	119.6432
	-1.1137	35.737	0.39	633316.59	330.17	0.49321517E-03
1778.00	-10.2202	-12.6701	43453.5	378.74	-88.3704	119.5728
	-1.1126	35.702	0.39	635936.83	333.23	0.49778648E-03
1778.50	-10.2202	-12.6701	43266.0	376.83	-88.4343	119.5000
	-1.1113	35.661	0.39	638426.94	336.23	0.50227401E-03
1779.00	-10.2202	-12.6701	43079.2	374.93	-88.4960	119.4253
	-1.1101	35.621	0.39	640923.74	339.25	0.50678385E-03
1779.50	-10.2203	-12.6701	42892.5	373.06	-88.5553	119.3465
	-1.1089	35.582	0.39	643446.98	342.29	0.51133426E-03
1780.00	-10.2203	-12.6701	42706.0	371.21	-88.6125	119.2652
	-1.1077	35.545	0.38	645990.48	345.36	0.51591948E-03
1780.50	-10.2203	-12.6701	42522.2	369.37	-88.6676	119.1805
	-1.1065	35.506	0.38	648475.85	348.41	0.52047734E-03
1781.00	-10.2203	-12.6701	42334.2	367.56	-88.7206	119.0924
	-1.1055	35.475	0.38	651122.16	351.56	0.52518243E-03
1781.50	-10.2203	-12.6701	42151.0	365.76	-88.7716	119.0011
	-1.1044	35.439	0.38	653648.34	354.66	0.52980959E-03

TABLE V. - PROJECT FIRE FLIGHT I REENTRY TRAJECTORY PARAMETERS - Continued

Elapsed time, sec	Geodetic latitude, deg	Longitude, deg	Altitude, ft	Earth relative velocity, fps	Earth relative flight-path angle, deg	Earth relative heading angle, deg
	Acceleration, g units	Dynamic pressure, psf	Mach number	Reynolds number per foot	Atmospheric pressure, psf	Atmospheric density, slugs/cu ft
1782.00	-10.2203 -1.1031	-12.6700 35.399	41971.2 0.38	363.98 656093.61	-88.8207 357.73	118.9069 0.53438810E-03
1782.50	-10.2203 -1.1021	-12.6700 35.364	41789.2 0.37	362.22 658634.23	-88.8680 360.86	118.8099 0.53906433E-03
1783.00	-10.2203 -1.1010	-12.6700 35.330	41608.0 0.37	360.48 661180.84	-88.9134 364.00	118.7067 0.54376201E-03
1783.50	-10.2203 -1.0999	-12.6700 35.294	41429.2 0.37	358.76 663674.52	-88.9571 367.13	118.6007 0.54843504E-03
1784.00	-10.2203 -1.0989	-12.6700 35.262	41249.0 0.37	357.05 666241.31	-88.9991 370.31	118.4927 0.55318809E-03
1784.50	-10.2203 -1.0977	-12.6700 35.224	41073.5 0.37	355.36 668687.89	-89.0394 373.44	118.3781 0.55785554E-03
1785.00	-10.2203 -1.0968	-12.6700 35.195	40893.5 0.37	353.69 671304.60	-89.0782 376.67	118.2601 0.56268366E-03
1785.50	-10.2203 -1.0958	-12.6700 35.163	40716.7 0.36	352.04 673840.71	-89.1155 379.87	118.1373 0.56746533E-03
1786.00	-10.2203 -1.0948	-12.6700 35.132	40540.5 0.36	350.40 676390.37	-89.1512 383.09	118.0087 0.57227398E-03
1786.50	-10.2203 -1.0938	-12.6700 35.098	40367.0 0.36	348.78 678876.02	-89.1856 386.28	117.8773 0.57704752E-03
1787.00	-10.2203 -1.0929	-12.6700 35.069	40191.5 0.36	347.17 681455.01	-89.2186 389.54	117.7404 0.58191670E-03
1787.50	-10.2203 -1.0917	-12.6700 35.032	40022.2 0.36	345.59 683856.37	-89.2503 392.71	117.6001 0.58665142E-03
1788.00	-10.2203 -1.0909	-12.6700 35.005	39847.5 0.36	344.01 686466.24	-89.2807 396.01	117.4519 0.59158056E-03
1788.50	-10.2203 -1.0899	-12.6700 34.975	39676.0 0.35	342.46 688992.77	-89.3098 399.28	117.2991 0.59645832E-03
1789.00	-10.2203 -1.0890	-12.6700 34.945	39505.2 0.35	340.91 691517.88	-89.3378 402.56	117.1391 0.60135486E-03
1789.50	-10.2203 -1.0881	-12.6699 34.916	39335.2 0.35	339.39 694047.01	-89.3646 405.85	116.9806 0.60626984E-03

TABLE V. - PROJECT FIRE FLIGHT I REENTRY TRAJECTORY PARAMETERS - Continued

Elapsed time, sec	Geodetic latitude, deg	Longitude, deg	Altitude, ft	Earth relative velocity, fps	Earth relative flight-path angle, deg	Earth relative heading angle, deg
	Acceleration, g units	Dynamic pressure, psf	Mach number	Reynolds number per foot	Atmospheric pressure, psf	Atmospheric density, slugs/cu ft
1750.00	-10.2203 -1.0873	-12.6699 34.889	39164.7 0.35	337.87 696618.35	-89.3903 409.17	116.8079 0.61123973E-03
1750.50	-10.2203 -1.0863	-12.6699 34.857	38998.2 0.35	336.38 699081.36	-89.4149 412.45	116.6317 0.61613238E-03
1751.00	-10.2203 -1.0855	-12.6699 34.831	38829.5 0.35	334.89 701647.31	-89.4385 415.79	116.4486 0.62113128E-03
1751.50	-10.2203 -1.0846	-12.6699 34.805	38661.7 0.34	333.43 704206.09	-89.4611 419.15	116.2599 0.62614070E-03
1752.00	-10.2203 -1.0838	-12.6699 34.777	38496.0 0.34	331.97 706721.38	-89.4828 422.49	116.0671 0.63113028E-03
1752.50	-10.2203 -1.0829	-12.6699 34.749	38331.2 0.34	330.53 709227.70	-89.5035 425.83	115.8639 0.63612921E-03
1753.00	-10.2203 -1.0821	-12.6699 34.724	38165.0 0.34	329.10 711806.81	-89.5234 429.24	115.6564 0.64121381E-03
1753.50	-10.2203 -1.0813	-12.6699 34.698	38001.2 0.34	327.69 714329.24	-89.5425 432.62	115.4414 0.64626180E-03
1754.00	-10.2204 -1.0805	-12.6699 34.672	37838.0 0.34	326.29 716859.68	-89.5606 436.01	115.2203 0.65133406E-03
1754.50	-10.2204 -1.0798	-12.6699 34.651	37672.7 0.34	324.90 719483.36	-89.5780 439.48	114.9897 0.65650897E-03
1755.00	-10.2204 -1.0790	-12.6699 34.625	37511.0 0.33	323.52 722007.63	-89.5947 442.89	114.7496 0.66161426E-03
1755.50	-10.2204 -1.0781	-12.6699 34.596	37352.0 0.33	322.16 724462.34	-89.6106 446.28	114.5098 0.66667151E-03
1756.00	-10.2204 -1.0774	-12.6699 34.572	37191.2 0.33	320.81 727002.07	-89.6258 449.73	114.2593 0.67182381E-03
1756.50	-10.2204 -1.0768	-12.6699 34.553	37028.2 0.33	319.48 729646.74	-89.6404 453.25	113.9975 0.67708895E-03
1757.00	-10.2204 -1.0759	-12.6699 34.526	36871.2 0.33	318.15 732101.77	-89.6543 456.67	113.7336 0.68219940E-03
1757.50	-10.2204 -1.0752	-12.6699 34.503	36712.2 0.33	316.83 734651.44	-89.6676 460.16	113.4586 0.68741425E-03

TABLE V. - PROJECT FIRE FLIGHT I REENTRY TRAJECTORY PARAMETERS - Continued

Elapsed time, sec	Geodetic latitude, deg	Longitude, deg	Altitude, ft	Earth relative velocity, fps	Earth relative flight-path angle, deg	Earth relative heading angle, deg
	Acceleration, g units	Dynamic pressure, psf	Mach number	Reynolds number per foot	Atmospheric pressure, psf	Atmospheric density, slugs/cu ft
1798.00	-10.2204 -1.0746	-12.6699 34.481	36553.5 0.33	315.53 737218.43	-89.6803 463.68	113.1759 0.69266087E-03
1798.50	-10.2204 -1.0738	-12.6699 34.456	36398.0 0.32	314.24 739693.42	-89.6924 467.14	112.8858 0.69783894E-03
1799.00	-10.2204 -1.0731	-12.6699 34.436	36239.7 0.32	312.97 742291.59	-89.7040 470.70	112.5873 0.70314834E-03
1799.50	-10.2204 -1.0717	-12.6699 34.391	36085.5 0.32	311.70 743946.60	-89.7150 474.19	112.2774 0.70793426E-03
1800.00	-10.2204 -1.0696	-12.6699 34.323	35931.5 0.32	310.47 744562.67	-89.7256 477.69	111.9657 0.71216974E-03
1800.50	-10.2204 -1.0675	-12.6699 34.267	35773.2 0.32	309.27 745334.19	-89.7356 481.32	111.6493 0.71654233E-03
1801.00	-10.2204 -1.0661	-12.6699 34.209	35620.5 0.32	308.09 746035.63	-89.7453 484.84	111.3257 0.72078257E-03
1801.50	-10.2204 -1.0645	-12.6699 34.158	35465.5 0.32	306.95 746839.84	-89.7545 488.43	110.9891 0.72510478E-03
1802.00	-10.2204 -1.0629	-12.6699 34.109	35313.5 0.31	305.83 747623.64	-89.7632 491.98	110.6457 0.72936266E-03
1802.50	-10.2204 -1.0616	-12.6699 34.066	35159.2 0.31	304.73 748503.77	-89.7715 495.59	110.2969 0.73370329E-03
1803.00	-10.2204 -1.0603	-12.6699 34.023	35008.5 0.31	303.66 749342.75	-89.7794 499.15	109.9466 0.73796442E-03
1803.50	-10.2204 -1.0590	-12.6699 33.983	34857.7 0.31	302.60 750221.88	-89.7869 502.73	109.5755 0.74224450E-03
1804.00	-10.2204 -1.0580	-12.6699 33.951	34703.0 0.31	301.57 751225.86	-89.7941 506.42	109.2109 0.74665803E-03
1804.50	-10.2204 -1.0569	-12.6699 33.916	34553.5 0.31	300.55 752138.61	-89.8011 510.01	108.8484 0.75094090E-03
1805.00	-10.2204 -1.0559	-12.6699 33.883	34404.5 0.31	299.55 753072.31	-89.8075 513.61	108.4605 0.75522815E-03
1805.50	-10.2204 -1.0549	-12.6699 33.852	34255.7 0.31	298.56 754029.55	-89.8137 517.22	108.0898 0.75952698E-03

TABLE V. - PROJECT FIRE FLIGHT I REENTRY TRAJECTORY PARAMETERS - Continued

Elapsed time, sec	Geodetic latitude, deg	Longitude, deg	Altitude, ft	Earth relative velocity, fps	Earth relative flight-path angle, deg	Earth relative heading angle, deg
	Acceleration, g units	Dynamic pressure, psf	Mach number	Reynolds number per foot	Atmospheric pressure, psf	Atmospheric density, slugs/cu ft
1806.00	-10.2204 -1.0541	-12.6699 33.826	34105.0 0.30	297.59 755057.20	-89.8197 520.91	107.7044 0.76390270E-03
1806.50	-10.2204 -1.0533	-12.6699 33.798	33957.2 0.30	296.63 756040.87	-89.8253 524.54	107.3112 0.76821012E-03
1807.00	-10.2204 -1.0525	-12.6699 33.772	33809.7 0.30	295.69 757043.00	-89.8307 528.18	106.9119 0.77252877E-03
1807.50	-10.2204 -1.0517	-12.6699 33.748	33663.0 0.30	294.76 758050.16	-89.8358 531.83	106.5244 0.77684405E-03
1808.00	-10.2204 -1.0511	-12.6699 33.728	33513.5 0.30	293.84 759138.49	-89.8406 535.56	106.1280 0.78125913E-03
1808.50	-10.2204 -1.0504	-12.6699 33.706	33367.5 0.30	292.93 760165.33	-89.8451 539.23	105.7182 0.78558942E-03
1809.00	-10.2204 -1.0497	-12.6699 33.684	33222.0 0.30	292.04 761198.99	-89.8496 542.91	105.3226 0.78992312E-03
1809.50	-10.2204 -1.0491	-12.6699 33.665	33076.5 0.30	291.15 762250.94	-89.8537 546.60	104.9220 0.79427520E-03
1810.00	-10.2204 -1.0485	-12.6699 33.646	32931.5 0.30	290.27 763308.00	-89.8576 550.31	104.5143 0.79863060E-03
1810.50	-10.2204 -1.0479	-12.6699 33.627	32787.0 0.29	289.41 764368.55	-89.8614 554.02	104.1066 0.80298918E-03
1811.00	-10.2204 -1.0474	-12.6699 33.610	32643.2 0.29	288.55 765426.90	-89.8650 557.73	103.7023 0.80734319E-03
1811.50	-10.2204 -1.0471	-12.6699 33.599	32494.2 0.29	287.70 766614.17	-89.8684 561.60	103.3094 0.81187534E-03
1812.00	-10.2204 -1.0465	-12.6699 33.582	32351.0 0.29	286.85 767680.98	-89.8716 565.34	102.9209 0.81625106E-03
1812.50	-10.2204 -1.0460	-12.6699 33.566	32208.2 0.29	286.02 768750.20	-89.8746 569.09	102.5146 0.82062946E-03
1813.00	-10.2204 -1.0456	-12.6699 33.551	32065.7 0.29	285.19 769826.27	-89.8776 572.85	102.1210 0.82501820E-03
1813.50	-10.2204 -1.0451	-12.6699 33.536	31923.7 0.29	284.37 770903.23	-89.8803 576.62	101.7207 0.82940925E-03

TABLE V. - PROJECT FIRE FLIGHT I REENTRY TRAJECTORY PARAMETERS - Continued

Elapsed time, sec	Geodetic latitude, deg	Longitude, deg	Altitude, ft	Earth relative velocity, fps	Earth relative flight-path angle, deg	Earth relative heading angle, deg
	Acceleration, g units	Dynamic pressure, psf	Mach number	Reynolds number per foot	Atmospheric pressure, psf	Atmospheric density, slugs/cu ft
1814.00	-10.2204 -1.0447	-12.6698 33.522	31782.0 0.29	283.56 771985.94	-89.8829 580.40	101.3504 0.83381058E-03
1814.50	-10.2204 -1.0442	-12.6699 33.508	31640.7 0.29	282.76 773068.07	-89.8854 584.18	100.9803 0.83821421E-03
1815.00	-10.2204 -1.0438	-12.6698 33.494	31500.0 0.29	281.96 774149.74	-89.8879 587.98	100.6115 0.84261996E-03
1815.50	-10.2204 -1.0434	-12.6698 33.482	31359.2 0.28	281.17 775242.14	-89.8901 591.79	100.2312 0.84704347E-03
1816.00	-10.2204 -1.0430	-12.6698 33.469	31219.2 0.28	280.38 776326.70	-89.8922 595.61	99.8748 0.85146111E-03
1816.50	-10.2204 -1.0426	-12.6698 33.456	31079.5 0.28	279.61 777411.91	-89.8943 599.43	99.5162 0.85588840E-03
1817.00	-10.2204 -1.0422	-12.6698 33.444	30940.2 0.28	278.83 778497.21	-89.8963 603.27	99.1637 0.86031746E-03
1817.50	-10.2204 -1.0420	-12.6698 33.436	30798.7 0.28	278.07 779642.35	-89.8980 607.18	98.8356 0.86483606E-03
1818.00	-10.2204 -1.0416	-12.6698 33.424	30660.0 0.28	277.31 780731.57	-89.8998 611.04	98.5031 0.86928444E-03
1818.50	-10.2204 -1.0413	-12.6698 33.413	30521.7 0.28	276.55 781818.38	-89.9015 614.91	98.1819 0.87373444E-03
1819.00	-10.2204 -1.0409	-12.6698 33.402	30383.7 0.28	275.81 782907.70	-89.9031 618.79	97.8558 0.87819360E-03
1819.50	-10.2204 -1.0406	-12.6698 33.391	30246.2 0.28	275.06 783994.41	-89.9046 622.67	97.5413 0.88265407E-03
1820.00	-10.2204 -1.0402	-12.6698 33.380	30109.0 0.28	274.33 785083.31	-89.9060 626.57	97.2410 0.88712364E-03
1820.50	-10.2204 -1.0399	-12.6698 33.370	29972.2 0.27	273.59 786168.39	-89.9074 630.47	96.9582 0.89159426E-03
1821.00	-10.2204 -1.0396	-12.6698 33.359	29836.0 0.27	272.87 787250.18	-89.9087 634.37	96.6591 0.89606580E-03
1821.50	-10.2204 -1.0393	-12.6698 33.350	29699.7 0.27	272.15 788339.71	-89.9099 638.30	96.4017 0.90055447E-03

TABLE V. - PROJECT FIRE FLIGHT I REENTRY TRAJECTORY PARAMETERS - Continued

Elapsed time, sec	Geodetic latitude, deg	Longitude, deg	Altitude, ft	Earth relative velocity, fps	Earth relative flight-path angle, deg	Earth relative heading angle, deg
	Acceleration, g units	Dynamic pressure, psf	Mach number	Reynolds number per foot	Atmospheric pressure, psf	Atmospheric density, slugs/cu ft
1822.00	-10.2204 -1.0390	-12.6698 33.340	29564.0 0.27	271.43 789424.95	-89.9111 642.23	96.1268 0.90504374E-03
1822.50	-10.2204 -1.0387	-12.6698 33.330	29428.5 0.27	270.72 790511.73	-89.9122 646.18	95.8635 0.90954200E-03
1823.00	-10.2204 -1.0384	-12.6698 33.321	29293.5 0.27	270.02 791593.98	-89.9133 650.13	95.6407 0.91404054E-03
1823.50	-10.2204 -1.0381	-12.6698 33.311	29158.7 0.27	269.32 792677.59	-89.9143 654.09	95.3942 0.91854783E-03
1824.00	-10.2204 -1.0378	-12.6698 33.302	29024.5 0.27	268.62 793756.53	-89.9153 658.05	95.1561 0.92305534E-03
1824.50	-10.2204 -1.0375	-12.6698 33.293	28890.2 0.27	267.93 794842.53	-89.9162 662.04	94.9216 0.92757980E-03
1825.00	-10.2204 -1.0372	-12.6698 33.284	28756.7 0.27	267.24 795917.61	-89.9171 666.02	94.7317 0.93209594E-03
1825.50	-10.2204 -1.0370	-12.6698 33.276	28623.2 0.27	266.56 796999.91	-89.9179 670.03	94.5108 0.93662892E-03
1826.00	-10.2204 -1.0367	-12.6698 33.267	28490.2 0.27	265.88 798076.67	-89.9187 674.03	94.3312 0.94116167E-03
1826.50	-10.2204 -1.0364	-12.6698 33.258	28357.5 0.26	265.21 799154.26	-89.9195 678.05	94.1192 0.94570265E-03
1827.00	-10.2204 -1.0362	-12.6698 33.250	28225.2 0.26	264.54 800226.99	-89.9202 682.07	93.9444 0.95024328E-03
1827.50	-10.2204 -1.0359	-12.6698 33.242	28093.2 0.26	263.88 801300.09	-89.9209 686.11	93.7716 0.95479207E-03
1828.00	-10.2204 -1.0357	-12.6698 33.234	27961.5 0.26	263.22 802373.58	-89.9216 690.15	93.6029 0.95934884E-03
1828.50	-10.2204 -1.0354	-12.6698 33.226	27830.0 0.26	262.56 803447.84	-89.9222 694.21	93.4699 0.96391344E-03
1829.00	-10.2204 -1.0352	-12.6698 33.218	27699.0 0.26	261.91 804516.42	-89.9229 698.27	93.2971 0.96847745E-03
1829.50	-10.2204 -1.0350	-12.6698 33.213	27565.7 0.26	261.26 805642.75	-89.9235 702.42	93.1528 0.97313670E-03

TABLE V. - PROJECT FIRE FLIGHT I REENTRY TRAJECTORY PARAMETERS - Continued

Elapsed time, sec	Geodetic latitude, deg	Longitude, deg	Altitude, ft	Earth relative velocity, fps	Earth relative flight-path angle, deg	Earth relative heading angle, deg
	Acceleration, g units	Dynamic pressure, psf	Mach number	Reynolds number per foot	Atmospheric pressure, psf	Atmospheric density, slugs/cu ft
1830.00	-10.2204 -1.0347	-12.6698 33.201	27438.0 0.26	260.62 806644.16	-89.9241 706.42	93.0197 0.97761980E-03
1830.50	-10.2204 -1.0345	-12.6698 33.197	27305.2 0.26	259.98 807772.84	-89.9246 710.60	92.8799 0.98229528E-03
1831.00	-10.2204 -1.0342	-12.6698 33.186	27178.0 0.26	259.35 808777.45	-89.9251 714.62	92.7665 0.98679294E-03
1831.50	-10.2204 -1.0340	-12.6698 33.182	27046.0 0.26	258.72 809898.12	-89.9256 718.81	92.6302 0.99147534E-03
1832.00	-10.2204 -1.0338	-12.6698 33.174	26917.0 0.26	258.09 810952.10	-89.9261 722.92	92.5089 0.99606774E-03
1832.50	-10.2204 -1.0336	-12.6698 33.166	26788.0 0.26	257.46 812013.17	-89.9265 727.05	92.4278 0.10006765E-02
1833.00	-10.2204 -1.0333	-12.6698 33.159	26659.5 0.25	256.84 813068.04	-89.9270 731.19	92.2961 0.10052835E-02
1833.50	-10.2204 -1.0331	-12.6698 33.151	26531.2 0.25	256.23 814123.19	-89.9274 735.34	92.1960 0.10098980E-02
1834.00	-10.2204 -1.0329	-12.6698 33.144	26403.2 0.25	255.62 815178.34	-89.9278 739.50	92.1300 0.10145195E-02
1834.50	-10.2204 -1.0327	-12.6698 33.137	26275.7 0.25	255.01 816228.54	-89.9282 743.66	92.0141 0.10191393E-02
1835.00	-10.2204 -1.0324	-12.6698 33.130	26148.2 0.25	254.40 817283.63	-89.9287 747.84	91.9699 0.10237749E-02
1835.50	-10.2204 -1.0322	-12.6698 33.123	26021.2 0.25	253.80 818333.23	-89.9290 752.02	91.8665 0.10284086E-02
1836.00	-10.2204 -1.0320	-12.6698 33.116	25894.7 0.25	253.21 819377.30	-89.9293 756.20	91.7944 0.10330400E-02
1836.50	-10.2204 -1.0318	-12.6698 33.109	25768.2 0.25	252.61 820426.63	-89.9297 760.41	91.7054 0.10376874E-02
1837.00	-10.2204 -1.0316	-12.6698 33.102	25642.2 0.25	252.02 821469.99	-89.9300 764.61	91.6418 0.10423324E-02
1837.50	-10.2204 -1.0314	-12.6698 33.095	25516.2 0.25	251.44 822519.01	-89.9303 768.84	91.6041 0.10469934E-02

TABLE V. - PROJECT FIRE FLIGHT I REENTRY TRAJECTORY PARAMETERS - Continued

Elapsed time, sec	Geodetic latitude, deg	Longitude, deg	Altitude, ft	Earth relative velocity, fps	Earth relative flight-path angle, deg	Earth relative heading angle, deg
	Acceleration, g units	Dynamic pressure, psf	Mach number	Reynolds number per foot	Atmospheric pressure, psf	Atmospheric density, slugs/cu ft
1838.00	-10.2204 -1.0312	-12.6698 33.089	25390.5 0.25	250.85 823567.01	-89.9307 773.07	91.5418 0.10516609E-02
1838.50	-10.2204 -1.0310	-12.6698 33.082	25265.5 0.25	250.27 824603.38	-89.9310 777.30	91.4591 0.10563166E-02
1839.00	-10.2204 -1.0308	-12.6698 33.076	25140.2 0.25	249.70 825651.13	-89.9313 781.56	91.4464 0.10609972E-02
1839.50	-10.2204 -1.0306	-12.6698 33.069	25015.7 0.25	249.13 826686.60	-89.9316 785.81	91.3604 0.10656658E-02
1840.00	-10.2204 -1.0304	-12.6698 33.063	24891.2 0.24	248.56 827727.30	-89.9319 790.07	91.3431 0.10703500E-02
1840.50	-10.2204 -1.0302	-12.6698 33.057	24767.2 0.24	247.99 828761.79	-89.9322 794.34	91.2987 0.10750312E-02
1841.00	-10.2204 -1.0300	-12.6698 33.051	24643.2 0.24	247.43 829801.53	-89.9324 798.63	91.2252 0.10797280E-02
1841.50	-10.2204 -1.0298	-12.6698 33.044	24520.0 0.24	246.87 830828.59	-89.9326 802.91	91.2136 0.10844120E-02
1842.00	-10.2204 -1.0296	-12.6698 33.039	24396.5 0.24	246.31 831867.11	-89.9329 807.22	91.1741 0.10891213E-02
1842.50	-10.2204 -1.0294	-12.6698 33.033	24273.5 0.24	245.76 832898.58	-89.9332 811.53	91.0994 0.10938269E-02
1843.00	-10.2204 -1.0292	-12.6698 33.027	24151.0 0.24	245.21 833923.63	-89.9333 815.84	91.0878 0.10985290E-02
1843.50	-10.2204 -1.0290	-12.6698 33.021	24028.2 0.24	244.67 834959.59	-89.9336 820.18	91.0406 0.11032561E-02
1844.00	-10.2204 -1.0289	-12.6698 33.015	23906.2 0.24	244.12 835982.59	-89.9339 824.51	91.0533 0.11079700E-02
1844.50	-10.2204 -1.0287	-12.6698 33.009	23784.2 0.24	243.58 837011.28	-89.9341 828.86	90.9832 0.11126992E-02
1845.00	-10.2204 -1.0285	-12.6698 33.003	23662.7 0.24	243.04 838032.69	-89.9343 833.21	90.9698 0.11174244E-02
1845.50	-10.2204 -1.0283	-12.6698 32.998	23541.2 0.24	242.51 839059.16	-89.9345 837.57	90.9679 0.11221650E-02

TABLE V. - PROJECT FIRE FLIGHT I REENTRY TRAJECTORY PARAMETERS - Continued

Elapsed time, sec	Geodetic latitude, deg	Longitude, deg	Altitude, ft	Earth relative velocity, fps	Earth relative flight-path angle, deg	Earth relative heading angle, deg
	Acceleration, g units	Dynamic pressure, psf	Mach number	Reynolds number per foot	Atmospheric pressure, psf	Atmospheric density, slugs/cu ft
1846.00	-10.2204 -1.0282	-12.6698 32.992	23420.2 0.24	241.98 840078.82	-89.9348 841.94	90.9237 0.11269015E-02
1846.50	-10.2204 -1.0280	-12.6698 32.987	23299.2 0.24	241.45 841103.30	-89.9350 846.33	90.8859 0.11316532E-02
1847.00	-10.2204 -1.0278	-12.6698 32.981	23178.7 0.24	240.93 842120.90	-89.9351 850.71	90.9079 0.11364006E-02
1847.50	-10.2204 -1.0276	-12.6698 32.976	23058.5 0.23	240.40 843137.41	-89.9353 855.11	90.8821 0.11411535E-02
1848.00	-10.2204 -1.0275	-12.6698 32.971	22938.2 0.23	239.88 844158.63	-89.9355 859.53	90.8618 0.11459215E-02
1848.50	-10.2204 -1.0273	-12.6698 32.965	22818.5 0.23	239.37 845172.87	-89.9357 863.94	90.8454 0.11506849E-02
1849.00	-10.2204 -1.0271	-12.6698 32.960	22699.0 0.23	238.85 846185.93	-89.9359 868.36	90.8322 0.11554535E-02
1849.50	-10.2204 -1.0270	-12.6698 32.955	22579.7 0.23	238.34 847197.58	-89.9361 872.80	90.8188 0.11602273E-02
1850.00	-10.2204 -1.0268	-12.6698 32.950	22460.7 0.23	237.84 848208.66	-89.9362 877.24	90.8109 0.11650062E-02
1850.50	-10.2204 -1.0267	-12.6698 32.945	22342.0 0.23	237.33 849218.13	-89.9364 881.69	90.7485 0.11697899E-02
1851.00	-10.2204 -1.0265	-12.6698 32.939	22223.5 0.23	236.83 850226.27	-89.9366 886.15	90.7372 0.11745787E-02
1851.50	-10.2204 -1.0264	-12.6698 32.935	22105.0 0.23	236.33 851238.70	-89.9368 890.63	90.7759 0.11793824E-02
1852.00	-10.2204 -1.0262	-12.6698 32.930	21987.0 0.23	235.83 852244.30	-89.9369 895.10	90.7608 0.11841810E-02
1852.50	-10.2204 -1.0260	-12.6698 32.925	21869.2 0.23	235.34 853248.14	-89.9371 899.59	90.7384 0.11889843E-02
1853.00	-10.2204 -1.0259	-12.6698 32.920	21751.7 0.23	234.84 854250.70	-89.9373 904.08	90.7132 0.11937921E-02
1853.50	-10.2204 -1.0257	-12.6698 32.915	21634.5 0.23	234.35 855251.95	-89.9375 908.59	90.7382 0.11986048E-02

TABLE V. - PROJECT FIRE FLIGHT I REENTRY TRAJECTORY PARAMETERS - Continued

Elapsed time, sec	Geodetic latitude, deg	Longitude, deg	Altitude, ft	Earth relative velocity, fps	Earth relative flight-path angle, deg	Earth relative heading angle, deg
	Acceleration, g units	Dynamic pressure, psf	Mach number	Reynolds number per foot	Atmospheric pressure, psf	Atmospheric density, slugs/cu ft
1854.00	-10.2204 -1.0256	-12.6698 32.910	21517.2 0.23	233.87 856257.74	-89.9376 913.11	90.7009 0.12034323E-02
1854.50	-10.2204 -1.0254	-12.6698 32.906	21400.5 0.23	233.38 857256.34	-89.9377 917.63	90.7144 0.12082541E-02
1855.00	-10.2204 -1.0253	-12.6698 32.901	21284.0 0.23	232.90 858253.23	-89.9379 922.16	90.7178 0.12130802E-02
1855.50	-10.2204 -1.0252	-12.6698 32.896	21167.7 0.23	232.42 859248.27	-89.9381 926.69	90.7085 0.12179108E-02
1856.00	-10.2204 -1.0250	-12.6698 32.891	21051.7 0.22	231.95 860242.41	-89.9382 931.24	90.6952 0.12227458E-02
1856.50	-10.2204 -1.0249	-12.6698 32.887	20935.7 0.22	231.47 861240.53	-89.9384 935.80	90.6669 0.12275954E-02
1857.00	-10.2204 -1.0247	-12.6698 32.883	20820.0 0.22	231.00 862236.42	-89.9386 940.38	90.6778 0.12324491E-02
1857.50	-10.2204 -1.0246	-12.6698 32.878	20704.7 0.22	230.53 863225.19	-89.9387 944.95	90.6779 0.12372968E-02
1858.00	-10.2204 -1.0244	-12.6698 32.873	20589.7 0.22	230.06 864212.70	-89.9388 949.52	90.6699 0.12421483E-02
1858.50	-10.2204 -1.0243	-12.6698 32.869	20474.7 0.22	229.60 865204.63	-89.9389 954.12	90.6486 0.12470145E-02
1859.00	-10.2204 -1.0242	-12.6698 32.865	20360.0 0.22	229.14 866194.33	-89.9391 958.72	90.6632 0.12518847E-02
1859.50	-10.2204 -1.0240	-12.6698 32.860	20245.5 0.22	228.68 867182.16	-89.9393 963.34	90.6605 0.12567588E-02
1860.00	-10.2204 -1.0239	-12.6698 32.856	20131.5 0.22	228.22 868162.30	-89.9394 967.94	90.6410 0.12616260E-02
1860.50	-10.2204 -1.0238	-12.6698 32.852	20017.2 0.22	227.77 869153.09	-89.9396 972.58	90.6651 0.12665186E-02
1861.00	-10.2204 -1.0236	-12.6698 32.847	19903.7 0.22	227.31 870129.98	-89.9397 977.21	90.6690 0.12713933E-02
1861.50	-10.2204 -1.0235	-12.6698 32.843	19790.2 0.22	226.86 871111.10	-89.9398 981.85	90.6536 0.12762824E-02

TABLE V. - PROJECT FIRE FLIGHT I REENTRY TRAJECTORY PARAMETERS - Continued

Elapsed time, sec	Geodetic latitude, deg	Longitude, deg	Altitude, ft	Earth relative velocity, fps	Earth relative flight-path angle, deg	Earth relative heading angle, deg
	Acceleration, g units	Dynamic pressure, psf	Mach number	Reynolds number per foot	Atmospheric pressure, psf	Atmospheric density, slugs/cu ft
1862.00	-10.2204 -1.0234	-12.6698 32.839	19676.7 0.22	226.42 872096.06	-89.9399 986.51	90.6744 0.12811860E-02
1862.50	-10.2204 -1.0233	-12.6698 32.835	19563.7 0.22	225.97 873072.94	-89.9401 991.17	90.6689 0.12860824E-02
1863.00	-10.2204 -1.0231	-12.6698 32.831	19451.0 0.22	225.53 874048.35	-89.9402 995.84	90.6452 0.12909823E-02
1863.50	-10.2204 -1.0230	-12.6698 32.827	19338.2 0.22	225.08 875027.88	-89.9403 1000.52	90.6595 0.12958963E-02
1864.00	-10.2204 -1.0229	-12.6698 32.823	19225.7 0.22	224.64 876005.11	-89.9405 1005.21	90.6450 0.13008138E-02
1864.50	-10.2204 -1.0227	-12.6698 32.819	19113.7 0.22	224.21 876975.22	-89.9406 1009.90	90.6135 0.13057237E-02
1865.00	-10.2204 -1.0226	-12.6698 32.815	19001.7 0.21	223.77 877948.59	-89.9408 1014.60	90.6690 0.13106479E-02
1865.50	-10.2204 -1.0225	-12.6698 32.811	18889.7 0.21	223.34 878926.38	-89.9409 1019.33	90.6421 0.13155863E-02
1866.00	-10.2204 -1.0224	-12.6698 32.807	18778.2 0.21	222.91 879896.21	-89.9410 1024.05	90.6459 0.13205168E-02
1866.50	-10.2204 -1.0223	-12.6698 32.804	18666.7 0.21	222.48 880869.45	-89.9411 1028.78	90.6168 0.13254616E-02
1867.00	-10.2204 -1.0222	-12.6698 32.800	18555.7 0.21	222.05 881834.89	-89.9412 1033.52	90.6219 0.13303982E-02
1867.50	-10.2204 -1.0220	-12.6698 32.796	18445.0 0.21	221.63 882797.55	-89.9414 1038.26	90.6513 0.13353378E-02
1868.00	-10.2204 -1.0219	-12.6698 32.792	18334.2 0.21	221.21 883764.88	-89.9415 1043.02	90.6578 0.13402915E-02
1868.50	-10.2204 -1.0218	-12.6698 32.788	18223.7 0.21	220.79 884729.71	-89.9417 1047.78	90.6285 0.13452479E-02
1869.00	-10.2204 -1.0217	-12.6698 32.785	18113.5 0.21	220.37 885693.05	-89.9417 1052.56	90.6338 0.13502073E-02
1869.50	-10.2204 -1.0216	-12.6698 32.781	18003.5 0.21	219.95 886653.52	-89.9419 1057.33	90.6616 0.13551692E-02

TABLE V. - PROJECT FIRE FLIGHT I REENTRY TRAJECTORY PARAMETERS - Continued

Elapsed time, sec	Geodetic latitude, deg	Longitude, deg	Altitude, ft	Earth relative velocity, fps	Earth relative flight-path angle, deg	Earth relative heading angle, deg
	Acceleration, g units	Dynamic pressure, psf	Mach number	Reynolds number per foot	Atmospheric pressure, psf	Atmospheric density, slugs/cu ft
1870.00	-10.2204 -1.0215	-12.6698 32.777	17893.5 0.21	219.54 887618.34	-89.9419 1062.13	90.6605 0.13601453E-02
1870.50	-10.2204 -1.0213	-12.6698 32.774	17783.7 0.21	219.13 888580.14	-89.9421 1066.93	90.6786 0.13651241E-02
1871.00	-10.2204 -1.0212	-12.6698 32.770	17674.5 0.21	218.72 889534.14	-89.9422 1071.73	90.6638 0.13700940E-02
1871.50	-10.2204 -1.0211	-12.6698 32.767	17565.0 0.21	218.31 890498.02	-89.9424 1076.56	90.6780 0.13750891E-02
1872.00	-10.2204 -1.0210	-12.6698 32.763	17456.0 0.21	217.90 891453.43	-89.9425 1081.38	90.6508 0.13800754E-02
1872.50	-10.2204 -1.0209	-12.6698 32.760	17347.2 0.21	217.50 892406.50	-89.9426 1086.21	90.6483 0.13850640E-02
1873.00	-10.2204 -1.0208	-12.6698 32.757	17238.5 0.21	217.09 893363.70	-89.9426 1091.06	90.6743 0.13900664E-02
1873.50	-10.2204 -1.0207	-12.6698 32.753	17130.2 0.21	216.69 894311.99	-89.9428 1095.90	90.6531 0.13950598E-02
1874.00	-10.2204 -1.0206	-12.6698 32.750	17022.0 0.21	216.29 895264.20	-89.9429 1100.76	90.6593 0.14000668E-02
1874.50	-10.2204 -1.0205	-12.6698 32.746	16914.0 0.21	215.90 896214.13	-89.9430 1105.63	90.6894 0.14050760E-02
1875.00	-10.2204 -1.0204	-12.6698 32.743	16806.0 0.21	215.50 897167.45	-89.9432 1110.51	90.6723 0.14100990E-02
1875.50	-10.2204 -1.0203	-12.6698 32.740	16698.2 0.20	215.11 898118.47	-89.9432 1115.40	90.6797 0.14151241E-02
1876.00	-10.2204 -1.0202	-12.6698 32.736	16591.0 0.20	214.72 899060.74	-89.9434 1120.28	90.6382 0.14201394E-02
1876.50	-10.2204 -1.0201	-12.6698 32.733	16483.7 0.20	214.33 900007.10	-89.9435 1125.19	90.6897 0.14251684E-02
1877.00	-10.2204 -1.0200	-12.6698 32.730	16376.5 0.20	213.94 900956.90	-89.9436 1130.10	90.6928 0.14302111E-02
1877.50	-10.2204 -1.0199	-12.6698 32.727	16269.7 0.20	213.55 901897.94	-89.9438 1135.02	90.6439 0.14352439E-02

TABLE V. - PROJECT FIRE FLIGHT I REENTRY TRAJECTORY PARAMETERS - Continued

Elapsed time, sec	Geodetic latitude, deg	Longitude, deg	Altitude, ft	Earth relative velocity, fps	Earth relative flight-path angle, deg	Earth relative heading angle, deg
	Acceleration, g units	Dynamic pressure, psf	Mach number	Reynolds number per foot	Atmospheric pressure, psf	Atmospheric density, slugs/cu ft
1878.00	-10.2204 -1.0198	-12.6698 32.724	16163.0 0.20	213.17 902842.84	-89.9438 1139.95	90.6859 0.14402903E-02
1878.50	-10.2204 -1.0197	-12.6698 32.720	16056.5 0.20	212.78 903785.26	-89.9439 1144.88	90.6787 0.14453384E-02
1879.00	-10.2204 -1.0196	-12.6698 32.717	15950.2 0.20	212.40 904724.95	-89.9440 1149.83	90.6866 0.14503883E-02
1879.50	-10.2204 -1.0195	-12.6698 32.714	15844.2 0.20	212.02 905661.90	-89.9442 1154.77	90.6442 0.14554396E-02
1880.00	-10.2204 -1.0194	-12.6698 32.711	15738.2 0.20	211.65 906602.71	-89.9442 1159.74	90.6888 0.14605045E-02
1880.50	-10.2204 -1.0193	-12.6698 32.708	15632.7 0.20	211.27 907534.69	-89.9443 1164.70	90.6790 0.14655589E-02
1881.00	-10.2204 -1.0192	-12.6698 32.705	15527.0 0.20	210.90 908475.95	-89.9445 1169.69	90.6827 0.14706389E-02
1881.50	-10.2204 -1.0191	-12.6698 32.702	15421.7 0.20	210.52 909408.87	-89.9446 1174.67	90.7036 0.14757081E-02
1882.00	-10.2204 -1.0190	-12.6698 32.699	15316.5 0.20	210.15 910344.60	-89.9447 1179.67	90.6659 0.14807908E-02
1882.50	-10.2204 -1.0189	-12.6698 32.696	15211.5 0.20	209.78 911277.97	-89.9448 1184.67	90.7119 0.14858748E-02
1883.00	-10.2204 -1.0188	-12.6698 32.693	15106.7 0.20	209.42 912208.38	-89.9449 1189.68	90.7006 0.14909600E-02
1883.50	-10.2204 -1.0187	-12.6698 32.690	15002.0 0.20	209.05 913143.16	-89.9449 1194.70	90.7092 0.14960587E-02
1884.00	-10.2204 -1.0186	-12.6698 32.687	14897.7 0.20	208.69 914068.35	-89.9451 1199.72	90.6543 0.15011461E-02
1884.50	-10.2204 -1.0186	-12.6698 32.684	14793.5 0.20	208.32 914997.16	-89.9452 1204.76	90.6820 0.15062471E-02
1885.00	-10.2204 -1.0185	-12.6698 32.682	14689.2 0.20	207.96 915928.70	-89.9453 1209.81	90.7187 0.15113610E-02
1885.50	-10.2204 -1.0184	-12.6698 32.679	14585.5 0.20	207.60 916852.13	-89.9454 1214.86	90.6981 0.15164640E-02

TABLE V. - PROJECT FIRE FLIGHT I REENTRY TRAJECTORY PARAMETERS - Continued

Elapsed time, sec	Geodetic latitude, deg	Longitude, deg	Altitude, ft	Earth relative velocity, fps	Earth relative flight-path angle, deg	Earth relative heading angle, deg
	Acceleration, g units	Dynamic pressure, psf	Mach number	Reynolds number per foot	Atmospheric pressure, psf	Atmospheric density, slugs/cu ft
1886.00	-10.2204 -1.0183	-12.6698 32.676	14481.7 0.20	207.24 917778.99	-89.9455 1219.92	90.6915 0.15215799E-02
1886.50	-10.2204 -1.0182	-12.6698 32.673	14378.2 0.20	206.89 918702.87	-89.9456 1224.99	90.6909 0.15266968E-02
1887.00	-10.2204 -1.0181	-12.6698 32.671	14275.0 0.19	206.53 919624.04	-89.9457 1230.07	90.6984 0.15318147E-02
1887.50	-10.2204 -1.0180	-12.6698 32.668	14171.7 0.19	206.18 920547.77	-89.9459 1235.16	90.7103 0.15369456E-02
1888.00	-10.2204 -1.0180	-12.6698 32.665	14068.7 0.19	205.83 921469.02	-89.9459 1240.25	90.7324 0.15420771E-02
1888.50	-10.2204 -1.0179	-12.6698 32.662	13966.0 0.19	205.48 922387.72	-89.9460 1245.35	90.6909 0.15472095E-02
1889.00	-10.2204 -1.0178	-12.6698 32.660	13863.2 0.19	205.13 923309.03	-89.9462 1250.47	90.7253 0.15523547E-02
1889.50	-10.2204 -1.0177	-12.6698 32.657	13760.7 0.19	204.78 924228.43	-89.9461 1255.59	90.7006 0.15575007E-02
1890.00	-10.2204 -1.0176	-12.6698 32.654	13658.5 0.19	204.44 925143.27	-89.9463 1260.71	90.7409 0.15626469E-02
1890.50	-10.2204 -1.0175	-12.6698 32.652	13556.2 0.19	204.09 926062.59	-89.9464 1265.86	90.7229 0.15678065E-02
1891.00	-10.2204 -1.0175	-12.6698 32.649	13454.5 0.19	203.75 926972.63	-89.9464 1270.99	90.7072 0.15729538E-02
1891.50	-10.2204 -1.0174	-12.6698 32.647	13352.7 0.19	203.41 927885.78	-89.9466 1276.14	90.6974 0.15781140E-02
1892.00	-10.2204 -1.0173	-12.6698 32.644	13251.2 0.19	203.07 928795.85	-89.9467 1281.30	90.6889 0.15832744E-02
1892.50	-10.2204 -1.0172	-12.6698 32.642	13149.7 0.19	202.73 929710.03	-89.9467 1286.47	90.6921 0.15884477E-02
1893.00	-10.2204 -1.0171	-12.6698 32.639	13048.5 0.19	202.39 930620.05	-89.9468 1291.65	90.7642 0.15936212E-02
1893.50	-10.2204 -1.0171	-12.6698 32.637	12947.2 0.19	202.05 931533.09	-89.9470 1296.84	90.7607 0.15988078E-02

TABLE V. - PROJECT FIRE FLIGHT I REENTRY TRAJECTORY PARAMETERS - Continued

Elapsed time, sec	Geodetic latitude, deg	Longitude, deg	Altitude, ft	Earth relative velocity, fps	Earth relative flight-path angle, deg	Earth relative heading angle, deg
	Acceleration, g units	Dynamic pressure, psf	Mach number	Reynolds number per foot	Atmospheric pressure, psf	Atmospheric density, slugs/cu ft
1894.00	-10.2204 -1.0170	-12.6698 32.634	12846.5 0.19	201.72 932437.73	-89.9470 1302.02	90.6900 0.16039814E-02
1894.50	-10.2204 -1.0169	-12.6698 32.632	12745.5 0.19	201.39 933350.53	-89.9472 1307.24	90.7619 0.16091809E-02
1895.00	-10.2204 -1.0168	-12.6698 32.629	12645.0 0.19	201.06 934254.61	-89.9473 1312.44	90.7618 0.16143676E-02
1895.50	-10.2204 -1.0168	-12.6698 32.627	12544.5 0.19	200.73 935161.79	-89.9473 1317.67	90.7613 0.16195671E-02
1896.00	-10.2204 -1.0167	-12.6698 32.624	12444.2 0.19	200.40 936066.01	-89.9474 1322.89	90.7640 0.16247663E-02
1896.50	-10.2204 -1.0166	-12.6698 32.622	12344.0 0.19	200.07 936972.88	-89.9476 1328.14	90.7598 0.16299784E-02
1897.00	-10.2204 -1.0165	-12.6698 32.620	12244.2 0.19	199.74 937871.09	-89.9475 1333.37	90.7631 0.16351771E-02
1897.50	-10.2204 -1.0165	-12.6698 32.617	12144.5 0.19	199.42 938772.37	-89.9476 1338.62	90.7599 0.16403888E-02
1898.00	-10.2204 -1.0164	-12.6698 32.615	12044.7 0.19	199.09 939675.75	-89.9478 1343.89	90.7484 0.16456132E-02
1898.50	-10.2204 -1.0163	-12.6698 32.613	11945.2 0.19	198.77 940576.48	-89.9479 1349.16	90.7374 0.16508370E-02
1899.00	-10.2204 -1.0162	-12.6698 32.610	11846.0 0.19	198.45 941474.00	-89.9480 1354.43	90.7240 0.16560605E-02
1899.50	-10.2204 -1.0162	-12.6698 32.608	11747.0 0.19	198.13 942368.38	-89.9481 1359.71	90.7063 0.16612834E-02
1900.00	-10.2204 -1.0161	-12.6698 32.606	11648.0 0.18	197.81 943265.68	-89.9482 1365.00	90.7613 0.16665191E-02
1900.50	-10.2204 -1.0160	-12.6698 32.604	11549.0 0.18	197.50 944166.48	-89.9482 1370.31	90.7392 0.16717672E-02
1901.00	-10.2204 -1.0160	-12.6698 32.601	11450.5 0.18	197.18 945056.97	-89.9483 1375.61	90.7807 0.16770018E-02
1901.50	-10.2204 -1.0159	-12.6698 32.599	11351.7 0.18	196.87 945957.36	-89.9484 1380.94	90.7450 0.16822620E-02

TABLE V. - PROJECT FIRE FLIGHT I REENTRY TRAJECTORY PARAMETERS - Continued

Elapsed time, sec	Geodetic latitude, deg	Longitude, deg	Altitude, ft	Earth relative velocity, fps	Earth relative flight-path angle, deg	Earth relative heading angle, deg
	Acceleration, g units	Dynamic pressure, psf	Mach number	Reynolds number per foot	Atmospheric pressure, psf	Atmospheric density, slugs/cu ft
1902.00	-10.2204 -1.0158	-12.6698 32.597	11253.5 0.18	196.55 946847.65	-89.9484 1386.26	90.7746 0.16875082E-02
1902.50	-10.2204 -1.0158	-12.6698 32.595	11155.2 0.18	196.24 947741.13	-89.9486 1391.60	90.7208 0.16927669E-02
1903.00	-10.2204 -1.0157	-12.6698 32.593	11057.2 0.18	195.93 948631.07	-89.9487 1396.94	90.7368 0.16980247E-02
1903.50	-10.2204 -1.0156	-12.6698 32.590	10959.5 0.18	195.62 949518.08	-89.9488 1402.28	90.7498 0.17032818E-02
1904.00	-10.2204 -1.0156	-12.6698 32.588	10861.7 0.18	195.31 950408.16	-89.9488 1407.64	90.7524 0.17085513E-02
1904.50	-10.2204 -1.0155	-12.6698 32.586	10764.0 0.18	195.01 951300.23	-89.9489 1413.02	90.7401 0.17138334E-02
1905.00	-10.2204 -1.0154	-12.6698 32.584	10666.7 0.18	194.70 952182.83	-89.9490 1418.39	90.7988 0.17191006E-02
1905.50	-10.2204 -1.0154	-12.6698 32.582	10569.7 0.18	194.40 953062.97	-89.9490 1423.75	90.7759 0.17243669E-02
1906.00	-10.2204 -1.0153	-12.6698 32.580	10472.2 0.18	194.09 953957.99	-89.9492 1429.17	90.7396 0.17296726E-02
1906.50	-10.2204 -1.0152	-12.6698 32.578	10375.5 0.18	193.79 954836.84	-89.9493 1434.55	90.7685 0.17349502E-02
1907.00	-10.2204 -1.0152	-12.6698 32.576	10278.7 0.18	193.49 955719.18	-89.9493 1439.96	90.7947 0.17402399E-02
1907.50	-10.2204 -1.0151	-12.6698 32.574	10181.7 0.18	193.19 956609.66	-89.9495 1445.39	90.7999 0.17455560E-02
1908.00	-10.2204 -1.0150	-12.6698 32.572	10085.2 0.18	192.89 957490.74	-89.9496 1450.81	90.7928 0.17508568E-02
1908.50	-10.2204 -1.0150	-12.6698 32.570	9989.0 0.18	192.59 958368.73	-89.9496 1456.24	90.7774 0.17561560E-02
1909.00	-10.2204 -1.0149	-12.6698 32.568	9892.7 0.18	192.30 959248.63	-89.9498 1461.68	90.8241 0.17614678E-02
1909.50	-10.2204 -1.0149	-12.6698 32.566	9796.7 0.18	192.00 960126.91	-89.9497 1467.12	90.7878 0.17667782E-02

TABLE V. - PROJECT FIRE FLIGHT I REENTRY TRAJECTORY PARAMETERS - Continued

Elapsed time, sec	Geodetic latitude, deg	Longitude, deg	Altitude, ft	Earth relative velocity, fps	Earth relative flight-path angle, deg	Earth relative heading angle, deg
	Acceleration, g units	Dynamic pressure, psf	Mach number	Reynolds number per foot	Atmospheric pressure, psf	Atmospheric density, slugs/cu ft
1910.00	-10.2204 -1.0148	-12.6698 32.564	9701.0 0.18	191.71 960999.57	-89.9499 1472.57	90.8019 0.17720868E-02
1910.50	-10.2204 -1.0147	-12.6698 32.562	9605.0 0.18	191.41 961882.52	-89.9499 1478.05	90.8159 0.17774215E-02
1911.00	-10.2204 -1.0147	-12.6698 32.560	9509.5 0.18	191.12 962755.52	-89.9500 1483.51	90.8112 0.17827408E-02
1911.50	-10.2204 -1.0146	-12.6698 32.558	9414.0 0.18	190.83 963630.55	-89.9502 1488.99	90.7829 0.17880721E-02
1912.00	-10.2204 -1.0146	-12.6698 32.556	9318.7 0.18	190.54 964503.16	-89.9501 1494.47	90.8348 0.17934019E-02
1912.50	-10.2204 -1.0145	-12.6698 32.554	9223.5 0.18	190.25 965377.73	-89.9502 1499.97	90.7756 0.17987438E-02
1913.00	-10.2204 -1.0144	-12.6698 32.552	9128.5 0.18	189.97 966248.62	-89.9504 1505.47	90.7850 0.18040839E-02
1913.50	-10.2204 -1.0144	-12.6698 32.550	9033.5 0.18	189.68 967122.63	-89.9505 1510.99	90.7799 0.18094359E-02
1914.00	-10.2204 -1.0143	-12.6698 32.548	8938.7 0.18	189.39 967992.54	-89.9505 1516.51	90.8381 0.18147862E-02
1914.50	-10.2204 -1.0143	-12.6698 32.547	8844.0 0.17	189.11 968865.84	-89.9505 1522.05	90.7959 0.18201488E-02
1915.00	-10.2204 -1.0142	-12.6698 32.545	8749.7 0.17	188.83 969728.83	-89.9506 1527.57	90.8196 0.18254948E-02
1915.50	-10.2204 -1.0142	-12.6698 32.543	8655.2 0.17	188.55 970601.09	-89.9507 1533.12	90.8274 0.18308672E-02
1916.00	-10.2204 -1.0141	-12.6698 32.541	8561.2 0.17	188.26 971463.35	-89.9508 1538.67	90.8149 0.18362233E-02
1916.50	-10.2204 -1.0140	-12.6698 32.539	8467.0 0.17	187.98 972334.06	-89.9508 1544.24	90.7727 0.18416057E-02
1917.00	-10.2204 -1.0140	-12.6698 32.538	8373.0 0.17	187.71 973201.07	-89.9510 1549.81	90.7983 0.18469858E-02
1917.50	-10.2204 -1.0139	-12.6698 32.536	8279.2 0.17	187.43 974064.38	-89.9511 1555.39	90.8020 0.18523638E-02

TABLE V. - PROJECT FIRE FLIGHT I REENTRY TRAJECTORY PARAMETERS - Continued

Elapsed time, sec	Geodetic latitude, deg	Longitude, deg	Altitude, ft	Earth relative velocity, fps	Earth relative flight-path angle, deg	Earth relative heading angle, deg
	Acceleration, g units	Dynamic pressure, psf	Mach number	Reynolds number per foot	Atmospheric pressure, psf	Atmospheric density, slugs/cu ft
1918.00	-10.2204 -1.0139	-12.6698 32.534	8185.7 0.17	187.15 974924.71	-89.9511 1560.96	90.7888 0.18577393E-02
1918.50	-10.2204 -1.0138	-12.6698 32.532	8092.2 0.17	186.87 975787.18	-89.9512 1566.55	90.8412 0.18631266E-02
1919.00	-10.2204 -1.0138	-12.6698 32.530	7999.0 0.17	186.60 976645.99	-89.9513 1572.15	90.8684 0.18685117E-02
1919.50	-10.2204 -1.0137	-12.6698 32.529	7905.7 0.17	186.33 977508.27	-89.9513 1577.76	90.7913 0.18739089E-02
1920.00	-10.2204 -1.0137	-12.6698 32.527	7812.5 0.17	186.05 978372.38	-89.9514 1583.38	90.8648 0.18793177E-02
1920.50	-10.2204 -1.0136	-12.6698 32.525	7719.7 0.17	185.78 979226.16	-89.9515 1589.00	90.8196 0.18847095E-02
1921.00	-10.2204 -1.0136	-12.6698 32.524	7626.7 0.17	185.51 980089.65	-89.9515 1594.64	90.8485 0.18901277E-02
1921.50	-10.2204 -1.0135	-12.6698 32.522	7534.2 0.17	185.24 980941.86	-89.9517 1600.27	90.8378 0.18955288E-02
1922.00	-10.2204 -1.0134	-12.6698 32.520	7441.5 0.17	184.97 981803.88	-89.9517 1605.93	90.8133 0.19009561E-02
1922.50	-10.2204 -1.0134	-12.6698 32.519	7349.2 0.17	184.70 982654.57	-89.9519 1611.57	90.8338 0.19063663E-02
1923.00	-10.2204 -1.0133	-12.6698 32.517	7257.0 0.17	184.44 983509.16	-89.9518 1617.24	90.8489 0.19117882E-02
1923.50	-10.2204 -1.0133	-12.6698 32.515	7164.7 0.17	184.17 984365.73	-89.9519 1622.92	90.8325 0.19172218E-02
1924.00	-10.2204 -1.0132	-12.6698 32.514	7072.7 0.17	183.91 985218.93	-89.9519 1628.59	90.8804 0.19226526E-02
1924.50	-10.2204 -1.0132	-12.6698 32.512	6980.7 0.17	183.64 986074.19	-89.9520 1634.29	90.8035 0.19280954E-02
1925.00	-10.2204 -1.0131	-12.6698 32.510	6889.2 0.17	183.38 986918.59	-89.9522 1639.97	90.8762 0.19335201E-02
1925.50	-10.2204 -1.0131	-12.6698 32.509	6797.2 0.17	183.12 987779.50	-89.9522 1645.70	90.8421 0.19389864E-02

TABLE V.- PROJECT FIRE FLIGHT I REENTRY TRAJECTORY PARAMETERS - Continued

Elapsed time, sec	Geodetic latitude, deg	Longitude, deg	Altitude, ft	Earth relative velocity, fps	Earth relative flight-path angle, deg	Earth relative heading angle, deg
	Acceleration, g units	Dynamic pressure, psf	Mach number	Reynolds number per foot	Atmospheric pressure, psf	Atmospheric density, slugs/cu ft
1926.00	-10.2204 -1.0130	-12.6698 32.507	6706.0 0.17	182.86 988622.70	-89.9523 1651.40	90.8621 0.19444195E-02
1926.50	-10.2204 -1.0130	-12.6698 32.506	6614.7 0.17	182.60 989469.70	-89.9523 1657.11	90.8607 0.19498648E-02
1927.00	-10.2204 -1.0129	-12.6698 32.504	6523.5 0.17	182.34 990317.84	-89.9525 1662.84	90.8177 0.19553214E-02
1927.50	-10.2204 -1.0129	-12.6698 32.503	6432.2 0.17	182.08 991169.21	-89.9525 1668.58	90.8428 0.19607900E-02
1928.00	-10.2204 -1.0128	-12.6698 32.501	6341.2 0.17	181.82 992016.55	-89.9525 1674.33	90.8375 0.19662552E-02
1928.50	-10.2204 -1.0128	-12.6698 32.500	6250.5 0.17	181.56 992859.38	-89.9527 1680.07	90.8886 0.19717171E-02
1929.00	-10.2204 -1.0127	-12.6698 32.498	6160.0 0.17	181.31 993699.33	-89.9527 1685.82	90.8234 0.19771755E-02
1929.50	-10.2204 -1.0127	-12.6698 32.497	6069.2 0.17	181.05 994547.63	-89.9527 1691.60	90.9110 0.19826607E-02
1930.00	-10.2204 -1.0127	-12.6698 32.495	5978.7 0.17	180.80 995392.09	-89.9528 1697.37	90.8716 0.19881424E-02
1930.50	-10.2204 -1.0126	-12.6698 32.494	5888.5 0.17	180.55 996231.87	-89.9529 1703.15	90.8860 0.19936203E-02
1931.00	-10.2204 -1.0126	-12.6698 32.492	5798.2 0.16	180.30 997074.09	-89.9530 1708.95	90.8664 0.19991099E-02
1931.50	-10.2204 -1.0125	-12.6698 32.491	5708.2 0.16	180.04 997912.57	-89.9532 1714.74	90.9115 0.20045960E-02
1932.00	-10.2204 -1.0125	-12.6698 32.489	5618.2 0.16	179.79 998754.41	-89.9531 1720.55	90.8336 0.20100936E-02
1932.50	-10.2204 -1.0124	-12.6698 32.488	5528.2 0.16	179.54 999596.71	-89.9532 1726.37	90.8961 0.20156026E-02
1933.00	-10.2204 -1.0124	-12.6698 32.486	5438.7 0.16	179.30 000429.99	-89.9533 1732.18	90.8372 0.20210926E-02
1933.50	-10.2204 -1.0123	-12.6698 32.485	5349.0 0.16	179.05 001271.52	-89.9533 1738.02	90.9339 0.20266096E-02

TABLE V. - PROJECT FIRE FLIGHT I REENTRY TRAJECTORY PARAMETERS - Continued

Elapsed time, sec	Geodetic latitude, deg	Longitude, deg	Altitude, ft	Earth relative velocity, fps	Earth relative flight-path angle, deg	Earth relative heading angle, deg
	Acceleration, g units	Dynamic pressure, psf	Mach number	Reynolds number per foot	Atmospheric pressure, psf	Atmospheric density, slugs/cu ft
1934.00	-10.2204 -1.0123	-12.6698 32.483	5259.5 0.16	178.80 002108.65	-89.9535 1743.87	90.8917 0.20321228E-02
1934.50	-10.2204 -1.0122	-12.6698 32.482	5170.2 0.16	178.56 002942.41	-89.9535 1749.71	90.9138 0.20376318E-02
1935.00	-10.2204 -1.0122	-12.6698 32.481	5081.0 0.16	178.31 003778.26	-89.9535 1755.56	90.8962 0.20431525E-02
1935.50	-10.2204 -1.0122	-12.6698 32.479	4992.0 0.16	178.07 004610.16	-89.9537 1761.42	90.8466 0.20486689E-02
1936.00	-10.2204 -1.0121	-12.6698 32.478	4903.0 0.16	177.82 005445.19	-89.9536 1767.29	90.8620 0.20541970E-02
1936.50	-10.2204 -1.0121	-12.6698 32.476	4814.2 0.16	177.58 006275.04	-89.9537 1773.16	90.9246 0.20597208E-02
1937.00	-10.2204 -1.0120	-12.6698 32.475	4725.5 0.16	177.34 007107.63	-89.9538 1779.05	90.8555 0.20652561E-02
1937.50	-10.2204 -1.0120	-12.6698 32.474	4636.7 0.16	177.10 007942.15	-89.9539 1784.95	90.9423 0.20708027E-02
1938.00	-10.2204 -1.0119	-12.6698 32.472	4548.5 0.16	176.86 008766.74	-89.9540 1790.83	90.8916 0.20763296E-02
1938.50	-10.2204 -1.0119	-12.6698 32.471	4460.0 0.16	176.62 009599.44	-89.9541 1796.75	90.8971 0.20818835E-02
1939.00	-10.2204 -1.0119	-12.6698 32.470	4371.7 0.16	176.38 010428.50	-89.9541 1802.67	90.8631 0.20874330E-02
1939.50	-10.2204 -1.0118	-12.6698 32.468	4283.7 0.16	176.14 011253.39	-89.9540 1808.58	90.8881 0.20929778E-02
1940.00	-10.2204 -1.0118	-12.6698 32.467	4195.7 0.16	175.90 012080.04	-89.9542 1814.52	90.8700 0.20985342E-02
1940.50	-10.2204 -1.0117	-12.6698 32.466	4107.7 0.16	175.67 012909.52	-89.9542 1820.46	90.9121 0.21041021E-02
1941.00	-10.2204 -1.0117	-12.6698 32.464	4020.0 0.16	175.43 013734.08	-89.9543 1826.41	90.9045 0.21096651E-02
1941.50	-10.2204 -1.0117	-12.6698 32.463	3932.2 0.16	175.20 014561.23	-89.9544 1832.37	90.9598 0.21152397E-02

TABLE V. - PROJECT FIRE FLIGHT I REENTRY TRAJECTORY PARAMETERS - Continued

Elapsed time, sec	Geodetic latitude, deg	Longitude, deg	Altitude, ft	Earth relative velocity, fps	Earth relative flight-path angle, deg	Earth relative heading angle, deg
	Acceleration, g units	Dynamic pressure, psf	Mach number	Reynolds number per foot	Atmospheric pressure, psf	Atmospheric density, slugs/cu ft
1542.00	-10.2204 -1.0116	-12.6698 32.462	3844.7 0.16	174.96 015384.99	-89.9544 1838.33	90.8772 0.21208095E-02
1942.50	-10.2204 -1.0116	-12.6698 32.460	3757.5 0.16	174.73 016203.81	-89.9545 1844.29	90.9440 0.21263746E-02
1943.00	-10.2204 -1.0115	-12.6698 32.459	3670.0 0.16	174.50 017030.88	-89.9546 1850.28	90.9673 0.21319669E-02
1943.50	-10.2204 -1.0115	-12.6698 32.458	3583.0 0.16	174.27 017848.23	-89.9547 1856.26	90.9516 0.21375385E-02
1944.00	-10.2204 -1.0115	-12.6698 32.457	3496.0 0.16	174.04 018667.95	-89.9546 1862.24	90.8925 0.21431213E-02
1944.50	-10.2204 -1.0114	-12.6698 32.455	3409.0 0.16	173.81 019489.01	-89.9548 1868.25	90.8834 0.21487154E-02
1945.00	-10.2204 -1.0114	-12.6698 32.454	3322.0 0.16	173.58 020313.15	-89.9548 1874.27	90.9387 0.21543205E-02
1945.50	-10.2204 -1.0113	-12.6698 32.453	3235.5 0.16	173.35 021125.39	-89.9549 1880.27	90.9345 0.21599046E-02
1946.00	-10.2204 -1.0113	-12.6698 32.452	3148.7 0.16	173.12 021946.99	-89.9550 1886.31	90.8934 0.21655159E-02
1946.50	-10.2204 -1.0113	-12.6698 32.451	3062.2 0.16	172.90 022764.73	-89.9550 1892.34	90.9097 0.21711223E-02
1947.00	-10.2204 -1.0112	-12.6698 32.449	2975.7 0.16	172.67 023583.96	-89.9551 1898.39	90.9771 0.21767396E-02
1947.50	-10.2204 -1.0112	-12.6698 32.448	2889.5 0.16	172.44 024398.90	-89.9552 1904.43	90.8909 0.21823522E-02
1948.00	-10.2204 -1.0112	-12.6698 32.447	2803.5 0.16	172.22 025209.81	-89.9552 1910.48	90.9668 0.21879593E-02
1948.50	-10.2204 -1.0111	-12.6698 32.446	2717.2 0.16	172.00 026029.77	-89.9552 1916.56	90.8924 0.21935940E-02
1949.00	-10.2204 -1.0111	-12.6698 32.444	2631.5 0.16	171.77 026837.42	-89.9553 1922.61	90.9663 0.21992068E-02
1949.50	-10.2204 -1.0110	-12.6698 32.443	2545.5 0.16	171.55 027654.88	-89.9554 1928.71	90.8962 0.22048472E-02

TABLE V. - PROJECT FIRE FLIGHT I REENTRY TRAJECTORY PARAMETERS - Continued

Elapsed time, sec	Geodetic latitude, deg	Longitude, deg	Altitude, ft	Earth relative velocity, fps	Earth relative flight-path angle, deg	Earth relative heading angle, deg
	Acceleration, g units	Dynamic pressure, psf	Mach number	Reynolds number per foot	Atmospheric pressure, psf	Atmospheric density, slugs/cu ft
1950.00	-10.2204 -1.0110	-12.6698 32.442	2460.0 0.15	171.33 028461.34	-89.9554 1934.78	90.9820 0.22104659E-02
1950.50	-10.2204 -1.0110	-12.6698 32.441	2374.2 0.15	171.11 029276.64	-89.9554 1940.88	90.9160 0.22161121E-02
1951.00	-10.2204 -1.0109	-12.6698 32.440	2288.7 0.15	170.89 030086.96	-89.9555 1946.99	91.0057 0.22217526E-02
1951.50	-10.2204 -1.0109	-12.6698 32.439	2203.2 0.15	170.67 030899.95	-89.9555 1953.10	90.9420 0.22274043E-02
1952.00	-10.2204 -1.0109	-12.6698 32.438	2118.0 0.15	170.45 031707.92	-89.9556 1959.22	90.9259 0.22330505E-02
1952.50	-10.2204 -1.0108	-12.6698 32.436	2033.0 0.15	170.23 032511.70	-89.9558 1965.33	90.9662 0.22386911E-02
1953.00	-10.2204 -1.0108	-12.6698 32.435	1948.0 0.15	170.01 033318.33	-89.9558 1971.46	90.9620 0.22443424E-02
1953.50	-10.2204 -1.0108	-12.6698 32.434	1863.0 0.15	169.79 034126.77	-89.9558 1977.61	91.0088 0.22500050E-02
1954.00	-10.2204 -1.0107	-12.6698 32.433	1778.2 0.15	169.58 034930.07	-89.9560 1983.75	90.9938 0.22556616E-02
1954.50	-10.2204 -1.0107	-12.6698 32.432	1693.5 0.15	169.36 035736.16	-89.9560 1989.91	90.9345 0.22613291E-02
1955.00	-10.2204 -1.0107	-12.6698 32.431	1608.7 0.15	169.15 036544.45	-89.9560 1996.08	90.9292 0.22670077E-02
1955.50	-10.2204 -1.0106	-12.6698 32.430	1524.2 0.15	168.93 037347.95	-89.9561 2002.25	90.9713 0.22726803E-02
1956.00	-10.2204 -1.0106	-12.6698 32.429	1440.0 0.15	168.72 038147.06	-89.9562 2008.42	90.9595 0.22783471E-02
1956.50	-10.2204 -1.0106	-12.6698 32.428	1355.5 0.15	168.51 038954.43	-89.9562 2014.62	91.0012 0.22840416E-02
1957.00	-10.2204 -1.0105	-12.6698 32.427	1271.2 0.15	168.30 039757.54	-89.9563 2020.82	90.9854 0.22897301E-02
1957.50	-10.2204 -1.0105	-12.6698 32.426	1187.2 0.15	168.08 040556.95	-89.9563 2027.01	90.9207 0.22954126E-02

TABLE V. - PROJECT FIRE FLIGHT I REENTRY TRAJECTORY PARAMETERS - Concluded

Elapsed time, sec	Geodetic latitude, deg	Longitude, deg	Altitude, ft	Earth relative velocity, fps	Earth relative flight-path angle, deg	Earth relative heading angle, deg
	Acceleration, g units	Dynamic pressure, psf	Mach number	Reynolds number per foot	Atmospheric pressure, psf	Atmospheric density, slugs/cu ft
1958.00	-10.2204	-12.6698	1103.2	167.87	-89.9563	91.0137
	-1.0105	32.424	0.15	041357.74	2033.22	0.23011059E-02
1958.50	-10.2204	-12.6698	1019.5	167.66	-89.9564	90.9382
	-1.0104	32.423	0.15	042154.15	2039.43	0.23067930E-02
1959.00	-10.2204	-12.6698	935.7	167.45	-89.9566	91.0244
	-1.0104	32.422	0.15	042952.25	2045.65	0.23124910E-02
1959.50	-10.2204	-12.6698	852.0	167.25	-89.9566	90.9463
	-1.0104	32.421	0.15	043752.70	2051.89	0.23181997E-02
1960.00	-10.2204	-12.6698	768.5	167.04	-89.9566	91.0286
	-1.0103	32.420	0.15	044548.73	2058.13	0.23239022E-02
1960.50	-10.2204	-12.6698	685.0	166.83	-89.9566	90.9470
	-1.0103	32.419	0.15	045347.28	2064.38	0.23296155E-02
1961.00	-10.2204	-12.6698	601.5	166.62	-89.9567	91.0219
	-1.0103	32.418	0.15	046146.80	2070.64	0.23353395E-02
1961.50	-10.2204	-12.6698	518.5	166.42	-89.9568	91.0314
	-1.0102	32.417	0.15	046935.08	2076.89	0.23410399E-02
1962.00	-10.2204	-12.6698	435.2	166.21	-89.9569	90.9923
	-1.0102	32.416	0.15	047732.95	2083.16	0.23467680E-02
1962.50	-10.2204	-12.6698	352.2	166.01	-89.9568	91.0106
	-1.0102	32.415	0.15	048526.95	2089.44	0.23524902E-02
1963.00	-10.2204	-12.6698	269.2	165.80	-89.9569	90.9522
	-1.0101	32.414	0.15	049321.03	2095.73	0.23582228E-02
1963.50	-10.2204	-12.6698	186.5	165.60	-89.9570	90.9522
	-1.0101	32.413	0.15	050111.48	2102.01	0.23639486E-02
1964.00	-10.2204	-12.6698	103.7	165.40	-89.9571	90.9994
	-1.0101	32.412	0.15	050903.27	2108.32	0.23696852E-02
1964.50	-10.2204	-12.6698	21.0	165.19	-89.9571	90.9893
	-1.0100	32.411	0.15	051697.80	2114.63	0.23754325E-02
1964.63	-10.2204	-12.6698	0.	165.14	-89.9571	90.9545
	-1.0100	32.411	0.15	051899.23	2116.24	0.23768929E-02

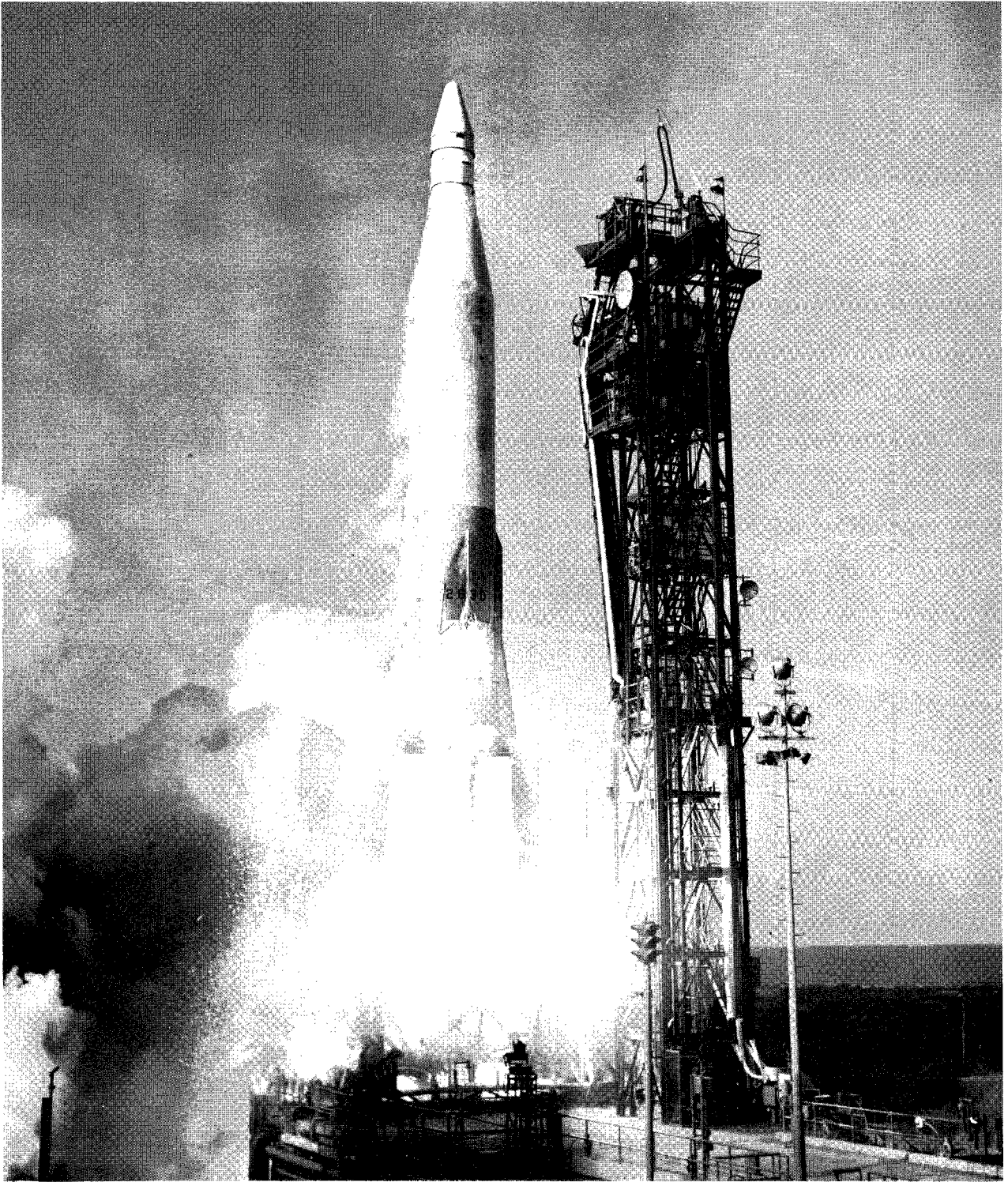

Figure 1.- Lift-off of Project Fire space vehicle.

L-65-139

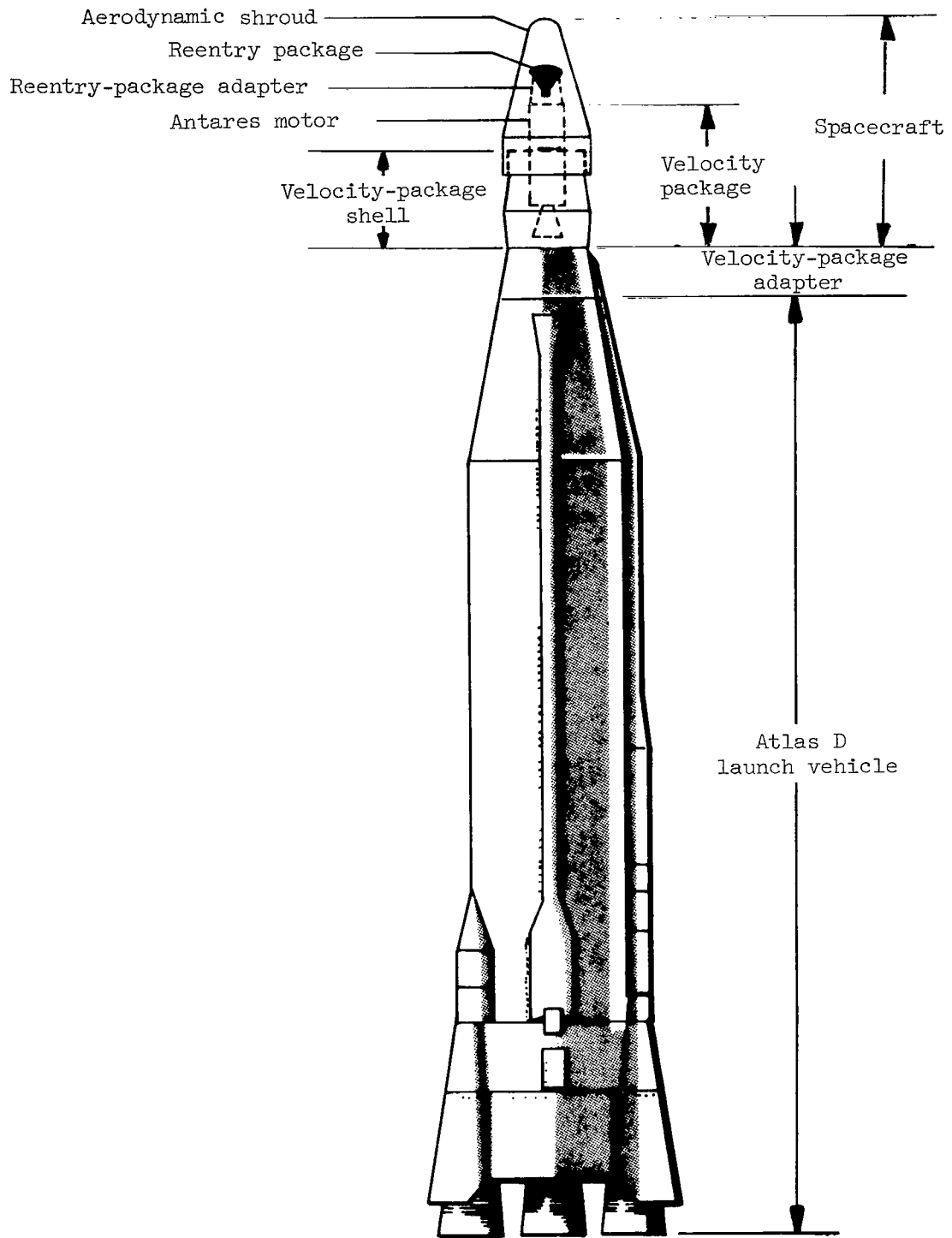
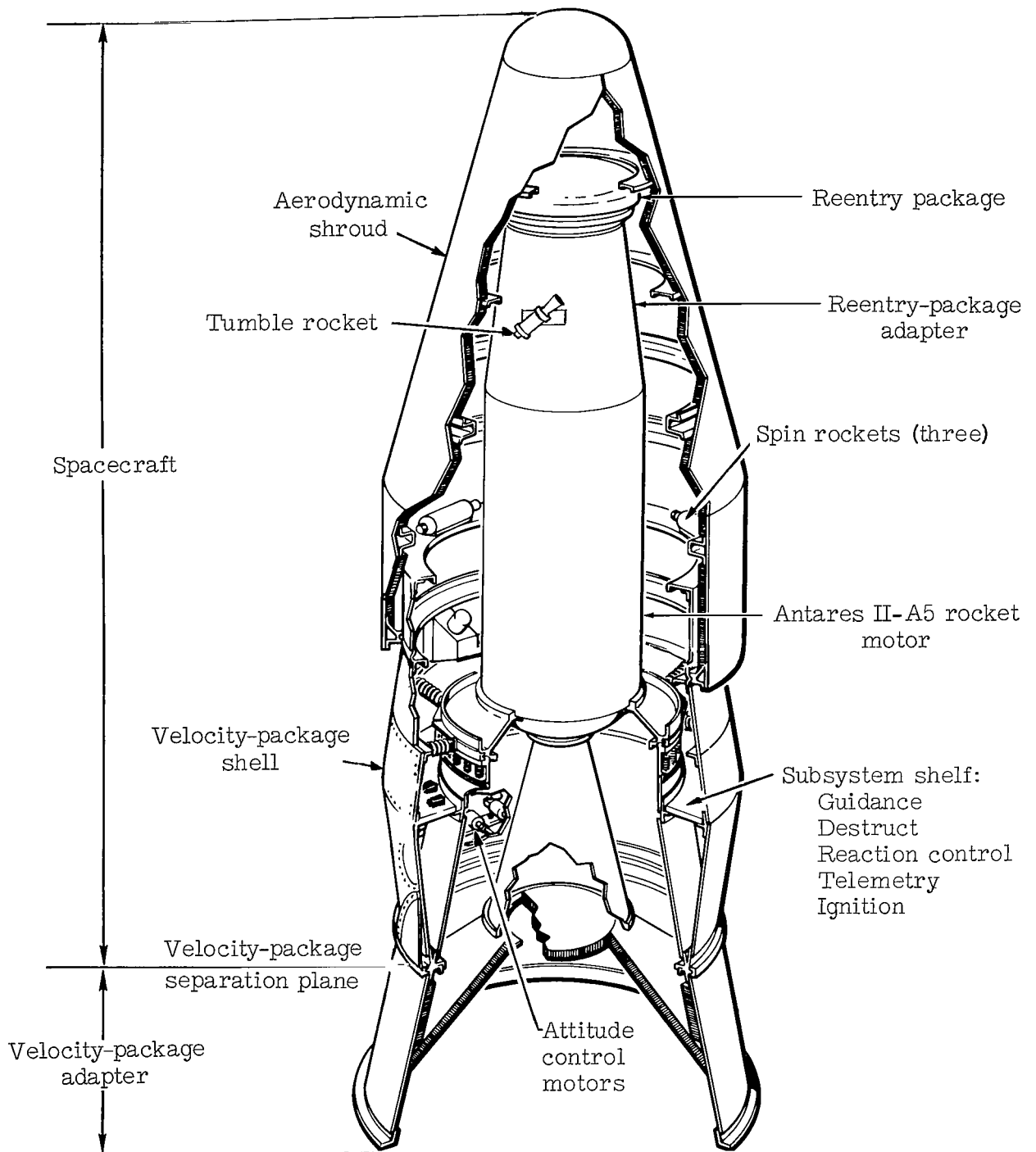
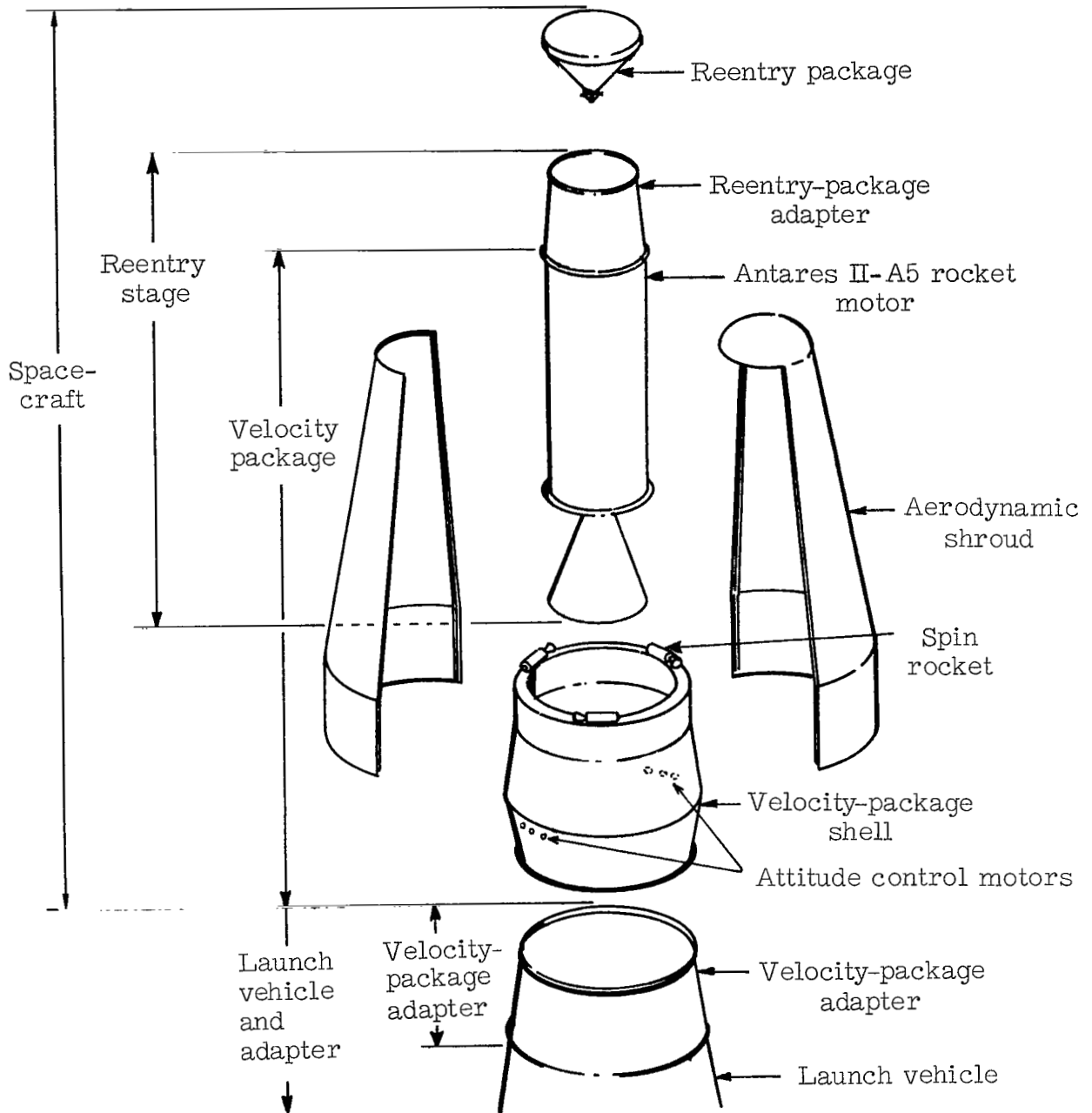

Figure 2.- Project Fire space vehicle.



(a) Cutaway view of spacecraft.

Figure 3.- General spacecraft configuration.



(b) Exploded view of spacecraft.

Figure 3.- Continued.

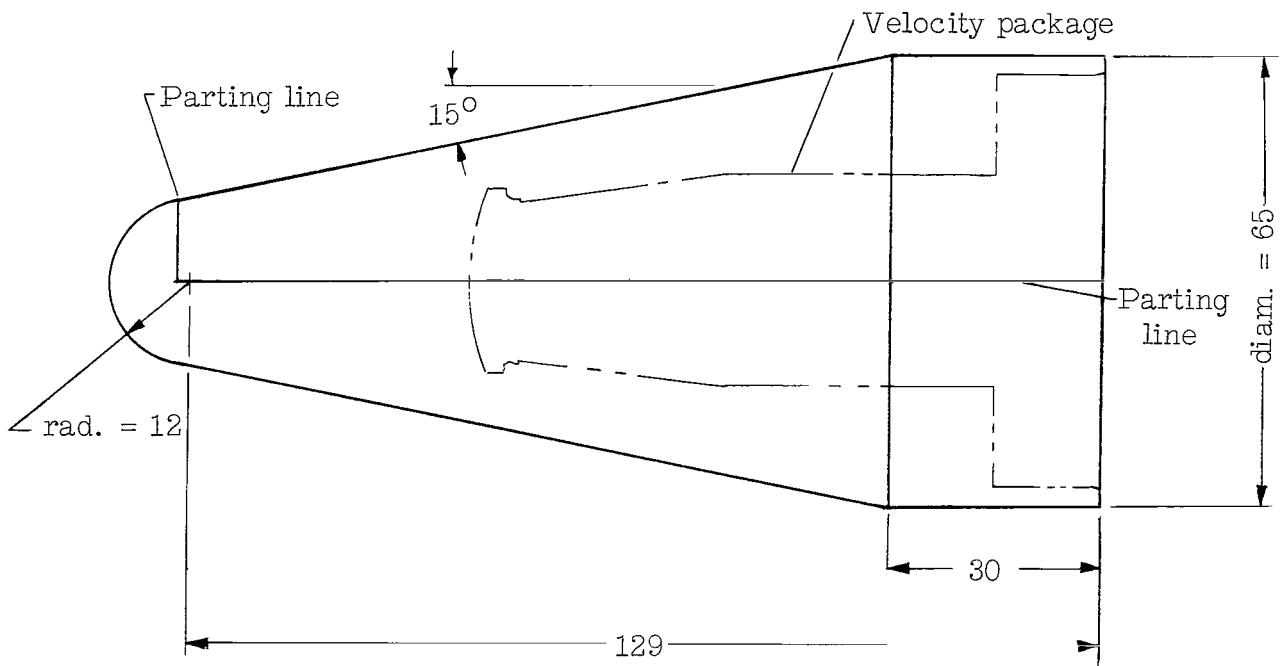

(c) Aerodynamic shroud. (All dimensions are in inches unless otherwise noted.)

Figure 3.- Concluded.

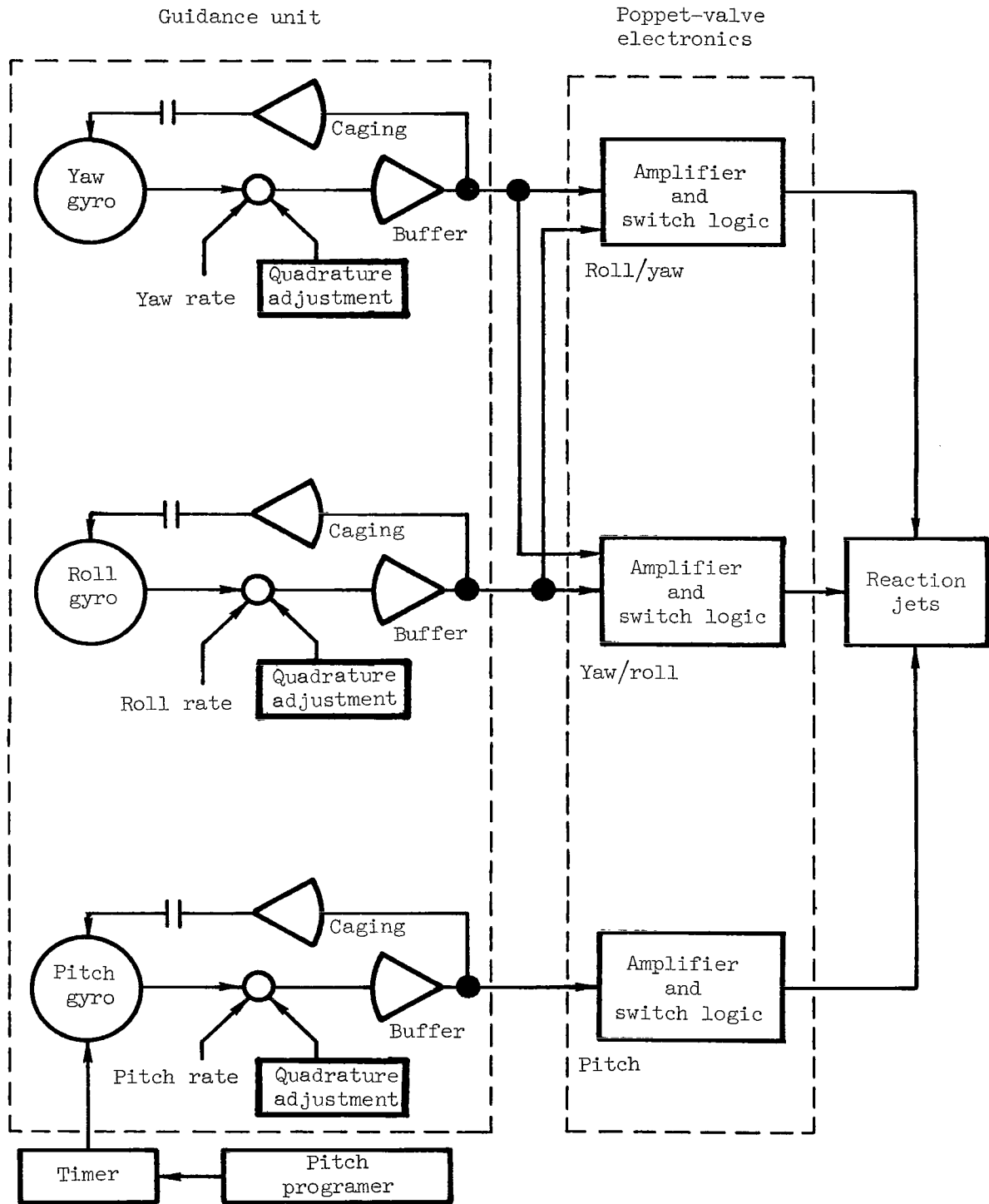

Figure 4.- Block diagram of velocity-package stabilization and control system.

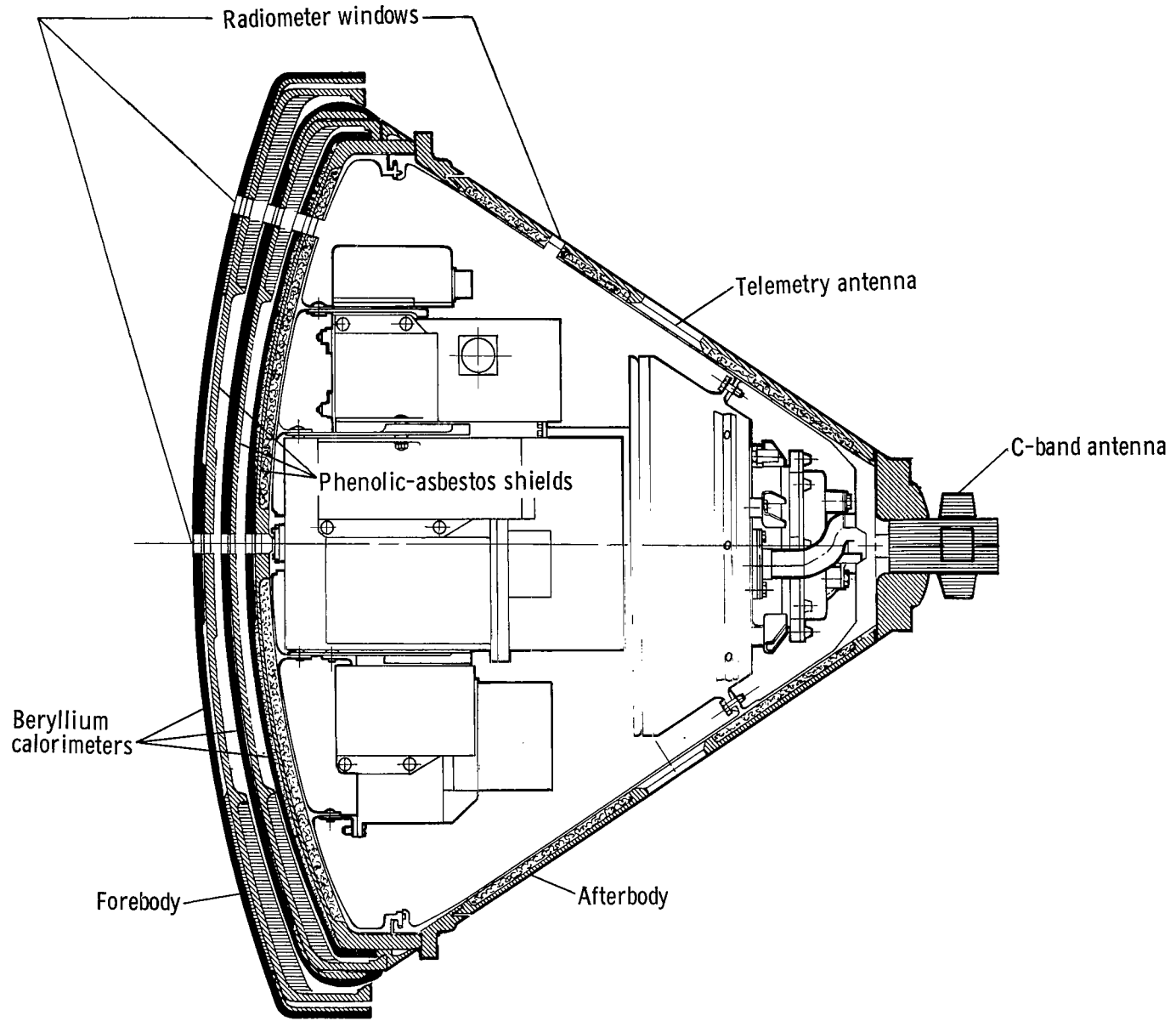

Figure 5.- Sectional sketch of reentry package showing general arrangement of forebody calorimeters and heat shields.

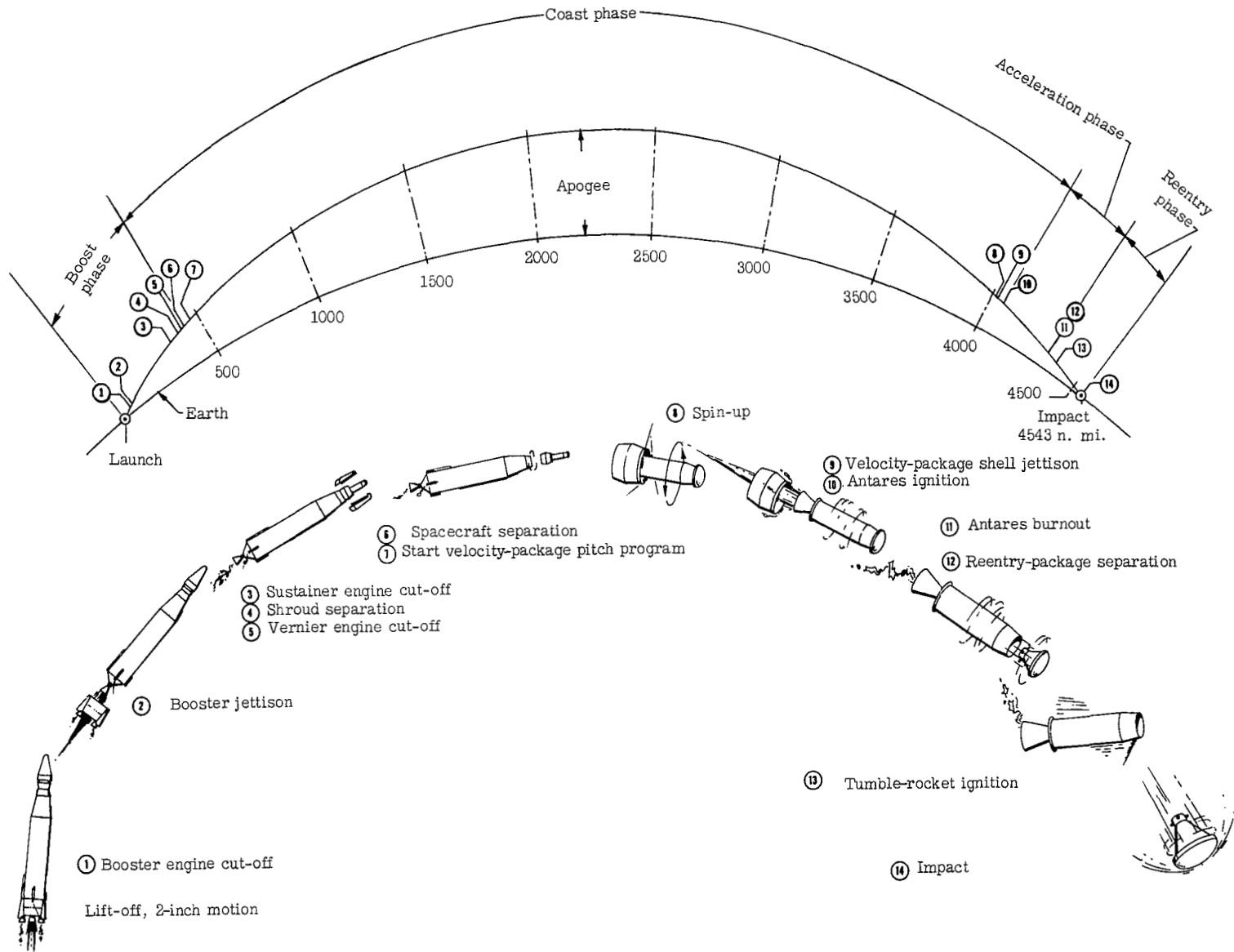
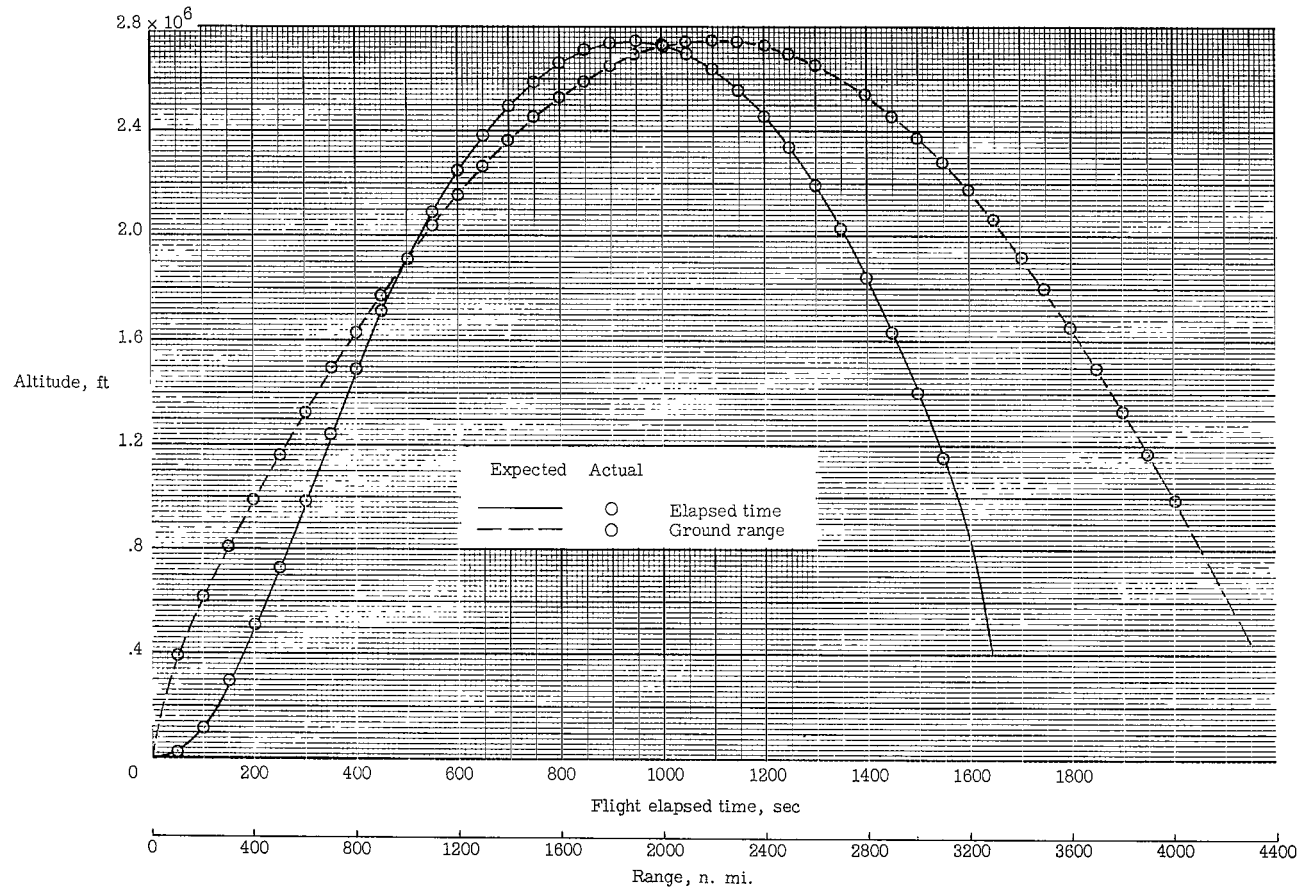
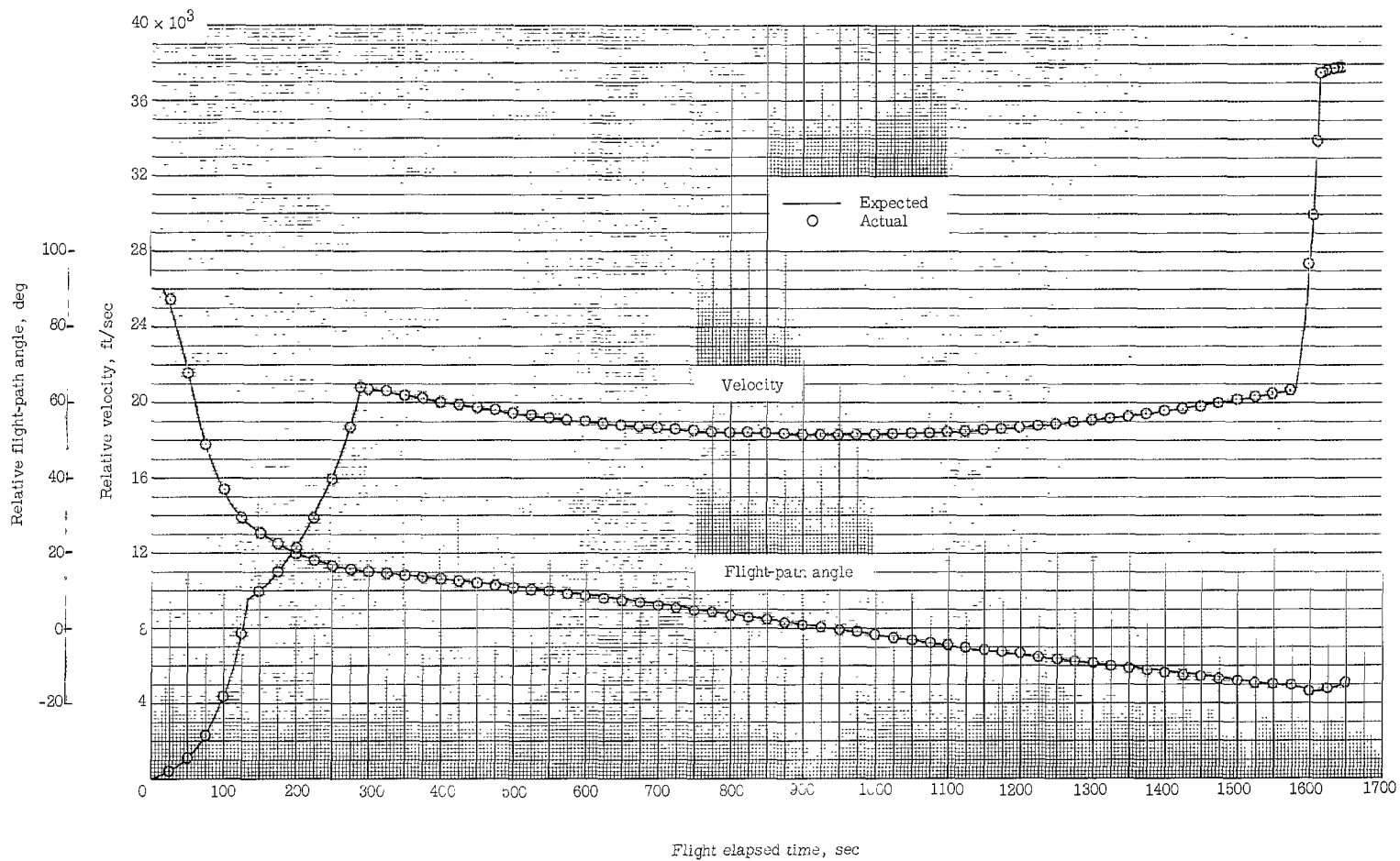

Figure 6.- Sequence of events in Project Fire flight 1.



(a) Variation of altitude with ground range and flight elapsed time.

Figure 7.- Trajectory parameters as determined from Eastern Test Range tracking data.



(b) Variation of velocity and flight-path angle with elapsed time.

Figure 7.- Continued.

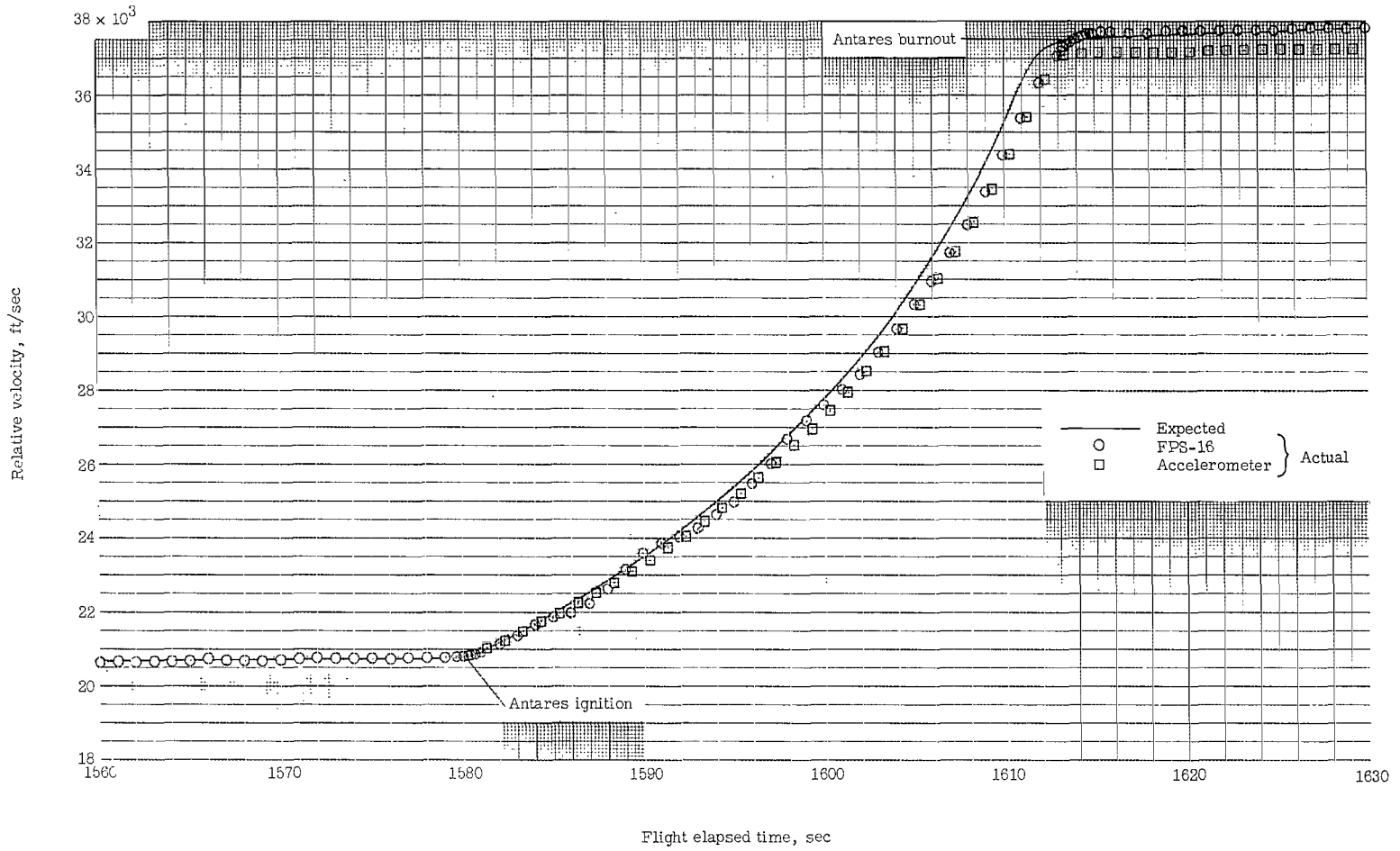

(c) Variation of velocity with time during burning of Antares II-A5.

Figure 7.- Concluded.

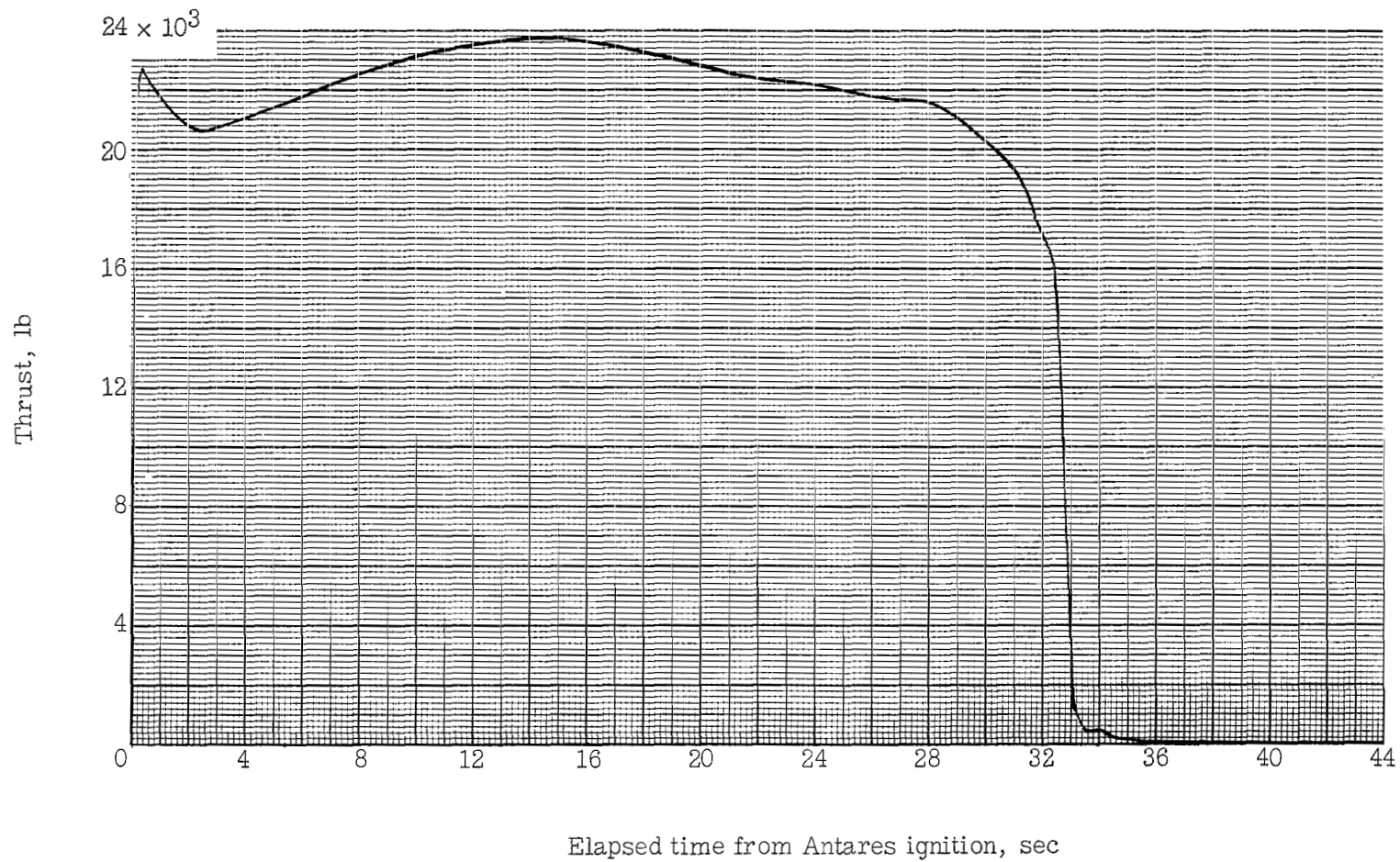

(a) Variation of thrust with time.

Figure 8.- Performance parameters for Antares II-A5.

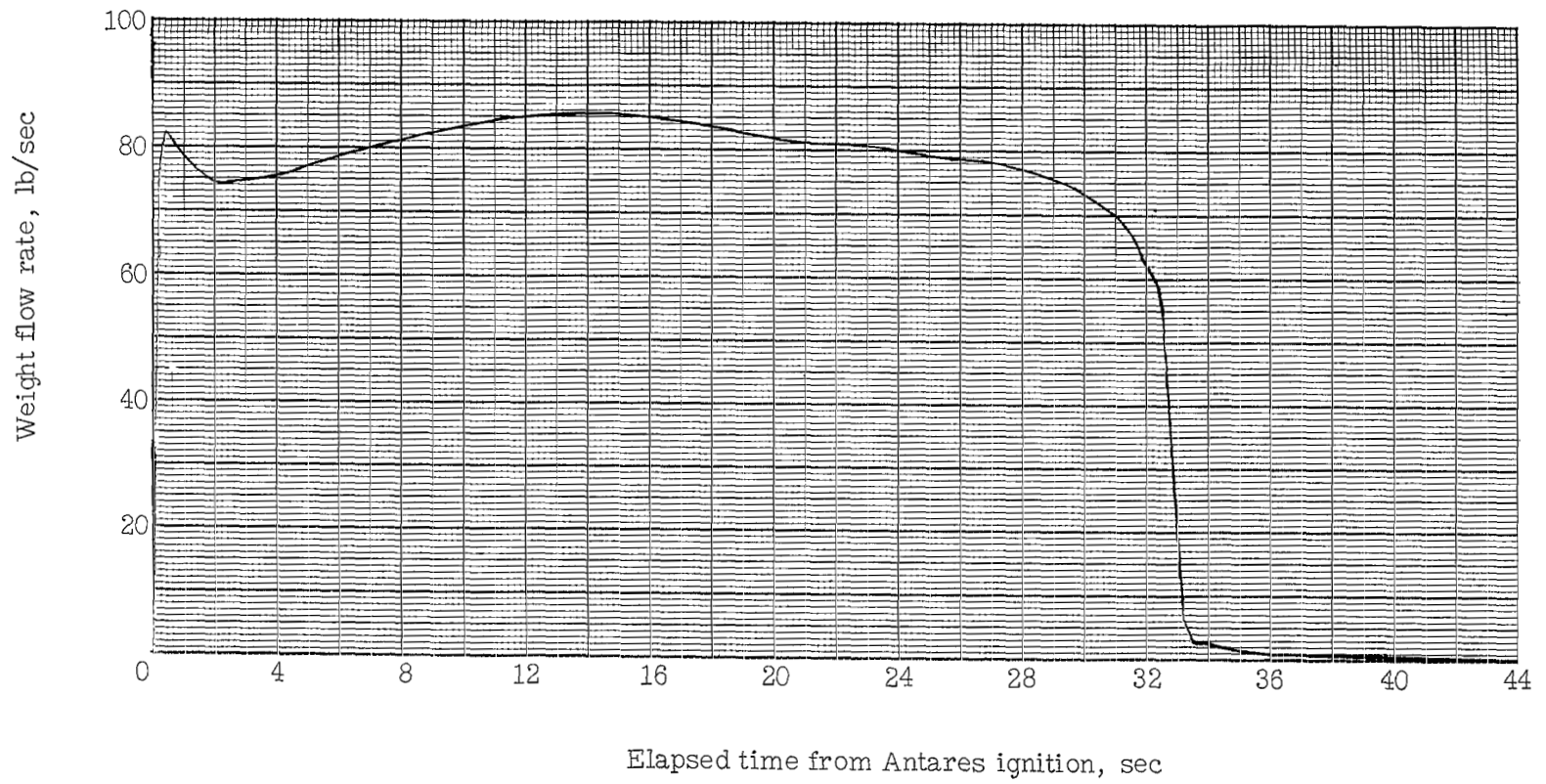

(b) Variation of weight flow rate with time.

Figure 8.- Concluded.

Disturbance: elapsed time = 1665.94

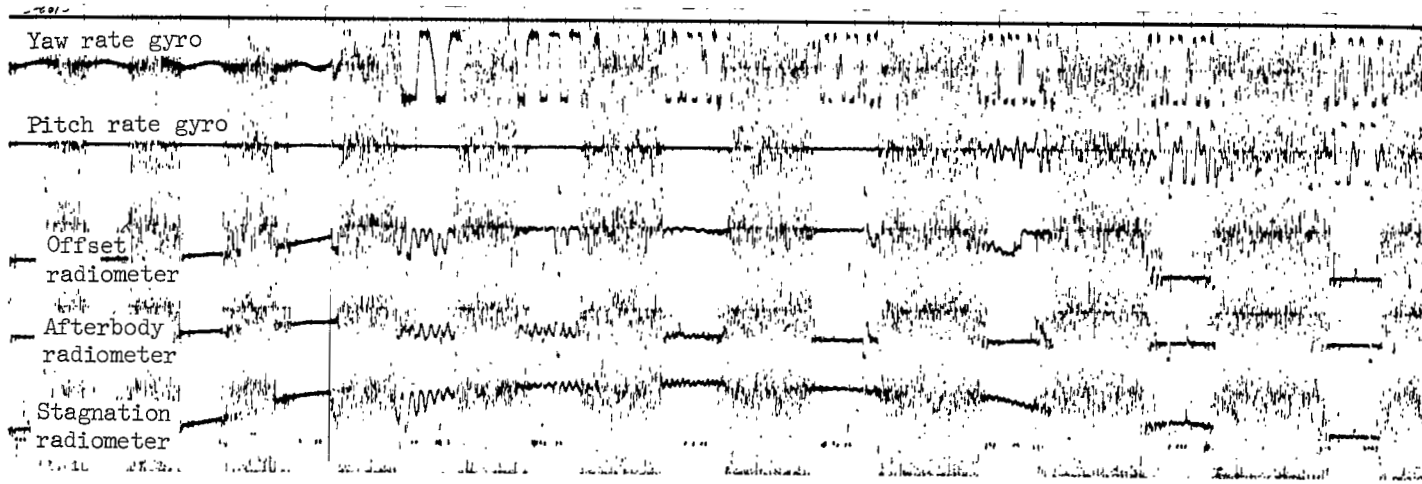

First playback

Disturbance: elapsed time = 1665.94

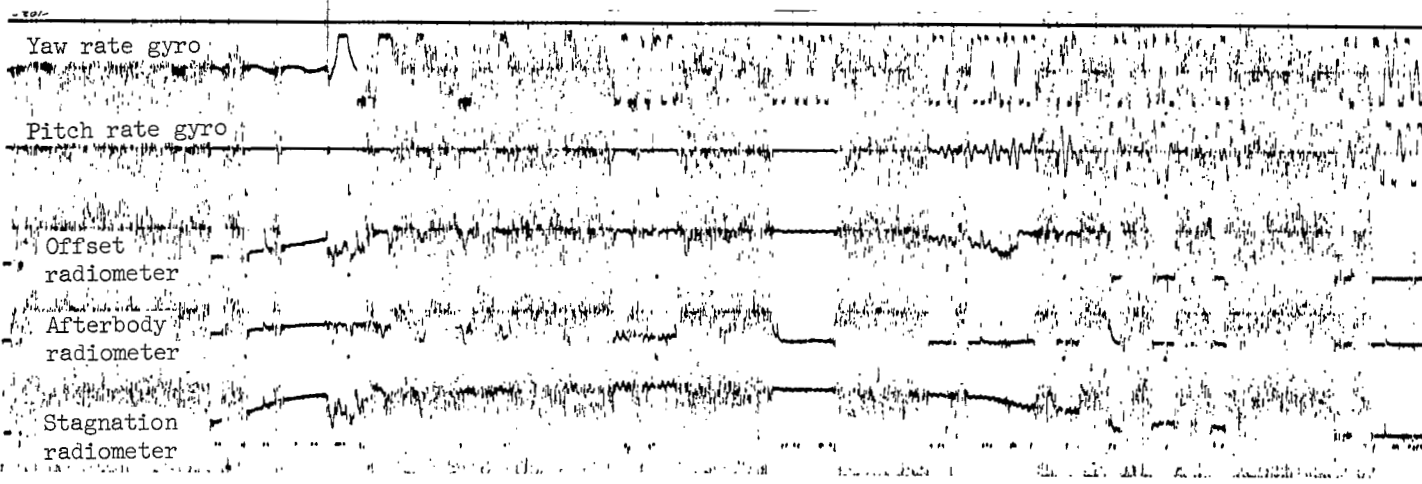

Second playback

Figure 9.- Samples of continuous-channel telemetered data received by Ascension Island telemetry receiver (TLM-18) site during first and second playback transmissions.

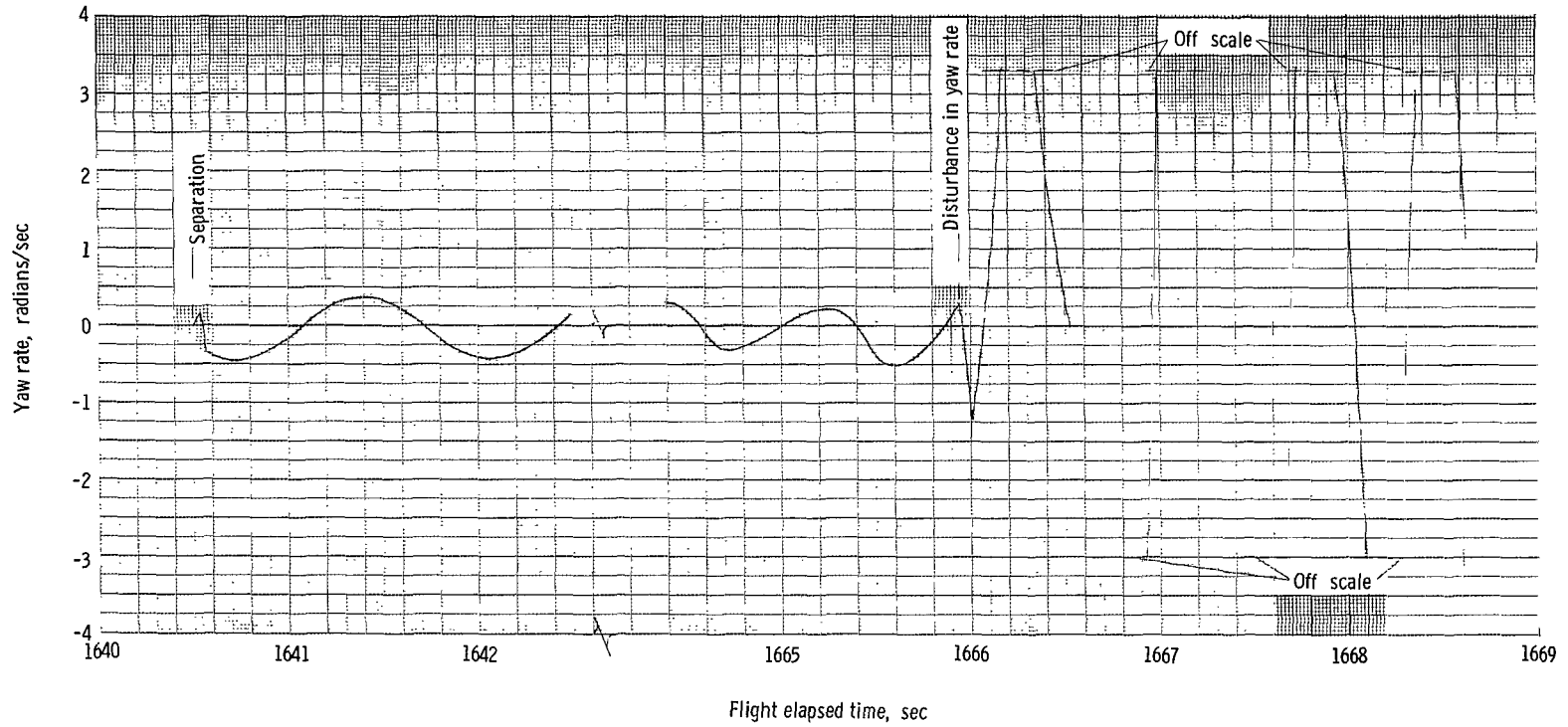

Figure 10.- Variation of yaw rate with flight elapsed time.

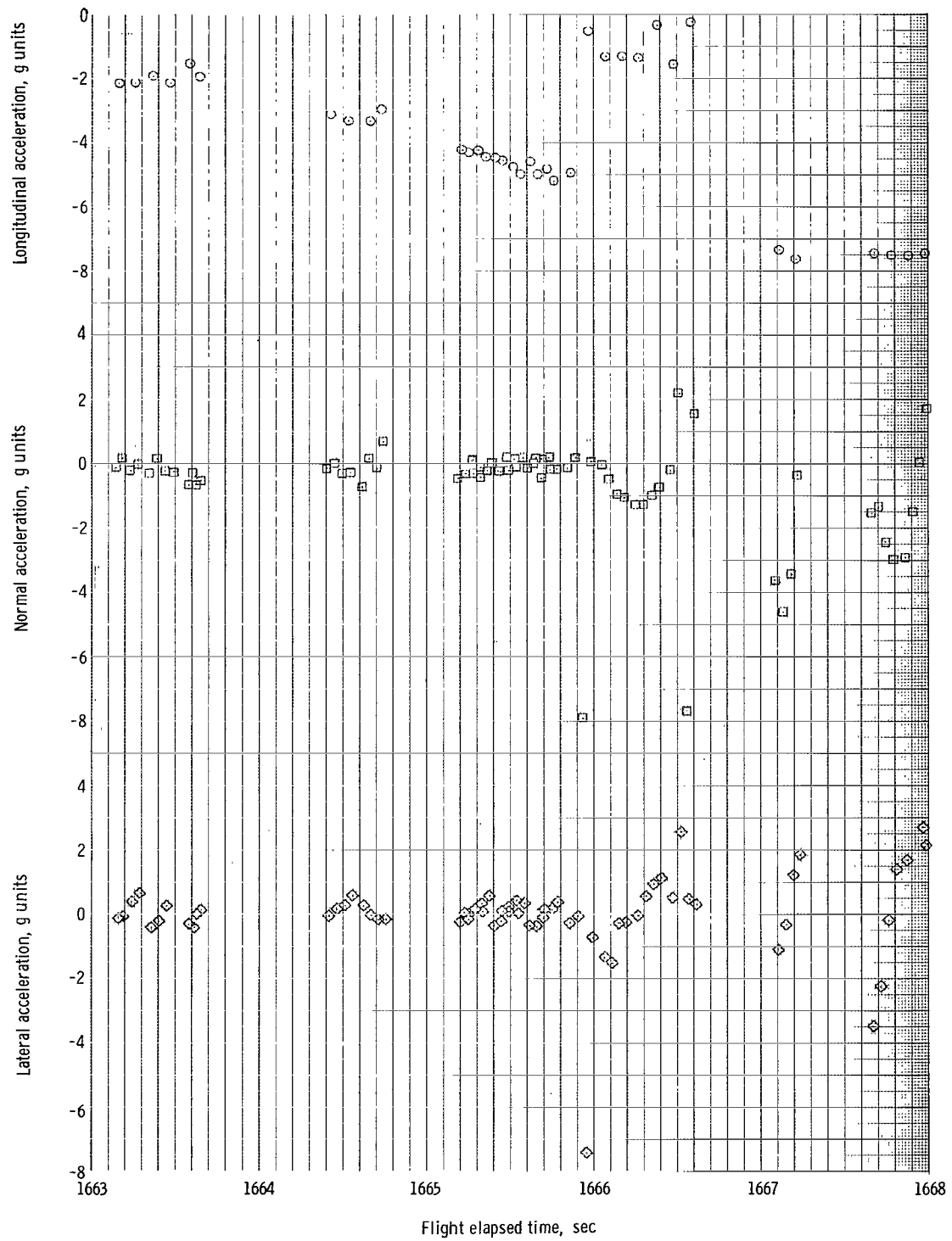
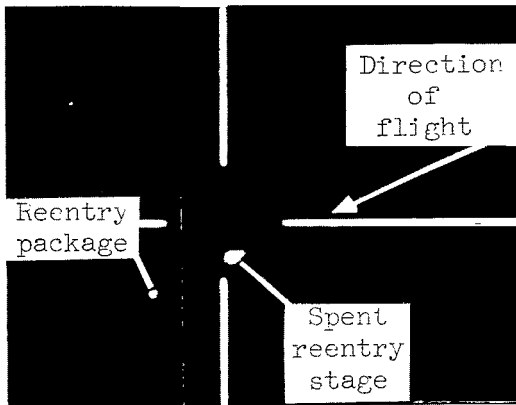
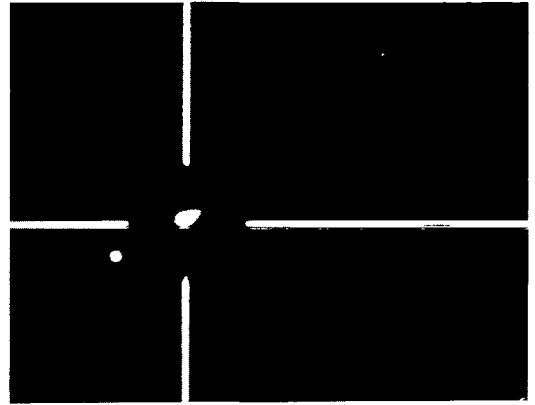

Figure 11.- Variation of longitudinal, normal, and lateral accelerations with time.



Time = 1661.1 sec



Time = 1663.0 sec

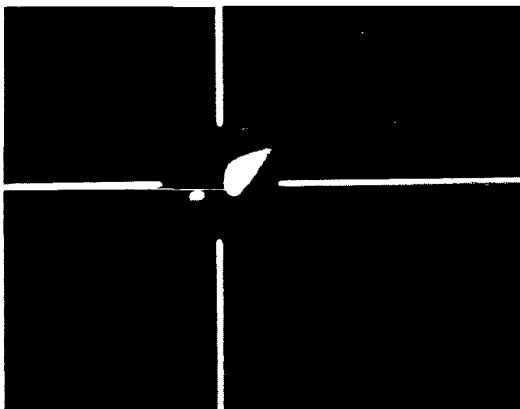

Time = 1664.4 sec

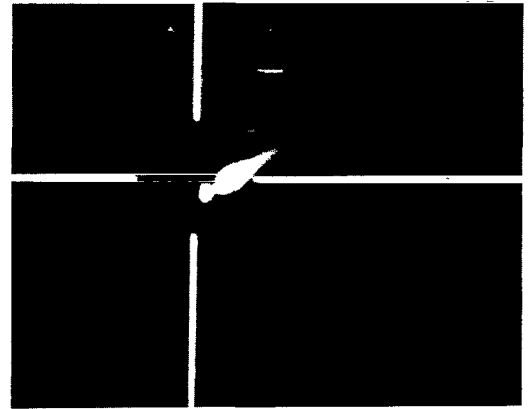

Time = 1665.4 sec

Figure 12.- Four representative frames of motion-picture film taken during reentry.

L-65-194

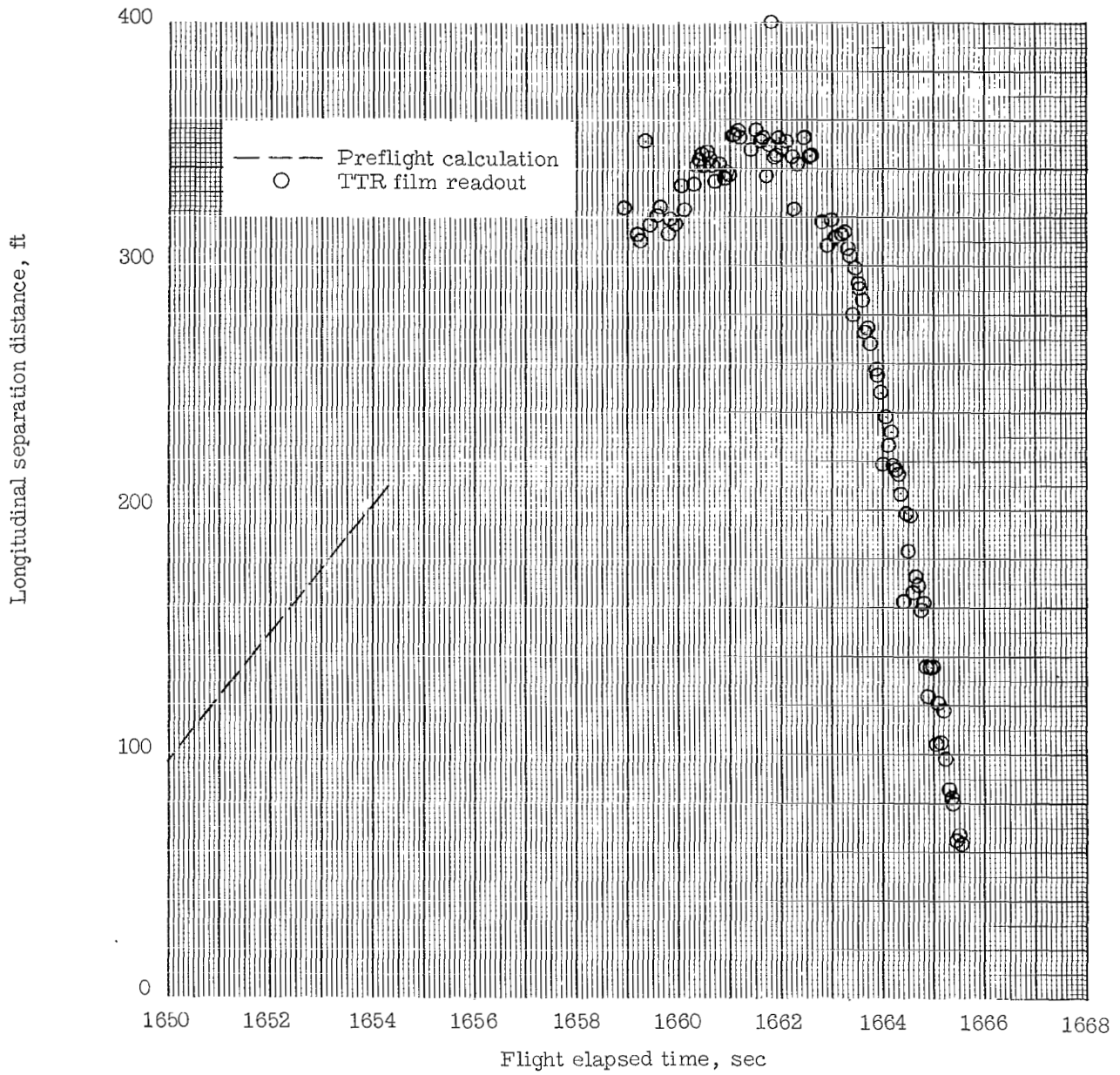

Figure 13.- Variation of longitudinal separation distance with elapsed time as obtained from motion-picture film.



Figure 14.- Reentry-stage shock wave impinging on reentry-package at a Mach number of 4.60. $y/d = 4$.

L-65-140

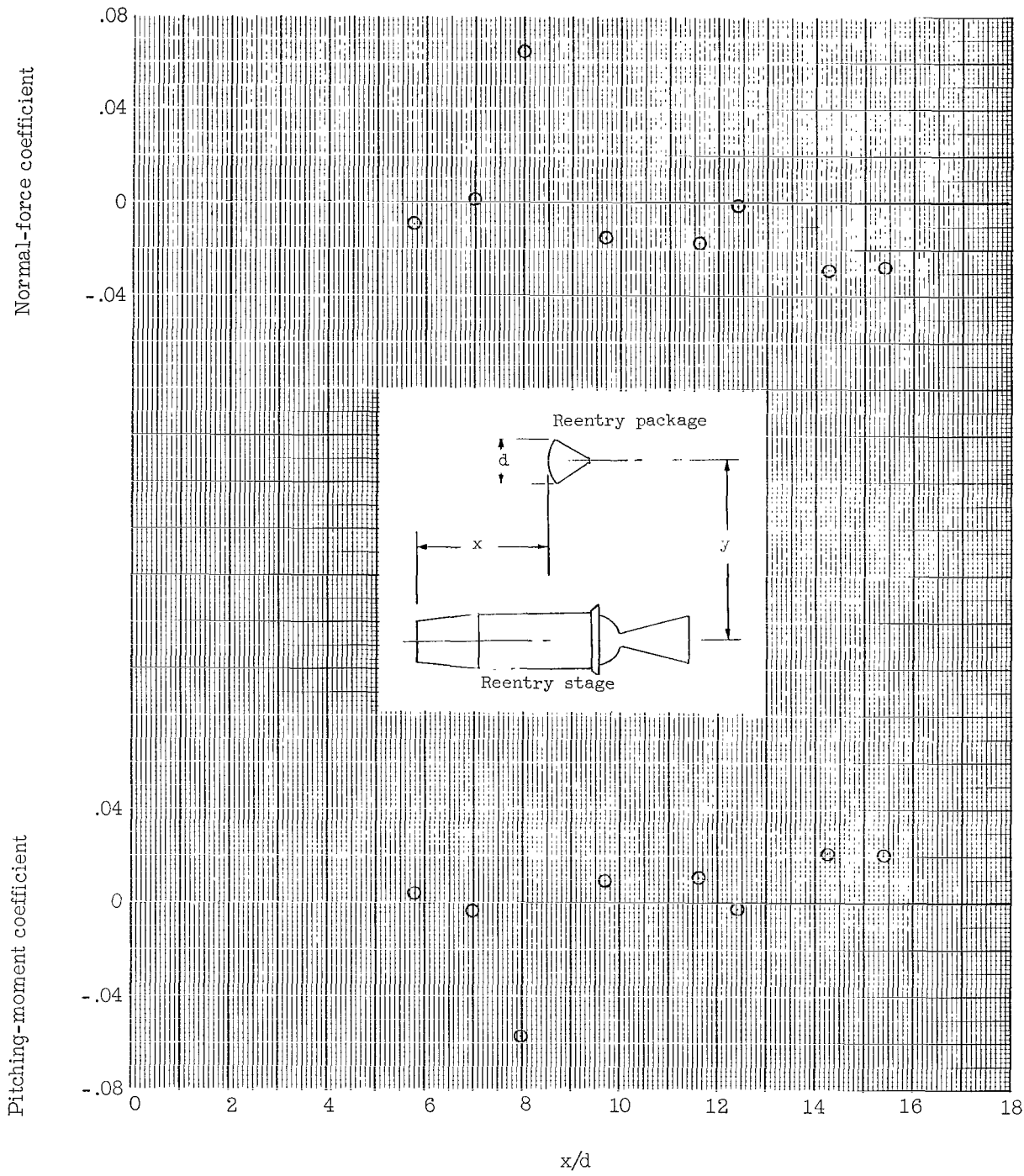

Figure 15.- Variation of normal-force and pitching-moment coefficients with x/d for reentry package in proximity to reentry stage at a Mach number of 4.63. $y/d = 4$.

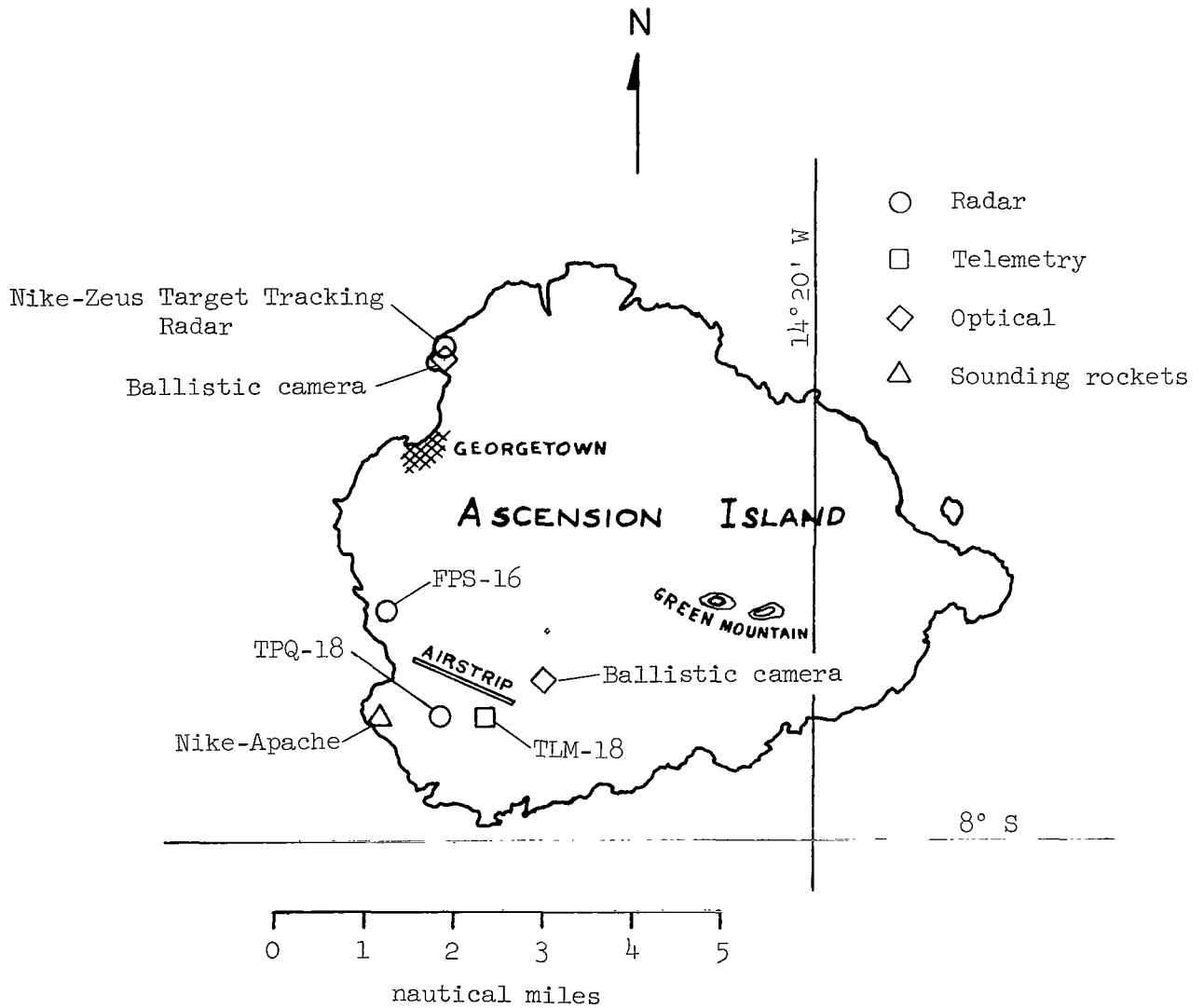
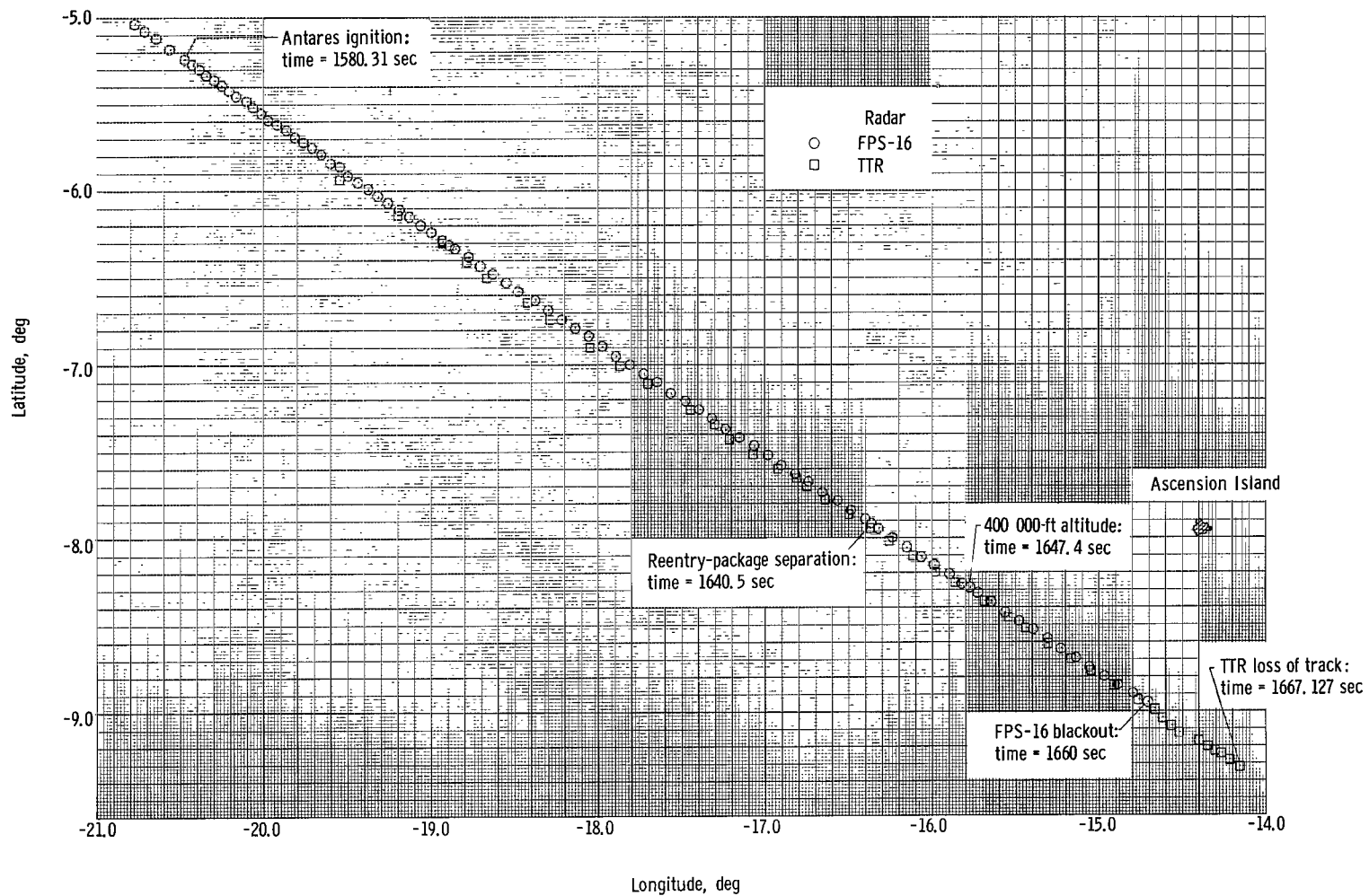
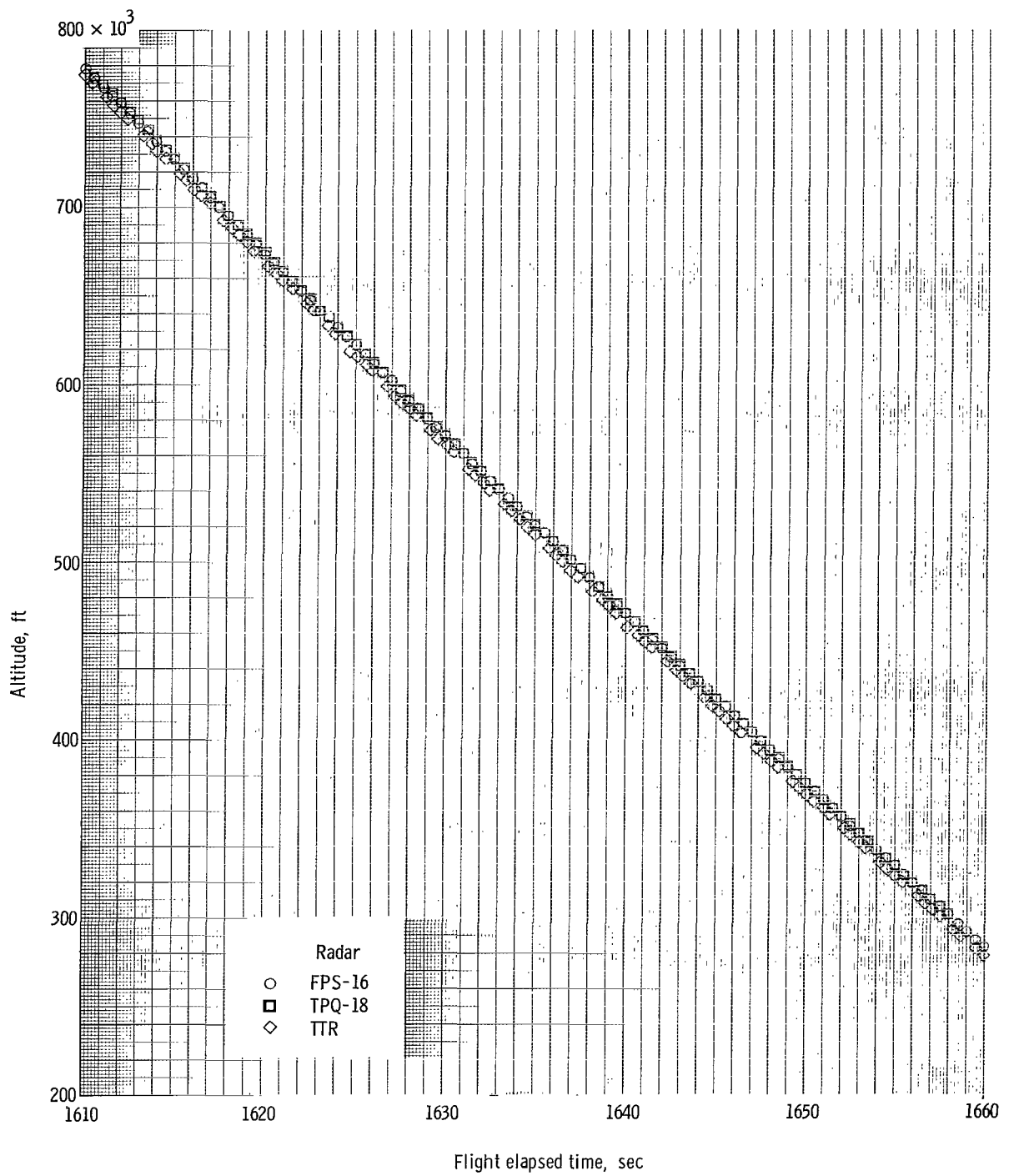

Figure 16.- Major sources of data on Ascension Island.



(a) Ground track obtained from radar data between 1569.0 and 1667.127 sec.

Figure 17.- Comparison of flight trajectory parameters obtained from Ascension Island trackers.



(b) Variation of altitude with time.

Figure 17.- Continued.

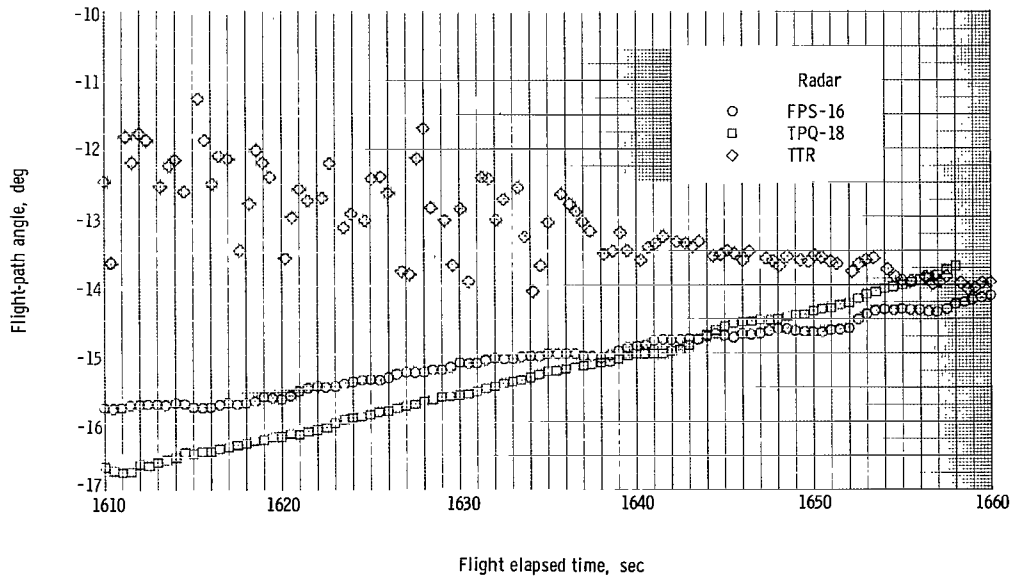
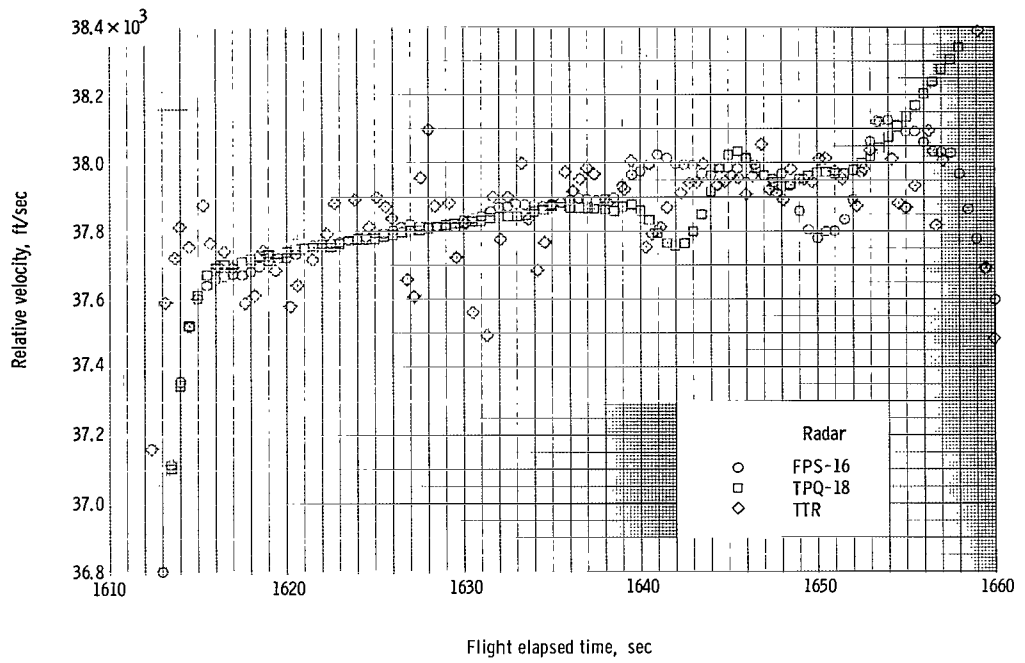

(c) Variation of velocity and flight-path angle with time.

Figure 17.- Concluded.

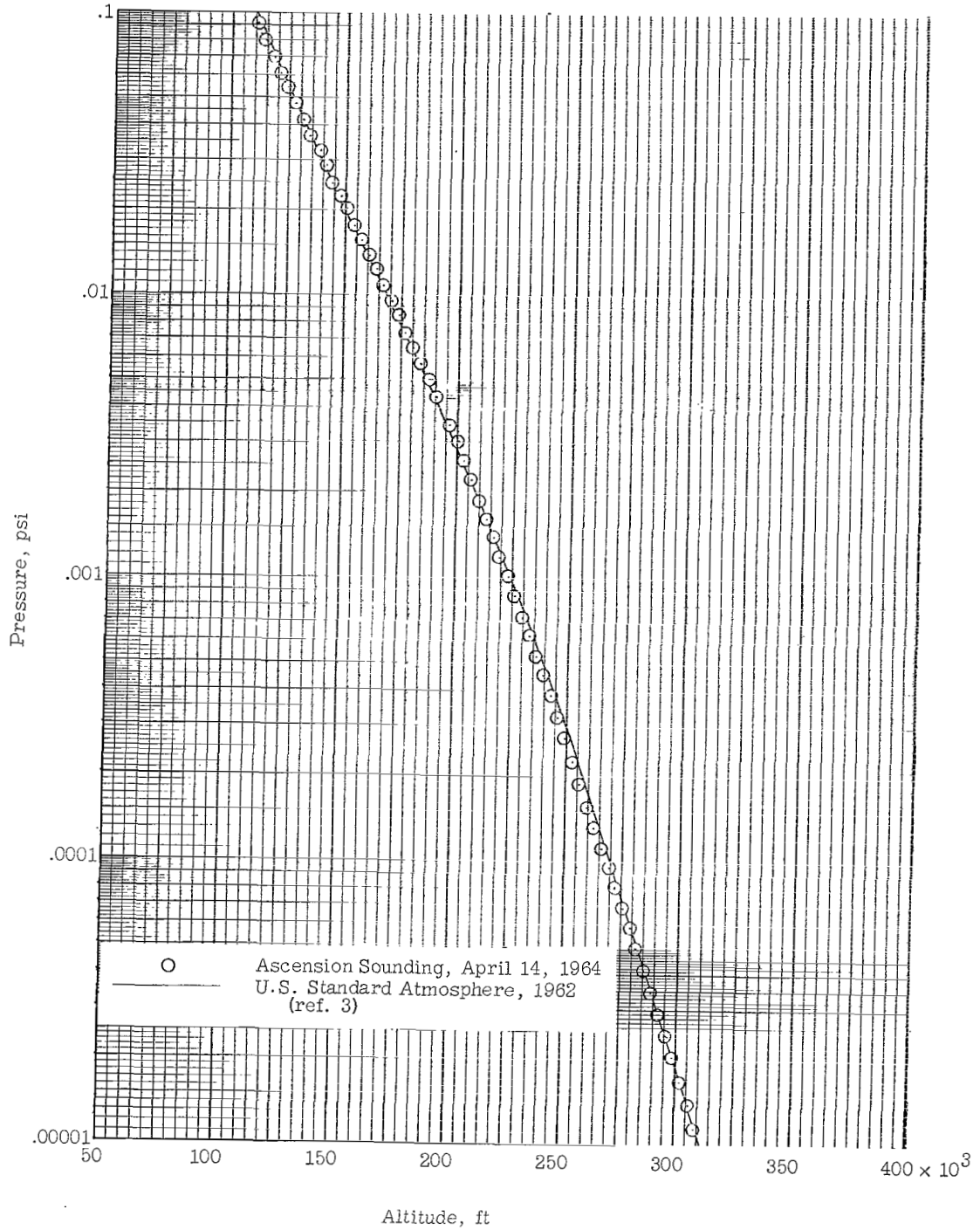

(a) Variation of pressure with altitude. Sea-level pressure = 14.68055 psi.

Figure 18.- Ambient atmospheric conditions as obtained from sounding rockets at Ascension Island.

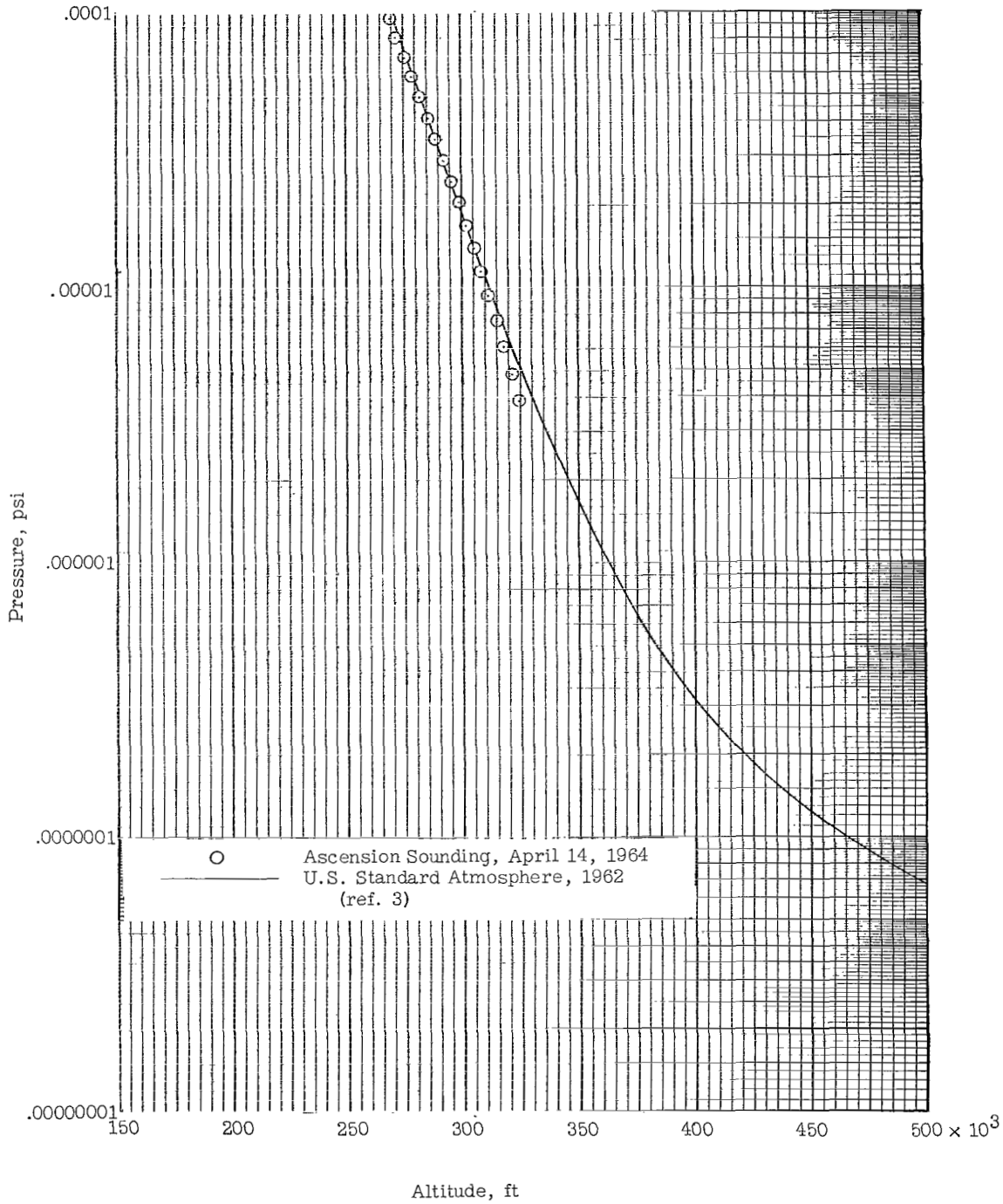

(a) Concluded.

Figure 18.- Continued.

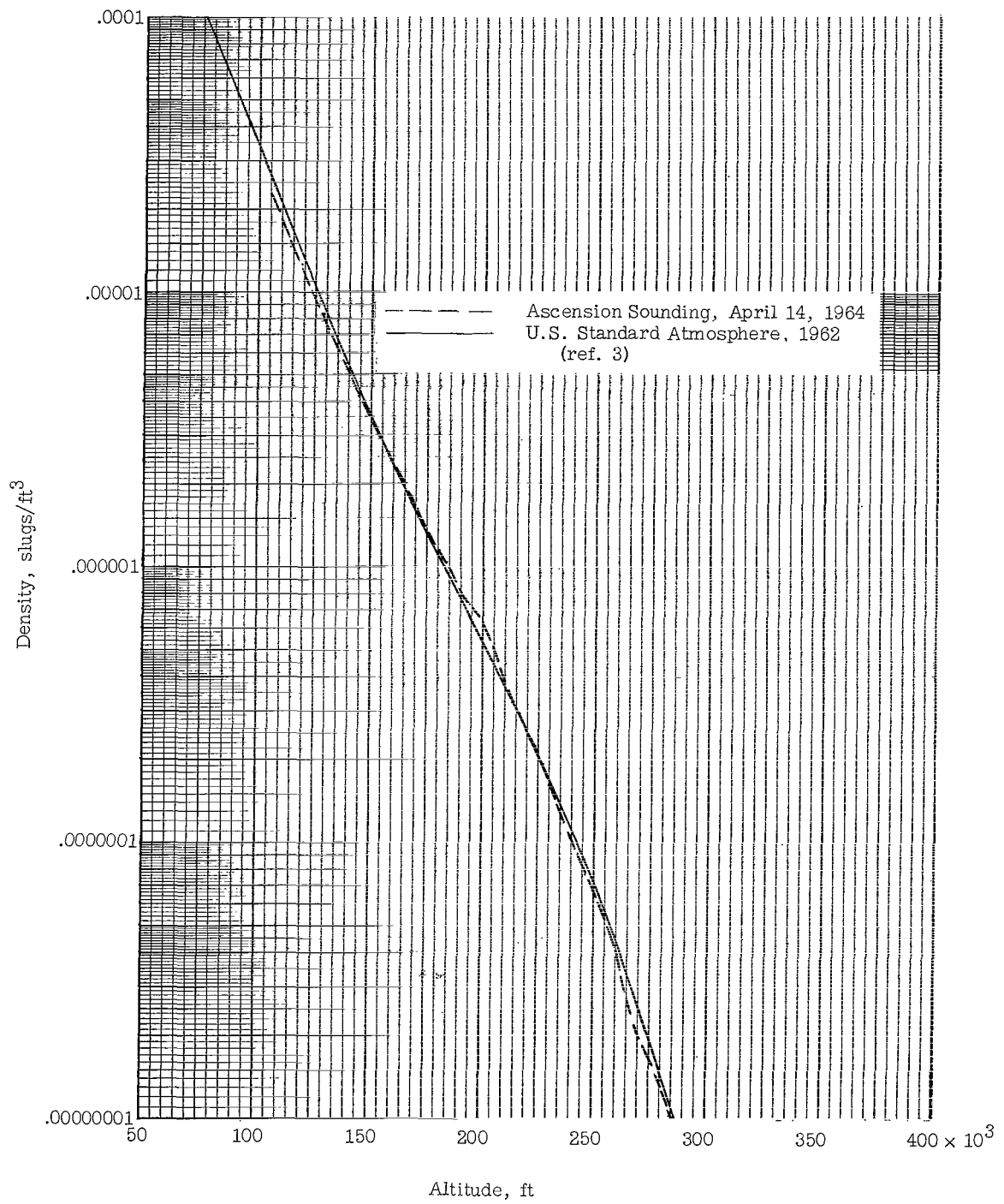

(b) Variation of density with altitude. Sea-level density = 0.00228 slug/ft³.

Figure 18.- Continued.

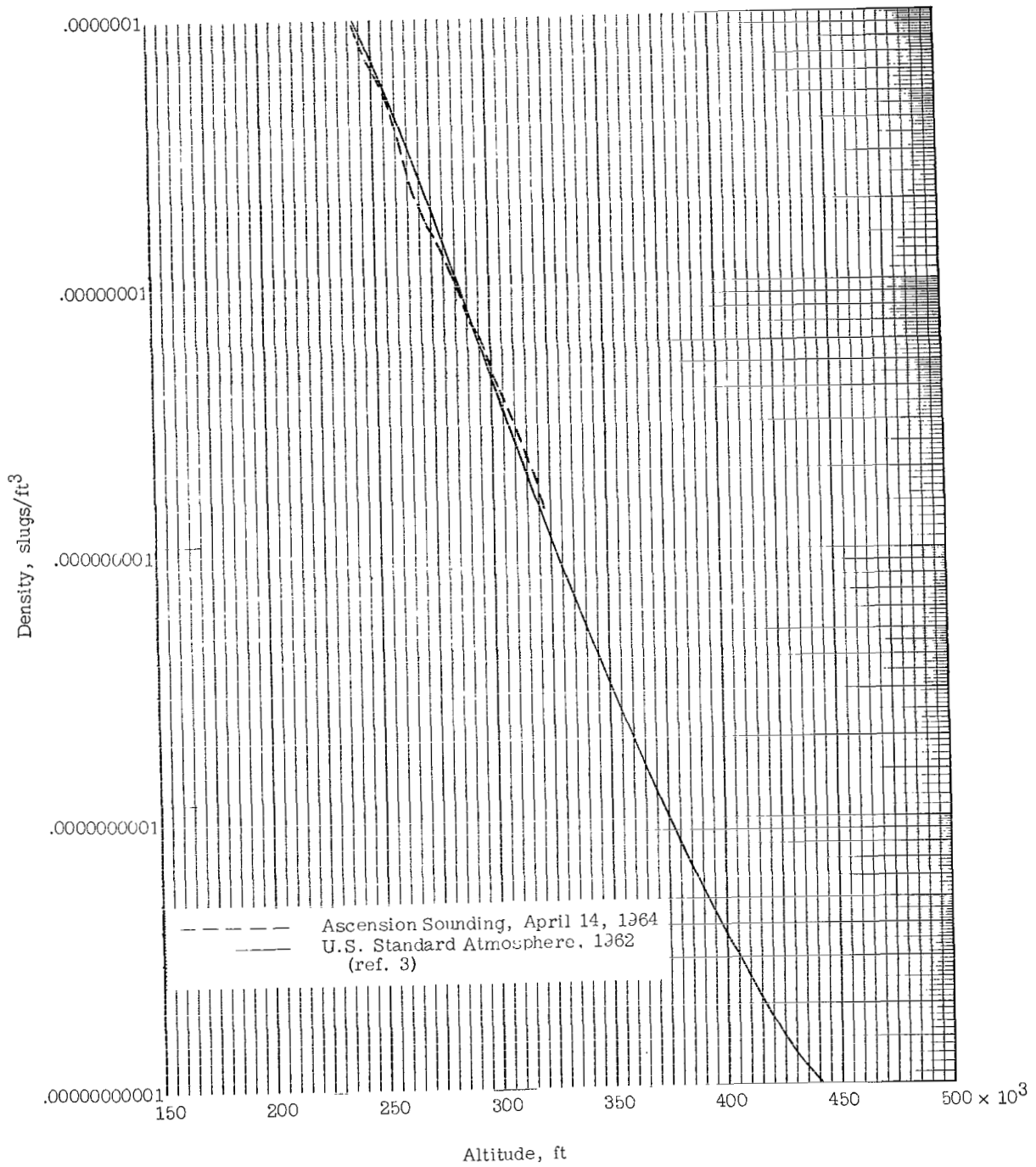

(b) Concluded.

Figure 18.- Continued.

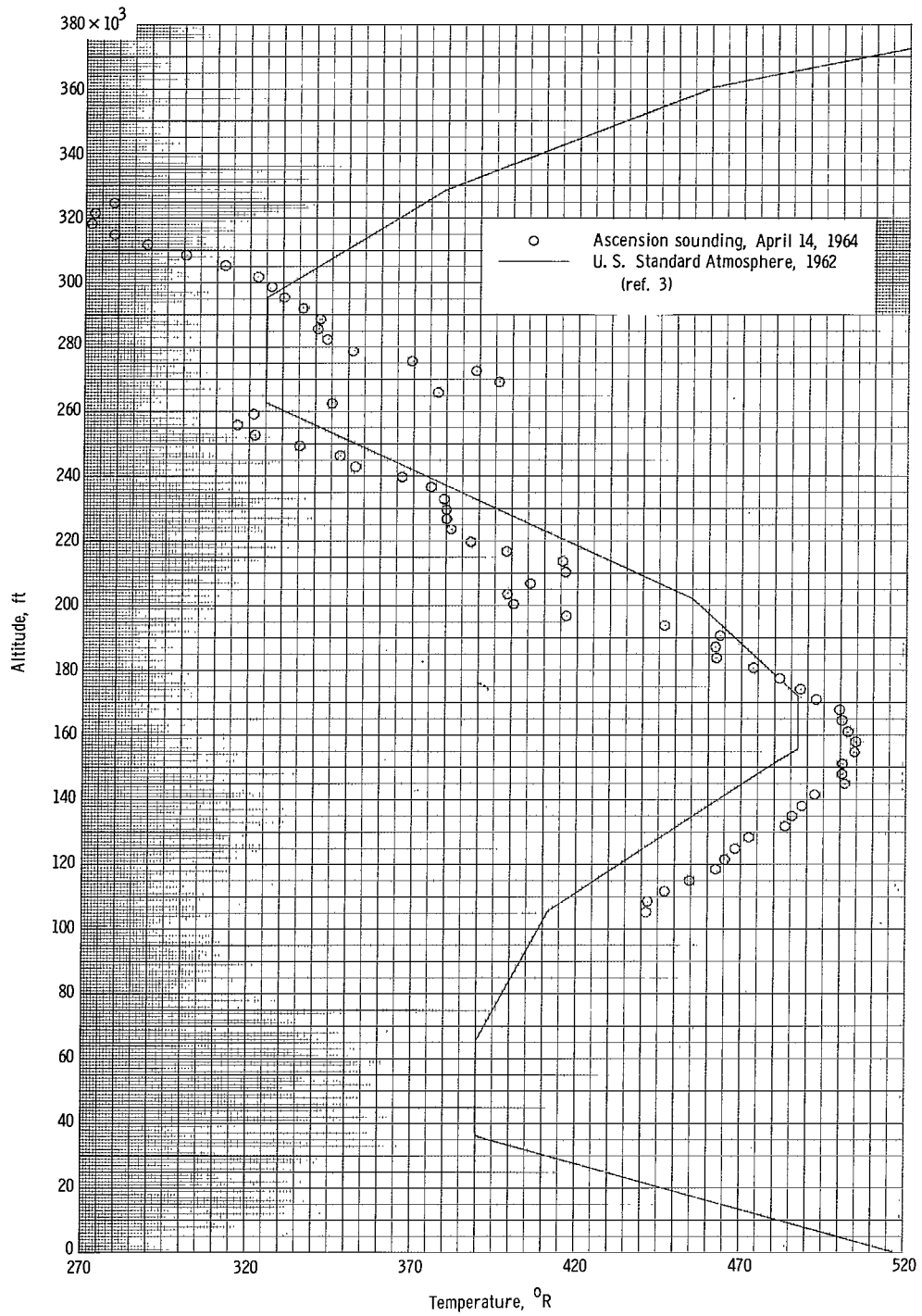

(c) Variation of temperature with altitude. Sea-level temperature = 539.7° R.

Figure 18.- Concluded.

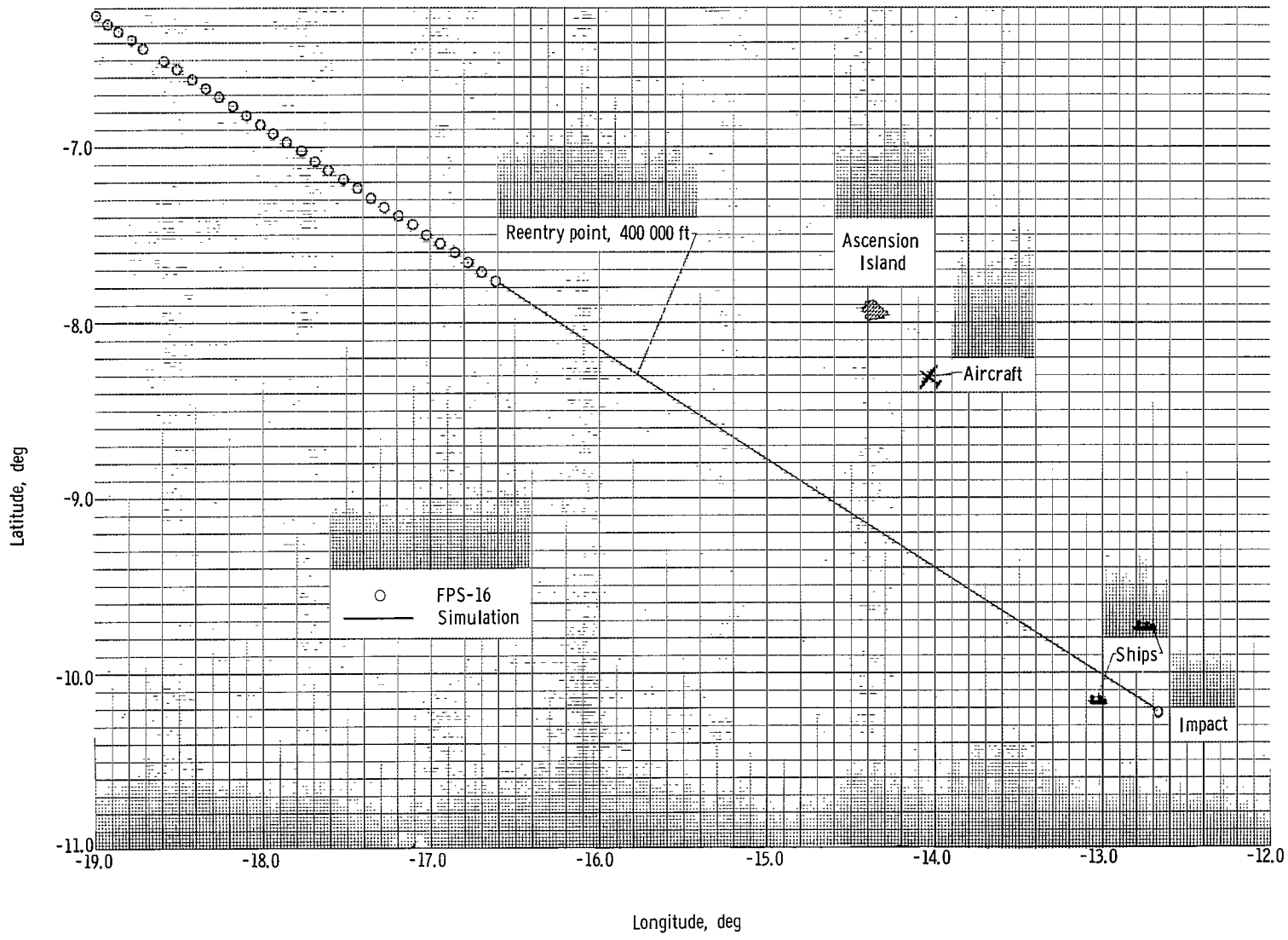

(a) Reentry ground track.

Figure 19.- Reentry trajectory parameters as obtained from computer simulation.

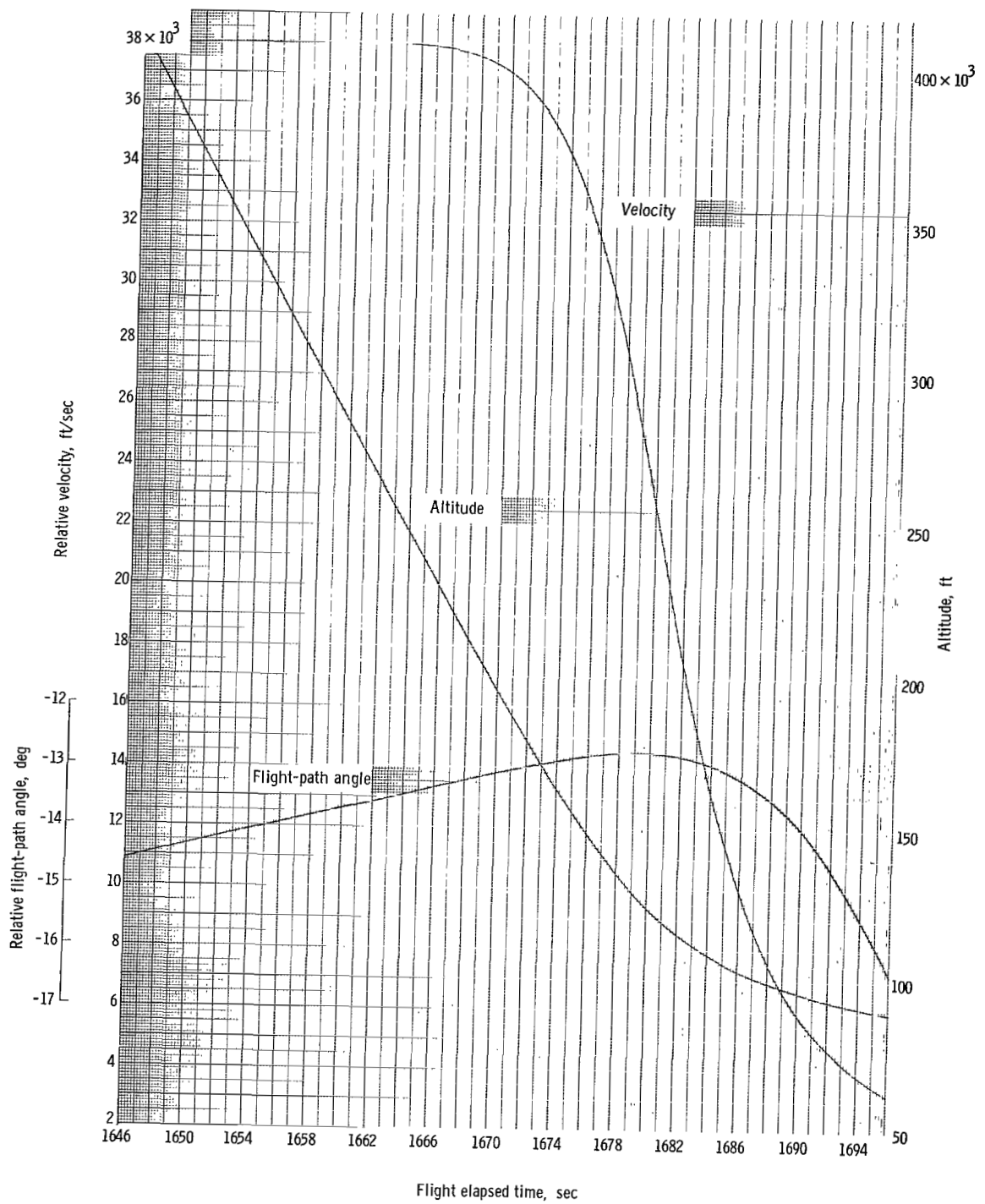

(b) Variation of altitude, velocity, and flight-path angle with time from reentry point (altitude = 400 000 feet).

Figure 19.- Concluded.

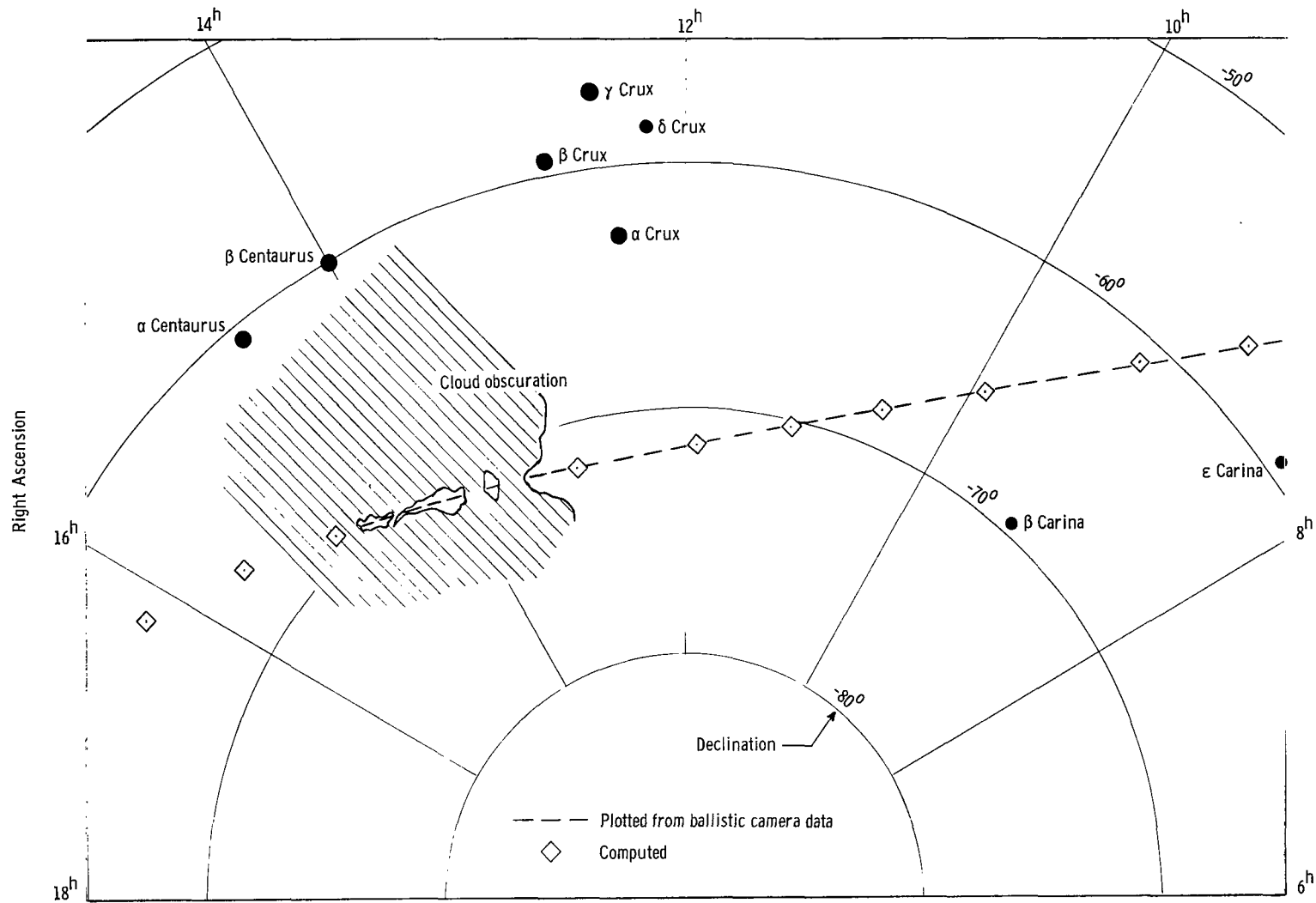

Figure 20.- Comparison of reentry trail as computed from simulation with that obtained from ballistic-camera data showing its relationship to prominent stars.

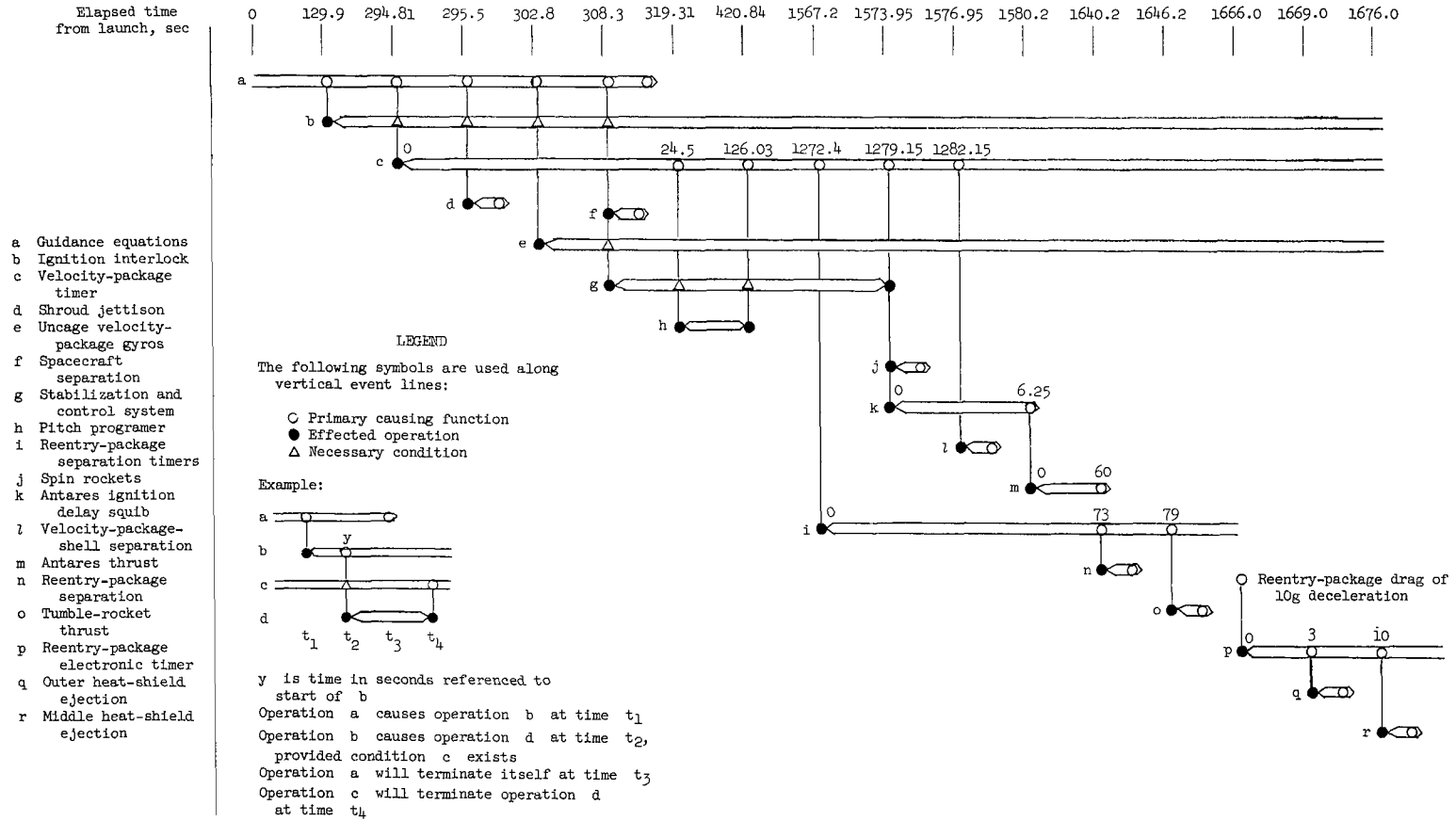

Figure 21.- Logic diagram showing functional relationship of major spacecraft events.