

**NASA TECHNICAL NOTE**

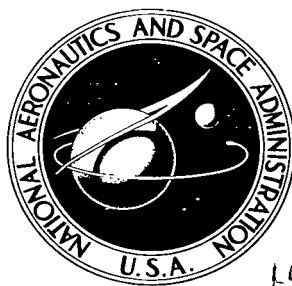

**NASA TN D-3428**

**NASA TN D-3428**

c 1

LOAN COPY: F  
AFWL (W  
KIRTLAND AF

0130165



TECH LIBRARY KAFB, NM

# PERFORMANCE OF ROCKET NOZZLE MATERIALS WITH SEVERAL SOLID PROPELLANTS

*by James R. Johnston, Robert A. Signorelli, and John C. Freche*

*Lewis Research Center*

*Cleveland, Ohio*

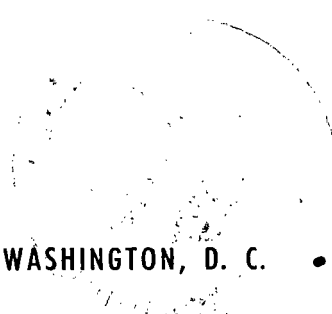



PERFORMANCE OF ROCKET NOZZLE MATERIALS WITH  
SEVERAL SOLID PROPELLANTS

By James R. Johnston, Robert A. Signorelli, and John C. Freche

Lewis Research Center  
Cleveland, Ohio

NATIONAL AERONAUTICS AND SPACE ADMINISTRATION

---

For sale by the Clearinghouse for Federal Scientific and Technical Information  
Springfield, Virginia 22151 - Price \$1.00

# PERFORMANCE OF ROCKET NOZZLE MATERIALS WITH SEVERAL SOLID PROPELLANTS

by James R. Johnston, Robert A. Signorelli, and John C. Freche

Lewis Research Center

## SUMMARY

Rocket nozzle throat insert materials were investigated by using three small-scale solid-propellant rocket engines. The materials used included refractory metals, refractory-metal carbides, graphites, ceramics, cermets, and fiber-reinforced plastics. Three propellants with widely differing flame temperatures and oxidation characteristics were used. The flame temperatures were 4700<sup>o</sup>, 5600<sup>o</sup>, and 6400<sup>o</sup> F. The engines were designed to provide a chamber pressure of 1000 pounds per square inch and a firing duration of 30 seconds with a nozzle throat diameter of 0.289 inch.

No one material performed best with all three propellants. Failure by erosion or cracking occurred with each material with at least one propellant. However, certain classes of materials demonstrated superior performance under specific operating conditions.

The fully densified refractory-metal nozzles generally were more resistant to erosion and thermal-stress cracking than the other materials. The graphite nozzles performed well with the least oxidizing 5600<sup>o</sup> F propellant but generally eroded severely with the other propellants. Some of the refractory-metal carbide nozzles showed outstanding erosion resistance with all three propellants, comparable to that of the best refractory-metal nozzle. However, all of these nozzles cracked as the result of thermal stresses, as did the cermets, silicon nitride, and porous sintered tungsten. Fiber-reinforced plastic nozzles as a class were the least erosion resistant materials.

## INTRODUCTION

The thermal, chemical, and mechanical environments produced by high-performance solid propellants introduce many materials problems in the development of rocket nozzles. Some propellants are highly corrosive, many contain metal additives, and typical flame temperatures range from 5000<sup>o</sup> to 6400<sup>o</sup> F. The interaction of environmental conditions together with the usual requirement that dimensional stability in the

nozzle throat be maintained makes the selection of suitable rocket nozzle materials extremely difficult. Usually, materials for typical large solid-propellant rocket nozzles are incorporated into suitable design configurations only after many full-scale prototype test firings. In order to limit full-scale tests to highly promising materials and to generate knowledge of the basic failure mechanisms of materials exposed to rocket propellant combustion gases, small-scale rocket nozzle tests have been widely used in industry and associated research organizations such as Atlantic Research Corporation, Thiokol Chemical Corporation, Aerojet-General Corporation, Hercules Powder Company, and Battelle Memorial Institute.

Only full-scale engine tests can completely evaluate rocket nozzle materials. However, most of the important conditions encountered in full-scale engines can be simulated with small-scale engine tests. Parameters such as flame temperature, combustion products, and gas velocity are readily duplicated. However, two major conditions, the nozzle surface temperature history and the nozzle thermal stress, may be greatly influenced by size effects. Full-scale nozzle surface temperature history can be approximated in a small-scale nozzle by appropriate selection of wall thickness. The thermal stresses that may be encountered in full-scale nozzles, however, are markedly influenced by many interrelated factors such as size, shape, and specific installation configuration. In general, the thermal stresses encountered in small-scale engines are less severe than those in full-scale engines. Consequently, it is not considered practical to evaluate thermal-stress behavior fully by small-scale tests, although an indication of the relative resistance of nozzle materials to thermal stresses can be obtained by small-scale engine tests.

In order to understand more fully the importance of the various environmental conditions such as flame temperature, chemical reactivity, and the presence of metal additives on nozzle failure mechanisms, it is necessary to expose nozzle materials to several different propellants. Accordingly, a rocket nozzle materials program was conducted at the Lewis Research Center. Various nozzle materials with widely differing properties were investigated in small-scale rocket engines by using three different propellants. Two polyvinyl-chloride - ammonium perchlorate propellants were used. One of these was not aluminized (Arcite 368), while the other was aluminized (Arcite 373). The third propellant used was an aluminized double-base type formulated from nitroglycerin and nitrocellulose (Hercules HDBM). The nozzle materials investigated included refractory metals, refractory-metal carbides, graphites, ceramics, cermets, and fiber-reinforced plastics. The initial results of this investigation are reported in reference 1. These deal with a limited number of materials tested with the nonaluminized propellant, Arcite 368. The present report covers the results obtained with all three propellants as well as additional materials. Thus it provides a compilation of results obtained over a period of several years. The rocket engines used in this study

were designed to operate at a nominal chamber pressure of 1000 pounds per square inch for approximately 30 seconds with a nozzle throat diameter of 0.289 inch.

## NOZZLE INSERTS

### Materials

The general classes of materials investigated (table I) were refractory metals, re-

TABLE I. - NOZZLE MATERIALS

Class	Material	Fabrication	Source
Refractory metals	Molybdenum	Arc cast	Climax Molybdenum Company
	Tungsten	Arc cast	Lewis Research Center
	Tungsten	Arc cast	Universal Cyclops
	Tungsten	Cold pressed, sintered and forged	Westinghouse Corporation
	Tungsten, 75 percent dense	Cold pressed and sintered	Lewis Research Center
	Tungsten, 65 percent dense	Cold pressed and sintered	Lewis Research Center
Refractory compounds	4 Parts tantalum carbide and 1 part zirconium carbide with graphite	Hot pressed	Carborundum Company
	4 Parts tantalum carbide and 1 part hafnium carbide with graphite	↓	↓
	Columbium carbide with graphite		
	8 Parts tantalum carbide and 1 part zirconium carbide with graphite		
	Tantalum carbide with graphite		
	Tantalum carbide with tungsten	Cold pressed and sintered	Kennametal, Inc.
	Columbium carbide with tungsten	Cold pressed and sintered	Kennametal, Inc.
	Columbium carbide with tungsten and silver infiltrant	Cold pressed, sintered and infiltrated	Kennametal, Inc.
	<sup>a</sup> LT1B	Slipcast and sintered	Haynes Stellite Company
	<sup>b</sup> LT2	Slipcast and sintered	Haynes Stellite Company
Silicon nitride	Slipcast and sintered	Haynes Stellite Company	
Graphite	ZT graphite	Molded and recrystallized	National Carbon Company
	Speer 3499 graphite	Molded	Speer Carbon
	ATJ graphite	Molded	National Carbon Company
Reinforced plastics	Phenolic refrasil (40 percent resin)	Molded	Goodyear Aircraft Corporation
	Phenolic refrasil (20 percent resin)	↓	Goodyear Aircraft Corporation
	Phenolic with graphite		Goodyear Aircraft Corporation
	Phenolic with nylon		Narmco Industries

<sup>a</sup>LT1B: 59 chromium, 19 aluminum oxide, 20 molybdenum, 2 titanium oxide.

<sup>b</sup>LT2: 60 tungsten, 25 chromium, 15 aluminum oxide.

fractory compounds, graphites, and reinforced-plastic materials. In most cases nozzle insert materials were obtained from commercial sources in semifinished form, and final machining was performed at the Lewis Research Center. The reinforced-plastic nozzles were obtained from commercial sources completely finished. The graphite nozzles were machined so that the axial direction was parallel to the direction in which the graphites were pressed during molding. The refractory-metal-carbide - graphite nozzle compositions varied radially with essentially pure carbide at the inner diameter and increasing amounts of graphite content toward the outer diameter (ref. 2). The refractory-metal-carbide - tungsten nozzles were formed by a proprietary carbon exchange process in which, for example, a mixture of tungsten carbide and tantalum metal was transformed during processing to a mixture of tantalum carbide and tungsten metal.

## Nozzle Configuration

The dimensions and contour of the nozzle inserts used in this investigation were the same as those used in the earlier investigation (ref. 1) and are shown in figure 1. The nozzle was a conventional converging-diverging type with entrance and exit angles of  $120^{\circ}$  and  $30^{\circ}$ , respectively. The expansion ratio was approximately 8 to 1. The throat diameter was  $0.289 \pm 0.001$  inch.

In order to make more meaningful comparisons between nozzle inserts with the various propellants it was desirable to use a uniform nozzle geometry while maintaining a constant chamber pressure. To achieve this, since each propellant had different characteristics (e. g. , burning rate, density, etc. ), it was necessary to specify a different grain diameter for each propellant.

## TEST FACILITIES

### Rocket Engines

The typical configuration of the rocket test engines is shown in figure 2; specific dimensions of the engines were selected to accommodate the three different propellants. Each engine consisted essentially of a heavy walled steel tube open at each end with a provision for mounting the nozzle insert in a removable retainer. The propellant grain was inserted from the head end of the engine and was held in place by a steel end closure. Neoprene O-rings were used to seal against gas leakage. The nozzle retainer and the steel end closure were held in place by segmented steel retaining rings. Explosive bolts were provided to permit ejection of the nozzle insert assembly during engine firing if desired.

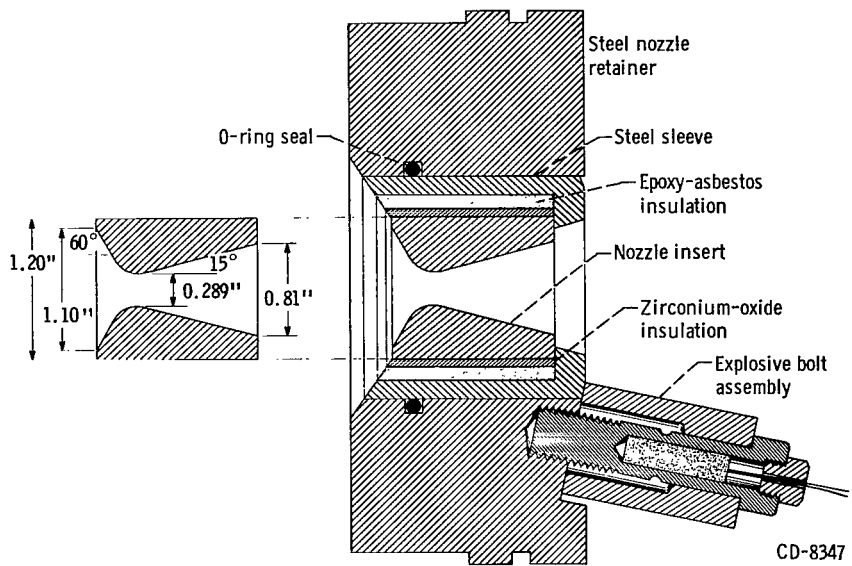

Figure 1. - Nozzle retainer and insert assembly.

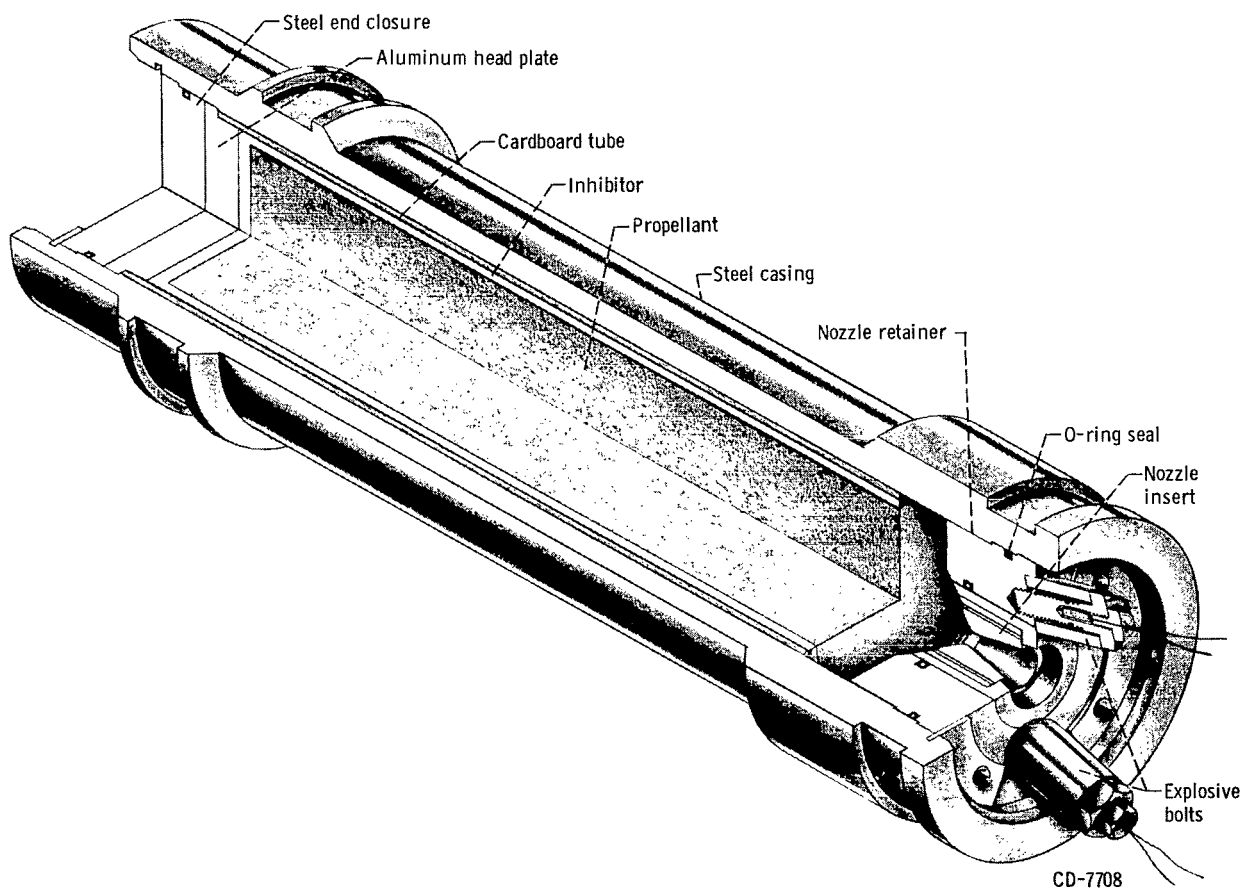

Figure 2. - Rocket engine and propellant grain assembly.

TABLE II. - PROPELLANTS

Propellant	Source	Composition	Flame temperature, °F	Relative characteristics
Arcite 368	Atlantic Research Corporation	Polyvinyl chloride and ammonium perchlorate	4700	Lowest temperature Most oxidizing Least abrasive
Arcite 373	Atlantic Research Corporation	Aluminized polyvinyl chloride and ammonium perchlorate	5600	Intermediate temperature Least oxidizing Abrasive
HDBM	Hercules Powder Company	Aluminized nitroglycerine nitrocellulose	6400	Highest temperature Intermediate oxidizing Abrasive

Insulation was not applied to the internal surfaces of the engine tube or to the internal end face of the nozzle retainer. The heavy steel wall construction of the engines obviated the need for insulation and avoided unnecessary contamination of exhaust gases by deterioration of the insulation.

## Nozzle Installation

The nozzle retainer and insert assembly configurations used for all three test engines are shown in figure 1. The outside cylindrical surfaces of the nozzle inserts with the exception of the reinforced plastic materials were coated by flame spraying with zirconium oxide insulation to a thickness of 0.05 inch. An epoxy-resin - asbestos insulation was then cast between the coated nozzle and a steel sleeve. The sleeve and nozzle assembly was inserted into the heavy steel nozzle retainer with a conventional neoprene O-ring seal to prevent gas leakage. The removable steel sleeve was used to facilitate disassembly after firing without damaging the insert and to permit ejection by use of explosive bolts.

## Propellants

Three types of propellants were used in this investigation. These were Arcite 368 and Arcite 373, obtained from the Atlantic Research Corporation, and HDBM, obtained from the Hercules Powder Co. Table II summarizes the propellant characteristics. The relative oxidation characteristics of the propellants were determined from comparisons of the hydrogen-water and carbon monoxide-carbon dioxide ratios for the combustion gases of the respective propellants. A sketch of a propellant grain installed in an engine is



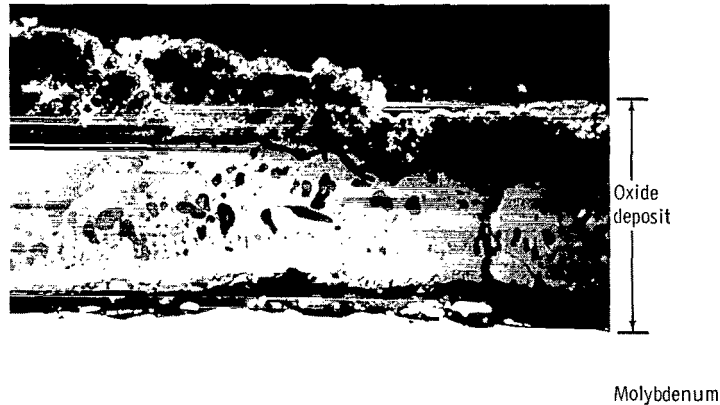

C-66-215

Figure 3. - Aluminum oxide deposit on throat surface of molybdenum nozzle insert. X500. (Reduced 35 percent in printing.)

shown in figure 2. The end-burning grains were formed by sealing precast cylinders of propellants into cardboard tubes with an inhibiting compound. An aluminum head plate was also bonded to one end face of the propellant to facilitate retention of the grain within the engine. The length and diameter of each propellant grain were selected to provide approximately 30 seconds burning time at a chamber pressure of 1000 pounds per square inch.

The selection of the aluminized propellant dimensions was complicated by the deposit of aluminum oxide on the nozzle insert throat during firing. An example of this deposit on a molybdenum nozzle is shown in figure 3. Because of the varying thickness of oxide deposits on different insert materials, it was not possible to specify the propellant diameter which would provide 1000-pound-per-square-inch chamber pressure in all instances. With the Arcite 373 propellant a chamber pressure of approximately 830 pounds per square inch was obtained when no oxide deposit occurred. A value of 1000 pounds per square inch was obtained for the HDBM propellant when no oxide deposit occurred, and for the nonaluminized Arcite 368 propellant.

## Instrumentation

Conventional pressure transducers were used to measure chamber pressure. Pressure data were recorded on a multichannel oscillograph and on a strip-chart potentiometer. Nozzle inserts of several materials were instrumented with tungsten - tungsten-rhenium thermocouples at four positions (fig. 4). During each instrumented run, all temperatures were recorded simultaneously on an oscillograph.

Thermo-couple	Distance from throat surface, in.
1	0.05
2	.22
3	.40
4	.05

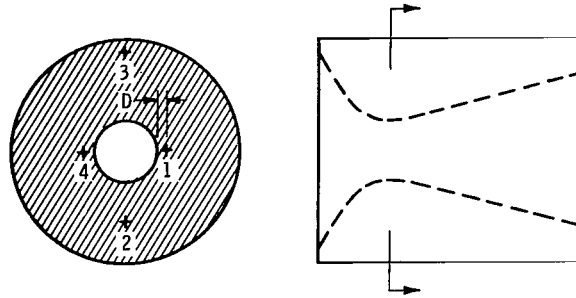

Figure 4. - Location of tungsten - tungsten-rhenium thermocouples in rocket nozzle insert.

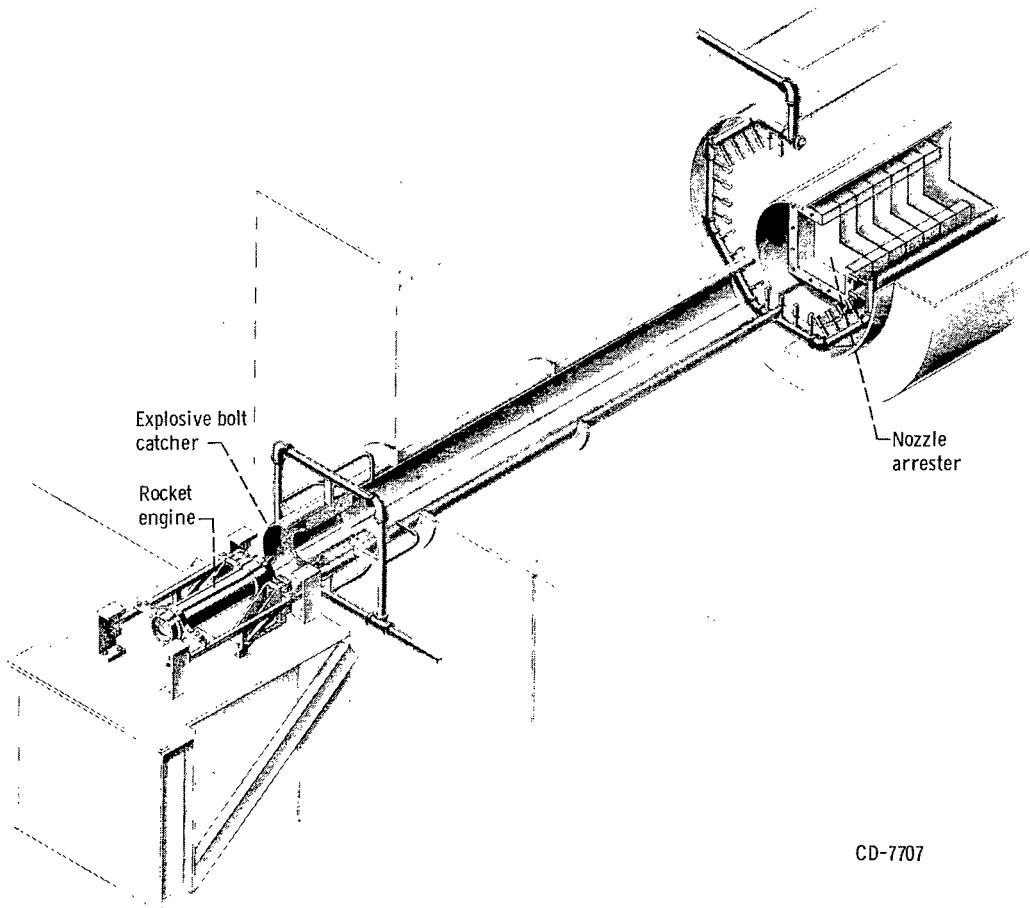

Figure 5. - Nozzle ejection and arresting system.

CD-7707

## Nozzle Ejection and Arresting System

In order to permit examination of the rocket nozzle insert at times other than after a full duration firing, a nozzle ejection and arresting system was provided. The system is illustrated in figure 5. As described in the section Rocket Engines, the nozzle insert assembly was retained by explosive bolts. When the nozzle insert was to be ejected, the bolts were fired and the combustion chamber pressure propelled the insert assembly into the arrester. Deceleration of the insert assembly was achieved by rupture of a series of thin aluminum sheets. The explosive bolts were angled in such a manner that on firing they were trapped in an annular chamber (fig. 5) and could not interfere with the subsequent passage of the insert assembly. Automatic controls were used to terminate exhaust system cooling water flow so that wetting of the nozzle insert was prevented.

### TEST PROCEDURE

#### Pretest Preparation

Prior to each firing, the chamber pressure sensing and recording instrumentation was calibrated. Both pressure transducers were calibrated against a laboratory test gage having an accuracy of  $\pm 2$  pounds per square inch.

Since the burning rate of the propellant was temperature sensitive, propellant grains were maintained at  $70^{\circ} \pm 2^{\circ}$  F in a temperature-controlled storage chest. Each propellant grain was removed from storage shortly before installation and firing. The rocket engine test stand was located in a heated building; thus, a relatively stable ambient temperature environment was provided for the tests. The propellant was ignited with a squib and pellet igniter electrically energized by wires inserted through the nozzle.

#### Propellant-Burning Surface Modifications

Theoretically, the chamber pressure of an end-burning rocket would be constant throughout the firing if no nozzle erosion occurred. A stable chamber pressure, however, is often not obtained in practice because of variations in propellant-burning characteristics. In preliminary firings of this investigation, the pressure increased gradually over a period of time before stabilizing at design pressure. Since the success of the investigation depended on a comparison of the results from one test with those of another, it was imperative that uniform test conditions be maintained. The chamber pressure recorded during the firing was an important part of the data obtained in this investigation, since it was used to indicate the degree of nozzle erosion that occurred. In order to use

the recorded change in pressure as a measure of nozzle erosion, it was necessary to prevent pressure variations resulting from causes other than nozzle erosion. Therefore, the pressure transient obtained in preliminary firings of as-received propellant grains was minimized by modifying the grains to provide an increased burning surface area in the manner described in reference 1.

## Postoperation Analysis

The pressure data were used to determine the relative performance of the nozzle materials. The final chamber pressure and the following equation were used to calculate total erosion of each nozzle:

$$A_t = \frac{Sr\rho}{PC_d}$$

where  $A_t$  is the nozzle throat area,  $S$  is the burning surface area,  $r$  is the burning rate,  $\rho$  is the propellant density,  $P$  is the chamber pressure, and  $C_d$  is the nozzle discharge coefficient. The values of  $C_d$  and  $\rho$  and the variations of  $r$  with chamber pressure were supplied by the propellant manufacturer. A shadowgraph of the nozzle cross section was obtained in all instances after firing except in those cases where thermal-shock failure resulted in fragmentation of the nozzle insert. The area of the nozzle throat determined from each shadowgraph was used to verify the erosion determined by calculation. General agreement was obtained between the calculated and observed areas, and this provided confidence in the validity of the calculations for those cases where only calculated values could be obtained.

In order to define erosion rate, particularly in those cases where rapid erosion occurred at higher pressures, rate comparisons were made during the initial portions of the firings. The average erosion rate was calculated over the time increment during which two-thirds of the total pressure regression occurred.

Nozzle inserts were sectioned axially after firing for macro- and microexamination. Macrographs as well as micrographs were taken of the sectioned nozzles.

## RESULTS AND DISCUSSION

The main requirement of a solid-propellant rocket nozzle is to retain dimensional integrity. Degradation occurs by erosion of the exposed internal surface or by cracking. Cracking is usually thermally induced and could result in the loss of large fragments of

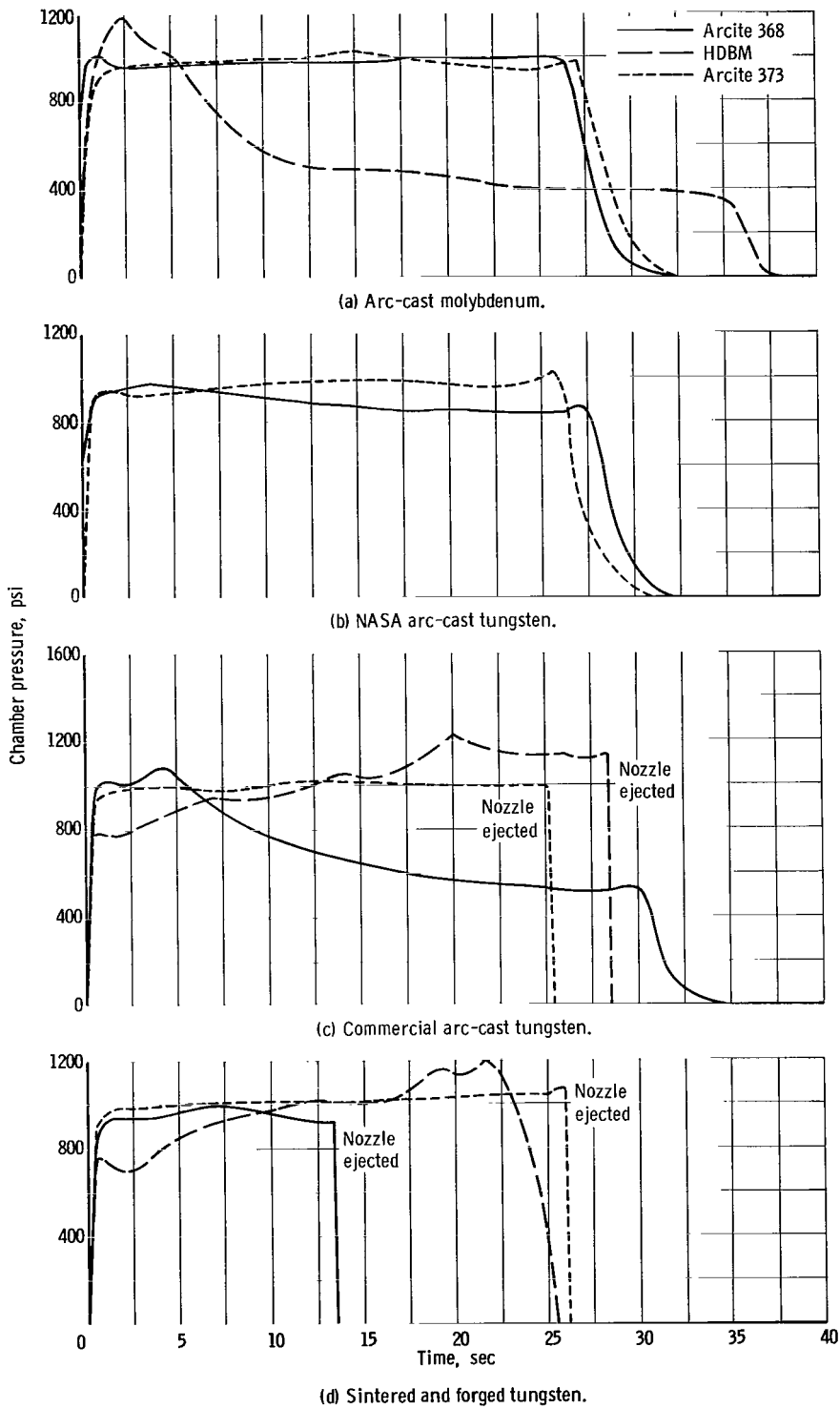
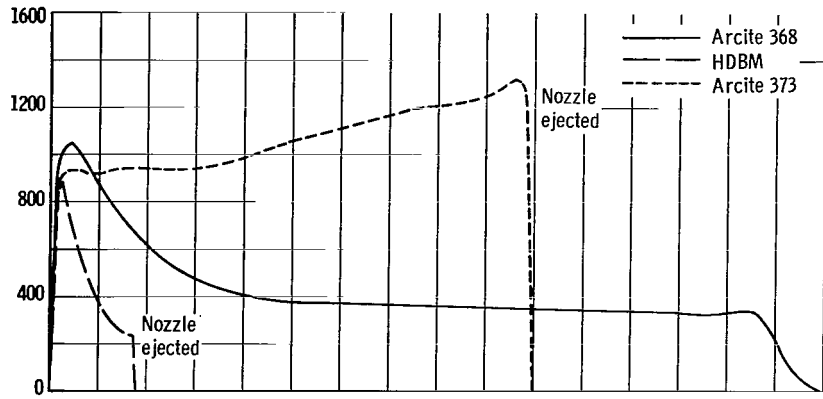
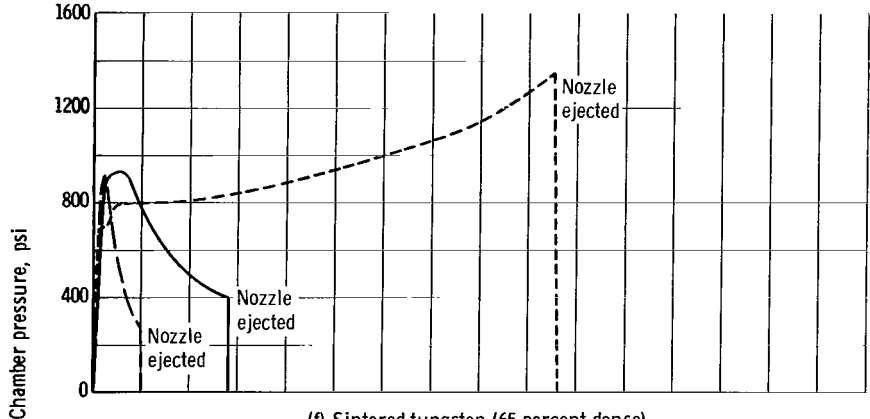

Figure 6. - Chamber pressure - time traces obtained during material-evaluation firings.



(e) Sintered tungsten (75 percent dense).



(f) Sintered tungsten (65 percent dense).

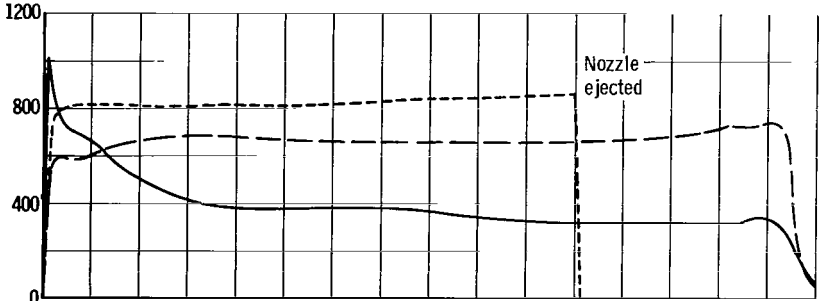

(g) 4 Parts tantalum carbide and 1 part zirconium carbide with graphite.

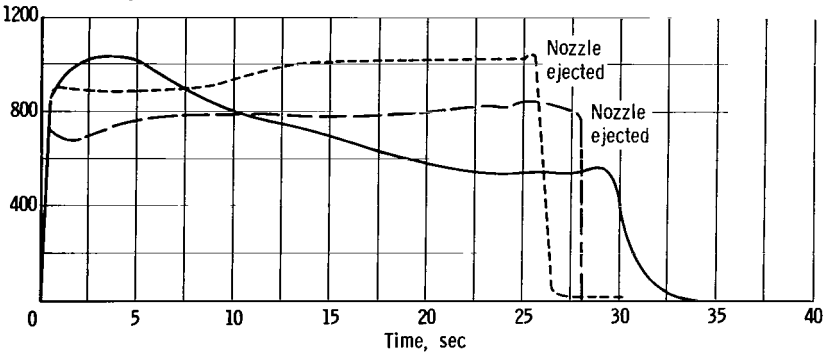

(h) 4 Parts tantalum carbide and 1 part hafnium carbide with graphite.

Figure 6. - Continued.

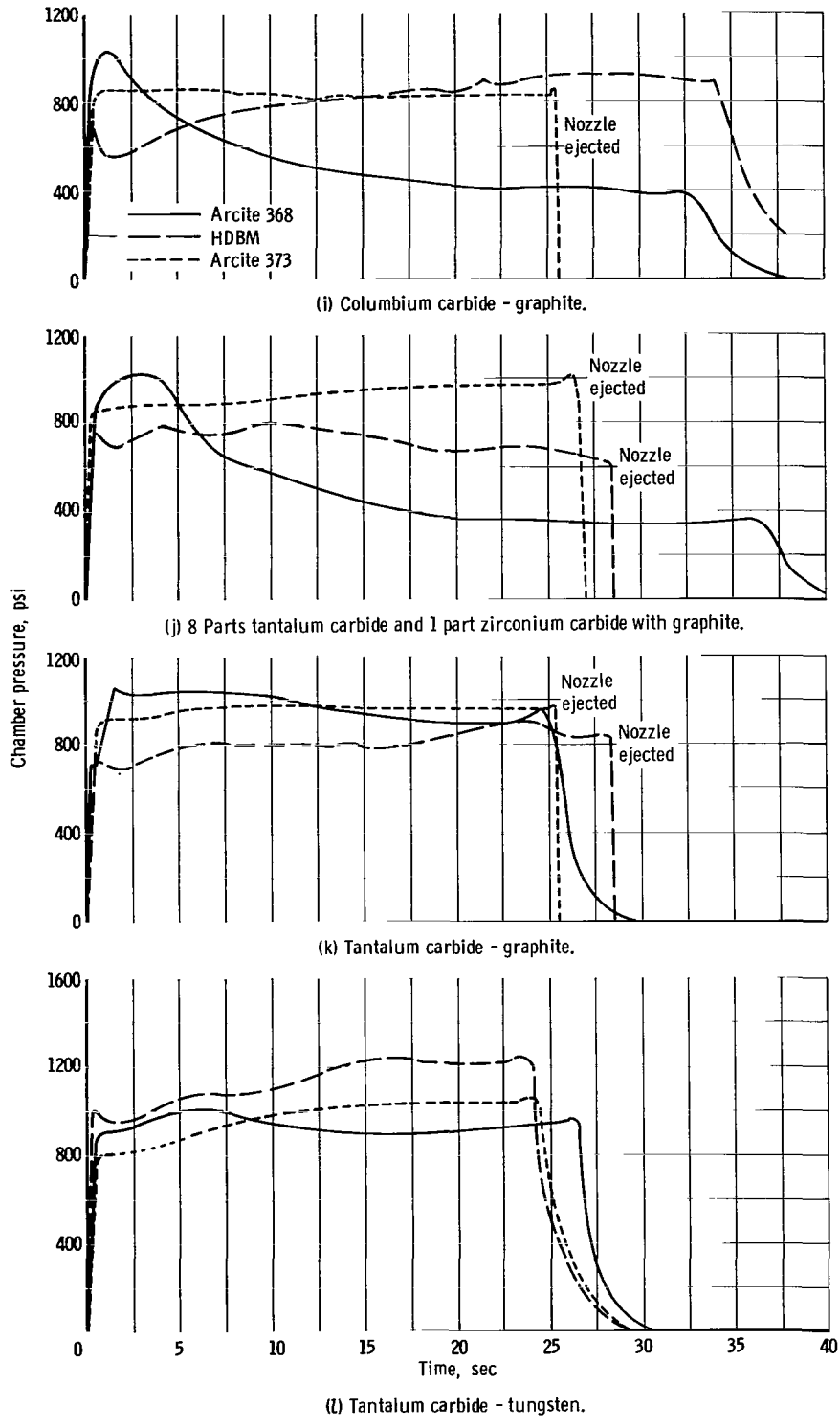
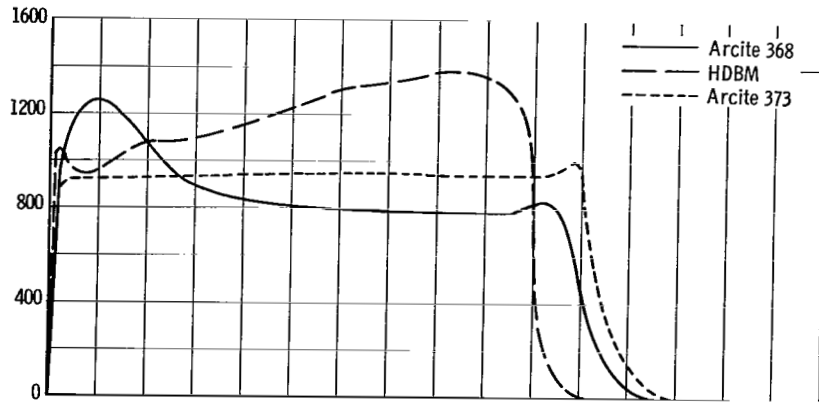
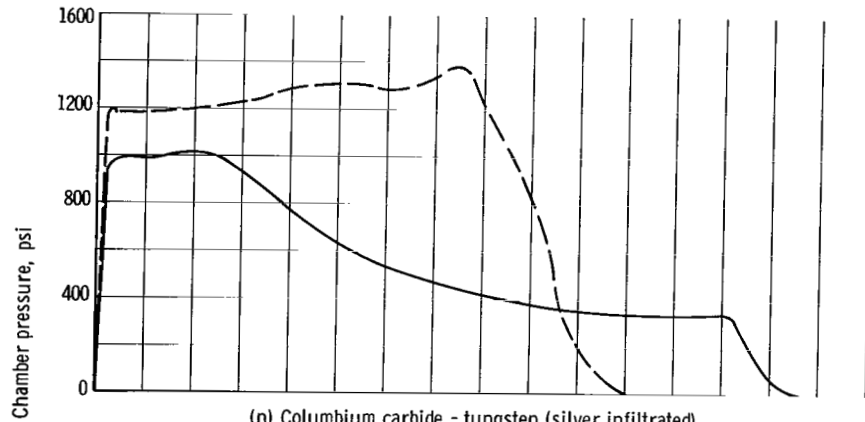

Figure 6. - Continued.



(m) Columbian carbide - tungsten.



(n) Columbian carbide - tungsten (silver infiltrated).

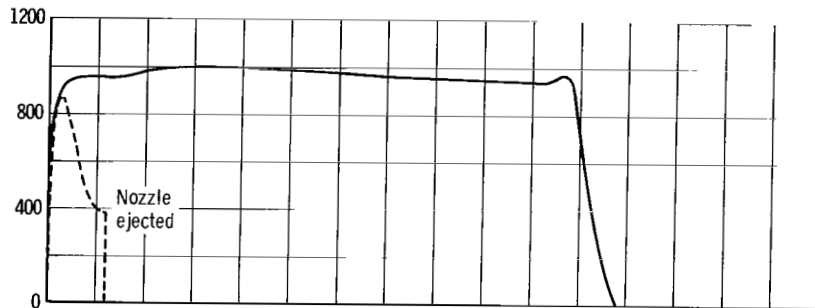

(o) LTIB.

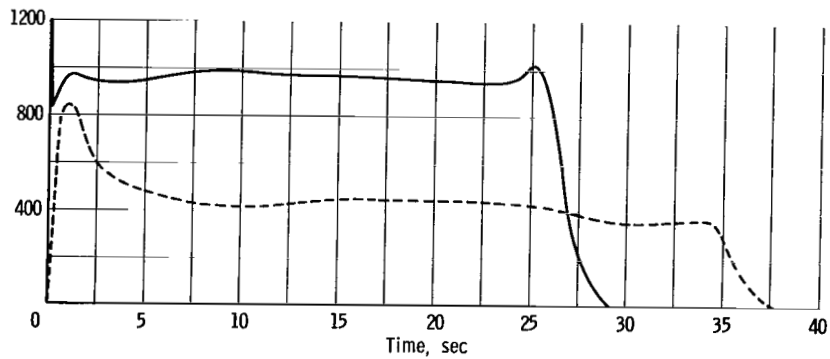

(p) LT2.

Figure 6. - Continued.



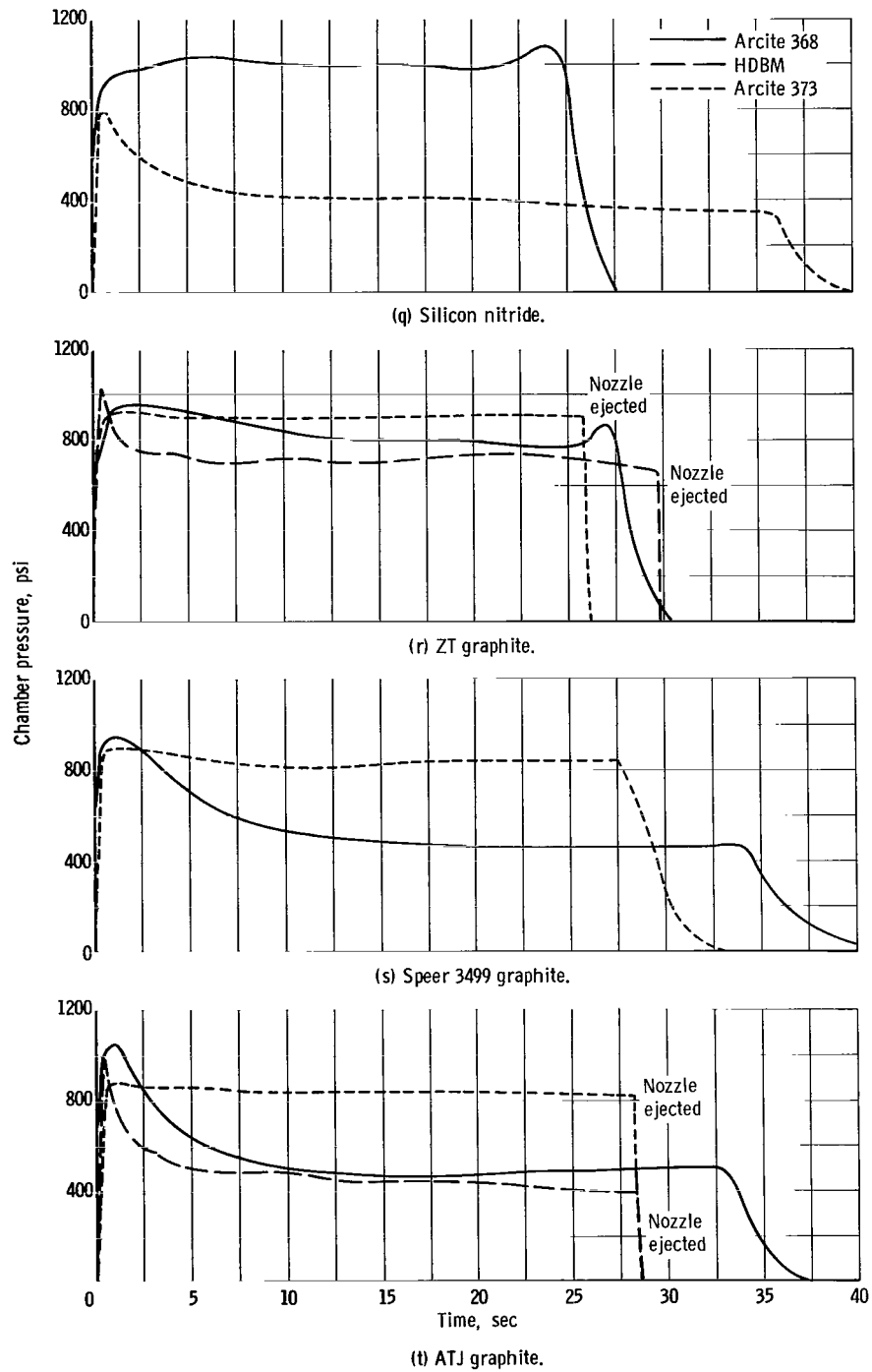

Figure 6. - Continued.

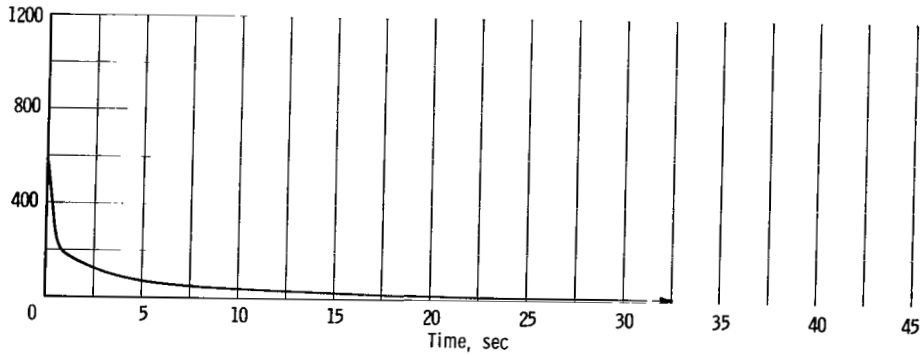
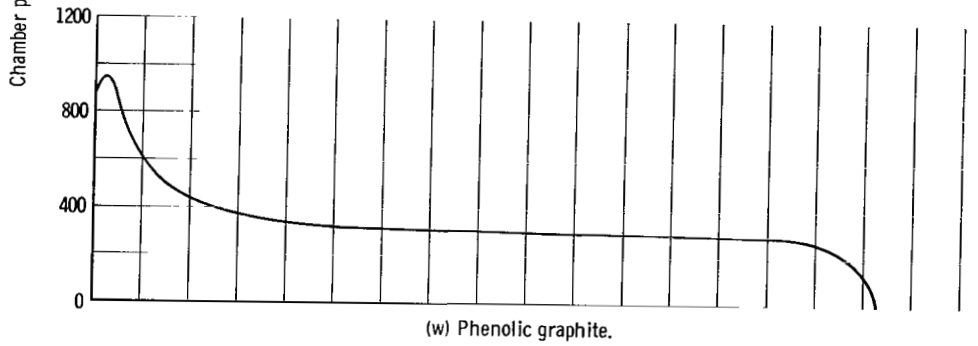
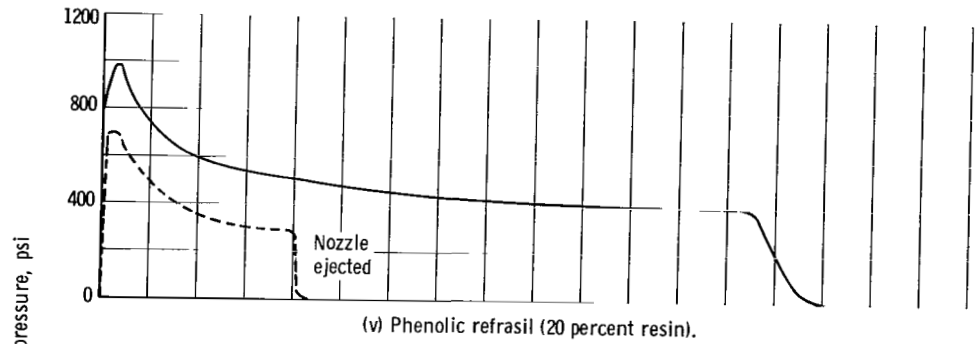
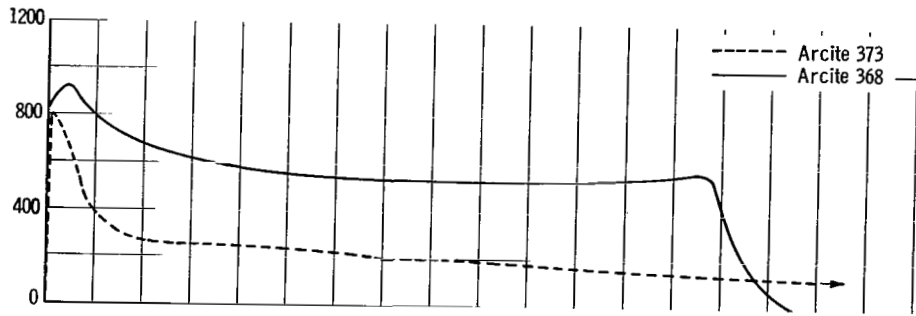

Figure 6. - Concluded.

TABLE III. - PERFORMANCE OF NOZZLE MATERIALS

Class	Material	Arcite 368 (a)				Arcite 373 (b)				HDBM (c)			
		Final chamber pressure, psi	High-pressure erosion rate, mils/sec	Total erosion, mils	Erosion rating (d)	Final chamber pressure, psi	High-pressure erosion rate, mils/sec	Total erosion, mils	Erosion rating (d)	Final chamber pressure, psi	High-pressure erosion rate, mils/sec	Total erosion, mils	Erosion rating (d)
Refractory metals	Arc-cast molybdenum	1000	Nil	0	Slight	1000	Nil	-9.2	Slight	340	2.2	48.9	Catastrophic
	Arc-cast tungsten from NASA	840	0.2	5.0	Moderate	960	↓	-9.0	↓	-----	-----	-----	-----
	Arc-cast tungsten from Commercial supplier	520	1.1	26.2	Severe	1000	↓	-9.2	↓	1150	Nil	-5.8	Slight
	Sintered and forged tungsten	920	Nil	<sup>e</sup> 3.6 (13.5)	Slight	1000	↓	-10.5	↓	1120	Nil	-4.7	Slight
	Sintered tungsten, 75 percent dense	340	4.0	44.7	Catastrophic	1270	↓	-19.4	↓	<sup>e</sup> 240 (4)	<sup>f</sup> 16.4	<sup>e</sup> 72.4 (4)	Catastrophic
	Sintered tungsten, 65 percent dense	400	5.4	59.2	Catastrophic	1350	↓	-21.8	↓	<sup>e</sup> 260 (2.5)	<sup>f</sup> 23.8	<sup>e</sup> 67.5 (2.5)	Catastrophic
	Refractory compounds	4 Parts tantalum carbide and 1 part zirconium carbide with graphite	320	<sup>f</sup> 5.1	46.6	Catastrophic	850	<sup>f</sup> Nil	-1.8	Slight	720	(f, g)	13.1
4 Parts tantalum carbide and 1 part hafnium carbide with graphite		540	<sup>f</sup> 1.0	25.0	Severe	1020	↓	-10.2	↓	830	↓	7.8	Moderate
Columbium carbide with graphite		380	<sup>f</sup> 2.3	40.4	Catastrophic	830	↓	0.3	↓	900	↓	4.0	Slight
8 Parts tantalum carbide and 1 part zirconium carbide with graphite		345	<sup>f</sup> 2.1	45.0	Catastrophic	975	↓	-8.2	↓	620	↓	21.0	Severe
Tantalum carbide with graphite		920	<sup>f</sup> 1	3.0	Slight	960	↓	-7.5	↓	840	↓	7.3	Moderate
Tantalum carbide with tungsten		925	(f, g)	3.0	Slight	1040	↓	-11.0	↓	1200	<sup>f</sup> Nil	-7.5	Slight
Columbium carbide with tungsten		780	(f, g)	9.5	Moderate	940	↓	-6.5	↓	1380	<sup>f</sup> Nil	-12.5	Slight
Columbium carbide with tungsten and silver infiltrate		340	<sup>f</sup> 2.2	45.5	Catastrophic	-----	-----	-----	-----	940	<sup>f</sup> Nil	2.5	Slight
LT1B		940	Nil	1.0	Slight	<sup>e</sup> 380 (3)	<sup>f</sup> 6.7	<sup>e</sup> 40.2 (3)	Catastrophic	-----	-----	-----	-----
LT2		950	Nil	2.0	Slight	370	<sup>f</sup> 3.9	-----	Catastrophic	-----	-----	-----	-----
Silicon nitride	980	Nil	.5	Slight	320	<sup>f</sup> 5.8	51.3	Catastrophic	-----	-----	-----	-----	
Graphites	ZT graphite	775	0.6	9.5	Moderate	910	Nil	-5.1	Slight	660	6.1	18.0	Severe
	Speer 3498 graphite	460	2.7	30.3	Severe	840	Nil	-2.8	Slight	-----	-----	-----	-----
	ATJ graphite	470	3.4	30.5	Severe	835	Nil	-1.6	Slight	400	7.8	40.0	Catastrophic
Reinforced plastics	Phenolic refrasil (40 percent resin)	525	3.6	25.8	Severe	100	15.5	141.8	Catastrophic	-----	-----	-----	-----
	Phenolic refrasil (20 percent resin)	390	4.5	43.5	Catastrophic	<sup>e</sup> 290 (10)	9.0	<sup>e</sup> 57.7 (10)	Catastrophic	-----	-----	-----	-----
	Phenolic with graphite	280	7.5	54.2	Catastrophic	-----	-----	-----	-----	-----	-----	-----	-----
	Phenolic with nylon	-20	∞	Total	Catastrophic	-----	-----	-----	-----	-----	-----	-----	-----

<sup>a</sup>Flame temperature, 4700° F; nonaluminized.

<sup>b</sup>Flame temperature, 5600° F; aluminized.

<sup>c</sup>Flame temperature, 6400° F; aluminized.

<sup>d</sup>Slight, final pressure 90 to 100 percent of design pressure; moderate, final pressure 75 to 90 percent of design pressure; severe, final pressure 40 to 75 percent design pressure; catastrophic, final pressure 0 to 40 percent design pressure.

<sup>e</sup>Run terminated by nozzle ejection in number of seconds shown.

<sup>f</sup>Denotes thermal-stress cracks.

<sup>g</sup>Not computed.

the nozzle. In cases where cracking does not cause fragmentation of the nozzle, it may lead to locally severe erosion.

It was found in this investigation that no one material performed best with all three propellants. Failure by erosion or cracking occurred with each material with at least one of the propellants. However, certain classes of materials demonstrated superior performance under specific operating conditions. The data of this investigation, which represent the results of a systematic study of various classes of material exposed to several propellant environments, should be helpful in selecting promising candidate materials for particular rocket nozzle applications.

## Nozzle Erosion

The chamber-pressure - time traces obtained from material evaluation firings are shown in figure 6. The erosion characteristics as determined from these data are summarized in table III. Erosion mechanisms fall into three distinct categories: melting or sublimation, oxidation, and mechanical abrasion. In general, the erosion characteristics of materials when exposed to the combustion gases of various propellants can be related to material properties and thermal and chemical environments. These relations are described for the various types of materials in the following sections.

Refractory metals. - Overall, the fully densified refractory metals were the most erosion resistant group of materials. Molybdenum did not erode (fig. 6(a)) in the two lower temperature propellant environments, but it eroded catastrophically with the highest temperature propellant. In general, the high-density (arc-cast, sintered, and forged) tungsten nozzles performed with only slight to moderate erosion with all three propellants (figs. 6(b) to (d)). The one nozzle that experienced severe erosion (commercial arc-cast tungsten) showed grain separation during machining. The lower density powder-metallurgy tungsten nozzles eroded catastrophically (figs. 6(e) and (f)) in the two more oxidizing propellants, Arcite 368 and HDBM. However, no erosion occurred with the least oxidizing, intermediate-temperature propellant, Arcite 373.

The failure mechanisms involved with these materials differed. Molybdenum did not erode with the most oxidizing propellant or with the relatively abrasive intermediate-temperature aluminized propellant. This suggests that molybdenum was not particularly susceptible to oxidation or abrasion except at the highest flame temperature. The HDBM propellant flame temperature is approximately 1700<sup>0</sup> F higher than the melting point of molybdenum. It is probable that the catastrophic erosion observed for this material was due to melting and oxidation. This is further substantiated by the nozzle temperature measurements shown in figure 7. Although data were not obtained for a molybdenum nozzle with the HDBM propellant, temperature data obtained with tungsten and ZT

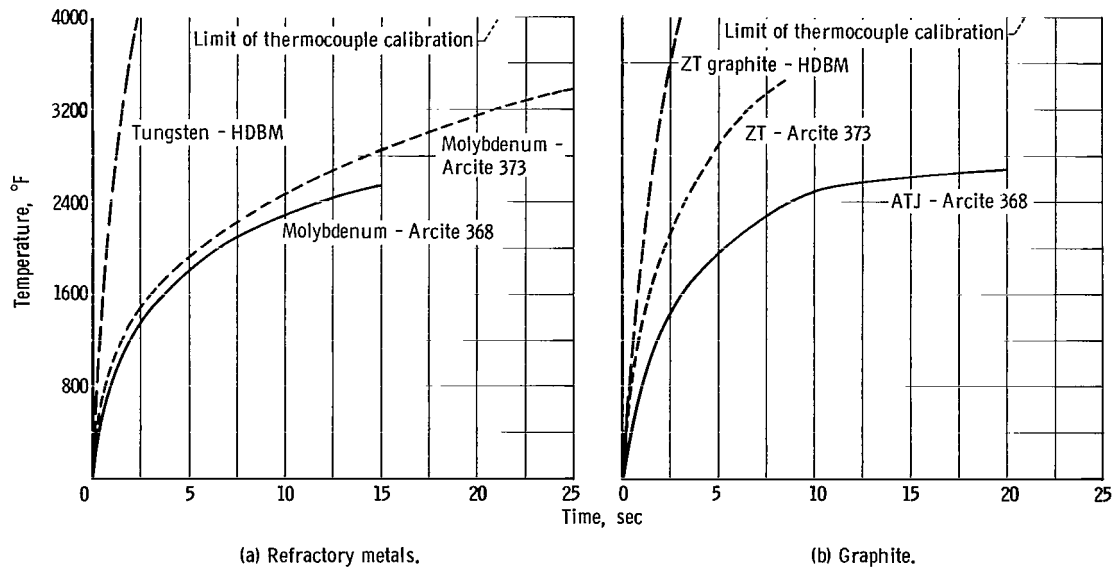

Figure 7. - Nozzle-insert temperature-time curves. Thermocouple junction, 0.05 inch from nozzle throat surface.

graphite nozzles when exposed to the HDBM propellant (figs. 7(a) and (b)) indicate that the nozzle surface temperature of molybdenum would be expected to approach the melting point with this propellant. Also, the fact that substantial erosion occurred very early in the firing (fig. 6(a)), probably before the melting point of molybdenum had been reached, suggests that oxidation occurred. Finally, X-ray diffraction data of scrapings taken from the nozzle after firing indicated the presence of molybdenum oxide.

In the tests of the high-density tungsten nozzles, measurable erosion was observed only with the Arcite 368 propellant (table III). Since this propellant provided the lowest temperature, most oxidizing, and least abrasive environment, it is most likely that oxidation was the failure mechanism in this case. The low-density tungsten nozzles failed catastrophically with both Arcite 368 and HDBM propellants and did not erode with the Arcite 373 propellant. These results also suggest that oxidation was the primary mechanism, but deterioration was probably aggravated by mechanical abrasion of these relatively weak porous structures.

**Refractory compounds.** - By definition the refractory compounds considered in this investigation include the refractory-metal-carbide - graphite combinations, refractory-metal-carbide - tungsten materials, metal-impregnated refractory compounds (including cermets), and a ceramic (silicon nitride). The refractory-metal-carbide - graphite materials showed essentially no erosion with the Arcite 373 propellant, but severe or catastrophic erosion occurred with the Arcite 368 propellant except for the tantalum carbide - graphite nozzle, which showed only slight erosion. The performance of these materials with the highest temperature HDBM propellant was intermediate to that obtained with the other propellants (figs. 6(g) to (k) and table III). These results suggest that erosion re-

sulted primarily from oxidation, since erosion increased with increasing severity of oxidizing environment.

The refractory-metal-carbide - tungsten nozzles (except for the silver infiltrated nozzle) showed outstanding performance in resisting erosion, comparable to that of the best refractory-metal nozzle (slight to moderate erosion with all propellants, table III and figs. 6(l) to (n)). However, thermal-stress cracking was encountered. Such erosion as did occur was probably due to oxidation since the greatest erosion occurred with the most oxidizing propellant. The silver infiltrated columbium carbide - tungsten material eroded only slightly with the HDBM propellant but eroded catastrophically with the more oxidizing Arcite 368. It is possible that the greater surface area exposed as the silver was melted from the porous columbium carbide - tungsten skeleton contributed to making the nozzle more subject to oxidation than the fully densified columbium carbide - tungsten. While a nozzle of this material was not available for firing with the 373 propellant, erosion would not be expected to occur with this, the least oxidizing propellant.

The cermets and the silicon nitride nozzles eroded only slightly with the most oxidizing propellant, but catastrophic erosion occurred with the least oxidizing, intermediate-temperature propellant (figs. 6(o) to (q) and table III). The catastrophic erosion of these materials was attributed to melting or sublimation. Melting of LT1B and LT2 and sublimation of silicon nitride occur at temperatures ranging from 3100<sup>0</sup> to 3500<sup>0</sup> F (refs. 3 and 4). Estimates based on material properties and measured nozzle temperatures of other materials (fig. 7) indicate that the nozzle surface temperature of the two cermet and the silicon nitride nozzles were probably above the melting or sublimation temperature when exposed to the 5600<sup>0</sup> F Arcite 373 propellant.

Graphites. - Graphites (figs. 6(r) to (t)) in general showed relatively poor erosion resistance in comparison with the refractory metals. Erosion varied from moderate to catastrophic for the two more oxidizing propellants, while essentially no erosion was observed with the least oxidizing propellant. Thus, it is evident that oxidation was the major failure mechanism. It may also be inferred from the results that mechanical abrasion was a contributing failure mechanism. Of the two propellants with which severe erosion was observed, HDBM and Arcite 368, the greater degree of erosion occurred with the aluminum-bearing HDBM propellant. Another indication that mechanical abrasion was a contributing factor is the fact that the higher density, higher strength ZT graphite was substantially more resistant to erosion with the aluminum-bearing HDBM propellant than the conventional molded ATJ graphite.

If mechanical abrasion contributed to failure, the erosion rate would be expected to diminish with reduced chamber pressure. That the erosion rate was diminished for two of the graphite materials is evident from the pressure traces in which the pressure regression is relatively flat in the lower pressure region as compared to the initial high-pressure operation (figs. 6(s) and (t)). This may be seen quantitatively by comparison of

the erosion rate data for the same portions of the pressure regression. For example, the high-pressure erosion rate of the ATJ nozzle with the HDBM propellant was relatively high, 7.8 mils per second (table III). Calculation of the erosion rate for the remaining pressure regression indicates a much lower value of 0.8 mil per second.

Fiber-reinforced plastics. - Severe or catastrophic erosion occurred by ablation with all fiber-reinforced plastic nozzles tested. The severity of erosion increased with increased flame temperature (figs. 6(u) to (x)). For example, total erosion of the 40 percent resin phenolic-refrasil nozzle increased from approximately 26 to 142 mils when the nozzle was tested with Arcite 368 and 373 propellants, respectively (table III).

Since melting and volatilization of plastic materials normally occurs in the ablative process, the increased flame temperature of the 373 propellant would be expected to increase erosion. In addition, the ablative effectiveness of the refrasil-reinforced nozzles was probably reduced by reaction (fluxing) between the silica in the nozzle and the aluminum oxide in the Arcite 373 propellant combustion products. More specifically, this lower effectiveness could be attributed to the lower melting point of the glass formed, and the attendant reduction in viscosity would allow the molten glass to be more readily swept from the nozzle surface.

As in the case of the graphites, the fiber-reinforced plastic nozzles showed a lower erosion rate with lower pressure operation as compared with that at high pressure. This is shown very well in figure 6(u) by the low slopes of the pressure traces in the later portion of the firings. In this case with the Arcite 368 propellant the high-pressure erosion rate was 3.6 mils per second as compared with 0.39 mil per second for the remaining pressure regression. The generally poor performance demonstrated by these materials at these operating pressures precluded additional firings with the higher temperature propellants.

## Thermal-Stress Cracking

Of all of the materials investigated, only the refractory compounds and the lower density, porous-tungsten nozzles developed thermal-stress cracks. In all instances, however, the nozzles remained in place, and no sudden decreases in chamber pressure were noted. Some nozzles were cracked extensively both radially and circumferentially so that nozzles separated into several pieces on removal from the retainer. The silicon nitride, cermet, and refractory-metal-carbide - graphite nozzles cracked extensively (figs. 8(a) to (c)). The refractory-metal-carbide - tungsten nozzles cracked less severely than the carbide-graphite type; in some cases only a single fracture occurred, as indicated in figure 8(d). The lower density, porous-tungsten nozzle showed only micro-cracks, as indicated in figure 8(e).



(a) Silicon nitride.



(b) LT1B.

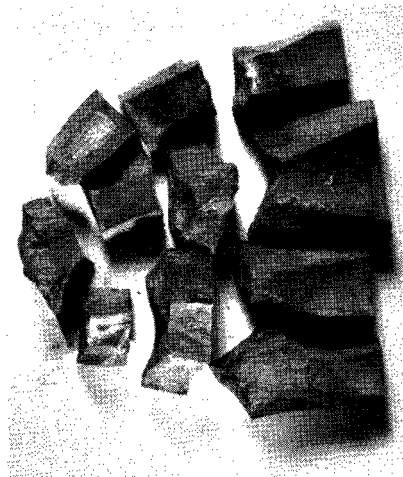

(c) 8 Parts tantalum carbide and 1 part zirconium carbide.



(d) Columbium carbide - tungsten.

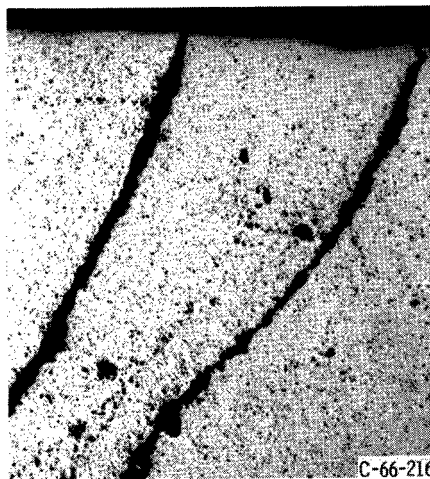

(e) Sintered tungsten, 75 percent dense. X75.

Figure 8. - Thermal-stress failure in nozzle inserts. (Reduced 40 percent in printing.)



It should be emphasized that there is an important size factor which must be taken into consideration in extrapolating the thermal-stress performance of nozzles in small-scale tests to full-size applications. The effect of nozzle size on thermal stresses is complex and cannot be determined readily. Comparisons based on simplified models (ref. 1) have indicated that the thermal stresses induced in the small nozzles of this investigation appear to be lower than those that would occur in a typical large nozzle. Accordingly, nozzle materials that cracked extensively in this investigation would also not be suitable for most large-scale applications. Materials that cracked only slightly in this investigation would be expected to crack more extensively in many large-scale applications.

## GENERAL REMARKS

The range of conditions considered in this investigation necessarily places certain limitations on the interpretation of the relative performance of the various materials investigated. It should be emphasized that, under other conditions of exposure, the relative rating of nozzle materials could be considerably different from that indicated in the present investigation. The major factors influencing the results are flame temperature, chamber pressure, chemical reactivity of the combustion gases, and nozzle size.

Although high-density tungsten demonstrated overall superiority in resisting erosion and thermal-stress cracking in the tests described in this report, it is expected that use of propellants with appreciably higher flame temperatures would preclude the use of tungsten. Instead, it is likely that only materials such as the refractory-metal carbides would have the potential for application in uncooled nozzles if propellants with flame temperatures of the order of 7000<sup>o</sup> F and above are successfully developed. Of course, the potential of the carbide nozzle materials would be improved if the chemical reactivity of the higher temperature propellant combustion products were low and if the thermal-stress problem could be overcome, perhaps by improved design.

Just as the use of higher temperatures would affect the relative merits of nozzle materials, so would the use of very low chamber pressures. It was noted in the results of this investigation that both the graphite and the fiber-reinforced phenolic materials demonstrated improved erosion resistance at lower chamber pressures. Hence, at very low pressures, such as 100 pounds per square inch, these materials may be preferable to refractory metals, especially where weight and fabricability are important factors.

The relative merit of fiber-reinforced plastic nozzles also may be improved in applications to very large rocket nozzles. Rocket motors are now under development in which the nozzle throat diameter may be well over 6 feet. In nozzles of this size, removal of ablative material from the surface at rates of several mils per second is unim-

portant since the nozzle area and thrust would be essentially unaffected even for firing durations of several minutes.

Finally, it should be noted that, in areas other than the nozzle throat, such as nozzle entrance and exit cones, where material loss can better be tolerated, fiber-reinforced plastics as well as graphite have found widespread use. Of course, in these areas environmental conditions are less severe, and thus material loss would tend to be reduced.

## SUMMARY OF RESULTS

An investigation was conducted to determine the performance of uncooled rocket-nozzle insert materials in small-scale solid-propellant rocket engines. The materials investigated include refractory metals, refractory-metal carbides, graphites, ceramics, cermets, and fiber-reinforced plastics. Propellants with flame temperatures of 4700<sup>o</sup>, 5600<sup>o</sup>, and 6400<sup>o</sup> F were used. These varied widely in oxidation characteristics. The 4700<sup>o</sup> F propellant, which was not aluminized, provided the most oxidizing and least abrasive environment, whereas the 5600<sup>o</sup> F propellant provided the least oxidizing environment. Both the 5600<sup>o</sup> and 6400<sup>o</sup> F propellants contained aluminum and thus provided very abrasive exhaust products. The test engines were designed to provide a chamber pressure of 1000 pounds per square inch and a firing duration of 30 seconds with a nozzle throat diameter of 0.289 inch. The following results were obtained:

1. No one material performed best with all three propellants. Failure by erosion or cracking occurred with each material with at least one propellant. However, certain classes of materials demonstrated superior performance under specific operating conditions.

2. The fully densified refractory-metal nozzles generally were more resistant to erosion and cracking than the other materials. In those cases where erosion occurred, the refractory metals as a group tended to fail by chemical reaction or by a combination of chemical reaction and mechanical abrasion. The latter failure mechanism occurred with lower density tungsten nozzles fabricated by powder-metallurgy techniques. The relatively slight erosion that occurred with the high-density tungsten (i. e., arc-cast or sintered and forged) nozzles was attributed to oxidation. Thermal-stress cracks were noted in a few low-density tungsten nozzles. Arc-cast molybdenum nozzles showed no evidence of erosion with the two lower temperature propellants. However, severe erosion, attributed to melting and oxidation, occurred with the highest temperature propellant.

3. The graphite nozzles were essentially not eroded by the least oxidizing (5600<sup>o</sup> F) propellant. However, when exposed to the other two propellants, they were eroded by a

combination of chemical reaction and mechanical abrasion. As a group, these nozzles generally eroded more extensively than the refractory metals, but none failed by thermal cracking. The higher density recrystallized graphite performed appreciably better than conventional molded types.

4. All the refractory-metal carbide nozzles failed by thermal-stress cracking. In addition, most of these nozzles were eroded by chemical reaction where the propellant environment tended to promote this failure mechanism. Several of the carbide nozzles showed outstanding erosion resistance with all three propellants, comparable to the best refractory-metal nozzle. These materials, because of their high melting points, may afford a potential advantage for application at flame temperatures above those used in this investigation.

5. The cermet and silicon nitride materials performed well insofar as resistance to erosion was concerned with the lowest temperature propellant despite the oxidizing environment, but the low melting or sublimation point of the cermet and silicon nitride materials places a definite limit on the flame temperatures that they can withstand. In addition, thermal-stress cracking was observed. Exposure to the intermediate temperature propellant resulted in severe erosion caused by melting or sublimation.

6. Fiber-reinforced plastic nozzles as a class were the least erosion-resistant materials. They eroded catastrophically by ablation with the two lower temperature propellants and were therefore not tested with the 6400<sup>0</sup> F propellant.

Lewis Research Center,  
National Aeronautics and Space Administration,  
Cleveland, Ohio, January 10, 1966.

## REFERENCES

1. Signorelli, Robert A.; and Johnston, James R.: Erosion Resistance and Failure Mechanisms of Several Nozzle Materials in a Small Solid-Propellant Rocket Engine. NASA TN D-1658, 1963.
2. Shaffer, Peter T. B.: Thermal Shock Resistant Refractories. Industrial Research, vol. 5, no. 5, May 1963, pp. 36-40.
3. Anon.: Data Folder - Haynes Stellite Metal Ceramics. Haynes Stellite Co., July 1959.
4. Anon.: Data Folder-Silicon Nitride. Haynes Stellite Co., Nov. 1960.

*"The aeronautical and space activities of the United States shall be conducted so as to contribute . . . to the expansion of human knowledge of phenomena in the atmosphere and space. The Administration shall provide for the widest practicable and appropriate dissemination of information concerning its activities and the results thereof."*

—NATIONAL AERONAUTICS AND SPACE ACT OF 1958

## NASA SCIENTIFIC AND TECHNICAL PUBLICATIONS

**TECHNICAL REPORTS:** Scientific and technical information considered important, complete, and a lasting contribution to existing knowledge.

**TECHNICAL NOTES:** Information less broad in scope but nevertheless of importance as a contribution to existing knowledge.

**TECHNICAL MEMORANDUMS:** Information receiving limited distribution because of preliminary data, security classification, or other reasons.

**CONTRACTOR REPORTS:** Technical information generated in connection with a NASA contract or grant and released under NASA auspices.

**TECHNICAL TRANSLATIONS:** Information published in a foreign language considered to merit NASA distribution in English.

**TECHNICAL REPRINTS:** Information derived from NASA activities and initially published in the form of journal articles.

**SPECIAL PUBLICATIONS:** Information derived from or of value to NASA activities but not necessarily reporting the results of individual NASA-programmed scientific efforts. Publications include conference proceedings, monographs, data compilations, handbooks, sourcebooks, and special bibliographies.

*Details on the availability of these publications may be obtained from:*

SCIENTIFIC AND TECHNICAL INFORMATION DIVISION  
NATIONAL AERONAUTICS AND SPACE ADMINISTRATION  
Washington, D.C. 20546