

NASA TECHNICAL MEMORANDUM

NASA TM X-52240

NASA TM X-52240

FACILITY FORM 602

N66 37046 (ACCESSION NUMBER)	(THRU)
30 (PAGES)	1 (CODE)
TMX-52240 (NASA CR OR TMX OR AD NUMBER)	28 (CATEGORY)

PROGRESS IN AIRCRAFT GAS TURBINE ENGINE DEVELOPMENT

by Abe Silverstein
 Lewis Research Center
 Cleveland, Ohio

GPO PRICE \$ _____
 CFSTI PRICE(S) \$ _____

Presentation to the International Council of the
 Aeronautical Sciences Fifth Congress
 London, England, September 12-16, 1966

Hard copy (HC) 2.00
 Microfiche (MF) .50

ff 653 July 65

PROGRESS IN AIRCRAFT GAS TURBINE ENGINE DEVELOPMENT

by Abe Silverstein

Lewis Research Center
Cleveland, Ohio

Presentation to the

International Council of the Aeronautical Sciences Fifth Congress
London, England, September 12-16, 1966

NATIONAL AERONAUTICS AND SPACE ADMINISTRATION

PROGRESS IN AIRCRAFT GAS TURBINE ENGINE DEVELOPMENT

by Abe Silverstein*

NASA Lewis Research Center
Cleveland, Ohio

Summary

Proposals on gas turbine engines now in design and development show turbine-inlet temperatures much higher than those now used in airline operations. The status of some research and development efforts on materials and cooling and a summary of supersonic inlet-engine matching problems is given to provide a basis for discussing the selection of realistic "design" values of turbine-inlet temperature for use in the engines of advanced aircraft.

Interesting recent studies on the use of liquid methane as an aircraft fuel, and researches on noise attenuation of the turbofan engines are also briefly outlined.

Author

* Director

E-3643

The remarkable accomplishments of air transport in recent years have been led by the advancements that have been made in aircraft gas turbine propulsion systems. Aircraft engines have been lightened, fuel consumptions have been reduced, and the reliability and durability of the engine in flight operations have been greatly increased.

Despite these outstanding past developments, current researches show that substantial further gains in engine performance and operational capability are still available.

New ideas and more extensive application of older ideas have been stimulated by the current requirement for advanced subsonic transport and logistic aircraft, for supersonic transports and fighters, and for aircraft that combine the capability for vertical landing and high-speed flight.

These requirements lead to complex engine machinery which must be compromised to provide not only effective and economical performance and operations but which must also operate quietly. Further, the need for efficiency generally conflicts with the requirement that the aircraft be tolerant of flight environment and forgiving of error in design, construction, and handling.

Turbine Inlet Temperature

Cycle calculations (ref. 1) show that the long-range subsonic airplane requirements are best met with high pressure-ratio turbofan engines such as are being provided for the Lockheed C5A and Boeing 747 airplanes. Turbofan engines optimized for maximum thrust per unit engine weight are also of considerable interest for VTOL aircraft. For the supersonic fighter, bomber, or transport it is of greatest importance (ref. 2) that the turbine-inlet temperature for either the turbofan or turbojet engine be increased above values used currently in the engine of subsonic transport airplanes.

The maximum temperatures of turbine engines have gradually increased from values of 1300° to 1400° F in the late 1940's to almost 2000° F in one

of our current high performance aircraft. Of greater significance than maximum temperatures is the value of the turbine-inlet temperature for cruise. Temperatures of 1500^o to 1600^o F have been used in cruise for engines that have established records of thousands of hours between overhauls. When we speak of "high-temperature cruise" the question is then "how high?"

The stress-rupture life of superalloys is increased about ten times for each 100^o F decrease in turbine-blade temperature; the practical reward for selection of a low value of engine cruise temperature is, therefore, substantial. The engine size and weight increase rapidly, however, with a decrease in engine temperature with a possible decrease in payload. The trade-off exercise between these and other variables in the problem is an interesting one.

Since the achievement of higher engine temperature occupies the attention of designers for engines to be used in subsonic, supersonic, and VTOL aircraft, it may be desirable to discuss separately the elements entering into the choice of a "design" engine temperature and the status of some of the current work that is applicable. Mention will be made of some problems encountered only at supersonic speeds where the aircraft performance is acutely sensitive to all of the engine's characteristics.

Materials

To operate engines at higher temperatures than are used currently requires better materials, coatings, and increased engine cooling. Improved materials for the hot components of airbreathing engines are, of course, continually needed. For long-lived engines, such as those used in subsonic and supersonic transports, the problem is not only to achieve high-temperature strength, but also resistance to attack by air and combustion gases. Coatings will be required for superalloys for use at advanced temperatures to provide both oxidation and sulfidation protection for long operating times. This need has been accelerated by the current trend of

decreasing the chromium content of superalloys to achieve better high-temperature strength at the sacrifice of some oxidation resistance.

Based on the strength of the better cast nickel-based alloys now available (fig. 1), it is estimated that turbine-inlet temperatures as high as 1800° F can be used in modern engines without any assistance from cooling. If we consider also the corrosion and erosion life of these metals uncoated, it is probably necessary to decrease this allowable turbine-inlet temperature at least 100° F. The development of high-temperature coatings for superalloys for use on the rotating turbine blades, on the stationary vanes of the turbine, and on all the hot sheetmetal parts that form the engine structure is one of the most important current research and development tasks for the metallurgist.

Continuing research on the superalloys of nickel and cobalt in recent laboratory studies promises perhaps an additional 60° F increase in operating temperatures for uncoated blades. Gains to be made from further improvement in the nickel and cobalt superalloys will come slowly and the end point is in sight.

The need for further increases in operating temperatures above those for the conventional superalloys has stimulated consideration of long-range, novel approaches in materials development. Typical are dispersion-strengthened superalloys, fiber-strengthened superalloys, alloys of the refractory metals tantalum and columbium, and alloys of chromium.

Recent data on dispersion-strengthened nickel-base materials (DuPont's TD-nickel and TD-nickel-chromium alloys) indicate that these materials will be useful in low-stress applications, such as stator vanes, at higher temperatures than competitive nickel or cobalt-base superalloys.

The concept of strengthening relatively weak but highly oxidation-resistant materials with high-strength refractory metal fibers holds promise. Large increases in allowable temperature may be achieved by adding refractory alloy wires to the superalloy IN-100 (fig. 2); however, detrimental reactions between the fiber and the matrix may occur. Thus, considerably stronger fibers or improvements in composite processing

may be required and are currently under study.

Some progress has been made in developing oxidation-resistant coatings for the tantalum alloy T-222. Some laboratory specimens have achieved lifetimes in static air in excess of 600 hours in cyclic furnace tests to 2400^o F. If sufficient reliability in the turbojet engine environment could be achieved, such coated tantalum alloys would be promising for stator vane application. Process optimization and simulated service testing are required before the potential of this system can be assessed.

Finally, gains have recently been made in the alloying of chromium. Some chromium alloys may offer a significant strength advantage over available superalloys. However, these alloys are brittle at temperatures below about 400^o F and are further embrittled by absorption of nitrogen from an air environment. It is probable that utilization of such high-strength chromium alloys in advanced engines will be dependent both on design advances which would permit the use of brittle materials and on development of coatings which are not only oxidation resistant but act as diffusion barriers to nitrogen contamination.

Engine Cooling

Although much of the research in materials that has been outlined is of great interest and importance for the future, the next generation of development engines will probably use cast nickel superalloys for turbine blade materials with 1000-hour stress-rupture life and corrosion resistance available at about 1700^o F turbine-inlet temperature. The use of higher engine temperatures must depend upon effective engine cooling. Advanced subsonic aircraft that will use turbofan engines with high bypass ratios optimize cruising performance at turbine-inlet temperatures not much higher than 1800^o to 1900^o F. Only moderate cooling is necessary for these engines.

For supersonic aircraft, however, the turbine-inlet temperatures optimize at higher values variously calculated above 2000^o F. Engine

operation at such high temperatures will require considerable cooling of the turbine blades and guide vanes and carefully tailored cooling on almost all of the other engine hot parts. The blades and vanes must, of course, be designed for long operating times between overhauls if used in commercial operation. At supersonic cruise, the compressor air that is bled to cool the turbine blades may reach a temperature of 1100° to 1200° F at the turbine-blade root. This value is only several hundred degrees lower than the uncooled blade temperatures during cruise in current subsonic transports. It is necessary to utilize cooling methods that are much more effective than those now in use. New casting techniques and the use of electrochemical and electrical discharge machining may make this possible.

Four cooling methods which are the basis of practically all cooled turbine-blade configurations are illustrated in figure 3. Two cooled turbine blades are shown that between them employ all four of the methods.

Transpiration cooling is an extremely effective method of blade cooling. Cooling air flows through a porous or perforated wall material and forms an insulating blanket between the hot engine gas and the blade wall. A development engine has operated for some time at temperatures exceeding 2000° F using transpiration cooling, and eventually this method may find extensive use in turbine engines.

Greatest current effort is on convection-cooled blades which are being developed throughout the industry. Normally (fig. 3), the midchord region of these blades has closely spaced fins which augment the surface area and provide acceptable cooling. At the blade leading edge the heat input from the gas stream is greatest, and a very effective internal cooling method is required. Impingement cooling in which air jets are directed against the inside of the leading edge has been found by investigators in both the United States and Europe to be an effective method for leading-edge cooling. The trailing edge of the blade is usually too narrow to contain cooling passages and film cooling may be used.

To make the most effective use of the cooling air for aerodynamic as well as cooling considerations, it is desirable to discharge all of the

cooling air in the direction of the turbine gas stream. A blade configuration that uses this principle is illustrated in figure 4. This blade also has impingement cooling in the leading edge. The air from the leading-edge cooling duct is then bled into the gas stream through film cooling slots or holes. The midchord region of the blade is cooled by air that comes up the central passage and is directed into closely spaced fins that are aligned in the direction of the external gas flow. The air from these fins is finally discharged through the trailing edge.

Taking into consideration only the data on the current strength and corrosion resistance of the superalloys at 1700^o F turbine-inlet temperature and the 400^o to 500^o F reductions in turbine-blade temperatures that have been demonstrated in engine cooling tests, it appears possible that operation in continuous supersonic cruise at turbine-inlet temperatures above 2000^o F may be possible for the engines now in development. This conclusion must be qualified by the following considerations:

(1) Allowable blade temperatures were based on 1000-hour stress-rupture life, whereas longer turbine-blade life may be desired for economy.

(2) No design margin was allowed for a change in the temperature profile at the combustion-chamber outlet that occurs in time as a result of dirt in fuel nozzles, minor combustion-chamber failures, etc.

(3) Temperature transients associated, for example, with engine stall and bad temperature distortions resulting from interaction between the inlet system and the engine have not been properly taken into account.

This interaction between the inlet and the engine is greatest in supersonic flight. Inherently, the margin between normal engine operation and stall is reduced at high engine-inlet temperatures, so that disturbances to the inlet flow of no consequence at sea-level takeoff can stall the engine in supersonic cruise.

Although the problem of supersonic inlet-engine matching and the possible effects of mismatch on the engine operation are rather well known, recent history in applying the knowledge to practice is bad, and some review may be in order. It is definitely pertinent to the question of what is an engine "design" temperature.

Engine-Inlet Matching

The airflow characteristics of the propulsion system components must be matched over the entire speed range.

For supersonic cruise aircraft, the cruise airflow requirements determine the size and basic design of the components. At speeds less than design, variable geometry and special ducting arrangements are required to maintain performance at an acceptable level. This situation is illustrated (fig. 5) in which the inlet supply meets the engine demand plus the nozzle secondary flow requirement at supersonic cruise. Although some of the inlet boundary-layer bleed air may be utilized to meet the nozzle requirement, a substantial portion of it may be at such a low pressure level that it will be discharged directly overboard. As Mach number decreases, the engine demand will vary, depending upon its specific design. However, the inlet supply will always be less than the engine demand, and low performance will result unless the inlet geometry is varied. The inlet supply shown on the illustration is obtained from a design that provides a large centerbody geometry variation so as to maintain inlet recovery at high levels over the entire speed range. The manner in which the excess air supplied by the inlet is utilized in the nozzle and bypass is determined by a detailed optimization of the specific installation.

Several factors are considered in the selection of the inlet design at supersonic cruise. As design Mach number increases, the supersonic compression must increase in order to minimize the pressure loss of the inlet terminal shock. As illustrated (fig. 6), at least a portion of this compressive turning is accomplished externally by the centerbody. However, if large amounts of turning are required, the external cowl angles become so steep that the drag is high. Hence, a portion of the turning may be done internally by the cowl surfaces. The division of external and internal compression is at the discretion of the designer. Two possible combinations are shown in the illustration. On the lower part of the figure are shown the corresponding flow characteristics for each type. At moderate supersonic speeds the external-compression-type may provide a fairly high peak

pressure recovery with only moderate boundary-layer bleed requirements. However, as Mach number increases, the stable range of subcritical flow diminishes and may vanish entirely unless supercritical oblique shock spillage is utilized. Normally, the severity of buzz intensifies as the inlet flow is progressively decreased into the unstable range; however, the inlet can be readily stabilized by opening the bypass area so as to increase the capture mass-flow ratio. No adjustment of centerbody geometry is required.

A different inlet characteristic is associated with mixed-compression inlets. During normal operation, higher peak pressure recoveries can be attained but at the expense of increased boundary-layer bleed. The stable subcritical range may be quite small and is only a result of increased bleed flow as the terminal shock approaches the bleed sections of the throat. In conventional inlet concepts the terminal shock cannot be positioned in the convergent passage ahead of the throat and hence an unstart occurs wherein the shock pops out of the inlet and causes a sharp reduction in flow and pressure at the engine face. The severity of the unstart depends upon the free-stream Mach number and, as indicated by the figure, upon the amount of internal contraction. Following an unstart, inlet buzz may also ensue, but it can be arrested by opening the bypass sufficiently to choke the throat. However, to restart the inlet, the contraction of the convergent passage must be reduced so that the terminal shock can be returned within the diffuser. Frequently, the terminal shock reenters to a highly supercritical condition and is subsequently returned to the desired location by closing the bypass.

For all these inlets, an additional limitation must be observed in that highly supercritical operation causes increased shock boundary-layer interaction in the subsonic diffuser. This results in time-variant distortion patterns at the diffuser discharge. The consequences of these undesirable characteristics of the inlet (buzz, unstart, restart, and distortion) will vary depending upon the specific engine design. The effects on the engine may be severe, and serious malfunction and overheating may result.

A primary effect of distortion is the reduction in the margin allowed in the design to avoid rotating stall and compressor surge. Other deleterious

effects include reduction in compressor efficiency and airflow capacity, high stresses in compressor blades, and hot spots downstream of the combustor. The time-variant distortion patterns accompanying inlet buzz may be quite severe, but the problem is additionally complex in that the varying diffuser discharge pressure may further reduce stall margin by causing a dynamic mismatch of the compressor stages. Drastic effects which may also accompany inlet unstart include compressor stall and either combustor flameout or overtemperature of the engine hot components. These effects within a single engine may be further compounded through its effect on the airframe motions and on the operation of adjacent propulsion units.

It is apparent then that only a fairly limited portion of the inlet stable range will be usable after providing proper margins for other perturbing effects such as gusts, aircraft maneuvers, ambient temperature gradients, and possibly armament firing. The fast acting and accurate control systems which are obviously required must be tolerant of the wide temperature and pressure variations inherent in supersonic flight, and they are complex because of the large number of control loops and anticipatory signals. The propulsion-system components requiring control are shown (fig. 7), and their transient behavior is indicated schematically for a normal afterburner ignition. Following initiation of afterburner fuel flow, exhaust-nozzle area may increase in anticipation of ignition. The resulting variation in afterburner pressure would tend to cause variations in engine speed (and hence airflow) and thereby produce transient variations in main fuel flow, compressor geometry, and bypass position. Although the inlet centerbody control may not respond to the transient, its position must be appropriate, so that the resulting variation in terminal shock position does not cause buzz, unstart, or high distortion. For certain applications, anticipatory signals may be needed from both the engine system and the airframe control system to ensure adequate maneuver capability.

The development status of materials, engine cooling, and engine inlets such as has been presented and information on the level of technology existing

and expected in many other applicable engineering fields are used in selecting a "design" engine temperature. Since the selected engine temperature in most cases sizes the engine, it is of greatest importance that reasonably conservative values of design temperatures be used so that the engine can initially meet the aircraft thrust requirements and can be uprated to meet future needs. It is the author's belief that "design" cruise turbine-inlet temperatures in excess of 2000^o F fail to meet this test of conservatism for engines now in development.

The engine temperature is only one of the critical propulsion-system variables. The faster an airplane flies, the more critically its overall performance depends on the performance of each component. From a Lewis Research Center calculation for a typical large supersonic airplane (Mach 3) the change in range in miles is given (fig. 8) for a 1-percent change in the performance index of a number of the important propulsion-system components. For example, a 1-percent loss in exit nozzle efficiency reduced the range by 120 nautical miles, whereas a corresponding efficiency drop in the compressor reduced the range by about 34 nautical miles. A 1-percent loss in efficiency for each of the components shown in figure 8 would land a marginally designed transoceanic transport about 300 miles at sea. The extreme sensitivity of the supersonic airplane to the values of component efficiency needs emphasis, as well as the probability of interactions among the components that can lead to loss of efficiency. If a well-designed supersonic inlet is required to operate at 10 percent less than the best efficiency to prevent engine stall, a sacrifice of 250 miles of aircraft range results (fig. 8). The range performance of the subsonic aircraft is less critically dependent on the component performance, and there is less interaction among the propulsion-system components and between the propulsion system and the aircraft. A transfer of expectations based on prior subsonic aircraft experience can, therefore, be hazardous. The quotation of supersonic airplane performance based on maximum expected performance values for each of the propulsion-system components is likewise hazardous.

Liquid Methane Fuel

Studies recently reported by Mr. Weber et al. (ref. 3) of the Lewis Research Center reveal the exciting possibilities of liquid methane as a turbine engine fuel. Prior study in 1956 by Mr. Robert R. Hibbard (ref. 4) had also shown promise for methane. Because it has a higher heating value, greater cooling capacity, and a lower current price per pound, the authors estimated that the payload of a commercial supersonic transport might be increased by 30 percent through the use of methane instead of standard jet fuel, and the direct operating cost reduced a like amount (fig. 9). These gains were, of course, contingent on finding space in the airframe for storing the liquid methane which has only a little more than one-half the density of jet fuel, and on the development of fuel tanks to hold the cryogenic liquid methane without excessive loss in climb or cruising flight. The researches conducted on the storage, containment, pressurization, etc. of liquid hydrogen used in NASA's Centaur and Saturn launch vehicles provide a substantial technological background for handling these problems of cryogenic liquids.

The possibility of using liquid methane in subsonic aircraft and for vertical take-off and landing craft is also of great interest. In the VTOL aircraft the relatively low flight speeds may reduce the penalties for carrying the large volume tanks that are best for cryogenic fuels. Of even greater interest may be the possibility of using the superb cooling capacity of liquid methane for turbine and engine cooling so that extremely high turbine inlet temperatures, high compression ratios, and large bypass ratios can be used in direct-lift fan engines. Alternate methods for cooling the turbine blades and turbine guide vanes are shown in figure 10. In one of the methods an air-methane heat exchanger is used to cool the air bled from the compressor on its way to the turbine blades. Alternatively, the methane can be taken into the turbine wheel and be used to cool the blades directly, or indirectly by means of a liquid metal-methane heat exchanger. With either method the efficiency and relatively low noise levels that may be possible with engines of this type may provide for much higher performance and

usefulness than is possible now with other turbine engines used for direct lift.

Much more needs to be learned about both flight and ground equipment before liquid methane can be seriously considered as an aircraft fuel. If it can be used it may make possible a class of supersonic airplanes that will fly with reasonable efficiency at Mach numbers of from 4 to 5. This may be the Mach number range for our next round of high speed aircraft.

Noise

The prospects for reducing the noise associated with fan-jet powered aircraft are encouraging. The introduction of fan-jet engines for turbojet engines in subsonic transports several years ago resulted in a jet noise reduction of about 8 decibels. This reduction was accomplished with engines having low bypass ratios. The fan noise for these engines is just below the jet noise levels at the take-off power settings, and for approach power settings where the jet noise is greatly reduced the fan noise is predominant.

Calculations on the noise level and payload of a large subsonic form engine airplane are of interest in comparing the turbojet and turbofan engines for a range of fan bypass ratios. The calculations were carried out for a series of engines with different compressor pressure ratios, and with varying fan pressure ratios and fan bypass ratios appropriate to the gas generator cycle pressure ratios and temperatures used. Typical values of the variables from figure 11 are as follow:

Compressor pressure ratio	Turbine inlet temperatures, °F	Optimum bypass ratio
15	1475	3
20	1900	5
25	2600	6

It is clear from the results (fig. 11) that the airplane when fitted with the fan engines carries the most payload and has the lowest jet noise levels. If the fan noise of these engines in take-off and throttled landing can be reduced to values comparable with the jet noise then the scourge of turbine engine noise will have been eradicated from the engine type most effective for propelling payload at subsonic speed.

There appear to be important possibilities for reducing the fan noise. Recent work by Douglas Aircraft Corporation with Pratt and Whitney Aircraft Division of United Aircraft Corporation has shown in duct tests that the frequencies characteristic of the fan can be greatly attenuated by the use of treated walls in the ducts.

Using similar treatment, the Lewis Research Center has modified the inlet cowling for the J-65 engine on the B-57 airplane, as shown in figure 12. The inner surfaces of the cowling were lined with porous metal which was supported over a 1-inch cavity lying just behind the metal. The porous metal and cavity were designed to be an effective absorber in the range of frequencies around 3000 cycles per second. A circumferential splitter ring and form radial supports were fabricated with a similar cavity and porous metal covering.

A photograph of the cowling installed on the inlet of the J-65 engine is shown in figure 13. The J-65 engine does not produce an outstanding discrete tone similar to a fan. The inlet guide vanes were, therefore, modified to produce a predominant whine at an engine speed corresponding to aircraft letdown.

Measured noise levels with the modified and unmodified cowling (fig. 14) show a reduction of about 12 decibels in the level of the whine with the modified cowling. Attenuations of the same general magnitude were measured over a broad band of frequencies on both sides of the predominant one.

In addition to the gains achieved by cowl treatment, it is possible to design a fan so that it is inherently less of a noise producer. It has been determined that the noise associated with fans is critically dependent on the interactions between stationary and rotating members (ref. 5). Model

tests have shown that reductions of 10 decibels in some instances can be achieved by increasing the spacing between rotor and stator blade rows. Some limited experience with full-scale fans bears out this principle but additional experiments are necessary in order to determine the full potential of design modifications such as this. Another approach to the fan noise problem is to design the fan for operation at subsonic tip speeds. The available pressure ratio per stage is thereby decreased which may require an increase in the number of fan and turbine stages. The resultant compromise in engine performance has not been determined.

In an attempt to increase the loading of fan and compressor blading so as to avoid increasing the number of stages, some interesting tests have recently been made on slotted compressor blades in a static cascade and the encouraging results have been revealed. Measured wakes behind the slotted and unslotted blades (fig. 15) show that flow separation was delayed an additional 5° angle of attack for the slotted blade. Slots are commonly used to delay stalling of aircraft lifting surfaces but they have as yet not been applied to fans. The current work on noise suppression holds substantial promise for alleviation of the noise problem of the fan-jet engine.

REFERENCES

1. Bagby, C. L.; and Andersen, W. Lee: Effect of Cycle Variables on Aircraft Cruise Performance. Paper 65-796, AIAA, Nov. 15-18, 1965.
2. Silverstein, Abe: Research on Aircraft Propulsion Systems. J. Aeron. Sci., vol. 16, no. 4, April 1949, pp. 197-226.
3. Weber, Richard J.; Dugan, James F., Jr.; and Luidens, Roger W.: Methane-Fueled Propulsions Systems. Paper 66-685, AIAA, June 13-17, 1966.
4. Hibbard, Robert R.: Evaluation of Liquefied Hydrocarbon Gases as Turbojet Fuels. NACA RM E56I21, 1956.
5. Sharland, I. J.: Sources of Noise in Axial Flow Fans. J. Sound Vib., vol. I, no. 3, 1964, pp. 302-322.

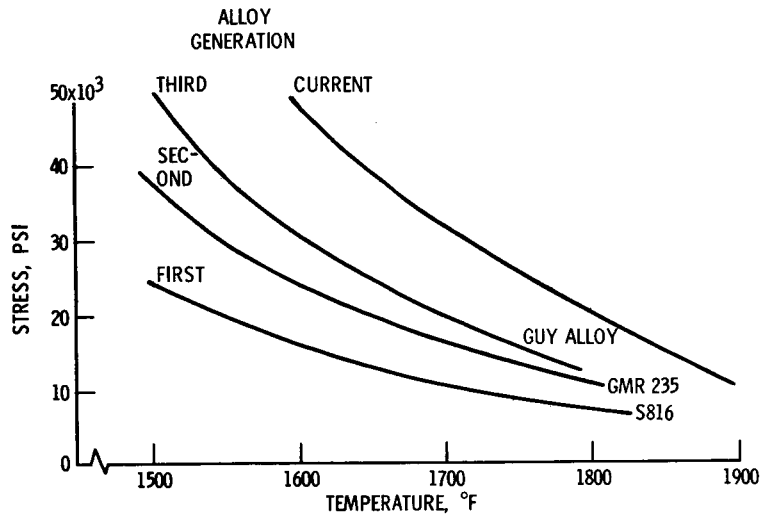

Figure 1. - 100-Hour stress-rupture life of various alloys.

CS-40735

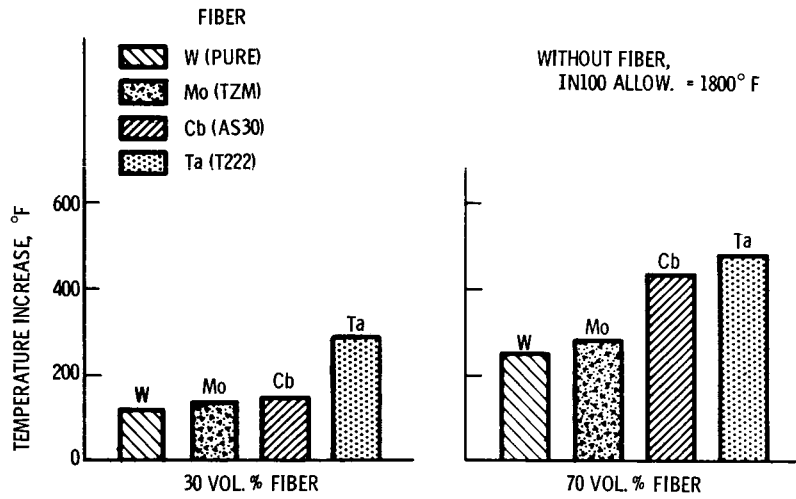

Figure 2. - Increase in allowable temperature by addition of refractory fibers to super-alloy (IN100) (calculated). Strength/density, 52 500 inches for 1000 hours.

CS-37228

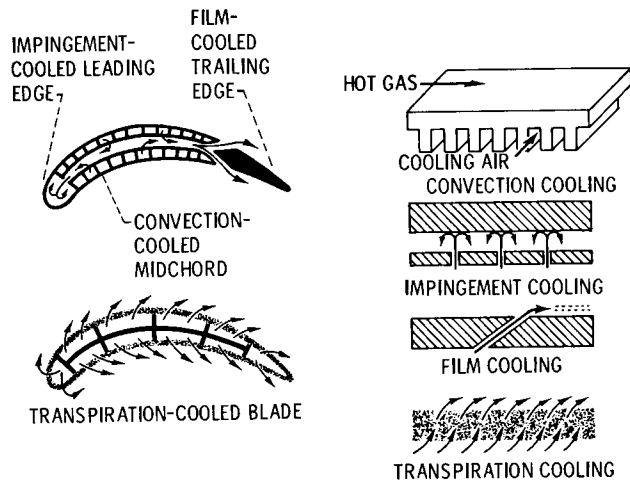
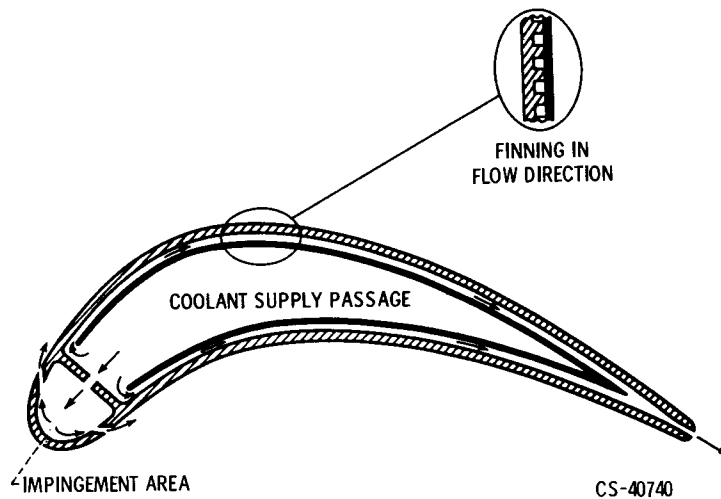

Figure 3. - Methods of turbine-blade cooling.

CS-40739



CS-40740

Figure 4. - Advanced cooled-blade configuration.

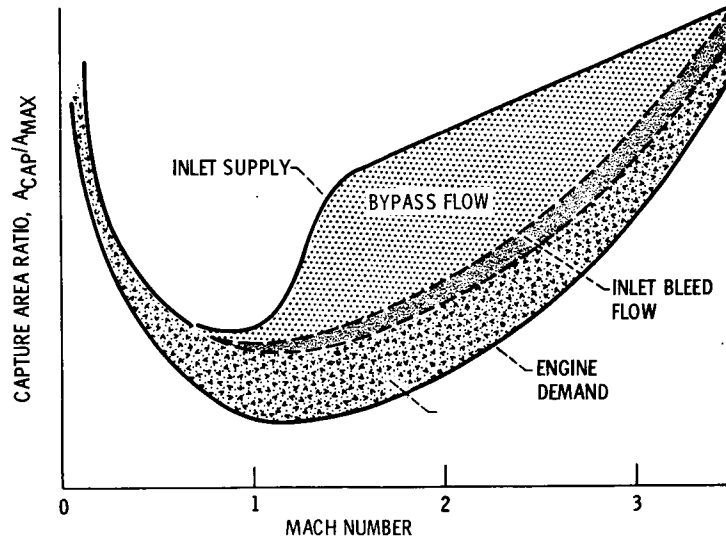

Figure 5. - Airflow matching.

CS-40741

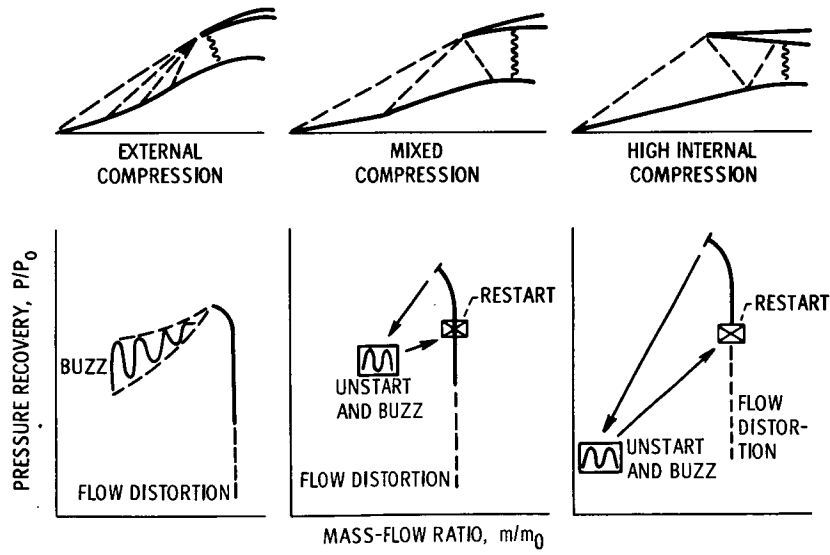

Figure 6. - Inlet characteristics.

CS-40737

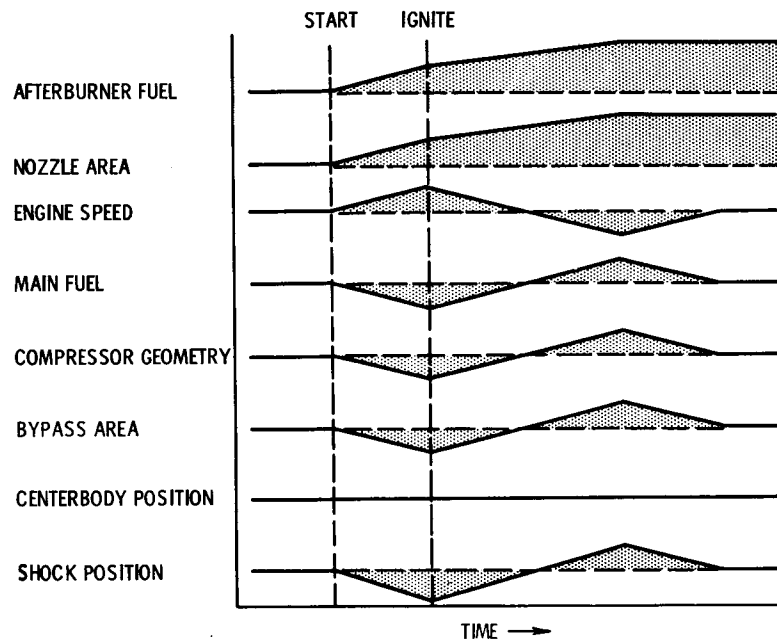

Figure 7. - Typical start transient.

CS-40742

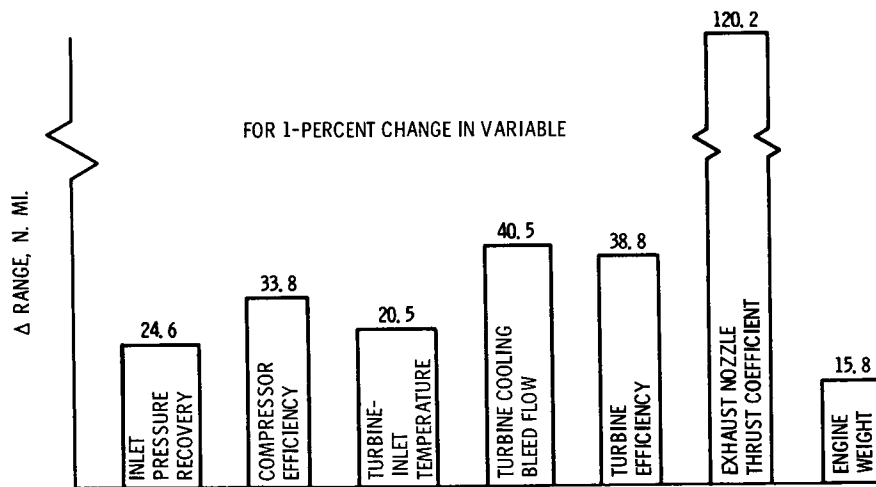

Figure 8. - Effect of engine characteristics on range for large turbojet-powered aircraft; Mach 3.

CS-40730

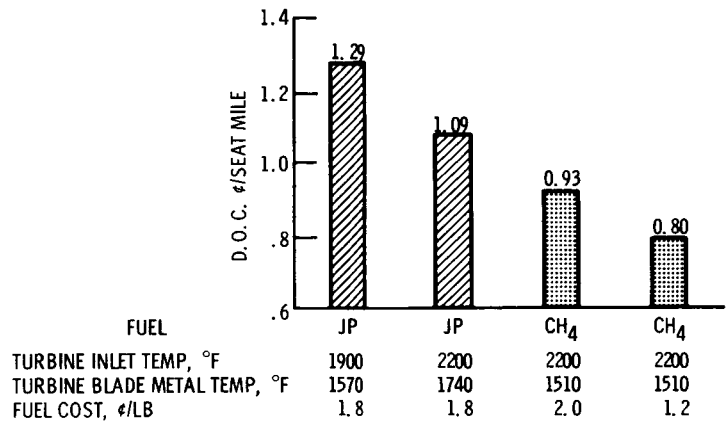
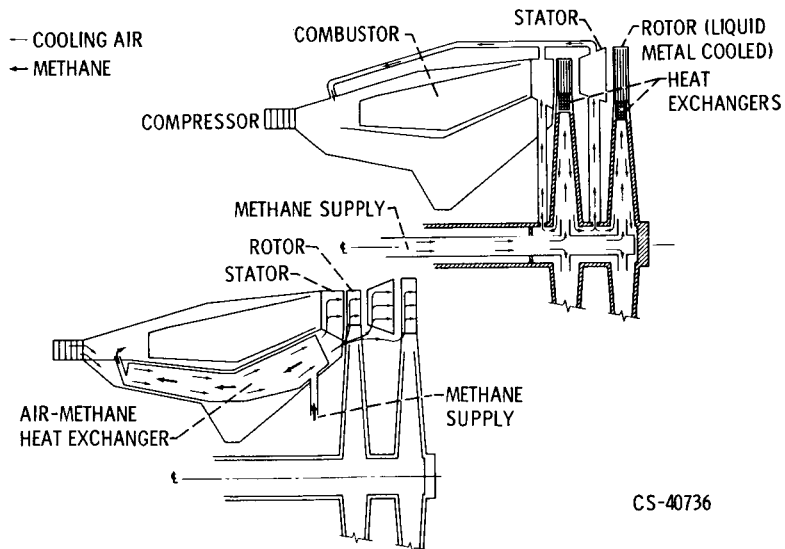

Figure 9. - Methane may reduce operating costs.

CS-39546



CS-40736

Figure 10. - Alternate turbine cooling methods with methane fuel.

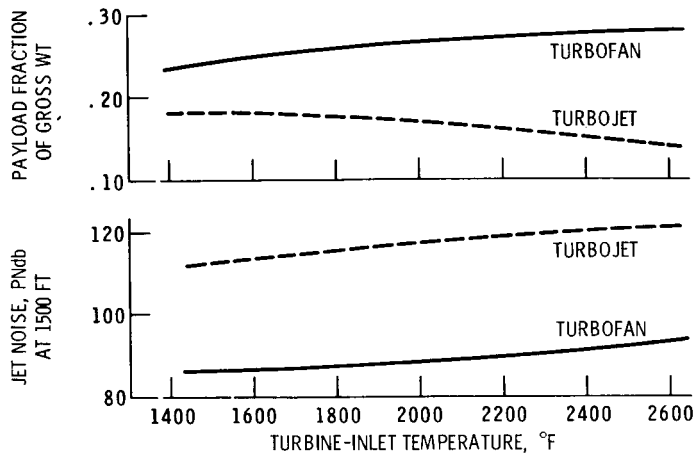

Figure 11. - Subsonic turbofan and turbojet airplane performance - noise level and payload. Mach 0.82; range, 4000 miles.

CS-40734

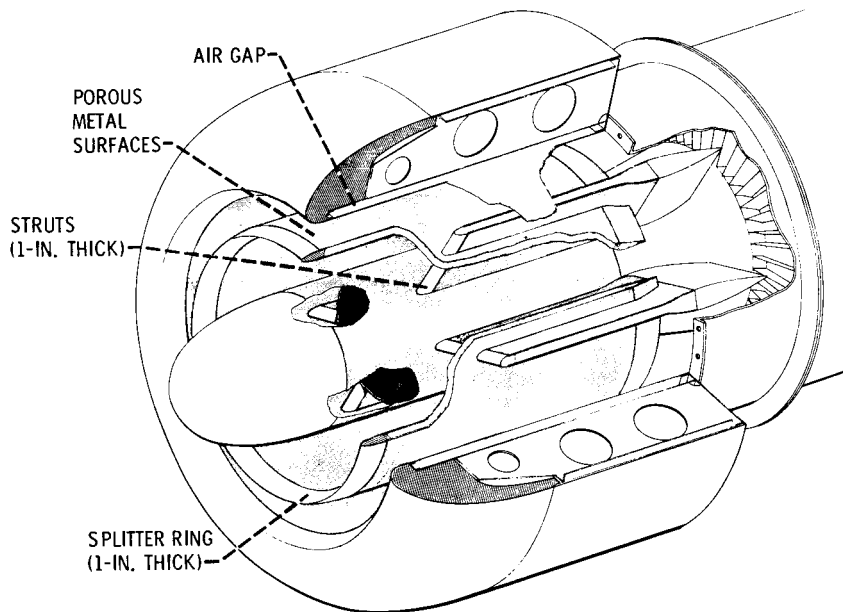

Figure 12. - Engine cowling modified to reduce noise.

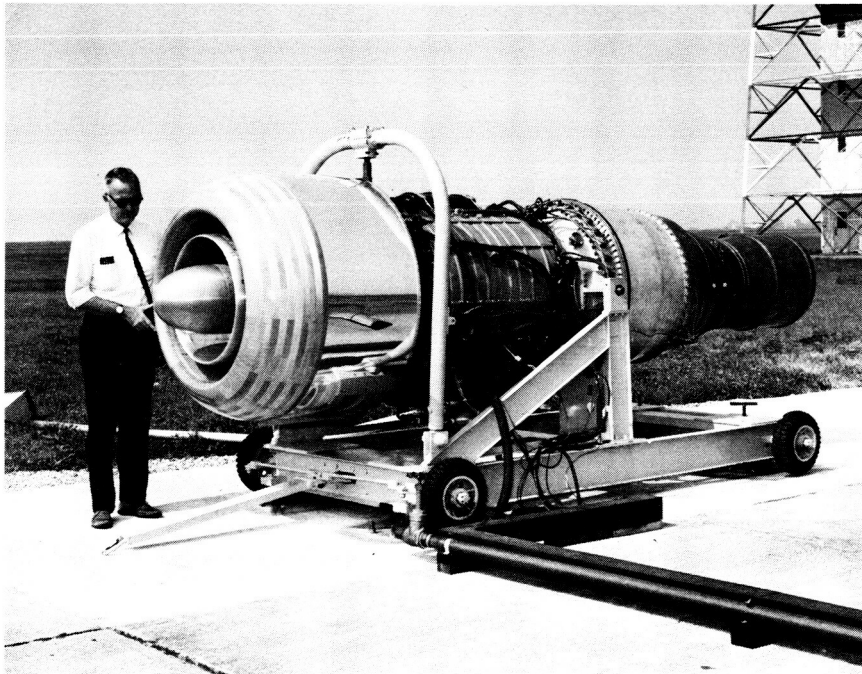

Figure 13. - Noise reduction cowl installed on J-65 engine.

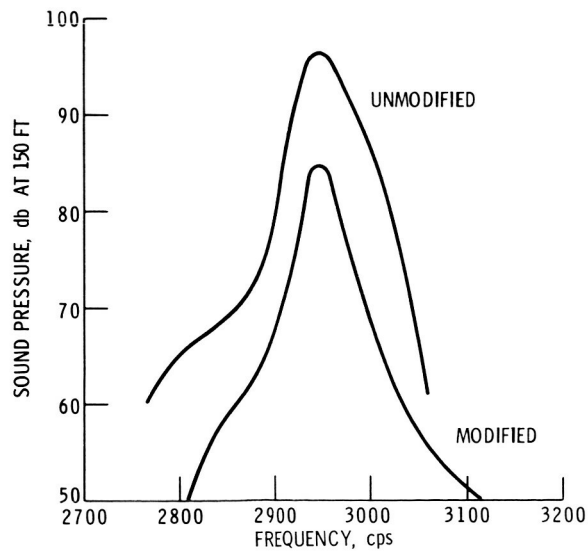

Figure 14. - Noise level with modified cowling.

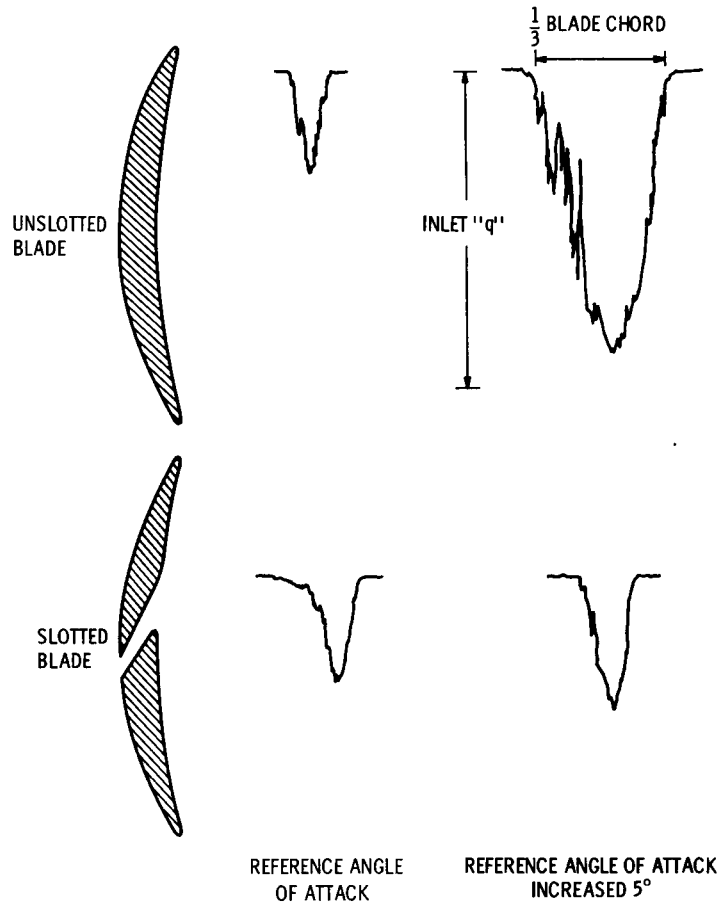

Figure 15. - Wake profiles of compressor blades.