

X-623-68-281

PREPRINT

NASA TM X-63344

CYLINDRICAL ELECTROSTATIC PROBES EMPLOYED ON ALOUETTE II AND EXPLORER 31 SATELLITES

J. A. FINDLAY
L. H. BRACE

GPO PRICE \$ _____
CSFTI PRICE(S) \$ _____

Hard copy (HC) _____
Microfiche (MF) _____

JULY 1968

ff 653 July 65



GODDARD SPACE FLIGHT CENTER
GREENBELT, MARYLAND

N 68-35771

FACILITY FORM 602

(ACCESSION NUMBER) _____
(PAGES) 21
(NASA CR OR TMX OR AD NUMBER) TMX-63344

(THRU) _____
(CODE) 5
(CATEGORY) _____

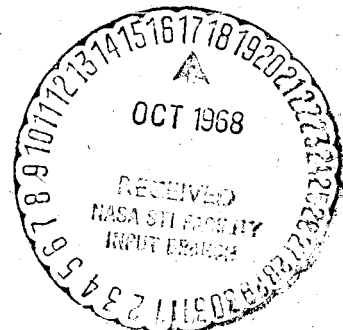

X-623-68-281

PREPRINT

CYLINDRICAL ELECTROSTATIC PROBES EMPLOYED
ON ALOUETTE II AND EXPLORER 31 SATELLITES

J. A. Findlay

L. H. Brace

July 1968

GODDARD SPACE FLIGHT CENTER

Greenbelt, Maryland

CYLINDRICAL ELECTROSTATIC PROBES EMPLOYED
ON ALOUETTE II AND EXPLORER 31 SATELLITES

J. A. Findlay

L. H. Brace

ABSTRACT

The Cylindrical Electrostatic Probe experiment, employed on both the Alouette II and the Explorer 31 satellites, provided a common denominator for inter-satellite comparisons of directly measured parameters. The instruments used identical sensors, but differences in satellites resulted in some differences in data formats and experiment potentials. There was considerable interference from the topside sounder seen on the probe data from Alouette II which made data processing difficult, though not impossible.

CONTENTS

	<u>Page</u>
ABSTRACT	iii
INTRODUCTION	1
THE EXPERIMENTS.....	2
Background	2
Theory	2
Vehicle Potential	3
Electron Temperature.....	3
Electron Density.....	4
Range of Measurements	4
The Sensors.....	5
Electronics	6
SOUNDER EXPERIMENT INTERFERENCE	8
ACKNOWLEDGMENTS	9
REFERENCES.....	10

CYLINDRICAL ELECTROSTATIC PROBES EMPLOYED
ON ALOUETTE II AND EXPLORER 31 SATELLITES

INTRODUCTION

Of the experiments aboard the ISIS-X satellites the one common to both Alouette II and Explorer 31 was the Cylindrical Electrostatic Probe (CEP). This Langmuir-type probe was employed to make direct measurements of electron temperature (T_e) and density (N_e) in the ionosphere at the satellites.

There were several reasons for including the CEP in both payloads:

1. To study the feasibility of making direct ionospheric measurements and topside soundings from a single satellite such as the follow-on satellites ISIS-A and ISIS-B. (Franklin et al., 1968.)
2. To provide a common denominator, when the two satellites are near each other, for inter-satellite data studies using the topside sounder aboard the Alouette II and the various direct measurement experiments aboard the Explorer 31 as reported in a companion paper by Donley et al. (1968).
3. To provide continuous direct measurement of T_e and N_e on the Alouette II for use with the N_e profiles derived from the sounder data.
4. To permit study of the Alouette II satellite potential behavior.

To best accomplish the above goals the instrumentation for the two experiments was designed as nearly the same as practical. What differences there were resulted from basic differences in the two spacecraft such as external configuration, in-orbit orientation and telemetry formats.

The resultant differences in instruments included sensor location, sensor voltages, sampling sequences and rates. In a companion paper (1968), Brace and Findlay,

employing data from the two satellites when close together, find no significant differences in N_e or T_e .

THE EXPERIMENTS

Background

The cylindrical probe technique consists of measuring the current of free electrons and ions to the cylindrical collectors, which are extended into the plasma surrounding the spacecraft, as a known regular sawtooth voltage is programmed. These currents are converted to signals suitable for telemetry and transmitted to the ground.

The CEP has been flown in similar configurations on several previous satellite and rocket programs (Spencer et al., 1962, Spencer et al., 1965, Brace et al., 1965, Brace, Reddy 1965, Reddy et al., 1967). The theoretical basis for the experiment was established by Mott-Smith and Langmuir (1926). The theory was extended to ionospheric application by others including Boggess et al., (1959) and Spencer et al., (1962). In view of the previous coverage only a brief review of the general aspects is given here along with those aspects which are peculiar to the ISIS mission.

Theory

A predicted current vs. voltage relation for the experiment is shown in Figure 1. The volt-ampere characteristic has three distinct regions, two of which are predominantly electron current and one predominantly ion current. Although much information is contained in the ion saturation region, the ISIS-X experiment was not designed toward ion current studies and this paper will deal only with the electron current.

Vehicle Potential

The satellite potential is just that applied voltage required to drive the probe to the plasma potential ($V = 0$ in Figure 1). This is identified as the point of inflection on the volt-ampere curve between the electron retardation and electron saturation regions.

Electron Temperature

The expression for electron current in the electron retardation region is

$$I_e = A N_e e (kT_e / 2\pi m_e)^{1/2} \exp - (eV/kT_e) \quad (1)$$

where

A is the collector area

N_e is the electron density

e is the electron charge, 1.602×10^{-19} coulomb

k is Boltzmann's constant, 1.38×10^{-23} joule/°K

T_e is the electron temperature

m_e is the electron mass, 9.11×10^{-31} Kg

V is the retarding potential of the collector.

Taking the logarithm of both sides and assuming the values of N_e and T_e remain constant over a voltage sweep we have

$$\ln I_e = \ln \text{Constant} - eV/kT_e \quad (2)$$

Differentiating both sides and solving for temperature gives

$$T_e = \frac{e}{k} \frac{dV}{d(\ln I_e)} \quad (3)$$

This relation is used to determine T_e from the data. Note that the determination of T_e is independent of N_e .

Electron Density

The third region of the volt-ampere curve is the electron saturation region where electrons are accelerated to the collector. To a very close approximation the electron current to the collector is given by

$$I_e = \frac{2A N_e e}{\pi^{1/2}} \left(\frac{kT_e}{2\pi m_e} \right)^{1/2} \left(1 + \frac{eV}{kT_e} \right)^{1/2} \quad (4)$$

Note that this expression is nearly independent of T_e . It has been shown by Spencer et al. (1965) that for sufficiently positive voltages the current to the collector can be approximated by the temperature independent expression

$$I_e = \frac{A N_e e}{\pi} \left(\frac{2eV}{m_e} \right)^{1/2} \quad (5)$$

from which N_e is readily obtained.

Range of Measurement

The amplifier sensitivities of the ISIS-X instruments were chosen with emphasis on providing resolution in the electron retardation and electron saturation regions for the densities expected in the ISIS-X orbit. This includes densities from about 6.5×10^5 electrons/cc (saturation on the 8×10^{-6} ampere amplifier range) to about 100 electrons/cc (10% of full scale on the 2×10^{-8} ampere range). Temperatures can be resolved for densities greater than about 1×10^3 electrons/cc over the range of about 400°K to about 15,000°K, a much wider range than that actually observed.

The Sensors

The cylindrical probes used on the two satellites are identical (see Figure 2) and are operated independently. They consisted of a collector electrode 0.057 cm diameter, 23 cm long, and a coaxially mounted guard electrode of 23 cm length and of 0.170 cm diameter. The guard electrode is electrically isolated from the collector but is driven at the same voltage. The guard provides continuity in the electric field and separates the collector from the spacecraft thus reducing wake and sheath effects. An electrically floating conductor of 0.23 cm diameter and 21.2 cm long is mounted concentric to the guard electrode. This reduces the total current to the guard and thus increases the area ratio between satellite and collector. The guard and collector are mounted to a screw-on type coaxial connector through coaxial helical springs which allowed the sensors to be stowed in a folded configuration for launch.

The mounting locations of the two sets of probes on the two satellites and their orientation in space is shown in Figure 3. The Alouette II probes protrude at a 45° angle to the spin axis on opposite sides of the satellite. The Explorer 31 probes are 90° to the spin axis, also on opposite sides and near one end of the satellite. The Alouette II spin axis remains generally in the orbital plane pointing approximately north while the Explorer 31 spin axis is maintained approximately normal to the orbital plane by a spin axis control system (Nelson, 1968). The result is that the data from each probe on Explorer 31 is modulated by satellite wake effects relatively uniformly throughout the orbit while that from Alouette II is modulated most in the middle and high latitudes and relatively little in the lower latitudes. Also, the modulation is greater on northbound passes where the probes are generally trailing the spacecraft than on

southbound passes where they generally lead. These modulations can be as great as 90% under extreme conditions such as near perigee where the satellite velocity greatly exceeds the ion thermal velocity, but is usually much less. The wake data are not used in determining electron temperature or density however, and in a companion paper Brace and Findlay (1968) show that the accuracy of the measurement is not significantly affected by either the spin modulation or the presence of the booms. Spatial resolution is maintained by using two collectors generally on opposite sides of the spacecraft so that at any time there will be at least one probe taking non wake data.

Electronics

It follows from the above discussion that to make good measurements two requirements must be met. First, the probe must be driven sufficiently positive and negative with respect to the plasma to cover the three regions of the volt-ampere characteristics; and second, each voltage sweep must be taken in sufficiently short time that the spin modulation does not affect the shape of the characteristic, but not so short a time that the telemetry cannot adequately follow. These considerations resulted in the remaining differences between the two experiments.

Regarding the first consideration, that of the amplitude of the applied voltage, one of the unknown aspects of the Alouette II spacecraft was the potential the main body would assume. Two complications to predicting this potential were:

(1) The long sounder booms across which a time varying voltage would be induced,

$$\vec{E} = \vec{v} \times \vec{B} \cdot l \quad (6)$$

where

v is the satellite velocity, about 7.5 km/sec

\bar{B} is the Earth's magnetic field

l is the length of the sounder, 73.15 meters and 22.86 meters for the long and short dipoles respectively.

(This would be a time varying voltage at twice the satellite spin rate); and
(2) a negative biasing of the spacecraft into the ion saturation region by the presence of the positive exposed conductors on the solar array. These conductors being driven a fixed positive voltage with respect to the satellite would tend to collect electrons beyond the ability of the remaining spacecraft surface to collect positive ions. Thus the potential of both would then adjust with respect to the plasma to maintain charge balance.

Although countermeasures were taken for each of these problems, specifically, electrical isolation of the booms with capacitive coupling for sounding (see companion paper by Franklin) and coating the exposed conductors on the solar array with an insulating material (see companion paper by Florida), it was felt necessary to provide a sufficiently large applied voltage sweep to cover the possibility of failure in either case. This required an applied voltage sweep of -3v to +10.5v on Alouette II as opposed to -1.7v to +5.1v on Explorer 31 which had neither of these potential problems.

The second basic consideration, the time over which a sample is taken, is controlled by the amplitude of the applied voltage sweep as discussed above and the maximum rate of change of applied voltage for which the amplifier response time and telemetry resolution are adequate. On Explorer 31 the PCM telemetry allocated to the experiment limited the applied voltage rate to 5.4 volts per second,

while on Alouette II the FM system allowed a rate of 17.5 volts per second. The resultant sweep periods were 1.26 and 0.700 seconds respectively.

The other significant difference between the two experiments resulted from the number of telemetry channels available on the two spacecraft. On Explorer 31 the experiment was provided two data channels so that both probes could be monitored continuously. The Alouette II telemetry system provided only one data channel, thus the two probes were sampled alternately for one sweep period each. Current range switching was synchronized to the sounder sweep system providing range switching about every 27 seconds. In-flight calibration of the amplifiers was provided by periodically substituting a known resistance in place of the probes. A functional block diagram of the two experiments is given in Figure 4. Note that identical current sensitivities were used in the two systems. Typical raw data from the experiments is shown in Figure 5.

SOUNDER EXPERIMENT INTERFERENCE

The greatest problem in analyzing data from aboard the Alouette II satellite was not entirely anticipated. It was expected that the 400 watt transmitter would generate electromagnetic interference signals, and in fact some filtering was provided within the sensor mounting boxes. It appeared from ground based tests that the remaining noise would not interfere with data reduction. In orbit however, the nature of interference was drastically different. Through some combination of plasma disturbance and instantaneous potential shifting of either the spacecraft or collectors or both there is observed on the probe data a spike, or pulse, each time the sounder pulses. The width and amplitude of the spike vary as a function of sounder frequency and plasma density from negligible to

a point where reduction of the data is impossible. The level of disruption is usually greatest when the sounder frequency is near the plasma frequency. Figure 6 shows an example of the variation of spikes through one sounder sweep on a typical data run. Fortunately there is a 4 second period preceeding each sounder sweep when the sounder power amplifiers are turned off, providing completely undisturbed data. It is this data which is used for bulk analysis. Comparisons between undisturbed and moderately disturbed data show no effect on the amplitude of the electron saturation region; therefore, the N_e measurements are unaffected. We have also found that even under conditions of moderate interference the spikes are sufficiently short that evaluation of T_e , though impractical on a large scale basis, can be carried out by hand with no significant loss in accuracy. A more complete comparison and evaluation of data taken from the two spacecraft is included in a companion paper by Brace and Findlay (1968).

To minimize the sounder interference on the follow-on ISIS-A satellite which uses a PCM telemetry system synchronized to the sounder pulses, the telemetry format was modified so that direct ionospheric data samples will be taken as long after a sounder pulse as possible. It is the hope that under most conditions both the electromagnetic and ionospheric plasma spikes will have sufficient time to damp out in the interval between pulse and direct sample.

ACKNOWLEDGMENTS

Design and fabrication of the instruments was by Tuck Bin Lee at the University of Michigan. We wish to thank Ernest Busboso for his efforts during integration, test and launch operations.

REFERENCES

1. Boggess, R. L., L. H. Brace, and N. W. Spencer, "Langmuir Probe Measurements in the Ionosphere," J. Geophys. Res., 64, 1627, 1959.
2. Brace, L. H., and J. A. Findlay, "Comparison of Cylindrical Electrostatic Probe Measurements on Alouette II and Explorer 31 Satellites" (in this issue).
3. Brace, L. H., and B. M. Reddy, "Early Electrostatic Probe Results from Explorer XXII," J. Geophys. Res., 70, 5783-5792, 1965.
4. Brace, L. H., N. W. Spencer, and A. Dalgarno, "Detailed Behavior of the Midlatitude Ionosphere from Explorer XVII Satellite," Planet. Space Sci., 13, 647-666, 1965.
5. Donley, J. L., L. H. Brace, J. A. Findlay, J. H. Hoffman, and G. L. Wrenn, "Comparison of Results of Explorer XXXI Direct Measurement Probes" (in this issue).
6. Florida, C. D., "The Alouette II Satellite" (in this issue).
7. Franklin, C. A., "The Alouette Topside Sounder" (in this issue).
8. Nelson, E. D., "The Explorer 31 Direct Measurement Satellite" (in this issue).
9. Mott-Smith, H. M., and I. Langmuir, "The Theory of Collectors in Gaseous Discharges," Phys. Rev., 28, 727-763, 1926.
10. Reddy, B. M., L. H. Brace, and J. A. Findlay, "The Ionosphere at 640 Kilometers on Quiet and Disturbed Days," J. Geophys. Res., 72, 2709-2727, 1967.
11. Spencer, N. W., L. H. Brace, and G. R. Carignan, "Electron Temperature Evidence for Nonthermal Equilibrium in the Ionosphere," J. Geophys. Res., 67, 157-175, 1962.
12. Spencer, N. W., L. H. Brace, G. R. Carignan, D. R. Tausch, and H. Niemann, "Electron and Molecular Nitrogen Temperature and Density in the Thermosphere," J. Geophys. Res., 70, 2665-2698, 1965.

LIST OF FIGURES

Figure

- 1 Predicted current characteristic of small cylindrical probe. The plasma potential ($V = 0$) is identified as the inflection point.
- 2 Cylindrical Probe. Visible elements include collector electrode, guard electrode, floating electrode, coaxial helical spring and coaxial connector.
- 3 Mounting position and in-orbit orientation of cylindrical probes on Alouette II and Explorer 31.
- 4 Functional block diagrams of Alouette II and Explorer 31 cylindrical probe experiments.
- 5 Typical cylindrical probe data from Alouette II and Explorer 31. Differences in data format resulted from basic differences in spacecraft. Modulation seen on current amplitude represents satellite wake effect.
- 6 Alouette II cylindrical probe data demonstrating typical interference spikes from sounder experiment. Curve showing maximum spike effect was taken with sounder pulsing near plasma frequency.

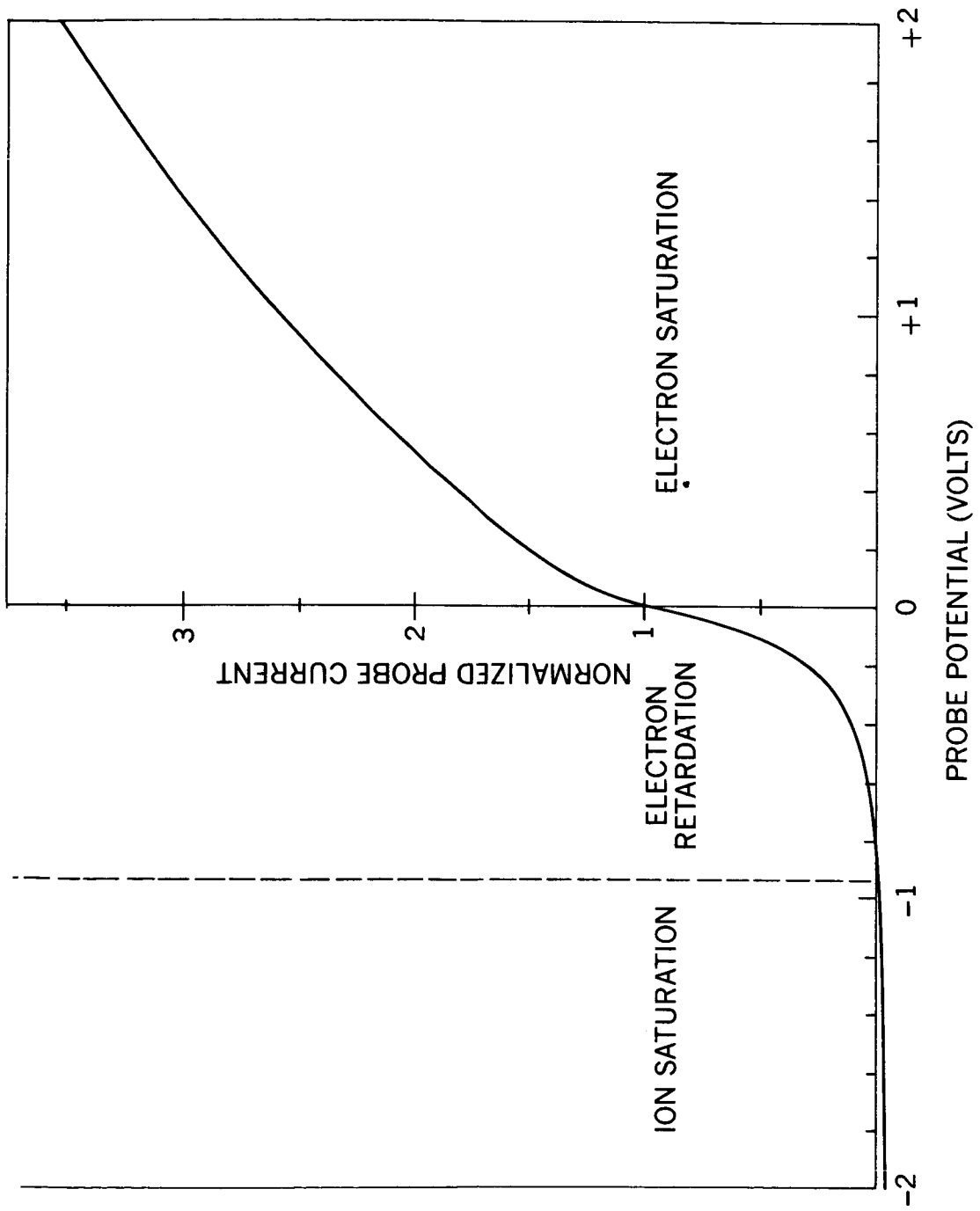

Figure 1. Predicted current characteristic of small cylindrical probe. The plasma potential ($V = 0$) is identified as the inflection point.

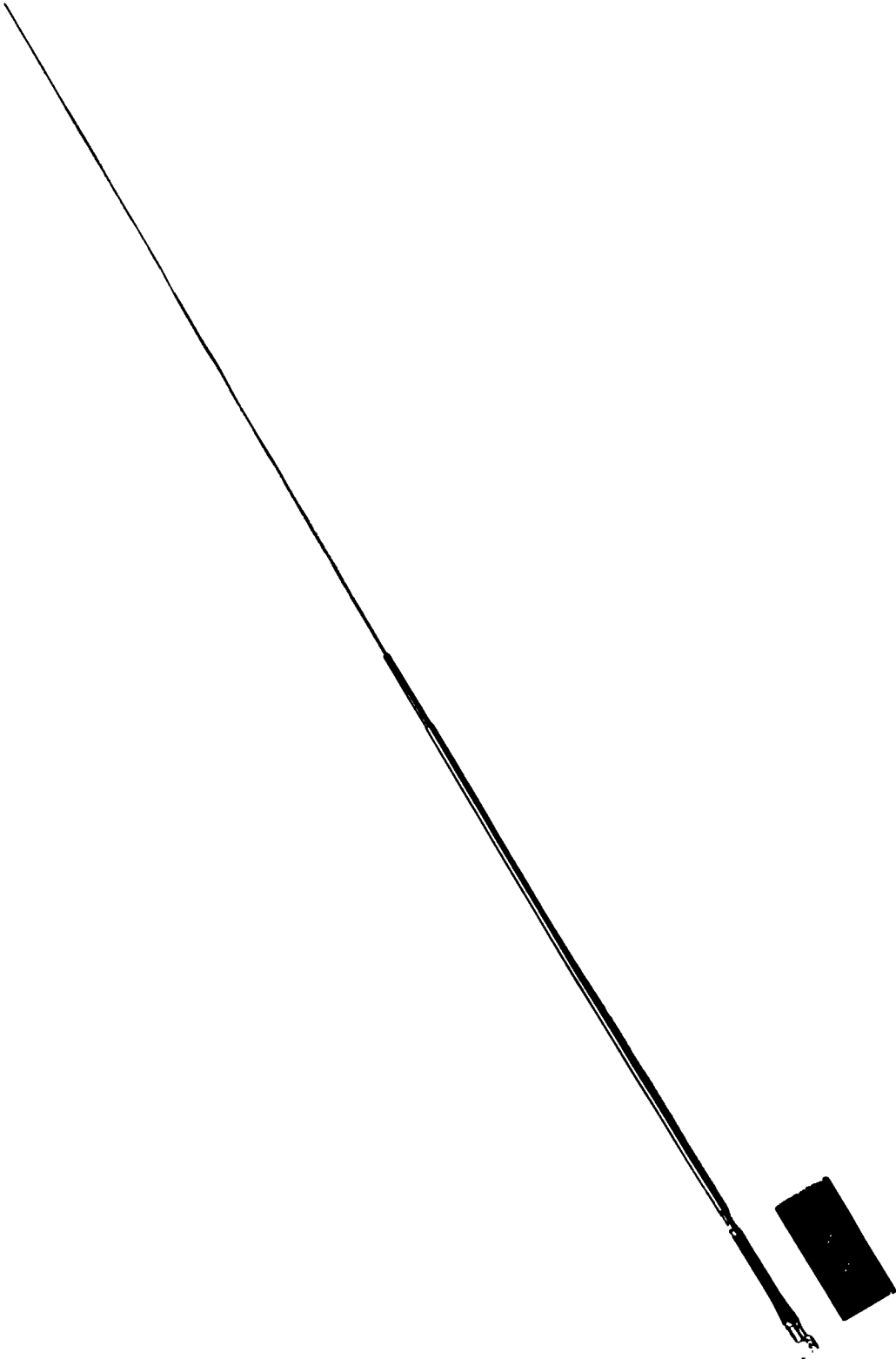

Figure 2. Cylindrical Probe. Visible elements include collector electrode, guard electrode, floating electrode, coaxial helical spring and coaxial connector.

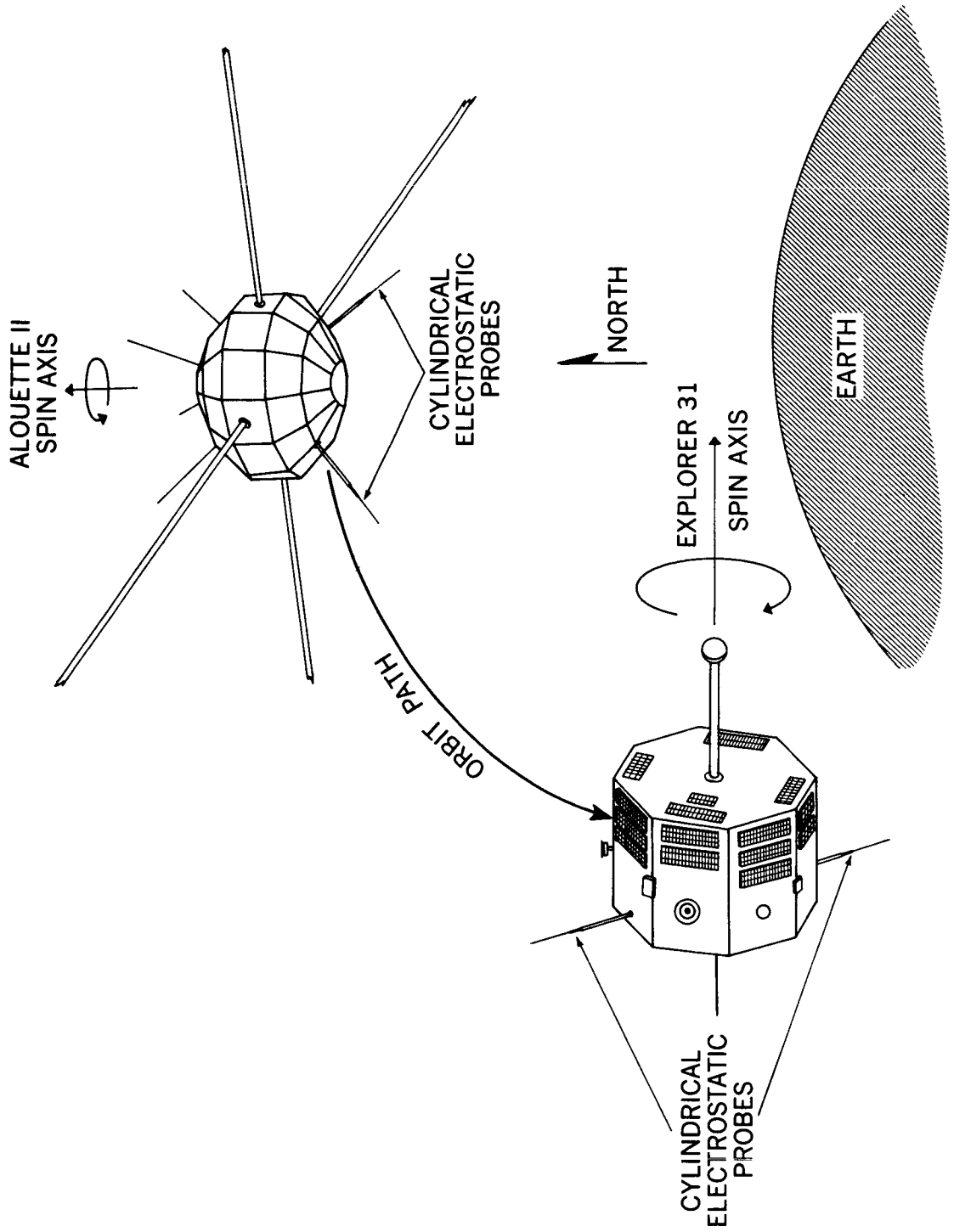

Figure 3. Mounting position and in-orbit orientation of cylindrical probes on Alouette II and Explorer 31.

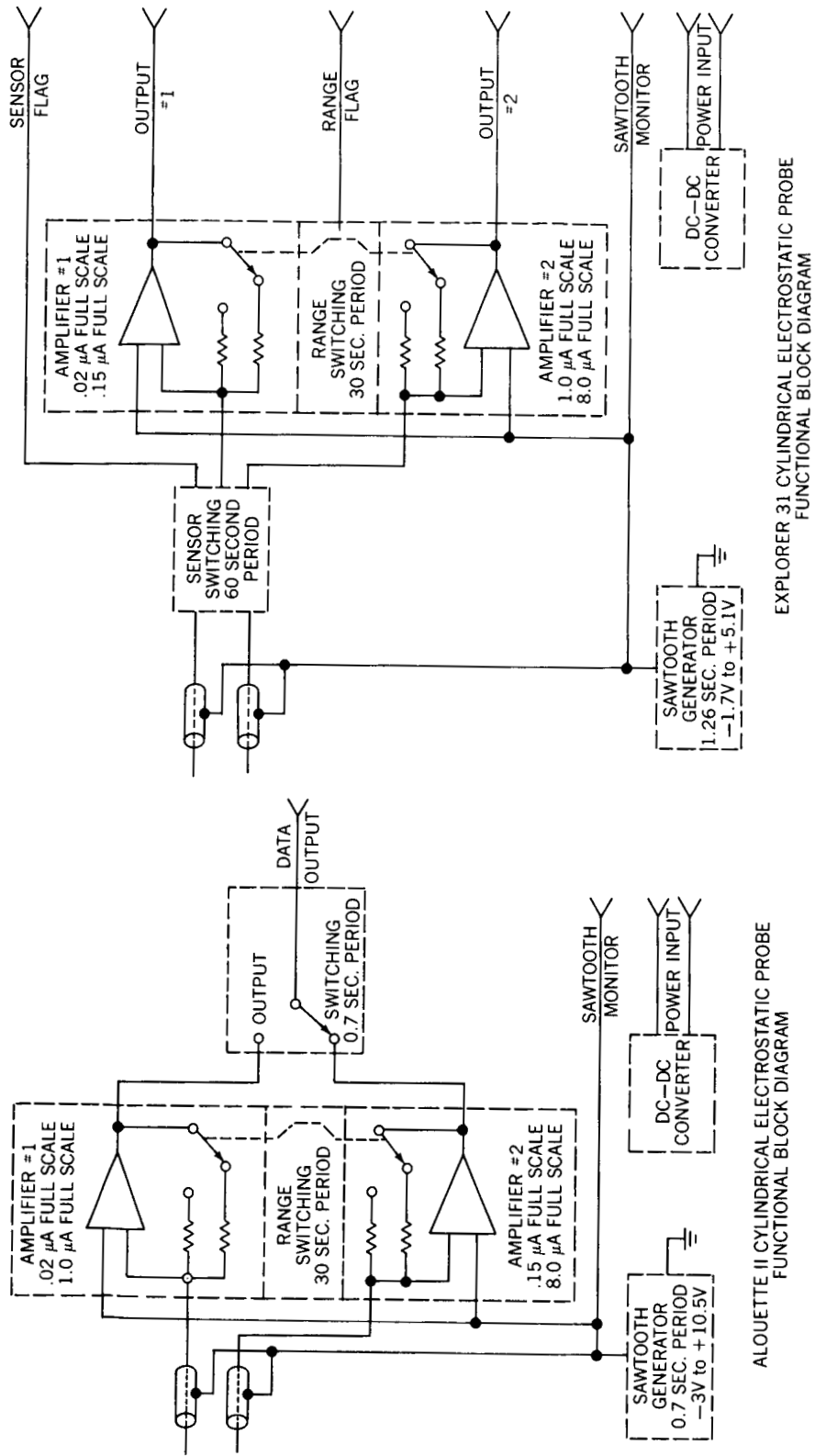
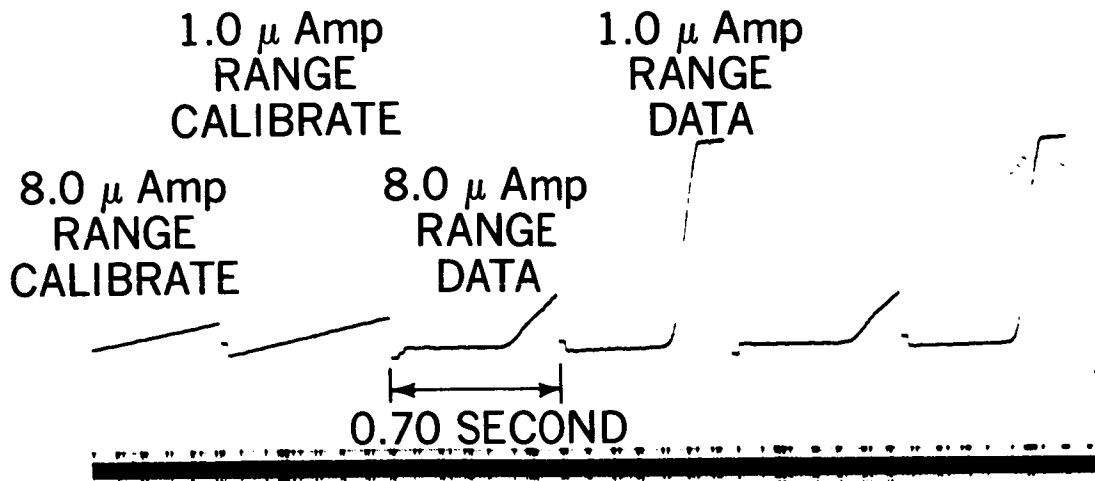
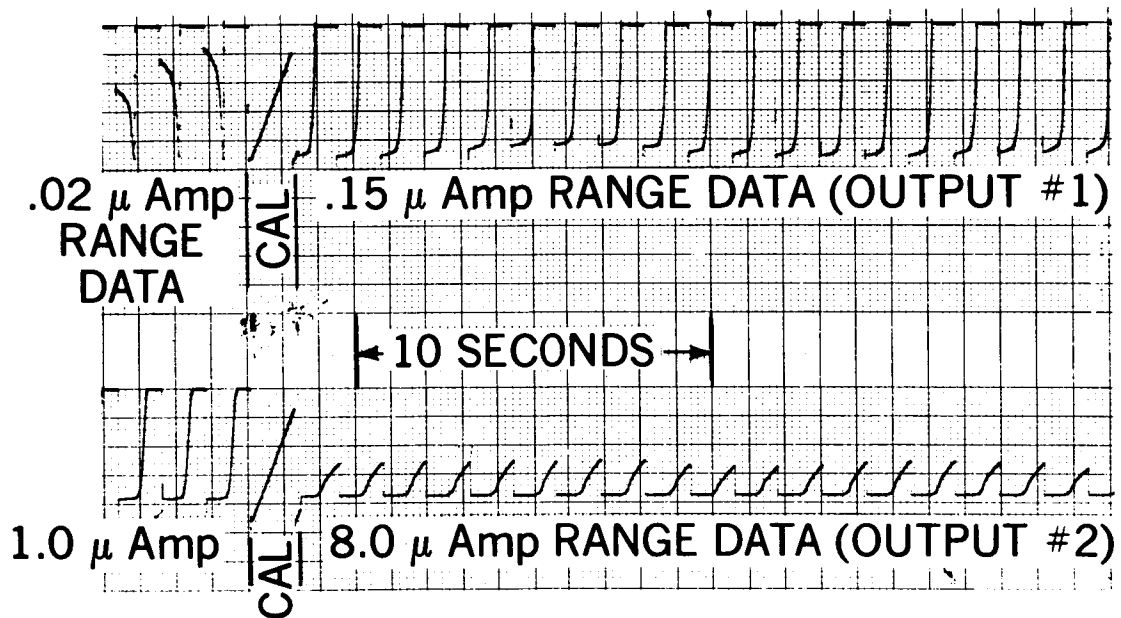

Figure 4. Functional block diagrams of Alouette II and Explorer 31 cylindrical probe experiments.



ALOUETTE—II



EXPLORER 31

CYLINDRICAL PROBE IONOSPHERIC DATA

Figure 5. Typical cylindrical probe data from Alouette II and Explorer 31. Differences in data format resulted from basic differences in spacecraft. Modulation seen on current amplitude represents satellite wake effect.

ALOUETTE-II
CYLINDRICAL
ELECTROSTATIC PROBE

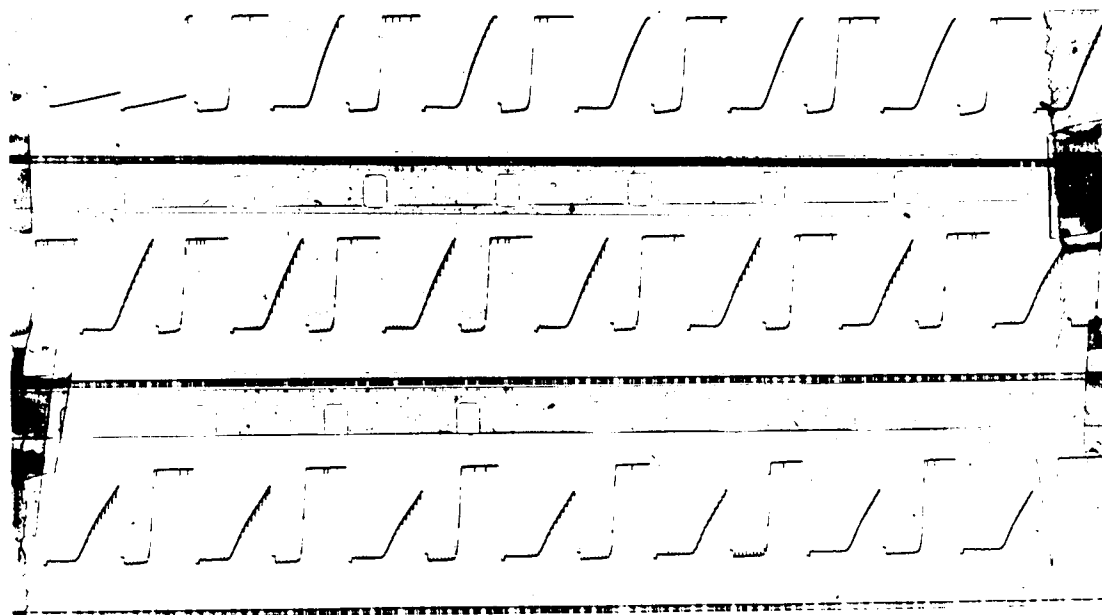

Figure 6. Alouette II cylindrical probe data demonstrating typical interference spikes from sounder experiment. Curve showing maximum spike effect was taken with sounder pulsing near plasma frequency.