

NASA TECHNICAL NOTE



NASA TN D-5179

c.1

NASA TN D-5179

LOAN COPY: RETURN TO
AFWL (WLIL-2)
KIRTLAND AFB, N MEX

0131825



TECH LIBRARY KAFB, NM

**SURFACE TEMPERATURE MAPPING WITH
INFRARED PHOTOGRAPHIC PYROMETRY
FOR TURBINE COOLING INVESTIGATIONS**

by Frank G. Pollack and Robert O. Hickel

Lewis Research Center

Cleveland, Ohio



**SURFACE TEMPERATURE MAPPING WITH INFRARED PHOTOGRAPHIC
PYROMETRY FOR TURBINE COOLING INVESTIGATIONS**

By Frank G. Pollack and Robert O. Hickel

**Lewis Research Center
Cleveland, Ohio**

NATIONAL AERONAUTICS AND SPACE ADMINISTRATION

For sale by the Clearinghouse for Federal Scientific and Technical Information
Springfield, Virginia 22151 - CFSTI price \$3.00

ABSTRACT

An infrared photographic pyrometry system was investigated to map surface temperature distribution in the range of 1000⁰ to 2500⁰ F. The system was designed to determine the surface temperature distribution of cooled turbine vanes installed in a static cascade facility. A relative energy measurement technique was used for calibrating film density to surface temperature. The calibration method was independent of surface emissivity and viewpath attenuation factor, and compensates for photographic variations. Experimental test targets in air and a hot gas stream were photographed. These thermal images of the targets are evaluated. Temperature information is reduced from each thermal image. The data are presented in the form of calibrated temperature contour maps. Temperature measurements with this method were within the 1-percent accuracy of the calibration point reference temperature over a considerable portion of the film response curve.

CONTENTS

	Page
SUMMARY	1
INTRODUCTION	2
SYMBOLS	3
INFRARED PHOTOGRAPHIC PYROMETRY	4
System Description	4
Radiometry	5
Photography	7
Thermal image	7
Film density measurement	8
FUNDAMENTAL THEORY	9
Calibration Procedure	9
Basic Relations	11
Master temperature distribution curve (MTD curve)	11
Film response curve (FR curve)	15
Calibration point	20
Typical Temperature Level-Camera Exposure Combinations	21
APPARATUS AND TEST PROCEDURES	23
Photographic Apparatus	23
Camera system	23
Sensitometer	23
Photographic processor	23
Photographic Test Procedure	23
Densitometer	24
Thermal Image Evaluation Procedure	27
Test Targets and Test Conditions	28
Heated flat plate	28
Airfoil	29
RESULTS AND DISCUSSION	31
Thermal Image Evaluation	31
Heated flat plate exposure, f16 - 1/2 second	31
Heated flat plate exposure, f16 - 1/60 second	34
Airfoil exposure, f16 - 1 second	38
General Comments	41

SUMMARY OF RESULTS	42
CONCLUDING REMARKS	43
REFERENCES	44

SURFACE TEMPERATURE MAPPING WITH INFRARED PHOTOGRAPHIC PYROMETRY FOR TURBINE COOLING INVESTIGATIONS

by Frank G. Pollack and Robert O. Hickel

Lewis Research Center

SUMMARY

An infrared photographic pyrometer system was developed and investigated. The system was designed to determine the surface temperature distribution of cooled turbine vanes installed in a static cascade facility. The system was capable of mapping surface temperatures ranging from about 1000^o to 2500^o F.

A relative energy measurement technique was employed, and the development and use of the technique are presented in detail. The calibration of film density to surface temperature was done by a cross plot of one calculated curve and one experimentally obtained curve about a calibration point. The calculated master temperature distribution curve related temperature to relative radiant energy. The experimental film response curve related film density to relative film exposure energy. A calibration point reference temperature was obtained from a thermocouple installed on the target surface. The calibration method was independent of surface emissivity and viewpath attenuation factors, and compensated for photographic variations.

Experimental test targets consisted of a heated flat plate in an air atmosphere, and an airfoil heated in a hot gas stream. The targets were evaluated using commercially available equipment and 35-millimeter infrared film. The targets were equipped with an array of thermocouples to permit a comparison between temperatures obtained with conventional thermocouples and the temperatures obtained by the calibration method.

Three thermal images of the test targets were evaluated. Surface temperature distributions were obtained initially in the form of automatically plotted contour maps of film density. The density contours were assigned temperatures from the calibration curves. The temperatures obtained with the infrared photographic pyrometer system were in agreement with the conventional thermocouples and were within the 1-percent accuracy of the thermocouples over a considerable portion of the film response curve.

INTRODUCTION

An investigation was conducted on an infrared (IR) photographic pyrometry system. The system was used to accurately map surface temperature distribution over the range 1000° to 2500° F. Such a system is useful in experimental static test facilities for investigating the performance of cooled turbine vanes and blades. Surface temperature and temperature gradients are required to study cooling scheme effectiveness, thermal stresses, blade life potential, and heat-transfer processes.

Photographic pyrometry systems measure emitted radiation from a heated target surface. The film density distribution is a function of the surface temperature distribution. A reference temperature is required for a calibration point. The method has been employed for several years to obtain surface temperature measurements of heated opaque objects and is discussed in detail in reference 1. One of the first applications of photographic pyrometry to jet engine research was in 1950 (ref. 2) for the investigation of surface temperature in a ram jet combustor. Some other systems and applications are discussed in references 3 to 5.

There are several major advantages of using thermal photography rather than many surface thermocouples or radiation pyrometers. They are

(1) A thermal photograph can be taken of an entire surface area of a target in 1 second of time or less without interfering with the target surface or subsurface.

(2) The film serves as a permanent record of the target thermal image and provides complete temperature information.

(3) The film density distribution on the target image can be evaluated in a qualitative or highly quantitative manner as required.

These features are of utmost importance when heat-transfer processes are being studied, such as in cooled turbine vanes, where the presence of thermocouples and thermocouple leads may interfere with the heat transfer process being investigated. Thermocouples may interfere by upsetting boundary layers, obstructing narrow cooling passages, or altering the conduction heat transfer paths within the vane wall. Frequently, the presence of thermocouples may also be impractical from the standpoint of structural considerations.

Reference 6 describes an IR photographic pyrometry system that was developed to evaluate the performance of cooled turbine vanes in a hot gas static cascade facility. The calibration method, as well as others in the past, were restricted to the linear portion of the film response curve. This curve relates film density to film exposure energy. The reference temperatures for the system were obtained indirectly from an external radiance source such as a strip lamp filament. Indirect methods require elaborate control in order to obtain an accurate correspondence between the external radiance source and the test target which is required for calibration.

An investigation was conducted into each aspect of the general IR photographic pyrometry method. The objectives of the work reported herein were

- (1) Develop a direct accurate calibration procedure for determining the relation between film density and target surface temperature
- (2) Extend the usable portion of the film response curve in order to increase the temperature range of any thermal photograph made with conventional film and processing techniques
- (3) Present the thermal data in the form of isotherm maps over the photographed target area with a high degree of accuracy, precision, and position location
- (4) Present a general review of background information in the fields of radiometry and photography

The system included a single exposure of a calibrated relative energy scale (step tablet or grey scale) on each film strip. This one exposure accurately determined the film response curve for all images on the balance of the uniformly processed film strip. With a single reference temperature for each thermal image, a considerable range of the film response curve was correlated to a master temperature distribution curve. This calculated curve shows the distribution of temperature with relative radiant energy. A cross plot of the two curves, the film response curve, and the master temperature distribution curve provides a calibration of film density distribution to surface temperature distribution. The reference temperature calibration point for this application was provided by a single thermocouple on the photographed surface of the target. After processing, the film was evaluated with a densitometer which incorporated an automatic plotter of equal film density contours. The contours were assigned temperatures from the calibration curve.

The suitability of the overall approach was experimentally verified by investigating the heated surfaces of a metal plate in air and an airfoil in a hot gas stream. The surface temperature of these targets ranged from about 1000^o to 2000^o F. The targets were equipped with an array of thermocouples to compare with temperatures obtained with the calibration method. Three experimental examples of test target thermal images are presented and evaluated. Much information contained herein may appear elementary to those familiar with radiation pyrometry and photometric photography. This report was written to assist the engineer who is not familiar with the problem of making surface temperature measurements with photographic pyrometry. The major emphasis was placed on the calibration method, data reduction, and final presentation of the thermal data.

SYMBOLS

- C_1, C_2 constants
 e natural logarithm base
 F_1 fraction of total radiant emittance between 0 and λ_1

F_2	fraction of total radiant emittance between 0 and λ_2
T	absolute temperature
W	total radiant emittance
W_λ	monochromatic radiant emittance
$W_{\lambda_2-\lambda_1}$	spectral bandwidth radiant emittance
α	$\lambda T/C_2$
$\epsilon_{\lambda_2-\lambda_1}$	spectral bandwidth emissivity
λ	wavelength
$\lambda_2-\lambda_1$	spectral bandwidth

INFRARED PHOTOGRAPHIC PYROMETRY

Infrared (IR) photographic pyrometry is one aspect of the broad field of radiation pyrometry. The method is a noncontact, passive system of radiation collection, detection, and measurement. The interplay of two distinct sciences are involved; namely, radiometry and photography. Radiometry, or more specifically radiation pyrometry, deals with the characteristic nature of heated surface radiation and the precise variation of radiated energy with temperature. Photography or photometric photography in this application is concerned with the quantitative measurement of the relative energy from the heated surface irradiating the film. The photographic process and the science of densitometry are used to obtain these photometric measurements. The use of IR sensitive film permits the photographing of lower temperatures than is possible with films sensitized for the visible region of the spectrum. There are many references available that provide pertinent information in the fields of radiometry and photography. References 7 and 8 are examples in each field, respectively.

System Description

The general system employed in this investigation is illustrated schematically in figure 1. The system consisted of the following four major components:

- (1) A heated target which, in this example, was a symmetrical airfoil installed in a hot gas flow tunnel
- (2) An optical viewpath and a camera system, to uniformly transmit and image the target radiation from the heated surface to the IR sensitive film during a camera exposure

- (3) A film processing system, for the uniform development of the latent thermal images on the film strip
- (4) A densitometer, for measuring and recording the film density variation of a given thermal image and to automatically plot equal density contour maps of the film density distribution of the thermal image

A thermal image of the heated target was formed on IR sensitive film by a conventional camera system. The film strip, including a preexposed step tablet image, was developed and evaluated with a densitometer. The final data were presented as two-dimensional contour maps of temperature.

Each of the major components, as well as the test procedures required to use the IR photographic process to determine the target surface temperature distribution, will be discussed in detail in later sections of this report.

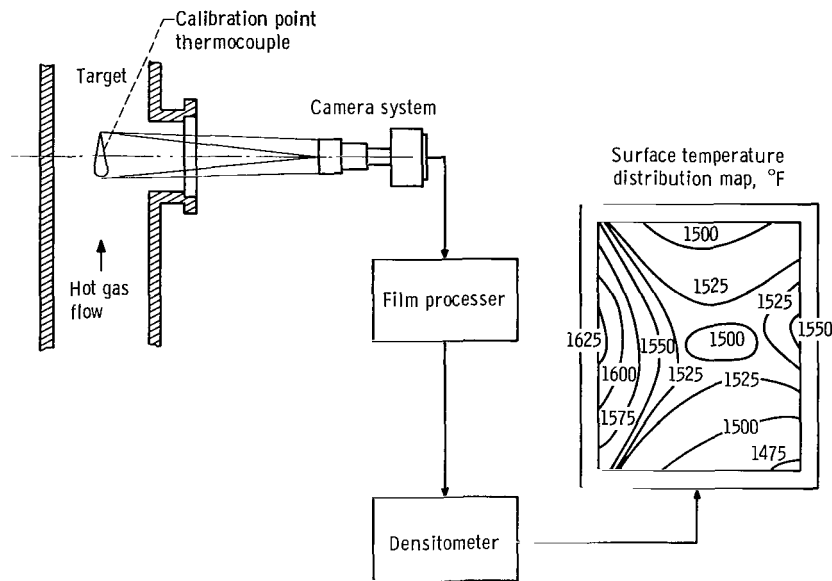

Figure 1. - General diagram of typical photographic pyrometry system.

Radiometry

Surfaces emit radiation as a function of their absolute temperature. The spectral distribution of the emitted radiation energy is influenced by a number of factors, the principal one being the physical state of the object. Radiation from a solid or a liquid usually contains a broad continuous band of wavelengths, similar to blackbody or grey-body radiation. Radiation from gases, on the other hand, generally consists of discrete wavelengths (spectral lines) or bands.

The pyrometry system herein deals with the measurement of the relative energy distribution radiated from an opaque solid surface. No absolute measurements are involved. The detected radiation is restricted to a narrow wavelength interval (spectral bandwidth) in the near IR region. The wavelength interval, 0.85 to 0.90 micron, was determined by a combination of IR film and an 87 C high pass filter.

No attempt was made to provide detailed analytical procedures to account for all factors that can possibly be involved in radiant heat transfer. Reference 9 provides an excellent insight into detailed considerations when a problem is initially considered from a theoretical as well as a practical viewpoint. The approach herein assumes isotropic radiation from a heated target; it also assumes no serious interfering reflection problems.

An indication of the typical energy variation with wavelength for several blackbody (or greybody) temperatures is shown in figure 2. The shaded region indicates the wavelength interval of concern. It can be seen that this bandwidth (0.85 to 0.90 micron) represents a very small fraction of the total available energy at any given temperature. The selection of a narrow bandwidth was dictated by good pyrometric practice which ideally suggests that monochromatic radiation be used. In the narrow bandwidth shown in figure 2, there is sufficient power radiated to permit the recording of temperatures as low as 1000^o F. That is, with normal camera exposures and regular high speed infrared film (HSIR), usable film densities were obtained. Reference 1 illustrates some other film-filter combinations and the associated temperature ranges.

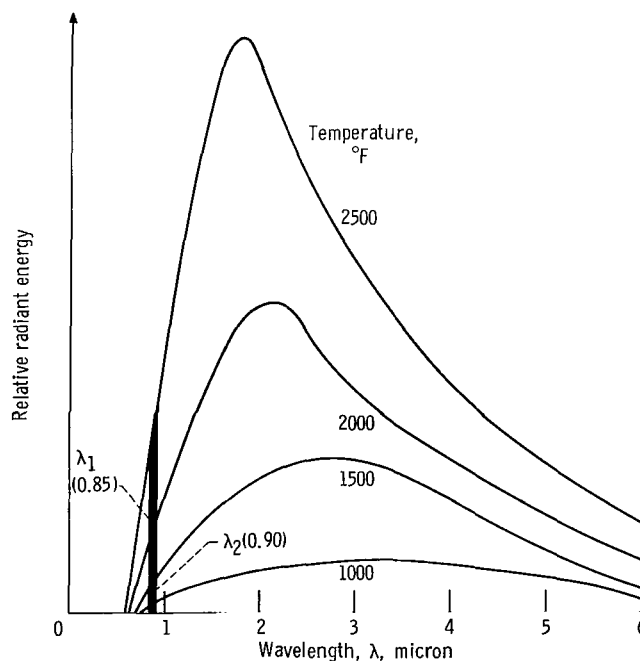

Figure 2. - Typical blackbody spectral energy distribution for various temperatures.

In the near IR region, the emissivity for metals is generally higher and more stable than at the longer wavelengths. In addition, radiant emission from combusted jet fuels have no interfering lines or significant band radiation in the 0.85- to 0.90-micron wavelength interval to cause errors in surface temperature measurements. Also the bandwidth employed herein is in the general optical radiation band, which includes the ultraviolet, visible, and near IR; this permits the use of conventional optical techniques and photography. The emissivity of real targets (such as an unpolished nonblackbody surface) is essentially constant over a wide viewing angle. For practical systems, a conservative viewing angle should be between 0° to 45° to the surface normal. Finally, the radiated energy in this wavelength interval varies rapidly with small changes in temperature thereby inherently providing high sensitivity.

Photography

A photograph captures the intensity distribution of a scene. Photographic pyrometry techniques use this unique panoramic property of film emulsions to record, in an instant of time, the temperature distribution over any size target area.

Thermal image. - Thermal photographs differ from conventional photographs because a thermal image is formed by emitted radiation. A thermal image resembles a continuous tone conventional photographic film negative. Although any target size can be photographed, a thermal image will not necessarily outline the entire target. The portions of the target within a limited temperature range will be imaged with a suitable camera exposure. Target areas below this temperature range will not cause any film darkening while areas above the temperature range will be imaged but will be too dark for any useful quantitative measurements. The temperature range detected by the film is determined by the exposure latitude or contrast ratio of the film. The temperature level detected is controlled by the camera exposure variables, just as sunlight conditions are considered in conventional photography.

Generally, the size of the film image is smaller than the target and will depend upon the system magnification. This is the ratio of the image size to the actual target size obtained with the camera system. The magnification is determined by the working distance between the target and the camera, and the focal length of the lens. The image of the target area can be resolved into very small area increments called resolution elements. The minimum area increment depends upon the film graininess, camera optics, and the densitometer sensitivity. For one example in this investigation, the resolution element was about 0.005 inch square on the film image. The size of the resolution element was larger than the minimum size possible with the system. The corresponding size of the resolution element on the target surface was about 0.025 inch square when the system

magnification was 1/5. The resolution element covers an area of the film emulsion which contains thousands of photosensitive film grains. It is the collective darkening of this cluster of grains that is referred to as film density.

Film density measurement. - Latent film images on unprocessed film contain certain intrinsic density distributions as a result of exposure of the film to radiant energy. The photographic development solution accelerates the relative darkening process of the photosensitive crystals suspended in the film emulsion. After the processing cycle, the final levels of darkness are permanently "set" into the film, and the film is ready for density measurement and evaluation.

Film density is measured with an optical instrument known as a "densitometer." In general, a densitometer contains a narrow beam of light which passes through a measuring aperture and impinges upon a photomultiplier or other suitable type of detector. The size of the aperture corresponds to the resolution element mentioned before. When a transparent film negative containing an image is introduced into the path of the light beam, only a fraction of the initial beam is transmitted to the photomultiplier. The magnitude of this fraction (transmission) is determined by the light stopping power (due to light absorption and scattering) of the film that intercepts the light beam. Density is a secondary quantity, and is, by definition, the \log_{10} of the reciprocal of the film transmission. The reciprocal of transmission is referred to as the film "opacity." The term "density" was found to be more useful in the field of photography than the term "transmission" or "opacity." The measured value of density increases with relative film darkening.

Microdensitometers use small measuring apertures and can measure film transmissions from 1.0 to about 0.001. Transmissions of 1.0 (100 percent), 0.1 (10 percent), 0.01 (1 percent), and 0.001 (0.1 percent) correspond to density values of 0, 1.0, 2.0, and 3.0, respectively.

Relative film darkening (contrast) depends upon the photoprocessing cycle as well as the relative energy irradiating the film. The numerical value of the measured film density associated with a resolution element on a processed image is also affected by the optical geometry of the densitometer measuring beam system and an arbitrary zero starting point. The numerical value of density by itself is meaningless because it is a relative number. It has no absolute relation to temperature; rather, it is simply a detector (film) output that must ultimately be calibrated to measure surface temperature in this application.

Quantitative relative energy techniques that utilize photographic emulsions (photometric photography) require that the calibration information be contained on the same film as the unknown test information. All information on the film must subsequently be uniformly processed and then measured with the same densitometer in exactly the same manner. Only then can an accurate correspondence be made between the calibration information and the unknown test information. The calibration information (in this applica-

tion) consists of a film response curve and a reference temperature calibration point. The unknown test information is a thermal image of a test target.

FUNDAMENTAL THEORY

The calibration of film density to surface temperature requires the following basic information:

- (1) A calculated relation between the surface temperature and the relative radiant energy, which results in a "master temperature distribution curve" (MTD curve)
- (2) An experimentally determined relation between film density and the relative film exposure energy, which results in a "film response curve" (FR curve)
- (3) A calibration point which is a reference temperature on the target surface that can be associated with a corresponding reference film density for each thermal image

Calibration Procedure

The calibration procedure is presented here, before the sections dealing with the precise determination of the three basic relations, so that the reader can have some appreciation for the method involved. At this point the reader should assume that the MTD curve and the FR curve have been accurately determined. Also a calibration point consisting of a thermocouple installed on the target surface in the field of view was recorded during the test at the time the thermal image was photographed.

The basic information and procedure required to calibrate film density to surface temperature is summarized in figure 3. The upper curve (fig. 3(a)) represents a typical MTD curve. The lower curve (fig. 3(b)) represents a typical FR curve. In this illustration, it was assumed that the calibration point reference temperature thermocouple measured a temperature of 1400⁰ F, and the reference film density measured with a densitometer at the thermocouple location on the processed thermal image measured 1.35 density units.

The independently determined figures 3(a) and (b) are used in conjunction with each other in relating film density to surface temperature; therefore, each curve must be accurately determined and plotted with the abscissa of each curve having identical logarithmic relative energy scales. For example, equal energy percentage changes are represented by the same equal length intervals on figures 3(a) and (b).

With the above information a simple procedure is followed for crossplotting the two

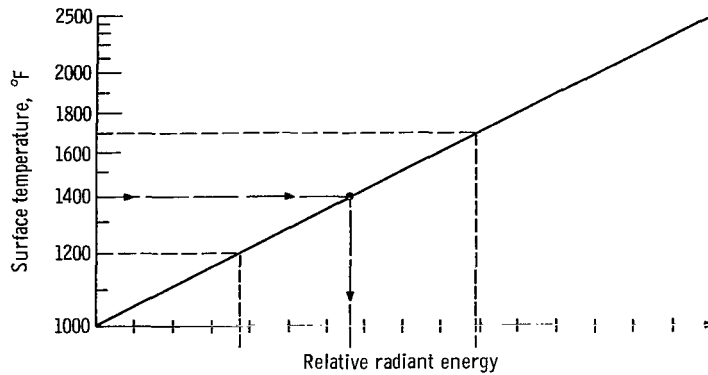

(a) Master temperature distribution (MTD) curve.

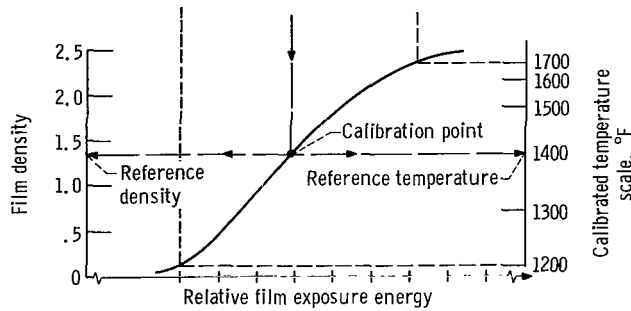

(b) Film response (FR) curve.

Figure 3. - Example of correlation curves to calibrate thermal image film density to target surface temperature.

curves. The FR curve (fig. 3(b)) is positioned laterally on figure 3 so that the film density (1.35) at the calibration point temperature (1400^o F) coincided with the projection of the same temperature (1400^o F) on the MTD curve (fig. 3(a)). The large-dashed line with the arrow heads indicates this alinement. Once this calibration point is established, other temperatures from the MTD curve (fig. 3(a)) can be transferred (small-dashed lines) to the density scale on the film response curve (fig. 3(b)), thereby providing a complete film density-surface temperature calibration for the specific thermal image. The surface temperature represented by the film density, measured at any location on the thermal image, can now be obtained. The calibrated temperature scale is shown along the right ordinate in figure 3(b). The temperature range for this example is from about 1200^o to 1700^o F with a corresponding film density range between 0.1 and 2.3 density units. The accuracy of the calibration point temperature influences the accuracy of all temperature determinations obtained from the calibrated temperature scale. The temperature sensitivity changes along the calibrated temperature scale due to the shape of the FR curve and the nonlinear distribution of temperature with equal percentage changes of radiant energy as indicated on figure 3(a).

Basic Relations

Master temperature distribution curve (MTD curve). - The first basic relation is a plot of radiant energy distribution with temperature. This curve is a quantitative plot of the radiant emittance $(W_{\lambda_2-\lambda_1})$ in the spectral bandwidth between 0.85 and 0.90 micron for various temperatures. Radiant emittance (power) is energy radiated from a surface per unit area per unit time. The values for λ_1 and λ_2 were selected from a superposition of published curves pertaining to IR film spectral sensitivity in combination with transmission characteristics of an 87 C filter. The selection of the nominal values (0.85 and 0.90 micron) for these wavelengths were found to be adequate in this investigation.

Figure 4 shows the MTD curve in two different forms. The solid straight line in figure 4(a) was determined by plotting the blackbody temperature T versus the calculated spectral bandwidth radiant emittance $W_{\lambda_2-\lambda_1}$. Figure 4(b) is a convenient tape form of the same information and will be discussed later. The calculations are based upon Planck's fundamental blackbody law which can be expressed as

$$(W_{\lambda})_T = \frac{C_1}{\lambda^5 (e^{C_2/\lambda T} - 1)} \quad (1)$$

For low value of λT , Wien's approximation of Planck's law shows that

$$(W_{\lambda})_T = \frac{C_1}{\lambda^5 e^{C_2/\lambda T}} \quad (2)$$

or

$$\ln(W_{\lambda})_T = \ln C_1 - 5 \ln \lambda - \frac{C_2}{\lambda T} \quad (3)$$

and

$$\ln(W_{\lambda})_T \propto -\frac{1}{T} \quad (4)$$

Equation (4) indicates that a logarithmic increase in monochromatic radiant emittance W_{λ} is proportional to the negative reciprocal of the absolute temperature. For a small wavelength interval, the logarithmic increases in spectral bandwidth radiant emittance $W_{\lambda_2-\lambda_1}$ is approximately proportional to the negative reciprocal of the absolute temperature. The solid line of figure 4(a) therefore can be determined by two points.

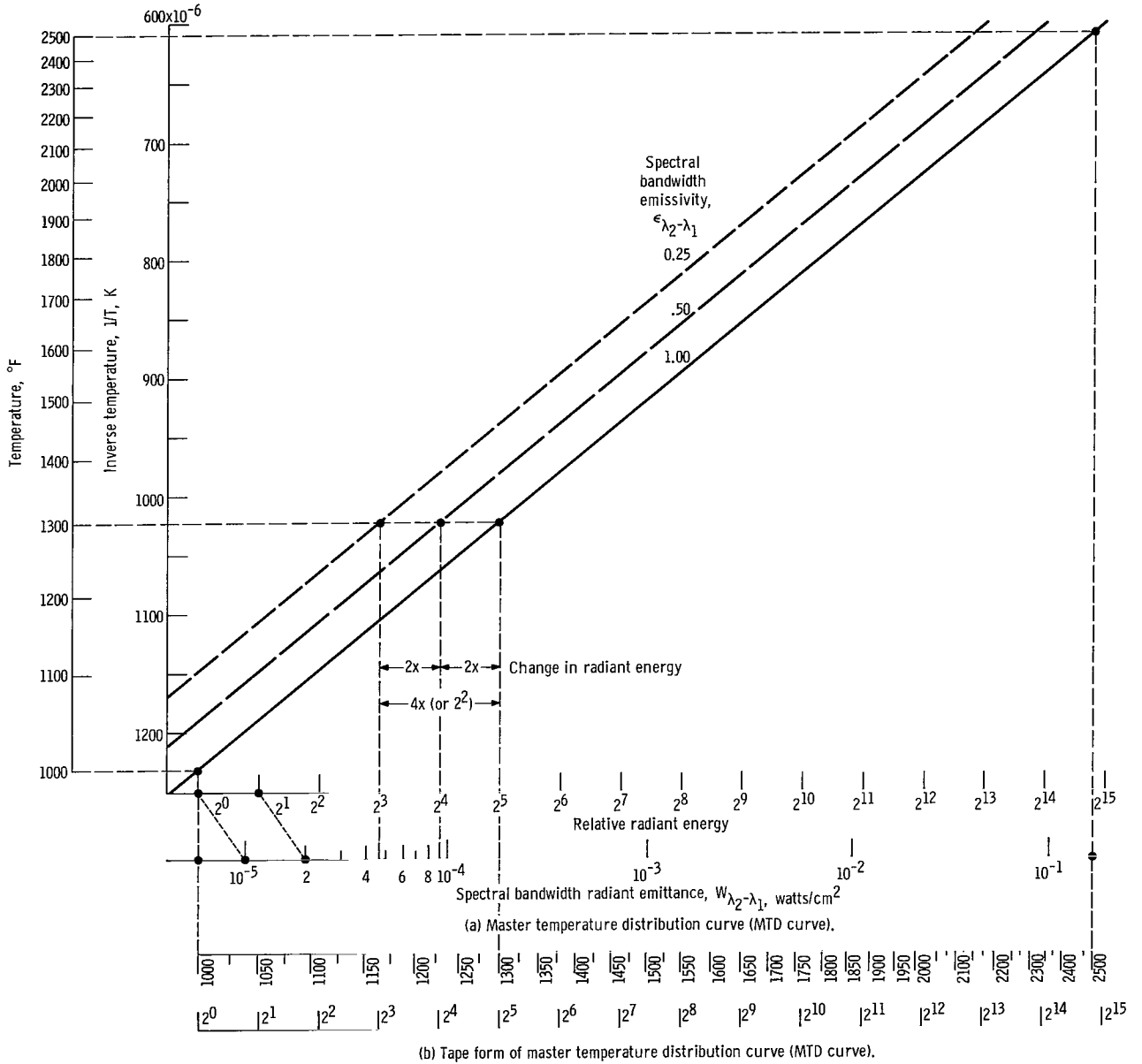

Figure 4. - Radiant energy distribution for wavelength interval of 0.85 to 0.90 micron, for temperatures between 1000° and 2500° F.

In order to calculate the spectral bandwidth radiant emittance, $W_{\lambda_2-\lambda_1}$, at any temperature, it is necessary to integrate equation (1) between the wavelength limits of λ_1 and λ_2 . Therefore,

$$\left(W_{\lambda_2-\lambda_1}\right)_T = \int_{\lambda_1}^{\lambda_2} W \, d\lambda \quad (5)$$

or

$$\left(W_{\lambda_2-\lambda_1}\right)_T = \frac{C_1}{\lambda^4} e^{-1/\alpha} (6\alpha^4 + 6\alpha^3 + 3\alpha^2 + \alpha) \quad (6)$$

where

$$\alpha = \frac{\lambda T}{C_2}$$

Equation (6) may be evaluated directly or published tables of blackbody functions such as those available in references 9 and 10 can be used. In this case, equation (6) can also be written as

$$W_{\lambda_2-\lambda_1} \, T = \int_0^{\infty} W \, d\lambda \left(\frac{\int_0^{\lambda_2} W \, d\lambda}{\int_0^{\infty} W \, d\lambda} - \frac{\int_0^{\lambda_1} W \, d\lambda}{\int_0^{\infty} W \, d\lambda} \right) \quad (7)$$

or

$$\left(W_{\lambda_2-\lambda_1}\right)_T = (W)_T (F_2 - F_1) \quad (8)$$

In published tables the total radiant emittance W is tabulated as a function of T . And the fractions of the total (F_2 and F_1) are tabulated as a function of the product λT . Slide rule calculators are also available commercially to provide this information.

The solid line in figure 4(a) was obtained by calculating the blackbody $W_{\lambda_2-\lambda_1}$ at 811 K (1000° F) and 1644 K (2500° F). Equation (8) and the tables in reference 10 were used.

Real targets are nonblackbody. The absolute temperature in combination with sur-

face emissivity determines the amount of radiant emittance. Emissivity is a surface characteristic that relates the actual radiant emittance from a surface to the ideal, if the surface was a blackbody radiator for the same temperature. Therefore, the absolute value of $W_{\lambda_2-\lambda_1}$ will vary proportionally with the spectral bandwidth emissivity $\epsilon_{\lambda_2-\lambda_1}$.

This is illustrated with the dashed lines in figure 4(a). For any temperature, the $\epsilon_{\lambda_2-\lambda_1} = 1.0$ curve shows twice (2×) the radiant emittance as the $\epsilon_{\lambda_2-\lambda_1} = 0.5$ curve, and 2^2 (4×) the radiant emittance as the $\epsilon_{\lambda_2-\lambda_1} = 0.25$ curve. Figure 4(a) also shows that the relative radiant emittance ratio between any two temperatures is the same for any constant value of surface emissivity. The calibration method in this report depends upon relative energy. As a consequence, a knowledge of the target $\epsilon_{\lambda_2-\lambda_1}$ is not essential. More important than the true value of $\epsilon_{\lambda_2-\lambda_1}$ is the variation of $\epsilon_{\lambda_2-\lambda_1}$ over the photographed surface. This variation can result from surface conditions and differences in temperatures on the target. On well prepared targets the small variations that sometimes exist are not significant. Even gross variations in $\epsilon_{\lambda_2-\lambda_1}$ in the order of 15 to 20 percent would only result in calibrated temperature errors of about 1 percent. This is true because (in the wavelength interval and temperature range considered herein), $W_{\lambda_2-\lambda_1}$ varies with $T^{15 \text{ to } 20}$ as compared to $W_{\lambda_2-\lambda_1}$ varying with the first power of $\epsilon_{\lambda_2-\lambda_1}$.

Figure 4(a) contains two temperature scales along the ordinate. One is the linear $1/T$ scale used to establish the curves. This scale was plotted in reverse order to compensate for the negative (-) sign in equation (4). The other ordinate scale is a corresponding scale in $^{\circ}\text{F}$. The $^{\circ}\text{F}$ scale will be the temperature scale used in this report.

The abscissa contains two corresponding logarithmic scales. The spectral bandwidth radiant emittance $W_{\lambda_2-\lambda_1}$ scale was used to establish the curve and is in values of \log_{10} . The other abscissa scale is a relative radiant energy scale. The term "relative radiant energy" is used rather than relative radiant emittance (power) simply because the curve will be used in conjunction with a film response curve. And film responds to energy rather than power. The two terms, power and energy, are proportional. Since we are dealing with ratios, it is inconsequential which is used. The relative radiant energy scale is shown as a geometric progression with a ratio of 2 (\log_2) normalized with respect to the radiant emittance at 1000°F . The ratio of 2 was chosen because of certain photographic procedures and practices which will be discussed later. The ratio scale was easily made by starting at 1000°F and repeating the distance between the digits 1 and 2 of the \log_{10} scale used to establish the curve. The relative radiant energy at 1000°F was arbitrarily assigned a value of 1 (or 2^0).

A convenient horizontal "tape form" of the MTD curve is shown in figure 4(b). The tape form was constructed from figure 4(a) by projecting the ordinate, in $^{\circ}\text{F}$, onto the

relative energy ratio scale of the abscissa. The purpose of this form is to simplify the cross plot of information with the FR curve during routine film evaluation. This tape shows at a glance how the relative radiant energy will vary with temperature. And conversely, how temperature will vary about a reference temperature when the relative energy distribution is known. An energy change of $2\times$ is represented by the distance between divisions along the lower edge of the tape shown on figure 4(b). No finer divisions are required because once the tape form is constructed, the distance between relative energy points will be used rather than the actual numerical values. This procedure will become more apparent in later sections of the report dealing with specific examples of film evaluation.

Film response curve (FR curve). - The second basic relation required for density-temperature calibration is the film response curve. The use of film as a radiation detector for obtaining quantitative temperature information requires the measurement of detector output (in this case, film density) as well as the correlation of the detector output to energy (film irradiance) input. A typical FR curve for high speed IR film is shown in figure 5. The data for the curve were plotted as a function of the linear film density on the ordinate against relative film exposure energy (geometric progression with a ratio

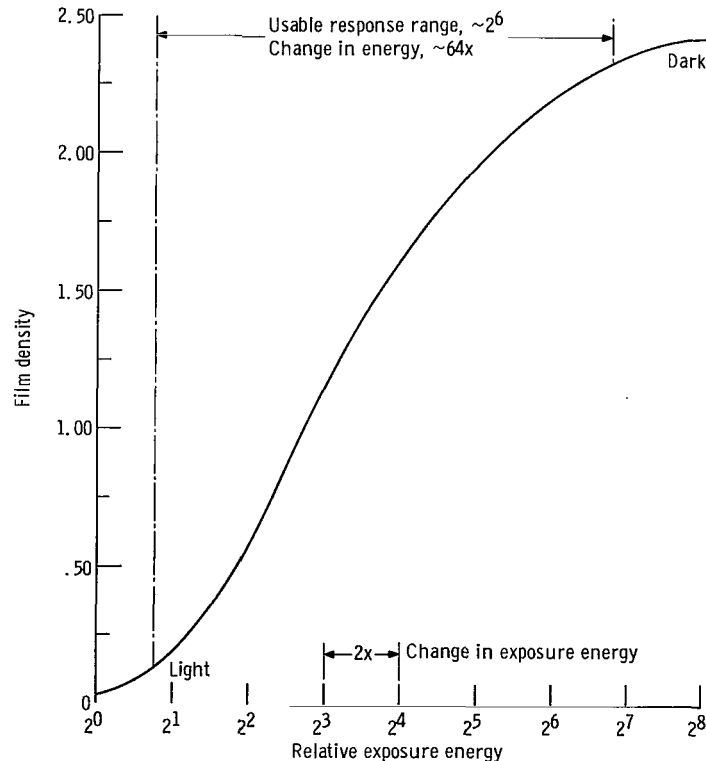

Figure 5. - Typical film response curve for high speed infrared film.

of 2) on the abscissa. The film response curve typically has a flattened "S" shape with one or two regions in the central portion of the curve that are nearly linear. There are also regions at the extreme left and right ends of the curve where there is little change in film density for a reasonable change in input energy. These extremes represent regions on the film that are either underexposed (film is too light) or overexposed (film too dark), and no suitable density changes can be detected. The portion of the FR curve between the extreme ends where detectable relative energy changes can be measured is referred to as the "usable response range" of the film (sometimes referred to as exposure latitude or contrast ratio). In order to use as much of the FR curve as possible, it is necessary to determine the total response range and then select that portion of the curve that will produce the accuracy and precision of the final temperature determination that is required. A typical usable response range is indicated in figure 5; it can be seen that for high speed IR film the usable relative exposure energy range is about 2^6 or $64\times$.

Special IR film and processing chemistry are available which would extend the relative energy response range. However, it is not within the scope of this report to investigate nonconventional approaches; this report will only be concerned with conventional techniques and commercially available equipment and processes requiring no special attention.

The FR curve cannot be calculated, but is precisely determined experimentally by a simple sensitometric technique. This technique is referred to as intensity scale modulation and is described in detail in reference 11. Sensitometry, in general, deals with the measurement of the photographic characteristics of light sensitive materials. As employed herein, the sensitometric technique provides the essential information by simply forming an image (contact negative) of a "calibrated stepped relative exposure scale" on a portion of the film strip that is to be used for photographing the thermal images of the test target. Each "step" of the scale transmits a known discrete fraction of energy from a constant radiance source which in turn forms a series of known relative exposure steps on the film strip. After the film strip is developed, the film density of each "step" is measured with a densitometer and the film density is plotted against the known fraction of relative exposure energy associated with each step. The calibrated exposure scales are also referred to as "grey scales" or "step tablets."

The image of the calibrated step tablet was formed upon the film strip by placing a portion of the film strip into a commercially available sensitometer. Briefly, a sensitometer is an instrument which contains a uniform light source, a synchronous rotary shutter, and a calibrated step tablet. Provision for using various photographic filters in the sensitometer light system is provided. The film strip requiring film response calibration is held in contact with the step tablet and exposed to the uniform light source during a short exposure by the rotary shutter. In the case of the calibrations made for this investigation, an 87 C filter was placed in the optical path of the light source. This filter

was used in the sensitometer optical path because it is necessary to obtain the film response curve with the same spectral bandwidth that is employed in the camera system. When the film strip is developed, the resultant image of the calibrated step tablet on the film strip inherently contains all of the information required for an accurate determination of the FR curve.

Figure 6 illustrates how a film response curve is obtained with the "intensity scale modulation technique." A reproduction of the calibrated step tablet used in this investigation is shown in figure 6(a). The exposure scale step tablet consisted of 21 adjacent steps. When a portion of a test film is irradiated through such a step tablet by a constant radiance source (within the sensitometer) the test film effectively "sees" 21 discreetly different intensity sources side by side. In this example the calibrated transmission fac-

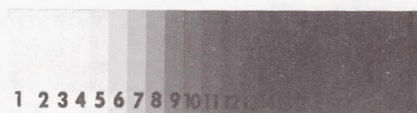

→ 2x ← Change in exposure energy

(a) Calibrated relative exposure scale (step tablet).

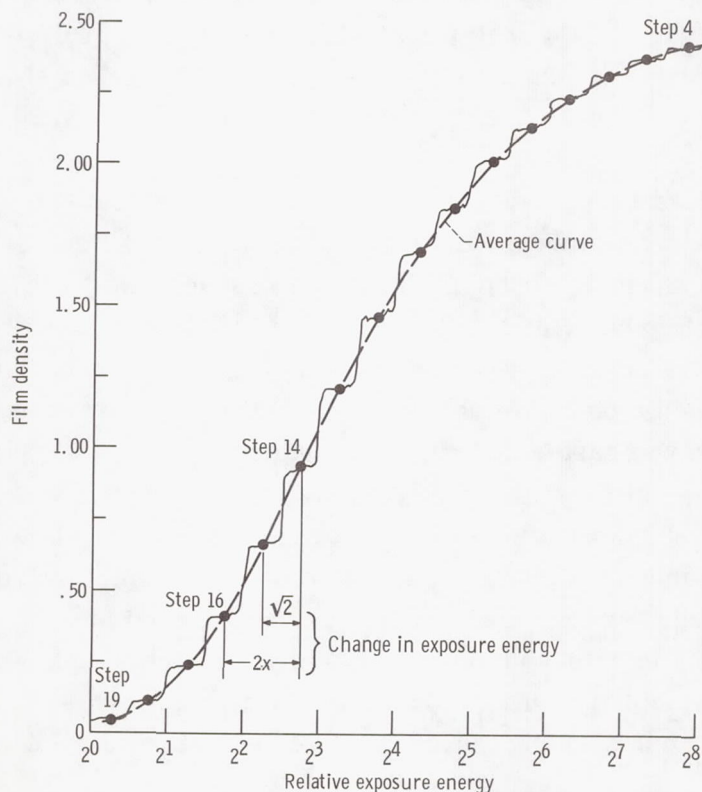

(b) Enlarged film density profile scan across calibrated exposure scale image.

Figure 6. - Film response curve obtained with intensity scale modulation technique.

tor between adjacent steps was $\sqrt{2}$. The change in transmission between any set of alternate steps, therefore, was a ratio of 2.

The stepped curve shown in figure 6(b) was obtained by making an enlarged density profile scan of the film image of the calibrated step tablet with a recording densitometer. The film density (ordinate) is linear, and the relative film exposure energy (abscissa) is a geometric progression with a ratio of 2. For convenience the enlargement was chosen so that the recorded width of each step corresponded to one-half of the distance between divisions on the abscissa scale and represents the equivalent of a $\sqrt{2}$ change in film exposure energy. A relative exposure energy change of $2\times$ is, therefore, represented by one division on the abscissa scale. This is also the identical spacing used to plot the tape form of the MTD curve, shown in figure 4(b). This satisfies the condition mentioned in the section Calibration Procedure that the independently determined MTD and FR curves be plotted with the abscissa of each curve having identical logarithmic relative energy scales.

The order of increasing film density on the film image was, of course, in reverse order to that of the original step tablet scale shown in figure 6(a). Step 1 on the image was the darkest (most density), while step 21 was the lightest. The film image was merely scanned in the reverse direction to obtain the curve shown in figure 6(b). Although the original step tablet, and the film image of the step tablet, had 21 steps, only the density profile scan of 16 steps (from step 4 to step 19, inclusive) is shown in figure 6(b). Steps 1, 2, and 3 on the film image were overexposed while steps 20 and 21 were underexposed.

An "average" film response curve can be drawn as indicated by the dashed curve in figure 6(b), which is drawn through the midpoint of each of the steps. It is this average curve which is referred to and used as the "film response curve." The same curve could have been obtained by measuring the film density of each step in succession, and then plotting the successive density values one-half division (ratio of $\sqrt{2}$) apart on the abscissa scale. With the densitometer available, the expanded recorder scan of the entire calibrated step tablet image was faster and more convenient.

The general shape of the film response curve can be controlled to some degree; this, in turn, permits some reasonable selection of the sensitivity of the film response curve to a change in relative exposure energy and also permits some control over the range of relative radiant energy (or temperature) that can be covered in one target-image exposure. This flexibility is achieved simply by controlling the length of time the film is processed in the developing solution. In automatic film processors the length of time the film is developed is controlled by the linear speed at which the film is passed through the developer solution.

The effects of various linear speeds of the film through the developer is illustrated in figure 7, where the linear film speed ranged from 2 to 10 feet per minute. Each curve

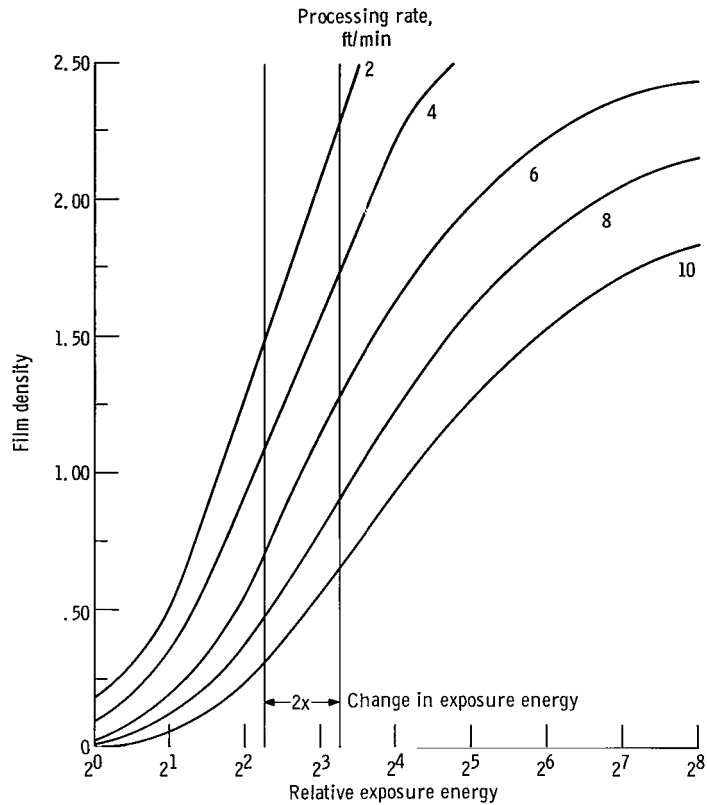

Figure 7. - Control of film response characteristics by varying feed rate through film processor.

shown is an average film response curve that was obtained from a profile scan of a calibrated step tablet that was exposed on a film strip in a sensitometer. Each step tablet image was obtained with identical sensitometer exposure conditions; therefore, the variation among the curves shown in figure 7 is caused entirely by differences in development time.

From figure 7 it can be seen that for slow film speeds through the developer (2 and 4 ft/min) rather large changes in measured film density indicate relatively small changes in relative exposure energy (high sensitivity). This permits excellent precision in the measurement of relatively small changes in temperature but severely limits the range of temperature that can be covered in one target-image photograph. On the other hand, the high film travel speeds through the developer (8 and 10 ft/min) result in a lesser change in film density with the same change in relative exposure energy as above. This results in less precision in determining the temperature of the target surface but permits a wider temperature range to be recorded on a given target-image photograph. Figure 7 illustrates the flexibility that can be achieved in controlling the film response curve through changes in film development time. The final choice of the film response curve

that should be employed for a given application depends on the precision of final temperature measurement that is desired and upon the range of temperatures that is required in a single thermal-image photograph.

As indicated in the INTRODUCTION, the IR photographic pyrometer system investigated herein was intended to be used primarily for investigating the temperature distributions on cooled turbine vanes. For many turbine cooling applications, the temperature variation on a given surface will probably be of the order of 200^o to 300^o F. This temperature range should be easily covered with a high degree of sensitivity by any one camera exposure using conventional IR film and film processing techniques.

Calibration point. - The third basic relation is the calibration point. This point associates a known temperature with a measured film density value on a thermal image. A direct calibration point was established by photographing a heated surface containing a thermocouple. Although only one calibration point is required, it may be desirable (where possible) to install several thermocouples on the target to provide alternate calibration points in case of thermocouple failure. Thermocouples have long been regarded as reliable temperature measuring devices, and they are generally convenient to use in static test facilities. The properly installed thermocouple(s) must be flush mounted on the surface in the field of view at a noncritical location from the standpoint of affecting heat transfer. Some methods for thermocouple installation in thin walls for measuring surface temperature of cooled turbine blades or vanes are discussed and illustrated in reference 12.

Many factors in addition to temperature affect film density. The use of a thermocouple as a direct calibration point eliminates the uncertainty associated with estimating and correcting for such factors as surface emissivity and viewpath attenuation. In addition, film density is affected by variations in film characteristics, film processing, camera-exposure repeatability, and densitometry. The transfer of radiant energy between the heated target and the film must be uniform over the field of view. There should be no optical distortion due to the camera system. The camera shuttering action must be uniform. The radiation attenuation, by whatever means, must also be uniform over the field of view. And, of course, there can be no obstructions in the viewpath.

A relative energy measuring technique, along with a direct calibration point, eliminates the inaccuracy resulting from the accumulation of the subtle error sources mentioned above. The FR curve provides the precise relation of film density to relative film-exposure energy. The MTD curve provides the precise relation of surface temperature to relative radiated energy. The direct calibration point serves to correlate the FR curve with the MTD curve to effect an accurate calibration of film density to surface temperature.

Typical Temperature Level-Camera Exposure Combinations

The important distinction between film emulsions and other types of conventional radiation transducers is that film responds to the "total energy" received in an accumulative manner. Conventional radiation transducers produce outputs (voltage, etc.) which are proportional to the radiant power. Film density, on the other hand, is proportional to the radiant power and camera-exposure variables. This is why the average level of surface temperature to be photographed can conveniently be changed by varying the camera exposure control parameters of aperture and exposure time.

A typical system calibration guide chart is illustrated in figure 8. The figure combines the MTD curve with the FR curve. The chart shows the camera exposure setting for a range of temperature levels with a given response curve. Figure 8 was determined for a flat steel plate heated in air, and will be discussed later as a test target. A chart is prepared for each system application by simply calibrating one exposure condition. This is done by photographing the same known temperature target with a sequence of different camera settings. After processing, the images are checked to find the exposure whose calibration point fell near the center of the usable density range. For this example, the accented curve (f16 - 1/4 sec) was used. The accented FR curve was correlated to the MTD curve with the aid of a calibration point temperature, as was illustrated previously in figure 3. The midrange temperature level for this exposure is about 1400⁰ F. The exposure has a usable response range of about 500⁰ F and a usable temperature range from 1200⁰ to 1700⁰ F.

Several locations of the FR curve are shown. The locations about the accented curve were determined by the relative camera settings. The camera settings are one aperture stop apart; that is, the film exposure energy is changed by a nominal factor of 2 from one setting to the next. The factor is determined by comparing the ratios of exposure time to aperture² for adjacent settings. The camera exposure settings in figure 8 cover the total temperature range between 1000⁰ and 2500⁰ F. The specific temperature range covered with a given camera exposure depends upon the level of temperature and the usable response range. A usable response range of 2⁶ corresponds to a temperature range of about 400⁰ F at the 1000⁰ F level of temperature. The same 2⁶ range corresponds to about a 700⁰ F range at the 1800⁰ F temperature level. Except for the calibrated exposure, the calibration guide chart is used as a coarse temperature range guide to permit the user to select the proper camera exposure. Each evaluated image must have its own calibration point to correlate the FR curve precisely to the MTD curve.

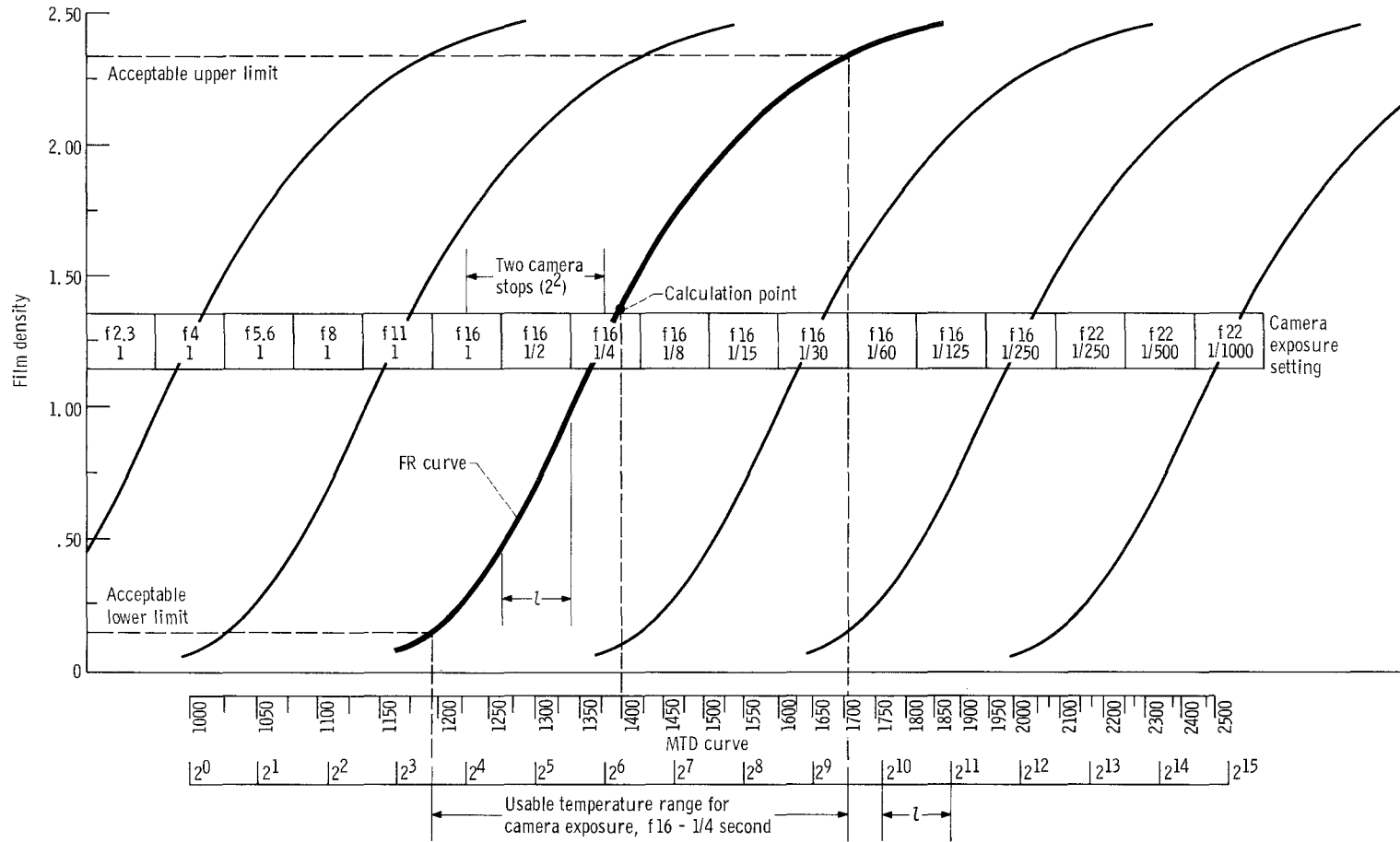

Figure 8. - Typical system calibration guide chart showing usable temperature range for various camera exposures. $l = 2x$ change in relative energy.

APPARATUS AND TEST PROCEDURES

The apparatus used in this investigation consisted of a conventional camera system, a sensitometer, a film processor, a densitometer, and two types of test specimens. Except for the test specimens, the apparatus is standard, commercially available equipment. The instrumentation and the test procedures are discussed in the following sections.

Photographic Apparatus

Camera system. - A conventional single-lens camera system was used. The system included a 35-millimeter camera body, a reflex viewfinder, an extension bellows, and a 135-millimeter focal length lens. The camera body incorporated a focal plane shutter with graduated exposure time selection between 1 second and 1/1000 second. The lens aperture was adjustable from f2.8 to f32. The film cassette contained a 36-exposure film strip of 35-millimeter, high-speed infrared (HSIR) film. The camera was tripod mounted, and the target image was focused onto the film with the aid of a reflex viewfinder attached to the camera. A high pass filter (87 C) was attached to the camera lens after focusing.

Sensitometer. - A process control sensitometer was used to make a contact negative of a calibrated relative exposure step tablet on the leader of each 36-exposure film strip. The step tablet consisted of 21 adjacent steps. Alternate steps transmitted twice (2×) as much radiation from a common constant radiance source within the sensitometer. An 87 C filter was used in the light path so that a contact image of the step tablet was obtained with the same spectral bandwidth as detected by the camera system from the targets. As received, the step tablet was calibrated for visible radiation. The relative transmission ratio, however, is the same for near IR radiation. This was verified with a spectrophotometric test in the wavelength region between 0.85 and 0.90 micron.

Photographic processor. - A Kodak Versamat (Model 11C-M) film processor with "B" chemistry was used to process the exposed film strip. The film traveled through the processor at a constant rate of speed. The rate of speed of the film through the processor was used to control the degree of development. For these tests a film rate of 6 feet per minute was used.

Photographic Test Procedure

The photographic test procedure was straightforward and routine for each test. The procedure consisted of three sequential steps:

(1) A calibrated step tablet was imaged onto the leader of each film strip with the sensitometer.

(2) Thermal-image photographs of the targets were taken on the remainder of the film strip.

(3) The exposed film strip was uniformly processed.

High-speed IR film must be handled in total darkness. After the step tablet exposure was made, the film leader was rewound into the cassette and stored at a reduced temperature until ready for use. A number of film strips were prepared in this manner in succession at the same time. As required, a cassette (or several cassettes) was removed from the refrigerator and allowed to reach room temperature. The cassette was then loaded into the camera body and a sufficient portion of the leader, containing the step tablet image, was wound onto the takeup spool. This was to ensure that a double exposure (thermal-image exposure over the step tablet image) did not occur. The camera was first focused onto the target with the viewfinder, using visible light. The 87 C filter was then attached to the camera lens. (No focusing compensation for the filter was found to be necessary.) The camera exposure variables of time and aperture were set manually. The viewpath was shielded so that only emitted radiation from the target entered the lens. For these experimental tests, a sequence of photographs were recorded in succession at different camera exposures. This was done in order to determine the optimum exposure conditions required for various temperature levels and also to obtain information to generate the general series of curves shown in figure 8.

The film strip was processed several hours after exposure in order to allow the latent images on the film to equilibrate. The processing cycle was selected by considering the sensitivity (slope) and temperature range coverage, as discussed previously and illustrated in figure 7. For these tests, a processor film travel speed of 6 feet per minute was used. After processing, the film was kept in a container to reduce the possibility of dirt, fingerprints, or scratches which may interfere with the subsequent thermal-image evaluation.

Densitometer

A double-beam, null-balance-type microdensitometer was used for film evaluation and data presentation. The instrument incorporated an isodensity system for rapid presentation of two-dimensional photometric information. Isodensity contour maps were automatically made from variable density (continuous tone) transparencies. A thorough description of the instrument is provided in reference 13. The application of the isodensitracer for photometric image evaluation is elaborated upon in references 14 and 15.

Figure 9 is used to illustrate the performance of the densitometer system. A typical

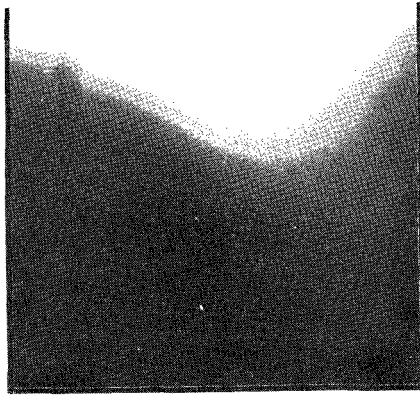

(a) Typical variable density thermal image.

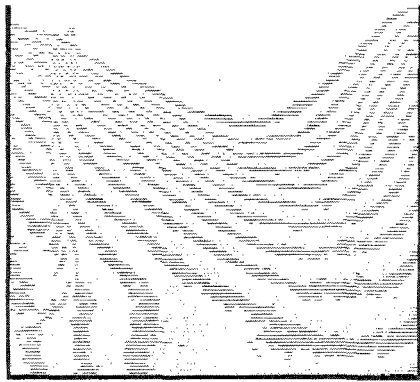

(b) Isodensity map of thermal image shown above.

Figure 9. - Comparison of variable density and isodensity presentations.

thermal image of an airfoil is shown in figure 9(a). The original image had a film density range from about 0 to 2.0. A complete scan of the thermal image results in an isodensity map as shown in figure 9(b). The contours of equal density are generated as the instrument automatically drives the film image over a small stationary measuring aperture in a series of equally spaced parallel scans. The isodensity system encoded and printed out (with a solenoid operated pen) the density distribution in about 40 equal increments of 0.05 density units each. This was done with a three symbol code and a dropline technique. The symbols are space, dots, or a line, as illustrated in figure 9(b). These symbols are recorded in a repeated sequence along each scan line as the density increases. A decrease in density along the scan line results in a reverse of the symbol sequences. Figures 9(a) and (b) are shown about the same size for direct comparison purposes. Actually, the isodensity map was recorded at 10 to 1 enlargement of the original film image. The densitometer permitted adjustment of the enlargement ratio, the density range, the density increment, the measuring aperture, and the scan spacing.

A comparison of the shadings on figure 9(a) with the isodensity map on figure 9(b) shows a similarity in the high contrast region. It can be seen that the isodensity map has outlined many more contours of constant film density than is possible with the naked eye. The usefulness of such a contour map display for temperature distribution studies is apparent.

The various methods of thermal-image information presentation used in this report are illustrated in figure 10. Figure 10(a) is a typical reproduction of a portion of a thermal image containing film density variations. Figure 10(b) is an isodensity map of the same image area automatically plotted at 10x expansion into equal density contours. The contours become more evident when the corresponding symbols in adjacent scans are

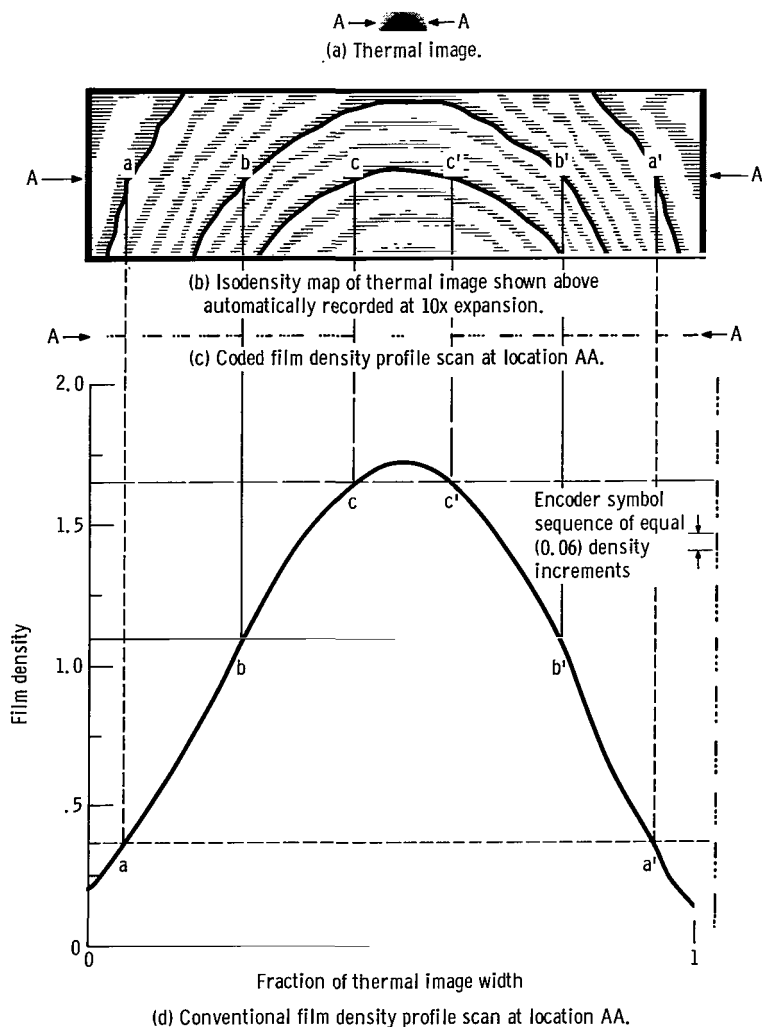

Figure 10. - Film density presentation methods used for thermal image evaluation.

manually connected with a solid line when the automatic plot is finished. Three such hand-drawn contour lines are shown in figure 10(b).

A single coded film density profile scan is shown in figure 10(c). The position of this coded scan line along the Y-axis is indicated on figure 10(a) and (b). Coded scan AA was isolated in order to illustrate the correspondence between a coded scan and a conventional density profile scan along the same path. A conventional profile scan records density as a function of position along a scan line. (This is the usual method of recording film density on most densitometers.) Figure 10(d) represents a conventional density profile scan along AA. The two scan modes are in positive register (matching) along the X-axis, because they are recorded with the same expansion ratio although they are recorded separately. The equal density increment (0.06 for this illustration) encoder symbol sequence is presented along the right side of figure 10(b) and will aid in determining the correspondence between the two scans (figs. 10(c) and (d)). The density at any location along the coded scan (fig. 10(c)) is obtained by projecting the location onto the conventional scan (fig. 10(d)) as illustrated by points a, b, and c on figure 10(b), or by matching the distance along the scanned image width. Locations a and a' have the same density and therefore must be on the same contour. The same is true for locations b and b' as well as for c and c'. A combination of both scan methods are used in film evaluation. The coded scan method provides the two-dimensional equal density contour map. The conventional scan method provides the precise density measurement at any X-axis location along a scan line. Temperatures from the film density to surface temperature calibration curves can then be assigned to each contour in place of density for surface temperature mapping. The test specimens in the following sections will be evaluated in this manner.

Thermal Image Evaluation Procedure

The processed film can be analyzed at any convenient time in a qualitative, semi-quantitative, or quantitative manner depending upon the information required. The examples that follow in the section RESULTS AND DISCUSSION were analyzed in a quantitative manner according to the calibration procedure described previously.

To obtain an accurate, detailed surface temperature distribution map, a systematic evaluation procedure was followed. This final phase of the IR photographic pyrometry system is primarily concerned with routine densitometry and routine calibration procedure. The final results, however, are a culmination of the entire method. The evaluation procedure was as follows:

- (1) Record an isodensity map of the entire thermal image (or area of interest)
- (2) Record the conventional profile scans required (at least one through the calibration point reference thermocouple location)

- (3) Record the FR curve with a conventional scan of the calibrated step tablet image
- (4) Calibrate the density scale of the FR curve to represent temperature, and transfer the calibrated temperature scale to the conventional profile scan record
- (5) Assign temperatures to the contours from the calibrated temperature scale by matching positions and density increment symbols on corresponding coded scans and conventional scans

All measured densities are relative to a zero density reference. The zero reference (100 percent transmission) was set through a clear portion of the film strip for each evaluation. In this investigation, thermal images with density variations up to about 2.5 were used. High density images should be avoided because of a tendency of the developed grains to "bleed." This affects adjacent area density especially at sharp boundaries. The densitometer operating parameters must be held constant during any one complete evaluation in order to obtain a true correspondence between the three plots listed in steps 1, 2, and 3 above. The operating parameters were chosen by considering several factors, such as the density range on the particular film image, the required size of the target resolution element, the temperature resolution desired, etc. Steps 1, 2, and 3 were completely performed with the densitometer. Step 4 is the calibration procedure and involved steps 2 and 3 as well as the calibration point reference temperature and the MTD curve. Step 5 involved steps 1, 2, and 4. The contours on the isodensity map were assigned temperatures from the density-temperature calibration curve by locating their position on a conventional profile scan. The conventional profile scan shows the temperature (density) at any position along the scan line.

Test Targets and Test Conditions

Two test targets were used in this investigation. The first test target consisted of a simple flat plate heated in air. The second test target consisted of an airfoil heated in a hot gas tunnel.

Heated flat plate. - A stainless-steel plate 0.060 inch thick with a number of thermocouples on the surface was heated in air with a stable oxyacetylene torch. The tip of the flame was directed at a spot on the rear side of the target so that a simple radial temperature gradient resulted. A sketch of the heated flat plate is shown in figure 11 along with a listing of thermocouple readings (to the nearest 5^o F) which were recorded during the test.

The swaged thermocouples were Chromel-Alumel and leads were 0.005 inch in diameter contained in an 0.032-inch-diameter insulated sheath. The sheaths were placed

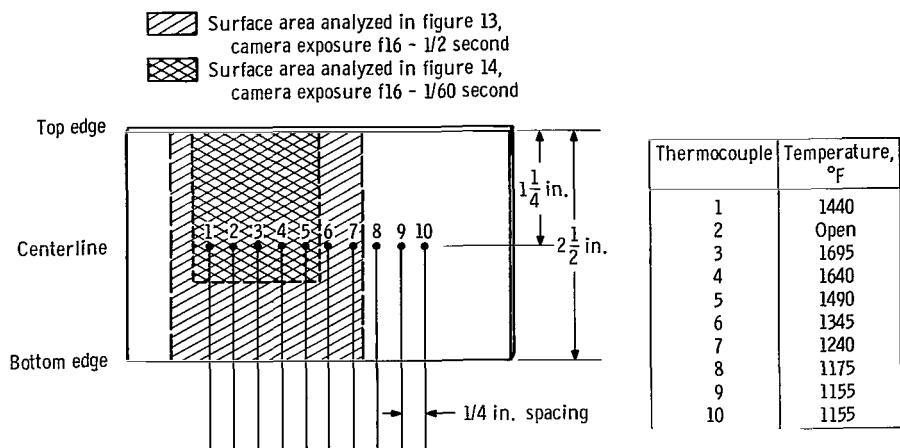
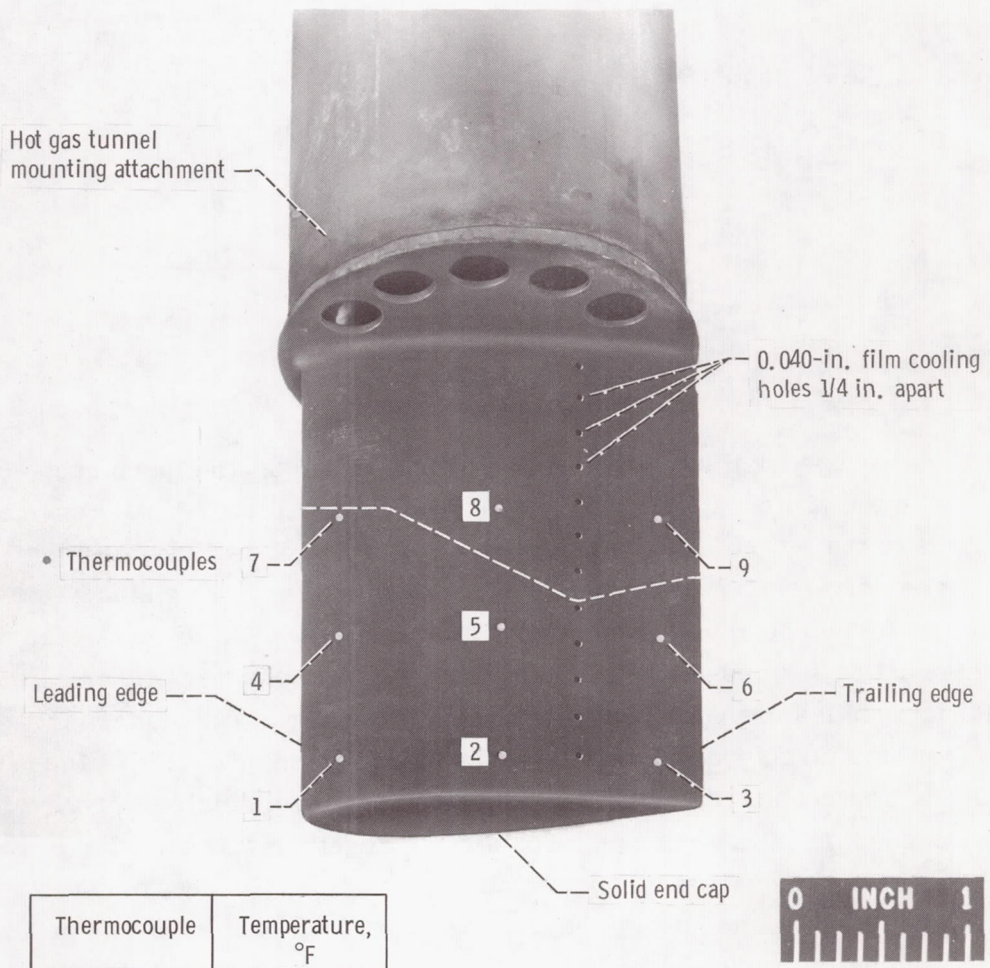

Figure 11. - Diagram of heated flatplate test target. Temperatures are measured by thermocouples and recorded at test condition.

in grooves and secured with high temperature cement so that the thermocouple junctions were flush with the photographed surface. The thermocouples were $\frac{1}{4}$ inch apart along the centerline of the $2\frac{1}{2}$ -inch width and trailed off the target as shown in figure 11. The thermocouples were recorded on a multipoint potentiometer during steady-state conditions when the surface was photographed. The target was initially preheated so that a stable oxide coating formed on the surface. The photographs were taken with the camera system at right angles to the target surface in ambient air. The camera film plane was 30 inches from the target which resulted in about a $\frac{1}{3}$ magnification of the target.

Airfoil. - The second test specimen consisted of a symmetrical airfoil with a number of thermocouples on the surface. The airfoil, together with a listing of the thermocouple readings (to the nearest 5° F) and surface locations, is shown on figure 12. The target consisted of a stainless-steel hollow airfoil with an end cap. The upper end was attached to a mounting arrangement which was secured to a flange of the cooled wall tunnel test section. A series of airfoil cooling holes, 0.040 inch diameter, are located $\frac{1}{4}$ inch apart near the trailing edge.

The swaged thermocouples were Chromel-Alumel, and the leads were 0.005 inch in diameter contained in a 0.032-inch-diameter insulated sheath. The thermocouple junction was flush mounted to the outside surface through small holes from the inside of the hollow airfoil. After the junctions were inserted in the holes, the holes were filled with a high temperature braze material. The airfoil was mounted in the test section of a hot gas tunnel, and thermal images were photographed at an approximately 90° to the surface through a quartz viewport, as shown on the left in figure 1. A cone of hot gas from a 3-inch-diameter nozzle surrounded part of the airfoil during the tests. The hot gas was obtained from combusted hydrocarbon fuel, and the gas temperature was about 1900° F. The tunnel was operated with a flow of about 1 pound of gas per second at a total pressure



Thermocouple	Temperature, °F
1	1610
2	1495
3	1490
4	1550
5	1350
6	1355
7	1395
8	805
9	920

CD-10318-33

Figure 12. - Airfoil test target. Temperatures are measured by thermocouples and recorded at test conditions. Surface area below dashed line is analyzed in figure 16 for camera exposure of f16 - 1 second.

of about 15 pounds per square inch absolute and a free stream Mach number of 0.5. The quartz viewport was contained in a mounting which incorporated a series of air impingement jets to flush the viewport surface. The thermocouple outputs were recorded at steady-state operating conditions. The camera film plane was 40 inches from the target surface, which resulted in a $1/5$ magnification of the target.

RESULTS AND DISCUSSION

Three examples of thermal image evaluation are presented in detail. The original thermal images were recorded on 35-millimeter high speed IR film. The examples thoroughly demonstrate the technique of film density to surface temperature calibration. In each evaluation, the final data presentation is a detailed surface temperature distribution map of the target area imaged on the thermal photograph.

The temperature distributions obtained with this method of calibration are compared to temperatures of thermocouple arrays which were located on the test target surfaces. The evaluations will systematically summarize the complete method and will illustrate the degree of accuracy and precision that were attained. Some limitations of the method are also presented.

Thermal Image Evaluation

Two thermal images of the same heated flat plate and one thermal image of an airfoil were evaluated. The first two thermal images were photographed in rapid succession on the same film strip with different camera exposures. One image was taken at $f16 - 1/2$ second, and the other at $f16 - 1/60$ second. Both exposures had the same field of view. The partial areas of the heated flat plate that were imaged on the film during these exposures are outlined by the crosshatching in figure 11. The $1/2$ -second exposure resulted in a usable thermal image that covered a larger area of the target than the usable thermal image obtained with the $1/60$ -second exposure. The longer exposure time accumulated sufficient energy from lower temperature regions on the surface to produce usable density on the film.

The thermal image of the airfoil that was evaluated was exposed at $f16 - 1$ second. The partial area that was imaged on the film and evaluated herein is the area below the dashed line across the airfoil shown in figure 12.

Heated flat plate exposure, $f16 - 1/2$ second. - The evaluation of the heated flat plate thermal image, obtained with a camera exposure of $f16 - 1/2$ second is summarized in figure 13. The thermal image was photographed at about $1/3$ magnification. Figure 13(a)

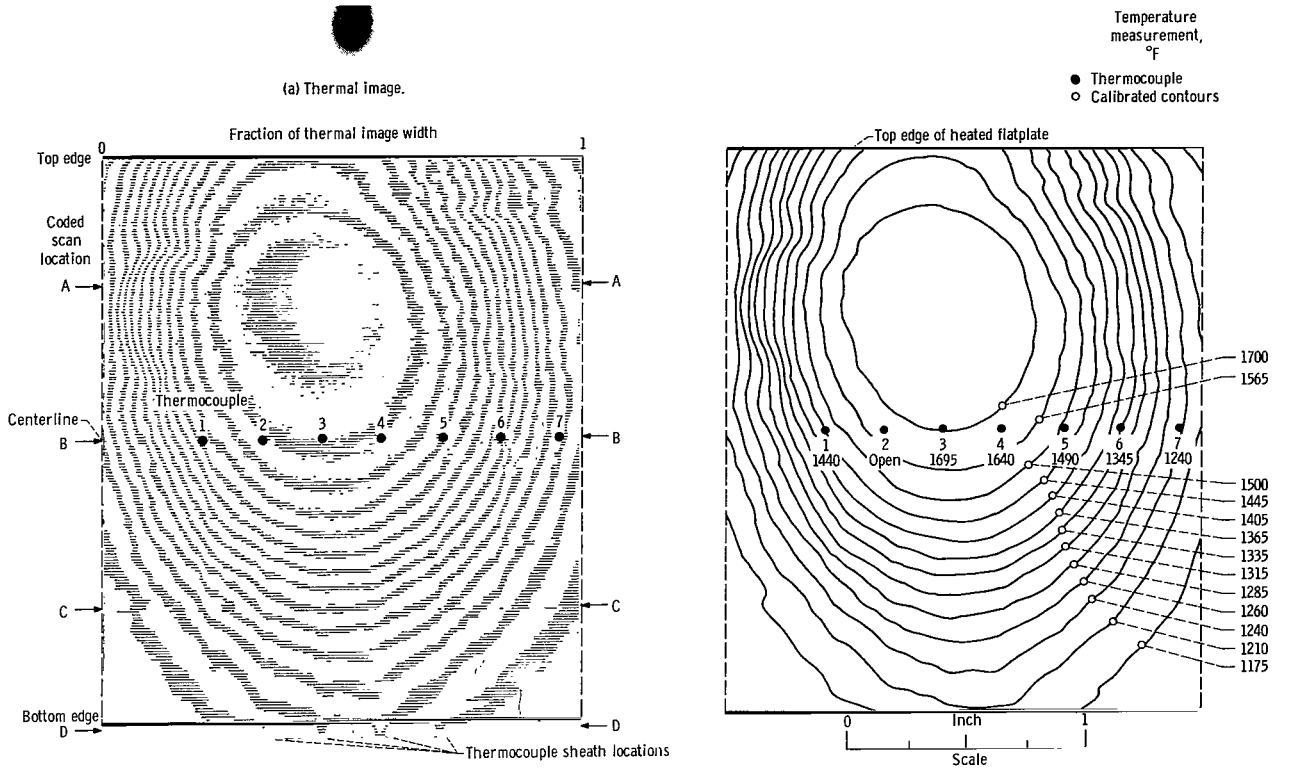

(b) Isodensity map of thermal image at 10x expansion.

(e) Surface temperature distribution map.

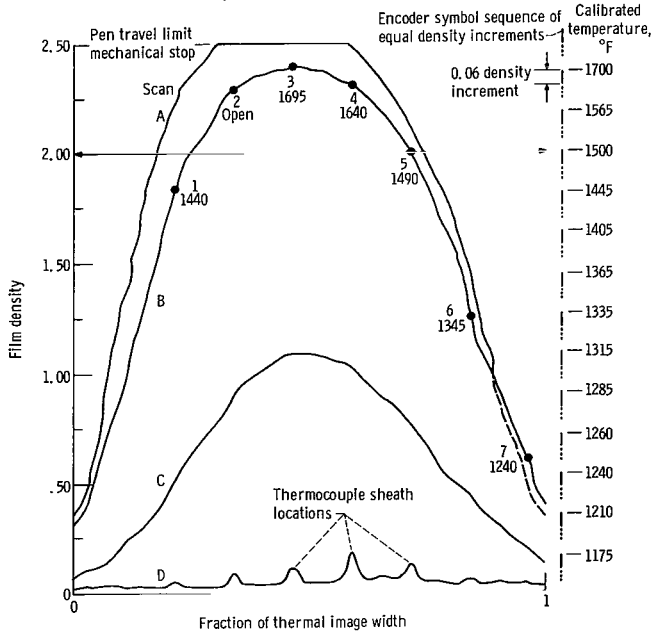

(c) Conventional film density profile scan at thermocouple locations indicated on (b).

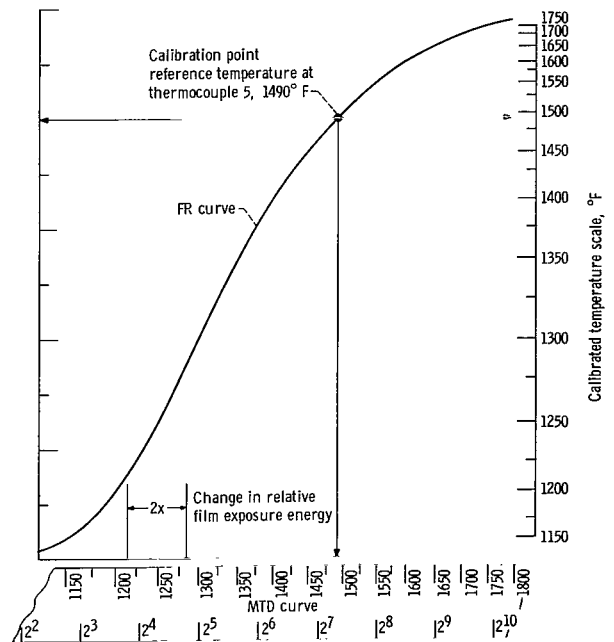

(d) Calibration curve of film density to surface temperature.

Figure 13. - Thermal image evaluation of heated flatplate test target with camera exposure of f16 - 1/2 second.

is a reproduction of the thermal image. The isodensity map shown in figure 13(b) was obtained directly from the original thermal image and was recorded at an expansion ratio of 10 to 1. The original isodensity map was about three times the target area portion shown on figure 11. The densitometer operating parameters included a 0 to 2.5 density range and a measuring aperture (resolution element) equivalent to a 0.020-inch square on the target surface. Successive aperture scans overlapped, and were 0.013 inch apart. About 200 scans were required to cover the $2\frac{1}{2}$ -inch target width. The coded scan sequence, dots-line-space, indicates an increasing density (or temperature) while the reverse sequence indicates a decreasing density. Each coded increment represents an equal density change of 0.06 density units.

The calibration point reference temperature thermocouple(s) must be accurately located on the thermal image. Generally, an edge, a hole, a defect, or some other distinguishing feature is available, or can be made available, as a location reference. These features can be accurately located by examination of the original thermal image, the isodensity map, and the conventional profile scans. The thermocouple locations on the isodensity map (fig. 13(b)) are indicated by the black dots. The locations were accurately determined by projecting the thermocouple sheath locations (shown along the bottom edge of fig. 13(b)) to the horizontal centerline of the target.

Any number of conventional profile scans can be recorded. Conventional profile scans were recorded at the coded scan locations AA, BB, CC, and DD (fig. 13(b)) and are shown on figure 13(c). The coded symbol sequence is shown along the right side margin. The scans are in positive register along the X-direction with the respective coded scans on figure 13(b). Scan AA was taken through a steep density gradient (closely spaced contours) and in the region of maximum density. Scan BB was taken along the centerline of the heated flat plate on which the thermocouples were located. The thermocouple locations are indicated on this profile by the black dots. Scan CC was at a location where the temperature was lower and the gradient less severe. Scan DD was taken immediately below the lower edge of the plate across the thermocouple sheaths that trailed off the plate (see fig. 11). The profiles of the sheaths on scan DD are apparent and were used to locate the horizontal position of the thermocouples on scan BB by vertical projection. These locations are coincident with the ones shown on figure 13(b), scan location BB. The film density at any location along the four profile scans illustrated (on figs. 13(b) and (c)) can be obtained from the density scale along the left ordinate on figure 13(c).

In order to relate the density scale into a calibrated temperature scale, a FR curve was used. The FR curve was made by recording a conventional profile scan across the calibrated step tablet image (as illustrated in fig. 6) included on the film strip leader. The resultant averaged FR curve is shown on figure 13(d). For this example, thermocouple 5 (1490° F) was used as the calibration point reference temperature. The film

density (2.00) representing this temperature on the exposure was obtained from figure 13(c) (scan BB) and transferred to figure 13(d). The MTD curve (prepared earlier in tape form) was positioned along the relative energy scale of the FR curve so that 1490° F was coincident; this accomplishes the same effect as moving the FR curve along the fixed MTD curve, as was discussed previously in relation to figure 8. The MTD curve was transferred to the film density scale of figure 13(d) through the FR curve. This procedure was illustrated in figure 3 and provides the necessary film density - surface temperature calibration for the thermal image. The calibrated temperature scale was added to figure 13(c), and temperatures are shown at selected coded symbol boundaries. The temperature at any location along any conventional profile scan can be determined and transferred to the same location on the respective coded scan in figure 13(b).

The surface temperature distribution map is shown on figure 13(e). This figure is essentially a duplicate of figure 13(b) except for the hand-drawn solid contour lines added along some of the coded symbol boundaries. The coded symbols were omitted for clarity. Temperatures were assigned to the contours from figure 13(c) by matching corresponding scan locations and coded symbols, as illustrated in figure 10. The final surface temperature map can, of course, be prepared on a transparent overlay to show uniform temperature increment contours but some interpolation is required. The surface temperature map along with the conventional profile scans furnish a wealth of information for surface temperature analysis. The temperature information is presented with a high degree of accuracy, precision, and position location on the target surface.

A comparison of the other thermocouple temperatures on the surface with temperatures obtained from the calibrated temperature scale shows excellent agreement. These comparisons can be obtained from figure 13(c) (scan BB) or from figure 13(e) and show agreement within the 1 percent accuracy of the thermocouples. Any of the thermocouples, of course, could have been used as the reference temperature. The camera exposure (f16 - 1/2 sec) for this specific example resulted in usable film density for temperatures between about 1150° and about 1650° F. The maximum sensitivity was at 1300° F. Inspection of the calibrated temperature scale on figure 13(c) shows the specific temperature range covered in any (0.06) equal density increment. A density increment of 0.06 represents approximately 10° F at the most sensitive region, while the same increment at 1150° and 1650° F represents 20° and 45° F, respectively. It is not possible to obtain the maximum surface temperature with this exposure because of the density measuring limitation. This is shown as the flattened top portion of scan AA in figure 13(c). To determine the maximum surface temperature, a less dense film (faster exposure time) is required.

Heated flat plate exposure, f16 - 1/60 second. - In order to determine the maximum surface temperature on the heated flat plate, a 1/60 second exposure was used. In addition, this exposure resolves the hottest temperature region more precisely than the pre-

vious 1/2-second exposure. The evaluation of the heated flat plate thermal image, obtained with camera exposure f16 - 1/60 second, is illustrated in figure 14. The procedure and densitometer operating parameters were the same as described in the previous evaluation.

A reproduction of the thermal image is shown in figure 14(a), while figure 14(b) shows an enlarged isodensity map of the image. The corresponding area for this exposure on the target surface is indicated by the smaller area bounded by dashed lines on figure 11. Approximately 130 coded scans were required to cover the thermal image. The isodensity map contains about $1\frac{3}{4}$ inch of the $2\frac{1}{2}$ inch width including the top edge of the heated flat plate. The thermocouple locations (black dots) were superimposed on the isodensity map with the aid of information obtained in figure 13.

The coded profile scans AA and BB in figure 14(b) were also recorded as conventional profile scans and are shown on figure 14(c). Scan AA was made through the zone of maximum temperature, and scan BB was made through the horizontal centerline of the heated flat plate. The thermocouple locations and temperature indications were included on scan BB. Thermocouple 3 (1695° F) was selected as the calibration point temperature. The film density value (0.75) was transferred to the FR curve shown in figure 14(d). This is the same film response curve as the previous example, since the two exposures were on the same film strip. However, the step tablet on the leader was rescanned after figures 14(b) and (c) were recorded to assure true correspondence between the three plots. The MTD curve was positioned along the relative energy scale of the FR curve so that 1695° F was coincident. The MTD curve was then transferred to the film density scale on figure 14(d) through the FR curve. The resultant calibrated temperature scale was then added to figure 14(c) and temperatures are shown at selected coded symbol boundaries.

The final surface temperature map shown on figure 14(e) is essentially figure 14(b) with some solid contours added and the coded symbols omitted. Temperatures were assigned to the contours by locating the respective horizontal position on the conventional profile scans shown on figure 14(c). The maximum temperature along scan AA was determined to be 2000° F. The improved temperature resolution in this area compared to the same area location on figure 13(e) is obvious. A comparison of the other thermocouple temperatures on the surface with the calibrated temperature scale on figure 14(c) can be made. Thermocouple 4 is within the 1 percent thermocouple accuracy. Thermocouples 1 and 5 read below 1500° F. This level of temperature is related to very low film density readings (below 0.1) for this camera exposure. Such low density corresponds to the relatively insensitive portion of the FR curve and reduces the accuracy and precision of the measurements in this region.

The exposure was usable for temperatures between about 1500° and 2300° F with maximum sensitivity at about 1750° F. The density range covered by an equal density

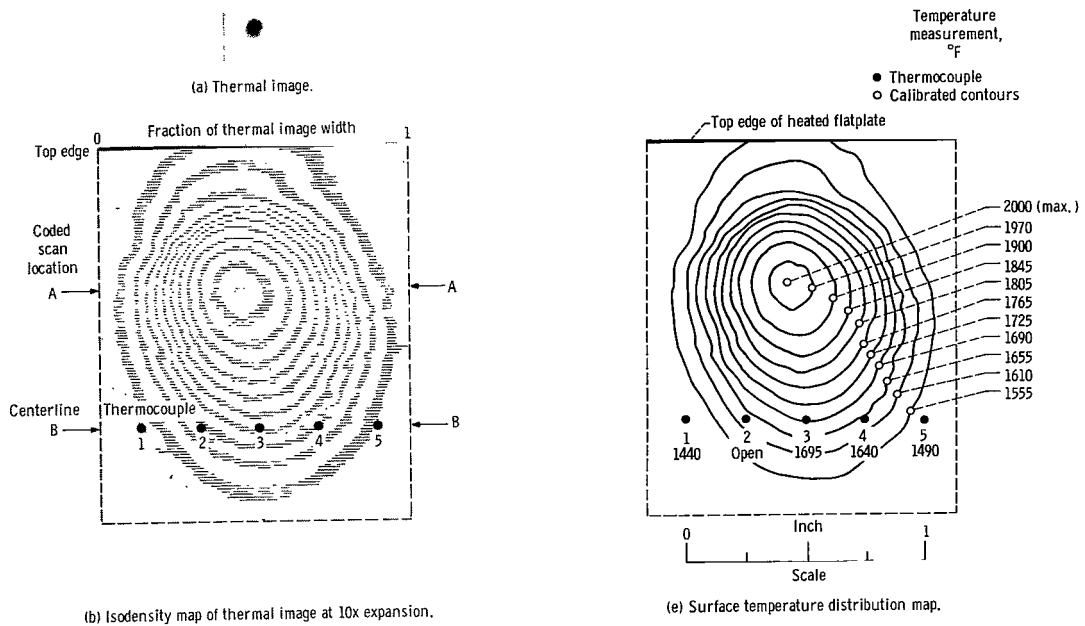

(b) Isodensity map of thermal image at 10x expansion.

(e) Surface temperature distribution map.

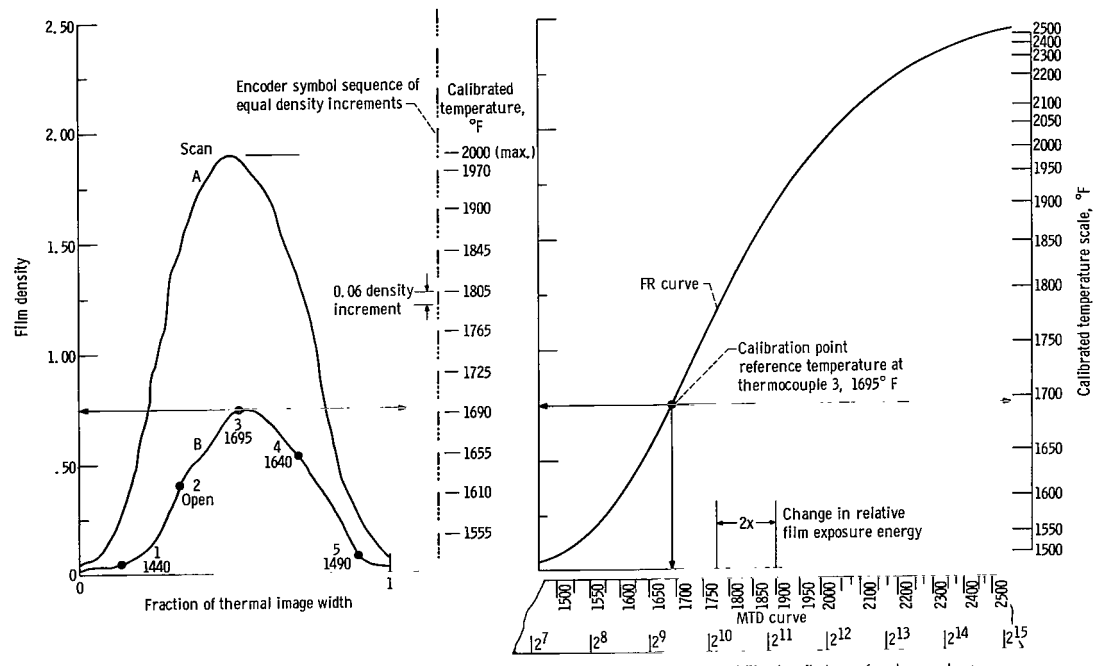

(c) Conventional film density profile scan at thermocouple locations indicated in (b).

(d) Calibration curve of film density to surface temperature.

Figure 14. - Thermal image evaluation of heated flatplate test target with camera exposure of f16 - 1/60 second.

increment (0.06) is shown on figure 14(c). The 0.06 density increment represents approximately 12° F at the most sensitive region. At 1500° and 2300° F the same increment represents approximately 30° and 70° F, respectively.

Figure 15 is a composite of figures 13(e) and 14(e) and was obtained by an overlay of figure 14(e) on figure 13(e). This comprehensive surface temperature map was assembled to demonstrate the precise position, location, and temperature resolution that can be obtained. The figure also demonstrates a method by which a broad temperature range can be covered by using two (or more) exposure settings for a given data point. The temperature information from the most sensitive regions of two (or more) separately analyzed exposures is then simply combined, as illustrated in figure 15.

In general, the temperature range covered by one exposure is sufficient for turbine cooling investigations. In fact, as the temperature range on the surface is reduced, more precision and temperature resolution is obtainable. A smaller density range com-

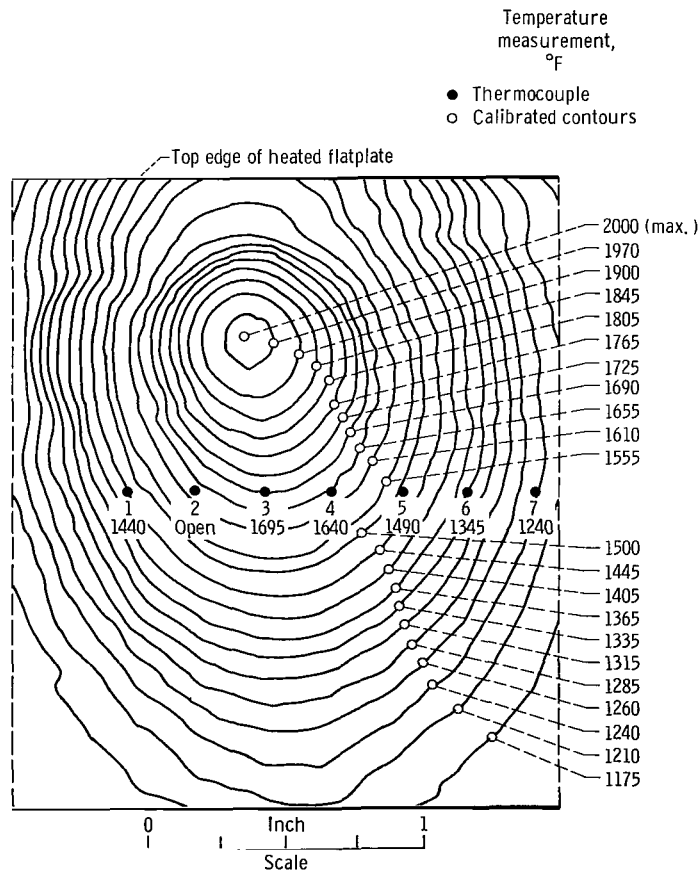

Figure 15. - Surface temperature distribution map of heated flatplate showing temperature contours between 1175° and 2000° F.

bined with steeper film response curves can be used to obtain temperature resolution of the order of a few degrees.

Airfoil exposure, f16 - 1 second. - The airfoil test target thermal image was evaluated in order to determine the effect of photographing a target in a hot gas stream through a viewport. For this exposure (f16 - 1 sec), no film density was obtained from the lower temperature area above the dashed line shown on the airfoil in figure 12. The rapid decrease in temperature in this zone (as indicated by the measurements from thermocouples 8 and 9) occurred because, in this investigation, the airfoil was only partially submerged in the hot gas stream. Consequently only the surface area containing thermocouples 1 to 7 was evaluated. This evaluation is summarized in figure 16.

The thermal image was photographed at about 1/5 magnification with a camera exposure of f16 - 1 second. Figure 16(a) is a reproduction of the thermal image. The isodensity map shown in figure 16(b) was obtained from the original thermal image. The map was recorded at an expansion ratio of 20 to 1. The original isodensity map was about four times as large as the airfoil area shown below the dashed line in figure 12. The same thermal image evaluation procedure was followed as in the two previous examples. However, the densitometer parameters now used a 0 to 2.0 density range and a measuring aperture (resolution element) equivalent to a 0.025-inch square on the airfoil surface. The successive aperture scans (about 200) overlapped and were about 0.020 inch apart. The density range along with a 40-increment encoder provided coded profile scans in 0.05 density increments.

The thermocouple locations are indicated by the black dots in figure 16(b). A qualitative idea of temperature distribution is clearly evident from the isodensity map. An additional item of interest that can be observed from figure 16(b) is that the location and outline of the series of film cooling holes (1/4 in. apart) near the trailing edge of the airfoil are clearly resolved by the densitometer. This resolution capability was used to aid in the precise location of the reference thermocouple. The relative location between the thermocouples and the film cooling holes was accurately known from measurements made on the instrumented airfoil. The coded profile scans AA, BB, and CC were through the thermocouple locations as indicated on figure 16(b).

The conventional profile scans at locations AA, BB, and CC are shown in figure 16(c). The respective thermocouple locations and the temperature measured by the thermocouples are also indicated. The resolution of the cooling hole contained in scan AA is evident from the large vertical displacement of the curve between thermocouples 2 and 3. The film density scale is shown along the left ordinate. Thermocouple 5 (1350⁰ F) was selected as the calibration point reference temperature. The density (0.72) at this location was located on the FR curve shown in figure 16(d). The MTD curve was positioned along the relative energy scale of the FR curve so that 1350⁰ F was coincident. The temperature distribution about this point (1350⁰ F) was transferred to the density scale and

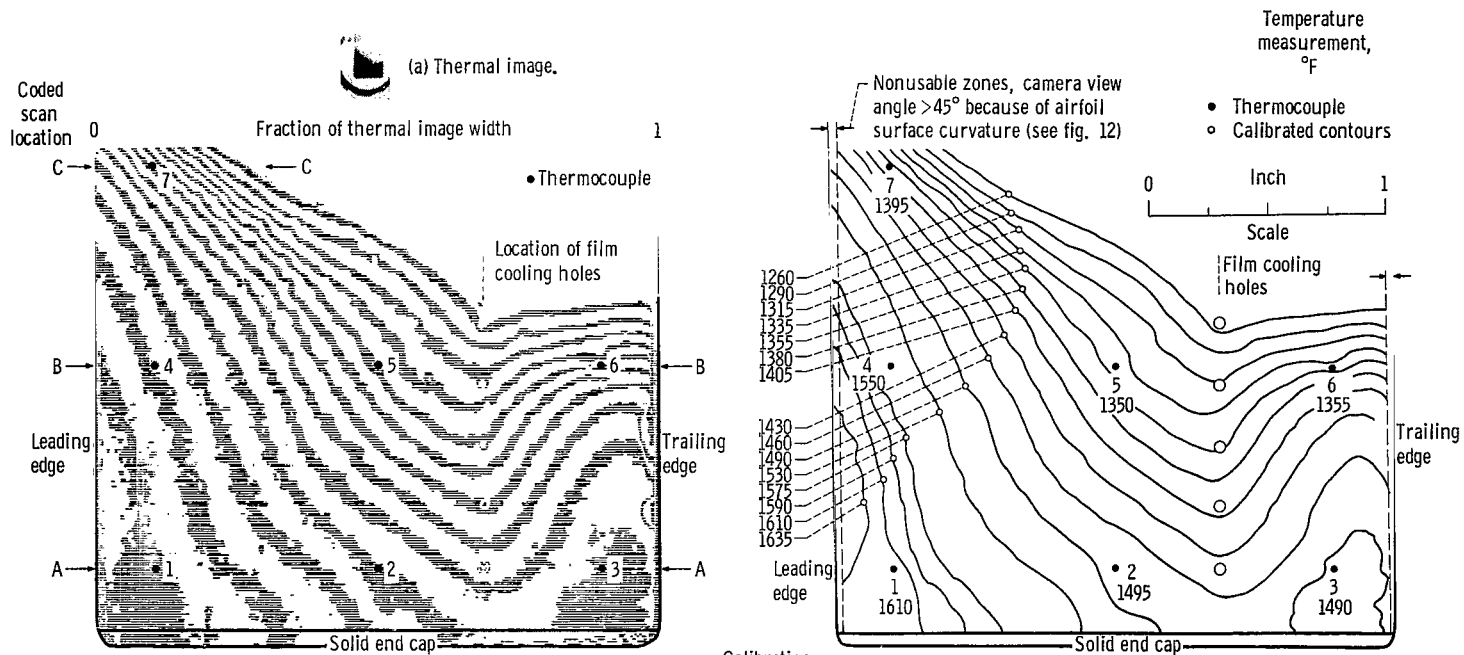

(a) Thermal image.
 (b) Isodensity map of thermal image at 20x expansion.
 (c) Conventional film density profile scan at locations indicated in (b).

(d) Calibration curve of film density to surface temperature.
 (e) Surface temperature distribution map.

Figure 16. - Thermal image evaluation of airfoil test target with camera exposure of f16 - 1 second.

is shown along the right ordinate as the calibrated temperature scale. The calibrated temperature scale was then added to figure 16(c) so that the temperature at any location along the conventional profile scans can be determined as well as at selected coded symbol boundaries. These temperature determinations were then transferred to the corresponding coded scan location to form the temperature distribution map shown in figure 16(e). Figure 16(e) is essentially a reproduction of figure 16(b) with some solid contour lines added and the coded symbols omitted. Temperatures were assigned to the contours from figure 16(c) in the same manner as the two previous evaluations. The figure represents a frontal projection of the curved airfoil surface. The extreme right and left regions were designated as nonusable because the surface curvature was greater than the aforementioned accepted 45° viewpath limitation.

The exposure, f16 - 1 second, was usable for surface temperatures between 1250° and 1700° F. The maximum sensitivity is in the region of 1400° F where a density increment of 0.05 represents a temperature increment of about 7° F. At 1250° and 1700° F, the same increment represents 10° and 25° F, respectively. Comparison between the other surface thermocouple readings (figs. 16(c) and (e)) and the calibrated temperature scale show agreement within the 1-percent thermocouple accuracy.

This test has shown the effect of adding a hot gas stream and viewport to the viewpath. It should be noted that the exposure, f16 - 1 second, was approximately two camera stops (4 \times) greater than that indicated for this temperature range in figure 8, which was for a heated flat plate in air. For maximum sensitivity at about 1400° F, figure 8 indicates an f16 - 1/4-second exposure. The increased exposure time (f16 - 1 sec) reflects the increase in attenuation (decrease in radiation striking the film) due to the viewport and hot gas stream conditions around the airfoil which were not part of the system when the curves in figure 8 were plotted. These factors (and others) are difficult to estimate or measure accurately, since they can vary with running time and gas stream conditions. This example points up the advantage of having a surface thermocouple as a calibration point reference temperature. In effect, the entire MTD curve in figure 8 would be shifted to the left approximately two camera stops to provide a system calibration guide chart for this airfoil test application.

In addition to this evaluation, many others were performed. A total of six different gas temperature levels were used in a series of tests which resulted in different airfoil temperature distributions. The surface temperatures varied from $<1000^{\circ}$ to about 1800° F. Several different exposures at each temperature level were evaluated. Some film strips had different processing cycles and density ranges. Comparison between thermocouple temperatures and calibrated temperatures for each test were in good agreement and generally within the 1-percent thermocouple accuracy mentioned previously. The investigation served to establish a high degree of confidence in the method.

General Comments

Some slight loss of contrast and detail, as well as register, between related sets of figures occurred during figure reproduction for report presentation. However, all original working data were in positive register. The original recording of all the FR curves and conventional profile scans shown in this report were on 8- by 10-inch paper with a millimeter square grid. This fine grid background conveniently and accurately matched corresponding film density values between related plots. A pair of dividers was used to match positions (X-direction) along corresponding coded and convention scan lines.

The isodensitance of figures 13(b), 14(b), and 16(b) alone provides a qualitative indication of temperature distribution. A more thorough indication of the temperature distribution can be obtained, in two different ways, when using targets containing several thermocouples. First, the thermocouple locations can be superimposed on the isodensity map. This has been done as indicated by the black dots on the three figures. A semi-quantitative indication of the temperature distribution can be deduced by interpolating the thermocouple readings between the constant density contours which are apparent on the figures. The second method for obtaining a semiquantitative analysis involves the use of a similar series of curves, as shown in figure 8, and is adequate for many applications. The series of curves is basically the film response (FR) curve with the horizontal location of each curve determined by a prior system calibration for a specific application. The position of each curve is determined by camera exposure conditions and provides the temperature range coverage for the exposure. The curves on figure 8 are shown as uniformly spaced for simplicity. This is not the case in practice, due to several factors, which include the failure of film reciprocity and the rather unprecise ratio of exposure variables on conventional cameras. In addition, the repeatability of the same camera exposure settings can vary the film energy by as much as 1/2 stop.

The series of curves must be initially determined for a specific system and application. Use of such a series of curves precludes variation of any system variable, and for reasonable accuracies (within 5 percent of thermocouple indication) confines the density-temperature measurement to the most sensitive, linear portion of the film response curve. Precise duplication of each test procedure is essential to obtain meaningful temperature measurements. Any factor that can affect the emitted radiated energy, as well as the collection, detection, and measurement, must be the same as during the initial system calibration. Once calibrated, this method would not require a reference temperature. However, use of a reference temperature would compensate for many system errors which affect the total energy reaching the film during a camera exposure. The major source of error then would result from variations in film processing and densitometry techniques. The magnitude of these errors is evident by inspection of figure 7 along with figure 8.

In some applications, it may be desirable to standardize on the processing cycle if the flexibility is not essential. Only periodic checks of the film response curve would be required if the processing cycle were reproducible. This would eliminate the necessity of including a calibrated step tablet image on every film strip. However, a portion of the calibrated step tablet image could be used as a secondary reference temperature or a backup in case of thermocouple failure. This would require a prior calibration so that the film density of a selected step could be related to a temperature for a specific thermal-image camera exposure. This approach is less accurate than the use of a reference thermocouple due to several possible sources of error and would also require exact duplication and rigid control of each test procedure.

SUMMARY OF RESULTS

The results of the investigation of an infrared photographic pyrometer system for surface temperature measurement in the range of 1000⁰ to 2500⁰ F were as follows:

1. IR photographic pyrometry is feasible for surface temperature mapping for turbine cooling investigations as well as many other applications.
2. A relative energy measurement technique along with a single calibration point reference temperature was used to obtain calibration of film density to surface temperature. The method is independent of surface emissivity and optical viewpath attenuation factor and compensates for photographic variations.
3. The master temperature curve, over a wide temperature range, was determined by a simple calculation at two points. This distribution was presented in a convenient tape form for easy crossplotting with the film response curve.
4. The film response curve was determined experimentally with an intensity modulation technique by including a calibrated relative exposure scale (step tablet) image on each test film strip.
5. Complete temperature information was thoroughly reduced from each thermal image within the temperature measuring accuracy of the calibration point reference temperature. This was true over a considerable range of the film response curve.
6. Use of a geometric progression scale with a ratio of 2, on both the master temperature distribution and film response curves, simplified the correspondence of these curves with standard camera exposure control variables and the calibrated step tablet.
7. All calibration information is recorded on film and remains as part of the permanent record for possible reexamination.

CONCLUDING REMARKS

There are many methods for measuring temperature. Each method is useful and has some advantages and some disadvantages. A combination of methods is often used to increase reliability by serving as checks on one another as well as backups. The best combination or compromise must be selected for each application. Photography is used to explore surface temperature distribution in great detail.

The detailed analysis of a thermal image can reveal significant information that is not possible to obtain with limited temperature sampling. The method provides a permanent temperature record of a heated target in an instant of time for subsequent analysis. The surface temperature distribution can be presented in great detail. The method has an inherent high degree of accuracy and precision for quantitative measurements but can be used in a less rigorous manner for obtaining semiquantitative and qualitative information.

The accuracy of the method is determined principally by the accuracy of the calibration point reference temperature as well as the control exercised. The precision of the measurement is determined by the slope of the film response curve and the detail of the master temperature distribution curve. The temperature resolution, the accuracy of position location, and the resolution element (resolvable spot size on the target) are determined to a great extent by the densitometer system.

Photographic pyrometry involves an interplay of radiometry and photography and is more involved than some other methods but resolves into systematic routines. It is applicable in areas where detailed surface temperature mapping is essential and optical viewpaths are feasible. The system described herein was tailored to an experimental turbine cooling program. However, the system variables and procedures apply to the field of photographic pyrometry in general. The availability of standard equipment has simplified the method, and substantially increased the accuracy, precision, and resolution of measuring surface temperature distribution. Temperature gradients can be imaged with accurate correspondence between each point on a target surface, the film image, and the final enlarged surface temperature map.

Many different camera systems, manual as well as remotely operated, can be employed at a number of test sites with one centralized "master station" for film calibration and evaluation.

Although a variety of camera systems can be designed for specific applications, the fundamentals of the method remain basically the same. As stated previously, the following relations are necessary:

- (1) Master temperature distribution curve
- (2) Film response curve
- (3) Calibration point reference temperature

These relations eliminate the effect of nonuniform system errors, as well as the possible accumulation of many subtle errors. With a small amount of experience in following the routine procedures, accepted practices, and reasonable control, a high degree of proficiency and confidence in the method is obtained.

This report described in detail a specific applied system together with the calibration method, instrumentation, test targets, and procedures. In addition, it was intended to review general background information in the fields of radiometry and photography to provide an understanding and an appreciation for the problems associated with photographic pyrometry.

Lewis Research Center,
National Aeronautics and Space Administration,
Cleveland, Ohio, January 21, 1969,
126-15-02-47-22.

REFERENCES

1. Londeree, J. W., Jr.: Photographic Pyrometry. J. Am. Ceramic Soc., vol. 37, no. 8, Aug. 1954, pp. 354-360.
2. Male, Donald W.: A Photographic Pyrometer. Rev. Sci. Instr., vol. 22, no. 10, Oct. 1951, pp. 769-772.
3. Bortzmeyer; and Salter: Applying the Technique of Infrared Photography to Wall Temperature Measurements in Rocket Motors. NASA TT F-9485, July 1965.
4. Siviter, James H., Jr.; and Strass, H. Kurt: An Investigation of a Photographic Technique of Measuring High Surface Temperatures. NASA TN D-617, 1960.
5. Exton, Reginald J.: Theory and Operation of a Variable Exposure Photographic Pyrometer Over the Temperature Range 1800^o to 3600^o F (1255^o to 2255^o K). NASA TN D-2660, 1965.
6. Goodbar, W. L.: An Improved Method for Measuring Turbine Vane Temperatures in Hot Cascade Rigs. Allison Res. and Eng., vol. 11, Third Quarter 1966, pp. 2-10.
7. Harrison, Thomas R.: Radiation Pyrometry and its Underlying Principles of Radiant Heat Transfer. John Wiley & Sons, Inc., 1960.
8. Mees, C. E. Kenneth: The Theory of the Photographic Process. Second ed., Macmillan Co., 1954.

9. Siegel, Robert; and Howell, John R.: Thermal Radiation Heat Transfer. Vol. 1: The Blackbody, Electromagnetic Theory, and Material Properties. NASA SP-164, Vol. 1, 1968.
10. Gray, Dwight E., ed.: American Institute of Physics Handbook. Second ed., McGraw-Hill Book Co., Inc., 1963, ch. 6, pp. 154-155.
11. Soc. Motion Picture and Television Eng.: Control Techniques in Film Processing. Profile Press, 1960.
12. Stepka, Francis S.; and Hickel, Robert O.: Methods for Measuring Temperatures of Thin-Walled Gas-Turbine Blades. NACA RM E56G17, 1956.
13. Miller, C. S.; Parsons, F. G.; and Kofsky, I. L.: Simplified Two-Dimensional Microdensitometry. Nature, vol. 202, no. 4938, June 20, 1964, pp. 1196-1210.
14. Kofsky, Irving L.: Reduction of Pictorial Data by Microdensitometry. Aerospace Measurement Techniques. Gene G. Mannella, ed., NASA SP-132, 1967, pp. 133-154.
15. Miller, C. S.: Isodensitometry as an Aid in the Analysis of Photographically Recorded Information. Preprint 101-89, Soc. Motion Picture and Television Eng., Apr. 1967.

FIRST CLASS MAIL

69100 00903
C30 001 37 51 30S
AIR FORCE WEAPONS LABORATORY/WFLW/
KIRTLAND AIR FORCE BASE, NEW MEXICO 87117

ATTN: LUD. EDWARDS, ACTING CHIEF TECH. LIAISON

POSTMASTER: If Undeliverable (Section 158
Postal Manual) Do Not Return

"The aeronautical and space activities of the United States shall be conducted so as to contribute . . . to the expansion of human knowledge of phenomena in the atmosphere and space. The Administration shall provide for the widest practicable and appropriate dissemination of information concerning its activities and the results thereof."

— NATIONAL AERONAUTICS AND SPACE ACT OF 1958

NASA SCIENTIFIC AND TECHNICAL PUBLICATIONS

TECHNICAL REPORTS: Scientific and technical information considered important, complete, and a lasting contribution to existing knowledge.

TECHNICAL NOTES: Information less broad in scope but nevertheless of importance as a contribution to existing knowledge.

TECHNICAL MEMORANDUMS: Information receiving limited distribution because of preliminary data, security classification, or other reasons.

CONTRACTOR REPORTS: Scientific and technical information generated under a NASA contract or grant and considered an important contribution to existing knowledge.

TECHNICAL TRANSLATIONS: Information published in a foreign language considered to merit NASA distribution in English.

SPECIAL PUBLICATIONS: Information derived from or of value to NASA activities. Publications include conference proceedings, monographs, data compilations, handbooks, sourcebooks, and special bibliographies.

TECHNOLOGY UTILIZATION PUBLICATIONS: Information on technology used by NASA that may be of particular interest in commercial and other non-aerospace applications. Publications include Tech Briefs, Technology Utilization Reports and Notes, and Technology Surveys.

Details on the availability of these publications may be obtained from:

SCIENTIFIC AND TECHNICAL INFORMATION DIVISION
NATIONAL AERONAUTICS AND SPACE ADMINISTRATION
Washington, D.C. 20546