

N 70 26934

**NASA TECHNICAL  
MEMORANDUM**

NASA TM X-52795

NASA TM X-52795

**CASE FILE  
COPY**

**STEADY-STATE PERFORMANCE OF A SNAP-8 DOUBLE-CONTAINMENT  
TANTALUM-STAINLESS STEEL MERCURY BOILER**

by Roy A. Lottig and Ronald H. Soeder  
Lewis Research Center  
Cleveland, Ohio

This information is being published in preliminary form in order to expedite its early release

STEADY-STATE PERFORMANCE OF A SNAP-8  
DOUBLE-CONTAINMENT TANTALUM-STAINLESS STEEL MERCURY BOILER

By

Roy A. Lottig and Ronald H. Soeder

Lewis Research Center  
Cleveland, Ohio

March 1970

## ABSTRACT

Boiler performance mapping was performed between SNAP-8 system startup tests. The mercury boiler was a counterflow heat exchanger with double-containment, tantalum and stainless steel construction. Boiler performance data obtained between early startup tests (3 through 21) indicated a boiler deconditioning (mercury-side surface contamination) problem. The boiler did condition (mercury-side surface contamination removed) for later startups (34 through 135) resulting in an overall pressure drop of 183 psi for a mercury flow rate of 6600 lbm/hr and a boiler inventory of 26 pounds. At the design mercury flow rate of 12,300 lbm/hr the boiler overall pressure drop was 129 psi with a boiler inventory of 34 pounds. The boiler NaK flow rate and inlet temperature for both of the above mercury flow rates were approximately 46,000 lbm/hr and 1280° F and 45,700 lbm/hr and 1300° F, respectively.

STEADY-STATE PERFORMANCE OF A SNAP-8  
DOUBLE-CONTAINMENT TANTALUM-STAINLESS STEEL MERCURY BOILER

By

Roy A. Lottig and Ronald H. Soeder

Lewis Research Center  
Cleveland, Ohio

SUMMARY

AN-5658  
An experimental investigation of SNAP-8 startup and shutdown characteristics was conducted at the Lewis Research Center. During stabilized system operation following startup tests, a limited amount of steady-state boiler performance mapping was accomplished. The pertinent boiler parameters varied were mercury flow rate, NaK flow rate, and NaK inlet temperature. The variation of overall boiler mercury-side pressure drop for a range of mercury flow rates from 6100 to 12,300 lbm/hr was examined. In addition, the changes in overall pressure drop for a range of NaK flow rates from 39,800 to 46,500 lbm/hr and a range of NaK inlet temperatures from 1260° to 1300° F were examined.

The results showed the boiler underwent periods of deconditioning (mercury-side surface contamination) and conditioning (removal of mercury-side surface contamination) during the early startup tests (numbers 3 through 21) before attaining a conditioned state. The early deconditioned state of the boiler caused lower mercury-side overall pressure drops than would have been obtained if the boiler had been conditioned. However, two important boiler operating points were defined when the boiler was conditioned, one at the self-sustaining mercury flow rate (6600 lbm/hr) and the other at the design flow rate (12,300 lbm/hr). For the self-sustaining mercury flow rate (6600 lbm/hr) the boiler overall pressure drop was 183 psi. The mercury liquid inventory was 26 pounds and the NaK flow rate and inlet temperature were 46,000 lbm/hr and 1280° F, respectively. For the design flow rate the overall pressure drop was 129 psi. For this pressure drop the boiler liquid inventory was 34 pounds and the NaK flow rate and inlet temperature were 45,700 lbm/hr and 1300° F, respectively.

The boiler shell temperature profiles obtained during early (start-ups 3 through 21) mapping showed that a mercury flow maldistribution occurred for some boiler operating points. This flow maldistribution was not observed when the boiler was conditioned, but the amount of steady-state conditioned boiler data obtained during this investigation was too limited to exclude the possibility of its occurrence.

## INTRODUCTION

A system that will produce a continuous electrical power supply and also have the capability of numerous startups and shutdowns upon command without performance degradation is required for long-term space mission applications. One such system, presently under development, is the SNAP-8 nuclear-Rankine, turboelectric power system (ref. 1). The basic SNAP-8 system is designed to produce a minimum of 35 kilowatts of usable electrical energy. In this liquid metal system an eutectic mixture of sodium and potassium (NaK-78) is used in both the reactor primary loop and heat rejection loop, while mercury is used in the power conversion loop.

In order to determine the startup and shutdown procedure for the SNAP-8 system, a series of 135 startups were performed at NASA Lewis Research Center. A breadboard SNAP-8 system using flight-type components with an electric heat source and air-cooled heat exchangers, simulating a nuclear reactor and a space radiator, respectively, was tested.

The boiler component has undergone several design changes prior to the current double-containment, tantalum and stainless steel concept (ref. 2). A boiler similar in design was used during earlier component and system endurance testing in the Lewis SNAP-8 test facility. The major difference between that boiler and the one used in the startup tests was the size of the inlet orifice restrictions. The earlier boiler had an orifice diameter of 0.070 inch as compared to an orifice diameter of 0.080 inch in the startup-test boiler. The results of the endurance boiler performance are covered in reference 3.

During the startup-test program some steady-state boiler performance data were acquired for a range of mercury flow rates, NaK flow rates and NaK inlet temperatures. Basic SNAP-8 mercury loop startup requirements call for a mercury flow ramp from zero to the system self-sustaining flow rate (6600 lbm/hr). After system transients settle out, a mercury flow ramp from the self-sustaining flow to the design flow (12,300 lbm/hr), concludes the power conversion loop startup. To define the boiler mercury-side overall pressure drop during system startup, mercury flow rates from 6100 lbm/hr to 12,300 lbm/hr were tested, while NaK flow rate and NaK inlet temperature ranges from 39,800 to 47,500 lbm/hr and 1260 to 1340° F, respectively, were tested. These data are presented and discussed in this report.

## SNAP-8 TEST SYSTEM

### General Description

A schematic diagram of the three major loops in the SNAP-8 test system are shown in figure 1. The primary (heating) loop contained a pump-motor assembly, an electric heater, electromagnetic flowmeter,

the tube-in-shell boiler, and an auxiliary start heat exchanger. The electric heater, ignitron power controller, and analog computer simulated the operation of a nuclear reactor (refs. 4 and 5). The variation of primary loop flow was accomplished by altering the position of the valve (V-115) at the primary pump outlet. The primary loop piping consisted of AISI type 304 stainless steel from the boiler NaK outlet to approximately 5 feet beyond the pump-motor assembly outlet. The remainder of the loop piping consisted of AISI type 316 stainless steel.

The power loop (mercury loop) used AISI type 316 stainless steel for all piping from the boiler outlet to the condenser inlet and for all three venturi meters. AISI type 304 stainless steel was used for the remaining piping. The components in the mercury loop included a pump-motor assembly, the tube-in-shell boiler, a four-stage axial-flow turbine-alternator assembly, a condenser and three venturi meters. Mercury in the power loop flowed through the pump, a gas operated valve (V-247), an electro-hydraulic flow-control valve (V-230) controlled by an analog computer signal and a hydraulic backup valve (V-206). It then flowed through a venturi meter, a gas operated valve (V-260) and through the boiler. The vapor flowed through the turbine and into the condenser where it was condensed and subcooled. The mercury then passed through a gas operated valve (V-210), a venturi meter and V-207, a gas operated valve at the pump inlet. A gas operated valve (V-217) was in a line connecting the mercury standpipe with the power loop. V-204 is a variable position gas controlled valve in the mercury bypass line. The following valves in the mercury loop were used in a fully open or closed position: V-207, V-247, V-210 and V-217.

The feedback control circuit, shown schematically in figure 2, was used for automatic control of the electro-hydraulic flow control valve (V-230). The control circuit utilized a combination of open loop and integral-plus-proportional control. A detailed description of the operation of valve (V-230) is discussed in reference 6.

The heat rejection loop utilized AISI 304 stainless steel for all the piping between components. The loop consisted of a pump-motor assembly, an electromagnetic flowmeter, a condenser, two-finned NaK-to-air heat exchangers and a second electromagnetic flowmeter positioned at the outlet of one of the heat exchangers. Butterfly valves controlled by an analog computer signal varied the air flow to the NaK-to-air heat exchangers, to simulate operation of a space radiator. The pressure at the mercury inlet side of the condenser was sensed and converted into a command signal to actuate valve (V-314) at the pump outlet. This valve movement in turn varied the heat rejection loop flow.

Expansion tanks were used with both NaK loops to provide for changes in volume of the NaK fluid due to temperature variations and to maintain sufficient pressure at the inlet of the pumps. An oxide control system,

common to both NaK loops was used to precipitate out oxides from the NaK fluid during periods when the mercury loop was not in operation. An increase in concentration of oxides in the NaK fluid is undesirable since these oxides cause plugging of system valves and piping. A lubricant-coolant loop containing polyphenol ether (4P3E) was used to lubricate the turbine-alternator assembly and mercury pump-motor assembly bearings. The 4P3E was also used to cool the remaining system pumps and certain parts of the turbine-alternator assembly and mercury pump-motor assembly. Vacuum, argon, and nitrogen systems were also used for proper operation of the three main loops.

### Double Containment Boiler

The double-containment boiler was a tube-in-shell counterflow heat exchanger as shown in figure 3. A single inlet tube led into a plenum where the liquid-mercury flow was distributed into orifices at the entrance to each of seven boiler tubes. The tantalum orifices had an upstream diameter of 0.590 inch, a throat diameter of 0.080 inch and a metering length of 1.81 inches. The tantalum tubes had a 0.75-inch outside diameter, 0.040-inch wall thickness and an approximate length of 37 feet. Each of these tubes was placed into a 316 stainless-steel tube with an outside diameter of 1 inch, 0.035-inch wall thickness and an approximate length of 36.7 feet. These seven 1-inch diameter tubes were swaged into an oval shape prior to insertion of the 0.75-inch diameter tubes (fig. 4(a)). The oval shape of the containment tubes was to allow for radial movement of the inner tantalum tube which compensates for the difference in thermal expansion between the tantalum and the 316 stainless steel. The void between the outside surface of the 0.75-inch diameter tube and the inside surface of the oval tube was filled with static NaK, which served as a heat transfer medium between the flowing NaK and the mercury loop. An additional function of the static NaK passage is to provide a containment region for flowing NaK or mercury in the event of internal boiler failure. The double-containment boiler construction thus prevents contamination of the mercury loop with primary loop NaK and vice-versa.

The next sequence in the boiler assembly was to insert the seven double containment tubes into a 316 stainless-steel shell with a 5-inch outside diameter, 0.095-inch wall thickness and approximately 38.9 feet in length (fig. 4(a)). The completed boiler assembly consisted of straight inlet and outlet sections 74.3 and 15.5 inches long, respectively. The center section of the boiler comprised a  $2\frac{1}{2}$  turn helix with a pitch of 10.5 inches and a pitch diameter of 48 inches. The double-containment tube bundle was supported within the outer shell by support brackets placed at 15-inch increments throughout the first full turn of the helical section of the boiler, beginning at the plug-section exit. The remaining support brackets were placed at 31-inch increments.



A spiralled-passage, multi-fluted "plug" at the tantalum tube inlet, approximately 55 inches in length, was used to restrict mercury flow and thus to increase liquid velocity. The plug, a 0.662-inch diameter grooved tantalum rod (fig. 4(b)) was fixed at the inlet end by a threaded shaft which was part of the orifice assembly. The downstream end of the plug coincided with the end of the straight inlet section (boiler station 12, fig. 3).

At the plug outlet was another swirl inducer which extended to within 1 inch of the tantalum tube outlet. The swirl inducer consisted of 0.062-inch diameter tantalum wire with a pitch diameter of 0.608 inch and a pitch of 2 inches. This wire was intended to centrifuge liquid from the vapor to the inner wall of the tantalum tube thus increasing heat transfer rates and reducing the amount of liquid carryover to the turbine. The seven-tube outlet manifold led into a plenum which formed a single mercury outlet passage.

### Boiler Cleaning

The mercury boiler was cleaned as an individual component before installation into the system. An argon purge was imposed on the mercury, flowing NaK and static NaK passages of the boiler to prevent contamination of the tantalum tubes by the surrounding atmosphere. The mercury passage of the boiler was then evacuated to 0.02 torr and then filled with trichloroethane. After a soaking period of  $\frac{1}{2}$  hour the mercury passage was gravity drained. A chemical analysis of the solvent indicated the same composition as the original solvent. The flowing NaK passage of the boiler was then filled with trichloroethane and drained after a soaking period of  $\frac{1}{2}$  hour. The chemical analysis of the solvent indicated no contamination of the original solvent.

Mercury and flowing NaK passages of the boiler were leaked checked by injecting helium into the static NaK passage. A vacuum was then imposed on the mercury passage of the boiler. The vacuum was allowed to decay over an 8-hour period and it was determined that the rate of decay was 0.004 torr/hour, an acceptable value for component testing.

Finally the static NaK passage of the boiler was filled with trichloroethane and allowed to soak for a period of  $\frac{1}{2}$  hour, before the passage was drained. The procedure was performed twice due to the deposition of minute metal chips on filter paper used to screen the efflux of trichloroethane from the static NaK passage during the first drain. The analysis of the trichloroethane after a second  $\frac{1}{2}$  hour soaking period and subsequent drain indicated no change in the original solvent.

## INSTRUMENTATION

A discussion of instrumentation used in the SNAP-8 facility is found in references 7 and 8. A description of boiler instrumentation follows.

### Temperature

Boiler temperature-measuring instrumentation consisted of shell thermocouples, immersion thermocouples in the mercury outlet tube, and surface thermocouples on the inlet and outlet piping for both mercury and NaK. The three surface thermocouples on the mercury inlet piping were constructed of Instrument Society of America (ISA) standard calibration J (Iron-Constantan) wires which were located 8 inches upstream of the boiler inlet. All other thermocouples were constructed of ISA standard calibration K (Chromel-Alumel) wires. Three thermocouples were welded on the mercury outlet piping, 120 degrees apart (section B-B in fig. 3). Four immersion thermocouples were located in a 11-inch section welded to the mercury boiler outlet. Immersion thermocouples A and B were inserted at a 45 degree angle in a direction opposite to the vapor flow direction. Thermocouple A was also located at the top of the outlet piping, while thermocouple B was located at an angle of 30 degrees (clockwise) with respect to thermocouple A (view C-C in figure 3). The direction of mercury flow in view C-C is out of the paper. Immersion thermocouples C and D were inserted at a 45 degree angle pointing in the same direction as mercury vapor flow. These thermocouples were also located at the bottom of the outlet piping (view C-C in fig. 3). The NaK inlet thermocouples were placed on the surface of the NaK inlet transition section and were located 4.75 inches from the NaK shell-flow-direction centerline. The thermocouples at the NaK outlet were placed on the transition section at a location 4 inches from the NaK shell-flow-direction centerline.

Both the top and bottom surfaces of the boiler shell were instrumented with thermocouples to give an indication of the NaK temperature distribution. Thermocouples were placed at location A (section A-A fig. 3) for all station numbers except number 4. The circumferential location of thermocouples at station 12 (section A-A fig. 3) defines the location positions used at any station along the boiler, see table I. All thermocouple stations were located with respect to the vertical centerline through the boiler NaK outlet transition section. Table I lists all the boiler shell thermocouples and their respective locations for each station number.

### Pressure and Flow

The boiler pressure instrumentation consisted of one absolute pressure transducer at the mercury boiler inlet and two absolute pressure

transducers at the mercury boiler outlet passage. A differential pressure transducer was also used to measure pressure drop across the NaK side of the boiler. The absolute and differential pressure transducers were of the slack diaphragm and capillary tube type. A detailed description of the internal mechanism associated with each type of transducer can be found in reference 9. Each pressure transducer was calibrated over its design range. The boiler inlet pressure transducer had a design range of zero to 500 pounds per square inch absolute and the outlet pressure transducers had design ranges of zero to 300 and zero to 400 pounds per square inch absolute. The accuracy of each absolute pressure transducer measurement was within 1 percent of its range. The differential pressure transducer had a design range of zero to 10 pounds per square inch and its accuracy was 1 percent of its range. The locations of the pressure taps for the three absolute and one differential pressure transducer are shown in figure 3.

The primary loop NaK flow into the boiler was measured by an electromagnetic flowmeter. Mercury liquid and vapor flow were measured by calibrated venturi flowmeters upstream and downstream of the boiler (fig. 1). The pressure drop across each venturi flowmeter from the inlet to the throat was measured by a differential pressure transducer. Each transducer was calibrated over its entire range of zero to 20 pounds per square inch and the accuracy of a given reading was 1 percent of its range.

### Data Recording

All pressures and temperatures used for analysis were recorded using a computerized digital data recording system. This system was used to record both steady-state and transient test system conditions. The recording system scanned and recorded a cycle of data, containing 400 different instrument outputs, in 11.43 seconds. During steady-state tests a data run consisted of taking the average of three cycles of the 400 different instrument outputs during an interval of 34.3 seconds. A computer program was used to calculate the test parameters during steady-state runs. The results were stored on magnetic tape and used to produce the computer plots of steady-state boiler shell temperature profiles shown in the report.

## RESULTS AND DISCUSSION

### Performance History

The following discussion is focused on boiler steady-state data acquired integrally with startup tests. In general, each data point presented in table II was obtained after a unique mercury-loop startup from zero flow to the self-sustaining mercury flow rate of approximately 6600 lbm/hr. The data in table III were obtained after mercury flow

ramps from the self-sustaining level to the rated flow rate of approximately 12,300 lbm/hr.

The boiler mercury overall pressure drops, recorded between 5 and 8 minutes after startup to the self-sustaining flow level, are shown as a function of startup number in figure 5. During mercury-loop startups an automatic-digital data-recording system was cycled continuously for 8 to 9 minutes through 400 words of information. A time of 11.43 seconds was required to record each cycle of information. An average of 48 to 49 cycles of data were acquired per startup. Near the end of the data acquisition time the boiler parameters, flow rates, temperatures and pressures, appeared to have reached a steady-state level. Consequently, the boiler overall pressure drops shown in figure 5 represent steady-state data. During some startups the digital data-recording system did not function properly; thus, the digital-startup data was lost. In figure 5 this problem is indicated by the absence of a data point for these startups. All of the data points were connected consecutively with a straight line. Therefore, for a startup number having no data point, the overall pressure drop may be misrepresented by the intersection of the startup number and with the straight line connecting preceding and following data points.

For the early startups (3 through 21) in figure 5, the boiler overall pressure drop experienced numerous significant changes. Overall pressure drops from 55 to 205 psi were obtained during this period. The large changes in boiler overall pressure drop did not affect turbine inlet conditions (to be shown later) because in the SNAP-8 test facility a constant mercury flow rate was maintained by using a closed-loop feedback signal for the mercury flow control valve. However, for simplicity, the flight system mercury flow control valve will have open-loop control. If in the flight system the boiler mercury overall pressure drop varied as it did during the early startups (3 through 21) the mercury flow rate would vary considerably with the possible consequence being large liquid mercury carryover into the turbine.

The reason for the large boiler overall pressure drop changes during the early startups (3 through 21) is not explicitly known, but a possible cause could be varying boiler deconditioning and conditioning. Boiler deconditioning will be defined as the reduction of clean tantalum surface area on the mercury side due to a surface contamination, while conditioning means the surface contamination is being removed. A contaminated tantalum surface (boiler deconditioned) will impede the mercury boiling, while a clean tantalum surface (boiler conditioned) will enhance mercury boiling. In addition to the condition of the boiler, the physical makeup of the boiler affects the overall pressure drop. In the SNAP-8 test facility boiler, the mercury flow area in the plug region was considerably smaller than the mercury flow area downstream of the plug; therefore, fluid velocities were higher in the plug region. As long as the boiler remained conditioned, all or most, depending upon the mercury flow rate, of the boiling occurred in the plug region where

the frictional pressure losses were high. Once the boiler became deconditioned, more of the high quality boiling occurred downstream of the plug where the frictional pressure losses were lower than in the plug. Thus, deconditioning would cause the boiler mercury side overall pressure drop to decrease.

Possible sources of tantalum surface contamination in the test system were vacuum-pump oil and lubricant-coolant loop oil. Post-test analysis of the mercury in the dump tank did show the presence of some vacuum-pump oil and lubricant-coolant loop oil.

After startup 21 the boiler apparently underwent a conditioning process until the overall pressure drop obtained a level of approximately  $195 \pm 15$  psi (fig. 5). It remained at this level until startup 109, when the boiler apparently underwent a slight deconditioning. The overall pressure drop history from this point shows a gradual upward trend in level (fig. 5).

Boiler performance data were taken after startup numbers 8 and 10. As can be seen in figure 5, there were large changes in pressure drop after these startups and before the following startup. The total time of boiler operation after startup number 8 was 47 hours, while the boiler was in operation approximately 2 hours after startup number 10. The additional boiler data presented in this report were acquired after startup numbers 20, 93, and 122. After these startups the boiler data were obtained while the boiler was operating with constant flow rates and temperatures. Over the time period of 135 startups there were loop downtime periods of approximately two weeks in length. Loop downtime resulted from making necessary loop repairs and to accomplish recalibration of instrumentation. The loop downtimes occurred after startup numbers 4, 10, 15, 50 and 108.

#### Boiler Performance With Variable Conditioning

The boiler data obtained after startups 8 and 10 are presented in tables IV and V, respectively. The results of these data are also shown in figures 6 through 11. In figure 6(a) the mercury overall pressure drop is shown as a function of time after startup for constant mercury and NaK flow rates, and constant NaK inlet temperature. The overall pressure drop falls rapidly from a value of 180 psi to 157 psi in a time interval of 2 hours and then falls gradually from 157 psi to 148 psi in 11.5 hours. At 14.5 hours after startup number 8 the primary NaK flow rate was increased and preparations were made to map the boiler overall pressure drop as a function of mercury flow rate. These results are presented later.

Boiler NaK shell temperature profiles for the first and last data points shown in figure 6(a) are shown in figures 7(a) and 7(b), respectively. In these figures as in following boiler shell temperature profile plots, the end of the mercury tube plug insert occurs at a distance of 4 feet from station 3. Station 3 is located at the NaK outlet of the boiler. In figure 7(a) boiling has essentially stopped by the end of the plug, while in figure 7(b) boiling is still occurring downstream of the end of the plug; indicating the boiler has deconditioned.

The affect of the SNAP-8 test facility boiler deconditioning on turbine inlet conditions or boiler outlet conditions can be seen in table IV (CADDE readings 290-297). These readings represent the data presented in figure 6(a). Data in the table shows that the boiler outlet conditions remained approximately constant during the boiler deconditioning.

Further comparison of the profiles in figures 7(a) and 7(b) showed that the amount of required boiling heat transfer area increased with time and a different heat flux distribution developed between the top and bottom of the boiler. The heat transfer area increase was caused by the boiler deconditioning problem mentioned earlier and the latter by an apparent mercury flow maldistribution. The boiler deconditioning would cause an increase in liquid mercury inventory. This was verified by examination of the mercury condenser inlet and outlet pressure transducer readings for these same data points, which showed that the condenser inventory did decrease with time. Since all of the valves not in the mercury flow loop were closed, the loss of condenser inventory had to be caused by an increase in boiler inventory.

In figure 6(b) the affect of NaK inlet temperature on boiler overall pressure drop is shown for three different NaK flow rates. These data are a continuation of the boiler mapping data obtained after startup number 8. As expected, the boiler overall pressure drop decreased with a decrease in NaK inlet temperature for NaK flow rates of 46,500 and 39,800 lbm/hr. However, for a NaK flow rate of 42,800 lbm/hr the overall pressure drop decreased with an increase in NaK inlet temperature. At this time it might be important to digress for a moment and point out the sequence in which the data were obtained. Starting with a NaK flow rate of 46,500 lbm/hr and holding it constant, the NaK inlet temperature was decreased. Then the NaK flow rate was decreased to 42,800 lbm/hr and held constant, while the NaK inlet temperature was increased. Finally, the NaK flow rate was reduced to 39,800 lbm/hr and held constant, while the NaK inlet temperature was decreased. This sequence of data acquisition should not have influenced the results obtained, but it does represent increasing boiler operating time. Therefore, it was surmised that the boiler deconditioning with time had more of an influence on the results shown in figure 6(b) than the variation of the NaK inlet temperature.

Boiler shell temperature profiles at the highest and lowest NaK inlet temperature for each NaK flow rate curve in figure 6(b) are shown in figures 8(a) through 8(f). Included in these are the elapsed times after startup number 8. Comparison of figures 8(a), 8(d), and 8(e) with figures 8(b), 8(c), and 8(f) shows a different heat flux distribution developed between the top and bottom tubes of the boiler, when the boiler NaK inlet temperature was reduced from 1320 to 1262<sup>o</sup> F. A reexamination of figures 7(a) and 7(b) shows a similar situation occurred when the NaK inlet temperature dropped only 3 to 4<sup>o</sup> F. For both cases it was assumed that a mercury flow maldistribution was responsible for the variance in heat transfer between the top and bottom of the boiler.

In figure 9 the boiler mercury-side overall pressure drop is shown as a function of mercury flow rate for data obtained after startup numbers 8 and 10. In general, the boiler overall pressure drop for the same mercury flow rate was 6 to 13 psi higher after startup number 8 than after startup number 10. Earlier it was pointed out that the boiler appeared to be deconditioning after startup 8 as shown in figure 5. Also, figure 5 shows that the boiler was in the process of becoming conditioned after startup 10. Since the boiler was apparently deconditioned after startups 8 and 10 the overall pressure drop curve for a fully conditioned boiler would be different than those shown in figure 9.

Boiler shell temperature profiles for the data shown in figures 9(a) and 9(b) are shown in figures 10 and 11, respectively. The data presented in these figures are presented in an order of increasing mercury flow rate. Again, the separation of the top and bottom temperature profiles was evident as observed in figures 10(b), 10(c), 10(f), 11(b), 11(e) and 11(f).

After startup number 20 a mercury flow rate plateau of 7500 lbm/hr was reached. At this flow rate the mercury loop was operated for a continuous time period of 19 hours and 40 minutes, while the NaK flow rate and NaK inlet temperature to the boiler were held constant. During the above time period the boiler mercury overall pressure drop decreased from a value of 121 psi to 66 psi as shown in figure 12. Boiler data for this time period are shown in table VI. Boiler shell temperature profiles for the first and last data points in figure 12 are shown in figures 13(a) and 13(b), respectively. Comparison of these latter figures shows a change in boiler heat transfer conditions with time; indicating boiler deconditioning. There was also a large change in boiler overall pressure drop for the self-sustaining mercury flow rate between startup numbers 20 and 21 as shown in figure 5. This shows the boiler was deconditioning between startup numbers 20 and 21. Again, notice the constant boiler outlet conditions in table VI.

## Performance of Conditioned Boiler

Between mercury loop startup 93 and 94 condenser inventory mapping was performed at the mercury self-sustaining flow rate of 6600 lbm/hr. The boiler inventory was calculated and found to be 26 pounds. This boiler inventory remained constant during the condenser mapping as indicated by the boiler data in table VII and the boiler shell temperature profiles for the first and last data points, figures 14(a) and 14(b). Examination of table VII and figures 14(a) and 14(b) show negligible change in boiler overall pressure drop from the 183 psi level, and that essentially all of the boiling occurred within the mercury tube plug length. During this period the boiler NaK flow rate and inlet temperature were held constant at 46,000 lbm/hr and 1280° F, respectively.

After startup 122 condenser inventory mapping was accomplished at the design mercury flow rate of 12,300 lbm/hr. Based on the condenser inventory determined from this mapping, the boiler inventory was found to be 34 pounds. Boiler data taken during this period are shown in table VIII. As shown in table VIII, the boiler mercury flow rate, 12,300 lbm/hr, NaK flow rate, 45,700 lbm/hr, and NaK inlet temperature, 1300° F, remained constant for approximately five hours during the condenser mapping. Furthermore, the boiler overall pressure drop remained constant at approximately 129 psi; showing the boiler condition remained constant. Boiler shell temperature profiles for the first and last data points in table VIII are shown in figures 15(a) and 15(b), respectively. Scrutinization of figures 15(a) and 15(b) shows the boiling heat transfer characteristics did not change in the boiler over the five-hour period.

The boiler shell temperature profiles in figures 14 and 15 did not show any significant separation of top and bottom profiles as experienced during some of the early boiler mapping tests. However, when the boiler was conditioned, steady-state boiler data were obtained only during the condenser mapping. Consequently, it is not known whether the flow maldistribution problem would have occurred if the earlier steady-state boiler flow and temperature ranges had been repeated.

## SUMMARY OF RESULTS

The results of the steady-state boiler data obtained between SNAP-8 system startup tests can be summarized as follows:

- (1) During early startup tests (numbers 3 to 21) the boiler apparently underwent various degrees of deconditioning and conditioning. The overall boiler mercury-side pressure drop varied between 55 to 205 psi during this period. With each successive startup between numbers 21 and 34 the boiler pressure drop increased; indicating that the boiler was conditioning. From startup number 34 to startup number



135 the boiler overall pressure drop was approximately constant.

(2) The variation in the SNAP-8 test facility boiler overall pressure drop obtained during the early startups (3 through 21) did not affect turbine inlet (boiler outlet) conditions, because the mercury flow rate was held constant by utilizing a feedback signal to the mercury flow control valve. However, in the flight system for simplification reasons, the mercury flow control valve will have open loop control. Any boiler overall pressure drop changes of the magnitude experienced during SNAP-8 test facility boiler deconditioning, will cause large changes in mercury flow rate; resulting in the possibility of large liquid mercury carryover into the turbine.

(3) A mercury flow maldistribution problem was indicated by some boiler shell temperature profiles obtained during early boiler operation (startups 3 through 21). However, when the boiler was conditioned, steady-state boiler data were obtained only during the condenser mapping. Consequently, it is not known whether the flow maldistribution problem would have occurred if the early steady-state boiler flow and temperature ranges had been repeated.

(4) When the boiler was conditioned, the overall pressure drop at the system self-sustaining mercury flow rate (6600 lbm/hr) was 183 psi. For this pressure drop the NaK flow rate was 46,000 lbm/hr, the NaK inlet temperature was 1280<sup>o</sup> F and the boiler liquid mercury inventory was 26 pounds.

(5) The conditioned boiler overall pressure drop at the design mercury flow rate (12,300 lbm/hr) was 129 psi. For this pressure drop the NaK flow rate was 45,700 lbm/hr, the NaK inlet temperature was 1300<sup>o</sup> F and the boiler liquid mercury inventory was 34 pounds.

Lewis Research Center  
National Aeronautics and Space Administration  
Cleveland, Ohio, March 26, 1970

## REFERENCES

1. Thur, George M.: SNAP-8 Power Conversion System Assessment. Intersociety Energy Conversion Engineering Conference. Vol. 1. IEEE, 1968, pp. 329-337.
2. Gertsma, L. W.; Thollot, P. A.; Medwid, D. W.; and Sellers, A. J.: The Double Containment Tantalum-Stainless Steel SNAP-8 Boiler. Intersociety Energy Conversion Engineering Conference. Vol. I. IEEE, 1968, pp. 363-369.
3. Albers, James A.; Soeder, Ronald H.; and Thollot, Pierre A.: Design-Point Performance of a Double-Containment Tantalum-and-Stainless-Steel Mercury Boiler for SNAP-8. NASA TN D-4926, 1968.
4. Jefferies, Kent S.; Packe, Donald R.; and Dittrich, Ralph T.: Design and Performance of a Nuclear Reactor Simulator for Non-nuclear Testing of Space Power Systems. NASA TN D-4095, 1967.
5. Thollot, Pierre A.; Block, Henry B.; and Jefferies, Kent S.: Experimental Investigation of Reactor-Loop Transients During Startup of a Simulated SNAP-8 System. NASA TN D-4546, 1968.
6. Soeder, Ronald H.; and Lottig, Roy A.: Investigation of Pump Transfer Frequencies from Auxiliary Power to Alternator Power During Startup of the SNAP-8 System. NASA TM X-52712, 1969.
7. Deyo, James N.; and Wintucky, William T.: Instrumentation of a SNAP-8 Simulator Facility. NASA TM X-1525, 1968.
8. Macosko, Robert P.; Hanna, William T.; Gorland, Sol H.; and Jefferies, Kent S.: Performance Evaluation of an Experimental SNAP-8 Power Conversion System. NASA TM X-1732, 1969.
9. Lottig, Roy A.; and Soeder, Ronald H.: Investigation of Mercury-Flow Ramp Rates for Startup of the SNAP-8 System. NASA TM X-52689, 1969.

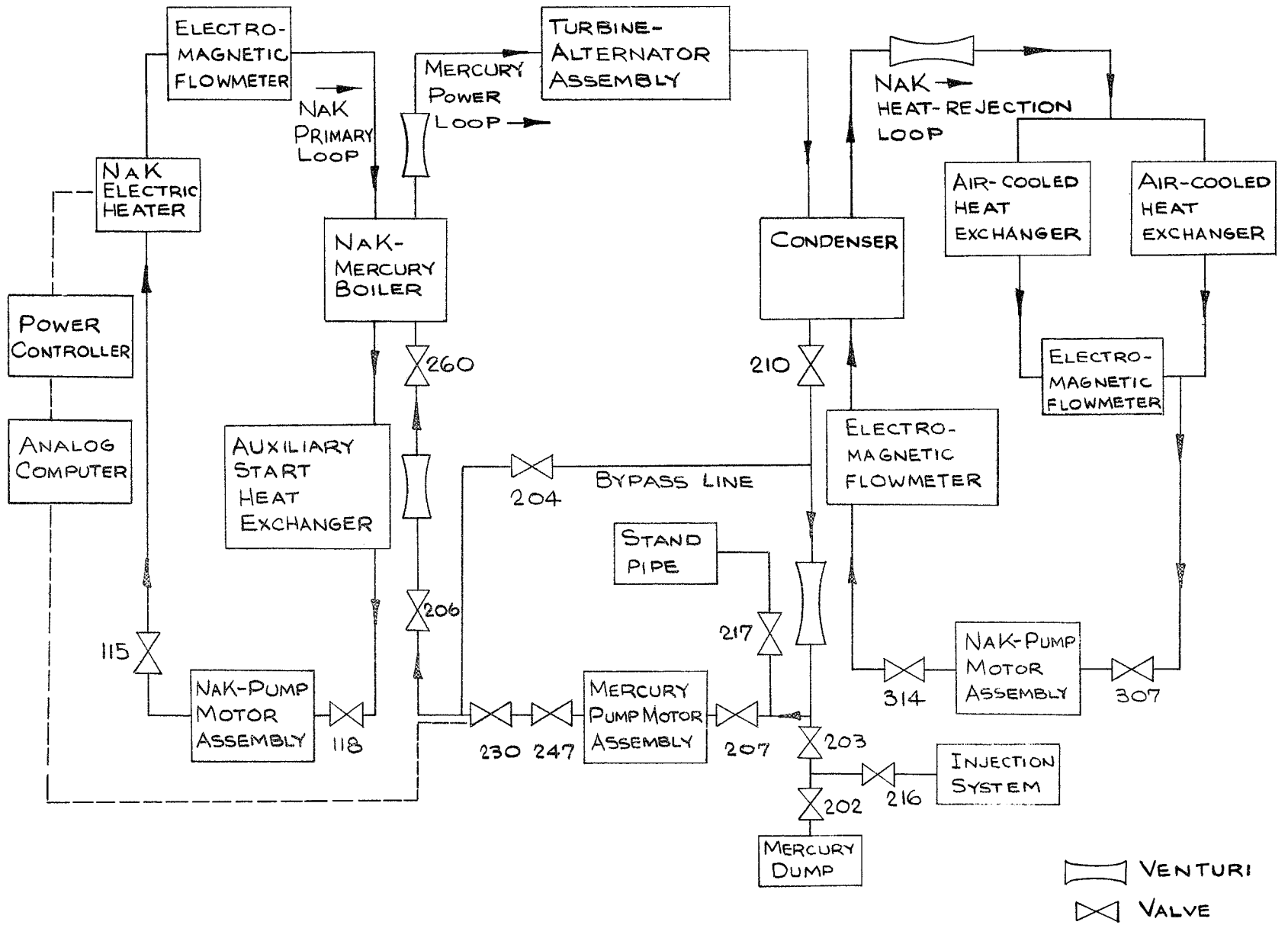

FIGURE 1.- SCHEMATIC OF SNAP-8 TEST SYSTEM

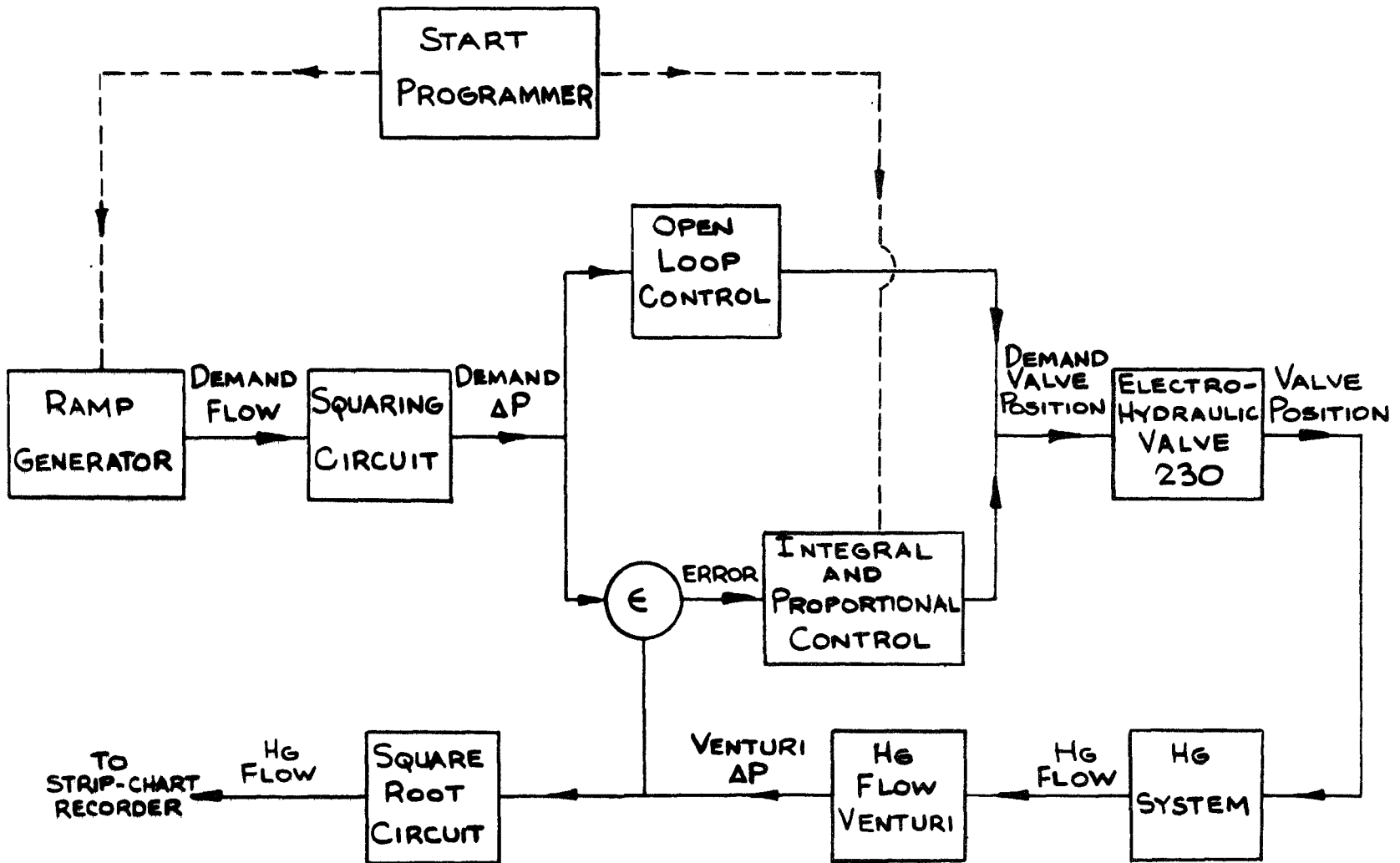

FIGURE 2. - ELECTRO-HYDRAULIC VALVE 230 FEEDBACK CONTROL CIRCUIT

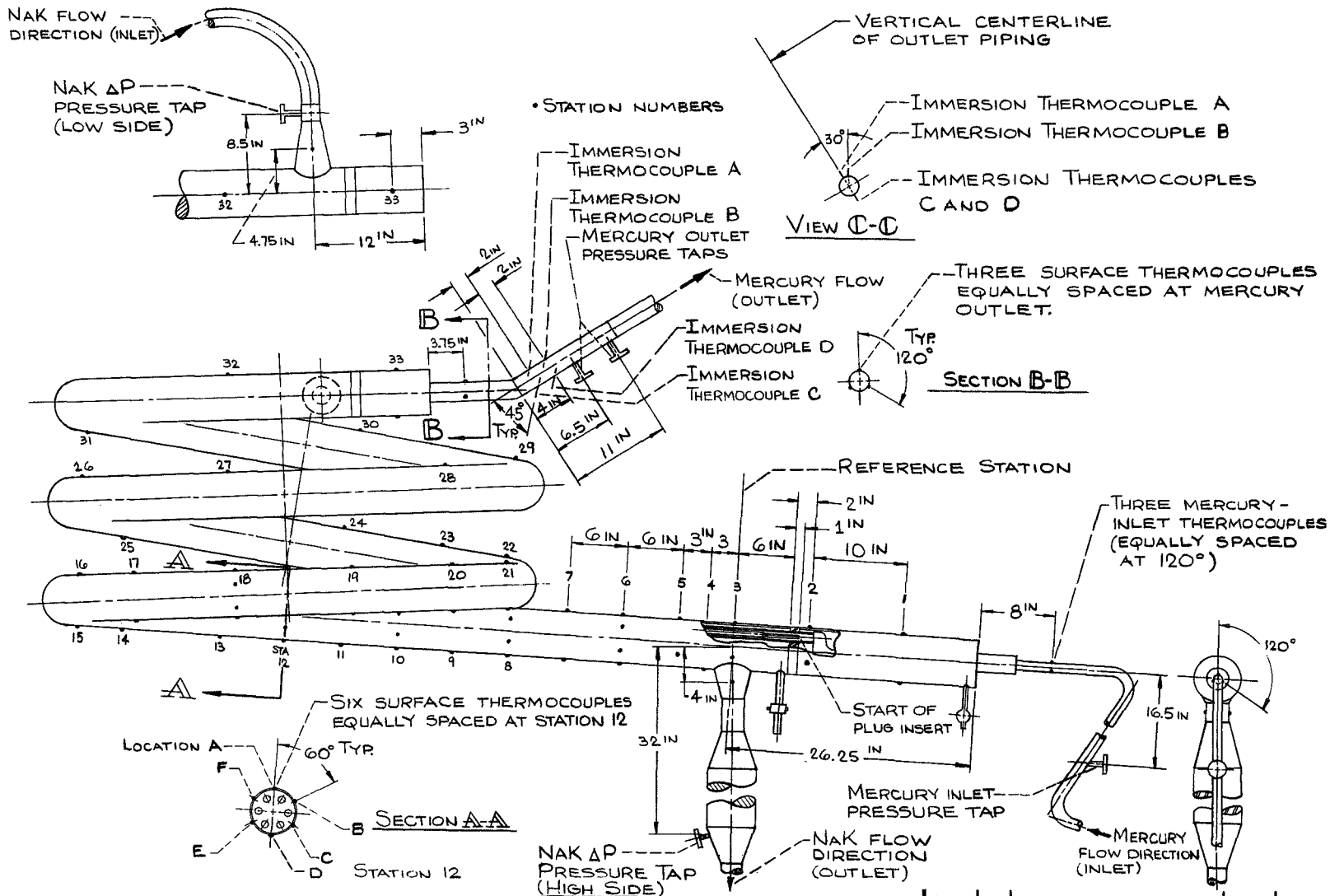
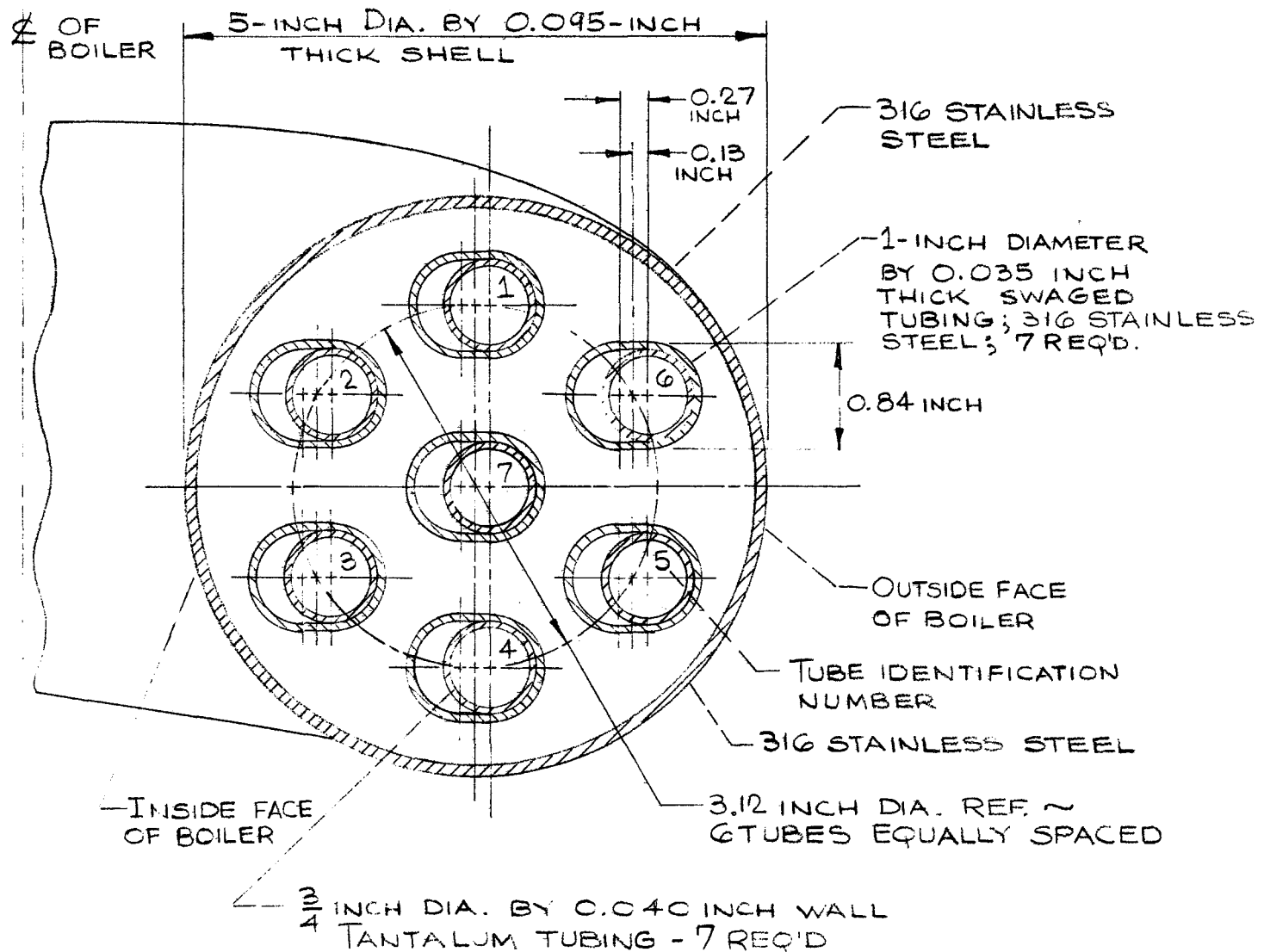

FIGURE 3 - BOILER INSTRUMENTATION

SCALE	REFERENCE	INITIAL	DATE	CHANGE NO.	REVISION	DATE	CHK. APP.
UNLESS OTHERWISE SPECIFIED		DR.					
.X DIM. MAY VARY ±		CK.					
.XX DIM. MAY VARY ±		D.ENG.					
.XXX DIM. MAY VARY ±		B. ENG.					
ANGULAR DIM. MAY VARY ±		P. ENG.					
DIM. MAY VARY ±	SAFETY APPROVAL	B.S. HD.					
BREAK SHARP EDGES	REQUIRED <input type="checkbox"/> NOT REQ. <input type="checkbox"/>	R.S. HD.					
	PROJECT ENG. DATE	D. R. CH.					
		D. D. CH.					
		R. D. CH.					

NATIONAL AERONAUTICS AND SPACE  
ADMINISTRATION  
LEWIS RESEARCH CENTER  
CLEVELAND, OHIO

CC



(a) CROSS SECTION OF BOILER TUBE BUNDLE CONFIGURATION TAKEN IN DIRECTION OF MERCURY FLOW AT PLUG EXIT.

FIGURE 4.- SNAP-8 BOILER DETAILS.

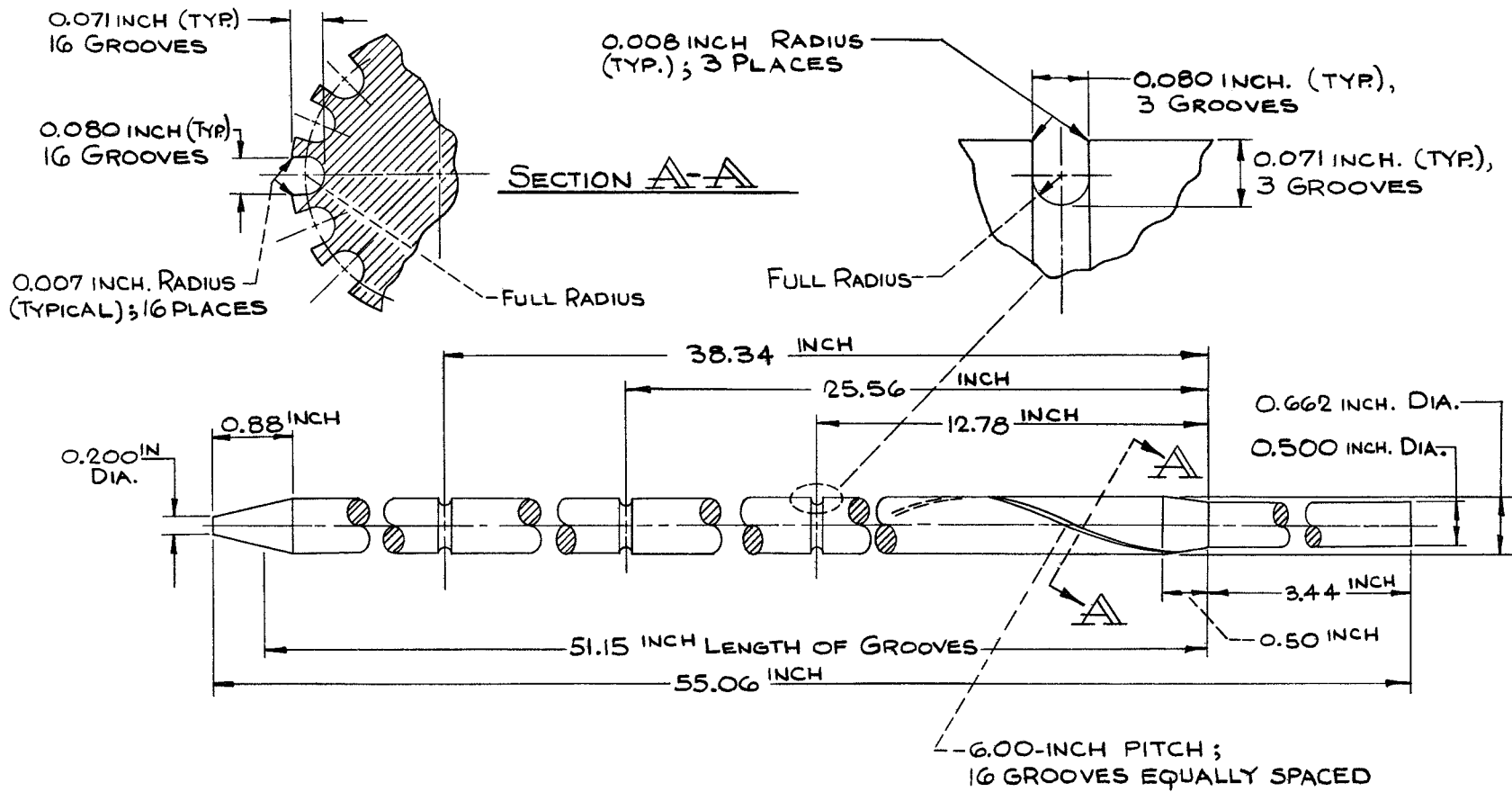

(b) MULTIFLUTED BOILER PLUG. PLUG MATERIAL, TANTALUM

FIGURE 4 - CONCLUDED

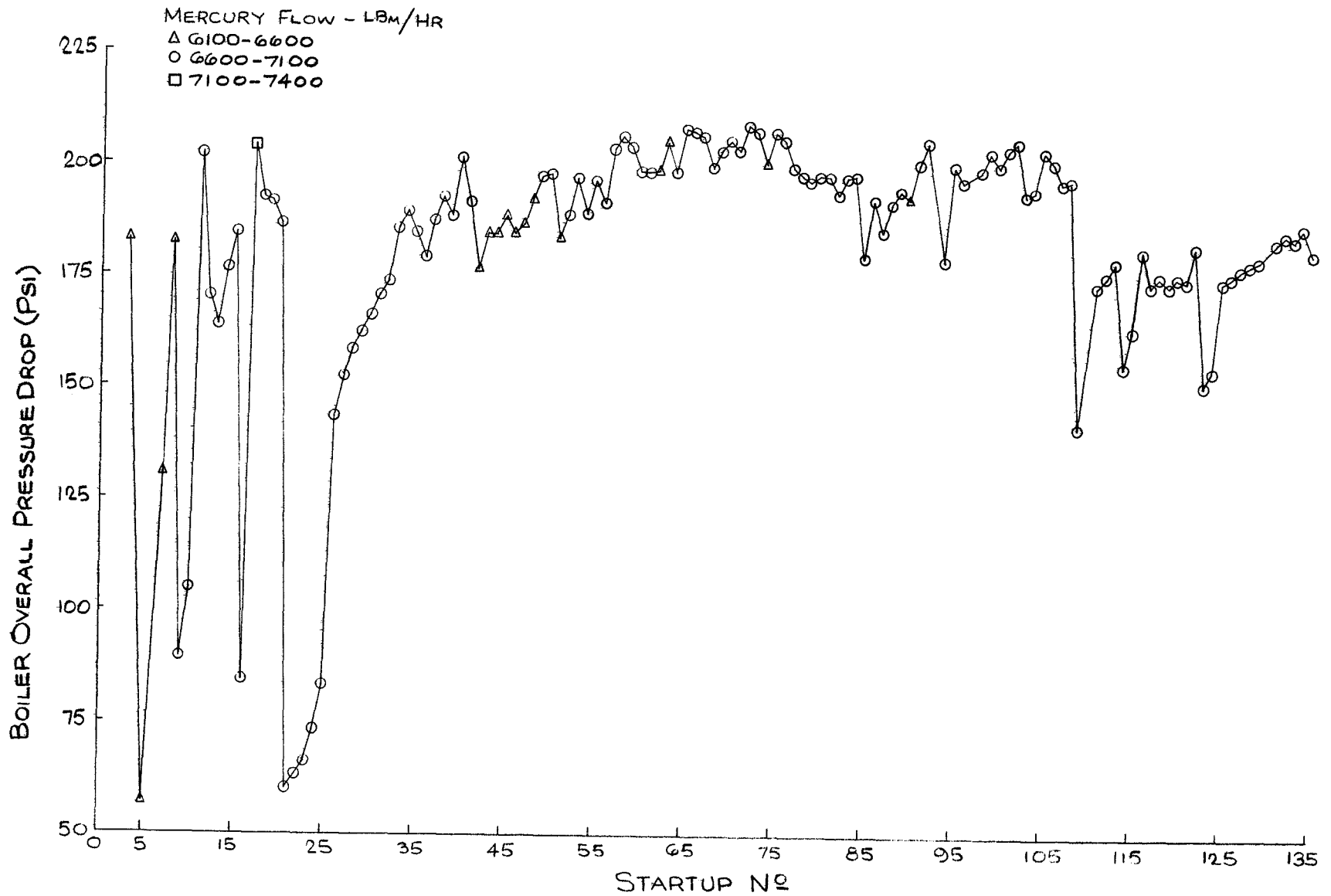
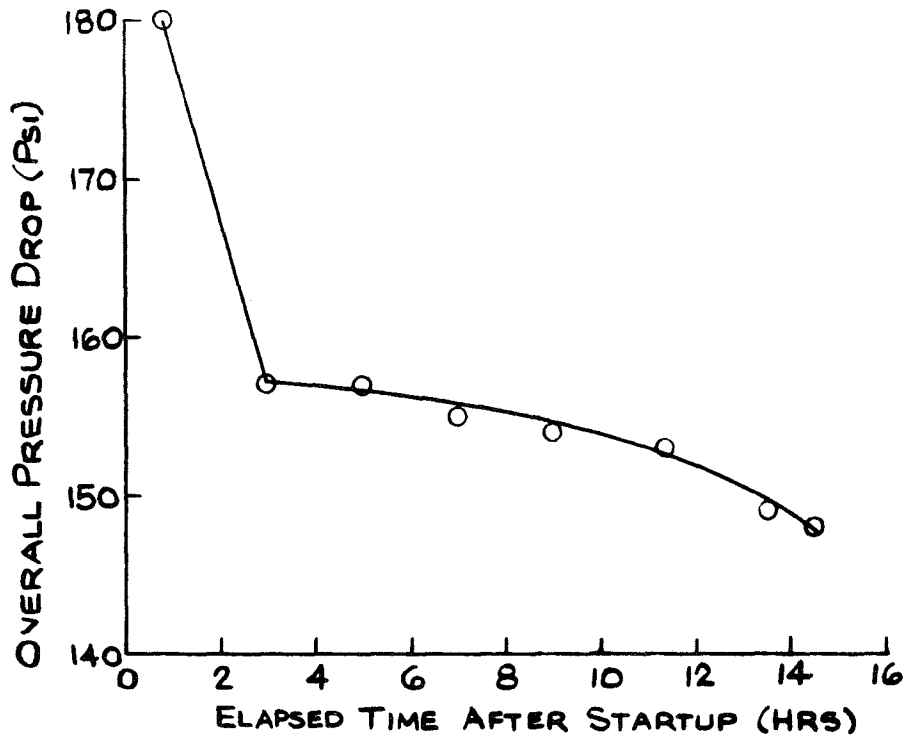
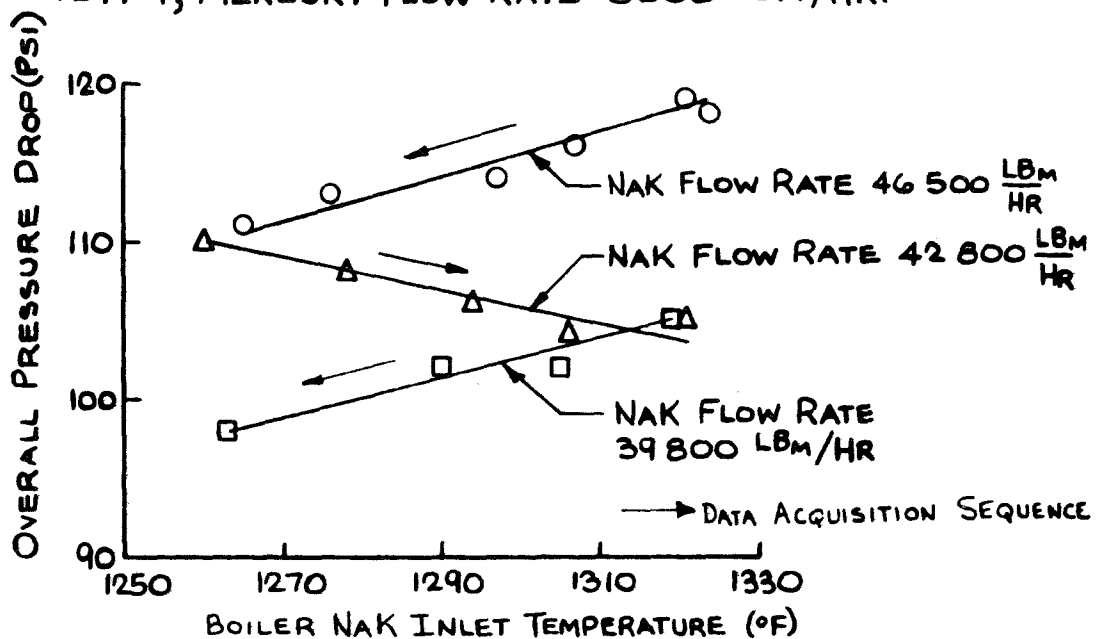

FIGURE 5.- BOILER MERCURY OVERALL PRESSURE DROP HISTORY AS A FUNCTION OF STARTUP NUMBER FOR THE SELF-SUSTAINING MERCURY FLOW RATE.





(a) NAK FLOW RATE 40600 LB<sub>M</sub>/HR, NAK INLET TEMPERATURE 1294 °F, MERCURY FLOW RATE 8000 LB<sub>M</sub>/HR.



(b) MERCURY FLOW RATE 8060 LB<sub>M</sub>/HR. DATA TAKEN BETWEEN 31 HOURS AND 30 MINUTES, AND 47 HOURS AND 5 MINUTES AFTER STARTUP #8.

FIGURE 6.- BOILER DATA TAKEN BETWEEN STARTUP #8 AND #9.

H-1B

TIME RECORDED

4

8

17

20

22

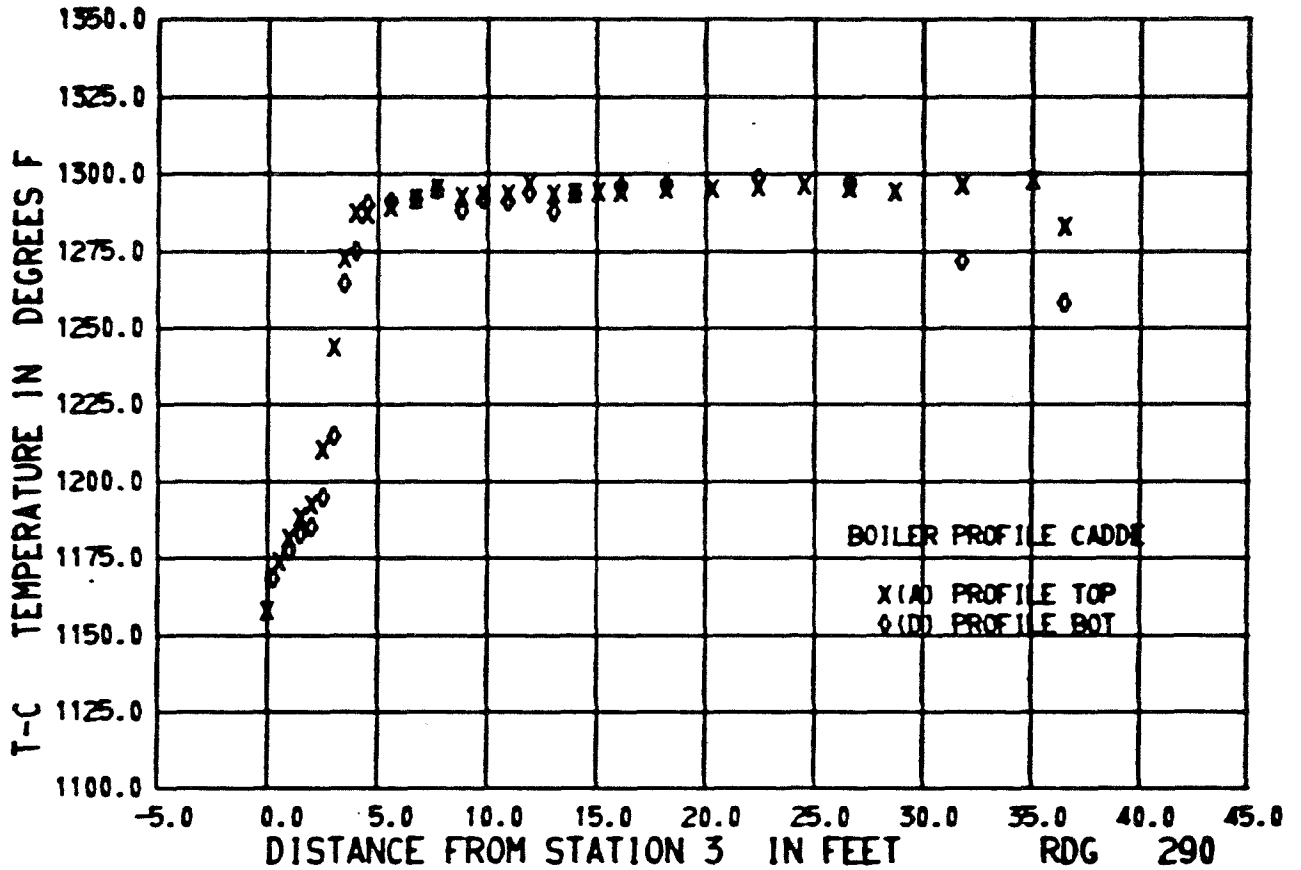

NAK SIDE DATA

FLOW RATE 40650.722 LB/HR  
 PRESS DROP 1.472 PSI  
 THERMAL POWER 335.246 KW  
 AVG INLET TEMP 1293.190 F  
 AVE OUTLET TEMP 1159.131 F

MERCURY SIDE DATA

LIQUID FLOW RATE 8133.100 LB/HR  
 VAPOR FLOW RATE 8385.782 LB/HR  
 QUALITY (HT. BAL.) 0.909 0/0  
 AVG ENTHALPY OUT 150.551 BTU/LB  
 INLET PRESS 340.903 PSIA  
 OUTLET PRESS 160.959 PSIA  
 SAT TEMP OUT 980.983 F  
 TEMP OUT 1283.747 F  
 AVG TEMP IN 435.852 F  
 THERMAL POWER 363.545 KW

FIGURE 7(a).- BOILER SHELL TEMPERATURE PROFILES.  
49 MINUTES AFTER STARTUP #8.

H-1B

TIME RECORDED

4

9

7

0

0

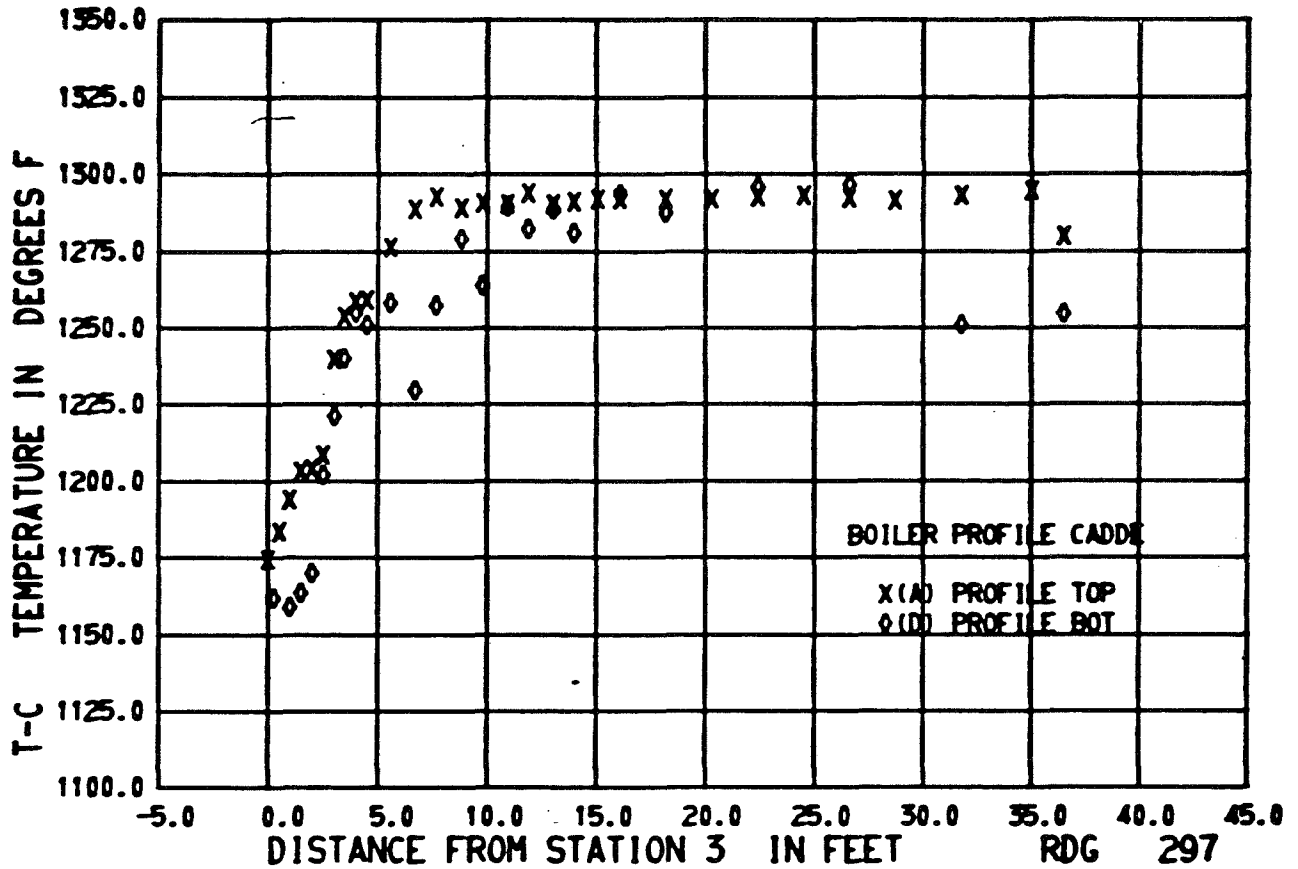

NAK SIDE DATA

FLOW RATE 40611.706 LB/HR  
 PRESS DROP 1.256 PSI  
 THERMAL POWER 330.267 KW  
 AVG INLET TEMP 1289.688 F  
 AVE OUTLET TEMP 1157.479 F

MERCURY SIDE DATA

LIQUID FLOW RATE 7908.769 LB/HR  
 VAPOR FLOW RATE 8174.247 LB/HR  
 QUALITY (HT. BAL.) 0.928 0/0  
 AVG ENTHALPY OUT 152.953 BTU/LB  
 INLET PRESS 305.002 PSIA  
 OUTLET PRESS 156.602 PSIA  
 SAT TEMP OUT 976.716 F  
 TEMP OUT 1279.222 F  
 AVG TEMP IN 436.430 F  
 THERMAL POWER 352.007 KW

FIGURE 7(b).- BOILER SHELL TEMPERATURE PROFILES.  
 14 HOURS AND 29 MINUTES AFTER STARTUP #8.

H-1B

TIME RECORDED

4

10

0

20

58

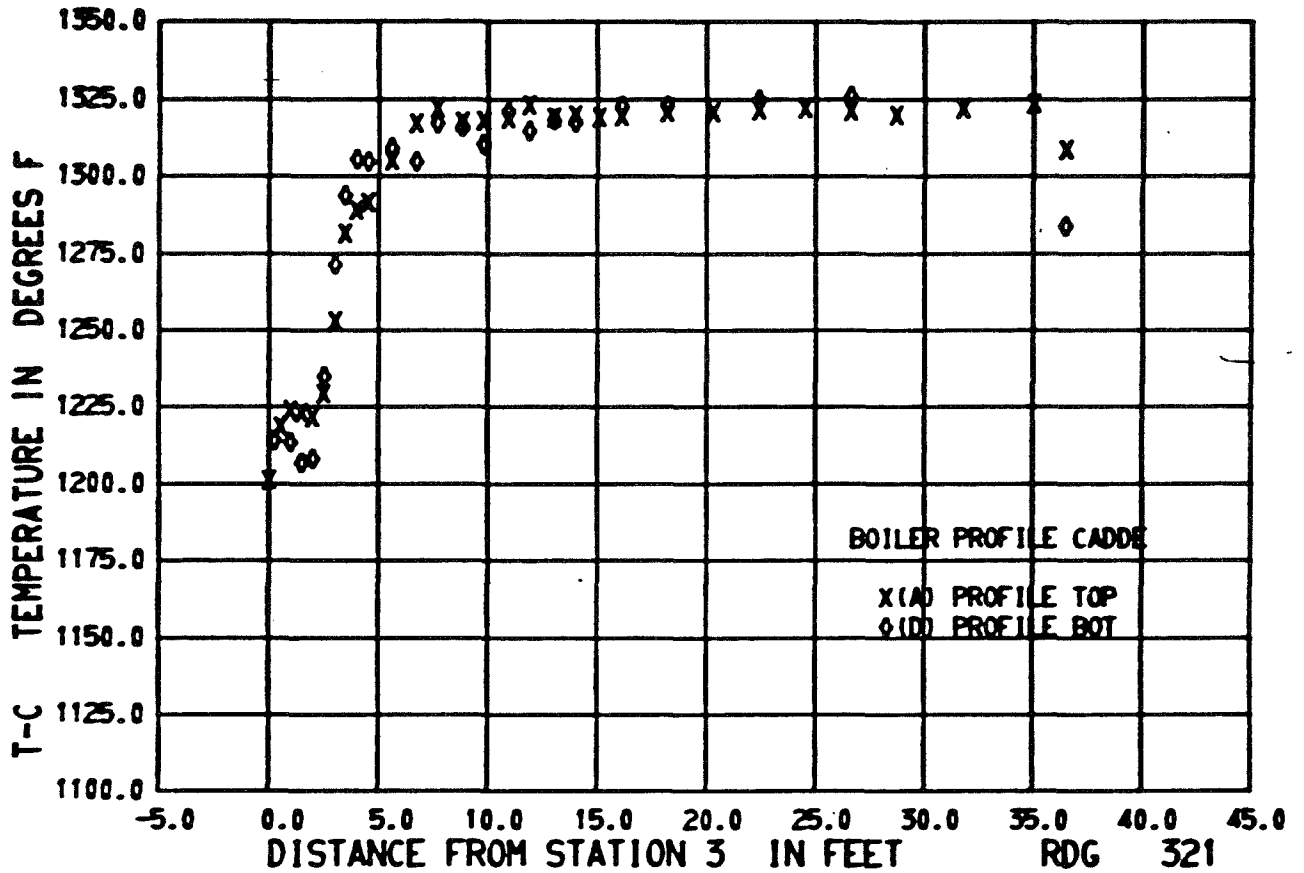

NAK SIDE DATA

FLOW RATE 46470.542 LB/HR  
 PRESS DROP 1.631 PSI  
 THERMAL POWER 347.948 KW  
 AVG INLET TEMP 1320.692 F  
 AVE OUTLET TEMP 1199.167 F

MERCURY SIDE DATA

LIQUID FLOW RATE 8107.241 LB/HR  
 VAPOR FLOW RATE 8342.467 LB/HR  
 QUALITY (HT. BAL.) 0.958 0/0  
 AVG ENTHALPY OUT 157.476 BTU/LB  
 INLET PRESS 281.165 PSIA  
 OUTLET PRESS 162.439 PSIA  
 SAT TEMP OUT 982.409 F  
 TEMP OUT 1307.095 F  
 AVG TEMP IN 453.124 F  
 THERMAL POWER 361.189 KW

FIGURE 8(2). - BOILER SHELL TEMPERATURE PROFILES.  
 31 HOURS AND 50 MINUTES AFTER STARTUP #8.

H-1B

TIME RECORDED

4

10

4

40

56

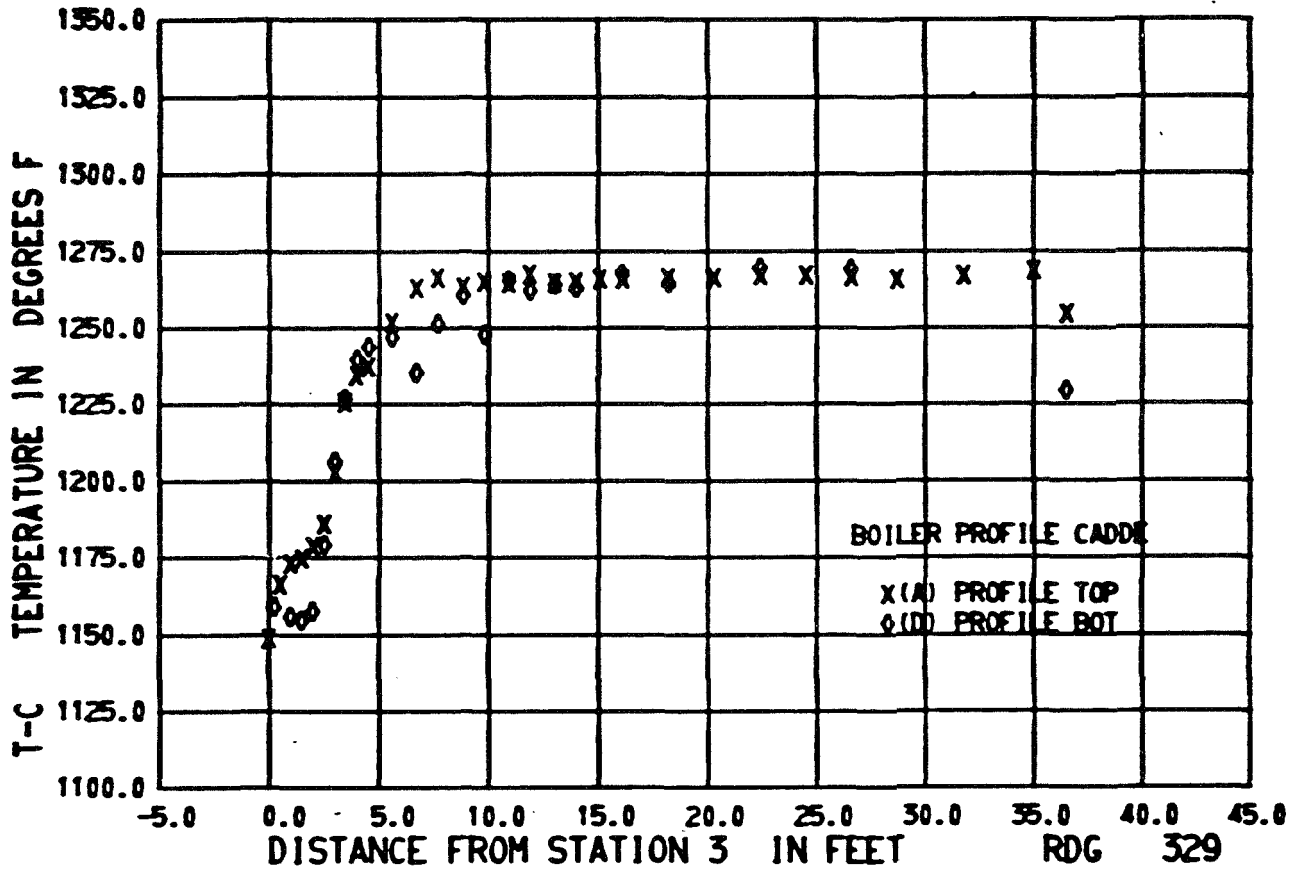

NAK SIDE DATA

FLOW RATE 46982.942 LB/HR  
 PRESS DROP 1.645 PSI  
 THERMAL POWER 532.994 KW  
 AVG INLET TEMP 1264.946 F  
 AVE OUTLET TEMP 1149.643 F

MERCURY SIDE DATA

LIQUID FLOW RATE 8088.057 LB/HR  
 VAPOR FLOW RATE 8577.819 LB/HR  
 QUALITY (HT. BAL.) 0.922 0/0  
 AVG ENTHALPY OUT 151.604 BTU/LB  
 INLET PRESS 270.728 PSIA  
 OUTLET PRESS 159.611 PSIA  
 SAT TEMP OUT 979.675 F  
 TEMP OUT 1253.857 F  
 AVG TEMP IN 432.546 F  
 THERMAL POWER 356.932 KW

FIGURE 8(b).- BOILER SHELL TEMPERATURE PROFILES.  
 36 HOURS AND 10 MINUTES AFTER STARTUP #8.

H-1B

TIME RECORDED

4

10

6

0

48

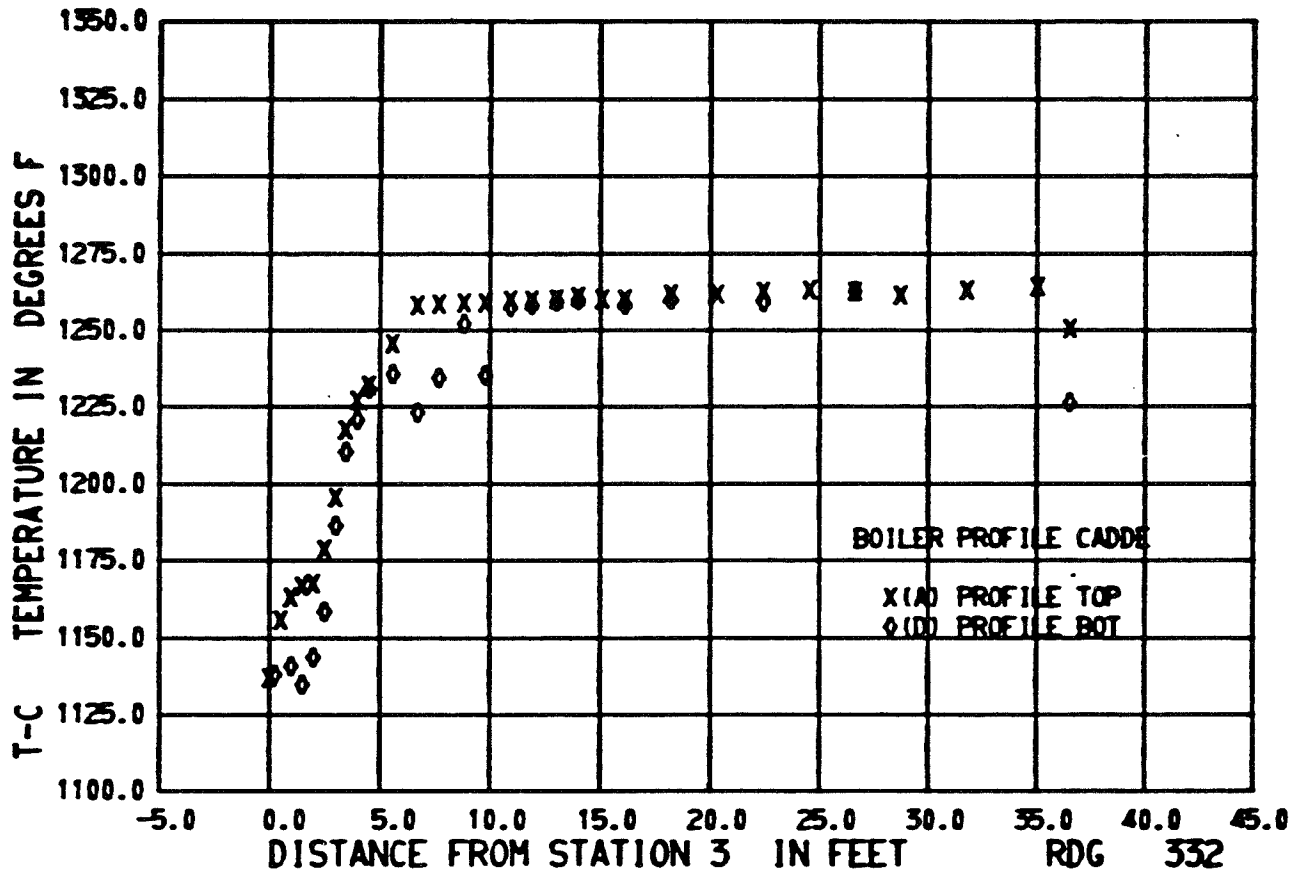

NAK SIDE DATA

FLOW RATE 43219.914 LB/HR  
 PRESS DROP 1.394 PSI  
 THERMAL POWER 336.252 KW  
 AVG INLET TEMP 1260.319 F  
 AVE OUTLET TEMP 1133.699 F

MERCURY SIDE DATA

LIQUID FLOW RATE 8122.061 LB/HR  
 VAPOR FLOW RATE 8389.258 LB/HR  
 QUALITY (HT. BAL.) 0.928 0/0  
 AVG ENTHALPY OUT 152.245 BTU/LB  
 INLET PRESS 269.575 PSIA  
 OUTLET PRESS 159.769 PSIA  
 SAT TEMP OUT 979.828 F  
 TEMP OUT 1249.338 F  
 AVG TEMP IN 427.162 F  
 THERMAL POWER 358.504 KW

FIGURE 8(c).- BOILER SHELL TEMPERATURE PROFILES.  
 37 HOURS AND 30 MINUTES AFTER STARTUP #8.

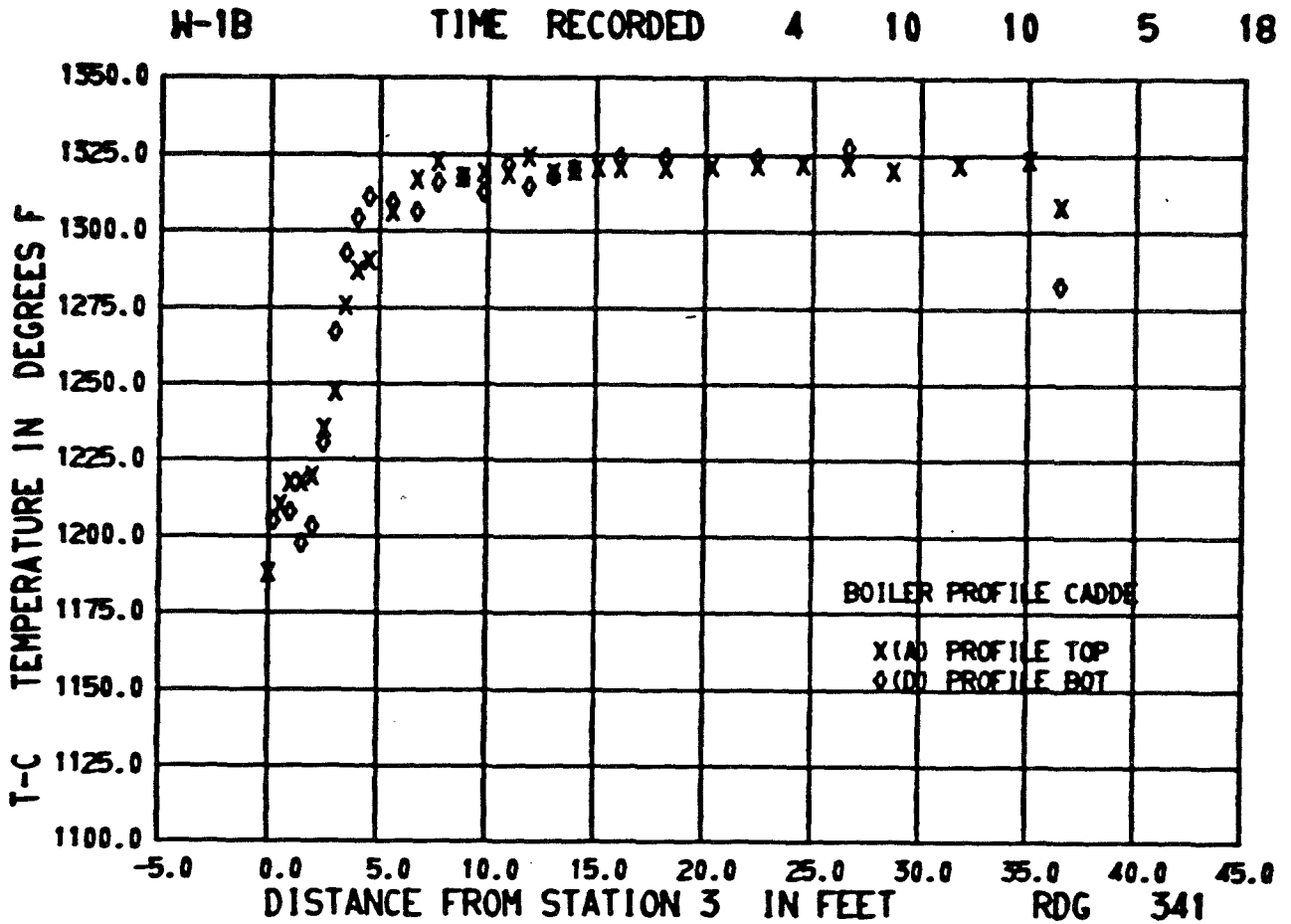

**NAK SIDE DATA**

FLOW RATE                      42510.879 LB/HR  
 PRESS DROP                    1.302 PSI  
 THERMAL POWER                336.130 KW  
 AVG INLET TEMP                1320.515 F  
 AVE OUTLET TEMP               1192.161 F

**MERCURY SIDE DATA**

LIQUID FLOW RATE              8054.488 LB/HR  
 VAPOR FLOW RATE              8299.898 LB/HR  
 QUALITY (HT. BAL.)            0.927 0/0  
 AVG ENTHALPY OUT             153.492 BTU/LB  
 INLET PRESS                    267.572 PSIA  
 OUTLET PRESS                  161.808 PSIA  
 SAT TEMP OUT                  981.802 F  
 TEMP OUT                       1308.440 F  
 AVG TEMP IN                    427.253 F  
 THERMAL POWER                358.737 KW

FIGURE 8(d).- BOILER SHELL TEMPERATURE PROFILES.  
 41 HOURS AND 34 MINUTES AFTER STARTUP #8.

H-1B

TIME RECORDED

4

10

11

4

20

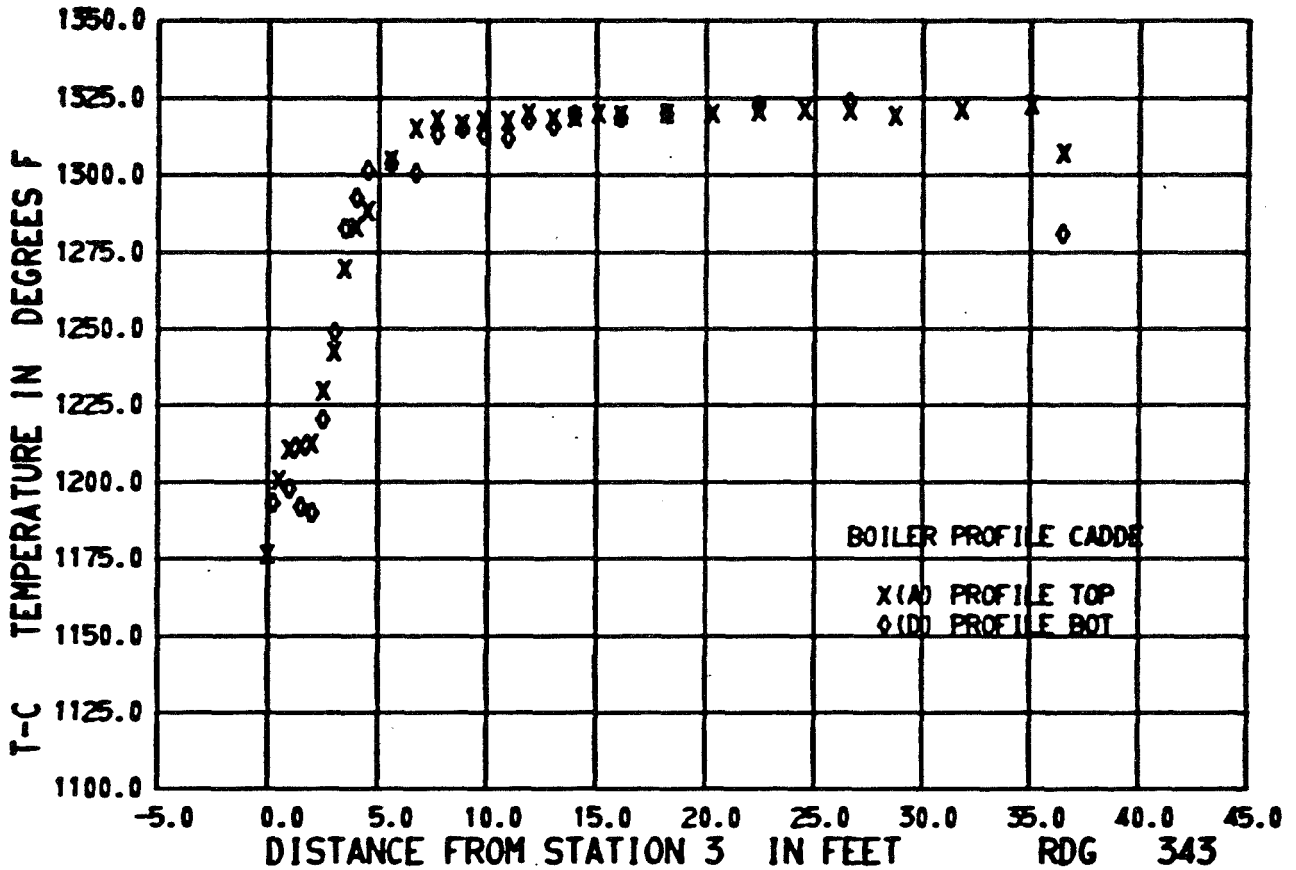

NAK SIDE DATA

FLOW RATE 39584.830 LB/HR  
 PRESS DROP 1.110 PSI  
 THERMAL POWER 336.115 KW  
 AVG INLET TEMP 1318.567 F  
 AVE OUTLET TEMP 1180.688 F

MERCURY SIDE DATA

LIQUID FLOW RATE 8053.697 LB/HR  
 VAPOR FLOW RATE 8323.938 LB/HR  
 QUALITY (HT. BAL.) 0.928 0/0  
 AVG ENTHALPY OUT 153.555 BTU/LB  
 INLET PRESS 266.837 PSIA  
 OUTLET PRESS 161.760 PSIA  
 SAT TEMP OUT 981.755 F  
 TEMP OUT 1307.520 F  
 AVG TEMP IN 428.662 F  
 THERMAL POWER 358.518 KW

FIGURE 8(e).- BOILER SHELL TEMPERATURE PROFILES.  
 42 HOURS AND 33 MINUTES AFTER STARTUP #8.



H-1B

TIME RECORDED

4

10

15

35

50

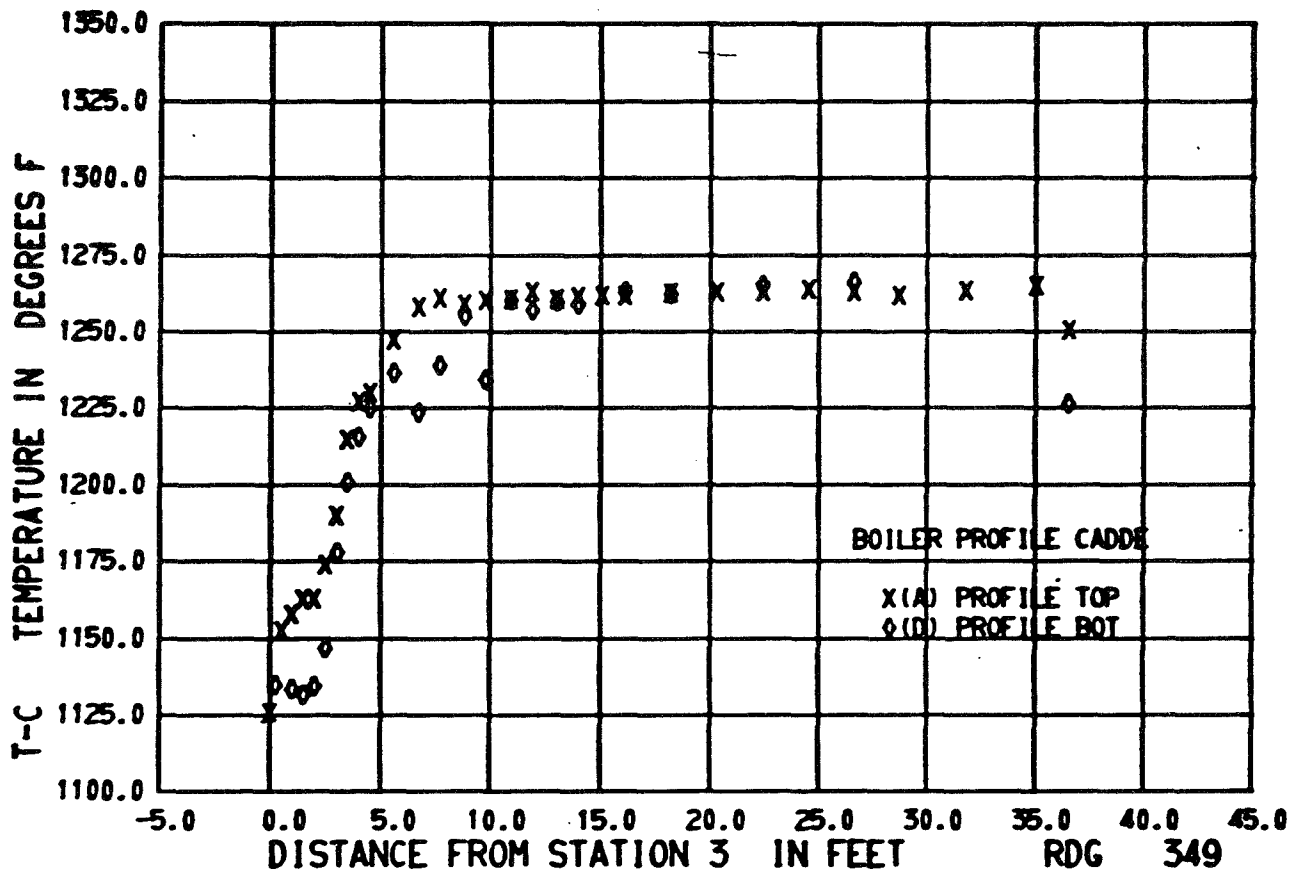

NAK SIDE DATA

FLOW RATE 39820.546 LB/HR  
 PRESS DROP 1.156 PSI  
 THERMAL POWER 339.591 KW  
 AVG INLET TEMP 1262.756 F  
 AVE OUTLET TEMP 1123.943 F

MERCURY SIDE DATA

LIQUID FLOW RATE 8065.656 LB/HR  
 VAPOR FLOW RATE 8359.774 LB/HR  
 QUALITY (HT. BAL.) 0.946 0/0  
 AVG ENTHALPY OUT 154.572 BTU/LB  
 INLET PRESS 258.212 PSIA  
 OUTLET PRESS 159.575 PSIA  
 SAT TEMP OUT 979.639 F  
 TEMP OUT 1251.032 F  
 AVG TEMP IN 417.299 F  
 THERMAL POWER 356.313 KW

FIGURE 8(f).- BOILER SHELL TEMPERATURE PROFILES.  
 47 HOURS AND 5 MINUTES AFTER STARTUP #8.

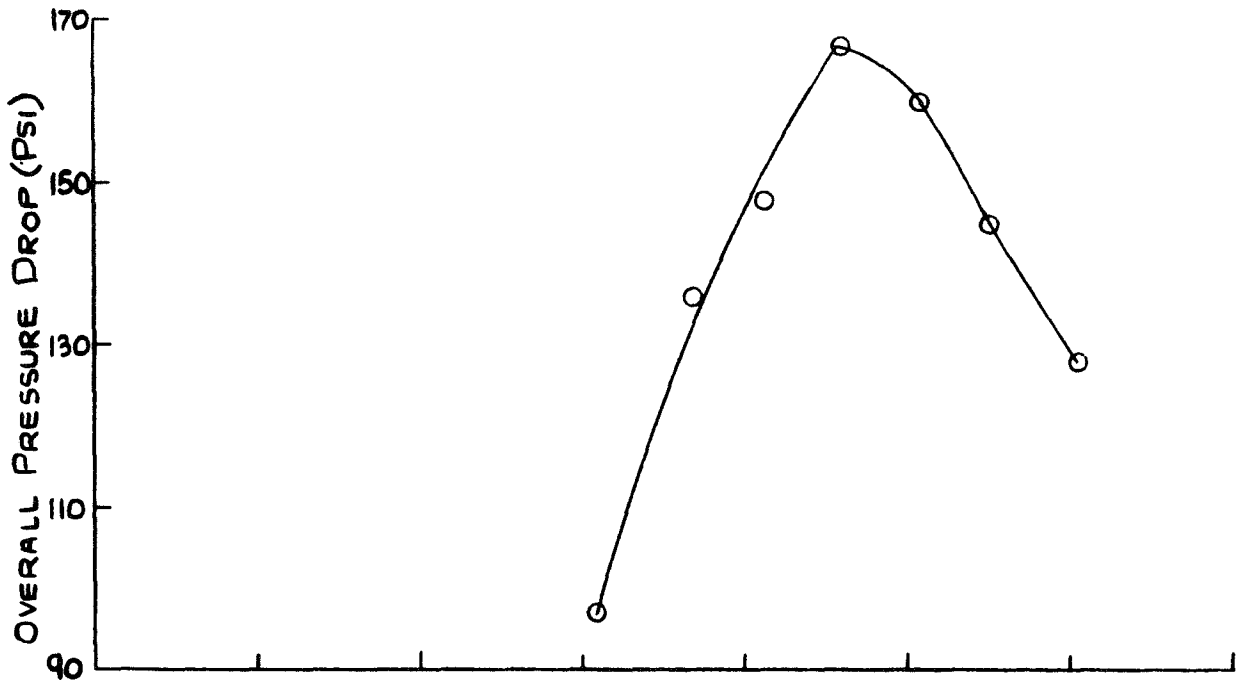

(a) DATA ACQUIRED BETWEEN 19 HOURS AND 10 MINUTES, AND 27 HOURS AND 25 MINUTES AFTER STARTUP\*8. NAK FLOW RATE 46500 LBM/HR, NAK INLET TEMPERATURE 1291 °F.

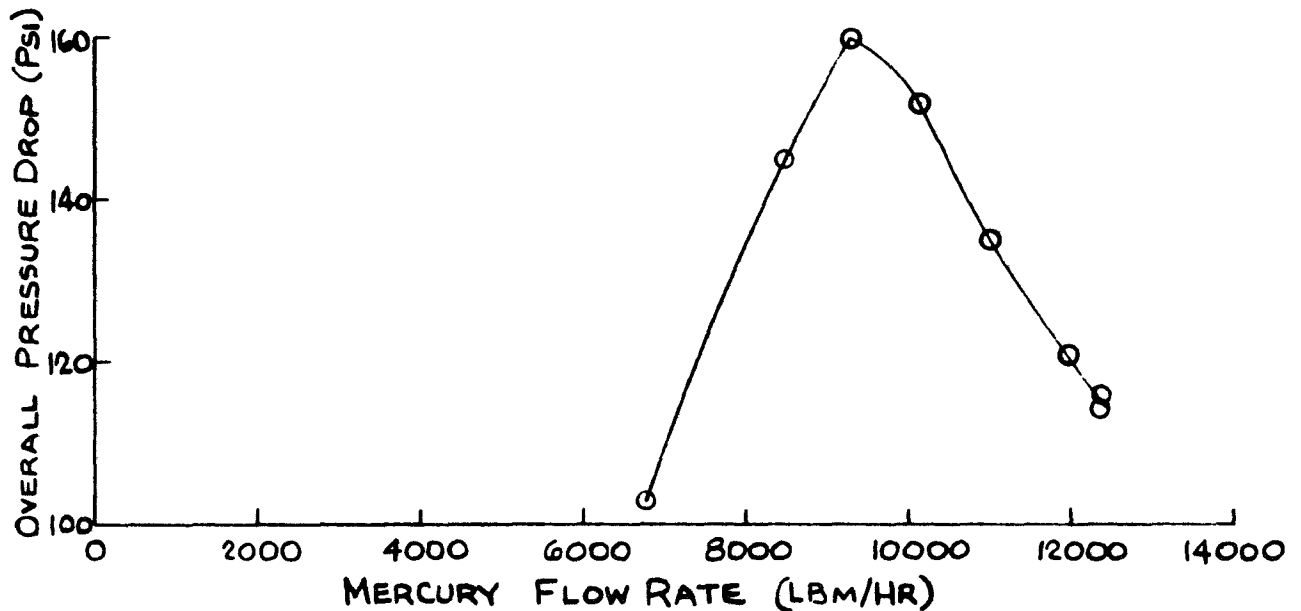

(b) DATA ACQUIRED BETWEEN 15 MINUTES, AND 1 HOUR AND 29 MINUTES AFTER STARTUP\*10. NAK FLOW RATE 47000 LBM/HR, NAK INLET TEMPERATURE 1286 °F.

FIGURE 9. - VARIATION OF BOILER OVERALL PRESSURE DROP AS A FUNCTION OF LIQUID MERCURY FLOW RATE.

W-1B

TIME RECORDED

4

9

19

55

2

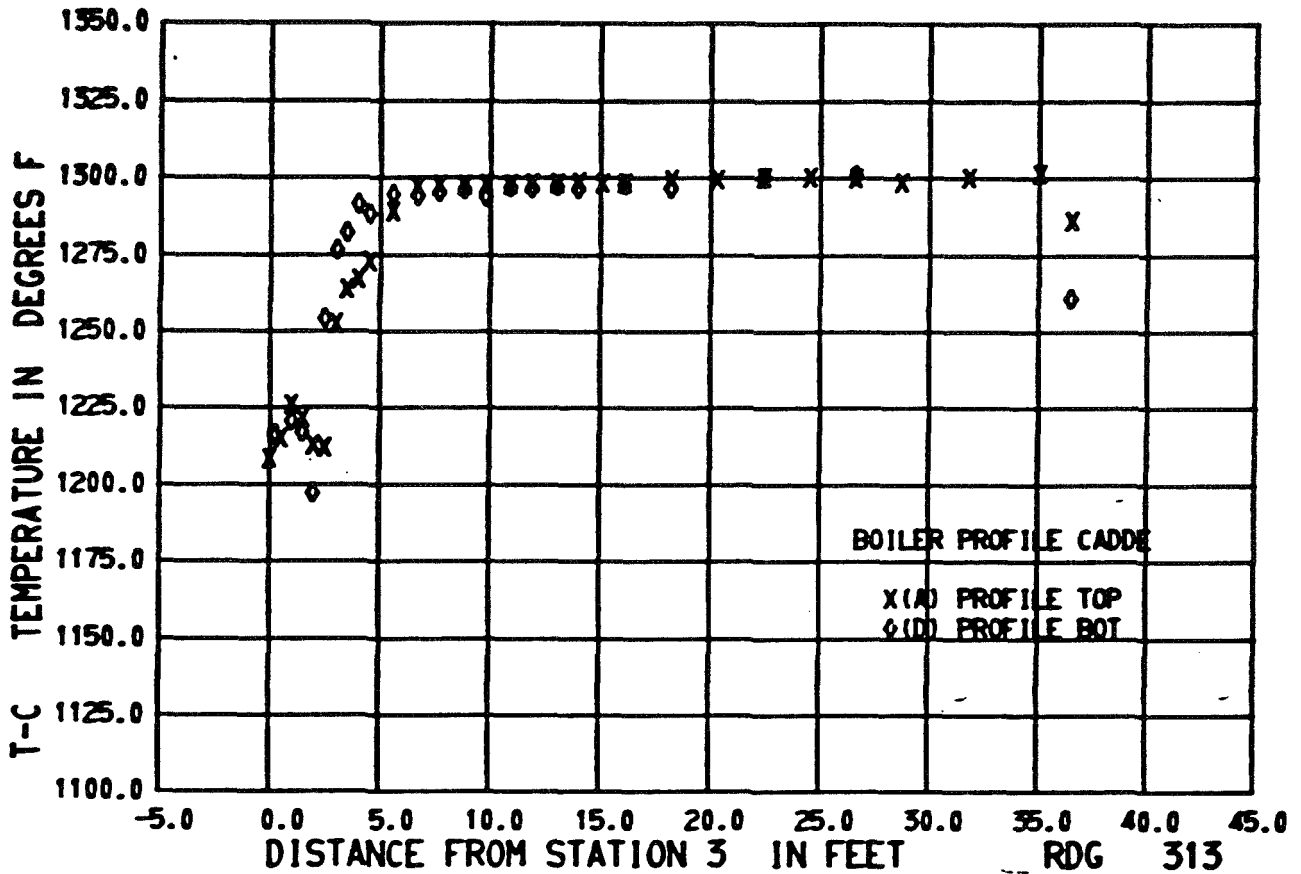

NAK SIDE DATA

FLOW RATE 46247.900 LB/HR  
 PRESS DROP 1.662 PSI  
 THERMAL POWER 255.024 KW  
 AVG INLET TEMP 1297.152 F  
 AVE OUTLET TEMP 1207.621 F

MERCURY SIDE DATA

LIQUID FLOW RATE 6151.905 LB/HR  
 VAPOR FLOW RATE 6295.878 LB/HR  
 QUALITY (HT. BAL.) 0.922 0/0  
 AVG ENTHALPY OUT 152.178 BTU/LB  
 INLET PRESS 216.506 PSIA  
 OUTLET PRESS 119.792 PSIA  
 SAT TEMP OUT 935.655 F  
 TEMP OUT 1283.535 F  
 AVG TEMP IN 425.554 F  
 THERMAL POWER 273.572 KW

FIGURE 10(2).- BOILER SHELL TEMPERATURE PROFILES.  
 27 HOURS AND 25 MINUTES AFTER STARTUP #8.

H-1B TIME RECORDED 4 9 18 10 1

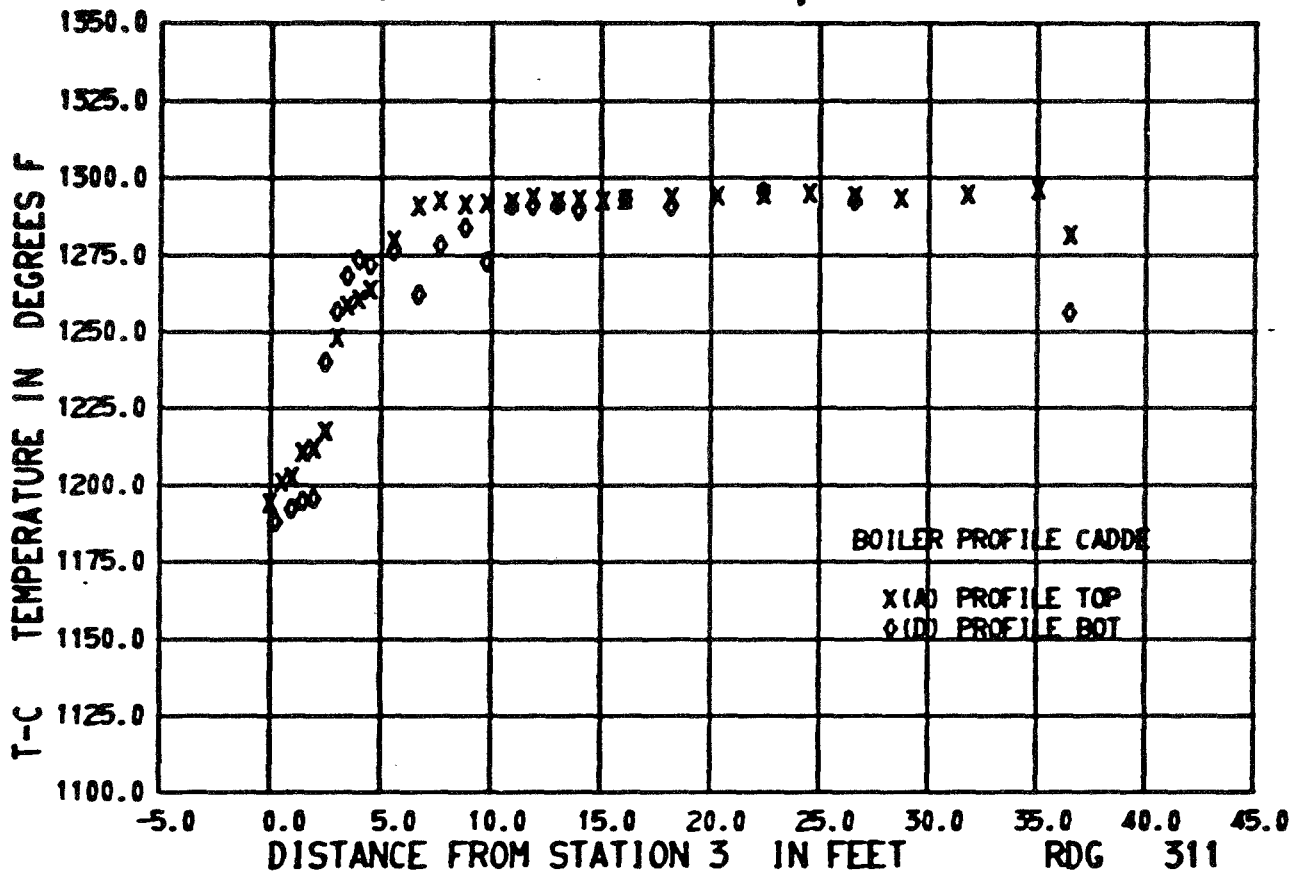

NAK SIDE DATA

FLOW RATE 46215.507 LB/HR  
 PRESS DROP 1.658 PSI  
 THERMAL POWER 310.209 KW  
 AVG INLET TEMP 1292.836 F  
 AVE OUTLET TEMP 1183.784 F

MERCURY SIDE DATA

LIQUID FLOW RATE 7327.213 LB/HR  
 VAPOR FLOW RATE 7569.147 LB/HR  
 QUALITY (HT. BAL.) 0.942 0/0  
 AVG ENTHALPY OUT 154.736 BTU/LB  
 INLET PRESS 281.206 PSIA  
 OUTLET PRESS 144.478 PSIA  
 SAT TEMP OUT 964.254 F  
 TEMP OUT 1279.788 F  
 AVG TEMP IN 427.813 F  
 THERMAL POWER 326.585 KW

FIGURE 10(b).- BOILER SHELL TEMPERATURE PROFILES.  
 25 HOURS AND 40 MINUTES AFTER STARTUP #8.

H-1B

TIME RECORDED

4

9

17

10

1

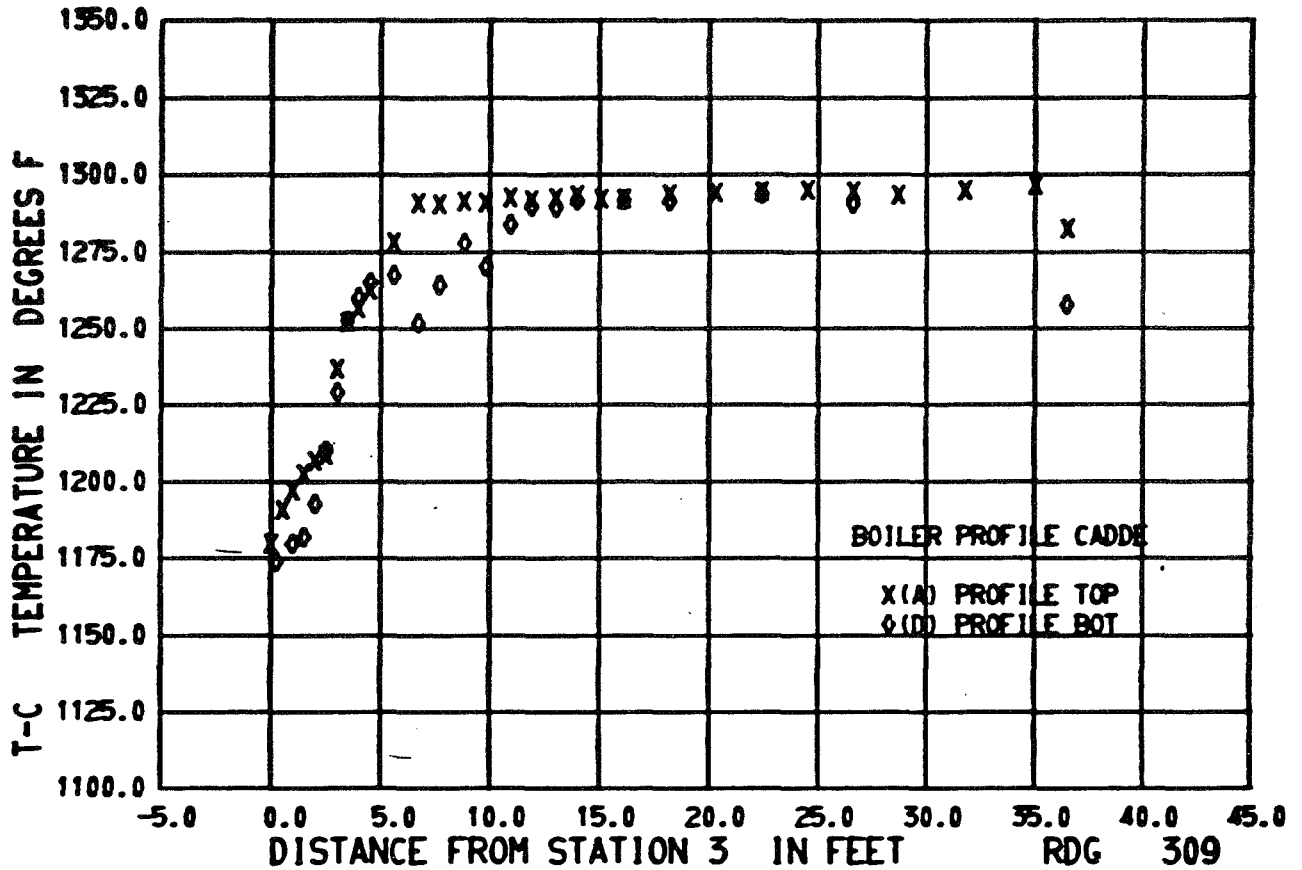

NAK SIDE DATA

FLOW RATE 46648.782 LB/HR  
 PRESS DROP 1.693 PSI  
 THERMAL POWER 345.623 KW  
 AVG INLET TEMP 1291.775 F  
 AVE OUTLET TEMP 1171.366 F

MERCURY SIDE DATA

LIQUID FLOW RATE 8214.817 LB/HR  
 VAPOR FLOW RATE 8499.852 LB/HR  
 QUALITY (HT. BAL.) 0.934 0/0  
 AVG ENTHALPY OUT 153.765 BTU/LB  
 INLET PRESS 311.055 PSIA  
 OUTLET PRESS 162.730 PSIA  
 SAT TEMP OUT 982.688 F  
 TEMP OUT 1280.565 F  
 AVG TEMP IN 425.988 F  
 THERMAL POWER 366.332 KW

FIGURE 10 (C).- BOILER SHELL TEMPERATURE PROFILES.  
 24 HOURS AND 40 MINUTES AFTER STARTUP #8.

H-1B

TIME RECORDED

4

9

11

41

26

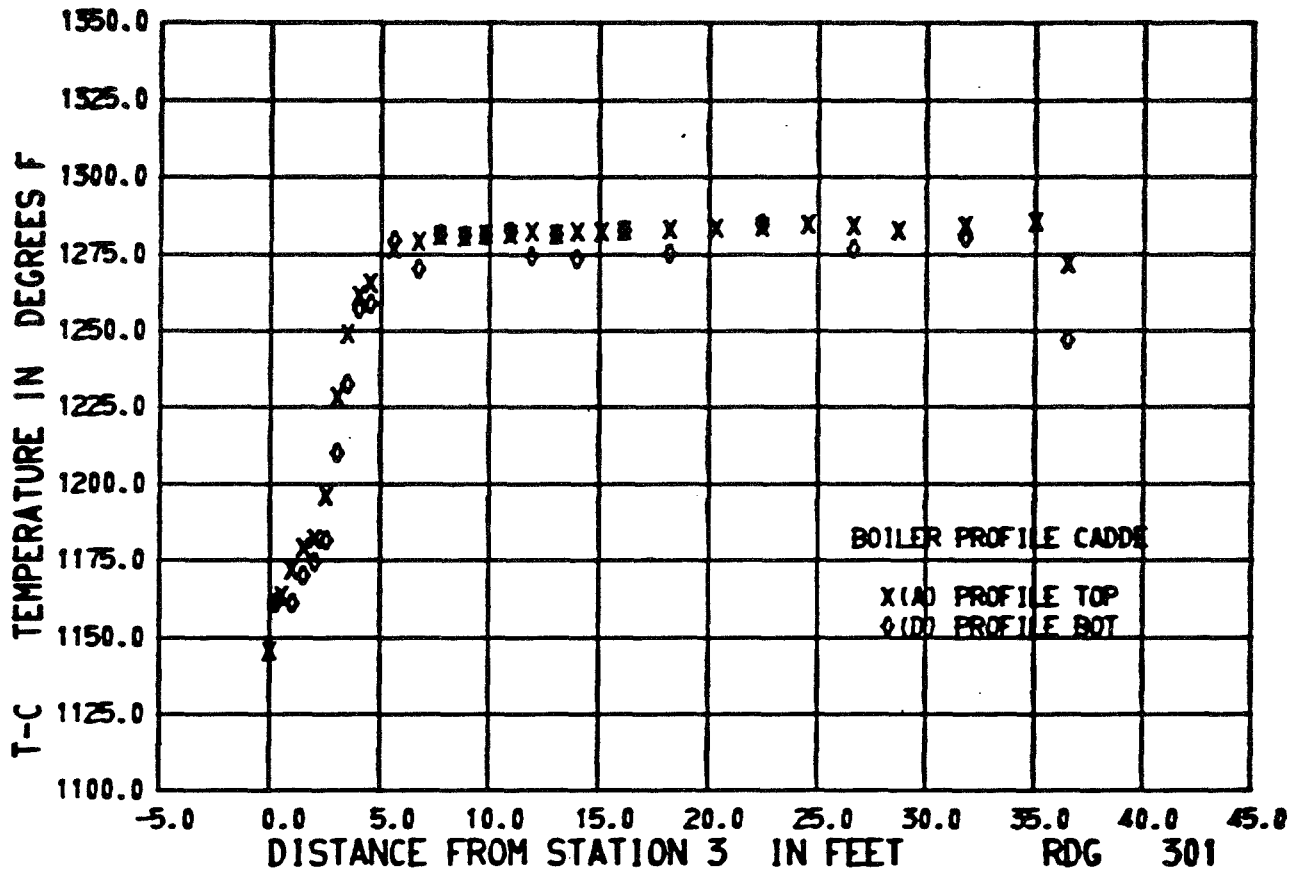

NAK SIDE DATA

FLOW RATE 46815.350 LB/HR  
 PRESS DROP 1.696 PSI  
 THERMAL POWER 377.108 KW  
 AVG INLET TEMP 1281.485 F  
 AVE OUTLET TEMP 1150.486 F

MERCURY SIDE DATA

LIQUID FLOW RATE 9166.829 LB/HR  
 VAPOR FLOW RATE 9508.047 LB/HR  
 QUALITY (HT. BAL.) 0.909 0/0  
 AVG ENTHALPY OUT 150.383 BTU/LB  
 INLET PRESS 348.582 PSIA  
 OUTLET PRESS 181.978 PSIA  
 SAT TEMP OUT 1000.203 F  
 TEMP OUT 1272.578 F  
 AVG TEMP IN 424.272 F  
 THERMAL POWER 408.704 KW

FIGURE 10(d).- BOILER SHELL TEMPERATURE PROFILES.  
 19 HOURS AND 10 MINUTES AFTER STARTUP #8.

H-1B

TIME RECORDED

4

9

12

28

43

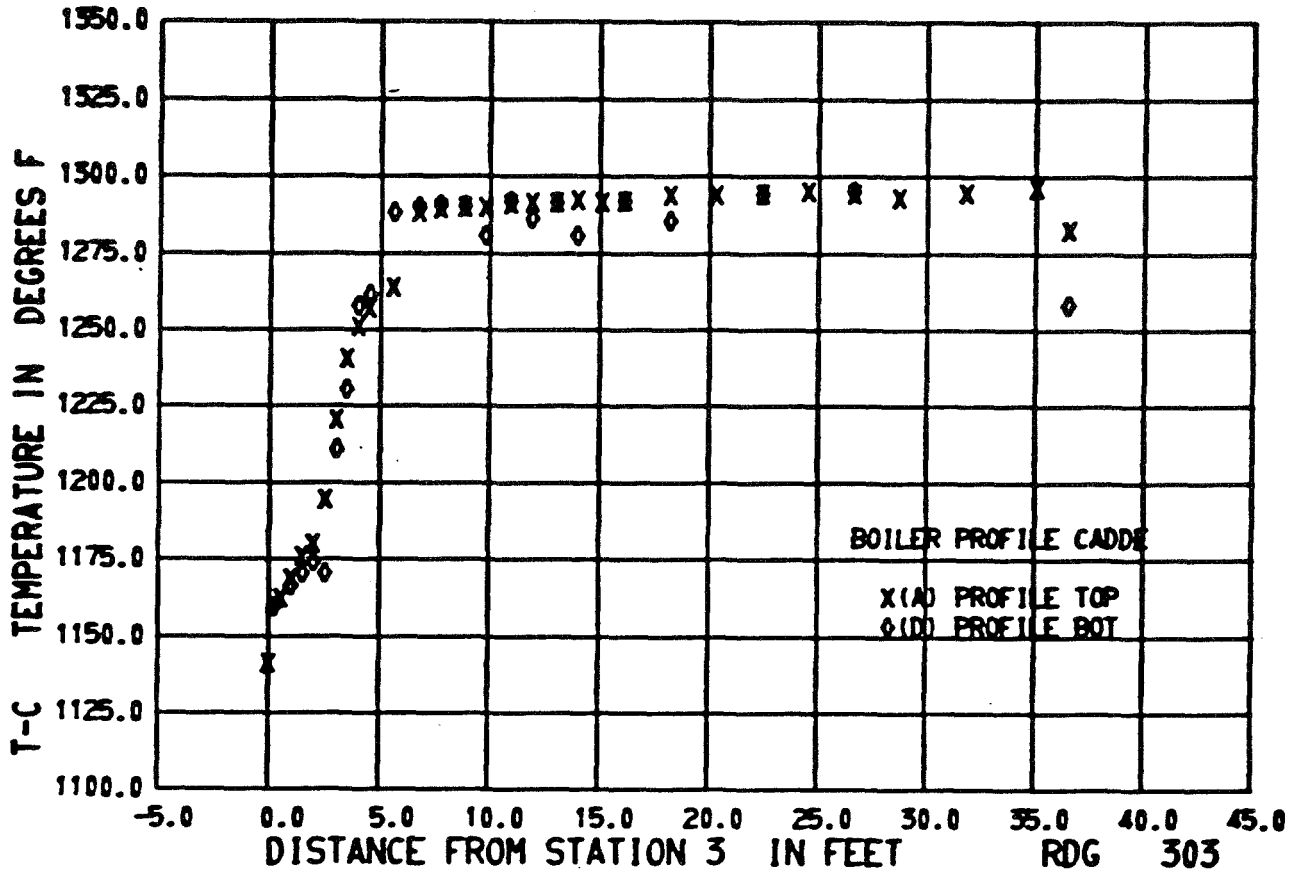

NAK SIDE DATA

FLOW RATE 46955.593 LB/HR  
 PRESS DROP 1.741 PSI  
 THERMAL POWER 420.687 KW  
 AVG INLET TEMP 1291.952 F  
 AVE OUTLET TEMP 1146.271 F

MERCURY SIDE DATA

LIQUID FLOW RATE 10131.005 LB/HR  
 VAPOR FLOW RATE 10537.269 LB/HR  
 QUALITY (HT. BAL.) 0.919 0/0  
 AVG ENTHALPY OUT 151.875 BTU/LB  
 INLET PRESS 362.703 PSIA  
 OUTLET PRESS 203.399 PSIA  
 SAT TEMP OUT 1017.939 F  
 TEMP OUT 1281.485 F  
 AVG TEMP IN 419.087 F  
 THERMAL POWER 451.846 KW

FIGURE 10(e).- BOILER SHELL TEMPERATURE PROFILES.  
 19 HOURS AND 58 MINUTES AFTER STARTUP #8.

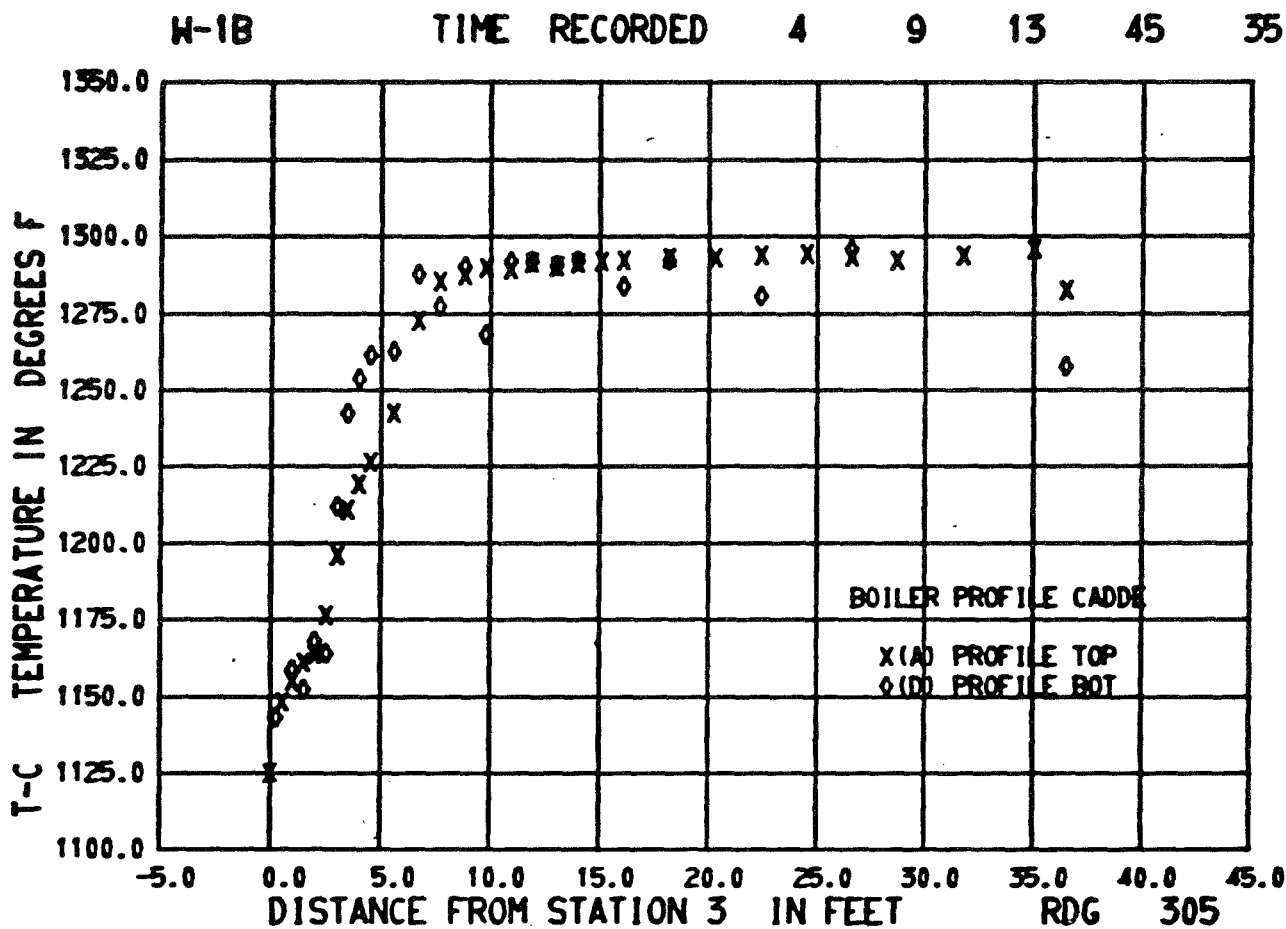

**NAK SIDE DATA**

FLOW RATE                      47220.992 LB/HR  
 PRESS DROP                      1.727 PSI  
 THERMAL POWER                      457.264 KW  
 AVG INLET TEMP                      1290.608 F  
 AVE OUTLET TEMP                      1133.103 F

**MERCURY SIDE DATA**

LIQUID FLOW RATE                      11012.212 LB/HR  
 VAPOR FLOW RATE                      11495.727 LB/HR  
 QUALITY (HT. BAL.)                      0.920 0/0  
 AVG ENTHALPY OUT                      152.101 BTU/LB  
 INLET PRESS                      367.150 PSIA  
 OUTLET PRESS                      221.749 PSIA  
 SAT TEMP OUT                      1033.025 F  
 TEMP OUT                      1282.899 F  
 AVG TEMP IN                      413.126 F  
 THERMAL POWER                      490.522 KW

FIGURE 10(f).- BOILER SHELL TEMPERATURE PROFILES.  
 21 HOURS AND 15 MINUTES AFTER STARTUP #8.



H-1B

TIME RECORDED

4

9

14

55

17

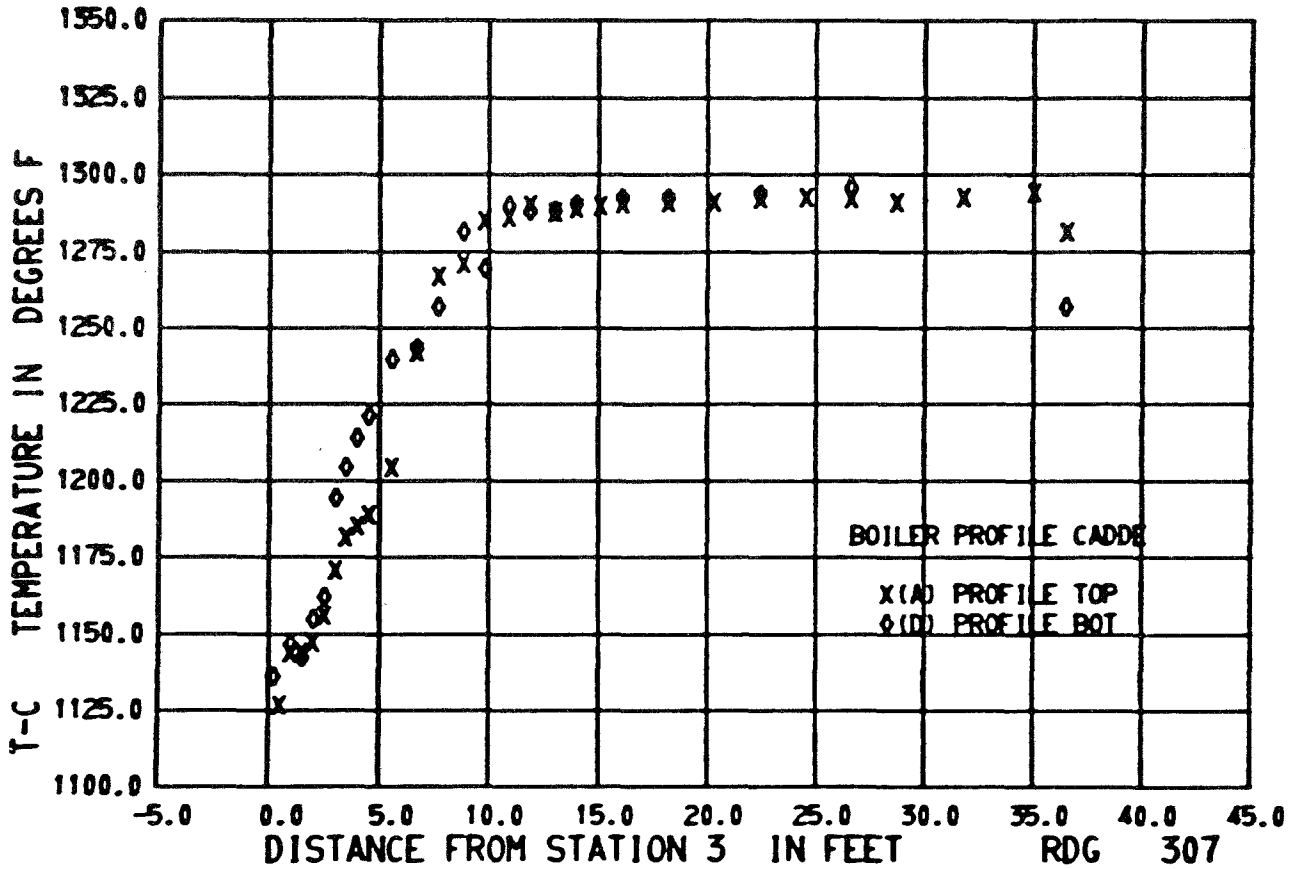

NAK SIDE DATA

FLOW RATE 47039.679 LB/HR  
 PRESS DROP 1.700 PSI  
 THERMAL POWER 509.690 KW  
 AVG INLET TEMP 1290.254 F  
 AVE OUTLET TEMP 1113.945 F

MERCURY SIDE DATA

LIQUID FLOW RATE 12097.185 LB/HR  
 VAPOR FLOW RATE 12714.079 LB/HR  
 QUALITY (HT. BAL.) 0.939 0/0  
 AVG ENTHALPY OUT 154.516 BTU/LB  
 INLET PRESS 373.181 PSIA  
 OUTLET PRESS 245.111 PSIA  
 SAT TEMP OUT 1051.191 F  
 TEMP OUT 1281.555 F  
 AVG TEMP IN 407.670 F  
 THERMAL POWER 537.576 KW

FIGURE 10(g).- BOILER SHELL TEMPERATURE PROFILES.  
 22 HOURS AND 25 MINUTES AFTER STARTUP #8.

N-1B TIME RECORDED 4 10 20 22 21

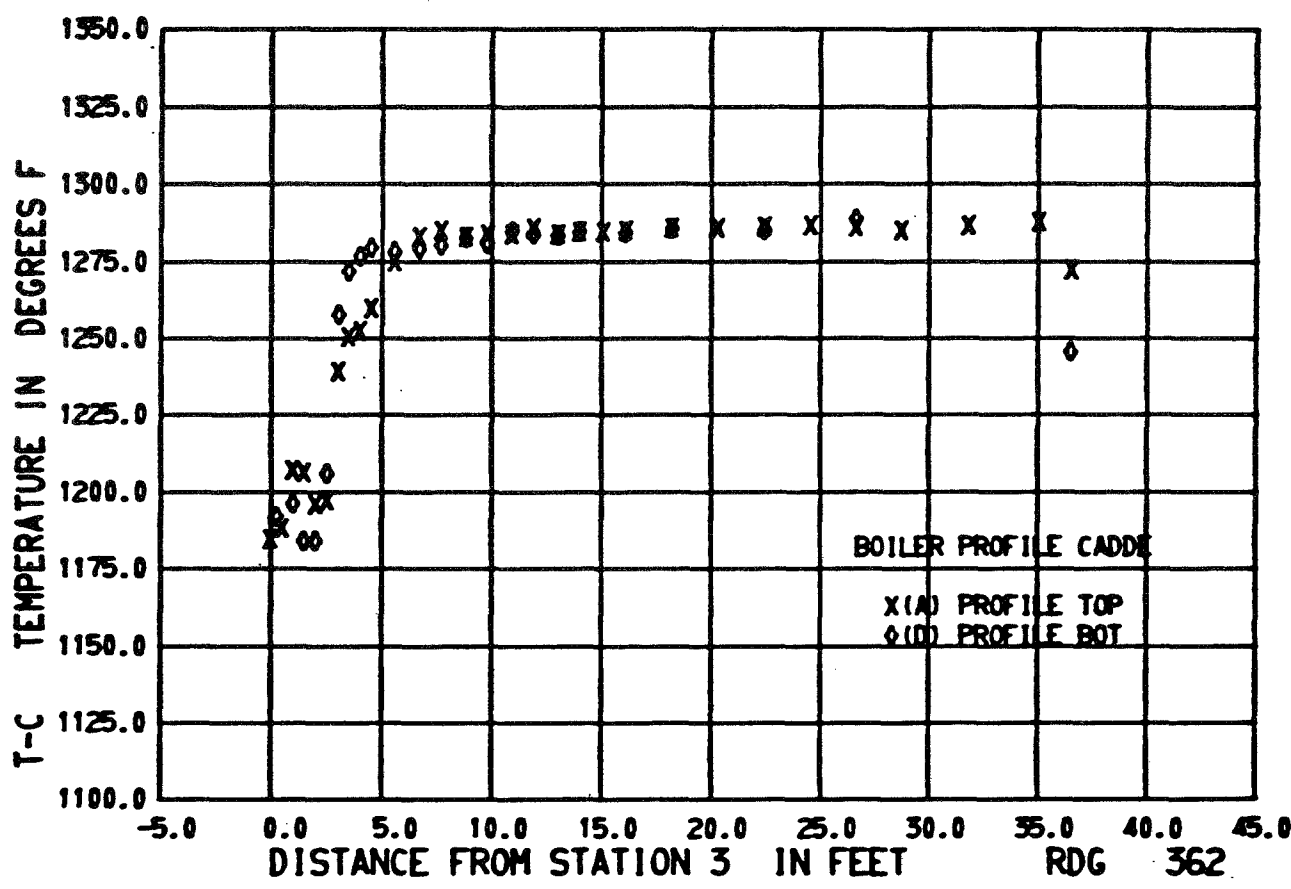

NAK SIDE DATA

FLOW RATE 46613.977 LB/HR  
 PRESS DROP 2.067 PSI  
 THERMAL POWER 299.365 KW  
 AVG INLET TEMP 1284.843 F  
 AVE OUTLET TEMP 1180.477 F

MERCURY SIDE DATA

LIQUID FLOW RATE 6750.139 LB/HR  
 VAPOR FLOW RATE 6965.239 LB/HR  
 QUALITY (HT. BAL.) 0.953 0/0  
 AVG ENTHALPY OUT 155.901 BTU/LB  
 INLET PRESS 234.806 PSIA  
 OUTLET PRESS 131.7 -76.147 PSIA  
 SAT TEMP OUT 950.090 F  
 TEMP OUT 1270.245 F  
 AVG TEMP IN 252.716 F  
 THERMAL POWER 311.710 KW

FIGURE 11(2).- BOILER SHELL TEMPERATURE PROFILES.  
 15 MINUTES AFTER STARTUP #10.

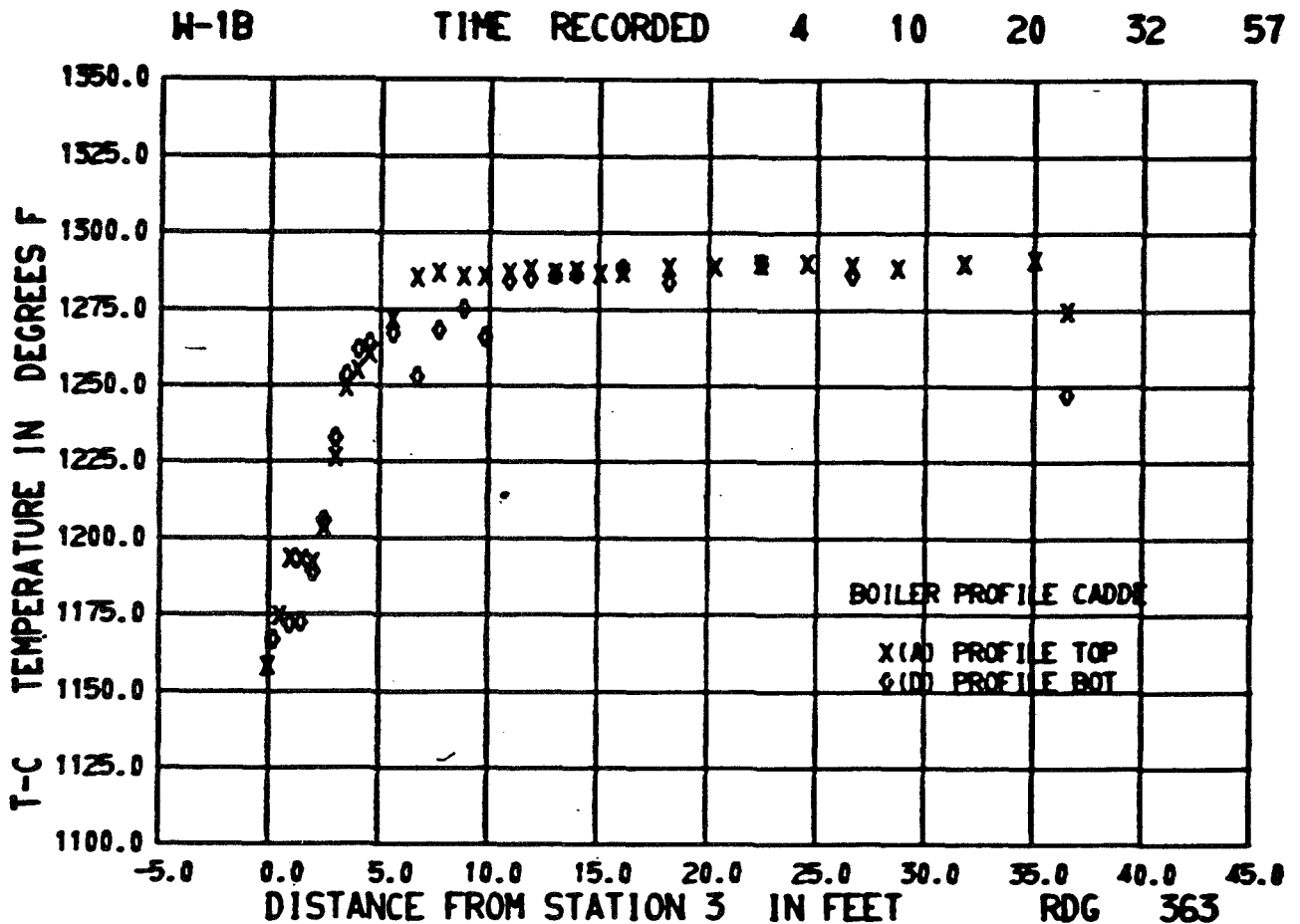

**NAK SIDE DATA**

FLOW RATE                      46769.159 LB/HR  
 PRESS DROP                    2.160 PSI  
 THERMAL POWER                370.012 KW  
 AVG INLET TEMP                1288.415 F  
 AVE OUTLET TEMP               1159.799 F

**MERCURY SIDE DATA**

LIQUID FLOW RATE              8474.754 LB/HR  
 VAPOR FLOW RATE              8721.424 LB/HR  
 QUALITY (HT. BAL.)            0.938 0/0  
 AVG ENTHALPY OUT             154.062 BTU/LB  
 INLET PRESS                    310.828 PSIA  
 OUTLET PRESS                  166.0 -75.249 PSIA  
 SAT TEMP OUT                   985.792 F  
 TEMP OUT                       1274.344 F  
 AVG TEMP IN                    262.740 F  
 THERMAL POWER                390.260 KW

FIGURE 11(b).- BOILER SHELL TEMPERATURE PROFILES.  
 26 MINUTES AFTER STARTUP #10.

H-1B

TIME RECORDED

4

10

20

38

0

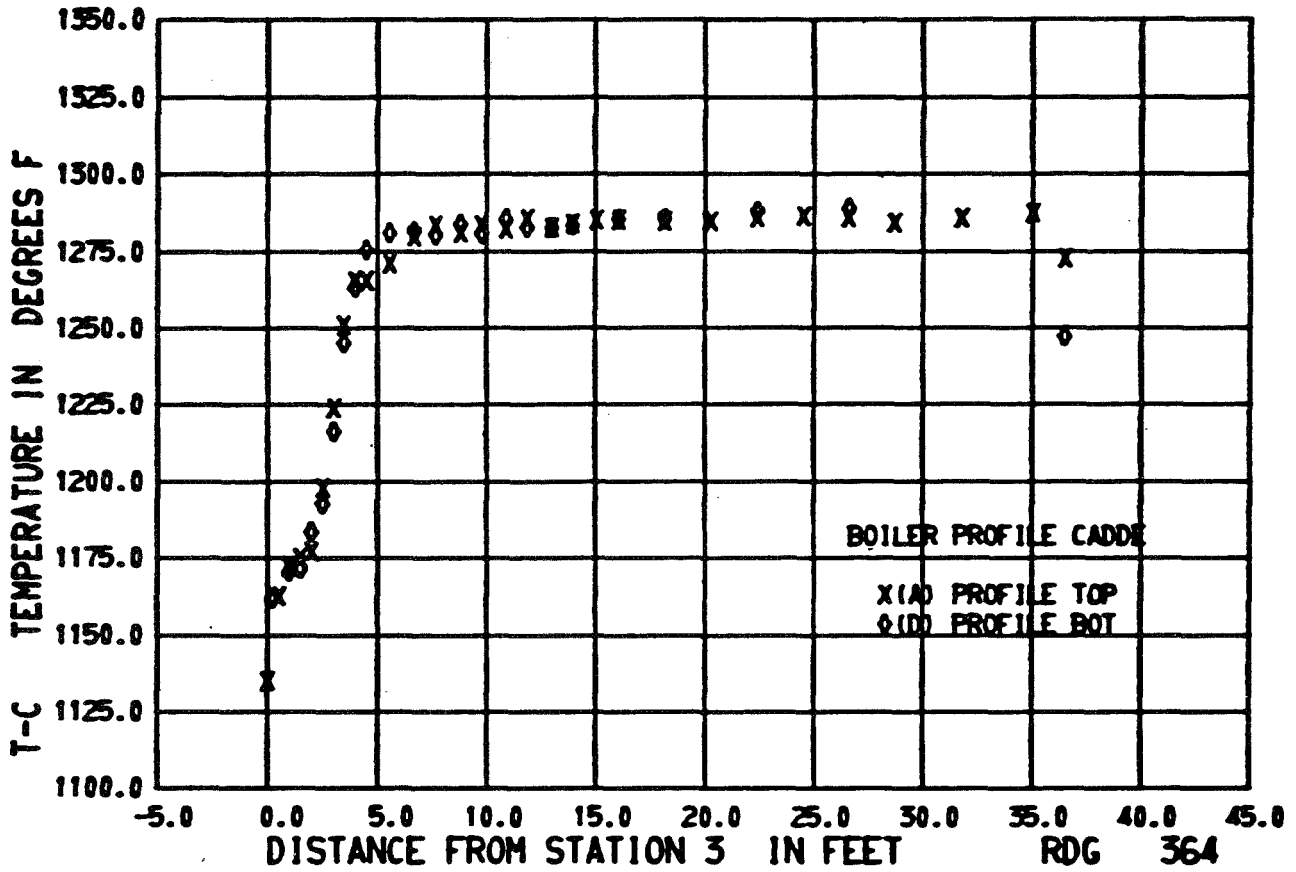

NAK SIDE DATA

FLOW RATE 47045.933 LB/HR  
 PRESS DROP 2.152 PSI  
 THERMAL POWER 399.822 KW  
 AVG INLET TEMP 1283.853 F  
 AVE OUTLET TEMP 1145.639 F

MERCURY SIDE DATA

LIQUID FLOW RATE 9282.001 LB/HR  
 VAPOR FLOW RATE 9593.135 LB/HR  
 QUALITY (HT. BAL.) 0.924 0/0  
 AVG ENTHALPY OUT 152.317 BTU/LB  
 INLET PRESS 343.147 PSIA  
 OUTLET PRESS 183.0 -75.953 PSIA  
 SAT TEMP OUT 1001.106 F  
 TEMP OUT 1275.263 F  
 AVG TEMP IN 274.034 F  
 THERMAL POWER 426.762 KW

FIGURE 11(C).- BOILER SHELL TEMPERATURE PROFILES.  
 31 MINUTES AFTER STARTUP #10.

H-1B

TIME RECORDED

4

10

21

4

1

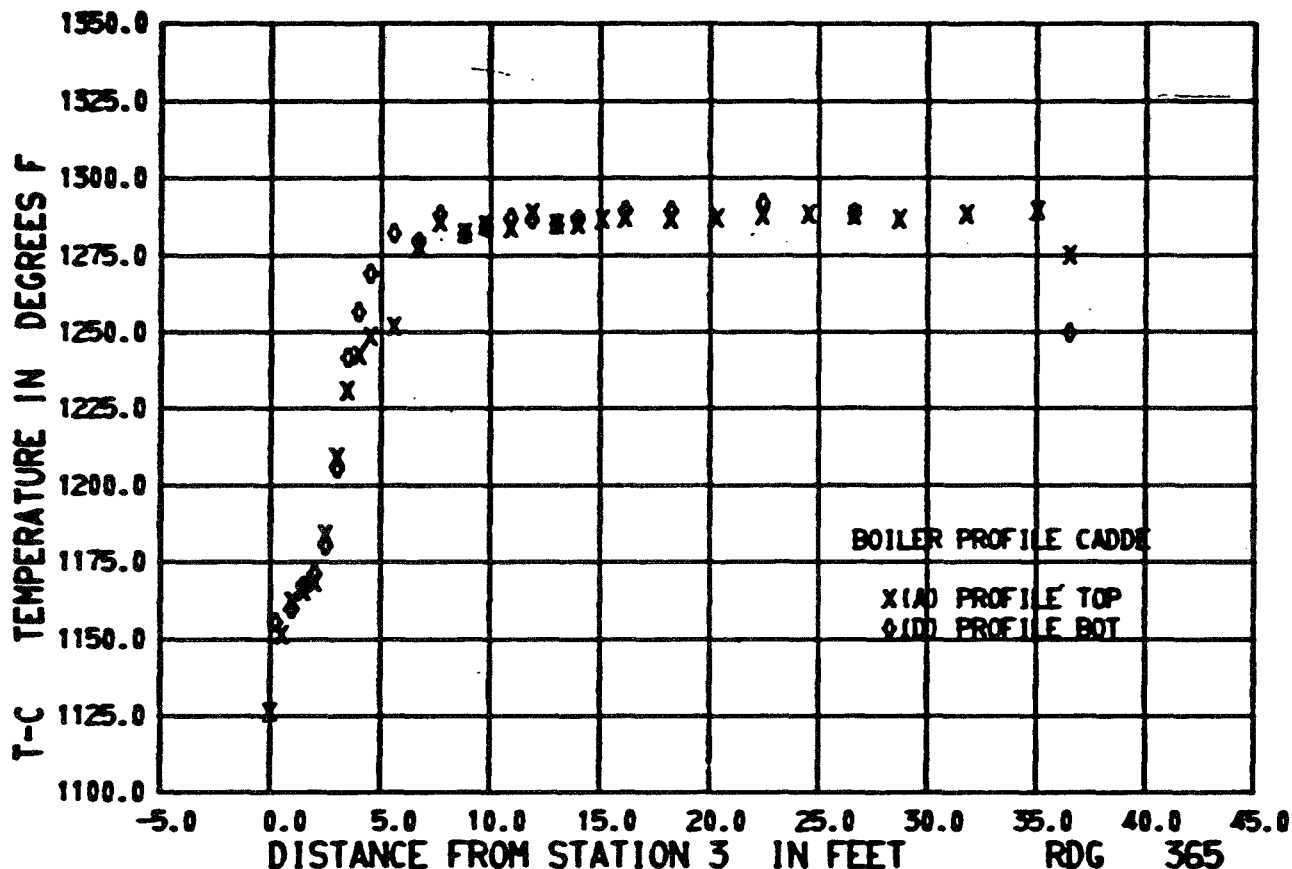

NAK SIDE DATA

FLOW RATE 47067.111 LB/HR  
 PRESS DROP 2.119 PSI  
 THERMAL POWER 429.270 KW  
 AVG INLET TEMP 1286.187 F  
 AVE OUTLET TEMP 1137.842 F

MERCURY SIDE DATA

LIQUID FLOW RATE 10148.239 LB/HR  
 VAPOR FLOW RATE 10436.025 LB/HR  
 QUALITY (HT. BAL.) 0.919 0/0  
 AVG ENTHALPY OUT 151.775 BTU/LB  
 INLET PRESS 351.958 PSIA  
 OUTLET PRESS 200.3 252.698 PSIA  
 SAT TEMP OUT 1015.280 F  
 TEMP OUT 1277.031 F  
 AVG TEMP IN 329.986 F  
 THERMAL POWER 460.456 KW

FIGURE 11(d).- BOILER SHELL TEMPERATURE PROFILES.  
 57 MINUTES AFTER STARTUP # 10.

H-1B

TIME RECORDED

4

10

21

16

1

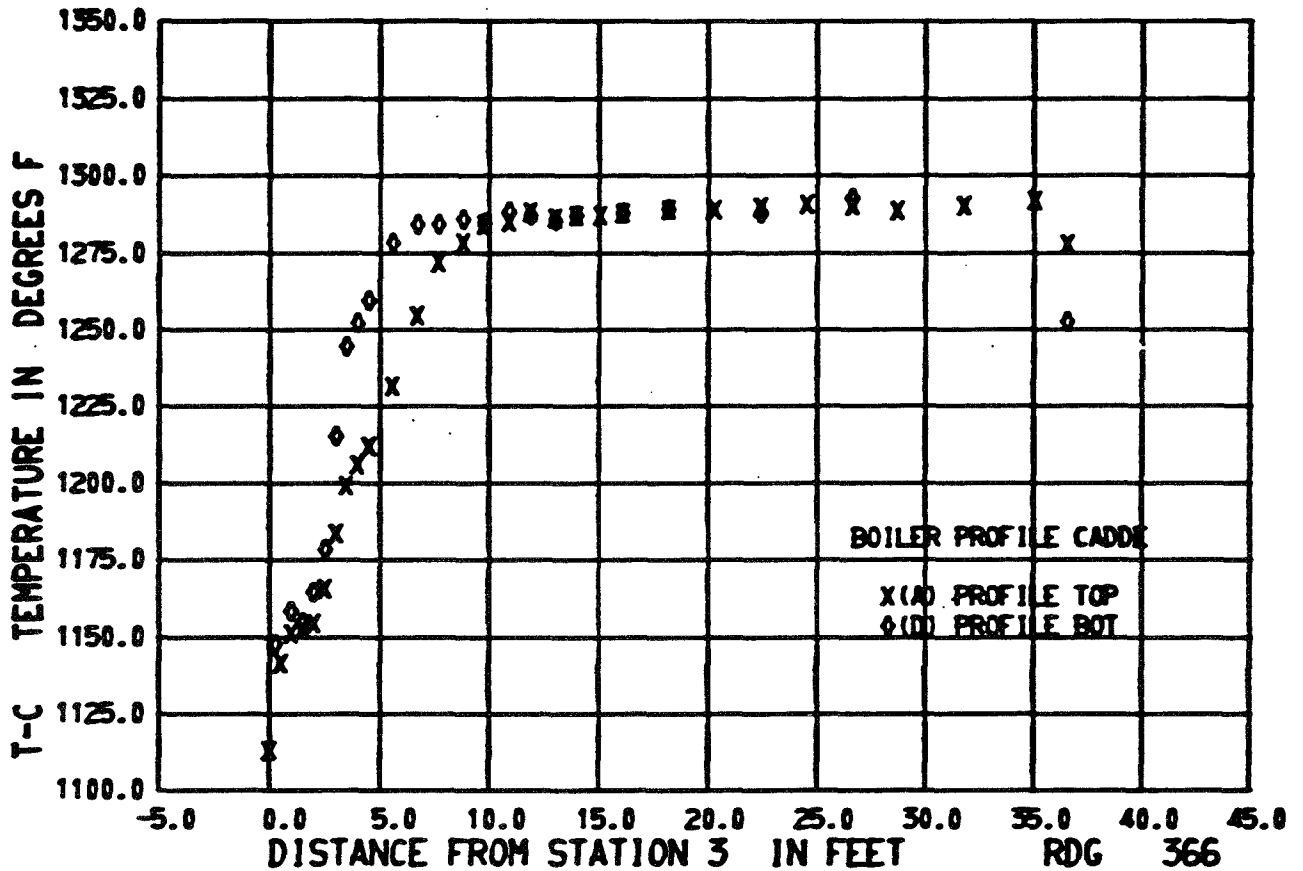

NAK SIDE DATA

FLOW RATE 47578.857 LB/HR  
 PRESS DROP 2.073 PSI  
 THERMAL POWER 468.857 KW  
 AVG INLET TEMP 1287.531 F  
 AVE OUTLET TEMP 1126.539 F

MERCURY SIDE DATA

LIQUID FLOW RATE 11014.595 LB/HR  
 VAPOR FLOW RATE 11518.826 LB/HR  
 QUALITY (HT. BAL.) 0.938 0/0  
 AVG ENTHALPY OUT 154.344 BTU/LB  
 INLET PRESS 357.619 PSIA  
 OUTLET PRESS 222.829 PSIA  
 SAT TEMP OUT 1033.889 F  
 TEMP OUT 1278.091 F  
 AVG TEMP IN 365.867 F  
 THERMAL POWER 494.528 KW

FIGURE 11 (e).- BOILER SHELL TEMPERATURE PROFILES.  
 1 HOUR AND 9 MINUTES AFTER STARTUP #10.

H-1B

TIME RECORDED

4

10

21

26

1

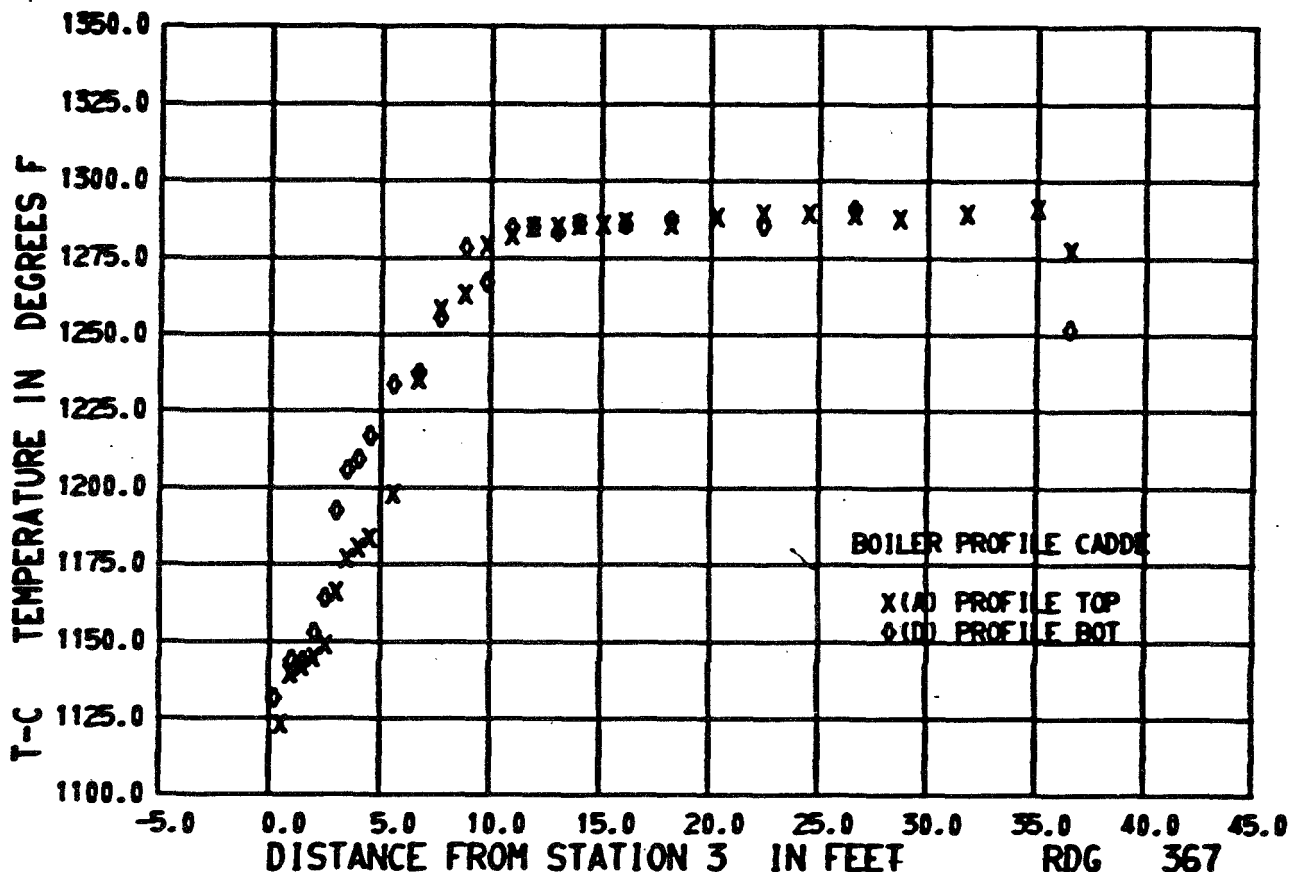

NAK SIDE DATA

FLOW RATE 47457.125 LB/HR  
 PRESS DROP 2.054 PSI  
 THERMAL POWER 510.916 KW  
 AVG INLET TEMP 1287.425 F  
 AVE OUTLET TEMP 1112.156 F

MERCURY SIDE DATA

LIQUID FLOW RATE 11988.906 LB/HR  
 VAPOR FLOW RATE 12578.274 LB/HR  
 QUALITY (HT. BAL.) 0.950 0/0  
 AVG ENTHALPY OUT 155.915 BTU/LB  
 INLET PRESS 363.506 PSIA  
 OUTLET PRESS 243.096 PSIA  
 SAT TEMP OUT 1049.667 F  
 TEMP OUT 1277.667 F  
 AVG TEMP IN 396.289 F  
 THERMAL POWER 533.319 KW

FIGURE 11(f).- BOILER SHELL TEMPERATURE PROFILES.  
 1 HOUR AND 19 MINUTES AFTER STARTUP #10.

H-1B

TIME RECORDED

4

10

21

36

1

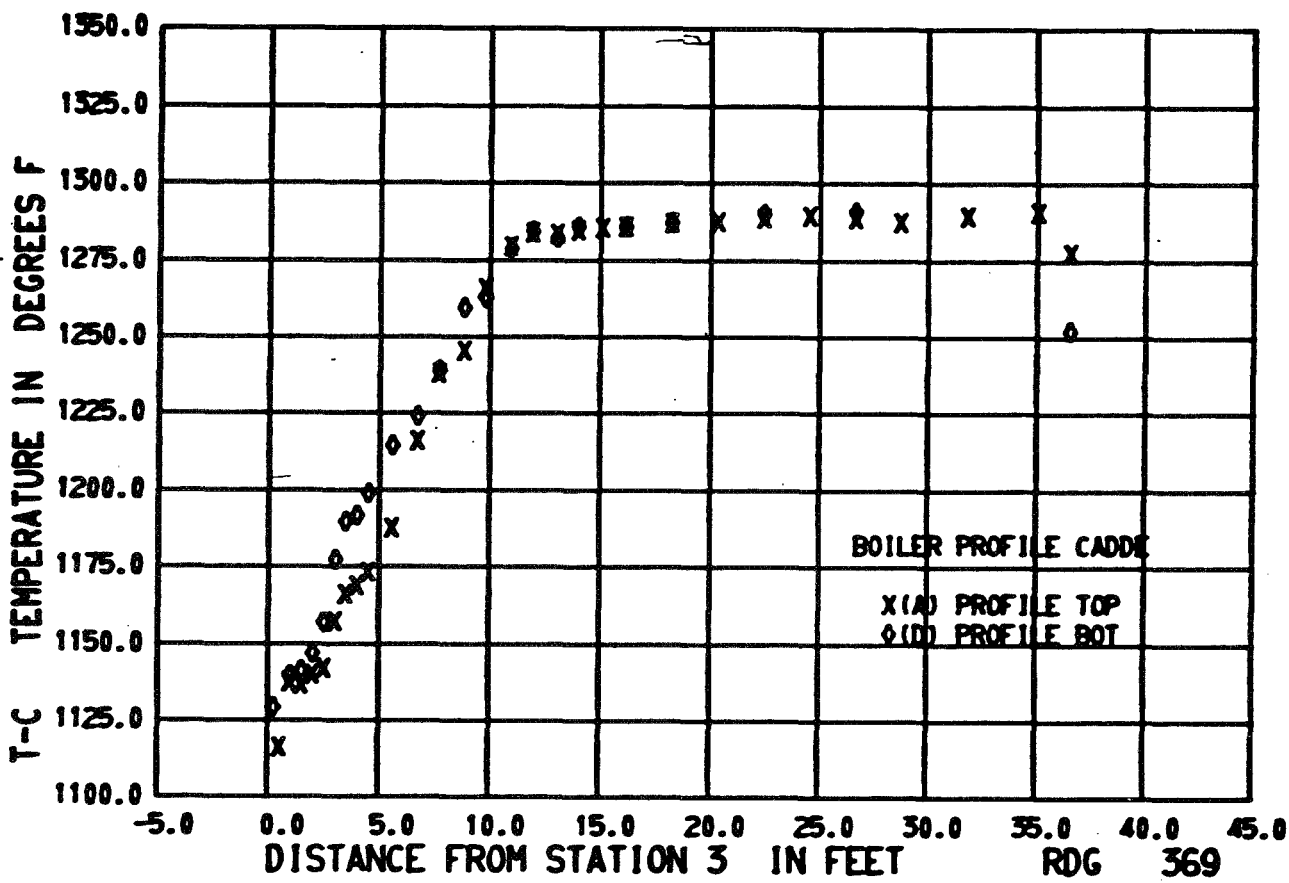

NAK SIDE DATA

FLOW RATE 47548.477 LB/HR  
 PRESS DROP 2.020 PSI  
 THERMAL POWER 524.505 KW  
 AVG INLET TEMP 1285.975 F  
 AVE OUTLET TEMP 1106.441 F

MERCURY SIDE DATA

LIQUID FLOW RATE 12382.391 LB/HR  
 VAPOR FLOW RATE 13055.154 LB/HR  
 QUALITY (HT. BAL.) 0.940 O/O  
 AVG ENTHALPY OUT 154.622 BTU/LB  
 INLET PRESS 367.129 PSIA  
 OUTLET PRESS 251.385 PSIA  
 SAT TEMP OUT 1055.890 F  
 TEMP OUT 1277.455 F  
 AVG TEMP IN 378.766 F  
 THERMAL POWER 552.302 KW

FIGURE 11(g).- BOILER SHELL TEMPERATURE PROFILES 1 HOUR AND 29 MINUTES AFTER STARTUP #10.



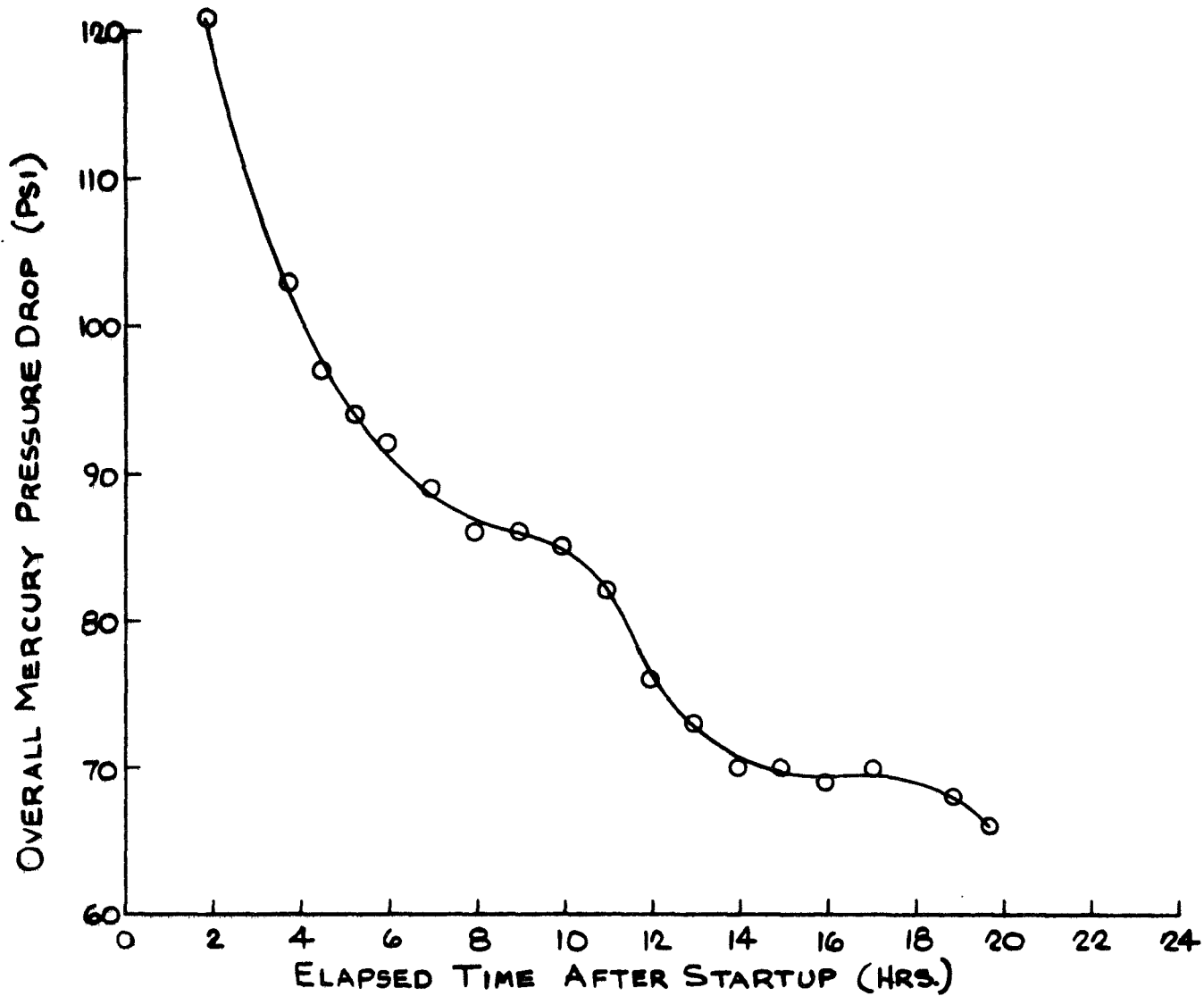

FIGURE 12. VARIATION OF BOILER OVERALL MERCURY PRESSURE DROP WITH ELAPSED TIME AFTER STARTUP #20. NAK FLOW RATE 45,400 LBM/HR, NAK INLET TEMPERATURE 1290 °F, MERCURY FLOW RATE 7500 LBM/HR.

N-1B

TIME RECORDED

5

17

19

2

23

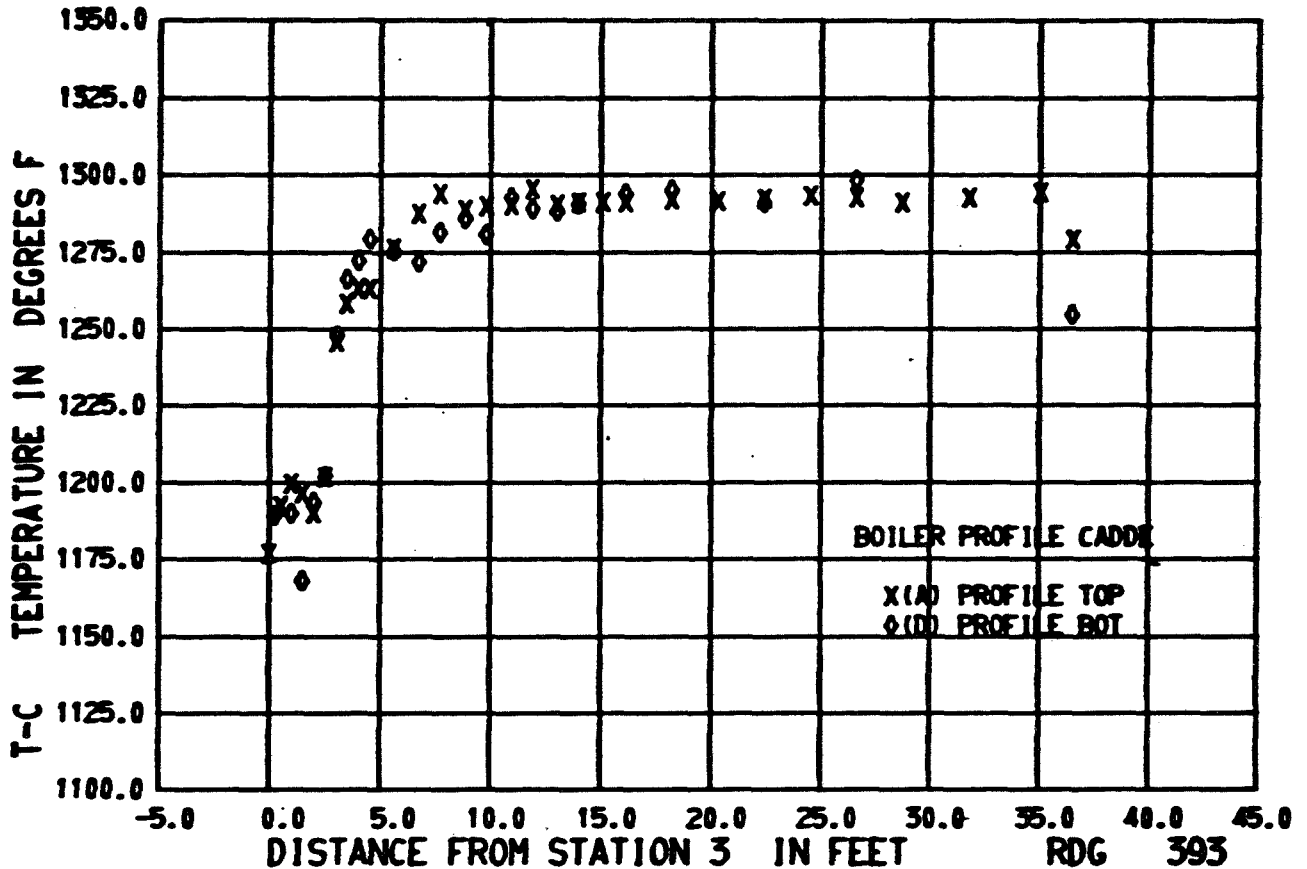

NAK SIDE DATA

FLOW RATE 45489.125 LB/HR  
 PRESS DROP 1.596 PSI  
 THERMAL POWER 310.073 KW  
 AVG INLET TEMP 1290.183 F  
 AVE OUTLET TEMP 1179.421 F

MERCURY SIDE DATA

LIQUID FLOW RATE 7491.103 LB/HR  
 VAPOR FLOW RATE 7702.056 LB/HR  
 QUALITY (HT. BAL.) 0.924 0/0  
 AVG ENTHALPY OUT 152.321 BTU/LB  
 INLET PRESS 269.431 PSIA  
 OUTLET PRESS 148.470 PSIA  
 SAT TEMP OUT 968.460 F  
 TEMP OUT 1279.151 F  
 AVG TEMP IN 441.651 F  
 THERMAL POWER 332.061 KW

FIGURE 13 (a).- BOILER SHELL TEMPERATURE PROFILES.  
 1 HOUR AND 54 MINUTES AFTER STARTUP #20.

H-1B

TIME RECORDED

5

18

12

47

52

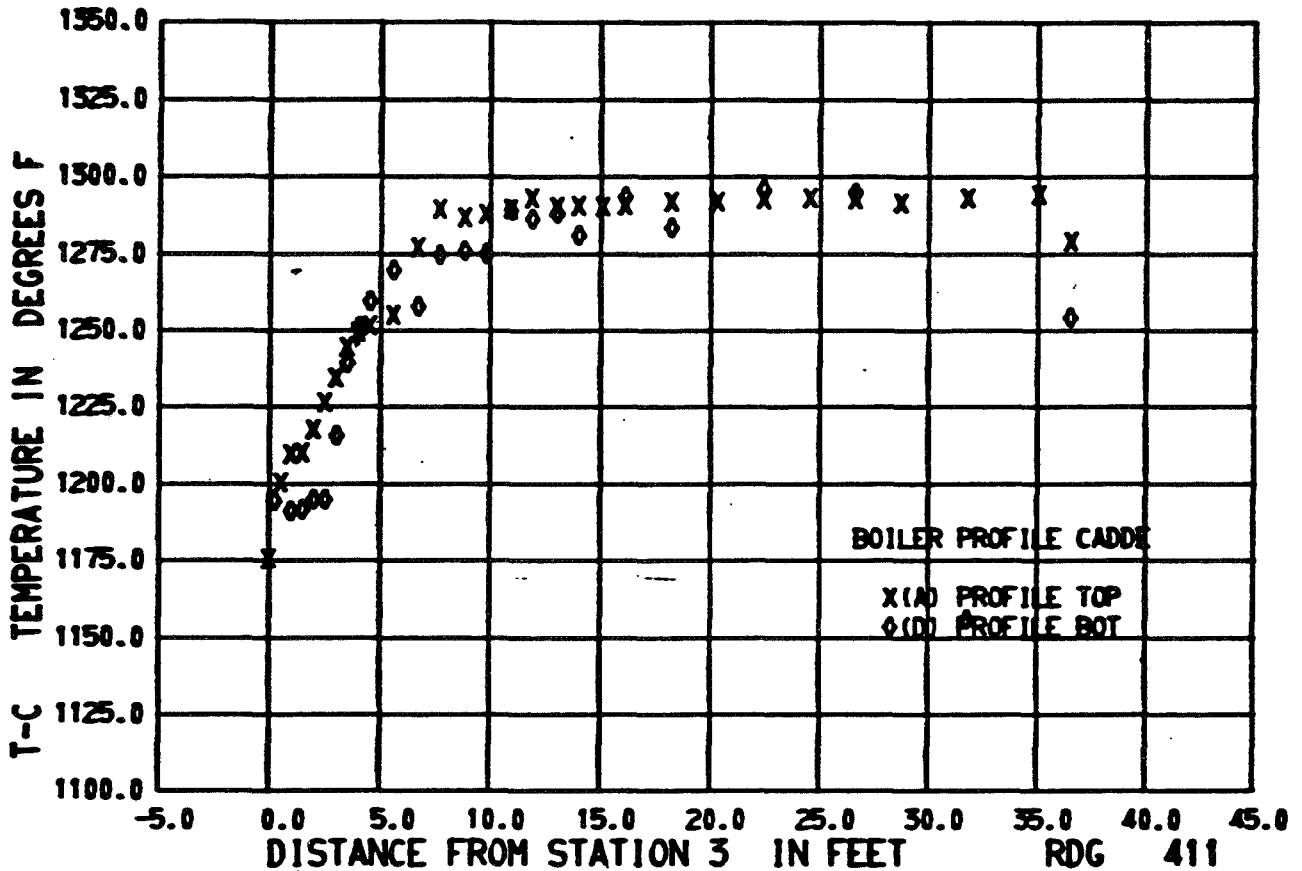

NAK SIDE DATA

FLOW RATE 45544.725 LB/HR  
 PRESS DROP 1.370 PSI  
 THERMAL POWER 304.759 KW  
 AVG INLET TEMP 1290.608 F  
 AVE OUTLET TEMP 1181.884 F

MERCURY SIDE DATA

LIQUID FLOW RATE 7460.257 LB/HR  
 VAPOR FLOW RATE 7608.099 LB/HR  
 QUALITY (HT. BAL.) 0.918 0/0  
 AVG ENTHALPY OUT 151.488 BTU/LB  
 INLET PRESS 213.809 PSIA  
 OUTLET PRESS 148.228 PSIA  
 SAT TEMP OUT 968.207 F  
 TEMP OUT 1278.091 F  
 AVG TEMP IN 434.388 F  
 THERMAL POWER 328.447 KW

FIGURE 13(b).- BOILER SHELL TEMPERATURE PROFILES.  
 19 HOURS AND 40 MINUTES AFTER STARTUP #20.

H-1B

TIME RECORDED

6

9

13

38

3

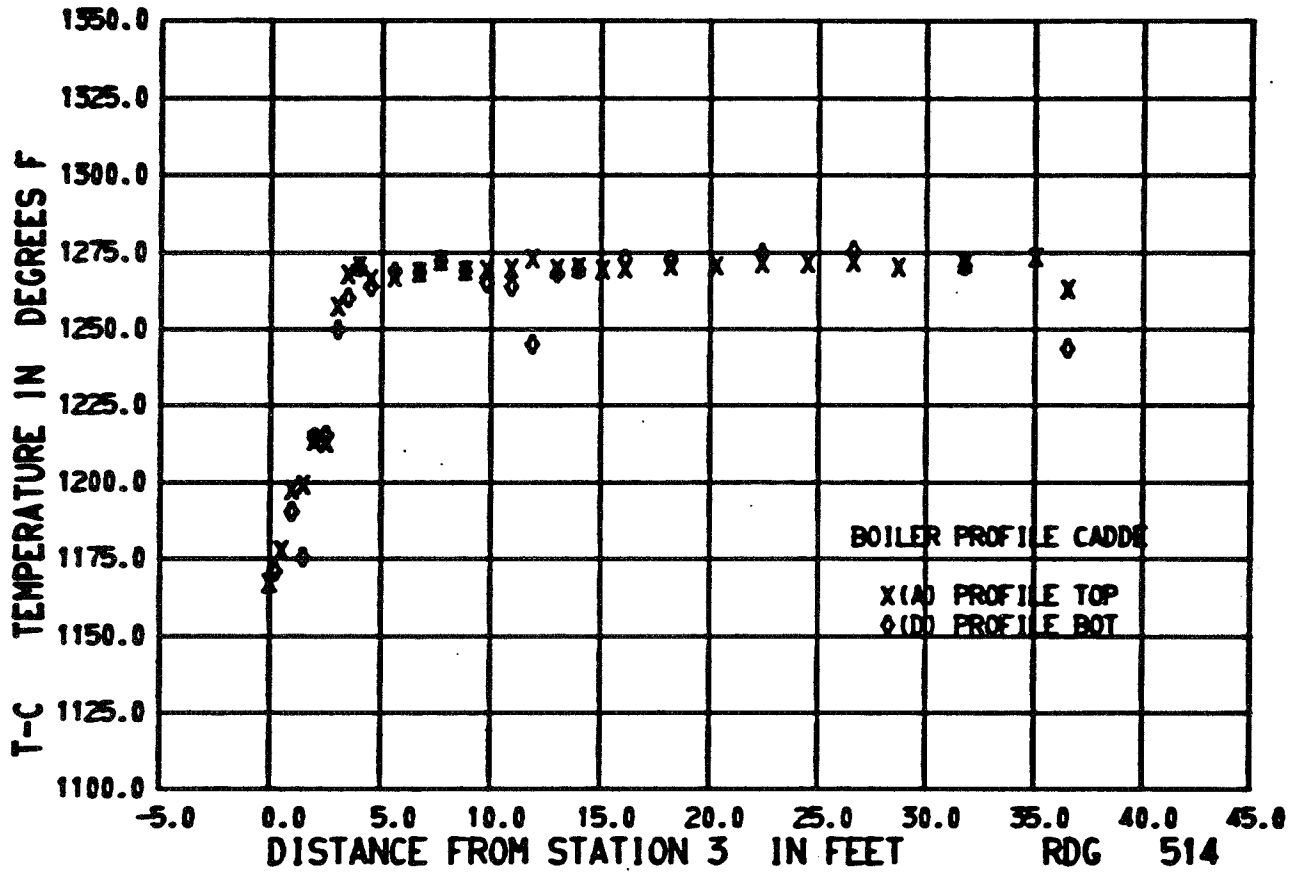

NAK SIDE DATA

FLOW RATE 45682.662 LB/HR  
 PRESS DROP 1.889 PSI  
 THERMAL POWER 293.519 KW  
 AVG INLET TEMP 1271.341 F  
 AVE OUTLET TEMP 1166.865 F

MERCURY SIDE DATA

LIQUID FLOW RATE 6742.598 LB/HR  
 VAPOR FLOW RATE 6886.761 LB/HR  
 QUALITY (HT. BAL.) 0.925 0/0  
 AVG ENTHALPY OUT 151.963 BTU/LB  
 INLET PRESS 310.725 PSIA  
 OUTLET PRESS 131.637 PSIA  
 SAT TEMP OUT 949.982 F  
 TEMP OUT 1257.882 F  
 AVG TEMP IN 246.527 F  
 THERMAL POWER 312.958 KW

FIGURE 14(a).- BOILER SHELL TEMPERATURE PROFILES.  
 22 MINUTES AFTER STARTUP # 93.

H-1B

TIME RECORDED

6

9

14

59

29

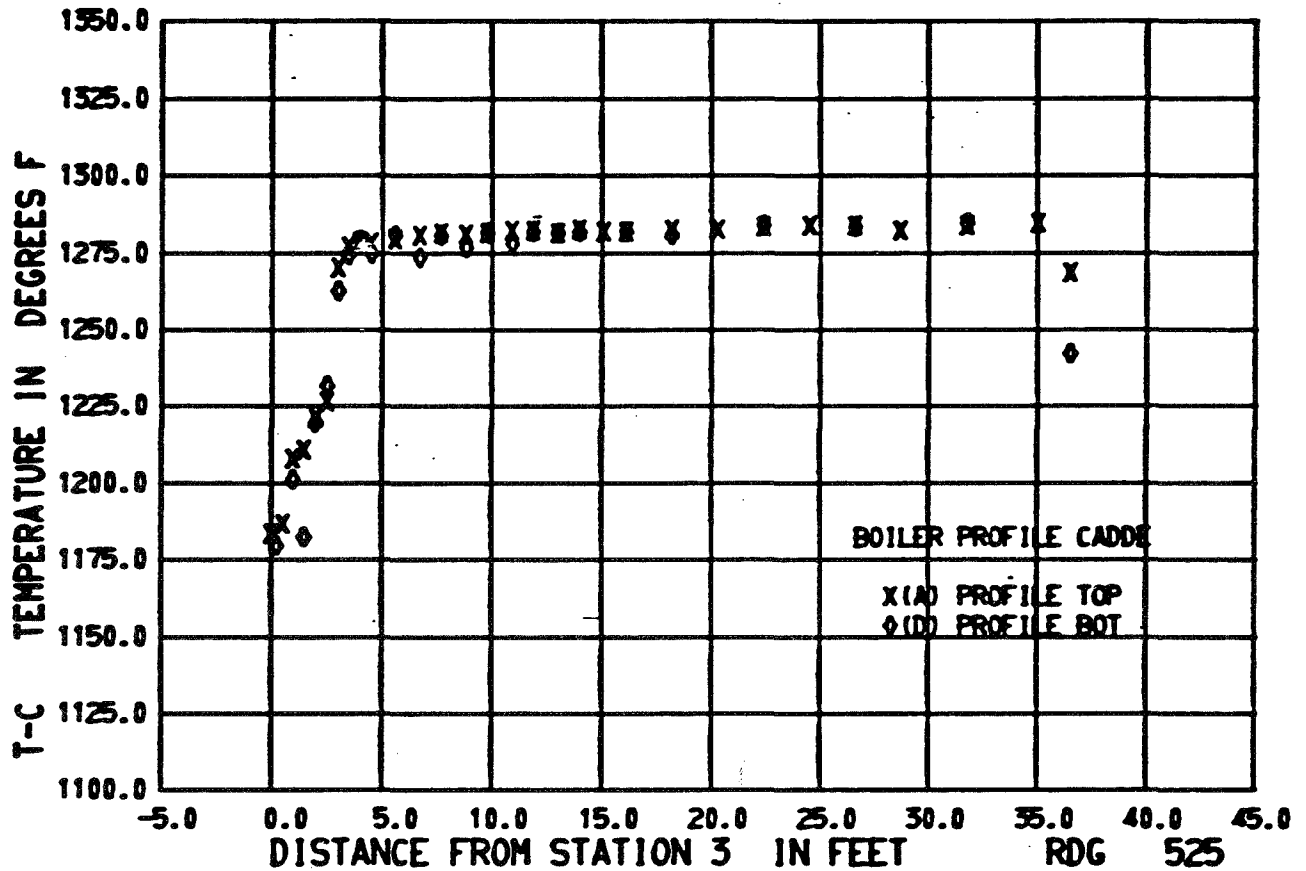

NAK SIDE DATA

FLOW RATE 46274.317 LB/HR  
 PRESS DROP 1.823 PSI  
 THERMAL POWER 286.143 KW  
 AVG INLET TEMP 1279.293 F  
 AVE OUTLET TEMP 1178.788 F

MERCURY SIDE DATA

LIQUID FLOW RATE 6759.557 LB/HR  
 VAPOR FLOW RATE 6858.222 LB/HR  
 QUALITY (HT. BAL.) 0.897 0/0  
 AVG ENTHALPY OUT 148.535 BTU/LB  
 INLET PRESS 316.345 PSIA  
 OUTLET PRESS 132.548 PSIA  
 SAT TEMP OUT 951.034 F  
 TEMP OUT 1266.995 F  
 AVG TEMP IN 270.323 F  
 THERMAL POWER 312.826 KW

FIGURE 14(b).- BOILER SHELL TEMPERATURE PROFILES.  
 1 HOUR AND 43 MINUTES AFTER STARTUP #93.

H-1B

TIME RECORDED

6

25

10

20

26

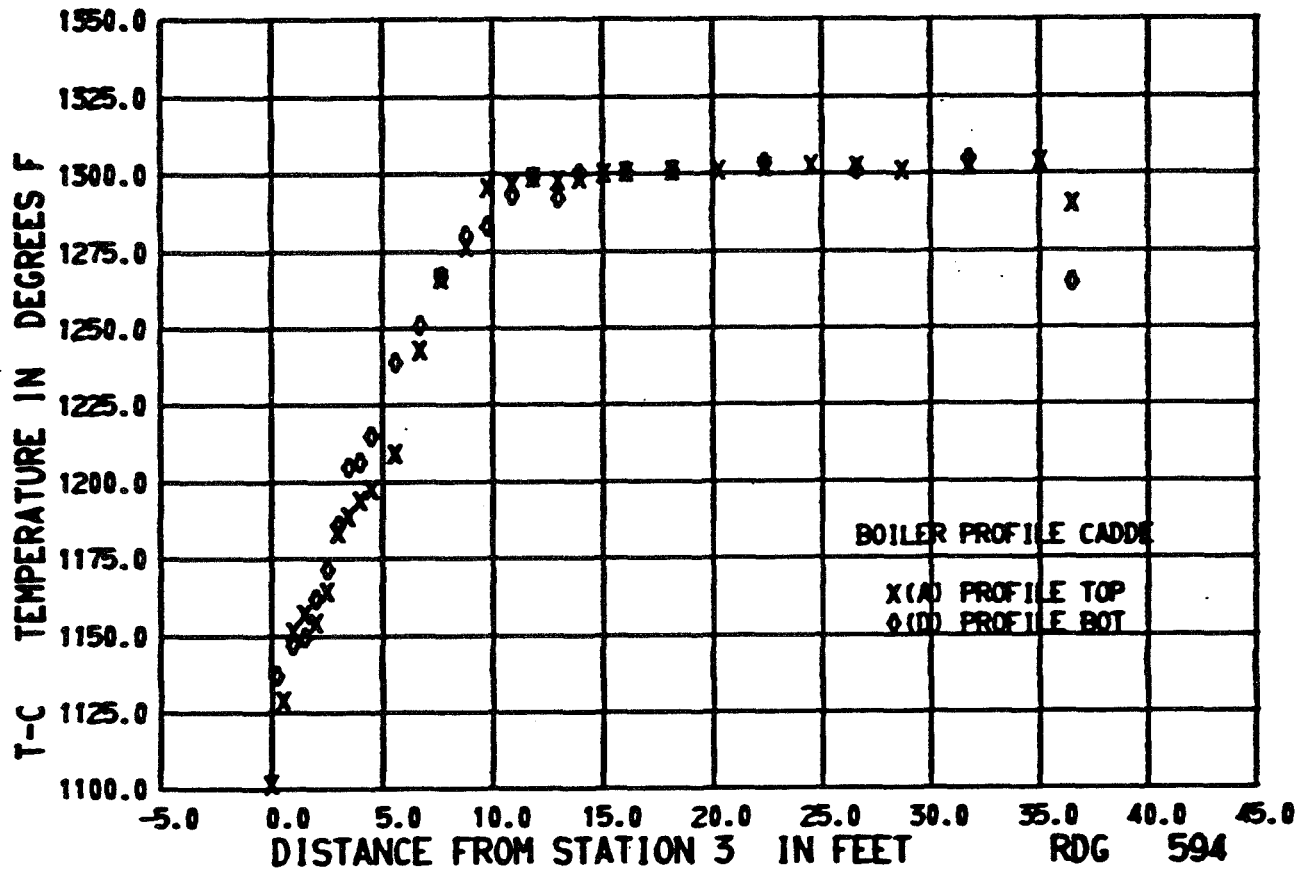

NAK SIDE DATA

FLOW RATE 45707.387 LB/HR  
 PRESS DROP 1.525 PSI  
 THERMAL POWER 516.706 KW  
 AVG INLET TEMP 1300.265 F  
 AVE OUTLET TEMP 1116.365 F

MERCURY SIDE DATA

LIQUID FLOW RATE 12206.508 LB/HR  
 VAPOR FLOW RATE 12847.818 LB/HR  
 QUALITY (HT. BAL.) 0.948 O/O  
 AVG ENTHALPY OUT 155.943 BTU/LB  
 INLET PRESS 376.249 PSIA  
 OUTLET PRESS 247.684 PSIA  
 SAT TEMP OUT 1053.298 F  
 TEMP OUT 1291.810 F  
 AVG TEMP IN 430.450 F  
 THERMAL POWER 540.671 KW

FIGURE 15(a).- BOILER SHELL TEMPERATURE PROFILES.  
 48 MINUTES AFTER STARTUP #122.

H-1B

TIME RECORDED 6 25 15 37 37

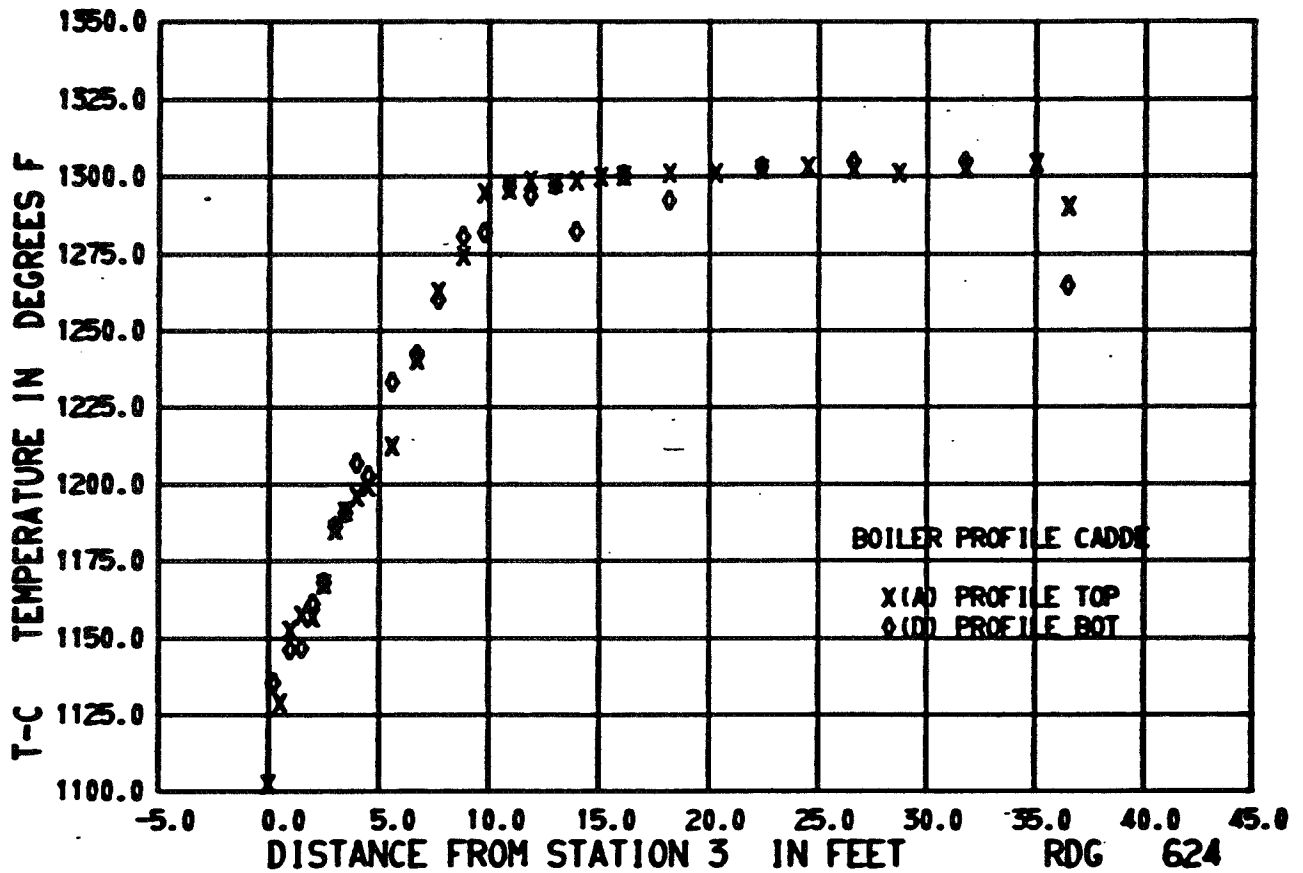

**NAK SIDE DATA**

FLOW RATE 45776.946 LB/HR  
 PRESS DROP 1.365 PSI  
 THERMAL POWER 510.467 KW  
 AVG INLET TEMP 1299.310 F  
 AVE OUTLET TEMP 1117.909 F

**MERCURY SIDE DATA**

LIQUID FLOW RATE 12232.239 LB/HR  
 VAPOR FLOW RATE 12715.557 LB/HR  
 QUALITY (HT. BAL.) 0.933 0/0  
 AVG ENTHALPY OUT 153.965 BTU/LB  
 INLET PRESS 376.063 PSIA  
 OUTLET PRESS 247.927 PSIA  
 SAT TEMP OUT 1052.700 F  
 TEMP OUT 1291.456 F  
 AVG TEMP IN 433.124 F  
 THERMAL POWER 541.518 KW

FIGURE 15(b).- BOILER SHELL TEMPERATURE PROFILES.  
 6 HOURS AND 5 MINUTES AFTER STARTUP #122.

TABLE I. - THERMOCOUPLE LOCATIONS ALONG BOILER SHELL

STATION NUMBER	LOCATION POSITIONS FOR THERMOCOUPLES AT GIVEN STATION NUMBER <sup>a</sup>	LENGTH
		INCHES <sup>b</sup>
1	A,D	-18.0
2	A,C,D,E	-8.0
3	A,B,C,E,F	0
4	D	3.0
5	A,C,E	6.0
6	A,B,C,D,E,F	12.0
7	A,D	18.0
8	A,B,C,D,E,F	24.0
9	A,D	30.0
10	A,B,C,D,E,F	36.0
11	A,D	42.0

STATION NUMBER	LOCATION POSITIONS FOR THERMOCOUPLES AT GIVEN STATION NUMBER	LENGTH
		INCHES <sup>b</sup>
12	A,B,C,D,E,F	48.0
13	A,D	54.0
14	A,D	67.2
15	A,B,C,D,E,F	80.4
16	A,D	92.4
17	A,D	105.6
18	A,B,C,D	117.6
19	A,D	130.8
20	A,D	142.8
21	A,D	156.0
22	A,D	168.0

STATION NUMBER	LOCATION POSITIONS FOR THERMOCOUPLES AT GIVEN STATION NUMBER	LENGTH
		INCHES <sup>b</sup>
23	A	181.2
24	A,D	193.2
25	A,D	218.4
26	A	243.6
27	A,D	268.8
28	A	294.0
29	A,D	319.2
30	A	344.4
31	A,D	381.6
32	A	420.0
33	A,D	436.3

<sup>a</sup> SEE FIG. 3. SECTION A-A.

<sup>b</sup> SEE FIG. 3. REFERENCE STATION AT CENTERLINE OF NAK OUTLET PASSAGE. DIMENSIONS SHOWN ARE BASED ON THERMOCOUPLE POSITIONS A AND D.







TABLE IV. - BOILER DATA TAKEN BETWEEN STARTUP #8 AND #9.

DATE AND TIME OF STARTUP #8 ARE 4/8/69 AND 16:31,  
RESPECTIVELY.

R.O. \_\_\_\_\_  
DATE \_\_\_\_\_

CADDE RDG. NO.	DATE OF CADDE RDG.	TIME OF CADDE RDG.	NAK FLOW RATE	NAK INLET TEMP.	NAK OUTLET TEMP.	NAK PRESS. DROP	HG FLOW RATE	HG INLET TEMP.	HG OUTLET TEMP.	HG INLET PRESS.	HG OUTLET PRESS.	HG PRESS. DROP	PINCH POINT TEMP. DIFF.	SUPER HEAT	OUTLET QUAL. (HEAT BAL.)
	Mo/DAY/YR	HR:MIN	LB/HR	°F	°F	PSI	LB/HR	°F	°F	PSIA	PSIA	PSI	°F	°F	%
289	4/8/69	16:47	40575	1291	1184	1.63	6245	330	1278	291	122	169	124	340	92
290		17:20	40651	1293	1159	1.47	8133	436	1284	341	161	180	73	303	91
291		19:30	40409	1295	1154	1.25	8190	435	1282	320	163	157	80	300	95
292		21:30	40788	1295	1159	1.27	8012	436	1282	316	159	157	88	304	94
293		23:30	40771	1294	1159	1.19	8050	442	1284	315	160	155	88	304	93
294	4/9/69	01:30	40643	1296	1162	1.22	7905	436	1283	311	157	154	93	307	94
295		03:51	40473	1301	1167	1.16	7852	434	1286	309	156	153	99	310	95
296		06:01	40470	1291	1157	1.21	7995	439	1279	307	158	149	91	301	93
297		07:00	40612	1290	1158	1.26	7909	436	1279	305	157	148	93	303	93
298		09:30	46663	1281	1163	1.69	8147	437	1271	314	162	152	91	289	92
299		10:45	46714	1283	1165	1.70	8141	425	1270	311	161	150	95	290	92
301		11:41	46815	1282	1151	1.70	9167	424	1273	349	182	167	62	272	91
303		12:29	46956	1292	1146	1.74	10131	419	1282	363	203	160	54	264	92
305		13:46	47221	1291	1133	1.73	11012	413	1283	367	222	145	42	250	92
307		14:55	47040	1290	1114	1.70	12097	408	1282	373	245	128	25	230	94
309		17:10	46649	1292	1171	1.69	8215	426	1281	311	163	148	102	298	93
311		18:10	46216	1293	1184	1.66	7327	428	1280	281	145	136	131	316	94
313		19:55	46248	1298	1208	1.66	6152	426	1284	217	120	97	198	348	92
315		21:20	45990	1293	1219	1.72	5190	417	1277	147	98	49	269	371	90
317		21:52	45613	1290	1229	1.70	4528	402	1275	126	85	41	300	391	84
320	4/10/69	00:01	46306	1324	1205	1.60	8087	432	1312	281	163	118	155	330	93
321		00:21	46470	1321	1199	1.63	8107	433	1307	281	162	119	149	325	96
323		01:40	46371	1307	1187	1.67	8114	431	1296	278	162	116	139	314	94
325		02:45	46450	1297	1179	1.65	8075	433	1285	275	161	114	133	304	93
327		03:46	46645	1276	1159	1.65	8072	432	1266	273	160	113	114	286	93













