

14p

File AS - AD-734543

AMRL-TR-71-83

DRM 602

(ACCESSION NUMBER)

29

(THRU)

23

N72-13060

(NASA-CR-124835) TOXIC HAZARDS RESEARCH

UNIT Annual Technical Report, Jun. 1970 -

May 1971 J.D. MacEwen, et al (Systemed

Corp.) Oct. 1971 29 p

CSSL 06T

Unclas
11106

102

G3/04

TOXIC HAZARDS RESEARCH UNIT ANNUAL TECHNICAL REPORT: 1971

J. D. MacEWEN

E. H. VERNOT

SYSTEMED CORPORATION

OCTOBER 1971

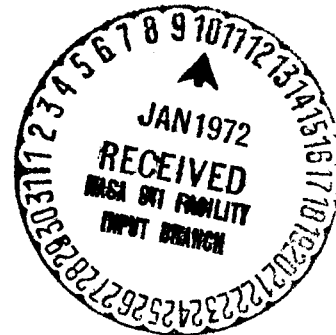

JOINT NASA/USAF STUDY

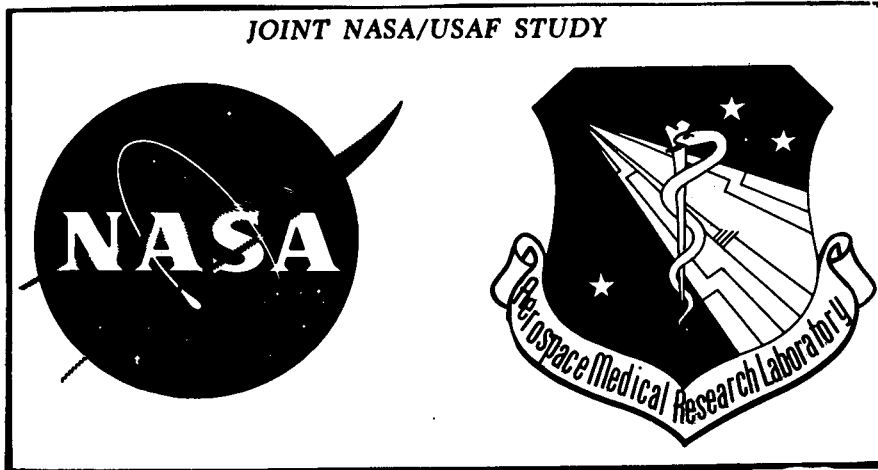

Approved for public release; distribution unlimited

AEROSPACE MEDICAL RESEARCH LABORATORY
AEROSPACE MEDICAL DIVISION
AIR FORCE SYSTEMS COMMAND
WRIGHT-PATTERSON AIR FORCE BASE, OHIO

NOTICES

When US Government drawings, specifications, or other data are used for any purpose other than a definitely related Government procurement operation, the Government thereby incurs no responsibility nor any obligation whatsoever, and the fact that the Government may have formulated, furnished, or in any way supplied the said drawings, specifications, or other data, is not to be regarded by implication or otherwise, as in any manner licensing the holder or any other person or corporation, or conveying any rights or permission to manufacture, use, or sell any patented invention that may in any way be related thereto.

The experiments reported herein were conducted according to the "Guide for Laboratory Animal Facilities and Care," 1965 prepared by the Committee on the Guide for Laboratory Animal Resources, National Academy of Sciences – National Research Council.

AIR FORCE: 10-12-71/100

DOCUMENT CONTROL DATA - R&D

(Security classification of title, body of abstract and indexing annotation must be entered when the overall report is classified)

1. ORIGINATING ACTIVITY (Corporate author) SysteMed Corporation Overlook Branch, P. O. Box 3067 Dayton, Ohio 45431		2a. REPORT SECURITY CLASSIFICATION UNCLASSIFIED	
		2b. GROUP N/A	
3. REPORT TITLE TOXIC HAZARDS RESEARCH UNIT ANNUAL TECHNICAL REPORT: 1971			
4. DESCRIPTIVE NOTES (Type of report and inclusive dates) Final Report, June 1970 - May 1971			
5. AUTHOR(S) (Last name, first name, initial) J. D. MacEwen, PhD and E. H. Vernot			
6. REPORT DATE October 1971		7a. TOTAL NO. OF PAGES 91	7b. NO. OF REFS 29
8a. CONTRACT OR GRANT NO. F33615-70-C-1046 and NASA PR T-80498		9a. ORIGINATOR'S REPORT NUMBER(S) SysteMed Report No. W-71004	
b. PROJECT NO. 6302		9b. OTHER REPORT NO(S) (Any other numbers that may be assigned this report) AMRL-TR-71-83	
c. Task No. 01			
d.			
10. AVAILABILITY/LIMITATION NOTICES Approved for public release; distribution unlimited			
11. SUPPLEMENTARY NOTES Supported in part by the National Aeronautics and Space Administration (NASA) under NASA PR T-80498		12. SPONSORING MILITARY ACTIVITY Aerospace Medical Research Laboratory Aerospace Medical Div., Air Force Sys. Command, Wright-Patterson AFB, OH 45433	
13. ABSTRACT The activities of the Toxic Hazards Research Unit (THRU) for the period of June 1970 through May 1971 are reviewed in this report. Modification of the animal exposure facilities primarily for improved human safety but also for experimental integrity and continuity are discussed. Acute toxicity experiments were conducted on hydrogen fluoride (HF), hydrogen chloride (HCl), nitrogen dioxide (NO ₂), and hydrogen cyanide (HCN) both singly and in combination with carbon dioxide (CO). Additional acute toxicity experiments were conducted on oxygen difluoride (OF ₂) and chlorine pentafluoride (ClF ₅). Subacute toxicity studies were conducted on methylisobutylketone and dichloromethane (methylene dichloride). The interim results of further chronic toxicity experiments on monomethylhydrazine (MMH) are also described. Key Words:			
Toxicology	Hydrogen Chloride	Methylisobutylketone	
Thomas Domes	Nitrogen Dioxide	Monomethylhydrazine	
Instrumentation	Hydrogen Cyanide	Oxygen Difluoride	
Medical Research	Carbon Monoxide	Chlorine Pentafluoride	
Materials Testing	Chlorine Pentafluoride		
Hydrogen Fluoride	Dichloromethane		

FOREWORD

This is the seventh annual report of the Toxic Hazards Research Unit (THRU) and concerns work performed by SysteMed Corporation on behalf of the Air Force under Contract No. F33615-70-C-1046. This constitutes the second report under the current contract and describes the accomplishments of the THRU from June 1970 through May 1971.

The contract for operation of the laboratory was initiated in 1963 under Project 6302 "Toxic Hazards of Propellants and Materials," Task 01 "Toxicology" Work Unit No. 630201008 and continued under No. 630201010. K. C. Back, PhD, Chief of the Toxicology Branch, was the technical contract monitor for the Aerospace Medical Research Laboratory.

J. D. MacEwen, PhD, of SysteMed Corporation, served as principal investigator and Laboratory Director for the THRU. Acknowledgement is made to C. E. Johnson, C. C. Haun, G. L. Fogle and J. H. Archibald for their significant contributions and assistance in the preparation of this report. The National Aeronautics and Space Administration provided support for Apollo Materials Screening Program.

This report is designated as SysteMed Corporation Report No. W-71004.

This technical report has been reviewed and is approved.

CLINTON L. HOLT, Colonel, USAF, MC
Commander
Aerospace Medical Research Laboratory

TABLE OF CONTENTS

<u>Section</u>		<u>Page</u>
I.	INTRODUCTION	1
II.	FACILITIES	3
	ANALYTICAL CHEMISTRY PROGRAMS	3
	Analysis of Chlorine Pentafluoride	3
	Specific Ion Electrode Methodology	5
	Methylene Chloride Analysis	8
	Hemoglobin Reaction with Monomethylhydrazine	12
	Oxidizer Disposal System	14
	ENGINEERING PROGRAMS	14
	Airlock Oxygen Analyzer	16
	Relocation of Standby Instrument Air Compressor	17
	Ambient Laboratory Air Conditioning System	17
	Ambient Laboratory Lighting Redesign	23
	Gas Analyzer Calibration System	23
	Dome Facility A Electrical Modifications	27
	Auxiliary Automatic Animal Weighing System	27
	Ambient Chamber Preheater Controllers	32
	Dome Hoist Safety Switches	32
	Mouse Activity Measurement Equipment	32
	Storage Facilities	35

TABLE OF CONTENTS (CONT'D)

<u>Section</u>	<u>Page</u>
COMPUTER PROGRAM SERVICES	35
TRAINING PROGRAMS	39
Laboratory Operations Training	39
Animal Care Training	41
III. RESEARCH PROGRAM	43
The Acute Toxicity of Brief Exposures to HF, HCl, NO ₂ and HCN Singly and in Combination with CO	43
Acute Toxicity of Chlorine Pentafluoride	64
Oxygen Difluoride Toxicity	66
90-Day Continuous Exposure to MIBK	69
Methylene Chloride, 90-Day Chronic Toxicity Study	69
Monomethylhydrazine Chronic Toxicity	75
REFERENCES	89

LIST OF FIGURES

<u>Figure</u>		<u>Page</u>
1	Chlorine Pentafluoride Calibration Curve	6
2	Specific Ion Electrode Analytical System	9
3	Electrode Flow Cell	10
4	Comparison of In-Vitro MMH Induced Methemoglobin Production in Blood of Various Species	13
5	Oxidizer Disposal Reactor	15
6	Airlock Oxygen Analyzer	18
7	Airlock Oxygen Analyzer Selector Switch	19
8	Plan View of Instrument Air Compressor Stations	20
9	New Layout of Instrument Air Compressors	21
10	Ambient Laboratory Air Supply System	22
11	Plan View of Revised Ambient Laboratory Lighting System	24
12	Gas Analyzer Calibration Control Panel	25
13	Schematic View of Gas Analyzer Calibration System	26
14	Revised Altitude Facility A Emergency Power System	28
15	Revised Altitude Facility A Power Transformer and Distribution System	29
16	Schematic View of Revised Automatic Animal Weighing System	30
17	Automatic Animal Weighing System Console	31
18	Auxiliary Animal Weighing Station	33
19	Crane Overload Safety Switch	34

LIST OF FIGURES (CONT'D)

<u>Figure</u>		<u>Page</u>
20	Mouse Activity Measurement System	36
21	Animal Cage Storage Facility	37
22	Gas Cylinder Storage Facility	38
23	Carboxyhemoglobin Formation in Rodents Exposed to CO for 5 Minutes	45
24	Five Minute LC ₅₀ for Rats Exposed to HF Singly and in Combination with CO	49
25	Five Minute LC ₅₀ for Mice Exposed to HF Singly and in Combination with CO	50
26	Five Minute LC ₅₀ for Rats Exposed to HCl Singly and in Combination with CO	53
27	Five Minute LC ₅₀ for Mice Exposed to HCl Singly and in Combination with CO	54
28	Five Minute LC ₅₀ for Rats Exposed to NO ₂ Singly and in Combination with CO	57
29	Five Minute LC ₅₀ for Mice Exposed to NO ₂ Singly and in Combination with CO	58
30	Five Minute LC ₅₀ for Rats Exposed to HCN Singly and in Combination with CO	62
31	Five Minute LC ₅₀ for Mice Exposed to HCN Singly and in Combination with CO	63
32	Effect of Chronic Monomethylhydrazine Exposure on Rat Growth	77
33	Effect of Chronic Monomethylhydrazine Exposure on Dog Hematocrit Values	79

LIST OF FIGURES (CONT'D)

<u>Figure</u>		<u>Page</u>
34	Effect of Chronic Monomethylhydrazine Exposure on Dog Hemoglobin Levels	80
35	Effect of Chronic Monomethylhydrazine Exposure on Dog Red Blood Cell Counts	81
36	Effect of Chronic Monomethylhydrazine Exposure on Red Blood Cell Fragility in Dogs	84
37	Effect of Chronic Monomethylhydrazine Exposure on Serum Bilirubin Levels in Dogs	85
38	Effect of Chronic Monomethylhydrazine Exposure on Serum Alkaline Phosphatase Levels in Dogs	86
39	Effect of Chronic Monomethylhydrazine Exposure on Serum Phosphorus Levels in Dogs	87

LIST OF TABLES

<u>Table</u>		<u>Page</u>
I	Comparison of Chlorine Pentafluoride Standard Bag Samples with Analyzer Recovery	7
II	7-Day Mortality Response of Rats Exposed 5 Minutes to HF Gas Singly and in Combination with CO (25% Carboxyhemoglobin)	47
III	7-Day Mortality Response of Mice Exposed 5 Minutes to HF Gas Singly and in Combination with CO (25% Carboxyhemoglobin)	48
IV	7-Day Mortality Response of Rats Exposed 5 Minutes to HCl Vapors Singly and in Combination with CO (25% Carboxyhemoglobin)	51
V	7-Day Mortality Response of Mice Exposed 5 Minutes to HCl Vapors Singly and in Combination with CO (25% Carboxyhemoglobin)	52
VI	7-Day Mortality Response of Rats Exposed 5 Minutes to NO ₂ Singly and in Combination with CO (25% Carboxyhemoglobin)	55
VII	7-Day Mortality Response of Mice Exposed 5 Minutes to NO ₂ Singly and in Combination with CO (25% Carboxyhemoglobin)	56
VIII	7-Day Mortality Response of Rats Exposed 5 Minutes to HCN Singly and in Combination with CO (25% Carboxyhemoglobin)	60
IX	7-Day Mortality Response of Mice Exposed 5 Minutes to HCN Singly and in Combination with CO (25% Carboxyhemoglobin)	61
X	LC ₅₀ Values and 95% Confidence Limits for Rodents and Monkeys Exposed to ClF ₅	65
XI	Mortality Response of Monkeys and Dogs to Inhaled OF ₂ After a 15-Minute Single Exposure	66

LIST OF TABLES (CONT'D)

<u>Table</u>		<u>Page</u>
XII	Mortality Response of Rodents to inhaled OF ₂ After Single 15-Minute Exposures	67
XIII	LC ₅₀ Values and 95% Confidence Limits for Four Animal Species Exposed to OF ₂ for 15 Minutes	68
XIV	Methylene Chloride Blood Levels in Dogs Exposed Continuously for 16 Days	72
XV	Results of BSP Liver Function Tests on Monkeys Continuously Exposed to Methylene Chloride for 30 Days	74

SECTION I

INTRODUCTION

The Toxic Hazards Research Unit (THRU) is an interdisciplinary team of research scientists formed to conduct toxicologic investigations on potentially hazardous chemicals and materials of interest to the Air Force. This inhalation toxicology group utilizes the skills of analytical chemistry, engineering, medical technology, pathology and biological sciences to perform investigations designed to characterize the acute or chronic effects of materials to which military or civilian personnel may be exposed.

The research operations of the THRU, conducted by SysteMed Corporation personnel, are supported by the Veterinary Medicine Division and The Toxic Hazards Division of the Aerospace Medical Research Laboratory. These support services include veterinary medical care, procurement of laboratory animals, and both clinical and anatomical pathology examinations of animal tissues.

During the first six years of operations of the THRU, considerable effort was expended in the conduct of research to provide information on the health hazards of the confined atmospheres of spacecraft. In the past year the research programs of the THRU were reoriented to meet the changing needs of the Air Force and primary emphasis was placed on the toxicological problems of aircraft and environmental pollutants. A significant research effort was, however, conducted for the National Aeronautics and Space Administration to define the toxicological hazards of space flight and to establish safe environmental standards for such flights. Research into toxicologic problems of manned space flight is concerned with defining the risk of breathing air contaminants resulting from outgassing of agents incorporated in cabin construction materials and from chemicals used for propulsion and life support systems. This research is conducted on several species of laboratory animals under conditions which simulate space flight as closely as possible, with the exception of radiation and weightlessness.

The continuing research programs of the THRU are conducted in the animal exposure facilities and supporting laboratories. These facilities consist of three types of animal exposure chambers, each performing a separate function. Preconditioning chambers are used to prepare and stabilize animals in a controlled environment. Rochester and Longley Chambers are used for exposing animals to atmospheric contaminants under ambient conditions of pressure and air composition. Two groups of four specially designed altitude chambers (designated hereafter as Thomas Domes) are utilized for exposing

animals to atmospheric compositions of 100% oxygen or varying mixtures of oxygen and nitrogen at pressures ranging from ambient to as low as 5 psia (1/3 atmosphere). The Thomas Domes are equally useful for the conduct of chronic toxicity studies at ambient conditions for the simulation of long duration continuous exposures to low concentrations of air pollutant materials. More detailed discussion on the design and operation of the THRU facility is published in references 1 through 7.

During each contract year a technical conference is presented by Systemed Corporation to disseminate new toxicological information to Air Force and industrial professional personnel. These conferences have open forum discussions after each technical session to provide an interchange of ideas and problem solutions concerning the use of military chemicals and their environmental control. This year's conference was held September 10-12, 1970 in Fairborn, Ohio where 23 technical papers were presented. The utilization of THRU personnel for audio-visual services greatly improved these presentations over past years when commercial services were engaged.

SECTION II

FACILITIES

The support activities of the THRU essential to the operation of a research laboratory are usually not of sufficient magnitude to merit separate technical reports. Therefore these activities are grouped together under the general heading "Facilities" to describe their contributions to the overall mission of the laboratory. Included herein are special projects in analytical chemistry, training programs, computer program services and engineering modifications to the physical research facilities.

ANALYTICAL CHEMISTRY PROGRAMS

The chemistry department of the THRU performs the routine tasks of monitoring animal exposure chamber concentrations and special analysis on biological samples for non-routine clinical chemistry such as contaminant blood levels. Continuous monitoring methods of analysis are frequently not available for the Air Force materials subjected to toxicity investigations. Therefore, considerable effort is expended in the development and modification of analytical methods. These projects are the subject of this portion of the annual report.

Analysis of Chlorine Pentafluoride

Chlorine pentafluoride (ClF_5) is a relatively new compound and the literature pertaining to its chemical properties is limited. We assumed that it would have properties similar to chlorine trifluoride (ClF_3) and that it would be easier and safer to handle as a 1% dilution in nitrogen. A dilution system, completed in 1969 for work with oxygen difluoride (OF_2), was available for making the desired dilutions. Concurrently, there was a requirement for both qualitative and quantitative methods for analyzing ClF_5 .

These requirements had been successfully attained for OF_2 . With OF_2 , two separate pieces of apparatus were used. The dilution apparatus utilized a large cylinder of OF_2 and the analytical system used a small cylinder in a laboratory hood. Only large cylinders of ClF_5 were available and, therefore, it was necessary to modify the dilution apparatus to permit withdrawing pure samples for analysis. The analytical system for OF_2 consisted of Teflon[®] tubing and an HF trap for use with a continuous flow Teflon[®] infrared cell. Since information gleaned from the literature indicated that ClF_5 was erratically absorbed and released by Teflon[®], the tubing was replaced with stainless steel and a monel infrared cell was used.

Before any of the equipment could be used for ClF_6 processing, a passivating procedure was necessary. This consisted of preflushing all gas lines with ClF_6 . During preliminary flushing, a reaction took place which formed an oily paste of unknown composition within the HF trap containing sodium fluoride. Further work indicated that it was not possible to clean and dry the lines and the trap sufficiently well to prevent this reaction. The traps were therefore removed from the system.

The first two attempts to prepare a cylinder of 1-2% ClF_6 in nitrogen resulted in combustion of the cylinder valves which had been used for diluting OF_2 without incident. The seats and packing in these valves were replaced with Kel-F units obtained from the valve manufacturer. The Kel-F valve seats proved to be compatible with ClF_6 .

The analytical system added to the modified dilution system has also functioned properly without an HF trap. A direct line to the flow-through infrared cell has been used to obtain samples for recording of spectra. The spectra obtained by this method compare well with those published for ClF_6 by Gatti et al. (reference 8). The exact similarity of wavelength of the absorption curves gave assurance that the diluted ClF_6 had not decomposed or reacted with the dilution system. The spectra of air samples of ClF_6 prepared in compressed air at various water vapor concentrations were then examined to determine the effect of relative humidity. These spectra showed no decomposition of ClF_6 , a problem which made animal exposure to ClF_6 very difficult.

An infrared calibration curve for a concentration range 0.0 to 1.5% ClF_6 in air was constructed from static samples injected into the infrared cell from a syringe. This calibration curve was used for the semiquantitative analysis of ClF_6 content of the cylinders of dilute gas.

During the period while the technique for the dilution of ClF_6 was being developed, two methods of analysis were simultaneously developed for monitoring exposure chamber gas concentrations. These methods utilized a fluoride specific ion electrode and the Mine Safety Appliance (MSA) Billionaire. Both techniques proved capable of precise measurement of the desired concentration, but the fluoride electrode method was the more convenient of the two.

The electrode method required that a measured amount of the ClF_6 be converted to a water solution of F^- ion. The reaction of ClF_6 with water has been described by Pilipovich et al. (reference 9) and Dost and Wang (reference 10) as follows:



Dost et al. (reference 11) had shown that bicarbonate aided in reduction of ClF_6 in aqueous solutions. After a series of experiments, the following buffer solution was selected:

20 g sodium chloride

20 g sodium acetate trihydrate

0.6 g dibasic sodium citrate

3.5 g sodium bicarbonate

the above dissolved in 2 liters of water.

The recovery of ClF_6 by the system was determined using gas bag standards containing 100, 300, 400 and 500 ppm of ClF_6 in air and comparing with NaF standard solutions of comparable concentration range. A typical calibration curve (figure 1) illustrates the nonlinear recovery. The measured fluoride ion recovery is shown in table I which illustrates the variability of individual analyses.

The rate of loss decreases with increased ClF_6 concentration. One might expect the opposite result. If the loss of fluoride ion is due to reaction with silica to form silicon tetrafluoride, an increased rate of loss would be expected with increased ClF_6 . Even though the reason for low recoveries has not been discovered, experience has shown that the loss of fluoride is reproducible at each level.

Specific Ion Electrode Methodology

In the experiments performed for the FAA on HCl, HF and HCN as well as the work done with the fluorine containing oxidizers, the potential of specific ion electrodes as a means of analysis became quite apparent. These electrodes are specific in the sense that their sensitivity to a particular ion is orders of magnitude higher than to possibly interfering ions. Their operation depends on the ability of the measured ions to diffuse through the electrode face and to establish a potential when they come into contact with an internal reference electrode or standard solution. This potential in millivolts is a function of the concentration of the ion of interest. Standard curves are constructed through use of known concentrations of the ions.

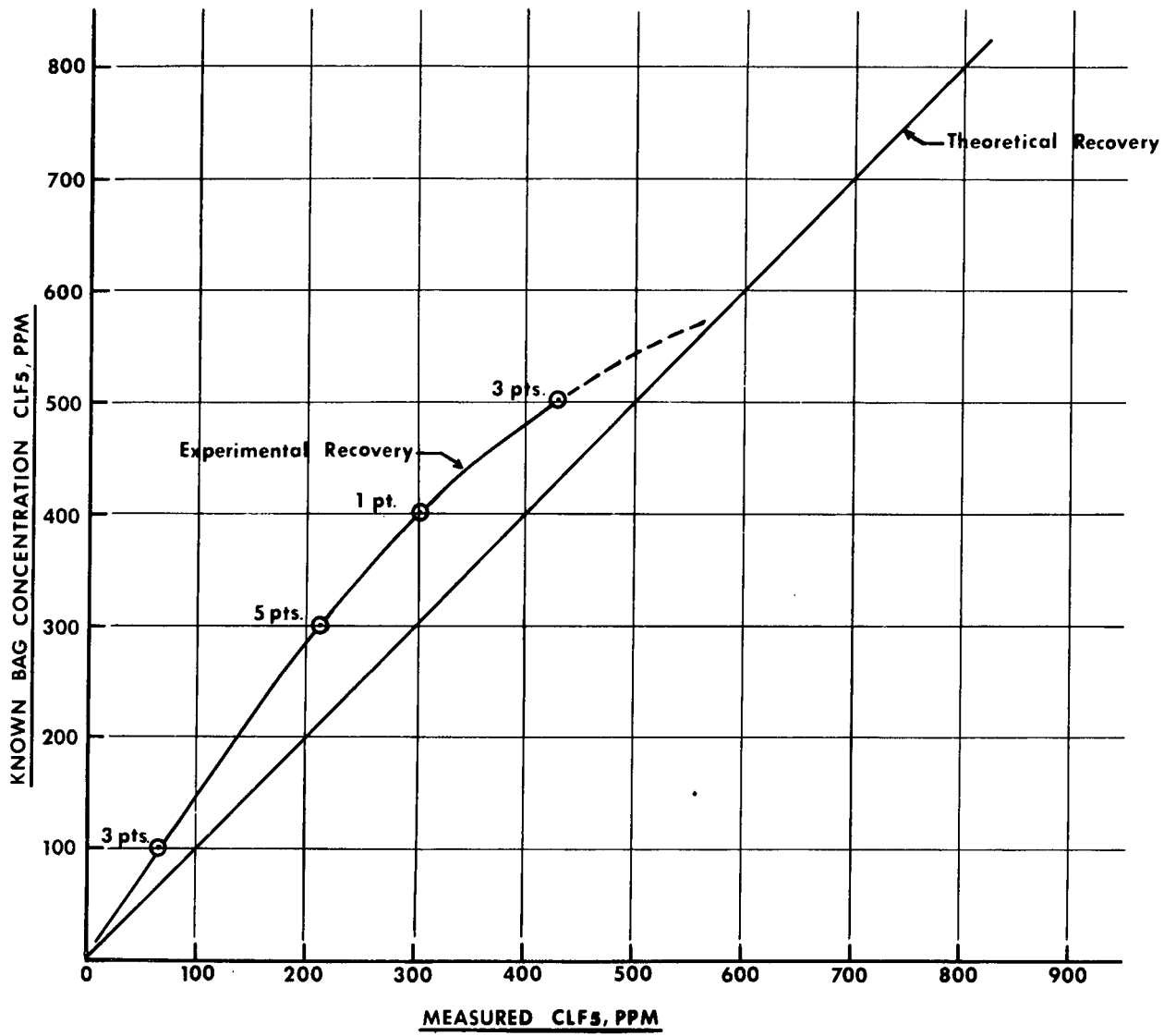

Figure 1
Chlorine Pentafluoride Calibration Curve

TABLE I

Comparison of Chlorine Pentafluoride Standard Bag
Samples with Analyzed Recovery

Gas Bag Sample No.	Nominal Sample ClF ₅ Concentration (ppm)	Measured F ⁻ ion (Moles)	Measured ClF ₅ (ppm)
1	100	6.45 x 10 ⁻³	64
2	100	6.40 x 10 ⁻³	63
3	100	6.60 x 10 ⁻³	65
4	300	2.45 x 10 ⁻²	233
5	300	1.93 x 10 ⁻²	190
6	300	2.20 x 10 ⁻²	217
7	300	2.05 x 10 ⁻²	202
8	300	2.18 x 10 ⁻²	215
9	400	3.20 x 10 ⁻²	304
10	500	4.20 x 10 ⁻²	414
11	500	4.40 x 10 ⁻²	433
12	500	4.70 x 10 ⁻²	447

In the analysis of HF, HCN and HCl vapor exposures using the specific ion electrodes, the problem of interfering ions was minor, since the contaminant introduced was the only significant ionizable species in the atmosphere. Therefore, the method development in each case concerned itself with establishing conditions for continuous extraction of the acid from the vapor state into a buffered aqueous stream at the optimum concentration, and measurement of the flowing stream concentration in a manner which yielded the concentration of the solution at the time it had completely extracted the acid from the vapor.

Figure 2 illustrates the system which satisfactorily accomplished the first objective. A peristaltic pump was used to draw solution at a desired rate through the scrubber coil, through which vapor from the exposure chamber was also being drawn. A portion of the effluent was then delivered to the electrodes. The second objective was accomplished by design of the cell in which the measurement electrodes were housed. In order to prevent mixing of portions of the solutions representing different exposure times, the volume of the solution flowing through the cell had to be kept to a minimum. This was achieved by making the bottom of the flow cell flat so that a thin stream of solution flowed past the faces of the electrodes and by inserting the electrodes into the flow cell through O-rings (figure 3) which sealed the cell and prevented evaporation of the solution. In this way, one could be certain that the instrument readout corresponded to an instantaneous chamber concentration.

Fluoride, cyanide and chloride electrodes were found to give accurate and reproducible results for HF, HCN and HCl chamber concentrations when this methodology was utilized.

Methylene Chloride Analysis

A method of analysis for methylene chloride (CH_2Cl_2) was investigated using a commercial hydrocarbon analyzer. The experiments were to be conducted in the Thomas Domes at concentrations of 5000 and 1000 ppm. Previously performed analyses of the control Thomas Dome atmosphere under maximum animal load indicated that the maximum organic vapor concentration to be expected was 2 ppm. Since this concentration would be insignificant compared to the planned CH_2Cl_2 concentration as far as detection by a flame ionization detector (used in this hydrocarbon analyzer) was concerned, it was decided that this method would be satisfactory for the control of the CH_2Cl_2 concentrations.

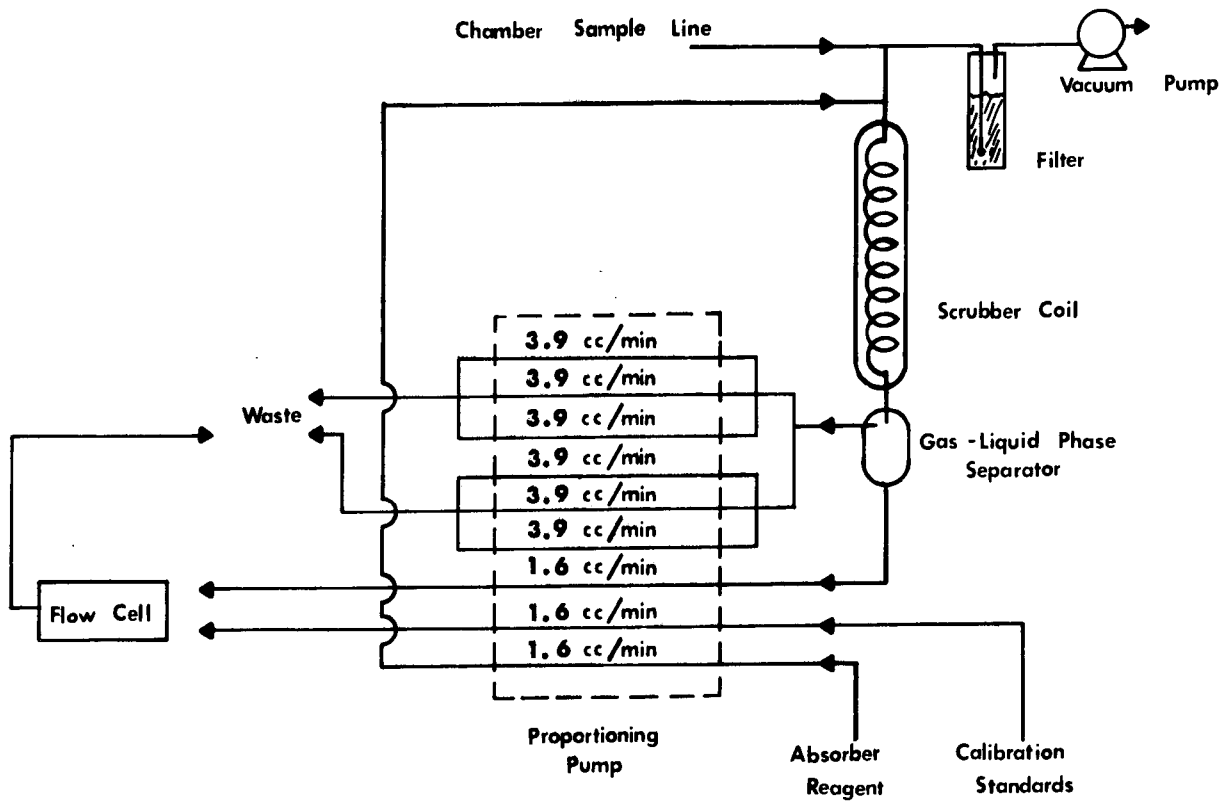

Figure 2

Specific Ion Electrode Analytical System

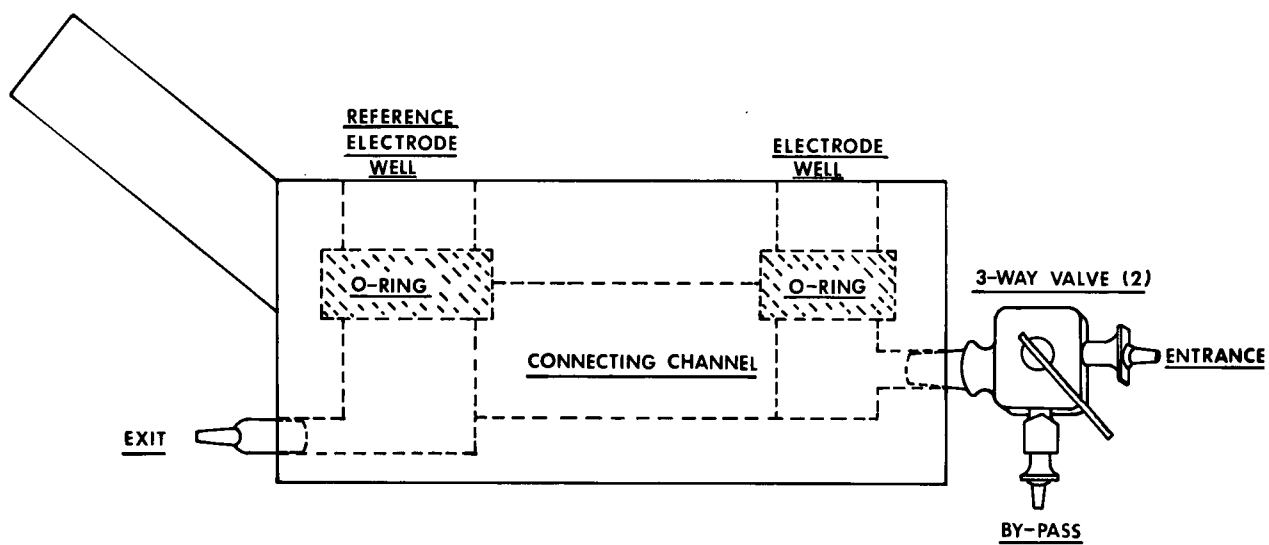

Figure 3
Electrode Flow Cell

Accordingly, standard CH_2Cl_2 bag samples were used to construct calibration curves which demonstrated linearity of analyzer response between zero and 5000 ppm concentration. A timer controlled solenoid valve system was constructed to switch the dome being sampled every 5 minutes. The 95% confidence limits of the determination were ± 55 ppm, about 6% relative at the 1000 ppm level. This procedure operated throughout the 5000 and 1000 ppm exposures with no difficulty of any sort.

Knowledge of the equilibrium concentration of CH_2Cl_2 in blood during continuous exposure to this agent would be useful to the toxicologist in estimating transfer of the material into the body of an experimental animal. If future work is done on rate of absorption of CH_2Cl_2 during exposure and rate of loss after exposure, knowledge of the equilibrium values would allow rates to be calculated relative to the end point expected.

The method selected for the determination of CH_2Cl_2 in blood involves heating 5 ml of heparinized blood at 60 C for 15 minutes in a 15 ml stoppered test tube. After this time, 1 ml of the headspace gas is drawn off and injected into a gas chromatograph. The gas chromatographic conditions which separate the CH_2Cl_2 peak from interferences are:

Column - 4' x 1/8" Porapak Q

Temperature - 70 C

Carrier Gas - Helium at 15 psi

Detector - Flame Ionization

Investigation revealed a number of points in the procedure where error might be introduced unless close control over the procedure is maintained.

1. The blood must be injected into the headspace equilibration tube as soon as it is sampled since CH_2Cl_2 vaporizes from blood quickly even at room temperature.
2. The tube stoppers can gas off unknown materials which interfere with the procedure. They also adsorb CH_2Cl_2 during the equilibration and release it when reused for another sample. Use of only new stoppers and boiling before use prevents both of these from occurring.
3. Adsorption on the standard rubber stopper slowly lowers the concentration of the headspace CH_2Cl_2 . This problem is minimized by close control of off-gassing time.

4. Standard curves show a straight line through the origin, but the slope varies from day to day and from animal to animal. To determine the concentration with accuracy, it is necessary to standardize each blood sample with known additions of CH_2Cl_2 in the following manner. The heparized blood sample from each dog is split into 2 equal portions. One portion is analyzed after the addition of a known volume of pure distilled water and the other after addition of an identical volume of distilled water containing 250 mg/liter CH_2Cl_2 . Simple proportion then yields the initial concentration of CH_2Cl_2 in blood.

Perfomed in this manner, the method can measure as little as $1 \mu\text{g/ml}$ CH_2Cl_2 in blood.

Hemoglobin Reaction with Monomethylhydrazine

Experiments reported in the last annual report had demonstrated the following characteristics of the hemoglobin-MMH reaction:

1. Oxygen is necessary for the production of methemoglobin by MMH. In the absence of available oxygen, the MMH (or some unidentified intermediate compound) is stable for at least two hours. If oxygen is admitted to the system after this time, methemoglobin formation occurs as before.
2. Rate of methemoglobin formation is directly proportional to MMH concentration.
3. One mole of MMH appears capable of oxidizing 2 moles of heme and, when this ratio of dog blood hemoglobin and MMH is mixed, 75-80% of the total hemoglobin is converted to methemoglobin.

Further work was conducted in this reporting period, primarily in an effort to determine the differences, if any, among blood samples from various species in their reaction with MMH. When human, rat and monkey blood were mixed with MMH in the ratio 1 mole MMH/2 moles heme, much lower equilibrium conversions of hemoglobin to methemoglobin were obtained. The following equilibrium conversions to methemoglobin were measured under these conditions: Human blood - 30%, rat blood - 20%, monkey blood - 18%.

Figure 4 illustrates this through use of bar graphs. In the figure, gram % methemoglobin after equilibration is plotted for each species.

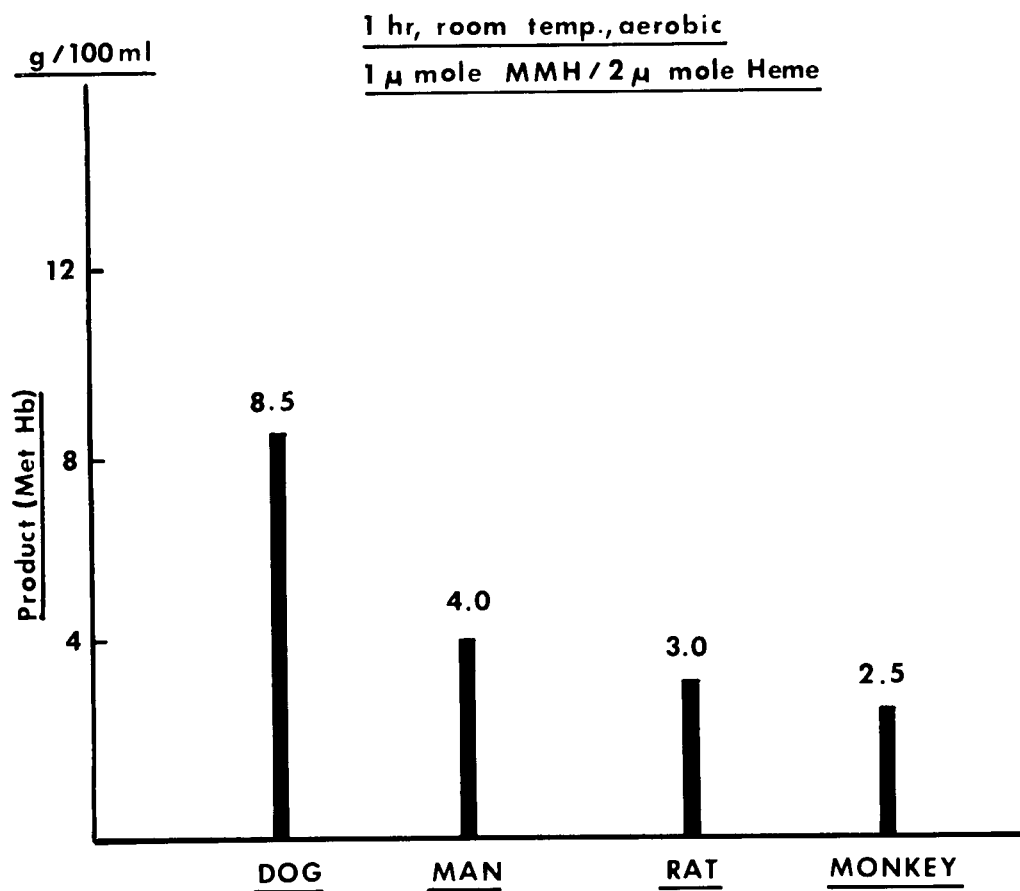

Figure 4

Comparison of In-Vitro MMH Induced Methemoglobin
Production in Blood of Various Species

The headspace gas over the reaction mixture, in sealed tubes, was sampled for gas chromatographic analysis. Molecular nitrogen and methane appeared as oxygen was consumed. After complete reaction, 80% of the nitrogen in MMH had been converted to molecular nitrogen and 20% of the carbon had been converted to methane. These conversion ratios are remarkably similar to those obtained by Vernot et al. (reference 12) during the air oxidation of MMH vapor, although the reason for this similarity has not yet been determined.

Oxidizer Disposal System

One of the requirements associated with the use of very reactive hazardous materials is the occasional necessity for disposal of excess material or leaking containers. This is of particular importance in the case of the fluorinated oxidizers when their toxicity is being estimated by the THRU. In many cases, significant amounts of these materials remain after all animal exposures have been completed. They must be disposed of without the hazard of explosion or of releasing concentrated toxic reaction products to the air.

A reactor was designed to accomplish these objectives through combination of the oxidizers with charcoal to form mostly non-toxic CF_4 . Figure 5 illustrates this reactor which utilizes commercial 30 gallon solvent drums. The oxidizer is vaporized into the bottom of the drum, diluted with air drawn into the system by the draft of the reactor. The air-oxidizer mixture flows through the charcoal bed where complete destruction of the oxidizer takes place. A 10-foot stack releases the effluent reaction products high enough to be dispersed by normal atmospheric processes. The grate is replaceable since it is severely corroded by the oxidizer during normal use.

This unit has been utilized a number of times to dispose of excess oxidizers such as ClF_3 . The Wright-Patterson Base Explosive Safety Unit has approved the method and reserved an area for its use. Before disposal operations are conducted, all necessary safety and police personnel are notified.

ENGINEERING PROGRAMS

The preventive maintenance program initiated in the previous report period was expanded during the past year to provide surveillance over mechanical equipment which was not under THRU jurisdiction but was critical to the operation of equipment for which the THRU was responsible. A review of the results of the preventive maintenance program showed a considerable reduction in the amount of corrective repair and down time for major laboratory equipment except for those systems which depended on base maintained

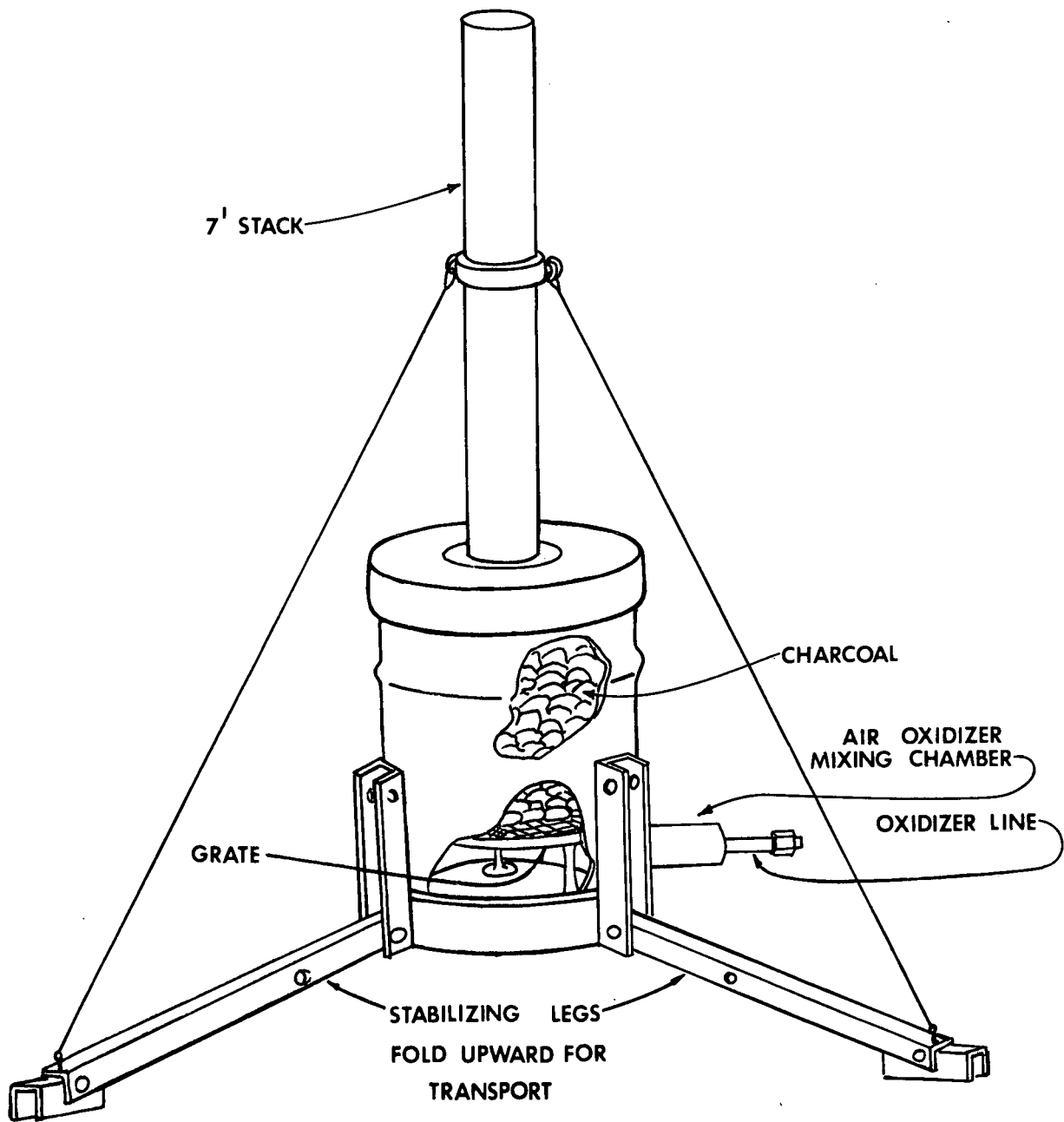

Figure 5
Oxidizer Disposal Reactor

equipment for reliable operation. The problems encountered included periodic inability to control temperature and relative humidity in the animal exposure chambers, breakdown of high volume vacuum pumps and instrument air compressor failure.

The breakdown of the 6 vacuum pumps resulted from the failure of the building water softening system which did not give satisfactory performance for the last 6 months of the report period. To prevent further damage to the vacuum pumps, small water softening units were installed in each pump room as back up unit for the building system. These back up systems have protected the pumps from additional damage.

Continual problems were encountered with the primary instrument air supply. The warranty had expired on this equipment and it was functioning in an unsatisfactory manner. An examination of the compressor revealed corroded cooling lines, broken feather valves, reversed installation of the packing plate, and oil leaks into the cylinder head. The compressor was repaired and incorporated into the THRU preventive maintenance program. No further problems have been encountered with the system.

Seven years operation of the animal exposure facilities had resulted in general deterioration of the animal water supply system in the original set of Thomas Domes. A complete replacement of the system was accomplished at which time the components were upgraded to duplicate those in the newer domes. Both sets of domes were supplied with different types of pressure regulators for the mouse and rat water services. The regulators used previously did not work well in dead end service and had to be reset after pressure excursions. The regulators selected were more sensitive and were designed for use in low pressure air systems. Aluminum surfaces exposed to water were anodized or Teflon[®] coated for free operation. A chamber pressure feed back system was utilized to maintain the line pressure of water at 2 psig above the absolute pressure within the chamber.

Primary emphasis on other projects completed during the report period was in modifications of systems to provide increased safety and reliability for dome operations and to extend functional systems into additional areas of the laboratory facility.

Airlock Oxygen Analyzer

The new Thomas Domes were not equipped with airlock oxygen analyzers during their construction. This made it necessary for a dome entrant to use a portable oxygen analyzer each time a dome entry was made under altitude conditions. To provide a safer and more reliable method of monitoring airlock oxygen content during the flushing operation a paramagnetic oxygen analyzer

system was incorporated into the system. The control and analyzer console shown in figure 6 was located adjacent to the dome Master Control Panel. Each airlock is connected to the analyzer through solenoid valves controlled by a selector switch mounted on top the Master Control Panel. The actual oxygen concentration in each airlock can be read from a meter on the selector switch panel as shown in figure 7. This installation was much more convenient for use than the system in the Facility A because all operating controls were located on one floor in one area; therefore, the Facility A airlock oxygen analyzer system was modified to this configuration.

Relocation of Standby Instrument Air Compressor

The majority of the THRU animal exposure chamber operating controls and environmental monitoring instruments are pneumatically operated. The instrument air is supplied by two air compressors, one of which serves as a standby unit in case of failure of the primary system. The primary air compressor is located in the new mechanical equipment room, built as part of the Military Construction Program described in the preceding THRU Annual Report (reference 6). The backup compressor was located in another area of Building 79 as shown in plan view in figure 8. When the primary compressor failed, an alarm sounded and it was necessary for the chamber technician on duty to go to one room to turn off an electrical switch and close a valve then hasten to another room, open a second valve and finally go to a third location and start up the standby compressor. This procedure required considerable time and occasionally resulted in related system failures.

The standby air compressor was relocated to a position adjacent to the primary unit so that the air receiver and the heat exchanger could be used in common. The relocation of the standby unit resulted in a simplified change-over procedure which eliminated all steps except turning 2 electrical switches located within 2 feet of each other. The present layout is shown in figure 9. Manual isolation valves are installed in the piping system if repairs of either unit are required.

Ambient Laboratory Air Conditioning System

The air supply system for the ambient laboratory was originally installed in a small equipment room located next to the laboratory area. Due to space restrictions, the conditioning system, consisting of filters, chiller and heater coils, were fitted into a section of ducting that formed a series of 90 degree bends to fill a corner of ceiling space. This configuration resulted in a system that was completely inaccessible for maintenance without complete teardown. The system finally became inoperative and the package air treatment unit selected for replacement was floor mounted for easy service. The new unit shown in figure 10, is located in the space vacated by the relocation of the standby instrument air compressor.

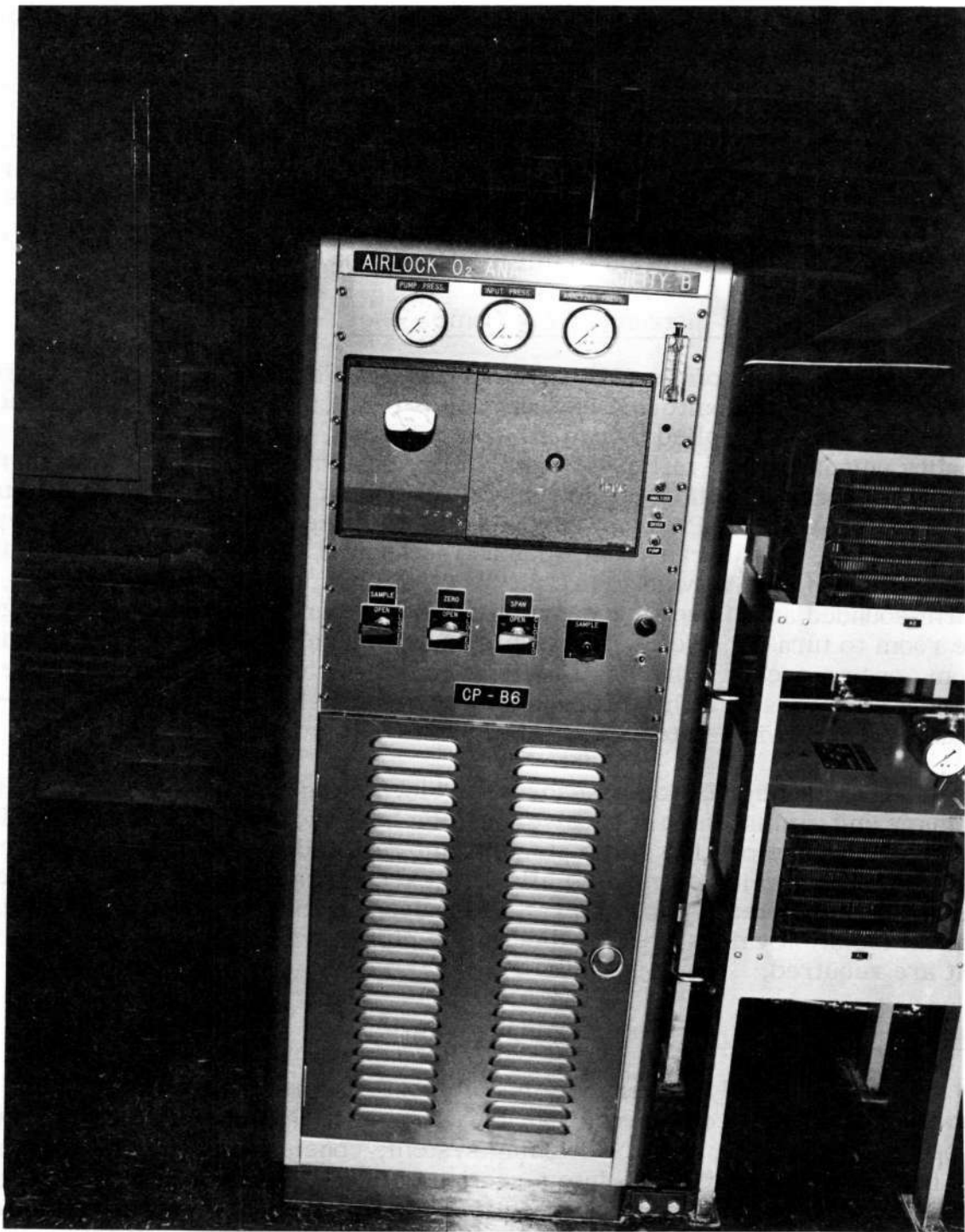

Figure 6

Airlock Oxygen Analyzer



Figure 7

Airlock Oxygen Analyzer Selector Switch

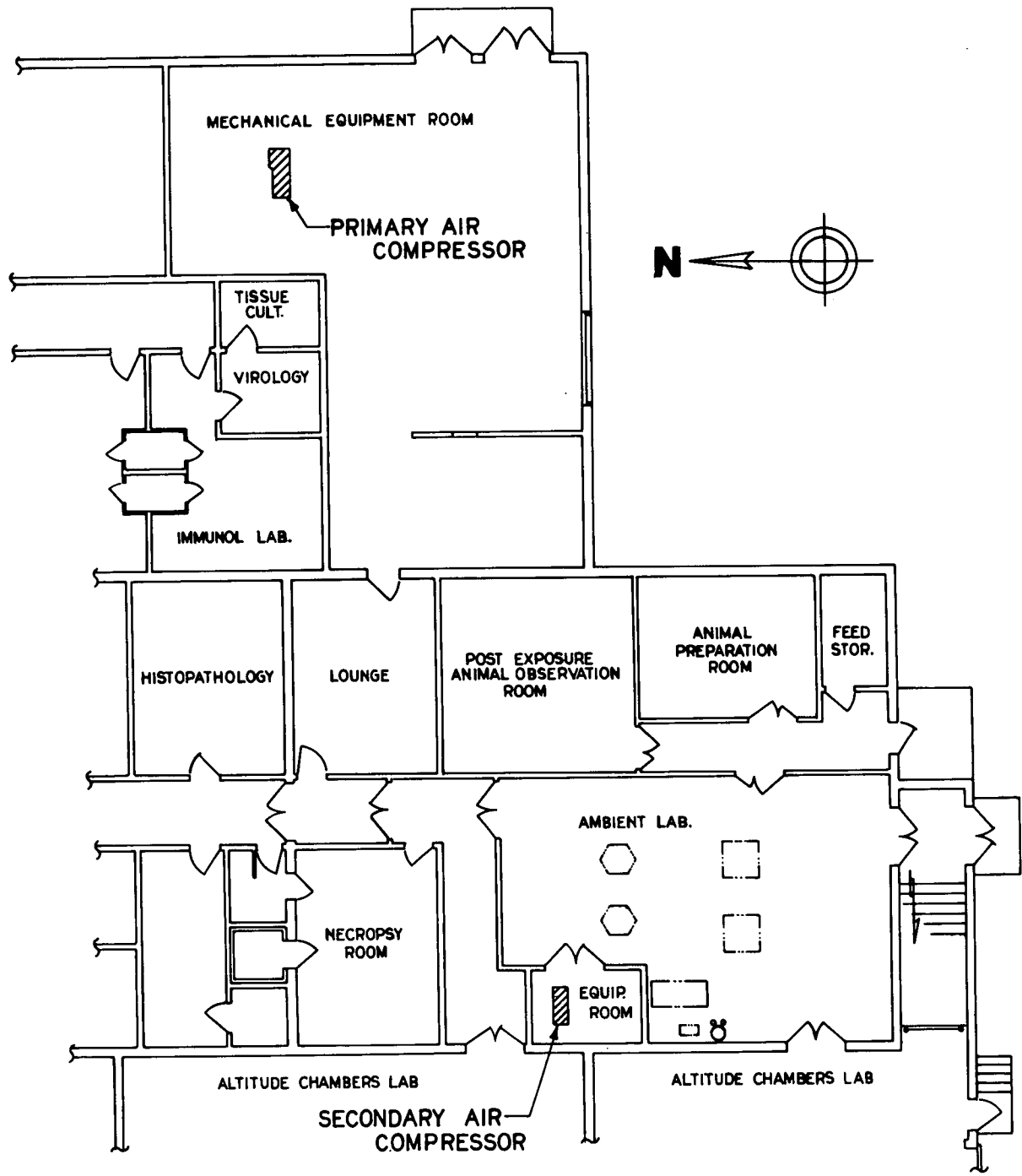

Figure 8

Plan View of Instrument Air Compressor Stations

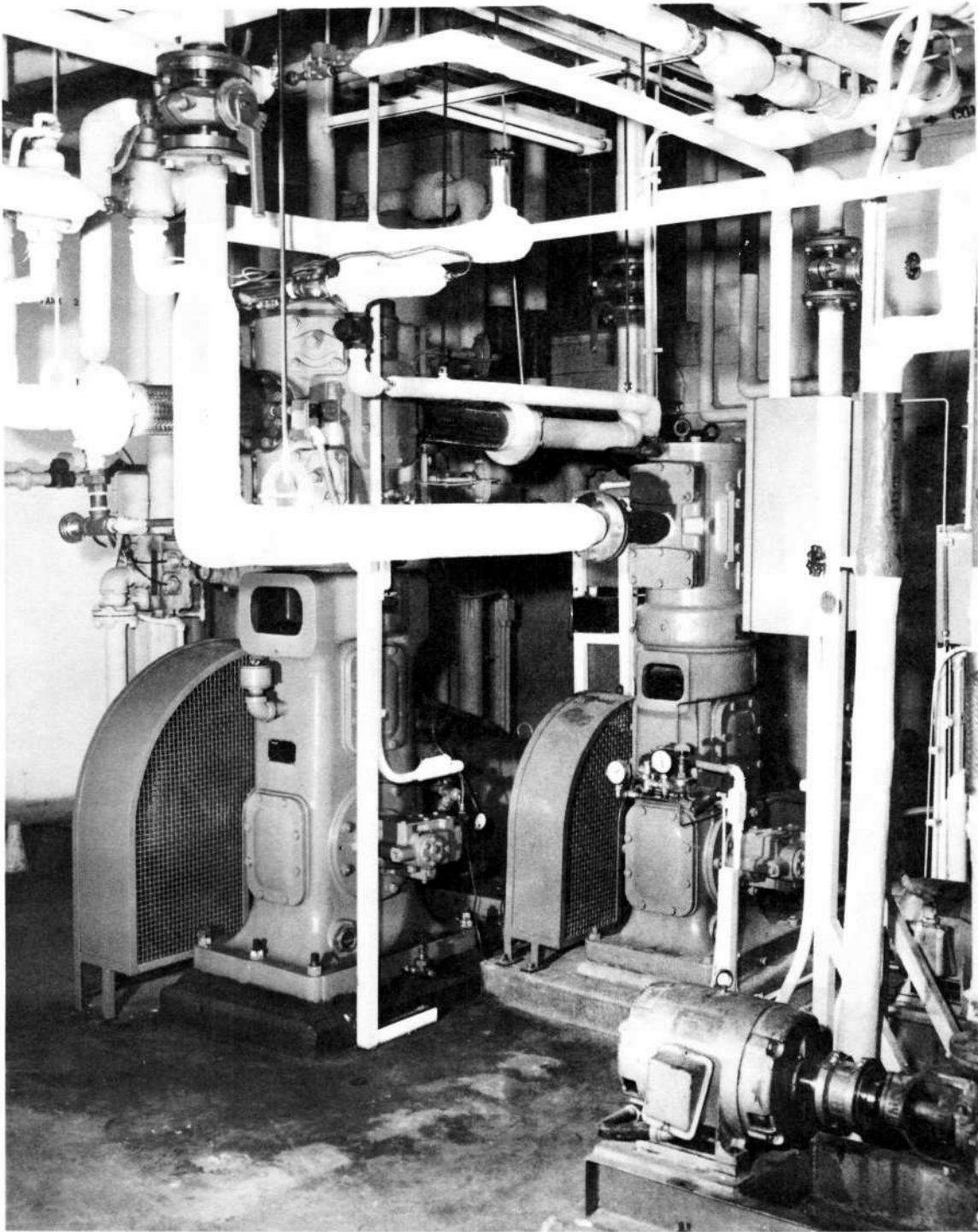

Figure 9

New Layout of Instrument Air Compressors

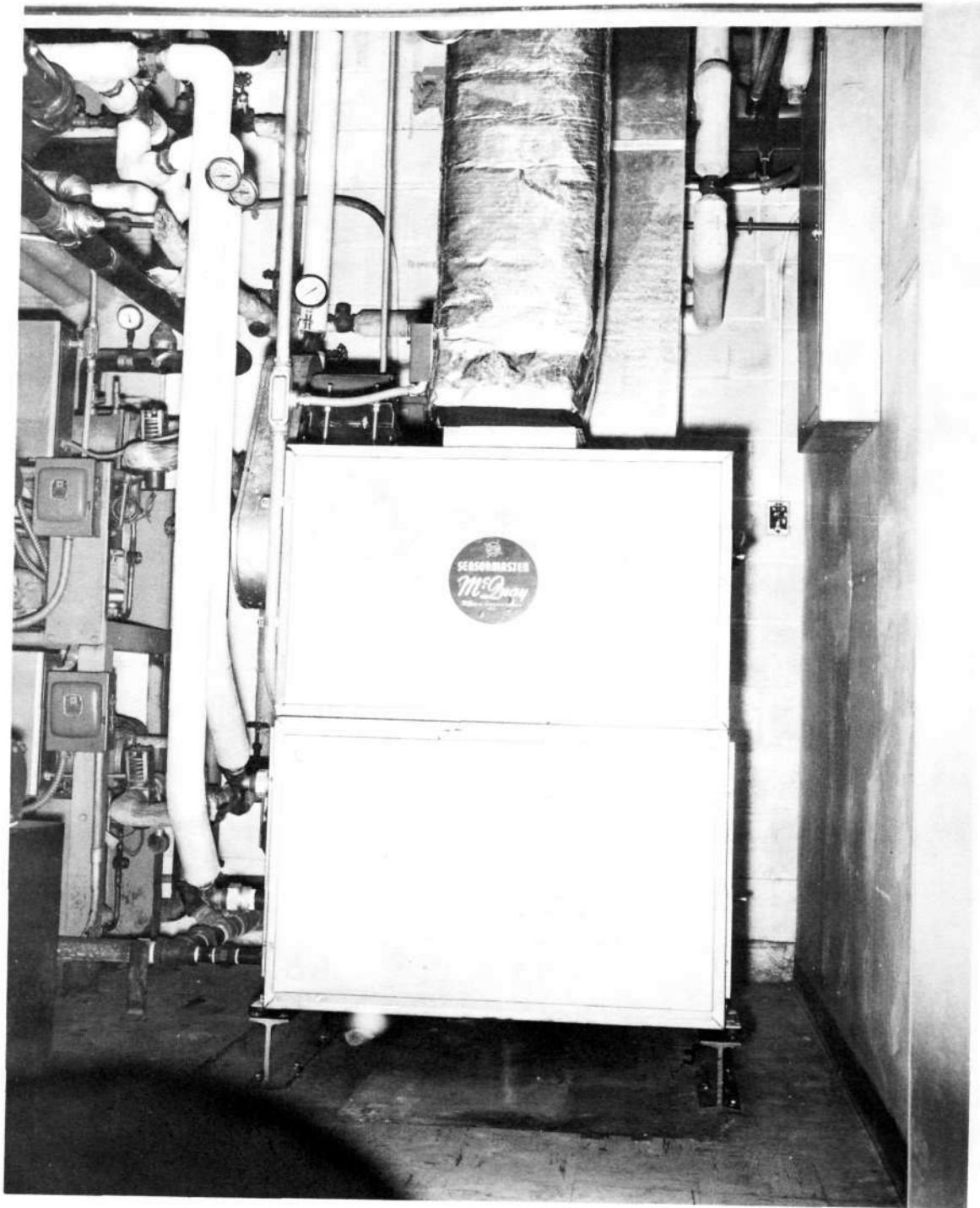

Figure 10

Ambient Laboratory Air Supply System

Ambient Laboratory Lighting Redesign

The ambient laboratory was found to have insufficient illumination around the exposure areas of the chambers and in certain work areas of the laboratory to meet minimum safety standards. To overcome this deficiency, the lighting system was redesigned to provide adequate illumination for safe and economical operation. The redesigned system provides 50 foot candles of illumination to all aisles, hallways and nonworking areas. One hundred foot candles of illumination are provided to the exposure chambers, work benches and control panels.

Standard 4-foot light fixtures were installed as indicated in figure 11. Seven of the 17 light fixtures are the 3-tube type while the remaining are the 2-tube type. These fixtures accept a standard 40 W tube. The seven 3-tube fixtures were distributed in the ambient laboratory to provide the necessary increased illumination in high work areas. The redesigned system utilizes new wiring which is fully enclosed in conduit, replacing the open wiring installed in 1944. The lights illuminating the exposure chambers are wired separately from the fixtures illuminating the outlying work areas of the laboratory. Individual off/on switches were installed to provide separate lighting control to these areas.

Gas Analyzer Calibration System

Oxygen and carbon dioxide analyzers are used extensively in the THRU laboratory for control of the Thomas Dome operating conditions and for dome entrant safety in both airlock and domes. Each of the analyzers is calibrated on a routine basis by means of instrument zero and span gases. These compressed gases were originally located adjacent to each analyzer unit resulting in a large number of gas cylinders in current usage, each drawing demurrage charges for long periods of time. In addition to the demurrage expense, the large number of cylinders represented potential safety problems; therefore, a system was designed to utilize one set of calibration gases for all of the O₂ and CO₂ analyzers.

A control panel, shown in figure 12, houses the gas cylinders in an enclosed cabinet. The desired gas pressure settings are made on the control section located at the top of the panel. This centralized control panel, located in altitude Facility A, provides calibration to all sections of the THRU laboratory as shown in schematic form in figure 13.

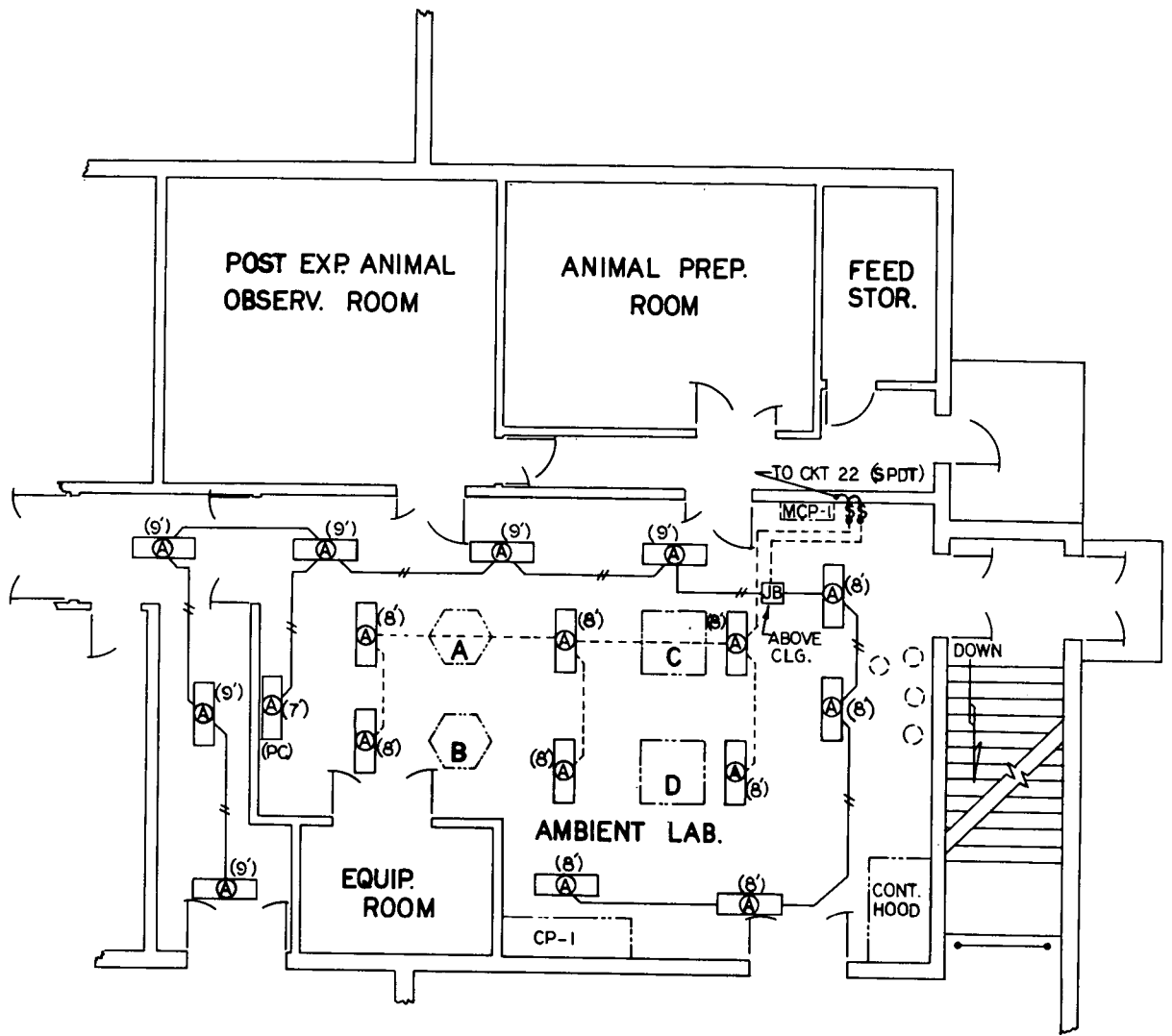

LEGEND

- - - SWITCHED LINE
- § WALL SWITCH
- (A) 4 FT. 3 (40 WATT) TUBE LIGHT FIXTURE
- (7') MOUNTING HEIGHT
- (PC) PULL CHAIN
- (JB) JUNCTION BOX

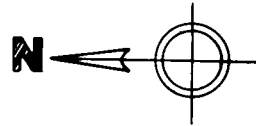

Figure 11

Plan View of Revised Ambient Laboratory Lighting System

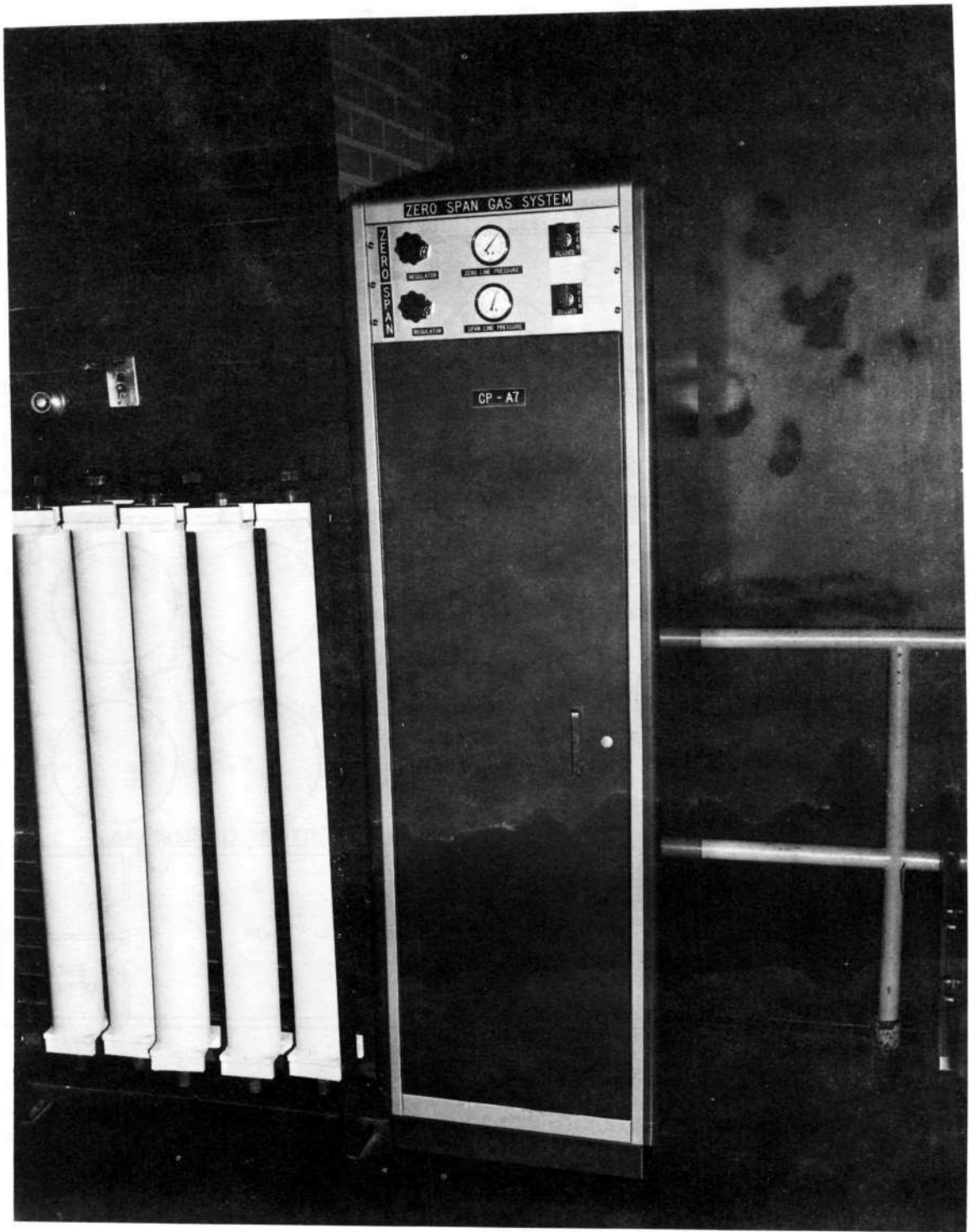
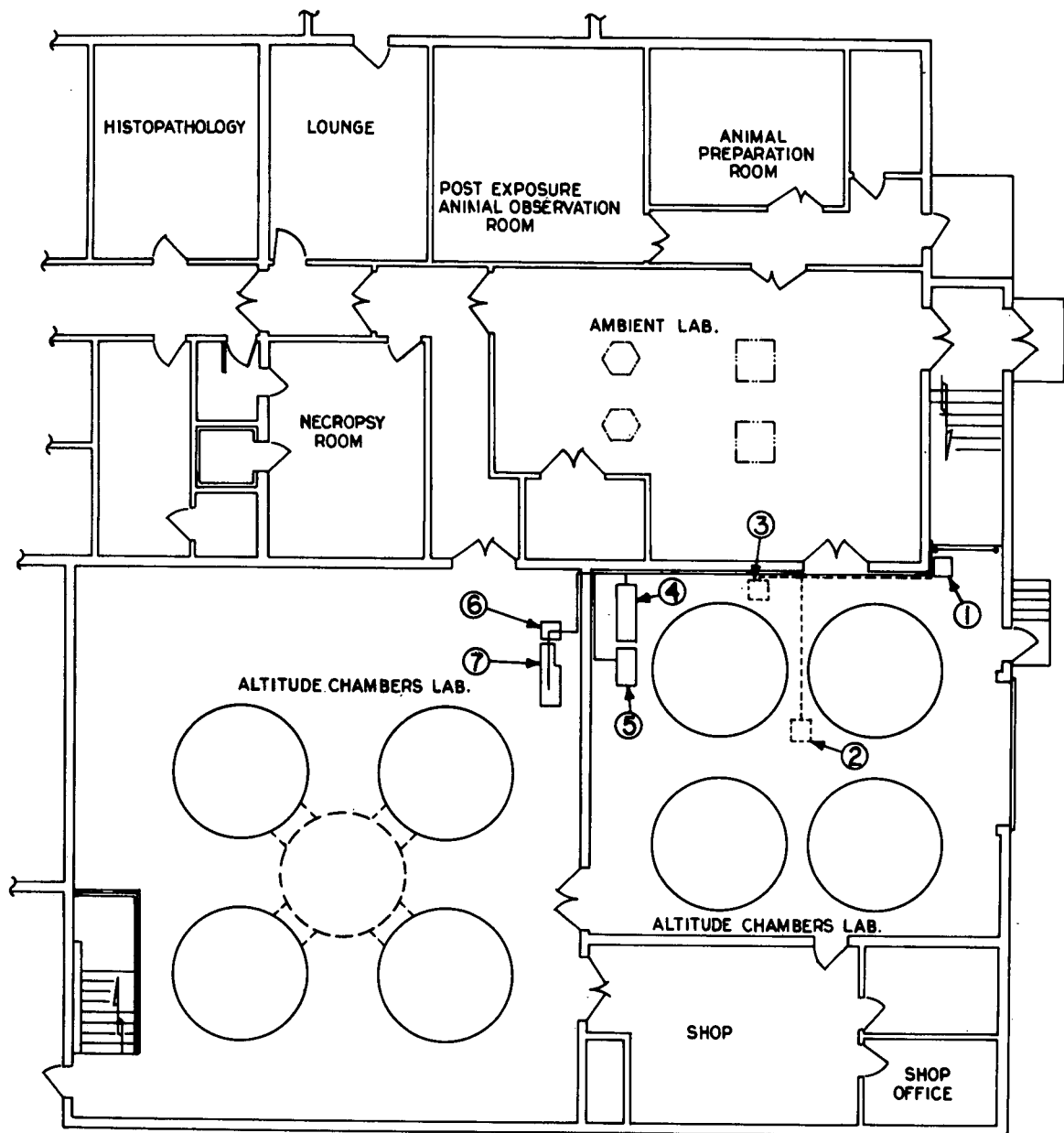

Figure 12

Gas Analyzer Calibration Control Panel



LEGEND

- 1 CP-A7 ZERO & SPAN GAS CABINET
- 2 CP-A3 DOME CO₂ CONSOLE LOCATED IN BSMT
- 3 CP-A6 FAC A AIRLOCK O₂ CONSOLE LOCATED IN BSMT
- 4 CP-A5 CABIN MATERIAL CONSOLE
- 5 CP-A4 FAC A O₂ CONSOLE
- 6 CP-B6 FAC B AIRLOCK O₂ CONSOLE
- 7 CP-B2 FAC B O₂ CONSOLE

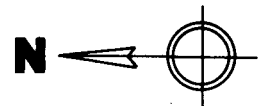

Figure 13

Schematic View of Gas Analyzer Calibration System

Dome Facility A Electrical Modifications

An evaluation of the emergency power requirements of the facility was conducted to determine the feasibility of eliminating the 150 KVA standby generator. Replacement parts for this World War II vintage model generator were almost impossible to obtain. Maintenance problems were routinely encountered during operation and reliability was marginal. Analysis of the power capacity of the automatic 300 KVA diesel generator installed in Facility B revealed that it would provide sufficient electrical power to operate the entire THRU facility during an emergency period. Consequently, the electrical load from Facility A was connected to the large generator as shown in figure 14. Tests conducted with the 300 KVA generator under simulated emergency conditions confirmed the modified system was capable of satisfying total THRU facility requirements.

A new 50 KVA transformer was installed in the basement of Altitude Facility A to replace an older unit which was overheating. The power potential of the new transformer was increased to meet anticipated future requirements of the laboratory. A power distribution panel with circuit breaker services was installed on the low voltage side of the transformer as shown in figure 15. This additional equipment permits the air conditioner and auxiliary power panels to be turned off independently thus permitting the individual equipment systems to be serviced separately without having to turn off the power to the entire Facility A laboratory. Electrical power is also evenly distributed throughout Facility A without overloading individual branches and in addition, electrical circuits for new equipment may be installed with minimum disruption to experiments in progress.

Auxiliary Automatic Animal Weighing System

The automatic animal weighing system described in the last annual report (reference 6) was expanded to provide weighing stations in the pre- and postexposure animal holding rooms in Building 79 and 429 as shown in figure 16. The new weighing stations are identical to those located in each Thomas Dome - thus permitting animals to be weighed by the same method throughout the experimental period and increasing the reliability of growth rate determination.

Two additional transducer switching units were installed in the center section of the console shown in figure 17. These switching units are used in conjunction with the readout units already present in the system. An auxiliary communication system with its own power supply was designed and installed to provide communication between the console operator and outlying areas. This auxiliary system is independent of the dome communication system.

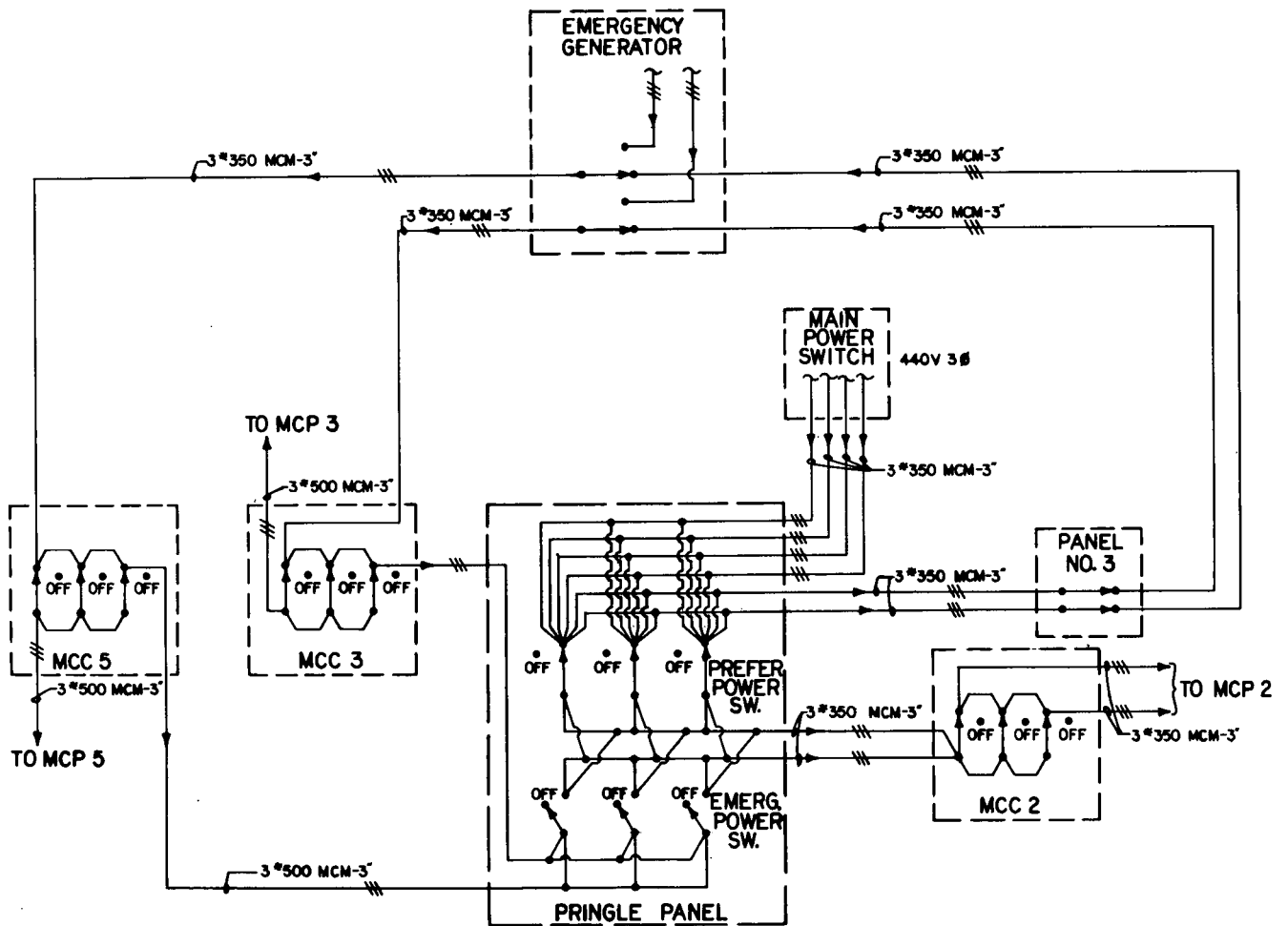

Figure 14

Revised Altitude Facility A Emergency Power System

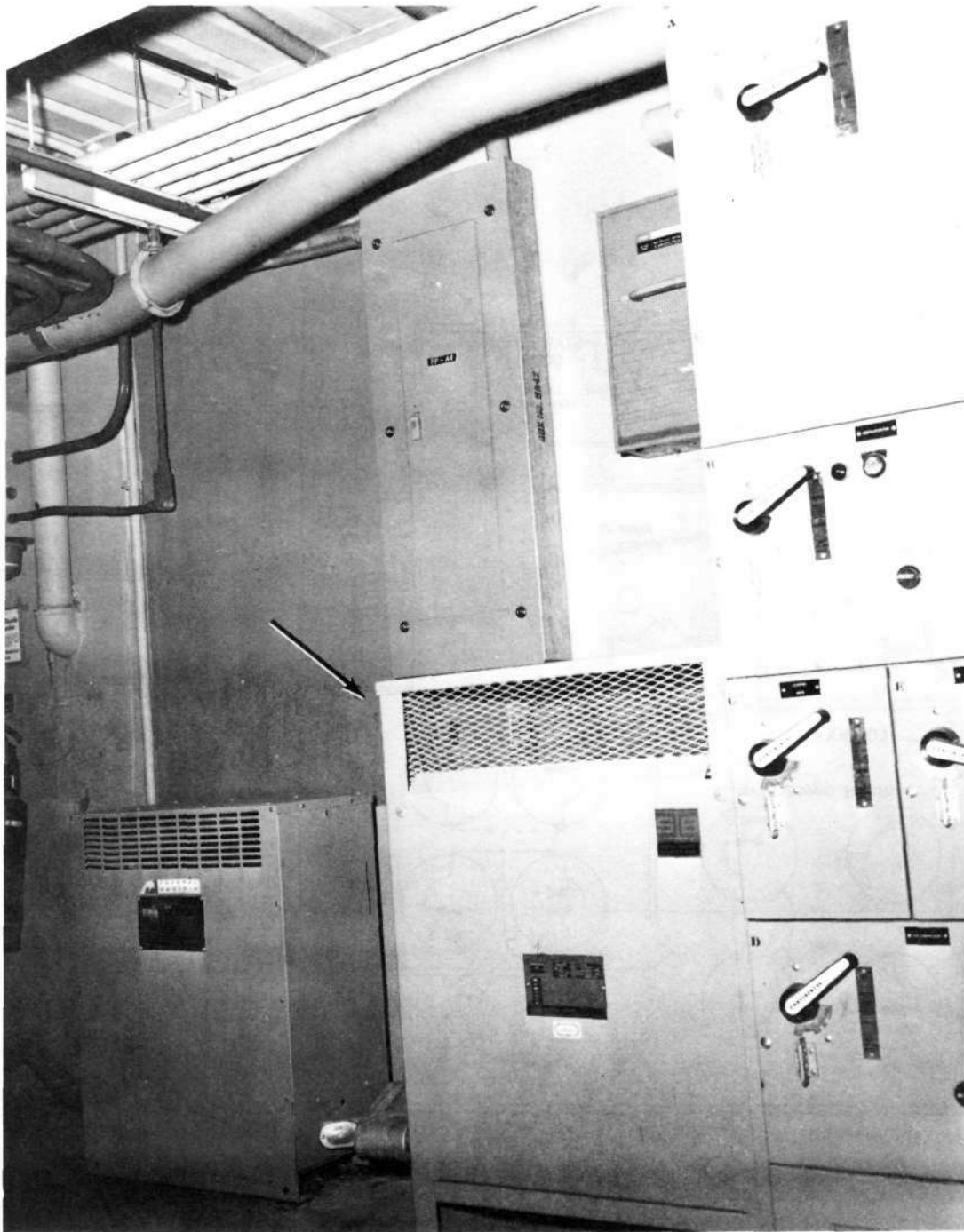

Figure 15

Revised Altitude Facility A Power Transformer and
Distribution System

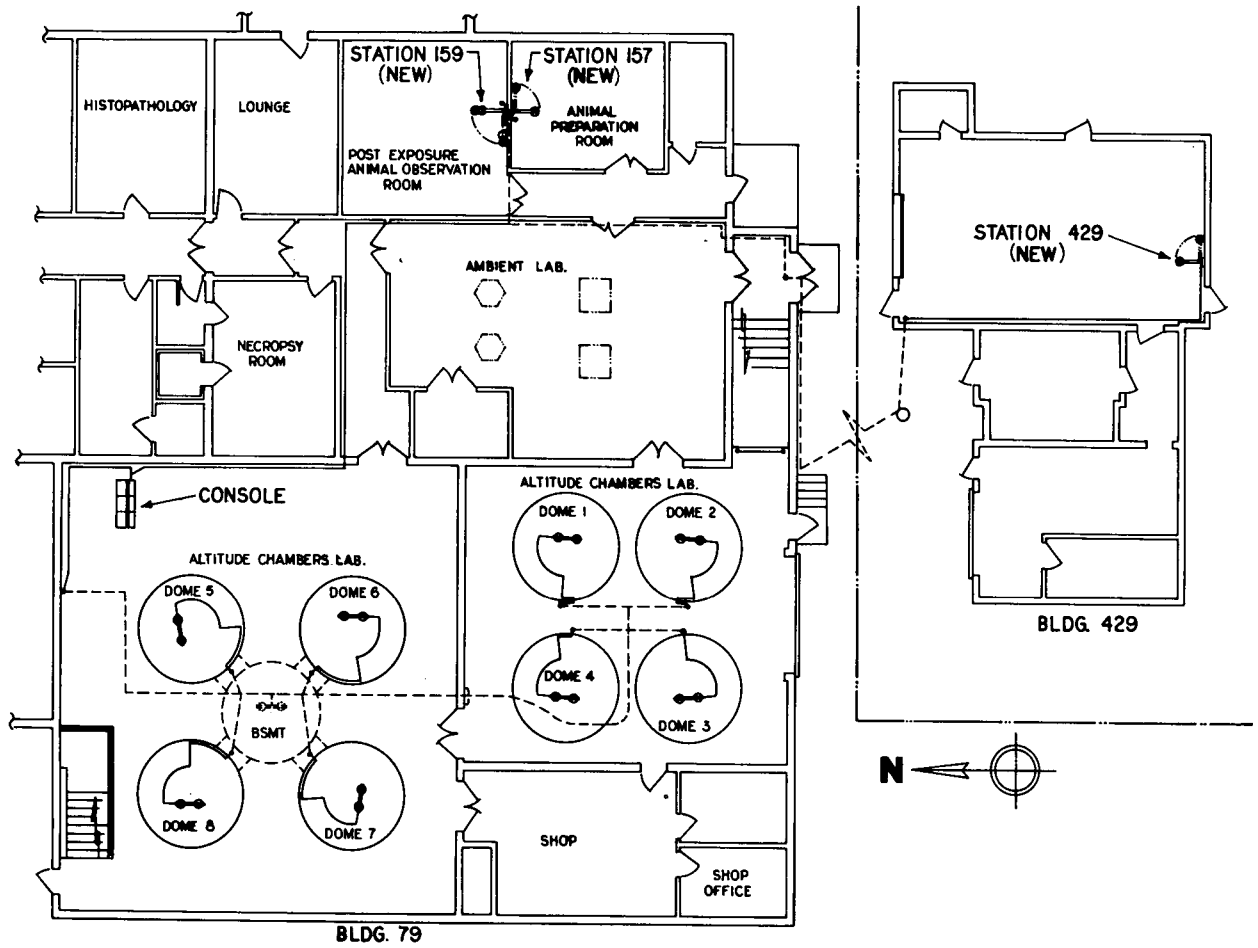

Figure 16

Schematic View of Revised Automatic Animal Weighing System

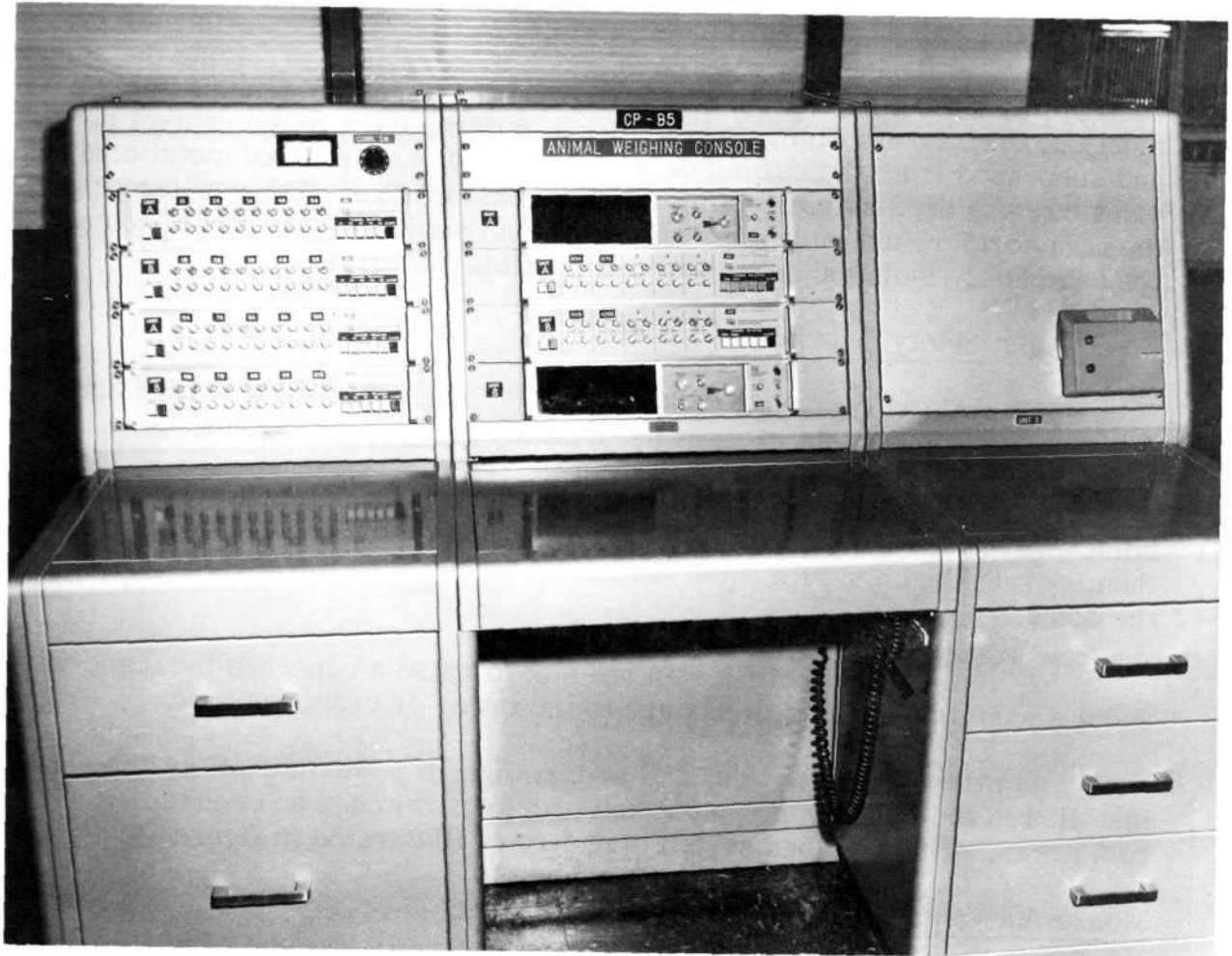

Figure 17

Automatic Animal Weighing System Console

The load cell of a weighing station in the rodent postexposure holding room is shown in figure 18. A special feature of this station is that the load cell support bar may be rotated to store the cell against the wall when not in use to allow more bench working area.

Ambient Chamber Preheater Controllers

The ambient chamber air conditioning system heating units are of the electrical type supplied by 480 volt and 220 volt power. Heating control is accomplished by automatically controlling two large adjustable transformers. These transformers were installed originally in an open type rack at the rear of the ambient system control panel. This location of the transformer presented not only a danger of electrical shock to personnel servicing the adjacent control panel but also represented a fire hazard in case of transformer malfunction. The transformers were relocated to the front of the control panel and suspended from the ceiling of the laboratory. A fireproof metal equipment box was used as a mounting for the transformers. The new location of the transformers not only removes them from accidental personnel contact but completely isolates them from combustible materials.

Dome Hoist Safety Switches

An evaluation of the Facility A and B dome crane system revealed deficiencies which might present hazards to operating personnel.

1. In Facility A, there was no safety switch to cut off power to the hoist when it was not in use. Accidental activation of the control switch could then operate the hoist at a time when technicians were working in or around the dome.

2. In both facilities an attempt to raise a cap when the dome was under vacuum might lead to damage to the crane or crane support.

In order to correct these shortcomings, a power cut-off switch was installed in the Facility A system and overload switches were installed in both areas. The overload switch circuitry is illustrated in figure 19.

Mouse Activity Measurement Equipment

In the past, animal activity measurements in the Thomas Domes have been conducted on dogs. Equipment has recently been designed to monitor the activity of mice located in the domes. Several different configurations of equipment were investigated to obtain the proper experimental conditions.



Figure 18

Auxiliary Animal Weighing Station

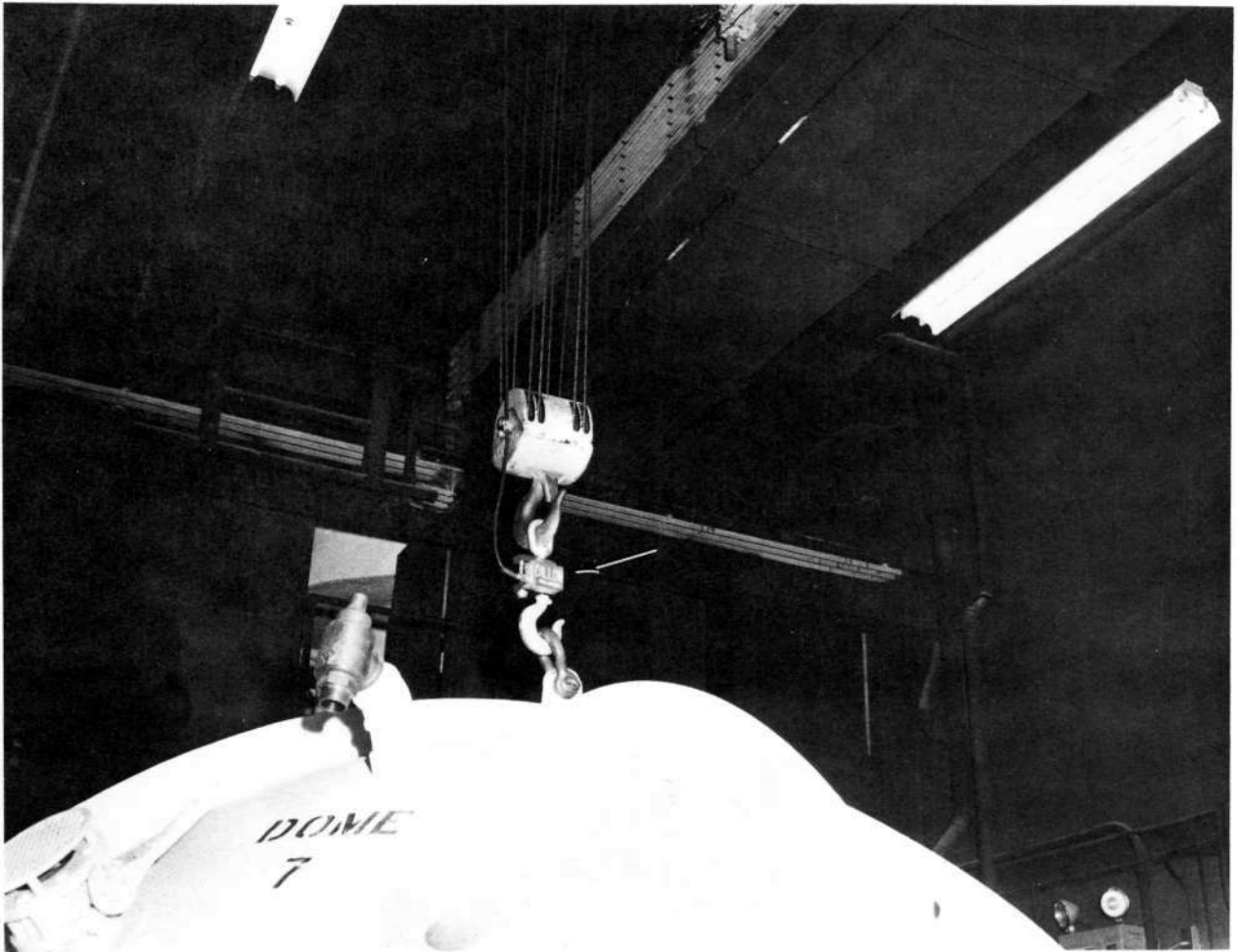

Figure 19

Crane Overload Safety Switch

Criteria for selection of the final configuration were lighting conditions, cage location, test repeatability and equipment stability. A cage was designed to be placed directly in front of one of the dome windows. The dome window was utilized as the front of the cage so that camera viewing would be through only one pane of glass. A rack was constructed inside the Thomas Dome to provide a rigid support for the mouse cage. A mount was designed to support the TV camera from the dome top and hold the field of view stationary to the area selected in the mouse cage. The camera mounting and cage location are shown in figure 20.

The signal output of the TV camera is delivered via a coaxial cable to another room which contains the video monitor, recorder, and the animal activity analyzer. Activity runs are made each day, and results indicate that the equipment is operating as designed.

Storage Facilities

Inadequate storage space is a common problem for research laboratories and the THRU facilities are not exceptions. Exterior storage of some bulky materials is necessary and new storage areas were constructed to minimize handling and corrosion problems associated with outside storage.

The number of animal cages used in exposure chambers varies considerably with the types of experiments in progress. Since all animal cages used in the THRU facility are constructed of stainless steel, it was feasible to store unused cages outside. The rack shown in figure 21 was constructed to give partial protection from the elements to the cages and to keep them stacked in an orderly manner. This cage rack and one other is attached to the exterior of Building 429.

Many THRU and Air Force operations in Building 79 use compressed gases in large quantities. Two gas cylinder storage racks were constructed, as shown in figure 22, at the south end of the building for safe handling and for separation of oxidizers and fuels. An additional storage rack was constructed in the laboratory basement outside the chemistry laboratory to hold the gas cylinders used for chromatographic equipment. Gas manifold systems are used to provide common gases to various instruments to minimize the number of cylinders stored in this location.

COMPUTER PROGRAM SERVICES

The replacement of Air Force Computers with newer systems required extensive rewriting of individual computer programs used by the THRU. The computers previously used were the IBM 7094 direct coupled with an IBM 7044. This system used the Fortran IV computer language, while the new Control Data Corporation 6600 Series Computer uses a Fortran Extended language.

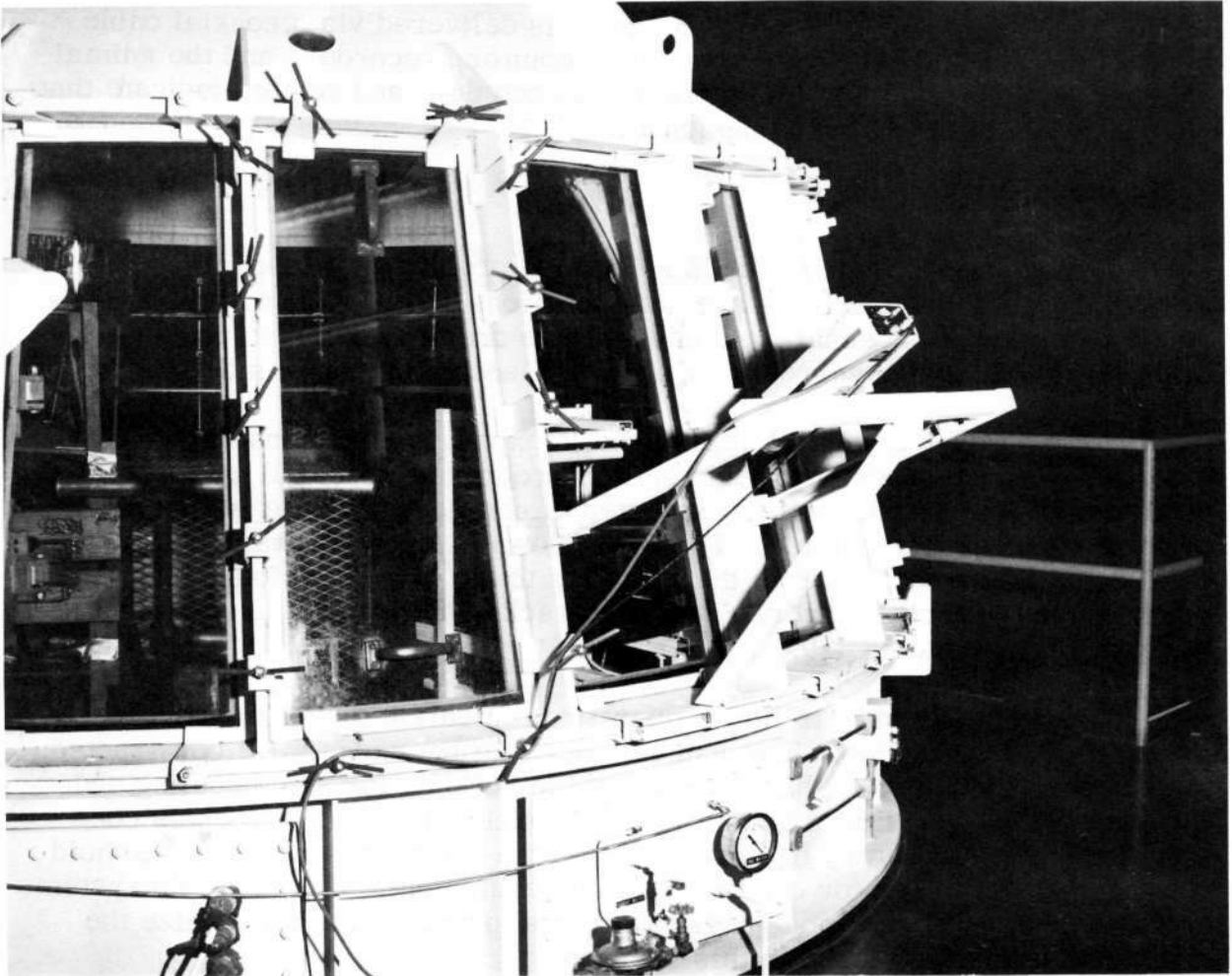

Figure 20

Mouse Activity Measurement System

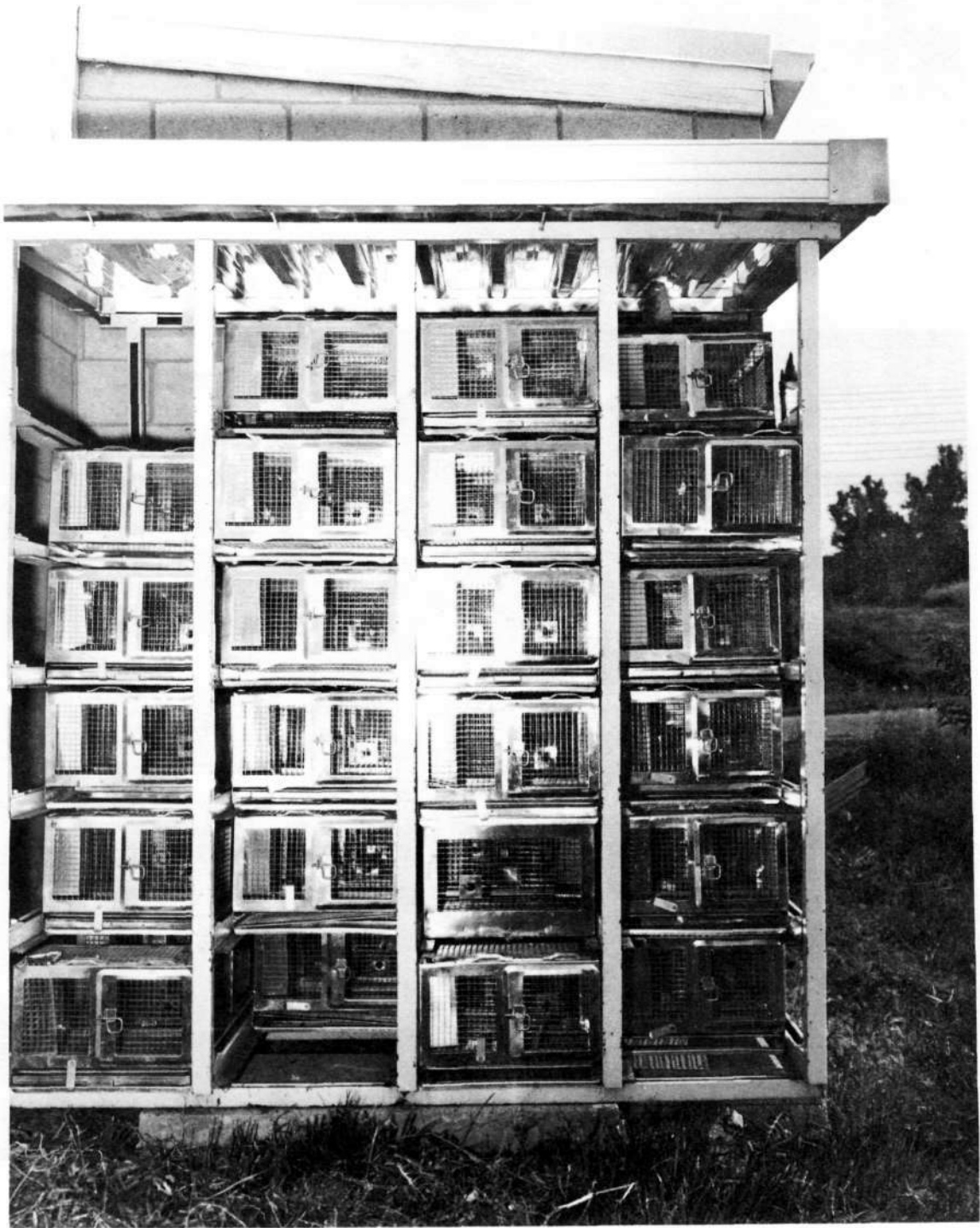

Figure 21
Animal Cage Storage Facility



Figure 22

Gas Cylinder Storage Facility

This difference in computer language was responsible for part of the program revisions required but the major problem was the inclusion of data from previous users retained in the memory banks with THRU data. The new system does not automatically clear its memory banks and program instructions for this process must be written and included at various steps in each program. All but one of the standard programs used by THRU have been converted and the last program is currently being reworked.

An additional feature of the Air Force Computer Facility has been utilized during the past year to provide graphic displays of biological data from animals used in long term experiments. A Calcomp Plotter takes the summary data output from the computer and prints out graphs of data such as animal body weights or serial blood analysis by sampling interval. Bi-weekly sampling data from long-term toxicological experiments are presented to the investigator as plotted data within days after completion of analysis for review of experimental results. This technique replaces the manual preparation of graphs from the computer output of analyzed data and makes it available for review much sooner with less work.

TRAINING PROGRAMS

A continuing activity of the THRU is the training of new technicians in laboratory operations and the retraining and testing of all technicians in emergency procedures. This continuous training program has been one of the primary factors in the success of the laboratory in conducting long term continuous exposure toxicity experiments without interruptions or shutdown. Additional training in the area of laboratory animal care and handling is also given to chamber technicians and animal handlers.

Laboratory Operations Training

This program is designed to train the chamber attendant in all phases of his job in the most effective manner and in the shortest possible time. There are four primary chamber attendant roles involved in the operation of the Thomas Domes, each with different responsibilities. These are designated Dome Entrant, and Observers A, B and C for simplicity. A complete description of the specific responsibilities of each of these roles is detailed in the Thomas Dome Standard Operating Procedures manual, a copy of which is given to each new chamber attendant. A new chamber attendant must be thoroughly trained to carry out each of these responsibilities. Two primary types of training are utilized to accomplish this objective, on-the-job training and formal classroom training.

On-the-job training is conducted on a daily basis. While learning the responsibilities required for each role, the new chamber attendant is assigned to a qualified person acting in the role he is learning. To learn the duties of an Observer A requires such assignment for 16 to 24 hours per week for a period of 6 to 10 weeks. A new chamber attendant can be trained as a Dome Entrant, and as an Observer B or C in a matter of a few weeks, although he is not permitted to function alone in any of these capacities until the entire training cycle has been completed. As a part of the on-the-job training program, the new chamber attendant learns several other aspects of his job such as how the chamber data is properly recorded, correct animal holding and bleeding techniques, preexposure preparation procedures, and animal care and maintenance. This portion of the training is necessarily of a repetitive nature for it is through repetition that a chamber attendant learns to perform his job in the most efficient manner. While the new chamber attendant is involved in the training program, he is expected to study his SOP manual whenever time permits.

The formal classroom training program consists of no less than 8 training classes of 1 to 2 hours each, and 4 combination written-practical exams. This program may be generally broken down into two categories; Phase I training covering emergency procedures involving dome entrants, and Phase II training covering equipment failures directly involved with dome operation. This program requires 8 to 10 weeks for completion depending on class size and work requirements at the time. Classroom and on-the-job training programs are conducted concurrently, and, generally, both are completed at approximately the same time. The following is a brief outline of the topics covered in the formal training program.

Phase I - Emergency Procedures

- I - The automatic fire control system.
- II - Fire in the dome or airlock, with and without a dome entrant.
- III - Rescue of an incapacitated dome entrant.
- IV - Fire in the exposure laboratory area.
- V - Miscellaneous emergencies.

Phase II - Equipment Failures

- I - Vacuum pump failure.
- II - Air Compressor and ambient blower failure.
- III - Liquid oxygen apparatus failure.
- IV - Complete power failure.

All of the above equipment failures are of equal importance, as all facility systems listed contribute jointly to the normal operation of the facility.

Chamber attendants who begin work in the middle of a training cycle usually begin training immediately and then pick up the portions which have been missed following the completion of the regular training cycle. At the present time, the entire training cycle is repeated at least twice during the year. During this annual reporting period, eight new chamber attendants completed the entire training cycle.

One other form of training is conducted on a regular basis. Monthly Emergency Training involves the deliberate causing of an equipment shut-down or emergency situation and the observers on duty are graded as to their ability to perform their duties quickly and correctly. These deliberate failures or emergencies are unannounced to simulate as nearly as possible an actual emergency situation. Examples of recent monthly emergency training situations are as follows:

	<u>Date</u>	<u>Observer Participation</u>
Vacuum Pump	November 1970	A
Fire in Dome	December 1970	A, B and C
Fire in Airlock	January 1971	A, B and C
Air Compressor	February 1971	A
Power Outage	March 1971	A

Animal Care Training

In order to insure that all laboratory personnel who have occasion to handle laboratory animals being used in the experimental programs at this Facility have an understanding of the fundamental aspects of animal care and handling, all new chamber attendants and animal handlers are required to successfully complete a course in the care of laboratory animals. The course presently being used is provided by the Purina Company, St. Louis, Missouri.

The course comes complete with study manuals and exams which are graded by the Purina Company, and upon the successful completion, a certificate is issued. The course is designed as a home-study correspondence course, but better results are obtained when a professional member of the Toxicology Department acts as a monitor and conducts formal classes on a weekly basis until all sections of the course have been completed. In addition to insuring a more complete understanding of the material, this allows an excellent opportunity to teach the new personnel several aspects of toxicology

and biology which are directly related to the work being conducted in the laboratory, and which are not incorporated in any of the other training programs at the Facility. As a part of this course, arrangements were made with the Veterinary Medicine Division of AMRL for two lectures to be given by the veterinarian, and with the THP Branch of the Toxic Hazards Division for a lecture by the pathologist. These lectures were on information pertinent to the course and directly related to the specialties of the lecturers.

During this annual reporting period, nine chamber attendants, one lab technician and one member of the professional staff have attended an average of nine lectures, each about 90 minutes long, and completed all the required exams. Eight have received the certificate of completion from Purina, and the remaining three are awaiting final grading of exams.

The following is a brief outline of the main topics covered in this course.

- I. Physiological and biochemical considerations of the laboratory animal.
 - A. Important animal systems
 - B. Nutrition and nutritive requirements
- II. Management of laboratory animals
- III. Housing equipment and handling
- IV. Disease and control.

SECTION III

RESEARCH PROGRAM

The inhalation toxicology research program of the THRU covers a broad area of interest ranging from standard industrial hygiene toxicology problems to the more exotic but real problems of determining safe limits for continuous low level contaminant exposures in spacecraft or other closed system atmospheres. The primary mission of the THRU program is to provide answers to these practical problems concerning the health not only of Air Force personnel but of the civilian population working with the same or related materials.

As in previous report periods, some of the research experiments discussed herein were initiated in the preceding year and some that were started this year will carry over into the next reporting period. Toxicity screening of space cabin construction material is a continuing project with individual experiments conducted whenever sufficient materials are made available for testing.

The Acute Toxicity of Brief Exposures to HF, HCl, NO₂ and HCN Singly and in Combination with CO

Comprehensive aircraft safety necessitates the rapid evacuation of passengers surviving crashes. Many crashes result in at least a portion of the aircraft bursting into flames. Since inhalation of the combustion products of aircraft components may present a considerable toxicity hazard, it would be wise to select totally nonflammable construction materials, or lacking nonflammable material, to select those having the least dangerous combustion products.

Many plastic formulations contain halogen, cyanide, and nitrogenous moieties which are released during combustion to form the corresponding halogen acid gases (HCl and HF), hydrogen cyanide gas (HCN) and nitrogen dioxide (NO₂). Inadequate information was available for comparison of the acute toxicity of these materials under very brief exposure conditions such as might be experienced in the evacuation of a burning aircraft. Animal experiments were conducted to provide this specific information as well as to explore the effect of a simultaneous exposure to carbon monoxide (CO) since it is extremely probable that an aircraft fire would produce such a situation.

Ten rats and 15 mice per group were exposed to a series of atmospheric concentrations of each test material to determine LC₅₀ values. At the time of exposure the rats weighed from 250 to 275 grams, while individual mice ranged from 30 to 35 grams. Quality control examinations were conducted on each shipment of rats and mice received to assure that healthy animals were used in the toxicity studies.

The animals were exposed in a dynamic flow system using a standard Rochester Chamber (reference 13) modified to subject the animals to a precisely timed 5-minute exposure. The modification consisted of a cage constructed with gasketed solid ends mounted on a slide track which was installed in one of the plastic panels on the Rochester Chamber. When the desired chamber contaminant concentration was achieved, the cage with animals was rapidly pushed into the chamber and the sealing clamps were secured. After 5 minutes of exposure the procedure was reversed and another experiment was started by readjusting contaminant concentration.

The animals were observed closely for 7 days postexposure in order to include any delayed deaths.

A series of animal exposures was conducted to determine the concentration of CO required to produce 25% COHb (this COHb concentration induces minor CNS effects in man but is not lethal per se). Initial experimental CO concentrations were based on calculations made from human CO uptake data of Forbes et al. (reference 14). Blood carboxyhemoglobin measurements were made on pooled blood samples from simultaneously exposed groups of 3 or 4 rats, using the methods of Goldbaum et al. (reference 15). The COHb data for rats are shown in figure 23. Also shown in this figure is the average value of 24 individual mice exposed to a single carbon monoxide concentration. Since all animal species have from 0.5 to 1.0% endogenous COHb from hemoglobin catabolism, this is essentially a 2-point plot showing that the 25% COHb level is achieved in mice in 5 minutes exposure to 1500 ppm CO. The 5-minute CO concentration required to achieve 25% COHb in rats is 2100 ppm.

All contaminant exposure concentrations were controlled by continuous monitoring. Hydrogen fluoride, HCl, and HCN concentrations were monitored using specific ion electrodes as detailed earlier in this report. Nitrogen dioxide was analyzed by continuous spectrophotometric measurement of atmospheric samples absorbed in Saltzman reagent using an AutoAnalyzer (reference 16). Calibration curves were prepared by analytical measurement of standard gas bag concentrations backed up by standardization with permeation tubes (reference 17). Nitrogen dioxide diffuses through the Teflon[®] walls of this tube at a constant rate determined by gravimetric measurements and is capable of giving precise air concentrations at fixed air flow rates.

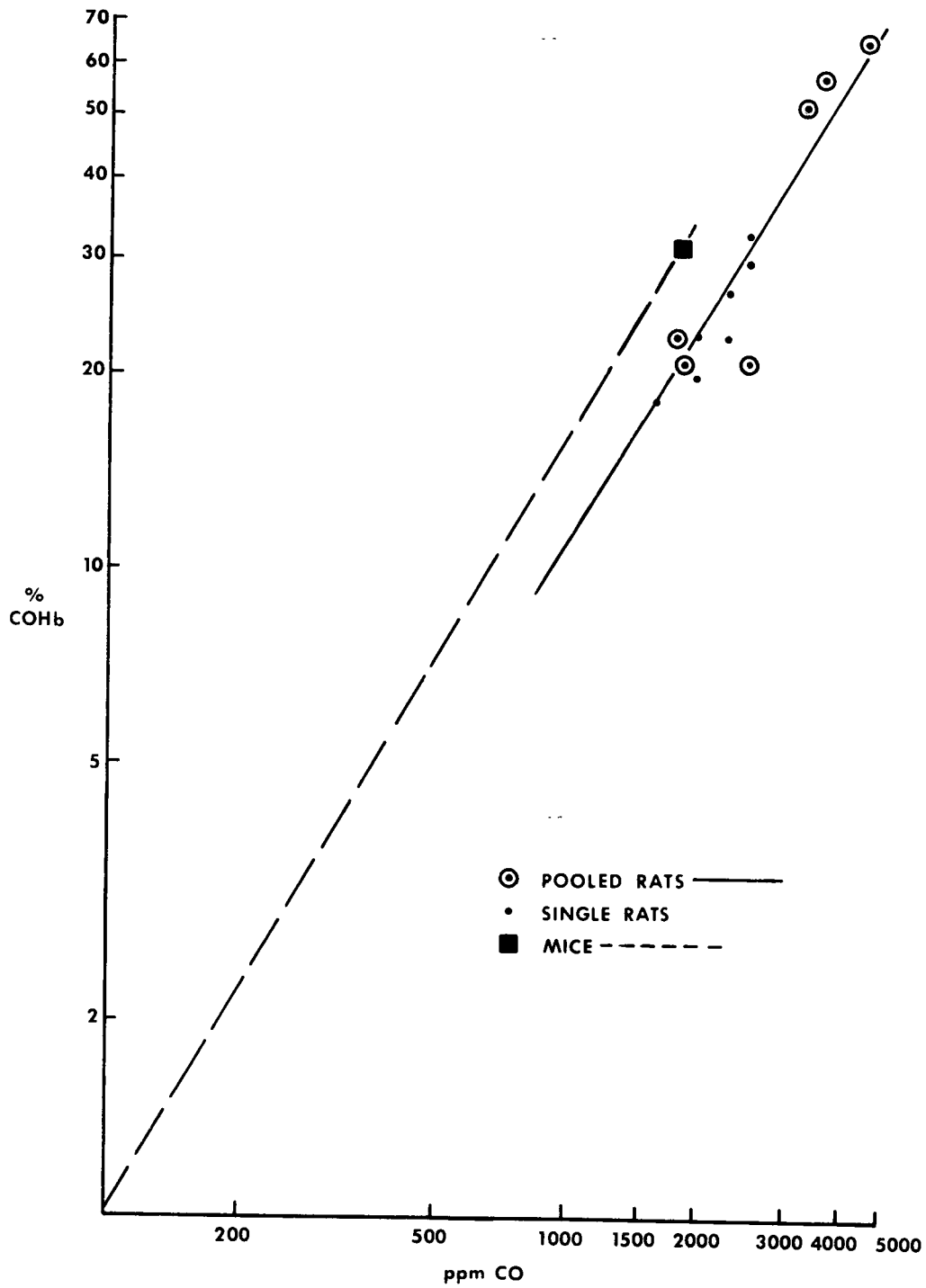

Figure 23

Carboxyhemoglobin Formation in Rodents
Exposed to CO for 5 Minutes

The LC_{50} values for each series of exposures to the compounds tested, either singly or in combination with CO, were calculated by the method of Litchfield and Wilcoxon (reference 18) using computer program techniques. This method results in a slope calculated by the method of least squares which results in the lowest Chi square value possible.

Hydrogen fluoride produced pulmonary edema of varying degrees of severity in most of the exposed animals. In animals that died during or shortly after exposure to concentrations above the LC_{50} value, pulmonary hemorrhage was a common finding. Delayed deaths were routinely seen with this compound in exposures below the LC_{50} level, with peak mortality occurring about 24 hours postexposure, although occasional deaths occurred 3 to 4 days later. The mortality response of rats to inhaled HF is presented in table II and for mice in table III. The LC_{50} slopes for rats and mice are presented in figures 24 and 25, respectively. The slopes for the HF and HF + CO exposures, although somewhat different in appearance, are not statistically different. There is no apparent effect attributable to concurrent exposures to carbon monoxide. Indeed, a single slope could be plotted by combining the 2 sets of exposure data which would result in a more precise LC_{50} value with narrower 95% confidence limits.

Exposures of rats to HCl resulted in LC_{50} values of 40,989 ppm for the pure compound and 39,010 ppm for the combined exposure of HCl and CO as shown in table IV. This difference was not statistically significant; neither was the greater difference found in mice as shown in table V. The LC_{50} slopes are plotted in figure 26 for rats and in figure 27 for mice. Hydrogen chloride is definitely less toxic to rats than is HF, but the effective range of lethal response to HCl in mice overlaps that of HF. It should be noted that the range of HCl concentrations which had to be used was much wider than that with HF. Consequently the 5 minute toxicity of HCl is much less predictable than that of HF. The lowest concentration of HCl causing death in mice was 3200 ppm while 100% deaths were not achieved at the highest concentration tested, 30,000 ppm, an order of magnitude greater.

Most NO_2 induced animal deaths were seen within 12 hours postexposure and resulted from pulmonary edema with a few animals exhibiting pulmonary hemorrhage. Again, as shown in tables VI and VII, there was no significant difference between exposure to NO_2 alone and exposure to NO_2 in combination with CO. The combined exposure of CO and NO_2 to rats resulted in a slightly higher LC_{50} , an indication of a slightly less toxic response. The results of LC_{50} studies of NO_2 on rats are almost identical to those reported by Gray (reference 19) who found a 5-minute LC_{50} value of 832 ppm which compares well with our value of 831 ppm. Mortality plots for rats and mice are presented in figures 28 and 29 respectively.

TABLE II

7-Day Mortality Response of Rats
Exposed 5 Minutes to HF Gas Singly and in
Combination with CO (25% Carboxyhemoglobin)

HF Concentration (ppm)	% Deaths	
	HF	HF + CO
11,550		0
12,440	10	
12,890		0
15,990		10
17,615	30	
17,750		40
18,580	80	
20,730	70	
21,125		100
22,355		90
22,740		100
23,540		100
25,690	100	
LC ₅₀ 95% Confidence Limits	18,200 ppm 15,965-20,748 ppm	18,208 ppm 13,698-24,202 ppm

TABLE III

7-Day Mortality Response of Mice
Exposed 5 Minutes to HF Gas Singly and in
Combination with CO (25% Carboxyhemoglobin)

HF Concentration (ppm)	% Deaths	
	HF	HF + CO
2,430	0	
4,480		7
4,500	33	
6,220		33
7,410		60
7,615	67	
8,140	53	
8,760		93
10,190		100
11,010	100	
LC ₅₀ 95% Confidence Limits	6,247 ppm 4,789-8,149 ppm	6,670 ppm 5,690-7,807 ppm

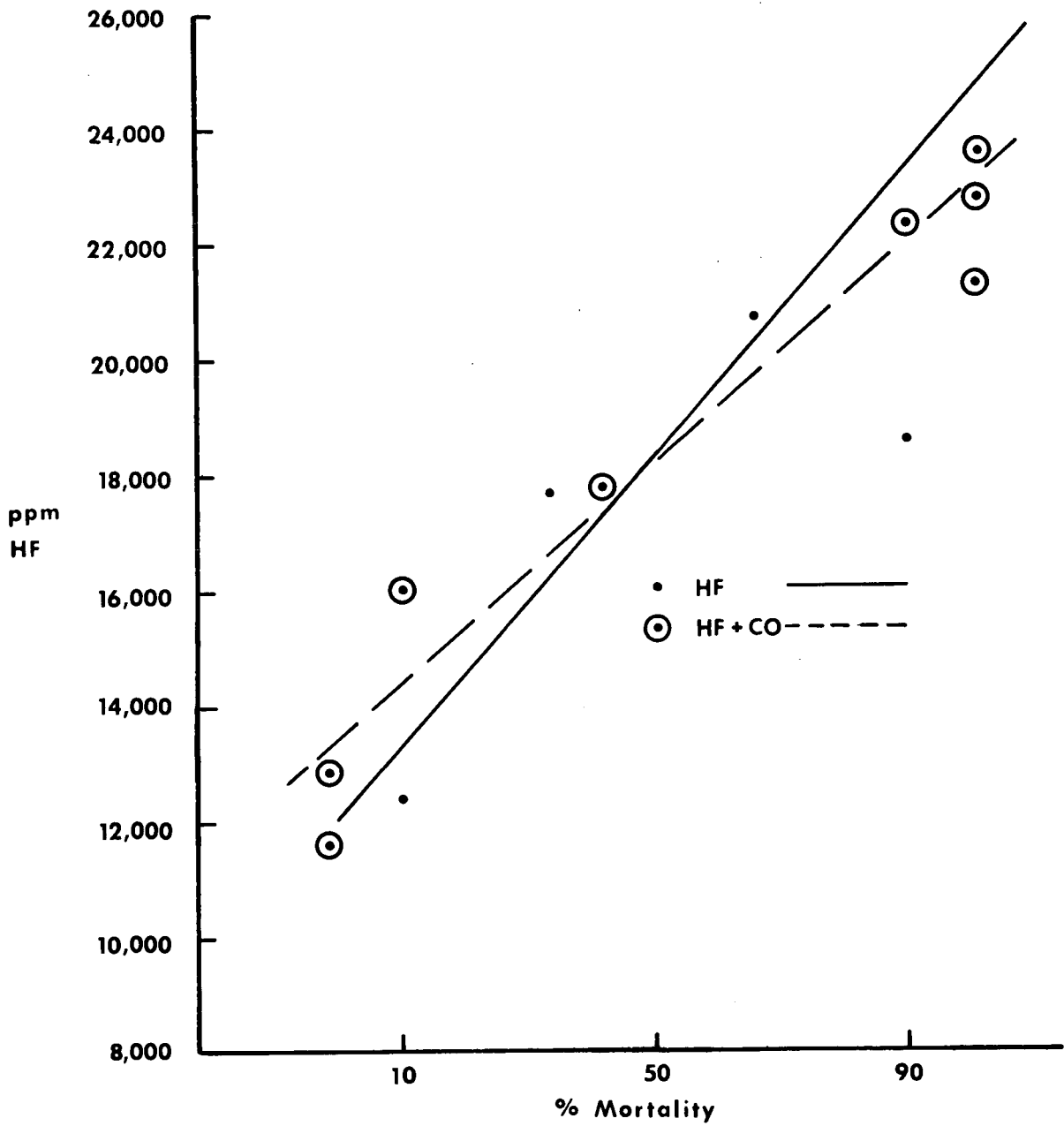

Figure 24

Five Minute LC_{50} for Rats Exposed to HF
Singly and in Combination with CO

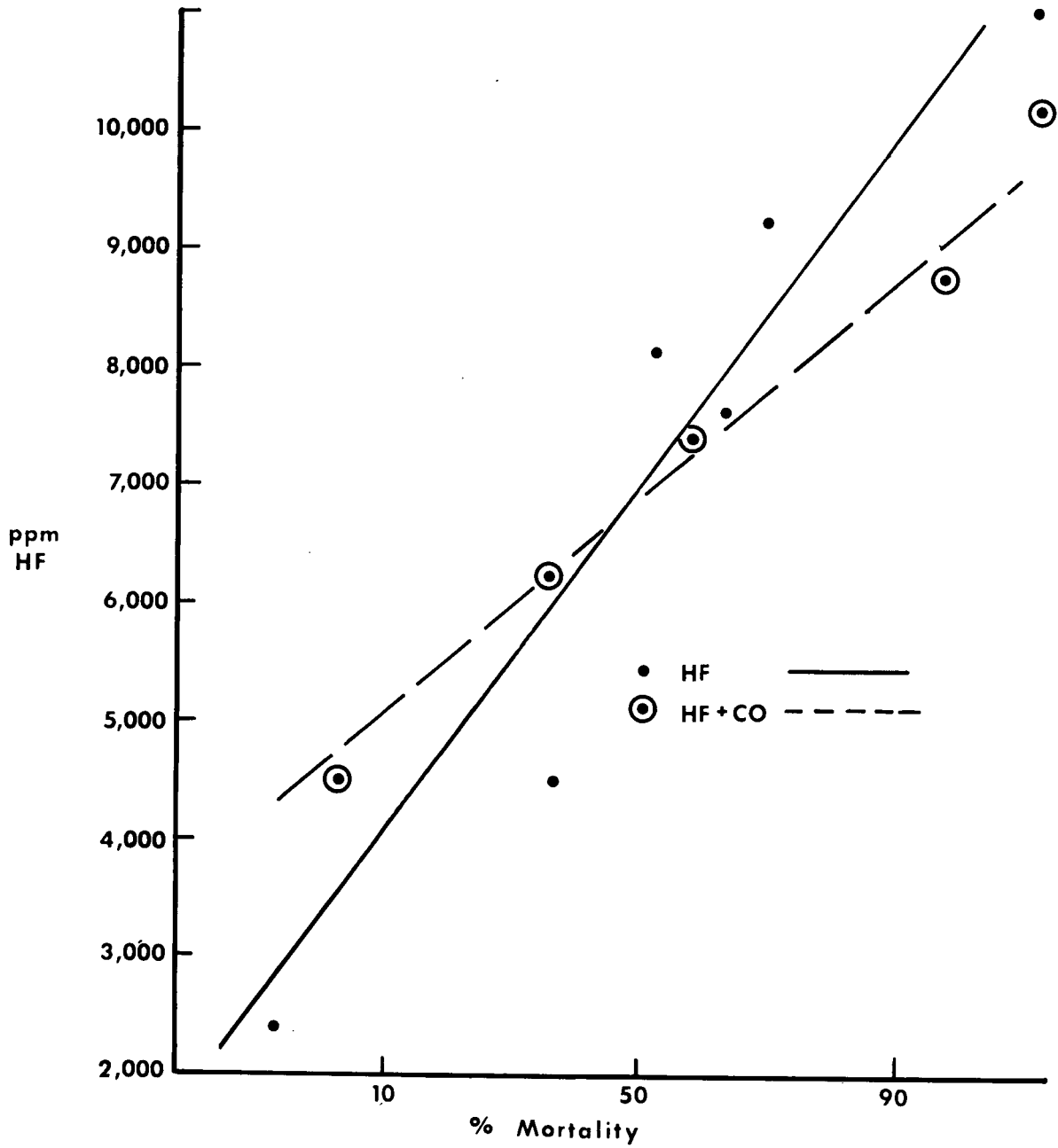

Figure 25

Five Minute LC₅₀ for Mice Exposed to HF
Singly and in Combination with CO

TABLE IV

7-Day Mortality Response of Rats
Exposed 5 Minutes to HCl Vapors Singly and in
Combination with CO (25% Carboxyhemoglobin)

HCl Concentration (ppm)	% Deaths	
	HCl	HCl + CO
30,000	0	
32,000	10	
33,980		10
39,850	60	
42,460		80
45,200	70	
49,580		100
56,046		90
57,290	90	
59,280		100
LC ₅₀ 95% Confidence Limits	40,989 ppm 34,803-48,272 ppm	39,010 ppm 35,049-43,419 ppm

TABLE V

7-Day Mortality Response of Mice
Exposed 5 Minutes to HCl Gas Singly and in
Combination with CO (25% Carboxyhemoglobin)

HCl Concentration (ppm)	% Deaths	
	HCl	HCl + CO
3,200	7	
4,920		10
5,060	7	
6,145	13	
6,410	0	
7,525	40	
8,065	13	
9,276	33	
12,805		70
13,655	40	
21,010		80
26,485	87	
27,386		90
30,000	87	
LC ₅₀ 95% Confidence Limits	13,745 ppm 10,333-18,283 ppm	10,663 ppm 6,921-16,428 ppm

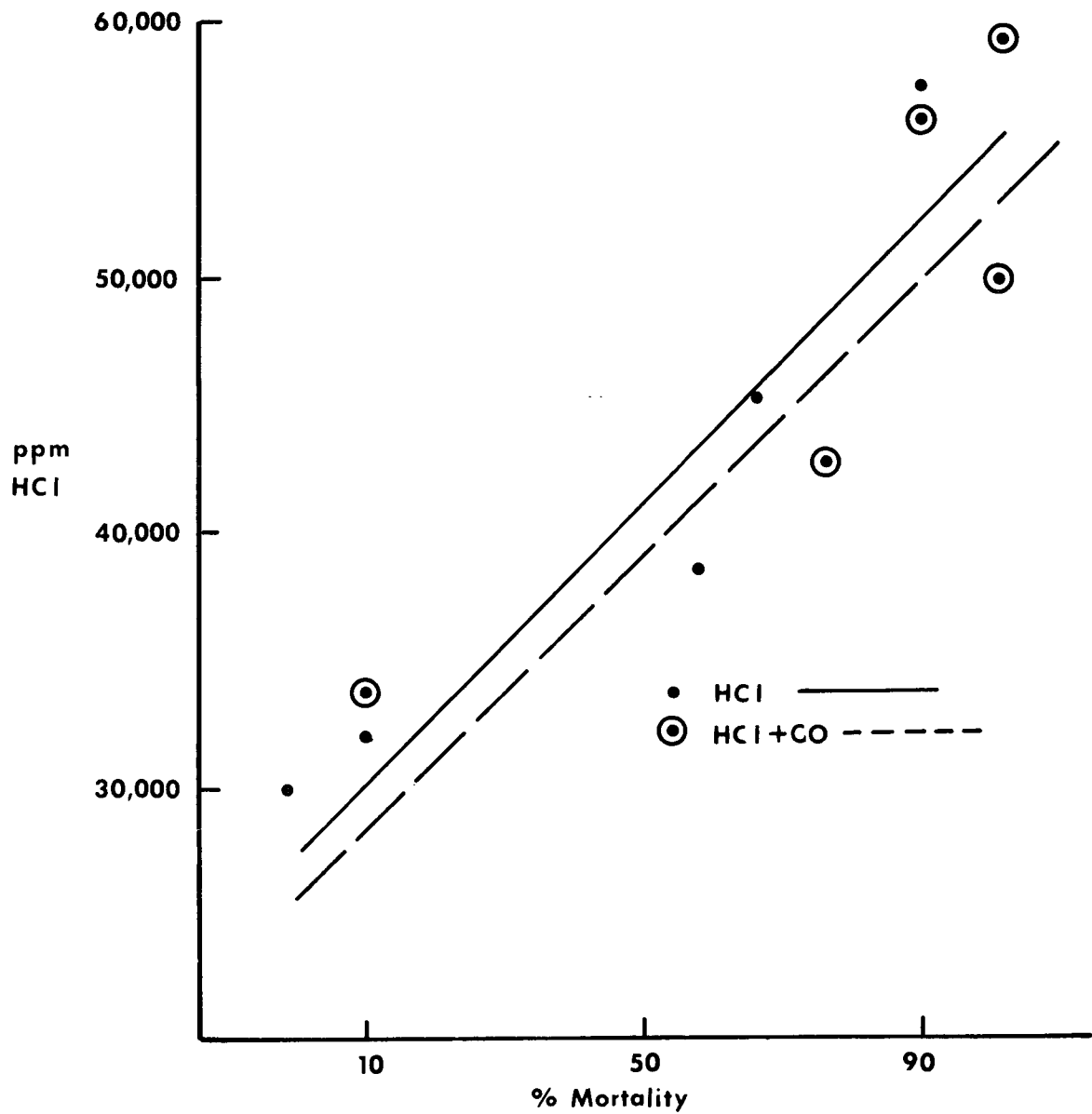

Figure 26

Five Minute LC_{50} for Rats Exposed to HCl
Singly and in Combination with CO

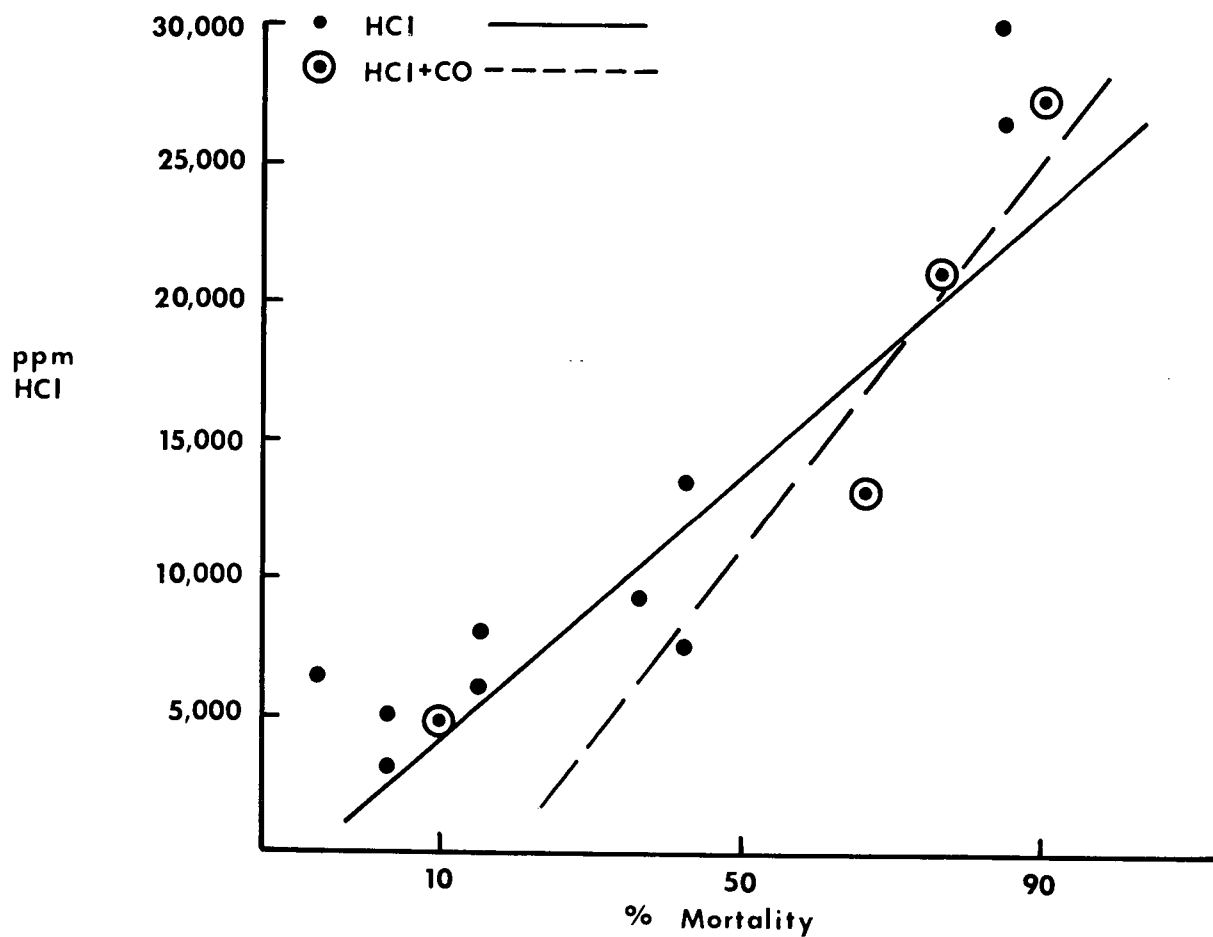

Figure 27

Five Minute LC_{50} for Mice Exposed to HCl
Singly and in Combination with CO

TABLE VI

7-Day Mortality Response of Rats
Exposed 5 Minutes to NO₂ Singly and in
Combination with CO (25% Carboxyhemoglobin)

NO ₂ Concentration (ppm)	% Deaths	
	NO ₂	NO ₂ + CO
260	10	
270		0
550	40	
580		0
590	30	
750		20
840	30	
850	30	
1,000		40
1,200	50	
1,250	90	
1,380	100	
1,660		80
LC ₅₀ 95% Confidence Limits	831 ppm 556-1,240 ppm	1,140 ppm 720-1,707 ppm

TABLE VII

7-Day Mortality Response of Mice
Exposed 5 Minutes to NO₂ Singly and in
Combination with CO (25% Carboxyhemoglobin)

NO ₂ Concentration (ppm)	% Deaths	
	NO ₂	NO ₂ + CO
260	7	
550	27	
580		0
590	0	
840	7	
850	0	
950		7
1,200	40	
1,250	13	
1,380	47	
1,500		53
1,990	20	
2,280		74
2,560	67	
2,950	74	
2,980	100	
3,280		93
LC ₅₀ 95% Confidence Limits	1,880 ppm 1,345-2,626 ppm	1,644 ppm 1,203-2,247 ppm

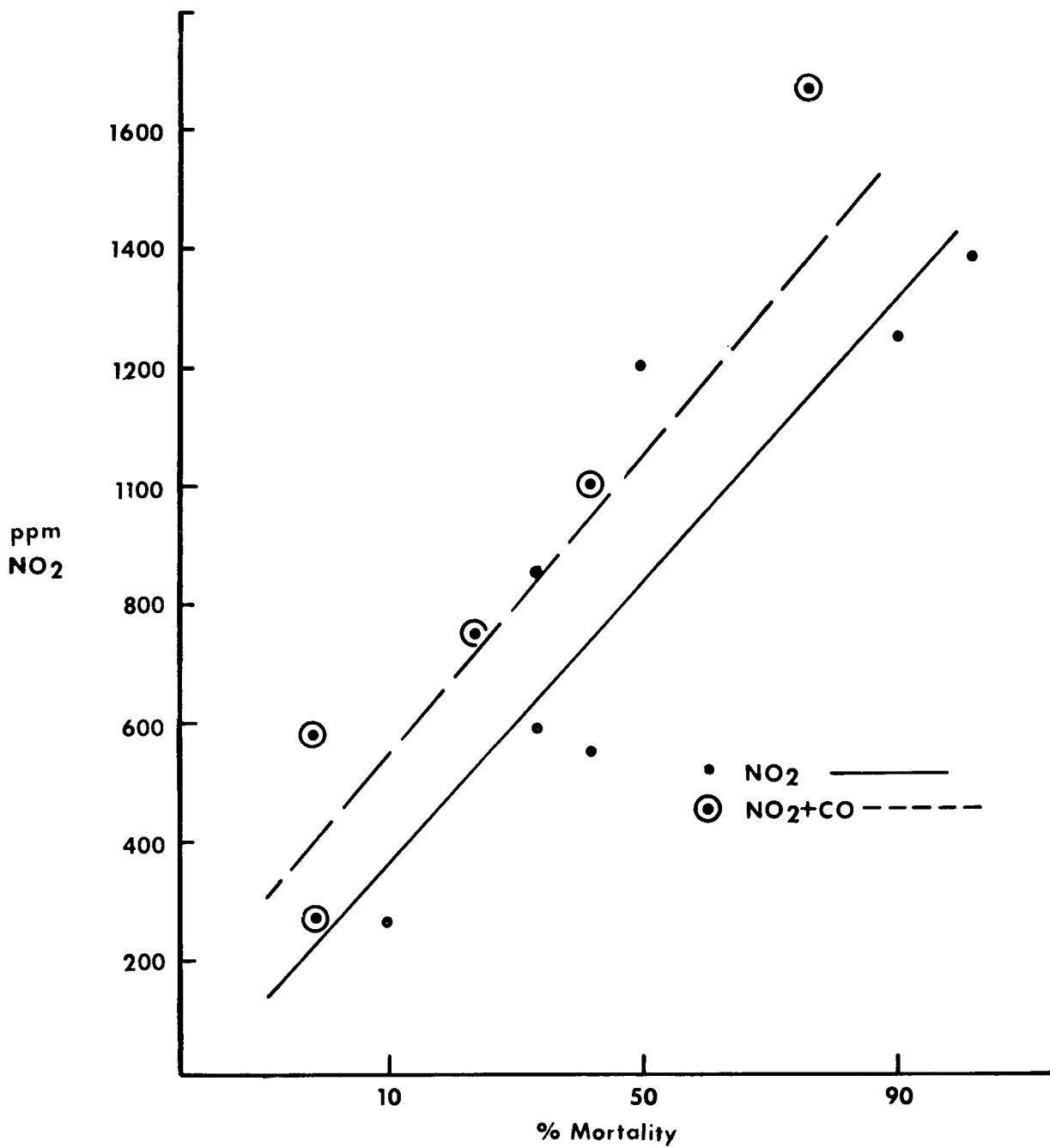

Figure 28

Five Minute LC_{50} for Rats Exposed to NO_2
Singly and in Combination with CO

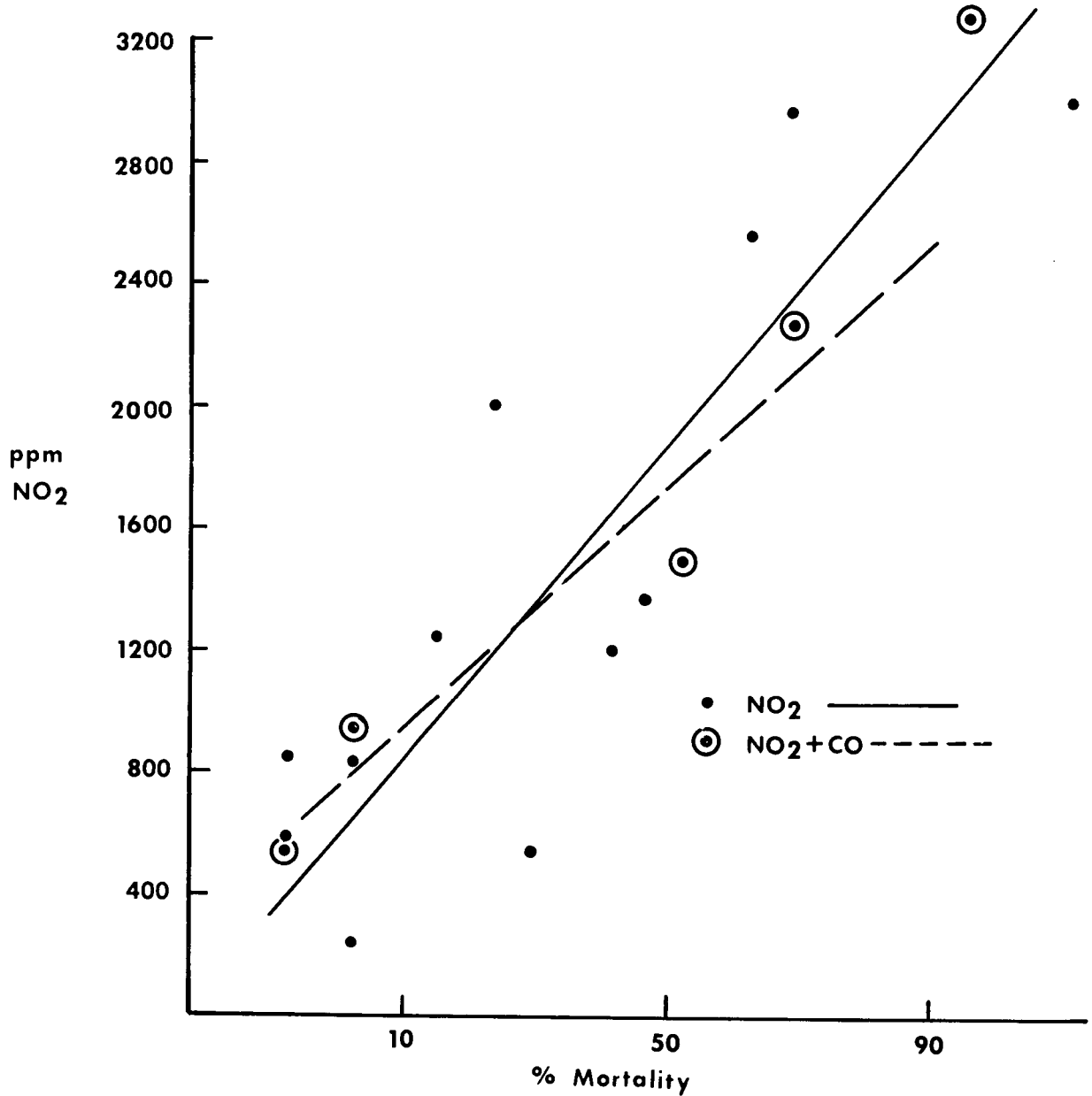

Figure 29

Five Minute LC₅₀ for Mice Exposed to NO₂ Singly and in Combination with CO

In HCN exposures, either singly or in combination with CO, all deaths occurred during the exposure period or within 20 minutes post-exposure; there were no delayed deaths. The results of the experiments are given in table VIII and IX for rats and mice, respectively. Carbon monoxide at the 25% carboxyhemoglobin level had no effect on the acute toxicity of HCN. Since the primary effect of HCN intoxication is a block of the intracellular oxygen transport through the cytochrome system, the slightly decreased extracellular oxygen transport caused by CO was not an important factor. Although aircraft fires most certainly will result in concurrent exposure to CO and other contaminants, and our animal exposure period technique simulated the "real world" situation, we were concerned that a response might not be seen because of the short fraction of the 5-minute exposure period that the animals would be at the 25% COHb level.

There was the possibility that the period of real extracellular oxygen transport impairment was too short to cause any added effect on the HCN induced cellular oxygen deficiency. To determine whether this factor was a possible shortcoming in the experimental design, we exposed 2 additional groups of rats to HCN immediately following CO exposures resulting in 25% COHb for one group and 50% COHb for the second group. The results of these exposures were no different from those in which the CO and HCN were used simultaneously. The data are presented graphically in figure 30 for rats, and in figure 31 for mice.

Another possible action of the CO exposure superimposed on the individual contaminant exposures could have resulted in more rapid response such as a decreased time to death. Such a response would be important in consideration of potential hazard for aircraft passengers. We compared the mortality time data of singly and combined exposures and found no significant differences or trends.

While these acute toxicity studies show the toxicity ranking of the 4 materials tested to be HCN, NO₂, HF and HCl, in decreasing order, the hazard rating of various plastic formulations would require experimental determination of the amounts of these materials produced by pyrolysis of comparable quantities (i.e. although the combustion of 100 pounds of a cyanide-containing plastic might produce an aircraft cabin concentration of 200 ppm HCN, it is possible that the combustion of some chloride-producing plastic might yield cabin concentrations as high as 50,000 ppm); in this event the chloride containing plastic would present the greater hazard.

We have shown in these experiments that carbon monoxide concentrations which are not hazardous to life do not enhance the toxic response to the 4 toxic substances tested. Although some of the combined exposure LC₅₀ values are slightly lower than those of the compounds alone, the series of exposures of rats to NO₂ in combination with CO indicates that there is no trend to a slight enhancement of toxicity but that the results are random to the extent one would expect from repeated series of 5-minute LC₅₀ values for the various compounds if conducted at different times of the year.

TABLE VIII

7-Day Mortality Response of Rats
Exposed 5 Minutes to HCN Singly and in
Combination with CO (25% Carboxyhemoglobin)

HCN Concentration (ppm)	% Deaths	
	HCN	HCN + CO
280		0
283	0	
334		10
357	10	
368	20	
497	20	
504		70
557		70
583	80	
690	100	
LC ₅₀ 95% Confidence Limits	503 ppm 403-626 ppm	467 ppm 395-553 ppm

TABLE IX

7-Day Mortality Response of Mice
Exposed 5 Minutes to HCN Singly and in
Combination with CO (25% Carboxyhemoglobin)

HCN Concentration (ppm)	% Deaths	
	HCN	HCN + CO
188		0
200	0	
283	27	
288		61
300		40
319		87
357	80	
360		87
368	67	
414	80	
427	100	
LC ₅₀ 95% Confidence Limits	323 ppm 276-377 ppm	289 ppm 245-340 ppm

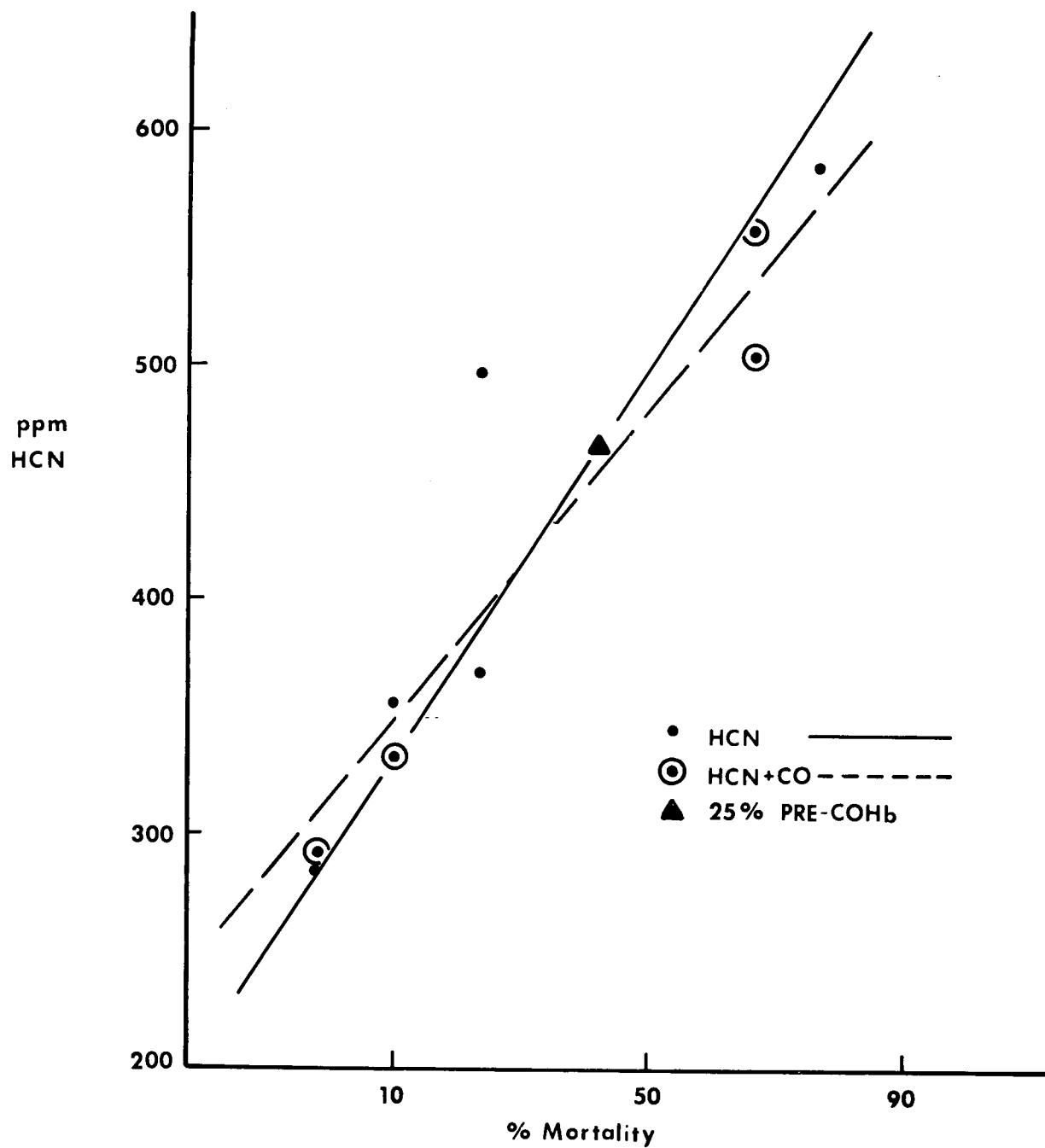

Figure 30

Five Minute LC_{50} for Rats Exposed to HCN
Singly and in Combination with CO

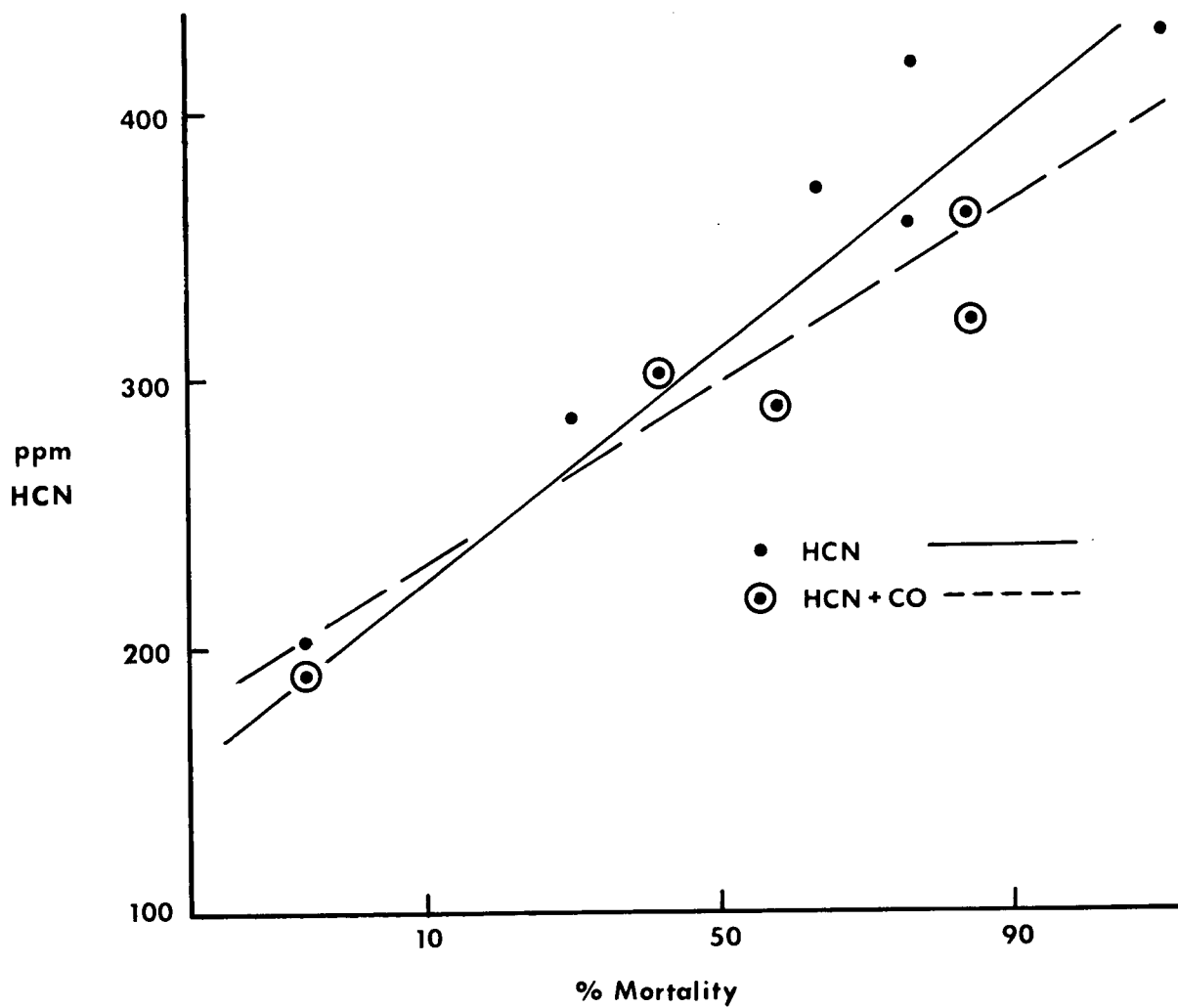

Figure 31

Five Minute LC_{50} for Mice Exposed to HCN
Singly and in Combination with CO

Acute Toxicity of Chlorine Pentafluoride

Chlorine pentafluoride is one of a series of fluorinated oxidizers of interest to the Air Force. Because of its potential use as a missile oxidizing propellant, information on the toxic hazard potential associated with its storage and handling was of interest. During this annual reporting period, a study of the acute inhalation toxicity of ClF₅ was initiated. The purpose of this study was to determine LC₅₀ values for 15, 30 and 60 minute exposures to ClF₅ in rats, mice, dogs and monkeys.

ClF₅ was first prepared by Smith (reference 20) in 1963, by combining ClF₃ and F₂ at high temperatures and pressures (350 C for 1 hour at 250 atm.). According to Smith, ClF₅ is a square pyramidal molecule with a lower melting point and a higher vapor pressure than ClF₃. There is some disagreement as to the reactivity of this compound with water. Smith found that ClF₅ reacted violently with water in any form, giving ClO₂F and HF according to the following reaction:



Dost and Wang (reference 10) found that ClF₅ apparently did react with water vapor according to the above reaction, but that the reaction was a slow one.

Very little investigation of the acute inhalation toxicity of ClF₅ has been done. Weinberg and Goldhamer (reference 21) conducted a short series of exposures of rats to ClF₅, and found that all of six animals died from an exposure to 400 ppm ClF₅ in air for 10 minutes, while 9 of 10 animals survived an exposure to 200 ppm ClF₅ for the same length of time. Periodic sacrifice of these 9 rats over the 24 hours following exposure showed evidence of denaturation of lung protein, and a lack of respiratory enzyme activity which was restored within 16 hours postexposure, indicating a reversible alveolar destruction.

All our exposures were made in a standard Rochester Chamber. The experimental animals were observed for visible symptomatology and mortality both during exposure and for a 14-day postexposure observation period. Gross and histopathological examinations of a representative sample of each of the 4 species for each exposure time was conducted by the Pathology Branch. This included animals that died both during and after exposure as well as those that survived for the full 14-day postexposure period.

Experimental animals included male Sprague-Dawley rats and male ICR mice from A. R. Schmidt and Company, male and female beagle dogs from Hazelton Company and Ridgeland Farms, and male and female Rhesus monkeys (*Macaca mulatta*) from Primate Imports, Inc.

Although the experiments are still in progress, enough information has been gathered to justify some preliminary reporting of results. LC₅₀ values with 95% confidence limits completed thus far are listed in table X.

TABLE X

LC₅₀ Values and 95% Confidence Limits for
Rodents and Monkeys Exposed to ClF₅

<u>Species</u>	<u>Duration of Exposure</u>	<u>LC₅₀ Values in PPM (95% Confidence Limits)</u>
Rats	30 min	194 (135-278)
Rats	60 min	122 (108-139)
Mice	60 min	57 (47-70)
Monkeys	15 min	236 (149-373)

In comparison with other oxidizing agents, ClF₅ appears to be considerably less toxic than OF₂ but more toxic than either HF or ClF₃. There are no accounts in the literature of the symptomatology of ClF₅ exposure, but, as might be expected, symptoms appear to be similar to those of HF and ClF₃. Rodents showed lacrimation, rhinorrhea, salivation and respiratory distress during exposure. This generally led to anoxic hyperactivity just prior to death, a state which resembled very closely CNS stimulation. Corneal opacity was a common occurrence with rodents and dogs, but was less pronounced in the monkeys. Dogs and monkeys showed evidence of irritation almost immediately after onset of the exposure. This was demonstrated by marked salivation, lacrimation, sneezing, nausea and dyspnea. Some animals lost consciousness. Cyanosis was usually evident in both dogs and monkeys by the end of the exposure.

Gross pathological examination of animals killed by ClF₅ showed that the lungs and respiratory passages were the primary targets. The lungs failed to collapse upon opening the chest cavity, and were found to contain edema fluid and blood, indicating alveolar destruction. Nasal and bronchial passages generally contained large amounts of mucous and other fluids, and, in some cases, blood. There were no other apparent systemic effects. Although tissue samples have been taken for histopathological examination, these have not been completed at this time. Examination of animals that survived the full 14-day postexposure observation period showed that the effects on the respiratory system had almost completely resolved within this period of time.

The death pattern of exposures done thus far appears similar to that of OF₂, and HF, with delayed deaths in all four species. Dogs and monkeys generally die within 48 hours following exposure, and rodent deaths occur throughout the entire 14-day postexposure period. There have been more delayed deaths with mice than with rats. The mice appeared to lose weight following exposure, probably due to a decreased food intake.

Animal exposures to ClF₃ are continuing and the results of these experiments will be described in a separate technical report upon completion.

Oxygen Difluoride Toxicity

The last annual report included results of exposures of dogs, monkeys, rats and mice to various concentrations of oxygen difluoride for 60-minute periods. Since that report, additional experiments were conducted to determine the mortality response to 15-minute OF₂ exposure. Table XI presents mortality results for dogs and monkeys; and table XII for rodents. The comparative LC₅₀ values and 95% confidence limits obtained for the 4 species tested are shown in table XIII.

TABLE XI

Mortality Response of Monkeys and Dogs to Inhaled
OF₂ After a 15 Minute Single Exposure

<u>Species</u>	<u>Mean Measured Concentration (ppm)</u>	<u>No. Died/No. Exposed</u>
Rhesus Monkey	60	0/4
	100	2/4
	120	2/4
	140	4/4
Beagle Dog	60	0/4
	80	1/4
	100	3/4

TABLE XII

Mortality Response of Rodents to Inhaled
OF₂ After Single 15-Minute Exposures

<u>Species</u>	<u>Mean Measured Concentration (ppm)</u>	<u>No. Died/No. Exposed</u>
Rat	9.5	0/10
	10.4	1/10
	11.0	3/10
	11.9	1/10
	13.8	9/10
	15.2	8/10
	16.5	9/10
Mouse	4.5	8/15
	5.8	1/15
	7.5	8/15
	8.5	4/15
	9.5	12/15
	11.0	8/15
	11.9	15/15
	15.2	12/15
16.5	14/15	

There were no deaths during exposure in any of the animals used in the 60- and 15-minute experiments. The majority of monkey and dog deaths occurred by 24 hours, while most rodent deaths occurred between 24 and 72 hours postexposure.

TABLE XIII

LC₅₀ Values and 95% Confidence Limits for Four Animal Species Exposed to OF₂ for 15 Minutes

<u>Species</u>	<u>LC₅₀ Values (ppm)</u>	<u>95% Confidence Limits (ppm)</u>
Monkeys	129	86 - 194
Dogs	90	63 - 128
Rats	12.7	11.5 - 14.1
Mice	7.5	6.1 - 9.2

Delayed deaths, as late as 7 days, were noted in a few of the 60-minute monkey and dog exposures. Mice in the 15-minute tests showed a significant number of deaths 4 and 5 days postexposure.

Pathology of dogs and monkeys dying a few hours postexposure indicated severe pulmonary congestion and edema, manifested in a lobular arrangement distributed alternately with normal tissue, giving a marbled appearance. Those large animals dying 1 to 2 days postexposure showed mild fatty changes of the liver in addition to moderate interstitial and mild alveolar emphysema. At 14 days the survivors of both species showed a reversal of the damage occurring from the initial exposure. Several monkeys, including one sacrificed 5 months postexposure, exhibited pleural adhesions.

Pathologic changes in rodents were similar to those seen in the large animals. Marbled congestion and edema were noted in animals dying several hours to one day postexposure. Several animals sacrificed 14 days postexposure possessed areas of consolidation in addition to interstitial edema and pneumonia.

Clinical chemistry determinations were made on blood samples from dogs and monkeys exposed for 15 minutes to sublethal concentrations of 60 and 30 ppm OF_2 at 1, 2, 7 and 15 days postexposure. These tests consisted of uric acid, urea, creatinine, serum alkaline phosphatase, glutamic oxaloacetic transaminase, blood glucose, electrolyte and prothrombin time determinations. No significant differences between exposed and control values were seen in any parameter.

90-Day Continuous Exposure to MIBK

Animals exposed continuously to 410 mg/ M^3 MIBK for 90 days under simulated space cabin environmental conditions were not adversely affected, with the exception of albino rats. Hyaline droplet tubular nephrosis developed in albino rats under the experimental conditions used but did not result in debilitation or death. The lesions developed within 2 weeks of exposure and were reversible upon removal from the MIBK environment even after 90-day exposure. Based on the results of these experiments in space cabin environments, concentrations of MIBK up to 410 mg/ M^3 (1000 ppm equivalent) should be tolerable for man for the time period investigated. Furthermore, these data indicate that the 60-minute emergency limit of 100 ppm and the 90- and 1000-day provisional limit of 20 ppm as established by the Space Science Board, NAS/NRC, in 1968 contain a wide margin of safety. The complete details of this study are published as AMRL-TR-71-65.

Methylene Chloride, 90-Day Chronic Toxicity Study

During this annual reporting period, a 14-week study was initiated to determine the chronic toxicity of CH_2Cl_2 by continuous exposure of rats, mice, dogs and monkeys to concentrations of 1000 and 5000 ppm. In a previous study, Heppel et al. (reference 24) exposed dogs, rabbits, guinea pigs and rats to 5000 ppm intermittently for 7 hours per day, 5 days per week for up to 6 months. They found subnormal weight gains, decreased food intake and death of 3 of the 8 guinea pigs after 35, 90 and 96 exposures. Examination of the animals that died showed pneumonia and centrilobular fatty degeneration of the liver. None of the other species, however, showed any evidence of toxicity during the course of the exposures. Lehmann and Schmidt-Kehl (reference 25) conducted a continuous exposure of cats and rabbits to 1728-2036 ppm CH_2Cl_2 for four weeks, and observed only drowsiness and slight reduction of body temperature. Little other work has been reported on the chronic toxicity of CH_2Cl_2 . Acute LC_{50} values for mice have been variously reported as 14,500 ppm for a 2-hour exposure (reference 26) and 16,186 ppm for a 7-hour exposure (reference 27).

Both CH_2Cl_2 exposed groups and the control set consisted initially of 8 female beagle dogs, 4 female rhesus monkeys, 20 male Sprague-Dawley rats and 380 female ICR mice. An additional 20 mice were used in the 5000 ppm exposure to measure spontaneous activity.

In this study, each group of animals was housed in a separate Thomas Dome operated at 725 mm Hg pressure to avoid leakage of CH_2Cl_2 , with nominal air flows of 40 cfm. A continuous analysis of the CH_2Cl_2 level in each dome was obtained using a Beckman 109A hydrocarbon analyzer. A detailed report of both the introduction and analytical procedures for CH_2Cl_2 is given elsewhere in this report under the Analytical Chemistry Program Section.

Clinical testing is being conducted on the animals throughout the experiment according to the following schedule: the SMA-12 battery of blood tests, at the beginning and conclusion of the study; hematology, liver enzyme (isocitrate dehydrogenase and serum glutamic pyruvic transaminase) determinations and BSP clearance tests on dogs and monkeys, at initiation and after 4, 8 and 13 weeks of exposure; determination of blood CH_2Cl_2 levels in dogs and monkeys after 4 and 13 weeks, and urinary formic acid tests on one dog in each group after 6 and 12 weeks of exposure; body weight measurements on dogs, monkeys and rats every other week during the entire experimental period; sleeping time tests on mice in groups of 20 mice per dome per day on days 28-32, 56-60 and 91-95; also, 10 mice from each dome of days 30, 60 and 91 for cytochrome b_5 and cytochrome P450 analyses.

Activity measurements are being made on dogs in both CH_2Cl_2 exposure groups using the standard time lapse photographic technique. Additional activity measurements were made on a group of 20 mice during the first 30 days of exposure at the 5000 ppm level, using video tape recording of all activity for a 3-hour period during weekdays only.

At this writing, 8 weeks of exposure have been completed, and the results available thus far will be reported here. The most pronounced and more immediate effects were observed in the group being exposed to 5000 ppm CH_2Cl_2 . The narcotic effects of exposure to CH_2Cl_2 became manifest during the first day of the exposure in dogs and to a lesser extent monkeys and mice. The rats appeared to be affected very little if at all during the first few days of exposure. By the second day of exposure, the dogs, monkeys and mice regained their coordination, but maintained a lethargic behavioral state until death due to exposure or sacrifice. Food consumption was noticeably reduced in all animals from the very first day of exposure on. Emaciation in dogs and monkeys became progressively worse as the exposure continued.

When body weights were taken at the end of 2 weeks of exposure, rats, dogs and monkeys all showed substantial weight loss compared to controls (mice were not weighed). At 4 weeks, dogs and monkeys showed additional weight loss, while rat weights reflected large compensatory increases. The mean rat weight, however, was significantly less than that of the controls.

The animals exposed to 1000 ppm CH_2Cl_2 showed similar signs of toxicity, but to a far less degree. Appetite suppression was evident in about 80% of the dogs and monkeys in this dome, and rodents displayed little visible evidence of toxicity. When the two and four week body weights were taken, all dogs and 2 of 4 monkeys had lost weight while the other 2 monkeys maintained their original weights. The rats showed normal weight gains compared to controls.

Death of animals began within 3 days after onset of exposure when 2 mice died in the high exposure dome (5000 ppm CH_2Cl_2). By 4 days, 23 more mice had died in the same dome. From that time on, mice in that dome continued to die at the rate of 3-6 per day. By day 30, a total of 122 mice had died in the 5000 ppm dome, and an additional 26 mice had been removed for pathological examination.

By 8 weeks, a total of 7 mice had succumbed to the lethal effects of 1000 ppm CH_2Cl_2 . One mouse was found dead on the 19th day of exposure, 6 more died during the 41st day of exposure. Twenty-two mice were removed at various times during the 8-week period for comparison of pathology with 5000 ppm exposed and control mice. No rat deaths occurred during the first 8 weeks of exposure.

Analysis of the blood of dogs exposed to 5000 and 1000 ppm CH_2Cl_2 for 16 days gave the results shown in table XIV. The blood concentration of CH_2Cl_2 in dogs exposed to 5000 ppm is almost exactly 5 times that in those exposed to 1000 ppm. In vitro comparison of the partition of CH_2Cl_2 between liquid and air indicates that the compound is considerably more soluble in blood than in distilled water.

The first death of a large animal occurred on day 12 when a monkey from the 5000 ppm dome died. This was followed by the death of four of the 8 dogs in the same dome during the 3rd and 4th weeks of exposure, on days 18, 22, 23 and 24. Six of 8 dogs exposed to 1000 ppm CH_2Cl_2 died in the 6th and 7th week of that study; 2 during the 6th and 4 during the 7th week of exposure. The remaining 2 dogs were tested and necropsied at the end of 7 weeks. Again, no monkey deaths occurred during the first 8 weeks of exposure in the 1000 ppm experiment.

TABLE XIV

Methylene Chloride Blood Levels in Dogs Exposed
Continuously for 16 Days

5000 ppm Exposure		1000 ppm Exposure	
Dog No.	CH ₂ Cl ₂ in blood, mg/liter	Dog No.	CH ₂ Cl ₂ in blood, mg/liter
M-89	175	N-05	35
N-23	130	N-07	30
N-29	200	N-09	34
N-31	160	N-11	36
N-33	250	N-13	41
		N-15	32
		N-19	57
		N-21	25

Pathologic examination of mice that died or were sacrificed during exposure to 5000 ppm showed that CH_2Cl_2 at this concentration was both hepatotoxic and nephrotoxic. The hepatic lesion initially showed degeneration of centrilobular hepatocytes and mid-zonal fatty change. This was followed at 4 days by a frank centrilobular necrosis and at 7 days by a striking centrilobular regeneration. Subsequent examination during the first 30 days of exposure showed that this degeneration-necrosis-regeneration cycle was repeated in an attenuated form. There was a transient neutral fat accumulation in the proximal tubules of the kidneys at the light microscopic level which peaked at approximately 48 hours. The hepatic and renal lesions are now being examined by electron microscopy. Pathology results for the 1000 ppm mice are not available at this time.

Of the dogs that died during exposure to 5000 and 1000 ppm CH_2Cl_2 , or were sacrificed, gross pathological examinations showed fatty yellow livers, brain edema in some cases, acute to subacute pneumonia, and extreme emaciation. Similar pathology was seen in one monkey which died as a result of exposure to 5000 ppm. Tissue samples were taken for histopathological examination but these have not been processed at this time.

Due to the extreme toxicity of continuous exposure to 5000 ppm CH_2Cl_2 , it was decided to sacrifice and examine the remaining mice, dogs and monkeys in that dome during the 4th week of exposure. Half the rats, however, continued to be exposed at this level, with the other half being sacrificed for complete gross and histopathological examinations and organ to body weight ratios. Five rats from the control dome were also sacrificed for comparison with the rats that had been exposed to 5000 ppm. BSP clearance tests were done on the remaining monkeys prior to their sacrifice during the 4th week of exposure. The results of the BSP tests are shown in table XV. The low value in the 1000 ppm methylene chloride dome reflects a difficulty in obtaining a blood sample from one of the monkeys in that group.

In view of the results reported here for the first 8 weeks of continuous exposure to 1000 ppm and 5000 ppm CH_2Cl_2 , it becomes obvious that toxicity associated with continuous exposure to CH_2Cl_2 is substantially different from that reported previously for intermittent exposure to the same compound. Whereas an exposure to 5000 ppm CH_2Cl_2 for 7 hours per day, 5 days per week for periods up to 6 months produced no evidence of toxicity in dogs, according to Heppel (reference 24), this

continuous exposure at the same concentration produced death in 4 of the 8 dogs exposed within 24 days, and it appeared the remaining dogs would have died had their exposure continued. Furthermore, 6 of 8 dogs died during the second month of exposure to 1000 ppm. Death appeared to be certain for the remaining 2 dogs. The same intermittent exposure did, however, produce toxic effects in guinea pigs similar to those reported here in mice, dogs and monkeys. Heppel et al. observed weight loss, decreased food intake and death in 3 of 8 guinea pigs exposed, and at necropsy found pneumonia and centrilobular fatty degeneration of liver tissue. These same phenomena became manifest to a greater degree and over a much shorter period of time during a continuous exposure to CH_2Cl_2 . The primary target organ or system is not entirely clear at this time, although several systems appear to be affected.

TABLE XV

Results of BSP Liver Function Tests on Monkeys Continuously Exposed to Methylene Chloride for 30 Days

<u>Controls</u>	<u>% Dye Retention</u>	
	<u>1000 ppm CH_2Cl_2</u>	<u>5000 ppm CH_2Cl_2</u>
2	21	9
3	38	5
2	5	
5	17	

Effects on the central nervous system are indicated by the observed narcosis in the animals, and by the finding of edema in the brains of dogs and monkeys that died during exposure. The decreased food intake and the resulting cachexia may account for the brain edema produced.

There is substantial indication of liver damage by CH_2Cl_2 in the data reported here. Not only did gross and histopathological examination by light microscope show evidence of fatty degeneration of liver tissue, but also liver enzyme tests showed marked differences from control values in dogs and some of the monkeys. BSP retention was considerably higher in the monkeys exposed to 1000 ppm CH_2Cl_2 , also indicative of liver damage, but was not elevated in the 2 monkeys tested in the high exposure dome immediately prior to sacrifice. The reasons for this are not known, although several factors may have been involved.

The species difference in susceptibility to CH_2Cl_2 is of interest. Whereas mice offered very little resistance to the toxic effects of the exposure to 5000 ppm CH_2Cl_2 , rats were affected only to a very slight degree. At both exposure levels, dogs appear to be the most sensitive species, followed by mice, monkeys and rats.

Monomethylhydrazine Chronic Toxicity

The results of the 6-month chronic exposures of dogs, monkeys, rats and mice to 2 and 5 ppm MMH were reported in 1970 (references 6 and 28). Overall assessment of results provided evidence that definite dose related toxic effects were produced in all 4 species and that further investigations were warranted. Therefore, additional experiments were planned and conducted in an effort to establish a no-effect level of MMH. The air concentrations selected were 0.2 ppm for continuous exposure, and 0.2 and 1.0 ppm MMH for intermittent daily exposures. The current 8-hour industrial threshold limit value (TLV) for MMH is 0.2 ppm.

The 3 MMH exposure groups, as well as the control group, consisted of 8 beagle dogs, 4 rhesus monkeys, 40 Wistar rats and 40 ICR mice. All animals, except mice, were male. Exposures of 0.2 and 1.0 ppm MMH were conducted on a 6 hour/day, 5 day/week basis. The third group of test animals was exposed continuously to 0.2 ppm MMH. The control group was exposed to air continuously in another chamber throughout the 30-week study period.

Tests used to measure the toxicity of MMH in this study were identical to those used in the previous chronic experiment. However, deleted from the total number of parameters tested were those that had shown no indications of effect at the higher dose levels used in the previous study.

As in the previous 6-month study, the Thomas Domes were operated with nominal air flow of 40 cfm, and at slightly reduced pressure, 725 mm Hg, to avoid leakage of MMH. Continuous monitoring of chamber MMH concentrations was made with an AutoAnalyzer (reference 29).

There were no observable indications of toxicity in appearance or behavior of any of the animals tested, except in one dog exposed intermittently to 1.0 ppm MMH. This animal showed an obvious relaxation of the nictitating membranes during the 4th and 5th daily exposures in the 8th week of the study. This sign continued to appear on the same daily schedule for an additional 5 weeks, then disappeared. The significance of this finding is not clear but it was also seen in the higher level MMH exposures previously reported.

Very few deaths occurred during the course of the various exposures. Pathologically, none can be directly attributed to the toxic influence of MMH. Catarrhal enteritis was a common finding. One mouse death, in each case, was recorded for the 0.2 ppm continuous MMH exposed, the 0.2 ppm intermittent MMH exposed, and the control groups. Three rats died during the study. All succumbed to pneumonia, one in the 0.2 ppm continuous, and 2 in the 1.0 ppm intermittent exposures. All rodent deaths occurred at various times during the 5th and 6th month of the study.

Figure 32 presents the growth rates of the 4 rat groups. Weight measurements were made after 1 week of exposure, then on a biweekly schedule thereafter. The last nonfasting weights were taken 1 week prior to the conclusion of the study.

Body weight data present some evidence of minimal dose dependent effects of MMH exposure at the 2 highest concentrations. At no time interval were the mean weights of the rats exposed to the lowest dose level (0.2 ppm intermittent) statistically different than those of the control group. Differences, significant at the 0.01 level, were seen from the 1st to the 9th week for the 1.0 ppm MMH intermittently exposed group and at weeks 7, 9 and 13 in the case of the 0.2 ppm continuous exposure rats. This information suggests a deleterious effect of MMH in the rats exposed to the highest dose levels, more immediate certainly for the 1.0 ppm intermittently exposed rats.

High temperatures caused by heating equipment malfunction occurred in the laboratory area containing the chamber in which the control animals were housed. Unfortunately, the control rats experienced actual weight losses resulting from the heat stress and comparisons with controls after the 13th week are valueless.

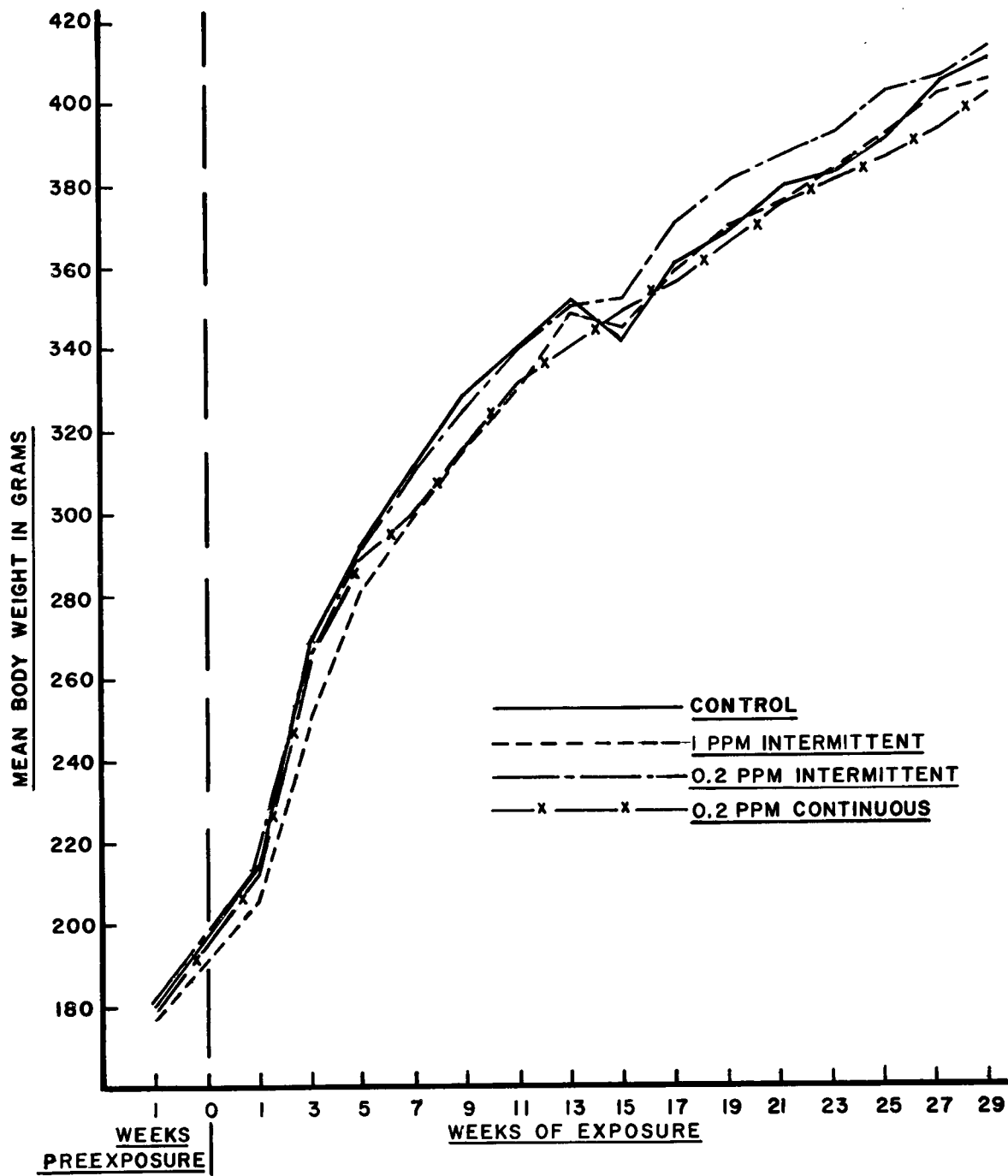

Figure 32

Effect of Chronic Monomethylhydrazine
Exposure on Rat Growth

A selected battery consisting of 22 clinical laboratory tests were performed on blood samples taken from all large animals prior to the initiation of the study, after one week of exposure, then on a biweekly schedule thereafter.

Mean hematocrit, hemoglobin, and red blood cell values for all groups of exposed and control dogs are shown graphically in figures 33 to 35. The hemolytic effects of MMH inhalation were most obvious in dogs from the two highest exposure levels. Maximum depression in HCT, HGB and RBC values occurred within the first 9 weeks of exposure. Calculated as percentage decreases from preexposure values the results were:

<u>MMH Concentration (ppm)</u>	<u>% Maximum Depression</u>	<u>Time in Weeks</u>
0.2 continuous	$\frac{\text{HCT}}{12.5}$	7
1.0 intermittent	6	3
0.2 intermittent	0	-
0.2 continuous	$\frac{\text{HGB}}{20.5}$	9
1.0 intermittent	15.8	3
0.2 intermittent	0	-
0.2 continuous	$\frac{\text{RBC}}{31.0}$	1
1.0 intermittent	20.5	3
0.2 intermittent	9.3	5

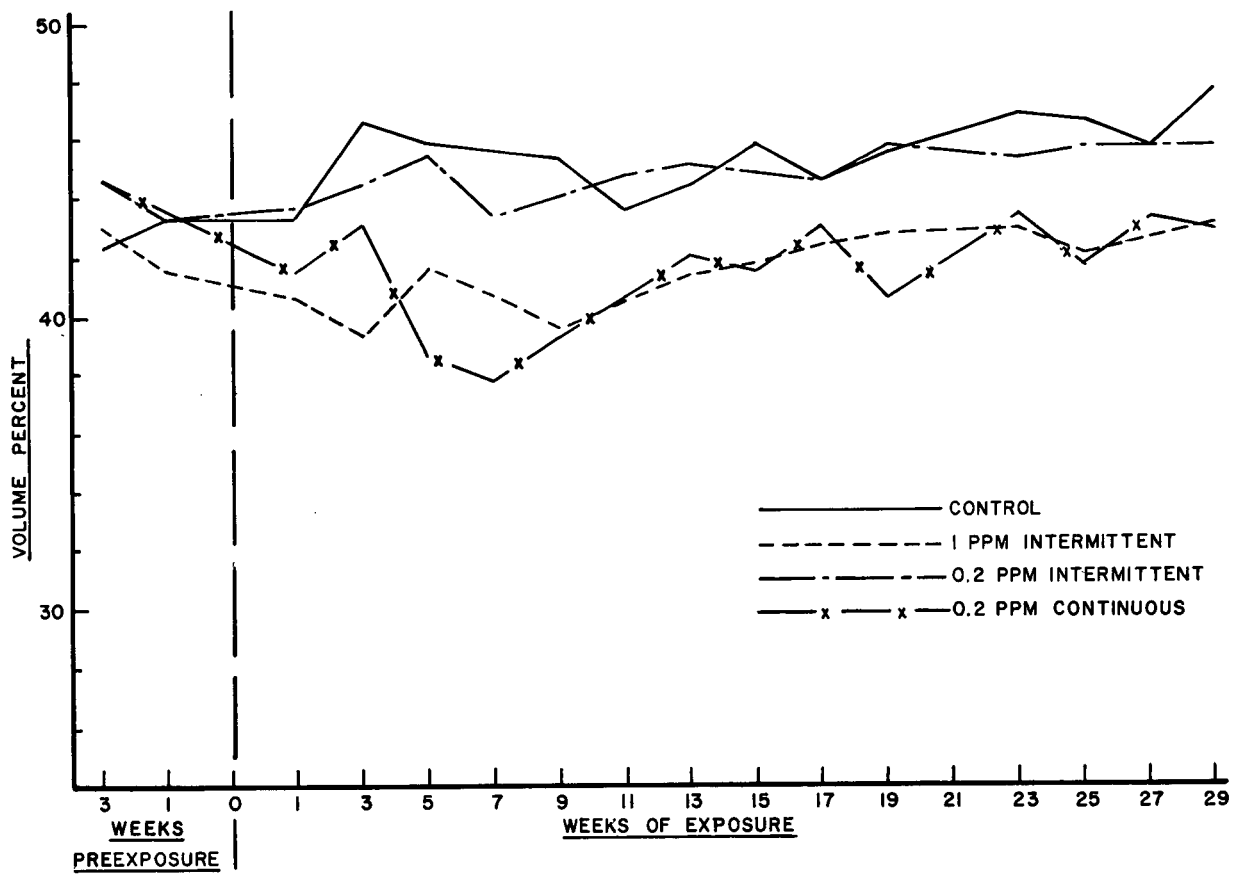

Figure 33

Effect of Chronic Monomethylhydrazine Exposure on Dog Hematocrit Values

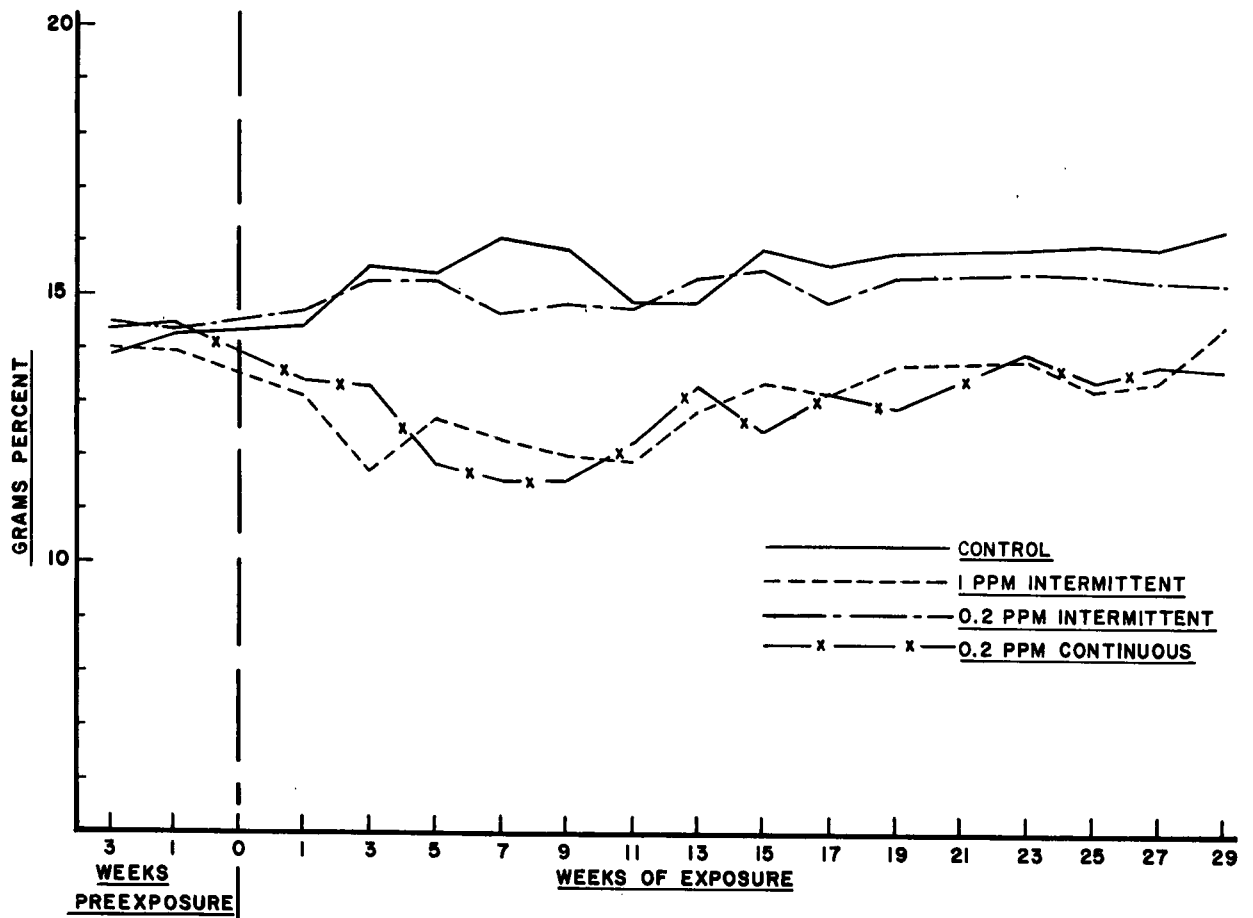

Figure 34

Effect of Chronic Monomethylhydrazine Exposure on Dog Hemoglobin Levels

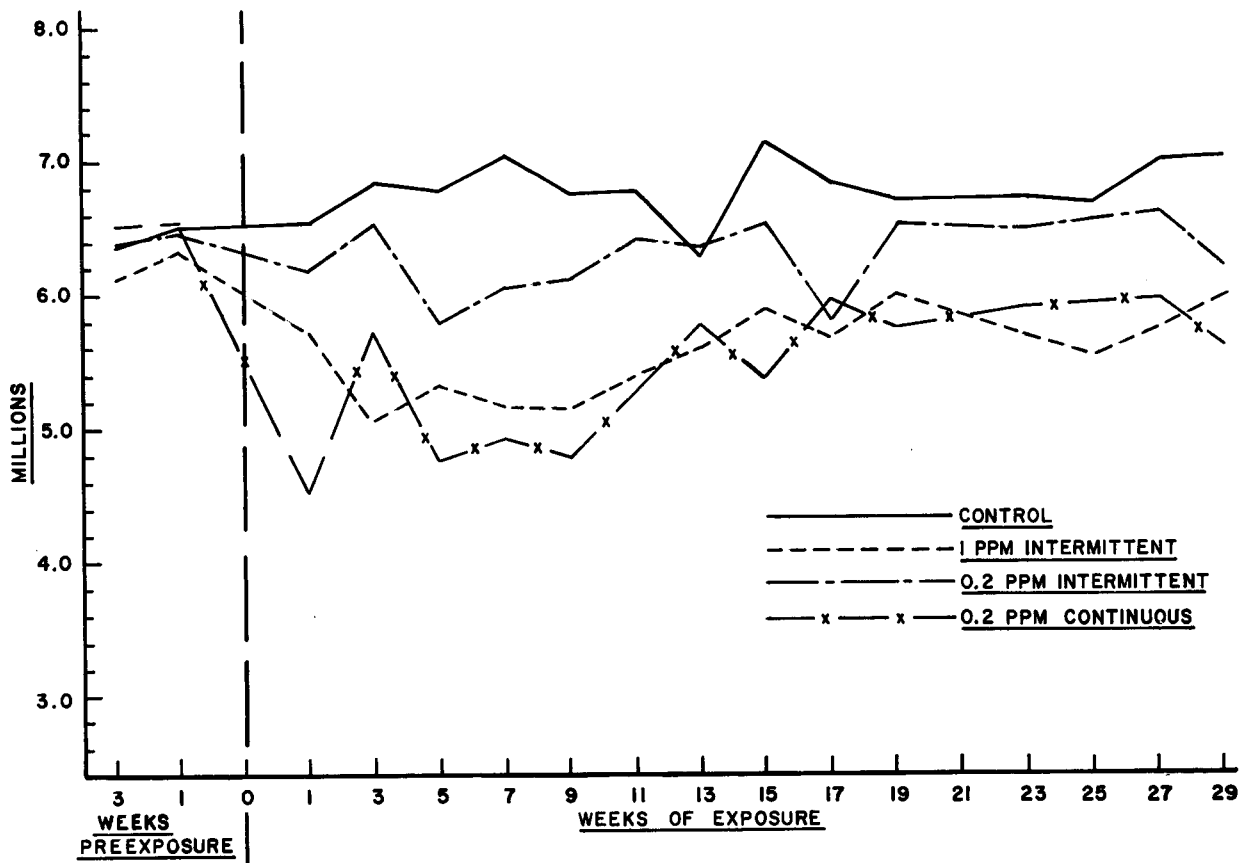

Figure 35

Effect of Chronic Monomethylhydrazine Exposure on
Dog Red Blood Cell Counts

Dogs continuously exposed to 0.2 ppm MMH showed the most pronounced hemolytic response, particularly in regard to the immediate and severe depression of RBC production. Significantly, but to a lesser extent, dogs exposed to 1.0 ppm MMH intermittently also show depressions in the same hematology measurements. Of these parameters, reduced RBC production is the only indication of effect in dogs exposed to the lowest dose level of MMH.

Compensation for RBC destruction in dogs by reticulocyte production began with the first few weeks of exposure and reached maximum levels at approximately 13 weeks when stabilization of HCT, HGB and RBC parameters occurs for the dogs exposed to the two highest doses of MMH. Reticulocytosis became maximal between 7 to 11 weeks in the case of the dogs exposed to 0.2 ppm intermittently, but is of borderline significance when compared with control values. After 13 weeks of exposure, stabilization of HCT, HGB and RBC values occurred at similar subnormal levels for dogs at the highest exposure doses. This stabilization response is reflected in the slow decrease in reticulocyte production during the same time period. HCT, HGB and RBC values for dogs from the lowest dose parallel control values rather closely until the end of the study.

Statistical analysis of this biweekly data revealed with few exceptions that hematology values obtained for the 0.2 ppm continuously and the 1.0 ppm intermittently exposed dogs were significantly lower than their controls in the 0.01 confidence level. Values for dogs exposed to the lowest dose level (0.2 ppm intermittent) were statistically different from controls in RBC (6 of 15) and reticulocyte (4 of 15) measurements only.

Monkey hematology data collected on the same biweekly schedule used for dogs were examined and tested for trends of biological and statistical importance. The overall net depression of HCT, HGB and RBC values for all exposed groups was 5-11% below preexposure values. Although statistical differences from control values were produced at various time periods, there were no consistent patterns of effect that could be related to exposure levels. No meaningful dose response relationship was evident. However, increased reticulocytosis between 1 to 7 weeks of exposure provided some minimal evidence of the hemolytic influence of MMH at the two highest dose levels.

Methemoglobin determinations were done on dogs once a month during the course of the study. The mean values obtained in all exposed groups of dogs were significantly elevated above the control value at 4 weeks but by 8 weeks test values were sharply reduced. However, the differences between the two highest dose levels and controls, although small, were still significant at 8 weeks and remained so for the duration of the study.

Increased susceptibility of dog red blood cells to hemolysis after exposure to MMH was measured in this study by means of an erythrocyte osmotic fragility test. Figure 36 shows fragiligrams for the exposed and control dog groups. Values plotted for each graph are the mean of 12 determinations. The tests were performed on 2 dogs from each group 3 times during the 4th month of exposure and then once a month in each of the remaining 3 months of the study. Hemolysis began at much higher salt concentrations in blood from dogs exposed to the two highest concentrations while the differences are borderline for dogs in the 0.2 ppm MMH intermittent exposure when compared with controls.

Blood samples taken from all dogs and monkeys at 3, 4, 5 and 7 months were examined microscopically for the presence of Heinz bodies. Group mean values from all sampling periods were always relatively low, but positive for all exposed groups. Mean values of from 1 to 5 Heinz bodies in 100 red blood cells were found in each sample from MMH exposed animals. No dose or species related effects were evident. Overall assessment of the results of this test suggests, however, that minimal hemolytic effects were induced in monkeys as well as dogs as a result of low level exposures to MMH.

Examination of clinical chemistry data, consisting of 16 separate determinations performed on a regular biweekly schedule for dogs and monkeys during the course of the study revealed that mean bilirubin, alkaline phosphatase and total inorganic phosphorus values for all exposed dog groups were, for the most part, statistically higher than control values.

Serum bilirubin and alkaline phosphatase levels were significantly elevated in all dog exposure groups at all sampling periods from 3 weeks to the conclusion of the study. Figures 37 and 38 present group mean values for each of these determinations. Dose dependent effects are noticeable in both figures. Values for dogs exposed to the two highest MMH concentration levels were consistently higher than those recorded for the lowest MMH concentration exposure group. To a lesser extent, the latter values were repeatedly higher than control. Total inorganic phosphorus results, figure 39, were less pronounced, particularly for dogs exposed to the lowest concentration level, but are indicative, as are the abnormally high bilirubin and alkaline phosphatase levels, of the intrahepatic cholestasis produced in dog livers as a result of chronic exposure to MMH.

All exposed and control animals were sacrificed at the conclusion of the study and submitted for gross necropsy. Major organs from all dogs, monkeys, 10 rats and 10 mice from each group were saved for histopathologic examination. Additionally, dog and monkey kidneys were sampled by technicians from the Armed Forces Institute of Pathology for electron microscopic examination.

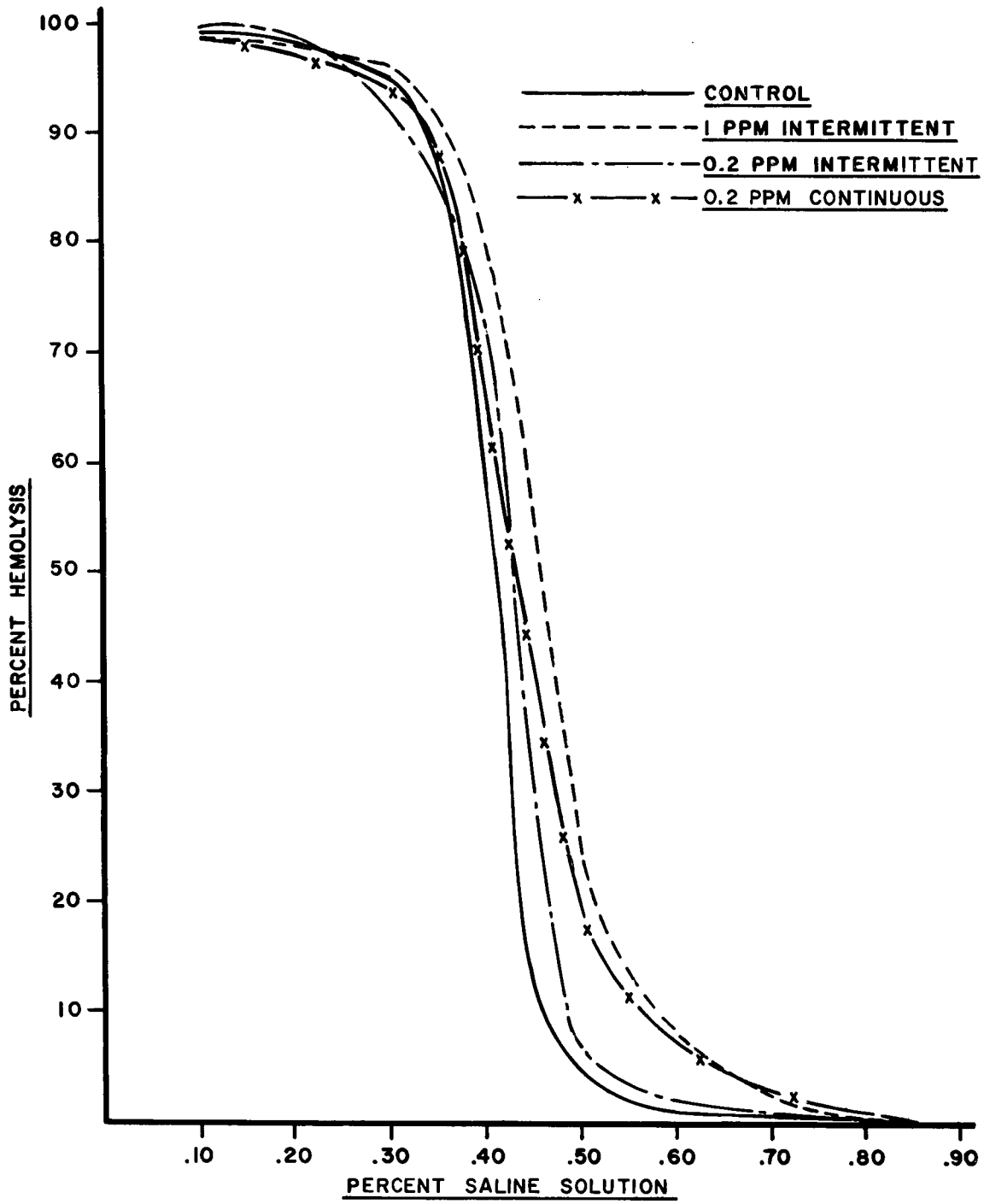

Figure 36

Effect of Chronic Monomethylhydrazine Exposure on Red Blood Cell Fragility in Dogs

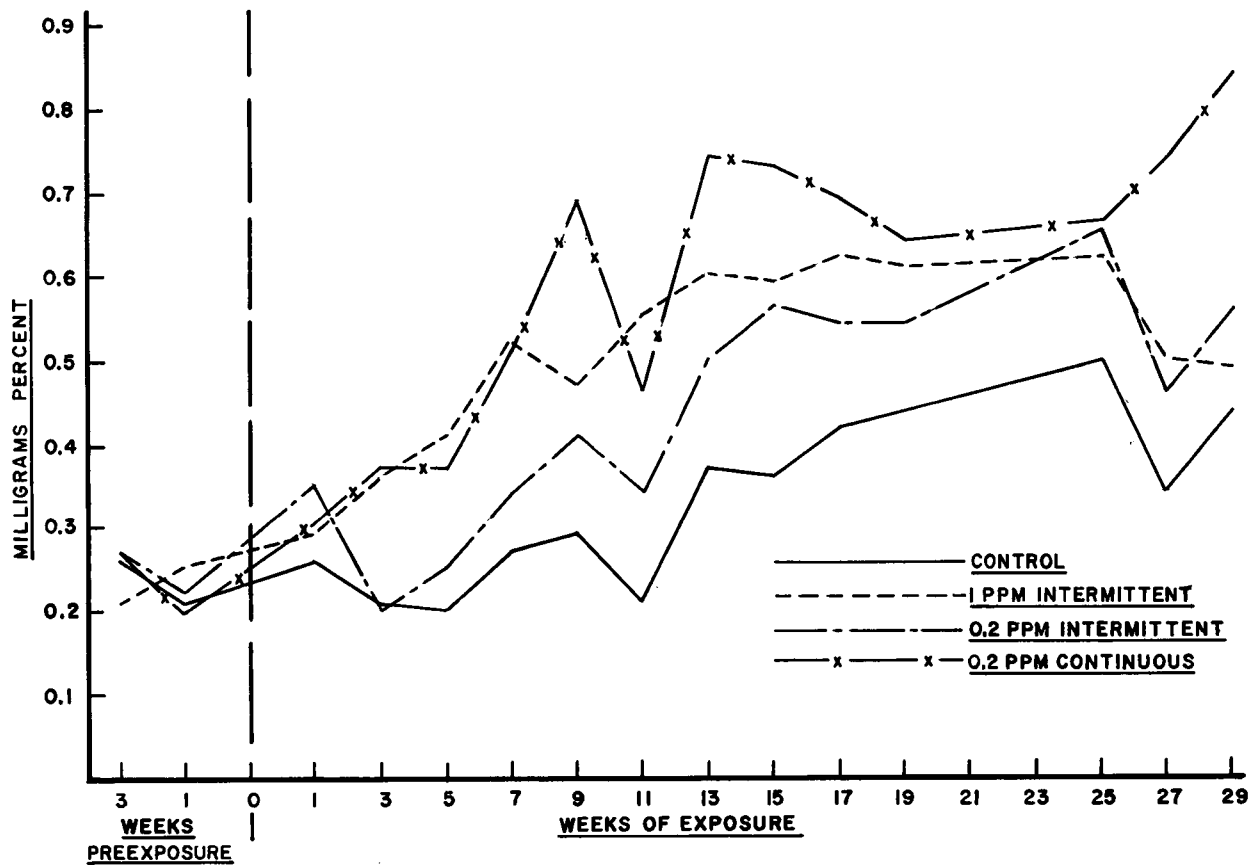

Figure 37

Effect of Chronic Monomethylhydrazine Exposure on Serum Bilirubin Levels in Dogs

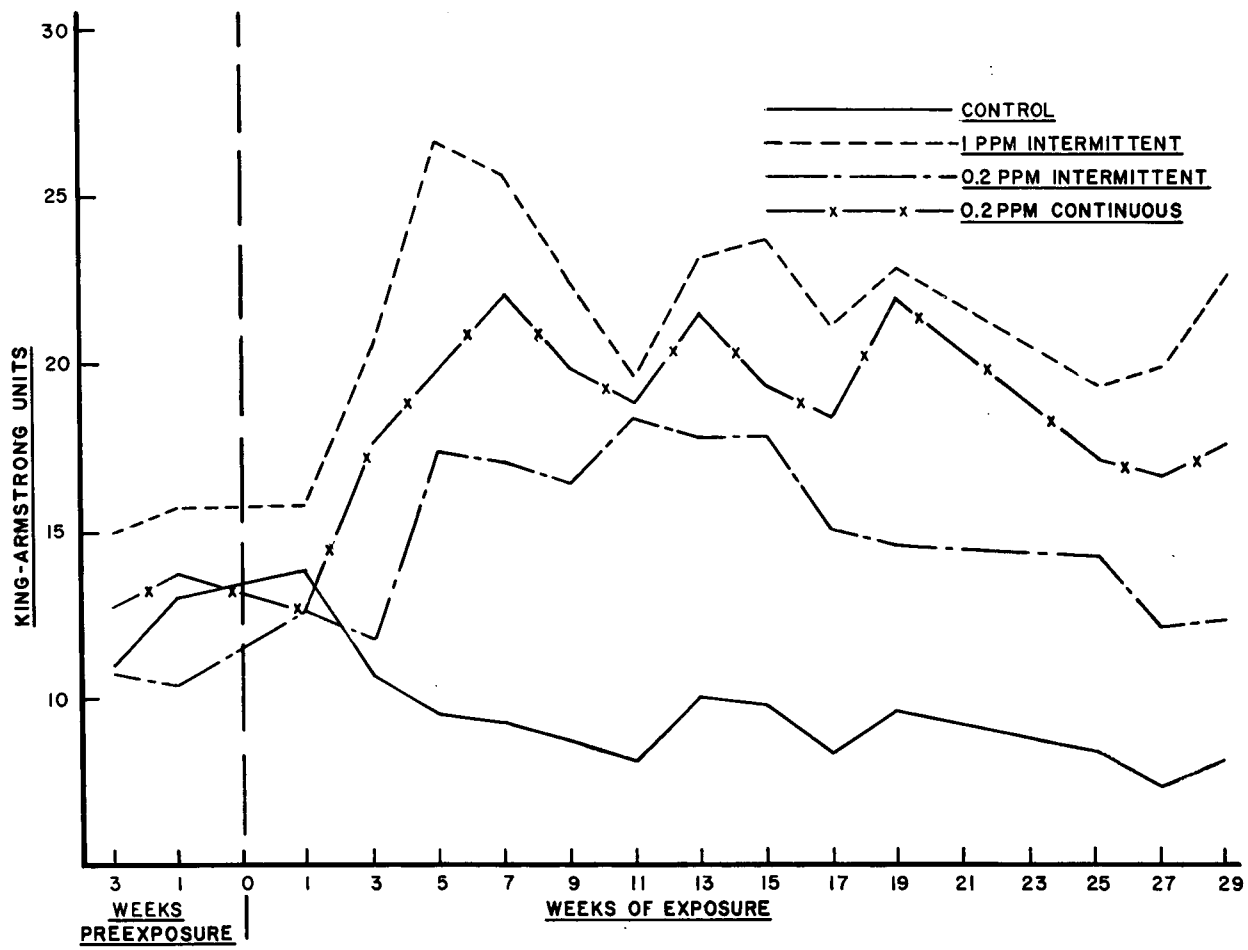

Figure 38

Effect of Chronic Monomethylhydrazine Exposure on Serum Alkaline Phosphatase Levels in Dogs

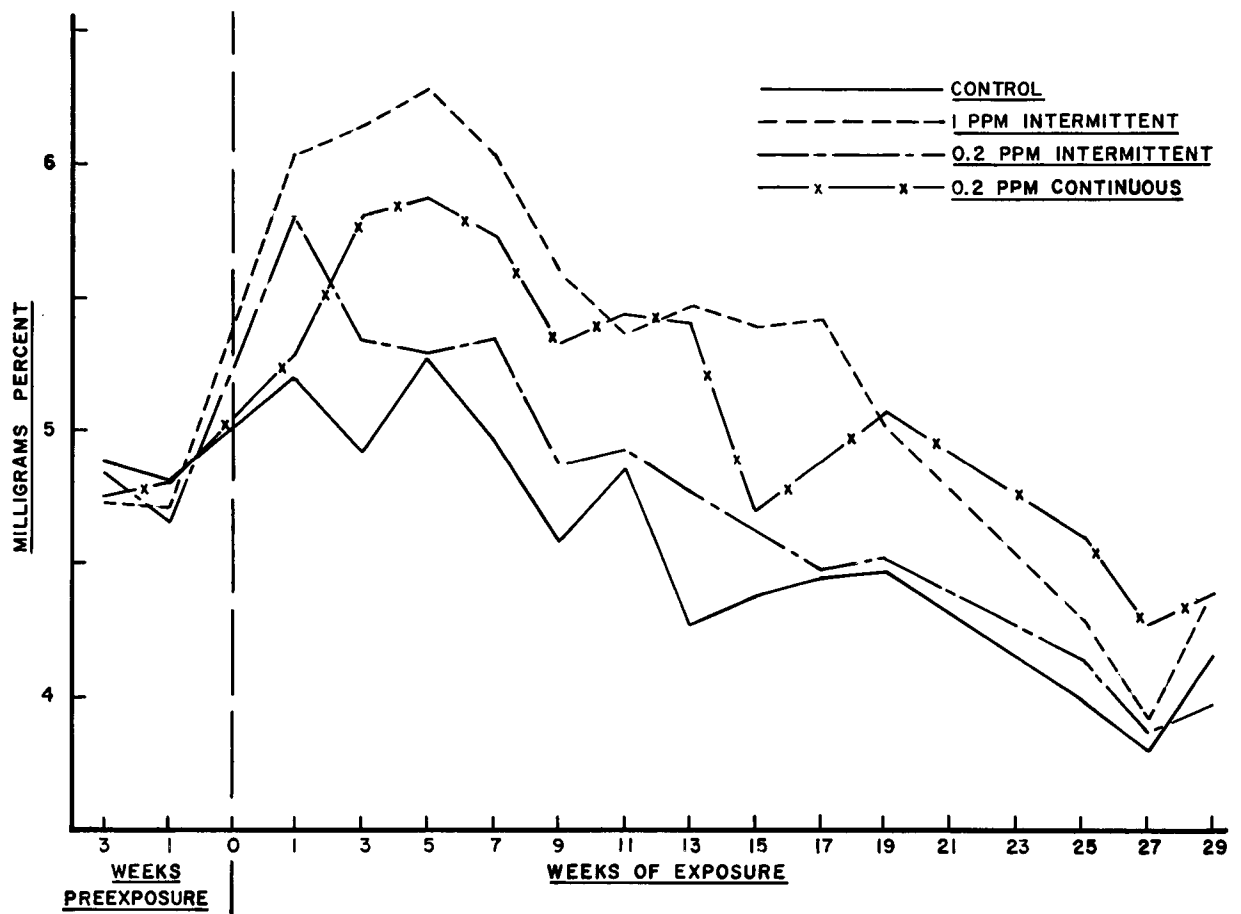

Figure 39

Effect of Chronic Monomethylhydrazine Exposure on Serum Phosphorus Levels in Dogs

Gross pathology revealed that dogs from all exposure levels had abnormally dark livers and associated lymph nodes. The darkest livers were from the 0.2 ppm MMH continuous exposure, then the 1.0 ppm MMH intermittently exposed, and the lightest from the 0.2 ppm MMH intermittent exposure group. There were no grossly discernible effects on monkeys, rats or mice which can be attributed to MMH exposure.

The results of histopathologic examination are not yet available and will be included in a separate comprehensive report.

REFERENCES

1. Fairchild, II, E. J., Toxic Hazards Research Unit Annual Technical Report: 1967, AMRL-TR-67-137, Aerospace Medical Research Laboratory, Wright-Patterson AFB, Ohio, December 1967.
2. MacEwen, J. D., Toxic Hazards Research Unit Design and Construction Phase, AMRL-TR-65-125, Aerospace Medical Research Laboratory, Wright-Patterson AFB, Ohio, September 1965.
3. MacEwen, J. D. and R. P. Geckler, Toxic Hazards Research Unit Annual Technical Report, AMRL-TR-66-177, Aerospace Medical Research Laboratory, Wright-Patterson AFB, Ohio, December 1966
4. MacEwen, J. D. and E. H. Vernot, Toxic Hazards Research Unit Annual Technical Report, AMRL-TR-68-133, Aerospace Medical Research Laboratory, Wright-Patterson AFB, Ohio, October 1968.
5. MacEwen, J. D. and E. H. Vernot, Toxic Hazards Research Unit Annual Technical Report, AMRL-TR-69-84, Aerospace Medical Research Laboratory, Wright-Patterson AFB, Ohio, September 1969.
6. MacEwen, J. D. and E. H. Vernot, Toxic Hazards Research Unit Annual Technical Report, AMRL-TR-70-77, Aerospace Medical Research Laboratory, Wright-Patterson AFB, Ohio, August 1970.
7. Thomas, A. A., "Low Ambient Pressure Environments and Toxicity," A.M.A. Arch. Environ. Health, 11, 316, 1968.
8. Gatti, R., R. K. Krieger, J. E. Sicre, and H. C. Schumacher, "A New Method of Preparation and Some Properties of Chlorine Pentafluoride," J. Inorg. Nucl. Chem., 28, 655, 1966.
9. Pilipovich, D., W. Maya, E. A. Lawton, H. F. Bauer, D. F. Sheehan, N. N. Ogimachi, R. D. Wilson, F. C. Gunderloy, and V. E. Bedwell, "Chlorine Pentafluoride Preparation and Properties," Inorg. Chem., 6, 1918, 1967.
10. Dost, F. N. and C. H. Wang, Studies on Environmental Pollution by Missile Propellants, AMRL-TR-69-116, Aerospace Medical Research Laboratory, Wright-Patterson AFB, Ohio, January 1970.

12. Vernot, E. H., J. D. MacEwen, D. L. Geiger and C. C. Haun, "The Air Oxidation of Monomethylhydrazine," Amer. Ind. Hyg. Assoc. J., 28, 343, 1967.
13. Leach, L. J., C. J. Spiegl, R. H. Wilson, G. E. Sylvester and K. E. Lauterbach, "A Multiple Chamber Exposure Unit Designed for Chronic Inhalation Studies," Amer. Ind. Hyg. Assoc. J., 29, 13, 1959.
14. Forbes, W. H., F. Sargent, and F. J. W. Roughton, "The Rate of Carbon Monoxide Uptake by Normal Men," Amer. J. Physiol., 143, 594, 1945.
15. Goldbaum, L. R., E. L. Schloegel, and A. M. Dominguez, "Application of Gas Chromatography to Toxicology," Progress in Chemical Toxicology, 1, 26, A. Stolman, Ed., Academic Press, N. Y., 1963.
16. Saltzman, B. E., "Modified Nitrogen Dioxide Reagent for Recording Air Analyzers," Anal. Chem., 32, 135, 1960.
17. O'Keefe, A. E., G. C. Ortman, "Primary Standards for Trace Gas Analysis," Anal. Chem., 38, 760, 1966.
18. Litchfield, Jr., J. T. and F. Wilcoxon, "A Simplified Method of Evaluating Dose-Effect Experiments," J. Pharmacol. Exptl. Therap., 96, 99, 1949.
19. Grey, E. L., F. M. Patton, S. B. Goldberg, and E. Kaplan, "Toxicity of the Oxides of Nitrogen, II. Acute Inhalation Toxicity of Nitrogen Dioxide, Red Fuming Nitric Acid and White Fuming Nitric Acid," Arch. Ind. Hyg. and Occ. Med., 10, 418, 1954.
20. Smith, D. F., "Chlorine Pentafluoride," Science, 141, 1039, 1963.
21. Weinberg, M. S. and R. E. Goldhamer, Pharmacology and Metabolism of Compound A, AMRL-TR-66-238, Aerospace Medical Research Laboratory, Wright-Patterson AFB, Ohio, December 1967.
22. Elkins, H. B., The Chemistry of Industrial Toxicology, 2nd ed., Wiley, New York, 1959.
23. Silverman, L., H. Schulet and M. First, "Further Studies on Sensory Response to Certain Industrial Solvent Vapors," J. Ind. Hyg. Toxicol., 28, 262, 1946.

24. Heppel, L. A., P. A. Neal, T. L. Perrin, M. L. Orr and V. T. Porterfield, "Toxicology of Dichloromethane (Methylene Chloride) I. Studies on Effects of Daily Inhalation," J. Ind. Hyg. Toxicol., 26, 8, 1944.
25. Lehmann, K. B., and L. Schmidt-Kehl, "Die 13 Wichtigstenchlorkohlenwasserstoffe der Fettreihe Vom Standpunkt der Gewerbehygiene," Arch. f. Hyg., 116, 131, 1936.
26. Browning, E., Toxicity and Metabolism of Industrial Solvents, Elsevier Publishing Company, p. 243, 1965.
27. Svirbely, J. L., B. Highman, W. C. Alford, and W. F. Von Oettingen, "The Toxicity and Narcotic Action of Monochloro-monobromomethane with Special Reference to Inorganic and Volatile Bromide in Blood, Urine and Brain," J. Ind. Hyg. Toxicol., 29, 382, 1947.
28. Haun, C. C., "Chronic Exposure to Low Concentrations of Monomethylhydrazine," Proceedings of Conference on Environmental Toxicology, AMRL-TR-70-102, Aerospace Medical Research Laboratory, Wright-Patterson AFB, Ohio, September 1970.
29. Geiger, D. L., "Approaches to Continuous Analysis of Exposure Chamber Atmospheres," Proceedings of the 3rd Annual Conference on Atmospheric Contamination in Confined Spaces, p. 263, AMRL-TR-67-200, Aerospace Medical Research Laboratory, Wright-Patterson AFB, Ohio, December 1967.