

NASA TECHNICAL NOTE



NASA TN D-6710

C.1

NASA TN D-6710

LOAN COPY: RETURN
AFWL (DOUL)
KIRTLAND AFB, N. M.



NOISE MEASUREMENTS OF MODEL JET-AUGMENTED LIFT SYSTEMS

by Frederick W. Gibson
Langley Research Center
Hampton, Va. 23365



0133396

1. Report No. NASA TN D-6710	2. Government Accession No.	3. Recipient's Catalog No.	
4. Title and Subtitle NOISE MEASUREMENTS OF MODEL JET-AUGMENTED LIFT SYSTEMS		5. Report Date April 1972	6. Performing Organization Code
7. Author(s) Frederick W. Gibson	8. Performing Organization Report No. L-8187		10. Work Unit No. 764-72-01-01
9. Performing Organization Name and Address NASA Langley Research Center Hampton, Va. 23365		11. Contract or Grant No.	
12. Sponsoring Agency Name and Address National Aeronautics and Space Administration Washington, D.C. 20546		13. Type of Report and Period Covered Technical Note	
15. Supplementary Notes		14. Sponsoring Agency Code	
16. Abstract <p>Noise measurements were obtained on models of jet-augmented lift systems which are currently being considered for use on proposed short take-off and landing (STOL) vehicles. These configurations included a conventional internally blown flap, an augments wing, an externally blown flap, and modifications of these basic concepts. The tests were conducted in the Langley anechoic noise facility at zero forward speed with cold air jets.</p> <p>The conventional internally blown flap exhibited lower noise levels than the augments wing and the externally blown flap at the same pressure ratios, being of the order of 8 dB or more at the lowest pressure ratio and of the order of 20 dB at the highest pressure ratio of the tests. The data also indicated that for the conventional internally blown flap, there may be an optimum gap size (other than zero) between the turning lip and the flap leading edge from the standpoint of minimum noise generation or admittance.</p> <p>Increasing the trailing-edge thickness of the plain internally blown flap produced no appreciable change in the overall sound pressure level or frequency spectral content in the range of the tests. The data indicated that at a position on the ground directly under the jet exit, the externally blown flap and the augments-wing overall noise levels are comparable to each other throughout the pressure-ratio range of the tests.</p>			
17. Key Words (Suggested by Author(s)) Noise measurements Externally blown flap Augments wing Internally blown flap Jet noise	18. Distribution Statement Unclassified - Unlimited		
19. Security Classif. (of this report) Unclassified	20. Security Classif. (of this page) Unclassified	21. No. of Pages 34	22. Price* \$3.00

NOISE MEASUREMENTS OF MODEL JET-AUGMENTED LIFT SYSTEMS

By Frederick W. Gibson
Langley Research Center

SUMMARY

Noise measurements were obtained on models of jet-augmented lift systems which are currently being considered for use on proposed short take-off and landing (STOL) vehicles. These configurations included a conventional internally blown flap, an aug-menter wing, an externally blown flap, and modifications of these basic concepts. The tests were conducted in the Langley anechoic noise facility at zero forward speed with cold air jets.

The conventional internally blown flap exhibited lower noise levels than the aug-menter wing and the externally blown flap at the same pressure ratios, being of the order of 8 dB or more at the lowest pressure ratio and of the order of 20 dB at the highest pres-sure ratio of the tests. The data also indicated that for the conventional internally blown flap, there may be an optimum gap size (other than zero) between the turning lip and the flap leading edge from the standpoint of minimum noise generation or admittance.

Increasing the trailing-edge thickness of the plain internally blown flap produced no appreciable change in the overall sound pressure level or frequency spectral content in the range of the tests. The data indicated that at a position on the ground directly under the jet exit, the externally blown flap and the aug-menter-wing overall noise levels are comparable to each other throughout the pressure-ratio range of the tests.

INTRODUCTION

Since short take-off and landing (STOL) vehicles will need acceptable community noise characteristics, noise will be one of the primary factors in the selection of a propulsion-lift system for these vehicles. The propulsion-lift systems that are currently being considered for STOL aircraft include a conventional internally blown flap, an aug-menter wing, and an externally blown flap configuration. Studies of the noise character-istics of these configurations are reported in references 1 to 5 and the present work is an attempt to extend and complement these studies by evaluating the effects of configura-tion variables on the noise characteristics. The models were tested in the Langley anechoic noise facility at zero forward velocity with cold air jets. The results of the tests are presented herein in the form of overall sound pressure levels, radiation patterns, and frequency spectra for a range of nozzle pressure ratios.

SYMBOLS

The measurements were made in U.S. Customary Units and are presented herein in the SI system.

g	width of gap between nozzle and flap leading edge (fig. 1(c))
h	short dimension of rectangular nozzle (fig. 1(a))
l	flap length (fig. 1(b))
r	radius of measurements (distance of microphone from center of jet exit)
t	flap trailing-edge thickness
w	long dimension of rectangular nozzle (fig. 2(c))
X,Y,Z	coordinate axes
γ	angle measured from jet axis in XZ-plane (positive counterclockwise) (see fig. 6)

APPARATUS AND METHODS

Models

The test configurations consisted of models of a conventional internally blown flap, an augmentor wing, an externally blown flap, and modifications of these basic concepts. These test configurations are shown schematically in figures 1 to 4. All nozzles had approximately the same exit area which was equivalent to a circular nozzle with a diameter of 0.0508 meter.

Internally blown flap arrangements.- In figures 1(a) and 1(b) are indicated two turning-flap configurations that were tested as internally blown flaps of different chord length. Figure 1(c) shows the modification of the long flap which was used to investigate the effect of leading-edge gap size. Two internally blown flaps using a rectangular nozzle of aspect ratio 200 are shown in figure 2. Figure 2(a) shows the air being turned by blowing under and against the flap (impingement) and figure 2(b) shows the air being turned by blowing over the upper surface and such an arrangement is called a Coanda flap.

Augmenter wing.- Figure 3 shows a standard augmenter-wing configuration. The dashed lines and shaded section in the gaps between the lower elements indicate how the gaps were sealed and faired for a separate and distinct configuration.

Rectangular nozzle.- The plain internally blown flap and the augmenter-wing models incorporated the rectangular nozzle indicated in figure 3. The nozzle had a length of 0.913 meter and a height of 0.00254 meter and hence had an aspect ratio of 360. There was a 60 to 1 contraction ratio from the plenum chamber to the nozzle, and aluminum honeycomb was inserted ahead of the nozzle to smooth the flow.

Externally blown flap.- Figure 4 is a sketch of the externally blown flap configurations. The dashed lines and shaded sections indicate a modification which consisted of sealing and fairing the gaps between the elements to provide a simple turning surface. A circular nozzle with a 0.0508-meter diameter was used with the externally blown flap configurations.

Test Setup

All tests were conducted in the Langley anechoic noise facility. A photograph of the test chamber is shown in figure 5. Shown in the figure is the test setup for the standard augmenter-wing configuration of figure 3 with one of the end plates removed to show the flap components. The test-chamber dimensions are approximately 8 meters on each side and details of its construction are given in reference 6. Shown also in the photograph is an adjustable microphone boom which can be oriented to obtain far-field noise radiation patterns and frequency spectra in any particular plane of interest. The data of the report were obtained in the plane of the nozzle-flap center line which is identified in figure 6 as the XZ-plane. Some data are presented for the YZ-plane which includes the plane of the jet exit.

The mass flows at equal pressure ratios were equal for the configurations using the rectangular nozzle with aspect ratio 360 (internally blown flap and augmenter wing) but were approximately 12 percent lower for the externally blown flap (circular nozzle) at the same pressure ratios.

Noise-Measuring Equipment

The noise measurements were made by utilizing two condenser-type microphones, one mounted on a rotatable boom and the other on a stand in a fixed position for reference purposes. The system frequency response was flat to within ± 1 dB from 50 Hz to 40 kHz. During the tests the outputs of the microphones were analyzed directly on a one-third-octave band frequency spectrum analyzer, which determined sound pressure level spectra (referenced to $20 \mu\text{N}/\text{m}^2$), and were recorded simultaneously on a magnetic tape recorder

as a backup record to allow subsequent analyses. The sound measurement system was calibrated by use of a discrete frequency calibrator at frequent intervals during the testing.

Tests

The tests were made over a range of nominal nozzle pressure ratios from 1.1 to 2.2. The pressure ratio is described as the ratio of pressure in the plenum chamber just upstream of the nozzle to ambient pressure. Noise measurements were made in the XZ-plane and YZ-plane at a radius of 3.048 meters from a point on the jet exit and jet center line for all the configurations. The microphone boom was maneuvered through the desired range of angular positions, and real-time frequency spectrum analyses were performed in real time and recorded on magnetic tape.

RESULTS AND DISCUSSION

Base-Line Circular and Slot Jets

Radiation patterns.- As an aid in the interpretation of the jet-augmented flap noise data to follow, the XZ-plane radiation patterns for the base-line circular and rectangular jets without turning flaps are presented in figure 7. The circular jet and the slot jet have radiation patterns which peak at approximately 40° from the thrust axis in the XZ-plane. The overall noise levels are noted to be generally lower for the slot nozzle than for the circular nozzle at the same pressure ratios.

Frequency spectra.- The data of figure 8 relate to the noise from the basic circular and slot jets of the jet-augmented flap configurations and are presented as an aid in interpreting the spectral data of these configurations. It can be seen that the frequency spectra from these slot jets have substantially more high-frequency content than do the noise spectra from a circular jet of a comparable area and nozzle pressure ratio.

Internally Blown Flap Arrangements

Radiation patterns.- Radiation-pattern data for the internally blown flap configurations are shown in figures 9 to 16. Radiation patterns in the XZ-plane are shown in figure 9 for both short ($\frac{l}{h} = 5$) and long ($\frac{l}{h} = 90$) turning flaps for a range of nozzle pressure ratios from 1.3 to 2.2. Note that the gap in the patterns indicates that the flow deflections were not as similar as the angular setting of the flap would imply. These data show that the short flap had much higher noise levels below the wing than the long flap.

Comparisons are made in figures 10 and 11 of the noise radiation patterns of two types of turning flaps utilizing a rectangular jet with an aspect ratio of 200. One flap

turns the flow by means of the Coanda principle, and the other turns the flow by impingement. The data of the figures provide a comparison of the noise radiated in the XZ-plane and in the YZ-plane. It can be seen that the noise on the side shielded by the flap is comparable in both cases, there being slightly higher levels for the impinged flap. The implication from these data is that more efficient flow turning from a noise standpoint can be achieved by means of a Coanda flap. It can also be seen in figures 10 and 11 that the long flap is quieter than the short flap; these results are in agreement with those of figure 7.

Figures 12(a) and 12(b) show the noise radiation patterns in the XZ- and YZ-planes, respectively, for the plain internally blown flap with sharp trailing edge and with several degrees of trailing-edge thickness. (Note the change in decibel scale as the pressure ratio increases.) These data show no change in radiation patterns with changes in trailing-edge thickness. Note that different models were tested to obtain the data of figures 9 and 12(a) for the sharp-trailing-edge models; this fact explains any small differences in radiation pattern data which may be found.

Figure 13 shows the overall sound pressure level measured at $\gamma = 90^\circ$ as a function of pressure ratio, for the long internally blown flap with trailing-edge-thickness modifications. These data also indicate that there is no apparent change in overall sound pressure level with increasing trailing-edge thickness within the range of the tests.

The effect of leading-edge gap on the noise-radiation patterns can be seen in the data of figure 14. The dashed curves in the column on the left of the figures are the data for the plain long internally blown flap with no gap. The data across the top row (low pressure ratio) show that with just a small gap, the noise increases approximately 10 dB above the flap and about 20 dB below the flap with very little increase beyond this level with increasing gap dimension. However, as the pressure ratio increases up to the maximum ratio of 2.2, the sound pressure decreases as the gap becomes larger. The data in the bottom row (pressure ratio, 2.2) show that the radiation patterns for the zero-gap configuration (dashed line on the left) and the maximum gap (configuration $\frac{g}{h} = 4$) are very similar. In figure 15, the overall sound pressure level data measured at $\gamma = 90^\circ$ are plotted as a function of pressure ratio and nondimensionalized leading-edge gap size. The figure graphically illustrates the sharp increase in noise with the introduction of a small gap (the effect being most pronounced at a pressure ratio of 1.3) and a decrease in noise as the gap dimension is increased. At the highest pressure ratio (2.2), the noise at $\gamma = 90^\circ$ is only slightly higher for the largest gap configuration than for the zero gap configuration.

Frequency spectra.- The data of figures 16 and 17 relate to the plain internally blown flap configurations having both short and long flaps and modifications of the long flap which include variations of trailing-edge thickness and leading-edge gap size. The spectra for the short-flap configuration (fig. 16(a)) have shapes similar to those shown in

figure 8 for the rectangular slot jet. In the case of the plain long flap (fig. 16(b)), there is substantially less high-frequency content and higher intensities in the low-frequency components than for the short flap at the high pressure ratio. These low-frequency changes in the spectra are believed to be associated with an interaction of the jet exhaust flow and the flap surface. The changes at the higher frequencies result in part from the shielding action of the flap in the downward direction.

The data of figure 17(a) indicate that increasing the trailing-edge thickness induces an increase (approximately 3 dB) in the low-frequency content up to 2 kHz with a reversal of this trend from 2 kHz to 40 kHz.

Figure 17(b) shows that the introduction of a small gap between the turning lip and the long flap leading edge increases the low-frequency content. This gap also introduces a sharp peak in the spectrum between 20 kHz to 40 kHz. The peak diminishes as the gap is widened. A possible explanation of this effect is that when there is no gap, the flow from the jet attaches immediately and the low frequencies dominate. When a small gap is introduced, high-velocity flow is induced in the gap and this high-velocity flow causes the flow over the flap to become detached; thus, high frequencies are generated. As the gap becomes wider, the velocity of the air aspirating through the gap decreases and allows the flow to become partially attached.

Figure 18 gives frequency spectra above and below a Coanda flap and an impingement flap for comparison. It can be seen that the noise spectra on the shielded side are comparable; whereas, directly below the flap or jet exit, there is a marked reduction of the noise over the entire frequency range above 1 kHz.

Augmenter Wing

Radiation patterns.- Augmenter-wing radiation pattern data are presented in figure 19 for the XZ-plane. Data are presented for a range of nozzle pressure ratios for both the standard configuration and a modified version which incorporated sealing the slots between the bottom flaps. It can be concluded from the figure that markedly less noise is radiated in the downward direction when the bottom slots are sealed than when they are open.

Frequency spectra.- The data of figure 20 relate to the jet augmenter-wing model having the bottom slots both open and closed. The spectra for the standard-slots-open model indicate very little change in the shape of the spectrum but increase in the noise levels across the entire spectrum as the pressure ratio is increased. The peak levels at all pressure ratios were less for the slots-closed configuration than for the slots-open configuration.

Externally Blown Flap Arrangements

Radiation patterns.- Radiation-pattern data for the externally blown flaps are presented in figures 21(a) and 21(b). Data are given for both the standard configuration and a modified version having the slots closed and faired to form a smooth turning surface for a range of pressure ratios. It can be seen from the XZ-plane data of figure 21(a) that slightly lower noise levels in the downward direction are associated with the smooth turning surface configuration compared with the slots-open configuration.

Frequency spectra.- Figure 22 represents comparable data for a standard, slots-open, externally blown flap model and a modified, slots-closed, externally blown flap model. It can be seen that at pressure ratios of 1.1 to 1.3, there is significantly less noise being radiated from the slots-closed configuration than for the slots-open configuration. At pressure ratios of 1.5 and above, the peak levels of the two configurations appear to be the same. The differences in the shapes of the spectra indicate that closing the slots sharply reduced the high-frequency content whereas the low-frequency content remained essentially the same.

Comparison of Various Configurations

In an attempt to compare the noise characteristics of some of the configurations tested, the data of figure 23 are presented. In the figure, overall noise levels are plotted as a function of pressure ratio for the basic configurations. Although data are included for a wide range of pressure ratios, it should be noted that the most practical operating range for the externally blown flap configuration is from 1.1 to about 1.3 and between 1.8 and 2.2 for the internally blown flap and the augments wing. The indications are that the augments-wing configuration has markedly higher noise levels than the internally blown flap. This difference is due to the fact that the multielement lower flap system is not as effective as the internally blown flap for acoustical shielding and that some noise is generated in the gaps. It is obvious that the augments-wing system can be improved from a noise standpoint with the use of a solid lower flap construction. In addition, unpublished studies have suggested that there is a potential for noise reduction through proper application of acoustic treatment.

CONCLUSIONS

Noise measurements were obtained on models of jet-augmented lift systems which are currently being considered for use on proposed short take-off and landing (STOL) vehicles. These configurations included a conventional internally blown flap, the augments wing, an externally blown flap, and modifications of these basic concepts. The

tests were conducted in the Langley anechoic noise facility at zero forward speed with cold air jets. From these tests, the following conclusions are drawn:

1. The plain internally blown flap exhibited much lower noise characteristics than the augments wing and the externally blown flap.
2. The overall sound pressure levels of the plain internally blown flap are insensitive to trailing-edge thickness.
3. A small gap at the leading edge of the long internally blown flap produced a sharp, substantial increase in noise. As the size of the gap was increased, the noise level decreased; this effect is more pronounced as the nozzle pressure ratio was increased.

Langley Research Center,
National Aeronautics and Space Administration,
Hampton, Va., February 24, 1972.

REFERENCES

1. Maglieri, Domenic J.; and Hubbard, Harvey H.: Preliminary Measurements of the Noise Characteristics of Some Jet-Augmented-Flap Configurations. NASA MEMO 12-4-58L, 1959.
2. Chestnutt, David; Hubbard, Harvey H.; and Feiler, Charles E.: Trends in Noise Control for Aircraft Gas-Turbine Power Plants. NASA Aircraft Safety and Operating Problems Conference, Vol. I, NASA SP-270, 1971, pp. 417-427.
3. Kramer, James J.; Chestnutt, David; Krejsa, Eugene A.; Lucas, James G.; and Rice, Edward J.: Noise Reduction. Aircraft Propulsion, NASA SP-259, 1971, pp. 169-209.
4. Coles, Willard D.: Jet-Engine Exhaust Noise From Slot Nozzles. NASA TN D-60, 1959.
5. Dorsch, R. G.; Krejsa, E. A.; and Olsen, W. A.: Blown Flap Noise Research. AIAA Paper No. 71-745, June 1971. (Available as NASA TM X-67850.)
6. Kantarges, George T.; and Cawthorn, Jimmy M.: Effects of Temperature on Noise of Bypass Jets as Measured in the Langley Noise Research Facility. NASA TN D-2378, 1964.

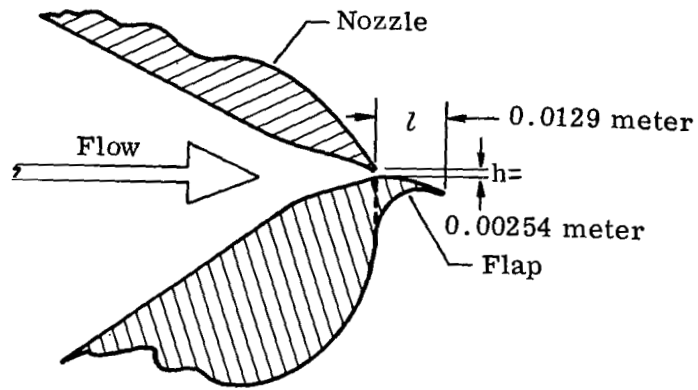

(a) Short internally blown flap.

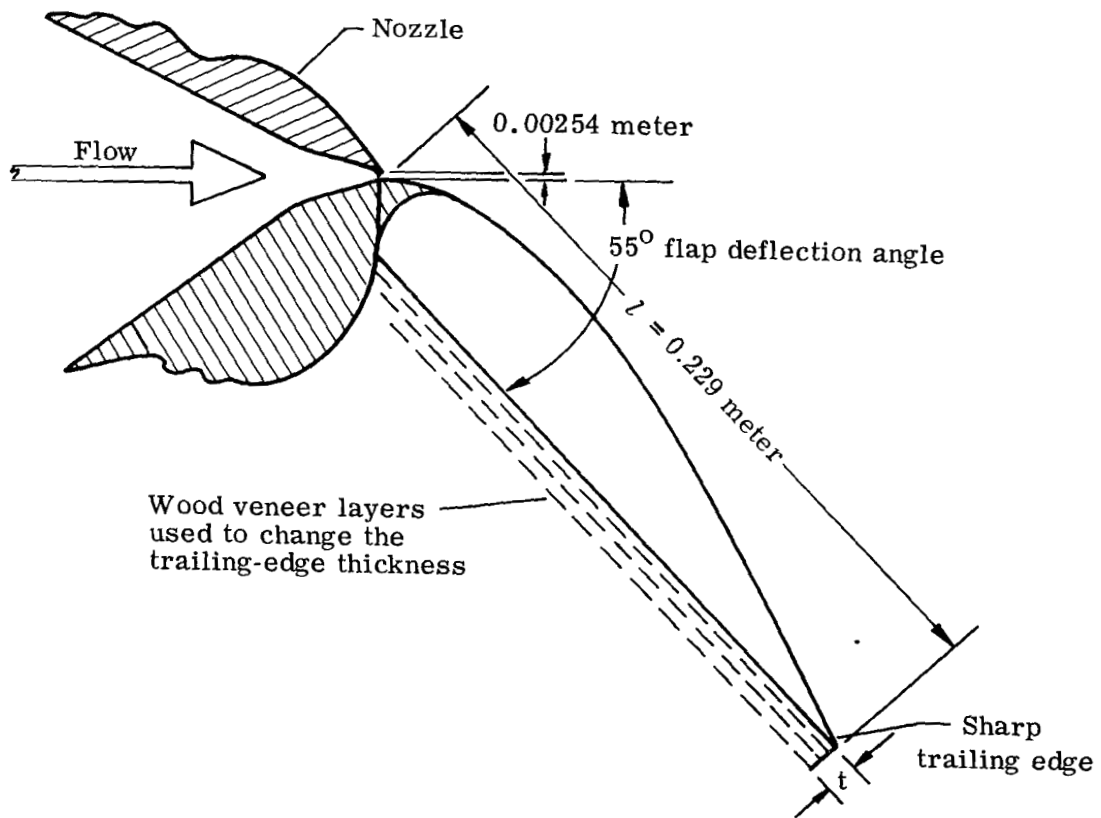

(b) Long internally blown flap.

Figure 1.- Sketches of models.

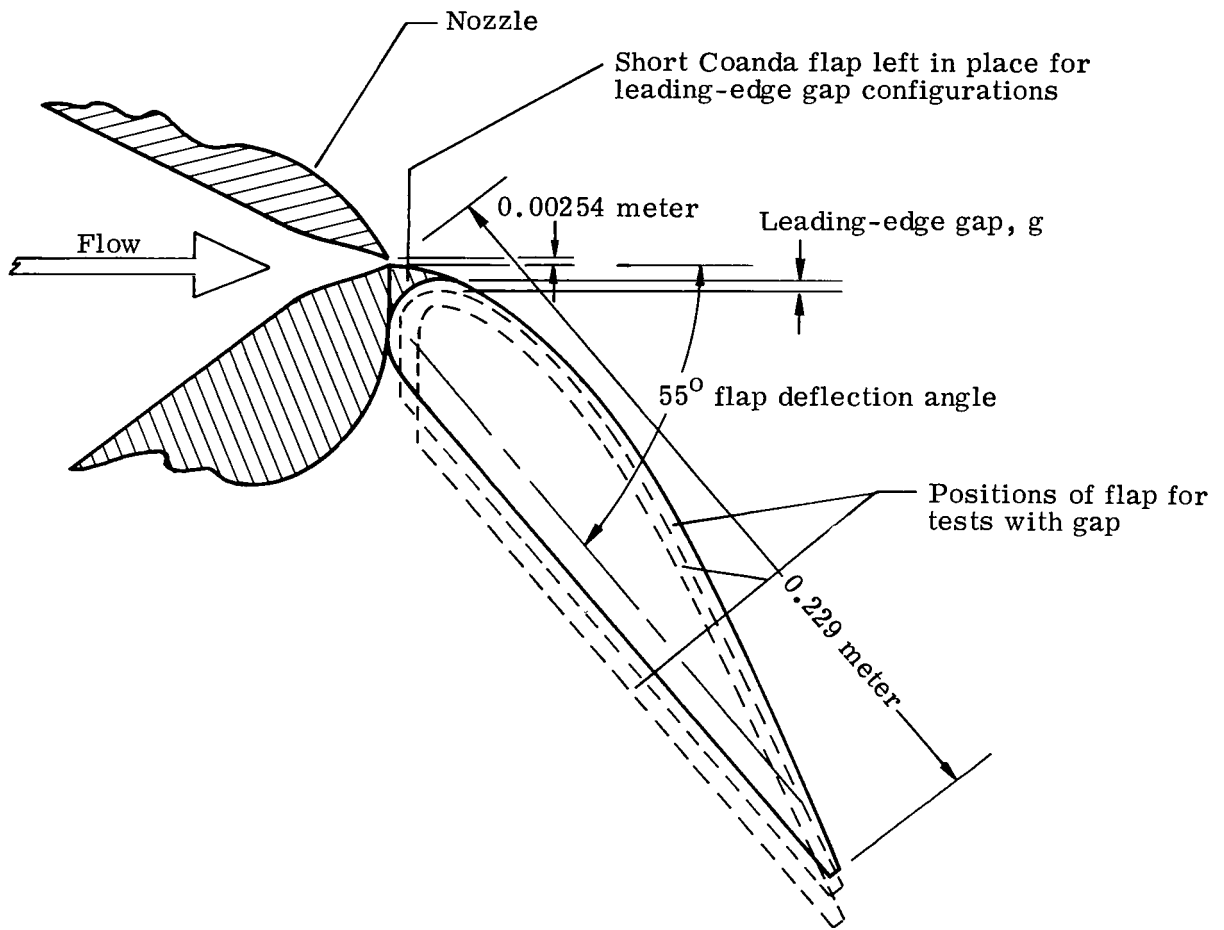

(c) Internally blown flap showing the positioning of flap for leading-edge gap effect tests.

Figure 1.- Concluded.

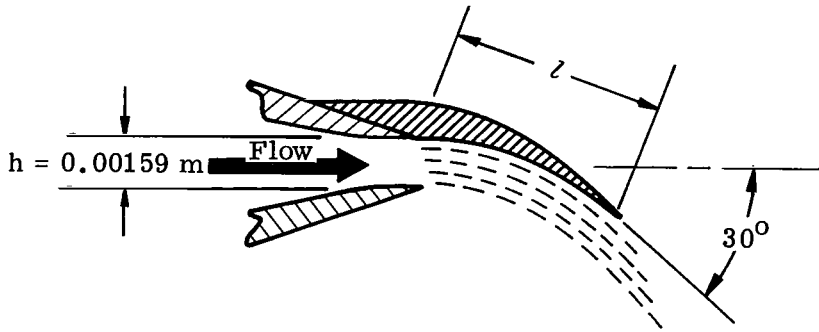

(a) Impingement flap.

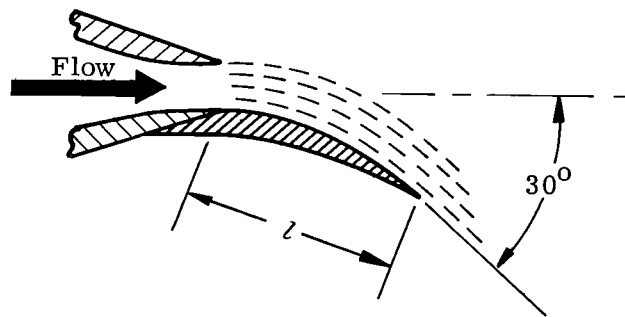

(b) Coanda flap.

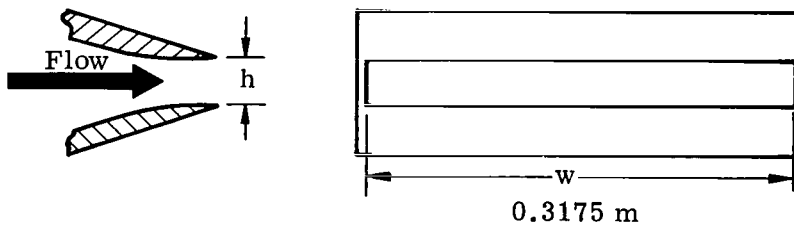

(c) Rectangular nozzle (aspect ratio, 200).

Figure 2.- Over and under internally blown flap models.

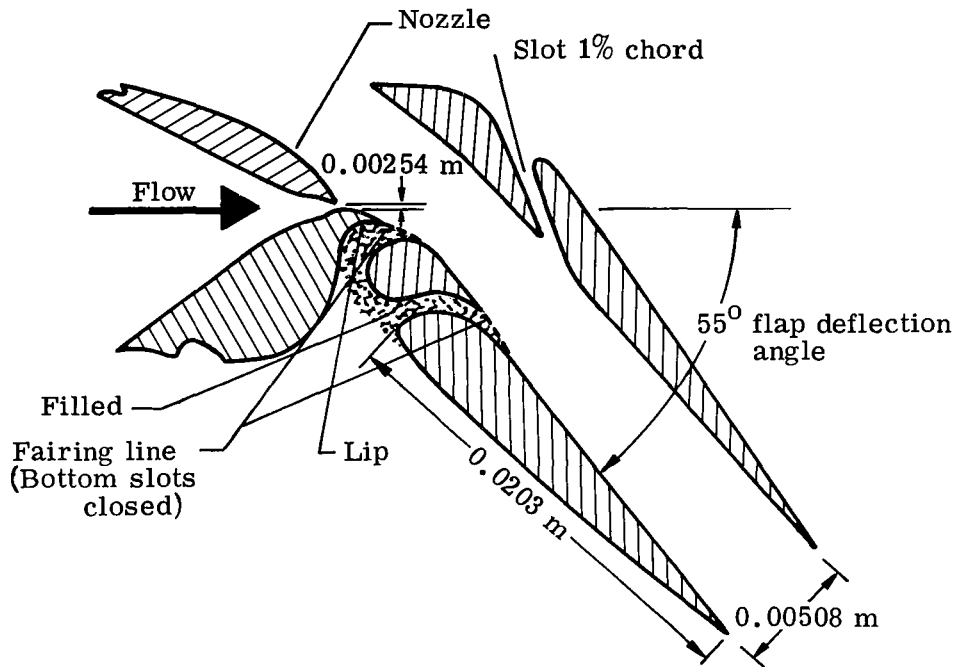

Figure 3.- Augmenter-wing model.

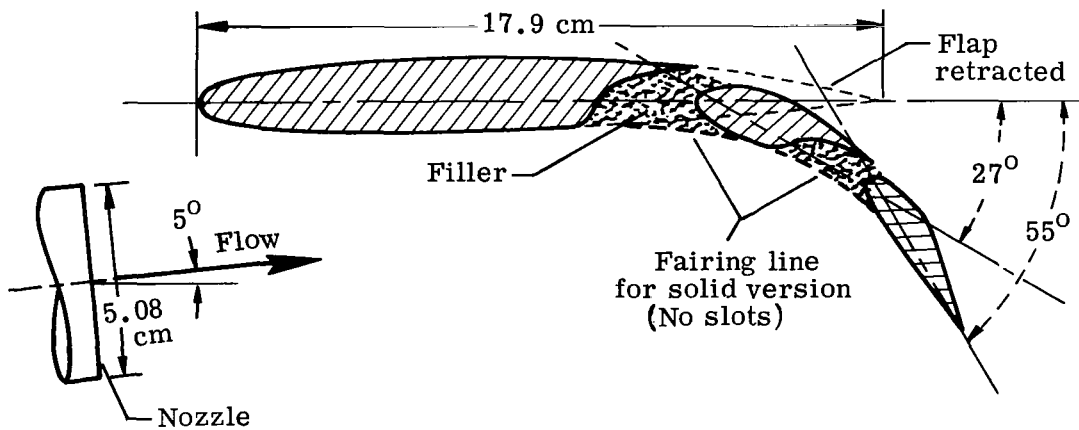
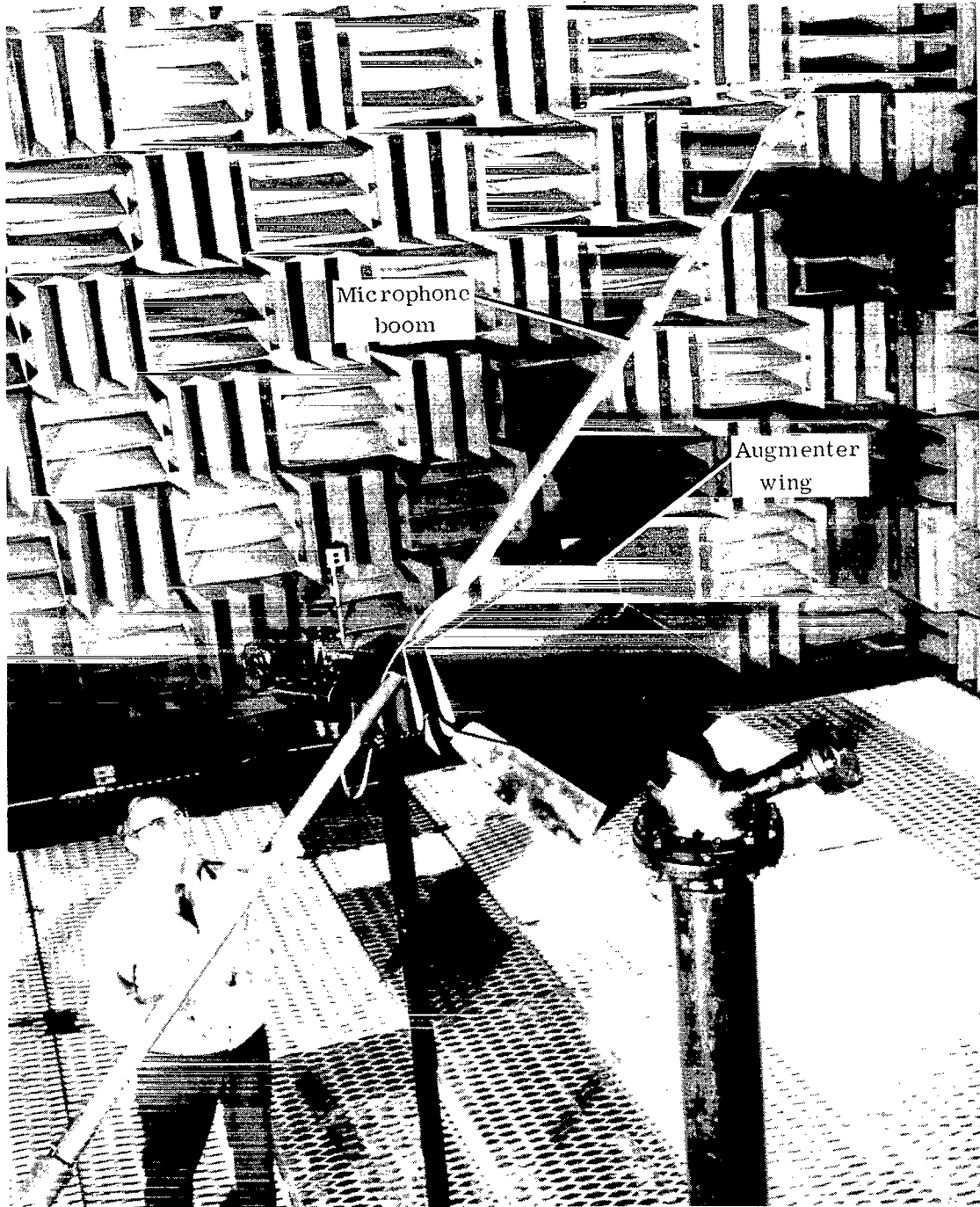

Figure 4.- Externally blown flap model.



L-72-140

Figure 5.- Augmenter-wing model with one end plate removed, mounted in the Langley anechoic noise facility.

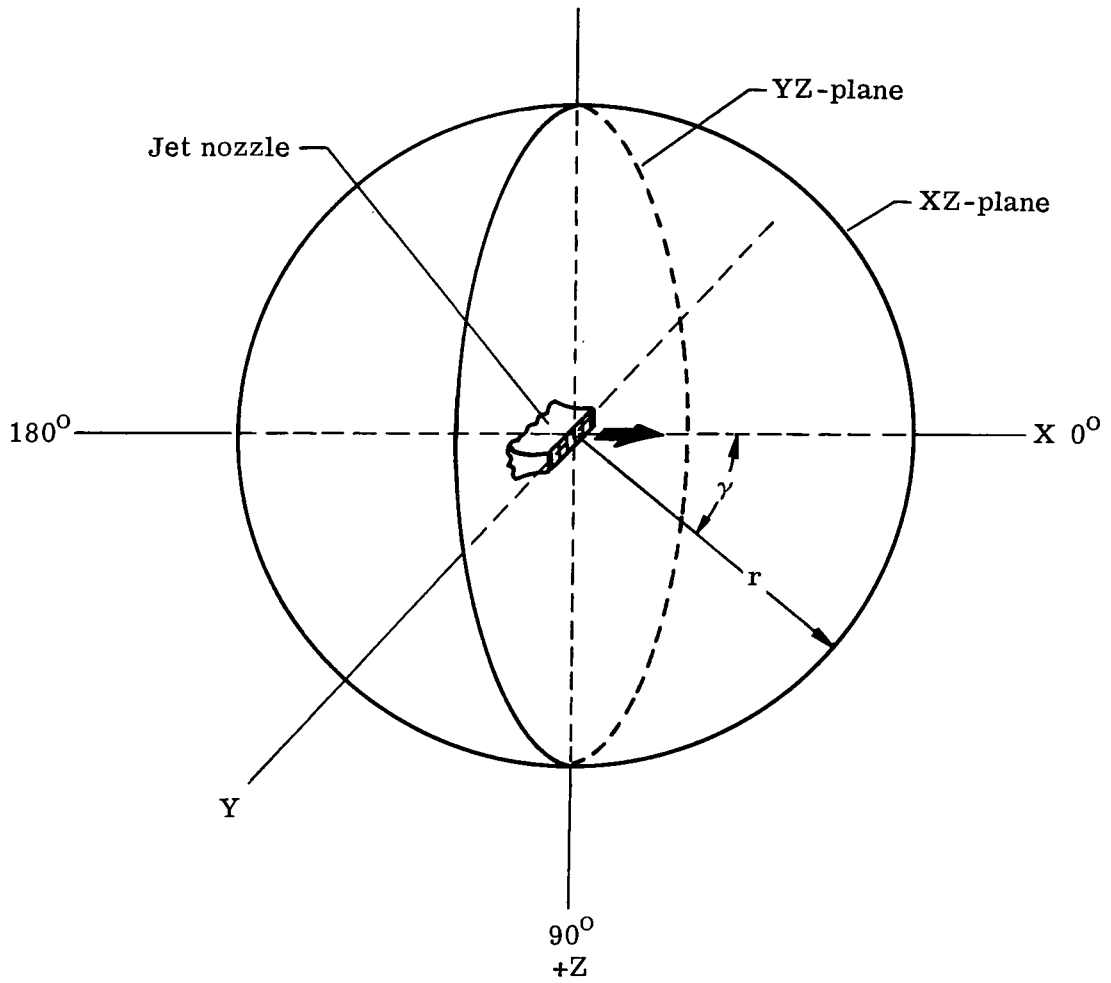

Figure 6.- Coordinate system used for noise surveys.

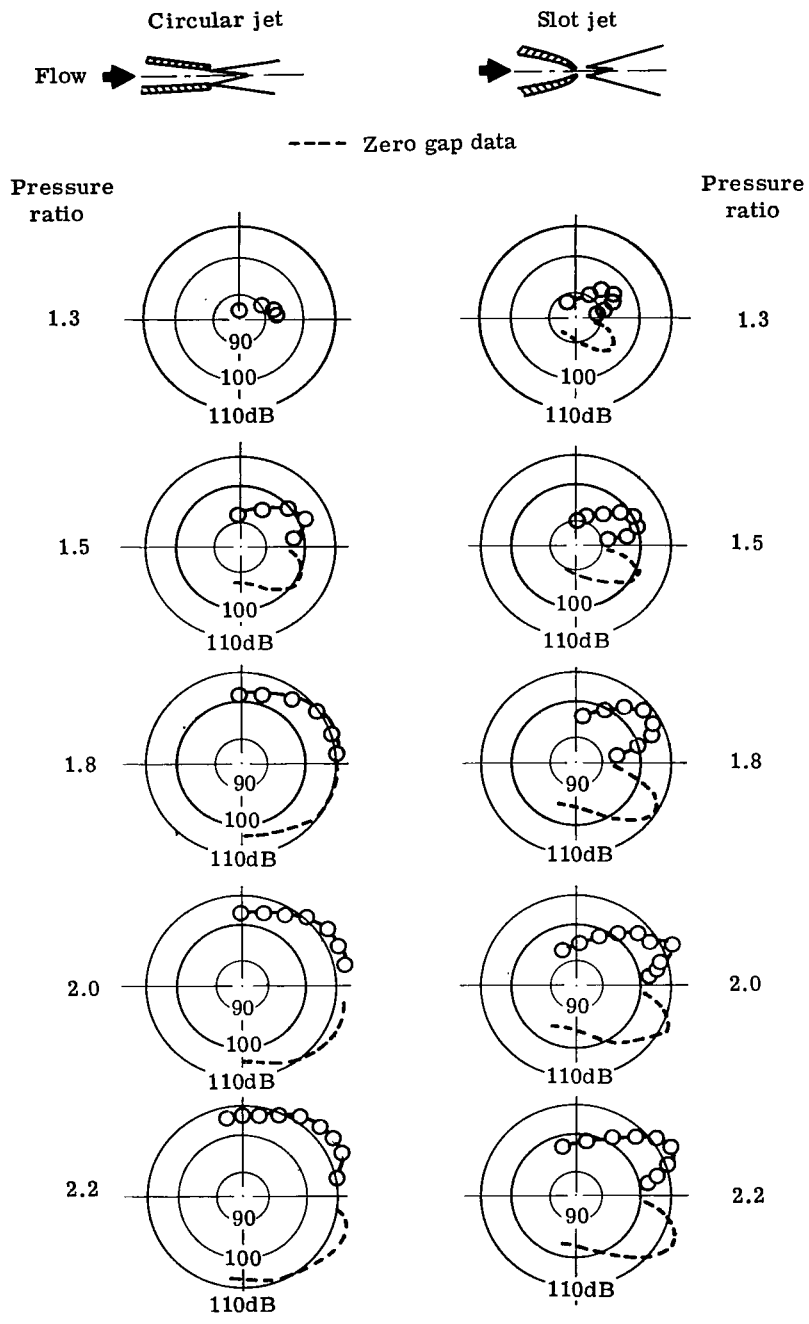

Figure 7.- Overall sound pressure level radiation patterns in the XZ-plane for the circular and slot base-line jets.

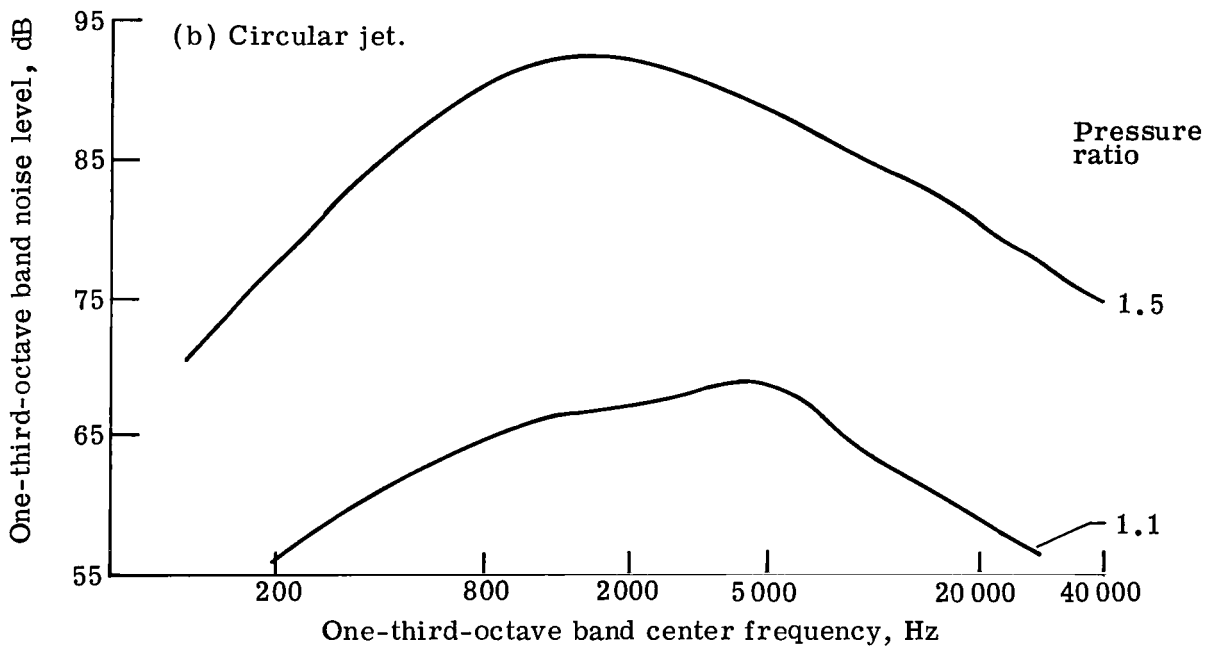
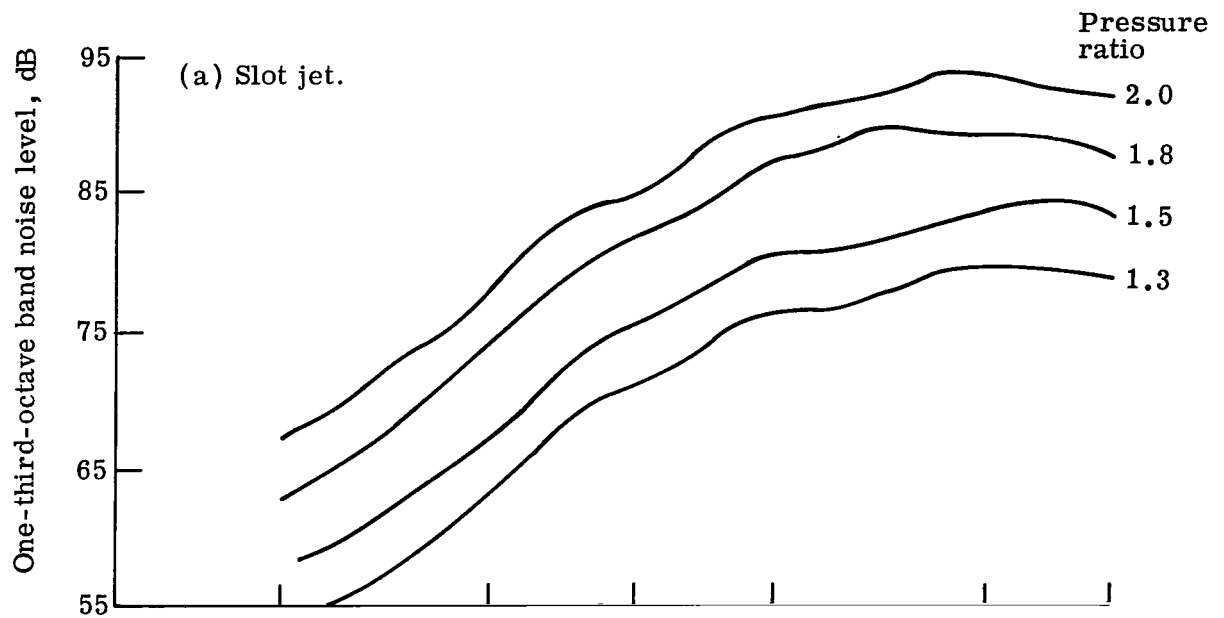

Figure 8.- Frequency spectra for the base-line jets at $\gamma = 90^\circ$. XZ-plane.

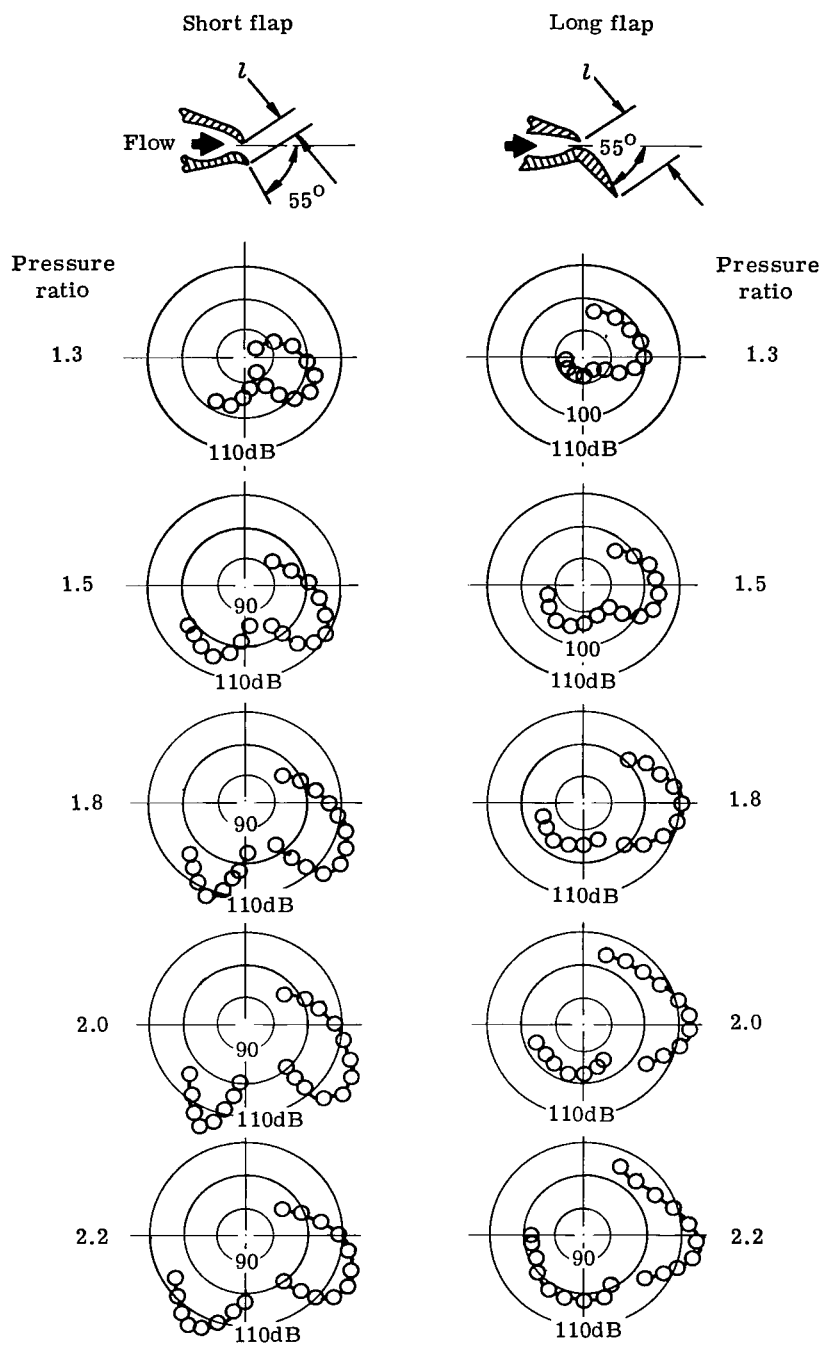

Figure 9.- Overall sound pressure level radiation patterns in the XZ-plane for the short ($\frac{l}{h} = 5$) and long ($\frac{l}{h} = 90$) internally blown flaps.

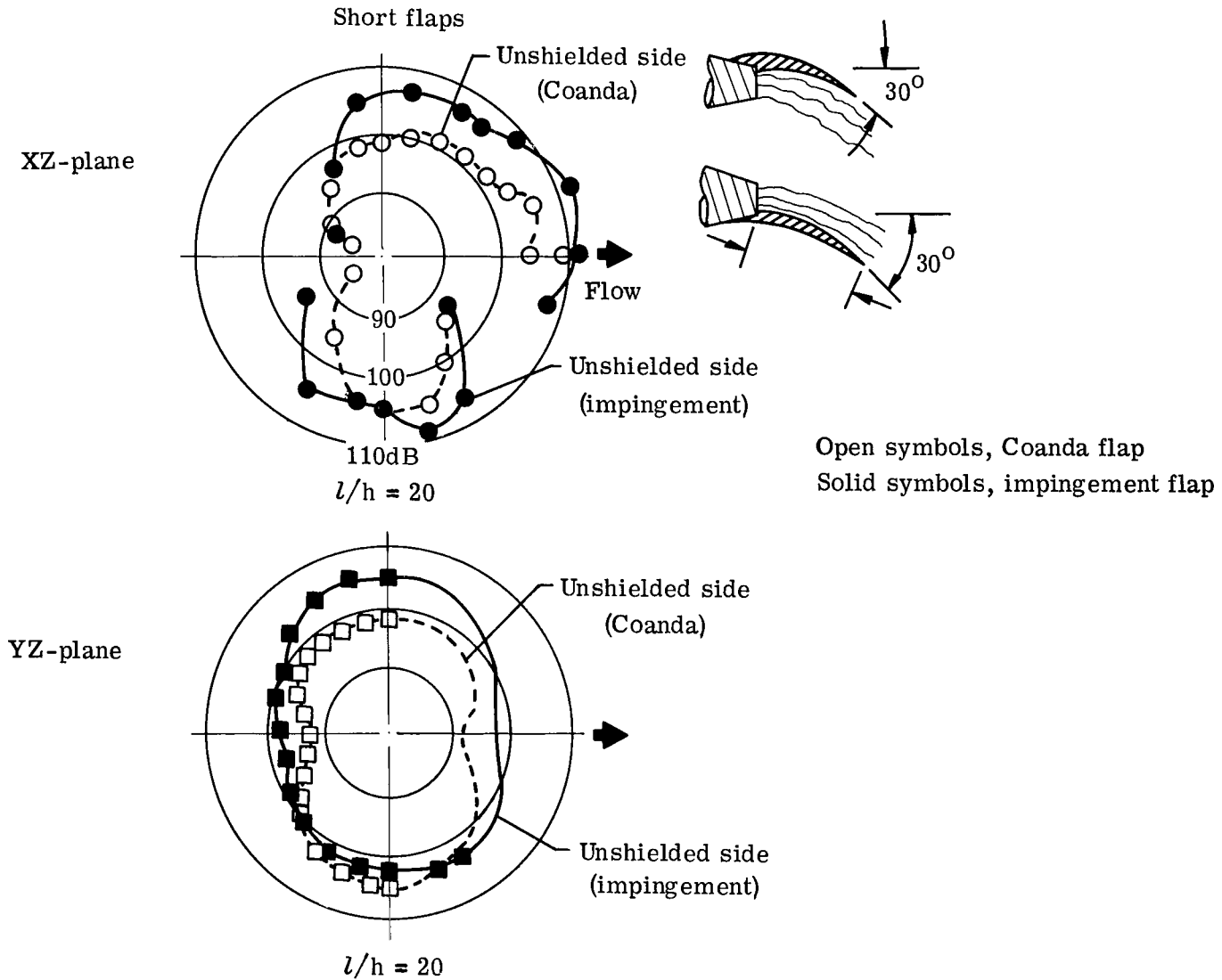

Figure 10.- Overall sound pressure level radiation patterns in the XZ- and YZ-planes for the short internal flow flap configurations with flap above jet and flap below jet. Flap deflection angle, 30° ; w/h , 200; l/h , 20.

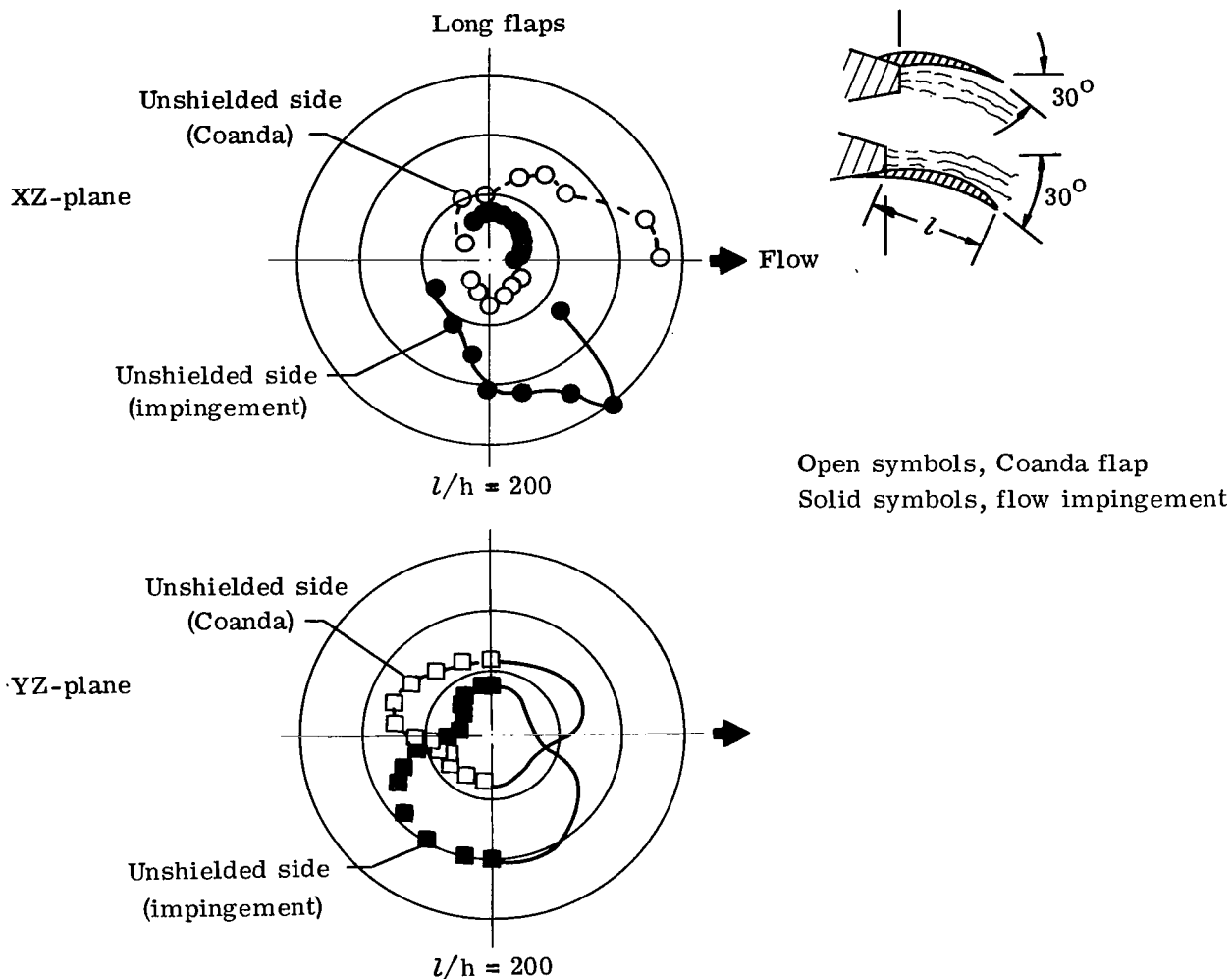
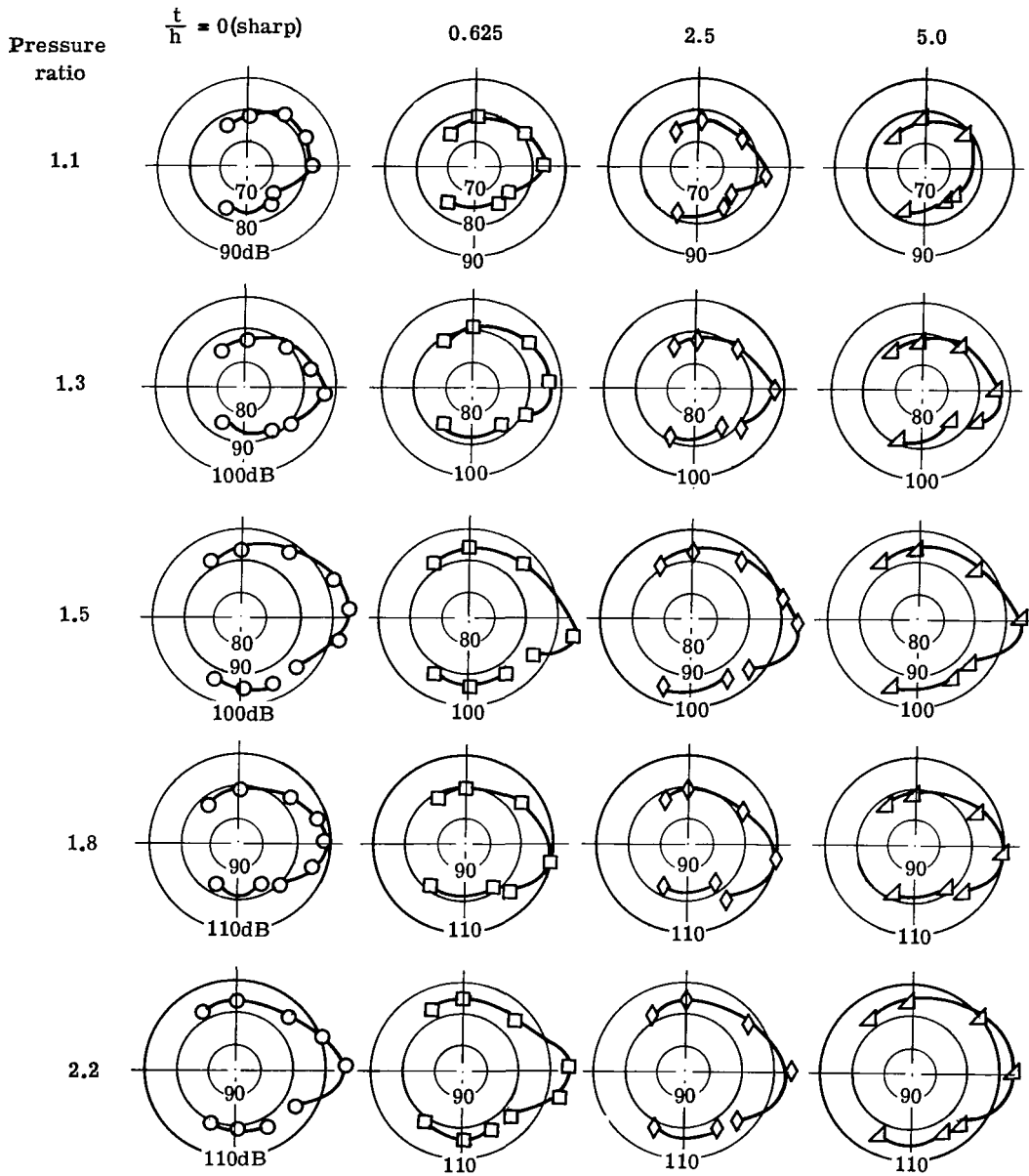
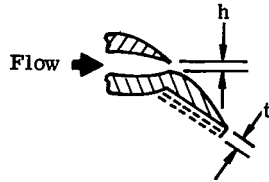
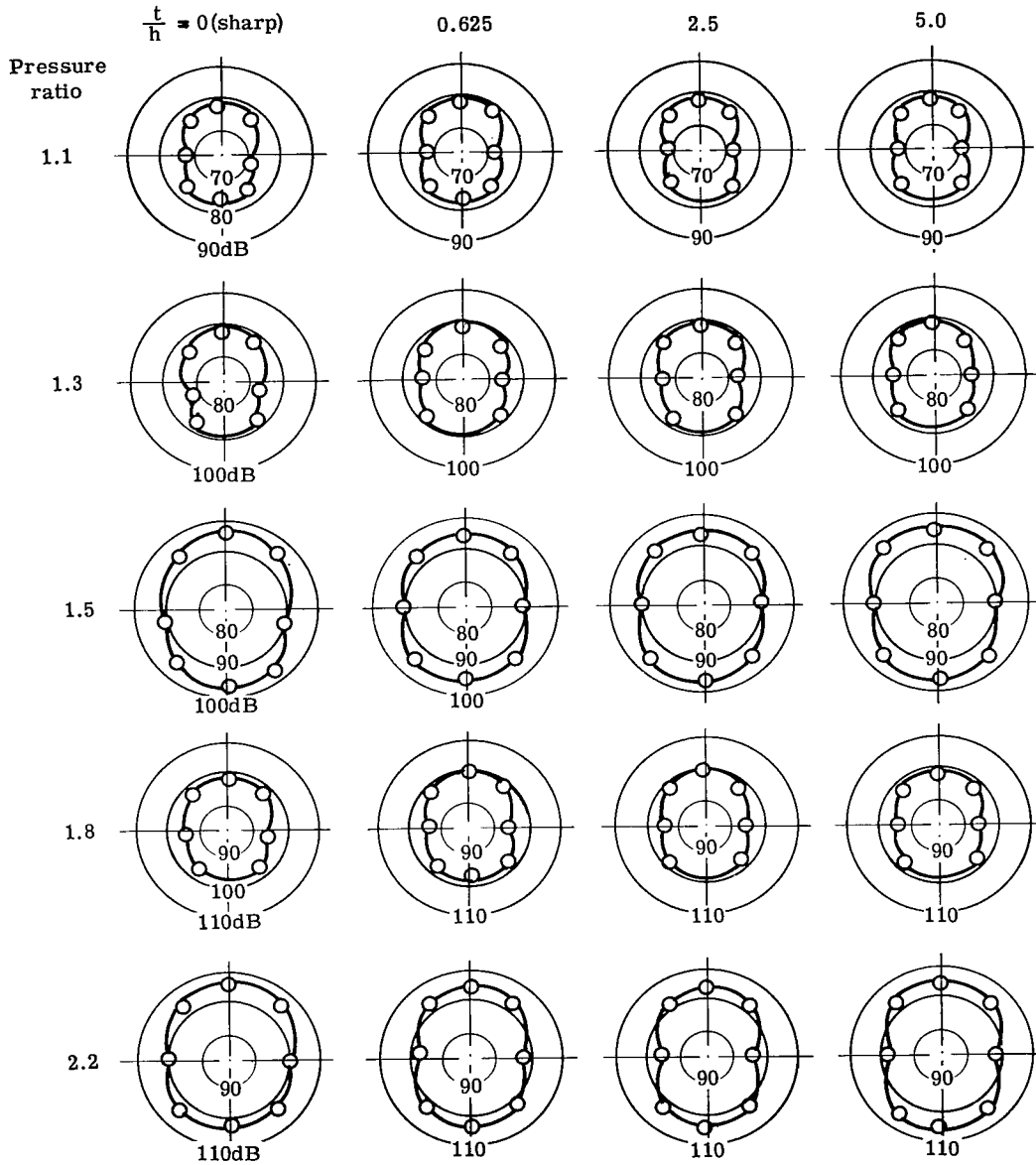
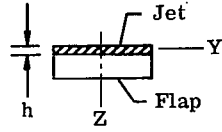

Figure 11.- Overall sound pressure level radiation patterns in the XZ- and YZ-planes for the long internal flow flap configurations with flap above jet and flap below jet. Flap deflection angle, 30° ; w/h , 200; l/h , 200.



(a) XZ-plane.

Figure 12.- Overall sound pressure level radiation patterns for the internally blown flap with sharp trailing edge and several degrees of trailing-edge bluntness.



(b) YZ-plane.

Figure 12.- Concluded.

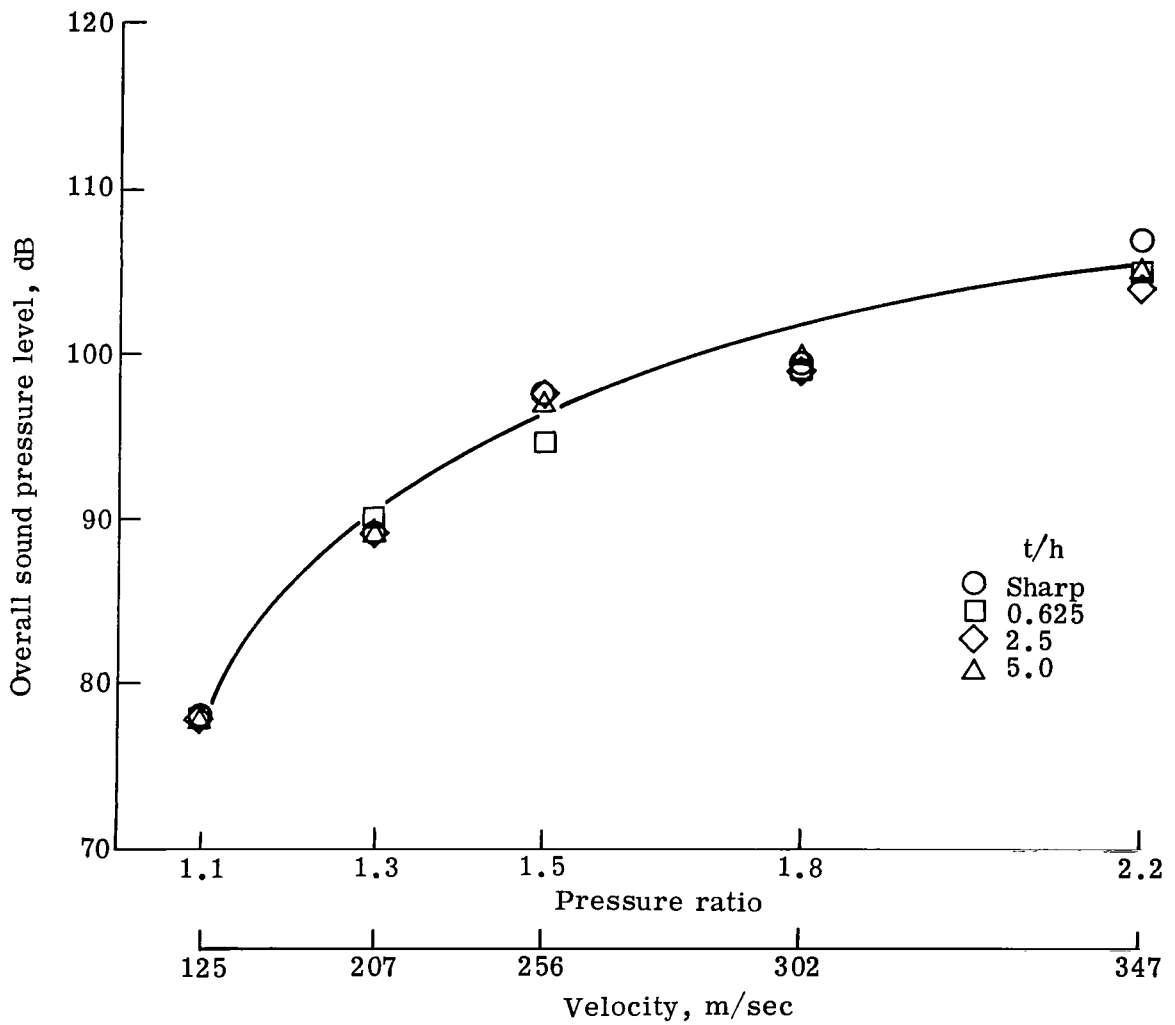
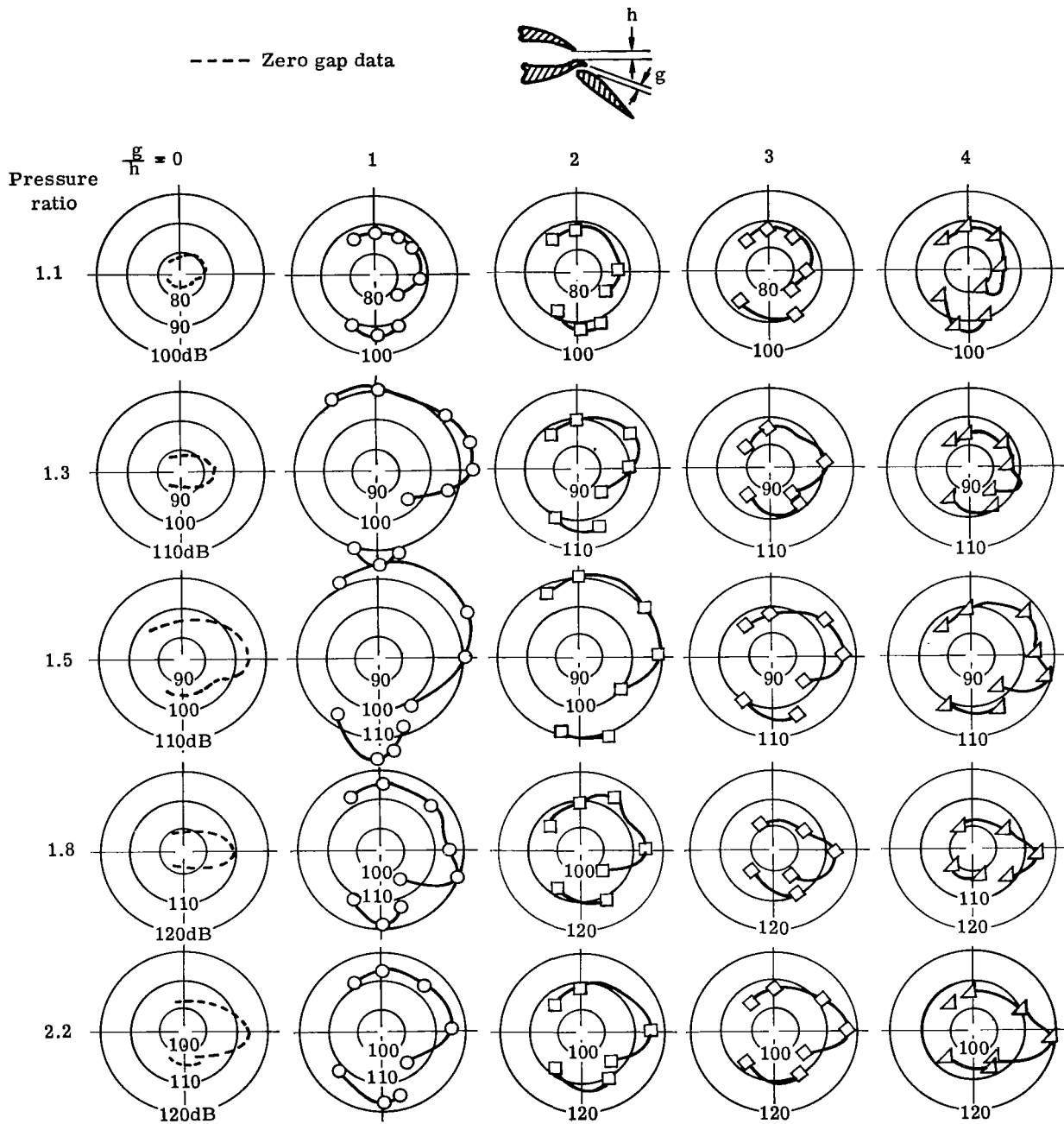

Figure 13.- Overall sound pressure level measured at $\gamma = 90^\circ$, 3.048-meter radius for the internally blown flap with sharp trailing edge and several degrees of trailing-edge bluntness as a function of nozzle pressure ratio and exit velocity.



(a) XZ-plane.

Figure 14.- Overall sound pressure level radiation patterns for the internally blown flap with several degrees of flap leading-edge gap.

----- Zero gap data

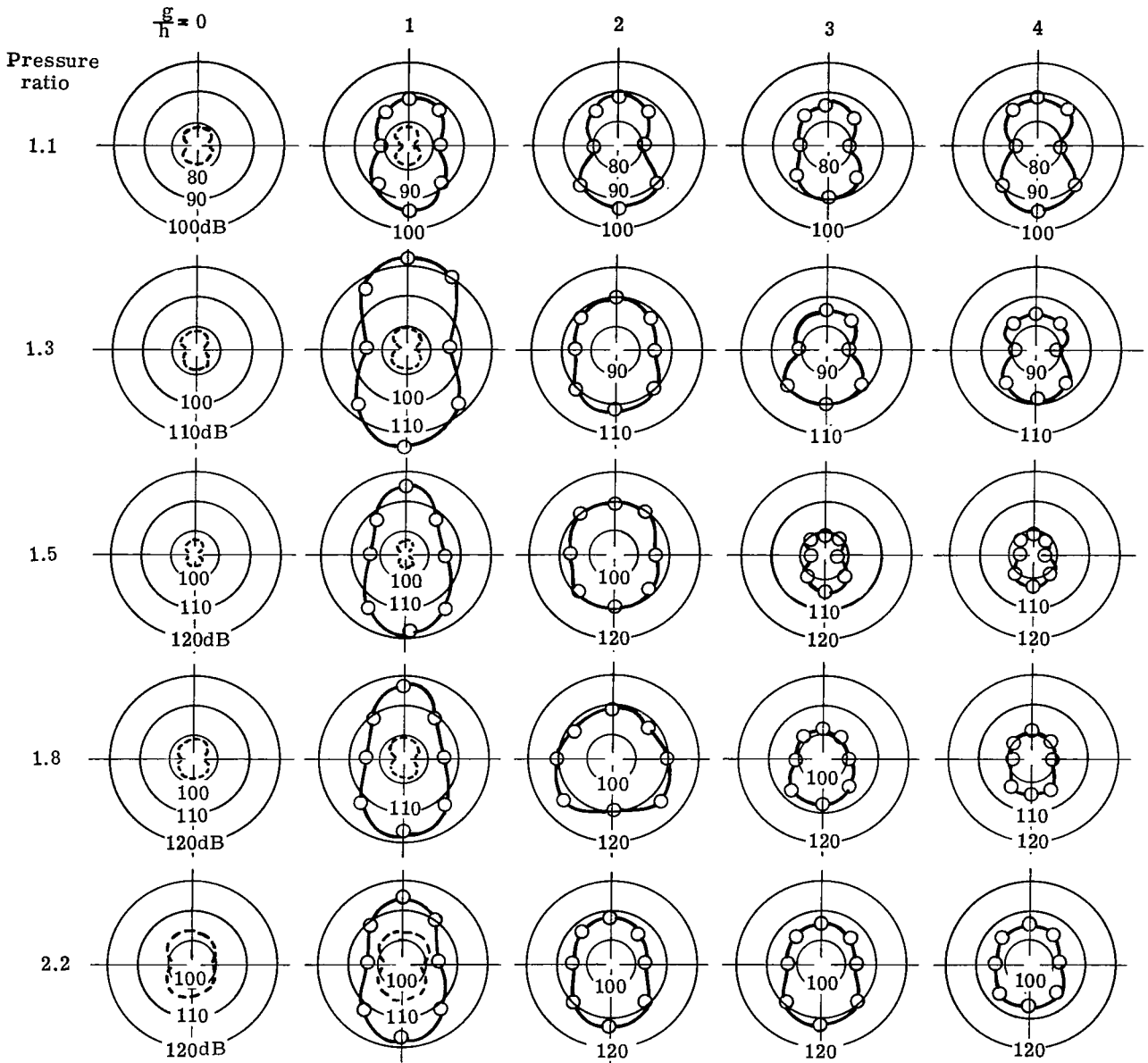
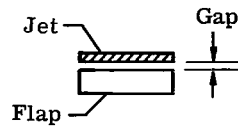

(b) YZ-plane.

Figure 14.- Concluded.

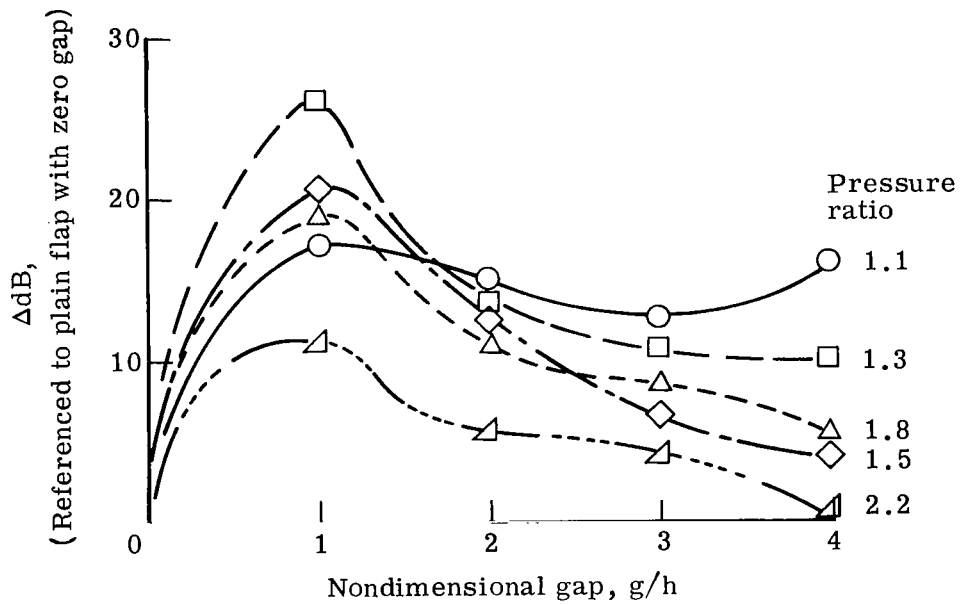

Figure 15.- Effect of leading-edge gap size on overall sound pressure level measured at $\gamma = 90^\circ$. (g , gap size; h , nozzle height.)

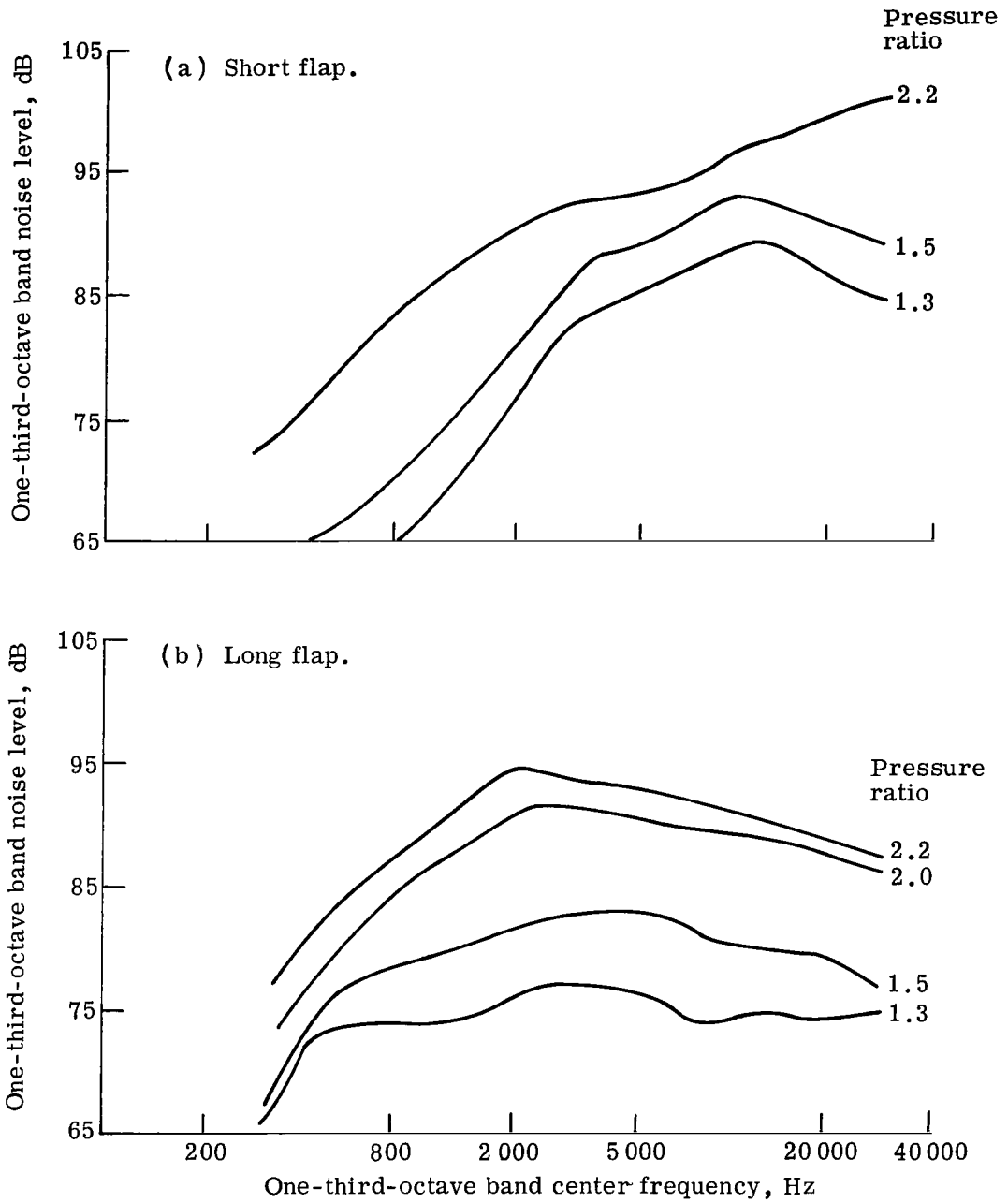

Figure 16.- Frequency spectra for the short ($\frac{l}{h} = 5$) and long ($\frac{l}{h} = 90$) internally blown flaps for several pressure ratios at $\gamma = 90^\circ$. XZ-plane.

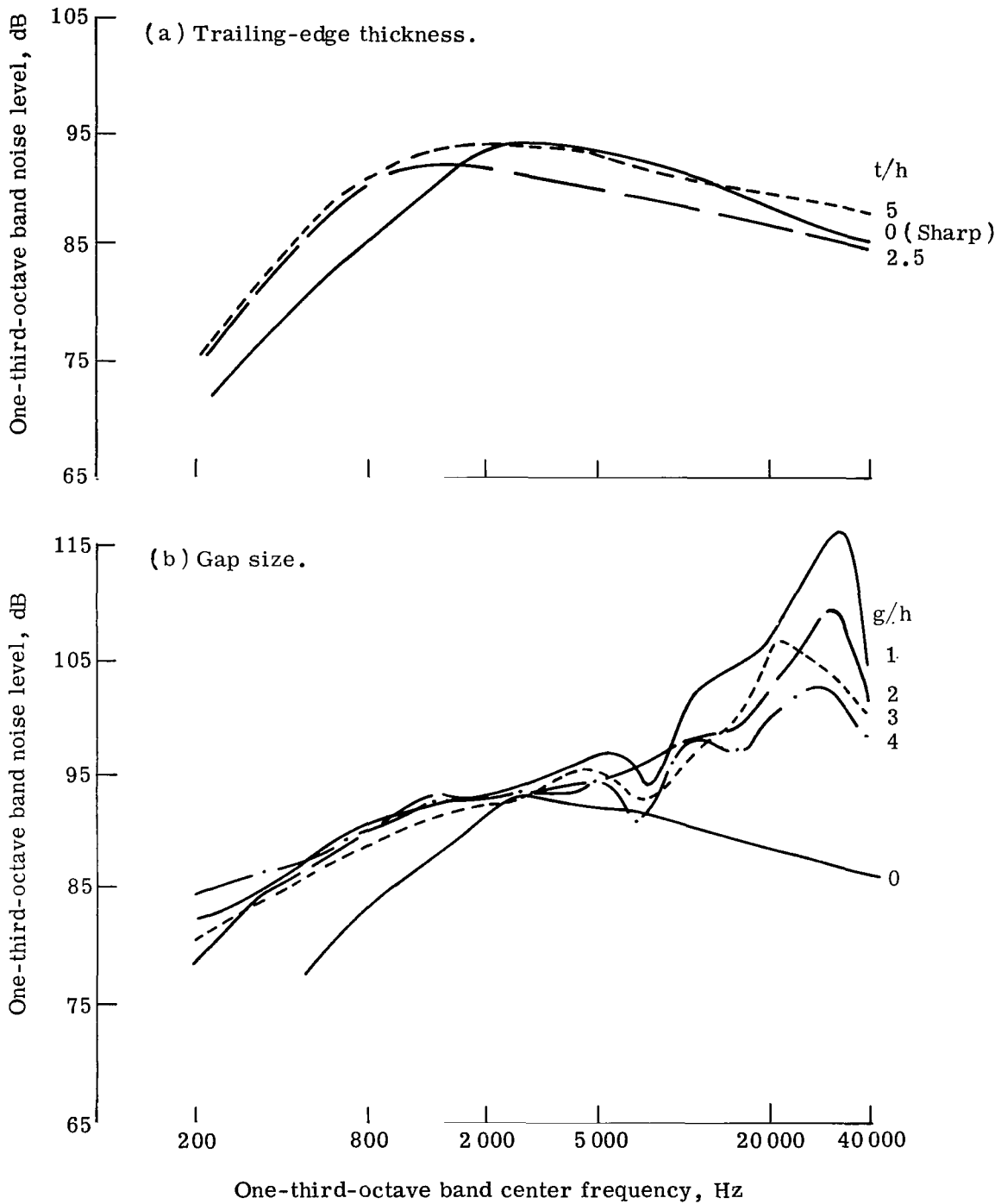

Figure 17.- Effect of trailing-edge thickness and leading-edge gap size on the frequency spectra of the long internally blown flap at $\gamma = 90^\circ$. Pressure ratio, 2.2.

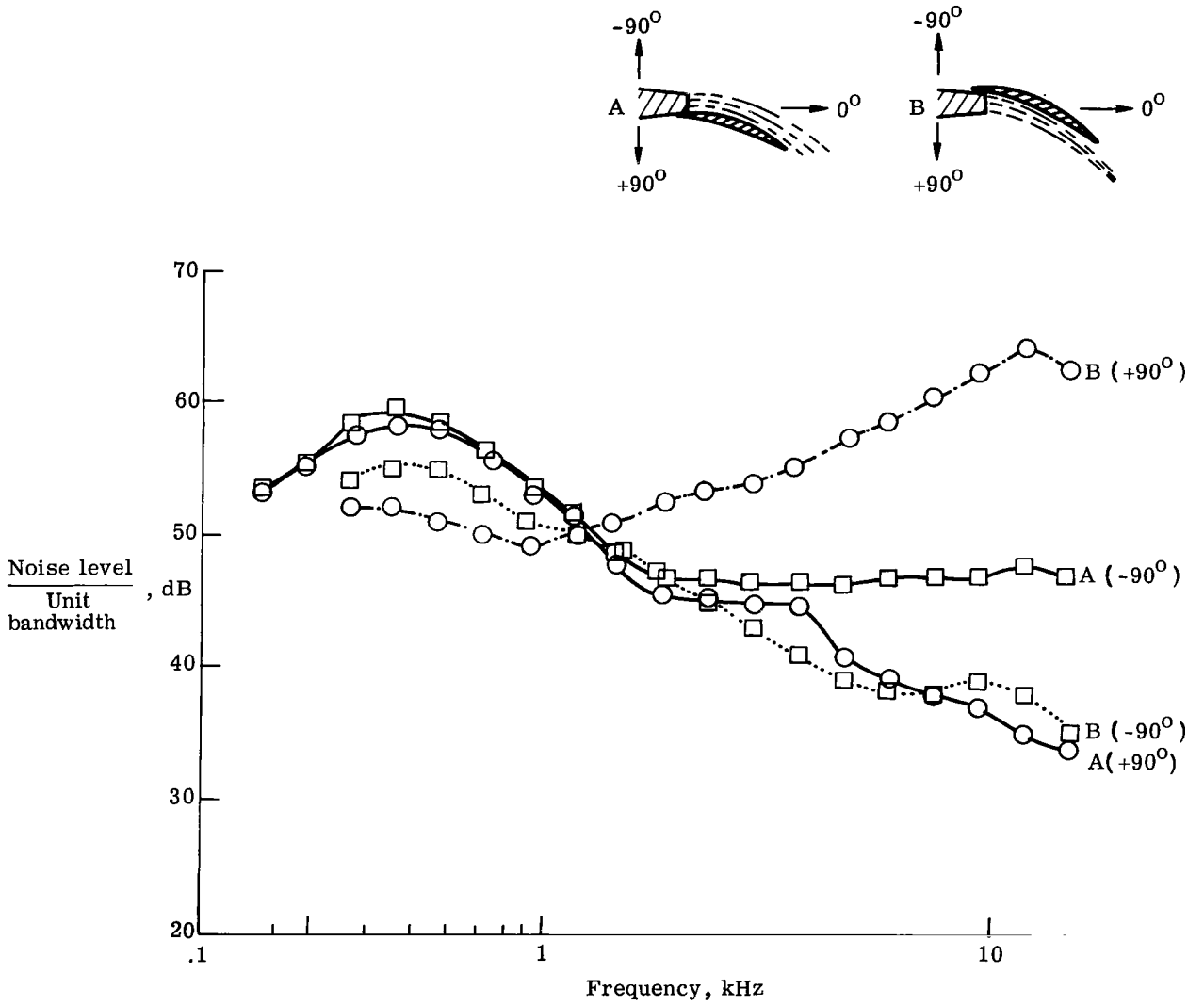

Figure 18.- Frequency spectra for two internal flow flap configurations measured at 90° from the jet axis above and below the flaps. w/h , 200; l/h , 190; long flaps.

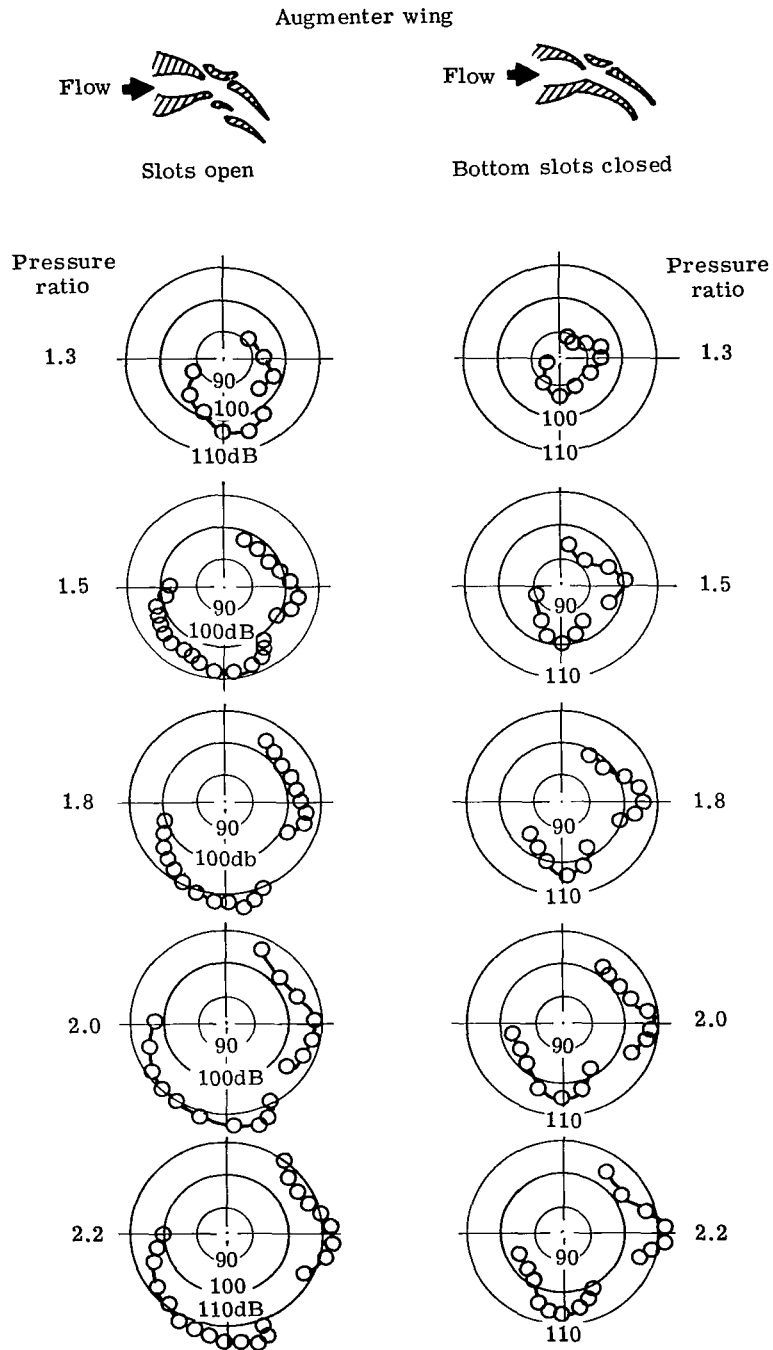

Figure 19.- Overall sound pressure level radiation patterns in the XZ-plane for the augmenter-wing standard configuration and the model with bottom slots closed.

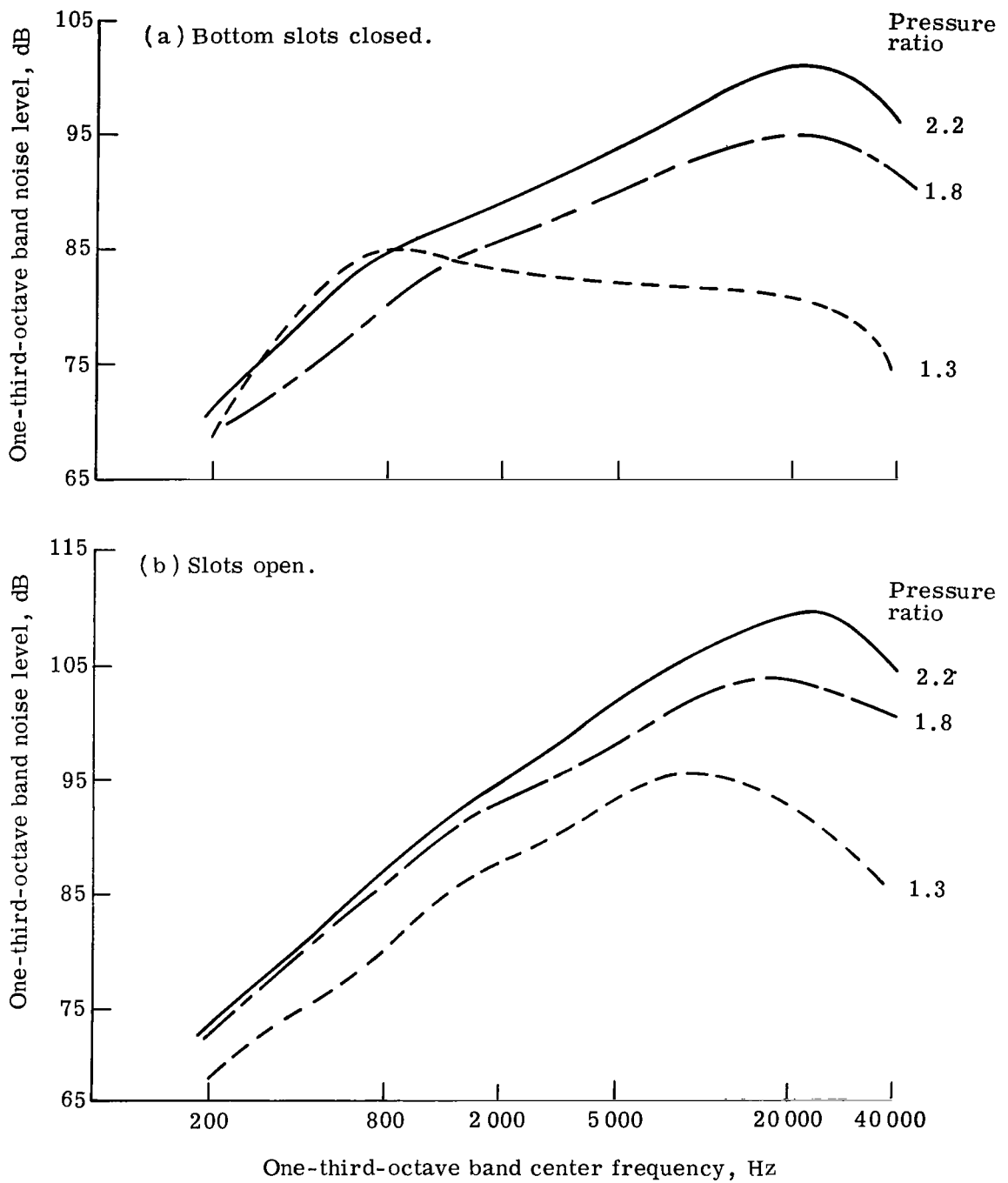
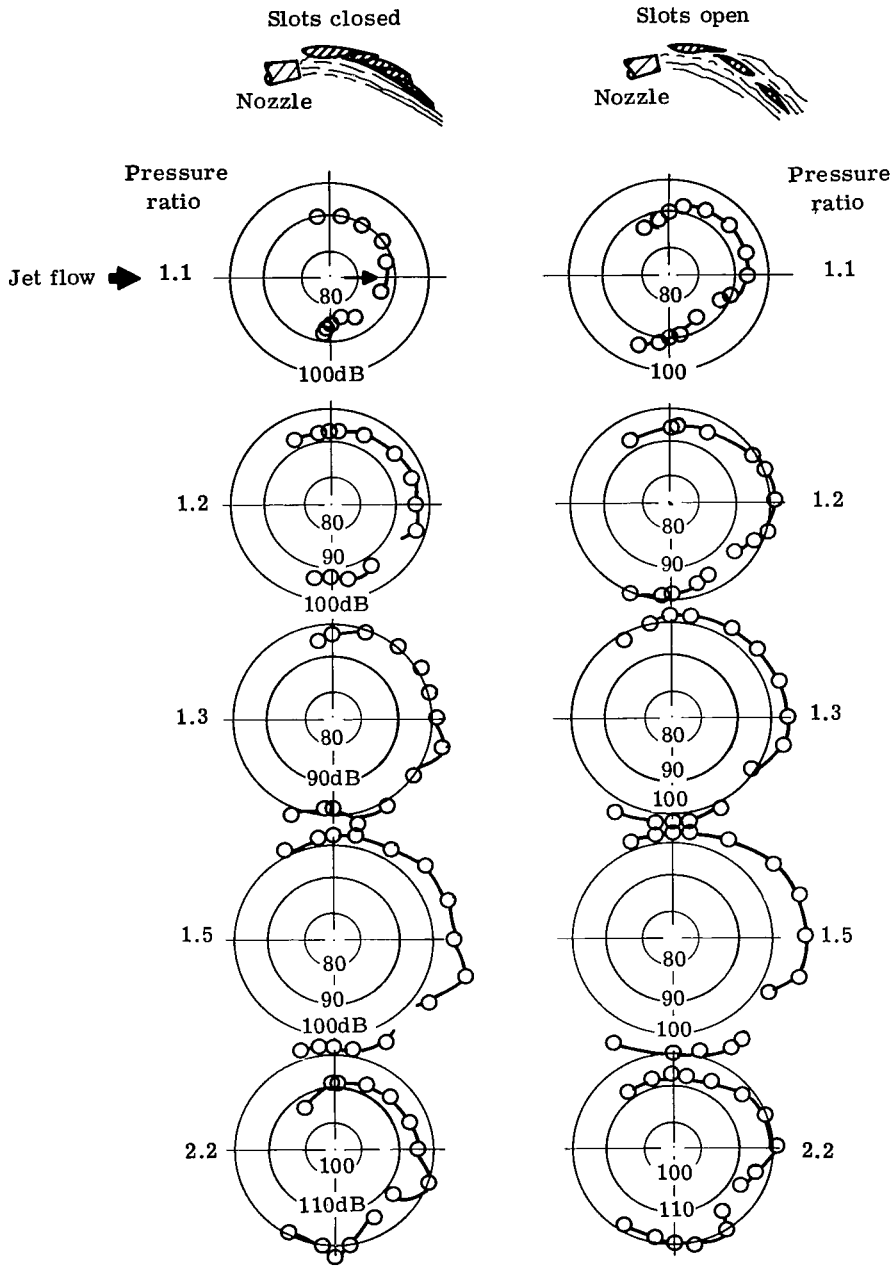

Figure 20.- Frequency spectra for the augments-wing model with bottom slots closed and the standard configuration at three pressure ratios. $\gamma = 90^\circ$; XZ-plane.

Externally blown flap



(a) XZ-plane.

Figure 21.- Overall sound pressure level radiation patterns for the externally blown flap with slots open and closed.

Externally blown flap

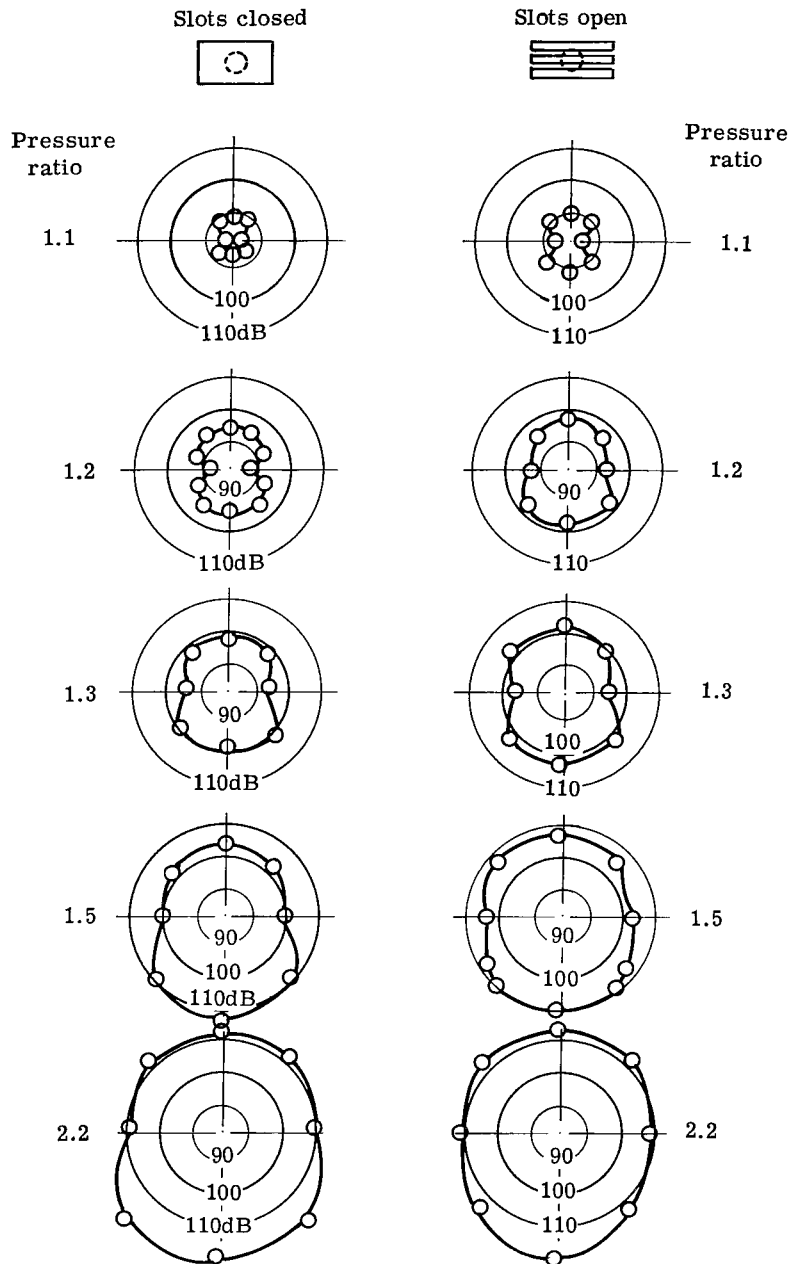

(b) YZ-plane.

Figure 21.- Concluded.

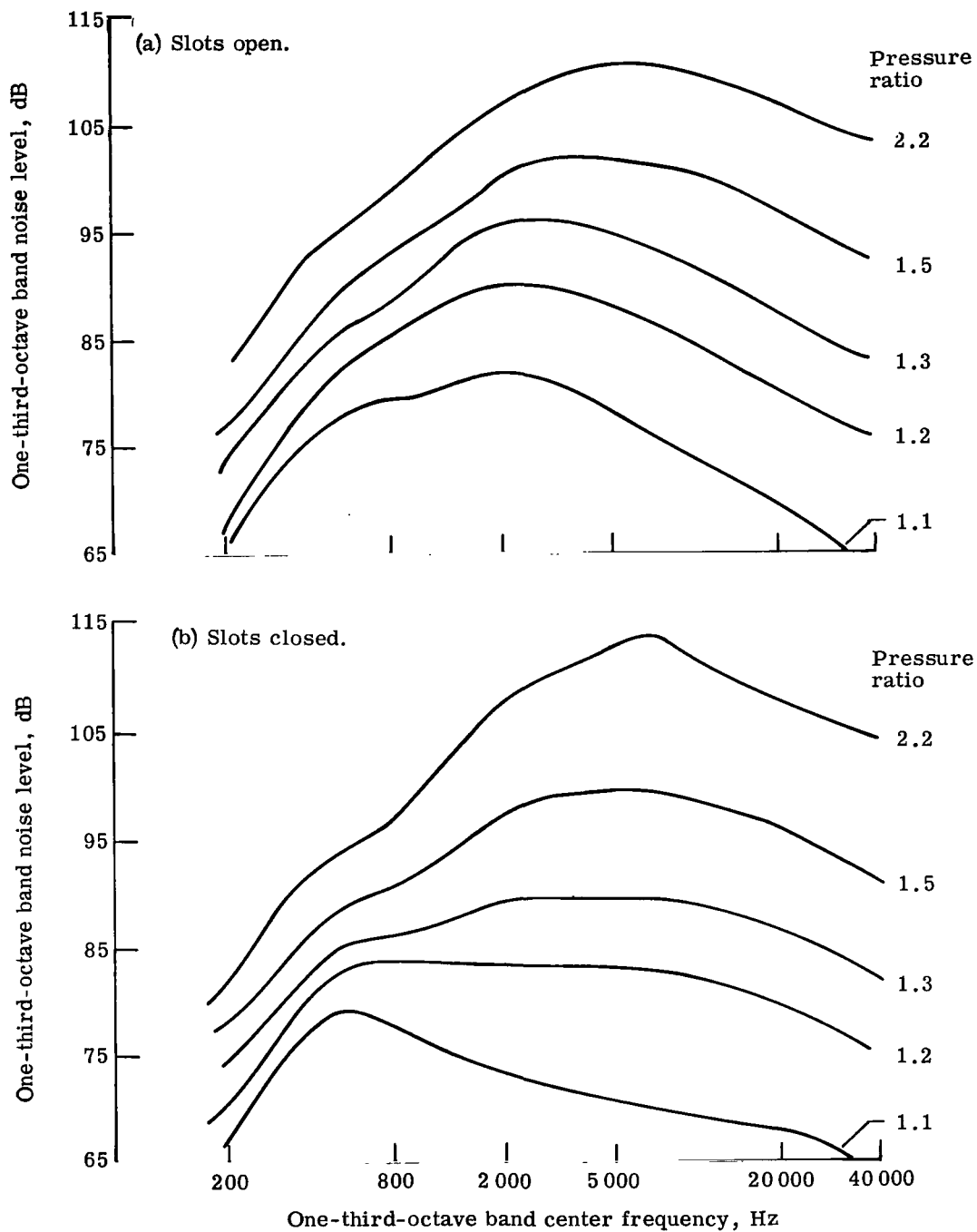

Figure 22.- Frequency spectra for the externally blown flap model with slots open and closed. $\gamma = 90^\circ$; XZ-plane.

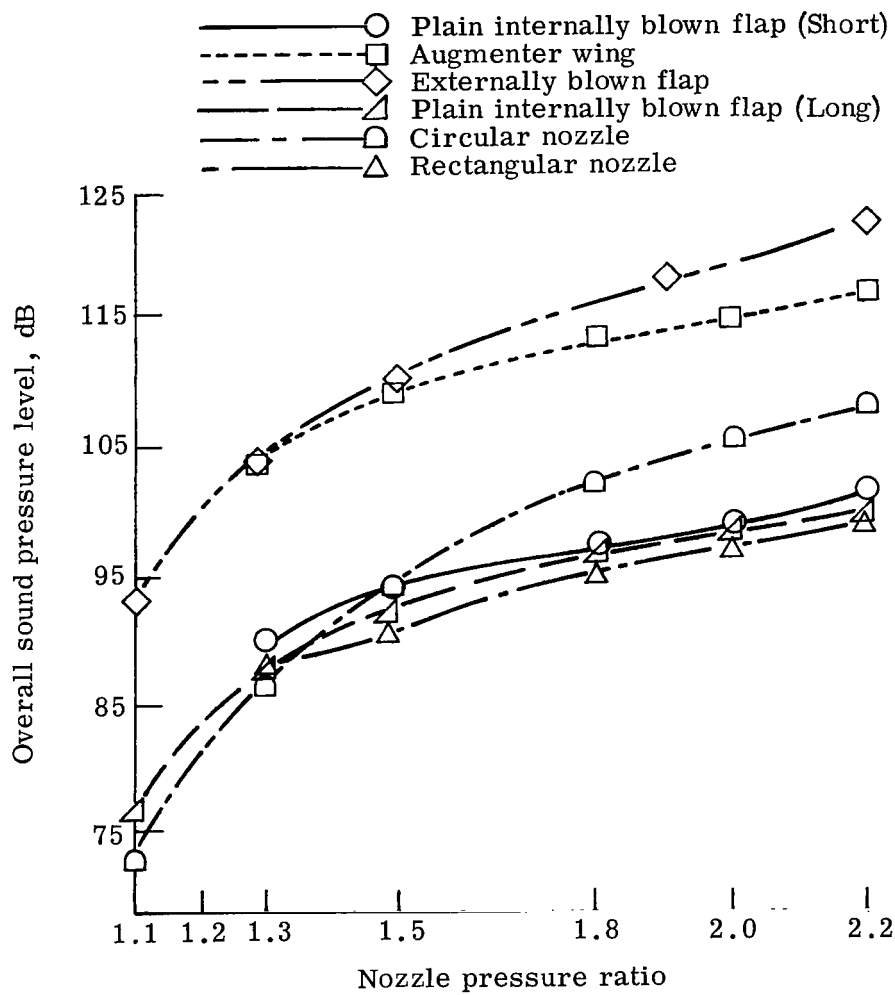

Figure 23.- Overall sound pressure level as a function of pressure ratio for four flap configurations and two bare nozzles. $\gamma = 90^\circ$; XZ-plane.



030 001 C1 U 02 720317 S00903DS
DEPT OF THE AIR FORCE
AF WEAPONS LAB (AFSC)
TECH LIBRARY/WLOL/
ATTN: E LOU BOWMAN, CHIEF
KIRTLAND AFB NM 87117

POSTMASTER: If Undeliverable (Section 15
Postal Manual) Do Not Ret

"The aeronautical and space activities of the United States shall be conducted so as to contribute . . . to the expansion of human knowledge of phenomena in the atmosphere and space. The Administration shall provide for the widest practicable and appropriate dissemination of information concerning its activities and the results thereof."

— NATIONAL AERONAUTICS AND SPACE ACT OF 1958

NASA SCIENTIFIC AND TECHNICAL PUBLICATIONS

TECHNICAL REPORTS: Scientific and technical information considered important, complete, and a lasting contribution to existing knowledge.

TECHNICAL NOTES: Information less broad in scope but nevertheless of importance as a contribution to existing knowledge.

TECHNICAL MEMORANDUMS: Information receiving limited distribution because of preliminary data, security classification, or other reasons.

CONTRACTOR REPORTS: Scientific and technical information generated under a NASA contract or grant and considered an important contribution to existing knowledge.

TECHNICAL TRANSLATIONS: Information published in a foreign language considered to merit NASA distribution in English.

SPECIAL PUBLICATIONS: Information derived from or of value to NASA activities. Publications include conference proceedings, monographs, data compilations, handbooks, sourcebooks, and special bibliographies.

TECHNOLOGY UTILIZATION PUBLICATIONS: Information on technology used by NASA that may be of particular interest in commercial and other non-aerospace applications. Publications include Tech Briefs, Technology Utilization Reports and Technology Surveys.

Details on the availability of these publications may be obtained from:

SCIENTIFIC AND TECHNICAL INFORMATION OFFICE

NATIONAL AERONAUTICS AND SPACE ADMINISTRATION

Washington, D.C. 20546