

**CONFIDENTIAL**

The X-20 (Dyna-Soar) Progress Report

Calvin B. Hargis, Jr.  
Ass't Deputy Director/Engineering  
X-20 System Program Office  
Aeronautical Systems Division  
U. S. Air Force

Background

1. X-20 (Dyna-Soar) background encompasses an extensive time period from 1957 to date (see Figure 1). Active research and development has been accomplished during dual phase I competition between Boeing and Martin between mid-1958 and mid-1959, and during the current Dyna-Soar program, which was placed under contract in May 1960.

2. It is to be noted that the active R&D has been accompanied by considerable planning and study efforts. These studies have examined numerous alternate plans for conducting the program, as well as a large number of possible alternate vehicle configurations. Relationship of the X-20A program with other national space programs and with the Air Force Space Plan has been extensively examined in various studies.

3. The initiation of the program in November 1957, was preceded by approximately 4 years of study of methods of extending system performance into the high hypersonic speed flight regime by exploiting large rocket boosters which were under development for the ballistic missile program. It was found that as speed and altitude performance increased, that military potential became of interest. A large number of technical problems were identified and found to be of such a magnitude that a research program was required for their solution. After careful study within the Air Force and NASA, it was concluded that the various interrelated problems could best be solved by a research or "conceptual test vehicle" which would be capable of extending the flight capabilities of the X-15 into the high hypersonic flight regime up to orbital speeds.

4. A Development Directive issued in November 1957, was followed by a competition involving 9 major aircraft companies. From this competition a selection was made of The Boeing and Martin companies to further pursue the relative merits of each company's proposal. During the Phase I competition, both contractors evolved configurations of a wing-body type having very similar characteristics and capabilities. The AF/NASA evaluation concluded that the Boeing glider design and the Martin booster design should be selected for further development.

5. During this period, because of extensive NACA interests in a hypersonic flight research aircraft, a joint Memorandum of Understanding was prepared to make the program a joint AF/NASA program.

6. A three-step program was devised. Step I utilized the Titan I ICBM booster to boost the glider from Cape Canaveral down the Atlantic Missile Range to velocities of approximately 18,000 ft/sec. While not as high as desired, this speed did permit initial investigation of the high

hypersonic heating regime which occurs between 18,000 and 22,000 ft/sec.

7. The second step of the three-step program was planned to utilize the same basic glider in conjunction with a larger, but undefined booster to achieve the orbital velocities necessary for complete re-entry tests. Studies were authorized to examine all possible candidates for this step of the program and to examine possible military equipment tests which could be carried on during the orbital phase of the flights.

8. The third step envisioned future use of the technology developed by the first two steps to develop a weapon system.

9. Increased glider weight and safety considerations resulted in a change to the Titan II booster in January 1961. This change in boosters provided a suborbital capability up to 22,000 ft/sec.

10. The MMSP (Manned Military Space Program) study (November 1961) concluded that the best alternative to the current Dyna-Soar program would be to adapt the glider and the Titan III booster together to achieve orbital flight. A ten shot program limited to single orbits was proposed in a development plan dated 16 November 1961, and submitted in conjunction with a White Paper which outlined Air Force objectives in space, and the essentiality of filling the potential critical gap which then existed in the development of controllable maneuvering re-entry vehicles with man integrated into the system. This program was approved in December 1961, and resulted in the initiation of the current orbital Dyna-Soar program.

11. During 1962, two multi-orbit flights were added within the 10 flight program by direction of Hq. USAF, and a change was later made to utilize the five segment Titan III booster as a result of a change of the standard booster from four to five solid segments.

Objectives

The objectives of the X-20A Program are as stated in Figure 2. The X-20A is a R&D program of a military test system to explore and demonstrate maneuverable re-entry of a piloted orbital space vehicle which will effect a controlled landing in a conventional manner at a selected landing site. The program will gather research data in the hypersonic flight regime, will test vehicle equipments, will investigate man-machine capabilities and represents a fundamental building block for the attainment of future military piloted space capabilities.

X-20 Flight Corridor

1. Figure 3 illustrates the wide range of altitude, velocity, and flight path control over which the X-20 has the capability of gathering research data.

2. The X-20 possesses the capability of dynamically flying at any point below the recovery ceiling, but above the structural limit. Controlled equilibrium flight is possible between max.  $C_L$  and the structural limit line. The initial flight shall be in the middle of the corridor for which the thermal margins are maximum, with later flights investigating the limit lines.

Research Regime

1. The widely different re-entry durations and heat flux rates (Figure 4) for the semi-ballistic capsule and the X-20 vehicle illustrate the difference in the re-entry heating problem for the two classes of vehicles. The large heat flux rates associated with capsule re-entry dictates ablative shields which work well when the re-entry duration is of the order of 10 minutes or less. The smaller heat flux rates of the X-20 vehicle actually result in a greater total heat flux because of the longer duration. However, this heat is radiated away into the atmosphere by the outer skin and only a very small percentage (2 to 5%) is absorbed into the structure.

2. The technology associated with high heat short duration re-entry is based on past ballistic missile programs and is well defined. However, little of this technology is applicable to lifting re-entry vehicles. The X-20 will provide the aerothermodynamic technology associated with slender re-entry vehicles capable of extensive maneuverability at hypersonic speeds.

3. Present day aircraft are exploring only a small region of the potential atmospheric flight regime. While the X-15 has greatly extended the investigation at the lowest end of this corridor, the greater portion remains unexplored. Arc facilities are presently available that duplicate the gas enthalpy and density corresponding to altitudes of about 200,000 feet and flight velocities of about 10,000 ft/sec. Partial simulation of some of the flight parameters is possible in conventional hypersonic wind tunnels and shock tubes. Complete simulation of the gas conditions in the entire corridor is possible in the near future only by actual flight. The X-20 is a program that will provide the vital data required to develop the necessary technology for hypersonic flight.

Re-entry Research

1. The X-20 configuration provides many features which will contribute to a number of technical areas (see Figure 5). One of its unique features is the radiation cooled metal structure which can evaluate the effects of the dissociated, chemically reacting gas flows on

heat transfer properties, materials, and oxidation resistant coatings. The ability to fly in a real gas, high enthalpy flow regime for extended time periods will add vital new data-technological anchor points - unobtainable from ground facilities.

2. The effectiveness of blended reaction and aerodynamic controls to control the vehicle over a wide range of angles of attack (0 to 50°), densities and Reynolds Numbers will provide extensive performance and stability data. The extent of laminar flow over the vehicle surface will provide data on transitional flows and boundary layer stability. Refractory heat shields and the ceramic nose cap on the X-20 are components which could have application to future radiation cooled systems. The refractory shields are easily replaceable permitting tests of alternate designs. The flight program will also provide a large amount of test data in the areas of flutter, aeroelasticity, acoustics and vibration.

3. The X-20A program will greatly expand our technology in the area of piloted flight operation (Figure 6) from the relatively short X-15 flights to global re-entry operations. The development of sophisticated re-entry management and thermal margin displays and adaptive control augmentation will enable the pilot to exercise full command of the guidance and control functions and obtain significant research on display effectiveness and pilot control capabilities. Valuable handling qualities criteria will be obtained throughout the hypersonic corridor and during approach and landing operation. From this technology, it will be possible to verify ground based flight simulation techniques and develop improved simulation programs.

4. Re-entry flight operations research will be provided by particular investigations in the following areas:

- Abort Techniques
- Energy management techniques
- Corridor exploration
- Re-entry communications through ionized flow
- Transition from reaction to aerodynamic controls

Design Criteria Impact

The X-20 flight research program will provide design criteria (Figure 7) which will be needed for the design of efficient future systems. Since these criteria are not now available, the X-20A has been conservatively designed. Turbulent flow has been used to determine heat transfer rates and an allowance of 20% has been added to account for roughness, small waves, and joints in the skin surface. Equilibrium flow has been assumed in the leading edge region which results in the highest heat transfer. Heat transfer on the wing surface may be reduced as much as 50% if extensive laminar flow is obtained in flight. Reductions in

leading edge heat transfer up to 50% may be realized if the dissociated flow is prevented from recombining at the wall by the use of a "non-catalytic" coating. If the effects of roughness prove to be less detrimental than expected, less blunt leading edges might be used which could increase the lift/drag ratio by 25% with a corresponding lateral range increase of 50%, as well as a payload increase of up to 6000 pounds.

#### Re-entry Maneuverability

1. Development of capabilities for re-entry maneuverability represents a basic need of the nation and one of the prime objectives of the X-20. The ballistic re-entry concept has now been demonstrated and has further emphasized the need of distance and direction control capabilities during re-entry. The Gemini project will provide a minimal improvement in these parameters. The X-20A project represents the prime national effort to provide a system with a high degree of re-entry maneuverability.

2. The payoffs of re-entry maneuverability are many. The principle payoff is the wide choice of landing sites available during re-entry from orbit, during emergencies, or in the event unforeseen circumstances require a change in plans during the re-entry and approach phases of the flight. Another key advantage is the elimination of extensive time in orbit, waiting for an opportunity to land at a selected site. The advantages of re-entry maneuverability are discussed in the following paragraphs.

#### Re-entry Maneuverability (Distance and Direction Control)

1. An illustration of the use of distance and direction control during re-entry is shown in Figure 8. After re-entering the atmosphere, a maneuverable re-entry vehicle such as the X-20A is capable of employing aerodynamic lift to vary its landing point. Normally, a landing to a pre-selected site as shown in the center of the ground landing area "footprint" would be planned with flight at a nominal glider re-entry attitude (angle of attack) and L/D. By flying at relatively low glider angles of attack, it is possible with the X-20 to extend range by approximately 3,000 nautical miles over the nominal re-entry path. By flying at a high angle of attack, it is possible to shorten the landing distance by approximately 3000 nautical miles, thus providing considerable flexibility for landing at an alternate site if necessary. It is also possible to bank the glider and perform a gradual turn in order to land at sites as much as 2,000 nautical miles displacement from one side of the orbital track.

2. In comparison, a ballistic re-entry vehicle is constrained to a landing essentially along its orbital track, controlled in range by the timing of the retro rocket firing.

#### X-20 Maneuver Flexibility

1. Choice of landing areas available as a result of the X-20 maneuver flexibility is shown in Figure 9 for a typical orbital flight, with the ground track limited to that of a single orbit for clarity. During the orbital flight, the pilot has the option of landing at any site within the broad band indicated on the chart, whereas a ballistic device could land only along the orbital track shown within this band.

2. Typical landing footprints are shown to illustrate the size of the landing area available to the pilot after a deorbit has been accomplished. Such a footprint is always potentially available to the pilot, with its center some 8000 miles ahead of his actual position, and may be visualized as moving along the orbital track ahead of the vehicle and becoming available after deorbit. The considerable flexibility such a capability provides should be of considerable importance to operational missions which cannot always be completely preplanned, as well as facilitating the accomplishment of preplanned test missions.

#### Test Vehicle Equipment and Explore Man's Function in Space and Re-entry

1. One of the objectives of the X-20A program is to test the vehicle's equipment and to explore the role of the pilot during orbit.

2. Initially, the more important portions of the flight testing effort will necessarily concentrate in the boost and re-entry areas until confidence and equipment reliability are fully established. Hence, the initial flights are being planned as single orbit flights. Even so, these flights provide a significant 43 minutes in orbit in which to accomplish additional testing of both man and machine. This testing extends to all of the vehicle subsystems as well.

3. Later, multi-orbit flights will serve to extend this testing time when a shift of emphasis to broader system testing becomes appropriate.

4. With all elements adequately instrumented for research and performance testing, the X-20A then provides the means for meeting its test objectives.

#### Mission

Now that the history and the basic program objectives have been covered, a discussion of our present program is in order. First, the:

#### Air Launch Program

The purpose of the air launch program is to demonstrate low supersonic, transonic and subsonic flight and landing capabilities, operation of subsystems, evaluate the integrated glider subsystems in flight prior to ground launch, and to conduct pilot training. One glider is scheduled to accomplish 20 air launches. The test program is planned

to fully explore the low speed portion of the flight corridor (70,000 feet altitude and up to speeds of approximately Mach 1.4). The glider is air launched at an altitude of approximately 50,000 feet and at a speed of approximately Mach 0.8. The acceleration rocket will be used on four power-air-launches to obtain low supersonic performance.

#### Ground Launch Program

1. The first phase of the ground launch program will be a two shot unmanned configuration utilizing developmental boosters. The next phase of the program consists of manned shots of both single and multi-orbit configurations. The nature of these flights is depicted in Figure 10.

2. Prime mission of the single orbit flights is exploration of the re-entry flight regime and demonstration of controlled maneuvering re-entry. These flights are launched from Cape Canaveral and directed along the Atlantic Missile Range, but tilted over to a flatter boost trajectory than is common for ballistic launches, so as to avoid violating the aerodynamic flight recovery ceiling. Boost burnout occurs approximately 1,000 miles down range where the vehicle is injected into an elliptical orbit with an apogee over South Africa (altitude approximately 100 nautical miles) and a perigee within the atmosphere (altitude approximately 60 nautical miles) northwest of Australia. At this point, advantage is taken of the X-20's aerodynamic controllability to prevent re-emergence and thus initiate re-entry. There follows a 7,000 nautical mile hypersonic re-entry approach through the Pacific Missile Range to Edwards AFB in California, where a horizontal landing is effected on the dry lake bed. Nominal re-entry time is 50 minutes. All critical action regions of the hypersonic boost and re-entry flight are covered with SHF range instrumentation and data collection facilities.

#### The Multi-Orbit Flights

These are very similar to the single orbit flights in the launch and re-entry areas, except that the launch azimuth is reduced to allow for precession of the ground track due to earth rotation during the orbital time period. The Titan III transtage is retained as part of the orbital vehicle to provide propulsion in orbit. Upon reaching the apogee, the transtage rocket motors are fired briefly to circularize the orbit. Thereafter, orbital flight proceeds for three orbits to a point over the Indian Ocean where the glider orientation is reversed and the transtage again fired briefly to effect deorbit. The glider orientation is turned for re-entry and thereafter, re-entry is executed as for the single orbit flights.

#### Configuration

1. The X-20 (Figure 11) consists of a 12,250 pound glider, of which 1000 pounds is payload, and a

5,750 pound transition section. The glider lower surface area is 345 square feet. The maximum length is 35.3 feet, the maximum height is 8.9 and the maximum width is 20.8 feet. The re-entry and landing weights of the glider are 12,000 and 11,700 pounds, respectively. The transition section is 15 feet in length and has a maximum diameter of 10 feet. It is divided into a 4.7 foot emergency propulsion section and 10.3 foot mating and multi-orbit equipment section.

2. The glider is shown mounted on the Air Force's Standard Space Launch Vehicle (Titan III). This booster will not be discussed here, but will be the subject of a separate paper in another section of this symposium.

3. Figure 12 shows the three compartments within the glider which are cooled. The pilot's compartment and the equipment compartment are both pressurized and cooled and the rear or secondary power compartment is provided with heat protection by means of a water wall.

4. The equipment compartment is designed to provide 75 cubic feet of available space and is shaped to easily accommodate a wide variety of payloads. It is designed for 1000 pounds payload and is currently utilized to house the test instrumentation subsystem and portions of the communications subsystem. It is provided with a 100% nitrogen atmosphere pressurized to 10 PSIA, and thus is well suited for the test of prototype electronic equipment which has not necessarily been made explosion-proof.

5. The secondary power compartment houses the hydrogen tank, oxygen tanks, auxiliary power units, and other equipment required to generate and distribute power. Hydrogen is stored supercritically in order to assure expulsion under weightless conditions, and is utilized as a heat sink as well as for fuel for the APU's.

Technical Developments

1. This first portion of the presentation was to acquaint the unfamiliar with the basic Dyna-Soar program. Now we will turn our attention to some of the technical areas of interest to discuss in more detail.

2. One of the first important decisions that was made in the Dyna-Soar program was to choose a hot primary structure approach instead of an active cooled aluminum sub-structure. These two concepts were evaluated in the June 1959 evaluation between The Boeing and Martin Companies. Although the cooled approach had many desirable characteristics including much better volumetric efficiency, there was considerable doubt at the time as to the feasibility of developing a heat shield system for the cooled structure which could effectively restrict heat shorts through attachments and hot boundary layer air leakage to the cooled structure. The feasibility and reliability of employing extensive coolant tubing throughout the glider was also considered a serious problem. The feasibility of the hot structures, however, had been demonstrated by Boeing during Phase I and the inherent reliability of a passive cooling system were important factors in the decision.

3. The state-of-the-art has advanced considerably in both areas since 1959, and follow-on applications of the Dyna-Soar technology may have either a hot or cool sub-structure depending on the overall system requirements.

X-20 Structure

1. The X-20 structure is one which is subjected to a severe re-entry environment. Temperature varies between 3650°F on the nose cap to a life environment for the pilot and equipment. The vehicle is subjected to dynamic pressures up to 860 psf during boost, sonic vibrations of 147 decibels, maneuver factors between - 1g and + 4g, and sink rates up to 8 fps during landing.

2. The system consists predominantly of trusses fabricated from materials selected to sustain the thermal environment (see Figure 13). The structure is designed to operate in an environment up to 1800°F. It is capable of withstanding at least four maximum condition re-entries. The conditions of major concern to the designer are thermal gradients across the structure and maximum structural temperatures. Accommodation of maximum temperatures is primarily a matter of material selection. For Dyna-Soar, Rene' 41 (nickel-base superalloy) has been selected. This alloy exhibits the best combination of availability, workability, and strength at elevated temperature. The accommodation of thermal gradients, which are as high as 500°F across a structural section, is an arrangement and concept problem. On Dyna-Soar, the basic approach is use of truss-type construction. Trusses were chosen because of their ability to reorient to the thermally induced shape without causing excessive secondary stresses. This principle is demonstrated in

Figure 14 for a single, three-sided truss. As member AB heats to a greater temperature than the other members, and hence, elongates more than the other members, the triangle changes shape by rotating about the joints.

3. This accommodation of gradients, which are nonlinear, is also best handled by trusses since the loads are carried in discrete members separated by air spaces as opposed to shear webs which have continuous shear material between the joints. Where thermal gradients are nonlinear, high shear stresses can be created by the large differences in thermal deformation across small distances. Where the thermal gradient is linear and the structural members are isolated, corrugated shear webs function satisfactorily.

4. The Dyna-Soar glider truss arrangement is as shown in Figure 13. Structural details of the various truss areas are predicated on the loading conditions, thermal environment, space available, manufacturing capabilities, and other peculiarities in the area in question. The fuselage main beams utilize rectangular, round and square members, pinned and fixed joints, joint fittings made from forgings and bar stock, and both standard and special fasteners.

5. The exterior surface consists of Rene' 41 corrugation-stiffened panels, either uninsulated or insulated, depending on the location of the panel on the glider. Insulated panels are used in all areas where the surface temperature exceeds 2000°F and includes the entire lower surface of the glider, the outboard surface of the fin and rudder, and a small portion of the forward sides of the body aft of the nose cap. Uninsulated panels are used on the upper surface of the wing, body, and elevon, and on the inboard surface of the fin and rudder. The configuration, sizes, and materials selected for these panels resulted from design considerations that include thermal, flutter, sonic, air pressure, and shear loads, fabricability, and maintainability. The insulated panel, as shown in Figure 15 consists of a Rene' 41 corrugated panel with TZM molybdenum or D-36 columbium alloy heatshields attached with stand-off clips, and Q-felt insulation sandwiched between the two.

6. The D-36 and TZM heatshields assemblies are protected against oxidation by a disilicide coating. Individual parts are precoated prior to riveting, and the completed riveted assembly is recoated to protect the riveted area and the faying surface between the clip flange and the shield.

7. The leading edges are defined as all edges that face into the airstream. Altogether, the glider has approximately 140 running feet of leading edge construction and about 140 square feet of exposed area. Average transverse spans are on the order of 8 inches. The edge radii vary from a maximum of 7.5 inches at the nose cap to

a minimum of 2.06 inches on the inboard side of the elevon. The radii are jointed by faired and tapered sections. These sections were selected to be consistent with a maximum design short-time temperature of 2900°F and an equilibrium temperature of 2825°F. Nonmetallic leading-edge specimens have been built of graphite, ceramic, and composites. Metallic specimens have been built of forged molybdenum and sheet-metal tantalum, columbium and molybdenum. Of the metallic specimens, only the molybdenum and columbium sheet-metal have reached detail design status. The effort spent on graphite, ceramic and composite designs did not result in arrangements which were competitive with sheet-metal designs in terms of joint smoothness, suitability for sealing, and applicability to geometry. In addition, both the nonmetallic and the forged refractory specimens appear to be heavier, as shown in Figure 16, TZM molybdenum alloy sheet metal will be used for most of the leading edges, and D-36 columbium alloy for areas where temperatures do not exceed 2450°F.

#### Nose Cap

1. The nose cap of the Dyna-Soar glider is required to sustain very high temperatures over a much longer period than that of a ballistic re-entry vehicle. Because of this relatively long period at temperature and the desirability of maintaining aerodynamic shape, the development effort has centered around heat-sustaining materials. Two structural configurations of different material combinations are being developed, one by the Chance-Vought Corporation and the other by The Boeing Company. This dual effort has been considered necessary because this piece of hardware is so critical to the successful flight of the vehicle.

2. The Chance-Vought concept utilizes a structural shell of National Carbon RT-0029 graphite protected by a silicon carbide coating. The shell is further protected by an outer cover of zirconia tile retained by zirconia pins in such a manner that the major thermal stresses in the protective cover are relieved by mechanical motion between the zirconia tiles. This cap is illustrated in Figure 17.

3. The Boeing nose-cap effort is directed toward developing a monolithic shell of zirconia reinforced with platinum wire. The forward face of the shell is grooved to relieve the thermal stress on the surface. This surface grooving is accomplished by inserting a paper honeycomb configuration into the mold, pressing, and burning the paper out during the firing operation.

4. The mounting of the nose-cap shell to the glider structure has been a joint effort of the two companies. The mounting is so arranged that the attachment of the two nose-cap shells to the support ring differs in only minor details.

#### Landing Gear

The Dyna-Soar landing gear configuration is an all-skid, tricycle arrangement utilizing

yielding metal (energy strap) shock absorbers. Each of the two main and the single nose gear are composed of three major elements: a skid, a pivoting support strut, and an energy strap (see Figure 18). The main skids are wire brush types to generate a high coefficient of friction, and the nose skid is hard coated to provide a low coefficient of friction. The support struts are assembled from machined Rene' 41 forgings and are designed to pivot aft under load. This pivoting motion causes the energy straps to yield and absorb the landing impact energy.

2. All landing-gear doors are operated mechanically by the extension motion of the gear. The gear itself is extended at 275 knots by a high-pressure pneumatic system which moves the gear to an external position where aerodynamics and gravity complete the extension cycle. The major portion of this pneumatic system, as well as the gear itself, will experience a high-temperature soak in the 1600°F to 1800°F range.

3. A test program is presently being conducted at Holloman Air Force Base, Track Test Division on both the nose and main skids. Asphalt, concrete, and lakebed surfaces have been laid down in the sled track trough so that 5000-foot slide-outs can be made to verify the coefficient of friction, wear, and bump capability on each type surface. A special rocket sled permits the glider to start the slide-outs at the maximum glider landing velocity of 220 knots and to coast to a full stop in 5000 feet.

#### Integrated Power and Cooling

1. The operation of Glider Subsystems results in a 34HP Design Requirement for Secondary Power Generation. This total can be broken down into the primary electrical load, such as guidance, communications, flight controls, TIS, cockpit displays and lights that account for 6.9 KVA, and secondary electrical loads associated with environmental control equipments and cryogenics supply requiring 3.8 KVA. The remainder can be attributed to the 8.5 GPM, 3000 psi hydraulic load. Considering the duty cycle of the subsystems, the total energy demand could vary from approximately 12 to 80 horsepower-hours.

2. Figure 19 shows the secondary power generation spectrum derived from initial and projected program requirements superimposed over load regimes within which particular energy conversion units operate most effectively. Note that the chemical dynamic APU is shown as the most suitable prime mover for the X-20A application. A cryogenic bipropellant, hydrogen and oxygen, was selected on the basis of results comparing many propellant combinations. The two most promising schemes are shown in Figure 20. Here hydrazine weight requirements are approximately 2 1/4 times that of the hydrogen-oxygen unit. On this basis, the hydrogen-oxygen bipropellant combination was selected. The operation of electrical and hydraulic equipment, combined with the effects of aerodynamic heating

results in a total heat load of approximately 200,000 BTU's. Two approaches were taken to dissipate this energy:

a. Equipment cooling would be accomplished by the environmental control system within the framework of the 3 compartments.

b. The major portion of aerodynamically generated heat passing through the outer surface would be removed by a system mounted to the outer face of the compartment walls.

3. The selection of this propellant combination resulted in the use of hydrogen as heat sink for equipment cooling, since a comparison with water (see Figure 21) indicates a considerable weight saving and a wide temperature range to accommodate the cooling of equipments having different operating temperatures. The effect of adding ammonia to water results in a wider temperature range at low altitude.

4. When the implications of Figures 20 and 21 are resolved in terms of hardware and subsystem requirements, the impact of specific concepts can be evaluated. Two of the most promising approaches were selected for comparison: an integrated hydrogen-oxygen system utilizing hydrogen-oxygen for power generation and hydrogen for cooling, and hydrazine power generation units combined with a water-ammonia cooling system.

5. The weight advantages of an integrated hydrogen-oxygen system are shown in Figure 22. Although a comparison of re-entry weights shows only a small savings for the cryogenic systems, the growth capability for multi-orbit missions is significant.

6. As a result of this study, the integrated cryogenic system was selected and a hydrogen-oxygen reaction control system incorporated by including propellant for attitude control in tankage common to both systems. This additional feature was short-lived since analog flight simulator studies indicated hydrogen requirements for attitude control that exceeded the capability of the hydrogen storage system and tank pressure controls.

7. A schematic of the integrated system is shown in Figure 23. Hydrogen, transported directly from the permanent vacuum insulated storage vessel is utilized in the primary heat exchanger to absorb heat from the pressurized compartments and a number of equipments. A secondary loop, employing an aqueous solution of ethylene glycol and water as the working fluid, transports heat from the compartment atmosphere, hydraulic oil, AFU gearbox and controls, and the alternator to the primary coolant. After passing through the primary heat exchanger, hydrogen is combined with oxygen in the combustion chamber of the AFU to drive the hydraulic pump and alternator through a 3-stage re-entry turbine. Both cryogens are stored above the critical pressure by supplying heat to the fluids to maintain a constant

expulsion pressure and are stirred to prevent stratification. When the hydrogen requirement for cooling exceed that for power generation, the excess is exhausted overboard and, if the reverse is the case, the additional hydrogen is supplied to the prime mover via the heat exchanger by-pass line.

8. Several problems encountered in the development of the integrated system are mentioned in Table 1. Satisfactory design approaches have been adapted to solve most, and in many cases, operation of revised development hardware has been demonstrated.

#### Water Wall

1. Thermal protection for the X-20 during re-entry flight is provided by a radiation-cooled outer surface employing coated refractory metals or René 41. Since this method is not totally effective in preventing the influx of aerodynamically generated heat to the vehicle interior, additional protection must be included to absorb this energy to minimize the effect on the internal environmental control system.

2. Two possible choices are available: insulating the compartments with a sufficient quantity of material to prevent heat from reaching the interior, or combining insulation with a cooling system. From a weight standpoint, Figure 24 shows that when re-entry times and average surface temperatures are considered, the concept of insulation and cooling results in the lightest weight.

3. After considering many possible insulations, a light-weight fibrous quartz material, Q-felt, was selected as one of the most thermally effective material for application to the X-20.

4. The selection of a cooling system considered both active and passive types. The passive system was selected because it offered more inherent reliability, was of simple construction, and was readily adapted to a hot structural concept that has few heat shorts to the cooled compartments. Also, the weight of the passive system was less.

5. A schematic of the water-wall system is shown in Figure 25. The insulation is covered with a 2 mil metal foil, that acts as a retention sheet. This outer surface is supported by perforated discs to distribute the load into the cover and to provide outlets for outgassing of air from the insulation during boost.

6. The cooling system dissipates the heat transferred from the hot outer surfaces by utilizing the latent heat of vaporization of an expendable coolant. It is an open ended type consisting of an assembly of polyurethane foam sections contained by aluminized mylar laminated faces. A gel, composed primarily of water, is retained within the cellular foam structure from the time of system fabrication until evaporated

during flight of the X-20 through the earth's atmosphere.

7. Since the coolant is not circulated, successful operation depends upon the ability of the system to contain a sufficient supply at desired locations. The coolant supply will be installed during fabrication of individual panels and remains in tact until the time of use.

8. Problems encountered in the development of this system included difficulties in meeting life requirements and developing "field" filling procedures. As a result, it was decided to factory fill the panels and replace them after each flight.

#### Flight Control

1. Now I would like to turn our attention to the flight control subsystem. The X-20 flight control system utilizes the self-adaptive control principle as the primary technique for stability and control of the glider and the glider plus transition configurations. Early self-adaptive flight control work was accomplished by the Flight Control Laboratory at ASD, Wright-Patterson Air Force Base, Ohio. This work was followed by the application of this development in the X-15 flight control subsystem. The X-15 self-adaptive flight control program is being monitored for application of this experience to the X-20 flight control development.

2. Figure No. 26 illustrates the flight control subsystem as planned for the X-20 vehicle. In the manual mode of operation, the flight control subsystem electronics utilizes signals derived from the pilot's sidestick controls and rudder pedals. These controls are provided with dual position transducers to provide electrical signals for the flight control subsystem electronics. Electrical signals are sent to the servo valves of the aerodynamic and thrust vector controls for activation of these portions of the system. The thrust vector controls are used only in the event of an abort. Electrical signals are also sent to the reaction control system for activation of the reaction control solenoid valves. Dual and triple redundancy is employed throughout the entire flight control subsystem. Switching logic is employed with monitors for fail safe operation in event of a malfunction of the dual redundant electronics. These monitors provide automatic switching to switch out any malfunctioning channel of operation. Automatic operation is provided by signals derived from the primary guidance system. These signals command the correct pitch attitude or angle of attack, bank angle and zero sideslip.

3. A variety of control, stabilization and gain techniques are used in the flight control system. The automatic mode utilizes the self-adaptive gain control principle. Two manual modes are provided. The manual augmented mode utilizes the self-adaptive gain control principle. Additionally, provision is made for pilot selection of an appropriate gain. The manual direct mode provides for pilot selectable gain adjustment of

the controlling element gain, i.e., aerodynamic control and thrust vector controls. The manual direct mode provides through threshold switches the direct electrical control of the reaction control solenoid valves.

4. Flight control subsystem electronics development, analysis and design is essentially complete. The functional requirements and performance requirements have been established. Production flight control subsystem electronics mechanization diagrams have been released. The first production prototype unit has been fabricated and delivered to The Boeing Company for installation in the guidance and control development model. This equipment is presently being installed in a mock-up wherein all interfacing electronic equipment is also installed. Tests during this phase will determine equipment compatibility. Qualification testing of the production flight control electronics is planned to start approximately September 1963.

5. It is apparent to most of you that the X-20 flight control subsystem is a very sophisticated development. Now let us turn our attention to the problems it must solve and why it must be complex. In Figure 27, the stability and control problems are shown as a function of the mission. During the boost phase of the mission, the X-20 stability and control problem is primarily that of the potential abort configuration. During the boost phase, the aerodynamic controls are locked by hydraulic means to fixed positions most favorable to the worst abort conditions. The fact that the center of gravity is behind the aerodynamic center of pressure for the abort configuration imposes exacting requirements in the flight control subsystem design. The self-adaptive flight control system must therefore have suitable initial condition gains and be capable of adapting to the optimum gain rather quickly. The static instability is sufficiently great that stability augmentation must be relied upon. It is questionable whether the pilot could provide the necessary damping in the event of stability augmentation failure in one or more axes. The orbital phase of operation provides problems in the area of maintaining the desired attitude accuracy in the automatic mode in view of fuel utilization restrictions. Consequently, trade-offs are being made involving the attitude accuracy in the automatic mode. Present indications are that fuel utilization will be satisfactory in the manual modes of operation. During re-entry both reaction and aerodynamic controls are utilized for stability and control. The use of reaction controls is discontinued when the aerodynamic pressure increases to a point where the aerodynamic controls provide the majority of control effectiveness. During this phase of operation very low load factor limits are observed in order to preclude exceeding the glider temperature limits. Considerable work has been done in this area to define acceptable handling qualities requirements at these low dynamic pressures. The hypersonic glide regime provides stability and control problems in terms of providing satisfactory roll



**CONFIDENTIAL**

control and high angles of attack. The fundamental nature of the problem is that aerodynamic surfaces produce moments about the body axis where it is required that a moment be produced about the roll stability axis. This problem is further complicated by the fact that the elevons produce relatively strong yawing moments. Several solutions have been found to this problem including the cross feed of roll commands into the rudder surfaces. As shown in Figure 27, the close proximity of structural frequencies, self-adaptive limit cycle frequencies, the aerodynamic short period and handling quality requirement frequencies have required careful attention to detail. The aero-servo-elastic coupling problem has resulted in the design of structural coupling filters in the flight control subsystem electronics to provide a very high attenuation of any structural feedback signals to the gyros. Additionally, careful attention has been given to the design of the self-adaptive limit cycle circuitry to preclude the possibility of structural mode oscillations reducing the self-adaptive gain unnecessarily. Attention has also been given to gust and pilot input frequencies in order to preclude undesirable changes of self-adaptive gain due to these inputs. The basic fundamentals of the self-adaptive technique utilized in the X-20 flight control system are reasonably simple. The concept that is employed involves use of a high gain control loop preceded by a model or filter designed to provide the characteristics of the desired handling qualities. The assumption being that if the loop gain is sufficiently high, the outer loop performance will conform to that defined by the model. Gain is maintained by the self-adaptive gain computer. This device utilizes signals obtained from the moment producing control element, for example, the elevator in the pitch axis. The gain computer maintains the necessary gain to keep the pitch rate innerloop on the verge of an unstable oscillation. This is accomplished by virtue of measurement of the elevator deflection. The deflection signals are passed through logic filters, through a rectifier to obtain the absolute value of motion of the surface, then through appropriate limiters and shaping circuits, and finally to the variable gain circuitry. The logic filters are designed for frequencies of approximately four tenths of a cycle per second for the up gain logic and four cycles per second for the down gain logic. Operationally, this will mean that any oscillatory energy of the elevator in the vicinity of four tenths of a cycle per second will result in increasing the gain of the flight control system. Similarly, elevator activity in the vicinity of four cycles per second will result in a decrease of the flight control system gain. Nominally, a very small amplitude oscillation of the control surface will exist during flight with a frequency of approximately one to two cycles per second.

#### Guidance

1. The Dyna-Soar program, at its inception presented the first requirement for a full navigation and guidance capability from launch

thru re-entry and thence to landing of a manned space vehicle. The configuration requirements were established about a primary system that would provide the greatest reliability of performance at a minimum cost thru employment of proven system elements to the greatest extent feasible. A reliable simple backup capability was to be provided to enable safe re-entry in the event of failure of the primary system.

2. Initially, a guidance configuration was established during the boost portion of flight by providing guidance and control from the glider inertial guidance subsystem. Backup was to be provided by an available Radio Guidance System in the event of an IGS failure. Upon reorientation of the program to the Titan III Space Launch Vehicle, the boost guidance configuration was revised to control this portion of the trajectory from the available booster Inertial Guidance System. Currently a booster guidance backup capability has not been established. However, simulation investigations have indicated the feasibility of the pilot to control the booster, with the aid of proper instrument displays, thru the flight control system to the point of injection within acceptable limits. Studies are currently underway to determine manner and cost associated with mechanization of such a capability.

3. During orbit and re-entry, navigation and guidance capability will be provided by the glider's Inertial Guidance System. The elements of this system are shown in Figure 29. This system provided by Minneapolis-Honeywell consists of three major elements: the inertial platform, which is a further refinement of a platform initially developed for the NASA (Centaur Program) a combined general purpose (g.p.) and digital differential analyzer computer popularly known as Verden digital computer employed on the GAM-77 missile; for the X-20 application, its g.p. computation capacity will be increased about four fold; and a coupler electronics unit which houses the various circuit elements of the system. As displayed in Figure 30, the IGS provides an attitude reference for the automatic flight control system as well as the necessary steering commands to automatically control the glider on its path. In addition, the flight instruments are also provided their sensing inputs from the IGS to facilitate pilot manual control of the glider. The key instrument receiving these inputs (Figure 31) is an instrument known as an Energy Management Display, which thru overlays calibrated for speed and landing destination controlled from the IGS, provides the pilot with a display showing bank angle and angle of attack relationship with his footprint capability of attaining the desired landing area. The guidance then accomplished during re-entry is maintaining the desired angle of attack and bank angle so that the vehicle's kinetic and potential energy is dissipated in such a manner that the structural and thermal limits are not exceeded and the vehicle arrives at the desired high key point for landing with the proper energy for a landing.

**CONFIDENTIAL**

4. The landing phase of flight will commence about 100 miles from Edwards with approximately a 4000 ft/sec velocity and an altitude of 130,000 ft. A visual approach, let down and landing will follow.

5. The glider will employ an Emergency Re-entry Subsystem as a backup to the Inertial Guidance Subsystem. This system will consist of an all attitude reference which will operate the pilots attitude indicator. In the event of an IGS failure, this reference will enable the pilot to maintain a safe attitude during the critical portion of re-entry.

#### Communications and Tracking

1. A reliable communications net is essential for the early flights to control and gather data from the first exploratory flights. At that time, there will be urgent needs for flight safety, design verification and/or failure analysis data coverage. This coverage entails overflying a chain of interconnected surface communications, tracking, and data collection range stations positioned along the (Atlantic and Pacific) orbital and re-entry track (see Figure 32). Many of these stations already exist in the Atlantic and Pacific Missile Ranges and the NASA Mercury net. A major problem presented itself in utilizing these range stations and existing equipment. Experience with the preceding ballistic missile and orbiting satellite programs had demonstrated that a vehicle re-entering the atmosphere at hypersonic speeds becomes enveloped with a thermally ionized plasma-sheath configured to the flow field around the vehicle, as illustrated in Figure 33. This plasma sheath effectively acts as an electrical conductor, thus forming a highly reflective and absorptive media about the vehicle, which serves to obstruct and black-out conventional tracking radar and radio communications to and from the vehicle. A black-out occurs in the region of the re-entry hypersonic flight regime where Dyna-Soar is required to carry out its prime flight-research mission. To solve this problem, advantage was taken of concurrent research on the interaction of electromagnetic radiations and plasma fields and those findings extended. This research had demonstrated a distinct frequency sensitive behavior for the plasma sheath. In fact, it indicated the existence of a window in the frequency spectrum above the expected plasma resonant frequencies and below the onset of absorption by water vapor, oxygen and other constituents of the atmosphere (see Figure 34). For Dyna-Soar lifting re-entry flight conditions, a choice of communications frequencies in the SHF band in the vicinity of 10 KMC to 15 KMC was indicated.

2. Other approaches, such as seeding or cooling of the plasma adjacent to the affected antennas and using special propagation modes established by magnetic fields, appeared possible. Another possibility was the use of a thin sharp spike antenna which would not produce a dense

shock wave and associated plasma in the vicinity of the radiating elements. These latter approaches, while attractive, were still in early stages of development and have not been adequately proven for flights similar to those planned for Dyna-Soar. The bulk of the available research data suggested that greatest confidence would result from pursuing the frequency-choice route, which was done.

3. The configuration adopted is shown on Figure 35. The figure illustrates the configuration adopted for both the airborne and ground (prime) communications subsystems to be used in the launch and re-entry areas. The SHF ground-to-air link frequency selected was in the region of 10.4 KMC. The air-to-ground link frequency selected was at 13.5 KMC to take best advantage of available microwave equipment components. Not specifically identified in Figure 35, but included in the system are a pair of similar UHF voice communications links and a C-band transponder to be compatible with the range station equipments existing along the established missile and orbiting-satellite ranges in the non-re-entry regions.

4. New SHF equipment for both glider and surface station adaptation is being developed and procured. The surface station adaptation equipment is self-tracking in both azimuth and elevation. Inclusion of a tone-ranging circuit also provides a measurement of slant range; thus providing simultaneously for both the needed radio communications and vehicle position tracking in the otherwise blacked-out re-entry region of the mission. In addition, a higher-powered (5 watt peak) UHF rescue beacon/transceiver is being provided to yield greater homing range capability for pilot rescue.

#### Test Instrumentation Subsystem

The Test Instrumentation Subsystem of the X-20A program encompasses all areas of airborne data collection, signal conditioning, multiplexing, translating and recording of data in the glider. Also included is the necessary ground based equipments for demultiplexing, detranslating recording/reproducing, formatting and data calibration up to the point of providing calibrated data tapes to the various data users for the required analysis. The X-20A Program Office is responsible for the overall management of the test instrumentation area of the program. However since the X-20 is a joint effort between the USAF and NASA, a team of instrumentation specialists was established to provide the Program Office technical support and recommendations in the area of test instrumentation. This team is composed of members of the USAF and NASA and is chaired by a NASA member.

#### Design Considerations

1. The basic design considerations for the TIS subsystem consisted of the number and type of sensors to be employed and bandwidth impairment

of transmission range. A list of measurements was established that included approximately 1000 parameters. Flight safety and failure analysis type data received top priority with design validation and basic research data following a close second. The majority of the parameters to be measured are quasi-static or have a very slow rate-of-change, thus lending themselves to narrow-band digital time division multiplex. However, not all the measurements fall into this category. Required are a number of continuous time-history parameters best cared for with analog (frequency division) multiplex, at the expense of transmission range, i.e., there are 3 parameters with frequencies from 50 cycles per second to 10,000 cycles per second (acoustics data). Eleven parameters with frequencies from dc to 2000 cycles per second (vibration), and 12 parameters of dc to 1000 cycles per second (flutter). Thus, it is seen that a combined digital/analog system was needed to care for both classes of data. A further limitation was imposed on the instrumentation subsystem, that of weight. In the early design phase of the program, a payload allocation was made based on X-15 experience. This allocation was 1000 lbs. In the research version of the X-20, the 1000 lbs. is allocated to the test instrumentation subsystem. Approximately half of this weight allocation is used for wiring, tubing, racks and environmental control. A majority of the parameters to be measured are located in a very high temperature environment requiring special type wire and insulation. Also, tubing is used from pressure ports on the X-20 surfaces to an environmentally controlled compartment where the pressure sensors are installed. This is necessitated by the present state-of-the-art pressure sensors.

2. Instrumentation configurations depicting the locations of the various sensors have been established, (see Figure 36). The primary change in the instrumentation configuration from flight is the type and location of external surface sensors. One configuration emphasizes external surface pressures while another configuration emphasizes external surface temperature measurements. In all configurations the internal subsystems measurements remain the same. This configuration change approach is used to obtain the numerous research measurements required to meet program objectives within the number of flights and weight limitations imposed on the test instrumentation subsystem.

3. On-board recording of the data is required on the X-20 so the validation and research data can be obtained throughout the flight regime of the glider. Telemetry is being used in areas of the flight regime where engineering analysis indicates the glider will be subjected to the maximum environmental hazard, such as high temperatures, aerodynamic loads, potential flutter etc. These areas present the higher probability of structural failure and are instrumented to obtain data for failure analysis in the event that the mission is not successful.

#### Telemetry Equipment Considered

1. A considerable number of different types and/or combinations of telemetry equipment were considered for use on the X-20A program. A basic philosophy established early in the program was that the test instrumentation subsystem design was to use "off-the-shelf" type techniques. We did not want to run a research program while we were still testing the basic means of obtaining data. Basically, we have held to this philosophy in the design of the system. However, there are some cases where slight modifications had to be made to off-the-shelf techniques to make them suitable for our requirements. As an example, the use of a video-recorder on-board the glider. To provide the bandwidth and channel capability, design effort was required to achieve tighter phase delay compensation and the reduction of time-base instabilities induced by flutter, wow and tape skew. This design effort is underway and tests on engineering models indicate the system will operate satisfactorily.

2. FM/FM and PDM/FM/FM telemetry subsystems were considered. Due to the large number of measurements, the bandwidth of high frequency response parameters require excessive transmitter power and exceeded the weight limitations allowed and was removed from further consideration.

3. From time to time throughout the existence of the program, an all PCM/FM telemetry subsystem seemed attractive. In the early phases of the program, the PCM/FM system was considered to be beyond the state-of-the-art due to the high bit rate required. Also, there was reluctance on the part of some data users to accept the low-rate sampled data as sufficient for analysis purposes. At this early point in the program, a decision was made to incorporate the present system, a hybrid PCM/FM/FM telemetry equipment, into the X-20A. The hybrid PCM/FM/FM system uses a frequency translation technique. The high frequency analogue parameters are fed into standard telemetry voltage controlled oscillators. The outputs of the oscillators are then grouped according to frequency and translated to a higher frequency.

4. There are 42 of these high frequency response channels that are grouped and translated to six different frequency bands. These six frequency bands and the PCM (144,000 bits per sec) are then mixed in three combinations.

5. All data measured on the glider is combined into the largest bandwidth for on-board recording only (see Figure 37). Two abbreviated combinations are separated out for sequential telemetering to the surface data collection stations in the terminal and mid-course regions of the mission. In the terminal areas, the acoustic noise measurements are omitted and the vibration data analyzed on-board into simpler power spectral density data for transmission to the ground along with the remainder of the complex and called the wide band case (see Figure 38). In

**CONFIDENTIAL**

the mid-course regions (beyond the two terminal flutter inducing regions) all the flutter data is omitted and a single slant-range measuring a signal channel substituted to form the third, or narrow-band combination. This conserves bandwidth and extends data transmission to a maximum in the regions where range is a prime consideration.

Summary and Conclusions

1. The major program milestones are shown in Figure 39. Ninety percent drawing release is scheduled for September 1963. The first air launch is scheduled for January 1965; the initial unmanned ground launch in November 1965; the first manned ground launch in May 1966; and the final flight in September 1967.

2. Significant progress has been made on the program to date. The development effort is essentially completed. Production drawings are being released to the manufacturing shops and the qualification test program has begun. The problems to come should not be in the development or state-of-the-art area, but rather in the hardware and integration of the various system elements. Though we have not yet reached the flight test part of the program, a significant step forward has been made in the specific areas which have been covered as well as in innumerable other technological fields. It is our view that the lifting re-entry technology, which is being developed by the X-20, is filling an important gap in this country's overall research and development effort which will in turn provide a sound technological base for the design and development of future systems in the National Space Program.

**CONFIDENTIAL**

PROBLEM AREA	CONCLUSION	ACTION
INTEGRATION OF H <sub>2</sub> -O <sub>2</sub> REACTION CONTROL	INTEGRATION NOT PRACTICAL	INDEPENDENT H <sub>2</sub> -O <sub>2</sub> SYSTEM BEING PROCURED
POSITIVE EXPULSION OF CRYOGENS	SOLUTION NOT WITHIN X-20 TIME PERIOD	SUPERCRITICAL STORAGE SELECTED (EXCEPT FOR N <sub>2</sub> ) WITH HEAT ADDITION
STRATIFICATION OF CRYOGEN IN STORAGE TANK	POSITIVE APPROACH TO BE TAKEN	FORCE CIRCULATION ADOPTED USING CENTRIFICAL BLOWERS
HEAT LEAK TO CRYOGENIC SYSTEMS	USE EFFECTIVE INSULATION	PERMANENT VACUUM JACKETED TANK AND LINES SELECTED AND DEVELOPMENT COMPLETED
GLYCOL-WATER FREEZING IN PRIMARY HEAT EXCHANGER	DEVELOP A DESIGN TO ELIMINATE THE POSSIBILITY OF FREEZING	RECIRCULATION OF WARMED H <sub>2</sub> TO HEAT EXCHANGE INLET SELECTED AND DEMONSTRATED
APU HIGH SPEED ASSEMBLY FAILURES	CHANGE NATURAL FREQ. OF TURBINE BLADES	REVISED DEVELOPMENT PLAN SUCCESSFUL TO DATE
ZERO G LUBRICATION OF APU GEAR BOX	SELECT POSITIVE SOLUTION	FORCED FEED LUBRICATION SELECTED & DEVELOPMENT COMPLETE
DEVELOPMENT OF 4 LIGHT WEIGHT H <sub>2</sub> TANK	THIN OUTER SHELL NOT PRACTICAL FOR THIS APPLICATION	STRUCTURAL OUTER SHELL IN DESIGN

Table I. Major Problem Areas

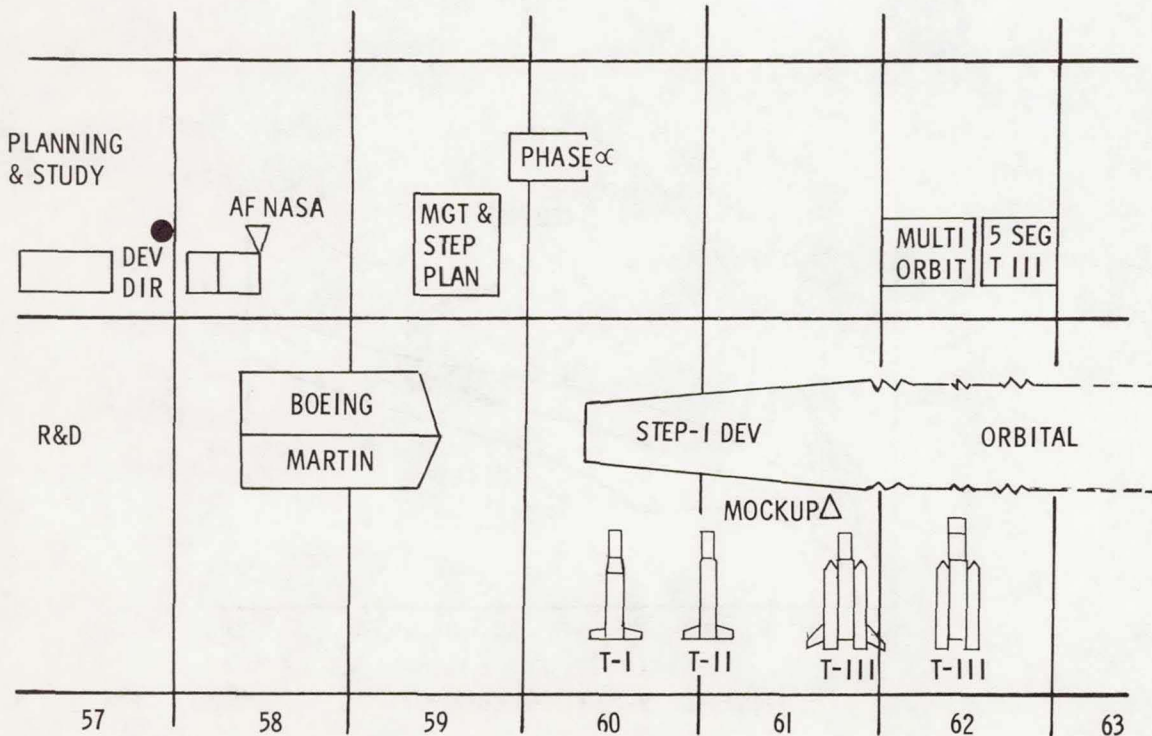

Figure I. Dyna-Soar Background

- PROVIDE PILOTED, MANEUVERABLE GLIDERS AND ASSOCIATED SUPPORT EQUIPMENT FOR THE CONDUCT OF FLIGHT TESTING IN THE HYPERSONIC AND ORBITAL FLIGHT REGIME TO INCLUDE:

GATHERING OF RESEARCH DATA TO SOLVE DESIGN PROBLEMS OF CONTROLLED, LIFTING RE-ENTRY FROM ORBITAL FLIGHT

DEMONSTRATE PILOTED, MANEUVERING RE-ENTRY AND EFFECT A CONVENTIONAL LANDING AT A PRESELECTED LANDING SITE

THE TESTING OF VEHICLE EQUIPMENTS AND EXPLORATION OF MILITARY MAN'S FUNCTIONS IN SPACE

FOLLOWING SUCCESSFUL ORBITAL DEMONSTRATION, TO PROVIDE THE CAPABILITY FOR QUICK EXPLOITATION OF TECHNOLOGICAL ADVANCES THROUGH FUTURE TESTS

- EXPLORE THE POTENTIAL OF MAN TO ACCOMPLISH MILITARY FUNCTIONS IN SPACE

Figure 2. Program Objectives

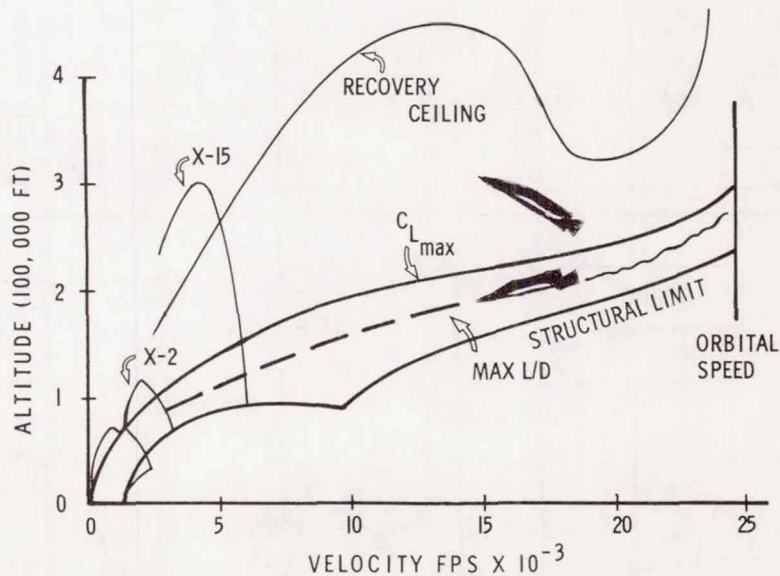

Figure 3. X-20 Flight Corridor

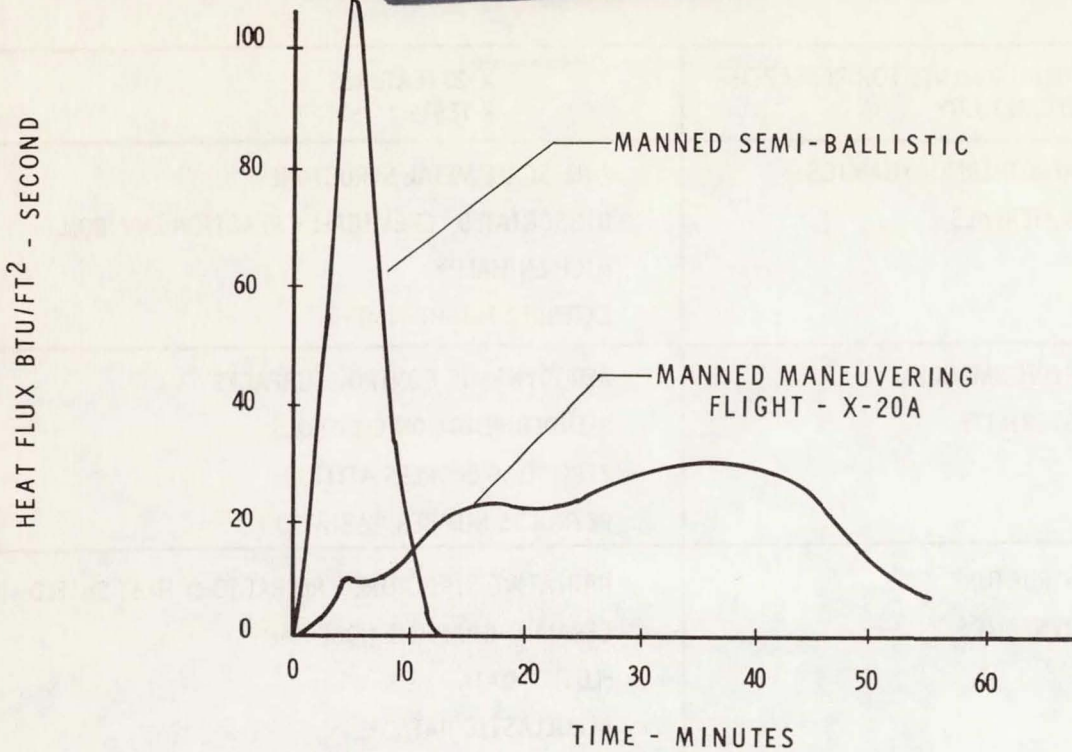

Figure 4. Research Regime

REQUIREMENTS FOR RESEARCH TECHNOLOGY	X-20 FEATURES & TESTS
PILOT CONTROL PILOT DISPLAYS FLIGHT SIMULATION HANDLING QUALITIES	PILOT INTEGRATED IN CONTROL-GUIDANCE LOOP ADAPTIVE CONTROL AUGMENTATION ENERGY MANAGEMENT AND DISPLAYS HYPERSONIC FLIGHT ENVIRONMENT RE-ENTRY APPROACH & LANDING TECHNIQUES
FLIGHT OPERATIONS	ABORT TECHNIQUES GUIDANCE EVALUATION DURING RE-ENTRY CORRIDOR EXPLORATION COMMUNICATIONS THROUGH ION SHEATH INSTRUMENTATION RESEARCH

Figure 5. Re-Entry Research

REQUIREMENTS FOR RESEARCH TECHNOLOGY	X-20 FEATURES & TESTS
AEROTHERMODYNAMICS MATERIALS	FULL SCALE METAL STRUCTURE DISSOCIATED, CHEMICALLY REACTION ENVIRON. HIGH ENTHALPY EXTENDED FLIGHT TIME
PERFORMANCE STABILITY	AERODYNAMIC CONTROL SURFACES BLENDED REACTION CONTROLS ZERO TO 50 DEGREES ATTITUDE REYNOLDS NUMBER VARIATION
STRUCTURE DYNAMICS	RADIATIVE STRUCTURE - REFRACTORY HEAT SHIELD CERAMIC-GRAPHITE NOSE CAP FLUTTER DATA AEROELASTIC DATA ACOUSTICS AND VIBRATION DATA

Figure 6. Re-Entry Research

RESEARCH AREA	X-20 DESIGN REQUIREMENTS	FUTURE POSSIBILITY
HEAT TRANSFER	TURBULENT FLOW  ROUGHNESS MARGIN - 20%  EQUILIBRIUM FLOW	LAMINAR FLOW — 50% REDUCTION IN HEAT TRANS. SMOOTH SURFACES — UP TO 6000# INCREASE IN RE-ENTRY PAYLOAD NON-CATALYTIC WALL — 50% REDUCTION IN LEADING EDGE HEAT TRANSFER
PERFORMANCE	TURBULENT FLOW "BLUNT" LEADING EDGES	LAMINAR FLOW "THIN" LEADING EDGES — 25% INCREASE IN L/D 50% INCREASE IN LATERAL RANGE

Figure 7. Design Criteria Impact



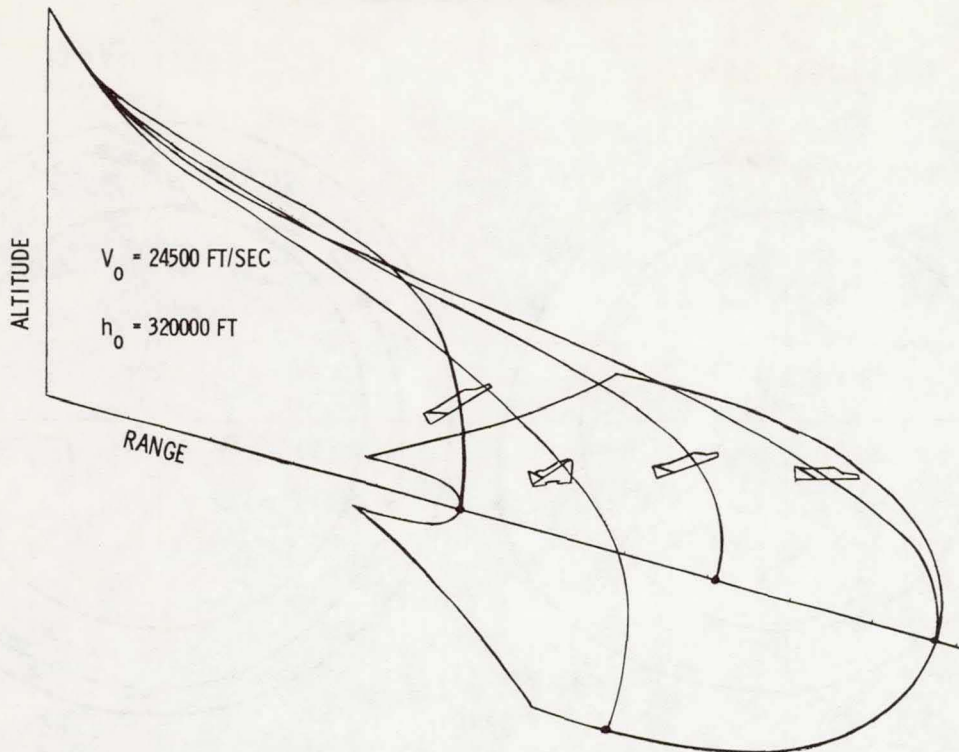

Figure 8. Distance and Direction Control Re-Entry Maneuverability

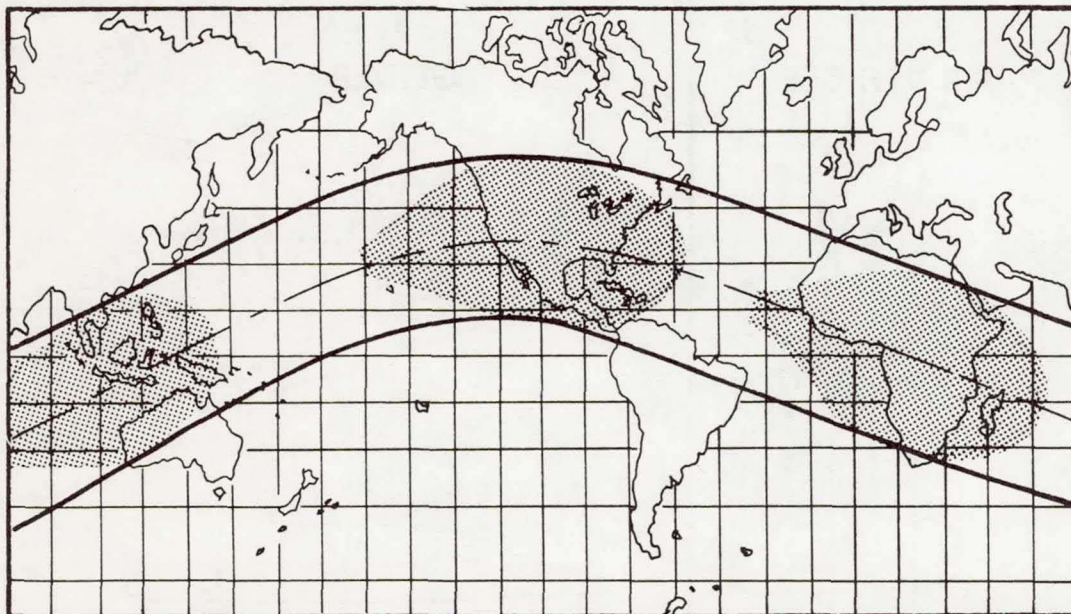

Figure 9. X-20 Maneuver Flexibility  
110° Launch From CCMTC

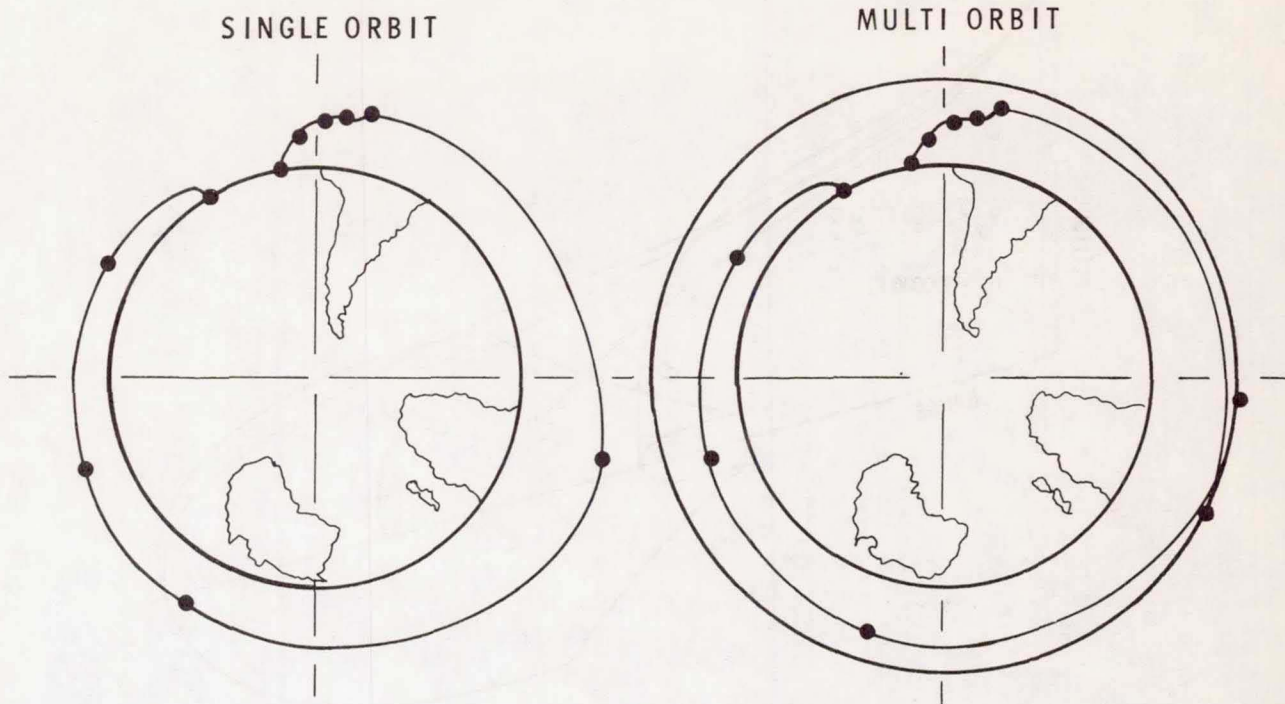
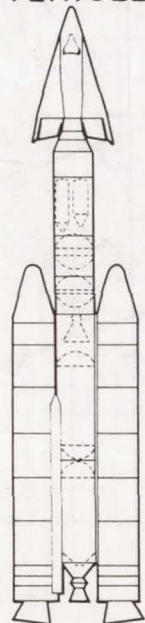

Figure 10. Mission Profiles

**AIR VEHICLE**



**GLIDER**

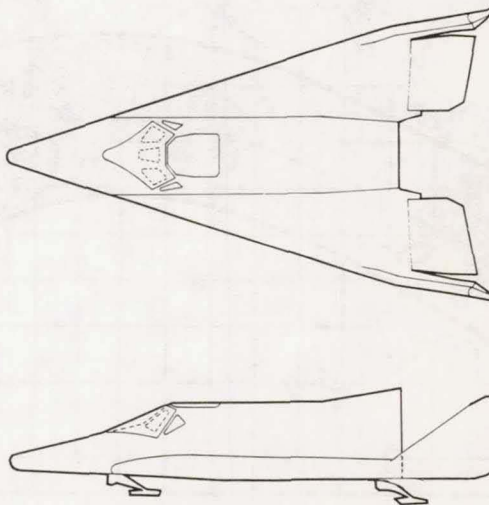

Figure 11. X-20 Configuration

**CONFIDENTIAL**

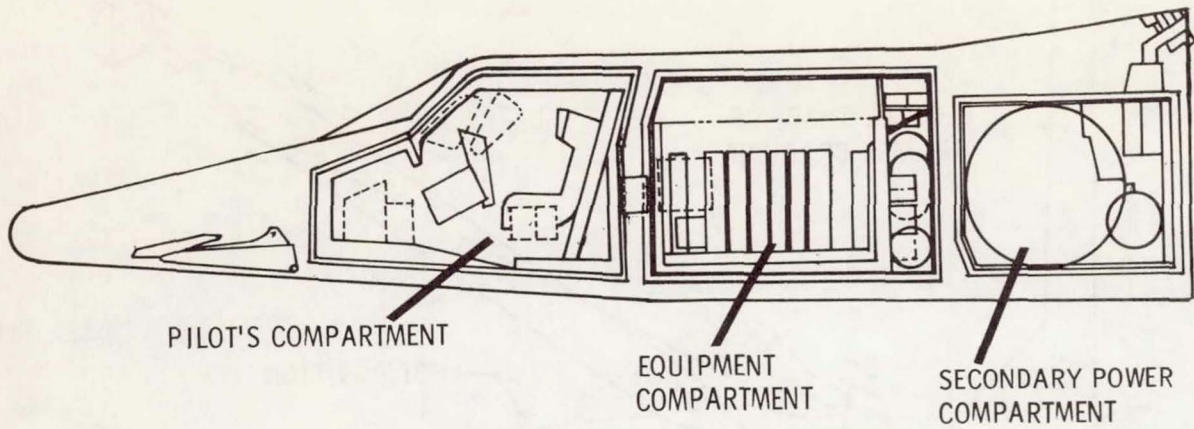

Figure 12. Inboard Profile

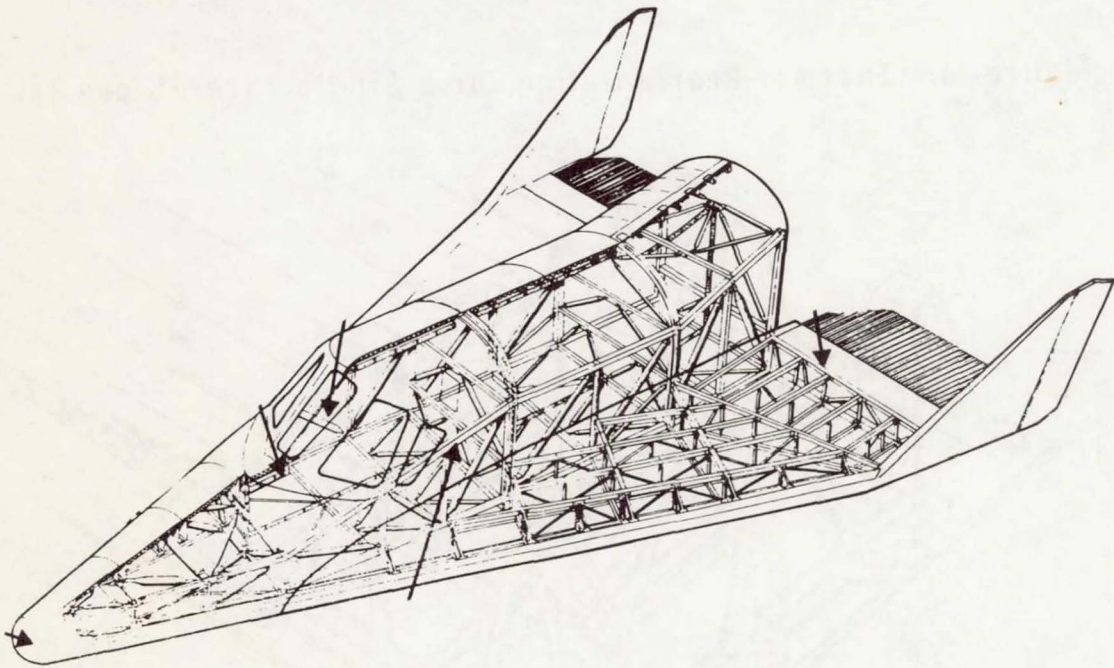

Figure 13. X-20 Truss Structure

**CONFIDENTIAL**

**CONFIDENTIAL**

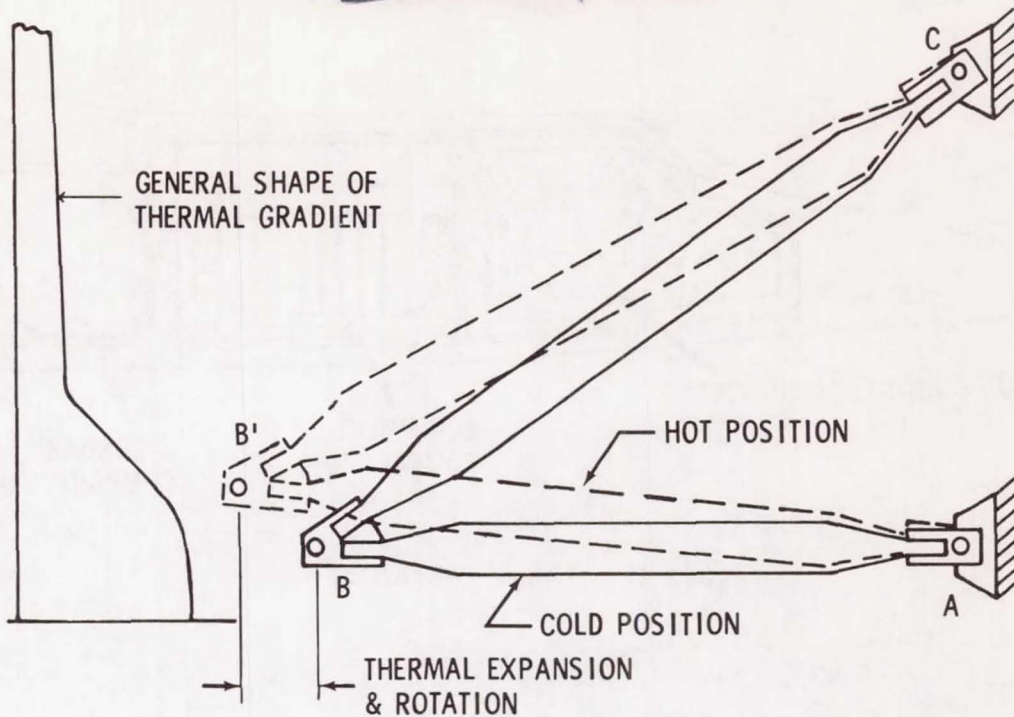

Figure 14. Thermal Reorientation for a Single Three-Sided Truss

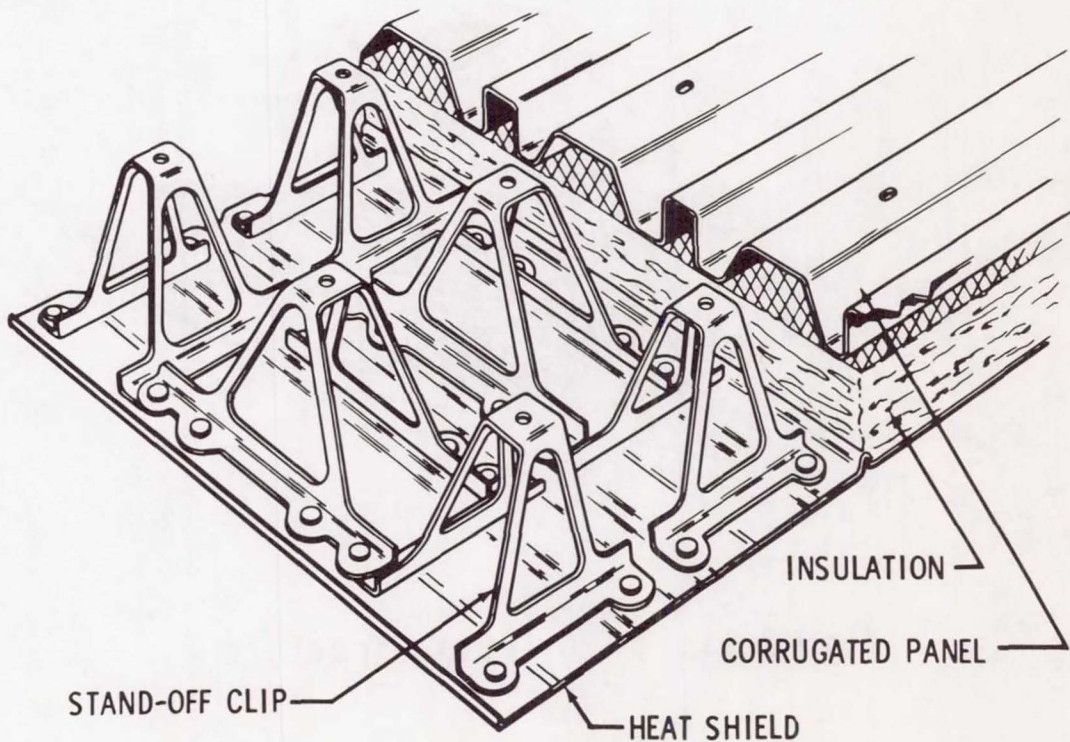

Figure 15. Typical Insulated Panel

**CONFIDENTIAL**

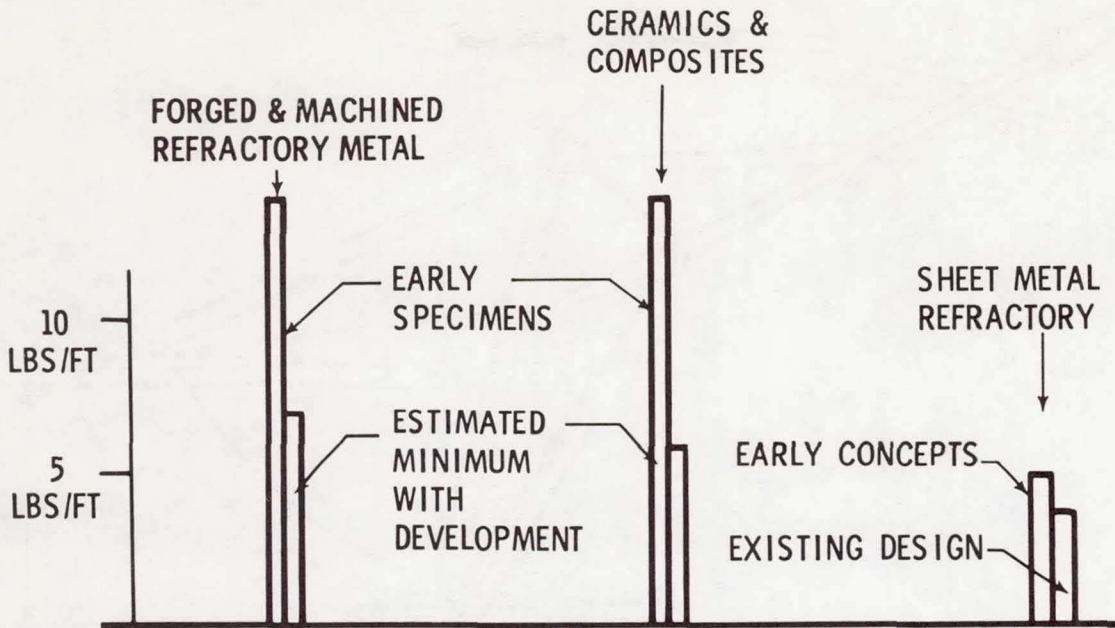

Figure 16. Comparative Weights of Leading Edge Specimens

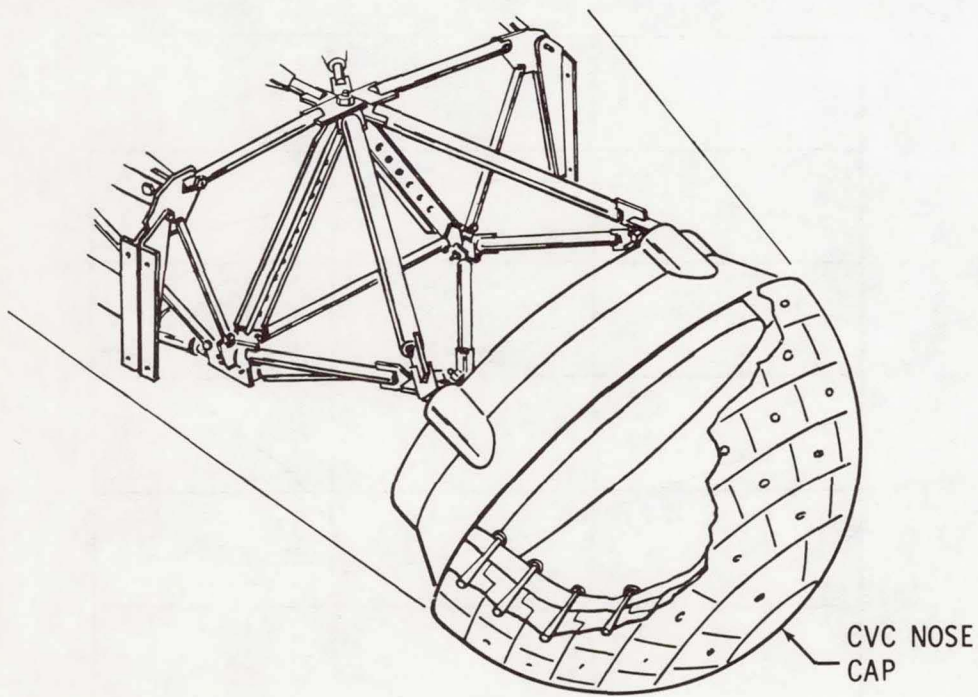

Figure 17. Nose Cap and Support Structure

**CONFIDENTIAL**

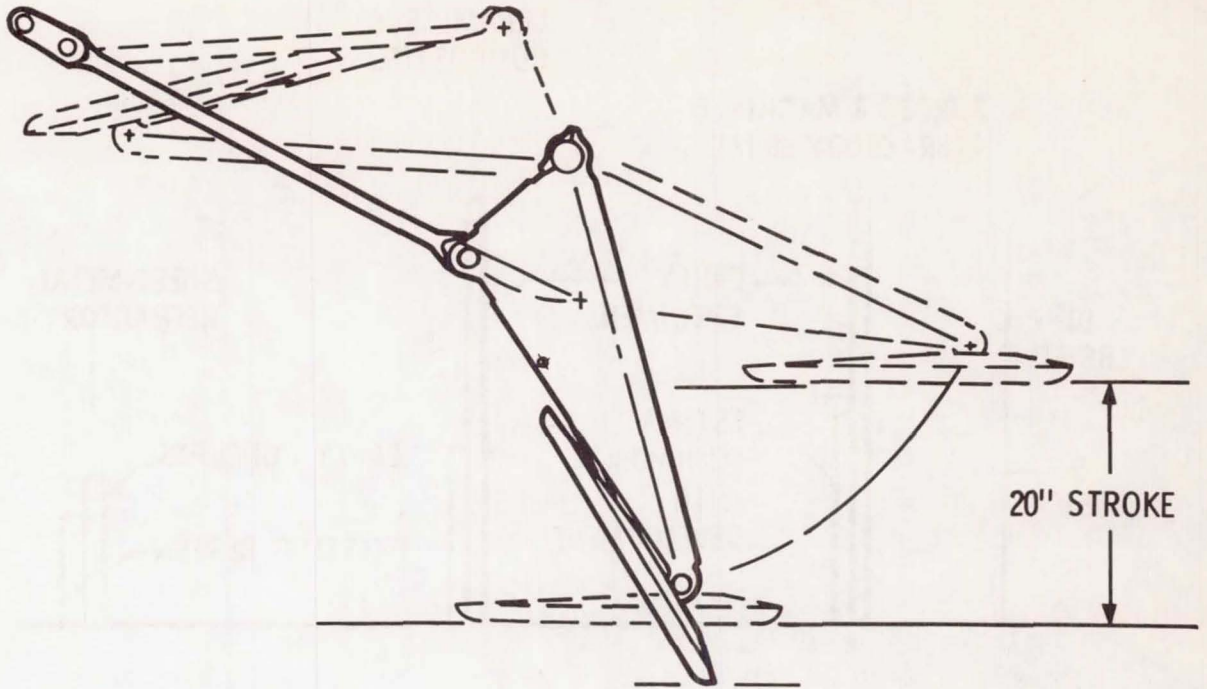

Figure 18. Nose Gear Arrangement

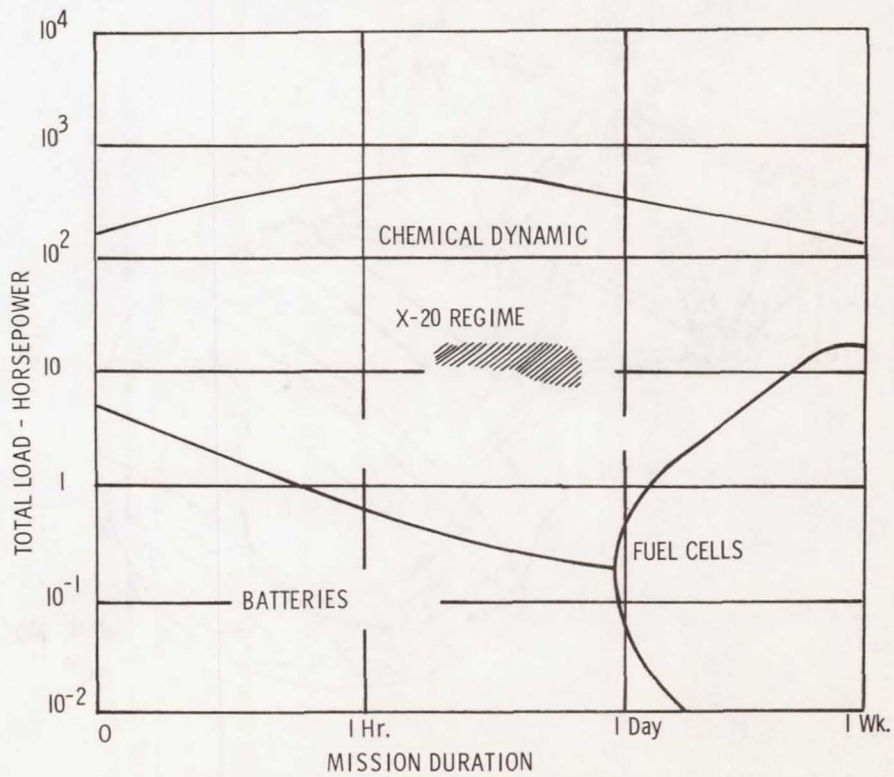

Figure 19. Source of Secondary Power Generation

**CONFIDENTIAL**

**CONFIDENTIAL**

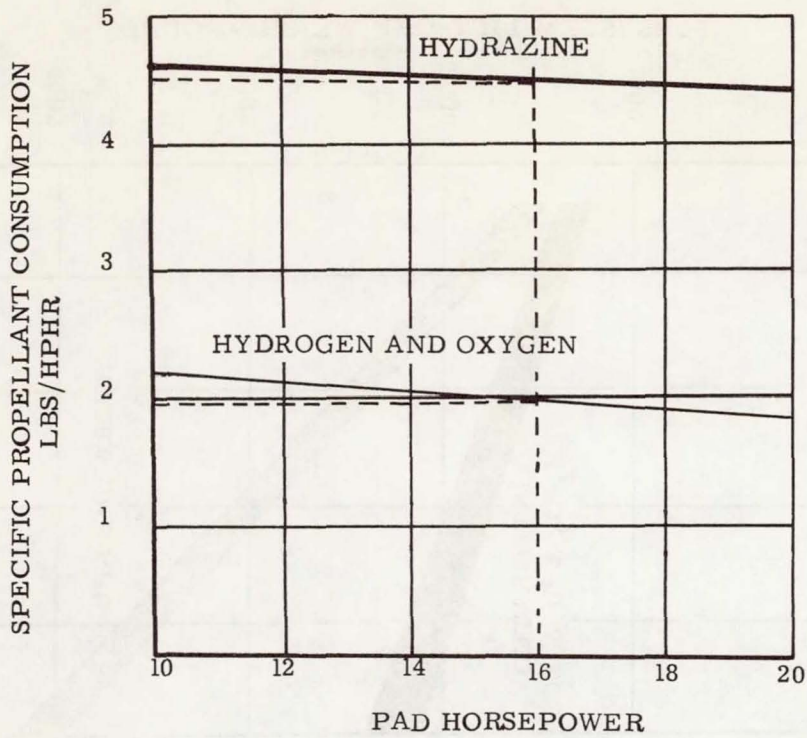

Figure 20. APU SPC Comparison

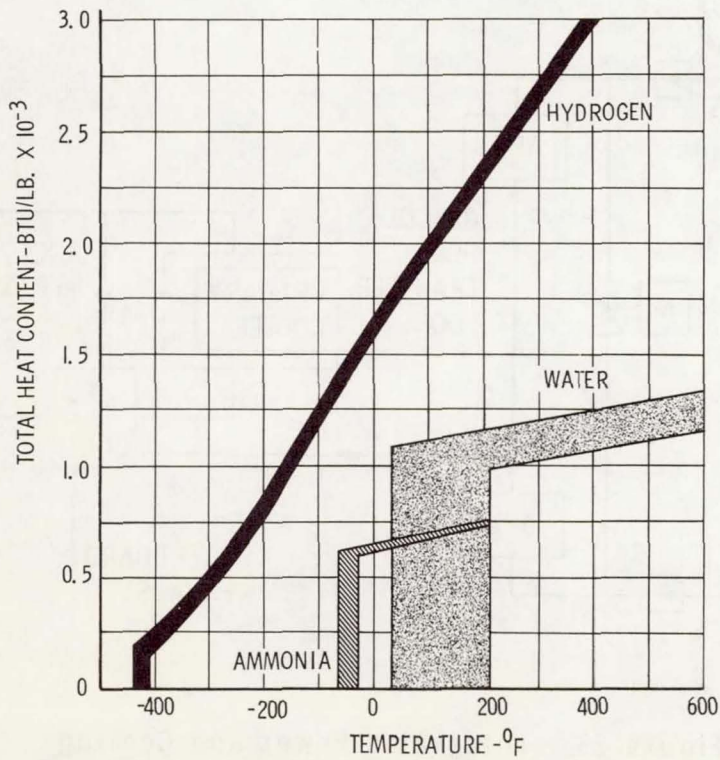

Figure 21. Potential Heat Capacity of Three Coolants

**CONFIDENTIAL**

**CONFIDENTIAL**

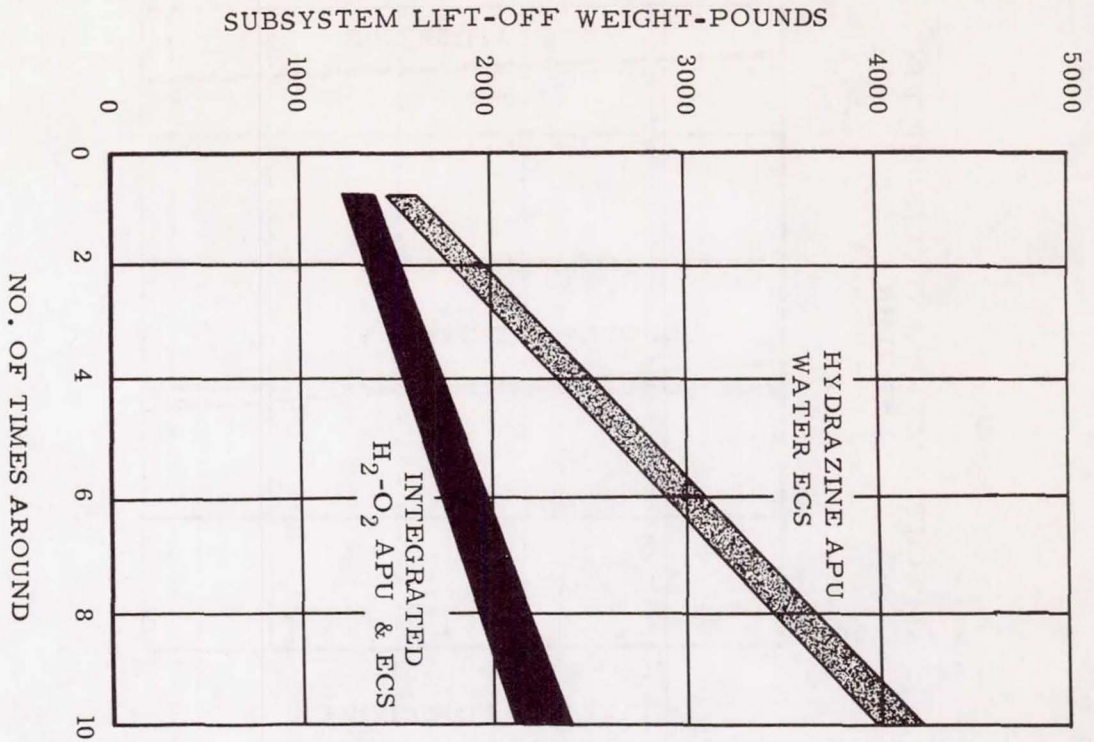

Figure 22. Weight Comparison

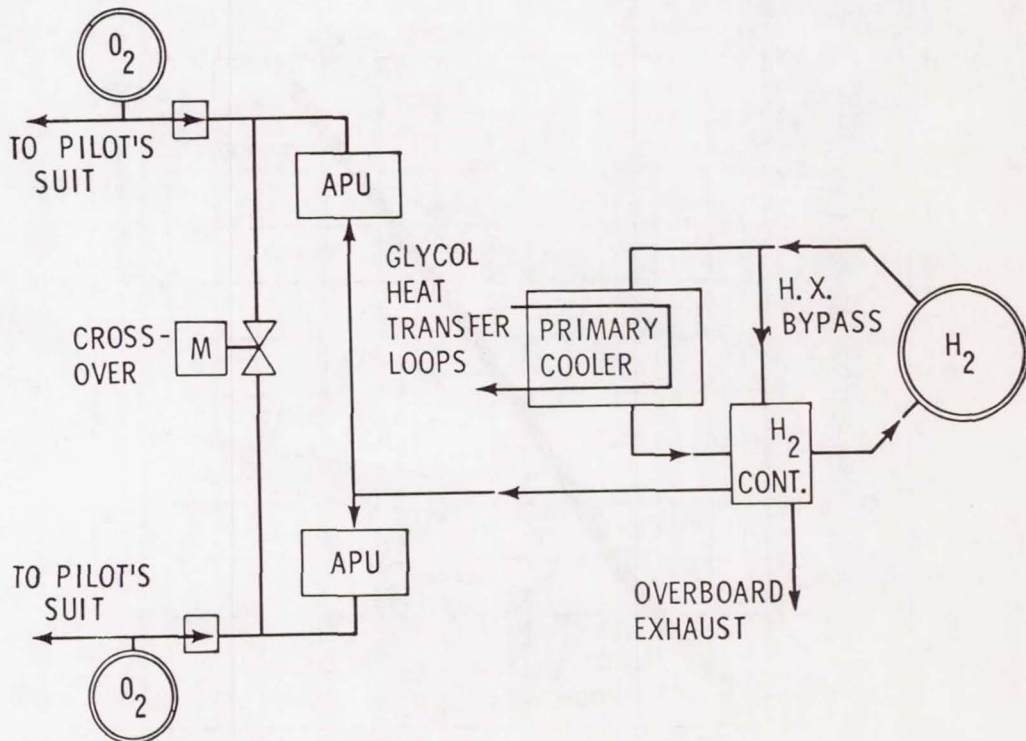

Figure 23. Integrated Power and Cooling

**CONFIDENTIAL**



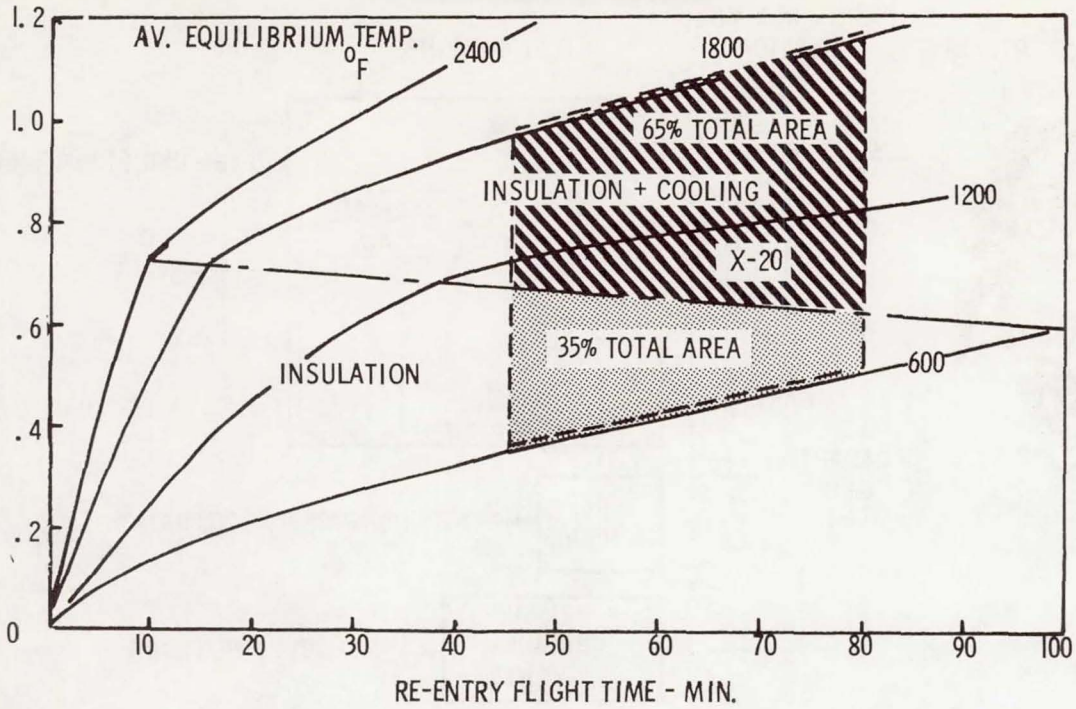

Figure 24. Minimum Weight Thermal Protection

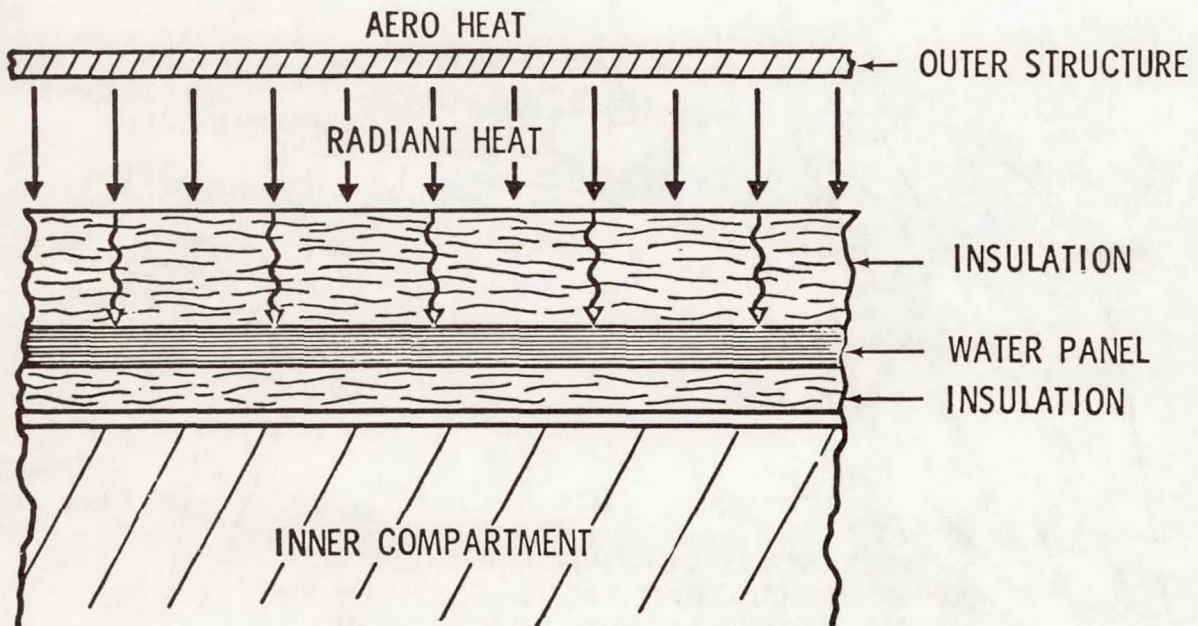

Figure 25. Water-Wall System (Schematic)

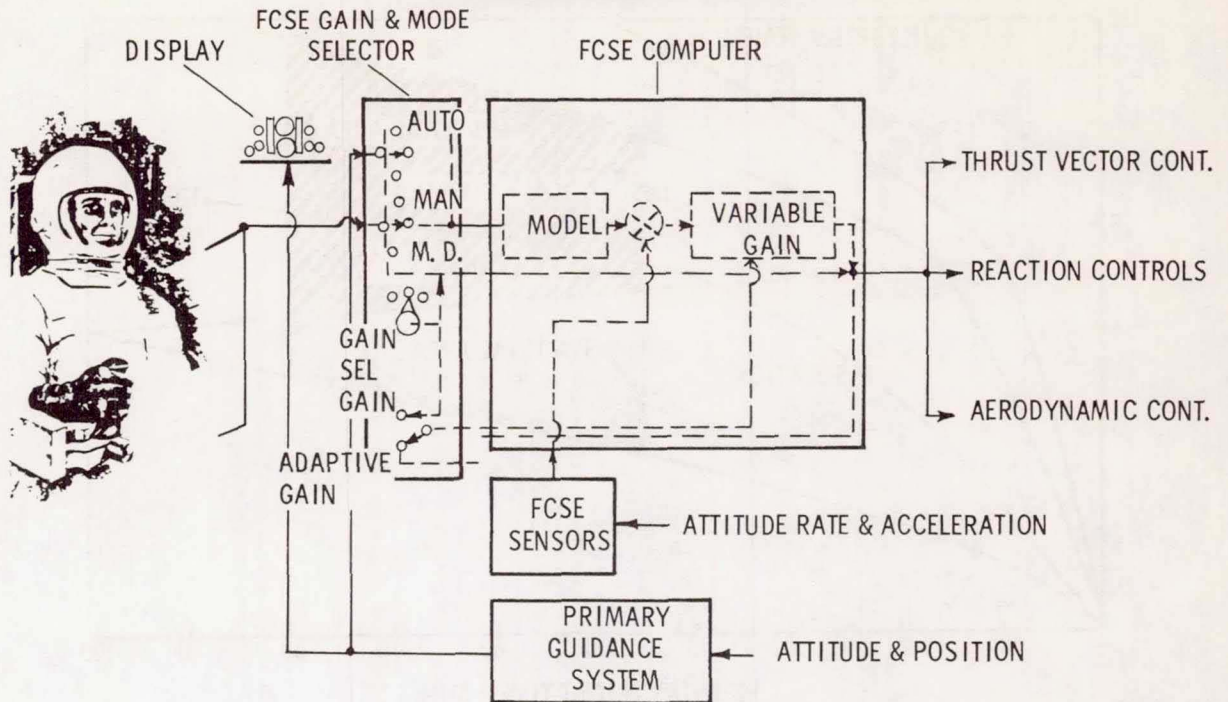

Figure 26. Flight Control Subsystem Electronics (Sensors, Computer & Mode Selectors)

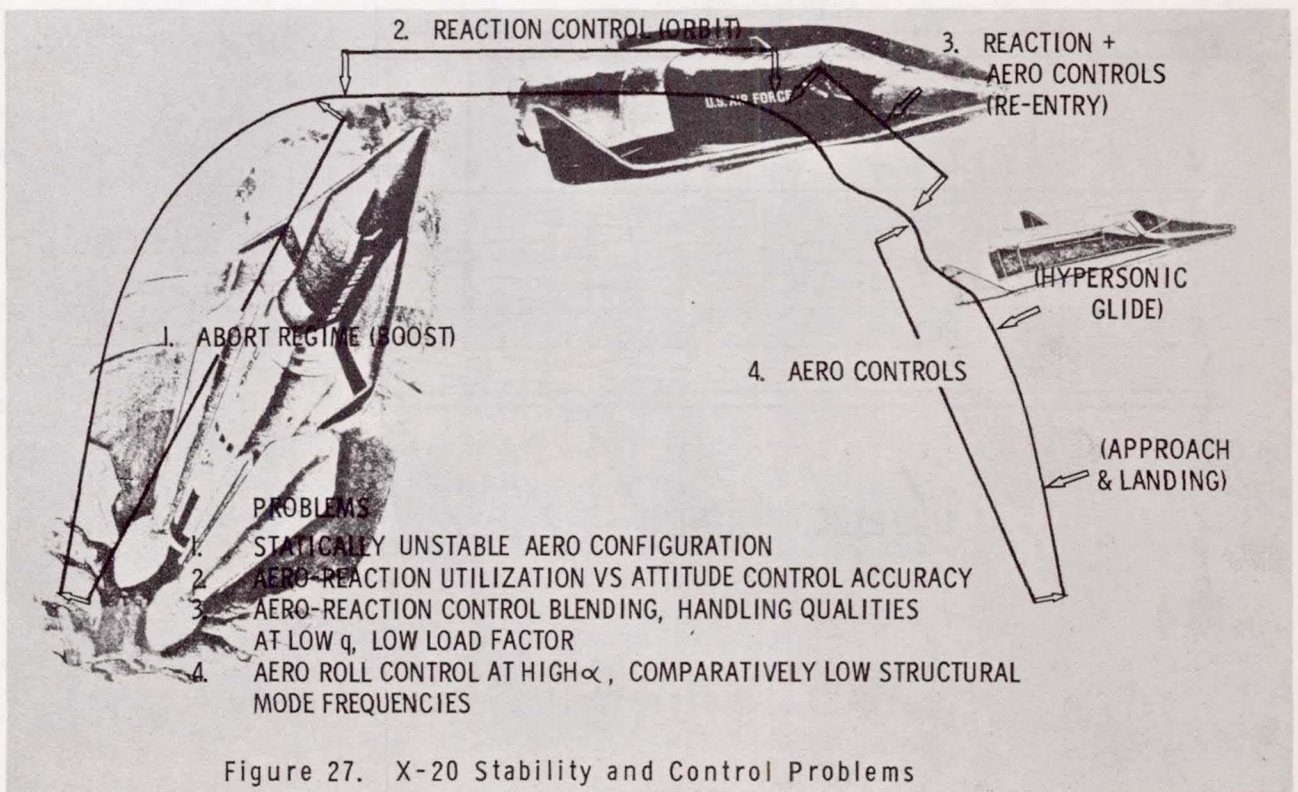

Figure 27. X-20 Stability and Control Problems

**CONFIDENTIAL**

CLOSE PROXIMITY OF STRUCTURAL & CONTROL FREQUENCIES RESULTS IN EXCITATION OF STRUCTURE BY CONTROL SYSTEM

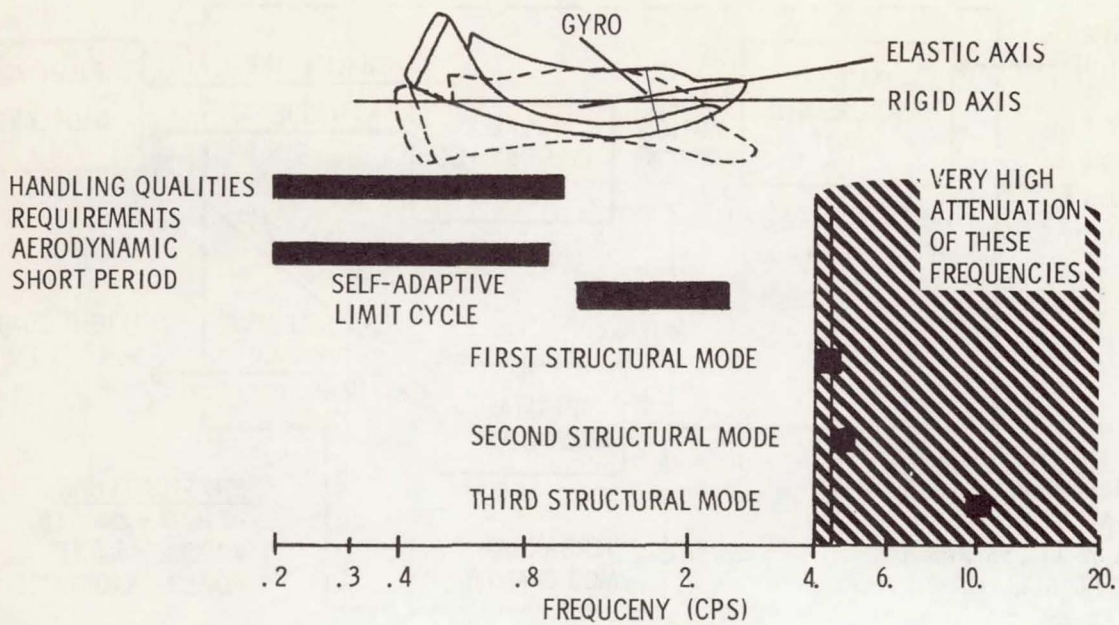

Figure 28. Problem Aero-Servo-Elastic Coupling

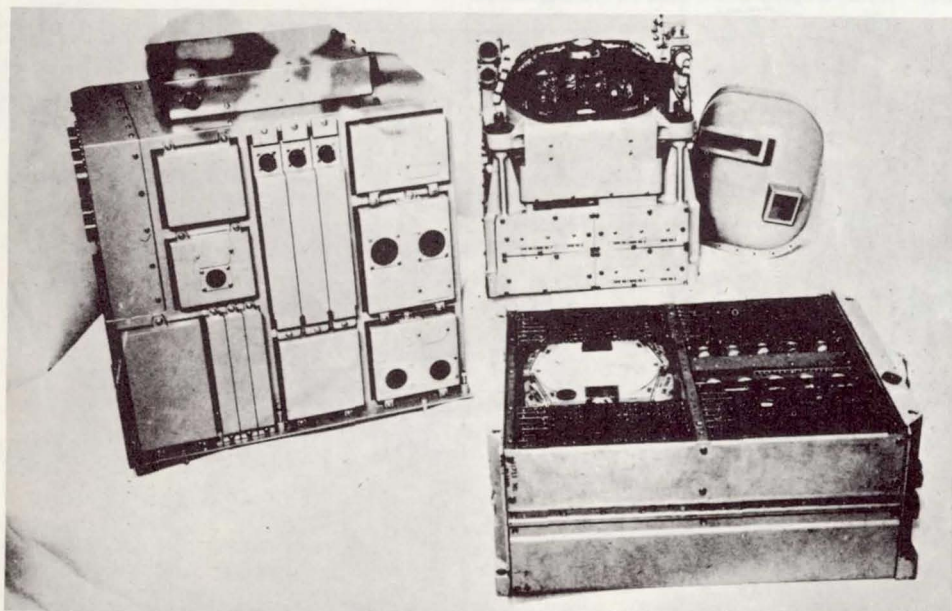

Figure 29. X-20 Inertial Guidance Subsystem

**CONFIDENTIAL**

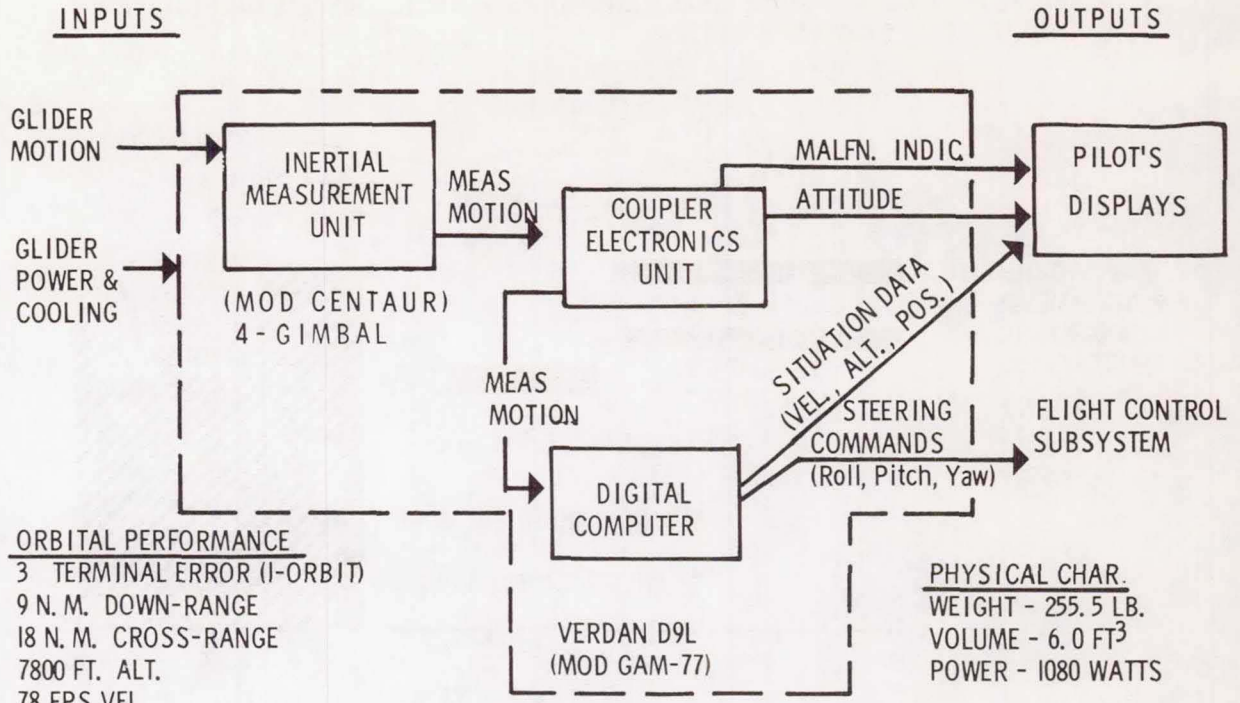

Figure 30. X-20A Inertial Guidance Subsystem

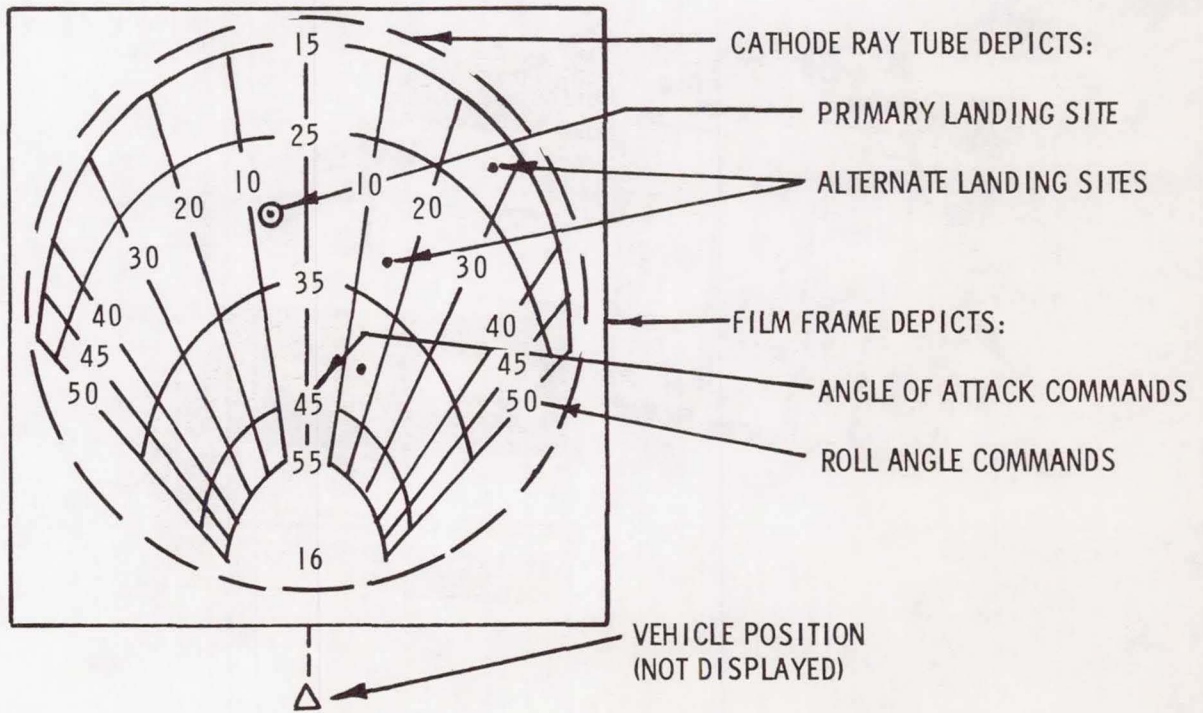

Figure 31. Typical Energy Management Display

**CONFIDENTIAL**

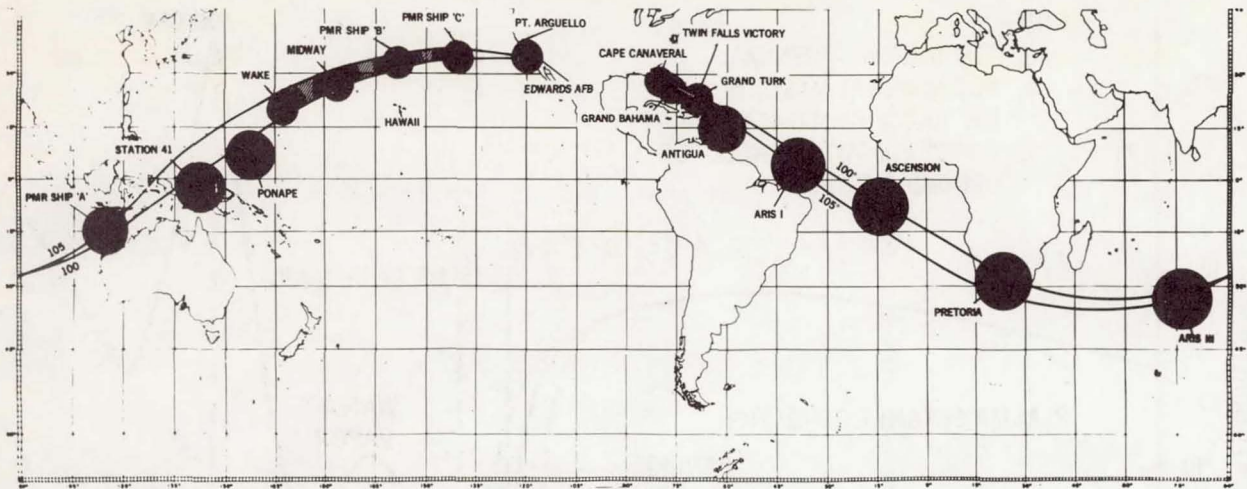
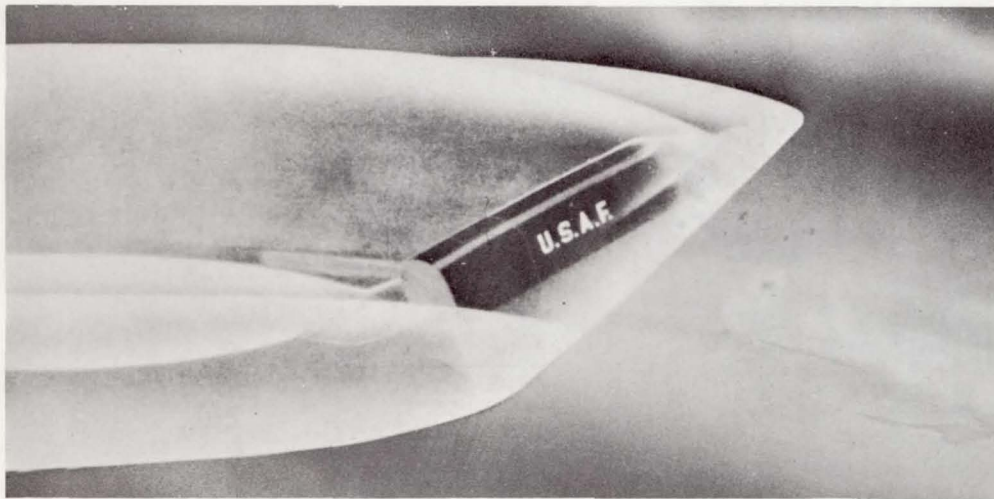

Figure 32. Single Orbit



**PLASMA SHEATH**

ELECTRO-OPTICAL (ABSORPTION, REFLECTION, & REFRACTION)

ANTENNA VOLTAGE BREAKDOWN

PLASMA-INDUCED NOISE

Figure 33. Hypersonic Re-Entry Communications

**CONFIDENTIAL**

**CONFIDENTIAL**

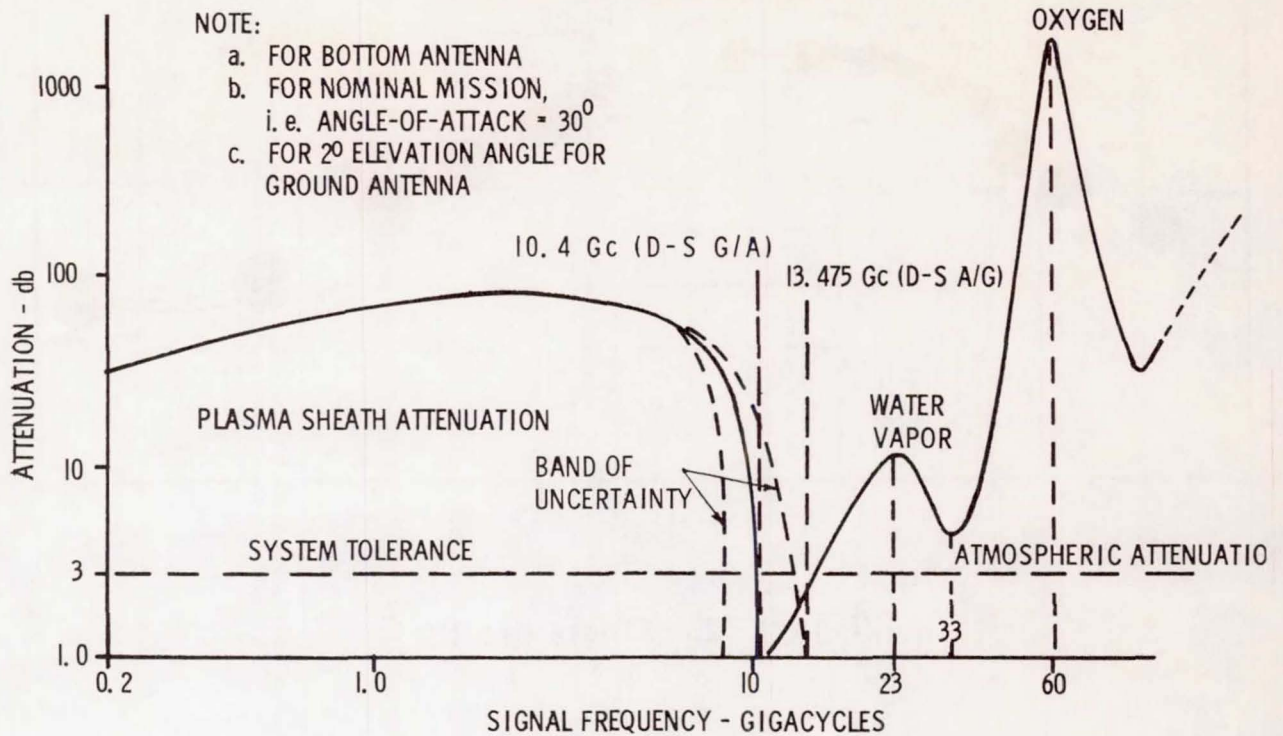

Figure 34. Attenuation Vs Frequency for X-20 (Dyna-Soar) Re-Entry

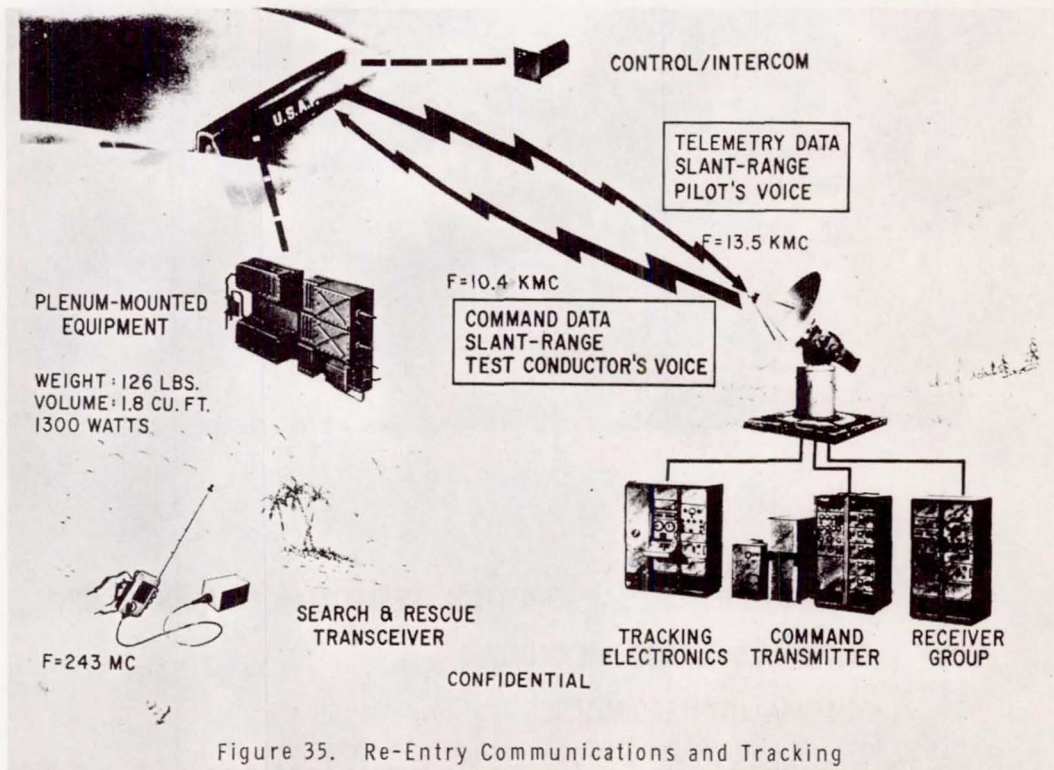

Figure 35. Re-Entry Communications and Tracking

**CONFIDENTIAL**

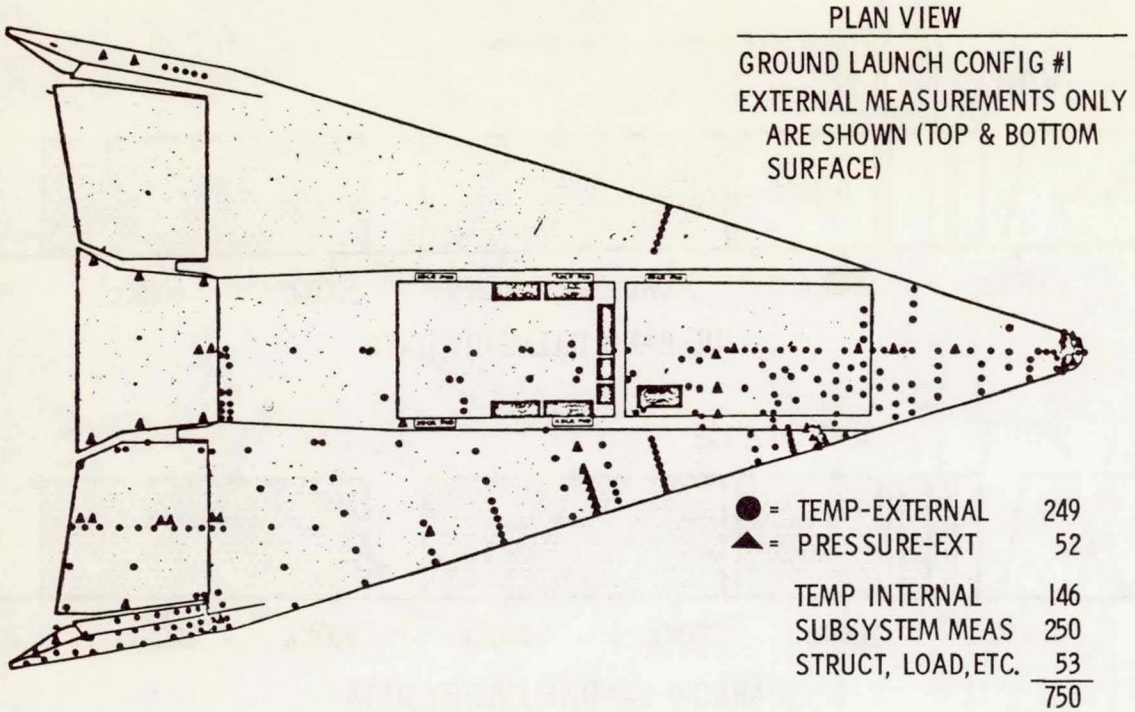

Figure 36. TIS-Equipment Locations

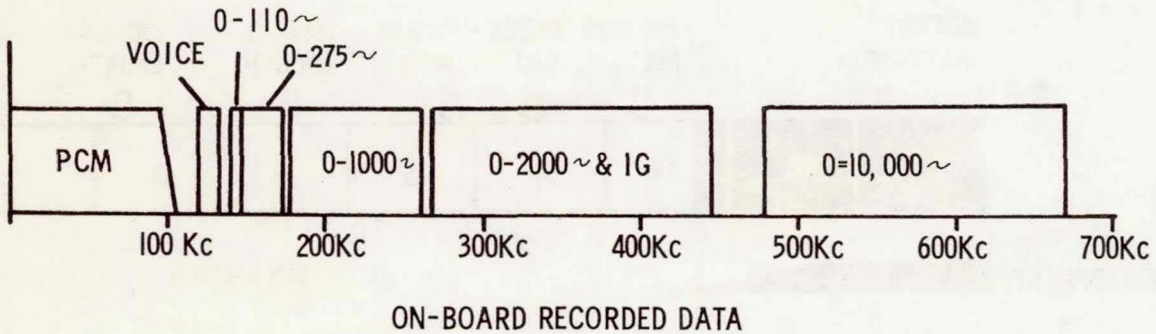

Figure 37. Data Baseband Spectrum

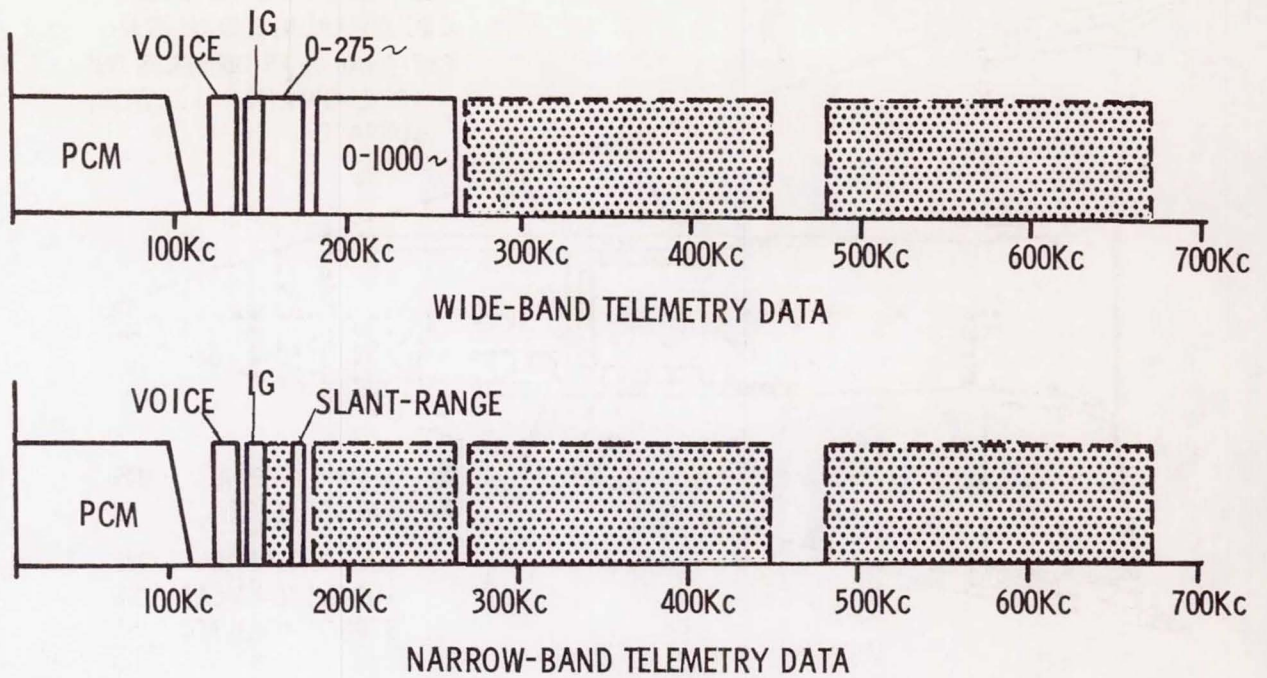

Figure 38. Data Baseband Spectrum

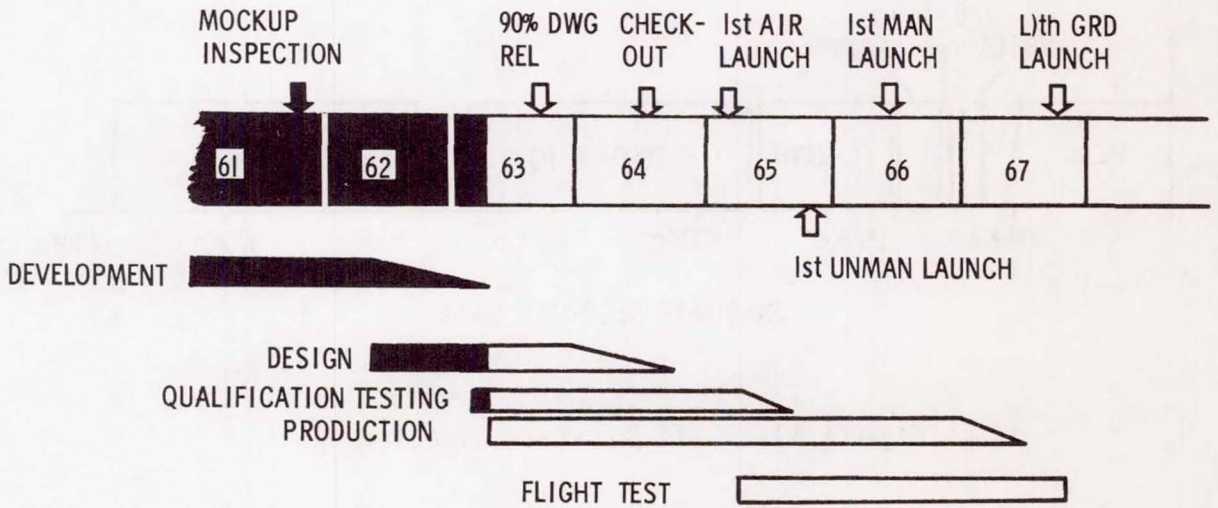

Figure 39. X-20A Schedule And Status