

CR-133981

20029-H203-R0-00

ANTENNA AND PROPAGATION STUDIES FOR SPACECRAFT SYSTEMS

TASK E-53 I

TECHNICAL REPORT

PREFLIGHT SL-1/SL-3 SKYLAB VHF RANGING

COVERAGE (NOMINAL TPI)

NAS 9-12330

13 July 1973

Prepared for  
NATIONAL AERONAUTICS AND SPACE ADMINISTRATION  
JOHNSON SPACE CENTER  
HOUSTON, TEXAS

(NASA-CR-133981)	PREFLIGHT SL-1/SL-3	N73-28020
SKYLAB VHF RANGING COVERAGE (NOMINAL		
TPI). ANIENNA AND PROPAGATION STUDIES		
FOR SPACECRAFT SYSTEMS, TASK E-531 (TRW		Unclass
Systems Group) 47 p HC \$4.50 CSCL 17B	G3/07	1.353

Prepared by  
Electronic Systems Engineering Department



20029-H203-R0-00

---

ANTENNA AND PROPAGATION STUDIES FOR SPACECRAFT SYSTEMS

TASK E-53 I  
TECHNICAL REPORT

---

PREFLIGHT SL-1/SL-3 SKYLAB VHF RANGING  
COVERAGE (NOMINAL TPI)

---

NAS 9-12330

13 July 1973

Prepared for  
NATIONAL AERONAUTICS AND SPACE ADMINISTRATION  
JOHNSON SPACE CENTER  
HOUSTON, TEXAS

Prepared by  
D. R. Eisenhauer  
D. A. James

Approved by:



L. H. Robinson, Jr., Manager  
Task E-53I

Approved by:

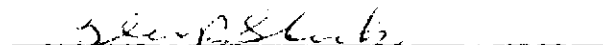

G. R. Shook, Manager  
Electronic Systems Engineering  
Department

**TRW**  
SYSTEMS GROUP

## TABLE OF CONTENTS

	<u>Page</u>
1. INTRODUCTION AND SUMMARY . . . . .	1
2. TECHNICAL DISCUSSION . . . . .	4
2.1 General . . . . .	4
2.2 Objectives . . . . .	9
2.3 Assumptions . . . . .	9
2.4 Approach . . . . .	9
2.5 Assessment of Spacecraft to Spacecraft VHF Ranging Coverage . . . . .	11
3. CONCLUSIONS . . . . .	18
APPENDIXES	
A TIMELINE PLOTS . . . . .	19
B SYSTEM PARAMETER VALUES . . . . .	37
REFERENCES . . . . .	39

## ILLUSTRATIONS

	Page
1. CSM and Skylab SWS $\theta$ , $\phi$ Look Angle Conventions . . . . .	5
2. Skylab OA Coordinate System . . . . .	6
3. CSM Coordinate System and Location of the CSM VHF Antennas . .	7
4. Location of the Skylab VHF Ranging Antenna . . . . .	8
5. VHF Simplex Link Summary - 296.8 MHz and 259.7 MHz - Maximum Signal . . . . .	15
6. VHF Simplex Link Summary - 296.8 MHz and 259.7 MHz - Minimum Signal . . . . .	16
7. VHF Duplex Link Summary . . . . .	17
8. Range Between CSM and SWS . . . . .	20
9. Look Angles CSM to SWS . . . . .	21
10. Look Angles SWS to CSM . . . . .	22
11. CSM Left Antenna Gain - 259.7 MHz . . . . .	23
12. CSM Right Antenna Gain - 259.7 MHz . . . . .	24
13. SWS Antenna Gain - 259.7 MHz . . . . .	25
14. CSM Left Antenna Gain - 296.8 MHz . . . . .	26
15. CSM Right Antenna Gain - 296.8 MHz . . . . .	27
16. SWS Antenna Gain - 296.8 MHz . . . . .	28
17. Maximum Received Power - 259.7 MHz - CSM Left and SWS Helix . . . . .	29
18. Minimum Received Power - 259.7 MHz - CSM Left and SWS Helix . . . . .	30

ILLUSTRATIONS (Continued)

	Page
19. Maximum Received Power - 259.7 MHz - CSM Right and SWS Helix . . . . .	31
20. Minimum Received Power - 259.7 MHz - CSM Right and SWS Helix . . . . .	32
21. Maximum Received Power - 296.8 MHz - CSM Left and SWS Helix . . . . .	33
22. Minimum Received Power - 296.8 MHz - CSM Left and SWS Helix . . . . .	34
23. Maximum Received Power - 296.8 MHz - CSM Right and SWS Helix . . . . .	35
24. Minimum Received Power - 296.8 MHz - CSM Right and SWS Helix . . . . .	36

## ABBREVIATIONS

AM	Airlock Module (DA + FAS + STS)
ATM	Apollo Telescope Mount
BETA ( $\beta$ )	Elevation Angle of Sun from SWS Orbit Plane
CM	Command Module
COAS	Crewman Optical Alignment Sight (CSM Tracking Attitude)
CSM	Command and Service Modules
CSM-LEFT (CSM-LF)	CSM Left VHF Antenna
CSM-RIGHT (CSM-RT)	CSM Right VHF Antenna
DA	Deployment Assembly
DOCK	CSM-SWS Docking
FAS	Fixed Airlock Shroud
G.E.T.	Ground Elapsed Time
IU	Instrument Unit
M	Number of CSM Orbits Required for Rendezvous
MDA	Multiple Docking Adapter
MHz	Megahertz
NCC	Corrective Combination Maneuver (Rendezvous)
NC1	Phasing 1 Maneuver (Rendezvous)
NC2	Phasing 2 Maneuver (Rendezvous)
n.mi.	Nautical Miles
NPC	Plane Change Maneuver (Rendezvous)
NSR	Coelliptic Maneuver (Rendezvous)

OA	Orbital Assembly (CSM + SWS)
OWS	Orbital Workshop
SEXT	Sextant (CSM Tracking Attitude)
SI	Solar Inertial
SL-1	SWS Launch and Orbiting Mission
SL-2	First CSM Launch (Manned)
SL-3	Second CSM Launch (Manned)
SL-4	Third CSM Launch (Manned)
SLM-1	First Skylab Mission (SL-1/SL-2)
SLM-2	Second Skylab Mission (SL-1/SL-3)
SLM-3	Third Skylab Mission (SL-1/SL-4)
SM	Service Module
STS	Structural Transition Section
S-IVB	Saturn IB Second Stage
SWS	Saturn Workshop (AM+ATM+FAS+IU+MDA+OWS)
TPF	Terminal Phase Finalization Maneuver (Rendezvous)
TPI	Terminal Phase Initiation Maneuver (Rendezvous)
TPM1	First Midcourse Correction Following TPI
TPM2	Second Midcourse Correction Following TPI
VHF	Very High Frequency (259.7 MHz and 296.8 MHz in this report)
Z-LV	Z-Local Vertical

PREFLIGHT SL-1/SL-3 VHF RANGING COVERAGE  
(NOMINAL TPI)

1. INTRODUCTION AND SUMMARY

This report presents a preflight assessment of the Skylab VHF ranging coverage for the rendezvous portion of the nominal SL-1/SL-3 mission, assuming a 28 July 1973 SL-3 launch. The data in this report is based on a nominal attitude trajectory, which has the Saturn Workshop (SWS) in a solar inertial (SI) attitude throughout the rendezvous; the CSM terminal phase initiation (TPI) maneuver is nominal. An addendum to this report is being prepared, which considers the effects of early and late TPI maneuvers.

Curves are presented in Appendix A of this report which show the variation in received power levels on both spacecraft-to-spacecraft links from about 600 n.mi. range to CSM and SWS station keeping. Appropriate threshold levels are shown on these received power curves to indicate zero circuit margins for the ranging function.

The overall performance of the VHF ranging links is summarized in the bar charts presented in Section 2. These bar charts are based on the received power curves, where the bars represent positive circuit margins, and the gaps represent negative margins. Positive circuit margin bars begin only when the received power is greater than or equal to -104 dBm and do not drop out until the received power falls below -107 dBm. The VHF ranging duplex link summary bar chart presents expected acquisition, availability, and loss of the VHF ranging function, since the VHF system will be operating in the duplex mode where adequate margins are required both on the link from the CSM to the SWS and on the return link.



Based on an examination of the variation in received power on the two VHF links (using either the right CSM VHF antenna or the left CSM VHF antenna) as a function of mission time, the following conclusions and recommendations are made:

- 1) The SWS solar inertial attitude causes the expected VHF ranging coverage to be very sparse. Ranging coverage is available roughly once each orbital revolution, during that relatively short interval when the SWS happens to be favorably oriented toward the CSM.
- 2) The CSM right VHF antenna provides the best overall performance margins and should be selected throughout the entire rendezvous sequence. This link shows the least amount of multipath interference and should allow the earliest possible acquisition of the ranging function during each revolution.
- 3) Using a ranging acquisition threshold of -104 dBm, a tracking dropout threshold of -107 dBm, and the minimum received power data (direct signal minus multipath signal), the minimum availability of the ranging function should be as follows:
  - a) The initial ranging acquisition should occur at least by about 4:10 g.e.t. (about 355 n.mi. range). This initial, pre-NC2 tracking period should be available for at least 12 minutes, with loss of the ranging function occurring no earlier than about 4:22 g.e.t. (about 295 n.mi. range).
  - b) A second, 21 minute tracking period should be possible prior to NSR, with acquisition occurring at least by about 5:35 g.e.t. (about 120 n.mi.) and dropout no earlier than about 5:56 g.e.t. (about 97 n.mi.).
  - c) A third but momentary (30 seconds to one minute) tracking period may be possible in the vicinity of 6:11 g.e.t. (about 82 n.mi.).
  - d) The fourth and final tracking period should be available without dropouts from just prior to TPI until the end of the ranging requirements at station keeping. The final acquisition should occur by at least 7:10 g.e.t. (about 24 n.mi.).

The coverage assessment in this report is based on operational attitude trajectory information, as supplied by the SL-1/SL-3 rendezvous attitude tape for a 28 July 1973 SL-3 launch (NASA/JSC tape A09584) [1]. This coverage assessment is also based on antenna pattern data supplied by NASA/JSC, as documented in [2]. The system parameter values used in this assessment are given in Appendix B of this report.

## 2. TECHNICAL DISCUSSION

### 2.1 GENERAL

#### 2.1.1 SL-1/SL-3 SKYLAB Mission [3,4]

The SL-1/SL-3 Skylab mission is the second of three low-earth-orbit missions currently scheduled in the manned space station Skylab program. The unmanned SL-1 Saturn V Workshop (SWS) was launched on 14 May 1973 and placed into a circular earth orbit of about 235 n.mi. altitude and 50° inclination. On 28 July 1973, the manned SL-3 CSM, a modified Apollo spacecraft, will be launched and subsequently will dock with the SL-1 SWS to form an orbital assembly.

#### 2.1.2 Coordinate Definitions and Antenna Locations

The conventions used to define the look angles  $\theta$  and  $\phi$  are shown in Figure 1. In both cases, the angle  $\theta$  is defined from the +X axis. The angle  $\phi$ , however, is defined from the -Z axis for the CSM and from the +Y axis for the SWS. These conventions are determined by those used in determining the antenna patterns incorporated in the VHF computer analysis program. When the two spacecraft are docked,  $+X_C$  and  $-X_S$  are in the same direction, while  $+Y_C$  is oriented 55° from  $+Z_S$  towards  $-Y_S$  and  $+Z_C$  is oriented 35° from  $+Z_S$  towards  $+Y_S$  [4]. Coordinate conventions for the SWS and CSM are shown in Figures 2 and 3, respectively.

The CSM is equipped with two essentially linearly polarized omnidirectional scimitar type VHF antennas, mounted on opposite sides of the service module in the locations shown in Figure 3. To avoid signal cancellation effects, only one antenna is used at a given time. The antenna in use is selected by an astronaut-controlled switch.

As shown in Figure 4, the VHF turnaround ranging between the CSM and the SWS during rendezvous is accomplished using an essentially right-circularly polarized helical antenna mounted on the SWS Apollo telescope mount (ATM) deployment assembly. The Skylab VHF ranging antenna is located

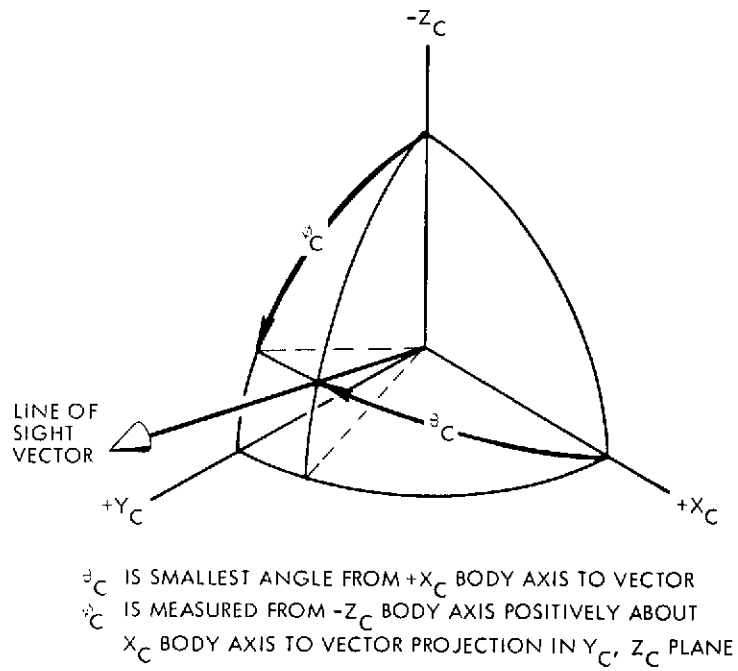

a. CSM Convention

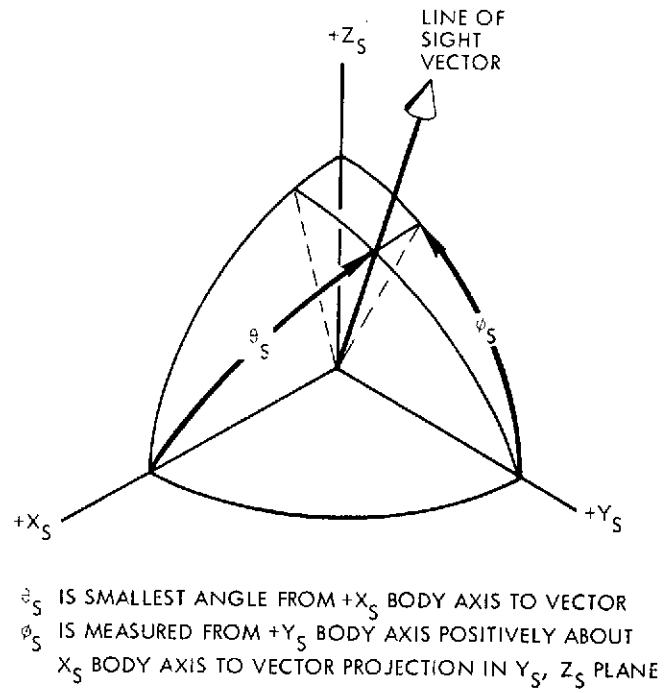

b. Skylab SWS (MDAC) Convention

Figure 1. CSM and Skylab SWS  $\theta, \phi$  Look Angle Conventions

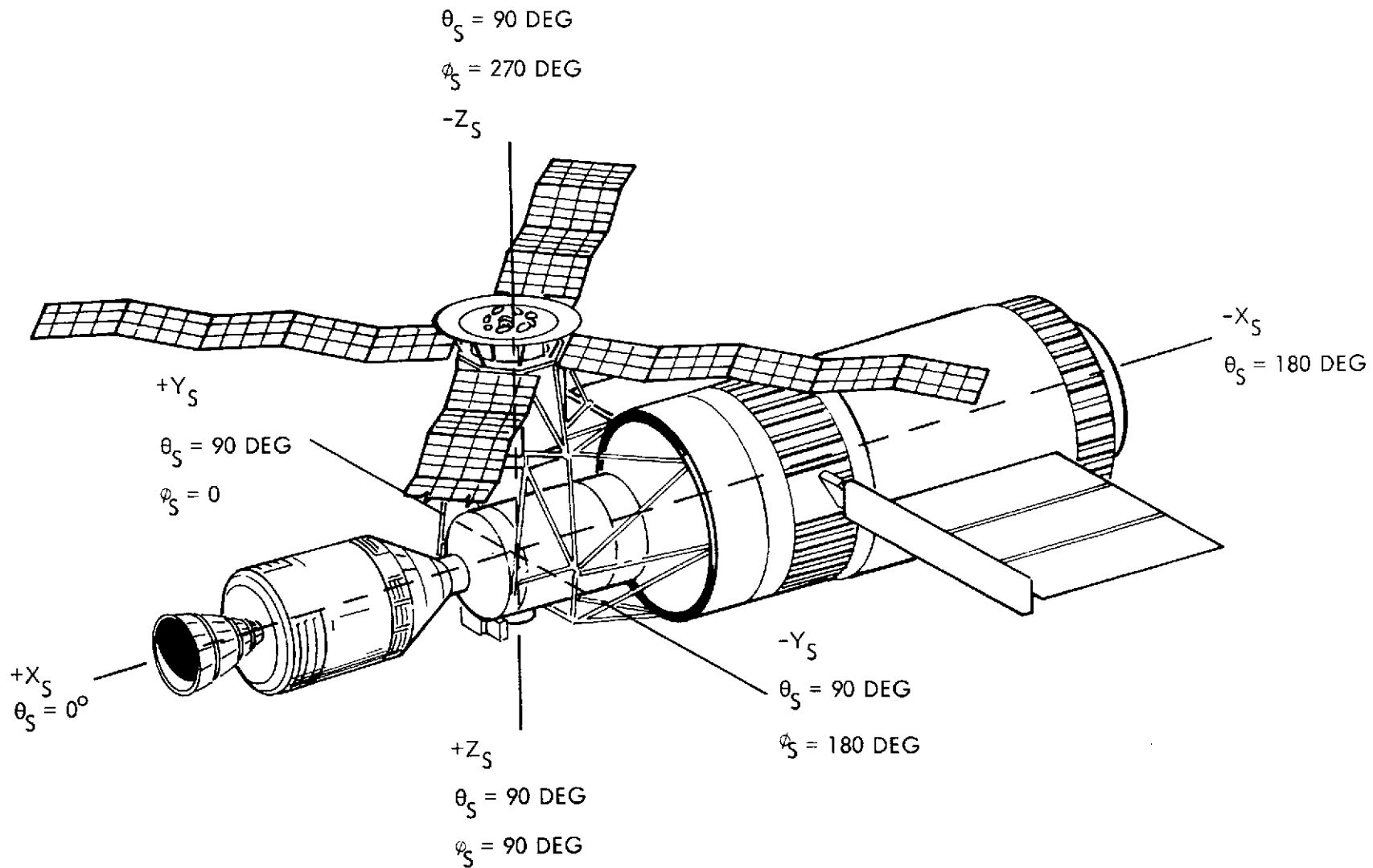

Figure 2. Skylab OA Coordinate System (MDAC  $\theta$ ,  $\phi$  Convention)

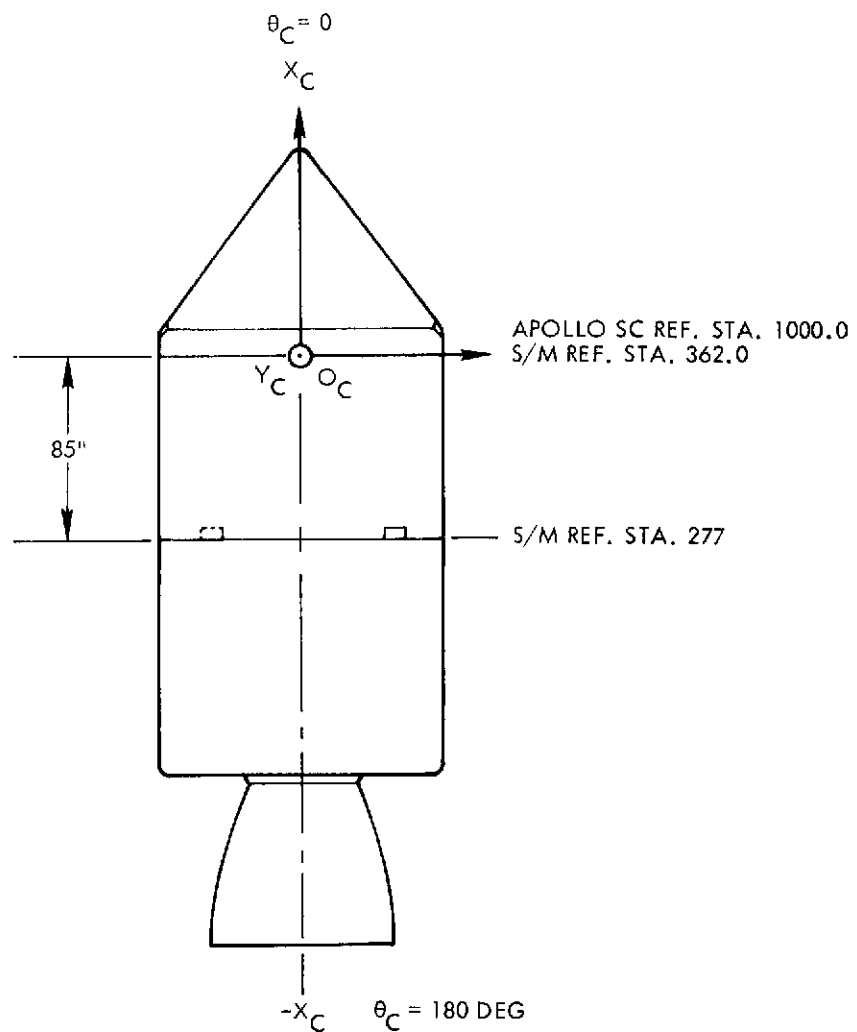
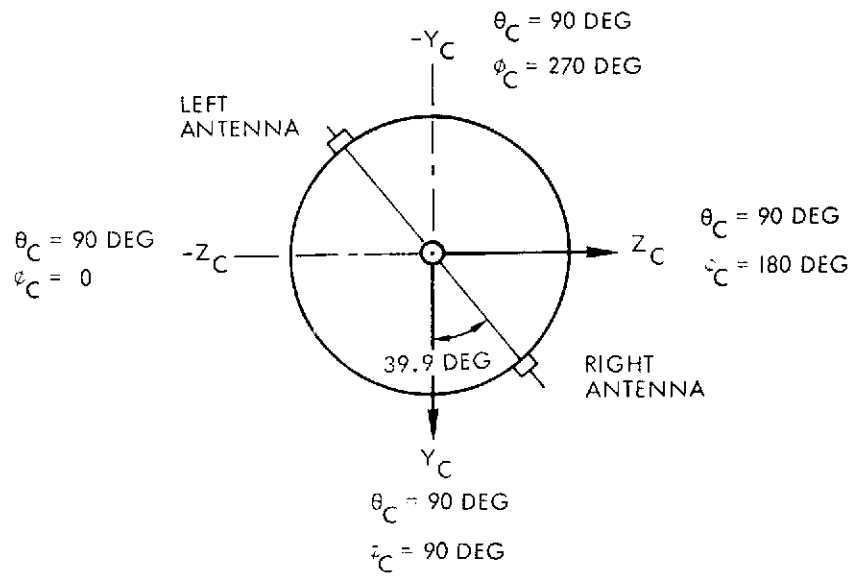

Figure 3. The CSM Coordinate System and Location of CSM VHF Antennas

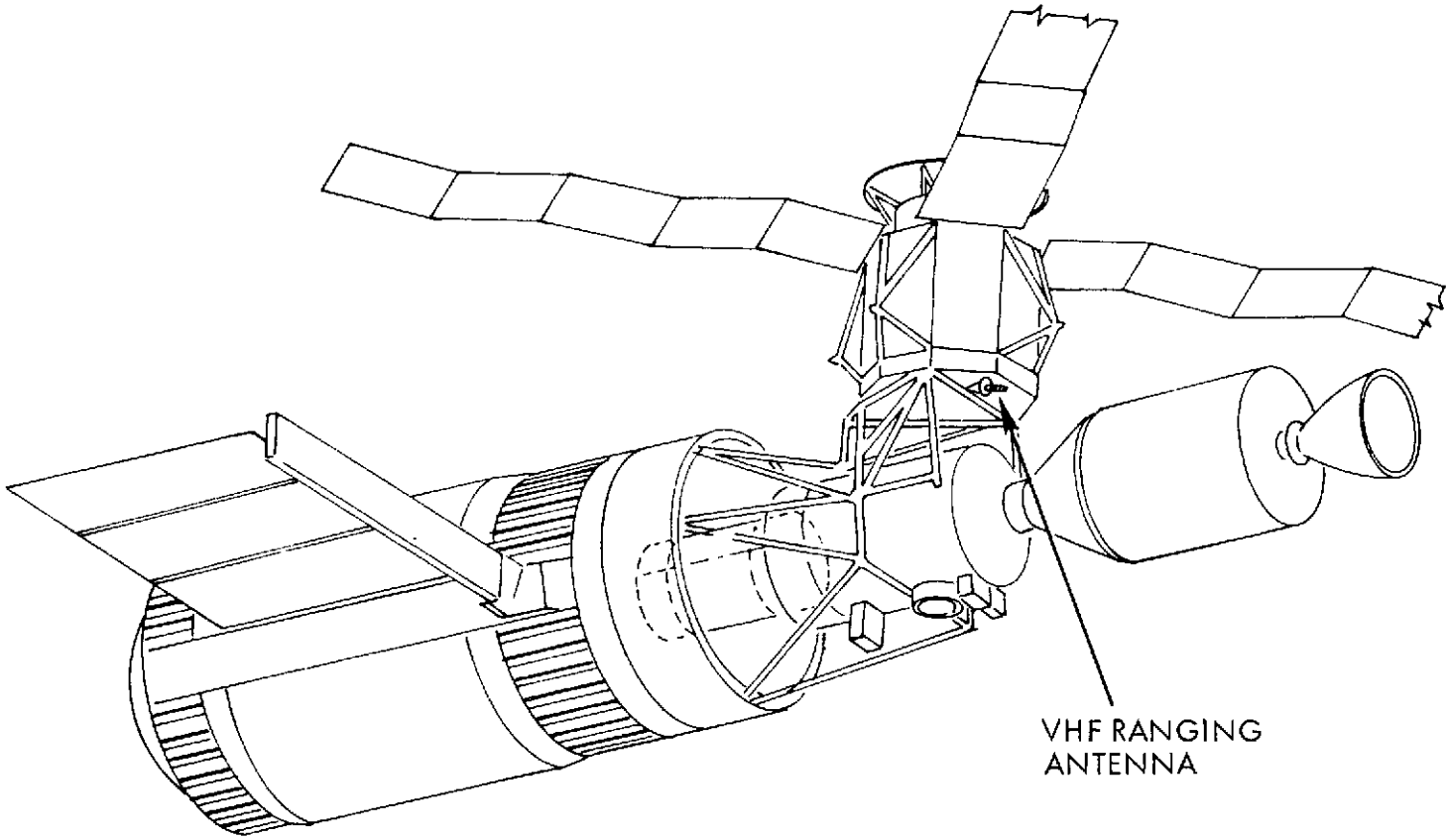

Figure 4. Location of Skylab VHF Ranging Antenna

approximately over and on the  $+Y_S$  side of the multiple docking adapter and below the main body of the ATM [5]. The antenna is oriented to provide coverage primarily in the  $+X_S, +Z_S$  quadrant of the  $X_S, Z_S$  plane for rendezvous and docking.

## 2.2 OBJECTIVES

The objectives of the SL-1/SL-3 Skylab VHF ranging coverage study are 1) to determine whether or not satisfactory VHF ranging will be possible between the CSM and the SWS during the rendezvous portion of the manned SL-1/SL-3 Skylab mission and 2) to select the optimum antenna combinations to be used at specific times throughout the rendezvous sequence.

## 2.3 ASSUMPTIONS

The coverage study in this report is based on the assumptions that

- 1) The NASA operational rendezvous trajectory tape A09584 is an accurate representation of the rendezvous portion of the SL-1/SL-3 Skylab mission [1].
- 2) The CSM and SWS antenna patterns stored in the HV014E computer program accurately represent the true antenna patterns. (See the Preliminary Skylab VHF Ranging Coverage Report [2] for the assumed radiation pattern contour plots.)
- 3) The system parameter values given in Appendix B accurately represent the actual values.
- 4) VHF ranging signals will be transmitted from the CSM on 259.7 MHz and received by the CSM on 296.8 MHz.
- 5) No communication degradation occurs due to engine plume effects while engines are thrusting.

## 2.4 APPROACH

The Skylab VHF ranging coverage study makes use of the TRW-developed VHF Computer Analysis Program, HV014E, run on the NASA UNIVAC 1108 system in conjunction with a TRW-modified, Grumman-developed [6] Circuit Margin Performance Analysis Program (CMPAP), which has been incorporated as an integral part of HV014E [7].



These programs, originally developed during the Apollo program for CSM-LM studies, can simulate the CSM-SWS VHF communication links for all Skylab missions when given the appropriate antenna pattern data, system parameter values, and attitude trajectory data for both the CSM and SWS. For the Skylab missions, multipath effects will be encountered, and the multipath portion of the HV014E program is used in this analysis.

The computer output consists of printouts and plots (via the TRWPLT general plotting program) of the range between the CSM and SWS as a function of mission time, and the corresponding CSM and SWS look angles, total received power, CSM and SWS antenna gains, polarization losses, and gain products at each time point. Only the range, look angle, antenna gain, and total received power plots have been included in this report, where the plots showing total received power in dBm also show threshold levels corresponding to zero dB circuit margins for the VHF ranging function; the threshold values and other system parameters are summarized in Appendix B.

The effects of multipath reflections from the earth's surface are computed by the VHF Computer Analysis Program, assuming that the earth acts as a smooth spherical reflecting surface. The reflection coefficient of the terrestrial surface is computed assuming seawater,\* and a divergence factor is also incorporated. The details of how this multipath analysis is performed, and other considerations leading up to the developed program, can be found in References 8 through 11.

The maximum and minimum received power plots presented in Appendix A indicate the amount of signal fluctuation to be expected from multipath effects. The maximum curves give the total received power for the condition where the direct and multipath signals add in-phase. The minimum curves give the total received power when the direct and multipath signals are out-of-phase. Since the actual phase difference between the direct and multipath signals varies rapidly as a function of time, the amplitude of the net received signal can be expected to fluctuate between the two extremes given by the maximum and minimum received power curves.

---

\* The greatest portion of the rendezvous trajectories will be over water, and worst-case multipath assessments can be made by assuming a seawater reflecting surface throughout the entire rendezvous sequence.

## 2.5 ASSESSMENT OF SPACECRAFT TO SPACECRAFT VHF RANGING COVERAGE

### 2.5.1 General Consequences of SWS SI versus Z-LV(R) Attitudes

To increase the maximum operating range of the VHF ranging system over that obtained during Apollo missions, a relatively high gain, narrow beam VHF helix antenna was selected for use on the SWS. The resultant increase in the maximum range at which the system would acquire was obtained at the sacrifice of angular coverage; the CSM as viewed from the SWS would have to remain in the same general direction throughout the rendezvous sequence. Prior to the launch of SL-1, this pointing constraint was to be satisfied by having the SWS in a retrograde Z-axis local vertical [Z-LV(R)] attitude during the critical portion of the rendezvous. As documented in [2] and [12], the Z-LV(R) attitude should have been adequate for a wide variety of rendezvous profiles.

Unfortunately, the difficulties experienced by SL-1 operationally precluded the use of Z-LV(R), and the SL-2 rendezvous was flown with the SWS in a modified solar inertial (SI) attitude.\* The current SL-3 plans are for the SWS to be in a (true) SI attitude during the rendezvous.

With the SWS in SI, or any other (inertial) attitude hold profile, the SWS local attitude is continually changing in a cyclic fashion, repeating generally once each orbit. The CSM as viewed from the SWS will appear to spiral around the SWS, and for a significant portion of each orbital revolution the CSM will be to the side and/or rear of the SWS, away from the front where the SWS helix gain is highest. Under these conditions, ranging coverage most likely will be available periodically, roughly once each orbit, during those (possibly very short) intervals when the SWS

---

\* For the SL-2 rendezvous, the SWS was in the "Eagle Special" attitude, essentially pitched up toward the sun about 45° from a true SI attitude.

happens to be favorably oriented toward the CSM. Of course, the pointing constraint should become less stringent as the distance between the two spacecraft decreases; this is particularly true at short ranges (less than about 10 n.mi.).

The impact of a SWS attitude hold profile upon the expected ranging performance is directly related to how the combined effects of range (distance), unfavorable pointing directions, and multipath interference\* coincide with the times of critical ranging system operation. If the SWS helix is pointed near enough to the CSM during these times, the possible lack of continuous ranging coverage may not be too important. For example, ranging dropouts occurred as expected during the SL-2 rendezvous, but the SWS "Eagle Special" attitude was sufficiently favorable that satisfactory ranging system performance was obtained prior to and during the terminal phase of the rendezvous. A preflight assessment of a similar rendezvous profile is given as Case 2 in [13].

While the SL-2 pitched-up SWS attitude proved adequate, because the SWS antenna was generally pointed at the CSM during the latter portion of the rendezvous, a true SI attitude may not be as satisfactory. First, the SWS antenna will be pitched further away from the CSM during this portion of the rendezvous (by about  $45^\circ$ ).\*\* All other considerations being equal, this would tend to delay the occurrence of a favorable line-of-communication by at least 12 minutes; the loss of favorable conditions would be similarly delayed. Second, the SWS helix antenna has a somewhat undesirable sidelobe and backlobe pattern; there are many deep nulls in the antenna gain away from the main lobe, and there are correspondingly

---

\* During a portion of each revolution, the SWS helix could be directed more toward the ground than toward the CSM.

\*\* The sun angle (beta) is about the same for SL-2 and SL-3;  $\beta \approx -28^\circ$ .

Large fluctuations in the polarization.\* The CSM may be illuminated by this portion of the antenna pattern while ranging acquisition is being attempted; the ranging links might experience large fluctuations in received power due to variations in antenna gain and polarization loss in this region.

Summarizing, the Z-LV(R) attitude is preferred for best overall performance of the ranging system. Inertial SWS attitudes will provide periodic coverage at best. A modified SI attitude similar to the SL-2 Eagle Special should allow adequate pre- and post-TPI performance and is preferred over a pure SI attitude.

### 2.5.2 Detailed Evaluation of SL-3 Results

Using a ranging system acquisition threshold of -104 dBm and a tracking dropout threshold of -107 dBm, the total received power plots (Figures 17 - 24) indicate that three tracking periods should be available during the SL-3 rendezvous. The CSM right antenna to SWS helix antenna link provides the best overall performance margins: the first tracking period should exist for at least 12 minutes, from about 4:10 to 4:22 g.e.t. (about 354 n.mi. to 295 n.mi.). After this time, the total received power decreases rapidly with decreasing distance, primarily because the CSM is being positioned steadily further away from the SWS helix main beam. The second tracking period should exist from about 5:35 to 5:56 g.e.t. (about 119 n.mi. to 97 n.mi.), as the CSM once again passes through the SWS main beam.\*\* The third and final tracking period begins just prior to TPI, at 7:10 g.e.t. (about 24 n.mi.), and continues without further dropouts until the ranging system is turned off at CSM and SWS station

---

\* The SWS helix is right circularly polarized in the main lobe, but almost linear polarization exists at places within the sidelobe and backlobe patterns.

\*\* A momentary tracking opportunity is shown in the vicinity of 6:11 g.e.t., but the interval is too short to be of much use.

keeping. The times of the various planned maneuvers can be identified by the fluctuations both in the look angle plots (Figures 8 - 10) and in the antenna gain plots (Figures 11 - 16).

The bar charts presented in Figures 5 - 7 summarize the information available in the total received power plots. The first two charts (Figures 5 - 6) are simplex charts, representing only a one-way transmission-reception link. Each of the eight bars on the two charts corresponds to one of the total received power plots. Each bar begins when the total received power reaches the acquisition threshold of -104 dBm. Gaps in the bars begin at those times for which the total received power has dropped below the tracking threshold of -107 dBm and end only when the acquisition threshold of -104 dBm has been achieved again.

The duplex bar chart represents a two-way link and is derived from the simplex charts. A gap in a duplex bar indicates that there is a gap in either of the two simplex bars from which the duplex bar was constructed. As a result, the presence of duplex bars represents those times for which the ranging function is available with the CSM transmitting on 259.7 MHz and receiving on 296.8 MHz. For example, from the minimum CSM right-SWS helix duplex link summary, the acquisition threshold should be exceeded near 4:10, 5:35, 6:10, and 7:10 g.e.t., and the dropout threshold should be reached in between near 4:22, 5:56, and 6:11 g.e.t.

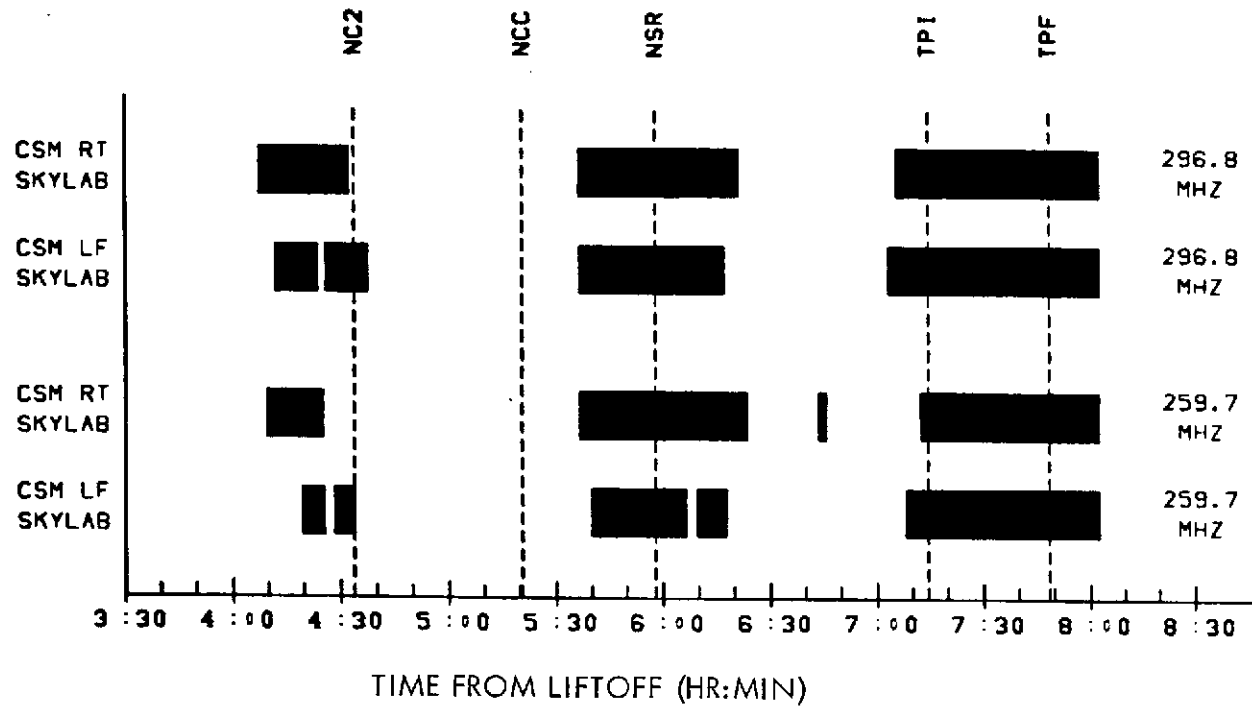

Figure 5. VHF Simplex Link Summary - 296.8 MHz and 259.7 MHz Maximum Signal

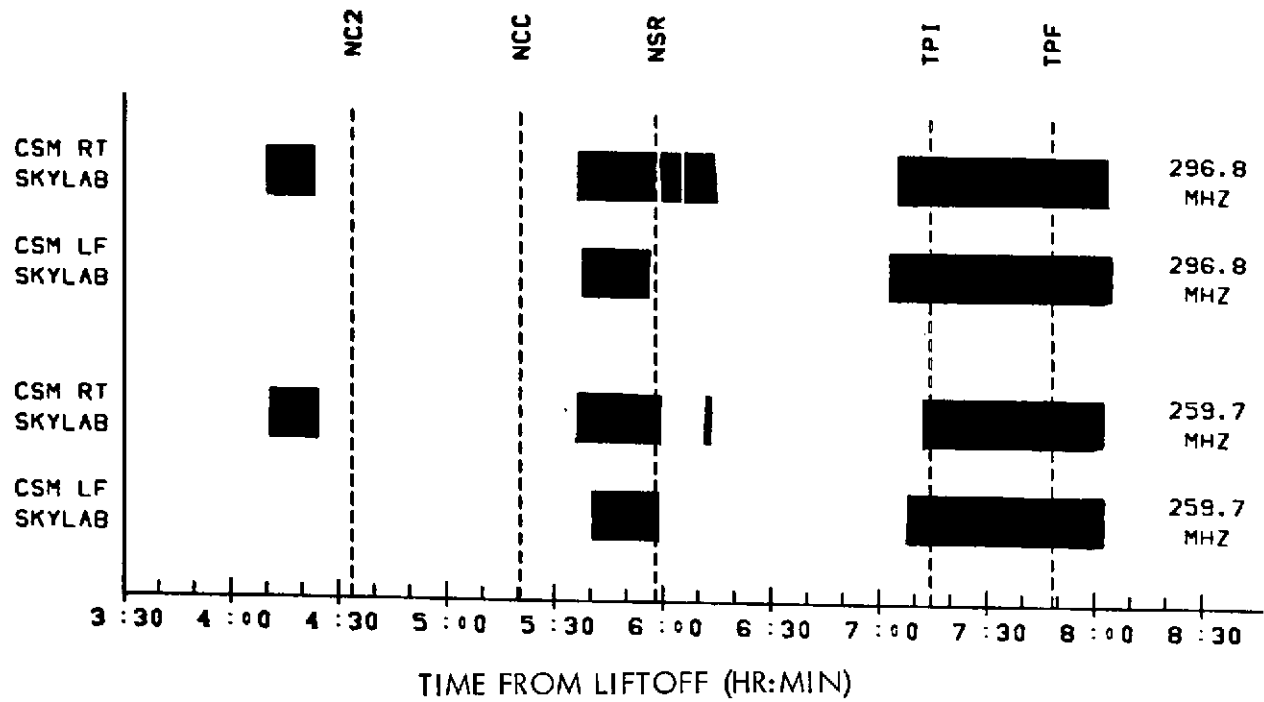

Figure 6. VHF Simplex Link Summary - 296.8 MHz and 259.7 MHz  
Minimum Signal

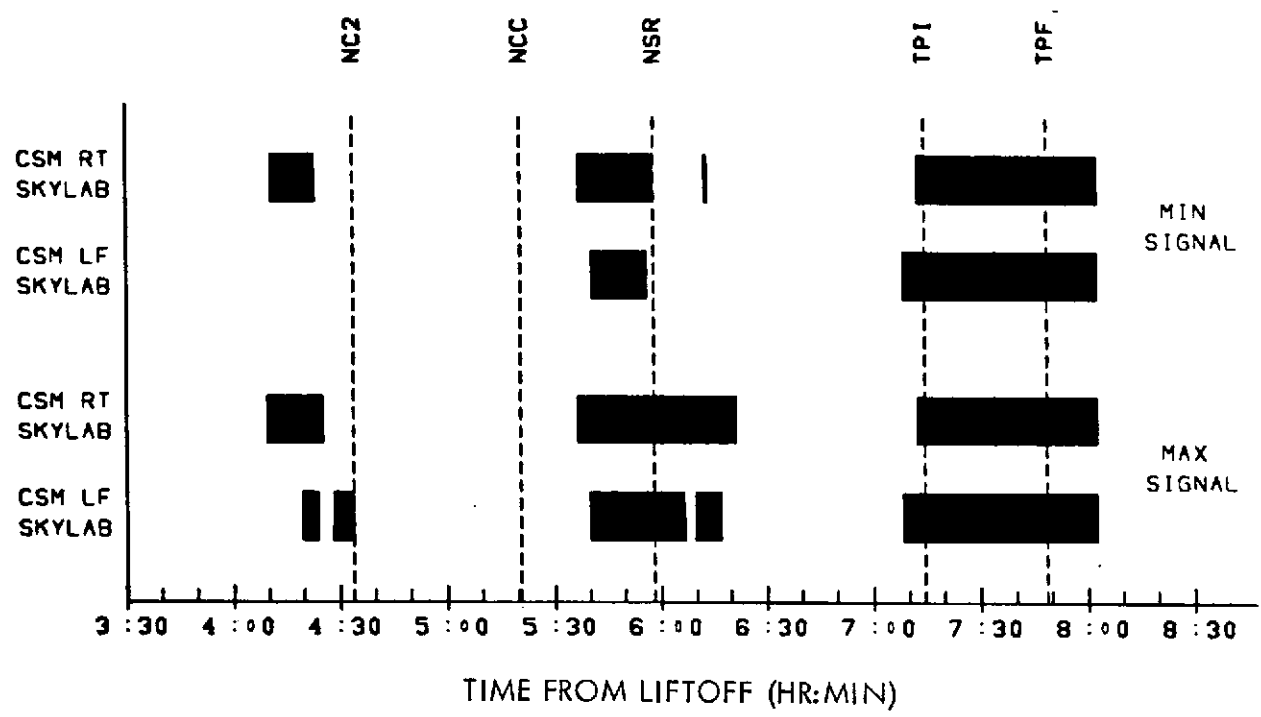

Figure 7. VHF Duplex Link Summary



### 3. CONCLUSIONS

With proper CSM VHF antenna selection, VHF ranging between the CSM and SWS should be available during portions of the rendezvous segment of the SL-1/SL-3 Skylab mission. Using the criteria of earliest possible acquisitions, latest possible dropouts, greatest overall received power margins, and minimum antenna switching, the CSM right antenna should be selected for the entire rendezvous sequence.

Using the CSM right antenna, three range tracking periods are predicted:

1. From 4:10 (Hr:min) SL-3 g.e.t. to 4:22 g.e.t. (at CSM-SWS range of 354 n.mi. to 295 n.mi.),
2. From 5:35 to 5:56 g.e.t. (119 to 97 n.mi.), and
3. From 7:10 g.e.t. (24 n.mi.) to station keeping.

These tracking periods correspond to those portions of each orbital revolution when the SWS happens to be favorably oriented toward the CSM. Increased coverage intervals could probably be achieved by pitching the SWS up toward the sun (e.g., the SL-2 "Eagle Special" attitude). Essentially continuous coverage and earlier initial acquisition could probably be expected if a SWS Z-LV(R) attitude were used during rendezvous.

APPENDIX A  
SL-1/SL-3 SKYLAB TIMELINE PLOTS

The figures in this Appendix (Figures 8 through 24) present, as functions of mission time, plots of the range between the CSM and the SWS (Figure 8), the CSM and SWS look angles (Figures 9 through 10), the CSM and SWS antenna gains (Figures 11 through 16), and the maximum and minimum received power variations on each link (Figure 17 through 24).

In the look angle plots, the  $\phi$  curve is plain, and the  $\theta$  curve is marked by "+" ticks at each data point. Both curves, as well as all of the curves shown in this appendix, consist of straight lines connecting the data points. The ticks on the  $\theta$  curves serve as a guide for the time location of the processed data points and their relative spacing.

All look angles are plotted in degrees with  $\theta$  ranging from  $0^\circ$  to  $180^\circ$  and  $\phi$  ranging from  $0^\circ$  to  $360^\circ$ . A sudden jump in the  $\phi$  curve from nearly  $360^\circ$  to  $0^\circ$  or vice versa is merely a result of the plotting limits, and the curve may be considered continuous. Also, as the  $\theta$  curve approaches  $0^\circ$  or  $180^\circ$ , the  $\phi$  curve may be required to change rapidly by  $180^\circ$  due to the nature of spherical coordinates.

The CSM and SWS antenna gain plots presented in this appendix are based on antenna patterns [2] derived from scale model measurements. As noted in [5], these patterns, rectangular projections describing the total power radiated to a theoretical sphere surrounding the antenna, are taken in 1 dB increments in amplitude and  $2^\circ$  increments in  $\theta$  and  $\phi$  (angular distribution).

The received power plots demonstrate the maximum and minimum received power for each ranging link. Maximum received power plots represent the case where the multipath signal is added in-phase with the direct path signal, while minimum received power plots represent out-of-phase multipath signal contributions. On each of the plots the VHF ranging acquisition threshold is shown as -104 dBm and the ranging function tracking dropout threshold as -107 dBm.

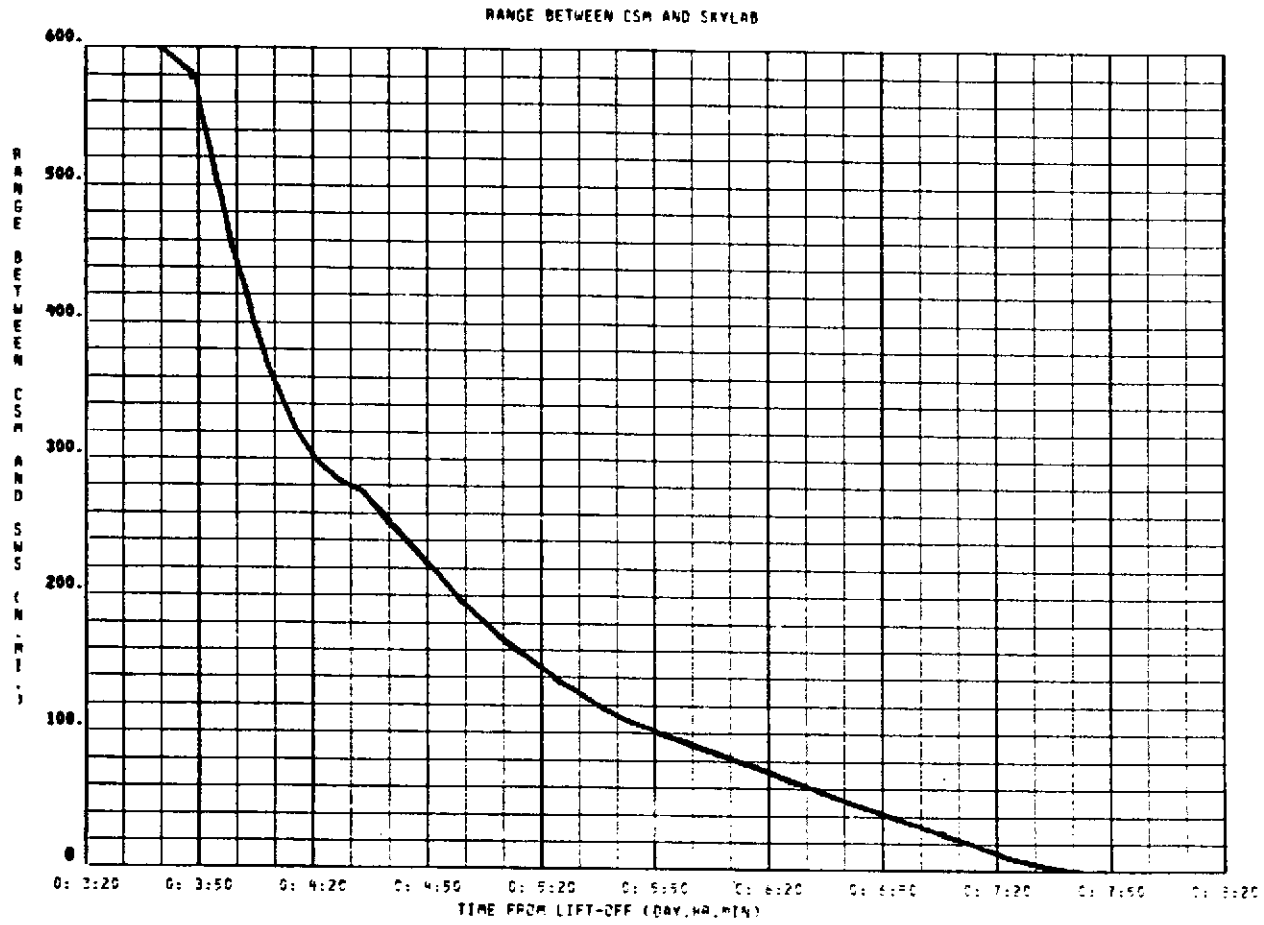
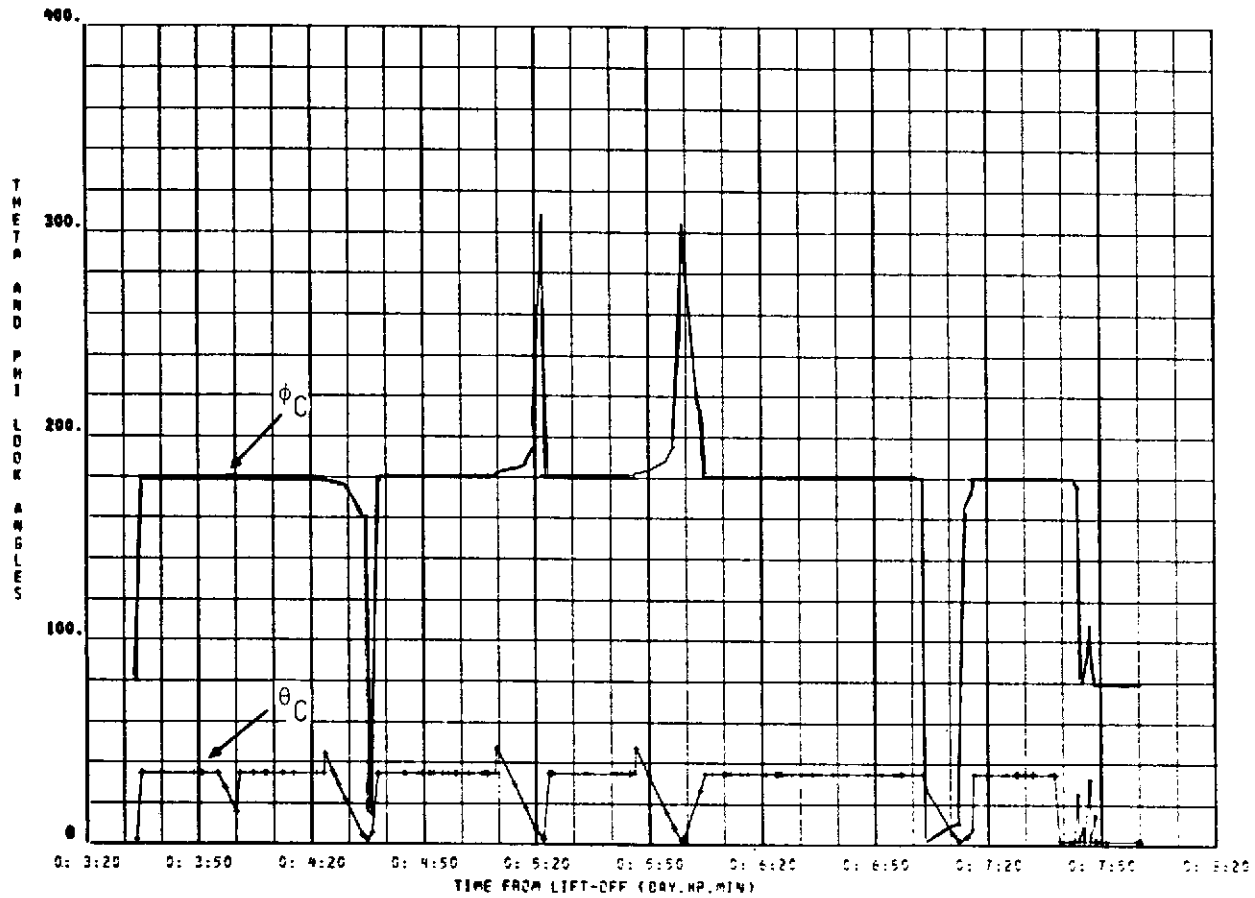

Figure 8. Range Between CSM and SWS (n.mi)



PAGE 11.

Figure 9. Look Angles CSM to SWS (DEG)

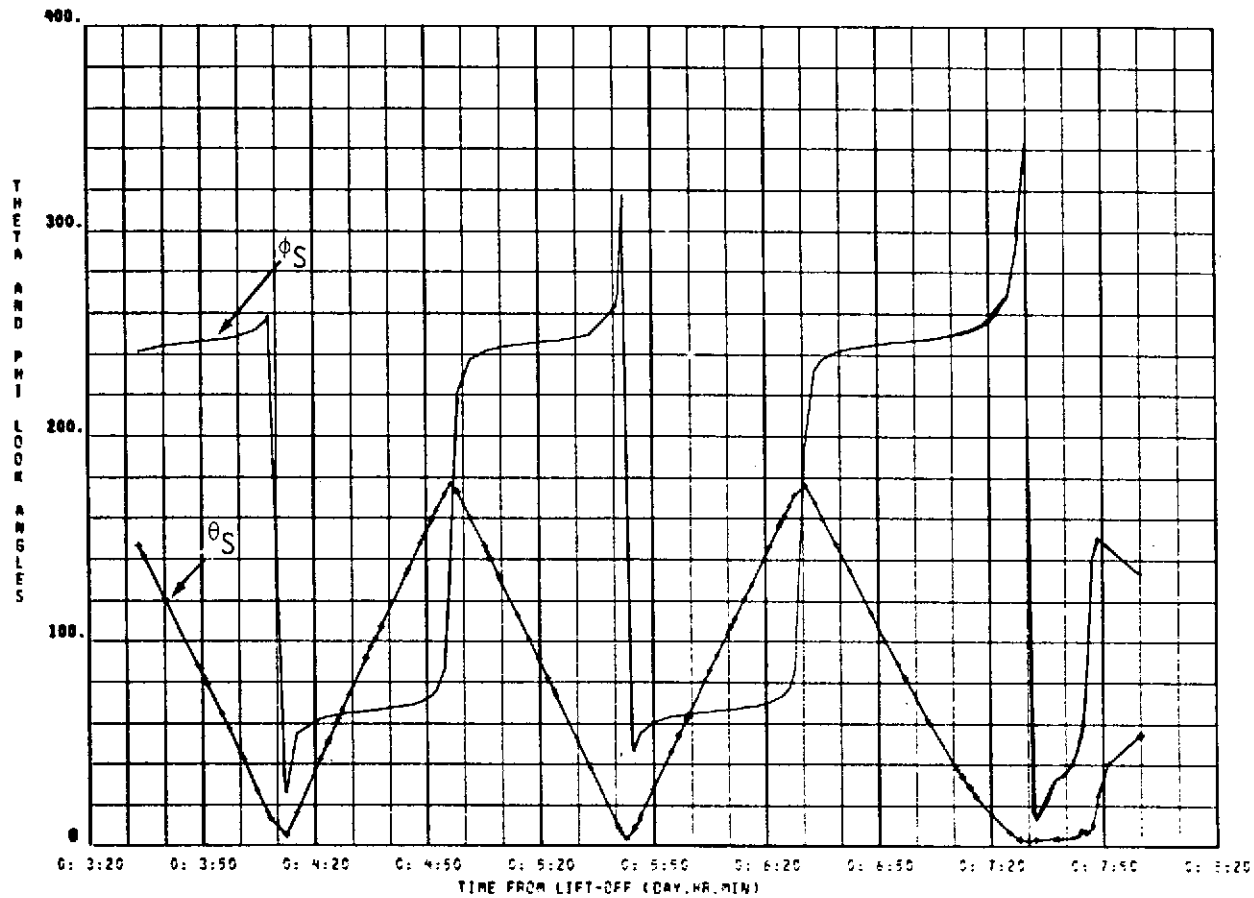

Figure 10. Look Angles SWS to CSM (DEG)

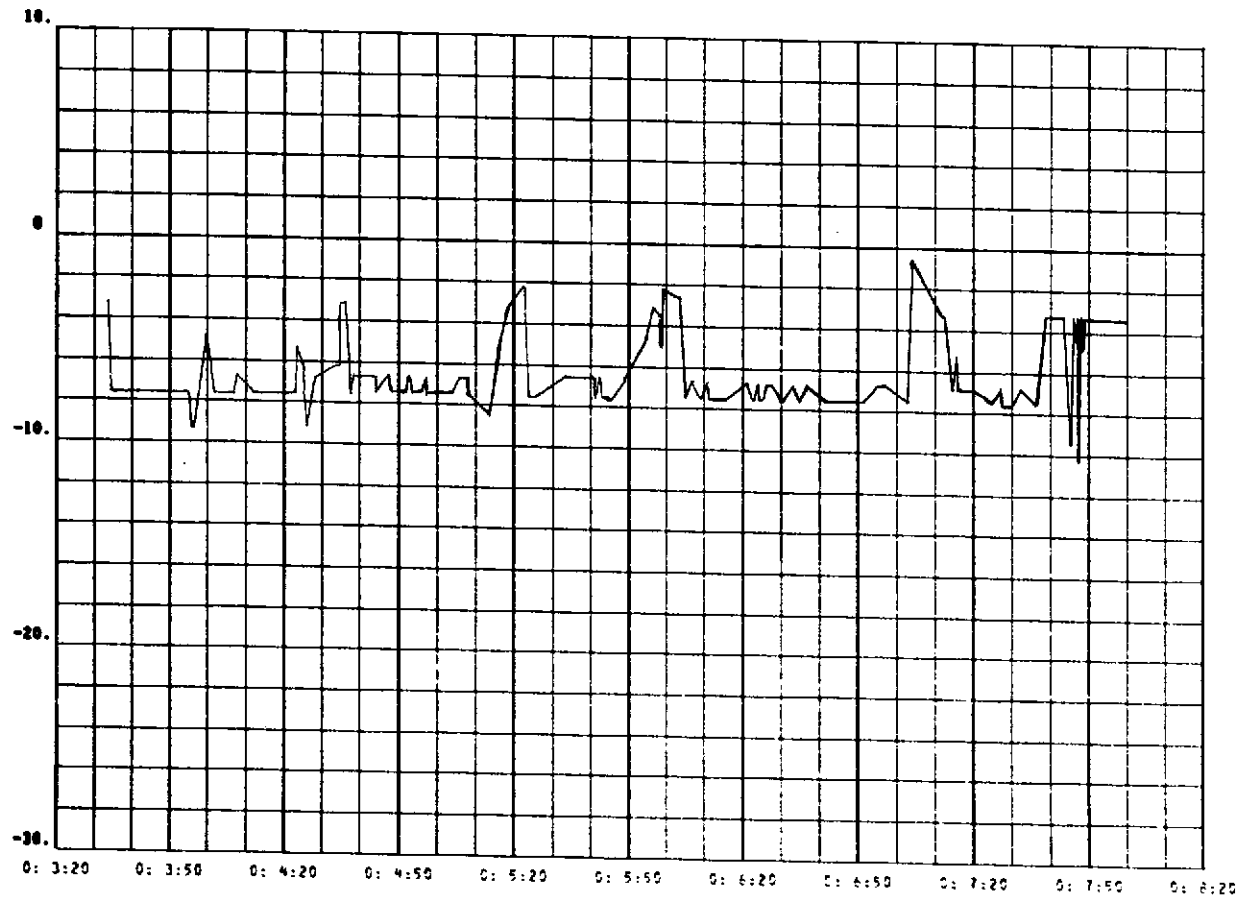

Figure 11. CSM Left Antenna Gain - 259.7 MHz

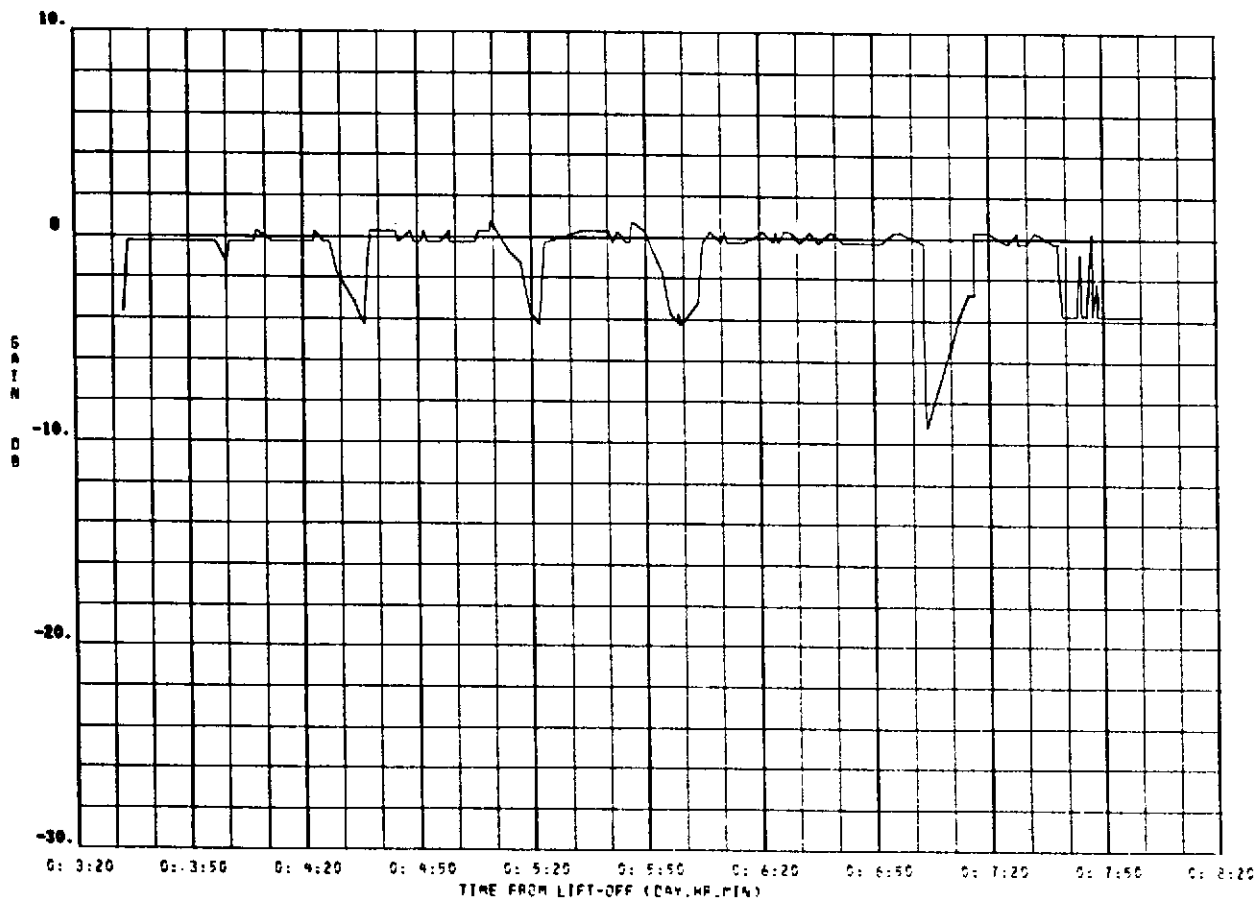

Figure 12. CSM Right Antenna Gain - 259.7 MHz

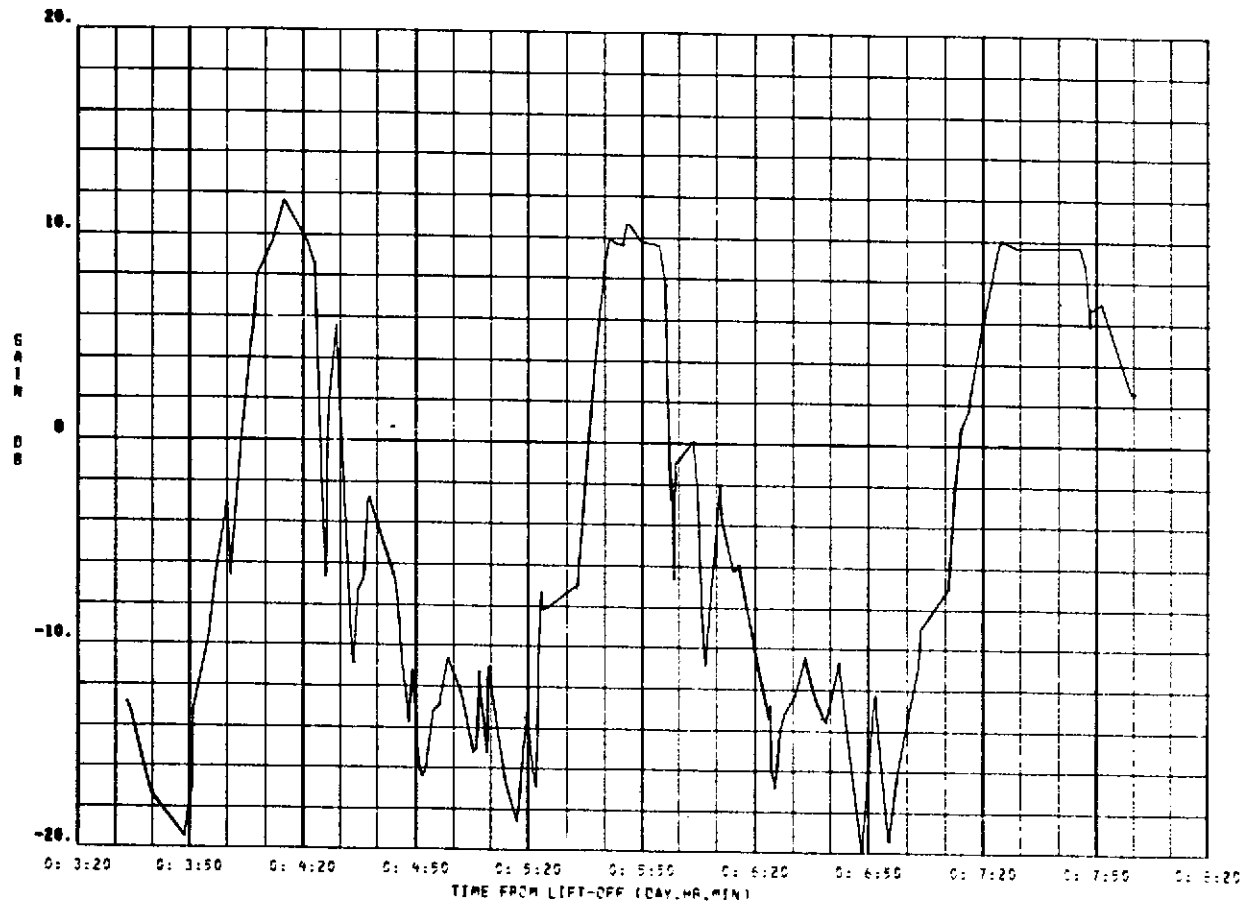

Figure 13. SWS Antenna Gain - 259.7 MHz



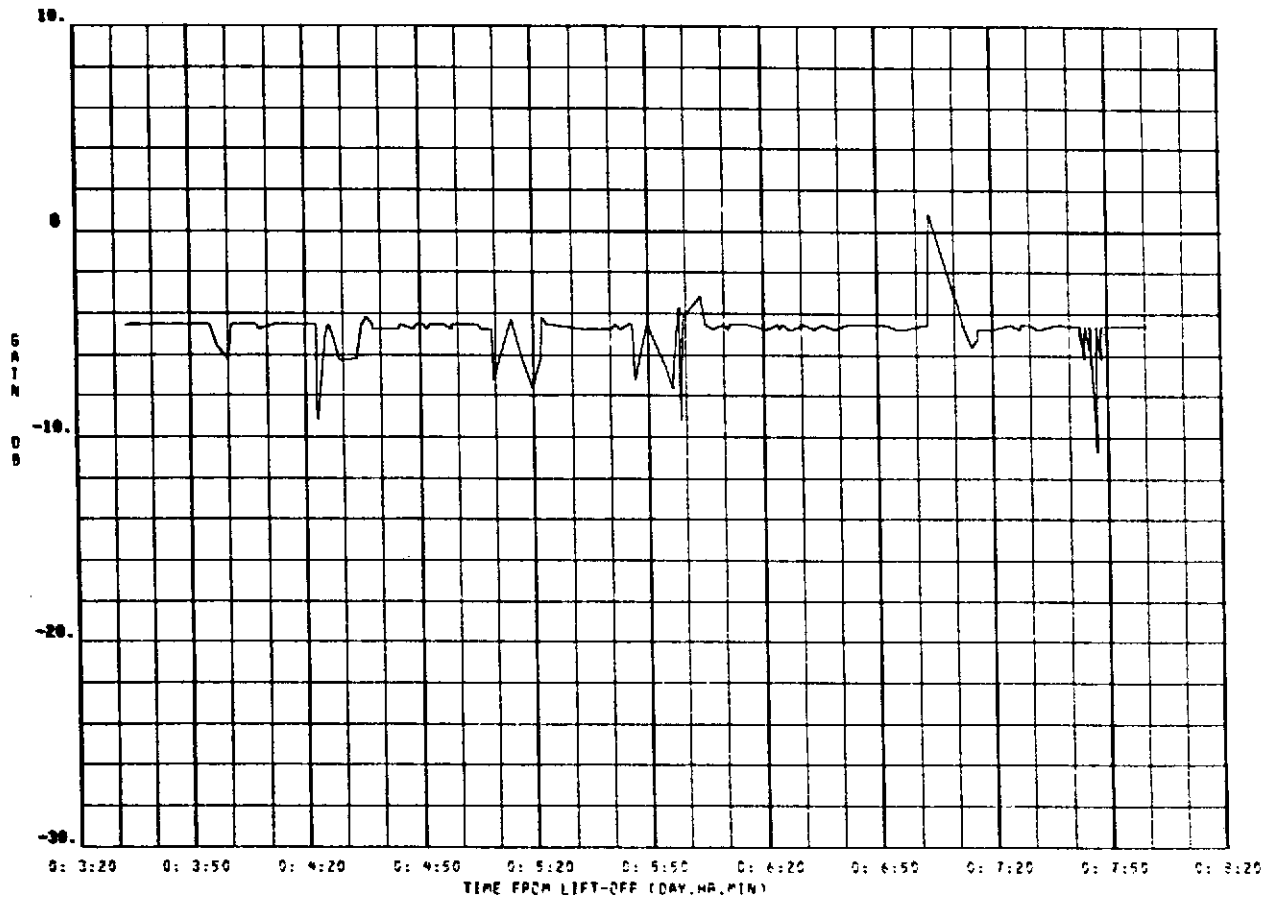

Figure 14. CSM Left Antenna Gain - 296.8 MHz

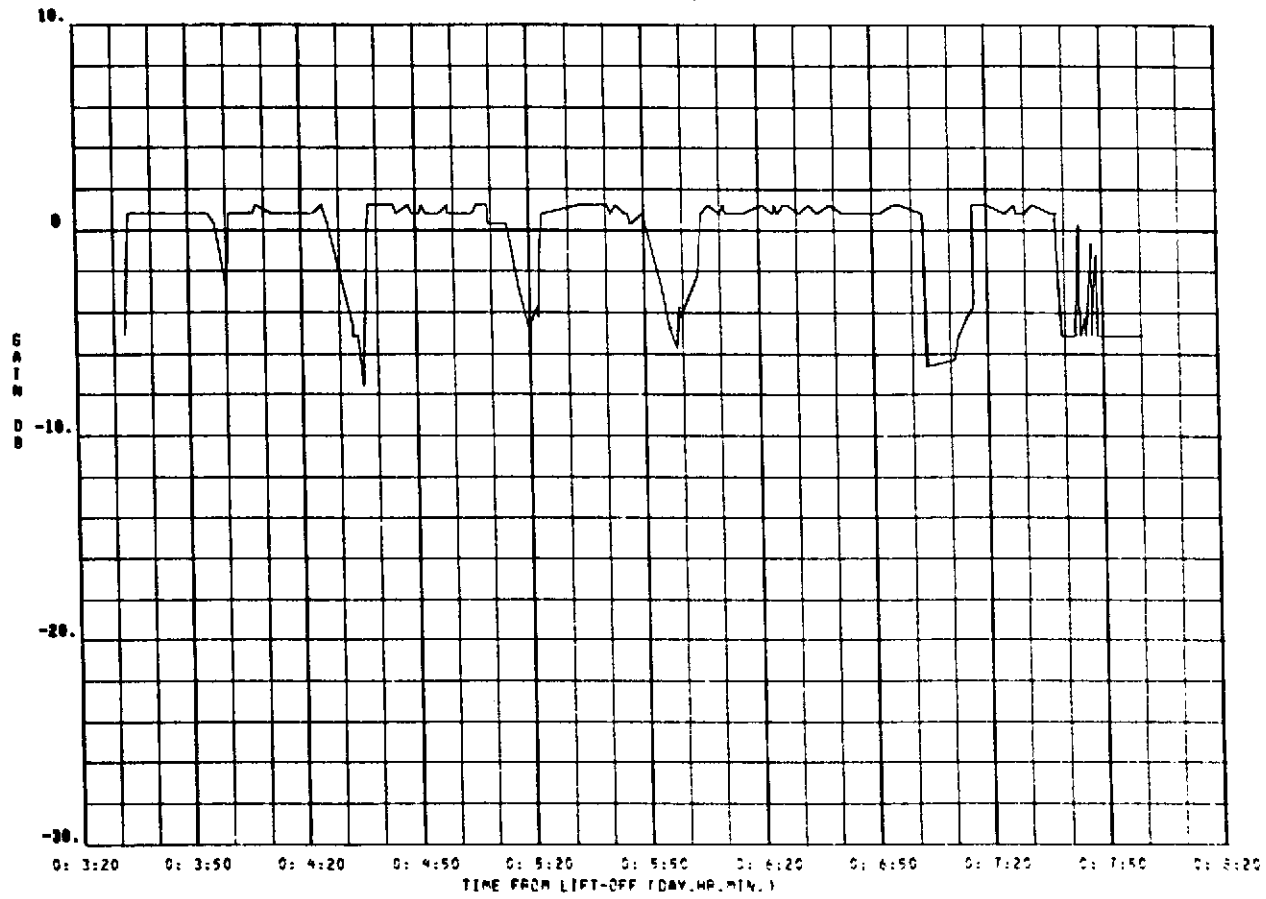

Figure 15. CSM Right Antenna Gain - 296.8 MHz

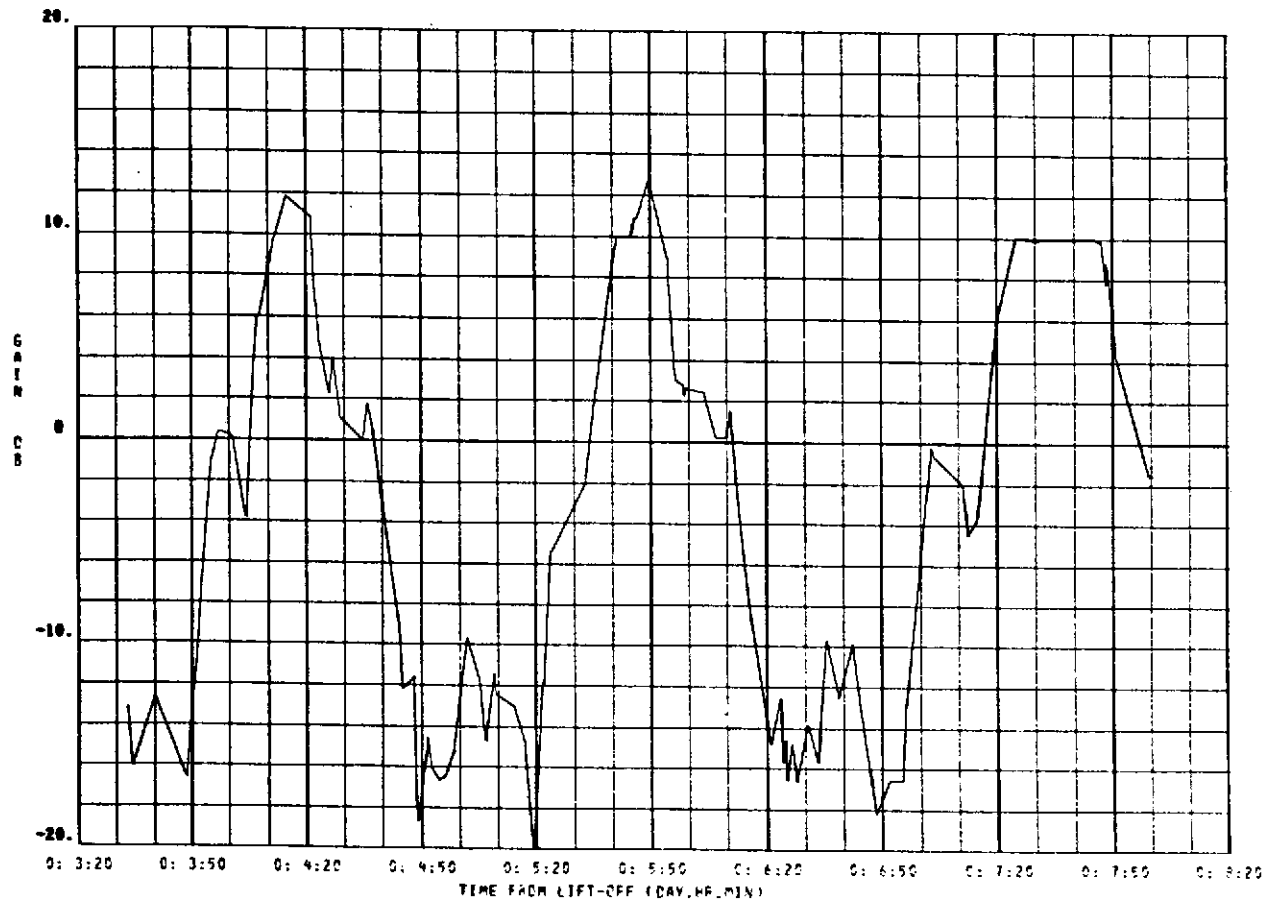

Figure 16. SWS Antenna Gain - 296.8 MHz

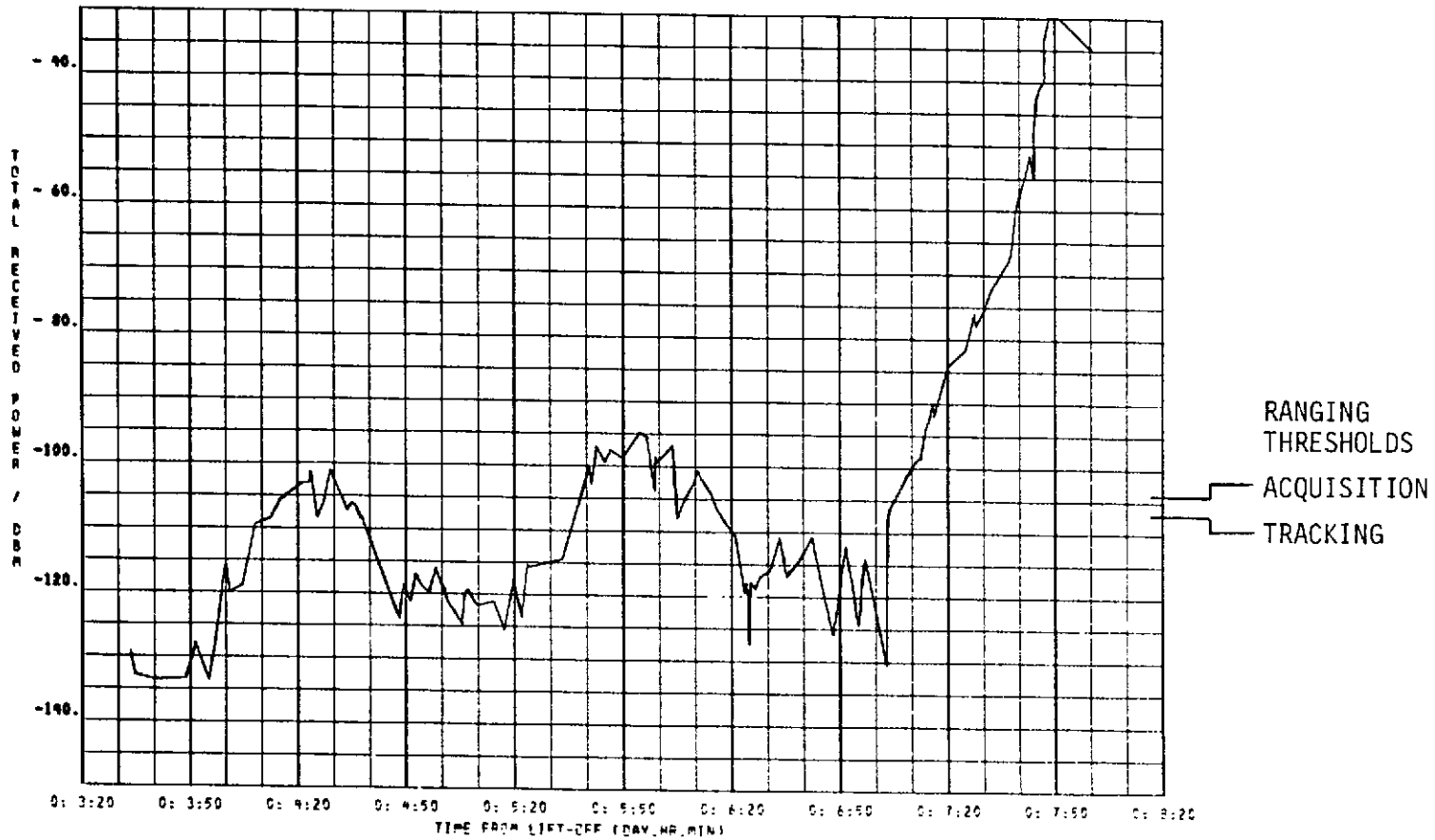

Figure 17. Maximum Received Power - 259.7 MHz - CSM Left and SWS Helix

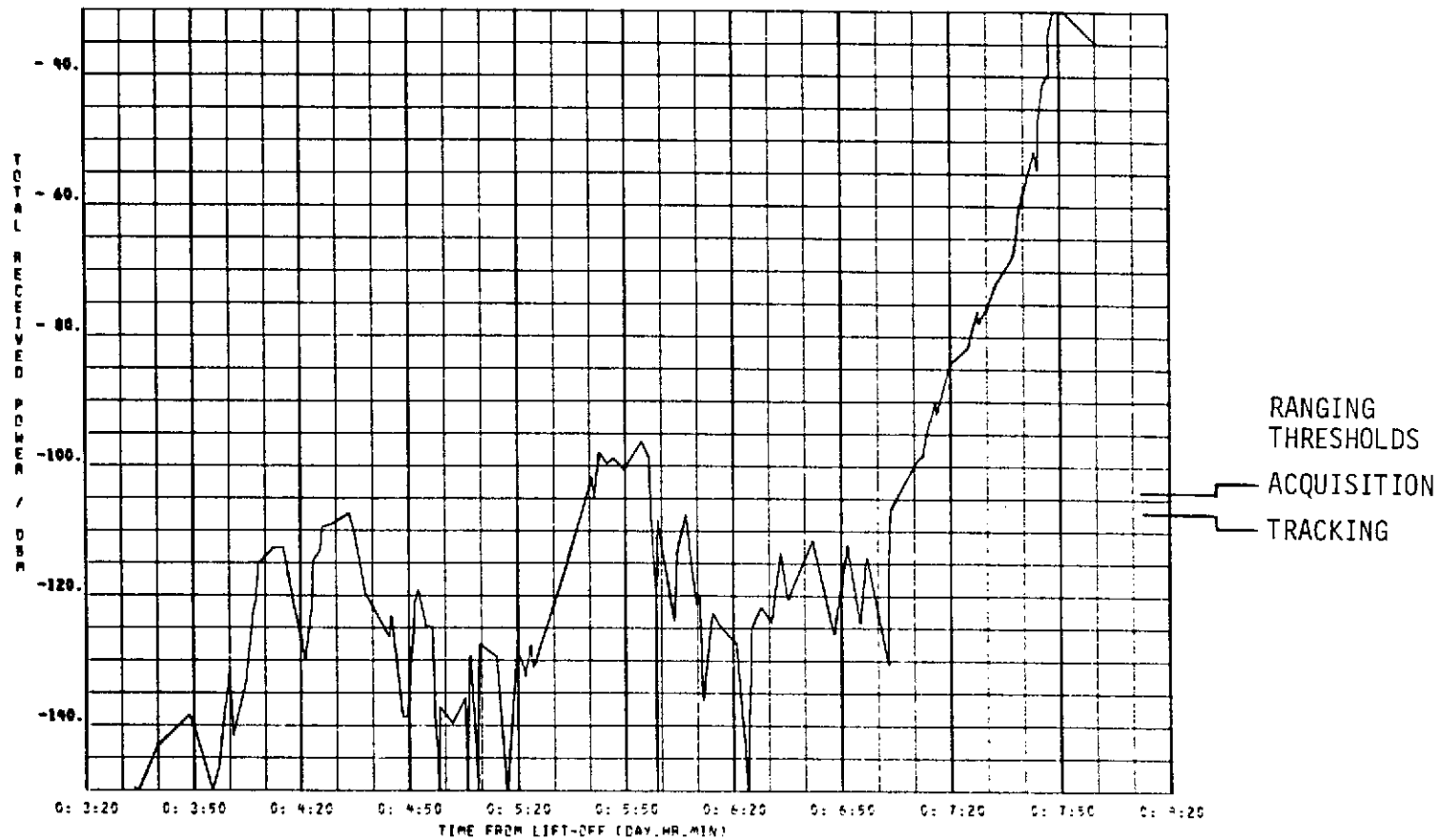

Figure 18. Minimum Received Power - 259.7 MHz - CSM Left and SWS Helix

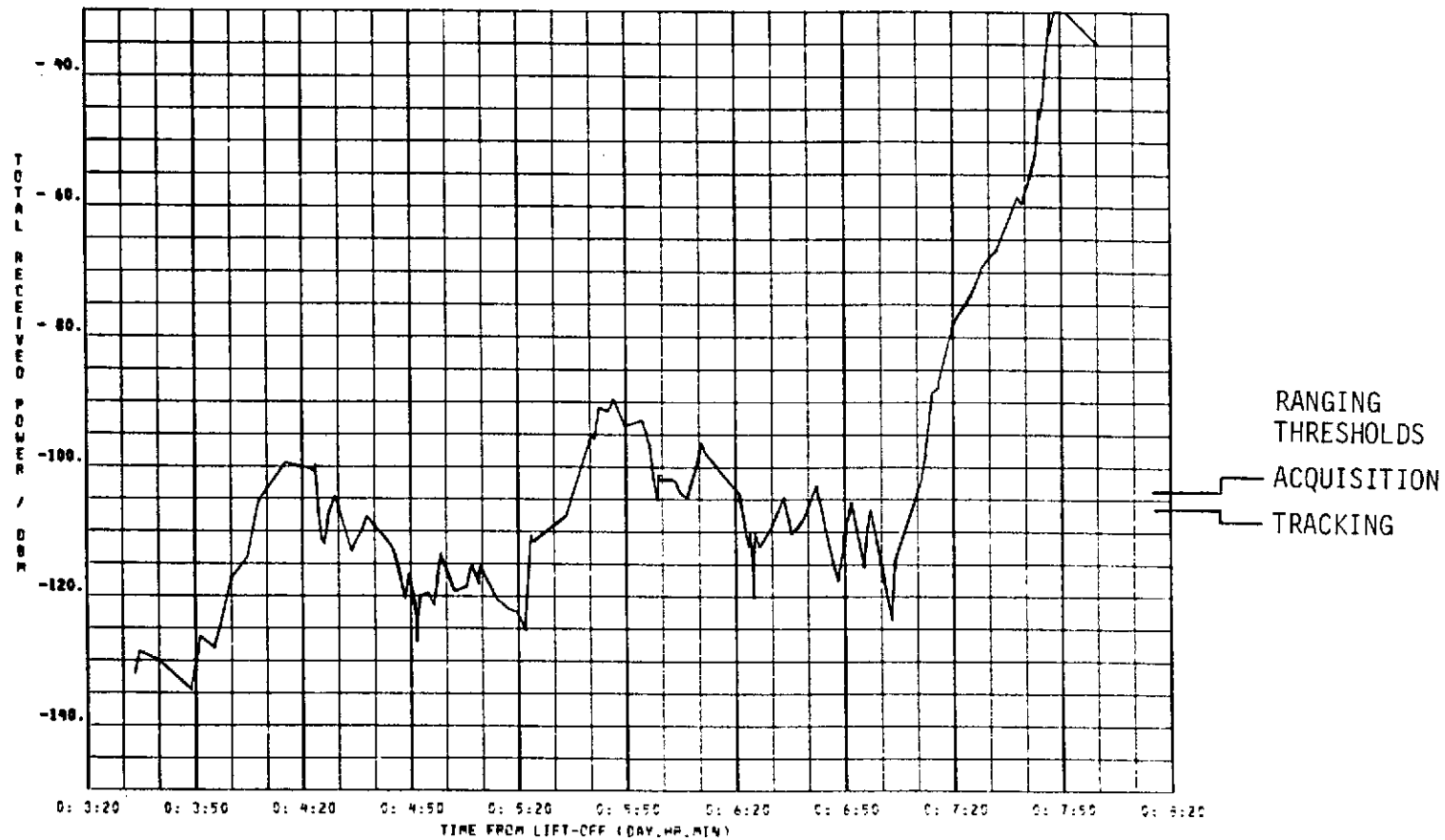

Figure 19. Maximum Received Power - 259.7 MHz CSM Right and SWS Helix

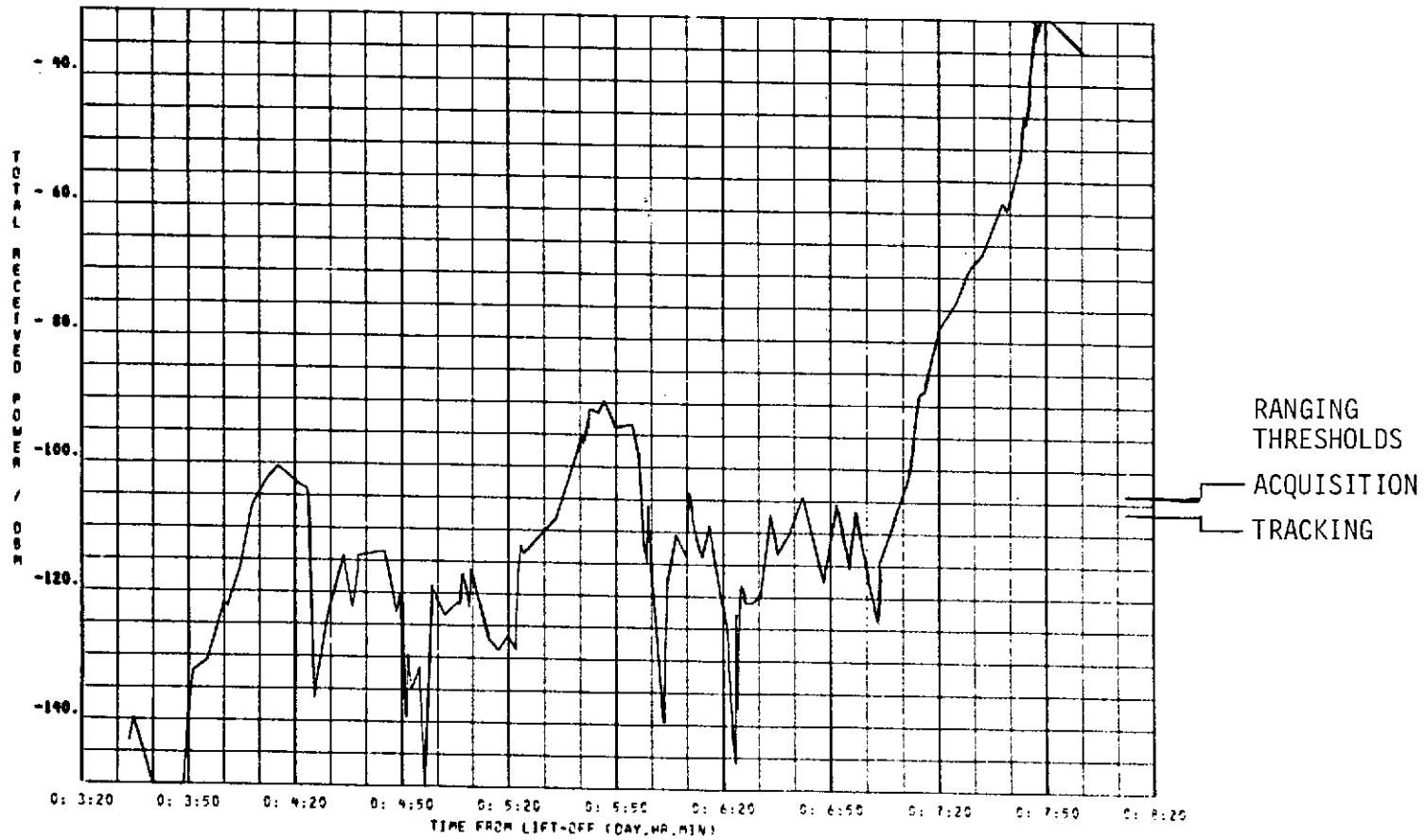

Figure 20. Minimum Received Power - 259.7 MHz - CSM Right and SWS Helix

63

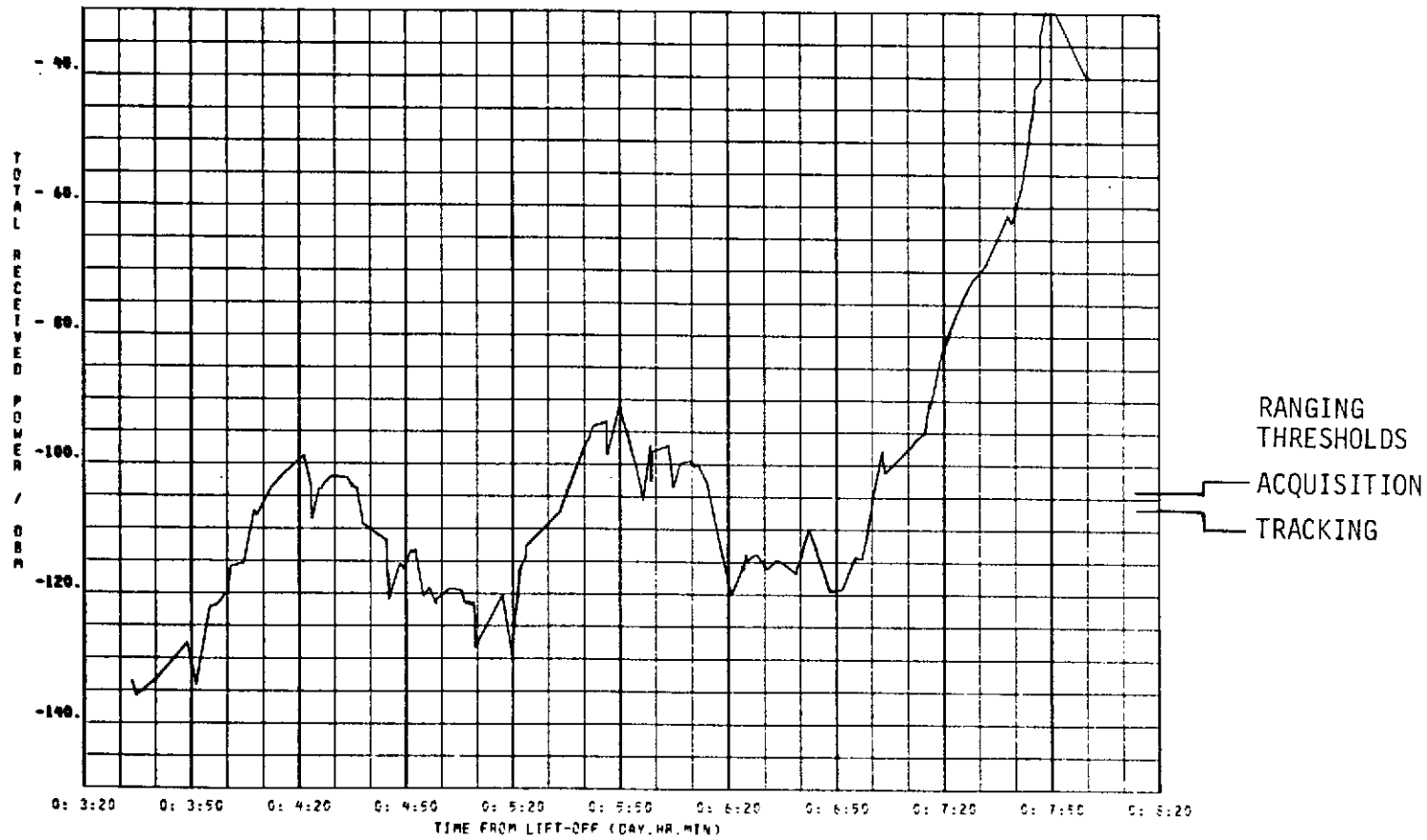

Figure 21. Maximum Received Power - 296.8 MHz - CSM Left and SWS Helix



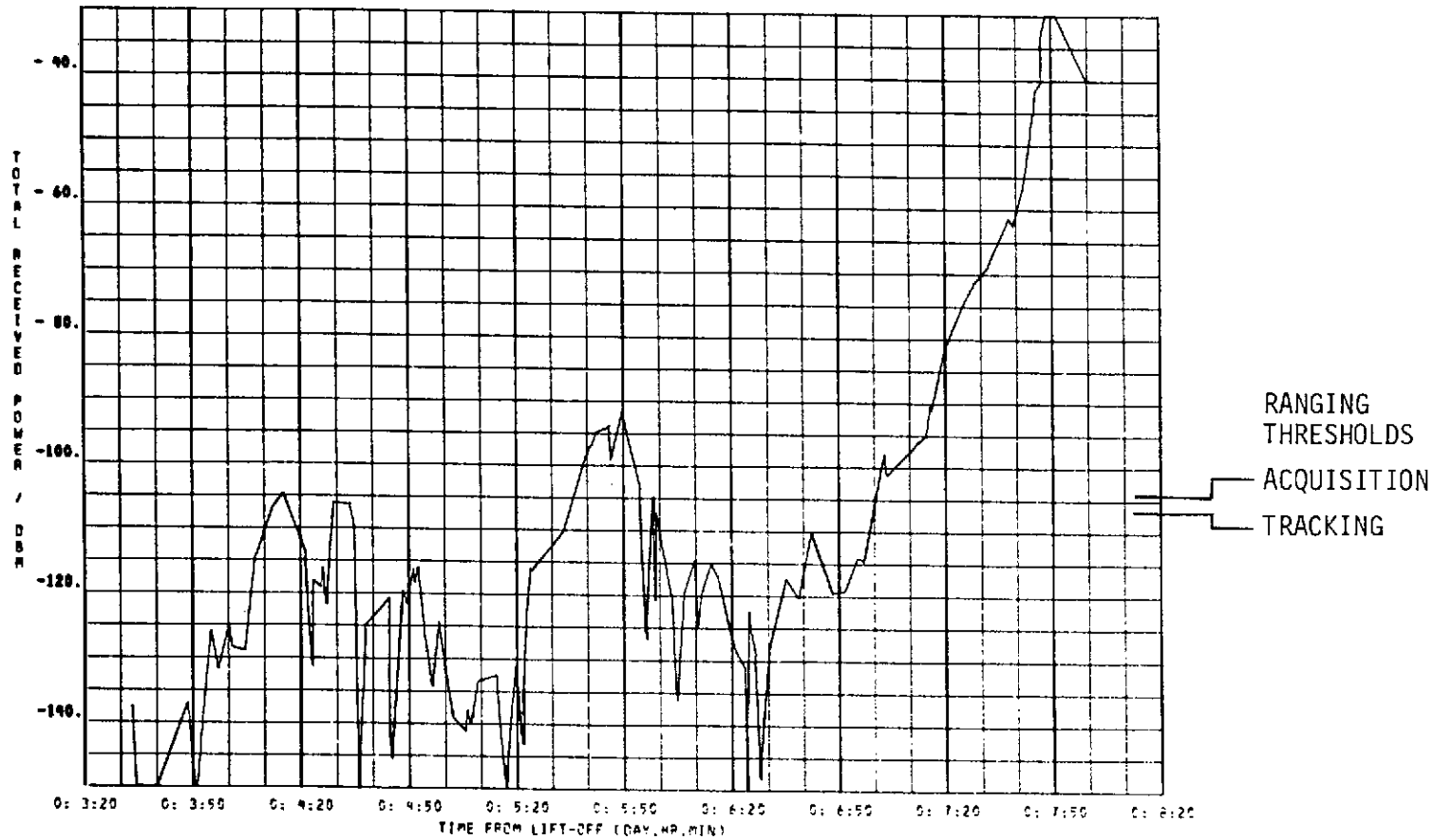

Figure 22. Minimum Received Power - 296.8 MHz - CSM Left and SWS Helix

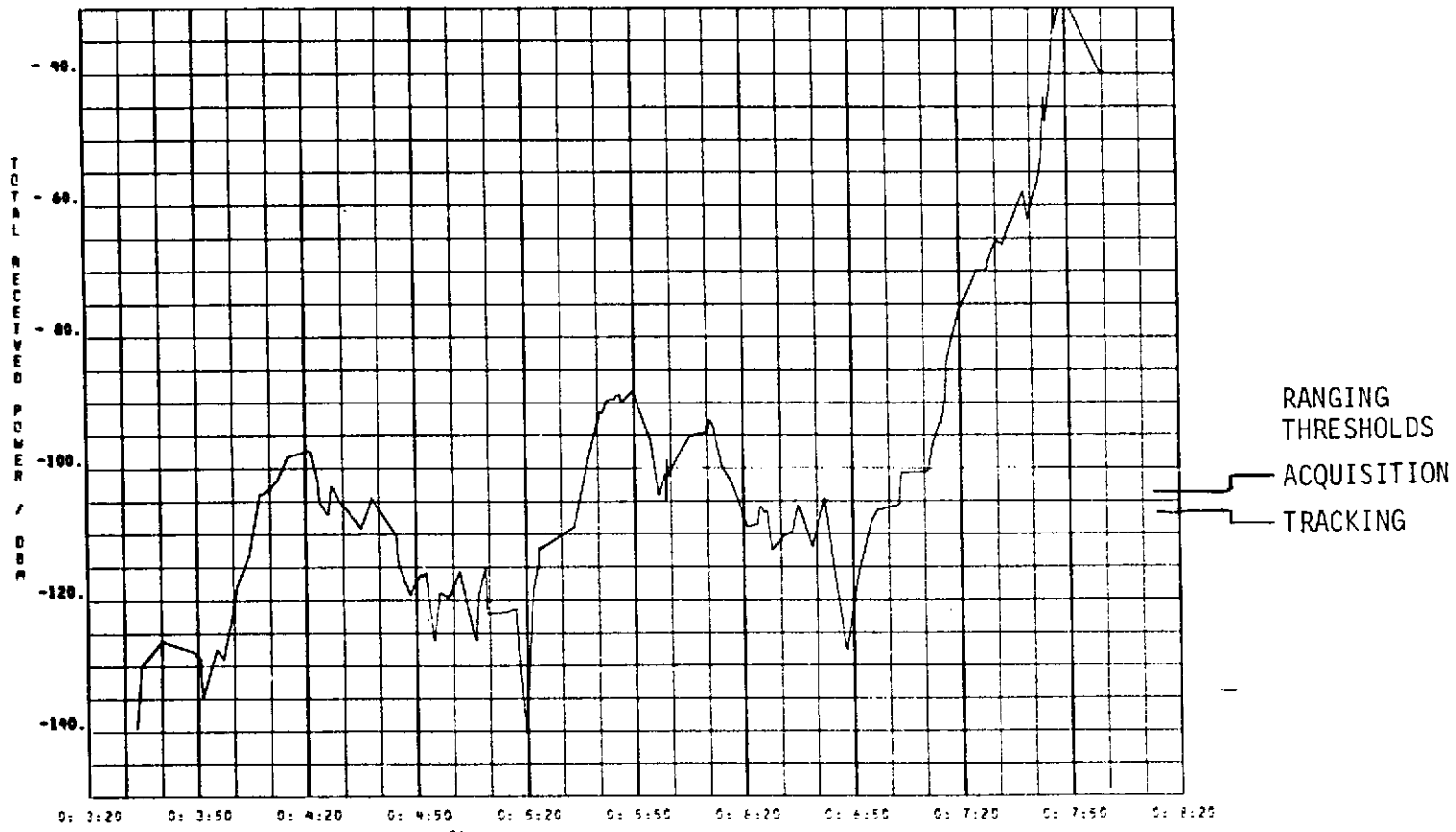

Figure 23. Maximum Received Power - 296.8 MHz CSM Right and SWS Helix

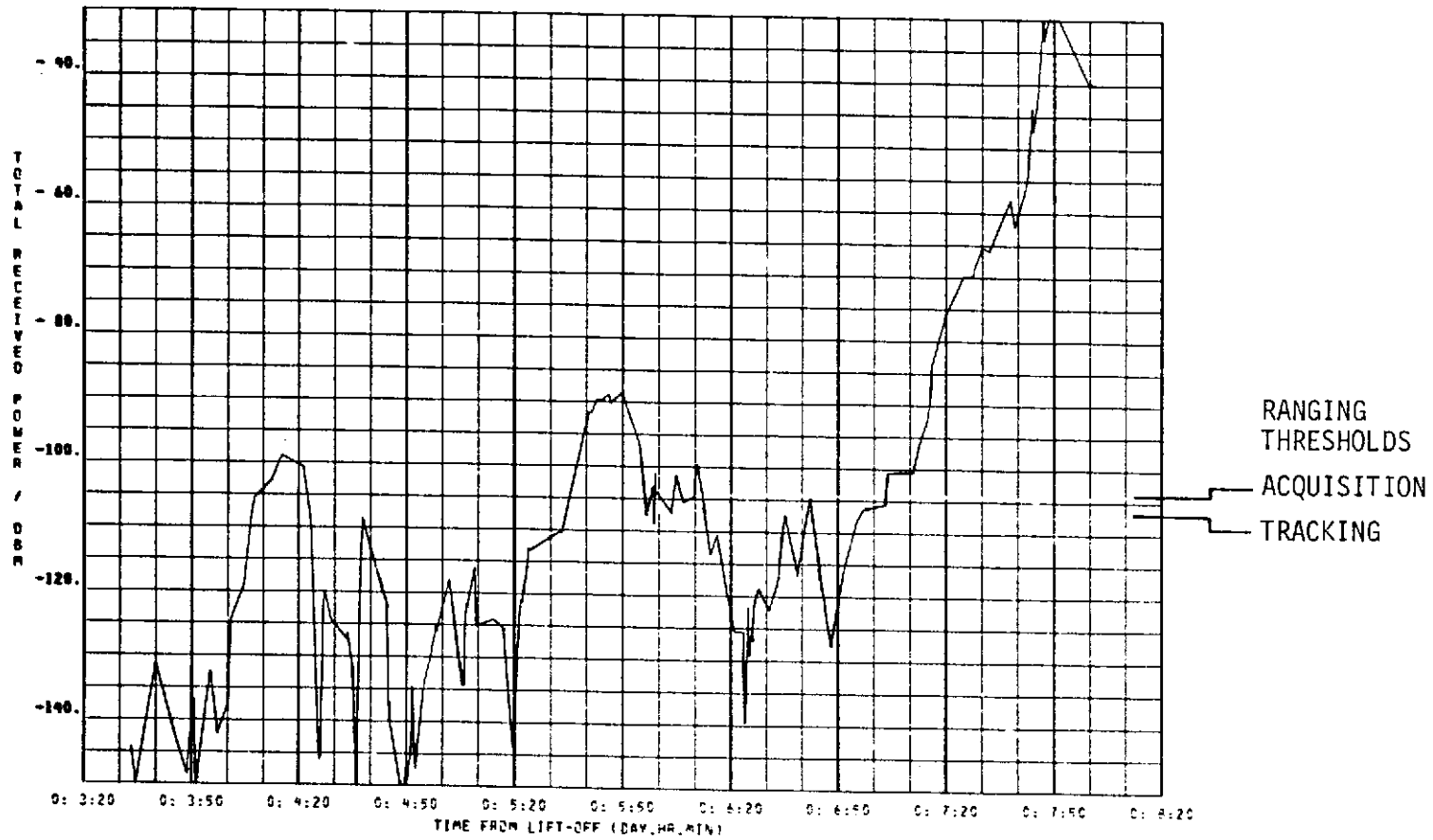

Figure 24. Minimum Received Power - 296.8 MHz - CSM Right and SWS Helix

APPENDIX B  
SYSTEM PARAMETER VALUES

This appendix provides a listing of the parameters used to define the expected performance of the VHF Ranging System during the rendezvous phases of a Skylab mission. The parameters listed in Tables B-1, B-2, and B-3 were used in deriving the data presented in this report. These parameters are the nominal specified values, or measured values where they are available. This information was supplied by NASA/JSC, and no specific references are available.

Table B-1. CSM to SWS VHF Ranging System Parameters

<u>Parameter</u>	<u>Value</u>	<u>Unit</u>
CSM Transmitter Power (Average Modulated)	5.0	Watts
CSM Cable Loss	-3.6	dB
CSM Mismatch Loss	-0.1	dB
SWS Cable Loss	-4.6	dB
SWS Mismatch Loss	-0.2	dB
SWS Diplexer Loss	-0.5	dB

Table B-2. SWS to CSM VHF Ranging System Parameters

<u>Parameter</u>	<u>Value</u>	<u>Unit</u>
SWS Transmitter Power (Average Modulated)	5.0	Watts
SWS Cable Loss	-3.9	dB
SWS Mismatch Loss	-0.1	dB
SWS Diplexer Loss	-0.5	dB
CSM Cable Loss	-3.5	dB
CSM Mismatch Loss	-0.1	dB

Table B-3. Threshold Requirements

<u>Type of Service</u>	<u>Requirement for 0 dB Circuit Margin*</u>	
VHF Ranging	Acquisition	-104 dBm
	Tracking	-107 dBm

\* Thresholds based on average power, not peak power.

## REFERENCES

1. Connelly, L. C., "SL-1/SL-3 Rendezvous Attitude Tape for July 28 SL-3 Launch," TRW Letter No. 6531.9-73-103, 28 June 1973.
2. Robinson, L. H., "Preliminary Skylab VHF Ranging Coverage," TRW Report Number 20029-H161-RO-00, 26 January 1973.
3. Disher, J. H., "The Skylab Communications Systems," AIAA Paper Number 72-543, AIAA 4th Communications Satellite Systems Conference, Washington, D.C., 24-26 April 1972.
4. Benny, A. H., J. C. Harpold, et.al., "Revision 2 to the Skylab Preliminary Reference Trajectory," NASA/MSD Internal Note Number 71-FM-313, 11 August 1971.
5. Besthorn, J. W., "Skylab Antenna Coverage Handbook," (Bendix Corp.), Martin Marietta Corporation, Denver Division, Document Number ED-2002-1120 Rev. B, April 1971.
6. Grins, Z., and I. Kadar, "Computer Program and Mathematical Model for LM Communication Systems Performance Analysis," Grumman Aircraft Engineering Corporation Report Number LED 380-20, 20 May 1968.
7. Kehrman, R. W., and M. R. Ellis, "VHF Communications Analysis Program (VHFCAP) HV014E User's Manual," TRW Report Number 11176-H423-RO-00, Volumes I and II, 19 December 1969.
8. Warren, W. B., "Bimonthly Technical Report, Number 1," TRW Report Number 11176-H010-RO-00, 1 August 1968.
9. Warren, W. B., "Apollo Mission G Spacecraft to Spacecraft VHF Coverage," TRW Report Number 11176-H272-RO-00, 26 June 1969.
10. Pool, J. W., and R. Mireles, "Mathematical Model for VHF Antenna Coverage Analysis of Apollo Missions D & E," TRW Report Number 05952-H431-RO-00, 27 February 1968.
11. Dupree, J. E., "LM-CSM VHF Multipath Analysis," TRW Report Number 11176-H417-RO-00, 10 December 1969.

REFERENCES (Continued)

12. Eisenhauer, D. R., and D. A. James, "Preflight SL-1/SL-2 Skylab VHF Ranging Coverage," TRW Report No. 20029-H183-R0-00, 10 May 1973.
13. Robinson, L. H., Jr., "Revised VHF Ranging Assessment for SL-1/SL-2 with a 25 May 1973 SL-2 Launch," Attachment to "Task E-53H Progress Report for the Period 1 May to 31 May 1973," TRW IOC No. 73:7153.6-84, 29 May 1973.