

NASA/TM-2017-43; 7: 6

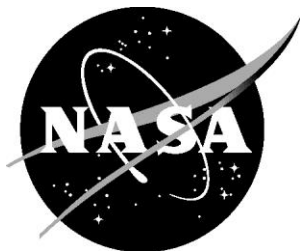

Emergency Locator Transmitter Survivability and Reliability Study

Chad M. Stimson ^{cpf} *Justin D. Littell*
Langley Research Center, Hampton, Virginia

Lisa M. Mazzuca ^{cpf} *Anthony W. Foster*
Goddard Space Flight Center, Greenbelt, Maryland

George J. Theodorakos
ASRC Federal-Space and Defense, Inc., Beltsville, Maryland

February 2017

NASA STI Program . . . in Profile

Since its founding, NASA has been dedicated to the advancement of aeronautics and space science. The NASA scientific and technical information (STI) program plays a key part in helping NASA maintain this important role.

The NASA STI program operates under the auspices of the Agency Chief Information Officer. It collects, organizes, provides for archiving, and disseminates NASA's STI. The NASA STI program provides access to the NTRS Registered and its public interface, the NASA Technical Reports Server, thus providing one of the largest collections of aeronautical and space science STI in the world. Results are published in both non-NASA channels and by NASA in the NASA STI Report Series, which includes the following report types:

- **TECHNICAL PUBLICATION.** Reports of completed research or a major significant phase of research that present the results of NASA Programs and include extensive data or theoretical analysis. Includes compilations of significant scientific and technical data and information deemed to be of continuing reference value. NASA counter-part of peer-reviewed formal professional papers but has less stringent limitations on manuscript length and extent of graphic presentations.
- **TECHNICAL MEMORANDUM.** Scientific and technical findings that are preliminary or of specialized interest, e.g., quick release reports, working papers, and bibliographies that contain minimal annotation. Does not contain extensive analysis.
- **CONTRACTOR REPORT.** Scientific and technical findings by NASA-sponsored contractors and grantees.

- **CONFERENCE PUBLICATION.** Collected papers from scientific and technical conferences, symposia, seminars, or other meetings sponsored or co-sponsored by NASA.
- **SPECIAL PUBLICATION.** Scientific, technical, or historical information from NASA programs, projects, and missions, often concerned with subjects having substantial public interest.
- **TECHNICAL TRANSLATION.** English-language translations of foreign scientific and technical material pertinent to NASA's mission.

Specialized services also include organizing and publishing research results, distributing specialized research announcements and feeds, providing information desk and personal search support, and enabling data exchange services.

For more information about the NASA STI program, see the following:

- Access the NASA STI program home page at <http://www.sti.nasa.gov>
- E-mail your question to help@sti.nasa.gov
- Phone the NASA STI Information Desk at 757-864-9658
- Write to:
NASA STI Information Desk
Mail Stop 148
NASA Langley Research Center
Hampton, VA 23681-2199



Emergency Locator Transmitter Survivability and Reliability Study

Chad M. Stimson ^{cpf} *Justin D. Littell*
Langley Research Center, Hampton, Virginia

Lisa M. Mazzuca ^{cpf} *Anthony W. Foster*
Goddard Space Flight Center, Greenbelt, Maryland

George J. Theodorakos
ASRC Federal-Space and Defense, Inc., Beltsville, Maryland

National Aeronautics and
Space Administration

Langley Research Center
Hampton, Virginia 23681-2199

Errata

Issued May 2018 for

NASA-TM-2017-219584

Emergency Locator Transmitter Survivability and Reliability Study

Chad M. Stimson, Justin D. Littell, Lisa M. Mazzuca, Anthony W. Foster, and George J. Theodorakos

Summary of Changes:

Full-scale Crash Simulation Conclusions summarized in Section 6.3 should call for cabling support intervals not more than 24-in.

Note, the corresponding recommendation found in Table 4 is correct as originally presented and is consistent with practices outlined in [31].

The use of trademarks or names of manufacturers in this report is for accurate reporting and does not constitute an official endorsement, either expressed or implied, of such products of manufacturers by the National Aeronautics and Space Administration.

Available from:

NASA STI Program / Mail Stop 148
NASA Langley Research Center
Hampton, VA 23681-2199
Fax: 757-864-6500

Table of Contents

1	Abstract.....	1
2	Introduction.....	1
3	ELT Performance Review	2
3.1	Historical Performance	2
3.2	Current Performance	3
3.2.1	Australian Transport Safety Bureau	4
3.2.2	Defence Research and Development Canada.....	4
3.2.3	German Fedral Bureau of Aircraft Accident Investigation	4
3.2.4	International Civil Aviation Organization.....	4
3.2.5	New Zealand Civil Aviation Authority.....	5
3.2.6	Selected Aviation Crash Reports.....	5
3.2.7	NTSB Special Study and Enhanced Data Collection.....	6
4	Subsystem Testing.....	7
4.1	Crash Safety Testing	8
4.1.1	Crash Safety Test Objective.....	8
4.1.2	Crash Safety Testing	9
4.1.3	Crash Safety Test Structural Integrity Results	11
4.1.4	Crash Safety Test Functionality Results	12
4.1.5	Summary of Crash Safety Testing	14
4.2	Vibration Testing	14
4.2.1	Vibration Test Objective	15
4.2.2	Vibration Test Conduct.....	15
4.2.3	Reciprocating/Turboprop Vibration Test Results	16
4.2.4	Helicopter Vibration Test Results.....	17
4.2.5	Turbojet/Turbofan Vibration Test Results	17
4.2.6	Summary of Vibration Testing.....	18
4.3	Antenna Cable Testing.....	18
4.3.1	Static Strength Testing Summary.....	19
4.3.2	Dynamic Strength Testing Summary	20
4.3.3	Antenna Cable Strength Testing Summary.....	21
4.3.4	Fire Survivability Testing.....	21
4.3.5	Antenna Cable Fire Survivability Test Objective	22
4.3.6	Antenna Cable Fire Survivability Test Conduct	22

4.3.7	Antenna Cable Fire Survivability Test Results	22
4.3.8	Antenna Cable Fire Surviability Summary	23
5	Full-Scale Crash Testing	23
5.1	Second Transport Rotorcraft Airframe Crash Testbed (TRACT 2)	24
5.1.1	TRACT 2 ELT Test Objective	25
5.1.2	TRACT 2 ELT Test Conduct	25
5.1.3	TRACT 2 ELT Test Results Summary	29
5.2	Airplane Crash Test Series Objective	30
5.2.1	First Airplane Crash Test Conduct.....	31
5.2.2	First Airplane Crash Test Results Summary	32
5.2.3	First Airplane Crash Test Conclusions	35
5.2.4	Second Airplane Crash Test Conduct	35
5.2.5	Second Airplane Crash Test Results Summary.....	36
5.2.6	Second Airplane Crash Test Conclusions	38
5.2.7	Third Airplane Crash Test Conduct	38
5.2.8	Third Airplane Crash Test Results Summary	39
5.2.9	Third Airplane Crash Test Conclusions	42
6	Full-Scale Crash Simulation	42
6.1	Full-Scale Crash Simulation Objective.....	44
6.2	Cable Connector Force Mitigation Techniques	44
6.3	Full-scale Crash Simulation Conclusions	45
7	Conclusion	46
8	Recommendations	47
9	Acknowledgements	49
10	References	50

List of Figures

Figure 1. Vertical Drop Tower at LaRC	8
Figure 2. Crash Safety Test Fixtures (accelerometer highlighted)	9
Figure 3. Representative Crash Safety Test Pulseforms	11
Figure 4. Crash Safety Test - Automatic Activation Rate as a Function of Beacon Orientation	13
Figure 5. Crash Safety Test - Automatic Activation Rate as a Function of Pulseform	13
Figure 6. Vibration Test Facility	14
Figure 7. Vibration Test - Aliveness Pulses Compared to Crash Sensor MOPS	16
Figure 8. Antenna Cable Tensile Test Setup	19
Figure 9. Antenna Cable Connector Failures from Strength Testing	20
Figure 10. Antenna Cable System Dynamic Strength Test Setup	20
Figure 11. Fire Testing of an Antenna Cable without (left) and with (right) a Firesleeve	22
Figure 12. Firesleeve Post-Test Condition	23
Figure 13. TRACT 2 Test Article	25
Figure 14. ELT Experiment Suite Onboard TRACT 2	26
Figure 15. ELT Shelf Onboard TRACT 2	26
Figure 16. ELT Experiment Suite Configuration for TRACT 2	27
Figure 17. ELT Antenna Locations Onboard TRACT 2	28
Figure 18. ELT Acceleration Time-History Onboard TRACT 2	29
Figure 19. Hook-and-Loop Mounting System Behavior During TRACT 2	30
Figure 20. Impact Sequence - Airplane Crash Test 1	31
Figure 21. Beacon Layout - Airplane Crash Test 1	32
Figure 22. Beacon Accelerations - Airplane Crash Test 1	33
Figure 23. Relative Timing of ELT Visual Status Indications	34
Figure 24. Impact Sequence – Airplane Crash Test 2	35
Figure 25. Beacon Layout - Airplane Crash Test 2	36
Figure 26. Beacon Accelerations - Airplane Crash Test 2	36
Figure 27. Antenna Cable Damage Observed After Airplane Crash Test 2	37
Figure 28. Impact Sequence - Airplane Crash Test 3	38
Figure 29. Beacon Layout - Airplane Crash Test 3	39
Figure 30. Beacon Accelerations - Airplane Crash Test 3	40
Figure 31. Cutaway View of G-switch Assemblies	41
Figure 32. G-switch Variation Between ELT 2 (left) and ELT 4 (right)	41
Figure 33. Damaged Antenna Cables - ELT 3 (left), Dummy 1 (center), Dummy 2 (right)	42
Figure 34. Simulation of Second Airplane Crash Test	43
Figure 35. Half-Model Showing Internal Details	43
Figure 36. Comparison of Dynamic Cable Connector Forces for Taut and Slack Conditions	44

List of Tables

Table 1. Summary of General Conclusions [2]	3
Table 2. NTSB Special Study Case Summary	7
Table 3. ELT Performance Summary by TSO	7
Table 4. Summary of MOPS Recommendations	47

List of Acronyms

AF – Automatic-Fixed
AHS – American Helicopter Society
ATD – Anthropomorphic Test Device
ATSB – Australian Transport Safety Bureau
BFU – German Federal Bureau of Aircraft Accident Investigation
BNC – Bayonet Neill-Concelman
CAA – Civil Aviation Authority
CFC – Channel Frequency Class
DAS – Data Acquisition System
EASA – European Aviation Safety Agency
ELT – Emergency Locator Transmitter
EUROCAE – European Organisation for Civil Aviation Equipment
FAA – Federal Aviation Administration
FEM – Finite Element Model
GA – General Aviation
GEO – Geostationary Earth Orbit
GSFC – Goddard Space Flight Center
ICAO – International Civil Aviation Organization
IRIG – Inter-Range Instrumentation Group
LaRC – Langley Research Center
LandIR – Landing and Impact Research Facility
LEO – Low Earth Orbit
LUT – Local User Terminal
MEO – Medium Earth Orbit
MIL-DTL – Military Detail Specification
MOPS – Minimum Operational Performance Specification
NASA – National Aeronautics and Space Administration
NOAA – National Oceanic and Atmospheric Administration
NTSB – National Transportation Safety Board
RTCA – Radio Technical Commission for Aeronautics
SAE – Society of Automotive Engineers
SAR – Search and Rescue
SARSAT – Search and Rescue Sattelite Aided Tracking
SC – Special Committee
TRACT 2 – Second Transport Rotorcraft Airframe Crash Testbed
TSB – Transportation Safety Board of Canada
TSO – Technical Standard Order
VSWR – Voltage Standing Wave Radio
WG – Working Group

1 Abstract

A comprehensive study of Emergency Locator Transmitter (ELT) performance was conducted over a three year period concluding in 2016 in support of the Search and Rescue (SAR) Mission Office at National Aeronautics and Space Administration (NASA) Goddard Space Flight Center (GSFC). The study began with a review of reported performance cited in a collection of works published as early as 1980 as well as analysis of a focused set of contemporary aviation crash reports. Based on initial research findings, a series of subscale and fullscale system tests were performed at NASA Langley Research Center (LaRC) with the goals of investigating ELT system failure modes and developing recommended improvements to the Radio Technical Commission for Aeronautics (RTCA) Minimum Operational Performance Specification (MOPS) that will result in improved system performance. Enhanced performance of ELT systems in aviation accidents will reduce unnecessary loss of human life and make SAR operations safer and less costly by reducing the amount of time required to locate accident sites.

2 Introduction

The subject of ELT performance in aviation accidents has been a topic of interest for the aviation community over the past several decades. Although iterations on the ELT MOPS have resulted in performance increases in latest generation systems, further gains can be made through implementation of empirically-based upgrades to the MOPS that will govern future installations of ELT systems.

It is for these reasons that the NASA SAR Mission Office endeavored to study the complete ELT system operational environment, determine the primary issues that may preclude successful operation, and define an approach to improving future systems. Because of its rich history in aviation safety research and unique facilities to support the effort, the resulting study was performed at NASA LaRC.

This document is organized to describe each phase of the ELTSTAR Study as follows:

- Section 3 discusses ELT performance as detailed in a variety of studies over time and around the world. Based on the findings resulting from a review of these sources, and others, a series of laboratory tests were designed for the purpose of studying primary failure modes reported to inhibit successful operation of ELT systems in aviation accidents.
- Section 4 describes the resulting subsystem tests listed below. Test conduct, observations, and resulting recommendations for future MOPS are summarized.
 - Crash Safety Testing - The primary objective was to assess ELT system performance under a set of loading conditions that were representative of actual aviation crash environments. This assessment included both structural (mounting) and functional (automatic activation) aspects of ELT systems.
 - Vibration Testing - The primary objective of vibration testing was to identify a vibration test environment applicable to ELTs that may reproduce the failure mode related to crash sensor vibration sensitivity.

- Antenna Cable Testing - The primary objective was to assess the strength and fire survivability of ELT antenna cable systems
- Section 5 describes ELT system performance onboard a series of four fullscale airframe crash tests performed under the ELTSAR Study at LaRC in 2014 and 2015. Test objectives included obtaining real-world ELT crash performance data, establishing an airframe response database for analysis model calibration and supporting recommendations to RTCA & the European Organisation for Civil Aviation Equipment (EUROCAE) regarding ELT system installation.
- Section 6 describes Finite Element Models (FEMs) of each airplane that were developed and calibrated using the airframe response data obtained from the fullscale crash testing. Once calibrated, the models provided simulation testbeds that were used to assess a wider array of ELT installation techniques and configurations than had been tested.
- Finally, Sections 7 and 8 summarize the conclusions and pragmatic recommendations for improved MOPS that were derived from the results of the study.

These recommendations have been presented to the joint RTCA Special Committee 229 (SC-229) and EUROCAE Working Group 98 (WG-98) for consideration for adoption in the future revisions of ELT MOPS. These recommendations, should they be adopted, will increase the success of SAR operations, while also reducing the associated cost and risk.

3 ELT Performance Review

The approach to conducting ELT performance research during the initial phase of the study consisted primarily of literature review of other publically available studies, articles and crash reports published by a variety of sources from around the world. Although some of the more detailed studies proved to be insightful, they were dated and therefore not relevant in supporting the primary objectives of this study. Accordingly, the initial research phase was further subdivided into *Historical* and *Current Performance* categories.

3.1 Historical Performance

A study prepared for NASA by the Atlantic Research Corporation summarized ELT performance after a thorough review of thousands of aviation crash reports and special studies conducted throughout the 1970's and 1980's [1]. As such, the ELTs included in the study were manufactured in accordance with Federal Aviation Administration (FAA) Technical Standard Order (TSO) - C91.

Some key takeaways from the study include high rates of non-activation (70%), false alarm (97%) and the loss of 58 human lives per year due to ELT system and/or installation failure. These results were generally attributed to component robustness, environmental factors, g-switch (crash sensor) reliability, and lack of an effective inspection and maintenance program. The benefits associated with implementation of FAA TSO-C91a were presented, based on assumptions as to the effectiveness of a number of recommendations for addressing the primary failure modes discussed.

The Crash Research Institute prepared a study for NASA in 1980 that focused on assessing ELT performance from a systems perspective [2]. The review included 1,135 General Aviation (GA) accidents and aimed to produce data to assist in the establishment of installation and mounting criteria, improved design standards for automatic crash sensing/activation subsystems, and crashworthiness requirements. The “Summary of General Conclusions” are reproduced in the following table for convenience.

Table 1. Summary of General Conclusions [2]

1.	In order to have the highest probability of operating properly after a general aviation fixed-wing accident, any ELT should:
	a. be capable of operation in any aircraft attitude.
	b. be mounted as far aft as possible.
	c. have some degree of crashworthiness, including fire resistance.
	d. be securely fastened in its mount and connected to an antenna as nearby as possible, preferably integral with the ELT, and external to the airframe.
	e. sense the crash as far forward in the aircraft as possible.
2.	Increased enforcement of regulations could reduce the 8% violation rate of ELT installation rules (carriage requirements), and the 5% having expired batteries.
3.	The NASA 406 MHz ELT should be designed with this data in mind, incorporating as many of the following provisions as possible:
	a. crashworthy and fire resistant.
	b. integral, external antenna.
	c. aft location for ELT.
	d. forward location for sensing crash.
	e. semi-permanent mount, no quick disconnect.
	f. remote cockpit control and testing.

Conclusions 3c and 3d in the above table point to a system design in which the crash sensor is not integral to the beacon. This is due to the competing environmental factors related to crash-sensing and crashworthiness. Crash-sensing is generally improved in the forward stations of a fixed-wing aircraft, where crash loads tend to be higher, while crashworthiness is generally improved in the aft sections.

In other words, the very protection provided by locating an ELT beacon in the aft section of an aircraft may serve to undermine its functionality related to crash-sensing and automatic activation. Therefore, when the crash-sensing and distress transmission functions are integrated into a single unit, a trade must be made between crashworthiness and crash-sensing performance when determining the installation location for the beacon. Typically, current designs include integral crash sensors and the current MOPS recommend installing the beacon in the aft-section of the aircraft.

3.2 Current Performance

Since a number of MOPS updates were made subsequent to the historical performance summary discussed above, emphasis is placed on more recently published works and a selected set of these

studies is summarized in the following subsections. Furthermore, a focused set of aviation crash reports was studied and is presented at the conclusion of this section.

3.2.1 Australian Transport Safety Bureau

A study performed by the Australian Transport Safety Bureau (ATSB) investigated the effectiveness of ELTs in aviation accidents over the period 1993-2012 [3]. The successful activation rate of ELTs was estimated to be 40%-60%, however, the uncertainty was noted to be high due to the lack of information contained in crash reporting. For example, ELT fitment was unknown in 69% of the 1,691 cases studied. Information regarding the TSO under which the subject ELTs were manufactured was not provided as part of this study. However, it is possible that the results represent a cross-section of all ELT designs and that the actual performance of late generation ELTs may be on the high side of the published estimate.

The report continued to detail a number of cases of ELT non-activation in “high-g accidents” and photographs of notable cases are provided. The reasons for failure in the case studies presented include: incorrect installation, disconnected antenna, fire damage, water submersion, antenna shielded by post-crash environment, and “indeterminate”.

3.2.2 Defence Research and Development Canada

Defence Research and Development Canada published a study of ELT performance in aviation accidents over the period 2003-2008 [4]. Similar to the ATSB findings, the study concluded that there was a low rate of sufficient ELT performance data in crash investigation reports as only 13% of the 1,301 cases studied included adequate information from which performance conclusions could be drawn.

Successful activation of ELTs was determined to be 74% (64% by automatic means) and a false alarm rate of 90% was cited. Suggested areas for ELT performance improvement were presented, including: crash impact survivability, fire survivability, survivability of the connecting coaxial cable (external antenna cable), survivability of the antenna, survivability and operation on submersion in water, and improved educational efforts aimed to address human factors issues.

3.2.3 German Federal Bureau of Aircraft Accident Investigation

The German Federal Bureau of Aircraft Accident Investigation (BFU) presented a summary of six aviation accident case studies to the Cospas-Sarsat Experts Working Group in 2011 [5]. In five of these accidents, the ELT antenna was disconnected from the beacon due to crash forces and some of these events were human-survivable. Later investigation showed that the beacons were operational, which points to antenna connection survivability as an area of concern.

3.2.4 International Civil Aviation Organization

A safety recommendation was made to the International Civil Aviation Organization (ICAO) that ELTs should include an additional internal antenna, or the external antenna should be designed in a way that the emission of the emergency signal is ensured after an accident. Similar safety recommendations were sent to the FAA and European Aviation Safety Agency (EASA).

ICAO raised the issue of ELT performance and data reporting in accident investigations over the period 2000-2010 at the 45th Session of the Cospas-Sarsat Council [6]. Similar to other studies, it was shown that ELT information was largely missing from crash reports as 97% of the 4,291 cases studied contained no ELT information at all. Furthermore, reliability in ELT performance was noted to be unacceptably low.

3.2.5 *New Zealand Civil Aviation Authority*

Through interactions with ELT system and component manufacturers throughout the present study, the issue of vibration sensitivity became an area for further consideration. Some ELT g-switch designs have been prone to mechanical wear that would ultimately impede their successful operation after undetermined exposure to in-service vibration environments. This issue was documented by the Civil Aviation Authority (CAA) of New Zealand in 2010, and although the cited publication refers to one specific brand of ELTs, the g-switch used in that particular unit was common to many other brands as well [7].

3.2.6 *Selected Aviation Crash Reports*

One of the more widely publicized and well documented GA accidents of recent history was the crash in Aleknagik, Alaska on 9 August 2010 due to the high profile nature of two of the passengers. In total, the pilot and 4 of the 8 passengers were fatally wounded by the crash. A detailed report was published by the National Transportation Safety Board (NTSB) that includes a description of the ELT [8].

Investigators determined that the ELT failed to transmit a distress signal because it had become dislodged from its mounting tray due to crash forces, thus disconnecting the external antenna from the beacon. Investigators later found that the beacon functioned properly when tested and concluded that had it not become detached from its antenna, the ELT would have been capable of transmitting detectable distress signals.

In response to the ensuing NTSB Safety Recommendation, A-10-170, FAA determined that hook-and-loop fasteners should no longer be permitted as a means of satisfying crash safety requirements for qualifying new ELT designs. This requirement is included in the latest revision to the TSO governing first generation 406 MHz ELT designs, C126b [9].

Another detailed GA crash report involving beacon ejection and antenna disconnection was published by the Transportation Safety Board of Canada (TSB) in 2013 [10]. As with the Alaska incident summarized above, this case also involved an ELT design utilizing a hook-and-loop fastener, which was side-wall mounted to the airframe as a means of beacon retention.

The theme of beacon mounting hardware failure was again highlighted in an accident report released by NTSB in 2013, which described the crash of a GA airplane in which no ELT signals were detected by SAR because the ELT “*had become separated from the airplane’s structure (and thus its antenna) during the impact sequence*” [11]. The report continues to state that, “*pilot’s injuries fell within the “severely” injured category, and analysis of emergency evacuation and*

trauma treatment resources revealed that with prompt ELT notification, medical response would have been greatly augmented, and he may have survived the accident”.

An additional focus area identified through literature review was fire protection, which was motivated in part by several human-survivable aviation accidents [12]-[15]. Each of these 4 cases involved extreme post-crash fire, at least 1 survivor, and an ELT that did not function because it was overcome by the flames. Fortunately for the survivors, the crash sites were not in remote locations and they were rescued by observers and local emergency units.

3.2.7 NTSB Special Study and Enhanced Data Collection

In order to increase the amount of useful ELT performance data, NASA met with the NTSB to discuss the need for enhanced data collection and a focused set of crash reports to augment the current study. At that time, the NTSB was in the process of developing an update to its aviation accident report form that would include several fields for accident investigators to populate related to the exact make, model and TSO of ELT that was involved in the accident [16]. The form update would also provide documentation of ELT performance and observed or suspected reasons for failure, if applicable.

NTSB provided a database of 469 accidents and incidents over the prior 5 year period (2009-2014). Although the aviation accident report form in use during that period did not contain the enhancements discussed above, useful information related to ELT performance was found in a portion of the reports. This database was sorted in order to identify and study accidents that resulted in injury or fatality and included a later generation ELT (TSO-C91a, or later).

These criteria resulted in 62 cases of interest (13% of the total set). The primary reasons for such a low number of cases for further study is that, as has been noted in previous studies, little to no ELT information is included in the vast majority of accident reports. This is expected to improve, however, with implementation of the NTSB’s new accident reporting form. In addition, the majority of in-service ELTs continue to be of older vintages [17], which further reduced the number of usable cases.

The make and model of each aircraft involved in the 26 cases of interest where the ELT did not activate was recorded. No correlation between ELT performance and a particular aircraft make or model was identified. Rather, the set simply mirrored a generic cross section of the class of airplanes that constitute the majority of aviation accidents, which is GA [18]. In light of this finding, procurement efforts related to full-scale airplane crash testing to be performed later in the study were focused on the Cessna 172 series, the most common GA aircraft historically, as a suitable test article to represent a typical GA airplane crash.

Table 2 and Table 3 summarize the data analysis portion of the special study. As shown in Table 3, the later generation ELTs (C91a + C126) were confirmed to have not operated in 26 accidents of significant severity compared to 36 cases where successful operation was confirmed, resulting in a 58% success rate. This result is consistent with findings from other sources discussed previously, despite the relatively small population size.

The make and model of each aircraft involved in the 26 cases of interest where the ELT did not activate was recorded. No correlation between ELT performance and a particular aircraft make or model was identified. Rather, the set simply mirrored a generic cross section of the class of airplanes that constitute the majority of aviation accidents, which is GA [18]. In light of this finding, procurement efforts related to full-scale airplane crash testing to be performed later in the study were focused on the Cessna 172 series, the most common GA aircraft historically, as a suitable test article to represent a typical GA airplane crash.

Table 2. NTSB Special Study Case Summary

Unique Events		ELT Operated			Reason for Non-activation (Possibly multiple per event)						
		Y	N	U	Low G's	Water	Un-armed	Antenna Dis-connected	Fire	Impact	Unk.
Accident	455	138	296	21	74	6	4	1	20	26	193
Incident	14	0	14	0	14	0	0	0	0	0	0
TOTAL	469	138	310	21	88	6	4	1	20	26	193

Table 3. ELT Performance Summary by TSO

	Unknown	C91	C91a	C126	C91a + C126
Injurious or Fatal Accidents	86	33	45	23	68
ELT Operated	22	17	24	12	36
ELT Did Not Operate	61	14	18	8	26
ELT Operation Unknown	3	2	3	3	6

4 Subsystem Testing

In light of the lessons learned during initial research and interaction with ELT manufacturers, the current ELT MOPS [19] were reviewed and a series of laboratory tests were designed to investigate ELT performance under a set of environments that were suspected of governing the particular failure modes of interest. The series of tests included crash safety (vertical drop tower), vibration, antenna cable system strength, and antenna cable fire survivability.

4.1 Crash Safety Testing

Crash safety testing was performed on a variety of commercially available ELTs representative of typical Automatic-Fixed (AF) GA systems. A total of 287 tests were conducted using the 14-ft vertical drop tower facility at LaRC, which is shown in Figure 1.



Figure 1. Vertical Drop Tower at LaRC

4.1.1 Crash Safety Test Objective

The motivation for performing these tests was in response to several well-documented cases of ELT mounting failures and non-activation in human survivable crashes as summarized in the preceding sections.

The primary objective of crash safety testing was to assess ELT system performance under a set of loading conditions that were representative of actual aviation crash environments. This assessment included both structural and functional aspects of ELT systems, whereas current performance standards do not include demonstration of functionality during the simulated crash event.

The reason for including mounting systems that used hook-and-loop fasteners was to identify a set of test conditions that may replicate the documented failure mode of beacon ejection and antenna disconnect. These systems continued to be available for purchase subsequent to issuance of C126b because the TSO only precluded hook-and-loop fasteners in qualification of new designs.

4.1.2 Crash Safety Testing

The set of ELTs tested was comprised of 6 different models from a total of 4 manufacturers and included a representative sample of the types of crash sensor and beacon mounting designs that were available to consumers at the time.

In contrast to the testing specified in the current ELT MOPS for crash safety, NASA testing included:

- Simultaneous multi-axial loading of the beacon instead of uni-axial
- Variety of load profiles instead of a single load profile
- Automatic activation monitoring during environment exposure instead of beacon aliveness, which only requires a post-environment self-test, as defined in [19]

The load cases were randomized throughout the series with respect to each unit tested.

A pair of fixtures were fabricated and installed as shown in Figure 2. Each fixture provided four mounting planes: horizontal (up or down); left-side; right-side; and 45° (up or down) with respect to vertical. Interface holes were added to allow for clocking of the beacon within the mounting planes at 45° increments. An accelerometer was mounted to the drop mass for measuring the crash pulse and is highlighted in the view below.

With the beacon mounted to either of the 45° angle plates, or clocked at a 45° orientation on either of the triangular-shaped, side-facing plates shown in Figure 2, simultaneous multi-axis loading was imparted with respect to the beacon primary directions. This was a key test parameter since the dynamic loading experienced by an ELT involved in a real-world aviation crash is multi-axial in nature.

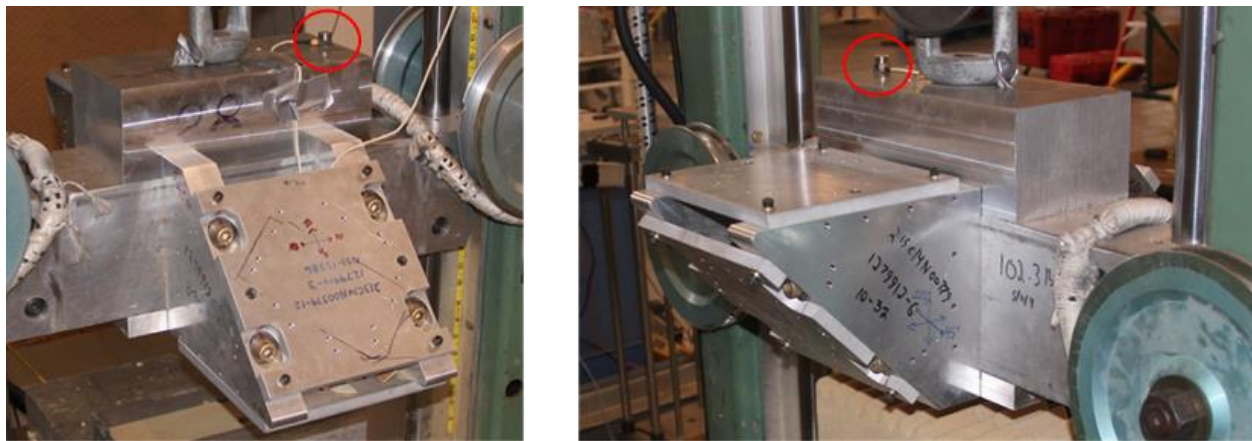

Figure 2. Crash Safety Test Fixtures (accelerometer highlighted)

The beacons and mounting hardware were tested for functionality and inspected for structural damage prior to each test in the series. In the event of structural failure, brand new hardware was obtained and the series was resumed with the load case that caused the failure. This was done to assess repeatability and cumulative damage effects. Beacon activation was determined using a

beacon tester connected to the antenna output and by monitoring of the visual and aural cues provided by the beacon. In the event of a failure to activate automatically, the beacon self-test function was activated by depressing the appropriate button on the beacon and crash sensor activation was demonstrated by shaking the beacon by hand. Although some beacons were exposed to many simulated crash events, only beacons that were free from visible defect and passed all functional tests were used throughout the series.

As noted above, one of the primary differences with the conduct of this test and testing required by the current MOPS is that NASA testing introduced multi-axial loading. The series included tests along each of the primary directions of the beacon, as is required by the current standard, but also included tests at $\pm 45^\circ$. This resulted in 2- and 3-dimensional loading of the ELT.

Furthermore, rather than use the pulse defined in the applicable MOPS, which was 100-g, 23-msec, half-sinusoid [19], it was decided that a pair of pulses grounded in research of full-scale aviation crashes should be used to study the effect of varying the load profile within the expected range of “severe but survivable” crash pulses. In order to determine a pair of appropriate pulses to use, the series of airplane crash tests performed at LaRC in the 1970’s was reviewed [20]. This resulted in the design and implementation of an (approximately) 15-g, 80-msec, trapezoidal crash pulse, referred to as the “P200” pulse in reference to the energy absorbing material used to generate the pulseform. It is noted that the P200 Pulse duration and peak-g’s are similar to those used in certification of aircraft occupant seats and restraints for emergency landing dynamic conditions under Federal Aviation Regulation Parts 23.562 and 25.562, which call for 14 to 26 minimum peak-g’s for a total duration of 80- to 120-msec. In order to study the effect of a shorter duration, higher-g pulse, another trapezoidal pulse was also used. This pulse was approximately 20-msec in duration with peak loading on the order of 70-80-g’s and is referred to as the “P600” pulse.

It is noted that the total energy contained within either pulse was lower than the one required by the current MOPS, ensuring that any negative performance observations would not be due to structural over-test. Given the correlation with fullscale airframe crash data and other existing standards governing emergency landing conditions, the P200/P600 pair was deemed to be a reasonable set with which to conduct the series of tests. A representative time-history of both pulses is shown in Figure 3.

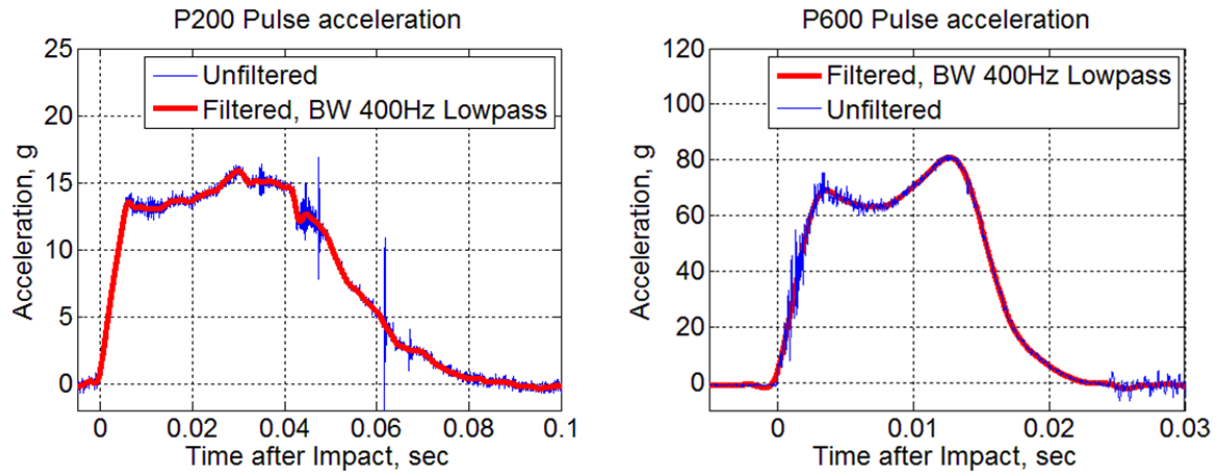

Figure 3. Representative Crash Safety Test Pulseforms

4.1.3 Crash Safety Test Structural Integrity Results

Structural failure of ELT mounting systems and beacon ejection was observed on a number of occasions throughout the series with multiple designs. In each case, the failures occurred when the systems were exposed to the P600 pulse discussed above in conjunction with multi-axis loading conditions.

In one case, the failure was with respect to a non-TSO-C126b compliant system that utilized a hook-and-loop fastener as a means of beacon retention. This system exhibited the phenomenon of beacon ejection when mounted to the 45° downward-facing mounting plane. High-speed video recorded during the tests showed that the beacon was able to escape its mounting tray due to excessive stretching and/or tearing of the hook-and-loop fastener. This was a repeatable result with new hardware undergoing the same load case.

In another case, a similar failure was observed in conjunction with a system that did utilize a TSO C-126b compliant mounting system. Visual inspection revealed that the metallic clasp used to restrain the beacon had become unfastened during the test, however, the behavior was not repeatable with new hardware in subsequent testing.

In the final case of interest, another system that utilized a TSO C-126b compliant mounting system was observed to demonstrate the phenomenon of beacon ejection in a repeatable fashion. The sensitive orientation for this system was when mounted to one of the triangular, side-facing mounting planes shown in Figure 2, with the beacon primary sensing axis clocked 45° with respect to the drop direction. Rather than a metallic strap and clasp system or hook-and-loop fastener, this mounting system utilized a synthetic fabric strap and plastic buckle. As such, this finding is a motivating example of the need for improvements to the existing performance-based requirements, rather than elimination of a single design characteristic based on real world outcomes.

Structural failures of the beacons themselves, including internal components, were not observed during the test series or during a full teardown of each unit at the conclusion of testing. There was not a single case of a beacon failing an internal self-check at any point in the series, which included

as many as 48 tests for some units. Structural failures observed were limited to beacon mounting hardware only.

4.1.4 Crash Safety Test Functionality Results

Successful automatic activation was observed in 48% of the 190 tests of live ELT systems utilizing mechanical g-switch crash sensors. One beacon model contained a solid state crash sensor instead of a mechanical g-switch and successfully activated in all 15 tests performed. The remaining 82 of the 287 total tests involved “dummy” ELT systems that were tested for structural integrity only.

None of the ELTs utilizing mechanical g-switches, even the ones that include six-axis sensors (multiple g-switches), activated automatically in all cases. Furthermore, all of the beacons exhibited some level of “preference” with respect to automatic activation under one of the pulses utilized, with some of the units’ preference being characterized as “strong”.

For example, one of the units equipped with a six-axis mechanical crash sensor activated in only 1 of 24 tests under the higher-g, P600 loading, as compared with 13 successes out of 24 tests at the lower-g, P200 level. In the case of another unit with a six-axis mechanical crash sensor, successful operation was observed in all 24 tests involving the higher-g loading, but the success rate dropped to 63% (15/24) in conjunction with the lower-g loading (i.e. strong preference). Overall, the performance of six-axis mechanical crash sensor equipped ELTs was only modestly better than their single-axis sensing counterparts, at 55% as compared to 41%, through 48 total tests of each unit (24 each at the high and low g-level).

Figure 4 summarizes the activation rate for the 5 ELTs tested as a function of the crash sensor orientation with respect to the gravity vector. The term “Aero”, or “airplane”, is used to refer to an ELT with a single-axis crash sensor and “Helo”, or “helicopter”, is used to denote a six-axis crash sensor. “Helo 3” incorporated a solid-state crash sensor, whereas all others employed mechanical crash sensors, or g-switches.

As shown in Figure 4, all but one of the units tested activated automatically 100% of the time when the crash sensor was oriented within $\pm 45^\circ$ of the gravity vector. Outside of that range, performance decreased significantly for the mechanical g-switch equipped units. The only unit to activate automatically in response to every test was “Helo 3”, which used a solid-state, six-axis crash sensor. It was not possible to test this unit in the + or - 180° orientations due to interference issues with the test facility.

Figure 5 displays the activation rate for each ELT as a function of crash pulse. As discussed above, P200 was the lower-g, longer duration pulse with respect to P600. As can be seen, the activation rate is higher in response to the higher-g, P600 pulse, for 3 of the 5 units tested. 1 of the units performed best when subject to the P200 pulse and, again, the unit with the solid-state crash sensor activated in all cases, regardless of pulseform.

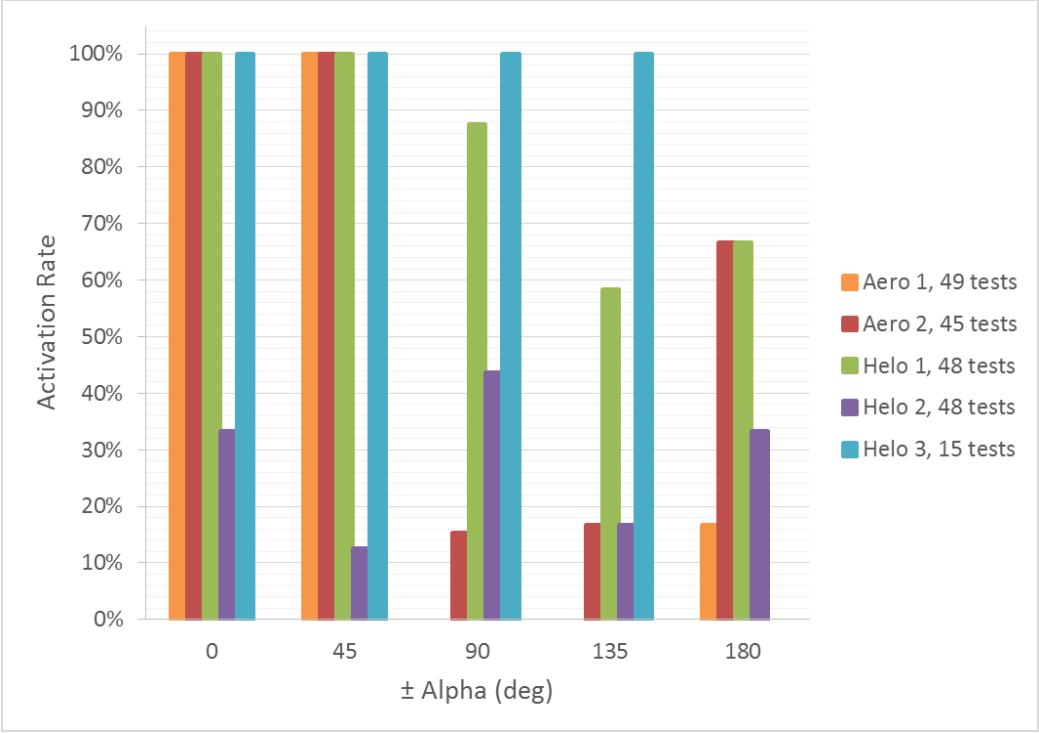

Figure 4. Crash Safety Test - Automatic Activation Rate as a Function of Beacon Orientation

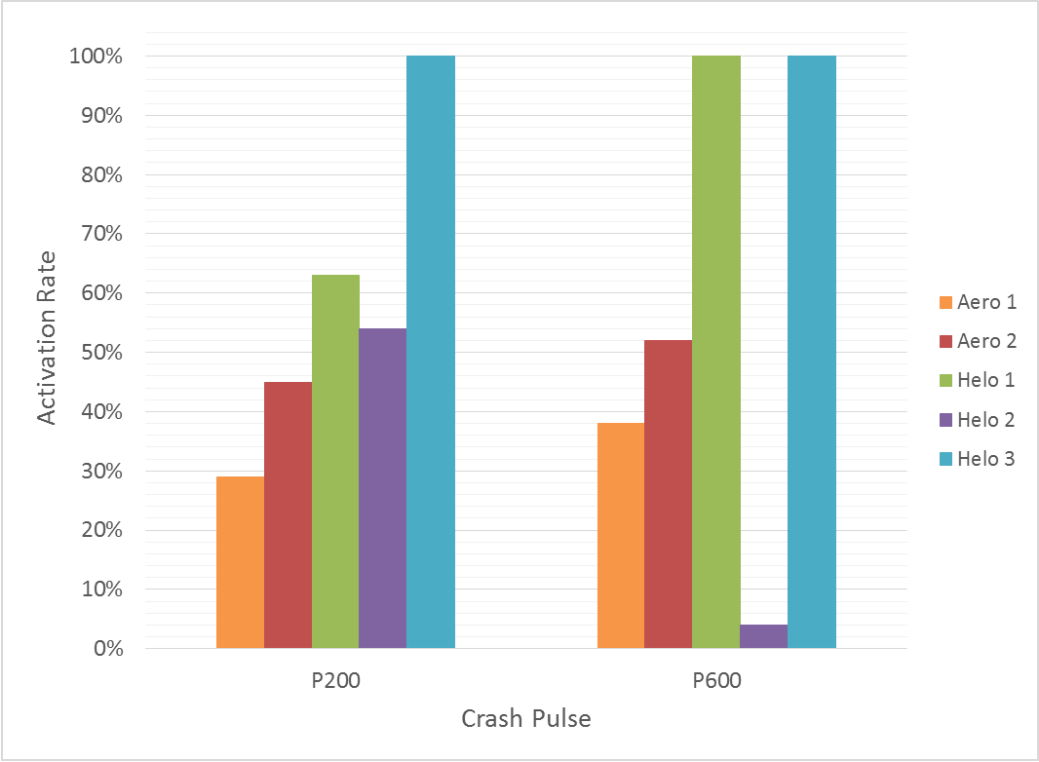

Figure 5. Crash Safety Test - Automatic Activation Rate as a Function of Pulseform

4.1.5 Summary of Crash Safety Testing

The crash safety test series was successful at demonstrating structural and functional vulnerabilities of previously qualified ELT systems under a set of loading conditions that are representative of real-world aviation accidents. This success was despite the fact that the total crash energy and peak g-levels were lower than those required by the current standard (not due to over-test).

Therefore, the ELT performance standards for crash safety are in need of revision due to the possibility of beacons coming out of their mounts and creating both occupant safety and ELT performance issues. The antenna cable connection is typically severed when the beacon is separated from its mounting tray and additional injury risk is introduced to occupants when the beacon becomes a projectile within the cabin.

Functional performance results indicate the need for increased rigor in qualifying ELT systems for automatic activation and corroborate reports of inactivated ELTs involved in aviation accidents. A simple approach to addressing this issue would be to require successful automatic activation of ELTs equipped with crash sensors when conducting crash safety qualification testing.

It is recommended that crash safety test procedures be updated to include additional tests that impart simultaneous multi-axis loading, a pair of pulseforms within the range of “severe but survivable” crashes and demonstration of successful automatic activation of AF systems during environmental exposure. Improvements to performance of beacon mounting systems, antenna connection survivability and crash sensor performance are expected as a result.

4.2 Vibration Testing

In light of documented performance issues of ELT crash sensors after exposure to in-service vibration environments [7], vibration testing of a variety of ELTs was conducted on the electro-dynamic shaker at LaRC shown in Figure 6.



Figure 6. Vibration Test Facility

4.2.1 *Vibration Test Objective*

The primary objective of vibration testing was to identify a vibration test environment applicable to ELTs that may reproduce the failure mode related to crash sensor vibration sensitivity as discussed previously. The robust vibration environments defined by the RTCA [21] were selected for assessment since they have been accepted by the aviation industry and are intended for usage with vibration sensitive equipment and/or equipment to be installed onboard helicopters. Since ELTs fit one or both of these criteria, the environments were deemed applicable.

4.2.2 *Vibration Test Conduct*

Vibration testing was performed on a variety of commercially available ELT systems. Environment definitions were based on the robust levels defined by the RTCA for general application to airborne equipment (a minimum standard) [21], which are more severe than required test levels found in the ELT performance standard. Each ELT tested was subjected to either the reciprocating/turboprop, helicopter, or turbojet/turnofan environment.

In order to assess system performance throughout the test series, an aliveness check was performed that consisted of exposing the beacon to a single pulse that should result in automatic activation of the ELT. The aliveness pulse was defined to be a trapezoidal pulse, 6 peak-g's, 29.5-msec duration, 5.5-ft/sec delta-velocity (ΔV), with 1-msec ramp-up and -down period.

In the event that the aliveness pulse did not trigger the ELT to activate, an alternate pulse was used. This pulse was similar except for 15.7 peak-g's and 11.9-msec duration. Each of these pulses lie within the "must activate" range as defined in current ELT MOPS for crash sensor performance as shown in Figure 7. If the unit continued to fail to activate automatically, another series of pulses were input by the shaker and are labeled as "optional" in the figure below. In the event that the beacon failed to activate in response to all of the pulseforms input from the shaker, the unit was removed from its mount, shaken by hand until activation occurred, and the acceleration time-history was recorded by an accelerometer mounted directly to the beacon outer casing. Examples of the pulses recorded in this fashion are included in Figure 7.

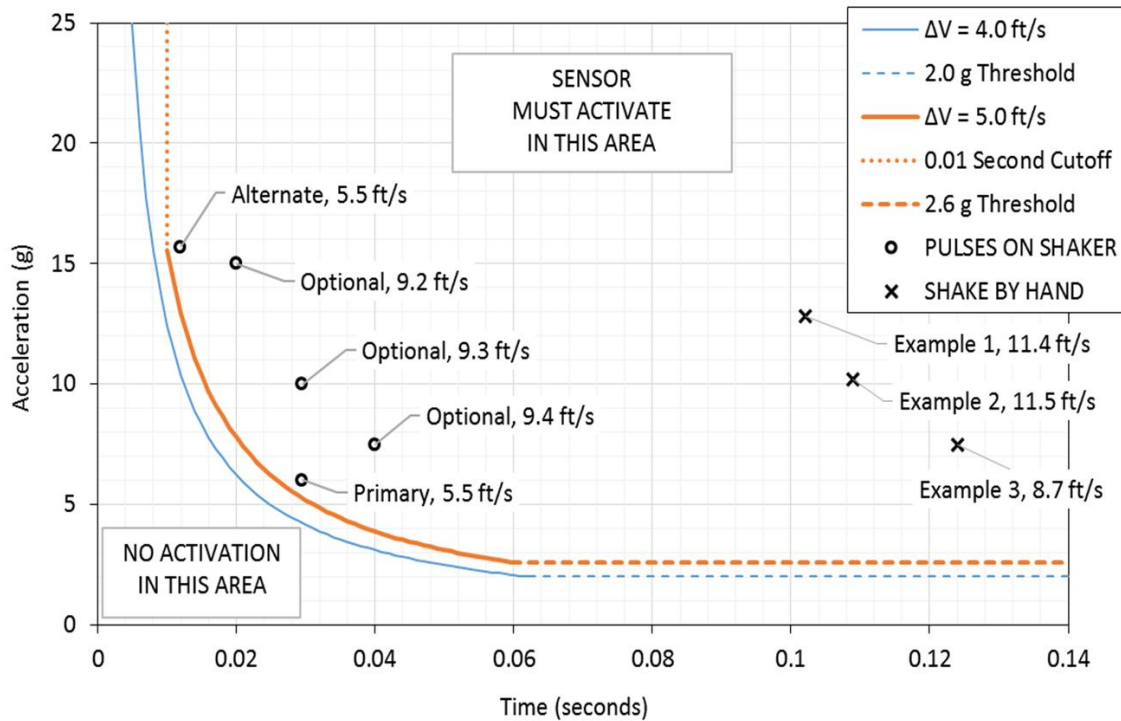

Figure 7. *Vibration Test - Aliveness Pulses Compared to Crash Sensor MOPS*

The aliveness check was performed prior to testing and subsequent to exposure to the vibration environment in each axis. In all cases, the aliveness check was performed inline with the primary sensing axis of the ELT, which required a configuration change subsequent to testing 2 of the 3 axes.

Five different commercially available ELT designs, each from a different manufacturer, were tested to one of the three different robust vibration environments defined by the RTCA. Results specific to each test series are discussed in the following subsections.

4.2.3 *Reciprocating/Turboprop Vibration Test Results*

The reciprocating/turboprop test consists of a sine sweep and sine dwell to level T, category R, as defined in [21]. Two of the five ELTs were selected for this test series – one with a single-axis mechanical g-switch and the other with a six-axis solid-state g-switch.

The unit with the mechanical g-switch failed to activate under both the primary (6-g, 29.5-msec) and alternate (15.7-g, 11.9-msec) aliveness pulses defined above, as well as the three optional (7.5- to 15-g, 30- to 40-msec) aliveness pulses on the shaker. Several manual shakes of the beacon showed that automatic activation occurred in conjunction with pulses on the order of 7- to 13-g applied for more than 100-msec at delta-velocities of 9- to 11.5-ft/sec. The unit exhibited internal failure during the test series and failed aliveness testing and internal self-checks following testing in the 2nd of 3 axes. The test was ended and the unit was disassembled and inspected. It was found that several internal fasteners had failed as well as one of the electrical leads to the g-switch.

The unit with the solid-state g-switch passed pre-vibration aliveness testing, however, the structural assembly failed during the sine dwell at the first critical frequency. Electrical connector fasteners failed and degradation of connections between modules was observed. These failures precluded further testing.

4.2.4 Helicopter Vibration Test Results

Two units were selected for exposure to helicopter environment testing, which was performed to levels F & F1 (Category U2) as defined in [21]. This exposure was a random vibration test intended for application onboard helicopters with unknown frequencies.

One of the units contained a six-axis mechanical g-switch and no issues were observed during pre-test aliveness checks. However, following testing in the 1st of 3 axes, the unit failed to activate twice when exposed to the 6-g aliveness test defined above. The third attempt was successful and testing continued. Following testing in the 3rd and final direction, the unit failed to activate in response to the 6-g aliveness test, but did activate on the second attempt. No signs of structural issues were identified during post test teardown and inspection.

The second unit exposed to helicopter environments utilized a single-axis mechanical g-switch. The test conduct defined in [21] was modified slightly in order to assess the effects of exposure in a flight-like installation onboard a helicopter, which calls for mounting the beacon to the cabin ceiling in a 45° nose-down configuration per manufacturer instructions. Therefore, instead of testing the beacon in line with the first two primary, orthogonal directions, the beacon was tested at ±45°. The third axis, which is performed with the beacon mounting plate orthogonal to vibration input, was performed according to normal protocol. This unit passed all tests for pre- and post-test aliveness and exhibited no signs of structural or internal failure. However, because the unit was not exposed to robust vibration environments inline with the crash sensor, the severity of the test was decreased in that respect.

4.2.5 Turbojet/Turbofan Vibration Test Results

The turbojet/turbofan test consisted of two steps, with level and category definitions provided in [21]. The first step included a random vibration test to levels E & E1, followed by a category R, high-level sine sweep. The second step was a high-level, short duration vibration test to level P, category H. The rationale for performing the high-level, short duration test was because that test applies to equipment that must function during and after engine fan blade loss, which is a condition that may contribute to a subsequent crash event. The random vibration tests were performed to levels E & E1 in order to increase the probability of observing vibration sensitivity. These levels envelope all potential ELT installation locations, as well as some higher level environments, such as the empennage and fin tip.

An ELT with a single-axis mechanical g-switch was selected for this test series. The unit failed to activate in response to the primary 6-g aliveness test, but did activate in response to the alternate 15.7-g pulse. The unit activated automatically 1 hour and 12 minutes into random vibration testing in the 3rd axis, which was perpendicular to the g-switch sensing direction and beacon mount. The test was paused, the ELT was reset, and testing resumed until the ELT activated 10 seconds later.

It was apparent that the cross-axis sensitivity of the g-switch had been altered by exposure to the environment. Testing in the 3rd axis was completed with the unit turned off so as not to drain the battery.

Following completion of the entire series, the unit failed to activate in response to the primary and alternate aliveness pulses, twice. However, the unit reported no error codes when the internal self-check routine was run and the ELT activated automatically when shaken by hand.

This ELT was included in the first full-scale airplane crash test in order to assess the affects of pre-crash vibration exposure and the results will be discussed in that section.

4.2.6 Summary of Vibration Testing

Two of the designs failed to activate multiple times when exposed to a “must activate” load during pre-vibration aliveness testing. These were brand-new units that passed internal self-check routines and used single-axis mechanical g-switches. This finding highlights the need for enhanced automatic activation testing of ELTs equipped with crash sensors and requiring positive demonstration of performance in response to a series of “must activate” pulses is a sensible way to address this need.

Crash sensor performance degradation was observed at different points during the test series with three of the four units that utilize mechanical g-switches. This result included units exposed to the “helicopter” and “turbojet/turbofan” environments.

Finally, catastrophic structural damage was observed with both of the ELTs subjected to the “reciprocating engine/turboprop environment” early in the test series. This finding included designs utilizing both ball-and-spring and solid-state crash sensors. Since structural failure of ELT systems or components due to in-service environments had not been observed in literature or crash report review, these results appeared to be due to over-test. Therefore, this test environment has not been recommended.

In contrast, the robust “turbojet/turbofan” and “helicopter” tests both reproduced the documented failure mode related to mechanical g-switch performance degradation on multiple occasions. As such, the robust vibration tests described above, including pre- and post-test confirmation of crash sensor performance, are recommended as pragmatic ways to mitigate vibration sensitivity and increase automatic activation performance at the same time.

4.3 Antenna Cable Testing

Failure of ELT systems due to disconnection of external antenna connections or lack of adequate fire robustness have been identified as recurring themes precluding successful operation of ELTs in human-survivable aviation accidents. In cases such as these, the antenna cabling was determined to be the weak-link in the system. Therefore, a series of tests were performed at LaRC to assess the strength and fire survivability of ELT antenna cable systems. Cable systems provided by ELT manufacturers range from generic, unmarked cables, to MIL standard designs. The objective of these tests was to quantify the relative strength and robustness of the range of designs found in

service and identify performance standards for antenna cabling that will lead to a more complete and enhanced definition of the end-to-end ELT system.

4.3.1 Static Strength Testing Summary

Static pull testing of a variety of ELT cable systems (coaxial cable and Bayonet Neill-Concelman (BNC) connectors) was performed using a tensile test facility at a pull rate of 0.1-in/min. The objective was to determine relative strengths of a variety of cable systems commonly used in ELT installations. Cable systems were inspected for structural and electrical continuity during and following each test. The test setup, shown in Figure 8, included a circular ring to take up additional cable length beyond what could be accommodated within the facility stroke limit.



Figure 8. Antenna Cable Tensile Test Setup

A variety of brand new cable systems supplied by ELT manufacturers and fabricated by a certified aircraft technician at LaRC were included in a total of ten tests. Tests were conducted to failure, which occurred at the BNC connector in each case.

It was observed that vendor supplied cables manufactured in accordance with MIL-DTL-17 exhibited higher static strength characteristics than generic, unmarked cables by a wide margin. For example, the range of static strengths observed with MIL-DTL-17 cable systems was on the order of 80-100 lbf as compared to 20-30 lbf for the generic cables supplied by some ELT vendors. Representative failures are shown in Figure 9.



Figure 9. Antenna Cable Connector Failures from Strength Testing

4.3.2 Dynamic Strength Testing Summary

A schematic of the custom facility used for dynamic strength testing of ELT antenna cable systems is provided in Figure 10. The facility was designed to impart an impulsive tensile load on the ELT antenna cable, which was connected to the “top coax mass” and “bottom coax mass” by means of normal BNC connectors.

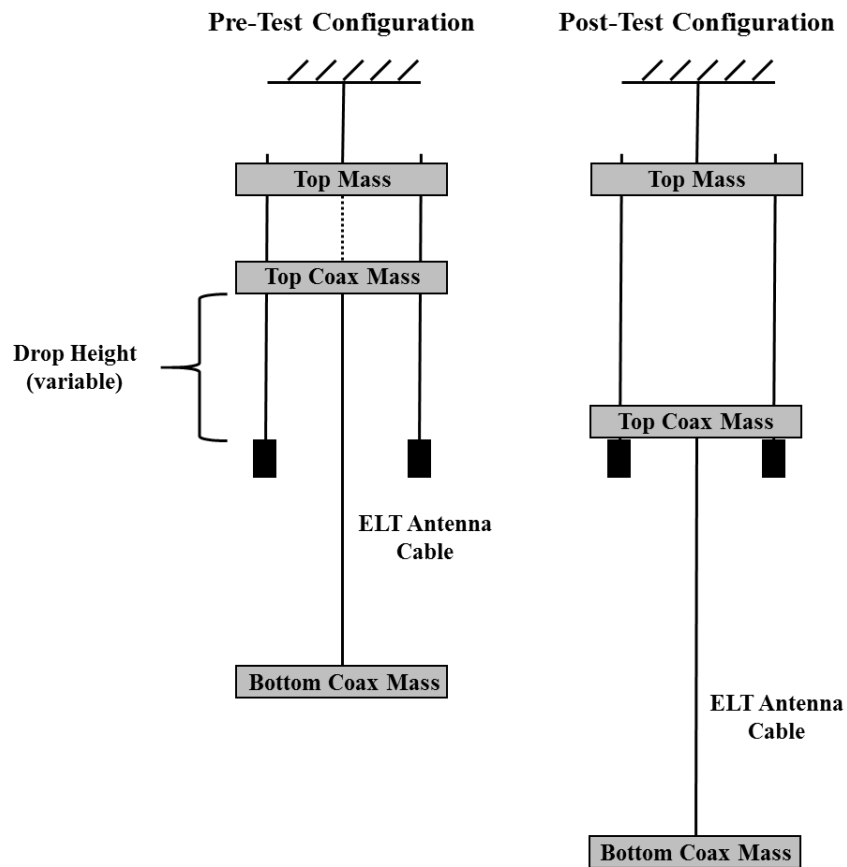

Figure 10. Antenna Cable System Dynamic Strength Test Setup

The test sequence began by severing the connection to the “top mass”, shown with dotted line in the left view of Figure 10, thereby initiating the freefall of the “top coax mass”, ELT antenna cable, and “bottom coax mass”. The freefall was guided by a pair of rods and ended when the “top coax mass” impacted a pair of stops. Two different freefall, or “drop height”, distances were tested, resulting in 5-ft/sec and 10-ft/sec velocities.

The “bottom coax mass” did not impact the ground unless the ELT antenna cable connection to either mass failed. All three masses were instrumented with accelerometers in order to determine the loading imparted on the cable system and electrical continuity was monitored across the cable during testing.

The “bottom coax mass” weighed 3.7 lbs and was intended to impart loads on the cabling that may be similar to that experienced by an ELT cable connection in the event that the beacon was dislodged from its mounting during a crash. Since typical beacons range from 2 to 3 lbs, the mass used in this test included approximately 30% margin.

Six tests were performed on ELT antenna cables obtained from commercial sources. Similar to the static strength tests discussed previously, the cables manufactured in accordance with MIL-DTL-17 possessed superior load carrying capability and survived 2 repeats of the 10-ft/sec test, resulting in observation of peak dynamic forces in excess of 500-lbf without failure. Generic, unmarked cable systems failed the 5-ft/sec tests with peak forces on the order of a few pounds causing failure in the cable connections on either end.

4.3.3 Antenna Cable Strength Testing Summary

Given that the tested MIL standard cable systems exhibited vastly superior strength and are readily available from aircraft supply stores and ELT manufacturers, the minimum performance standard for ELT antenna cables is recommended to be MIL-DTL-17. This will help to improve external antenna connection survivability during accidents involving significant airframe deformation.

4.3.4 Fire Survivability Testing

A series of tests were conducted to determine the fire survivability of the antenna cable, both with and without the addition of optional thermal protection. The application of firesleeves is recommended, but not required, in the installation of ELT systems under the current MOPS [19] and no performance requirement is provided for the material to be used.

These tests were motivated by recognition that the 15-sec flame test duration required by the ELT MOPS does not envelope the nominal delay of 50-sec required between automatic activation and initial 406 MHz distress signal transmission [19]. The implication is that test protocols do not demonstrate that the system possess adequate thermal protection to perform its intended function in the presence of post-crash fire.

The results of this test serve only as an indication of the feasibility of extending the functional life of antenna cables since the ability to transmit the 406 MHz distress signal was not monitored. Instead, electrical continuity of the cable alone was observed to alleviate safety issues related to exposing live ELT beacons, which may include Lithium batteries, to a high temperature flame. It

is suspected that the 406 MHz distress signal was degraded prior to when complete loss of electrical continuity was observed.

4.3.5 Antenna Cable Fire Survivability Test Objective

The objective of this test was to determine if economical, commercially available, thermal protective materials may be used to increase fire survivability of ELT antenna cables since post-crash fire is common in aviation accidents and electrical continuity between the beacon and antenna is required for successful operation of the system.

4.3.6 Antenna Cable Fire Test Conduct

A variety of ELT antenna cables were tested with and without a variety of commercially available thermal insulation materials. The cables were directly exposed to a 2,000 °F flame and the time to loss of electrical continuity was recorded. The temperature was measured by a thermocouple placed directly in the flame before and after each test.

A Bunsen burner provided the flame, which enveloped a 1-2-in length of the cable under test. Thermal insulation products tested included an intumescent tape and a variety of firesleeves that are all marketed for the purpose of protecting electrical cables. A picture of a cable and firesleeve undergoing fire testing is shown in Figure 11.



Figure 11. Fire Testing of an Antenna Cable without (left) and with (right) a Firesleeve

4.3.7 Antenna Cable Fire Survivability Test Results

After a total of ten tests, an average time to electrical continuity loss of approximately 2 minutes was observed. In the case of a generic, unmarked, cable provided by an ELT manufacturer, the time to signal loss was approximately 1 minute, or less.

All of the fire protection products tested performed reasonably well and extended the time to electrical loss by at least a factor of 2. The top performer was a firesleeve manufactured in accordance with Society of Automotive Engineers (SAE) AS1072. This material extended performance to more than 16 minutes before the test was halted. It was also one of the most economical products at less than \$3 per linear foot and available from numerous online sources. A picture of the post-test condition of the firesleeve is shown in Figure 12.



Figure 12. Firesleeve Post-Test Condition

4.3.8 Antenna Cable Fire Survivability Summary

Given that the SAE AS1072 firesleeve outperformed all other candidate materials tested, is commercially available, easy to use, and economical, it is recommended that AS1072 firesleeves be required for ELT system installation. This will also address the ambiguity in the current MOPS where antenna cable firesleeves are recommended, but no performance specification is provided.

5 Full-Scale Crash Testing

Multiple ELT systems were installed onboard 4 different full-scale airframe crash tests at LaRC in 2014 and 2015. Each test was designed to replicate a “severe but human-survivable” crash event and included multiple Anthropomorphic Test Devices (ATDs, or crash test dummies) to represent occupant and crew mass and establish potential injury criteria.

Test objectives included obtaining real-world ELT crash performance data, establishing an airframe response database for FEM calibration (Section 6) and supporting recommendations to RTCA & EUROCAE regarding ELT system installation.

During each crash test, NASA utilized its SAR Lab at GSFC, in Greenbelt, Maryland, to verify signal detection and beacon location via the Cospas-Sarsat system. This step, which was in addition to the local monitoring of the 121.5 MHz secondary homing signal, added to the realism of each crash test by demonstrating transmission by the ELT, and detection of the 406 MHz signal by the Cospas-Sarsat space segment. The SAR Lab is uniquely suited for this type of verification, as it is the research and development system that is routinely used by the U.S. operational SAR agencies for development, verification and technical analysis. Consisting of a full, six-channel Medium Earth Orbit (MEO) Local User Terminal (LUT), the SAR Lab also maintains single channel Low Earth Orbit (LEO) and Geostationary Earth Orbit (GEO) LUT capabilities. For each test, all three systems were used to verify transmission and receipt of the ELT signal.

Approval to test the beacons and transmit the distress signals at 406 MHz was obtained from National Oceanic and Atmospheric Administration (NOAA) prior to performing the test. The beacons were test-coded to ensure that testing did not interfere with the operational system. This process was used for each airplane crash test as well as pre and post-test checks.

Testing was also closely coordinated with the U.S. SAR Satellite-Aided Tracking (SARSAT) Program to bring awareness to all operational parties. During testing, NASA SAR personnel at the SAR Lab recorded and reported detections by the LEO and MEO systems in realtime. These detections were also noted, in some cases, by NASA SAR personnel at LaRC, utilizing the Rescue Coordination Center Network (RCCNet) remote software tool. The results of this effort are further provided in previous reports issued by NASA ([24] and [26]).

5.1 Second Transport Rotorcraft Airframe Crash Testbed (TRACT 2)

The TRACT 2 test was performed at the LaRC Landing and Impact Research Facility (LandIR) in October of 2014. The test article, a CH-46E fuselage carrying over a dozen experiments onboard, impacted soft soil at 33-ft/sec forward and 25-ft/sec vertical combined velocities. A full description of the test, except for the ELT component, was presented to the American Helicopter Society (AHS) International 71st Annual Forum [22]. A view of the test article exterior is shown in Figure 13.



Figure 13. TRACT 2 Test Article

5.1.1 TRACT 2 ELT Test Objective

Although the TRACT 2 experiment had been previously designed to provide a testbed for numerous onboard experiments, the predicted environment offered the opportunity to obtain relevant ELT performance data onboard an actual crash event of known conditions. As such, a variety of systems were installed and operated during the test.

5.1.2 TRACT 2 ELT Test Conduct

The ELT experiment suite was installed in the forward section of the main cabin, on a shelf on the left side of the front bulkhead. This location was chosen because, of the volumes available, it was large enough to accommodate multiple ELTs and was structurally adequate to satisfy all ELT installation requirements for mounting surface rigidity (no more than 0.1” deflection under 100 lbf load [19]). Figure 14 shows the approximate location of the ELT experiment suite.

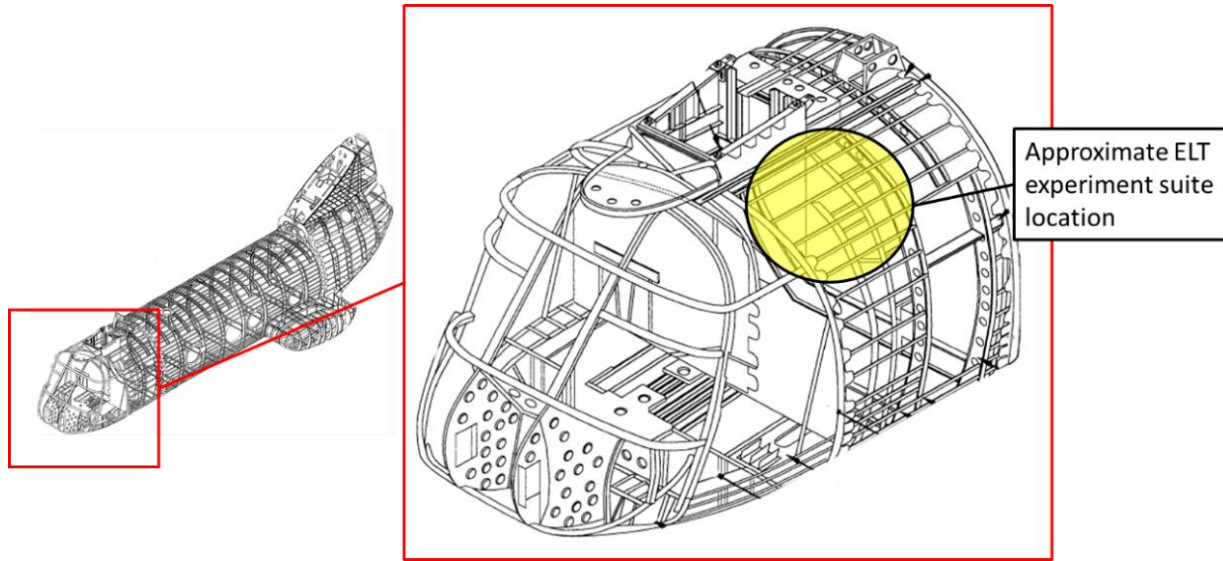

Figure 14. ELT Experiment Suite Onboard TRACT 2

Figure 15, left, shows a picture of the main cabin of the CH-46E. The picture was taken from the midway point of the main cabin, looking forward. Figure 15, right, shows a close-up of the ELT shelf area, which was the uppermost of three shelves. The remaining shelves eventually housed power distribution and communication equipment for the test.



Figure 15. ELT Shelf Onboard TRACT 2

The ELT shelf was a ½-in thick aluminum honeycomb sandwich plate with 0.025-in aluminum face sheet structure. It was fastened to the forward bulkhead, cockpit walkway wall and frame section 120. The shelf was approximately 18-in deep by 15-in wide. In order to simulate various ELT mounting orientations, a 6-in square, ¼-in wall-thickness, aluminum box tube was attached to the shelf and used to provide the ELT mounting surfaces.

Figure 16 shows an illustration of the ELT mounting configurations, with the shelf removed for clarity. ELT 1 was in a sidewall-mounted configuration, orientated 16° nose-up to simulate additional pitch beyond the 2.6° orientation of the airframe at impact. ELT 2 was mounted on the top outer surface of the tube, simulating a horizontal floor mounted configuration. ELT 3 was mounted on the top inner surface of the tube, simulating a ceiling mounted configuration, and ELT 4 was sidewall mounted, oriented at 26° nose-up. In all instances, the ELTs were pointing forward, toward the direction of forward flight.

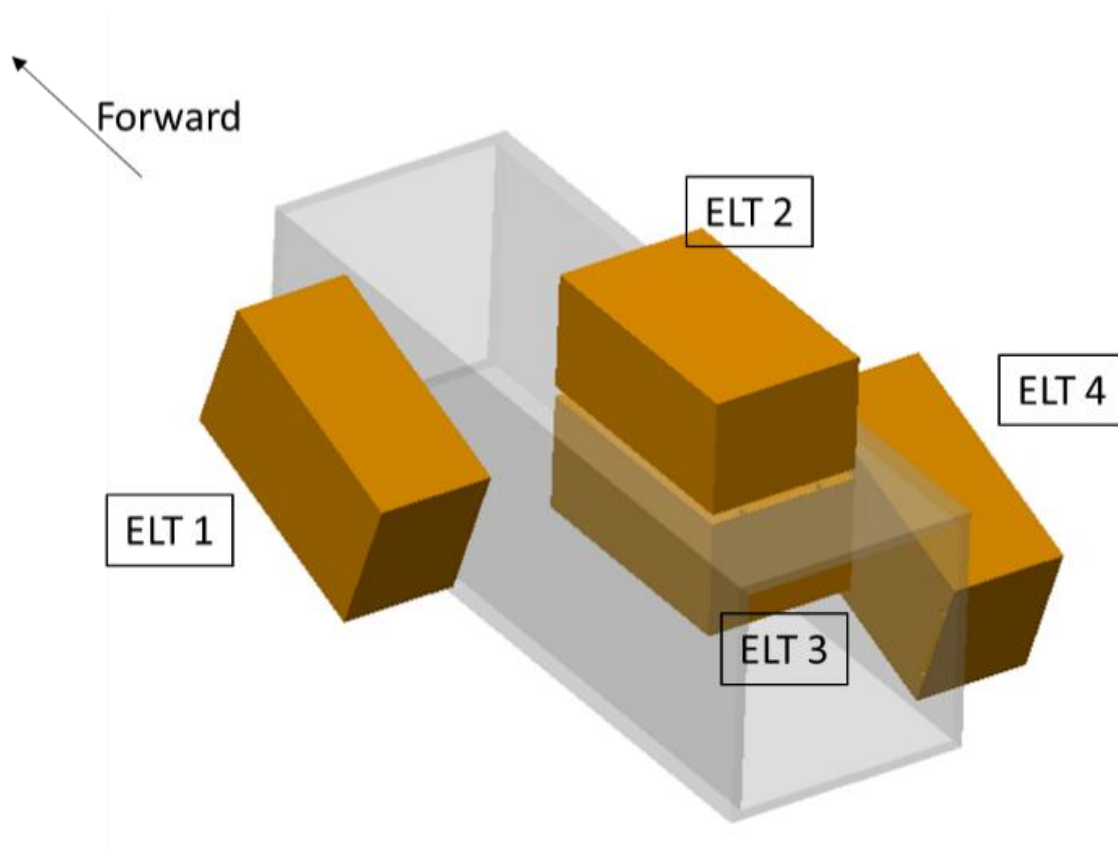

Figure 16. ELT Experiment Suite Configuration for TRACT 2

All ELTs used manufacturer provided mounting hardware installed in accordance with provided instructions. ELTs 1, 2, and 3 included single-axis, mechanical g-switches. ELT 4 included a multi-axis, mechanical g-switch. ELTs 1, 2 and 4 used mounting hardware in compliance with TSO-126b. ELT 3 implemented a hook-and-loop fastener for beacon restraint.

Each ELT was connected to an exterior antenna. The antennas were mounted directly above the ELT shelf, spaced six inches apart, next to the forward rotor mounting area as shown in Figure 17.

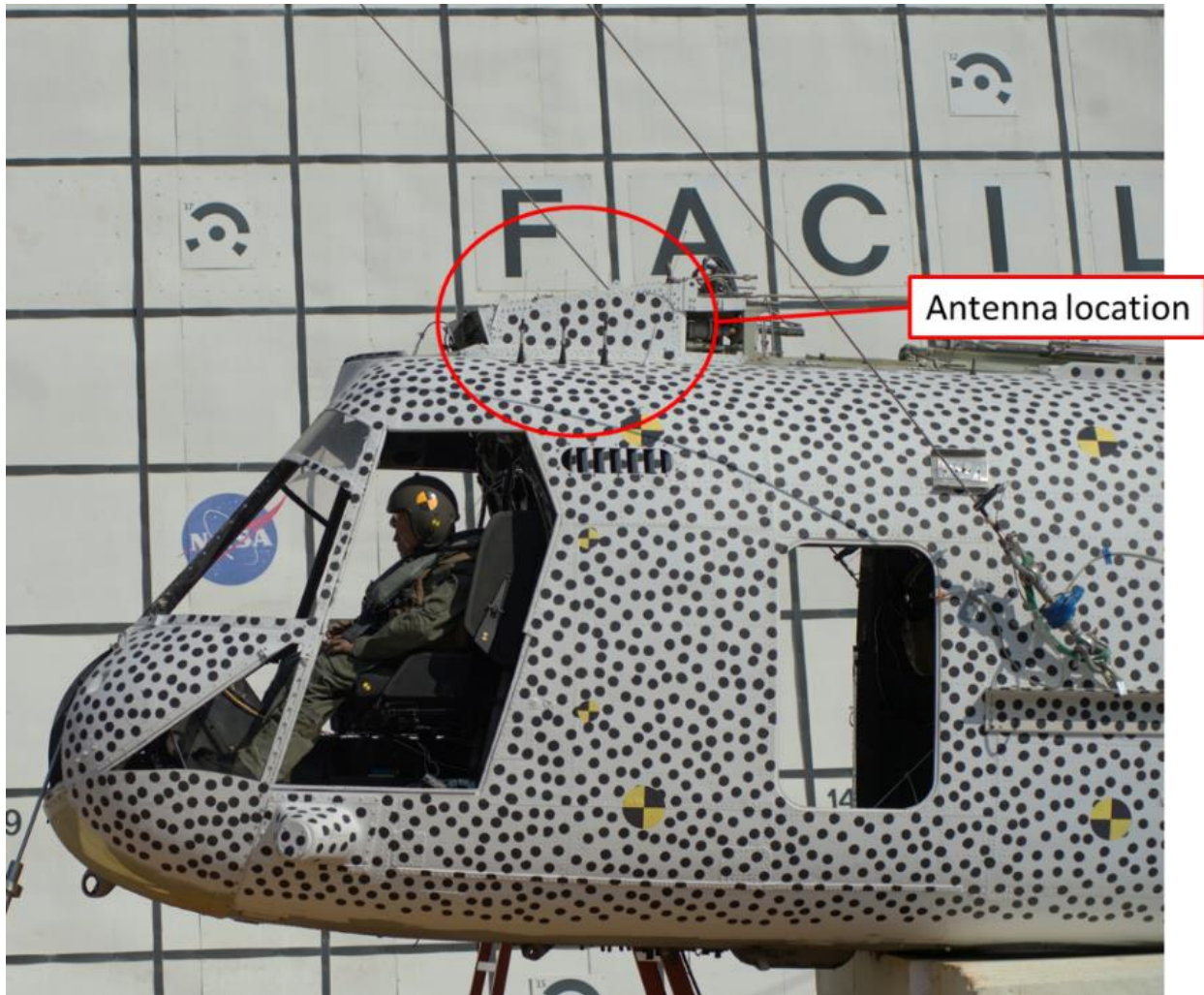

Figure 17. ELT Antenna Locations Onboard TRACT 2

Four accelerometers were located near the ELT experiment suite. One pair measured forward and vertical accelerations of the ELT shelf, while the other pair recorded similar responses on the outer horizontal surface of the ELT mounting box tube. The accelerometers were of the piezo-resistive type, having a maximum range of ± 500 -g. All instrumentation data were collected and recorded via an onboard Data Acquisition System (DAS) sampling at 10 kHz.

In addition to the DAS data, there were two onboard cameras filming the ELT experiment suite. An overhead camera was filming at 720P resolution at 120 frames per second. An aft-mounted, forward-facing, high-speed camera was filming at 1080P resolution at 500 frames per second. The aft-mount, forward-facing camera was capable of being synchronized with the DAS system, using a common Inter-Range Instrumentation Group (IRIG) –B time code.

5.1.3 TRACT 2 ELT Test Results Summary

Accelerations were recorded for both the ELT shelf and box tube and are presented in Figure 18. All acceleration data was filtered at a Channel Frequency Class (CFC) low-pass filter of 60 Hz, which is the cutoff frequency for vehicle structural responses as called out in [23].

The peak acceleration values differ between the shelf and tube responses, as the tube maximum was approximately 69-g, while the shelf maximum was approximately 43-g in the vertical direction. This difference is due to the flexure mode of the shelf, which amplified the acceleration peak. The ELT shelf accelerometer was mounted on the aft-right corner of the shelf, near the cockpit vertical wall, adjacent to the shelf-to-wall attachments. This placement was a more rigid configuration with minimal shelf deflection.

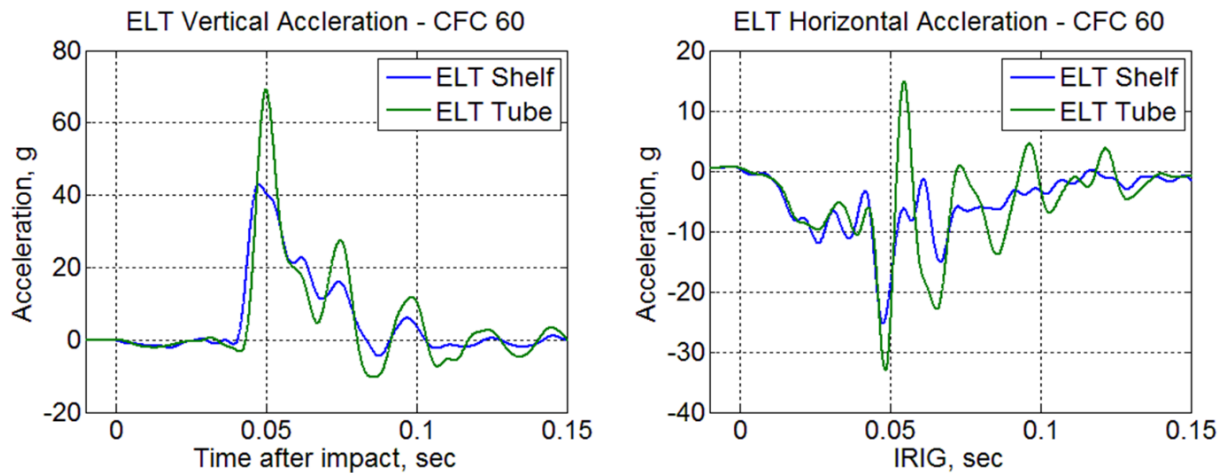

Figure 18. ELT Acceleration Time-History Onboard TRACT 2

Comparing the measured accelerations to Figure 7, the TRACT 2 environment should have resulted in automatic activation of each ELT, regardless of the variations in beacon orientation.

There was nominal structural responses from ELTs 1, 2 and 4 during the test, all of which utilized TSO-C126b compliant mounting systems. All units showed no signs of damage when reviewing the video or during post-test inspections. ELT 3, however, exhibited an unseating/reseating behavior as summarized in Figure 19. ELT 3 utilized a hook-and-loop style mounting system, but was brand new.

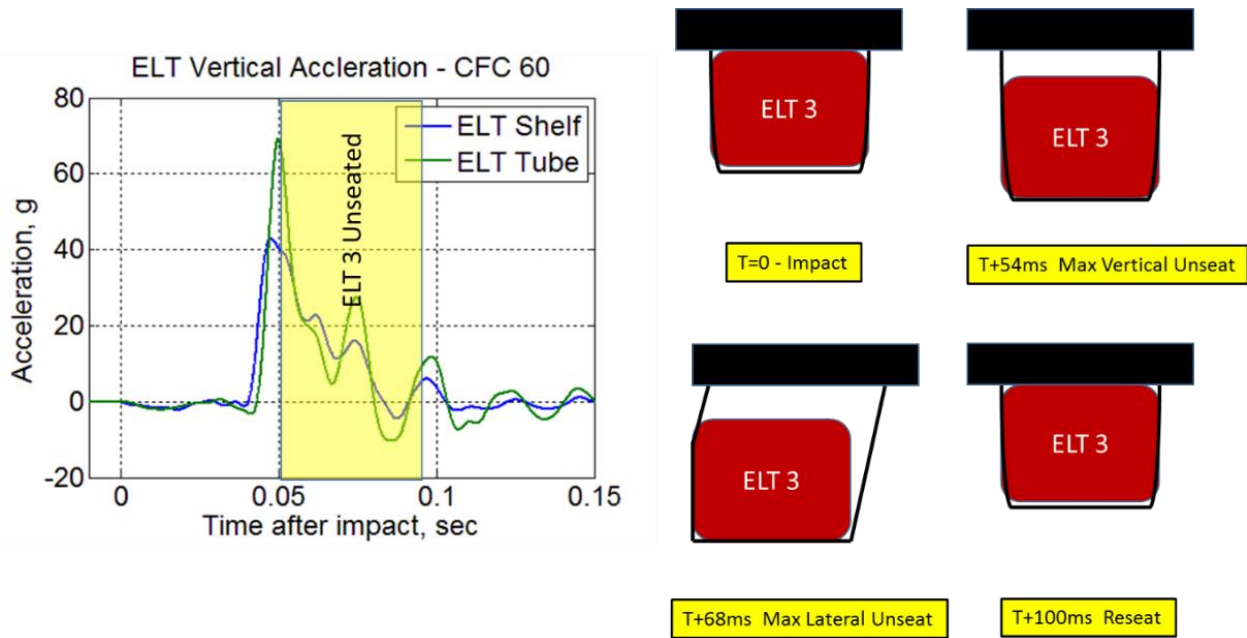

Figure 19. Hook-and-Loop Mounting System Behavior During TRACT 2

ELTs 1 and 3 automatically activated during the test and transmitted the 406 MHz distress signal until reset as confirmed by satellite transmission log files received by the NASA SARLab. ELTs 2 and 4 did not activate automatically during the test and, therefore, did not transmit a distress signal.

All ELTs passed pre- and post-test functionality and activation checks as confirmed by the NASA SARLab and beacon responses observed on the ground.

5.2 Airplane Crash Test Series Objective

Multiple ELT systems were installed onboard 3 different Cessna 172 airplanes and full-scale crash tests were conducted at LandIR in 2015. Each test was designed to replicate a “severe but human-survivable” crash event and included a pair of ATDs to represent pilot/co-pilot mass and establish potential injury criteria.

The objective of the series of tests was to: 1) obtain real-world ELT crash performance data; 2) develop an airframe response database to be used for analysis model calibration; 3) support recommendations to RTCA & EUROCAE regarding ELT system installation.

This document provides a high-level description of each test and summary of the results obtained. A series of memos have been published that include further details related to the crash test results and airframe responses [24], ATD responses [25], ELT performance [26], and photogrammetric techniques [27].

5.2.1 First Airplane Crash Test Conduct

The first crash test scenario simulated a pilot attempting an emergency landing on concrete and proceeding to flare-to-stall the aircraft above ground, leading to large vertical sink rates and accelerations. The airplane was oriented 1.5° nose-up with a flight path velocity of 64.4-ft/sec at impact.

A net was used to arrest the aircraft following ground impact in order to ensure that the test article did not enter a pool used for water impact testing at the test facility. This impact scenario resulted in two distinct impact events as depicted in Figure 20 and discussed further in the results subsection.

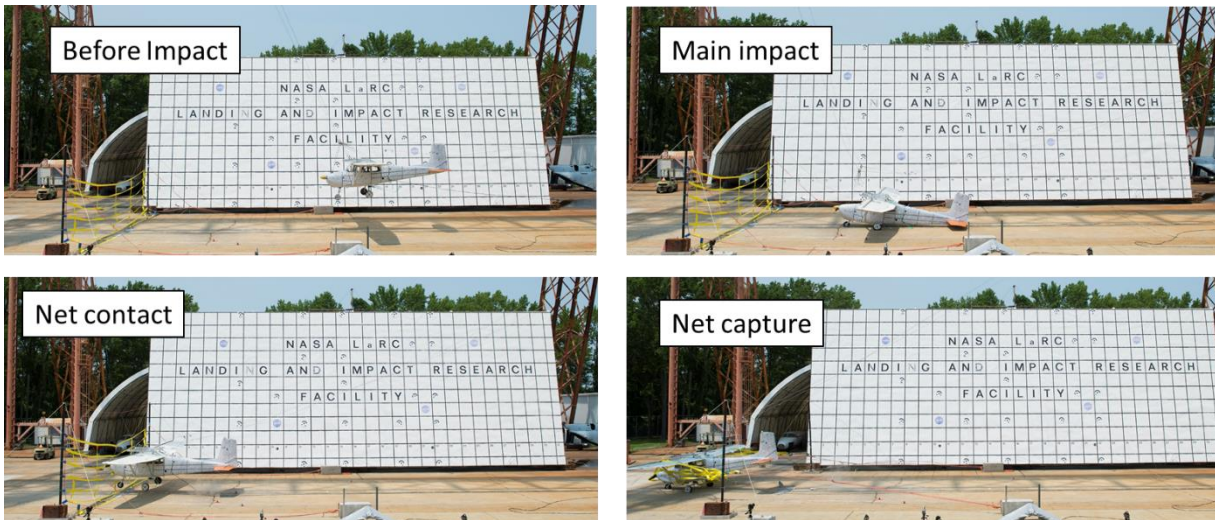

Figure 20. Impact Sequence - Airplane Crash Test 1

Four different ELTs were installed using typical methods employed in GA aircraft. A schematic of the beacon layout is provided in Figure 21. ELTs 1 and 2 were from the same manufacturer, but different models. The beacons were mounted to the structural members of either sidewall in the cabin or tail section of the aircraft. ELTs 3 and 4 were of the same make and model, installed in similar fashion, with the beacons mounted to the aft cabin subfloor supports. The primary difference was that ELT 3 had previously undergone vibration testing, resulting in alteration of the g-switch performance characteristic, as discussed previously.

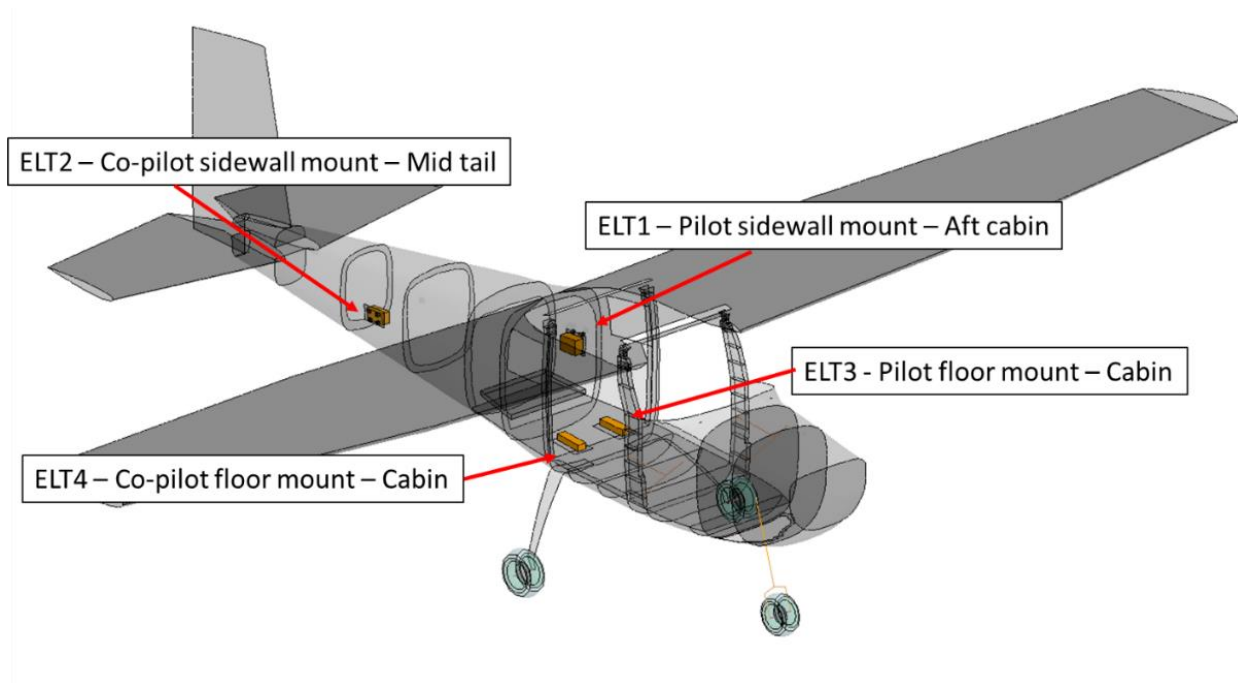

Figure 21. Beacon Layout - Airplane Crash Test 1

Antenna locations and cable routing was varied across the set of installations to mimic a range of possible configurations. A pair of “dummy” ELT installations were also onboard, each consisting of a mass-representation of a beacon connected to an external antenna with typical antenna cables and connectors. The purpose of these installations was to allow observation of antenna cable survivability with respect to additional installation techniques.

5.2.2 First Airplane Crash Test Results Summary

Figure 22 shows the acceleration environment experienced by each ELT beacon. Ground impact corresponds approximately from time 0- to 0.4-sec as shown in the vertical acceleration plot. Net impact corresponds approximately from time 0.9- to 1.6-sec as shown in the horizontal acceleration plot.

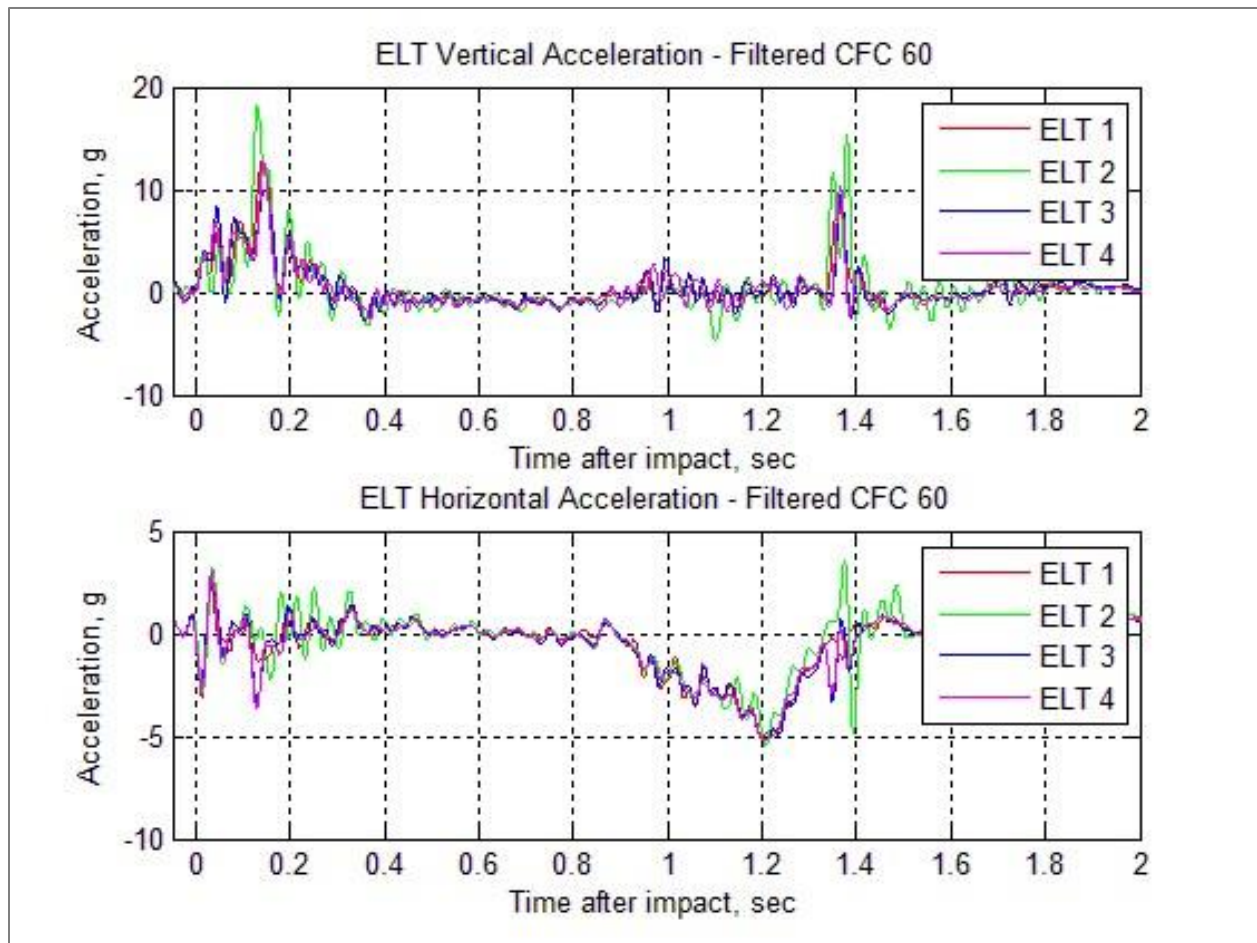

Figure 22. Beacon Accelerations - Airplane Crash Test 1

All four of the ELTs activated automatically and transmitted the 406 MHz distress signal to the Cospas-Sarsat system as confirmed by post-test inspection and review of satellite transmission log files. However, further review of the onboard video evidence suggested that three of the four ELT activations were as a result of the net capture event and not impact with the ground. Furthermore, it was determined that the ELT that positively activated in response to ground impact was the system that had developed significant cross-axis sensitivity during vibration testing.

Figure 23 compares the relative timing of the visual status indicators for each ELT to the acceleration environment measured in the engine compartment.

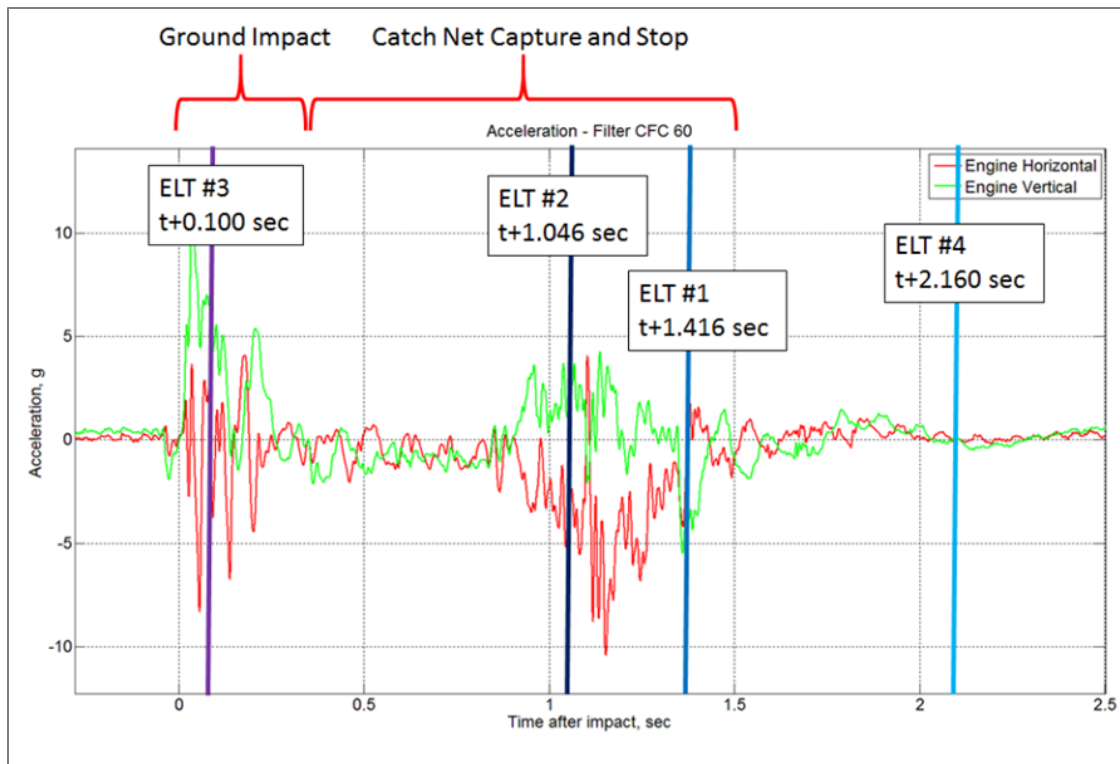

Figure 23. Relative Timing of ELT Visual Status Indications

Further review of time-synchronized, high-speed video recorded during crash safety testing of another unit of the same model as ELT 1 provided evidence that the time delay between the triggering event (initial impact) and illumination of the visual indicator was approximately 0.4-sec. Comparison of this value to the results shown above suggests strongly that ELT 1 was triggered by the (primarily horizontal) acceleration environment generated by impact with the catch net approximately 1.0-sec after initial ground impact (primarily vertical acceleration). Given that ELT 1 possessed a single-axis g-switch aligned with the horizontal direction, the assessment above seems reasonable, although not conclusive.

Since ELT 3 and 4 were of identical make and model, but ELT 3 had already demonstrated heightened cross-axis sensitivity due to vibration testing, it appeared that the vertical environment generated by ground impact led to activation of ELT 3. The delayed indication from ELT 4 suggested that it was triggered by the net capture event. Crash safety testing was performed with a “dummy” beacon of this model only, therefore, conclusions related to the relative timing of triggering and illumination could not be made.

No signs of structural damage were observed in any of the antenna cables or connectors because the crash environment did not produce significant deformation of the aircraft fuselage.

Analysis of the ATD data and inspection of the post-test condition of the aircraft confirm that the crash environment was survivable but the aircraft was not in a flyable condition. Therefore, ELT operation would be critical in a similar real-world accident where survivors had no other means or cognizance to call for help.

5.2.3 First Airplane Crash Test Conclusions

The observations and results discussed above suggest that 3 of the 4 ELTs activated automatically as a result of impact with the catch net and not due to ground impact. Had this been an actual crash that did not include an impediment to arrest post-crash forward motion so abruptly, the ELTs may not have transmitted the distress signal unless activated manually by a survivor.

Automatic activation of the remaining ELT is attributed to the heightened cross-axis sensitivity of the g-switch as a result of vibration testing. Given the level of sensitivity displayed at the end of the vibration test, it is likely that this beacon would have been responsible for one or more nuisance transmissions to SAR prior to the crash event and been replaced.

5.2.4 Second Airplane Crash Test Conduct

The second airplane crash test simulated a controlled flight into terrain scenario. The aircraft was oriented in a 12.2° nose-down configuration at impact with a flight path velocity of 74.4-ft/sec prior to impacting soil. The sequence of events are depicted in Figure 24.

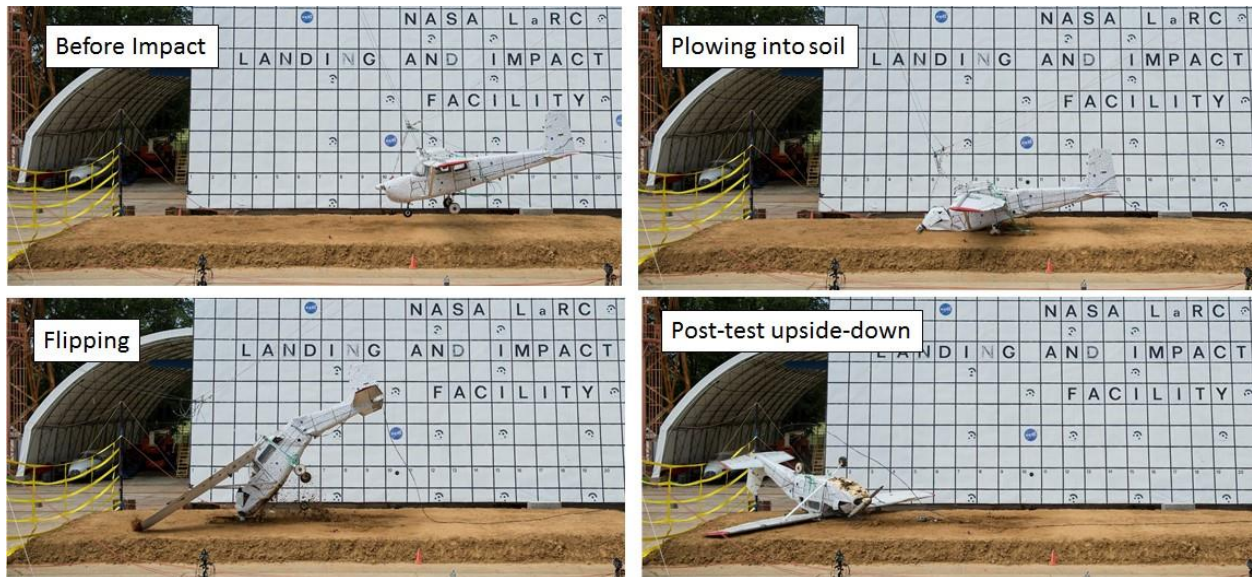

Figure 24. Impact Sequence – Airplane Crash Test 2

This was a much more severe environment than the first airplane crash test, but ATD results confirmed that the crash event was survivable. Given the potential for severe injury, this test represented a prime scenario for SAR.

The layout of the 5 ELT beacons installed onboard the aircraft is depicted in Figure 25. Again, these installations represent a range of typical GA aircraft configurations. The ELT 1 beacon was installed in the typical fashion for helicopter applications when using an ELT with a single-axis crash sensor (cabin ceiling mounted at a 45° nose-down orientation). ELT 2 was a “helicopter model” containing a collection of six g-switches. These types of models are to be installed flatwise

and again, a ceiling-mounted configuration was selected aft of the ELT 1 beacon. ELTs 3-5 contained single-axis, mechanical g-switches and were located as shown.

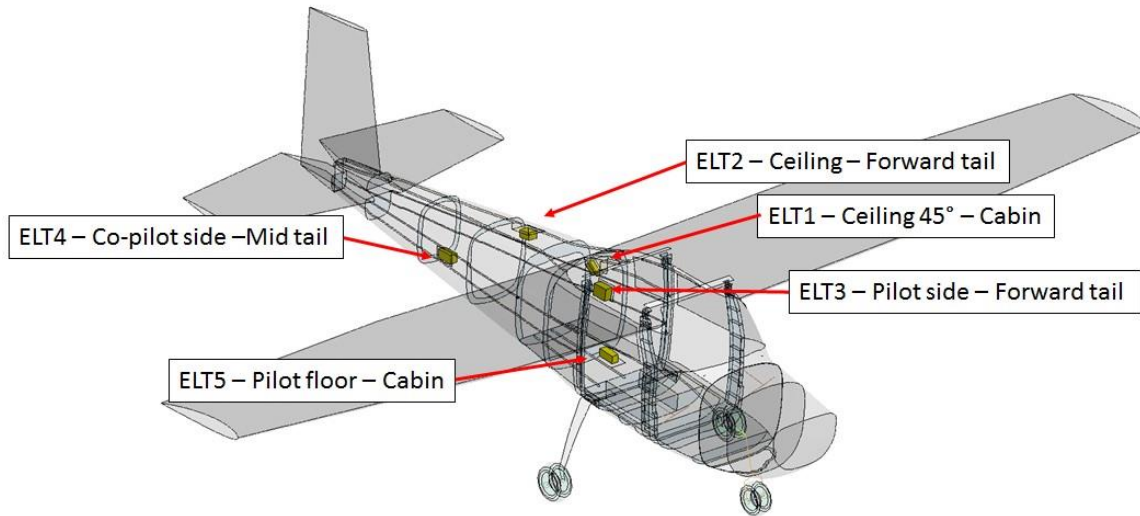

Figure 25. Beacon Layout - Airplane Crash Test 2

Similar to airplane crash test 1, the antenna locations and cable treatment was varied among the installations to represent typical arrangements and a pair of “dummy” ELTs were installed and connected to external antennas with coaxial cables and BNC connectors.

5.2.5 Second Airplane Crash Test Results Summary

The acceleration environment experienced by each ELT beacon is shown in Figure 26. The relative amplitude and duration of loading experienced by each unit varies depending on installation location and orientation.

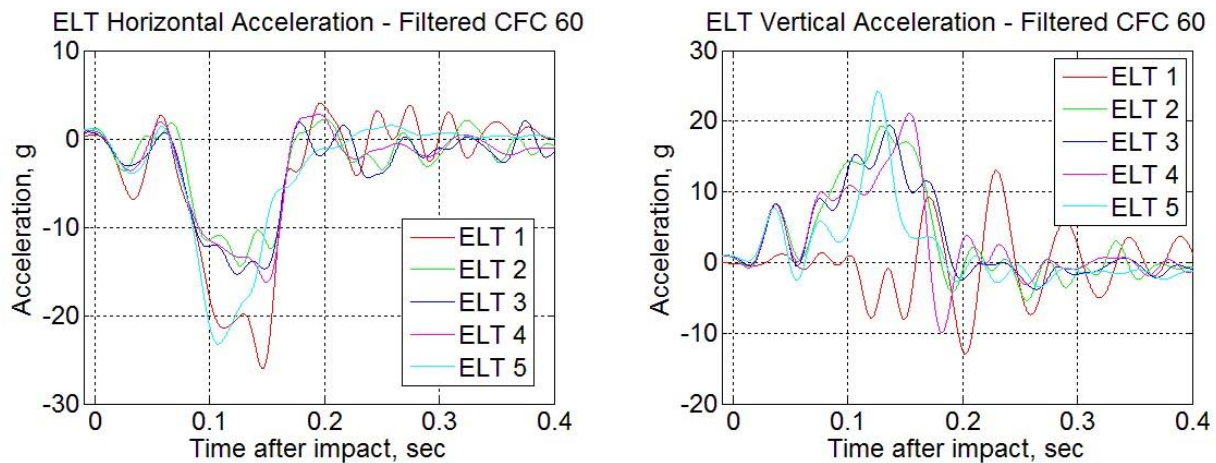

Figure 26. Beacon Accelerations - Airplane Crash Test 2

The largest horizontal loads were experienced by the forwardmost beacons, ELTs 1 and 5, which were installed in the cabin. In general, peak accelerations across the entire set ranged from 10- to 26-g and the pulseform can be described as trapezoidal of approximately 120-msec duration.

Vertical loads were consistent for ELT beacons 2 through 5 and the pulseforms can be described as triangular in shape with peaks on the order of 20-g's and a total duration in excess of 130-msec. The trace for ELT 1 does not follow the others because the vertical accelerometer was oriented in line with the beacon, which was oriented at a 45° angle with respect to the others.

Four of the five ELTs activated automatically and transmitted the distress signal to the SARSAT system during the test. The visual indicator on ELT 4 was not illuminated during post-test inspections, indicating that activation had not occurred. The internal self-test procedure was executed via the cockpit remote switch in accordance with the manufacturer's instructions, producing an error code indicating "High Voltage Standing Wave Radio (VSWR) or High Current", which may indicate a problem with the antenna connection.

Closer inspection of ELT 4 showed that the antenna cable had partially pulled out of the end fitting at the antenna connection as shown in Figure 27. Although the installation of this particular system followed all requirements, it intentionally did not follow best practice in that the antenna and beacon were not co-located in the same airframe station, causing the antenna cable to cross the production break between the cabin and tail section of the fuselage. It is believed that the large deformation of this region during the crash test led to the cable connection failure.

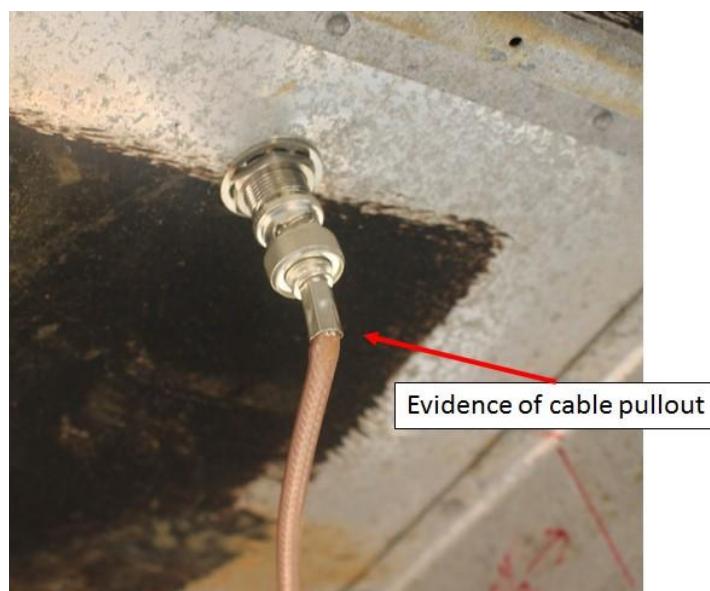

Figure 27. Antenna Cable Damage Observed After Airplane Crash Test 2

Despite the fact that both "dummy" ELT antenna cables crossed the major airframe production break between the cabin and tail sections, neither displayed any visual signs of damage following the test. This finding was because care was taken to follow installation best practices - strain relief was provided at each end and the cables were loosely feathered to airframe structure wherever possible.

5.2.6 Second Airplane Crash Test Conclusions

406 MHz distress signals were received by SARSAT space assets from all four of the ELTs that activated automatically during the crash test, as verified by the NASA SARLab. This result was despite the fact that the airplane flipped over during the crash sequence, resulting in the antennas pointing vertically downward.

The only ELT that did not function during the test exhibited two different failures. First, the beacon failed to activate regardless of the fact that the measured acceleration environment was in family with that experienced by the other beacons and well above the minimum activation threshold required. Secondly, the installation plan for the ELT that did not function during the test did not follow best practice as the antenna cable spanned a major airframe production break. This installation resulted in visible post-crash damage to the cable and an error code referring to a possible antenna cable issue as reported by the beacon during post-crash self-test procedures.

Following best practice guidelines for providing strain relief at either end of the antenna cable and teathering it to the airframe wherever possible helped preserve antenna connection integrity – even in the cases where major airframe production breaks were spanned. However, the crossing of major airframe production breaks is not recommended in any case in order to maintain the highest levels of integrity of the system.

5.2.7 Third Airplane Crash Test Conduct

The third airplane crash test scenario was representative of a controlled flight into terrain, where the pilot unsuccessfully attempted to pull the aircraft up, resulting in a tail-strike condition. The airplane made initial impact with the ground at a flight path velocity of 66.1-ft/sec in a 8.0° nose-up orientation. The sequence of events are depicted in Figure 28. Similar to the second airplane crash test, ATD results confirmed that the crash event was survivable. Given the potential for severe injury, this test represented another prime scenario for SAR.

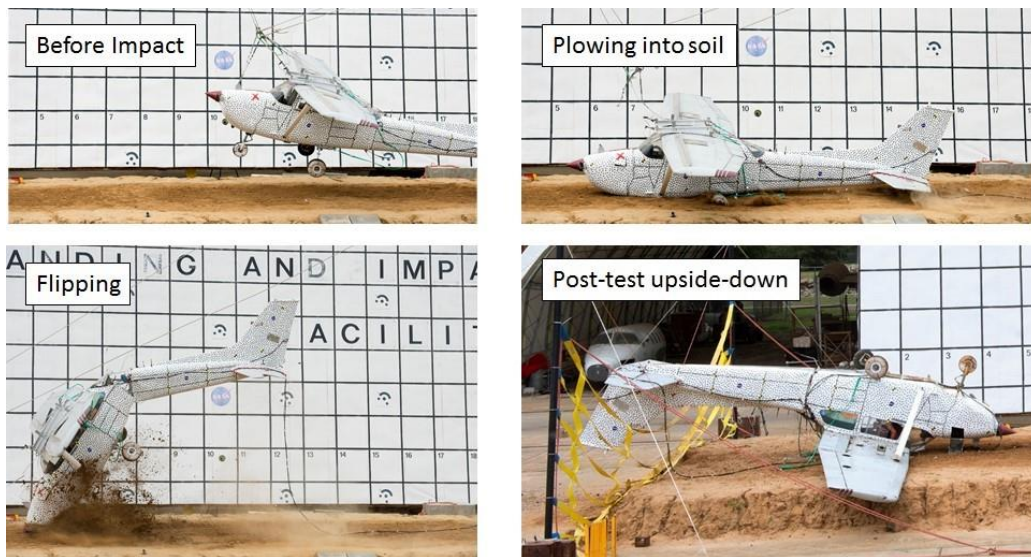

Figure 28. Impact Sequence - Airplane Crash Test 3

The relative locations of the 5 beacons are shown in Figure 29. Two “dummy” ELT system installations were included once again to provide additional insight with respect to performance impacts related to antenna cable installation techniques. The ELT 1 and 5 beacons were installed on the cabin floor, beacons 2 through 4 were mounted to the sidewall structures in the tail section.

The installation schemes were designed to replicate different techniques that are commonly employed. ELTs 1 through 4 contained single-axis, mechanical g-switches, while ELT 5 utilized a six-axis, solid-state, crash-sensor. This ELT was a new unit, but of the same make and model as the solid-state sensor equipped ELT that was included in crash safety and vibration testing.

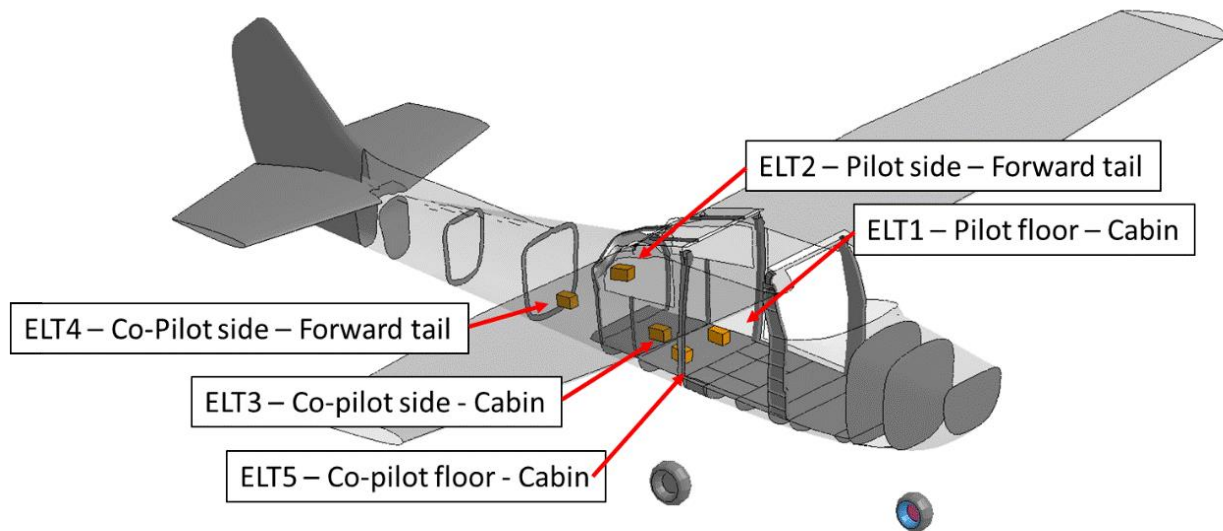

Figure 29. Beacon Layout - Airplane Crash Test 3

5.2.8 Third Airplane Crash Test Results Summary

Figure 30 shows the acceleration environment measured at each beacon location during the third crash test. Variations in magnitude and dynamic content seen in the horizontal acceleration data are attributed to the large airframe deformation and structural failure of the fuselage at the cabin-tail juncture. As shown in the lower left view of Figure 28, the tail was almost completely severed during the sequence. The recorded acceleration environment at each ELT location exceeded the minimum threshold for automatic activation.

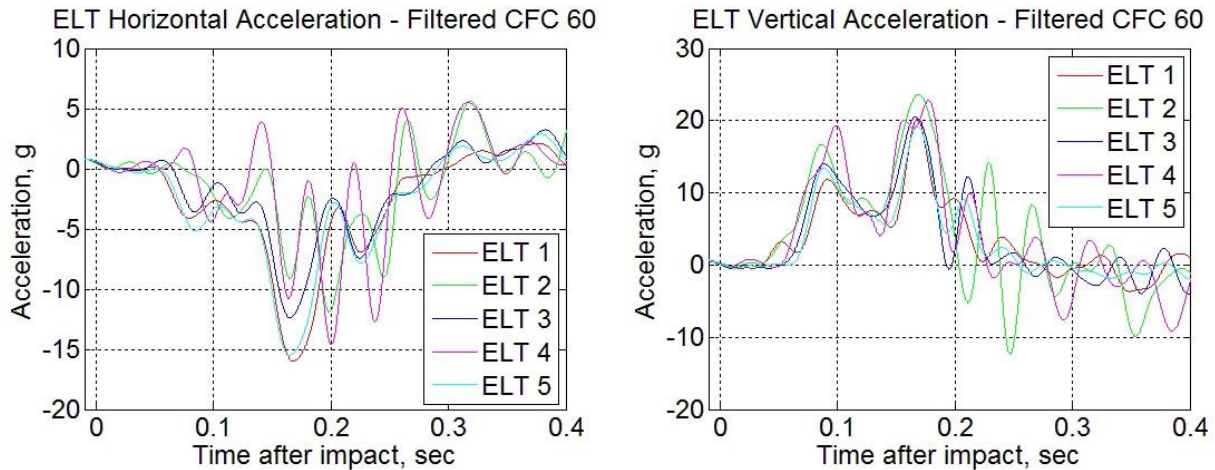

Figure 30. Beacon Accelerations - Airplane Crash Test 3

Four of the five ELTs activated automatically and transmitted the distress signal to SAR as confirmed by review of the satellite transmission log files. The beacon that failed to activate corresponded to ELT 2, which was an identical model as ELT 4. The beacons were installed in mirror-image configurations to the left and right sidewalls of the forward tail section.

ELT 2 passed post-crash internal self-test per the manufacturer’s instructions and activated automatically when armed and shaken by hand. This procedure indicated that the crash test performance was due to the g-switch failing to trigger. ELTs 2 and 4 were both disassembled and inspected. Although both systems were acquired in a single purchase order, the g-switches were observed to be different. The coloring and finish of both cylinders and internal masses varied from a dull, brass-like appearance to shiny gold-like appearance. The number of coil winds also varied between the springs contained in each g-switch. These differences are visible in Figure 31.

As shown in Figure 32, under 1-g vertical loading, the spring inside the g-switch on the right has collapsed to the point that the mass is making contact with the lead, resulting in a “closed” condition. However, the spring inside the g-switch on the left is apparently stiffer and the switch remains in the “open” condition. Given these differences, it should be expected that each switch should perform differently under dynamic loading conditions, which is consistent with crash test performance observations.

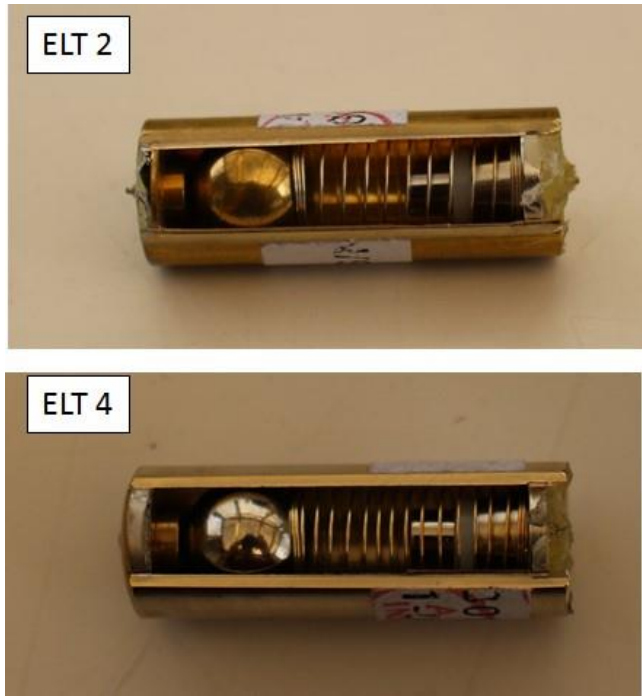

Figure 31. Cutaway View of G-switch Assemblies

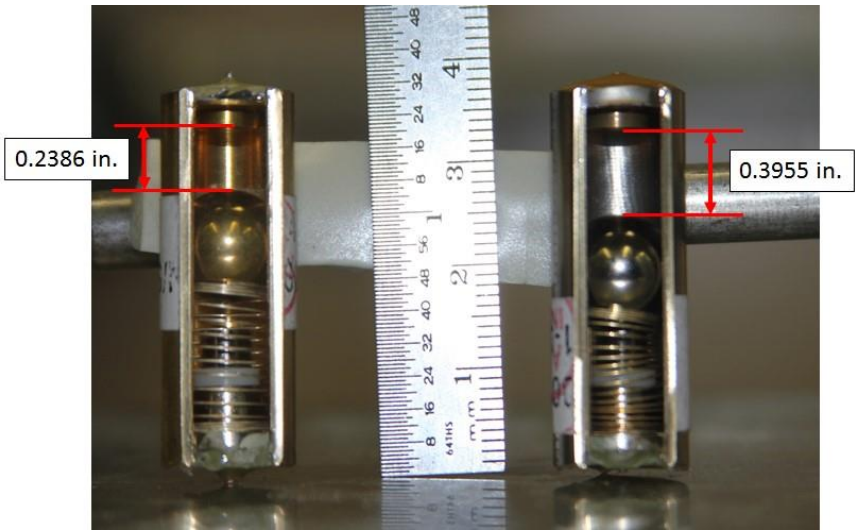

Figure 32. G-switch Variation Between ELT 2 (left) and ELT 4 (right)

Physical damage was observed in three of the seven antenna cables after the crash test. The damaged cables corresponded to ELT 3 and both “dummy” ELTs. Although the ELT 3 cable showed signs of failure near the antenna connection, the damage did not prohibit successful transmission of the 406 MHz distress signal. More severe damage was exhibited by the “dummy” installations, with cable 1 becoming disconnected, but intact, and cable 2 being severed as the cable pulled out of the end fitting at the antenna connector. The damage experienced by each of these cables is depicted in Figure 33 and was the result of providing little to no slack in the cable runs.

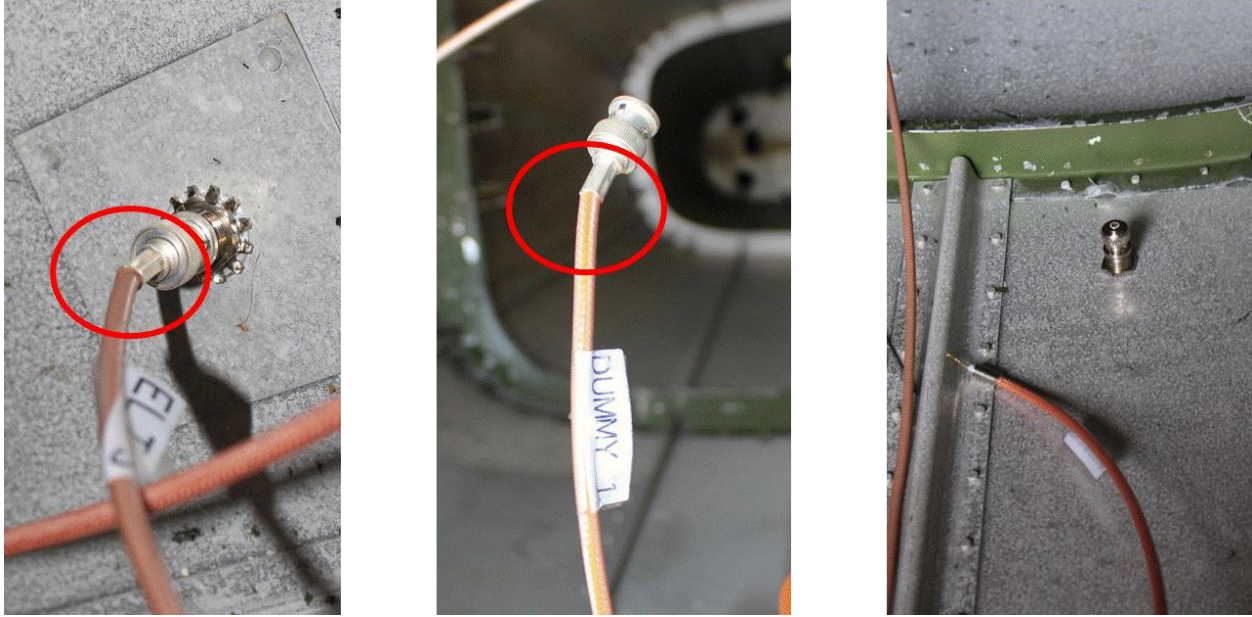

Figure 33. Damaged Antenna Cables - ELT 3 (left), Dummy 1 (center), Dummy 2 (right)

5.2.9 Third Airplane Crash Test Conclusions

Four of the five ELTs onboard the third airplane crash test functioned properly and distress signals were received by the SARSAT system despite the upside-down post-crash orientation of the aircraft.

The one ELT that failed to activate during the test was installed in a mirror configuration to an identical model that did activate during the test. Further inspection revealed that the failed g-switch was made of different materials and behaved differently under 1-g loading than the one that performed as intended.

All three of the antenna cables that crossed the airframe production break between the cabin and tail displayed varying degrees of damage, ranging from superficial to catastrophic, due to the absence of sufficient slack at either end of the cable runs.

6 Full-Scale Crash Simulation

Finite Element Models (FEMs) were constructed of each airplane and analyzed under tested crash conditions using LS-DYNA and Abaqus as detailed in [28] through [30]. After model calibration, a series of simulations were run with variations on aircraft pitch attitude, velocity and impact surface. Simulation results were then used to help formulate recommendations for ELT system installation. An example of one of the analysis model of the second airplane crash test is shown in Figure 34. Some internal modelling details can be seen in the half-model shown in Figure 35 (Note, DAS = Data Acquisition System).

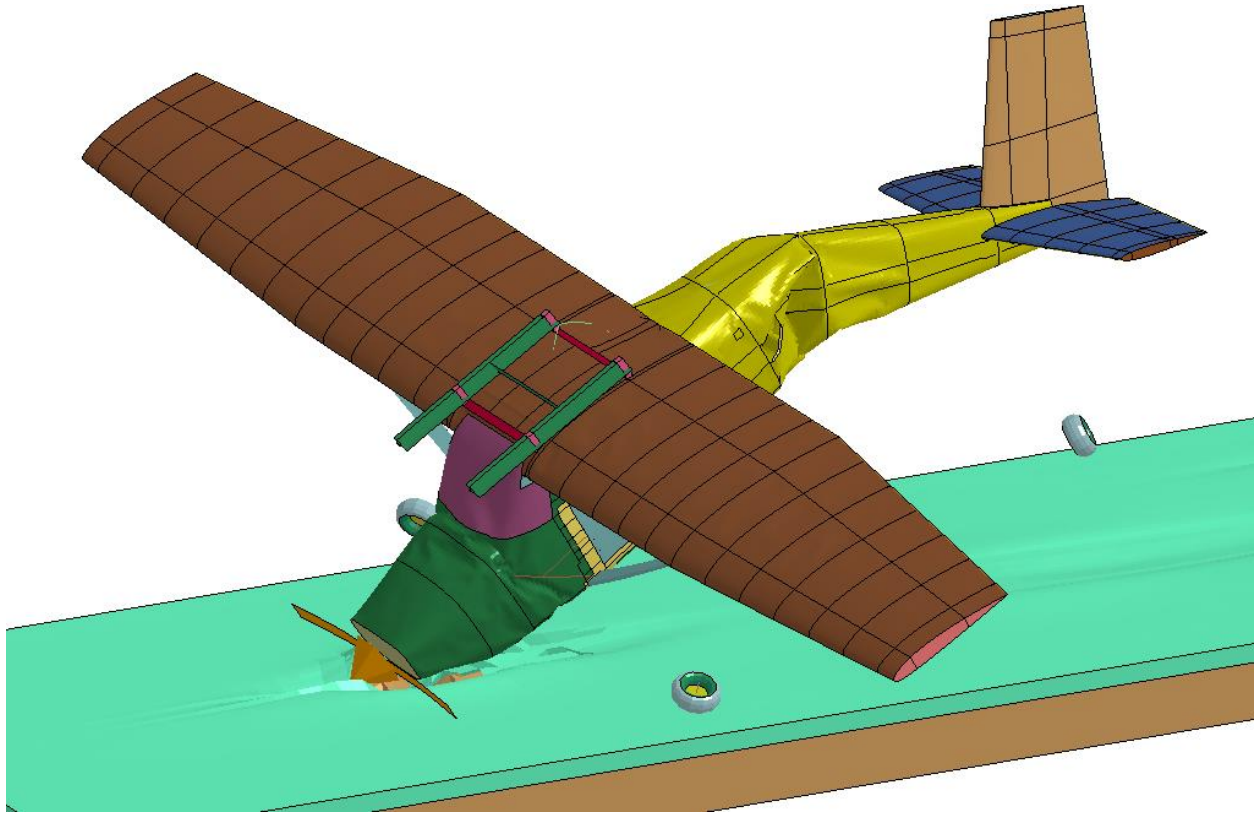

Figure 34. Simulation of Second Airplane Crash Test

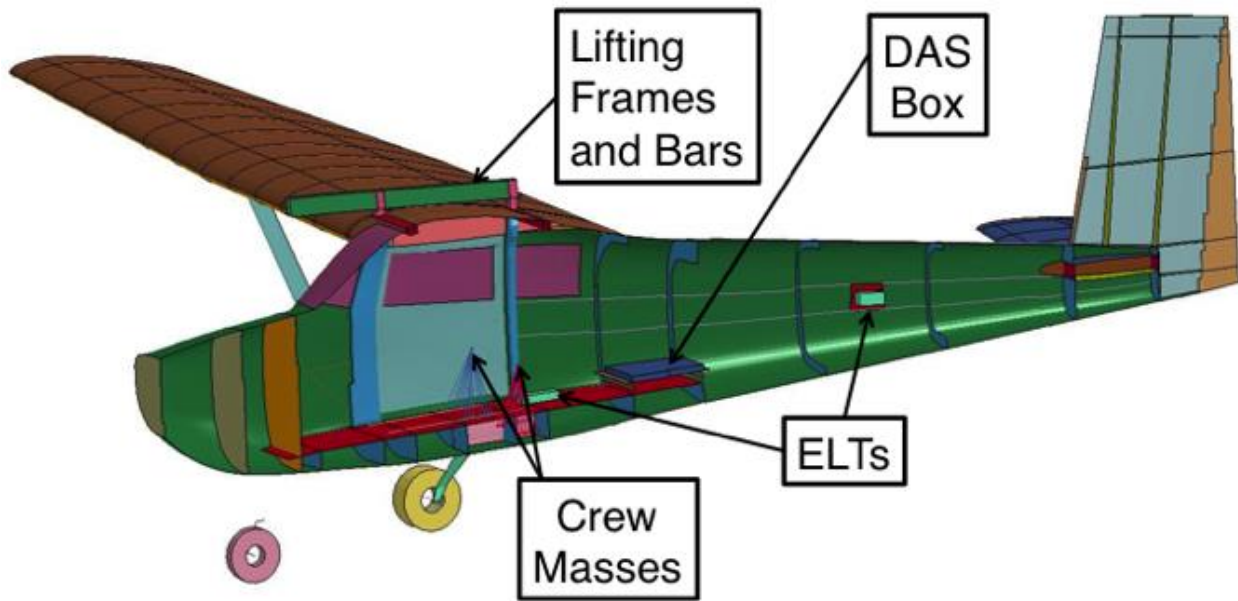

Figure 35. Half-Model Showing Internal Details

6.1 Full-Scale Crash Simulation Objective

The primary purpose of producing computer models of each of the three crash tests was to generate a data set to augment the investigation of ELT system installation. Once calibrated, the models provided simulation testbeds that were used to assess a wider array of ELT installation techniques and configurations than had been tested.

Although it was recognized that there would not be one optimal approach for all variations of airframes and crash conditions, the goal was to identify best practices that, if adopted, may result in gains in crashworthiness and functionality of the ELT system.

The survivability of antenna cable connections as a prime contributor to ELT system functionality was an area of focus given that antenna disconnection had been identified as one of the classic failure modes as previously discussed. Specifically, the effects of implementing the methods and best practices pertaining to coaxial cable installation onboard aircraft as a means of reducing the probability of ELT system failure was investigated.

6.2 Cable Connector Force Mitigation Techniques

It was found that following the best practices described in [31] contributed positively to reducing the forces experienced by the antenna cable connections to acceptable levels. Figure 36 shows the predicted tensile load experienced by the antenna cable connector for two different cable installation schemes undergoing the same crash event. The simulated crash conditions were similar to those tested with the third airplane described previously, but with a rigid (e.g. concrete) impact surface instead of soil.

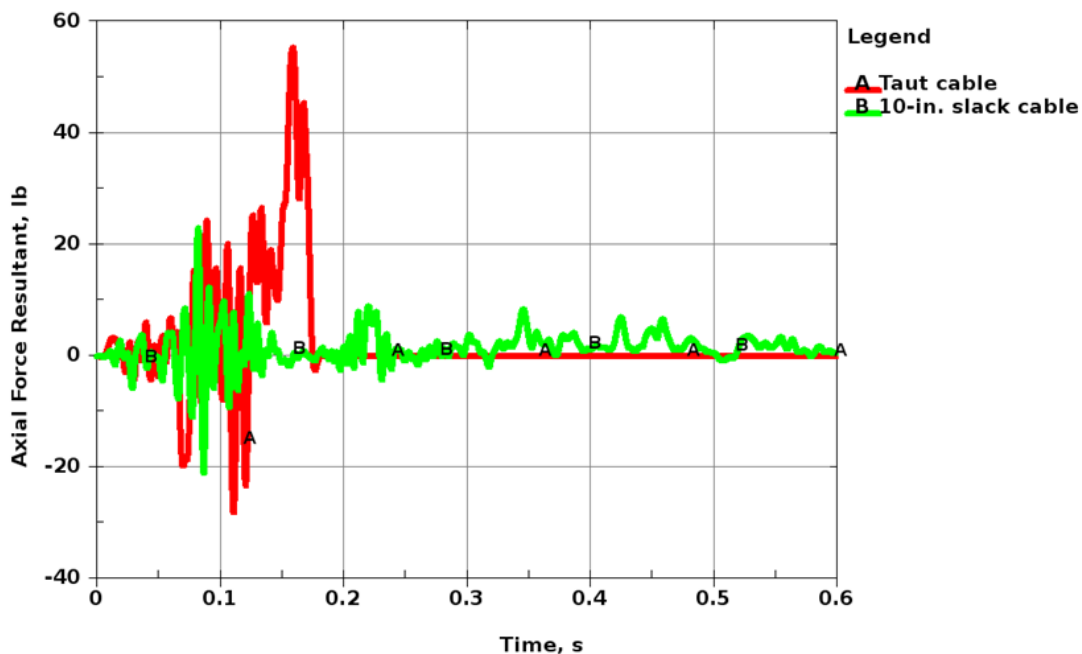

Figure 36. Comparison of Dynamic Cable Connector Forces for Taut and Slack Conditions

As described in greater detail in [28], the routing for both the “taught” and “slack” antenna cables was similar in that they were connected to a beacon installed along the aft cabin sidewall and an antenna in the forward tail section. The only difference was that the “slack” cable contained an additional 10-in of length dedicated to strain relief. This value was deduced from the best practices outlined in [31] where a minimum bend radius of 6 times the outer diameter of coaxial cables is recommended. Therefore, a complete strain relief loop for a ¼-in diameter coaxial cable should have a minimum circumference of approximately 9.4-in. This value was rounded up to 10-in in the analysis model.

The results show that the tension, or axial, force in the taut cable (Figure 36, red curve) reach a maximum value of approximately 55 lbs before rapidly decreasing to zero at a point in time around 0.17-sec after initial impact. The rapid unloading of the cable connector corresponds to the time in which the antenna cable is severed during the simulation. The failure criteria for the antenna cable model was based on strain data produced during tensile testing described previously and the failure load corresponds well with ultimate system strength results obtained in the laboratory.

In contrast, it can be seen that the tension force in the slack cable (Figure 36, green curve) never exceeds 23 lbs and oscillates around magnitudes less than 10 lbs during the post-impact period in which the taut cable has already failed. These low-level forces experienced by the cable connector are attributed to the mass of the cable itself as the amount of slack initially provided did not payout entirely. Therefore the antenna cable connections were protected from being stressed by airframe deformation between the beacon and antenna.

6.3 Full-scale Crash Simulation Conclusions

The crash simulations clearly demonstrate the need for strong ELT system requirements on cabling and ELT system placement within the aircraft. While it is recognized that there will be unsurvivable crash scenarios with excessively large airframe deformations, it is also true that survivable crashes can have airframe structural damage significant enough to cause ELT system failures. Therefore, several items, some of which exist in current guidance, should be clearly and firmly stated within revised flight standards DO-204B and ED-62B.

The preferred approach to maintaining system interconnections is to minimize the separation between the beacon and the antenna, to locate the beacon and antenna at the same longitudinal station of the airframe, and to follow the practices outlined in [31] for cabling that call for support intervals no less than 24-in and minimum bend radii no less than 6 times the outer diameter of coaxial cable.

At a minimum, it is recommended that the following be included in each ELT manufacturer’s installation and user manual for effective system operation:

- Minimal separation between the ELT unit and the antenna
- Locate the ELT unit and antenna at the same longitudinal station of the airframe
- Cabling support intervals no less than 24 inches

- Minimum cable bend radii no less than six times the outer diameter of the antenna cable
- Strain relief loops at both ends of the antenna cable, with sufficient loop circumference based on the minimum bend radii.

These recommendations are further summarized in Section 8, Table 4. Ensuring that the above are clearly communicated to end users not only allows for verification of strict adherence to the current ELT installation guidance, it also requires ELT users and installers to follow the practices outlined in [31].

7 Conclusion

Several areas for ELT system improvement were identified throughout this study that can be addressed through pragmatic changes to the MOPS as discussed above and summarized in Table 4. Antenna connection integrity and crash sensing, along with installation and mounting issues, were observed to contribute significantly to system failures and both can be addressed by modifying the way in which new designs are qualified. Vibration and fire sensitivity have also been shown to detract from ELT performance and means for mitigating those effects have also been demonstrated.

The overall system performance is subject to the methods used when installing the system and connecting its components. Since human-survivable crash environments can be so severe as to result in large airframe deformation, it is critically important that the ELT system cabling and installation recommendations resulting from this study be required for inclusion in ELT manufacturer manuals, and that this requirement be included in changes to the MOPS as summarized in Section 8, Table 4.

Beacon robustness was observed to be very high when testing current models. Although older vintage beacons had been sometimes shown to be prone to failure due to mechanical loading experienced during crash events, this behavior was not observed throughout crash safety or full-scale crash testing. This finding may be attributed in part to the addition of crush and impact/penetration test requirements for ELTs over the years.

Implementation of the latest NTSB accident report form should yield greater insight into ELT system performance in the years to come. If the TSO field is routinely populated on that form and performance information is included, it will be possible to perform a meaningful statistical analysis on the trajectory of ELT performance with respect to MOPS revisions and identify further areas for improvement.

It is hoped that this study, or portions thereof, will be repeated in the future when the next generation of ELT systems are in service. With the aide of the updated NTSB accident report form and database, it would be of great benefit to study and contrast the performance of future ELT systems with those studied under this and prior efforts (

Table 1 - Table 3). That knowledge will inform the SAR community on areas of success as well as possible areas requiring further attention in the development of future MOPS.

Another area for future work would be to characterize the performance of the next generation of ELT systems under the same or similar conditions as the current generation systems were subjected to in this study. It will be several years before crash report data is publically available that may contain real-world crash performance data pertaining to next generation ELT systems. However, systems designed under the next generation MOPS will be available for study at an earlier date and identification of vulnerabilities prior to life-threatening accidents will allow for preventive action to be taken.

Finally, the unique analysis and test capabilities at NASA LaRC should continue to be utilized in order to provide the highest fidelity data possible for formulation of MOPS of ELT systems. The airframe models that have been developed under this study may be used to augment the study of other crash scenarios and the full-scale crash test facility can be used to perform system-level crash testing of other types of aircraft that were not included in this test series, such as commercial or business jets and GA helicopters.

8 Recommendations

A summary of recommended changes to future ELT MOPS is provided in Table 4. The relevant paragraphs in the current MOPS are provided along with the rationale for each recommendation, which is based on the empirical evidence summarized above. Note that the first two recommendations under “Automatic Crash Activation” were not discussed previously but are presented as a means for arriving at a more complete performance specification for ELT crash sensors.

Table 4. Summary of MOPS Recommendations

Topic	MOPS §	Recommendation(s)	Rationale
ELT Manufacturer Documents	DO-204A 3.0 ED-62A 6.0	1. Require inclusion of specific ELT System installation requirements within the ELT Manufacturer-supplied documentation.	1. In order to maximize visibility of recommendations for improving system installation, mandate the inclusion of specific requirements within manufacturer-supplied documentation (e.g. Beacon user and installation manuals).
Vibration	DO-204A 2.3.5; ED-62A 4.4.4	1. Require vibration testing in accordance with robust levels defined in DO-160G § 8.2.1.2. 2. Require pre-and post-test verification of crash-sensor performance. 3. Perform vibration testing in the sequence of tests required to be performed with a single unit, before shock and crash safety.	1. Robust vibration testing was effective at reproducing the failure mode of g-switch performance degradation. 2. Pre- and post-vibration functionality checks of the crash sensor will help ensure functionality throughout equipment life. 3. Including vibration testing in the series of tests performed with a single unit more accurately portrays the life of an ELT system. This is especially true if crash sensor performance is vetted before and after the recommended robust vibration test series, followed by shock and crash safety.

Topic	MOPS §	Recommendation(s)	Rationale
Automatic Crash Activation	DO-204A 2.6.3.1; ED-62A 5.4	<ol style="list-style-type: none"> 1. Require verification of performance in the “no activation” region for pulses of less than 10-msec duration. 2. Define crash activation sensor response curves with increased activation thresholds in directions other than normal flight. 3. If crash safety testing is updated to include multi-axis load conditions and automatic activation is required (as applicable), the “cross-axis inputs” test may be optional. 	<ol style="list-style-type: none"> 1. Reduced nuisance alarm rates and increased performance in crashes will result from more complete verification of performance in accordance with the sensor response curve. 2. No performance specification currently exists for 5 of the 6 directions in ELTs equipped with multi-axis crash sensors. 3. The “cross-axis inputs” test is not necessary if recommendations for updated crash safety testing are implemented.
Crash Safety	DO-204A 2.6.3.2; ED-62A 4.5.7.3	<ol style="list-style-type: none"> 1. Require demonstration of functionality (including automatic activation, as applicable) for all tests performed. 2. Require 6 additional test cases with the beacon oriented at $\pm 45^\circ$ with respect to each of the 3 primary directions. 3. Require an additional test case for each of the 3 primary beacon directions using a pulse of no less than 15-g and no less than 50-msec duration. 	<ol style="list-style-type: none"> 1. Crash events are the design environment for ELT functionality. 2. Multi-axis load cases caused beacon ejection in lab testing, including TSO-C126b compliant designs. 3. Crash sensor performance varied as a function of load amplitude and duration in lab testing even though all pulses were representative of real world crashes and should have resulted in automatic activation.
Flame Test	DO-204A 2.3.7.1; ED-62A 4.5.11	<ol style="list-style-type: none"> 1. Require the duration of exposure to support system functionality, i.e., no less than the time between automatic activation and the first 406 MHz transmission. 2. Require demonstration of full system functionality after exposure to the environment, i.e. successful VSWR test of the antenna and coaxial cable (outfitted with a firesleeve, if necessary). 	<ol style="list-style-type: none"> 1. The test environment should be adequate for assessment of sufficient thermal protection to perform intended functions in the presence of post-crash fire. 2. The current requirement only calls for beacon aliveness to be demonstrated after exposure to the flame test and there is no confirmation that the antenna cable will be capable of performing its intended function.
External Antenna Location	DO-204A 3.1.10.2; ED-62A 6.1.10.2	<ol style="list-style-type: none"> 1. The antenna should be located at the same longitudinal location as the beacon. In the event this is not possible, a strain relief loop in accordance with FAA AC 43-13-1B requirements for minimum bend radius of coaxial cables should be required. 	<ol style="list-style-type: none"> 1. Antenna connection integrity is vulnerable to relative longitudinal displacement of airframe stations during a crash event.

Topic	MOPS §	Recommendation(s)	Rationale
Coaxial Cable	DO-204A 3.1.11; ED-62A 6.1.11	<ol style="list-style-type: none"> 1. Require application of fire resistant material in accordance with SAE AS1072. 2. Replace the requirement for “vibration-proof RF connectors” with “MIL-DTL-17 cables and connectors or equipment that is appropriate for the vibration profile at the installation location”. 3. In addition to the requirement to include “some slack” in the cable, require a strain relief loop of minimum bend radius 6 times the outer diameter of the cable whenever the beacon and antenna are not located at the same longitudinal station in the aircraft. 4. In addition to the requirement for the cable to “be secured to the aircraft structures for support and protection.”, require that such support be provided at intervals of not more than 24”. 5. Provide additional clarification to the definition of “aircraft production breaks”. 	<ol style="list-style-type: none"> 1. AS1072 firesleeves are economical, readily available from numerous sources and provide sufficient thermal protection to significantly extend the functional life of antenna cables. 2. MIL-DTL-17 references MIL-PRF-39012 for vibration performance specification of the connectors. It is permissible for the installer to select other equipment if they can show that the hardware is satisfactory for the intended application. 3. The recommended bend radius of a strain relief loop is in accordance with best practices outlined in FAA AC 43.13-1B. The study found that following these guidelines may reduce the dynamic loading experienced by the cable connectors during a survivable crash event to acceptable levels, thereby contributing to overall ELT system functionality. 4. The recommended support interval is in accordance with best practices outlined in FAA AC 43-13-1B. 5. Antenna cable connections are at risk of failure when cables are installed across aircraft production breaks, but this definition could benefit from improvement that considers the range of potential types of airframes for ELT installation.

9 Acknowledgements

This research was sponsored by the NASA SAR Mission Office at GSFC in Greenbelt, MD. The individuals contributing to the ELTSAR Study at LaRC would like to extend their sincere thanks to NASA SAR management for their support as well as the members of RTCA SC-229 and EUROCAE WG-98. The positive collaboration of other United States Government Agencies, such as FAA, NOAA and NTSB is also noted and appreciated.

10 References

- [1] NASA/CR-4330, “Current ELT Deficiencies and Potential Improvements Utilizing TSO-C91a ELTs”, Trudell, B. and Dreibelbis, R., dated 1990.
- [2] NASA CR-160036, “Systems Analysis of the Installation, Mounting, and Activation of Emergency Locator Transmitters in General Aviation Aircraft”, Hall, D., dated 10 January 1980.
- [3] ATSB Report AR-2012-12B, “A Review of the Effectiveness of Emergency Locator Transmitters in Aviation Accidents”, dated 21 May 2013.
- [4] Defence R&D Canada Report TR 2009-101, “ELT Performance in Canada from 2003 to 2008”, Keillor, J. et al, dated September 2009.
- [5] German BFU Presentation to the Cospas-Sarsat Experts Working Group, “Reliability of 406 MHz ELT in Aircraft”, Lampert, P., dated January 2011.
- [6] Cospas-Sarsat Council 45th Session Open Meeting Agenda Item 8.2, “Continuous Monitoring of the Performance of Beacons Through Integrated Safety Analysis”, ICAO, dated 7 September 2010.
- [7] Vector Magazine, “ELT Airworthiness Directive”, CAA of New Zealand, dated July/August 2010.
- [8] NTSB Report AAR-11/03, “Collision into Mountainous Terrain, CGI Communication Corp., de Havilland DHC-3T, N455A, Aleknagik, Alaska, August 9, 2010”, dated 24 May 2011.
- [9] FAA TSO-C126b, “406 MHz ELT”, dated 26 November 2012.
- [10] TSB of Canada Aviation Investigation Report A11W0151, “Controlled Flight into Terrain”, dated 20 March 2013.
- [11] NTSB Accident Report WPR12FA184, dated 2 December 2013.
- [12] NTSB Accident Report WPR12FA067, date of accident 15 December 2011.
- [13] NTSB Accident Report ERA12FA540, date of accident 1 September 2012.
- [14] NTSB Accident Report ERA14LA043, date of accident 15 November, 2013.
- [15] NTSB Accident Report WPR14FA124, date of accident 26 February, 2014.
- [16] NTSB Form 6120.1, “Pilot/Operator Aircraft Accident/Incident Report”, dated 9 September 2013.
- [17] NTSB Safety Alert 030, “‘Armed’ for Safety: Emergency Locator Transmitters,” dated December 2013.
- [18] NTSB Press Release, “Acting Chairman Hart Announces Slight Drop in 2013 Transportation Fatalities in Most Categories; Rail Deaths Rise”, dated 2 February 2015.
- [19] RTCA DO-204A, “Minimum Operational Performance Standards for 406 MHz ELT”, dated 6 December 2007.
- [20] NASA TP-2083, “Correlation and Assessment of Structural Airplane Crash Data with Flight Parameters at Impact”, Carden, H., dated November 1982.
- [21] RTCA DO-160G, “Environmental Conditions and Test Procedures for Airborne Equipment”, dated 8 December 2010.
- [22] AHS International 71st Annual Forum, “Evaluation of the Second Transport Rotorcraft Airframe Crash Testbed (TRACT 2) Full Scale Crash Test”, Annett, M., and Littell, J., dated 5-7 May 2015.

- [23] SAE J211/1-1.2007, "Instrumentation for Impact Test-Part 1-Electronic Instrumentation", dated 27 July 2007.
- [24] NASA/TM-2015-218987, "Crash Tests of Three Cessna 172 Aircraft at NASA Langley Research Center's Landing and Impact Research Facility", Littell, J.D., dated November 2015.
- [25] NASA/TM-2016-219175, "ATD Occupant Responses from Three Full-Scale General Aviation Crash Tests", Littell, J.D., and Annett, M.S., dated March 2016.
- [26] NASA/TM-2016/219217, "Emergency Locator Transmitter System Performance from Three Full Scale General Aviation Crash Tests", Littell, J.D., and Stimson, C.M., dated July 2016.
- [27] NASA/TM-2016/219168, "Experimental Photogrammetric Techniques used on Five Full-Scale Aircraft Crash Tests", Littell, J.D., dated March 2016.
- [28] NASA/TM-2017/(in publication), "Simulating the Impact Response of Three Full-Scale Crash Tests of Cessna 172 Aircraft", Jackson, K.E., et al., dated (in publication).
- [29] AIAA Paper 2017-0631, 2017 AIAA Science and Technology Forum and Exposition, Grapevine, TX, January 2017, "Finite Element Simulation of Three Full-Scale Crash Tests for Cessna 172 Aircraft", Mason, B.H., and Warren Jr., J.E..
- [30] Proceedings of the 2015 Aerospace Structural Impact Dynamics International Conference, "Full-Scale Crash Tests and Analyses of Three High-Wing Single Engine Aircraft", Annett, M.S., et al., dated 17 November 2015.
- [31] FAA Advisory Circular 43.13-1B, "Acceptable Methods, Techniques, and Practices - Aircraft Inspection and Repair", dated 8 September 1998.

REPORT DOCUMENTATION PAGE

Form Approved
OMB No. 0704-0188

The public reporting burden for this collection of information is estimated to average 1 hour per response, including the time for reviewing instructions, searching existing data sources, gathering and maintaining the data needed, and completing and reviewing the collection of information. Send comments regarding this burden estimate or any other aspect of this collection of information, including suggestions for reducing the burden, to Department of Defense, Washington Headquarters Services, Directorate for Information Operations and Reports (0704-0188), 1215 Jefferson Davis Highway, Suite 1204, Arlington, VA 22202-4302. Respondents should be aware that notwithstanding any other provision of law, no person shall be subject to any penalty for failing to comply with a collection of information if it does not display a currently valid OMB control number.
PLEASE DO NOT RETURN YOUR FORM TO THE ABOVE ADDRESS.

1. REPORT DATE (DD-MM-YYYY) 01-02-2017		2. REPORT TYPE Technical Memorandum		3. DATES COVERED (From - To)	
4. TITLE AND SUBTITLE Emergency Locator Transmitter Survivability and Reliability Study				5a. CONTRACT NUMBER	
				5b. GRANT NUMBER	
				5c. PROGRAM ELEMENT NUMBER	
6. AUTHOR(S) Stimson, Chad M.; Littell, Justin D.; Mazzuca, Lisa M.; Foster, Anthony W.; Theodorakos, George J.				5d. PROJECT NUMBER	
				5e. TASK NUMBER	
				5f. WORK UNIT NUMBER 432938.11.01.07.42.12	
7. PERFORMING ORGANIZATION NAME(S) AND ADDRESS(ES) NASA Langley Research Center Hampton, VA 23681-2199				8. PERFORMING ORGANIZATION REPORT NUMBER L-20788	
9. SPONSORING/MONITORING AGENCY NAME(S) AND ADDRESS(ES) National Aeronautics and Space Administration Washington, DC 20546-0001				10. SPONSOR/MONITOR'S ACRONYM(S) NASA	
				11. SPONSOR/MONITOR'S REPORT NUMBER(S) NASA-TM-2017-219584	
12. DISTRIBUTION/AVAILABILITY STATEMENT Unclassified Subject Category 03 Availability: NASA STI Program (757) 864-9658					
13. SUPPLEMENTARY NOTES An Errata was added to this document May 2018.					
14. ABSTRACT A comprehensive study of Emergency Locator Transmitter (ELT) performance was conducted over a three year period concluding in 2016 in support of the Search and Rescue (SAR) Mission Office at National Aeronautics and Space Administration (NASA) Goddard Space Flight Center (GSFC). The study began with a review of reported performance cited in a collection of works published as early as 1980 as well as analysis of a focused set of contemporary aviation crash reports. Based on initial research findings, a series of subscale and fullscale system tests were performed at NASA Langley Research Center (LaRC) with the goals of investigating ELT system failure modes and developing recommended improvements to the Minimum Operational Performance Specification (MOPS) that will result in improved system performance. Enhanced performance of ELT systems in aviation accidents will reduce unnecessary loss of human life and make SAR operations safer and less costly by reducing the amount of time required to locate accident sites.					
15. SUBJECT TERMS Airplane crash test; Aviation safety; Crash survivability; Emergency locator transmitter; Minimum operational performance Standard; Rescue; Search					
16. SECURITY CLASSIFICATION OF:			17. LIMITATION OF ABSTRACT	18. NUMBER OF PAGES	19a. NAME OF RESPONSIBLE PERSON
a. REPORT	b. ABSTRACT	c. THIS PAGE			STI Help Desk (email: help@sti.nasa.gov)
U	U	U	UU	60	19b. TELEPHONE NUMBER (Include area code) (757) 864-9658