

Alma Mater Studiorum – Università di Bologna

DOTTORATO DI RICERCA IN CHIMICA

Ciclo XXVIII

Settore Concorsuale di Afferenza: 03/D2

Settore Scientifico Disciplinare: CHIM/09

***Study of different technologies for film coating of drug
layered pellets using ethylcellulose as functional polymer***

Presentata da: Cecilia Melegari

Coordinatore Dottorato

Chiar.mo Prof. Aldo Roda

Relatore

Prof. ssa Beatrice Albertini

Prof. ssa Nadia Passerini

Esame finale anno 2016

Summary

1. HISTORICAL DEVELOPMENT OF MEDICINAL COATING	6
1.1. Sugar-Coating	6
1.1.1. Stages in sugar coating	7
1.2. Film-Coating	10
1.2.1. Equipments	10
2. COMPOSITION OF FILM COATING FORMULA	17
2.1. Polymers	18
2.2. Plasticizer	19
2.3. Dyes and Pigments	21
2.4. Glossing and Polishing Agents	22
2.5. Antiadherents.....	23
2.6. Surfactants	23
3. FILM FORMATION	24
3.1. Film Formation from Solutions.....	25
3.2. Film Formation from Aqueous-Based Polymeric Dispersions	26
3.2.1. Stability of aqueous polymeric film coatings	30
4. FUNCTIONS OF COATINGS	34
4.1. Non Functional Coatings or Cosmetic Applications.....	34
4.2. Immediate Release Application.....	35
4.2.1. Film coatings for taste masking and moisture protection.....	35
4.2.2. Improving ease of ingestion / swallowing	45
4.2.3. Sub - coats and top - coats.....	45
4.2.4. Coating materials for immediate release application	46
4.3. Film Coating for Modified Release Applications.....	49

4.3.1. Film coating for enteric release.....	49
4.3.2. Film coating for sustained release.....	55
5. COATING OF PELLETS.....	62
5.1. Multiple-Unit Dosage Forms: The Rationale.....	62
5.2. Manufacturing Techniques.....	63
5.2.1. Pellets by solution/suspension layering	63
5.2.2. Pellets by powder layering.....	64
6. ADVANCES IN FILM COATING	64
7. DRY POWDER COATING	66
7.1. Film Formation Mechanisms in Dry Powder Coating.....	66
7.1.1. Liquid assisted coating.....	70
7.1.2. Thermal adhesion.....	72
7.1.3. Electrostatic coating	74
8. REFERENCES.....	76
9. AIM OF THE RESEARCH PROJECT	85
10. CASE STUDY 1: Ethylcellulose film coating of guaifenesin-loaded pellets: A comprehensive evaluation of the manufacturing process to prevent drug migration.....	86
10.1. INTRODUCTION.....	87
10.2. MATERIALS AND METHODS.....	88
10.2.1. Materials	88
10.2.2. Methods	89
10.2.2.1. Preparation of drug loaded pellets.....	89
10.2.2.2. Viscosity measurements of the layering solutions.....	90
10.2.2.3. Coating of GFN loaded pellets.....	90
10.2.2.4. Curing operations	91

10.2.2.5. Determination of drug content	91
10.2.2.6. In vitro drug release studies.....	92
10.2.2.7. Pellets morphological analysis	93
10.2.2.8. Thermal analysis.....	93
10.2.2.9. X-ray powder diffraction (XRD) analysis	94
10.2.2.10. Long term storage stability	94
10.3. RESULTS AND DISCUSSION	95
10.3.1. Evaluation of Drug Layering and Film Coating Processes	95
10.3.2. Influence of Curing Process on GFN Release from Pellets.....	97
10.3.3. Influence of GFN Loading and Coating Level on the Properties of Controlled Released Pellets	105
10.3.4. Effect of the Layering Solution on the properties of Controlled Released Pellets.....	111
10.4. CONCLUSIONS.....	118
10.5. REFERENCES.....	118
11. CASE STUDY 2: A novel dry powder coating of pellets using ethylcellulose. Part I: An investigation into the formulation of free-films and on process manufacturing.....	121
11.1. INTRODUCTION.....	122
11.2. Materials and Methods	124
11.2.1. Materials	124
11.2.2. Methods	124
11.2.2.1. Preformulation study: screening of polymer and plasticizers	124
11.2.2.2. Free Films preparation.....	127
11.2.2.3. Development of dry powder coating process on placebo pellets.....	129
11.2.2.4. Morphological analysis	133
11.2.2.5. Long term storage stability of free films and pellets.....	133
11.3. RESULTS	134

11.3.1. Screening of Polymers and Plasticizers	134
11.3.2. Free Films Characterization	141
11.3.3. Dry Powder Coating Process on Placebo Pellets	148
11.3.3.1. Excipients' addition manner inside the equipment.....	148
11.3.3.2. Excipients' addition order inside the granulation chamber.....	150
11.4. CONCLUSIONS.....	152
11.5. REFERENCES.....	153
12. CASE STUDY 2: A novel dry powder coating of pellets using ethylcellulose. Part II: Process optimization on placebo pellets and on drug-loaded pellets.	154
12.1. INTRODUCTION.....	155
12.2. MATERIALS AND METHODS.....	157
12.2.1. Materials	157
12.2.2. Methods	157
12.2.2.1. Dry powder coating of placebo pellets.....	157
12.2.2.2. Preparation of drug loaded pellets: CFN solution layering.....	158
12.2.2.3. Dry Powder coating process on CFN-loaded pellets.....	159
12.2.2.4. Determination of drug content	160
12.2.2.5. In vitro drug release studies.....	161
12.2.2.6. Pellets morphological analysis	162
12.2.2.7. Pellets thermal analysis	162
12.2.2.8. Long term storage stability of pellets.....	163
12.3. RESULTS AND DISCUSSION	164
12.3.1. Optimization of the Process on Placebo Pellets.....	164
12.3.2. Preparation of Drug Loaded Pellets (Drug Layering).....	168
12.3.3. Dry Powder Coating Process on Caffeine Loaded Pellets.....	169
12.3.3.1. Effect of the weight gain.....	169

12.3.3.2. Drug loading	171
12.3.3.3. Particle size of Suglets®.....	172
12.3.3.4. Effect of the coating formulation	173
12.3.3.5. Impact of anti- sticking agents on the coating effectiveness.....	178
12.4. CONCLUSIONS.....	183
12.5. REFERENCES	184
13. FINAL CONSIDERATIONS.....	186

1. HISTORICAL DEVELOPMENT OF MEDICINAL COATING

The first reports on pill coating date from Greek-Arabic civilization. Al Razil (AD 850-930) coated pills with mucilage from *Plantago psyllium* and Aricienna (AD 980-1037) reported the use of silver, which is the first reference to pigment coating. In medieval France, the art of coating with honey was developed and later with sugar to sweeten bitter pills. With the development of sugar cane and sugar beet cultivation in the 19th century, sugar became more easily accessible to Europeans and North Americans and greatly stimulated candy production [1]. Thus, the candy-making industry was the first to develop and enhance the art of coating [2].

Today **sugar coating** has been partially replaced by **film coating**, but is still in use and competitive, especially if modern equipment and effective atomization allow short processing times. The application of thin coating layers can be automatically controlled and optimized in modern equipment, which was developed from the conventional coating pan in the form of perforated cylindrical drums. The prototype was the Accela Cota introduced in the 1950s.

The fluid bed spraying process for coating was introduced by Wurster and became important for coating smaller particles as pellets. The evolution of automatic spray coating operations started in the mid-1950s since it was found to give much better homogeneity and smoother surface and time-consuming procedures could be shortened [1].

1.1. Sugar-Coating

Despite the undoubted disadvantages of the sugar-coating process in terms of process length, intensive operator attention and so forth, it is important to be aware that sugar coating can have certain advantages:

- it utilizes inexpensive and readily available raw materials;
- constituent raw materials are widely accepted and no regulatory problems occurred;
- modern, simplified techniques have greatly reduced coating times over traditional sugar-coating methods;
- no complex equipment or services are required;
- the process is capable of being controlled and documented to meet modern GMP standards;

- simplicity of equipment and ready availability of raw materials make sugar coating an ideal coating method for developing countries;
- the process is generally not as critical as film coating; recovering and reworking procedures are usually possible;
- for high humidity climates, it generally offers a stability advantage over film-coated tablets;
- results are aesthetically pleasing and have wide consumer acceptability;
- tablet cores may generally be softer than those demanded by film coating, especially those for aqueous film coating.

1.1.1. Stages in sugar coating

Sugar coating requires several working steps: sealing, sub-coating, smoothing, coloring, polishing and eventually printing.

Figure 1: Stages in sugar coating [3].

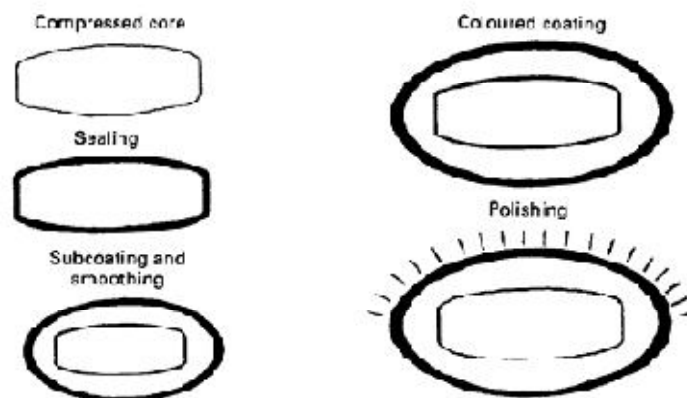

First of all, it is necessary to protect the tablet core from the aqueous nature of sucrose applications to follow. Sealing also prevents certain types of materials from migrating to the tablet surface and spoiling the appearance, e.g. oils, acids, etc. This is unfortunately an organic solvent-dependent step in an otherwise aqueous process. A film of water-impervious polymer is built up using materials such as shellac, cellulose acetate phthalate (CAP), polyvinyl acetate phthalate (PVAP) and zein. Shellac has all the disadvantages of a natural material whereas the other polymers used tend to be those which have an additional use as enteric-coating materials, so that they should be applied only in sufficient quantity to form an efficient seal. A lamination process,

whereby an application of sealant is followed by an application of dusting power, e.g. talc, is nearly always used.

During the sugar-coating process the increase in weight achieved can be 30–50% of the weight of the original tablet core. Much of the added weight is applied at the sub - coating stage. Sub - coating serves to confer on the tablet core a perfectly rounded aspect.

The ideal shape for sugar coating is a deeply convex core with minimal edges. This condition will obviously require less coating material than where the tablet edge is comparatively thick. Basically, there are two methods. In the lamination process, a volume of binder solution is applied to the sealed cores in the coating pan. Once this has spread over the tablet bed, an application of powder is dusted into the pan and, when this has evenly distributed itself over the contents, drying air is applied. The drying air process needs to be carefully controlled to prevent too rapid evaporation of the water. The objective should be to create as smooth a coat as possible in order to reduce the time for smoothing the coat in the final stages of process. Excessively rapid drying results in a very uneven surface. Too low an evaporation rate gives rise to a lengthy process and the danger of cores adhering together. In recent years, automation in the sugar-coating process has required the use of a liquid sub - coat. These are generally suspensions of filler materials(i.e. calcium carbonate, talc or sucrose in the gum solutions.

The system contains only approximately 23% water and consequently dries quickly.

The product at the end of the sub - coating will be too rough to continue with colour coating. Smoothing is usually achieved by applications of plain 70% w/w syrup. However large degrees of unevenness will require some sub - coating solids in the initial smoothing coats. Typically, however, if sub - coating is carried out well, then approximately ten applications of 70% syrup will be required for tablets that are suitable for the next stage.

Colour coating is one of the most important steps in the sugar-coating process as it has immediate visual impact. During this step the coating syrup contains the colour solids necessary to achieve the desired shade. Water-soluble dyes were used previously as colouring agents for sugar-coated tablets. This has largely been superseded by the use of modern water-insoluble pigment forms including the aluminium lakes of the water-soluble colours. Here, the water-soluble dye is adsorbed onto a hydrated alumina surface, filtered, washed and dried. By careful processing, the optimum particle size profile is achieved. The smaller and more even the particle size, the greater the colouring power and hence the smaller the quantity that need be used to achieve the same result. These lake pigments are essentially insoluble in aqueous systems between pH 3.5 and 9.0

and find important uses in tablet coatings both using the sugar and film-coating processes. The advantages of lakes over soluble dyes, including the soluble natural colours, are multi-fold. A pigment system is superior to a water-soluble dye for colouring sugar-coated tablets due to:

(i) maintenance of evenness of colour because:

- the colour is not water soluble and thus is not prone to colour migration problems;
- the colour is opaque, and thus is not affected by any minor unevenness in the sub - coat layer;

(ii) maintenance of colour uniformity from batch to batch, which results from the fact that, again because the colorant is opaque, the final colour is not affected by small fluctuations in the quantity of colour solution applied;

(iii) reduction in overall processing time;

(iv) reduction in the thickness of the colour-coating layer.

After the colour-coating process, the tablets have a somewhat dull, matt appearance which requires a separate polishing step to give them the high degree of gloss traditionally associated with sugar-coated tablets. Methods vary considerably, but it is generally important that the tablets are dry prior to polishing. Preferably they should be at least trayed overnight in a suitable atmosphere. Some examples of polishing methods which are currently in use include:

- application of an organic solvent solution/suspension of waxes, (i.e. carnauba and beeswax). A recently available variant on this theme provides an emulsion of both waxes in an aqueous continuous phase stabilized by a food and pharmaceutically acceptable surfactant. The results obtained are equivalent to traditional methods utilizing organic solvent solutions but, of course, with the big bonus of aqueous processing;

- use of wax-lined pan;
- use of canvas-lined pan with wax solution/suspension;
- finely powdered wax application;
- mineral oil application.

In addition, there are polishing techniques reliant upon the use of glazes containing shellac in alcohol with or without waxes. The use of these materials is rather more dependable, and is not so reliant on atmospheric conditions of temperature and humidity to obtain the optimum result. This

comment does not apply, however, to the aqueous material, which has a high degree of dependability in use.

Some regulatory authorities demand that tablets, be they coated or uncoated, should possess some detailed identifying mark. Those authorities who do not actually require this actively encourage it as part of the overall GMP and product acceptability requirements. Unfortunately, unlike film-coated tablets, sugar-coated tablets cannot be monogrammed by engraving the punch tooling. Instead a printing process is used [3].

1.2. Film-Coating

Film coatings are an integral part of the dosage form development process. The process of film coating involves the application of a thin polymeric film onto the surface of a solid substrate. The substrate can be tablets, capsules, granules or particles. Typically, the coating is approximately 25 to 100 μm in thickness and is applied to improve the physical and chemical properties of the substrate. Though new uses of coatings are being continually developed, film coating are mainly applied to:

- protect drugs from environmental factors such as light, moisture and air, in order to improve chemical and physical stability;
- change product appearance to enhance marketability and product identity or high undesirable color changes of the substrate;
- mask unpleasant taste, texture or odor;
- facilitate the swallowing of the dosage form;
- improve handling during packaging operations by reducing dust formation;
- control or modify drug release;
- prevent the interaction of incompatible ingredients [4; 5].

1.2.1. Equipments

Typical core materials for film coating processes are tablets or pellets; in some cases the coating of small particles such as crystals is described. Pharmaceutical coating processes take place in coating pans or fluid bed apparatuses. Most tablets are coated in (perforated) pans or drums but also fluid bed equipment is in use. Pellet coating is typically performed in a fluid bed [6].

1.2.1.1. Coating Pan

Conventionally coating pans are usually pear – shaped, but sometimes hexagonal or spherical. They are made from stainless steel or copper. To prevent abrasion, an insulating layer should be sprayed on before starting process [1].

Film coating in pan involves spraying the coating composition through one or more spray guns onto a rotating bed of the cores to be coated, typically tablets. The spray gun is fixed and the cores pass through the application zone. Most of the time the tumbling cores are drying outside the application area. Thus, the coating process consist of a continuous application of liquid coating to a small portion of the product in pan. The applied coating must dry before it touches the coating pan or receives its next application. As the cores rotate in pan, a portion of the applied coating composition may be physically transferred from to the coated cores to the adjacent ones. To attain a continuous coating operation, the rate of liquid (organic solvent or water) evaporation from the coated product must be equal to the rate of liquid applied.

At equilibrium, there is a balance between the *input* and the *exhaust variables*. The input variables include temperature and humidity of the drying air, spray rate and surface area of cores to be coated. The exhaust variables include exhaust air, rate of liquid (organic solvent or water) evaporation from the coated product and coated core surfaces from which the solvent or water should evaporate.

The coating pan schematized in Figures 2 - 4 can provide adequate air flow and control over the coating process [5].

Figure 2: Simplified diagram of Accela Cota [7].

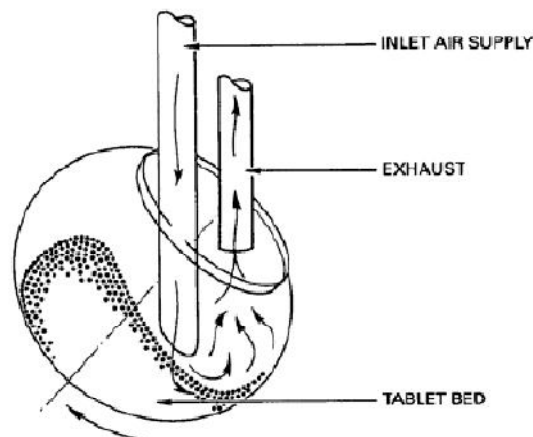

The Accela Cota has a horizontal rotating cylindrical drum, the curved surface of which is uniformly perforated. The ends of the cylinder are conically dished, so that tablets in the drum are inverted and also mixed laterally during the coating operation. There are baffles to assist the mixing process. Drying air enters the drum through the perforations on the side remote from the tablet bed, and is drawn through the bed by the exhaust fan located in the exhaust duct connected to the plenum positioned under the tablet bed. This plenum has a mouth that fits closely to the outside of the perforated curved surface of the drum. The angles of the front and rear sides of the pan are 56° and 61° respectively, which was originally intended to ensure complete mixing of the tablets from the top of the bed to the bottom and from front to rear. However, it was found that this was insufficient to ensure homogeneous mixing and baffles were fitted. Generally, the baffles are of the same shape but of different size for each model and can be easily removed or replaced with those of a different design depending on the physical characteristics of the tablet to be coated, e.g. friability.

The batch size for each particular model will depend upon the bulk density of the tablets. Maximum loading will be achieved with tablets made from a high-density material or from small tablets which will have a high packing density. Exceeding these maximum loadings can cause damage to the drive mechanism. Minimum loadings are found by experience and depend on size and shape of the tablets. If the units are used with batch sizes below these levels, then it is likely that problems will be encountered due to a large portion of the baffles being exposed above the tablet bed. In addition, the exhaust plenum will not be completely covered and this can result in the drying air bypassing the tablets before entering the exhaust duct.

Shape can affect the coating process in a number of ways. Tablets shaped as squares can cause sticking problems and the formation of 'twins'. Logos across the centre of bi-convex tablets result in damage to the intagliations. It is, therefore, an aspect of tablet design which should be appreciated by both marketing and formulation departments. Small tablets produce a very dense bed in the coating pan which tends to reduce the batch size and increase the coating time [7].

Other side-vented coating pans, which are very similar to the Accela Cota, are manufactured by Dumoulin in France and by Freund in Japan who manufactured the Hi-Coater. The Hi-Coater was originally designed to overcome the patents on the Accela Cota held by Eli Lilly, the inventors. It has four perforated panels linked to air ducts that are in constant contact with the exhaust ducts.

Figure 3: Simplified diagram of Hi- Coater [7].

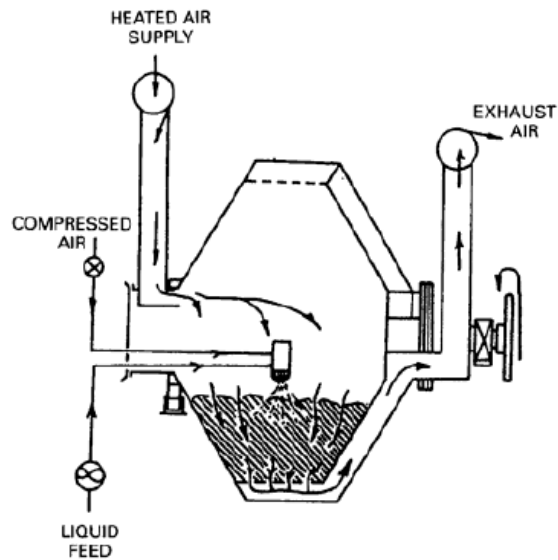

Capacities range from 500 g load up to the HCF 200, claimed to hold 700 kg. Loading and unloading can be achieved through the front of the unit and by a flap in the pan which discharges into a mobile container under the machine or onto a conveyor [7].

Figure 4: Diagram of Driam [7].

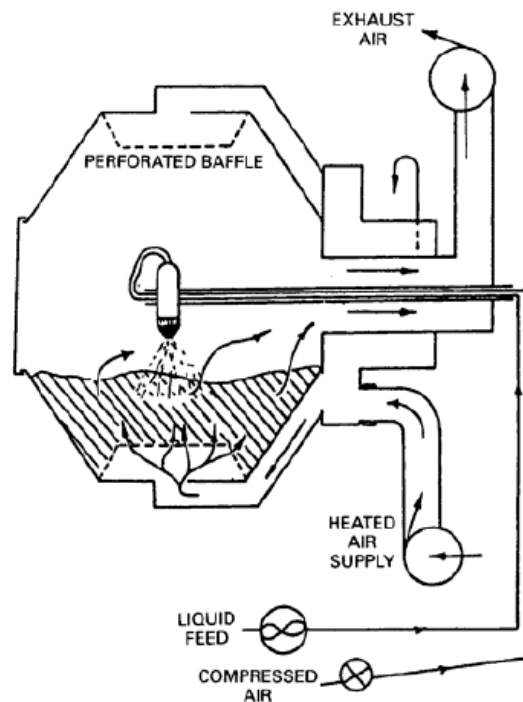

The Driam differs from the Accela Cota coaters in the shape of the coating pan and the way the air is utilized in the drying process. On the outside of the drum covering the perforated areas, there are the air flow channels with removable covers. At the rear of the pan the air channels are connected to the air distributor. This distributor guides the drying air through the air channels and the perforations into the product. The direction of air flow is reversible.

Direct Air Flow: air is supplied through the perforated areas at the top of the pan and through the product bed, and the air exhausted through the perforated areas under the product.

Reverse Air Flow: air is supplied through the perforated areas at the bottom of the pan and through the product bed. It is exhausted through the perforated areas at the top of the pan or through the hollow shaft at the rear.

In contrast to the production machines, the laboratory unit is a complete and self-contained piece of equipment with built-in air supply and exhaust, steam heating, spray system, a completely contained cleaning system with pump, and all control and monitoring instruments. The unit is mobile, requiring little space, and is operational after connections have been made to electric power, steam and compressed air supply. The air volume and the differential pressure in the drum are adjusted by the air control dampers in the air supply and exhaust system. A built-in temperature control stabilizes the preset air supply temperature [7].

GS Technology manufactures non-perforated pans with capacities from 10 to 1000 litres. Originally developed for sugar coating, they use baffles which give a very even distribution of the drying air through the tablet bed or pellets. An advantage of this type of pan is that it can be used for coating a large range of particulate sizes from less than a millimeter to tablets of all shapes and sizes. It is claimed to be the best statistical mixer for coating available. A typical system is shown schematically in Figure 5.

The GS control and coating systems can be fitted to any coating pan, be it Accela Cota, Driam and Hi-Coater. This control, it is claimed, results in dramatic decreases in coating times, particularly for sugar. For film coating, GS have a special reciprocating piston pump, the speed of which is automatically controlled from the bed temperature. For sugar coating, a modified GRACO pump is used. The type of spray-gun, nozzle configuration and position above the bed is critical in all coating processes. These are all either fully interchangeable or adjustable in the GS system.

Drying is effected through perforated baffles immersed in the bed of cores, similar to the immersion- Sword technique, giving a very even distribution of drying of air and allowing a very low differential pressure to be employed which reduces attrition considerably

Figure 5: GS control system [7].

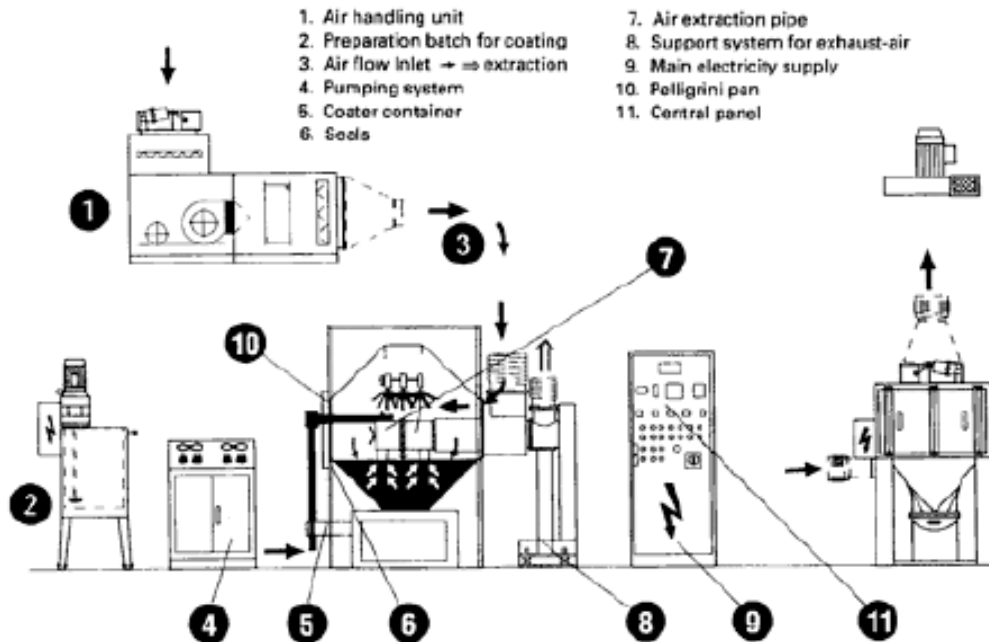

1.2.1.2. Fluid Bed Coaters

Fluid bed top - spray, Würster bottom spray columns and rotating disk granulators are commonly employed to apply film coating to pharmaceutical powder, granules, pellets and mini – tablets.

(a) Top - spray coating

The top - spray coater has been used to apply aqueous and organic solvent based film coatings, controlled release coating and hot melts on granules and small particles.

The top spray coating machinery exhibits a conically shaped lengthened expansion chamber to allow powders to remain fluidized longer and to move with higher velocity so that agglomeration is minimized, permitting a uniform deceleration of the air stream. Moreover, the nozzle is positioned low in the expansion chamber so that coating materials impinge on the fluidized particles a short distance from the nozzle: this reduces droplets spray drying and provides for longer subsequent drying of coated particles. The filler housing is larger and designed to shake the fine back into the bed without interrupting fluidization, thus, reducing agglomeration tendencies [7].

(b) Bottom spray coating

The Würster machine (Figure 6) employs a cylindrical product container with perforated plate. Inside the container is a second cylinder (coating partition), which is raised slightly above perforated plate. Centered in the plate below this partition, is a spray nozzle used to dispense the coating solution. The perforated plate is designed with large holes in the area under the coating partition and smaller holes in the remainder of the plate, except for one ring of large holes at the perimeter. This design allows the substrate particles to be pneumatically transported upward through the coating partition and downward outside this partition. Material passing through the coating partition receives a layer of coating material, dries in the expansion chamber and falls back in a semi fluidized state. Material circulates rapidly in this fashion and receives a layer of coating on each pass through the coating partition. The ring of large holes on the periphery of the perforate plate prevents the accumulation of the material at the container wall. The Würster process provides a highly organized particle flow and high quality reproducible films. For this reason the system is used extensively for sustained release coatings where product performance requirements are the most rigorous. The process is capable for handling solvents, aqueous solution, emulsions, suspensions and hot melts [8].

(c) Rotating disk granulators and coaters

This technique combines an expansion chamber to form the rotating disk granulator and a fluid bed coater device (Figure 6). It employs a rotating disk in the product container. The disk can be moved up or down to create a variable slit opening between the outer perimeter of the disk and the side wall of the container. This allow independent control of air velocity over air volume. This fluidized the material along the circumferential surface of the product container. At the same time disk rotates at varying speeds and move s the product by centrifugal force to the outer portions where it is lifted by the fluidizing air stream into the expansion chamber. As the material decelerates, it descends to the center of the disk and repeat the sequence. The motion of the fluidized material is, thus, controlled by the forces of fluidization, centrifugal force and gravity. This fluidization pattern is often described as a spiraling helix or rope – like pattern around the inside of the rotor chamber. Spray nozzle can be immersed in the bed of fluidized material and the spray applied in tangential fashion with respect to the particle flow. The particle can be coated with polymeric material. Additionally, dry powders can be fed into the wet bed, resulting in a build up of powder layers onto the particles substrate (layering technique). At the end of the coating

process the liquid spray is shut off and the material in the product chamber dried by increasing the fluidizing air volume and temperature [8].

Figure 6: Bottom spray and rotating disk coaters [7].

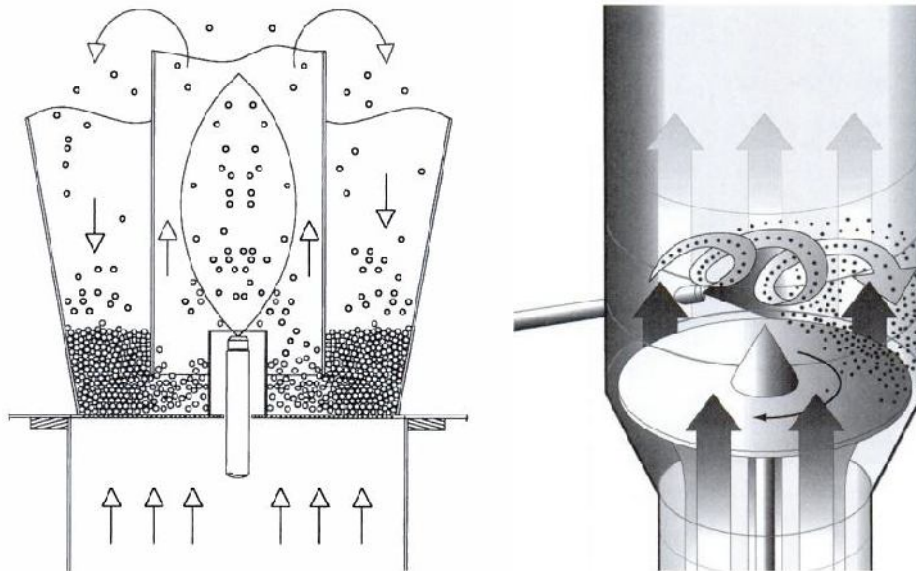

2. COMPOSITION OF FILM COATING FORMULA

Pharmaceutically acceptable film coating of solid dosage forms are primarily based on acrylic or cellulosic polymers. Many of these polymers have been formulated into aqueous colloidal dispersions (e.g., latexes or pseudolatexes) in order to overcome the high costs, potential toxicities and environmental concerns associated with the use of organic polymer solutions.

Film coating has been successfully utilized to control the release of active ingredients, prevent interaction between ingredients, increase the strength of the dosage form to maintain product integrity during shipping and protect the dosage form from the environment.

Most formulations contain plasticizers that impart flexibility to the films and reduce the incidence of crack formation. Coating formulations usually contain many additives, in addition to the polymer, that aid in processing, appearance and product performance. The amount and type of plasticizer in the film and the presence of other additives in the coating can significantly impact the film's mechanical properties. Pigments may be added to alter the appearance of the final product and lubricants may be required to prevent agglomeration of the coated substrates. In

addition, factors such as storage conditions and processing temperature will influence coalescence and film formation and thus product performance [9].

2.1. Polymers

The film former is the major ingredient in a coating formulation. For aqueous-based coating systems, the polymers can be divided into two essential classes: aqueous soluble polymer and water insoluble or pH dependent soluble polymers.

The most commonly used **aqueous soluble polymers** consist primarily of *polyethylene glycols*, *polyvinyl pyrrolidone* (povidone) and cellulosic polymers (*Carboxymethyl cellulose sodium*, *Hydroxypropyl cellulose*, *Hydroxypropyl methylcellulose* and *Methylcellulose*) [5].

The **water insoluble polymers** are used when an enteric coating or a special controlled release delivery system is desired. Enteric coatings constitute the major portion of the pH dependent polymers. These polymers can be solubilized by adjusting the pH of the coating or they can be formulated to be suspended in aqueous media and applied as insoluble polymer particles.

Some of the most common polymer with pH-dependent solubility are *cellulose acetate phthalate* (CAP), *hydroxypropyl methylcellulose phthalate* (HPMCP), *polyvinyl acetate phthalate* (PVAP), (meth)acrylic acid copolymer (*Eudragit® E*, *Eudragit® L*, *Eudragit® S*). Among water insoluble coating polymers, *Eudragit® RL*, *Eudragit® RS*, *polyvinyl acetate* and *ethylcellulose* are included [5].

Polymers used for different coating purpose are better elucidate in section 4.

Table 1 shows a list of some ready-to-use coating formula.

Table 1: Ready-to-use formulations with poly(meth)acrylates [10].

Name	Polymer	Manufacturer	Application
EUDRAGIT® E PO Ready Mix	Poly(butyl methacrylate-co-(2-dimethylaminoethyl) methacrylate-co-methyl methacrylate) 1:2:1	Biogrund	Protective coatings
Acryl-EZE®	Poly(methacrylic acid-co-ethyl acrylate) 1:1	Colorcon	Enteric coating
Aquapolish® E	Acrylic acid copolymer	Biogrund	Enteric coating
Aquapolish® R	Ammonio methacrylate copolymer (type A and type B)	Biogrund	Sustained release

2.2. Plasticizer

Films prepared from pure polymers frequently are brittle and crack on drying. To correct this deficiency, the polymer can be chemically modified or other excipients can be added to make the film more pliable [5].

Plasticizers are added to polymeric solutions or dispersions to increase workability or flexibility of the polymer, reduce its brittleness, improve flowability, increase toughness and tear resistance of the films. These effects are the result of the plasticizer's ability to weaken intermolecular attractions and allow the polymeric molecules to move more easily [9].

Thus, plasticizers can be classified into two general categories: **internal and external plasticizers**. Internal plasticizing involves the chemical modification of a basic polymer to alter the physical properties of the polymer. Changes both in degree and type of substitution or in polymer chain length could influence the physical characteristic of the polymeric film.

Generally, the formulator must work with polymers that are available and the film properties are altered by the addition of external plasticizers. The external plasticizer can be another polymer, a nonvolatile liquid or even the aqueous solvent. The plasticizer alters the polymer – polymer interactions to improve the flexibility of the film by relieving molecular rigidity. As general rule, the film will become more flexible and more resistant to mechanical stress when a plasticizer is added to a coating composition [5]. Thus, several theories have been proposed to explain the mechanism by which the plasticizing agents impart flexibility to polymeric films.

According to the **lubricity theory**, the plasticizer functions as an internal lubricant and facilitates movement of the polymer chains. The **gel theory** proposes that the un- plasticized polymer exists as a three-dimensional gel and that the plasticizer functions by cleaving the intermolecular bonds within the gel. Finally, the **free volume theory** states that plasticizers increase the free space around the polymer chains, providing a greater area for movement of the polymer molecules. In addition, enhancing the flexibility of the film, plasticizers influence permeability and drug release [5].

Plasticizer acts by interposing itself between the polymer chains to decrease the degree of interaction between the polymer molecules thereby enhancing chain mobility and the dissipation of internal stresses that lead to bridging and cracking of film [4; 5].

Moreover, plasticizers alter the thermo- mechanical properties of film forming polymers lowering its softening temperature of the polymer (MST). Thus, the degree of lowering is

considered a common measure of plasticizer effectiveness: the more efficient the plasticizer, the more the softening temperature was lowered. The greater decreases in T_g is dependent both to a large extent on type and amount of plasticizer added to the coating formulation and to the extent of polymer–plasticizer interactions [4; 9].

Typically, plasticizers facilitate the transformation of the discrete polymer particles on the sprayed surface into a continuous film and increase the ease of film deformation. This was manifested by a decrease in tensile strength, an increase in elongation at break and a reduction of the modulus of elasticity [4; 5]. Typical plasticizers are listed in table 2.

To be effective, plasticizers must be compatible with the polymer: water insoluble polymer suspension formulations require high concentration of water insoluble plasticizers [5].

Plasticizers that are soluble in the solvent phase can be added directly to the mixture or may be dissolved first in the solvent prior to addition of the polymer. Water insoluble plasticizers should be first emulsified in water using latex- compatible emulsifiers and then appropriately agitated with the entire mixture until an equilibrium plasticizer distribution occurs between the water and polymer phases.

Table 2: Plasticizers [5].

<i>PLASTICIZERS</i>
Castor oil, USP
Propylene glycol, USP
Glycerin, USP
Polyethylene glycols (PEG), NF, low molecular weights (200 – 400 series)
Polysorbates NF (Tweens)
Sorbitans NF (Spans)
Polyoxyl derivatives NF
Diethyl Phthalate
Acetylated monoglycerides
Triacetin
Triethyl citrate (TEC)
Dibutyl sebacate (DBS)

The incorporation of a plasticizer into an aqueous polymeric dispersion is crucial and a sufficient time must be allowed for the plasticizer to partition into the polymer phase before starting the

coating process. The rate and extent of plasticizer partitioning for an aqueous dispersion is dependent on the solubility of the plasticizer in water and its affinity toward the polymer phase.

Equilibration of plasticizer distribution in an aqueous polymeric dispersion for water-soluble plasticizers has been shown to occur rapidly, whereas the time required to achieve equilibrium distribution for water-insoluble agents requires substantially longer mixing times. If insufficient time is allowed, the unincorporated plasticizer droplets as well as the plasticized polymer particles will be sprayed onto the substrate during the coating process. Uneven plasticizer distribution within the film could result and, potentially, cause changes in the mechanical properties of the film during aging [9].

2.3. Dyes and Pigments

Often a distinctive color is desired to give the product a unique identity. It is a GMP requirement that products must be differentiated at all stages during the manufacturing and distribution cycle [1]. The colorant can be either solubilized in the solvent system or suspended as insoluble particles. The addition of pigments into a coating formulation may improve the esthetic appearance of the final product, providing distinctive color and pharmaceutical elegance to the coated substrates [5].

Table 3: Colorants and Opaquants [5].

<i>COLORANTS and OPAQUANTS</i>	
<i>Colorants</i>	<i>Opaquants</i>
<i>FD&C dyes</i>	<i>Silicates</i>
<i>FD&C lakes</i>	<i>Talc</i>
<i>Iron oxides</i>	<i>Aluminium silicate</i>
<i>Titanium dioxide</i>	<i>Magnesium carbonate</i>
<i>Natural colorants</i>	<i>Calcium sulfate</i>
<i>Anthocyanins</i>	<i>Magnesium oxide</i>
<i>Caramel</i>	<i>Aluminium hydroxide</i>
<i>Carotenoids</i>	
<i>Flavones</i>	
<i>Tumeric</i>	
<i>Carmine</i>	
<i>Annatto</i>	
<i>Amaranth</i>	

The most brilliant colorants are provided by certified Food, Drug and Cosmetic (FD&C) or Drug and Cosmetics (D&C) dyes and lakes. Lakes are prepared from dyes by precipitating the colorants with aluminium or talc carriers. These synthetic colorants are water insoluble and provide the most reproducible colors. Commercially available lakes generally contain 10 to 30% dye content, but some lakes may contain up to 50%. Although lakes are water insoluble, dye can be displaced from carrier through the use of solvent systems that dissolve the dye. Table 3 is a list of colorants and opaquants.

Commercial color concentrates and film coating concentrates are available. They are promoted as providing less batch - to- batch color variation. To achieve reproducible colors, the insoluble colorants should be milled and matched with a color standard. The two commercial materials for aqueous film coating are **Opaspry**® (an opaque color concentrate for film coating) and **Opadry**® (a complete film coating concentrate) available from Colorcon [5].

The addition of pigments into a coating formulation may improve the esthetic appearance of the final product. Opaquants (such as titanium dioxide) may be used in coatings to protect photosensitive drugs from exposure to light, thus improving product stability. The addition of pigments in the coating will significantly influence the mechanical, adhesive and drug-release properties of the resulting film. As the concentration of an insoluble pigment is increased, the amount of polymer necessary to completely surround the particles increases. At a specific concentration, known as the critical pigment volume concentration (CPVC), the polymer present is insufficient to surround all of the insoluble particles and marked changes in the mechanical properties of the film will occur. The CPVC is a characteristic of specific polymer–filler combinations and theoretic determinations of this value are practically impossible [9].

2.4. Glossing and Polishing Agents

At the end of the coating process, some gloss is developed directly from the polymers, especially with poly(meth)acrylates. Gloss could be improved by polyethylene glycols solutions sprayed on the film coating at the end of the process or by the application of an additional layer of wax dissolved in an organic solvent.

2.5. Antiadherents

Fillers are mainly powder materials which are insoluble in coating solvents and reduce the sticking effects on the binder. If the binder is sugar, the fillers are mainly calcium carbonate, calcium phosphate, starch and titanium dioxide which, additionally, is a white pigment [1]. Nevertheless, stickiness and tackiness of polymeric films is a concern during both coating process and storage. The extent of product agglomeration may be influenced by processing temperature, curing temperature, plasticizer content and polymer type. To minimize product agglomeration, antiadherents may be incorporated into the coating formulation [9]. Substances that reduce sticking effect in film coating and improve smoothness of the surface are also called glidants. Talc and stearates (such as magnesium stearate alone or in combination with talc and glyceryl monostearate, GMS) are the most commonly employed antiadherents in film coating formulations [1]. These fillers, however, are not water soluble and they have been shown to influence the mechanical and drug-release properties[9]. Moreover, Carbosil (fumed silica) and micronized silica (Syloid) are acceptable glidants but, tend to increase the permeability by pore formation and give matt surfaces in high concentrations [1].

2.6. Surfactants

As mentioned above, incorporating water-insoluble plasticizers into an aqueous polymeric dispersions requires that the plasticizer first be emulsified in water with an appropriate surfactant. The addition of these compounds to film coating formulations has been shown to influence the mechanical properties of the films. Sorbitan mono- oleate and polysorbate 80 are the most commonly employed surfactants in films coating based on Eudragit® L 30 D-55 plasticized with the hydrophobic tributyl citrate, while no significant benefits were noted when the polymeric dispersion was plasticized with the water-soluble triethyl citrate. Moreover, surfactants should be added to the film coating formulation in order to improve the spreadability of the coating material across the core surfaces and, thus, modulate drug release [9].

3. FILM FORMATION

In order to select the appropriate coating excipients, an understanding of the mechanisms behind film formation is necessary.

There is a fundamental difference in film-formation between aqueous polymer dispersions, where the polymer and the liquid phase are in a heterogeneous system, and polymer solutions, where the polymer and the liquid phase are in a homogeneous system. Whereas film formation from a solution simply occurs upon solvent evaporation (sol to gel transition), dispersed polymer systems require polymer spheres to deform, coalesce and fuse together to form a continuous film [10; 11]. It should be mentioned that even if the polymer particles completely fuse together and form a continuous polymeric film without defects, the inner film structure can be very different from the structure of films of identical composition, but prepared from organic polymer solutions. For instance, if a blend of two miscible polymers is used, films prepared from organic solutions are likely to exhibit a very high degree of polymer–polymer chain entanglement throughout the network. The composition of the films is homogeneous, even in the nanometer size range. In contrast, films prepared from aqueous polymer dispersions are likely to contain nano-domains of the respective pure polymers, since polymer–polymer chain inter-diffusion is generally restricted to the surface near regions of the initially individual polymer particles. This difference in the nanostructure of the films of identical composition, but prepared from aqueous dispersions or organic solutions, can potentially strongly affect the resulting film properties and, thus, drug release kinetics [12; 13].

For aqueous polymer dispersion the minimum film-forming temperature (MFFT) and glass transition temperature (T_g) of the system are key parameters for efficient film formation.

(a) Glass Transition Temperature

The glass transition temperature (T_g) is the temperature at which the mechanical behavior of a film changes. Below this temperature, the polymer exists in a glassy state that is characterized by a substructure in which there is minimal polymer chain movement. Above the T_g , the polymer is in a rubbery state, which is characterized by increased polymer chain movement and polymer elasticity [9].

(b) Minimum Film Forming Temperature (MFFT)

The MFFT is the temperature above which a continuous film is formed under defined drying conditions. Upon drying, the particles come into direct contact with each other and form dense

sphere packaging, due to evaporation and the surface tension between water and polymer. During further evaporation, capillary forces lead to coalescence of the particles and the forming of a homogeneous film. Coalescence only occurs at temperatures above MFFT. To achieve fast film formation, the temperature should be 10–20°C above MFFT [10].

3.1. Film Formation from Solutions

Film formation from polymeric solutions is a relatively straightforward process since the polymer is in the dissolved state. The sprayed droplets spread onto the substrate surface and, as the solvent evaporates, the polymer chains interpenetrate, going through a gel state then forming the film with further drying. Polymer chain interpenetration occurs at a specific concentration which is the reciprocal of the intrinsic viscosity of the solution. The intrinsic viscosity, thus, is an indication of the hydrodynamic interaction between the polymer and the solvent.

The rate of solvent evaporation is critical in the film formation process for polymeric solutions: if a solvent evaporates too slowly, the substrates become over-wetted and, in extreme cases, begin to dissolve. In contrast, if a solvent evaporates too quickly, the polymer-containing droplets may dry before either impinging on the substrate surface (spray drying) or spreading on the surface (orange peel effect).

Solvent evaporation is dependent on temperature, atmospheric pressure, air movement and, in the case of water, relative humidity. Most of these variables can be adjusted by manipulating processing conditions [11]. In film coating processes, several surface tensions are involved, as shown in figure 7, including liquid–air, solid–liquid and solid–air interfaces.

Figure 7: Overview of the film formation process and surface tensions involved [11].

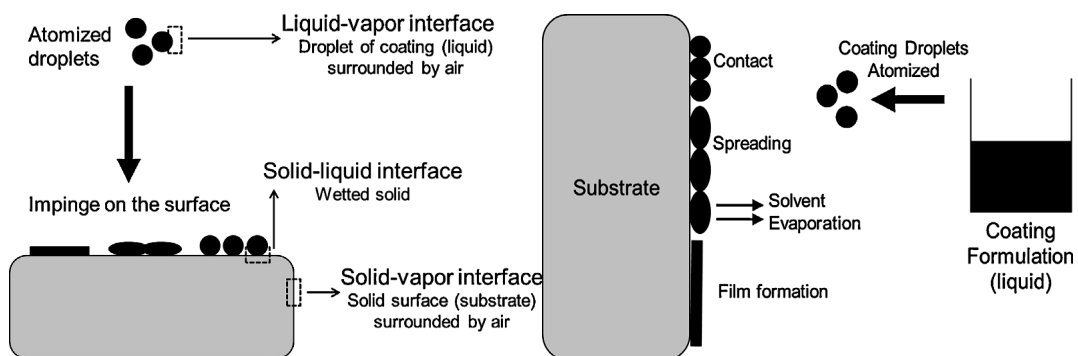

Spreading of the polymer-containing liquid droplets can be described as surface wetting or replacement of a solid–air interface with a solid–liquid interface. The process is dependent on the ability of the atomized droplets to wet the substrate (wetting power) and the ability of the substrate to be wetted by the droplets. Thus, ‘wetting’ is influenced not only by solutions properties but also by the solid substrate characteristics. Three types of wetting are involved in film formation from polymeric solution:

- *adhesional*, where the liquid–air interface disappears [14];
- *spreading*, where a liquid–air interface forms [15];
- *immersional*, where there is no change in the liquid–air inter-face [16].

Variables that influence wetting are related to substrate formulation (such as surface roughness, porosity, hydrophobicity), coating formulation (for example viscosity) and processing conditions (including droplet momentum, atomizing air pressure, distance between the spray gun and substrate and the rate of solvent evaporation).

Viscosity is a key variable in coating operations involving solutions. As the concentration of the polymer is increased, solution viscosity increases. Viscosity is also dependent on the molecular weight of the polymer, with higher molecular weight grades exhibiting higher viscosities at a given temperature [11]. Higher solution viscosities require more energy to atomize the solution [17].

In practical terms, solution viscosity limits the concentration of polymer that can be used in film coating operations. In fact, this limitation has generated a great deal of research to develop new ‘high solids’ polymer coating systems that allow higher polymer concentrations without the significant concomitant increase in solution viscosity [15]. Viscosity also influences droplet spreading, with more viscous solutions not able to readily spread across the substrate surface before solvent evaporation occurs. Since the viscosity of the individual polymer-containing droplets increases as the solvent evaporates (i.e. polymer concentration increases), adequate initial spreading is critical to obtain a smooth film [11].

3.2. Film Formation from Aqueous-Based Polymeric Dispersions

Over the past several decades, modified release film coating technologies have shifted from organic-based polymer solutions to aqueous-based dispersed systems. Such aqueous-based polymeric dispersions eliminate potential toxicities associated with residual organic solvents in the film. In addition, there are significant economic and environmental benefits. In terms of

processing, a major advantage of these dispersed polymer systems is that viscosity is independent of polymer concentration or the molecular weight of the polymer, since the polymer is present as discrete spheres suspended in water. Thus, higher polymer concentrations may be used in coating processes.

Film coating with aqueous-based polymeric dispersions is similar to the process of coating with organic solvent-based systems in that the same type of machinery is used. The processing parameters, such as spray rate, bed temperature and gun-to-bed distance, however, must be adjusted to compensate for the higher latent heat of evaporation of water. While the application process is similar, the mechanism of film formation from aqueous-based polymeric dispersions is quite different from solutions.

Figure 8 shows the major steps involved in film formation from an aqueous-based polymeric dispersion [11].

Figure 8: Steps in film formation (i) and film formation mechanism (ii) from aqueous dispersion [10; 11].

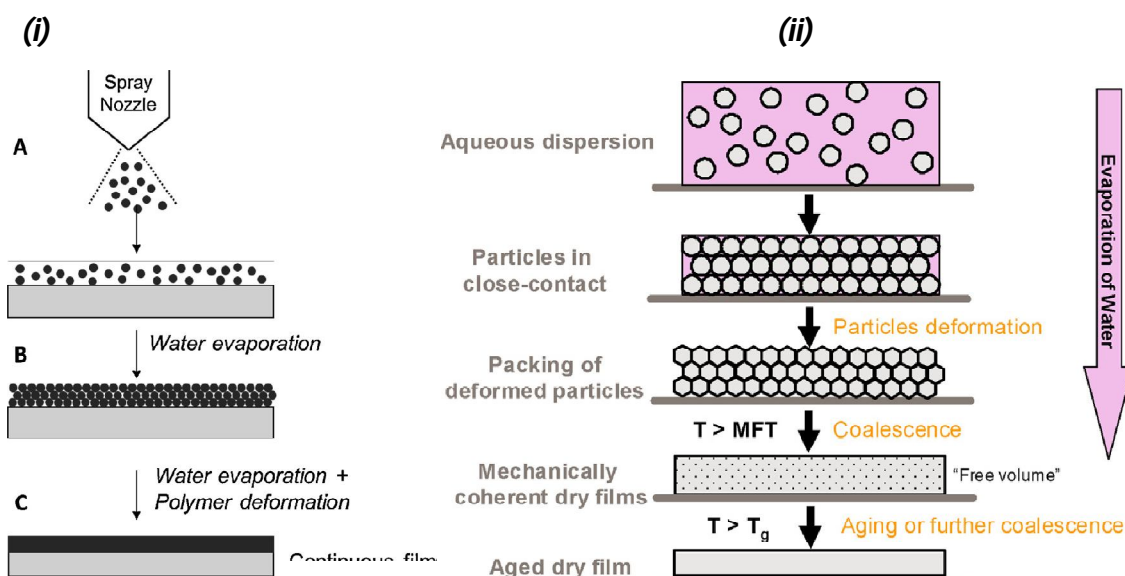

At the top, water droplets created by the spraying nozzle (A) accelerated toward the surface of the dosage form to be coated (e.g., pellet, tablet or capsule). Water droplets contain very small polymer particles, which are often in the nanometer size range. Upon water evaporation (the temperature during coating is generally increased and the air flow rate elevated), the polymer particles approach each other (B) until a dense packing is achieved. Then, under appropriate conditions (especially temperature, relative humidity and in the presence of an appropriate plasticizer in sufficient quantity) the polymer particles coalesce and fuse together in a continuous

aqueous film (C), in which the polymer particles are dispersed [12]. The degree of coalescence is dependent on the intensity of capillary forces that are generated upon water evaporation and the time exposed to such forces. Complete coalescence of latex particles occurs when the polymeric molecules located at the interface between adjacent particles interpenetrate due to viscous flow [9]. Simplified, the disappearance of the water between the nanoparticles creates a pressure, which drives the particles together. If particles wouldn't deform and fill voids, a vacuum would be created. If the mobility of the macromolecules is sufficient, this will lead to permanent polymer particle deformation and polymer-polymer chain inter - diffusion between neighboring particles. In ideal cases, a continuous, intensely entangled polymeric network is created and a homogeneous polymeric film without defects is formed [12]. Thus, temperature may significantly influence the completeness of coalescence because polymer chain mobility often strongly increases with temperature [9; 12].

As mentioned earlier (paragraph 3.1), polymer solution will form film coating at room temperature, whereas dispersed polymer systems exhibit a minimum film forming temperature and, thus, its knowledge is critical in developing a coating process as processing temperatures must exceed the MFFT to form a film: below MFFT, a polymeric dispersion will form an opaque and discontinuous material upon solvent evaporation, whereas a clear continuous film will be formed at temperatures above the MFFT. Moreover, drying at temperatures above the MFFT provides sufficient capillary force for coalescence to occur: rapid drying rates are generally considered desirable, but may have adverse effects on the resulting film [11].

For this reason, processing parameters used during coating must be carefully controlled to ensure an appropriate balance between the bed temperature of the coating apparatus and the rate of water removal, which is critical for the development of capillary forces [9]. A rapid loss of water, for example, may not allow for the development of the capillary pressure necessary and thus inhibit deformation and coalescence [18]; whereas excess drying can also prevent the droplets from spreading across the substrate during the coating process [11].

Moreover, low spray rates of aqueous polymeric dispersions, especially when combined with higher bed temperatures, can result in spray drying, where the solvent evaporates before the polymer chains coalesce and brittle films are produced. In contrast, high spray rates can over wet the substrate and cause surface dissolution of the product, with a potential for drug/excipient migration into the resulting film coat [9].

In addition to temperature, the relative humidity (RH) during this step is decisive, since it affects the water evaporation kinetics [12]. High humidity conditions have been shown to facilitate coalescence as adequate capillary pressure is attained [19] and also increase polymer chain interdiffusion [20]. Moreover, water itself can function as a plasticizing agent to soften the polymer spheres and allow for viscous flow and polymer chain interpenetration [11].

Low molecular weight plasticizers could be added to the film coating formulations [12] in order to soften the polymer spheres and facilitate its coalescence at lower temperatures: plasticizers reduce the intermolecular forces between the polymer chains and reduce internal stresses within a film [11]. For softening of the polymer spheres in an aqueous dispersion, the plasticizer must partition into the polymer phase. For water soluble plasticizers, uptake into the polymer spheres has been shown to occur relatively quickly, whereas longer equilibration times are required for water insoluble plasticizers [21]. Sufficient mixing time to allow for plasticizer partitioning into the polymer phase prior to initiation of coating is critical, as insufficient mixing can lead to non homogenous distribution of the plasticizer which could adversely affect the coalescence process [11]. The addition of plasticizers to film coating formulations generally results in a lowering of the T_g of the polymer, an increase in film flexibility and a decrease in the incidence of cracking [11; 22]. Moreover, both plasticizer type and plasticizer concentration have a significant impact to influence the MFFT of the dispersed coating systems [11; 23].

Nevertheless, the complete polymer particle coalescence and the formation of a continuous homogeneous film are often not yet achieved at the end of the coating process. Film defects, such as holes and/or channels, are still present [12]. Moreover, an incomplete or a partial coalesced can lead to changes in polymer properties over time and it could be crucial especially for modified release systems [11]. Thus, in order to minimize film imperfections and further promote film formation, a *curing stage* is generally applied. The idea is to increase the temperature in order to increase the mobility of the polymer chains to facilitate the fusion of the polymer particles. The efficiency of the curing step is particularly high, if a sufficient amount of plasticizer is present in the system and the relative humidity is increased, since water acting as a plasticizer and being mandatory for the capillary forces involved in the process [12].

Curing can be accomplished by placing the coated substrates in an oven set to a specific temperature after application of the coating dispersion (static curing) or allowing the product to remain moving within the heated coating equipment (dynamic curing) [11; 24].

The other major concern on aqueous dispersion is *physical aging*. Most polymers used in coating formulations are amorphous and are not at thermodynamic equilibrium at temperatures below their T_g . Over time, amorphous polymers undergo a slow transformation toward a thermodynamic equilibrium. As temperatures are cooled to below the T_g , the free volume of the polymer will slowly relax toward a lower free energy state. Although this equilibration process is slow at ambient conditions, physical aging may produce significant changes in polymer properties [9].

If a polymeric film coating still contains defects and imperfections after the curing process, the system might be unstable during long term storage: even at room temperature polymer particle coalescence might continue although at a much lower rate than during coating and curing, resulting in denser and less permeable films and, thus, decreased drug release rates [12].

3.2.1. Stability of aqueous polymeric film coatings

Aqueous polymeric film coatings provide a great potential to accurately control the release rate of a drug from a pharmaceutical dosage form, while avoiding the various disadvantages associated with the use of organic solvents. However, long term instability of drug release, due to imperfect film formation during coating and curing, can be a serious concern. If the coalescence of the particles continues during storage, the film permeability can decrease, slowing down drug release. Different strategies can be used to effectively avoid this phenomenon, including optimized curing conditions, the addition of appropriate additives and the use of specific packaging materials [12].

3.2.1.1. Physical aging in pharmaceutical polymers and the effect on solid oral dosage form stability

Physical aging affects all amorphous polymers used in pharmaceutical coating systems. This phenomenon has been shown to cause changes in the mechanical, permeability and drug release properties of polymeric films due to a densification and decrease in free volume of the polymer as it relaxes to an equilibrated thermodynamic state. Aging has been shown to be influenced by a number of factors including humidity and temperature during storage as well as excipients in the coating formulation. Polymeric coatings should be adequately cured following processing, with careful attention given to curing temperature, humidity, and time. Care must be taken to investigate the potential for aging effects during the early stages of product development [25].

3.2.1.1.1. The origin of physical aging

Physical aging is characterized by an increase in rigidity, brittleness and density of a polymer film [26]. Amorphous materials were not in thermodynamic equilibrium at temperatures below their T_g . This unstable state is the result of a material possessing a greater volume, enthalpy and entropy than that found in the equilibrium state [25].

Figure 9: Graphical representation of the origin of physical aging. T_g is the glass transition temperature of the polymer and T_β is the temperature of the highest secondary transition [25; 27].

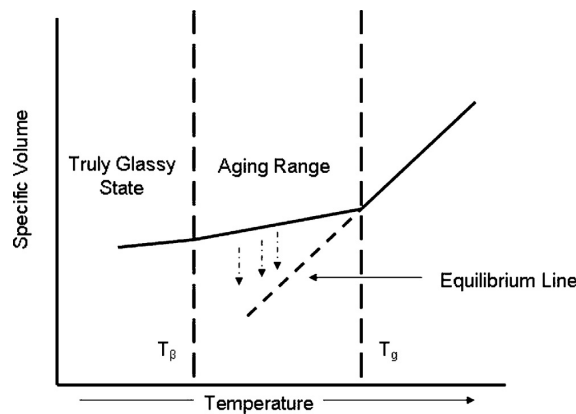

The transport mobility of particles or polymer chains in a tightly packed system, as defined by the free volume concept, is primarily dependent on the degree of packing and, thus, the “free volume” of said system. Once the polymer is cooled to a temperature below its T_g , the free volume is greater than it would be at equilibrium and the volume will decrease slowly over time [27; 28]. This contraction is accompanied by a decrease in the polymer chain mobility, which leads to a densification of the polymer. Changes in both porosity and tortuosity in the film can significantly impact drug release [28; 29].

3.2.1.1.2. The effect of physical aging on diffusion-based drug release

The diffusion of drug through a thin permeable or semi-permeable membrane can be described mathematically by Fick’s first law of diffusion (Eq. 1):

$$Q = \frac{K \cdot D \cdot S \cdot (C_1 - C_2) \cdot t}{h} \quad \text{Eq. 1}$$

where Q = quantity of drug to diffuse through the film over time, t ; h = film thickness; S = the surface area available for diffusion; C_1 = the concentration of drug in the donor compartment; C_2 = the concentration of drug in the acceptor compartment; D = the diffusion coefficient of the drug and K = the partition coefficient of the drug with respect to the membrane separating the donor and acceptor compartments.

The Iyer equation (Eq. 2) shows that physical aging of a thin polymeric film has an effect on the diffusion coefficient, D [30]:

$$D = \frac{D_w \cdot e}{\tau} \quad \text{Eq. 2}$$

where D_w = diffusion coefficient of the drug in water, e = film's porosity and τ = tortuosity.

Drug transport occurs predominantly by diffusion through water-filled pores. It can be seen from Eq. 2 that the diffusion coefficient of the drug is a function of both porosity and tortuosity. As a film ages and the density increases [26], the decrease in film porosity and increase in tortuosity will result in a decrease in drug dissolution rate [29].

3.2.1.2. Factors that influence physical aging

3.2.1.2.1. Plasticizers

Plasticizers act to reduce the intermolecular attractions between polymer chains, resulting in an increase in film flexibility. In addition, plasticizers enhance the formation of thin films from aqueous lattices by softening the polymer spheres to allow for viscous flow. The selection of a plasticizer is critical when formulating a polymeric coating dispersion. Plasticizing agents must be compatible with the polymer. Using a plasticizer that is incompatible with an aqueous polymeric dispersion can result in poor film formation and instabilities in drug release during storage [25]. The amount of plasticizer in a coating dispersion is also of great importance. Insufficient plasticization can result in polymer films that are brittle or that require longer curing times to attain stable films [22]. The coalescence of latex particles is also a function of the concentration of plasticizer in the formulation, with higher concentrations of plasticizer producing enhanced or more complete film formation, as the softened polymer spheres more readily flow together [25].

3.2.1.2.2. Curing and storage conditions

After completion of the coating process, coated dosage forms are often stored at elevated temperatures to promote coalescence of the film, a process known as *curing* [25]. Both curing temperature and curing time can significantly affect the drug release rate [31- 33]. Curing of coated dosage forms is an important component in film formation from aqueous lattices. The film formation process from these aqueous dispersions relies on capillary forces to draw together and deform the latex particles and is influenced by temperature and humidity. Water acts as a plasticizer and, at high humidity conditions, the higher water content in the polymer film increases the mobility of the polymer chains and enhances coalescence of the latex particles. In contrast, the amount of water in the polymeric film is reduced in low humidity environments and consequently the capillary forces that facilitate film formation may not be adequate for coalescence. Although the presence of water can enhance coalescence of polymeric films during curing, high levels of humidity during storage can also destabilize the films, leading to changes in the drug release rate over time [25].

Changes in drug release during curing have been reported for high glass transition temperature polymers, such as ethylcellulose. Incomplete film formation and further gradual coalescence during storage cause instability in the drug release rate.

For films cast from an organic solution, a significant shift in creep compliance was noted as aging progressed, indicating a decrease in free volume of the film and increased densification of the polymer structure. These changes were also responsible for a reduction in the water vapor permeability coefficient as a function of aging time [25; 34].

For aqueous-based cellulosic films, a decrease in free volume was also noted as a result of further gradual coalescence of the pseudolatex particles [25; 35]. When dosage forms are cured at high temperatures, the time required to reach a fully coalesced film decreases in comparison to curing at lower temperatures [25; 36]. At temperatures above the T_g of the film, the mobility of the polymer chains increases and latex coalescence is accelerated so that films are nearly completely coalesced when removed from the coating apparatus [25].

4. FUNCTIONS OF COATINGS

At least three types of coating for the production of solid dosage forms exist concerning the function of the coat. **Non-functional coatings** are applied to improve the compliance by better appearance and distinguish ability, easier intake and swallowing and to protect the dosage form against environmental influences. **Functional coatings** can be used to mask the bad taste or smell of a product, to protect the API (active pharmaceutical ingredient) against the acid environment of the stomach or the gastric mucosa against an aggressive API. A large part of functional coatings lead to prolonged release of the API. **Active coatings** contain an API in the coat. They are applied to realize different fixed dose combinations, to prevent interaction of different drugs or to combine different release behavior in one single solid dosage form.

The thickness and integrity of the coating is of great importance especially for functional coatings. A minimum thickness and the absence of cracks in the film are required to ensure gastro resistance of a dosage form. Otherwise the API will be (partly) released in the acid gastric fluid and degradation of the API or irritation or damage of the stomach mucosa can occur. Sustained release coatings build a barrier around the dosage form. The drug is released via diffusion through the polymer film or through pores in the film. Beside the diffusion coefficient of the drug in the film, the thickness of the film determines the dissolution rate of the drug. In active coating processes, the API is applied together with a film forming agent and/or a binder on a core which can be a placebo or contain a second API. The amount of API in the film is directly correlated to the film thickness when a uniform distribution on the core and a constant density of the film layer are achieved [6].

4.1. Non Functional Coatings or Cosmetic Applications

Most solid oral dosage form are colored not only to improve their appearance, but also to satisfy good manufacturing practices requirements that require products be differentiable at all stages during the manufacturing and distribution cycle. Therefore, film coating with pigments is essential in many cases to meet production regulations and thus, has vast importance to pharmaceutical manufacturing. Also, lustrous surfaces of solid pharmaceutical dosage forms are commonly recognize as more applying to the consumer than a dull surface which often elicits an unfavorable impression as to the quality of its content. Thus, film coating is widely used to enhance the pharmaceutical elegance of dosage forms by increasing surface luster. Some active ingredients or

excipients can cause a dosage form to appear spotted, mottled or unpleasantly colored leading the consumer to believe the content have degraded. In these cases, opaque coats are added to hide unsightly appearance.

Brand recognition is also important with regard to the aesthetic appearance of pharmaceutical products. Therefore, with regard to the commercialization of pharmaceutical dosage forms, it is essential to consider appearance as it is an important factor with regard to consumer opinions and awareness.

4.2. Immediate Release Application

4.2.1. Film coatings for taste masking and moisture protection

Taste masking and moisture protection of oral dosage forms contribute significantly to the therapeutic effect of pharmaceutical and nutraceutical formulations either by ensuring patient compliance or by providing stability through shelf life in order to provide the desired efficacy to the end user. Among different types of taste, bitter taste is the most relevant for patient acceptance because of the extremely high sensitivity of taste buds on the back of the tongue.

As hydrolysis is the most common mode of degradation of an active ingredient, moisture protection plays a vital role in the stability of the active. Moisture protection can be achieved by reducing the initial moisture content of the formulation and inhibiting further moisture seepage into the formulation during manufacturing and storage. Optimized oral dosage forms need to reliably hinder the release of bitter drug molecules in the mouth or ensure stability of the active compound, while also ensuring fast drug release in the stomach to enable early therapeutic onset. Besides different formulation concepts, film coating is found to be the most effective and commonly used approach for taste masking and moisture protection.

Film coating can be achieved through the use of water-soluble, cationic, anionic or neutral insoluble polymers from different chemical structures. Use of water-soluble polymers often results in a compromise of the isolation or moisture protection ability of the film. Use of anionic or neutral polymers necessitates thin films in order to ensure quick release in the gastric fluid. Cationic polymers provide efficient moisture protection without influencing the release of the drug in the gastric fluids.

Polymers may be sprayed onto various types of cores from dispersions or solutions in organic solvents or water. Organic solvents offer the safest option. However, due to environmental

concerns, aqueous formulations are often preferred. Efficient drying with coating equipment can ensure effective use of aqueous systems without compromises.

Coating thickness ranging from 0.5 to 50 μm or more, represents the most important influence on the desired function besides physicochemical properties of the coating material.

Insulating excipients with the least affinity to moisture also taste mask and ensure patient compliance as well as keeping the moisture uptake to a minimum during storage. Hydrophobic plasticizers would enhance the moisture protection ability of the film over the hydrophilic ones. Close attention needs to be paid to the quantity of the plasticizer. Pigments used for esthetics can be additionally exploited for their ability to physically obstruct the passage of drug or water molecules in the coating films. Efficient taste masking and reliable moisture protection of solid oral dosage forms can be achieved by film coating implementing the options of pharmaceutical polymers and processes, while also overcoming possible interactions with the active compound or different excipients.

4.2.1.1. Need and concepts of taste masking

The beneficial therapeutic effect of pharmaceuticals is dependent on regular dosing following manufacturer advice. The oral self-dosage route is the most common method for the application of many drugs. However, patients tend to neglect instructions when they are inconvenient or unpleasant. Particularly for oral pharmaceuticals, compliance depends significantly on the taste of the dosage form. Thus, masking bitter taste is the key parameter to improve patient compliance as well as the therapeutic efficiency of oral pharmaceuticals [38]. Measures to mask the taste of oral dosage forms must include efficiency, but also avoid any negative effect of sensory awareness, such as mucosa irritation, roughness in the mouth or hindered swallowing. Another important aspect is to not negatively affect the bioavailability of the active compound by hindering its release or delaying its effect. This can be accomplished by designing a release kinetic which functions over an extended time period after ingestion.

Several concepts of taste masking for pharmaceuticals have been developed and put into practise. **Molecular concepts** include chemical modifications, such as the prodrug approach or salt formation using either anions [39] or cations or interaction with ionogenic polymers, such as (meth)acrylates (i.e. Eudragit[®] E) [40]. **Physical taste masking** may be achieved by complexation (i.e., inclusion in cyclodextrins), its derivatives (i.e. hydroxypropyl-beta-cyclodextrin). Additionally practiced are **concepts of binding** to ion exchange resins, which have been revealed to be effective

taste masking agents. Cross-linked polymers and copolymers of (meth)acrylic acid are available in pharmaceutical grades and optimized variations for different classes of drug may be tested.

Formulation concepts for taste masking include the incorporation of specific flavour enhancers. Examples may be sweeteners, amino acids and their phosphate derivatives, natural products including fruit juices, aromatic oils, herbs, alkaline earth oxides, hydroxides and spices in forms such as high concentrated extracts or dried solids, as well as either alcoholic or aqueous solutions. Further functional excipients, which improve the organoleptic perception of unpleasant oral formulations, are effervescent agents or rheological modifiers, such as gel forming gums.

The type of taste masking suitable for final formulation is very much influenced by the selected manufacturing process. Processes for applying taste masking are melt and liquid extrusion, spray or freeze drying to form solid dispersions or agglomerates, coating with lipids or waxes, formation of lipid vesicles or multiple emulsions. Coating processes are preferably used for taste masking of tablets or mini-tablets. Commonly applied processes include liquid melt or powder coating with lipids, waxes and polysaccharides. Compression coating is an unconventional, alternative method with limited practical relevance. A modern variation of coating techniques is film coating particularly suitable for microencapsulation of small particles to form taste masked multi-unit dosage forms. The functional coating is applied by spray processes from organic or aqueous solutions or preferably from aqueous solutions or dispersions including natural or synthetic polymers. Among these varieties of formulation designs, film coating provides the highest efficiency [37].

4.2.1.2. Need and concepts of moisture protection

An active pharmaceutical ingredient in a dosage form needs to be stable until the end of its shelf life, in order to ensure its efficacy and safety for the patient. Degradation of the active ingredient can occur through hydrolysis, thermal degradation, oxidation, light, microorganisms or any other chemical reaction that renders the active ineffective for its intended purpose [41]. In addition, moisture is considered to be one of the most important factors influencing the stability of a pharmaceutical formulation. Atmospheric humidity is one of the main sources of moisture that chemically or physically influences the active ingredient. However, a formulator also needs to consider the inherent moisture of some of the excipients, which could be potential contributors of water molecules for hydrolysis. Many active ingredients are hygroscopic in nature and need to be protected from moisture. Moreover, moisture protection is often needed when the cores are

hygroscopic [42], as is the case with many herbal products. For most powders, residual humidity modifies their mechanical and rheological properties. Protecting a formulation from hydrolytic degradation is also possible through appropriate packaging, however it does not exclude moisture from seeping into the container during multiple openings. Protecting the cores with a moisture barrier film is found to be more appropriate, since it also eliminates the problem caused by multiple openings of the container. Thus, of all the alternatives available, coating the formulations is found to be the most appropriate and widely used technique.

Moisture-protective polymer coatings are often used to prolong the storage stability of water-sensitive drugs, including many herbal extracts [43; 44].

While developing a coating formulation for a moisture sensitive drug, the following strategies need to be considered during the entire development process:

- Designing the dosage form with non-hygroscopic/low water-activity excipients;
- Formulating the core with the least amount of inherent moisture;
- Providing the dosage form with a moisture protective coating;
- Packaging the dosage form with an appropriate moisture-resistant material [37].

4.2.1.3. Polymers and formulations

4.2.1.3.1. Polymers [39]

Moisture protecting and taste masking polymers used in film coating processes are based on polysaccharide, polypeptide or vinyl polymer chemistry. Their physicochemical properties vary over a wide range, indicating enormous variability and different formulation approaches.

Traditionally, water-soluble polymers (Table 4) are used for taste masking. However, some of them, like polyvinyl alcohol (PVA), are also used for moisture protection. Expected is the enablement of fast drug release independent of the dissolution medium, with no negative effect on drug release or therapeutic effect.

Table 4: Water-soluble polymers used for taste masking and moisture protection by film coating.

Polymer	Trade name	Monographs	Manufacturer
HEC Hydroxyethyl cellulose	Natrosol, Oxycellulose	EP, USP	Ashland Aqualon
HPMC Hydroxypropyl methyl cellulose	Methocel® E3/E5/E6/E15 Pharmacoat® 603/645/606/615 Walocel® HM 3 PA/HM 5 PA/HM 6 PA/HM 15 PA Spectracel™	EP, USP, JPE	Dow Chemical Shin-Etsu Wolff Cellulosics Sensient
Na CMC Sodium carboxymethyl cellulose	Walocel® CRT A	EP, USP, JPE	Wolff Cellulosics
PVP Polyvinyl pyrrolidone	Kollidon	EP, USP	BASF
PVA-PEG copolymer (polyvinylalcohol-polyethylenglycol-copolymer)	Kollicoat® IR AquaPolish®	EP, USP, JPE	BASF BioGrund
Polyvinyl alcohol	Opadry® AMB	EP	Colorcon
PVA-PEG: PVA	Kollicoat® IR Protect	EP, USP	BASF

These polymers include soluble starch derivatives, cellulose ethers and synthetic vinyl polymers or hydrophilic block copolymers. Since these polymers do not carry ionic groups, there is only a slight risk of chemical interaction with the active drug. However, efficiency of blocking the interaction of bitter drug molecules with taste receptors is somewhat limited. Reliable taste masking needs coatings up to 10 µm in thickness or more. In addition, long process times will reduce the economy of the manufacturing process.

Films of entero-soluble cationic polymers (Table 5) provide optimized functionality for taste masking and moisture protection. Insoluble in water at the neutral pH of saliva, they provide an effective barrier against the movement of drug molecules to the surface and water molecules to the core, thus providing taste masking and moisture protection.

Table 5: Entero-soluble cationic polymers used for taste masking and moisture protection by film coating.

Polymer	Trade name	Monographs	Manufacturer
Amino dimethyl methacrylate copolymer	EUDRAGIT® E EUDRAGIT® E PO EUDRAGIT® E 12.5	EP, JPE, DMF 1242 (USA)	Evonik
Amino diethyl-methacrylate copolymer	Kollicoat® Smartseal 30 D	EP, USP	BASF

EUDRAGIT® E is a cationic copolymer based on dimethylaminoethyl (meth)acrylate, butyl (meth)acrylate and methyl (meth)acrylate with a ratio of 2:1:1. It is available as a micronized powder for aqueous dispersion as EUDRAGIT® E PO and in granule form for organic solution preparation as EUDRAGIT® E 100. The tertiary amino groups of EUDRAGIT® E polymer types become protonated in the acid media of the human stomach and, hence, rapidly dissolve. Thus,

fast drug release is secured even if thicker coatings are applied when needed for moisture protection. Kollicoat® Smart seal 30D is also a cationic polymer. It is supplied as an aqueous polymer dispersion containing methyl (meth)acrylate and dimethylaminoethyl(meth)acrylate copolymer stabilized with ~0.6% macrogol cetostearyl ether and ~0.8% sodium lauryl sulfate. The solids concentration is approximately 30% w/w.

Anionic polymers (Table 6) include natural polymers such as shellac and alginates, carboxymethyl derivatives of cellulose, cellulose acetate derivatives of phthalic acid and butyric acid, and specifically optimized (meth)acrylates carrying different amounts of carboxylic groups.

Table 6: Enteric anionic polymers used for taste masking and moisture protection by film coating.

Polymer	Trade name (selection)	Monographs	Manufacturer
Sodium alginate	Keltone LV CR	USP	FMC biopolymers
Shellac	SSB 55 Pharma	USP	SSB Pharm
Carboxymethyl cellulose CMC	Akucell	EP, USP	Aqualon
Cellulose acetate phthalat CAP	Aquacoat® CPD	EP, USP/NF, JPE	FMC
	Eastman C-A-P NF	EP, USP/NF	Eastman
Cellulose acetat butyrate CAB	CAB Eastman	nf	Eastman
Methacrylic acid copolymer, Type A	EUDRAGIT® L 30 D-55/L 100-55	EP, USP/NF, JPE	Evonik
	Kollicoat® MAE 30 DP/100 P		BASF
	Eastacryl 30 D NF		Eastman
Methacrylic acid copolymer, Type B	EUDRAGIT® L 12,5/	EP, USP/NF	Evonik
	EUDRAGIT® L 100	EP, USP/NF, JPE	
Methacrylic acid copolymer, Type C	EUDRAGIT® S 12,5/	EP, USP/NF	Evonik
	EUDRAGIT® S 100	EP, USP/NF, JPE	
Methacrylic acid copolymer	EUDRAGIT® FS 30 D		Evonik

These polymers ensure targeted drug release and controlled dissolution of the coating at a defined pH. Primarily, the polymers provide enteric functionality and are used for taste masking and moisture protection due to their efficiency in blocking drug release in the mouth and seepage of moisture until the formulation is swallowed. Furthermore, free carboxylic groups may adversely interact with cationic groups of the active compound leading to instability. Isolating sub - coats may be necessary to hinder this chemical interaction.

Cationic or anionic copolymers, particularly the (meth)acrylates, may be partially neutralized, leading to improved drug release more independent of pH while maintaining a barrier effect for dissolved molecules in saliva. Cationic amino(meth)acrylate copolymer, carrying tertiary amino groups, may be neutralized with a combination of mono and dicarboxylic acids, such as malic or tartaric acid in order to achieve solubility of the coating in water. While maintaining a significant taste masking effect, the instant therapeutic effect is maintained more independently of the physiological influences of the human gastro-intestinal tract.

Table 7: Insoluble polymers used for taste masking and moisture protection by film coating.

Polymer	Trade name	Monographs	Manufacturer
Ethyl cellulose	Ethocel TM Aquacoat [®] ECD Surelease [®] (Fertigprodukt)	EP, USP	Dow Chemical FMC Colorcon
Cellulose acetate	Eastman CA	EP, USP	Eastman
Poly(ethyl acrylate-co-methyl methacrylate) 2:1	EUDRAGIT [®] NE 30 D EUDRAGIT [®] NM 30 D	EP, JPE EP	Evonik
Ammonio methacrylate Type A: Poly(ethyl acrylate-co-methyl methacrylate-co-trimethylammonioethyl methacrylate chlorid) 1:2:0.2	EUDRAGIT [®] RL 30 D EUDRAGIT [®] RL 100/RL PO EUDRAGIT [®] RL 12.5	USP/NF EP, USP/NF, JPE	Evonik
Ammonio methacrylate Type B: Poly(ethyl acrylate-co-methyl methacrylate-co-trimethylammonioethyl methacrylate chlorid) 1:2:0.1	EUDRAGIT [®] RS 30 D EUDRAGIT [®] RS 100/RS PO EUDRAGIT [®] RS 12.5	USP/NF EP, USP/NF, JPE	Evonik
Polyvinyl acetate	Kollocoat [®] SR 30 D		BASF

The neutral ethyl acrylate and methyl(meth)acrylate dispersions (EUDRAGIT[®]NE 30 D and EUDRAGIT[®]NM 30 D) provide coatings with medium permeability while the ammonio (meth)acrylate copolymers form films of high (Type A) (EUDRAGIT[®]RL) and low permeability (Type B) (EUDRAGIT[®]RS). Based on the physicochemical characteristics, the type A polymer may be the preferred coating polymer, however, mixtures are often applied for optimized functionality. Due to insolubility in water and low permeability the polymers can efficiently mask unpleasant taste and provide moisture protection, but fast drug release requires thin coatings similar to the anionic polymers.

Ethylcellulose-based formulations (Aquacoat[®] ECD) also provide moisture protection. Improvement in moisture protection is achieved with an increase in film thickness.

A further alternative of coating formulation design is a combination of different polymers in the coating. Preferably, water-soluble and insoluble types of polymers are combined in various ratios. As a result, the positive effect of blocking bitter tasting molecules from interacting with receptors on the tongue and instant drug release in the stomach can be linked. Publications mention film coatings containing ethylcellulose [45] and low substituted hydroxypropyl cellulose or hydroxypropyl methyl cellulose [46]. The insoluble polymer of EUDRAGIT[®] NE 30 D was combined with hydroxypropyl cellulose [47] and insoluble EUDRAGIT[®] RL 30 D dispersion was co-processed with water soluble carboxy methyl cellulose sodium in a 9–1 polymer ratio. The resulting coating maintained efficient taste masking combined with instant drug release due to rapid disintegration of the polymer layer in water independent of pH [48]. Taste masking of acetaminophen particles has been achieved by film coating with EUDRAGIT[®] RL/Blanose (sodium CMC) in a 9–1 combination [49].

Cationic entero-soluble EUDRAGIT® E 100 may be combined with swellable MCC and water soluble HPC or with water insoluble cellulose acetate [50].

Kollicoat® IR protect is a blend of PVA/PEG graft copolymer and PVA in a 6:4 ratio. The high capacity of this polymer mixture to bind insoluble pigments, due to its low viscosity, has shown to be useful for providing oxygen and moisture protection to formulations.

4.2.1.3.2. Formulation principles

Polymers may be applied by spray coating from organic or aqueous solutions. Preferred solvents are ethanol, isopropanol or its mixtures with acetone. Safety and toxicological reasons, as well as specific product and formulation development, changed coating processes to aqueous fluids containing the polymer in dissolved or dispersed form. Polymer dispersion may be prepared by emulsion polymerization, solvent evaporation from emulsions or micronized polymer particles. For moisture sensitive drugs, there are concerns about moisture penetrating during the coating process itself when using aqueous coating formulations. However, the latest coating equipment offers better drying techniques, preventing this moisture penetration during the coating processes. Thus, based on optimized formulations, aqueous coatings provide equivalent functionality to solvent based coatings.

Cores used for taste masking and moisture protection by film coatings may have many different structures and a wide variety of particle sizes. They can range from crystals or particles of a few μm , to granules and pellets up to 2 mm, or tablets of different shapes up to 15 mm or more. Traditionally, the preferred application process for tablets needing taste masking and moisture protection has been by film and spray coating in drums. Based on optimized formulations in terms of shape and hardness, the coating process usually involves little risk of complications and offers high reproducibility.

The thickness of the coating film and the composition of the excipients used in the film are important factors influencing the movement of water molecules through the film. Increasing the film thickness results both in an improvement of the tensile strength of the core [51] and in greater amounts of water retained in the film. This could result in larger amounts of moisture condensing in the pores, either because of chemisorption or because of the different nature of the internal microporous structure of the thick film. In a typical coating process, the particle size of the substrates is heterogeneous, and so is the coating film thickness on each substrate. If films of

varying thickness retain different amounts of moisture, the process variables should be closely controlled to achieve as uniform a coating thickness as possible for satisfactory product performance. This is of vital importance for moisture-protective coating applications because the residual moisture in the coating film may migrate into the core and interact with the active ingredient in an adverse manner during storage [37].

The glass transition temperatures of the polymers used for coatings affect the moisture protection ability and the stability of the formulation. Polymers in the amorphous state have a higher capacity for moisture sorption than in the crystalline state [52]. The up taken water may be thought of as “dissolving” into the amorphous structure and acting as a plasticizer [53]. Consequently, the glass transition temperature of the polymeric system decreases with increasing water content. Thus, water which permeates through a moisture barrier film would also have an influence on the T_g of the film and hence on the stability of the film and the formulation. In the presence of moisture, glassy-to-rubbery state transition occurred with the polymeric system of Opadry® AMB as opposed to EUDRAGIT® E PO, which did not show this transition under the test conditions. Hence, the water uptake with the Opadry® AMB films tend to increase with increasing temperature, due to the higher mobility of the macromolecules [54].

The plasticizer effect is based on molecular interaction with the polymer chains, thus helping to open the polymer chains and helping them interact with each other in order to develop more firm bonds, which result in coalescence of the film and film formation. Plasticizers are required to impart the essential flexibility to the film. This is obtained through a reduction in the glass transition temperature of the film, thus reducing its tensile strength [55]. Plasticizer also helps with adhering the film to the core surface. Appropriate concentrations of the plasticizer are important in determining the moisture protection properties of the final film. Quantities above the optimum level result in molecular scale holes in the film, which help water molecules pass through the structure, thus reducing the moisture protection property of the film. The effects of the presence of different types of plasticizers in polymeric coating formulations have been reported in literature [56 - 58]. The nature of the plasticizer drastically influences the moisture-resistance ability of the film. Films having a hydrophilic plasticizer are found to permeate moisture more rapidly. On the other hand, addition of hydrophobic plasticizers helps to increase lipophilicity and thus the moisture resistance of the film [59].

In addition to a plasticizer, pigments have an important role to play in moisture resistant film coatings. Due to the presence of intermolecular spaces in polymeric films, a complete barrier to

the movement of air or vapor is not possible. Insoluble additives are hence used on the coatings in order to block these intermolecular spaces [60]. Pigments, being discrete particles, serve as a barrier to the diffusion of moisture through the film. The moisture has to bypass these particles, thus increasing the passage time, thereby improving the moisture protection ability of the film. This, however, depends on the concentration of the pigments, referred to as critical pigment volume concentration. Above this level pigment pores are generated, thus facilitating the movement of moisture and resulting in poor moisture protection by the film. Pigments added to a polymer need to be distributed uniformly in order not to form agglomerates, which would interrupt film formation and possibly result in weaker films. Inadequate pigment distribution would also adversely affect film adhesion to the surface. Polyhydric material such as film formers or plasticizers can form hydrogen bonds with the water molecules, thus reducing the possibility of water molecules to reach the core and in turn provide moisture protection [51].

Aqueous coating processes are normally associated with longer drying times. Non-aqueous coatings are largely discouraged due to the hazards associated with the environment and solvent handlings. A solvent-free process with micronized powders for film coating of tablets using acrylic polymers such as EUDRAGIT® E PO has been developed. The coated tablets, observed using a scanning electron microscope, exhibited a continuous and uniform film coating. The results of dissolution testing indicated that in pH 6.8 buffer media, film coating resulted in a delay in the release of the drug, while no delay was observed in acidic medium. On the basis of these behaviors, taste masking, moisture protection and controlled release applications are expected from such films [61].

Lipidic/waxy excipients with low melting points are also sprayed in their molten state to form a uniformly continuous film that acts as the rate-controlling membrane for drug release as well as for moisture protection. The hydrophobic wax coating presents a barrier for moisture ingress into the drug-laden substrate. The most commonly used waxy excipient is glyceryl behenate. With glyceryl behenate, there may be binding of water molecules to the electronegative oxygen atom in the terminal carboxylic group via hydrogen bonding. Further, as temperature increases and is closer to the melting temperature of the wax, the intermolecular distances increase, leading to a greater number of carboxylic groups becoming available. Thus the effective moisture content (EMC) increases with increasing temperature for glyceryl behenate film [54].

As long term storage of oral dosage forms, often under elevated temperatures and high humidity, create a high stress on dosage forms during storage, packaging may be necessary

additionally to ensure storage stability of the dosage forms during an adequate period of time. Thus plastic or metal containers may be used to strengthen moisture protection over a longer period of time or plastic foils out of polyethylene, polypropylene or polyester, probably even laminated with aluminum [37].

4.2.2. Improving ease of injection / swallowing

Film coated dosage forms have been reported to improve esophageal transit/swallowing over the uncoated counterpart. Film coatings can act as barriers to prevent adhesion of the dosage form to the esophagus and in this way act as a lubricant to improve the motility of dosage forms through the esophagus. Additionally, film coats can prevent disintegration of dosage forms in the esophagus that can lead to extensive adhesion of particulates to the esophagus. Films coatings can also be applied to cover sharp tablet edges and increase roundness such that the tablet will be easier and more comfortable to swallow [62].

4.2.3. Sub - coats and top - coats

Immediate release film coats are also used as sub - coats that are applied to substrates prior to the addition of functional coatings. Sub - coats are often necessary to improve the adhesion of functional coatings. This not only improves continuous film formation but also increases coating efficiency by reducing the amount of the coating dispersion that must be applied to achieve the desired release profile. Sub - coats are also applied to prevent the partitioning of active from the core into the outer coat as this can result in a burst release of drug and can impair film functionality.

Immediate release film coats are also applied on top of functional coats to reduce adhesion of substrates caused by the tackiness of soft film coats after spraying. Topcoats can also be utilized to improve color or increase the gloss of film coated dosage forms [62].

4.2.4. Coating materials for immediate release application

4.2.4.1. Water soluble cellulose ethers

The most commonly used water – soluble cellulose derivatives for film coating applications include hydroxyethylcellulose (HEC), hydroxypropylcellulose (HPC) and hydroxypropyl methyl cellulose (HPMC). The leading commercial brand of HPC is Klucel®, HEC is available under the branded names Natrosol® and Cellosize™. Bulk HPMC is available under a variety of brand names, but most notably as Methocel™ which is marketed by the Dow Chemical Company [62].

The European Pharmacopoeia (8.7 Ed.) describes hypromellose as a partly O-methylated and O-2-hydroxypropylated cellulose. It is available in several grades that vary in viscosity and extent of substitution. The degree of polymerization may be distinguished by appending a number indicative of the apparent viscosity, in mPa*s (cps), of a 2% w/w aqueous solution at 20°C. Hypromellose defined in USP 39/ NF 34 specifies the substitution type appending a four-digit number to the non-proprietary name: the first two digits refer to the approximate percentage content of the methoxy group (OCH₃); the second two digits refer to the approximate percentage content of the hydroxypropoxy group (OCH₂CH(OH)CH₃), calculated on a dried basis. Pharmacopoeial specifications for hypromellose are summarized in table 8. Depending upon the viscosity grade, concentrations of 2-20% w/w are used for film forming solutions to film-coat tablets [63].

Table 8: Pharmacopoeial specifications for hypromellose [63].

Type	Methoxy content USP	Methoxy content Eur. Ph	Hydroxypropoxy content USP	Hydroxypropoxy content Eur. Ph
1828	16.5-20.0%	16.5-20.0%	23.0-32.0%	23.0-32.0%
2208	19.0-24.0%	19.0-24.0%	4.0-12.0%	4.0-12.0%
2906	27.0-30.0%	27.0-30.0%	4.0-7.5%	4.0-7.5%
2910	28.0-30%	28.0-30%	7.0-12.0%	7.0-12.0%

The substitution affects the solubility–temperature relationship. Among the three grades 2208, 2906 and 2910, which have long been commercially available worldwide, 2910 has the best solubility in organic solvents and so it has often been used for organic solvent–based coating. Even

though aqueous coating has been replacing solvent-based coating and the solubility in organic solvents is of less importance, the 2910 grade is still widely used. Substitution grades other than 2910 are also applicable for aqueous coating, but there are few suitable commercial products of those substitution grades having low viscosity [63].

The required viscosity of a solution for aqueous film coating is commonly less than 100 mPa*sec. The maximum concentrations of 3, 6, and 15 mPa *sec grades, which can be used in film coating, are therefore approximately 14%, 7.5%, and 4.5% w/w, respectively. Thus, the maximum concentrations available depend on the viscosity grade of HPMC used. Aqueous solutions of HPMC gel upon heating. The thermal gelling temperature, which is close to the clouding point, depends on the level of substitution and it is also affected by such factors as viscosity, concentration, heating rate and the addition of salts. Dramatic increases in viscosity are observed at near 60°C, which indicates the occurrence of gelation. Problems might be encountered if the solutions were at around this temperature. Preparation temperature of the coating solution should be less than 40°C for complete dissolution of HPMC particles [64]. Films prepared with this polymer generally will need another polymer, or plasticizer, to improve the adhesion to the core surfaces. HPMC forms transparent, tough and flexible films from aqueous solutions. The films dissolve completely in the gastrointestinal tract at any biological pH and HPMC provides good bioavailability of the active ingredients. The mechanical properties of HPMC films vary with viscosity grade. Both tensile strength and elongation of HPMC films decreased as the viscosity decreased. These observations suggest that the possibility of crack formation in coated films should be taken into consideration when an HPMC of lower viscosity grade is used. [64]. Polyethylene glycol (PEG), especially a high molecular weight type such as PEG 6000, is a suitable plasticizer. Liquid type PEG such as PEG 400 is also applicable particularly for peeling and for avoiding logo-bridging. Although a greater effect is expected as the content of plasticizer increases, it should preferably be added at the minimum effective level (usually 20– 30% w/w with respect to the polymer). Excessive amounts of plasticizer may cause tablet tacking, plasticizer bleeding, color depletion or interaction with the active ingredients. Propylene glycol is also effective as a plasticizer to some extent, but tends to volatilize during the coating process and storage [64].

4.2.4.2. Eudragit® E100

Aminoalkyl (meth)acrylate Copolymer EUDRAGIT® E is a cationic copolymer produced by radical copolymerization of butyl (meth)acrylate, dimethylaminoethyl (meth)acrylate and methyl (meth)acrylate in a ratio 1:2:1 having an average molecular weight of 150.000 Da. The polymer is insoluble at pH greater than 5.5, but becomes soluble at pH below 5.5 due to the protonization of the dimethylaminoethyl (meth)acrylate groups that results in a dense cationic charge on the polymer backbone that increases the hydrophilicity of the molecule. EUDRAGIT® E 100 is insoluble in the saliva (pH 6.8 – 7.4) but readily soluble in gastric fluids (pH 1.5) [62].

4.2.4.3. Kollicoat® IR

Kollicoat® IR is a polyvinyl alcohol – polyethylene glycol graft copolymer consisting of 75 % polyvinyl alcohol units and 25 % PEG units with an average molecular weight of 45.000 Da. Kollicoat® IR is freely soluble in aqueous media over the entire range of physiological pH and therefore is primarily used for instant release film coating applications. Films produced from Kollicoat® IR are clear, have excellent pigment binding capacity and can be easily printed; thus, are frequently utilized to improve the appearance of pharmaceutical dosage forms and to create brand trademarks. Kollicoat® IR films are extremely flexible showing much greater elongation at break than cellulose derivatives and therefore do not require the use of a plasticizer and in some cases may be more resistant to cracking or breaking than these more traditional coating alternatives [62].

4.2.4.4. Polyethylene glycol and Povidone

Polyethylene glycol and povidone (PVP) are readily water – soluble polymers that are used in numerous pharmaceutical applications; however, their applications to film coating are limited by their hygroscopicity. Thus, films produced from these polymers are typically tacky, making coated dosage forms difficult to handle due to their adhesiveness. PEG and PVP are, however, used as additives to film coating formulations to stabilize pigments and to increase the gloss of film coatings. Low molecular weight PEGs (500 – 600) are also commonly used as plasticizers in immediate release film coated formulations [62].

4.3. Film Coating for Modified Release Applications

The evolution in film coating into modifying the release of actives has led to very advanced delivery systems that have substantially expanded the complexity and capabilities of oral drug delivery. The different modes of modified drug delivery and the materials that enable these modes of delivery will be discussed in the following sections.

4.3.1. Film coating for enteric release

Enteric release refers to drug delivery that circumvents the stomach to release the delivered drug in the intestinal tract. Therefore, enteric – coated oral dosage forms remain intact in the stomach, releasing negligible amounts of drug, but dissolve rapidly in the intestinal tract. Polymers used for enteric film coating therefore resist dissolution in acidic media, yet dissolve readily in slightly acidic to neutral pH environments. There are a few reasons that enteric release is preferred for certain actives. If the active is irritating to the gastric mucosa, enteric delivery is preferred to avoid the discomfort and injury that may be experienced by the patient with an immediate release dosage form. If a drug molecule is acid labile or degraded by digestive enzymes in the stomach, enteric delivery is essential to maintain its therapeutic activity as all or a portion of the dose may be degraded in the stomach thereby reducing bioavailability. Enteric delivery has also been demonstrated to improve the absorbance of some poorly water – soluble drugs. Since there is vastly more surface area for drug absorption in the small intestine than in the stomach, targeting the delivery of the maximum dissolved drug concentrations to the small intestine can substantially improve oral absorption.

There are two types of materials that have been used for enteric coating of pharmaceutical dosage forms:

- (i) slowly eroding materials that provide enteric protection only if complete erosion does not occur before dosage forms exit the stomach;
- (ii) pH sensitive polymers.

Erosion based enteric systems are highly dependent on gastric conditions and emptying times and thus are not reliable. Therefore, pH sensitive polymers are more widely used for enteric coating as they provide greater consistency with respect to enteric drug release.

All pH sensitive polymers used in enteric film coating exhibit enteric functionality as a result of free carboxyl groups contained on the polymer backbone. In acidic environments, these free

carboxyl groups remain protonated (neutrally charged) and consequently the polymer remains hydrophobic and insoluble. As the acidity of the surrounding media is decreased, the free carboxyl groups become deprotonated and anionically charged rendering the polymer increasingly more hydrophilic up to a critical pH where the polymer becomes freely soluble. The pH at which this transition occurs depends on the degree of substitution of free carboxyl groups and the pKa of the substituent acid groups on the polymer chain. A greater degree of acidic functional group substitution corresponds to greater solubility of the enteric polymer.

Enteric polymers can be coated from aqueous latexes or from aqueous solutions that are produced by solubilizing the polymer via pH neutralization with the addition of an alkali or organic base (i.e. ammonia, sodium hydroxide, triethanolamine, ammonium hydrogen carbonate). In the most cases acid pretreatment is required to convert the enteric polymer from its salt state back to the neutral state to achieve enteric functionality of the polymer.

The plasticizer requirement is usually less when enteric coats are produced from neutralized aqueous solutions versus latex dispersion since the process of particle coalescence to achieve film formation is avoided. Plasticizer is only required in sufficient concentrations to improve film flexibility to avoid splitting or cracking. When enteric coating is conducted with latex formulations, in most cases, curing at elevated temperatures and relative humidity is required to complete film formation and ensure gastro – protection of enteric coat [62].

4.3.1.1. Enteric cellulose derivatives: CAP, HPMCP and HPMCAS

Cellulose acetate phthalate (CAP), cellulose acetate trivelliate (CAT), cellulose acetate succinate (CAS), hydroxypropyl methylcellulose phthalate (HPMCP) and hydroxypropyl methylcellulose acetate succinate (HPMCAS) are widely used for enteric coating applications.

CAP is produced by reacting partial acetate ester of cellulose with phthalic anhydride in the presence of a tertiary organic base or a strong acid. The USP specifies that CAP must contain 21.5 – 26 % acetyl groups and 30 – 36 % on the cellulose backbone as calculated on an anhydrous basis. This degree of substitution equates to acylation of about half of the available hydroxyl groups and about one quarter esterified with one of the two free carboxyl groups of phthalic anhydride. With only one carboxyl group on the phthalic moiety involved in the substitution, the other remains free to form salts and thus provides the enteric functionality to the polymer.

CAP shows aqueous solubility around pH 6. Degree of substitution is key to complete film dissolution in intestinal fluids. It has been determined that CAP has a threshold of approximately 20% phthalyl substitution to ensure rapid dissolution at intestinal pH.

The glassy transition temperature (T_g) of CAP ranges from 160°C to 175°C and therefore the addition of plasticizer is required to reduce the T_g of the polymer so as to improve film flexibility and robustness and to achieve complete film formation. The formation of a continuous film is essential to achieve adequate protection of the dosage form in the gastric environment. Therefore, plasticization of enteric polymers, particularly cellulose based-polymers is recommended to ensure the formation of a continuous film and to eliminate incidences of cracking or splitting of the film. Typically, 25% – 35% plasticizer based on dry polymer weight is sufficient. CAP is compatible with most water – soluble and insoluble plasticizers with diethyl phthalate (DEP), tributyl citrate (TBC), triethyl citrate (TEC), tributryin and triacetin being the most commonly used [62].

Depending on the degree of phthalyl substitution, *HPMCP* is soluble in aqueous media in a pH range of 5 – 5.5. There are three primary grades of HPMCP: HP 50, HP 55 and HP 55 S. The HP 50 grade has a 24% nominal phthalyl content and dissolves at $\text{pH} \geq 5.0$, while the HP 55 and HP 55 S grades have a 31% nominal phthalyl content and dissolve at $\text{pH} \geq 5.5$. HP 55 S has a greater molecular weight than the HP 50 grade which results in higher solution viscosity, greater film strength and increased resistance to simulated gastric fluid. The HP 55 S grade therefore requires less applied coating for enteric functionality and exhibits greater cracking than the HP 55 grade.

One of the benefits of HPMCP over CAP is that HPMCP is soluble in water/ethanol co solvent system which allows for improved drying efficiency and eliminates the need for neutralization to produce an aqueous – based solution coating system. Additionally, solutions and film coats prepared from HPMCP show great thermal stability compared to CAP and CAT.

HP 50 and HP 55 have a glass transition temperatures of 137°C and 133°C, respectively, and hence plasticizers are required to improve film flexibility and film formation from latex systems. Although HPMCP can be applied to substrates without plasticizer from neutralized solutions, the addition of plasticizer will reduce film cracking and thus improve resistance. Effective plasticizers include: TEC, diacetin, triacetin, diethyl and dibutyl phthalate, castor oil, acetyl monoglyceride and PEGs. The addition of 30 % plasticizer was found to be sufficient for the formation of a continuous HPMCP film pseudolatex dispersions and TEC was determined to be a more efficient

plasticizer than DEP. For coating of HPMCP from neutralized aqueous solutions, TEC concentration from 2.5 to 5 % w/w have been reported to be sufficient [62].

HPMCAS, or hypromellose acetate succinate as it is known in the USP/NF, is derived from HPMC by the esterification of free hydroxyl groups on the polymer backbone with acetic anhydride and succinic anhydride. HPMCAS was marketed as AQOAT[®], a re-dispersible powder form of the polymer. HPMCAS is insoluble in acidic media, yet soluble in neutral pH according to the percent of acetyl and succinoyl substitution. These three grades are available in both granular and micronized powder form. The onset of aqueous solubility of HPMCAS is in a pH range of 5.5 – 6.8 according to the polymer grade where determining solubility factor is the succinoyl to acetyl group substitution.

The T_g of HPMCAS lies in the range of 120°C – 135°C according to the polymer grade. Since HPMCAS is a relatively rigid polymer, plasticization is utilized to improve film flexibility and reduce cracking as well as to promote film formation from HPMCAS aqueous dispersion. TEC, triacetin and propylene carbonate formed clear, continuous films from HPMCAS dispersion at concentrations in the range of 30% – 50% by weight of HPMCAS [62].

The mechanism of film formation in aqueous latex systems has been suggested by several researchers. The particles get closer during the drying process and the capillary force makes the particles eventually coalesce with each other. It is considered that this theory can be applied for the film formation of HPMCAS, but due to its larger particle size compared with other latex emulsions, the mechanism can be slightly different [64].

A suggested theory of film formation from the aqueous dispersion of HPMCAS is that the plasticizer is separated from the water phase during the drying process and it dissolves or gels the particles of HPMCAS. The particles then fuse to each other to form a film. At the beginning of drying, particles dispersed in water are observed. As the water evaporates, the particles are pulled together and an increase in temperature causes TEC to separate from water. Separated TEC can be seen surrounding aggregates of particles. At the end of drying, TEC fuses the polymer and film formation is completed [64].

4.3.1.2. (Meth)acrylic acid Copolymers

(Meth)acrylic acid copolymers are widely used for enteric coating application. There are four types of Eudragit® polymers with enteric release capabilities: Eudragit® L 100 – 55 (also marketed as Kollicoat MAE 100P), Eudragit® L 100, Eudragit® S 100 and Eudragit® FS 30 D.

Eudragit® L 100 – 55, or (meth)acrylic acid copolymer type C USP/NF, is an anionic copolymer of (meth)acrylic acid and ethyl acrylate having an average molecular weight of approximately 250.000 Da. The ratio of free carboxyl groups to ester groups is approximately 1:1. The molecular structure of Eudragit® L 100 – 55, most importantly the functional group ratio, gives the polymer its characteristic pH dependent aqueous solubility profile. The onset of dissolution begins at or above pH 5.5 according to the ionization of free carboxyl groups.

The Tg of Eudragit® L 100 – 55 has been reported to be in the range of 123°C – 129 °C and thus, films formed from this polymer require plasticizer to facilitate film formation and to improve the mechanical properties of films. With the addition of 10 – 20 % plasticizer, the MFFT of Eudragit® L 100 – 55 is reduced to about 15°C. TEC is a commonly used plasticizer for Eudragit® L 100 – 55. Triacetin and low molecular weight PEGs have also been successfully utilized.

Eudragit® L 100 – 55, the spray dried form of the coating material, can be easily re-dispersed in water to solids contents of 30 – 40 % with the addition of 3 – 5 % of a neutralizing agent such as an alkali or organic base. The addition of a neutralizing agent increases the dispersion pH, ideally to a pH of about 5, which improves the wetting of latex particles and facilitates the dispersion of agglomerates as primary particles in aqueous medium.

Acryl-Eze® MP, a product of Colorcon, is a complete pre – formulated enteric coating system based on (meth)acrylic acid copolymer Type C. Acryl-Eze® MP is a powder mixture of Eudragit® L 100 – 55 along with neutralizing agents, plasticizers and pigments that is easily redispersed in water. This complete coating system eliminates several of the production steps required for the preparation of the coating dispersion and thus improves coating efficiency particularly for large scale production.

Eudragit® L 30 D 55 is a polymeric dispersion in water which following the addition of plasticizer, other functional additives, and dilution with deionized water is readily for spray application to substrate [62]. To achieve more flexible films for coating of particles, EUDRAGIT® L 30 D-55 can be mixed with flexible polymers such as EUDRAGIT® NE 30 D or FS 30 D [10].

Eudragit® L 100 and Eudragit® S 100 are (meth)acrylic acid copolymer Types A and B, as they are respectively titled in USP/NF, are anionic copolymers of (meth)acrylic acid and methyl

(meth)acrylate having an average molecular weight of approximately 135,000 Da. The ratio (meth)acrylic acid to methyl (meth)acrylate units is approximately 1:1 for Eudragit® L 100 and 1:2 for Eudragit® S 100. Thus, Eudragit® L 100 has a greater concentration of free carboxyl groups on the polymer backbone than Eudragit® S 100. Consequently, the dissolution of Eudragit® L 100 begins at about pH 6.0 while Eudragit® S 100 begins to dissolve at pH 7. Both polymers provide enteric protection to coated substrates: however, with Eudragit® S 100 the onset of drug release is further delayed and will occur in the more distal regions of the intestinal tract as compared to Eudragit® L 100.

The T_g of Eudragit® L 100 and Eudragit® S 100 have been reported to be about 160°C and the MFFT has been reported to be 85°C. Thus, continuous film formation is problematic at typical coating conditions and resulting films are brittle. Therefore, relatively large amounts of plasticizers (40 – 50 % based on dry polymer weight) are required to achieve complete film formation and to improve film flexibility. Plasticizers such as triacetin, poloxamer and TEC at a concentration of about 50% have been demonstrated to produce film coats with sufficient gastric resistance.

Eudragit® FS 30 D is a 30 % (w/w) aqueous dispersion of a copolymer produced by the polymerization of (meth)acrylic, methyl acrylate and methyl (meth)acrylate monomers. The free carboxyl to ester group ratio of this polymer is approximately 1:10 and thus this polymer is less soluble than the previously discussed Eudragit®. The onset of dissolution for Eudragit® FS 30 D with increasing pH occurs above pH 7 [62].

Table 9: Chemical names and compendial compliance of poly(meth)acrylates used for delayed release coatings [10].

Chemical/IUPAC name	Commercial name	Ph. Eur.	USP/NF	JPE	Behavior in digestive fluids
Poly(methacrylic acid-co-ethyl acrylate) 1:1	EUDRAGIT® L30D-55/L100-55 Kollicoat® MAE 30DP/100	Methacrylic acid-ethyl acrylate copolymer (1:1) type A	Methacrylic acid copolymer, type C – NF	Dried methacrylic acid copolymer LD	Soluble > pH 5.5
Poly(methacrylic acid-co-methyl methacrylate) 1:1	EUDRAGIT® L100/EUDRAGIT® L 12.5	Methacrylic acid-methyl methacrylate copolymer (1:1)	Methacrylic acid copolymer, type A – NF	Methacrylic acid copolymer L	Soluble > pH 6.0
Poly(methacrylic acid-co-methyl methacrylate) 1:2	EUDRAGIT® S100/EUDRAGIT® S 12.5	Methacrylic acid-methyl methacrylate copolymer (1:2)	Methacrylic acid copolymer, type B – NF	Methacrylic acid copolymer S	Soluble > pH 7.0
Poly(methyl acrylate-co-methyl methacrylate-co-methacrylic acid) 7:3:1	EUDRAGIT® FS 30D	–	–	–	Soluble > pH 7.0

4.3.1.3. Polyvinyl acetate phthalate

Polyvinyl acetate phthalate (PVAP) is the reaction product of phthalic anhydride and partially hydrolyzed polyvinyl acetate (PVAc) that contains less than 55.0 % and no more than 62.0 % phthalyl groups. The onset of aqueous dissolution of PVAP begins at a pH of about 5.0 allowing for enteric release as well as the potential for targeted drug release to the proximal intestine.

Although the T_g of PVAP is relatively low, plasticizers are typically incorporated for film coating applications to facilitate film formation and to reduce splitting or cracking. PVAP is compatible with several of the most common plasticizers: glyceril triacetate, TEC, acetyl triethyl citrate, DEP and PEG 400. Sureteric[®] is a complete pre formulated coating system consisting of a powder blend of PVAP, plasticizers and other functional ingredients intended for reconstitution in water for rapid coating dispersion production [62].

4.3.2. Film coating for sustained release

The overall goal in designing sustained release oral dosage form is to provide systemic drug concentrations that remain within the therapeutic concentration range for a prolonged time period. The primary benefit of sustained release dosage forms is the reduction of the daily regime for drug therapies requiring several daily doses. In many cases sustained release delivery systems can reduce dosing to a twice or once-daily schedule. By reducing the number of required daily dose, the convenience of the drug therapy is improved resulting in better patient compliance and often reduced cost. Additionally, a well-designed sustained release dosage form can stabilize systemic drug concentrations by providing a constant rate of drug release (and absorption), as opposed to the peaks and valleys of systemic drug levels seen with multi-dosing [65 - 67].

Sustained release polymeric film coating is based upon a generic reservoir device design in which the release of the active from a concentrated core is controlled by an encompassing semi-permeable membrane. The membrane controls the rate of water permeation into the drug core, thereby controlling the dissolution and subsequent outward diffusion of the active agent. The semi-permeable membrane, in almost all modern oral sustained release coating formulations, is primarily composed of a polymer which is insoluble in water over the entire range of gastrointestinal tract. Therefore, insoluble cellulose derivatives, insoluble poly(meth)acrylates, as well as polyvinyl acetate are the most commonly used polymer for sustained release film coating owing to their water-insolubility [62].

Membrane permeability is a function of thickness, porosity, tortuosity and composition. Therefore, film formation is a substantial determinant of drug release rate through a sustained release film coat. Drug release through an insoluble polymeric membrane produced from a latex dispersion will decrease with the evolution of film formation owing to decreasing porosity and increasing tortuosity of the polymer film. Therefore, a sustained drug release profile that is stable with time depends almost entirely on the formation of a complete polymeric film and the static nature of that film over time and under various storage conditions. The utilization of appropriate plasticizers as well post-treatment of coated substrates is essential to complete and stabilize film formation with sustained release polymers.

4.3.2.1. Ethylcellulose

Ethylcellulose is one of the most commonly used polymers for sustained release film coating. The polymer is insoluble, but permeable in water over the range of gastro-intestinal pH, and thus can be utilized to produce semi-permeable membranes that control the rate of drug release from coated substrates. Ethylcellulose contains not less than 44.0 % and not more than 51.0 % ethoxy groups as calculated based on dry polymer weight. Bulk ethylcellulose is produced by the Dow Chemical Company with a Standard ethoxy content of 48.0 – 49.5 %. Ethylcellulose is available in a variety of molecular weights corresponding to 5% solution viscosities of 3 – 385 cPs [68]. Ethylcellulose is soluble in alcohols, chlorinated solvents and natural oils. Therefore, solvent coating with ethylcellulose is commonly conducted from ethanolic solutions, while pseudolatex system must be used for aqueous film coating [62].

Modified-release tablet formulations may also be produced using ethylcellulose as a matrix former. Ethylcellulose, dissolved in an organic solvent or solvent mixture, can be used on its own to produce water-insoluble films. Higher-viscosity ethylcellulose grades tend to produce stronger and more durable films. Ethylcellulose films may be modified to alter their solubility by the addition of hypromellose or a plasticizer. Thus, ethylcellulose is compatible with the following plasticizers: dibutyl phthalate; diethyl phthalate; dibutyl sebacate; triethyl citrate; tributyl citrate; acetylated monoglyceride; acetyl tributyl citrate; triacetin; dimethyl phthalate; benzyl benzoate; butyl and glycol esters of fatty acids; refined mineral oils; oleic acid; stearic acid; ethyl alcohol; stearyl alcohol; castor oil; corn oil and camphor [68].

Although coating with organic polymer solutions is still widespread, aqueous ethylcellulose dispersions have been developed to overcome problems associated with organic solvents.

Two aqueous ethylcellulose pseudolatexes dispersions are commercially available: **Aquacoat®** manufactured by FMC Biopolymer (Philadelphia, PA, U.S.A.) and **Surelease®** by Colorcon (West Point, PA, U.S.A.) [69].

Aquacoat® ECD is produced by an emulsification/solvent evaporation process that utilizes sodium lauryl sulfate and cetyl alcohol as colloid stabilizers [62;70]. The Aquacoat® ECD dispersion contains approximately 27 % ethylcellulose and 30 % total solids. The dispersion does not contain plasticizer and therefore an appropriate plasticizer must be added to the dispersion prior to coating. The dispersion is typically diluted to a final solids content in the range of 15 – 20 % w/w prior to spray coating. Although, intended to be a pH – independent sustained release coating system, the content of sodium lauryl sulfate in the Aquacoat® ECD dispersion has been demonstrated to cause reduced drug release rates in acidic media versus media of neutral pH [30; 62; 71].

Surelease® is produced by first melt extruding ethylcellulose with oleic acid and dibutyl sebacate (DBS) (or fractioned coconut oil) to form a molten plasticized polymeric blend. This molten blend of plasticized ethylcellulose is then introduced into an ammoniated water solution under high shear and pressure to disperse small droplets of plasticized ethylcellulose into the water phase. Ammonium oleate is produced in situ during this emulsification process to stabilize the colloidal ethylcellulose particles. Additional purified water is added to reduce the final solids content of the pseudolatex dispersion to 25 % [30; 72]. Surelease® is supplied as a 25% (w/w) solids dispersion, which is recommended to be diluted with water to 15% (w/w) solids before use. Before dilution, the container of Surelease is required to be agitated to ensure homogenization of solids in the dispersion. Then the dispersion is diluted by adding two parts of purified water to three parts of Surelease and stirred with a low shear mixer for approximately 15 min. It is advisable to continue gentle agitation throughout the coating process to prevent potential sedimentation of solid particles [73].

The compositions of various types of Surelease® are summarized in Table 10. The Surelease® coating system does not contain an ionic surfactant and therefore does not exhibit the pH dependent drug release observed with Aquacoat® ECD [30; 62].

Table 10: Composition of Surelease Product Range (Surelease®-E-7-x) [73].

Ingredient	Function	x-19020	x-19030	x-19040	x-19050
Ethylcellulose	Polymer	✓	✓	✓	✓
Fractionated coconut oil	Plasticizer			✓	
Dibutyl sebacate	Plasticizer	✓	✓		
Ammonium hydroxide (28%)	Stabilizer	✓	✓	✓	✓
Oleic acid	Stabilizer/ plasticizer	✓	✓	✓	✓
Purified water	Vehicle	✓	✓	✓	✓
Colloidal SiO ₂	Flow aid		✓		
Hypromellose	Stabilizer				✓

Surelease® is applied onto drug layered nonpareils, extruded spheres, granules, drug crystals and mini-tablets preferably using fluid-bed coating technology. Top spray coating may be used for small particulates such as drug crystals; however, a Würster process (bottom spray) is generally recommended. Drug release from Surelease® coated multiparticulates is mainly controller by the coating film thickness (theoretical weight gain) [73].

The Tg of bulk ethylcellulose is in the range of 129°C – 133°C and therefore, at ambient conditions films of ethylcellulose are substantially brittle. To be used in film coating applications, ethylcellulose requires the addition of plasticizer to improve film flexibility and toughness. The Tg of dried latex particles of Aquacoat ECD has been reported to be 89°C [62; 74]. The reduced Tg of ethylcellulose dried from a pseudolatex is the result of the temporary plasticizing effects of water. Although the Tg of ethylcellulose pseudolatex particles is less than that of bulk ethylcellulose, additional plasticizer is required to reduce the internal stress of latex particles and facilitates their coalescence during film formation [62; 74]. In order to maximize coalescence and prevent spray drying, a product bed temperature range of 40 to 42°C is recommended, keeping the atomization pressure around 1.5 to 2 bars. Some typical process conditions established with Glatt fluid bed coating machines are shown in Table 11 [73].

Table 11: Typical Process Parameters Used for Application of Surelease® to Drug- Layered Pellets for Bottom Spray Würster Systems [73].

Process parameter	Coating process conditions		
	Glatt GPCG-3	Glatt GPCG-60	Glatt GPCG-200
Batch size (kg)	3	70	200
Spray gun	Schlick 970	Schlick HS	Schlick 940
Fluidizing air volume (m ³ /hr)	83–107	800–900	N/A
Inlet air temperature (°C)	64–67	60–66	72–75
Exhaust air temperature (°C)	40–45	39–41	47–51
Product bed temperature (°C)	41–47	40–46	43–46
Atomizing air pressure (bar)	1.5	2.0	2.0
Spray rate (g/min)	25–28	210–306	500–650

The majority of extended release (ER) barrier membrane coating systems require a thermal post coating treatment (curing) in order to achieve reproducible and storage-stable drug release characteristics. For example, FMC literature recommends that multiparticulates coated with *Aquacoat® ECD* are incubated in a tray dryer at 60°C for two hours post coating to promote complete coalescence of polymer particles in the film [73]. Surelease® family products are optimally plasticized systems and, as a consequence of plasticization of the polymer during manufacture, generally Surelease® films do not require a curing step. However, it is advisable to test for the occurrence of incomplete polymer coalescence during coating by placing the Surelease® - coated products at 50°C to 60°C for 2, 12, 24 hours and comparing the release profiles from these units with “uncured” beads. A curing effect may be noted if the elevated temperature incubation results in a decrease in the rate of drug release. The need for a curing step may be eliminated through optimization of the coating process [73].

4.3.2.2. Poly(meth)acrylates

Poly(meth)acrylate latex coating systems are also used for sustained release film coating. The different grades include Eudragit® RL 100, Eudragit® RS 100 and Eudragit® NE 30 D. The Eudragit® RL 100 and RS 100 are available as a fine powder (PO), granules, 12.5 % w/w organic solution and as a 30% (w/w) aqueous colloidal dispersion. These system are composed of polymers that are water insoluble, but swallable over the range of physiological pH and thus, are idea for sustained release film coating application.

Eudragit® RL 100 and RS 100, also known as ammonio (meth)acrylate copolymers Types A and B USP/NF, respectively are produced by radical copolymerization of ethyl acrylate, methyl (meth)acrylate and trimethyl ammonioethyl (meth)acrylate chloride in a 1:2:0.2 ratio (RL 100) and 1:2:0.1 (RS 100). In aqueous media, the quaternary ammonium groups on the Eudragit® RL 100, and RS 100 polymers become ionized causing films to swell by ionic repulsion resulting in controlled permeation of the surrounding medium. Eudragit® RL 100 has a greater concentration of ammonio (meth)acrylate pendant groups and hence, films produced from this polymer are substantially more permeable than films produced from Eudragit® RS 100. Blending of these two polymers is a common method to achieve intermediate sustained drug release rates [62].

Insoluble ionic poly(meth)acrylates EUDRAGIT® RL (highly permeable) and EUDRAGIT® RS (slightly permeable) can be mixed in any ratio in either organic or aqueous form to obtain specific release patterns [10]. EUDRAGIT® RL contains more quaternary ammonium groups, is more hydrophilic and shows a higher permeability. This means that an increased amount of EUDRAGIT® RL accelerates the drug release [75]. In addition to the ratio of the polymers, the thickness of the film also controls the release profile. Since the polymer with higher permeability dominates the release characteristics, amounts of 5 – 10% w/w are recommended for the blends [10]. In extended-release formulations, the amount of EUDRAGIT® RS polymer is usually much higher, since the EUDRAGIT® RL properties are dominant. A good starting point for new developments is 10 % w/w EUDRAGIT® RL, which can then be adapted based on the solubility of the drug and the targeted release profile [10]. The MFFT of Eudragit® RL 100 and RS 100 polymers range between 40°C and 50°C and thus, plasticizer is required to form continuous films at typical coating and curing temperatures [62].

Due to environmental, safety and cost considerations, pharmaceutical manufacturing has been moving from organic to aqueous coating systems [10]. Re-dispersed aqueous dispersions of EUDRAGIT® L 100-55, L 100 and S 100 necessitate much higher plasticizer amounts (50–70% w/w on dry polymer substance) compared to respective organic coatings where no plasticizer is necessary. These higher plasticizer volumes lead to faster dissolution speed in the buffer media [76]. With polymers such as EUDRAGIT® RL, EUDRAGIT® RS or EUDRAGIT® E, organic coating formulations can be easily replaced by an aqueous system.

All poly(meth)acrylates are available in both systems, except for EUDRAGIT® FS 30D, EUDRAGIT® NE 30D and EUDRAGIT® NM 30D, which are only available as aqueous dispersions. In some cases, replacing organic with aqueous systems requires formulation adaptations to create bioequivalent

release profiles. The difference between the two systems lies in film density and variances in formulation excipients and volumes [10].

Eudragit® NE 30D is a poly (meth)acrylate based coating system used for sustained release film coating. Eudragit® NE 30D is a latex dispersion of a neutral polymer produced by emulsion polymerization of ethyl acrylate and methyl (meth)acrylate. The ratio of ethyl acrylate to methyl (meth)acrylate on the polymer chain is 2:1 and the average molecular weight of the polymer is 800.000 Da [62]. Eudragit® NE 30D is similar to Eudragit® RL 100 and RS 100 polymers in that it is insoluble in aqueous media over the entire range of physiological pH, but is swellable independent of media pH. Therefore, Eudragit® NE 30D is used in film coating application as a drug release rate – controlling membrane to sustained release of active over the entire length of the gastrointestinal tract. With respect to permeability, the Eudragit® NE 30D films are moderately permeable producing drug release rates between that of Eudragit® RL 100 and RS 100. The MFFT of Eudragit® NE 30D is 5°C and therefore plasticization is not required for formation of continuous flexible films [62]. Films produced from this latex dispersion undergo further gradual coalescence. Therefore, substrates coated with Eudragit® NE 30D should be treated following the coating process to accelerate the formation of a stable film and ensure static drug release profile on storage [62].

With EUDRAGIT® NM 30 (permeable), all carboxylic groups are esterified so that they have no reactive functional groups. Thus, drug release is mainly controlled by the coating thickness. Depending on drug solubility, 5 – 20 % of dry polymer substance based on tablet weight is usually sufficient to control drug dissolution and release over a period of 6–8 h [10].

4.3.2.3. Polyvinyl acetate

Kollicoat® SR 30 D is a sustained release coating dispersion based on PVAc. Kollicoat® SR 30D is a 30 % (w/w) dispersion of PVAc in water stabilized by povidone (2.7 %) and sodium lauryl sulfate (0.3 %) prepared by an emulsification polymerization method [62]. PVAc is insoluble in aqueous media and therefore provides sustained release of active agents from coated substrates by controlling the rate of media diffusion through the film [62]. Coating levels of Kollicoat® SR 30D between 1 and 5 mg/cm² were sufficient for extended release coatings of multiple unit dosage forms depending on the solubility of the active and the targeted release rate. Coatings below 1 mg/cm² (approximately thickness 10 µm) will result in incomplete coverage of the surface [77].

Kollicoat® SR dispersion has a MFFT of 18°C and therefore can be utilized for film coating without the need for plasticization or curing; however plasticization will enhance film formation and flexibility. Recommended plasticizer concentration is in the range of 0 -10 % based on the dry PVAc weight. TEC has been shown to be an efficient plasticizer reducing the MFFT to 1° C at a concentration of 10 %. As a result of the low MFFT, sticking commonly occurs with substrates coated with Kollicoat® SR and therefore, anti – tacking agents such as talc should be added to the coating dispersion or the coated substrates should be mixed with colloidal silica after coating [62].

5. COATING OF PELLETS

5.1. Multiple-Unit Dosage Forms: The Rationale

MUPs (Multiple-Unit Particulate Systems) are modified release preparations which consist of a number of discrete units (pellets) combined into one dosage form (capsule or disintegrating tablet). In pharmaceutical industry, pellets can be defined as small, free-flowing, spherical or semi-spherical solid units with a narrow size distribution (typically ranging from 0.5 to 1.5 mm) manufactured by the agglomeration of fine powders or granules of drug substances and excipients using appropriate processing equipments.

Pellets have numerous therapeutic advantages over traditional single units, such as tablets and powder-filled capsules. Indeed, pellets can be divided into desired dose strengths without formulation or process changes and can also be blended to deliver incompatible bioactive agents simultaneously or particles with different release profiles at the same site or at different sites within the GIT.

When pellets are orally administered, they disperse freely in the GIT and exhibit a more predictable and reproducible gastrointestinal transit reflected in a lower inter and intra subjects variability, minimize local irritation of the mucosa by certain irritant APIs because of the small quantity of drug available in a single units, reduce the risk of dose dumping, empty gradually from the stomach regardless of the feeding state and improve flexibility of dose release performances [78].

5.2. Manufacturing Techniques

Pelletization techniques are mainly based on direct pelletization (production of matrix pellets in which drug and excipients undergo to direct pelletization) or pelletization by layering. Layering processes are probably the most well-controlled and straightforward pelletization techniques that have been used over the years. They are classified into three categories: solution layering, suspension layering and powder layering. Table 12 summarizes the characteristics of the different layering methods.

Table 12: Different layering methods.

solution/suspension layering	powder layering
easier to develop (as a spray coating process)	faster process; lower cost
traditional coating equipments	pelletization equipment should have powder feeder
formulation of drug solution/dispersion	formulation of binder solution and of dry powder of drug and/or excipients
higher process temperatures to permit solvent removal	lower process temperatures; suitable for thermo labile APIs; lower solvent amount applied
drug compatibility with selected solvent	more suitable for high drug load; no dilution factor
smooth surface (suitable for further polymeric/drug coating)	a seal coat is suggested/necessary to reduce the roughness surface

5.2.1. Pellets by solution/suspension layering

Solution and suspension layering involve the deposition of successive layers of solutions or suspensions of drug substances, respectively, on non-pareil seeds (starter cores) which may be inert materials or crystals or granules of the same drug.

Conventional coating-pans, fluid-bed centrifugal granulators and Wurster coaters could be used to manufacture pellets by solution or suspension layering. Indeed, during solution or suspension layering, all the components of the formulation are dissolved or suspended in the application medium and hence determine solids content and viscosity of the liquid sprayed. As the solution or suspension is sprayed onto the product bed, the droplets impinge on starter seeds and spread on their surface. This is followed by a drying phase which allow dissolved materials to crystallize and form solid bridges between the core and initial layer of the drug substance as well as among the

successive layers of drug substances. The process continues until the desired layers of API and hence the potency of pellets are achieved. The rate of particle growth is rather slow due to the incremental addition of the dissolved or suspended drug. In this process, though the amount of seeds inside the product chamber remains the same, the size of pellets increases as a function of time and, as a result, the total mass of the entire system increases.

5.2.2. Pellets by powder layering

Powder layering involves the deposition of successive layers of dry powder drug and/or excipients on preformed nuclei or cores with the help of a binding liquid. During powder layering, a binding solution and a finely milled powder are simultaneously added, at a controlled rate, to a bed of starter seeds. In the initial stages, the drug particles are bound to the starter inert seeds and subsequently to the forming pellets with the help of liquid bridges originated from the sprayed binding liquid. These liquid bridges are replaced by solid bridges derived either from a binder in the application medium or from any other substance, including the API, that is soluble in the binding liquid. Successive layering of drug and binder solution continues until the desired pellet size is reached. Throughout the process, it is extremely important to deliver the powder at a predetermined rate and in a manner that maintains an equilibrium between the binder liquid application rate and the powder delivery rate.

If the powder delivery rate is not maintained at predetermined levels, over wetting or dust generation occurs and neither the quality nor the yield of the product can be maximized.

6. ADVANCES IN FILM COATING

Although film coating is fairly well-controlled and widespread in pharmaceutical production processes, comprehensive studies, including Quality-by-Design (QbD) and troubleshooting investigations, are necessary to cope with the numerous issues that arise during formulations developments. Furthermore, according to the latest FDA guidance (ICH Q8) on Process Analytical Technologies (PAT) [80], the most appropriate approach for optimizing pharmaceutical production involves process understanding.

Recent development of analytical techniques to monitor the coating process of pharmaceutical solid dosage forms such as pellets and tablets are described in literature [6]. The progress from off- or at-line measurements to on- or in-line applications is shown for the spectroscopic methods

near infrared (NIR) and Raman spectroscopy as well as for terahertz pulsed imaging (TPI) and image analysis.

The common goal of all these methods is to control or at least to monitor the coating process and/or to estimate the coating endpoint through timely measurements. Beside the average coating thickness of the dosage form, other process and quality parameters have to be monitored during a coating process: the coating has to be homogeneously distributed over the surfaces of all particles. Intra- and inter-tablet/pellet variations should be as small as possible. Film formation from aqueous dispersion or aqueous or organic solutions/suspensions has to be complete. A high coating quality regarding surface roughness and homogeneous distribution of pigments and dyes can be required. Holes and cracks in the film have to be avoided. Sticking and adhesion between the particles and to the container walls have to be minimized. Over-wetting has to be avoided and the moisture of the particles has to be monitored at the end of the coating during the drying phase.

The spectroscopic methods NIR [81 - 83] and Raman spectroscopy [84 - 87] seem to be the most advanced techniques for the control of the coating process of solid dosage forms. In-line measurements in industrial scale pan coaters were successfully applied for both methods to monitor the coating thickness on tablets. NIR has the additional advantage to allow the simultaneous estimation of the moisture content of the tablets. The determination of the coating end point in an industrial process should be possible with these spectroscopic methods. Their measuring principle leads to average values of a number of tablets; single tablet in-line measurements are not described in literature to date and, thus, coating uniformity could not be investigated. A disadvantage is the need to use multivariate data analysis with data pre-treatment and construction of PLS models in most cases.

Terahertz pulsed imaging could be shown to be able to estimate the thickness of individual tablets in-line in a drum coater in a proof of concept investigation. This could be used to calculate the coating uniformity of a batch. No chemometric calibration model is required, but the knowledge of the refraction index is needed [88; 89].

Image analysis with fast visual digital imaging systems is a promising tool for the on-line measurement of size and shape of pellets and therefore for the estimation of coating thickness. However, the technique seems to be limited to spherical dosage forms like pellets and the pellets have to be diverted from the process for measuring and returned later [90 - 92].

7. DRY POWDER COATING

Dry powder coating is a technique with no need of any solvents or dispersion media. The film forming polymer is applied in powdered form to the cores consisting of the active enabling very short process time compared to conventional coating process [93]. Dry powder coating can be performed using different technological approaches which include liquid assisted, or thermal adhesion or electrostatic coating [94].

The thermal adhesion (melt coating) process requires the application of low melting point materials and is performed in a fluid bed coater with the aid of heating systems for atomized air to provide a molten spray plume. Unlike conventional fluid bed coating which uses heated gas to remove solvent, inlet air will enter the system for melt coating at a reduced temperature to solidify the molten coating on the substrate. Implementing a similar strategy, liquid assisted layering strategies rely on interfacial capillary action of liquid formulation components to aid in the adhesion of the coating layer onto the substrate. In this technology, the liquid additive can be partially mixed into the feedstock or added as a separate feed stream into the processing zone.

Based on the process similarity with conventional strategies, existing equipment, specifically fluid beds, can easily be modified to support production, although formulations of this type will typically require higher levels of plasticizer or tackifying agent. Thus, the choice of excipients will be governed by thermal properties of the coating materials to provide sufficient softening at moderate temperatures while still providing suitable mechanical properties at room temperature. Adhesion, plastic deformation and consolidation will all be critical points to consider during formulation design. Longer processing times and additional post processing curing steps may also be required.

Electrostatic modalities differ from the other forms of dry powder coating both in terms of excipients as well as manufacturing equipment. For successful coating, the material must be conductive to allow for charge differential formation while exhibiting desired film forming characteristics. Electrostatic coating equipment creates specific charge fields allowing for the coating of complex designs that cannot be achieved with traditional systems.

7.1. Film Formation Mechanisms in Dry Powder Coating

From a mechanistic perspective, dry powder coating processes consist of the same sequence of steps that are employed with conventional solvent based coatings (paragraphs 3.1 and 3.2). In all

cases, the process begins with the pre-treatment of the coating material. This is followed by the application of coating material to the substrate, relying on the adhesive nature of the formulation to maintain uniformity of coating during the film formation process. Film formation occurs by a process of evaporation, coalescence and sintering which are influenced by process and formulation considerations. Pre-treatment of the coating material varies greatly based on the type of coating process utilized. For dry powder coating applications, careful consideration of material particle size will be essential to ensure appropriate uniformity for the coating. It is generally recommended that coating material diameter be less than 1% the size of the coating substrate. This allows for acceptable uniformity of the material on the substrate surface, improving adhesion, appearance and processing times. During the dry powder coating process, the substrates are often heated above the glass transition temperature of the layering materials so that the coating materials soften and adhere to the substrate. For conventional film coating, spreading and adherence is well defined based on surface free energies and capillary forces where mobility is not a limiting interaction. However, powder systems may become limited by mobility, particularly when liquid levels are reduced to the point where solid particle deformation becomes rate limiting. This introduces a series of constraints related to mechanical and thermal properties of the coating formulation. Coalescence and film formation, which are highly dependent on capillary forces in conventional coating systems, will also be dependent on these properties. As such, glass transition temperature and plastic deformation characteristics of the coating materials are paramount to the success of the process and if materials are deficient in these properties then it may be necessary to engineer the formulations with the desired characteristics.

Many pharmaceutical coating materials are amorphous polymers, exhibiting a glass transition temperature related to the change from a glass to a super cooled liquid. On transition, which occurs at a specific temperature, mobility of the system increases significantly. The greater mobility allows for molecular rearrangement and alters the plastic deformation characteristics of the materials. The addition of low glass transition materials to the overall composition is a common approach in many dry powder coating formulations to improve coalescence and adhesive properties. When processing above the glass transition temperature of a coating material, the surface is more "liquid-like" and more susceptible to plastic deformation. Depending on the difference between glass transition temperature and processing temperature, the viscosity of the coating material can be reduced sufficiently to result in the formation of capillary forces which aid

in the adherence of the powder to the surface. Under such conditions, surface energy differentials can aid in the spreading of the semi-molten polymer to enhance coating efficiency.

Dry powder coating applications also rely on mechanical compaction that occurs naturally during the process to facilitate adhesion and coalescence. During this process stresses on the coating layer result in consolidation of the bed and deformation driven spreading across the interface. For elastic materials, the deformation of the material is reversible, leading to poor contact across the surface. When coatings exhibit plastic behaviour, the deformation is irreversible and the mechanical compaction leads to greater adhesion of the surface layer due to a larger surface area for contact between substrate and coating, as well as possible mechanical interlocking of the materials.

Adhesion and spreading behaviour can also be modified through the application of a sub-coat to the substrate. To further promote adhesion with the coating layer, the sub coat can actually be intentionally selected to be partially molten at the processing temperatures. The molten priming layer promotes the adhesion of the powder coating particles by forming liquid bridges with the core surface. Since the spreading of the priming layer on the surface of the coating cores is crucial, the best sub coating material is selected by measuring the contact angle with water of the core surface and those of the primer and of the polymeric material to be layered [94 - 96].

Figure 10: Schematic representation of film formation in dry powder coating systems [94].

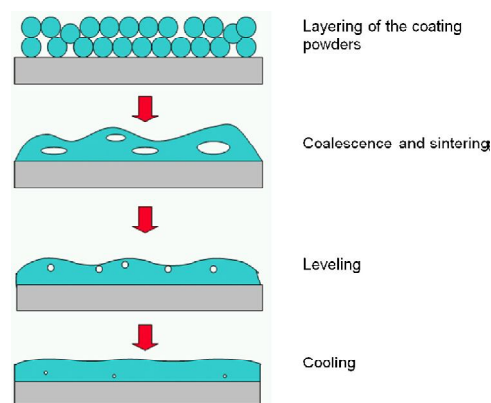

The mechanism of film formation of the powders layered onto the solid cores is schematized in Figure 10 and consist of 3 steps:

- (i) coalescence and sintering of the particles of the polymeric materials in a process that involves the partial fusion of the polymer;

- (ii) levelling of the coating material includes densification of the layer with reduction of the empty spaces and smoothing of the surface;
- (iii) cooling of the layer and hardening of the coating.

In conventional coating applications, coalescence is driven by the presence and subsequent removal of solvent which creates capillary forces inside the film and lowers the glass transition temperature of the polymer. The mechanism for coalescence of dry powder coated films is similar, although much more reliant on non-solvent forces to achieve a uniform film.

$$t = \frac{k \cdot \mu \cdot R}{\gamma} \qquad \text{Eq. 3}$$

According to equation 3 the time (t) required for two powder particles to coalesce is directly related to the viscosity of the powder coating (μ), the radius of the particles R and the surface tension of the coating (γ) where k is a constant describing the process [97]. From this equation, it is clear that it could maintain low polymer viscosity to promote distribution of the material over the surface of the solid in order to yield an acceptable film. For thermoplastic powders, this will depend on the molecular weight of the polymers and on the curing temperature. Unlike many solvent-based systems, curing of dry powder coated products is nearly ubiquitous for both immediate release and controlled release systems to achieve a visually and functionally acceptable layer.

In order to reduce the processing temperature of the powder coating and to shorten the curing phases, polymers which show excessively high T_g ($> 60^\circ\text{C}$) are combined with plasticizers able to decrease the T_g of the coating powders [95; 96; 98]. Specific amounts of liquid or solid plasticizers can be added to the polymeric materials via physical mixture, concurrent addition during production or by the preparation of a solid dispersion coating formulation containing plasticizer prior to the coating operation. The nature of plasticizer addition will ultimately contribute to the type of coating process selected. Each of these approaches provides unique advantages and disadvantages, as summarized in Table 13.

Alternatively, a polymeric solution containing the plasticizer can be spray dried so that a fine pre-plasticized polymeric powder can be obtained [99]. In general, powders having a particle size below $100 \mu\text{m}$ (d_{v50}) have been demonstrated to be suitable for powder coating. Further consideration of the coating to substrate particle size ratio is necessary to ensure appropriate

adhesion and visual appearance. Examining the dry powder coating process as a whole, one notes a strong dependence on coating and substrate properties, as well as the interaction between the interfaces formed during the process. Successful implementation of dry powder coating technologies requires engineering of the product and process to carefully achieve the desired material attributes of the finished product.

Table 13: Comparison of pre-processing techniques for dry powder coating [94].

Technology	Advantage	Disadvantage
Liquid assisted	Use of conventional coating equipment Reduced liquid removal	Requires co-metering technology for feed addition Potential for heterogeneity of film components
Thermal adhesion	No requirements for co-metering No liquid removal	Requires pre-processing of feed powders Narrow temperature operation window
Electrostatic	Complex pattern coating	Need for specialized equipment

7.1.1. Liquid assisted coating

While conventional coating technologies rely on large volumes of solvent to ensure adhesion and the formation of a uniform coating, liquid assisted technologies limit the amount of liquid within the formulation. Additionally, this approach will often use a liquid phase excipient intended to remain in the drug product which will serve as an adhesive aid while providing some functionality for film formation. Since this approach is mechanistically different than conventional film coating technologies, theoretical aspects as well as technological considerations must be balanced to ensure success.

The processes were performed using both a centrifugal granulator or fluidized bed for coating pellets and a perforated coating pan for coating tablets. A schematic illustration of each apparatus is shown in Figure 11. Since these apparatuses are normally employed for solid oral dosage form unit operations, slight modifications were necessary. In addition to the liquid atomizers already in-place, these units were retro-fitted with powder feeders to support in-line addition of the dry powder coating. The dosing rate of the powders was monitored and controlled by loss-in-weight feeders, with feed streams entering directly into the processing chambers. During processing, differential air flows and gravitational forces, in combination with simultaneous addition of the

liquid plasticizer ensured adhesion of the powder to the substrate. Elevated temperatures within the processing chamber along with mechanical forces resulting from product bed movement further facilitated adhesion and film formation during the layering and curing processes.

Figure 11: Schematic illustration of dry coating with: (a) centrifugal granulator [100]; (b1) top spray fluidized bed [100]; (b2) rotary fluidized bed [101] and (c) perforated pan tablet coating machine [100].

(a)

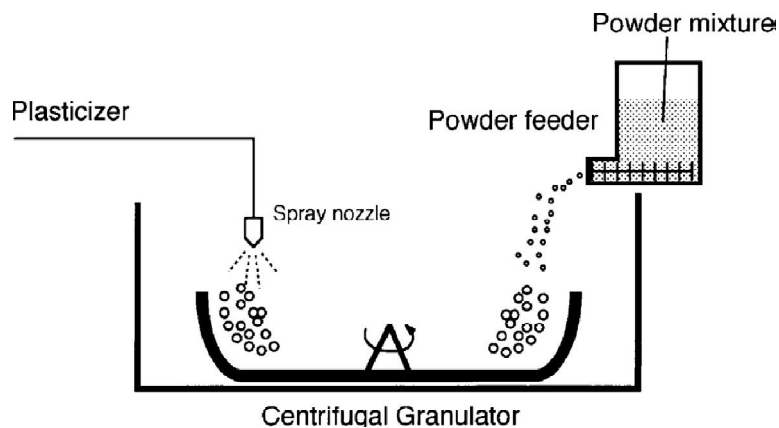

(b1)

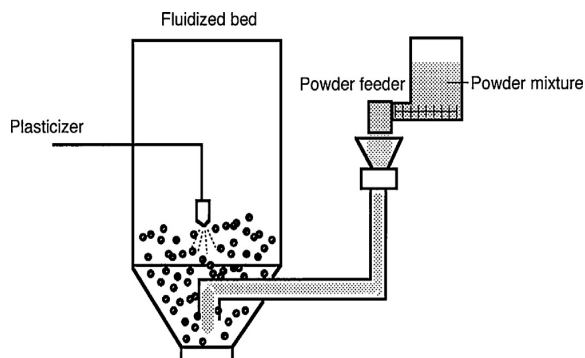

(b2)

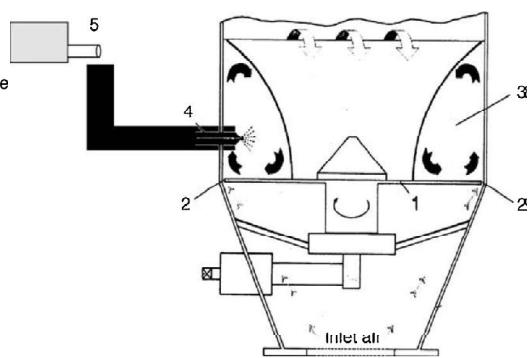

(c)

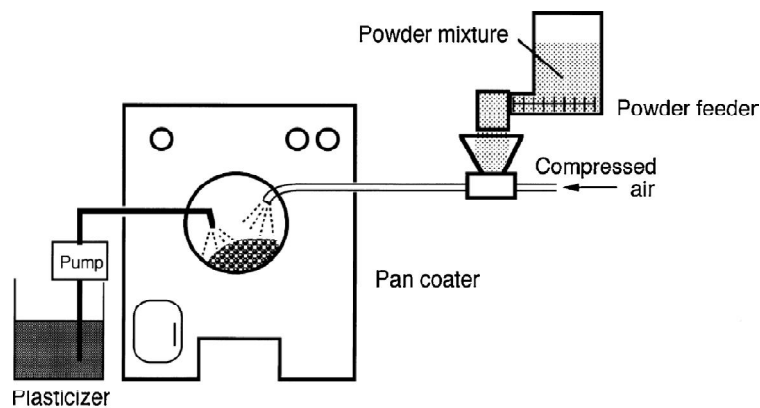

7.1.2. Thermal adhesion

Operating in the extreme of liquid assisted processes, where the adhesive liquid level is minimized, one generally observes a greater dependence on the thermal characteristics of the coating powder. In fact, it becomes possible to remove the liquid aid altogether to rely solely on thermal adhesion of the coating powder. Due to the complex nature of the thermal adhesion mechanism in combination with the requirements for manufacturability and drug product stability, these formulations must be engineered to a greater degree than the liquid assisted systems. When compared to liquid assisted dry powder coating, thermal adhesion methods have received less attention, although they too have traditionally relied on adaptation of existing manufacturing equipment to support production. Several of the most common adaptations have largely been centered around spheronizers and rotary fluid beds. For these processes, the substrate is maintained at a temperature that facilitates softening and spreading of the coating powder. This is further aided by mechanical forces of the process which work to compact powders on the surface of the substrate. It is also critical that the temperature is maintained below the critical threshold for agglomeration of the powder and drug product. Given the narrow operating window for processing, it is imperative to maintain a high accuracy of process control during manufacture. One technique extensively reported in the literature has been the adaptation of a spheronizer to the production of dry powder coated drug product [61; 95; 98]. This process involved only solid materials using a laboratory scale spheronizer (Model 120, G.B. Caleva; Dorset, UK) with a smooth stainless steel disc. Represented in Figure 12, the edges of the disk (1) were tilted at a 45° angle to facilitate the tumbling movement of the tablets and to prevent the loss of the coating powders.

Figure 12: Schematic representation of the laboratory scale spheronizer used for the thermal coating process: (1) rotating disk; (2) infrared lamp; (3) powder feeder; (4) temperature probe; (5) coating cores; and (6) glass cover.

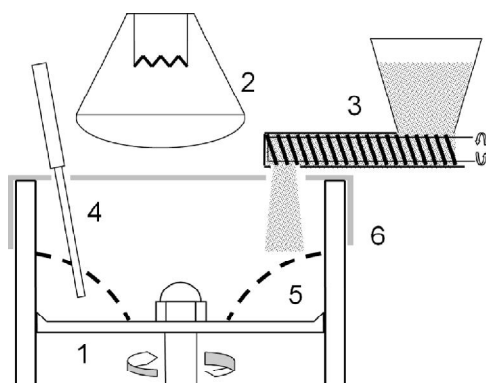

The heat necessary to perform the powder coating was generated by an infrared lamp (2) positioned 3 cm above the top of the spheronisation chamber (250 W Infrared Red Heat Bulb, General Electric, USA). The temperature of the coating chamber was controlled by adjusting the power of the lamp with a variable transformer (TYPE PF 1010, Staco, Inc., Dayton, OH, USA). The temperature of the coating bed (5) was constantly monitored with a digital thermo probe (4). The powders were distributed at a constant rate on the top of the rotating coating bed using a single screw powder feeder (3). To prevent the heat loss during the process the spheronizer chamber was closed by a glass cover (6) [61].

The temperature control was the most critical parameter during the powder coating. Due to the small scale of the equipment and to the low amount of cores involved, coating trials that employed forced hot air as the heating source were unsuccessful. With this technique poor quality coatings having reduced yields resulted. Curing of the powdered drug products was performed in either the spheronizer or in a static oven on Teflon® plates. This application is of critical importance because most of the formulations used will not have sufficient time to coalesce. It is also theoretically possible to incorporate pressure cycles to the powder to mimic the effects of mechanical agitation in the bed [61].

Dry powder coating formulations are engineered to provide the necessary thermal characteristics. Compositionally, this is achieved through the incorporation of polymer, plasticizer, opacifier, colorant and anti-sticking agent. Unlike traditional formulations, higher levels of plasticizers are required to ensure adhesion and film formation. A pre-plasticization process for the controlled release polymer ethyl-cellulose could be adapted.

Anti-sticking agents are also a necessity in coating formulations to prevent adhesion during processing. Even though the amount of anti-sticking agent inside the powder coating formulation has never been extensively investigated, the presence of 10% of talc in the powder coating blends has been considered successful by researchers in the field for preventing the agglomeration of the powder particles during storage and during the distribution of the powders on the cores [61; 94].

The colorants, together with opacifiers, are materials that are commonly used in all formulations intended for film coating for their esthetic contribution to the final product. The colours enhance the image of the product making it easier for market promotion and identification of the product both by the patient and during packaging operations. At the same time the use of dyes in the coating layer can help to improve the stability of the active ingredient by protecting it from light degradation. For aqueous film coating, water-insoluble colorants (pigments and lacquers) are

preferred over soluble dyes due to the fact that during the drying step the solvent tends to migrate to the surface bringing the soluble dye molecules with it. In the dry powder coating, since no liquids are involved and the process does not include a drying phase, no migration of the colorant is expected. The level of plasticizer becomes a critical aspect of successful formulation that strongly impacts performance [94].

7.1.3. Electrostatic coating

Electrostatic powder coatings are commonly used in the metal finishing industry and involves the deposition of charged coating powder onto a grounded substrate [102]. While this technique has seen the lowest level of publication for any of the dry powder techniques, it has also been shown to be the most advanced in terms of commercial application. Application of the technology within the pharmaceutical industry has demonstrated that more intricate patterns can be formed on the coating for brand identification purposes while also providing comparable production outputs to larger commercial units. Requiring specialized equipment, Phoqus Pharmaceuticals, Ltd. developed an electrostatic powder coating process for tablets [103]. In this system they utilized a custom engineered coating apparatus to coat both sides of the tablet cores separately. Infrared radiation was applied for a short amount of time to facilitate film formation of Eudragit® RS coatings. The technology known as LeQtracoat® exploited the electro-static attraction between oppositely charged materials to promote the adhesion of the coating powders onto the surface of tablets (Figure 13).

Figure 13: Schematic diagram of the electrostatic dry powder coating process [94].

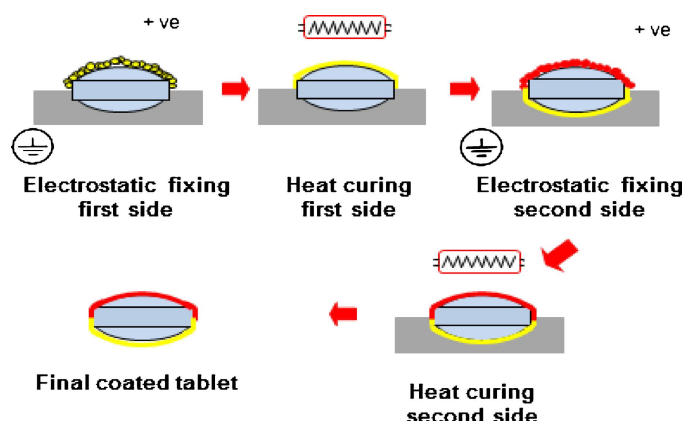

With the same principle as the ink toner deposition in electro-photography (photocopying), the tablets were coated individually one side at a time in special manufacturing plants with capacity

up to 250,000 units/h. With this technique, the coating material was directed with such precision that 3D images could be created. Final curing leading to film formation could also be achieved within the same apparatus, allowing for similar performance to conventional coating operations.

Qiao et al. developed a powder coating process that combined electrostatic powder coating technology with a traditional liquid pan coating technique for the powder coating of tablets [104]. The pan coater was equipped with a liquid spray nozzle (an electrostatic spray gun) and a powder feeder. Ibuprofen was used a model drug for the study. The polymers Opadry® AMB (polyvinyl alcohol based coating blend) and Eudragit® E PO were evaluated. The coating process consisted of the following steps: pre-heating, plasticizer spraying, feeding of the charged particles into the coating bed and curing at elevated temperature. In addition to lowering the glass transition temperature, the plasticizer layer promoted powder adhesion by capillary forces and reduction of the electrical resistivity of the core tablets. The polymer particles were negatively charged using an electrostatic spray gun and followed the direction of the electrical field between tip of the spray gun and grounded coating pan. The repulsive forces between the polymer particles promoted the dispersion of the coating powder. The coating level was dependent on the charging voltage used to spray the coating powder.

By achieving a charge on the powder it was possible to coat a drug product using this electrostatic – liquid assisted hybrid methodology. Such combinations of technologies provide benefits for more effective film formation and may also represent the next steps for applying this technology more broadly throughout the industry.

8. REFERENCES

- [1] K. Lehmann, B. Brögmann, Tablet Coating in: *Encyclopaedia of Pharmaceutical Technology*, vol. 14 pp. 355 – 384.
- [2] J.- L. Johnson, Pharmaceutical Tablet Coating in: A.- A. Tracton (Ed), *Coatings Technology Handbook 3rd Edition*, Taylor and Francis Group LLC, 2006, pp. 112.1 - 112.3.
- [3] J.- E. Hogan, Sugar Coating in: G. Cole (Ed), *Pharmaceutical Coating Technology*, Taylor & Francis Ltd, 1995, pp. 53 – 63.
- [4] G.W. Radebaugh, *Film Coatings and Film Forming Materials: Evaluation*, pp. 1 - 28
- [5] J. A. Seitz, Aqueous Film Coating in: *Encyclopaedia of Pharmaceutical Technology*, Vol 1, pp. 337 – 349.
- [6] K. Knop, P. Kleinebudde, PAT-tools for process control in pharmaceutical film coating applications, *Int. J. Pharm.* 457 (2013) 527 – 536.
- [7] G. Cole, Coating Pans and Coating Columns in: G. Cole (Ed), *Pharmaceutical Coating Technology*, Taylor & Francis Ltd, 1995, pp. 205 - 239.
- [8] L.K. Mathur, Fluid Bed Dryers, Granulators and Coaters in: *Encyclopaedia of Pharmaceutical Technology*, Vol. 6, pp. 171 – 195.
- [9] L.- A. Felton, P. O' Donnell, J.-W. McGinity, Properties of Polymeric Films prepared from Aqueous Dispersion, in: L.- A. Felton, J.- W. McGinity (Eds), *Aqueous Polymeric Coatings for Pharmaceutical Dosage Forms 3rd Edition*, Drug and Pharmaceutical Sciences vol. 176, Informa Healthcare USA Inc., 2008, pp. 105 - 128.
- [10] K. Nollenberger, J. Albers, Poly(meth)acrylate-based coatings, *Int. J. Pharm.* 457 (2013) 461 – 469.
- [11] L.- A. Felton, Mechanisms of polymeric film formation, *Int. J. Pharm.* 457 (2013) 423 - 427.
- [12] J. Siepmann, F. Siepmann, Stability of aqueous polymeric controlled release film coatings, *Int. J. Pharm.* 457 (2013) 437 - 445.
- [13] F. Lecomte, J. Siepmann, M. Walther, R.J. Mac Rae, R. Bodmeier, Polymer blends used for the coating of multi particulates: comparison of aqueous and organic coating techniques, *Pharm. Res.* 21 (2004) 882 – 890.
- [14] S.C. Porter, Coating of pharmaceutical dosage forms. In: Allen, L.V.E.A. (Ed.), *Remington the Science and Practice of Pharmacy*, Pharmaceutical Press, London, 2012, pp. 977 – 987.

- [15] H.F. Bruce, P.J. Sheskey, P. Garcia-Todd, L. – A. Felton, Novel low-molecular-weight hypromellose polymeric films for aqueous film coating applications, *Drug Dev. Ind. Pharm.* 37 (2011) 1439 – 1445.
- [16] N. Pearnchob, J. Siepmann, R. Bodmeier, Pharmaceutical applications of shellac: moisture-protective and taste-masking coatings and extended-release matrix tablets, *Drug Dev. Ind. Pharm.* 29 (2003) 925 – 938.
- [17] W. Chen, S. –H Chang, S. Kiang, W. Early, S. Paruchuri, D. Desai, The measurement of spray quality for pan coating processes, *J. Pharm. Innov.* 3 (2008) 1 – 3.
- [18] M. Paulsson, S. K. Singh, Colloidal and thermal characteristics of concentrated dispersions of poly (meth) acrylate-based lattices for aqueous enteric coating, *J. Pharm. Sci.* 88 (1999) 406 – 441.
- [19] B. Carlin, J.-X. Li, L.A. Felton, Pseudolatex dispersions for controlled drug delivery. In: L.- A. Felton, J.- W. McGinity (Eds.), *Aqueous Polymeric Coatings for Pharmaceutical Dosage Forms* 3rd Edition, *Drug and Pharmaceutical Sciences* vol. 176, Informa Healthcare USA Inc., 2008, pp. 1 - 46.
- [20] J.C. Haley, Y. Liu, M.A. Winnik, W. Lau, The onset of polymer diffusion in a drying acrylate latex: how water initially retards coalescence but ultimately enhances diffusion, *J. Coat. Technol.* 5 (2008) 157 – 216.
- [21] J. Siepmann, O. Paeratakul, R. Bodmeier, Modeling plasticizer uptake in aqueous polymer dispersions, *Int. J. Pharm* 165 (1998) 191 – 200.
- [22] Q.- W. Yang, M.- P. Flament, F. Siepmann, V. Busignies, B. Leclerc, C. Herry, P. Tchoreloff, J. Siepmann, Curing of aqueous polymeric film coatings: Importance of the coating level and type of plasticizer, *Eur. J. Pharm. Biopharm.* 74 (2010) 362 - 370.
- [23] A. Flosser, K. Kolter, H. B. Reich, G. Schepky, Variation of composition of an enteric formulation based on Kollicoat MAE 30D, *Drug Dev. Ind. Pharm.* 26 (2000) 177 – 187.
- [24] S. Muschert, F. Siepmann, B. Leclercq, J. Siepmann, Dynamic and static curing of ethylcellulose: PVA-PEG graft copolymer film coatings, *Eur. J. Pharm. Biopharm.* 78 (2011) 455 - 461.
- [25] S.- A. Kucera, L.- A. Felton, J.-W. McGinity, Physical aging in pharmaceutical polymers and the effect on solid oral dosage form stability, *Int. J. Pharm.* 457 (2013) 428 - 436.
- [26] R. Greiner, F.R. Schwarzl, Volume relaxation and physical aging of amorphous polymers. I. Theory of volume relaxation after single temperature jumps, *Colloid. Polym. Sci.* 267 (1989) 39 – 47.

- [27] L.C.E. Struik, Chapter 1— Scope of the work, In: L.C.E. Struik (Ed.), *Physical Aging in Amorphous Polymers and Other Materials*. Elsevier Scientific Publishing Company, New York, (1978), p. 1.
- [28] J. -H. Guo, Aging processes in pharmaceutical polymers, *Pharm. Sci. Technol. Today* 2 (1999) 478 – 483.
- [29] W. Zheng, D. Sauer, J.W. McGinity, Influence of hydroxyethylcellulose on the drug release properties of theophylline pellets coated with Eudragit® RS 30 D, *Eur. J. Pharm. Biopharm.* 59 (2005) 147 – 154.
- [30] U. Iyer, W. -H.Hong, N. Das, I. Ghebre-Sellassie, Comparative evaluation of three organic solvent and dispersion-based ethylcellulose coating formulations, *Pharm. Technol.* 14 (1990) 68 – 86.
- [31] N. Billa, K.-H. Yuen, K.-K. Peh, Diclofenac release from Eudragit-containing matrices and effects of thermal treatment. *Drug Dev. Ind. Pharm.* 24 (1998), 45 – 50.
- [32] A.Y. Lin, L.L. Augsburger, Study of crystallization of endogenous surfactant in Eudragit® NE 30 D-Free films and its influence on drug-release properties of controlled-release diphenhydramine HCl pellets coated with Eudragit NE 30 D. *AAPS Pharm. Sci.* 3 (2) 2001.
- [33] Z. J. Shao, L. Moralesi, S. Diaz, N. A. Muhammadi, Drug release from Kollicoat® SR 30D-coated nonpareil beads: evaluation of coating level, plasticizer type, and curing condition. *AAPS Pharm. Sci. Tech* 3 (2) 2002.
- [34] J.- H. Guo, R. E. Robertson, G. L. Amidon, Influence of physical aging on mechanical properties of polymer free films: the prediction of long-term aging effects on the water permeability and dissolution rate of polymer film-coated tablets, *Pharm. Res.* 8 (1991) 1500 – 1504.
- [35] J.- H. Guo, R. E. Robertson, G. L. Amidon, An investigation into the mechanical and transport properties of aqueous latex films: a new hypothesis for the film-forming mechanism of aqueous dispersion system, *Pharm. Res.* 10 (1993) 405 – 410.
- [36] M. Wesseling, R. Bodmeier, Influence of plasticization time, curing conditions, storage time, and core properties on the drug release from Aquacoat® – coated pellets, *Pharm. Dev. Technol.* 6 (2001) 325 – 331.
- [37] S. Joshi, H.-U. Petereit, Film coatings for taste masking and moisture protection, *Int. J. Pharm.* 457 (2013) 395 - 406.

- [38] M. Valleri, P. Mura, F. Maestrelli, M. Cirri, R. Bellerini, Development and Evaluation of Glyburide Fast Dissolving Tablets Using Solid Dispersion Technique, *Drug Dev. Ind. Pharm.* 30 (2004) 525 – 534.
- [39] H. Sohi, Y. Sultana, R.K. Khar, Taste Masking Technologies in Oral Pharmaceuticals: Recent Developments and Approaches, *Drug Dev. Ind. Pharm.* 30 (2004) 429 – 448.
- [40] S. Sharma, S. Lewis, Taste masking technologies: A review, *Int. J. Pharm. Pharm. Sci.* 2 (2010) 6 – 13.
- [41] C. Ahlneck, G. Zografi, The molecular basis of moisture effects on the physical and chemical stability of drugs in the solid state, *Int. J. Pharm.* 62 (2010) 87 – 95.
- [42] P. Prinderre, E. Cauture, Ph. Piccerelle, G. Kalantzis, J. Kaloustian, J. Joachim, Evaluation of Some Protective Agents on Stability and Controlled Release of Oral Pharmaceutical Forms by Fluid Bed Technique, *Drug Dev. Ind. Pharm.* 23 (1997) 817 – 826.
- [43] E.M Rudnic, M.K. Kottke, In: G.S. Banker, C.T. Rhodes (Eds.), *Modern Pharmaceutics*, 3rd Ed. Marcel Dekker, New York, 1996, pp. 333 – 394.
- [44] J. Du, S. W. Hoag, The Influence of Excipients on the Stability of the Moisture Sensitive Drugs Aspirin and Niacinamide: Comparison of Tablets Containing Lactose Monohydrate with Tablets Containing Anhydrous Lactose, *Pharm. Dev. Technol.* 6 (2001) 159 – 166.
- [45] DE 3900811 (1990).
- [46] CA 1336819 (1995).
- [47] EP 0551820 (1993).
- [48] EP 0955041 (1999).
- [49] C. Meier, *EUDRAGIT Workshop*, 2002.
- [50] US 6.586.012 (2003).
- [51] S. C. Porter, The effect of additives on the properties of an aqueous film coating, *Pharm. Technol.* 4 (1980) 67 – 75.
- [52] B. C. Hancock, G. Zografi, The Relationship Between the Glass Transition Temperature and the Water Content of Amorphous Pharmaceutical Solids, *Pharm. Res.* 11 (1994) 471 – 477.
- [53] B.C. Hancock, G. Zografi, Characteristics and significance of the amorphous state in pharmaceutical systems, *J. Pharm. Sci.* 86 (1997) 1 – 12.
- [54] O. Bley, J. Siepmann, R. Bodmeier, Importance of glassy-to-rubbery state transitions in moisture-protective polymer coatings, *Eur. J. Pharm. Biopharm.* 73 (2009) 146 – 153.

- [55] L.A. Felton, J.- W. McGinity, Influence of plasticizers on the adhesive properties of an acrylic resin copolymer to hydrophilic and hydrophobic tablet compacts, *Int. J. Pharm.* 254 (1997) 167 – 178.
- [56] K. Johnson, R. Hathaway, P. Leung, R. Franz, Effect of triacetin and polyethylene glycol 400 on some physical properties of hydroxypropyl methylcellulose free films, *Int. J. Pharm.* 73 (1991) 197 – 208.
- [57] J.T. Heinamaki, V.M. Lehtola, P. Nikupaavo, J.K. Yliruusi, The mechanical and moisture permeability properties of aqueous-based hydroxypropyl methylcellulose coating systems plasticized with polyethylene glycol, *Int. J. Pharm.* 112 (1994) 191 – 196.
- [58] J.H. Guo, Effects of Plasticizers on Water Permeation and Mechanical Properties of Cellulose Acetate: Antiplasticization in Slightly Plasticized Polymer Film, *Int. J. Pharm.* 99 (1993) 1541 – 1555.
- [59] S. Benita, P. Dor, M. Aronhime, G. Marom, Permeability and mechanical properties of a new polymer: cellulose hydrogen phthalate, *Int. J. Pharm.* 33 (1986) 71 – 80.
- [60] M. Mistry, T. Cech, Investigating the influence of a film-forming formulation on oxygen & moisture vapor transmission rates, *Drug Dev. Deliv.* 11 (2011) 28 – 33.
- [61] M. Cerea, W. Zheng, C.R. Young, J.W. McGinity, A novel powder coating process for attaining taste masking and moisture protective films applied to tablets. *Int. J. Pharm.* 279 (1–2) (2004) 127 – 139.
- [62] D.- A. Miller, J.-W. McGinity, Aqueous Polymeric Film Coating, in: L.- L. Augsburger, S. W. Hoag (Eds), *Pharmaceutical Dosage Forms: Tablets 3rd Edition*, vol. 1: Unit Operation and Mechanical Properties, Informa Healthcare USA Inc., 2008, pp. 399 - 437.
- [63] TL Rogers, Hypromellose, in: R.- C. Rowe, P. –J. Shekey, M.- E. Quinn (Eds), *Handbook of Pharmaceutical Excipients 6th Edition*, Pharmaceutical Press and the American Pharmacists Association, USA, 2009, pp. 326 - 329.
- [64] S.Obara, H. Kokubo, Application of HPMC and HPMCAS to Aqueous Film Coating of Pharmaceutical Dosage Forms, In L.- A. Felton, J.- W. McGinity (Eds.), *Aqueous Polymeric Coatings for Pharmaceutical Dosage Forms 3rd Edition*, Drug and Pharmaceutical Sciences vol. 176, Informa Healthcare USA Inc., 2008, pp. 279 – 322.
- [65] J.E. Hogan, Coating of tablets and Multiparticulates, In: M.E. Aulton (Ed Pharmaceutics) *The science of Dosage Form Design*, New York Churchill Livingstone, 2001, pp. 441 - 448.

- [66] J. Collett, C. Monton, Modified release peroral dosage form, In: M.E. Aulton (Ed Pharmaceutics) The science of Dosage Form Design, New York Churchill Livingstone, 2001, pp. 289 – 305.
- [67] B. Abrahamsson, M. Alpsten, U.E. Jonsson, P.J. Lundberg, A. Sandberg, M. Sundgren, A. Svenheden, J. Tölli, Gastro-intestinal transit of a multiple-unit formulation (metoprolol CR/ZOK) and a non-disintegrating tablet with the emphasis on colon, *Int. J. Pharm* 140 (1996) 229 – 235.
- [68] TC Dahl, Ethylcellulose, in: R.- C. Rowe, P. –J. Shekey, M.- E. Quinn (Eds), *Handbook of Pharmaceutical Excipients 6th Edition*, Pharmaceutical Press and the American Pharmacists Association, USA, 2009, pp. 262 - 267.
- [69] J. Siepman, F. Siepman, O. Paeratakul, R. Bodmeier, Process and Formulation Factors Affecting Drug Release from Pellets Coated with Ethylcellulose Pseudolatex Aquacoat[®], in: L.- A. Felton, J.- W. McGinity (Eds), *Aqueous Polymeric Coatings for Pharmaceutical Dosage Forms 3rd Edition*, Drug and Pharmaceutical Sciences vol. 176, Informa Healthcare USA Inc., 2008, pp. 203 - 235.
- [70] A. Onions, Films from water based colloidal dispersion, *Manufact. Chem.* 57 (1986) pp. 66 – 67.
- [71] R. Bodmeier, O. Paeratakul, Process and formulation variables affecting the drug release from chlorpheniramine maleate-loaded beads coated with commercial and self-prepared aqueous ethyl cellulose pseudolatexes, *Int. J. Pharm.* 70 (1991) 59 – 68.
- [72] De Leng, W.L. Sigelko, F.L. Saunders inventors, The Dow Chemical Company assignee, *Aqueous dispersions of plasticized polymer particles*, 1985, US PATENT 4.502.888.
- [73] A.-R. Rajabi Siahboomi, T.P. Farrell, The Applications of Formulated Systems for the Aqueous Film Coating of Pharmaceutical Oral Solid Dosage Forms, in: L.A. Felton, J.W. McGinity (Eds), *Aqueous Polymeric Coatings for Pharmaceutical Dosage Forms 3rd Edition*, Drug and Pharmaceutical Sciences vol. 176, Informa Healthcare USA Inc., 2008, pp. 323 - 343.
- [74] T.A. Wheatley, C.R. Steuernagel, Latex emulsions for controlled drug delivery, In: J.- W. McGinity (Ed), *Aqueous Polymeric Coatings for Pharmaceutical Dosage Forms 2nd Edition*, Marcel Dekker 1997, p. 15
- [75] K. Amighi, A.J. Moes, Evaluation of Thermal and Film Forming Properties of Acrylic Aqueous Polymer Dispersion Blends: Application to the Formulation of Sustained-Release Film Coated Theophylline Pellets, *Drug. Dev. Ind. Pharm* 21 (1995) 2355 - 2369.

- [76] H. Bando, J. W. McGinity, Physicochemical properties of enteric films prepared from aqueous dispersions and organic solutions. *Int. J. Pharm.* 313 (2006), 43 – 48 (Epub17 2006 17).
- [77] K. Kolter, A. Dashevsky, Muhamad Irfan, R. Bodmeier, Polyvinyl acetate-based film coatings *Int. J. Pharm.* 457 (2013) 470 – 479.
- [78] H. Bechgaard, G.H. Nielson, Controlled release multiple units and single unit doses, *Drug. Dev. Ind. Pharm.* 4 (1978) 53 – 67.
- [79] I. Ghebre – Sellassie, A. Knoch, Pelletization Techniques in: *Encyclopaedia of Pharmaceutical Technology*, pp. 369 – 394.
- [80] (International Conference on Harmonisation of Technical Requirements for Registration of Pharmaceuticals for Human Use). ICH Harmonised Tripartite Guideline: Pharmaceutical Development Q8(R2) 2009.
- [81] M.J. Lee, C.R. Park, A.Y. Kim, B.S. Kwon, K.H. Bang, Y.S. Cho, M.Y. Jeong, G.J. Choi, Dynamic calibration for the in-line NIR monitoring of film thickness of pharmaceutical tablets processed in a fluid-bed coater, *J. Pharm. Sci.* 99 (2010) 325 – 335.
- [82] M.J. Lee, D.Y. Seo, H.E. Lee, I.C. Wang, W.S Kim, M.Y. Jeong, G.J. Choi, In line NIR quantification of film thickness on pharmaceutical pellets during a fluid bed coating process, *Int. J. Pharm.* 403 (2011) 66 – 72.
- [83] C.V. Möltgen, T. Puchert, J.C. Menezes, D. Lochmann, G. Reich, A novel in-line NIR spectroscopy application for the monitoring of tablet film coating in an industrial scale process. *Talanta* 92 (2012) 26 – 37.
- [84] J. Müller, K. Knop, J. Thies, C. Uerpmann, P. Kleinebudde, Feasibility of Raman spectroscopy as PAT tool in active coating, *Drug Dev. Ind. Pharm.* 36 (2010) 234 – 243.
- [85] M. Wirges, J. Müller, P. Kása Jr, G. Regdon Jr., K. Pintye-Hódi, K. Knop, P. Kleinebudde, From mini to micro scale-feasibility of Raman spectroscopy as a process analytical tool (PAT), *Pharmaceutics* 3 (2011) 723 – 730.
- [86] J. Müller, D. Brock, K. Knop, J. Axel Zeitler, P. Kleinebudde, Prediction of dissolution time and coating thickness of sustained release formulations using Raman spectroscopy and terahertz pulsed imaging, *Eur. J. Pharm. Biopharm.* 80 (2012) 690 – 697.
- [87] M. Wirges, A. Funke, P. Serno, K. Knop, P. Kleinebudde, Development and in-line validation of a Process Analytical Technology to facilitate the scale up of coating processes. *J. Pharm. Biomed. Anal.* (2013) 57 – 64.

- [88] R.K. May, M. J. Evans, S.C. Zhong, I. Warr, L. F. Gladden, Y.C. Shen, J.A Zeitler. Terahertz in-line sensor for direct coating thickness measurement of individual tablets during film coating in real-time, *J. Pharm. Sci.* 100 (2011) 1535 – 1544.
- [89] I. S. Russe, D. Brock, K. Knop, P. Kleinebudde, J.A. Zeitler, Validation of terahertz coating thickness measurements using X-ray microtomography, *Mol. Pharm.* 9 (2012) 3551 – 3559.
- [90] G. Heinicke, J. B. Schwartz, Particle size distribution of inert spheres and pelletized pharmaceutical products by image analysis, *Pharm. Dev. Technol.* 9 (2004) 359 – 367.
- [91] M. Mozina, D. Tomazevic, S. Leben, F. Pernus, B. Likar, Digital imaging as a process analytical technology tool for fluid-bed pellet coating process, *Eur. J.Pharm. Sci.* 41 (2010) 156 – 162.
- [92] S. Kucheryavski, K.H. Esbensen, A. Bogomolov, Monitoring of pellet coating process with image analysis-a feasibility study, *J. Chemom* 24 (2010) 472 – 480.
- [93] M. Smikalla, A. Mescher, P. Walzel, N.A. Urbanetz, Impact of excipients on coating efficiency in dry powder coating, *Int. J. Pharm.* 405 (2015) 122 – 131.
- [94] D. Sauer, M. Cerea, J. Di Nunzio, J. W. McGinity, Dry powder coating of pharmaceuticals: A review, *Int. J. Pharm.* 457 (2013) 488 – 502.
- [95] D. Sauer, W. Zheng, L. B Coots, J. W. McGinity, Influence of processing parameters and formulation factors on the drug release from tablets powder-coated with Eudragit® L 100-55. *Eur. J. Pharm. Biopharm.* 67 (2) (2007) 464 – 475.
- [96] D. Sauer, J. W. McGinity, Influence of additives on melt viscosity, surface tension, and film formation of dry powder coatings, *Drug Dev. Ind. Pharm.* 35(6) (2009) 646 – 654.
- [97] Z. Huang, L. E. Scriven, H.T. Davis, W. E. Eklund, Film formation in powder coatings. In: *Abstracts of the Waterborne, Higher-Solids and Powder Coatings Symposium*, New Orleans, LA, February 5–7, 1997, pp. 328 – 341.
- [98] W. Zheng, M. Cerea, D. Sauer, J. W. McGinity, Properties of theophylline tablets powder-coated with methacrylate ester copolymers, *J. Drug Deliv. Sci. Technol.* 14 (4) (2004) 319 – 325.
- [99] I. Terebesi, R. Bodmeier, Optimized process and formulation conditions for extended release dry polymer powder-coated pellets, *Eur. J. Pharm. Biopharm.* 75 (2010) 63 – 70.
- [100] S. Obara, N Maruyama, Y. Nishiyama, H. Kokubo, Dry coating: an innovative enteric coating method using a cellulose derivative, *Eur. J. Pharm. Biopharm.* 47(1) (1999) 51 – 59.
- [101] C.D. Kablitz, K. Harder, N.A. Urbanetz, Dry coating in a rotary fluid bed, *Eur. J. Pharm. Sci.* 27, (2006) 212 – 219.

- [102] Y. Luo, J. Zhu, Y. Ma, H. Zhang, Dry coating, a novel coating technology for solid pharmaceutical dosage forms. *Int. J. Pharm.*, 358 (2008) 16 – 22.
- [103] J.E. Hogan, T. Page, L. Reeves, J.N. Staniforth, Powder coating composition for electrostatic coating of pharmaceutical substrates (2006) US Patent 7.008.668.
- [104] M. Qiao, L. Zhang, Y. Ma, J. Zhu, K. Chow, A novel electrostatic dry powder coating process for pharmaceutical dosage forms: immediate release coatings for tablets, *Eur. J. Pharm. Biopharm.* 76 (2) (2010) 304 – 310.

9. AIM OF THE RESEARCH PROJECT

The whole doctoral research project focused on the study of different technologies for film coating of pellets using ethylcellulose (Surelease[®]) as barrier-membrane coating polymer.

In particular, the research carried out during the first and the half part of second year of the PhD provided a comprehensive study of the coating process of guaifenesin (GFN)-loaded pellets in order to understand the variables affecting the drug migration through the barrier-membrane film coating and thus the stability over time of the final dosage form. The analysed process comprised the drug layering followed by the conventional aqueous film coating technique in a Wurster fluid bed. The effect of curing conditions, drug loading and coating level and of the drug-layering solution on the technological properties of pellets was fully evaluated.

In the last part of the second year and during the third year, an innovative dry powder coating technology was developed to apply the functional ethylcellulose based coating upon pellets avoiding the use of solvents (neither organic solvents nor water). In particular, the study was designed along three steps: i) preparation of free films to study the film formation process and to achieve the minimum film forming temperature of the coating formula; ii) Powder coating process of unloaded pellets; iii) Powder coating of drug-loaded pellets.

The results of this research have then been divided in two parts: PART I) development of suitable coating formulations analyzing different combination of polymer, plasticizer, co-plasticizer and other adjuvants, characterization of the free films and their assessment through curing and storage; finally development of the manufacturing process upon placebo pellets; PART II) evaluation of the best coating formula during the dry powder coating of unloaded pellets and then manufacturing and characterization of drug-loaded pellets.

10. CASE STUDY 1: Ethylcellulose film coating of guaifenesin-loaded pellets: A comprehensive evaluation of the manufacturing process to prevent drug migration.

10.1. INTRODUCTION

Ethylcellulose is an insoluble polymer used in film coating which offers a great potential to accurately control drug release from pharmaceutical oral solid dosage forms [1; 2]. Water-insoluble polymeric film coatings can either be applied from organic polymer solutions or from aqueous polymer dispersions [2]. Functional aqueous polymer coatings are of steadily increasing importance while avoiding the well known concerns related to the use of organic solvents [2; 3]; moreover higher solids content in aqueous coating formulations can be used, due to lower viscosities and decreased sticking tendencies, considerably reducing processing time [2]. However, a challenging task of aqueous polymer dispersions is to achieve an efficient polymer particle coalescence during the coating process, fundamental to obtaining stable drug release profiles. When coalescence is not complete at the beginning, polymer particle fusion can continue during storage, affecting film coating structures and, thus, the stability of the release patterns [3 - 5]. This is the reason why a thermal post-coating treatment, known as a curing-step, is generally required to achieve complete film formation and prevent or stabilize physical aging on diffusion based-drug release [3; 6].

One of the major remaining challenges associated with a potential imperfect film formation during coating and curing is to provide the long-term stability of aqueous polymeric controlled release film coatings. Several excellent reviews have provided an overview on the current state of the art in this field, covering different types of polymer coatings and drugs, and exhaustively identify different strategies to effectively overcome the stability hurdle [2; 6]. These include different coating levels, the use of appropriate plasticizers, the addition of immiscible hydrophilic excipients or high glass transition temperature of polymeric materials and finally the optimization of curing and storage conditions.

A further problem which negatively affects the stability of aqueous polymeric coatings is the phenomenon of migration of several APIs through the barrier membrane coating layer. It has been reported [7 - 10] that this phenomenon occurred regardless of the polymer used (Eudragit® NE 30D, Eudragit® L 100-55 or Acryl-EZE®, ethylcellulose both as Aquacoat® and Surelease®). In particular, water soluble drugs are subjected to significant migration when coated with aqueous systems and in the case of diltiazem hydrochloride, the amorphous drug migrated and recrystallized in the film coating [7]. A highly soluble drug, such as isosorbide 5 mononitrate, migrated to the surface of the coating exhibiting crystallization followed by sublimation [8]. In

addition to drug-polymer affinity, when drugs with low melting point such as ibuprofen or guaifenesin were used, the high temperature involved in the curing step accelerated the migration process [9]. Such behaviour is responsible of unstable drug release profiles from pellets or tablets upon storage. This phenomenon was controlled by applying either a double layer coating [8] or a seal-coating with a polymer having a low affinity for the drug thus avoiding the contact of the drug and ethylcellulose membrane [9] or by modifying the curing time and/or temperature according to the formulation variables [10].

The influence of several variables involved in the whole manufacturing process of pellets has not deeply investigate and the influence of the drug layer underneath the barrier membrane film coating has not yet been studied. The aim of this work was to investigate the formulation factors and the process parameters that influence drug migration through the ethylcellulose film and the strategies to hinder or inhibit this phenomenon. Guaifenesin (GFN), a highly water soluble drug (BCS Class I) was used as model drug. It also has a melting point very close to coating process conditions. Therefore, it has the potential to migrate through the barrier membrane and crystallize in or on the film surface. In particular, pellets were prepared by drug layering and then film coating in a Würster fluidized bed coater, analysing both formulation variables (drug loading, coating level, polymer type in the binding solution) and process-related parameters (different curing conditions) that might influence process efficiency, GFN content uniformity, film properties, drug migration process and pellet stability upon storage.

10.2. MATERIALS AND METHODS

10.2.1. Materials

Guaifenesin (USP/Eur. Ph. Grade, Rhodia, France, batch n° FGG0529902), Sugar spheres (Suglets® 25-30 mesh size, 600-710 µm diameter, composed of sucrose and starch), Hypromellose (Methocel E5, E10, E15 LV, Hydroxypropylmethylcellulose, HPMC, 2910 USP grade) and Surelease® Ethylcellulose Aqueous dispersion (type B NF, grade E-7-19040) were kindly supplied by Colorcon Ltd (Dartford, Kent, UK). Sodium alginate from brown algae (medium viscosity), chitosan FG90 high purity (≥93% w/w, 100 kDa) and methylcellulose (low viscosity) were purchased from Fluka (Sigma Aldrich, Milan, Italy). Phosphate buffer pH 6.8 was prepared as reported in Eur. Ph. 8.7 Ed; all

components were from Sigma-Aldrich and Milli-RX20 water (Millipore, Molsheim, France) was used throughout.

10.2.2. Methods

10.2.2.1. Preparation of drug loaded pellets

Drug loaded multiparticulate pellets were prepared by solution layering, involving the deposition of the GFN onto starting non Suglet® seeds in a Mini-Glatt fluidized bed (Glatt GmbH, Binzen, Germany) equipped with a Wurster column (bottom spray assessment). Three different batches were prepared: batches L1 and L2 with HPMC (Methocel E5) and batch L3 with sodium alginate as drug layering binders.

For batches L1 and L2, GFN was loaded at two different theoretical concentrations (4.5% and 20% w/w, respectively) on batches of 200 g of Suglets®. The aqueous layering solution was prepared adding 10% or 20% w/w of GFN to a 5% w/w HPMC E5 solution. For batch L3, the 20% w/w of GFN was added to a 2% w/w sodium alginate aqueous solution. The liquid temperature was set at 50°C during the preparation of the all the layering solutions to ensure complete GFN solubilisation.

Drug layering conditions within the fluid bed equipment were: inlet air temperature 60.0±0.5°C; product temperature 40.0±0.5 °C; fluidization air flow 21-38 Nm³/h; atomizing air pressure 1.45±0.50 bar and a spray rate 1.12±0.03 g/min.

The yield, the theoretical drug loading and the process efficiency expressed as the Relative Standard Deviation of the weight applied (RSD_w) on a mean of three layering experiments [11; 12] were calculated using the following equations:

$$\text{Yield\%} = \frac{W_{LP}}{W_S} * 100 \quad \text{Eq.4}$$

$$\text{Theoretical drug loading} = \frac{W_{GFN} \cdot W_{LS}}{W_S + W_P + W_{GFN}} * 100 \quad \text{Eq. 5}$$

$$\text{RSD}_w \% = \frac{\sqrt{(SD W_{LP})^2 - (SD W_S)^2}}{W_{LP} - W_S} * 100 \quad \text{Eq. 6}$$

where: W_{LP}= mean weight of loaded pellets; W_S = mean weight of Suglets; W_{GFN}= GFN weight; W_{LS} = weight of layering solution; W_P= polymer weight and SD= standard deviation.

The composition of the different batches and the process related parameters are summarized in Table 15 (p. 95).

10.2.2.2. Viscosity measurements of the layering solutions

Several polymers with different viscosity and at various concentrations were examined in the layering solution: HPMC E5, E15, E50, sodium alginate, methylcellulose and chitosan.

The viscosity determination was performed on binder solutions, before and after the GFN solubilization at 50°C. Briefly, 10 ml of each layering solution was placed in the small sample adapter of the rheometer (Visco Star R, Fungilab SA, Barcelona, Spain), which was previously heated to the temperature set for the layering.

10.2.2.3. Coating of GFN loaded pellets

Drug-loaded pellets with theoretical drug loading of 4.5% and 20% w/w were coated in a Mini-Glatt fluidized bed (Glatt GmbH, Binzen, Germany) equipped with a Wurster column in bottom spray assembly using Surelease[®]. Briefly, Surelease[®] is an aqueous ethylcellulose dispersion at 25% w/w solids (composed of ethylcellulose 20 cps, medium chain triglycerides and oleic acid) [13] which was diluted to 15% w/w dispersion by adding distilled water before use. Then the aqueous dispersion was sprayed onto GFN loaded pellets and different thicknesses equivalent to theoretical weight gains of 12% (batches C1 and C2) and 20% w/w (batch C3) for Methocel E5 and 17% w/w in the case of sodium alginate (batch C4) were achieved. The batch size for each experiment was 200 g and the process conditions were: inlet air temperature 60±0.5°C; product temperature 40.0±0.5 °C; fluidization air flow 20-38 Nm³/h; atomizing air pressure 1.22-1.55 bar and spray rate 1.4±0.5 g/min. Weight gain (WG %), total yield (%), coating efficiency (RSD_w %) expressed as the Relative Standard Deviation of the weight applied (RSD_w) on a mean of three coating experiments and coating loss (%) were calculated as follows:

$$WG \% = \frac{W_{CP} - W_{LP}}{W_{LP}} * 100 \quad \text{Eq. 7}$$

$$Yield\% = \frac{W_{CP}}{W_{LP}} * 100 \quad \text{Eq. 8}$$

$$RSD_W \% = \frac{\sqrt{(SD W_{CP})^2 - (SD W_{LP})^2}}{W_{CP} - W_{LP}} * 100 \quad \text{Eq. 9}$$

$$\text{Coating loss\%} = \frac{W_{th} - W_r}{W_{th}} * 100 \quad \text{Eq. 10}$$

where: W_{LP} = mean weight of loaded pellets (equivalent to uncoated pellets), W_{CP} = mean weight of coated pellets, W_{th} = weight of solids to be applied and W_r = weight of solids applied.

The composition of the different batches and the process related parameters are summarized in Table 15.

10.2.2.4. Curing operations

After coating, pellets were defluidized for 15 minutes and subsequently a post-coating thermal treatment was performed both under static conditions in an air forced oven (at 40°C and 60°C for 2 and 24 hours) and under dynamic performances using either a solid wall pan coater (GS Coating System HT, Bologna, Italy) at 60°C for 2 hours (pan speed 16 rpm, in air T= 78°C; out air T= 54°C) or inside the fluid bed equipment (at 40°C and 60°C for 2 hours). Different curing conditions are summarized in Table 14.

All pellets were stored in polyethylene closed bottles at 25°C/ 60% RH and used for pellets characterization.

Table 14: Different conditions of curing process.

Batches	Type	Equipment	Time (hours)		Temperature (°C)	
			2	24	40	60
C1	dynamic	Fluid bed	X		X	X
		solid wall pan	X	X	X	X
	static	air forced oven	X			X
C2	dynamic	fluid bed	X		X	
	static	air forced oven	X		X	
C3	dynamic	fluid bed	X		X	
C4	dynamic	fluid bed	X		X	

10.2.2.5. Determination of drug content

The determination of GFN content of each batch was performed off-line throughout the whole manufacturing process. Briefly, 50 mg of each sample has been accurately weighed, ground to a

fine powder using pestle and mortar and dissolved in 50 mL of phosphate buffer pH 6.8. The system was heated up at 50°C and shaken for 15 minutes. Finally, the solution was filtered and the drug content has been spectrophotometrically assayed at 273 nm (Unicam Helios β Thermoscientific, Milan, Italy).

The analytical method was validated in terms of linearity, sensitivity expressed as limit of detection (LOD) and limit of quantification (LOQ) and finally repeatability. The correlation coefficient (r^2) was 0.99991 (range of concentration 5.5-110 $\mu\text{g/ml}$); the LOD was 0.151 ($\mu\text{g/ml}$) and the LOQ was 0.458 ($\mu\text{g/ml}$). For the repeatability study three absorption measures for three samples with different well-known concentrations (11; 77; 110 $\mu\text{g/ml}$) had been collected and the answer factor was found to calculate the coefficient of variation (CV%).

CV % had a value smaller than 0.3% for each level of concentration, demonstrating the repeatability of measurements. The results of the drug content are expressed as a mean of at least three determinations \pm standard deviation (SD). The % relative standard deviation of drug content (RSD_c) was calculated using the following equation:

$$\text{RSD}_c \% = \frac{SD}{\text{meanGFNcontent}} * 100 \quad \text{Eq. 11}$$

10.2.2.6. In vitro drug release studies

In vitro dissolution tests of pellets was performed using USP II dissolution apparatus (ERWEKA DT800) rotating at 50 rpm in 500 ml phosphate buffer pH 6.8 and at a temperature of $37 \pm 0.5^\circ\text{C}$. Each sample contained about 25-30 mg of GFN. The studies ran over a period of 3 hours (batch 1) and 8 hours (batches 2-4) during which 3 ml aliquots of the release medium were collected at specific time intervals and replaced with an equal volume of fresh medium. The samples were filtered (0.45 μm) and assayed for guaifenesin spectrophotometrically at $\lambda=273$ nm. The mean of at least six determinations has been used to determine the API release for each formulation.

Comparison between drug release profiles from pellets were carried out using both the similarity factor f_2 and the difference factor f_1 . The difference factor is proportional to the average difference between the two profiles, whereas the similarity factor [14] is a logarithmic reciprocal square-root transformation of the sum of squared error and is a measurement of the closeness in percentage of dissolution between two release profiles.

$$f_1 = \left\{ \frac{\sum_{t=1}^n |R_t - T_t|}{\sum_{t=1}^n R_t} \right\} * 100 \quad \text{Eq. 12}$$

$$f_2 = 50 * \log \left\{ 1 + \left[\frac{1}{n} * \sum_{t=1}^n (R_t - T_t)^2 \right]^{-0.5} * 100 \right\} \quad \text{Eq. 13}$$

where n is the sampling number, R_t and T_t are the cumulative percent dissolved of the reference and the test products at each time point t . In dissolution profile comparisons, in order to assure performance similarity of the two products, it is important to know how close the two dissolution curves are to each other and also to have a measure which is sensitive to large differences at any particular time point. For f_2 and f_1 calculation, sampling number lower than 85% of drug released have been considered. The similarity factor fits the result between 0 and 100. Two drug release profiles are similar if the f_2 is greater than or equal to 50 and f_1 values are less than or equal to 15.

10.2.2.7. Pellets morphological analysis

Scanning electron microscopy (SEM) was used both to evaluate the surface morphology of pellets in terms of coating uniformity and to investigate the possible GFN migration and re-crystallization processes on pellets surface. Samples were fixed on the sample holder with a double sided adhesive tape, sputter coated with Au/Pd under an argon atmosphere performed using a vacuum evaporator (Edwards, Crawley UK) and examined by means of a scanning electron microscope SEM (Philips XL30) operating at an accelerating voltage of 20 kV.

10.2.2.8. Thermal analysis

Hot stage microscopy (HSM) studies were performed using a hot stage apparatus (Mettler Toledo Spa, Novate Milanese Italy) mounted on a Nikon Eclipse 400 optical microscope connected to a Nikon Digital Net camera DN 100 for images acquisition. A small amount of sample was placed on a glass slide, equilibrated at 25°C for 1 minute and then heated at 10°C/min in the temperature range of 25°C to 180°C. The changes of samples were monitored via optical microscope at a magnification of 40X.

DSC thermograms were performed on samples obtained throughout the whole manufacturing process (layering, coating and curing) of both uncured and cured pellets using a differential scanning calorimeter Perkin-Helmer DSC 6 (Perkin-Elmer, Beaconsfield, UK) equipped with Pyris

Software. The instrument was calibrated with indium and lead for temperature, and with indium for the measurement of the enthalpy. Samples of 10-15 mg were sealed in an aluminium pan and heated from 25°C to 180°C at a scanning rate of 10°C/min under a nitrogen flow rate of 20 ml/min. For comparison, the same procedure was followed for the raw materials. Each analysis was carried out in duplicate experiments.

10.2.2.9. X-ray powder diffraction (XRD) analysis

Raw GFN and GFN re-crystallized after 24 h from its melting were studied by X-ray powder diffraction technique using a X'Pert PRO (PAN-analytical, Almelo, NL) diffractometer with CuK α radiation ($\lambda = 1.5418 \text{ \AA}$) mono-chromatized by a secondary flat graphite crystal. The voltage was 40 kV and the current 40 mA. The scanning angle ranged from 3 to 40° of 2 θ , steps were of 0.016° of 2 θ and the counting time was of 100s/step.

10.2.2.10. Long term storage stability

To assess long term storage stability, uncured and cured pellets were stored at 25°C/ 60 \pm 0.5% relative humidity (R.H.) in PE closed bottles. Drug release from pellets was measured after 3 months (batch C1) and 6 months (batches C2-C4) of storage. Day 0 corresponded to the day after the preparation of layered and coated pellets.

10.3. RESULTS AND DISCUSSION

10.3.1. Evaluation of Drug Layering and Film Coating Processes

The process parameters related to layering and coating are summarized in Table 15 .

Table 15: Composition of the batches and results of drug layering and barrier membrane film coating processes.

Process related parameters	Drug LAYERING PROCESS			
	Batch L1	Batches L2	Batch L3	
<i>Binder solution</i>	<i>Methocel E5 LV</i> (5% w/w)	<i>Methocel E5 LV</i> (5% w/w)	<i>Sodium Alginate MV</i> (2% w/w)	
<i>Yield %</i>	98.5	96.0	96.4	
<i>RSD_w %</i>	5.36	4.08	<i>n.a.*</i>	
<i>GFN (±SD) %</i>	4.65(±0.09)	19.5(±0.22)	19.20(±0.08)	
<i>RSD_c %</i>	1.94	1.14	0.42	
Process related parameters	Barrier Membrane COATING PROCESS			
	Batch C1	Batch C2	Batch C3	Batch C4
<i>WG %</i>	13.36	12.60	20.50	17.80
<i>Yield %</i>	98.4	95.0	94.0	93.3
<i>RSD_w %</i>	<i>n.a.*</i>	4.12	3.51	<i>n.a.*</i>
<i>Coating loss %</i>	1.04	4.50	3.12	4.85
<i>GFN (±SD) %</i>	4.10(±0.25)	17.3(±0.35)	15.5(±0.23)	16.3(±0.78)
<i>RSD_c %</i>	6.1	2.02	1.48	4.85

The results of the drug layering process of batch L1 show a very good yield and a good layering efficiency: the mass variability based on RSD_w calculation was 5.36%, indicating a good reproducibility of the process. In relation to the drug content of this batch (4.65±0.09%), the value of RSD_c is high (1.94%). In fact, to assure the quality of dosage units, the drug content of each unit in a batch should be distributed in a narrow range around the label strength. Generally, RSD values can vary depending on the drug concentration and a low RSD ensures a small distribution of the values around the labeled value [15 - 17].

Increasing the drug loading to the theoretical value of 20% (batch L2), the layering efficiency slightly increased, as the RSD_w reduced from 5.36 % of batch L1 to 4.08 % for batch L2. Furthermore, the GFN content results show values close to the theoretical one and the RSD_c of the drug content dropped up to 1.14%, highlighting a good drug loading uniformity. Replacing HPMC with sodium alginate in the layering solution, pellets (batch L3) exhibited a very good content uniformity (RSD_c=0.42%). Comparing the RSD of the real GFN content of the three batches (L1-L3),

the best drug uniformity was obtained by using sodium alginate in the layering solution. Presumably, the higher viscosity of this polymer minimized the variation in the distribution of the applied drug to the Suglet® cores.

With regards to drug dissolution of pure drug and of drug layered pellets (graph not shown), raw guaifenesin is freely soluble in aqueous media (BCS class I) and it was completely dissolved within 5 min. The initial 85% of the drug loaded was dissolved within three minutes from L1 pellets and the complete drug dissolution occurred within 30 minutes. It was noticed that the dissolution profiles performed immediately after the production of L1 pellets were different from those obtained the day after (day 0). In particular, at day 0 the dissolution profiles were slightly higher, suggesting a quick crystallization of GFN on the surface of the HPMC layer. In order to obtain comparable data, all the dissolution profiles of the layered pellets were performed the day after (day 0) their production. As expected, the drug release from layered pellets with higher GFN content (batch L2) increased and the 93 % of the drug dissolving after three minutes. The dissolution profile of L3 pellets is superimposed to that of batch L2, indicating that the change of the binder (hypromellose or sodium alginate) did not affect the GFN dissolution behaviour.

The next step was focused on the Surelease® coating process of drug layered pellets (L1-L3) with four batches of film coated pellets at two different theoretical coating levels (12 and 20% weight gain) (C1-C4). The real drug content of batch C1 decreased to $4.10 \pm 0.25\%$ due to the applied weight gain (13.36%) and the RSDC value was 6.1%. Anyhow, the yield of the coated batch was high. Batch L2 was coated applying the two coating levels and the weight gain was 12.60% for batch C2 and 20.50% for batch C3. The maximum variation of the GFN content (RSD_C) dropped up to 2.02% and 1.48% for batch C2 and C3, respectively, achieving a very good content uniformity. Likewise the coating efficiency values showed great uniformity of the coating layer with RSD_W of 4.12% for batch C2 and 3.51% for batch C3, indicating very low coating losses during the coating process (Table 15). Finally, when batch L3 was coated, the real GFN content of batch C4 was $16.3 \pm 0.78\%$, the RSD_C % was less than 5% and the yield remained high.

The results showed that changes in the formulation, such as the increase of GFN concentration in the hypromellose-based layering solution (L1 vs L2) and of the Surelease® coating level (C2 vs C3) did not affect the overall weight variation. In fact, the RSD_W results demonstrated the repeatability and robustness of both the technological procedures (drug layering and functional coating) performed in the fluid bed. Considering the drug content uniformity (RSD_C), the lower the GFN loading, the higher was the variability. Therefore, both the drug layering (using hypromellose or

sodium alginate as binders) and the Surelease coating processes were conducted in a reproducible and well-controlled manner and uniformity of dosage units was obtained.

10.3.2. Influence of Curing Process on GFN Release from Pellets

After film coating of pellets with Surelease, the drug release from pellets (batch C1) significantly decreased and the 80% of the drug was dissolved within 3 hours (Figure 14), indicating that the ethylcellulose based coating significantly controlled the GFN release rate.

As previously reported, one of the main challenge associated with functional aqueous ethylcellulose-based coating is to achieve complete polymer particle coalescence during the coating process and provide stable drug release profiles over time [3, 4]. Since a complete polymer particle coalescence is difficult to be assured during the coating process, a curing step is usually recommended. Several critical parameters of curing, such as relative humidity (RH), temperature and time, may have significant effects on drug release properties and need to be investigated, according to the chemical stability of drugs and/or excipients involved [2, 6]. Thus, the optimization of curing conditions is very important to ensure the long term stability of samples.

The post-coating drying step is traditionally carried out under static conditions, requiring the transfer of samples in an air forced oven. Nevertheless, performing curing operations directly inside the coating equipment under dynamic conditions could be advantageous [4]. The influence of different curing conditions on the first batch of pellets (Table 14) was studied and the effect of the curing step on the stability of pellets was evaluated through the analysis of their release profiles and of their thermal behaviour.

Analysing the dissolution data of batch C1, no significant differences of the release profiles between the uncured and the cured pellets at 40°C in the fluid bed equipment were observed (Figure14), both before storage (t_0) ($f_2=86.06\pm 3.41$; $f_1=5.78\pm 3.22$) and at t_{90} ($f_2=76.95\pm 1.71$; $f_1=4.86\pm 0.43$), indicating the stability of the ethylcellulose-based Surelease coating of both untreated/ treated samples.

Figure 14: Influence of curing conditions on the dissolution profiles of C1 pellets at day 0 and after 90 days of storage: 40°C in fluid bed.

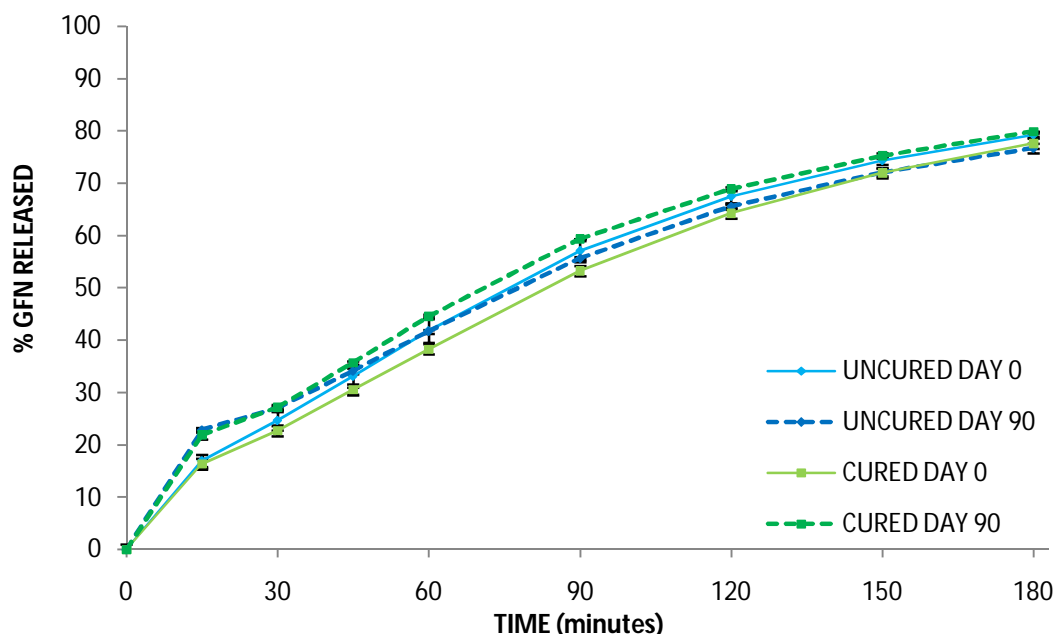

The pellets were then analysed by means of DSC throughout the whole pharmaceutical manufacturing process (layering, coating and curing) to detect possible drug solid state modification.

Figure 15a shows the DSC curves of raw drug and layered pellets. GFN is a low melting drug and displayed a sharp endothermic peak at $84.84 \pm 0.29^\circ\text{C}$ ($T_{\text{onset}} = 81.59 \pm 1.14^\circ\text{C}$). The integration of the melting endotherm yielded an enthalpy of fusion equal to $183.68 \pm 0.61 \text{ J/g}$, in agreement with the data reported in literature for the racemic form of the drug [18]. Looking inside to the solid state of GFN in the layered pellets, GFN exhibited a shift of the endothermic peak to $78.38 \pm 0.23^\circ\text{C}$, due to the dilution effect in presence of hypromellose (5% w/w). In addition, it was noticed the appearance of a new endothermic peak at $71.26 \pm 0.24^\circ\text{C}$ ($T_{\text{onset}} = 69.52 \pm 0.59^\circ\text{C}$). This peak appeared also during the analysis of GFN re-crystallized after 24 h (Figure 15a).

Figure 15: DSC curves as a function of storage time of (a): raw GFN, GFN recrystallized from the HPMC solution, L1 pellets; (b) uncured and cured C1 pellets. Curing was performed in fluid bed at 40°C for 2 hours.

(a)

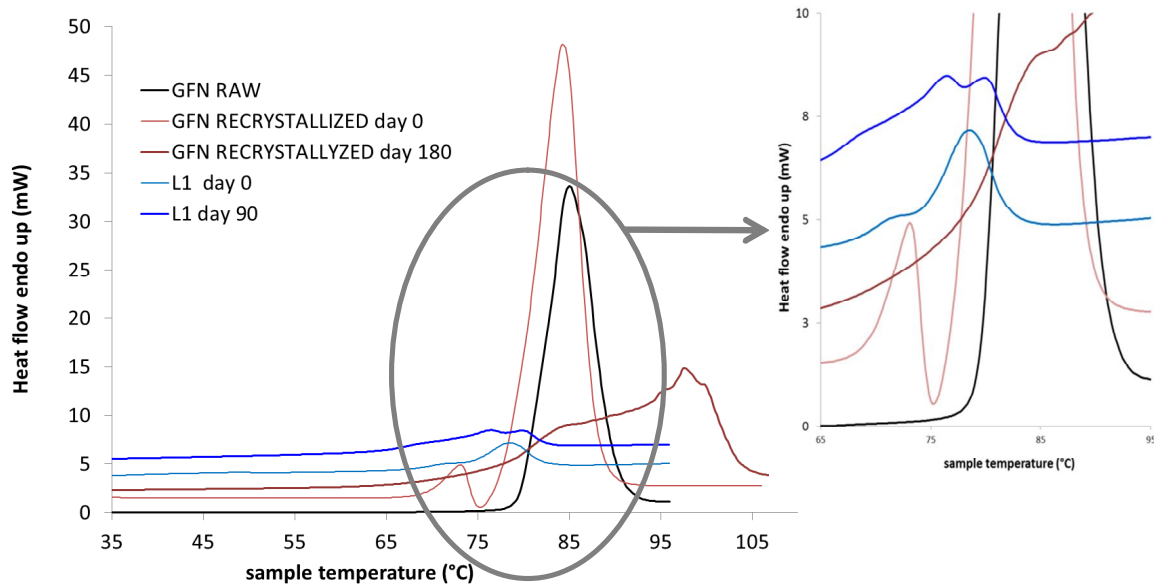

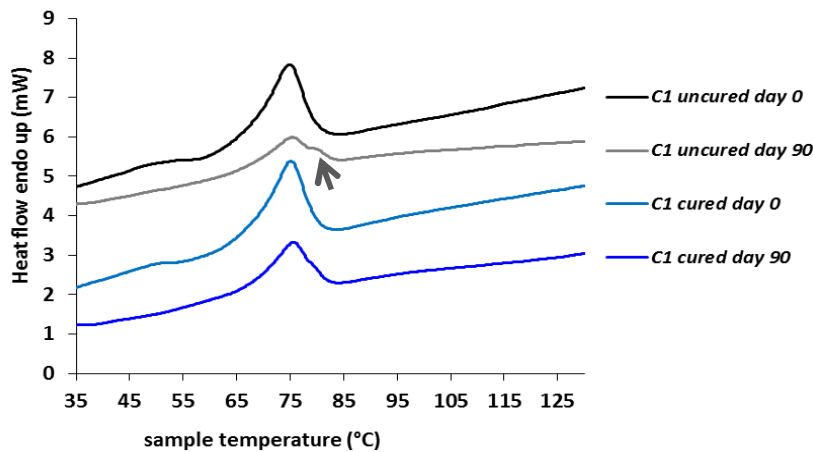

(b)

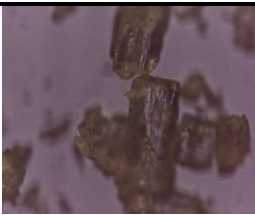

This thermal event was also visualized by the HSM analysis (Table 16): during the temperature scan, re-crystallized GFN started its fusion at about 68°C, presumably corresponding to a modification of its original form, and completely melted at about 85°C.

Table 16: HSM images of raw GFN and re-crystallized GFN taken after 24 hours from its melting (magnification 10x).

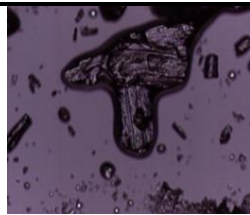
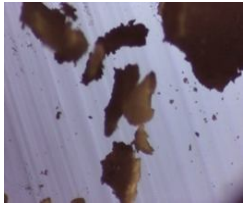
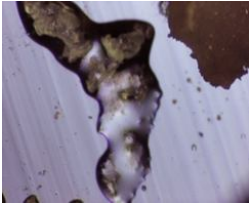
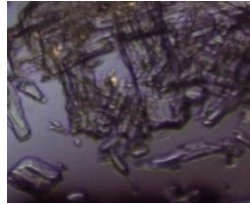
Temperatures	40°C	68°C	85°C
GFN			
recrystallized GFN			

In order to better elucidate this behaviour, XRD analysis was performed and the diffractograms of raw GFN and of re-crystallized GFN (assessed after 24 hours) are shown in Figure 16.

Figure 16: XRD diffraction spectra of raw GFN and of re-crystallized GFN taken after 24 hours from its melting.

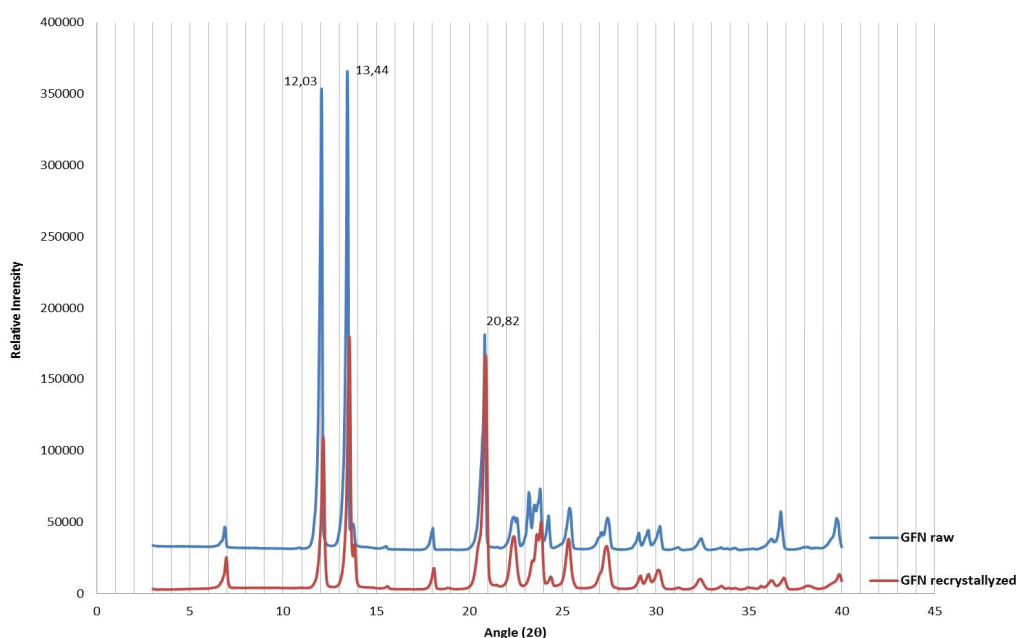

The diffraction pattern of raw GFN exactly matched with the GFN racemic form [18; 19]. Analysing the pattern of re-crystallized GFN, all the drug reflections were detectable and any shift or broadening of the reflections were visualized, indicating that no polymorphic change happened.

On the other hand, a dramatic reduction of the intensity of the two main reflections at 12° and 13.4° (2θ) was observed. Presumably, amorphous GFN was formed during the drug layering phase (confirmed by the higher dissolution profiles of fresh L1 pellets) and its re-crystallization occurred quickly, starting with the formation of nuclei in a nanocrystal phase which then grew into crystals. The change in the crystal habit and the size reduction reflected on the decrease of the melting temperature, in agreement with previous thermal analysis results (DSC and HSM). An interesting review [20] gives evidence of this phenomenon and could be a reasonable explanation of the GFN behaviour upon pellets. Analyzing the stored samples (L1, t_{90}), the left shoulder of the main peak at $66.11 \pm 0.47^\circ\text{C}$ was still present and the splitting of the main melting endotherm became better visualized on the right side of Figure 15a. The first peak was at $76.4 \pm 0.01^\circ\text{C}$ due to the melting of racemic GFN and the second one at $80.08 \pm 0.22^\circ\text{C}$, probably due to the presence of a small amount of the (*S*) – enantiomer of GFN. In fact, it has been reported in literature [18] that (*S*)-guaifenesin exhibits a higher melting point with respect to the commercialized racemic form.

This hypothesis was supported by the DSC analysis of GFN re-crystallized by HPMC 5% w/w solution layering after six month of storage (Figure 15b). In fact its DSC curve highlights two distinguishable thermal events: the first one at $85.78 \pm 0.62^\circ\text{C}$ ($T_{\text{onset}} = 81.14 \pm 1.53^\circ\text{C}$), according to the racemic API raw material melting point, and the second one at $97.46 \pm 0.13^\circ\text{C}$ ($T_{\text{onset}} = 93.33 \pm 1.89^\circ\text{C}$), attributable to the (*S*)- enantiomer of GFN which presents a melting range of $95\text{-}97^\circ\text{C}$ [18]. These results suggested that GFN re-crystallized on the layered pellets in its original racemic form; after 90 days of storage a further form, the (*S*)- enantiomer, appeared. Since all the GFN physical forms are very soluble, no significant differences in the dissolution profiles between drug layered pellets were observed, as previously described.

DSC scans of both uncured and cured t0 C1 samples, as illustrated in Figure 15b, showed only one broad endothermic peak ranging from 60°C to 80°C , which comprised two thermal events non-distinguishable to each other: the GFN melting peaks and the glass transition of the ethylcellulose pseudolatex at about 62.5°C . While the T_g of raw ethylcellulose is about $129\text{-}133^\circ\text{C}$, the presence of medium chain triglycerides and oleic acid as plasticizers in the film, strongly decreased the glass transition temperature of the polymer and the resulting T_g of the coating formula (Surelease®) is reported to be around 62°C . After 90 days of storage, the DSC analysis was repeated and the splitting of the main melting endotherm appeared in the DSC scans of uncured pellets, while it was less pronounced but still present in cured samples.

Therefore it can be summarized that layered pellets with the lower drug loading showed a modification of the GFN solid state but it did not affect the release profiles of GFN (Figure 1a) from the coated pellets. Finally, the influence of curing in fluid bed at 40°C for 2 h on the dissolution profiles of C1 pellets was negligible, also after 90 days of storage.

After two hours of curing at 40°C in an air forced oven, the release profiles (Figure 17) of uncured vs cured pellets were similar both at t_0 ($f_2=59.81\pm 2.83$; $f_1=10.06\pm 1.94$) and t_{90} ($f_2=55.39\pm 0.21$; $f_1=14.52\pm 0.92$). Looking inside to the stored cured samples, a higher burst effect was clearly observed and the data were more variable with respect to the uncured ones. In fact, after 90 days of storage, a great decrease of f_2 values was noticed: f_2 value calculated between the uncured pellets (t_0 and t_{90}) was 75.5 ± 2.36 ($f_1=4.97\pm 0.65$), while f_2 value calculated between cured ones (t_0 and t_{90}) was 58.85 ± 3.02 ($f_1=14.62\pm 0.71$).

Figure 17: Influence of curing conditions on the dissolution profiles of C1 pellets at day 0 and after 90 days of storage: 40°C in oven.

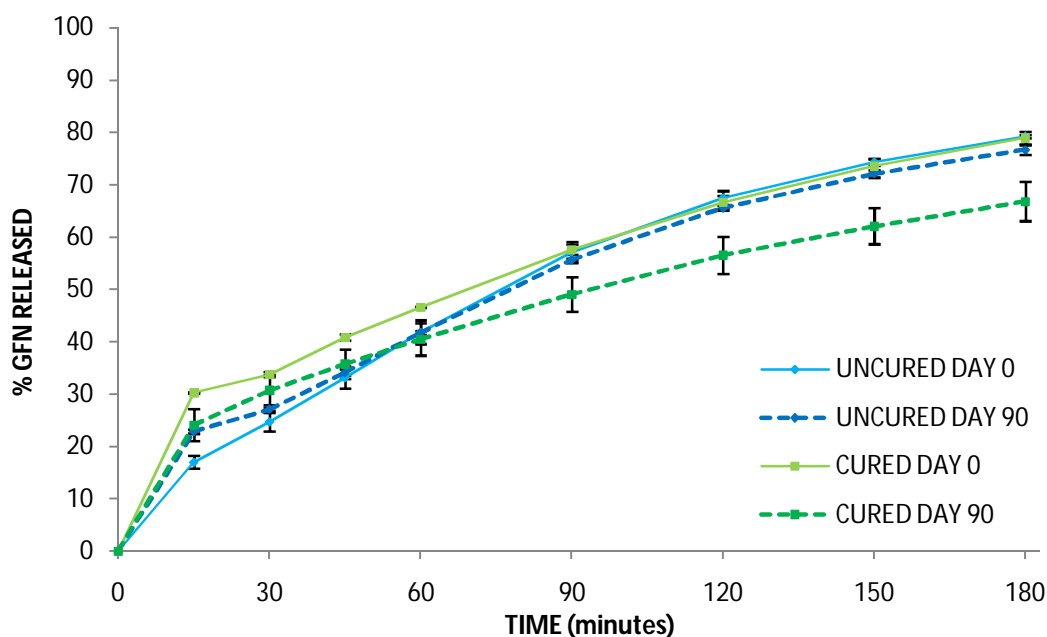

When pellets were cured for two hours at 60°C, it was impossible to perform a post coating thermal treatment in fluid bed, as samples stuck and softened along with pellets de-fluidization, due to the similar T_g of the polymer/plasticizers blend (around 62°C). Therefore the coating pan equipment has been chosen to assess the dynamic curing, owing to its ability to rotate the pellets inside the pan. A certain sticking of pellets on the pan wall still occurred without affecting the

process. The effect of the curing conditions in the solid wall pan revealed a different behaviour of pellets, especially during storage (Figure 18). After 90 days, the release profiles of cured pellets showed a significant burst effect within 15 minutes and an increase in API released. According to the similarity factor values, the release profiles of cured vs uncured pellets were similar at t0 ($f_2=66.49\pm 1.48$) and significantly different ($f_2=27.56\pm 1.47$) after 90 days. Furthermore, the release profiles of cured samples at t0 vs t90 were significantly different ($f_2=29.93\pm 2.04$).

This phenomenon could be attributed to the complete solubilisation of the drug into the coating layer as a function of both process temperature and low GFN concentration of C1 pellets. As described in the literature [19; 21], GFN has a plasticizing effect on several polymers and, when the process temperature is high, the formation of API crystals on pellets surface occurs. Siepmann et al [2; 9; 10] also reported that the GFN triggered migration through Aquacoat® coatings resulted in a drug re-crystallization on film surface upon storage. Therefore, a dynamic curing step at 60°C affected the API crystallization rate upon pellets surface, accelerating the formation of nuclei which then grew into crystals.

Figure 18: Influence of curing conditions on the dissolution profiles of C1 pellets at day 0 and after 90 days of storage: 60°C in pan coater.

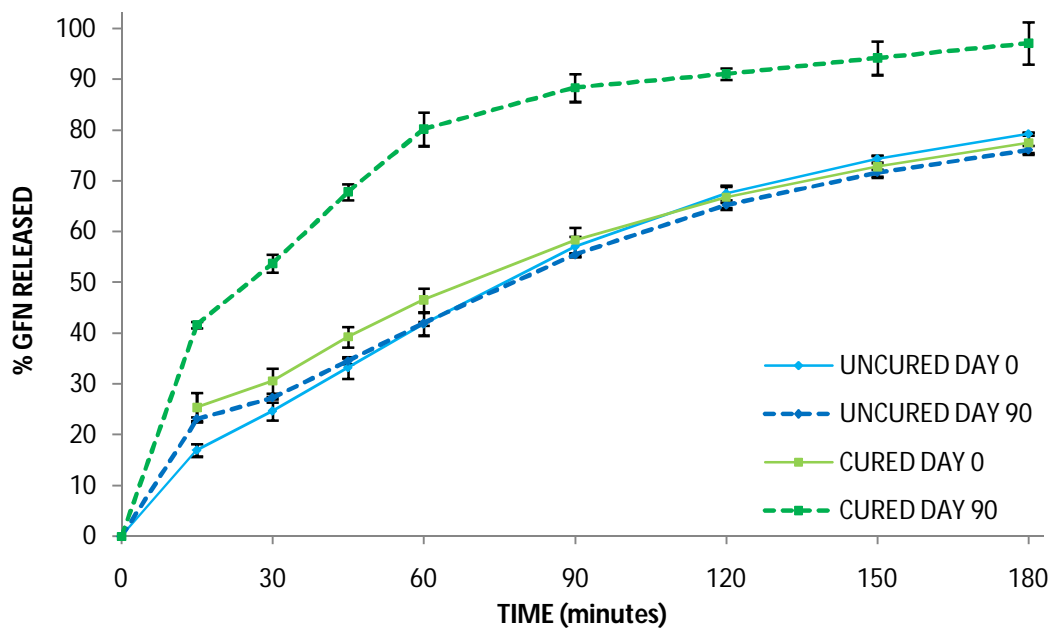

Similarly, when the curing is performed under static conditions at 60°C (Figure 19), the release profiles of uncured and cured samples were similar at t0 ($f_2=57.36\pm 0.21$).

Figure 19: Influence of curing conditions on the dissolution profiles of C1 pellets at day 0 and after 90 days of storage: 60°C in oven.

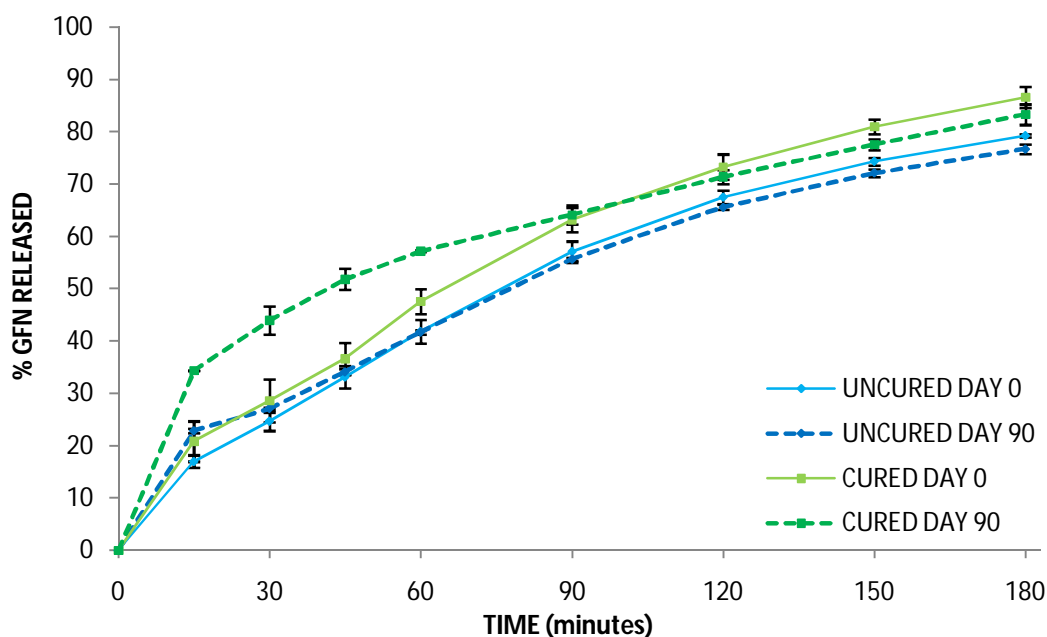

After 90 days of storage the release profiles of cured t_0 vs cured t_{90} were borderline not significantly different ($f_2=50.25\pm 3.98$; $f_1=10.56\pm 2.07$) at the end of dissolution test, but significantly different ($f_2=41.23\pm 4.02$; $f_1=24.31\pm 3.97$) after the first hour of dissolution, where the 50% of the drug loaded was already released. The faster GFN release after the thermal treatment in oven at 60°C is less pronounced than in the coating pan at 60°C, which may be due to the lower thermal exchange of the static curing system.

The results reveal that the dynamic curing performance was better in terms of stability of drug release profiles. Dynamic curing in fluid bed at a suitable temperature (40°C) did not show a significant effect on long term stability of pellets coated with aqueous ethylcellulose dispersion (Surelease®). Therefore it can be stated that using this formulation (C1: 4.65% GFN layered and 13.36% Surelease® coating level) together with the described process parameters (dynamic curing for 2 h at 40°C), the applied coating layer was stable and a further phase of curing for stabilizing the film coating may be unnecessary, at least for the examined time.

10.3.3. Influence of GFN Loading and Coating Level on the Properties of Controlled Released Pellets

Once the best curing conditions for the GFN-loaded pellets established, the next step was to investigate the influence of increasing the GFN loading from 4.5% w/w to 20% w/w onto the sugar spheres on the pellets' properties. Batch L2 with a theoretical GFN loading of 20% w/w was produced and two different coating levels were applied to obtain a theoretical weight gain (WG) of 12% (batch C2) and 20% w/w (batch C3), respectively. The results of the effective weight gain and drug loading are reported in Table 15 (p. 95).

The dissolution profiles of C2 pellets are shown in Figure 20.

Figure 20: Influence of GFN loading on dissolution profiles; comparison between batch C1 and C2 (both uncured and cured pellets) at t_0 . Curing was performed in fluid bed for both batches at 40°C for 2 hours.

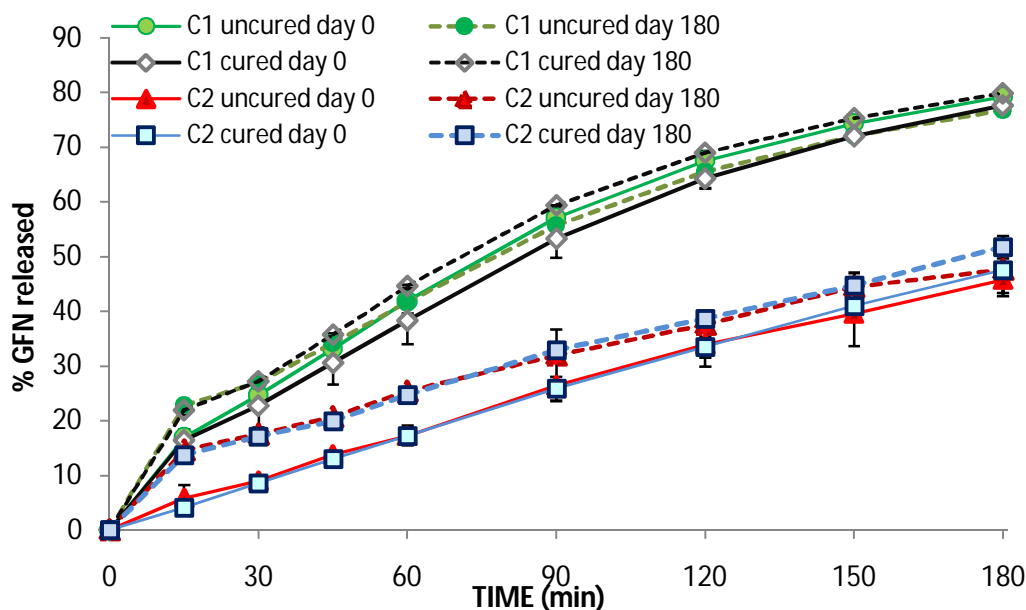

Increasing the theoretical drug loading, the GFN release from ethylcellulose coated pellets is still controlled by diffusion across the film coating. No significant differences on the release profiles between the cured and uncured pellets were observed for both t_0 ($f_2= 81.79\pm 4.0$) and t_{180} ($f_2= 74.09\pm 4.53$). However, an appreciable burst effect within the first hour of dissolution of both stored samples (uncured and cured) was clearly observed. As previously reported, this effect could be attributed to the GFN partial solubilisation into the polymeric coating and to the GFN displacement outward the polymeric film thickness and its surface re-crystallization.

This phenomenon appeared to be closely related to the drug concentration in the HPMC layering solution. In fact, comparing the release profiles of cured pellets of batch C1 and batch C2 (Figure 20) having approximatively the same coating level (13.36% vs 12.60%, respectively), it can clearly be seen that, after 6 months of storage, the extent of burst effect increased in the pellets with higher drug loading. This is in agreement with Bruce et al. [21], who reported that the supersaturation of the drug in the studied systems was the driving force for its re-crystallization. In this case the higher GFN concentration in the HPMC layering solution caused its re-crystallization on L2, as clearly shown in Table 5, triggering the migration process through the Surelease barrier membrane layer of C2 pellets. Nevertheless, C2 stored samples overall exhibited more controlled release profiles and a lower burst effect (as absolute value) than those of batch C1 (Figure 20). Therefore, this behavior suggests that drug re-crystallization occurred anyway, but the increase in drug loading mitigated the burst effect and better controlled the drug release profiles.

Increasing the coating level from 12.6% w/w (batch C2) to 20.5% w/w (batch C3), the percentage of GFN released within 8 hours from both uncured and cured C3 pellets is less than 65% with respect to the 80% drug released from coated pellets of batch C2 (Figure 21), indicating that the higher ethylcellulose coating level mostly controlled the GFN release rate.

Figure 21: Influence of coating level on GFN dissolution profile: comparison between batch C2 and C3 (both uncured and cured pellets) at t_0 . Curing was performed in fluid bed for both batches at 40°C for 2 hours.

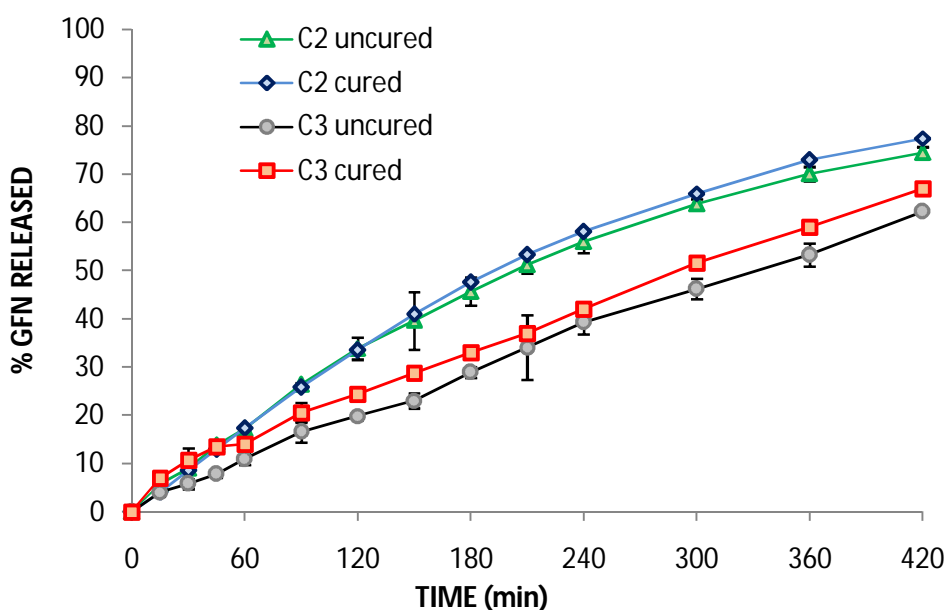

In fact f_2 values calculated between C2 and C3 was 43.95 ± 2.35 and 50.28 ± 0.14 ($f_1 = 22.82 \pm 1.28$) for uncured and cured samples, respectively, indicating a significant difference between the two batches. Furthermore, the drug release from batch C3 was characterized by a less pronounced burst effect followed by a linear portion, indicating a region of constant drug release.

Comparing C2 and C3 uncured pellets at day 0 and after 30 days of storage (25°C/60% RH) (*graphs not shown*), it was noticed that the release profiles of pellets with the lower weight gain (batch C2) were significantly different ($f_2 = 47.93 \pm 0.3$; $f_1 = 27.93 \pm 0.83$), while the release profiles of pellets with the higher weight gain (batch C3) were similar ($f_2 = 70.74 \pm 5.12$; $f_1 = 10.81 \pm 3.73$). The SEM images reported in Table 17 serve as an explanation for the release patterns obtained after 1 month of storage.

At day 0, uncured C2 pellets showed a great GFN crystallization extent indicating the migration of GFN outside the coating layer. Moreover, drug crystals on pellet surface (t_0) exhibited a needle-like structure with respect to a rod-like morphology [18] of GFN raw crystals. After 30 days of storage at 25°C/60 RH (Table 5), C2 uncured pellets exhibit a further increase of GFN migration throughout the coating thickness: GFN crystals grew across to the pellets surface and a rapid burst effect within the first hour of dissolution was clearly observed.

Moreover, no clear differences on the surfaces were observed between C2 uncured pellets and those cured either in the fluid bed or in the oven (Table 17). Increasing the weight gain (batch C3), the GFN migration throughout the coating level slowed, but it wasn't completely prevented or avoided (Table 17). In fact, pictures of both uncured and cured C3 pellets shows several GFN crystals out of the coating level already at day 0, even if in a less pronounced manner than C2 pellets. The image of C3 cured pellets after 30 days clearly depicts the GFN crystals that migrated out of the film layer.

Table 17: SEM pictures of raw materials, layered pellets (L2) and coated pellets (batches C2 and C3) taken at the day 0 and after 30 days of storage at different magnifications.

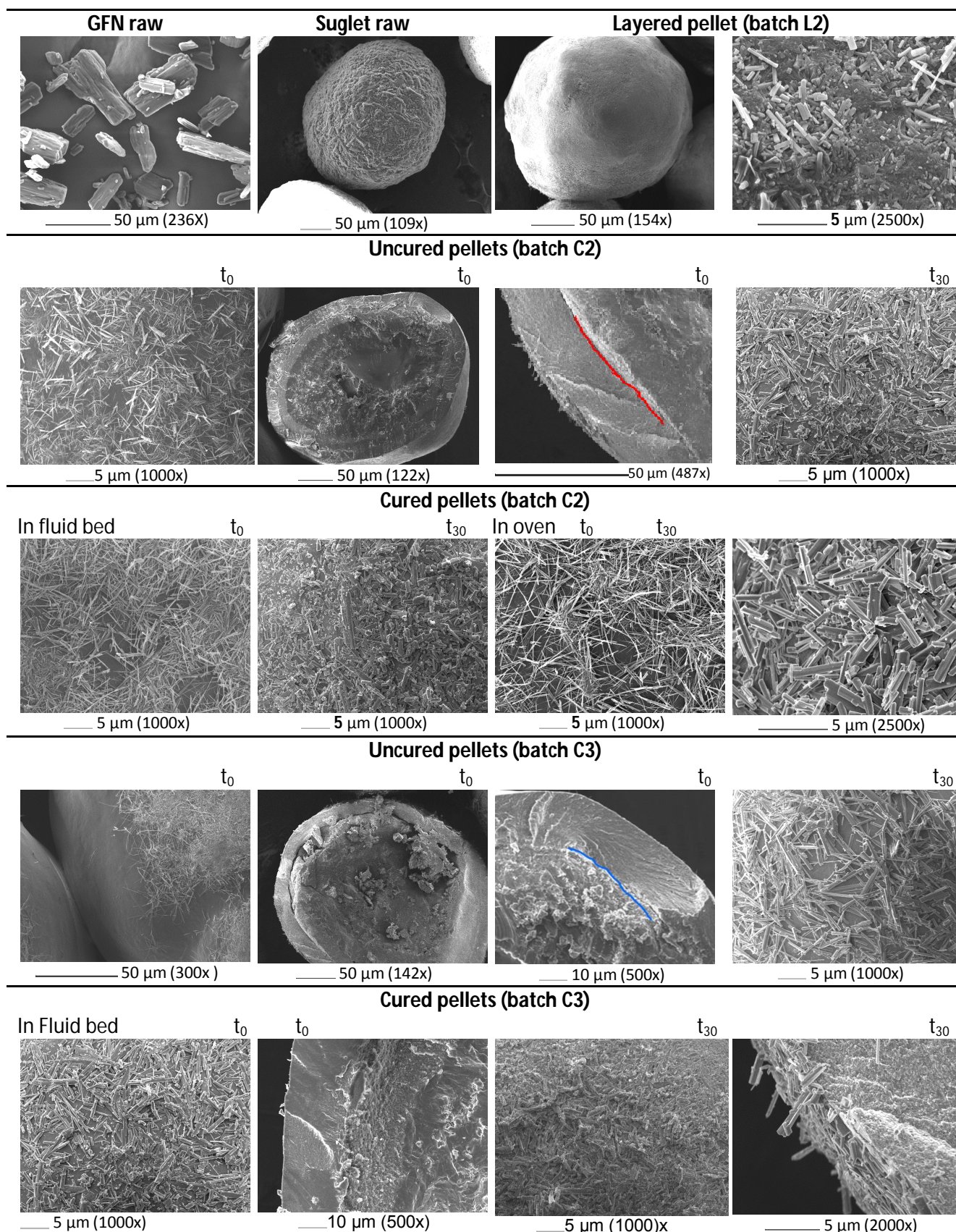

After 180 days of storage (Figure 22), the release profile of batch C3 uncured pellets decreased but remained similar to that of same pellets at day 0.

Figure 22. Influence of coating level on GFN dissolution profile: comparison between batch C2 and C3 (both uncured and cured pellets) after 180 days of storage at 25°C/60% RH. Curing was performed in fluid bed for both batches at 40°C for 2 hours.

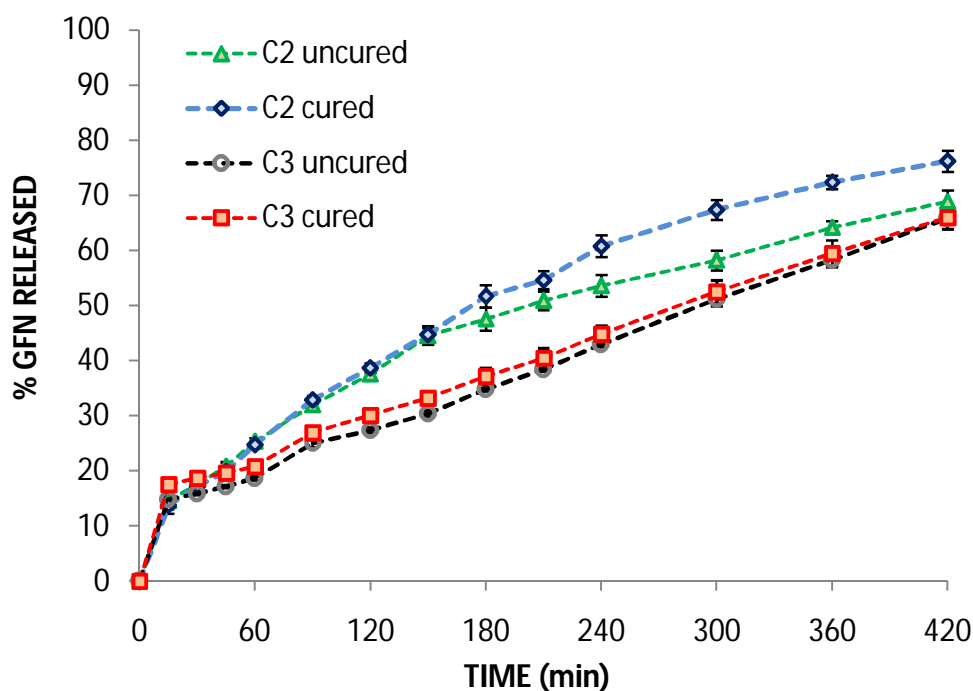

This fact was confirmed by the decreasing of the f_2 values: from 70.74 ± 5.12 at t_{30} to 56.28 ± 1.76 at t_{180} . Analyzing the stability of cured samples, the release profiles were similar both at t_0 and t_{180} both for batch C2 ($f_2 = 59.94 \pm 1.75$; $f_1 = 13.14 \pm 0.95$) and batch C3 ($f_2 = 62.37 \pm 1.13$; $f_1 = 12.38 \pm 0.88$), indicating the better stability of the ethylcellulose-based coating of cured samples with respect to the untreated ones.

Considering the solid state of the drug, the DSC scans of both uncured and cured C2 pellets at day 0 (Figure 23a) were similar to DSC curves of batch C1 (Figure 15b).

Figure 23: DSC curves of uncured and cured pellets of batches C2 and C3 at (a) day 0 and (b) after 180 days of storage at 25°C/60% RH.

(a)

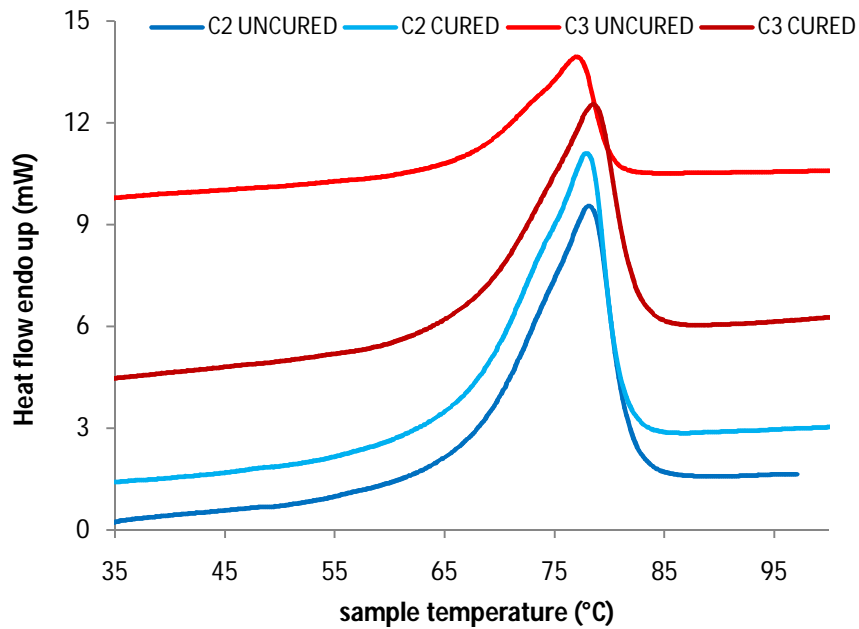

(b)

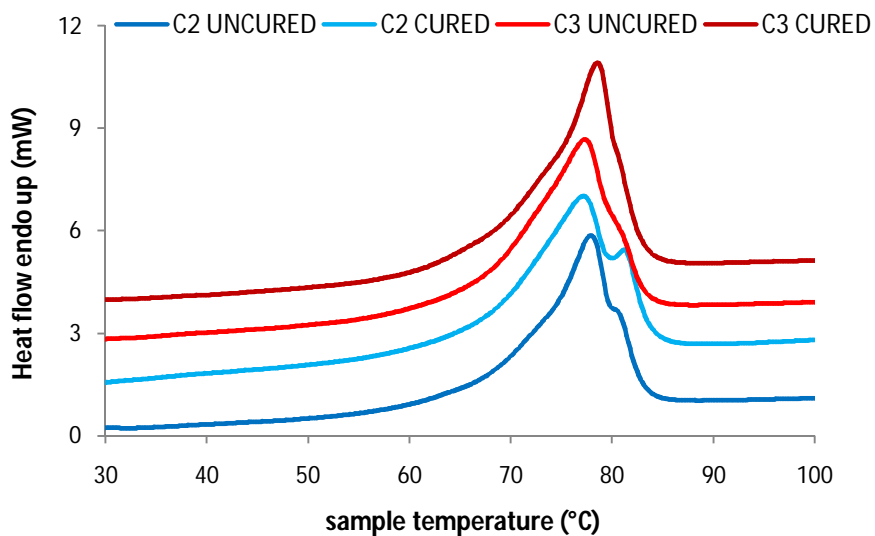

After 180 days of storage at 25°C/60% RH (Figure 23b), the splitting of the main endotherm, clearly observed in C1 pellets with a lower API content, likewise appeared in both uncured and cured C2 pellets. This result indicated that pellets with higher drug content and the same weight gain had the same behaviour upon storage. Increasing the weight gain, DSC curves of batch C3 at day 0 were similar to those of batch C2 exhibiting only one broad endothermic peak (Figure 23a). After 6 months of storage (Figure 23b), only the thermogram of C3 uncured pellets exhibited

the splitting of the GFN main melting peak, displaying the second peak at higher temperature ($T_{\text{peak}}=80.83\pm 0.11^{\circ}\text{C}$). Conversely, this thermal event did not appear in the DSC trace of batch C3 cured pellets, suggesting that increasing the coating level might prevent the GFN solid state modification.

In conclusion, the film properties were strongly affected by the chemical –physical interaction between GFN and ethylcellulose and, increasing the drug content, a post-coating thermal treatment was absolutely required to stabilize the crystalline state of GFN and consequently the film effectiveness. Increasing the coating level, the API migration upon pellet surface was limited or delayed but it was impossible to prevent or completely avoid.

10.3.4. Effect of the Layering Solution on the properties of Controlled Released Pellets

In order to limit or to minimize the GFN migration process throughout the film and to reduce its re-crystallization on pellets surface, it was decided to investigate various polymers with different rheological properties and to evaluate the role of the polymer used in the layering process in controlling the GFN diffusion into the coating layer.

The viscosity values obtained are summarized in Table 18. Methocel E5 exhibited a very low viscosity even after the addition of the drug (10 and 20% w/w). Increasing the HPMC molecular weight (Methocel E15 and E50), the viscosity of the layering solution increased till 50 cps and cps, respectively. The addition of GFN led to a viscosity decrease, especially for Methocel E50.

Table 18: Composition of the drug layering solutions used in the viscosity studies and their relative viscosity values – This shows the viscosity of the binders and drug binder solutions (*measured at 20 rpm and 50°C*); * not detectable using the TR8 spindle.

Polymer	Polymer (% w/w)	Viscosity (mPa s)	GFN (% w/w) added to the polymer sol.	Viscosity (mPa s)
Methocel E5	5	n. d. *	10	n. d. *
			20	20
Methocel E15	5	50	10	n. d. *
			20	50
Methocel E50	5	280	10	n. d. *
			20	130

Methylcellulose (MC)	0.5	n. d. *		n. d. *
	1	50	20	80
Chitosan	1	40		30
	2	180	20	120
	3	650		430
Sodium alginate	1	40		40
	2	450	20	430
	3	2300		2210

Figure 24 clearly shows the shear thinning behaviour, thus it is possible to hypothesize that GFN caused a complete disentanglement of the polymer chains by the reduction of intermolecular attractions between polymer chains, acting as plasticizer. Since all Methocel E (5, 15 and 50) underwent a strong decrease of viscosity in the presence of the drug, different polysaccharides were investigated in order to identify one that did not drastically affect its viscosity in the presence of the drug. Methylcellulose was tested only at 0.5% and 1% w/w, because at higher concentrations (2% w/w) the viscosity was too high for the nozzle atomization. Its viscosity increased with GFN but the values were similar to those obtained with Methocel E solutions.

Figure 24: Viscosity curves (from left to right and return) of different: Methocel E50 (5% w/w) solutions.

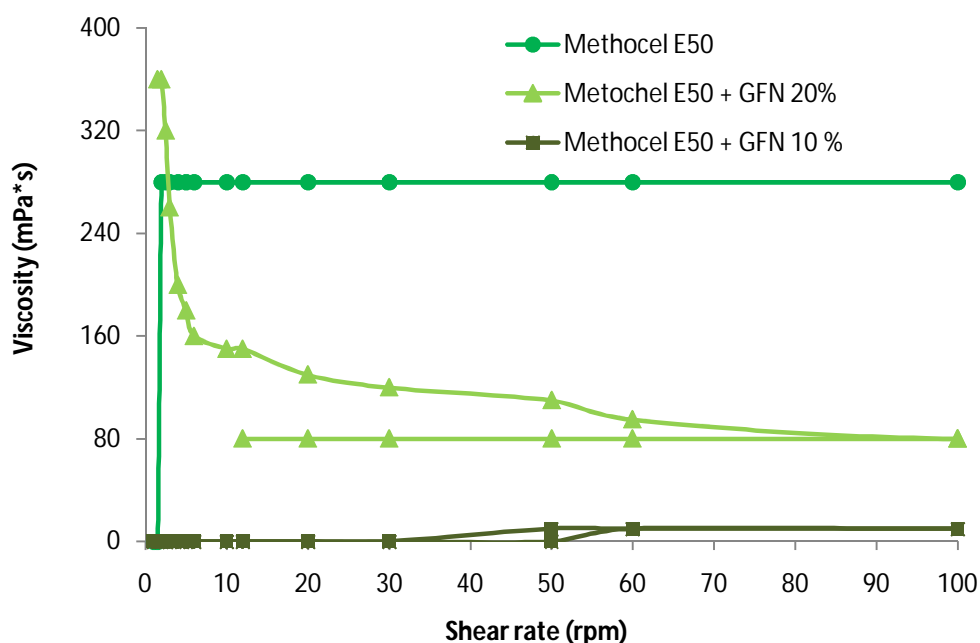

Pure chitosan displayed higher viscosity than Methocel and after the addition of GFN, viscosity values decreased with increasing the polymer concentration, especially at 3% w/w (Figure

25). Sodium Alginate exhibited the highest viscosity values and in presence of GFN very slight changes in its thixotropic behavior were observed (Figure 26).

Specifically, the polymer solution of 1% w/w was slightly viscous, while the 3% w/w polymer solution with and without GFN was too viscous to ensure a correct and optimal atomization. At the concentration of 2% w/w, no viscosity changes in the presence of the drug were observed at 20 rpm (420 cps), allowing its atomization.

Moreover, unlike the chitosan, which requires the addition of acetic acid at a concentration 1% w/V to dissolve, the solubilisation of sodium alginate is only time dependent. This ensures a greater process simplicity, as it is not necessary to remove the organic solvent during drying. Therefore, sodium alginate at a concentration of 2% w/w was selected as a binder for the drug preparation of the layering solution.

Figure 25: Viscosity curves (from left to right and return) of different chitosan (1-3% w/w) solutions before and after the addition of GFN.

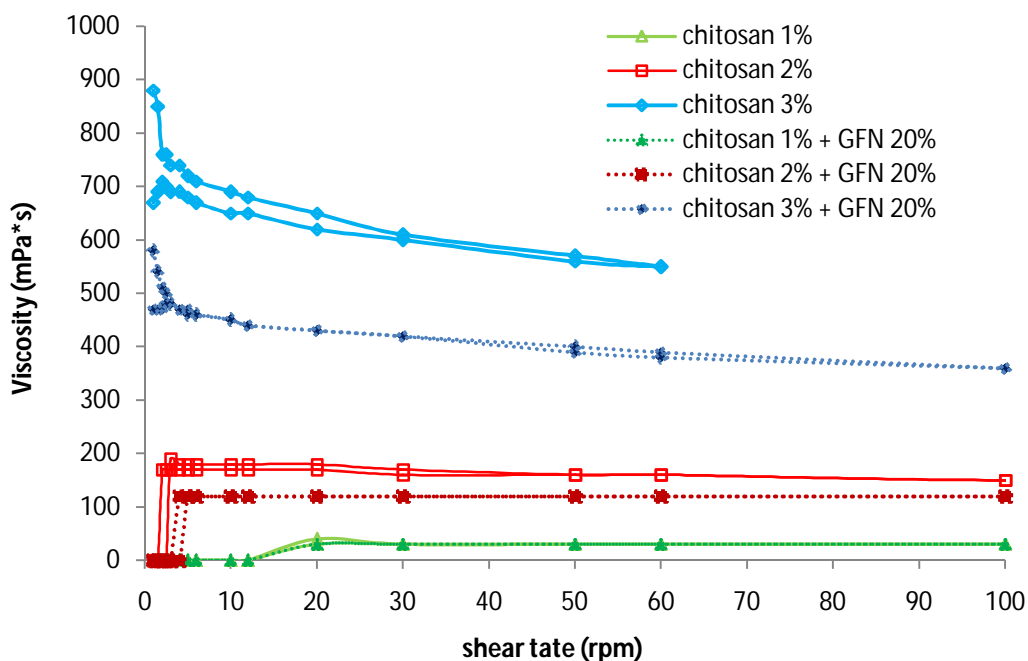
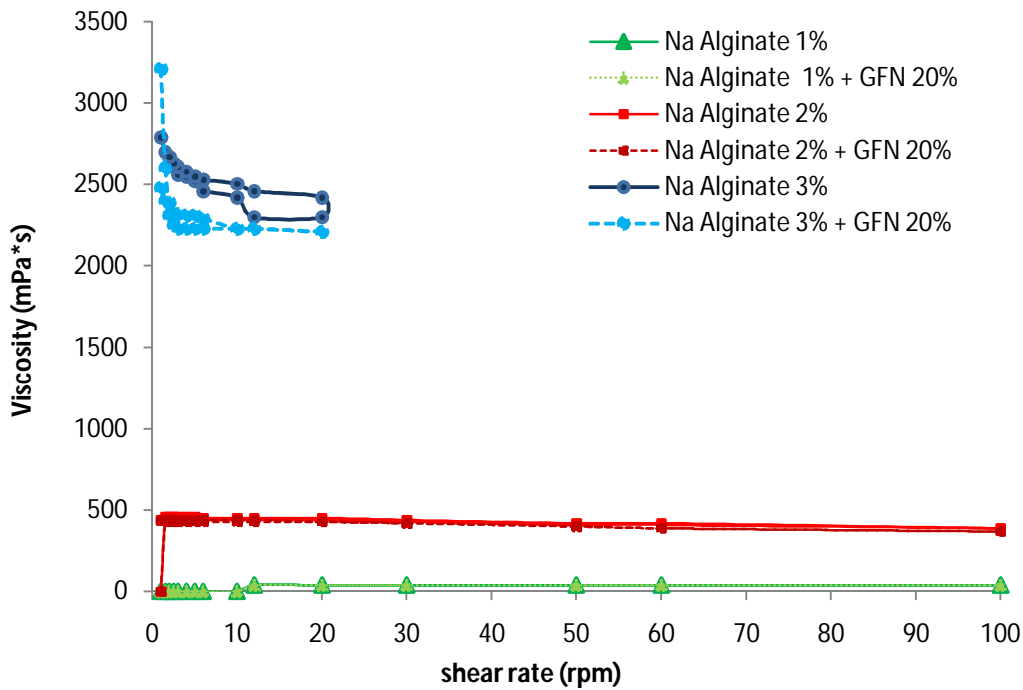

Figure 26: Viscosity curves (from left to right and return) of different Na Alginate (1-3% w/w) solutions before and after the addition of GFN.



As reported for Methocel E5, the sodium alginate layering solution was heated at 50°C to obtain the complete GFN solubilization. Fluid bed sodium alginate layered pellets were then produced (L3) and coated to obtain batch C4. Pellets were then analyzed by means of DSC (Figure 27).

Contrary to hypromellose, sodium alginate is a crystalline polymer exhibiting a melting peak at 146.58±0.29°C. For both L3 and C4 pellets (t0), the only detected thermal event was a sharp endothermic peak around 81°C - 82°C very close to the GFN main melting peak (84.84±0.29°C). After six months of storage, the thermograms of L3 pellets and uncured and cured samples remained unchanged and depicted only a sharp main melting peak at about 80°C.

Figure 27: DSC curves of layered pellets with sodium alginate (L3) and of batch C4 uncured and cured pellets at day 0 and after 180 days of storage at 25°C/60% RH.

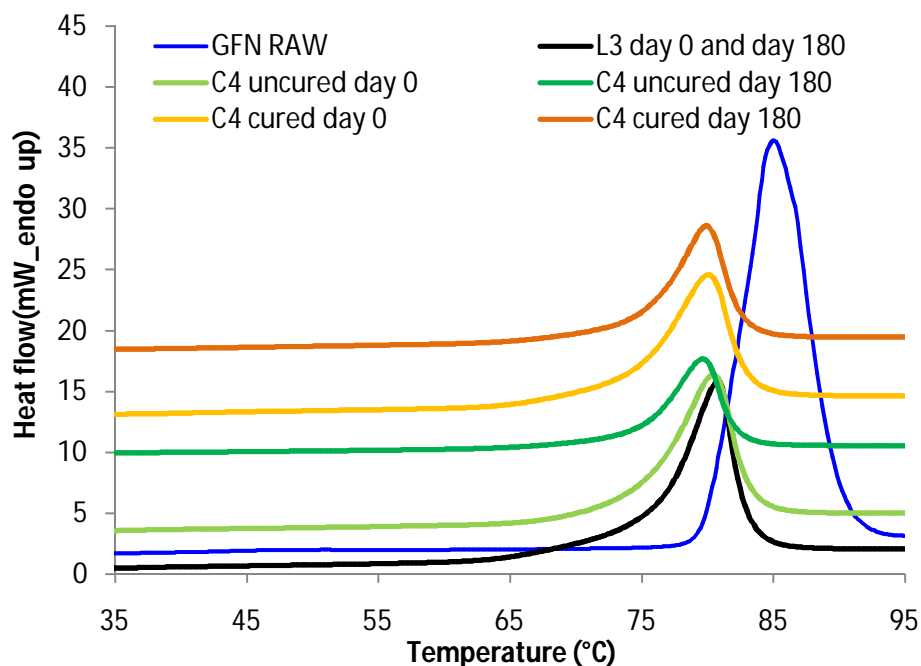

SEM images (Table 19) highlighted a smoother layered samples surface than the HPMC-based ones (Table 17) and no GFN crystals grew during storage (30 days). This behaviour suggest that the drug supersaturation is not the main driving force of GFN crystallization and the affinity between the drug and the binder layering polymer played an important role. It can be thus hypothesized that GFN formed a stable solid dispersion with sodium alginate, which inhibit GFN re-crystallization on the layered pellets. After Surelease® film coating, alginate-based pellets displayed a weight gain of 17.8% and a drug content of $16.3 \pm 0.88\%$ w/w (Table 15).

Table 19: SEM pictures of layered pellets (L3) and coated pellets (batch C4) after 30 days of storage, at different magnifications.

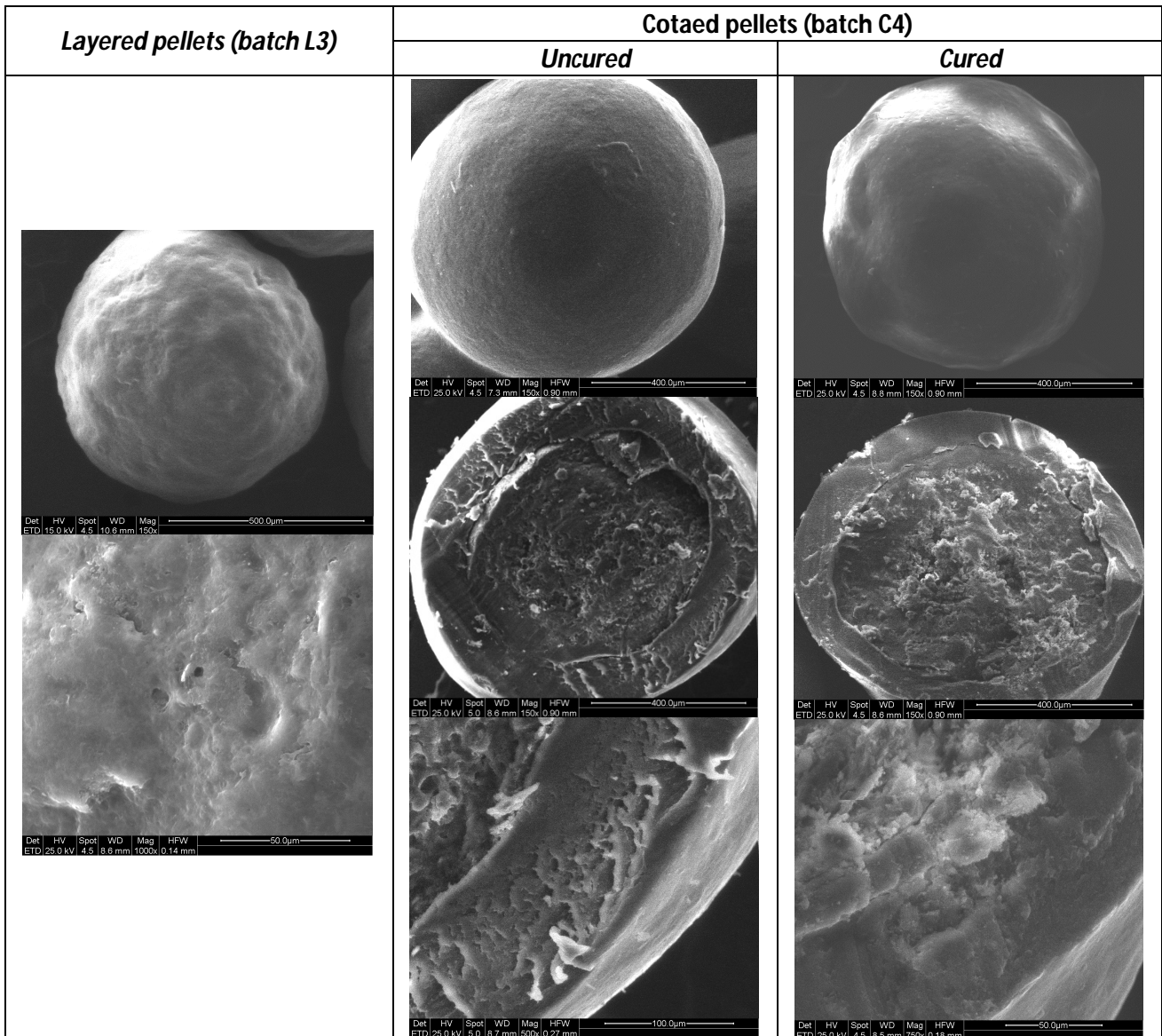
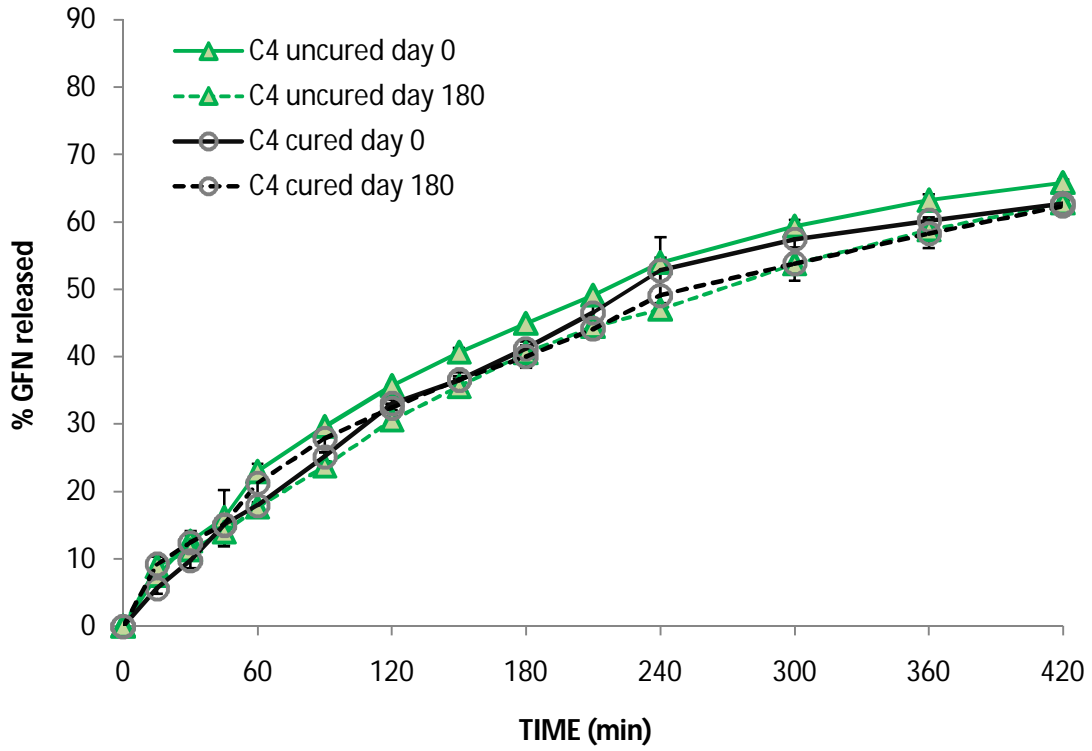

Figure 28 shows the dissolution profiles C4 pellets upon storage. Uncured pellets released 50% of the GFN within 3 hours with respect to the six hours required by uncured pellets of batch C3 ($f_2=45.18\pm 1.7$), indicating a faster dissolution rate due to the sodium alginate. After curing, the pellets (C4) showed a very similar release profile, as confirmed by the f_2 results ($f_{2\text{uncured/cured}}=72.28\pm 1.94$). According to SEM images (Table 19), GFN did not migrate through the film coating after 30 days storage of both uncured/cured samples. After 180 days of storage, the release profiles of both untreated/treated samples remained unchanged with respect to the initial (day 0) dissolution profiles, even without thermal treatment ($f_2=66.04\pm 0.56$, $f_1=10.56\pm 0.14$

for the uncured; $f_2 = 75.49 \pm 1.98$, $f_1 = 6.79 \pm 1.59$ for cured pellets), which was necessary to stabilise pellets layered with hypromellose.

Figure 28: Dissolution profiles of C4 uncured/cured pellets at day 0 and after 180 days of storage at 25°C/60% RH.



10.4. CONCLUSIONS

The paper provided a comprehensive study of the coating process of guaifenesin-loaded pellets in order to understand the variables affecting the drug migration and thus the stability of the final dosage form. This study showed that the optimization of a manufacturing process is very complicated and despite the well-known and established available technologies, it is extremely important during the development of a formulation to thoroughly analyze the whole process and its variables. Surprisingly, the results indicated that the drug layering phase was the critical step of the whole manufacturing process. The polymer used in the drug layering solution influenced the GFN crystallization on the layered pellets becoming the main driving force in the Surelease-based film instability. When HPMC is used as a binder in the layering solution, at low drug concentration the film stability was ensured even without curing, while at high GFN content a post coating thermal treatment may be required regardless of the coating level applied. Replacing HPMC with sodium alginate, the migration of the drug was negligible; in addition the curing step was not necessary to achieve stable release profiles of pellets upon storage.

Changing the model drug with another active pharmaceutical ingredient, even of the same BCS Class, will not necessarily lead to the same conclusions and it will be necessary to repeat the whole evaluation process.

10.5. REFERENCES

- [1] TC Dahl, Ethylcellulose, in: R.- C. Rowe, P. -J. Shekey, M.- E. Quinn (Eds), Handbook of Pharmaceutical Excipients 6th Edition, Pharmaceutical Press and the American Pharmacists Association, USA, 2009, pp. 262 - 267.
- [2] J. Siepmann, F. Siepmann, Stability of aqueous polymeric controlled release film coatings, *Int. J. Pharm.* 457 (2013) 437 - 445.
- [3] Q.- W. Yang, M.- P. Flament, F. Siepmann, V. Busignies, B. Leclerc, C. Herry, P. Tchoreloff, J. Siepmann, Curing of aqueous polymeric film coatings: Importance of the coating level and type of plasticizer, *Eur. J. Pharm. Biopharm.* 74 (2010) 362 - 370.
- [4] C. Gendre, M. Genty, B. Fayard, A. Tfayli, M. Boiret, O. Lecoq, M. Baron, P. Chaminade, J.- M. Péan, Comparative static curing versus dynamic curing on tablets coating structures, *Int. J. Pharm.* 453 (2013) 448 - 453.

- [5] L.- A. Felton, Mechanisms of polymeric film formation, *Int. J. Pharm.* 457 (2013) 423 - 427.
- [6] S.- A. Kucera, L.- A. Felton, J.-W. McGinity, Physical aging in pharmaceutical polymers and the effect on solid oral dosage form stability, *Int. J. Pharm.* 457 (2013) 428 - 436.
- [7] K. Nikowitz, K. Pintye- Hódi, G. Regdon Jr, Study of the recrystallization in coated pellets – Effect of coating on API crystallinity, *Eur. J. Pharm. Sci.* 48 (2013) 563 - 571.
- [8] G. Li, D. Ha, T. Guan, X. Zhao, H. He, X. Tang, Isosorbide- 5- mononitrate (5- ISMN) sustained-release pellets prepared by double layer coating for reducing 5- ISMN migration and sublimation, *Int. J. Pharm.* 400 (2010) 138 - 144.
- [9] J. Siepmann, F. Siepmann, O. Paeratakul, R. Bodmeier, Process and Formulation Factors Affecting Drug Release from Pellets Coated with Ethylcellulose Pseudolatex Aquacoat®, in: L.- A. Felton, J.- W. McGinity (Eds), *Aqueous Polymeric Coatings for Pharmaceutical Dosage Forms 3rd Edition*, Drug and Pharmaceutical Sciences vol. 176, Informa Healthcare USA Inc., 2008, pp. 203 - 235.
- [10] R. Bodmeier, O. Paeratakul, The effect of curing on drug release and morphological properties of ethylcellulose pseudolatex- coated beads, *Drug Dev. Ind. Pharm* 20 (1994) 1517 - 1533.
- [11] N. Katori, N. Aoyagi, S. Kojima, Mass Variation Tests for Coating Tablets and Hard Capsules: Rational Application of Mass Variation Tests, *Chem. Pharm. Bull.* 50 (9) (2002) 1176 - 1180.
- [12] W. Chen, S.- Y. Chang, S. Kiang, A. Marchut, O. Lyngberg, J. Wang, W. Rao, D. Desai, H. Stamato, W. Early, Modelling of Pan Coating Processes: Prediction of Tablet Content Uniformity and Determination of Critical Process Parameters, *J. Pharm. Sci.* 99 (7) (2010) 3213 - 3225.
- [13] Surelease® Ethylcellulose Dispersion Type B NF e-7-19040 Specification product, Colorcon, Inc.
- [14] J.- W. Moore, H.- H. Flanner, Mathematical comparison of dissolution profiles, *Pharm. Tech.* 20 (1996) 64-74.
- [15] D. Brock, J.- A. Zeitler, A. Funke, K. Knop, P. Kleinebudde, Evaluation of critical process parameters for inter-tablet coating uniformity of active-coated GITS using Terahertz Pulsed Imaging, *Eur. J. Pharm. Biopharm.* 88 (2014) 434 - 442.
- [16] B.- D. Rege, J. Gawel, J.- H. Kou, Identification of critical process variables for coating actives onto tablets via statically designed experiments, *Int. J. Pharm.* 237 (2002) 87 - 94.
- [17] J.-J. Moes, M.- M. Ruijken, E. Gout, H.- W. Frijlink, M.- I. Ugwoke, Application of process analytical technology in tablet process development using NIR spectroscopy: Blend uniformity, content uniformity and coating thickness measurements, *Int. J. Pharm.* 357 (2008) 108 - 118.

- [18] L.- A. Shervington, A. Shervington, Guaifenesin, in: H.- G. Brittain (Eds), *Analytical Profiles of Drug Sustances and Excipients Vol. 25*, Academic Press Inc., New Jersey, 1998, pp. 124 - 163.
- [19] C. Bruce, K.- A. Fegely, A.-R. Rajabi Siahboomi, J.- W. McGinity, Crystal growth formation in melt extrudates, *Int .J. Pharm.* 241 (2007) 162 - 172.
- [20] D. Hasa, D. Voinovich, B. Perissutti, G. Grassi , S. Fiorentino, R. Farra, M. Abrami, I. Colombo, M.Grassi, Reduction of melting temperature and enthalpy of drug crystals: Theoretical aspects, *Eur. J. Pharm. Sci.* 50 (2013) 17 - 28.
- [21] C. Bruce, K.- A. Fegely, A.-R. Rajabi Siahboomi, J.- W. McGinity, The influence of heterogeneous nucleation on the surface crystallization of guaifenesin from melt extrudates containing Eudragit® L10055 or Acryl- EZE®, *Eur. J. Pharm. Biopharm.* 75 (2010) 71 - 78.

Most of the data reported in this chapter has been recently published in the *European Journal of Pharmaceutics and Biopharmaceutics*.

11. CASE STUDY 2: A novel dry powder coating of pellets using ethylcellulose. Part I: An investigation into the formulation of free-films and on process manufacturing.

11.1. INTRODUCTION

Conventional technologies for the application of film coatings onto pharmaceutical dosage forms involve the atomization of polymeric systems as solution or suspension in volatile organic solvents and/or aqueous vehicles. While the use of organic solvents is generally faster with simplified film formation processes because of the dissolved nature of the polymer, the use of aqueous systems remains the preferred manufacturing approach due to the absence of solvent toxicity, increased process safety and lower manufacturing costs [1].

Even in light of the benefits of aqueous systems, there are several cases where aqueous systems are inappropriate and organic solvent coatings may be necessary. This is particularly true when the pharmaceutical ingredient is sensitive to water and organic solvents are used to prevent this issue. In addition to degradation of the active ingredient, migration of water with aqueous systems may occur during the coating process during storage thus compromising the quality of the finished product. The need to avoid aqueous and organic solvents may be particularly critical if the drug product is formulated as an amorphous solid dispersion. Moreover, from a process standpoint, aqueous coatings require both a substantial amount of water, as well as energy to evaporate the water during manufacturing. While thermal energies to drive evaporation of solvents may be lower, the need for environmentally friendly and safe solvent recovery significantly increases costs around solvent operations. Overall, this leads to longer processing times and greater overhead costs for conventional film coating operations [2].

In the last decade, dry powder coating of pharmaceuticals has been recognized to be an environmentally-friendly and a promising coating technology to overcome the well-known disadvantages associated with organic and aqueous coating systems. Driven by a combination of cost considerations and functionality, a range of dry powder coating technologies have been developed in both academic and industrial settings. Actually, dry powder coating technology for pharmaceutical applications has gained increasing attention over the last decade and the first review of this process has been published last year in a special issue of IJP, entitled "Progress in film coating" [3].

Dry powder coating technologies can be generally classified into three major types based on the layer formation process: thermal adhesion (melt coating), liquid assisted and electrostatic [1]. In addition to specific manufacturing processes that must be implemented to achieve the desired

product attributes, many of these techniques also require the use of novel excipients and specific formulations to provide acceptable manufacturability [4].

Ethylcellulose is one of the most commonly used polymers for sustained release film coating. Considering ethylcellulose as film forming polymer in a dry powder coating process, its high glass transition temperature (T_g) could represent an obstacle for the process execution.

Several studies investigated the dry powder coating of pellets with ethylcellulose in a fluidized bed coater [5; 6]. A smaller polymer particle size promoted particle film formation. In general, pellets coated with polymer powders required higher coating levels to obtain similar drug release patterns as pellets coated with organic polymer solutions and aqueous polymer dispersions [5]. High plasticizer concentrations (40%) of tributyl citrate (TBC) and a thermal after-treatment (curing) were necessary for the coalescence of the polymer particles and good film formation. Although ethylcellulose-coated pellets had an uneven surface, extended drug release could be obtained with coating level of 15% [6]. Alternatively, to reduce the coating temperature and the random deposition of the polymer particles on the core surface, pre-plasticized ethylcellulose with 20% w/w of MCT was investigated [7]. Hot-melt extrusion/cryogenic grinding and spray drying two commercially available plasticized aqueous colloidal ethylcellulose dispersions were used for that purpose.

Smikalla et al., (2011) analyzed several liquid additives (isopropyl myristate, cocoylcaprylocaprate, triacetin, octyldodecanol, triethylcitrate, PEG 400 and glycerol) (30-50% w/w rel. to the dry polymer) to lower the T_g of ethylcellulose and to enhance the adhesion of the powder to the cores inside a fluid bed with a rotor insert. Curing at 80°C for three days and isopropyl myristate resulted in the highest coating efficiency [8].

In this study a different approach of dry powder coating process was developed for the application of functional ethylcellulose based-coating upon pellets. In particular, a novel approach based on a combination of both liquid assisted and thermal adhesion technology within a high-shear rotogranulator was developed and both the formulation and the process-related parameters were fully investigated. To this purpose, plastic deformation of ethylcellulose in combination with several plasticizers and film formation ability were considered critical points for formulation design and process carrying out. Therefore the impact of type and amount of polymers, plasticizers and other suitable excipients on the formation and stability of free film were studied.

The experimental design has been divided in two parts. In the first one, the research focused on the film formation process through the preparation of free-films. Formulation variables as polymer

particle size, plasticizing activity and minimum film formation temperature were considered. The best coating formula on the basis of the minimum film forming temperature and film stability were then investigated upon placebo pellets using the novel dry powder coating process. Once the feasibility of the process was ascertained, in the second part of the research the process manufacturing was optimized using placebo pellets and then applied onto drug-loaded pellets.

11.2. Materials and Methods

11.2.1. Materials

Ethocel® Standard E7, E10 and E20 FP (fine particle, with mean dimension of the particles of 9.7 µm) and Sugar spheres (Suglets® 14/16 mesh size, 1180-1400 µm diameter, composed of sucrose and starch (batch n° DT 405540) were kindly donated by Colorcon Ltd (Dartford, Kent, UK).

The used plasticizers belong to two different categories: saturated fatty acids: oleic acid (OA, Carlo Erba, batch n° 3185E100); lauric acid (LA, Sigma-Aldrich, batch n° MKBQ4605V) and myristic acid (MA, Fluka) and medium-chain triglycerides: Dynasan 114 (Sasol, batch n° 402156), glycerylmonostearate (GMS, Sigma-Aldrich), Myvatex (Prabo srl, Cremona, Italy) and Myverol (Prabo srl, Cremona, Italy).

Kollidon-vinyl acetate copolymer (KVA 64, batch n° 61611468E0) was gently donated by BASF. Talc was supplied by ACEF SpA (Piacenza, Italy).

11.2.2. Methods

11.2.2.1. Preformulation study: screening of polymer and plasticizers

At the beginning, a pre-formulation study based on binary physical mixtures was carried out through DSC measurements. The thermal properties of raw Ethocel® and of the samples were characterized using a differential scanning calorimeter Perkin-Helmer DSC 6 (Perkin-Elmer, Beaconsfield, UK) equipped with Pyris Software. Samples, weighting 8-12 mg, were sealed in an aluminium pan and heated from 25°C to 180°C at a scanning rate of 10°C/min under a nitrogen flow rate of 20 ml/min. Each analysis was carried out in duplicate experiments. The mean glass transition temperature (T_g) was then calculated.

The analysed samples were raw ethylcellulose and powder mixtures containing several types of low melting plasticizers at different concentrations to evaluate their efficiency in lowering the T_g

of the coating blend. In particular, three types of ethylcellulose, which essentially differed in molecular weight and viscosity degree, were used (E7, E10 and E20). The screening of the plasticizer was conducted preparing 10 physical mixtures with Ethocel E7 and all plasticizers listed above in different percentage ratios. The composition of each physical mixture is reported in Table 20.

Table 20: Binary physical mixtures based on Ethocel E7 and several type of low melting plasticizers at different concentrations.

<i>Polymer (% w/w)</i>	<i>Plasticizer (% w/w)</i>						<i>Physical mixture</i>
Ethocel E7	LA	MA	Dynasan 114	GMS	Myvatex	Myverol	Ratio (% w/w)
90	10	X	X	X	X	X	90:10
80	20	X	X	X	X	X	80:20
70	30	X	X	X	X	X	70:30
90	X	10	X	X	X	X	90:10
80	X	20	X	X	X	X	80:20
70	X	30	X	X	X	X	70:30
90	X	X	10	X	X	X	90:10
90	X	X	X	10	X	X	90:10
90	X	X	X	X	10	X	90:10
90	X	X	X	X	X	10	90:10

The best plasticizer of Ethocel E7 was then used with the other types of Ethocel (E10 and E20). Table 21 lists the composition of the binary physical mixtures containing lauric acid (LA) and Ethocel E10 and E20.

Table 21: Binary physical mixtures based on Ethocel E10 or E20 and LA at different concentrations.

<i>Polymer (%w/w)</i>	<i>Plasticizer (%w/w)</i>	<i>Physical mixture</i>
Ethocel E10	Lauric acid	ratio (% w/w)
90	10	90:10
80	20	80:20
70	30	70:30
Ethocel E20	Lauric acid	ratio (% w/w)
90	10	90:10
80	20	80:20
70	30	70:30

Ternary physical mixture based on Ethocel E10, LA and OA were then prepared and their compositions are listed in Table 22.

Table 22: Ternary physical mixture based on Ethocel E10, LA and OA at different concentrations.

<i>Polymer (% w/w)</i>	<i>Plasticizer (% w/w)</i>		<i>Physical mixture</i>
Ethocel E10	LA	OA	Ratio (% w/w)
85		5	85:10:5
80	10	10	80:10:10
70		20	70:10:20
75		5	75:20:5
70	20	10	70:20:10
60		20	60:20:20
65		5	65:30:5
60	30	10	60:30:10
50		20	50:30:20

Finally, Kollidon vinyl acetate (KVA 64) was added to the binary physical mixture at a fixed concentration of 2.5% w/w (Table 23) in order to prevent, slow down or inhibit a possible surface re-crystallization of the main plasticizer (LA).

Table 23: Ternary physical mixture based on Ethocel E10, LA and KVA 64 at different concentrations.

<i>Polymer (%w/w)</i>	<i>Plasticizer (% w/w)</i>	<i>Adjuvant (%w/w)</i>	<i>physical mixture</i>
Ethocel E10	LA	KVA 64	ratio(% w/w)
87.5	10		87.5:10:2.5
77.5	20	2.5	77.5:20:2.5
67.5	30		67.5:30:2.5

11.2.2.2. Free Films preparation

Forty six free films based on ethylcellulose Ethocel® Standard 10 FP (9.7 µm), lauric acid (main solid plasticizer), oleic acid (second liquid plasticizer acting as adhesion enhancer) and KVA 64 (lauric acid re-crystallization inhibitor) in different percentages were prepared and characterized. Moreover, free films based on ethylcellulose: lauric acid: oleic acid (70:20:10 %, w/w) containing 2% and 5% w/w of talc extra-formulation were realized in order to verify the influence of the anti-sticking agent on film formation.

Briefly, the free films were obtained by tableting the physical coating blend (ethylcellulose plus plasticizers) in an alternative press machine (EKO, Korsh) equipped with flat faced punches (diameter: 25 mm). Firstly, the determination of the minimum polymer- softening temperature was carried out on a heating balance (Top Rey, Alessandrini) equipped with a metal plate with a variable temperature gradient (50 - 105°C) and the degree of the film formation was determined by observing the appearance of transparency of the free film. Afterwards, the free films were cured in a static oven (Friocell, MMM Med Center) at the MFFT for at least three hours to complete the polymer particle coalescence. Finally the stability of uncured/cured films was evaluated (T= 25°C; RH= 60% and t= 1 year).

The free films were classified according to the percentage w/w of the main solid plasticizer lauric acid, (independent variable of the pre-formulation study) and their compositions are reported in Table 24.

Table 24: Free films compositions.

<i>Ethocel</i>		<i>Plasticizers (% w/w)</i>		<i>Adjuvants</i>	<i>Free – Film</i>
<i>type</i>	<i>% (w/w)</i>	<i>LA</i>	<i>OA</i>	<i>KVA 64 (% w/w)</i>	<i>ratio (% w/w)</i>
E7	90	10	-	-	90:10
	90		-		90:10
E10	85	10	5	-	85:10:5
	80		10		80:10:10
E20	90	10	-	-	90:10
E7	77.5	15	7.5	-	77.5:15:7.5
	75		10		75:15:10
E7	75	15	7.5	2.5	75:15:7.5:2.5
	72.5		10		72.5:15:10:2.5
E7	80	20	-	-	80:20
	80		-		80:20
	75		5		75:20:5
	72.5		7.5		72.5:20:7.5
E10	70	20	10	-	70:20:10
	65		15		65:20:15
	60		20		60:20:20
	50		30		50:20:30
E10	72.5		5		72.5:20:5:2.5
	70	20	7.5	2.5	70:20:7.5:2.5
	67.5		10		67.5:20:10:2.5
	70		5		70:20:5:5
	67.5		7.5		67.5:20:7.5:5
E10	65	20	10	5	65:20:10:5
	60		15		60:20:15:5
	55		20		55:20:20:5
	45		30		45:20:30:5
E10	77.5	20	-	2.5	77.5:20:2.5
E20	80	20	-	-	80:20
	70		5		70:25:5
E10	67.5	25	7.5	-	67.5:25:7.5
	65		10		65:25:10
	67.5		5		85:10:5
E10	65	25	7.5	2.5	65:25:7.5:2.5
	62.5		10		62.5:25:10:2.5
	65		5		65:25:5:5
E10	62.5	25	7.5	5	62.5:25:7.5:5
	60		10		60:25:10:5
E7	70	30	-	-	70:30

	70		-		70:30
E10	65	30	5	-	65:30:5
	62.5		7.5		62.5:30:7.5
	60		10		60:30:10
E10	62.5	30	5	2,5	62.5:30:5:2.5
	60		7.5		60:30:7.5:2.5
	57.5		10		57.5:30:10:2.5
E10	60	30	5	5	60:30:5:5
	55		10		55:30:10:5
E20	70	30	-	-	70:30

11.2.2.3. Development of dry powder coating process on placebo pellets

Dry powder coating process was performed in a laboratory scale high shear mixer granulator (Roto Lab Zanchetta IMA) and preliminary trials were conducted to optimize the equipment configuration on the basis of the selected pellets size and friability. In particular, dry powder coating process consisted of three phases (Figure 29): 1) **pre-heating** of the sugar spheres at minimum film forming temperature of the formulation with tilting of the bowl of the Rotolab; 2) **powdering**: addition of the components of the coating formula (the mode and the order of addition varied through the trials and were finally optimized) and 3) **curing**: half batch of each trial was cured at minimum film forming temperature (MFFT) for 24 hours in an air forced oven; the uncured pellets were immediately stored at room temperature in PE closed bottles. A batch size of 150 g sugar spheres (1180-1400 μm) was processed in each run of coating.

Figure 29: The outline of dry coating process [9].

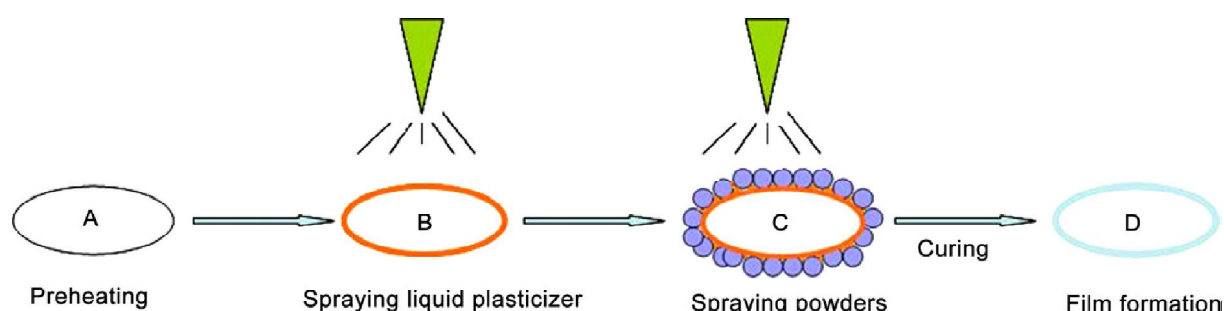

Moreover, formulation variables (particle size of the plasticizer, addition of the anti-sticking agent) and process related parameters (jacket temperature, impeller rotation speed, excipients' addition mode and order inside the granulation chamber, tilting on/off) were fully investigated.

Since ethylcellulose was employed as FP (lower than 9.7 μm) and the second plasticizer (oleic acid) is liquid at room temperature, the influence of three different particle size of the main plasticizer (lauric acid) on the whole process was evaluated: <500 μm , <150 μm and <100 μm . Then, the influence of the impeller speed on both pellet crushing at the beginning of the coating process and on the extent of coated pellets sticking at the end of the film coating process was evaluated. Thus, three different rotation speeds, namely 120, 150 and 180 rpm, were assessed in order to identify the optimal rotation speed able to minimize pellets fractiousness and, thus reducing the coating loss. Subsequently, in order to evaluate and standardize the addition mode of the coating excipients, impeller speed, polymer particle size and addition order of the excipients into the chamber were first kept unchanged. Thus, ethylcellulose was directly transferred into the chamber as fine powder and distributed onto the cores when the impeller was rotating at 120 rpm.

Contrarily, lauric acid was introduced into the bowl of the high shear granulator in three different modes: (i) as micronized powder; (ii) atomized at 3.5 bar by a compressed air gun inserted into the lid of the granulation chamber; (iii) molten and poured in the bowl of the high shear granulator together with the second liquid plasticizer, oleic acid, through the lid of the chamber.

Similarly to lauric acid, oleic acid was added in two different modes: (i) sprayed into the bowl of the high shear granulator through a second liquid spray gun at 1.5 bar inserted into the lid of the granulation chamber; (ii) molten and poured in the bowl of the high shear granulator together with molten lauric acid through the lid of the chamber.

Talc was added extra- formulation in percentages equal to 2.5% or 5% w/w with respected to the theoretical amount of solid applied to reduce pellets aggregation and adhesion on the coating chamber.

Since the maximum working temperature allowed inside the granulation chamber was 80°C and higher values were not feasible inside the bowl of the high shear granulator, the lead coating formulations should have required an equal MFFT value or lower values. The formulation based on the E10FP:LA:OA weight ratio of 70:20:10 exhibited a MFFT equal to 80°C and thus, was preliminarily selected as a *model coating formulation* in order to fully investigated the formulation variables and process related parameters listed above. Table 25 lists the details of the different mode of addition of the excipients in the first trials.

Table 25: Different mode of addition of the excipients.

Trials	Formulation variables and process parameters							
	Ethocel E10		Lauric Acid			Oleic Acid		Talc
	(% w/w)	added as	(% w/w)	µm	added as	(% w/w)	added as	(% w/w)
I	70	fine powder	20	< 500	powder	10	molten	X
II	70	fine powder	20	< 500	molten	10	molten	X
III	70	fine powder	20	< 150	powder	10	nebulised	X
IV								X
V	70	fine powder	20	< 100	atomized	10	nebulised	2,5
VI								5

Oleic acid was then coloured with lipophilic dye, *Red Sudan III*, to visually evaluate the uniformity of oleic acid distribution on the moving pellets. Four trials were performed while maintaining unchanged the formulation variables and process related parameters previously optimized. The selected coating formulation (E10:LA:OA w/w equal to 60:20:20) contained an higher amount of oleic acid allowing an easier evaluation of its distribution around the Suglets®: in the first trial, according to the desired theoretical weight gain, all the amount of ethylcellulose accurately weighed was transferred into the granulation chamber during the pre-heating phase and intimately distributed onto the pellets to be coated. When the pellets reached the MFFT, plasticizers were sequentially introduced inside the bowl: firstly, oleic acid was sprayed through a liquid spray gun at 1.5 bar followed by the atomization of lauric acid at 3.5 bar by a compressed air gun inserted into the lid of the granulation chamber.

Alternatively, only the first half of the entire amount of ethylcellulose required for the coating process was intimately distributed onto the pellets in the bowl of the chamber during the pre-heating phase. When the product reached the MFFT, the oleic acid was continuously sprayed at 1.5 bar followed by the gradually addition to the second half of ethylcellulose required for the coating process. Finally lauric acid is atomized at 3.5 bar by a compressed air gun.

During the third trial, placebo pellets were pre-heated to the expected MFFT of the coating formulation in absence of plasticizers and ethylcellulose. Reached the MFFT, oleic acid was continuously sprayed at 1.5 bar onto the cores to be coated in order to allow a greater adhesion

around Suglets® of the total amount of ethylcellulose necessary to achieve the desired weight gain. Afterwards, lauric acid was continuously atomized at 3.5 bar through a compressed air gun.

Similarly, in the latest trial, placebo pellets were pre-heated to the expected MFFT of the coating formulation in absence of plasticizers and ethylcellulose. Once reached the working temperature required by the coating formula, the oleic acid was continuously sprayed at 1.5 bar onto the cores to be coated, whereas ethylcellulose and lauric acid were alternatively introduced into the granulation chamber.

Figure 30 shows the details of the two spray guns used for the plasticizers atomization: the one for the liquid OA and the other for the milled LA.

Figure 30: Details of the two spray guns used for the plasticizers atomization.



Weight gain (WG %), total yield (%), coating loss (%), pellets aggregation (%), coating efficiency ($cRSD_w$ %) were calculated using equations (14-17).

$$WG \% = \frac{W_{CP} - W_{LP}}{W_{LP}} * 100 \quad \text{Eq. 14}$$

$$Yield \% = \frac{W_{LP}}{W_S} * 100 \quad \text{Eq. 15}$$

$$Coating\ loss\ \% = \frac{W_{th} - W_r}{W_{th}} * 100 \quad \text{Eq. 16}$$

$$RSD_w \% = \frac{\sqrt{(SDW_{CP})^2 - (SDW_S)^2}}{W_{CP} - W_S} * 100 \quad \text{Eq. 17}$$

where: W_S = mean weight of placebo pellets (equivalent to uncoated pellets), W_{CP} = mean weight of coated pellets, W_{th} = weight of solids to be applied and W_r = weight of solids applied.

In particular, $cRSD_w$ % was expressed as the Relative Standard Deviation of the weight applied (RSD_w) on a mean of at least six measurements on 50 pellets within the same coating experiment.

The pellets aggregation was determined by calculating the percentage of coated pellets that did not pass through a 2000 μm sieve with respect to the collected amount of pellets at the end of the process, since single coated pellets had dimension lower than 2000 μm .

11.2.2.4. Morphological analysis

Free films and coated placebo pellets were observed using a an optical microscope (Nikon SNZ 2T) connected through a camera (Panasonic GP KR 222) to an image acquisition system (CV 9000, FKV S.r.l. BG, Italy).

11.2.2.5. Long term storage stability of free films and pellets

To assess long term storage stability, uncured and cured pellets were stored at 25°C/ 60 \pm 0.5% relative humidity (R.H.) in PE closed bottles. Drug release from pellets was measured after 1 year of storage. Day 0 corresponded to the day after the preparation of layered and coated pellets.

11.3. RESULTS

11.3.1. Screening of Polymers and Plasticizers

As extended release coating polymer three types of ethylcellulose with different molecular weight and viscosity grade were evaluated. DSC curve of pure ETHOCEL E7, E10 and E20 raw materials are reported in Figure 31, whereas their glassy transition temperature values were 137.24 (± 0.51) $^{\circ}\text{C}$, 131.07 (± 0.59) $^{\circ}\text{C}$ and 127.08 (± 0.67) $^{\circ}\text{C}$, respectively.

Figure 31: DSC scans of pure ETHOCEL E7, E10 and E20 raw materials.

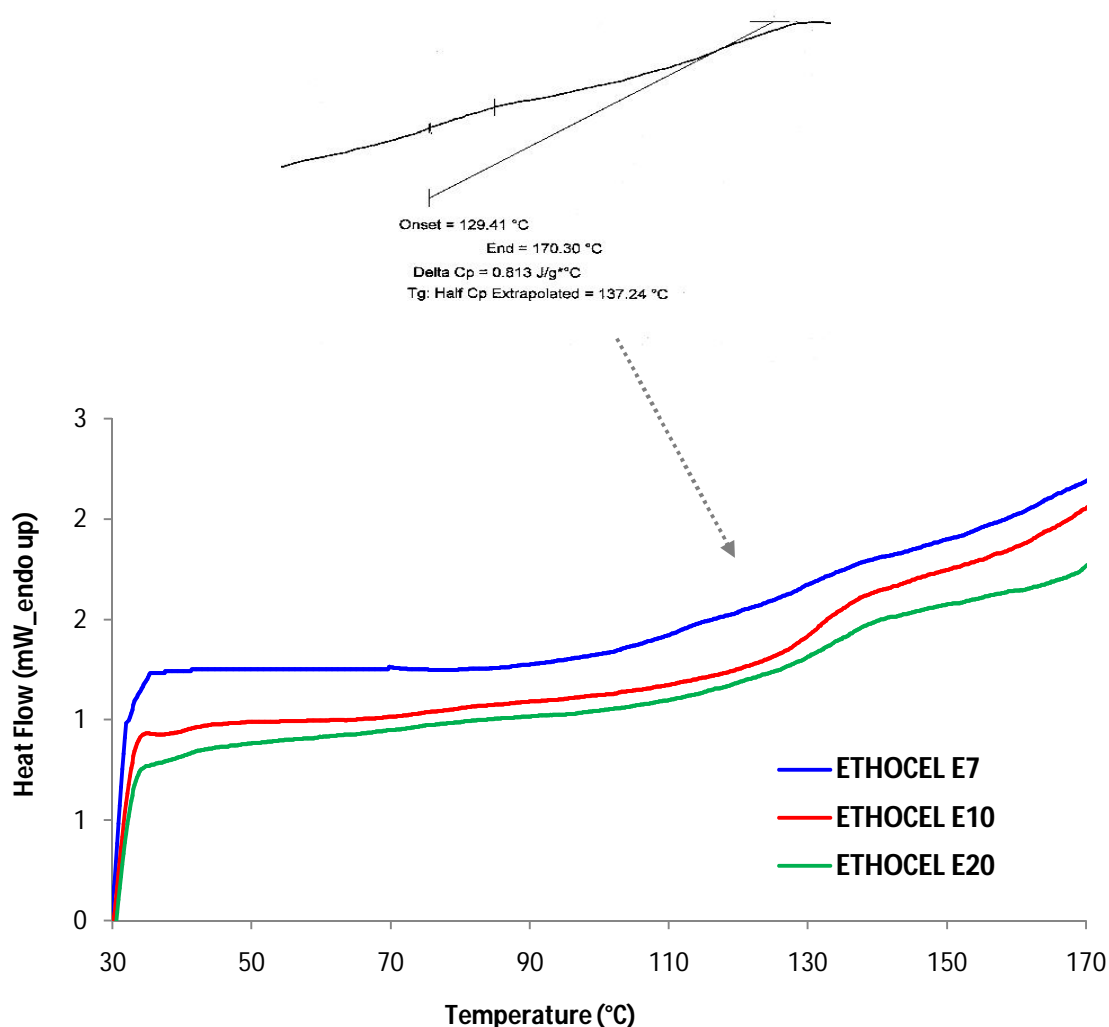

Based on the results, ethylcellulose raw material exhibits a high glass transition temperature and forms weak and brittle films [8]. These characteristics require the use of plasticizers to lower the minimum film forming temperature (MFFT) and to improve the film properties. In dry powder

coating, plasticizers are of particular importance, as, besides the enhancement of film formation by lowering the T_g, they improve the adhesion of coating material to the core pellets by forming liquid bridges. Moreover, due to the fact that no water was used, which could act as temporary plasticizer, a sufficient plasticizing activity of the used additives is necessary. Therefore, DSC measurements of both plasticized and pure ethylcellulose were conducted with commonly used plasticizers of various concentration to evaluate their efficiency in lowering the T_g of ethylcellulose.

Binary physical mixtures based on Ethocel E7 and low melting fatty acids, lauric (LA) and myristic (MA) acid, Dynasan 114, glyceryl monostearate (GMS), Myvatex and Myverol at different concentrations (10%, 20% and 30% w/w based on the dry polymer weight) were prepared and characterized by means of DSC in order to lower the T_g of the coating blend and, thus, to reach the working temperature allowed by the high shear rotogranulator, which works at a maximum temperature of 80°C. The results are listed in Table 26.

Table 26: T_g (°C) ± SD of binary physical mixtures based on Ethocel E7 and low melting fatty acids at different concentrations.

<i>Polymer</i> (% w/w)	<i>Plasticizer (% w/w)</i>						<i>Physical mixture</i>	
Ethocel E7	LA	MA	Dynasan 114	GMS	Myvatex	Myverol	Ratio (% w/w)	T_g (°C) ± SD
90	10	X	X	X	X	X	90:10	102.01 ± 2.31
80	20	X	X	X	X	X	80:20	98.84 ± 2.85
70	30	X	X	X	X	X	70:30	84.73 ± 0.43
90	X	10	X	X	X	X	90:10	111.69 ± 0.21
80	X	20	X	X	X	X	80:20	110.7 ± 0.78
70	X	30	X	X	X	X	70:30	100.22 ± 1.91
90	X	X	10	X	X	X	90:10	120.97 ± 0.30
90	X	X	X	10	X	X	90:10	131.61 ± 0.37
90	X	X	X	X	10	X	90:10	125.22 ± 2.96
90	X	X	X	X	X	10	90:10	131.21 ± 0.14

As expected, the minimum polymer softening temperature (MST) decreased as the plasticizer concentration increased. The efficiency of the plasticizer to lower the MST was in order: *lauric*

acid> myristic acid> Dynasan 114> Myvatex> Myverol> GSM. Therefore, the lowest melting fatty acid, **lauric acid**, was chosen as main solid plasticizer for further pre-formulation studies. Thus, several weight ratio between lauric acid and two ethylcellulose with different viscosity grade were evaluated. The experimental results are shown in Table 27, the glassy transition temperature values of all type of Ethocel decreased as the lauric acid concentration increased.

Table 27: Tg (°C) ± SD of binary physical mixtures based on LA and Ethocel E10 or E20 at different concentrations.

<i>Ethocel (%w/w)</i>	<i>Plasticizer (%w/w)</i>	<i>Physical mixture</i>	
<i>E10</i>	<i>Lauric acid</i>	<i>ratio (% w/w)</i>	<i>Tg (°C) ± SD</i>
90	10	90:10	111.12 ± 0.22
80	20	80:20	100.09 ± 0.53
70	30	70:30	85.69 ± 0.98
<i>E20</i>	<i>Lauric acid</i>	<i>ratio (% w/w)</i>	<i>Tg (°C) ± SD</i>
90	10	90:10	107.9 ± 0.61
80	20	80:20	102.83 ± 0.70
70	30	70:30	99.04 ± 0.44

DSC scans of both pure and plasticized (20% lauric acid based on dry polymer weight) ethylcellulose are compared in Figure 32.

Figure 32: DSC scans of both pure ETHOCEL E10 and of the physical mixture based on E10:LA/80:20.

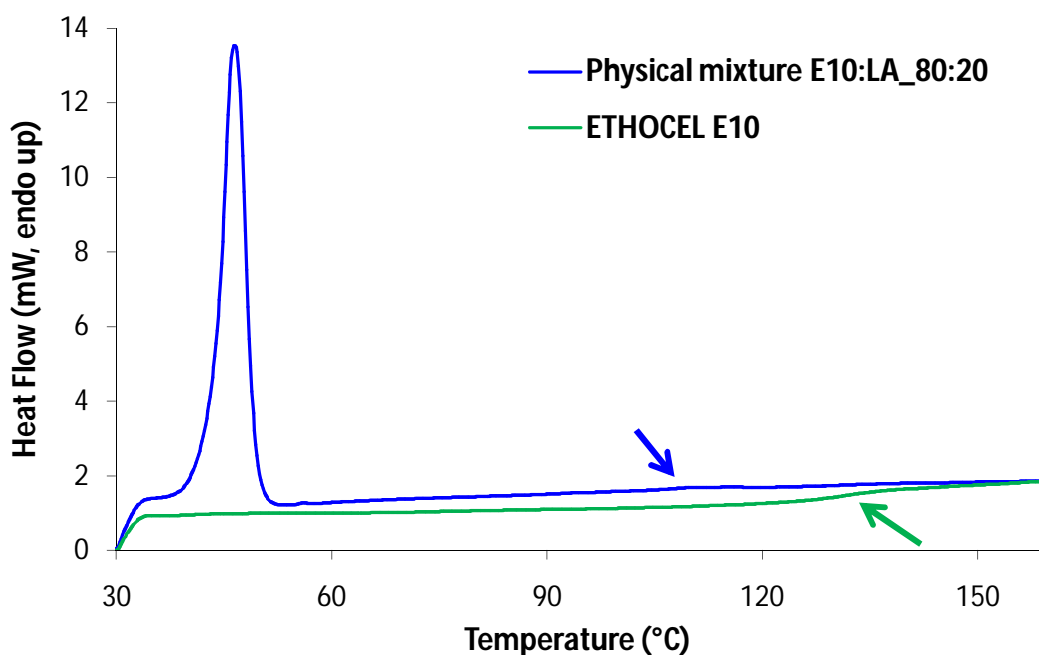

T_g values assessed throughout the DSC measurements plotted as a function of the percentage of lauric acid (based on the dry polymer weight) added to the coating formulation are reported in Figure 33. Ethocel E10 exhibits a more linear trend ($r^2 = 0.986$) with respect to the other cellulosic polymer evaluated.

Figure 33: T_g values plotted as a function of the percentage of lauric acid (based on the dry polymer weight).

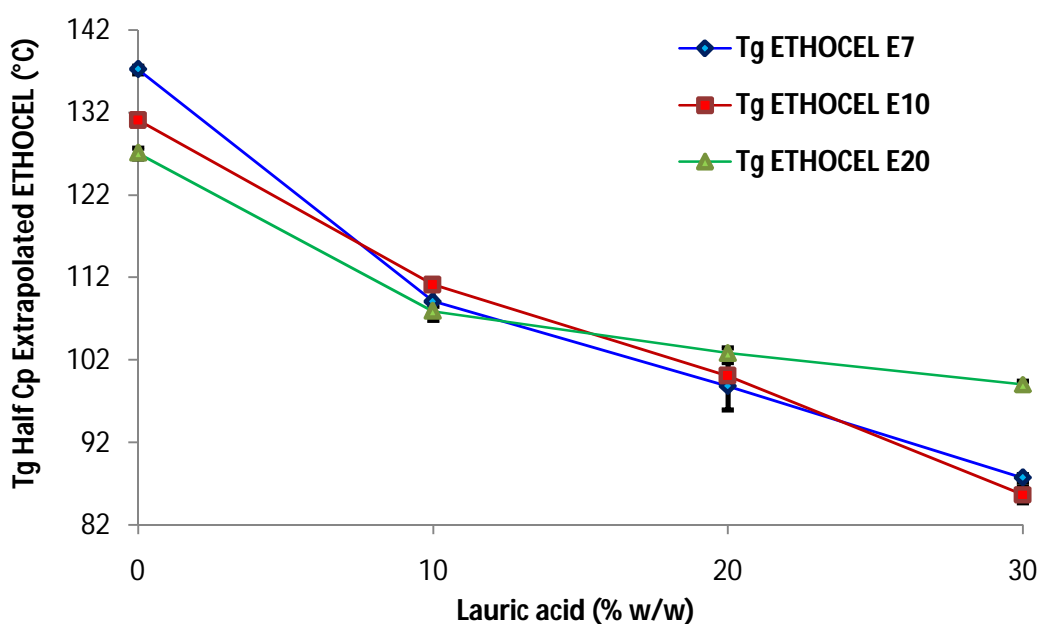

Nevertheless, the Tg measured was still too high and the desired working temperature hadn't reached. Therefore, a second liquid plasticizer, *oleic acid*, was added to the powder coating blend in order to further lower the Tg of ethylcellulose. Oleic acid was selected as suitable excipient, since its salt form (ammonium oleate) commonly acts as a plasticizer in aqueous based ethylcellulose dispersions of (i.e. Surelease®). To this purpose, 9 physical mixtures containing both lauric and oleic acid were prepared. The obtained glassy transition temperature are listed in Table 28. The experimental results revealed that the powder coating blend based on at least 20% w/w of lauric acid and 10% w/w of oleic acid reached the target Tg value.

Table 28: Tg (°C) ± SD of ternary physical mixtures based on Ethocel E10: LA: OA at different concentrations.

<i>Polymer (% w/w)</i>	<i>Plasticizer (% w/w)</i>		<i>Physical mixture</i>	
	<i>LA</i>	<i>OA</i>	<i>Ratio (% w/w)</i>	<i>Tg (°C) ± SD</i>
85		5	85:10:5	107.33 ± 0.36
80	10	10	80:10:10	93.42 ± 0.89
70		20	70:10:20	85.56 ± 0.25
75	20	5	75:20:5	93.2 ± 0.28
70	20	10	70:20:10	78.07 ± 0.72
60		20	60:20:20	72.06 ± 0.76
65		5	65:30:5	83.04 ± 0.11
60	30	10	60:30:10	66.66 ± 0.14
50		20	50:30:20	60.04 ± 0.17

Figure 34 compares the DSC measurements of the physical mixture based on Ethocel: LA: OA/ 70: 20: 10 with respect to the pure polymer and the same physical mixture (Figure 32, p. 137) without the liquid plasticizer. The DSC scan of the ternary mixture exhibited the lower Tg with respect to the binary one.

Figure 34: DSC scans of: pure ETHOCEL E10; binary physical mixture based on E10:LA/80:20; ternary physical mixture based on E10:LA:OA/70:20:10.

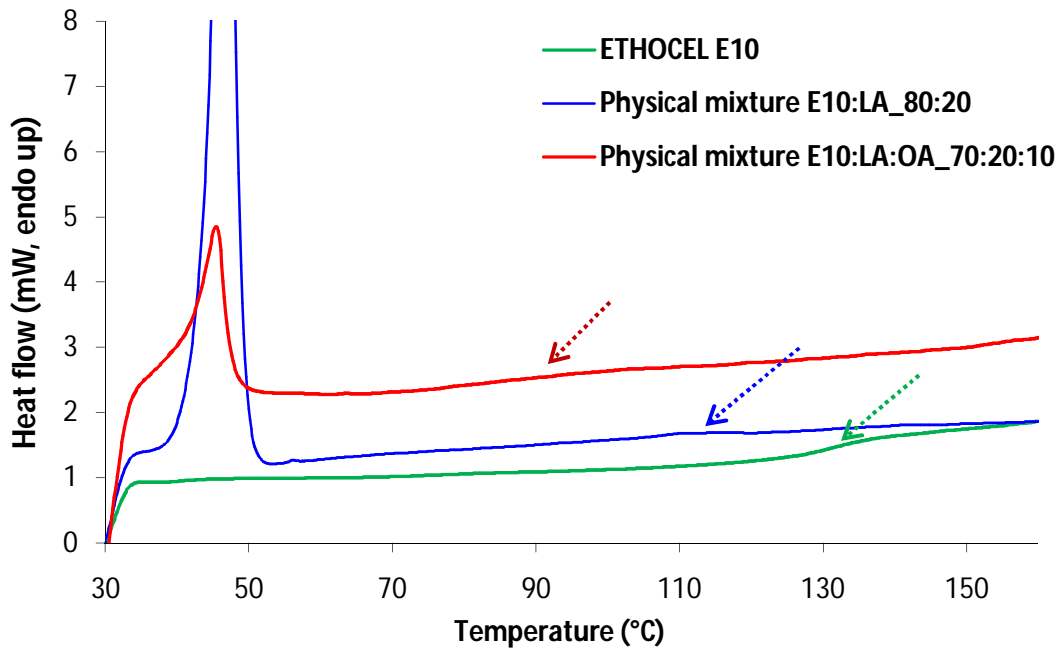

In Figure 35, T_g values assessed throughout the DSC measurements were plotted as a function of the percentage of LA (based on the dry polymer weight) added to the coating formulation (10 – 30% w/w) in presence of 5%, 10% and 20% w/w of OA.

Figure 35: T_g values plotted as a function of the percentage of LA (10 – 30%) in presence of OA (5 -20%).

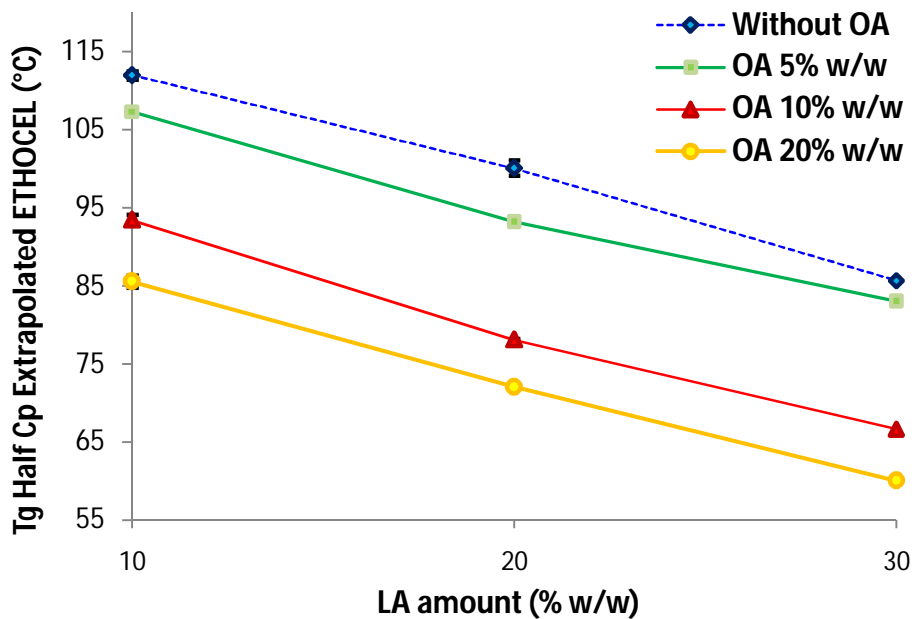

It can be noticed that, the main solid plasticizer, LA, and the second liquid one, OA, had a synergistic effect in lowering Tg of the polymer. Indeed, the physical mixture containing the 30% w/w only of LA exhibited a Tg value equal to 85.69 (\pm 0.98) $^{\circ}$ C. This value decreased to 78.07 (\pm 0.72) $^{\circ}$ C in the physical mixtures based on LA:OA/2:1 weight ratio maintaining, thereby, the total amount of plasticizer closed to 30% w/w and reaching the target Tg value.

Afterwards, the influence of KVA 64 as adjuvant to prevent the surface re-crystallization of lauric acid on the glassy transition temperature of the plasticized ethylcellulose was evaluated. The Tg values assessed by means of DSC measurements are listed in Table 29 and they were plotted as a function of the percentage of LA (based on the dry polymer weight) added to the coating formulation (10 – 30% w/w). The graph obtained is depicted in Figure 36. KVA 64 didn't affected the glassy transition temperature of the plasticized ethylcellulose.

Table 29: Tg ($^{\circ}$ C) \pm SD of ternary physical mixtures based on Ethocel E10: LA: KVA 64 at different concentrations.

<i>Ethocel (%w/w)</i>	<i>Plasticizer (% w/w)</i>	<i>Adjuvant (%w/w)</i>	<i>physical mixture</i>	
E10	LA	KVA 64	ratio(% w/w)	Tg ($^{\circ}$C) \pm SD
87.5	10		87.5:10:2.5	113.96 \pm 0.65
77.5	20	2.5	77.5:20:2.5	103.75 \pm 0.31
67.5	30		67.5:30:2.5	89.98 \pm 0.54

Figure 36: Tg values plotted as a function of the percentage of LA (10 – 30% w/w) in absence and presence of a fixed concentration of KVA 64 (2.5 % w/w).

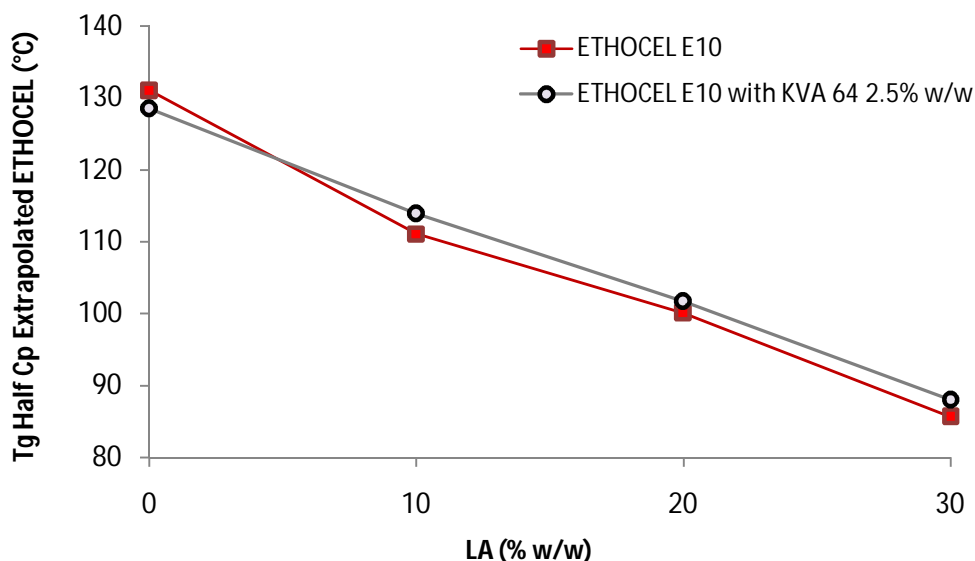

11.3.2. Free Films Characterization

In order to better understand the film formation process and to achieve the minimum film forming temperature (MFFT) of each coating blend, free film were prepared and analysed. The free films based on ethylcellulose as hydrophobic coating agent have been classified into 5 groups (Table 30) according to the amount of the main solid plasticizer, LA, added to the coating formulation (10/15/20/25/30 % w/w). Oleic acid was the second liquid plasticizer acting as adhesion enhancer. The experiments considered also the addition of Kollidon –vinyl acetate copolymer (KVA 64). The degree of the film formation was determined by observing the appearance of transparency of the free film.

Table 30: MFFT of the free films.

<i>type</i>	<i>Ethocel</i>	<i>Plasticizers (% w/w)</i>		<i>Adjuvants KVA 64 (% w/w)</i>	<i>Free – Film ratio (% w/w)</i>	<i>MFFT (°C)</i>
	<i>% (w/w)</i>	<i>LA</i>	<i>OA</i>			
E7	90	10	-	-	90:10	-
	90		-		90:10	-
E10	85	10	5	-	85:10:5	100
	80		10		80:10:10	90
E20	90	10	-	-	90:10	-
E7	77.5	15	7.5	-	77.5:15:7.5	85
	75		10		75:15:10	
E7	75	15	7.5	2.5	75:15:7.5:2.5	85
	72.5		10		72.5:15:10:2.5	
E7	80	20	-	-	80:20	100
	80		-		80:20	
E10	75	20	5	-	75:20:5	90
	72.5		7.5		72.5:20:7.5	80
	70		10		70:20:10	80
	65		15		65:20:15	75
	60		20		60:20:20	70
	50		30		50:20:30	50
	72.5		5		72.5:20:5:2.5	90
E10	70	20	7.5	2.5	70:20:7.5:2.5	80
	67.5		10		67.5:20:10:2.5	80
E10	70	20	5	5	70:20:5:5	90
	67.5		7.5		67.5:20:7.5:5	
	65		10		65:20:10:5	80
	60		15		60:20:15:5	
	55		20		55:20:20:5	70
	45		30		45:20:30:5	50

E10	77.5	20	-	2.5	77.5:20:2.5	100
E20	80	20	-	-	80:20	100
	70		5		70:25:5	
E10	67.5	25	7.5	-	67.5:25:7.5	80
	65		10		65:25:10	
	67.5		5		85:10:5	
E10	65	25	7.5	2.5	65:25:7.5:2.5	80
	62.5		10		62.5:25:10:2.5	
	65		5		65:25:5:5	
E10	62.5	25	7.5	5	62.5:25:7.5:5	80
	60		10		60:25:10:5	
E7	70	30	-	-	70:30	90
	70		-		70:30	90
	65		5		65:30:5	
E10	62.5	30	7.5	-	62.5:30:7.5	80
	60		10		60:30:10	
	62.5		5		62.5:30:5:2.5	
E10	60	30	7.5	2.5	60:30:7.5:2.5	80
	57.5		10		57.5:30:10:2.5	
	60		5		60:30:5:5	
E10	55	30	10	5	55:30:10:5	80
E20	70	30	-	-	70:30	90

All the films based on both 10% w/w and 15% w/w of lauric acid did not achieve the Tg target value as about 80°C closed to the working temperature allowed by the high shear granulator. All the films with 20% of LA and more than 7.5 % w/w of OA reached the Tg target value between 50°C and 80°C and the presence of KVA form 2.5% w/w to 5% w/w to prevent the lauric acid surface re- crystallization didn't avoid the film formation.

With regards to the stability, cured and uncured free - films based on at least 1.33:1 weight ratio of LA:OA (i.e. 20% LA and 15% OA) resulted stable for one year (Tables 30 and 31) and no re-crystallization of low melting fatty acid occurred, even in absence of KVA 64 (Figure 37a). Moreover, cured free films based on 2:1 ratio of LA:OA (i.e. 20% LA and 10% OA) resulted stable for one year only in presence of 5 % KVA 64. Contrarily, LA re- crystallized throughout the surfaces of both 10 cured and uncured free films based on 2:1 ratio of LA:OA when the coating blend did not contained KVA 64.

All the films containing the 25% w/w of lauric acid reached the expected Tg target value as about 80°C (Table 30), but after only 3 months of storage they didn't appear stable: lauric acid re-crystallized with or without KVA 64 on the surface of both cured and uncured free films (Tables 31

and 32). In fact, the free films analyzed by means of DSC measurements both at t_0 and $t_{1 \text{ year}}$ (Figure 37b) revealed a sharp endothermic peak at $45.08 \pm 0.35^\circ\text{C}$, temperature value very closed to the LA main melting peak, after one year of storage ($25^\circ\text{C}/60 \text{ RH}$). As previously disclosed, the free films with 30% w/w of lauric acid achieved the T_g target value but the amount of oleic acid and KVA used was too low to completely avoid or minimize the lauric acid re-crystallization at room temperature immediately after the film formation (Tables 31 and 32). This thermal behavior was clearly highlighted throughout the DSC measurements depicted in Figure 37c.

Table 31: Stability of free – films after 3, 6 months and 1 year of storage at 25°C/60% RH.

<i>Coating formulations</i>		<i>Stability (25°C / 60% RH)</i>					
<i>LA % (w/w)</i>	<i>E10:LA:OA:KVA 64 weight ratio</i>	<i>3 months</i>		<i>6 months</i>		<i>1 year</i>	
		<i>uncured</i>	<i>cured</i>	<i>Uncured</i>	<i>cured</i>	<i>uncured</i>	<i>cured</i>
20	72.5:20:7.5:0	✓	✓	✗	✓	✗	✗
	70:20:10:0	✓	✓	✗	✓	✗	✗
	65:20:15:0	✓	✓	✓	✓	✓	✓
	60:20:20:0	✓	✓	✓	✓	✓	✓
	50:20:30:0	✓	✓	✓	✓	✓	✓
	70:20:7.5:2.5	✓	✓	✓	✓	✗	✗
	67.5:20:10:2.5	✓	✓	✓	✓	✗	✗
	67.5:20:7.5:5	✓	✓	✓	✓	✗	✗
	65:20:10:5	✓	✓	✗	✓	✗	✓
	60:20:15:5	✓	✓	✓	✓	✗	✗
	55:20:20:5	✓	✓	✓	✓	✓	✓
	45:20:30:5	✓	✓	✓	✓	✓	✓
	70:25:5:0	✗	✗	✗	✗	✗	✗
	67.5:25:7.5:0	✗	✗	✗	✗	✗	✗
65:25:10:0	✗	✗	✗	✗	✗	✗	
67.5:25:5:2.5	✗	✓*	✗	✗	✗	✗	
65:25:7.5:2.5	✗	✓*	✗	✗	✗	✗	
62.5:25:10:2.5	✗	✗	✗	✗	✗	✗	
65:25:5:5	✗	✓*	✗	✗	✗	✗	
62.5:25:7.5:5	✗	✓*	✗	✗	✗	✗	
60:25:10:5	✗	✗	✗	✗	✗	✗	
30	65:30:5:0	✗	✗	✗	✗	✗	✗
	62.5:30:7.5:0	✗	✗	✗	✗	✗	✗
	60:30:10:0	✗	✗	✗	✗	✗	✗
	62.5:30:5:2.5	✗	✗	✗	✗	✗	✗
	60:30:7.5:2.5	✗	✗	✗	✗	✗	✗
	57.5:30:10:2.5	✗	✗	✗	✗	✗	✗
	60:30:5:5	✗	✗	✗	✗	✗	✗
	55:30:10:5	✗	✗	✗	✗	✗	✗

Table 32: Pictures of free films upon storage.











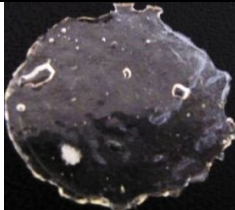
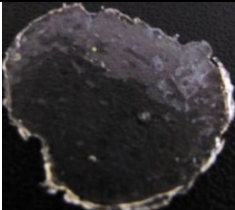

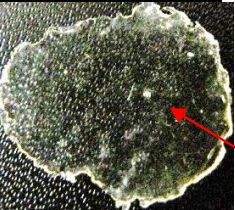
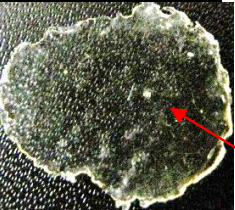

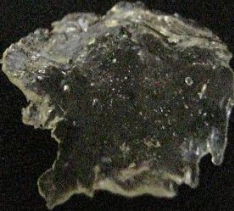
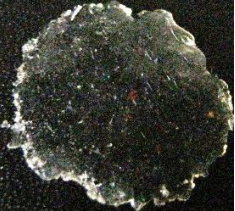

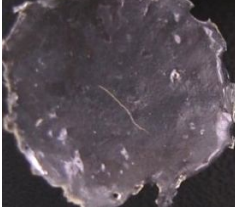

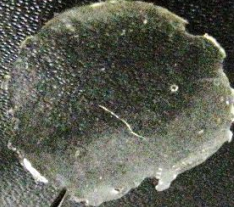

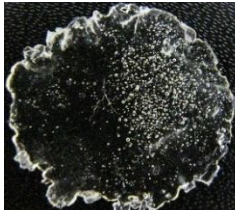
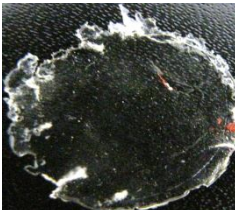

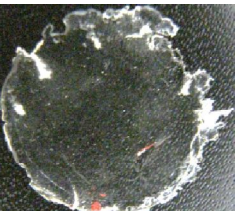
<i>Coating formulations</i>		<i>Stability (25°C / 60% RH)</i>			
E10:LA:OA:KVA 64		<i>day 0</i>		<i>1 year</i>	
<i>weight ratio</i>	<i>uncured</i>	<i>cured</i>	<i>uncured</i>	<i>Cured</i>	
70:20:10:0					
60:20:20:0					
65:20:10:5					
55:20:20:5					
62.5:25:10:2.5					
60:25:10:5					
55:30:10:5					

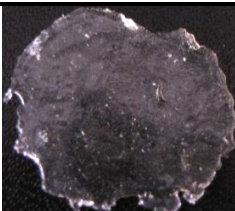
Figure 37: DSC scan of free films upon storage containing: a) 20% ; b) 25% and c) 30% w/w of LA.

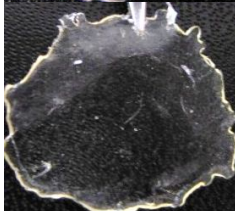
a)

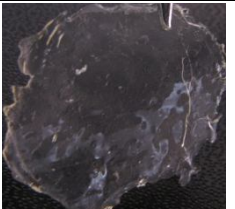
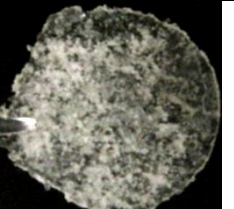

b)

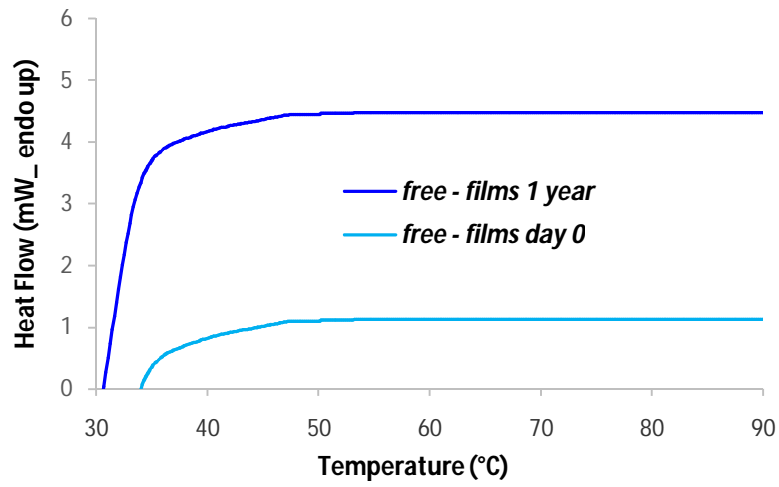
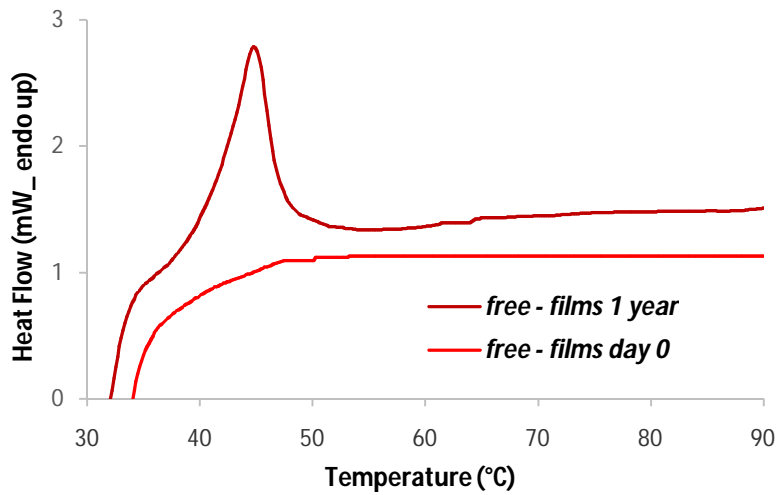

c)

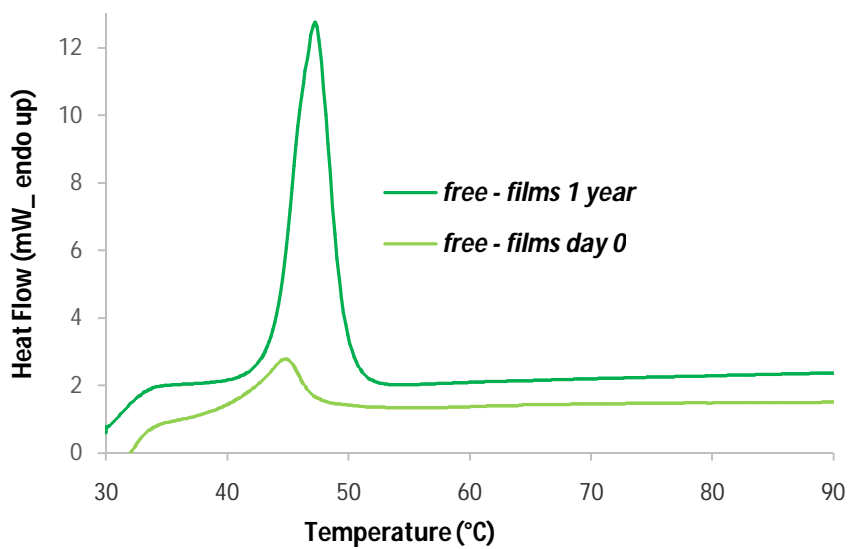

Therefore it can be stated that the optimal concentration of the solid plasticizer was 20% w/w. Formulations with lower concentration of lauric acid showed T_g of the polymer greater than 80°C, too high to be able to be maintained in the course of a coating process. At LA concentration higher than 20%, some extent of re-crystallization occurred: lauric acid molecules tend to diffuse out of the polymer of ethyl cellulose chains, forming crystals on the film surface, as clearly shown by the picture reported in Table 32.

Oleic acid, the liquid plasticizer, was important for the formation of the film concurring with lauric acid to a significant lowering of the MFFT. Oleic acid percentages ranging between 7.5% and 10% w/w decreased the MFFT to 80°C. To achieve lower temperature values without increase the solid plasticizer, it was necessary to increase the concentration of oleic acid up to values between 15% (MFFT= 75°C) and 20% w/w (MFFT= 70°C). In the presence of 30% of oleic acid, the film was formed at 50 °C but was extremely soft and poorly applicable to the dry powder coating process. The optimum concentration of oleic acid was thus between 10% and 20% w/w.

The curing phase was important to ensure the formation of a homogeneous and stable film over time, as well as to improve the appearance.

As regards the adjuvant, KVA 64 did not alter the fundamental properties of the film (although it slightly increased the rigidity) and acted as a stabilizer decreasing the extent of re-crystallization of the solid plasticizer; however it was not decisive for the stability of the film. Generally it was preferable to use the KVA in concentrations up to 2.5% w/w, but if used in the presence of oleic acid, it was possible to use up to 5% w/w.

11.3.3. Dry Powder Coating Process on Placebo Pellets

Dry powder coating process was performed in a laboratory scale high shear mixer granulator (Roto Lab Zanchetta IMA) and preliminary trials were conducted to optimize the equipment configuration and setting it for a layering/coating process. Then preliminary tests were performed to optimize the formulation parameters (i. e., particle size of LA) and standardize the process parameters involved (i.e. mode of addition of the excipients and their order).

11.3.3.1. Excipients' addition manner inside the equipment

The formulation based on ethylcellulose **E10 FP:LA:OA/70:20:10** exhibited a MFFT equal to 80°C and thus, was preliminarily selected as a *model coating formulation* in order to fully investigated the process related parameters. Six experiments were assessed and a batch size of 150 pellets (1180 – 1400 µm) was coated in each process in order to apply a theoretical weight gain equal to 15% w/w. In each run of coating, ethylcellulose was firstly transferred into the granulation chamber as micronized powder lower than 9.7 µm and distributed onto the cores when the impeller was rotating at the fixed rotating speed closed to 120 rpm. Afterwards, both lauric and oleic acid has been introduced into the bowl of the high shear granulator in different ways summarized in Table 25 (p. 131; paragraph 11.2.2.3).

(I) lauric acid was added as micronized powder lower than 500 µm whereas oleic acid was poured into the granulation chamber;

(II) lauric acid was molten and poured in the bowl of the high shear granulator together with the second liquid plasticizer oleic acid through the lid of the chamber;

(III) lauric acid was inserted as micronized powder lower than 150 µm whereas oleic acid was sprayed into the bowl of the high shear granulator through a liquid spray gun at 1.5 bar inserted into the lid of the granulation chamber;

(IV) lauric acid was micronized in a fine powder lower than 100 µm and, afterwards, was atomized at 3.5 bar by a compressed air gun inserted into the lid of the granulation chamber, whereas oleic acid was sprayed into the bowl of the high shear granulator through a second liquid spray gun at 1.5 bar inserted into the lid of the granulation chamber.

The anti-sticking properties of talc was also studied in order to optimize the coating efficiency. Thereby, the ability of talc to reduce pellets aggregation to each other and to minimize their adhesion both on the wall of the granulation chamber as well as on the impeller during the coating

process was evaluated. Talc, in percentages equal to 2.5% (**V**) or 5% w/w (**VI**) with respect to the amount of solid applied, was transferred into the granulation chamber together with the ethylcellulose and homogeneously distributed onto the cores before the film formation during the pre-heating phase of the dry powder coating process.

The particle size of the powders involved in the coating process was a critical key formulation parameter leading to a successful powder adhesion and improving the film properties; thereby micronized ethylcellulose powders lower than 9.7 μm and atomized lauric acid particles lower than 100 μm were necessary to assure both the adhesion around the Suglets® and the uniformity of the final film.

Based on the obtained results using this formulation, the optimized process was structured as follows: placebo pellets were pre-heated to the selected temperature of 80°C, since it is the MFFT of the model coating formulation. During the powdering phase, Ethocel® E10 fine powder (< 9.7 μm) was alternatively transferred into the granulation chamber and distributed onto the cores using an impeller speed at 120 rpm, meanwhile the main solid plasticizer lauric acid (particle size < 100 μm) was atomized inside the bowl through a compressed air spray gun at 3.5 bar inserted into the lid of the granulation chamber. Afterward, the second liquid plasticizer oleic acid was sprayed through a second spray gun at 1.5 bar to promote both polymer particle adhesion and coalescence and, thus, the formation of the film layer around the Suglets®. Talc, in percentages equal to 5% w/w with respect to the theoretical amount of solid applied, was added to coated cores at the end of the coating process, when the film formation has been already occurred, in order to minimize the percentage of aggregation of pellets during the curing step in oven at the MFFT.

Coated pellets were further cured for 24 hours in a static oven at 80°C and weight gain (wg %), total yield (%), coating efficiency (RSD_w %) expressed as the Relative Standard Deviation of the weight applied (RSD_w) on a mean of at least three coating experiments, coating loss (%) and percentage of aggregation/sticking calculated are shown in Table 33.

The results demonstrate the impact of the spreading behaviour of plasticizers and consequently their influence on the coating efficiency of the process: in agreement with the cRSD_w % results reported in Table 33, the atomization of both the main solid plasticizer lauric acid and the second liquid adhesion enhancer oleic acid at 3.5 bar and 1.5 bar respectively (**trials IV and VI**) is suggested in order to maximize the coating efficiency. The experimental weight gains applied were closed to the theoretical ones, total yields were higher than 80% (ranging from 83.59 % to 88.47 %) and cLoss decreased from 32.21% - 36.01% (**trials I - II**) to 11.53 % (**trial VI**).

The optimized dry powder coating process (*trials IV and VI*) was reproducible with relative standard deviation intra batches ($cRSD_w\%$) ranging from 3.32% to 5.39% for cured coated pellets whereas the $cRSD_w\%$ values for the untreated samples varied within 5.35 % and 7.63 %. Thus, the post coating thermal treatment at the MFFT of the coating formulation was successful for lowering the $cRSD_w\%$ values than the USP reference value closed to 6.25% and resulting in a better coating uniformity.

Furthermore, talc in percentages equal to 5% w/w optimized the percentage of sticking without significantly affecting the $cRSD_w\%$ both reducing pellets aggregation to each other and minimizing their adhesion on the wall of the granulation chamber as well as on the impeller during the coating process. Thereby, the % of aggregation of pellets lowered from 34.04 % (*trial II*) – 28.97 % (*trial IV*) without talc to 6.79 % (*trial VI*) having 5% w/w of talc.

Table 33: Dry powder coating process related parameters and $cRSD_w\%$ intra batch values.

trial n°	Dry Powder Coating Process Related Parameters					cRSD w % INTRA BATCH	
	Yield	cLoss	WG (th.) %	WG (s) %	Pellets aggregation (%)	cured (24h)	uncured
<i>I</i>	67.79	32.21	15	10.17	23.36	6.60	11.91
<i>II</i>	63.99	36.01	15	9.60	34.04	n.a	9.23
<i>III</i>	87.56	12.44	15	13.14	31.46	4.88	6.33
<i>IV</i>	86.57	13.43	15	12.99	28.97	3.32	5.35
<i>V</i>	83.59	16.41	15	12.54	13.42	5.39	7.63
<i>VI</i>	88.47	11.53	15	13.27	6.79	3.64	7.21

11.3.3.2. Excipients' addition order inside the granulation chamber

In order to investigate the impact of the order of addition of the excipients inside the working chamber on the reproducibility of the dry powder coating process, oleic acid has been colored with a lipophilic dye, *Red Sudan III* to visually evaluate the oleic acid distribution uniformity on the pellets. To this purpose, four preliminary trials were carried out using a coating formulation based on **E10:LA:OA/ 60:20:20** since it exhibits a MFFT equal 70°C and, according to the weight gain applied, the greatest amount of oleic acid required allows an easier evaluation of its distribution around the Suglets® (Figure 38). Each run of coating has been previously described in paragraph 11.2.2.3. OA was not intimately distributed onto the pellets if oleic acid was sprayed inside the

bowl after the entire amount or the half of ethylcellulose, (trial I – II described in paragraph 11.2.2.3); thus the coating uniformity wasn't reached (Figure 38a). Otherwise, during the powdering phase, if ethylcellulose and lauric acid weren't alternatively transferred into the bowl of the high shear granulator, the coating was not uniform as well.

To successfully achieve the coating uniformity (Figure 38b), placebo pellets were pre-heated to the MFFT of the coating formulation (70°C) in absence of both plasticizers (lauric and oleic acid) and ethylcellulose. Reached the working temperature required by the coating formulation, the oleic acid is continuously sprayed at 1.5 bar onto the cores to be coated through a liquid spray gun inserted into the lid of the granulation chamber in order to promote the subsequent polymer particle adhesion and coalescence and, thus, the formation of the film layer around the Suglets®.

Afterwards, during the powdering phase, Ethocel® E10 fine powder (< 9.7 µm) was alternatively transferred into the granulation chamber and distributed onto the cores using an impeller speed at 120 rpm, meanwhile the main solid plasticizer lauric acid (particle size < 100 µm) was atomized inside the bowl through a compressed air spray gun at 3.5 bar inserted into the lid of the granulation chamber. The powder coated pellets were further cured for 24 hours in a static oven at the MMFT of the selected coating formulation.

Figure 38: Oleic acid distribution uniformity evaluation.

(a) coating uniformity not reached



(b) coating uniformity reached



11.4. CONCLUSIONS

The results showed that it was possible to carry out the process of dry powder coating based on ethylcellulose without the use of water or organic solvents inside a rotogranulator, usually proper for granulation and pelletization procedures. Physical mixtures of ethylcellulose with suitable plasticizers formed transparent and flexible films. Each physical mixture or "coating formula", according to its composition showed a different MFFT.

The most active plasticizers were lauric acid, a low melting lipid, and oleic acid, a liquid fatty acid, which, besides having a synergistic effect in lowering the T_g of the polymer, worked by adhesion enhancer by "wetting" the cores. The results demonstrate that the optimal amount of lauric acid in the mixture was 20% (w/w). The best oleic acid percentages varied between 15-20% (w/w).

Another important parameter was the particle size of the powders, that greatly influenced the formation of the film and powders in the micronized form were effective.

The study on free films considered also the addition of Kollidon –vinyl acetate copolymer (KVA 64) as adjuvant to prevent the re-crystallization of lauric acid, especially when the lauric acid was in a concentration higher than 20%. Therefore, the composition of the coating mixture contained a relatively high percentage of plasticizer (35-40% w/w based on dry polymer), to allow a lowering of the T_g of the polymer from 131° C to a temperature equal to 80°C or less. A temperature range of 70-80°C was necessary to enable the process of dry powder coating inside the selected high shear rotogranulator, specifically adapted to this novel process.

The dry powder coating process was developed onto placebo pellets and the coating trials revealed that first pellets must be heated until the MFFT; then OA has to be atomized to enable the adhesion of Ethocel and lauric acid, the main polymer plasticizer. The powder was added alternately till the end of the process. The third stage of the process was the curing phase, a heat treatment able to improve the appearance of the film (transparency and uniformity) as well as the formation of a homogeneous and stable film over time.

In conclusion, a dry powder coating process based on suitably plasticized ethylcellulose was developed, highlighting the influence of the manner and order of addition of the excipients inside the equipment on the powder distribution and adhesion onto placebo pellets and finally on film uniformity.

11.5. REFERENCES

- [1] D. Sauer, M. Cerea, J. Di Nunzio, J. W. McGinity, Dry powder coating of pharmaceuticals: A review, *Int. J. Pharm.* 457 (2013) 488 – 502.
- [2] S. Bose, R. Bogner, Solventless pharmaceutical coating processes: a review. *Pharm. Dev. Technol.* 12 (2007) 115 – 131.
- [3] J. Siepman, *Progress in Film Coating*, 457 (2013) 361.
- [4] M. Cerea, L. Zema, L. Palugan, A. Gazzaniga, Recent developments in dry coating. *Pharm. Technol. Eur.* 2 (2008) 40 – 44.
- [5] N. Pearnchob, R Bodmeier, Dry polymer powder coating and comparison with conventional liquid-based coatings for Eudragit® RS, ethylcellulose and shellac, *Eur. J. Pharm. Biopharm.* 56 (3), (2003) 363 – 369.
- [6] N. Pearnchob, R Bodmeier, Coating of pellets with micronized ethylcellulose particles by a dry powder coating technique, *Int. J. Pharm.* 268 (1–2) (2003) 1 – 11.
- [7] I. Terebesi, R. Bodmeier, Optimized process and formulation conditions for extended release dry polymer powder-coated pellets, *Eur. J. Pharm. Biopharm.* 75 (2010) 63 – 70.
- [8] M. Smikalla, A. Mescher, P. Walzel, N.A. Urbanetz, Impact of excipients on coating efficiency in dry powder coating, *Int. J. Pharm.* 405 (2015) 122 – 131.
- [9] M.Qiao, L. Zhang, Y.Ma, J. Zhu, W. Xiao, A novel electrostatic dry coating process for enteric coating of tablets with Eudragit® L100-55, *Eur. J. Pharm.* 83 (2013) 293 – 300.

12. CASE STUDY 2: A novel dry powder coating of pellets using ethylcellulose. Part II: Process optimization on placebo pellets and on drug-loaded pellets.

12.1. INTRODUCTION

The first example of a dry coating was realized in 1999 by Obara, as part of a filming process in which an enteric coating upon pellets and tablets was applied [1]. The polymer used was hypromellose acetate succinate (HPMCAS, Shin-Etsu), while the liquid plasticizer, triethyl citrate (TEC), was sprayed at the same time the addition of the polymer. The pellet coating was conducted both in a centrifugal granulator and in a fluidized bed, while the tablets were coated in perforated coating pan.

Pearnchob and Bodmeier [2 – 4] reported a series of experiments of liquid assisted coating of pellets using a physical mixtures of several polymers (ethylcellulose, Eudragit® RS and shellac), employing a fluid bed in the Würster configuration. The tested plasticizers, which include TEC, acetyl tributyl citrate (ATC) and acetylated monoglycerides (AMG), were spray-dried in the course of the process. For each plasticizer various concentrations, respectively 20%, 30% and 40% on the dry weight of the polymer, were investigated and in a second stage they were diluted with an aqueous 10% solution of HPMC to limit the pellets agglomeration.

HPMCAS was also employed as a polymer of dry powder coating by other researchers to produce enteric coated pellets and as plasticizer, a liquid mixture consisting of TEC, glycerol triacetate and AMG, were employed. The process was conducted in a fluid-bed granulator [5; 6].

Cerea et al. (2008) used the same excipients (HPMCAS plasticized by TEC or mixtures of TEC and AMG nebulised) for dry coating soft gelatin capsules [7].

Examples of dry powder coating based on the principle of thermal adhesion were conducted by the same researchers of the University of Milan, which coated tablets using Eudragit® E PO as polymer and various solid additives such as glycerol monostearate, PEG 3350 and PVP K-90, pre-mixed with the polymer inside of a spheronizer, suitably adapted [8].

In literature, a further strategy of dry powder coating based on thermal adhesion was reported and consisted in the physical mixing of polymer and plasticizer to form single solid component, which was then added to the substrate during the process. This technique was applied in 2004 by Zheng on theophylline-loaded tablets and a mixture of Eudragit® RS/RL PO (95: 5) pre-plasticized with TEC by hot melt extrusion, were used. In this case the atomization phase of the liquid component during the process was deleted [9].

Finally, Sauer used the same technique of Zheng to film tablets with Eudragit® L 100-55 pre-

plasticized with a 40% w / w of the TEC. During the process the mixture of solid coating consisting of polymer and plasticizer, PEG 3350, used as a solid adhesive agent was added [10].

More recently, the dry powder coating technique has been exploited with success in the production of muco- adhesive pharmaceutical dosage forms with the aim to increase the oral bioavailability of the active ingredient. For instance, Cao et al. [11] obtained muco- adhesive pellets of valsartan, using as HPMC and carbomer polymers (CB), the polymer mixture suitable to ensure good adhesion to the walls of the gastrointestinal tract. The process of dry coating was carried out in a spheronizer and the polymer mixture was added simultaneously to a solution of 70% ethanol as wetting agent and SiO₂ as lubricant.

In this research a novel dry powder coating process based on both liquid assisted and thermal adhesion technology was set up and its development is reported in the Part I of the study. Once the process parameters (impeller speed, temperature, method and order of powder layering) and the main formulation variables (size and molecular weight of the dry polymer, kind and amount of plasticizers and of adjuvant, minimum film forming temperature (MFFT)) were established (Part I), in the second part of the research (Part II) the process was optimized on placebo pellets to assess the best coating formulation in terms of yield, coating loss, pellets aggregation and relative standard deviation (RSD) of the weight. The coating experiments considered also the addition of Kollidon – vinyl acetate copolymer (KVA 64) as adjuvant and different weight ratio between plasticizers and KVA 64 were studied to prevent the surface re-crystallization of lauric acid upon storage. The stability of dry coated pellets was investigate over 1 year. The coating efficiency was then assessed on loaded pellets and the extent of drug release over time through the applied coating layer was studied. Caffeine (CFN) was selected as BCS class I model drug, being suitable for formulating modified release systems. To this aim, the effect of weight gain, drug loading, Suglets® particle size, coating formulation and of glidants on the drug release profiles was fully investigated.

12.2. MATERIALS AND METHODS

12.2.1. Materials

Ethocel® Standard E10 FP (fine particle, with mean dimension of the particles of 9.7 µm), Sugar spheres (Suglets® 14/16 mesh size, 1180-1400 µm diameter, composed of sucrose and starch (batch n° DT 405540) and hypromellose (Methocel E5, Hydroxypropylmethylcellulose, HPMC, 2910 USP grade) were kindly donated by Colorcon Ltd (Dartford, Kent, UK). The plasticizers were oleic acid (OA, Carlo Erba, batch n° 3185E100) and lauric acid (LA, Sigma-Aldrich, batch n° MKBQ4605V). Kollidon-vinyl acetate copolymer (KVA 64, batch n° 61611468E0) and Aerosil® R974 were gently donated by BASF. Talc was purchased from ACEF SpA (Piacenza, Italy). Caffein (CFN) was supplied by Sigma-Aldrich.

12.2.2. Methods

12.2.2.1. Dry powder coating of placebo pellets

The dry powder coating process was performed in a laboratory scale high shear mixer granulator (Roto Lab Zanchetta IMA) and consisted of three phases: pre- heating, powdering and curing. This process was developed and set up in the Part I of the research. In this Part II of the work, several placebo formulations having different MFFT were investigated keeping fixed the process parameters and the addition order of the excipients. The theoretical weight gain was 15% (w/w). The analysed placebo formulations (P1-P6) are listed in Table 34. Talc, in percentages equal to 5% w/w with respected to the theoretical amount of solid applied, was added in all trials at the end of the coating process, before the curing process. Curing at minimum film forming temperature (MFFT) for 24 hours in an air forced oven was then performed.

Weight gain (WG %), total yield (%), coating loss (%), coating efficiency (RSD_w %) and pellets aggregation (%) were calculated as follows:

$$WG \% = \frac{W_{CP} - W_{LP}}{W_{LP}} * 100 \quad \text{Eq. 18}$$

$$Yield \% = \frac{W_{LP}}{W_S} * 100 \quad \text{Eq. 19}$$

$$Coating loss \% = \frac{W_{th} - W_r}{W_{th}} * 100 \quad \text{Eq. 20}$$

$$RSD_W = \frac{\sqrt{(SDW_{CP})^2 - (SDW_S)^2}}{W_{CP} - W_S} * 100 \quad \text{Eq. 21}$$

where: W_S = mean weight of placebo (equivalent to uncoated pellets), W_{CP} = mean weight of coated pellets, W_{th} = weight of solids to be applied and W_r = weight of solids applied.

In particular, ${}_cRSD_W$ % was expressed as the Relative Standard Deviation of the weight applied (RSD_W) on a mean of at least six measurements on 50 pellets within the same coating experiment.

The pellets aggregation was determined by calculating the percentage of coated pellets that did not pass through a 2000 μm sieve with respect to the collected amount of pellets at the end of the process, since single coated pellets had dimension lower than 2000 μm .

Table 34: Dry powder coating on placebo pellets. The theoretical WG was 15% w/w.

Batch	E10:LA:OA:KVA	MFFT	Yield	cLoss	WG	Pellets	${}_cRSD_W$ % intra batch	
	Weight ratio	(°C)	%	%	%(exp.)	aggregation (%)	cured	uncured
P1	70:20:10:0	80	88.47	11.53	13.27	6.79	3.64	7.21
P2	65:20:10:5	80	85.83	14.18	12.87	9.21	5.01	6.88
P3	65:20:15:0	75	93.91	6.09	14.09	10.11	1.16	4.12
P4	60:20:20:0	70	89.24	10.76	13.39	16.24	4.76	6.05
P5	55:20:20:5	70	87.42	12.58	13.14	13.55	5.93	6.96
P6	55:20:25:0	70	74.78	25.23	11.22	Maximum	8.61	24.09

12.2.2.2. Preparation of drug loaded pellets: CFN solution layering

Drug loaded multiparticulate pellets were prepared by solution layering, involving the deposition of the CFN onto starting non Suglet[®] seeds in a Mini-Glatt fluidized bed (Glatt GmbH, Binzen, Germany) equipped with a Wurster column (bottom spray assessment).

The aqueous layering solution was prepared adding 2% or 4% of CFN to a 5% w/w HPMC E5 solution. Drug layering conditions within the fluid bed equipment were: inlet air temperature 60 \pm 0.5°C; product temperature 33.8 \pm 0.5 °C; fluidization air flow in the range 18-22 Nm³/h; atomizing air pressure 1.43 \pm 0.60 bar and a spray rate 1.9 \pm 0.01 g/min.

The yield, the theoretical drug loading and the process efficiency expressed as the Relative Standard Deviation of the weight applied (RSD_W) on a mean of at least seven (2% CFN) or two (4% CFN) layering experiments [109; 110] were calculated using the following equations:

$$\text{Yield \%} = \frac{W_{LP}}{W_S} * 100 \quad \text{Eq. 22}$$

$$\text{Theoretical drug loading} = \frac{W_{CFN} \cdot W_{LS}}{W_S + W_P + W_{CFN}} \quad \text{Eq. 23}$$

$$RSD_w \% = \frac{\sqrt{(SDW_{LP})^2 - (SDW_S)^2}}{W_{LP} - W_S} * 100 \quad \text{Eq. 24}$$

where: W_{LP} = mean weight of loaded pellets; W_S = mean weight of Suglets; W_{CFN} = CFN weight; W_{LS} = weight of layering solution; W_P = polymer weight and SD= standard deviation.

12.2.2.3. Dry Powder coating process on CFN-loaded pellets

The drug-loaded pellets were then coated using the systematic approach based on both liquid assisted and thermal adhesion technology optimized using placebo pellets.

A batch size of 150 g caffeine loaded pellets (1180 - 1400 μm) was coated. First, the powder adhesion onto the sugar beads surface was promoted by the liquid plasticizer oleic acid continuously atomized at 1.5 bar by a compressed air gun inserted into the lid of the granulation chamber. Afterward, Ethocel® E10 FP was alternatively transferred into the granulation chamber and distributed onto the cores using an impeller speed at 120 rpm (the lowest rotation speed allowed), meanwhile the main solid plasticizer lauric acid (particle size < 100 μm) was atomized inside the bowl through a second spray gun at 3.5 bar to promote the coalescence of the powder particles and the formation of the final film layer around the Suglets®.

The coated pellets were further cured for 24 hours in a static oven at the MMFT of selected coating formulations based on two different weight ratio of E10FP:LA:OA: the first one was 60:20:20 and second one was 65: 20: 15. Moreover, the introduction of talc or Aerosil® R974 within the coating formulation as adjuvant to avoid agglomeration and sticking of pellets during the coating process and curing step. From a practical point of view, the anti-sticking agents were added extra-formulation in percentages equal to 2.5% or 5% w/w with respected to the theoretical amount of solid applied. Overall eleven different trials at three different theoretical weight gain: 10%, 15% and 20% were performed. The analyzed formulations are shown in Table 35.

Drug loading (CFN%), weight gain (WG %), total yield (%), pellets aggregation (%), coating efficiency ($cRSD_w$ %) expressed as the Relative Standard Deviation of the weight applied (RSD_w) on a mean of at least six measurements on 50 pellets within the same coating experiment and coating loss (%) were evaluated.

$$WG \% = \frac{W_{CP} - W_{LP}}{W_{LP}} * 100 \quad \text{Eq. 25}$$

$$Yield \% = \frac{W_{LP}}{W_S} * 100 \quad \text{Eq. 26}$$

$$Coating\ loss\ \% = \frac{W_{th} - W_r}{W_{th}} * 100 \quad \text{Eq. 27}$$

$$RSD_w \% = \frac{\sqrt{(SDW_{CP})^2 - (SDW_{LP})^2}}{W_{CP} - W_{LP}} * 100 \quad \text{Eq. 28}$$

where: W_{LP} = mean weight of loaded pellets (equivalent to uncoated pellets), W_{CP} = mean weight of coated pellets, W_{th} = weight of solids to be applied and W_r = weight of solids applied.

Table 35: Experiments of dry powder coating process of CFN-loaded pellets starting from Suglets® of 1180 - 1400 µm size.

Batch	E10:LA:OA Weight ratio	Antisticking agent		Th. wg.(%, w/w)	Th CFN content(%, w/w)
		Type	Addition way		
I	60:20:20	-	-	10	2
II	60:20:20	-	-	15	2
III	60:20:20	-	-	20	2
IV	60:20:20	-	-	15	4
V*	60:20:20	-	-	15	4
VI	65:20:15	-	-	15	2
VII	60:20:20	Talc, 5%	at the beginning	15	2
VIII	60:20:20	Talc, 5%	at the end	15	2
IX	60:20:20	Talc, 5%	throughout the whole process	15	2
X	60:20:20	Talc, 2.5%	atomized with lauric acid	15	2
XI	60:20:20	Aerosil® R794, 2.5%	atomized with lauric acid	15	2

* different pellets size: 850-1000 µm.

12.2.2.4. Determination of drug content

The determination of CFN content within each batch was performed off-line throughout the whole manufacturing process. Briefly, 50 mg of each sample has been accurately weighed, ground to a fine powder using pestle and mortar and dissolved in 50 ml of phosphate buffer pH 6.8. The

system was shaken for 45 minutes. Finally, the solution was filtered and the drug content has been spectrophotometrically assayed at 273 nm (Unicam Helios β Thermoscientific, Milan, Italy). The analytical method was validated in terms of linearity, sensitivity expressed as limit of detection (LOD) and limit of quantification (LOQ) and finally repeatability. The correlation coefficient (r^2) was 0.9997 (range of concentration 0.1 – 20 $\mu\text{g/ml}$); the LOD was 0.029 ($\mu\text{g/ml}$) and the LOQ was 0.088 ($\mu\text{g/ml}$). For the repeatability study three absorption measures for three samples with different well-known concentrations (0.5; 5; 20 $\mu\text{g/ml}$) had been collected and the answer factor was found to calculate the coefficient of variation (CV%). CV % had a value smaller than 0.25 for each level of concentration, demonstrating the repeatability of measurements.

The results of the drug content are expressed as a mean of at least three determinations \pm standard deviation (SD). The % relative standard deviation of drug content (RSD_c) was calculated using the following equation:

$$\text{RSD}_c \% = \frac{SD}{\text{meanCFNcontent}} * 100 \quad \text{Eq. 29}$$

12.2.2.5. In vitro drug release studies

In vitro dissolution tests of pellets was performed using USP II dissolution apparatus (ERWEKA DT800) rotating at 50 rpm in 500 ml phosphate buffer pH 6.8 and at a temperature of $37 \pm 0.5^\circ\text{C}$. Each sample contained about 8-10 mg of CFN. The studies ran over a period of 90 minutes during which 3 ml aliquots of the release medium were collected at specific time intervals and replaced with an equal volume of fresh medium. The samples were filtered (0.45 μm) and assayed for caffeine spectrophotometrically at $\lambda=273$ nm. The mean of at least six determinations has been used to determine the API release for each formulation.

Comparison between drug release profiles from pellets were carried out using both the similarity factor f_2 and the difference factor f_1 . The difference factor is proportional to the average difference between the two profiles, whereas the similarity factor [12] is a logarithmic reciprocal square-root transformation of the sum of squared error and is a measurement of the closeness in percentage of dissolution between two release profiles.

$$f_1 = \left\{ \frac{\sum_{t=1}^n |R_t - T_t|}{\sum_{t=1}^n R_t} \right\} * 100 \quad \text{Eq. 30}$$

$$f_2 = 50 * \log \left\{ 1 + \left[\frac{1}{n} * \sum_{t=1}^n (R_t - T_t)^2 \right]^{-0.5} * 100 \right\} \quad \text{Eq. 31}$$

where n is the sampling number, R_t and T_t are the cumulative percent dissolved of the reference and the test products at each time point t .

In dissolution profile comparisons, especially to assure similarity in product performance, regulatory interest is both in knowing how closeness two curves are and to have a measure which is more sensitive to large differences at any particular time point. For f_2 and f_1 values calculation, sampling number lower than 85% of drug released have been considered. The similarity factor fits the result between 0 and 100. Two drug release profiles are similar if the f_2 is greater than or equal to 50 and f_1 values are less than or equal to 15.

12.2.2.6. Pellets morphological analysis

During the process optimization, the surface of the coated pellets was observed using an optical microscope (Nikon SNZ 2T) connected through a camera (Panasonic GP KR 222) to an image acquisition system (CV 9000, FKV S.r.l. BG, Italy). Moreover, scanning electron microscopy (SEM) was used both to better evaluate the surface morphology of CFN-loaded pellets. Samples were fixed on the sample holder with a double sided adhesive tape, sputter coated with Au/Pd under an argon atmosphere performed using a vacuum evaporator (Edwards, Crawley UK) and examined by means of a scanning electron microscope SEM (Philips XL30) operating at an accelerating voltage of 20 kV.

12.2.2.7. Pellets thermal analysis

The thermal properties of unloaded and CFN-loaded pellets were characterized using a differential scanning calorimeter (DSC) Perkin-Helmer DSC 6 (Perkin-Elmer, Beaconsfield, UK) equipped with Pyris Software. Samples, weighting 8-12 mg, were sealed in an aluminium pan and heated from 25°C to 180°C at a scanning rate of 10°C/min under a nitrogen flow rate of 20 ml/min. Each analysis was carried out in duplicate experiments. The mean glass transition temperature (T_g) of the coating formula and the fusion of the drug were then calculated.

12.2.2.8. Long term storage stability of pellets

To assess long term storage stability, uncured and cured pellets were stored at 25°C/ 60 ± 0.5% relative humidity (R.H.) in PE closed bottles. Drug release from pellets was measured after 1 year of storage. Day 0 corresponded to the day after the preparation of layered and coated pellets.

12.3. RESULTS AND DISCUSSION

12.3.1. Optimization of the Process on Placebo Pellets

A novel dry powder coating process using ethylcellulose as film forming agent was maximized and six different coating formulations were additionally investigated for further coating experiments. The composition of the different formulations with respect to the results of the coating procedure are listed in Table 34 (p. 158).

The experimental weight gain applied was closed to the theoretical one for each run of coating. All formulations wherein the plasticizers ratio LA:OA was 1:1 or 2:1 displayed total yields higher than 85% and ranging from 85.83 % to 93.91 % (P1 – P5). On the contrary, P6 having more OA than LA exhibited a total yield closed to 75% and a doubled coating loss % (25.23 %) with respect to the previous trials. Therefore a larger amount of the liquid plasticizer could minimize pellets fractiousness and promote the coalescence of the powder particles leading to a successful powder adhesion around the Suglets® and film uniformity. On the other hand an excessive percentage of liquid plasticizer resulted in pellets aggregation (Table 34, p. 158) and further adhesion on the wall of the granulation chamber, increasing coating losses and agglomeration, even in presence of lubricants. In the last formulation (P6), having the highest OA concentration, the pellets aggregation was absolute as reported in Figure 39.

Figure 39: Pellets aggregation inside the granulation chamber.



Optical microscopy was then used to evaluate the surface morphology of pellets and the captured images are shown in Figures 40 and 41.

Figure 40 depicted the surface morphology of a pellet raw material with respected to dry coated uncured pellets. Suglets® looked opaque and perfectly spherical whereas uncured coated pellets exhibited a more glossy and less regular surface and, thereby, it's possible to clearly recognize a certain powder deposition around the pellets surfaces.

Figure 40: Surface morphology of a pellet raw material with respected to dry coated uncured ones.

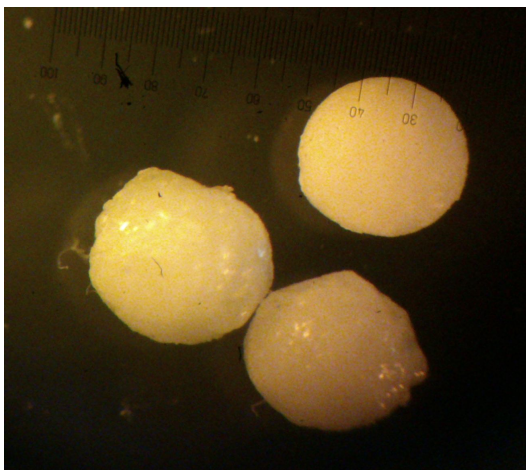

← *Suglets raw*

← *Dry coated pellets*

Moreover, figure 41 compared the surface morphology of cured pellets with respected to the untreated ones in order to evaluate the impact of a post coating thermal treatment for 24 hours at the MFFT of the coating formulation on both the appearance of the final film.

Figure 41: Surface morphology of cured pellets with respected to the untreated ones.

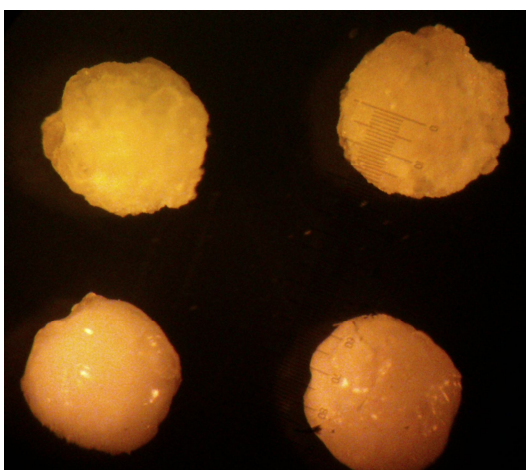

← *Dry coated uncured pellets*

← *Dry coated cured pellets*

Once the suitable temperature was obtained, during the dry powder coating both plasticizers LA and OA interposed between the polymer chains and lowered the T_g of ethylcellulose, thereby

significantly enhancing the mobility of the polymeric system. The greater mobility allowed for molecular rearrangement and alters the plastic deformation characteristics of the materials. Based on literature [13], the addition of low melting materials or liquid excipients to the overall composition is a common approach in many dry powder coating formulations to improve coalescence and adhesive properties. When processing above the glass transition temperature of a coating material, the surface is more “liquid-like” and more susceptible to plastic deformation.

Depending on the difference between glass transition temperature and processing temperature, the viscosity of the coating material can be reduced sufficiently to result in the formation of capillary forces which aid in the adherence and coalescence of the powder to the pellets surface promoting of the final film layer around the Suglets®. Nevertheless, a complete particle coalescence couldn't occur at the end of the dry powder coating process and, thus, a post coating thermal treatment was absolutely required in order to obtain a continuous film. Indeed, treated samples exhibited a more homogeneous and less wrinkled surfaces with respect to the untreated pellets (as shown in Figure 41).

The $cRSD_w\%$ intra-batch for the optimized process are listed in Table 34 (p. 158). Dry powder coating resulted reproducible both for uncured and cured pellets, especially for P3 and P4 coating formulations (E10:LA:OA weight ratio at 65:20:15 and 60:20:20, respectively). $cRSD_w\%$ values were less than 6.25 % and ranging from 1.16 % to 4.76 % for treated samples and from 4.12 % to 6.05 % for the untreated ones. Therefore the best coating formula were P3 and P4.

Moreover, the solid state of the pellets, especially of the main solid plasticizer lauric acid, was investigated by means of DSC and the stability of cured samples during storage was evaluated. After six months of storage (graphs not shown) at 25°C/60 RH any re-crystallization of lauric acid occurred for the coating formulations with the plasticizers LA:OA weight ratio of 2:1 (P1 and P2) or 1:1 (P4 and P5), both for uncured and cured pellets. After one year of storage, only P1 pellets showed a clear endotherm associated to LA re-crystallization both for uncured and cured samples. These results indicate that curing was not sufficient enough to completely inhibiting the plasticizer re-crystallization process and the presence of 5% (w/w) of KVA 64 in P2 was fundamental to pellets stability; therefore the 1:1 plasticizers weight ratio (corresponding to a 40% w/w based on the dry polymer) resulted the better coating formula. Figure 42 depicted the DSC scans of both cured and uncured pellets with respect to the initial DSC trace of P1 pellets. In the case of P3 sample having a LA:OA weight ratio of 1.33 to 1, both uncured and cured pellets remained stable

after 1 year of storage (graph not shown). The percentages of LA re- crystallization are listed in Table 36.

Figure 42: DSC scans of uncured and cured pellets based on P1 coating formulation at day 0 and after 1 year of storage at 25°C/60 RH.

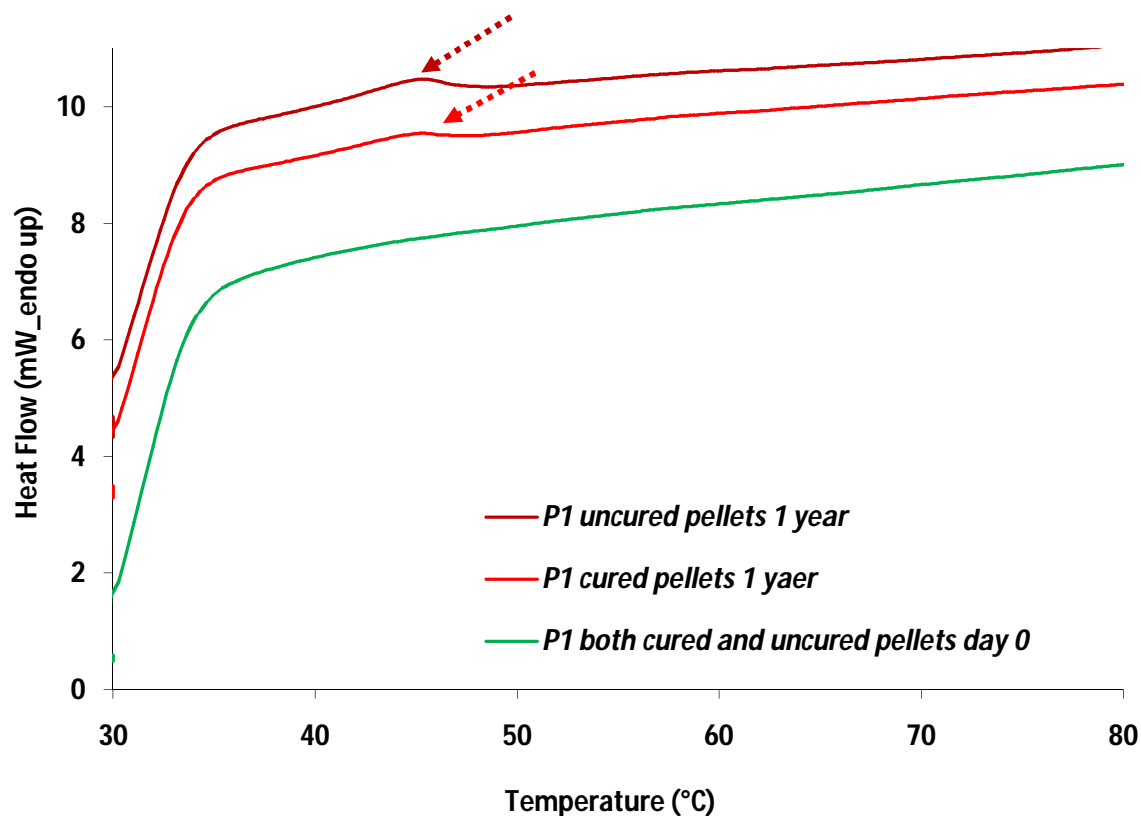

Table 36: Percentages of LA re- crystallization.

trial	LA/OA RATIO	KVA 64 (5% w/w)	% LA re - crystallized <i>after 1 year</i>	
			cured samples (24 h)	uncured samples
P1	2:1	X	0.27	4.31
P2	2:1	✓	✓	✓
P3	1.33:1	X	✓	✓
P4	1:1	X	✓	✓
P5	1:1	✓	✓	✓

Therefore, coated pellets based on 1:1 and 1.33:1 weight ratios of oleic acid and lauric acid resulted stable for one year and no re-crystallization of the solid plasticizer occurred, even in absence of KVA 64 and were selected for further investigations.

12.3.2. Preparation of Drug Loaded Pellets (Drug Layering)

To assess the coating efficiency, in the next step the caffeine loading onto the starting pellets with a solution layering process was performed. CFN concentrations of 2% and 4% (w/w) were beneath than the saturation solubility in the 5% (w/w) HPMC solution; while CFN concentration higher than 4% (w/w) produced a suspension.

The results related to drug layering trials are summarized in Table 37 and evidenced a very good yield and a good layering efficiency: the mass variability based on RSD_w calculation was 3.92%, indicating a good reproducibility of the process. In relation to the low drug loading ranging from 1.79 % to 2.32 %, the value of the obtained RSD_c is of relevance ($\leq 2\%$). In fact, to assure the quality of dosage units, the drug content of each unit in a batch should be distributed in a narrow range around the label strength. Generally, RSD values can vary depending on the drug concentration and a low RSD ensures a small distribution of the values around the average value [14 - 16]. Increasing the drug loading to the theoretical value of 4%, the layering efficiency mildly increased, as the RSD_w reduced from 3.92 % to 2.84 %. Furthermore, CFN content resulted very closed to the theoretical one and the RSD_c highlighted a good drug loading uniformity. Thus, increasing CFN concentration in the hypromellose – based layering solution did not affect the mass variation.

The RSD_w results demonstrated the repeatability and robustness of the technological procedure performed in fluid bed. Therefore, the layering process was performed in a reproducible and well – controlled manner and the uniformity of dosage units was obtained.

Table 37: Results of drug layering processes.

<i>Batch</i>	<i>Yield (%)</i>	<i>powder Loss (%)</i>	<i>RSD_w %</i>	<i>% CFN ($\pm SD$)</i>	<i>%RSD_c</i>
L1	89.61	10.39		1.79 (± 0.01)	0.4
L2	92.53	7.47		1.89 (± 0.03)	1.78
L3	98.38	1.62		1.90 (± 0.04)	2.00
L4	94.48	5.52	3.92	1.98 (± 0.02)	1.27
L5	97.66	2.34		2.18 (± 0.03)	1.35
L6	99.49	0.51		2.18 (± 0.04)	1.96
L7	99.59	0.41		2.32 (± 0.00)	0.14
L8	92.26	7.74	2.84	4.07 (± 0.05)	1.22
L9	96.67	3.34		4.06 (± 0.01)	0.36

12.3.3. Dry Powder Coating Process on Caffeine Loaded Pellets

Based on the results of process optimization, the coating blend based on E10FP:LA:OA/60: 20: 20 (P4) (MFFT closed to 70°C) was selected as model coating formulation and drug loading (CFN%), weight gain (WG %), total yield (%), coating loss (%), pellets aggregation (%) and coating efficiency ($cRSD_w$ %) were calculated and the extent of drug release over time through the applied coating thickness was evaluated. For a better assessment of the film effectiveness, formulation P3 (MFFT at 75°C) was also applied to CFN-loaded pellets. Overall 11 coating experiments were performed and the results of the best coating trials are displayed in Table 38.

Table 38: Results of drug powder coating processes.

BATCH	WG (%)	Yield (%)	c Loss (%)	Pellets aggregation (%)	% CFN (\pm SD) layering	% CFN (\pm SD) coating	RSD _c %	$cRSD_w$ % intra batch	
								cured	uncured
I	9.87	98.69	1.31	n. d.	1.79 (\pm 0.01)	1.61 (\pm 0.03)	1.86	--	--
II	13.97	91.93	8.52	15.48	1.89 (\pm 0.03)	1.64 (\pm 0.02)	1.22	4.68	4.68
III	12.57	62.86	37.14	n. d.	1.98 (\pm 0.02)	1.73 (\pm 0.03)	1.73	3.68	3.68
IV	11.69	78.62	21.38	n. d.	4.07 (\pm 0.05)	3.59 (\pm 0.03)	0.84	--	--
V	10.87	73.45	26.55	n. d.	4.06 (\pm 0.01)	3.61 (\pm 0.02)	0.55	--	--
VI	14.54	96.30	3.70	8.40	1.90 (\pm 0.04)	1.62 (\pm 0.01)	0.62	1.02	3.98
VII	13.75	88.20	11.8	6.60	1.89 (\pm 0.03)	1.63 (\pm 0.03)	1.84	2.30	7.86
VIII	14.08	86.55	13.45	16.75	1.90 (\pm 0.04)	1.63 (\pm 0.03)	1.84	3.70	4.34
IX	13.55	83.84	16.16	13.62	2.18 (\pm 0.03)	1.88 (\pm 0.02)	1.06	3.64	7.21
X	13.39	88.39	11.61	12.81	2.18 (\pm 0.04)	1.95 (\pm 0.03)	1.54	3.01	3.41
XI	13.88	86.86	13.14	12.13	2.32 (\pm 0.00)	1.99 (\pm 0.03)	1.50	3.32	5.35

n. d.: not determined

12.3.3.1. Effect of the weight gain

In order to verify the extent of drug release over time through the coating thickness, three different theoretical weight gains ranging from 10% to 20% w/w (batches I-III) onto 1180 – 1400 μ m CFN-loaded (2% w/w) sugar sphere were applied. Considering the coating level applied, the lower weight gain, the higher was the total yield and the lower was the coating loss (batches I and II). Contrarily, increasing the coating level (batch III), total yield dramatically decreased from 98.69% to 62.86% and coating loss significantly increased to 37.14 %. These results suggested that a 20% (w/w) powder layering was too high to adhere on the pellets surface and to form the final coating.

Comparing the parameters related to the dry powder coating process assessed onto placebo pellets (batch P4, Table 34, p.158) with those of CFN loaded pellets (batch II), the yields of both trials were similar; moreover the ρ_{Loss} decreased from 10.76% of placebo pellets to 8.52% of CFN loaded ones. Considering the coating efficiency, the mass variability based on RSD_w calculation (intra-batch) was lowered from 6.05% to 4.68% indicating the uniform distribution of the coating within the processed batches. After the post-coating thermal treatment, the RSD_w mildly reduced from 4.76% to 3.68%, confirming the importance of the curing in the dry powder coating procedure.

Moreover, the ρ_{RSD_w} inter-batches values (1.84% and 3.11% for cured and uncured pellets, respectively) calculated on a mean of three coating processes, highlighted that the process was performed in a well-controlled manner and demonstrated the repeatability and robustness of the coating process. In addition, the process resulted more reproducible for the cured pellets than for the untreated ones.

With regards to drug dissolution, raw CFN is freely soluble in aqueous media as belongs to BCS class I and after two minutes it was completely dissolved (graph not shown). The 90% of the drug loaded was dissolved in 5 minutes from layered pellets and the complete dissolution occurred within 30 minutes. Analysing the pellets with the lower weight gain (9.87% w/w), the drug release from uncured pellets decreased but the 80% of the drug was dissolved within 60 minutes (Figure 43). Furthermore, no significant differences of the release profiles between the cured and the uncured pellets were observed ($f_2=60.65\pm 1.79$).

Increasing the coating level from 9.87% to 13.97% w/w (batch II), the percentage of CFN released from uncured pellets within the first hour of dissolution was equally closed to 80%, but a significant difference between the release profile of cured and uncured pellets was noticed ($f_2=44.19\pm 1.29$). In effect, the 50% of the drug loaded was released within 25 minutes, indicating that both the curing step and the higher ethylcellulose coating level most modified the CFN release rate.

To the light of the result of the first three trials, the following batches were processed to obtain a final WG of 15%.

Figure 43: Influence of coating level on CFN dissolution profile: comparison between batch I and II (both uncured and cured pellets) at day 0.

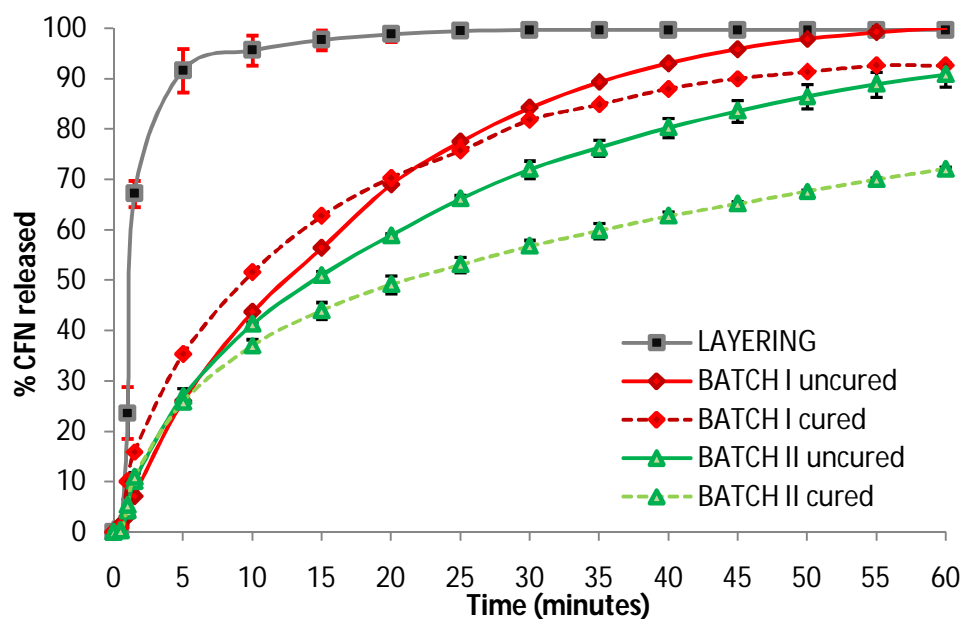

12.3.3.2. Drug loading

The real drug content of each batch was lowered according to the weight gain achieved and the variation of the API content (RSD_c %) evidenced a good drug content uniformity of dosage units.

According to the solubility of the CFN in the hypromellose based solution, the CFN loading was increased from 2.0% w/w to 4% w/w and the theoretical WG of 15% w/w was applied. The dissolution profile of 2% CFN layered pellets was superimposed to that of 4% CFN loaded sugar spheres.

Comparing the results of batch II with batch IV (Table 38, p.169), the experimental WG was a little bit lower for batch IV; while the maximum variation of the CFN content lowered from 1.22% to 0.84%, achieving a very good content uniformity. With regards to total yield and coating loss, the higher the CFN loading, the lower was the yield and the higher was the coating loss. The filling volume of the chamber was similar but batch IV pellets were bigger and the batch size resulted lower (150 g for batch II vs 135/139 g for batch IV). Moreover during the process pellets crushed more, probably because they were less hard. Moreover, the CFN release throughout the coated pellets was still controlled by diffusion through the film thickness (Figure 44). Contrarily to batch II, no significant differences on the release profiles between the cured and the uncured pellets of batch IV were noticed ($f_2=66.80 \pm 1.87$). Comparing the release profiles between the batches,

uncured pellets of batch IV exhibited a more controlled release profile with respect to the uncured pellets of batch II ($f_2=51.83$; $f_1=26.48$). Conversely, the release profiles of cured pellets of both batches were similar ($f_2=68.03 \pm 1.67$) although the extent of burst effect (as absolute value) in batch II was slightly higher.

Figure 44: Influence of drug loading on CFN dissolution profile: comparison between batch II and IV (both uncured and cured pellets) at day 0.

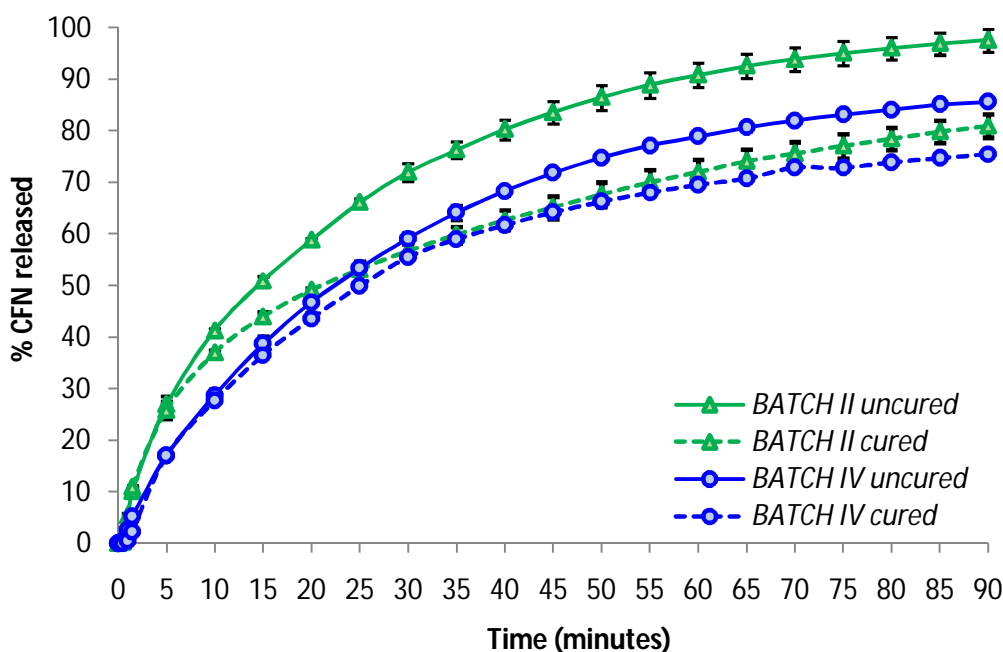

12.3.3.3. Particle size of Suglets®

Once stated the influence of both coating level and CFN loading on the properties of modified released pellets was investigated, two different particle size of the sugar spheres was then studied. Precisely, a theoretical weight gain of 15% w/w onto both 1180 – 1400 μm and 850 – 1000 μm CFN 4% w/w loaded sugar spheres was applied. The parameters related to the coating processes are shown in Table 38 (p. 169). The coated pellets of both batches (IV and V) had approximately the same coating level (11.69% vs 10.78%, respectively), indicating a good reproducibility of the process. Contrarily to what happened changing the drug loading, the size of pellets significantly affected the drug release rate (Figure 45). As expected, the pellets with the lower particle size (batch V, 850 – 1000 μm) exhibited a faster release profile ($f_2=40.53 \pm 2.27$) since the surface area exposed to the dissolution medium was greater than that of the pellets with

the higher particle size. Significant differences of the release profiles between the cured and the uncured pellets with the lower dimensions were noticed ($f_2=49.43$; $f_1=30.41$). Nevertheless, the ethylcellulose based coating did not significantly control the CFN release rate and within 15 minutes the 50% of the drug loaded was already released.

Figure 45: Influence of drug loading on CFN dissolution profile: comparison between batch IV and V(both uncured and cured pellets) at day 0.

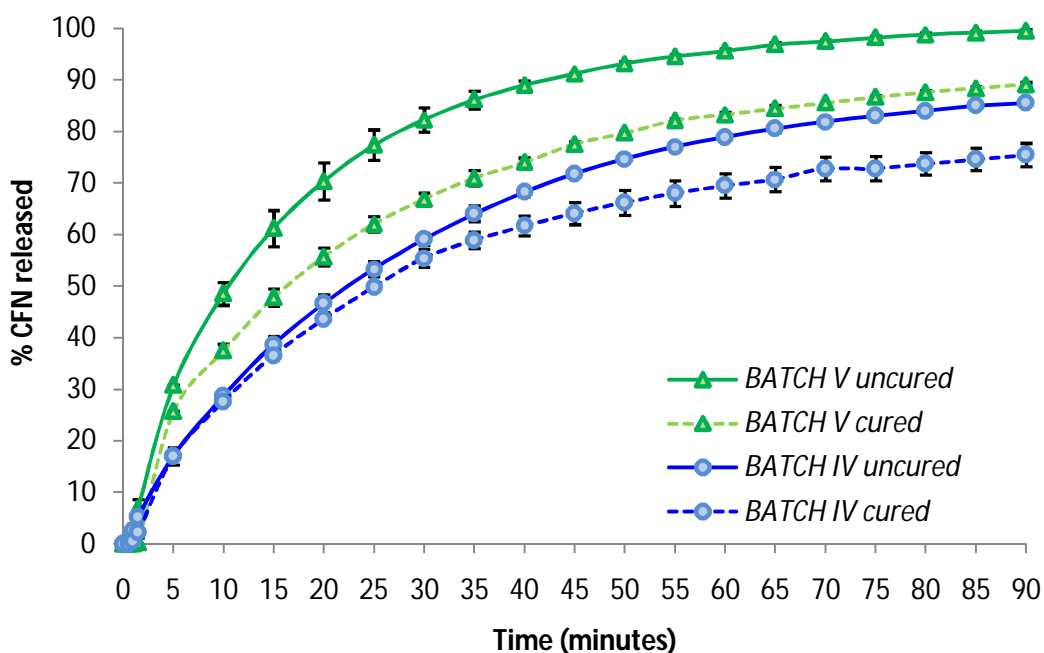

12.3.3.4. Effect of the coating formulation

The next step focused on changes in coating formulation in order to evaluate the extent of controlled drug release over time through the applied ethylcellulose based coating layer. The coating formula E10FP:LA:OA/60:20:20 (batch II) was then compared with the E10FP:LA:OA/65:20:15 (batch VI). The process parameters related to layering and coating are summarized in Table 38 (p. 169). Both batches had approximately the same coating level (14.54% vs 13.97%, respectively) and the drug uniformity increased increasing the OA amount in the coating formulation (the RSD_c %, dropped up to 0.62%). Moreover comparing the $cRSD_w$ of batches II and VI, the value reduced from 4.68% to 1.02%, respectively, indicating a very good coating efficiency using both coating formulations.

Comparing the parameters related to the dry powder coating process assessed onto placebo pellets (batch P3, Table 34, p. 158) with those of CFN loaded pellets (batch VI, Table 38, p. 169),

the yields of both batches were similar (93.91% vs 96.30% respectively); moreover the ρ_{Loss} decreased from 6.07% of placebo pellets to 3.70% of CFN loaded ones. Considering the coating efficiency, the mass variability based on RSD_w calculation was lowered from 4.12% to 3.98% for uncured pellets demonstrating the repeatability and robustness of the dry powder coating processes. After curing the RSD_w dropped up to 1%.

With regards to drug release (Figure 46), significant differences between uncured and cured samples of batch VI were clearly observed ($f_2=45.56 \pm 3.14$) at day 0, as noticed for the previous batches. The release profile of cured pellets of batches II and IV were similar ($f_2=67.08 \pm 2.41$), suggesting that the two different coating formula did not affect significantly the CFN release profile.

Figure 46: Influence of coating formulation on CFN dissolution profile: comparison between batch II and VI (both uncured and cured pellets) at day 0.

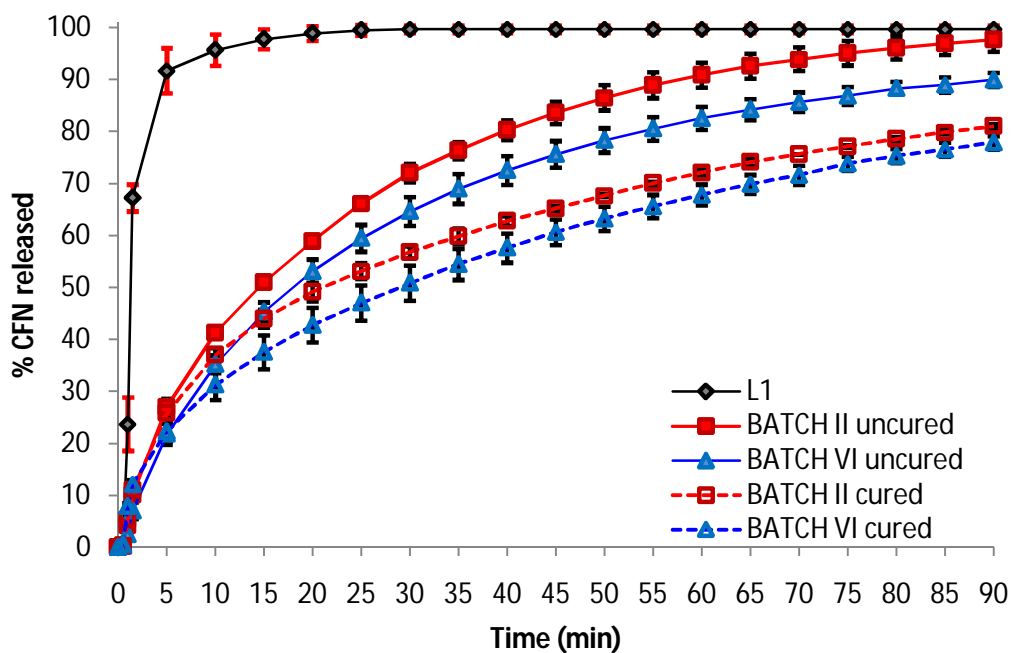

Subsequently the two different coating formulation were analyzed during storage: after one year, the difference (Figure 47) between the release profiles of uncured and cured pellets of batch VI stored at the MFFT (equal to 75°C) was maintained ($f_2=44.85 \pm 0.31$).

Looking inside to the stored uncured samples, an higher burst effect was clearly observed and, after one year of storage, significant differences on the release profile between the uncured pellets (t_0 and $t_{1\text{ year}}$) were observed ($f_2= 43.27 \pm 1.98$). Otherwise cured stored samples were similar at $t_{1\text{ year}}$ ($f_2= 61.75 \pm 0.31$) indicating the better stability of cured pellets with respected to the uncured ones.

Figure 47: Comparison between the release profile of both uncured and cured pellets of *batch IV* at day 0 and after one year of storage at 25°C/60 RH.

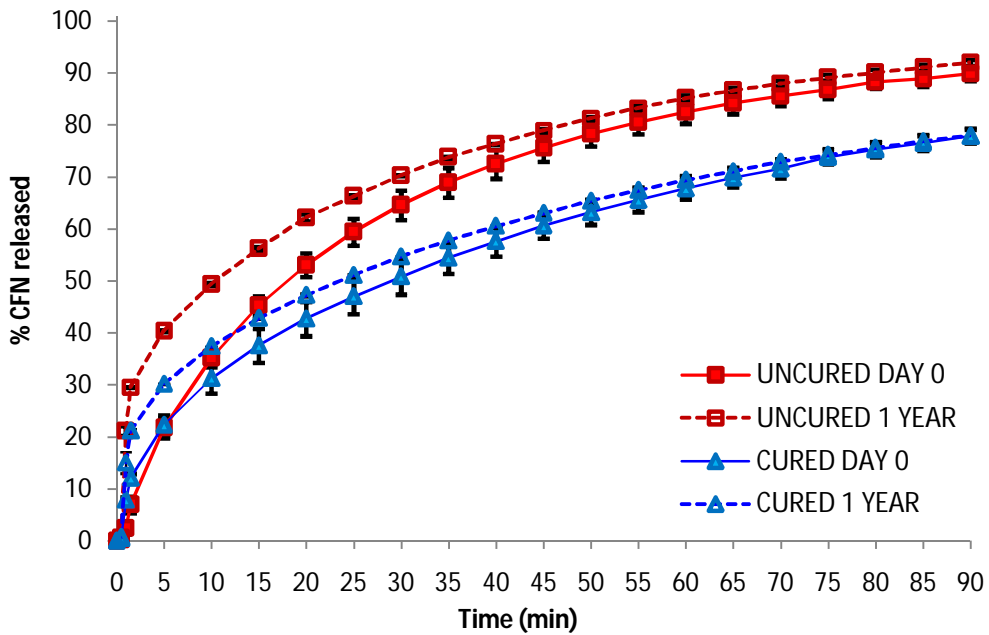
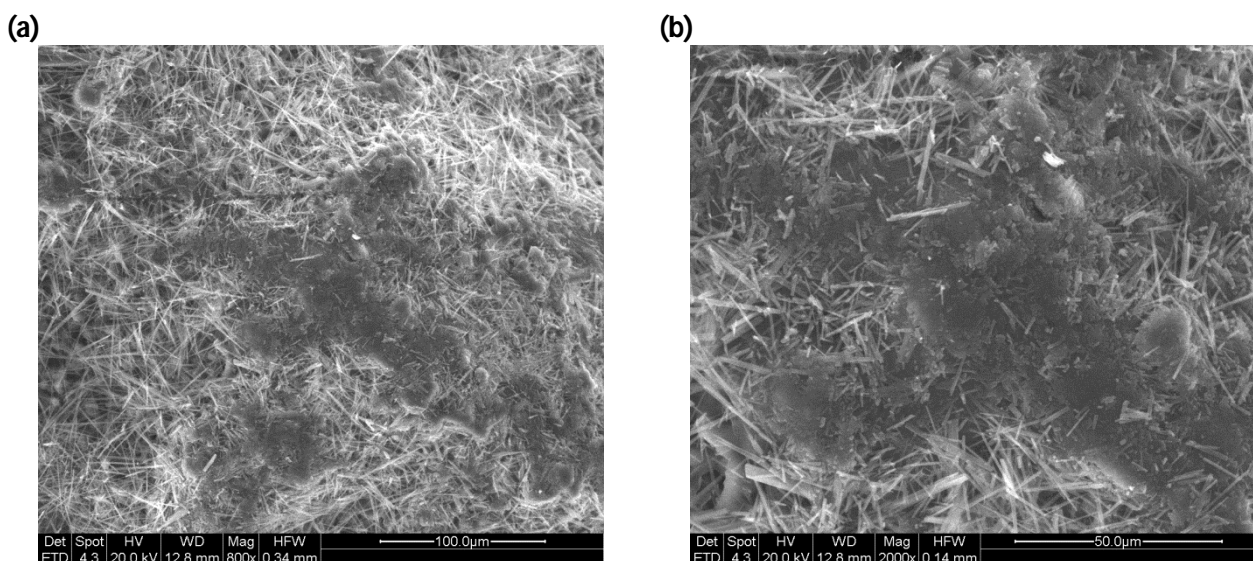

Figure 48 reports the SEM pictures of uncured (Fig. 48 a) and cured (Fig 48 b) pellets after 1 year of storage. Both pellets exhibited a great CFN crystallization extent indicating the migration of the drug outside the coating layer determining the rapid burst effect clearly observed in the dissolution profiles. Furthermore, Fig 48b shows a minor CFN crystallization onto the coating layer, suggesting that curing step was fundamental for film strengthening; the complete film formation could thus slowed the CFN migration process through the film thickness but didn't completely avoid it.

Figure 48: SEM pictures of uncured (a) and cured (b) pellets of batch VI taken after 1 year of storage at different magnifications.



Therefore, this behaviour suggests that drug re-crystallization anyhow occurred but the post-coating thermal treatment mitigated the burst effect and better controlled the drug release profiles. This phenomenon has been fully described in the Case study 1.

Moreover during storage, DSC measurements were performed, too. DSC scans (Figure 49) of indicated that no re-crystallization of the main solid plasticizer, LA, occurred for both cured and uncured pellets of batch VI, as previously disclosed (paragraph 12.3.1). Therefore, as observed for P3 pellets, the film formed around the cores was stable.

Figure 49: DSC scans of both uncured and cured pellets based on E10: LA:OA/ 65:20:15 coating formulation: comparison between P3 (placebo) and batch VI (drug loaded) formulations at day 0 and after 1 year of storage at 25°C/60 RH.

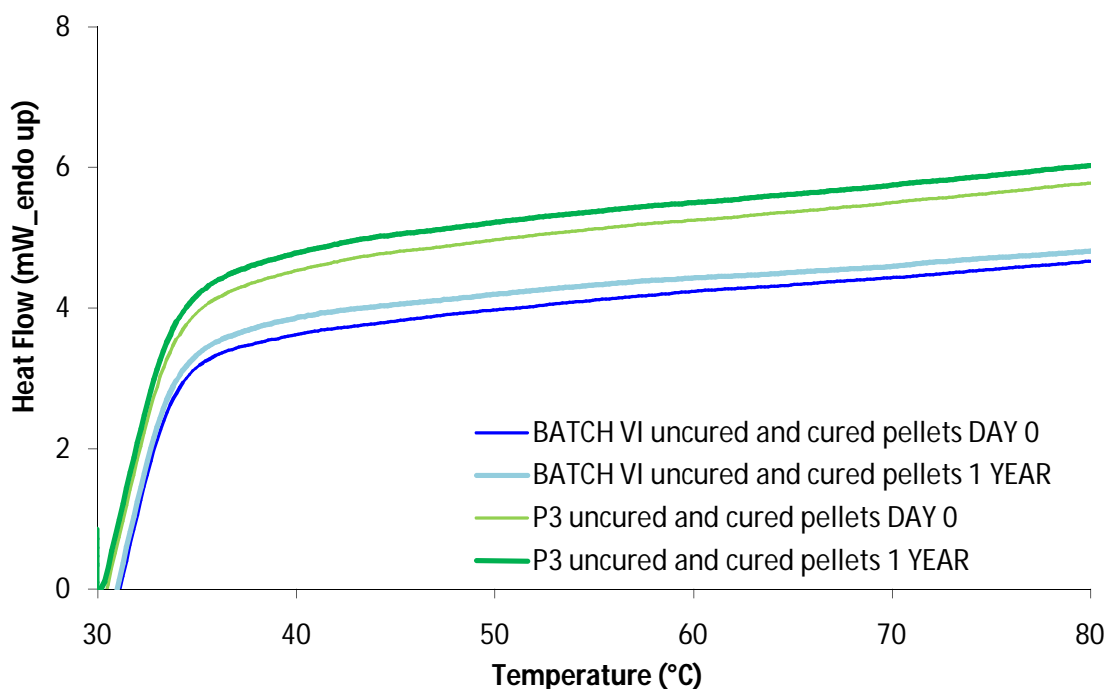

Considering batch II, significant differences of the release profiles between the uncured and the cured pellets were observed at t_0 (as previously reported at p. 169, the similarity factor was lower than 50, $f_2=44.19 \pm 1.829$); whereas analysing the dissolution data of batch II pellets (after one year of storage at 25°C/60 RH Figure 50), the release profile of uncured and cured samples were similar ($f_2=71.35 \pm 4.29$). Moreover the similarity of the dissolution profiles of uncured pellets resulted borderline different (day 0 vs1 year of storage: $f_2=51.76 \pm 3.89$ and $f_1 18.71 \pm 3.08$); while the dissolution profiles of cured pellets remained superimposed ($f_2= 75.6 \pm 4.66$).

These results confirm again the better long term storage stability of cured pellets with respected to the uncured ones. As previously reported, one of the main challenge associated with the dry powder coating is to achieve both complete powder adhesion and coalescence around Suglets® during the coating process leading to a uniform final film. Incomplete film formation and further gradual coalescence during storage (uncured pellets t_0 vs $t_{1 \text{ year}}$) cause instability in the drug release rate. Thus, a curing step is recommended to assure the long term stability of samples.

Figure 50: Comparison between the release profile of both uncured and cured pellets of *batch II* at day 0 and after one year of storage at 25°C/60 RH.

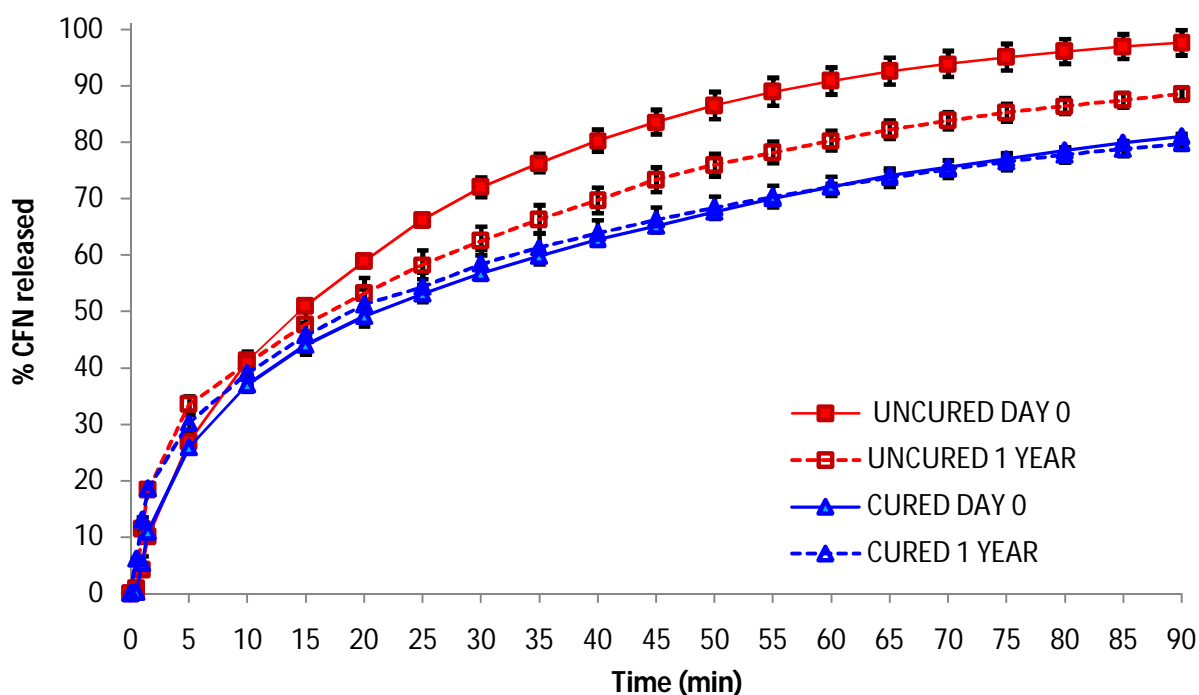

The batch II pellets were then analysed by means of DSC to verify eventual LA re-crystallization, even if placebo pellets having the same coating formulation (P4) did not show any thermal event (Figure 42, p.167). DSC scans (graph not shown) of both uncured and cured pellets were superimposed both to those of placebo pellets, confirming the stability of this coating formulation.

Therefore these results showed indicate that the used LA:OA weight ratio (20:20 or 20:15) didn't affect the main solid plasticizer re-crystallization process throughout the pellets surface also after 1 year of storage. Regarding drug release, both formulations likewise controlled the CFN release from cured coated pellets ($f_2=67.08 \pm 2.41$ cured II vs VI day 0 and $f_2=63.45 \pm 3.86$ cured II vs VI 1 year), as reported in Figure 51.

Figure 51: Comparison between release profile of cured pellets of both batch II and VI both at day 0 and after 1 year of storage 25°C/ 60 RH.

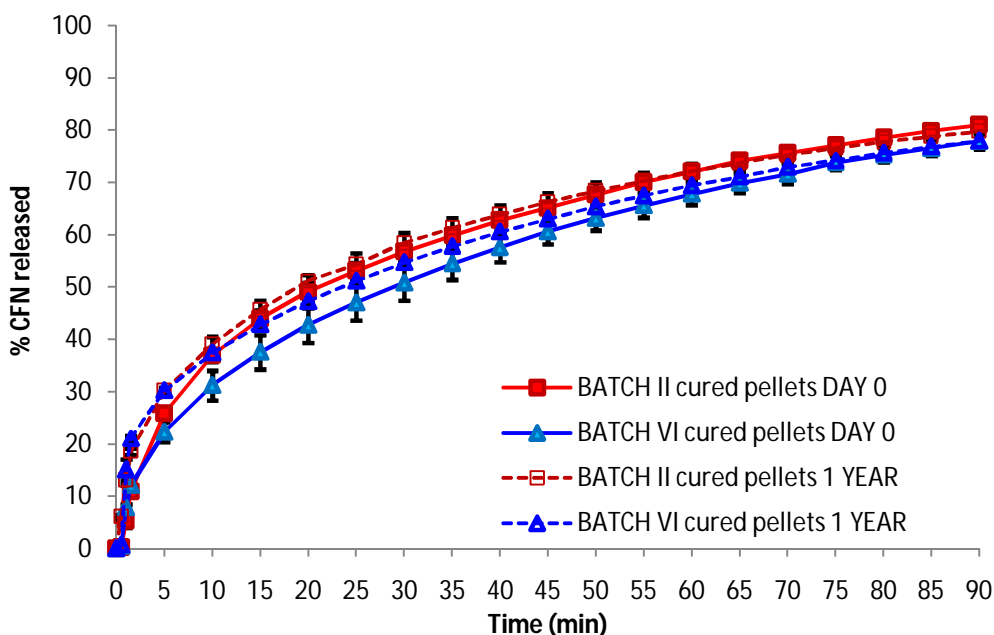

12.3.3.5. Impact of anti-sticking agents on the coating effectiveness

The percentage of pellets aggregation during trial P4 about was 16% w/w and talc was added in an amount equal to 5% w/w extra formulation to prevent aggregation during the curing phase. The effect of talc onto to the performance of the dry powder coating was preliminary evaluated in trials V and VI (reported in the Part I of this study), which contained talc at 2.5% and 5% w/w, respectively, added in blend with the polymer. The percentage of pellets aggregation resulted very low and dropped to 13.4% with 2.5% of talc and to 6.8% w/w with the 5% (w/w) of the glidant. Here the effect of talc or Aerosil® R974 within the coating blend on the manufacturing of CFN-loaded pellets and mostly on CFN release was investigated.

Different trials (batches **VII – X**) reported in Table 35 (p. 160) were carried out as follow:

- Talc (5% w/w) was transferred into the granulation chamber together with the ethylcellulose and homogeneously distributed onto the cores before the film formation during the pre-heating phase of the dry powder coating process (batch **VII**);
- Talc (5% w/w) was added to coated cores at the end of the coating process, when the film formation has been already occurred, in order to minimize the percentage of aggregation of pellets during the curing step in oven at the MFFT (batch **VIII**);

- Talc (1.25% w/w) was transferred into the granulation chamber together with the ethylcellulose and homogeneously distributed onto the cores before the film formation during the pre-heating phase of the dry powder coating process. Afterwards, further 2.5% w/w of talc was atomized with the main solid plasticizer (LA) during the powdering phase; whereas the remaining 1.25% w/w was added to coated pellets at the end of the process (when the film formation has been already occurred) before the curing step (batch **IX**);
- Talc (2.5% w/w) was atomized at 3.5 bar once mixed with the main solid plasticizer (LA) during the powdering phase (batch **X**);
- Lipophilic Aerosil[®] R974 (2.5% w/w) was atomized at 3.5 bar with the main solid plasticizer (LA) during the powdering phase (batch **XI**).

The parameters related to the coating processes are shown in Table 38 (p. 169). After the coating process, the variation of the CFN content (RSD_C %) evidenced a good drug content uniformity of dosage units for all batches. The results evidenced good yields (ranging from 83% to 89%) and weight gains closed to the theoretical ones. Moreover, with respect to batch II, the greater the amount of powder to layer, the higher the coating losses. Anyhow the RSD_w intra-batch values demonstrated the uniform distribution of the powder upon pellets, especially for the cured ones.

Regarding the extent of pellets aggregation, the addition of the glidant was helpful (Table 38, p.169) and in line with the results obtained on placebo pellets. The better results were obtained with batch VII and then with batches X and XI.

Analysing the dissolution data (Figure 52) of cured pellets, the addition of the anti-sticking agent deeply influenced the drug release throughout the coating thickness. With the addition of 5% of talc to the coating formula (batch VII) the CFN release profile changed dramatically with respect to batch II. To explain this behaviour was hypothesized that talc would form a lubricant layer, that interfered with the powder adhesion upon sugar spheres and consequently with the film formation. This hypothesis was confirmed by the picture (Figure 53) taken at the end of the dissolution of these pellets. The applied coating layer fractured already after 5 min of dissolution and detached from the CFN-layered core. On the contrary, the addition of talc at the end of the process (batch VIII) resulted in a greater controlled release of CFN than batch VII; however the release profiles was significantly different from that of batch II ($f_2=34.01 \pm 1.14$), indicating that that amount of talc at the end interfered with the completion of the film formation during the curing step. The addition of the same amount of talc along the whole process (batch IX) produced pellets having the same release profile of pellets from batch II ($f_2= 64.37 \pm 0.48$). In this case the

Loss slightly increased with respect to batch II and VIII, but the pellets aggregation decreased, suggesting that the atomization of a smaller amount of talc together with the plasticizer could be useful.

Actually, the best dissolution performance was achieved by atomizing talc 2.5% w/w with LA (batch X, green line). Furthermore, the CFN release from pellets of batch X was characterized by a less pronounced burst effect followed by a linear portion, indicating a region of constant drug release ($y = 0.589x + 22.98$; $r^2 = 0.96$). The release profile of cured pellets of batch X vs cured pellets batch II were significantly different ($f_2 = 45.73 \pm 3.30$; $f_{2(D50)} = 42.41 \pm 3.31$). Similarly, the release profile of cured pellets of batch X vs cured pellets batch XI (containing Aerosil® R974) were significantly different ($f_2 = 41.54 \pm 1.14$) and no significant differences of drug release ($f_2 = 73.48 \pm 2.17$) were observed with respect to batch II (blue line).

Figure 54 shows the SEM pictures of cured pellets of batches II and X and XI. These SEM images explain the release patterns obtained. Cured pellets of batch II (pictures c and e) and XI (picture a) exhibited a greater CFN crystallization on pellets surface; hence a similar CFN release profile was observed. Contrarily, cured pellets of batch X (pictures b and d) exhibited a lower CFN crystallization extent throughout the film thickness and less crystals appeared onto the surface of treated samples. Thus, the ethylcellulose based coating layer mostly controlled the CFN release rate.

Figure 52: Influence of antisticking agents on CFN dissolution profile: comparison between cured pellets of batches II and VII – XI at day 0.

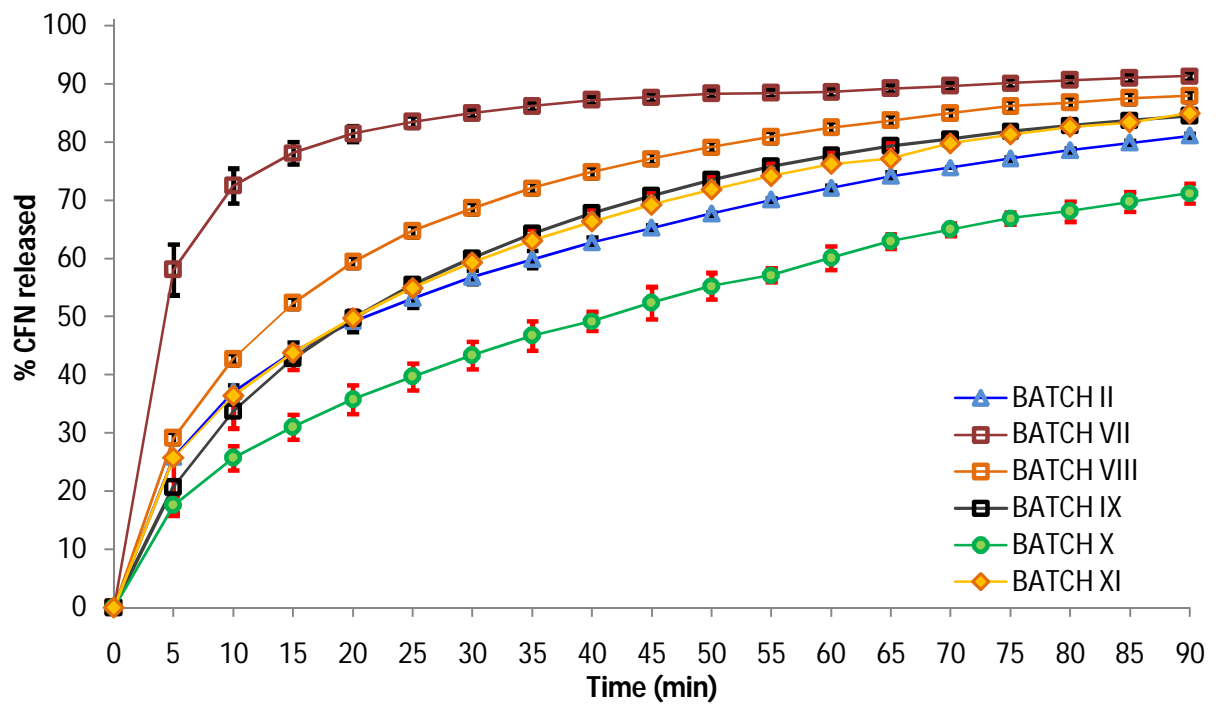
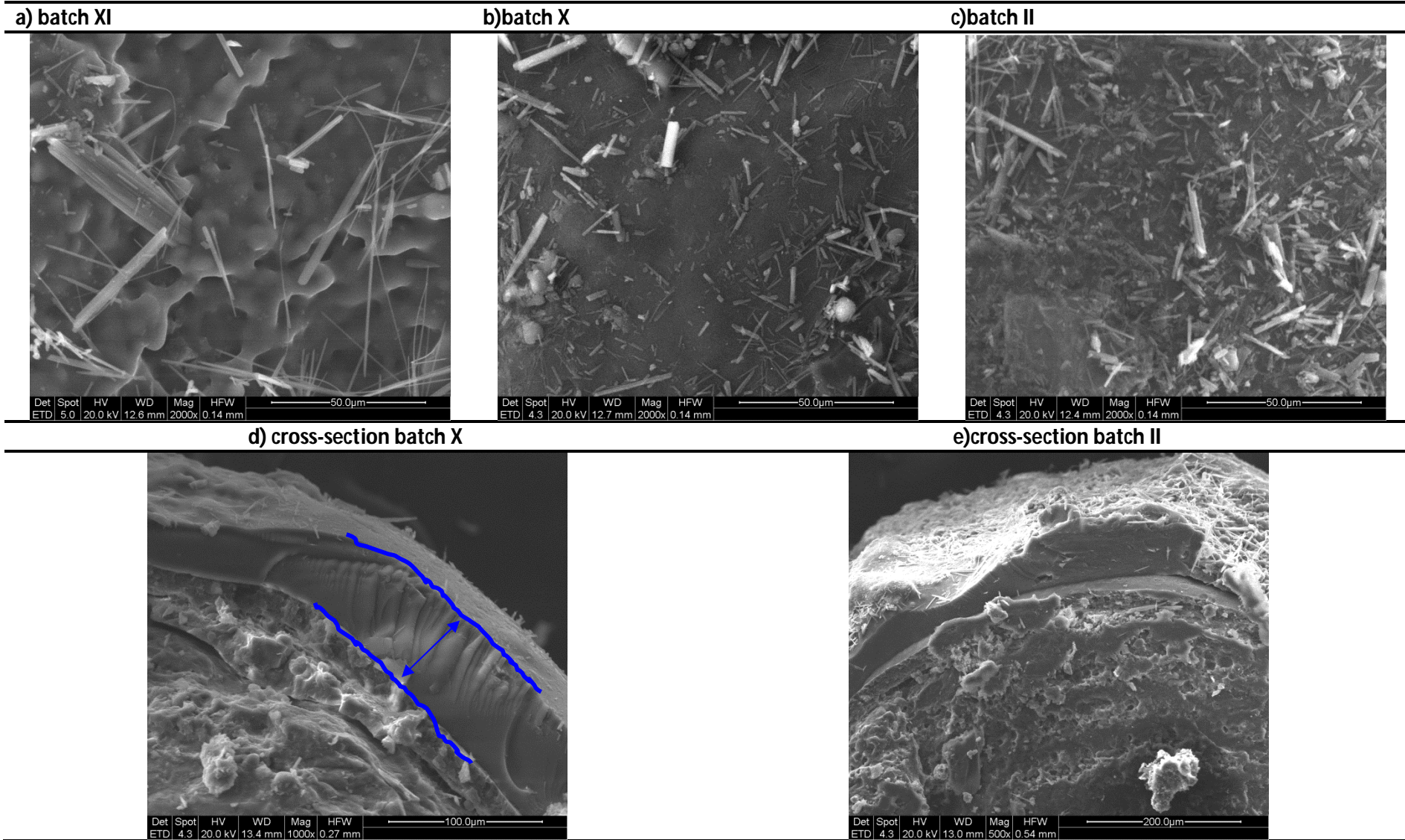

Figure 53: Pellets of batch VII taken at the end of the dissolution.



Figure 53: SEM pictures of cured pellets of batches XI (a); X (b; d) and II (c; e).



12.4. CONCLUSIONS

An innovative dry powder coating technology developed into a rotogranulator was used to apply a functional ethylcellulose based coating upon pellets, avoiding the use of organic solvents or water. Lauric acid (LA) was the main solid plasticizer of Ethocel® (E10 FP) and oleic acid (OA) was the second liquid plasticizer acting as adhesion enhancer. The coating process was optimized according to the selected coating formulation (Ethocel E10FP:LA:OA at 60:20:20 weight ratio, corresponding to 40% (w/w) on the dry polymer) owing to its minimum film forming temperature (70°C) and to its stability during 1 year storage. Despite the processing time was very short (maximum 20 min once reached the MFFT), the results indicated that curing was fundamental for film completion. The very low values of mass variability based on RSD_w calculation (intra-batch) revealed the uniform distribution of the coating around the pellets.

The dry powder coating effectiveness on drug release highlighted that the coating level applied modified the CFN release and the optimal WG was 15% w/w. The size of sugar spheres highly influenced the dissolution profiles, while negligible changes were observed varying the amount of plasticizers from 40% to 35% (w/w) on the dry polymer. The better dissolution performance was obtained by atomizing the anti-sticking agent (talc 2.5% w/w) with the main solid plasticizer.

Finally, the stability over 1 year of storage at RT of cured formulations confirmed that the dry powder coating process using ethylcellulose performed in a high-shear mixer granulator was successful.

12.5. REFERENCES

- [1] S. Obara, N Maruyama, Y. Nishiyama, H. Kokubo, Dry coating: an innovative enteric coating method using a cellulose derivative. *Eur. J. Pharm. Biopharm.* 47(1) (1999) 51 – 59.
- [2] N. Pearnchob, R Bodmeier, Dry polymer powder coating and comparison with conventional liquid-based coatings for Eudragit® RS, ethylcellulose and shellac, *Eur. J. Pharm. Biopharm.* 56 (3), (2003) 363 – 369.
- [3] N. Pearnchob, R Bodmeier, Coating of pellets with micronized ethylcellulose particles by a dry powder coating technique, *Int. J. Pharm.* 268 (1–2) (2003) 1 – 11.
- [4] N. Pearnchob, R Bodmeier, Dry powder coating of pellets with micronized Eudragit® RS for extended drug release, *Pharm. Res.* 20 (12) (2003) 1970 – 1976.
- [5] C.D. Kablitz, K. Harder, N.A. Urbanetz, Dry coating in a rotary fluid bed, *Eur. J. Pharm. Sci.* 27 (2006) 212 – 219.
- [6] C.D. Kablitz, N.A. Urbanetz, Stability of dry coated solid dosage forms, *Pharm. Dev. Technol.* 14 (6) (2009) 613 – 622.
- [7] M. Cerea, A. Foppoli, A. Maroni, L. Palugan, L. Zema, M. E. Sangalli, Dry coating of soft gelatin capsules with HPMCAS, *Drug Dev. Ind. Pharm.* 34 (11) (2008) 1196 – 1200.
- [8] M. Cerea, W. Zheng, C.R. Young, J.W. McGinity, A novel powder coating process for attaining taste masking and moisture protective films applied to tablets. *Int. J. Pharm.* 279 (1–2)(2004) 127 – 139.
- [9] W. Zheng, M. Cerea, D. Sauer, J. W. McGinity, Properties of theophylline tablets powder-coated with (meth)acrylate ester copolymers, *J. Drug Deliv. Sci. Technol.* 14 (4) (2004) 319 – 325.
- [10] D. Sauer, J.W McGinity, Properties of theophylline tablets dry powder coated with Eudragit® E PO and Eudragit® L 100-55, *Drug Dev. Technol.* 14 (6) (2009) 632 – 641.
- [11] Q.-R. Cao, Y. Liu, W.-J. Xu, B. -J. Lee, M. Yang, J.-H. Cui, Enhanced oral bioavailability of novel muco- adhesive pellets containing valsartan prepared by a dry powder-coating technique, *Int. J. Pharm.* 343 (2012) 325 – 333.
- [12] J.- W. Moore, H.- H. Flanner, Mathematical comparison of dissolution profiles, *Pharm. Tech.* 20 (1996) 64 - 74.
- [13] M. Smikalla, A. Mescher, P. Walzel, N.A. Urbanetz, Impact of excipients on coating efficiency in dry powder coating, *Int. J. Pharm.* 405 (2015) 122 – 131.

- [14] D. Brock, J.- A. Zeitler, A. Funke, K. Knop, P. Kleinebudde, Evaluation of critical process parameters for inter-tablet coating uniformity of active-coated GITS using Terahertz Pulsed Imaging, *Eur. J. Pharm. Biopharm.* 88 (2014) 434 - 442.
- [15] B.- D. Rege, J. Gawel, J.- H. Kou, Identification of critical process variables for coating actives onto tablets via statically designed experiments, *Int. J. Pharm.* 237 (2002) 87 - 94.
- [16] J.-J. Moes, M.- M. Ruijken, E. Gout, H.- W. Frijlink, M.- I. Ugwoke, Application of process analytical technology in tablet process development using NIR spectroscopy: Blend uniformity, content uniformity and coating thickness measurements, *Int. J. Pharm.* 357 (2008) 108 - 118.

13. FINAL CONSIDERATIONS

Film coating represents one of the major technology used in the pharmaceutical and nowadays also in the nutraceutical industries. This research addressed on two different aspects of the coating technology linked with the same film forming functional polymer upon pellets.

The first case study focused on a traditional film coating process and analyzed the problem of drug migration throughout the ethylcellulose-based film layer. This behavior was observed for numerous soluble drugs seriously affecting the stability of the coated dosage forms during storage. The study highlighted that the optimization of a coating manufacturing process is very complicated and despite the well-known and established available technologies, it is extremely important during the development of a formulation to thoroughly analyze the whole process and its variables. The results revealed that variables joined with the drug layering process resulted the predominant critical parameters on the whole manufacturing process and they were closely related to the chemical-physical characteristic of the drug. The substitution of hypromellose, the polymer generally used for constituting the layering solution, significantly decreased the phenomenon of drug diffusion and crystallization on the surface of coated pellets.

The second case study approached to an innovative method of dry powder coating, a technological procedure that has been considerably developed over the last decade. The method studied in this thesis combined two types of the layering formation process: the liquid assisted and the thermal adhesion (melt coating) methods. Unlike conventional fluid bed coating, the used equipment, an high shear rotogranulator, was specifically adapted to enable the dry powder coating of pellets. The research analyzed in details the film formation process through the screening of several coating formula forming free-films to select the better plasticizers/adjuvants of ethylcellulose suitable for the adopted technological procedure. The selected coating formulation reached the minimum film forming temperature at 70°C, easy to maintain inside the equipment. The process optimized first on placebo pellets obtained high yields and low pellets aggregation. The same procedure applied on drug-loaded pellets has proven to be effective to reproducibly coat pellets with ethylcellulose without solvents. The stability over 1 year of storage of both films containing the 35%-40% (w/w) of plasticizers on the dry polymer and of the drug release from cured pellets demonstrated that the coating formulation and the manufacturing process were successful developed and optimized.