

CHAPTER 12

Materials for Liquid Propulsion Systems

John A. Halchak
Consultant, Los Angeles, California
James L. Cannon
NASA Marshall Space Flight Center, Huntsville, Alabama
Corey Brown
Aerojet-Rocketdyne, West Palm Beach, Florida

12.1 Introduction

Earth to orbit launch vehicles are propelled by rocket engines and motors, both liquid and solid. This chapter will discuss liquid engines. The heart of a launch vehicle is its engine. The remainder of the vehicle (with the notable exceptions of the payload and guidance system) is an aero structure to support the propellant tanks which provide the fuel and oxidizer to feed the engine or engines.

The basic principle behind a rocket engine is straightforward. The engine is a means to convert potential thermochemical energy of one or more propellants into exhaust jet kinetic energy. Fuel and oxidizer are burned in a combustion chamber where they create hot gases under high pressure. These hot gases are allowed to expand through a nozzle. The molecules of hot gas are first constricted by the throat of the nozzle (de-Laval nozzle) which forces them to accelerate; then as the nozzle flares outwards, they expand and further accelerate. It is the mass of the combustion gases times their velocity, reacting against the walls of the combustion chamber and nozzle, which produce thrust according to Newton's third law: for every action there is an equal and opposite reaction. [1]

Solid rocket motors are cheaper to manufacture and offer good values for their cost. Liquid propellant engines offer higher performance, that is, they deliver greater thrust per unit weight of propellant burned. They also have a considerably higher thrust to weight ratio. Since liquid rocket engines can be tested several times before flight, they have the capability to be more reliable, and their ability to shut down once started provides an extra margin of safety. Liquid propellant engines also can be designed with restart capability to provide orbital maneuvering capability. In some instances, liquid engines also can be designed to be reusable. On the solid side, hybrid solid motors also have been developed with the capability to stop and restart. Solid motors are covered in detail in chapter 11.

Liquid rocket engine operational factors can be described in terms of extremes: temperatures ranging from that of liquid hydrogen (-423°F) to 6000°F hot gases; enormous thermal shock ($7000^{\circ}\text{F}/\text{sec}$); large temperature differentials between contiguous components; reactive propellants; extreme acoustic environments; high rotational speeds for turbo machinery and extreme power densities. These factors place great demands on materials selection and each must be dealt with while maintaining an engine of the lightest possible weight.

This chapter will describe the design considerations for the materials used in the various components of liquid rocket engines and provide examples of usage and experiences in each.

12.2 Liquid Rocket Engines

Liquid rocket engines are either mono-propellant or bi-propellant. Mono-propellant engines either use a straight gaseous system or employ a catalyst to decompose the propellant in an exothermic reaction. An example was the reaction control system on the Mercury capsule in which each small thruster used hydrogen peroxide decomposed by a silver catalyst to provide attitude control for the vehicle. [2] Mono-propellant thrusters are usually used only for low thrust systems such as satellite propulsion systems. Bi-propellant systems use either hypergolic propellants or propellants that require a source of ignition. Hypergolic propellants usually are storable, that is, they are sufficiently stable to remain in their tanks for a considerable period of time under normal earth or space conditions. The most commonly used hypergolic propellants are nitric acid, nitrogen tetra oxide (NTO), hydrogen peroxide, mono-methyl hydrazine (MMH), and unsymmetric di-methyl hydrazine (UDMH). Non-hypergolic propellants that have been most commonly used are liquid oxygen, alcohol, kerosene, and liquid hydrogen. Liquid rocket engines differ greatly depending on mission, materials of construction, and launch vehicle design. The four broad categories into which liquid engines may be placed are: 1. first stage or core (booster) engines; 2. upper stage engines; 3. satellite propulsion engines; and 4. attitude control systems. Each of these categories has its own, unique requirements which significantly influence the engine design.

In a liquid engine, the fuel and oxidizer propellants must be delivered to the combustion chamber at a pressure significantly greater than that in the propellant storage tanks. For relatively low thrust engines, (e.g., satellite propulsion or attitude control) this may be done by pressurizing the propellant storage tanks. For higher-thrust, high-performance engines, pumps must be used. To obtain the necessary power to drive high-performance pumps, a turbine drive is needed. To power the turbine, hot gases or high-pressure fluids are needed. There are many methods to provide the gases or fluids to drive the turbines. One of the most common methods is to provide hot gases by tapping off and combusting a small portion of propellants in a separate chamber called a gas generator. Another common method, the expander cycle, utilizes the energy of expanding fuel, heated by the combustion chamber and nozzle, to drive the turbines. Expander cycles require a low vapor pressure propellant, which limits them to propellants such as hydrogen or methane. Another cycle, the staged-combustion cycle, partially combusts almost all of the fuel with a portion of the oxidizer before entering the main combustion chamber where it is mixed with the remaining oxidizer to complete the combustion process. An alternative staged combustion cycle reverses the process by utilizing oxidizer rich pre-combustion with combustion completed by injecting the remaining fuel into the main combustion chamber. This version of staged combustion is favored by Russian designers. [2] Staged combustion is used when large power inputs are required to produce very high combustion chamber pressures (ex. 3000+ psi). No matter what the cycle, ducting is needed for the transfer of propellants to various engine components. To control the flow of propellants, one needs valves that are quick-acting and able to operate against very high pressure fluids. To actuate the valves, hydraulic, pneumatic, or electrical actuators are necessary. A method is needed to uniformly inject and mix the propellants in the combustion chamber to assure uniform, efficient, and stable combustion – this is called the “injector” of the combustion chamber. Unless hypergolic propellants are used, a method to initiate combustion is required - common methods to do this include: the use of a

pyrotechnic device; the injection of a hypergolic compound; or the use of spark ignition. A nozzle and sometimes a nozzle extension are needed to capture as much reactive thrust as practical. The combustion chamber and nozzle must be cooled to prevent them from melting from the heat of combustion. Cooling methods include regenerative, dump, film, transpiration, and ablative, or some combination of these. Commonly used for cooling is a double-walled design through which fuel (and sometimes oxidizer) is circulated to extract heat. For directional control of the vehicle, gimbaling of the engine or vanes in the exhaust stream may be used; either of these requires actuators. Sensors are required at key locations to monitor engine performance and make appropriate propellant flow changes or provide for rapid shut down if an anomaly is detected. To manage all this, a control system is needed which usually takes the form of an electronic computer. All of these elements must come together in an efficient, light-weight package which operates smoothly, efficiently, and reliably. The materials of construction are a key element to achieving the goals of performance, reliability, and relatively light weight.

12.2.1 Propellant Selection

The choice of propellant combination for a liquid rocket stage is of fundamental importance, since it helps to determine the size, weight, performance characteristics and cost of the resulting vehicle. Liquid rocket propellants can be divided into two broad categories: *storable* propellants, which are in the liquid state at room temperature and pressure, and *cryogenics*, which must be kept cold to prevent them from boiling. Storable propellants may be kept in the vehicle for extended periods before launch, and many storable propellant combinations are also hypergolic, which means they ignite on contact and do not require an ignition source. Cryogenics, on the other hand, offer higher specific impulse (I_{sp}) than storable propellants, and are often used for applications where performance is critical. [3]

The selection of propellant combination is influenced by two important factors: the engine's operating environment (booster or upper stage), and its thrust size. Upper stages have often used liquid hydrogen as a fuel, since the performance benefits of this cryogenic fuel frequently outweigh the difficulty and cost of maintaining it in the liquid state. The performance of upper stage engines is critical, since any loss in efficiency will require more propellants to lift a given payload, impacting the design of both the upper stage and the booster stage which must lift it. For small stages, however, performance has less of an impact on the overall vehicle, and many small engines have been designed to use storable propellants. Booster stages, for which performance is somewhat less critical, often have used RP-1, a refined form of kerosene, or storable fuels such as hydrazine. The denser fuel reduces the physical size of the stage, which is beneficial since the booster stage is the largest stage in the vehicle, and dictates the size of the handling and launch facilities. Stages using either kerosene or hydrogen fuel generally use liquid oxygen, which can be obtained and stored fairly easily, as the oxidizer, while those stages using storable fuels such as hydrazine typically use nitrogen tetra oxide (N_2O_4) oxidizer, creating a propellant combination that is both storable and hypergolic.

12.2.2 Historical Perspectives

All of the early rocket pioneers – Tsiolkovsky, Goddard and Oberth - concluded that, to achieve their performance aims, liquid propellant engines would be needed. These three men also independently conceived the concept of staging for the practical delivery of a payload into earth orbit. Of these three, only Robert H. Goddard actually put theory into practice. Goddard

was the first person to actually fly a liquid propelled rocket, in March 1926, using a crude rocket that burned liquid oxygen and gasoline. Interestingly, all early rocket scientists recognized that hydrogen would provide the highest performance as a fuel, some 50 years before the first successful hydrogen-fueled rocket engine was developed – the Pratt & Whitney RL-10.

Throughout the 1930's Goddard designed, built and tested an increasingly sophisticated series of test rockets. He received over 200 patents for various features of his rockets. Dr. Goddard was the quintessential 19th century lone-wolf inventor – he attempted to do everything himself and he patented everything that he invented. However, he was living in the 20th century and rocketry was a technology that, to successfully advance, required interdisciplinary teams of engineers and scientists working together to create the successful technology. Still, Goddard was a prolific inventor and the rockets that he designed and built pioneered most of the common features of today's launch vehicles. In the 1930's, while Goddard was laboring in the New Mexico desert in virtual secrecy with a small amount of funding from the Guggenheim Foundation, [4] teams of engineers in Germany and the Soviet Union began work on rockets with substantial government funding. It is interesting to note that in the mid 1930's, the most advanced rocket engines in the world were under development in the Soviet Union. However, that ended abruptly in 1937 with Stalin's great purge of the Soviet military and intelligentsia. Because of their association with key military leaders that Stalin considered potential rivals, the rocket design bureaus were caught in the purge and many of their top scientists were sent to the gulags while the military officers who supported them were executed. Work on advanced rocketry in the Soviet Union did not begin again until after the end of World War II. In contrast, a well-funded rocket development effort was underway in Germany under the leadership of Colonel (later General) Walter Dornberger and the brilliant Dr. Wernher von Braun. The young von Braun had recognized that rocketry was "big science" that required the funding that only a government could provide. So when the German army offered him a position in their recently formed rocket development program, he readily accepted. The final result of the German effort was the remarkable A4 ballistic missile, better known as the V-2. The V-2 was the world's first man-made object to leave the Earth's atmosphere and enter outer space. While not a decisive weapon, it ravaged London and Antwerp and actually affected Allied war strategy. At the end of the war, both the Americans and the Soviets each captured components for about 100 V-2 missiles and brought them to their countries for study and development. Both countries each hired over one hundred German engineers to aid in missile development. Led by von Braun, almost all the top German engineers signed on with the Americans. The Soviets obtained the second tier engineers, but these also were very good people who significantly aided Soviet rocket development. The Soviets immediately gave rocket development a high priority as it was perceived as the way to counter the commanding lead of the United States in manned bombers. By way of contrast, in the United States, rocket development progressed at a leisurely pace. In the late 1940's, there were four major American rocket engine companies: Reaction Motors, which was formed by members of the American Rocket Society around 1940; Aerojet, which was founded around 1942 by Theodore von Karman and some of his graduate students at California Institute of Technology; General Electric, which had the contract from the Army to oversee the launching of V-2 rockets from White Sands proving ground in New Mexico; and the relative newcomer to the field – North American Aviation (NAA), a leading military aircraft company, located in Los Angeles. In the 1950's two additional companies worthy of note entered into liquid rocket engine development and production – Bell Aircraft (Bell Aerospace Div.) and

the Marquardt Company, which originally was founded to produce ramjets, but entered the realm of small rocket engines in 1959.

NAA entered the rocket engine business because of a contract from the Air Force to produce an intercontinental cruise missile (the X-10/SM-64 Navajo) that needed a rocket boost to activate its ramjet propulsion. The other rocket engine companies were competitors, so NAA had no choice but to do it themselves. They made the logical decision to build upon V-2 technology. The key to the success of NAA's rocket engine business, later to be named Rocketdyne, was that the corporation was both willing and able to invest large amounts of company funds in the business, up front, with the vision that contracts would eventually follow. The other companies either had difficulty obtaining financing or had corporate management reluctant to invest company funds into development efforts without obvious contracts on the horizon. In 1946, NAA began by testing small rocket motors, then built three duplicate versions of the V-2 engines, followed by the development of an improvement on the V-2 engine that had higher thrust yet lower weight [5]

In the late '40s and early '50's, Aerojet built engines for the Aerobee sounding rocket and the Corporal ballistic missile. Reaction Motors built the engine for the Viking sounding rocket. This engine had the distinction of being the first rocket engine to use gimbaling for directional control. Reaction Motors also made the small rocket motors for a series of piloted research planes, including the Bell X-1 and X-2, and the Douglas Skyrocket. Some years later, they provided the rocket motor for the X-15, the first piloted aircraft to enter outer space. Edward Nu, an engineer at Reaction Motors, developed and patented the concept of the tubular-wall combustion chamber; however, he never applied it beyond small, demonstration models. Reaction Motors became a subsidiary of Thiokol in 1958 and went out of business in 1972 for lack of contracts.

In 1950, NAA developed the first high-thrust American engine (75,000 pounds thrust), the XLR43-NA-1, which evolved into the A6 and A7, better known as the Redstone engine.[5] This was followed by the first production tubular wall combustion chambers for the Navaho missile. All of the early rocket engines used either alcohol or aniline as a fuel. NAA's 1953 investment in corporate funds to gain basic knowledge in kerosene fueled engines paid off in 1954 when the Air Force unexpectedly released a request for quote for engines for Convair's Atlas ICBM. NAA's groundwork research on rocket engines fueled with kerosene enabled them to easily win the competition. This was followed in a year by contracts for engines for both the Thor and the Jupiter IRBMs. The increased business justified the formation of a separate division, which was given the name "Rocketdyne" in 1955. For its part, Aerojet obtained the engine contract for the Titan ICBM a year after the Atlas engine contract (1955). Aerojet then made a significant improvement in the Titan engines by converting propellants from LOX and kerosene to the hypergolic propellants NTO and MMH. General Electric made some singular contributions in injector design and provided the first stage engine for the Vanguard launch vehicle, which was slated to launch a satellite in 1958. Due to a corporate decision to focus on turbojet engines, GE left the rocket engine business around 1966. Marquardt became a leader in providing small thrusters for satellites and manned space vehicles; however, the company became a victim of the end of the cold war downturn and its existence ended in the early 1990's. Bell Aerospace produced a number of relatively small monopropellant and bi-propellant thrusters and most notably, the Agena family of upper stage engines. Bell Aerospace was purchased by Atlantic Research Corporation in 1983. [2]

In the Soviet Union, the engine design bureau headed by Valentin Glushko also built on V-2 technology and developed many different engines, including the RD107/108 family of engines in 1957. This four-combustion chamber, LOX-Kerosene engine, developing 220,000 pounds thrust, powered Sergei Korolev's R7 rocket to launch the world's first artificial satellite. When the Soviet Union beat the United States in launching the first Earth satellite, the unexpected propaganda coup spawned the space race. To partially counter the Soviet accomplishment, Von Braun used the Army's Redstone missile, with its reliable A7 engine, to launch America's first satellite. The same Redstone then was used to place the first American astronauts into space with the Mercury suborbital flights. The Atlas and Titan ICBMs were turned into launch vehicles for both human flight and satellite launching. For their part, the Soviets used the R-7 with its reliable RD107/108 engines to launch the first man into space, followed by many "firsts" in manned space flight. Interestingly, the R-7 with its RD107/108 engines, remains to this day the only man-rated Russian launch vehicle.

In 1958, another company – Pratt & Whitney entered the rocket engine business with the world's first hydrogen fueled rocket engine, the 15,000 pound thrust RL-10. In 1959 Rocketdyne began work on the F-1, which at 1.5 million pounds thrust, would eventually power the first stage of the Saturn V Moon rocket and hold the title of the world's largest rocket engine for almost 20 years. In 1962, Rocketdyne also began development of the J-2, a 230,000 pound thrust hydrogen fueled engine. For the Apollo Moon mission, Rocketdyne provided booster engines for the Saturn V vehicle - first stage (5 F-1 engines); second stage (5 J-2 engines); and third stage (1 J-2 engine). Aerojet provided the all-important engine for the Command and Service Module. TRW provided the Lunar Excursion Module (LEM) Descent Engine, while a Bell-Rocketdyne team furnished the LEM Ascent Engine. Marquardt was the supplier of the reaction control engines (RCS) on the LEM, while Rocketdyne provided the RCS for the Apollo Capsule.

Following the successful Apollo Moon mission, design of the main liquid propulsion engines for the Space Shuttle began, with Rocketdyne receiving the development and production contract. Later, Pratt & Whitney received a contract to provide improved high-pressure fuel and oxidizer pumps for the Shuttle engines. When designed in the early 1970's, the Space Shuttle Main Engine (SSME) was the most advanced rocket engine in the world. At the time of development, the SSME had the highest specific impulse (Isp), could be throttled between 60% and 109% of rated thrust, and was also reusable. This was the first engine in the west to utilize the "staged combustion" principle, wherein the majority of the propellants were first partially combusted in a "preburner", the gases from which were used to drive high-pressure turbopumps, before entering the main combustion chamber to be mixed with the remaining propellants and complete the combustion process. The staged-combustion process enabled very high combustion chamber pressures, which greatly improved the efficiency of the engine. This staged-combustion, high-combustion chamber pressure concept had first been developed in the United States by Pratt & Whitney.

In the Soviet Union, the staged combustion concept was pioneered around 1958 and this concept was adopted by the leading rocket engine designer, Valentin Glushko, who also decided to shift from LOX-kerosene to hypergolic propellants in the early 1960's. Glushko had had considerable difficulty with combustion instability in large, LOX-kerosene engines. Mitigating instability was the reason for dividing the RD107/108 into four separate combustion chambers, thereby separating combustion into smaller chambers wherein instability was more manageable. The multiple chamber design remains a feature on most Russian LOX-hydrocarbon engines. Glushko was attracted by the higher performance and inherent stability of hypergolic propellants.

This led to a major conflict with the Soviet chief vehicle designer, Serge Korolov, who favored kerosene-fueled vehicles. Korolov brought the Kuznetsov design bureau into the picture to produce the LOX-kerosene engines for his N-1 Moon rocket. This design bureau adopted the staged combustion cycle for LOX-kerosene engines. Prior to this, most large engines had powered their turbopump turbines with gas generators. By utilizing all of the fuel and oxidizer in a two-stage combustion process, the staged-combustion cycle provided the highest performance attainable in LOX-kerosene engines. The Soviets also had elected to use oxygen-rich preburner combustion to control turbine temperatures, as opposed to the West, where fuel-rich gas generator and preburner combustion was used. The use of oxygen-rich combustion, while riskier than fuel-rich, provided an extra margin of performance due to the higher mass flow. Although the Soviets belatedly developed hydrogen fueled engines, their main focus was, and remains, kerosene-oxygen and hypergolic propellant engines. It is interesting to note that, in the 1960's race to the Moon, engineers in the United States elected to go with the relatively simple, gas-generator cycle for their F-1 and J-2 engines for the Saturn V-Apollo launch vehicle. This required tackling the issues of combustion instability and learning how to deal with liquid hydrogen, but offered the advantages of reliability and high-performance (in the case of hydrogen) in highly producible engine designs. In contrast, the Soviets expended considerable effort on the design complexities of staged-combustion, which in the final analysis may have adversely affected the development schedule and reliability of their N-1 Moon rocket.

In the 1970's other countries also began the development of their own, indigenous, rocket engine technology. These included Japan, Europe (France, Germany, Sweden, etc.), and China. These developments borrowed heavily from American and Soviet technology, but each also contributed their own, unique design features to their engines.

In recent years, an emphasis has been placed on cost as opposed to strictly focusing on performance. In this, Russia has a distinct advantage due to the poor exchange rate of the ruble. In the West, Japan, the United States and Europe have made significant efforts to produce lower cost engines. One example is the RS-68 engine, which may be the first rocket engine in which, as a design factor, cost was given equal consideration with performance and the overall weight of the engine.

12.3 GENERAL DESIGN CONSIDERATIONS FOR MATERIALS SELECTION

The most basic division among liquid rocket engines is between pressure-fed and pump-fed engines. In the first type the propellant tanks are pressurized to provide the desired combustion pressure, while in the second type pumps are used to raise the pressure of the fuel and oxidizer after they leave the tanks. Pressure-fed engines are inherently simpler, and have found wide application for small upper stage engines. In order to avoid making the propellant tanks too heavy, the combustion pressure for pressure-fed engines is generally limited to 100-200 psia. Table 12.1 lists some existing pressure-fed engines, and the thrust size and combustion pressure for each.

Table 12.1. Historical Pressure-Fed Rocket Engines

Engine	Vehicle	Propellants	Thrust (lbf)	Chamber Pressure (psia)
AJ10-118K	Delta II	N ₂ O ₄ /Aerozine-50	9800	125

RS-18	Apollo lunar module (ascent stage)	N ₂ O ₄ /Aerozine-50	3500	122
LMDE	Apollo lunar module (descent stage)	N ₂ O ₄ /Aerozine-50	9850	103
AJ10-137	Apollo service module	N ₂ O ₄ /Aerozine-50	20500	97
Aestus	Ariane 5	N ₂ O ₄ /MMH	6744	160

The higher propellant tank weights inherent in the pressure-fed approach, along with the low combustion pressures, limit the applicability of this type of engine. Large stages tend to accept the higher complexity of pump-fed systems in order to obtain lower stage weights. In addition, low combustion pressures limit the nozzle expansion ratio for booster engines, since the exhaust flow will separate from the nozzle wall if its pressure drops too far below the ambient air pressure. For this reason, booster engines typically use the pump-fed approach.

Once a pump-fed engine has been selected, it is necessary to determine how the power to drive the pumps will be obtained. In most pump-fed engines, a gas turbine is used to drive the pump; the source of the gas for this turbine determines the “cycle,” the general architecture of the engine. The rocket cycles in most common usage today can be grouped into three broad categories:

1. Expander
2. Gas Generator
3. Staged Combustion

In the expander cycle, one of the propellants—typically the fuel—flows through passages in the thrust chamber, picking up heat to keep the chamber cool. The propellant warms up, gasifies, and is used to drive the turbine. The turbine temperatures are fairly low, which is good for hardware life, but because the amount of heat that can be picked up by the coolant is limited, the expander cycle usually operates at moderate to low combustion pressures. Expander cycles may be either open or closed; in the open type, the turbine discharge flow is routed overboard or into the divergent part of the nozzle, while in the closed type the turbine flow is routed to the combustion chamber to be burned. The closed expander cycle is shown schematically in Figure 12.1.

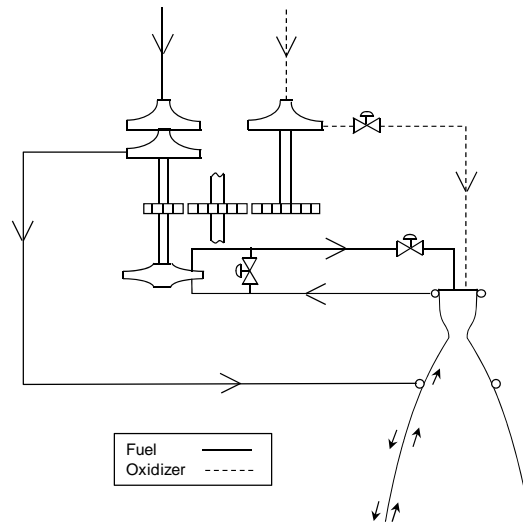

Figure 12-1. Closed Expander Engine Schematic

In the above schematic, the fuel first passes through a two-stage pump, which is driven by a gas turbine. The fuel then cools the thrust chamber, which increases the fuel's temperature and converts it from a liquid to a gas. Next the fuel passes through the turbine, where it provides the power to turn the fuel and oxidizer pumps. The fuel then flows through the main injector, enters the combustion chamber and is burned. The oxygen first passes through a single-stage pump, which is driven by the single turbine via a gear assembly. The oxygen then passes through a control valve, which is used to vary the relative amounts of fuel and oxidizer flowing through the engine. Then the oxygen flows through the main injector and into the combustion chamber.

In the open expander cycle, a relatively small fraction of the fuel cools the thrust chamber, then drives the turbines and is discharged overboard, or into the divergent section of the nozzle. In this way higher turbine pressure ratios can be achieved, allowing a more complete release of the energy in the coolant flow and enabling higher chamber pressure operation. The additional chamber pressure allows a higher nozzle expansion ratio within a given envelope, helping to offset the performance loss incurred by routing the turbine flow around the combustion chamber. Figure 12-2 shows a schematic of an open expander.

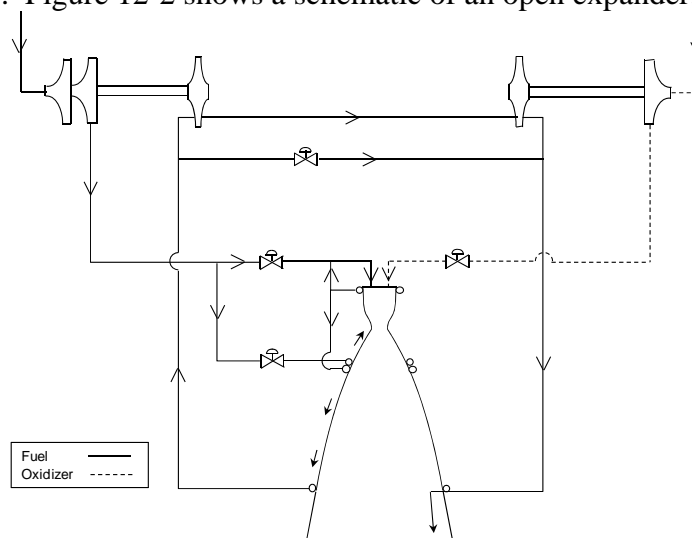

Figure 12-2. Open Expander Engine Schematic

Expander engines offer a simple engine architecture, but have a limited range of applicability. Only fuels which gasify readily and cleanly, such as hydrogen or methane, are appropriate for expander cycles; kerosene fuel, one of the most common rocket propellants, does not satisfy this requirement. Also, because the thrust chamber surface area increases more slowly than its internal volume as the engine's thrust size goes up, the relative amount of heat pickup in the coolant circuit decreases and reduces the achievable chamber pressure. As a result, expander engines have typically been used for smaller upper stage engines, though some large booster applications are being studied.

In order to get more energy into the flow driving the turbine, some rocket engines have an auxiliary combustor, called either a "gas generator" or a "preburner," which burns some of the propellants and increases the temperature of the gas flowing into the turbine. The difference between the gas generator and preburner of a staged combustion cycles lies in what happens to the turbine exhaust. In gas generator cycles, the turbine exhaust is routed overboard, either through an external pipe or into the divergent section of the nozzle. This method is fairly simple, and allows a high pressure ratio across the turbines, but is wasteful because the turbine gases are not fully expanded in the nozzle. In the staged combustion engine, the turbine exhaust is routed to the main injector, where it is burned with the rest of the propellants. This method is more efficient, but because it requires that the turbine exhaust pressure be higher than the main combustion chamber pressure, system pressures tend to be quite high and the engine system is complex. A schematic of a gas generator engine is shown in Figure 12-3.

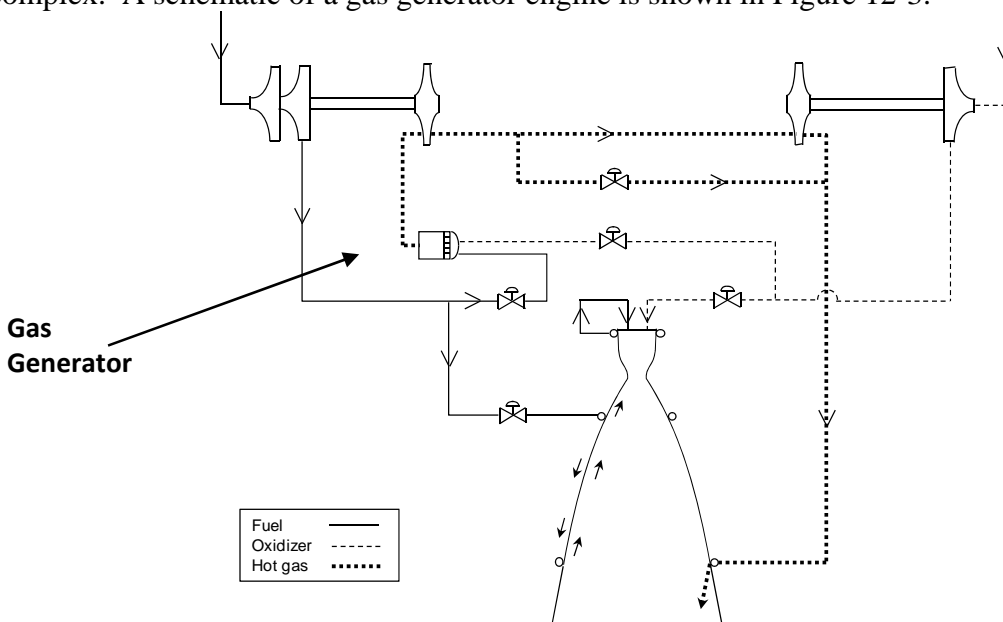

Figure 12-3. Gas Generator Engine Schematic

In this engine, a small part of the fuel exiting the pump is routed to the gas generator, where it is burned with a small amount of oxygen to provide the hot gas to drive the turbines. The rest of the fuel goes to cool the thrust chamber, as does the oxygen not used by the gas generator. The hot gas from the gas generator drives the fuel and oxygen turbines in series. The

turbine exhaust is then routed into the divergent section of the nozzle, so that it may expand and contribute some thrust before leaving the engine.

Figure 12-4 shows a schematic for a staged combustion engine. In this cycle, most of the fuel goes to cool the nozzle and then moves on to the preburner. The remainder of the fuel cools the combustion chamber and then goes to the main injector. On the oxidizer side, a small portion of the flow goes to the preburner, with the rest passing through the oxidizer control valve and then to the main injector. The hot gas produced by the preburner powers the turbines for the fuel and oxidizer pumps. Once it has left the turbines, the hot gas moves to the main injector and into the combustion chamber, where it joins the rest of the fuel and oxidizer. To keep the hot gas temperatures within acceptable limits for the turbine hardware, staged combustion engines run the preburner with large amounts of excess fuel or oxygen; the excess flow does not burn and reduces the combustion temperature to acceptable levels. The choice of whether to run the preburner fuel-rich or LOX-rich is made to obtain the maximum possible energy extraction in the turbines, and depends on the particular fuel being used. Hydrogen-fueled engines like the Space Shuttle Main Engine (SSME) use fuel-rich preburners, while kerosene-fueled engines like the RD-180 run the preburner LOX-rich. Gas generator engines, on the other hand, tend to run the GG fuel-rich, whether the fuel is hydrogen or kerosene, because this minimizes the fuel routed overboard through the turbine circuit, thereby maximizing overall engine performance.

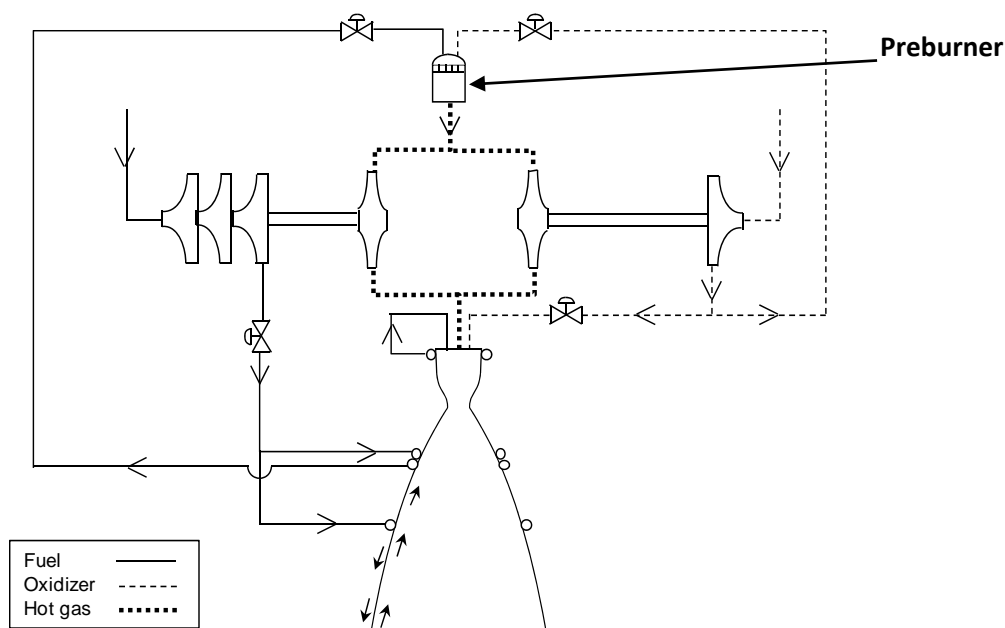

Figure 12-4. Staged Combustion Engine Schematic

It should be noted that there are many variations on the schematics shown in Figures 12-4. The fuel and oxidizer pumps may be separate or on a single shaft. If separate, each may be driven by its own turbine or by a single turbine through a gear train. Staged combustion engines may have one preburner or two. The exact configuration is chosen to optimize the final engine design, taking into account the relative impacts of cost, complexity, weight and performance, as

well as the technological limitations placed on the engine design, such as material limits for operating stress and temperature.

The choice of cycle depends largely on how the engine will be used. Booster engines, which must operate at high pressure to avoid flow separation in the nozzle, usually use the gas generator or staged combustion cycles. Upper stage engines, which operate in a near-vacuum and are not susceptible to flow separation, can operate at the lower pressure of the expander cycle. Figure 12-5 shows the range of chamber pressure for various types of cycles, including existing rocket engines and some which did not progress beyond the conceptual stage. It can be seen that a broad range of chamber pressures exists for each cycle, and that there is a fair amount of overlap between the different types. The requirements of each application will drive not only the choice of cycle but the choice of chamber pressure as well.

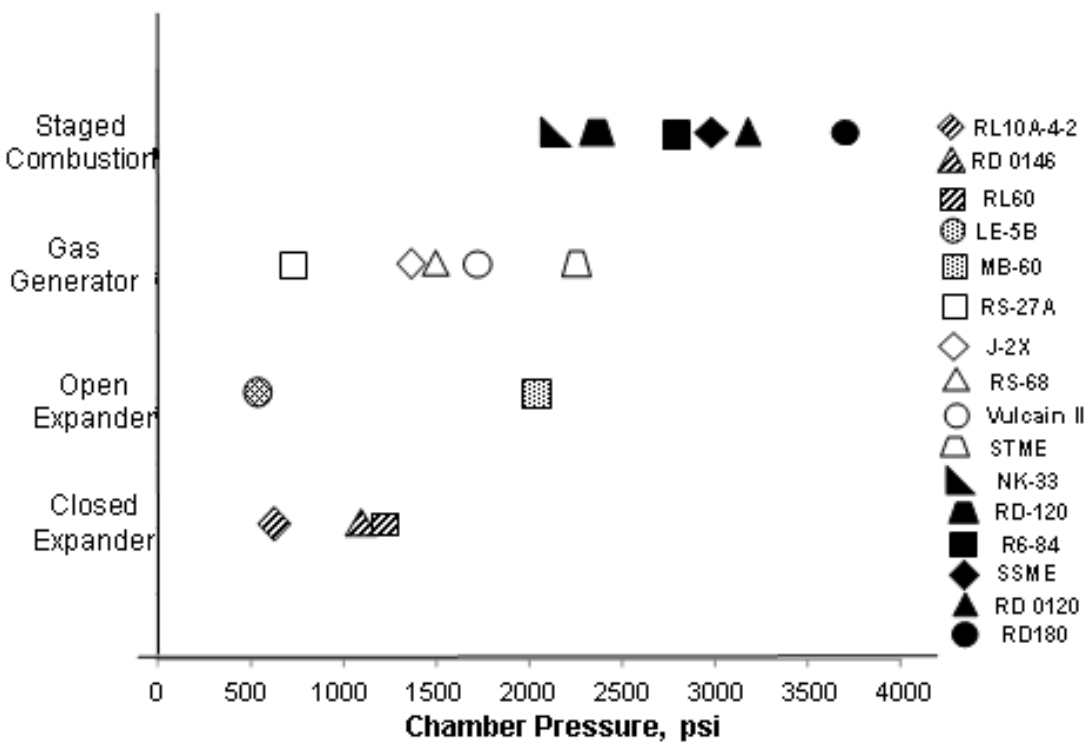

Figure 12-5. Chamber Pressure Range for Various Pump-Fed Cycles

12.4 Materials

Materials were very important from the very beginning of rocketry. Congreve's solid rockets ("the rockets' red glare" of the American National Anthem) were an improvement over the Indian war rockets because they used iron as the casing material. Goddard used an eclectic combination of materials – aluminum tubing, ceramic-lined aluminum combustion chambers, ceramic coated tool steel nozzles, asbestos thermal protection, pump housings made of aluminum, brass and steel impellers, aluminum alloy turbines, etc. Materials usage progressed to increasingly higher-strength and higher-temperature alloys, as pressures and temperatures increased to achieve higher performance. More recently, non-metallic materials such as

ceramics, ceramic matrix composites, and even polymeric composites have been considered for specific applications. At one time or another, just about every engineering material known has been employed in rocket engine construction.

Environmental factors are a major concern in the selection of materials for liquid rocket engines. Most of the propellants are reactive fluids. Oxygen, hydrogen, nitrogen tetroxide, hydrazine and red fuming nitric acid – all have potentially detrimental effects on materials. Their effects vary considerably from material to material, but at one time or another, each has caused problems. The specific environmental effect of a propellant must be taken into account in the material selection and design process. [6] One of the challenges is to develop suitable screening tests to evaluate the effect of a propellant, under expected operational conditions, on the materials of choice. Efforts also have been made to develop materials that are tailored for the operational environment. Considerable work has been expended in developing materials such as hydrogen-embrittlement-resistant and oxygen-ignition-resistant alloys. Development of a new material for rocket engine application requires a lengthy development process. This involves advancing the material technology readiness from understanding the fundamental material properties, to developing mechanical properties over the anticipated operating range, developing manufacturing processes, and developing a design data base. There also is a considerable financial investment required to develop, certify, and incorporate a new material into components for a flight system.

The materials selection for a liquid rocket engine is determined by five general factors: the size of the engine; the engine duty cycle (expendable or reusable); the propellants; the turbine drive cycle; and the stage in which the engine will be used (booster or upper stage). Large engines today almost always require extensive use of metals. Small engines (thrust in the range of a few pounds to a few thousand pounds thrust) can be made from ablatives, high-temperature alloys, or high-emissivity alloys.

Generally speaking, the higher the combustion chamber pressure in a rocket engine, the greater the material issues, for a couple of reasons. First, higher pressures mean that material strength, particularly specific strength (strength-to-weight ratio) becomes very important. At high operating pressures, material thickness and component weight can become unwieldy unless materials of suitable specific strength can be employed. Second, high strength materials tend to be more complex and difficult to fabricate. With some notable exceptions, high-strength materials also tend to have toughness and ductility issues. They also tend to be more susceptible to environmental effects. Hence, careful screening and thorough material characterization are necessary.

For material selection, the engineer must first know and understand the duty cycle of the particular component. The operating temperature range must be considered – both cryogenic and elevated temperatures pose unique issues. The propellants and combustion products must be taken into account for their potential effects on material properties. The principal limiting structural loads must be taken into account – whether they be high or low cycle fatigue, fracture toughness, specific strength, stress rupture, etc. Depending upon the design and operational factors, external environmental effects such as galvanic corrosion or stress corrosion cracking susceptibility of the materials being considered for use must be taken into account. In liquid oxygen systems, oxygen compatibility must be known. In hydrogen systems, depending on the operating temperature, environmental hydrogen embrittlement, internal hydrogen embrittlement, or hydrogen reaction (hydride formation) must be considered. Other propellants, such as nitrogen

tetraoxide, hydrogen peroxide, nitrous oxide, methane, red fuming nitric acid, and hydrazine, may also present their own compatibility problems.

For rotating components in pumps, high specific strength and ductility are important. For pump housings, castings often are the most cost-effective method of production; therefore, alloys with adequate specific strength and good castability are preferred. For ducting and lines, good specific strength, weldability, and good formability are important. For valves handling liquid oxygen, poppets and seats having high resistance to ignition in LOX are mandatory. Combustion chambers require liners with good thermal conductivity and thermal fatigue resistance. Many materials options are available for nozzles and the particular design and cost constrains will determine whether regenerative cooling, film cooling, ablation, or radiation cooling will be used. Each of these choices dictates a specific type of material – conventional metal alloy, refractory metal, ceramic composite, silica-phenolic ablative, etc. Material selection for major components of the liquid rocket engines is discussed in the next sections. [6]

12.5 Thrust Chamber Materials

The basic elements of a thrust chamber include the propellant inlet and distribution manifolds, the injector, ignition device (for non-hypergolic propellants), combustion chamber, de Laval type converging-diverging nozzle, and expansion nozzle (Figure 12.6, 12.7). For almost all liquid rocket engines, the combustion chamber and nozzle are integral. For many engines, the expansion nozzle, or part thereof, also is integral with the combustion chamber and nozzle. The nozzle extension, by definition, is a separate structure designed to capture the exhaust energy that might otherwise be lost at high altitudes or in space. Because all are interrelated, they will be discussed together in this section.

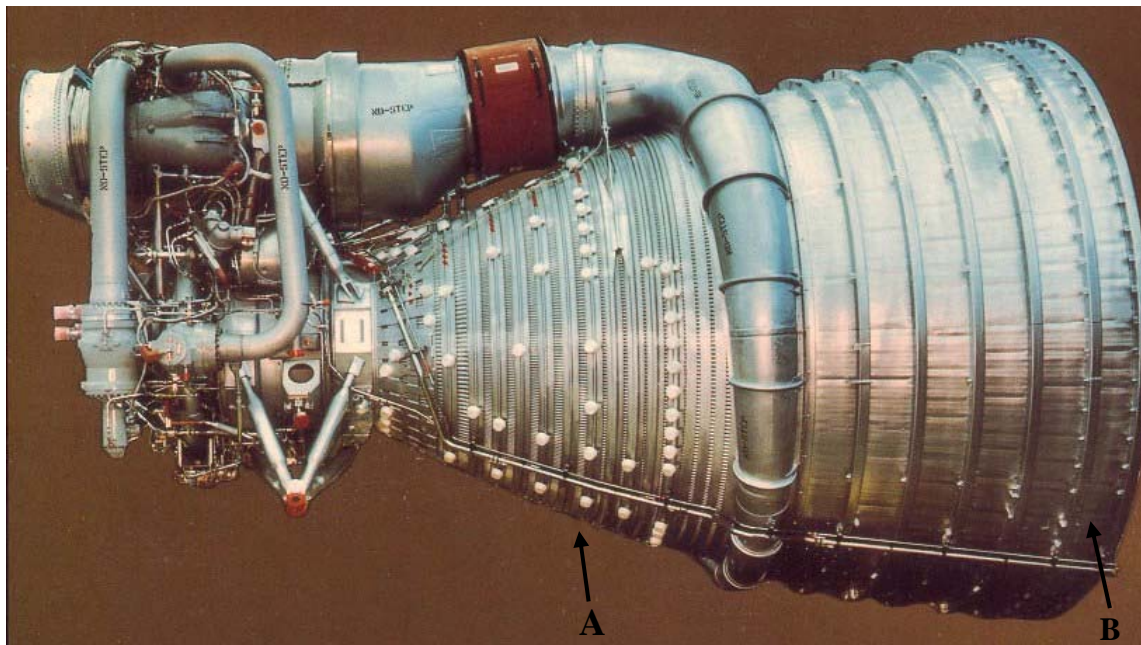

Figure 12-6. An F-1 rocket engine, showing A - the expansion portion of the nozzle and B, the bolted on nozzle extension (B). (NASA photo archives)

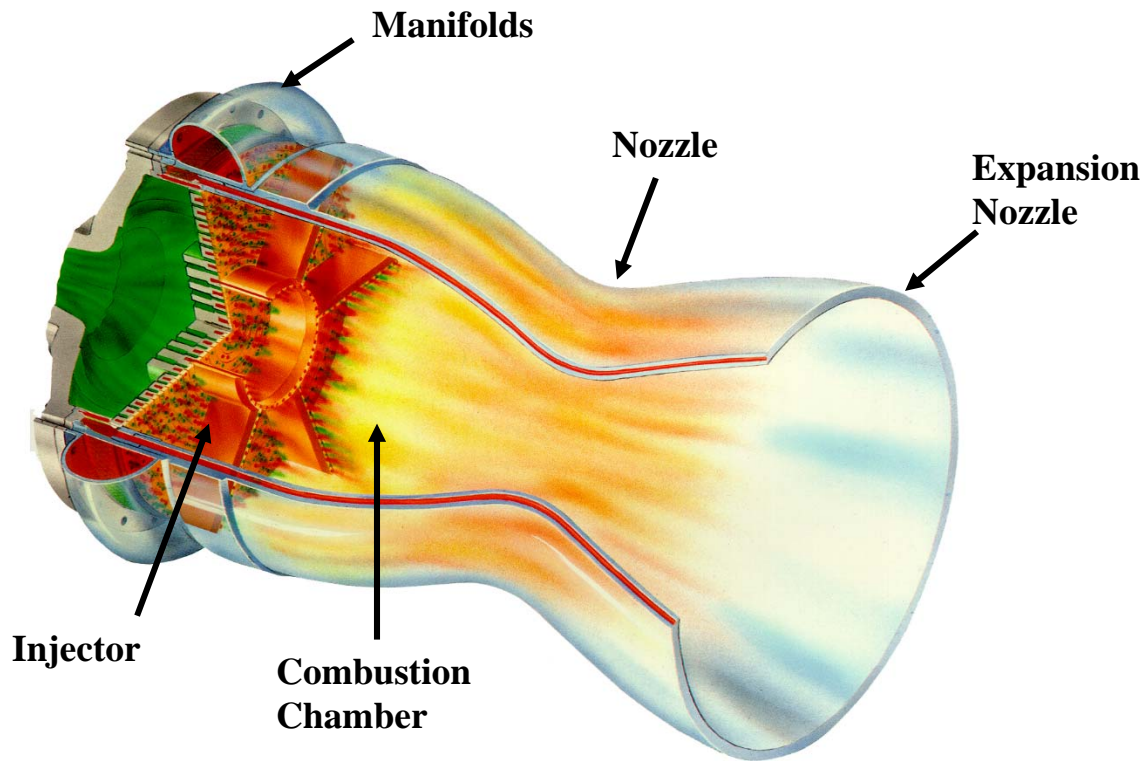

Figure 12.7 Rocket engine thrust chamber.

(NASA Archives)

The combustion chamber is where the propellants are mixed, ignited, and thereby form the pressurized hot gases which then are accelerated and ejected through the nozzle, reacting against the injector face and expansion nozzle (and, if present, the nozzle extension) to propel the rocket. The combustion chamber includes the injector as well as the chamber itself. The function of the nozzle is to convert the chemical-thermal energy generated in the combustion chamber into kinetic energy. The de Laval contraction-expansion nozzle converts relatively slow moving, high pressure, high temperature gas in the combustion chamber into high velocity gas of lower pressure and temperature. The expansion portion of the nozzle, as well as the nozzle extension, are there to capture as much of the exhaust energy as is practical. The nozzle of a rocket engine is not an inconsequential component, for it can account for as much as 40% or more of the total thrust generated by the engine. [3]

12.5.1 INJECTORS

The purpose of the injector is to introduce the propellants into the combustion chamber, atomize and mix them as thoroughly as possible to provide efficient and stable combustion. Injectors are of a wide variety of designs, depending upon the type and nature of propellants to be mixed, the required operational characteristics of the engine, and the individual judgment of the design engineer. A detailed discussion of the theory behind injector designs is beyond the scope of this chapter. However, some general design characteristics and the materials used will be discussed here.

The first injectors were simple spray nozzles that incompletely mixed propellants such that long combustion chambers were necessary to assure complete combustion. The V-2

introduced a somewhat more sophisticated injector design with its eighteen “burner cups” depicted in Figures 12-8, 12-9 and 12-10. In the V-2, the alcohol fuel and liquid oxygen oxidizer were injected through brass nozzles and combustion initiated in 18 “burner cups” welded to the top of the combustion chamber. This design was an expedient that was adopted when the German engineers at Peenemunde were unable to obtain stable combustion with flat-faced injector designs.[7] The burner cups, like the rest of the thrust chamber were a Cr-V alloy steel.[8] The injector nozzles themselves were made of brass and threaded into the walls of the burner cup. The burner cup design was difficult and inefficient from a production standpoint as each had to be welded separately onto the dome of the combustion chamber. It also resulted in the “plumbers nightmare” of eighteen separate aluminum oxygen lines feeding the burner cups. Each burner cup had its own set of nozzles and was, in effect a separate combustion chamber where combustion was initiated and then completed in the main chamber. In the 1940’s, combustion instability was not understood, but the burner cup arrangement effectively negated instability for the V-2.

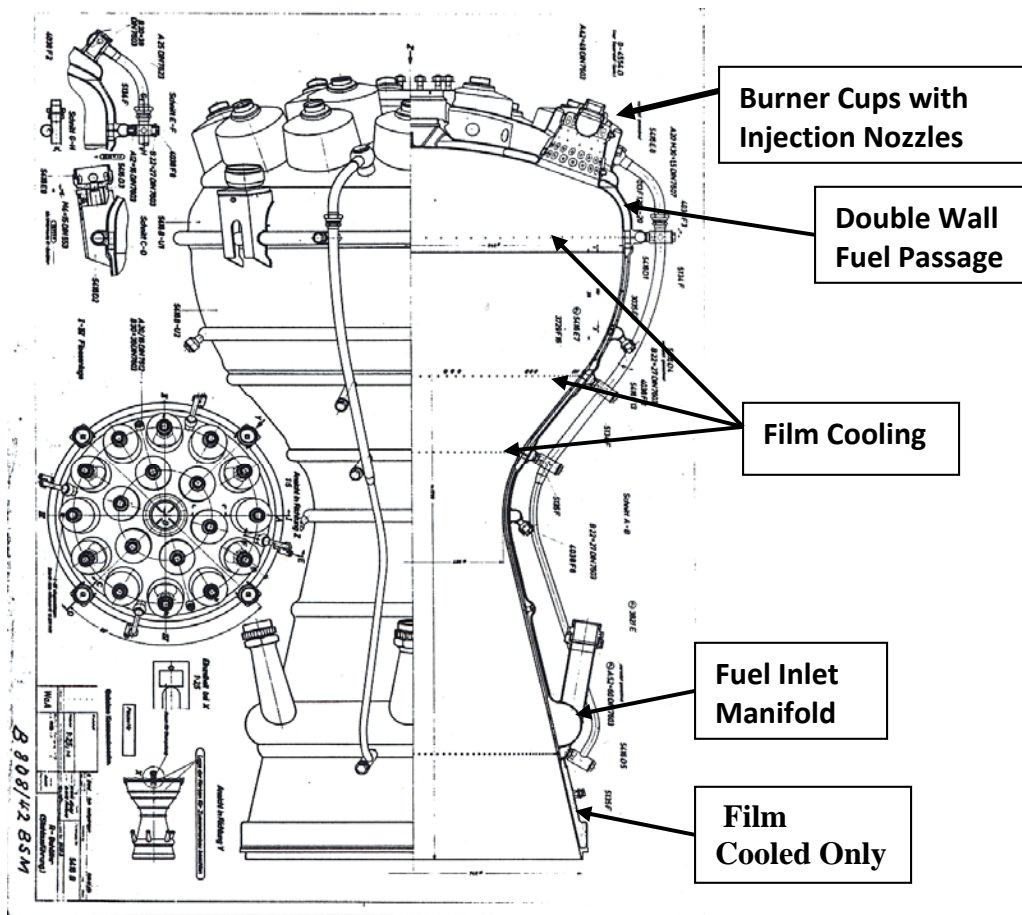

Figure 12-8. Cut-away section of the double-wall V-2 combustion chamber. Fuel enters at the lower manifold (arrow) and makes one upward pass to the injector nozzles at the top of the combustion chamber. (Original German drawing, Huntsville Space Museum archives)

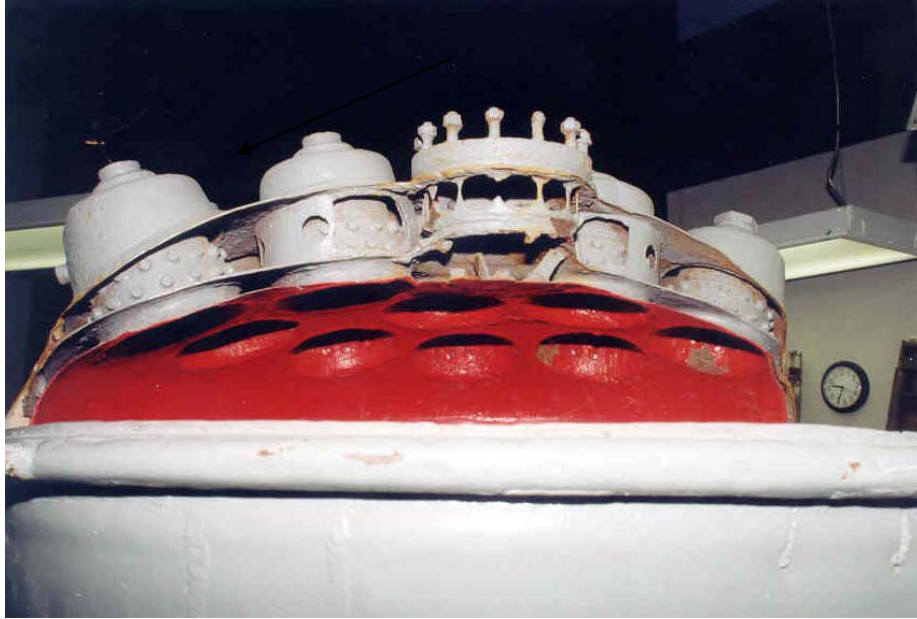

Figure 12-9: Cut-away section of a V-2 combustion chamber head, showing the triple-wall configuration and “burner cup” injector arrangement. (Photo taken at the Kansas Cosmosphere Museum)

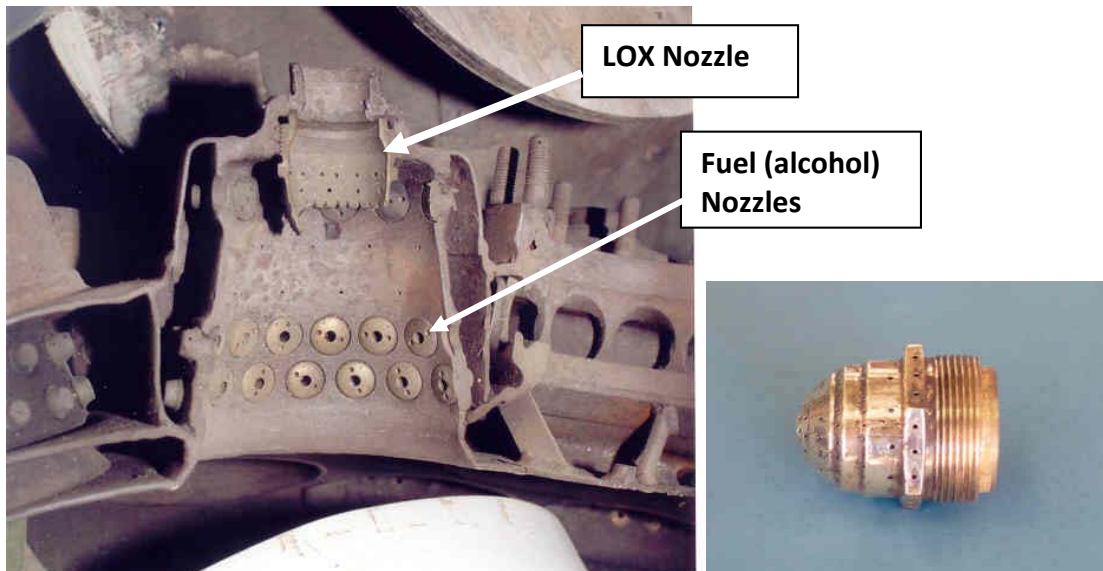

Figure 12-10. Cut-away section of a V-2 burner cup. Injector head at top is for liquid oxygen, fuel (alcohol) injection heads are arranged circumferentially in two rows. Pictured is a LOX injector head. All injector heads were made of brass and were threaded into each burner cup. (Photos taken at the Kansas Cosmosphere)

It is noted that the German engineers had attempted to develop a flat-faced injector, but encountered combustion instability, which they simply described as “high-frequency vibrations”. [7] This burner cup type of design, in modified forms, continued to be used on a variety of engines designed in the late 1940’s and throughout the 1950’s.

A significant improvement in injector design was the development of the flat-faced, concentric-ring injector of the A6/A7 “Redstone” engine, depicted in Figure 12-11. The rings alternated between fuel and oxidizer and could be manifolded such that no joints were needed to separate fuel from oxidizer. This design provided better propellant mixing and considerably simplified production.[2][14] Initially, the rings were 4130 Cr-Mo alloy steel, nickel plated and brazed with pure copper into a backup body also of nickel plated 4130. A significant achievement of the Redstone injector was its freedom from combustion instability. As engines grew in size, baffles were added to enhance combustion stability and materials were changed to OFHC copper rings brazed into an austenitic stainless steel backing body - Figures 12.12, 12.13. [5]

In order to keep the injector face from melting, injector elements are designed to maintain the fire of combustion a short distance from the injector face. However, heat extraction is still necessary; therefore, it is desirable to have materials with good thermal conductivity or some form of active cooling. As mentioned above, OFHC copper, with its high thermal conductivity, was often used in injector faces. For the RL-10, which was the first hydrogen fueled engine, transpiration cooling was devised for the injector face, using a unique porous metal named “Rigimesh”. Rigimesh is a commercial product mainly used for filters which was adapted for the face of rocket engine injectors. It consists of multiple layers of fine, austenitic stainless steel screens which are compressed and diffusion bonded to produce a quite strong, yet porous metal product. This material is used for the face of many hydrogen fueled rocket engines. For injectors which must mix a gas with a liquid, tube within a tube (coaxial) injectors are used. Examples of this are the J-2 and Vulcain engines (Figure 12-14) and the various Russian kerosene-fueled, staged-combustion engines. [2]

A wide variety of metal alloys have been used for injectors – alloy steel, copper alloys, stainless steels, aluminum alloys, titanium alloys, cobalt-base alloys and nickel-base alloys. Any of these materials may be acceptable, depending upon the propellant and, the duty cycle of the engine.



Figure 12-11. A concentric-ring injector. Rings alternate: fuel, oxidizer, fuel, oxidizer, etc. Materials are 4130 Cr-V alloy steel, nickel plated and copper brazed into a body also of nickel plated 4130. (Photo taken at the Huntsville space museum)



Figure 12-12. A baffled, concentric-ring injector for an Atlas launch vehicle. OFHC Copper rings brazed into a stainless steel body. (NASA archives)

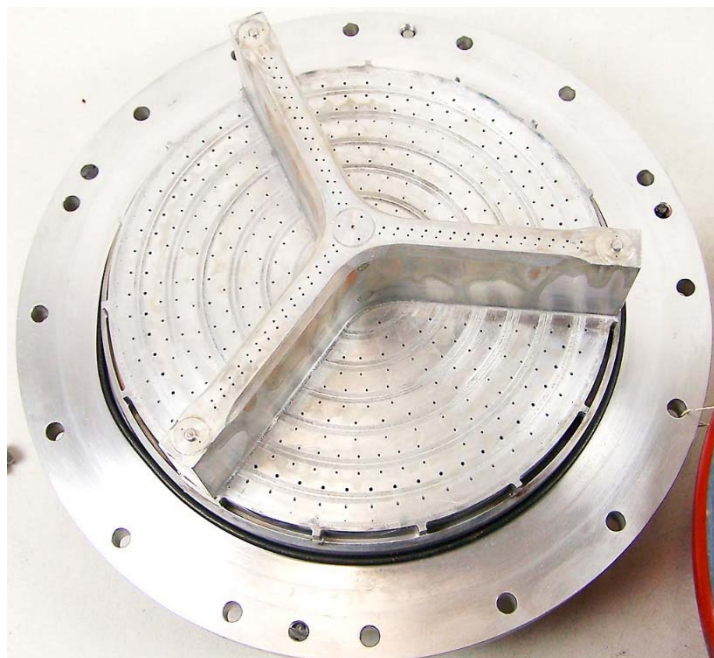

Figure 12-13. Aluminum alloy injector with baffles.

(NASA Archives)

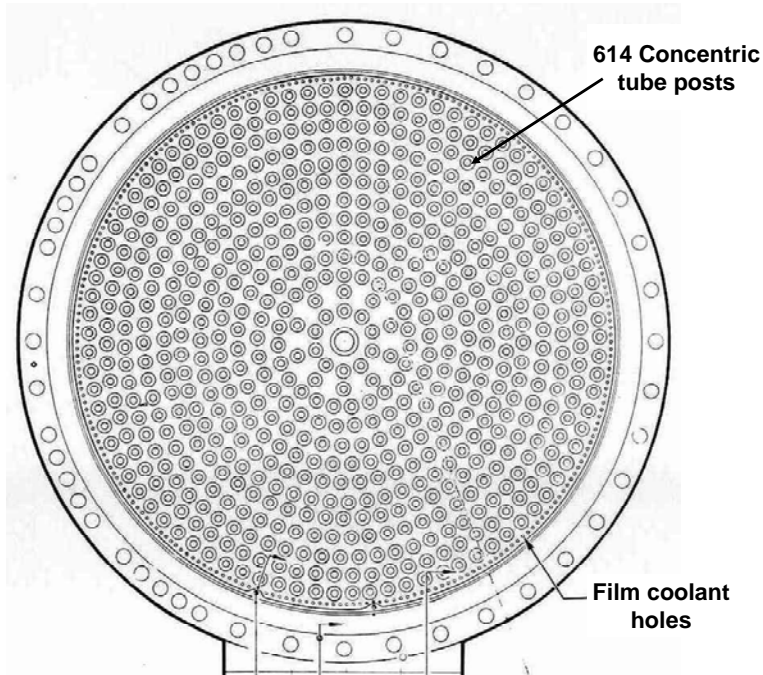

Figure 12-14: Coaxial injector face of the J-2 engine, consisting of 614 tube-within-a-tube elements. Material: austenitic stainless steel. (NASA archives)

Recent advances in manufacturing technology such as additive manufacturing are being explored to help reduce the cost and time to develop propulsion hardware such as injectors. Using conventional materials, such as the Inconels, injectors which previously required hundreds of pieces can now be fabricated as a single piece or several pieces as shown in Figure 12-15. This 3-D printed injector was successfully hot fired tested in LOX/LH₂ with no noticeable loss of performance over a conventionally fabricated injector. [18]



Figure 12-15 Left: 3-D printed rocket injector as it looked immediately after it was removed from the selected laser melting printer. Right: Injector after inspection and polishing. (Source: NASA/MSFC)

12.5.2 COMBUSTION CHAMBERS, NOZZLES, EXPANSION NOZZLES

Combustion chambers, nozzles and expansion nozzles are of many designs – tubular, channel wall, sandwich wall, solid one piece (sometimes ceramic coated), or ablative. Materials selections that have been used include: aluminum alloys, low-alloy steel, stainless steel, pure nickel, nickel-base alloys, cobalt base alloys, titanium alloys, copper alloys, niobium alloys, carbon-carbon, ceramic matrix composites, glass-phenolic, beryllium, and refractory metals. These also can be regenerative cooled, dump cooled, film cooled, radiation cooled, or ablative cooled. Nozzle extensions also use these cooling techniques with the exception that they rarely are regenerative cooled. Fabrication techniques include: machining, tube forming, welding, brazing, diffusion bonding, composite layups with autoclaving, or woven fabric infiltrated by chemical-vapor deposition.

Originally, American, European and Japanese designs tended to favor tubular construction for the combustion chambers and nozzle of larger engines, although welded sheet metal with ceramic coatings sometimes were used. Tubular designs have used nickel 200, stainless steels 316 and 347, Inconel 600, X750, and A286. Newer engines operating at higher pressures have gone to channel-wall construction for combustion chambers, while sometimes retaining tubular expansion nozzles. Carbon-carbon composites have been used for nozzle extensions on upper stage engines, such as the RL-10 and Vinci engines. Russian designs traditionally have used channel-wall construction for combustion chambers, using a combination of copper-chromium alloy inner liner and low-alloy steel, stainless steel or nickel-base outer shells. [10]

The MC-I (previously known as Fastrac) program provided a low-cost, 60,000-lb (60K) thrust rocket engine to the aerospace community. Part of this low-cost design is an ablative chamber/nozzle assembly that is actively film cooled with RPI. The chamber/nozzle is designed for one time use only and will be replaced after every flight. The baseline chamber/nozzle consists of a tape-wrapped silica phenolic liner with a filament-wound carbon epoxy overwrap added for extra strength. A filament wound glass phenolic overwrap was also developed. [19]

Dr. Robert Goddard's first rocket used a combustion chamber made of aluminum with a layered liner consisting of asbestos and alundum/alumina (Al_2O_3) sleeves. The nozzle, which was threaded into the combustion chamber, was made of alloy steel with asbestos and alundum (Al_2O_3) sleeves (Figure 12-16). Goddard then used tool steel for his combustion chambers and nozzles, then later nickel or Monel. For thermal protection, the interior surfaces of his combustion chambers were usually coated with alumina. Although Goddard understood regenerative cooling, he considered it too complex and used only film cooling. Because of this he was constantly plagued by burn-through of the chamber walls. In some of Goddard's designs, the copper tubing was wrapped around and soldered to the exterior of the combustion chamber. However, this was not for cooling purposes. Instead, it was to heat gases, such as nitrogen, to power gyroscopes or pump turbines (Figure 12-17). [9]



Figure 12-16: A replica of Dr. Robert H. Goddard's first combustion chamber and nozzle. Combustion chamber was aluminum with a layered liner of asbestos and alumina. The nozzle was alloy steel with an asbestos and alumina liner. Not visible on this replica is that the nozzle was threaded into the end of the aluminum combustion chamber. (Photo taken at the Huntsville Space Museum)

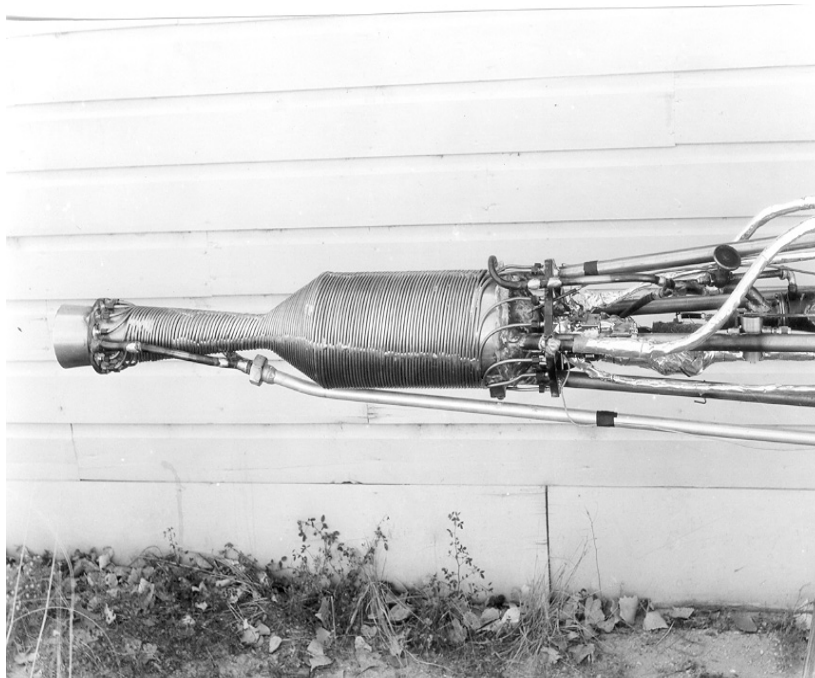

Figure 12-17: Combustion chamber and nozzle from one of Dr. Robert Goddard's rockets. (Courtesy of the Goddard Museum, Clark University)

The V-2 rocket engine had a very short expansion nozzle. This was a result of limitations on the overall missile length. It was a double-wall configuration which was integral with the combustion chamber. It was made of welded sheet metal, low-alloy steel (6000 series, 0.9Cr-0.15V-0.3C-1.0Mn) [7]. All things considered, 6000 series steel probably was the best material available in the 1940's for a sheet metal rocket engine. The steel producers were held to tight specification requirements in spite of the exigencies of World War II in Germany.[8] At the burner cup end, a triple-wall configuration was used (Figure 12-9). This area was dump-filled with alcohol prior to engine start in order to keep the injectors from melting before fuel regenerative cooling took effect. The alcohol fuel and liquid oxygen oxidizer were injected through brass nozzles and combustion initiated in 18 "burner cups" welded to the top of the combustion chamber. This design was an expedient when the German engineers at Peenemunde were unable to obtain stable combustion with flat-faced injector designs. [7] For cooling, the fuel (75% alcohol-25% water) was circulated through the double-wall sides of the combustion chamber. As this was not entirely adequate, film cooling also was used in "hot spots". Aluminum tubing was used to transfer liquid oxygen from the turbopump to the combustion chamber. As 18 of these tubes were needed to feed each of the 18 burner cups, it resulted in the complex assembly so apparent in V-2 engines (Figure 12-18). The lower exit nozzle portion of the thrust chamber, below the fuel inlet manifold was only film cooled (Figure 12-8). In place of fuel circulation, fiberglass insulation filled the space between the double walls of the lower chamber. Steel tubing carried the alcohol fuel to a lower manifold which then circulated upwards through the double walls and into the injectors. Both oxidizer and fuel tubes contained bends to allow for thermal expansion (Figure 12-18).



Figure 12-18: V-2 Combustion Chamber and Nozzle. Red colored tubes are fuel lines made of steel. Blue colored tubes at top of photo are liquid oxygen lines made of aluminum alloy. (Photo taken at the Huntsville Space Museum restoration shop)

Developed in the late 1940's, the NAA A6/A7 engine (Redstone engine) essentially was a significantly improved version of the V-2 engine. Like the V-2, it followed the welded, double-wall, sheet metal configuration, with a relatively short expansion nozzle (Figure 12.19). 4130 low-alloy steel (Cr-Mo) sheet metal was used for the thrust chamber with an aluminum alloy LOX dome bolted onto the injector end. The most important improvement of this engine was the development of a stable, flat-faced injector. The chief injector designer, George Sutton, created an injector consisting of 19 concentric rings, made of nickel-plated, 4130 rings brazed into a 4130 injector body, using pure copper as the brazing medium. The key to stability was the orifice pattern which provided intimate mixing and rapid combustion of the fuel and oxidizer. [2] A humorous (although it was not thought so at the time) anecdote involving a materials selection for the Redstone engine occurred during its first test. In front of Army generals and corporate executives, the first engine test resulted in an explosion which destroyed the engine. It seems the designer had selected alloy steel for the LOX dome which, at an operating temperature of -290F, was well below the ductile-to-brittle transition of the steel. Startup shock fractured the dome and resulted in the explosion. From then on, LOX domes were made from aluminum alloys.

Because of high-strength materials and more efficient design, the A6/A7 engine weighed 34% less than the V-2 while producing 78,000 pounds thrust as opposed to the 56,000 pounds thrust of the V-2 (both sea level thrust values). The Reaction Motors XLR-10 rocket engine for the Navy's Viking sounding rocket also had a V-2-like design, employing a welded double walled configuration. This engine used nickel 200 sheet metal instead of steel.

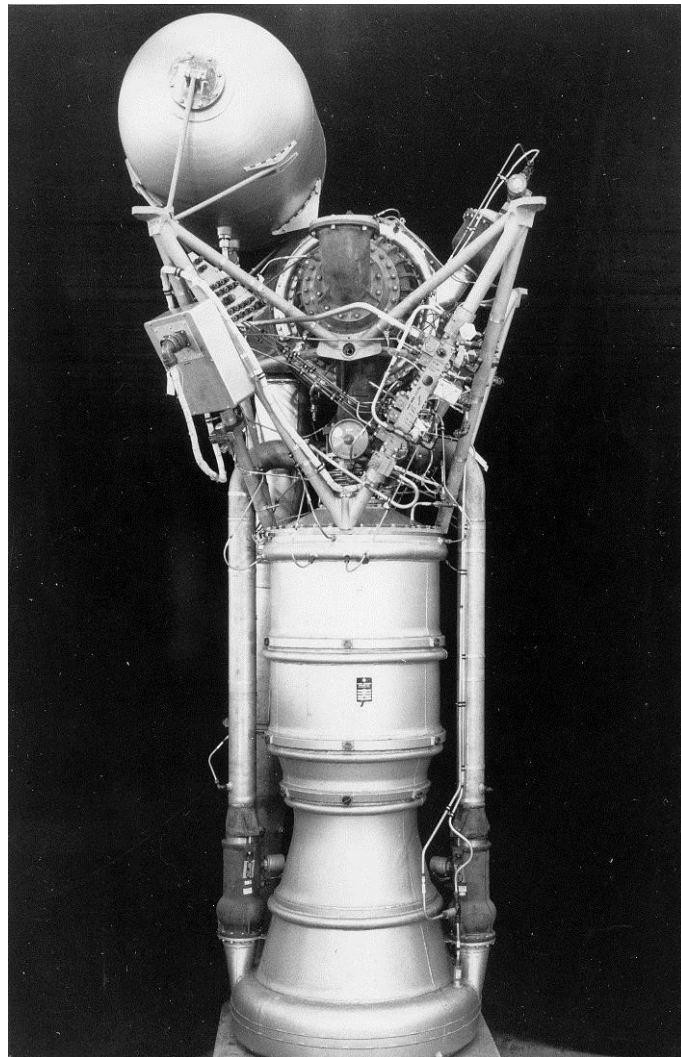

Figure 12-19. NAA (Rocketdyne) A6 rocket engine. Double-wall, welded sheet metal.
(NASA Archives)

When engines went to higher thrust levels, the sheet metal configuration reached a limit – walls thin enough to maintain heat transfer would buckle, whereas walls thick enough to resist buckling would have insufficient heat transfer. The answer in the United States was to go to a tubular configuration (Figure 12-20.). Tubes were brazed to each other and to a metal shell or hat-bands for stiffening. The result was a light-weight yet flexible structure which resisted buckling and had good heat transfer characteristics. At first, tubes were made of nickel 200 and

the assembly was hand brazed. Later, tubes were made of stainless steel or nickel-base alloys and furnace brazed (Figure 25). Joining the tubular assembly by welding also was attempted, but was not successful until many years later, when Volvo developed a successful welding procedure for nozzles. [10]

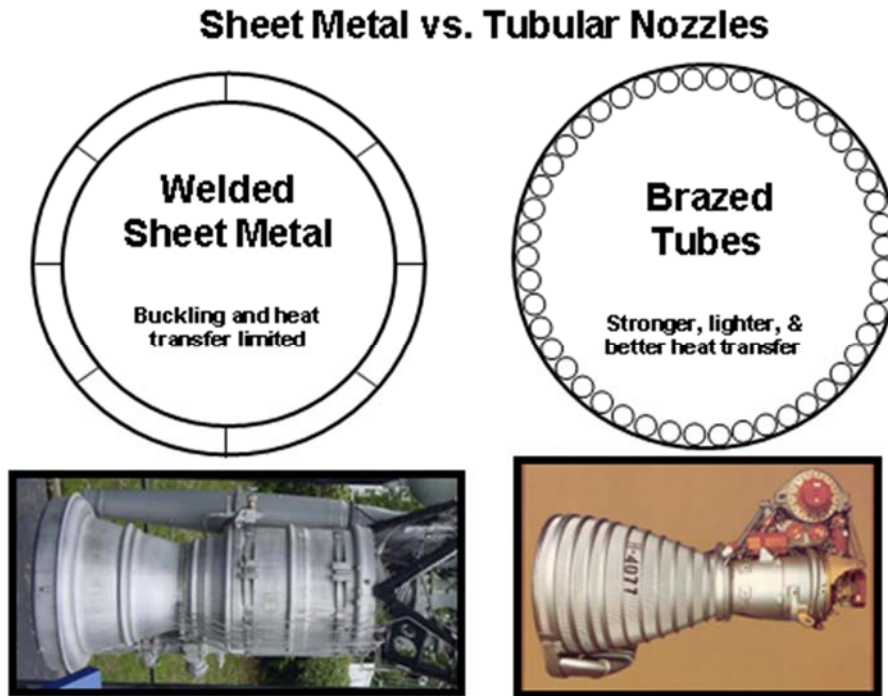

Figure 12-20. Comparison of welded sheet metal nozzle to tubular nozzle. Sheet metal nozzle walls become too thick for high-thrust engines. Tubular nozzle is stronger, lighter, and has better heat transfer.

In the late 1950's and throughout the Apollo program in the 1960's, the combustion chamber and nozzle were made of the same construction, for example, both were of tubular construction, with the tube wall of the combustion chamber simply extending to form the nozzle. When the Space Shuttle Main Engine (SSME) began development, it was apparent that the higher combustion chamber temperature and pressure required much stronger construction, as well as an extremely high heat transfer capability. This dictated a channel-wall construction along with a copper alloy hot wall for high thermal conductivity. A new copper alloy, "Narloy-Z", containing 3% silver and 0.5% zirconium, was developed to meet these requirements. Narloy-Z provided better strength and thermal fatigue at the operating temperature than existing copper alloys, while retaining a thermal conductivity 80% that of high-purity copper. It was the key to obtaining the combustion efficiency of the SSME. [6][17]

In the Soviet Union, channel wall or sandwich wall combustion chamber-nozzle configurations were used. Usually the inner liner was a copper-chromium (Cu~3%Cr) alloy into which slots or channels were milled and then this was brazed to a cover/close-out sheet of low alloy steel, stainless steel, or nickel-base alloy. Figure 12-21 illustrates both the channel-wall and sandwich wall configurations. Usually, the channel-wall design is used for the combustion chamber, although on higher performance engines, it also may be used for the expansion nozzle. For medium-performance engines, such as the RD-107, the expansion nozzle is a sandwich structure

in which the inner liner is a Cu-Cr alloy, a corrugated sheet metal is used as the divider and the outer shell can be alloy steel, stainless steel or nickel-base alloy. The entire assembly is brazed and the corrugations provide flow passages for coolant circulation. The channel wall design provides both strength and superior heat transfer. Channel wall and sandwich wall designs are also reputed to be cheaper to fabricate than tubular configurations. The drawback to channel wall or sandwich nozzles is that they are heavier than tubular nozzles. Originally, in the 1930's time period, the liner and outer shell were only bolted together and the resultant leakage between channels simply tolerated. Following WWII, a pressure brazing method was developed to securely bond the milled channel wall liner to the outer shell. The development of this brazing method, termed "solder-welding" in Russia, was a technological improvement that made possible effective, efficient and reliable rocket engines (Figure 12-22).

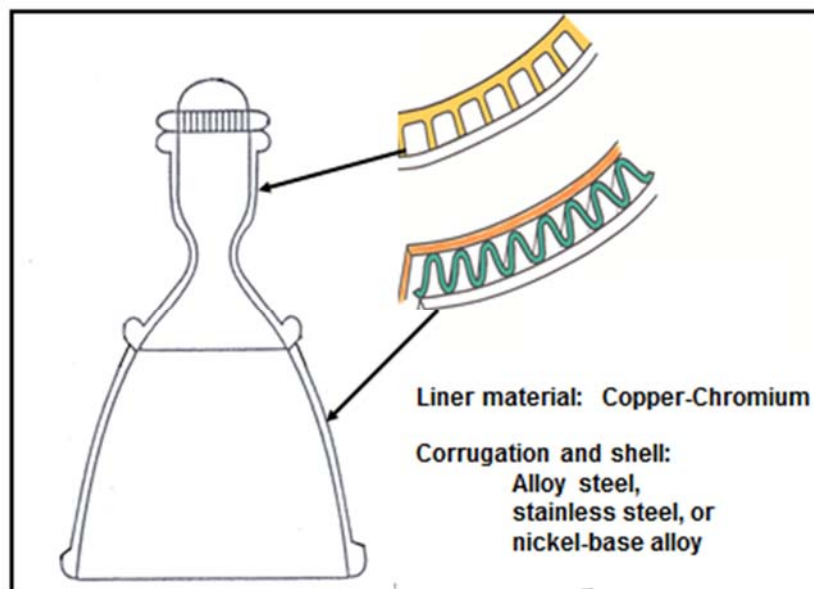

Figure 12-21. Illustration of a Russian combustion chamber and nozzle, showing both channel-wall and corrugation-sandwich configurations. Inner liner in both instances is a copper-chromium alloy. Brazing is used to join inner liner to close out shell.



Figure 12-22. Photo of a Russian RD107 Engine clearly showing the copper alloy inner liner of the nozzles. (Photo taken at the Kansas Cosmosphere museum)

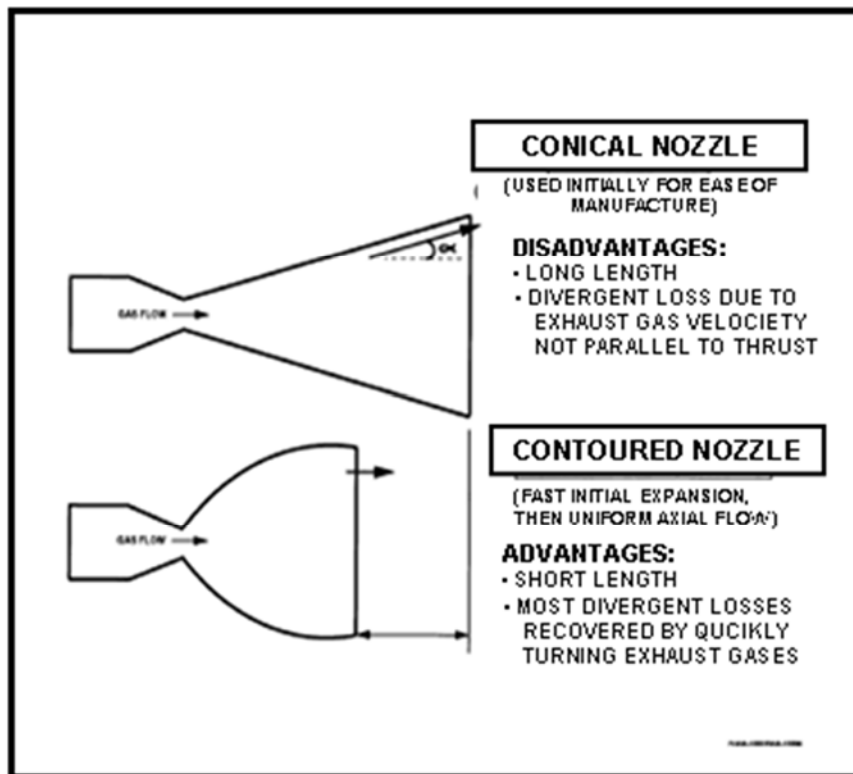

Figure 12-23. Conical versus Contoured Nozzle. The bell-shaped, contoured nozzle eliminates divergent gas losses. Dr. Rau of Rocketdyne developed the equations to generate the optimum nozzle contour for any given thrust level. The contoured nozzle requires complex tube shaping.

Initially, almost all nozzles were straight cone shapes. The conical nozzle provided ease of manufacturing, but at the expense of thrust loss due to the divergent flow from the axis of

thrust. As engines grew in size, the increasing nozzle length and thrust losses of conical nozzles became unacceptable. Dr. Rau, at what was then North American Aviation's aerophysics laboratory, then later Rocketdyne, developed the "Rau Equations" which generated the optimum contour shape for a bell-shaped nozzle. The contoured or "bell shaped" nozzle provided quick turning of exhaust gases for optimum thrust recovery and significantly shortened the overall length of the nozzle (Figure 12-23). The disadvantage of the contoured nozzle was the requirement for tubing with complex, tapered shapes. A tubing manufacturer located in Los Angeles, who specialized in golf club shafts, developed the technology for producing tubing having the required shape and taper for rocket nozzles.

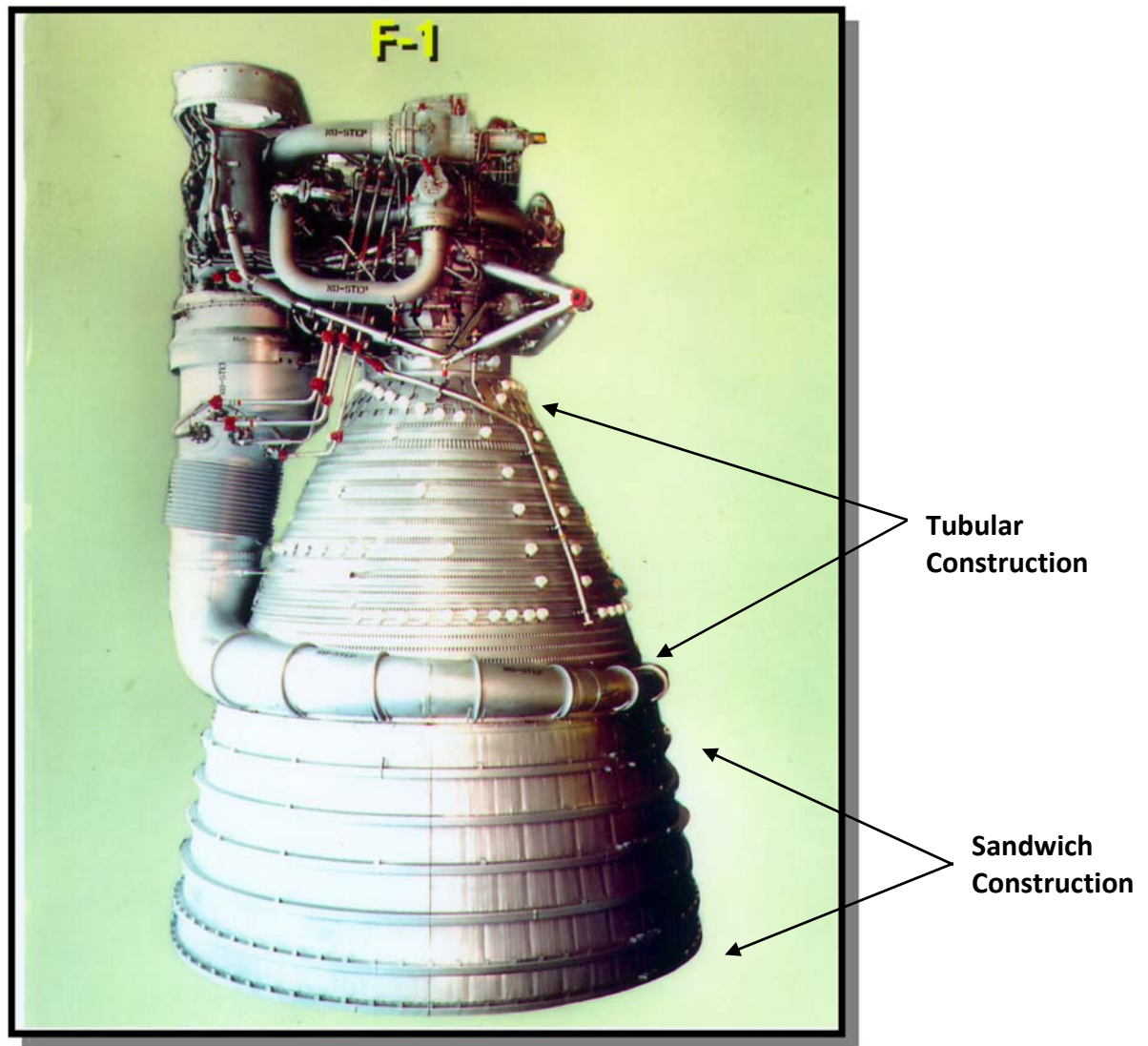

Figure 12-24. F-1 Rocket engine. Combination of a tubular wall combustion chamber, nozzle and upper nozzle extension with a sandwich construction lower nozzle extension. Tubes are of alloy X750. Sandwich construction is Hastelloy C. (NASA photo archives)

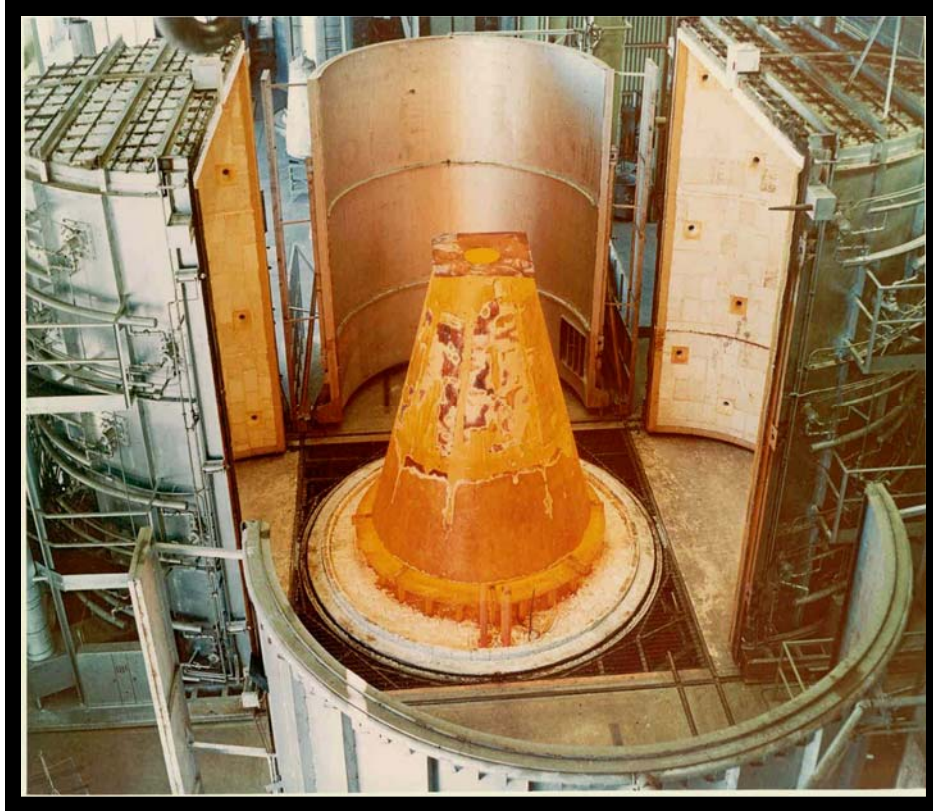

Figure 12-25. Brazing the F-1 Nozzle. Brazing was performed in a retort under a cover gas of hydrogen. Photo shows the outer retort still glowing red hot after completion of the brazing cycle. (NASA photo archives)

The nozzle of the Space Shuttle Main Engine was a brazed tubular assembly, consisting of 1080 tubes of A286 stainless steel which were brazed to each other and to a 718 alloy backup shell. Brazing was a considerable challenge as the process had to accommodate the difference in thermal expansion coefficient between the A286 tubes and the 718 shell.

In Europe, the expansion nozzles for the Vulcain engine are made by Volvo to a unique tubular design. The Inconel 600 tubes have a square cross-section; the tubes are wrapped in a spiral pattern so as obviate the need for tapering. Instead of brazing, tubes are joined by gas-tungsten arc (GTA) fillet welds (Figure 12-26, 12-27). A newer Volvo design for a nozzle extension to the uprated Vulcain engine involves sandwich construction in which the inner liner is a milled channel configuration which is closed out by a cover sheet which is stitched in place by burn-through laser welds (Figures 12-28, 12-29). The material of construction is reported to be stainless steel. [10] [11][12]



Figure 12.26. Assembly of a Volvo Aero tubular nozzle. (Courtesy of Volvo Aero)



Figure 12-27. Completed Volvo Aero Tubular nozzle. (Courtesy of Volvo Aero)

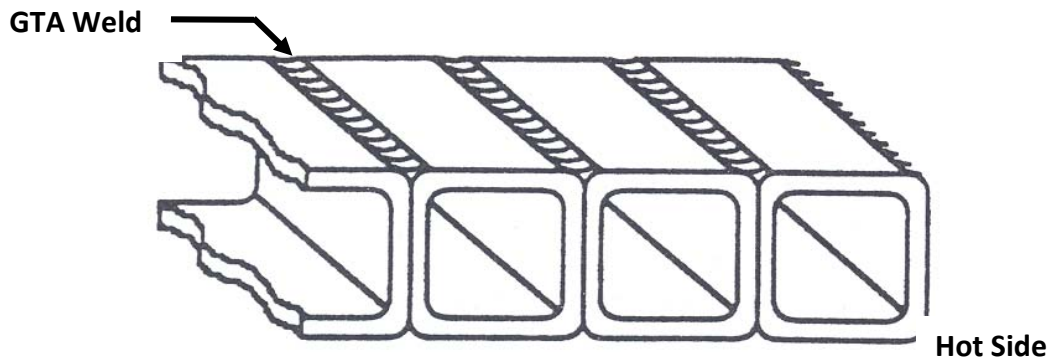

Figure 12-28. Schematic of the Volvo welded square tube nozzle design.
Material is Inconel 600 [12] (Courtesy of Volvo Aero)

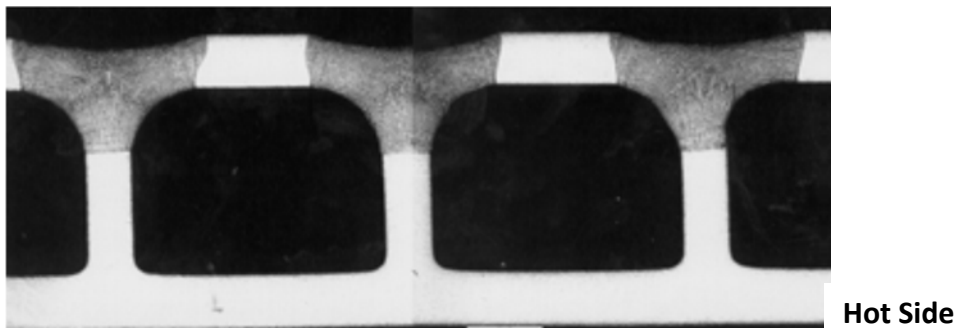

Figure 12-29. Volvo laser welded sandwich expansion nozzle.
Tubes and cover sheet are stainless steel. [11][12]
(Courtesy of Volvo Aero)

Solid metallic nozzles and nozzle extensions also are used. Some examples are the European Aestus upper stage nozzle extension made of Haynes 25 sheet metal, and the Apollo Service Propulsion engine nozzle extension made of a welded assembly combination of niobium C103 and titanium alloy (Figures 12-30, 12-31). The F-1 engine used a nozzle extension of Hastelloy-C sheet in a type of welded, double-wall configuration in which cooling was obtained by ducting warm turbine exhaust gas in a dump-cooling arrangement. Small thrusters have been made of beryllium because of its unique heat capacity and thermal radiation characteristics (Figure 12-32). Carbon-carbon nozzle extensions are used on engines such as the RL-10B2 (Figure 12-33) and the Vinci upper stage engines. Ablative nozzles are exemplified by the glass-phenolic nozzle extension of the RS-68 booster engine and RCS and OMS engines such as the SE-6 for the Gemini program and SE-8 for the Apollo Command Module (Figure 12-34). Typical ablative materials are carbon cloth phenolic, glass cloth phenolic, and silica cloth phenolic (Figure 12-34). Fabrication of ablatives is similar – for example, the carbon cloth is impregnated with a phenolic resin and carbon filler, then oven cured. [13]

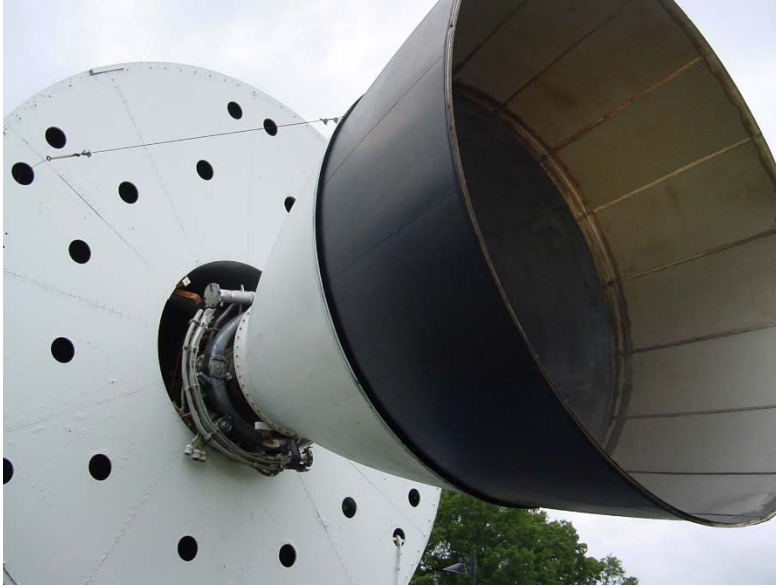

Figure 12-30. Apollo Service Propulsion Module Engine. Expansion nozzle is made from niobium alloy C103. Nozzle extension is welded titanium alloy sheet metal. (Photo taken at the Huntsville Space Museum)

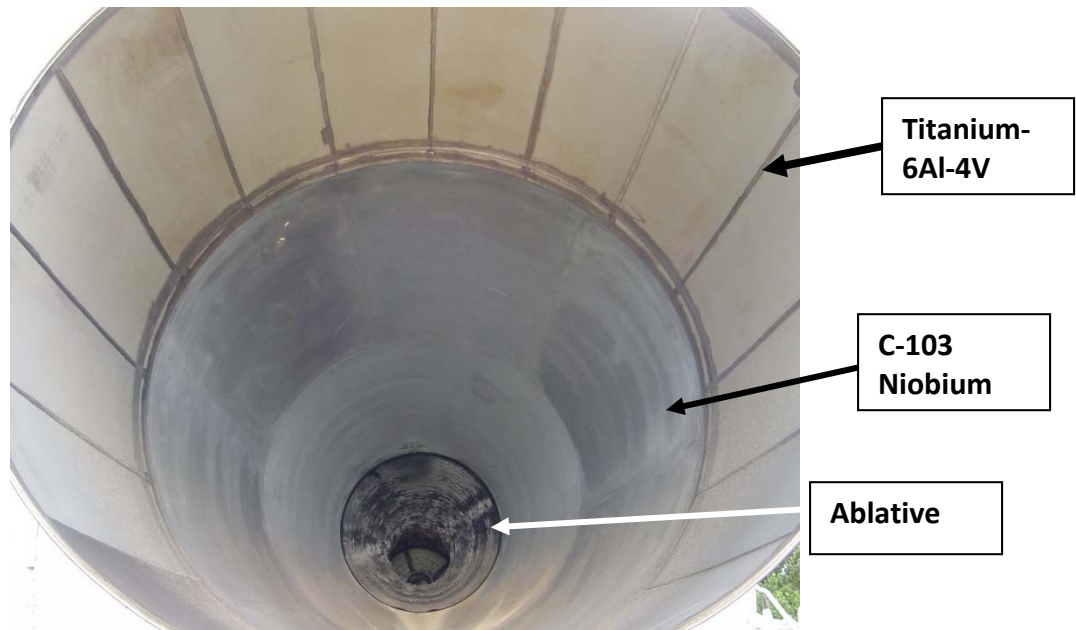

Figure 12-31. AJ-10 Apollo Service Propulsion Module Engine Nozzle and Nozzle Extension. Nozzle is C103 Niobium alloy. Nozzle Extension is Titanium alloy. (Photo taken at the Huntsville Space Museum)

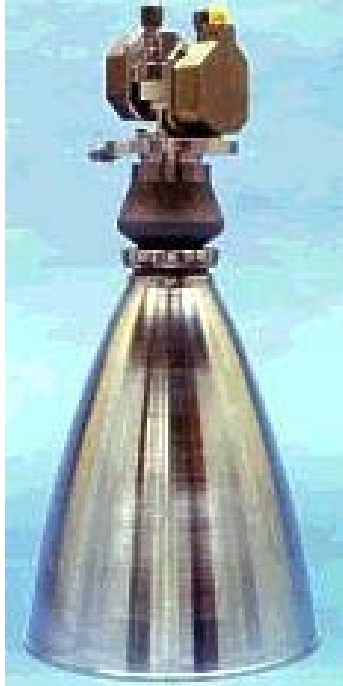

Figure 12-32. Small thruster with beryllium combustion chamber and high temperature alloy nozzle. (NASA photo archives)



Figure 12-33. RL-10 Engine with extendable carbon-carbon nozzle extension (NASA photo archives)

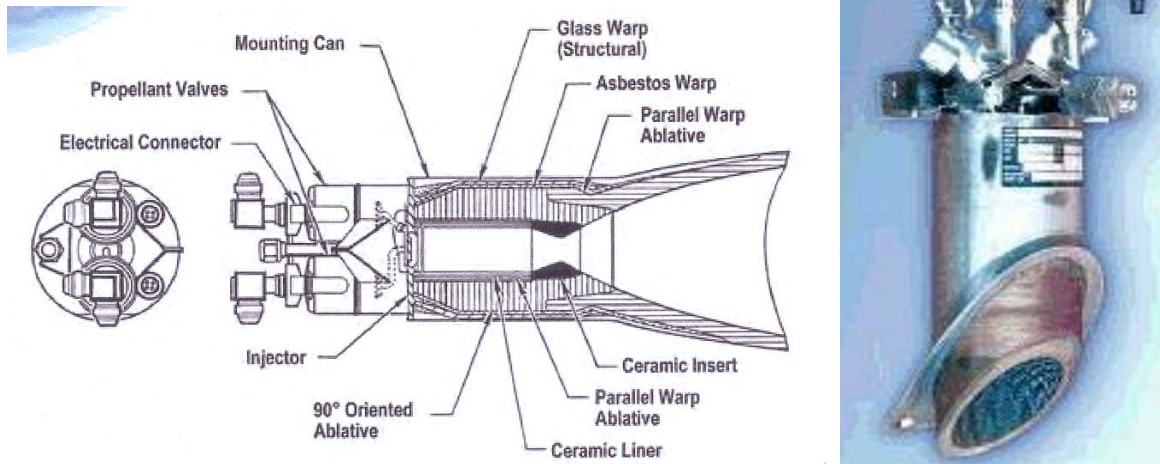

Figure 12-34. Cross section of a small ablative reaction-control (RCS) engine.
(NASA Photo Archives)

In the late 1990's, an ablative chamber/nozzle was developed for the Fastrac engine. The chamber/nozzle was built as one piece with an ablative liner and a composite overwrap. The ablative liner is tape-wrapped using Silica Phenolic tape and then cured on the tape-wrap mandrel. After completing the liner, it is machined, and the injector attachment flange then is bonded to the exterior of the liner. A carbon-epoxy overwrap is then filament wound around the entire structure and cured. The nozzle is then machined to the correct length. Interface hardware fabricated from 304 stainless steel is bonded to the composite nozzle with mechanical locks in high temperature and high stress locations. (Figure 12-35)[19][20]



Figure 12-35. Fastrac Engine Hot-Fre Test at NASA/ Marshall Center
(Source: NASA/MSFC)

12.6 Turbopump materials

12.6.1 Introduction

Turbine driven pumps become necessary when the rocket engine requirements (thrust level, mission duration, ability to be throttled to various power levels, etc.) exceeded the capability of pressurized propellant feed tank systems. The word “turbopump” was coined to describe these pump/turbine components. The common theme of all turbopumps is that the power to pump the propellant is provided by passing a fluid, usually (but not always) an expanding gas, and usually (but not always) at elevated temperatures, through a series of turbine blades to impart rotational torque to power either a centrifugal or axial flow pump. The goal of all turbopumps is to produce the required pumping power and flow with as lightweight and compact a package as possible while maintaining adequate structural margin over the anticipated mission duty cycle. [15][16]

The methods used to develop the turbine drive fluid depends on the type of system used, which has been described previously. However, the propellants (fuel and oxidizer) being “pumped” are necessarily liquid so that the pumping elements can increase the pressure and flow rates of the propellant to levels required by the engine system. The starting pressures are low, usually dependent on the vehicle’s propellant storage tank volume, but must be raised to sufficiently support the required combustion levels after being forced through various ducting arrangements throughout the engine system. The propellants end up at the main injector before being directed into the main combustion chamber to be ignited, producing the smoke and fire rockets are famous for.[15]

The materials utilized in turbine end of the turbopumps are dependent on the chemical composition of drive gas used, its pressure, temperature, and flow rate - all will influence how the media will interact with the metallic and non-metallic mechanical components along the way. Also, by the very nature of a rotating pump there will be fatigue life implications that must be taken into account in addition to expected (and unexpected) material strength requirements. Likewise, the fluids being pumped, the oxidizer and fuel, present their own set of challenges dependent on the material used which are likewise dependent on the pressure, temperature, flow rates, chemical stability or lack of, etc.[6][17]

Turbine driven pumps may be directly coupled to the pumping elements using a single shaft or may be indirectly coupled with the turbine generated power directed to the pumping elements using a gear speed reduction transmission arrangement as was utilized on the RL10 and the Atlas MA-2, MA-3, MA-5 engine series. Gear arrangements add complexity to a system and lubrication issues are common.

Finally, the type of rocket system being constructed will impact the material selection decisions greatly. Rocket Engine systems are usually separated into 2 general groups: Reusable and Expendable. A reusable rocket engine system, for instance, is intended to be used over and over again thus greatly lengthening the required life of the hardware. Being reused again and again subjects the engine system to potentially a large number of “hot fires” or starts which tend to load the hardware to the highest stress levels. Also the increased hot fire duration of multiple missions will subject the hardware to longer fatigue related damage over the useful life of the engine. While individual high wear components may be changed out after each flight, the major

components will be reused with little more than a cleanup and inspection. The SSME is an example of such an engine system.

An Expendable rocket system is intended to be utilized for a single mission with a minimum of individual number of starts before actual flight. And after the mission is completed, the spent 1st stage or “booster” engines are usually jettisoned into the ocean or a remote land, never to be utilized again. These engines are usually designed to take advantage of the minimum mission life expectancies by operating higher on the material’s strength and fatigue life capability and may allow higher levels of propellant interaction than what would be considered prudent for a reusable system. This type of system would be appropriate for ballistic missiles as well as satellite or cargo delivery rockets such as the current Atlas, Delta, H-II, Long March, and Ariane families of rocket systems.

In considering materials selection, there are really two, distinct portions of the turbopump – the pump end and the turbine end. Usually, the materials selection considerations for these are quite different. The pump operating temperatures vary from room temperature to cryogenic temperatures. Environmental effects of the fluids being pumped must be considered, but often the effects are limited to temperature alone, as the cryogenic temperatures often ameliorate environmental effects by reducing chemical reactivity. On the other hand, high pressure oxygen presents the unique danger of an oxygen fire if a source of ignition is present. For this reason, the oxygen-compatibility of the materials employed must be considered.[6]

The turbine end of the turbopump operates at temperatures that can vary from cryogenic (for turbines driven by propellants in their liquid state) to significantly elevated temperatures. The reactivity of propellant gases often can be exacerbated by elevated operating temperatures. This summary is intended to give an overview of some of the different materials that are utilized for a variety of turbopump engine systems with various types of drive systems pumping various types of propellants.[6][15][16]

12.6.2 Sample Turbopump Configurations

To get a better feel as to how turbopump designs can vary, several representative pumps from different eras are shown with a short description of features:

Robert Goddard’s Turbopumps – Late 1930’s:

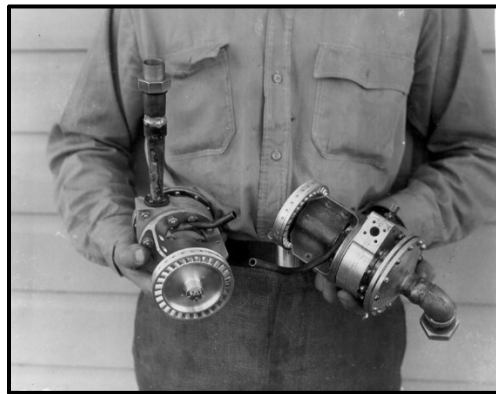

Figure 12-36 Fuel and oxidizer turbopumps for Dr. Robert Goddard’s rocket. (Clark University archives)

Dr. Robert Goddard was the first to use turbopumps to deliver propellants (gasoline and LOX) to a rocket engine combustion chamber. Goddard used impellers made of brass and steel. Aluminum alloy 2017 (4Cu-0.5Mn-0.5Mg) was used for turbines and pump housings. Turbines were machined from 2017 and driven by gaseous oxygen. Dowmetal (Magnesium-Al-Mn) also was used for pump housings. The risk of using a magnesium alloy in an oxygen pump was unknown in Goddard's day and may have impacted the reliability of his systems.

A4 (V2) Turbopump - 1940's design

As it was the world's first ballistic missile, the turbopumps for the V-2 were initially an unknown quantity. The engine required pumps that could quickly start and rapidly develop a high head. To the surprise of the German engineers, fire pumps fit their requirements, and the pump design progressed without much difficulty, although the incorporation of a turbine drive proved to be a challenge. The turbopump for the V-2 engine was a rather unique design, having a direct-drive turbine situated between the fuel and oxidizer pump with pump inlets entering from the center of the pump instead of from the ends (Figure 12-37). The V-2 turbopump developed 665 HP at 3800 rpm. The turbine drive gas was produced in a separate system and consisted of steam created by the catalytic decomposition of hydrogen peroxide, using potassium permanganate as the catalyst. Pump impellers were of the shrouded centrifugal-flow type. The pump housings and impellers were castings of an aluminum- 13% silicon – 0.3 Mn alloy, generally called "Silumin", which is a family of aluminum casting alloys which were commonly used in the 1930-40 time period (but still are in use today).[2][8][15] The shaft and steam manifold were low alloy steel, while the turbine disk was an aluminum alloy having the composition Al-2Mg-1.4Mn. The turbine blades were aluminum permanent mold castings of 13X alloy (Al-13%Si). In those days, permanent mold casting was performed in air, so each turbine blade developed a thin layer of oxide on its surface. This thin oxide layer had the effect of providing a sort of "ceramic" coating that protected each blade from the hot turbine steam (400+F) for the duration of the powered portion of the flight (~56 seconds). This same turbine blade feature was copied for the Rocketdyne A6/A7 Redstone rocket engine turbine.

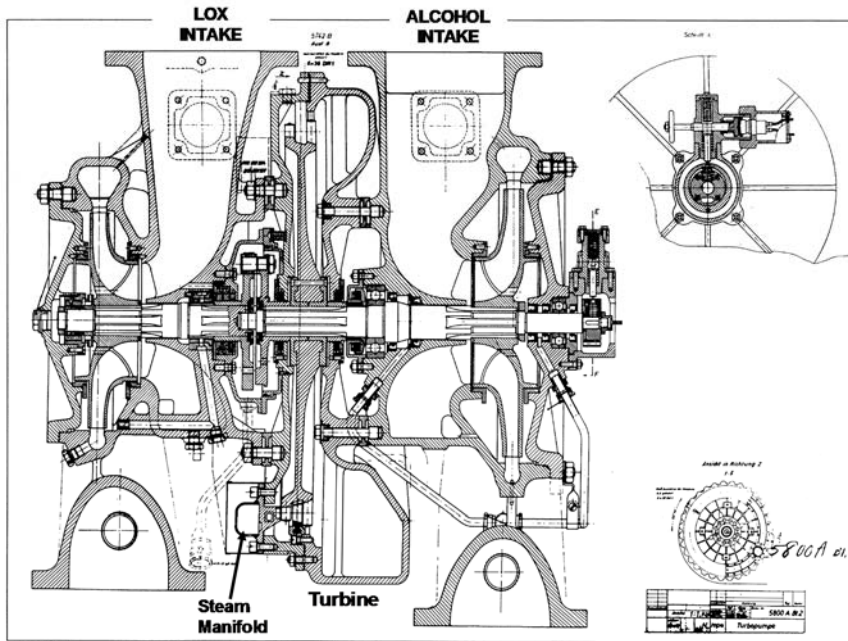

Figure 12-37 Turbopump for the A-4 (V-2) Missile. The two-stage turbine is located between the fuel and oxidizer pumps. 665 HP, 3800 RPM (Huntsville Space Museum Archives)

Redstone Engine A6/A7 Turbopump – Early 1950's Design

The turbopump for the NAA A6 engine, which became the Redstone engine, can be looked upon as an improved version of the German V-2 turbopump. The turbine remained located between the fuel and oxidizer pumps, and the turbine drive gas remained steam from decomposed hydrogen peroxide, except a silver coated screen was used as the catalyst. Also, the permanent mold 13X cast aluminum turbine blades on the V-2, with their oxide layer coating, were retained. The turbine disk alloy was changed to 7075 aluminum. The pump inlets were reversed to a more logical configuration at the ends of each pump and inducers were added to increase performance. (Figure 12-38) Impellers and housings were changed to 356-T6 cast aluminum alloy, a significantly stronger material than the "Silumin" used in the V-2 pumps. The design changes, combined with higher strength materials, provided a lighter yet higher performing turbopump. The A7 turbopump produced 836 HP versus the 665 HP of the V-2. [5]

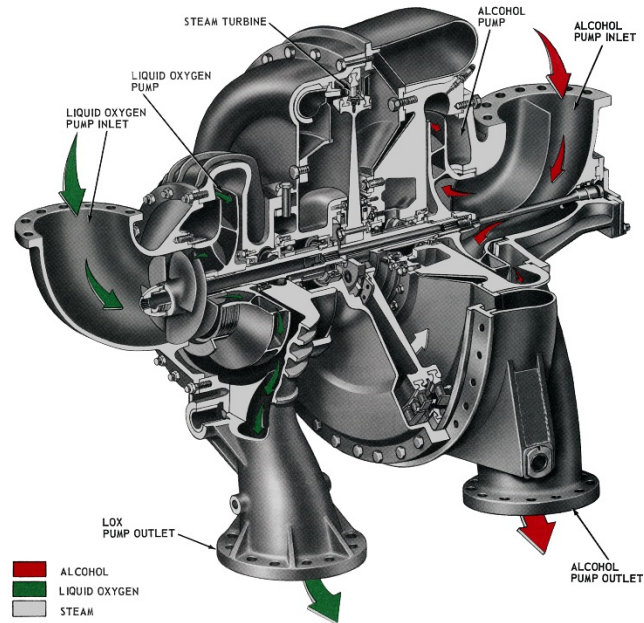

Figure V-4 – Operation of the Turbopump

Figure 12-38. Cutaway of a XLR43-NA-1 engine turbopump, also the same design as used on the A6 and A7 Redstone engines. 836 HP, 4840 RPM. (NASA archives)

Atlas Turbopump – Late 1950's design

With the advent of high performance rocket engines, the demands on materials increased dramatically. Gas generators now provided hot gasses for turbine drives, requiring materials with good high temperature properties. The Mark 3 was the first high-performance turbopump in the Western world. Originally designed for the Atlas ICBM, it has been used, in various modified forms, for the engines of the Atlas, Thor, Jupiter, Delta I, Delta II and Delta III rockets. The Mark 3 featured fuel and oxidizer pumps on a common shaft, driven through four gears by a two-stage turbine.[3][15] For the first time, high-purity kerosene was used for the fuel along with liquid oxygen (LOX) oxidizer. The high-strength, cast aluminum alloy Tens-50 (the precursor to A357) was used for the impellers and pump housings. Inducers were 7075 aluminum forgings. The common pump shaft was 4340 high-strength, low-alloy steel. Turbine disks were forged 16-25-6, an early austenitic high-temperature alloy (Fe-16Cr-25Ni-6Mo). Turbine blades were investment castings of Stellite 21 (Co-27Cr-5Mo-2.5Ni) and were welded to the turbine disks. Gears were 9310 alloy steel, carburized. (Figure 12-39)

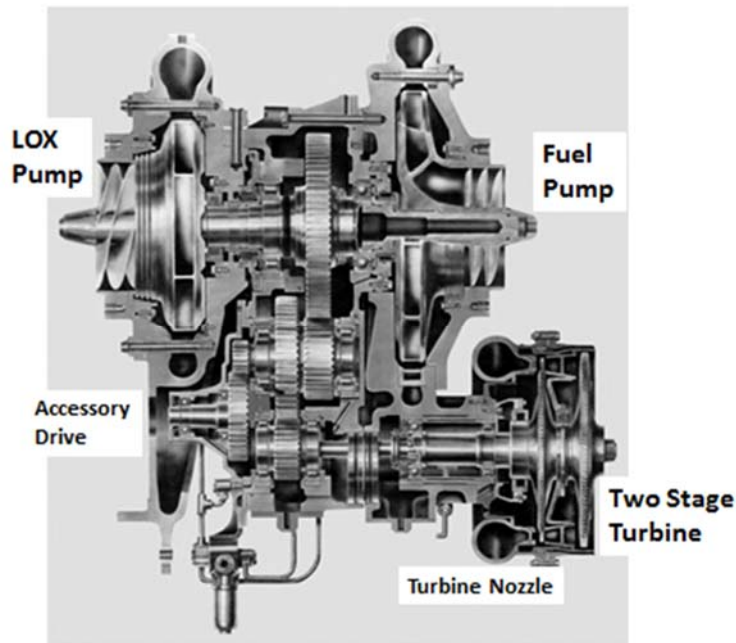

Figure 12-39 The Mark 3 turbopump used on the Atlas, Thor, Jupiter and Delta I & II launch vehicles. Pump = 2550 HP, 6700 rpm. Turbine = 30,000 rpm (NASA archives)

F1 Turbopump (Mark 10) – late 1950's Design

The 1.5 million pound thrust F-1 engine for the Saturn V launch vehicle required new thinking for turbopump design (Figure 12-40). Gearing was abandoned in favor of direct drive, with the turbine coupled by a single shaft to both the fuel (RP-1) and oxidizer (LOX) pumps. The extremely high power requirements of the Mark 10 pump would place an impossible load on any gear train. [15]

The Mark 10 was the first turbopump where many parts were too large for a workman to lift, necessitating the use of cranes. The Tens-50 aluminum pump housings and impellers were cast in specially designed, highly-chilled molds which provided very rapid solidification rates to obtain never-before seen strength and ductility in aluminum castings of that size. The turbine disks and manifold utilized the newly developed high-temperature alloy, Rene 41(Ni-19Cr-12Co-10Mo-3Ti-1.5Al-1.2C). This alloy produced challenges in welding which eventually were overcome by post-weld vacuum heat treatment.

MATERIALS

Pump Housing: Tens-50 Al casting

Impellers: Tens-50 Al castings

LOX Inducer: Monel K500 Forging

Fuel Inducer: 7075-T73 Forging

Turbine Disk: Rene '41 Forging

**Turbine Blades: 713C Investment
castings**

Turbine Manifold: Rene '41 Sheet

Shaft: 4340 Forged Bar

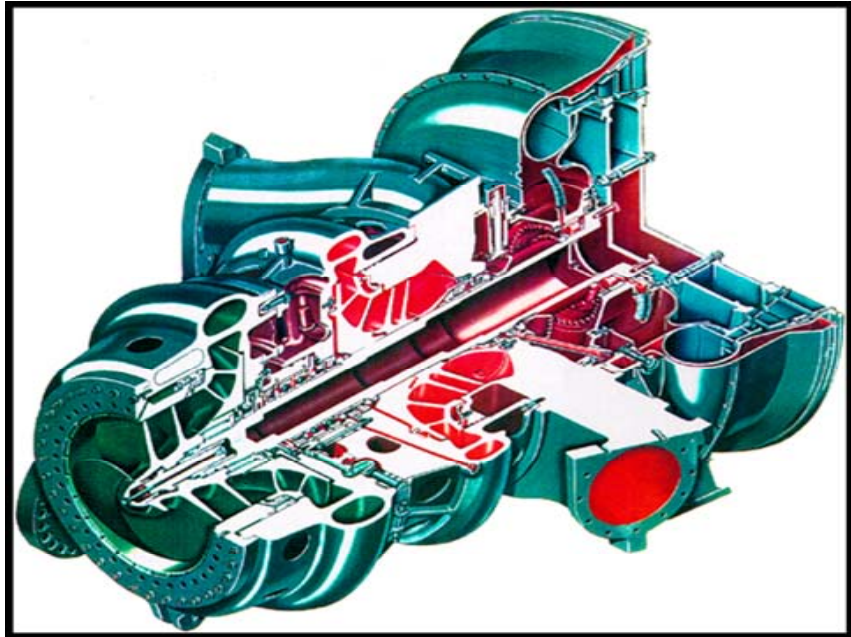

Figure 12-40 Mark-10 Turbopump for the F-1 Engine. 53,000 HP, 5500 RPM,
FLOW RATES: 25,000 GPM LOX, 15,600 GPM RP-1 (NASA archives)

Hydrogen Turbopumps (RL-10 and Mark 15) – Late 50's to Early 1960's Designs

The RL-10 (Figure 12-41) was the world's first hydrogen fueled rocket engine. It was an expander cycle engine with a moderate thrust of 15,000 pounds. Because it was an expander cycle, driven by the expansion of gasified hydrogen, turbine temperatures were near room temperature and pressures were relatively low. Therefore, aluminum alloys could be used for the turbine as well as the pumps. The RL-10 is remarkable in that it remains in production to this day – a time span of over 55 years.

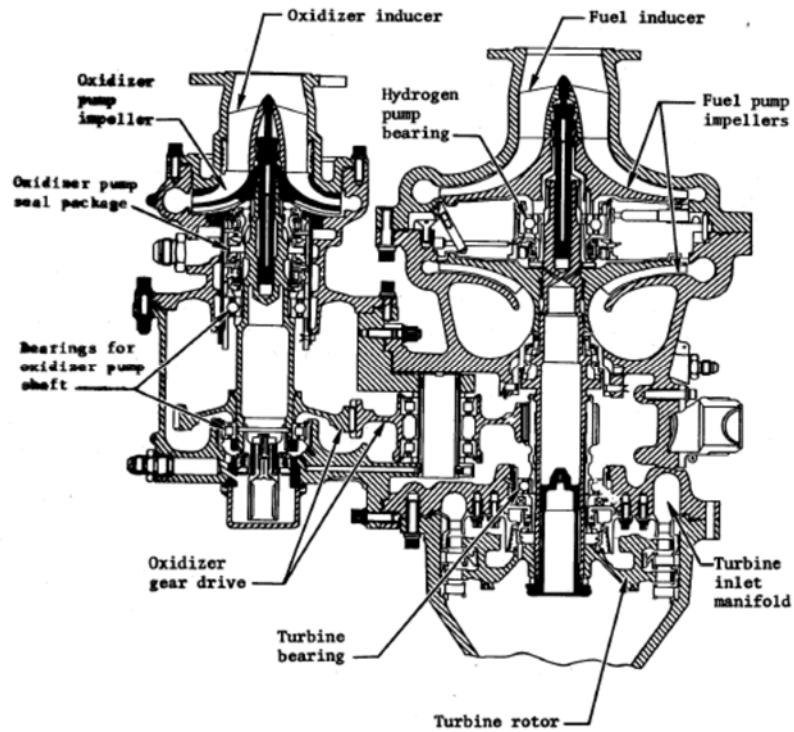

Figure 12-41 RL10A Turbopump Assembly
 Source: NASA SP 8107 Turbopump Systems for Liquid Rocket Engines (NASA archives)

SSME Turbopump– 70’s design

The turbopumps for the Space Shuttle Main Engine (SSME) presented significant challenges from design and materials standpoints. The turbopumps were to be reused many times over, pressures were very high (6000-8000psi), and turbines had to endure hydrogen-rich combustion products at temperatures on the order of 840°C (1550 F). Figure 12-43 shows an early version of the hydrogen turbopump. Hydrogen embrittlement became an issue for the turbines and the high pressures in the oxygen pump presented a serious potential for oxygen fires if an ignition source, such as a severe rub, were present. [6][17]

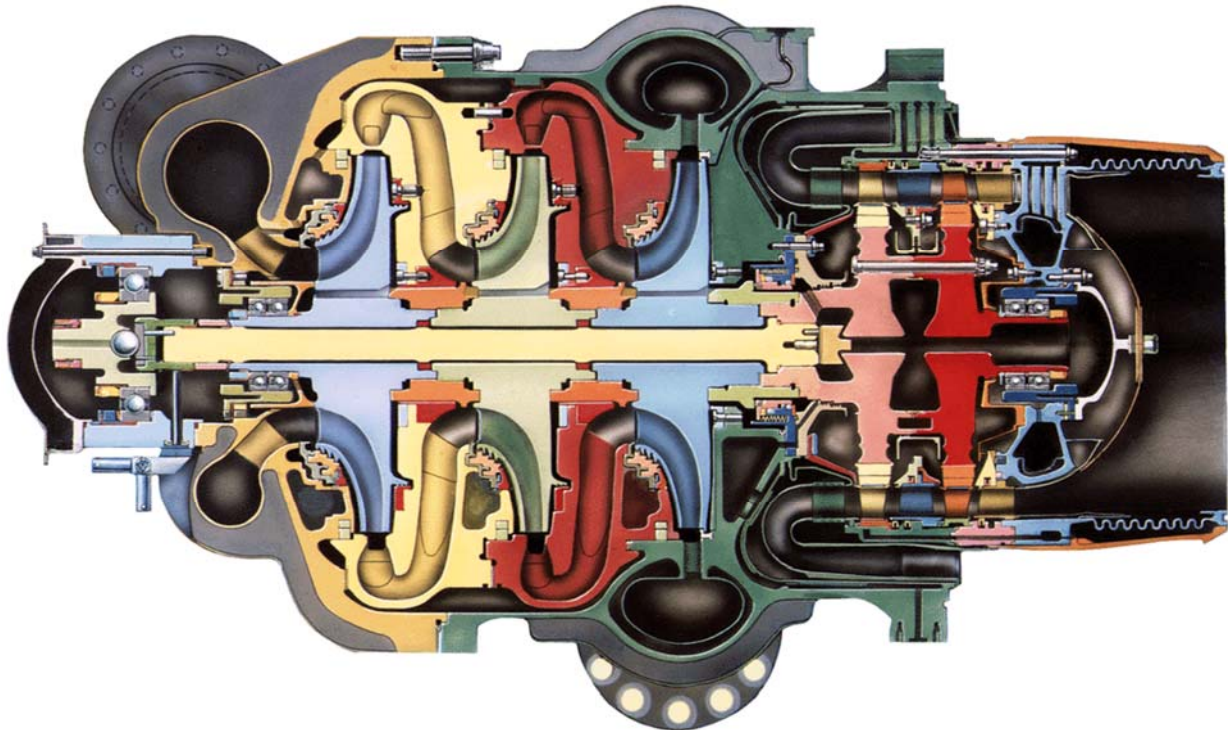

Figure 12-43 The original High-Pressure Fuel Turbopump for the Space Shuttle Main Engine 70,000 HP, 38,000 RPM, 6800 psi discharge pressure (NASA Archives)

SSME Alternate Turbopump - 1990's Design

The late 1980's saw the start of a new Space Shuttle Main (SSME) Engine High Pressure Oxidizer Turbopump (HPOTP) design. This new turbopump was specifically designed to improve flight life and eliminate critical vulnerabilities in the original HPOTP. A heavier allowable weight permitted a much stronger, stiffer rotor system, as well as more robust pump and turbine housings. Material advances in casting technologies permitted the incorporation of complex, fine-grained castings which allowed the elimination of 293 welds within the turbopump, including all 250 welds for which there was no root side access for inspection at fabrication. Silicon nitride rolling elements were used in the pump-end bearing, virtually eliminating bearing wear and fatigue concerns. Single-crystal alloy blades with thin-walled,

hollow airfoils were incorporated to address blade cracking. This new HPOTP design first flew in 1995.[21]

In the mid 1990's a redesigned HPFTP was restarted as part of the SSME Block II program. It incorporated improvements similar to those on the Alternative (Block I) HPOTP. The new HPFTP design had no welds and utilized silicon nitride rolling elements in both of its bearings. Similar to the Block I HPOTP, single crystal alloy turbine blades with thin airfoils essentially eliminated blade cracking in the Block II HPFTP. This new HPFTP design first flew in 2001.[21]

Technology Development Turbopumps – Late 1990's – early 2000's

There were other turbopump technology programs in the mid to late 1990's and early 2000's which focused on turbomachinery technology to reduce part count, and improve overall design and manufacturing cycle time. The NASA Low Cost Boost Technology Project objectives were to significantly lower the cost of access to space for small payloads. There were two projects funded to completion, producing hot fire test results to address these challenges: the Fastrac engine turbopump and the Bantam turbopump. These projects focused on adapting common manufacturing techniques and existing commercial, off-the-shelf hardware to the aerospace applications. [22]

The MC-1 Engine, a NASA- led in-house design, (formerly known as the Fastrac 60K) is a pump-fed liquid rocket engine with fixed thrust and gimbaling capability. The engine was initially designed for the Low Cost Boost Technology (LCBT) Project and small space vehicles. The engine burns a mixture of RP-1 hydrocarbon fuel and liquid oxygen (LOX) propellants in a gas generator (GG) power cycle. The MC-1 Fastrac turbopump design stepped away from the traditional gearbox design and, like the F-1 turbopump, incorporated the oxidizer impeller, the fuel impeller and the turbine on a single shaft.[23] The Bantam turbopump also was designed to meet the MC-1 engine requirements but took a different approach in by using twin rotating shafts within a single housing. NASA contracted with Rocketdyne who teamed with Barber Nichols Inc. to design, fabricate and test the Bantam turbopump.[24]

The US Air Force , NASA and leading aerospace industry contractors joined forces to develop the Integrated Powerhead Demonstrator (IPD), a risk-reduction effort to develop engine technologies for a full-flow, hydrogen-fueled, staged-combustion rocket engine in the 250,000-pound thrust class. The IPD engine employed dual preburners that provide both oxygen-rich and hydrogen-rich gases for the staged combustion engine.

The IPD project was intended to address two major turbomachinery technological challenges -- turbine life and bearing wear -- traditional life limiters for rocket engines turbomachinery. The high-performance turbomachinery developed for the IPD demonstrator included hydrostatic bearings that fully support the rotor of both the fuel and oxidizer pump instead of ball bearings or roller bearings which are typically used. The use of oxygen-rich steam to power the IPD oxygen turbopump is intended to dramatically increase safety of engine system operation, limiting seal

failure between the pump and the turbine that could leak extremely hot gases into the turbine and cause them to burn prematurely. The IPD program introduced materials to address oxygen rich environments, hydrogen rich environments, and bearings to address hardware life issues experienced in other high power density rocket engine turbomachinery.[25]

During the NASA Reusable Launch Vehicle (RLV) program in the late 1990's and early 2000's, materials technology projects were established to explore the use of aluminum (Al) and copper (Cu) metal matrix composites (MMC) and carbon fiber-reinforced, silicon carbide (C/SiC) ceramic matrix composites (CMC). These technology efforts were started to address the program goals for reducing engine component weight and reduce hardware costs and operational costs. The Al MMC's were considered for turbopump housings applications. Housings for high performance rocket engine turbopumps make up a very high percentage of a turbopumps total weight. MMC's offered the potential benefits of high specific strength, tailoring properties, propellant compatibility, reducing cost, and producibility. [29] [30]

The C/SiC CMC's for turbopump applications were also investigated during the RLV program. The use of ceramic composites in rocket engine turbines was to address turbine life issues on reusable turbopump systems, to increase safety and reduce costs. One intriguing characteristic of C/SiC CMC's is its ability to withstand damage. In extensive testing, the ceramic blisk continued to perform normally despite a crack in one of the blades. The ceramic blisk also can withstand temperatures of 2,000°F(1,093°C), considerably higher than the 1,200°F (649°C) temperature limit for nickel-alloy turbines. A 7.6 inch diameter C/SiC CMC blisk , Figure 12-44, was tested in a rocket engine turbopump repeatedly accumulating data that will be used to predict CMC blisk life.[26]

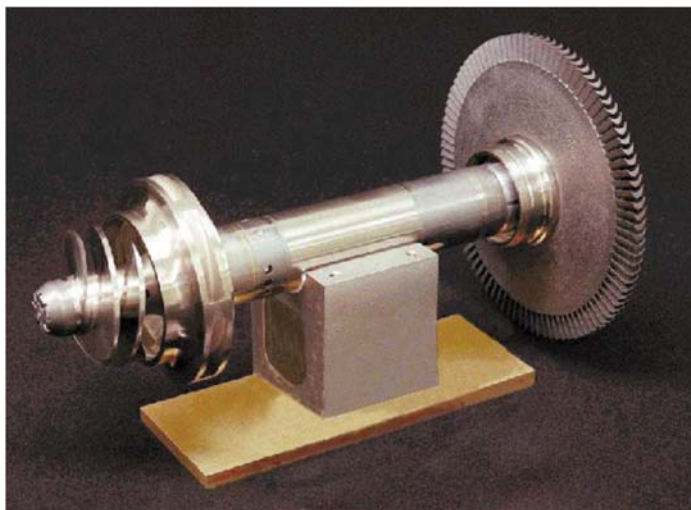

Figure 12-44. Ceramic Matrix Composite Disk
(NASA/MSFC Turbopumps – 2010)

Recent advances in additive manufacturing have made it possible to make complex parts for rocket engine turbomachinery hardware. The idea is to make complex parts quicker at lower cost and be able to test hardware in a representative environment to drive down risk. In 2015, a LH2 turbopump designed using 3-D printed parts, Figure 12-45, was hot fire tested as a component and then as part of a breadboard engine. The LH2 turbopump is for a 35K lbf

expander cycle engine. The 3-D printed turbopump has 45 percent fewer parts than similar pumps made with traditional welding and assembly techniques. The pump design speed is 90,000 RPM.[27]



Figure 12-45. 3-D Printed Liquid Hydrogen Turbopump
(Source NASA/MSFC)

12.6.3 Turbine Drive Methods & Components

To drive the pump(s), high pressure gas must be introduced to the turbine portion of the turbopump. How the gas is generated depends on the type of engine system being used. The three major methods are: gas generator cycle, staged combustion cycle and expander cycle [14][16]

Basically what is happening is that gas is ducted to the turbine inlet portion of the pump. The gas is introduced to a pressure vessel housing which directs the flow, usually through a nozzle and into the turbine blades. Depending on the propellants used, various component materials may be utilized. Except for expander cycles, all must have a reasonably high strength at elevated operating temperatures (which could be as high as 1500°F), and have a sufficient resistance to high and low cycle fatigue. And should hydrogen be the fuel and the hot gas fuel rich, a review of the selected materials' resistance to hydrogen embrittlement is necessary. Also, there are some designs that rely that on an oxidizer rich hot gas which would be sensitive to catastrophic ignition depending the temperature, pressure and the possibility of entrained particles (potential impact ignition sources).

Examples of previously selected materials include housings composed of nickel based superalloys such as Inconel 625 and 718, precipitation hardening iron based stainless steels such as A286 and Incoloy 903 as well as a variety of cobalt based alloys such as Haynes 188. Depending on the need for light weight, the housing may actually be fabricated assemblies composed of many different parts usually welded together. If weight isn't a major design driver, suitable castings (usually investment) may be employed – the penalty of added weight is offset

by a reduction in the number of weldments, eliminating the quality issues and difficult inspection requirements that usually accompany a welded assembly.

The turbine blades themselves may be separately cast as individual blades and some may be welded onto the appropriate hub or even integral to the forged hub known as a blisk (short for bladed disc). Some blisks have been cast, but the preference is for forged components in high stressed rotating applications. The RS27 Engines utilized Stellite 21 cast blades welded on to a 16-25-6 stainless hub. The original SSME turbines utilized cast individual MAR-M 246 blades with fir tree bases secured onto Waspaloy hubs. The original MAR-M-246 directionally-solidified turbine blades of the SSME proved to be susceptible to hydrogen embrittlement. These were replaced in the alternative turbopump by single crystal PW1480 blades which proved much more resistant to hydrogen effects.

Some systems have such high power loads that the individual blades may extract up to 600 horse power each from the hot turbine gas. Also, designs may require multiple rows of blades to extract the necessary power from the available gas. Such systems employ interstage stators (stationary structures with aerodynamic vanes) to help direct the hot gas flow through the blades. For hydrogen fueled engines, such as the SSME, to protect the components from hydrogen environmental embrittlement damage (HEE) and internal hydrogen embrittlement (IHE), coatings impermeable to hydrogen (gold or copper) or overlays (iron based) are used. [6][17]

12.6.4 Propellant Pumping Elements

The power provided by the turbine must be linked to the propellant pump portions of the turbopump. As mentioned, this may be directly coupled to the pumps using a single shaft connecting the turbine to the pump. The F-1 engine utilized 4340 steel alloy forged shafts for this purpose. The F-1 application was a little less challenging since the fuel is RP-1, a ambient temperature kerosene type of fuel, hence the 4340 steel shaft is fully suitable. Shafts of any nature require rotational and axial support to maintain proper alignment during operation. Bearings of various configurations such as roller bearings, ball bearings, hydrostatic bearings are all employed.

Materials for the respective races and rolling elements are usually extremely hard: 440C stainless steels or an earlier 52100 1C-1.5Cr bearing steel have been used, more recently, Cronidur 30 stainless steel (15Cr-.5Ni-.4N2-.3C) has also been utilized for bearings in SSME and RS68 pumps. The rolling elements are often made of 440C high hardness stainless steel. Some pumps have begun to employ bearings using ceramic (Silicon Nitride) rolling elements. If the connection is an indirect one whereby a gear set is utilized, the gears may be low carbon steel (such as 9310) with a carburized layer(case) to produce high hardness, wear resistant gear teeth surfaces while maintaining a tough core. During operation, lubrication is an issue since many systems utilize the propellants themselves to provide the necessary lubrication which usually not very effective.

The pumped propellant's density determines the pump's ability to do work on the fluid to increase its pressure and flow rate – a less dense fluid, with hydrogen being the least dense, requires additional effort to get the needed pump discharge levels.

Fuels include such materials as gasoline, alcohol, hydrazine, RP-1, liquid hydrogen and others [3][6]. Gasoline and its relative kerosene are relatively benign fuels from a material selection perspective since they are relatively warm (ambient temperatures) while liquid

hydrogen is cryogenic (-423 °F) which may eliminate some materials' ductility and promote embrittlement as well, which can lead to completely unexpected failures.

Oxidizers, the other half of the combustion equation, also vary widely with such materials as hydrogen peroxide, nitrogen tetroxide, nitric oxide, and liquid oxygen (LOX) providing free oxygen to support the combustion process [3]. As with the fuels, oxidizers vary in their reactivity and in addition, LOX, is cryogenic (-290F), which requires the consideration of low temperature ductility. The high reactivity of LOX makes unexpected ignition a concern if an energy source of ignition is present, such as a severe rub of an impeller or an impact from foreign object debris (FOD).

Propellants are delivered to the pump inlet housing from the tanks at relatively low pressure and increase the pressure using either axial or centrifugal (radial) pumping elements, the latter being far more common. In most turbopumps, the propellant is flowed through an inducer for a moderate pressure increase before flowing into the impeller for a bigger boost in pressure. Inducers guarantee a solid head of propellant to assure that cavitation does not occur in the impellers. If the propellant is dense enough, a single stage impeller may be all that is required. If not, such as for liquid hydrogen, multiple stages of impellers will be required with diffusers, also known as crossovers, in between, before exiting the pump at the required pressure and flow rates. High specific strength is a key property for impellers, as it determines the maximum rotational tip speed and therefore, the pumping efficiency, that can be attained.

The materials involved for the various components have to be compatible with the respective propellants while providing the necessary function. Because weight is a key issue with any rocket engine, we see high usages of high specific strength such as aluminum and titanium alloys which would not be suitable for high temperature turbine components. For impellers, high specific strength is a key design criterion, as it governs the maximum tip speed that can be attained.

Housings have been produced from lightweight aluminum alloys including Tens-50 investment castings for the F-1 engine to various nickel based super alloys including centrifugally cast alloy 625 for the RS68 Fuel turbopump. Other materials such as investment cased alloy 718 have also been used.

Inducers have been produced using nickel-copper alloys such as K-500 Monel forgings for LOX pumps (to prevent ignition) or titanium alloys Ti-5Al – 2.5Sn forgings for the fuel pump. Impellers can be composed of both forged and cast aluminum alloys such as A357 which was mentioned previously.[18]

The SSME fuel turbopump uses 3 titanium alloy (Ti-5Al-2.5SnELI) forged impellers. Between each impeller is a (usually cast) diffuser or crossover which takes the high pressure impeller discharge at the impeller outside diameter and routes (and slows) the hydrogen back near the shaft so that it will engage properly with the next stage for the next pressure boost. SSME used A357 cast aluminum for this purpose while the latest pumps utilize the latest, beryllium-free version of this alloy: F-357.

12.7 Valves

Propellant valves are a key to controlling the flow of propellants and gases to various parts of a rocket engine. They may control the flow of propellants to main thrust chambers and gas generators or preburners. Other functions include control of bleed flow, spark igniter flow, and various thermal conditionings. Although most valves are usually of the two-position (open-closed), normally closed design, they may include an intermediate opening position in order to meet specific sequencing requirements. For thrust- or mixture-control purposes, a continuously-variable opening position may be required on some propellant system valves.

Prime design considerations for propellant valves include the following objectives:[1]

- Propellant compatibility
- Structural integrity
- No leakage of propellant through the valve when closed.
- Proper actuating time during opening and closing in accordance with the requirements of the control system
- Minimum pressure drop
- Meet fail-safe and /or fail-operational system requirements.

Among the great variety of propellant valve types available, each has certain characteristics that make it suitable for a specific application. Frequently used propellant valves can be classified according to their design configurations:

- Butterfly
- Ball
- Poppet
- Venturi
- Gate

Valves are actuated by mechanical actuators which in turn are driven hydraulically, pneumatically, electrically, or even explosively.

A discussion of the detailed design, operation and advantages of each valve type is beyond the scope of this chapter. However, there are certain common considerations from a material standpoint that are shared by all valves.

The ability to reliably seal when closed: Sealing is usually achieved by a hard surface going into a softer one – such as a metal on a polymeric or elastomeric material (such as Teflon or Kel-F), or a high-strength metal (sometimes with a hard coating such as tungsten carbide) into a soft metal, such as a copper alloy. If the valve is operating in oxygen service, extreme care must be taken to assure that both mating surfaces are oxygen compatible. Examples of ball, butterfly, and poppet valves are given in Figures 12-46, 12-47 and 12-48, respectively .

Recent work with 3-D printing has resulted in valves being produced with fewer parts and reduced cost using conventional materials. Hot fire testing of in liquid oxygen and liquid hydrogen has resulted in positive results.[27]

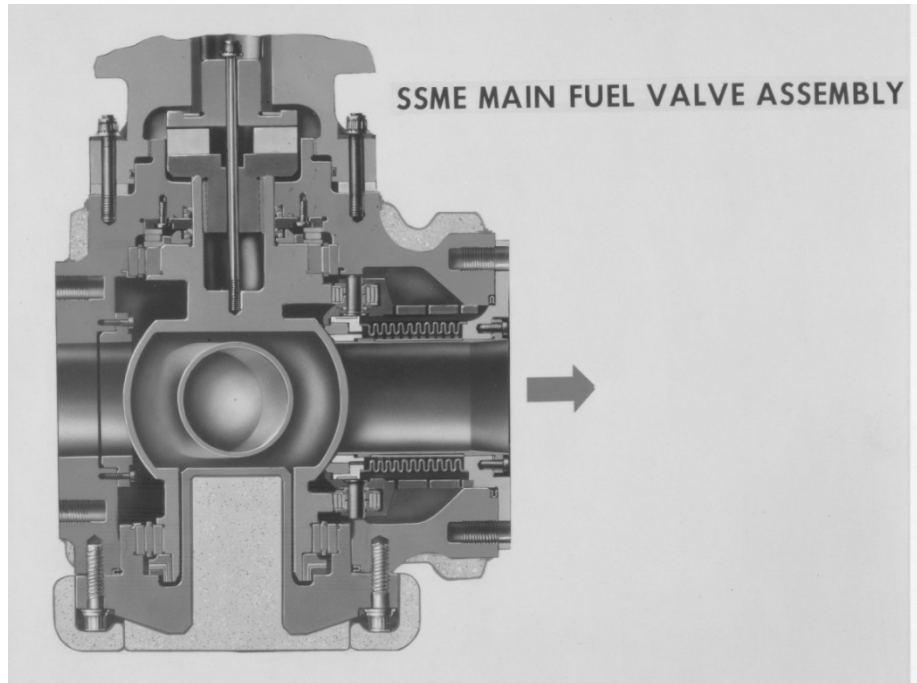

Figure 12-46. Cross-section of the SSME Main Fuel Valve.
 Housing is Titanium-5Al-2.5Sn alloy. Ball/shaft is 718. Main ball seal is Kel-F
 (NASA photo archives)

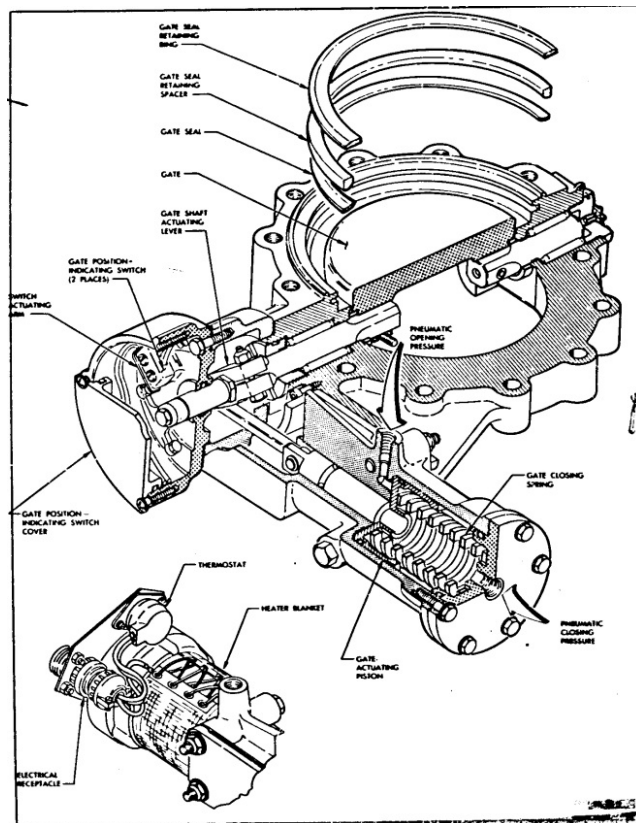
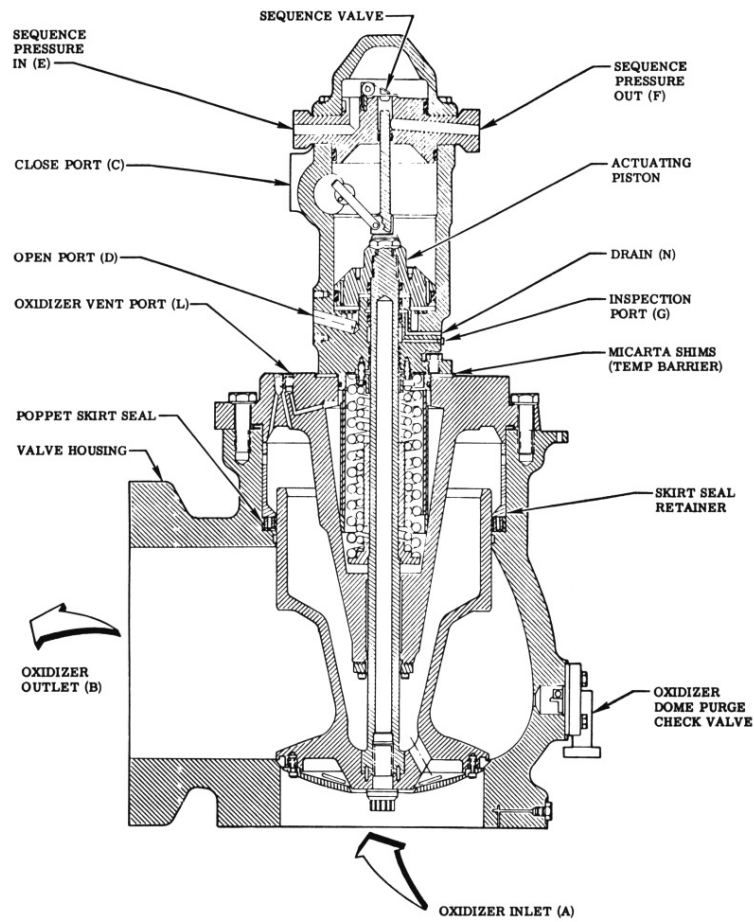

Figure 12-47 Butterfly valve – expanded view
 (NASA archives)



Figure 12.47 Typical Butterfly valve. (NASA photo Archives)



Oxidizer Valve

Figure 12-48 A typical poppet valve (NASA Archives)

Over the years, a variety of materials have been used in valves. A favorite material for valve housing has been aluminum alloy, either cast or wrought. Cast valve housings have typically been of either A356 or A357 high-strength aluminum. For wrought housings, forged 7075 or 2024 are common. When using aluminum alloys, care must be taken to use only heat treatments that are not susceptible to stress corrosion cracking. For higher strength needs, nickel-base alloys such as 625 and 718, or titanium alloys such as Ti-6Al-4V or for liquid hydrogen, Ti-5Al-2.5Sn ELI, have all been used. A perennial favorite for valve internals such as poppets, has been precipitation hardening stainless steels, 17-4Ph and 15-5Ph. However, their susceptibility to hydrogen environment embrittlement and poor toughness at cryogenic temperatures limits the use of PH stainless under these conditions.

The bottom line for materials selection for valves is to use whatever material makes sense from a strength, compatibility and cost standpoint.

12.8 Lines and Ducts

There are a large variety of lines and ducts on a liquid rocket engine: High and low pressure propellant ducts, hydraulic lines, lines to carry purge gases, sensor lines, and drain lines. Like valve bodies, a number of materials have been used for lines and ducts – stainless steels, aluminum alloys, nickel-base alloys, iron-base superalloys, and even titanium alloys. Probably the favorite material for lines and ducts has been austenitic stainless steels, due to their weldability, ready formability and reasonably good corrosion resistance. Staged combustion engines, with their high combustion chamber pressures fed by high-pressure pumps, require propellant ducting with a high specific strength in order to limit engine weight. The high strength nickel-base 718 alloy is often chosen for these applications.

A notable example of how a combination of a design change and material change can result in a significant cost reduction occurred during the F-1 engine program. This was the successful replacement of the articulated stainless steel propellant ducts with rigid aluminum alloy ducts. The four original stainless steel ducts, which cost in excess of \$100,000, were replaced with four 6061 aluminum ducts costing only \$5000. The actions to accomplish this included a redesign of the ducts, innovative material processes, and creative manufacturing fit-up procedures.

As can be seen in the J-2X picture, Figure 12-49, lines and ducts take on compact complex shapes in order to package the engine design. These complex shapes challenge traditional manufacturing techniques such castings, forging, roll forming, spinning, and welding. With an increase emphasis on cost reduction and improved manufacturing time, rapid manufacturing techniques such as Direct Metal Laser Sintering (DMLS) are being adapted and evaluated for fabrication of complex parts such as the J-2x Gas Generator (GG) Exhaust Duct, Figure 12-50. [] The GG exhaust duct was made from alloy 625 using DMLS at a reduced cost and schedule over one made by conventional means. This duct was hot fire tested and NDE inspected post hot fire testing with positive results.[28]



Figure 12-49 J-2X Engine (NASA/SSC photo)



Figure 12-50 J-2X DMLS Gas Generator Discharge Duct (NASA/MSFC photo)

12.9 Summary

The importance of materials in liquid rocket engines is fairly obvious and will continue to be so in the future. With the present emphasis on commercial space, cost has become an important parameter and in indeed is now often considered as a variable of equal importance with weight and performance. Therefore, material and fabrication costs have become prime considerations in any material selection decision. This has resulted in considerable interest in Additive Manufacturing (AM) as a means to reduce both fabrication costs and the amount of material used to produce a component. The projected cost and schedule savings resulting from AM are extremely attractive. However, as with any new, potentially revolutionary process, many issues need to be addressed, such as: materials characterization, development of reliable process parameters, an understanding of the metallurgy of the deposits, and quality control procedures. Metals and metal alloys remain the primary materials of construction. Ceramics, ceramic composites and polymeric composites have found limited usage and hold promise for the future, but, although offering much promise, these non-metallic materials have not yet reached their potential for widespread application in rocket engines.

References:

- [1] “An Introduction into Rocket Missile Propulsion” North American Aviation 1958
- [2] Sutton, George P., “History of Liquid Propellant Rocket Engines”,
AIAA publication, 2006
- [3]. Hutzler, Dieter.K. and Huang David H., “Design of Liquid Propellant Rocket Engines”
AIAA Volume 147 1992
- [4]. Durant, Fredrick C, “Robert Goddard: Accomplishments of the Roswell Years, 1930- 1941”
AAS 89-268 American Astronautical Society History Series, Chapter 19, 1986
- [5] Ezell, W.F. and Mitchell, J.K. , “Engine One” Rocketdyne Threshold Journal,
Summer 1991, pp.53-63
- [6] Shoemaker, M. and Somerville J. “A Material Difference”, Threshold Journal, Number 4,
Spring 1989 pp.29-33.
- [7] Private communication with Konrad Dannenberg, retired NASA engineer and former
Peenemunde design engineer. 2002
- [8] Private communication with Rudy Schlidt, retired NASA engineer and former Peenemunde
quality control engineer, 2002
- [9] Ball, I.M, “Construction of a Replica of Robert H. Goddard’s First Successful Liquid-
Propellant Rocket” AAS 92-339, American Astronautical Society History Series,
Chapter 14, 1993
- [10] Stenholm, T., et al, “The Development of the Vulcain Nozzle Extension”

AIAA-98-4013 34th Joint Propulsion Conference, July 12-15, 1998

- [11] Haggander, J., et al, "Current Status of Laser Welded Sandwich Nozzle"
AIAA-2002-4146 38th Joint Propulsion Conference, July 07-10, 2002
- [12] Ryden, R., et al, "The Volvo Aero Laser Welded Sandwich Nozzle for Booster Engines" IAC-04-IAC-S.3.07 International Astronautical Conference
Vancouver, Canada Oct 4-8, 2004
- [13] "Application of Ablative Composites to Nozzles for Reusable Solid Rocket Motors"
NASA Practice No. PD-ED-1218 Marshall Space Flight Center
- [14] Sutton, George P. and Biblarz, Oscar "Rocket Propulsion Elements" 8th Edition
John Wiley & Sons, 2010
- [15] Stangeland, M. "Turbopumps for Liquid Rocket Engines", Threshold Journal, Number 3,
Summer 1988 pp.35-43.
- [16] Sutton, George P., "Turbopumps, a Historical Perspective", AIAA 2006-5033, pp.3-4.,
42nd AIAA/ASME/SAE/ASEE Joint Propulsion Conference 9-12 July 2006,
Sacramento, CA.
- [17] Lewis, J., "Materials and Processes for Space Shuttle's Engines", Metal Progress,
American Society for Materials, March 1975, pp. 4
- [18] <http://www.nasa.gov/exploration/systems/sls/3dprinting.html> July 24, 2013.
- [19] Peters, Warren, Rogers, P, Lawrence, T., Davis, D., D'agostino, M., and Brown, A.,
"FASTRAC Nozzle Design, Performance and Development," AIAA-2000-3397
- [20] Turbopump Systems for Liquid Rocket Engines ,NASA SPACE VEHICLE DESIGN
CRITERIA (CHEMICAL PROPULSION) , NASA SP 8107, August 1974.
- [21] Van Hooser, Katherine P and Bradley Douglas P, "Space Shuttle Main Engine The
Relentless Pursuit of Improvement", AIAA SPACE 2011 Conference Long Beach, CA
September 27-29, 2011.
- [22] Marshall Star, Vol. 37 / Num. 27, NASA Marshall Space Flight Center March 19, 1997.
- [23] Ballard, Richard O. and Olive, Tim, "Development Status of the NASA MC-1
(Fastrac) Engine", AIAA 2000-3898
- [24] <http://www.barber-nichols.com/products/rocket-engine-turbopumps>
- [25] NASA Facts National Aeronautics and Space Administration

Marshall Space Flight Center Huntsville, Alabama 35812
FS-2005-01-05-MSFC January 2005

[26] [NASA Advanced Space Transportation Summary Pub 8-1279 FS-2001-04-76-MSFC .
http://www.nasa.gov/centers/marshall/pdf/100395main_ceramic_matrix.pdf]

[27] NASA News Release, “Piece by Piece: NASA Team Moves Closer to Building a 3-D
Printed Rocket Engine” Dec. 17, 2015.

[28] Betts, E. M., Eddleman, D.E., Reynolds, D.C., and Hardin, N. A., “USING INNOVATIVE
TECHNOLOGIES FOR MANUFACTURING ROCKET ENGINE HARDWARE”,
JANNAF 6th Liquid Propulsion Conference December 7, 2011, Distribution Statement A.

[29] Lee, Jonathan and Elam, Sandy, “DEVELOPMENT OF METAL MATRIX COMPOSITES
FOR NASA’S ADVANCED PROPULSION SYSTEMS,” : Proceedings of the 4th
Conference on Aerospace Materials, Processes, and Environmental Technology D.E.
Griffin, D. Cross Stanley, Editors
Marshall Space Flight Center, Marshall Space Flight Center, Alabama NASA/CP—
2001–210427.

[30] Effinger, M., Clinton, R.G., Dennis, Jay, Elam, Sandra, Genge, G., Kiser, D., Eckel, A.,
Jaskowiak, M. and Land, J. , “*Fabrication and Testing of Ceramic Matrix Composite Propulsion
Components,*” Proceedings of the 4th Conference on Aerospace Materials, Processes,
and Environmental Technology D.E. Griffin, D. Cross Stanley, Editors Marshall
Space Flight Center, Marshall Space Flight Center, Alabama NASA/CP—2001–210427.