

Printable Spacecraft: Flexible Electronic Platforms For NASA Missions

September 2012



Phase One Final Report
by Kendra Short and
Dave Van Buren

**FINAL REPORT
EARLY STAGE INNOVATION
NASA INNOVATIVE ADVANCED CONCEPTS (NIAC)**

**Printable Spacecraft:
Flexible Electronic Platforms
For NASA Missions**

**Kendra Short, Principal Investigator
Dr. David Van Buren, Co-Investigator
Jet Propulsion Laboratory**

September 30, 2012

Acknowledgement

This research was carried out at the Jet Propulsion Laboratory, California Institute of Technology, under a contract with the National Aeronautics and Space Administration.

© 2012 California Institute of Technology. Government sponsorship acknowledged.

Contents

1	INTRODUCTION	1-1
2	PHASE ONE STUDY APPROACH	2-2
2.1	Approach to Study	2-2
2.2	Assessment Against Phase One Goals	2-2
3	TECHNOLOGY OVERVIEW	3-4
3.1	Background on Printed Electronics	3-4
3.2	Integrated Printed Systems	3-7
4	FINDINGS AND RESULTS	4-9
4.1	Industry and Component Survey	4-9
4.1.1	Power Systems.....	4-9
4.1.2	Logic and Memory	4-12
4.1.3	Communications.....	4-14
4.1.4	Propulsion, Mobility and Control.....	4-16
4.1.5	Sensors	4-16
4.1.6	Functionality vs. Maturity	4-19
4.2	Technology Roadmap and Investment Strategy	4-22
4.2.1	Elements of the Roadmap – Context and Key Technologies.....	4-22
4.2.2	Component Functionality.....	4-23
4.2.3	Instruments and Sensors.....	4-31
4.2.4	Environmental compatibility	4-33
4.2.5	Manufacturing Advances	4-34
4.2.6	System Technologies	4-35
4.3	Mission Advantages and Engineering Applications	4-36
4.3.1	Science Missions	4-36
4.3.2	Engineering Applications and Attributes	4-40
4.4	Risks and Challenges	4-42
5	SUMMARY	5-44
6	ACKNOWLEDGEMENT OF SUPPORT	6-46
7	BIBLIOGRAPHY	7-47

1 Introduction

Atmospheric confetti. Inchworm crawlers. Blankets of ground penetrating radar. These are some of the unique mission concepts which could be enabled by a printable spacecraft. Printed electronics technology offers enormous potential to transform the way NASA builds spacecraft. A printed spacecraft's low mass, volume and cost offer dramatic potential impacts to many missions. Network missions could increase from a few discrete measurements to tens of thousands of platforms improving areal density and system reliability. Printed platforms could be added to any prime mission as a low-cost, minimum resource secondary payload to augment the science return. For a small fraction of the mass and cost of a traditional lander, a Europa flagship mission might carry experimental printed surface platforms. An Enceladus Explorer could carry feather-light printed platforms to release into volcanic plumes to measure composition and impact energies. The ability to print circuits directly onto a variety of surfaces, opens the possibility of multi-functional structures and membranes such as "smart" solar sails and balloons. The inherent flexibility of a printed platform allows for in-situ re-configurability for aerodynamic control or mobility. Engineering telemetry of wheel/soil interactions are possible with a conformal printed sensor tape fit around a rover wheel. Environmental time history within a sample return canister could be recorded with a printed sensor array that fits flush to the interior of the canister.

Phase One of the NIAC task entitled "Printable Spacecraft" investigated the viability of printed electronics technologies for creating multi-functional spacecraft platforms. Mission concepts and architectures that could be enhanced or enabled with this technology were explored. This final report captures the results and conclusions of the Phase One study. First, the report presents the approach taken in conducting the study and a mapping of results against the proposed Phase One objectives. Then an overview of the general field of printed electronics is provided, including manufacturing approaches, commercial drivers, and the current state of integrated systems. The bulk of the report contains the results and findings of Phase One organized into four sections: a survey of components required for a printable spacecraft, technology roadmaps considerations, science mission and engineering applications, and potential risks and challenges of the technology.

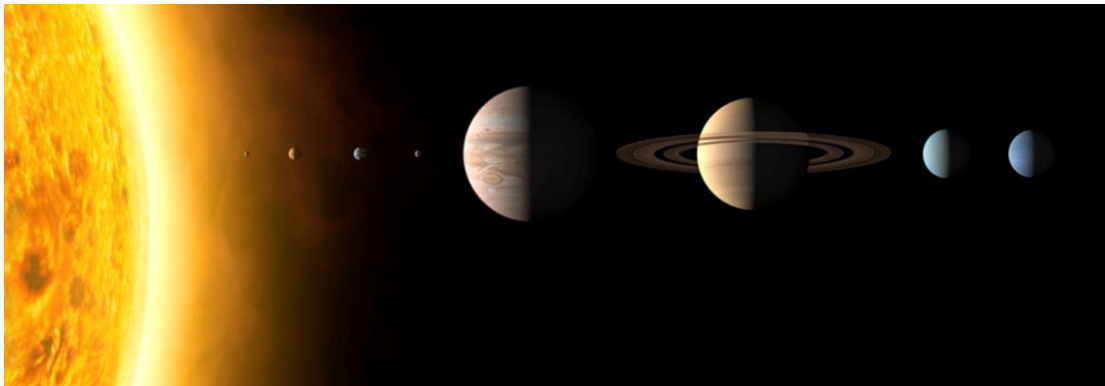

Figure 1 – Solar System Image Compilation (Credit: NASA/JPL)

2 Phase One Study Approach

2.1 Approach to Study

The expanding and multifaceted field of printed electronics teems with information on its progress, prospects and products. Information and data is contained in various sources such as research journals publications, professional societies, conferences, industry forecasts, and product marketing material. A small team of engineers at JPL canvassed the varied sources of material from relevant research publications on materials development to new product releases. Participation in technical associations such as the FlexTech Alliance and the International Microelectronics and Packaging Society allowed access to information from key players in the field of printed electronics. Forums in which developers and users came together to discuss needs and capabilities such as the IDTechEx conferences were excellent opportunities to interact with industry, government and academia, all of whom are investing in printed electronics. Other sources included one on one interaction, visits and interviews with leaders in the field such as the John Rogers Research Group at the University of Illinois and the staff at the Western Michigan University Center for the Advancement of Printed Electronics.

The Jet Propulsion Laboratory employs many individuals who are researching and applying printed electronics in specialized areas such as radar systems and flexible circuits, as well as a staff of scientists and mission concept developers. Two workshops were held in order to tap into this wealth of knowledge and creativity, with invited JPL staff members and participation by experts in printed and flexible electronics from Xerox PARC. The two workshops focused on Mission Concepts and Science Instruments and then Engineering Challenges. The conclusions and contributions made at the workshops are folded into the Results and Findings sections.

2.2 Assessment Against Phase One Goals

The goals of the Phase One study were to explore the viability of printed technologies for creating small two dimensional spacecraft by identifying mission concepts and applications; surveying the state of the art and assessing the availability and capability of relevant sensors and spacecraft components; and characterizing the gap between what is currently available in industry and what is required for space applications. The Phase One proposal identified six distinct activities which are listed below with an assessment of whether the intent of the task was met and where the results are contained in the report.

- Develop a suite of mission concepts that are enabled or significantly enhanced through this architecture.
This was achieved through the Science Mission Workshop as well as the team's evaluation of the proposed decadal missions. See Section 4.3 for results.
- Survey and inventory what is available from industry in terms of subsystems and components, their capabilities, and functionality.
This activity was completed and summary findings are contained in Section 4.1.
- Assess manufacturability including processing types (e.g. inkjet, vapor deposition, etching) and materials (inks, substrates, coating).
This assessment was completed and is summarized as part of the general technology overview in Section 3.0.

- Create an end-to-end spacecraft system point design to explore the functional compatibility between subsystems within this media. Sketch at a high level the implementation of each subsystem with a printed approach, and associate the closest state-of-the art product available in the printed regime.
Through the two workshops, a candidate mission concept and platform was selected (environmental surface lander for Mars) and the details of that platform design and fabrication of a prototype will be executed in the Phase Two task. It was recognized that the requirements for each of the functional subsystems would be dramatically different depending on the specific mission application. An “Ashby-plot” of functionality vs. maturity for the functional components was created to help characterize the gaps between state of the art today and the needs of the NASA applications. This plot is contained in Section 4.1.
- Evaluate environmental compatibility in terms of radiation, temperature, vacuum etc. between existing terrestrial components and space application requirements.
Materials choices and manufacturing formulations are critical elements in the functionality of printed electronic components. Environmental parameters which would be the driving cases for survivability were identified. A brief assessment is contained in the Technology Roadmap discussion (Section 4.2) as this is likely to be a driver for more robust materials and manufacturing approaches. A materials compatibility test program is contained in the Phase Two activities.
- Generate a technology gap assessment and identify areas of necessary investment or development above and beyond current industry investments.
A road map for development and NASA’s role in pursuing those areas of unique interest to space applications was formulated. This is discussed in Section 4.2.

3 Technology Overview

3.1 Background on Printed Electronics

Printed electronics is a fast growing field which is enabled by the development of solution-processable materials developments and the fabrication techniques that exploit the properties of these liquid materials. The basic elements of traditional electronic circuitry (dielectrics, conductors and semiconductors) are produced in a soluble form allowing the generation of “functional inks”. Inks may contain organic or inorganic compounds or even be infused with carbon nanotubes to elicit a particular behavior. These inks are “printed” onto a variety of substrates either rigid or flexible to form thin sheets of electronic circuits. When applied in combinations and layers, these materials can produce simple building blocks (e.g. transistors) or complex elements such as solar cells, CMOS circuitry, batteries and sensors. Some of these elements are shown in Figure 2 A-D below.

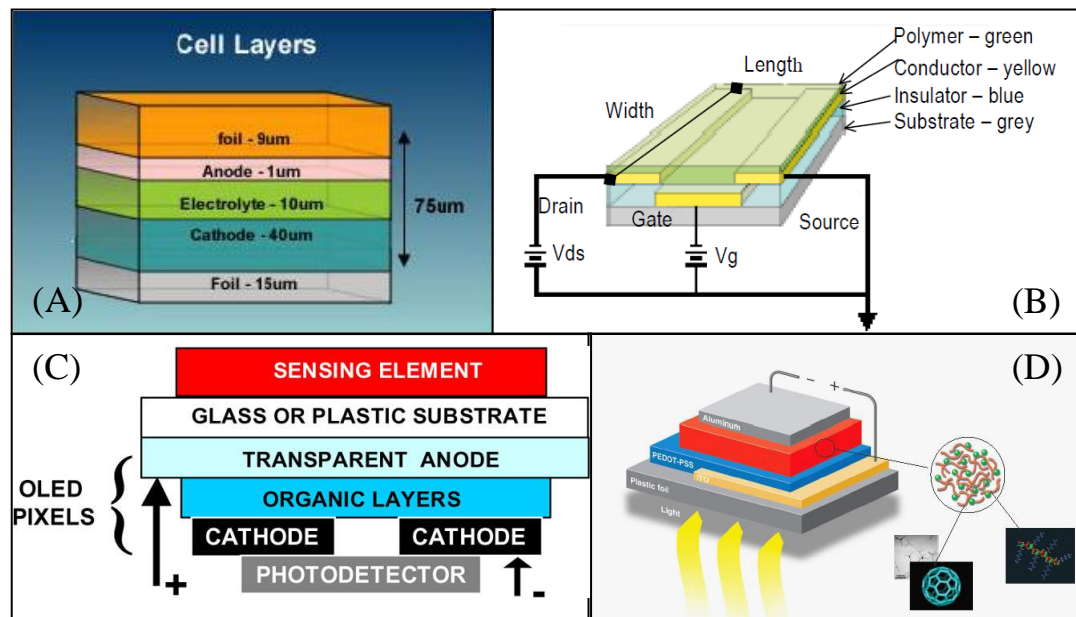

Figure 2: A– Solid State Battery Layers (Credit: Planar Energy). B - Traditional geometry for a field effect transistor (Credit: IDTechEx). C – Photoresistive Sensor (Credit: SPIE). D – Typical Construction of an organic solar cell (Credit: IDTechEx)

The combination of a soluble ink and a flexible substrate gives rise to several manufacturing approaches that can be included under the umbrella of “printing”. Inkjet printing, or drop on demand, deposits ink directly onto a substrate using a precision controlled print head. A similar but inverted method is called e-jet printing in which the substrate is moved on a precision controlled linear table. The ink is charged and extracted from the head onto the substrate through the use of an electric field. This allows extremely precise control of the droplet size and position. Aerosol-jet printing is a third ink deposition method in which the ink is atomized and aerodynamically directed onto the substrate. These are all sheet fed, non-contact means of printing and make efficient use of costly inks. Other techniques, such as gravure, screen printing and flexography, are more similar to traditional ink printing methods. These are methods in

which inks are deposited onto the substrate using a mask or a master drum. This method is most conducive to scaling up for high volume roll to roll applications. Other more exotic means of “printing” include stamping and direct write. Stamping is used to transfer a feature or device fabricated on one substrate, adhere it electrostatically or otherwise to a transfer medium and then place it on the final substrate. Direct write is like ink jet printing in three dimensions. Functional inks can be printed directly onto a 3D surface (e.g. spherical substrate or aircraft wing) using a 6DOF print head.

The flexibility and ease of manufacturing are driving many industries to adopt printed electronics in a wide variety of applications. Large corporations such as United Technologies, Boeing, Panasonic, SONY and Proctor & Gamble, which represent a wide spectrum of products from consumer electronics to healthcare to sportswear, are some of the key players and developers in printed electronics. Their research has been driving the technical advancements and functionality of printed electronics for their specific product requirements. In addition to the large corporations, a large number of smaller companies perform more focused research and product development. Much of that development to date has been directed at materials development and optimizing the printed performance of specific components. The possibilities of extremely low cost, high volume production have been embraced by many suppliers which now provide everything from OLED displays to biomedical sensors and transparent photovoltaic solar arrays¹⁰.

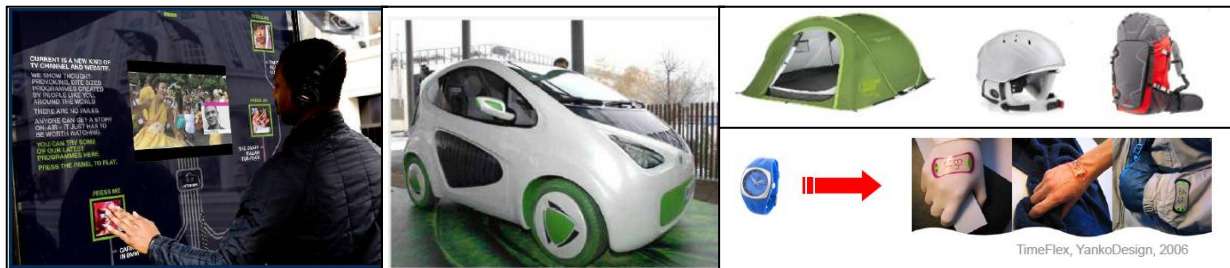

Figure 3 – Examples of consumer products envisioned with printed electronics (Credit: IDTechEx, SolarPrint, TimeFlex)



Figure 4 – Various manufacturing approaches for printed electronics.

3.2 Integrated Printed Systems

While prevalent in the commercial world, the use of printed electronics in aerospace seems to be limited to specific applications such as flex-print cables for robotic mechanisms and microstrip antenna. Therefore, to design and fabricate an entire end to end functional spacecraft represents a large step forward for space applications. Similarly, to apply printed electronics in a multi-functional platform by implementing every subsystem that a spacecraft might need from the scientific sensor through the data downlink *and* have it survive and function in a space environment represents a challenge for the technology. The printed spacecraft requirements push the current state of the art for functionality as well as introduce design and manufacturing compatibility challenges among the functional subsystems. As indicated in Figure 5, the bulk of the industry is focused on providing building blocks and components. There are very few integrated system being pursued. Current projections of industry growth and commercial investments expect the functionality of available basic building blocks and components to advance synergistically with NASA’s needs^{9,10,11}. However, the system design, environmental survivability, unique sensors and mission implementation will be NASA’s challenges.

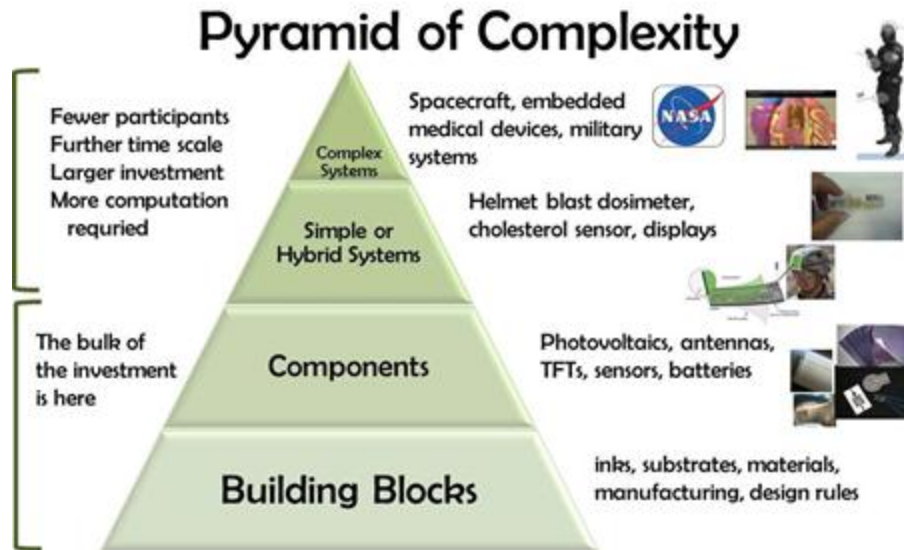

Figure 5 – Much of the industry is focused on building blocks and components. Fewer companies are performing systems integration and complex design.

Most of the system design projects are executed by consortiums and partnerships to offer more complex “product” developments. Three such on-going system developments represent early analogues to an integrated spacecraft concept. ThinFilm Electronics intends to develop a plastic temperature-recording sticker that could provide detailed histories of crates of food or bottles of vaccine. This device would be the first to use all-printed electronics components—including memory, logic, and even the battery. The first prototype using all of the components is expected later this year¹². Similarly, the European Union is funding over the next three years the Smart Integrated Miniature Sensor (SIMS) project to create a single-substrate, disposable device which can read a blood sample and analyze cholesterol levels²⁰. Lastly, DARPA funded a significant multiyear development at PARC to devise a printed blast dosimeter sensor tape complete with sensors, data processing and memory¹³. One example that represents an evolutionary step is the GSI Technologies one time pass code card. It uses a printed electro-chromic display, with

printed circuits. Batteries and a microcontroller chip are laminated together with the printed circuits. The company is striving for fully printed version in the future³³.

A printed spacecraft represents a more complicated system design which pushes the functionality required by the technology a bit more than the systems described above (more data storage and processing, more capable communications, higher power generation and storage). However, the commitment shown to bring these systems to market within a short time span (~three years), shows that the priorities of the printed electronics industry and players is heading in a direction that is compatible with the needs of NASA.



Figure 6 – Integrated Printed Systems under development by several partnerships. PARC blast dosimeter project funded by DARPA (Credit: PARC). One time use pass card (Credit: GSI Technologies). Integrated cholesterol sensor funded by European Union (Credit: SIMS project web page).

4 Findings and Results

The findings and results of the Phase One study are consolidated into four main sections. The first section (4.1) is a summary of our survey of industry and the readiness of printed subsystems to address the needs of a printed spacecraft. A potential roadmap for investments and future development opportunities are discussed in Section 4.2. Section 4.3 describes the possible benefits that printed electronics can play in various scientific missions, instrument concepts and engineering applications. Section 4.4 outlines the known limitations, challenges and risks associated with printed electronic applications in space.

4.1 Industry and Component Survey

The industry survey focused on the components necessary to formulate a spacecraft platform. We have redefined the traditional “subsystems” of a spacecraft into functional areas for a printed spacecraft (see Table 1). Each of these functional areas is described below in terms of the current state of the art in commercial product functionality. At the end, an assessment is made on the readiness for NASA applications.

Table 1 – Functional Subsystems of a Printed Spacecraft

Functional Area	What it includes
Power	Power generation and storage including photovoltaic cells and batteries.
Logic and Memory	Includes building blocks (e.g. transistor) to more sophisticated circuits for data processing, data storage, data transmission.
Communications	Antennas, transmitters, receivers. Some overlap between communication electronics and logic.
Propulsion/Mobility/Control	Contains traditional delta-V propulsion systems, re-configurability for mobility and or attitude sensing and control. This functional area may not be needed by all mission types and is the most immature in terms of development.
Sensors	Instruments and sensors to gather scientific data of relevance to the mission. This category is further broken down by sensor type.

4.1.1 Power Systems

The power system functionality is primarily focused on batteries and photovoltaic (PV) power generation. This functional area is extremely mature for terrestrial applications with many companies involved in both product development and manufacturing. Performance metrics are still less than the non-printed counterparts, but the power consumption of printed and microelectronics is driving the need lower and lower. For printed PV, the biggest challenge is environmental compatibility and performance in low light/low intensity environments. For batteries, the manufacturing techniques are somewhat customized with multi-layering required and are not yet fully compatible with other component fabrication techniques.

Photovoltaic: PV is one of the largest investment areas for printed technology comprising roughly 20-25% of the current market which is projected to be \$17B in a decade²¹. The terrestrial market is driving performance up steadily to be more competitive to the crystalline Si and GaAs solar cells, with the benefit of lower cost and conformability, and other interesting features like transparency. A history of performance advancements in terms of cell efficiency is shown in Figure 7. While organic PV, the most common printed PV, does not yet rival the efficiency of advanced crystalline cells (~ 8% vs. 20-30%), the trend is increasing. Research is being conducted into other approaches such as dye sensitized cells and converting thin film cells (amorphous Si) to printing methodologies to drive efficiency up even higher.

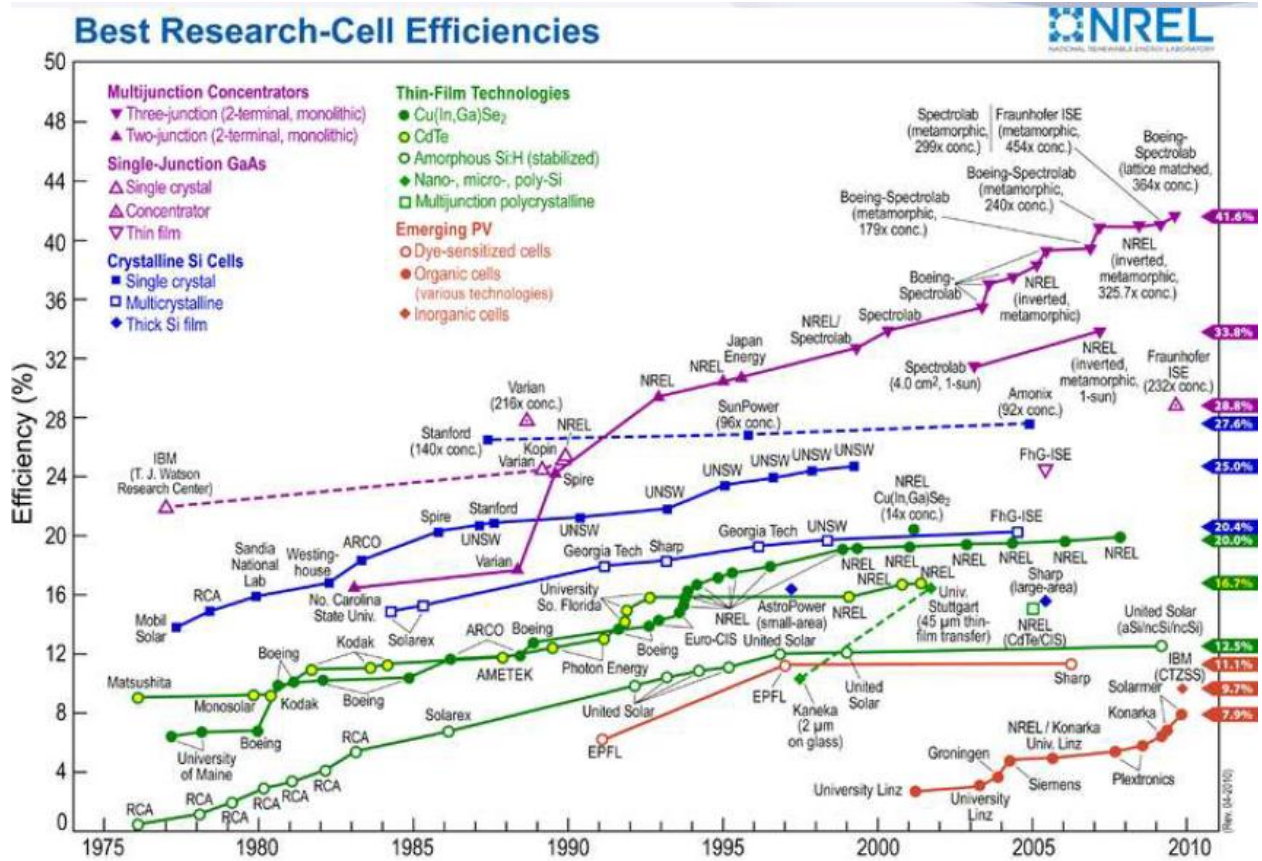

Figure 7 – Photovoltaic Cell Efficiencies as verified by NREL.

The performance against need for NASA applications is difficult to pinpoint. The variety of mission types require a full spectrum of performance. Certainly for the simpler applications (e.g. surface landers) in solar illuminated targets (e.g. Mars) the performance of the printed PV could already meet the need. For large power applications (radar) or targets further away from the sun (e.g. interstellar solar sails), the efficiency needs to increase significantly especially in low intensity, low light environments in order to make the PV array a manageable size. Materials that are currently used in terrestrial printed manufacturing are common substances used in current aerospace applications and individually have known properties in space environments. Verification is needed on the survivability of the combined materials and encapsulation techniques. For example, the CTE effect on the ink to substrate interface under extreme thermal

and fatigue cycling could delaminate the cell. Also, vacuum conditions and degradation of inks and array performance in radiation environments is a concern.

Batteries - The printed battery market is emerging as many consumer products are driving to embedded power sources. While the leading choice of small embedded power sources are the coin cell batteries, new products such as laminar batteries are on the market to satisfy the needs where the energy storage needs to be compatible with flexible substrates. The basic idea of a laminar battery is to take the elements of a chemical battery (cathode, anode, electrolyte, and separator) and create them in layers of functional films (see Figure 2A) . There are thin films and thick film batteries ranging from 50-750 microns. The stacking can be repeated depending on the performance desired (e.g. more layers gives high voltage and capacity). Thin film batteries are typically created through vacuum deposition processes that tend to be high cost. Thick film batteries may be more conducive to the printing approaches currently used in the PV industry, but lose some of their flexibility.



Figure 8 – Several commercially available laminar batteries (Credit: Enfucell, Infinite Power Solutions, Contour Energy)

A review of most “pre-packaged” commercial battery products reveals a range of 0.5 to 40 mAh capacity and 1.5 to 4 Volts nominal. This performance may be compatible with many of the terrestrial applications such as cell phones, RFID tags, etc. However spacecraft applications will require significantly more power for functions such as data processing, communication, and radar transmission. The extensibility of the current battery fabrication approach to larger areas and system with higher capacity needs to be verified. Another limitation on the current commercially available products is the rechargeability. While most laminar batteries are rechargeable secondary batteries, charge cycles and lifetime are not robust in comparison to the lifetime needs of a spacecraft platform – some indicate a shelf life of less than one year with <10,000 cycles. Also, the more sophisticated charge control circuits and voltage regulation are just now being brought into the product lines. The material complement and “packaging” for batteries is a challenge for space application. While some of the basic layers represent materials that have known properties (Li, MgO₂Zn), the weak link is the packaging and sealing for containment in a vacuum environment. There continues to be active research into materials and manufacturing of printed batteries to bring performance up and costs down. Some companies like Paper Battery Co are beginning to develop higher voltage (5-14V) solutions such as their Power Patch™ technology which is similar to a supercapacitor.

4.1.2 Logic and Memory

Data handling includes simple computational circuits to more complex logic as well as data storage, retrieval and management functions. With the establishment of the printed thin film transistor (TFTs), all the fundamental building blocks of a circuit can be printed using known techniques and materials today. Transistors, switches, capacitors, diodes, etc have all been demonstrated in many material combinations and performance ranges. However, the sophistication of the circuit functionality in printed form is one of the more immature areas of the printed electronics industry.

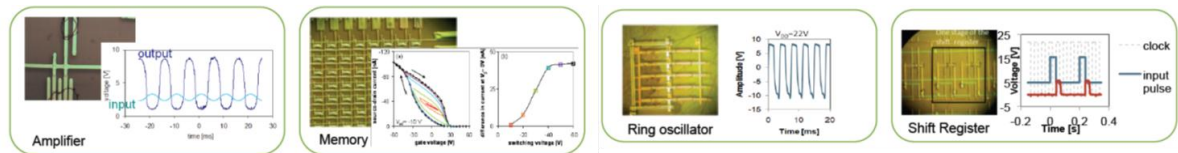

Figure 9 - Representative printed circuit elements developed by PARC. (Credit: PARC)

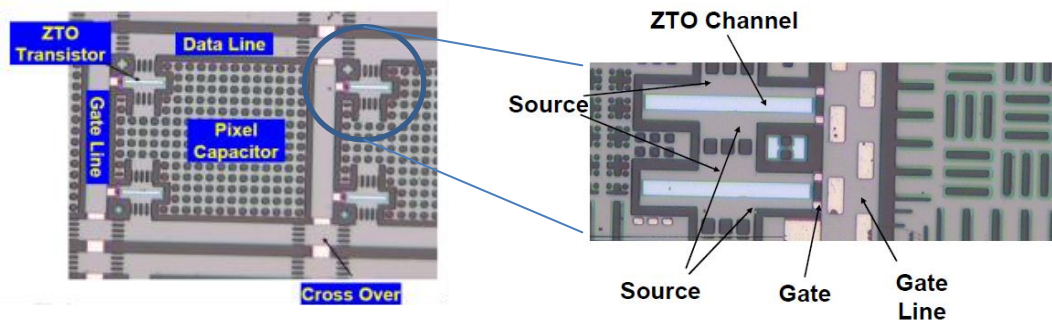

Figure 10 - Zinc Tin Oxides (ZTO) TFTs and ZTO arrays on polyimide substrate (SAIL technology) (Credit: Hewlett – Packard)

Computing / Circuitry - The challenge is feature size and performance. Key metrics for things like mobility and voltage drop, current leakage are not comparable to the state of the art with discrete devices. The density of features with printed manufacturing comes nowhere near the silicon IC capabilities and the performance metrics are roughly equivalent to the 1970s IC performance (see Figure 11). For this reason, there has not been a major push or need to develop flexible substrate printed data processing and storage. Most systems requirements including mobile electronics can be met more effectively (performance and cost) with discrete components embedded into the design. The ability to “replace” the current complexity of spacecraft data systems and processing such as power bus management, data encrypting, data bus management, fault protection are a long way off. Printed spacecraft data architectures will need to be rethought with a reduction in complexity harking back to the functionality of the Voyagers or Vikings. For example, the Viking orbiters CPUs were capable of 25,000 instructions per second.

Significant manufacturing advances for more precise and finer features are required to increase component density. Also new materials may be required to overcome the apparent physical limitations of the current ink/substrate combinations. Advances in materials and manufacturing

are showing promise to improve the performance. There are companies investing in developing more programmable logic circuits and processing capability (e.g. PARC, ThinFilm, PolyIC, Soligie) as the industry believes that Moore’s law applies and that eventually printed circuit manufacturing could approach the traditional Si-chip performance with the associated benefits of flexible substrates and lower costs. The advent of both p-type and n-type organic transistor materials from companies like Polyera now enables CMOS design construction in printed logic circuits which will hopefully accelerate developments.

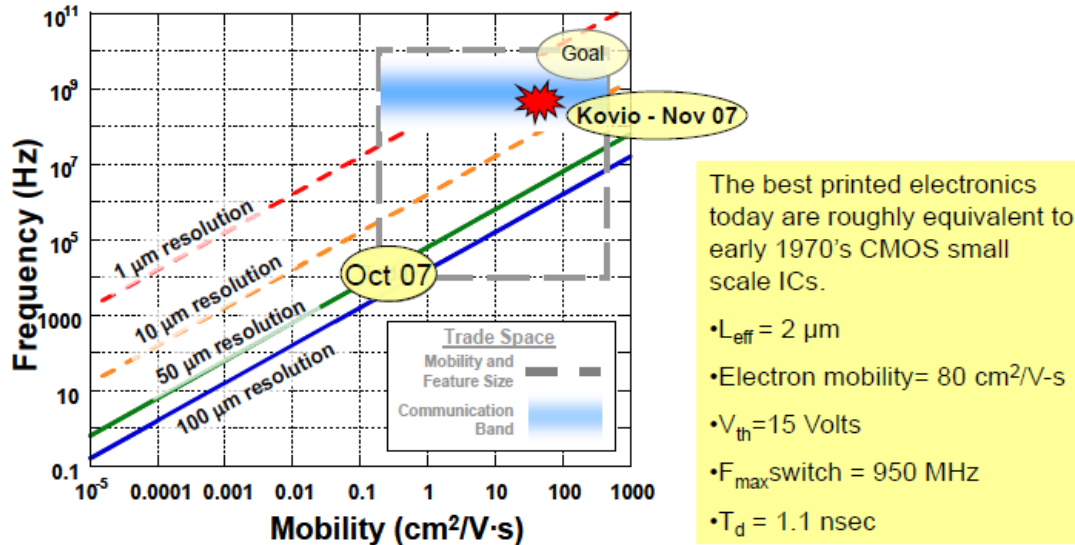

Figure 11 – Mobility vs Frequency vs Feature Size (Credit: US Army ARDEC)

Data Storage / Memory - ThinFilm and its partners are leading the market today with printed data storage banks or bit registers at about the 20bit level. Gaming systems and disposable medical devices seem to be the near term applications. Comparing this performance to the early spacecraft capabilities (Voyager had 64kB of data storage), it is easy to see that the data storage capacity of existing printed memory is far more limited than the needs of a scientific spacecraft. However, there are data architecture choices that can be made to perform logical processing of the data (thresholding, and/or gates, differencing) to minimize the data storage volume needed. Applications are numerous for more data storage such as autonomous medical devices measuring longer term trends (dosimeter sensor, ECG daily log), or inventory monitoring (temperature cycling during transportation) in field applications in which regular transmissibility or downloading is not possible. Companies such as ThinFilm and PARC are investing heavily in the development of larger, more sophisticated programmable memory and expect to have a 128kbit programmable memory in only a few years.

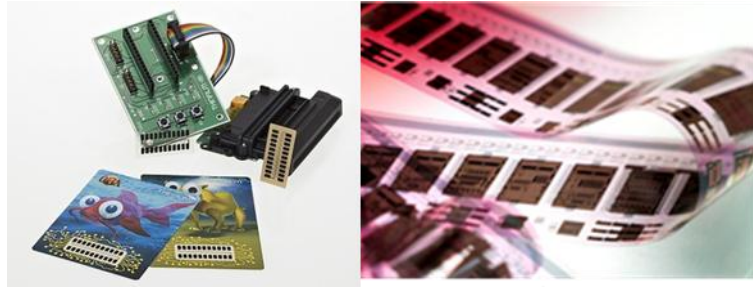

Figure 12 – Printed Memory (Credit: ThinFilm) and Logic Circuits (Credit: PolyIC)

One approach in the near term to work around this limitation of purely printed logic and data processing is to use a hybrid approach of incorporating discrete integrated circuits onto a flexible and even stretchy substrate. Novel developments in flexible interconnects and transfer printing allow higher performance computing through discrete chips, but maintain the flexibility and conformability of a printed electronic circuit. One company, MC10, has leveraged some of the research performed by Dr. John Rogers at University of Illinois to create sensor arrays, such as the brain sensor shown in Figure 13, that are truly conformable but have much higher performance (e.g. multiplexing, local amplification of signal, advanced CMOS)³⁷.

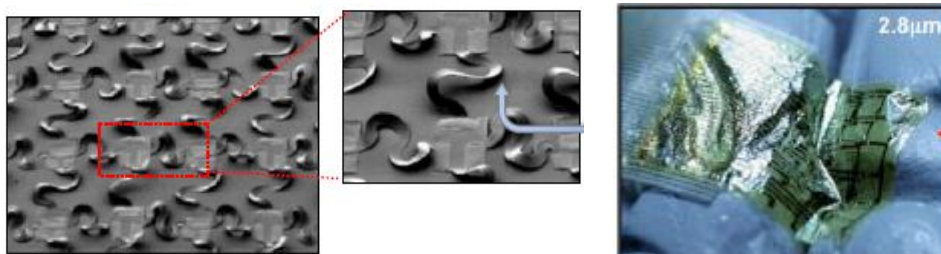

Figure 13 – Flexible interconnects of discrete Si wafers achieve extreme conformability of flexible substrate with higher computational abilities (Credit: MC10 and John Rogers Research Group).

The number of players in the TFT field is high but far fewer companies are building readily available functional circuits. Large companies are able to integrate these elements together into their own printed systems. But it does not seem profitable for smaller companies to fill the void between transistors and modular circuits.

4.1.3 Communications

Communications is one of the fields that have embraced printed capabilities. The vast majority of the focus, however, is in near-field communications (NFC). Close proximity, small data rates and power are the hallmarks of NFC applications like smart labels, RFID, inventory control. While these commercial uses have formed the foundation for other communication applications, the market is not driven to the same requirements as NASA spacecraft.

Antenna - Patch antenna, microstrip arrays, low frequency antennas have all been manufactured using printing techniques. A significant amount of research and experimentation has been done to develop design guides for trace width, spacing, material combinations, ground planes, etc. for

the design of printed antennas²⁴. RFID is one of the biggest commercial uses of printed antenna which typically operate in the HF and UHF bands (~ 13.5 Mhz).

Other more advanced developments with printed antenna include direct write techniques on three dimensional substrates. The University of Illinois has developed nanoparticle inks to use in direct write printing of antenna on spherical substrates to increase the gain. However higher frequency antennae (X-band, K-band) have not been demonstrated using printed techniques of flexible substrates. The S-band and X-band patch antenna flown on such spacecraft as NEAR are mounted to a rigid substrate and do not deal with the issues due to flexibility of larger area, higher frequency, flexible antenna. Most companies focusing on the RFID/near field communications needs are not addressing the requirements that may exist for space applications – higher gains in the antenna, higher frequencies antenna.

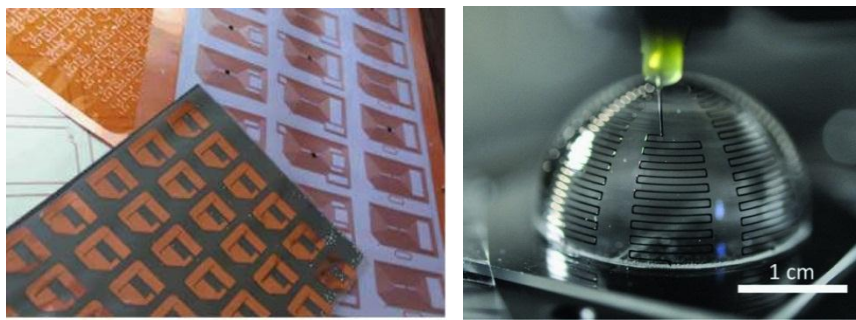

Figure 14 – Typical micro strip 2-D printed antenna (Credit: TBD) and 3-D direct write antenna on curved substrate (Credit: University of Illinois).

Communications electronics - There is significant maturity in defining near field communication protocol and modulation schemes through ISO standards (e.g. ISO14443)²³. Kovio, a small business, is a leading developer of NFC systems and has developed its own high-performance silicon, dopant, metal, and insulator inks. Kovio uses their proprietary inks to manufacture an entire RFID circuit that is printed on a substrate with the antenna patterned in (Figure 15). Most of Kovio's production steps can be performed in ambient environment and are additive in nature, which enables the company to mass-produce fully functional electronic devices at a fraction of the cost of traditional semiconductor methods²⁷.

Power amplification, printed transmitters, and telemetry encoding is not being readily addressed by the commercial sector and suffers the same limitations discussed under data handling. As elements of printed circuits are further developed, the more complex needs of data communications will be addressed. Similar to the work-around described in 4.1.2 with the conformable hybrid arrays produced by MC10, work has been done to develop flexible circuit board micro-machining fabrication techniques to produce traditional RF transmitter circuits on thin, flexible substrates allowing a potential hybrid solution which maintains the flexibility of a printed system²⁸.

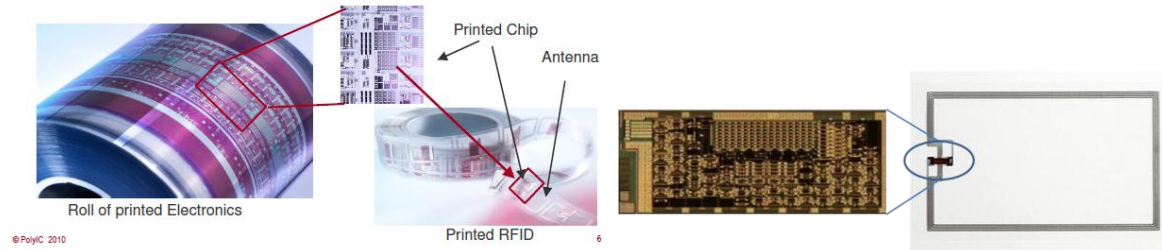

Figure 15 – Integrated RFID printed circuits and antennas (Credit: PolyIC PolyID™ and Kovio)

4.1.4 Propulsion, Mobility and Control

There are currently no industry “products” for printed propulsion, mobility, control sensors or actuators. Enacting these functions on a printed spacecraft would require either a hybrid approach or developing something new from the basic features of printed electronics. For mobility or actuation, the combination of a flexible substrate and electrostrictive materials to enact a change in shape has been demonstrated in the lab³⁵. These fundamental demonstrations would be the basis of mobility or actuation of a printed spacecraft. Propulsion is likely to be a hybrid approach for some time. Strong candidates for early propulsion “add-ons” are some of the solid state micro-thrusters that are in development. JPL is investing in a fully integrated solid state micro-electrospray thruster that could be as small as a thumbnail.

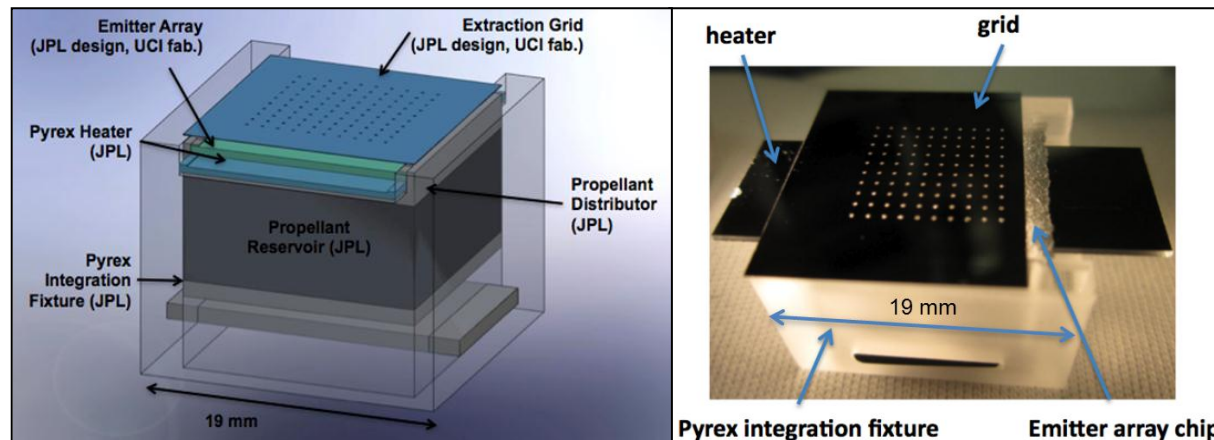

Figure 16- Micro-electrospray propulsion thrusters are being developed for small, micro and nano satellite applications.

4.1.5 Sensors

Sensors are the key enabling element in a scientific spacecraft to characterize the environment it is in. This characterization consists of both simple and complex measurements. Simple measurements such as pressure, temperature, humidity, pH levels, even constituent gases are critical measurements on their own when used to define a new environment or when used in conjunction with more sophisticated measurements. These simple sensors are all readily available in printed form. Printed and flexible sensors are a relatively small piece of the overall printed electronics market flourishing mostly where there is a profitable product to be made. For example, home biomedical devices, such as disposable glucose strips, are by far the largest commercial applications for printed sensors. The high volume, low cost manufacturing that

comes with printed techniques is driving this market sector quickly to fully printed disposable devices. However, even though they represent smaller sectors, sensor applications in which the unique form factor (flexible, thin) prove advantageous are growing and research is being conducted to convert these sensors into printed equivalents. Places where the industry is challenged include materials research to convert high temperature cure materials into low temperature manufacturing compatible with flexible substrates. Also, sensitivity/calibration of the device across environmental variations is a challenge. More sophisticated sensors – ones that require processing or other support electronics – are slow in coming to fruition. For example, many gas sensors provide threshold detection or require a visual observation of the physical change in the sensors to detect concentration, as opposed to a continuous concentration reading. A brief overview of the classes of sensors available and their state of performance/maturity relative to a NASA scientific mission need are characterized below.

Temperature - Temperature sensors can be of two basic types: continuous or threshold. Threshold sensors are valuable in product monitoring (e.g. temperature limit exceeded in transportation) whereas active or continuous sensors are useful in monitoring long term phenomenon such as patient temperatures, manufacturing environments or automotive applications. Active temperature sensor arrays with built in data recording seem to be the most favorable areas for investments in that printed arrays can more effectively measure spatial distributed temperatures than conventional non-printed sensors. Materials developments in graphite polydimethylsiloxane and nano-silicone have been demonstrated in printed temperature sensors. Other materials approaches such as multi-walled carbon nanotube (MWNT) show promise. Mass produced commercial products are slow to be released into the market as there is only a small financial incentive for these simple sensors. However, companies such as PST Sensors are hoping to develop more sophisticated arrays with the data logging built in to open a market of temperature sensors best addressed with a printed solution. Also, calibration and stability of measurements in temperature sensors is being investigated and characterized. PARC and Soligie have just completed a project in which they fully characterized the stability of printed temperature sensors over a wide range of environments⁹.



Figure 17 – Flexiforce™ printed force and pressure sensor (Credit: Tekscan) and printed NTC thermal sensor (Credit: PST sensors).

Pressure / Force - The commercial market is strong with printed pressure and force sensors. Ranging from manufacturing control systems to touch screens and gaming force feedback, force and pressure sensors have adapted well to printed technologies. The key is the ink formulation and the layering construction. Essentially, deformation of the conductive ink layer changes the resistance by moving conductive particles closer or further away from each other. There are

many commercial companies that produce printed pressure sensors such as Tekscan's FlexiForce™. Other more novel sensing systems are being developed in academic labs such as the highly sensitive pressure film developed by Zhenan Bao at Stanford. Its pyramid microstructure within the sensing layer allows extreme sensitivity in the range of less than 1 kPa³⁰. The team at Stanford has also created a stretchable pressure sensor based on charge storage sensing by single walled nano-tube (SWNT) "springs"²⁰. Strain sensors and PZTs are also common printed sensors where layers are screen printed onto the substrate. However, PZT sensors are usually printed onto rigid substrates (like ceramic) to tolerate the high cure temperatures. Adapting PZT sensors to low temperature cure is still in development. However, recent advances in a "spray on" PZT material that does not need the high cure temperature shows promise³².

Gas / Biochemical - Printed gas and environmental sensors have a strong place in automotive applications, manufacturing monitoring systems and the biomedical field. Defense applications and homeland security are also potential markets for these measurements. Most chemical sensors are based on the premise that the sensor material when interacting with the target chemical changes resistance in a predictable way. Calibrating this reaction can provide accurate sensing of concentration. Chemical sensors can interact with gaseous specimens or liquid. The array of products on the market are typically driven by chemical species of interest to profit centers such as medical test strips for blood glucose, disease markers, or oxygen sensing. While printed sensors are still improving in terms of sensitivity, calibration and stability, one benefit is the ability to print integrated sensor arrays that can investigate the presence of many chemicals as shown in the printed sensor array from BDI.

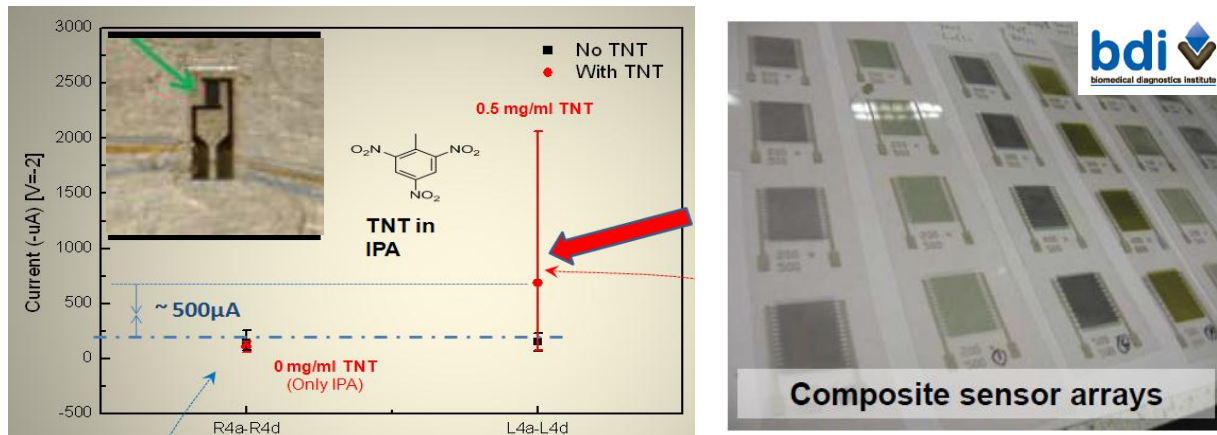

Figure 18 – Printed TNT Sensor shows resistance change in presence of explosives (Credit: Raptor Detection technologies). Chemical sensor array for NH₃, H₂S, CO, NO_x, Cl₂ (Credit: Biomedical Diagnostics Institute).

4.1.6 Functionality vs. Maturity

Having analyzed the capabilities of the printed electronics industry for the components of a functional spacecraft, it is very difficult to answer in one word the question of whether the state of the technology is ready to support a printed spacecraft. The answer is a resounding “it depends”. Where commercial interests are driving the market, both maturity and capability are high, for example as is the case with organic photovoltaics, OLEDs, and RFID-like technologies. Some functional components, are more challenging to transform into a printed format and therefore are less mature and have less performance in the printed form. In order to characterize the maturity and usability of the components of interest to a spacecraft application, we chose two key parameters and established a scale of measure. Those two key parameters are (1) the functionality of a printed component compared to what is available in a non-printed format and (2) the maturity with respect to design and manufacturing. These scales were used to graphically display where we considered certain printed component families to be currently (see Figure 19).

Overall the PV and batteries industry have reasonably mature components from a manufacturing stand point but represent less functionality/performance compared to their non-printed counterparts for spacecraft applications. The logic circuits and memory components, as described, are fairly immature as far as products on the market. However, the research areas show a lot of promise. The capability map for the communication area is fairly straightforward in that few elements of a spacecraft telecommunication systems have been demonstrated in printed systems. Antenna in the UHF range are prevalent. While microstrip and patch antenna have been produced and flown at higher frequencies (and polarized), they are usually thicker layers (mm) and adhered to a rigid substrate. A summary of the subsystem functional areas along with an overlay of the sensor categories is provided in Figure 20.

If Figure 20 can be interpreted literally, it says that if the printed spacecraft is solar powered, measures temperature and pressure, stores and processes only a little bit of data and communicates via UHF antenna to reasonably close receive station – then it can probably be made today. Adding functionality beyond those areas shown at the top right hand corner of the graph will need some development.

Looking at the areas in the lower left hand corner of the chart, it is a safe bet that commercial industry will continue to advance the state of batteries, data storage and computational power as these have wide ranging applicability to many commercial products and sectors. However, more sophisticated sensors (such as microfluidic pumps, high resolution imaging) are not being driven by the commercial sector. Certainly engineering components such as propulsion, mobility, and high power transmitters are also not going to be the focus of commercial development. These must be picked up by NASA as specific developments if they are to advance forward. The roadmap for advancing all relevant functions of a printed spacecraft will have elements to be performed by industry and elements that NASA would need to invest in.

NEXT PAGE

Figure 19 – Graphical representation of printed component maturity relative to NASA needs.

Capability Maps of Functional Areas

Functionality vs. Maturity

Functionality / Performance	
1	Basic functionality demonstrated but too low for practical use
2	Functionality supportive of rudimentary systems
3	Acceptable performance but less than that of non-printed counterparts.
4	Similar performance but with notable drawbacks
5	Performance equivalent to non-printed counterparts

Design Maturity/Manufacturing	
1	Demonstrated in lab/university environment
2	Demonstrated by commercial company
3	First generation product
4	Second generation product/optimized for manufacturing
5	Third generation product/mass production.

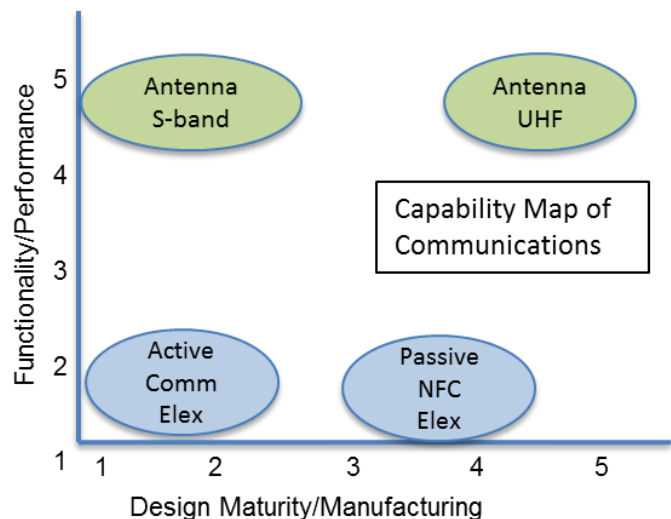
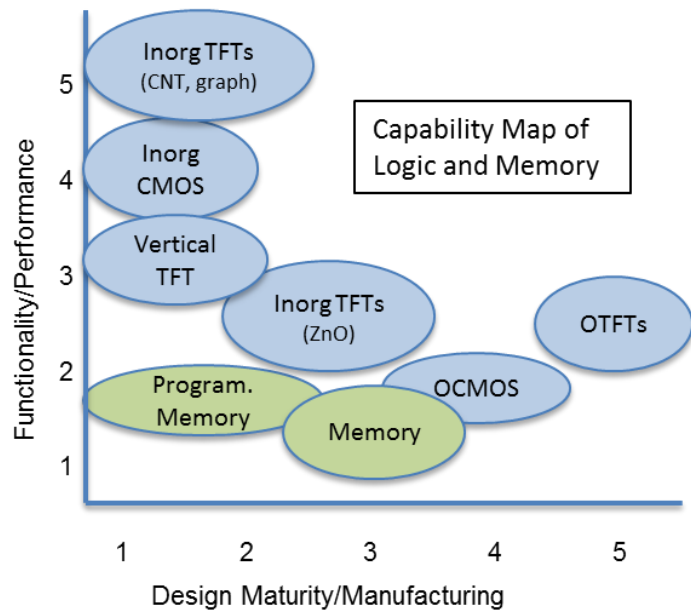
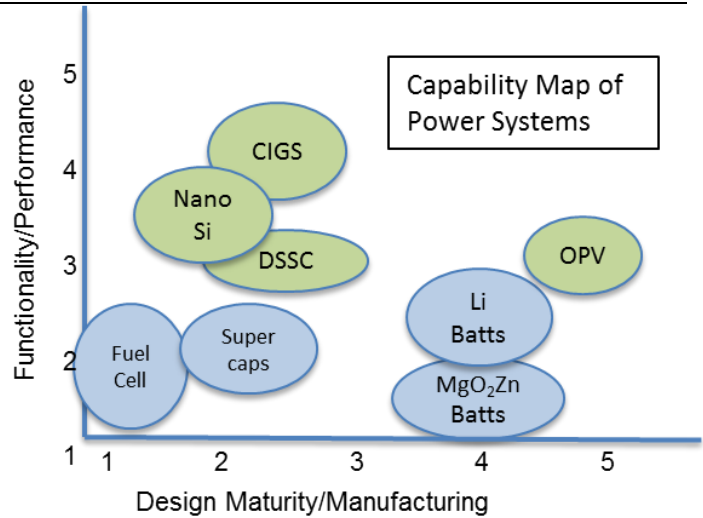

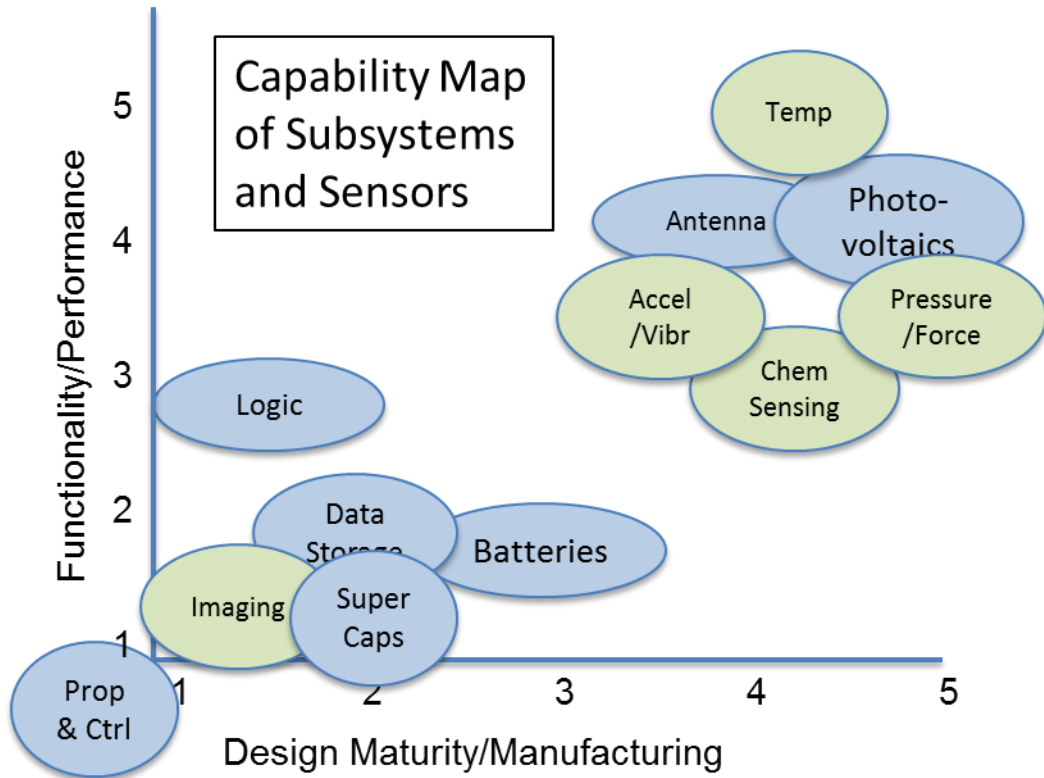

Figure 20 – Capability Map of Subsystems and Sensors

4.2 Technology Roadmap and Investment Strategy

4.2.1 Elements of the Roadmap – Context and Key Technologies

A roadmap shows how a technology gets from here to there, in particular the paths describing the order and linking of intermediate technology way-points representing what is currently missing and needs to be incorporated into the first use technology suite. There is no single route, rather a combined set of routes which start from the now, proceed through the road net, and converge, tying together the comprehensive suite of technologies and capabilities adequate to implement a system solution for a particular application. A roadmap is a hierarchical thing. At the top, there may be a modest handful of key technologies areas that need to be developed and integrated to reach the end capability. But each of those key areas can be broken down into their own roadmap of technologies and challenges that need to be met. When doing so it may make sense to make links across boundaries to avoid discontinuities and maintain a more incremental approach. Figure 21 illustrates the basic format of several roadmaps that have been included in this section for specific technology areas showing a progression from current state (green) through development tasks (blue) to the desired end state (red).

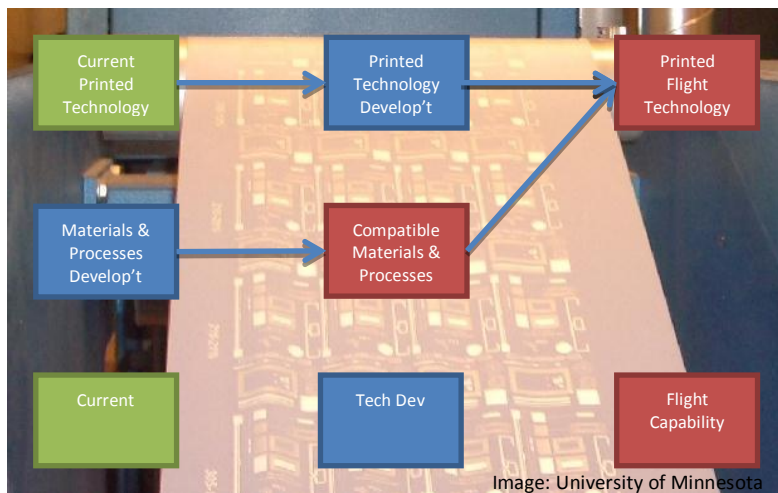

Figure 21 – General Layout of Roadmap

A set of five key technology areas necessary to support NASA’s needs in a printed spacecraft are shown in Figure 22. Listed below the five areas, are examples of specific advancements driven by NASA mission needs. Complementing these NASA-driven-areas are the commercially driven developments (inks and materials development, manufacturing optimization and component functionality), in which NASA may not invest directly but from which NASA would certainly benefit. These five areas are described in this section to give a sense of where the industry research is heading and the synergy between NASA and industry investments. Proposed within the Phase Two task, is to mature this list of technology advancements into a formal Technology Area Roadmap, in which capability maturity is mapped against the time-phased needs of demonstration milestones, program architectures and mission sets.

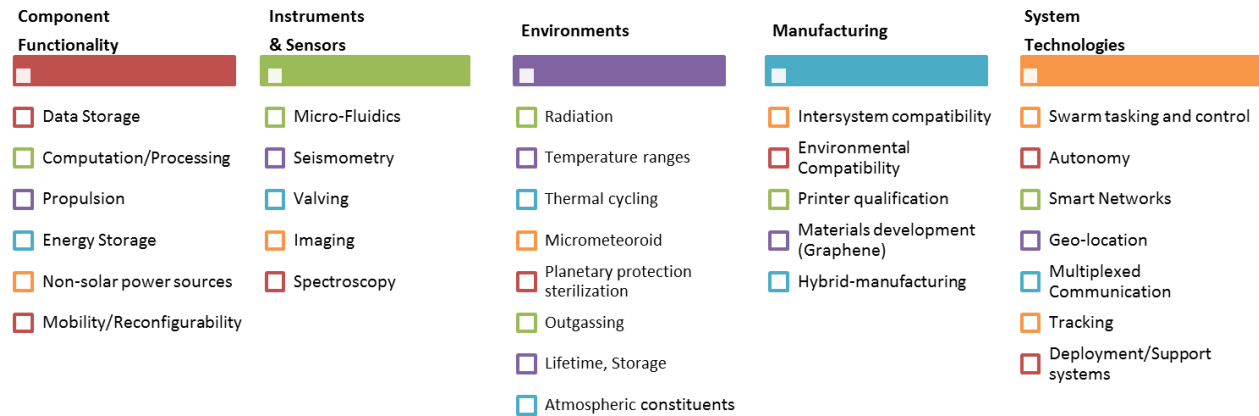

Figure 22 - Printed Spacecraft Technology Areas – These five areas represent the critical focus areas for NASA technology investment and development

4.2.2 Component Functionality

4.2.2.1 Power Systems

Commercial drivers are rapidly evolving printed photovoltaics and energy harvesting subsystems. Advances are being made in both crystalline applications and thin films that show promise for printability. The key advances needed for NASA applications in the photovoltaic area are increased efficiency, increased lifetime and performance in space environments. Starting with a materials assessment, currently printed PV systems are centered on organic photovoltaics (OPVs). However, other materials that are still in the research phase show potential for printability. Amorphous Si, dye sensitized materials and even CIGS (CuInGaSe) offer the potential for better performance if they can be formulated and the manufacturing can be made compatible with large scale printing approaches. New formulations and additives to the absorption layer material such as carbon nanotubes can help harness the charge carriers and improve the efficiency. There are many things that can be done in addition to optimizing the photo-absorbing material itself. The construction of the layers, the material interaction of the layers, even applying some of the techniques used in traditional solar cells like multi-layers and multi-junction construction approaches – tailored for printables – are all being pursued. Life time and interaction with the space environment are key elements that needs to be explored for NASA. Several of the printed OPVs have potential limitations due to the CTE mismatch between the inks and the substrate. In both terrestrial and space applications, this is a predominate life limiting characteristics. It may also be detrimental for space applications in that it would require thermal control on the PV portion of the platform, or may limit the locations in which it could be deployed. On the other hand, an advantage to some of the printable PV materials is their performance outside the “normal” terrestrial illumination spectrum is much better. Several formulations have very good low light, low illumination angle performance. Similarly, several PV materials generate electricity in response to IR radiation which could be advantages in some applications such as hot bodies.

For applications in which PV sources are non-ideal (e.g. shadowed ravines, eclipse, large AUs), alternate power sources are needed. In a traditional spacecraft nuclear sources are the typical

non-solar choice. For obvious reasons, a printed RTG is beyond the planning horizon of our roadmap. However, energy harvesting techniques are a feasible non-solar alternative. Energy harvesting converts mechanical strain energy to electrical energy. Many commercial applications are investigating this possibility for athletic equipment, clothing, and other products. Current levels of energy harvesting are limited to milli-watts and do not provide a significant power source. However, space applications may provide large areas over which the mechanical strain energy could be harvested or in atmospheric conditions, high frequency cycling which could increase the amount of power harvested.

Printed (or laminar) batteries are currently being manufactured and marketed by a number of companies. The desire for high volumetric energy density and low cost is driving these developments. Current state of the art achieves energy densities of order 150 W-hr/kg, somewhat less than conventionally manufactured Li-ion batteries, which currently attain ~250 W-hr/kg. Near term advancements will likely bring printed batteries on par. For printed spacecraft there are additional needs for rechargability, charging control, and compatibility with the flight environment. Current research in the laminar battery industry is with alternate material choices to increase the energy density and to reduce the layer thicknesses to achieve a higher capacitance and voltage without increase the thickness (and thus stiffness) of the battery itself. Integrated power control and conditioning circuits are beginning to be developed and would be necessary for a spacecraft application.

Solid state fuel cells are also compatible with printed manufacturing. While more akin to a primary battery than a recirculating fuel cell, these offer high power discharge that can be useful in applications like communication bursts. Existing units are considered “disposable” and may not be useful for long life space applications. However, DARPA is providing some investment funds to investigate increased performance and longer life options.

Overall the roadmap in power systems is straightforward and industry’s needs are synergistic with NASA’s – increase performance. Several research and development efforts in materials and manufacturing have been discussed. Most of these are best executed by the large industrial base that exists for printed power systems. As mentioned, NASA’s key role in power systems will be environmental compatibility and perhaps scaling products to larger area and capabilities.

4.2.2.2 Communications.

The current state of the art for printed communication includes conductive signal traces and connectors, RFID-like short range technologies, and visible signaling through LEDs and color-changing functional inks. Active RF communication is an emerging capability and acoustic signaling is an obvious capability that could be applied to atmospheric and fluid environments. A possible step in the direction of increased bandwidth which industry is studying is to implement dynamic near field communications where the data content is modified based on a control signal. This strategy is suitable for low bandwidth state-reporting systems. While rapid progress on commercial applications is expected, especially on low-cost passive/active RFID, the needs of a printed spacecraft will push the technology in other directions.

The essential parameters to optimize are bandwidth and achievable link distance. Developments should proceed in those areas that can increase both parameters (gain, frequency and power). Link length improvements are needed for eventual deployed space systems as current near field communications operate at distances under a few hundred meters at best. Several methods are available for improving distance performance. First, beam shaping can focus the returned power on the incident direction, much like an optical corner cube does. This requires sophisticated antenna design and implementation via printing. Second, overcoming the challenges with increasing the operating frequency to S, X or K band for printed antennas would allow better link performance over longer distances. Third, higher power amplification electronics would allow larger data sets to be transmitted. The development roadmap would apply a hybrid chip / printed strategy which piecemeal moves chip functionality to printed functionality toward the goal of a fully printed implementation.

Visible signaling is a strategy currently used in printed systems for moving data off the platform. In its simplest form this is just an indicator light (LED) or a color change. A telemetry stream can be encoded in the LED as a time-series of on/off states or even an analog signal of continuously varying brightness. Similarly when a camera-bearing asset (e.g. high resolution imager on an orbiter) can survey the location of the printed platform a change in color of the platform is a way to communicate information. With sufficient contrast against the environment, the different colors can be distinguished provided the dynamic component fills enough of a camera pixel. While this strategy is mainly a state-reporting strategy, it may be an efficient way to poll a large number of sensors scattered over an area.

For the communications roadmap, NASA will need to take an active role in defining the paths forward to meet its needs in printed spacecraft. Several of the potential techniques discussed are mapped out in Figure 23.

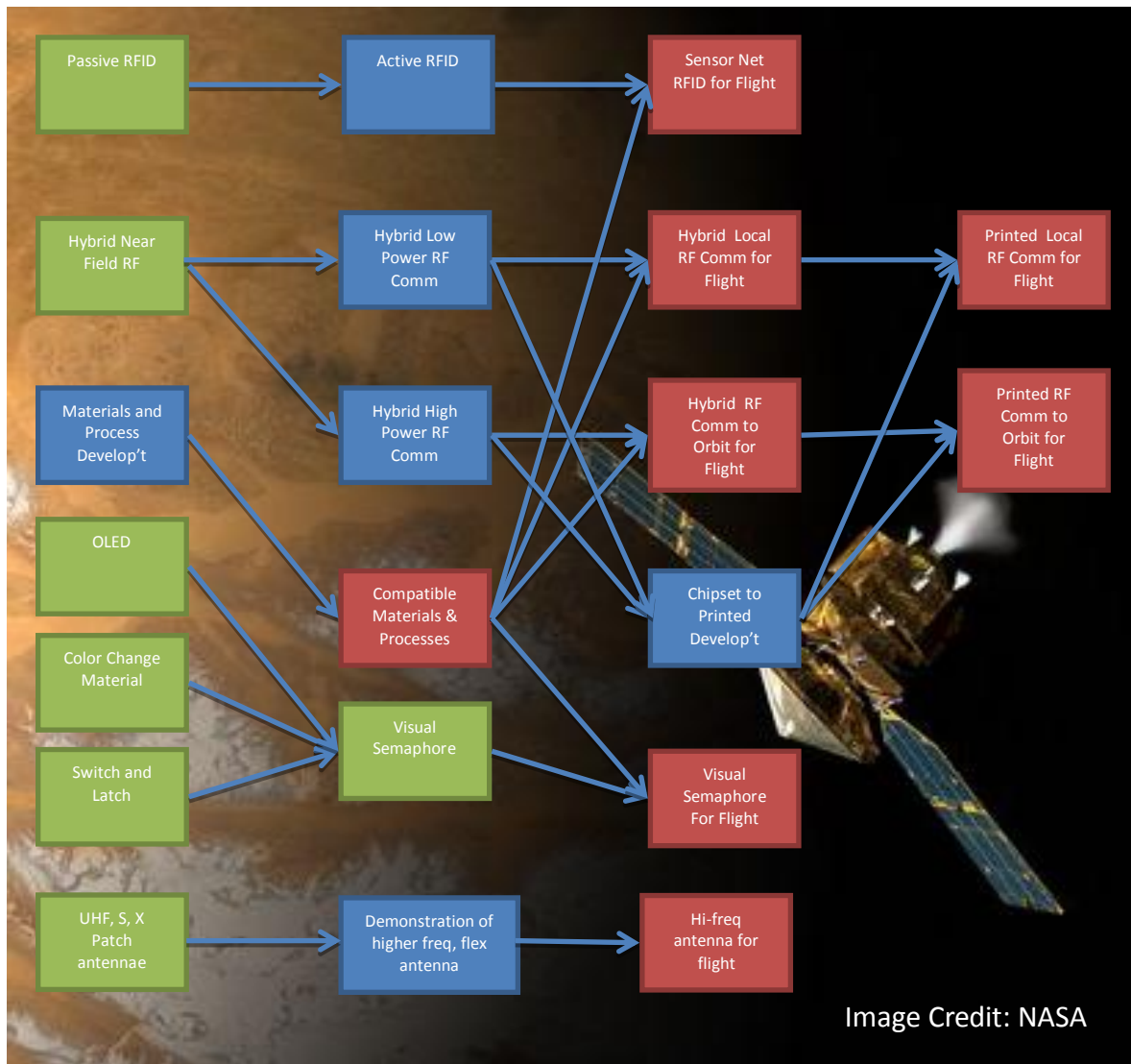

Image Credit: NASA

Figure 23 – Communications Roadmap

4.2.2.3 Logic Circuits and Memory

For an industry that has seen unparalleled growth in functionality with traditional Si chip manufacturing, printed logic has seen a rocky start. A significant number of companies have been actively maturing the field of organic printed TFTs. Manufacturing techniques, ink formulations, substrate developments have been plentiful with over 500 companies engaged is some part of this industry³². Several key aspects have stymied a more rapid growth and adoption: lack of product pull due to the relatively cheap nature of small Si-chips; low performance of OTFTs for key parameters like mobility or latch up voltage; costly investments in the infrastructure to manufacture high volume. This is not to say that the industry is giving up – more like readjusting its vision. New materials are the key technology for the advancement of

printed logic. Inorganic inks such as liquid silicon and metal oxides (ZnO) are demonstrating significantly higher mobility's than organic and material formulations which avoid high annealing temperatures are becoming more prevalent. Manufacturing techniques that increase the resolution (small feature and line size) to less than 10 microns are allowing better performance for both organic and inorganic TFTs. Organic additives such as Si-nanoparticles, graphene and CNTs are showing promise for improving performance as well. One key advantage for organic circuits is the advent of both p-type and n-type inks allowing CMOS design approaches with organic circuits. This remains a key challenge to inorganic logic as it is more difficult to achieve p-type materials in metal oxides³².

Investments and advances in printed logic circuits are truly in the hands of the industry – from all levels including ink formulation, manufacturing and products. However, government sponsored investments and providing driving requirements/product pull are critical. Military and NASA needs for computational power and data storage are likely to exceed any profitable commercial applications. NASA and DOD can certainly benefit from the unique features of printed systems (flexibility/conformability, rapid cycle time, large area, weight reduction) This is a key area where NASA could make significant investments and facilitate advancements in capability that would not only satisfy NASA's needs, but also result in spin offs into commercial industry.

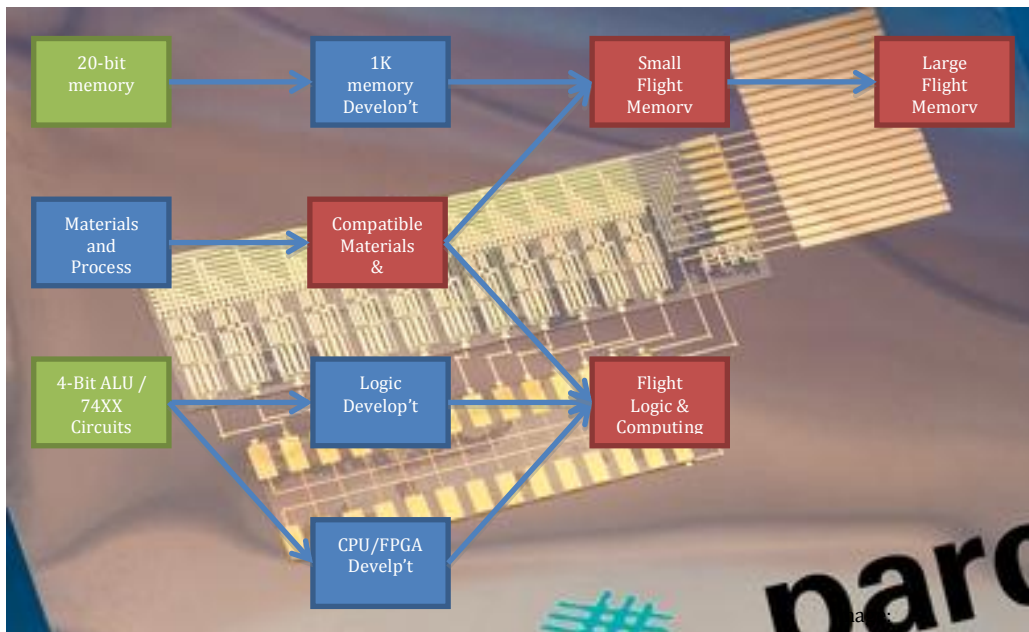

Figure 24 – Logic and Memory Roadmap

4.2.2.4 Mobility / Actuators / Reconfigurability

Because there is essentially no commercial presence in these functions, most of the novel developments and functional demonstrations will be NASA's to undertake. Several approaches and concepts are given here to seed a more detailed roadmap development pulling from other NASA Technology Area Roadmaps. Electrostrictive and photostrictive polymers are likely to provide mobility when used as artificial muscles. These polymers, incorporated into inks, can be printed into filaments that act like muscle bundles, contracting when a voltage is placed across them, or when illuminated by light with particular characteristics. Electrostrictive printed

actuators will require in turn development of moderate voltage power circuits and their control implemented as printables. Photostrictive printed actuators have advantages over electrostrictive for low force applications. These actuators are triggered by polarized light which causes a conformational change in the polymer. Essentially the polymer folds up in the presence of one polarization and unfolds in the presence of the other. By delivering the polarized light to the polymer via printed optical fibers fed by printed OLEDs (a mature technology), the actuator can be controlled by turning on and off the OLEDs.

The technology roadmap for surface mobility or reconfigurability centers on developing an “actuator” be it electrostrictive or photostrictive. The next step along each track is to print an actuator on a substrate with its moderate-voltage trace (electrostrictive) or fiber optic illuminator (photostrictive). In parallel with these the voltage generator and polarizing OLED light source can be developed, then integrated with the actuator as a complete subsystem. Materials substitution where needed for flight compatibility is the next step, taking advantage of progress along the materials track. Finally, qualification of demonstrators via environmental, functional, and life tests can bring the kind of mobility to sufficient maturity for flight applications.

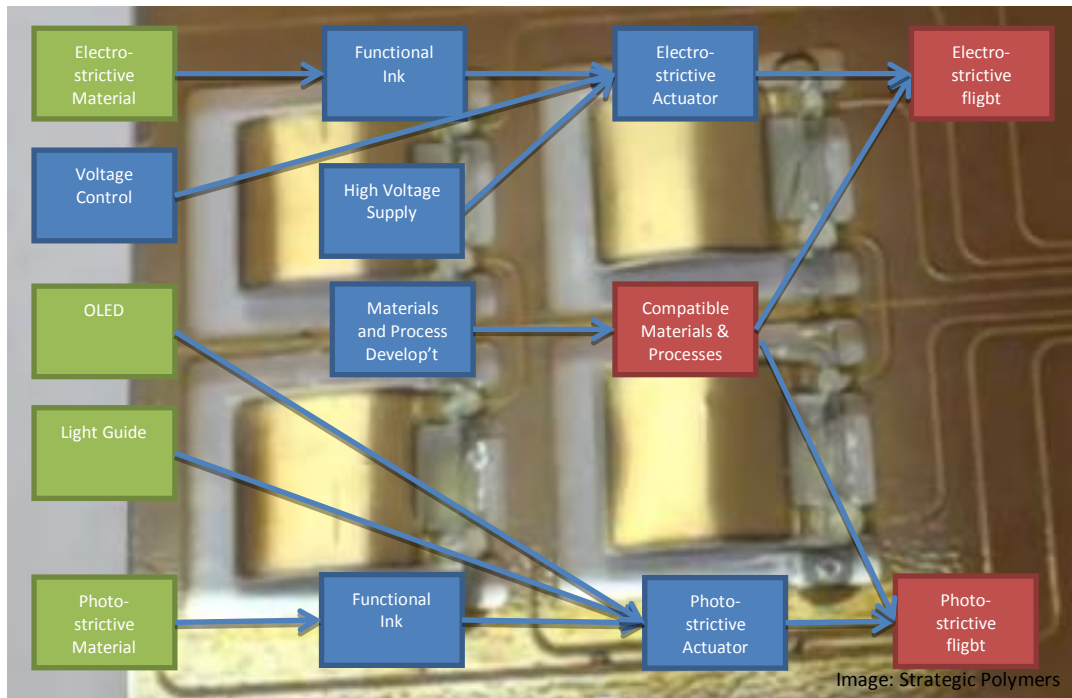

Figure 25 – Electrostrictive and Photostrictive Actuator Roadmap

4.2.2.5 Propulsion and control surfaces

Propulsion is a particular challenge for printed systems because propulsive forces require significant momentum exchange. Currently there are no known printed propulsion systems. However, hybrid systems utilizing micro-systems such as the electro-spray thruster being developed by JPL are possible. Another challenge for propulsion systems is that because they generally create a force vector in a desired direction it is necessary to have some sort of attitude sensing and control. In some cases, for example when randomly dispersing a network / swarm / constellation, vector thrust control may not be needed. However, for other sensing

constellations, the orientation of the platform would need to be controlled or known in order to feed the science results. This is purely a NASA investment area as no viable commercial ventures currently exist for these areas. Candidates for possible printed propulsion are described below.

Solar sail - Sunlight exerts pressure on a sail via momentum transfer of absorbed and reflected photons making it an attractive “propulsion” system. While a very small pressure, it is always present and its effect builds with time. Two solar sail demonstrators have flown: IKAROS the Japanese spacecraft launched in tandem with their Venus mission and NASA’s NanoSail-D which was an Earth orbiter demonstrating sail-based satellite decommissioning. Adding “printing” to a sail could enhance its functionality. A printed solar sail needs control elements to provide maintenance of the force vector. On a sail, these are typically trimtabs located at the sail periphery. The trimtabs’ reflectivity can be changed to generate forces that in turn orient the sail. Reflectivity changes could be provided by printed albedo change material that can go from light to dark via a thermal, electrical or other signal. There are already temperature sensitive polymer pigments that could be used, coupled with printed heater elements that would run off photovoltaics printed right on the sail.



Figure 26 – Printed Solar Sail Roadmap

Chemical propulsion - While not strictly printed, the laminated cap gun rolls used in toy cap guns illustrates what a type of printed chemical propulsion system could look like. Small dots of explosive materials triggered by an electric circuit can provide small impulses. Maintaining net thrust vectors through the center of mass and providing attitude control are likely to prove challenging problems. Coupled with the limited amount of reaction mass and low specific impulse available, this technique is likely to have limited niche applicability where small impulses and low precision are appropriate, such as providing random dispersal on small velocity vectors or asteroid surface hopping. The technology path would demonstrate printed

propulsives (currently doable with silk-screen techniques) along with heat-filament initiators and control circuits. Moving to a more monolithic process using propulsive inks would require an ink development trajectory to demonstrate integrated manufacturing.

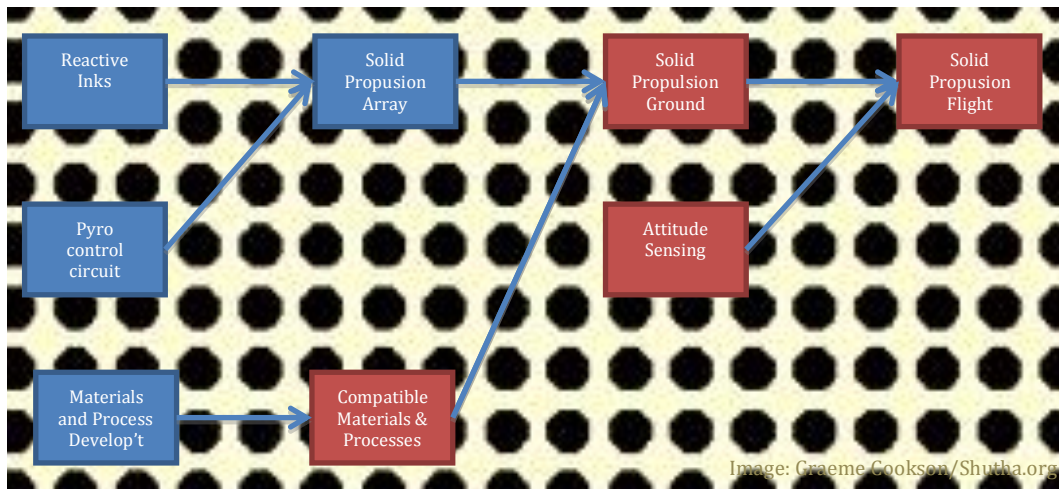

Figure 27 – Chemical Propulsion Roadmap

Electro-magnetic propulsion in planetary magnetospheres - Echo I experienced an anomalous acceleration later explained as interaction of the large conducting balloon with the Earth’s magnetosphere via passively generated transverse currents. Magnetic torque rods, used for spacecraft angular momentum control are another example of this technique, which is based on the force generated on electric currents in a spacecraft by the ambient magnetic field. While the force generated is small, it can be applied as long as power is supplied to the circuit, and as long as the spacecraft is embedded within magnetized conducting plasma. As such it is applicable for missions in Earth orbit and in the Jovian system.

On a printed spacecraft this would be implemented by driving a controlled current across a conducting trace from one side of the spacecraft to the other. The trace is terminated on each end by a large area conducting patch that couples to the ambient plasma, allowing the current to make a complete circuit through the plasma.

The technology roadmap for electro-magnetic propulsion would have a ground-based demonstration in a strong field to measure efficiencies prior to a flight demonstration, which could be carried out once compatibility with the space environment is achieved. A flight demonstration may be as simple as release of a test article from say, a Dragon trunk, with optical tracking to measure the differential acceleration.

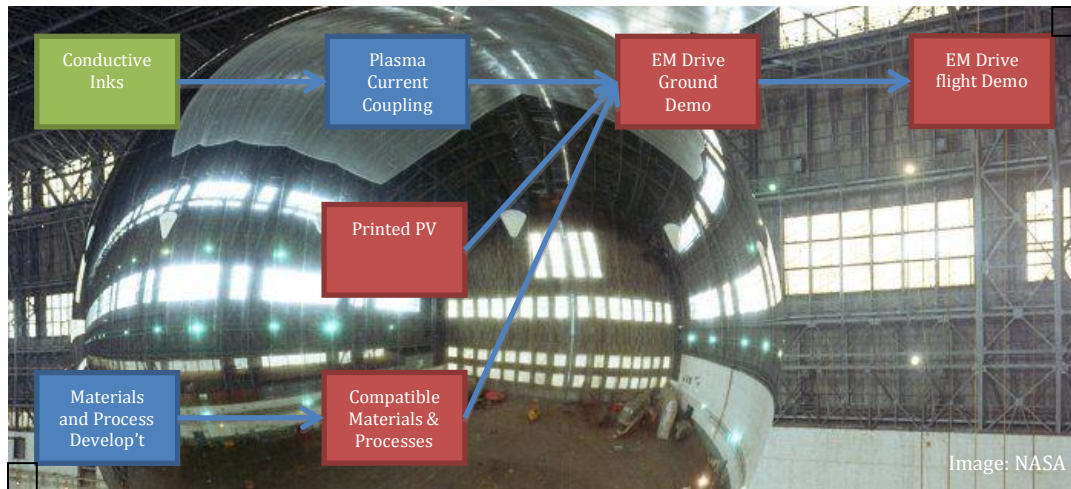

Figure 28 – Electromagnetic Propulsion Roadmap

4.2.3 Instruments and Sensors

Printed sensors are on a rapid development trajectory, driven by biomedical, food, engineering, and security markets. Adopting and extending these sensors to flight is through specialization of function to the particular experiment and adoption of materials and manufacturing processes compatible with the flight environment and required on-station lifetimes.

Chemical sensing of gases and liquids is a key area, with typical sensors undergoing a change in electrical or spectral properties upon exposure to a particular constituent. Assay (many constituent) and time-series sampling (of a single or limited set of constituents) are two approaches that will find application. Development of small hydrocarbon assay sensors for Titan and other potentially organic compound-bearing destinations is clearly a priority. These sensors are derived from current commercial and academic chemical and biomedical printed sensors, tailored for specific constituents of interest, and made compatible with the flight environment through materials and process development.

Chemical sensor readouts are typically through an electronic circuit that senses a change in conductivity, for example, due to the evolved CO₂ binding to a substrate upon exposure of glucose oxidase to glucose in a printed blood sugar monitor. Other readout mechanisms are optical, sensing the change in color of a sensor using fiber optics for illumination and photodiodes for sensing as in, for example, a finger-clamp blood oxygen monitor. These readout systems need to be made flight compatible, integrated with electronics to generate quantitative signals, and coupled to sampling systems. Sampling systems can be as simple as static exposure to the environment or microfluidic/actuated channels and pumps delivering material to the sensor in a controlled manner.

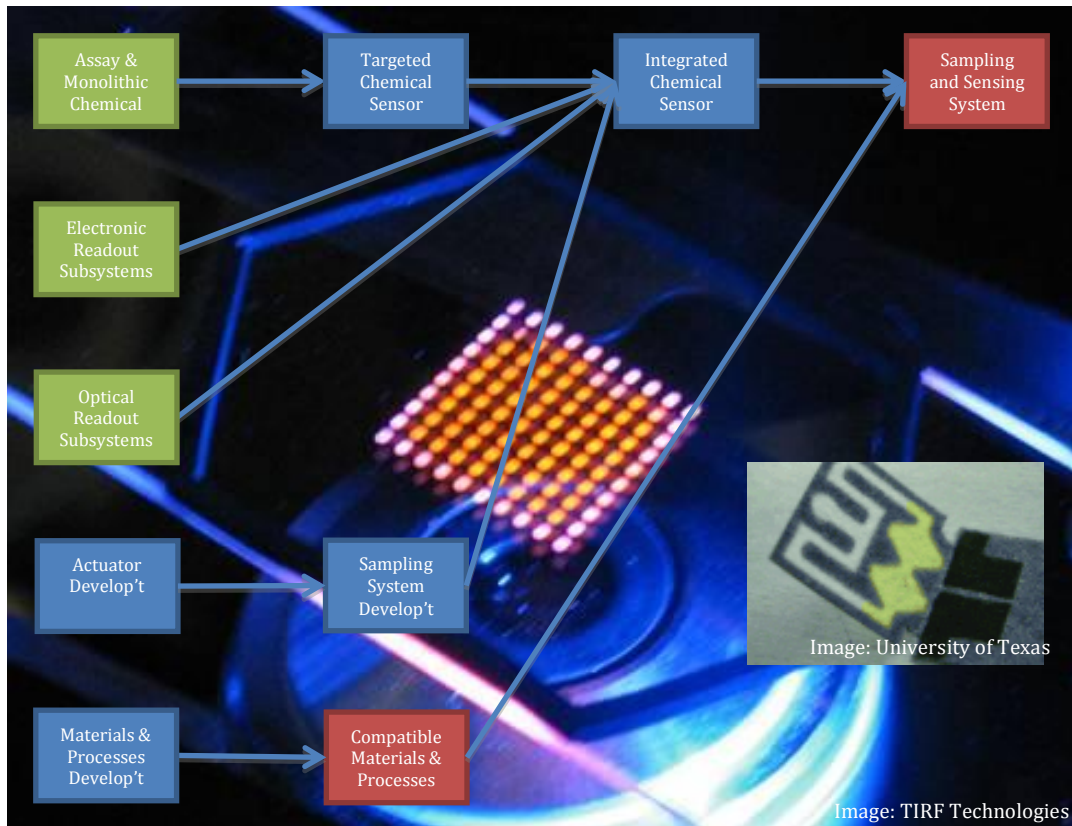

Figure 29 – Chemical Sensor Roadmap

Mechanical sensing, particularly strain sensing is a valuable modality for generating engineering data on flight systems. These sensors are currently available in printed form, implemented as bridges. The roadmap to flight proceeds through targeted development for application to flight structures, by adopting flight compatible materials and processes, integrating with power and communications subsystems into a fully printed system. The final step is to use in a flight system to monitor flight loads.

Similar roadmaps can be made for photodetectors, where arrays, infrared and x-ray capabilities are now available at low quantum efficiencies. Commercial drivers are moving these detectors toward more pixels, higher sensitivity, and further into the infrared. X-ray applications include in-situ NDE evaluation of flight structures, while optical and infrared applications include imaging for navigation and spectroscopy for mineralogy. Photodetectors are also integral elements of some chemical sensors.

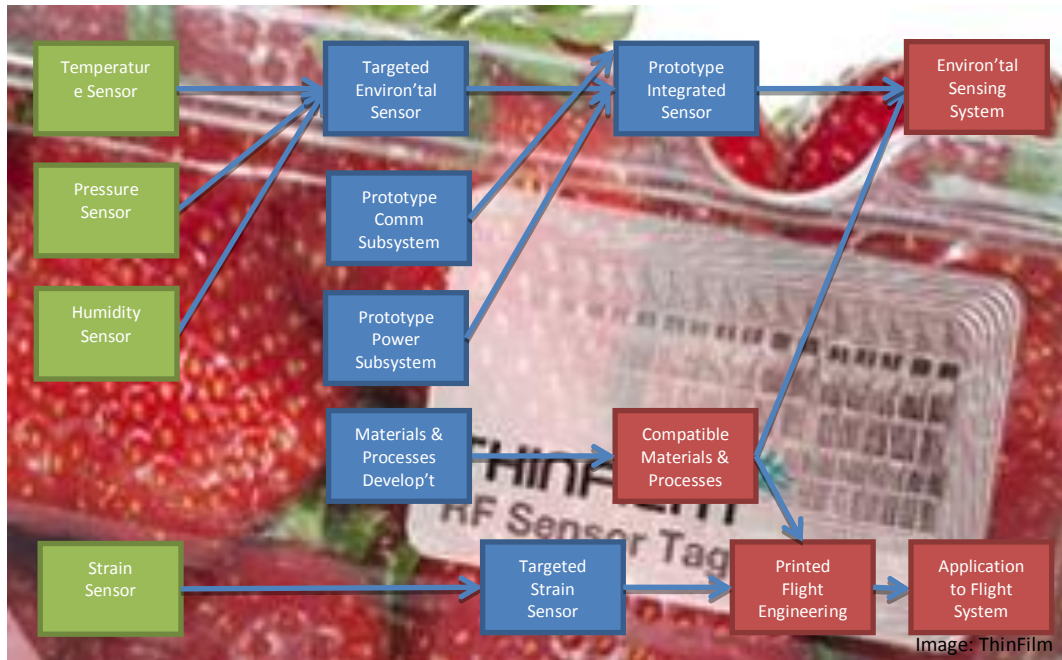

Figure 30 – Environmental Sensors and Engineering Strain Sensor Roadmap

4.2.4 Environmental compatibility

Development and maturation of materials and manufacturing processes leading to long-lived systems exposed to a flight environment is absolutely critical. These environments include high and low temperatures and temperature cycling, significant UV and energetic particle ionizing radiation doses, exposure to the space vacuum and outgassing behaviors, and planetary atmospheres with chemically active constituents, micrometeoroid environments and potentially planetary protection sterilization protocols. An essential first step is to investigate the environmental compatibility of currently used substrate and ink materials. This is done by designing simple functional systems, printing them, and testing their performance in vacuum under appropriate thermal conditions. Additional tests of function after exposure to radiation and space charge effects will also need to be performed. Finally, life tests and not just exposure tests will demonstrate compatibility with mission requirements and complete their qualification.

In the cases where materials fail the compatibility test, alternate materials will need to be considered. One area from which good candidates may arise is from the set of materials used for printed biomedical applications since these materials need to be stable in the body and non-reactive. Additional materials will undoubtedly need to be developed for functionalities that do not have an existing material or ink that is space compatible.

In terms of a roadmap, the sequence of steps is: environmentally test current materials commonly used for various functions; where gaps exist consider higher-cost biomedical materials and test them; finally develop new materials in concert with industry, screen them for both space environment compatibility and process compatibility individually, then qualify them in functional test articles.

4.2.5 Manufacturing Advances

Manufacturing advances within the commercial sector are driving towards as cost efficient processes as possible. Targets for manufacturing advancements include fully integrated roll to roll systems, reduction of steps and elimination of expensive vacuum processes. While NASA applications will certainly benefit from any reductions in cost of manufacturing, there are some NASA unique developments that would be desirable.

Resolution of feature size is a critical parameter that impacts the behavior of critical elements such performance of circuitry, antenna gain and overall size of platform. Industry is also driving towards smaller feature size and control, but may be hampered in its pace by the profitability of the changes. Unique, smaller scale fabrication systems such as the e-jet designed by University of Illinois are setting new standards for achievable resolution. Investments in academic institutions to continue to advance these kinds of systems are important aspects of the manufacturing roadmap.

The eventual goal for a printed spacecraft is to manufacture a full system from PV, to batteries, to logic circuits and sensors. To do so in a fully integrated manufacturing approach may require a wider array of materials to be deposited than what is available in system today. Most automated manufacturing systems are optimized to apply four or five materials. A full spacecraft could contain up to twelve unique materials including encapsulation and isolation layers.

In the long run the printer itself will be deployed to the remote work area in space and the build files uploaded over a telecom link to construct the printed spacecraft in-situ. Flight qualification of a printer unit would certainly be a desirable activity later in the roadmap after manufacturing has been optimized, simplified and miniaturized.

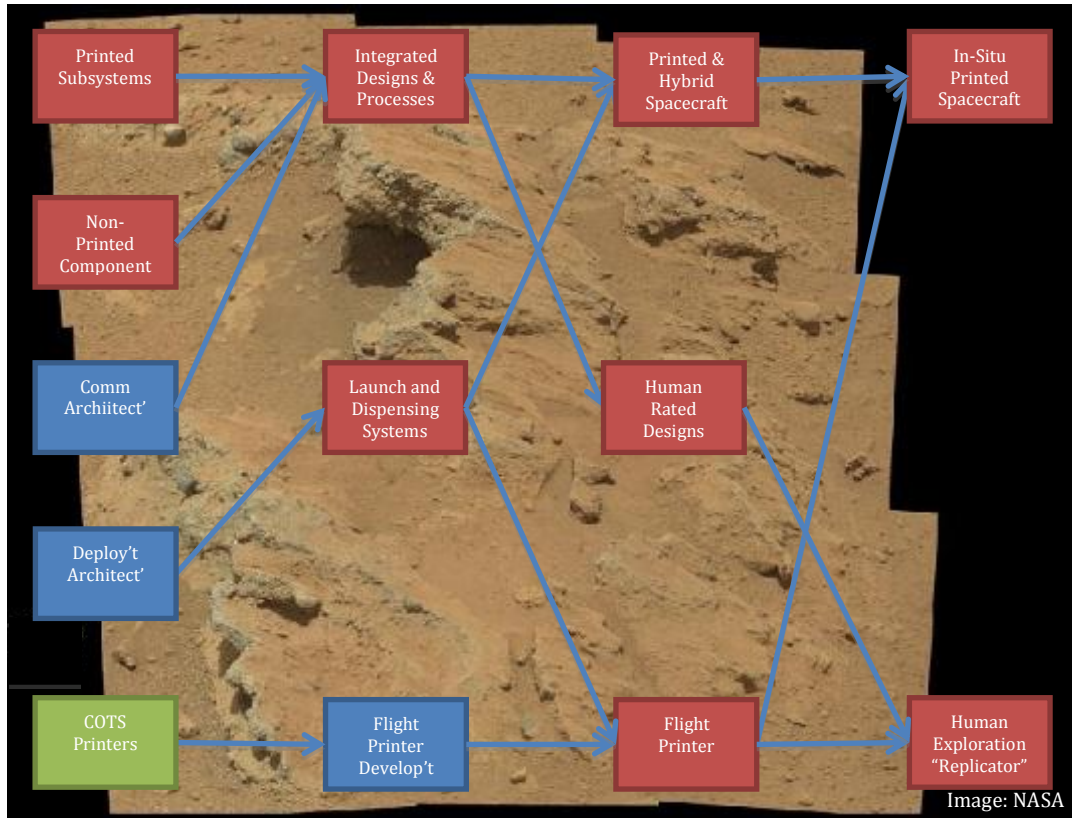

Figure 31 – Manufacturing and System Technologies

4.2.6 System Technologies

Another aspect of the roadmap, although not a focus of the Phase One task, is to explore the “system drivers” that may come from unique needs of these kinds of platforms. For example, multiplexed communications for the atmospheric confetti or smart networks in which platforms work together as a unified and optimized collective system. Many of these specific areas are also noted within the Technology Area Strategic Roadmaps such as Nanotechnology (TA10) and Robotics/telerobotics (TA04)^{2,3}.

4.3 Mission Advantages and Engineering Applications

4.3.1 Science Missions

The playing field of potential science missions is vast. In order to focus the assessment of the missions and science applications, the field was narrowed based on whether the mission could benefit from or was enabled by the unique characteristics of printed systems. For printed electronics, the distinctive features are thin form factor, flexibility/large area products, short cycle time and lower cost manufacturing. The impacts of these features on spacecraft development are described below.

- **Form Factor.** Because circuits are applied to light-weight thin substrates, the mass and volume of the platform is significantly reduced from a conventional PCB. The thin sheets of printed electronic systems make a printed spacecraft attractive as secondary payloads. Accommodating and stowing large numbers of units is simpler when multiple platforms can be stacked together like a ream of paper.
- **Flexibility and Large Area.** The flexible substrate of a printed spacecraft provides many options for storage and deployment. Reconfiguring on orbit or after deployment enables a third dimension to be realized for additional structural rigidity, improved performance (antenna or optics shape), or even mobility. Conformability to surfaces is advantageous in many engineering applications. Large area products such as sheets of solar cells and large diameter antenna can be manufactured as standalone sheets or direct write on to large structures.
- **Shorter Cycle Times.** For a printed platform, the design paradigm shifts away from mechanical packaging challenges to a focus on electrical layouts and fabrication flow. The 2D geometry vastly simplifies mechanical design to essentially a flat layout limited only by the desired size of the substrate. Circuits can be printed easily by a number of lab-scale printers allowing platform designs to be prototyped, tested, and modified quickly. Other streamlining in the development schedule can be realized. Component libraries and design rules can be built up over time and will further reduce design times. Functional analysis and performance simulations can be constructed virtually on the computer prior to committing to manufacturing. Manufacturing will span days, not months. Touch labor integration is virtually eliminated in favor of integrated manufacturing. Testing can be done in parallel on multiple copies, rather than serially on a qualification and flight units. All of these effects result in shorter development times which in turn help contain costs and open up flight opportunities that require fast turnaround times.
- **Low Cost.** Depending on the specific system, the cost of recurring engineering may be less than a traditional assembled system. This makes it an attractive platform for large numbers (networks) or “disposable” applications.

The mission classes that could benefit most from the printed systems are: network missions – surface and atmospheric; space physics missions, persistent atmospheric missions (e.g. balloons), and ground radar. These are shown in Table 2 below with an “X” indicating which features of the printed architecture that mission class benefits from. Within these mission classes, the instrument suite and desirable measurements need to be feasible with printed technology. The types of science sensor/measurements that are readily attainable with printed systems are shown mapped to each mission class.

Table 2 – Mission Classes and Instruments for Printed Architectures.

	Characteristics of Printed Spacecraft							Instruments /Science Measurements							
	Flexibility	Low Mass	Thin Form Factor	Large numbers	Unique Manufacturability	Large area	Low Unit Cost	heat flow	magnetic field	seismic	soil composition	gas composition	temperature	pressure	particle impacts
Network Mission - Surface	X	X	X	X	X		X	X	X	X	X	X	X	X	
Network Mission - Atmospheric		X	X	X	X		X	X	X			X	X	X	X
Space Physics			X		X	X			X				X	X	X
Persistent Atmospheric	X		X		X	X		X				X	X	X	X
Exploratory		X	X	X	X		X	X				X	X	X	X
Surface Sounder/Radar	X		X		X	X									

Network missions - The key figure of merit is the density of the network. Spatial distribution of sensors to look for variability of measurements across large areas greatly enhances the scientific return. The challenge to date for many network concepts is the unit cost of each platform and the ability to emplace them in a distributed manner. Printed electronics offer several unique advantages to the network mission. Most dramatic is the potential for low unit costs due to the unique manufacturability which allows large quantities of network stations to be fabricated. The thin form factor and low mass allow the larger quantity to be carried by the delivery system without a corresponding increase in that infrastructure. The flexibility and thin form factor may also provide some advantages in terms of delivery to surface or its “flight” properties in the atmosphere. The concept of a flutter lander which, once released, gently drifts through the atmosphere until it comes to rest of the surface is where the printed spacecraft concept started. The behavior of a printed flutter lander would need to be characterized for the target atmosphere, mass of the platform and shape.

Space physics missions – Printed electronics can support the objectives of the space physics community in two ways. One of the key regions of scientific interest is the distant reaches of the heliosphere. Solar sail missions are proposed to transport payloads to explore the interplanetary space and the edges of the heliopause with instrumentation to measure magnetic fields and energetic ions³⁴. Integration of sensors directly printed or laminated onto the solar sail as a substrate could provide large area detection of measurements across the span of the sail itself. Incorporating engineering subsystems (such as antenna or solar cells) on to the sail can provide potential mass savings or performance benefits.

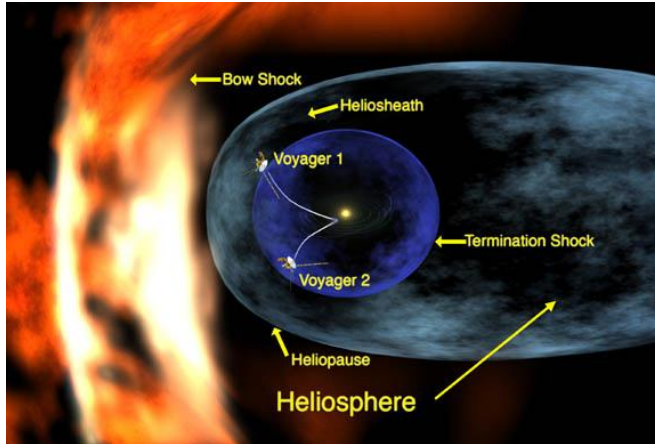

Figure 32 – A schematic image of the regions of the heliosphere (Credit: NASA/GSFC)

In a different vein, the space physics community is advocating for increased utilization of micro-satellites. A printed space physics platform can certainly be considered a candidate for satisfying the desires expressed below.

“A new experimental capability has emerged since the 2003 decadal survey for very small spacecraft, which can act as stand-alone measurement platforms or can be integrated into a greater whole. These platforms are enabled by innovations in miniature, low-power, highly integrated electronics and nanoscale manufacturing techniques, and they provide potentially revolutionary approaches to experimental space science. For example, small, low-cost satellites may be deployed into regions where satellite lifetimes are short, but where important, hitherto insufficiently characterized scientific linkages take place.”³⁸

Exploratory missions - Exploratory missions are ones in which a high-risk environment might be explored and survival of the spacecraft is uncertain. Known hazards such as comet tails, hot volcanic plumes, ravines may be explored best with a low cost, expendable system that is intended to perform simple characterizations until being destroyed. Printed spacecraft potentially offer a simple, low cost platform to implement these types of missions. The low use of resources such as mass and volume on the host spacecraft make them ideal as secondary or augmenting payloads.

Radar sounders - Subsurface characterization using radar sounders benefit from separation of transmit and receive antennas along a length. Low power systems such as the CRUX GPR if re-configured compatible with printed electronics can be rolled up and stowed on a lander to unfurl on the surface²⁵. Long lengths can be implemented without significantly more challenging deployments.

There are clearly missions and measurements that would not substantially benefit from a printed architecture. Missions such as global remote sensing, high resolution imaging, large telescopes, spectrometers, hyper spectral imaging, microscopy, subsurface excavation and sampling are not candidates for consideration in a printed system. It is not to say that these systems do not have opportunity to benefit from engineering enhancements from printed electronics (mass, volume,

form factors) but the science per se of these investigations are not specifically enhanced by the characteristics of the printed systems.

Planetary Decadal Mission Enhancements - Given the general overlay of mission classes and benefits, and using the mission set in the planetary decadal study as a reference, we were able to show that printed technologies can enrich the currently envisioned NASA science objectives¹. Inside a ten year timeframe, sensor networks made up of printed spacecraft could be a low cost, low resource augmentation to many of the recommended landing and atmospheric sampling missions. Table 3 below describes the nature of the enhancements for several Decadal Missions.

Table 3 Decadal missions enhanced by a printable component

Decadal Mission	Potential Printed Enhancement
Mars Trace Gas Orbiter	Aeroshell drops printed passive CH ₄ surface sensors capable of nanomolar detection that are subsequently observable by a high resolution imager. These would be dropped over a site showing detection of CH ₄ from orbit and would map the origin of the gas.
Comet Surface Sample Return	“Leaves” are dropped over the surface of the comet to assess organic content to provide a statistical representation of surface composition rather than a single point and guide site selection for gathering the return sample.
Lunar Geophysical Network	Deploy sensor nets around landers to perform seismic, ground-penetrating radar, mineralogical, and heat-flow measurements.
Lunar South Pole Aitken Basin Sample Return	Simple precursor lander sends out printed “crawlers” which perform large area surface reconnaissance to identify the optimal site for main lander to gather return samples.
Saturn Probe, Uranus Orbiter and Probe, Venus Climate Mission	Main probes eject printed atmospheric sensors which perform nearby multi-point/multi-path sensing to give 3-D distributions of atmospheric parameters. Also possible are printed balloons which provide persistent measurements along their paths as carried by the winds.
Mars Astrobiology Explorer-Cacher	A printed film records data within the sample return canister to document the sample environment from collection to return.

Thinking Differently

Some of the interesting discussions in our Science Mission Workshop centered around thinking differently about how to execute science missions with a printed platform. Printed spacecraft offer a “disruptive technology” to think of missions in different ways. Detection and threshold measurements rather than detailed model validation might be more compatible with the early capabilities of a printed spacecraft. For example, NASA wants to explore the surface of new worlds, places we have never been before. Rather than baselining the mission objectives on validation of predictive models of the environment (which may drive resolution, data volumes, lifetimes), the first step could be more rudimentary. Detection of chemical species – confirm existence or a concentration threshold (ie a methane sensor would trigger only when the methane concentration exceeds 1 ppm) – narrow and expected temperature range. Adopting a threshold sensing strategy allows very simple sensors and minimizes the data processing and return. These may be a more affordable intermediate step to improve our knowledge of uncharacterized targets.

Swarm mission use optimized individual platforms that either distribute or divide the job based on specific functionality or when data is taken in combination represents a more powerful data set than singular measurements. This concept has been proposed using other nanosatellite platforms and has a lot of merit for multi-point systems. A printed spacecraft offers another platform option to consider for swarm missions. This does require some development to manage and control the distributed behaviors of the network.

Purely passive platforms that respond with data to RF or other interrogation can be considered. This is the basis of the RFID industry. The tag remains passive until energized by the interrogating device (cell phone, scanner, etc.) and then data is transmitted to the receiver. Spacecraft platform can possibly minimize the onboard power resources by “harvesting” energy from the interrogating spacecraft RF beam and only transmit when requested.

Hybrid systems which integrate non-printed components into a printed platform can dramatically increase performance in nearer term systems without negating the benefits of a printed system (e.g. a comm chipset or monolithic propulsion thruster). Several examples are described in Section 3.2 as examples of where industry is striving to develop fully printed systems but can meet functionality targets with hybrid designs.

There is a size/complexity stratification of printed systems: large sheets which may be entire highly capable spacecraft (meter and larger), leaves (10-30 cm “pages”) with some multifunctional capability, and confetti (cm-scale sensors) which do one simple thing only.

4.3.2 Engineering Applications and Attributes

In addition to the enhancements and new missions that can be envisioned to support science exploration, there are many engineering applications that benefit from printed systems. Many of these are singular functions rather than fully integrated multifunctional systems as would be with a scientific platform or spacecraft. Many of the engineering applications exploit the flexibility of a printed platform. This makes sense in that engineering measurements are primarily in-situ or in contact with structure or other physical entities and are usually dependent on the intimate contact with the interface. Several engineering applications are described below.

Reconfigurability - Flexible substrates can enable options for reconfigurable systems. This has been demonstrated in applications such as origami structures and flexible mechanisms³⁵. This allows a system to be packaged one way and then achieve a different configuration in the application by expanding into a third dimension. One can imagine the usefulness of this for backup structures for membrane materials, achieving prescribed shapes for antennas or optics in situ or even perhaps assisting with mobility (erecting a sail or a sheet autonomously folding itself into a “paper airplane”). Other forms of reconfigurable mobility are rolling/unrolling and inchworm motions can be possible. The way this is achieved through printed systems is to activate a conductive trace with current or temperature to command the flexible substrate into the shape desired. This has been proven with structural origami and toys. Significant research has gone into the geometric modeling of folded structures and preferred folding patterns for deployments considering material bend radius and properties³⁶.

Conformal Sensing - Many applications require a sensing of physical parameters or interactions where inherent contact and conformability to the surface is critical to the measurement. Strain gauges represent the basic form of this. The more intrinsically the strain gauge is attached to the structure which it is sensing, the better. However, some applications and materials are not as conducive to simple “bonded sensors”. Structures can be curved or could be soft-goods or could be extremely large areas in which discrete sensor arrays and the wiring for them would be impractical. One conformable application would be a sensor suite added internally to the sealed sample canister intended to monitor and record the temperature, humidity, dynamic shock, and perhaps chemical species emitted during the transport of the sample back to Earth. The sensor suite would need to be conformal to the canister itself and be of sufficient low mass and volume so as not to drive the canister size any larger than the minimum needed. No external connection would be allowed and so the sensor unit would need to have data storage and power management embedded in it. Other applications would be contact sensing that is printed or overlaid onto rover wheels to take data on ground pressure to assist in avoiding potentially hazardous terrain. In situ measurements of the performance of soft goods are critical to engineering systems like parachutes and airbags or tethers. Traditional strain gauges and sensors are bulky and do not respond to the flexibility of the soft goods. Some more novel printing techniques are being applied to fabric and other “stretchable” substrates. Embedding or printing a suite of sensors onto a parachute to measure the actual strain and forces during deployment in-situ at Mars or during high altitude drop tests would greatly enhance the design knowledge for these challenging systems.

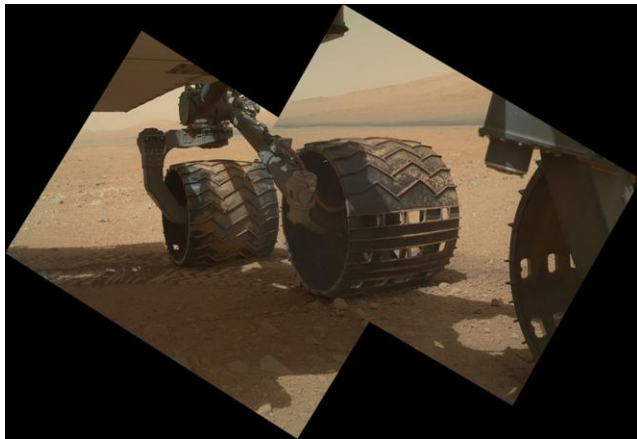

Figure 33 – Mars Science Laboratory Curiosity rover wheels on the surface of Mars. (Credit: NASA/JPL)

Intelligent structures - Embedding sensing and knowledge into a structure is a goal of many applications. Strain, damage detection, applied loads, temperature are all pieces of data that if known throughout the structure could be used to intelligently adjust parameters or features of the structure. Alternately, these systems could monitor a pressurized tank or space station module and alert the crew to different hazardous conditions such as a breach in hull integrity.



Figure 34 – ISS could benefit from embedded printed sensors (Credit: NASA)

Mass / power volume savings - The form factor associated with printed electronics can be advantageous in simply reducing the current mass and volume needs for existing systems. As has been seen in the replacement of round wire cables with flex print cables, the thin form factor and materials choices with printed electronics can offer weight savings in applications where functionality can be maintain in printed electronics. For example, the Boeing Corporation is evaluating using printed electronics in its 747 system to replace traditional wiring systems as well as in new applications such as antennae, sensors, and entertainment displays in an effort to reduce weight per vehicle²².

4.4 Risks and Challenges

For the concept of a printable spacecraft to succeed there are both technical and programmatic risks that must be addressed. Technical feasibility issues consist of fundamental developments (e.g. inks and substrate development, manufacturing techniques and optimization, functionality, speed, efficiency) and more complex issues such as systems integration and environmental compatibility. The first technical risk is that the advancements anticipated in industry for critical functional elements such as memory and logic circuits do not have the speed to provide the functionality desirable for a spacecraft platform. Some postulate that the mobility ($\text{cm}^2/\text{V}\cdot\text{s}$) possible with printed circuits may never reach the equivalent of silicon circuits. Similarly, the capability of science instruments with the measurement fidelity and sophistication desired by the science community may not be possible in this form factor. If these advances do not happen and functions are limited to current demonstrated capabilities, the printed platforms would be beneficial to a much smaller portion of the mission application space. A means of overcoming this risk would be the “hybrid” platform previously described – a system not completely printed but rather a combination of IC chips and printed systems. A second technical risk is that the manufacturing approaches that are most commonly used in high volume commercial production are not compatible with the environmental extremes of the space environment and that custom

manufacturing approaches must be devised, thereby not allowing space applications to achieve the full potential of a key benefit - low cost fabrication.

The primary programmatic risk for a printed spacecraft is not achieving an adequate cost/benefit ratio. In other words, the implementation costs remain too high, and the science return does not justify the cost. One contributing factor to this risk is that the platforms and mission concepts (such as the atmospheric confetti) require an increase in the “support infrastructure” such as relay communication assets or sophisticated algorithms (e.g. complex path tracking of thousands of platforms) on the host spacecraft. The increased cost for the support assets could outweigh the benefit of the printed platform itself. Programmatic feasibility relies on being able to present examples of favorable performance/cost/benefit trades. For uniquely enabled applications, ones that cannot be achieved any other way, the benefit may be so high that performance and costs may not be significant drivers. However, for applications in which traditional platforms can do the job, then the printed platform needs to show significantly less mass, volume or cost for similar functionality.

5 Summary

Summary

In this report, we have documented the findings of the Phase One task entitled “Printable Spacecraft”. We met the goals set forth in the task proposal and plan to extend the activities further in the recently awarded Phase Two task. In this report we provided a general overview of the industry and the commercial applications of printed electronics. We assessed the potential applications to scientific missions and engineering applications. We provided a brief evaluation of the state of the art in industry for the functional areas required on a printed spacecraft. We considered key technology advancements that are critical for NASA applications and offered areas where NASA may play a vital role. Finally, we candidly acknowledged the potential limitations and risks of a printed spacecraft.

Conclusions

Several critical conclusions were reached that were speculative at the start of the project. These have been revealed through the material in this report but are summarized below.

1. The idea of designing and manufacturing an end to end spacecraft from printed electronics is within reach for the industry. A spacecraft represents the high end of integrated systems being considered today, and near term platforms would need to be architected in a way compatible with the existing state of the art. But within a ten year horizon, increased functionality is guaranteed.
2. Materials development is the most critical aspect in this field. It impacts the performance of devices, survivability in environments and manufacturability. NASA should stay aware of new developments and invest in NASA unique or critical developments as the cornerstone of new spacecraft capabilities.
3. Product development by industry is driven by commercial viability. Investment in certain key technologies may be delayed, stymied or even dropped due to the inability to be cost effective. NASA would need to provide sufficiently strong product pull to continue development by industry and academia in the technologies that may prove most valuable for NASA applications.
4. Much like in industry, the application of printed electronics to science missions must compete on its value proposition. What can it do cheaper, better, uniquely? Mission architecting and programmatic trades have to be part of the decision making process for when and how to apply printed systems to a science mission. Up until that point, opportunities abound for lab developments and low risk/low cost flight demonstrations of printed platforms.
5. NASA’s must focus critical attention on the three things that will likely never be inherited from the printed electronics industry: spacecraft system design, space environments compatibility, and scientifically valuable instruments and sensors.

Final Words

Printed electronics is a growing and evolving field with applications as wide spread as novel consumer products to revolutionary biomedical devices. Somewhere in that spectrum are NASA scientific and engineering applications. A technology can “replace the old” or “enable the new”. Printed electronics definitely would “enable the new” for NASA.

- Enable new flutter landers
- Enable new surface network missions
- Enable new volcanic explorers
- Enable new space physics constellations
- Enable safer human outposts
- Enable new in-situ manufacturing

The missions, ideas and opportunities are there. The critical elements of a spacecraft exist in the industry today. New developments will increase performance, survivability, and system functionality. The road ahead is broad and NASA can play an important part in shaping that road and where it leads.



6 Acknowledgement of Support

The authors would like to acknowledge the team of JPL engineers that showed such enthusiasm and commitment to the quest of a Printable Spacecraft. Their efforts were invaluable.

Dr. Shannon Statham
Dr. Brian Trease
Dr. Peter Dillon
Mr. Michael Burger

We would like to thank Dr. Greg Whiting, Dr. Leah Lavery, and Dr. Tina Ng from PARC. Their consultation on this project was particularly insightful and much appreciated.

We thank Professor John Rogers at University of Illinois and Professor Margaret Joyce at Western Michigan University's Center for the Advancement of Printed Electronics for hosting our very productive visits to their respective research groups and facilities.

We would like to thank Dr. Andrew Shapiro, Early Stage Innovation Program Manager at JPL, for co-sponsoring the workshops that supported this task. Also we thank him for his guidance and advice along the way.

Dr. Greg Davis, Chief Technologist for the Mechanical Systems Division at JPL was supportive of this effort and provided advice and review of key products.

7 Bibliography

1. "Vision and Voyages for Planetary Science in the Decade 2013-2022", NRC Committee on the Planetary Science Decadal Survey Space Studies Board, 2011.
2. "NASA Technology Area 10 Roadmap: Nanotechnology", NRC Report November 2010.
3. "NASA Technology Area 04 Roadmap: Robotics, Tele-robotics and Autonomous Systems", NRC Report November 2010.
4. Peck, Mason, "Chips in Space", IEEE Spectrum, August 2011, pg 42-47.
5. Chung, S.-J. and Hadaegh, F. Y., "Swarms of Femtosats for Synthetic Aperture Applications," Proceedings of the Fourth International Conference on Spacecraft Formation Flying Missions & Technologies, St-Hubert, Quebec, May 2011.
6. Mankins, John C. (6 April 1995). "Technology Readiness Levels: A White Paper". NASA, Office of Space Access and Technology, Advanced Concepts Office. <http://www.hq.nasa.gov/office/codeq/trl/trl.pdf>.
7. L. Del Castillo, A. Moussessian, R. MacPherson, T. Zhang, Z. Hou, R. Dean, R. Johnson, "Flexible Electronic Assemblies for Space Applications," IEEE A&E Systems Magazine, June 2010.
8. "Report to the President on Ensuring American Leadership in Advanced Manufacturing", Presidents Council of Advisors on Science and Technology, report dated June 2011.
9. Proceedings and Presentations from the Printed Electronics USA 2011 Conference held in Santa Clara, CA, November 30 – December 1, 2011.
10. IDTechEx keynote presentation, Raghu Das, "Printed Electronics, 2011-2012".
11. Proceedings and Presentations from the Printed Electronics Europe 2012 Conference held in Berlin, Germany, April 3-4, 2012.
12. "Printed Stickers Designed to Monitor Food Temperatures", MIT Technology Review, January 2012.
13. PARC, a Xerox Company, Case Study, "Meeting a High-Value, Custom Application Need Through Low-Cost, Novel Electronics".
14. PARC, a Xerox Company, Capabilities Overview "Printed and Flexible Electronics Services: Application development".
15. Mars Science Laboratory, Technical Specification for the Robotic Arm FlexPrint Cable.
16. Strategic partnership discussions between JPL and Loral management.
17. J. Ritter, J. Brozik, S. Basame, M. Fallbach, L. Bradford, D. Douglas, and G. Miner, "Photonic Muscles: Optically Controlled Active Optics", *Quantum Communications and Quantum Imaging III*, edited by R. E. Meyers and Y. Shih, Proceedings of the SPIE, 5894, 379-390 (2005)
18. Marrese-Reading, Colleen "Electrospray Thruster Array Feasibility Demonstration", JPL Proposal to DARPA TTO, September 2010.
19. Y. Bar-Cohen and Qiming Zhang, "Electroactive Polymer Actuators and Sensors," Special Issue dedicated to EAP, Materials Research Society (MRS) Bulletin Vol. 33, No. 3, (March 2008) pp. 173-177.
20. Bergeron, Louis. "Stanford researchers build transparent, super-stretchy skin-like sensor." *Stanford News*. October 24, 2011. <http://news.stanford.edu/news/2011/october/stretchy-skinlike-sensor-102411.html>.
21. "Printed and Flexible Sensors Forecasts, Players, and Opportunities for 2012-202". Market Analysis, Cambridge, MA: IDTechEx, 2012. Dr. Harry Igbenehi and Raghu Das.
22. Duce, Jeff. "Applications, Needs, and Requirements for Printed Electronics in Aerospace." *IDTechEx Printed Electronics Conference*. Santa Clara, 2010.

23. International Standards Organization. ISO/IEC 14443, Identification cards -- Contactless integrated circuit cards -- Proximity cards – Part 1-4.
24. Joyce, Dr. Margaret, *Director CAPE at Western Michigan University* interview by Kendra Short (August 2011).
25. Kim, Soon-Sam. *Miniature Ground Penetrating Radar, CRUX GPR*. IEEE Paper, IEEE, 2006.
26. Machine Design. "Selecting a low-power force sensor for seamless integration and sleeker designs." *Machine Design*, TBD: 2-9.
27. Mashkooori, Mr., interview by Stock News. *CEO Kovio* (2011).
28. Myoung, Seong-Sik. "A Flexible RF Transmitter Module Based on Flexible Printed Circuit Board by Using Micro-machining Fabrication Process." *Microwave and Optical Technology Letters*, December 2010: 2636.
29. Randolph, Michael Aaron. "Commercial Assessment of Roll to Roll Manufacturing of Electronic Displays." MIT Masters Thesis, 2006.
30. Stefan C. B. Mannsfeld, Benjamin C-K. Tee, Randall M. Stoltenberg, Christopher V. H-H. Chen,. "Highly sensitive flexible pressure sensors with." *Nature Materials*, 2010: 859.
31. Takao Someya, Yusaku Kato, Tsuyoshi Sekitani, Shingo Iba, Yoshiaki Noguchi, yousuke Murase, Hiroshi Kawaguchi, Takayasu Sakurai. "Conformable, flexible, large-area networks of pressure and thermal sensors with organic transistor active matrixes." *PNAS*, 2005: 12321-12325.
32. "Printable, Organic and Flexible Electronics Forecast, Players and Opportunities, 2012-2022", Market Analysis, Cambridge, MA: IDTechEx, 2012, Raghu Das and Dr Peter Harrop.
33. "A desktop electrohydrodynamic jet printing system". Kira Barton, Sandipan Mishra, K. Alex Shorter, Andrew Alleyne, Placid Ferreira, John Rogers. *Mechatronics*, 2010, pp 611-616.
34. "The Sun to the Earth and Beyond – a Decadal Research Strategy in Solar and Space Physics", NRC Committee on the Solar and Space Physics Space Studies Board, 2003.
35. "Origami That Folds Itself", *Nature on-line*,
36. "Designing One-DOF Mechanisms for Architecture by Rationalizing Curved Folding", Tomohiro Tachi, Gregory Epps, *Proceedings of the International Symposium on Algorithmic Design for Architecture and Urban Design*, March 2011.
37. Proceedings and Presentations from the Printed Electronics USA 2010 Conference held in Santa Clara, CA, December 1 – December 3, 2010.
38. "Solar and Space Physics: A Science for a Technological Society", NRC Committee on the Solar and Space Physics Space Studies Board, 2012.
39. SIMS web page. <http://www.fp7-sims.eu/index.html>
40. FlexTech Alliance web page. <http://www.flextech.org/>