

Adaptive Control Optimization in Micro-Milling of Hardened Steels - Evaluation of Optimization Approaches

Ricardo Coppel¹, Jose V. Abellan-Nebot², Hector R Siller^{1}, Ciro A. Rodriguez, Federico Guedea*

¹Ricardo Coppel, Hector R. Siller, Ciro A. Rodriguez, Federico Guedea*

Tecnologico de Monterrey, Ave. Eugenio Garza Sada 2501 Sur, CP64849, Monterrey, México.

Tel. (52) 8183582000 ext. 5149

*e-mail: A01220529@itesm.mx, hector.siller@itesm.mx**

**corresponding author*

²J. V. Abellan-Nebot

*Department of Industrial Systems Engineering and Design. Universitat Jaume I, Av. Sos Baynat s/n
CP12071 Castellón. Spain.*

Tel (34) 964728186

e-mail: abellan@uji.es

NOMENCLATURE

A = Penalization for quality loss, surface roughness (€)

AVG = Average

AGE = Average Geometric Error

A_{rw} = Penalization for rework, surface roughness

B = Penalization for quality loss, width error (€)

C = Penalization for quality loss, form error (€)

C_{tot}^{ith} = Cost per pass (€)

c_0 = Overhead cost (€/hr)

c_1 = Labour cost (€/hr)

c_2 = Labour cost + overhead cost (€/hr)

c_t = Tool cost (€)

c_{mat} = Cost of raw material per part

F = Feedrate (mm/min)

GE_p = Evaluated form error (%)

GE_w = Evaluated width error (%)

PGE_p = Predicted form error (%)

$PGE_{p_{max}}$ = Maximum form error defined by specifications (%)

$PGE_{p_{tgt}}$ = Target value for form error (%)

PGE_w = Predicted width error (%)

$PGE_{w_{max}}$ = Maximum width error defined by specifications (%)

$PGE_{w_{tgt}}$ = Target value for width error (%)

Ra = Average Surface Roughness (μm)

Ra_{max} = Maximum Ra defined by specifications (μm)

Ra_{tgt} = Target value for Ra (μm)

N = Spindle speed (rev/min)

T = Cutting tool life

t_m^{ith} = Machining time for the *ith* tool pass

Vf = Feedrate (mm/min)

β_{ith}^2 = Mean square deviation for R_a

Δ^2 = Maximum permissible square deviation

%ICF = Percentage of increment in cutting forces

Abstract

Nowadays, the miniaturization of many consumer products is extending the use of micro-milling operations with high quality requirements. However, the impacts of cutting-tool wear on part dimensions, form and surface integrity are not negligible and part quality assurance for a minimum production cost is a challenging task. In fact, industrial practices usually set conservative cutting parameters and early cutting replacement policies in order to minimize the impact of cutting-tool wear on part quality. Although these practices may ensure part integrity, the production cost is far away to be minimized, especially in highly tool-consuming operations like mold and die micro-manufacturing. In this paper, an Adaptive Control Optimization (ACO) system is proposed to estimate cutting-tool wear in terms of part quality and adapt the cutting conditions accordingly in order to minimize the production cost, ensuring quality specifications in hardened steel micro-parts. The ACO system is based on: i) a monitoring sensor system composed of a dynamometer; ii) an estimation module with Artificial Neural Networks models; iii) an optimization module with evolutionary optimization algorithms; and iv) a CNC interface module. In order to operate in a nearly real time basis and facilitate the implementation of the ACO system, different evolutionary optimization algorithms are evaluated such as Particle Swarm Optimization (PSO), Genetic Algorithms (GA) and Simulated Annealing (SA) in terms of accuracy, precision and robustness. The results for a given micro-milling operation showed that PSO algorithm performs better than GA and SA algorithms under computing time constraints. Furthermore, the implementation of the final ACO system reported a decrease in the production cost of 12.3% and 29% in comparison with conservative and high production strategies, respectively.

1. Introduction

Micro-milling operations have been commonly applied in industries such as medical and electronics. Nowadays, the miniaturization of many consumer products has moved micro-milling systems to be part of conventional shop floors, extending their use to other industries. The process flexibility and high quality of these machining systems make them to be a suitable technique for manufacturing micro injection molds used for mass production of metal and plastic micro components [1, 2] and forming dies from hardened tool steels [2, 3]. Furthermore, recent studies have increased the attention on micro-milling operations of hardened steels because of their outperforming capability with respect to Electric Discharge Machining (EDM) processes [4].

In spite of the extended use of micro-milling systems in recent years, the performance of these processes is still specially challenging because of unpredictable tool life of micro end mills, high wear rates and the negative impact of tool wear on dimensional accuracy and surface quality [5]. In practice, essential product attributes in micro machined parts are nano-range surface finish, high dimensional accuracy and minimal burr size. To meet these requirements the selection of optimum cutting conditions and adequate monitoring systems are essential but demanding [6]. In most cases, in order to avoid negative impacts of tool wear in part quality, conservative cutting conditions are set, lowering the productivity and increasing manufacturing costs. In traditional machining systems where surface roughness and part quality are less demanding, machining parameters can be optimized according to different production strategies [7]: production time, production cost and profit rate. The maximum production rate objective (minimum production time) seeks to identify the cutting conditions that best balance the material removal rate (MRR) and tool life to produce at the highest rate. The production cost objective seeks to find a balance between MRR and tool life to produce at the lowest cost. For the case of the maximum rate of profit

criterion, there is a balance between the contributions of both minimum production cost and production time criterion into the objective function. The maximum profit rate criterion tends to lie close to the minimum production cost criterion unless the profit margin is high.

In machining systems where the minimum production cost is applied, the objective function, according to [7], can be defined as:

$$C_u = c_{mat} + (c_1 + c_0)t_s + (c_1 + c_0)t_m + (c_1t_{tc} + c_t + c_0t_{tc})\frac{t_m}{T} \quad (1)$$

where c_{mat} is the cost of the raw material per part, c_0 is the overhead cost, c_1 is the labor cost, t_s is the set-up time, t_m is the machining time, t_{tc} is the time for tool change, c_t is the cutting tool cost and T is the tool life.

Generally, the objective function in Eq. (1) is optimized off-line in order to define the optimal cutting parameters that will be set in the machine-tool throughout the machining operation. This common practice is adequate in most of the machining processes, however, this approach can be only applied if the following assumptions hold: i) the tool state does not affect the final quality of the work-piece or it can be considered negligible; ii) the machining process is consistent in time. Thus, this function does not reflect the impact of tool life in the workpiece surface quality, which is the real effect to consider in actual machining processes.

In general, micro-milling processes do not hold the assumptions listed above, and the use of previous optimization strategies can set cutting conditions far away from optimal. In fact, tool life and premature failure of micro tools is a major process constraint. Tool wear is critical since it influences component tolerance, quality, production times and costs [5]. As the cutting tool wears out surface quality is affected and thus, a set of cutting parameters may not be appropriate for the entire life of the cutting-tool [8]. Furthermore, in the

regime of micro-milling, the ploughing phenomenon prevents to accurately model the process [5]. To deal with this problem, it is necessary to estimate the cutting-tool wear state and its impact on dimensional and surface quality in order to set the most convenient cutting parameters.

In this work, an Adaptive Control Optimization (ACO) system is proposed to optimize cutting parameters according to the estimation of cutting-tool wear state and the prediction of the part quality outcome. The proposed system is composed of the following modules: i) monitoring sensor system module based on a dynamometer, ii) an estimation module based on ANN models that evaluate tool wear state and predict part quality outcome, and iii) an optimization module that looks on-line for the optimal cutting conditions according to the estimation of process performance. The last unit is critical due to the rapid wear of micro end mills and its influence on part quality, which means that the optimization unit should be able to response in few seconds to let the ACO system operate nearly in real time. Under this constrain and in order to obtain the best performance of the optimization unit, different optimization approaches such as Genetic Algorithms (GA), Particle Swarm Optimization (PSO) and Simulated Annealing (SA) are evaluated in terms of computational time, solution consistency and robustness.

This work is organized as follows. Section 2 reviews previous research works related to ACO systems in machining and latest studies in micro-milling of hardened steels. Section 3 describes the micro-milling process analyzed in this work. Section 4 describes the ACO system proposed and overviews its modules and performance. Section 5 shows in detail the modeling procedure to acquire the process behavior and Section 6 shows a comparison of different optimization algorithms in order to implement the most adequate in the ACO system. Section 7 shows the validation results of the ACO system, which outperforms the traditional off-line optimization approach. Finally, Section 8 concludes the paper.

2. State of the art

2.1. Adaptive Control Optimization (ACO) in machining

In the literature, the adaptation of cutting parameters according to the state of the machining operation has been successfully implemented under three major strategies [9]:

- a) Geometric Adaptive Control (GAC), where process parameters are modified to maintain dimensional accuracy and/or surface finish quality [10].
- b) Adaptive Control with Constrains (ACC), where the cutting conditions are adjusted to maximize one or more output parameters such as feedrate or cutting force [11].
- c) Adaptive Control with Optimization (ACO), where a performance index such as MRR or production cost is maximized or minimized adjusting cutting parameters (feed-rate, spindle speed, depth of cut) to an optimum value [8].

According to these definitions, an ACO system is the strategy that better deals with the micro-milling problem stated above. In general, an ACO system is composed of four interrelated modules: i) a monitoring module; ii) an estimation module; iii) an optimization module; and iv) a CNC interaction module. The main characteristics of these modules are defined as follows:

2.1.1. Monitoring Module

In order to optimize a machining performance index, an estimation of the state of the machine-tool is required, and thus, some kind of sensor information should be available. As the critical aspect of the operation is the cutting-tool state (cutting-tool wear), sensors applied in tool condition monitoring are commonly used. A large number of research works have been

conducted for cutting-tool monitoring and some of them applied to micro-milling operations on hardened steels can be found in [12-15]. In general, the monitoring module is composed of a sensor system unit, amplification and conditioning unit, and a signal processing and feature extraction unit. In tool condition monitoring systems for machining operations, different sensors have been successfully applied, such as dynamometers [12, 14, 16, 17], accelerometers [12, 15], acoustic emission [13, 14], etcetera. Different studies have been also conducted in signal processing and feature extraction [18-21]. According to Abellán & Subirón [19], the most relevant feature extraction techniques applied in machining are time domain (Root Mean Square, Peak, Mean, Standard Dev, Kurtosis, etc.), frequency domain (Single Harmonic and Power Spectral Density), and wavelet domain (Root Mean Square and Peak).

2.1.2. Estimation module

The estimation module defines the process models that estimate the state of the machining process. Some variables that are usually estimated are surface roughness, tool wear, cutting-force, etc. The models defined are usually developed from a previous experimentation by some kind of design of experiments (DoE) or from data mining approaches. Process models are defined using cutting parameters (feedrate, spindle speed, depth of cut, etc.) and the features extracted from the monitoring sensor system.

For micro and macro milling operations different modeling techniques have been applied for tool wear or part quality estimation and they include response surfaces [8, 22-25], and Artificial Intelligence (AI) models such as Artificial Neural Networks (ANN) [8, 11-13, 15, 23-27], Adaptive Neuro Fuzzy Inference Systems (ANFIS) [28, 29], Fuzzy Systems [12, 30, 31], Hidden Markov Models (HMM) [24], Bayesian Networks (BN) [32, 33] and Least Squares Support Vector Machines (LS-SVM) [34-36]. Comprehensive

reviews about modeling techniques applied in machining can be found in [19, 37, 38].

2.1.3. Optimization module

The core of the ACO system is the optimization unit which optimizes the machining process in terms of production cost, material removal rate, tool life, etcetera, according to the real state of the machining process which is estimated by the process models using the monitoring sensor system information.

It is worth to remind that the ACO system adapts the cutting parameters on-line, so the time response of the optimization unit is critical. An extensive review of the optimization techniques used in machining can be found in [39] and [40]. In [39], Yusup et al. reported the use of evolutionary techniques to optimize models based on Artificial Intelligent approaches such as ANN, ANFIS, and so on. Most of these technics are inspired by nature or animal behavior such Genetic Algorithms (GA), Simulated Annealing (SA), Ant Colony Optimization (ACOP), Artificial Bee Colony (ABC) and Particle Swarm Optimization (PSO).

2.1.4. CNC interaction module

After the optimal cutting policy is obtained, the new cutting parameters have to be sent to the machine-tool. In most common machine-tools, the interaction between the optimization module and the CNC can be done through the use of analog inputs or via communication ports. The modification of machine parameters such as spindle speed, cutting feed, depth of cut, etc., can be then conducted in nearly real time.

2.2. Previous Adaptive Control systems

In the literature, some researches have been made in adaptive control systems applied to machining operations.

In Chiang et al. [11], a neural network based adaptive control optimization system (NNBACO) was analyzed. They proposed the use of two neural networks, a first one to model the cutting process and the second one, which used the Augmented Lagrange multiplier algorithm (ALM), to find the optimal cutting parameters to maximize the MRR.

Liu et al. [27] proposed an ACO system to maximize MRR using ANN for modeling purposes and GA for optimizing. The same work presented an ACC system to adapt the feedrate in order to keep a specific force value, using ANN and expert rules.

Both Chiang's and Liu's research works applied an online parameter optimization procedure in an efficient way to maximize the MRR, but the modeling of cutting-tool wear and how it affects the part quality outcome was not considered.

In Saikumar & Shunmugam [25] a feedrate adaption control system for high speed milling was proposed. In the research work, different control strategies were used for rough and finishing operations. At the roughing operation the objective was to maximize the MRR whereas the objective of keeping the surface quality under certain level was set at finishing operation. The impact of cutting-tool wear on part quality was considered and modeled by response surfaces and artificial neural networks.

An adaptive control strategy of feedrate was also reported in Zuperl et al. [26]. The feedrate was maximized with the constraint of an allowable cutting

force on the tool. The purposes were to adjust feedrate to prevent excessive tool wear and breakage and to maintain a high MRR.

Vallejo & Morales-Menendez [24] proposed an ACO system where the main goal was the achievement of a specific surface roughness and production cost. The system integrates four modules: data acquisition, surface roughness monitoring, tool wear monitoring and intelligent process planning. Genetic algorithms and Markov decision process (MDP) were implemented to compute an optimal machining policy. The solution found with the MDP is a policy mapping tool states (fresh, half new, half worn and worn) to actions, where the state transitions must minimize the cost according to a performance criterion that depends on depreciation, energy, labor and cutting tool cost.

Abellán et al. [8] proposed an ACO system to optimize a multi objective function based on desirability functions where MRR, surface roughness and cutting tool life were considered in face milling of hardened steels. A performance comparison was made between the traditional off-line optimization approach and the ACO system, using i) statistical regression models and ii) ANN models. The ACO system outperformed the traditional approach and a better performance was observed using ANN models. However, their work presents a generic multi-objective function based on desirability functions and the process of setting the weights of the multi-objective function may tend to be subjective.

Despite previous research efforts, the ACO systems analyzed do not deal with a real optimization of the production cost considering the impact of cutting-tool wear on part quality. Recently, Silva et al. [23] overcame this limitation by defining a cutting-tool pass cost that has to be optimized according to the current cutting-tool state. They proposed an ACO system for face milling operations in hardened steels where ANN were used to model

surface roughness, cutting-tool wear and tool life. An optimization algorithm based on genetic algorithms combined with a mesh adaptive direct search algorithm was used to optimize the cutting-tool pass cost. Although the system minimized the production cost better than other approaches, the optimization algorithms applied require some computing time which make them unfeasible to be applied in a more demanding real-time environment such as micro-milling processes.

In this research, an ACO system is proposed for micro-milling operations where quality requirements are much demanding, not only in terms of quality (surface roughness and geometric quality) but also in terms of time response since the cutting tool wears out much faster than in traditional milling operations. Besides considering geometric constraints, a study of different optimization algorithms is conducted in order to ensure minimum computing time and make the system suitable for micro-milling operations.

3. Process description

The machining process analyzed is a micro-milling (grooving) operation for manufacturing micro geometric features for miniature molds and dies. The channels are 20 mm long and 30 μm depth and the raw material are ground workpieces of 30 mm x 65 mm made of AISI H13 tool steel at 56-58 HRC (Rockwell Hardness C).

The cutting-tool used is a two-flute uncoated WC (tungsten carbide) end mill with a diameter of 500 μm and 30° helix angle. A vertical machining center brand Makino F3 with a mini dynamometer Kistler 9256C installed in the machine-tool table was used to perform the micro-milling operations. Figure 1 shows the micro end-mills used and the machined features. Tables 1 and 2 indicate the equipment specifications.

Table 1. Machine-tool specifications.

Variable Name	Unit	Data
Max N	rev/min	30,000
Max Vf	mm/min	20,000
Travels (X x Y x Z)	Mm	650 x 500 x 450
Positioning Accuracy	μm	1.5
Coolant	Air	
Spindle Nose Interface	HSK – A63	
Power (30 min rating)	Hp	20

Table 2. Kistler 9256C Mini-dynamometer specifications.

Variable Name	Parameter	Unit	Data
Measuring Range	Fx, Fy and Fz	N	-250 to 250
Threshold		N	< 0,002
Sensitivity	Fx and Fz	pC/N	\approx -26
	Fy		\approx -13
Rigidity	Cx and Cz	N/ μm	>250
	Cy		>300
Dimensions		mm	75 x 80 x 25
Natural Frequency	Fn(x)	kHz	5,1
	Fn(y)		5,5
	Fn(z)		5,6
Working piece clamping area		mm	39 x 80

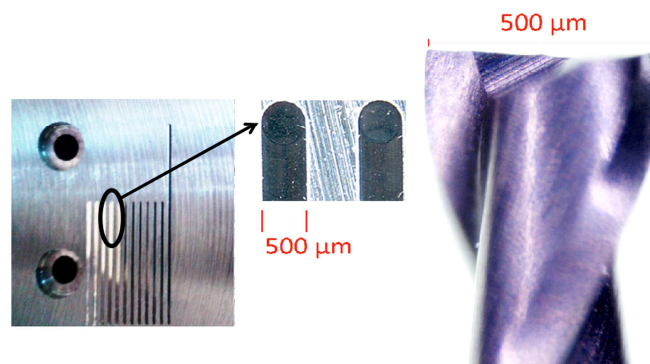

Figure 1. Stereoscopic microscope photography of micro end mill and micro-channels approximate dimensions.

The resulting micro-milled channels require a high dimensional and surface quality. Three key aspects define the quality of the product: dimensional accuracy in terms of dimensional error (width reduction) and form error (perpendicularity of wall channels); and surface quality in terms of surface

roughness. To inspect these key quality characteristics, a confocal microscope Zeiss Axio CSM 700 with 20X objectives and resolution of 0.05 μm was used. The difference between a new tool and a worn tool is presented in Figure 2. Figures 3, 4 and 5 show the inspection measurement of the key quality characteristics and the effect of the cutting-tool wear over them. It can be easily noted that the cutting-tool wear effect is critical to ensure part quality in this micro-milling operation.

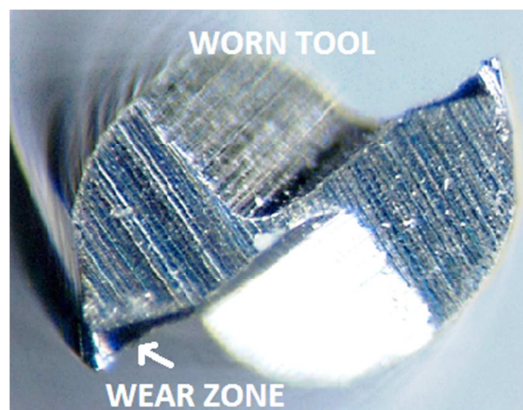

Figure 2. Stereoscopic microscope photography of tool wear in micro end mills.

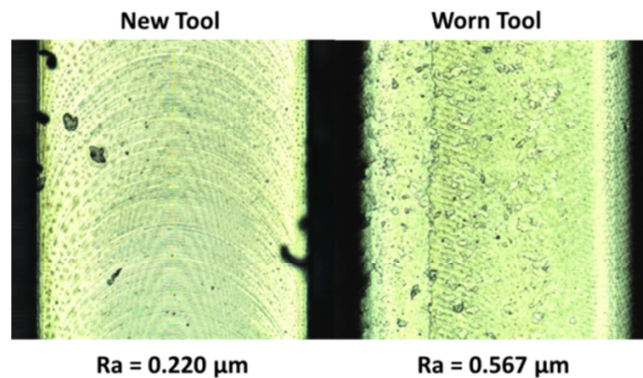

Figure 3. Example of cutting-tool wear impact on surface roughness.

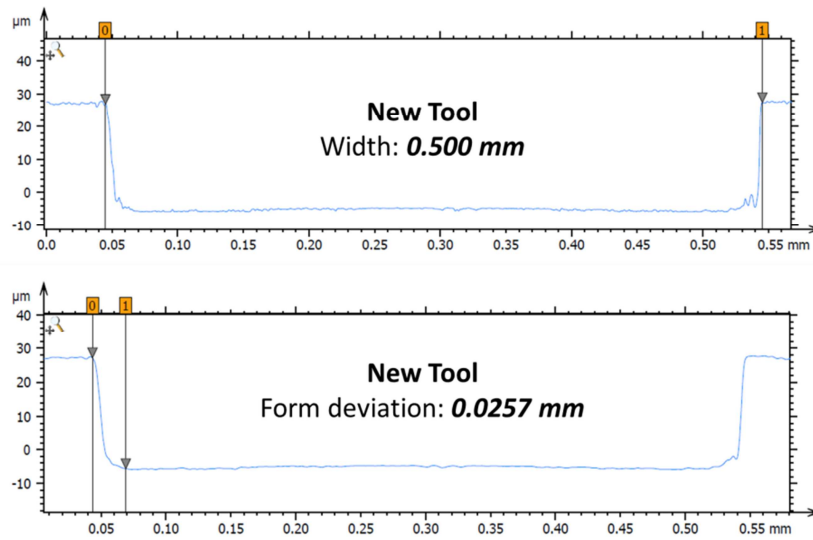

Figure 4. Examples of geometric errors generated on the workpiece by new tool.

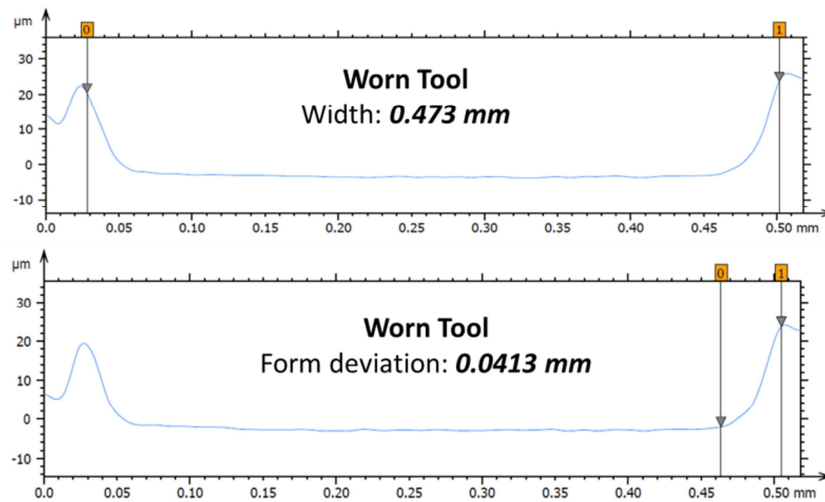

Figure 5. Examples of geometric errors generated on the workpiece by a worn tool.

4. Proposed ACO System

The ACO system proposed is shown in Figure 6 and the characteristic of its modules are as follows:

4.1. Monitoring Module

Cutting forces are measured with the mini dynamometer Kistler 9256C and then amplified with a 3 channel charge amplifier Kistler 5010 series with sensitivity of -25.7 pC/N for the X axis, -13.0 pC/N for the Y axis and -26.1 pC/N for the Z axis. In order to design a proper filter and to choose a correct sampling rate, the machining frequency was calculated as follows:

$$f_{mach}(Hz) = \frac{N \times n_{flutes}}{60} \quad (2)$$

For this research the spindle speed, denoted by N, is set in a range from 15,000 to 30,000 rev/min and the number of flutes, denoted as n_{flutes} , is 2 so the machining frequency is within 500 Hz – 1 kHz. According to the Nyquist-Shannon sampling theorem, the sampling frequency has to be at least two times the frequency of the signal that wants to be acquired [19]. The sampling frequency of the data acquisition was set to 10 KHz and the data acquired was digitally filtered by a Matlab© routine using a 6th order Butterworth low-pass filter with a cut-off frequency of 3 kHz. This frequency lets extract the information at the machining frequency and tries to minimize the effects of the natural frequency of the dynamometer.

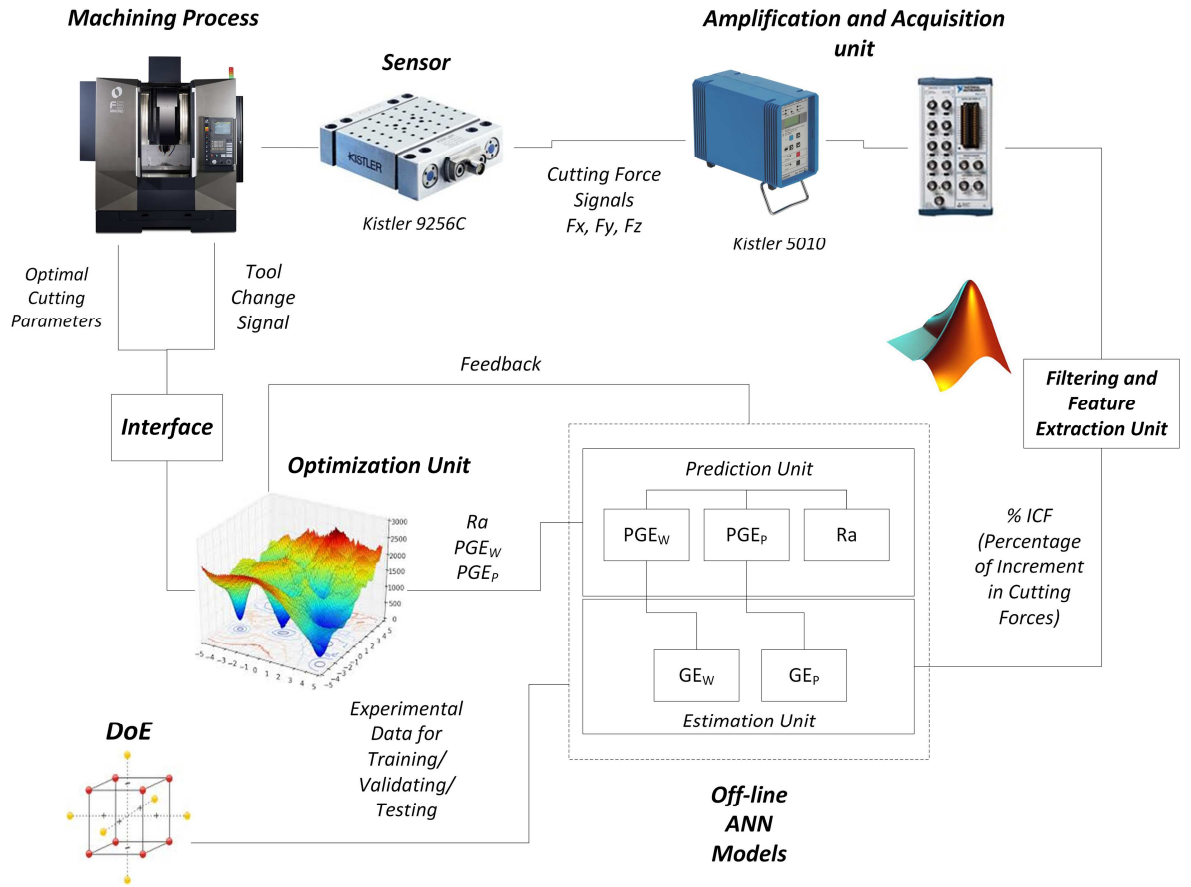

Figure 6. Diagram of proposed ACO system for micro-milling of hardened steels.

After the cutting force data in X, Y and Z direction is filtered, the root mean square (RMS) value of all cutting components are used as a significant descriptor. This descriptor has been widely used in the literature for both tool wear and part accuracy monitoring systems [19].

The RMS value for a cutting component is obtained as follows:

$$F_{RMS} = \sqrt{\frac{1}{n} \sum_{i=1}^n F_i^2} \quad (3)$$

After the RMS value for each axis is obtained, the resultant cutting force is calculated as follows:

$$F_T = \sqrt{(F_{RMS-x})^2 + (F_{RMS-y})^2 + (F_{RMS-z})^2} \quad (4)$$

Since micro-milling operations can present slight differences when a new cutting-tool is loaded or a new workpiece is mounted (variability in the depth of cut due to inaccuracy in the setup may produce an unexpected increase of the cutting force for a new cutting-tool), the final descriptor that is used from the monitoring sensor module is the percentage of increment of cutting force (%ICF) with respect to a first cutting pass. This value, denoted as %ICF, is defined as:

$$\%ICF = \left(\frac{F_{T_{ith}} - F_{T_0}}{F_{T_0}} \right) \times 100 \quad (5)$$

where $F_{T_{ith}}$ is the actual resultant average force and F_{T_0} is the resultant average force of the first machined micro channel.

4.2. Estimation Module

The estimation module is composed of two units. The first unit, named quality and tool wear evaluation unit, evaluates the current part quality and cutting-tool state according to the increment of cutting forces measured (%ICF) and current cutting parameters. The evaluation is conducted using AI models that have been built off-line previously, as it is explained in Section 5. Two key aspects define the part quality at the macro-geometric level: dimensional error (width reduction) and form error (lack of perpendicularity of the channel walls). To estimate each aspect, two AI models are used; the GE_W model and the GE-P model, respectively. Unlike other works where a flank wear value is estimated to define cutting-tool state, the cutting-tool wear is estimated in terms of part quality error since tool wear and part quality are directly related.

The second unit, named geometric error prediction unit, predicts part quality for the next tool pass given the evaluation of the cutting-tool state and the new cutting parameters. The prediction is based on three AI models. The first and second models (PGE_W & PGE_P) predict the dimensional and form error, respectively, for a given cutting-tool state and cutting parameters. The third model predicts the surface roughness (Ra) given the Average Geometric Error (AGE) -defined as the average of width error prediction (PGE_W) and form error prediction (PGE_P)- and cutting parameters. Note that this prediction unit requires the evaluation of the current operation so the inputs of these models are the outputs of the models existing in the first unit (GE_W & GE_P). When a new tool is used, the value of width and form deviation percentage is set to 0.

Figure 7 shows the elements that integrate the estimation module and how they are interconnected.

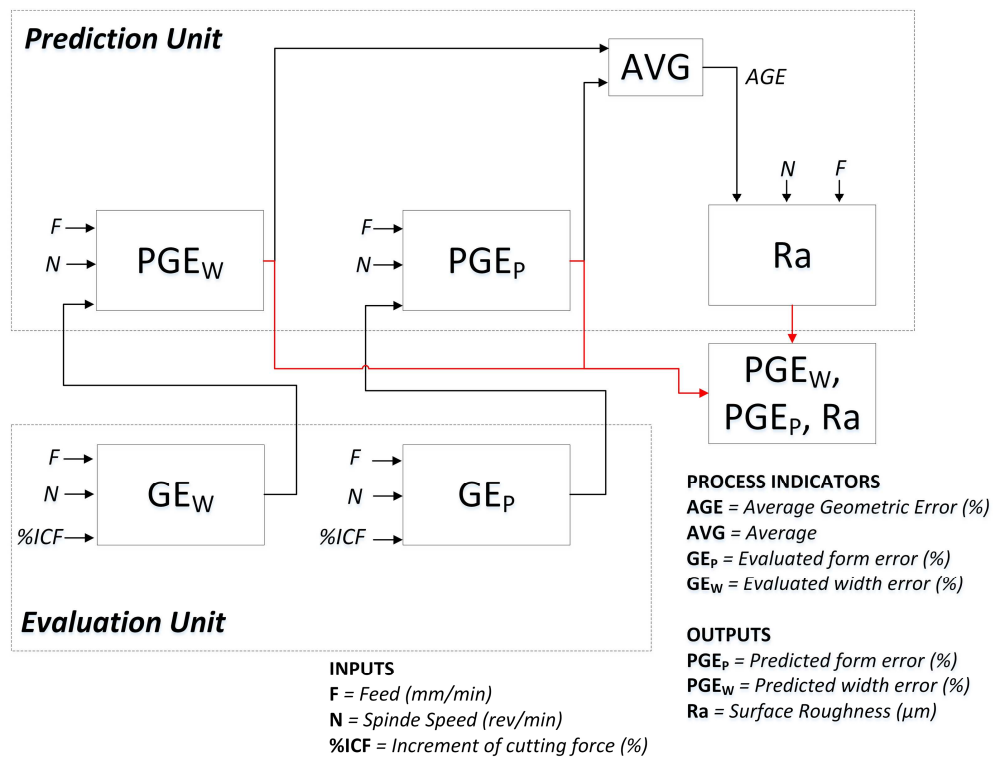

Figure 7. Estimation module composed of the Evaluation unit and the Prediction unit.

4.3. Optimization Module

As the cutting-tool wear impacts on part quality, the optimal cutting conditions will vary throughout the cutting-tool wearing process. In order to evaluate the product costs along the cutting-tool life, the cutting-tool cost per pass criterion is applied [23]. According to the above-mentioned research, the cost per cutting pass can be expressed as in Eq. 6:

$$C_{tot}^{ith} = (c_1 + c_0)t_m^{ith} + (c_1 t_{tc} + c_t + c_0 t_{tc}) \frac{t_m^{ith}}{T} + A_{rw} \frac{\beta_{ith}^2}{\Delta^2} \quad (6)$$

where

$$\beta_{ith}^2 = (Ra - Ra_{target})^2 \quad (7)$$

$$\Delta^2 = (Ra_{max} - Ra_{target})^2 \quad (8)$$

In the expression of Eq. 6, t_m^{ith} is the machining time for the i th tool pass; A_{rw} is the penalization for rework if the surface quality is not achieved; β_{ith}^2 is the mean square deviation for Ra , which is the surface roughness; Δ^2 is the maximum permissible square deviation for Ra ; Ra_{target} is the target value for the surface quality; and Ra_{max} is the maximum permissible value for Ra .

As it can be seen in Eq. (6), the final cost per pass depends on three aspects: i) the machining cost which depends on the time t_m^{ith} that the tool pass takes to be performed, ii) the cutting-tool cost which depends on the percentage of usage of the cutting tool expressed as $\frac{t_m^{ith}}{T}$, and iii) the loss quality cost which depends on the surface roughness quality deviations.

In this approach, additional non-quality terms are added since dimensional (width) and form errors in our micro-milling operation are key quality characteristics. Thus, the optimization unit will seek the best parameter

combination given an estimation of the cutting-tool state that minimizes the following cost function:

$$C_{tot}^{ith} = c_2 * t_m^{ith} + \frac{(PGE_W - GE_W) + (PGE_P - GE_P)}{2 * 100} * c_t + \frac{A (Ra - Ra_{tgt})^2}{(Ra_{max} - Ra_{tgt})^2} + \frac{B (PGE_W - PGE_{W_{tgt}})^2}{(PGE_{W_{max}} - PGE_{W_{tgt}})^2} + \frac{C (PGE_P - PGE_{P_{tgt}})^2}{(PGE_{P_{max}} - PGE_{P_{tgt}})^2}, \quad (9)$$

where c_2 is the labor cost + overhead cost, PGE_W and PGE_P are the predicted width and form errors, GE_W and GE_P are the evaluated width and form errors, $PGE_{W_{tgt}}$ is the target value for width error, $PGE_{W_{max}}$ is the maximum width error defined by specifications, $PGE_{P_{tgt}}$ is the target value for form error, $PGE_{P_{max}}$ is the maximum form error defined by specifications, A , B and C are the penalizations for quality loss for surface roughness, width and form errors, respectively. Note that A in Eq. (9) refers to A_{rw} in Eq. (6).

In Eq. (9) the first term is time dependent, penalizing operations as the machining time increases. The second term penalizes combinations of cutting parameters that generate a higher cutting-tool wear, considering the intensification of cutting-tool wear as the cause of increment of the part geometric error. Specifically, the expected increase on cutting-tool wear defined by the increase in width ($PGE_W - GE_W$) and form error ($PGE_P - GE_P$) is penalized by the tool cost c_t . The last three terms are based on Taguchi's Quality Loss function used in [23]. They are related to surface roughness, width error and form error, respectively, and they penalize the function depending on how far from the target is the predicted value.

4.4. CNC Interaction Module

The ACO system is prepared to send the resulting optimal parameters through Digital/Analog output from the computer system to the CNC. An open controller able to read analog signals and CNC commands to interpret these analog signals as reference for cutting parameters is required. Without loss of generality, the optimized cutting conditions used in the prototype system are sent to the CNC controller through the human interface every cutting pass. Figure 8 shows the flow chart of the proposed ACO system. Note that the finishing criterion in the flow diagram refers to the maximum computing time set in the ACO system. This is because the studied application requires a fast response from the ACO system, so the computing time allowed in the optimization unit should be constrained.

5. Modeling geometric errors and surface quality with AI techniques

To operate the ACO system, the estimation module needs to be configured according to process knowledge. Although part quality (surface roughness and geometric errors) and cutting-tool wear are related, the physical relationships between cutting parameters, tool wear and part quality are process-dependent, especially in micro-milling. Thus, a DoE (Design of Experiments) is usually required to build models able to capture the inter-relationships among performance and process variables.

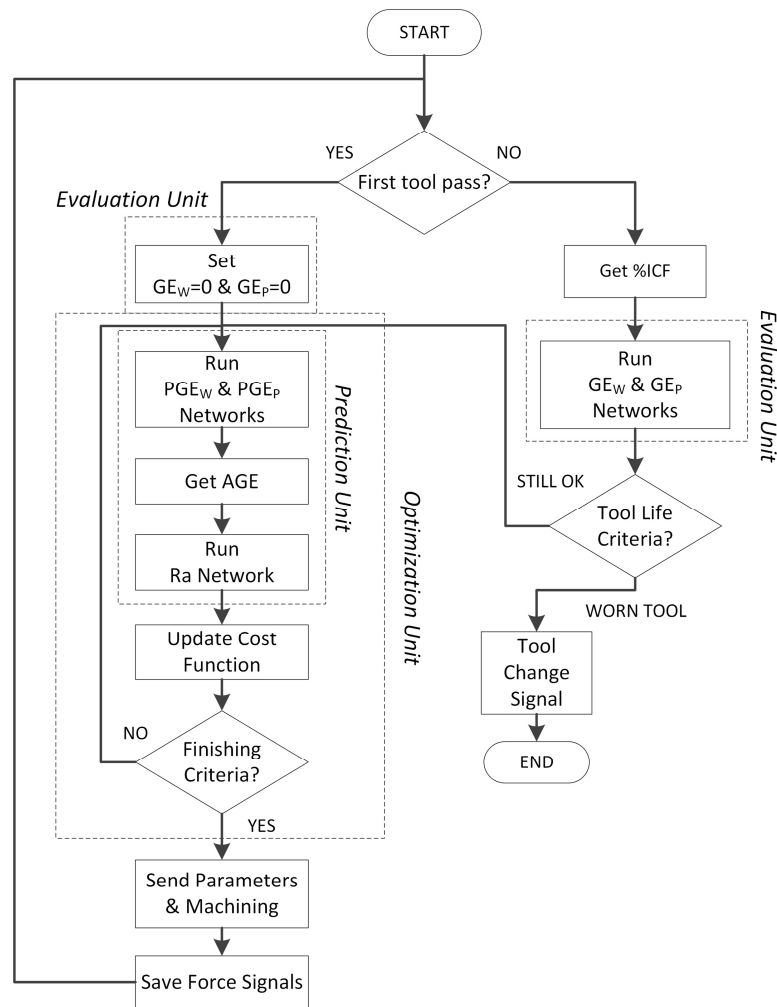

Figure 8. Flow chart for the ACO system.

5.1. Design of Experiments

As it can be noted in most of the research works related to modeling machining operations, the models are not expected to be highly non-linear for the range of cutting conditions that cutting-tool vendors recommend. In general, to learn about the relationships of cutting parameters and performance variables, three levels may be enough to have an appropriate description of the process [19]. According to this statement and based on the cutting parameters obtained from the literature (Table 2), 3 levels of Spindle Speed (N) [15,000; 22,500; 30,000 rev/min] and Feedrate (Vf) [50 mm/min;

100 mm/min; 150 mm] were chosen for the Design of Experiments. Note that for the application studied, the axial depth of cut is kept constant. Thus, a 3^2 design of experiments was prepared (Figure 9).

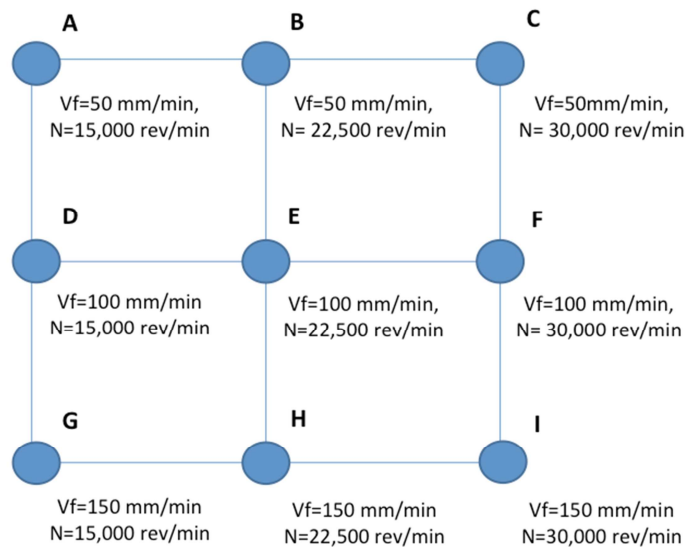

Figure 9. Design of Experiments used for modeling width and form error.

A new tool was used for each one of the 9 combinations of cutting parameters. Micro channels were machined until the geometric error exceeded specifications. In Saedon et al. [22] the channel width was used as an indirect measurement of tool wear and a reduction of 30 μm in width was defined as a criterion for tool life end. A similar practice is followed in this research, and the reach of a 6% of width and a 10% of form errors were used as tool life end criteria, i.e, as cutting-tool replacement policy. Note that the percentage error refers to the nominal value of width channel (500 μm), so 6% and 10% means 30 μm and 50 μm of dimensional (width) and form error, respectively. Then 100% of GE-W corresponds to 6% of width error and 100% of GE-P corresponds to 10% of form error.

A confocal microscope was used to measure the following aspects: Surface roughness (Ra), dimensional and form errors. These features were measured

in the middle of every machined micro channel. Several channels were milled for each cutting parameter combination until the tool life end criterion was reached. An example of how geometric error progresses along the machining process could be seen in Figures 10 and 11. Figure 10 shows the evolution of width error for the cutting parameter combination (N=15,000 rev/min, Vf=50 mm/min), denoted as point A in the DoE. Figure 11 shows the evolution of form error for the cutting parameter combination (N=15,000 rev/min, Vf=100 mm/min), denoted as point D in the DoE. As it can be seen, both figures follow a typical tool wear progress with initial, uniform and accelerated wear zones as mentioned in Chen et al. [41]. This justifies the linking of the geometric degradation of the channels with tool wear progression.

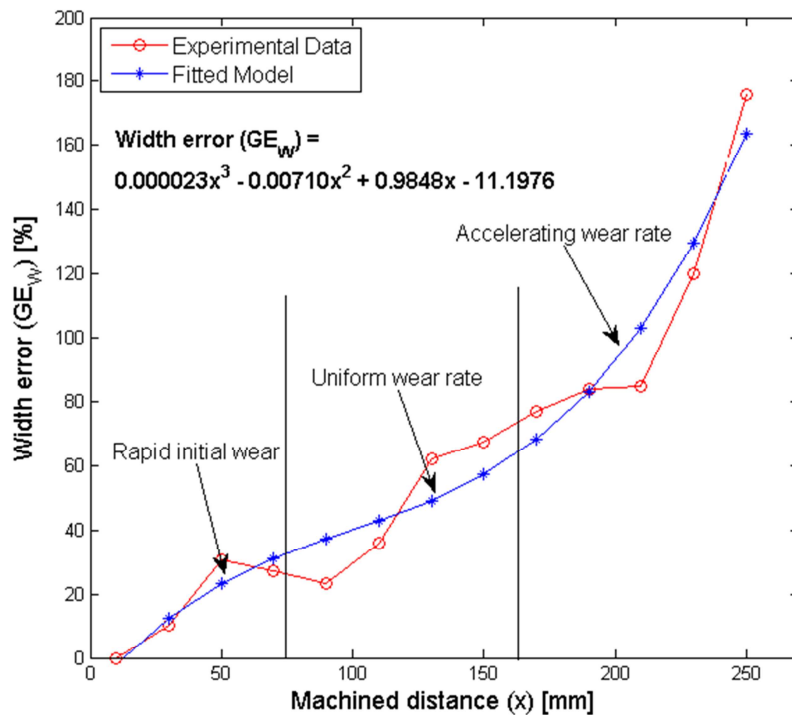

Figure 10. Width error (GE_w) for point A in the Design of Experiments.

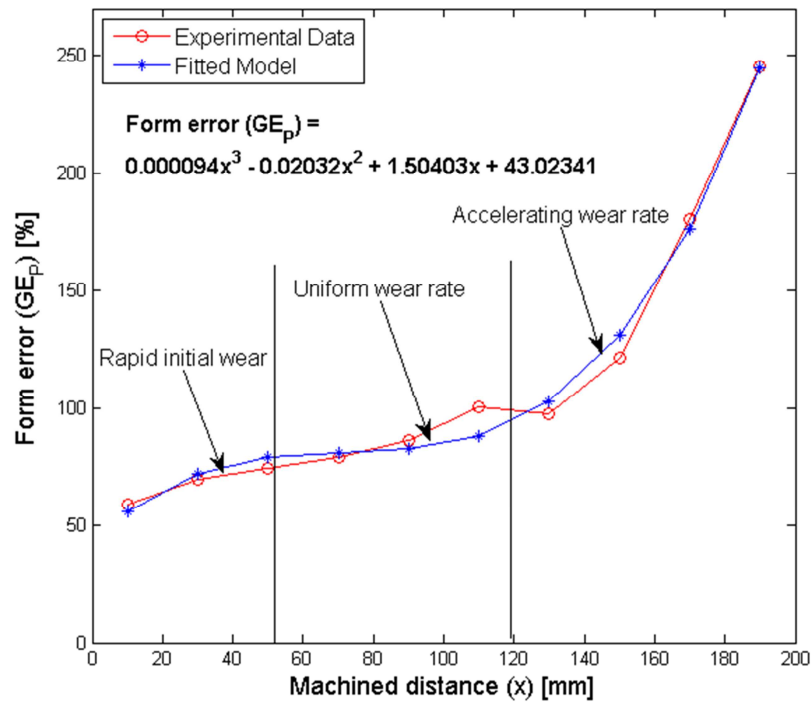

Figure 11. Form error (GE_p) for point D in the Design of Experiments.

5.2. Training, testing and validating AI models

After conducting the DoE, 68 samples were obtained. All the samples include data for geometric error (width and form) and surface roughness modeling. Table 3 shows the results obtained from the cutting conditions (15,000 rev/min; 50 mm/min) as an example.

Table 3. Geometric error and surface quality data obtained for Point A in the DoE.

Machined distance [mm]	Feedrate, Vf [mm/min]	Spindle Speed, N [rev/min]	Increment in cutting forces, %ICF	Evaluated width error, GE _w [%]	Evaluated form error, GE _p [%]	Average Geometric Error, AGE [%]	Surface Roughness, Ra [μm]
10	50	15,000	0.0	0.0	56.5	28.3	0.278
30	50	15,000	54.1	12.6	53.9	33.3	0.220
50	50	15,000	88.9	23.3	57.8	40.5	0.266
70	50	15,000	117.7	31.1	63.2	47.1	0.208
90	50	15,000	171.0	37.3	66.9	52.1	0.259
110	50	15,000	148.6	42.9	67.8	55.4	0.155
130	50	15,000	170.4	49.2	66.5	57.8	0.239
150	50	15,000	189.1	57.2	65.5	61.3	0.262
170	50	15,000	221.2	68.1	69.1	68.6	0.267
190	50	15,000	331.4	83.0	83.6	83.3	0.262
210	50	15,000	475.6	103.1	117.0	110.0	0.285

As explained above, the estimation module is composed of the evaluation and the prediction units and it is based on 5 different AI models: width error prediction (PGE_w); form error prediction (PGE_p); width error evaluation (GE_w); form error evaluation (GE_p); surface roughness prediction (Ra).

In the literature, more than half of research works about intelligent machining systems apply ANN for modeling purposes, especially in surface roughness prediction, cutting-tool flank wear prediction and cutting-tool state diagnosis [19]. Recently, Support Vector Machines (SVM) such as Least Squares Support Vector Machines (LS-SVM) have been successfully applied in machining systems for surface roughness prediction [34, 35] and cutting-tool wear [36] and several research works remark the advantages of LS-SVM with respect to ANN in terms of better generalization, global minimum and less overfitting problems [35, 36]. In this work, both ANN and LS-SVM models are developed and analyzed in order to apply the most adequate in the ACO system. For this purpose, data samples were randomly divided in training samples (70%), validating samples (15%) and testing samples (15%).

The main properties of the ANN models trained are shown in Table 4. As recommended in previous reviews in intelligent machining systems [37], the Levenberg-Marquardt training algorithm and the tangent sigmoid mapping function were applied. A critical issue in ANN modeling is over-fitting. One can easily observe that increasing the number of neurons in the hidden layer the model fits better to the experimental training data. Thus, the ANN model obtained can avoid over-fitting in the zones where the DoE data come from. However, the model behavior for cutting parameters between the combination parameters tested in the DoE can be misleading. The ANN model may report senseless predictions such as excessive surface roughness values, negative dimension or form errors values, etc. To avoid these problems, the ANN models were tested with cutting parameter combinations different from the ones used in the DoE in order to ensure a reasonable behavior of the model, assuming as it was stated before, that the process behaves smooth between the combinations tested in the DoE.

All networks were trained using Matlab © Neural Network Toolbox. After training/validating/testing up to 12 neurons in the hidden layer for each ANN model, the structure and properties of the best ANN models were defined as shown in Table 4.

The fundamentals of LS-SVM models for surface roughness and tool wear prediction can be found in previous research works such as [34-36]. As suggested in these works, the LS-SVM models used are based on Gaussian radial basis functions as nonlinear kernels in order to improve the generalization capability. The parameters to be defined are the kernel parameter σ and the regularization parameter C which determines the trade-off between the training error minimization and smoothness. These two parameters define the performance of the LS-SVM models. Therefore, to achieve a high level of performance with LS-SVM models, C and σ has to be tuned. A grid-search technique with fivefold cross-validation to the training and validating data set is applied to tune these parameters and find the

optimal parameter values for each model. All models were built using Matlab © and the LS-SVMlab1.8 Toolbox [42]. Table 4 shows the final parameters of the optimal LS-SVM models obtained for the ACO system.

Table 4. AI models analyzed for the ACO system.

AI model	Modeling Variable	Predicted Geometric Error – Width, PGE_W	Predicted Geometric Error – Form, PGE_P	Evaluated Geometric Error-Width, GE_W	Evaluated Geometric Error-Form, GE_P	Surface Roughness model, Ra
ANN & LS-SVM	Inputs	F,N, GE_W	F,N, GE_P	F,N,%ICF	F,N,%ICF	F,N,AGE
	Outputs	PGE_W	PGE_P	GE_W	GE_P	Ra
ANN	Type	Backpropagation				
	Hidden layers	1	1	1	1	1
	Hidden neurons	2	2	4	4	2
	Mapping Function	Tangent sigmoid				
	Training	Lev-marq				
LS-SVM	Kernel function	Nonlinear radial basis				
	Regularization Parameter (C)	273.5e3	62.24	93.7	73.7	62.1
	Kernel Parameter (σ^2)	116.3e3	11.84	1.91	8.1	2.38

In order to evaluate the difference of LS-SVM and ANN models for the ACO application, the performance of both models was analyzed using the testing data. The root mean squared error (RMSE) and the coefficient of correlation (R) for each model were evaluated as it is shown in Table 5. For comparison purposes, a hypothesis testing was conducted for each pair of models to find out if there is a statistical significance between both models. A Welch's test t-test was conducted where the null hypothesis is defined as $H_0: \mu_{RMSE (LS-SVM)} = \mu_{RMSE (ANN)}$ whereas the alternative hypothesis is $H_1: \mu_{RMSE (LS-SVM)} \neq \mu_{RMSE (ANN)}$. According to the results, the null hypothesis was not rejected in any case, which means that the LS-SVM model performance is not statistically different from the ANN model performance. At this point, since the ANN models are more commonly used in intelligent machining systems, the ACO system developed in this paper is based on this type of AI models.

Table 5. Comparison of ANN and LS-SVM model performance

Modeling Variable	Predicted Geometric Error – Width, PGE _w		Predicted Geometric Error – Form, PGE _p		Evaluated Geometric Error-Width, GE _w		Evaluated Geometric Error-Form, GE _p		Surface Roughness model, Ra	
	RMSE	R	RMSE	R	RMSE	R	RMSE	R	RMSE	R
LS-SVM	0.72e1	0.97	1.4e1	0.97	2.6e1	0.91	2.2e1	0.94	0.061	0.92
ANN	1.3e1	0.92	2.1e1	0.96	2.7e1	0.91	1.5e1	0.96	0.069	0.89
Ho: $\mu_{RMSE(LS-SVM)} = \mu_{RMSE(ANN)}$	Ho Non-rejected		Ho Non-rejected		Ho Non-rejected		Ho Non-rejected		Ho Non-rejected	

6. Selection and parameters definition of the Optimization Algorithm

6.1. Optimization Algorithms

As stated above, different optimization approaches have been applied in machining processes for cutting parameter optimization. For micro-milling applications where the cutting tool wears out faster than conventional machining operations and its impact on part quality is high, the optimization algorithm must be capable to compute the solution with the least amount of time in order to make feasible an adaption of cutting parameters during the machining. According to the literature [39], the most popular evolutionary algorithms to optimize objective functions based on AI models are Genetic Algorithms, Particle Swarm Optimization and Simulated Annealing.

Genetic algorithms are computerized search and optimization algorithms based on the mechanics of natural selection. In order to solve a problem, the variables are coded into string structures in binary code. Three main operators then process the population: selection, crossover and mutation in order to create a new and improved group of individuals. Selection operator

finds the best individuals and gives them more chances to reproduce. Crossover operator combines the genetic information of the best individuals to form new ones with a certain probability (crossover rate). Finally the mutation operator modifies each new solution with a low probability (mutation rate). Readers interested in the applications of GA in machining optimization are referred to [43-46].

The Particle Swarm Optimization (PSO) approach simulates the behaviors of bird flocking in two-dimension space. Each single solution is a bird or particle in the search space and its location is represented by XY coordinates and its velocity is expressed by v_x (for x axis) and v_y (for y axis). Each bird knows its best value so far, called *pbest*, and its position XY. Moreover, each bird knows the best value so far in the group, called *gbest*. In other words, each bird knows which one is flying the best (closer to the optimum) and tries to follow it modifying its velocity (v_x and v_y) considering the distance (XY difference) between itself (*pbest*) and the best bird (*gbest*). Readers interested in the principles of PSO are referred to [47-49].

Simulated Annealing (SA) algorithm resembles the cooling process of heated metals through annealing. At high temperatures, the atoms in the heated metal can move freely, but as the temperature is reduced, the movement of the atoms gets restricted. The atoms start to get ordered, and finally form crystals having the minimum possible energy. Even though, it requires a high number of iterations to find the optimum solution, it can find the global optimum with high probability. Readers interested in the principles of SA are referred to [50-53].

The majority of previous studies have been applied for off-line optimization in conventional machining processes, without making comparison of the performance of different optimization algorithms. Under that condition, computing time is not critical and the accuracy of the solution obtained is

similar. However, when dealing with ACO systems, especially in micro-milling processes with short cycle times, computing time is critical and the performance of the optimization algorithms may be different under time constraints. For this reason, an analysis of GA, PSO and SA performance should be conducted in terms of accuracy, consistency and robustness in order to implement the most efficient one.

6.2. Performance Comparison of Optimization Algorithms

6.2.1. Time, accuracy and variability of optimal solution

The ACO application, especially for micro-milling operations, requires a fast response thus the optimization unit cannot be running for a long time to converge. Consequently, a comparison of optimization performance in terms of computing time, accuracy and variability of the optimal solution time should be conducted.

After a preliminary analysis, it was shown that the cost function to be optimized is more complex after a cutting-tool wear value of 50% and the algorithms need some time to reach the optimal solution. Thus, the algorithm performance was analyzed for a tool life value of 60%, 70%, 80% and 90%. For comparison purposes, every algorithm was executed 20 times at each tool life value, and an average of computing time, accuracy and variability was obtained. All simulations were run using Matlab© Optimization Toolbox and the final values obtained were: mean value of the optimal solution; variability of the optimal solution; and computing time. The processor used for this evaluation was an Intel® Core™ i5-450M @ 2.40 GHz.

Since the performance of the algorithms are related to their setting parameters, a first trial and error procedure was conducted to select the parameters that give better performance for each algorithm. One of the critical

parameter was the population size for GA and PSO algorithm. A higher population leads to more accurate solutions and lower variability but the computing time also increases and can make the optimization procedure unfeasible for the ACO system. A lower number of individuals or particles decrease the computing time but the accuracy of the solution and its variability decreases notably. For both cases, 1, 5, 10, 15, 20, 25 and 50 elements were tested and it was found that 15 individuals or particles give a reasonable convergence time with moderate accuracy and variability. Other critical parameters such as the ones showed in Tables 6, 7 and 8 were fixed according to recommended practices reported in previous research works cited in Section 6.1.

Table 6. Genetic Algorithm Configuration parameters.

GA Configuration	
Parameter	Value or Type
Population Size	15
Selection Function	Binary Tournament
Crossover Function	Single Point Probability=0.8
Mutation Function	Uniform Rate=0.05

Table 7. Particle Swarm Optimization Configuration parameters.

PSO Configuration	
Parameter	Value or Type
Population Size	15
Learning Constant c1	2
Learning Constant c2	2
Min and Max inertia weight	0.4 & 0.9

Table 8. Simulated Annealing Configuration parameters.

SA Configuration	
Parameter	Value or Type
Annealing Function	Fast Annealing
Temperature Function	Exponential
Initial Temperature	300
Reannealing interval	50

The average performance of each optimization algorithm in terms of computing time versus accuracy and variability are shown in Figures 12 and

13. As it can be noted, the GA and PSO algorithms performed better than the SA in both the average error and standard deviation. From 1.7 seconds onward, the PSO performs slightly better than the GA in both the average error and standard deviation.

For the ACO system to be applied in this micro-milling process, a reasonable response time for each cutting parameter adaption is between 2 and 3 seconds. Thus, the PSO algorithm seems to be more efficient in terms of computing time than GA or SA algorithms.

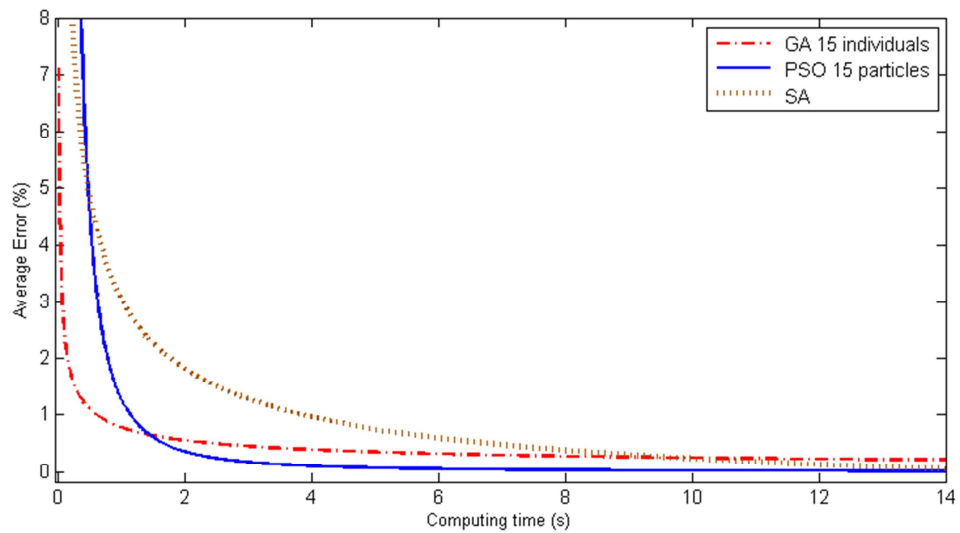

Figure 12. Average error versus computing time for SA, PSO and GA.

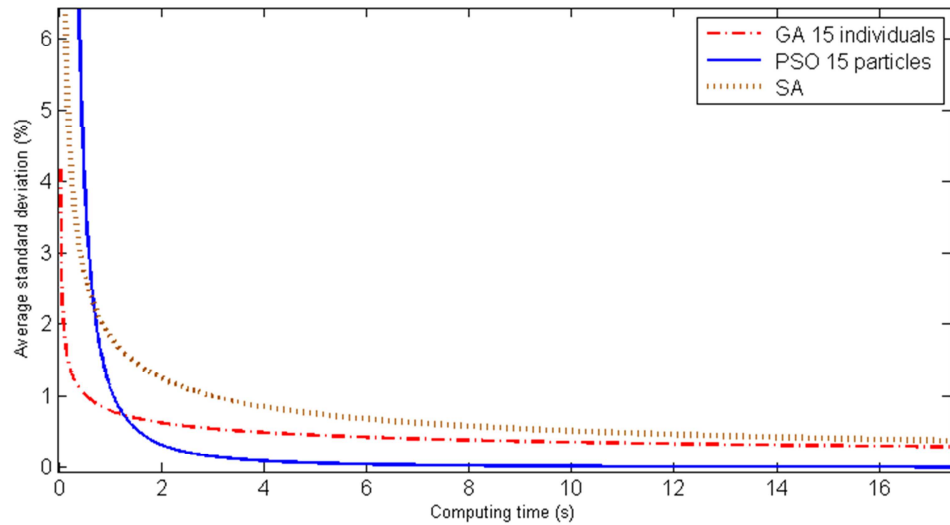

Figure 13. Average standard deviation versus computing time for SA, PSO and GA.

6.2.2. Robustness

Optimization algorithms such as GA, PSO and SA can be hard to be configured without previous knowledge of evolutionary optimization algorithms. Therefore, one may be interested in the implementation of an optimization algorithm that is less sensitive to its configuration parameters or, in other words, is more robust in this kind of applications.

Previous section has shown that SA optimization algorithm is not adequate for its use in the ACO system due to the excessive computing time required for convergence. Thus, the robustness analysis is only conducted for GA and PSO techniques. The sensitivity analysis is conducted through a Design of Experiment and statistical analysis. The parameters considered in the DoE are those that can notably modify the optimization performance. For GA, the parameters considered in the DoE are mutation constant, selection function and crossover probability. For PSO, the parameters considered are the learning constants and the inertia weights. Only two levels are considered for the DoE, and their values are set as the extreme points of the common range

of application found in the literature. Tables 9 and 10 show the DoE for each optimization algorithm and the 2-level values.

Table 9. DoE for sensitivity analysis for Genetic Algorithms.

DoE for sensitivity analysis in GA		
Parameter	Level 1	Level -1
Mutation constant	0.05	0.01
Selection Function	Binary Tournament	Roulette
Crossover Probability	1	0.6

Table 10. DoE for sensitivity analysis for Particle Swarm Optimization.

DoE for sensitivity analysis in PSO		
Parameter	Level 1	Level -1
Learning Constants	C1=C2=4	C1=C2=1
Inertia Weights	0.1 & 1	0.5 & 0.7

For each combination parameter of the DoE, 9 replicas were evaluated. The algorithm was executed to optimize the cutting process for a cutting-tool wear of 60%, 70%, 80% and 90% considering a response time (maximum computing time) of 2.5 seconds. For each replica, the average error of the final solution was calculated. This error depends on how far from the real optimum the final solution is and it is measured in terms of deviation with respect to the minimum cutting cost. The 9 replicas obtained from each combination parameter do not present a statistical normal distribution, so an Analysis of Variance (ANOVA) could not be used to check the significance of configuration parameters for each algorithm. Instead, non parametric tests were studied and Mood's median test was selected since normal or equal distributions of the samples are not required. The results of the test to analyze the robustness of GA and PSO are shown in Table 11 and 12, respectively.

As it can be seen in Table 11, there is a clear influence of GA parameters on the optimization performance. For instance, the selection parameter is statistically significant on the optimization solution when the crossover and the mutation values are set to their low levels 0.6 and 0.01, respectively. In

this case, a better performance of the optimization algorithm is obtained when binary tournament is applied. However, its influence seems to be not statistically significant when crossover and mutation values are different.

Similarly, crossover parameter is significant when mutation and selection parameter values are set to their low levels, and in this case, the optimization algorithm performs better when crossover value is in its high level. Other combinations of mutation and selection seem to make the crossover parameter less important in the algorithm performance.

Finally, the mutation parameter is statistically significant if crossover and selection parameters are set both to their high level. In this case, the mutation value is recommended to be its high value. As a conclusion, the GA parameters present some interrelationships that impact on the optimization performance and it may make the GA parameter definition not straightforward.

Table 11. GA sensitivity analysis.

GA								
Selection			Crossover			Mutation		
Fixed	P-Value	Best	Fixed	P-Value	Best	Fixed	P-Value	Best
Crossover (-1) & Mutation (1)	0.637	N/A	Mutation (-1) & Selection (-1)	0.018	Crossover Probability 0.8	Crossover(1) & Selection (-1)	0.157	N/A
Crossover (-1) & Mutation (-1)	0.018	Binary Tournament	Mutation (-1) & Selection (1)	0.157	N/A	Crossover (-1) & Selection (-1)	0.157	N/A
Crossover (1) & Mutation (-1)	0.157	N/A	Mutation (1) & Selection (-1)	0.637	N/A	Crossover (1) & Selection (1)	0.018	Mutation Constant 0.05
Crossover (1) & Mutation (1)	0.157	N/A	Mutation (1) & Selection (1)	0.157	N/A	Crossover (-1) & Selection (1)	0.157	N/A

Unlike GA, PSO algorithm presents a more robust performance according to the results shown in Table 12. As it is shown, there is no significant difference between the average error samples at any parameter combination.

Table 12. PSO sensitivity analysis.

PSO					
Constant			Weight		
Fixed	P-Value	Best	Fixed	P-Value	Best
Weight (-1)	0.157	N/A	Constant (-1)	0.637	N/A
Weight (1)	0.637	N/A	Constant (1)	0.637	N/A

The algorithm has, statistically, the same performance even if the parameter configuration is changed within their common range of application. Therefore, for the micro-milling operation analyzed and the ACO system proposed, the parameter setting is easier and less sensitive in the PSO algorithm than in the GA, and its implementation is recommended. The final parameters set in the PSO algorithm for the ACO system is shown in Table 13.

Table 13. PSO Algorithm configuration.

Parameter	Value
Number of particles	15
Cognitive Constant (C1)	2
Social Constant (C2)	2
Max/Min Inertia Weight	0.9/0.4
Iterations	10

7. Validation of the ACO proposed system

The performance of the proposed ACO system for the micro-milling process was compared with the conventional practices where an off-line optimization procedure is conducted and the cutting parameters are kept constant throughout the machining operation. The characteristics of the micro-milling process can be set as in Table 14.

Table 14. Fixed characteristics of the micro-milling process taken for validation of the ACO proposed system.

Tool	
Diameter	500 μm
Material	Uncoated carbide(WC)
Number of Flutes	2
Wokpiece	
Material	AISI H13
Hardness	56-58 HRC
Process parameters	
t_m^{ith}	(20 mm / Vf) min
A	10 €
B	10 €
C	10 €
C_t	20 €
c_2	90 €/hr
Ra_{max}	0.5 μm
Ra_{tgt}	0.2 μm
$PGE_{W_{\text{max}}}$	100 %
$PGE_{W_{\text{tgt}}}$	10 %
$PGE_{P_{\text{max}}}$	100 %
$PGE_{P_{\text{tgt}}}$	50 %

For comparison purposes, three machining conditions were tested. The first set is the most conservative one of the DoE ($V_f = 50 \text{ mm/min} - N = 15,000 \text{ rev/min}$). According to the machinist, these conditions lead to ensure part quality specifications because tool wear rate is lower. The second tested conditions refer to higher productive conditions such as ($V_f = 100 \text{ mm/min} - N = 22,500 \text{ rev/min}$). The machinist recommends these conditions if the production rate should be higher. The third tested conditions are the resulting ones from the ACO system, and thus, the cutting parameters changes along the cutting-tool life.

The cost results from the three testing conditions are shown in Table 15. It can be shown that applying an adaptive control methodology a cost reduction of 12.69% and 29% is obtained in comparison with the conservative and the high production conditions, respectively.

Table 15. Cost comparison between different cutting strategies.

Previous geometric error (%)	Conservative conditions			High production conditions			Optimized conditions		
	Feedrate, Vf [m/min]	Spindle speed, N [rev/min]	C_{tot}^{ith} (€)	Feedrate, Vf [mm/min]	Spindle speed, N [rev/min]	C_{tot}^{ith} (€)	Feedrate, Vf [mm/min]	Spindle speed, N [rev/min]	C_{tot}^{ith} (€)
10	50	15,000	4.4	100	22,500	7.7	50	15,000	4.4
20	50	15,000	4.1	100	22,500	7.8	50	15,000	4.1
30	50	15,000	4.1	100	22,500	8.1	50	15,000	4.1
40	50	15,000	4.3	100	22,500	8.7	50	15,000	4.3
50	50	15,000	5.0	100	22,500	9.5	50	15,000	5.0
60	50	15,000	6.5	100	22,500	10.6	50	15,000	6.5
70	50	15,000	9.5	100	22,500	12.3	62	15,000	9.4
80	50	15,000	15.7	100	22,500	15.0	67	19,820	13.7
90	50	15,000	27.2	100	22,500	20.8	69	23,909	19.0
		TOTAL	81.3		TOTAL	101.0		TOTAL	71.0

As it can be shown, the ACO system estimates that, from around the 60% of cutting-tool wear onwards, the optimal cutting conditions look for increasing productivity. It seems that at the beginning, milling at conservative cutting conditions is better since the part quality is higher and this is a critical issue in micro-milling parts. However, when the cutting-tool wear increases, conservative cutting parameters do not keep the part quality lower than less conservative cutting conditions, and thus, the productivity gains importance to reduce the total production cost. The last statement could be explained with Figure 14; clearly the average surface roughness is not reduced using the conservative conditions after the 60% of AGE. Production time gains importance in the cost function at this point since the performance differences between optimized conditions and conservative, in terms of part quality are negligible.

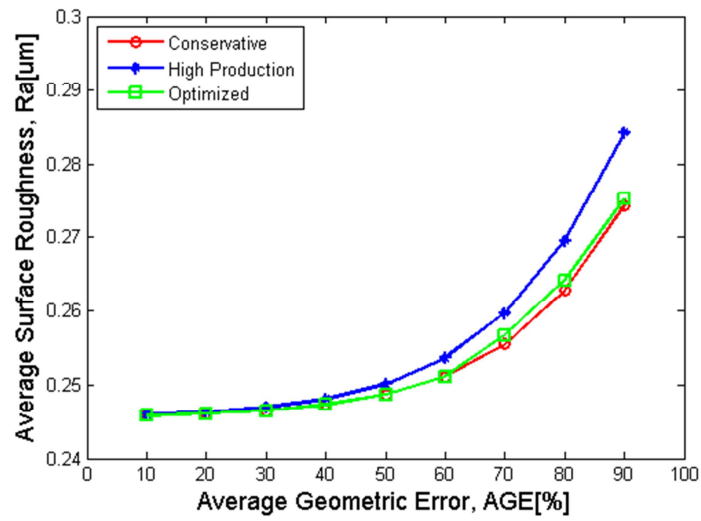

Figure 14. Evolution of Average Surface Roughness vs tool wear in terms of Average Geometric Error for different conditions.

Figures 15 and 16 demonstrate that as the Average Geometric Error (AGE) increases, the cost function gets more complex and not precisely the most conservative conditions are the optimal values to minimize the machining costs. The previous statement probes that with a correct monitoring and modeling of the tool status corrective actions could be applied to optimize complex machining operations as micro-milling of hardened steels.

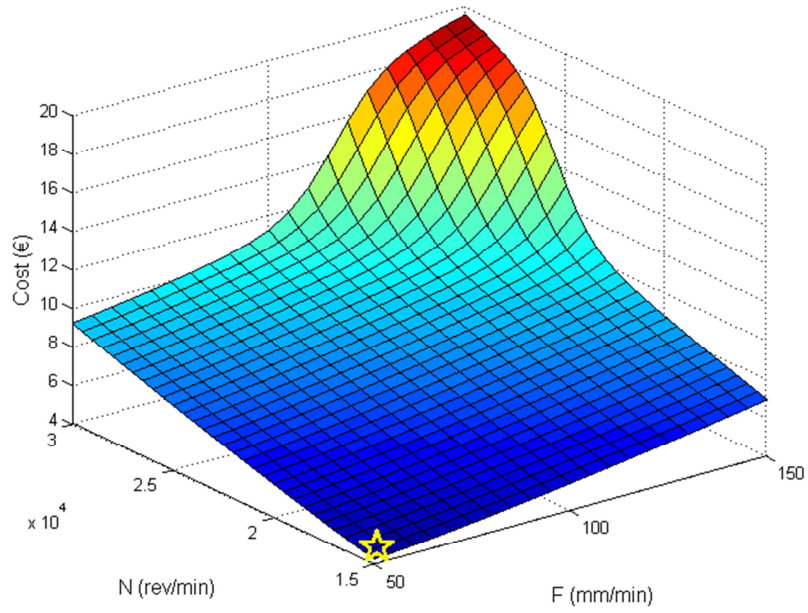

Figure 15. Cost per pass C_{tot}^{ith} [€] at Average Geometric Error, AGE=25%

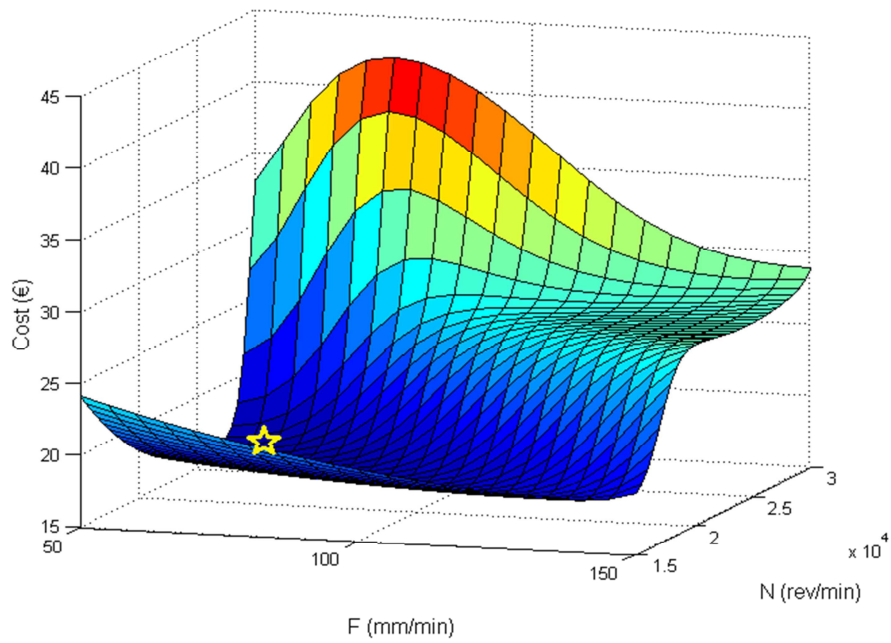

Figure 16. Cost per pass C_{tot}^{ith} [€] at Average Geometric Error, AGE=80%

8. Conclusions

In the present work, an on-line adaptive control optimization (ACO) system for micro-milling is presented. The system is able to adapt the cutting conditions to reach a minimum production cost and considering the real cutting-tool wear state in terms of hardened steel parts quality. In micro-milling processes, traditional off-line optimization approaches cannot lead to optimal cutting conditions since part quality is influenced by cutting-tool wear, therefore cutting conditions should be adapted throughout the cutting-tool life. This research work considers the cutting cost pass as the optimization index to reach a global optimization of the cutting process, considering the costs related to machining time, cutting-tools and quality loss cost on surface roughness and dimensional and geometric errors.

The process models required for estimating the cutting tool wear and predict the part quality were defined using AI models and DoE. Two AI models were briefly compared for this purpose, Artificial Neural Networks and Least Squared Support Vector Machine models, and the use of ANN was finally adopted. Due to the importance of computing time in ACO systems, the feasibility of different optimization approaches such as Genetic algorithm (GA), Particle Swarm Optimization (PSO) and Simulated Annealing (SA) was analyzed. A comprehensive analysis of the optimization algorithms in terms of computing time versus accuracy and precision was conducted. The study revealed that SA algorithms required more computing time to convergence than GA or PSO algorithms. Furthermore, the PSO algorithms seem to perform slightly better than GA for a computing time around 2-3 seconds, which is considered adequate for the application analyzed. In terms of robustness, the PSO outperforms the GA so the implementation of PSO in ACO systems seems to be less sensitive to its optimization parameters and easier to deal with than GA.

Finally, the ACO system based on a PSO optimization approach was proved to outperform off-line optimization strategies and a cost reduction of 12.3% and 29% was reported with respect to conservative and high production strategies, respectively. The optimum conditions resulted to be a combination of both. For a new cutting-tool, a conservative strategy to minimize the tool wear rate is the best strategy. However, when cutting-tool wear is around 50-60% associated to its superior limit of acceptable wear, the best strategy is to progressively increase the feedrate and the spindle speed to increase the productivity since conservative conditions cannot keep surface quality errors much lower than a less conservative conditions.

As future work, the authors suggest to try the implementation of ACO systems based on other non-intrusive sensors in order to expand its industrial application.

9. References

- [1] G. Bissacco, H.N. Hansen, L.D. Chiffre, Micromilling of hardened tool steel for mould making applications, *Journal of Materials Processing Technology*, 167 (2005) 201-207.
- [2] E. Vázquez Lepe, A. Amaro, Q.D. Ciurana, Rodríguez González, C.Á., Process planning considerations for micromilling of mould cavities used in ultrasonic moulding technology, *Precision Engineering*, 39 (2015) 252-260.
- [3] D. Biermann, A. Baschin, E. Krebs, J. Schlenker, Manufacturing of dies from hardened tool steels by 3-axis micromilling, *Prod. Eng. Res. Devel.*, 5 (2011) 209-217.
- [4] S. De Cristofano, N. Funaro, G.C. Feriti, M. Rostango, M. Comoglio, A. Merlo, C. Stefanini, P. Dario, High-speed micro-milling: Novel coatings for tool wear reduction, *International Journal of Machine Tools & Manufacture*, 63 (2012) 16-20.
- [5] A. Aramcharoen, P.T. Mativenga, S. Yang, K.E. Cooke, D.G. Teer, Evaluation and selection of hard coatings for micro milling of hardened tool steel, *International Journal of Machine Tools & Manufacture*, 48 (2008) 1578-1584.
- [6] A. Aramcharoen, P.T. Mativenga, Size effect and tool geometry in micromilling of tool steel, *Precision Engineering*, (2008) 402-407.
- [7] D.A. Stephenson, J.S. Agapiou, *Metal cutting theory and practice*, Marcel Dekker, New York, 1997.
- [8] J.V. Abellan, F. Romero, H.R. Siller, A. Estruch, C. Vila, Adaptive Control Optimization of Cutting Parameters for High Quality Machining Operations based on Neural Networks and

Search Algorithms, *Advances in Robotics, Automation and Control*, InTech, Austria, 2008, pp. 472-491.

- [9] Y. Koren, Adaptive control systems for machining, *Manufacturing Review*, 2 (1989) 6-15.
- [10] S.A. Coker, Y.C. Shin, In-process control of surface roughness due to tool wear using a new ultrasonic system, *Int. J. Mach. Tools Manufact.*, 36 (1996) 411-422.
- [11] S.-T. Chiang, D.I. Liu, A.-C. Lee, W.-H. Chieng, Adaptive Control Optimization in end milling using neural networks, *Int. J. Mach. Tools Manufact.*, 34 (1995) 637-660.
- [12] M. Malekian, S.S. Park, M.B.G. Jun, Tool wear monitoring of micro-milling operations, *Journal of Materials Processing Technology*, 209 (2009) 4903-4914.
- [13] I. Tansel, M. Trujillo, A. Nedouyan, C. Velez, W.-Y. Bao, T.T. Arkan, B. Tansel, Micro-end-milling—III. Wear estimation and tool breakage detection using acoustic emission signals, *International Journal of Machine Tools & Manufacture*, 38 (1998) 1449-1466.
- [14] K. Jemenielniak, P.J. Arrazola, Application of AE and cutting force signals in tool condition monitoring in micro-milling, *CIRP Journal of Manufacturing Science and Technology*, (2008) 97-102.
- [15] W.-H. Hsieh, M.-C. Lu, S.-J. Chiou, Application of backpropagation neural network for spindle vibration-based tool wear monitoring in micro-milling, *Int J Adv Manuf Technol*, 61 (2012) 53-61.
- [16] L.N. López de Lacalle, A. Lamikiz, J.A. Sánchez, I. Fernández de Bustos, Recording of real cutting forces along the milling of complex parts, *Mechatronics*, 16 (2006) 21-32.
- [17] S. Huang, K.K. Tan, G.S. Hong, Y.S. Wong, Cutting force control of milling machine, *Mechatronics*, 17 (2007) 533-541.
- [18] Z. Kunpeng, W.Y. San, H.G. Soon, Wavelet analysis of sensor signals for tool condition monitoring: A review and some new results, *International Journal of Machine Tools & Manufacture*, 49 (2009) 537-553.
- [19] J.V. Abellán-Nebot, F.R. Subirón, A review of machining monitoring systems based on artificial intelligence process models, *International Journal of Advanced Manufacturing Technology*, 47 (2010) 237-257.
- [20] M. Elangovan, V. Sugumaran, K.I. Ramachandran, S. Ravikumar, Effect of SVM kernel functions on classification of vibration signals of a single point cutting tool, *Expert Systems with Applications*, 38 (2011) 15202-15207.
- [21] D.E. Dimla Snr, Sensor signals for tool-wear monitoring in metal cutting operations—a review of methods, *International Journal of Machine Tools & Manufacture*, 40 (2000) 1073-1098.
- [22] J.B. Saedon, S.L. Soo, D.K. Aspinwall, A. Barnacle, N.H. Saad, Prediction and Optimization of Tool Life in Micromilling AISI D2 (62 HRC) Hardened Steel, *Procedia Engineering*, (2012) 1674-1683.
- [23] J.A. Silva, J.V. Abellán-Nebot, H.R. Siller, F. Guedea-Elizalde, Adaptive control optimization system for minimizing production cost in hard milling operations, *International Journal of Computer Integrated*, (2012) 1-13.
- [24] A.J. Vallejo, R. Morales-Mendez, Cost-effective supervisory control system in peripheral milling using HSM, *Annual Reviews in Control*, 34 (2010) 155-162.
- [25] S. Saikumar, M.S. Shunmugam, Development of a feed rate adaption control system for high-speed rough and finish end milling of hardened EN24 steel, *Int J Adv Manuf Technol*, 59 (2011) 869-884.
- [26] U. Zuperl, F. Cus, M. Reibenschuh, Neural control strategy of constant cutting force system in end milling, *Robotics and Computer-Integrated Manufacturing*, (2011) 485-493.

- [27] Y. Liu, L. Zuo, C. Wang, Intelligent adaptive control in milling processes, *Int. J. Computer Integrated Manufacturing*, 12 (1999) 453-460.
- [28] F. Dweiri, M. Al-Jarrah, H. Al-Wedyan, Fuzzy surface roughness modeling of CNC down milling of alumic-79, *Journal of Materials Processing Technology*, 133 (2003) 266-275.
- [29] S.Y. Ho, K.C. Lee, S.S. Chen, S.J. Ho, Accurate modeling and prediction of surface roughness by computer vision operations using an adaptive neuro-fuzzy inference system, *Int. J. of Machine Tools and Manuf*, 42 (2002) 1441-1446.
- [30] S.J. Lou, J.C. Chen, In-process surface roughness recognition (ISRR) system in end-milling operations, *International Journal of Advanced Manufacturing Technology*, 15 (1999) 200-209.
- [31] J.C. Chen, M. Savage, A fuzzy-net-based multilevel in-process surface roughness recognition system in milling operations, *International Journal of Advanced Manufacturing Technology*, 17 (2001) 670-676.
- [32] S. Dey, J.A. Stori, A Bayesian network approach to root cause diagnosis of process variations, *Int. J. of Machine Tools and Manufacture*, 45 (2005) 75-91.
- [33] M. Correa, C. Bielza, M. de Ramirez, J. Alique, A Bayesian network model for surface roughness prediction in the machining process, *International Journal of Systems Science*, 39 (2008) 1181-1192.
- [34] D.R. Salgado, F.J. Alonso, Cambero, I., A. Marcelo, In-process surface roughness prediction system using cutting vibrations in turning, *The International Journal of Advanced Manufacturing Technology*, 1-2 (2009) 40-51.
- [35] U. Caydas, S. Ekici, Support vector machines models for surface roughness prediction in CNC turning of AISI 304 austenitic stainless steel, *Journal of Intelligent Manufacturing*, (2012) 639-650.
- [36] D. Shi, N.N. Gindy, Tool wear predictive model based on least squares support vector machines, *Mechanical Systems and Signal Processing*, (2007) 1799-1814.
- [37] Abellan-Nebot, J.V., A review of artificial intelligent approaches applied to part accuracy prediction, *International J. of Machining and Machinability of Materials*, 1-2 (2010) 6-37.
- [38] D.W. Dimla Jr, P.M. Lister, N.J. Leighton, Neural network solutions to the tool condition monitoring problem in metal cutting - A critical review of methods, *International Journal of Advanced Manufacturing Technology*, 37 (1997) 1219-1241.
- [39] N. Yusup, A.M. Zain, S.Z.M. Hashim, Evolutionary techniques in optimizing machining parameters: Review and recent applications (2007-2011), *Expert Systems with Applications*, 39 (2012) 9909-9927.
- [40] M. Chandrasekaran, M. Muralidhar, U.S.D. Krishna, Application of soft computing techniques in machining performance prediction and optimization: A literature review, *International Journal of Advanced Manufacturing Technology*, 46 (2010) 445-464.
- [41] X.Q. Chen, H.Z. Li, Development of a tool wear observer model for online tool, *International Journal of Advanced Manufacturing Technology*, (2009) 786-800.
- [42] K. De Brabanter, P. Karsmakers, F. Ojeda, C. Alzate, J. De Brabanter, K. Pelckmans, LS-SVM lab toolbox users guide version 1.8, Leuven, Belgium, 2011.
- [43] Z.G. Wang, Y.S. Wong, M. Rahman, Optimisation of multi-pass milling using genetic algorithm and genetic simulated annealing, *International Journal of Advanced Manufacturing Technology*, (2004) 727-732.
- [44] S. Aggarwal, P. Xirouchakis, Selecting of optimal cutting conditions for pocket milling using genetic algorithm, *International Journal of Advanced Manufacturing Technology*, (2013) 1943-1958.

- [45] J.K. Rai, D. Brand, M. Slama, P. Xirouchakis, Optimal selection of cutting parameters in multi-tool milling operations, *International Journal of Production Research*, 49 (2011) 3045-3068.
- [46] A. Wibowo, M. Ishak Desa, Kernel based regression and genetic algorithms for estimating cutting conditions, *Expert Systems with Applications*, (2012) 11634-11641.
- [47] U. Deepak, Optimization of Milling Operation using Genetic and PSO Algorithm, *International Journal of Software Engineering and Soft Computing*, 1 (2011).
- [48] Y.Z. Lee, S.G. Ponnambalam, Optimisation of multipass turning operations using PSO and GA-AIS algorithms, *International Journal of Production Research*, 50 (2012) 6499-6518.
- [49] C.-J. Lin, P.-T. Lin, Particle swarm optimization based feedforward controller for a XY PZT positioning stage, *Mechatronics*, 22 (2012) 614-628.
- [50] S. Bharathi Raja, N. Baskar, Optimization techniques for machining operations: a retrospective research based on various mathematical models, *International Journal of Advance Manufacturing Technology*, (2010) 1075-1090.
- [51] A. Mohd Zain, H. Haron, S. Sharif, Simulated Annealing to estimate the optimal cutting conditions for minimizing surface roughness in end milling Ti-6Al-4V, *Machining Science and Technology*, 14 (2010) 43-62.
- [52] K.P. Somashekhar, J. Mathew, N. Ramachandran, A feasibility approach by simulated annealing on optimization of micro-wire electric discharge machining parameters, *International Journal of Advanced Manufacturing Technology*, 61 (2012) 1209-1213.
- [53] D. Olvera, A. Elías-Zúñiga, H. Martínez-Alfaro, L.N. López de Lacalle, C.A. Rodríguez, F.J. Campa, Determination of the stability lobes in milling operations based on homotopy and simulated annealing techniques, *Mechatronics*, 24 (2014) 177-185.