

©Copyright JASSS

[Xiaoguang Gong and Renbin Xiao \(2007\)](#)

Research on Multi-Agent Simulation of Epidemic News Spread Characteristics

Journal of Artificial Societies and Social Simulation vol. 10, no. 3 1
<<http://jasss.soc.surrey.ac.uk/10/3/1.html>>

For information about citing this article, click [here](#)

Received: 22-Feb-2006 Accepted: 13-Mar-2007 Published: 30-Jun-2007



Abstract

The spread of news about an epidemic can easily lead to a social panic. In order to devise measures to control such a panic, it is necessary to consider characteristics of the spread of epidemic news, based on mechanisms at the individual level. In this paper, first, some features of multi-agent simulation are reviewed. Then a multi-agent simulation model of epidemic news spread (ENS) is designed and realized. Based on simulation experiments and sensitivity analyses, the influence of social relationships, the degree of trust in news of the epidemic, the epidemic spread intensity and the network structure of the epidemic news spread are studied. The research results include: (1) As the number of social relationships increases, the rate of spread of epidemic news rapidly rises, and the ratio of people who have heard the news directly decreases. The result is that the 'radiation effect' of the epidemic news spread will be enhanced when the number of social relationships increases. (2) With the increase of the degree of trust in the news, the rate of spread of the news will also rapidly increase, but variation in the ratio of the people who have heard the news directly is not significant. This means that the 'radiation effect' of the spread of the news does not change much more in relation to the degree of trust in the epidemic news. (3) The ratio of the people who have heard the news directly increases when the infection range increases (i.e. the spread intensity of epidemic increases), and vice versa. But the variation of the speed of the epidemic news spread is not significant. (4) When the network structure is assumed to be a small world network, the spread speed will be slower than that in a random network with the same average vertex degree and the forgetting speed will be faster than that in a random network with the same average vertex degree.

Keywords:

Multi-Agent Simulation, News Spread, Small World Network, Epidemic

Introduction

1.1

Most people are not familiar with new epidemic, so the authenticity of the news about the epidemic can not be immediately verified ([Kapferer 1990](#)). Therefore, the spread of epidemic news leads to a panic usually, which makes bad effects on the control of the epidemic. Most empirical researches suggest that the spread of news about war, marketing, disaster and epidemic will mislead people and result in some unnecessary disturbance ([Elliott et al 1958](#), [Rosnow 1988](#), [Wert and Salovey 2004](#), [Litman and Pezzo 2005](#)).

1.2

Many simulation researches on the spread of epidemic have been done. With a Monte-Carlo simulation model of disease spread within a slaughter pig herd, Jørgensen compared different disease resistant strategies ([Jørgensen 2000a](#)). Karsten et al developed a Monte Carlo simulation model to describe the spread of classical swine fever virus among the farms within a certain region ([Karsten et al 2005a](#); [2005b](#)). Tran and Raffy proposed a spatial and temporal dynamics of dengue fever model, in which the transmission processes are described by a set of differential equations ([Tran and Raffy 2006](#)). Dietrich and Muhammad proposed a discrete model of news spread. In the model, different groups of people have different degree of susceptibility to a given 'extreme' subject. What is more, they compared the model with the deterministic continuum model and demonstrated its features ([Dietrich](#)

[and Muhammad 2006](#)).

1.3

One common disadvantage of these models is that micro mechanisms of spread process are ignored. Multi-agent simulation is considered as a new method to investigate the micro mechanisms of complex systems ([Gong 2003](#)). Cellular Automata (CA) simulation can also be regarded as a kind of multi-agent simulation. Chaussalet et al developed a CA model of the spread of barley yellow dwarf virus and performed sensitivity analysis ([Chaussalet et al 2000](#)). Deng et al developed a multi-agent simulation model to study disease spread processes under different amount of initial patients, different infecting ratio, different cure ratio, different infecting rule, and different people density environment ([Deng et al 2004](#)). Demetrios et al developed an agent community, the 'GeneCity', to test some hypothesis about the spread of thalassaemia ([Demetrios et al 2005](#)). Although the mechanisms at the individual level are described in these models, the network structures in the spread processes are ignored.

1.4

The traditional mathematical methods always take the network in epidemic spread as regular or random network. But researches on complex networks in recent years show that most of the real complex networks, including the networks formed in the process of epidemic and epidemic news spread, belong to the small world networks or scale-free networks instead of regular or random networks ([Newman 2003](#), [Wang 2002](#), [Watts and Strogatz 1998](#), [Kuperman and Abramson 2001](#), [Agiza et al 2003](#)). The theory of small world networks is considered as a new method for the epidemiological modelling ([Huang et al 2004](#)). Zhou regarded the theory of small world network as a useful tool to analyze the spread of rumor since small world network exists through the whole spread process ([Zhou 2005](#)).

1.5

This paper focuses on the characteristics of the spread of epidemic news based on micro level through multi-agent simulation. Compared with previous works, this paper has the following three particular aspects. Firstly, the ratio of the agents who have heard the news directly or indirectly has been distinguished, which is difficult to be fulfilled in the former empirical researches. Secondly, the effect of the epidemic contagious intensity on the epidemic news spread process has been studied, which is not found before. Thirdly, the network structure of spread process has been considered. The simulation results and analyses are described in section [4](#).

1.6

The outline of this paper is as follows. Section [2](#) reviews some features of multi-agent simulation. In section [3](#), the design and realization of the multi-agent simulation model of epidemic news spread are described in details. Section [4](#) analyzes the characteristics of the spread of news through simulation experiments and sensitive analyses, and probes into the characteristics of the spread process based on micro level. Some conclusions were drawn in section [5](#).



A review on multi-agent simulation

The limitations of methods based on differential equations

2.1

Traditional methods of modelling and simulation on complex systems are mainly based on differential equations. Although these equations have been widely used to simulate social systems, they have some limitations.

1. Failing to express the relationships between micro and macro level
The input and output parameters at the same level must be defined to build differential equations. But in most social systems, the global situations emerge from the interactions of autonomous individuals and interactions between individuals and the environment ([Holland 1998](#)). Differential equations can not express the relationships between global parameters and the local parameters ([Drougoul and Ferber 1992](#)). The strategies of individuals marked by the local parameters have strong influence on the global efficiency, but differential equations are not suitable to describe these strategies and the corresponding actions. Therefore, it is not enough to study complex systems only from the description of macro level.
2. Rigorous data requirement
Firstly, the inner structure of the system on macro level is usually not clear. Secondly, it is difficult to get data because many macro features of societies are emergent ([Sander et al 2002](#)). Thirdly, it is not suitable to deal with the qualitative data in the numerical way.
3. Neglecting network structure
In the models based on differential equations, the network structures of complex systems are always presumed as regular or random networks. But the researches on complex networks in recent years show that most of the real networks of complex systems belong to small world networks or scale-free networks instead of regular or random networks. Unfortunately, the differential equations can not express the features of small world network or scale-free network.

The advantages of multi-agent simulation

2.2

A model of multi-agent simulation consists of series of incorporated software objects, called agents ([Wooldridge et al 1999](#)). The agent representing the 'individual' is programmed to be autonomous and can communicate with the environment and other agents. Multi-agent simulation can cope with different models, ranging from simple entities (usually called 'reactive' agents) to more complex entities (usually called 'cognitive' agents). Therefore, researchers can build models on different levels of intelligence. Multi-agent simulation has been introduced into more and more fields, such as sociology ([Gilbert 1993](#), [Goldspink 2002](#)), biology ([Drogoul et al 1995](#)), physics ([Schweitzer et al 2001](#)), economics ([Bensaid et al 2002](#)), and marketing ([Zawadowskia 2002](#), [López-Sánchez 2005](#)). Compared with the traditional methods based on differential equations, multi-agent simulation has its own advantages.

1. Bridging the gap between micro and macro level

The main difference between the methods based on differential equations and multi-agent simulation lies in that the former is used at macro level while the latter is used to bridge the gap between micro level and macro level by letting global configurations emerge from local agents' interactions. Data and statistics collected at macro level are still important in multi-agent simulations, but they are used to compare the results obtained from simulation and those observed from 'real' world.

2. Less data requirement

Different from the inductive methodology of collecting data first and then building models that describe and summarize those data, multi-agent simulation is more like a deductive method ([Gilbert 2005](#)). After a multi-agent simulation model is designed and tested, the relationships between the propositions and factors can be simulated whether the data is available or not. Therefore, the inner structure of the system on macro level, which is not clear before, can be deduced or observed from multi-agent simulation experiments. Some emergent features of social system which is difficult to be observed can be recorded and studied. The advantage of this model is that it needs less data while it can reflect the nature of complex society.

3. Integrating knowledge in different fields

Multi-agent simulation can be applied to integrate the knowledge in different fields, i.e. sociology, ethnology, cognitive psychology, into a united framework ([Bousquet et al 1992](#)). It can even integrate some qualitative and quantitative knowledge ([Li 2005](#)). Therefore, multi-agent simulation makes it possible to create 'artificial' societies in which individuals and organizations could be expressed more directly.

2.3

Multi-agent simulation is suitable for the description of network structure of complex network. The nodes in complex network can be regarded as individual agents in the multi-agent model and dynamic connections among nodes can be taken as communications among agents. Therefore, the theory of complex network can be easily integrated into the model of multi-agent simulation. In this paper, the multi-agent simulation model is considered as a framework to integrate theories of epidemiology, sociology and complex network.

The tools for multi-agent simulation

2.4

Among software development tools to build agent-based simulation system, e.g. Swarm, AnyLogic™, Agentsheets and Netlogo, Swarm developed by Santa Fe Institute is the most famous one. Swarm provides a standard platform for modelling, debugging, running and analyzing of the simulation result. It is widely used in the research fields of biology evolution, ecosystem, economics and sociology ([Li and Xiao 2006](#), [Xiao and Xi 2005](#)). Some similar software released in recent years have some breakthroughs on visualized modelling and simulation analyzing, e.g. AnyLogic™ and Agentsheets.

2.5

The model of multi-agent simulation in this paper was realized by using AnyLogic™. AnyLogic™ is a hybrid simulator, which can integrate models of discrete event, models of system dynamics, and agent-based models. It is based on Unified Modelling Language for Real-Time (UML-RT) and has been applied to many different domains to build business models, strategy models, business games, economic models, social system models, war-gaming models, biological systems models, physics models, and software performance models. Models generated by AnyLogic™ can be easily uploaded to web by creating a Java applet.



The design and realization of the multi-agent simulation model of ENS

The description of epidemic and epidemic news spread process

3.1

In order to illustrate the spread process of epidemic and epidemic news, we adopt an instance with 25 people in the grid of 5*5 who cannot move freely. At the beginning of simulation, only one person was infected and marked with red color in the top-left part of figure 1. The infecting range was marked with dotted circles. When the spread process begins, the infected person would spread the news about the epidemic to his relatives or friends, who will

get the news directly. People who have got the news directly are marked with pink color as are shown in the top-right part of figure 1. The uninfected person who is yet to receive the news was marked with light gray color in figure 1.

3.2

In the following spread process, the infected person will spread the epidemic and the news about epidemic. The person who has gotten news directly will also spread the news to others. The individuals that got the news indirectly were marked with blue color, as shown in the bottom-left part of figure 1. The individuals that got the news both directly and indirectly are treated as direct news recipient, such as the second person on the first line in the bottom-left of figure 1.

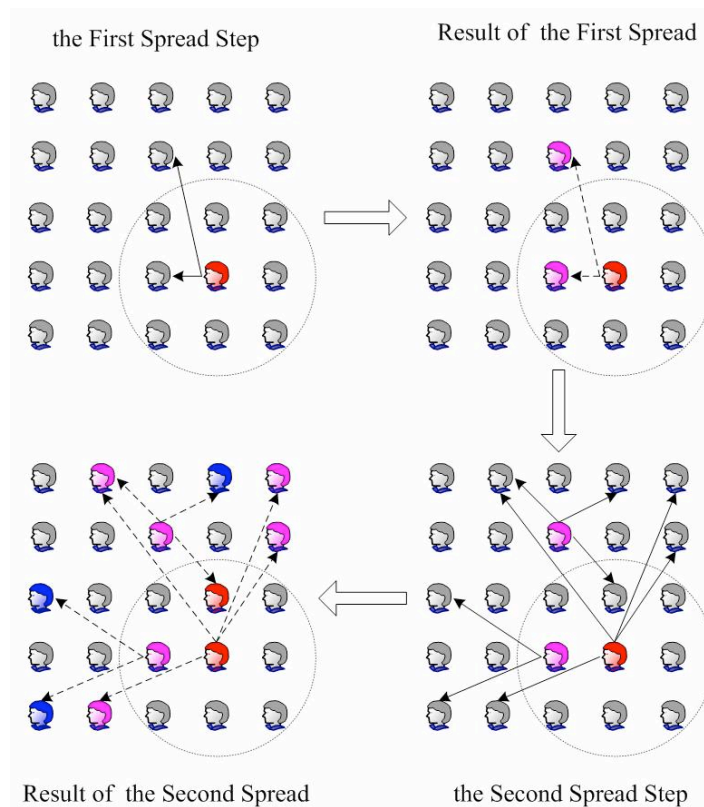

Figure 1. The description of the spread process of epidemic and epidemic news

The design of the multi-agent simulation model of ENS

3.3

The scene settings of the model

The real-life process of the spread of epidemic and epidemic news is much more complex than that described above. In order to make a model reflect the real-life process of epidemic and epidemic news spread, the scene of the model is set as follows.

- When an infection case happens in a region, the news about the epidemic spreads from the infected person first. The news from the infected person is regarded as direct news, and the news from others is considered as indirect news.
- Since all people are not familiar with the new epidemic, the government and the mass media do nothing to control the spread of the epidemic and news.
- The persons who have gotten the news are likely to spread it to others, such as their friends and relatives.
- Everyone can move around freely. The person who is close to the infected person may get infected. The cure of the infected case is temporarily neglected.
- If the person who has heard the news before does not receive new information again, he will forget it within a certain period of time.

The definition of agent classes and the organization of agents

3.4

Two agent classes are defined in the simulation model. One is circumstance agent class and the other is spread agent class.

3.5

The circumstance agent class has only one instance that is called circumstance agent. While the spread agent class has many instances that are called spread agents. They are the active agents in simulating. Figure 2 shows the organization of the model of multi-agent simulation of ENS with only five spread agents encapsulated in the circumstance agent.

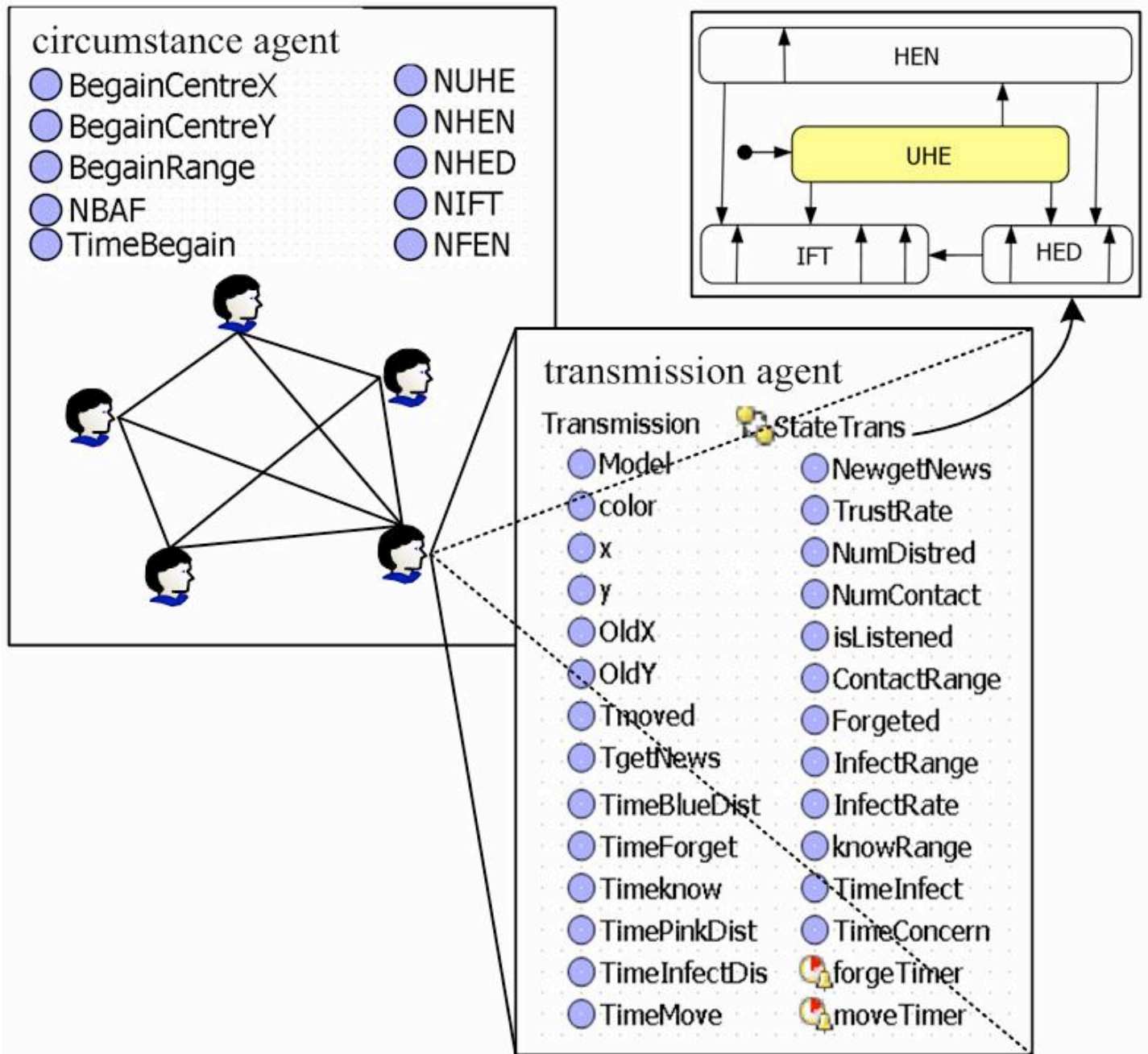

Figure 2. The organization of the model of multi-agent simulation of ENS

3.6

In figure 2, the circumstance agent acts as the container of all spread agents. It records the quantities of the spread agents under different states during simulating, and makes some spread agents infected at 'TimeBegin'. The attributes and their explanations are listed in table 1.

Table 1: The attributes and default values of the circumstance agent class

Attributes	Data Types	Default values	Explanations
NBAF	real	3	The number of the initial infected spread agents
BegainRange	real	80	The radius of spread of the initial infected agents
NIFT	real	0	The number of the infected agents
BegainCentreY	real	0	The Y-coordinate value of the spread circle center of the initial infected

			agents
BegainCentreX	real	0	The X-coordinate value of the spread circle center of the initial infected agents
NHED	real	0	The number of the agents who have heard of epidemic news directly, excluding the infected agents
NHEN	real	0	The number of the agents who have heard of epidemic news, including the infected agents
NUHD	real	0	The number of the agents unheard of epidemic news
NFEN	real	0	The number of the agents who have forgotten epidemic news
TimeBegin	real	0.00001	The delay time to make some agents infected after the simulation begins

3.7

Spread agents are encapsulated in the circumstance agent. They can spread epidemic and the news about the epidemic freely within the circumstance agent. The attributes and default values of the spread agent class are explained in table 2.

Table 2: The attributes and default values of the spread agent class

Attributes	Data Types	Default values	Explanations
TrustRate	real	uniform (0.01, 0.5)	the degree of trust in epidemic news when the agent heard epidemic news indirectly
ContactRange	real	uniform (600)	Communication radius of the agent
InfectRange	real	9	Infecting range radius of the infecting circle range
InfectRate	real	0.5	Contagious probability in the infecting circle range
KnowRange	real	21	Circle range of an infected agent known by other agents
isListened	boolean	false	Whether heard epidemic news or not
NumDistred	real	0	Number of objects spreaded out from the agent
TgetNews	real	-1	Time when heard of epidemic news
NumContact	real	uniform (0, 10)	The number of social relationships of a spread agent
Newgetnews	boolean	false	Whether hear the epidemic news newly or not
Tmoved	real	-1	The begin time of the last movement
OldY	real	uniform (600)	Y-coordinate value of the agent position at the beginning
OldX	real	uniform (600)	X-coordinate value of the agent position at the beginning
color	Color	Color.light gray	Be used to mark agents' state
y	real	uniform (600)	Recent Y-coordinate value of the agent position
x	real	uniform (600)	Recent X-coordinate value of the agent position
TimePinkDist	real	uniform (0.01, 0.5)	The delay time to spread epidemic news after the agent heard epidemic news directly
TimeInfectDis	real	uniform (0.01, 0.2)	The delay time to spread epidemic news after the agent found himself infected
TimeInfect	real	uniform (1, 4)	The delay time to be found infected
TimeKnow	real	uniform (0.02, 1)	The delay time to be known by the agent around the infected agent
TimeBlueDist	real	uniform (0.02, 1)	The delay time to spread epidemic news after the agent heard epidemic news indirectly
TimeMove	real	uniform (0.5, 4)	The time interval between movements
TimeForget	real	uniform (2, 6)	The time span to forget the epidemic news
Model	Main	(Main)getOwner()	A reference of the container object (circumstance agent)

3.8

To the best of our knowledge, there is no specific statistical research on the following variables in the model: 'NumContact', 'TimePinkDist', 'TimeInfectDis', 'TimeInfect', 'TimeKnow', 'TimeBlueDist', 'TimeMove'. Therefore, we presume that they satisfy uniform distribution. To study a particular epidemic, the prior distribution of the parameters can be got through statistical researches.

3.9

Since it is very convenient to communicate with others or travel to other places in the current society, we temporarily set uniform (600) to 'y', 'x' and 'ContactRange' to ensure that spread agents can freely spread the news and move around freely within the circumstance agent.

3.10

Usually, it will take some time for people to get contact with others. We also presume that the infected agent (IFT) and the agent heard the epidemic news directly (HED) will spread the news much faster than the agent heard the epidemic news indirectly does. Therefore, we set uniform (0.1, 0.5) to 'TimePinkDist', set uniform (0.1, 0.2) to 'TimeInfectDis', and set uniform (0.2, 1) to 'TimeBlueDist'.

3.11

Since people will spend some time finding the infected neighbors, we set uniform (0.02, 1) to 'TimeKnow' to denote the time.

The description of behaviors of spread agents

3.12

The model of multi-agent simulation proposed in this paper is constructed to study epidemic news spread process through the interaction behaviors of the spread agents. Their behaviors will directly lead to the change of their states. According to different states, the spread agents are classified into four groups, viz. the infected agent (IFT), the agent heard of the epidemic news (UHE), the agent heard the epidemic news directly (HED), and the agent heard epidemic news indirectly (HEI). In order to distinguish them, we used the 'color' attributes to mark them, viz. IFT with red, UHE with light gray, HED with pink and HEI with blue.

3.13

Since the characteristics of the spread process of the news about epidemic are determined by behaviors of spread agents, we deliberately designed their behaviors. The state changes and behaviors of spread agents are shown in figure 3.

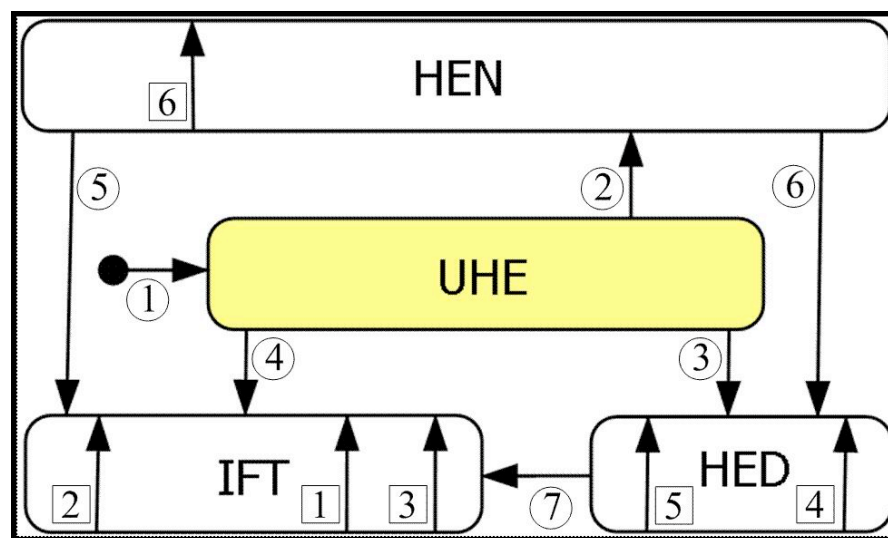

Figure 3. The state change and behavior of spread agents

3.14

In figure 3, the four states (HEN, UHE, IFT, HED) are marked by rectangles. The seven state changes are marked with numbers in circle and the five activities are marked with numbers in squares. The heavy dot presents the initial state of the spread agents. The activities and state changes of the spread agents are described as follows. (a) At the beginning of simulation, all spread agents do not hear of any news about the epidemic. The corresponding state change is (1). Then the circumstance agent makes some spread agents infected and the corresponding state change is (4). (b) During the simulation process, IFT will spread the epidemic news to other spread agent. The corresponding behavior is [1], and the corresponding state changes are (3) and (6). Within the range of 'KnowRange', UHE or HEI will become HED. The corresponding behavior is [2] and the corresponding state changes are (3) and (6). (c) The uninfected spread agents within a certain distance of the infected agent will be infected under a certain ratio. The corresponding behavior is [3] and the corresponding state changes are (4), (5) and (7). (d) HED can spread epidemic news quickly, which makes UHE become HEI. The corresponding behavior is [4] and the corresponding state change is (2). (e) HEI can also spread epidemic news. But the velocity of spread is slower than that of HED or that of IFT. The corresponding behavior is [5] and the corresponding state change is (2).

3.15

All the settings of timeout, the java source codes of behaviors and all the codes of the state changes are listed in

the [appendix](#).

3.16

Additionally, the positions of spread agents will be rearranged at the random time interval: 'TimeMove'. If the agent who has heard the news does not receive new information again in 'TimeForget', they will forget the epidemic news.

Simulation experiments and sensitivity analyses

Initial simulation settings

4.1

The simulation space is a square region with 600×600 pixels and each spread agent was set as a lattice with 3×3 pixels. The runtime state of the multi-agent simulation model of ENS is shown in figure 4.

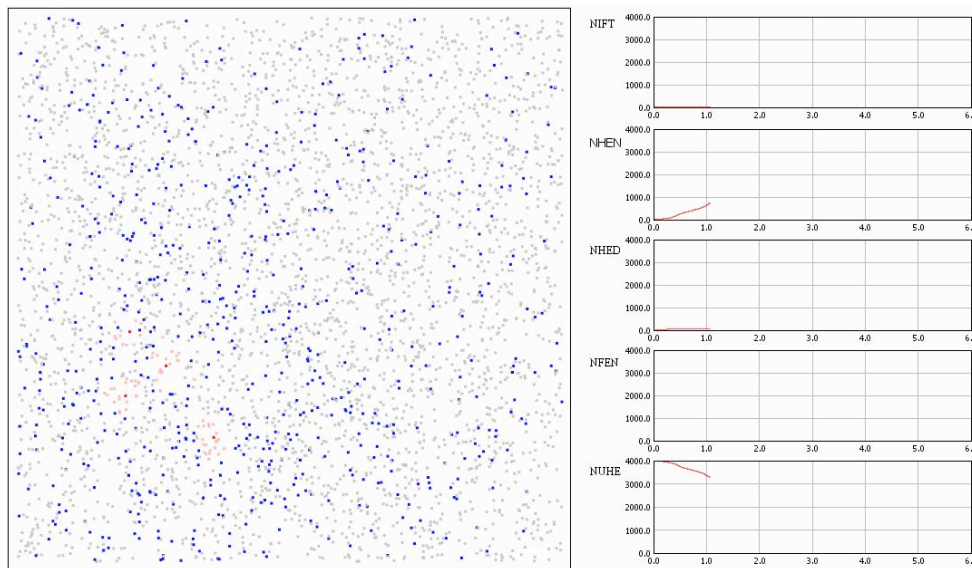

Figure 4. Runtime state of the model of multi-agent simulation of ENS [\[1\]](#)

4.2

The left square region in figure 4 is the simulation space with 4000 spread agents encapsulated in the circumstance agent. The tables on the right region are used to show the change of NIFT, NHEN, NHED, NFEN and NUHE in simulating.

4.3

The unit of one simulation clock is set to a day. Shortly after a simulation begins (TimeBegin = 0.00001 day), the circumstance agent makes three spread agents infected, which are separated in a circle with a radius of 80.

Sensitivity analyses on 'NumContact'

4.4

Two methods are often used to study social relationships. One is the network method, focusing on the valid network structures of social relationships. The other is the contact approach, emphasizing characteristics of active social relationships. Both methods treat social relationships as a black box whose inner mechanisms is not clear ([Lai 2002](#)). However, the influence of social relationships on information spread is seldom studied directly.

4.5

In order to study the influence of 'NumContact' on NHEN, we perform the sensitivity analyses on 'NumContact' by running the simulation experiments based on default values in table 1 and table 2 with different values of 'NumContact'. The average results of seven simulation experiments are shown in figure 5 and figure 6.

4.6

In figure 5, at the time point of 1.69, the five curves from top to bottom show the changes of NHEN in sequence when 'NumContact' equals uniform (0, 20), uniform (0, 10), 10, 5 and uniform (0, 5).

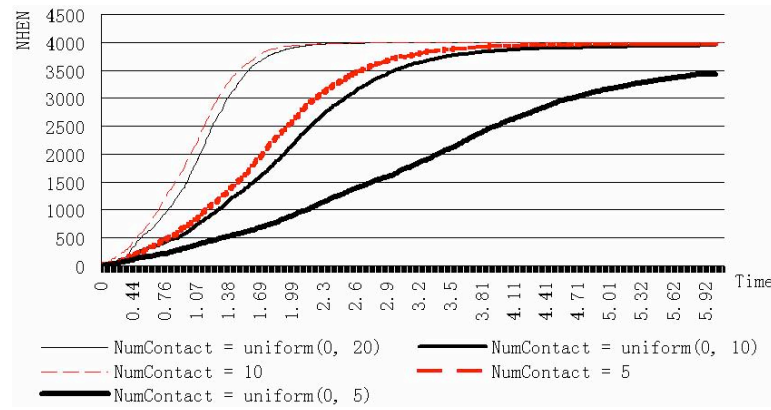

Figure 5. The influence of 'NumContact' on NHEN [2]

4.7

Each curve in figure 5 is a kind of S-shaped curve, which means that NHEN increases slowly at the beginning, then goes up with high speed, and slows down at the end. The shape of the curves is similar to the results from other researches in promulgation system dynamics (Hethcote 2000, Sander et al 2002). After comparing the three curves when "NumContact" is uniform (0, 20), uniform (0, 10), and uniform (0, 5), it was found that the spread of the news will get a higher speed when 'NumContact' increases.

4.8

With convenient communication in modern society, it is easy for people to communicate with others quickly and the Internet makes people spread the epidemic news to more groups of people out of the circle of their acquaintances. So, the number of 'NumContact' would be much larger than uniform (0, 10) or uniform (0, 20). Therefore, the spread speed of the news would be faster than the results got from simulation.

4.9

In order to study the 'radiation effect' of social relationships on the epidemic news spread process, a new statistical variable named RHEI (the ratio of the number heard the epidemic news indirectly) is introduced:

$$RHEI = (NHEN - NHED - NIFT) / NHEN$$

4.10

In figure 6, all five curves show that the ratios ascend rapidly at the beginning, and descend gradually after they reach their highest point. The reason for the phenomenon is that the spread of epidemic is much slower than the spread of epidemic news. So, most of the agents will get the epidemic news indirectly and RHEI will keep in high value in a relative long period. That reason is validated in 4.19.

4.11

In figure 6, at the time point of 5.16, the five curves from top to bottom show the change of RHEI in sequence when 'NumContact' is uniform (0, 20), uniform (0, 10), 10, 5 and uniform (0, 5). It is evident that RHEI will increase when 'NumContact' increases. That is to say, the 'radiation effect' of social relationships on the epidemic news spread process will be enhanced when the number of social relationships increases.

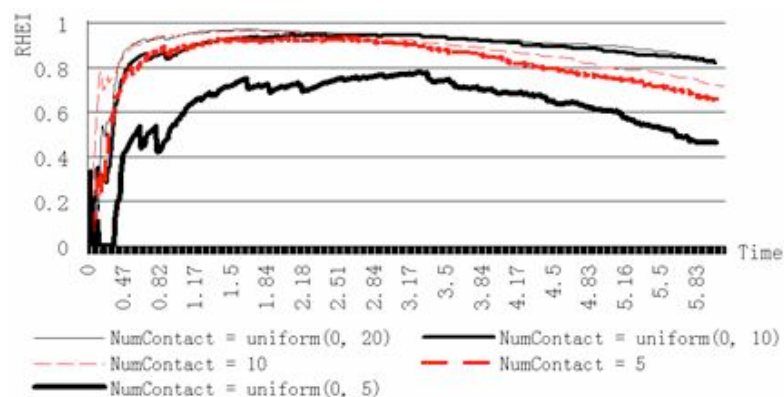

Figure 6. The influence of 'NumContact' on RHEI

Sensitivity analyses on 'TrustRate'

4.12

The willingness to spread information may influence the flow of information (Hansen 1999). To study the influence of 'TrustRate' on NHEN, the sensitivity analyses on 'TrustRate' by running simulation experiments has

been done based on default values in table 1 and table 2 with different values of 'TrustRate'. The average results of seven simulation experiments are shown in figure 7 and figure 8.

4.13

In figure 7, at the time point of 2.08, the five curves from top to bottom describe the changes of NHEN in sequence when 'NumContact' is 0.6, uniform (0.02, 1), 0.255, uniform (0.01, 0.5) and uniform (0.005, 0.25). It is clear that the rate of the spread of epidemic news increases with the increase of 'TrustRate'.

4.14

However, the influence of 'TrustRate' on RHEI is not as distinct as that of 'NumContact' on RHEI. As is shown in figure 8, the five curves are close to each other. It means that 'TrustRate' has little influence on RHEI.

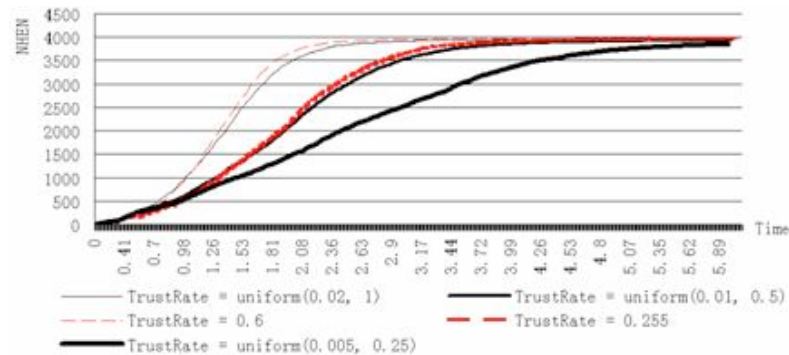

Figure 7. The influence of 'TrustRate' on NHEN

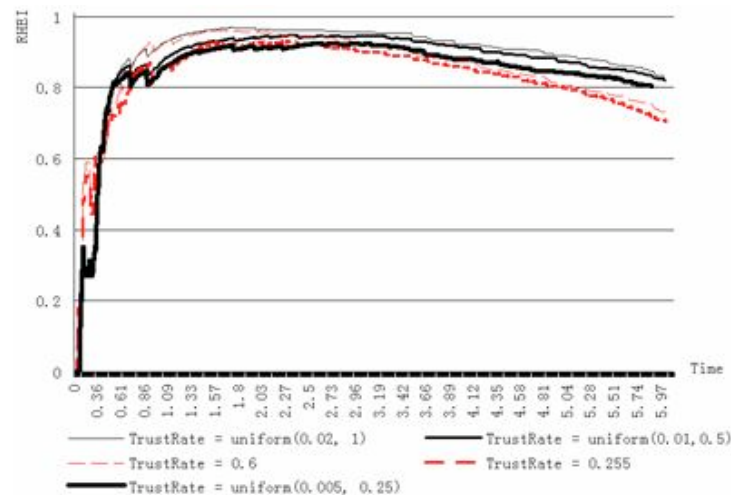

Figure 8. The influence of 'TrustRate' on RHEI

Sensitivity analyses on 'InfectRange'

4.15

Although many factors influence the spread of epidemic, 'InfectRange' is a decisive one. In order to study the relationship between the spread intensity of epidemic and the spread speed of epidemic news, The sensitivity analyses has been performed by running simulation experiments based on default values in table 1 and table 2 with different values of 'InfectRange'. The average results of seven simulation experiments are shown in figure 9, figure 10 and figure 11.

4.16

Figure 9 showed that 'InfectRange' had great influence on the spread of epidemic. At the time point of 5.73, when 'InfectRange' equals 27, NIFT was larger than when 'InfectRange' equals 18; and much larger than when 'InfectRange' equals 9 or 3.

4.17

Figure 10 shows that 'InfectRange' had great influence on RHEI. When 'InfectRange' becomes higher, the spread intensity of epidemic will increase and more agents will get infected. Then more agents will get the news directly. Therefore, the ratio of the agents who have heard the epidemic news indirectly will decrease.

4.18

Figure 11 shows the influence of 'InfectRange' on NHEN. When 'InfectRange' equals 9, NHEN is almost the same as that when 'InfectRange' equals 3, but it is a little smaller than when 'InfectRange' equals 18 or 27. Therefore, the influence of 'InfectRange' on NHEN is not as distinct as that on NIFT or RHEI. It is because the spread speed of

epidemic news is much faster than the spread speed of epidemic.

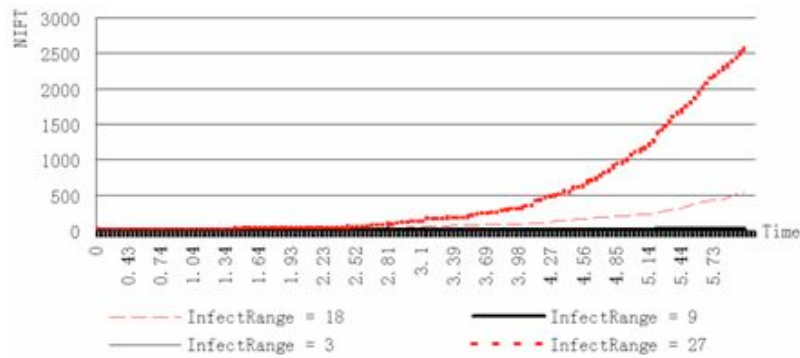

Figure 9. The influence of 'InfectRange' on NIFT

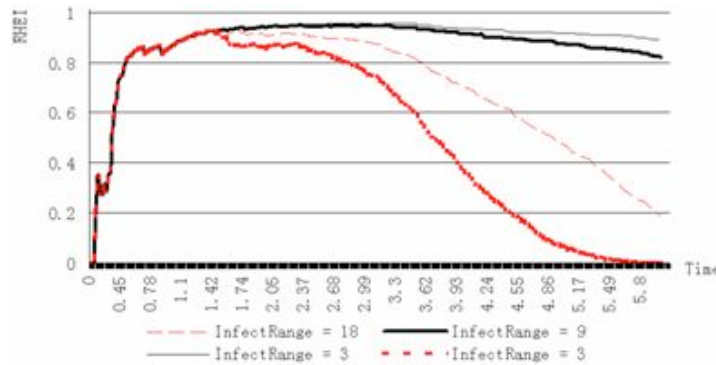

Figure 10. The influence of 'InfectRange' on RHEI

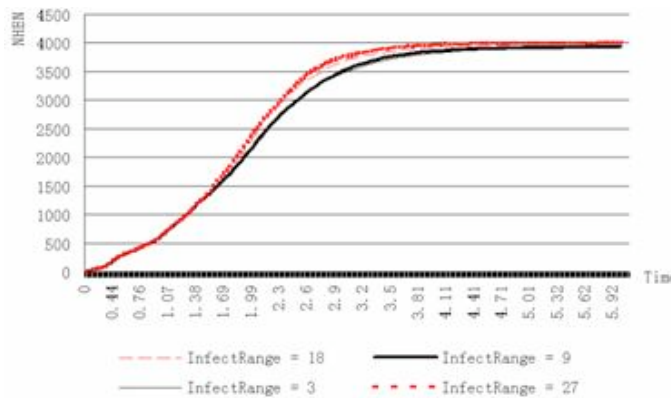

Figure 11. The influence of 'InfectRange' on NHEN

The influence of network structure

4.19

In figure 5, since the average value of uniform (0, 20) equals 10 when 'NumContact' is uniform (0, 20), the simulation result should be similar to the result when 'NumContact' equals 10. However, the results in the figure show when 'NumContact' is uniform (0, 20) the spread speed is faster than the speed when 'NumContact' equals 10. When 'NumContact' is uniform (0, 10), the simulation result should also be similar to the result when 'NumContact' equals 5. However, the results in the figure show that the speed when 'NumContact' is uniform (0, 10) was also faster than the speed when 'NumContact' equals 5.

4.20

When the value of "NumContact" was set to 10 or 5, it formed a kind of random network with fixed number of vertexes and connection sides during the spread process. The network formed when "NumContact" which equalled to uniform (0, 20) has the approximate number of vertexes to the network formed when "NumContact" was equal to 10. The network formed when "NumContact" is equal to uniform (0, 10) has the approximate number of vertexes to the network formed when "NumContact" is equal to 5. However, the network formed in the spread process when "NumContact" is equal to uniform (0, 20) or uniform (0, 10) has variable connection sides, which is a kind of small network instead of regular network or random network.

4.21

So, when the network structure is assumed to be a small world network, the spread speed will be slower than that

in a random network with the same average vertex degree.

4.22

In fact, many researches have indicated that most of the real networks including what has been studied in this paper belong to small world network. Watts and Strogatz found that the spread of disease in small world network will become faster and easier than that in regular network, but slower than that in random network through simulation experiments of a simple model of disease spread (Watts and Strogatz 1998). Therefore, the results obtained in this paper are consistent with what Watts and Strogatz found.

4.23

Moreover, in figure 7, it is clear that the spread speed in small world network is a bit slower than that in random network. For example, when 'TrustRate' is uniform (0.02, 1), the speed is slower than that when 'TrustRate' equals 0.6. When 'TrustRate' is uniform (0.01, 0.5), the speed is slower than that when 'TrustRate' equals 0.255.

4.24

The speed of forgetting the news is probably influenced by the network structure. So we perform the sensitivity analysis on 'NumContact' through simulation experiments based on default values in table 1 and table 2 with different values of 'NumContact'. The average results of seven simulation experiments are shown in figure 12. In figure 12, at the time point of 5.98, the five curves from top to bottom showed the change of NFEN in sequence when 'NumContact' is uniform (0, 5), uniform (0, 10), 5, uniform (0, 20) and 10. It is obvious that NFEN increases slower with the increase of 'NumContact'. When 'NumContact' is uniform (0, 10), NFEN increases faster than when 'NumContact' equals 5. Similarly, when 'NumContact' is uniform (0, 20), NFEN increases faster than when 'NumContact' equals 10. So the speed of forgetting news in small world network is faster than that in random network. This result is consistent with the above result that the spread speed in small world network is a bit slower than that in random network.

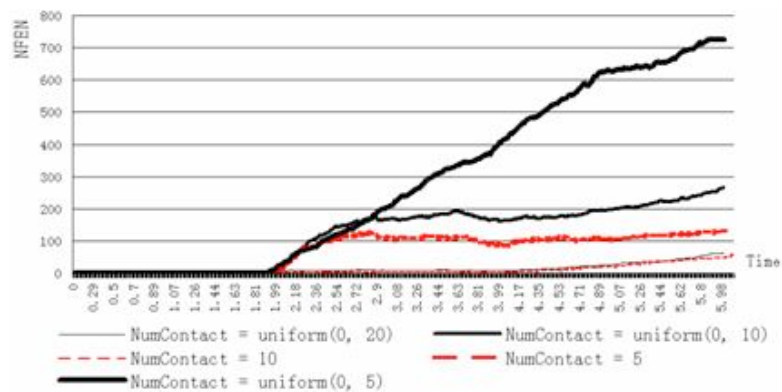

Figure 12. The influence of 'NumContact' on NFEN



Conclusions

5.1

Based on multi-agent simulation experiments and sensitivity analyses, micro mechanisms and characteristics of epidemic new spread process were studied from several aspects and some conclusions are drawn as follows.

1. As the number of social relationships increases, the rate of spread of epidemic news rapidly rises, and the ratio of people who have heard the news directly decreases. The result is that the 'radiation effect' of the epidemic news spread will be enhanced when the number of social relationships increases.
2. With the increase of the degree of trust in the news, the rate of spread of the news will also rapidly increase, but variation in the ratio of the people who have heard the news directly is not significant. This means that the 'radiation effect' of the spread of the news does not change much more in relation to the degree of trust in the epidemic news.
3. The ratio of the people who have heard the news directly increases when the infection range increases (i.e. the spread intensity of epidemic increases), and vice versa. But the variation of the speed of the epidemic news spread is not significant.
4. When the network structure is assumed to be a small world network, the spread speed will be slower than that in a random network with the same average vertex degree and the forgetting speed will be faster than that in a random network with the same average vertex degree.

5.2

The data used in the simulation model is just set for sensitivity analyses. For the spread of a particular epidemic news, the parameters, e.g. 'TrustRate', 'ContactRange', 'InfectRange', 'InfectRate', 'KnowRange' and 'NumContact', need to be reset and the real-life network structure formed in spread also need further studied. Nevertheless, some valuable illumination can also be drawn from these conclusions. For instance, with the convenience of communication in modern society, epidemic news will spread very fast, while the ratio of the people heard the

epidemic news directly decreases. It is very easy to distort the epidemic news to some horrific one, which will lead to an unnecessary panic. Therefore, government or mass media should guide the spread of the news in time to avoid the panic. One effective way to avoid the panic is to decrease the number of social relationships since the 'radiation effect' will be enhanced when the number of social relationships increases.

Acknowledgements

The work described in this paper was supported by the National Natural Science Foundation of the People's Republic of China under the Grant No. 60474077 and the Program for New Century Excellent Talents in University of China under the Grant No. NCET-05-0653. The authors are thankful to associate professor Wei Huang (Department of Management Sciences, City University of Hong Kong, Tat Chee Avenue, Kowloon, Hong Kong, wei Huang@cityu.edu.hk) and associate professor Ping Zhao (Foreign Language Department, Huazhong Agricultural University, Wuhan, China, zhaoping@mail.hzau.edu.cn) for their assistance on English expression.

Notes

¹ The model can be accessed at http://imsim.hust.edu.cn/james/Epidemic_News_Spread.htm

² Anylogic™ gets statistic variables' values of all changes of simulation time points and simulation events, and the original simulation data exceed 150000 groups, which goes beyond the capacity of one sheet with maximum capacity of 65536 groups in Microsoft Excel. So we developed a program to get simulation statistic data of an interval time of 0.01 day and export the new data to Microsoft Excel for analysis.

References

- AGIZA H N, Elgazzar A S, Youssef S A (2003) Phase Transitions in Some Epidemic Models Defined on Small-World Networks. *Int.J.Mod.Phys.C*, 2003, 14, pp. 825-833.
- BENSAID L, Bouron T, Drogoul A (2002) Agent-based Interaction Analysis of Consumer Behavior, Proceedings of the First International Joint Conference on Autonomous Agents and Multi-Agent Systems (AAMAS'02), Bologna, Italy, 2002, pp. 183-189.
- BOUSQUET F, Cambier C, Mullon C and Quensiere J (1992) Simulating Fishermen Society. In : Gilbert N. (ed.) *Simulating Societies*. Guilford : University of Surrey, 1992, pp. 63-79. http://horizon.documentation.ird.fr/exl-doc/pleins_textes/pleins_textes_5/b_fdi_31-32/35494.pdf.
- CHAUSSALET TJ, Mann JA, Perry JN and Francos-Rodriguez JC (2000) A Nearest Neighbour Approach to the Simulation of Spread of Barley Yellow Dwarf Virus. *Computers and Electronics in Agriculture*, 2000, 28, pp.51-65.
- DEMETRIOS E, Andreas L, Symeonidis, Pericles A, Mitkas (2005) GeneCity: A Multi Agent Simulation Environment for Hereditary Diseases. *Third European Workshop on Multi-Agent Systems (EUMAS) 2005*, pp. 137-147.
- DENG H Z, CHI Y, TANG Y J (2004) Multi agent-Based Simulation of Disease Infection. *Computer simulation*, 2004, 21(6), pp. 167-175.
- DIETRICH S and Muhammad S. (2006) Discrete simulation of the dynamics of spread of extreme opinions in a society. *Physica A*, 364, pp. 537-543.
- DROGOUL A, Corbara B, Fresneau D, MANTA (1995) New Experimental Results on the Emergence of (Artificial) Ant Societies, in *Artificial Societies: the computer simulation of social life*, Gilbert N. & Conte R. (Eds), UCL Press, London, 1995.
- DROUGOUL A, Ferber J (1992) Multi-Agent Simulation as a Tool for Modelling Societies: Application to Social Differentiation in Ant Colonies. *Proceedings of Maamaw '92*, Rome, C. Castelfranchi and E. Werner (Ed.), North-Holland, 1992.
- ELLIOTT R, Danzig, Pouf W Thayer and Lila R (1958) *Galanter: The Effects of a Threatening Rumor on a Disaster-Stricken Community*, National Academy of Science National Research Council, Washington, D. C.
- GILBERT N (1993) Computer simulation of social processes. *Social Research Update* 6, 1993 <http://sru.soc.surrey.ac.uk/SRU6.html>.
- GILBERT, N (2005). *Agent-Based Social Simulation: Dealing with Complexity*. http://www.complexityscience.org/NoE/ABSS-dealing_with_complexity-1-1.pdf.

- GOLDSPIK C (2002) Methodological Implications of Complex Systems Approaches to Sociality: Simulation as a Foundation for Knowledge. *Journal of Artificial Societies and Social Simulation*, 2002, 5. <http://jasss.soc.surrey.ac.uk/5/1/3.html>.
- GONG X G and LI Z C (2003) Study on Multi-Agent Simulation of New Product Market Diffusion. *System Engineering Theory and Practice*, 2003, 12, pp. 60–63,110.
- HANSEN M T (1999) The Search-transfer Problem: the Role of Weak Ties in Sharing Knowledge Across Organization Subunits. *Administrative Science Quarterly*, 1999, 44, pp. 82–111.
- HETHCOTE H W (2000) The Mathematics of Infectious Diseases. *SIAM Review*, 2000, 42, pp. 599–653.
- HOLLAND J H (1998) *Emergence*. New York: Addison-Wesley, 1998.
- HUANG C Y, Sun C T, Hsieh J L, and Lin H (2004) Simulating SARS: Small-World Epidemiological Modelling and Public Health Policy Assessments. *Journal of Artificial Societies and Social Simulation*, 2004,7(4). <http://jasss.soc.surrey.ac.uk/7/4/2.html>.
- JØRGENSEN E (2000a) Calibration of a Monte Carlo Simulation Model of Disease Spread in Slaughter Pig Units. *Computers and Electronics in Agriculture*, 2000, 25, pp. 245–259. <http://citeseer.ist.psu.edu/54117.html>.
- KAPFERER J N (1990) *Rumors: Uses, Interpretations, and Images*. New Brunswick, CT: Transaction Publishers, 1990.
- KARSTEN S, Rave G and Krieter J (2005) Monte Carlo simulation of classical swine fever epidemics and control. I. General concepts and description of the model. *Veterinary Microbiology*, 2005,108, pp. 187–198.
- KARSTEN S, Rave G and Krieter J (2005) Monte Carlo simulation of classical swine fever epidemics and control. II. Validation of the model. *Veterinary Microbiology*, 2005, 108, pp. 199–205.
- KUPERMAN M, Abramson G (2001) Small World Effect in an Epidemiological Model. *Phys Rev Lett*, 2001, 86, pp. 2909–2912.
- LAI G and Wong O (2002) The Tie Effect on Information Dissemination: The Spread of a Commercial Rumor in Hong Kong. *Social Networks*, 2002, 24(1), pp. 49–75.
- LI H L and Xiao R B (2006) A multi-agent virtual enterprise model and its simulation with Swarm. *International Journal of Production Research*, 2006, 44(9), pp. 1719–1737.
- LI Z C, HU B, FU X H and GONG X G (2005) *The Theory and Application of Qualitative Simulation in Management System*. Science Press, Beijing, 2005.5.
- LITMAN J A and Pezzo M V (2005) Individual Differences in Attitudes Towards Gossip. *Personality and Individual Differences*, 2005, 38, pp. 963–980.
- LPEZ-SNCHEZ M, Noria X, Rodríguez JA, and Gilbert N (2005) Multi-agent Based Simulation of News Digital Markets. *International Journal of Computer Science & Applications*, 2005, 2(1), pp. 7–14.
- NEWMAN M E J (2003) The Structure and Function of Complex Networks. *SIAM Review*, 2003, 45, pp. 167–256.
- ROSNOW R L (1988) Rumor as Communication: a Contextualist Approach, *Journal of Communication*, 1988, 38(I), pp. 12–28.
- SANDER L M, Warren C P, et al (2002) Percolation on Disordered Networks As a Model for Epidemics. *Math Biosci*, 2002, 180, pp. 293–305.
- SCHWEITZER F, Zimmermann J (2001) Communication and Self-Organization in Complex Systems: A Basic Approach, in: *Knowledge, Complexity and Innovation Systems* (Eds. M. M. Fischer, J. Fröhlich), Springer, Berlin, 2001.
- TRAN A and Raffy M (2006) On the Dynamics of Dengue Epidemics From Large-scale Information. *Theoretical Population Biology*, 2006, 69(1), pp. 3–12.
- WANG X F (2002) Complex Networks: Topology, Dynamics and Synchronization. *Int J Bifurcation & Chaos*, 2002, 12, pp. 885–916.
- WATTS D. J, Strogatz S H (1998) Collective Dynamics of 'Small world' Networks. *Nature*, 1998, 393, pp. 440–442.
- WERT S R and Salovey P (2004) A Social Comparison Account of Gossip. *Review of General Psychology*, 2004, 8, pp. 122–137.
- WOOLDRIDGE J, Jennings N, and Kinny D (1999) *A Methodology for Agent-Oriented Analysis and Design*. In

International Conference on Autonomous Agents, New York, 1999, pp. 69–76.

XIAO G and Xi B (2005) Swarm Based Logistics Supply Structure Evolving Simulation for Strategic Decision. 2005 International Conference on Machine Learning and Cybernetics, ICMLC 2005, pp. 3624–3628.

ZAWADOWSKIA A G, Karadia R and Kertesz J (2002) Price Drops, Fluctuations, and Correlation in a Multi-Agent Model of Stock Markets. Physica A, 2002, 316, pp. 403–412.

ZHOU H (2005) Research of the Small-World Character During Rumor's Propagation. Journal of Wuhan University of Science and Engineering, 2005, 18(1), pp. 113–116.



Appendix

Java source code for [1]

```
// timeout is "TimeInfectDis"
// the infected agent spread out the rumor
if (color == Color.red)
{
    for( int i=0; i< model.people.size() && numdistred<=NumContact; i++ )
    {
        person p = Model.people.item(uniform_discr( Model.people.size() - 1 ));
        if( distance( p.x, p.y ) <= ContactRange)
        {
            NumDistred++;
            if( p.color==Color.lightGray )
            {
                p.StateTrans.fireEvent( "unknowntoknow" ); // state change (3)
            }
            if(p.color==Color.blue )
            {
                p.StateTrans.fireEvent( "listoknow" ); // state change (6)
            }
        }
    };
};
Model.setModified();
```

Java source code for [2]

```
// timeout is "TimeKnow"
// their neighbour find the infected fact
if (color == Color.red )
{
    for( int i=0; i< model.people.size() ; i++ )
    {
        person p = Model.people.item(i);
        if(distance( p.x, p.y )<= KnowRange)
        {
            if(p.color==Color.blue)
            {
                p.StateTrans.fireEvent("listoknow"); // state change (6)
            }else if( p.color==Color.lightGray )
            {
                p.StateTrans.fireEvent("unknowntoknow"); // state change (3)
            }
        }
    };
};
Model.setModified();
```

Java source code for [3]

```
// timeout is "TimeInfect"
// the infect process
if (color == Color.red )
{
    for( int i=0; i< model.people.size() ; i++ )
    {
        person p = Model.people.item(i);
        if((distance( p.x, p.y )<= InfectRange) && (uniform ()<=InfectRate))
        {
```

```

    if (p.color==Color.lightGray)
    {
        p.StateTrans.fireEvent("unknowntoinfect"); // state change (4)
    }else if (p.color==Color.pink)
    {
        p.StateTrans.fireEvent("knowtoinfect"); // state change (7)
    }else if (p.color==Color.blue)
    {
        p.StateTrans.fireEvent("listoinfect"); // state change (5)
    }
}
};

```

Java source code for [4]

```

// timeout is "TimePinkDist"
Model.setModified();
//the agent heard rumor directly spread out the rumor
if (color == Color.pink)
{
    for( int i=0; i< model.people.size() && numdistred<=NumContact; i++ )
    {
        person p = Model.people.item(uniform_discr( Model.people.size() - 1 ));
        if( distance( p.x, p.y ) <= ContactRange)
        {
            NumDistred++;
            if( p.color==Color.lightGray )
            {
                p.StateTrans.fireEvent( "tolis" ); // state change (2)
            };
            if(p.color==Color.blue )
            {
                p.NewgetRumor= true;
                p.TgetNews=getTime();
            };
        };
    };
};
};

```

Java source code for [5]

```

// timeout is "TimeBlueDist"
Model.setModified();
//the agent heard rumor indirectly will spread out the rumor
if ((color == Color.blue) && (NewgetRumor==true))
{
    NewgetRumor=false;
    int k=0;
    for( int i=0; i< model.people.size(); i++ )
    {
        if ( numdistred<=NumContact && k <= NumContact * TrustRate)
        {
            Person p = Model.people.item(uniform_discr( Model.people.size() - 1 ));
            if( distance( p.x, p.y ) <= ContactRange )
            {
                k++;
                NumDistred++;
                if( p.color==Color.lightGray )
                {
                    p.StateTrans.fireEvent( "tolis" ); // state change (2)
                }
                if(p.color==Color.blue )
                {
                    p.NewgetRumor=true;
                    p.TgetNews=getTime();
                }
            }
        }
    }
};
Model.setModified();

```

Java source code for change to HEN

```
Entry action
Model.NHEN++;
isListened=true;
Model.setModified();
Forgeted = false;
Exit action
Model.NHEN--;
Model.setModified();
```

Java source code for change to UHE

```
Model.NUHE++;
//Model.NHEN++;
Model.setModified();
isListened=false;
color=Color.lightGray;
Exit action
Model.NUHE--;
Model.setModified();
```

Java source code for change t IFT

```
Model.NHEN++;
isListened=true;
Model.NIFT++;
Model.setModified();
Exit action
//Model.NHEN--;
Model.NIFT--;
Model.setModified();
```

Java source code for change to HED

```
Entry action
Model.NHEN++;
isListened=true;
Model.NHED++;
Model.setModified();
Exit action
Model.setModified();
Model.NHED--;
Model.NHEN--;
```

[Return to Contents of this issue](#)

© [Copyright Journal of Artificial Societies and Social Simulation, \[2007\]](#)

