



CHALMERS

Chalmers Publication Library

An E-band Cylindrical Reflector Antenna for Wireless Communication Systems

This document has been downloaded from Chalmers Publication Library (CPL). It is the author's version of a work that was accepted for publication in:

7th European Conference on Antennas and Propagation, EuCAP 2013, Gothenburg, Sweden, 8-12 April 2013

Citation for the published paper:

Yang, J. ; Papageorgiou, I. ; Derneryd, A. (2013) "An E-band Cylindrical Reflector Antenna for Wireless Communication Systems". 7th European Conference on Antennas and Propagation, EuCAP 2013, Gothenburg, Sweden, 8-12 April 2013

Downloaded from: <http://publications.lib.chalmers.se/publication/179728>

Notice: Changes introduced as a result of publishing processes such as copy-editing and formatting may not be reflected in this document. For a definitive version of this work, please refer to the published source. Please note that access to the published version might require a subscription.

Chalmers Publication Library (CPL) offers the possibility of retrieving research publications produced at Chalmers University of Technology. It covers all types of publications: articles, dissertations, licentiate theses, masters theses, conference papers, reports etc. Since 2006 it is the official tool for Chalmers official publication statistics. To ensure that Chalmers research results are disseminated as widely as possible, an Open Access Policy has been adopted. The CPL service is administrated and maintained by Chalmers Library.

(article starts on next page)

An E-band Cylindrical Reflector Antenna for Wireless Communication Systems

Ioannis Papageorgiou*, Anders Derneryd[†], Lars Manholm[†] and Jian Yang[‡]

*Kongsberg Norspace AS, Horten, Norway

[†]Ericsson AB, Gothenburg, Sweden

[‡]Chalmers University of Technology, Gothenburg, Sweden

Abstract—The increasing demand of radio links with high data rates is satisfied by the allocation of new frequency spectrum. A novel cylindrical reflector antenna is designed to operate in the E-band (71–86 GHz), which was already allocated in 2003 for radio link applications. Presented simulation results are preliminary and the directivity of the antenna at the center frequency is calculated to be 41.4 dBi with an aperture efficiency of 60% or -2.2dB.¹

Index Terms—cylindrical reflector antenna; hat feed; parallel plate; millimeter waves; E-band

I. INTRODUCTION

During the last years the need of new services and communication systems led to an overcrowded frequency spectrum. The allocation of the E-band (71–86 GHz) enables a new frequency spectrum that has a great potential for point-to-point wireless links and wireless backhaul applications. These wireless links are capable of replacing fiber optics, because they are less costly and easier to deploy [1].

The E-band antennas are required to be mechanically small, of high gain and suitable for integration with the radio. The ETSI standard requires a minimum antenna gain of 38 dBi, and radiation pattern envelope classes 2, 3 and 4 are released for different applications [2]. Several types of antennas have already been developed in the E-band and they are used for different applications [3]–[6].

Reflector antennas are very attractive candidates for use at high frequencies, because they have high gain and low loss. In this paper, a new quadratical reflector antenna is presented, which is partly inspired by hat-fed reflector antennas [7]–[11]. The main advantages of the new antenna compared with the hat-fed reflector antenna are low manufacture cost since there is no dielectric head involved and higher gain.

A preliminary design of the cylindrical reflector antenna with a rectangular aperture is presented in the following sections.

II. ANTENNA STRUCTURE

The configuration of the proposed cylindrical reflector antenna is shown in Fig. 1. The cylindrical reflector is illuminated by a corrugated linear hat feed, which is fed by a parallel plate structure. Inside the parallel plate there is an

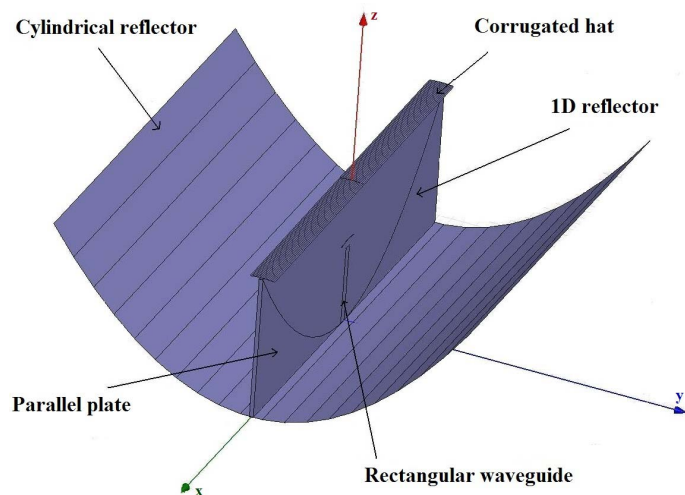

Fig. 1. Cylindrical parabolic reflector antenna

one-dimensional reflector antenna, which is illuminated by a hat feed. This hat feed is fed by a standard WR-12 rectangular waveguide, operating in the E-band. The antenna has a square aperture and the length of the side is $d = 168.4$ mm. The focal length for both reflectors is set as $F = 32.3$ mm, and the antenna depth is $\Delta z = 54.85$ mm. Therefore, the half subtended angle is 105° .

The hat inside the parallel plate has no corrugations and does not need any dielectric support, because it is already supported by the parallel plates. The dominant TE_{10} mode propagates in the WR-12 waveguide. The spacing between the hat and the open end of the waveguide should be equal to or larger than half a wavelength, in order to avoid the propagation mode being cut-off.

The corrugated cylindrical hat feed that is located on top of the parallel plate is designed in order to achieve low sidelobes in the radiation pattern. The depth of each corrugation is selected to be $\lambda_0/4$, where λ_0 is the wavelength at the center frequency, and there are three corrugations on each side of the hat.

III. THEORY AND FORMULATIONS

The far-field function of a rectangular cylindrical reflector can be calculated analytically, assuming that the aperture

¹This work was performed at Ericsson AB in Gothenburg as a master thesis project of Chalmers master's program Wireless and Photonics Engineering.

distribution is the truncated Gaussian. The general expression of the far-field function of an aperture distribution can be written on its Fourier transform as [12]

$$G(\theta, \varphi) = -2C_k \cos^2\left(\frac{\theta}{2}\right) (\cos\varphi \hat{\theta} - \sin\varphi \hat{\varphi}) \tilde{\tilde{E}}_{ax} - 2C_k \cos^2\left(\frac{\theta}{2}\right) (\sin\varphi \hat{\theta} - \cos\varphi \hat{\varphi}) \tilde{\tilde{E}}_{ay}, \quad (1)$$

where $C_k = -jk/(4\pi)$.

For y-polarized antenna, the far-field function is proportional to

$$\begin{aligned} \tilde{\tilde{E}}_{ay}(k \sin\theta \cos\varphi, k \sin\theta \sin\varphi) &= \tilde{\tilde{E}}_{ay}(k \hat{x} \cdot \hat{r}, k \hat{y} \cdot \hat{r}) \\ &= \tilde{A}(k \hat{x} \cdot \hat{r}) \tilde{B}(k \hat{y} \cdot \hat{r}) \end{aligned} \quad (2)$$

with

$$\begin{aligned} \tilde{A}(k \hat{x} \cdot \hat{r}) &= \int_{-d/2}^{d/2} e^{-(x/\rho_\alpha)^2} e^{(jkx \hat{x} \cdot \hat{r})} dx \\ \tilde{B}(k \hat{y} \cdot \hat{r}) &= \int_{-d/2}^{d/2} e^{-(y/\rho_\alpha)^2} e^{(jky \hat{y} \cdot \hat{r})} dy \end{aligned} \quad (3)$$

where $\rho_\alpha = d/(2\sqrt{0.4 \ln 10})$, for 10 dB of illumination taper.

The maximum of the absolute of the far-field is proportional to the maximum of the one dimensional Fourier transforms and this occurs when $\theta = 0$, i.e.,

$$\begin{aligned} G_{\max} &= \tilde{\tilde{E}}_{ay}(k \hat{x} \cdot \hat{r}, k \hat{y} \cdot \hat{r})_{\max} \\ &= \tilde{A}(0) \tilde{B}(0) = \pi \rho_\alpha^2 \operatorname{erf}^2\left(\frac{d}{2\rho_\alpha}\right) \end{aligned} \quad (4)$$

where $\operatorname{erf}(x) = \frac{2}{\sqrt{\pi}} \int_0^x e^{-t^2} dt$ is the error function.

The total power of the far-field function is equal to the square of the aperture integral function,

$$\begin{aligned} P &= \int_{-d/2}^{d/2} \int_{-d/2}^{d/2} |\mathbf{E}_{ay}(x, y)|^2 dx dy \\ &= \int_{-d/2}^{d/2} \int_{-d/2}^{d/2} e^{-2(\frac{x}{\rho_\alpha})^2} e^{-2(\frac{y}{\rho_\alpha})^2} dx dy \\ &= \frac{\pi}{2} \rho_\alpha^2 \operatorname{erf}^2\left(\frac{\sqrt{2}d}{2\rho_\alpha}\right). \end{aligned} \quad (5)$$

Therefore, the directivity of a rectangular aperture can be calculated by

$$D = \frac{4\pi |G_{\max}|^2}{P} = \frac{4\pi \operatorname{erf}^4\left(\frac{d}{2\rho_\alpha}\right)}{\lambda^2 \operatorname{erf}^2\left(\frac{\sqrt{2}d}{2\rho_\alpha}\right)} \quad (6)$$

IV. BLOCKAGE OF THE CYLINDRICAL REFLECTOR

The total blockage loss of the cylindrical reflector is the result of the blockage from both hat feeds that illuminate the reflectors, which leads to a higher blockage loss than that of a typical hat feed.

The blockage at the first dimension occurs from the hat feed inside the parallel plate and the blockage at the second dimension occurs from the linear hat feed that is extended

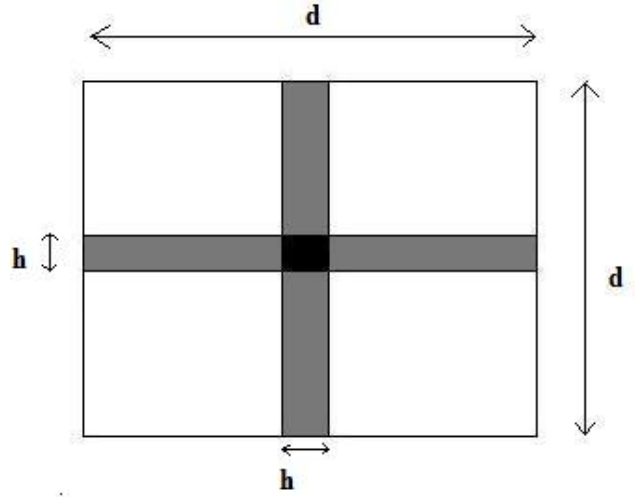

Fig. 2. Blockage in the rectangular aperture of the cylindrical reflector (a is the total area of the aperture, b is the area that is blocked along the two dimensions and corresponds to the grey area of the figure and c is the black common blocked area at the center)

along the aperture of the parallel plate. A schematic of the blockage in the rectangular aperture is shown in Fig. 2, where a square aperture and the same size of hat feeds are assumed for simplicity.

The directivity of the antenna including only the blockage loss can be calculated approximately by the directivity of the antenna without the blockage minus the directivity from the area which is blocked. The directivity from the common area in the center should be added, because otherwise it would be subtracted twice in Eq. (12).

$$D_b = \frac{4\pi |G_a - 2G_b + G_c|_{\max}^2}{P_a - 2P_b + P_c} \quad (7)$$

where

$$G_a = \pi \rho_\alpha^2 \operatorname{erf}^2\left(\frac{d}{2\rho_\alpha}\right) \quad (8)$$

$$\begin{aligned} G_b &= E_{ay}(k \hat{x} \cdot \hat{r}, k \hat{y} \cdot \hat{r})_{\max} \\ &= A(k \hat{x} \cdot \hat{r}) B(k \hat{y} \cdot \hat{r}) \\ &= \int_{-d/2}^{d/2} \int_{-h/2}^{h/2} e^{-(\frac{x}{\rho_\alpha})^2} e^{-(\frac{y}{\rho_\alpha})^2} dx dy \\ &= \pi \rho_\alpha^2 \operatorname{erf}\left(\frac{d}{2\rho_\alpha}\right) \operatorname{erf}\left(\frac{h}{2\rho_\alpha}\right) \end{aligned} \quad (9)$$

$$\begin{aligned} G_c &= A(k \hat{x} \cdot \hat{r}) B(k \hat{y} \cdot \hat{r}) \\ &= \int_{-h/2}^{h/2} \int_{-h/2}^{h/2} e^{-(\frac{x}{\rho_\alpha})^2} e^{-(\frac{y}{\rho_\alpha})^2} dx dy \\ &= \pi \rho_\alpha^2 \operatorname{erf}^2\left(\frac{h}{2\rho_\alpha}\right) \end{aligned} \quad (10)$$

In a similar way the power of each aperture area is calculated and it is found to be

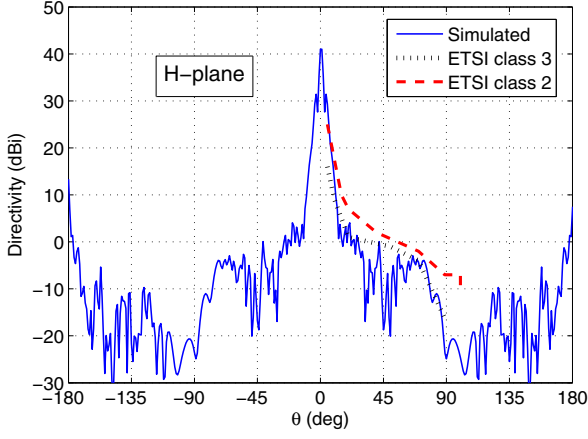

Fig. 3. Calculated H-plane of the cylindrical reflector for $f = 78.5$ GHz

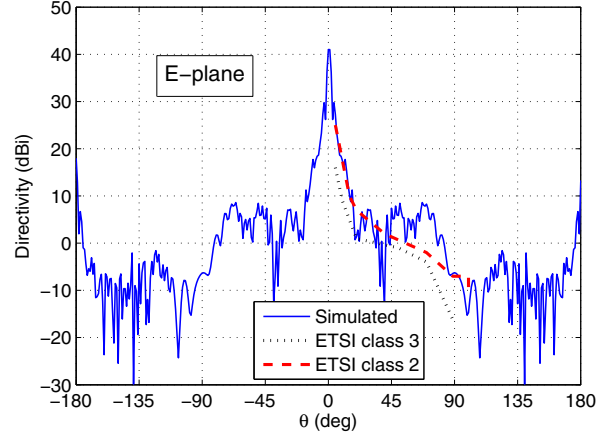

Fig. 4. Calculated E-plane of the cylindrical reflector for $f = 78.5$ GHz

$$\begin{aligned}
 P_a &= \frac{\pi}{2} \rho_\alpha^2 \operatorname{erf}^2\left(\frac{\sqrt{2}d}{2\rho_\alpha}\right) \\
 P_b &= \frac{\pi}{2} \rho_\alpha^2 \operatorname{erf}\left(\frac{\sqrt{2}d}{2\rho_\alpha}\right) \operatorname{erf}\left(\frac{\sqrt{2}h}{2\rho_\alpha}\right) \\
 P_c &= \frac{\pi}{2} \rho_\alpha^2 \operatorname{erf}^2\left(\frac{\sqrt{2}h}{2\rho_\alpha}\right)
 \end{aligned} \quad (11)$$

Therefore, the total directivity of the antenna including the blockage can be approximated by

$$D_b = \frac{8\pi^2 \rho_\alpha^2 \left| \operatorname{erf}\left(\frac{d}{2\rho_\alpha}\right) - \operatorname{erf}\left(\frac{h}{2\rho_\alpha}\right) \right|^4}{\lambda^2 \left(\operatorname{erf}\left(\frac{\sqrt{2}d}{2\rho_\alpha}\right) - \operatorname{erf}\left(\frac{\sqrt{2}h}{2\rho_\alpha}\right) \right)^2}. \quad (12)$$

Finally, the blockage efficiency is

$$e_b = \frac{D_b}{D}. \quad (13)$$

V. SIMULATION RESULTS

The radiation patterns of the cylindrical antenna were simulated by using both HFSS [13] and G2DMULT [14].

G2DMULT is a general algorithm based on the S2DS technique that calculates the spectral Greens functions of 2-D multiregion structures by using the method of moment (MoM). G2DMULT makes use of the Fourier transform of the 3-D excitations in the uniform direction of the 2-D structure to arrive into a spectral domain problem that can be solved by 2-D spatial techniques. Therefore, instead of solving a very large 3-D problem directly, G2DMULT provides a very efficient simulation for 2-D cylindrical geometry problems [15]–[19], such as also in the case of this work.

The simulated radiation patterns in H-, E- and 45°-planes of the antenna at the center frequency of 78.5 GHz, using G2DMULT, are plotted in Figs. 3–5, respectively. It can be seen that the H-plane pattern almost satisfies the ETSI class 2 requirement, while the E-plane pattern does not, and the 45°-plane pattern satisfies even the ETSI class 3 requirement.

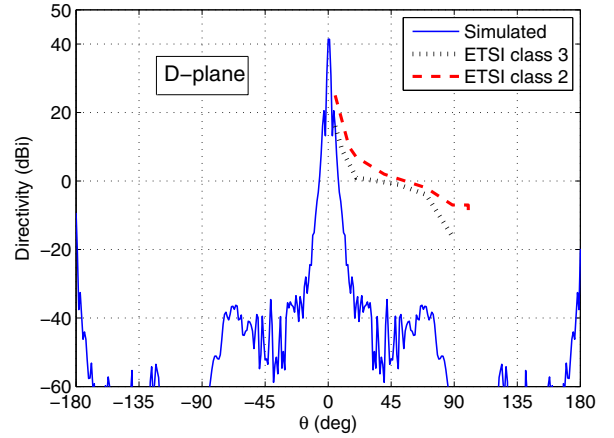

Fig. 5. Calculated 45°-plane of the cylindrical reflector for $f = 78.5$ GHz

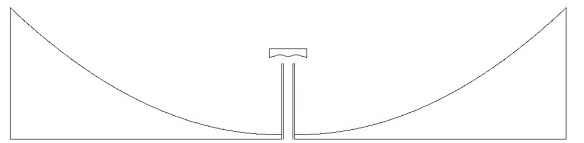

Fig. 6. G2DMULT geometry for the cross section of the 1D reflector (E-plane)

The geometry of the antenna in G2DMULT is shown in Figs. 6–7 for the E- and H-planes respectively.

The 45°-plane radiation pattern in Fig. 5 is calculated based on the simulated radiation patterns in E- and H-planes. The complete cylindrical reflector antenna could not be simulated as a whole in the softwares, because of the complexity of the design and computer memory limitations. Therefore, the

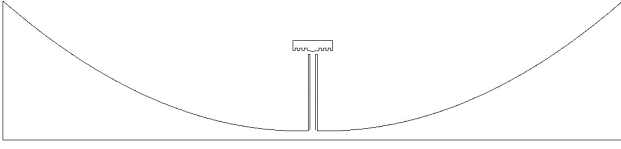

Fig. 7. G2DMULT geometry for the cross section of the cylindrical reflector (H-plane)

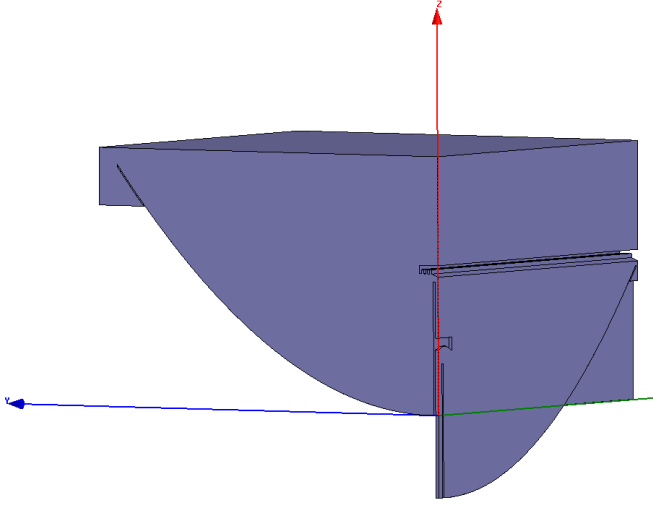

Fig. 8. One quarter of the cylindrical reflector as simulated in HFSS

results were calculated by two different methods.

The first method was to simulate the cross section of the one-dimensional cylindrical reflector and the cross section of the cylindrical reflector, thus the E- and H-planes, respectively, by using G2DMULT. Then, the 45°-plane is calculated.

The other method was to design one quarter of the antenna as it is shown in Fig. 8 in HFSS by exploiting the symmetry in E- and H-planes. In that way all the planes could be simulated and they are plotted in Fig. 9.

The simulation results from both methods seem to agree with each other and the 45° plane is the only one that satisfies both class 2 and class 3 ETSI requirements. Therefore, the antenna should be mounted in such a way that the 45° plane is in the horizontal plane.

Finally, the directivity of the antenna has been obtained by two methods: 1) simulation in both softwares; 2) calculation by subtracting its sub-efficiencies from the theoretical maximum directivity. The results over the E-band are plotted in Fig. 10, and they differ with up to 1dB.

The total aperture efficiency is calculated by:

$$e_{ap} = e_{sp}e_{ill}e_{\phi}e_b e_{pol} \quad (14)$$

where, $e_{sp} = 0.987$, $e_{ill} = 0.74$, $e_{\phi} = 0.953$, $e_b = 0.866$ and $e_{pol} = 1$ for the center frequency and it is found to be $e_{ap} = 0.6$.

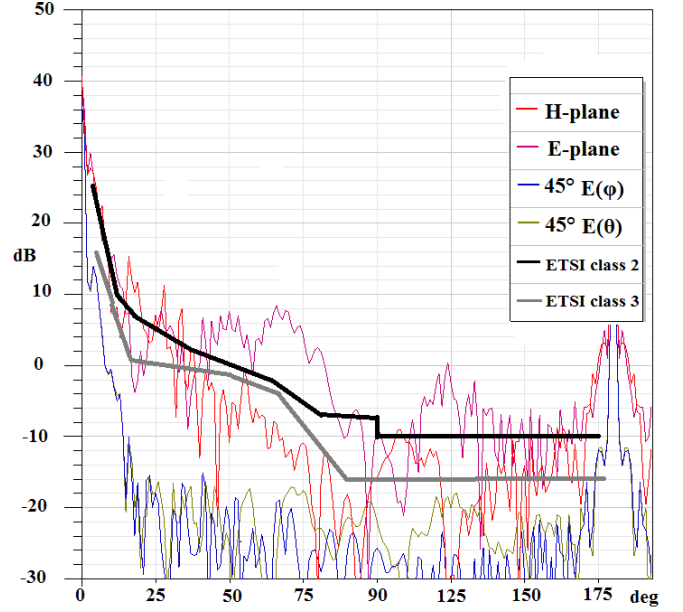

Fig. 9. Simulated E, H and 45°-plane of cylindrical reflector for $f = 78.5$ GHz

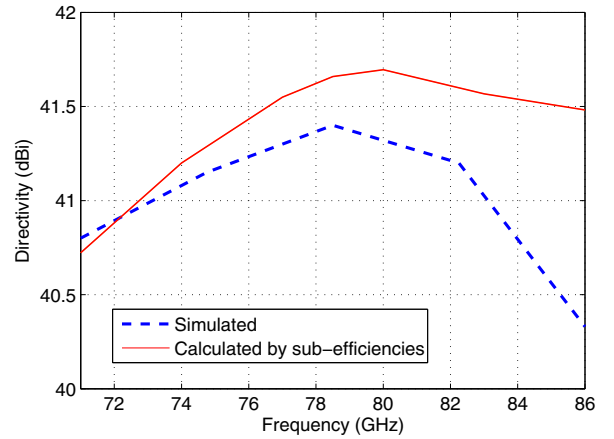

Fig. 10. Directivity over the E-band obtained by two methods: 1) simulation; 2) $D = D_{max} - e_{sp} - e_{\phi} - e_b - e_{ill}$, where e_{sp} is the spillover loss, e_{ϕ} the phase loss, e_b the blockage loss and e_{ill} the illumination loss.

Apart from the blockage efficiency that is already defined in a previous section the rest of the sub efficiencies are calculated by equations from [20].

VI. CONCLUSION

A new E-band antenna concept has been proposed for wireless backhaul solution to high data rate links. This cylindrical reflector antenna is compact, provides high gain and it is easier and cheaper to manufacture in comparison with circular reflector antennas. Both the directivity and the sidelobe level satisfy the ETSI requirements, thus this antenna has a great potential to be used in the the next generation of mobile networks.

REFERENCES

- [1] V. Dyadyuk, Y. J. Guo, and J. D. Bunton, "Multi-gigabit wireless communication technology in the E-band," in *IEEE Wireless VITAE 2009*, pp. 137–141, 2009.
- [2] ETSI EN 302 217-4-2, "Fixed radio systems; Characteristics and requirements for point-to-point equipment and antennas; Part 4-2: Antennas; Harmonized EN covering the essential requirements of article 3.2 of R&TTE directive," pp. 2 – 35, 2010 - 01.
- [3] M. Gueye, H. Ouslimani, S. Burokur, A. Priou, Y. Letestu, and A. Bayon, "Antenna array for point-to-point communications in E-band frequency range," *IEEE*, pp. 2077 –2079, 2009.
- [4] D. Neculoiu, S. I. Ene, A. A. Muller, and C. Buiculescu, "Electromagnetic modeling and design of 77 GHz antennas in LTCC technology," *2009 IEEE*, pp. 341 – 344, 2009.
- [5] Y. Kimura, K. Fukazawa, and J. Hirokawa, "Low sidelobe single-layer slotted waveguide arrays at 76 GHz band," *IEICE transactions on communications*, vol. 84, no. 9, pp. 2377–2386, 2001.
- [6] F. Schafer, F. Gallee, G. Landrac, and M. Ney, "Optimum reflector shapes for anticollision radar at 76 GHz," *Microwave and Optical technology letters*, vol. Vol. 24, No. 6, pp. 400 – 404, March 20 2000.
- [7] P.-S. Kildal, "The hat-feed: A dual-mode rear-radiating waveguide antenna having low cross polarization," *IEEE Transactions on Antennas and Propagation*, vol. 35, no. 9, pp. 1010–1016, 1987.
- [8] P.-S. Kildal and J. Yang, "FDTD optimizations of the bandwidth of the hat feed for MM-wave reflector antennas," *IEEE Antennas and Propagation Society International Symposium*, vol. 4, pp. 2046–2049, 1998.
- [9] M. Densted, T. Ostling, J. Yang, and P. S. Kildal, "Tripling bandwidth of hat feed by genetic algorithm optimization," in *2007 IEEE Antennas and Propagation Society International Symposium*, pp. 2197–2200, 2007.
- [10] W. Wei, J. Yang, T. Ostling, and T. Schafer, "A new hat feed for reflector antennas realized without dielectrics for reducing manufacturing cost and improving reflection coefficient," *IET Microwaves, Antennas & Propagation*, vol. 5, no. 7, pp. 837–843, July, 2011.
- [11] G. E. Geterud, J. Yang, T. Ostling, and P. Bergmark, "Design and optimization of a compact wideband hat-fed reflector antenna for satellite communications," *IEEE Transactions on Antennas and Propagation*, vol. 61, no. 1, pp. 125–132, Jan. 2013.
- [12] P.-S. Kildal, *Foundations of Antennas - A unified approach for line-of-sight and multipath*. Studentlitteratur, 2000.
- [13] "<http://www.ansys.com>."
- [14] P.-S. Kildal, "Description of G2DMULT moment method algorithm for calculating spectral Green's functions of cylindrical multiconductor structures of arbitrary cross section," in *1999 IEEE Antennas and Propagation Society International Symposium*, vol. 4, pp. 2200–2203, 1999.
- [15] J. Yang, B. Lindmark, and P.-S. Kildal, "Studies of cylindrical base station antennas for future communication systems by using G2DMULT," in *9th COST meeting and workshop on smart antennas, Gothenburg, Sweden, May 2001*, 2001.
- [16] J. Yang and P.-S. Kildal, "Presentation of the spectral electric and magnetic field integral equations used in G2DMULT for analyzing cylindrical structures of multi-material regions," *Microwave Opt. Tech. Lett.*, vol. 34, no. 2, pp. 88 – 93, 20 July 2002.
- [17] J. Yang, J. Carlsson, P.-S. Kildal, and C. Carlsson, "Calculation of self impedance and radiation efficiency of a dipole near a lossy cylinder with arbitrary cross section by using the moment method and a spectrum of two-dimensional solutions," *Microwave Opt. Tech. Lett.*, vol. 32, no. 2, pp. 108 – 112, 20 Jan. 2002.
- [18] J. Yang and P.-S. Kildal, "A fast algorithm for calculating the radiation pattern in the longitudinal plane of antennas with cylindrical structure by applying asymptotic waveform evaluation in a spectrum of two-dimensional solutions," *IEEE Trans. on Antennas Propagat.*, vol. 52, no. 7, pp. 1700–1706, July, 2004.
- [19] J. Yang, U. Caldberg, P.-S. Kildal, and M. Ng, "A fast mode analysis for waveguides of arbitrary cross section with multiple regions by using a spectrum of two-dimensional solutions and asymptotic waveform evaluation," *IEEE Trans. on MTT*, vol. 52, no. 6, pp. 590 – 600, June 2004.
- [20] P.-S. Kildal, "Aperture efficiency and linear phase center of parabolic cylindrical reflector antenna," *IEEE Transactions on Antennas and Propagation*, vol. 32, no. 6, pp. 553–561, June 1984.