

Research report 2011:07

Pressure Sensitive Paints: The Basics & Applications

MOHSEN JAHANMIRI

Division of Fluid Dynamics
Department of Applied Mechanics
CHALMERS UNIVERSITY OF TECHNOLOGY
Göteborg, Sweden, 2011

Pressure Sensitive Paints: The Basics & Applications

MOHSEN JAHANMIRI

© MOHSEN JAHANMIRI, 2011

Research report 2011:07
ISSN 1652-8549

Division of Fluid Dynamics
Department of Applied Mechanics
CHALMERS UNIVERSITY OF TECHNOLOGY
SE-412 96 Göteborg
Sverige
Telephone +46 (0)31 772 1000

Pressure Sensitive Paints: The Basics & Applications

Dept. of Applied Mechanics, Chalmers University of Technology
Göteborg, Sweden

&

Dept. of Mech. and Aerospace Engineering, Shiraz University of Technology
Shiraz, Iran

Abstract

Surface pressure measurement is one of the fundamental measurements in fluid dynamics experiments. Pressure sensitive paint (PSP) is a relatively new tool that has the unique capability of providing a field measurement over the entire surface of a model. This method is based on the attenuation by oxygen of the luminescence emitted by certain excited molecules in the visible or ultraviolet spectrums. The higher the pressure, the higher the partial pressure of the oxygen and the more the intensity emitted by the coating is attenuated. Then all that is needed is to measure the intensity of the emission to find the pressure. Because of its many advantages over the traditional techniques, it has been extensively used in almost all the fluid dynamics flow regimes. The following document describes the basics of PSP and its applications.

Introduction

Traditional measurement techniques for acquiring surface pressure distributions on models have utilized embedded arrays of pressure taps. This requires extensive construction time while producing data with limited spatial resolution. An alternative approach is to use Pressure- Sensitive Paint (PSP) to measure surface pressure. Pressure measurements using PSP (Liu et al., 1997) have been demonstrated in several challenging flow fields such as on the suction surface of an advanced compressor blade (Navarra et la., 2001) and an aircraft wing (Lachendro et al., 1998) in flight. The advantages of PSP include non-intrusive pressure measurements and high spatial resolution when compared to conventional measurement techniques (Innovative Scientific Solutions, Inc.).

In fact, PSP is the first global optical technique that is able to give non-contact, quantitative surface pressure visualization for complex aerodynamic flows and provide tremendous information on flow structures that cannot be easily obtained using conventional pressure sensors.

Since PSP is a non-contact technique, it is particularly suitable to pressure measurements on high-speed rotating blades in rotating machinery where conventional techniques are difficult to use. Both CCD camera and laser scanning systems have been used for PSP measurements on rotating blades in turbine engines and helicopters. Impinging jets were used in some studies as a canonical flow for testing the performance of PSP systems. Flight test is a challenging area where PSP has showed its advantages as a non-contact, optical pressure measurement technique. The pressure distributions on wings and parts of aircrafts have been measured using film-based camera systems in early in-flight experiments and a laser scanning system in recent flight tests.

The working principles of PSP are based on the oxygen quenching of luminescence that was first discovered by Kautsky and Hirsch (1935). The quenching effect of luminescence by oxygen was used to detect small quantities of oxygen in medical applications (Gewehr and Delpy 1993) and analytical chemistry (Lakowicz 1991, 1999) before experimental aerodynamicists realized its utility as an optical sensor for measuring air pressure on a surface. Peterson and Fitzgerald (1980) demonstrated a surface flow visualization technique based on the oxygen quenching of dye fluorescence and revealed the possibility of using oxygen sensors for surface pressure measurements. Pioneering studies of applying oxygen sensors to aerodynamic experiments were initiated independently by scientists at the Central Aero-Hydrodynamic Institute (TsAGI) in Russia

and the University of Washington in collaboration with the Boeing Company and the NASA Ames Research Center in the United States. The conceptual transformation from oxygen concentration measurement to surface pressure measurement was really a critical step for aerodynamic applications of PSP, signifying a paradigm shift from conventional point-based pressure measurement to global pressure mapping (Liu and Sullivan, 2005).

Pervushin and Nevsky (1981) of TsAGI, inspired by the work of Zakharov et al. (1964, 1974) on oxygen measurement, suggested the use of the oxygen quenching phenomenon for pressure measurements in aerodynamic experiments. The first PSP measurements at TsAGI were conducted at Mach 3 on a sphere, a half-cone and a flat plate with an upright block that were coated with a long-lifetime luminescent paint excited by a flash lamp. A photographic film camera was used for imaging the luminescent intensity field. The results obtained in these tests were in reasonable agreement with the known theoretical solution and pressure tap data (Ardasheva et al. 1982, 1985). Interestingly, scientists in the Western World were not aware of Russia's work on PSP until reading the advertisement. Then, TsAGI's PSP system was demonstrated in several wind tunnel tests at the Boeing Company in 1990 and Deutsche Forschungsanstalt für Luft- und Raumfahrt (DLR) in Germany in 1991, which attracted widespread attention of researchers in the aerospace community (Volan and Alati 1991).

Excellent work on PSP was also made at the former McDonnell Douglas (MD, now the Boeing Company at St. Louis) (Morris et al., 1993a, 1993b; Morris, 1995; Morris and Donovan 1994; Donovan et al. 1993; Dowgwillo et al. 1994, 1996; Crites 1993; Crites and Benne 1995). MD PSPs were mainly based on Ruthenium compounds that were successfully used in subsonic, transonic and supersonic flows for a generic wing-body model, a full-span ramp, F-15 model, and a converging-diverging nozzle. Other major PSP research groups in the United States include NASA Langley, NASA Glenn, Arnold Engineering Development Center (AEDC), United States Air Force Wright-Patterson Laboratory, Purdue University, and University of Florida. European researchers in DLR (Germany), British Aerospace (BAe, UK), British Defense Evaluation and Research Agency (DERA, UK), and Office National d'Etudes et de Recherches Aérospatiales (ONERA, France) have been active in the field of PSP (Engler et al. 1991, 1992; Engler and Klein 1997a, 1997b; Engler 1995; Davies et al. 1995; Lyonnet et al. 1997). In Japan, the National Aerospace Laboratory (NAL), in collaboration with Purdue and a number of Japanese universities, developed cryogenic and fastresponding PSPs (Asai 1999; Asai et al. 2001, 2003). More and more research institutions all over the world are becoming interested in developing PSP technology because of its obvious advantages over conventional techniques. Brown (2000) gave a historical review with personal notes and recollections from some pioneers on early PSP development.

PSP have become an active and growing interdisciplinary research area, offering the promise of quantitative pressure mapping on the one hand and giving new technical challenges on the other hand. Useful reviews were given by Crites (1993), McLachlan and Bell (1995), Crites and Benne (1995), Liu et al. (1997), Mosharov et al. (1997), Bell et al. (2001), and Sullivan (2001).

It is aim of this report to emphasize the importance of this technique by explaining its basic concepts, operation and reviewing worldwide applications in many engineering research areas.

It is worth to mention here that, the PSP technique can be applied in two different approaches, the intensity based and the decay based method (Mantel, 2005). The intensity based method is generally applied with satisfying performance. The decay based method is used less commonly, both speed and accuracy are considered insufficient for commercial wind tunnel use. Briefly, the difference of these two methods is explained: After illumination the paint loses part of its energy to the surrounding air and part by photon emission, which is called luminescence. The decay process is

affected by the level of oxygen in the surroundings, which makes it sensitive to the local air pressure. Both the total emitted light and the time it takes to fade can be measured and used as the principle information for the determination of the pressure (Engler et al., 2000). Correspondingly intensity and decay based system are used.

Basic Physics and Principle of Operation

Pressure Sensitive Paint, or PSP, is essentially a luminescent dye dispersed in an oxygen permeable binder. The dye is excited by absorbing light, usually from the blue or UV portion of the spectrum, and it then returns to its ground state by emitting light, usually in the red portion of the spectrum. There is an alternate process in which the dye can return to its ground state without emitting light by interacting with an oxygen molecule. This process is known as oxygen quenching (Figure 1). Thus, as the pressure of the oxygen above the PSP increases, the oxygen concentration within the binder will increase, and the intensity of the emitted radiation will decrease (Jackson, 1999).

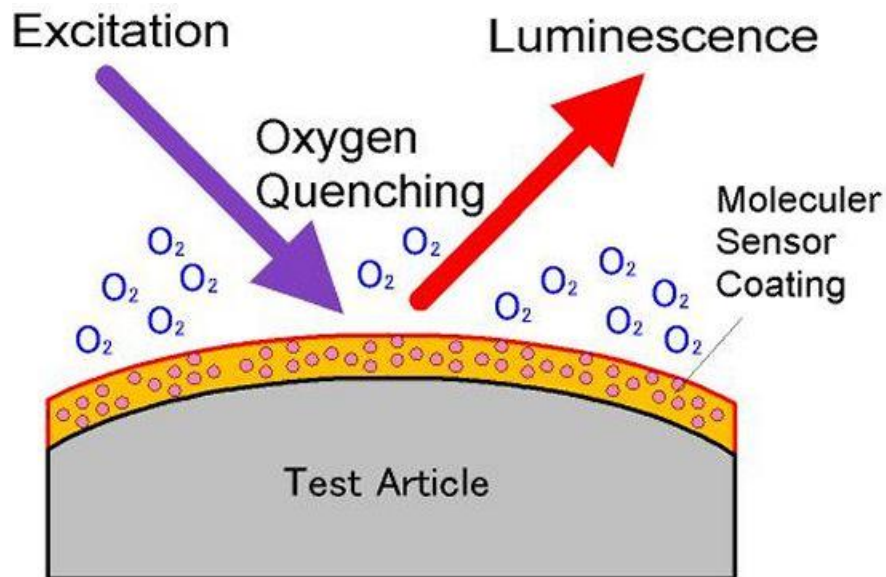

Figure 1: Overview of PSP, its excitation and luminescence.

Photon Excitation:

In its simplest terms, the PSP method is based on the sensitivity of some luminescent dye to molecular oxygen. After absorbing a photon, a luminescent molecule is placed in an excited state. The molecule then returns to its ground state by emitting a new photon at a longer wavelength, as illustrated below (Figure 2).

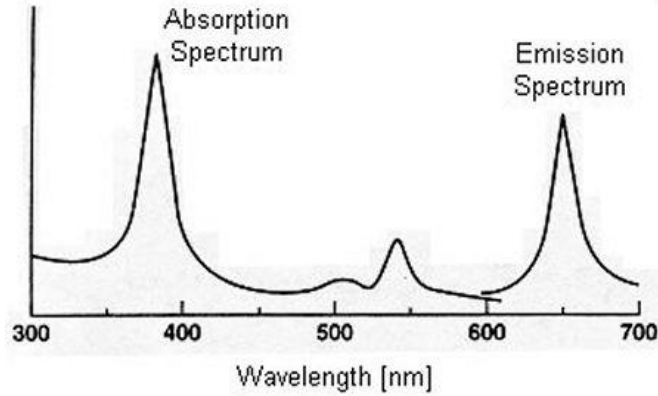

Figure 2: Typical PSP absorption and emission spectra [from McLachlan and Bell, 1995].

For some luminescent molecules, however, oxygen quenching allows the molecule to return to a ground state without emitting a photon. Hence, for a given level of excitation, the emitted light intensity from the luminescent molecules varies inversely with the local oxygen partial pressure. Since the mole fraction of oxygen in air is fixed, the oxygen partial pressure is easily converted into the air pressure.

Oxygen Quenching:

The oxygen quenching process can be mathematically described by the Stern-Volmer relation:

$$\frac{I_{\max}}{I} = 1 + Kc$$

where, for PSP, I is the intensity of the luminescence, I_{\max} is the maximum intensity in the absence of oxygen, K is the Stern-Volmer quenching constant that is characteristic of the luminescent molecule, and c is the concentration of oxygen (O_2). Both the I_{\max} and K values are dependent on temperature. Since the luminescent molecules of PSP are suspended in an oxygen permeable binder, Henry's law is needed to relate the oxygen concentration within the binder to that on the PSP surface:

$$c = SXP$$

In this equation, S is the Henry's law coefficient (which is dependent on temperature), X is the mole fraction of oxygen in air, and P is the air pressure. By substituting the second relation into the first, the Stern-Volmer relation can be rewritten as:

$$\frac{I_{\max}}{I} = 1 + KSXP$$

At this point, the relationship between the air pressure and the luminescence intensity is quite clear. As the pressure P increases, the luminescence intensity I must decrease. Unfortunately, this form of the Stern-Volmer equation is not very useful for an experimental setup, since it is usually not practical to obtain the maximum luminescence intensity in the absence of oxygen. A more suitable form of the above equation can be derived by taking the ratio of intensities for two different flow conditions:

$$\frac{I_0}{I} = A(T) + B(T) \frac{P_0}{P}$$

In this equation, the zero subscripts denote a "no-flow" condition, where the pressure is constant over the entire surface. The coefficients A and B are coating sensitivities (which are temperature dependent) that are determined by an experimental calibration.

An interesting aspect that arises out of this equation is that the relative intensity is linearly related to the relative pressure. This relationship arises because of the assumption in Henry's law that the concentration of oxygen in the binder is linearly dependent on the pressure over the surface. For most coatings and experimental conditions, the linear assumption is accurate enough. However, for some coatings and conditions, the relationship between the oxygen concentration and the pressure is nonlinear, resulting in a nonlinear relationship between the relative intensities and relative pressures.

In these cases, a more general form of Henry's law is needed where S is no longer a function of only the temperature, but pressure as well. When this more general form is used, the coefficients A and B also become functions of both temperature and pressure. As might be expected, this dependency on temperature and pressure is not desirable. Hence, in this situation it is usual to write the coefficient S as a polynomial expansion in pressure, in which the expansion coefficients are only functions of temperature. This manipulation gives a more manageable form of the Stern-Volmer equation:

$$\frac{I_0}{I} = A(T) + B(T) \left(\frac{P}{P_0} \right) + C(T) \left(\frac{P}{P_0} \right)^2 + \dots$$

For most cases, the second order approximation shown is adequate enough to describe the behavior of "nonlinear" coatings.

Application to Testing:

Both of the above relationships are practical equations for use in aerodynamic testing. To use these equations, it is readily obvious that intensity measurements must be taken for flow on and flow off conditions. Since the pressure in the flow off condition is known (P_0) and the intensities I and I_0 are measured, the pressure P is easily determined from the proper equation. Taking the ratio of the equations that produces these relations has an added benefit besides that of eliminating the need to determine I_{max} . By taking the ratio of the intensities, the effects of non-uniform illumination and PSP distribution are effectively factored out. This benefit is only valid, however, when the assumption is made that the geometry of the experimental setup and the illumination source remains constant between the measurement of I and I_0 . Another assumption that needs to be made in the derivation of these equations is that the intensity of the excitation illumination is low enough so that the majority of the luminescent molecules are in their ground state. If the excitation illumination intensity is too high, then a majority of the molecules will be in their excited state, and the coefficients A and B would become functions the illumination intensity as well. A final important note that needs to be made about these equations is that their form will not change if I and I_0 are acquired at different temperatures. As long as the flow off temperature is a known constant that is uniform over the entire surface, then its effect on the equation is nothing more than a multiplicative constant that can be incorporated into the coefficients A, B, and C (Jackson, 1999).

Measurement System

A measurement system for PSP is generally composed of paint, illumination light, photodetector, and data acquisition/processing unit. Figure 3 shows a generic CCD camera system for PSP (Liu and Sullivan, 2005). Many light sources are available for illuminating PSP, including lasers, ultraviolet (UV) lamps, xenon lamps, and light-emitting-diode (LED) arrays. Scientific-grade chargecoupled device (CCD) cameras are often used as detectors because of their good linear response, high dynamic range and low noise. Other commonly-used photodetectors are photomultiplier tubes

(PMT) and photodiodes (PD). A generic laser-scanning system, as shown in Figure 4 (Liu and Sullivan, 2005), typically uses a laser with a computer-controlled scanning mirror as an illumination source and a PMT as a detector along with a lock-in amplifier for both intensity and phase measurements. Optical filters are used in both systems to separate the luminescent emission from the excitation light.

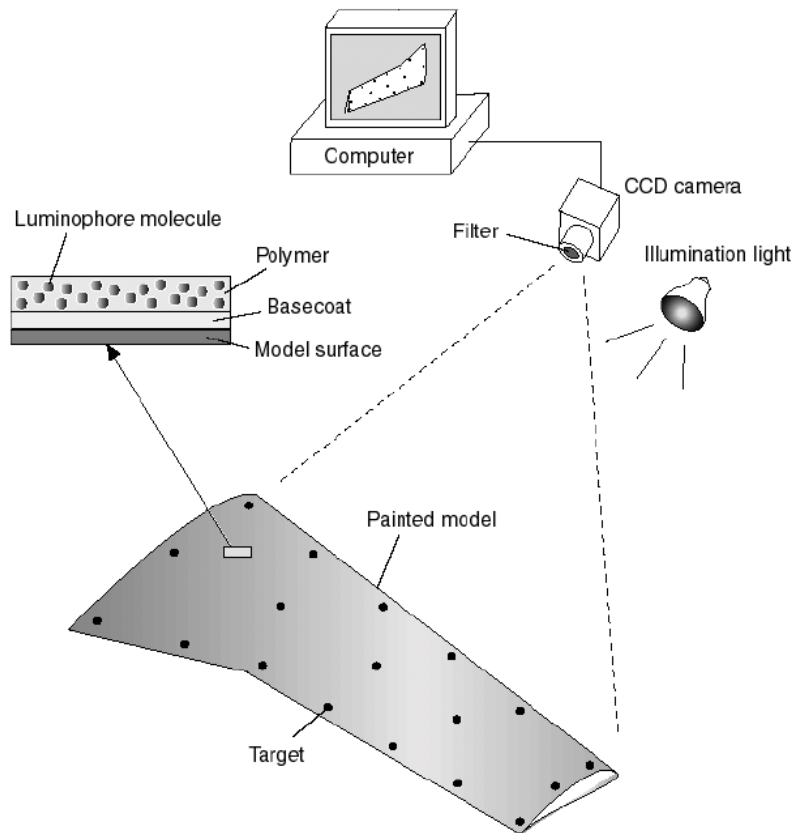

Figure 3: Generic CCD camera system for PSP.

Once PSP is calibrated, in principle, pressure can be directly calculated from the luminescent intensity using the Stern-Volmer relation. Nevertheless, practical data processing is more elaborate in order to suppress the error sources and improve the measurement accuracy of PSP. For an intensity-based CCD camera system, the wind-on image often does not align with the wind-off reference image due to aeroelastic deformation of a model in wind tunnel testing. Therefore, the image registration technique must be used to re-align the wind-on image to the wind-off image before taking a ratio between those images. Also, since the Stern-Volmer coefficients A and B are temperature-dependent, temperature correction is certainly required since the temperature effect of PSP is the most dominant error source in PSP measurements. In wind tunnel testing, the temperature effect of PSP is to a great extent compensated by the in-situ calibration procedure that directly correlates the luminescent intensity to pressure tap data obtained at well distributed locations on a model during tests. To further reduce the measurement uncertainty, additional data processing procedures are applied, including image summation, dark-current correction, flat-field correction, illumination compensation, and self-illumination correction. After a pressure image is obtained, to make pressure data more useful to aircraft design engineers, data in the image plane should be mapped onto a model surface grid in the 3D object space. Therefore, geometric camera

calibration and image resection are necessary to establish the relationship between the image plane and the 3D object space.

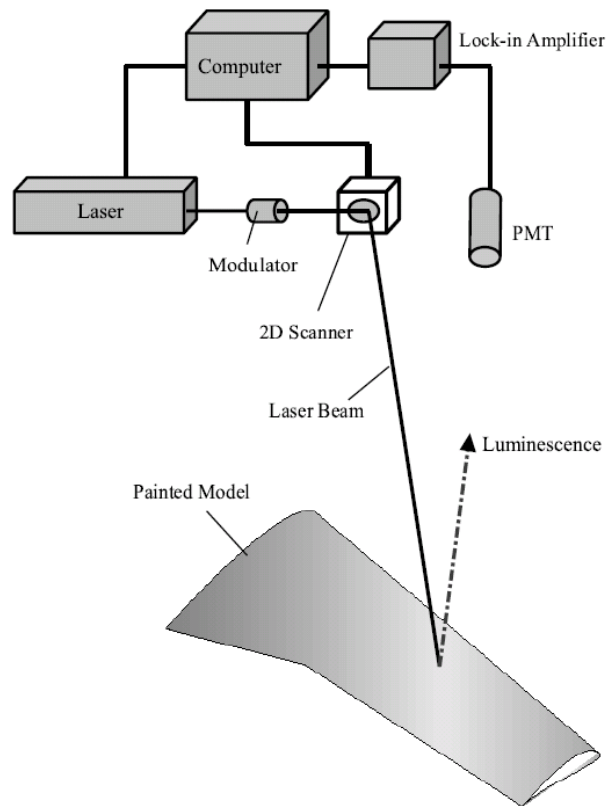

Figure 4: Generic laser scanning lifetime system for PSP.

Since PSP is a non-contact technique, it is particularly suitable to pressure measurements on high-speed rotating blades in rotating machinery where conventional techniques are difficult to use. Both CCD camera and laser scanning systems have been used for PSP measurements on rotating blades in turbine engines and helicopters. Impinging jets were used in some studies as a canonical flow for testing the performance of PSP systems. Flight test is a challenging area where PSP has showed its advantages as a non-contact, optical pressure measurement technique. The pressure distributions on wings and parts of aircrafts have been measured using film-based camera systems in early in-flight experiments and a laser scanning system in recent flight tests.

Measurement Considerations

Calibration of PSP

The functional relationship between luminescent intensity from a paint and the pressure and temperature experienced is determined using the PSP calibration chamber (Figure 5). A small aluminum coupon is painted with the PSP to be calibrated and this coupon is mounted onto a Peltier thermo-electric cooler and mounted inside the calibration chamber. The pressure inside the calibration chamber is controlled using a Ruska pressure controller while the temperature of the sample is controlled using an Omega temperature controller. The sample is illuminated using an ISSI LM-2 Lamp, this lamp uses an array of 76 LEDs to produce excitation at $405 \pm 10 \text{ nm}$. The luminescence from the sample is collected through a long-pass filter onto a PCO Series 1600 CCD camera. The calibration is begun by recording the luminescence of the sample at 298°K and 14.696 psia , this serves as the reference condition. The temperature and pressure within the

chamber are then varied over a range of temperatures and pressures. The luminescence from the sample is recorded at each condition and the ratio $I(T_{ref}, P_{ref})$ over $I(T, P)$ is computed and plotted versus pressure (where I is luminescent intensity of the paint). Calibrations for a PSP formulation is shown in Figure 6. A quick description of paint formulation is included (Innovative Scientific Solutions, Inc.).

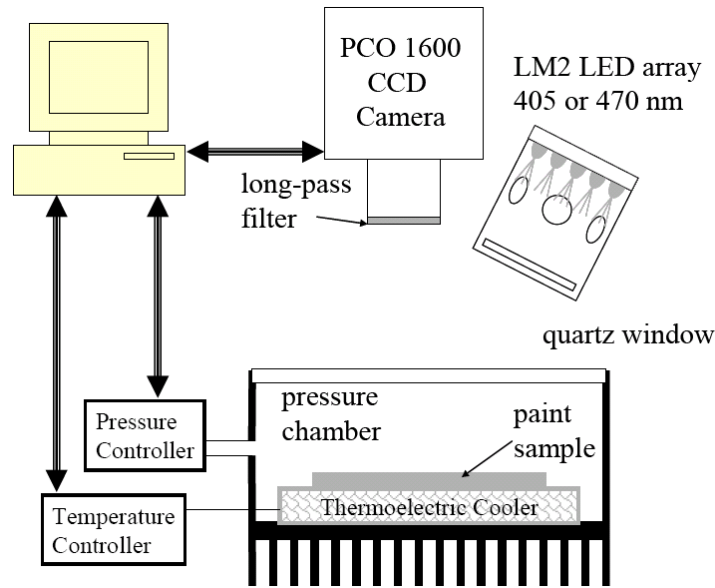

Figure 5: Pressure-Sensitive Paint calibration system.

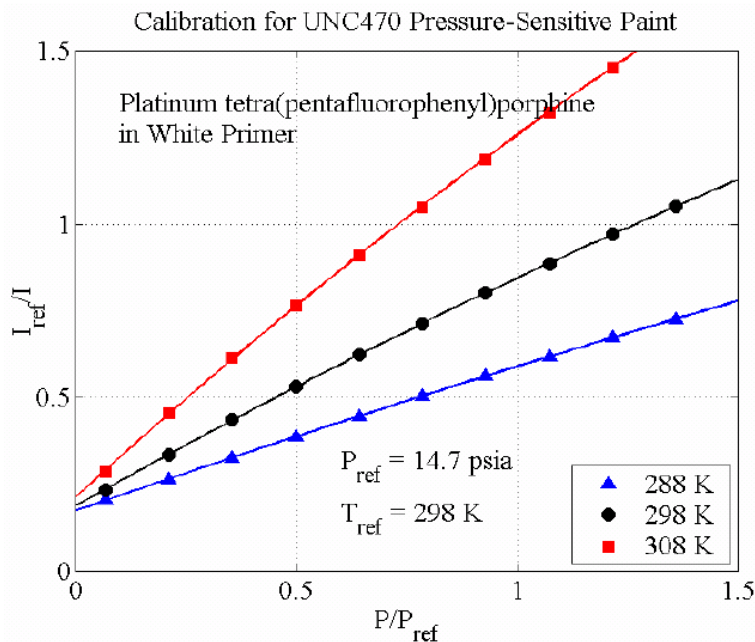

Figure 6: ISSI Unicoat. Simple application and storage (shipped in a spray paint can) and long shelf life. Exhibits good pressure sensitivity (4% per psi) but is also very sensitive to temperature (2% per K) Recommended for entry level PSP studies.

Temperature Correction

The temperature dependence of luminescent coatings which measure surface pressure is a well established problem. Temperature correction of the surface pressure measurement is often carried out by incorporating a second luminescent coating or by co-immobilizing a second luminophore to provide a surface temperature profile. This usually complicates the measurement process by requiring a second camera or sophisticated filtering to distinguish between the two luminescent processes.

Hradil et al., (2002) developed a single-camera, temperature-corrected PSP system. Here, a new oxygen-permeable sol-gel-based paint, containing both a temperature- and a pressure-sensitive luminophore is introduced. The low-cost, porous, sol-gel paint can be easily applied over a large area. The fluorescence decay times of the two luminophores are separated by several orders of magnitude. This allows pressure- and temperature-dependent luminescent decay measurements to be separated in the time domain. In addition, the two luminophores were selected such that their absorption and emission spectra occur in similar spectral regions. This avoids the need for different excitation sources or detection filters. Hence a single camera with a gated image intensifier can be used to measure the lifetime of each luminophore within the same cycle. Image alignment issues experienced in dual-camera systems are also avoided.

This new PSP has the potential to provide a temperature-corrected surface pressure profile using a single excitation source and detection system.

Excitation Illumination Variation:

PSP simply consists of a luminescent molecule suspended in some type of oxygen permeable binder (see Figure 7). Currently, the majority of these binders are some form of silicone polymer. The vast majority of PSP formulations to date come in a liquid form that is suitable for use with normal spray-painting equipment and methods.

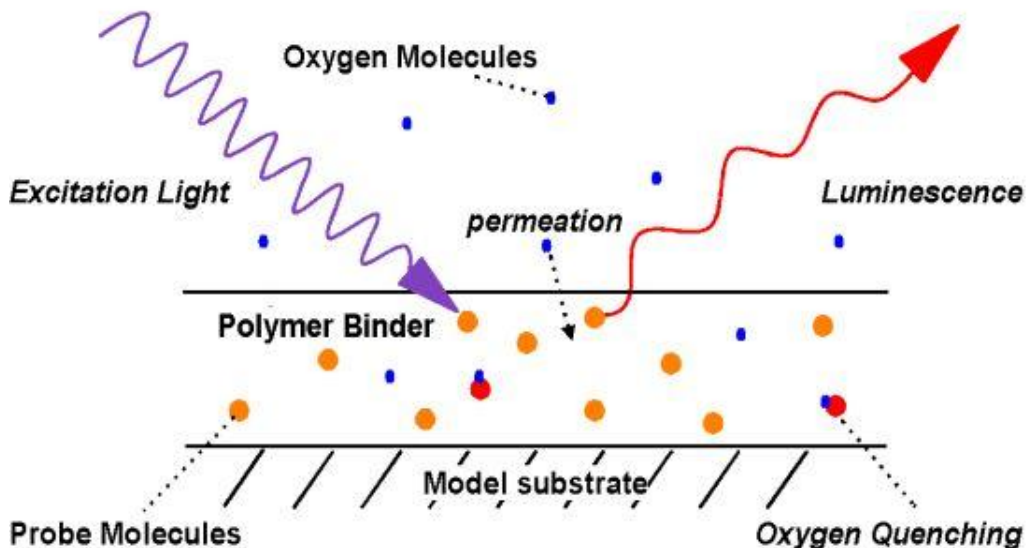

Figure 7: PSP excitation and luminescence

Regardless of the choice of illumination element, changes in the element's output over time are always a possibility. Even when the element itself is stable over time, it is possible that movement and deformation of the model can create an unstable excitation illumination. A common method used to account for variation in the excitation illumination is to use luminescent molecules that are insensitive to both temperature and pressure measurements. These molecules are either applied as a separate coating on a different area of the model, or blended with the PSP, but emitting in a different wavelength than the PSP molecules. These "insensitive" molecules can then be used as a reference between the wind-on and wind-off conditions, allowing the proper corrections to be made.

Mapping of the Data:

When the data is acquired for analysis and reduction, problems arise from the fact that the images are two-dimensional, while the actual model is three-dimensional. Other problems are created by lens distortion, perspective effects, and model curvature (some of which are related to the three-dimensionality of the model). All of these problems must be considered in order to correctly relate any point on the two-dimensional image to the three-dimensional model. Fortunately, this problem is very common in photogrammetry, and there are many sophisticated mathematic methods available to deal with these errors.

Intrusiveness:

One of the advantages of PSP is that it is essentially a non-intrusive measurement. Unfortunately, the application of PSP to a model surface can alter the aerodynamic characteristics of the model. These alterations can have both viscous and inviscid effects. In the viscous regime, roughness and unevenness of the PSP coating can easily effect transition of the flow over the surface. In the inviscid regime, the thickness of the PSP coating may alter the model's geometry which would result in less accurate results. This issue should be taken into account while measurements.

Image and Data Analysis Techniques

For quantitative PSP measurements, cameras should be geometrically calibrated to establish the accurate relationship between the image plane and the 3D object space and map data in images onto a surface grid in the object space. Since PSP is based on radiometric measurements, an ideal camera should have a linear response to the luminescent radiance. For a camera having a non-linear response, radiometric camera calibration is required to determine the radiometric response function of the camera for correcting the image intensity before taking a ratio between the wind-on and wind-off images. The self-illumination of PSP may cause a significant error near a juncture of surfaces when a strong exchange of the radiative energy occurs between neighboring surfaces. The numerical methods for correcting the self-illumination are generally proposed and the errors associated with the self-illumination are estimated. The self-illumination correction is usually made on a surface grid in the object space since it highly depends on the surface geometry. A standard procedure in the intensity-based method for PSP is to take a ratio between the wind-on and wind-off images to eliminate the effects of non-homogenous illumination intensity, dye concentration, and paint thickness. However, since a model deforms due to aerodynamic loads, the wind-on image does not align with the wind-off image. A crucial step for PSP is to accurately convert the luminescent intensity to pressure; cautious use of the calibration relations with a correction of the temperature effect of PSP to be considered. PSP measurements in low-speed flows are particularly difficult since a very small pressure change has to be sufficiently resolved by PSP. The pressure-correction method

is used as an alternative to extrapolate the incompressible pressure coefficient from PSP measurements at suitably higher Mach numbers by removing the compressibility effect. The final processing step for PSP is to map results in images onto a model surface grid in the object space. When a model has a large deformation produced by aerodynamic loads, a deformed surface grid should be generated for more accurate PSP mapping (for detail discussion, see Liu and Sullivan, 2005).

The data acquisition and post processing in most PSP applications is done in a modular fashion. Initially the camera and computer acquire images for wind-on and wind-off conditions. These images can then be corrected and processed as necessary, either on the same or different machine. This modular approach provides a benefit in that the processing for small-scale tests can easily be done with common software running on PCs. In larger-scale facilities, however, much more computing power is needed, as runs can easily produce large amounts of data that need to be processed. This leads to the requirement of high power graphics workstations and high capacity storage facilities. It is also important to note that in the false color is typically added to the images in the post-processing phase in order to facilitate flow visualization (PSP is monochromatic).

The most basic processing procedure in the intensity-based method for PSP and TSP (temperature sensitive paint) is taking a ratio between the wind-on image and the wind-off reference image to correct the effects of non-homogenous illumination, uneven paint thickness and non-uniform luminophore concentration (see Liu and Sullivan, 2005). However, this ratioing procedure is complicated by model deformation induced by aerodynamic loads, which results in misalignment between the wind-on and wind-off images. Therefore, additional correction procedures are required to eliminate (or reduce) the error sources associated with model deformation, the temperature effect of PSP, self-illumination, and camera noises (dark current and fixed pattern noise).

Figure 8 (Liu and Sullivan, 2005) shows a generic data processing flowchart for intensity-based measurements of PSP and TSP with a CCD camera. A laser scanning system has similar data processing procedures for intensity-based measurements. The wind-on and wind-off images are acquired using a CCD camera. Usually, a sequence of acquired images is averaged to reduce the random noise like the photon shot noise. The dark current image and ambient lighting image are subtracted from data images to eliminate the dark current noise of the CCD camera and the contribution from the ambient light. The dark current image is usually acquired when the camera shutter is closed. In a wind tunnel environment, there is always weak ambient light that may cause a bias error in data images. The ambient lighting image is acquired when the shutter is open while all controllable light sources are turned off. The integration time for the dark current image and ambient lighting image should be the same as that for data images. The data images are then divided by the flat-field image to correct the fixed pattern noise. At a very high signal level, this correction is necessary since the fixed pattern noise may surpass the photon shot noise. Ideally, the flat-field image is acquired from a uniformly illuminated scene. A simple but less accurate approach is use of several diffuse scattering glasses mounted in the front of the lens of the camera to generate an approximately uniform illumination field. When a uniform illumination field cannot be achieved, a more complex noise-model-based approach can be used to obtain the fixed pattern noise field for a CCD camera (Healey and Kondepudy 1994). Normally, a scientific grade CCD camera has a good linear response of the camera output to the incident irradiance of light. However, conventional CCD video cameras often exhibit a non-linear response to the incident light intensity; in this case, a video camera should be radiometrically calibrated to correct the non-linearity.

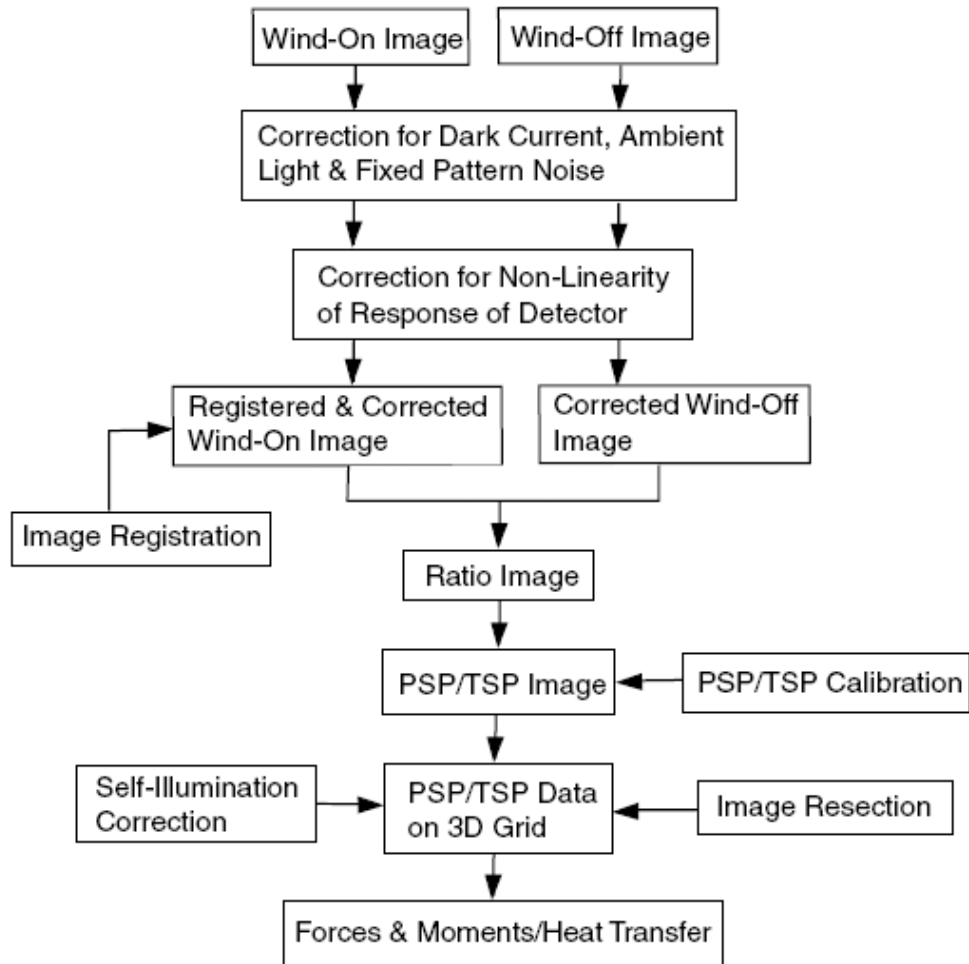

Figure 8: Generic data processing flowchart for intensity-based PSP and TSP measurements.

Application Examples

There are numerous application fields where PSP is a reasonable candidate for pressure measurements. Here are some examples:

1.High-Speed and Unsteady Aerodynamics

Gregory et al. (2008) in their paper describe the development of pressure-sensitive paint technology as an advanced measurement technique for unsteady flow fields and short-duration wind tunnels. These include experiments with shock tubes, hypersonic tunnels, unsteady delta wing aerodynamics, fluidic oscillator flows, Hartmann tube oscillations, acoustics, and turbomachinery. They pointed out that, conventional paint formulations have been limited to step response times on the order of seconds, whereas the development of porous PSP formulations has enabled step responses approaching $1\mu\text{s}$. The time response of PSP is governed by gas diffusion within the paint layer, such that the thickness of the paint and the diffusivity of the binder determine the paint response. PSP binders such as anodized aluminium, thin-layer chromatography (TLC) plate, and polymer/ceramic all have highly porous structures with large surface area, thus enabling rapid response times. Polymer binders with very high gas permeability, such as poly[1-(trimethylsilyl)-1-

propyne, abbreviated here as TMSP], have also been developed. Dynamic calibration techniques such as shock tubes, solenoid valves, loudspeakers, or fluidic oscillators have been used to characterize the frequency response limitations of the new paint formulations. Modelling work has also been done to determine the optimum thickness of PSP, to develop dynamic compensators, to describe the complex diffusion phenomena in porous binders, and to investigate non-linear quenching behaviour in paint binders. Upon development of paint formulations with rapid response times, PSP has been applied to various high-speed facilities such as shock tubes, Ludweig tubes, and short-duration hypersonic flow (Figure 9). Porous PSP formulations have also been applied to many unsteady flow-fields such as unsteady shock/vortex interaction on a delta wing model, oscillating shocks, and propagating acoustic waves from a Hartmann tube, oscillating jets from fluidic oscillators, resonant acoustics, oscillating airfoils, and unsteady flow in turbomachinery (Figure 10). The highest fundamental frequencies tested in these various experiments range up to 21kHz, whereas the pressures tested were as low as ~ 100 Pa in acoustics testing.

Significant strides have been made in the development of PSP for unsteady measurements, yet a substantial amount of work remains to further develop the technology. Future work should focus on increasing the brightness of the luminescence emitted by the paint formulation. This will enhance the SNR (signal-to-noise ratio) and facilitate real-time detection of pressure fluctuations. Further development of low-noise sensors will also improve the SNR of real-time PSP measurements. Another area for improvement involves the sensitivity of PSP. This development will allow for enhanced measurement of acoustic-level pressures, and lower the minimum-detectable level. Temperature sensitivity remains a problem for porous PSP formulations, and may be addressed through the development of bi-luminophore paint formulations suitable for unsteady measurements. Finally, a robust dynamic calibration technique must be developed. Ideally this would involve a flow-field large enough to cover a region of the PSP as well as a co-located unsteady pressure transducer. The calibration device will provide unsteady pressure fluctuations that will fully exercise the frequency response characteristics of the fastest paint formulations, and provide a pressure jump in both the negative and positive-going directions.

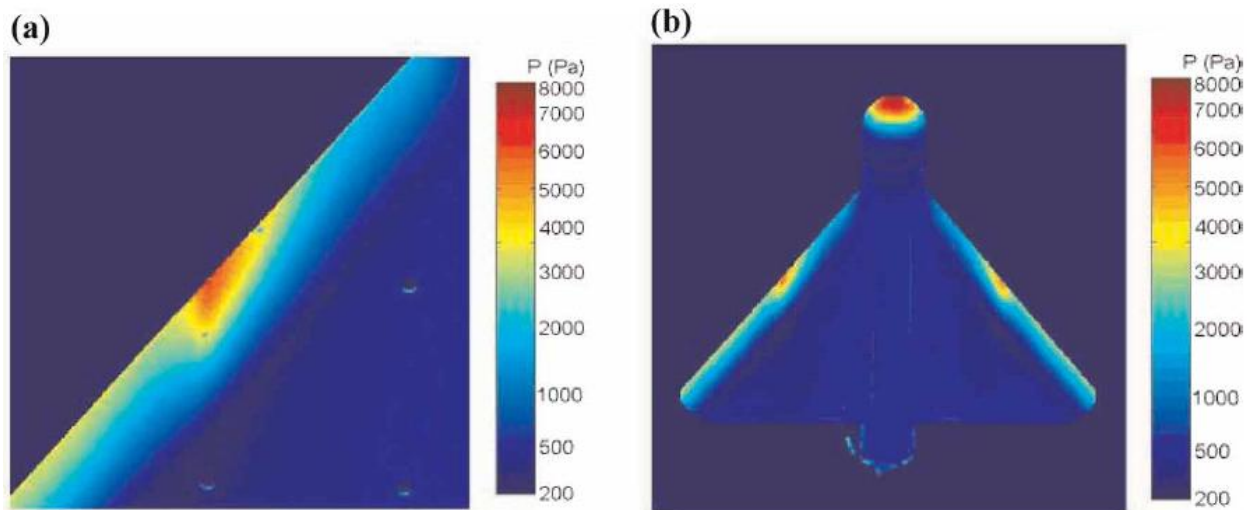

Figure 9: PSP images and pressure distribution on the wing body model at Mach 10 and an angle of attack of zero degree. (a) full view, (b) close-up view of the interaction region.

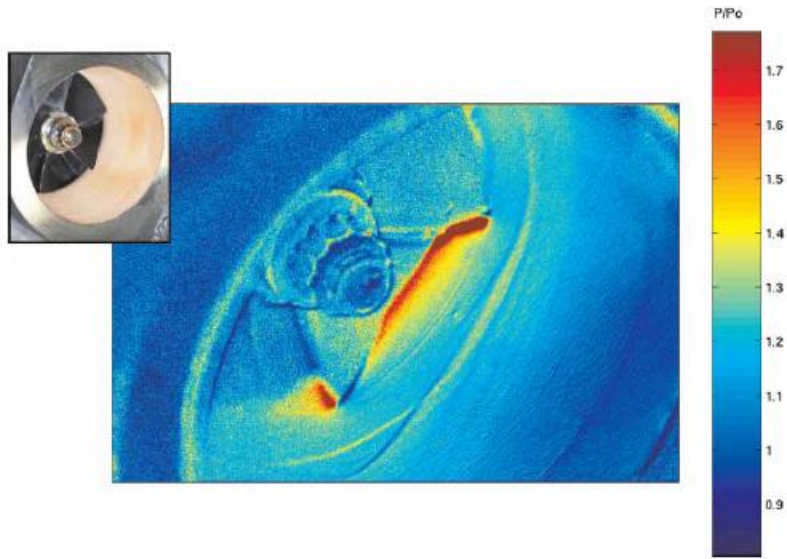

Figure 10: Unsteady wall pressure about compressor blades, normalized with respect to inlet total pressure (Gregory, 2004).

Another research work conducted in supersonic flow is by Saito et al., (2007). Using Pressure Sensitive Paint, the pressure distributions on thin wings of the Busemann biplane model were measured in the small supersonic indraft wind tunnel. Their results show that, A complicated pressure distribution was captured using PSP for a thin airfoil of Busemann biplane (Figure 11). The observed phenomenon is different from the simple theory. Comparing PSP data with Schlieren picture and CFD, it is found that a complex pressure field on the model was caused by a shock wave generated behind the ridge line.

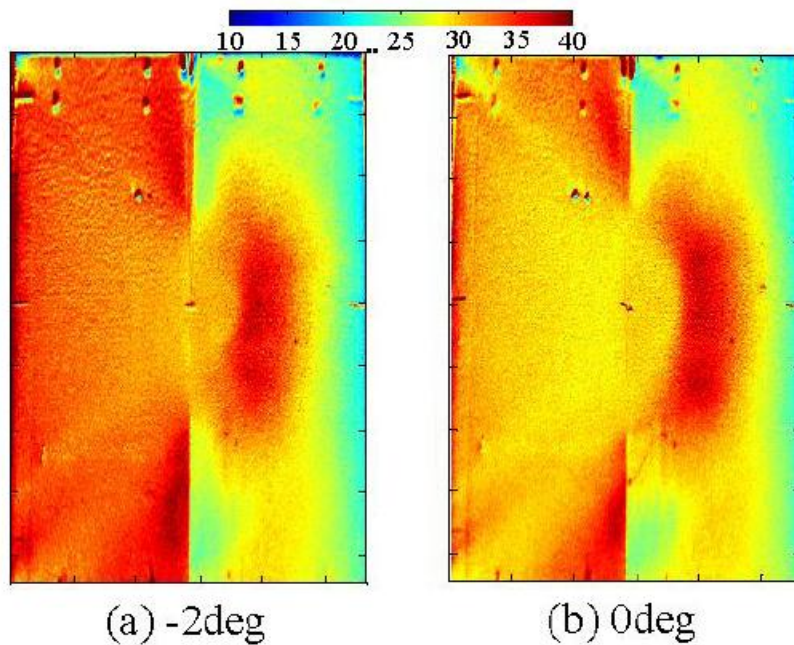

Figure 11: PSP images for angle of attack of -2 and 0 degree, biplane configuration. The flow runs from left to right.

Raju et al., (2006) carried out a set of experiments, documenting the pressure field on the lee-side of a delta-wing at three incidence angles (5° , 10° , and 15°) and at Mach 1.8 using a PSP (Pressure Sensitive Paint) technique. The measurements were made using the well known Optrod-B1 binary pressure sensitive paint. The model was instrumented with 31 static pressure ports along the model span for comparison with PSP results. Resection methodology was utilized for processing the PSP images. The overall agreement of the PSP results with the pressure port data may be considered very good (see Figure 12). Also, the PSP technique has captured all the essential features of the vortex flow including flow asymmetry at higher α .

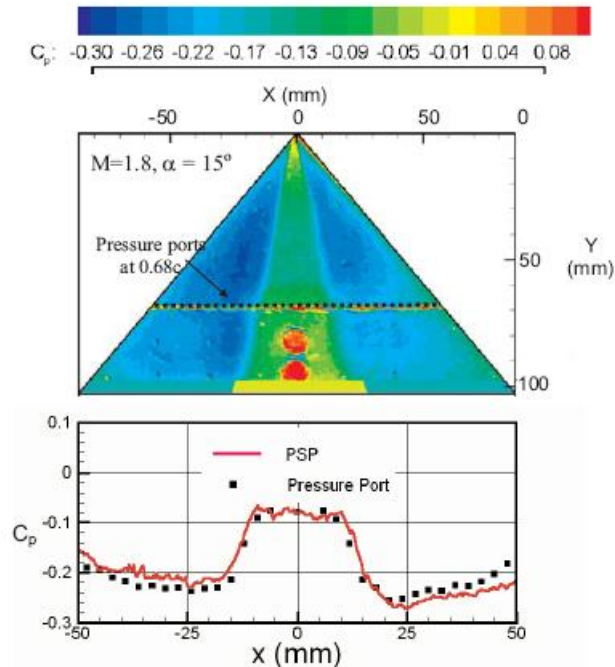

Figure 12: Typical results on the delta-wing model showing comparison between PSP and pressure port data.

2. PSP at Large Wind Tunnel

Japan Aerospace Exploration Agency (JAXA) has constructed the JAXA practical pressure-sensitive paint (PSP) measurement system for their large industrial wind tunnels (Nakakita et al., 2004 & 2006). Its main targets are the 2m×2m transonic wind tunnel (TWT1) and the 1m×1m supersonic wind tunnel (SWT1). Extension to a low-speed application is also under development (Mitsuo et al., 2004). The final goal of the JAXA PSP measurement system is to achieve an industrial pressure measurement test using a force model without a pressure model. JAXA's standard PSP consists of platinum(II) mesotetra(pentafluorophenyl) porphine (PtTFPP) as a probe molecule and poly(isobutylmethacrylate-co-trifluoroethylmethacrylate) (poly(IBM-co-TFEM)) as an oxygen permeable polymer, and those of temperature sensitive paint are dichlorotris(1,10-phenanthroline)- ruthenium(II) hydrate (Ru(phen)) as a probe molecule and polyurethane.

Figure 13 is the PSP measurement set-up at TWT1. There are three sets of CCD camera and illumination. They correspond to an upper measurement system and a side one. The side measurement system consists of both left and right systems. Because a test model is painted using PSP and TSP symmetrically, the upper system can measure both PSP and TSP sides at the same time;

however, the side system needs two sets of CCD camera and illumination to measure the PSP side and the TSP one at the same time.

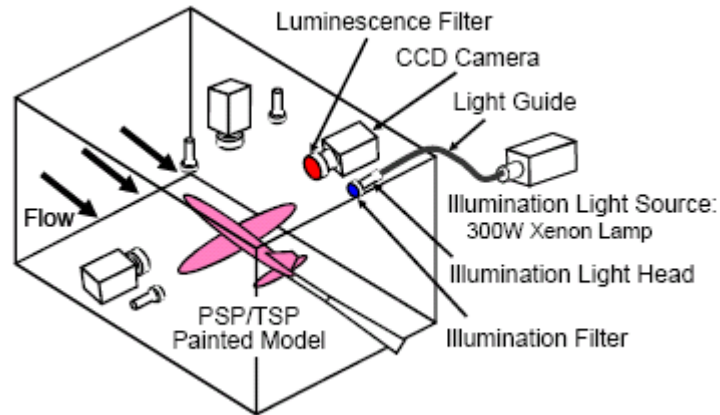

Figure 13: Components of the JAXA practical PSP measurement system.

Through the PSP validation experiment using the ONERA M5 standard model at TWT1 (Figure 14), it was confirmed that the JAXA productive PSP measurement system could give global and detailed quantitative pressure distribution and its accuracy was 1.9kPa as 2σ . Pressure distribution measurements for more than 200 cases were conducted and supplied to aircraft design. Its accuracy of 2σ was $C_p=0.06$ at a reference dynamic pressure of cruising condition. It was proved that the present PSP system could be applied to practical tests at a large industrial transonic wind tunnel and PSP has great potential to become a powerful and useful tool for research and development of aerodynamics, structural analysis, CFD code validation and so on.

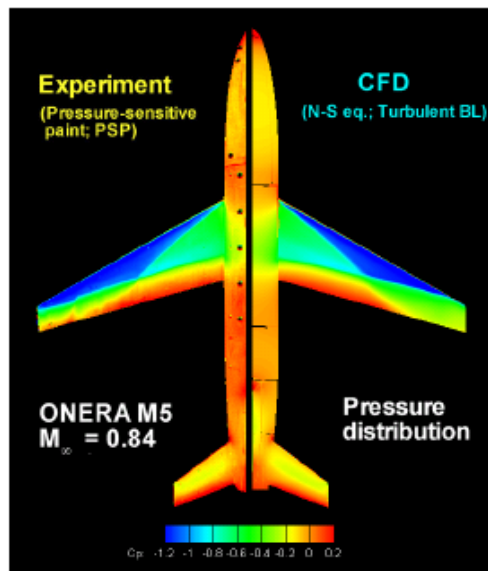

Figure 14: PSP and CFD Comparison ($M=0.84$, $\alpha=0.6^\circ$, $Re=1.7M$) Left-Hand Side: PSP, Right-Hand Side: CFD.

Earlier Shimbo et al., (2000) established a pressure sensitive paint (PSP) technique and demonstrated in the large production wind tunnels in Japan based on a commercially available paint

and a CCD camera-based measurement system. The PSP data converted by the new PSP/TSP combined calibration showed good agreement with the pressure tap measurement, and worked as well as the conventional in situ calibration without using any pressure tap information in the transonic testing. The method successfully corrected the unfavorable temperature sensitivity of the PSP and expanded the paint technique application to blow-down supersonic testing where the model surface temperature changed time by time. In addition, the paint data successfully provided valuable pressure field visualization through the work, which was not usually achieved by the point measurement by the pressure taps. It was first applied in the continuous 2m transonic wind tunnel testing where both pressure and temperature conditions on the model were steady, and the test results of a rigid-body axisymmetric model (Figure 15 & 16) and a deformative wing-body model showed very good agreement with the pressure tap data. Then, the paint technique was expanded to the blow-down 1m supersonic wind tunnel testing where the model surface temperature changed with respect to time. The test results of a thin-wing SST model (Figure 17) also showed good agreement with the pressure tap measurement even there was about 10K drop in the model surface temperature during 40 seconds blow at $M=2$.

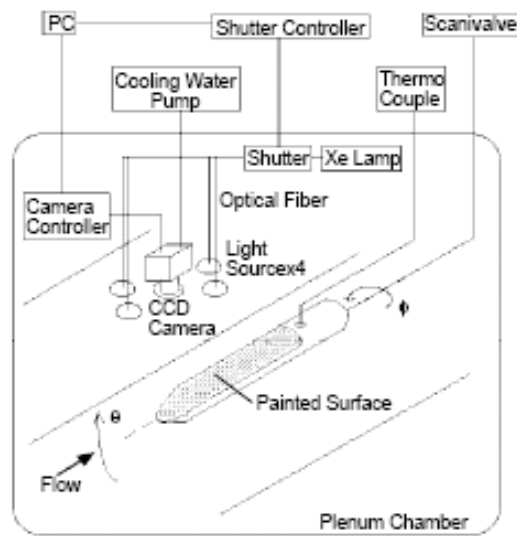

Figure 15: Experimental set-up for the Rigid-body (H-II) model in Transonic Testing.

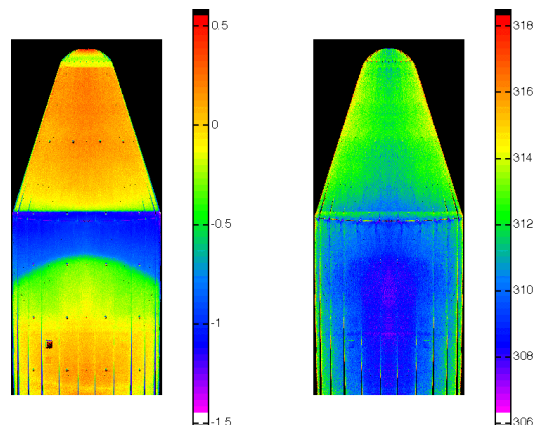

Figure 16: Pressure and temperature field for the H-II test ($M=0.9$, $\alpha=4$ deg).

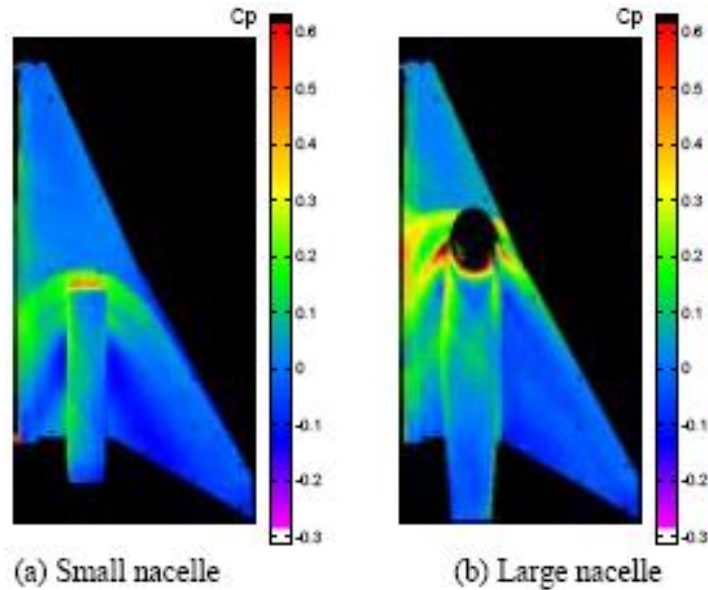

Figure 17: Pressure field for the SST test ($M=2$).

3. Oscillating Airfoil

A new experimental setup for accurate experimental determination of the frequency response of pressure sensitive paints on an oscillating airfoil is designed by Borbye (2008). It is demonstrated that the measurement system including the PSP is adequately described as a linear time-invariant system, allowing for characterization of the paint by a transfer function. In a wind tunnel campaign in the DNW-TWG in collaboration with the DLR institute of Aeroelasticity, a 2D airfoil coated with a fast-responding PSP was investigated. The airfoil was subject to 30 Hz forced pitching oscillation at a Mach number of 0.72 and an angle of attack of $1.12^\circ \pm 0.6^\circ$. Phase-locked pressure field measurements were compared to conventional pressure measurements for a chordal section. Correction of the pressure time series was conducted, by computing the Fourier series, truncating it at $f=120$ Hz, and correcting phase and amplitude by means of the transfer function determined for the PSP.

The iPSP (unsteady PSP) was used for measurement of phase-locked full-field pressure distributions on the suction side of an oscillating profile in transonic flow (Figure 18). Under assumption of periodicity, the phase-locked data were recombined to give an equivalent sampling rate of 3840Hz with full spatial resolution. This gave an excellent visualization of the dynamics of the pressure distribution, which can neither be obtained by conventional pressure measurement techniques, nor conventional PSP. The iPSP generally agreed well with reference pressure measurements, sufficiently well for qualitative conclusions to be made based on uncorrected measurements.

Unsteady PSP for industrial applications has a vast potential, but still many challenges must be overcome. In this work the problems of developing a formulation which is more durable and less sensitive to minor variations in composition and synthesis procedure are pointed out.

With the unsteady PSP project of DLR Göttingen considerable advancements has been made for both paint synthesis, and within development of measurement systems and software. Combined with the fact that the rapid development of new cameras, light detectors and sources continually widens the envelope of applicable PSP formulations and measurement techniques, there is reason for optimism for the future of unsteady pressure sensitive paints.

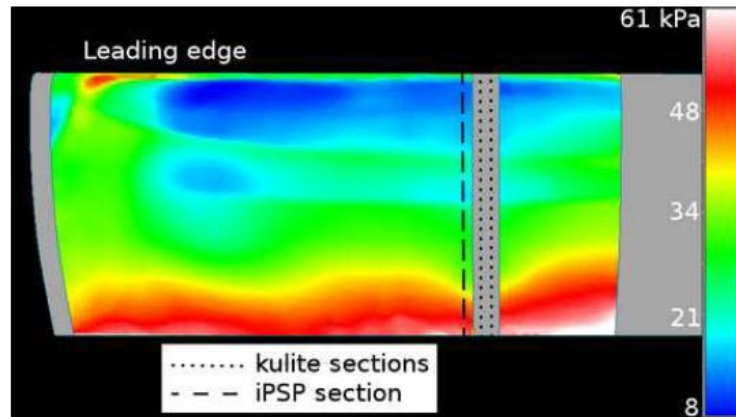

Figure 18: The measured pressure field at $t/T \approx 0.42$. The two sections of reference pressure sensors are marked with dotted lines, and the evaluation section for iPSP pressures with a dashed line.

4. Scramjet Nozzle Flow

The application of the PSP technique to two different scramjet nozzles in a Mach 7 flow in the DLR H2K hypersonic wind tunnel (Figure 19) has been successfully demonstrated (Beck et al., 2008). The agreement with results from pressure taps is very good. Surface pressure measurements enabled deeper insights into the physical flow phenomena, and also helped to explain the anomalous (wavy) behavior of the static pressure distribution seen along the centerline (Figure 20, also shown are the positions of the pressure orifices on left, center and right lines) which had been observed in previous pressure tap measurements; they also showed the way for further optimizing the location of gas injection into the nozzle. An error analysis revealed that a major source of error in the PSP results was due to the non-uniform temperature distribution over the nozzle surface.

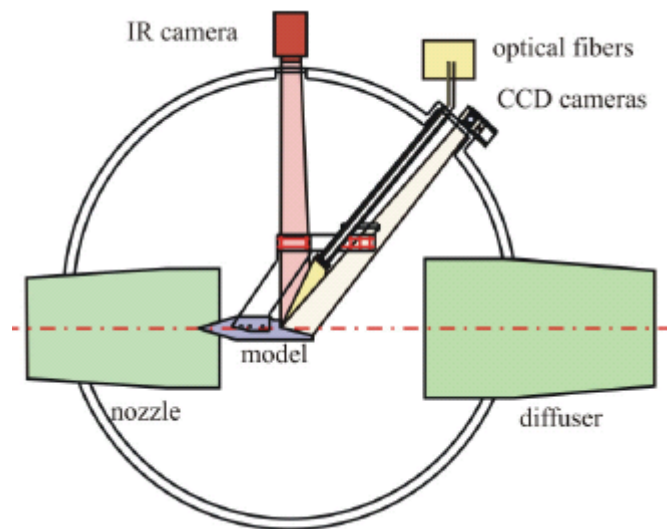

Figure 19: Setup for PSP on H2K.

The utilization of PSP on a large, industry-scale wind tunnel which was carried out successfully in these experiments, pointing the way for the longer term aim of applying PSP to flows of much shorter duration, such as in the High Enthalpy Shock Tunnel HEG of the DLR in Göttingen.

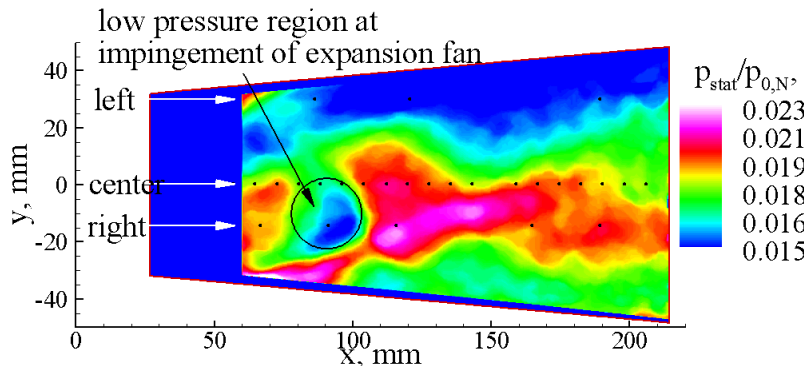

Figure 20: PSP measurement results for $Re_U = 8 \times 10^6$ and nozzle pressure ratio= 500.

5. Turbomachinery Application

Navarra (1997) and Navarra et al. (2001) developed a technique for using PSP in turbomachinery applications. New pressure-and temperature-sensitive paints have been developed for application to a state-of-the-art transonic compressor where pressures up to 2 atm and surface temperatures up to 140°C are expected for the first-stage rotor. PSP and TSP data has been acquired from the suction surface of the first-stage rotor of a transonic compressor operating at its peak-efficiency condition. Visual comparison of the final PSP image presented in Figure 21 and the CFD prediction reveal similar pressure trends.

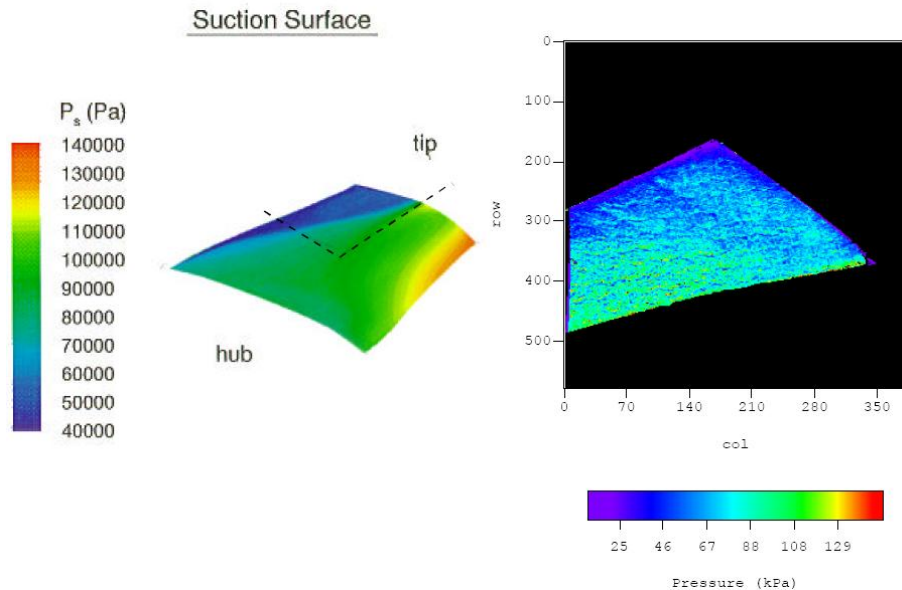

Figure 21: CFD prediction and calibrated temperature-corrected PSP image, 85% N_c (corrected speed) peak-efficiency operating condition.

Lepicovsky and Bencic (2002) used pressure-sensitive paint for diagnostics in turbomachinery flows with shocks. Investigations were first carried out in a narrow supersonic channel of Mach number 2.5. A single wedge or a combination of two wedges was used to generate a complex shock wave structure in the flow (Figure 22). The experience gained in a small supersonic channel was used for surface pressure measurements on the stator vane of a supersonic throughflow fan (Figure

23). The experimental results for several fan operating conditions presented in a concise form, including performance map test points, midspan static tap pressure distributions, and vane suction side pressure fields. Finally, the PSP technique was used in the NASA transonic flutter cascade to compliment flow visualization data and to acquire backwall pressure fields to assess the cascade flow periodicity (Figure 24).

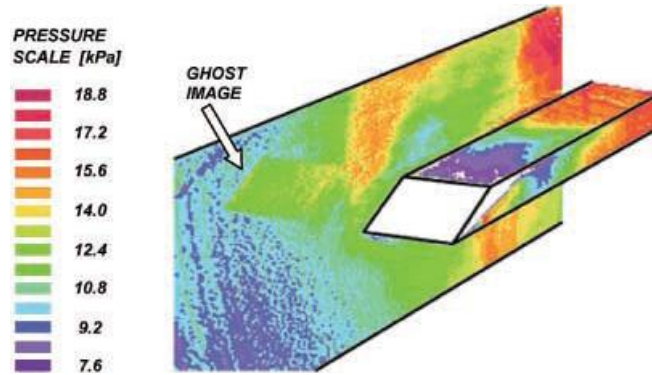

Figure 22: PSP signal reflection of the wedge face pressure field on the backwall surface pressure map.

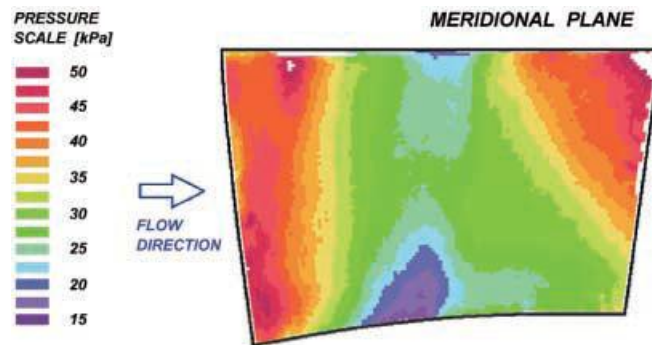

Figure 23: Meridional plane suction-side vane surface pressure field.

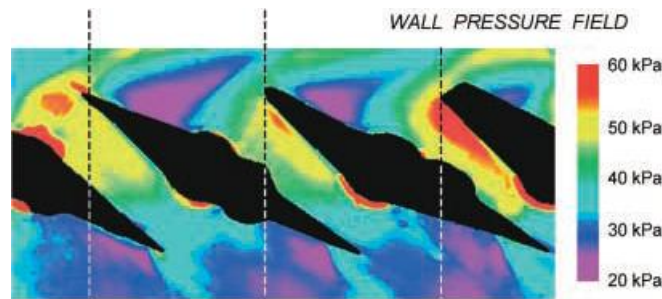

Figure 24: Cascade flowfield for Mach number 1.3.

The results show that this nonintrusive experimental technique can be successfully used as a valuable diagnostic tool in turbomachinery research for steady-state conditions. The results achieved indicate the potential of the PSP technique for acquiring pressure field data efficiently,

particularly for off-design operating conditions, where analytical predictions are not always available. The obvious advantage of the PSP technology is instantaneous visualization of the entire surface pressure field.

Engler et al. (2000) carried out experiments by using the pressure-sensitive paint (PSP) intensity and lifetime methods for basic research and PSP measurements in wind tunnels and turbomachines, to investigate and understand the qualitative and quantitative aerodynamic measurements mainly in transonic flow. Various models were investigated, from the basic configuration of a double-delta-wing up to a complex Airbus A340 half model and oscillating turbine blades. In co-operation with the Institute of Aeroelasticity of Göttingen and EPFL Lausanne, several tests in turbomachinery applications have been performed. A good agreement has been observed between the conventional Kulite pressures and the intensity PSP pressures in the unsteady wind tunnel of EPFL. The test results using both intensity PSP and lifetime PSP on the NACA 3506 blade profile in a compressor cascade gave a good quantitative assessment of the flow and finally the comparison between the two was excellent (Figure 25).

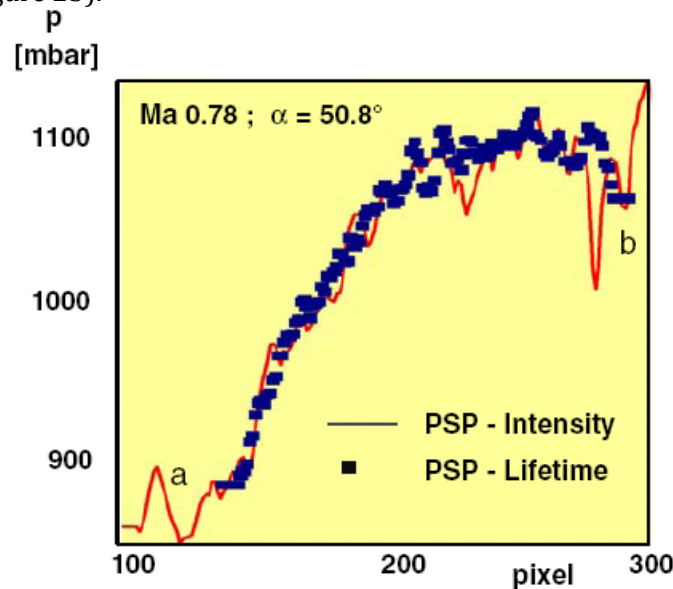

Figure 25: Comparison of PSP intensity and lifetime measurement in the suction area of the turbine blade of the compressor cascade.

Quite a few studies have been carried out on film cooling of turbine blades using PSP namely, works of Ahn et al., (2005) and Suryanarayanan et al., (2009). In the earlier work of Ahn et al., (2005), the film-cooling effectiveness distributions were measured on the blade tip using the pressure-sensitive paint technique. PSP is a photoluminescent material that emits light with intensity proportional to the surrounding partial pressure of oxygen. Any pressure variation on the PSP-coated surface causes emitting light intensity to change because of an oxygen-quenching process. A CCD camera measures this change of intensity. To measure the film-cooling effectiveness and to obtain the intensity ratio from PSP, four kinds of images are required. A reference image (with illumination, no mainstream flow, surrounding pressure uniform at 1 atm), an air image (with illumination and mainstream flow, air used as coolant), an air/nitrogen image (with illumination and mainstream flow, nitrogen gas used as coolant), and a black image (no illumination and no mainstream and coolant flow) to remove noise effects due to the camera.

Results of these experiments show that the locations of the film-cooling holes and the presence of squealer have significant effects on surface static pressure and film-cooling effectiveness (Figure 26), with film-cooling effectiveness increasing with increasing blowing ratio.

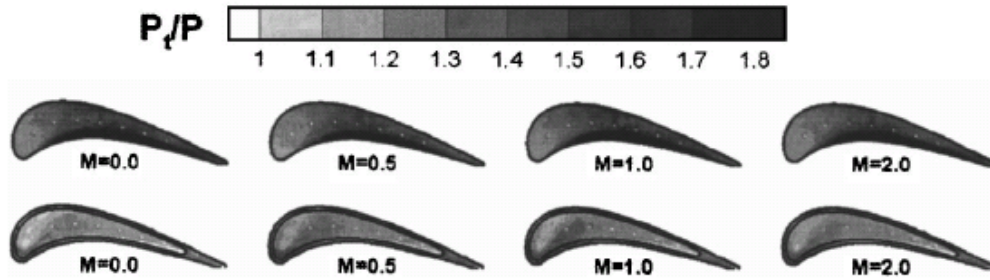

Figure 26: Distributions of pressure ratio (P_t/P) for plane blade tip (top row) and squealer blade tip (bottom row) for coolant injection through tip holes only.

Suryanarayanan et al., (2009) performed another set of experiments on a rotating blade platform using a pressure sensitive paint for film cooling effectiveness measurements. The PSP technique for film cooling effectiveness is based on mass transfer analogy and is free from heat conduction related errors frequently encountered with other heat transfer measurement techniques measuring adiabatic effectiveness. A detailed working methodology of PSP to measure film cooling effectiveness has been described in Wright et al. (2005).

A schematic of the optical components setup for these measurements is depicted in Figure 27 and effectiveness results obtained from using PSP for the reference rotating condition of 2550 rpm are plotted in Figure 28.

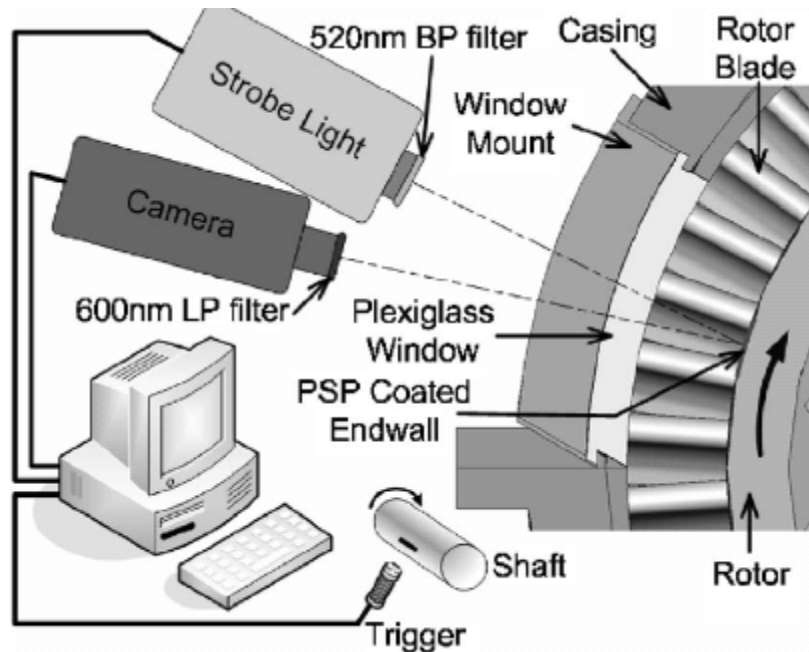

Figure 27: Optical components setup for the model turbine and PSP.

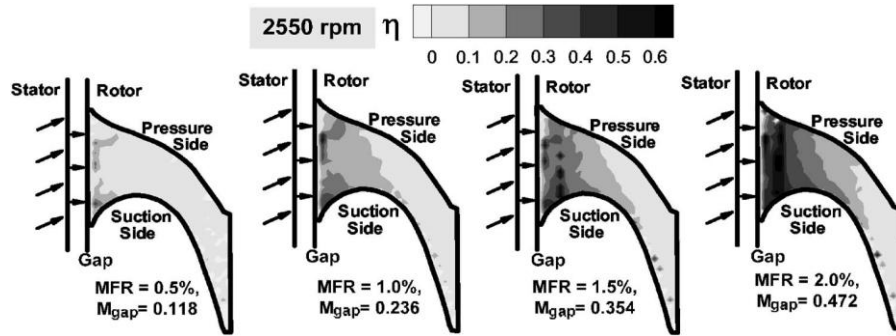

Figure 28: Film cooling effectiveness distribution on the rotating platform for 2550 rpm.

This research work provided detailed data on film cooling on a rotating platform using PSP measurements for the first time in open literature. Turbine researchers and designers will be better equipped with knowledge for film cooling under rotating conditions, by utilizing these results for film cooling,

6. PSP in a Automotive Engineering

Measurements of surface pressure in low-speed tunnels using PSP has been an area of significant interest for several years. Generally, the effects of temperature and model deformation/displacement have significantly degraded the quality of the data. Also, potential problems in applying pressure sensitive paints to automobiles are low time resolution and less accuracy in the low-speed flow field.

In order improve the accuracy of Pressure Sensitive Paints (PSP) at the low-speed flow, a suction-type, low-temperature drift wind tunnel and array of ultraviolet LEDs (Figure 29) were developed (Fukuyama et al., 2007). The pressure distributions of the square cylinder were measured at the velocity ranges from 35 m/s to 75 m/s. The experimental results showed that changes in the PSP utilized here could not be measured accurately in the low-speed region. However, the reproduction of images produced was fine. The calibration coefficients were almost constant during the experiments. The error of the pressure measurements at velocities of 65 m/s and 75 m/s was about 10%. The pressure profiles on the surface were in agreement with that of the conventional measurements and the numerical simulations. Results indicated that the calibration coefficients of the Stern-Volmer relation were the almost constant during the experiments. They revealed that the suction-type wind tunnel is suitable for PSP measurements.

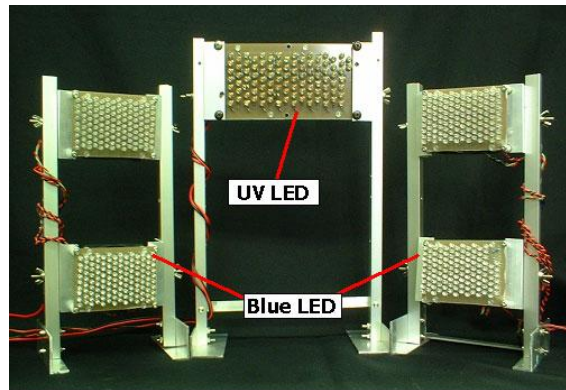

Figure 29: Ultraviolet LED array (wavelength = 375nm) and BLUE LED array (wavelength = 470nm).

Earlier, in another attempt to improve the PSP measurement quality Mébarki et al., (2003) conducted a PSP evaluation using a simplified car model at the 2m×3m continuous atmospheric wind tunnel. Image averaging permitted accurate data to speed as low as 27m/s and qualitative measurements at 11m/s. Several paint formulations, including in-house and commercial types have been used. In particular, a formulation combining PTMSP and pyrene was applied for the first time in the low-speed regime.

The early PSP results found two sharp suction peaks that were missed by the pressure taps. The high resolution PSP results were used to position two additional taps at those locations. This example clearly shows one benefit of the PSP technique. The linear in situ calibration, sufficient for all paint formulations, provided a better accuracy than the a priori methods. However, the tap distribution was critical for the precision of the in situ results.

PSP not only provides quantitative pressure measurement, it can complement usual visualization techniques. During this test conducted by Mébarki et al., (2003), surface flow visualization was used to show the surface flow features. The oil drops were applied directly on top of the PSP Unicoat and images of the surface flow development were recorded using the PSP camera. Because the oil streaks reduced the PSP intensity, the evolution of the intensity level in these images revealed the path followed by the oil streaks. The resulting negative oil flow images are presented in Figure 30. The infrared images, showing the surface temperature changes due to turbulent wedges or to local flow acceleration, are also presented in Figure 30 along with the PSP images at the same conditions.

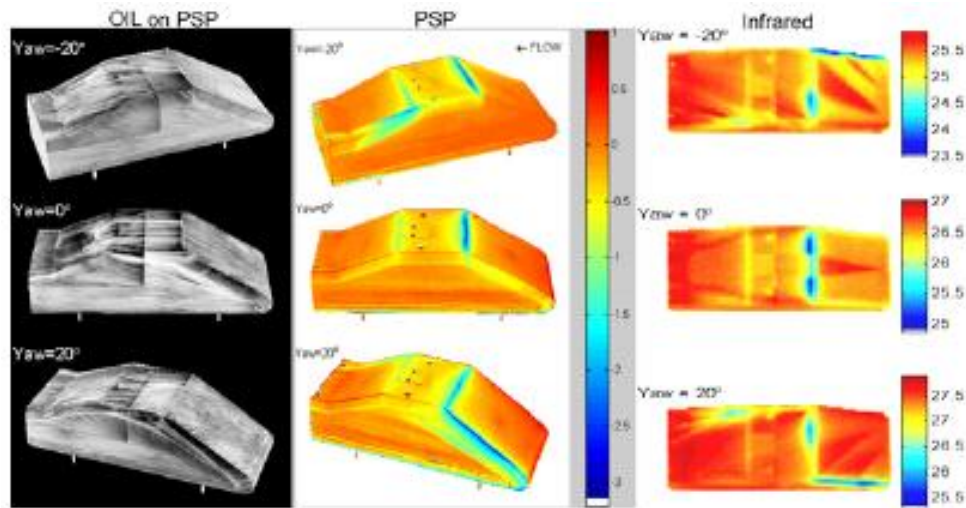

Figure 30: Oil flow visualization on PSP (inverted image), PSP image (C_p results from PSP Unifib) and infrared measurements (temperature in degree C) at $V=92$ m/s.

It is to be emphasized that, in applying pressure-sensitive paint to low-speed flow wind tunnel testing, it is important to minimize any measurement uncertainties. There are various error sources such as camera noise, misalignment of images due to model displacement and temperature distribution over the model. Among these factors, the effects of temperature distribution change during tests on pressure measurement accuracies were studied by Yamashita et al. (2007). Pressure and temperature distributions over a simplified car model (1/10 scale Ahmed model) were measured using PSP and TSP. Sequential images were acquired at the same intervals over the entire test period, including for the conditions before and after the tunnel run. As a result, it was found that the measurement error caused by temperature distribution over the model could be reduced using a

single-point temperature measurement. In addition, by measuring surface temperature distributions on the model using TSP, it was proved that the most accurate pressure measurement could be made by rationing the wind-off image acquired immediately after shutting down the tunnel to the wind-on image acquired immediately before shutting down the tunnel. Using the present measurement technique, the complex pressure fields over the Ahmed model (Abbaspour, M. and Jahanmiri, M., 2010), caused by flow separation, reattachment and vortices, were successfully visualized (see Figure 31).

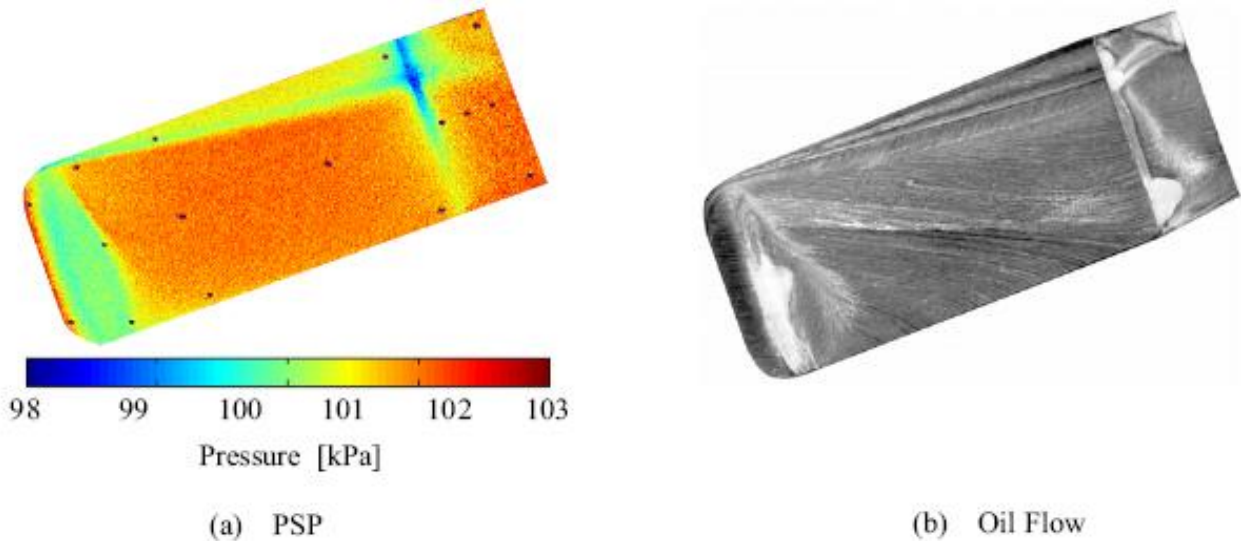

Figure 31: Visualization in the case of $\theta=20$ [deg].

Gouterman et al. (2004) found out PSP has a number of advantages over discrete pressure taps traditionally used on conventional wind tunnel models: (i) PSP measures pressure distributions over a surface area thereby allowing visualization of dynamic flow processes with high spatial resolution limited only by the imaging system. (ii) PSP allows measurement in regions where conventional pressure taps cannot be used, such as leading and trailing edges. (iii) PSP allows real-time modelling and better integration of experimental and computational fluid dynamics giving significant reductions in the time required for prototyping of new designs. (iv) Surface-flow features, such as shock location and boundary layer separation and reattachment, can often be observed in the raw PSP images. Thus PSP can serve as a surface-flow visualization tool during wind tunnel testing. PSP application to auto model testing at low speeds, where the lift pressure is a small fraction of the static pressure, will require careful temperature corrections. In the work reported by Gouterman et al. (2004) the temperature-induced error is corrected by using a dual luminophor PSP ratio, PSP/TSP, (for application to automotive model testing) such that the temperature dependence of the sensor and reference luminophors almost completely cancels. This formulation is composed of a pressure sensitive component (PSP) emitting near 750nm and a temperature sensitive component (TSP) emitting around 650nm. The simple PSP/TSP ratio appears more promising for temperature and excitation correction due to the fact that the two components have similar temperature sensitivities.

The pressure distribution along the centreline station is compared in Figure 32 with the discrete measurements obtained at $V=94\text{ms}^{-1}$, $\alpha=20^\circ$. It confirms the better performance of the ratio

PSP/TSP and of the parameter PSP_{corr} (new parameter was formed from the pressure and temperature images to further reduce the temperature sensitivity) on a notch-back passenger car model centreline.

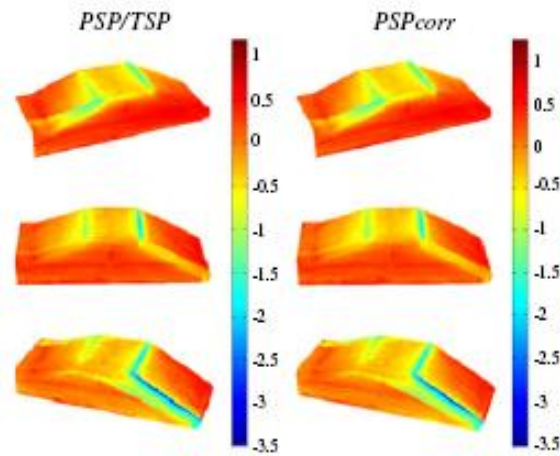

Figure 32: C_p results obtained for binary formulation at $V=94 \text{ m s}^{-1}$, three yaw angles: -20° , 0° and 20° for the ratio PSP/TSP (left) and the parameter PSP_{corr} (right). Flow direction is from right to left.

Concluding Remarks

Pressure sensitive paint is a powerful tool for the aerodynamic community to acquire full field pressure distributions on aerodynamic models. PSP technique is not only important for the amount of data that are collected in wind tunnel experiments, but also it significantly reduces the time and cost of the experiments compared to loads analyses. However, the technique has some drawbacks, the most important one being temperature interference in pressure estimation. The second most of important disadvantage of PSP technique is image registration which might be difficult to achieve for some PSP experiments. The most successful approach to the temperature problem is introducing a temperature sensitive luminophore in PSP coating along with a pressure sensitive luminophore which can be used to measure temperature variation concurrently with pressure variation (Kose, 2005). Afterwards, correction to the PSL response is made by using temperature information in the coating. Similarly, image registration problem can be eliminated by using a reference luminophore again in PSP coating which is neither temperature nor pressure sensitive.

Since the PSP is coating sensors with luminescence molecules, the pressure ports or taps are not required to measure the surface pressure profiles. PSP based on the oxygen quenching process of the luminescence molecules, gives a much higher range of pressure measurements than the dynamic pressure range of conventional measurements in automobile industries. The pressure range is suitable for measuring high-speed flow such as the supersonic flow around an aircraft. Since the PSP is the absolute pressure sensor, measurements of the low-pressure regions such as the flow around automobiles are quite difficult to obtain. Attempts were made to improve the PSP measurements at the low-speed region with a low-temperature drift wind tunnel and array of ultra violet LED as the lighting system for the PSP (Fukuyama et al., 2007).

It should be emphasized that, PSP is the first global optical technique that is able to give non-contact, quantitative surface pressure visualization for complex aerodynamic flows and provide tremendous information on flow structures that cannot be easily obtained using conventional pressure sensors.

Acknowledgements

I am thankful to all researchers whose papers are quoted in this report. This work is supported by Dept. of Fluid Dynamics of Chalmers University and Shiraz University of Technology.

References

- Abbaspour, M. and Jahanmiri, M., (2010) "Computational study of aerodynamic drag reduction on Ahmed body using active strategies" 13th Annual & 2nd International Fluid Dynamics conference Fd2010-26-28 Oct. Shiraz University of Technology, Shiraz, Iran.
- Ahn, J., Mhetras, S., Han, J. C. (2005) "Film-Cooling Effectiveness on a Gas Turbine Blade Tip Using Pressure-Sensitive Paint" Transactions of the ASME, Journal of Heat Transfer, May issue, vol. 127, pp. 521-530.
- Ardasheva, M. M., Nevsky, L. B., Pervushin, G. E. (1982) "Method of pressure distribution visualization with the organic luminophores" (in Russian), III the USSR School on the Methods of Aerophysical Investigations, Novosibirsk, pp. 103-107.
- Ardasheva, M. M., Nevsky, L. B., Pervushin, G. E. (1985) "Measurement of pressure distribution by means of indicator coatings" Journal of Applied Mechanics and Technical Physics 4: pp. 24-33.
- Asai, K. (1999) "Status of pressure sensitive paint technology at National Aerospace Laboratory" In: 18th International Congress on Instrumentation in Aerospace Simulation Facilities (ICIASF 1999), Toulouse, France, June 14-17.
- Asai, K., Nakakita, K., Kameda, M., Teduka, K. (2001) "Recent topics in fast-responding pressure-sensitive paint technology at National Aerospace Laboratory" In: ICIASF 2001 Record, 19th International Congress on Instrumentation in Aerospace Simulation Facilities, Cleveland, Ohio, August 27-30, pp. 25-36.
- Asai, K., Okura, I., Mizushima, H. (2003) "Mosaic project – summary of phase one program." In: ICIASF 2003 Record, 20th International Congress on Instrumentation in Aerospace Simulation Facilities, Göttingen, Germany, August 25-29, pp. 89-94.
- Beck, W. H., Henne, U., Hirschen, C. (2008) "Application of the Pressure Sensitive Paint Technique to a Scramjet Nozzle Flow in the DLR Hypersonic Wind Tunnel" 14th Int. Symp. on Applications of Laser Techniques to Fluid Mechanics Lisbon, Portugal, 07-10 July.
- Bell, J. H., Shairer, E. T., Hand, L. A., Mehta, R. D. (2001) "Surface pressure measurements using luminescent coatings" Annual Review of Fluid Mechanics 33: pp. 155-206.
- Borbye, J. (2008) "Experimental Investigation of Frequency Response of Unsteady Pressure Sensitive Paint and Application for an Oscillating Airfoil" Msc. Thesis, Technical University of Denmark (DTU).
- Brown, O. C., (2000) "Low-speed pressure measurements using a luminescent coating system" Ph.D. Thesis, Department of Aeronautics and Astronautics, Stanford University.

Crites, R. C. (1993) "Measurement techniques—pressure sensitive paint technique" In: Lecture Series 1993-05, April, The von Karman Institute for Fluid Dynamics, Belgium.

Crites, R. C., Benne, M. (1995) "Emerging technology for pressure measurements in wind tunnels—pressure sensitive paint" AIAA Paper 95-0106.

Davies, A. G., Bedwell, D., Dunleavy, M., Brownjohn, N. (1995) "Pressure sensitive paint measurements using a phosphorescence lifetime method" In: Seventh International Symposium on Flow Visualization, September 11-14, Seattle, Washington.

Donovan, J. F., Morris, M. J., Pal, A., Benne, M. E., Crites, R. C. (1993) "Data analysis techniques for pressure- and temperature-sensitive paint" AIAA Paper 93-0176.

Dowgwillo, R. M., Morris, M. J., Donovan, J. F., Benne, M. E. (1994) "The application of the pressure sensitive paint technique to high speed wind tunnel testing of a fighter aircraft configuration with complex store loadings" AIAA Paper 94-1932.

Dowgwillo, R. M., Morris, M. J., Donovan, J. F., Benne, M. E. (1996) "Pressure sensitive paint in transonic wind-tunnel testing of the F-15" *Journal of Aircraft* 33(1): pp. 109-116.

Engler, R. H. (1995) "Further developments of pressure sensitive paint (OPMS) for non-flat models in steady transonic flow and unsteady conditions" In: Proc. 16th Int. Cong. Instrumentation in Aerospace Simulation Facilities (ICIASF), Institute of Electrical and Electronics Engineers, Wright-Patterson Air Force Base, Dayton, OH, USA, pp. 33.1- 33.8.

Engler, R. H., Hartmann, K., Schultze, B. (1991) "Aerodynamic assessment of an optical pressure measurement system (OPMS) by comparison with conventional pressure measurements in a high speed wind tunnel" In: Proc. 14th Int. Cong. Instrumentation in Aerospace Simulation Facilities (ICIASF), Institute of Electrical and Electronics Engineers, Rockville, MD, pp. 17-24.

Engler, R. H., Hartmann, K., Troyanovski, I., Vollan, A. (1992) "Description and assessment of a new optical pressure measurement system (OPMS) demonstrated in the high speed wind tunnel of DLR in Göttingen" DLR Report DLR-FB 92-24.

Engler, R. H., Klein, C. (1997a) "DLR PSP system: intensity and lifetime measurements" In: ICIASF '97 Record, International Congress on Instrumentation in Aerospace Simulation Facilities, Pacific Grove, CA, September 29-October 2, pp. 46-56.

Engler, R. H., Klein, C. (1997b) "First results using the new DLR PSP system—intensity and lifetime measurements" In: *Wind Tunnels and Wind Tunnel Test Techniques*, Cambridge, UK.

Engler, R. H., Klein, C., and Trinks, O. (2000) "Pressure sensitive paint systems for pressure distribution measurements in wind tunnels and turbomachines" *Meas. Sci. Technol.* 11, pp. 1077-1085.

Fukuyama, E., Hoshino, T., Iida, A., and Brown, R. J. (2007) "Pressure Field Visualization on the Surface of a Square Cylinder with Pressure Sensitive Paints" 16th Australasian Fluid Mechanics Conference, 2-7 December, Gold Coast, Australia.

Gewehr, P. M., Delpy, D. T. (1993) "Optical oxygen sensor based on phosphorescence lifetime quenching and employing a polymer immobilised metalloporphyrin probe" *Medical & Biological Engineering & Computing*, January: pp. 2-21.

Gouterman, M., Callis, J., Dalton, L., Khalil, G., Mébarki, Y., Cooper, K. R., and Grenier, M. (2004) "Dual luminophor pressure-sensitive paint: III. Application to automotive model testing" *Meas. Sci. Technol.* 15, pp. 1986–1994.

Gregory, J. W. (2004) "Porous pressure-sensitive paint for measurement of unsteady pressures in turbomachinery" In *Proceedings of the 42nd AIAA Aerospace Sciences Meeting*, American Institute of Aeronautics and Astronautics, Reston, VA, AIAA 2004-0294.

Gregory, J. W., Asai, K., Kameda, M., Liu, T., and Sullivan, J. P. (2008) "A review of pressure-sensitive paint for high-speed and unsteady aerodynamics" *Proc. IMechE* vol. 222, Part G: J. Aerospace Engineering, pp. 249-290.

Healey, G. E., Kondepudy, R. (1994) "Radiometric CCD camera calibration and noise estimation" *IEEE Transaction on Pattern Analysis and Machine Intelligence*, 16(3): pp. 267-276.

Hradil, J., Davis, C., Mongey, K., McDonagh C., and MacCraith, B. D. (2002) "Temperature-corrected pressure-sensitive paint measurements using a single camera and a dual-lifetime approach" *Meas. Sci. Technol.* 13, pp. 1552–1557.

Innovative Scientific Solutions, Inc., "Pressure-Sensitive Paint" Innovative Scientific Solutions, Inc., www.innssi.com.

Jackson, D. T. (1999) "Pressure Sensitive Paint" www.aerospaceweb.org.

Kautsky, H., Hirsch, H. (1935) "Detection of minutest amounts of oxygen by extinction of phosphorescence" (in German). *Z Anorg Allg Chem*: 222-216.

Kose, M. E. (2005) "Multi-Luminophore Coatings for Pressure Sensitive Paint Applications" Ph.d Thesis, University of Florida, USA.

Lachendro, N., Crafton, J., Guille, M., Sullivan, J. P. (1998) "In Flight Pressure Measurements of a Transonic Wing Using A Pressure Sensitive Paint Based Laser Scanning System" *PSP Workshop*, Seattle, WA.

Lakowicz, J. R. (1991) "Topics in fluorescence spectroscopy" vol 1: techniques. Plenum Press, New York and London.

Lakowicz, J. R. (1999) "Principles of fluorescence spectroscopy" 2nd edn. Kluwer Academic/Plenum Publisher, New York.

Lepicovsky, J., Bencic, T.J. (2002) "Use of pressure-sensitive paint for diagnostics in turbomachinery flows with shocks" *Experiments in Fluids*, 33, pp. 531–538.

Liu, T., Sullivan, J. (2005) "Pressure and Temperature Sensitive Paints", Springer-Verlag, Berlin.

- Liu, T., Campbell, B. T., Burns, S.P., Sullivan, J. P. (1997) "Temperature-and Pressure-Sensitive Luminescent Paints in Aerodynamics" *Applied Mechanics Reviews*, vol. 50, pp.227-246.
- Lyonnet, M., Deleglise, B., Grenat, G., Modane, O., Bykov, A., Mosharov, V., Orlov, A., Fonov, S. (1997) "The two-component PSP investigation on a civil aircraft model in S2MA wind tunnel" In: AGARD Conference Proceedings CP-601: Advanced Aerodynamic Measurement Technology, pp. 30-1-30-8.
- Mantel, J. (2005) "Understanding and Improving Pressure Sensitive Paint based on luminescence decay" Department of Aerospace Engineering, Delft University of Technology.
- McLachlan, B. G., Bell, J. H. (1995) "Pressure-sensitive paint in aerodynamic testing" *Experimental Thermal and Fluid Science* 10: pp. 470-485.
- Mébarki, Y., Cooper, K. R., and Reichert, T. M. (2003) "Automotive Testing Using Pressure-Sensitive Paint" *Journal of Visualization*, vol. 6, No. 4, pp. 381-393.
- Mitsuo, K., Nakakita, K., and Kurita, M. (2004) "Application of pressure-sensitive paint to low-speed wind tunnel testing at Japan Aerospace Exploration Agency" 24th Congress of the International Council of the Aeronautical Sciences, ICAS 2004-3.2.3, September, Yokohama, Japan.
- Morris, M. J., (1995) "Use of pressure-sensitive paints in low-speed flows" In: Proc. 16th Int. Cong. Instrumentation in Aerospace Simulation Facilities (ICIASF), Institute of Electrical and Electronics Engineers, Wright-Patterson Air Force Base, Dayton, OH, USA, pp. 31.1-31.10.
- Morris, M. J., Benne, M. E., Crites, R. C., Donovan, J. F., (1993a) "Aerodynamics measurements based on photoluminescence" AIAA Paper 93-0175.
- Morris, M. J., Donovan, J. F., Kegelman, J. T., Schwab, S. D., Levy, R. L., Crites, R. C. (1993b) "Aerodynamic applications of pressure sensitive paint" *AIAA Journal* 31(3): pp. 419-425.
- Morris, M.J., Donovan, J. F., (1994) "Application of pressure-and temperature-sensitive paints to high-speed flows" AIAA Paper 94-2231.
- Mosharov, V. E., Radchenko, V. N., Fonov, S. D. (1997) "Luminescent pressure sensors in aerodynamic experiments" Central Aerohydrodynamic Institute (TsAGI), CWA Int. Corp., Moscow.
- Nakakita, K., Kurita, M., Mitsuo, K., and Watanabe, S. (2006) "Practical pressure-sensitive paint measurement system for industrial wind tunnels at JAXA" *Meas. Sci. Technol.* 17, pp. 359-366.
- Nakakita, K., Kurita, M., and Mitsuo, K. (2004) "Development of the Pressure-Sensitive Paint Measurement for Large Wind Tunnels at Japan Aerospace Exploration Agency" 24TH International Congress of the Aeronautical Sciences, ICAS 2004, September, Yokohama, Japan.
- Navarra, K. R. (1997) "Development of the Pressure-Sensitive-Paint Technique for Advanced Turbomachinery Applications" Msc. Thesis, Virginia Polytechnic Institute and State University, Virginia, USA.

Navarra, K. R., Rabe, D. C., Fonov, S. D., Goss, L. P., Hah, C. (2001) "The Application of Pressure- and Temperature-Sensitive Paints to an Advanced Compressor" Transactions of the ASME, Journal of Turbomachinery, October issue, vol. 123, pp. 823-829.

Navarra, K., Rabe, D., Fonov, S., Goss, L., Hah, C. (2001) "The Application of Pressure and Temperature Sensitive Paints to an Advanced Compressor" Journal of Turbomachinery, vol. 123, n 4, pp. 823-829.

Pervushin, G. E., Nevsky, L. B. (1981) "Composition for indicating coating" (in Russian) Patent of USSR-SU 1065452.

Peterson, J. I., Fitzgerald, R. V. (1980) "New technique of surface flow visualization based on oxygen quenching of fluorescence". Rev Sci. Instrum. 51(5): pp. 670-671.

Raju, L. C., Venkatakrishnan, L., and Viswanath, P. R. (2006) "Pressure sensitive paint measurements on a delta-wing in supersonic flow" The Aeronautical J., November issue, pp. 767-771.

Saito, K., Nagai, H., Ogawa, T., Asai, K. (2007) "Development of Pressure-Sensitive Paint Technique in a Supersonic Indraft Wind Tunnel and its Application to a Busemann Biplane" 22nd International Congress on Instrumentation in Aerospace Simulation Facilities, ICIASF 2007, California, USA.

Shimbo, Y., Asai, K., Komatsu, N. (2000) "Pressure Sensitive Paint Application at Large Production Wind Tunnels" 22nd Congress of International Council of the Aeronautical Sciences, ICAS 2000 Congress, UK.

Sullivan, J. P. (2001) "Temperature and pressure sensitive paint" In: Lecture Series 2000-2001, Advanced Measurement Techniques, January, The von Karman Institute for Fluid Mechanics, Belgium,.

Suryanarayanan, A., Mhetras, S. P., Schobeiri, M. T., Han, J. C. (2009) "Film-Cooling Effectiveness on a Rotating Blade Platform" Transactions of the ASME, Journal of Turbomachinery, January issue, vol. 131.

Volan, A., Alati, L. (1991) "A new optical pressure measurement system" In: Proc. 14th Int. Cong. Instrumentation in Aerospace Simulation Facilities (ICIASF), Institute of Electrical and Electronics Engineers, New York, pp. 10-16.

Wright, L. M., Gao, Z., Varvel, T. A., and Han, J. C., (2005) "Assessment of Steady State PSP, TSP and IR Measurement Techniques for Flat Plate Film Cooling" ASME Paper No. HT-2005-72363.

Yamashita, T., Sugiura, H., Nagai, H., Asai, K., and Ishida, K. (2007) "Pressure-Sensitive Paint Measurement of the Flow around a Simplified Car Model" Journal of Visualization, vol. 10, No. 3, pp. 289-298.

Zakharov, I. A., Aleskovsky, V. B. (1964) "Phosphorescence of tryptaflavin on silica and its quenching by oxygen" (in Russian). J Appl Spectr N1: 348.

Zakharov, I. A., Aleskovsky, V. B., Grishaeva, T. I. (1974) "Lifetime changing of adsorbed molecules by oxygen quenching" (in Russian), Opt & Spectr 36: 925.