

RING TEST FOR EVALUATION OF BOND PROPERTIES OF REINFORCING BARS

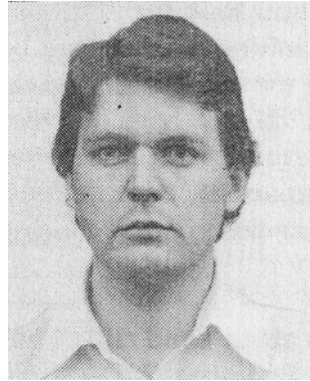

Ralejs Tefers
Tekn dr
Division of Building Technology
Chalmers University of Technology
SE-412 96 Göteborg
Sweden



Per-Åke Olsson
Civ Eng
Division of Concrete Structures
Chalmers University of Technology
SE-412 96 Göteborg
Sweden

ABSTRACT

A pull-out bond test with short bond length for estimation of the splitting tendency of different rib shapes for reinforcing bars is proposed and investigated. In the test the bond force component along the bar is separated from the radial one. The radial component is determined by measuring circumferential strain in a steel ring surrounding the concrete of the pull-out specimen. The force component, which is longitudinal to the bar, is obtained by supporting the pull-out specimen with a teflon covered circular support close to the bar. Bars with specially turned ribs are studied concerning rib height and rib distance. Swedish standard high bond bars are also studied. The splitting tendency is stated as a function of the slip of the free bar end and also of the related rib area of the bars.

Key-words: Concrete, reinforcement, bond, pull-out test, splitting.

NOTATION

- F force pulling the bar
- F_r Force pulling the bar at radial cracking of Ring-test specimen
- f_R related rib area of reinforcement bar
- E_s modulus of elasticity of steel, 200,000 MPa
- f_{cc} compressive cube strength of concrete (0.150^3 m^3)
- f_{ct} splitting tensile strength of concrete
- f_{sy} yield stress of reinforcement bar
- h height of steel ring, 0.048 m
- s rib spacing

- t thickness of steel ring, 0.0065 m
- α angle between direction of bond forces and bar axis
- δ free bar end slip
- $\delta_{F_{max}}$ free bar end slip at maximum load
- ϵ_{rs} circumferential steel ring strain
- \emptyset core diameter of the bar
- \emptyset_1 diameter including ribs of the bar
- σ circumferential stress in steel ring
- τ bond stress

1 INTRODUCTION

The bond characteristics of reinforcing bars for time being are characterized by pull-out tests in combination with different types of beam tests. Some of these tests are standardized. The best known of these tests are the RILEM-tests specified in: "RILEM/CEB/FIP Recommendations on reinforcement steel for reinforced concrete", RC5 for "Beam test" and RC6 for "Pull-out test". The standardized tests give however only a part of the necessary information. It can be said that the beam test characterizes the bond in general terms and the pull-out test gives information about the maximum possible bond strength. The tests do not give clear information about the splitting action on the surrounding concrete from bars with different types of lugs. Knowledge about the magnitude of the splitting forces is very important, because most bond failures are splitting failures. It is important, that a reinforcing bar has good anchoring capacity and at the same time the splitting forces from bond are small.

Different pull-out tests have been developed to obtain better information about bond /12/. Thus Rehm /1/ studied the bond of only one lug in pull-out tests. Losberg /2/, Berggren /3/, Losberg & Olsson /6/ have used a pull-out test with short (3 bar diameters) bond length. Goto (1971) has studied the flow of the bond forces from the lugs out into surrounding concrete by injecting inc in the developed micro cracks near the surface of the reinforcement. Otsuka /14/ has made X-ray photographs of the cracks close to the bar surface. Tepfers /5/, /8/ has deduced analytic expressions for determination of the splitting resistance of the bar surrounding the concrete in the anchoring zone.

However none of these investigations analyze the bond by isolating the splitting forces from the principal bond forces during the loading sequence. An attempt to this end is made at Chalmers University of Technology, Division of Concrete Structures by the development of a pull-out test within a steel ring, the "Ring Test", which enables a separation of the bond forces into splitting and anchoring force components and an analysis of them.

2 RING TEST - DESIGN AND FUNCTION

An ordinary pull-out test specimen is made of a reinforcing bar, which is cast in a concrete block usually in form of a cube. The bond length between reinforcement and concrete is often rather short and is embedded in a concrete mass, which is big enough to resist the splitting forces from the anchored bar. The failures usually are pull-out failures, which mainly give information about the shear strength of the concrete. This type of failure however is rare, when bond in a reinforced concrete member is tested. Instead the usual type of failure is splitting failure. When analyzing such failures, the splitting forces are estimated assuming the bond forces being directed a 45 degree angle α outward into the surrounding concrete. The bond forces become directed outward from the bar when the micro cracking along the bar appears due to the fact, that the principal tensile stress reaches the tensile strength of the concrete, Goto /4/ and Tepfers /5/, /8/. In

reality, however, the splitting tendency is not the same for different types of ribbed bars and it changes also with the intensity of load. It cannot always be estimated with α being 45 degrees.

The idea behind the "Ring Test" is to separate the bond forces directed outward into concrete from the bar in two components parallel and perpendicular to the axis of the bar. The magnitude and the direction of the bond forces can then be studied.

The "Ring Test" is carried out as a pull-out test, where the specimen is a low concrete cylinder with the studied reinforcing bar embedded along the centre axis of the cylinder, FIG. 1. The bond length corresponds to the height of the cylinder, which is chosen to be 3 diameters of the bar, so the bond stress along the bond length becomes practically evenly distributed, Losberg /2/. The cylinder is cast in a thin steel tube (the ring), which becomes a part of the test specimen. Further the "Ring Test" pull-out specimen is supported with a teflon, low friction, narrow ring close to the bar. This support takes care only of the bond force component, which is parallel to the bar. The bond force component perpendicular to the bar is resisted by the concrete and steel ring. When the concrete cylinder cracks in radial direction the force component is resisted only by the steel ring surrounding the concrete. After radial cracking the steel ring will keep the concrete pieces together. Because of the steel ring reinforcing effect it is possible to increase the pull-out force after radial cracking. The radial components of the bond forces give rise to strains in the steel ring. The strains can be measured with strain gauges. Knowing the dimensions of the ring and the modulus of elasticity of the steel, the radial forces can be determined at the same time as the pulling force and slip between the bar and surrounding concrete is measured.

Tests with the "Ring Test" FIG. 2, and also a holographic photo, Beranek /10/ show, that many radial cracks appear in the concrete surrounding the anchored bar. This means that the pressure from the anchored bar against the steel ring will have a rather even distribution.

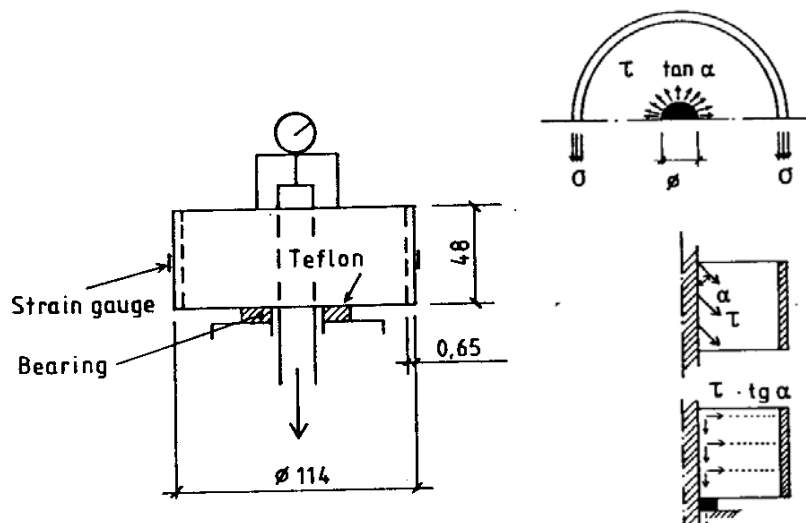

Figure 1: The "Ring Test" arrangement.

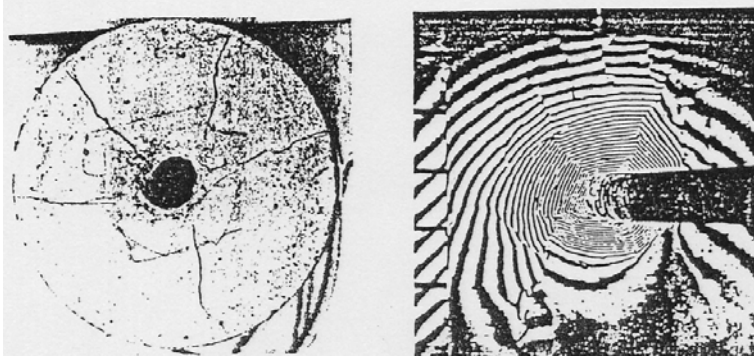

Figure 2: Radial splitting cracks appearing around an anchored bar. Left figure shows a Ring test specimen and the right one a holography of a pull-out specimen according to Beranek/10!

If it is assumed that the strains are the same all around the steel ring and that the splitting forces from the bar can be regarded as an internal hydraulic pressure, then an equilibrium equation can be established and the magnitude of the splitting force corresponding to the actual strain in the steel ring can be determined. The angle α under which the bond forces leave the bar can also be determined.

By this method different reinforcing bars can be compared not only regarding pure bond, but also regarding the splitting forces that occur.

3 AIM OF INVESTIGATION

There are two intentions with the "Ring Test".

The first intention is to determine the magnitude and development of the splitting forces from anchored reinforcing bars with different types of ribs. The splitting forces are studied on three types of Swedish standard hot rolled reinforcing bars and also on specially manufactured bars, where the influence of height of the lugs and lug distance is investigated.

The second intention is to demonstrate the possibilities of the "Ring Test" as standard test for evaluation of anchoring qualities of different types of reinforcing bars.

4 PROGRAM OF THE INVESTIGATION

Two series of standard Swedish reinforcing bars and two series of specially turned bars are investigated.

In the FIRST SERIES three Swedish standard high-bond bars of quality Ks400 and Ks600 according to Swedish standard SIS 212513 respective SIS 212515 with nominal diameter $\varnothing = 16$ mm and to the axis of the bar inclined and also transverse ribs are tested.

In the SECOND SERIES the height of the ribs of specially turned bars is varied. The core diameter of the bar is kept constant to $\varnothing = 16$ mm. The circular ribs are perpendicular to the bar axis and the width of the ribs is 2 mm.

The design of the specially turned bars in principle is shown in FIG. 3.

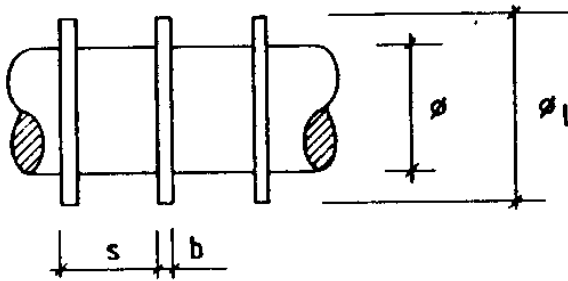

Figure 3: Design in principle of specially turned bars.

In the THIRD SERIES the spacing between the ribs of specially turned bars is varied. The core diameter of the bar is kept constant to $\varnothing = 16$ mm. The circular ribs are perpendicular to the axis of the bar and the width of the ribs is 2 mm. This series is completed with a turned bar without lugs and diameter $\varnothing = 16$ mm.

In the FOURTH SERIES five equal "Ring Tests" are performed with Swedish standard hot rolled high-bond bar Ks400 with to the axis of the bar inclined ribs. The aim of this series is to investigate the dispersion in the test results, however not in the ring strain.

The parameters for all the tested bars are presented in TABLE 1 together with the strength of concrete in the "Ring Test" specimen.

TABLE 1. Investigated bars with core diameter 16 mm and strengths of concrete of the pull-out specimen.

| Series | Test | Bar type | Rib angle to bar axis | Diam. of ribs \varnothing_1 mm | Rib spacing s mm | Specific rib area f_R (DIN488) | Rib weight /Bar length $\frac{m}{m}$ *) | Concrete compressive strength f_{cc} MPa | Concrete tensile strength f_{ct} MPa |
|--------|------|----------|-----------------------|----------------------------------|------------------|----------------------------------|---|--|--|
| 1 | 1 | Ks49 | 90° | 18.5 | 12 | 0.064 | 0.060 | 25.5 | 2.4 |
| | 2 | Ks40 | 45° | 18.5 | 12 | 0.064 | 0.060 | 37.7 | 2.9 |
| | 3 | Ks60 | 90° | 18.5 | 8 | 0.127 | 0.090 | 27.6 | 3.0 |
| 2 | 4 | Turned | 90° | 16.5 | 12 | 0.021 | 0.016 | 28.4 | 2.8 |
| | 5 | Turned | 90° | 17.5 | 12 | 0.065 | 0.051 | 28.3 | 2.7 |
| | 6 | Turned | 90° | 18.5 | 12 | 0.112 | 0.087 | 28.7 | 2.7 |
| | 7 | Turned | 90° | 19.5 | 12 | 0.162 | 0.125 | 29.5 | 2.6 |
| 3 | 8 | Turned | 90° | 18.5 | 16 | 0.084 | 0.065 | 28.6 | 2.9 |
| | 6 | Turned | 90° | 18.5 | 12 | 0.112 | 0.087 | 28.7 | 2.7 |
| | 9 | Turned | 90° | 18.5 | 8 | 0.168 | 0.130 | 29.9 | 2.9 |
| | 10 | Turned | 90° | 18.5 | 4 | 0.337 | 0.261 | 30.5 | 2.9 |
| | 11 | Turned | 90° | 18.5 | - | 0 | 0 | 29.5 | 2.8 |
| 4 | 12 | Ks40 | 45° | 18.5 | 12 | 0.064 | 0.060 | 22.0 | 1.9 |
| | 13 | Ks40 | 45° | 18.5 | 12 | 0.064 | 0.060 | 22.0 | 1.9 |
| | 14 | Ks40 | 45° | 18.5 | 12 | 0.064 | 0.060 | 22.0 | 1.9 |
| | 15 | Ks40 | 45° | 18.5 | 12 | 0.064 | 0.060 | 22.0 | 1.9 |
| | 16 | Ks40 | 45° | 18.5 | 12 | 0.064 | 0.060 | 22.0 | 1.9 |

*) The density of steel is presumed to be 7700 kg/m³ in series 2 and 3. Notional values in series 1 and 4.

5 CONCRETE AND CASTING OF SPECIMEN

The concrete is composed to have a mean compressive strength of $f_{cc} = 25$ MPa after 14 days. The compositions shown in TABLE 2 are used.

TABLE 2 Composition of concrete.

| | Series 1 | Series 2 | Series 3 and 4 |
|--------------------------|-------------------|-------------------|-------------------|
| ***** | kg/m ³ | kg/m ³ | kg/m ³ |
| Standard Portland cement | 232 | 236 | 266 |
| Sand | 1202 | 1121 | 1127 |
| Crushed stone - granite | 627 | 691 | 727 |
| Water | 205 | 210 | 211 |
| ***** | | | |
| Finess modulus sand | 3.03 | 2.74 | 2.36 |
| Finess modulus stone | 6.6 | 6.6 | 6.8 |

Maximum stone size is 16 mm. CaCl₂ with an amount of 2 % of the cement weight is used as accelerator. The consistency was 4 VB.

The concrete compressive strength f_{cc} is determined using cubes with side length of 150 mm. The tensile strength f_{ct} is determined with splitting tests using cubes of the same size. The concrete strengths in form of mean values of three tests are presented in TABLE 1.

The size of the concrete batches was 0.25 m³. The concrete in the steel ring is cast using a special stand and hand compacted using a steel rod. The cubes are vibrated on a vibrating table. The specimens are covered by wet blankets, remolded after 2 days and stored under water for 5 days. Thereafter the specimens are stored in the laboratory at 20⁰C and 50 % relative humidity up to the time for testing, which did vary for different specimens.

6 QUALITIES OF THE REINFORCEMENT

The characteristic parameters of the bars are presented in TABLE 1.

The bars have the following nominal characteristic yield strengths and related rib areas:

Standard reinforcing bars

* Swedish standard SS 212513, Ks400 high bond bar, $f_{sy} = 390$ MPa, $f_R = 0.06$

* Swedish standard SS 212515, Ks600 high bond bar, $f_{sy} = 590$ MPa, $f_R = 0.13$

Turned bars

* Swedish standard SS 212511, Ss260 plain bar, $f_{sy} = 260$ MPa, $f_R = 0.00$.

7 PERFORMANCE OF THE TESTS

The "Ring Test" specimens are loaded in a mechanical loading machine with constant rate of deformation 1 mm/min. The specimen are supported by a teflon ring on a spherical bearing close around the pulled bar.

This support takes care of the reaction from the pulling force in its direction and takes practically nothing of the lateral splitting force from the bar. The displacement between the concrete and the free bar end is continuously noted as a function of applied load. The steel ring circumferential tension is measured with two opposite strain gauges and noted continuously as a function of applied load. The load is measured with a load cell.

8 TEST RESULTS

8.1 Presentation of test results

The measured relation between anchored load F and free bar end displacement δ relative to the concrete is presented in FIG. 4. The bond stress is assumed to be uniformly distributed. This assumption for a bond length of 3 bar diameters ϕ is justified according to Losberg [2].

From the displacement measurements Series 1, it can be concluded, that for Swedish standard bars transverse ribs give stiffer and more brittle anchorage resistance, than to the axis of the bar inclined ribs. An increase in the relative rib area, K_s600 , makes also the anchorage resistance stiffer and a bit more brittle.

In Series 2 the measured anchored load F and displacement δ relations are shown for bars with successively increasing rib height and constant rib distance. The test No 11 has no ribs. This means, that it is a smooth bar. It can be stated, that with increasing rib height the anchoring capacity increases and also the stiffness of the bond.

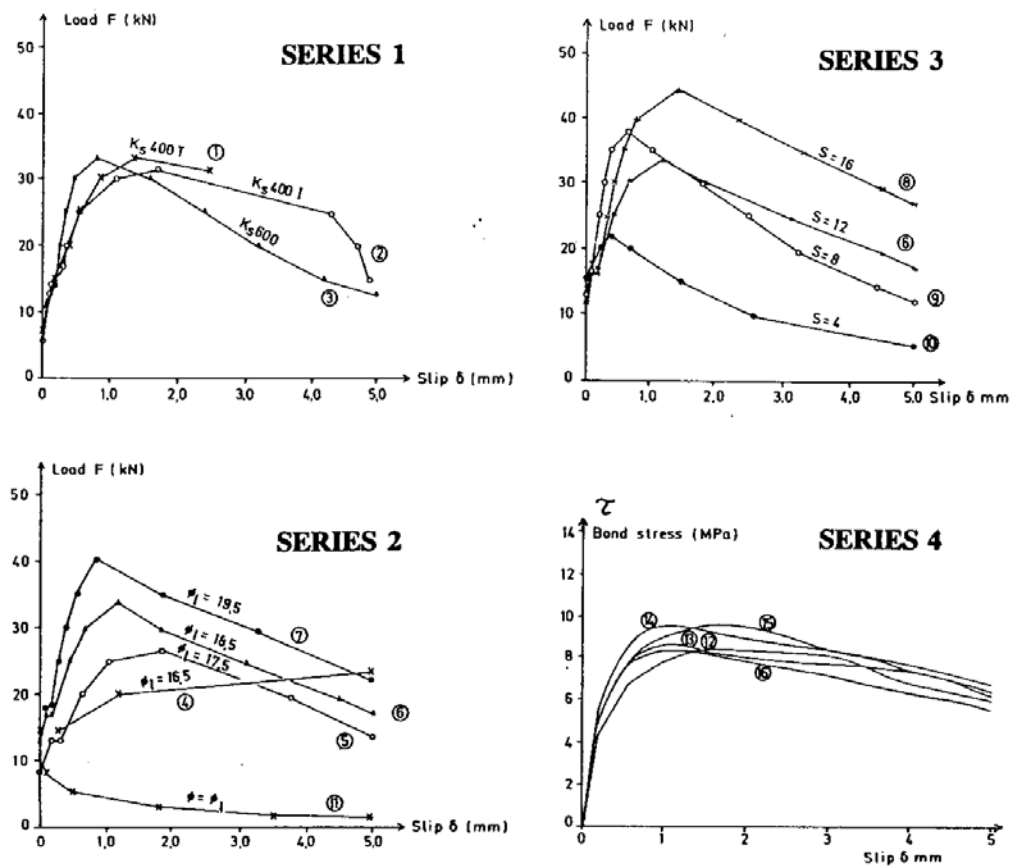

Figure 4: Measured relation between load or stress and free bar end slip relative to the concrete.

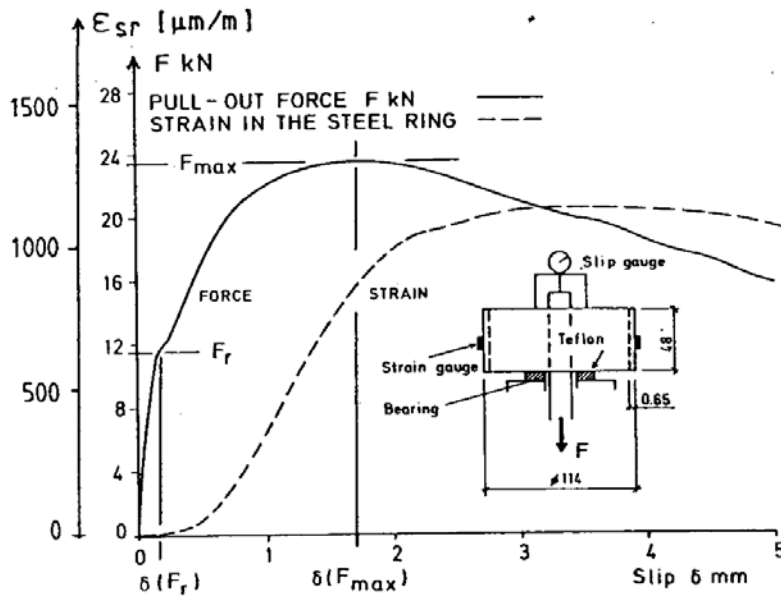

Figure 5: Schematic presentation of the load - slip and load - ring strain - slip curves for a "Ring Test".

In Series 3 the rib distances are varied, while the rib height is kept constant. It can be concluded from the measurements, that the displacement δ at maximum anchored load F becomes bigger with increasing rib distance. The maximum load increases also with exception for test No 6.

The "Ring Test" specimen No 12 to No 16 are equal and the aim with the Series 4 was to state the dispersion in the results. From the measurements it can be concluded, that the scatter in bond stress τ at corresponding displacement is about 20 %. The maximum bond stresses are reached in the displacement interval 1.0 to 2.5 mm.

The load-displacement curve for a "Ring Test" is shown schematically in FIG. 5. At the load F_r , there is an increase in displacement due to the radial cracking of the concrete specimen. At this moment the confinement of the steel ring is activated and the observed change in displacement δ is necessary for this activation. The increase in displacement at the load F_r can be observed also in FIG. 4. When the steel ring is stressed the pull-out test again becomes stiffer.

8.2 Evaluation of angle between bond forces and bar axis

The angle α is evaluated from the measurements as follows:

$$\text{Bond stress in the direction of the bar} = \tau = F/\pi \cdot \delta \cdot h \quad \dots(1)$$

$$\text{To the bar lateral bond stress component} = \tau \tan \alpha \quad \dots(2)$$

It is assumed that the lateral bond forces act as hydraulic pressure through the concrete against the steel ring and this gives

$$\tau \tan \alpha \cdot \delta \cdot h = 2\varepsilon_{rs} E h t \quad \dots(3)$$

Transcribed with the expression for α and steel ring dimensions inserted

$$\alpha = \arctan(2\varepsilon_{rs} E t / \tau \varnothing) = \arctan(2E t h \pi / F) = \arctan(2 \cdot 200 \cdot 10^9 \cdot 0.00065 \cdot 0.048 \pi \varepsilon_{rs} / F) \quad \dots(4)$$

$$\alpha = \arctan(39.2 \cdot 10^6 \varepsilon_{rs} / F) \quad \dots(5)$$

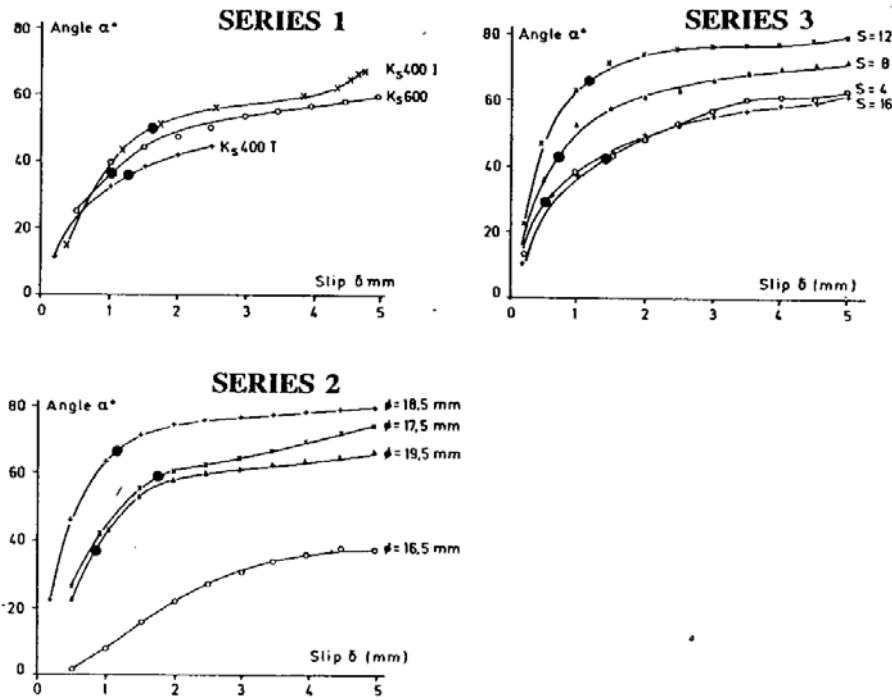

Figure 6: The angle between bond forces and bar axis versus the slip of the free bar end relative concrete. The angle α between the bond forces and the bar axis is evaluated for the tests in Series 1, 2 and 3 and presented versus slip in FIG. 6.

It can be observed for all series that the angle α in the beginning of the loading has a small value, which increases. The angle at maximum load is marked with a black point. The splitting tendency of the anchorage forces increases with the anchored load. From SERIES 1 it can be observed that the angle α at maximum load for the standard bars is about 35 degrees for bars with transverse ribs and about 45 degrees for bar with inclined ribs. From SERIES 2 it does not become quite evident how the angle α is influenced by the rib height. The bar with the smallest rib height does not reach maximum load within the slip range in the diagram. SERIES 3 gives that small and big rib spacing gives small angles α and there in between higher α -values.

8.3 Analysis of the test results

The maximum load versus the related rib area f_R is shown in FIG. 7. Increased rib height, when the rib spacing is unchanged, results in higher ultimate bond failure load. Decreasing rib distances, when the rib height is kept constant results in reduced ultimate bond failure load. Dense ribs however give a high related rib area, but the distance between the ribs is so small that the bar starts to perform as a smooth bar and the ultimate bond load begins to fall.

The slip at maximum load is shown in FIG. 8. The tests No 4 and 11 are excluded from diagram, because these did not reach maximum load within the observed slip range. The slip decreases dramatically, when

the related rib area starts to increase from zero. For $f_R > 0.10$ there is no gain in reduced slip. Standard bars with to the bar axis inclined ribs give somewhat higher slip value than transverse ribs.

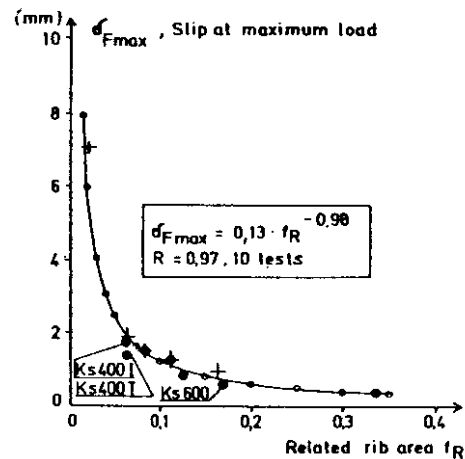
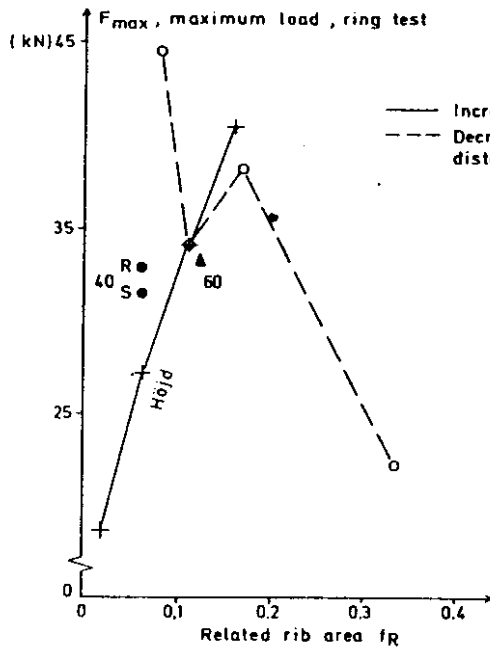

Figure 7: Load at ultimate bond resistance versus related rib area for the bars in SERIES 1, 2 and 3.

Figure 8: Slip at maximum load versus related rib area for the bars in SERIES 1, 2, and 3.

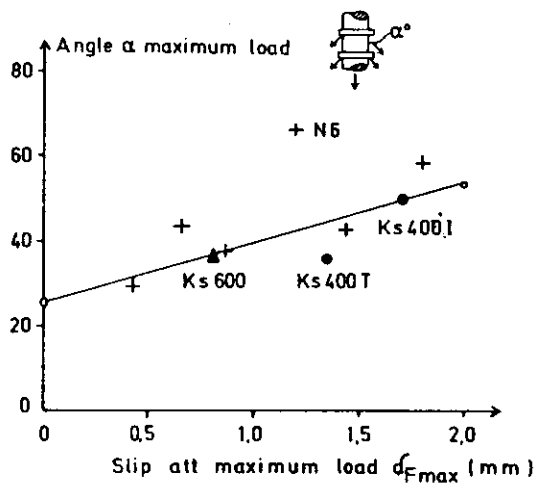

Figure 9: Angle α between bond forces and bar versus slip at maximum load. SERIES 1, 2 and 3.

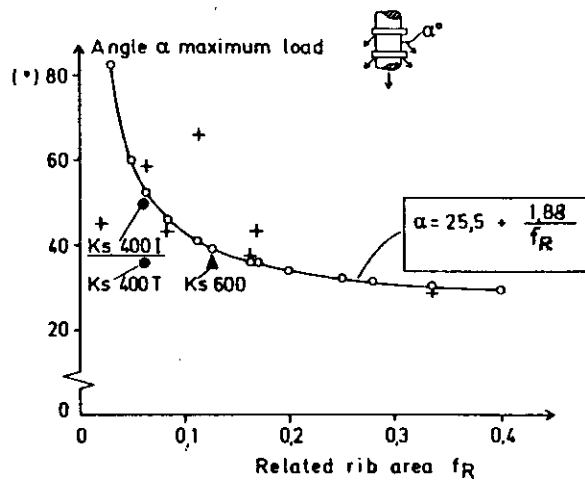

Figure 10: Angle α between bond forces axis and bar axis versus related rib area. SERIES 1, 2 and 3

The angle α increases when the slip at maximum load δ_{Fmax} grows, as it becomes evident from the regression line in FIG. 9. The test No 6 seems to give a deviating value.

The angle α decreases when the related rib area f_R increases, as it is shown by the regression curve in FIG.

10. The scatter is considerable. The standard bars with transverse ribs give smaller α -values than the bar with to the bar axis inclined ribs.

9 CONCLUSIONS

The tests with the "Ring test" show that it is possible to use this testing performance to compare the splitting tendency of reinforcing bars having different shapes of lugs.

Further it can be stated that increasing lug height improves the bond. There is an optimum rib distance with the best bond. If the distance becomes too short the bar starts to act as a smooth bar with a diameter including the bar ribs. The slip at maximum load decreases, when the related rib area increases. The splitting tendency increases with increasing angle α between the bond forces and the axis of the bar. Angle α increase, when the slip at maximum load increases and α decrease, when the related rib area grows.

10 REFERENCES

- /1/ Rehm, G.: Über die Grundlagen des Verbundes zwischen Stahl und Beton. (The fundamentals of bond between reinforcement and concrete). Deutscher Ausschuss für Stahlbeton, Heft 138, p.59, 1961.
- /2/ Losberg A.: Kraftöverföring och spänningsfördelning vid förankring och avslutning av arnering. (Transmission of force and distribution of stress at anchorage and curtailment of reinforcement.) Chalmers University of Technology, Division of Concrete Structures. p. 49. Göteborg 1963.
- /3/ Berggren L.: Utdragsprov med kort vidhäftningslängd. (Pull-out tests with short bond length). Chalmers University of Technology, Division of Concrete Structures, No 686. p. 85. Göteborg, 1965.
- /4/ Goto, Y.: Cracks Formed in Concrete around Deformed Reinforcing Bars. Journal of the ACI, 1971. pp.244-251.
- /5/ Tepfers, R.: A Theory of Bond Applied to Overlapped Tensile Reinforcement Splices for Deformed Bars. Chalmers University of Technology, Division of Concrete Structures, Publication 73:2, p. 328. Göteborg, 1973.
- /6/ Losberg, A., Olsson, P-Å.: Bond failure of Deformed Reinforcing Bars Based on the Longitudinal Splitting Effect of the Bars. ACI-Journal, January 1979, No. 1, Proceedings V. 76. pp.5-18.
- /8/ Tepfers, R.: Cracking of Concrete Cover Along Anchored Deformed Reinforcing Bars. Magazine of Concrete Research, Vol. 31, No. 106, March 1979. pp.3-12.
- /9/ Goto Y., Otsuka K.: Experimental studies on Cracks Formed in Concrete Around Deformed Tension Bars. The Technology Reports of Tohoku University, Vol. 44 (1979) No. 1, Sendai, June 1979. pp. 49-83.
- /10/ Beranek, W. J.: Private communication. IBBC-TNO, Afd. Experimentele Mechanica. Delft 1980.
- /11/ RILEM/CEB/FIP Recommendations on reinforcement steel for reinforced concrete. Revised edition of: RC5 Bond test for reinforcement steel: (1) Beam test. Comité Euro-International du Béton, CEB News No 61. Paris April 1982.
- /12/ Bond Action and Bond Behaviour of Reinforcement. CEB, Bulletin d'Information No 151. Comité Euro-International du Béton, CH-1015 Lausanne, April 1982. p.153.
- /13/ RILEM/CEB/FIP Recommendations on reinforcement steel for reinforced concrete. Revised edition of: RC6 Bond test for reinforcement steel:(2) Pull-out test. Comité Euro-International du Béton, CEB News No 73. Lausanne May 1983.
- /14/ Otsuka K.: X-ray technique with contrast medium to detect fine cracks in reinforced concrete. International Workshop on Fracture Toughness and Fracture Energy. Sendai, 12-14 October 1988. A.A.Balkema Publishers, Rotterdam 1989.

The reference to this paper is:

Tepfers R., Olsson P-Å.: Ring Test for Evaluation of Bond Properties of Reinforcing Bars. International Conference. *"Bond in Concrete - From Research to Practice"*, Riga, Latvia, October 1992. pp.1-89 - 1-99.