

From Department of Molecular Medicine and Surgery  
Section for Integrative Physiology  
Karolinska Institutet, Stockholm, Sweden

# **EPIGENETIC INFLUENCES ON TYPE 2 DIABETES AND OBESITY**

Jie Yan



**Karolinska  
Institutet**

Stockholm 2012

***Supervisor***

Prof. Juleen Zierath  
Section for Integrative Physiology, Department of Molecular Medicine and Surgery  
Karolinska Institutet, Stockholm, Sweden

***Co-Supervisor***

Prof. Anna Krook  
Section for Integrative Physiology, Department of Physiology and Pharmacology  
Karolinska Institutet, Stockholm, Sweden

***Opponent***

Associate Prof. Rebecca A. Simmons  
Department of Pediatrics  
Perelman School of Medicine at University of Pennsylvania, Philadelphia, USA

***Examination Board***

Prof. Rachel Fisher  
Department of Medicine, Solna  
Karolinska Institutet, Stockholm, Sweden

Prof. Peter Stenvinkel  
Department of Clinical Science, Intervention and Technology  
Karolinska Institutet, Stockholm, Sweden

Associate Prof. Charlotte Ling  
Department of Clinical Sciences, Malmö  
Faculty of Medicine at Lund University, Malmö, Sweden

All previously published papers were reproduced with permission from the publisher.

**Front cover:** The picture shows the role of the environmental factors on insulin sensitivity through DNA methylation. Changes in DNA methylation may be an early event in the pathogenesis of Type 2 diabetes.

Published by Karolinska Institutet. Printed by Karolinska Universitetsservice US-AB.

© **Jie Yan, 2012**

ISBN 978-91-7457-592-7

***To My Family***

致我的家人



*"If I have ever made any valuable discoveries, it has been owing more to patient attention than to any other talent."*

**Isaac Newton**

(25 December 1642 – 20 March 1727)



## ABSTRACT

Type 2 diabetes and obesity are multifactorial diseases involving interactions between genetic and environmental factors. A common feature shared between these two diseases is skeletal muscle insulin resistance. Insulin resistance refers to a state when the normal biological effect is not achieved by a normal amount of insulin. Complicated genetics alone is unlikely to explain the diversity of phenotypes in the general population. Epigenetics provides a mechanism which may explain the etiology of Type 2 diabetes and obesity, as well as other human diseases.

DNA methylation is an epigenetic modification that plays a key role in various biological processes including imprinting, mammalian development and maintaining genomic stability. DNA methylation is believed to be modulated by environmental and nutritional factors, essentially functioning as a molecular switch to turn genes on or off. The research on the role of DNA methylation in metabolic diseases is still in its infancy. This thesis aims at elucidating the role of DNA methylation in regulating expression of genes involved in controlling mitochondrial function and insulin sensitivity. Emphasis has been placed on the role of methylation in a non-CpG context.

DNA methylation in a CpG context is considered to be the predominant DNA methylation pattern in mammals. The existence of non-CpG methylation in mammals is still under discussion. In Paper I, we provide evidence that high levels of non-CpG methylation exist in human and rodent tissues, both at the whole genome level and at specific promoter regions. Using an adapted Luminometric-based Assay, we detected 7-13% non-CpG methylation in mouse tissues at the genomic level, and similar levels were for specific promoter sequences through different bisulfite sequencing strategies.

Mitochondrial dysfunction is associated with skeletal muscle insulin resistance in Type 2 diabetes and obesity. In Paper II, we show that mitochondria number is reduced and mitochondria morphology is altered, in skeletal muscle from Type 2 diabetic patients. The promoter region of *PGC1 $\alpha$* , a gene involved in mitochondrial biogenesis, was differentially methylated in Type 2 diabetic patients using whole genome promoter methylation analysis. Methylation level of *PGC1 $\alpha$*  was negatively correlated with mRNA expression. Non-CpG methylation of *PGC1 $\alpha$*  promoter was induced in human myotubes by culturing cells in the presence of tumor necrosis factor  $\alpha$  or free fatty acids. These changes in methylation could be prevented by silencing DNA methyltransferase 3B.

Many morbidly obese individuals undergo gastric bypass surgery as a means to reduce daily calorie consumption and lose weight, since conventional strategies for obesity treatment are often insufficient. Insulin sensitivity can be dramatically improved after the surgery. In Paper III, we report that concomitant with the weight loss, the expression of genes involved in mitochondrial function and insulin sensitivity in obese subjects was normalized to levels of normal weight controls. Furthermore methylation levels of *PGC1 $\alpha$*  and *PDK4* promoter regions are altered in obese subjects, and methylation of these regions is dynamically changed with weight loss.

In conclusion, we identify the existence of non-CpG methylation in mammals and report a functional role in regulating genes associated with skeletal muscle insulin resistance, which is of relevance to the pathogenesis of Type 2 diabetes and obesity. We also provide evidence that DNA methylation is dynamically remodeled, concomitant with alterations in insulin sensitivity. Environmental factors are potential triggers for changes in DNA methylation.





# LIST OF PUBLICATIONS

## Articles included in this thesis

- I. **Yan J**, Zierath JR, Barrès R. Evidence for non-CpG methylation in mammals. *Exp Cell Res.* 2011 **317**:2555-2561.
- II. Barrès R, Osler ME, **Yan J**, Rune A, Fritz T, Caidahl K, Krook A, Zierath JR. Non-CpG methylation of the PGC-1alpha promoter through DNMT3B controls mitochondrial density. *Cell Metab.* 2009 **10**:189-198.
- III. Barrès R\*, **Yan J**\*, Rasmussen M, Krook A, Näslund E, Zierath JR. Weight loss after gastric bypass surgery induces epigenetic modifications in human obesity. Manuscript submitted.  
(\*Both authors contributed equally to this work)

## Articles not included in this thesis

Barrès R, **Yan J**, Egan B, Treebak JT, Rasmussen M, Fritz T, Caidahl K, Krook A, O'Gorman DJ, Zierath JR. Exercise Remodels Promoter Methylation in Human Skeletal Muscle. Manuscript submitted.

Markljung E, Jiang L, Jaffe JD, Mikkelsen TS, Wallerman O, Larhammar M, Zhang X, Wang L, Saenz-Vash V, Gnirke A, Lindroth AM, Barrés R, **Yan J**, Strömberg S, De S, Pontén F, Lander ES, Carr SA, Zierath JR, Kullander K, Wadelius C, Lindblad-Toh K, Andersson G, Hjältn G, Andersson L. ZBED6, a novel transcription factor derived from a domesticated DNA transposon regulates IGF2 expression and muscle growth. *PLoS Biol.* 2009 **7**:e1000256.

Feng X, **Yan J**, Wang Y, Zierath JR, Nordenskjöld M, Henter JI, Fadeel B, Zheng C. The proteasome inhibitor bortezomib disrupts tumor necrosis factor-related apoptosis-inducing ligand (TRAIL) expression and natural killer (NK) cell killing of TRAIL receptor-positive multiple myeloma cells. *Mol Immunol.* 2010 **47**:2388-2396.

# CONTENTS

1	Introduction and background.....	1
1.1	Type 2 diabetes and obesity.....	1
1.1.1	General introduction.....	1
1.1.2	Diagnostic criteria.....	1
1.1.3	Intervention and treatment.....	2
	• Conventional management.....	2
	• Gastric bypass surgery.....	3
1.1.4	The regulation of metabolism by insulin.....	4
1.1.5	Insulin resistance.....	5
	• Fat overload and insulin resistance.....	6
	• Inflammation and insulin resistance.....	7
1.1.6	Metabolic flexibility in skeletal muscle.....	7
1.1.7	Mitochondrial function.....	9
1.1.8	Target genes.....	9
	• <i>PGC1<math>\alpha</math></i> .....	9
	• <i>TFAM</i> .....	10
	• <i>PDK4</i> .....	11
1.2	DNA methylation.....	11
1.2.1	Epigenetic modifications.....	11
1.2.2	DNA methylation.....	12
1.2.3	Non-CpG methylation.....	13
1.2.4	DNA methyltransferase (DNMT).....	14
2	Present investigation.....	15
2.1	Aim of the thesis.....	15
2.2	Materials and methods.....	16
2.2.1	Study participants.....	16
2.2.2	Animal model-The leptin deficient ( <i>ob/ob</i> ) mice.....	17
2.2.3	Primary human skeletal muscle cell culture.....	18
2.2.4	Comments on strategies to study DNA methylation.....	18
	• Methylation isoschizomers.....	18
	• Luminometric Methylation Assay (LUMA).....	19
	• MeDIP-qPCR.....	19

	• Methylated DNA enrichment by MBD protein .....	20
	• Bisulfite sequencing .....	21
2.3	Results and discussion .....	24
2.3.1	Paper I.....	24
	• Evidence for non-CpG methylation using adapted LUMA .....	24
	• Bisulfite sequencing shows significant levels of non-CpG methylation .....	25
2.3.2	Paper II.....	26
	• <i>PGC1<math>\alpha</math></i> promoter is hypermethylated in Type 2 diabetic subjects .....	26
	• <i>PGC1<math>\alpha</math></i> methylation regulates <i>PGC1<math>\alpha</math></i> mRNA expression .....	27
	• Free fatty acids and TNF $\alpha$ induces hypermethylation of <i>PGC1<math>\alpha</math></i> .....	28
	• DNMT3B is involved in palmitate-triggered <i>PGC1<math>\alpha</math></i> hypermethylation .....	29
2.3.3	Paper III .....	30
	• Clinical characteristics of the study participants .....	30
	• The transcription of metabolic genes and DNA methylation pattern.....	31
	• <i>PGC1<math>\alpha</math></i> and <i>PDK4</i> methylation is altered with obesity and weight loss. ....	31
3	Summary .....	35
4	Conclusion .....	37
5	Future perspectives .....	38
5.1	Tissue-specific DNA methylation.....	38
5.2	Other epigenetic mechanisms.....	38
5.3	Refining definition of ‘epigenetics’ .....	38
5.4	Linking <i>in utero</i> environmental stimuli to adult metabolic disease. ....	39
6	Acknowledgements .....	40
7	References.....	43

## LIST OF ABBREVIATIONS

BMI	Body mass index
CREB	cAMP response element-binding protein
CRP	C-reactive protein
DAG	Diacylglycerol
DMEM	Dulbecco's Modified Eagle Medium
DMR	Differentially methylated region
DNA	Deoxyribonucleic acid
DNMTs	DNA methyltransferases
dNTP	Deoxyribonucleotide triphosphate
EDL	<i>Extensor digitorum longus</i> muscle
EDTA	Ethylenediaminetetraacetic acid
EtOH	Ethanol
FDA	Food and Drug Administration (U.S.)
GAPDH	Glyceraldehydes 3-phosphate dehydrogenase
GBP	Gastric bypass surgery
GI	Gastrointestinal
GLP-1	Glucagon-like peptide-1
GWAS	Genome-wide association study
HbA1c	Hemoglobin A1c
HDL	High density lipoprotein
HGF	Hepatocyte growth factor
HOMA	Homeostatic model assessment
IFG	Impaired fasting glucose
IGT	Impaired glucose tolerance
IL6	Interleukin-6
LUMA	Luminometric Methylation Assay
MBD	Methyl-CpG-binding domain
MeDIP	Methylated DNA ImmunoPrecipitation
MEF	Mouse embryonic fibroblasts
mRNA	Messenger RNA
mtDNA	mitochondrial DNA
NaOAc	Sodium acetate
NEFA	Non-esterified fatty acids
NGT	Normal glucose tolerance
NRF	Nuclear respiratory factor
PBS	Phosphate-buffered saline
PCR	Polymerase Chain Reaction
PDH	Pyruvate dehydrogenase complex
PDK4	Pyruvate dehydrogenase kinase isozyme 4, mitochondrial
PGC1 $\alpha$	Proliferator-activated receptor $\gamma$ coactivator 1 $\alpha$
PPi	Pyrophosphate
RNA	Ribonucleic acid
ROS	Reactive oxygen species
RQ	Respiratory quotient
T2D	Type 2 diabetes
TCA	Tricarboxylic acid cycle or Krebs cycle
TFAM	Transcription factor A, mitochondrial
TNF- $\alpha$	Tumor necrosis factor $\alpha$
TZD	Thiazolidinediones
WHO	World Health Organization

# 1 INTRODUCTION AND BACKGROUND

## 1.1 TYPE 2 DIABETES AND OBESITY

### 1.1.1 General introduction

The metabolic syndrome is defined by a group of diseases including high blood glucose, high blood lipids level, hypertension, central obesity (Haller, 1977; Singer, 1977) [Figure 1]. Type 2 diabetes afflicts more than 300 million people worldwide (World Health Organization data updated 2011 August). Type 2 diabetes is associated with a series of health problems including increased risk of strokes, heart attacks, diabetic retinopathy, kidney failure, as well as amputation (Kolata, 1979; Porte and Schwartz, 1996). Obesity is a major risk for the development of insulin resistance, Type 2 diabetes, fatty liver disease, cardiovascular disease, degenerative disorders, airway disease and some cancers (Haslam and James, 2005; Sims et al., 1973). Type 2 diabetes and obesity are multifactorial diseases involving interactions between genetic and environmental factors.

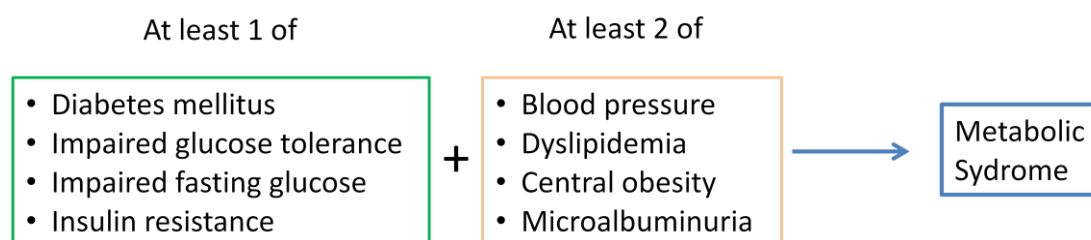

**Figure 1 WHO criteria (1999) of Metabolic Syndrome.** (World Health Organization. Definition, diagnosis and classification of diabetes mellitus and its complications: report of a WHO Consultation. Part 1: diagnosis and classification of diabetes mellitus. Geneva, Switzerland: World Health Organization; 1999. Available at: [http://whqlibdoc.who.int/hq/1999/who\\_ncd\\_ncs\\_99.2.pdf](http://whqlibdoc.who.int/hq/1999/who_ncd_ncs_99.2.pdf).)

### 1.1.2 Diagnostic criteria

Type 2 diabetes is defined according to elevated fasting plasma glucose level or 2 hour plasma glucose level after a oral glucose tolerance test [Table 1]. HbA1c (hemoglobin A1c) is a glycosylated form of hemoglobin and serves as a marker for average blood glucose levels over the past 3-4 months. HbA1c  $\geq 6.5\%$  is added as another criterion for the diagnosis of diabetes (Executive summary: Standards of medical care in diabetes-2010). Overweight and obesity are defined as excessive fat accumulation and can be roughly estimated by body mass index (BMI, stands for a person's weight divided by the square of the person's height,  $\text{kg}/\text{m}^2$ ). Obesity is classified if a person's BMI is over  $30 \text{ kg}/\text{m}^2$  [Table 2].

**Table 1** WHO (2006) diabetes diagnostic criteria\*

	<b>Fasting glucose</b>	<b>2 hour glucose</b>
	mmol/L	mmol/L
Normal	<6.1	<7.8
Impaired fasting glucose (IFG)	6.1≤IFG<7.0	<7.8
Impaired glucose tolerance (IGT)	<7.0	≥7.8
Diabetes	≥7.0	≥11.1

\*WHO. **Definition and Diagnosis of Diabetes Mellitus and Intermediate Hyperglycemia.** Available at: [http://whqlibdoc.who.int/publications/2006/9241594934\\_eng.pdf](http://whqlibdoc.who.int/publications/2006/9241594934_eng.pdf).

**Table 2** WHO classification of adult obesity according to BMI\*

<b>BMI</b>	<b>Classification</b>
kg/m <sup>2</sup>	
<18.5	Underweight
18.5-24.9	Normal weight
25.0-29.9	Overweight
30.0-34.9	Class I Obese
35.0-39.9	Class II Obese
≥40.0	Class III Obese

\*WHO. **Obesity: preventing and managing the global epidemic. Report of a WHO Consultation.** WHO Technical Report Series 894. Geneva: World Health Organization, 2000. Available at: [http://whqlibdoc.who.int/trs/WHO\\_TRS\\_894.pdf](http://whqlibdoc.who.int/trs/WHO_TRS_894.pdf).

### 1.1.3 Intervention and treatment

#### 1.1.3.1 Conventional management

Management of Type 2 diabetes aims to normalize glucose levels throughout the day, such that the development of diabetes-induced complications are reduced or prevented.

Conventional management of Type 2 diabetes can be summarized into five aspects:

- Diet control: Low glycemic index diet is recommended.
- Exercise: Aerobic exercise increases insulin sensitivity and VO<sub>2max</sub> and reduces HbA<sub>1c</sub> (Zanuso et al., 2010).
- Medications: Anti-diabetic oral medications include Biguanides, Thiazolidinediones (TZD), Sulfonylureas, and alpha-glucosidase inhibitors. These medications reduce blood glucose levels either by stimulating insulin secretion from the pancreas, increasing target tissue sensitivity to insulin or by delaying glucose absorption from the gastrointestinal tract. Metformin (a biguanide) is currently the first line medication to treat Type 2 diabetes. Insulin therapy is necessary when sufficient control of blood glucose levels cannot be achieved only by use of oral medications. Glucagon-like peptide-1 (GLP-1) analogs are a new class of drug for treatment of Type 2 diabetes with glucose-

dependent action (Exenatide approved by FDA in 2005, liraglutide approved by FDA in 2010).

- Education: Adequate information about Type 2 diabetes and relevant training should be delivered to newly diagnosed Type 2 diabetic patients.
- Self-monitoring of blood glucose: It is important for patients to monitor blood glucose in order to maintain normal blood glucose level.

The main management of obesity includes dieting and exercise in order to lose weight coupled with some form of behavior therapy. Orlistat, a lipase inhibitor, is a medication designed to treat obesity by decreasing fat absorption in the intestine.

### *1.1.3.2 Gastric bypass surgery*

Conventional strategies described above for the treatment of Type 2 diabetes and obesity, including lifestyle modifications of diet and exercise behavior, are often insufficient and pharmacological options are limited (Matthews et al., 1998; Turner et al., 1999). When diet and drugs no longer work, many morbidly obese individuals opt to undergo bariatric surgery as a means to reduce daily calorie consumption and to lose weight. People who have a BMI of 40 kg/m<sup>2</sup> or higher, or with BMI of 35 kg/m<sup>2</sup> or higher with one or more comorbid conditions can be considered as candidates for bariatric surgery according to NIH (National Institutes of Health) recommended criteria (NIH, 1992). The preoperative evaluation is still critical for bariatric surgery even though the first attempts were performed in the 1950s.

During the last two decades, the vertical banded gastroplasty, gastric banding and gastric bypass were the most commonly used procedures in Sweden. In Sweden, 96% of all bariatric surgeries performed today are gastric bypass (Scandinavian Obesity Surgery Registry) (Marsk, 2009). Gastric bypass entails the creation of a small upper pouch of the stomach. This pouch has a volume of about 30 ml. A piece of divided jejunum (Roux-limb) is anastomosed to the pouch and the remaining part of the divided jejunum is re-attached 1 m distal to the gastro-jejunal anastomosis [Figure 2]. Gastric bypass surgery dramatically improves insulin sensitivity and leads to the clinical resolution or remission of Type 2 diabetes (Greenway et al., 2002; Rubino et al., 2010; Sjostrom et al., 2007). The improvement in insulin sensitivity noted after surgery cannot only be explained by weight loss since Type 2 diabetes is resolved even shortly after the surgery. Changes in gastrointestinal (GI) peptide release, such as glucagon-like peptide-1, after gastric bypass surgery has been proposed to participate in the improvement of glucose metabolism, but the underlying molecular mechanism is incompletely resolved (Butner et al., 2010; Falken et al., 2011)

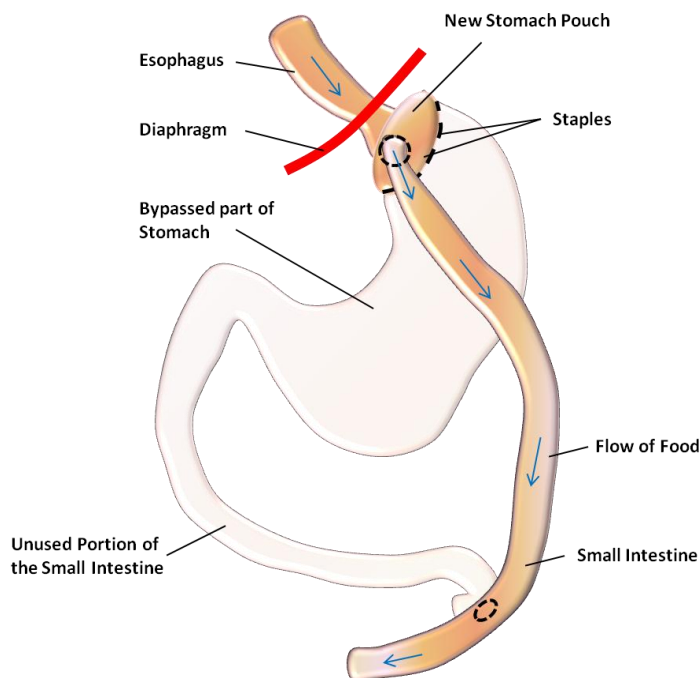

Figure 2 A schematic drawing of Roux-en-Y gastric bypass procedure for obesity.

#### 1.1.4 The regulation of metabolism by insulin

Insulin is a peptide hormone (51 amino acids in total) and has a molecular weight of 5808 Da (Sanger and Tuppy, 1951a, b). Insulin is produced within the  $\beta$ -cells of the islets of Langerhans in the pancreas (Orci and Unger, 1975; Steiner and Oyer, 1967). In the  $\beta$  cells, insulin is synthesized from the precursor molecule proinsulin by removing the center of the molecule (C-peptide) through proteolytic enzymes (Steiner and Oyer, 1967).

Insulin orchestrates fuel homeostasis by stimulating glucose uptake into peripheral tissues, inhibiting glucose production by the liver and suppressing stored lipids release from adipose tissue. The normal glucose level is tightly controlled, ranging from 4 to 7 mM, despite the nutritional status (fasting versus fed). Insulin activates the pathways to control glucose, free fatty acids, amino acids uptake into cells and promote storage of glycogen and lipids, as well as protein synthesis [Figure 3].



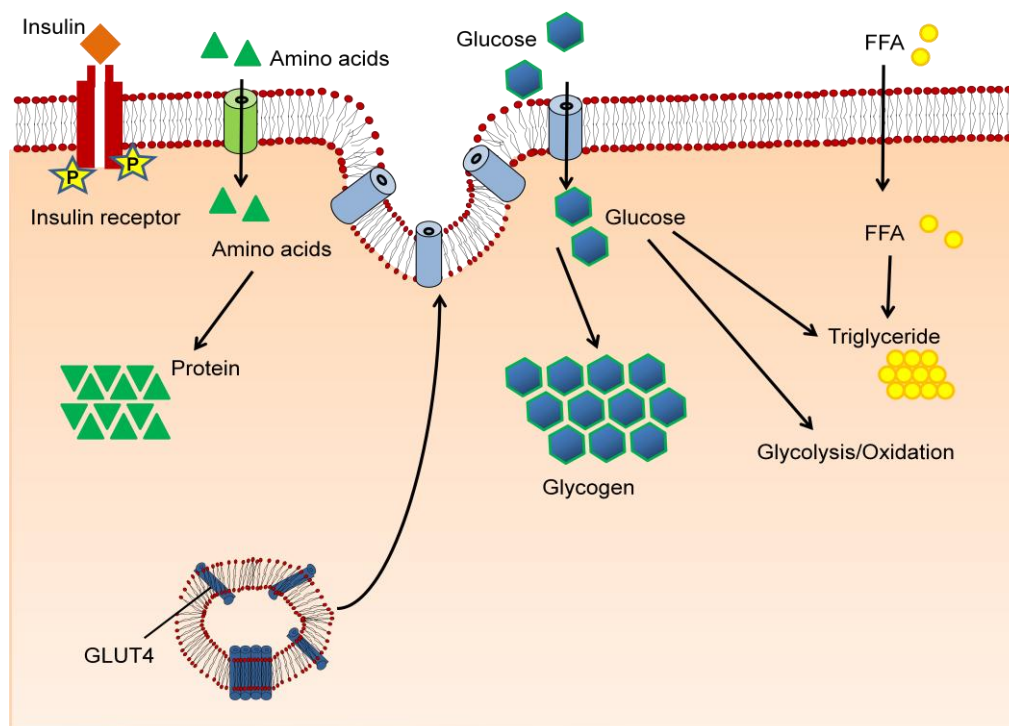
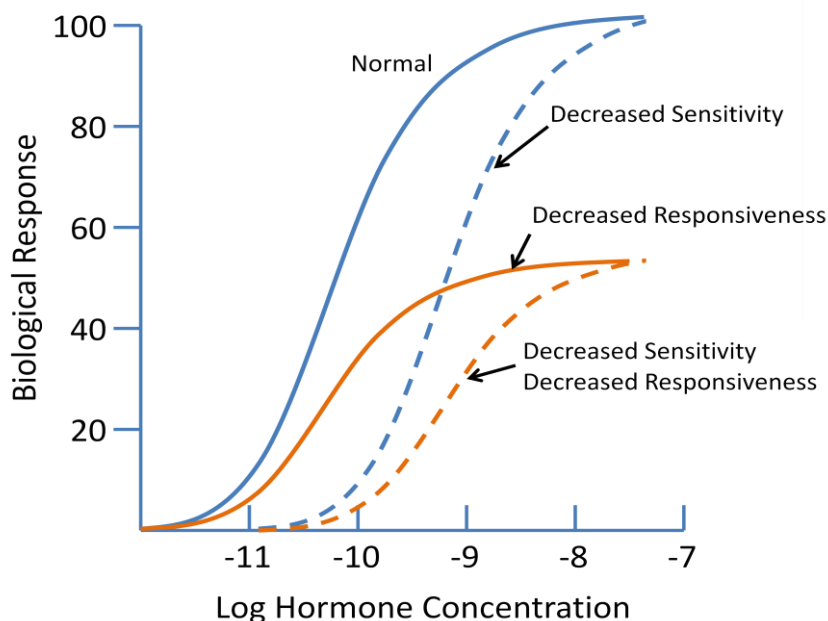

Figure 3 The regulation of metabolism by insulin.

### 1.1.5 Insulin resistance

Skeletal muscle insulin resistance is a common feature of many metabolic disorders including Type 2 diabetes, obesity, cardiovascular disease, hypertension and polycystic ovary syndrome (Reaven, 2005).

*'Insulin resistance may be said to exist whenever normal concentrations of insulin produce a less than normal biologic response. Hormone resistant states may be divided into those due to decreased sensitivity to a hormone (i.e., a shift in the dose-response curve to the right), those due to a decrease in the maximal response to the hormone, and those that are combinations of decreased sensitivity and decreased responsiveness.'* (Kahn, 1978) [Figure 4]



**Figure 4** Types of resistance to hormone action. (Picture redrawn from Kahn CR. *Metabolism*. 1978 Dec;27(12 Suppl 2):1893-902.)

Insulin resistance may occur at three levels: 1) Before the interaction of insulin with the receptor, such as increased insulin degradation or insulin competing to bind other proteins rather than insulin receptor; 2) At the level of the insulin receptor, due to alterations in receptor amount or binding affinity; 3) Downstream of the insulin-receptor interaction, due to a change from hormone-receptor complexes to the final biologic effects (Kahn, 1978).

Insulin resistance often precedes the development of overt diabetes. This is due to the fact that as insulin resistance develops, the  $\beta$ -cell compensates by increasing insulin secretion, thus maintaining blood glucose levels within a healthy range. Eventually the  $\beta$ -cell fails to adequately meet demand, and blood glucose levels rise (Clark et al., 1988; Donath and Halban, 2004; Kloppel et al., 1985; Wajchenberg, 2007).

*1.1.5.1 Fat overload and insulin resistance*

A fat overload theory for the development of insulin resistance has been emerging over the past several decades (Griffin et al., 1999; Petersen et al., 1998; Roden et al., 1996). A role for free fatty acids in the development of insulin resistance was proposed, based on the observations that insulin resistance is associated with elevated free fatty acids level in blood (Reaven et al., 1988). Fat is usually stored in adipocytes in the form of triglycerides. Ectopic lipid storage contributes to insulin resistance in different tissues such as skeletal muscle, pancreas, heart and liver (Boden et al., 2001; Krssak et al., 1999; Perseghin et al., 1997; Perseghin et al., 1999). Diacylglycerol (DAG) and ceramide, intermediates from incomplete  $\beta$ -oxidation, accumulate in muscle cells and inhibit insulin signaling pathway (Yu et al., 2002) [Figure 5].

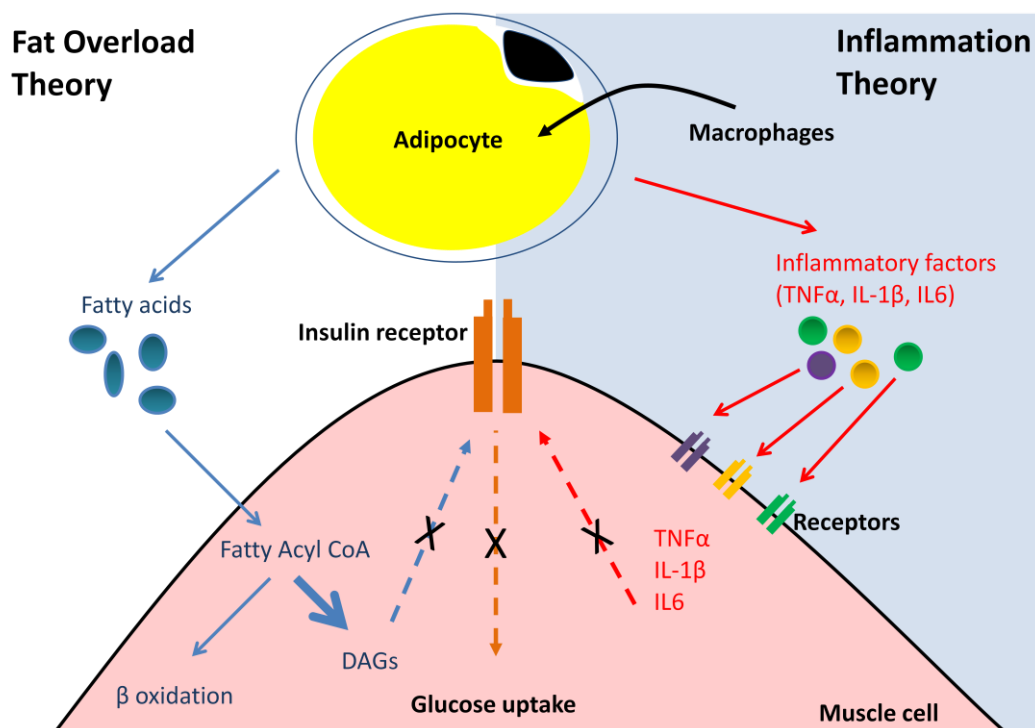

Figure 5 Two general theories to illustrate insulin resistance (Fat overload theory, white background on the left side; Inflammation theory, grey background on the right side).

#### 1.1.5.2 Inflammation and insulin resistance

Inflammation is an alternative theory to explain insulin resistance. Unsurprisingly, obesity itself is an inflammatory state. Different inflammatory factors secreted from adipocytes may attenuate insulin action through enhanced JNK activation in skeletal muscle cells. Increased activation of this kinase impairs insulin signaling and glucose transport (Hotamisligil et al., 1996; Uysal et al., 1997; Vallerie et al., 2008; Yuan et al., 2001) [Figure 5]. Macrophages are believed to infiltrate the fat cells and initiate these inflammatory responses by secreting cytokines which act on peripheral tissues.

#### 1.1.6 Metabolic flexibility in skeletal muscle

Skeletal muscle comprises 40-50% of the body mass and is the major site of substrate metabolism. Skeletal muscle is the primary site for postprandial glucose clearance (DeFronzo et al., 1985) and skeletal muscle is the major site of insulin resistance in Type 2 diabetic patients [Figure 6] (DeFronzo, 1988). Thus, defects in insulin-stimulated glucose transport in skeletal muscle account for the whole body insulin resistance noted in people with severe obesity or Type 2 diabetes (Dohm et al., 1988; Goodyear et al., 1995; Zierath et al., 1994).

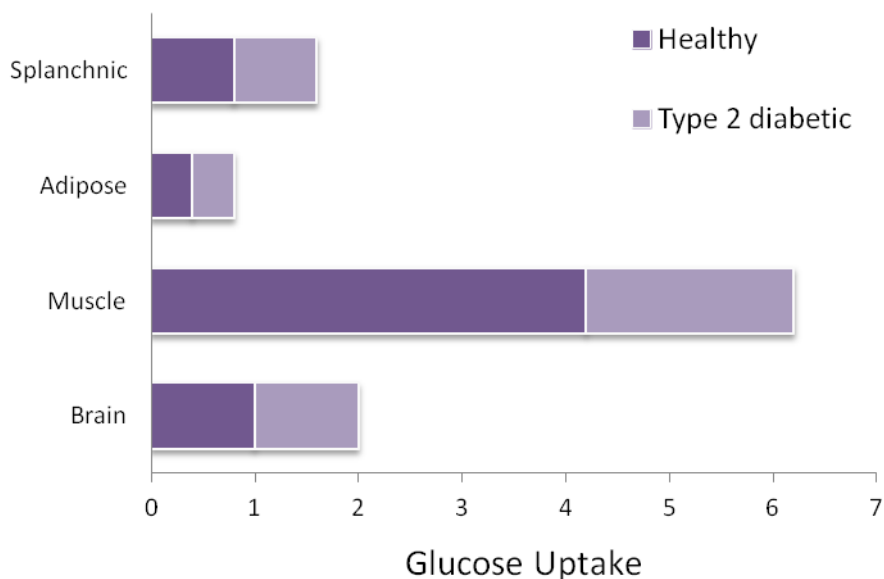

**Figure 6** Glucose uptake in healthy and Type 2 diabetic subjects. (Picture adapted from DeFronzo RA. Lilly Lecture 1987. Diabetes. 1988;37:667-687.)

Metabolic flexibility is one of the physiological characteristics of skeletal muscle that allows either carbohydrate or fatty acid utilization (Randle et al., 1963). However, in skeletal muscle of obese, sedentary individuals there is a narrower range in the switch between fat and glucose oxidation compared to aerobically fit and lean individuals [Figure 7]. This reduced capacity to the transitions has been described as ‘metabolic inflexibility’ of skeletal muscle (Kelley and Mandarino, 2000).

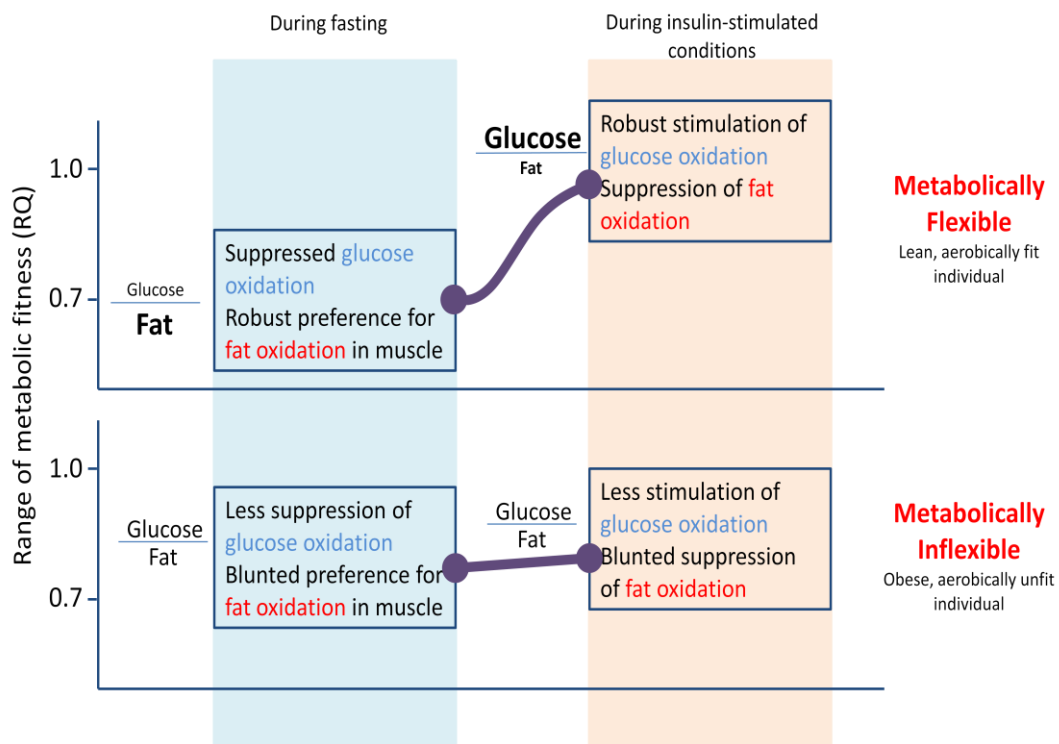

**Figure 7** Metabolic Flexibility and Metabolic Inflexibility of skeletal muscle.

### 1.1.7 Mitochondrial function

The human mitochondrial genome encodes 13 proteins, 22 tRNAs and 2rRNAs that play an important role in composition of mitochondrial respiratory chain and translational machinery (Anderson et al., 1981). Mitochondria, described as the ‘power plant’ in cells, regulate metabolism and energy homeostasis by metabolizing nutrients and producing ATP. Pyruvate produced from glycolysis is transported to the mitochondrial matrix and oxidized to acetyl-CoA, the entry molecular for *tricarboxylic acid (TCA) cycle* or *Krebs cycle*. Fatty acids are also broken down to acetyl-CoA in mitochondria through  $\beta$ -oxidation.

There is ample evidence that mitochondrial dysfunction is associated with skeletal muscle insulin resistance in Type 2 diabetes and age-related insulin resistance (Petersen et al., 2003; Stump et al., 2003). The underlying mechanism is believed to involve an accumulation of intracellular lipid metabolites from incomplete lipid oxidation that inhibit insulin signal transduction to glucose transport (Kim et al., 2000; Petersen et al., 2004; Ritov et al., 2005). Reduced mitochondria number and altered mitochondria morphology have been reported in skeletal muscle of Type 2 diabetic patients. Mitochondrial DNA (mtDNA) content is decreased in obese subjects compared to lean volunteers in skeletal muscle (Ritov et al., 2005). In insulin resistant states, mtDNA seems to be vulnerable, probably due to the physiological role of mitochondria to produce ROS (Reactive oxygen species) (Linnane et al., 1989). Thus, systemic insulin resistance may arise from alterations in the size or number of mitochondria, as well as impaired oxidative capacity in skeletal muscle.

There appears to be considerable evidence focused on the correlative nature of the relationship between mitochondrial dysfunction and insulin resistance. The theory suggesting that insulin resistance comes from impaired fatty acids uptake and oxidation in mitochondria has been challenged (An et al., 2004; Monetti et al., 2007). Several lines of evidence suggest that obesity-associated glucose intolerance might be due to metabolic overload of muscle mitochondria and that skeletal muscle insulin resistance may rise from excessive  $\beta$ -oxidation rather than reduced (An et al., 2004; Koves et al., 2005).

### 1.1.8 Target genes

This thesis is mainly focused on genes participating in glucose and lipid metabolism, specifically genes related to insulin sensitivity and mitochondrial function. Emphasis was placed on the *PGC-1 $\alpha$* , *TFAM*, and *PDK4* as outlined below:

#### 1.1.8.1 *PGC-1 $\alpha$*

**PGC-1 $\alpha$  (peroxisome proliferator-activated receptor  $\gamma$  coactivator 1 $\alpha$ )** contains 798 amino acids in the human sequence (797 in the mouse sequence). The encoded gene *PPARGC1* is located on chromosome 4 in human (chromosome 5 in mouse). PGC-1 was first identified as a transcriptional coactivator regulating adipocyte differentiation through interacting with nuclear receptor PPAR $\gamma$  (Puigserver et al., 1998). PGC-1 $\alpha$  is highly expressed in brown adipose tissue, skeletal muscle and heart and at a relatively low level in white adipose tissue and liver (Puigserver et al., 1998). PGC1 $\alpha$  interacts

with multiple transcription factors [Table 3] including cAMP response element-binding protein (CREB) and nuclear respiratory factors (NRFs) and plays a critical role in linking nuclear receptors to adaptive thermogenesis, mitochondrial biogenesis and muscle fiber type switching (Lin et al., 2002; Puigserver et al., 1998; Wu et al., 1999b).

**Table 3** Selected transcription factors with which PGC-1 $\alpha$  works as a coactivator

Transcription Factor	Function	Reference
NRF1	Mitochondrial biogenesis	(Wu et al., 1999b)
ERR- $\alpha$	Mitochondrial biogenesis	(Mootha et al., 2004)
PPAR- $\alpha$	Fatty acid oxidation	(Vega et al., 2000)
PPAR- $\delta$	Fatty acid oxidation	(Wang et al., 2003)
PPAR- $\gamma$	Brown adipocyte differentiation; UCP-1 induction	(Puigserver et al., 1998)
GR	Gluconeogenesis	(Knutti et al., 2000)
HNF-4 $\alpha$	Gluconeogenesis	(Yoon et al., 2001)
FOXO1	Gluconeogenesis	(Puigserver et al., 2003)

**NRF**, nuclear respiratory factor; **ERR**, estrogen-related receptor; **PPAR**, peroxisome proliferator-activated receptor; **GR**, glucocorticoid receptor; **HNF**, hepatic nuclear factor; **FOXO1**, forkhead box O1.

PGC1 $\alpha$  stimulates mitochondrial biogenesis and respiration in skeletal muscle cells (Wu et al., 1999b). Two DNA array studies have shown that PGC-1 $\alpha$  is downregulated in skeletal muscle obtained from Type 2 diabetic patients (Mootha et al., 2003; Patti et al., 2003). A common polymorphism in the coding region of the *PPARGC1A* gene (Gly482Ser) leading to gene expression defect is associated with the risk of Type 2 diabetes, which provides a direct link between PGC1 $\alpha$  function and disease outcome (Yang et al., 2011). In contrast to these studies, mRNA expression levels of *PGC1 $\alpha$* , *NRF-1* and *NRF-2* were not altered in insulin-resistant offspring (Morino et al., 2005). These data suggest there may be additional unknown factors important in the regulation of mitochondrial biogenesis.

#### 1.1.8.2 TFAM

This gene encodes **Transcription factor A, mitochondrial** (TFAM), which is important for mitochondrial transcription, as well as mitochondrial genome replication. TFAM contains 204 amino acids and was identified for its ability to activate mitochondrial DNA promoters in experiments where human TFAM was cloned into bacteria (Parisi and Clayton, 1991). Furthermore, *in vivo* studies demonstrate TFAM is critical for regulating mitochondrial DNA (mtDNA) copy number and maintaining mitochondrial biogenesis, as well as embryonic development (Larsson et al., 1998). Given that TFAM shares DNA packaging ability feature with the high mobility group (HMG) proteins, and that TFAM may be 1700 fold more abundant than mtDNA (Takamatsu et al., 2002), it is likely that TFAM is involved in forming nucleoid structures to keep mtDNA integrity (Kang et al., 2007). The observation that mtDNA is not detected in homozygous *Tfam* knockout mice provides a direct link between TFAM biological function and mtDNA (Larsson et al., 1998).

### 1.1.8.3 PDK4

**Pyruvate dehydrogenase kinase isozyme 4, mitochondrial** is an isozyme of pyruvate dehydrogenase kinase encoded by *PDK4* gene (Rowles et al., 1996). The PDK4 protein is located in the mitochondrial matrix and suppresses conversion from pyruvate to acetyl-CoA by inhibiting pyruvate dehydrogenase complex (PDH), which is the rate-limiting step in the regulation of glucose oxidation in muscle [Figure 8]. In skeletal muscle, PDK4 is induced by exercise (Hildebrandt et al., 2003; Pilegaard et al., 2000), starvation, as well as diabetes (Wu et al., 1999a) concomitant with inactivation of pyruvate dehydrogenase complex.

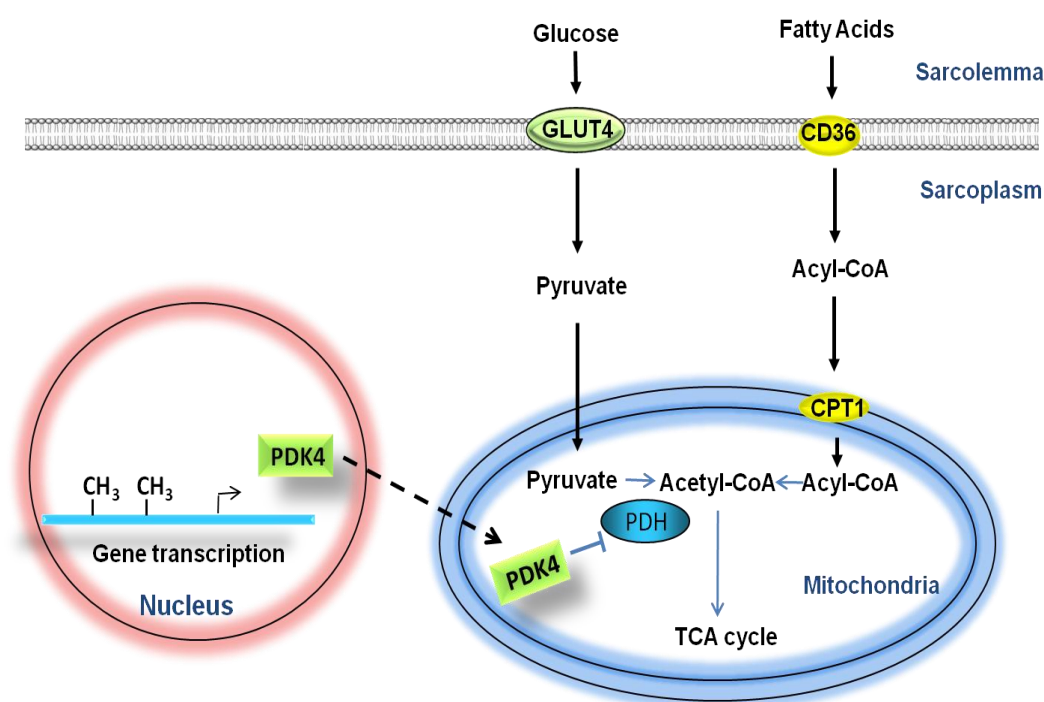

Figure 8 PDK4 is a negative regulator in glucose oxidation in skeletal muscle. PDH, pyruvate dehydrogenase; CD36, fatty acid translocase; CPT1, carnitine palmitoyl transferase 1; TCA, tricarboxylic acid cycle.

## 1.2 DNA METHYLATION

### 1.2.1 Epigenetic modifications

The term ‘Epigenetics’ was first coined by the developmental biologist and evolutionist Conrad H. Waddington (1905-1975) aiming to emphasize the mechanism driving the genotype to the phenotype during development (Waddington, C. H. *The Strategy of the Genes*, Allen & Unwin, London, 1957). The definition has been changed and refined from time to time. The commonly accepted definition was described by Arthur Riggs and colleagues, ‘the study of mitotically and/or meiotically heritable changes in gene function that cannot be explained by changes in DNA sequence’ (Russo, V.E.A.,

Martienssen, R.A. & Riggs, A.D. *Epigenetic Mechanisms of Gene Regulation*, Cold Spring Harbor Laboratory Press, Woodbury, 1996). According to this definition, epigenetics refers to modifications ‘above the genetics’ and it has three characteristics: ① modifications are superimposed on DNA or histones (proteins package DNA); ② the DNA sequence itself does not change; ③ modifications could affect gene activity. Key events have been discovered in the field of epigenetics in the past seven decades [Figure 9] and scientists are dedicated to map the human epigenome.

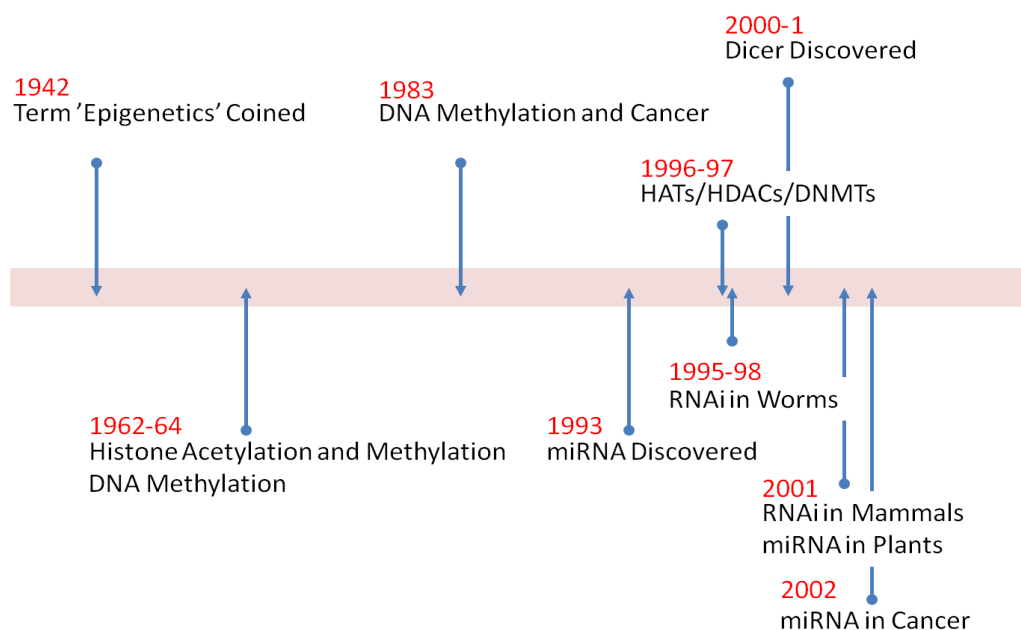

**Figure 9** Timeline of key events and discoveries in the field of epigenetics. HATs, histone acetylases; HDACs, histone decetylases; DNMTs, DNA methyltransferases; miRNA, microRNA. Picture adapted from (Zaidi et al., 2011).

A close relationship has been hypothesized to exist between epigenetic modifications and environmental factors. A number of studies have been found to support this hypothesis. For example, maternal care such as licking and nursing behavior in rats can influence epigenetic markers of the glucocorticoid receptor promoter and further affect offspring behaviors (Weaver et al., 2004). Disease susceptibility is not the same in monozygotic twins in the face of what appears to be similar environments. This indicates epigenetic differences that arise during ageing may play a role in disease development. Young twin pairs have similar distribution of DNA methylation through the genome, whereas older twin pairs show marked differences in the amount and pattern of DNA methylation (Fraga et al., 2005).

### 1.2.2 DNA methylation

DNA methylation and histone tail modifications are two major epigenetic modifications that could control and regulate genes at different layers. DNA methylation occurs on the 5 position of the pyrimidine ring of cytosine. DNA methylation has been widely related to imprinting, mammalian development and genomic stability maintenance (Kurukuti et al., 2006; Reik et al., 2001). In particular, 5-methyl cytosine followed by guanosine (CpG dinucleotide) is the dominate type of



methylation pattern in mammals. Furthermore, CpG sites are usually clustered (also known as CpG islands) in the promoter regions of many genes to modulate gene expression by blocking transcription factor access to DNA [Figure 10].

DNA methylation is considered to be established early in embryonic stage and remains dynamic only during cell division and differentiation. A number of cell type-specific DNA methylation patterns are created during this period of development. Environmental events and nutritional conditions may induce permanent DNA methylation mark changes *in utero* and these adaptive changes can have a lasting impact on adult disease later (Barker et al., 1989). The potential plasticity of DNA methylation also enables reprogramming, depending on exposure to nutritional, chemical, and environmental factors.

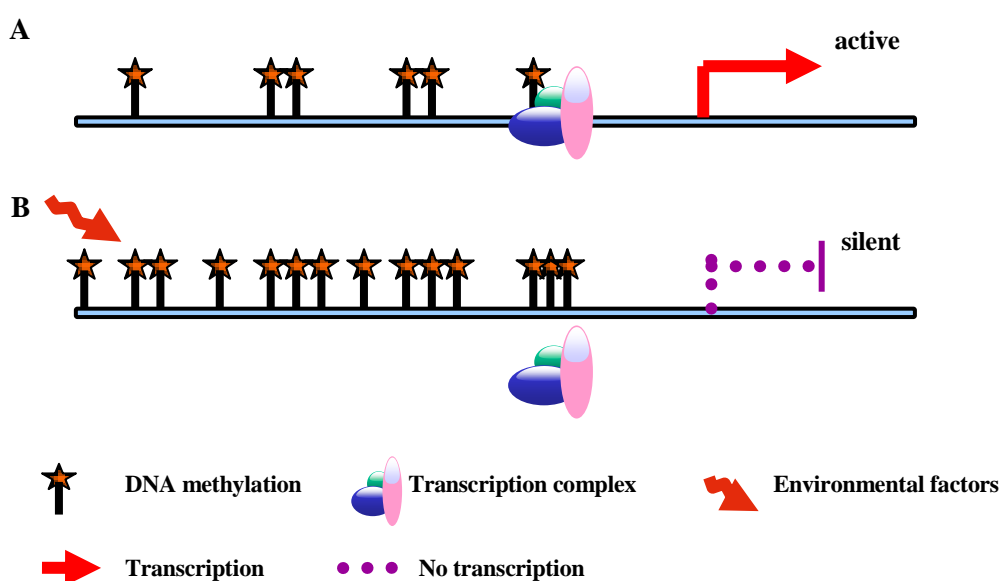

Figure 10 Regulation of gene expression by DNA methylation. By modifying DNA methylation, environmental factors may alter the binding of transcription complexes, thus leading to inhibition of gene expression.

### 1.2.3 Non-CpG methylation

5-methyl cytosine accounts for around 1% of total DNA bases in human somatic cells and 70-80% of CpG dinucleotides are methylated through the genome (Ehrlich et al., 1982). Several studies have been performed to elucidate the role of CpG methylation in regulating gene expression in human diseases. Non-CpG methylation (referring to methylated cytosine within CpA, CpT or CpC) has been reported in plants and embryonic stem cells (Grandjean et al., 2007; Meyer et al., 1994; Ramsahoye et al., 2000). Nevertheless, more attention has been paid to the physiological role of cytosine methylation in non-CpG contexts. More abundant non-CpG methylation than originally anticipated has been identified in human embryonic stem cells through a genome-wide, single-base-resolution approach, suggesting non-CpG methylation may play a critical role in regulating gene expression in cells that have the potential to differentiate (Lister et al., 2009).

### 1.2.4 DNA methyltransferase (DNMT)

The enzymes which catalyze the addition of methyl groups to cytosine, DNA methyltransferases (DNMT1, DNMT3A and DNMT3B) have been identified (Xie et al., 1999; Yen et al., 1992). A fourth enzyme previously named as DNMT2 was shown to be tRNA methyltransferase and does not methylate DNA (Goll et al., 2006). DNMT1 is thought to be responsible for maintenance of methylation during DNA synthesis, and DNMT3A and DNMT3B are required for *de novo* methylation (Bestor and Ingram, 1983; Okano et al., 1999). The fundamental mechanism of DNMTs is still unclear. Biochemical studies demonstrated the DNA methylation process was based on the enzymatic reaction by forming transient covalent complex between DNMT1 and targeted cytosine (Santi et al., 1983) [Figure 11]. The rationale for maintaining and modifying the specific DNA methylation pattern is complicated to understand due to the fact that the methylation process itself depends on multiple factors including interactions between different methyltransferases, nuclear factors, chromatin structure, as well as methyl donors.

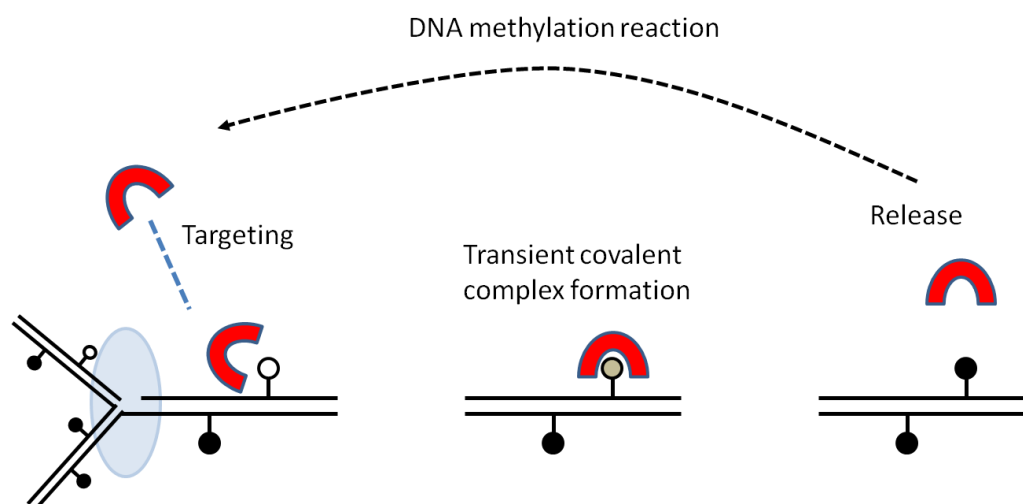

**Figure 11 Demonstration of DNA methylation reaction [Take DNMT1 for example, red in the picture]. Unmethylated and methylated cytosines are shown in white and dark circles. Picture redrawn from (Schermelleh et al., 2005).**

Epigenetics is not only involved in normal development, but also disease progression. Meanwhile, the diversity of phenotypes in the population is unlikely to be explained by genetics alone. The concept of epigenetics emerges to provide a potential mechanism for different susceptibilities to a disease, as well as a link between environmental factors and diseases consequences. Numerous genes can become abnormally methylated during the development of tumors (Bedford and van Helden, 1987; Cheng et al., 1997; Kim et al., 1994; Lin et al., 2001; Wahlfors et al., 1992). Epigenetics may establish a better understanding of the etiology of Type 2 diabetes and obesity and provide a rational model to explain the mechanism by which environmental factors (diet/nutrition, exercise, smoking, stress etc.) influence metabolic diseases.

## 2 PRESENT INVESTIGATION

### 2.1 AIM OF THE THESIS

Type 2 diabetes and obesity are multifactorial diseases involving interactions between genetic and environmental influences. Based on GWAS (genome-wide association study), a number of gene defects due to coding sequence changes have been shown to contribute to metabolic diseases (Brito et al., 2009; Franks et al., 2007a; Ruchat et al., 2010). For examples, a common *FTO* variant (rs9939609) has been associated with Type 2 diabetes in multiple populations by increasing obesity risk (Frayling et al., 2007). There is also a strong inheritance risk for Type 2 diabetes. Those with first-degree relatives suffering from Type 2 diabetes have a much higher risk to develop Type 2 diabetes (Deo et al., 2006; Mills et al., 2010). However, genetics alone is unlikely to explain the different susceptibilities to diseases in a population. The genetic variants identified in GWAS generally provide an explanation for only a fraction of the cases of metabolic diseases. Genotype-environment interactions may contribute to the understanding of complexity of human diseases (Eichler et al., 2010; Franks et al., 2007b; Manolio et al., 2009).

A major challenge is to gain evidence linking environmental and nutritional factors to the control of gene expression. Epigenetics provides a rationale framework to understand the etiology of Type 2 diabetes and obesity from another point of view. In this thesis, emphasis has been placed on the role of DNA methylation, a major epigenetic modification, involved in Type 2 diabetes and obesity. Specific aims for this thesis are:

1. To investigate the existence of cytosine methylation on non-CpG sequences in mammals.
2. To characterize the role of DNA methylation in Type 2 diabetes.
3. To determine if DNA methylation is altered following weight loss induced by gastric bypass surgery in human obesity.

## 2.2 MATERIALS AND METHODS

### 2.2.1 Study participants

This thesis is based on studies of human material and tissue biopsies. These unique and precious samples allow for a direct study of human disease. All experiments performed in this thesis work have been approved by the Local Ethics Committee. Informed written consent was obtained from all participants before any testing was initiated. In **Paper II**, we studied male subjects with normal glucose tolerance (NGT) or impaired glucose tolerance (IGT) and Type 2 diabetic patients (T2D). The diagnosis was confirmed according to clinical data before the study was initiated. Type 2 diabetic patients were treated with diet, metformin or sulfonylureas. Patients were excluded from the study if under treatment with  $\beta$ -blockers, ACE inhibitors or hormone therapy. The level of fasting glucose and hemoglobin A1c in Type 2 diabetic patients was significantly higher than the other two groups. Age, BMI, triglycerides and  $VO_2$ max were matched in all three groups [Table 4].

**Table 4** Clinical characteristics of participants in **Paper II**

	N	Age (years)	BMI (kg/m <sup>2</sup> )	Fasting glucose (mM)	Hemoglobin A1c (%)	Triglycerides (mmol/L)	VO <sub>2</sub> max (L/min)
NGT	15	57±2	26.4±0.6	5.0±0.1	4.6±0.1	1.25±0.21	2.2±0.2
IGT	8	60±2	28.0±0.9	5.5±0.6	4.8±0.3	1.34±0.52	2.3±0.2
T2D	15	59±2	27.7±0.6	8.3±0.4*	6.4±0.3*	1.35±0.12	2.2±0.1

Results are mean±SEM, for subjects with Normal Glucose Tolerance (NGT), Impaired Glucose Tolerance (IGT) or Type 2 Diabetes (T2DM). \*P<10<sup>-7</sup>.

In **Paper III**, we studied eight non-diabetic obese women (mean BMI=42.1 kg/m<sup>2</sup>) who underwent gastric bypass surgery. The homeostatic model assessment (HOMA) values indicate insulin resistance and  $\beta$ -cell functional defects in obese participants. Laparoscopic Roux-en-Y gastric bypass (Lonroth et al., 1996; Wittgrove et al., 1996; Wittgrove et al., 1994) was performed in this study. Sixteen normal weight women were studied as a control group. The level of insulin, triglycerides, high density lipoprotein (HDL), and non-esterified fatty acids (NEFA) in the obese women was significantly different compared to the normal weight subjects. Leptin, interleukin-6 (IL6), hepatocyte growth factor (HGF) and C-reactive protein (CRP) were increased with obesity. Dramatic weight loss was induced by the surgery from 122.3 kg (mean value) before surgery to 88.1 kg (mean value) after surgery. Furthermore, fasting glucose, insulin, lipids levels, inflammatory factors were normalized after gastric bypass surgery [Table 5].

Skeletal muscle biopsies (50-100 mg) were obtained from *vastus lateralis* portion of the *quadriceps femoris muscle* either under local anesthesia (Lidocaine hydrochloride) or under general anesthesia, before the surgery was initiated.

**Table 5** Anthropometric and clinical characteristics of the participants in **Paper III**

	Obese Women (n=8)		Lean Women (n=16)
	Before Surgery	After Surgery	
Age – yr	42±4	42±4	40±3
Weight – kg	122.3±4.1 <sup>††</sup>	88.1±6.6 <sup>**,††</sup>	70.1±2.8
Body mass index – kg/m <sup>2</sup>	42.1±1.5 <sup>††</sup>	31.2±1.6 <sup>**,††</sup>	25.0±0.8
Fasting plasma glucose – mmol/L	5.6±0.3	4.8±0.2 <sup>*</sup>	5.0±0.1
Insulin – pmol/L	105.2±17.8 <sup>††</sup>	59.2±8.6 <sup>*,†</sup>	40.8±3.6
HOMA-IR	4.4±0.8 <sup>††</sup>	2.1±0.3 <sup>*</sup>	1.5±0.2
Plasma Cholesterol – mmol/L			
Total	5.05±0.37	4.13±0.34 <sup>*</sup>	3.84±0.22
Low density lipoprotein	3.23±0.31	2.35±0.35 <sup>*</sup>	2.85±0.21
High density lipoprotein	1.14±0.06 <sup>††</sup>	1.36±0.12	1.61±0.12
Triglyceride – mmol/L	1.57±0.26 <sup>†</sup>	0.89±0.13 <sup>*</sup>	1.03±0.15
Non-esterified fatty acids – mmol/L	0.62±0.05 <sup>†</sup>	0.39±0.08 <sup>*</sup>	0.36±0.08
Leptin – ng/ml	60.6±7.4 <sup>††</sup>	21.3±6.9 <sup>**</sup>	10.7±3.4
Interleukin-6 – pg/ml	4.80±0.73 <sup>†</sup>	4.17±1.39	2.00±0.59
Interleukin-8 – pg/ml	3.96±2.05	2.42±0.85	2.23±0.22
Monocyte chemotactic protein-1 – pg/ml	127.2±14.4 <sup>†</sup>	98.8±18.3 <sup>*,††</sup>	243.3±26.7
Hepatocyte growth factor – pg/ml	1,371±588 <sup>†</sup>	587±128 <sup>†</sup>	264±57
C-reactive protein - ng/ml	1,227±85 <sup>††</sup>	476±120 <sup>**</sup>	313±112
TNF- $\alpha$ – pg/ml	4.6±0.7	4.2±0.7	3.3±0.5

Results are mean±SEM. Differences before versus after surgery were determined using a paired Students t-test. \*P<0.05, \*\*P<0.001 versus before surgery. Differences between obese and normal weight (lean) women were determined using an unpaired Students t-test. †P<0.05, ††P<0.005 versus normal weight (lean) women.

### 2.2.2 Animal model-The leptin deficient (*ob/ob*) mice

Leptin is encoded by the *ob* gene and regulates energy balance in the mouse (Zhang et al., 1994). Leptin inhibits appetite through acting on its receptors in the hypothalamus of the brain. Thus, leptin deficiency will lead to a failure to control food intake, and this will ultimately lead to obesity. The leptin-deficient *ob/ob* mouse is characterized by obesity, hyperphagia, hyperglycemia, hyperinsulinemia, hyperlipidemia and insulin resistance, and is widely used to study Type 2 diabetes, obesity and other metabolic diseases (Huang et al., 2011; Hue et al., 2009; Mark et al., 1999; Okada et al., 2007; Wendel et al., 2010).

Female *ob/ob* mice and their lean littermate controls were used in **Paper I**. Animals were generated on a C57BL/6J background. Animals were housed with free access to food and water. Room temperature and humidity were maintained stable and under a 12-hour light/dark cycle. Experiments were performed with approval from the Regional Animal Ethical Committee Stockholm, Sweden. *Extensor digitorum longus* (EDL) muscle, *soleus* muscle, heart, liver, different fat pads were carefully dissected from 13

week old mice. Tissues were dissected from visible blood vessels and immediately frozen in liquid nitrogen.

### 2.2.3 Primary human skeletal muscle cell culture

Satellite cells were isolated from human skeletal biopsies using trypsin digestion. *Vastus lateralis* muscle biopsies from people with normal glucose tolerance were placed in cold phosphate-buffered saline (PBS) supplemented with 1% PeSt (100 units/ml penicillin, 100 $\mu$ g/ml streptomycin) and kept in the freezer for one day. Then biopsies were dissected free from visible connective and fat tissue, finely sliced, mixed with trypsin-EDTA and finally incubated with agitation at 37°C for 10 minutes. The supernatant containing liberated satellite cells was collected and transferred to growth medium (DMEM/Ham's F12 medium supplemented with 20% fetal bovine serum (FBS), 1% PeSt and 1% Fungizone). The remaining tissue was repeatedly digested. The satellite cells were pooled and incubated with non-coated petri dish for 1 hour for 37°C to remove non-myogenic (fast adherent) cells contamination. The supernatant containing satellite cells was cultured in culture flasks. Growth medium was changed every second day. Subculture 4-5 passages were used for experiments. Confluent (90%) myoblasts were initiated to differentiate into myotubes by changing to differentiation medium (DMEM supplemented with 4% FBS, 1% PeSt and 1% Fungizone) for two days. Then cells were cultured in lower serum level (2% FBS) medium for another three days. During the last 48 hours of differentiation, cells were treated with factors have been known to induce insulin resistance, 120 nM insulin, 20 mM glucose, 1  $\mu$ M tumor necrosis factor  $\alpha$  (TNF- $\alpha$ ), 0.5 mM palmitate or 0.5 mM oleate.

### 2.2.4 Comments on strategies to study DNA methylation

The methods used for **Paper I-III** can be found in section "Material and Method" from each respective paper. **Paper I** specifically addressed methods used to demonstrate non-CpG methylation in mammals. Currently, there is a wide range of methods aiming to measure global methylation level and also methylation status of specific sequences. Some different approaches to study DNA methylation will be described and commented on in this thesis offering clarity to the results presented in this work.

#### 2.2.4.1 Methylation isoschizomers

Isoschizomers are pairs of restriction enzymes which recognize the same DNA sequence. In some special cases, one of a pair of isoschizomers recognizes and cleaves both the methylated and unmethylated form of the same sequence (methylation-insensitive endonuclease). The other isoschizomer is only able to cut the unmethylated form (methylation-sensitive endonuclease). Several methylation assays generally utilized this property to distinguish the methylation state of the specific restriction site. Two isoschizomers, *HpaII* and *MspI*, specifically digest DNA at a CCGG sequence and are generally used to determine the genome-wide CpG methylation level. If the internal cytosine is methylated (C<sup>m</sup>CGG), *HpaII* is unable to digest, whereas *MspI* is insensitive to methylation status. Different techniques have been developed to estimate the CpG methylation level following enzyme digestion in a CCGG context. Similarly, *Psp6I* and *AjnI* are isoschizomers for the sequence CCWGG (W=A or T). *Psp6I* is methylation sensitive and *AjnI* is not in the context of C<sup>m</sup>CWGG.

### 2.2.4.2 Luminometric Methylation Assay (LUMA)

The Luminometric Methylation Assay (LUMA) method [Figure 12] is based on methylation-sensitive enzymes digestion and following polymerase extension assay by the Pyrosequencing method (Karimi et al., 2006). Briefly, 500 to 1000 ng of genomic DNA samples were digested in two reactions *HpaII+EcoRI* and *MspI+EcoRI* in Tango® buffer for 4 hours at 37°C for a complete digestion. Samples were then transferred to 96 well Pyrosequencing plates and Pyrosequencing Annealing Buffer was added to each reaction. Pyrophosphate (PPi) was released when DNA polymerase incorporates deoxyribonucleotide triphosphate (dNTP) into the complementary template strand. ATP sulfurylase converts PPi to ATP in the presence of adenosine 5' phosphosulfate (APS) and ATP drives luciferase-mediated conversion of luciferin to oxyluciferin generating visible light, which is proportional to the amount of ATP. Thus, the amount of nucleotides incorporated can be estimated by the height of peak value (light signal). Results were obtained from a Pyrosequencer machine and the %CCGG methylation level was calculated with the following equation:  $[1 - (HpaII/EcoRI)/(MspI/EcoRI)] \times 100$ .

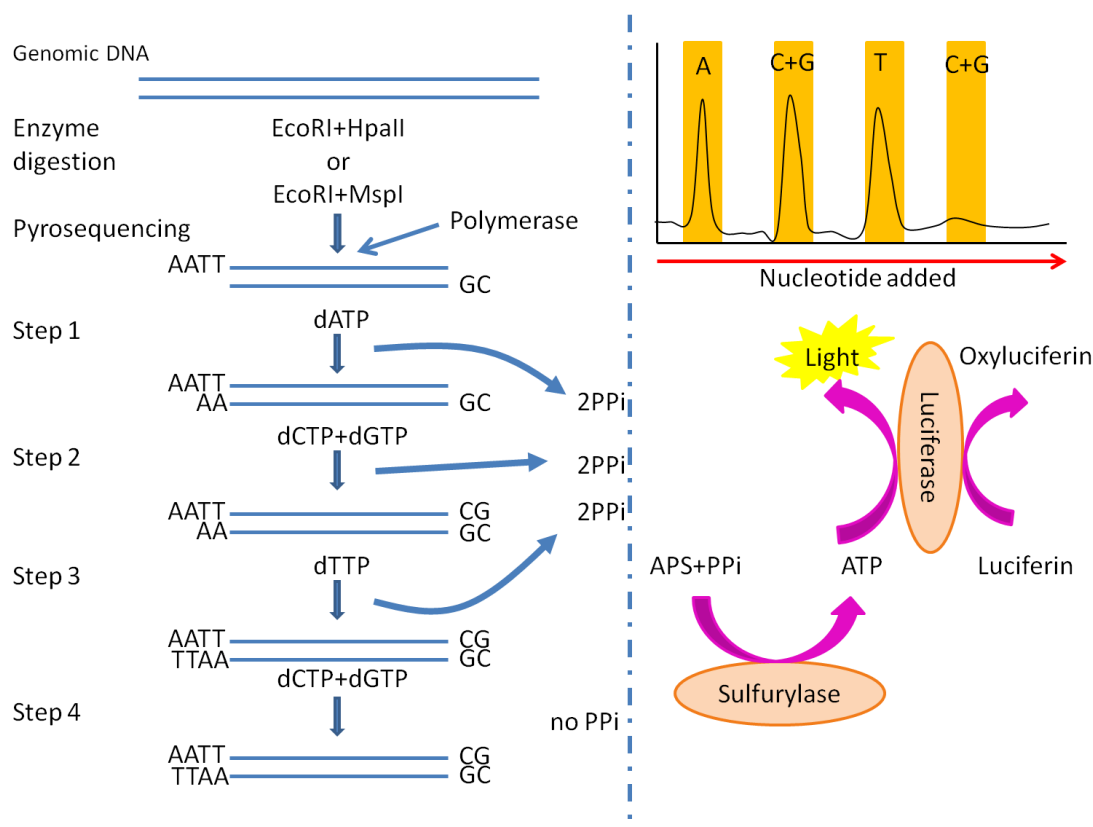

**Figure 12 Principle of LUMA method based on enzyme digestion and Pyrosequencing. Picture adapted from (Karimi et al., 2006). PPi, pyrophosphate; APS, adenosine 5' phosphosulfate.**

### 2.2.4.3 MeDIP-qPCR

Methylated DNA immunoprecipitation (MeDIP) is a large-scale technique isolating methylated DNA fragments via an antibody against 5-methylcytosine. Purified genomic DNA prepared from cultured cells or tissue samples is either digested with restriction enzyme or sonicated into small fragments. Single-stranded DNA and

appropriate fragment size are critical elements to enhance antibody binding affinity. After denaturation, DNA fragments are incubated with monoclonal 5-methylcytosine antibodies, which can be captured by magnetic beads conjugated to anti-mouse-IgG. Immunoprecipitated DNA is then recovered with Proteinase K digestion followed by column-based purification [Figure 13]. Based on the principle that the antibody recognizes and binds to 5-methylcytosine, both CpG methylation and non-CpG methylation can be determined. Downstream epigenetic applications to assess methylated DNA include real-time Polymerase Chain Reaction (MeDIP-qPCR), array-based hybridization (MeDIP-chip) and high-throughput sequencing (MeDIP-seq).

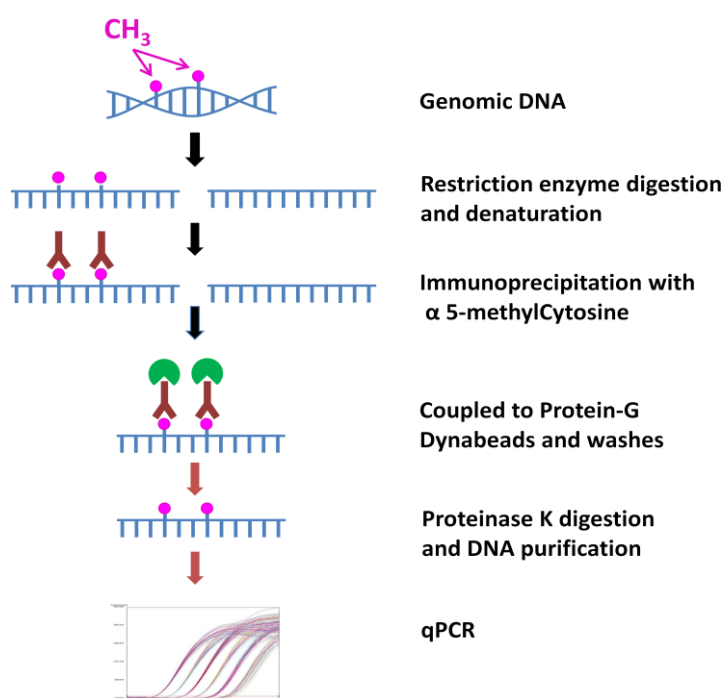

Figure 13 MeDIP flow chart.

#### 2.2.4.4 Methylated DNA enrichment by MBD protein

Another methylated DNA enrichment protocol is supplied by the MethylMiner kit (Invitrogen). The capture reaction is performed by adding fragmented DNA to the MBD (Methyl-CpG-binding domain)-magnetic beads. Unbound DNA is removed in the supernatant. The methylated DNA is eluted as a single fraction with a high-salt elution buffer (2000mM NaCl) and precipitated using NaOAc and EtOH precipitation.

The MethylMiner kit captures both CpG methylated DNA and non-CpG methylated DNA fragments (Dr. Romain Barrès, personal communication). We also validated the MethylMiner kit before initiating experiments using input genomic DNA mixed with methylated and non-methylated fragments according to the protocol. PCR was performed on the different fractions from the procedure amplified by specific primers to detect non-methylated or methylated sequences. The non-captured fraction was only detected as non-methylated DNA and the eluted fraction was captured as methylated DNA, which indicates the MethylMiner kit is able to exclusively isolate the methylated DNA [Figure 14].



Compared to antibody-based methods, MBD binding revealed a high affinity for methylated DNA. Given that the low amount of DNA materials obtained from cells or tissues, the MBD-based method is much more sensitive than antibody-based methods. These two commonly used approaches have been compared in a prostate cancer study to enrich methylated DNA regions of the genome and discover differentially methylated regions (DMRs). The results provide evidence that MeDIP commonly enriched for methylated regions with a low CpG density, while MBD captured is usually identified by high CpG density regions (Nair et al., 2011).

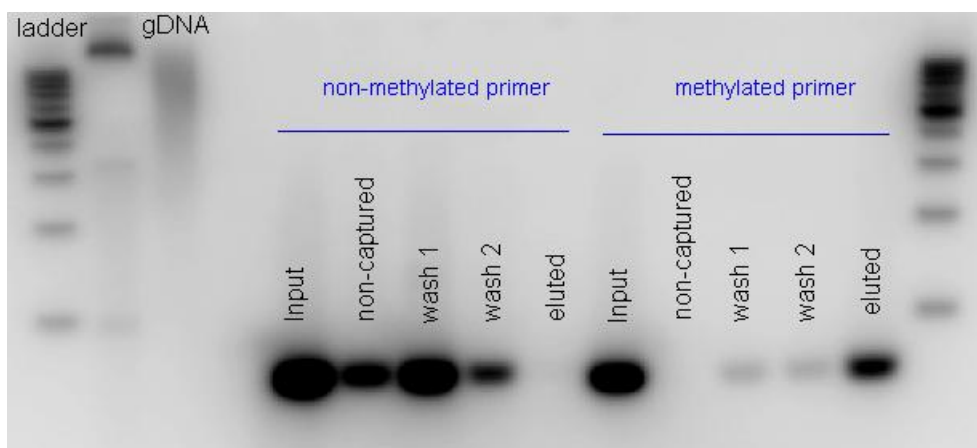

**Figure 14** Validation of MethylMiner DNA enrichment kit. The lanes are as follows: Input, genomic DNA+mix of non-methylated and methylated DNA; Non-captured, non-captured (unbound) DNA fraction; Wash 1, Wash 2, washing steps; Eluted, high salt elution fraction. PCR was performed on the different fractions from the procedure amplified by specific primers to detect non-methylated or methylated sequences.

#### 2.2.4.5 Bisulfite sequencing

Bisulfite sequencing (i.e. applying routine sequencing methods to bisulfite treated DNA) is the most powerful method to detect cytosine methylation in a site-specific manner (Frommer et al., 1992). Bisulfite treatment of the DNA template converts cytosine residues to uracil, but has no effect on 5-methylcytosine residues (Hayatsu et al., 1970; Shapiro et al., 1973) [Figure 15]. Based on this principle, bisulfite treatment could introduce specific changes in the DNA sequence through chemical modifications in the presence of sodium bisulfite and this will provide information at the single-nucleotide level regarding the DNA methylation state.

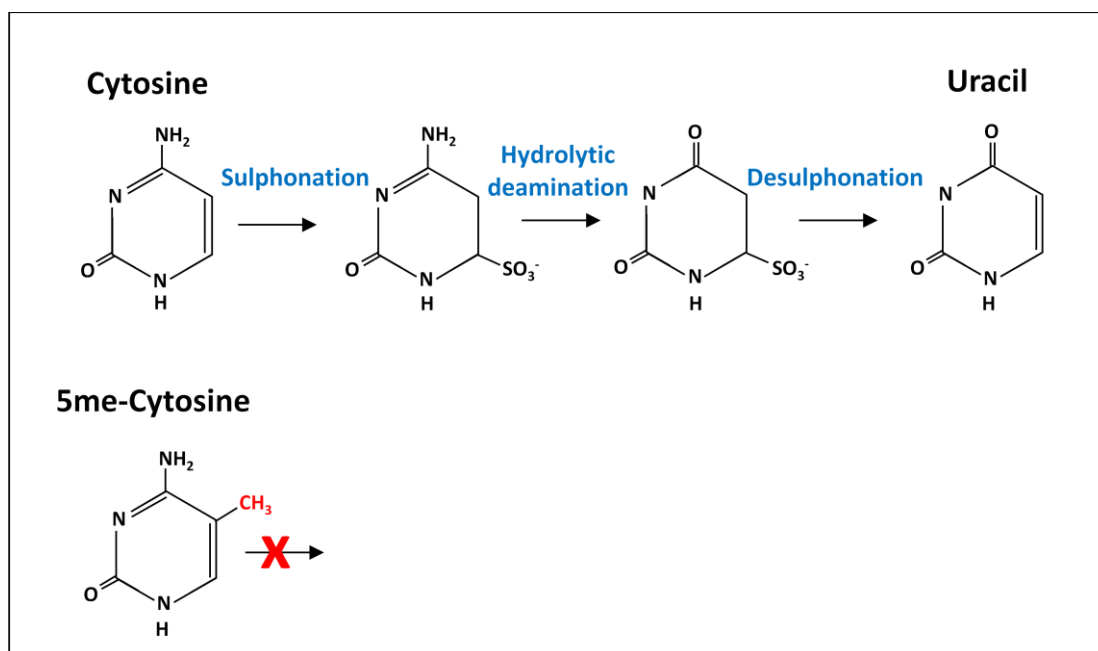
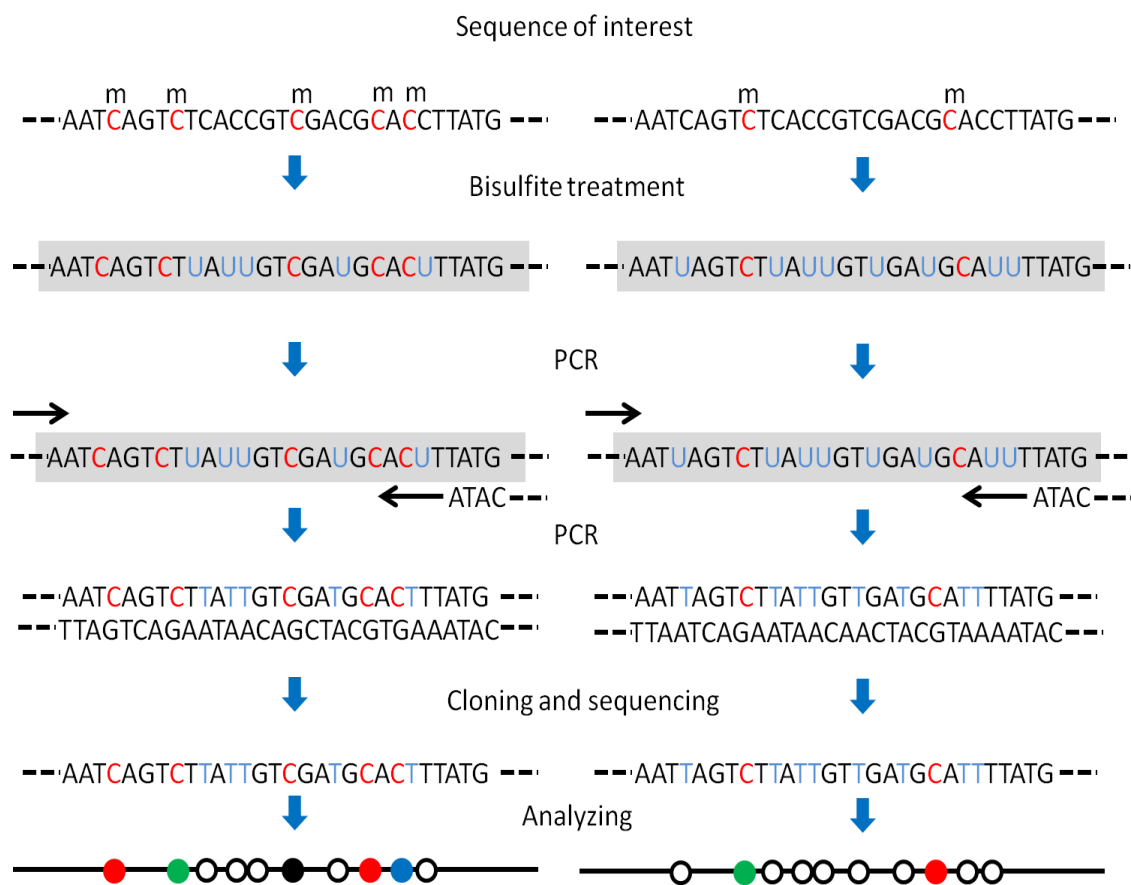

Figure 15 Bisulfite-mediated conversion of cytosine to uracil.

To analyze bisulfite-treated DNA material, we utilized PCR and standard DNA sequencing approaches to detect the specific methylation sites. This approach requires cloning of PCR products before DNA sequencing to obtain adequate sensitivity. Primers flanking the region of interest are designed to be only complementary to bisulfite-treated DNA and amplify both methylated and unmethylated sequences. In the sense strand, unmethylated cytosines are shown as thymines and as adenines in the antisense strand instead [Figure 16].

A major challenge with the bisulfite sequencing technique is incomplete conversion. If the conversion process of each individual cytosine to uracil is incomplete, this will increase the chance of reporting false positive methylation levels. This is due to interpreting unconverted unmethylated cytosines to methylated cytosines. Bisulfite has better access to single-stranded DNA templates (Fraga and Esteller, 2002), which allows for complete conversion. To maintain DNA in a single-stranded form, and prevent denatured DNA strands renaturing during bisulfite treatment, a modified approach (Olek et al., 1996) based on DNA material embedded in low melting point (LMP) agarose to facilitate the bisulfite conversions and also avoid losing DNA materials was used.



**Figure 16 Rationale for bisulfite sequencing.** Methylated cytosine in red (C) and unmethylated cytosine in blue (C). ● 5meCpG; ● 5meCpA; ● 5meCpT; ● 5meCpC.

Another concern is the degradation of DNA material due to the bisulfite treatment conditions to ensure complete conversion, such as a long incubation time, elevated temperature and high chemical concentration. The lack of intact DNA templates could lead to subsequent PCR amplification failure. Thereafter, optimizing the bisulfite conditions to minimum DNA degradation is critical.

## 2.3 RESULTS AND DISCUSSION

### 2.3.1 Paper I

#### Evidence for non-CpG methylation in mammals

Non-CpG methylation (cytosine methylation within CpA, CpT or CpC context) has been identified in plants (Meyer et al., 1994) and mammalian embryonic stem cells (Ramsahoye et al., 2000). The existence of non-CpG methylation in mammalian tissues is still under discussion.

##### 2.3.1.1 Evidence for non-CpG methylation using adapted LUMA

We adapted the conventional LUMA to determine global non-CpG methylation levels in CCWGG (W=A/T) context. The adapted method was combined with restriction enzyme digestion (*Psp6I* is methylation sensitive and *AjnI* is methylation insensitive) and Pyrosequencing [Figure 17]. Pyrophosphate (PPi) was released when DNA polymerase incorporates deoxyribonucleotide triphosphate (dNTP) into the complementary template strand. ATP sulfurylase converts PPi to ATP in the presence of adenosine 5' phosphosulfate (APS) and ATP drives luciferase-mediated conversion of luciferin to oxyluciferin generating visible light that is proportional to the amount of ATP. Thus, the amount of nucleotides incorporated can be estimated by the height of peak value (light signal). Results were obtained from pyrosequencing and the %CCWGG methylation level calculated with the following equation:  $[1 - Psp6I/AjnI] \times 100$ .

To test the linearity of this adapted assay, we applied the approach using synthetic DNA with different known methylation levels. The results were highly linear ( $R^2=0.915$ ). Further validation was performed using 3T3 fibroblasts and mouse embryonic fibroblasts (MEF). Eight percent of cytosines were observed to be methylated in non-CpG motifs in MEF, whereas 1% in 3T3 fibroblasts, which was consistent with previous findings (Lister et al., 2009; Ramsahoye et al., 2000). Surprisingly, substantial cytosine methylation levels in CCWGG context were also detected in several adult mouse tissues in **Paper I**, 7.2% in *EDL*, 7.7% in *soleus*, 8.5% in liver, 7.0% in fat and 13.2% in heart.

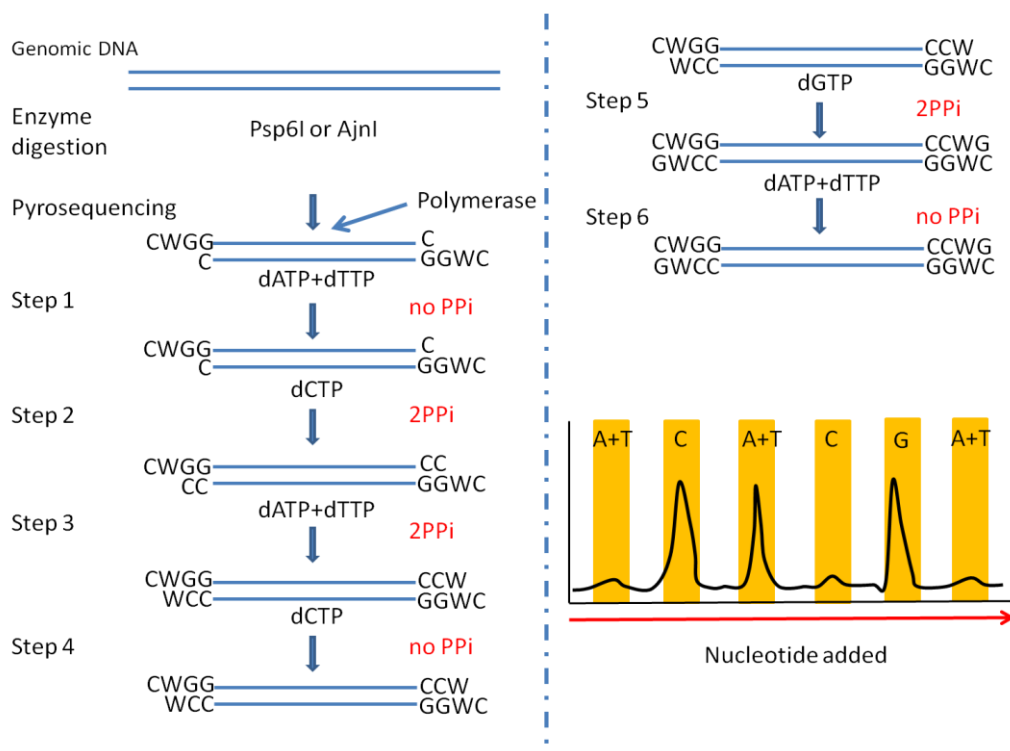

Figure 17 Illustration for adapted LUMA method to detect global non-CpG methylation in CCWGG context.

### 2.3.1.2 Bisulfite sequencing shows significant levels of non-CpG methylation

$C^m$ CWGG might not represent all non-CpG methylation sites. Bisulfite sequencing, the gold standard method to investigate DNA methylation, provides single-nucleotide resolution information regarding the DNA methylation state. Non-CpG methylation of the *TFAM* promoter and *GAPDH* promoter (glyceraldehydes 3-phosphate dehydrogenase promoter containing a high content of cytosines) was determined in human skeletal muscle to be 2.6% and 0.8% respectively. Our data provides evidence that non-CpG methylation is unevenly distributed through genome, thus implying site-specific physiological importance of non-CpG methylation rich regions spanning the 5' end of the regulatory regions of specific genes.

Incomplete conversion in bisulfite sequencing is a challenging caveat that might overestimate the methylation levels since unconverted unmethylated cytosines are interpreted as methylated cytosines. Bisulfite modification of the *TFAM* promoter was performed using various protocols and commercially available kits. Applying different approaches, we revealed similar level of non-CpG methylated cytosines, that corresponds to 2.2% using the original protocol (Frommer et al., 1992), 2.6% for commercial kit and 2.8% using a low melting point (LMP) agarose approach (Olek et al., 1996). A further control was also included to discriminate the actual presence of non-CpG methylation from the incomplete conversion background. The strategy involved spiking a single copy level of unmethylated human template of *TFAM* promoter generated by PCR into mouse genomic DNA, by which an unmethylated template could be bisulfite treated and denatured in genomic surroundings. We found 0.9% incomplete conversion using this control and defined this as our background for

*TFAM*, which also indicated the observed non-CpG methylation levels in human skeletal muscle are above background threshold.

Our data demonstrates non-CpG methylation contributes to the total DNA methylation in mammals. Indeed, the few reports focusing on non-CpG methylation in mammals are conflicting and non-CpG methylation is often overlooked due to methodological differences (Grandjean et al., 2007; Lister et al., 2009). Typically, two rounds of PCR are applied and this could partially explain the conflicting results. Bisulfite sequencing primer design excludes CpG sites and assumes other cytosines to be unmethylated, thus resultant primers have a higher affinity to and are prone to amplify unmethylated templates.

The pervasive DNA methylation in non-CpG contexts in embryonic stem cells (Lister et al., 2009) suggested a role for carrying and maintaining the pluripotent ability in cells. Future work will be needed to explore the prevalence of non-CpG methylation and different methylation patterns in various somatic mammalian tissues.

### 2.3.2 Paper II

#### **Non-CpG methylation of the *PGC1 $\alpha$* promoter through DNMT3B controls mitochondrial density**

Epigenetic modifications of the genome, including DNA methylation, provide a potential molecular basis for the interaction between genetic and environment factors on glucose homeostasis and may contribute to the manifestation of Type 2 diabetes. Here we determined whether change in promoter methylation is associated with insulin resistance.

##### *2.3.2.1 PGC1 $\alpha$ promoter is hypermethylated in Type 2 diabetic subjects*

To have a whole picture of genome promoter DNA methylation patterns and further investigate candidate genes for methylation change specifically in Type 2 diabetes, we performed a MeDIP array (Methylated DNA immunoprecipitation followed by microarray technology) on *vastus lateralis* skeletal muscle obtained from Type 2 diabetic patients (T2D) or normal glucose tolerant subjects (NGT). We discovered 838 gene promoter regions were differentially methylated in Type 2 diabetes (out of 25,500 promoter regions represented on the array), of which 44 positive promoter regions were identified to be related to mitochondrial structure and function. Particularly, cytosine hypermethylation of *Peroxisome Proliferator-Activated Receptor  $\gamma$  Coactivator-1  $\alpha$*  (*PGC-1 $\alpha$* ) was found in Type 2 diabetic patients.

We next validated our MeDIP result for the region covering the *PGC-1 $\alpha$*  promoter using the gold-standard method of bisulfite sequencing. More than a two fold increase in cytosine methylation was revealed in Type 2 diabetic patients compared to NGT subjects. Additionally, *PGC1 $\alpha$*  promoter methylation in skeletal muscle from impaired glucose tolerant (IGT) subjects was similar to that observed in Type 2 diabetic patients. This finding suggested that the methylation changes might occur at an early stage in the pathogenesis of Type 2 diabetes. Interestingly, methylation levels of the alternative

promoter of human *PGC1 $\alpha$* , *DHX15* and *GBA3* (two genes proximal to *PGC1 $\alpha$* ) were similar in NGT and Type 2 diabetic subjects, which indicated that the observed cytosine methylation change of *PGC1 $\alpha$*  was specifically located in the core promoter region rather than a broader portion of the chromatin.

Most of the methylated cytosines of *PGC-1 $\alpha$*  promoter were found in non-CpG contexts (as described in **Paper I**). Similarly, incomplete bisulfite conversion could be excluded using an unmethylated control generated by PCR. The background level of incomplete conversion was much lower than the levels of methylated cytosines detected in the experimental samples. An adapted LUMA approach based on restriction enzymes (*Psp6I* and *AjnI*) digestion and the pyrosequencing technique, rather than bisulfite conversion, provided further evidence that non-CpG methylation was present at measurable levels in human skeletal muscle. We retrieved numerous genes differentially methylated in Type 2 diabetic patients from MeDIP array. The antibody used for MeDIP recognizes and binds to 5-methylcytosine in both CpG and non-CpG contexts. Thus, non-CpG methylation should be considered when interpreting MeDIP results.

#### 2.3.2.2 *PGC1 $\alpha$* methylation regulates *PGC1 $\alpha$* mRNA expression

In parallel with the increase in *PGC1 $\alpha$*  promoter methylation level in Type 2 diabetic patients, mRNA expression of *PGC1 $\alpha$*  was downregulated by 38%, and negatively correlated with promoter methylation. Introducing a methyl group to a single cytosine residue of the *PGC1 $\alpha$*  promoter *in vitro* induced a marked suppression of gene activity using a gene reporter assay. Collectively, our results provide direct evidence that the methylation status of the *PGC1 $\alpha$*  promoter can regulate mRNA expression.

Reduced mRNA expression of *PGC-1 $\alpha$*  in skeletal muscle obtained from Type 2 diabetic patients is consistent with previous reports (Mootha et al., 2003; Patti et al., 2003). *PGC1 $\alpha$*  is involved in stimulation of mitochondrial biogenesis and respiration in muscle cells (Wu et al., 1999b). We also found that mitochondrial number was reduced and mitochondrial morphology was altered in Type 2 diabetic patients as compared to NGT subjects assessed by ultrastructural analysis of skeletal muscle. Additionally, several proteins of mitochondrial respiration chain (SUO/complex II, core I/complex III, and cytochrome C/CytC), as well as TFAM, a key regulator of mitochondrial DNA copy number, were significantly decreased in Type 2 diabetic patients measured by western blot analysis.

A large body of evidence indicates that mitochondrial dysfunction is associated with skeletal muscle insulin resistance in Type 2 diabetes (Holland et al., 2007; Morino et al., 2006; Ruderman et al., 1999; Yu et al., 2002). Our data provides evidence for a relationship between *PGC1 $\alpha$*  methylation status and mitochondrial function, which may further influence insulin sensitivity in Type 2 diabetes, since the magnitude of reduction in mtDNA was negatively correlated with quantitative methylation level of *PGC1 $\alpha$*  promoter. Thus, *PGC1 $\alpha$*  promoter hypermethylation may contribute to an impaired oxidative capacity in skeletal muscle and systemic insulin resistance through influencing gene expression. Furthermore, our MeDIP array results revealed 44 promoter regions related to mitochondrial function were differentially methylated in Type 2 diabetes compared to NGT subjects. Thus DNA methylation may play an

important role in mitochondrial function by controlling expression of genes involved in mitochondrial structure and function.

### 2.3.2.3 Free fatty acids and TNF $\alpha$ induces hypermethylation of *PGC1 $\alpha$*

Nutritional factors are related to insulin resistance based on the findings that the accumulation of intracellular lipid metabolites from incomplete lipid oxidation due to fat overload could inhibit insulin signal transduction to glucose transport (Kim et al., 2000; Petersen et al., 2004; Ritov et al., 2005). Epigenetic modifications act as information superimposed on genetics link environmental factors and gene expression. To examine if extracellular factors could alter DNA methylation status of *PGC1 $\alpha$* , we exposed primary human skeletal muscle cells to elevated concentrations of four different factors known to induce insulin resistance for 48 hours: glucose, insulin, free fatty acids or the inflammatory factor TNF- $\alpha$ . Free fatty acids and TNF- $\alpha$ , but not insulin or glucose dramatically triggered hypermethylation of the *PGC1 $\alpha$*  promoter [Figure 18]. The observed methylation level was similar after exposure to palmitate or oleate, suggesting the methylation process is unlikely to distinguish between a saturated fat and an unsaturated fat. Fat overload and inflammation are two competing theories to explain insulin resistance in skeletal muscle. The underlying mechanism is incompletely understood. Our findings suggest elevated free fatty acids and inflammatory factors may induce insulin resistance through epigenetic mechanisms. Future effort is warranted to elucidate the potential ‘rate-limiting’ metabolites in triggering DNA methylation in response to changes in lipid overload or inflammatory factors.

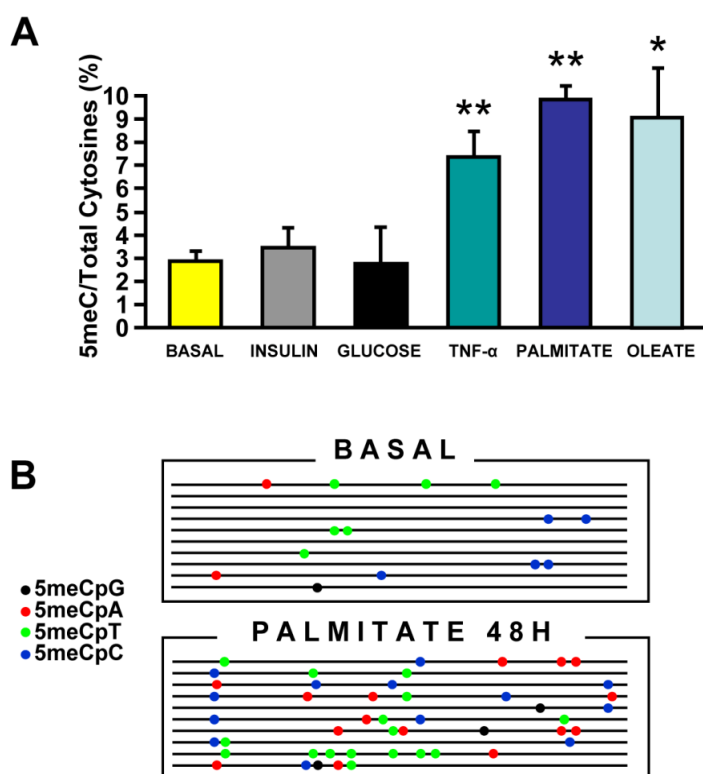

Figure 18 Free fatty acids induce *PGC1 $\alpha$*  promoter hypermethylation in cultured human myotubes (Paper II Figure 5).



### 2.3.2.4 DNMT3B is involved in palmitate-triggered *PGC1 $\alpha$* hypermethylation

Three functional isoforms of DNA methyltransferase (DNMT), DNMT1, DNMT3A, DNMT3B have been identified in mammals (Xie et al., 1999; Yen et al., 1992). The process of DNA methylation is based on an enzymatic reaction forming a transient covalent complex between DNMTs and targeted cytosine (Santi et al., 1983). To dissect whether DNMTs are involved in free fatty acid-induced hypermethylation of the *PGC1 $\alpha$*  promoter, we selectively silenced different DNMT isoforms in palmitate-treated cultured human skeletal muscle cells using siRNA. We transfected a scrambled siRNA as a negative control, which is a scrambled sequence of the siRNA target sequence to identify any changes of gene expression due to siRNA delivery method or siRNA against specific DNMT isoforms. Palmitate treatment increased methylation level of the *PGC1 $\alpha$*  promoter and decreased mitochondrial content as measured by the ratio mitochondria DNA per nucleus DNA (mtDNA/nDNA). mRNA expression levels of several genes related to mitochondrial function and biogenesis were downregulated upon palmitate treatment. Silencing of DNMT3B by 43% prevented palmitate-induced hypermethylation of *PGC1 $\alpha$*  and defects of mtDNA content, as well as expression of genes involved in mitochondrial function [Figure 19]. Silencing of DNMT1 or DNMT3A failed to achieve the same effect as silencing of DNMT3B. Based on these observations, we conclude DNMT3B is essential to induce hypermethylation of *PGC1 $\alpha$*  promoter in response to palmitate stimuli. However, protein content of DNMT3B was unaltered in this process. Maintaining and modifying the specific DNA methylation pattern is not only related to DNMTs protein amount, but also depends on multiple factors including interactions between different methyltransferases, nuclear factors and chromatin structure, as well as methyl donors.

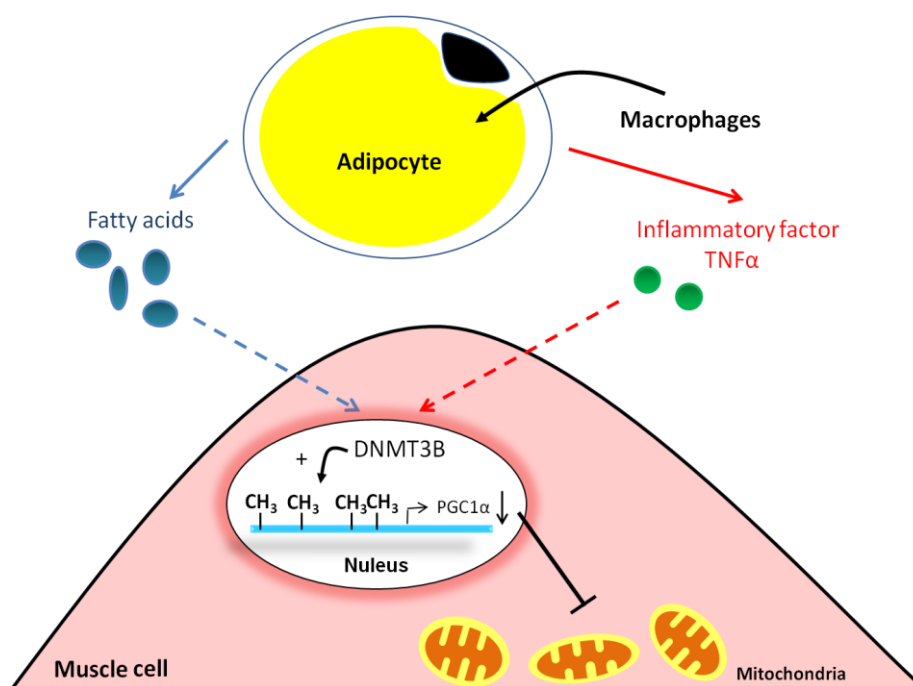

Figure 19 A model to illustrate the potential role of DNMT3B in inducing hypermethylation of the *PGC1 $\alpha$*  promoter, which would further influence *PGC1 $\alpha$*  mRNA expression and mitochondrial biogenesis.

DNA methylation has been considered to be established early in embryonic stage and remains dynamic only during cell division and differentiation. Here we observed that changes in DNA methylation levels were associated with alterations in the expression of genes involved in mitochondrial function in skeletal muscles obtained from Type 2 diabetic patients. Rapid DNA methylation changes after exposure to free fatty acids or TNF $\alpha$  in terminally differentiated primary human myotubes imply that epigenetic marks remain dynamic in somatic cells. These results provide evidence that DNA methylation may play an important role to regulate insulin sensitivity in metabolic disease states, indicating a strong link between gene and environment.

### 2.3.3 Paper III

#### **Weight loss after gastric bypass surgery induces epigenetic modifications in human obesity**

A collision of genetic and environmental factors has led to a rapid growth of obesity. Conventional strategies for the management of obesity, including lifestyle modifications of diet and exercise behavior, are often insufficient and pharmacological options are limited (Matthews et al., 1998; Turner et al., 1999). When diet and drugs no longer work, many severely obese individuals opt to undergo gastric bypass surgery as a means to reduce daily calorie absorption and lose weight. Several lines of evidence suggest that gastric bypass surgery reduces comorbidities and improves clinical outcomes associated with obesity (Hammoud et al., 2009; Marsk et al., 2010; Sjostrom et al., 2004).

##### *2.3.3.1 Clinical characteristics of the study participants*

In **Paper III**, eight non-diabetic obese women (mean BMI=42.1 kg/m<sup>2</sup>) were studied before and after gastric bypass surgery. The homeostatic model assessment (HOMA) value indicates insulin resistance and  $\beta$ -cell function defects in the obese participants. Laparoscopic Roux-en-Y gastric bypass was performed in this study. Sixteen normal weight women who did not undergo gastric bypass surgery were studied as control group. The levels of insulin, triglycerides, high density lipoprotein (HDL), non-esterified fatty acids (NEFA) in the obese women were significantly different compared to normal weight subjects. Leptin, interleukin-6 (IL6), hepatocyte growth factor (HGF) and C-reactive protein (CRP) were increased with obesity. Dramatic weight loss from 122.3 kg (mean value) before surgery to 88.1 kg (mean value) occurred from gastric bypass surgery. Furthermore, fasting glucose, insulin, lipids levels, inflammatory factors were normalized after gastric bypass surgery.

The mechanisms for the normalization of insulin sensitivity and reversal of type 2 diabetes after gastric bypass surgery are unexplained. Changes in DNA methylation may provide a mechanism by which environmental influences are linked to changes in gene expression and the control of insulin sensitivity with obesity. In **Paper II**, numerous gene promoters were shown to be differentially methylated in Type 2 diabetic patients compared to normal glucose tolerant subjects. Moreover, DNA methylation, particularly in non-CpG context, was involved in modulating insulin

sensitivity and mitochondrial function by influencing *PGC1 $\alpha$*  gene activity (**Paper II**). The aim of **Paper III** is to determine if DNA methylation is involved in the positive effect of gastric bypass surgery on human obesity.

### 2.3.3.2 *The transcription of metabolic genes and DNA methylation pattern*

To elucidate the potential role of epigenetic modifications in the regulation of gene expression in human obesity, as well as gastric bypass surgery-induced weight loss, we first examined altered expression of obesity related genes using genome-wide microarray approach. We identified 78 genes that were differentially expressed in skeletal muscle of obese women compared to normal weight women. These genes were classified in *lipid metabolic process* and *mitochondrion*. Furthermore, weight loss surgery normalized gene expression to similar levels as observed in normal weight women.

We determined the role of DNA methylation of specific promoters in regulating gene expression in obese women. We applied MBD-affinity methylated DNA enrichment protocol to investigate the methylation level of selective 16 genes promoters. Among 16 promoters studied, the methylation level of 8 promoters was negatively correlated with the gene expression, whereas the methylation level of 5 promoters showed a positive association. DNA methylation modulates transcription mainly through regulating the accessibility of transcriptional factors to the DNA template. Our data demonstrates three different transcriptional responses to increases in DNA methylation (Negative 8/16, Positive 5/16 and None 3/16). Thus, DNA methylation is not the only mechanism influencing gene expression. The consequence of DNA methylation regulation appears to be versatile, depending on the different contexts.

We also measured the global DNA methylation levels in skeletal muscle both in CpG (CCGG sequence) and non-CpG (CCA/TGG sequence) contexts using the LUMA technique. Consistent with our previous finding in **Paper II**, we detected similar levels of non-CpG methylation between lean and obese women. Global methylation was unaltered by either obesity or surgery-induced weight loss. Thus, the reported differential methylation level of specific promoters does not appear to reflect a global level change.

Fat contamination is a major concern in studies of skeletal muscle biopsies from obesity subjects. To exclude the possibility of fat difference in *vastus lateralis* skeletal muscle biopsies before and after the surgery, we measured mRNA expression of adipsin, an adipose tissue-enriched marker. mRNA expression of adipsin was similar in obese woman before versus after weight loss surgery. Thus, fat contamination in the muscle biopsies is unlikely to account for the changes in DNA methylation observed after weight loss.

### 2.3.3.3 *PGC1 $\alpha$ and PDK4 methylation is altered with obesity and weight loss*

*PGC1 $\alpha$*  and *PDK4* play an important role in the regulation of efficient energy utilization. Both *PGC1 $\alpha$*  and *PDK4* were among the 78 genes that were differentially expressed in obese women compared to normal weight subjects. We report that the decrease in *PGC1 $\alpha$*  mRNA expression and the increase in *PDK4* mRNA expression in

obesity was normalized by weight loss surgery. We then examined the methylation status of these two gene promoters. mRNA expression was inversely correlated with the methylation status of the promoters. We observed hypermethylation of *PGC1 $\alpha$*  and hypomethylation of *PDK4* in obese women in skeletal muscle. Interestingly, the methylation pattern after weight loss was normalized to the levels of normal weight subjects.

Consistent with our previous finding (**Paper I** and **Paper II**), the majority of DNA methylation we observed in skeletal muscle from obese women was in non-CpG context. To further determine the regulating role of non-CpG methylation in gene expression, we performed luciferase activity assay of *PDK4* promoter with a methylation site introduced in CpC context. Luciferase activity was decreased 19% by introducing the single non-CpG methylation site. Combined with our observation in **Paper II** showing a single CpG methylation site in the promoter region could lead to a marked suppression of *PGC1 $\alpha$*  luciferase activity, we provide a direct evidence methylation is acting as a causative role in regulating gene expression.

Environmental and nutritional factors influence the DNA methylation pattern in skeletal muscle. In **Paper II**, we demonstrated that exposure to free fatty acids or the inflammatory factor TNF $\alpha$  could induce hypermethylation of the *PGC1 $\alpha$*  promoter. Obesity is characterized by excess accumulation of white adipose tissue due to the imbalance between energy intake and expenditure (Rosen and Spiegelman, 2006). The elevated triglyceride and free fatty acid levels in obese participants were normalized after weight loss induced by gastric bypass surgery. Furthermore, triglyceride levels were found to be positively correlated with *PGC1 $\alpha$*  promoter methylation levels, which provide further evidence that lipid profiles could trigger dynamic methylation changes of the *PGC1 $\alpha$*  promoter in skeletal muscle.

Circulating cytokines and inflammatory factors were also found to be altered in obesity, and improved by weight loss surgery. *PGC1 $\alpha$*  methylation levels were positively correlated with CRP levels and leptin levels, whereas *PDK4* methylation levels were negatively correlated with these clinical characteristics. Thus, methylation pattern might be affected by systemic factors.

DNA methylation can be modulated by diet supplementation with methyl donors or mono carbon metabolites, such as folic acid and homocysteine (Cooney et al., 2002; Waterland et al., 2006; Weaver et al., 2005). Restricted food intake and malabsorption after gastric bypass surgery could induce folic acid and homocysteine deficiency. Furthermore, patients after gastric bypass surgery are prescribed folic acid supplementations routinely (5 mg per day). Folic acid and homocysteine measured were unaltered in our participants before and after surgery, thereby excluding this possibility and further supporting the notion that the observed DNA methylation changes are not due to changes of methyl donors.

Metabolic flexibility is used to describe the ability of skeletal muscle to switch between utilization of either carbohydrate or fatty acids. However, the ability of skeletal muscle from obese individuals to switch between fat and glucose oxidation is impaired (Kelley and Mandarino, 2000). Dynamic changes of DNA methylation might contribute to metabolic flexibility in skeletal muscle by sensing the environmental and nutritional status and modulating gene expression involved in energy homeostasis.

The response of DNA methylation change to weight loss was characterized in whole blood to determine whether there are tissue-specific changes in DNA methylation with obesity or weight loss. Global hypermethylation in peripheral blood leucocytes is correlated with systemic inflammation and increased mortality in patients suffered from chronic kidney disease (Stenvinkel et al., 2007). We observed that DNA methylation level of *PGC1 $\alpha$*  in whole blood coincided with the level in the skeletal muscle (**Paper III**). This result provides evidence to suggest that the DNA methylation pattern in blood may mirror the methylation level in muscle for *PGC1 $\alpha$* . However, we did not observe a similar level of methylation of the *PDK4* promoter between skeletal muscle and whole blood. In our study, we analyzed genomic DNA extracted from the whole blood cells. Given that mature human red blood cells and platelets do not have a nucleus containing DNA, the DNA from white blood cells contributes the majority of the whole blood DNA. Future studies to isolate the different types of white blood cells and study the cell type specific methylation pattern in blood are warranted. Moreover, additional studies are required to elucidate the methylation pattern in various tissues and cell types. Methylation information in blood may serve as a new biomarker in human diseases.

In **Paper III** we demonstrate that obesity and weight loss have a dynamic effect on the level of DNA methylation at non-CpG sites in the promoter regions of key genes involved in lipid and glucose oxidation in skeletal muscle. Changes in DNA methylation may be an early event in reprogramming the metabolic profile of human somatic tissues.

#### **Key findings:**

Collectively, our findings provide evidence that global DNA methylation levels are unaltered either by Type 2 diabetes or obesity in human skeletal muscle biopsies. However, DNA methylation alterations were found in specific promoters in Type 2 diabetes (based on MeDIP array data presented in **Paper II** (Supplemental Table 2)) and obesity (**Paper III**). We focused on the genes involved in mitochondrial function. Specifically, we studied the *PGC1 $\alpha$*  promoter methylation patterns in both **Paper II** and **Paper III**. To compare the data generated in different cohorts, we here normalized *PGC1 $\alpha$*  promoter methylation levels by the levels of NGT controls used in each study [Figure 20]. The changes in *PGC1 $\alpha$*  promoter methylation in *vastus lateralis* skeletal muscle observed in IGT, T2D and obese subjects were similar. Moreover, *PDK4* promoter methylation levels were also altered in Type 2 diabetic patients (Kulkarni et al., 2011) and obese subjects (**Paper III**).

Overall, our results provide evidence that the *PGC1 $\alpha$*  and *PDK4* promoter methylation levels are associated with insulin resistance states. The methylation changes in IGT and obese subjects suggest DNA methylation may be an early event in the pathogenesis of insulin resistance associated with Type 2 diabetes. The ‘memory’ of insulin resistance can be erased by reversing the insulin resistance (e.g. weight loss induced by gastric bypass surgery). Luciferase reporter assay results show that a single methylated cytosine in the promoter could reduce gene expression (*PGC1 $\alpha$*  in **Paper II** and *PDK4* in **Paper III**), which provides direct evidence that methylation may play a causative role in regulating gene expression.

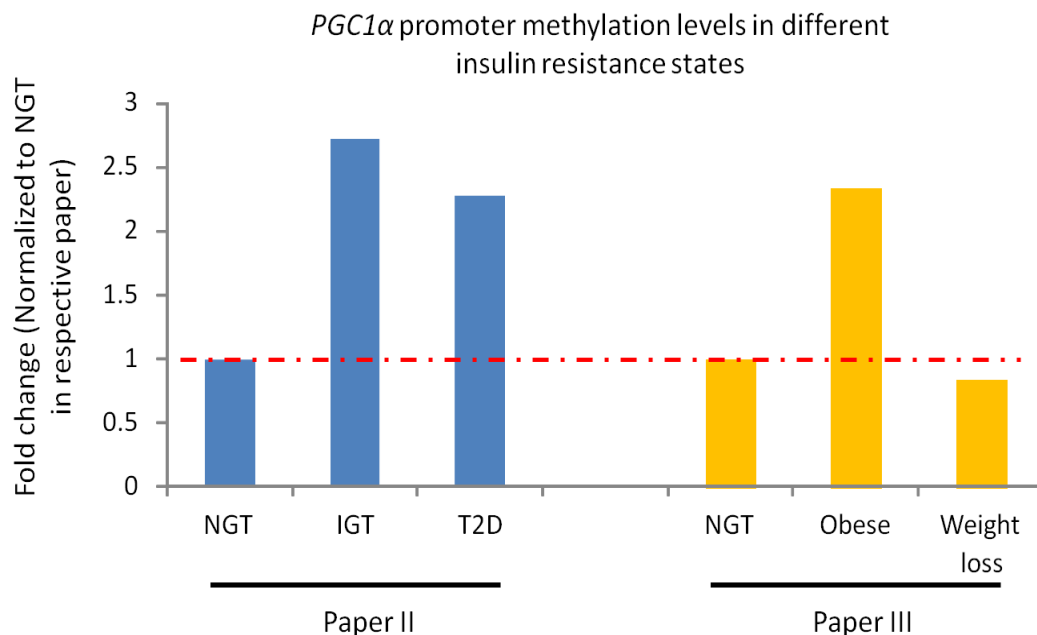

**Figure 20** *PGC1α* promoter methylation levels in different insulin resistance states (Data are normalized to levels measured in NGT subjects for each paper).

It worth noting that there is also a sex difference between cohorts used in **Paper II** and **Paper III**. Male subjects were studied in **Paper II** and female subjects in **Paper III**. Sex affects the risk for metabolic syndrome (Glumer et al., 2003; Hu et al., 2004) and diabetes (Glumer et al., 2003; Legato et al., 2006). We did not address sex-dependent influences on DNA methylation in this thesis. Future work is needed to answer this question.

DNA methylation can be triggered by environmental and nutritional factors. Rapid changes in DNA methylation were found in differentiated primary human myotubes after exposure to free fatty acids or TNF $\alpha$  (**Paper II**). The underlying mechanism to explain the dynamic changes in human tissues is still obscure. We have shown DNMT3B is involved in the palmitate-induced hypermethylation of *PGC1α* promoter (**Paper II**). Further evidence is needed to understand the crosstalk between different environmental factors and DNMTs. Additionally, weight loss induced by the surgery can restore the methylation of *PGC1α* promoter (**Paper III**), which implies demethylation mechanisms may be involved. Further investigation of unknown mechanism controlling demethylation is needed.

### 3 SUMMARY

Type 2 diabetes and obesity are multifactorial diseases involving interactions between genetic and environmental influences. Epigenetics links environmental influences to gene expression regulation. Studies presented in this thesis focus on the role of DNA methylation and they have expanded the understanding of the regulation of key genes involved in maintaining metabolic homeostasis.

- In **Paper I**, our data demonstrate non-CpG methylation contributes to the total DNA methylation in mammals and can be measured at substantial levels. We report a bisulfite sequencing bias, which appears to partially explain an underestimation of non-CpG methylation levels in mammals.
- In **Paper II**, using whole genome promoter methylation analysis of skeletal muscle from normal glucose tolerant and Type 2 diabetic subjects, 44 promoters of genes were found to be related to mitochondrial structure and function. We identified cytosine hypermethylation of *PGC-1 $\alpha$*  in Type 2 diabetic subjects and the majority cytosine methylation was in non-CpG context. Free fatty acids or TNF $\alpha$  could trigger hypermethylation in cultured human myotubes. Selective silencing of the DNMT3B, but not DNMT1 or DNMT3A, prevented palmitate-induced non-CpG methylation of *PGC-1 $\alpha$* .
- In **Paper III**, global cytosine methylation was unaltered by obesity or gastric bypass surgery. Bisulfite sequencing revealed promoter-specific DNA methylation changes of *PGC-1 $\alpha$*  and *PDK4* with obesity. We also report mRNA expression was inversely correlated with promoter methylation level of each respective gene. Weight loss restored promoter methylation and mRNA expression of *PGC-1 $\alpha$*  and *PDK4* to levels comparable with those of non-obese women.

Collectively, we identify the existence of non-CpG methylation in mammals and describe its functional role in regulating genes associated with insulin resistance in Type 2 diabetes and obesity. We also provide evidence that DNA methylation could be dynamically remodeled, concomitant with alterations in insulin sensitivity. Furthermore, environmental factors such as free fatty acids or TNF $\alpha$  trigger DNA methylation changes. Taken together, these studies provide evidence that changes in DNA methylation may contribute to the regulation of insulin sensitivity in Type 2 diabetes and obesity [Figure 21].

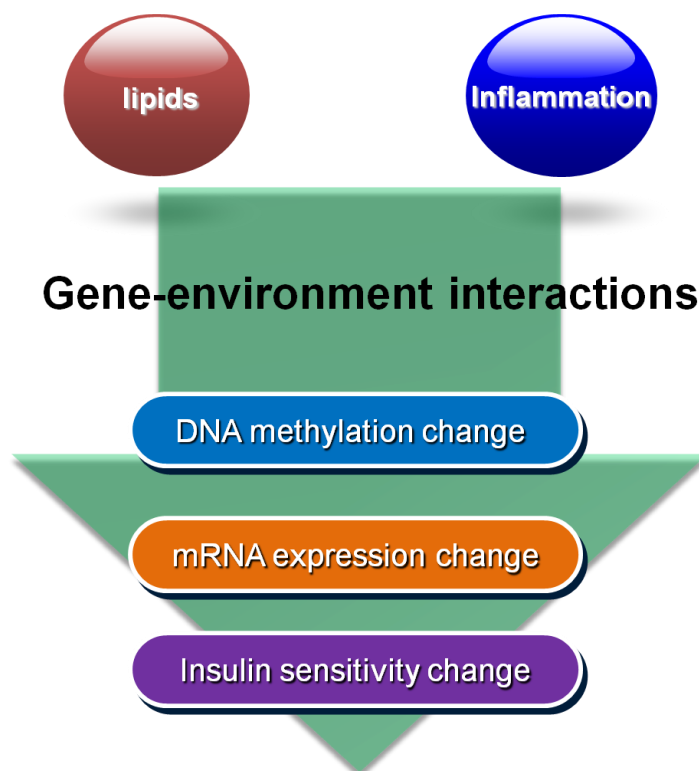

**Figure 21** DNA methylation contributes to the regulation of insulin sensitivity by modulating mRNA expression of genes involved in glucose and lipid metabolism.



## **4 CONCLUSION**

Environmental and nutritional factors have a dynamic effect on the level of DNA methylation in the promoter regions of key genes involved in lipid and glucose oxidation. The studies presented in this thesis have additional implications toward clarifying the role of the environmental factors on insulin sensitivity through DNA methylation. Changes in DNA methylation may be an early event in reprogramming the metabolic profile in human somatic tissues.

## 5 FUTURE PERSPECTIVES

### 5.1 Tissue-specific DNA methylation

This thesis was mainly focused on DNA methylation in skeletal muscle since this tissue is a major site for insulin-mediated glucose disposal (DeFronzo et al., 1985). Defects in skeletal muscle lead to the development of whole-body insulin resistance. However, Type 2 diabetes is a chronic disorder characterized by impaired insulin secretion of the  $\beta$ -pancreatic cells and insulin resistance in skeletal muscle, but also in adipose tissue and liver. Several lines of evidence support the role of DNA methylation in metabolic disease in individual tissues (Ling et al., 2008; Ling et al., 2007; Ronn et al., 2008). The rapid growth in sequencing technology provides an opportunity to investigate the epigenome of different tissues, and even the overall epigenetic state of a single cell type. Such knowledge will expand our understanding of responses to environmental stimuli in different tissues and the crosstalk between multiple organs. Tissue-specific methylation patterns may account for susceptibilities and pathogenesis of metabolic disease.

### 5.2 Other epigenetic mechanisms

DNA methylation and histone modifications are two major epigenetic changes. The studies in this thesis mainly focused on the potential role of DNA methylation in metabolic disease. MicroRNAs (miRNA) are small RNA molecules which could negatively regulate gene expression at posttranscriptional levels. miRNA is also considered to be within epigenetic arena. There are also interactions and influences between different epigenetic modifications (Hou et al., 2008; Lindahl Allen et al., 2009), e.g. DNA methylation affects histone acetylation and histone methylation (Klose and Bird, 2006); miRNA expression can be controlled by epigenetic mechanisms and epigenetic machinery can also be affected by miRNA *vice versa* (Chatterton et al., 2010; Chellappan et al., 2010). Future work is needed to elucidate how the other epigenetic mechanisms behave or interact with DNA methylation to modulate gene expression in human diseases.

### 5.3 Refining definition of 'epigenetics'

Term 'Epigenetics' was first coined by the developmental biologist and evolutionist Conrad H. Waddington (1905-1975) aiming to emphasize the mechanism driving the genotype to the phenotype during development. The definition has been changed and refined from time to time. The commonly accepted definition was described by Arthur Rigs and colleagues, '*the study of mitotically and/or meiotically heritable changes in gene function that cannot be explained by changes in DNA sequence*'. The major constraint of this definition is the requirement of 'heritability'. Are all epigenetic marks transmissible during mitosis or meiosis? The reason for questioning this is that many chromatin marks are transient. Phosphorylation of the variant histone H2AX after the double strand break (Rogakou et al., 1999) would be too transient to be considered a heritable epigenetic mark according to the definition described by Arthur Rigs and colleagues. In **Paper III**, we also observed DNA methylation could be altered in obesity and this 'memory of obesity' could be dynamically erased after weight loss induced by gastric bypass surgery.

The new definition of epigenetics has been suggested to include the biology of chromatin, the various chromatin marks, the RNA interference effects, as well as the higher-order structure of chromosomes and the nucleus (Bird, 2007). A unifying definition is emerging, '*the structural adaptation of chromosomal regions so as to register, signal or perpetuate altered activity states*'. The definitions of epigenetics may keep changing as long as we gain more knowledge of the epigenetic systems.

#### **5.4 Linking *in utero* environmental stimuli to adult metabolic disease**

Two decades ago, Dr. David Barker first showed that environmental events and nutritional conditions *in utero* could have a lasting impact on adult disease later (Barker et al., 1989). This was one of the first clues into why the *in utero* environment is important. The concept of 'DOHaD' (Developmental Origins of Health and Disease) is now widely accepted and it brings new insights into the pathogenesis and progression of human diseases. Fetal growth retardation and low birth weight increases the risk of coronary heart disease, Type 2 diabetes and hypertension. These metabolic diseases may originate from the poor nutritional environment *in utero* according to the 'Barker hypothesis'. The study of Dutch famine (1944-1945) also provides a link between maternal nutritional status and diseases in the offspring (Painter et al., 2005). Additionally, the timing of undernutrition exposure *in utero* appears to determine which organs are affected (Painter et al., 2005). The underlying mechanism is still obscure. Epigenetic mechanisms may provide an explanation for these phenomena. Studies on epigenetic modifications contribute to our understanding of long-term effects of *in utero* exposure (Breton et al., 2009; Simmons, 2009; Thompson et al., 2010).

DNA methylation appears to fine-tune cell programming, sensing environmental changes, marking the chromosome status, regulating gene expression and making the body ready to respond to outside. Aberrant DNA methylation is linked to pathogenesis of human diseases. In the future, DNA methylation may serve as a diagnostic approach to identify persons at risk for metabolic disease. Further studies to modify epigenetic influences may inform drug discoveries and treatment strategies for human diseases.

## 6 ACKNOWLEDGEMENTS

The work of this thesis was performed at the Section for Integrative Physiology, Department of Molecular Medicine and Surgery, Karolinska Institutet. I am grateful I could start my research in such an excellent environment. You are the finest team I've ever been a part of.

I want to say thank you to all those involved in making this happen and really want to hug you while mascara-soaked tears stream down my face. First of all, special thanks to **Professor Juleen Zierath**, **Professor Anna Krook**, **Professor Marc Gilbert** and **Professor Erik Näslund** for all the great discussions and comments during my thesis preparation.

**Professor Juleen Zierath**, my principal supervisor. Thanks for being involved in the collaboration program and taking risks to give me this opportunity to come to Sweden to start my research here, even though you knew nothing about me. Thanks for bringing me to the epigenetic field and guiding me from zero level until I could get comfortable with scientific thinking and working independently. You are such a charming person, a great group leader, an inspiring scientist. I am always motivated by your enthusiasm of work and life. I want to express my sincere gratitude for your understanding, your encouraging emails and short messages when I feel depressed or frustrated. I am so proud to be your student. You are a trailblazer.

**Professor Anna Krook**, my co-supervisor. Thanks not only for your sharp insight, but the willingness to share it in a direct way. Thanks for your advice, your guidance and your encouragement during the course of my Ph.D. You are a brilliant scientist and woman. You always look the bright side of the life and science. Your optimistic attitude is so admirable. Thanks for taking your time and listening to me when I got stuck. You always told us to calm down and take a deep breath when I was running around during each deadline-packed day.

**Dr. Romain Barrès**, my scientific supervisor. You are the person who picked me up at the airport when I arrived at Stockholm four years ago. Before I came here, I had no idea about science and experiments except some basic knowledge obtained from medical school training. Thanks for teaching me everything; from accurately pipetting a drop of water, to your guidance to get me to ask a question, bring up a hypothesis, design the experiment, carry out skilled process, calculate and present data. I was always excited to work with you.

**Professor Huixia Yang**, my mentor for the Ph.D study, my supervisor for my clinical training in China. You were so supportive when I decided to go abroad to pursue my research. Thank you so much for your advice on how to plan my future career.

**Gunilla Norhagen**, Director of International Affairs at Karolinska Institutet, thanks for interviewing me four years ago at Beijing and inviting me to join the MD-Ph.D program between KI and Peking University. **Yang Ke**, President of Peking University Health Science Center, **Qiudan Sun**, Director of International Cooperation Office, **Zhe Dong**, former Director of International Cooperation Office, and **Weimin Wang**,

Director of Education Office, thanks for establishing the cooperation and initiating the program. Otherwise, I wouldn't get four year full time scientific training.

All my lovely colleagues, we are family. You all make Integrative Physiology a nice place to work. We are an incredible team. We work together, solve problems together, teach each other and learn from each other. **Margareta Svedlund**, thanks for providing excellent administrative support to us and you are always helpful with all kinds of things. You step up when you need to and you do more than anyone asks you to do. **Ann Marklund**, welcome to join us and I believe you will love this group of people. **Professor Marc Gilbert**, thanks for sharing your broad knowledge of science and comments on my studies. **Docent Alexander Chibalin**, for all your knowledge and experience with chemicals and blotting. **Docent Lubna Al-Khalili**, for all your help with cells and warm hugs when I needed. **Dr. Marie Björnholm**, for always notifying me new papers published in epigenetic field and organizing the journal club. Thanks for your company when I feel sad. **Dr. Pablo Garcia-Roves** and **Dr. Håkan Karlsson**, thanks for your suggestion with assays and antibodies. **Dr. Qunfeng Lake Jiang**, I appreciate all detailed discussion about experimental approaches when I encountered difficulties in lab. Your hard working, your passion for research and curiosity about science has truly inspired me. **Katrin Bergdahl**, thanks for taking care of the ordering and making lab clean and organized. **Eva Palmer**, you are so creative and always helpful. I really enjoy working with you closely. **Torbjörn Morein**, for making me laugh everyday and convincing me the life is shining and bright. **Dr. Henriette Kirchner**, **Dr. Carolina Nylèn**, for great discussion and efforts we have made. Good luck with all your epigenetic projects. **Dr. Dana Galuska**, **Dr. Ulrika Widegren**, **Dr. Stefan Nobel**, **Dr. Louise Mannerås Holm**, **Dr. Emmani Nascimento**, **Dr. Hanneke Boon**, **Dr. Firoozeh Salehzadeh**, **Dr. Julie Massart**, **Dr. Mutsumi Katayama**, **Dr. Thais De Castro Barbosa**, **Dr. Boubacar Benziane**, **Maria Holmström**, **Dr. Fredrick Mashili**, **Sameer Kulkarni**, **Robby Tom**, **Dr. Ferenc Szekeres**, **Rasmus Sjögren**, **Isabelle Riedl**, **Leonidas Lundell**, **Dr. Inger Kühn**, **Dr. Atul Deshmukh**, **Dr. Zhou Zhou**, **Dr. Asuka Naito**, **Dr. Naoki Miyoshi**, **Dr. Eduardo Iglesias-Gutiérrez**, **Dr. Dorit Schleinitz**, **Daniella Esteves Duque-Guimaraes**, **Moshi Song**, thanks for sharing all your expertise in science. We had so much fun in the lab and outside the lab including many pleasant coffee-breaks. I would also like to thank those with whom I had the pleasure of sharing an office and for the many enjoyable and often instructive discussions we've had.

I would like to extend profound gratitude to my close collaborators, **Professor Erik Näslund** from Danderyd Hospital, **Professor Leif Andersson** from Uppsala Universitet, and my other co-authors, **Dr. Megan Osler**, **Dr. Morten Rasmussen**, **Dr. Brendan Egan**, **Dr. Anna Rune**, **Dr. Tomas Fritz**, **Dr. Kenneth Caidahl** for hard working, brilliant ideas, smooth communication and well organized work.

Thanks to **Lennart Helleday** and **Renee Andersson** for your generous and quick IT support, **Ann-Britt Wikström** for excellent administrative work to organize all my forms and give me advice to make a progress.

To **Counselor Ning Zhang** from Embassy of China in Sweden, **Wei Wang**, **Hong Zhang**, **Xudong Li** and **Rui Fan**, thanks for your kind support.

Jie Yan

A special thanks to my friends **Na Guan, Shijin Zhang, Xiaoqun Zhang, Zejun Feng**. We had so much fun in the lunch room and all conversation topics make my life much easier and happier. **Xiaoli Feng**, thanks for giving me your endless friendship for so many years, all good things and bad things we have experienced, all tears and laughter we have shared. All travelling, shopping and cooking stories with you will be my memories. Good luck with your research and best wishes to you and Yougen and your baby girl.

All friends in Stockholm, thanks to **Uncle Jinying Yan** and your family for taking care of me when I just arrived in Stockholm, **Anju Zhang** and your family for inviting me to celebrate the traditional Chinese festivals. **Yan Li** and **Bing Zhang**, thanks for all support from you and the great dinner we had last summer. **Zuheng Ma** and your family, thanks for your generous help. **Dr. Chengyun Zheng, Dr. Zhong-qun Yan, Associate Prof. Harvest F. Gu**, thanks for your inputs for my future career. **Zhengguo Qiao, Xun Huang, Zhaodong Zhong, Guoli Liu, Jingyi Ren, Hong Su**, thanks for all your generous help and great time we spent together. **Liyang Jiang, Yatao Du, Huihui Zhang, Bin Zhao, Ziming Du, Yao Shi, Qing Cheng, Qin Li, Ning Ma, Liang Zhang, Xinming Wang, Hongshi Qi, Jianren Song, Jianqiang Xu, Yuan Xue, Xiaoda Wang, Xiaofeng Zheng, Xin Wang, Liang Wu, Chengxi Shi, Qinzi Yan, Yu Li, Ying Ye, Yunlong Yang, Jinfeng Shen, Hong Xie, Lanjunzi Chen, Ci Song, Zheng Chang, Tianwei Gu, Qiaoling Deng, Yuan Fang, Jiaqi Huang, Chunchen Jia, Wei Jiao, Na Wang, Qiao Li, Yue Shi, Huiqing Liu, Yingqing Wang, Shulu Zu, Rong Geng, Mingmei Shang, Jiangning Yang, Meng Li, Jia Sun, Daohua Lou, Junwei Zhang, Xiaoyan Huang, Ting Jia, Jian Zhang** and **Bo Sun**, I thank all of you sincerely for being, each in their own way, so supportive to me.

To my best friends in Beijing, **Wei Lin** and **Fan Zhang**, we have been friends for more than ten years. Thanks for taking care of me for so many years. Be sure and check out the reunion parties. My teacher **Jian Li**, thanks for treating me like your own daughter and sharing your understanding of life.

My deepest love to **my parents**, thanks for giving birth to me and bringing me up. Thanks for teaching me to be honest, brave, confident and independent. You are brilliant parents. Thanks to my parents for their never fading support, belief and patience. I would never have made it through without the love from you. I've said it before and I will say it again, I love you.

**My dear husband Xin**, we have been in love for seven years and have been married for two years already. Thanks for always being there waiting for me and supporting me. I still remember when I was wearing the bridal crown, holding the pink roses, and walking to you accompanied by my Dad. I believe my heart stopped the moment you asked me to marry you and didn't start beating again until the ceremony was over. I know it is not easy for us to stay so far away from each other, but stay close emotionally. You never give up and you are always confident we could make our dreams come true. You are my best friend, my true love, the person I want to spend my whole life with, no matter what we face. For better, for worse, for richer, for poorer, in sickness and in health.

There is an old Chinese saying; 'The favor of a drop of water has been rewarded with the gratitude of a fountain of water.' Therefore, a big '**thanks**' to all of you.

## 7 REFERENCES

- An, J., Muoio, D.M., Shiota, M., Fujimoto, Y., Cline, G.W., Shulman, G.I., Koves, T.R., Stevens, R., Millington, D., and Newgard, C.B. (2004). Hepatic expression of malonyl-CoA decarboxylase reverses muscle, liver and whole-animal insulin resistance. *Nat Med* 10, 268-274.
- Anderson, S., Bankier, A.T., Barrell, B.G., de Bruijn, M.H., Coulson, A.R., Drouin, J., Eperon, I.C., Nierlich, D.P., Roe, B.A., Sanger, F., *et al.* (1981). Sequence and organization of the human mitochondrial genome. *Nature* 290, 457-465.
- Barker, D.J., Osmond, C., Golding, J., Kuh, D., and Wadsworth, M.E. (1989). Growth in utero, blood pressure in childhood and adult life, and mortality from cardiovascular disease. *BMJ* 298, 564-567.
- Bedford, M.T., and van Helden, P.D. (1987). Hypomethylation of DNA in pathological conditions of the human prostate. *Cancer Res* 47, 5274-5276.
- Bestor, T.H., and Ingram, V.M. (1983). Two DNA methyltransferases from murine erythroleukemia cells: purification, sequence specificity, and mode of interaction with DNA. *Proc Natl Acad Sci U S A* 80, 5559-5563.
- Bird, A. (2007). Perceptions of epigenetics. *Nature* 447, 396-398.
- Boden, G., Lebed, B., Schatz, M., Homko, C., and Lemieux, S. (2001). Effects of acute changes of plasma free fatty acids on intramyocellular fat content and insulin resistance in healthy subjects. *Diabetes* 50, 1612-1617.
- Breton, C.V., Byun, H.M., Wenten, M., Pan, F., Yang, A., and Gilliland, F.D. (2009). Prenatal tobacco smoke exposure affects global and gene-specific DNA methylation. *Am J Respir Crit Care Med* 180, 462-467.
- Brito, E.C., Lyssenko, V., Renstrom, F., Berglund, G., Nilsson, P.M., Groop, L., and Franks, P.W. (2009). Previously associated type 2 diabetes variants may interact with physical activity to modify the risk of impaired glucose regulation and type 2 diabetes: a study of 16,003 Swedish adults. *Diabetes* 58, 1411-1418.
- Butner, K.L., Nickols-Richardson, S.M., Clark, S.F., Ramp, W.K., and Herbert, W.G. (2010). A review of weight loss following Roux-en-Y gastric bypass vs restrictive bariatric surgery: impact on adiponectin and insulin. *Obes Surg* 20, 559-568.
- Chatterton, Z., Morenos, L., Saffery, R., Craig, J.M., Ashley, D., and Wong, N.C. (2010). DNA methylation and miRNA expression profiling in childhood B-cell acute lymphoblastic leukemia. *Epigenomics* 2, 697-708.
- Chellappan, P., Xia, J., Zhou, X., Gao, S., Zhang, X., Coutino, G., Vazquez, F., Zhang, W., and Jin, H. (2010). siRNAs from miRNA sites mediate DNA methylation of target genes. *Nucleic Acids Res* 38, 6883-6894.

Cheng, P., Schmutte, C., Cofer, K.F., Felix, J.C., Yu, M.C., and Dubeau, L. (1997). Alterations in DNA methylation are early, but not initial, events in ovarian tumorigenesis. *Br J Cancer* 75, 396-402.

Clark, A., Wells, C.A., Buley, I.D., Cruickshank, J.K., Vanhegan, R.I., Matthews, D.R., Cooper, G.J., Holman, R.R., and Turner, R.C. (1988). Islet amyloid, increased A-cells, reduced B-cells and exocrine fibrosis: quantitative changes in the pancreas in type 2 diabetes. *Diabetes Res* 9, 151-159.

Cooney, C.A., Dave, A.A., and Wolff, G.L. (2002). Maternal methyl supplements in mice affect epigenetic variation and DNA methylation of offspring. *J Nutr* 132, 2393S-2400S.

DeFronzo, R.A. (1988). Lilly lecture 1987. The triumvirate: beta-cell, muscle, liver. A collusion responsible for NIDDM. *Diabetes* 37, 667-687.

DeFronzo, R.A., Gunnarsson, R., Bjorkman, O., Olsson, M., and Wahren, J. (1985). Effects of insulin on peripheral and splanchnic glucose metabolism in noninsulin-dependent (type II) diabetes mellitus. *J Clin Invest* 76, 149-155.

Deo, S.S., Gore, S.D., Deobagkar, D.N., and Deobagkar, D.D. (2006). Study of inheritance of diabetes mellitus in Western Indian population by pedigree analysis. *J Assoc Physicians India* 54, 441-444.

Diabetes, S.o.M.C.i. (2010). Executive summary: Standards of medical care in diabetes--2010. *Diabetes Care* 33 Suppl 1, S4-10.

Dohm, G.L., Tapscott, E.B., Pories, W.J., Dabbs, D.J., Flickinger, E.G., Meelheim, D., Fushiki, T., Atkinson, S.M., Elton, C.W., and Caro, J.F. (1988). An in vitro human muscle preparation suitable for metabolic studies. Decreased insulin stimulation of glucose transport in muscle from morbidly obese and diabetic subjects. *J Clin Invest* 82, 486-494.

Donath, M.Y., and Halban, P.A. (2004). Decreased beta-cell mass in diabetes: significance, mechanisms and therapeutic implications. *Diabetologia* 47, 581-589.

Ehrlich, M., Gama-Sosa, M.A., Huang, L.H., Midgett, R.M., Kuo, K.C., McCune, R.A., and Gehrke, C. (1982). Amount and distribution of 5-methylcytosine in human DNA from different types of tissues of cells. *Nucleic Acids Res* 10, 2709-2721.

Eichler, E.E., Flint, J., Gibson, G., Kong, A., Leal, S.M., Moore, J.H., and Nadeau, J.H. (2010). Missing heritability and strategies for finding the underlying causes of complex disease. *Nat Rev Genet* 11, 446-450.

Falken, Y., Hellstrom, P.M., Holst, J.J., and Naslund, E. (2011). Changes in glucose homeostasis after Roux-en-Y gastric bypass surgery for obesity at day three, two months, and one year after surgery: role of gut peptides. *J Clin Endocrinol Metab* 96, 2227-2235.

Fraga, M.F., Ballestar, E., Paz, M.F., Ropero, S., Setien, F., Ballestar, M.L., Heine-Suner, D., Cigudosa, J.C., Urioste, M., Benitez, J., *et al.* (2005). Epigenetic differences



arise during the lifetime of monozygotic twins. *Proc Natl Acad Sci U S A* *102*, 10604-10609.

Fraga, M.F., and Esteller, M. (2002). DNA methylation: a profile of methods and applications. *Biotechniques* *33*, 632, 634, 636-649.

Franks, P.W., Ekelund, U., Brage, S., Luan, J., Schafer, A.J., O'Rahilly, S., Barroso, I., and Wareham, N.J. (2007a). PPARGC1A coding variation may initiate impaired NEFA clearance during glucose challenge. *Diabetologia* *50*, 569-573.

Franks, P.W., Mesa, J.L., Harding, A.H., and Wareham, N.J. (2007b). Gene-lifestyle interaction on risk of type 2 diabetes. *Nutr Metab Cardiovasc Dis* *17*, 104-124.

Frayling, T.M., Timpson, N.J., Weedon, M.N., Zeggini, E., Freathy, R.M., Lindgren, C.M., Perry, J.R., Elliott, K.S., Lango, H., Rayner, N.W., *et al.* (2007). A common variant in the FTO gene is associated with body mass index and predisposes to childhood and adult obesity. *Science* *316*, 889-894.

Frommer, M., McDonald, L.E., Millar, D.S., Collis, C.M., Watt, F., Grigg, G.W., Molloy, P.L., and Paul, C.L. (1992). A genomic sequencing protocol that yields a positive display of 5-methylcytosine residues in individual DNA strands. *Proc Natl Acad Sci U S A* *89*, 1827-1831.

Glumer, C., Jorgensen, T., and Borch-Johnsen, K. (2003). Prevalences of diabetes and impaired glucose regulation in a Danish population: the Inter99 study. *Diabetes Care* *26*, 2335-2340.

Goll, M.G., Kirpekar, F., Maggert, K.A., Yoder, J.A., Hsieh, C.L., Zhang, X., Golic, K.G., Jacobsen, S.E., and Bestor, T.H. (2006). Methylation of tRNA<sup>Asp</sup> by the DNA methyltransferase homolog Dnmt2. *Science* *311*, 395-398.

Goodyear, L.J., Giorgino, F., Sherman, L.A., Carey, J., Smith, R.J., and Dohm, G.L. (1995). Insulin receptor phosphorylation, insulin receptor substrate-1 phosphorylation, and phosphatidylinositol 3-kinase activity are decreased in intact skeletal muscle strips from obese subjects. *J Clin Invest* *95*, 2195-2204.

Grandjean, V., Yaman, R., Cuzin, F., and Rassoulzadegan, M. (2007). Inheritance of an epigenetic mark: the CpG DNA methyltransferase 1 is required for de novo establishment of a complex pattern of non-CpG methylation. *PLoS One* *2*, e1136.

Greenway, S.E., Greenway, F.L., 3rd, and Klein, S. (2002). Effects of obesity surgery on non-insulin-dependent diabetes mellitus. *Arch Surg* *137*, 1109-1117.

Griffin, M.E., Marcucci, M.J., Cline, G.W., Bell, K., Barucci, N., Lee, D., Goodyear, L.J., Kraegen, E.W., White, M.F., and Shulman, G.I. (1999). Free fatty acid-induced insulin resistance is associated with activation of protein kinase C theta and alterations in the insulin signaling cascade. *Diabetes* *48*, 1270-1274.

Haller, H. (1977). [Epidemiology and associated risk factors of hyperlipoproteinemia]. *Z Gesamte Inn Med* *32*, 124-128.

Hammoud, A., Gibson, M., Hunt, S.C., Adams, T.D., Carrell, D.T., Kolotkin, R.L., and Meikle, A.W. (2009). Effect of Roux-en-Y gastric bypass surgery on the sex steroids and quality of life in obese men. *J Clin Endocrinol Metab* 94, 1329-1332.

Haslam, D.W., and James, W.P. (2005). Obesity. *Lancet* 366, 1197-1209.

Hayatsu, H., Wataya, Y., Kai, K., and Iida, S. (1970). Reaction of sodium bisulfite with uracil, cytosine, and their derivatives. *Biochemistry* 9, 2858-2865.

Hildebrandt, A.L., Pilegaard, H., and Neuffer, P.D. (2003). Differential transcriptional activation of select metabolic genes in response to variations in exercise intensity and duration. *Am J Physiol Endocrinol Metab* 285, E1021-1027.

Holland, W.L., Brozinick, J.T., Wang, L.P., Hawkins, E.D., Sargent, K.M., Liu, Y., Narra, K., Hoehn, K.L., Knotts, T.A., Siesky, A., *et al.* (2007). Inhibition of ceramide synthesis ameliorates glucocorticoid-, saturated-fat-, and obesity-induced insulin resistance. *Cell Metab* 5, 167-179.

Hotamisligil, G.S., Peraldi, P., Budavari, A., Ellis, R., White, M.F., and Spiegelman, B.M. (1996). IRS-1-mediated inhibition of insulin receptor tyrosine kinase activity in TNF- $\alpha$ - and obesity-induced insulin resistance. *Science* 271, 665-668.

Hou, J., Liu, L., Zhang, J., Cui, X.H., Yan, F.X., Guan, H., Chen, Y.F., and An, X.R. (2008). Epigenetic modification of histone 3 at lysine 9 in sheep zygotes and its relationship with DNA methylation. *BMC Dev Biol* 8, 60.

Hu, G., Qiao, Q., Tuomilehto, J., Balkau, B., Borch-Johnsen, K., and Pyorala, K. (2004). Prevalence of the metabolic syndrome and its relation to all-cause and cardiovascular mortality in nondiabetic European men and women. *Arch Intern Med* 164, 1066-1076.

Huang, J., Jia, Y., Fu, T., Viswakarma, N., Bai, L., Rao, M.S., Zhu, Y., Borensztajn, J., and Reddy, J.K. (2011). Sustained activation of PPAR $\alpha$  by endogenous ligands increases hepatic fatty acid oxidation and prevents obesity in ob/ob mice. *FASEB J*.

Hue, J.J., Lee, K.N., Jeong, J.H., Lee, S.H., Lee, Y.H., Jeong, S.W., Nam, S.Y., Yun, Y.W., and Lee, B.J. (2009). Anti-obesity activity of diglyceride containing conjugated linoleic acid in C57BL/6J ob/ob mice. *J Vet Sci* 10, 189-195.

Kahn, C.R. (1978). Insulin resistance, insulin insensitivity, and insulin unresponsiveness: a necessary distinction. *Metabolism* 27, 1893-1902.

Kang, D., Kim, S.H., and Hamasaki, N. (2007). Mitochondrial transcription factor A (TFAM): roles in maintenance of mtDNA and cellular functions. *Mitochondrion* 7, 39-44.

Karimi, M., Johansson, S., Stach, D., Corcoran, M., Grander, D., Schalling, M., Bakalkin, G., Lyko, F., Larsson, C., and Ekstrom, T.J. (2006). LUMA (LUMinometric Methylation Assay)--a high throughput method to the analysis of genomic DNA methylation. *Exp Cell Res* 312, 1989-1995.

Kelley, D.E., and Mandarino, L.J. (2000). Fuel selection in human skeletal muscle in insulin resistance - A reexamination. *Diabetes* 49, 677-683.

Kim, J.Y., Hickner, R.C., Cortright, R.L., Dohm, G.L., and Houmard, J.A. (2000). Lipid oxidation is reduced in obese human skeletal muscle. *Am J Physiol Endocrinol Metab* 279, E1039-1044.

Kim, Y.I., Giuliano, A., Hatch, K.D., Schneider, A., Nour, M.A., Dallal, G.E., Selhub, J., and Mason, J.B. (1994). Global DNA hypomethylation increases progressively in cervical dysplasia and carcinoma. *Cancer* 74, 893-899.

Kloppel, G., Lohr, M., Habich, K., Oberholzer, M., and Heitz, P.U. (1985). Islet pathology and the pathogenesis of type 1 and type 2 diabetes mellitus revisited. *Surv Synth Pathol Res* 4, 110-125.

Klose, R.J., and Bird, A.P. (2006). Genomic DNA methylation: the mark and its mediators. *Trends Biochem Sci* 31, 89-97.

Knutti, D., Kaul, A., and Kralli, A. (2000). A tissue-specific coactivator of steroid receptors, identified in a functional genetic screen. *Mol Cell Biol* 20, 2411-2422.

Kolata, G.B. (1979). Blood sugar and the complications of diabetes. *Science* 203, 1098-1099.

Koves, T.R., Noland, R.C., Bates, A.L., Henes, S.T., Muoio, D.M., and Cortright, R.N. (2005). Subsarcolemmal and intermyofibrillar mitochondria play distinct roles in regulating skeletal muscle fatty acid metabolism. *Am J Physiol Cell Physiol* 288, C1074-1082.

Krssak, M., Falk Petersen, K., Dresner, A., DiPietro, L., Vogel, S.M., Rothman, D.L., Roden, M., and Shulman, G.I. (1999). Intramyocellular lipid concentrations are correlated with insulin sensitivity in humans: a <sup>1</sup>H NMR spectroscopy study. *Diabetologia* 42, 113-116.

Kulkarni, S.S., Salehzadeh, F., Fritz, T., Zierath, J.R., Krook, A., and Osler, M.E. (2011). Mitochondrial regulators of fatty acid metabolism reflect metabolic dysfunction in type 2 diabetes mellitus. *Metabolism*.

Kurukuti, S., Tiwari, V.K., Tavoosidana, G., Pugacheva, E., Murrell, A., Zhao, Z., Lobanenko, V., Reik, W., and Ohlsson, R. (2006). CTCF binding at the H19 imprinting control region mediates maternally inherited higher-order chromatin conformation to restrict enhancer access to Igf2. *Proc Natl Acad Sci U S A* 103, 10684-10689.

Larsson, N.G., Wang, J., Wilhelmsson, H., Oldfors, A., Rustin, P., Lewandoski, M., Barsh, G.S., and Clayton, D.A. (1998). Mitochondrial transcription factor A is necessary for mtDNA maintenance and embryogenesis in mice. *Nat Genet* 18, 231-236.

Legato, M.J., Gelzer, A., Goland, R., Ebner, S.A., Rajan, S., Villagra, V., and Kosowski, M. (2006). Gender-specific care of the patient with diabetes: review and recommendations. *Gend Med* 3, 131-158.

Lin, C.H., Hsieh, S.Y., Sheen, I.S., Lee, W.C., Chen, T.C., Shyu, W.C., and Liaw, Y.F. (2001). Genome-wide hypomethylation in hepatocellular carcinogenesis. *Cancer Res* 61, 4238-4243.

Lin, J., Wu, H., Tarr, P.T., Zhang, C.Y., Wu, Z., Boss, O., Michael, L.F., Puigserver, P., Isotani, E., Olson, E.N., *et al.* (2002). Transcriptional co-activator PGC-1 alpha drives the formation of slow-twitch muscle fibres. *Nature* 418, 797-801.

Lindahl Allen, M., Koch, C.M., Clelland, G.K., Dunham, I., and Antoniou, M. (2009). DNA methylation-histone modification relationships across the desmin locus in human primary cells. *BMC Mol Biol* 10, 51.

Ling, C., Del Guerra, S., Lupi, R., Ronn, T., Granhall, C., Luthman, H., Masiello, P., Marchetti, P., Groop, L., and Del Prato, S. (2008). Epigenetic regulation of PPARGC1A in human type 2 diabetic islets and effect on insulin secretion. *Diabetologia* 51, 615-622.

Ling, C., Poulsen, P., Simonsson, S., Ronn, T., Holmkvist, J., Almgren, P., Hagert, P., Nilsson, E., Mabey, A.G., Nilsson, P., *et al.* (2007). Genetic and epigenetic factors are associated with expression of respiratory chain component NDUF6 in human skeletal muscle. *J Clin Invest* 117, 3427-3435.

Linnane, A.W., Marzuki, S., Ozawa, T., and Tanaka, M. (1989). Mitochondrial DNA mutations as an important contributor to ageing and degenerative diseases. *Lancet* 1, 642-645.

Lister, R., Pelizzola, M., Downen, R.H., Hawkins, R.D., Hon, G., Tonti-Filippini, J., Nery, J.R., Lee, L., Ye, Z., Ngo, Q.M., *et al.* (2009). Human DNA methylomes at base resolution show widespread epigenomic differences. *Nature* 462, 315-322.

Lonroth, H., Dalenback, J., Haglind, E., and Lundell, L. (1996). Laparoscopic gastric bypass. Another option in bariatric surgery. *Surg Endosc* 10, 636-638.

Manolio, T.A., Collins, F.S., Cox, N.J., Goldstein, D.B., Hindorff, L.A., Hunter, D.J., McCarthy, M.I., Ramos, E.M., Cardon, L.R., Chakravarti, A., *et al.* (2009). Finding the missing heritability of complex diseases. *Nature* 461, 747-753.

Mark, A.L., Shaffer, R.A., Correia, M.L., Morgan, D.A., Sigmund, C.D., and Haynes, W.G. (1999). Contrasting blood pressure effects of obesity in leptin-deficient ob/ob mice and agouti yellow obese mice. *J Hypertens* 17, 1949-1953.

Marsk, R. (2009). Morbidity and mortality after bariatric surgery in Sweden. In Department of Clinical Sciences, Danderyd Hospital and Department of Public Health Sciences (Stockholm, Karolinska Institutet), pp. 39.

Marsk, R., Naslund, E., Freedman, J., Tynelius, P., and Rasmussen, F. (2010). Bariatric surgery reduces mortality in Swedish men. *Br J Surg* 97, 877-883.

Matthews, D.R., Cull, C.A., Stratton, I.M., Holman, R.R., and Turner, R.C. (1998). UKPDS 26: Sulphonylurea failure in non-insulin-dependent diabetic patients over six years. UK Prospective Diabetes Study (UKPDS) Group. *Diabet Med* 15, 297-303.

Meyer, P., Niedenhof, I., and ten Lohuis, M. (1994). Evidence for cytosine methylation of non-symmetrical sequences in transgenic *Petunia hybrida*. *EMBO J* *13*, 2084-2088.

Mills, J.L., Irving, R.R., Choo-Kang, E.G., Wright-Pascoe, R., McLaughlin, W., Mullings, A.A., Morrison, E.Y., and Gabay, L. (2010). Multigenerational inheritance and clinical characteristics of three large pedigrees with early-onset type 2 diabetes in Jamaica. *Rev Panam Salud Publica* *27*, 435-441.

Monetti, M., Levin, M.C., Watt, M.J., Sajan, M.P., Marmor, S., Hubbard, B.K., Stevens, R.D., Bain, J.R., Newgard, C.B., Farese, R.V., Sr., *et al.* (2007). Dissociation of hepatic steatosis and insulin resistance in mice overexpressing DGAT in the liver. *Cell Metab* *6*, 69-78.

Mootha, V.K., Handschin, C., Arlow, D., Xie, X., St Pierre, J., Sihag, S., Yang, W., Altshuler, D., Puigserver, P., Patterson, N., *et al.* (2004). *Erralpha* and *Gabpa/b* specify PGC-1 $\alpha$ -dependent oxidative phosphorylation gene expression that is altered in diabetic muscle. *Proc Natl Acad Sci U S A* *101*, 6570-6575.

Mootha, V.K., Lindgren, C.M., Eriksson, K.F., Subramanian, A., Sihag, S., Lehar, J., Puigserver, P., Carlsson, E., Ridderstrale, M., Laurila, E., *et al.* (2003). PGC-1 $\alpha$ -responsive genes involved in oxidative phosphorylation are coordinately downregulated in human diabetes. *Nat Genet* *34*, 267-273.

Morino, K., Petersen, K.F., Dufour, S., Befroy, D., Frattini, J., Shatzkes, N., Neschen, S., White, M.F., Bilz, S., Sono, S., *et al.* (2005). Reduced mitochondrial density and increased IRS-1 serine phosphorylation in muscle of insulin-resistant offspring of type 2 diabetic parents. *J Clin Invest* *115*, 3587-3593.

Morino, K., Petersen, K.F., and Shulman, G.I. (2006). Molecular mechanisms of insulin resistance in humans and their potential links with mitochondrial dysfunction. *Diabetes* *55 Suppl 2*, S9-S15.

Nair, S.S., Coolen, M.W., Stirzaker, C., Song, J.Z., Statham, A.L., Strbenac, D., Robinson, M.W., and Clark, S.J. (2011). Comparison of methyl-DNA immunoprecipitation (MeDIP) and methyl-CpG binding domain (MBD) protein capture for genome-wide DNA methylation analysis reveal CpG sequence coverage bias. *Epigenetics* *6*, 34-44.

NIH (1992). Gastrointestinal surgery for severe obesity: National Institutes of Health Consensus Development Conference Statement. *Am J Clin Nutr* *55*, 615S-619S.

Okada, S., Kobayashi, K., Ishikawa, M., Inoue, N., Yamada, N., and Shimano, H. (2007). Abdominal Irradiation Ameliorates Obesity in *ob/ob* Mice. *J Clin Biochem Nutr* *40*, 123-130.

Okano, M., Bell, D.W., Haber, D.A., and Li, E. (1999). DNA methyltransferases *Dnmt3a* and *Dnmt3b* are essential for de novo methylation and mammalian development. *Cell* *99*, 247-257.

Olek, A., Oswald, J., and Walter, J. (1996). A modified and improved method for bisulphite based cytosine methylation analysis. *Nucleic Acids Res* *24*, 5064-5066.

Orci, L., and Unger, R.H. (1975). Functional subdivision of islets of Langerhans and possible role of D cells. *Lancet* 2, 1243-1244.

Painter, R.C., Roseboom, T.J., and Bleker, O.P. (2005). Prenatal exposure to the Dutch famine and disease in later life: an overview. *Reprod Toxicol* 20, 345-352.

Parisi, M.A., and Clayton, D.A. (1991). Similarity of human mitochondrial transcription factor 1 to high mobility group proteins. *Science* 252, 965-969.

Patti, M.E., Butte, A.J., Crunkhorn, S., Cusi, K., Berria, R., Kashyap, S., Miyazaki, Y., Kohane, I., Costello, M., Saccone, R., *et al.* (2003). Coordinated reduction of genes of oxidative metabolism in humans with insulin resistance and diabetes: Potential role of PGC1 and NRF1. *Proc Natl Acad Sci U S A* 100, 8466-8471.

Perseghin, G., Ghosh, S., Gerow, K., and Shulman, G.I. (1997). Metabolic defects in lean nondiabetic offspring of NIDDM parents: a cross-sectional study. *Diabetes* 46, 1001-1009.

Perseghin, G., Scifo, P., De Cobelli, F., Pagliato, E., Battezzati, A., Arcelloni, C., Vanzulli, A., Testolin, G., Pozza, G., Del Maschio, A., *et al.* (1999). Intramyocellular triglyceride content is a determinant of in vivo insulin resistance in humans: a 1H-13C nuclear magnetic resonance spectroscopy assessment in offspring of type 2 diabetic parents. *Diabetes* 48, 1600-1606.

Petersen, K.F., Befroy, D., Dufour, S., Dziura, J., Ariyan, C., Rothman, D.L., DiPietro, L., Cline, G.W., and Shulman, G.I. (2003). Mitochondrial dysfunction in the elderly: possible role in insulin resistance. *Science* 300, 1140-1142.

Petersen, K.F., Dufour, S., Befroy, D., Garcia, R., and Shulman, G.I. (2004). Impaired mitochondrial activity in the insulin-resistant offspring of patients with type 2 diabetes. *N Engl J Med* 350, 664-671.

Petersen, K.F., Hendler, R., Price, T., Perseghin, G., Rothman, D.L., Held, N., Amatruda, J.M., and Shulman, G.I. (1998). 13C/31P NMR studies on the mechanism of insulin resistance in obesity. *Diabetes* 47, 381-386.

Pilegaard, H., Ordway, G.A., Saltin, B., and Neufer, P.D. (2000). Transcriptional regulation of gene expression in human skeletal muscle during recovery from exercise. *Am J Physiol Endocrinol Metab* 279, E806-814.

Porte, D., Jr., and Schwartz, M.W. (1996). Diabetes complications: why is glucose potentially toxic? *Science* 272, 699-700.

Puigserver, P., Rhee, J., Donovan, J., Walkey, C.J., Yoon, J.C., Oriente, F., Kitamura, Y., Altomonte, J., Dong, H., Accili, D., *et al.* (2003). Insulin-regulated hepatic gluconeogenesis through FOXO1-PGC-1alpha interaction. *Nature* 423, 550-555.

Puigserver, P., Wu, Z., Park, C.W., Graves, R., Wright, M., and Spiegelman, B.M. (1998). A cold-inducible coactivator of nuclear receptors linked to adaptive thermogenesis. *Cell* 92, 829-839.

Ramsahoye, B.H., Biniszkiewicz, D., Lyko, F., Clark, V., Bird, A.P., and Jaenisch, R. (2000). Non-CpG methylation is prevalent in embryonic stem cells and may be mediated by DNA methyltransferase 3a. *Proc Natl Acad Sci U S A* 97, 5237-5242.

Randle, P.J., Garland, P.B., Hales, C.N., and Newsholme, E.A. (1963). The glucose fatty-acid cycle. Its role in insulin sensitivity and the metabolic disturbances of diabetes mellitus. *Lancet* 1, 785-789.

Reaven, G.M. (2005). The insulin resistance syndrome: definition and dietary approaches to treatment. *Annu Rev Nutr* 25, 391-406.

Reaven, G.M., Hollenbeck, C., Jeng, C.Y., Wu, M.S., and Chen, Y.D. (1988). Measurement of plasma glucose, free fatty acid, lactate, and insulin for 24 h in patients with NIDDM. *Diabetes* 37, 1020-1024.

Reik, W., Dean, W., and Walter, J. (2001). Epigenetic reprogramming in mammalian development. *Science* 293, 1089-1093.

Ritov, V.B., Menshikova, E.V., He, J., Ferrell, R.E., Goodpaster, B.H., and Kelley, D.E. (2005). Deficiency of subsarcolemmal mitochondria in obesity and type 2 diabetes. *Diabetes* 54, 8-14.

Roden, M., Price, T.B., Perseghin, G., Petersen, K.F., Rothman, D.L., Cline, G.W., and Shulman, G.I. (1996). Mechanism of free fatty acid-induced insulin resistance in humans. *J Clin Invest* 97, 2859-2865.

Rogakou, E.P., Boon, C., Redon, C., and Bonner, W.M. (1999). Megabase chromatin domains involved in DNA double-strand breaks in vivo. *J Cell Biol* 146, 905-916.

Ronn, T., Poulsen, P., Hansson, O., Holmkvist, J., Almgren, P., Nilsson, P., Tuomi, T., Isomaa, B., Groop, L., Vaag, A., *et al.* (2008). Age influences DNA methylation and gene expression of COX7A1 in human skeletal muscle. *Diabetologia* 51, 1159-1168.

Rosen, E.D., and Spiegelman, B.M. (2006). Adipocytes as regulators of energy balance and glucose homeostasis. *Nature* 444, 847-853.

Rowles, J., Scherer, S.W., Xi, T., Majer, M., Nickle, D.C., Rommens, J.M., Popov, K.M., Harris, R.A., Riebow, N.L., Xia, J., *et al.* (1996). Cloning and characterization of PDK4 on 7q21.3 encoding a fourth pyruvate dehydrogenase kinase isoenzyme in human. *J Biol Chem* 271, 22376-22382.

Rubino, F., Schauer, P.R., Kaplan, L.M., and Cummings, D.E. (2010). Metabolic surgery to treat type 2 diabetes: clinical outcomes and mechanisms of action. *Annu Rev Med* 61, 393-411.

Ruchat, S.M., Rankinen, T., Weisnagel, S.J., Rice, T., Rao, D.C., Bergman, R.N., Bouchard, C., and Perusse, L. (2010). Improvements in glucose homeostasis in response to regular exercise are influenced by the PPARG Pro12Ala variant: results from the HERITAGE Family Study. *Diabetologia* 53, 679-689.

Ruderman, N.B., Saha, A.K., Vavvas, D., and Witters, L.A. (1999). Malonyl-CoA, fuel sensing, and insulin resistance. *Am J Physiol* 276, E1-E18.

Sanger, F., and Tuppy, H. (1951a). The amino-acid sequence in the phenylalanyl chain of insulin. 2. The investigation of peptides from enzymic hydrolysates. *Biochem J* 49, 481-490.

Sanger, F., and Tuppy, H. (1951b). The amino-acid sequence in the phenylalanyl chain of insulin. I. The identification of lower peptides from partial hydrolysates. *Biochem J* 49, 463-481.

Santi, D.V., Garrett, C.E., and Barr, P.J. (1983). On the mechanism of inhibition of DNA-cytosine methyltransferases by cytosine analogs. *Cell* 33, 9-10.

Schermelleh, L., Spada, F., Easwaran, H.P., Zolghadr, K., Margot, J.B., Cardoso, M.C., and Leonhardt, H. (2005). Trapped in action: direct visualization of DNA methyltransferase activity in living cells. *Nat Methods* 2, 751-756.

Shapiro, R., Braverman, B., Louis, J.B., and Servis, R.E. (1973). Nucleic acid reactivity and conformation. II. Reaction of cytosine and uracil with sodium bisulfite. *J Biol Chem* 248, 4060-4064.

Simmons, R.A. (2009). Developmental origins of adult disease. *Pediatr Clin North Am* 56, 449-466, Table of Contents.

Sims, E.A., Danforth, E., Jr., Horton, E.S., Bray, G.A., Glennon, J.A., and Salans, L.B. (1973). Endocrine and metabolic effects of experimental obesity in man. *Recent Prog Horm Res* 29, 457-496.

Singer, P. (1977). [Diagnosis of primary hyperlipoproteinemias]. *Z Gesamte Inn Med* 32, 129-133 concl.

Sjostrom, L., Lindroos, A.K., Peltonen, M., Torgerson, J., Bouchard, C., Carlsson, B., Dahlgren, S., Larsson, B., Narbro, K., Sjostrom, C.D., *et al.* (2004). Lifestyle, diabetes, and cardiovascular risk factors 10 years after bariatric surgery. *N Engl J Med* 351, 2683-2693.

Sjostrom, L., Narbro, K., Sjostrom, C.D., Karason, K., Larsson, B., Wedel, H., Lystig, T., Sullivan, M., Bouchard, C., Carlsson, B., *et al.* (2007). Effects of bariatric surgery on mortality in Swedish obese subjects. *N Engl J Med* 357, 741-752.

Steiner, D.F., and Oyer, P.E. (1967). The biosynthesis of insulin and a probable precursor of insulin by a human islet cell adenoma. *Proc Natl Acad Sci U S A* 57, 473-480.

Stenvinkel, P., Karimi, M., Johansson, S., Axelsson, J., Suliman, M., Lindholm, B., Heimbürger, O., Barany, P., Alvestrand, A., Nordfors, L., *et al.* (2007). Impact of inflammation on epigenetic DNA methylation - a novel risk factor for cardiovascular disease? *J Intern Med* 261, 488-499.



Stump, C.S., Short, K.R., Bigelow, M.L., Schimke, J.M., and Nair, K.S. (2003). Effect of insulin on human skeletal muscle mitochondrial ATP production, protein synthesis, and mRNA transcripts. *Proc Natl Acad Sci U S A* *100*, 7996-8001.

Takamatsu, C., Umeda, S., Ohsato, T., Ohno, T., Abe, Y., Fukuoh, A., Shinagawa, H., Hamasaki, N., and Kang, D. (2002). Regulation of mitochondrial D-loops by transcription factor A and single-stranded DNA-binding protein. *EMBO Rep* *3*, 451-456.

Thompson, R.F., Fazzari, M.J., Niu, H., Barzilai, N., Simmons, R.A., and Grealley, J.M. (2010). Experimental intrauterine growth restriction induces alterations in DNA methylation and gene expression in pancreatic islets of rats. *J Biol Chem* *285*, 15111-15118.

Turner, R.C., Cull, C.A., Frighi, V., and Holman, R.R. (1999). Glycemic control with diet, sulfonylurea, metformin, or insulin in patients with type 2 diabetes mellitus: progressive requirement for multiple therapies (UKPDS 49). UK Prospective Diabetes Study (UKPDS) Group. *JAMA* *281*, 2005-2012.

Uysal, K.T., Wiesbrock, S.M., Marino, M.W., and Hotamisligil, G.S. (1997). Protection from obesity-induced insulin resistance in mice lacking TNF-alpha function. *Nature* *389*, 610-614.

Vallerie, S.N., Furuhashi, M., Fucho, R., and Hotamisligil, G.S. (2008). A predominant role for parenchymal c-Jun amino terminal kinase (JNK) in the regulation of systemic insulin sensitivity. *PLoS One* *3*, e3151.

Vega, R.B., Huss, J.M., and Kelly, D.P. (2000). The coactivator PGC-1 cooperates with peroxisome proliferator-activated receptor alpha in transcriptional control of nuclear genes encoding mitochondrial fatty acid oxidation enzymes. *Mol Cell Biol* *20*, 1868-1876.

Wahlfors, J., Hiltunen, H., Heinonen, K., Hamalainen, E., Alhonen, L., and Janne, J. (1992). Genomic hypomethylation in human chronic lymphocytic leukemia. *Blood* *80*, 2074-2080.

Wajchenberg, B.L. (2007). beta-cell failure in diabetes and preservation by clinical treatment. *Endocr Rev* *28*, 187-218.

Wang, Y.X., Lee, C.H., Tiep, S., Yu, R.T., Ham, J., Kang, H., and Evans, R.M. (2003). Peroxisome-proliferator-activated receptor delta activates fat metabolism to prevent obesity. *Cell* *113*, 159-170.

Waterland, R.A., Lin, J.R., Smith, C.A., and Jirtle, R.L. (2006). Post-weaning diet affects genomic imprinting at the insulin-like growth factor 2 (Igf2) locus. *Hum Mol Genet* *15*, 705-716.

Weaver, I.C., Cervoni, N., Champagne, F.A., D'Alessio, A.C., Sharma, S., Seckl, J.R., Dymov, S., Szyf, M., and Meaney, M.J. (2004). Epigenetic programming by maternal behavior. *Nat Neurosci* *7*, 847-854.

Weaver, I.C., Champagne, F.A., Brown, S.E., Dymov, S., Sharma, S., Meaney, M.J., and Szyf, M. (2005). Reversal of maternal programming of stress responses in adult offspring through methyl supplementation: altering epigenetic marking later in life. *J Neurosci* 25, 11045-11054.

Wendel, A.A., Li, L.O., Li, Y., Cline, G.W., Shulman, G.I., and Coleman, R.A. (2010). Glycerol-3-phosphate acyltransferase 1 deficiency in ob/ob mice diminishes hepatic steatosis but does not protect against insulin resistance or obesity. *Diabetes* 59, 1321-1329.

Wittgrove, A.C., Clark, G.W., and Schubert, K.R. (1996). Laparoscopic Gastric Bypass, Roux-en-Y: Technique and Results in 75 Patients With 3-30 Months Follow-up. *Obes Surg* 6, 500-504.

Wittgrove, A.C., Clark, G.W., and Tremblay, L.J. (1994). Laparoscopic Gastric Bypass, Roux-en-Y: Preliminary Report of Five Cases. *Obes Surg* 4, 353-357.

Wu, P., Inskip, K., Bowker-Kinley, M.M., Popov, K.M., and Harris, R.A. (1999a). Mechanism responsible for inactivation of skeletal muscle pyruvate dehydrogenase complex in starvation and diabetes. *Diabetes* 48, 1593-1599.

Wu, Z., Puigserver, P., Andersson, U., Zhang, C., Adelmant, G., Mootha, V., Troy, A., Cinti, S., Lowell, B., Scarpulla, R.C., *et al.* (1999b). Mechanisms controlling mitochondrial biogenesis and respiration through the thermogenic coactivator PGC-1. *Cell* 98, 115-124.

Xie, S., Wang, Z., Okano, M., Nogami, M., Li, Y., He, W.W., Okumura, K., and Li, E. (1999). Cloning, expression and chromosome locations of the human DNMT3 gene family. *Gene* 236, 87-95.

Yang, Y., Mo, X., Chen, S., Lu, X., and Gu, D. (2011). Association of peroxisome proliferator-activated receptor gamma coactivator 1 alpha (PPARGC1A) gene polymorphisms and type 2 diabetes mellitus: a meta-analysis. *Diabetes Metab Res Rev* 27, 177-184.

Yen, R.W., Vertino, P.M., Nelkin, B.D., Yu, J.J., el-Deiry, W., Cumaraswamy, A., Lennon, G.G., Trask, B.J., Celano, P., and Baylin, S.B. (1992). Isolation and characterization of the cDNA encoding human DNA methyltransferase. *Nucleic Acids Res* 20, 2287-2291.

Yoon, J.C., Puigserver, P., Chen, G., Donovan, J., Wu, Z., Rhee, J., Adelmant, G., Stafford, J., Kahn, C.R., Granner, D.K., *et al.* (2001). Control of hepatic gluconeogenesis through the transcriptional coactivator PGC-1. *Nature* 413, 131-138.

Yu, C., Chen, Y., Cline, G.W., Zhang, D., Zong, H., Wang, Y., Bergeron, R., Kim, J.K., Cushman, S.W., Cooney, G.J., *et al.* (2002). Mechanism by which fatty acids inhibit insulin activation of insulin receptor substrate-1 (IRS-1)-associated phosphatidylinositol 3-kinase activity in muscle. *J Biol Chem* 277, 50230-50236.

Yuan, M., Konstantopoulos, N., Lee, J., Hansen, L., Li, Z.W., Karin, M., and Shoelson, S.E. (2001). Reversal of obesity- and diet-induced insulin resistance with salicylates or targeted disruption of Ikkbeta. *Science* 293, 1673-1677.

Zaidi, S.K., Young, D.W., Montecino, M., van Wijnen, A.J., Stein, J.L., Lian, J.B., and Stein, G.S. (2011). Bookmarking the genome: maintenance of epigenetic information. *J Biol Chem* 286, 18355-18361.

Zanuso, S., Jimenez, A., Pugliese, G., Corigliano, G., and Balducci, S. (2010). Exercise for the management of type 2 diabetes: a review of the evidence. *Acta Diabetol* 47, 15-22.

Zhang, Y., Proenca, R., Maffei, M., Barone, M., Leopold, L., and Friedman, J.M. (1994). Positional cloning of the mouse obese gene and its human homologue. *Nature* 372, 425-432.

Zierath, J.R., Galuska, D., Nolte, L.A., Thorne, A., Kristensen, J.S., and Wallberg-Henriksson, H. (1994). Effects of glycaemia on glucose transport in isolated skeletal muscle from patients with NIDDM: in vitro reversal of muscular insulin resistance. *Diabetologia* 37, 270-277.