

NBER WORKING PAPER SERIES

REDUCING THE COMPLEXITY COSTS OF 401(K)
PARTICIPATION THROUGH QUICK ENROLLMENT™

James J. Choi
David Laibson
Brigitte C. Madrian

Working Paper 11979
<http://www.nber.org/papers/w11979>

NATIONAL BUREAU OF ECONOMIC RESEARCH
1050 Massachusetts Avenue
Cambridge, MA 02138
January 2006

We thank Hewitt Associates for their help in providing data. We are particularly grateful to Lori Lucas and Yan Xu, two of our many contacts at Hewitt Associates, and to Greg Stoner and other employees at the two companies studied in the paper. We thank Jonathan Skinner and participants at the 2005 NBER Aging Conference for helpful comments and Hongy Li for excellent research assistance. Choi acknowledges financial support from the Mustard Seed Foundation. Choi, Laibson, and Madrian acknowledge individual and collective financial support from the National Institute on Aging (grants R01-AG021650 and T32-AG00186). The opinions and conclusions expressed are solely those of the author(s) and do not represent the opinions or policy of NIA, the Federal Government, or the NBER. Laibson also acknowledges financial support from the Sloan Foundation. The views expressed herein are those of the author(s) and do not necessarily reflect the views of the National Bureau of Economic Research.

©2006 by James J. Choi, David Laibson, and Brigitte C. Madrian. All rights reserved. Short sections of text, not to exceed two paragraphs, may be quoted without explicit permission provided that full credit, including © notice, is given to the source.

Reducing the Complexity Costs of 401(k) Participation Through Quick Enrollment™
James J. Choi, David Laibson, and Brigitte C. Madrian
NBER Working Paper No. 11979
January 2006
JEL No. D0, E21, G23

ABSTRACT

The complexity of the retirement savings decision may overwhelm employees, encouraging procrastination and reducing 401(k) enrollment rates. We study a low-cost manipulation designed to simplify the 401(k) enrollment process. Employees are given the option to make a Quick Enrollment™ election to enroll in their 401(k) plan at a pre-selected contribution rate and asset allocation. By decoupling the participation decision from the savings rate and asset allocation decisions, the Quick Enrollment™ mechanism simplifies the savings plan decision process. We find that at one company, Quick Enrollment™ tripled 401(k) participation rates among new employees three months after hire. When Quick Enrollment™ was offered to previously hired non-participating employees at two firms, participation increased by 10 to 20 percentage points among those employees affected.

James J. Choi
Yale School of Management
135 Prospect Street
P.O. Box 208200
New Haven, CT 06520-8200
and NBER
james.choi@yale.edu

Brigitte C. Madrian
Department of Business and Public Policy
University of Pennsylvania, Wharton School
3620 Locust Walk
Philadelphia, PA 19104
and NBER
bmadrian@wharton.upenn.edu

David Laibson
Department of Economics
Harvard University
Littauer Center
Cambridge, MA 02138
and NBER
dlaibson@harvard.edu

Previous research has shown that 401(k) participation increases dramatically when companies switch from an opt-in to an opt-out (or automatic) enrollment regime (Madrian and Shea, 2001; Choi et al. 2004; Choi et al., 2006). Although automatic enrollment has been widely touted as an effective tool for encouraging saving, it has its detractors. Some libertarians dislike automatic enrollment because they view it as coercing individuals into the company-chosen default contribution rate and asset allocation. Indeed, the vast majority of automatically enrolled employees passively accept all of the defaults in the short run, and many remain at those defaults for years (Choi et al., 2004; Choi et al., 2006). Paternalists, in contrast, like the fact that automatic enrollment increases 401(k) participation but object to companies choosing default contribution rates that they perceive as too low and asset allocations that are too conservative.¹ Firms, however, have been reluctant to adopt more aggressive defaults for fear of participant lawsuits should the default investments decline in value.

One reason that automatic enrollment increases 401(k) participation is that it reduces the complexity of the decision-making task. Rather than evaluating all possible contribution rate and asset allocation options, employees need only compare the automatic enrollment default with non-participation. Relative to plans with automatic enrollment, opt-in plans impose a much greater decision-making burden on enrollees. But a high level of complexity in an opt-in plan is not necessary. There are ways to reduce complexity that are not as extreme as adopting automatic enrollment.

In this paper, we analyze one such alternative called Quick EnrollmentTM by Hewitt Associates². Quick Enrollment gives employees the option of enrolling in the savings plan by opting into a default contribution rate and asset allocation pre-selected by the employer. If Quick Enrollment succeeds in reducing complexity by allowing employees to focus on evaluating a smaller subset of options (e.g., non-enrollment and the default), savings plan participation should increase relative to a standard opt-in enrollment regime. The fact that all Quick Enrollment elections are affirmative also addresses both the libertarian and paternalist objections to automatic enrollment. For libertarians, there is no “coercion” into the default. For paternalists, affirmative elections reduce the legal risks from choosing a less conservative default asset allocation. The implementations studied in this paper may also motivate increased 401(k)

¹ See Hewitt (2005), Profit Sharing/401(k) Council of America (2001), and Vanguard (2001) for a description of the empirical distribution of automatic enrollment defaults.

² Hewitt Associates provided the data analyzed in this paper.

participation by giving employees a deadline for using Quick Enrollment to join the 401(k) plan, akin to the “active decision” approach to 401(k) enrollment analyzed in Choi et al. (2005).

We evaluate three different implementations of Quick Enrollment at two firms. Two of the implementations were short-term interventions that targeted non-participating employees who had previously been hired by the firms we study. The third was an ongoing intervention for newly hired employees. For all three implementations, we find that Quick Enrollment resulted in substantial 401(k) participation increases, although these increases are not nearly as large as those obtained through automatic enrollment in other firms. We also document the importance of the Quick Enrollment default for contribution rate and asset allocation outcomes.

The paper proceeds as follows. Section I describes the implementation of Quick Enrollment at the two firms we study and the data that we use to analyze its effect. Section II presents the results of our empirical analysis at the first company. Section III presents the results of our empirical analysis at the second company. We conclude in Section IV by comparing Quick Enrollment with other mechanisms for influencing 401(k) savings outcomes.

Section I. Quick Enrollment Implementation at Two Firms

The first Quick Enrollment implementation we study was at a large health services company—hereafter referred to as Company A—with approximately 40,000 employees at more than 20 locations. Table 1 gives demographic characteristics for the active employees at this firm on December 31, 2003, along with characteristics of all private sector employees in the March 2003 Current Population Survey (CPS) as a basis for comparison. Relative to the U.S. population, Company A workers are slightly older, earn a little more, and are much more likely to be female.

Table 2 presents features of the 401(k) plan at Company A. Virtually all Company A employees in our data are immediately eligible for the 401(k) plan. At most locations, employees who are at least 21 years old and have attained 1,000 hours of service are eligible for a 50% matching contribution from the company on the first 4% or 6% of pay contributed to the plan. Employees may contribute up to 100% of their pay (provided their contributions do not exceed the IRS dollar contribution limits) to 11 different investment options. There is no employer stock in the fund menu.

Figure 1 shows the Quick Enrollment timeline at Company A. Prior to July 2003, the company used a standard opt-in enrollment process: employees were not enrolled in the 401(k) plan unless they made an affirmative election through a toll-free phone call to the firm's benefits administrator or through visiting the benefits administration Web site. 401(k) participation, contribution rate, and investment allocation changes could be made at any time.

In July 2003, Company A adopted Quick Enrollment on a trial basis at its main location. New employees attending orientation were given Quick Enrollment cards which gave them the choice of checking a box to initiate 401(k) participation at a contribution rate of 2% of salary (before tax) and a pre-selected asset allocation (50% in a money market fund and 50% in a balanced fund). Returning the Quick Enrollment card was not mandatory and was not described to employees as mandatory. However, the cards did list a deadline of 2 weeks after orientation for submitting the card if the employees wished to use the Quick Enrollment process (the deadline on the card was a specific date which changed according to when the new employee orientation was held).³

From July through September, the Quick Enrollment form gave employees two options: "Yes! I want to enroll . . . and begin saving in the [Company A] Savings Plan" and "No. I don't want to enroll at this time." From October to December, the "No" option was eliminated from the Quick Enrollment form to investigate whether making non-participation salient through the "No" option affected enrollment. Failure to return either version of the form was treated as a negative 401(k) participation election. Employees also had the option to initiate participation on their own at any contribution rate and with any investment allocation through the standard channels (phone or Internet) throughout this time. In February 2004, Company A adopted Quick Enrollment as a permanent feature of its new employee orientation, with continued use of the yes-only form.

The second Quick Enrollment implementation took place at Company A from mid-June through early fall 2004 for non-participating employees who were already at the firm. This implementation occurred in conjunction with the adoption of a new Web-based benefits management system for all employees. As part of the transition to this new system, the company had employees meet individually with representatives of an outside vendor to help them register

³ The company reports that many of the Quick Enrollment cards were handed in during the orientation rather than taken home and mailed in. The deadline was not actually binding, although employees probably did not know this.

on the new system. These meetings were not designed to be individual financial planning sessions, but representatives answered questions about company benefits—in particular, the firm’s life insurance products and savings plan. Non-participating employees were given the opportunity to enroll in the 401(k) plan using a Web-based Quick Enrollment interface. This implementation offered the same asset allocation as the new hire implementation, but employees could choose any pre-tax contribution rate. Employees did not have the option to use the web-based Quick Enrollment option after the meeting.

The third Quick Enrollment implementation that we study is at Company B, a firm in the manufacturing industry. This company employs approximately 20,000 individuals. Table 1 gives demographic characteristics for the active employees at this firm on December 31, 2003. Company B employees are significantly older than the U.S. average and much more likely to be male. Other demographic data (e.g. race/ethnicity and pay) are not available for this company.

Table 2 describes the 401(k) plan features at Company B. Employees are immediately eligible for the 401(k) plan, which provides a variable matching contribution between 55% and 125%, depending on company profitability. on the first 6% of pay contributed to the plan. The employer match is invested in employer stock. Employees may contribute up to 25% of pay (subject to the IRS dollar contribution limits) and choose among nine investment options, including employer stock.

Quick Enrollment at Company B was implemented as a one-time mailing to non-participating employees already at the firm in the latter half of January 2003. Employees were given the option to check a box to enroll in the 401(k) plan at a 3% (before-tax) contribution rate invested entirely in a money market fund. Figure 2 shows the Quick Enrollment timeline at Company B. Although employees at Company B were given a two-week deadline for returning the Quick Enrollment cards, this deadline was not binding in practice. Cards returned after the deadline were held and processed in May 2003.

The data we use to analyze Quick Enrollment at these two firms come from Hewitt Associates, a large benefits administration and consulting firm. The data are a series of year-end cross-sections of all employees at Companies A and B. For Company A, we have cross-sections from year-end 2002, year-end 2003, and September 1, 2004. For Company B, we have cross-sections from year-ends 2002 and 2003. These cross-sections contain demographic information

such as birth date, hire date, gender, state of residence, and compensation.⁴ They also contain point-in-time information on 401(k) savings outcomes, including participation status in the plan, date of first participation, the contribution rate, asset allocation, and total balances. In addition, we have ethnicity data for Company A employees active at year-end 2003 and September 1, 2004.

Section II. Quick Enrollment and 401(k) Outcomes at Company A

In designing the Quick Enrollment implementation at Company A, our initial intent was to compare participation under three enrollment mechanisms: the yes/no Quick Enrollment card, the yes-only Quick Enrollment card, and the standard opt-in enrollment protocol without Quick Enrollment. The empirical methodology to do this would have been straightforward: we would have three different treatment regimes and treated and untreated locations (the main location versus everywhere else). The untreated locations would allow us to control for time effects that might otherwise confound comparisons of the different enrollment regimes at the treated location.

Our ability to carry out this methodology in a completely convincing fashion has been limited by three factors. First, although Quick Enrollment forms were only distributed at the main location's orientation sessions, employees do not necessarily attend orientation at the location where they work. Therefore, a nontrivial number of employees at the "untreated" locations actually had the opportunity to use Quick Enrollment. This contamination of the control locations will cause a comparison of the main location against other locations to underestimate the Quick Enrollment effect. Second, after seeing Quick Enrollment's success at the new employee orientations from July to September 2003, the benefits office decided to distribute Quick Enrollment forms at the firm's annual benefits fairs in October and November 2003. These benefits fairs were held at many locations, providing additional exposure to Quick Enrollment for employees at locations that would otherwise serve as controls. Third, the coincident timing of the benefits fairs with the yes-only Quick Enrollment form precludes a clean comparison of the yes-no and yes-only forms, since new employees also potentially attended the benefits fairs.

⁴ Compensation data are not available for Company B.

However, the permanent adoption of the yes-only Quick Enrollment form in February 2004 at the main location orientation sessions allows us to compare 401(k) outcomes at the main location from February 2004 onward to outcomes at the main location prior to Quick Enrollment's initial implementation in July 2003.

Recall that the firm offered Quick Enrollment in a different fashion to non-participating employees from June to August 2004 in conjunction with its Web-based benefits management program rollout. Because of this, we restrict our initial Quick Enrollment analysis to employees hired from February to May 2004, and we do not examine these employee's 401(k) outcomes beyond mid-June 2004. We use as our control group employees hired from February to May 2003 and February to May 2002. Table 3 shows that the demographic characteristics of employees at the company's main location who were hired from February to May of 2002, 2003, and 2004 appear very similar.

Figure 3 plots the 401(k) participation rate against tenure for employees hired at the company's main location before and after Quick Enrollment. For employees hired from February to May of 2002 and 2003, the 401(k) participation paths track each other quite closely, suggesting no dramatic changes in employee characteristics or other factors influencing 401(k) participation. The participation rates for newly hired employees are extremely low: about 5% after the first month of employment and 15% after 12 months. The participation rates under Quick Enrollment are dramatically higher: 19% after the first month of employment and 35% in the third month. We do not calculate Quick Enrollment participation rates at higher tenure levels because they would be potentially contaminated by the June to August intervention described above.

Figures 4A and 4B show the one-month and three-month participation rates at the company's main location by hire month. Although there is some participation rate variability across hire months both before and after Quick Enrollment, this variation is dwarfed by the large participation increases generated by Quick Enrollment.

To control for potential differences in the demographic composition of employees hired before and after Quick Enrollment, we run probit regressions of one-month and three-month participation in the 401(k) plan on age, gender, race, compensation, and a Quick Enrollment dummy, which is set to 1 for employees hired from February to May 2004. The sample in these regressions is employees hired from February to May of 2002, 2003 and 2004, with the

employees hired in 2002 and 2003 serving as a pre-Quick Enrollment control group.⁵ The first two columns of Table 4 list the marginal effects at the sample means from the probit regressions for employees at the firm's main location where Quick Enrollment was used. The only statistically significant demographic characteristics are compensation and age: higher-paid and older employees are much more likely to enroll. The Quick Enrollment effect is large and statistically significant, increasing the 1-month participation rate by 14 percentage points and the 3-month participation rate by 16 percentage points. This represents a tripling of the one- and three-month participation rates prior to Quick Enrollment.⁶

Because Quick Enrollment was only distributed at the main location orientations, a useful specification check is to see whether there is a Quick Enrollment effect at other locations. The last two columns of Table 4 present regression results for employees working at other locations. The Quick Enrollment coefficients are small in magnitude and statistically insignificant. These results suggest that estimated Quick Enrollment effect at the main location is indeed caused by Quick Enrollment and not spurious correlation with other factors.

Table 5 examines which employees are most affected by Quick Enrollment. In the first two columns, we break down the one-month participation rate by various demographic characteristics for employees hired prior to Quick Enrollment (February to May of 2002 and 2003) and after Quick Enrollment (February to May 2004).⁷ The last two columns of Table 5 divide the post-Quick Enrollment participants into two subgroups: those who enrolled using a non-Quick Enrollment channel, and those who enrolled using Quick Enrollment. Because we do not have data on who actually used Quick Enrollment, we attribute Quick Enrollment utilization to those employees who have the Quick Enrollment default asset allocation. Although this approach may generate some classification error, the magnitude is likely to be quite small given

⁵ In the three-month participation regressions, the sample is restricted to employees hired during February and March since we do not observe three-month participation rates for employees hired in April and May of 2004 prior to the individual meetings that started in June 2004. For the sake of comparability, we also restrict the sample of employees hired in 2002 and 2003 to those hired in February and March. The results are qualitatively similar when employees hired in April and May of 2002 and 2003 are not excluded from the three-month participation regressions.

⁶ OLS results, while not reported, yield qualitatively similar estimates.

⁷ The results in Table 5 are qualitatively similar for three-month rather than one-month enrollment rates. We report one-month enrollment rates in Table 5 because the sample sizes for some of the demographic subgroups are quite small if three-month enrollment rates are used.

that *none* of the new hires from January to June 2003 (before Quick Enrollment) who enrolled within their first month of employment elected the default asset allocation.⁸

For all of the demographic groups listed in Table 5, 401(k) participation rates are substantially higher under Quick Enrollment (column 1 vs. column 2). The absolute size of the participation increase is largest among those who are ages 30 to 50 (22 percentage points) and earning more than \$25,000 (26 percentage points for those earning between \$25,000 and \$50,000, and 32 percentage points for those earning more than \$50,000). The proportional increase relative to pre-Quick Enrollment participation rates is largest among blacks (385%), those earning less than \$25,000 (396%), and those ages 30 to 50 men (292%). Across all demographic groups, over 75% of all new-hire enrollments in the post-Quick Enrollment period occur through Quick Enrollment. Quick Enrollment is especially popular among blacks (83%) and those earning less than \$25,000 (82%).

As discussed previously, Company A's second Quick Enrollment implementation occurred from mid-June to early fall of 2004 in conjunction with the new benefits management Web site rollout. The aggregate participation impact of this extension of Quick Enrollment extension to all non-participating employees is striking (Figure 5). During a two-and-a-half month period, the firm's overall participation rate increased from 50% to 60%, converting 20% of non-participants into participants. The effects are similar for employees at both the main location and at other locations, which is not surprising given that in this intervention, Quick Enrollment was made available to all non-participating employees regardless of location.

Table 6, which is analogous to Table 5, examines the impact of Quick Enrollment on different demographic groups. The first column is the fraction of previously non-participating employees who enrolled from June to August of 2002 and 2003, prior to the adoption of Quick Enrollment.⁹ The second column gives the fraction of non-participating employees enrolling from June to August of 2003 during the second Quick Enrollment implement at Company A.

⁸ Employees could have enrolled using Quick Enrollment and then subsequently changed their asset allocation, which would also cause us to misclassify them. There are not likely to be many such employees given the frequency of our asset allocation observations.

⁹ Employees attending new hire orientation at the main location in July and August 2003 were exposed to the Quick Enrollment intervention, thus attenuating the difference between the Quick Enrollment population and the comparison population. These employees are a small fraction of the total non-participating population, so their presence should not have a significant impact. Note also that employees who were non-participants in 2002 and again in 2003 are included in the sample more than once (and, if non-participants again in 2004, are also in the sample for the last three columns of Table 6).

This is disaggregated in the last two columns according to whether the enrollment occurred through Quick Enrollment or not. Again, we identify Quick Enrollment usage through the presence of the default asset allocation which was elected by virtually none of the employees who initiated plan participation prior to Quick Enrollment.

For all demographic groups, 401(k) enrollment rates are much higher under Quick Enrollment, and the vast majority of enrollments (92% across the entire population) are submitted through Quick Enrollment. Absolute enrollment changes are largest for women (24 percentage points), blacks (24 percentage points), those earning more than \$25,000 (26 percentage points for those earning between \$25,000 and \$50,000, and 33 percentage points for those earning more than \$50,000), those aged 30 to 50 (24 percentage points), and those who have been at the company more than five years (26 percentage points). Relative increases are largest for those between ages 30 and 50 (823%), women (771%), blacks (1764%), those making less than \$25,000 a year (935%), and those who have been at the company for more than five years (1200%).

Given the evidence from previous research on the impact of defaults on 401(k) contribution rates and asset allocation, it is natural to ask how Quick Enrollment, which can be viewed as a default that is opted into, affects these same outcomes. We have already noted that virtually no participants enrolling in the 401(k) plan prior to Quick Enrollment selected the default asset allocation (indeed, we identified Quick Enrollment usage by whether the participant's asset allocation matched the Quick Enrollment default.) In contrast, 73% of newly hired participants (Table 5) and 92% of new participants among existing employees (Table 6) had the Quick Enrollment default asset allocation in the post-Quick Enrollment period. Clearly Quick Enrollment has an important effect on asset allocation outcomes.

Not surprisingly, Quick Enrollment has similar effects on contribution rates as well. Figure 6 shows the effect of Quick Enrollment on the distribution of contribution rates for new employees thirty days after hire.¹⁰ As is typical in companies with an employer match, the modal contribution rate prior to Quick Enrollment is the employer match threshold of 6%; approximately 1% of new hires or 25% of newly hired participants contribute at this rate. Under

¹⁰ We only observe contribution rates periodically, as described in Section I. In order to approximate the contribution rate distribution thirty days after hire, we use the contribution rate effective in the data extract closest to the employees' hire date and assign a zero contribution rate to those who did not enroll within thirty days of hire. Because our closest contribution rate observation is no more than eleven months after an employee's hire, this approximation should be very close to the actual distribution.

Quick Enrollment, however, the modal contribution rate shifts to 2%, the Quick Enrollment default. The fraction of employees contributing 2% increases more than 20-fold, from less than 1% of employees to 14% of employees. This represents an increase from 13% of participants to 75% of participants. We find no evidence for the type of contribution rate displacement that has been observed with automatic enrollment. Indeed, the increase in the fraction of employees contributing 2% of pay to the 401(k) plan at one month of tenure is approximately equal to the one-month participation increase attributable to Quick Enrollment from the probit regression in column 1 of Table 1.

The second Quick Enrollment implementation, which occurred in conjunction with the individual Web site registrations, gave employees the option to choose any contribution rate in conjunction with the Quick Enrollment default asset allocation. We would therefore expect less clustering at any particular contribution rate. Figure 7 shows the distribution of contribution rates for employees hired prior to June 2003, before Quick Enrollment was adopted in any form at Company A, at two points in time. The first distribution is from June 1, 2004, three weeks before the registration period Quick Enrollment implementation began, and the second is from September 1, 2004, which is our last data snapshot after this second Quick Enrollment implementation. As in Figure 6, the modal contribution rate before Quick Enrollment is the match threshold of 6%. Under Quick Enrollment, the fraction of employees with contribution rates between 1% and 6% increases noticeably, while there is little effect above 6%. Because Quick Enrollment participants are spread across several contribution rates, the match threshold remains the modal contribution rate.

Section III. Quick Enrollment and 401(k) Outcomes at Company B

We now turn to the Quick Enrollment implement at Company B which, similar to the second implement at Company A, also targeted previously hired non-participating employees.¹¹ As mentioned in Section I, this company executed a one-time mailing in late January 2003 to non-participating employees. Those returning the reply card were enrolled in the 401(k) plan at a 3% contribution rate, and all these contributions were invested in a money market fund. Cards

¹¹ The Quick Enrollment implementation at Company B used a yes/no reply card. The vast majority (88%) of cards returned had an affirmative election to participate in the 401(k) plan.

returned by the deadline were processed in February 2003; late reply cards were processed in May 2003.

In the case of Company B, our data identifies the employees who were mailed the Quick Enrollment cards. To measure the effect of Quick Enrollment, we need to identify what these recipients would have done in the absence of Quick Enrollment. We use two control groups for this purpose. The first is employees who were not participating on February 1, 2002, a year prior to Quick Enrollment. The second is the 16% of non-participants on February 1, 2003 who did not receive the Quick Enrollment mailing. We are not certain why the company did not send these employees Quick Enrollment cards.¹² Because selection into this group is unlikely to be random, comparisons with the Quick Enrollment recipients must be interpreted with caution.

Figure 8 shows the 401(k) participation time series for four groups of Company B employees: all non-participating employees as of February 1, 2002; all Quick Enrollment recipients; non-participants as of February 1, 2003 who received the Quick Enrollment mailing; and non-participants as of February 1, 2003 who did not receive the Quick Enrollment mailing. The x-axis in Figure 8, labeled “time since baseline”, is the number of months since February 1, 2002 for non-participants as of that date, and number of months since February 1, 2003 for the other three groups. Quick Enrollment forms are first processed between months 0 and 1 (February and March of 2003); the final processing of forms takes place between months 3 and 4 (May and June of 2003). Our time series for the February 2002 non-participants begins at February 2002, when our contribution rate data begin, and ends before the January 2003 Quick Enrollment mailing to avoid contamination with the Quick Enrollment mailing to some members of this group.

The February 2002 non-participants show a slow and steady increase in participation over time, with a participation rate of approximately 10% after ten months. The February 2003 non-participants who did not receive the Quick Enrollment mailing show a somewhat more sluggish increase in participation, with 6% of this group having enrolled after ten months (note the possible selection bias for this latter group). In contrast, the participation rate of Quick Enrollment recipients increases markedly between months 0 and 1, and again between months 3 and 4, which are exactly when the Quick Enrollment forms were processed. The group of all

¹² 7% of these individuals were hired in 2003, after the Quick Enrollment mailing list was formed. Another 9% were participating at the time the list was compiled. This leaves 84% unaccounted for.

Quick Enrollment recipients participates at a slightly higher rate (about 3 percentage points) than February 2003 non-participants who received Quick Enrollment. This difference, however, is completely accounted for by the fact that some Quick Enrollment recipients enrolled on their own in the lag between the time when the non-participant mailing list was drawn up and when these individuals actually received the mailing (that participation increase between time -1 and 0 for this group).

The patterns in Figure 8 suggest that a plausible measure of Quick Enrollment's impact is the participation difference between the February 2002 non-participants and the February 2003 non-participants who received Quick Enrollment. Averaging this difference over months 1 to 10 yields a 10 percentage point participation increase due to Quick Enrollment. At month 4, a few weeks after the last forms were processed, this represents a near tripling of the participation rate. However, company-wide participation increased by only 2 percentage points from a baseline of 74% between February 1 and June 1 of 2003.

There are several potential reasons why the Quick Enrollment effect was smaller at Company B than at Company A. First, Company B's initial participation rate was much higher, so the potential scope for increasing participation was smaller. Second, Company B's Quick Enrollment options may have been less attractive. Respondents were limited to only one contribution rate (3%) rather than many, and the available asset allocation was a money market fund rather than a mix of a money market fund and a balanced fund. Third, Company A had been using Quick Enrollment for new hires for almost a year when they began targeting previously hired non-participants, so there may have been a greater initial awareness and acceptance of Quick Enrollment. Finally, Company B's Quick Enrollment forms were distributed through a mailing, whereas Company A's forms were presented to employees in person.

Table 7, which is analogous to Tables 5 and 6, reports enrollment rates for various demographic groups at Company B. Enrollees under the Quick Enrollment regime are compared to employees who enrolled a year prior. As in Table 5 and 6, we attribute Quick Enrollment utilization to those employees with the Quick Enrollment default asset allocation. Of Company B employees who enrolled between January 1, 2002 and February 18, 2003 (just prior to the initial Quick Enrollment processing), only 5.9% had the Quick Enrollment default asset allocation at the end of their initial participation year. In contrast, 75% of those enrolling between February and May 2003 chose the Quick Enrollment default asset allocation.

As in Company A, we find that enrollment rates are higher under Quick Enrollment for all demographic groups at Company B and that the majority of enrollees use Quick Enrollment rather than a traditional enrollment channel. The largest absolute changes are among those over age 30 (14 percentage points for those between ages 30 and 50, and 15 percentage points for those over age 50) and those who have less than five years of tenure (16 percentage points). The largest relative changes are among those over age 50 (434%) those with more than five years of tenure (1050%).

Figure 9 shows the month 4 contribution rate distribution at Company B for the four employee groups in Figure 8. We do not show employees with a zero contribution rate in order to highlight the differences across the other contribution rates. As in Company A, the impact of Quick Enrollment on contribution rates is readily apparent. Almost none of the employees who did not receive Quick Enrollment chose a 3% contribution rate. Instead most enrollees chose rates at or above the 6% match threshold. In contrast, participants who received the Quick Enrollment mailing are largely enrolled at the 3% default contribution rate. In Company B we do find some evidence of contribution rate displacement. The 12% fraction of Quick Enrollment recipients at the default contribution rate exceeds the 10% impact of Quick Enrollment on participation. Quick Enrollment recipients at the 3% contribution rate thus appear to be comprised both of employees brought into the plan because of Quick Enrollment and of employees who would have enrolled at a different—and likely higher—contribution rate in the absence of Quick Enrollment. The magnitude of the contribution rate displacement is similar to that estimated for automatic enrollment (Madrian and Shea, 2001; Choi et al, 2004).

Section IV. Conclusions

Madrian and Shea (2001), Iyengar and Jiang (2003), and Iyengar et al. (2004) have argued that the complexity of the 401(k) savings decision discourages employees from timely enrollment, even when they prefer participation to non-participation. Quick Enrollment is a low-cost manipulation that reduces this complexity by allowing employees to enroll at a default contribution rate and asset allocation pre-selected by the employer. We find that Quick Enrollment tripled participation among new hires relative to a standard enrollment mechanism in which employees must actively select both a contribution rate and an asset allocation. When

Quick Enrollment was made available to previously hired employees who were not participating in their 401(k) plan, 10% to 20% of these non-participants enrolled in the plan.

Quick Enrollment has a much smaller participation effect than automatic enrollment, which typically induces near-universal participation. But relative to automatic enrollment, Quick Enrollment has the benefit of protecting employers from litigation if they pick defaults with equity exposure, since Quick Enrollment is an opt-in mechanism. Like automatic enrollment, Quick Enrollment causes clustering of enrollees at the employer-selected contribution rate and asset allocation. Those at the Quick Enrollment defaults include not only employees who would not have enrolled without Quick Enrollment, but also employees who would have otherwise enrolled with other elections. It is unlikely that this herding is first-best for employees. However, Quick Enrollment induces less herding than automatic enrollment.

The “active decision” approach to 401(k) participation—an alternative 401(k) enrollment mechanism studied by Choi et al. (2005)—requires employees to proactively make a retirement savings decision by a specific deadline without any employer guidance. The active decision participation effect lies well above the Quick Enrollment effect and below the automatic enrollment effect. The active decision approach’s advantage is that there is no clustering of savings outcomes; the contribution rate distribution three *months* after hire under active decision is indistinguishable from the contribution rate distribution three *years* after hire under a standard opt-in enrollment regime. On the other hand, active decision forces employees to struggle with a difficult decision in a domain where they may have little expertise. A mechanism that gives employees a hard deadline with a Quick Enrollment option that has a small number of choices may be a fruitful hybrid approach.¹³

Another issue which should attract additional study is the optimal number of Quick Enrollment options. Quick Enrollment’s primary goal is to increase 401(k) participation by reducing the complexity of enrolling in the 401(k) plan. However, employees who do not like the Quick Enrollment default will be unlikely to use it to enroll. Increasing the number of Quick Enrollment options makes Quick Enrollment attractive to a greater number of employees but also increases its complexity. An extremely large number of pre-bundled savings options would

¹³ This might include giving employees the option of explicitly stating that they would rather make their own elections using the standard channels; there is no need to restrict sophisticated employees who have strong preferences about their retirement savings.

defeat the purpose of Quick Enrollment. However, increasing the number of options from one to two is unlikely to significantly increase Quick Enrollment's complexity.

Recent psychology research provides a framework for thinking about these issues. There are two potential sources of complexity in this 401(k) decision: choosing an appropriate contribution rate and choosing an appropriate asset allocation. Expanding the array of Quick Enrollment options could involve increasing either the number of contribution rate options (as in Company A's second Quick Enrollment implementation for non-participating employees), the number of asset allocation options, or both. One key difference between contribution rates and asset allocations is the extent to which the available options are easily comparable. Different contribution rates are alignable outcomes—they can be easily ordered from low to high—and this makes the different possible choices easier to compare (Gourville and Soman, 2005). In contrast, different asset allocations are non-alignable outcomes: they vary in non-comparable dimensions like expected return, currency risk, inflation risk, business cycle risk, management fees, etc.

Gourville and Soman (2005) report results from brand choice experiments showing that increasing a brand's alignable options increases the probability that consumers purchase from that brand, whereas increasing non-alignable options decreases purchase probability. Other papers that look only at the impact of increasing non-alignable options find that more options increase the likelihood of not choosing anything (Dhar and Nowlis, 1999; Iyengar and Lepper, 2000). Most importantly for this paper's results, Iyengar and Jiang (2003) and Huberman, Iyengar and Jiang (2004) find a negative relationship between the number of funds in a 401(k) investment menu and 401(k) participation rates. This result holds even among firms with a relatively low number of funds.

In summary, the literature on the psychology of consumer choice suggests that increasing the number of alignable options (i.e. savings rates), will lead to increased Quick Enrollment utilization, whereas increasing the number of non-alignable options (i.e. asset allocation options), will lead to reduced Quick Enrollment utilization. The Quick Enrollment implementation for non-participating employees at Company A does not provide a direct test of this conjecture, as there was no variation in the number of contribution rate or asset allocation options. But it is worth noting that Quick Enrollment was very effective in increasing participation even when employees were able to choose from the full array of (alignable) contribution rates. Further

research on this front, where both the number of contribution rates and the number of asset allocation options were varied, would be informative for both the optimal design of Quick Enrollment-like interventions and for the literature on the psychology of choice more generally.

References

- Agnew, Julie and Lisa R. Szykman, 2004. "Asset Allocation and Information Overload: The Influence of Information Display, Asset Choice and Investor Experience," Center for Retirement Research at Boston College Working Paper 2004-15.
- Choi, James, David Laibson, Brigitte Madrian, and Andrew Metrick, 2004. "For Better or For Worse: Default Effects and 401(k) Savings Behavior," In David Wise, ed., *Perspectives in the Economics of Aging* (Chicago: University of Chicago Press): pp. 81-121.
- Choi, James, David Laibson, Brigitte Madrian, and Andrew Metrick, 2005. "Optimal Defaults and Active Decisions," NBER Working Paper 11074.
- Choi, James, David Laibson, Brigitte Madrian, and Andrew Metrick, 2006. "Saving for Retirement on the Path of Least Resistance," In Ed McCaffrey and Joel Slemrod, eds., *Behavioral Public Finance: Toward a New Agenda* (New York: Russell Sage Foundation): pp. 304-351.
- Dhar, Ravi and Stephen N. Nowlis, 1999. "The Effect of Time Pressure on Consumer Choice Deferral," *Journal of Consumer Research*, 25(4): pp. 369-84.
- Gourville, John T. and Dilip Soman, 2005. "Overchoice and Assortment Type: When and Why Variety Backfires," *Marketing Science*, 24(3): pp. 382-395.
- Hewitt Associates, 2005. "Survey Findings: Trends and Experiences in 401(k) Plans 2005" (Lincolnshire, IL: Hewitt Associates).
- Iyengar, Sheena S., Wei Jiang, and Gur Huberman, 2004. "How Much Choice Is Too Much?: Contributions to 401(k) Retirement Plans," In Olivia Mitchell and Stephen Utkus, eds., *Pension Design and Structure: New Lessons from Behavioral Finance* (Oxford, UK: Oxford University Press): pp. 83-96.
- Iyengar, Sheena S. and Mark Lepper, 2000. "When Choice is Demotivating: Can One Desire Too Much of a Good Thing?" *Journal of Personality and Social Psychology*, 79: 995-1006.
- Iyengar, Sheena and Wei Jiang, 2003. "Choosing Not To Choose: The Effect of More Choices on Retirement Savings Decisions," Columbia University working paper.
- Madrian, Brigitte and Dennis Shea, 2001. "The Power of Suggestion: Inertia in 401(k) Participation and Savings Behavior," *Quarterly Journal of Economics*, 116(4): pp. 1149-1187.
- Profit Sharing/401(k) Council of America, 2001. "Automatic Enrollment 2001: A Study of Automatic Enrollment Practices in 401(k) Plans," Chicago, IL: Profit Sharing/401(k) Council of America. Downloaded from <http://www.pesa.org/data/autoenroll2001.asp> on May 5, 2005.

Vanguard Center for Retirement Research, 2001. "Automatic Enrollment: Vanguard Client Experience," Valley Forge, PA: The Vanguard Group, 2001. Downloaded from https://institutional2.vanguard.com/iip/pdf/CRR_automatic_enrollment_clientexp.pdf on May 5, 2005.

Table 1. Employee Characteristics

	Company A Active Employees on Dec 31, 2003	Company B Active Employees on Dec 31, 2003	Private sector employees March 2003 CPS
<i>Average age (years)</i>	41.9	45.3	39.0
<i>Percent male</i>	26.5%	76.2%	53.4%
<i>Compensation</i>			
Avg. annual income	\$38,321	-	\$36,782
Median annual income	\$28,523	-	\$27,000
<i>Ethnic composition</i>			
White	84.3%	-	83.1%
Black	12.7%	-	10.5%
Other	3.0%	-	6.3%
<i>Number of employees</i>	~40,000	~20,000	-

Source: Authors' calculations. Information on ethnicity and income is not available for Company B. Private household workers are excluded from our sample for the U.S. private sector (column 3).

Table 2. 401(k) Plan Features

	Company A	Company B
<i>Eligibility</i>		
Eligible employees	Some small groups of employees not eligible (e.g., independent contractors, union employees).	U.S. employees
First eligible	Immediately upon hire	Immediately upon hire
Employer match eligible	Age 21 + 1,000 hours of service	Immediately upon hire
<i>Enrollment</i>	Daily	Daily
<i>Employee contributions</i>	Up to 100% of compensation	Up to 25% of compensation
<i>Employer matching contributions</i>		
Match rate and threshold	Depending on location and pay group, most employees receive a 50% match on the first 4% or 6% of pay contributed	Between 55% and 125% on the first 6% of pay contributed,, depending on company profitability
Investment restrictions	No restrictions on employer match	Matching contributions invested 100% in employer stock. May diversify 25% of balances at age 45, up to 100% at age 55.
Vesting of employer match	Vests 100% in 3 years	Immediate
<i>Other</i>		
Loans	Available	Available
Hardship withdrawals	Available	Available
Investment choices	11 options (no employer stock)	9 options, including employer stock

Source: Plan documents.

Table 3. Employee Characteristics by Hire Cohort: Company A (Main Location)

	Feb-May 2002 cohort in Jun 2002	Feb-May 2003 cohort in Jun 2003	Feb-May 2004 cohort in Jun 2004
<i>Average age (years)</i>	31.4	32.0	32.7
<i>Percent male</i>	27.6%	28.6%	28.9%
<i>Compensation</i>			
Avg. annual income	\$19,510	\$20,928	\$22,918
Median annual income	\$16,619	\$17,282	\$17,581
<i>Ethnic composition</i>			
White	77.1%	79.1%	75.6%
Black	20.6%	17.9%	21.6%
Other	2.3%	3.0%	2.8%
<i>Number of employees</i>	455	407	733

Source: Authors' calculations.

Table 4. Probit Regressions of 401(k) Enrollment at Company A: New Hires

	Main Location		Other locations	
	Enrolled in 1 month	Enrolled in 3 months	Enrolled in 1 month	Enrolled in 3 months
<i>Age (years)</i>	0.0013* (0.0006)	0.0031* (0.0013)	-0.0003 (0.0008)	0.0006 (0.0013)
<i>Female</i>	0.0034 (0.0147)	0.0191 (0.0300)	0.0436* (0.0152)	0.0109 (0.0320)
<i>Black</i>	0.0048 (0.0178)	-0.0544 (0.0329)	-0.0241 (0.0211)	-0.0525 (0.0305)
<i>Other/unknown race</i>	-0.0118 (0.0367)	-0.0137 (0.0721)	-- ^a	-- ^a
<i>Pay (\$1000s)</i>	0.0031** (0.0004)	0.0036** (0.0006)	0.0028** (0.0004)	0.0032** (0.0007)
<i>Quick Enrollment cohort</i>	0.1398** (0.0174)	0.1630** (0.0367)	0.0265 (0.0189)	-0.0192 (0.0286)
Sample size	N=1613	N=610	N=776	N=307
Pseudo R ²	0.1667	0.1468	0.1515	0.1787

Source: Authors' calculations. The table reports marginal effects at sample means from a probit regression where the dependent variable is whether the employee has enrolled in the 401(k) either one or three months after hire. The sample in the one-month regressions is employees hired from February to May of 2002, 2003 and 2004. The sample in the three-month regressions is employees hired in February and March of 2002, 2003 and 2004. *Female*, *Black*, and *Other/Unknown race* are dummy variables. *Quick Enrollment cohort* is a dummy for employees hired from February to May 2004 in the one-month regression and in February and March 2004 in the three-month regression. Standard errors are in parentheses under the point estimates.

** denotes significance at the 1% level. * denotes significance at the 5% level.

^a None of the sample of other/unknown race enrolled within 3 months of hire. Consequently, all of these employees as well as the *Other/unknown race* variable were dropped from this regression.

**Table 5. Enrollment Rates by Employee Characteristics:
New Hires at Company A's Main Location at One Month of Tenure**

	Before Quick Enrollment	After Quick Enrollment		
	Fraction enrolling at any allocation	Fraction enrolling at any allocation	Fraction enrolling at non-default allocation	Fraction enrolling at QE default allocation
<i>Age</i>				
< 30	4.4% [528]	12.2% [319]	3.4% [319]	8.8% [319]
30 – 50	7.4% [394]	29.3% [222]	7.7% [222]	21.6% [222]
> 50	8.1% [86]	26.5% [64]	6.3% [64]	20.3% [64]
<i>Gender</i>				
Female	5.9% [716]	18.5% [426]	4.5% [426]	14.1% [426]
Male	5.8% [292]	23.5% [179]	7.3% [179]	16.2% [179]
<i>Race/Ethnicity</i>				
Black	3.9% [205]	18.0% [133]	3.0% [133]	15.0% [133]
White	6.1% [776]	21.4% [454]	6.2% [454]	15.2% [454]
Other/unknown	14.8% [27]	0 [18]	0 [18]	0 [18]
<i>Compensation</i>				
< \$25K	2.7% [734]	13.0% [460]	2.4% [460]	10.7% [460]
\$25K-\$50K	10.0% [211]	35.5% [107]	11.2% [107]	24.3% [107]
>\$50K	28.6% [63]	60.5% [38]	23.6% [38]	36.8% [38]

Source: Authors' calculations. The sample in column 1 is employees hired from February to May of 2002 and 2003. The sample in the remaining columns is employees hired from February to May of 2004. Sample sizes for each cell reported in brackets.

**Table 6. Enrollment Rates by Employee Characteristics:
Previously Non-Participating Employees at Company A**

	Before Quick Enrollment	After Quick Enrollment		
	Fraction enrolling at any allocation	Fraction enrolling at any allocation	Fraction enrolling at non-default allocation	Fraction enrolling at QE default allocation
<i>Age</i>				
< 30	3.2% [5103]	24.8% [2560]	2.3% [2560]	22.5% [2560]
30 – 50	3.0% [4001]	26.5% [1871]	1.7% [1871]	24.7% [1871]
> 50	5.1% [686]	17.7% [367]	1.1% [367]	16.6% [367]
<i>Gender</i>				
Female	3.2% [7092]	26.7% [3489]	1.9% [3489]	24.7% [3489]
Male	3.3% [2698]	20.2% [1309]	2.1% [1309]	18.1% [1309]
<i>Race/Ethnicity</i>				
Black	1.4% [2369]	25.8% [1206]	1.1% [1206]	24.7% [1206]
White	3.8% [7246]	24.7% [3500]	2.3% [3500]	22.4% [3500]
Other/unknown	5.7% [175]	21.7% [92]	2.2% [92]	19.6% [92]
<i>Compensation</i>				
< \$25K	1.7% [5174]	17.5% [2451]	1.6% [2451]	15.9% [2451]
\$25K-\$50K	4.5% [3677]	30.4% [1806]	2.2% [1806]	28.2% [1806]
>\$50K	6.9% [939]	40.1% [541]	3.0% [541]	37.2% [541]
<i>Tenure</i>				
< 2 years	4.3% [4053]	20.1% [1795]	2.3% [1795]	17.8% [1795]
2 – 5 years	2.8% [2507]	27.6% [1488]	2.1% [1488]	25.5% [1488]
> 5 years	2.2% [3230]	27.9% [1515]	1.5% [1515]	26.4% [1515]

Source: Authors' calculations. The sample in column 1 is non-participants in June 2002 and June 2003 (some individuals will be included in the sample twice if non-participants in both 2002 and 2003). The time frame over which enrollment is calculated is June through August 2002 and 2003 for column 1, and June through August 2004 for the remaining columns. The sample in the remaining columns is non-participants in June 2004. Sample sizes for each cell reported in brackets.

**Table 7. Quick Enrollment Utilization by Employee Characteristics:
Previously Non-Participating Employees at Company B**

	Before Quick Enrollment	After Quick Enrollment		
	Fraction enrolling at any allocation	Fraction enrolling at any allocation	Fraction enrolling at non-default allocation	Fraction enrolling at QE default allocation
<i>Age</i>				
< 30	3.5% [824]	14.9% [697]	5.7% [697]	9.2% [697]
30 – 50	4.9% [1460]	19.3% [1385]	3.8% [1385]	15.5% [1385]
> 50	2.9% [275]	18.2% [302]	5.6% [302]	12.6% [302]
<i>Gender</i>				
Female	4.4% [611]	16.7% [491]	4.7% [491]	12.0% [491]
Male	4.2% [1948]	18.2% [1893]	4.5% [1893]	13.6% [1893]
<i>Tenure</i>				
< 2 years	6.8% [1341]	23.0% [979]	7.4% [979]	15.6% [979]
2 – 5 years	1.9% [755]	18.2% [898]	3.5% [898]	14.7% [898]
> 5 years	0.6% [463]	7.5% [507]	1.2% [507]	6.3% [507]

Source: Authors' calculations. The sample in column 1 is non-participants in February 2002. The sample in the remaining columns is non-participants in February 2003. The time frame over which enrollment is calculated is February through May of 2002 for column 1, and February through May of 2003 for the remaining columns. Sample sizes for each cell reported in brackets.

Figure 1. Timeline of Enrollment Mechanisms at Company A

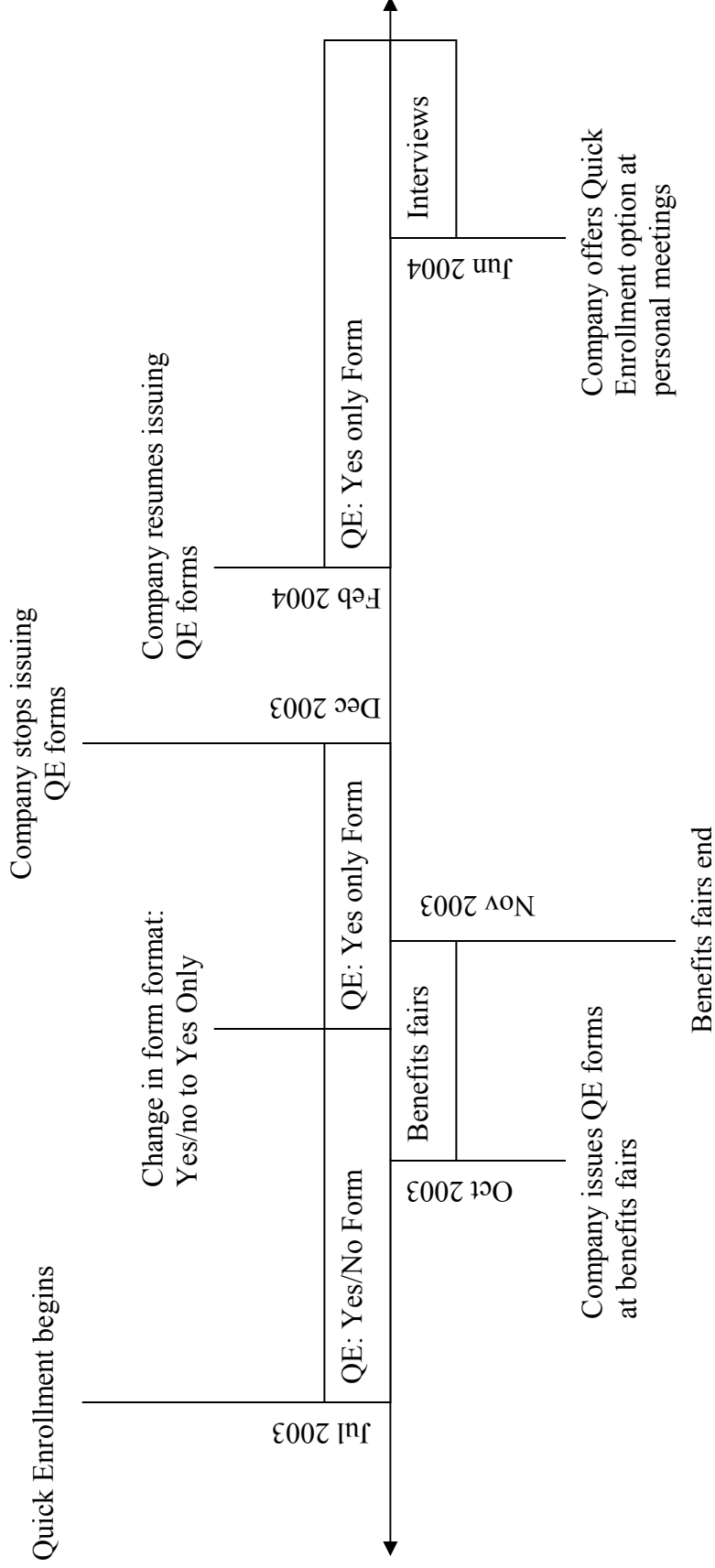
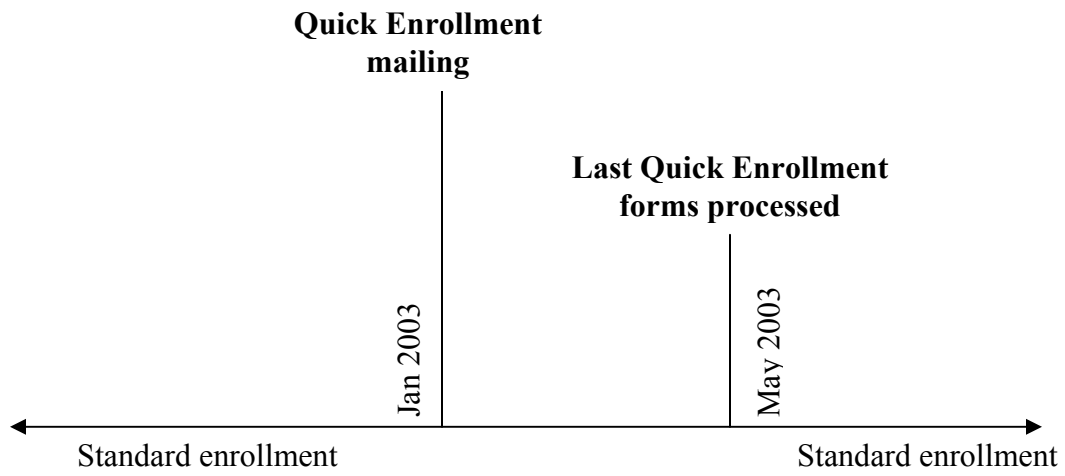

Figure 2. Timeline of Enrollment Mechanisms at Company B



**FIGURE 3. 401(k) Participation by Tenure
(Company A, Main Location)**

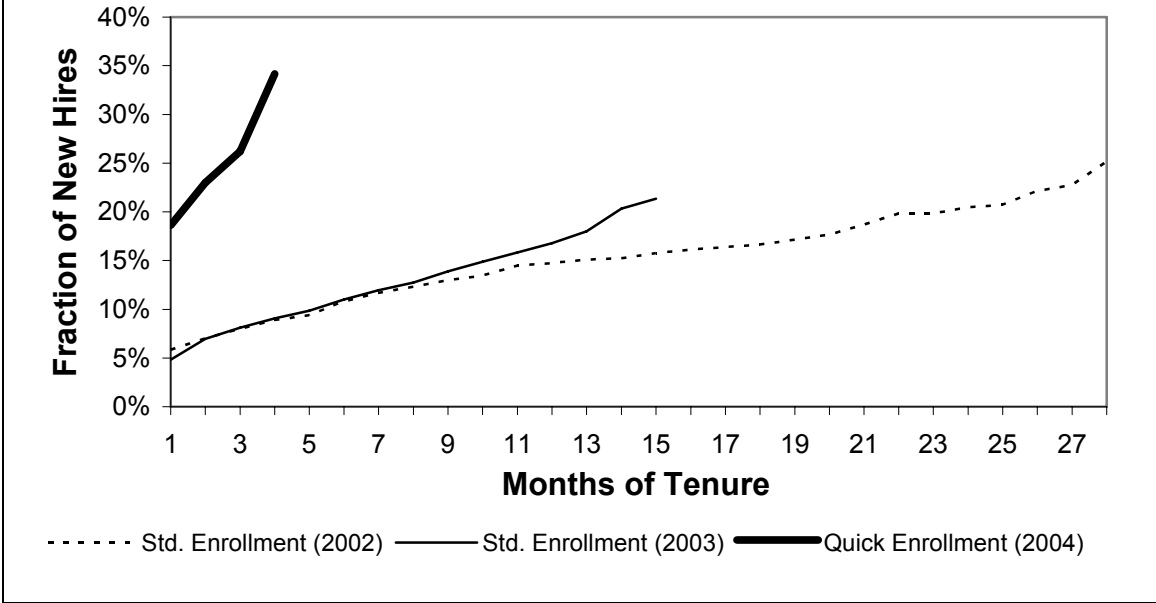

FIGURE 4A. 401(k) Participation 1 Month After Hire, by Hire Month (Company A, Main Location)

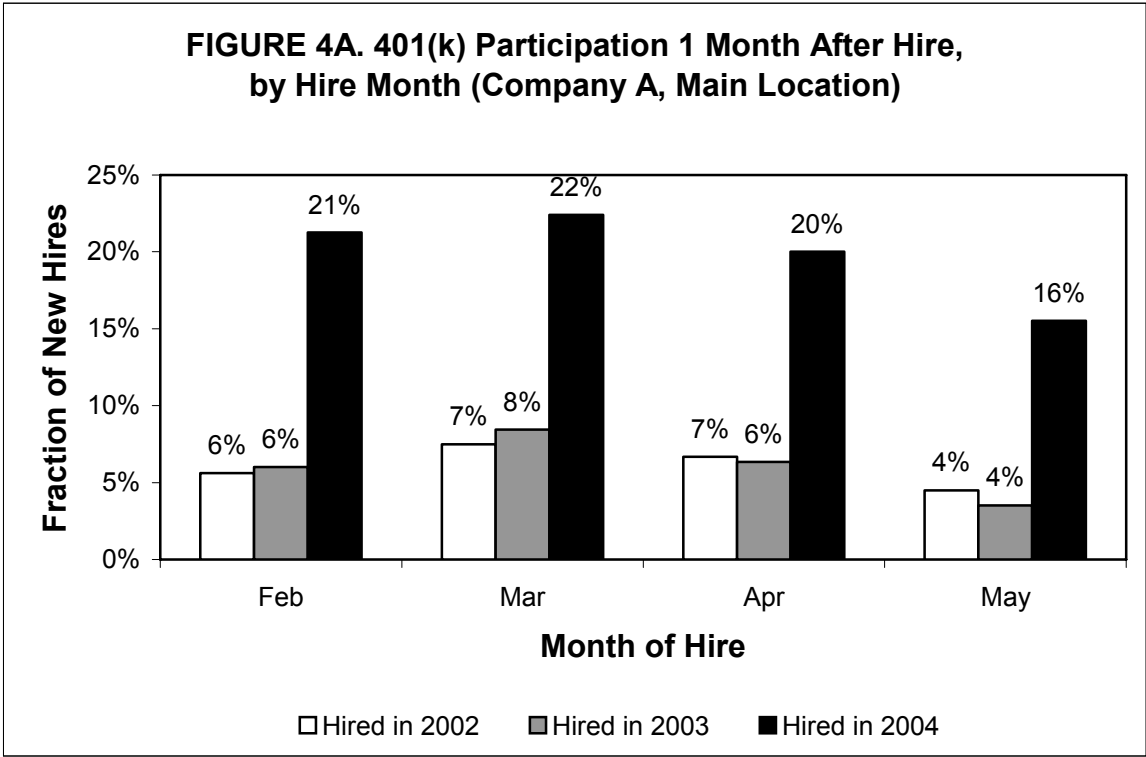
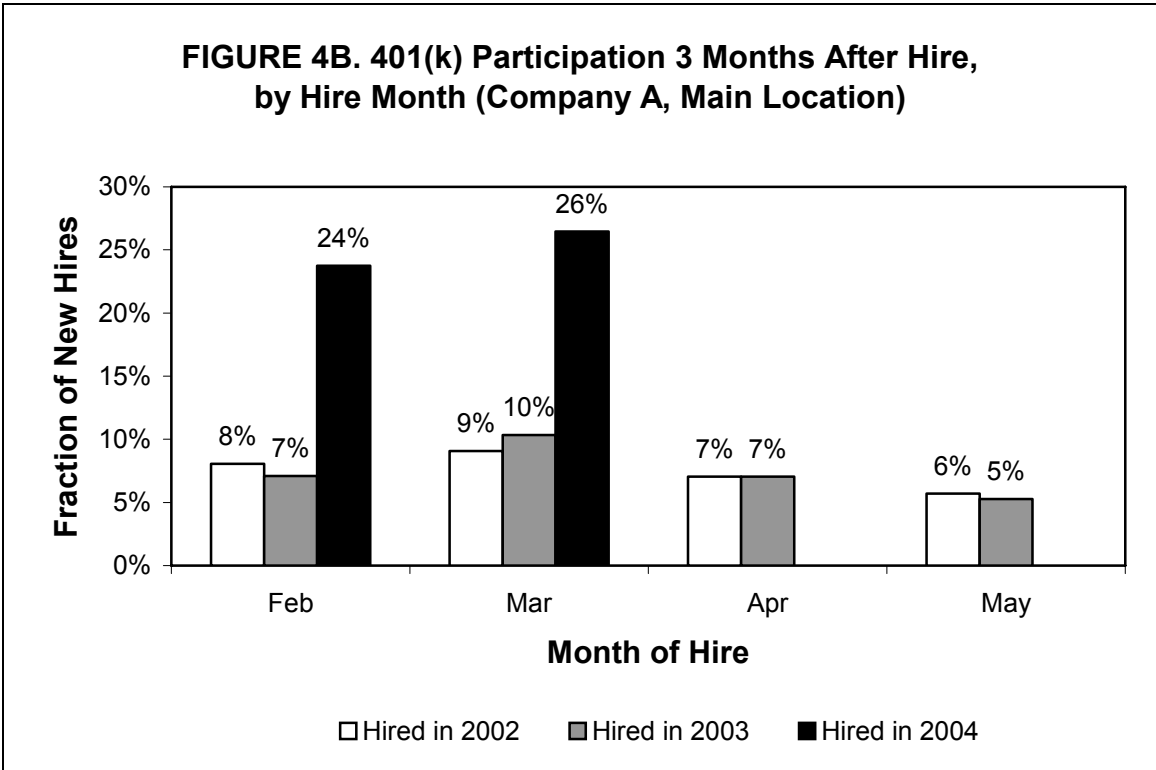

FIGURE 4B. 401(k) Participation 3 Months After Hire, by Hire Month (Company A, Main Location)



Note: 2004 three-month participation rates for April and May hires are not reported due to potential contamination with the June to August 2004 Quick Enrollment intervention for all employees.

**FIGURE 5. 401(k) Participation Rate
(Company A, All Employees at All Locations)**

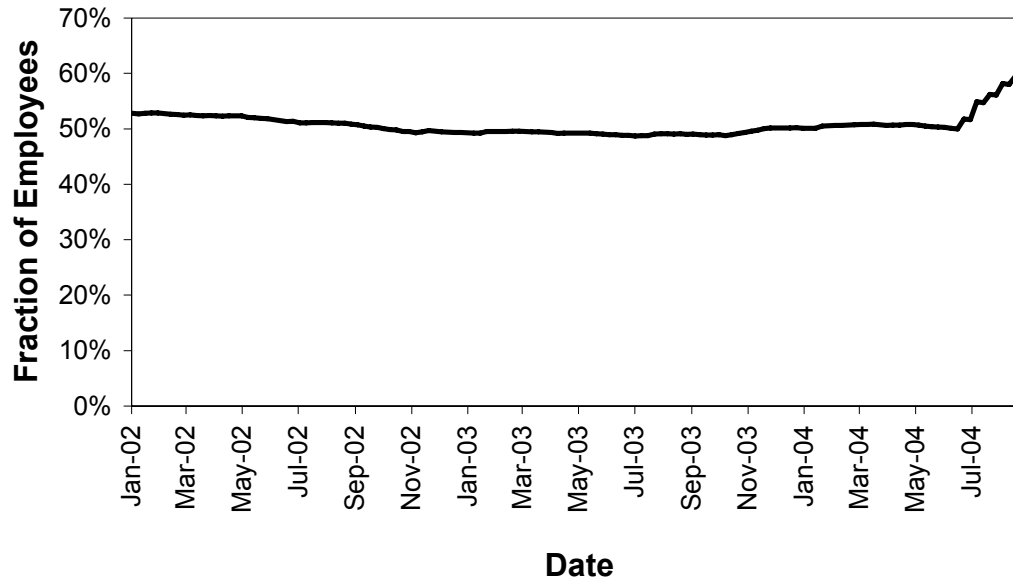
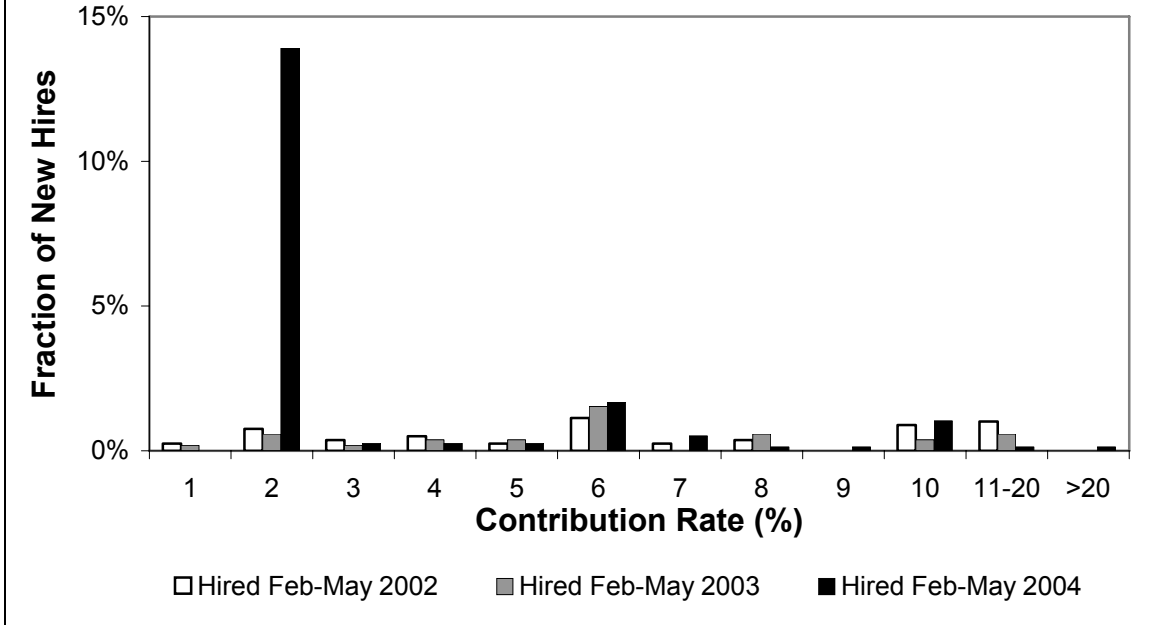
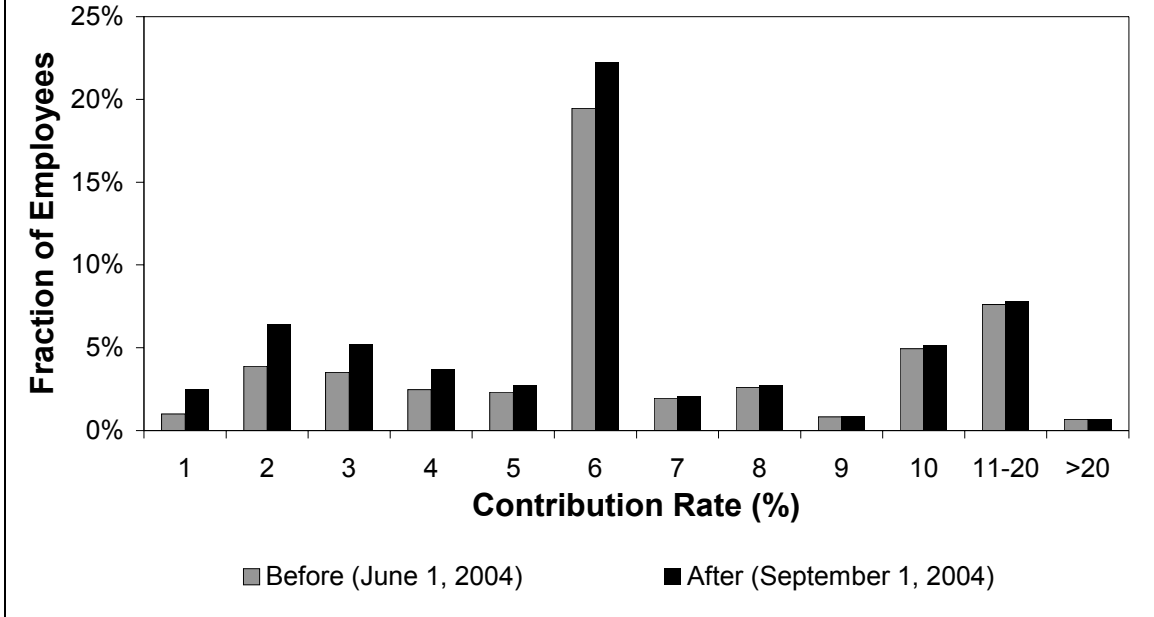

FIGURE 6. Contribution Rate Distribution of New Hires Enrolling Within 30 Days (Company A, Main Location)



Note: Employees who did not enroll in the 401(k) plan within 30 days of hire are classified as having a zero contribution rate and are included in calculating the fraction of new hires at a given contribution rate, although we do not show the fraction of new hires with a zero contribution rate in this figure.

FIGURE 7. Contribution Rate Distribution Before and After Individual Meetings (Company A, All Locations)



Note: Employees who had not enrolled in the 401(k) plan as of the snapshot date are classified as having a zero contribution rate and are included in calculating the fraction of total employees at a given contribution rate, although we do not show the fraction of employees with a zero contribution rate in this figure.

FIGURE 8. 401(k) Participation of Initial Non-Participants Over Time: (Company B)

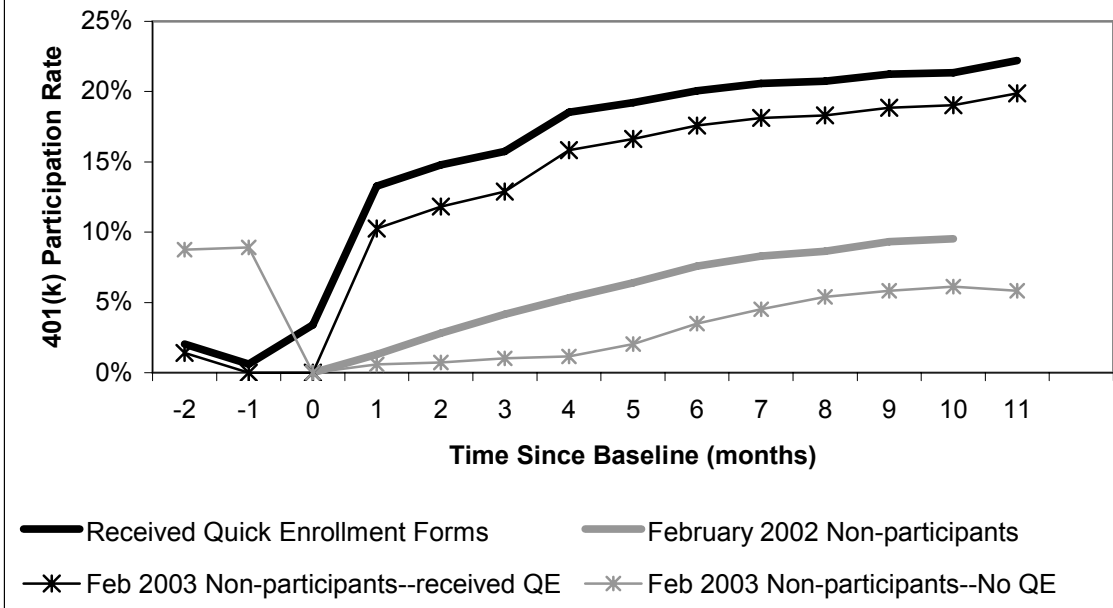

FIGURE 9. Distribution of 401(k) Contribution Rates for New Participants: (Company B)

