



Title	Behavior of Commercial banks and the Supply of Money
Author(s)	Fujino, Shozaburo
Citation	Hitotsubashi Journal of Economics, 2(1): 42-55
Issue Date	1961-09
Type	Departmental Bulletin Paper
Text Version	publisher
URL	http://hdl.handle.net/10086/8118
Right	

BEHAVIOR OF COMMERCIAL BANKS AND THE SUPPLY OF MONEY

By SHOZABURO FUJINO

Lecturer, Institute of Economic Research

I. Introduction

The purpose of this paper is to study the behavior pattern of commercial banks in order to clarify the mechanism whereby part of the money supply created through banking activity is changed, and to provide for one of the preliminary steps for approaching the business cycle.

A peculiarity of the asset and liability structure in post-war Japanese banks is their heavy dependence upon borrowings from the Bank of Japan, especially in the later stages of a boom and/or in the early stage of the downswing and also the relatively low holdings of securities. The former amounted to 305 billion yen and the latter to 799 billion yen at the end of December 1957 compared with 5,024 billion yen of loans and discounted bills at that time, while, according to the *Federal Reserve Bulletin*, in the United States at the same date loans amounted to 115,115 million, U.S. government obligations and other securities to 88,735 million and borrowings to 80 million dollars in the balance sheet of all the banks. Since the bond market has not recovered sufficiently to fully absorb the issues of corporate as well as government bonds, enabling the price of bonds to reflect market conditions, the banks prefer making loans and discounting to holding bonds. And in this situation they are likely to resort to funds supplied by the Bank of Japan, because of the shortage of their own available funds and the favorable differentials between the rate of interest on bills discounted as well as on loans and the rediscount rate, for instance, of commercial papers at the Bank of Japan.¹

Taking into account this characteristic of the asset-and liability-composition of commercial banks, we shall construct a model for our problem i.e., to see how the supply of new money created by the bank is determined through the demand for and supply of bank loans.^{2,3}

¹ In 1959 the average for the former was 8.12% and the latter 7.30% from January 1st to February 19th, 6.94% from February 20th to December 1st and 7.30% since December 2rd.

² The reader should keep in mind that the equilibrium between the demand for and supply of loans does not necessarily imply that between the demand for and supply of money, even when we define loans to include not only bank loans but also bonds.

³ What effect the supply of money, determined in the manner described in the following, has on investment and therefore on the economy, was analyzed in my paper "Cyclical Process of Growth and the Balance of Trade" (in Japanese), *Keizai Kenkyu*, Vol. 11, April 1960, pp. 148-159.

II. A Model for Deriving the Supply of Bank Loans

In monetary theory there are certain well-known formulas showing the relationship between autonomous increases in deposits and induced increases in bank loans during credit expansion. It is seldom noted, however, that these formulas are not based on the bank's motivation of profit maximization, so that they do not result in a supply schedule of bank loans.⁴ If the private bank pursues profits no less than the non-financial firm, we should take this into consideration in deriving the supply schedule of bank loans.

In constructing our model in the light of the peculiarity of the Japanese financial situation discussed above, we will ignore, for simplicity, bank holdings of securities, selecting as our strategic variables bank loans and bank borrowings from the Bank of Japan. First of all, let us define our concerned variables as follows;

- L_s : gross increase in the supply of bank loans,
- l_s : repaid amount of bank loans,
- ΔD_a : autonomous net increase in deposits, referring to that part of the increase which is beyond the control of the bank,
- ΔD_d : net increase in the deposits induced by the net increase in bank loans ($L_s - l_s$),
- ΔM : increase in the bank's required cash balances,
- B : the bank's gross new borrowing from the Bank of Japan,
- b : the repaid amount of the bank's borrowing from the Bank of Japan,
- i_1 : the rate of interest on bank loans,
- i_2 : the rate of interest on deposits (we assume that i_1 is greater than i_2),
- i_3 : the rate of interest on the bank's borrowed money from the Bank of Japan.

We shall ignore variables appearing in the bank's balance sheet other than those defined above.

We assume that the bank seeks to maximize profits brought about by a net increase in bank loans ($L_s - l_s$).⁵ Let us express profits by π which is defined as follows;

$$(II. 1) \quad \pi = i_1(L_s - l_s) - i_2(\Delta D_a + \Delta D_d) - i_3(B - b).$$

Next, the increase in the required cash balances ΔM is assumed to be proportional to

⁴ As far as the author knows, Professor H. Kawaguchi derives the supply curve of loans under the assumption that the bank maximizes profit. See H. Kawaguchi: *Money and the Economy*, (in Japanese), Tokyo, 1958, p. 225 ff.

⁵ Total profits earned by the bank in a given period, which we denote by π_w , will be expressed as follows;

$$\pi_w = i_1 L'_s - i_2(D'_a + D'_d) - i_3 B' - C,$$

where the notation ' is added to L_s , D_a , D_d and B , respectively to show the average balances of relevant variables during the period instead of the original flow-amounts, and C represents costs other than interest on deposits and on borrowed money, which are assumed to be constant. But in the short-run planning of the loan supply, the bank will maximize profits not with the total balances of loans in mind but with the increase in loans, because it cannot, for the moment, manipulate the balances of loans or of borrowed money which are predetermined in the short run. Thus, the bank will attempt to maximize the increase in total profits ($\pi_w - \pi_{w-1}$), where π_{w-1} is total profits in the previous period. ($\pi_w - \pi_{w-1}$) corresponds to π in the text.

the increase in deposits, i.e.,

$$(II. 2) \quad \Delta M = \alpha(\Delta D_a + \Delta D_d); \quad 1 > \alpha > 0.$$

α is not always constant in a long-run model, which takes account of the changes in the total asset-composition aiming at maximizing total profits defined in footnote 5). We assume, however, that it remains constant for the moment. On the other hand, we will suppose that the increase in the induced deposits ΔD_d is a function of the net increase in loans $(L_s - l_s)$ such that

$$(II. 3) \quad \Delta D_d = \beta(L_s - l_s); \quad 1 > \beta > 0.$$

Since the magnitude of β will fall with the lapse of time because of the withdrawal of the induced deposits, the value of β depends on the length of our unit period. We shall discuss this point later when we investigate the actual processes of the repercussion from L_s to B . For the moment we assume that it is constant.

Thus the increase in cash balances ΔM is shown as a function of the increase in autonomous deposits ΔD_a and that in bank loans $(L_s - l_s)$, and ΔD_d as a function of the latter. ΔD_a is autonomously given to the bank, the amount of which is assumed to be positive in the following, while l_s and b are predetermined in planning for the supply of new loans. Therefore the bank will manipulate both L_s and B in equation (II. 1) so as to maximize profits π . The manipulation is possible, however, only within certain limits, for there are restrictions on the bank's behavior. The first restriction is the following relating to the bank's balance sheet;

$$(II. 4) \quad L_s + \Delta M \leq \Delta D_a + \Delta D_d - l_s + B - b.$$

If we take the actual value of each variable in the above equation, we should have equality between the right-hand and the left-hand sides. But both sides do not necessarily coincide when ΔM expresses the required increase in cash balances, i.e., from the standpoint of the bank's available funds it suffices that the left-hand side showing the uses of the funds is at most equal to the right-hand side showing their sources.

Second, the new gross supply of loans as well as the new gross borrowing from the Bank of Japan cannot be negative, respectively. That is,

$$(II. 5) \quad L_s \geq 0; \quad B \geq 0.$$

Finally the *possible* amounts of money which can be newly borrowed from the Bank of Japan by bank, \tilde{B} , will be an increasing function of the gross increase in bank loans L_s , as suggested by the rediscounting of the discounted bills. However, the fact that the Bank of Japan decides monetary policy independently of bank's intention will set a ceiling on the amount of borrowing which can be expected by the latter. Let us denote the expected ceiling by \bar{B} , and suppose that

$$(II. 6) \quad \tilde{B} = \phi(L_s),$$

where the function ϕ is assumed to be equal to γL_s so far as the latter is less than or equal to \bar{B} , and equal to \bar{B} when γL_s is greater than \bar{B} . It is plausible to assume that γ is greater than zero and less than unity. Thus, we obtain the third restriction

$$(II. 7) \quad B \leq \tilde{B} = \phi(L_s).$$

The bank will determine the size of L_s and B , so that it may maximize the profit equation (II. 1) under the restrictions (II. 4), (II. 5) and (II. 7).

We can rewrite equation (II. 4) by taking into account equations (II. 2) and (II. 3) to get

$$(II. 8) \quad L_s \leq \delta_0 \Delta D_a - \delta_1 b + l_s + \delta_1 B,$$

where

$$(II. 9) \quad \delta_0 = (1 - \alpha) / [1 - (1 - \alpha)\beta],$$

and

$$(II. 10) \quad \delta_1 = 1 / [1 - (1 - \alpha)\beta].$$

The coefficient of ΔD_a , δ_0 , shows the maximum amount of credit expansion brought about by the autonomous increase of one unit of money in deposits, and similarly the coefficient of B , δ_1 , expresses the greatest magnitude of credit expansion possible by borrowing one unit of money from the Bank of Japan. Since the restriction (II. 5) means that a possible combination of L_s and B lies in the first quadrant of the $(L_s \cdot B)$ plane, the feasible set satisfying (II. 5) and (II. 8) should be included in the domain bounded by the straight line a , line $f_1 0$ and the B axis in Fig. 1, where line a is given by (II. 8) excluding the inequality, whose slope in regard to B is equal to δ_1 , therefore greater than unity. It is reasonable to assume that l_s is larger than b multiplied by the expansion coefficient δ_1 . For when bank loans were supplied by l_s , the bank probably borrowed from the Bank of Japan by b . This assumption is a sufficient condition for the intercept of straight line a on the vertical axis to be positive. On the other hand the feasible set must be located within the domain bounded by curve ϕ and the L_s axis in Fig. 1, because of the restrictions (II. 5) and (II. 7). Therefore it is the shaded area (a closed set) in the case of Fig. 1. It could take various shapes according to the magnitudes of the coefficients α , β and γ and the predetermined variables b and l_s . But we can analyze them similarly as in the case of Fig. 1, so that in the following we will confine ourselves to an analysis of the latter case.

Now by rewriting equation (II. 1) we get

$$(II. 11) \quad L_s = [(\pi + i_2 \Delta D_a - i_3 b) / (i_1 - i_2 \beta)] + l_s + [i_3 B / (i_1 - i_2 \beta)].$$

From this equation we are able to derive the iso-profit lines corresponding to the various amounts of π , under given rates of interest. If the derivative of the iso-profit line in regard to B is less than the slope of line a , i.e., if

$$(II. 12) \quad i_3 / (i_1 - i_2 \beta) < \delta_1,$$

we have iso-profit lines π_1 , π_2 , and π_3 as shown in Fig. 1. The greater the amount of profits π , the more the iso-profit line shifts upward, so that the π_2 line corresponds to greater profits than π_1 line, and similarly π_3 line to larger profits than π_2 line. Insofar as the bank seeks maximal profits within the feasible set, the iso-profit line passing through point f_2 produces the greatest profits, and that point gives it the optimal combination of L_s and B .

Secondly, provided that both slopes are equal to each other, i.e.,

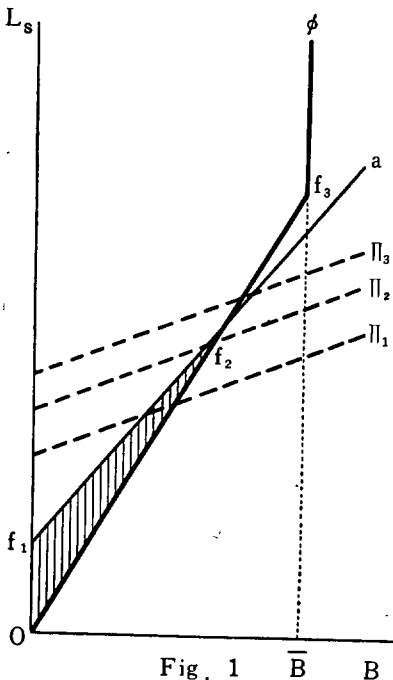

Fig. 1 \bar{B} B

$$(II. 13) \quad i_3 / (i_1 - i_2 \beta) = \delta_1,$$

any point belonging to the closed part of line a bounded by f_1 and f_2 is the optimal.

Thirdly, if

(II. 14)
$$i_3/(i_1 - i_2\beta) > \delta_1,$$

then point f_1 is optimal. Therefore bank's schedule relating the supply of loans with i_1 ,

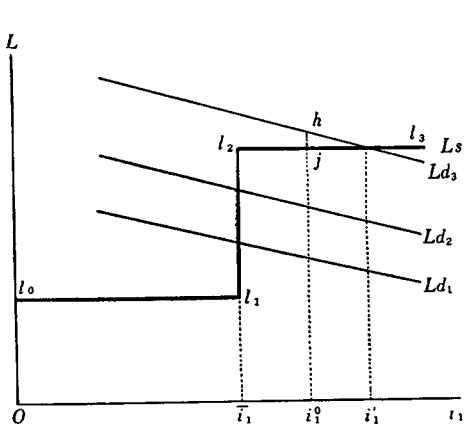

Fig 2

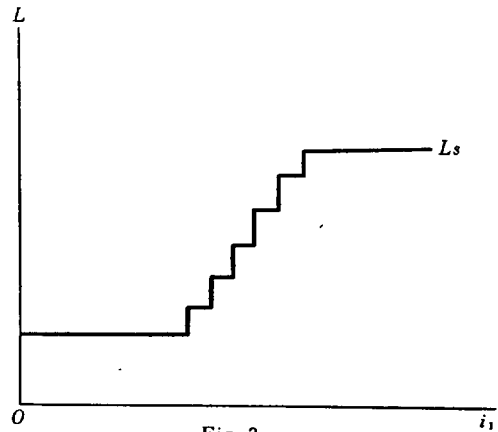

Fig 3

under given $\Delta D_a, l_s, b, i_2$ and i_3 is a step function as shown in Fig. 2. That is to say, when we denote the rate of interest on loans satisfying equation (II. 13) by \bar{i}_1 , the supply curve of loans jumps at \bar{i}_1 from l_1 to l_2 . Since different circumstances exist for different banks, it is possible that the size of α (or β) in one bank differs from those in another. If this is true, \bar{i}_1 in the former takes a different magnitude than in the latter, therefore the supply curve in the loan market as a whole will have many steps as indicated in Fig.3.

III. The Market for Loans and the Supply of Money

In the above we have worked out the supply curve of bank loans as a tool to investigate the market for loans and the supply of money relating to it. Now we will proceed to utilize it for our purposes.

For simplicity we will assume that the supply schedule of loans is given as in Fig.2, and that the firm's demand for loans L_d is given by

(III. 1)
$$L_d = L_d(Y, i_1), \quad \partial L_d / \partial Y > 0; \quad \partial L_d / \partial i_1 < 0,$$

where Y represents income.

A shift of the demand curve for loans induced by a change in income, say, that from L_{d1} to L_{d2} in Fig. 2 does not cause any change in the rate of interest. Namely, as far as the shift occurs within the vertical part of the L_s curve in Fig.2, the supply of loans is adjusted completely to the change in the demand for loans. We might say in this case that the former follows the so-called "needs of trade". But insofar as the latter shifts between l_2 and l_3 in the L_s curve, the amount of loans supplied does not change at all, and the effect is concentrated in changes in the rate of interest. Similarly the shift of demand

within the downward step l_0l_1 does not influence the amount of loans supplied. In both cases the supply of money connected with the bank loans behaves as if it were autonomous. Thus whether it is induced by the demand for loans—"needs of trade"—depends on the conditions that prevail in the economy. There are two extreme situations included within one supply schedule of loans. In one situation the supply of loans shows a completely flexible reaction to the demand and the rate of interest is completely inflexible, while in the other situation, the reverse is the case.⁶

Next let us see what kinds of adjustments will occur between the demand for and supply of bank loans, when changes in the interest rate on loans are restricted by a ceiling above which it cannot legally rise as in the case of post-war Japan.

The situation to be investigated here is where the highest possible rate of interest is less than the equilibrium rate of interest which would be obtained in a free market. Suppose that i_1^0 is the ceiling rate and that the demand curve for loans is located at L_{d3} in Fig. 2. There appears an excess demand for loans in the market by jh under i_1^0 . Then banks will compete for deposits from customers. Apart from the competition among banks for deposits,⁷ there are four possible ways to make the excess demand disappear. First, to some extent the bank has the power to shift the ϕ function (or l_2l_3 part of L_s curve) to the right (or upward), raising the supply of loans, for the ϕ function depends on the bank's expectation or judgement concerning the attitude of the Bank of Japan toward supplying funds to the bank. Or second, the bank could adjust the supply of loans to the demand under the given i_1^0 by decreasing the cash reserve ratio α . Taking the first or the second or both, the same kind of increasing risk exists, i.e., the probability greater than otherwise, that its vault cash balances will be depleted. When it faces the depletion of cash balances because of taking either the first or the second course, it will have to replenish its cash balances by means of call loans, which was ignored in the above analysis. It happens not infrequently in such cases that the call rate becomes higher than the rate of interest on loans as in 1957 and 1958. And the bank faces the gamble of sustaining a loss caused by a higher interest on call loans, if it does not succeed in maintaining cash reserves. By means of increasing the call rate, it is possible to adjust the gap between the demand for and supply of bank loans to some degree, when the loan rate is controlled and the call rate is not, as in the case of the present Japanese economy. When there is an excess demand for funds in one part of the economy, and at the same time there exists an excess supply of funds in the rest of economy, the call market could work as an adjustor for equilibrating the loan supply with the demand. But when there is a tendency for an over-all excess demand for loans, changes in the call rate are not in effective in bringing equilibrium to the loan market as a whole, apart from its function of adjusting the temporary surplus or short-

⁶ In the text we ignore the change in ΔD_a . But we probably have a changing ΔD_a , when the L_s curve shifts upwards or downwards owing to fluctuations in income, because ΔD_a is a function of income Y , even though it is a given datum to the bank itself.

⁷ This does not have any effect on the excess demand in the economy as a whole, unless the bank transforms savings held by the public in the types of assets other than deposits into deposits. But if the costs of gathering deposits are increased, so that the bank must raise i_2 , this will influence the situation to some extent. This point was suggested by Mr. H. Eguchi of the Bank of Japan.

age of bank funds.⁸ Thus the bank will resort to the third course, i.e., an upward shift of the upper step of the supply curve of loans by raising the marginal ratio of induced deposits to loans β . It is common practice in Japan that when a firm borrows funds from a bank, the latter asks the former to reserve some proportion of the loan in the form of deposits without withdrawal. Under the assumed situation the bank intensifies this kind of credit standard by an increase in β , which causes the excess demand for loans to disappear by an upward shift of the L_s curve, and at the same time raises the actual rate of interest on loans, even though the nominal rate remains at the level of i_1^0 . Therefore by this manipulation the bank can superficially increase the supply of loans by $j\bar{h}$, so as to equilibrate with funds demanded of $i_1^0\bar{h}$ in Fig.2, but in fact it attempts to approach the rate of interest i_1' corresponding to the the intersection of L_s curve and L_{d3} curve.

Fourth and finally, income Y has to fall in order for the L_d curve to shift downwards, if the above three means cannot restore equilibrium in the loan market. Falling income means that the firm must revise its original production plan and cut down production, because some amount of the funds needed at a certain level of expected sales or intended production can not be satisfied with the supply in the loan market. It is in this case that the supply of loans becomes a limiting factor on production. Although the increase in the money supply caused by the increased borrowing from the Bank of Japan appears as though it resulted from banking and business activity until the rate of interest reaches the ceiling, here we see the autonomous aspect of the money supply of the Bank of Japan through the medium of banks. It is to be noted that the upper as well as the lower step of the L_s curve will shift downward with falling income through a decrease in ΔD_a . Accordingly the cutback in production should cause a downward shift of the L_d curve sufficient to counter-balance that of the L_s curve.⁹

IV. *The Business Cycle and Expansion of Bank Loans*

Using the above model, now let us see how new bank loans expand and contract in relation to new borrowing from the Bank of Japan in the course of the business cycle. This will serve as a bridge connecting our theoretical analysis with the statistical data below.

Suppose that we are in the stage of recovery and / or upswing and that the initial starting point is a certain point belonging to the closed set bounded by point f_1 and f_2 on line a in Fig.4. If equation (II. 12) is satisfied in the loan market, then we have point f_2 as the starting point. Or if equation (II. 13) holds true there, it could be any point belonging to the closed set. Furthermore, when we have equation (II. 14), it is point f_1 . Provided

⁸ Although this temporary adjustment in the fund market is merely the original function of the call market, it seems to play other roles also in the present Japanese economy. That is, in the call market city banks appear as *permanent* borrowers and rural banks as well as other financial institutions as permanent lenders. When banks, especially city banks face diminishing cash reserves due to over-lending (compared to available funds), they first attempt to escape from the difficulty by borrowing funds from the Bank of Japan. But when they are not successful in borrowing, they try to transfer the overloans to the rural banks and other financial institutions by inviting call loans from the latter. This is one aspect of the peculiar financial situation in Japan described at the outset of this paper.

⁹ Here we implicitly assume that the demand for loans is more elastic in regard to income than the supply of loans, whose relation with income is realized through changes in the autonomous deposits ΔD_a .

that it is included in an open set marked off by f_1 and f_2 , market equilibrium will run upwards along f_1f_2 of line a as income increases, so far as line a remains at the original position. The increase in income will result, however, in an increase in ΔD_a , so that line a will shift upward and the equilibrium path will deviate from the original a line with the lapse of time. But, as long as the relationship among the interest rates makes the intersection of the ϕ curve and a line be an equilibrium point, the new bank loans L_s will move on the ϕ curve in the process of expansion. Under a sufficient increase in the demand for bank loans, the bank will find sooner or later that it has exhausted the expected maximal amount of

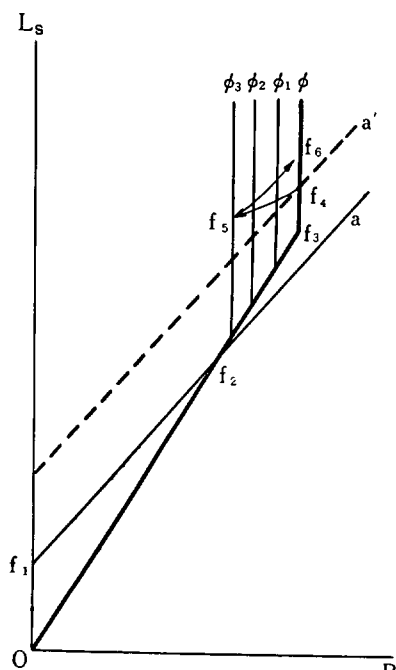

Fig. 4

borrowing from the Bank of Japan in spite of further increasing demand for new bank loans. If regulations fix a ceiling on the interest rate on loans, we shall find the excess demand for loans under the fixed rate, which will induce the movement toward adjustment as discussed above. But the maximal amount of borrowing \bar{B} itself is not at all constant, because it will be affected by the Bank of Japan's actual behavior which is mirrored in the fluctuations in its new supply of funds to the bank determined, for instance, on the basis of foreign exchange reserves. As a result, when the reserves are diminishing in the course of the upswing, \bar{B} cannot help decreasing gradually, and the ϕ curve will shift, as from ϕ to ϕ_1 and ϕ_2 in Fig. 4. Suppose \bar{B} begins to decrease at point f_4 . Then, if the balance sheet restriction on the bank remains at line a' , both L_s and B will be reduced along line a' . Alternatively, if it shows downward shifts from line a' because of falling income, we

obtain a contraction path having a steeper slope than line a' . By judging from the increase in the fixed time deposits, which does not fall even in the downswing, however, it seems reasonable at least in the Japanese economy to assume that the autonomous increase in deposits ΔD_a exhibits steady growth. If so, perhaps line a shifts upwards to some extent even in the downward process and we may observe a movement such as from f_4 to f_5 , although the decrease in $[L_s - \delta_1 b]$, if it occurs, could counterbalance the upward shift of line a .¹⁰ On the other hand, when the international balance of payments turns favorable, so that foreign exchange reserves are accumulated, we find the opposite phenomena. And when the ϕ curve shifts enough to make line a intersect with it in the initial form but in greater L_s and B than before, one cycle will have been finished.

¹⁰ Note that the intercept of line a on L_s axis is $[\delta_0 \Delta D_a - \delta_1 b + l_s]$.

V. A Statistical Investigation of the Behavior of the Bank

Let us turn to a statistical investigation of the behavior of the bank. First of all, we shall examine the course of expansion or the relationship between L_s and B over time. From now on our analysis will be stated in terms of the net increase in bank loans ΔL_s defined by $(L_s - l_s)$ and that in borrowing ΔB defined by $(B - b)$ instead of L_s and B , for the reason that figures for L_s and B are not available.¹¹

After adjusting the monthly data for seasonal variations by the use of twelve-month moving averages, we compare ΔL_s with ΔB and find that the latter lags behind the former. The fluctuations of ΔL_s are not immediately reflected in ΔB in the actual behavior of the bank, because the magnitude of β is not constant but falls with the passage of time as noted in Section II. Immediately after the bank has increased its loans, it will be nearly equal to unity. Then the bank need not depend on borrowing from the Bank of Japan. Only when deposits created by means of a loan expansion are withdrawn, so that the bank's cash reserves fall below the required needs, does the bank borrow funds from the Bank of Japan. Therefore, it is fully possible that the increase in borrowing ΔB corresponding to that in bank loans in a given period occurs some periods later in the form of, say, rediscount of bills at the Bank of Japan, which

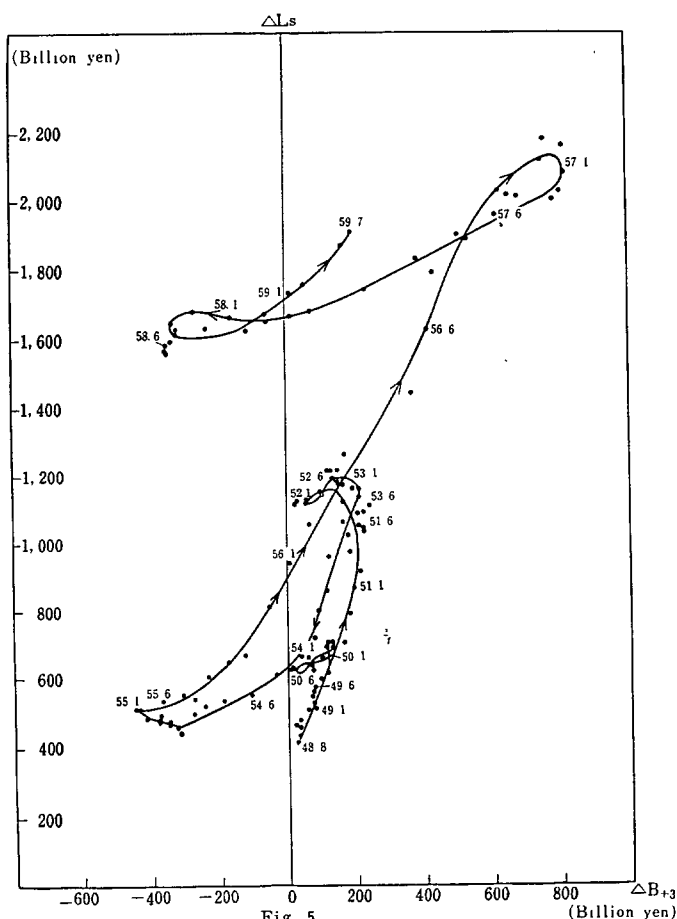

Fig. 5

¹¹ We can easily transform our a line and ϕ curve into those in terms of ΔL_s and ΔB . The transformation does not change the results obtained above except for a change in the intercept of line a from $(\delta_0 \Delta D_a - \delta_1 b + l_s)$ to $\delta_0 \Delta D_a$ and the appearance of a possibility that ΔL_s and ΔB could be negative though both L_s and B must be non-negative. Statistical data are taken from *Honpo Keizai Tokei* (Economic Statistics of Japan), published by the Bank of Japan, 1948-1959.

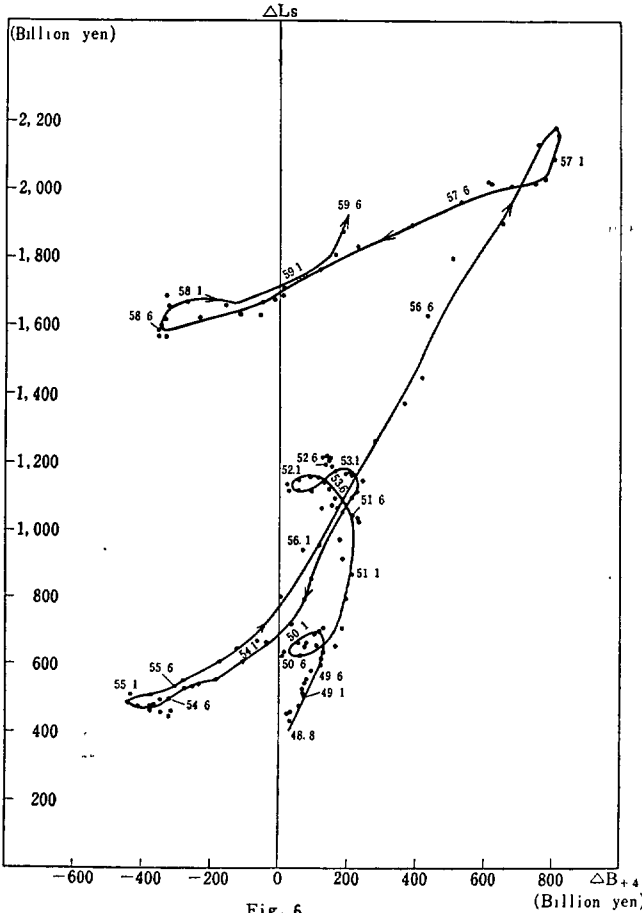

Fig. 6

were discounted at the bank after the original increase in loans. In the case of a three or four-month lag of ΔB behind ΔL_s , we obtain an expansion path which is nearly the same as that which could be expected theoretically, as shown in Fig. 5 or Fig. 6, where the numbers designate the month and year of the corresponding points, (as e.g., 48.8 denotes August 1948), and both ΔL_s and ΔB are seasonally adjusted but multiplied by 24 for convenience in computation.¹² In examining Fig. 5 and Fig. 6 closely, we find, however, that in the former the expansion path has a loop moving clockwise for one year starting from June 1956, which was not anticipated theoretically, and in the latter the path in January 1958 to June 1959 approaches closer to

that of June 1957 to June 1958 than we expected. Therefore the lag of ΔB behind ΔL_s seems to be three or four months and closer to three than to four months.

The characteristics of the expansion path will be clearer, if we can get information on interest rates, the required cash reserve ratio α and the induced deposit ratio β . The rate of interest on bank loans i_1 will be represented by the average of interest rates on loans and yield on securities held by ordinary banks and the rate of interest on deposits i_2 by the cost of the deposits borne by them.¹³ To get an indicator of i_3 , we divided the

¹² In order to take advantage of the series on borrowing by all banks for as long as possible, we shall use below not the increase in borrowing from the Bank of Japan but that in total borrowing. The difference between them is very small.

¹³ In our theoretical investigation we exclude, for simplicity, securities held by the banks, and assume that costs other than interest paid are constant. In order to deal with these points within our model, we pick up here the average of interest rates on loans and yield on securities held by ordinary banks and the cost of deposits instead of the rate of interest on loans and that on deposits.

Table 1

Fiscal year	i_1	i_2	i_3
1951 F. H.	8.978%	7.191%	5.525%
L. H.	9.162	7.452	6.531
1952 F. H.	9.032	7.346	6.189
L. H.	8.838	7.076	5.228
1953 F. H.	8.785	7.120	5.372
L. H.	8.632	6.680	6.187
1954 F. H.	8.722	7.027	7.456
L. H.	8.603	6.802	7.582
1955 F. H.	8.493	6.854	6.547
L. H.	8.258	6.673	5.513
1956 F. H.	8.078	6.604	1.928
L. H.	8.042	6.477	2.499
1957 F. H.	8.221	6.785	6.065
L. H.	8.351	6.827	8.949
1958 F. H.	8.306	6.993	10.389
L. H.	7.962	6.812	7.148

* F. H. refers to the period from April to September, and L. H. to that from September to March of the next year.

sum of the revenues on the interest on bills discounted and on loans by the average sum of bills discounted and loans at the end of each month in the Bank of Japan accounts.¹⁴ According to Table 1, i_3 was higher than i_1 only in the latter half of 1957 and the first half of 1958.¹⁵ Because the size of α will be negligible, the slope of line a will depend largely on that of β . On the other hand, the slopes of the iso-profit lines also depend upon β . Since it is very difficult to estimate, we are unable to determine how both slopes have changed in our concerned period. But provided it was nearly equal to 0.3,¹⁶ it seems that the slope of the iso-profit lines was less than that of line a except in the latter half of 1957 and the first half of 1958. We can therefore infer that condition (II. 12) prevailed in almost all periods. If this was true, the expansion path in the downswing and the depression of 1954 to 1955 in Fig.5 or Fig.6 might have been strongly affected by contractions in \bar{B} caused by the direct control of credits by the Bank of Japan. On the other hand, in the downswing of 1957 to 1958 it might have been influenced by the increase in the interest rate on borrowing from the Bank of Japan as well as by the direct control of loans, the former of which probably made the slope of the iso-profit line coincide with that of line a .

Next, what effect does the expansion of loans have on the supply of money? We will examine this by means of the following four magnitudes. (See Fig.7.¹⁷) The first is the difference between the monthly net increase in bank loans and that in saving deposits,

¹⁴ Data on interest revenues are taken from the Ministry of Finance: *Ginko Kyoku Kinyu Nenpo* (Annual Report of Banking), 1952-1959.

¹⁵ In 1956 i_3 was abnormally small. The reason seems to lie in our method of calculating i_3 by means of the average sum of bills discounted and loans at the end of month.

¹⁶ It is said that the restricted deposits remaining in the borrower's account comprise about 30% of the total. *Chuo-Ginko Seido* (Central Banking System), edited by the Ministry of Finance, 1959, p.29.

¹⁷ In Fig.7 we show the relevant magnitudes adjusted for seasonal variations by the use of twelve-month moving averages, but expressed in terms of a two-year rate except in the series for the call rate i .

defined as the sum of fixed time deposits and installment savings. Denote it by $\Delta(L_s - D_s)$. $\Delta(L_s - D_s)$ is merely the increase in the money supply induced by the banking activity. Secondly, by subtracting the increase in the bank's own deposits with other ΔD_n from that in the bank's borrowing ΔB , we can get an indicator expressing the change in the degree of the bank's dependance on the Bank of Japan. This indicator $\Delta(B - D_n)$ informs us of the nature of the fluctuations in the bank-notes issued through the commercial banks' activity. The third magnitude we are concerned with is $[\Delta(L_s - D_s) - \Delta(B - D_n)]$ showing part of changes in loans which is supplied by the bank without depending on borrowing from the Bank of Japan and also on saving deposits. And finally we are interested in the increase in short-term deposits¹⁸ less checks and bills held by the bank $\Delta(D_c - C_h)$.

In regard to the leads and lags among these four magnitudes we can observe the following points. First it is evident from Fig.7 that $\Delta(L_s - D_s)$ leads $\Delta(B - D_n)$ at the peak of the cycle, but both reach the bottom at about the same time. Second, $\Delta(L_s - D_s)$ lags behind $[\Delta(L_s - D_s) - \Delta(B - D_n)]$, while the latter conforms to that of $\Delta(D_c - C_h)$, with the result that $\Delta(D_c - C_h)$ leads $\Delta(L_s - D_s)$. Hence we have the following schema of timing of the relevant variables;

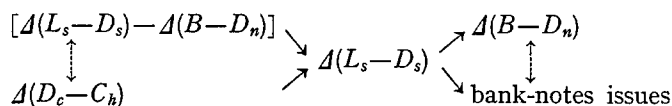

According to this schema, it seems at first sight there was a causal relationship between $\Delta(D_c - C_h)$ and $\Delta(L_s - D_n)$. But if we closely examine the entirety of the relationships, the fact that $\Delta(D_c - C_h)$ leads $\Delta(L_s - D_n)$ implies rather the following; in the early stage of recovery the bank supplies loans to the firms without borrowing from the Bank of Japan, so that the first "runner" is $[\Delta(L_s - D_s) - \Delta(B - D_n)]$, and at the same time the loans supplied in this way induce increases in short-term deposits, i.e., in deposit currency. Insofar as deposit currency thus created circulates among business firms, there does not occur any decrease in short-term deposits in the banks as a whole, so that it does not intensify dependance on the Bank of Japan. But when the firms have to make net payments to households, short-term deposits held by firms are withdrawn. Since households in Japan usually do not open current deposit accounts in the banks, although they hold assets in the form of ordinary deposits, the banks now face decreasing cash reserves, depending on borrowing to counterbalance the decrease in cash reserves. As a result bank-notes issues will increase.¹⁹ This is our explanation of the above leads and lags. It illustrates how the course of the business cycle changes the composition of the money supply created by banking activity, which consists of deposit currency and cash currency. This money supply is not autonomous but induced by banking and business activities, except when banking activity hits the ceiling fixed by the behavior of the Bank of Japan as described in Section III.

One of the interesting phenomena relating to the bank's money supply is the fact that the banks' increase in net call money (representing the increase in the difference between call money and call loans in the balance sheet) has begun to show a fairly large amplitude

¹⁸ Short-term deposits are defined here as the sum of current deposits, ordinary deposits, deposits at notice and special deposits—including bank deposits held by the government—.

¹⁹ See *Money-Flow—the Theory and its Application*—(in Japanese), edited by A. Koizumi, Tokyo, 1960, pp. 79–80.

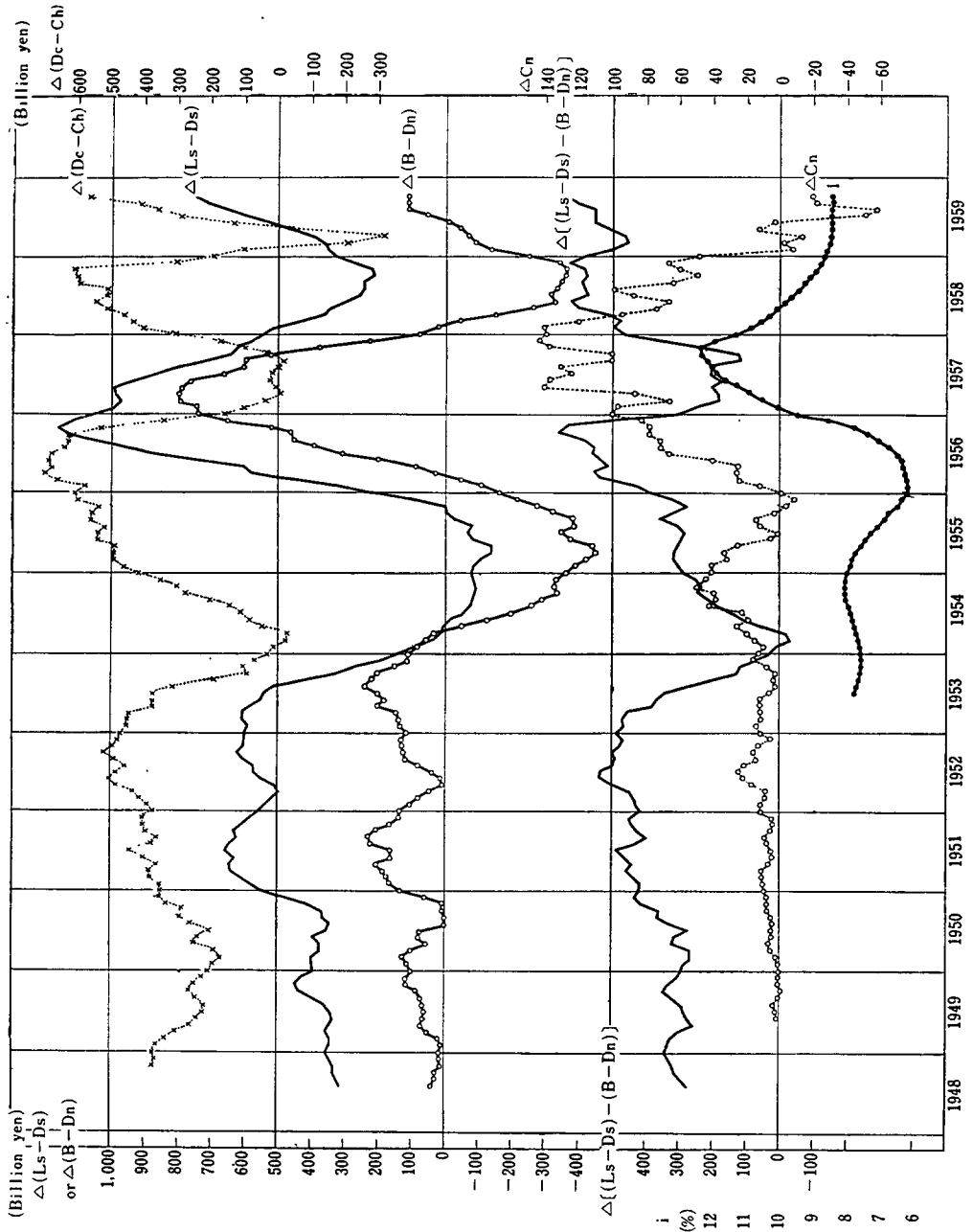

Fig 7

of fluctuation since 1954. Generally speaking, commercial banks as a whole are borrowers in the call market, while the lenders consist of the Central Cooperative Bank of Agriculture and Forestry, Prefectural Credit Federation of Agricultural Cooperations, Agricultural Cooperative Associations and so on. Among the commercial banks, the rural banks have always been lenders while the city banks have always been borrowers in the call market, as pointed out in footnote 8). But, for simplicity, let us look at the matter in terms of all commercial banks. Then the increase in the net call money in all banks ΔC_n , lags behind $\Delta(B-D_n)$. It shows that when banks, particularly the city banks, can no longer depend on borrowings from the Bank of Japan in the later stage of the boom, they try to tide over the drain of cash reserves by absorbing the idle funds still existing in rural areas. It vividly mirrors the situation where the city banks take advantage of call money as a substitute for loans from the Bank of Japan in order to remedy the difficulties arising from excessive lending. Thus, it is natural that the call rate i should rise higher than the interest rate on loans. Since August 1955, when the ceiling rate on call funds was abolished, there is a positive correlation with ΔC_n as observed in Fig.7.²⁰

The above statistical investigation seems to give strong empirical support for our simple model explaining the behavior of the bank and the bank's supply of money.

²⁰ The call rate here is represented by that on unconditional loans in Tokyo.